



RACE PROVEN. STREET LEGAL.™

DEMAND THE BEST.

DEMAND HAWK PERFORMANCE
BRAKE PRODUCTS.



2014

PERFORMANCE BRAKE CATALOG





ABOUT HAWK PERFORMANCE

Hawk Performance® is an industry leading supplier of brake products to the performance street and motorsports markets. Hawk Performance offers a wide variety of application-specific brake pads, rotors and calipers for domestic and import cars, trucks and SUV's. Our products provide improved braking, increased fade resistance and superior pad and rotor life for high performance brake applications. Hawk Performance also manufactures an extensive line of motorsport brake products for virtually any form of racing.

RACE PROVEN. STREET LEGAL.

Known as the "Official Brake Product" for motorsports organizations such as the Sports Car Club of America, Skip Barber Racing School and the Richard Petty Driving Experience, our racing heritage has its benefits. At Hawk Performance, research and development in race proven products is directly related to how we design, develop and engineer our high performing street legal brake applications.

From road circuits and oval tracks to highways and the street, Hawk Performance brake products are developed to win championships and engineered to meet the demands of high performance street applications.

HAWK PERFORMANCE MOTORSPORTS HERITAGE

Hawk Performance has dominated motorsports braking for over 20 years, offering highly engineered rotors and friction products for nearly every type of racing. The key to our success has been, and continues to be, our passion to develop and supply leading-edge product technologies. This passion and commitment to motorsports technology advancement has established Hawk Performance as a global market leader.

CONTINUOUS DEVELOPMENT

All Hawk Performance brake pads are American made, 100% asbestos free and manufactured in ISO certified facilities.

To ensure the utmost effective performance, all Hawk Performance brake calipers, rotors and pads are subjected to rigorous simulated testing on brake dynamometers. Our dynamometers are designed to accurately simulate real world applications from professional race tracks with speeds in excess of 200 MPH, to off-track street driving applications at speeds below 30 MPH.

In addition to "dyno" simulated testing, every product is subjected to extensive on-vehicle testing to further guarantee each component meets the specific performance criteria required before going to market. Such thorough testing allows Hawk Performance to continuously improve our product's quality, durability and the overall performance that our customers have come to expect.

Hawk Performance brand products are owned and manufactured by Carlisle Brake & Friction, the World's leading severe-duty and high performance friction products manufacturer.





TABLE OF CONTENTS

About Hawk Performance.....	2
Table of Contents.....	3
New Products.....	4-5
Motorsports Introduction.....	6
Motorsports Testimonials.....	7
Performance Street Brake Pads.....	8-9
HPS - High Performance Street Compound.....	10
Performance Ceramic-Luxury & Touring Compound.....	11
LTS - Light Truck & SUV.....	12
Commercial Truck/HP-Plus - Autocross & Racing.....	13
Performance Street Rotors.....	14-17
Motorsports Compound Guide.....	18
Motorsports Compound Codes & Descriptions.....	19
Motorsports Rotors.....	20
Talon Caliper and Performance Brake System.....	21-26
Brake Pad Legend and Code Reference.....	27
Brake Pad and Rotor Application Guide.....	28-132
Specialty Caliper Guide.....	133-136
Brake Pad Diagram & Code Reference.....	137
Performance Brake Pad Diagrams.....	138-220
FMSI Cross Reference.....	221-229
Street FAQs & Warranty.....	230-231
Motorsports FAQs.....	232-233
V-Twin.....	234
Hawk Performance Sponsorships.....	235



NEW PRODUCT



Components are for illustrative purposes only. Actual components will vary by vehicle type and fitment.

PERFORMANCE BRAKE SYSTEM

BRAKE SYSTEM INCLUDES

BRAKE PADS • TALON™ CALIPER • ROTORS

HAWK PERFORMANCE BRAKE PADS

Our Performance Street Compound is engineered with a specially formulated ferro-carbon compound that's ideal for spirited driving and aggressive stops.

- Strong, balanced initial bite on your first stop to your last stop
- 20–40% more stopping power over stock pads
- Rotor-friendly — will not shorten rotor life
- 40–70% longer pad life than stock brake pads
- Low dust, whisper-quiet performance

QUIET SLOT ROTORS

Proven performance and durability Quiet Slot™ rotors let you take full advantage of our brake pads and Talon calipers.

- Unique slot design improves braking performance and increases initial bite
- OEM sizes — no clearance or fitment issues
- Special steel alloy provides exceptional rotor life and virtually eliminates noise
- All rotors are finished with GEOMET™ coating for protection against corrosion on both internal and external surfaces



HAWK PERFORMANCE BRAKE SYSTEM

A matched set of precision components made to substantially increase your vehicle's braking performance.

- **SUBSTANTIALLY ENHANCED STOPPING POWER**
- **FAST, EASY INSTALL (OEM MOUNTING POINTS)**
- **SIGNIFICANT COST SAVINGS OVER OTHER "BIG-BRAKE" KITS**

TALON™ CALIPER

Billet-aluminum is the heart of our Performance Brake System. Our new three-piston Talon caliper is the key to upgrading your brakes while retaining stock mounting points and avoiding clearance issues*.

*Certain rear-brake fitments use a high-performance single piston design to retain parking brake function with stock mounting brackets.

- Up to 55% more clamping force than stock, depending on application
- Fast, easy install — no drilling, welding or fabricating
- Machined billet aluminum caliper body, anodized for durability and powder-coated for appearance
- Durable stainless steel pistons machined from solid 303 bar stock (factory caliper uses aluminum piston)
- High temperature internal dust seals are protected from direct heat and debris, and provide years of leak-free performance
- Designed to work with factory master cylinders and ABS systems

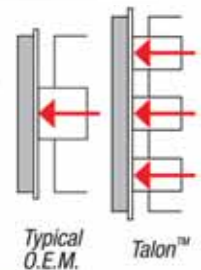



PERFORMANCE BRAKE PAD AND ROTOR KIT

Hawk Performance® has simplified the process to dramatically improve vehicle's stopping distance without upgrading to expensive specialty calipers. Now offering a vehicle specific, matched brake pad and rotor bundle that all comes in one box.

QUIET SLOT ROTOR



CHOICE OF FOUR BRAKE PAD COMPOUNDS



NEW PRODUCT



PERFORMANCE BRAKE PAD AND ROTOR KIT

INCLUDES

BRAKE PADS • ROTORS

QUIET SLOT™ ROTORS

- Unique gas slot pattern for low noise and HIGH TORQUE
- Direct OEM upgrade replacement
- Environmentally friendly Geomet® coating to prevent rust

AVAILABLE IN FOUR BRAKE PAD COMPOUNDS

PC - PERFORMANCE CERAMIC

- Minimal dust output
- Ultra quiet

HPS-HIGH PERFORMANCE STREET PADS

- Excellent for spirited driving
- Wide temperature range

LTS - LIGHT TRUCK AND SUV PADS

- Designed for full size trucks and SUV's
- Great for heavily loaded trucks and moderate towing

SD - SUPER DUTY PADS

- Extremely high brake torque for serious towing and hauling
- High fade resistance

HAWK PERFORMANCE...BRAKE PAD TECHNOLOGY OF CHAMPIONS.

Hawk Performance has dominated motorsports braking for over two decades, offering highly engineered friction products for nearly every type of racing. The key to our success has been, and continues to be, our passion to develop and supply leading-edge product technologies and maintain our position as the global market leader.

Hawk Performance offers over 10 different application-specific compounds designed to meet the needs of today's race teams. We also offer the largest selection of pad shapes that fit both OE and purpose-built racing calipers. Since its introduction in 2009, our short track race rotor continues to dominate both dirt, asphalt, and late model racing series.

**AUTOCROSS/CLUB RACING/TIME ATTACK**

This diverse group of motorsports enthusiast requires a brake pad product that is street worthy, yet maintains many of the high temperature and elevated coefficient of friction attributes of a pure race pad. Hawk Performance is proud to be the only brake supplier that offers a true intermediate brake product (HP Plus compound) that can transition between a race and street environment.

ROAD RACING/TOURING

Hawk Performance, the Official Brake Product of SCCA, NASA, and most recently, the Official Brake Pad of the PWC, has long been an industry leader in friction material development for sports car / GT racing and open wheel road racing. Hawk Performance offers a wide variety of brake compounds that are application specific and offer superior performance for all types and classes of road race cars.

**PAVEMENT CIRCLE TRACK**

This is where Hawk Performance first entered the motorsports market back in 1990. Our history of short track, intermediate and superspeedway wins is undeniable. The fact is our products truly outperform the competition in this high-temperature, brutal braking environment. From local short tracks to NASCAR, Hawk Performance is a proven champion.

DRAG

At Hawk Performance, we understand the unique brake pad requirements for drag racing. Our products provide the high cold-static coefficient of friction to hold the car on the line and the high-dynamic coefficient friction to stop the car at the finish. More importantly, our products can withstand the sudden burst of energy without glazing.

OFF-ROAD RACING

Hawk Performance has been the product of choice for top teams in TORC, SCORE and LOORRS off-road racing. The combination of exceptional stopping power, elevated fade resistance, extended pad life and superior bond strength makes our products ideal for this abusive environment.

**DIRT CIRCLE TRACK**

From IMCA to the Lucas Oil series, Hawk Performance has been the brake pad supplier of championship teams for over a decade. Our products provide superior performance for both open-wheel and late model stock cars. Get dirty and stop fast with Hawk.

FORMULA

Hawk Performance offers a wide variety of brake compounds with features designed to exceed the demanding environments found in open-wheel formula racing.

RALLY RACING

The varied terrain and conditions in rally racing create a unique and harsh environment for brake products. The transitions between steep downhill trails in the dirt to forging water to meeting the pavement and ascending through switchbacks require a versatile and progressive brake pad. That's why championship teams specify Hawk Performance... the first and best rally brake pad solution.

Photo by Andrew Snucins



"I've used Hawk products at an amateur level long before I had an association with the company in a professional capacity. The support is excellent from grassroots motorsports all the way to Formula One, with a focus on listening to their customer base to improve the product constantly."

- Mike Skeen
World Challenge



"Ever since I started using Hawk Performance Brake pads my braking power has increased an incredible amount and the amount of wear has decreased!"

- Casey Currie
Driver of the
Monster Energy #2 Pro Lite



"There is not much out there that will stop Grave Digger but the thing we count on stopping it is Hawk Brakes!"

- Dennis Anderson
Grave Digger
USHRA Monster Jam



"Following a number of track tests, the Ron Fellows Performance Driving School at Spring Mountain Motor Resort & Country Club selected HAWK Performance brake materials for their excellent stopping power and overall durability"

- Ron Fellows
4 time Le Mans champion, 19 Trans-Am Series races,
2 Craftsman Truck Series races, 4-time recipient of the ALMS Most Popular Driver Award, 2011 Inductee to the Corvette Hall of Fame



"The pads have superior cold bite and do not fade late in the race. The rotors stand up very well to heavy braking and high temps that I put them through every weekend. I depend on Hawk DTC products to continue to put me in the victory lane and winning championships"

-Tim Brown
Brown Motorsports



"From Grand-Am to club racing, the only brake pad I use to out-brake the competition is Hawk Performance"

-Andrew Aquilante
Phoenix Performance

SUPERIOR STREET PRODUCTS BY DESIGN

Hawk Performance understands that brake pads are critical components that directly affect vehicle handling, safety and driver confidence. That's why our products are engineered to meet and exceed the braking demands of today's severe-duty & high

performance vehicle applications. Each Hawk Performance brand product incorporates advanced engineering design, world-class friction technology and premium-quality raw materials.

POWDER COAT & ZINC DICHROMATE PLATING

- Hawk's dual layer outer shell offers superior corrosion resistance and smooth brake engagement.
- Each backing plate is first coated with zinc dichromate. The finished part is later sealed with an aerospace-grade, high-temperature, electrostatic powder coat.

FRICTION MATERIAL

- Hawk Performance's world-class friction formulations deliver superior stopping power and durability for any high performance or severe-duty application.

SURFACE PREPARATION

- Diamond ground for exceptional surface conditioning and flatness.

SLOTTED FRICTION

- Adds friction flexibility to relieve stress.
- Aids in the removal of friction debris.

MECHANICAL RETENTION SYSTEM

- Hawk's mechanical bond/retention system features hundreds of small extruded hooks that are molded directly into the friction material. In terms of bond and shear strength, there is no better product.

BACKING LAYER

- Hawk incorporates a special backing material at the bond line that creates a micro heat shield and optimizes bond strength.

STEEL BACKING PLATE

- Engineered to meet Original Equipment design for fitment.
- Hawk's mono-block backing plate design increases flexural strength, and provides superior braking engagement.

HOT BOND SHIM

- Hawk's advanced engineered shims feature a single layer of steel with a high-temperature rubber coating. Each shim is designed to dampen noise and hot bonded to eliminate delamination.

PAD CHAMFER

- Engineered to eliminate noise and vibration.
- Improves brake engagement quality.

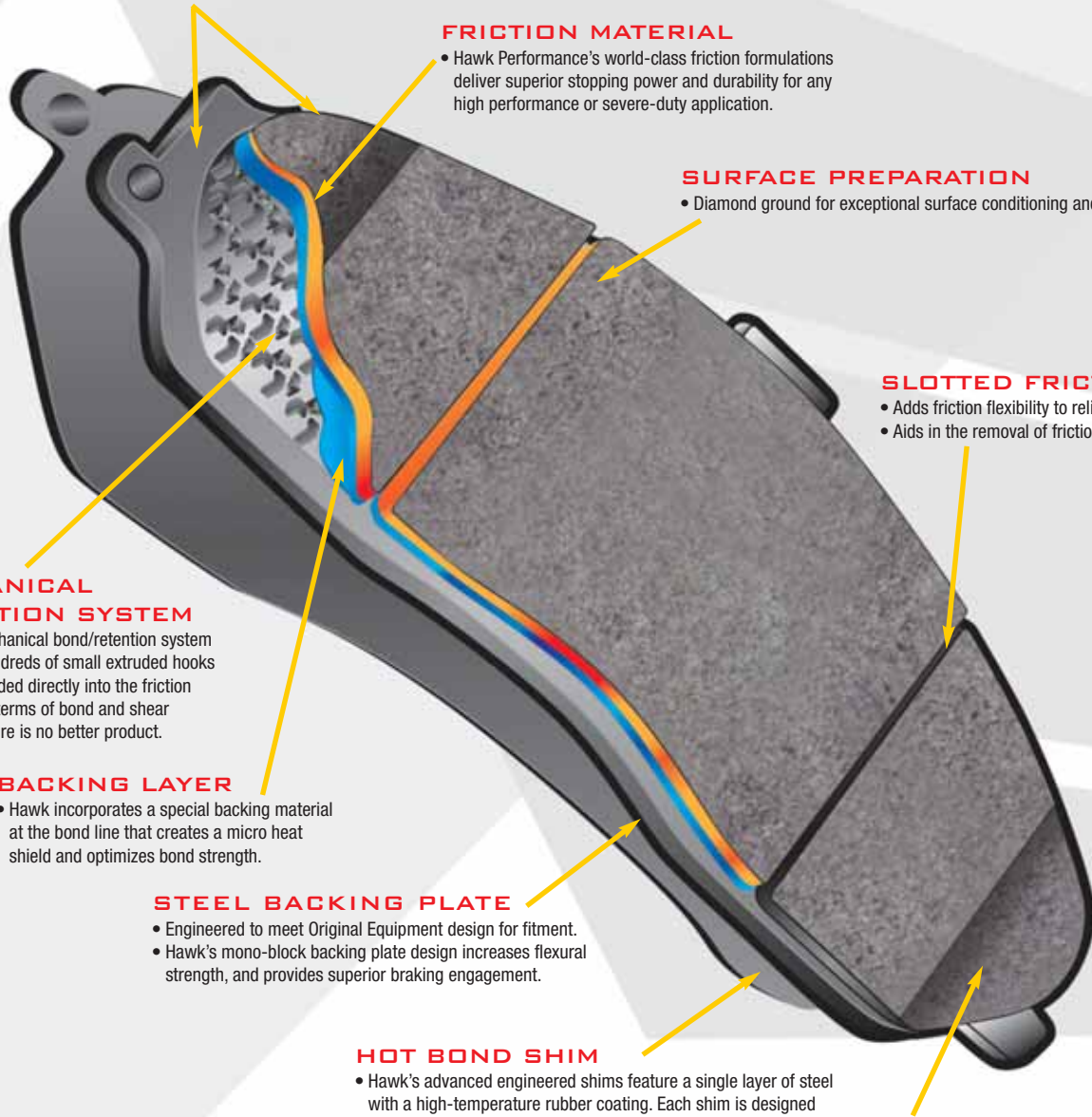

HAWK—THE SOLUTION FOR BETTER BRAKING PERFORMANCE

Whether you drive in spirited fashion through canyon switchbacks or pull 20,000 lbs over 4,000-foot summits, Hawk Performance has engineered the right pad friction compound for your street performance goals. Using a properly performing brake system, you'll enjoy the peace of mind in knowing that your vehicle will safely stop each and every time.

Selecting the right product for your specific car or truck is critical for performance and safety. The graphs to the right illustrate the performance ratings of our street products. Each graph represents a vehicle group and the product rating for the following key characteristics.

- Stopping power
- Rotor & pad wear
- Noise
- Dust

THE HAWK ADVANTAGE:

- 20-40% more stopping power than stock pads
- Quick warm-up
- Strong, balanced initial bite
- Superior fade resistance
- Low dust properties
- Rotor friendly—will not shorten rotor life
- Outlast stock brake pads
- Lifetime warranty

Reference pages 10 to 13 for complete street product line descriptions. For make, model and year applications guide turn to page 28. If you have purchased a conversion brake kit or non-OE caliper, use our “specialty caliper guide” on page 133.

DO YOU RACE?

Hawk Performance has over ten application-specific race pad compounds for practically any form of motorsports. Please refer to page 6 for an introduction to our comprehensive line of motorsports products & applications.

STREET COMPOUNDS

BRAKE PAD	COMPOUNDS
HPS Performance Street	F
Performance Ceramic	Z
LTS Light Truck & SUV	Y
SuperDuty	P



PRODUCT RATING GUIDE*

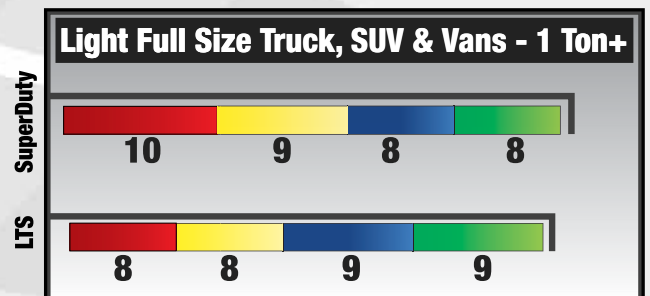
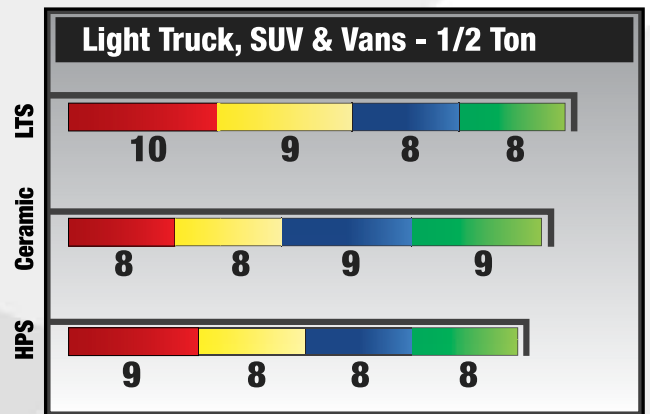
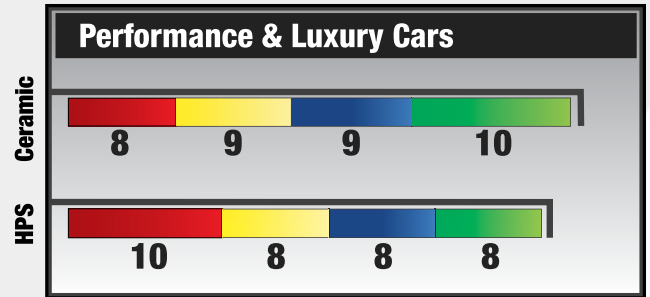

BRAKE PAD CODE BREAKDOWN

H B 2 4 5 x . 6 3 1
 HAWK BRAKE PAD SHAPE INSERT COMPOUND CODE PAD THICKNESS

PAD/ROTOR KIT CODE BREAKDOWN

H K x 4 2 8 4 4 8
 HAWK KIT INSERT COMPOUND CODE ROTOR PAD SHAPE



HPS BRAKE PAD KEY FEATURES:

- Increased stopping power
- High friction/torque hot or cold
- Gentle on rotors
- Extended pad life
- Low dust
- Virtually noise-free
- Ideal for import and domestic automobiles

HPS-HIGH PERFORMANCE STREET

WHEN IT COMES TO PERFORMANCE BRAKING FOR STREET VEHICLES, THERE IS NO EQUAL.

SUPERIOR STOPPING POWER FOR THE STREET

HPS - (High Performance Street) disc brake pads are world-renowned for increasing stopping power on your street legal vehicle. Hawk Performance's engineers developed the HPS compound by blending the safety and quality aspects of aerospace design with braking technology derived from motorsports efforts. The result is a unique ferro-carbon brake compound that delivers significant advantages of increased stopping power, extended pad life, extended rotor life and low dust properties for street applications.

Our high performance street compound offers a higher coefficient of friction over stock brake pads and can provide you 20-40% more stopping power, with higher resistance to brake fade than standard replacement pads.

All Hawk Performance street brake pads provide a limited lifetime warranty, ensuring products to be free of defects from manufacturer's workmanship and materials. Please see page 231 for complete warranty information.

IMPORTANT INSTALLATION INSTRUCTIONS

All brake pads require a burnishing or bedding-in procedure in order to achieve optimal performance and durability. During the bedding-in process the pad conforms to the rotor surface and generates an important transfer film. Prior to installation, make sure the brake system is free and clear of debris, brake fluid is replaced and all brake components are properly installed and in good working order. See the FAQ section on page 230 for more information on proper brake pad bedding procedure.



Results based on A04D Dyno tests using D52 automotive platform. Actual on-vehicle performance may vary.

IDEAL FOR IMPORT & DOMESTIC AUTOMOBILES.

PERFORMANCE CERAMIC BRAKE PAD KEY FEATURES:

- Extremely quiet—engineered to reduce brake NVH (Noise, Vibration and Harshness)
- Increased stopping power
- Increased rotor life
- Extended pad life
- Ultra-low dust
- Stable friction output
- Ideal for import and domestic touring and luxury automobiles



PERFORMANCE CERAMIC-LUXURY & TOURING

QUIET, CLEAN AND QUICK STOPPING PERFORMANCE CERAMIC IS BETTER THAN STANDARD REPLACEMENT CERAMIC BRAKE PADS.

QUIET, CLEAN PERFORMANCE

Hawk understands the demands of today’s ceramic brake pad users, and specifically formulated our ceramic composite material to meet the ultra-low dust, low noise performance of OE ceramic pads. The advantage of our performance ceramic compound is that we don’t sacrifice stopping power in order to achieve the traditional ceramic pad attributes. Additionally, our ceramic product provides a linear friction profile which allows your ABS system to operate more effectively.

IMPORTANT INSTALLATION INSTRUCTIONS

All brake pads require a burnishing or bedding-in procedure in order to achieve optimal performance and durability. During the bedding-in process the pad conforms to the rotor surface and generates an important transfer film. Prior to installation, make sure the brake system is free and clear of debris, brake fluid is replaced and all brake components are properly installed and in good working order. See the FAQ section on page 230 for more information on proper brake pad bedding procedure.



Results based on A04D Dyno tests using D52 automotive platform. Actual on-vehicle performance may vary.

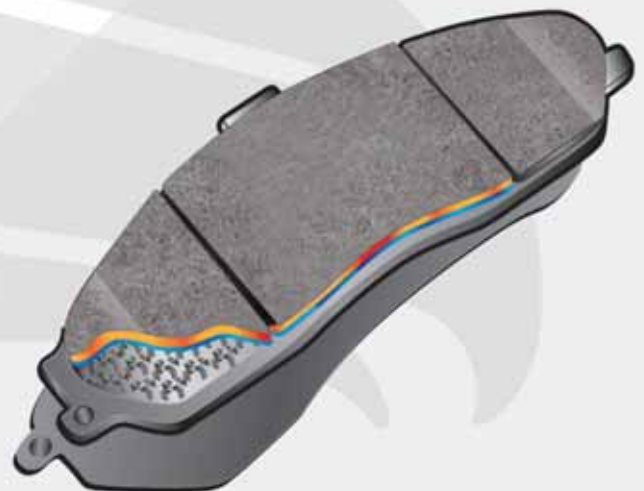

RECOMMENDED FOR IMPORT & DOMESTIC AUTOMOBILES, LUXURY SUVs, SPORT TRUCKS & VANS.



LTS BRAKE PAD KEY FEATURES:

- Designed for large brake systems found on full-size trucks
- Engineered using technology from fleet & military applications
- Ferro-carbon friction material delivers more braking power and fade resistance than OE pads
- Low dust
- Excellent pad and rotor life
- Virtually noise-free
- Ideal for import and domestic full-size trucks, vans and SUVs (1/2 ton) with moderate towing and hauling duty

LTS-LIGHT TRUCK & SUV

STOP PUTTING CAR BRAKES ON YOUR TRUCK. HAWK'S LTS COMPOUND IS SPECIFICALLY FORMULATED FOR LARGE BRAKE SYSTEMS FOUND ON FULL-SIZE TRUCKS AND SUVs.

ENGINEERED BY TRUCK BRAKE PAD EXPERTS

At Hawk Performance, we understand that traditional car brake pad technology just doesn't cut it on today's trucks. This is especially true if you haul heavy payloads or trailers. Install our LTS brake compound and dramatically improve your truck's stopping power and fade resistance. Additionally, Hawk Performance LTS compound will outlast the competition in terms of rotor and pad wear.

WHAT MAKES US THE TRUCK EXPERTS?

For over forty years, we have developed and supplied friction solutions for some of the largest trucks on the planet. Our products are utilized by both OE and aftermarket companies servicing the mining, construction, military and commercial truck markets. We have utilized this technology and combined it with aerospace design quality to develop the ultimate on-highway truck and SUV specific friction material.

All Hawk Performance street brake pads provide a limited lifetime warranty, ensuring products to be free of defects from manufacturer's workmanship and materials. Please see page 255 for complete warranty information.

IMPORTANT INSTALLATION INSTRUCTIONS

All brake pads require a burnishing or bedding-in procedure in order to achieve optimal performance and durability. During the bedding-in process the pad conforms to the rotor surface and generates an important transfer film. Prior to installation, make sure the brake system is free and clear of debris, brake fluid is replaced and all brake components are properly installed and in good working order. See the FAQ section on page 230 for more information on proper brake pad bedding procedure.

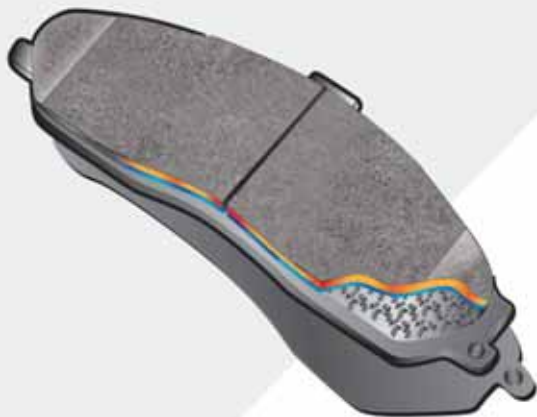

IDEAL FOR IMPORT AND DOMESTIC FULL-SIZE TRUCKS, SUVs AND VANS WITH MODERATE TOWING AND HAULING DUTY.



Results based on A04D Dyno tests using D655 1 ton truck platform. Actual on-vehicle performance may vary.

SUPERDUTY - SEVERE-DUTY TRUCK

FOR SERIOUS TOWING/HAULING AND COMMERCIAL TRUCK FLEETS.

SUPERDUTY BRAKE PAD KEY FEATURES:

- Engineered from technology used in heavy-duty on/off-highway and military applications
- Extremely high coefficient of friction and fade resistance
- Recommended for professional fleets (greater than 1 ton) and light trucks towing excessive payloads

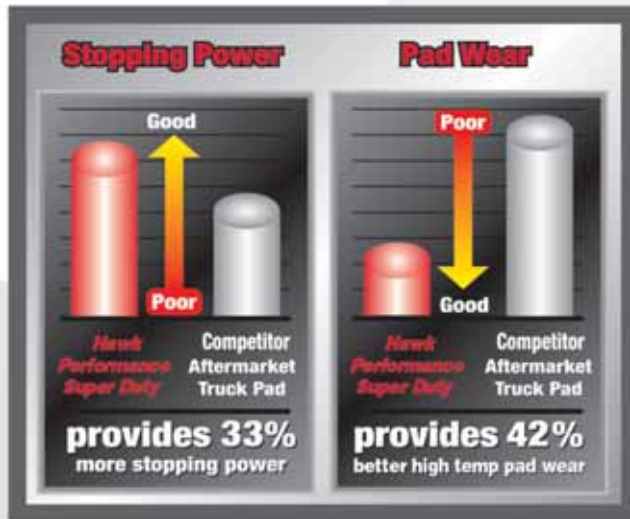

Results based on A04D Dyno tests using D655 1 ton truck platform.
Actual on-vehicle performance may vary.



UNEQUALED FOR SEVERE DUTY USE

Hawk Performance SuperDuty brake pads utilize our OE and aftermarket severe-duty friction technology. This product has been engineered for class 2 and higher on-highway commercial trucks. This unique ferro-carbon material delivers extremely high fade resistance, with superior high temperature rotor and brake pad wear. **This product is not recommended for personal or recreational trucks and SUVs.**

IMPORTANT INSTALLATION INSTRUCTIONS

See page 230 for proper brake pad bedding procedures.

HP-PLUS - AUTOCROSS & RACING

FOR IMPORT AND DOMESTIC STREET CARS THAT COMPETE IN AUTOCROSS, SOLO AND TRACK DAY COMPETITION.

HP PLUS BRAKE PAD KEY FEATURES:

- Extremely high friction output
- Extremely high fade resistance

THE ULTIMATE DOUBLE DUTY FRICTION COMPOUND

Hawk's HP Plus race compound can take the heat of the track, and get you home safely without having to change back to street brake pads. HP Plus was developed and manufactured for sport driving in Track Day applications. This friction formulation offers lower wear rates and higher torque values than other competitive materials..

WARNING: Due to the dramatic friction levels produced by this product to achieve "race-level" braking, rotor wear, noise, dust and pad life may be affected. All Hawk Performance HP Plus/Autocross brake pads provide a limited lifetime warranty, ensuring products to be free of defects from manufacturer's workmanship and materials. Please see page 231 for complete warranty information.



IMPORTANT INSTALLATION INSTRUCTIONS

See page 230 for proper brake pad bedding procedures.

HAWK PERFORMANCE® QUIET SLOT™ ROTORS

SUPERIOR STOPS WITH QUIET SLOT™

QUIET SLOT™

High Torque Output, Wear Indicator, Extremely Quiet

ROTOR DESIGN

Performance Rotor with Direct OE Replacement Design

METALLURGY

Durable, Increased Heat Resistance

GEOMET PLATING

Environmentally Friendly



GRADING DIFFERENT ROTOR STYLES	QUIET SLOT™	HEAVILY SLOTTED	CROSS-DRILLED	SLOTTED & DIMPLED
NVH (NOISE, VIBRATION AND HARSHNESS)	A	B	D	B
LOW BRAKE DUST	B+	C	D	C
OVERALL BRAKE TORQUE OUTPUT	A	B	C	B
BRAKE PAD & ROTOR LIFE	A-	C+	D	B
RESISTANT TO HEAT CRACKING & WARPAGE	A	B	F	B
ENVIRONMENTALLY FRIENDLY	A	C	C	C

*Performance ratings are provided as a general recommendation. Actual performance rating of any given product will vary as vehicle application or brake components change.



PERCENT OF NOISY OCCURANCES

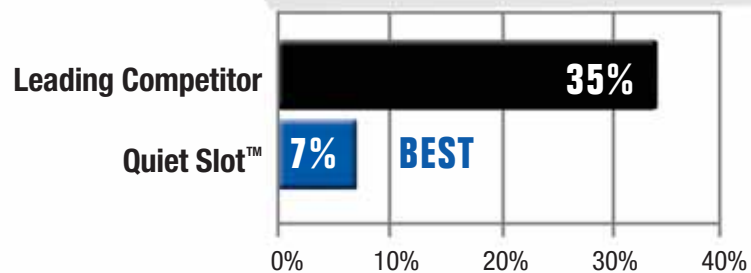

HAWK PERFORMANCE® QUIET SLOT™ ROTORS

KEY FEATURES:

METALLURGY: Quiet Slot™ rotors are cast from a proprietary formulation of premium alloys producing a superior performance street product.

- Noise dampening steel formulation.
- Long grain carbon iron for maximum thermal stability.
- Molybdenum additive for high temperature strength and thermal crack resistance.
- Unique alloy blend provides exceptional rotor life and durability.

DESIGN: Quiet Slot™ rotors combines the look, feel and durability of a true performance rotor with the fitment and convenience of OE design.

- Performance design – Direct OE replacement.
- Unidirectional vanes eliminate the need for left and right side rotors.
- Optimal rotor vane and wall thickness improves structural strength, noise dampening and heat capacity.
Note: Heat cracking and rotor warpage are inherent risks with cross drilled rotors.
- OE style vane design combined with increased heat capacity dramatically improves brake pad and rotor life.

QUIET SLOTS: Hawk Performance® Quiet Slot™ rotors feature a unique slot design specifically engineered to improve your car’s braking performance and driver comfort.

- Increases initial bite.
- Improves wet weather brake performance.
- Effectively removes gas and wear debris.
Note: Cross drilled & dimpled and heavily slotted rotors accelerate pad wear generating excessive brake dust and premature pad wear.
- When the brakes are not engaged, the Quiet Slot™ rotor vane and surface slot design effectively cuts through the surrounding air flow virtually eliminating the “whirling” noise typically encountered with cross drilled or heavily slotted rotors.
- Visual wear indicator. Rotors should be replaced when slots are worn down and no longer visible.
- Optimizes overall brake performance. **Note:** Cross drilled, heavily slotted and dimpled rotors reduce the contact area of the rotor with the brake pad. This environment reduces the effectiveness of the brake pad, can cause damage to the desired transfer film and increase rotor surface temperatures.

SLOTTED VS. CROSS-DRILLED & DIMPLED ROTORS



SURFACE FINISH:

- Swirl ground surface for improved brake pad bed-in and “green” out of the box performance.
- Specific RMS finish accelerates the creation of a proper transfer film when run with Hawk Performance® brand brake pads.
- All rotors are finished with a GEOMET® coating that protects both the internal and external surfaces from rust and corrosion.

WHAT IS GEOMET®?

GEOMET® is a proprietary water-based coating dispersion containing metal oxides, metallic zinc and aluminum flakes. The zinc and aluminum platelets align in multiple layers forming a metallic silver-gray coating. Applied as a liquid, the coating becomes totally inorganic after curing at 575-600° F (300-315°C).

ENVIRONMENTAL BENEFITS:

CHROMIUM-FREE- Does not contain any chromium (NO HEXAVALENT and NO TRIVALENT). GEOMET® meets the following regulations:

- Environmental Protection Agency (EPA)
- Occupational Safety and Health Administration (OSHA)
- DaimlerChrysler CS-9003
- General Motors GMW 3059
- Ford WSS-M99P9999-A1 (Hex 9)
- EU Directive on End of Life Vehicles

NO TOXIC METALS- Free from nickel, cadmium, lead, barium and mercury.

QUALITY: All Quiet Slot™ rotors are meticulously checked for proper balance, thickness, flatness and runout. All rotors are manufactured in ISO certified facilities.

HAWK PERFORMANCE® QUIET SLOT™ ROTORS

Hawk Part #	Outer Diameter (mm)	Nom. Thickness (mm)	Min. Thickness (mm)	Height (mm)	Bolt Circle (mm)	Bolt Holes (Qty.)
HUS308	238.00	10.00	9.00	48.40	100.00	4
HUS358	289.50	10.00	9.75	75.80	100.00	5
HUS359	266.00	10.00	9.90	66.80	100.00	5
HUS421	354.50	32.00	30.00	49.20	114.30	5
HUS427	308.00	16.00	14.00	62.00	114.30	5
HUS428	319.50	28.00	26.00	49.20	114.30	5
HUS463	294.00	24.00	22.40	45.50	114.30	5
HUS466	350.00	32.00	30.00	43.70	114.30	5
HUS467	330.00	22.00	20.00	58.20	114.30	5
HUS474	315.80	30.00	28.00	56.90	100.00	5
HUS498	312.00	25.00	22.00	46.70	112.00	9
HUS499	285.80	12.00	10.00	48.30	112.00	9
HUS501	345.00	20.00	18.50	85.40	139.70	6
HUS502	319.00	28.00	26.00	67.50	139.70	6
HUS503	312.00	18.00	16.00	68.10	139.70	6
HUS504	350.00	31.90	30.50	54.50	127.00	5
HUS505	330.00	14.00	12.50	63.70	127.00	5
HUS506	275.00	22.00	19.00	46.50	100.00	5
HUS518	256.00	24.00	23.87	45.00	114.30	5
HUS522	261.50	21.00	20.90	44.70	100.00	4
HUS523	260.00	10.00	9.87	58.60	100.00	4
HUS524	259.80	23.00	22.85	34.00	114.30	4
HUS525	240.00	21.00	20.88	44.50	100.00	4
HUS526	259.20	10.00	9.75	58.80	114.30	4
HUS528	282.00	23.00	22.75	46.60	114.30	5
HUS557	160.50	22.00	20.00	49.00	114.30	4
HUS560	329.30	32.10	30.00	49.50	112.00	9
HUS561	330.00	16.00	15.00	62.00	114.30	5
HUS577	257.80	24.00	23.80	48.50	114.30	5
HUS578	320.00	25.00	23.00	48.20	114.30	5
HUS579	254.50	20.00	18.00	45.00	100.00	4
HUS580	300.00	22.00	21.87	57.00	114.30	5
HUS581	319.70	32.00	31.75	43.50	114.30	5
HUS583	276.00	24.00	23.87	45.20	114.30	6
HUS583	276.00	24.00	23.87	45.20	111.00	5
HUS585	289.50	22.00	20.00	45.00	114.30	5
HUS586	276.00	26.00	25.80	45.50	114.30	5
HUS589	294.00	26.00	24.00	45.70	114.30	5
HUS600	299.90	20.00	18.00	66.10	120.00	5
HUS602	300.00	20.00	18.40	66.00	120.00	5
HUS614	312.00	28.00	27.75	34.00	100.00	9
HUS618	231.70	9.00	8.75	48.50	100.00	5
HUS619	300.00	22.00	21.75	73.50	120.00	5
HUS620	256.00	12.00	10.00	48.50	112.00	9
HUS621	288.00	24.85	22.00	49.70	112.00	9
HUS622	335.80	22.00	20.40	67.00	120.00	5
HUS624	300.00	20.00	18.40	76.00	120.00	5
HUS625	300.00	24.00	22.40	73.00	120.00	5
HUS626	258.70	10.00	9.75	43.80	100.00	4
HUS627	178.00	22.00	21.75	44.00	100.00	4
HUS630	348.00	30.00	28.40	73.20	120.00	5
HUS639	302.00	10.00	8.40	60.00	114.30	5
HUS640	312.00	24.00	22.40	73.80	120.00	5
HUS659	350.00	34.00	32.00	49.00	135.00	6
HUS678	302.00	28.00	26.00	55.20	127.00	5
HUS704	260.00	23.00	21.00	47.00	114.30	4
HUS705	295.50	24.00	23.75	49.30	114.30	5
HUS706	291.40	9.00	8.00	62.30	114.30	5
HUS709	281.70	23.00	22.75	47.00	114.30	5
HUS710	320.00	28.00	26.00	44.00	114.30	5

HAWK PERFORMANCE® QUIET SLOT™ ROTORS

Hawk Part #	Outer Diameter (mm)	Nom. Thickness (mm)	Min. Thickness (mm)	Height (mm)	Bolt Circle (mm)	Bolt Holes (Qty.)
HUS730	276.80	24.00	23.88	56.60	100.00	5
HUS732	293.70	24.00	24.98	56.70	100.00	5
HUS735	326.00	30.00	29.87	53.00	100.00	5
HUS736	316.00	20.00	19.75	65.70	100.00	5
HUS737	326.00	30.00	29.87	52.80	114.30	5
HUS738	316.00	20.00	19.87	65.80	114.30	5
HUS739	285.70	10.00	8.50	63.40	100.00	5
HUS740	273.60	10.00	8.50	67.60	100.00	5
HUS741	289.50	18.00	16.00	67.50	100.00	5
HUS762	302.80	24.00	22.00	45.00	114.30	5
HUS763	301.70	18.00	16.00	43.20	114.30	5
HUS764	322.70	24.00	22.00	45.00	114.30	5
HUS772	262.00	10.00	9.87	60.30	114.30	5
HUS7761	353.00	35.50	35.25	101.90	165.10	8
HUS795	196.00	28.00	27.87	70.20	139.70	6
HUS798	260.00	9.00	8.00	42.00	114.30	5
HUS2001L	330.00	28.00	26.00	28.00	203.20	12
HUS2001R	330.00	28.00	26.00	28.00	203.20	12
HUS2002L	355.00	32.00	30.00	32.00	215.90	12
HUS2002R	355.00	32.00	30.00	32.00	215.90	12
HUS8126	277.60	26.40	26.15	95.40	108.00	4
HUS8141	276.00	26.00	25.87	46.40	114.30	5
HUS8142	267.00	44.10	43.90	49.94	114.30	5
HUS8144	330.00	28.00	27.87	43.60	114.30	5
HUS8146	296.00	18.00	17.88	51.10	114.30	5
HUS8181	299.00	30.00	29.75	48.00	114.30	5
HUS8182	300.00	19.00	18.75	34.90	114.30	5
HUS8184	316.20	30.00	29.75	48.10	114.30	5
HUS8213	267.00	26.30	26.17	109.30	120.65	5
HUS8242	317.50	33.00	32.87	70.00	165.10	8
HUS8258	278.00	11.00	10.87	50.20	118.00	5
HUS8259	325.00	32.00	31.87	45.60	120.65	5
HUS8261	305.00	26.00	25.75	48.50	120.65	5
HUS8265	305.00	26.00	25.87	61.20	118.00	5
HUS8351	280.00	28.00	27.75	39.50	100.00	5
HUS8359	320.00	28.00	26.40	54.60	115.00	5
HUS8361	345.00	28.00	26.50	54.50	115.00	5
HUS8362	320.00	22.00	20.50	67.00	115.00	5
HUS8553	329.50	30.10	29.97	78.90	165.10	8
HUS8571	326.00	30.20	30.07	98.40	170.00	8
HUS8586	331.00	38.00	37.87	99.40	170.00	8
HUS8626	317.50	39.17	39.04	70.00	165.10	8
HUS8657	330.00	30.00	29.75	55.50	139.70	6
HUS8659	325.00	38.20	38.07	89.20	165.10	8
HUS8664	302.70	32.26	32.13	51.80	118.00	5
HUS8690	304.70	29.00	28.87	58.10	139.70	6
HUS8691	330.00	29.00	28.87	91.20	139.70	8
HUS8692	325.00	38.20	38.07	89.20	165.10	8
HUS8695	330.00	30.10	29.76	95.60	139.70	6
HUS8722	280.00	24.00	24.00	81.50	114.30	5
HUS8742	280.00	24.30	23.00	101.80	114.30	5
HUS8747	307.50	30.00	29.87	73.20	139.70	5
HUS8749	336.00	28.00	27.75	67.50	139.70	5
HUS8780	329.50	30.00	29.75	54.60	135.00	6
HUS910	259.70	9.00	8.87	48.30	114.30	4
HUS911	261.50	21.00	19.00	47.10	114.30	5
HUS912	300.00	25.00	24.75	47.00	114.30	5
HUS945	282.00	9.00	8.00	48.60	114.30	5
HUS946	300.00	28.00	27.75	47.10	114.30	5

COMPOUND	COMMENTS/REMARKS	OPERATING TEMP.	OPTIMAL TEMP. RANGE	TORQUE LEVEL	APPLICATIONS
DTC-70	<ul style="list-style-type: none"> - High temp. & high torque - Provide superior pad and rotor wear - Excellent torque control - Excellent modulation and release characteristics - Designed for high deceleration rates 	400-1600°F	800-1200°F	HIGH	<ul style="list-style-type: none"> - NASCAR/NASCAR Modified - ARCA - Super Late Models - Pavement circle track - Sports Car/GT/GS <ul style="list-style-type: none"> - All club levels - Open Wheel/Formula - Monster Trucks - Demanding Tarmac
DTC-60	<ul style="list-style-type: none"> - High temp. & high torque - Provide superior pad and rotor wear - Excellent torque control - Excellent modulation and release characteristics - Heavier gravel rally - Lighter tarmac rally 	400-1600°F	700-1100°F	HIGH	<ul style="list-style-type: none"> - NASCAR/NASCAR Modified - ARCA - Super Late Models - Pavement circle track - Sports Car/GT/GS - All club levels <ul style="list-style-type: none"> - Open Wheel/Formula - Popular choice on lightweight front axle apps w/o w/ ABS
DTC-30	<ul style="list-style-type: none"> - Wide temp range - Controllable torque - Smooth feel and bite - Excellent release characteristics - Multi-purpose gravel rally - Excellent brake rotor wear 	100-1200°F	100-800°F	MEDIUM	<ul style="list-style-type: none"> - NASCAR/NASCAR Modified - Circle Track - Dirt Track <ul style="list-style-type: none"> - Drag Racing - Sprint Cars
DTC-15	<ul style="list-style-type: none"> - Low to mid temp. range - Medium torque - Torque level just below DTC-30 	200-800°F	300-600°F	MEDIUM	<ul style="list-style-type: none"> - Circle Track - Dirt Track Late Model - Dirt Modified
DTC-05	<ul style="list-style-type: none"> - Low to mid temp. range - Smooth and predictable torque - Designed to provide lower torque 	100-700°F	100-500°F	LOW	<ul style="list-style-type: none"> - Autocross/Track Day Events - Dirt Modified <ul style="list-style-type: none"> - Specialty Caliper and brake kit
HT-14	<ul style="list-style-type: none"> - Designed for high deceleration rates - High temperature fade resistance - Very high torque with aggressive initial bite 	300-1400°F	500-1100°F	HIGH	<ul style="list-style-type: none"> - Open Wheel/Formula - Sports Car/GT <ul style="list-style-type: none"> - F2000 - F3000
HT-10	<ul style="list-style-type: none"> - Linear in-braking characteristics across temp. ranges - Intermediate to high torque 	300-1300°F	500-1100°F	HIGH	<ul style="list-style-type: none"> - Road Racing for higher torque than Blue 9012 <ul style="list-style-type: none"> - Increased track day performance
METALLIC	<ul style="list-style-type: none"> - Specifically designed for ceramic coated brake rotors - Linear in-braking characteristics across temp. ranges - Low pad wear with high fade resistance 	100-1700°F	200-1300°F	HIGH	<ul style="list-style-type: none"> - Sprint car
MT-4	<ul style="list-style-type: none"> - Mid to high initial bite - Intermediate to high torque 	400-1200°F	200-1300°F	HIGH	<ul style="list-style-type: none"> - Pavement Circle Track (under 2000 lbs.) - Pavement Street Stock (under 2800 lbs.) <ul style="list-style-type: none"> - NASCAR Modified - Pavement Limited - Late Model - Pavement Modified
BLUE 9012	<ul style="list-style-type: none"> - Low to mid temp range - Low to intermediate torque - Excellent modulation - Multi-purpose compound 	250-1000°F	350-800°F	MEDIUM	<ul style="list-style-type: none"> - Road and Rally Racing - Entry level race compound
BLACK	<ul style="list-style-type: none"> - Lower temp - Low to intermediate torque 	100-900°F	200-700°F	MEDIUM	<ul style="list-style-type: none"> - Circle Track - All-purpose compound - For lower temp and torque applications <ul style="list-style-type: none"> - Dirt modified - Pavement (IMCA Style Modified)
DR-97	<ul style="list-style-type: none"> - Designed for use on aluminum rotors - Good static and dynamic coefficient of friction 	100-900°F	100-700°F	MEDIUM	<ul style="list-style-type: none"> - Specialty calipers used in low-to-medium-deceleration drag racing
HP PLUS	<ul style="list-style-type: none"> - Designed to get you to and from the track without requiring a brake change - Low to mid temp range - Smooth and predictable torque 	100-800°F	300-600°F	LOW	<ul style="list-style-type: none"> - Autocross - Club track day events - Popular choice for rear axle use on GT, GS and club level applications with ABS

MOTORSPORTS COMPOUND CODES & DESCRIPTIONS

Below are descriptions of the available compounds for Hawk Performance motorsports brake pad compounds:

DTC-70

Extremely high torque with aggressive controllable initial bite. Superior release and torque control characteristics. Brake pads designed for cars with high deceleration rates with or without down force.

DTC-60

High torque with less initial bite than DTC 70. Superior release and torque control characteristics. Brake pads designed for cars with high deceleration rates with or without down force. Recommended for use with DTC-70 when split friction between front and rear axle is desired.

DTC-30

Brake pads are designed specifically for dirt circle track applications. Uniquely controllable torque with smooth consistent feel and bite. Superior release and torque control characteristics.

DTC-15

Developed specifically to meet the demands of dirt circle track applications. DTC-15 brake pads are a medium torque compound (less torque than DTC-30, more than DTC-5) with superior release characteristics and excellent cold effectiveness.

DTC-05

Developed specifically to meet the demands of lower torque dirt track racing. This friction formulation provides very controllable, higher temperature performance as compared to stock pads.

HT-14

Very high torque with aggressive initial bite. Excellent modulation and release characteristics. Brake pads designed for cars with extremely high deceleration rates and downforce.

HT-10

Intermediate to high torque with a smooth initial bite. Very consistent pedal feel. Excellent modulation and release characteristics.

Metallic

High torque with linear in-braking characteristics across temperature ranges. Specifically designed for ceramic coated brake rotors. Creates low pad wear with high fade resistance.

MT-4

Medium/high torque and temperature compound with medium/high initial bite. Brake pads designed for circle track cars under 2800 lbs without high deceleration rates.

BLUE 9012

Medium/high torque and temperature compound with excellent brake modulation. #1 selling brake pad material for SCCA.

BLACK

Medium torque and temperature compound designed to be a good, all-purpose low-cost racing brake pad.

DR-97

Excellent static and dynamic coefficient of friction. Smooth linear torque. Low pad and rotor wear. Brake pads specifically designed for use in drag racing applications.

HP PLUS

HP Plus utilizes a unique ferro-carbon, high-tech friction material that was developed and manufactured for sport driving in autocross, Solo II and "track day" applications. The ferro-carbon formulation offers lower wear rates and higher torque values than other competitive materials.

MOTORSPORTS COMPOUNDS	
BRAKE PAD	COMPOUNDS
DTC-70	U
DTC-60	G
DTC-30	W
DTC-15	A
DTC-05	H
HT-14	V
HT-10	S
Metallic	MB
MT-4	L
Blue 9012	E
Black	M
DR-97	J
HP Plus	N

BRAKE PAD CODE BREAKDOWN			
H B	2 4 5	X	.6 3 1
HAWK BRAKE	PAD SHAPE	INSERT COMPOUND CODE	PAD THICKNESS

PAD/ROTOR KIT CODE BREAKDOWN			
H K	X	4 2 8	4 4 8
HAWK KIT	INSERT COMPOUND CODE	ROTOR	PAD SHAPE

DTC ROTOR & BRAKE PAD SYSTEM

Hawk Performance has developed the ideal rotor that optimizes brake performance and durability for short track racing. Our DTC rotors combine advanced design and metallurgy to create the perfect “matched set” system when run with our DTC brake pads. More stopping power and longer life are what you get when you install DTC rotors and pads!

DTC ROTOR

KEY FEATURES:

METALLURGY: DTC rotors are cast from a proprietary formulation of premium alloys, including long grain carbon iron for maximum thermal stability and resistance to distortion. Additional elements include copper & molybdenum for high-temperature strength & thermal crack resistance.

DESIGN: DTC directional rotors are engineered to provide efficient cooling, exceptional wear and reduced rotating mass for hard and intermediate braking asphalt & dirt track applications. Additionally, the combination of our unique interior vane and mounting lug design provides superior structural integrity.

MULTI-PASS PROGRESSIVE SLOTS: DTC front rotors feature our exclusive slot design that produces superior initial bite, release characteristics and wear debris removal.

SURFACE FINISH: All DTC rotors incorporate a specific RMS finish that enhances the creation of a proper transfer film, especially when run with Hawk’s DTC brake pads.

QUALITY: Each DTC rotor is meticulously checked for proper balance, thickness, flatness and run-out. All rotors are manufactured in ISO certified facilities located in the U.S.A.

PART NUMBER	DIAMETER	WIDTH	BOLT CIRCLE	HOLE SIZE	FAR SIDE ID	LUG SIDE ID	GAS SLOT	VANES	RH/LH	WEIGHT
HR8000L	11.75	1.25	8X7.00"	5/16	8.05	6.38	YES	40 DIRECTIONAL	LH	13.1 LBS
HR8000R	11.75	1.25	8X7.00"	5/16	8.05	6.38	YES	40 DIRECTIONAL	RH	13.1 LBS
HR8002L	11.75	1.25	8X7.00"	5/16	8.05	6.38	NONE	40 DIRECTIONAL	LH	13.1 LBS
HR8002R	11.75	1.25	8X7.00"	5/16	8.05	6.38	NONE	40 DIRECTIONAL	RH	13.1 LBS
HR8003L	11.75	0.81	8X7.00"	5/16	8.05	6.38	YES	36 DIRECTIONAL	LH	9.9 LBS
HR8003R	11.75	0.81	8X7.00"	5/16	8.05	6.38	YES	36 DIRECTIONAL	RH	9.9 LBS
HR8004L	12.1875	1.25	8X7.00"	5/17	8.05	6.38	YES	36 DIRECTIONAL	LH	11.4 LBS
HR8004R	12.1875	1.25	8X7.00"	5/18	8.05	6.38	YES	36 DIRECTIONAL	RH	11.4 LBS
HRZERO-L	11.63	0.99	8X7.00"	5/16	8.46	6.38	YES	32 DIRECTIONAL	LH	6.6 LBS
HRZERO-R	11.63	0.99	8X7.00"	5/16	8.46	6.38	YES	32 DIRECTIONAL	RH	6.6 LBS



TALON™

PERFORMANCE BRAKE CALIPERS

Components are for illustrative purposes only.
Actual components will vary by vehicle type and fitment.

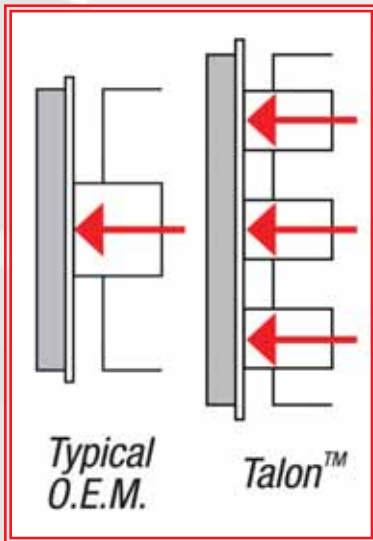

TALON™ CALIPER

Billet-aluminum is the heart of our Performance Brake System. Our new three-piston Talon caliper is the key to upgrading your brakes while retaining stock mounting points and avoiding clearance issues*.

*Certain rear-brake fitments use a high-performance single piston design to retain parking brake function with stock mounting brackets.

- Up to 55% more clamping force than stock, depending on application
- Fast, easy install — no drilling, welding or fabricating
- Machined billet aluminum caliper body, anodized for durability and powder-coated for appearance
- Durable stainless steel pistons machined from solid 303 bar stock (factory caliper uses aluminum piston)
- High temperature internal dust seals are protected from direct heat and debris, and provide years of leak-free performance
- Designed to work with factory master cylinders and ABS systems

HAWK PERFORMANCE BRAKE SYSTEM INCLUDES

BRAKE PADS

TALON™ CALIPER

ROTORS

A matched set of precision components made to substantially increase your vehicle's braking performance.

BRAKE PADS

Our Hawk Performance street compound is engineered with a specially formulated ferro-carbon compound that's ideal for spirited driving and aggressive stops.

TALON™ CALIPER

The new three-piston Talon caliper is made of durable stainless steel pistons with an internal dust seal and a machine billet aluminum body.

QUIET SLOT ROTORS

Proven performance and durability Quiet Slot™ rotors let you take full advantage of our brake pads and Talon calipers.

MAKE/ MODEL	SUBMODEL	ENGINE YRS. (LITER)	NOTE	FRONT				REAR				
				CALIPER SYSTEM	CALIPER	ROTOR	PADS	CALIPER SYSTEM	CALIPER	ROTOR	PADS	
CHEVROLET												
Corvette	Base	2008-2013	All		HCKS3000	HCAS300	HUS8259	HB247F.575	HCKS3001	HCAS301	HUS3000	HB247F.575
Corvette	Z06	2001-2004	All		HCKS3000	HCAS300	HUS8259	HB247F.575	HCKS3001	HCAS301	HUS3000	HB247F.575
Corvette		1997-2004	All		HCKS3000	HCAS300	HUS8259	HB247F.575	HCKS3001	HCAS301	HUS3000	HB247F.575
Corvette		2005-2009	All	Standard brakes	HCKS3000	HCAS300	HUS8259	HB247F.575	HCKS3001	HCAS301	HUS3000	HB247F.575
Silverado 1500	Classic LS	2007-2007	All	w/Rear Disc Brakes	HCKS3002	HCAS302	HUS8657	HB247F.575	HCKS3003	HCAS303	HUS8695	HB385F.640
Silverado 1500	Classic LS	2007-2007	All	w/Rear Drum Brakes	HCKS3002	HCAS302	HUS8657	HB247F.575				
Silverado 1500	Classic LT	2007-2007	All	w/Rear Disc Brakes	HCKS3002	HCAS302	HUS8657	HB247F.575	HCKS3003	HCAS303	HUS8695	HB385F.640
Silverado 1500	Classic LT	2007-2007	All	w/Rear Drum Brakes	HCKS3002	HCAS302	HUS8657	HB247F.575				
Silverado 1500	Classic WT	2007-2007	All	w/Rear Disc Brakes	HCKS3002	HCAS302	HUS8657	HB247F.575	HCKS3003	HCAS303	HUS8695	HB385F.640
Silverado 1500	Classic WT	2007-2007	All	w/Rear Drum Brakes	HCKS3002	HCAS302	HUS8657	HB247F.575				
Silverado 1500	Police	2008-2008	All		HCKS3002	HCAS302	HUS8657	HB247F.575	HCKS3003	HCAS303	HUS8695	HB385F.640
Silverado 1500	Police	2010-2010	All		HCKS3002	HCAS302	HUS8657	HB247F.575	HCKS3003	HCAS303	HUS8695	HB385F.640
Silverado 1500	SS	2003-2006	All	Must have 17" wheel or larger for rear kit	HCKS3002	HCAS302	HUS8657	HB247F.575	HCKS3003	HCAS303	HUS8695	HB385F.640
Silverado 1500		1999-2000	All	Must have 17" wheel or larger	HCKS3002	HCAS302	HUS8657	HB247F.575	HCKS3003	HCAS303	HUS8695	HB385F.640
Silverado 1500		2001-2001	All	2 Door. Reg Cab Must have 17" wheel or larger	HCKS3002	HCAS302	HUS8657	HB247F.575	HCKS3003	HCAS303	HUS8695	HB385F.640
Silverado 1500		2001-2001	All	2 Door Ext. Cab Must have 17" wheel or larger	HCKS3002	HCAS302	HUS8657	HB247F.575	HCKS3003	HCAS303	HUS8695	HB385F.640
Silverado 1500		2002-2002	All	Extended Cab. 4 Wheel Steering Must have 17" wheel or larger for rear kit	HCKS3002	HCAS302	HUS8657	HB247F.575	HCKS3003	HCAS303	HUS8695	HB385F.640
Silverado 1500		2002-2002	All	Regular Cab. 2 Wheel Steering Must have 17" wheel or larger for rear kit	HCKS3002	HCAS302	HUS8657	HB247F.575	HCKS3003	HCAS303	HUS8695	HB385F.640
Silverado 1500		2003-2003	All	4 Door Heavy Duty. 4 Wheel Steering Must have 17" wheel or larger	HCKS3002	HCAS302	HUS8657	HB247F.575	HCKS3003	HCAS303	HUS8695	HB385F.640
Silverado 1500		2003-2003	All	Extended Cab. 2 Wheel Steering Must have 17" wheel or larger	HCKS3002	HCAS302	HUS8657	HB247F.575	HCKS3003	HCAS303	HUS8695	HB385F.640
Silverado 1500		2003-2003	All	Extended Cab. 4 Wheel Steering 325mm Rear Disc, Must have 17" wheel or larger	HCKS3002	HCAS302	HUS8657	HB247F.575				
Silverado 1500		2003-2003	All	Extended Cab. 4 Wheel Steering 330mm Rear Disc Must have 17" wheel or larger	HCKS3002	HCAS302	HUS8657	HB247F.575	HCKS3003	HCAS303	HUS8695	HB385F.640
Silverado 1500		2003-2003	All	Regular Cab Must have 17" wheel or larger	HCKS3002	HCAS302	HUS8657	HB247F.575	HCKS3003	HCAS303	HUS8695	HB385F.640
Silverado 1500		2004-2004	All	Crew Cab Must have 17" wheel or larger	HCKS3002	HCAS302	HUS8657	HB247F.575	HCKS3003	HCAS303	HUS8695	HB385F.640
Silverado 1500		2004-2004	All	Extended Cab. 2 Wheel Steering Except Hybrid. Must have 17" wheel or larger	HCKS3002	HCAS302	HUS8657	HB247F.575	HCKS3003	HCAS303	HUS8695	HB385F.640
Silverado 1500		2004-2004	All	Extended Cab. 4 Wheel Steering Except Hybrid Must have 17" wheel or larger	HCKS3002	HCAS302	HUS8657	HB247F.575	HCKS3003	HCAS303	HUS8695	HB385F.640
Silverado 1500		2004-2004	All	Hybrid Must have 17" wheel or larger	HCKS3002	HCAS302	HUS8657	HB247F.575	HCKS3003	HCAS303	HUS8695	HB385F.640
Silverado 1500		2004-2004	All	Regular Cab Must have 17" wheel or larger	HCKS3002	HCAS302	HUS8657	HB247F.575	HCKS3003	HCAS303	HUS8695	HB385F.640
Silverado 1500		2005-2005	All	w/Rear Disc Brakes Must have 17" wheel or larger	HCKS3002	HCAS302	HUS8657	HB247F.575	HCKS3003	HCAS303	HUS8695	HB385F.640
Silverado 1500		2005-2005	All	w/Rear Disc Brakes. Ext Cab. Hybrid Must have 17" wheel or larger	HCKS3002	HCAS302	HUS8657	HB247F.575	HCKS3003	HCAS303	HUS8695	HB385F.640
Silverado 1500		2005-2005	All	w/Rear Drum Brakes	HCKS3002	HCAS302	HUS8657	HB247F.575				
Silverado 1500		2006-2006	6.0	"Ext. Cab Must have 17" wheel or larger	HCKS3002	HCAS302	HUS8657	HB247F.575	HCKS3003	HCAS303	HUS8695	HB385F.640

MAKE/ MODEL	SUBMODEL	YRS.	ENGINE (LITER)	NOTE	FRONT				REAR			
					CALIPER SYSTEM	CALIPER	ROTOR	PADS	CALIPER SYSTEM	CALIPER	ROTOR	PADS
CHEVROLET CONTINUED												
Silverado 1500		2006-2006	All	6400 lb. GVW, Rear Drum	HCKS3002	HCAS302	HUS8657	HB247F.575				
Silverado 1500		2006-2006	All	6400 lb. GVW, Rear Disc Must have 17" wheel or larger	HCKS3002	HCAS302	HUS8657	HB247F.575	HCKS3003	HCAS303	HUS8695	HB385F.640
Silverado 1500		2006-2006	All	7000 lb. GVW, Rear Drum	HCKS3002	HCAS302	HUS8657	HB247F.575				
Silverado 1500		2006-2006	All	7200 lb. GVW, Rear Disc Must have 17" wheel or larger	HCKS3002	HCAS302	HUS8657	HB247F.575	HCKS3003	HCAS303	HUS8695	HB385F.640
Silverado 1500		2007-2007	All	w/Rear Disc Brakes	HCKS3002	HCAS302	HUS8657	HB247F.575	HCKS3003	HCAS303	HUS8695	HB385F.640
Silverado 1500		2007-2007	All	w/Rear Drum Brakes	HCKS3002	HCAS302	HUS8657	HB247F.575				
Silverado 1500		2007-2007	All	w/Rear Disc Brakes	HCKS3002	HCAS302	HUS8657	HB247F.575	HCKS3003	HCAS303	HUS8695	HB385F.640
Silverado 1500		2007-2007	All	w/Rear Drum Brakes	HCKS3002	HCAS302	HUS8657	HB247F.575				
Silverado 1500		2008-2013	All	w/Rear Disc Brakes	HCKS3002	HCAS302	HUS8657	HB247F.575	HCKS3003	HCAS303	HUS8695	HB385F.640
Silverado 1500		2008-2013	All	w/Rear Drum Brakes, Except Hybrid	HCKS3002	HCAS302	HUS8657	HB247F.575				
Suburban 1500	Police	2010-2010	All		HCKS3002	HCAS302	HUS8657	HB247F.575	HCKS3003	HCAS303	HUS8695	HB385F.640
Suburban 1500		2000-2002	All	w/Limited Slip Must have 17" wheel or larger	HCKS3002	HCAS302	HUS8657	HB247F.575	HCKS3003	HCAS303	HUS8695	HB385F.640
Suburban 1500		2000-2002	All	w/o Limited Slip Must have 17" wheel or larger	HCKS3002	HCAS302	HUS8657	HB247F.575	HCKS3003	HCAS303	HUS8695	HB385F.640
Suburban 1500		2003-2006	All	2WD Must have 17" wheel or larger	HCKS3002	HCAS302	HUS8657	HB247F.575	HCKS3003	HCAS303	HUS8695	HB385F.640
Suburban 1500		2003-2006	All	4WD Must have 17" wheel or larger	HCKS3002	HCAS302	HUS8657	HB247F.575	HCKS3003	HCAS303	HUS8695	HB385F.640
Suburban 1500		2007-2013	All		HCKS3002	HCAS302	HUS8657	HB247F.575	HCKS3003	HCAS303	HUS8695	HB385F.640
Tahoe	Hybrid	2008-2008	All		HCKS3002	HCAS302	HUS8657	HB247F.575	HCKS3003	HCAS303	HUS8695	HB385F.640
Tahoe	LS	2007-2008	All		HCKS3002	HCAS302	HUS8657	HB247F.575	HCKS3003	HCAS303	HUS8695	HB385F.640
Tahoe	LS	2009-2013	All		HCKS3002	HCAS302	HUS8657	HB247F.575	HCKS3003	HCAS303	HUS8695	HB385F.640
Tahoe	LT	2007-2008	All		HCKS3002	HCAS302	HUS8657	HB247F.575	HCKS3003	HCAS303	HUS8695	HB385F.640
Tahoe	LT	2009-2013	All		HCKS3002	HCAS302	HUS8657	HB247F.575	HCKS3003	HCAS303	HUS8695	HB385F.640
Tahoe	LTZ	2007-2008	All		HCKS3002	HCAS302	HUS8657	HB247F.575	HCKS3003	HCAS303	HUS8695	HB385F.640
Tahoe	LTZ	2009-2013	All		HCKS3002	HCAS302	HUS8657	HB247F.575	HCKS3003	HCAS303	HUS8695	HB385F.640
Tahoe	Police	2007-2013	All		HCKS3002	HCAS302	HUS8657	HB247F.575	HCKS3003	HCAS303	HUS8695	HB385F.640
Tahoe		2000-2000	All	2WD. w/Rear Disc Brakes Must have 17" wheel or larger	HCKS3002	HCAS302	HUS8657	HB247F.575	HCKS3003	HCAS303	HUS8695	HB385F.640
Tahoe		2000-2000	All	4WD. w/Rear Disc Brakes. w/Limited Slip Must have 17" wheel or larger	HCKS3002	HCAS302	HUS8657	HB247F.575	HCKS3003	HCAS303	HUS8695	HB385F.640
Tahoe		2000-2000	All	4WD. w/Rear Disc Brakes. w/o Limited Slip Must have 17" wheel or larger	HCKS3002	HCAS302	HUS8657	HB247F.575	HCKS3003	HCAS303	HUS8695	HB385F.640
Tahoe		2001-2001	All	2WD Must have 17" wheel or larger	HCKS3002	HCAS302	HUS8657	HB247F.575	HCKS3003	HCAS303	HUS8695	HB385F.640
Tahoe		2001-2002	All	4WD. w/Limited Slip Must have 17" wheel or larger	HCKS3002	HCAS302	HUS8657	HB247F.575	HCKS3003	HCAS303	HUS8695	HB385F.640
Tahoe		2001-2002	All	4WD. w/o Limited Slip Must have 17" wheel or larger	HCKS3002	HCAS302	HUS8657	HB247F.575	HCKS3003	HCAS303	HUS8695	HB385F.640
Tahoe		2002-2002	All	2WD. Classic Style Must have 17" wheel or larger	HCKS3002	HCAS302	HUS8657	HB247F.575	HCKS3003	HCAS303	HUS8695	HB385F.640
Tahoe		2002-2002	All	2WD. New Style Must have 17" wheel or larger	HCKS3002	HCAS302	HUS8657	HB247F.575	HCKS3003	HCAS303	HUS8695	HB385F.640
Tahoe		2003-2006	All	2WD Must have 17" wheel or larger	HCKS3002	HCAS302	HUS8657	HB247F.575	HCKS3003	HCAS303	HUS8695	HB385F.640
Tahoe		2003-2006	All	4WD Must have 17" wheel or larger	HCKS3002	HCAS302	HUS8657	HB247F.575	HCKS3003	HCAS303	HUS8695	HB385F.640

MAKE/ MODEL	SUBMODEL	ENGINE YRS. (LITER)	NOTE	FRONT				REAR			
				CALIPER SYSTEM	CALIPER	ROTOR	PADS	CALIPER SYSTEM	CALIPER	ROTOR	PADS
CHRYSLER											
300	C	2005-2010	5.7 V8 NON SRT-8	HCKS3004	HCAS3004	HUS8361	HB247F.575				
300	C	2005-2010	5.7 V8 2WD & 4WD	HCKS3004	HCAS3004	HUS8361	HB247F.575				
300		2005-2010	All all except SRT 8. With Solid rear rotor	HCKS3004	HCAS3004	HUS8361	HB247F.575				
300		2005-2010	All all except SRT 8. With Vented rear rotor	HCKS3004	HCAS3004	HUS8361	HB247F.575				
300		2011-2013	3.6 RWD - with Solid rear rotor	HCKS3004	HCAS3004	HUS8361	HB247F.575				
300		2011	5.4 Hemi	HCKS3004	HCAS3004	HUS8361	HB247F.575				
300		2012-2013	All exc. SRT8 with vented rear rotors	HCKS3004	HCAS3004	HUS8361	HB247F.575				
300		2005-2007	2.7	HCKS3004	HCAS3004	HUS8361	HB247F.575				
DODGE											
Challenger	R/T	2009-2013	All Vented rear disc	HCKS3004	HCAS3004	HUS8361	HB247F.575				
Challenger	SE	2009-2013	3.5 Solid rear disc	HCKS3004	HCAS3004	HUS8361	HB247F.575				
Challenger	SE Rallye Pkg	2011-2013	3.6 Solid rear disc	HCKS3004	HCAS3004	HUS8361	HB247F.575				
Challenger	V6	2012-2013	All Solid rear disc	HCKS3004	HCAS3004	HUS8361	HB247F.575				
Challenger	V6	2012-2013	All Excl. SRT8, Performance brakes	HCKS3004	HCAS3004	HUS8361	HB247F.575				
Challenger	V8	2012-2013	All Excl. SRT8, Performance brakes	HCKS3004	HCAS3004	HUS8361	HB247F.575				
Challenger	V6	2012-2013	All Touring Brakes	HCKS3004	HCAS3004	HUS8361	HB247F.575				
Challenger		2008-2008	All	HCKS3004	HCAS3004	HUS8361	HB247F.575				
Charger	Daytona R/T	2006-2013	All w/Vented Rear Rotor	HCKS3004	HCAS3004	HUS8361	HB247F.575				
Charger	Police	2006-2013	All	HCKS3004	HCAS3004	HUS8361	HB247F.575				
Charger	R/T	2006-2013	All Vented Rear Rotor	HCKS3004	HCAS3004	HUS8361	HB247F.575				
Charger	SE	2006-2013	All RWD w/ Solid Rear Disc	HCKS3004	HCAS3004	HUS8361	HB247F.575				
Charger	SXT AWD	2006-2013	All AWD w/Vented Rear Disc	HCKS3004	HCAS3004	HUS8361	HB247F.575				
Charger	SXT RWD	2006-2013	All RWD w/ Solid Rear Disc	HCKS3004	HCAS3004	HUS8361	HB247F.575				
Magnum	R/T	2005-2008	5.7 w/vented rear rotor	HCKS3004	HCAS3004	HUS8361	HB247F.575				
Magnum	SE	2005-2008	2.7 w/vented rear rotor	HCKS3004	HCAS3004	HUS8361	HB247F.575				
Magnum	SXT	2005-2008	All w/vented rear rotor - AWD	HCKS3004	HCAS3004	HUS8361	HB247F.575				
Magnum	SXT	2005-2008	All w/vented rear rotor - RWD	HCKS3004	HCAS3004	HUS8361	HB247F.575				
Magnum	SXT Special Edition	2005-2005	All w/vented rear rotor - RWD	HCKS3004	HCAS3004	HUS8361	HB247F.575				
FORD											
F-150 Pickup		2004-2008	All 6 Lug Wheels - 4WD	HCKS3006	HCAS306	HUS8780	HB247F.575				
Mustang	5.0L Performance	2011-2012	5.0					HCKS1001	HCAS101	HUS8144	HB119F.594
Mustang	Boss 302	2012-2013	5.0					HCKS1001	HCAS101	HUS8144	HB119F.594
Mustang	Bullitt	2008-2009	4.6	HCKS3005	HCA305	HUS8184	HB247F.575	HCKS1001	HCAS101	HUS8144	HB119F.594
Mustang	GT	2005-2010	4.6	HCKS3005	HCA305	HUS8184	HB247F.575	HCKS1001	HCAS101	HUS8144	HB119F.594
Mustang	GT	2012-2013	5.0 Standard brakes	HCKS3005	HCA305	HUS8184	HB247F.575	HCKS1001	HCAS101	HUS8144	HB119F.594
Mustang	GT	2013-2014	All Performance brakes					HCKS1001	HCAS101	HUS8144	HB119F.594
Mustang	GT Brembo	2012-2012	All					HCKS1001	HCAS101	HUS8144	HB119F.594
Mustang	Shelby GT	2007-2008	4.6	HCKS3005	HCA305	HUS8184	HB247F.575	HCKS1001	HCAS101	HUS8144	HB119F.594
Mustang	Shelby GT500	2007-2009	5.4					HCKS1001	HCAS101	HUS8144	HB119F.594
Mustang	V6	2005-2010		HCKS3005	HCA305	HUS8184	HB247F.575	HCKS1001	HCAS101	HUS8144	HB119F.594
Mustang	V6	2011-2013	3.7 Front rotor fits models w/o performance brake pkg	HCKS3005	HCA305	HUS8184	HB247F.575	HCKS1001	HCAS101	HUS8144	HB119F.594
GMC											
Sierra 1500	Classic LS	2007-2007	All w/Rear Disc Brakes	HCKS3002	HCAS302	HUS8657	HB247F.575	HCKS3003	HCAS303	HUS8695	HB385F.640
Sierra 1500	Classic LS	2007-2007	All w/Rear Drum Brakes	HCKS3002	HCAS302	HUS8657	HB247F.575				
Sierra 1500	Classic LT	2007-2007	All w/Rear Disc Brakes	HCKS3002	HCAS302	HUS8657	HB247F.575	HCKS3003	HCAS303	HUS8695	HB385F.640
Sierra 1500	Classic LT	2007-2007	All w/Rear Drum Brakes	HCKS3002	HCAS302	HUS8657	HB247F.575				

MAKE/ MODEL	SUBMODEL	YRS.	ENGINE (LITER)	NOTE	FRONT				REAR			
					CALIPER SYSTEM	CALIPER	ROTOR	PADS	CALIPER SYSTEM	CALIPER	ROTOR	PADS
GMC CONTINUED												
Sierra 1500	Classic WT	2007-2007	All	w/Rear Disc Brakes	HCKS3002	HCAS302	HUS8657	HB247F.575	HCKS3003	HCAS303	HUS8695	HB385F.640
Sierra 1500	Classic WT	2007-2007	All	w/Rear Drum Brakes	HCKS3002	HCAS302	HUS8657	HB247F.575				
Sierra 1500	Police	2008-2008	All		HCKS3002	HCAS302	HUS8657	HB247F.575	HCKS3003	HCAS303	HUS8695	HB385F.640
Sierra 1500	Police	2010-2010	All		HCKS3002	HCAS302	HUS8657	HB247F.575	HCKS3003	HCAS303	HUS8695	HB385F.640
Sierra 1500	SS	2004-2006	All	Must have 17" wheels or larger for rear kit	HCKS3002	HCAS302	HUS8657	HB247F.575	HCKS3003	HCAS303	HUS8695	HB385F.640
Sierra 1500		1999-2000	All	Must have 17" wheels or larger	HCKS3002	HCAS302	HUS8657	HB247F.575	HCKS3003	HCAS303	HUS8695	HB385F.640
Sierra 1500		2001-2001	All	2 Door. Reg Cab Must have 17" wheels or larger	HCKS3002	HCAS302	HUS8657	HB247F.575	HCKS3003	HCAS303	HUS8695	HB385F.640
Sierra 1500		2001-2001	All	2 Door Ext. Cab Must have 17" wheels or larger	HCKS3002	HCAS302	HUS8657	HB247F.575	HCKS3003	HCAS303	HUS8695	HB385F.640
Sierra 1500		2002-2002	All	Extended Cab. 4 Wheel Steering Must have 17" wheels or larger for rear kit	HCKS3002	HCAS302	HUS8657	HB247F.575	HCKS3003	HCAS303	HUS8695	HB385F.640
Sierra 1500		2002-2002	All	Regular Cab. 2 Wheel Steering Must have 17" wheels or larger for rear kit	HCKS3002	HCAS302	HUS8657	HB247F.575	HCKS3003	HCAS303	HUS8695	HB385F.640
Sierra 1500		2003-2003	All	4 Door Heavy Duty. 2 Wheel Steering Must have 17" wheels or larger	HCKS3002	HCAS302	HUS8657	HB247F.575	HCKS3003	HCAS303	HUS8695	HB385F.640
Sierra 1500		2003-2003	All	4 Door Heavy Duty. 4 Wheel Steering Must have 17" wheels or larger	HCKS3002	HCAS302	HUS8657	HB247F.575	HCKS3003	HCAS303	HUS8695	HB385F.640
Sierra 1500		2003-2003	All	Extended Cab. 2 Wheel Steering Must have 17" wheels or larger	HCKS3002	HCAS302	HUS8657	HB247F.575	HCKS3003	HCAS303	HUS8695	HB385F.640
Sierra 1500		2003-2003	All	Extended Cab. 4 Wheel Steering 325mm Rear Disc Must have 17" wheels or larger	HCKS3002	HCAS302	HUS8657	HB247F.575				
Sierra 1500		2003-2003	All	Extended Cab. 4 Wheel Steering 330mm Rear Disc. Must have 17" wheels or larger	HCKS3002	HCAS302	HUS8657	HB247F.575	HCKS3003	HCAS303	HUS8695	HB385F.640
Sierra 1500		2003-2003	All	Regular Cab Must have 17" wheels or larger	HCKS3002	HCAS302	HUS8657	HB247F.575	HCKS3003	HCAS303	HUS8695	HB385F.640
Sierra 1500		2004-2004	All	Crew Cab Must have 17" wheels or larger	HCKS3002	HCAS302	HUS8657	HB247F.575	HCKS3003	HCAS303	HUS8695	HB385F.640
Sierra 1500		2004-2004	All	Extended Cab. 2 Wheel Steering Except Hybrid. Must have 17" wheels or larger	HCKS3002	HCAS302	HUS8657	HB247F.575	HCKS3003	HCAS303	HUS8695	HB385F.640
Sierra 1500		2004-2004	All	Extended Cab. 4 Wheel Steering Except Hybrid. Must have 17" wheels or larger	HCKS3002	HCAS302	HUS8657	HB247F.575	HCKS3003	HCAS303	HUS8695	HB385F.640
Sierra 1500		2004-2004	All	Hybrid. Must have 17" wheels or larger	HCKS3002	HCAS302	HUS8657	HB247F.575	HCKS3003	HCAS303	HUS8695	HB385F.640
Sierra 1500		2004-2004	All	Regular Cab Must have 17" wheels or larger	HCKS3002	HCAS302	HUS8657	HB247F.575	HCKS3003	HCAS303	HUS8695	HB385F.640
Sierra 1500		2005-2005	All	w/Rear Disc Brakes Must have 17" wheels or larger	HCKS3002	HCAS302	HUS8657	HB247F.575	HCKS3003	HCAS303	HUS8695	HB385F.640
Sierra 1500		2005-2005	All	w/Rear Disc Brakes. Ext Cab. Hybrid Must have 17" wheels or larger	HCKS3002	HCAS302	HUS8657	HB247F.575	HCKS3003	HCAS303	HUS8695	HB385F.640
Sierra 1500		2005-2005	All	w/Rear Drum Brakes	HCKS3002	HCAS302	HUS8657	HB247F.575				
Sierra 1500		2006-2006	6.0	Ext. Cab Must have 17" wheels or larger	HCKS3002	HCAS302	HUS8657	HB247F.575	HCKS3003	HCAS303	HUS8695	HB385F.640
Sierra 1500		2006-2006	All	6400 lb. GVW, Rear Drum	HCKS3002	HCAS302	HUS8657	HB247F.575				
Sierra 1500		2006-2006	All	6400 lb. GVW, Rear Disc Must have 17" wheels or larger	HCKS3002	HCAS302	HUS8657	HB247F.575	HCKS3003	HCAS303	HUS8695	HB385F.640
Sierra 1500		2006-2006	All	7000 lb. GVW, Rear Drum	HCKS3002	HCAS302	HUS8657	HB247F.575				
Sierra 1500		2006-2006	All	7200 lb. GVW, Rear Disc Must have 17" wheels or larger	HCKS3002	HCAS302	HUS8657	HB247F.575	HCKS3003	HCAS303	HUS8695	HB385F.640
Sierra 1500		2007-2007	All	w/Rear Disc Brakes	HCKS3002	HCAS302	HUS8657	HB247F.575	HCKS3003	HCAS303	HUS8695	HB385F.640
Sierra 1500		2007-2007	All	w/Rear Drum Brakes	HCKS3002	HCAS302	HUS8657	HB247F.575				
Sierra 1500		2007-2007	All	w/Rear Disc Brakes	HCKS3002	HCAS302	HUS8657	HB247F.575	HCKS3003	HCAS303	HUS8695	HB385F.640

MAKE/ MODEL	SUBMODEL	ENGINE YRS. (LITER)	NOTE	FRONT				REAR				
				CALIPER SYSTEM	CALIPER	ROTOR	PADS	CALIPER SYSTEM	CALIPER	ROTOR	PADS	
GMC CONTINUED												
Sierra 1500		2007-2007	All	w/Rear Drum Brakes	HCKS3002	HCAS302	HUS8657	HB247F.575				
Sierra 1500		2008-2013	All		HCKS3002	HCAS302	HUS8657	HB247F.575	HCKS3003	HCAS303	HUS8695	HB385F.640
Sierra 1500		2008-2013	All		HCKS3002	HCAS302	HUS8657	HB247F.575	HCKS3003	HCAS303	HUS8695	HB385F.640
Sierra 1500		2008-2013	All		HCKS3002	HCAS302	HUS8657	HB247F.575	HCKS3003	HCAS303	HUS8695	HB385F.640
Sierra 1500		2008-2013	All	w/Rear Drum Brakes	HCKS3002	HCAS302	HUS8657	HB247F.575				
Yukon	Hybrid	2008-2008	All		HCKS3002	HCAS302	HUS8657	HB247F.575	HCKS3003	HCAS303	HUS8695	HB385F.640
Yukon	LS	2007-2008	All		HCKS3002	HCAS302	HUS8657	HB247F.575	HCKS3003	HCAS303	HUS8695	HB385F.640
Yukon	LS	2009-2013	All		HCKS3002	HCAS302	HUS8657	HB247F.575	HCKS3003	HCAS303	HUS8695	HB385F.640
Yukon	LT	2007-2008	All		HCKS3002	HCAS302	HUS8657	HB247F.575	HCKS3003	HCAS303	HUS8695	HB385F.640
Yukon	LT	2009-2013	All		HCKS3002	HCAS302	HUS8657	HB247F.575	HCKS3003	HCAS303	HUS8695	HB385F.640
Yukon	LITZ	2007-2008	All		HCKS3002	HCAS302	HUS8657	HB247F.575	HCKS3003	HCAS303	HUS8695	HB385F.640
Yukon	LITZ	2009-2013	All		HCKS3002	HCAS302	HUS8657	HB247F.575	HCKS3003	HCAS303	HUS8695	HB385F.640
Yukon	Police	2007-2010	All		HCKS3002	HCAS302	HUS8657	HB247F.575	HCKS3003	HCAS303	HUS8695	HB385F.640
Yukon		2000-2000	All	2WD. w/Rear Disc Brakes Must have 17" wheels or larger	HCKS3002	HCAS302	HUS8657	HB247F.575	HCKS3003	HCAS303	HUS8695	HB385F.640
Yukon		2000-2000	All	4WD. w/Rear Disc Brakes. w/Limited Slip Must have 17" wheels or larger	HCKS3002	HCAS302	HUS8657	HB247F.575	HCKS3003	HCAS303	HUS8695	HB385F.640
Yukon		2000-2000	All	4WD. w/Rear Disc Brakes. w/o Limited Slip Must have 17" wheels or larger	HCKS3002	HCAS302	HUS8657	HB247F.575	HCKS3003	HCAS303	HUS8695	HB385F.640
Yukon		2001-2001	All	2WD Must have 17" wheels or larger	HCKS3002	HCAS302	HUS8657	HB247F.575	HCKS3003	HCAS303	HUS8695	HB385F.640
Yukon		2001-2002	All	4WD. w/Limited Slip Must have 17" wheels or larger	HCKS3002	HCAS302	HUS8657	HB247F.575	HCKS3003	HCAS303	HUS8695	HB385F.640
Yukon		2001-2002	All	4WD. w/o Limited Slip Must have 17" wheels or larger	HCKS3002	HCAS302	HUS8657	HB247F.575	HCKS3003	HCAS303	HUS8695	HB385F.640
Yukon		2002-2002	All	2WD. Classic Style Must have 17" wheels or larger	HCKS3002	HCAS302	HUS8657	HB247F.575	HCKS3003	HCAS303	HUS8695	HB385F.640
Yukon		2002-2002	All	2WD. New Style Must have 17" wheels or larger	HCKS3002	HCAS302	HUS8657	HB247F.575	HCKS3003	HCAS303	HUS8695	HB385F.640
Yukon		2003-2006	All	2WD Must have 17" wheels or larger	HCKS3002	HCAS302	HUS8657	HB247F.575	HCKS3003	HCAS303	HUS8695	HB385F.640
Yukon		2003-2006	All	4WD Must have 17" wheels or larger	HCKS3002	HCAS302	HUS8657	HB247F.575	HCKS3003	HCAS303	HUS8695	HB385F.640
JEEP												
Wrangler (07-10JK)	Rubicon	2007-2014	All		HCKS3007	HCAS307	HUS678	HB247F.575				
Wrangler (07-10JK)	Sahara	2007-2014	All		HCKS3007	HCAS307	HUS678	HB247F.575				
Wrangler (07-10JK)	Unlimited Rubicon	2007-2014	All		HCKS3007	HCAS307	HUS678	HB247F.575				
Wrangler (07-10JK)	Unlimited Sahara	2007-2014	All		HCKS3007	HCAS307	HUS678	HB247F.575				
Wrangler (07-10JK)	Unlimited X	2007-2014	All		HCKS3007	HCAS307	HUS678	HB247F.575				
Wrangler (07-10JK)	X	2007-2014	All		HCKS3007	HCAS307	HUS678	HB247F.575				

HAWK CALIPER REPLACEMENT PARTS

HAWK KIT NUMBER	HAWK PAD NUMBER	HAWK ROTOR NUMBER	CALIPER NUMBER
HCKS1001	HB119x.594	HUS8144	HCAS101
HCKS3000	HB247x.575	HUS8259	HCAS300
HCKS3001	HB247x.575	HUS3000	HCAS301
HCKS3002	HB247x.575	HUS8657	HCAS302
HCKS3003	HB385x.640	HUS8695	HCAS303

HAWK KIT NUMBER	HAWK PAD NUMBER	HAWK ROTOR NUMBER	CALIPER NUMBER
HCKS3004	HB247x.575	HUS8361	HCAS304
HCKS3005	HB247x.575	HUS8184	HCAS305
HCKS3006	HB247x.575	HUS8780	HCAS306
HCKS3007	HB247x.575	HUS678	HCAS307



BRAKE PAD LEGEND AND CODE REFERENCE

BRAKE PAD CODE BREAKDOWN

H B	2 4 5	X	.6 3 1
HAWK BRAKE	PAD SHAPE	INSERT COMPOUND CODE	PAD THICKNESS



PAD/ROTOR KIT CODE BREAKDOWN

H K	X	4 2 8	4 4 8
HAWK KIT	INSERT COMPOUND CODE	ROTOR	PAD SHAPE

MOTORSPORTS COMPOUNDS

BRAKE PAD	COMPOUNDS
DTC-70	U
DTC-60	G
DTC-30	W
DTC-15	A
DTC-05	H
HT-14	V
HT-10	S
Metallic	MB
MT-4	L
Blue 9012	E
Black	M
DR-97	J
HP Plus	N

STREET COMPOUNDS

BRAKE PAD	COMPOUNDS
HPS Performance Street	F
Performance Ceramic	Z
LTS Light Truck & SUV	Y
SuperDuty	P

BRAKE PAD CODE BREAKDOWN

H B **2 4 5** **x** **.6 3 1**

HAWK BRAKE PAD SHAPE INSERT COMPOUND CODE PAD THICKNESS

PAD/ROTOR KIT CODE BREAKDOWN

H K **x** **4 2 8** **4 4 8**

HAWK KIT INSERT COMPOUND CODE ROTOR PAD SHAPE

MAKE/ MODEL	SUBMODEL	YRS.	ENGINE (LITER)	NOTE	FRONT				REAR			
					PADS	PAD COMPOUND	ROTORS	PAD/ROTOR KIT	PADS	PAD COMPOUND	ROTORS	PAD/ROTOR KIT
ACURA												
CL	Type-S	2001-2003	All		HB366x.681	F, Z, N, U, W, G, E	HUS946	HKx946366	HB572x.570	F, Z, Y, E, G, W		
CL		1997-1997	2.2		HB275x.620	F, Z, N, G, U, W, S, E	HUS524	HKx524275	HB145x.570	F, Z, Y, N, G, U, W, S, E, M		
CL		1997-1997	3.0		HB143x.680	F, Z, N, G, U, W, S, E			HB145x.570	F, Z, Y, N, G, U, W, S, E, M		
CL		1998-1999	2.3		HB275x.620	F, Z, N, G, U, W, S, E	HUS704	HKx704275	HB145x.570	F, Z, Y, N, G, U, W, S, E, M	HUS526	HKx526145
CL		1998-1999	3.0		HB143x.680	F, Z, N, G, U, W, S, E			HB145x.570	F, Z, Y, N, G, U, W, S, E, M		
CL		2001-2003	All		HB366x.681	F, Z, N, U, W, G, E	HUS946	HKx946366	HB572x.570	F, Z, Y, E, G, W		
ILX		2013	All	Hybrid	HB418x.646	F, Z, N, G, U, S, E			HB145x.570	F, Z, Y, N, G, U, W, S, E, M		
ILX		2013	All		HB393x.665	F, Y			HB145x.570	F, Z, Y, N, G, U, W, S, E, M		
Integra	GS	1990-1993	All		HB242x.661	F, Z, N, G, E	HUS522	HKx522242	HB350x.496	F, Z, N, G, W, E, M	HUS308	HKx308350
Integra	GS	1997-2001	All		HB245x.631	F, Z, N, S, E, G	HUS522	HKx522245	HB350x.496	F, Z, N, G, W, E, M	HUS308	HKx308350
Integra	GSR	1990-1993	All		HB242x.661	F, Z, N, G, E	HUS522	HKx522242	HB350x.496	F, Z, N, G, W, E, M	HUS308	HKx308350
Integra	GSR	1994-2001	All		HB245x.631	F, Z, N, S, E, G	HUS522	HKx522245	HB350x.496	F, Z, N, G, W, E, M	HUS308	HKx308350
Integra	LS	1986-1989	All		HB403x.587	F			HB350x.496	F, Z, N, G, W, E, M		
Integra	LS	1990-1993	All		HB242x.661	F, Z, N, G, E	HUS522	HKx522242	HB350x.496	F, Z, N, G, W, E, M	HUS308	HKx308350
Integra	LS	1994-2001	All		HB245x.631	F, Z, N, S, E, G	HUS522	HKx522245	HB350x.496	F, Z, N, G, W, E, M	HUS308	HKx308350
Integra	RS	1986-1989	All		HB403x.587	F			HB350x.496	F, Z, N, G, W, E, M		
Integra	RS	1990-1993	All		HB242x.661	F, Z, N, G, E	HUS522	HKx522242	HB350x.496	F, Z, N, G, W, E, M	HUS308	HKx308350
Integra	RS	1994-1998	All		HB245x.631	F, Z, N, S, E, G	HUS522	HKx522245	HB350x.496	F, Z, N, G, W, E, M	HUS308	HKx308350
Integra	SE	1988-1988	All		HB403x.587	F			HB350x.496	F, Z, N, G, W, E, M		
Integra	Special Edition	1995-1996	All		HB245x.631	F, Z, N, S, E, G	HUS522	HKx522245	HB350x.496	F, Z, N, G, W, E, M	HUS308	HKx308350
Integra	Special Edition LS	1987-1987	All		HB403x.587	F						
Integra	Type-R	1997-2001	All		HB143x.680	F, Z, N, G, U, W, S, E	HUS528	HKx528143	HB145x.570	F, Z, Y, N, G, U, W, S, E, M	HUS910	HKx910145
Legend Coupe	GS	1994-1995	All		HB143x.680	F, Z, N, G, U, W, S, E			HB572x.570	F, Z, Y, E, G, W		
Legend Coupe	L	1988-1990	All		HB242x.661	F, Z, N, G, E						
Legend Coupe	L	1991-1992	All		HB143x.680	F, Z, N, G, U, W, S, E	HUS528	HKx528143	HB572x.570	F, Z, Y, E, G, W		
Legend Coupe	L	1993-1995	All		HB143x.680	F, Z, N, G, U, W, S, E			HB572x.570	F, Z, Y, E, G, W		
Legend Coupe	LS	1988-1990	All		HB242x.661	F, Z, N, G, E						
Legend Coupe	LS	1991-1992	All		HB143x.680	F, Z, N, G, U, W, S, E	HUS528	HKx528143	HB572x.570	F, Z, Y, E, G, W		
Legend Coupe	LS	1993-1995	All		HB143x.680	F, Z, N, G, U, W, S, E			HB572x.570	F, Z, Y, E, G, W		
Legend Coupe	SE	1995-1995	All		HB143x.680	F, Z, N, G, U, W, S, E			HB572x.570	F, Z, Y, E, G, W		
Legend Coupe		1988-1990	All		HB242x.661	F, Z, N, G, E						
Legend Coupe		1991-1992	All		HB143x.680	F, Z, N, G, U, W, S, E	HUS528	HKx528143	HB572x.570	F, Z, Y, E, G, W		
Legend Coupe		1993-1993	All		HB143x.680	F, Z, N, G, U, W, S, E			HB572x.570	F, Z, Y, E, G, W		
Legend Sedan	GS	1994-1995	All		HB143x.680	F, Z, N, G, U, W, S, E			HB572x.570	F, Z, Y, E, G, W		
Legend Sedan	L	1986-1990	All		HB242x.661	F, Z, N, G, E						
Legend Sedan	L	1991-1995	All		HB143x.680	F, Z, N, G, U, W, S, E	HUS528	HKx528143	HB572x.570	F, Z, Y, E, G, W		
Legend Sedan	LS	1986-1990	All		HB242x.661	F, Z, N, G, E						
Legend Sedan	LS	1991-1995	All		HB143x.680	F, Z, N, G, U, W, S, E	HUS528	HKx528143	HB572x.570	F, Z, Y, E, G, W		
Legend Sedan	SE	1995-1995	All		HB143x.680	F, Z, N, G, U, W, S, E	HUS528	HKx528143	HB572x.570	F, Z, Y, E, G, W		
Legend Sedan		1986-1987	All		HB242x.661	F, Z, N, G, E						
Legend Sedan		1988-1990	All		HB242x.661	F, Z, N, G, E						
Legend Sedan		1991-1993	All		HB143x.680	F, Z, N, G, U, W, S, E	HUS528	HKx528143	HB572x.570	F, Z, Y, E, G, W		
MDX	Touring	2001-2002	All				HUS946		HB506x.610	F, Z		
MDX	Touring	2003-2006	All		HB326x.646	F, Z, Y	HUS946	HKx946326	HB506x.610	F, Z		
MDX		2001-2002	All				HUS946		HB506x.610	F, Z		
MDX		2003-2006	All		HB326x.646	F, Z, Y	HUS946	HKx946326	HB506x.610	F, Z		
NSX	T	1995-1999	All		HB143x.680	F, Z, N, G, U, W, S, E			HB185x.590	F, N, E		
NSX		1991-2005	All		HB143x.680	F, Z, N, G, U, W, S, E			HB185x.590	F, N, E		

RACE PAD COMPOUNDS

DTC-70 - U	DTC-05 - H	MT-4 - L	HP Plus - N
DTC-60 - G	HT-14 - V	Blue 9012 - E	
DTC-30 - W	HT-10 - S	Black - M	
DTC-15 - A	Metallic - MB	DR-97 - J	

STREET PAD COMPOUNDS

HPS Performance Street - F	LTS Light Truck & SUV - Y
Performance Ceramic - Z	SuperDuty - P

MAKE/ MODEL	SUBMODEL	ENGINE YRS. (LITER)	NOTE	FRONT				REAR			
				PADS	PAD COMPOUND	ROTOR	PAD/ROTOR KIT	PADS	PAD COMPOUND	ROTOR	PAD/ROTOR KIT
ACURA CONTINUED											
RDX		2010-2012	All AWD					HB572x.570	F, Z, Y, E, G, W		
RL		1996-1998	All	HB143x.680	F, Z, N, G, U, W, S, E	HUS528	HKx528143	HB572x.570	F, Z, Y, E, G, W		
RL		1999-2004	All	HB366x.681	F, Z, N, U, W, G, E			HB572x.570	F, Z, Y, E, G, W		
RSX	Base Model	2002-2006	All	HB418x.646	F, Z, N, G, U, S, E	HUS911	HKx911418	HB145x.570	F, Z, Y, N, G, U, W, S, E, M	HUS910	HKx910145
RSX	Type-R	2002-2004	All Japan Spec	HB181x.660	F, N, U, G, E						
RSX	Type-S	2002-2006	All	HB361x.622	F, Z, N, U, W, G, S, E	HUS912	HKx912361	HB145x.570	F, Z, Y, N, G, U, W, S, E, M	HUS910	HKx910145
SLX		1996-1999	All	HB422x.610	F						
TL	Type-S	2002-2003	All	HB366x.681	F, Z, N, U, W, G, E	HUS946	HKx946366	HB572x.570	F, Z, Y, E, G, W		
TL	Type-S	2007-2008	All	HB530x.570	F, Z, N, G, U, W			HB572x.570	F, Z, Y, E, G, W		
TL		1995-1995	3.2	HB143x.680	F, Z, N, G, U, W, S, E			HB145x.570	F, Z, Y, N, G, U, W, S, E, M		
TL		1995-1998	2.5	HB143x.680	F, Z, N, G, U, W, S, E			HB145x.570	F, Z, Y, N, G, U, W, S, E, M		
TL		1996-1998	3.2	HB143x.680	F, Z, N, G, U, W, S, E	HUS528	HKx528143	HB145x.570	F, Z, Y, N, G, U, W, S, E, M		
TL		1999-2003	All	HB366x.681	F, Z, N, U, W, G, E	HUS946	HKx946366	HB572x.570	F, Z, Y, E, G, W		
TL		2004-2008	All w/Brembo Front Calipers	HB453x.585	F, Z, N, U, G, W, V, S, E			HB572x.570	F, Z, Y, E, G, W		
TL		2004-2008	All w/o Brembo Front Calipers	HB366x.681	F, Z, N, U, W, G, E	HUS946	HKx946366	HB572x.570	F, Z, Y, E, G, W		
TL		2009-2013	All	HB678x.709	Y, Z			HB679x.600	Y, Z		
TSX		2004-2008	All	HB366x.681	F, Z, N, U, W, G, E	HUS946	HKx946366	HB145x.570	F, Z, Y, N, G, U, W, S, E, M		
TSX		2009-2013	All	HB366x.681	F, Z, N, U, W, G, E	HUS946	HKx946366	HB626x.577	F, Z, E, G, W		
Vigor	GS	1992-1994	All	HB143x.680	F, Z, N, G, U, W, S, E			HB145x.570	F, Z, Y, N, G, U, W, S, E, M		
Vigor	LS	1992-1994	All	HB143x.680	F, Z, N, G, U, W, S, E			HB145x.570	F, Z, Y, N, G, U, W, S, E, M		
ALFA ROMEO											
Alfetta	GT	1975-1977	All	HB172x.595	F, Z, N, U, G, W, M, S, E						
Alfetta	Sport	1975-1977	All	HB172x.595	F, Z, N, U, G, W, M, S, E						
Berlina		1969-1972	All	HB171x.590	F, Z, N, U, W, S, E						
Berlina	Veloce	1968-1971	All					HB713x.590	F, Z, W, G		
GT Veloce		1969-1974	All	HB171x.590	F, Z, N, U, W, S, E						
GT series 1750		1968-1971	All					HB713x.590	F, Z, W, G		
GTV-6	2.5	1982-1982	All	HB171x.590	F, Z, N, U, W, S, E			HB713x.590	F, Z, W, G		
GTV-6	2.5	1984-1986	All	HB180x.560	F, Z, N, U, G, E						
Milano	Gold	1987-1989	All	HB180x.560	F, Z, N, U, G, E						
Milano	Platinum	1987-1988	All	HB180x.560	F, Z, N, U, G, E						
Milano	Silver	1987-1987	All	HB180x.560	F, Z, N, U, G, E						
Milano	Verde	1988-1989	All	HB180x.560	F, Z, N, U, G, E						
Spider	Graduate	1986-1990	All	HB180x.560	F, Z, N, U, G, E						
Spider	Quadrifoglio	1986-1990	All	HB180x.560	F, Z, N, U, G, E						
Spider	Veloce	1970-1982	All	HB171x.590	F, Z, N, U, W, S, E						
Spider	Veloce	1975-1982	All	HB171x.591	F, Z, N, U, W, S, E			HB713x.590	F, Z, W, G		
Spider	Veloce	1983-1990	All	HB180x.560	F, Z, N, U, G, E						
Spider		1968-1971	All	HB171x.590	F, Z, N, U, W, S, E			HB713x.590	F, Z, W, G		
Spider		1982-1994	All					HB713x.590	F, Z, W, G		
Sprint	Veloce	1977-1979	All	HB172x.595	F, Z, N, U, G, W, M, S, E						
AMERICAN MOTORS											
Ambassador		1971-1973	All	HB643x.595	F						
AMX		1971-1972	All	HB643x.595	F						
Gremlin	Custom	1976-1976	All w/KH Caliper	HB643x.595	F						
Gremlin	Custom	1976-1976	All w/Bendix Caliper	HB292x.674	F, P						
Gremlin		1973-1975	All w/KH Caliper	HB643x.595	F						

APPLICATION GUIDE

BRAKE PAD CODE BREAKDOWN

PAD/ROTOR KIT CODE BREAKDOWN

H B 2 4 5 x . 6 3 1
 HAWK BRAKE PAD SHAPE INSERT COMPOUND CODE PAD THICKNESS

H K x 4 2 8 4 4 8
 HAWK KIT INSERT COMPOUND CODE ROTOR PAD SHAPE

MAKE/ MODEL	SUBMODEL	ENGINE YRS. (LITER)	NOTE	FRONT				REAR			
				PADS	PAD COMPOUND	ROTOR	PAD/ROTOR KIT	PADS	PAD COMPOUND	ROTOR	PAD/ROTOR KIT
AMERICAN MOTORS CONTINUED											
Gremlin		1973-1975	All	w/Bendix Caliper	HB292x.674	F, P					
Hornet	Sportabout	1973-1976	All	w/KH Caliper	HB643x.595	F					
Hornet	Sportabout	1973-1976	All	w/Bendix Caliper	HB292x.674	F, P					
Hornet		1971-1972	All		HB643x.595	F					
Hornet		1973-1976	All	w/KH Caliper	HB643x.595	F					
Hornet		1973-1976	All	w/Bendix Caliper	HB292x.674	F, P					
Javelin		1971-1974	All		HB643x.595	F					
Matador		1971-1974	All		HB643x.595	F					
Matador		1975-1978	All		HB292x.674	F, P					
Pacer		1975-1976	All		HB292x.674	F, P					
ASTON MARTIN											
DB9		2005-2005	All		HB632x.586	F, Z, N					
Vantage		2004-2008	4.3		HB632x.586	F, Z, N					
Vantage		2008-2008	4.7		HB632x.586	F, Z, N					
AUDI											
80		1988-1992	All	w/Wear Sensor					HB271x.635	F, Z, N, E	
80		1988-1992	All		HB190x.730	F, G, S, E			HB271x.635	F, Z, N, E	
90	CS	1993-1993	All	w/Wear Sensor	HB270x.724A	F					
90	CS	1994-1994	All	w/Wear Sensor	HB270x.724A	F			HB271x.635	F, Z, N, E	
90	CS	1994-1994	All						HB271x.635	F, Z, N, E	
90	S	1993-1994	All	w/Wear Sensor	HB270x.724A	F			HB271x.635	F, Z, N, E	
90	S	1993-1994	All						HB271x.635	F, Z, N, E	
90	Sport	1995-1995	All	w/Wear Sensor	HB270x.724A	F			HB271x.635	F, Z, N, E	
90	Sport	1995-1995	All						HB271x.635	F, Z, N, E	
90		1988-1991	All	w/Wear Sensor					HB271x.635	F, Z, N, E	
90		1988-1991	All		HB190x.730	F, G, S, E			HB271x.635	F, Z, N, E	
100	CS	1992-1994	All	w/Large Round Wear Sensor	HB269x.763B	F			HB271x.635	F, Z, N, E	
100	CS	1992-1994	All	w/Oval Wear Sensor	HB269x.763A	F, Z			HB271x.635	F, Z, N, E	
100	CS	1992-1994	All		HB269x.763	F, Z, E			HB271x.635	F, Z, N, E	
100	S	1992-1994	All	w/Large Round Wear Sensor	HB269x.763B	F			HB271x.635	F, Z, N, E	
100	S	1992-1994	All	w/Oval Wear Sensor	HB269x.763A	F, Z			HB271x.635	F, Z, N, E	
100	S	1992-1994	All		HB269x.763	F, Z, E			HB271x.635	F, Z, N, E	
100		1992-1993	All	w/Large Round Wear Sensor	HB269x.763B	F			HB271x.635	F, Z, N, E	
100		1992-1993	All	w/Oval Wear Sensor	HB269x.763A	F, Z			HB271x.635	F, Z, N, E	
100		1992-1993	All		HB269x.763	F, Z, E			HB271x.635	F, Z, N, E	
200		1989-1991	All	w/ATE Front Caliper	HB135x.642	F			HB271x.635	F, Z, N, E	
200		1989-1991	All	w/Girling Front Caliper					HB271x.635	F, Z, N, E	
200		1989-1991	All	w/Girling Front Caliper, w/Wear Sensor	HB270x.724A	F			HB271x.635	F, Z, N, E	
5000	CS	1986-1987	All	w/Wear Sensor	HB270x.724A	F			HB271x.635	F, Z, N, E	
5000	CS	1986-1987	All						HB271x.635	F, Z, N, E	
5000	S	1980-1987	All	w/Wear Sensor					HB271x.635	F, Z, N, E	
5000	S	1980-1987	All		HB190x.730	F, G, S, E			HB271x.635	F, Z, N, E	
5000	S	1988-1988	All	w/Wear Sensor	HB270x.724A	F			HB271x.635	F, Z, N, E	
5000	S	1988-1988	All						HB271x.635	F, Z, N, E	
5000	S Turbo	1984-1985	All	w/Wear Sensor	HB190x.600A	F, Z			HB271x.635	F, Z, N, E	
5000	S Turbo	1984-1985	All		HB190x.600	F, N, E, W			HB271x.635	F, Z, N, E	

RACE PAD COMPOUNDS

DTC-70 - U	DTC-05 - H	MT-4 - L	HP Plus - N
DTC-60 - G	HT-14 - V	Blue 9012 - E	
DTC-30 - W	HT-10 - S	Black - M	
DTC-15 - A	Metallic - MB	DR-97 - J	

STREET PAD COMPOUNDS

HPS Performance Street - F	LTS Light Truck & SUV - Y
Performance Ceramic - Z	SuperDuty - P

MAKE/ MODEL	SUBMODEL	ENGINE YRS. (LITER)	NOTE	FRONT				REAR					
				PADS	PAD COMPOUND	ROTORS	PAD/ROTOR KIT	PADS	PAD COMPOUND	ROTORS	PAD/ROTOR KIT		
AUDI CONTINUED													
5000	Turbo	1981-1983	All	w/Wear Sensor						HB271x.635	F, Z, N, E		
5000	Turbo	1981-1983	All		HB190x.730	F, G, S, E				HB271x.635	F, Z, N, E		
5000		1980-1983	All	w/Wear Sensor						HB271x.635	F, Z, N, E		
5000		1980-1983	All		HB190x.730	F, G, S, E				HB271x.635	F, Z, N, E		
100 Quattro	CS	1992-1994	All	w/Large Round Wear Sensor	HB269x.763B	F				HB271x.635	F, Z, N, E		
100 Quattro	CS	1992-1994	All	w/Oval Wear Sensor	HB269x.763A	F, Z				HB271x.635	F, Z, N, E		
100 Quattro	CS	1992-1994	All		HB269x.763	F, Z, E				HB271x.635	F, Z, N, E		
200 Quattro	10V	1991-1991	All	w/ATE Front Caliper	HB135x.642	F				HB271x.635	F, Z, N, E		
200 Quattro	10V	1991-1991	All	w/Girling Front Caliper						HB271x.635	F, Z, N, E		
200 Quattro	10V	1991-1991	All	w/Girling Front Caliper, w/Wear Sensor	HB270x.724A	F				HB271x.635	F, Z, N, E		
200 Quattro	20V	1991-1991	All	w/ATE Front Caliper	HB135x.642	F				HB271x.635	F, Z, N, E		
200 Quattro	20V	1991-1991	All	w/Girling Front Caliper						HB271x.635	F, Z, N, E		
200 Quattro	20V	1991-1991	All	w/Girling Front Caliper w/Wear Sensor	HB270x.724A	F				HB271x.635	F, Z, N, E		
200 Quattro		1989-1990	All	w/ATE Front Caliper	HB135x.642	F				HB271x.635	F, Z, N, E		
200 Quattro		1989-1990	All	w/Girling Front Caliper						HB271x.635	F, Z, N, E		
200 Quattro		1989-1990	All	w/Girling Front Caliper w/Wear Sensor	HB270x.724A	F				HB271x.635	F, Z, N, E		
4000CS Quattro		1986-1987	All	w/Wear Sensor	HB190x.600A	F, Z				HB271x.635	F, Z, N, E		
4000CS Quattro		1986-1987	All		HB190x.600	F, N, E, W				HB271x.635	F, Z, N, E		
4000S Quattro		1984-1985	All	w/Wear Sensor	HB190x.600A	F, Z				HB271x.635	F, Z, N, E		
4000S Quattro		1984-1985	All		HB190x.600	F, N, E, W				HB271x.635	F, Z, N, E		
5000CS Quattro		1986-1986	All		HB190x.730	F, G, S, E							
5000CS Quattro		1987-1988	All	w/Wear Sensor	HB270x.724A	F				HB271x.635	F, Z, N, E		
5000CS Quattro		1987-1988	All							HB271x.635	F, Z, N, E		
80 Quattro		1988-1992	All	w/Wear Sensor						HB271x.635	F, Z, N, E		
80 Quattro		1988-1992	All		HB190x.730	F, G, S, E				HB271x.635	F, Z, N, E		
90 Quattro	20V	1990-1991	All	w/Wear Sensor						HB271x.635	F, Z, N, E		
90 Quattro	20V	1990-1991	All		HB190x.730	F, G, S, E				HB271x.635	F, Z, N, E		
90 Quattro	CS	1993-1994	All	w/Wear Sensor	HB270x.724A	F				HB271x.635	F, Z, N, E		
90 Quattro	CS	1993-1994	All							HB271x.635	F, Z, N, E		
90 Quattro	Sport	1995-1995	All	w/Wear Sensor	HB270x.724A	F				HB271x.635	F, Z, N, E		
90 Quattro	Sport	1995-1995	All							HB271x.635	F, Z, N, E		
90 Quattro		1988-1989	All	w/Wear Sensor						HB271x.635	F, Z, N, E		
90 Quattro		1988-1989	All		HB190x.730	F, G, S, E				HB271x.635	F, Z, N, E		
90 Quattro		1995-1995	All	w/Wear Sensor	HB270x.724A	F				HB271x.635	F, Z, N, E		
90 Quattro		1995-1995	All							HB271x.635	F, Z, N, E		
A3	TFSi Quattro	2006-2009	2.0		HB543x.760	F, Z, N, G	HUS498	HKx498543	HB544x.628	F, Z, N, S	HUS499	HKx499544	
A3	TDI Quattro	2006-2009	2.0		HB543x.760	F, Z, N, G	HUS498	HKx498543	HB544x.628	F, Z, N, S	HUS499	HKx499544	
A3	TDI 16v	2006-2009	2.0		HB543x.760	F, Z, N, G	HUS498	HKx498543	HB544x.628	F, Z, N, S	HUS499	HKx499544	
A3	Sportback TDI 16V	2006-2009	2.0		HB543x.760	F, Z, N, G	HUS498	HKx498543	HB544x.628	F, Z, N, S	HUS499	HKx499544	
A3	Sportback TDI 16V Quattro	2006-2009	2.0		HB543x.760	F, Z, N, G	HUS498	HKx498543	HB544x.628	F, Z, N, S	HUS499	HKx499544	
A3	V6 Quattro	2006-2009	3.2		HB543x.760	F, Z, N, G	HUS498	HKx498543	HB544x.628	F, Z, N, S	HUS499	HKx499544	
A3	Except TDI	2011-2013	All		HB543x.760	F, Z, N, G			HB695x.609				
A3	Except TDI	2006-2010	All		HB543x.760	F, Z, N, G			HB544x.628	F, Z, N, S			
A3	TDI	2010-2013	All		HB543x.760	F, Z, N, G			HB364x.642				
A4	Avant	1998-1998	All	w/Large Round Wear Sensor	HB269x.763B	F				HB364x.642	F, Z, N, E		
A4	Avant	1998-1998	All	w/Oval Wear Sensor	HB269x.763A	F, Z				HB364x.642	F, Z, N, E		

APPLICATION GUIDE

BRAKE PAD CODE BREAKDOWN

PAD/ROTOR KIT CODE BREAKDOWN

H B 2 4 5 x . 6 3 1
 HAWK BRAKE PAD SHAPE INSERT COMPOUND CODE PAD THICKNESS

H K x 4 2 8 4 4 8
 HAWK KIT INSERT COMPOUND CODE ROTOR PAD SHAPE

MAKE/ MODEL	SUBMODEL	YRS.	ENGINE (LITER)	NOTE	FRONT				REAR			
					PADS	PAD COMPOUND	ROTORS	PAD/ROTOR KIT	PADS	PAD COMPOUND	ROTORS	PAD/ROTOR KIT
AUDI CONTINUED												
A4	Avant	1998-1998	All		HB269x.763	F, Z, E			HB364x.642	F, Z, N, E		
A4	Cabriolet	2003-2004	All	w/Wear Sensor	HB354x.756A	F, Z			HB364x.642	F, Z, N, E		
A4	Cabriolet	2009-2009	All		HB538x.760	F, Z, N			HB544x.628	F, Z, N, S		
A4		1997-2001	All	w/Large Round Wear Sensor	HB269x.763B	F			HB364x.642	F, Z, N, E		
A4		1997-2001	All	w/Oval Wear Sensor	HB269x.763A	F, Z			HB364x.642	F, Z, N, E		
A4		1997-2001	All		HB269x.763	F, Z, E			HB364x.642	F, Z, N, E		
A4		2002-2004	All	w/Wear Sensor	HB354x.756A	F, Z			HB364x.642	F, Z, N, E		
A4		2005-2008	All		HB538x.760	F, Z, N			HB544x.628	F, Z, N, S		
A4		2009-2013	All		HB641x.696	F, Z			HB642x.658	F, Z		
A4 Quattro	Avant	1998-1999	All	w/Large Round Wear Sensor	HB269x.763B	F			HB271x.635	F, Z, N, E		
A4 Quattro	Avant	1998-1999	All	w/Oval Wear Sensor	HB269x.763A	F, Z			HB271x.635	F, Z, N, E		
A4 Quattro	Avant	1998-1999	All		HB269x.763	F, Z, E			HB271x.635	F, Z, N, E		
A4 Quattro	Avant	2000-2002	All	w/Large Round Wear Sensor	HB269x.763B	F						
A4 Quattro	Avant	2000-2002	All	w/Oval Wear Sensor	HB269x.763A	F, Z						
A4 Quattro	Avant	2000-2002	All		HB269x.763	F, Z, E						
A4 Quattro	Avant	2003-2004	All	w/Wear Sensor	HB354x.756A	F, Z						
A4 Quattro	Avant	2005-2008	All		HB538x.760	F, Z, N			HB544x.628	F, Z, N, S		
A4 Quattro	Cabriolet	2004-2004	All	w/Wear Sensor	HB354x.756A	F, Z						
A4 Quattro	Cabriolet	2007-2009	All		HB515x.760	F, Z			HB544x.628	F, Z, N, S		
A4 Quattro		1996-2002	All	w/Large Round Wear Sensor	HB269x.763B	F						
A4 Quattro		1996-2002	All	w/Oval Wear Sensor	HB269x.763A	F, Z						
A4 Quattro		1996-2002	All		HB269x.763	F, Z, E						
A4 Quattro		2003-2004	All	w/Wear Sensor	HB354x.756A	F, Z						
A4 Quattro		2005-2008	All		HB538x.760	F, Z, N			HB544x.628	F, Z, N, S		
A4 Quattro		2009-2013	All		HB641x.696	F, Z			HB642x.658	F, Z		
A5		2010-2013	All		HB641x.696	F, Z			HB642x.658	F, Z		
A5 Quattro		2008-2013	All	except premium	HB641x.696	F, Z			HB642x.658	F, Z		
A6		1995-1998	All	w/Large Round Wear Sensor	HB269x.763B	F			HB271x.635	F, Z, N, E		
A6		1995-1998	All	w/Oval Wear Sensor	HB269x.763A	F, Z			HB271x.635	F, Z, N, E		
A6		1995-1998	All		HB269x.763	F, Z, E			HB271x.635	F, Z, N, E		
A6		1999-1999	All	w/Large Round Wear Sensor	HB269x.763B	F						
A6		1999-1999	All	w/Oval Wear Sensor	HB269x.763A	F, Z						
A6		1999-1999	All		HB269x.763	F, Z, E						
A6		2000-2001	All	w/Large Round Wear Sensor	HB269x.763B	F			HB364x.642	F, Z, N, E		
A6		2000-2001	All	w/Oval Wear Sensor	HB269x.763A	F, Z			HB364x.642	F, Z, N, E		
A6		2000-2001	All		HB269x.763	F, Z, E			HB364x.642	F, Z, N, E		
A6		2002-2004	All	Front rotors 320mm	HB515x.760	F, Z			HB364x.587	F, Z, N, E		
A6		2002-2004	All	Front rotors 312mm	HB354x.756A	F, Z			HB364x.587	F, Z, N, E		
A6		2005-2009	All	Rear rotors 330mm	HB538x.760	F, Z, N			HB553x.652	F, Z, N, S		
A6		2005-2009	All	Rear rotors 302mm	HB538x.760	F, Z, N			HB544x.628	F, Z, N, S		
A6		2010-2011	All		HB538x.760	F, Z, N			HB544x.628	F, Z, N, S		
A6		2012-2013	All		HB641x.696	F, Z						
A6 Quattro	Avant	1999-1999	All	w/Large Round Wear Sensor	HB269x.763B	F						
A6 Quattro	Avant	1999-1999	All	w/Oval Wear Sensor	HB269x.763A	F, Z						
A6 Quattro	Avant	1999-1999	All		HB269x.763	F, Z, E						
A6 Quattro	Avant	2000-2001	All	w/Large Round Wear Sensor	HB363x.689B	F			HB364x.642	F, Z, N, E		
A6 Quattro	Avant	2000-2001	All	w/Oval Wear Sensor	HB363x.689A	F			HB364x.642	F, Z, N, E		
A6 Quattro	Avant	2000-2001	All		HB363x.689	F, N, E			HB364x.642	F, Z, N, E		

RACE PAD COMPOUNDS

DTC-70 - U	DTC-05 - H	MT-4 - L	HP Plus - N
DTC-60 - G	HT-14 - V	Blue 9012 - E	
DTC-30 - W	HT-10 - S	Black - M	
DTC-15 - A	Metallic - MB	DR-97 - J	

STREET PAD COMPOUNDS

HPS Performance Street - F	LTS Light Truck & SUV - Y
Performance Ceramic - Z	SuperDuty - P

MAKE/ MODEL	SUBMODEL	ENGINE YRS. (LITER)	NOTE	FRONT				REAR			
				PADS	PAD COMPOUND	ROTOR	PAD/ROTOR KIT	PADS	PAD COMPOUND	ROTOR	PAD/ROTOR KIT
AUDI CONTINUED											
A6 Quattro	Avant	2002-2003	All	HB515x.760	F, Z			HB364x.642	F, Z, N, E		
A6 Quattro	Avant	2004-2004	All w/Dual Piston	HB363x.689	F, N, E			HB364x.642	F, Z, N, E		
A6 Quattro	Avant	2004-2004	All w/Dual Piston, w/Large Round Wear Sensor	HB363x.689B	F			HB364x.642	F, Z, N, E		
A6 Quattro	Avant	2004-2004	All w/Dual Piston w/Oval Wear Sensor	HB363x.689A	F			HB364x.642	F, Z, N, E		
A6 Quattro	Avant	2004-2004	All w/Single Piston	HB515x.760	F, Z			HB364x.642	F, Z, N, E		
A6 Quattro	Avant	2006-2006	All	HB538x.760	F, Z, N			HB544x.628	F, Z, N, S		
A6 Quattro	Avant	2007-2008	All	HB538x.760	F, Z, N						
A6 Quattro		1995-1997	All w/Large Round Wear Sensor	HB269x.763B	F			HB271x.635	F, Z, N, E		
A6 Quattro		1995-1997	All w/Oval Wear Sensor	HB269x.763A	F, Z			HB271x.635	F, Z, N, E		
A6 Quattro		1995-1997	All	HB269x.763	F, Z, E			HB271x.635	F, Z, N, E		
A6 Quattro		1998-2001	All w/Large Round Wear Sensor	HB269x.763B	F			HB364x.642	F, Z, N, E		
A6 Quattro		1998-2001	All w/Oval Wear Sensor	HB269x.763A	F, Z			HB364x.642	F, Z, N, E		
A6 Quattro		1998-2001	All	HB269x.763	F, Z, E			HB364x.642	F, Z, N, E		
A6 Quattro		2002-2002	All w/Dual Piston	HB363x.689	F, N, E			HB364x.642	F, Z, N, E		
A6 Quattro		2002-2002	All w/Dual Piston w/Large Round Wear Sensor	HB363x.689B	F			HB364x.642	F, Z, N, E		
A6 Quattro		2002-2002	All w/Dual Piston w/Oval Wear Sensor	HB363x.689A	F			HB364x.642	F, Z, N, E		
A6 Quattro		2002-2002	All w/Single Piston	HB515x.760	F, Z			HB364x.642	F, Z, N, E		
A6 Quattro		2003-2003	All w/Large Round Wear Sensor	HB363x.689B	F			HB364x.642	F, Z, N, E		
A6 Quattro		2003-2003	All w/Oval Wear Sensor	HB363x.689A	F			HB364x.642	F, Z, N, E		
A6 Quattro		2003-2003	All	HB363x.689	F, N, E			HB364x.642	F, Z, N, E		
A6 Quattro		2004-2004	All w/Dual Piston	HB363x.689	F, N, E			HB364x.642	F, Z, N, E		
A6 Quattro		2004-2004	All w/Dual Piston w/Large Round Wear Sensor	HB363x.689B	F			HB364x.642	F, Z, N, E		
A6 Quattro		2004-2004	All w/Dual Piston w/Oval Wear Sensor	HB363x.689A	F			HB364x.642	F, Z, N, E		
A6 Quattro		2004-2004	All w/Single Piston	HB515x.760	F, Z			HB364x.642	F, Z, N, E		
A6 Quattro		2006-2011	All 330mm rotors	HB538x.760	F, Z, N			HB553x.652	F, Z, N		
A6 Quattro		2006-2009	All 302mm rotors	HB538x.760	F, Z, N			HB544x.628	F, Z, N, S		
A7 Quattro		2011-2012	All 320mm Front Disc	HB641x.696	F, Z						
A6 Quattro		2013	All 4 cyl engine	HB641x.696	F, Z						
A7 Quattro		2011-2012	All 345mm Front Disc	HB641x.696	F, Z						
A8		1997-1999	All w/Large Round Wear Sensor	HB269x.763B	F			HB271x.635	F, Z, N, E		
A8		1997-1999	All w/Oval Wear Sensor	HB269x.763A	F, Z			HB271x.635	F, Z, N, E		
A8		1997-1999	All	HB269x.763	F, Z, E			HB271x.635	F, Z, N, E		
A8 Quattro	L	2001-2003	All w/Large Round Wear Sensor	HB363x.689B	F			HB364x.642	F, Z, N, E		
A8 Quattro	L	2001-2003	All w/Oval Wear Sensor	HB363x.689A	F			HB364x.642	F, Z, N, E		
A8 Quattro	L	2001-2003	All	HB363x.689	F, N, E			HB364x.642	F, Z, N, E		
A8 Quattro		1997-1999	All w/Large Round Wear Sensor	HB269x.763B	F			HB271x.635	F, Z, N, E		
A8 Quattro		1997-1999	All w/Oval Wear Sensor	HB269x.763A	F, Z			HB271x.635	F, Z, N, E		
A8 Quattro		1997-1999	All	HB269x.763	F, Z, E			HB271x.635	F, Z, N, E		
A8 Quattro		2000-2003	All w/Large Round Wear Sensor	HB363x.689B	F			HB364x.642	F, Z, N, E		
A8 Quattro		2000-2003	All w/Oval Wear Sensor	HB363x.689A	F			HB364x.642	F, Z, N, E		
A8 Quattro		2000-2003	All	HB363x.689	F, N, E			HB364x.642	F, Z, N, E		
A8 Quattro		2001-2003	All w/Female Oval Wear Sensor 16.5 in. Long Lead	HB184x.650C	F						
A8 Quattro		2001-2003	All w/Female Oval Wear Sensor 8 in. Long Lead	HB184x.650B	F						

APPLICATION GUIDE

BRAKE PAD CODE BREAKDOWN

PAD/ROTOR KIT CODE BREAKDOWN

H B 2 4 5 x . 6 3 1
 HAWK BRAKE PAD SHAPE INSERT COMPOUND CODE PAD THICKNESS

H K x 4 2 8 4 4 8
 HAWK KIT INSERT COMPOUND CODE ROTOR PAD SHAPE

MAKE/ MODEL	SUBMODEL	ENGINE YRS. (LITER)	NOTE	FRONT				REAR			
				PADS	PAD COMPOUND	ROTORS	PAD/ROTOR KIT	PADS	PAD COMPOUND	ROTORS	PAD/ROTOR KIT
AUDI CONTINUED											
A8 Quattro		2004-2010	All	HB687x.750	F, N, Z			HB553x.652	F, Z, N		
Allroad Quattro		2001-2003	All w/Large Round Wear Sensor	HB363x.689B	F			HB364x.642	F, Z, N, E		
Allroad Quattro		2001-2003	All w/Oval Wear Sensor	HB363x.689A	F			HB364x.642	F, Z, N, E		
Allroad Quattro		2001-2003	All	HB363x.689	F, N, E			HB364x.642	F, Z, N, E		
Allroad Quattro		2003-2005	All w/Dual Piston	HB363x.689	F, N, E			HB364x.642	F, Z, N, E		
Allroad Quattro		2003-2005	All w/Dual Piston w/Large Round Wear Sensor	HB363x.689B	F			HB364x.642	F, Z, N, E		
Allroad Quattro		2003-2005	All w/Dual Piston w/Oval Wear Sensor	HB363x.689A	F			HB364x.642	F, Z, N, E		
Allroad Quattro		2003-2005	All w/Single Piston	HB515x.760	F, Z			HB364x.642	F, Z, N, E		
Allroad Quattro		2013	All	HB641x.696	F, Z			HB642x.658	F, Z		
Cabriolet		1994-1997	All w/Wear Sensor	HB270x.724A	F			HB271x.635	F, Z, N, E		
Cabriolet		1994-1997	All					HB271x.635	F, Z, N, E		
Coupe	GT	1985-1987	All w/Wear Sensor	HB190x.600A	F, Z						
Coupe	GT	1985-1987	All	HB190x.600	F, N, E, W						
Coupe Quattro	20V	1990-1991	All w/Wear Sensor	HB270x.724A	F			HB271x.635	F, Z, N, E		
Coupe Quattro	20V	1990-1991	All					HB271x.635	F, Z, N, E		
Q5		2009-2012	All	HB641x.696	F, Z			HB642x.658	F, Z		
Q5		2013	All					HB642x.658	F, Z		
Q5	Hybrid	2013	All	HB641x.696	F, Z			HB642x.658	F, Z		
Q7	Premium	2007-2013	All	HB501x.625	F, Z, Y, G, E			HB502x.606	F, Z, Y		
Q7		2007-2013	All	HB501x.625	F, Z, Y, G, E			HB502x.606	F, Z, Y		
R8		2008-2011	All Rear pad w/o wear sensor notch	HB609x.572	F, Z, N, E, G, S, U, W			HB193x.670	F, Z, N, U, G, W, V, S, E		
RS4		2007-2008	All	HB609x.572	F, Z, N, E, G, S, U, W			HB553x.652	F, Z, N		
RS6		2003-2004	All	HB609x.572	F, Z, N, E, G, S, U, W			HB553x.652	F, Z, N		
S3	European	2001-2010	All	HB625x.760	F, Z			HB544x.628	F, Z, N, S		
S4	Avant	2001-2002	All w/Large Round Wear Sensor	HB363x.689B	F			HB364x.642	F, Z, N, E		
S4	Avant	2001-2002	All w/Oval Wear Sensor	HB363x.689A	F			HB364x.642	F, Z, N, E		
S4	Avant	2001-2002	All	HB363x.689	F, N, E			HB364x.642	F, Z, N, E		
S4	Avant	2008-2008	All	HB538x.760	F, Z, N			HB553x.652	F, Z, N		
S4	Cabriolet	2004-2008	All	HB538x.760	F, Z, N			HB553x.652	F, Z, N		
S4		1993-1994	All w/Wear Sensor	HB270x.724A	F			HB271x.635	F, Z, N, E		
S4		1993-1994	All					HB271x.635	F, Z, N, E		
S4		2000-2002	All w/Large Round Wear Sensor	HB363x.689B	F			HB364x.642	F, Z, N, E		
S4		2000-2002	All w/Oval Wear Sensor	HB363x.689A	F			HB364x.642	F, Z, N, E		
S4		2000-2002	All	HB363x.689	F, N, E			HB364x.642	F, Z, N, E		
S4	Base	2004-2009	All	HB538x.760	F, Z, N			HB553x.652	F, Z, N		
S4		2010-2013	All	HB641x.696	F, Z			HB642x.658	F, Z		
S5		2009-2013	All	HB641x.696	F, Z			HB642x.658	F, Z		
S6	Avant	2002-2004	All w/Large Round Wear Sensor	HB363x.689B	F			HB364x.642	F, Z, N, E		
S6	Avant	2002-2004	All w/Oval Wear Sensor	HB363x.689A	F			HB364x.642	F, Z, N, E		
S6	Avant	2002-2004	All	HB363x.689	F, N, E			HB364x.642	F, Z, N, E		
S6		1995-1995	All w/Wear Sensor	HB270x.724A	F			HB271x.635	F, Z, N, E		
S6		1995-1995	All					HB271x.635	F, Z, N, E		
S6		2007-2011	All	HB687x.750	F, N, Z			HB553x.652	F, Z, N		
S8		2001-2003	All w/Female Oval Wear Sensor 8 in. Long Lead	HB184x.650C	F			HB364x.642	F, Z, N, E		
S8		2001-2003	All w/Female Oval Wear Sensor 16.5 in. Long Lead	HB184x.650B	F			HB364x.642	F, Z, N, E		

RACE PAD COMPOUNDS

DTC-70 - U	DTC-05 - H	MT-4 - L	HP Plus - N
DTC-60 - G	HT-14 - V	Blue 9012 - E	
DTC-30 - W	HT-10 - S	Black - M	
DTC-15 - A	Metallic - MB	DR-97 - J	

STREET PAD COMPOUNDS

HPS Performance Street - F	LTS Light Truck & SUV - Y
Performance Ceramic - Z	SuperDuty - P

MAKE/ MODEL	SUBMODEL	ENGINE YRS. (LITER)	NOTE	FRONT				REAR			
				PADS	PAD COMPOUND	ROTORS	PAD/ROTOR KIT	PADS	PAD COMPOUND	ROTORS	PAD/ROTOR KIT
AUDI CONTINUED											
S8		2007-2010	All	HB687x.750	F, N, Z			HB553x.652	F, Z, N		
Super 90		1970-1972	All	HB172x.595	F, Z, N, U, G, W, M, S, E						
TT		2000-2006	All w/Wear Sensor	HB272x.763A	F, Z	HUS614	HKx614272A	HB364x.642	F, Z, N, E	HUS618	HKx618364
TT		2000-2006	All	HB272x.763	F, Z, N, E	HUS614	HKx614272	HB364x.642	F, Z, N, E	HUS618	HKx618364
TT		2008-2008	All	HB625x.760	F, Z			HB544x.628	F, Z, N, S		
TT		2008-2010	All	HB543x.760	F, Z, N, G			HB544x.628	F, Z, N, S		
TT Quattro		2000-2006	1.8 w/Wear Sensor	HB272x.763A	F, Z	HUS614	HKx614272A	HB364x.642	F, Z, N, E		
TT Quattro		2000-2006	1.8	HB272x.763	F, Z, N, E	HUS614	HKx614272	HB364x.642	F, Z, N, E		
TT Quattro		2004-2006	3.2	HB497x.776	F, Z, U, S			HB364x.642	F, Z, N, E		
TT Quattro		2008-2009	3.2	HB625x.760	F, Z			HB544x.628	F, Z, N, S		
TT Quattro		2010 - 2013	all	HB543x.760				HB544x.628	F, Z, N, S		
TT Quattro	RS	2012 - 2013	all					HB544x.628	F, Z, N, S		
TT Quattro	S	2009-2013	3.2	HB625x.760	F, Z			HB544x.628	F, Z, N, S		
TTS		2009-2009	All	HB625x.760	F, Z			HB544x.628	F, Z, N, S		
V8 Quattro	32V	1990-1991	All w/Wear Sensor	HB270x.724A	F						
BMW											
325		1986-1988	All	HB195x.640	F, Z, N, G, S, E			HB399x.630	F, Z, N, S, E, U		
2000	Touring	1971-1971	All	HB206x.565	E			HB713x.590	F, Z, W, G		
2000		1969-1971	All	HB206x.565	E			HB713x.590	F, Z, W, G		
2002		1969-1971	All	HB206x.565	E						
2500		1969-1971	All	HB206x.565	E			HB713x.590	F, Z, W, G		
2800		1969-1971	All	HB206x.565	E			HB713x.590	F, Z, W, G		
125i		2011-2011	All	HB534x.750	F, Z, N, S, U			HB621x.638	F, Z, S, U		
128i		2008-2013	All	HB534x.750	F, Z, N, S, U	HUS625	HKx625534	HB621x.638	F, Z, S, U	HUS624	HKx624621
135i		2008-2013	All	HB603x.616	F, N, U, G, W, S			HB604x.598	F, N, G, W, S		
135is		2013	All	HB603x.616	F, N, U, G, W, S			HB604x.598	F, N, G, W, S		
2000C		1969-1970	All	HB206x.565	E						
2000CS		1969-1970	All	HB206x.565	E						
2000TI		1969-1971	All	HB206x.565	E						
2000TII	Lux	1969-1971	All	HB206x.565	E						
2000TII	Touring	1971-1971	All	HB206x.565	E						
2000TII		1969-1971	All	HB206x.565	E						
2002TI		1969-1971	All	HB206x.565	E						
2002TII		1971-1974	All	HB206x.565	E						
3.0CS		1972-1974	All	HB206x.565	E			HB713x.590	F, Z, W, G		
3.0CSI		1971-1974	All	HB206x.565	E						
3.0CSI		1971-1971	All	HB206x.565	E						
3.0S		1971-1974	All	HB206x.565	E						
3.0Si		1971-1971	All	HB206x.565	E						
3.0Si		1975-1976	All	HB206x.565	E			HB713x.590	F, Z, W, G		
318i	E30	1984-1985	All	HB195x.640	F, Z, N, G, S, E						
318i	E30	1991-1991	All	HB195x.640	F, Z, N, G, S, E			HB399x.630	F, Z, N, S, E, U		
318i		1992-1998	All	HB136x.690	F, Z, N, U, G, S, E			HB227x.630	F, Z, N, U, G, S, E		
318iC	E30	1991-1991	All	HB195x.640	F, Z, N, G, S, E			HB399x.630	F, Z, N, S, E, U		
318iC		1992-1992	All	HB136x.690	F, Z, N, U, G, S, E			HB227x.630	F, Z, N, U, G, S, E		
318iC		1994-1997	All	HB136x.690	F, Z, N, U, G, S, E			HB227x.630	F, Z, N, U, G, S, E		
318iS	E30	1991-1991	All	HB195x.640	F, Z, N, G, S, E			HB399x.630	F, Z, N, S, E, U		
318iS		1992-1997	All	HB136x.690	F, Z, N, U, G, S, E			HB227x.630	F, Z, N, U, G, S, E		

APPLICATION GUIDE

BRAKE PAD CODE BREAKDOWN

H B 2 4 5 x . 6 3 1
 HAWK BRAKE PAD SHAPE INSERT COMPOUND CODE PAD THICKNESS

PAD/ROTOR KIT CODE BREAKDOWN

H K x 4 2 8 4 4 8
 HAWK KIT INSERT COMPOUND CODE ROTOR PAD SHAPE

MAKE/ MODEL	SUBMODEL	ENGINE YRS. (LITER)	NOTE	FRONT				REAR			
				PADS	PAD COMPOUND	ROTORS	PAD/ROTOR KIT	PADS	PAD COMPOUND	ROTORS	PAD/ROTOR KIT
BMW CONTINUED											
318Ti		1995-1998	All	HB136x.690	F, Z, N, U, G, S, E			HB227x.630	F, Z, N, U, G, S, E		
318Ti		1999-1999	All	HB136x.690	F, Z, N, U, G, S, E			HB136x.690	F, Z, N, U, G, S, E		
320i		1977-1979	All	HB180x.560	F, Z, N, U, G, E						
320i		1980-1982	All	HB180x.560	F, Z, N, U, G, E						
323Ci		2000-2000	All	HB546x.654	F, Z, N, S, U			HB227x.630	F, Z, N, U, G, S, E		
323i	Sport Wagon	2000-2000	All	HB546x.654	F, Z, N, S, U			HB227x.630	F, Z, N, U, G, S, E		
323i		1999-2000	All	HB546x.654	F, Z, N, S, U			HB227x.630	F, Z, N, U, G, S, E		
323i		2010-2011	All	HB551x.748	F, Z, N, S, E, U			HB621x.638	F, Z, S, U		
			Wear sensor, front pads F & Z only								
323iC		1998-1999	All	HB546x.654	F, Z, N, S, U						
323iS		1998-1999	All	HB546x.654	F, Z, N, S, U			HB227x.630	F, Z, N, U, G, S, E		
325Ci		2001-2007	All	HB136x.690	F, Z, N, U, G, S, E	HUS619	HKx619136	HB227x.630	F, Z, N, U, G, S, E		
325e	E30	1984-1987	All	HB195x.640	F, Z, N, G, S, E			HB399x.630	F, Z, N, S, E, U		
325es	E30	1986-1987	All	HB195x.640	F, Z, N, G, S, E			HB399x.630	F, Z, N, S, E, U		
325i	E36	1992-1996	All	HB136x.690	F, Z, N, U, G, S, E	HUS619	HKx619136	HB227x.630	F, Z, N, U, G, S, E		
325i	E90	2006-2006	All	HB534x.750	F, Z, N, S, U	HUS625	HKx625534			HUS600	
325i	Sport Wagon	2001-2003	All	HB136x.690	F, Z, N, U, G, S, E	HUS619	HKx619136	HB227x.630	F, Z, N, U, G, S, E		
325i	E30	1987-1991	All	HB195x.640	F, Z, N, G, S, E			HB399x.630	F, Z, N, S, E, U		
325i		2001-2005	All	HB546x.654	F, Z, N, S, U	HUS619	HKx619546	HB227x.630	F, Z, N, U, G, S, E		
325is	E30	1987-1991	All	HB195x.640	F, Z, N, G, S, E			HB399x.630	F, Z, N, S, E, U		
325is		1992-1995	All	HB136x.690	F, Z, N, U, G, S, E			HB227x.630	F, Z, N, U, G, S, E		
325iX	E30	1988-1991	All	HB195x.640	F, Z, N, G, S, E			HB399x.630	F, Z, N, S, E, U		
325xi	Sport Wagon	2001-2003	All	HB136x.690	F, Z, N, U, G, S, E	HUS619	HKx619136	HB227x.630	F, Z, N, U, G, S, E		
325xi		2001-2005	All	HB136x.690	F, Z, N, U, G, S, E	HUS619	HKx619136	HB227x.630	F, Z, N, U, G, S, E		
325xi		2006-2006	All	HB534x.750	F, Z, N, S, U						
328Ci		2000-2000	2.8	HB136x.690	F, Z, N, U, G, S, E	HUS619	HKx619136	HB227x.630	F, Z, N, U, G, S, E		
328i	Xdrive	2009-2012	All	HB551x.748	F, Z, N, S, E, U	HUS640	HKx640551	HB621x.638	F, Z, S, U		
			AWD; E90, E91, E92 Wear sensor, front pads, F & Z								
328i	Xdrive	2012-2013	All	HB551x.748	F, Z, N, S, E, U			HB621x.638	F, Z, S, U		
328i		1998-1998	All	HB546x.654	F, Z, N, S, U			HB227x.630	F, Z, N, U, G, S, E		
328i		1999-2000	All	HB546x.654	F, Z, N, S, U	HUS619	HKx619546	HB227x.630	F, Z, N, U, G, S, E		
328i		2007-2007	All	HB534x.750	F, Z, N, S, U	HUS625	HKx625534	HB621x.638	F, Z, S, U	HUS600	HKx600621
328i		2007-2007	All	HB534x.750	F, Z, N, S, U	HUS625	HKx625534	HB621x.638	F, Z, S, U	HUS602	HKx602621
328i		2008-2012	All	HB551x.748	F, Z, N, S, E, U	HUS640	HKx640551	HB621x.638	F, Z, S, U	HUS600	HKx600621
328i		2008-2012	All	HB551x.748	F, Z, N, S, E, U	HUS640	HKx640551	HB621x.638	F, Z, S, U	HUS602	HKx602621
328i	L6	2013	All	HB551x.748	F, Z, N, S, E, U			HB621x.638	F, Z, S, U		
328iC		1998-1998	All	HB136x.690	F, Z, N, U, G, S, E			HB227x.630	F, Z, N, U, G, S, E		
328iC		1999-1999	All	HB136x.690	F, Z, N, U, G, S, E	HUS619	HKx619136	HB227x.630	F, Z, N, U, G, S, E		
328is		1998-1998	All	HB136x.690	F, Z, N, U, G, S, E			HB227x.630	F, Z, N, U, G, S, E		
328is		1999-1999	All	HB136x.690	F, Z, N, U, G, S, E	HUS619	HKx619136	HB227x.630	F, Z, N, U, G, S, E		
328xi		2007-2007	All	HB534x.750	F, Z, N, S, U			HB621x.638	F, Z, S, U		
328xi		2008-2008	All	HB551x.748	F, Z, N, S, E, U			HB621x.638	F, Z, S, U		
			Wear sensor, front pads F & Z only								
328xi		2011-2011	All	HB551x.748	F, Z, N, S, E, U			HB621x.638	F, Z, S, U		
			Wear sensor, front pads F & Z only								
330Ci		2001-2006	All	HB464x.764	F, Z, Y, N, U, G, V, S, E			HB518x.642	F, Z, Y, N, U, G, S, E		
330i		2001-2005	All	HB464x.764	F, Z, Y, N, U, G, V, S, E			HB518x.642	F, Z, Y, N, U, G, S, E		
330i		2006-2006	All	HB534x.750	F, Z, N, S, U			HB624x.642	F, Z, N, U, G, W		

APPLICATION GUIDE

RACE PAD COMPOUNDS

DTC-70 - U	DTC-05 - H	MT-4 - L	HP Plus - N
DTC-60 - G	HT-14 - V	Blue 9012 - E	
DTC-30 - W	HT-10 - S	Black - M	
DTC-15 - A	Metallic - MB	DR-97 - J	

STREET PAD COMPOUNDS

HPS Performance Street - F	LTS Light Truck & SUV - Y
Performance Ceramic - Z	SuperDuty - P

MAKE/ MODEL	SUBMODEL	ENGINE YRS. (LITER)	NOTE	FRONT				REAR			
				PADS	PAD COMPOUND	ROTOR	PAD/ROTOR KIT	PADS	PAD COMPOUND	ROTOR	PAD/ROTOR KIT
BMW CONTINUED											
330xi		2001-2005	All	HB464x.764	F, Z, Y, N, U, G, V, S, E			HB518x.642	F, Z, Y, N, U, G, S, E		
330xi		2006-2006	All	HB534x.750	F, Z, N, S, U			HB624x.642	F, Z, N		
335d		2009-2011	All Wear sensor, front pads F & Z only	HB551x.748	F, Z, N, S, E, U			HB624x.642	F, Z, N		
335i	Xdrive	2010-2012	All E90, E92, E93 Wear sensor, front pads, F & Z	HB551x.748	F, Z, N, S, E, U	HUS630	HKx630551	HB624x.642	F, Z, N	HUS622	HKx622624
335i	Xdrive	2013	All Non - Sedan	HB551x.748	F, Z, N, S, E, U			HB624x.642	F, Z, N		
335i		2007-2011	All E90, E92, E93 Wear sensor front pads, F & Z	HB551x.748	F, Z, N, S, E, U	HUS630	HKx630551	HB624x.642	F, Z, N	HUS622	HKx622624
335i	non- sedan	2012-2013	All	HB551x.748	F, Z, N, S, E, U			HB624x.642	F, Z, N		
335is		2011-2013	All Wear sensor, front pads F & Z only	HB551x.748	F, Z, N, S, E, U			HB624x.642	F, Z, N		
335xi		2007-2008	All Wear sensor, front pads F & Z only	HB551x.748	F, Z, N, S, E, U			HB624x.642	F, Z, N		
524td		1985-1986	All	HB137x.690	F, N, U, G, S			HB399x.630	F, Z, N, S, E, U		
525i	Sport Wagon	2001-2003	All	HB465x.764	F, Z			HB227x.630	F, Z, N, U, G, S, E		
525i		1989-1995	All	HB135x.770	F, Z, N, U, G, V, S, E			HB227x.630	F, Z, N, U, G, S, E		
525i		2001-2003	All	HB465x.764	F, Z			HB227x.630	F, Z, N, U, G, S, E		
525i		2004-2005	All Automatic trans.wear sensor front pads, F & Z only	HB551x.748	F, Z, N, S, E, U			HB458x.642	F, Z		
525i		2004-2005	All Manual Trans	HB534x.750	F, Z, N, S, U			HB458x.642	F, Z		
525i		2006-2006	All Wear sensor, front pads F & Z only	HB551x.748	F, Z, N, S, E, U			HB458x.642	F, Z		
525i		2007-2007	All	HB534x.750	F, Z, N, S, U			HB518x.642	F, Z, Y, N, U, G, S, E		
525iT		1993-1995	All	HB135x.770	F, Z, N, U, G, V, S, E			HB227x.630	F, Z, N, U, G, S, E		
525xi		2006-2007	All Wear sensor, front pads F & Z only	HB551x.748	F, Z, N, S, E, U			HB458x.642	F, Z		
528e		1982-1988	All	HB137x.690	F, N, U, G, S			HB399x.630	F, Z, N, S, E, U		
528i	Xdrive	2009-2010	All Wear sensor, front pads F & Z only	HB551x.748	F, Z, N, S, E, U			HB458x.642	F, Z		
528i		1979-1981	All	HB206x.565	E			HB713x.590	F, Z, W, G		
528i		1997-1998	All	HB135x.770	F, Z, N, U, G, V, S, E			HB227x.630	F, Z, N, U, G, S, E		
528i		2000-2000	All	HB465x.764	F, Z						
528i		2008-2010	All Wear sensor, front pads F & Z only	HB551x.748	F, Z, N, S, E, U			HB458x.642	F, Z		
528iT		1999-2000	All	HB465x.764	F, Z			HB227x.630	F, Z, N, U, G, S, E		
528xi		2008-2008	All Wear sensor, front pads F & Z only	HB551x.748	F, Z, N, S, E, U			HB458x.642	F, Z		
530i		1975-1978	All	HB206x.565	E			HB713x.590	F, Z, W, G		
530i		1994-1995	All	HB135x.770	F, Z, N, U, G, V, S, E			HB227x.630	F, Z, N, U, G, S, E		
530i		2001-2003	All	HB325x.720	F, Z, Y, N, S			HB227x.630	F, Z, N, U, G, S, E		
530i		2004-2007	All Wear sensor, front pads F & Z only	HB551x.748	F, Z, N, S, E, U			HB458x.642	F, Z		
530iT		1994-1995	All	HB135x.770	F, Z, N, U, G, V, S, E			HB227x.630	F, Z, N, U, G, S, E		
530xi		2006-2007	All Wear sensor, front pads F & Z only	HB551x.748	F, Z, N, S, E, U			HB458x.642	F, Z		
533i		1983-1984	All	HB137x.690	F, N, U, G, S			HB399x.630	F, Z, N, S, E, U		
535i	Xdrive	2009-2010	All Wear sensor, front pads F & Z only	HB551x.748	F, Z, N, S, E, U			HB458x.642	F, Z		
535i		1985-1987	All	HB137x.690	F, N, U, G, S			HB399x.630	F, Z, N, S, E, U		
535i		1988-1993	All	HB135x.770	F, Z, N, U, G, V, S, E			HB227x.630	F, Z, N, U, G, S, E		
535i		2008-2010	All Wear sensor, front pads F & Z only	HB551x.748	F, Z, N, S, E, U			HB630x.626	F, Z, N, U		

APPLICATION GUIDE

BRAKE PAD CODE BREAKDOWN

PAD/ROTOR KIT CODE BREAKDOWN

H B 2 4 5 x .6 3 1
 HAWK BRAKE PAD SHAPE INSERT COMPOUND CODE PAD THICKNESS

H K x 4 2 8 4 4 8
 HAWK KIT INSERT COMPOUND CODE ROTOR PAD SHAPE

MAKE/ MODEL	SUBMODEL	YRS.	ENGINE (LITER)	NOTE	FRONT				REAR			
					PADS	PAD COMPOUND	ROTORS	PAD/ROTOR KIT	PADS	PAD COMPOUND	ROTORS	PAD/ROTOR KIT
BMW CONTINUED												
535i	GT	2010-2013	All						HB630x.626	F, Z, N, U		
535i	GT Xdrive	2011-2013	All						HB630x.626	F, Z, N, U		
535is		1988-1988	All		HB137x.690	F, N, U, G, S						
535xi		2008-2009	All	Wear sensor, front pads F & Z only	HB551x.748	F, Z, N, S, E, U			HB458x.642	F, Z		
540i	Sport Wagon	2001-2003	All		HB325x.720	F, Z, Y, N, S			HB227x.630	F, Z, N, U, G, S, E		
540i		1994-1995	All		HB135x.770	F, Z, N, U, G, V, S, E			HB227x.630	F, Z, N, U, G, S, E		
540i		1997-2003	All		HB325x.720	F, Z, Y, N, S			HB227x.630	F, Z, N, U, G, S, E		
540iT		2000-2000	All		HB325x.720	F, Z, Y, N, S			HB227x.630	F, Z, N, U, G, S, E		
545i		2004-2005	All	Wear sensor, front pads F & Z only	HB551x.748	F, Z, N, S, E, U			HB630x.626	F, Z, N, U		
550i		2006-2010	All	Wear sensor, front pads F & Z only	HB551x.748	F, Z, N, S, E, U			HB630x.626	F, Z, N, U		
550i	GT	2010-2013	All						HB630x.626	F, Z, N, U		
550i	GT XDrive	2010-2013	All						HB630x.626	F, Z, N, U		
630CSI		1977-1977	All		HB206x.565	E						
633CSI		1979-1982	All		HB206x.565	E						
635CSI		1985-1988	All		HB137x.690	F, N, U, G, S			HB399x.630	F, Z, N, S, E, U		
645Ci		2004-2006	All	Wear sensor, front pads F & Z only	HB551x.748	F, Z, N, S, E, U			HB630x.626	F, Z, N, U		
650i		2006-2010	All	Wear sensor, front pads F & Z only	HB551x.748	F, Z, N, S, E, U			HB630x.626	F, Z, N, U		
733i		1978-1982	All		HB206x.565	E						
735i		1986-1986	All		HB206x.565	E			HB399x.630	F, Z, N, S, E, U		
735i		1987-1991	All		HB135x.770	F, Z, N, U, G, V, S, E			HB227x.630	F, Z, N, U, G, S, E		
735iL		1988-1992	All		HB135x.770	F, Z, N, U, G, V, S, E			HB227x.630	F, Z, N, U, G, S, E		
740i		1993-1994	All		HB135x.770	F, Z, N, U, G, V, S, E			HB227x.630	F, Z, N, U, G, S, E		
740i		1995-2001	All		HB325x.720	F, Z, Y, N, S			HB518x.642	F, Z, Y, N, U, G, S, E		
740i		2011-2013	All						HB630x.626	F, Z, N, U		
740iL		1993-1994	All		HB135x.642	F			HB227x.630	F, Z, N, U, G, S, E		
740iL		1995-1998	All		HB325x.720	F, Z, Y, N, S			HB518x.642	F, Z, Y, N, U, G, S, E		
740iL		2011-2013	All						HB630x.626	F, Z, N, U		
745i		2002-2005	All	Wear sensor, front pads F & Z only	HB551x.748	F, Z, N, S, E, U			HB630x.626	F, Z, N, U		
745Li		2002-2005	All	Wear sensor, front pads F & Z only	HB551x.748	F, Z, N, S, E, U			HB630x.626	F, Z, N, U		
750i		2006-2008	All	Wear sensor, front pads F & Z only	HB551x.748	F, Z, N, S, E, U			HB630x.626	F, Z, N, U		
750i		2010-2013	All						HB630x.626	F, Z, N, U		
750i	Xdrive	2010-2013	All						HB630x.626	F, Z, N, U		
750iL		1988-1994	All		HB135x.770	F, Z, N, U, G, V, S, E			HB227x.630	F, Z, N, U, G, S, E		
750iL		1996-2001	All		HB497x.776	F, Z, U, S			HB518x.642	F, Z, Y, N, U, G, S, E		
750Li		2006-2009	All	Wear sensor, front pads F & Z only	HB551x.748	F, Z, N, S, E, U			HB630x.626	F, Z, N, U		
750Li		2010-2013	All						HB630x.626	F, Z, N, U		
750Li	Xdrive	2010-2013	All						HB630x.626	F, Z, N, U		
760i		2004-2006	All	Wear sensor, front pads F & Z only	HB551x.748	F, Z, N, S, E, U			HB630x.626	F, Z, N, U		
760Li		2003-2007	All	Wear sensor, front pads F & Z only	HB551x.748	F, Z, N, S, E, U			HB630x.626	F, Z, N, U		
760Li		2010-2013	All						HB630x.626	F, Z, N, U		

RACE PAD COMPOUNDS

DTC-70 - U	DTC-05 - H	MT-4 - L	HP Plus - N
DTC-60 - G	HT-14 - V	Blue 9012 - E	
DTC-30 - W	HT-10 - S	Black - M	
DTC-15 - A	Metallic - MB	DR-97 - J	

STREET PAD COMPOUNDS

HPS Performance Street - F	LTS Light Truck & SUV - Y
Performance Ceramic - Z	SuperDuty - P

MAKE/ MODEL	SUBMODEL	ENGINE YRS. (LITER)	NOTE	FRONT				REAR			
				PADS	PAD COMPOUND	ROTORS	PAD/ROTOR KIT	PADS	PAD COMPOUND	ROTORS	PAD/ROTOR KIT
BMW CONTINUED											
840Ci		1994-1997	All	HB181x.660	F, N, U, G, E			HB362x.642	F, Y, N, S, E		
850Ci		1993-1993	All	HB325x.720	F, Z, Y, N, S			HB362x.642	F, Y, N, S, E		
850Ci		1994-1997	All	HB181x.660	F, N, U, G, E			HB362x.642	F, Y, N, S, E		
850CSi		1994-1995	All	HB325x.720	F, Z, Y, N, S			HB362x.642	F, Y, N, S, E		
850i		1991-1992	All	HB325x.720	F, Z, Y, N, S			HB362x.642	F, Y, N, S, E		
Alpina B7		2007-2008	All	HB676x.780	F, Z			HB630x.626	F, Z, N, U		
Alpina Roadster		2003-2003	All	HB497x.776	F, Z, U, S						
M1		2011-2012	All	HB551x.748	F, Z, N, S, E, U			HB630x.626	F, Z, N, U		
M3		1988-1991	All	HB137x.690	F, N, U, G, S			HB227x.630	F, Z, N, U, G, S, E		
M3		1995-1999	All	HB135x.770	F, Z, N, U, G, V, S, E			HB227x.630	F, Z, N, U, G, S, E		
M3		2001-2002	All	HB135x.770	F, Z, N, U, G, V, S, E			HB518x.642	F, Z, Y, N, U, G, S, E		
M3		2003-2006	All	HB464x.764	F, Z, Y, N, U, G, V, S, E			HB518x.642	F, Z, Y, N, U, G, S, E		
M3		2008-2013	All	Wear sensor, front pads F & Z only	HB551x.748	F, Z, N, S, E, U		HB630x.626	F, Z, N, U		
M5		1988-1988	All	HB206x.565	E						
M5		1991-1993	All	HB135x.770	F, Z, N, U, G, V, S, E			HB227x.630	F, Z, N, U, G, S, E		
M5		2000-2003	All	HB325x.720	F, Z, Y, N, S			HB518x.642	F, Z, Y, N, U, G, S, E		
M5		2006-2010	All	HB676x.780	F, Z			HB630x.626	F, Z, N, U		
M6		1987-1988	All	HB206x.565	E						
M6		2006-2010	All	HB676x.780	F, Z			HB630x.626	F, Z, N, U		
X1	XDrive 35i	2012-2013	All	HB551x.748	F, Z, N, S, E, U			HB624x.642	F, Z, N		
X1	XDrive 28i	2012-2014	All	HB551x.748	F, Z, N, S, E, U			HB621x.638	F, Z, S, U		
X1	S Drive 28i	2012	All	HB534x.750	F, Z, N, S, U			HB621x.638	F, Z, S, U		
X1	S Drive 28i	2013	All	HB551x.748	F, Z, N, S, E, U			HB621x.638	F, Z, S, U		
X3		2004-2010	All	HB464x.764	F, Z, Y, N, U, G, V, S, E			HB518x.642	F, Z, Y, N, U, G, S, E		
X5	3.0i	2001-2006	All	Will not fit 4.6iS	HB325x.720	F, Z, Y, N, S		HB518x.642	F, Z, Y, N, U, G, S, E		
X5	3.0si	2007-2008	All		HB708x.738	F, Z		HB458x.642	F, Z		
X5	4.4i	2000-2006	All	Will not fit 4.6iS	HB325x.720	F, Z, Y, N, S		HB518x.642	F, Z, Y, N, U, G, S, E		
X5	4.8i	2007-2008	All		HB708x.738	F, Z		HB630x.626	F, Z, N, U		
X5	Xdrive30i	2009-2010	All		HB708x.738	F, Z		HB458x.642	F, Z		
X5	Xdrive35d	2009-2013	All		HB708x.738	F, Z		HB458x.642	F, Z		
X5	Xdrive35i	2011-2013	All		HB708x.738	F, Z		HB458x.642	F, Z		
X5	Xdrive48i	2009-2010	All		HB708x.738	F, Z		HB630x.626	F, Z, N, U		
X5	Xdrive50i	2011-2013	All					HB630x.626	F, Z, N, U		
X6	Xdrive35i	2008-2009	All		HB708x.738	F, Z		HB630x.626	F, Z, N, U		
X6	Xdrive35i	2010-2013	All		HB708x.738	F, Z		HB458x.642	F, Z		
X6	Xdrive50i		All					HB630x.626	F, Z, N, U		
Z3	Coupe	1999-2000	All		HB546x.654	F, Z, N, S, U		HB227x.630	F, Z, N, U, G, S, E		
Z3	Coupe	2001-2002	2.5		HB546x.654	F, Z, N, S, U		HB227x.630	F, Z, N, U, G, S, E		
Z3	Coupe	2001-2002	3.0		HB546x.654	F, Z, N, S, U	HUS619	HKx619546	HB227x.630	F, Z, N, U, G, S, E	
Z3	M Coupe	1999-2002	All		HB135x.770	F, Z, N, U, G, V, S, E		HB227x.630	F, Z, N, U, G, S, E		
Z3	M Roadster	1998-2002	All		HB135x.770	F, Z, N, U, G, V, S, E		HB227x.630	F, Z, N, U, G, S, E		
Z3	Roadster	1996-1999	All		HB136x.690	F, Z, N, U, G, S, E		HB227x.630	F, Z, N, U, G, S, E		
Z3	Roadster	2000-2000	All		HB546x.654	F, Z, N, S, U		HB227x.630	F, Z, N, U, G, S, E		
Z3	Roadster	2001-2002	2.5		HB546x.654	F, Z, N, S, U		HB227x.630	F, Z, N, U, G, S, E		
Z3	Roadster	2001-2002	3.0		HB546x.654	F, Z, N, S, U	HUS619	HKx619546	HB227x.630	F, Z, N, U, G, S, E	
Z4	2.5i	2004-2005	2.5		HB546x.654	F, Z, N, S, U		HB227x.630	F, Z, N, U, G, S, E		
Z4	3.0i	2004-2005	3.0		HB546x.654	F, Z, N, S, U	HUS619	HKx619546	HB227x.630	F, Z, N, U, G, S, E	
Z4	Coupe 3.0si	2006-2008	3.0		HB464x.764	F, Z, Y, N, U, G, V, S, E	HUS619	HKx619464	HB227x.630	F, Z, N, U, G, S, E	

APPLICATION GUIDE

BRAKE PAD CODE BREAKDOWN

PAD/ROTOR KIT CODE BREAKDOWN

H B 2 4 5 x . 6 3 1
 HAWK BRAKE PAD SHAPE INSERT COMPOUND CODE PAD THICKNESS

H K x 4 2 8 4 4 8
 HAWK KIT INSERT COMPOUND CODE ROTOR PAD SHAPE

MAKE/ MODEL	SUBMODEL	YRS.	ENGINE (LITER)	NOTE	FRONT				REAR			
					PADS	PAD COMPOUND	ROTORS	PAD/ROTOR KIT	PADS	PAD COMPOUND	ROTORS	PAD/ROTOR KIT
BMW CONTINUED												
Z4	M Coupe	2006-2008	All		HB464x.764	F, Z, Y, N, U, G, V, S, E			HB518x.642	F, Z, Y, N, U, G, S, E		
Z4	M Roadster	2006-2008	All		HB464x.764	F, Z, Y, N, U, G, V, S, E			HB518x.642	F, Z, Y, N, U, G, S, E		
Z4	Roadster	2003-2003	2.5		HB546x.654	F, Z, N, S, U			HB227x.630	F, Z, N, U, G, S, E		
Z4	Roadster 3.0i	2006-2008	3.0		HB546x.654	F, Z, N, S, U	HUS619	HKx619546	HB227x.630	F, Z, N, U, G, S, E		
Z4	Roadster 3.0si	2006-2008	3.0		HB464x.764	F, Z, Y, N, U, G, V, S, E	HUS619	HKx619464	HB227x.630	F, Z, N, U, G, S, E		
Z4	Sdrive30i	2011-2012	All		HB534x.750	F, Z, N, S, U			HB669x.671	F, N, Z		
Z4	Sdrive35i	2011-2012	All		HB534x.750	F, Z, N, S, U			HB669x.671	F, N, Z		
Z4	Sdrive35is	2011-2012	All	Wear sensor, front pads F & Z only	HB551x.748	F, Z, N, S, E, U						
Z4		2009-2010	All		HB534x.750	F, Z, N, S, U			HB669x.671	F, N, Z		
Z8		2000-2003	All		HB497x.776	F, Z, U, S			HB518x.642	F, Z, Y, N, U, G, S, E		
BUICK												
Allure		2009-2009	All		HB535x.638	F			HB359x.543	F, Z, G		
Apollo	SR	1975-1975	All		HB103x.590	F, Z, Y, P, N, U, G W, H, S, L, E, M						
Apollo		1973-1975	All		HB103x.590	F, Z, Y, P, N, U, G W, H, S, L, E, M						
Centurion		1972-1973	All		HB103x.590	F, Z, Y, P, N, U, G W, H, S, L, E, M						
Century	Custom	1975-1977	All		HB103x.590	F, Z, Y, P, N, U, G W, H, S, L, E, M						
Century	Custom	1978-1979	All		HB119x.594	F, Z, Y, P, N, U, G, W H, S, L, E, M, A						
Century	Custom	1982-1986	All		HB400x.630	F						
Century	Custom	1987-1989	All	w/Standard Brakes	HB400x.630	F						
Century	Custom	1997-2000	All		HB360x.670	F, Z						
Century	Custom	2001-2005	All		HB360x.670	F, Z			HB359x.543	F, Z, G		
Century	Estate Wagon	1981-1981	All		HB119x.594	F, Z, Y, P, N, U, G W, H, S, L, E, M, A						
Century	Estate Wagon	1984-1986	All		HB400x.630	F						
Century	Estate Wagon	1987-1989	All	w/Standard Brakes	HB400x.630	F						
Century	Limited	1978-1981	All		HB119x.594	F, Z, Y, P, N, U, G W, H, S, L, E, M, A						
Century	Limited	1997-2005	All		HB360x.670	F, Z						
Century	Luxus	1973-1974	All		HB103x.590	F, Z, Y, P, N, U, G W, H, S, L, E, M						
Century	Special	1975-1977	All		HB103x.590	F, Z, Y, P, N, U, G W, H, S, L, E, M						
Century	Special	1978-1979	All		HB119x.594	F, Z, Y, P, N, U, G W, H, S, L, E, M, A						
Century	Special Edition	2005-2005	All		HB360x.670	F, Z			HB359x.543	F, Z, G		
Century	Sport	1978-1980	All		HB119x.594	F, Z, Y, P, N, U, G W, H, S, L, E, M, A						
Century	T-Type	1983-1986	All	w/Standard Brakes	HB400x.630	F						
Century		1973-1977	All		HB103x.590	F, Z, Y, P, N, U, G W, H, S, L, E, M						
Century		1980-1981	All		HB119x.594	F, Z, Y, P, N, U, G W, H, S, L, E, M, A						
Century		2003-2003	All		HB360x.670	F, Z			HB359x.543	F, Z, G		
Electra	225	1972-1978	All		HB103x.590	F, Z, Y, P, N, U, G W, H, S, L, E, M, A			HB103x.590	F, Z, Y, P, N, U, G W, H, S, L, E, M, A		
Electra	225	1979-1979	All		HB103x.590	F, Z, Y, P, N, U, G W, H, S, L, E, M, A						

RACE PAD COMPOUNDS

DTC-70 - U	DTC-05 - H	MT-4 - L	HP Plus - N
DTC-60 - G	HT-14 - V	Blue 9012 - E	
DTC-30 - W	HT-10 - S	Black - M	
DTC-15 - A	Metallic - MB	DR-97 - J	

STREET PAD COMPOUNDS

HPS Performance Street - F	LTS Light Truck & SUV - Y
Performance Ceramic - Z	SuperDuty - P

MAKE/ MODEL	SUBMODEL	ENGINE YRS. (LITER)	NOTE	FRONT				REAR			
				PADS	PAD COMPOUND	ROTORS	PAD/ROTOR KIT	PADS	PAD COMPOUND	ROTORS	PAD/ROTOR KIT
BUICK CONTINUED											
Electra	225 Custom	1972-1975	All	HB103x.590	F, Z, Y, P, N, U, G W, H, S, L, E, M, A			HB103x.590	F, Z, Y, P, N, U, G W, H, S, L, E, M, A		
Electra	225 Limited	1974-1977	All	HB103x.590	F, Z, Y, P, N, U, G W, H, S, L, E, M, A			HB103x.590	F, Z, Y, P, N, U, G W, H, S, L, E, M, A		
Electra	Estate Wagon	1980-1989	All	HB103x.590	F, Z, Y, P, N, U, G W, H, S, L, E, M, A						
Electra	Limited	1976-1978	All	HB103x.590	F, Z, Y, P, N, U, G W, H, S, L, E, M, A			HB103x.590	F, Z, Y, P, N, U, G W, H, S, L, E, M, A		
Electra	Limited	1979-1984	All	HB103x.590	F, Z, Y, P, N, U, G W, H, S, L, E, M, A						
Electra	Park Avenue	1978-1978	All	HB103x.590	F, Z, Y, P, N, U, G W, H, S, L, E, M, A			HB103x.590	F, Z, Y, P, N, U, G W, H, S, L, E, M, A		
Electra	Park Avenue	1979-1984	All	HB103x.590	F, Z, Y, P, N, U, G W, H, S, L, E, M, A						
Electra		1973-1973	All	HB103x.590	F, Z, Y, P, N, U, G W, H, S, L, E, M, A			HB103x.590	F, Z, Y, P, N, U, G W, H, S, L, E, M, A		
Enclave		2008-2013	All	HB617x.630	Y, Z			HB383x.685	F, Y		
Estate Wagon		1972-1979	All	HB103x.590	F, Z, Y, P, N, U, G W, H, S, L, E, M, A						
GS		1972-1972	All	HB103x.590	F, Z, Y, P, N, U, G W, H, S, L, E, M, A						
GS 455		1972-1972	All	HB103x.590	F, Z, Y, P, N, U, G W, H, S, L, E, M, A						
Lacrosse	CX	2005-2008	All					HB450x.555	F, Z		
Lacrosse	CX	2009-2009	All	HB535x.638	F			HB359x.543	F, Z, G		
Lacrosse	CXL	2005-2008	All					HB450x.555	F, Z		
Lacrosse	CXL	2009-2009	All	HB535x.638	F			HB359x.543	F, Z, G		
Lacrosse	CXS	2005-2008	All					HB450x.555	F, Z		
Lacrosse	Super	2008-2009	All	HB535x.638	F			HB359x.543	F, Z, G		
Lesabre	Custom	1972-1990	All	HB103x.590	F, Z, Y, P, N, U, G W, H, S, L, E, M, A						
Lesabre	Custom	1994-1998	All	HB217x.681	F, Z, E						
Lesabre	Custom	2000-2005	All	w/12 in. Front Discs HB360x.670	F, Z	HUS8664	HKx8664360	HB359x.543	F, Z, G		
Lesabre	Estate Wagon	1980-1990	All	HB103x.590	F, Z, Y, P, N, U, G W, H, S, L, E, M, A						
Lesabre	Limited	1979-1985	All	HB103x.590	F, Z, Y, P, N, U, G W, H, S, L, E, M, A						
Lesabre	Limited	1994-1998	All	HB217x.681	F, Z, E						
Lesabre	Limited	2000-2005	All	w/12 in. Front Discs HB360x.670	F, Z	HUS8664	HKx8664360	HB359x.543	F, Z, G		
Lesabre	Luxus	1974-1974	All	HB103x.590	F, Z, Y, P, N, U, G W, H, S, L, E, M, A						
Lesabre	Sport	1978-1980	All	HB103x.590	F, Z, Y, P, N, U, G W, H, S, L, E, M, A						
Lesabre		1972-1981	All	HB103x.590	F, Z, Y, P, N, U, G W, H, S, L, E, M, A						
Lesabre		1999-1999	All	HB217x.681	F, Z, E						
Lucerne		2009-2011	All	HB535x.638	F						
Park Avenue	Ultra	1994-1996	All	HB217x.681	F, Z, E						
Park Avenue	Ultra	1997-2005	All	HB360x.670	F, Z	HUS8664	HKx8664360	HB359x.543	F, Z, G		
Park Avenue		1994-1996	All	HB217x.681	F, Z, E						
Park Avenue		1997-2005	All	HB360x.670	F, Z	HUS8664	HKx8664360	HB359x.543	F, Z, G		
Rainier	Sport	2006-2008	All	HB617x.630	Y, Z			HB383x.685	F, Y		
Rainier		2004-2005	All	HB382x.657	F, Y			HB383x.685	F, Y		

BRAKE PAD CODE BREAKDOWN

H B **2 4 5** **x** **.6 3 1**

HAWK BRAKE PAD SHAPE INSERT COMPOUND CODE PAD THICKNESS

PAD/ROTOR KIT CODE BREAKDOWN

HK **x** **4 2 8** **4 4 8**

HAWK KIT INSERT COMPOUND CODE ROTOR PAD SHAPE

MAKE/ MODEL	SUBMODEL	ENGINE YRS. (LITER)	NOTE	FRONT				REAR			
				PADS	PAD COMPOUND	ROTORS	PAD/ROTOR KIT	PADS	PAD COMPOUND	ROTORS	PAD/ROTOR KIT
BUICK CONTINUED											
Rainier		2006-2008	All	HB617x.630	Y, Z			HB383x.685	F, Y		
Regal	Custom	1988-1993	All	HB232x.681	F						
Regal	Custom	1994-1996	All	HB232x.681	F			HB359x.543	F, Z, G		
Regal	Estate Wagon	1982-1983	All	HB119x.594	F, Z, Y, P, N, U, G W, H, S, L, E, M, A	HUS8213	HKx8213119				
Regal	Gran Sport	1992-1993	All	HB232x.681	F						
Regal	Gran Sport	1994-1996	All	HB232x.681	F			HB359x.543	F, Z, G		
Regal	Grand National	1984-1987	All	HB119x.594	F, Z, Y, P, N, U, G W, H, S, L, E, M, A	HUS8213	HKx8213119				
Regal	GS	1997-2004	All	HB360x.670	F, Z			HB359x.543	F, Z, G		
Regal	Limited	1978-1981	All	HB119x.594	F, Z, Y, P, N, U, G W, H, S, L, E, M, A						
Regal	Limited	1982-1987	All	HB119x.594	F, Z, Y, P, N, U, G W, H, S, L, E, M, A	HUS8213	HKx8213119				
Regal	Limited	1988-1993	All	HB232x.681	F						
Regal	Limited	1994-1996	All	HB232x.681	F			HB359x.543	F, Z, G		
Regal	LS	1997-2004	All	HB360x.670	F, Z			HB359x.543	F, Z, G		
Regal	Sport	1978-1981	All	HB119x.594	F, Z, Y, P, N, U, G W, H, S, L, E, M, A						
Regal	Sport	1982-1982	All	HB119x.594	F, Z, Y, P, N, U, G W, H, S, L, E, M, A	HUS8213	HKx8213119				
Regal	T-Type	1983-1986	All	HB119x.594	F, Z, Y, P, N, U, G W, H, S, L, E, M, A	HUS8213	HKx8213119				
Regal		1973-1977	All	HB103x.590	F, Z, Y, P, N, U, G W, H, S, L, E, M, A						
Regal		1978-1981	All	HB119x.594	F, Z, Y, P, N, U, G W, H, S, L, E, M, A						
Regal		1982-1983	All	HB119x.594	F, Z, Y, P, N, U, G W, H, S, L, E, M, A	HUS8213	HKx8213119				
Regal		1999-2004	All	HB360x.670	F, Z			HB359x.543	F, Z, G		
Regal	Turbo GS	2013	All	HB453x.585	F, Z, N, U, G, W, V, S, E						
Rendezvous	CX	2006-2007	All	HB373x.689	F			HB359x.543	F, Z, G		
Rendezvous	CXL	2006-2007	All	HB373x.689	F			HB359x.543	F, Z, G		
Rendezvous	CXL Plus	2005-2005	All	HB373x.689	F			HB359x.543	F, Z, G		
Rendezvous	Ultra	2004-2005	All	HB373x.689	F			HB359x.543	F, Z, G		
Rendezvous		2002-2005	All	HB373x.689	F			HB359x.543	F, Z, G		
Riviera	S	1979-1980	All	HB119x.594	F, Z, Y, P, N, U, G W, H, S, L, E, M, A			HB119x.594	F, Z, Y, P, N, U, G W, H, S, L, E, M, A		
Riviera	T-Type	1981-1985	All	HB119x.594	F, Z, Y, P, N, U, G W, H, S, L, E, M, A			HB119x.594	F, Z, Y, P, N, U, G W, H, S, L, E, M, A		
Riviera		1972-1978	All	HB103x.590	F, Z, Y, P, N, U, G W, H, S, L, E, M, A						
Riviera		1979-1985	All	HB119x.594	F, Z, Y, P, N, U, G W, H, S, L, E, M, A			HB119x.594	F, Z, Y, P, N, U, G W, H, S, L, E, M, A		
Riviera		1995-1996	All	HB217x.681	F, Z, E			HB359x.543	F, Z, G		
Riviera		1997-1999	All	HB360x.670	F, Z	HUS8664	HKx8664360	HB359x.543	F, Z, G		
Roadmaster	Estate	1991-1991	All	HB103x.590	F, Z, Y, P, N, U, G W, H, S, L, E, M, A						
Roadmaster	Limited	1992-1996	All	HB103x.590	F, Z, Y, P, N, U, G W, H, S, L, E, M, A						
Roadmaster	Limited Wagon	1996-1996	All	HB103x.590	F, Z, Y, P, N, U, G W, H, S, L, E, M, A						
Roadmaster		1991-1996	All	HB103x.590	F, Z, Y, P, N, U, G W, H, S, L, E, M, A						

RACE PAD COMPOUNDS

DTC-70 - U	DTC-05 - H	MT-4 - L	HP Plus - N
DTC-60 - G	HT-14 - V	Blue 9012 - E	
DTC-30 - W	HT-10 - S	Black - M	
DTC-15 - A	Metallic - MB	DR-97 - J	

STREET PAD COMPOUNDS

HPS Performance Street - F	LTS Light Truck & SUV - Y
Performance Ceramic - Z	SuperDuty - P

MAKE/ MODEL	SUBMODEL	ENGINE YRS. (LITER)	NOTE	FRONT				REAR			
				PADS	PAD COMPOUND	ROTORS	PAD/ROTOR KIT	PADS	PAD COMPOUND	ROTORS	PAD/ROTOR KIT
BUICK CONTINUED											
Skyhawk	Custom	1982-1987	All		HB400x.630	F					
Skyhawk	Limited	1982-1987	All		HB400x.630	F					
Skyhawk	Sport	1986-1987	All		HB400x.630	F					
Skyhawk		1975-1975	All		HB103x.590	F, Z, Y, P, N, U, G W, H, S, L, E, M, A					
Skyhawk		1988-1989	All		HB400x.630	F					
Skylark	Custom	1972-1979	All		HB103x.590	F, Z, Y, P, N, U, G W, H, S, L, E, M, A					
Skylark	Custom	1983-1989	All		HB400x.630	F					
Skylark	Custom	1990-1990	All	w/o Performance Package	HB400x.630	F					
Skylark	Custom	1990-1990	All	w/Performance Package	HB390x.602	F					
Skylark	Custom	1991-1997	All		HB390x.602	F					
Skylark	Gran Sport	1990-1990	All	w/o Performance Package	HB400x.630	F					
Skylark	Gran Sport	1990-1990	All	w/Performance Package	HB390x.602	F					
Skylark	Gran Sport	1991-1997	All		HB390x.602	F					
Skylark	Limited	1980-1989	All		HB400x.630	F					
Skylark	Limited	1993-1997	All		HB390x.602	F					
Skylark	Luxury Edition	1990-1990	All	w/o Performance Package	HB400x.630	F					
Skylark	Luxury Edition	1990-1990	All	w/Performance Package	HB390x.602	F					
Skylark	Luxury Edition	1991-1991	All		HB390x.602	F					
Skylark	S	1976-1979	All		HB103x.590	F, Z, Y, P, N, U, G W, H, S, L, E, M, A					
Skylark	Sport	1980-1982	All		HB400x.630	F					
Skylark	SR	1975-1977	All		HB103x.590	F, Z, Y, P, N, U, G W, H, S, L, E, M, A					
Skylark	T-Type	1983-1984	All		HB400x.630	F					
Skylark		1972-1979	All		HB103x.590	F, Z, Y, P, N, U, G W, H, S, L, E, M, A					
Skylark		1980-1982	All		HB400x.630	F					
Skylark		1990-1990	All	w/o Performance Package	HB400x.630	F					
Skylark		1990-1990	All	w/Performance Package	HB390x.602	F					
Skylark		1991-1992	All		HB390x.602	F					
Skylark		1998-1998	All		HB390x.602	F					
Somerset	Limited	1986-1987	All		HB400x.630	F					
Somerset	Regal	1985-1985	All		HB400x.630	F					
Somerset	Regal Limited	1985-1985	All		HB400x.630	F					
Somerset	T-Type	1986-1986	All		HB400x.630	F					
Somerset		1986-1987	All		HB400x.630	F					
Sportwagon		1972-1972	All		HB103x.590	F, Z, Y, P, N, U, G W, H, S, L, E, M, A					
Terraza	CX	2005-2007	All		HB360x.670	F, Z					
Terraza	CXL	2005-2007	All		HB360x.670	F, Z					
CADILLAC											
Cimarron		1982-1988	All		HB400x.630	F					
Commercial Chassis		1975-1984	All		HB103x.590	F, Z, Y, P, N, U, G W, H, S, L, E, M, A					
Concours		1994-1996	All		HB217x.681	F, Z, E			HB359x.543	F, Z, G	
Concours		1997-1999	All		HB360x.670	F, Z			HB359x.543	F, Z, G	
ATS		2013	All		HB453x.585	F, Z, N, U, G, W, V, S, E					
CTS	V	2004-2007	All		HB453x.585	F, Z, N, U, G, W, V, S, E			HB194x.570	F, Z, Y, N, U, V, S, E, W	

BRAKE PAD CODE BREAKDOWN

PAD/ROTOR KIT CODE BREAKDOWN

H B 2 4 5 x . 6 3 1
 HAWK BRAKE PAD SHAPE INSERT COMPOUND CODE PAD THICKNESS

H K x 4 2 8 4 4 8
 HAWK KIT INSERT COMPOUND CODE ROTOR PAD SHAPE

MAKE/ MODEL	SUBMODEL	YRS.	ENGINE (LITER)	NOTE	FRONT				REAR			
					PADS	PAD COMPOUND	ROTORS	PAD/ROTOR KIT	PADS	PAD COMPOUND	ROTORS	PAD/ROTOR KIT
CADILLAC CONTINUED												
CTS	V	2008-2013	All		HB649x.605	F, Z, U, G, W			HB194x.570	F, Z, Y, N, U, V, S, E, W		
CTS		2003-2005	All		HB439x.555	F, Z			HB440x.606	F, Z		
CTS		2006-2007	All	w/o Performance Package	HB439x.555	F, Z			HB440x.606	F, Z		
CTS		2007-2007	All	Sport Suspension	HB467x.540	F, Z						
CTS		2010 - 2013	All	Heavy Duty brakes					HB639x.645	F, Z, N, G		
CTS		2010 - 2013	All						HB639x.645	F, Z, N, G		
Deville	D-Elegance	1997-1997	All		HB360x.670	F, Z	HUS8664	HKx8664360	HB359x.543	F, Z, G		
Deville	DHS	2001-2005	All	w/Heavy Duty Brakes	HB322x.717	F, Z, Y, P	HUS8692	HKx8692322	HB359x.543	F, Z, G		
Deville	DHS	2001-2005	All	w/Standard Brakes	HB360x.670	F, Z	HUS8664	HKx8664360	HB359x.543	F, Z, G		
Deville	DTS	2001-2005	All	w/Heavy Duty Brakes	HB322x.717	F, Z, Y, P	HUS8692	HKx8692322	HB359x.543	F, Z, G		
Deville	DTS	2001-2005	All	w/Standard Brakes	HB360x.670	F, Z	HUS8664	HKx8664360	HB359x.543	F, Z, G		
Deville		1971-1984	All		HB103x.590	F, Z, Y, P, N, U, G W, H, S, L, E, M, A						
Deville		1994-1996	All		HB217x.681	F, Z, E			HB359x.543	F, Z, G		
Deville		1997-1999	All		HB360x.670	F, Z	HUS8664	HKx8664360	HB359x.543	F, Z, G		
Deville		2000-2005	All	w/Heavy Duty Brakes	HB322x.717	F, Z, Y, P	HUS8692	HKx8692322	HB359x.543	F, Z, G		
Deville		2000-2005	All	w/Standard Brakes	HB360x.670	F, Z	HUS8664	HKx8664360	HB359x.543	F, Z, G		
DTS	Platinum	2008-2008	All		HB535x.638	F						
DTS		2006-2011	All	w/Heavy Duty Brakes	HB322x.717	F, Z, Y, P			HB324x.673	F, Z, Y, P		
DTS		2006-2011	All	w/Standard Brakes	HB535x.638	F						
Eldorado	Biarritz	1984-1985	All		HB119x.594	F, Z, Y, P, N, U, G W, H, S, L, E, M, A			HB119x.594	F, Z, Y, P, N, U, G W, H, S, L, E, M, A		
Eldorado	ESC	2001-2002	All		HB360x.670	F, Z	HUS8664	HKx8664360	HB359x.543	F, Z, G		
Eldorado	ETC	1998-2002	All		HB360x.670	F, Z	HUS8664	HKx8664360	HB359x.543	F, Z, G		
Eldorado	Touring	1994-1996	All		HB217x.681	F, Z, E			HB359x.543	F, Z, G		
Eldorado	Touring	1997-1997	All		HB360x.670	F, Z	HUS8664	HKx8664360	HB359x.543	F, Z, G		
Eldorado		1971-1978	All		HB103x.590	F, Z, Y, P, N, U, G W, H, S, L, E, M, A						
Eldorado		1979-1985	All		HB119x.594	F, Z, Y, P, N, U, G W, H, S, L, E, M, A			HB119x.594	F, Z, Y, P, N, U, G W, H, S, L, E, M, A		
Eldorado		1994-1996	All		HB217x.681	F, Z, E			HB359x.543	F, Z, G		
Eldorado		1997-2000	All		HB360x.670	F, Z	HUS8664	HKx8664360	HB359x.543	F, Z, G		
Escalade	ESV	2007-2013	All		HB561x.710	F, Z, Y, P	HUS8657	HKx8657561	HB568x.666	F, Z, Y, P	HUS501	
Escalade	ESV Platinum	2008-2008	All		HB561x.710	F, Z, Y, P	HUS8657	HKx8657561	HB568x.666	F, Z, Y, P		
Escalade	EXT	2007-2013	All		HB561x.710	F, Z, Y, P	HUS8657	HKx8657561	HB568x.666	F, Z, Y, P	HUS501	
Escalade	Platinum	2008-2008	All		HB561x.710	F, Z, Y, P	HUS8657	HKx8657561	HB568x.666	F, Z, Y, P		
Escalade		1999-2000	All		HB332x.654	F, Z, Y, P						
Escalade		2002-2002	All		HB323x.724	F, Z, Y, P	HUS8690	HKx8690323	HB385x.640	F, Y		
Escalade		2003-2006	All	AWD	HB323x.724	F, Z, Y, P	HUS8690	HKx8690323	HB385x.640	F, Y		
Escalade		2003-2006	All	RWD	HB323x.724	F, Z, Y, P	HUS8690	HKx8690323	HB494x.670	F, Z, Y		
Escalade		2007-2013	All		HB561x.710	F, Z, Y, P	HUS8657	HKx8657561	HB568x.666	F, Z, Y, P	HUS501	
Fleetwood	60 Special	1971-1976	All		HB103x.590	F, Z, Y, P, N, U, G W, H, S, L, E, M, A						
Fleetwood	60 Special Brougham	1974-1974	All		HB103x.590	F, Z, Y, P, N, U, G W, H, S, L, E, M, A						
Fleetwood	75	1971-1976	All		HB103x.590	F, Z, Y, P, N, U, G W, H, S, L, E, M, A						
Fleetwood	Brougham	1977-1977	7.0		HB103x.590	F, Z, Y, P, N, U, G W, H, S, L, E, M, A						
Fleetwood	Brougham	1978-1978	All		HB103x.590	F, Z, Y, P, N, U, G W, H, S, L, E, M, A			HB103x.590	F, Z, Y, P, N, U, G W, H, S, L, E, M, A		

APPLICATION GUIDE

RACE PAD COMPOUNDS

DTC-70 - U	DTC-05 - H	MT-4 - L	HP Plus - N
DTC-60 - G	HT-14 - V	Blue 9012 - E	
DTC-30 - W	HT-10 - S	Black - M	
DTC-15 - A	Metallic - MB	DR-97 - J	

STREET PAD COMPOUNDS

HPS Performance Street - F	LTS Light Truck & SUV - Y
Performance Ceramic - Z	SuperDuty - P

MAKE/ MODEL	SUBMODEL	YRS.	ENGINE (LITER)	NOTE	FRONT				REAR			
					PADS	PAD COMPOUND	ROTOR	PAD/ROTOR KIT	PADS	PAD COMPOUND	ROTOR	PAD/ROTOR KIT
CADILLAC CONTINUED												
Fleetwood	Brougham	1980-1996	All		HB103x.590	F, Z, Y, P, N, U, G W, H, S, L, E, M, A						
Fleetwood	Formal	1977-1984	All		HB103x.590	F, Z, Y, P, N, U, G W, H, S, L, E, M, A						
Fleetwood		1971-1985	All		HB103x.590	F, Z, Y, P, N, U, G W, H, S, L, E, M, A						
Fleetwood		1991-1993	All		HB332x.654	F, Z, Y, P						
Seville	SLS	1994-1996	All		HB217x.681	F, Z, E			HB359x.543	F, Z, G		
Seville	SLS	1997-2002	All		HB360x.670	F, Z	HUS8664	HKx8664360	HB359x.543	F, Z, G		
Seville	SLS	2003-2003	All		HB360x.670	F, Z			HB359x.543	F, Z, G		
Seville	SLS	2004-2004	All		HB360x.670	F, Z						
Seville	STS	1994-1996	All		HB217x.681	F, Z, E			HB359x.543	F, Z, G		
Seville	STS	1997-2002	All		HB360x.670	F, Z	HUS8664	HKx8664360	HB359x.543	F, Z, G		
Seville	STS	2003-2003	All		HB360x.670	F, Z			HB359x.543	F, Z, G		
Seville		1976-1979	All		HB103x.590	F, Z, Y, P, N, U, G W, H, S, L, E, M, A						
Seville		1980-1985	All		HB119x.594	F, Z, Y, P, N, U, G W, H, S, L, E, M, A			HB119x.594	F, Z, Y, P, N, U, G W, H, S, L, E, M, A		
Seville		1999-2000	All		HB360x.670	F, Z	HUS8664	HKx8664360	HB359x.543	F, Z, G		
SRX		2004-2009	All		HB467x.540	F, Z						
SRX		2010 - 2013	All						HB639x.645	F, Z, N, G		
STS	Platinum	2008-2008	All	w/Standard Brakes	HB467x.540	F, Z			HB440x.606	F, Z		
STS	Platinum	2008-2010	All	w/Heavy Duty Brakes	HB453x.585	F, Z, N, U, G, W, V, S, E			HB194x.570	F, Z, Y, N, U, V, S, E, W		
STS	V	2006-2009	All		HB453x.585	F, Z, N, U, G, W, V, S, E			HB194x.570	F, Z, Y, N, U, V, S, E, W		
STS		2005-2008	All	w/Performance Brakes	HB467x.540	F, Z						
STS		2005-2008	All	w/Standard Brakes	HB439x.555	F, Z			HB440x.606	F, Z		
XTS		2013	All	Heavy Duty brakes	HB453x.585	F, Z, N, U, G, W, V, S, E			HB383x.685	F, Y		
XTS		2013	All		HB561x.710	F, Z, Y, P						
XLR	Platinum	2008-2009	All		HB247x.575	F, Z, N, U, G, W, V, S, E			HB248x.650	F, Z, N, U, G, W, S, E		
XLR	V	2006-2008	All		HB247x.575	F, Z, N, U, G, W, V, S, E			HB248x.650	F, Z, N, U, G, W, S, E		
XLR		2004-2009	All		HB247x.575	F, Z, N, U, G, W, V, S, E			HB248x.650	F, Z, N, U, G, W, S, E		
CHEVROLET												
Astro		1985-1989	All		HB103x.590	F, Z, Y, P, N, U, G W, H, S, L, E, M, A						
Astro		1990-1992	All	RWD	HB103x.590	F, Z, Y, P, N, U, G W, H, S, L, E, M, A						
Astro		1990-2002	All	AWD	HB332x.654	F, Z, Y, P						
Astro		2003-2005	All		HB323x.724	F, Z, Y, P	HUS8690	HKx8690323	HB324x.673	F, Z, Y, P	HUS8694	HKx8694324
Avalanche	LS	2007-2008	All		HB561x.710	F, Z, Y, P	HUS8657	HKx8657561	HB568x.666	F, Z, Y, P	HUS501	
Avalanche	LS	2009-2013	All		HB561x.710	F, Z, Y, P			HB568x.666	F, Z, Y, P	HUS501	
Avalanche	LT	2007-2008	All		HB561x.710	F, Z, Y, P	HUS8657	HKx8657561	HB568x.666	F, Z, Y, P	HUS501	
Avalanche	LT	2009-2013	All		HB561x.710	F, Z, Y, P			HB568x.666	F, Z, Y, P	HUS501	
Avalanche	LTZ	2007-2008	All		HB561x.710	F, Z, Y, P	HUS8657	HKx8657561	HB568x.666	F, Z, Y, P	HUS501	
Avalanche	LTZ	2009-2013	All		HB561x.710	F, Z, Y, P			HB568x.666	F, Z, Y, P	HUS501	
Avalanche	Police	2010-2013	All		HB561x.710	F, Z, Y, P			HB568x.666	F, Z, Y, P	HUS501	
Avalanche 1500	LT	2006-2006	All	2WD	HB323x.724	F, Z, Y, P	HUS8690	HKx8690323	HB494x.670	F, Z, Y	HUS8695	HKx8695494
Avalanche 1500	LT	2006-2006	All	4WD	HB323x.724	F, Z, Y, P	HUS8690	HKx8690323	HB496x.640	F, Z, Y	HUS8695	HKx8695496
Avalanche 1500	Z66	2006-2006	All	2WD	HB323x.724	F, Z, Y, P	HUS8690	HKx8690323	HB494x.670	F, Z, Y	HUS8695	HKx8695494
Avalanche 1500	Z71	2006-2006	All	4WD	HB323x.724	F, Z, Y, P	HUS8690	HKx8690323	HB496x.640	F, Z, Y	HUS8695	HKx8695496
Avalanche 1500		2002-2002	All	w/limited slip and dual piston rear caliper	HB323x.724	F, Z, Y, P	HUS8690	HKx8690323	HB385x.640	F, Y		

APPLICATION GUIDE

BRAKE PAD CODE BREAKDOWN

H B **2 4 5** **x** **.6 3 1**

HAWK BRAKE PAD SHAPE INSERT COMPOUND CODE PAD THICKNESS

PAD/ROTOR KIT CODE BREAKDOWN

HK **x** **4 2 8** **4 4 8**

HAWK KIT INSERT COMPOUND CODE ROTOR PAD SHAPE

MAKE/ MODEL	SUBMODEL	ENGINE YRS. (LITER)	NOTE	FRONT				REAR				
				PADS	PAD COMPOUND	ROTORS	PAD/ROTOR KIT	PADS	PAD COMPOUND	ROTORS	PAD/ROTOR KIT	
CHEVROLET CONTINUED												
Avalanche 1500		2002-2002	All	w/Single Piston Rear Caliper 18.5 Min Thick Rr Rotor	HB323x.724	F, Z, Y, P	HUS8690	HKx8690323	HB324x.673	F, Z, Y, P	HUS8694	HKx8694324
Avalanche 1500		2002-2002	All	w/Single Piston Rear Caliper 28.5 Min Thick Rr Rotor	HB323x.724	F, Z, Y, P	HUS8690	HKx8690323	HB324x.673	F, Z, Y, P	HUS8695	HKx8695324
Avalanche 1500		2003-2005	All	2WD	HB323x.724	F, Z, Y, P	HUS8690	HKx8690323	HB494x.670	F, Z, Y	HUS8695	HKx8695494
Avalanche 1500		2003-2005	All	4WD	HB323x.724	F, Z, Y, P	HUS8690	HKx8690323	HB496x.640	F, Z, Y	HUS8695	HKx8695496
Avalanche 2500	LS	2002-2002	All	Except Factory 2 in. Body Lift	HB322x.717	F, Z, Y, P	HUS8692	HKx8692322	HB323x.724	F, Z, Y, P		
Avalanche 2500	LS	2002-2002	All	w/Factory 2 in. Body Lift	HB322x.717	F, Z, Y, P	HUS8659	HKx8659322	HB323x.724	F, Z, Y, P		
Avalanche 2500	LS	2003-2008	All	Except Factory 2 in. Body Lift	HB322x.717	F, Z, Y, P	HUS8692	HKx8692322	HB323x.724	F, Z, Y, P	HUS8691	HKx8691323
Avalanche 2500	LS	2003-2008	All	w/Factory 2 in. Body Lift	HB322x.717	F, Z, Y, P	HUS8659	HKx8659322	HB323x.724	F, Z, Y, P	HUS8691	HKx8691323
Avalanche 2500	LT	2002-2002	All	Except Factory 2 in. Body Lift	HB322x.717	F, Z, Y, P	HUS8692	HKx8692322	HB323x.724	F, Z, Y, P		
Avalanche 2500	Lt	2002-2002	All	w/Factory 2 in. Body Lift	HB322x.717	F, Z, Y, P	HUS8659	HKx8659322	HB323x.724	F, Z, Y, P		
Avalanche 2500	LT	2003-2008	All	Except Factory 2 in. Body Lift	HB322x.717	F, Z, Y, P	HUS8692	HKx8692322	HB323x.724	F, Z, Y, P	HUS8691	HKx8691323
Avalanche 2500	LT	2003-2008	All	w/Factory 2 in. Body Lift	HB322x.717	F, Z, Y, P	HUS8659	HKx8659322	HB323x.724	F, Z, Y, P	HUS8691	HKx8691323
Aveo		2004-2011	All		HB592x.665	F						
Aveo5		2007-2011	All		HB592x.665	F						
B6p042		1983-1990	All		HB253x.750	P			HB253x.750	P		
B7i042		1992-1997	All		HB253x.750	P			HB253x.750	P		
Bel Air		1968-1975	All		HB103x.590	F, Z, Y, P, N, U, G W, H, S, L, E, M, A						
Beretta	GT	1989-1991	All		HB400x.630	F						
Beretta	GT	1992-1993	All		HB390x.602	F						
Beretta	GTZ	1990-1991	All		HB400x.630	F						
Beretta	GTZ	1992-1993	All		HB390x.602	F						
Beretta	Z26	1994-1996	All		HB390x.602	F						
Beretta		1987-1991	All		HB400x.630	F						
Beretta		1992-1996	All		HB390x.602	F						
Blazer		1969-1991	All		HB103x.590	F, Z, Y, P, N, U, G W, H, S, L, E, M, A						
Blazer		1992-1994	All		HB332x.654	F, Z, Y, P						
Blazer (S10 Series)		1995-1997	All	w/Rear Drum Brakes	HB119x.594	F, Z, Y, P, N, U, G W, H, S, L, E, M, A						
Blazer (S10 Series)		1997-2005	All	w/Rear Disc Brakes	HB304x.598	F, Z, Y			HB305x.610	F, Z, Y, P		
C1500 Pickup		1988-1991	All	Extended Cab	HB332x.654	F, Z, Y, P						
C1500 Pickup		1992-1999	All		HB332x.654	F, Z, Y, P						
C20 Pickup		1979-1986	All	w/11 in. Rear Drums	HB103x.590	F, Z, Y, P, N, U, G W, H, S, L, E, M, A						
C20 Pickup		1979-1986	All	w/13 in. Rear Drums	HB131x.595	F, P, U, G, W, L, M						
C20/R20 Pickup		1987-1988	All		HB131x.595	F, P, U, G, W, L, M						
C2500 Pickup		1988-2000	All	7200 lbs. GVWR	HB332x.654	F, Z, Y, P						
C2500 Pickup		1988-2000	All	8600 lbs. GVWR	HB296x.670	F, Z, Y, P						
C2500 Pickup		2011-2011	All		HB705x.776	Y, P			HB705x.776	Y, P		
C2500/R2500 Pickup		1989-1989	All		HB131x.595	F, P, U, G, W, L, M						
C30 Pickup		1979-1986	All	w/13 x 2.5 in. Drums	HB131x.595	F, P, U, G, W, L, M						
C30/R30 Pickup		1987-1988	All		HB131x.595	F, P, U, G, W, L, M						
C3500 Pickup		1988-1989	All		HB296x.670	F, Z, Y, P						
C3500 Pickup		1990-1993	All	w/Rear Drum Brakes	HB296x.670	F, Z, Y, P						
C3500 Pickup		1990-2000	All	Drum Rear Dual Rear Wheel	HB298x.787	F, Y, P						
C3500 Pickup		1998-2000	All	Drum Rear Single Rear Wheel	HB296x.670	F, Z, Y, P						
C3500 Pickup		1998-2000	All	Drum Rear Dual Rear Wheel	HB298x.787	F, Y, P						

RACE PAD COMPOUNDS

DTC-70 - U	DTC-05 - H	MT-4 - L	HP Plus - N
DTC-60 - G	HT-14 - V	Blue 9012 - E	
DTC-30 - W	HT-10 - S	Black - M	
DTC-15 - A	Metallic - MB	DR-97 - J	

STREET PAD COMPOUNDS

HPS Performance Street - F	LTS Light Truck & SUV - Y
Performance Ceramic - Z	SuperDuty - P

MAKE/ MODEL	SUBMODEL	ENGINE YRS. (LITER)	NOTE	FRONT				REAR			
				PADS	PAD COMPOUND	ROTORS	PAD/ROTOR KIT	PADS	PAD COMPOUND	ROTORS	PAD/ROTOR KIT
CHEVROLET CONTINUED											
C3500 Pickup		2011-2011	All	HB705x.776	Y, P			HB705x.776	Y, P		
C3500/R3500 Pickup		1989-1991	All w/13 x 2.5 in. Drums	HB131x.595	F, P, U, G, W, L, M						
C6D042		1983-1990	All	HB253x.750	P			HB253x.750	P		
C6H042 Kodiak		1992-1994	All	HB253x.750	P			HB253x.750	P		
C6H042 Kodiak		1995-1997	All Front Dayton Calipers Rear 2 Piston Calipers	HB253x.750	P			HB253x.750	P		
C6H042 Kodiak		1995-1997	All Front Dayton Calipers Rear 4 Piston Calipers	HB253x.750	P			HB344x.992	P		
C7D042		1983-1990	All	HB253x.750	P						
C7H042 Kodiak		1992-1994	All	HB253x.750	P			HB344x.992	P		
C7H042 Kodiak		1995-1997	All Front Dayton Calipers Rear 2 Piston Calipers	HB253x.750	P			HB253x.750	P		
C7H042 Kodiak		1995-1997	All Front Dayton Calipers Rear 4 Piston Calipers	HB253x.750	P			HB344x.992	P		
Camaro	Iroc-Z	1990-1990	All w/Heavy Duty Brakes	HB111x.610	F, Z, N, U, G, S, E, M			HB112x.540	F, Z, N, U, G, S, E, M		
Camaro	Iroc-Z	1990-1990	All w/Standard Brakes	HB119x.594	F, Z, Y, P, N, U, G W, H, S, L, E, M, A	HUS8213	HKx8213119	HB112x.540	F, Z, N, U, G, S, E, M		
Camaro	LT	1976-1977	All	HB103x.590	F, Z, Y, P, N, U, G W, H, S, L, E, M, A						
Camaro	RS	1990-1992	All w/Heavy Duty Brakes	HB111x.610	F, Z, N, U, G, S, E, M			HB112x.540	F, Z, N, U, G, S, E, M		
Camaro	RS	1990-1992	All w/Standard Brakes	HB119x.594	F, Z, Y, P, N, U, G W, H, S, L, E, M, A	HUS8213	HKx8213119	HB112x.540	F, Z, N, U, G, S, E, M		
Camaro	RS	1996-1997	All	HB217x.681	F, Z, E			HB112x.540	F, Z, N, U, G, S, E, M		
Camaro	SS	1998-2002	5.7	HB249x.575	F, Z, N, U, G, W, V, S	HUS8664	HKx8664249	HB250x.653	F, Z, N, U, G, S, E	HUS8265	HKx8265250
Camaro	SS	2010-2012	6.2	HB453x.585	F, Z, N, U, G, W, V, S, E			HB194x.570	F, Z, Y, N, U, V, S, E, W		
Camaro	Z28	1967-1968	All w/4 Wheel Disc Brakes	HB126x.505	F, Z, N, S, E			HB126x.505	F, Z, N, S, E		
Camaro	Z28	1972-1972	All	HB103x.590	F, Z, Y, P, N, U, G W, H, S, L, E, M, A						
Camaro	Z28	1991-1992	All w/Heavy Duty Brakes	HB111x.610	F, Z, N, U, G, S, E, M			HB112x.540	F, Z, N, U, G, S, E, M		
Camaro	Z28	1991-1992	All w/Standard Brakes	HB119x.594	F, Z, Y, P, N, U, G W, H, S, L, E, M, A	HUS8213	HKx8213119	HB112x.540	F, Z, N, U, G, S, E, M		
Camaro	Z28	1994-1997	All	HB217x.681	F, Z, E			HB112x.540	F, Z, N, U, G, S, E, M		
Camaro	Z28	1998-2002	All	HB249x.575	F, Z, N, U, G, W, V, S	HUS8664	HKx8664249	HB250x.653	F, Z, N, U, G, S, E	HUS8265	HKx8265250
Camaro		1969-1981	All	HB103x.590	F, Z, Y, P, N, U, G W, H, S, L, E, M, A						
Camaro		1982-1987	All	HB119x.594	F, Z, Y, P, N, U, G W, H, S, L, E, M, A	HUS8213	HKx8213119	HB119x.594	F, Z, Y, P, N, U, G W, H, S, L, E, M, A		
Camaro		1988-1988	All w/Standard Brakes	HB119x.594	F, Z, Y, P, N, U, G W, H, S, L, E, M, A	HUS8213	HKx8213119	HB119x.594	F, Z, Y, P, N, U, G W, H, S, L, E, M, A		
Camaro		1988-1989	All w/Heavy Duty Brakes	HB111x.610	F, Z, N, U, G, S, E, M			HB112x.540	F, Z, N, U, G, S, E, M		
Camaro		1989-1989	All w/Standard Brakes	HB119x.594	F, Z, Y, P, N, U, G W, H, S, L, E, M, A	HUS8213	HKx8213119				
Camaro		1994-1997	All	HB217x.681	F, Z, E			HB112x.540	F, Z, N, U, G, S, E, M		
Camaro		1998-2002	All	HB249x.575	F, Z, N, U, G, W, V, S	HUS8664	HKx8664249	HB250x.653	F, Z, N, U, G, S, E	HUS8265	HKx8265250
Camaro	LS	2010-2013	3.6	HB638x.702	F, Z			HB639x.645	F, Z, N, G		
Camaro	LT	2010-2013	3.6	HB638x.702	F, Z			HB639x.645	F, Z, N, G		
Camaro		2010-2013	6.2	HB453x.585	F, Z, N, U, G, W, V, S, E			HB194x.570	F, Z, Y, N, U, V, S, E, W		
Camaro	ZL1	2012-2013	6.2	HB649x.605	F, Z, U, G, W			HB194x.570	F, Z, Y, N, U, V, S, E, W		
Caprice	Classic	1973-1993	All	HB103x.590	F, Z, Y, P, N, U, G W, H, S, L, E, M, A						
Caprice	Classic	1994-1996	All Except Police	HB103x.590	F, Z, Y, P, N, U, G W, H, S, L, E, M, A						
Caprice	Classic	1994-1996	All Police	HB131x.595	F, P, U, G, W, L, M						

BRAKE PAD CODE BREAKDOWN

H B 2 4 5 x . 6 3 1
 HAWK BRAKE PAD SHAPE INSERT COMPOUND CODE PAD THICKNESS

PAD/ROTOR KIT CODE BREAKDOWN

H K x 4 2 8 4 4 8
 HAWK KIT INSERT COMPOUND CODE ROTOR PAD SHAPE

MAKE/ MODEL	SUBMODEL	ENGINE YRS. (LITER)	NOTE	FRONT				REAR			
				PADS	PAD COMPOUND	ROTOR	PAD/ROTOR KIT	PADS	PAD COMPOUND	ROTOR	PAD/ROTOR KIT
CHEVROLET CONTINUED											
Caprice	Classic Brougham	1987-1990	All	HB103x.590	F, Z, Y, P, N, U, G W, H, S, L, E, M, A						
Caprice	Classic LS	1993-1994	All	HB103x.590	F, Z, Y, P, N, U, G W, H, S, L, E, M, A						
Caprice	Classic LTZ	1991-1993	All	HB103x.590	F, Z, Y, P, N, U, G W, H, S, L, E, M, A						
Caprice	Estate	1973-1977	All	HB103x.590	F, Z, Y, P, N, U, G W, H, S, L, E, M, A						
Caprice	LS	1994-1994	All	HB103x.590	F, Z, Y, P, N, U, G W, H, S, L, E, M, A						
Caprice		1968-1993	All	HB103x.590	F, Z, Y, P, N, U, G W, H, S, L, E, M, A						
Caprice		1994-1994	All	Except Police	HB103x.590	F, Z, Y, P, N, U, G W, H, S, L, E, M, A					
Caprice		1994-1994	All	Police	HB131x.595	F, P, U, G, W, L, M					
Caprice		2011-2011	All	Police	HB638x.702	F, Z			HB607x.616	F, Z, N	
Caprice		2012	6.0		HB638x.702	F, Z			HB607x.616	F, Z, N	
Caprice		2012	3.6		HB606x.650	F, Z, N			HB607x.616	F, Z, N	
Caprice		2013	All		HB606x.650	F, Z, N			HB607x.616	F, Z, N	
Cavalier	CL	1983-1983	All	HB400x.630	F						
Cavalier	CS	1983-1987	All	HB400x.630	F						
Cavalier	LS	1995-1998	All	HB390x.602	F						
Cavalier	RS	1986-1991	All	HB400x.630	F						
Cavalier	RS	1992-1998	All	HB390x.602	F						
Cavalier	Type-10	1984-1985	All	HB400x.630	F						
Cavalier	VL	1988-1991	All	HB400x.630	F						
Cavalier	VL	1992-1994	All	HB390x.602	F						
Cavalier	Z24	1986-1991	All	HB400x.630	F						
Cavalier	Z24	1992-1998	All	HB390x.602	F						
Cavalier		1982-1990	All	HB400x.630	F						
Cavalier		1995-2005	All	HB390x.602	F						
Celebrity		1982-1982	All	HB400x.630	F						
Celebrity		1987-1989	All	w/Standard Brakes	HB400x.630	F					
Chevelle		1966-1977	All	HB103x.590	F, Z, Y, P, N, U, G W, H, S, L, E, M, A						
Cheyenne		2013	All	HB561x.710	F, Z, Y, P						
Citation		1980-1985	All	HB400x.630	F						
Classic		2004-2005	All	HB425x.661	F						
Cobalt	LS	2006-2010	All	HB517x.690	F, Z						
Cobalt	LT	2006-2010	All	HB517x.690	F, Z						
Cobalt	LTZ	2006-2007	All	HB517x.690	F, Z						
Cobalt	SS	2005-2007	All	Standard brakes	HB524x.740	F, Z, N, U, G, S, E			HB525x.540	F, Z, N, G	
Cobalt	SS	2007-2010	All	With Brembo Brakes	HB548x.590	F, N, U, W			HB478x.605	F, Z, N, G, U, S, E	
Cobalt		2005-2005	All		HB517x.690	F, Z					
Colorado	LS	2006-2008	All	HB554x.643	F, Z, Y, P, G, U, W						
Colorado	LT	2006-2008	All	HB554x.643	F, Z, Y, P, G, U, W						
Colorado	Sport	2005-2005	All	HB554x.643	F, Z, Y, P, G, U, W						
Colorado	Sport LS	2005-2005	All	HB554x.643	F, Z, Y, P, G, U, W						
Colorado	WT	2006-2008	All	HB554x.643	F, Z, Y, P, G, U, W						
Colorado	Z71	2005-2005	All	HB554x.643	F, Z, Y, P, G, U, W						
Colorado	Z71 LS	2005-2005	All	HB554x.643	F, Z, Y, P, G, U, W						

RACE PAD COMPOUNDS

DTC-70 - U	DTC-05 - H	MT-4 - L	HP Plus - N
DTC-60 - G	HT-14 - V	Blue 9012 - E	
DTC-30 - W	HT-10 - S	Black - M	
DTC-15 - A	Metallic - MB	DR-97 - J	

STREET PAD COMPOUNDS

HPS Performance Street - F	LTS Light Truck & SUV - Y
Performance Ceramic - Z	SuperDuty - P

MAKE/ MODEL	SUBMODEL	ENGINE YRS. (LITER)	NOTE	FRONT				REAR				
				PADS	PAD COMPOUND	ROTOR	PAD/ROTOR KIT	PADS	PAD COMPOUND	ROTOR	PAD/ROTOR KIT	
CHEVROLET CONTINUED												
Colorado	Z85	2005-2005	All	HB554x.643	F, Z, Y, P, G, U, W							
Colorado	Z85 LS	2005-2005	All	HB554x.643	F, Z, Y, P, G, U, W							
Colorado		2004-2004	All	HB554x.643	F, Z, Y, P, G, U, W							
Colorado		2009-2012	All	HB617x.630	Y, Z							
Corsica	LT	1990-1991	All	HB400x.630	F							
Corsica	LT	1992-1993	All	HB390x.602	F							
Corsica	LTZ	1989-1990	All	HB400x.630	F							
Corsica		1987-1989	All	HB400x.630	F							
Corsica		1994-1996	All	HB390x.602	F							
Corvette	Base	2008-2013	All	HB247x.575	F, Z, N, U, G, W, V, S, E			HB248x.650	F, Z, N, U, G, W, S, E			
Corvette	Grand Sport	2010-2013	All	HB531x.570	F, Z, N, U			HB532x.570	F, Z, N, U, G			
Corvette	Grand Sport	2010-2013	All	One-Piece Pads	HB658x.570	F, Z, N, U		HB659x.570	F, Z, N, U, G			
Corvette	Z06	2001-2004	All	HB247x.575	F, Z, N, U, G, W, V, S, E	HUS8259	HKx8259247	HB248x.650	F, Z, N, U, G, W, S, E	HUS8261	HKx8261248	
Corvette	Z06	2006-2013	All	HB531x.570	F, Z, N, U			HB532x.570	F, Z, N, U, G			
Corvette	Z06	2006-2013	All	One-Piece Pads	HB658x.570	F, Z, N, U		HB659x.570	F, Z, N, U, G			
Corvette	Z06	2009-2011	All	w/Carbon Ceramic Brake Package and Iron Rotors	HB631x.622	F, N, Z, U		HB632x.586	F, N, Z, U			
Corvette	Z51	2005-2009	All	Z51 package brakes	HB247x.575	F, Z, N, U, G, W, V, S, E		HB248x.650	F, Z, N, U, G, W, S, E			
Corvette	ZR-1	1990-1995	All		HB111x.610	F, Z, N, U, G, S, E, M		HB112x.540	F, Z, N, U, G, S, E, M			
Corvette	ZR-1	2009-2013	All	w/Carbon Ceramic Brake Package and Iron Rotors	HB631x.622	F, N, Z, U		HB632x.586	F, N, Z, U			
Corvette		1966-1982	All		HB126x.505	F, Z, N, S, E		HB126x.505	F, Z, N, S, E			
Corvette		1980-1980	All		HB126x.505	F, Z, N, S, E		HB126x.505	F, Z, N, S, E			
Corvette		1984-1987	All		HB173x.570	F, N		HB112x.540	F, Z, N, U, G, S, E, M			
Corvette		1988-1996	All		HB111x.610	F, Z, N, U, G, S, E, M		HB112x.540	F, Z, N, U, G, S, E, M			
Corvette		1997-2004	All		HB247x.575	F, Z, N, U, G, W, V, S, E	HUS8259	HKx8259247	HB248x.650	F, Z, N, U, G, W, S, E	HUS8261	HKx8261248
Corvette		2005-2009	All	Standard brakes	HB247x.575	F, Z, N, U, G, W, V, S, E	HUS8259	HKx8259247	HB248x.650	F, Z, N, U, G, W, S, E	HUS8261	HKx8261248
Cruze	Eco	2011-2013	All		HB706x.714	F, Z, N, W, G, U		HB707x.638	F, Z, N, W, G, U			
Cruze	LS	2011-2013	All		HB706x.714	F, Z, N, W, G, U		HB707x.638	F, Z, N, W, G, U			
Cruze	1LT	2011-2013	All		HB706x.714	F, Z, N, W, G, U		HB707x.638	F, Z, N, W, G, U			
Cruze	2LT	2011-2013	All		HB706x.714	F, Z, N, W, G, U		HB707x.638	F, Z, N, W, G, U			
Cruze	Ltz	2011-2013	All		HB706x.714	F, Z, N, W, G, U		HB707x.638	F, Z, N, W, G, U			
El Camino	Classic	1977-1977	All		HB103x.590	F, Z, Y, P, N, U, G W, H, S, L, E, M, A						
El Camino	Custom	1968-1974	All		HB103x.590	F, Z, Y, P, N, U, G W, H, S, L, E, M, A						
El Camino		1966-1977	All		HB103x.590	F, Z, Y, P, N, U, G W, H, S, L, E, M, A						
El Camino		1978-1981	All		HB119x.594	F, Z, Y, P, N, U, G W, H, S, L, E, M, A						
El Camino		1982-1987	All		HB119x.594	F, Z, Y, P, N, U, G W, H, S, L, E, M, A	HUS8213	HKx8213119				
Equinox	LS	2005-2006	All		HB472x.650	F, Z, Y						
Equinox	LT	2005-2006	All		HB472x.650	F, Z, Y						
Express 1500	LS	2003-2008	All		HB323x.724	F, Z, Y, P	HUS8690	HKx8690323	HB494x.670	F, Z, Y	HUS8695	HKx8695494
Express 1500	LT	2003-2008	All		HB323x.724	F, Z, Y, P	HUS8690	HKx8690323	HB494x.670	F, Z, Y	HUS8695	HKx8695494
Express 1500		1999-2002	All		HB332x.654	F, Z, Y, P						
Express 1500		2003-2008	All		HB323x.724	F, Z, Y, P	HUS8690	HKx8690323	HB494x.670	F, Z, Y	HUS8695	HKx8695494
Express 1500		2009-2013	All		HB561x.710	F, Z, Y, P			HB494x.670	F, Z, Y		
Express 2500	LS	2006-2011	All		HB322x.717	F, Z, Y, P	HUS8692	HKx8692322	HB494x.670	F, Z, Y		

APPLICATION GUIDE

BRAKE PAD CODE BREAKDOWN

H B **2 4 5** **x** **.6 3 1**
 HAWK BRAKE PAD SHAPE INSERT COMPOUND CODE PAD THICKNESS

PAD/ROTOR KIT CODE BREAKDOWN

HK **x** **4 2 8** **4 4 8**
 HAWK KIT INSERT COMPOUND CODE ROTOR PAD SHAPE

MAKE/ MODEL	SUBMODEL	YRS.	ENGINE (LITER)	NOTE	FRONT				REAR			
					PADS	PAD COMPOUND	ROTORS	PAD/ROTOR KIT	PADS	PAD COMPOUND	ROTORS	PAD/ROTOR KIT
CHEVROLET CONTINUED												
Express 2500	LT	2006-2011	All		HB322x.717	F, Z, Y, P	HUS8692	HKx8692322	HB494x.670	F, Z, Y		
Express 2500		1996-2000	All	8 Lug	HB296x.670	F, Z, Y, P						
Express 2500		1996-2002	All	6 Lug Wheels Only.	HB332x.654	F, Z, Y, P						
Express 2500		2001-2002	6.5	8 Lug, Diesel	HB298x.787	F, Y, P						
Express 2500		2001-2002	All	8 Lug, except Diesel	HB296x.670	F, Z, Y, P						
Express 2500		2003-2005	All	6 Lug Wheels Only.	HB323x.724	F, Z, Y, P	HUS8690	HKx8690323	HB494x.670	F, Z, Y		
Express 2500		2003-2005	All	8 Lug	HB322x.717	F, Z, Y, P	HUS8692	HKx8692322	HB494x.670	F, Z, Y		
Express 2500		2006-2013	All		HB322x.717	F, Z, Y, P	HUS8692	HKx8692322	HB494x.670	F, Z, Y		
Express 3500	LS	2003-2010	All	Single Rear Wheels 330 x 76mm Rear Rotor	HB322x.717	F, Z, Y, P	HUS8659	HKx8659322	HB494x.670	F, Z, Y		
Express 3500	LS	2003-2010	All	Single Rear Wheels 330 x 90mm Rear Rotor	HB322x.717	F, Z, Y, P	HUS8659	HKx8659322	HB494x.670	F, Z, Y	HUS8691	HKx8691494
Express 3500	LT	2003-2010	All	Single Rear Wheels 330 x 76mm Rear Rotor	HB322x.717	F, Z, Y, P	HUS8659	HKx8659322	HB494x.670	F, Z, Y		
Express 3500	LT	2003-2010	All	Single Rear Wheels 330 x 90mm Rear Rotor	HB322x.717	F, Z, Y, P	HUS8659	HKx8659322	HB494x.670	F, Z, Y	HUS8691	HKx8691494
Express 3500		1999-2002	All		HB298x.787	F, Y, P						
Express 3500		2003-2008	All	Dual Rear Wheels	HB322x.717	F, Z, Y, P	HUS8659	HKx8659322				
Express 3500		2003-2008	All	Single Rear Wheels 330 x 76mm Rear Rotor	HB322x.717	F, Z, Y, P	HUS8659	HKx8659322	HB494x.670	F, Z, Y		
Express 3500		2003-2008	All	Single Rear Wheels 330 x 90mm Rear Rotor	HB322x.717	F, Z, Y, P	HUS8659	HKx8659322	HB494x.670	F, Z, Y	HUS8691	HKx8691494
Express 3500		2008-2010	All	Dual Rear Wheels	HB322x.717	F, Z, Y, P			HB705x.776	Y, P		
Express 3500		2011-2013	All	Single rear wheel	HB322x.717	F, Z, Y, P			HB494x.670	F, Z, Y		
Express 3500		2011-2013	All	Dual Rear Wheels	HB322x.717	F, Z, Y, P			HB705x.776	Y, P		
Express 4500		2009-2013	All		HB322x.717	F, Z, Y, P			HB705x.776	Y, P		
F6B042		1997-1997	All		HB253x.750	P			HB253x.750	P		
G10 Van	Sportvan	1970-1991	All		HB103x.590	F, Z, Y, P, N, U, G W, H, S, L, E, M, A						
G10 Van		1970-1991	All		HB103x.590	F, Z, Y, P, N, U, G W, H, S, L, E, M, A						
G20 Van	Sportvan	1970-1991	All		HB103x.590	F, Z, Y, P, N, U, G W, H, S, L, E, M, A						
G20 Van		1970-1991	All		HB103x.590	F, Z, Y, P, N, U, G W, H, S, L, E, M, A						
G30 Van	Sportvan	1971-1978	All		HB103x.590	F, Z, Y, P, N, U, G W, H, S, L, E, M, A						
G30 Van	Sportvan	1979-1984	All	w/13 in. Rear Drums	HB131x.595	F, P, U, G, W, L, M						
G30 Van	Sportvan	1979-1984	All	w/11 in. Rear Drums	HB103x.590	F, Z, Y, P, N, U, G W, H, S, L, E, M, A						
G30 Van	Sportvan	1985-1985	All		HB103x.590	F, Z, Y, P, N, U, G W, H, S, L, E, M, A						
G30 Van	Sportvan	1985-1993	All		HB131x.595	F, P, U, G, W, L, M						
G30 Van	Sportvan	1996-1996	All		HB298x.787	F, Y, P						
G30 Van		1971-1975	All		HB103x.590	F, Z, Y, P, N, U, G W, H, S, L, E, M, A						
G30 Van		1976-1978	All	w/13 in. Rear Drums	HB103x.590	F, Z, Y, P, N, U, G W, H, S, L, E, M, A						
G30 Van		1979-1984	All	w/11 in. Rear Drums	HB103x.590	F, Z, Y, P, N, U, G W, H, S, L, E, M, A						
G30 Van		1979-1993	All	w/13 x 2.5 in. Drums	HB131x.595	F, P, U, G, W, L, M						
G30 Van		1996-1996	All		HB298x.787	F, Y, P						
HHR	LS	2006-2008	All		HB524x.740	F, Z, N, U, G, S, E						

APPLICATION GUIDE

RACE PAD COMPOUNDS

DTC-70 - U	DTC-05 - H	MT-4 - L	HP Plus - N
DTC-60 - G	HT-14 - V	Blue 9012 - E	
DTC-30 - W	HT-10 - S	Black - M	
DTC-15 - A	Metallic - MB	DR-97 - J	

STREET PAD COMPOUNDS

HPS Performance Street - F	LTS Light Truck & SUV - Y
Performance Ceramic - Z	SuperDuty - P

MAKE/ MODEL	SUBMODEL	ENGINE YRS. (LITER)	NOTE	FRONT				REAR				
				PADS	PAD COMPOUND	ROTORS	PAD/ROTOR KIT	PADS	PAD COMPOUND	ROTORS	PAD/ROTOR KIT	
CHEVROLET CONTINUED												
HHR	LS Panel	2006-2008	All		HB524x.740	F, Z, N, U, G, S, E						
HHR	LT	2006-2008	All		HB524x.740	F, Z, N, U, G, S, E						
HHR	LT Panel	2006-2008	All		HB524x.740	F, Z, N, U, G, S, E						
HHR	SS	2008-2010	All	w/Brembo Brakes	HB548x.590	F, N, U, W						
HHR	SS	2008-2011	All		HB524x.740	F, Z, N, U, G, S, E			HB525x.540	F, Z, N, G		
HHR	SS Panel	2009-2011	All		HB524x.740	F, Z, N, U, G, S, E			HB525x.540	F, Z, N, G		
Impala	Custom	1976-1977	All		HB103x.590	F, Z, Y, P, N, U, G W, H, S, L, E, M, A						
Impala	LS	2000-2004	All		HB360x.670	F, Z	HUS8664	HKx8664360	HB359x.543	F, Z, G	HUS8258	HKx8258359
Impala	LS	2005-2005	All		HB536x.704	F			HB359x.543	F, Z, G		
Impala	Police	2001-2001	All		HB360x.670	F, Z	HUS8664	HKx8664360	HB359x.543	F, Z, G	HUS8258	HKx8258359
Impala	Police	2003-2003	All		HB360x.670	F, Z	HUS8664	HKx8664360	HB359x.543	F, Z, G	HUS8258	HKx8258359
Impala	Police	2006-2010	All		HB535x.638	F			HB359x.543	F, Z, G		
Impala	Police	2011-2013	All		HB535x.638	F			HB450x.555	F, Z		
Impala	SS	2004-2004	All		HB360x.670	F, Z	HUS8664	HKx8664360	HB359x.543	F, Z, G	HUS8258	HKx8258359
Impala	SS	2005-2005	All		HB536x.704	F	HUS8664	HKx8664536			HUS8258	
Impala		1968-1985	All		HB103x.590	F, Z, Y, P, N, U, G W, H, S, L, E, M, A						
Impala		2000-2004	All		HB360x.670	F, Z	HUS8664	HKx8664360	HB359x.543	F, Z, G	HUS8258	HKx8258359
Impala		2005-2005	All		HB536x.704	F						
Impala		2006-2010	All		HB535x.638	F			HB359x.543	F, Z, G		
Impala		2011-2013	All		HB535x.638	F			HB450x.555	F, Z		
Impala SS		1994-1996	All		HB131x.595	F, P, U, G, W, L, M						
K1500 Pickup		1988-1991	All	Extended Cab	HB332x.654	F, Z, Y, P						
K1500 Pickup		1992-1998	All		HB332x.654	F, Z, Y, P						
K20 Pickup		1979-1985	All	w/13 in. Rear Drums	HB131x.595	F, P, U, G, W, L, M						
K20 Pickup		1986-1986	All		HB131x.595	F, P, U, G, W, L, M						
K20/V20 Pickup		1987-1987	All		HB131x.595	F, P, U, G, W, L, M						
K2500 Pickup		1988-2000	All	w/11 in. Rear Drums	HB332x.654	F, Z, Y, P						
K2500 Pickup		1988-2000	All	w/13 in. Rear Drums	HB296x.670	F, Z, Y, P	HUS8242	HKx8242296				
K2500 Pickup		2011-2011	All		HB705x.776	Y, P			HB705x.776	Y, P		
K3500 Pickup		1988-1989	All		HB296x.670	F, Z, Y, P	HUS8242	HKx8242296				
K3500 Pickup		1990-2000	All	Dual Rear Wheels	HB296x.787	F, Y, P	HUS8626	HKx8626298				
K3500 Pickup		1990-2000	All	Single Rear Wheels	HB296x.670	F, Z, Y, P	HUS8242	HKx8242296				
K3500 Pickup		2011-2011	All		HB705x.776	Y, P			HB705x.776	Y, P		
Laguna	Estate	1973-1973	All		HB103x.590	F, Z, Y, P, N, U, G W, H, S, L, E, M, A						
Laguna		1973-1976	All		HB103x.590	F, Z, Y, P, N, U, G W, H, S, L, E, M, A						
LLV Postal Van		1987-1995	All		HB119x.594	F, Z, Y, P, N, U, G W, H, S, L, E, M, A	HUS8213	HKx8213119				
Lumina	Euro	1990-1993	All		HB232x.681	F						
Lumina	Euro	1994-1994	All		HB232x.681	F						
Lumina	LS	1995-1997	All		HB232x.681	F			HB359x.543	F, Z, G		
Lumina	LTZ	1997-1998	All		HB232x.681	F			HB359x.543	F, Z, G		
Lumina	Z34	1991-1994	All		HB232x.681	F						
Lumina		1990-1993	All		HB232x.681	F						
Lumina		1998-1999	All		HB232x.681	F			HB359x.543	F, Z, G		
Lumina APV		1994-1996	All		HB217x.681	F, Z, E						

BRAKE PAD CODE BREAKDOWN

H B **2 4 5** **x** **.6 3 1**
 HAWK BRAKE PAD SHAPE INSERT COMPOUND CODE PAD THICKNESS

PAD/ROTOR KIT CODE BREAKDOWN

HK **x** **4 2 8** **4 4 8**
 HAWK KIT INSERT COMPOUND CODE ROTOR PAD SHAPE

MAKE/ MODEL	SUBMODEL	YRS.	ENGINE (LITER)	NOTE	FRONT				REAR			
					PADS	PAD COMPOUND	ROTORS	PAD/ROTOR KIT	PADS	PAD COMPOUND	ROTORS	PAD/ROTOR KIT
CHEVROLET CONTINUED												
Malibu	Classic	1974-1977	All		HB103x.590	F, Z, Y, P, N, U, G W, H, S, L, E, M, A						
Malibu	Classic	1978-1982	All		HB119x.594	F, Z, Y, P, N, U, G W, H, S, L, E, M, A						
Malibu	Estate	1973-1976	All		HB103x.590	F, Z, Y, P, N, U, G W, H, S, L, E, M, A						
Malibu	LS	1997-1998	All		HB425x.661	F						
Malibu	LS	2000-2003	All		HB425x.661	F						
Malibu	LS	2004-2012	All		HB524x.740	F, Z, N, U, G, S, E			HB525x.540	F, Z, N, G		
Malibu	LT	2004-2011	All		HB524x.740	F, Z, N, U, G, S, E			HB525x.540	F, Z, N, G		
Malibu	LTZ	2006-2012	All		HB524x.740	F, Z, N, U, G, S, E			HB525x.540	F, Z, N, G		
Malibu	Maxx	2004-2010	All		HB524x.740	F, Z, N, U, G, S, E			HB525x.540	F, Z, N, G		
Malibu	Maxx LS	2005-2010	All		HB524x.740	F, Z, N, U, G, S, E			HB525x.540	F, Z, N, G		
Malibu	Maxx LT	2005-2010	All		HB524x.740	F, Z, N, U, G, S, E			HB525x.540	F, Z, N, G		
Malibu	Maxx LTZ	2006-2010	All		HB524x.740	F, Z, N, U, G, S, E			HB525x.540	F, Z, N, G		
Malibu	Maxx SS	2006-2010	All		HB524x.740	F, Z, N, U, G, S, E			HB525x.540	F, Z, N, G		
Malibu	SS	2006-2012	All		HB524x.740	F, Z, N, U, G, S, E			HB525x.540	F, Z, N, G		
Malibu		1966-1977	All		HB103x.590	F, Z, Y, P, N, U, G W, H, S, L, E, M, A						
Malibu		1978-1983	All		HB119x.594	F, Z, Y, P, N, U, G W, H, S, L, E, M, A						
Malibu		1997-2003	All		HB425x.661	F						
Malibu		2004-2012	All		HB524x.740	F, Z, N, U, G, S, E			HB525x.540	F, Z, N, G		
Monte Carlo	LS	1995-1998	All		HB232x.681	F						
Monte Carlo	LS	2000-2004	All		HB360x.670	F, Z	HUS8664	HKx8664360	HB359x.543	F, Z, G	HUS8258	HKx8258359
Monte Carlo	LS	2005-2005	All		HB536x.704	F			HB359x.543	F, Z, G		
Monte Carlo	LT	2005-2005	All		HB536x.704	F			HB359x.543	F, Z, G		
Monte Carlo	SS	1984-1988	All		HB119x.594	F, Z, Y, P, N, U, G W, H, S, L, E, M, A	HUS8213	HKx8213119				
Monte Carlo	SS	2000-2004	All		HB360x.670	F, Z	HUS8664	HKx8664360	HB359x.543	F, Z, G	HUS8258	HKx8258359
Monte Carlo	SS	2005-2005	All		HB536x.704	F	HUS8664	HKx8664536	HB359x.543	F, Z, G	HUS8258	HKx8258359
Monte Carlo	Z34	1995-1998	All		HB232x.681	F						
Monte Carlo		1970-1977	All		HB103x.590	F, Z, Y, P, N, U, G W, H, S, L, E, M, A						
Monte Carlo		1978-1981	All		HB119x.594	F, Z, Y, P, N, U, G W, H, S, L, E, M, A						
Monte Carlo		1982-1988	All		HB119x.594	F, Z, Y, P, N, U, G W, H, S, L, E, M, A	HUS8213	HKx8213119				
Monte Carlo		1999-1999	All		HB232x.681	F						
Nova	Concours	1976-1977	All		HB103x.590	F, Z, Y, P, N, U, G W, H, S, L, E, M, A						
Nova	Custom	1973-1973	5.0		HB103x.590	F, Z, Y, P, N, U, G W, H, S, L, E, M, A						
Nova	Custom	1973-1979	All		HB103x.590	F, Z, Y, P, N, U, G W, H, S, L, E, M, A						
Nova		1970-1979	All		HB103x.590	F, Z, Y, P, N, U, G W, H, S, L, E, M, A						
Nova		1986-1988	All		HB191x.590	F, N, S, E						
Oprtra		2004-2004	All		HB592x.665	F						
P20 Van		1972-1978	All		HB103x.590	F, Z, Y, P, N, U, G W, H, S, L, E, M, A						
P20 Van		1979-1984	All	w/11 in. Rear Drums	HB103x.590	F, Z, Y, P, N, U, G W, H, S, L, E, M, A						

APPLICATION GUIDE

RACE PAD COMPOUNDS

DTC-70 - U	DTC-05 - H	MT-4 - L	HP Plus - N
DTC-60 - G	HT-14 - V	Blue 9012 - E	
DTC-30 - W	HT-10 - S	Black - M	
DTC-15 - A	Metallic - MB	DR-97 - J	

STREET PAD COMPOUNDS

HPS Performance Street - F	LTS Light Truck & SUV - Y
Performance Ceramic - Z	SuperDuty - P

MAKE/ MODEL	SUBMODEL	YRS.	ENGINE (LITER)	NOTE	FRONT				REAR			
					PADS	PAD COMPOUND	ROTOR	PAD/ROTOR KIT	PADS	PAD COMPOUND	ROTOR	PAD/ROTOR KIT
CHEVROLET CONTINUED												
P20 Van		1979-1984	All	w/13 in. Rear Drums	HB131x.595	F, P, U, G, W, L, M						
P20 Van		1985-1989	All	6800 lbs. GVW	HB103x.590	F, Z, Y, P, N, U, G W, H, S, L, E, M, A						
P20 Van		1985-1989	All	8000 lbs. GVW	HB131x.595	F, P, U, G, W, L, M						
P30 Van		1976-1978	All	w/ 13 x 2.5 in.	HB103x.590	F, Z, Y, P, N, U, G						
				Rear Drum Brakes		W, H, S, L, E, M, A						
P30 Van		1979-1984	All	w/ 13 x 2.5 in. Rear Drum Brakes	HB131x.595	F, P, U, G, W, L, M						
P30 Van		1985-1990	All	w/ 13 x 2.5 in. Rear Drum Brakes	HB131x.595	F, P, U, G, W, L, M						
P30 Van		1991-1993	All	8200 lbs. GVW	HB131x.595	F, P, U, G, W, L, M						
P30 Van		1997-1999	All	w/Rear Disc Brakes	HB252x.860	P			HB252x.860	P		
P6S042		1993-1996	All		HB253x.750	P			HB253x.750	P		
P6T042		1984-1990	All		HB253x.750	P						
Prizm		1998-2002	All		HB321x.650	F						
S10 Blazer		1985-1994	All		HB119x.594	F, Z, Y, P, N, U, G W, H, S, L, E, M, A						
S10 Blazer		1985-1994	All	2WD, w/o 4 Wheel ABS	HB119x.594	F, Z, Y, P, N, U, G W, H, S, L, E, M, A	HUS8213	HKx8213119				
S10 Pickup		1982-1996	All		HB119x.594	F, Z, Y, P, N, U, G W, H, S, L, E, M, A						
S10 Pickup		1998-2003	All	2WD	HB119x.594	F, Z, Y, P, N, U, G W, H, S, L, E, M, A			HB305x.610	F, Z, Y, P		
S10 Pickup		1998-2003	All	2WD	HB119x.594	F, Z, Y, P, N, U, G W, H, S, L, E, M, A			HB305x.610	F, Z, Y, P		
S10 Pickup		2004-2004	All		HB304x.598	F, Z, Y			HB305x.610	F, Z, Y, P		
Silverado 1500	Classic LS	2007-2007	All	w/Rear Disc Brakes	HB561x.710	F, Z, Y, P	HUS8657	HKx8657561	HB568x.666	F, Z, Y, P		
Silverado 1500	Classic LS	2007-2007	All	w/Rear Drum Brakes	HB561x.710	F, Z, Y, P	HUS8657	HKx8657561				
Silverado 1500	Classic LT	2007-2007	All	w/Rear Disc Brakes	HB561x.710	F, Z, Y, P	HUS8657	HKx8657561	HB568x.666	F, Z, Y, P		
Silverado 1500	Classic LT	2007-2007	All	w/Rear Drum Brakes	HB561x.710	F, Z, Y, P	HUS8657	HKx8657561				
Silverado 1500	Classic WT	2007-2007	All	w/Rear Disc Brakes	HB561x.710	F, Z, Y, P	HUS8657	HKx8657561	HB568x.666	F, Z, Y, P		
Silverado 1500	Classic WT	2007-2007	All	w/Rear Drum Brakes	HB561x.710	F, Z, Y, P	HUS8657	HKx8657561				
Silverado 1500	Police	2008-2008	All		HB561x.710	F, Z, Y, P	HUS8657	HKx8657561	HB568x.666	F, Z, Y, P	HUS501	
Silverado 1500	Police	2010-2010	All		HB561x.710	F, Z, Y, P			HB568x.666	F, Z, Y, P	HUS501	
Silverado 1500	SS	2003-2006	All	Must have 17" wheel or larger for rear kit	HB323x.724	F, Z, Y, P	HUS8690	HKx8690323	HB385x.640	F, Y	HUS8695	HKx8695385
Silverado 1500		1999-2000	All	Must have 17" wheel or larger	HB323x.724	F, Z, Y, P	HUS8690	HKx8690323	HB324x.673	F, Z, Y, P	HUS8694	HKx8694324
Silverado 1500		2001-2001	All	2 Door. Reg Cab Must have 17" wheel or larger	HB323x.724	F, Z, Y, P	HUS8690	HKx8690323	HB324x.673	F, Z, Y, P	HUS8694	HKx8694324
Silverado 1500		2001-2001	All	2 Door Ext. Cab Must have 17" wheel or larger	HB323x.724	F, Z, Y, P	HUS8690	HKx8690323	HB324x.673	F, Z, Y, P	HUS8695	HKx8695324
Silverado 1500		2001-2001	All	4 Door	HB322x.717	F, Z, Y, P			HB323x.724	F, Z, Y, P		
Silverado 1500		2002-2002	All	4 Door	HB322x.717	F, Z, Y, P			HB323x.724	F, Z, Y, P		
Silverado 1500		2002-2002	All	Extended Cab 4 Wheel Steering Must have 17" wheel or larger for rear kit	HB323x.724	F, Z, Y, P	HUS8690	HKx8690323	HB385x.640	F, Y	HUS8695	HKx8695385
Silverado 1500		2002-2002	All	Regular Cab. 2 Wheel Steering Must have 17" wheel or larger for rear kit	HB323x.724	F, Z, Y, P	HUS8690	HKx8690323	HB324x.673	F, Z, Y, P	HUS8694	HKx8694324
Silverado 1500		2003-2003	All	4 Door Heavy Duty 2 Wheel Steering	HB322x.717	F, Z, Y, P			HB323x.724	F, Z, Y, P		
Silverado 1500		2003-2003	All	4 Door Heavy Duty 4 Wheel Steering Must have 17" wheel or larger	HB323x.724	F, Z, Y, P			HB324x.673	F, Z, Y, P		

APPLICATION GUIDE

BRAKE PAD CODE BREAKDOWN

H B 2 4 5 x . 6 3 1
 HAWK BRAKE PAD SHAPE INSERT COMPOUND CODE PAD THICKNESS

PAD/ROTOR KIT CODE BREAKDOWN

H K x 4 2 8 4 4 8
 HAWK KIT INSERT COMPOUND CODE ROTOR PAD SHAPE

MAKE/ MODEL	SUBMODEL	YRS.	ENGINE (LITER)	NOTE	FRONT				REAR			
					PADS	PAD COMPOUND	ROTORS	PAD/ROTOR KIT	PADS	PAD COMPOUND	ROTORS	PAD/ROTOR KIT
CHEVROLET CONTINUED												
Silverado 1500		2003-2003	All	Extended Cab 2 Wheel Steering Must have 17" wheel or larger	HB323x.724	F, Z, Y, P	HUS8690	HKx8690323	HB324x.673	F, Z, Y, P	HUS8694	HKx8694324
Silverado 1500		2003-2003	All	Extended Cab 4 Wheel Steering 325mm Rear Disc Must have 17" wheel or larger	HB323x.724	F, Z, Y, P	HUS8690	HKx8690323	HB323x.724	F, Z, Y, P	HUS8694	HKx8694323
Silverado 1500		2003-2003	All	Extended Cab 4 Wheel Steering 330mm Rear Disc. Must have 17" wheel or larger	HB323x.724	F, Z, Y, P	HUS8690	HKx8690323	HB385x.640	F, Y	HUS8695	HKx8695385
Silverado 1500		2003-2003	All	Regular Cab Must have 17" wheel or larger	HB323x.724	F, Z, Y, P	HUS8690	HKx8690323	HB324x.673	F, Z, Y, P	HUS8694	HKx8694324
Silverado 1500		2004-2004	All	Crew Cab Must have 17" wheel or larger	HB323x.724	F, Z, Y, P	HUS8690	HKx8690323	HB385x.640	F, Y	HUS8695	HKx8695385
Silverado 1500		2004-2004	All	Extended Cab 2 Wheel Steering, Except Hybrid Must have 17" wheel or larger	HB323x.724	F, Z, Y, P	HUS8690	HKx8690323	HB324x.673	F, Z, Y, P	HUS8694	HKx8694324
Silverado 1500		2004-2004	All	Extended Cab 4 Wheel Steering, Except Hybrid Must have 17" wheel or larger	HB323x.724	F, Z, Y, P	HUS8690	HKx8690323	HB385x.640	F, Y	HUS8695	HKx8695385
Silverado 1500		2004-2004	All	Hybrid Must have 17" wheel or larger	HB323x.724	F, Z, Y, P	HUS8690	HKx8690323	HB324x.673	F, Z, Y, P	HUS8694	HKx8694324
Silverado 1500		2004-2004	All	Regular Cab Must have 17" wheel or larger	HB323x.724	F, Z, Y, P	HUS8690	HKx8690323	HB324x.673	F, Z, Y, P	HUS8694	HKx8694324
Silverado 1500		2005-2005	All	w/Rear Disc Brakes Must have 17" wheel or larger	HB323x.724	F, Z, Y, P	HUS8657	HKx8657323	HB324x.673	F, Z, Y, P		
Silverado 1500		2005-2005	All	w/Rear Disc Brakes Ext Cab, Hybrid Must have 17" wheel or larger	HB323x.724	F, Z, Y, P	HUS8690	HKx8690323	HB324x.673	F, Z, Y, P	HUS8694	HKx8694324
Silverado 1500		2005-2005	All	w/Rear Drum Brakes	HB561x.710	F, Z, Y, P	HUS8657	HKx8657561				
Silverado 1500		2006-2006	6.0	Ext. Cab Must have 17" wheel or larger	HB323x.724	F, Z, Y, P	HUS8690	HKx8690323	HB385x.640	F, Y	HUS8695	HKx8695385
Silverado 1500		2006-2006	All	6400 lb. GVW, Rear Drum	HB561x.710	F, Z, Y, P	HUS8657	HKx8657561				
Silverado 1500		2006-2006	All	6400 lb. GVW, Rear Disc Must have 17" wheel or larger	HB323x.724	F, Z, Y, P	HUS8690	HKx8690323	HB324x.673	F, Z, Y, P	HUS8694	HKx8694324
Silverado 1500		2006-2006	All	7000 lb. GVW, Rear Drum	HB561x.710	F, Z, Y, P	HUS8657	HKx8657561				
Silverado 1500		2006-2006	All	7200 lb. GVW, Rear Disc Must have 17" wheel or larger	HB323x.724	F, Z, Y, P	HUS8690	HKx8690323	HB324x.673	F, Z, Y, P	HUS8694	HKx8694324
Silverado 1500		2007-2007	All	w/Rear Disc Brakes	HB561x.710	F, Z, Y, P	HUS8657	HKx8657561	HB568x.666	F, Z, Y, P		
Silverado 1500		2007-2007	All	w/Rear Drum Brakes	HB561x.710	F, Z, Y, P	HUS8657	HKx8657561				
Silverado 1500		2007-2007	All	w/Rear Disc Brakes	HB561x.710	F, Z, Y, P	HUS8657	HKx8657561	HB568x.666	F, Z, Y, P		
Silverado 1500		2007-2007	All	w/Rear Drum Brakes	HB561x.710	F, Z, Y, P	HUS8657	HKx8657561				
Silverado 1500		2008-2013	All	w/Rear Drum Brakes	HB561x.710	F, Z, Y, P	HUS8657	HKx8657561	HB568x.666	F, Z, Y, P	HUS501	
Silverado 1500		2008-2013	All	w/Rear Drum Brakes Except Hybrid	HB561x.710	F, Z, Y, P	HUS8657	HKx8657561				
Silverado 1500HD	Classic LT	2007-2007	All	Except 4 Wheel Steering	HB322x.717	F, Z, Y, P	HUS8692	HKx8692322	HB323x.724	F, Z, Y, P		
Silverado 1500HD		2001-2005	All	Except 4 Wheel Steering	HB322x.717	F, Z, Y, P	HUS8692	HKx8692322	HB323x.724	F, Z, Y, P		
Silverado 1500HD		2006-2006	All	Except 4 Wheel Steering	HB322x.717	F, Z, Y, P	HUS8692	HKx8692322	HB323x.724	F, Z, Y, P		
Silverado 2500		1999-2000	6.0		HB322x.717	F, Z, Y, P	HUS8692	HKx8692322	HB323x.724	F, Z, Y, P	HUS8691	HKx8691323
Silverado 2500		1999-2000	All	Except 6.0L	HB322x.717	F, Z, Y, P	HUS8692	HKx8692322	HB323x.724	F, Z, Y, P		
Silverado 2500		2001-2004	All	Automatic	HB322x.717	F, Z, Y, P	HUS8692	HKx8692322	HB323x.724	F, Z, Y, P		
Silverado 2500		2001-2004	All	Manual	HB322x.717	F, Z, Y, P	HUS8692	HKx8692322	HB323x.724	F, Z, Y, P	HUS8691	HKx8691323
Silverado 2500		2005-2005	All		HB322x.717	F, Z, Y, P	HUS8692	HKx8692322	HB323x.724	F, Z, Y, P	HUS8691	HKx8691323
Silverado 2500		2006-2008	All		HB322x.717	F, Z, Y, P	HUS8659	HKx8659322	HB323x.724	F, Z, Y, P	HUS8691	HKx8691323

APPLICATION GUIDE

RACE PAD COMPOUNDS

DTC-70 - U	DTC-05 - H	MT-4 - L	HP Plus - N
DTC-60 - G	HT-14 - V	Blue 9012 - E	
DTC-30 - W	HT-10 - S	Black - M	
DTC-15 - A	Metallic - MB	DR-97 - J	

STREET PAD COMPOUNDS

HPS Performance Street - F	LTS Light Truck & SUV - Y
Performance Ceramic - Z	SuperDuty - P

MAKE/ MODEL	SUBMODEL	ENGINE YRS. (LITER)	NOTE	FRONT				REAR				
				PADS	PAD COMPOUND	ROTOR	PAD/ROTOR KIT	PADS	PAD COMPOUND	ROTOR	PAD/ROTOR KIT	
CHEVROLET CONTINUED												
Silverado 2500HD	Classic LS	2007-2007	All	HB322x.717	F, Z, Y, P	HUS8659	HKx8659322	HB323x.724	F, Z, Y, P	HUS8691	HKx8691323	
Silverado 2500HD	Classic LT	2007-2007	All	HB322x.717	F, Z, Y, P	HUS8659	HKx8659322	HB323x.724	F, Z, Y, P	HUS8691	HKx8691323	
Silverado 2500HD	Classic WT	2007-2007	All	HB322x.717	F, Z, Y, P	HUS8659	HKx8659322	HB323x.724	F, Z, Y, P	HUS8691	HKx8691323	
Silverado 2500HD	LS	2006-2006	All	HB322x.717	F, Z, Y, P	HUS8659	HKx8659322	HB323x.724	F, Z, Y, P	HUS8691	HKx8691323	
Silverado 2500HD	LT	2006-2010	All	HB322x.717	F, Z, Y, P	HUS8659	HKx8659322	HB323x.724	F, Z, Y, P	HUS8691	HKx8691323	
Silverado 2500HD	LTZ	2007-2010	All	HB322x.717	F, Z, Y, P	HUS8659	HKx8659322	HB323x.724	F, Z, Y, P	HUS8691	HKx8691323	
Silverado 2500HD	WT	2006-2010	All	HB322x.717	F, Z, Y, P	HUS8659	HKx8659322	HB323x.724	F, Z, Y, P	HUS8691	HKx8691323	
Silverado 2500HD		2001-2003	All	HB322x.717	F, Z, Y, P	HUS8659	HKx8659322	HB323x.724	F, Z, Y, P	HUS8691	HKx8691323	
Silverado 2500HD		2004-2004	All	2 Wheel Steering	HB322x.717	F, Z, Y, P	HUS8659	HKx8659322	HB323x.724	F, Z, Y, P	HUS8691	HKx8691323
Silverado 2500HD		2004-2004	All	4 Wheel Steering	HB322x.717	F, Z, Y, P	HUS8659	HKx8659322	HB323x.724	F, Z, Y, P	HUS8691	HKx8691323
Silverado 2500HD		2005-2005	All		HB322x.717	F, Z, Y, P	HUS8659	HKx8659322	HB323x.724	F, Z, Y, P	HUS8691	HKx8691323
Silverado 2500HD		2011-2013	All		HB705x.776	Y, P		HB705x.776	Y, P			
Silverado 3500	Classic LS	2007-2007	All	Single Rear Wheels	HB322x.717	F, Z, Y, P	HUS8659	HKx8659322	HB323x.724	F, Z, Y, P	HUS8691	HKx8691323
Silverado 3500	Classic LS	2007-2007	All	Single Rear Wheels	HB322x.717	F, Z, Y, P	HUS8659	HKx8659322	HB323x.724	F, Z, Y, P	HUS8691	HKx8691323
Silverado 3500	Classic WT	2007-2007	All	Single Rear Wheels	HB322x.717	F, Z, Y, P	HUS8659	HKx8659322	HB323x.724	F, Z, Y, P	HUS8691	HKx8691323
Silverado 3500	LS	2006-2006	All	Single Rear Wheels	HB322x.717	F, Z, Y, P	HUS8659	HKx8659322	HB323x.724	F, Z, Y, P	HUS8691	HKx8691323
Silverado 3500	LT	2006-2006	All	Single Rear Wheels	HB322x.717	F, Z, Y, P	HUS8659	HKx8659322	HB323x.724	F, Z, Y, P	HUS8691	HKx8691323
Silverado 3500	LT	2008-2008	All	Single Rear Wheels	HB322x.717	F, Z, Y, P	HUS8659	HKx8659322	HB323x.724	F, Z, Y, P	HUS8691	HKx8691323
Silverado 3500	LTZ	2008-2008	All	Single Rear Wheels	HB322x.717	F, Z, Y, P	HUS8659	HKx8659322	HB323x.724	F, Z, Y, P	HUS8691	HKx8691323
Silverado 3500	WT	2006-2006	All	Single Rear Wheels	HB322x.717	F, Z, Y, P	HUS8659	HKx8659322	HB323x.724	F, Z, Y, P	HUS8691	HKx8691323
Silverado 3500	WT	2008-2008	All	Single Rear Wheels	HB322x.717	F, Z, Y, P	HUS8659	HKx8659322	HB323x.724	F, Z, Y, P	HUS8691	HKx8691323
Silverado 3500		2001-2003	All	2WD/4WD	HB322x.717	F, Z, Y, P	HUS8659	HKx8659322	HB322x.717	F, Z, Y, P		
Silverado 3500		2004-2005	All	4WD. Single Rear Wheels	HB322x.717	F, Z, Y, P	HUS8659	HKx8659322	HB323x.724	F, Z, Y, P		
Silverado 3500		2004-2008	All	DRW	HB322x.717	F, Z, Y, P	HUS8659	HKx8659322	HB322x.717	F, Z, Y, P		
Silverado 3500HD		2007-2010	All	12,000 lbs. GVW	HB322x.717	F, Z, Y, P		HB322x.717	F, Z, Y, P			
Silverado 3500HD		2007-2010	All	9,900 lbs. GVW	HB322x.717	F, Z, Y, P		HB323x.724	F, Z, Y, P			
Silverado 3500HD		2011-2013	All		HB705x.776	Y, P		HB705x.776	Y, P			
Silverado SS		2003-2005	All		HB323x.724	F, Z, Y, P		HB385x.640	F, Y			
Sonic	LS	2012-2013	All	Manual or Automatic	HB706x.714	F, Z, N, W, G, U						
Sonic	LT	2012-2013	All	Manual or Automatic	HB706x.714	F, Z, N, W, G, U						
Sonic	LTZ	2012-2013	All	Manual or Automatic	HB706x.714	F, Z, N, W, G, U						
Spark		2013-2013	All		HB592x.665	F						
SSR		2003-2005	All		HB382x.657	F, Y		HB383x.685	F, Y			
SSR		2006-2007	All		HB617x.630	Y, Z		HB383x.685	F, Y			
Suburban 1500	Police	2010-2010	All		HB561x.710	F, Z, Y, P		HB568x.666	F, Z, Y, P	HUS501		
Suburban 1500		2000-2000	All	w/11 in. Rear Drums	HB332x.654	F, Z, Y, P						
Suburban 1500		2000-2000	All	w/13 in. Rear Drums. 6 Lug	HB296x.670	F, Z, Y, P						
Suburban 1500		2000-2000	All	w/13 in. Rear Drums. 8 Lug	HB296x.670	F, Z, Y, P	HUS8242	HKx8242296				
Suburban 1500		2000-2002	All	w/Limited Slip Must have 17" wheel or larger	HB323x.724	F, Z, Y, P	HUS8690	HKx8690323	HB385x.640	F, Y	HUS8695	HKx8695385
Suburban 1500		2000-2002	All	w/o Limited Slip Must have 17" wheel or larger	HB323x.724	F, Z, Y, P	HUS8690	HKx8690323	HB324x.673	F, Z, Y, P	HUS8694	HKx8694324
Suburban 1500		2003-2006	All	2WD Must have 17" wheel or larger	HB323x.724	F, Z, Y, P	HUS8690	HKx8690323	HB494x.670	F, Z, Y	HUS8695	HKx8695494
Suburban 1500		2003-2006	All	4WD Must have 17" wheel or larger	HB323x.724	F, Z, Y, P	HUS8690	HKx8690323	HB496x.640	F, Z, Y	HUS8695	HKx8695496
Suburban 1500		2007-2013	All		HB561x.710	F, Z, Y, P	HUS8657	HKx8657561	HB568x.666	F, Z, Y, P	HUS501	
Suburban 2500		2000-2000	All	w/Rear Drum Brakes	HB296x.670	F, Z, Y, P						
Suburban 2500		2000-2002	All	w/Rear Disc Brakes. w/4.63 in. Rear Disc Hub Hole	HB322x.717	F, Z, Y, P	HUS8692	HKx8692322	HB323x.724	F, Z, Y, P		

BRAKE PAD CODE BREAKDOWN

H B **2 4 5** **x** **.6 3 1**
 HAWK BRAKE PAD SHAPE INSERT COMPOUND CODE PAD THICKNESS

PAD/ROTOR KIT CODE BREAKDOWN

HK **x** **4 2 8** **4 4 8**
 HAWK KIT INSERT COMPOUND CODE ROTOR PAD SHAPE

MAKE/ MODEL	SUBMODEL	YRS.	ENGINE (LITER)	NOTE	FRONT				REAR			
					PADS	PAD COMPOUND	ROTORS	PAD/ROTOR KIT	PADS	PAD COMPOUND	ROTORS	PAD/ROTOR KIT
CHEVROLET CONTINUED												
Suburban 2500		2000-2002	All	w/Rear Disc Brakes. w/4.84 in. Rear Disc Hub Hole	HB322x.717	F, Z, Y, P	HUS8692	HKx8692322	HB323x.724	F, Z, Y, P	HUS8691	HKx8691323
Suburban 2500		2003-2005	All	2 Wheel Steering. w/4.63 in. Rear Disc Hub Hole	HB322x.717	F, Z, Y, P	HUS8692	HKx8692322	HB323x.724	F, Z, Y, P		
Suburban 2500		2003-2005	All	2 Wheel Steering. w/4.84 in. Rear Disc Hub Hole	HB322x.717	F, Z, Y, P	HUS8692	HKx8692322	HB323x.724	F, Z, Y, P	HUS8691	HKx8691323
Suburban 2500		2003-2005	All	4 Wheel Steering	HB322x.717	F, Z, Y, P	HUS8692	HKx8692322	HB324x.673	F, Z, Y, P	HUS8694	HKx8694324
Suburban 2500		2006-2006	All	w/Rear Disc Brakes. w/4.63 in. Rear Disc Hub Hole	HB322x.717	F, Z, Y, P	HUS8692	HKx8692322	HB323x.724	F, Z, Y, P		
Suburban 2500		2006-2006	All	w/Rear Disc Brakes. w/4.84 in. Rear Disc Hub Hole	HB322x.717	F, Z, Y, P	HUS8692	HKx8692322	HB323x.724	F, Z, Y, P	HUS8691	HKx8691323
Suburban 2500		2007-2007	All		HB322x.717	F, Z, Y, P	HUS8692	HKx8692322	HB323x.724	F, Z, Y, P		
Suburban 2500		2008-2008	All		HB322x.717	F, Z, Y, P	HUS8692	HKx8692322	HB323x.724	F, Z, Y, P	HUS8691	HKx8691323
Suburban 2500		2009-2013	All		HB322x.717	F, Z, Y, P	HUS8692	HKx8692322	HB323x.724	F, Z, Y, P		
Suburban C10		1970-1984	All		HB103x.590	F, Z, Y, P, N, U, G W, H, S, L, E, M, A						
Suburban C1500		1992-1993	All		HB332x.654	F, Z, Y, P						
Suburban C1500		1994-1999	All	w/11 in. Rear Drums	HB332x.654	F, Z, Y, P						
Suburban C1500		1994-1999	All	w/13 in. Rear Drums	HB296x.670	F, Z, Y, P						
Suburban C1500/R1500		1989-1991	All		HB131x.595	F, P, U, G, W, L, M						
Suburban C20		1970-1978	All		HB103x.590	F, Z, Y, P, N, U, G W, H, S, L, E, M, A						
Suburban C20		1979-1986	All	w/11 in. Rear Drums	HB103x.590	F, Z, Y, P, N, U, G W, H, S, L, E, M, A						
Suburban C20		1979-1986	All	w/13 in. Rear Drums	HB131x.595	F, P, U, G, W, L, M						
Suburban C20/R20		1987-1988	All		HB131x.595	F, P, U, G, W, L, M						
Suburban C2500		1992-1999	All		HB332x.654	F, Z, Y, P						
Suburban C2500/R2500		1989-1991	All		HB131x.595	F, P, U, G, W, L, M						
Suburban K10		1970-1986	All		HB103x.590	F, Z, Y, P, N, U, G W, H, S, L, E, M, A						
Suburban K1500		1994-1999	All	6 Lug	HB332x.654	F, Z, Y, P						
Suburban K1500		1994-1999	All	8 Lug	HB296x.670	F, Z, Y, P	HUS8242	HKx8242296				
Suburban K1500/V1500		1989-1991	All		HB131x.595	F, P, U, G, W, L, M						
Suburban K20		1979-1984	All	w/11 in. Rear Drums	HB103x.590	F, Z, Y, P, N, U, G W, H, S, L, E, M, A						
Suburban K20		1979-1984	All	w/13 in. Rear Drums	HB131x.595	F, P, U, G, W, L, M						
Suburban K20		1985-1986	All		HB131x.595	F, P, U, G, W, L, M						
Suburban K20/V20		1987-1988	All		HB131x.595	F, P, U, G, W, L, M						
Suburban K2500		1992-1999	All		HB296x.670	F, Z, Y, P	HUS8692	HKx8692296				
Suburban K2500/V2500		1989-1991	All		HB131x.595	F, P, U, G, W, L, M						
Tahoe	Hybrid	2008-2008	All		HB561x.710	F, Z, Y, P	HUS8657	HKx8657561	HB568x.666	F, Z, Y, P	HUS501	
Tahoe	LS	2007-2008	All		HB561x.710	F, Z, Y, P	HUS8657	HKx8657561	HB568x.666	F, Z, Y, P	HUS501	
Tahoe	LS	2009-2013	All		HB561x.710	F, Z, Y, P	HUS8657	HKx8657561	HB568x.666	F, Z, Y, P	HUS501	
Tahoe	LT	2007-2008	All		HB561x.710	F, Z, Y, P	HUS8657	HKx8657561	HB568x.666	F, Z, Y, P	HUS501	
Tahoe	LT	2009-2013	All		HB561x.710	F, Z, Y, P	HUS8657	HKx8657561	HB568x.666	F, Z, Y, P	HUS501	
Tahoe	LTZ	2007-2008	All		HB561x.710	F, Z, Y, P	HUS8657	HKx8657561	HB568x.666	F, Z, Y, P	HUS501	
Tahoe	LTZ	2009-2013	All		HB561x.710	F, Z, Y, P	HUS8657	HKx8657561	HB568x.666	F, Z, Y, P	HUS501	
Tahoe	Police	2007-2013	All		HB561x.710	F, Z, Y, P	HUS8657	HKx8657561	HB568x.666	F, Z, Y, P	HUS501	
Tahoe		1995-1997	All		HB332x.654	F, Z, Y, P						
Tahoe		1998-1999	All	Except Police	HB332x.654	F, Z, Y, P						
Tahoe		1998-1999	All	Police	HB296x.670	F, Z, Y, P						

APPLICATION GUIDE

RACE PAD COMPOUNDS

DTC-70 - U	DTC-05 - H	MT-4 - L	HP Plus - N
DTC-60 - G	HT-14 - V	Blue 9012 - E	
DTC-30 - W	HT-10 - S	Black - M	
DTC-15 - A	Metallic - MB	DR-97 - J	

STREET PAD COMPOUNDS

HPS Performance Street - F	LTS Light Truck & SUV - Y
Performance Ceramic - Z	SuperDuty - P

MAKE/ MODEL	SUBMODEL	ENGINE YRS. (LITER)	NOTE	FRONT				REAR			
				PADS	PAD COMPOUND	ROTOR	PAD/ROTOR KIT	PADS	PAD COMPOUND	ROTOR	PAD/ROTOR KIT
CHEVROLET CONTINUED											
Tahoe		2000-2000	All 2WD. Except Police w/Rear Drum Brakes	HB332x.654	F, Z, Y, P						
Tahoe		2000-2000	All 2WD. Police w/Rear Drum Brakes	HB296x.670	F, Z, Y, P						
Tahoe		2000-2000	All 2WD. w/Rear Disc Brakes Must have 17" wheel or larger	HB323x.724	F, Z, Y, P	HUS8690	HKx8690323	HB385x.640	F, Y	HUS8695	HKx8695385
Tahoe		2000-2000	All 4WD. w/Rear Drum Brakes	HB332x.654	F, Z, Y, P						
Tahoe		2000-2000	All 4WD. w/Rear Disc Brakes w/Limited Slip Must have 17" wheel or larger	HB323x.724	F, Z, Y, P	HUS8690	HKx8690323	HB385x.640	F, Y	HUS8695	HKx8695385
Tahoe		2000-2000	All 4WD. w/Rear Disc Brakes w/o Limited Slip Must have 17" wheel or larger	HB323x.724	F, Z, Y, P	HUS8690	HKx8690323	HB324x.673	F, Z, Y, P	HUS8694	HKx8694324
Tahoe		2001-2001	All 2WD Must have 17" wheel or larger	HB323x.724	F, Z, Y, P	HUS8690	HKx8690323	HB385x.640	F, Y	HUS8695	HKx8695385
Tahoe		2001-2002	All 4WD. w/Limited Slip Must have 17" wheel or larger	HB323x.724	F, Z, Y, P	HUS8690	HKx8690323	HB385x.640	F, Y	HUS8695	HKx8695385
Tahoe		2001-2002	All 4WD. w/o Limited Slip Must have 17" wheel or larger	HB323x.724	F, Z, Y, P	HUS8690	HKx8690323	HB324x.673	F, Z, Y, P	HUS8694	HKx8694324
Tahoe		2002-2002	All 2WD. Classic Style Must have 17" wheel or larger	HB323x.724	F, Z, Y, P	HUS8690	HKx8690323	HB385x.640	F, Y	HUS8695	HKx8695385
Tahoe		2002-2002	All 2WD. New Style Must have 17" wheel or larger	HB323x.724	F, Z, Y, P	HUS8690	HKx8690323	HB494x.670	F, Z, Y	HUS8695	HKx8695494
Tahoe		2003-2006	All 2WD Must have 17" wheel or larger	HB323x.724	F, Z, Y, P	HUS8690	HKx8690323	HB494x.670	F, Z, Y	HUS8695	HKx8695494
Tahoe		2003-2006	All 4WD Must have 17" wheel or larger	HB323x.724	F, Z, Y, P	HUS8690	HKx8690323	HB385x.640	F, Y	HUS8695	HKx8695385
Tracker		1998-2004	All	HB384x.587	F						
Trailblazer	EXT	2002-2004	All	HB382x.657	F, Y			HB383x.685	F, Y		
Trailblazer	EXT LS	2005-2005	All	HB382x.657	F, Y			HB383x.685	F, Y		
Trailblazer	EXT LT	2005-2005	All	HB382x.657	F, Y			HB383x.685	F, Y		
Trailblazer	LS	2005-2005	All	HB382x.657	F, Y			HB383x.685	F, Y		
Trailblazer	LT	2005-2005	All	HB382x.657	F, Y			HB383x.685	F, Y		
Trailblazer	Sport	2006-2007	All	HB617x.630	Y, Z			HB383x.685	F, Y		
Trailblazer	SS	2008-2008	All	HB617x.630	Y, Z			HB383x.685	F, Y		
Trailblazer		2002-2004	All	HB382x.657	F, Y			HB383x.685	F, Y		
Trailblazer		2006-2009	All	HB617x.630	Y, Z			HB383x.685	F, Y		
Traverse		2009-2013	All	HB617x.630	Y, Z			HB383x.685	F, Y		
Uplander	LS	2006-2008	All	HB360x.670	F, Z						
Uplander	LT	2006-2008	All	HB360x.670	F, Z						
Uplander		2005-2008	All	HB360x.670	F, Z						
Venture	LS	2005-2005	All AWD	HB373x.689	F			HB359x.543	F, Z, G		
Venture	LS	2005-2005	All FWD	HB360x.670	F, Z			HB359x.543	F, Z, G		
Venture	LT	2005-2005	All AWD	HB373x.689	F			HB359x.543	F, Z, G		
Venture	LT	2005-2005	All FWD	HB360x.670	F, Z			HB359x.543	F, Z, G		
Venture	Plus	2005-2005	All AWD	HB373x.689	F			HB359x.543	F, Z, G		
Venture	Plus	2005-2005	All FWD	HB360x.670	F, Z			HB359x.543	F, Z, G		
Venture		1997-2000	All	HB360x.670	F, Z						
Venture		2001-2001	All	HB360x.670	F, Z			HB359x.543	F, Z, G		
Venture		2002-2004	All AWD	HB373x.689	F			HB359x.543	F, Z, G		
Venture		2002-2004	All FWD	HB360x.670	F, Z			HB159x.492	F, Z, N, G, W, S, E, M		
Volt		2011 - 2013	All					HB707x.638	F, Z, N, W, G, U		

BRAKE PAD CODE BREAKDOWN

PAD/ROTOR KIT CODE BREAKDOWN

H B 2 4 5 x . 6 3 1
 HAWK BRAKE PAD SHAPE INSERT COMPOUND CODE PAD THICKNESS

H K x 4 2 8 4 4 8
 HAWK KIT INSERT COMPOUND CODE ROTOR PAD SHAPE

MAKE/ MODEL	SUBMODEL	YRS.	ENGINE (LITER)	NOTE	FRONT				REAR			
					PADS	PAD COMPOUND	ROTORS	PAD/ROTOR KIT	PADS	PAD COMPOUND	ROTORS	PAD/ROTOR KIT
CHRYSLER												
200		2011-2012	All	262mm Rear Rotors	HB435x.622	F, Y			HB457x.605	F, Z		
200		2011-2012	All	302mm Rear Rotors	HB435x.622	F, Y			HB675x.602	F, Y		
200		2013	All	295mm Front Rotors & 262mm Rear Rotors	HB435x.622	F, Y			HB457x.605	F, Z		
200		2013	All	295mm Front Rotors & 302mm Rear Rotors	HB435x.622	F, Y			HB675x.602	F, Y		
200		2013	All	340mm Front Rotors & 302mm Rear Rotors	HB509x.678	F, Z			HB675x.602	F, Y		
300	C	2005-2010	5.7	V8 NON SRT-8	HB509x.678	F, Z	HUS8361	HKx8361509	HB508x.675	F, Z	HUS8362	HKx8362508T2
300	C	2005-2010	5.7	V8 2WD & 4WD	HB509x.678	F, Z	HUS8361	HKx8361509	HB508x.675	F, Z	HUS8362	HKx8362508T2
300	C SRT8	2005-2013	6.1		HB563x.656	F, Z, Y, N			HB194x.570	F, Z, Y, N, U, V, S, E, W		
300		2005-2010	All	all except SRT 8 With Solid rear rotor	HB507x.711	F, Z	HUS8361	HKx8361507	HB508x.675	F, Z		
300		2005-2010	All	all except SRT 8 With vented rear rotor	HB509x.678	F, Z	HUS8361	HKx8361509	HB508x.586	F, Z	HUS8362	HKx8362508T2
300		2011-2013	3.6	RWD - with Solid rear rotor	HB507x.711	F, Z	HUS8361	HKx8361507	HB508x.675	F, Z		
300		2011	5.4	Hemi	HB509x.678	F, Z	HUS8361	HKx8361509	HB508x.586	F, Z	HUS8362	HKx8362508T2
300		2012-2013	All	exc. SRT8 w/vented rear rotors	HB509x.678	F, Z	HUS8361	HKx8361509	HB508x.586	F, Z	HUS8362	HKx8362508T2
300		1969-1971	All		HB643x.595	F						
300		2005-2007	2.7		HB507x.711	F, Z			HB508x.675	F, Z		
300M	Pro-Am Edition	2003-2003	All		HB260x.670	F, Z			HB176x.614	F, Z, N		
300M	Special	2002-2004	All		HB260x.670	F, Z			HB176x.614	F, Z, N		
300M		1999-2004	All		HB260x.670	F, Z			HB176x.614	F, Z, N		
Aspen	Limited	2007-2009	All		HB559x.695	F, Y	HUS8749	HKx8749559	HB513x.610	F, Y		
Cirrus	LXI	1997-1997	All						HB176x.614	F, Z, N		
Cirrus		1998-1998	All						HB176x.614	F, Z, N		
Concorde	Limited	2002-2004	All		HB260x.670	F, Z			HB176x.614	F, Z, N		
Concorde	LX	1996-1997	All		HB177x.710	F			HB176x.614	F, Z, N		
Concorde	LX	2002-2004	All		HB260x.670	F, Z			HB176x.614	F, Z, N		
Concorde	LXI	1996-1997	All		HB177x.710	F			HB176x.614	F, Z, N		
Concorde	LXI	2002-2004	All		HB260x.670	F, Z			HB176x.614	F, Z, N		
Concorde		1993-1994	All						HB176x.614	F, Z, N		
Concorde		1995-1995	All		HB177x.710	F			HB176x.614	F, Z, N		
Concorde		1998-2001	All		HB260x.670	F, Z			HB176x.614	F, Z, N		
Cordoba		1976-1977	All		HB643x.595	F						
Crossfire	Limited	2006-2006	All		HB497x.776	F, Z, U, S						
Crossfire	Srt-6	2005-2006	All		HB497x.776	F, Z, U, S			HB371x.600	F		
Crossfire		2006-2006	All		HB497x.776	F, Z, U, S						
Imperial		1970-1973	All		HB643x.595	F						
Imperial		1991-1993	All						HB176x.614	F, Z, N		
Imperial Crown		1970-1973	All		HB643x.595	F						
LHS		1994-1994	All						HB176x.614	F, Z, N		
LHS		1995-1997	All		HB177x.710	F			HB176x.614	F, Z, N		
LHS		1999-2001	All		HB260x.670	F, Z			HB176x.614	F, Z, N		
New Yorker	Fifth Avenue	1991-1993	All						HB176x.614	F, Z, N		
New Yorker	Salon	1991-1993	All						HB176x.614	F, Z, N		
New Yorker		1969-1973	All		HB643x.595	F						
New Yorker		1994-1994	All						HB176x.614	F, Z, N		
New Yorker		1995-1996	All		HB177x.710	F			HB176x.614	F, Z, N		
Newport		1961-1962	All	Except Wagon	HB643x.595	F						

RACE PAD COMPOUNDS

DTC-70 - U	DTC-05 - H	MT-4 - L	HP Plus - N
DTC-60 - G	HT-14 - V	Blue 9012 - E	
DTC-30 - W	HT-10 - S	Black - M	
DTC-15 - A	Metallic - MB	DR-97 - J	

STREET PAD COMPOUNDS

HPS Performance Street - F	LTS Light Truck & SUV - Y
Performance Ceramic - Z	SuperDuty - P

MAKE/ MODEL	SUBMODEL	YRS.	ENGINE (LITER)	NOTE	FRONT				REAR			
					PADS	PAD COMPOUND	ROTOR	PAD/ROTOR KIT	PADS	PAD COMPOUND	ROTOR	PAD/ROTOR KIT
CHRYSLER CONTINUED												
Newport		1970-1973	All		HB643x.595	F						
Pacifica	Limited	2006-2008	All		HB433x.654	F						
Pacifica	LX	2008-2008	All		HB433x.654	F						
Pacifica	Touring	2006-2008	All		HB433x.654	F						
Pacifica		2004-2007	All		HB433x.654	F						
Prowler		2001-2002	All		HB260x.670	F, Z			HB260x.670	F, Z		
PT Cruiser	Turbo	2003-2008	All		HB377x.760	F, Z, N, V, S, E	HUS8351	HKx8351377	HB176x.614	F, Z, N		
PT Cruiser		2001-2010	All	w/Rear Drum Brakes Except Turbo	HB377x.760	F, Z, N, V, S, E						
PT Cruiser		2001-2010	All	w/Rear Disc Brakes Except Turbo	HB377x.760	F, Z, N, V, S, E			HB176x.614	F, Z, N		
Sebring Convertible		1996-2000	All						HB176x.614	F, Z, N		
Sebring Convertible		2001-2006	All		HB498x.772	F			HB176x.614	F, Z, N		
Sebring Convertible		2008-2008	2.4		HB435x.622	F, Y						
Sebring Convertible		2008-2008	2.7		HB435x.622	F, Y			HB457x.605	F, Z		
Sebring Convertible		2008-2008	3.5		HB435x.622	F, Y			HB176x.614	F, Z, N		
Sebring Convertible		2010-2010	All		HB435x.622	F, Y			HB176x.614	F, Z, N		
Sebring Coupe		1995-2000	All		HB213x.626	F, Z, N, E	HUS518	HKx518213	HB367x.585	F, Z, N	HUS772	HKx772367
Sebring Coupe		2001-2005		4 Cyl., w/Rear Drum Brakes	HB213x.626	F, Z, N, E	HUS518	HKx518213				
Sebring Coupe		2001-2005		6 Cyl., w/Rear Disc Brakes	HB435x.622	F, Y	HUS586	HKx586435	HB367x.585	F, Z, N	HUS772	HKx772367
Sebring Sedan		2001-2002	All		HB498x.772	F			HB176x.614	F, Z, N		
Sebring Sedan		2003-2006		4 Cyl., w/Rear Drum Brakes	HB498x.772	F						
Sebring Sedan		2003-2006		6 Cyl., w/Rear Disc Brakes	HB498x.772	F			HB176x.614	F, Z, N		
Sebring Sedan		2007-2008	2.4		HB435x.622	F, Y						
Sebring Sedan		2007-2008	2.7		HB435x.622	F, Y			HB457x.605	F, Z		
Sebring Sedan		2007-2008	3.5		HB435x.622	F, Y						
Town & Country	Limited	2006-2007	All	w/Rear Disc Brakes	HB374x.700	F			HB372x.626	F, Y		
Town & Country	LX	1996-1998	All		HB177x.710	F						
Town & Country	LX	2001-2001	All	w/Rear Disc Brakes	HB374x.700	F			HB372x.626	F, Y		
Town & Country	LX	2006-2007	All	w/Rear Disc Brakes	HB374x.700	F			HB372x.626	F, Y		
Town & Country	LXI	1996-1998	All		HB177x.710	F						
Town & Country	LXI	2001-2001	All	w/Rear Disc Brakes	HB374x.700	F			HB372x.626	F, Y		
Town & Country	Touring	2006-2007	All	w/Rear Disc Brakes	HB374x.700	F			HB372x.626	F, Y		
Town & Country		1969-1973	All		HB643x.595	F						
Town & Country		1996-1996	All		HB177x.710	F						
Town & Country		1999-2000	All		HB177x.710	F						
Town & Country		2001-2006	All	w/Rear Drum Brakes	HB373x.689	F						
Town & Country		2001-2007	All	w/Rear Disc Brakes	HB374x.700	F			HB372x.626	F, Y		
DODGE												
330		1969-1973	All		HB643x.595	F						
330		1977-1978	All		HB643x.595	F						
440		1969-1973	All		HB643x.595	F						
440		1977-1978	All		HB643x.595	F						
500		1969-1973	All		HB643x.595	F						
500		1977-1978	All		HB643x.595	F						
Avenger	ES	1995-1998	All		HB213x.626	F, Z, N, E	HUS518	HKx518213	HB367x.585	F, Z, N	HUS772	HKx772367
Avenger	R/T	2008-2008	All	FWD	HB435x.622	F, Y			HB675x.602	F, Y		
Avenger		1995-1996	All		HB213x.626	F, Z, N, E	HUS518	HKx518213				

BRAKE PAD CODE BREAKDOWN

H B **2 4 5** **x** **. 6 3 1**

HAWK BRAKE PAD SHAPE INSERT COMPOUND CODE PAD THICKNESS

PAD/ROTOR KIT CODE BREAKDOWN

H K **x** **4 2 8** **4 4 8**

HAWK KIT INSERT COMPOUND CODE ROTOR PAD SHAPE

MAKE/ MODEL	SUBMODEL	YRS.	ENGINE (LITER)	NOTE	FRONT				REAR			
					PADS	PAD COMPOUND	ROTORS	PAD/ROTOR KIT	PADS	PAD COMPOUND	ROTORS	PAD/ROTOR KIT
DODGE CONTINUED												
Avenger		1997-2000	All		HB213x.626	F, Z, N, E	HUS518	HKx518213	HB367x.585	F, Z, N	HUS772	HKx772367
Avenger		2010-2010	All	Convertible	HB435x.622	F, Y			HB457x.605	F, Z		
Avenger		2010-2010	All	Sedan (4 Door)	HB435x.622	F, Y						
Avenger		2011-2012	All	262mm Rear Rotors	HB435x.622	F, Y			HB457x.605	F, Z		
Avenger		2011-2012	All	302mm Rear Rotors	HB435x.622	F, Y			HB675x.602	F, Y		
Avenger		2013	All	295mm Front Rotors & 262mm Rear Rotors	HB435x.622	F, Y			HB457x.605	F, Z		
Avenger		2013	All	295mm Front Rotors & 302mm Rear Rotors	HB435x.622	F, Y			HB675x.602	F, Y		
Avenger		2013	All	340mm Front Rotors & 302mm Rear Rotors	HB509x.678	F, Z			HB675x.602	F, Y		
B100 Van		1970-1972	All		HB643x.595	F						
B150 Van	Sportsman	1984-1987	All		HB398x.680	F						
B150 Van		1970-1972	All		HB643x.595	F						
B150 Van		1984-1987	All		HB398x.680	F						
B1500 Van	Sportsman	1995-1997	All		HB398x.680	F						
B1500 Van		1995-1997	All		HB398x.680	F						
B1500 Van		1998-1998	All		HB299x.650	F, Z, Y, P						
B250 Van	Sportsman	1984-1994	All		HB398x.680	F						
B250 Van		1984-1994	All		HB398x.680	F						
B2500 Van	Sportsman	1995-1997	All		HB398x.680	F						
B2500 Van		1995-1997	All		HB398x.680	F						
B2500 Van		1998-1998	All		HB334x.736	Y, P						
B350 Van	Sportsman	1984-1994	All		HB398x.680	F						
B3500 Van	Sportsman	1995-1997	All		HB398x.680	F						
B3500 Van		1995-1997	All		HB398x.680	F						
B3500 Van		1998-1998	All		HB334x.736	Y, P						
Caliber	R/T	2007-2013	All		HB435x.622	F, Y			HB457x.605	F, Z		
Caliber	SE	2008-2013	All		HB435x.622	F, Y						
Caliber	SRT-4	2008-2008	All		HB509x.678	F, Z						
Caliber	SXT	2008-2013	All		HB435x.622	F, Y			HB457x.605	F, Z		
Caravan	ES	1996-1997	All		HB177x.710	F						
Caravan	LE	1996-1997	All		HB177x.710	F						
Caravan	SE	1996-1997	All		HB177x.710	F						
Caravan	SE	1999-1999	All		HB177x.710	F						
Caravan	SE	2001-2001	All	w/Rear Disc Brakes	HB374x.700	F			HB372x.626	F, Y		
Caravan	SE	2001-2004	All	w/Rear Drum Brakes	HB373x.689	F						
Caravan	SE	2005-2005	All		HB374x.700	F			HB372x.626	F, Y		
Caravan	SE	2006-2007	All	w/Rear Disc Brakes	HB374x.700	F			HB372x.626	F, Y		
Caravan	SE	2006-2007	All	w/Rear Drum Brakes	HB373x.689	F						
Caravan	Sport	2001-2001	All	w/Rear Drum Brakes	HB373x.689	F						
Caravan	SXT	2006-2007	All	w/Rear Disc Brakes	HB374x.700	F			HB372x.626	F, Y		
Caravan	SXT	2006-2007	All	w/Rear Drum Brakes	HB373x.689	F						
Caravan		1996-2000	All		HB177x.710	F						
Caravan		2001-2004	All	w/Rear Drum Brakes	HB373x.689	F						
Caravan		2001-2004	All	w/Rear Disc Brakes	HB374x.700	F			HB372x.626	F, Y		
Caravan		2005-2007	All		HB374x.700	F			HB372x.626	F, Y		
Challenger	R/T	2009-2013	All	Vented rear disc	HB509x.678	F, Z	HUS8361	HKx8361509	HB508x.586	F, Z	HUS8362	HKx8362508T2

RACE PAD COMPOUNDS

DTC-70 - U	DTC-05 - H	MT-4 - L	HP Plus - N
DTC-60 - G	HT-14 - V	Blue 9012 - E	
DTC-30 - W	HT-10 - S	Black - M	
DTC-15 - A	Metallic - MB	DR-97 - J	

STREET PAD COMPOUNDS

HPS Performance Street - F	LTS Light Truck & SUV - Y
Performance Ceramic - Z	SuperDuty - P

MAKE/ MODEL	SUBMODEL	ENGINE YRS. (LITER)	NOTE	FRONT				REAR			
				PADS	PAD COMPOUND	ROTOR	PAD/ROTOR KIT	PADS	PAD COMPOUND	ROTOR	PAD/ROTOR KIT
DODGE CONTINUED											
Challenger	SE	2009-2013	3.5 Solid Rear Disc	HB507x.711	F, Z	HUS8359	HKx8359507	HB508x.675	F, Z		
Challenger	SE Rallye Pkg	2011-2013	3.6 Solid Rear Disc	HB507x.711	F, Z	HUS8359	HKx8359507	HB508x.675	F, Z		
Challenger	V6	2012-2013	All Solid Rear Disc	HB507x.711	F, Z	HUS8359	HKx8359507	HB508x.675	F, Z		
Challenger	V6	2012-2013	All Excl. SRT8, Perf. brakes	HB509x.678	F, Z	HUS8361	HKx8361509	HB508x.675	F, Z	HUS8362	HKx8362508T2
Challenger	V8	2012-2013	All Excl. SRT8, Perf. brakes	HB509x.678	F, Z	HUS8361	HKx8361509	HB508x.675	F, Z	HUS8362	HKx8362508T2
Challenger	V6	2012-2013	All Touring Brakes	HB507x.711	F, Z	HUS8359	HKx8359507	HB508x.675	F, Z		
Challenger	SRT8	2008-2013	6.1	HB563x.656	F, Z, Y, N			HB194x.570	F, Z, Y, N, U, V, S, E, W		
Challenger		1970-1974	All	HB643x.595	F						
Challenger		2008-2008	All	HB509x.678	F, Z			HB508x.675	F, Z		
Charger	Daytona R/T	2006-2013	All w/Vented Rear Rotor	HB509x.678	F, Z	HUS8361	HKx8361509	HB508x.586	F, Z		
Charger	Police	2006-2013	All	HB509x.678	F, Z	HUS8361	HKx8361509	HB508x.586	F, Z		
Charger	R/T	2006-2013	All Vented Rear Rotor	HB509x.678	F, Z	HUS8361	HKx8361509	HB508x.586	F, Z	HUS8362	HKx8362508T1
Charger	SE	2006-2013	All RWD w/ Solid Rear Disc	HB507x.711	F, Z	HUS8359	HKx8359507	HB508x.586	F, Z		
Charger	SRT8	2006-2013	All	HB563x.656	F, Z, Y, N			HB194x.570	F, Z, Y, N, U, V, S, E, W		
Charger	SXT AWD	2006-2013	All AWD w/Vented Rear Disc	HB509x.678	F, Z	HUS8361	HKx8361509	HB508x.586	F, Z	HUS8362	HKx8362508T1
Charger	SXT RWD	2006-2013	All RWD w/ Solid Rear Disc	HB507x.711	F, Z	HUS8359	HKx8359507	HB508x.586	F, Z		
Charger		1970-1977	All w/Pin Type Calipers	HB643x.595	F						
Coronet		1970-1977	All w/Pin Type Calipers	HB643x.595	F						
Crestwood		1970-1977	All w/Pin Type Calipers	HB643x.595	F						
Custom Wagon		1970-1977	All w/Pin Type Calipers	HB643x.595	F						
D100 Pickup		1986-1989	All	HB398x.680	F						
D150 Pickup	S	1990-1991	All	HB398x.680	F						
D150 Pickup		1984-1993	All	HB398x.680	F						
D200 Pickup		1972-1972	All	HB643x.595	F						
D250 Pickup		1972-1972	All	HB643x.595	F						
D250 Pickup		1984-1993	All	HB398x.680	F						
D300 Pickup		1972-1972	All Single Rear Wheels	HB643x.595	F						
D350 Pickup		1972-1972	All Single Rear Wheels	HB643x.595	F						
D350 Pickup		1984-1993	All	HB398x.680	F						
Dakota	Laramie	2006-2011	All	HB559x.695	F, Y						
Dakota	SLT	2006-2011	All	HB559x.695	F, Y						
Dakota	Sport	2008-2011	All	HB559x.695	F, Y						
Dakota	ST	2006-2011	All	HB559x.695	F, Y						
Dakota	SXT	2008-2011	All	HB559x.695	F, Y						
Dakota	TRX	2008-2011	All	HB559x.695	F, Y						
Dakota	TRX4	2008-2011	All	HB559x.695	F, Y						
Dakota		1999-1999	All	HB306x.795	F						
Dakota		2000-2002	All	HB307x.795	F, Z, Y, P						
Dakota		2003-2004	All	HB476x.707	F, Y			HB503x.790	Y		
Dakota		2005-2005	All	HB559x.695	F, Y						
Dart	270	1968-1968	All	HB471x.510	F, N, U, S						
Dart	Custom	1969-1972	All	HB471x.510	F, N, U, S						
Dart	Demon	1971-1972	All	HB471x.510	F, N, U, S						
Dart	Demon 340	1971-1972	All	HB471x.510	F, N, U, S						
Dart	GT	1968-1969	All	HB471x.510	F, N, U, S						
Dart	GTS	1968-1969	All	HB471x.510	F, N, U, S						
Dart	Special	1971-1972	All	HB471x.510	F, N, U, S						
Dart	Swinger	1969-1972	All	HB471x.510	F, N, U, S						

APPLICATION GUIDE

BRAKE PAD CODE BREAKDOWN

PAD/ROTOR KIT CODE BREAKDOWN

H B 2 4 5 x . 6 3 1
 HAWK BRAKE PAD SHAPE INSERT COMPOUND CODE PAD THICKNESS

H K x 4 2 8 4 4 8
 HAWK KIT INSERT COMPOUND CODE ROTOR PAD SHAPE

MAKE/ MODEL	SUBMODEL	ENGINE YRS. (LITER)	NOTE	FRONT				REAR			
				PADS	PAD COMPOUND	ROTORS	PAD/ROTOR KIT	PADS	PAD COMPOUND	ROTORS	PAD/ROTOR KIT
DODGE CONTINUED											
Dart		1966-1972	All	HB471x.510	F, N, U, S						
Durango	Citadel	2011-2013	3.6	HB701x.723	F, Z, Y			HB702x.662	F, Z, Y		
Durango	Citadel	2011-2013	3.6	350mm front rotor	HB701x.723	F, Z, Y	HUS504	HB702x.662	F, Z, Y		
Durango	Citadel	2011-2013	3.6	330mm front rotor	HB701x.723	F, Z, Y		HB702x.662	F, Z, Y	HUS505	
Durango	Crew	2011-2013	3.6		HB701x.723	F, Z, Y		HB702x.662	F, Z, Y		
Durango	Crew	2011-2013	3.6	350mm front rotor	HB701x.723	F, Z, Y	HUS504	HB702x.662	F, Z, Y		
Durango	Crew	2011-2013	3.6	330mm front rotor	HB701x.723	F, Z, Y		HB702x.662	F, Z, Y	HUS505	
Durango	Crewlux	2011-2013	3.6		HB701x.723	F, Z, Y		HB702x.662	F, Z, Y		
Durango	Crewlux	2011-2013	3.6	350mm front rotor	HB701x.723	F, Z, Y	HUS504	HB702x.662	F, Z, Y		
Durango	Crewlux	2011-2013	3.6	330mm front rotor	HB701x.723	F, Z, Y		HB702x.662	F, Z, Y	HUS505	
Durango	Express	2011-2013	3.6		HB701x.723	F, Z, Y		HB702x.662	F, Z, Y		
Durango	Express	2011-2013	3.6	350mm front rotor	HB701x.723	F, Z, Y	HUS504	HB702x.662	F, Z, Y		
Durango	Express	2011-2013	3.6	330mm front rotor	HB701x.723	F, Z, Y		HB702x.662	F, Z, Y	HUS505	
Durango	Heat	2011-2013	3.6		HB701x.723	F, Z, Y		HB702x.662	F, Z, Y		
Durango	Heat	2011-2013	3.6	350mm front rotor	HB701x.723	F, Z, Y	HUS504	HB702x.662	F, Z, Y		
Durango	Heat	2011-2013	3.6	330mm front rotor	HB701x.723	F, Z, Y		HB702x.662	F, Z, Y	HUS505	
Durango	R/T	2011-2013	5.7		HB701x.723	F, Z, Y		HB702x.662	F, Z, Y		
Durango		1998-1999	All		HB306x.795	F					
Durango		2000-2002	All		HB307x.795	F, Z, Y, P					
Durango		2003-2003	All		HB299x.650	F, Z, Y, P		HB513x.610	F, Y		
Durango		2004-2005	All		HB299x.650	F, Z, Y, P	HUS8749	HKx8749299	HB513x.610	F, Y	
Durango		2006-2006	All		HB299x.650	F, Z, Y, P	HUS8749	HKx8749299	HB513x.610	F, Y	
Durango		2007-2009	All		HB559x.695	F, Y	HUS8749	HKx8749559	HB513x.610	F, Y	
Dynasty	LE	1991-1993	All					HB176x.614	F, Z, N		
Dynasty		1991-1993	All					HB176x.614	F, Z, N		
Grand Caravan	ES	1996-1997	All		HB177x.710	F					
Grand Caravan	ES	2001-2001	All	w/Rear Disc Brakes	HB374x.700	F		HB372x.626	F, Y		
Grand Caravan	ES	2001-2001	All	w/Rear Drum Brakes	HB373x.689	F					
Grand Caravan	SE	1996-1997	All		HB177x.710	F					
Grand Caravan	SE	2001-2001	All	w/Rear Drum Brakes	HB373x.689	F					
Grand Caravan	SE	2006-2007	All		HB374x.700	F		HB372x.626	F, Y		
Grand Caravan	Sport	2001-2003	All	w/Rear Disc Brakes	HB374x.700	F		HB372x.626	F, Y		
Grand Caravan	Sport	2001-2003	All	w/Rear Drum Brakes	HB373x.689	F					
Grand Caravan	SXT	2006-2007	All		HB374x.700	F		HB372x.626	F, Y		
Grand Caravan		1996-2000	All		HB177x.710	F					
Grand Caravan		2001-2005	All	w/Rear Disc Brakes	HB374x.700	F		HB372x.626	F, Y		
Grand Caravan		2001-2005	All	w/Rear Drum Brakes	HB373x.689	F					
Grand Caravan		2006-2007	All		HB374x.700	F		HB372x.626	F, Y		
Intrepid	ES	1993-1994	All					HB176x.614	F, Z, N		
Intrepid	ES	1995-1997	All		HB177x.710	F		HB176x.614	F, Z, N		
Intrepid	ES	2000-2004	All		HB260x.670	F, Z		HB176x.614	F, Z, N		
Intrepid	Police	2004-2004	All		HB260x.670	F, Z		HB176x.614	F, Z, N		
Intrepid	R/T	2000-2000	All		HB260x.670	F, Z		HB176x.614	F, Z, N		
Intrepid	R/T	2002-2002	All		HB260x.670	F, Z					
Intrepid	SE	2002-2004	All		HB260x.670	F, Z		HB176x.614	F, Z, N		
Intrepid	SXT	2003-2004	All		HB260x.670	F, Z		HB176x.614	F, Z, N		
Intrepid		1993-1994	All					HB176x.614	F, Z, N		
Intrepid		1995-1997	All		HB177x.710	F		HB176x.614	F, Z, N		

APPLICATION GUIDE

RACE PAD COMPOUNDS

DTC-70 - U	DTC-05 - H	MT-4 - L	HP Plus - N
DTC-60 - G	HT-14 - V	Blue 9012 - E	
DTC-30 - W	HT-10 - S	Black - M	
DTC-15 - A	Metallic - MB	DR-97 - J	

STREET PAD COMPOUNDS

HPS Performance Street - F	LTS Light Truck & SUV - Y
Performance Ceramic - Z	SuperDuty - P

MAKE/ MODEL	SUBMODEL	ENGINE YRS. (LITER)	NOTE	FRONT				REAR			
				PADS	PAD COMPOUND	ROTOR	PAD/ROTOR KIT	PADS	PAD COMPOUND	ROTOR	PAD/ROTOR KIT
DODGE CONTINUED											
Intrepid		1998-2001	All	HB260x.670	F, Z			HB176x.614	F, Z, N		
Magnum	R/T	2005-2008	5.7 w/vented rear rotor	HB509x.678	F, Z	HUS8361	HKx8361509	HB508x.586	F	HUS8362	HKx8362508T1
Magnum	SE	2005-2008	2.7 w/vented rear rotor	HB507x.711	F, Z	HUS8361	HKx8361507	HB508x.586	F	HUS8362	HKx8362508T1
Magnum	SRT8	2006-2007	6.1	HB563x.656	F, Z, Y, N			HB194x.570	F, Z, Y, N, U, V, S, E, W		
Magnum	SXT	2005-2008	All w/vented rear rotor - AWD	HB509x.678	F, Z	HUS8361	HKx8361509	HB508x.586	F	HUS8362	HKx8362508T1
Magnum	SXT	2005-2008	All w/vented rear rotor - RWD	HB507x.711	F, Z	HUS8361	HKx8361507	HB508x.586	F	HUS8362	HKx8362508T1
Magnum	SXT Special Edition	2005-2005	All w/vented rear rotor - RWD	HB507x.711	F, Z	HUS8361	HKx8361507	HB508x.586	F	HUS8362	HKx8362508T1
Monaco		1969-1973	All	HB643x.595	F						
Monaco		1977-1978	All	HB643x.595	F						
Neon	ACR	2002-2002	All	HB260x.670	F, Z			HB176x.614	F, Z, N		
Neon	ES	2002-2002	All	HB260x.670	F, Z			HB176x.614	F, Z, N		
Neon	Highline	1995-1997	All	HB177x.630	F, N, G, S, E			HB176x.614	F, Z, N		
Neon	R/T	2001-2004	All	HB260x.670	F, Z			HB176x.614	F, Z, N		
Neon	SE	2002-2004	All	HB260x.670	F, Z			HB176x.614	F, Z, N		
Neon	Sport	1995-1997	All	HB177x.630	F, N, G, S, E			HB176x.614	F, Z, N		
Neon	SRT-4	2003-2005	All	HB377x.760	F, Z, N, V, S, E	HUS8351	HKx8351377	HB176x.614	F, Z, N		
Neon	SXT	2003-2004	All	HB260x.670	F, Z			HB176x.614	F, Z, N		
Neon		1995-1999	All	HB177x.630	F, N, G, S, E			HB176x.614	F, Z, N		
Neon		2000-2001	All	HB260x.670	F, Z			HB176x.614	F, Z, N		
Nitro	R/T	2007-2011	All	HB569x.650	F, Z, Y			HB608x.630	F, Y		
Nitro	SLT	2007-2011	All	HB569x.650	F, Z, Y			HB608x.630	F, Y		
Nitro	SXT	2007-2011	All	HB569x.650	F, Z, Y			HB608x.630	F, Y		
Polara		1969-1973	All	HB643x.595	F						
Polara		1977-1978	All	HB643x.595	F						
Raider		1988-1988	All	HB404x.642	F						
Ram 1500 Pickup		1994-1999	All	HB332x.654	F, Z, Y, P						
Ram 1500 Pickup		2000-2001	All 2WD	HB299x.650	F, Z, Y, P	HUS8749	HKx8749299				
Ram 1500 Pickup		2000-2001	All 4WD	HB299x.650	F, Z, Y, P	HUS8747	HKx8747299				
Ram 1500 Pickup		2002-2005	All 2/4WD	HB299x.650	F, Z, Y, P	HUS8749	HKx8749299	HB513x.610	F, Y		
Ram 1500 Pickup		2006-2008	All Quad Cab	HB559x.695	F, Y	HUS8749	HKx8749559	HB513x.610	F, Y		
Ram 1500 Pickup		2006-2008	All Mega Cab	HB552x.722	F, Y, P			HB299x.650	F, Z, Y, P		
Ram 1500 Pickup		2006-2008	All Quad Cab 4WD 5.7 liter V8	HB559x.695	F, Y	HUS8749	HKx8749559	HB514x.610	F, Y		
Ram 1500 Pickup		2009-2013	All	HB559x.695	F, Y	HUS8749	HKx8749559	HB513x.610	F, Y		
Ram 1500 Van		1999-2002	All	HB299x.650	F, Z, Y, P						
Ram 1500 Van		2003-2003	All	HB299x.650	F, Z, Y, P			HB514x.610	F, Y		
Ram 2500 Pickup		1994-1996	All 4WD. w/3500 lb. Front Axle	HB296x.670	F, Z, Y, P	HUS8242	HKx8242296				
Ram 2500 Pickup		1994-1996	All 4WD. w/4500 lb. Front Axle	HB298x.787	F, Y, P	HUS8626	HKx8626298				
Ram 2500 Pickup		1994-1999	All 2WD	HB296x.670	F, Z, Y, P						
Ram 2500 Pickup		1997-1997	All 4WD. 7500 lbs. GVW	HB296x.670	F, Z, Y, P	HUS8242	HKx8242296				
Ram 2500 Pickup		1997-1997	All 4WD. 8800 lbs. GVW	HB298x.787	F, Y, P	HUS8626	HKx8626298				
Ram 2500 Pickup		1998-1999	All 4WD	HB298x.787	F, Y, P	HUS8626	HKx8626298				
Ram 2500 Pickup		2000-2002	All 2/4WD	HB487x.733	F, Y			HB299x.650	F, Z, Y, P		
Ram 2500 Pickup		2003-2008	All 2/4WD	HB552x.722	F, Y, P	HUS7761	HKx7761552	HB299x.650	F, Z, Y, P		
Ram 2500 Pickup		2009-2011	All	HB633x.790	P			HB634x.750	P		
Ram 2500 Van		1999-2003	All	HB334x.736	Y, P						
Ram 3500 Pickup		1994-1999	All 2WD. w/Solid Front Axle	HB298x.787	F, Y, P	HUS8626	HKx8626298				
Ram 3500 Pickup		1994-1999	All 4WD	HB298x.787	F, Y, P	HUS8626	HKx8626298				
Ram 3500 Pickup		2000-2002	All 2/4WD	HB487x.733	F, Y			HB299x.650	F, Z, Y, P		

APPLICATION GUIDE

BRAKE PAD CODE BREAKDOWN

H B 2 4 5 x . 6 3 1
 HAWK BRAKE PAD SHAPE INSERT COMPOUND CODE PAD THICKNESS

PAD/ROTOR KIT CODE BREAKDOWN

H K x 4 2 8 4 4 8
 HAWK KIT INSERT COMPOUND CODE ROTOR PAD SHAPE

MAKE/ MODEL	SUBMODEL	ENGINE YRS. (LITER)	NOTE	FRONT				REAR				
				PADS	PAD COMPOUND	ROTORS	PAD/ROTOR KIT	PADS	PAD COMPOUND	ROTORS	PAD/ROTOR KIT	
DODGE CONTINUED												
Ram 3500 Pickup		2003-2008	All	2/4WD. SRW/DRW	HB552x.722	F, Y, P	HUS7761	HKx7761552	HB299x.650	F, Z, Y, P		
Ram 3500 Pickup		2009-2011	All	2/4WD	HB633x.790	P			HB634x.750	P		
Ram 3500 Van		1999-2003	All		HB334x.736	Y, P						
Ram 50	Custom	1987-1989	All		HB404x.642	F						
Ram 50	SE	1990-1993	All		HB404x.642	F						
Ram 50	Sport	1987-1989	All		HB404x.642	F						
Ram 50		1987-1993	All		HB404x.642	F						
Sprinter	2500	2003-2006	All						HB479x.700	P		
Sprinter	3500	2005-2006	All						HB479x.700	P		
Stealth	R/T Turbo	1995-1996	All	AWD	HB120x.560	F, Z, N, E			HB201x.620	F, N		
Stealth		1991-1993	All	2WD	HB214x.618	F, Z, N, S, E, G	HUS583	HKx583214	HB367x.585	F, Z, N		
Stealth		1991-1993	All	AWD	HB120x.560	F, Z, N, E						
Stealth		1994-1994	All	2WD	HB214x.618	F, Z, N, S, E, G	HUS583	HKx583214	HB367x.585	F, Z, N		
Stealth		1994-1994	All	AWD	HB120x.560	F, Z, N, E						
Stealth		1995-1996	All	2WD	HB214x.618	F, Z, N, S, E, G	HUS583	HKx583214	HB367x.585	F, Z, N		
Stealth		1995-1996	All	AWD	HB120x.560	F, Z, N, E			HB201x.620	F, N		
Stratus Coupe		2001-2005	All	4 Cyl. Only	HB213x.626	F, Z, N, E	HUS518	HKx518213				
Stratus Coupe		2001-2005	All	6 Cyl. Only	HB435x.622	F, Y	HUS586	HKx586435	HB367x.585	F, Z, N	HUS772	HKx772367
Stratus Sedan		1995-1997	All						HB176x.614	F, Z, N		
Stratus Sedan		1998-2000	All						HB176x.614	F, Z, N		
Stratus Sedan		2001-2006	All		HB498x.772	F			HB176x.614	F, Z, N		
Super Bee		1970-1977	All	w/Pin Type Calipers	HB643x.595	F						
Viper	GTS	1996-1996	All		HB194x.665	F, Z, N, U, V, S, E			HB278x.583	F, E		
Viper	GTS	2000-2000	All		HB194x.665	F, Z, N, U, V, S, E			HB278x.583	F, E		
Viper	GTS	2001-2002	All		HB194x.665	F, Z, N, U, V, S, E						
Viper	RT10	2000-2000	All		HB194x.665	F, Z, N, U, V, S, E			HB278x.583	F, E		
Viper	RT10	2001-2002	All		HB194x.665	F, Z, N, U, V, S, E						
Viper	SRT-10	2003-2006	All		HB193x.670	F, Z, N, U, G, W, V, S, E			HB193x.670	F, Z, N, U, G, W, V, S, E		
Viper	SRT-10	2008-2009	All		HB193x.670	F, Z, N, U, G, W, V, S, E			HB193x.670	F, Z, N, U, G, W, V, S, E		
Viper		1992-2000	All		HB194x.665	F, Z, N, U, V, S, E			HB278x.583	F, E		
Viper		2001-2002	All		HB194x.665	F, Z, N, U, V, S, E						
W100 Pickup		1986-1989	All		HB398x.680	F						
W150 Pickup	S	1990-1991	All		HB398x.680	F						
W150 Pickup		1984-1993	All		HB398x.680	F						
W250 Pickup		1984-1993	All	w/3800 lb. Front Axle	HB398x.680	F						
EAGLE												
Talon	TSI	1990-1992	All		HB213x.626	F, Z, N, E	HUS518	HKx518213				
Talon	TSI	1990-1992	All	2WD	HB213x.626	F, Z, N, E	HUS518	HKx518213				
Talon	TSI	1993-1994	All	AWD	HB214x.618	F, Z, N, S, E, G	HUS583	HKx583214				
Talon	TSI	1995-1996	All	AWD	HB214x.618	F, Z, N, S, E, G	HUS583	HKx583214				
Talon	TSI	1995-1999	All	2WD	HB213x.626	F, Z, N, E	HUS583	HKx583213	HB367x.585	F, Z, N	HUS772	HKx772367
Talon	TSI	1997-1997	All	AWD	HB214x.618	F, Z, N, S, E, G	HUS583	HKx583214	HB367x.585	F, Z, N	HUS772	HKx772367
Talon	TSI	1998-1999	All	AWD	HB214x.618	F, Z, N, S, E, G			HB367x.585	F, Z, N		
Vision	ESI	1993-1994	All						HB176x.614	F, Z, N		
Vision	ESI	1995-1997	All		HB177x.710	F			HB176x.614	F, Z, N		
Vision	TSI	1993-1994	All						HB176x.614	F, Z, N		
Vision	TSI	1995-1997	All		HB177x.710	F			HB176x.614	F, Z, N		

RACE PAD COMPOUNDS

DTC-70 - U	DTC-05 - H	MT-4 - L	HP Plus - N
DTC-60 - G	HT-14 - V	Blue 9012 - E	
DTC-30 - W	HT-10 - S	Black - M	
DTC-15 - A	Metallic - MB	DR-97 - J	

STREET PAD COMPOUNDS

HPS Performance Street - F	LTS Light Truck & SUV - Y
Performance Ceramic - Z	SuperDuty - P

MAKE/ MODEL	SUBMODEL	ENGINE YRS. (LITER)	NOTE	FRONT				REAR			
				PADS	PAD COMPOUND	ROTORS	PAD/ROTOR KIT	PADS	PAD COMPOUND	ROTORS	PAD/ROTOR KIT
FERRARI											
612		2004-2006	All	HB632x.586	F, Z, N						
348 GTB		1989-1995	All	HB170x.650	F, Z, N, U, G, S, E, M			HB170x.650	F, Z, N, U, G, S, E, M		
456 GT		1994-1996	All	HB193x.670	F, Z, N, U, G, W, V, S, E			HB141x.650	F, Z, N, U, G, W, V, S, E		
512 TR		1992-1994	All	HB193x.670	F, Z, N, U, G, W, V, S, E			HB170x.650	F, Z, N, U, G, S, E, M		
F355		1999-1999	All	HB170x.650	F, Z, N, U, G, S, E, M			HB170x.650	F, Z, N, U, G, S, E, M		
F40		1988-1992	All	HB193x.670	F, Z, N, U, G, W, V, S, E			HB193x.670	F, Z, N, U, G, W, V, S, E		
F50		1995-1997	All	HB193x.670	F, Z, N, U, G, W, V, S, E			HB193x.670	F, Z, N, U, G, W, V, S, E		
GTS		1989-1995	All	HB170x.650	F, Z, N, U, G, S, E, M			HB170x.650	F, Z, N, U, G, S, E, M		
Mondena		1998-2000	All	HB193x.670	F, Z, N, U, G, W, V, S, E						
Mondial		1982-1993	All	HB137x.690	F, N, U, G, S						
Testarossa		1988-1991	All	HB206x.565	E						
FORD											
Aerostar		1987-1997	All	HB279x.594	Y						
B-600		1984-1989	All	6000-7000 Front Axle	HB253x.750	P					
B-600		1984-1989	All	8000-12000 Front Axle	HB254x1.00	P					
B-700		1984-1989	All		HB254x1.00	P					
B-7000		1984-1987	All		HB254x1.00	P					
Bronco		1977-1986	All		HB292x.674	F, P					
Bronco		1988-1993	All		HB293x.668	F					
Bronco		1994-1996	All		HB295x.630	F, Y, P					
Bronco II		1984-1990	All		HB279x.594	Y					
C-600		1984-1986	All		HB253x.750	P					
C-700		1984-1986	All	6000-7000 Front Axle	HB253x.750	P					
C-700		1984-1986	All	8000-12000 Front Axle	HB254x1.00	P					
C-7000		1984-1986	All	6000-7000 Front Axle	HB253x.750	P					
C-7000		1984-1986	All	8000-12000 Front Axle	HB254x1.00	P					
C-800		1984-1987	All		HB254x1.00	P					
C-8000		1984-1984	All		HB254x1.00	P					
Contour	GL	1995-1998	All		HB420x.724	F		HB510x.580	F		
Contour	LX	1995-1998	All		HB420x.724	F		HB510x.580	F		
Contour	SE	1995-1998	All		HB420x.724	F		HB510x.580	F		
Contour	Sport	1996-1997	All		HB420x.724	F		HB510x.580	F		
Contour		1997-2000	All		HB420x.724	F		HB510x.580	F		
Country Squire	LX	1987-1991	All		HB125x.650	F, Z, E					
Country Squire		1973-1978	All		HB292x.674	F, P					
Country Squire		1987-1991	All		HB125x.650	F, Z, E					
Crown Victoria	LX	1992-1994	All		HB125x.650	F, Z, E					
Crown Victoria	LX	1998-1998	All		HB294x.646	F		HB353x.618	F, Y		
Crown Victoria	LX	2006-2010	All		HB433x.654	F		HB443x.614	F		
Crown Victoria	LX Sport	2006-2010	All		HB433x.654	F		HB443x.614	F		
Crown Victoria	Police Interceptor	1993-1994	All		HB125x.650	F, Z, E					
Crown Victoria	Police Interceptor	1998-1998	All		HB294x.646	F		HB353x.618	F, Y		
Crown Victoria	Police Interceptor	2003-2011	All		HB433x.654	F		HB443x.614	F		
Crown Victoria	S	1992-1994	All		HB125x.650	F, Z, E					
Crown Victoria	S	1998-1998	All		HB294x.646	F		HB353x.618	F, Y		
Crown Victoria	Touring Sedan	1992-1992	All		HB125x.650	F, Z, E					
Crown Victoria		1992-1994	All		HB125x.650	F, Z, E					
Crown Victoria		1998-2002	All		HB294x.646	F		HB341x.618	F		

APPLICATION GUIDE

BRAKE PAD CODE BREAKDOWN

PAD/ROTOR KIT CODE BREAKDOWN

H B 2 4 5 x . 6 3 1
 HAWK BRAKE PAD SHAPE INSERT COMPOUND CODE PAD THICKNESS

H K x 4 2 8 4 4 8
 HAWK KIT INSERT COMPOUND CODE ROTOR PAD SHAPE

MAKE/ MODEL	SUBMODEL	YRS.	ENGINE (LITER)	NOTE	FRONT				REAR			
					PADS	PAD COMPOUND	ROTOR	PAD/ROTOR KIT	PADS	PAD COMPOUND	ROTOR	PAD/ROTOR KIT
FORD CONTINUED												
Crown Victoria		2003-2010	All		HB433x.654	F			HB443x.614	F		
Custom 500		1975-1975	All		HB292x.674	F, P						
E-100 Econoline	Club Wagon	1975-1977	All		HB292x.674	F, P						
E-100 Econoline		1975-1976	All		HB292x.674	F, P						
E-150 Econoline	Club Wagon	1975-1986	All		HB292x.674	F, P						
E-150 Econoline	Club Wagon	1987-1993	All		HB293x.668	F						
E-150 Econoline	Club Wagon	1994-1998	All		HB295x.630	F, Y, P						
E-150 Econoline	Super	1985-1986	All		HB292x.674	F, P						
E-150 Econoline	Super	1987-1991	All		HB293x.668	F						
E-150 Econoline		1975-1976	All		HB292x.674	F, P						
E-150 Econoline		1987-1993	All		HB293x.668	F						
E-150 Econoline		1994-2003	All		HB295x.630	F, Y, P						
E-250		2006-2007	All		HB334x.736	Y, P			HB539x.650	Y		
E-250 Econoline	Club Wagon	1976-1988	All		HB255x.655	P						
E-250 Econoline	Club Wagon	1989-1991	All		HB336x.655	Y						
E-250 Econoline	HD	1991-1991	All		HB336x.655	Y						
E-250 Econoline	Super	1977-1988	All		HB255x.655	P						
E-250 Econoline	Super	1989-1991	All		HB336x.655	Y						
E-250 Econoline	Super	1995-1998	All		HB334x.736	Y, P						
E-250 Econoline	Super Wagon	1978-1984	All		HB255x.655	P						
E-250 Econoline		1989-1991	All		HB336x.655	Y						
E-250 Econoline		1995-1996	All		HB334x.736	Y, P						
E-250 Econoline		1997-2005	All		HB334x.736	Y, P			HB539x.650	Y		
E-350 Econoline	HD Club Wagon	1995-1998	All		HB334x.736	Y, P						
E-350 Econoline	Super	1978-1988	All		HB255x.655	P						
E-350 Econoline	Super	1989-1991	All		HB336x.655	Y						
E-350 Econoline	Super	1995-1998	All		HB334x.736	Y, P						
E-350 Econoline	Super	1999-1999	All		HB334x.736	Y, P			HB539x.650	Y		
E-350 Econoline	Super Wagon	1978-1988	All		HB255x.655	P						
E-350 Econoline	Super Wagon	1989-1991	All		HB336x.655	Y						
E-350 Econoline	Super Wagon	1995-1998	All		HB334x.736	Y, P						
E-350 Econoline	Super Wagon	1999-1999	All		HB334x.736	Y, P			HB539x.650	Y		
E-350 Econoline		1989-1991	All		HB336x.655	Y						
E-350 Econoline		1995-1998	All		HB334x.736	Y, P						
E-350 Econoline		1999-2005	All		HB334x.736	Y, P			HB539x.650	Y		
E-350 Super Duty	XL	2006-2007	All		HB334x.736	Y, P			HB539x.650	Y		
E-350 Super Duty	XLT	2006-2007	All		HB334x.736	Y, P			HB539x.650	Y		
E-350 Super Duty		2006-2007	All		HB334x.736	Y, P			HB539x.650	Y		
E-450 Econoline		2003-2003	All		HB334x.736	Y, P			HB334x.705	P		
Edge		2007-2010	All		HB656x.684	F			HB657x.667	F		
Edge		2011-2013	All		HB656x.684	F			HB674x.664	F, Z		
Elite		1975-1975	All		HB292x.674	F, P						
Escort	GT	1991-1996	All		HB246x.567	F, E, S			HB157x.484	F, N, G, W, E, M		
Escort	LX	1991-1996	All		HB246x.567	F, E, S						
Escort	LX	1997-1998	All		HB246x.567	F, E, S			HB159x.492	F, Z, N, G, W, S, E, M		
Escort	LX-E	1992-1993	All		HB246x.567	F, E, S						
Escort	Pony	1991-1992	All		HB246x.567	F, E, S						
Escort	Sport	1993-1995	All		HB246x.567	F, E, S						

RACE PAD COMPOUNDS

DTC-70 - U	DTC-05 - H	MT-4 - L	HP Plus - N
DTC-60 - G	HT-14 - V	Blue 9012 - E	
DTC-30 - W	HT-10 - S	Black - M	
DTC-15 - A	Metallic - MB	DR-97 - J	

STREET PAD COMPOUNDS

HPS Performance Street - F	LTS Light Truck & SUV - Y
Performance Ceramic - Z	SuperDuty - P

MAKE/ MODEL	SUBMODEL	ENGINE YRS. (LITER)	NOTE	FRONT				REAR			
				PADS	PAD COMPOUND	ROTORS	PAD/ROTOR KIT	PADS	PAD COMPOUND	ROTORS	PAD/ROTOR KIT
FORD CONTINUED											
Escort	Sport	1997-1998	All	HB246x.567	F, E, S			HB159x.492	F, Z, N, G, W, S, E, M		
Escort		1993-1996	All	HB246x.567	F, E, S						
Escort		1997-2002	All	HB246x.567	F, E, S			HB159x.492	F, Z, N, G, W, S, E, M		
Excursion		1999-2002	All	2WD	HB302x.700	F, Z, Y, P		HB303x.685	F, Z, Y, P		
Excursion		1999-2002	All	4WD	HB302x.700	F, Z, Y, P	HUS8586	HKx8586302	HB303x.685	F, Z, Y, P	HUS8571
Excursion		2003-2005	All	2WD	HB302x.700	F, Z, Y, P		HB303x.685	F, Z, Y, P		
Excursion		2003-2005	All	4WD	HB302x.700	F, Z, Y, P	HUS8586	HKx8586302	HB303x.685	F, Z, Y, P	HUS8571
Expedition	Eddie Bauer	2006-2006	All		HB462x.827	F, Z, Y		HB463x.787	F, Z, Y		
Expedition	Eddie Bauer	2007-2009	All		HB578x.735	Y	HUS659	HKx659578	HB579x.785	Y	
Expedition	EL Eddie Bauer	2007-2009	All		HB578x.735	Y	HUS659	HKx659578	HB579x.785	Y	
Expedition	EL King Ranch	2007-2009	All		HB578x.735	Y	HUS659	HKx659578	HB579x.785	Y	
Expedition	EL Limited	2007-2009	All		HB578x.735	Y	HUS659	HKx659578	HB579x.785	Y	
Expedition	EL Xlt	2007-2009	All		HB578x.735	Y	HUS659	HKx659578	HB579x.785	Y	
Expedition	Funkmaster Flex Edition	2007-2009	All		HB578x.735	Y	HUS659	HKx659578	HB579x.785	Y	
Expedition	King Ranch	2006-2006	All		HB462x.827	F, Z, Y		HB463x.787	F, Z, Y		
Expedition	King Ranch	2007-2009	All		HB578x.735	Y	HUS659	HKx659578	HB579x.785	Y	
Expedition	Limited	2006-2006	All		HB462x.827	F, Z, Y		HB463x.787	F, Z, Y		
Expedition	Limited	2007-2009	All		HB578x.735	Y	HUS659	HKx659578	HB579x.785	Y	
Expedition	XLS	2006-2006	All		HB462x.827	F, Z, Y		HB463x.787	F, Z, Y		
Expedition	XLT	2006-2006	All		HB462x.827	F, Z, Y		HB463x.787	F, Z, Y		
Expedition	XLT	2007-2009	All		HB578x.735	Y	HUS659	HKx659578	HB579x.785	Y	
Expedition	XLT Sport	2006-2006	All		HB462x.827	F, Z, Y		HB463x.787	F, Z, Y		
Expedition		1997-2002	All		HB299x.650	F, Z, Y, P		HB301x.630	F, Z, Y, P		
Expedition		2003-2005	All		HB462x.827	F, Z, Y		HB463x.787	F, Z, Y		
Expedition		2010-2013	All		HB672x.714	Y, Z	HUS659	HKx659672	HB579x.785	Y	
Explorer	Sport	2001-2001	All		HB472x.650	F, Z, Y					
Explorer	Sport	2002-2003	All		HB472x.650	F, Z, Y		HB287x.571	F, Z		
Explorer		1991-1994	All		HB279x.594	Y					
Explorer		1995-2001	All		HB283x.650	F, Z, Y, P		HB287x.571	F, Z		
Explorer		2002-2004	All		HB472x.650	F, Z, Y		HB520x.575	F, Z, Y		
Explorer		2005-2005	All		HB472x.650	F, Z, Y		HB613x.589	Y, Z		
Explorer		2006-2010	All		HB612x.690	Y, Z		HB613x.589	Y, Z		
Explorer		2011-2013	All	Standard brakes	HB710x.706	F, Z, Y, P		HB674x.664	F, Z		
Explorer Sport Trac		2001-2002	All		HB472x.650	F, Z, Y					
Explorer Sport Trac		2003-2005	All		HB472x.650	F, Z, Y		HB287x.571	F, Z		
Explorer Sport Trac		2007-2010	All		HB612x.690	Y, Z		HB613x.589	Y, Z		
F-100 Pickup	Super Cab	1977-1977	All		HB292x.674	F, P					
F-100 Pickup		1973-1977	All		HB292x.674	F, P					
F-150 Pickup	Heritage	2004-2004	All	5 Lug Wheels	HB266x.650	F, Z, Y, P		HB301x.630	F, Z, Y, P		
F-150 Pickup	Heritage	2004-2004	All	7 Lug Wheels	HB299x.650	F, Z, Y, P		HB301x.630	F, Z, Y, P		
F-150 Pickup	Lightning/HarleyDavidson	1997-1998	5.4		HB299x.650	F, Z, Y, P		HB301x.630	F, Z, Y, P		
F-150 Pickup	SVT Raptor	2010-2011	All		HB672x.714	Y, Z		HB456x.705	F, Z, Y		
F-150 Pickup		1975-1985	All		HB292x.674	F, P					
F-150 Pickup		1986-1993	All		HB293x.668	F					
F-150 Pickup		1994-1996	All		HB295x.630	F, Y, P					
F-150 Pickup		1997-1997	All		HB266x.650	F, Z, Y, P					
F-150 Pickup		1998-1998	All		HB266x.650	F, Z, Y, P		HB301x.630	F, Z, Y, P		
F-150 Pickup		1999-2003	All	5 Lug, Rear Disc Exc Lightning, From 12/99	HB266x.650	F, Z, Y, P		HB301x.630	F, Z, Y, P		

APPLICATION GUIDE

BRAKE PAD CODE BREAKDOWN

PAD/ROTOR KIT CODE BREAKDOWN

H B 2 4 5 x . 6 3 1
 HAWK BRAKE PAD SHAPE INSERT COMPOUND CODE PAD THICKNESS

H K x 4 2 8 4 4 8
 HAWK KIT INSERT COMPOUND CODE ROTOR PAD SHAPE

MAKE/ MODEL	SUBMODEL	YRS.	ENGINE (LITER)	NOTE	FRONT				REAR			
					PADS	PAD COMPOUND	ROTORS	PAD/ROTOR KIT	PADS	PAD COMPOUND	ROTORS	PAD/ROTOR KIT
FORD CONTINUED												
F-150 Pickup		1999-2003	All	5 Lug, Rear Drum, From 1/2/99	HB266x.650	F, Z, Y, P						
F-150 Pickup	Lightning/Harley-Davidson	1999-2003	All	Lightning, 5 Lug Rear Disc, From 12/99	HB299x.650	F, Z, Y, P			HB301x.630	F, Z, Y, P		
F-150 Pickup		1999-2003	All	7 Lug, Rear Disc	HB299x.650	F, Z, Y, P			HB301x.630	F, Z, Y, P		
F-150 Pickup		1999-2003	All	7 Lug, Rear Drum	HB299x.650	F, Z, Y, P						
F-150 Pickup		1999-2003	All	8 Lug	HB299x.650	F, Z, Y, P			HB539x.650	Y		
F-150 Pickup		2004-2008	All	6 Lug Wheels - 4WD	HB455x.785	F, Z, Y	HUS8780	HKx8780455	HB456x.705	F, Z, Y		
F-150 Pickup		2004-2008	All	6 Lug Wheels - 2WD	HB455x.785	F, Z, Y			HB456x.705	F, Z, Y		
F-150 Pickup		2004-2008	All	7 Lug Wheels	HB455x.785	F, Z, Y			HB456x.705	F, Z, Y		
F-150 Pickup		2008-2009	All	2008 is for Lariat model	HB644x.785	Y, Z			HB456x.705	F, Z, Y		
F-150 Pickup		2010-2011	All	Base, 2WD & 4WD 6 lug	HB672x.714	Y, Z	HUS659	HKx659672	HB456x.705	F, Z, Y		
F-150 Pickup		2012-2012	All	Prod. date to 10/23/2011 Base, 2WD & 4WD 6 lug	HB672x.714	Y, Z	HUS659	HKx659672				
F-150 Pickup		2012-2013	All	Prod. date from 10/24/2011 Base, 2WD & 4WD 6 lug	HB672x.713	Y, Z	HUS659	HKx659672				
F-250 Pickup		1973-1975	All		HB292x.674	F, P						
F-250 Pickup		1976-1976	All		HB255x.655	P						
F-250 Pickup		1977-1986	All	w/Dual Piston	HB255x.655	P						
F-250 Pickup		1977-1986	All	w/Single Piston	HB292x.674	F, P						
F-250 Pickup		1987-1988	All		HB255x.655	P						
F-250 Pickup		1989-1995	All		HB336x.655	Y						
F-250 Pickup		1996-1996	All	2WD	HB334x.705	P						
F-250 Pickup		1996-1996	All	4WD	HB334x.705	P	HUS8553	HKx8553334				
F-250 Pickup		1997-1999	All	w/ 7-lug Rear Drum and w/Rear Disc Brakes Only	HB299x.650	F, Z, Y, P			HB301x.630	F, Z, Y, P		
F-250 Pickup		1997-1999	All	w/ 8-lug and Rear Drum Brakes Only	HB334x.736	Y, P						
F-250 Super Duty Pickup		1999-2004	All		HB302x.700	F, Z, Y, P			HB303x.685	F, Z, Y, P		
F-250 Super Duty Pickup		2005-2007	All		HB528x.811	Y, P			HB529x.710	Y, P		
F-250 Super Duty Pickup		2008-2008	All		HB528x.811	Y, P			HB556x.710	Y, P		
F-250 Super Duty Pickup		2009-2011	All		HB528x.811	Y, P			HB556x.710	Y, P		
F-350 Pickup		1976-1988	All		HB255x.655	P						
F-350 Pickup		1989-1994	All		HB336x.655	Y						
F-350 Pickup		1995-1998	All	2WD	HB334x.736	Y, P						
F-350 Pickup		1995-1998	All	4WD	HB334x.736	Y, P	HUS8553	HKx8553334				
F-350 Super Duty Pickup		1999-2004	All	2WD	HB302x.700	F, Z, Y, P			HB303x.685	F, Z, Y, P		
F-350 Super Duty Pickup		1999-2004	All	4WD, Dual Rear Wheels From 3/22/1999	HB302x.700	F, Z, Y, P	HUS8586	HKx8586302	HB303x.685	F, Z, Y, P		
F-350 Super Duty Pickup		1999-2004	All	4WD, Single Rear Wheels From 3/22/1999	HB302x.700	F, Z, Y, P	HUS8586	HKx8586302	HB303x.685	F, Z, Y, P	HUS8571	HKx8571303
F-350 Super Duty Pickup		2005-2005	All	Dual Rear Wheels	HB528x.811	Y, P			HB556x.710	Y, P		
F-350 Super Duty Pickup		2005-2005	All	Single Rear Wheels	HB528x.811	Y, P			HB529x.710	Y, P		
F-350 Super Duty Pickup		2006-2007	All	Dual Rear Wheels	HB528x.811	Y, P			HB556x.710	Y, P		
F-350 Super Duty Pickup		2006-2007	All	Single Rear Wheels	HB528x.811	Y, P			HB529x.710	Y, P		
F-350 Super Duty Pickup		2008-2008	All		HB528x.811	Y, P			HB556x.710	Y, P		
F-350 Super Duty Pickup		2009-2012	All		HB528x.811	Y, P			HB556x.710	Y, P		
F-450 Super Duty Pickup	Lariat	2005-2011	All		HB547x.798	Y, P, W			HB547x.798	Y, P, W		
F-450 Super Duty Pickup	XL	2005-2011	All		HB547x.798	Y, P, W			HB547x.798	Y, P, W		
F-450 Super Duty Pickup	XLT	2005-2011	All		HB547x.798	Y, P, W			HB547x.798	Y, P, W		
F-450 Super Duty Pickup		1999-2004	All		HB335x.815	P			HB335x.815	F, P		

APPLICATION GUIDE

RACE PAD COMPOUNDS

DTC-70 - U	DTC-05 - H	MT-4 - L	HP Plus - N
DTC-60 - G	HT-14 - V	Blue 9012 - E	
DTC-30 - W	HT-10 - S	Black - M	
DTC-15 - A	Metallic - MB	DR-97 - J	

STREET PAD COMPOUNDS

HPS Performance Street - F	LTS Light Truck & SUV - Y
Performance Ceramic - Z	SuperDuty - P

MAKE/ MODEL	SUBMODEL	ENGINE YRS. (LITER)	NOTE	FRONT				REAR				
				PADS	PAD COMPOUND	ROTORS	PAD/ROTOR KIT	PADS	PAD COMPOUND	ROTORS	PAD/ROTOR KIT	
FORD CONTINUED												
F53 Stripped Chassis		1998-2004	All		HB335x.815	P			HB335x.815	F, P		
F53 Stripped Chassis		2010-2011	All		HB547x.798	Y, P, W			HB547x.798	Y, P, W		
F59 Stripped Chassis		1998-2004	All		HB335x.815	P			HB335x.815	F, P		
F59 Stripped Chassis		2008-2011	All	GVW 16,000 - 22,000	HB547x.798	Y, P, W			HB547x.798	Y, P, W		
F59 Stripped Chassis		2008-2011	All	GVW 24,000 - 26,000	HB327x.799	P			HB327x.799	P		
F-550 Super Duty Pickup	Lariat	2005-2013	All		HB547x.798	Y, P, W			HB547x.798	Y, P, W		
F-550 Super Duty Pickup	XL	2005-2013	All		HB547x.798	Y, P, W			HB547x.798	Y, P, W		
F-550 Super Duty Pickup	XLT	2005-2013	All		HB547x.798	Y, P, W			HB547x.798	Y, P, W		
F-550 Super Duty Pickup		2000-2004	All		HB335x.815	P			HB335x.815	F, P		
F-550 Super Duty Pickup		2011-2013	All	Dual Rear Wheels	HB528x.811	Y, P			HB556x.710	Y, P		
F-600		1984-1989	All		HB253x.750	P						
F-650		2003-2003	All		HB253x.750	P						
F-650 Super Duty		2007-2008	All		HB327x1.05	P			HB327x.799	P		
F-700		1984-1996	All	6000-7000 Front Axle	HB253x.750	P						
F-700		1984-1996	All	8000-12000 Front Axle	HB254x1.00	P						
F-7000		1984-1987	All	6000-7000 Front Axle	HB253x.750	P						
F-7000		1984-1987	All	8000-12000 Front Axle	HB254x1.00	P						
F-750		2001-2003	All		HB253x.750	P						
F-800		1983-1983	All		HB254x1.00	P						
F-800		1984-1989	All	6000-7000 Front Axle	HB253x.750	P						
F-800		1984-1989	All	8000-12000 Front Axle	HB254x1.00	P						
F-8000		1983-1983	All		HB254x1.00	P						
F-8000		1984-1986	All	6000-7000 Front Axle	HB253x.750	P						
F-8000		1984-1986	All	8000-12000 Front Axle	HB254x1.00	P						
Fairlane		1968-1970	All		HB646x.526	F						
Falcon		1968-1970	All		HB646x.526	F						
Fiesta	S Sedan	2011-2013	All		HB668x.567	F, N, Z, E, G, W						
Fiesta	SE Sedan/Hatchback	2011-2013	All		HB668x.567	F, N, Z, E, G, W						
Fiesta	SEL Sedan/Hatchback	2011-2013	All		HB668x.567	F, N, Z, E, G, W						
Fiesta		2005-2010	All	Without ABS (Brazil)	HB597x.681	F						
Flex		2009-2010	All		HB710x.706	F, Z, Y, P			HB674x.664	F, Z		
Flex		2012-2013	All	Standard brakes	HB710x.706	F, Z, Y, P			HB674x.664	F, Z		
Focus	LE	2000-2000	All		HB346x.713	F, E						
Focus	LX	2000-2000	All		HB346x.713	F, E						
Focus	LX	2001-2004	All		HB346x.713	F, E			HB430x.547	F, Z, N, E		
Focus	S	2007-2007	All		HB519x.682	F, N, G, V, S, E			HB430x.547	F, Z, N, E		
Focus	S2	2001-2002	All		HB346x.713	F, E			HB430x.547	F, Z, N, E		
Focus	SE	2000-2000	All		HB346x.713	F, E						
Focus	SE	2001-2004	All		HB346x.713	F, E			HB430x.547	F, Z, N, E		
Focus	SE	2007-2007	All		HB519x.682	F, N, G, V, S, E			HB430x.547	F, Z, N, E		
Focus	SES	2007-2007	All		HB519x.682	F, N, G, V, S, E			HB430x.547	F, Z, N, E		
Focus	ST	2007-2007	All		HB519x.682	F, N, G, V, S, E			HB430x.547	F, Z, N, E		
Focus	Street	2001-2002	All		HB346x.713	F, E			HB430x.547	F, Z, N, E		
Focus	SVT	2002-2004	All		HB449x.679	F, Z, N			HB430x.547	F, Z, N, E		
Focus	ZTS	2000-2000	All		HB346x.713	F, E						
Focus	ZTS	2001-2004	All		HB346x.713	F, E			HB430x.547	F, Z, N, E		
Focus	ZTW	2002-2004	All		HB346x.713	F, E			HB430x.547	F, Z, N, E		
Focus	ZX3	2000-2004	All		HB346x.713	F, E			HB430x.547	F, Z, N, E		

BRAKE PAD CODE BREAKDOWN

H B 2 4 5 x . 6 3 1
 HAWK BRAKE PAD SHAPE INSERT COMPOUND CODE PAD THICKNESS

PAD/ROTOR KIT CODE BREAKDOWN

H K x 4 2 8 4 4 8
 HAWK KIT INSERT COMPOUND CODE ROTOR PAD SHAPE

MAKE/ MODEL	SUBMODEL	YRS.	ENGINE (LITER)	NOTE	FRONT				REAR			
					PADS	PAD COMPOUND	ROTORS	PAD/ROTOR KIT	PADS	PAD COMPOUND	ROTORS	PAD/ROTOR KIT
FORD CONTINUED												
Focus	ZX3	2005-2006	All		HB519x.682	F, N, G, V, S, E			HB430x.547	F, Z, N, E		
Focus	ZX4	2005-2006	All		HB519x.682	F, N, G, V, S, E			HB430x.547	F, Z, N, E		
Focus	ZX4 ST	2005-2006	All		HB519x.682	F, N, G, V, S, E			HB430x.547	F, Z, N, E		
Focus	ZX5	2002-2004	All		HB346x.713	F, E			HB430x.547	F, Z, N, E		
Focus	ZX5	2005-2006	All		HB519x.682	F, N, G, V, S, E			HB430x.547	F, Z, N, E		
Focus	ZXW	2005-2006	All		HB519x.682	F, N, G, V, S, E			HB430x.547	F, Z, N, E		
Focus	ST	2013	All		HB712x.680	F, Z, N, W, G			HB478x.605	F, Z, N, G, U, S, E		
Focus	Base	2012-2013	All		HB519x.682	F, N, G, V, S, E			HB478x.605	F, Z, N, G, U, S, E		
Ft-800		1984-1986	All		HB254x1.00	P						
Ft-800		1985-1985	All	Air	HB254x1.00	P						
Ft-8000		1984-1984	All		HB254x1.00	P						
Ft-900		1985-1986	All		HB254x1.00	P						
Fusion	Hybrid	2008-2012	All		HB565x.688	F, Z			HB564x.567	F, Z		
Fusion	S	2006-2012	All		HB565x.688	F, Z			HB564x.567	F, Z		
Fusion	SE	2006-2012	All		HB565x.688	F, Z			HB564x.567	F, Z		
Fusion	SEL	2006-2012	All		HB565x.688	F, Z			HB564x.567	F, Z		
Gran Torino	Brougham	1974-1976	All		HB292x.674	F, P						
Gran Torino	Elite	1974-1974	All		HB292x.674	F, P						
Gran Torino	Sport	1974-1974	All		HB292x.674	F, P						
Gran Torino	Squire	1974-1976	All		HB292x.674	F, P						
Gran Torino		1974-1976	All		HB292x.674	F, P						
GT		2005-2006	All		HB453x.585	F, Z, N, U, G, W, V, S, E			HB453x.585	F, Z, N, U, G, W, V, S, E		
L-800		1984-1984	All	6000-7000 Front Axle	HB253x.750	P						
L-800		1984-1984	All	8000-12000 Front Axle	HB254x1.00	P						
L-8000		1984-1989	All	6000-7000 Front Axle	HB253x.750	P						
L-8000		1984-1989	All	8000-12000 Front Axle	HB254x1.00	P						
LN-600		1984-1984	All		HB253x.750	P						
LN-700		1984-1986	All	6000-7000 Front Axle	HB253x.750	P						
LN-700		1984-1986	All	8000-12000 Front Axle	HB254x1.00	P						
LN-7000		1984-1989	All	6000-7000 Front Axle	HB253x.750	P						
LN-7000		1984-1989	All	8000-12000 Front Axle	HB254x1.00	P						
LN-800		1984-1984	All	6000-7000 Front Axle	HB253x.750	P						
LN-800		1984-1984	All	8000-12000 Front Axle	HB254x1.00	P						
LN-8000		1984-1989	All	6000-7000 Front Axle	HB253x.750	P						
LN-8000		1984-1989	All	8000-12000 Front Axle	HB254x1.00	P						
LNT-800		1984-1984	All		HB254x1.00	P						
LNT-8000		1984-1984	All		HB254x1.00	P						
LT-800		1984-1984	All		HB254x1.00	P						
LT-8000		1984-1984	All		HB254x1.00	P						
LTD	Brougham	1972-1976	All		HB292x.674	F, P						
LTD	Brougham	1983-1986	All		HB125x.650	F, Z, E						
LTD	Country Squire	1981-1986	All		HB125x.650	F, Z, E						
LTD	Crown Victoria	1981-1986	All		HB125x.650	F, Z, E						
LTD	Landau	1975-1978	All		HB292x.674	F, P						
LTD	LX	1985-1985	All		HB125x.650	F, Z, E						
LTD	S	1981-1982	All		HB125x.650	F, Z, E						
LTD		1972-1978	All		HB292x.674	F, P						
LTD		1981-1985	All		HB125x.650	F, Z, E						

RACE PAD COMPOUNDS

DTC-70 - U	DTC-05 - H	MT-4 - L	HP Plus - N
DTC-60 - G	HT-14 - V	Blue 9012 - E	
DTC-30 - W	HT-10 - S	Black - M	
DTC-15 - A	Metallic - MB	DR-97 - J	

STREET PAD COMPOUNDS

HPS Performance Street - F	LTS Light Truck & SUV - Y
Performance Ceramic - Z	SuperDuty - P

MAKE/ MODEL	SUBMODEL	ENGINE YRS. (LITER)	NOTE	FRONT				REAR				
				PADS	PAD COMPOUND	ROTOR	PAD/ROTOR KIT	PADS	PAD COMPOUND	ROTOR	PAD/ROTOR KIT	
FORD CONTINUED												
LTD Crown Victoria	LX	1987-1991	All	HB125x.650	F, Z, E							
LTD Crown Victoria	S	1987-1991	All	HB125x.650	F, Z, E							
LTD Crown Victoria		1987-1991	All	HB125x.650	F, Z, E							
LTD II	Brougham	1977-1977	All	HB292x.674	F, P							
LTD II	S	1977-1979	All	HB292x.674	F, P							
LTD II	Squire	1977-1977	All	HB292x.674	F, P							
LTD II		1977-1979	All	HB292x.674	F, P							
Mustang	5.0L Performance	2011-2012	5.0	HB453x.585	F, Z, N, U, G, W, V, S, E			HB485x.656	F, Z, N, G, S, E			
Mustang	Base	1999-2004	3.8	HB274x.610	F, Z, N, S, E	HUS8141	HKx8141274	HB183x.660	F, Z, N, E	HUS8142	HKx8142183	
Mustang	Boss 302	2012-2013	5.0	HB453x.585	F, Z, N, U, G, W, V, S, E			HB485x.656	F, Z, N, G, S, E			
Mustang	Bullitt	2001-2001	4.6	HB111x.610	F, Z, N, U, G, S, E, M	HUS8144	HKx8144111	HB183x.585	F, Z, N, U, G, E, M	HUS8146	HKx8146183	
Mustang	Bullitt	2008-2009	4.6	HB484x.670	F, Z, N, U, G, V, S, E	HUS8184	HKx8184484	HB485x.656	F, Z, N, G, S, E	HUS8182	HKx8182485	
Mustang	Cobra	1994-1994	5.0	HB111x.610	F, Z, N, U, G, S, E, M	HUS8144	HKx8144111	HB183x.585	F, Z, N, U, G, E, M	HUS8146	HKx8146183	
Mustang	Cobra	1996-1999	4.6	HB111x.610	F, Z, N, U, G, S, E, M	HUS8144	HKx8144111	HB183x.585	F, Z, N, U, G, E, M	HUS8146	HKx8146183	
Mustang	Cobra	2001-2001	4.6	HB111x.610	F, Z, N, U, G, S, E, M	HUS8144	HKx8144111	HB183x.585	F, Z, N, U, G, E, M	HUS8146	HKx8146183	
Mustang	Cobra	2003-2004	4.6	HB111x.610	F, Z, N, U, G, S, E, M	HUS8144	HKx8144111	HB183x.585	F, Z, N, U, G, E, M	HUS8146	HKx8146183	
Mustang	Cobra R	1995-1995	5.8	HB111x.610	F, Z, N, U, G, S, E, M	HUS8144	HKx8144111	HB183x.585	F, Z, N, U, G, E, M	HUS8146	HKx8146183	
Mustang	Cobra SVT	1995-1995	5.0	HB111x.610	F, Z, N, U, G, S, E, M	HUS8144	HKx8144111	HB183x.585	F, Z, N, U, G, E, M	HUS8146	HKx8146183	
Mustang	GT	1987-1993	5.0	HB263x.650	F, Z, N, U, G, E	HUS8126	HKx8126263					
Mustang	GT	1994-1998	All	HB182x.660	F, Z, N, E	HUS8141	HKx8141182	HB183x.660	F, Z, N, E	HUS8142	HKx8142183	
Mustang	GT	1999-2004	4.6	HB274x.610	F, Z, N, S, E	HUS8141	HKx8141274	HB183x.660	F, Z, N, E	HUS8142	HKx8142183	
Mustang	GT	2005-2010	4.6	HB484x.670	F, Z, N, U, G, V, S, E	HUS8184	HKx8184484	HB485x.656	F, Z, N, G, S, E	HUS8182	HKx8182485	
Mustang	GT	2014	5.0	Standard brakes	HB484x.670	F, Z, N, U, G, V, S, E		HB485x.656	F, Z, N, G, S, E			
Mustang	GT	2012-2013	5.0	Standard brakes	HB484x.670	F, Z, N, U, G, V, S, E		HB485x.656	F, Z, N, G, S, E			
Mustang	GT	2013-2014	All	Performance brakes	HB453x.585	F, Z, N, U, G, W, V, S, E		HB485x.656	F, Z, N, G, S, E			
Mustang	GT Brembo	2012-2012	All		HB453x.585	F, Z, N, U, G, W, V, S, E		HB485x.656	F, Z, N, G, S, E			
Mustang	GTS	1995-1995	5.0		HB182x.660	F, Z, N, E	HUS8141	HKx8141182	HB183x.660	F, Z, N, E	HUS8142	HKx8142183
Mustang	LX	1987-1993	5.0		HB263x.650	F, Z, N, U, G, E	HUS8126	HKx8126263				
Mustang	Mach 1	2003-2004	4.6		HB111x.610	F, Z, N, U, G, S, E, M	HUS8144	HKx8144111	HB183x.585	F, Z, N, U, G, E, M	HUS8146	HKx8146183
Mustang	Saleen S281 Extreme	2007-2007	4.6	Alcon/AP Racing caliper	HB122x.710	Z, N, U, G, W, E						
Mustang	Shelby GT	2007-2008	4.6		HB484x.670	F, Z, N, U, G, V, S, E	HUS8184	HKx8184484	HB485x.656	F, Z, N, G, S, E	HUS8182	HKx8182485
Mustang	Shelby GT500	2007-2009	5.4		HB453x.585	F, Z, N, U, G, W, V, S, E		HB485x.656	F, Z, N, G, S, E			
Mustang	Shelby GT500	2010-2013	5.4		HB453x.585	F, Z, N, U, G, W, V, S, E						
Mustang	SVO	1984-1986	2.3		HB125x.650	F, Z, E						
Mustang	SVT Cobra R	2000-2000	5.4		HB194x.665	F, Z, N, U, V, S, E		HB183x.585	F, Z, N, U, G, E, M			
Mustang	V6	2005-2010			HB484x.670	F, Z, N, U, G, V, S, E	HUS8181	HKx8181484	HB485x.656	F, Z, N, G, S, E		
Mustang	V6	2011-2013	3.7	Front rotor fits models w/o performance brake pkg	HB484x.670	F, Z, N, U, G, V, S, E	HUS8184	HKx8184484	HB485x.656	F, Z, N, G, S, E		
Mustang		1965-1967	All	w/Front Disc Brakes	HB471x.510	F, N, U, S						
Mustang		1968-1973	All		HB646x.526	F						
Probe	GT	1993-1997	All	race material .634 thick	HB211x.606	F, Z, N, E	HUS577	HKx577211	HB212x.535	F, N, E		
Probe		1993-1997	All	race material .634 thick	HB211x.606	F, Z, N, E	HUS577	HKx577211	HB212x.535	F, N, E		
Ranchero	500	1976-1979	All		HB292x.674	F, P						
Ranchero	GT	1976-1979	All		HB292x.674	F, P						
Ranchero	Squire	1977-1979	All		HB292x.674	F, P						
Ranger	Edge	2001-2002	All		HB283x.650	F, Z, Y, P						
Ranger	Edge	2003-2005	All		HB472x.650	F, Z, Y						
Ranger	FX4	2005-2009	All		HB472x.650	F, Z, Y						

APPLICATION GUIDE

BRAKE PAD CODE BREAKDOWN

H B 2 4 5 x . 6 3 1
 HAWK BRAKE PAD SHAPE INSERT COMPOUND CODE PAD THICKNESS

PAD/ROTOR KIT CODE BREAKDOWN

H K x 4 2 8 4 4 8
 HAWK KIT INSERT COMPOUND CODE ROTOR PAD SHAPE

MAKE/ MODEL	SUBMODEL	ENGINE YRS. (LITER)	NOTE	FRONT				REAR			
				PADS	PAD COMPOUND	ROTOR	PAD/ROTOR KIT	PADS	PAD COMPOUND	ROTOR	PAD/ROTOR KIT
FORD CONTINUED											
Ranger	FX4	2010-2011	All	HB472x.650	F, Z, Y			HB443x.614	F		
Ranger	Sport	2006-2009	All	HB472x.650	F, Z, Y						
Ranger	Sport	2010-2011	All	HB472x.650	F, Z, Y			HB443x.614	F		
Ranger	STX	2006-2009	All	HB472x.650	F, Z, Y						
Ranger	STX	2010-2011	All	HB472x.650	F, Z, Y			HB443x.614	F		
Ranger	Super	1987-1994	All	HB279x.594	Y						
Ranger	Super	1995-1998	All	HB283x.650	F, Z, Y, P						
Ranger	XL	2005-2009	All	HB472x.650	F, Z, Y						
Ranger	XL	2010-2011	All	HB472x.650	F, Z, Y			HB443x.614	F		
Ranger	XLT	2005-2009	All	HB472x.650	F, Z, Y						
Ranger	XLT	2010-2011	All	HB472x.650	F, Z, Y			HB443x.614	F		
Ranger		1983-1994	All	HB279x.594	Y						
Ranger		1995-2002	All	HB283x.650	F, Z, Y, P						
Ranger		2003-2004	All	HB472x.650	F, Z, Y						
Taurus	G	1996-1997	All	HB347x.689	F, Z						
Taurus	GL	1987-1988	All	HB259x.620	F						
Taurus	GL	1989-1993	All	HB240x.620	F						
Taurus	GL	1994-1998	All	HB347x.689	F, Z						
Taurus	L	1987-1988	All	HB259x.620	F						
Taurus	L	1989-1992	All	HB240x.620	F						
Taurus	LX	1987-1988	All	HB259x.620	F						
Taurus	LX	1989-1993	All	HB240x.620	F						
Taurus	LX	1994-1998	All	HB347x.689	F, Z						
Taurus	MT5	1987-1988	All	HB259x.620	F						
Taurus	SE	1995-1995	All	HB347x.689	F, Z						
Taurus	SE	2006-2006	All	HB416x.689	F						
Taurus	SEL	2006-2006	All	HB416x.689	F						
Taurus	SHO	1989-1992	All	HB240x.620	F			HB580x.627	F, G, E		
Taurus	SHO	1994-1994	All	HB347x.689	F, Z			HB417x.659	F		
Taurus	SHO	1998-1999	All	HB416x.689	F			HB417x.659	F		
Taurus	SHO	2010-2012	All	HB612x.690	Y, Z			HB674x.664	F, Z		
Taurus	SHO	2012-2013	Excl Perf Pkg	HB710x.706	F, Z, Y, P			HB674x.664	F, Z		
Taurus		1986-1986	All	HB259x.620	F						
Taurus		1999-2000	All	HB347x.689	F, Z			HB417x.659	F		
Taurus		2001-2002	Police	HB347x.689	F, Z			HB417x.659	F		
Taurus		2001-2002	Except Police	HB416x.689	F			HB417x.659	F		
Taurus		2003-2007	All	HB416x.689	F			HB417x.659	F		
Taurus		2010-2013	All	HB612x.690	Y, Z			HB674x.664	F, Z		
Thunderbird	LX	1989-1992	All	HB240x.620	F						
Thunderbird	LX	1993-1997	All	HB182x.660	F, Z, N, E						
Thunderbird	SC	1989-1992	All	HB240x.620	F			HB580x.627	F, G, E		
Thunderbird	SC	1993-1995	All	HB182x.660	F, Z, N, E						
Thunderbird		1972-1978	All	HB292x.674	F, P						
Thunderbird		1987-1988	All	HB263x.650	F, Z, N, U, G, E						
Thunderbird		1989-1992	All	HB240x.620	F						
Thunderbird		2002-2005	All	HB376x.665	F			HB428x.650	F		
Torino		1968-1971	All	HB646x.526	F						
Torino		1975-1976	All	HB292x.674	F, P						

APPLICATION GUIDE

RACE PAD COMPOUNDS

DTC-70 - U	DTC-05 - H	MT-4 - L	HP Plus - N
DTC-60 - G	HT-14 - V	Blue 9012 - E	
DTC-30 - W	HT-10 - S	Black - M	
DTC-15 - A	Metallic - MB	DR-97 - J	

STREET PAD COMPOUNDS

HPS Performance Street - F	LTS Light Truck & SUV - Y
Performance Ceramic - Z	SuperDuty - P

MAKE/ MODEL	SUBMODEL	ENGINE YRS. (LITER)	NOTE	FRONT				REAR			
				PADS	PAD COMPOUND	ROTORS	PAD/ROTOR KIT	PADS	PAD COMPOUND	ROTORS	PAD/ROTOR KIT
FORD CONTINUED											
Transit Connect		2010-2013	All	HB449x.679	F, Z, N						
Windstar		1995-1998	All	HB347x.689	F, Z						
Windstar		1999-2003	All					HB284x.575	Z		
ZX2	S/R	1999-2000	All	HB246x.567	F, E, S			HB159x.492	F, Z, N, G, W, S, E, M		
ZX2		1998-2003	All	HB246x.567	F, E, S			HB159x.492	F, Z, N, G, W, S, E, M		
FREIGHTLINER											
Sprinter	2500	2006	All					HB479x.700	P		
Sprinter	3500	2006	All					HB479x.700	P		
GEO											
Prizm	GSI	1990-1992	All	HB191x.590	F, N, S, E			HB401x.587	F		
Prizm	LSI	1990-1992	All	HB191x.590	F, N, S, E						
Prizm	LSI	1993-1997	All	HB310x.689	F, Z						
Prizm		1993-1997	All	HB310x.689	F, Z						
Storm	2+2	1990-1993	All	HB148x.560	F, Z, N, G, W, S, E, M						
Storm	GSI	1990-1993	All	HB148x.560	F, Z, N, G, W, S, E, M						
Storm		1990-1993	All	HB148x.560	F, Z, N, G, W, S, E, M						
Tracker		1996-1997	All	4 Door HB384x.587	F						
GMC											
Acadia		2007-2013	All	HB617x.630	Y, Z			HB383x.685	F, Y		
B6P042		1983-1990	All	HB253x.750	P			HB253x.750	P		
B7T042		1995-1997	All	HB253x.750	P						
C15/C1500 Pickup	Big Ten	1977-1980	All	HB103x.590	F, Z, Y, P, N, U, G W, H, S, L, E, M, A						
C15/C1500 Pickup		1970-1985	All	HB103x.590	F, Z, Y, P, N, U, G W, H, S, L, E, M, A						
C1500 Pickup	Sierra	1989-1991	All	Extended Cab HB332x.654	F, Z, Y, P						
C1500 Pickup	Sierra	1992-1997	All	HB332x.654	F, Z, Y, P						
C1500 Pickup	Sierra XC	1989-1991	All	Extended Cab HB332x.654	F, Z, Y, P						
C1500 Pickup	Sierra XC	1992-1997	All	HB332x.654	F, Z, Y, P						
C1500 Pickup		1988-1988	All	Extended Cab HB332x.654	F, Z, Y, P						
C1500 Pickup		1998-1999	All	HB332x.654	F, Z, Y, P						
C25/C2500 Pickup		1970-1978	All	HB103x.590	F, Z, Y, P, N, U, G W, H, S, L, E, M, A						
C25/C2500 Pickup		1978-1985	All	w/11 in. Rear Drums HB103x.590	F, Z, Y, P, N, U, G W, H, S, L, E, M, A						
C25/C2500 Pickup		1979-1986	All	w/13 in. Rear Drums HB131x.595	F, P, U, G, W, L, M						
C2500 Pickup	Sierra	1989-1998	All	7200 lbs. GVWR HB332x.654	F, Z, Y, P						
C2500 Pickup	Sierra	1989-1998	All	8600 lbs. GVWR HB296x.670	F, Z, Y, P						
C2500 Pickup	Sierra XC	1989-1998	All	7200 lbs. GVWR HB332x.654	F, Z, Y, P						
C2500 Pickup	Sierra XC	1989-1998	All	8600 lbs. GVWR HB296x.670	F, Z, Y, P						
C2500 Pickup		1988-1998	All	7200 lbs. GVWR HB332x.654	F, Z, Y, P						
C2500 Pickup		1988-1998	All	8600 lbs. GVWR HB296x.670	F, Z, Y, P						
C2500 Pickup		1999-2000	All	HB296x.670	F, Z, Y, P						
C2500 Pickup		2011-2011	All	HB705x.776	Y, P			HB705x.776	Y, P		
C2500/R2500 Pickup		1987-1989	All	HB131x.595	F, P, U, G, W, L, M						
C35/C3500 Pickup		1970-1978	All	HB103x.590	F, Z, Y, P, N, U, G W, H, S, L, E, M, A						
C35/C3500 Pickup		1979-1980	All	w/13 x 2.5 in. Drums HB103x.590	F, Z, Y, P, N, U, G W, H, S, L, E, M, A						

APPLICATION GUIDE

BRAKE PAD CODE BREAKDOWN

PAD/ROTOR KIT CODE BREAKDOWN

H B 2 4 5 x .6 3 1
 HAWK BRAKE PAD SHAPE INSERT COMPOUND CODE PAD THICKNESS

H K x 4 2 8 4 4 8
 HAWK KIT INSERT COMPOUND CODE ROTOR PAD SHAPE

MAKE/ MODEL	SUBMODEL	YRS.	ENGINE (LITER)	NOTE	FRONT				REAR			
					PADS	PAD COMPOUND	ROTORS	PAD/ROTOR KIT	PADS	PAD COMPOUND	ROTORS	PAD/ROTOR KIT
GMC CONTINUED												
C35/C3500 Pickup		1981-1989	All	w/13 x 3.5 in. Drums	HB131x.595	F, P, U, G, W, L, M						
C3500 Pickup		1988-1989	All		HB296x.670	F, Z, Y, P						
C3500 Pickup		1990-1993	All	w/Rear Drum Brakes.	HB296x.670	F, Z, Y, P						
C3500 Pickup		1990-2000	All	Drum Rear. Dual Rear Wheel	HB298x.787	F, Y, P						
C3500 Pickup		1998-2000	All	Drum Rear. Single Rear Wheel	HB296x.670	F, Z, Y, P						
C3500 Pickup		1998-2000	All	Drum Rear. Dual Rear Wheel	HB298x.787	F, Y, P						
C3500 Pickup		2011-2011	All		HB705x.776	Y, P			HB705x.776	Y, P		
C3500/R3500 Pickup		1988-1988	All	w/13 x 2.5 in. Drums	HB131x.595	F, P, U, G, W, L, M						
C6D042		1983-1990	All		HB253x.750	P			HB253x.750	P		
C6H042 Kodiak		1992-1994	All		HB253x.750	P			HB253x.750	P		
C6H042 Kodiak		1995-1997	All	Front Dayton Calipers Rear 2 Piston Calipers	HB253x.750	P			HB253x.750	P		
C6H042 Kodiak		1995-1997	All	Front Dayton Calipers Rear 4 Piston Calipers	HB253x.750	P			HB344x.992	P		
C7D042		1983-1990	All		HB253x.750	P			HB344x.992	P		
C7H042 Kodiak		1992-1994	All		HB253x.750	P			HB344x.992	P		
C7H042 Kodiak		1995-1997	All	Front Dayton Calipers Rear 2 Piston Calipers	HB253x.750	P			HB253x.750	P		
C7H042 Kodiak		1995-1997	All	Front Dayton Calipers Rear 4 Piston Calipers	HB253x.750	P			HB344x.992	P		
Caballero		1978-1981	All		HB119x.594	F, Z, Y, P, N, U, G W, H, S, L, E, M, A						
Caballero		1982-1987	All		HB119x.594	F, Z, Y, P, N, U, G W, H, S, L, E, M, A	HUS8213	HKx8213119				
Canyon	SL	2006-2008	All		HB554x.643	F, Y, Z, G, U						
Canyon	SLE	2006-2008	All		HB554x.643	F, Y, Z, G, U						
Canyon	SLT	2006-2008	All		HB554x.643	F, Y, Z, G, U						
Canyon	WT	2006-2008	All		HB554x.643	F, Y, Z, G, U						
Canyon	Z71 Fleet	2005-2005	All		HB554x.643	F, Y, Z, G, U						
Canyon	Z71 SL	2005-2005	All		HB554x.643	F, Y, Z, G, U						
Canyon	Z71 SLE	2005-2005	All		HB554x.643	F, Y, Z, G, U						
Canyon	Z85 SL	2005-2005	All		HB554x.643	F, Y, Z, G, U						
Canyon	Z85 SLE	2005-2005	All		HB554x.643	F, Y, Z, G, U						
Canyon		2004-2004	All		HB554x.643	F, Y, Z, G, U						
Canyon		2009-2013	All		HB617x.630	Y, Z						
Envoy	Denali	2005-2005	All		HB382x.657	F, Y			HB383x.685	F, Y		
Envoy	SLE	2005-2005	All		HB382x.657	F, Y			HB383x.685	F, Y		
Envoy	SLT	2005-2005	All		HB382x.657	F, Y			HB383x.685	F, Y		
Envoy	Sport	2006-2007	All		HB617x.630	Y, Z			HB383x.685	F, Y		
Envoy	XL	2002-2004	All		HB382x.657	F, Y			HB383x.685	F, Y		
Envoy	XL Denali	2005-2005	All		HB382x.657	F, Y			HB383x.685	F, Y		
Envoy	XL SLE	2005-2005	All		HB382x.657	F, Y			HB383x.685	F, Y		
Envoy	XL SLT	2005-2005	All		HB382x.657	F, Y						
Envoy	XUV	2004-2004	All		HB382x.657	F, Y			HB383x.685	F, Y		
Envoy	XUV SLE	2005-2005	All		HB382x.657	F, Y			HB383x.685	F, Y		
Envoy	XUV SLT	2005-2005	All		HB382x.657	F, Y			HB383x.685	F, Y		
Envoy		2002-2004	All		HB382x.657	F, Y			HB383x.685	F, Y		
Envoy		2006-2009	All		HB617x.630	Y, Z			HB383x.685	F, Y		
F6B042		1997-1997	All		HB253x.750	P			HB253x.750	P		
F7B042		1997-1997	All		HB253x.750	P			HB253x.750	P		

APPLICATION GUIDE

RACE PAD COMPOUNDS

DTC-70 - U	DTC-05 - H	MT-4 - L	HP Plus - N
DTC-60 - G	HT-14 - V	Blue 9012 - E	
DTC-30 - W	HT-10 - S	Black - M	
DTC-15 - A	Metallic - MB	DR-97 - J	

STREET PAD COMPOUNDS

HPS Performance Street - F	LTS Light Truck & SUV - Y
Performance Ceramic - Z	SuperDuty - P

MAKE/ MODEL	SUBMODEL	ENGINE YRS. (LITER)	NOTE	FRONT				REAR			
				PADS	PAD COMPOUND	ROTORS	PAD/ROTOR KIT	PADS	PAD COMPOUND	ROTORS	PAD/ROTOR KIT
GMC CONTINUED											
G15/G1500 Van	Rally	1971-1993	All	HB103x.590	F, Z, Y, P, N, U, G W, H, S, L, E, M, A						
G15/G1500 Van	Vandura	1970-1995	All	HB103x.590	F, Z, Y, P, N, U, G W, H, S, L, E, M, A						
G15/G1500 Van		1970-1995	All	HB103x.590	F, Z, Y, P, N, U, G W, H, S, L, E, M, A						
G25/G2500 Van	Rally	1971-1995	All	HB103x.590	F, Z, Y, P, N, U, G W, H, S, L, E, M, A						
G25/G2500 Van	Vandura	1970-1995	All	HB103x.590	F, Z, Y, P, N, U, G W, H, S, L, E, M, A						
G25/G2500 Van		1970-1972	All	HB103x.590	F, Z, Y, P, N, U, G W, H, S, L, E, M, A						
G35/G3500 Van	Rally	1971-1978	All	HB103x.590	F, Z, Y, P, N, U, G W, H, S, L, E, M, A						
G35/G3500 Van	Rally	1979-1984	All	w/11 in. Rear Drums	HB103x.590	F, Z, Y, P, N, U, G W, H, S, L, E, M, A					
G35/G3500 Van	Rally	1979-1984	All	w/13 in. Rear Drums	HB131x.595	F, P, U, G, W, L, M					
G35/G3500 Van	Rally	1985-1995	All		HB131x.595	F, P, U, G, W, L, M					
G35/G3500 Van	Vandura	1971-1978	All		HB103x.590	F, Z, Y, P, N, U, G W, H, S, L, E, M, A					
G35/G3500 Van	Vandura	1979-1984	All	w/11 in. Rear Drums	HB103x.590	F, Z, Y, P, N, U, G W, H, S, L, E, M, A					
G35/G3500 Van	Vandura	1979-1984	All	w/13 in. Rear Drums	HB131x.595	F, P, U, G, W, L, M					
G35/G3500 Van	Vandura	1985-1989	All		HB131x.595	F, P, U, G, W, L, M					
G35/G3500 Van	Vandura	1990-1990	All	w/13 x 2.5 in. Drums	HB131x.595	F, P, U, G, W, L, M					
G35/G3500 Van	Vandura	1991-1995	All		HB131x.595	F, P, U, G, W, L, M					
G35/G3500 Van		1971-1971	All		HB103x.590	F, Z, Y, P, N, U, G, W H, S, L, E, M, A					
G35/G3500 Van		1974-1975	All		HB103x.590	F, Z, Y, P, N, U, G W, H, S, L, E, M, A					
G35/G3500 Van		1976-1978	All	w/13 in. Rear Drums	HB103x.590	F, Z, Y, P, N, U, G W, H, S, L, E, M, A					
G35/G3500 Van		1979-1984	All	w/11 in. Rear Drums	HB103x.590	F, Z, Y, P, N, U, G W, H, S, L, E, M, A					
G35/G3500 Van		1979-1995	All	w/13 in. Rear Drums	HB131x.595	F, P, U, G, W, L, M					
G3500 Van	Special	1996-1996	All		HB131x.595	F, P, U, G, W, L, M					
Jimmy	Envoy	1998-2001	All		HB304x.598	F, Z, Y			HB305x.610	F, Z, Y, P	
Jimmy		1970-1990	All		HB103x.590	F, Z, Y, P, N, U, G W, H, S, L, E, M, A					
Jimmy		1991-1991	All		HB119x.594	F, Z, Y, P, N, U, G W, H, S, L, E, M, A					
Jimmy		1995-1997	All		HB119x.594	F, Z, Y, P, N, U, G W, H, S, L, E, M, A					
Jimmy		1998-2001	All		HB304x.598	F, Z, Y			HB305x.610	F, Z, Y, P	
K15/K1500 Pickup		1970-1985	All		HB103x.590	F, Z, Y, P, N, U, G W, H, S, L, E, M, A					
K1500 Pickup		1988-1991	All	Extended Cab	HB332x.654	F, Z, Y, P					
K1500 Pickup		1992-1998	All		HB332x.654	F, Z, Y, P					
K25/K2500 Pickup		1970-1978	All		HB103x.590	F, Z, Y, P, N, U, G W, H, S, L, E, M, A					
K25/K2500 Pickup		1979-1985	All	w/13 in. Rear Drums	HB131x.595	F, P, U, G, W, L, M					
K25/K2500 Pickup		1986-1986	All		HB131x.595	F, P, U, G, W, L, M					
K25/V25 Pickup		1987-1987	All		HB131x.595	F, P, U, G, W, L, M					
K2500 Pickup		1988-2000	All	w/11 in. Rear Drums	HB332x.654	F, Z, Y, P					

APPLICATION GUIDE

BRAKE PAD CODE BREAKDOWN

H B 2 4 5 x .6 3 1
 HAWK BRAKE PAD SHAPE INSERT COMPOUND CODE PAD THICKNESS

PAD/ROTOR KIT CODE BREAKDOWN

H K x 4 2 8 4 4 8
 HAWK KIT INSERT COMPOUND CODE ROTOR PAD SHAPE

MAKE/ MODEL	SUBMODEL	YRS.	ENGINE (LITER)	NOTE	FRONT				REAR			
					PADS	PAD COMPOUND	ROTORS	PAD/ROTOR KIT	PADS	PAD COMPOUND	ROTORS	PAD/ROTOR KIT
GMC CONTINUED												
K2500 Pickup		1988-2000	All	w/13 in. Rear Drums	HB296x.670	F, Z, Y, P	HUS8242	HKx8242296				
K2500 Pickup		2011-2011	All		HB705x.776	Y, P			HB705x.776	Y, P		
K35/K3500 Pickup		1970-1978	All		HB103x.590	F, Z, Y, P, N, U, G W, H, S, L, E, M, A						
K3500 Pickup		1988-1989	All		HB296x.670	F, Z, Y, P	HUS8242	HKx8242296				
K3500 Pickup		1990-2000	All	Dual Rear Wheels	HB298x.787	F, Y, P	HUS8626	HKx8626298				
K3500 Pickup		1990-2000	All	Single Rear Wheels	HB296x.670	F, Z, Y, P	HUS8242	HKx8242296				
K3500 Pickup		2011-2011	All		HB705x.776	Y, P			HB705x.776	Y, P		
LV Postal Van		1987-1995	All		HB119x.594	F, Z, Y, P, N, U, G W, H, S, L, E, M, A	HUS8213	HKx8213119				
P15/P1500 Van		1970-1979	All		HB103x.590	F, Z, Y, P, N, U, G W, H, S, L, E, M, A						
P25/P2500 Van		1970-1974	All		HB103x.590	F, Z, Y, P, N, U, G W, H, S, L, E, M, A						
P25/P2500 Van		1979-1979	All		HB131x.595	F, P, U, G, W, L, M						
P25/P2500 Van		1979-1985	All	w/11 in. Rear Drums	HB103x.590	F, Z, Y, P, N, U, G W, H, S, L, E, M, A						
P25/P2500 Van		1980-1985	All	w/13 in. Rear Drums	HB131x.595	F, P, U, G, W, L, M						
P25/P2500 Van		1986-1989	All		HB131x.595	F, P, U, G, W, L, M						
P35/P3500 Van	Motor Home	1974-1974	All		HB103x.590	F, Z, Y, P, N, U, G W, H, S, L, E, M, A						
P35/P3500 Van		1970-1985	All		HB103x.590	F, Z, Y, P, N, U, G W, H, S, L, E, M, A						
P6S042		1993-1996	All		HB253x.750	P						
P6T042		1984-1990	All		HB253x.750	P						
S15 Jimmy		1983-1994	All		HB119x.594	F, Z, Y, P, N, U, G W, H, S, L, E, M, A						
S15 Pickup		1982-1990	All		HB119x.594	F, Z, Y, P, N, U, G W, H, S, L, E, M, A						
Safari	XT	1990-1997	All	AWD	HB332x.654	F, Z, Y, P						
Safari	XT	1991-1992	All	RWD	HB103x.590	F, Z, Y, P, N, U, G W, H, S, L, E, M, A						
Safari		1989-2002	All	AWD	HB332x.654	F, Z, Y, P						
Safari		1991-2002	All	RWD	HB103x.590	F, Z, Y, P, N, U, G W, H, S, L, E, M, A						
Safari		2003-2005	All		HB323x.724	F, Z, Y, P	HUS8690	HKx8690323	HB324x.673	F, Z, Y, P	HUS8694	HKx8694324
Savana 1500	LS	2003-2008	All		HB323x.724	F, Z, Y, P	HUS8690	HKx8690323	HB494x.670	F, Z, Y	HUS8695	HKx8695494
Savana 1500	LT	2003-2008	All		HB323x.724	F, Z, Y, P	HUS8690	HKx8690323	HB494x.670	F, Z, Y	HUS8695	HKx8695494
Savana 1500		1999-2002	All		HB332x.654	F, Z, Y, P						
Savana 1500		2003-2008	All		HB323x.724	F, Z, Y, P	HUS8690	HKx8690323	HB494x.670	F, Z, Y	HUS8695	HKx8695494
Savana 1500		2009-2013	All		HB561x.710				HB494x.670	F, Z, Y		
Savana 2500	LS	2006-2011	All		HB322x.717	F, Z, Y, P	HUS8692	HKx8692322	HB494x.670	F, Z, Y		
Savana 2500	LT	2006-2011	All		HB322x.717	F, Z, Y, P	HUS8692	HKx8692322	HB494x.670	F, Z, Y		
Savana 2500		1996-2000	All	8 Lug	HB296x.670	F, Z, Y, P						
Savana 2500		1996-2002	All	6 Lug Wheels Only	HB332x.654	F, Z, Y, P						
Savana 2500		2001-2002	6.5	8 Lug, Diesel	HB298x.787	F, Y, P						
Savana 2500		2001-2002	All	8 Lug, except Diesel	HB296x.670	F, Z, Y, P						
Savana 2500		2003-2005	All	6 Lug Wheels Only	HB323x.724	F, Z, Y, P	HUS8690	HKx8690323	HB494x.670	F, Z, Y		
Savana 2500		2003-2005	All	8 Lug	HB322x.717	F, Z, Y, P	HUS8692	HKx8692322	HB494x.670	F, Z, Y		
Savana 2500		2006-2013	All		HB322x.717	F, Z, Y, P	HUS8692	HKx8692322	HB494x.670	F, Z, Y		
Savana 3500		1996-1998	All	8 Lug	HB296x.670	F, Z, Y, P						

RACE PAD COMPOUNDS

DTC-70 - U	DTC-05 - H	MT-4 - L	HP Plus - N
DTC-60 - G	HT-14 - V	Blue 9012 - E	
DTC-30 - W	HT-10 - S	Black - M	
DTC-15 - A	Metallic - MB	DR-97 - J	

STREET PAD COMPOUNDS

HPS Performance Street - F	LTS Light Truck & SUV - Y
Performance Ceramic - Z	SuperDuty - P

MAKE/ MODEL	SUBMODEL	YRS.	ENGINE (LITER)	NOTE	FRONT				REAR			
					PADS	PAD COMPOUND	ROTOR	PAD/ROTOR KIT	PADS	PAD COMPOUND	ROTOR	PAD/ROTOR KIT
GMC CONTINUED												
Savana 3500		1999-2002	All		HB298x.787	F, Y, P						
Savana 3500		2003	All	SRW	HB322x.717	F, Z, Y, P	HUS8659	HKx8659322	HB494x.670	F, Z, Y	HUS8691	HKx8691494
Savana 3500		2003	All	DRW	HB322x.717	F, Z, Y, P	HUS8659	HKx8659322				
Savana 3500		2004-2013	All	SRW	HB322x.717	F, Z, Y, P	HUS8659	HKx8659322	HB494x.670	F, Z, Y		
Savana 3500		2004-2013	All	SRW W/ 91mm tall rear rotor	HB322x.717	F, Z, Y, P	HUS8659	HKx8659322	HB494x.670	F, Z, Y	HUS8691	HKx8691494
Savana 3500		2004-2013	All	SRW W/ 86mm tall rear rotor	HB322x.717	F, Z, Y, P	HUS8659	HKx8659322	HB494x.670	F, Z, Y		
Savana 3500		2004-2008	All	DRW	HB322x.717	F, Z, Y, P	HUS8659	HKx8659322				
Savana 3500		2009-2013	All	DRW	HB322x.717	F, Z, Y, P	HUS8659	HKx8659322	HB705x.776	Y, P		
Savana 3500		2003	All	SRW	HB322x.717	F, Z, Y, P	HUS8659	HKx8659322	HB494x.670	F, Z, Y	HUS8691	HKx8691494
Savana 3500		2003	All	DRW	HB322x.717	F, Z, Y, P	HUS8659	HKx8659322				
Savana 3500		2004-2013	All	SRW	HB322x.717	F, Z, Y, P	HUS8659	HKx8659322	HB494x.670	F, Z, Y		
Savana 3500		2004-2013	All	SRW W/ 91mm tall rear rotor	HB322x.717	F, Z, Y, P	HUS8659	HKx8659322	HB494x.670	F, Z, Y	HUS8691	HKx8691494
Savana 3500		2004-2013	All	SRW W/ 86mm tall rear rotor	HB322x.717	F, Z, Y, P	HUS8659	HKx8659322	HB494x.670	F, Z, Y		
Savana 3500		2004-2008	All	DRW	HB322x.717	F, Z, Y, P	HUS8659	HKx8659322				
Savana 3500		2009-2013	All	DRW	HB322x.717	F, Z, Y, P	HUS8659	HKx8659322	HB705x.776	Y, P		
Sierra 1500	Classic LS	2007-2007	All	w/Rear Disc Brakes	HB561x.710	F, Z, Y, P	HUS8657	HKx8657561	HB568x.666	F, Z, Y, P		
Sierra 1500	Classic LS	2007-2007	All	w/Rear Drum Brakes	HB561x.710	F, Z, Y, P	HUS8657	HKx8657561				
Sierra 1500	Classic LT	2007-2007	All	w/Rear Disc Brakes	HB561x.710	F, Z, Y, P	HUS8657	HKx8657561	HB568x.666	F, Z, Y, P		
Sierra 1500	Classic LT	2007-2007	All	w/Rear Drum Brakes	HB561x.710	F, Z, Y, P	HUS8657	HKx8657561				
Sierra 1500	Classic WT	2007-2007	All	w/Rear Disc Brakes	HB561x.710	F, Z, Y, P	HUS8657	HKx8657561	HB568x.666	F, Z, Y, P		
Sierra 1500	Classic WT	2007-2007	All	w/Rear Drum Brakes	HB561x.710	F, Z, Y, P	HUS8657	HKx8657561				
Sierra 1500	Denali	2002-2005	All	Extended Cab 4 Wheel Steering	HB323x.724	F, Z, Y, P	HUS8690	HKx8690323	HB385x.640	F, Y	HUS8695	HKx8695385
Sierra 1500	Police	2008-2008	All		HB561x.710	F, Z, Y, P	HUS8657	HKx8657561	HB568x.666	F, Z, Y, P		
Sierra 1500	Police	2010-2010	All		HB561x.710	F, Z, Y, P			HB568x.666	F, Z, Y, P		
Sierra 1500	SS	2004-2006	All	Must have 17" wheels or larger for rear kit	HB323x.724	F, Z, Y, P	HUS8690	HKx8690323	HB385x.640	F, Y	HUS8695	HKx8695385
Sierra 1500		1999-2000	All	Must have 17" wheels or larger	HB323x.724	F, Z, Y, P	HUS8690	HKx8690323	HB324x.673	F, Z, Y, P	HUS8694	HKx8694324
Sierra 1500		2001-2001	All	2 Door. Reg Cab Must have 17" wheels or larger	HB323x.724	F, Z, Y, P	HUS8690	HKx8690323	HB324x.673	F, Z, Y, P	HUS8694	HKx8694324
Sierra 1500		2001-2001	All	2 Door Ext. Cab Must have 17" wheels or larger	HB323x.724	F, Z, Y, P	HUS8690	HKx8690323	HB324x.673	F, Z, Y, P	HUS8695	HKx8695324
Sierra 1500		2001-2001	All	4 Door	HB322x.717	F, Z, Y, P			HB323x.724	F, Z, Y, P		
Sierra 1500		2002-2002	All	4 Door	HB322x.717	F, Z, Y, P			HB323x.724	F, Z, Y, P		
Sierra 1500		2002-2002	All	Extended Cab. 4 Wheel Steering Must have 17" wheels or larger for rear kit	HB323x.724	F, Z, Y, P	HUS8690	HKx8690323	HB385x.640	F, Y	HUS8695	HKx8695385
Sierra 1500		2002-2002	All	Regular Cab. 2 Wheel Steering Must have 17" wheels or larger for rear kit	HB323x.724	F, Z, Y, P	HUS8690	HKx8690323	HB324x.673	F, Z, Y, P	HUS8694	HKx8694324
Sierra 1500		2003-2003	All	4 Door Heavy Duty 2 Wheel Steering Must have 17" wheels or larger	HB322x.717	F, Z, Y, P			HB323x.724	F, Z, Y, P		
Sierra 1500		2003-2003	All	4 Door Heavy Duty 4 Wheel Steering Must have 17" wheels or larger	HB323x.724	F, Z, Y, P			HB324x.673	F, Z, Y, P		
Sierra 1500		2003-2003	All	Extended Cab. 2 Wheel Steering Must have 17" wheels or larger	HB323x.724	F, Z, Y, P	HUS8690	HKx8690323	HB324x.673	F, Z, Y, P	HUS8694	HKx8694324
Sierra 1500		2003-2003	All	Extended Cab. 4 Wheel Steering 325mm Rear Disc Must have 17" wheels or larger	HB323x.724	F, Z, Y, P	HUS8690	HKx8690323	HB323x.724	F, Z, Y, P	HUS8694	HKx8694323
Sierra 1500		2003-2003	All	Extended Cab. 4 Wheel Steering 330mm Rear Disc Must have 17" wheels or larger	HB323x.724	F, Z, Y, P	HUS8690	HKx8690323	HB385x.640	F, Y	HUS8695	HKx8695385

APPLICATION GUIDE

BRAKE PAD CODE BREAKDOWN

H B 2 4 5 x . 6 3 1
 HAWK BRAKE PAD SHAPE INSERT COMPOUND CODE PAD THICKNESS

PAD/ROTOR KIT CODE BREAKDOWN

H K x 4 2 8 4 4 8
 HAWK KIT INSERT COMPOUND CODE ROTOR PAD SHAPE

MAKE/ MODEL	SUBMODEL	ENGINE YRS. (LITER)	NOTE	FRONT				REAR			
				PADS	PAD COMPOUND	ROTORS	PAD/ROTOR KIT	PADS	PAD COMPOUND	ROTORS	PAD/ROTOR KIT
GMC CONTINUED											
Sierra 1500		2003-2003	All Regular Cab Must have 17" wheels or larger	HB323x.724	F, Z, Y, P	HUS8690	HKx8690323	HB324x.673	F, Z, Y, P	HUS8694	HKx8694324
Sierra 1500		2004-2004	All Crew Cab Must have 17" wheels or larger	HB323x.724	F, Z, Y, P	HUS8690	HKx8690323	HB385x.640	F, Y	HUS8695	HKx8695385
Sierra 1500		2004-2004	All Extended Cab 2 Wheel Steering. Except Hybrid Must have 17" wheels or larger	HB323x.724	F, Z, Y, P	HUS8690	HKx8690323	HB324x.673	F, Z, Y, P	HUS8694	HKx8694324
Sierra 1500		2004-2004	All Extended Cab 4 Wheel Steering. Except Hybrid Must have 17" wheels or larger	HB323x.724	F, Z, Y, P	HUS8690	HKx8690323	HB385x.640	F, Y	HUS8695	HKx8695385
Sierra 1500		2004-2004	All Hybrid Must have 17" wheels or larger	HB323x.724	F, Z, Y, P	HUS8690	HKx8690323	HB324x.673	F, Z, Y, P	HUS8694	HKx8694324
Sierra 1500		2004-2004	All Regular Cab Must have 17" wheels or larger	HB323x.724	F, Z, Y, P	HUS8690	HKx8690323	HB324x.673	F, Z, Y, P	HUS8694	HKx8694324
Sierra 1500		2005-2005	All w/Rear Disc Brakes Must have 17" wheels or larger	HB323x.724	F, Z, Y, P	HUS8657	HKx8657323	HB324x.673	F, Z, Y, P		
Sierra 1500		2005-2005	All w/Rear disc brakes. Ext. cab. Hybrid Must have 17" wheels or larger	HB323x.724	F, Z, Y, P	HUS8690	HKx8690323	HB324x.673	F, Z, Y, P	HUS8694	HKx8694324
Sierra 1500		2005-2005	All w/Rear Drum Brakes	HB561x.710	F, Z, Y, P	HUS8657	HKx8657561				
Sierra 1500		2006-2006	6.0 Ext. Cab Must have 17" wheels or larger	HB323x.724	F, Z, Y, P	HUS8690	HKx8690323	HB385x.640	F, Y	HUS8695	HKx8695385
Sierra 1500		2006-2006	All 6400 lb. GVW, Rear Drum	HB561x.710	F, Z, Y, P	HUS8657	HKx8657561				
Sierra 1500		2006-2006	All 6400 lb. GVW, Rear Disc Must have 17" wheels or larger	HB323x.724	F, Z, Y, P	HUS8690	HKx8690323	HB324x.673	F, Z, Y, P	HUS8694	HKx8694324
Sierra 1500		2006-2006	All 7000 lb. GVW, Rear Drum	HB561x.710	F, Z, Y, P	HUS8657	HKx8657561				
Sierra 1500		2006-2006	All "7200 lb. GVW, Rear Disc Must have 17" wheels or larger	HB323x.724	F, Z, Y, P	HUS8690	HKx8690323	HB324x.673	F, Z, Y, P	HUS8694	HKx8694324
Sierra 1500		2007-2007	All w/Rear Disc Brakes	HB561x.710	F, Z, Y, P	HUS8657	HKx8657561	HB568x.666	F, Z, Y, P		
Sierra 1500		2007-2007	All w/Rear Drum Brakes	HB561x.710	F, Z, Y, P	HUS8657	HKx8657561				
Sierra 1500		2007-2007	All w/Rear Disc Brakes	HB561x.710	F, Z, Y, P	HUS8657	HKx8657561	HB568x.666	F, Z, Y, P		
Sierra 1500		2007-2007	All w/Rear Drum Brakes	HB561x.710	F, Z, Y, P	HUS8657	HKx8657561				
Sierra 1500		2008-2013	All	HB561x.710	F, Z, Y, P	HUS8657	HKx8657561	HB568x.666	F, Z, Y, P	HUS501	
Sierra 1500		2008-2013	All	HB561x.710	F, Z, Y, P	HUS8657	HKx8657561	HB568x.666	F, Z, Y, P	HUS501	
Sierra 1500		2008-2013	All	HB561x.710	F, Z, Y, P	HUS8657	HKx8657561	HB568x.666	F, Z, Y, P	HUS501	
Sierra 1500		2008-2013	All w/Rear Drum Brakes	HB561x.710	F, Z, Y, P	HUS8657	HKx8657561			HUS501	
Sierra 1500HD	Classic LT	2007-2007	All Except 4 Wheel Steering	HB322x.717	F, Z, Y, P	HUS8692	HKx8692322	HB323x.724	F, Z, Y, P		
Sierra 1500HD		2001-2005	All Except 4 Wheel Steering	HB322x.717	F, Z, Y, P	HUS8692	HKx8692322	HB323x.724	F, Z, Y, P		
Sierra 1500HD		2006-2006	All Except 4 Wheel Steering	HB322x.717	F, Z, Y, P	HUS8692	HKx8692322	HB323x.724	F, Z, Y, P		
Sierra 2500		1999-2000	6.0	HB322x.717	F, Z, Y, P	HUS8692	HKx8692322	HB323x.724	F, Z, Y, P	HUS8691	HKx8691323
Sierra 2500		1999-2000	All Except 6.0L	HB322x.717	F, Z, Y, P	HUS8692	HKx8692322	HB323x.724	F, Z, Y, P		
Sierra 2500		2001-2004	All Automatic	HB322x.717	F, Z, Y, P	HUS8692	HKx8692322	HB323x.724	F, Z, Y, P		
Sierra 2500		2001-2004	All Manual	HB322x.717	F, Z, Y, P	HUS8692	HKx8692322	HB323x.724	F, Z, Y, P	HUS8691	HKx8691323
Sierra 2500		2005-2005	All	HB322x.717	F, Z, Y, P	HUS8692	HKx8692322	HB323x.724	F, Z, Y, P	HUS8691	HKx8691323
Sierra 2500		2006-2008	All	HB322x.717	F, Z, Y, P	HUS8659	HKx8659322	HB323x.724	F, Z, Y, P	HUS8691	HKx8691323
Sierra 2500HD	Classic LS	2007-2007	All	HB322x.717	F, Z, Y, P	HUS8659	HKx8659322	HB323x.724	F, Z, Y, P	HUS8691	HKx8691323
Sierra 2500HD	Classic LT	2007-2007	All	HB322x.717	F, Z, Y, P	HUS8659	HKx8659322	HB323x.724	F, Z, Y, P	HUS8691	HKx8691323
Sierra 2500HD	Classic WT	2007-2007	All	HB322x.717	F, Z, Y, P	HUS8659	HKx8659322	HB323x.724	F, Z, Y, P	HUS8691	HKx8691323
Sierra 2500HD	LS	2006-2006	All	HB322x.717	F, Z, Y, P	HUS8659	HKx8659322	HB323x.724	F, Z, Y, P	HUS8691	HKx8691323
Sierra 2500HD	LT	2006-2010	All	HB322x.717	F, Z, Y, P	HUS8659	HKx8659322	HB323x.724	F, Z, Y, P	HUS8691	HKx8691323
Sierra 2500HD	LITZ	2007-2010	All	HB322x.717	F, Z, Y, P	HUS8659	HKx8659322	HB323x.724	F, Z, Y, P	HUS8691	HKx8691323
Sierra 2500HD	WT	2006-2010	All	HB322x.717	F, Z, Y, P	HUS8659	HKx8659322	HB323x.724	F, Z, Y, P	HUS8691	HKx8691323
Sierra 2500HD		2001-2003	All	HB322x.717	F, Z, Y, P	HUS8659	HKx8659322	HB323x.724	F, Z, Y, P	HUS8691	HKx8691323

RACE PAD COMPOUNDS

DTC-70 - U	DTC-05 - H	MT-4 - L	HP Plus - N
DTC-60 - G	HT-14 - V	Blue 9012 - E	
DTC-30 - W	HT-10 - S	Black - M	
DTC-15 - A	Metallic - MB	DR-97 - J	

STREET PAD COMPOUNDS

HPS Performance Street - F	LTS Light Truck & SUV - Y
Performance Ceramic - Z	SuperDuty - P

MAKE/ MODEL	SUBMODEL	ENGINE YRS. (LITER)	NOTE	FRONT				REAR				
				PADS	PAD COMPOUND	ROTOR	PAD/ROTOR KIT	PADS	PAD COMPOUND	ROTOR	PAD/ROTOR KIT	
GMC CONTINUED												
Sierra 2500HD		2004-2004	All 2 Wheel Steering	HB322x.717	F, Z, Y, P	HUS8659	HKx8659322	HB323x.724	F, Z, Y, P	HUS8691	HKx8691323	
Sierra 2500HD		2004-2004	All 4 Wheel Steering	HB322x.717	F, Z, Y, P	HUS8659	HKx8659322	HB323x.724	F, Z, Y, P			
Sierra 2500HD		2005-2005	All	HB322x.717	F, Z, Y, P	HUS8659	HKx8659322	HB323x.724	F, Z, Y, P	HUS8691	HKx8691323	
Sierra 2500HD		2011-2013	All	HB705x.776	Y, P			HB705x.776	Y, P			
Sierra 3500	Classic LS	2007-2007	All Single Rear Wheels	HB322x.717	F, Z, Y, P	HUS8659	HKx8659322	HB323x.724	F, Z, Y, P	HUS8691	HKx8691323	
Sierra 3500	Classic LT	2007-2007	All Single Rear Wheels	HB322x.717	F, Z, Y, P	HUS8659	HKx8659322	HB323x.724	F, Z, Y, P	HUS8691	HKx8691323	
Sierra 3500	Classic WT	2007-2007	All Single Rear Wheels	HB322x.717	F, Z, Y, P	HUS8659	HKx8659322	HB323x.724	F, Z, Y, P	HUS8691	HKx8691323	
Sierra 3500	LS	2006-2006	All Single Rear Wheels	HB322x.717	F, Z, Y, P	HUS8659	HKx8659322	HB323x.724	F, Z, Y, P	HUS8691	HKx8691323	
Sierra 3500	LT	2006-2006	All Single Rear Wheels	HB322x.717	F, Z, Y, P	HUS8659	HKx8659322	HB323x.724	F, Z, Y, P	HUS8691	HKx8691323	
Sierra 3500	LT	2008-2008	All Single Rear Wheels	HB322x.717	F, Z, Y, P	HUS8659	HKx8659322	HB323x.724	F, Z, Y, P	HUS8691	HKx8691323	
Sierra 3500	LTZ	2008-2008	All Single Rear Wheels	HB322x.717	F, Z, Y, P	HUS8659	HKx8659322	HB323x.724	F, Z, Y, P	HUS8691	HKx8691323	
Sierra 3500	WT	2006-2006	All Single Rear Wheels	HB322x.717	F, Z, Y, P	HUS8659	HKx8659322	HB323x.724	F, Z, Y, P	HUS8691	HKx8691323	
Sierra 3500	WT	2008-2008	All Single Rear Wheels	HB322x.717	F, Z, Y, P	HUS8659	HKx8659322	HB323x.724	F, Z, Y, P	HUS8691	HKx8691323	
Sierra 3500		2001-2003	All 2WD/4WD	HB322x.717	F, Z, Y, P	HUS8659	HKx8659322	HB322x.717	F, Z, Y, P			
Sierra 3500		2004-2005	All 4WD, Single Rear Wheels	HB322x.717	F, Z, Y, P	HUS8659	HKx8659322	HB323x.724	F, Z, Y, P			
Sierra 3500		2004-2008	All 2WD	HB322x.717	F, Z, Y, P	HUS8659	HKx8659322	HB322x.717	F, Z, Y, P			
Sierra 3500		2004-2008	All 4WD, Dual Rear Wheels	HB322x.717	F, Z, Y, P	HUS8659	HKx8659322	HB322x.717	F, Z, Y, P			
Sierra 3500HD		2007-2010	All 12,000 lbs. GVW	HB322x.717	F, Z, Y, P			HB322x.717	F, Z, Y, P			
Sierra 3500HD		2007-2010	All 9,900 lbs. GVW	HB322x.717	F, Z, Y, P			HB323x.724	F, Z, Y, P			
Sierra 3500HD		2011-2013	All	HB705x.776	Y, P			HB705x.776	Y, P			
Sonoma		1991-1996	All	HB119x.594	F, Z, Y, P, N, U, G W, H, S, L, E, M, A							
Sonoma		1998-2003	All 2WD	HB119x.594	F, Z, Y, P, N, U, G W, H, S, L, E, M, A			HB305x.610	F, Z, Y, P			
Sonoma		1998-2003	All 2WD	HB119x.594	F, Z, Y, P, N, U, G W, H, S, L, E, M, A			HB305x.610	F, Z, Y, P			
Sonoma		2004-2004	All	HB304x.598	F, Z, Y			HB305x.610	F, Z, Y, P			
Sprint	Custom	1972-1977	All	HB103x.590	F, Z, Y, P, N, U, G W, H, S, L, E, M, A							
Sprint		1971-1977	All	HB103x.590	F, Z, Y, P, N, U, G W, H, S, L, E, M, A							
Suburban C15/C1500		1970-1984	All	HB103x.590	F, Z, Y, P, N, U, G W, H, S, L, E, M, A							
Suburban C1500		1992-1993	All	HB332x.654	F, Z, Y, P							
Suburban C1500		1994-1999	All w/11 in. Rear Drums	HB332x.654	F, Z, Y, P							
Suburban C1500		1994-1999	All w/13 in. Rear Drums	HB296x.670	F, Z, Y, P							
Suburban C1500/R1500		1989-1991	All	HB131x.595	F, P, U, G, W, L, M							
Suburban C25/C2500		1970-1978	All	HB103x.590	F, Z, Y, P, N, U, G W, H, S, L, E, M, A							
Suburban C25/C2500		1979-1986	All w/11 in. Rear Drums	HB103x.590	F, Z, Y, P, N, U, G W, H, S, L, E, M, A							
Suburban C25/C2500		1979-1986	All w/13 in. Rear Drums	HB131x.595	F, P, U, G, W, L, M							
Suburban C2500		1992-1999	All	HB332x.654	F, Z, Y, P							
Suburban C2500/R2500		1987-1988	All	HB131x.595	F, P, U, G, W, L, M							
Suburban C2500/R2500		1989-1991	All	HB131x.595	F, P, U, G, W, L, M							
Suburban K15/K1500		1970-1986	All	HB103x.590	F, Z, Y, P, N, U, G W, H, S, L, E, M, A							
Suburban K1500		1994-1999	All 6 Lug	HB332x.654	F, Z, Y, P							
Suburban K1500		1994-1999	All 8 Lug	HB296x.670	F, Z, Y, P	HUS8242	HKx8242296					
Suburban K1500/V1500		1989-1991	All	HB131x.595	F, P, U, G, W, L, M							

APPLICATION GUIDE

BRAKE PAD CODE BREAKDOWN

H B 2 4 5 x . 6 3 1
 HAWK BRAKE PAD SHAPE INSERT COMPOUND CODE PAD THICKNESS

PAD/ROTOR KIT CODE BREAKDOWN

H K x 4 2 8 4 4 8
 HAWK KIT INSERT COMPOUND CODE ROTOR PAD SHAPE

MAKE/ MODEL	SUBMODEL	ENGINE YRS. (LITER)	NOTE	FRONT				REAR			
				PADS	PAD COMPOUND	ROTORS	PAD/ROTOR KIT	PADS	PAD COMPOUND	ROTORS	PAD/ROTOR KIT
GMC CONTINUED											
Suburban K25/K2500		1979-1984	All	w/11 in. Rear Drums	HB103x.590	F, Z, Y, P, N, U, G W, H, S, L, E, M, A					
Suburban K25/K2500		1979-1984	All	w/13 in. Rear Drums	HB131x.595	F, P, U, G, W, L, M					
Suburban K25/K2500		1985-1986	All		HB131x.595	F, P, U, G, W, L, M					
Suburban K2500		1992-1999	All		HB296x.670	F, Z, Y, P	HUS8692	HKx8692296			
Suburban K2500/V2500		1987-1988	All		HB131x.595	F, P, U, G, W, L, M					
Suburban K2500/V2500		1989-1991	All		HB131x.595	F, P, U, G, W, L, M					
Syclone		1991-1991	All		HB119x.594	F, Z, Y, P, N, U, G W, H, S, L, E, M, A					
Yukon	Hybrid	2008-2008	All		HB561x.710	F, Z, Y, P	HUS8657	HKx8657561	HB568x.666	F, Z, Y, P	HUS501
Yukon	LS	2007-2008	All		HB561x.710	F, Z, Y, P	HUS8657	HKx8657561	HB568x.666	F, Z, Y, P	
Yukon	LS	2009-2013	All		HB561x.710	F, Z, Y, P			HB568x.666	F, Z, Y, P	
Yukon	LT	2007-2008	All		HB561x.710	F, Z, Y, P	HUS8657	HKx8657561	HB568x.666	F, Z, Y, P	
Yukon	LT	2009-2013	All		HB561x.710	F, Z, Y, P			HB568x.666	F, Z, Y, P	
Yukon	LTZ	2007-2008	All		HB561x.710	F, Z, Y, P	HUS8657	HKx8657561	HB568x.666	F, Z, Y, P	
Yukon	LTZ	2009-2013	All		HB561x.710	F, Z, Y, P			HB568x.666	F, Z, Y, P	
Yukon	Police	2007-2010	All		HB561x.710	F, Z, Y, P	HUS8657	HKx8657561	HB568x.666	F, Z, Y, P	
Yukon		1995-1997	All		HB332x.654	F, Z, Y, P					
Yukon		1998-1999	All	Except Police	HB332x.654	F, Z, Y, P					
Yukon		1998-1999	All	Police	HB296x.670	F, Z, Y, P					
Yukon		2000-2000	All	2WD. Except Police w/Rear Drum Brakes	HB332x.654	F, Z, Y, P					
Yukon		2000-2000	All	2WD. Police w/Rear Drum Brakes	HB296x.670	F, Z, Y, P					
Yukon		2000-2000	All	2WD. w/Rear Disc Brakes Must have 17" wheels or larger	HB323x.724	F, Z, Y, P	HUS8690	HKx8690323	HB385x.640	F, Y	HUS8695
Yukon		2000-2000	All	4WD. w/Rear Drum Brakes	HB332x.654	F, Z, Y, P					
Yukon		2000-2000	All	4WD. w/Rear Disc Brakes w/Limited Slip Must have 17" wheels or larger	HB323x.724	F, Z, Y, P	HUS8690	HKx8690323	HB385x.640	F, Y	HUS8695
Yukon		2000-2000	All	4WD. w/Rear Disc Brakes w/o Limited Slip Must have 17" wheels or larger	HB323x.724	F, Z, Y, P	HUS8690	HKx8690323	HB324x.673	F, Z, Y, P	HUS8694
Yukon		2001-2001	All	2WD Must have 17" wheels or larger	HB323x.724	F, Z, Y, P	HUS8690	HKx8690323	HB385x.640	F, Y	HUS8695
Yukon		2001-2002	All	4WD. w/Limited Slip Must have 17" wheels or larger	HB323x.724	F, Z, Y, P	HUS8690	HKx8690323	HB385x.640	F, Y	HUS8695
Yukon		2001-2002	All	4WD. w/o Limited Slip Must have 17" wheels or larger	HB323x.724	F, Z, Y, P	HUS8690	HKx8690323	HB324x.673	F, Z, Y, P	HUS8694
Yukon		2002-2002	All	2WD. Classic Style Must have 17" wheels or larger	HB323x.724	F, Z, Y, P	HUS8690	HKx8690323	HB385x.640	F, Y	HUS8695
Yukon		2002-2002	All	2WD. New Style Must have 17" wheels or larger	HB323x.724	F, Z, Y, P	HUS8690	HKx8690323	HB494x.670	F, Z, Y	HUS8695
Yukon		2003-2006	All	2WD Must have 17" wheels or larger	HB323x.724	F, Z, Y, P	HUS8690	HKx8690323	HB494x.670	F, Z, Y	HUS8695
Yukon		2003-2006	All	4WD Must have 17" wheels or larger	HB323x.724	F, Z, Y, P	HUS8690	HKx8690323	HB385x.640	F, Y	HUS8695
Yukon XL 1500	Police	2010-2010	All		HB561x.710	F, Z, Y, P			HB568x.666	F, Z, Y, P	HUS501
Yukon XL 1500		2000-2000	All	w/11 in. Rear Drums	HB332x.654	F, Z, Y, P					
Yukon XL 1500		2000-2000	All	w/13 in. Rear Drums. 6 Lug	HB296x.670	F, Z, Y, P					
Yukon XL 1500		2000-2000	All	w/13 in. Rear Drums. 8 Lug	HB296x.670	F, Z, Y, P	HUS8242	HKx8242296			
Yukon XL 1500		2000-2002	All	w/Limited Slip	HB323x.724	F, Z, Y, P	HUS8690	HKx8690323	HB385x.640	F, Y	HUS8695
Yukon XL 1500		2000-2002	All	w/o Limited Slip	HB323x.724	F, Z, Y, P	HUS8690	HKx8690323	HB324x.673	F, Z, Y, P	HUS8694

APPLICATION GUIDE

BRAKE PAD CODE BREAKDOWN

PAD/ROTOR KIT CODE BREAKDOWN

H B 2 4 5 X . 6 3 1
HAWK BRAKE PAD SHAPE INSERT COMPOUND CODE PAD THICKNESS

H K X 4 2 8 4 4 8
HAWK KIT INSERT COMPOUND CODE ROTOR PAD SHAPE

MAKE/ MODEL	SUBMODEL	YRS.	ENGINE (LITER)	NOTE	FRONT				REAR			
					PADS	PAD COMPOUND	ROTOR	PAD/ROTOR KIT	PADS	PAD COMPOUND	ROTOR	PAD/ROTOR KIT
HONDA CONTINUED												
Civic Sedan	GX	2006-2010	All		HB447x.667	F, Z	HUS709	HKx709447				
Civic Sedan	Hybrid	2003-2010	All		HB418x.646	F, Z, N, G, U, S, E						
Civic Sedan	Hybrid	2009-2011	All	rear disc	HB418x.646	F, Z, N, G, U, S, E	HUS911	HKx911418	HB145x.570	F, Z, Y, N, G, U, W, S, E, M	HUS798	HKx798145
Civic Sedan	LX	1990-1993	All		HB218x.583	F, Z, N, U, G, W, S, E	HUS525	HKx525218				
Civic Sedan	LX	1994-1995	All	w/ABS. w/Rear Disc Brakes	HB245x.631	F, Z, N, S, E, G	HUS522	HKx522245	HB350x.496	F, Z, N, G, W, E, M	HUS308	HKx308350
Civic Sedan	LX	1994-1995	All	w/o ABS. w/Rear Drum Brakes	HB218x.583	F, Z, N, U, G, W, S, E	HUS525	HKx525218				
Civic Sedan	LX	1996-1996	All	w/ABS & A/T	HB275x.620	F, Z, N, G, U, W, S, E	HUS522	HKx522275				
Civic Sedan	LX	1996-1996	All	w/ABS & M/T	HB218x.583	F, Z, N, U, G, W, S, E	HUS525	HKx525218				
Civic Sedan	LX	1996-1996	All	w/o ABS	HB218x.583	F, Z, N, U, G, W, S, E	HUS525	HKx525218				
Civic Sedan	LX	1997-2000	All		HB218x.583	F, Z, N, U, G, W, S, E	HUS525	HKx525218				
Civic Sedan	LX	2001-2005	All		HB275x.620	F, Z, N, G, U, W, S, E						
Civic Sedan	LX	2006-2011	All	rear drum	HB275x.620	F, Z, N, G, U, W, S, E	HUS911	HKx911275				
Civic Sedan	Si	2007-2011	All		HB361x.622	F, Z, N, U, W, G, S, E	HUS912	HKx912361	HB145x.570	F, Z, Y, N, G, U, W, S, E, M	HUS798	HKx798145
Civic Sedan	Si	2012-2012			HB393x.665	F, Y	HUS912	HKx912393	HB145x.570	F, Z, Y, N, G, U, W, S, E, M	HUS798	HKx798145
CR-V	EX	1998-2001	All		HB143x.680	F, Z, N, G, U, W, S, E	HUS528	HKx528143				
CR-V	EX	2005-2006	All		HB393x.665	F, Y	HUS912	HKx912393				
CR-V	LX	1997-2001	All		HB143x.680	F, Z, N, G, U, W, S, E	HUS528	HKx528143				
CR-V	LX	2002-2004	All	w/Drum Style Parking Brake	HB393x.665	F, Y	HUS709	HKx709393	HB145x.570	F, Z, Y, N, G, U, W, S, E, M		
CR-V	LX	2002-2004	All	w/Integrate Parking Brake	HB393x.665	F, Y	HUS709	HKx709393	HB572x.570	F, Z, Y, E, G, W		
CR-V	LX	2005-2006	All		HB393x.665	F, Y	HUS912	HKx912393	HB145x.570	F, Z, Y, N, G, U, W, S, E, M		
CR-V	SE	2000-2001	All		HB143x.680	F, Z, N, G, U, W, S, E	HUS528	HKx528143				
CR-V	SE	2005-2006	All		HB393x.665	F, Y	HUS912	HKx912393	HB145x.570	F, Z, Y, N, G, U, W, S, E, M		
CR-V	EX-L	2012	All		HB393x.665	F, Y						
CR-V	FWD	2013	All		HB393x.665	F, Y						
CR-X	1500 HF	1988-1989	All		HB397x.585	F						
CR-X	DX	1988-1989	All		HB218x.583	F, Z, N, U, G, W, S, E						
CR-X	DX	1990-1991	All		HB218x.583	F, Z, N, U, G, W, S, E	HUS525	HKx525218				
CR-X	HF	1990-1991	All		HB397x.585	F						
CR-X	Si	1986-1987	All		HB397x.585	F						
CR-X	Si	1988-1989	All		HB218x.583	F, Z, N, U, G, W, S, E						
CR-X	Si	1990-1991	All		HB113x.590	F, N, G, E			HB350x.496	F, Z, N, G, W, E, M		
Element	EX	2005-2011	All		HB393x.665	F, Y	HUS709	HKx709393	HB572x.570	F, Z, Y, E, G, W		
Element	LX	2004-2011	All		HB393x.665	F, Y	HUS709	HKx709393	HB572x.570	F, Z, Y, E, G, W		
Element	SC	2007-2011	All		HB393x.665	F, Y	HUS709	HKx709393	HB572x.570	F, Z, Y, E, G, W		
Element		2003-2004	All		HB393x.665	F, Y	HUS709	HKx709393	HB572x.570	F, Z, Y, E, G, W		
Fit	Sport	2007-2013	All		HB418x.646	F, Z, N, G, U, S, E						
Fit		2007-2013	All		HB418x.646	F, Z, N, G, U, S, E						
Insight	Electric	2001-2004	All	Automatic Transmission Only	HB397x.585	F						
Insight		2001-2006	All	Automatic Transmission Only	HB397x.585	F						
Insight		2010-2013	All		HB275x.620	F, Z, N, G, U, W, S, E						
Odyssey	EX	1995-1998	All	w/Drum Style Parking Brake	HB143x.680	F, Z, N, G, U, W, S, E	HUS528	HKx528143	HB145x.570	F, Z, Y, N, G, U, W, S, E, M		
Odyssey	EX	1995-1998	All	w/Integrate Parking Brake	HB143x.680	F, Z, N, G, U, W, S, E	HUS528	HKx528143	HB572x.570	F, Z, Y, E, G, W		
Odyssey	LX	1995-1998	All	w/Drum Style Parking Brake	HB143x.680	F, Z, N, G, U, W, S, E	HUS528	HKx528143	HB145x.570	F, Z, Y, N, G, U, W, S, E, M		
Odyssey	LX	1995-1998	All	w/Integrate Parking Brake	HB143x.680	F, Z, N, G, U, W, S, E	HUS528	HKx528143	HB572x.570	F, Z, Y, E, G, W		
Passport	DX	1994-1996	All		HB422x.610	F						
Passport	EX	1994-2001	All		HB422x.610	F						
Passport	LX	1994-2001	All		HB422x.610	F						
Pilot	EX	2006-2008	All		HB393x.665	F, Y	HUS946	HKx946393	HB506x.610	F, Z		

RACE PAD COMPOUNDS

DTC-70 - U	DTC-05 - H	MT-4 - L	HP Plus - N
DTC-60 - G	HT-14 - V	Blue 9012 - E	
DTC-30 - W	HT-10 - S	Black - M	
DTC-15 - A	Metallic - MB	DR-97 - J	

STREET PAD COMPOUNDS

HPS Performance Street - F	LTS Light Truck & SUV - Y
Performance Ceramic - Z	SuperDuty - P

MAKE/ MODEL	SUBMODEL	ENGINE YRS. (LITER)	NOTE	FRONT				REAR			
				PADS	PAD COMPOUND	ROTOR	PAD/ROTOR KIT	PADS	PAD COMPOUND	ROTOR	PAD/ROTOR KIT
HONDA CONTINUED											
Pilot	EX-L	2008-2008	All	HB393x.665	F, Y	HUS946	HKx946393	HB506x.610	F, Z		
Pilot	LX	2006-2007	All	HB393x.665	F, Y	HUS946	HKx946393	HB506x.610	F, Z		
Pilot	Special Edition	2008-2008	All	HB393x.665	F, Y	HUS946	HKx946393	HB506x.610	F, Z		
Pilot	Value Package	2008-2008	All	HB393x.665	F, Y	HUS946	HKx946393	HB506x.610	F, Z		
Pilot		2003-2005	All	HB393x.665	F, Y	HUS946	HKx946393	HB506x.610	F, Z		
Prelude	2.0 Si	1985-1987	All	HB403x.587	F			HB350x.496	F, Z, N, G, W, E, M		
Prelude	2.0 Si	1988-1991	All	HB242x.661	F, Z, N, G, E			HB350x.496	F, Z, N, G, W, E, M		
Prelude	2.0 Si 4WS	1988-1989	All	HB242x.661	F, Z, N, G, E			HB350x.496	F, Z, N, G, W, E, M		
Prelude	4WS	1993-1994	All	HB144x.719	F, N, Z, U, E	HUS704	HKx704144	HB145x.570	F, Z, Y, N, G, U, W, S, E, M		
Prelude	S	1992-1996	All	HB144x.719	F, N, Z, U, E	HUS704	HKx704144	HB145x.570	F, Z, Y, N, G, U, W, S, E, M		
Prelude	SE	1995-1995	All	HB144x.719	F, N, Z, U, E	HUS704	HKx704144	HB145x.570	F, Z, Y, N, G, U, W, S, E, M		
Prelude	SH	1997-2001	All	HB143x.680	F, Z, N, G, U, W, S, E	HUS528	HKx528143	HB145x.570	F, Z, Y, N, G, U, W, S, E, M	HUS798	HKx798145
Prelude	Si	1990-1991	All	HB242x.661	F, Z, N, G, E			HB350x.496	F, Z, N, G, W, E, M		
Prelude	Si	1992-1996	All	HB144x.719	F, N, Z, U, E	HUS704	HKx704144	HB145x.570	F, Z, Y, N, G, U, W, S, E, M		
Prelude	Si 4WS	1990-1991	All	HB242x.661	F, Z, N, G, E			HB350x.496	F, Z, N, G, W, E, M		
Prelude	Si 4WS	1992-1992	All	HB144x.719	F, N, Z, U, E	HUS704	HKx704144	HB145x.570	F, Z, Y, N, G, U, W, S, E, M		
Prelude	Si ALB	1990-1991	All	HB242x.661	F, Z, N, G, E			HB350x.496	F, Z, N, G, W, E, M		
Prelude	Vtec	1993-1996	All	HB143x.680	F, Z, N, G, U, W, S, E			HB145x.570	F, Z, Y, N, G, U, W, S, E, M		
Prelude		1983-1984	All	HB397x.585	F						
Prelude		1985-1987	All	HB397x.585	F			HB350x.496	F, Z, N, G, W, E, M		
Prelude		1997-2001	All	HB143x.680	F, Z, N, G, U, W, S, E	HUS528	HKx528143	HB145x.570	F, Z, Y, N, G, U, W, S, E, M	HUS798	HKx798145
Ridgeline		2006-2013	All	HB678x.709	Y, Z			HB679x.600	Y, Z		
S2000	CR	2008-2009	All	HB361x.622	F, Z, N, U, W, G, S, E			HB145x.570	F, Z, Y, N, G, U, W, S, E, M		
S2000		2000-2009	All	HB361x.622	F, Z, N, U, W, G, S, E			HB145x.570	F, Z, Y, N, G, U, W, S, E, M		
Wagovan		1986-1987	All	HB397x.585	F						
HUMMER											
H2		2003-2009	All	HB322x.717	F, Z, Y, P	HUS8692	HKx8692322	HB323x.724	F, Z, Y, P		
H3	Alpha	2008-2010	All	HB526x.665	Z, Y			HB527x.604	Z, Y		
H3	X	2008-2010	All	HB526x.665	Z, Y			HB527x.604	Z, Y		
H3		2006-2010	All	HB526x.665	Z, Y			HB527x.604	Z, Y		
H3t		2010-2010	All	HB526x.665	Z, Y			HB527x.604	Z, Y		
HYUNDAI											
Azera		2006-2011	All	HB368x.665	F, Z						
Elantra	Blue	2010-2010	All	HB636x.644	F, Z, N			HB637x.583	Z, N		
Elantra	GLS	2007-2010	All	HB368x.665	F, Z						
Elantra	Limited	2007-2007	All	HB368x.665	F, Z						
Elantra	SE	2007-2010	All	HB368x.665	F, Z						
Elantra		1998-2000	All					HB262x.540	F, Z, N, S, E		
Equus		2011-2011	All	HB636x.644	F, Z, N			HB662x.587	F, Z, N		
Equus			All					HB662x.587	F, Z, N		
Genesis	Sedan	2009-2010	3.8	V6 Only				HB637x.583	Z, N		
Genesis	Sedan	2009-2010	3.8	V8 Only	HB636x.644	F, Z, N		HB637x.583	Z, N		
Genesis	Sedan	2011	3.8	V8 Only	HB636x.644	F, Z, N					
Genesis	Sedan	2012-2013	All		HB636x.644	F, Z, N					
Genesis Coupe	Track	2010-2013	All	w/Brembo Brakes	HB453x.585	F, Z, N, U, G, W, V, S, E		HB663x.557	F, N, Z, G		
Genesis Coupe		2010-2013	All	w/o Brembo Brakes	HB661x.667	F, Z, N		HB662x.587	F, Z, N		
Santa Fe	GLS	2006-2006	All		HB461x.646	F, Y					

APPLICATION GUIDE

BRAKE PAD CODE BREAKDOWN

H B 2 4 5 x . 6 3 1
 HAWK BRAKE PAD SHAPE INSERT COMPOUND CODE PAD THICKNESS

PAD/ROTOR KIT CODE BREAKDOWN

H K x 4 2 8 4 4 8
 HAWK KIT INSERT COMPOUND CODE ROTOR PAD SHAPE

MAKE/ MODEL	SUBMODEL	YRS.	ENGINE (LITER)	NOTE	FRONT				REAR					
					PADS	PAD COMPOUND	ROTOR	PAD/ROTOR KIT	PADS	PAD COMPOUND	ROTOR	PAD/ROTOR KIT		
HYUNDAI CONTINUED														
Santa Fe	Limited	2006-2006	All		HB461x.646	F, Y								
Santa Fe		2001-2005	All		HB461x.646	F, Y								
Sonata	GL	2005-2006	All		HB368x.665	F, Z								
Sonata	GLS	2006-2010	All		HB368x.665	F, Z								
Sonata	Limited	2007-2010	All		HB368x.665	F, Z								
Sonata	LX	2005-2010	All		HB368x.665	F, Z								
Sonata	SE	2007-2010	All		HB368x.665	F, Z								
Sonata		2002-2004	2.4		HB368x.665	F, Z								
Tiburon	FX	1997-1998	All						HB262x.540	F, Z, N, S, E				
Tiburon	GS	2005-2006	All		HB368x.665	F, Z			HB262x.540	F, Z, N, S, E				
Tiburon	GS	2008-2008	All		HB368x.665	F, Z			HB262x.540	F, Z, N, S, E				
Tiburon	GT	2003-2006	All		HB368x.665	F, Z			HB262x.540	F, Z, N, S, E				
Tiburon	GT	2007-2007	All		HB368x.665	F, Z								
Tiburon	GT Limited	2007-2007	All		HB368x.665	F, Z								
Tiburon		2003-2004	All		HB368x.665	F, Z			HB262x.540	F, Z, N, S, E				
Tucson	GL	2005-2006	All		HB368x.665	F, Z								
Tucson	GLS	2005-2006	All		HB368x.665	F, Z								
Tucson	GLS	2008-2009	All		HB368x.665	F, Z								
Tucson	Limited	2006-2006	All		HB368x.665	F, Z								
Tucson	Limited	2008-2009	All		HB368x.665	F, Z								
Tucson	LX	2005-2005	All		HB368x.665	F, Z								
Tucson	SE	2008-2009	All		HB368x.665	F, Z								
XG300		2001-2001	All		HB461x.646	F, Y								
XG350	L	2002-2004	All		HB461x.646	F, Y								
XG350		2002-2005	All		HB461x.646	F, Y								
INFINITI														
EX35	Journey	2008-2010	All		HB387x.547	F, Z			HB600x.539	F, Z				
EX35		2008-2010	All		HB387x.547	F, Z			HB600x.539	F, Z				
EX35		2011-2012	All		HB387x.547	F, Z								
EX37		2013	All		HB387x.547	F, Z								
FX35		2003-2005	All		HB448x.610	F, Z, Y	HUS428	HKx428448	HB370x.559	F, Z, N, G, E				
FX35		2006-2006	All	Made On or After 11-1-05	HB387x.547	F, Z			HB370x.559	F, Z, N, G, E				
FX35		2006-2006	All	Made On or Before 10-31-05	HB448x.610	F, Z, Y	HUS428	HKx428448	HB370x.559	F, Z, N, G, E				
FX35		2007-2008	All		HB387x.547	F, Z			HB370x.559	F, Z, N, G, E				
FX35		2009-2010	All		HB387x.547	F, Z			HB600x.539	F, Z				
FX35		2011-2012	All		HB387x.547	F, Z								
FX37		2013	All		HB387x.547	F, Z								
FX45		2003-2005	All		HB448x.610	F, Z, Y	HUS428	HKx428448	HB370x.559	F, Z, N, G, E				
FX45		2006-2006	All	Made On or After 11-1-05	HB387x.547	F, Z			HB370x.559	F, Z, N, G, E				
FX45		2006-2006	All	Made On or Before 10-31-05	HB448x.610	F, Z, Y	HUS428	HKx428448	HB370x.559	F, Z, N, G, E				
FX45		2007-2008	All		HB387x.547	F, Z			HB370x.559	F, Z, N, G, E				
FX50	Sport	2010-2013	All		HB601x.626	F, Z, N, E, G, U, W	HUS421	HKx421601	HB602x.545	F, Z, N, E, G, U, W				
FX50		2010-2013	All		HB601x.626	F, Z, N, E, G, U, W	HUS421	HKx421601	HB602x.545	F, Z, N, E, G, U, W				
G20		1991-1996	All		HB235x.665	F, Z, N, E			HB421x.622	F				
G20		1999-2000	All		HB268x.665	F, Z, N, G	HUS557	HKx557268	HB421x.622	F				
G20		2001-2001	All	Made On or After 12-1-01	HB268x.665	F, Z, N, G	HUS557	HKx557268	HB378x.565	F, Z, N, S, E				
G20		2001-2001	All	Made On or Before 11-30-01	HB268x.665	F, Z, N, G	HUS557	HKx557268	HB421x.622	F				
G25		2011-2012	All		HB387x.547	F, Z								

APPLICATION GUIDE

RACE PAD COMPOUNDS

DTC-70 - U	DTC-05 - H	MT-4 - L	HP Plus - N
DTC-60 - G	HT-14 - V	Blue 9012 - E	
DTC-30 - W	HT-10 - S	Black - M	
DTC-15 - A	Metallic - MB	DR-97 - J	

STREET PAD COMPOUNDS

HPS Performance Street - F	LTS Light Truck & SUV - Y
Performance Ceramic - Z	SuperDuty - P

MAKE/ MODEL	SUBMODEL	YRS.	ENGINE (LITER)	NOTE	FRONT				REAR			
					PADS	PAD COMPOUND	ROTOR	PAD/ROTOR KIT	PADS	PAD COMPOUND	ROTOR	PAD/ROTOR KIT
INFINITI CONTINUED												
G35	X	2006-2006	All	AWD, 2WD	HB387x.547	F, Z			HB370x.559	F, Z, N, G, E		
G35		2003-2004	All	w/Brembo Brakes	HB545x.564	F, Z, N, U, G, W, E			HB180x.560	F, Z, N, U, G, W, S, E		
G35		2003-2004	All	w/o Brembo Brakes	HB268x.665	F, Z, N, G			HB370x.559	F, Z, N, G, E		
G35		2005-2005	All	RWD	HB387x.547	F, Z			HB370x.559	F, Z, N, G, E		
G35		2005-2006	All	AWD	HB268x.665	F, Z, N, G			HB370x.559	F, Z, N, G, E		
G35		2006-2006	All		HB387x.547	F, Z			HB370x.559	F, Z, N, G, E		
G35		2007-2007	All	Except Sport Models	HB387x.547	F, Z			HB370x.559	F, Z, N, G, E		
G35		2007-2008	All	Sport Models	HB599x.616	F, Z	HUS560	HKx560599	HB600x.539	F, Z	HUS561	HKx561600
G35		2008-2008	All	Except Sport Models	HB387x.547	F, Z			HB600x.539	F, Z		
G37		2009-2013	All	330mm front rotors	HB599x.616	F, Z	HUS560	HKx560599	HB370x.559	F, Z, N, G, E	HUS561	HKx561600
G37		2009-2013	All	320mm front rotors	HB387x.547	F, Z			HB370x.559	F, Z, N, G, E		
G37		2009-2013	All	355mm front rotors	HB601x.626	F, Z, N, E, G, U, W	HUS421	HKx421601	HB602x.545	F, Z, N, E, G, U, W		
G37		2008-2008	All	Except Sport Coupe	HB599x.616	F, Z	HUS560	HKx560599	HB370x.559	F, Z, N, G, E	HUS561	HKx561600
G37		2008-2008	All	Sport Coupe	HB601x.626	F, Z, N, E, G, U, W	HUS421	HKx421601	HB602x.545	F, Z, N, E, G, U, W		
I30		1996-1999	All		HB268x.665	F, Z, N, G						
I30		2000-2000	All		HB268x.665	F, Z, N, G			HB421x.622	F		
I30		2001-2001	All		HB268x.665	F, Z, N, G						
I35		2002-2004	All		HB268x.665	F, Z, N, G	HUS705	HKx705268	HB378x.565	F, Z, N, S, E		
J30		1993-1997	All		HB415x.583	F			HB437x.585	F		
M30		1990-1991	All		HB475x.642	F, E						
M35	Sport	2006-2009	All		HB387x.547	F, Z	HUS428	HKx428387	HB370x.559	F, Z, N, G, E	HUS427	HKx427370
M35	X	2006-2009	All		HB387x.547	F, Z	HUS428	HKx428387	HB370x.559	F, Z, N, G, E	HUS427	HKx427370
M35		2006-2009	All		HB387x.547	F, Z	HUS428	HKx428387	HB370x.559	F, Z, N, G, E	HUS427	HKx427370
M35		2010-2010	All		HB387x.547	F, Z	HUS428	HKx428387	HB600x.539	F, Z	HUS427	HKx427600
M37	Sport	2011-2013	All		HB601x.626	F, Z, N, E, G, U, W			HB602x.545	F, Z, N, E, G, U, W		
M37		2011-2013	All		HB387x.547	F, Z						
M45	Sport	2006-2009	All		HB387x.547	F, Z	HUS428	HKx428387	HB370x.559	F, Z, N, G, E	HUS427	HKx427370
M45		2003-2004	All		HB387x.547	F, Z			HB437x.585	F		
M45		2006-2009	All		HB387x.547	F, Z	HUS428	HKx428387	HB370x.559	F, Z, N, G, E	HUS427	HKx427370
M45		2010-2010	All		HB387x.547	F, Z	HUS428	HKx428387	HB600x.539	F, Z	HUS427	HKx427600
M56	Sport	2011-2013	All		HB601x.626	F, Z, N, E, G, U, W			HB602x.545	F, Z, N, E, G, U, W		
M56		2011-2013	All		HB387x.547	F, Z						
Q45		1997-2001	All		HB326x.646	F, Z, Y			HB437x.585	F		
Q45		2002-2005	All		HB387x.547	F, Z			HB437x.585	F		
Q45		2006-2006	All		HB387x.547	F, Z						
QX4		1997-2003	All		HB326x.646	F, Z, Y						
QX56		2004-2006	All	w/Bosch Front Caliper and 320mm Front Disc	HB567x.694	F, Z, Y			HB555x.678	F, Z, Y		
QX56		2006-2010	All	w/Akebono Front Caliper and 350mm Front Disc	HB620x.703	Y			HB555x.678	F, Z, Y		
INTERNATIONAL												
Pickup 100		1974-1974	All		HB292x.674	F, P						
Pickup 150		1975-1975	All		HB292x.674	F, P						
Scout II	SS2	1978-1979	All		HB292x.674	F, P						
Scout II	Terra	1976-1980	All		HB292x.674	F, P						
Scout II	Traveler	1976-1980	All		HB292x.674	F, P						
Scout II		1974-1980	All		HB292x.674	F, P						
TerraStar		2012	All		HB547x.798	Y, P, W			HB547x.798	Y, P, W		

APPLICATION GUIDE

BRAKE PAD CODE BREAKDOWN

H B **2 4 5** **x** **.6 3 1**
 HAWK BRAKE PAD SHAPE INSERT COMPOUND CODE PAD THICKNESS

PAD/ROTOR KIT CODE BREAKDOWN

H K **x** **4 2 8** **4 4 8**
 HAWK KIT INSERT COMPOUND CODE ROTOR PAD SHAPE

MAKE/ MODEL	SUBMODEL	YRS.	ENGINE (LITER)	NOTE	FRONT				REAR			
					PADS	PAD COMPOUND	ROTORS	PAD/ROTOR KIT	PADS	PAD COMPOUND	ROTORS	PAD/ROTOR KIT
ISUZU												
Amigo		1998-2000	All		HB422x.610	F						
Ascender	Limited	2005-2005	All		HB382x.657	F, Y			HB383x.685	F, Y		
Ascender	LS	2005-2006	All		HB382x.657	F, Y			HB383x.685	F, Y		
Ascender	S	2005-2005	All		HB382x.657	F, Y			HB383x.685	F, Y		
Ascender		2003-2004	All		HB382x.657	F, Y			HB383x.685	F, Y		
Ascender		2006-2006	All		HB382x.657	F, Y			HB383x.685	F, Y		
Ascender		2007-2008	All		HB617x.630	Y, Z			HB383x.685	F, Y		
Axiom		2002-2004	All		HB422x.610	F						
D-Max		2002-2006	All		HB554x.643	F, Y, Z, G, U						
Hombre		1996-2000	All	2WD	HB119x.594	F, Z, Y, P, N, U, G W, H, S, L, E, M, A						
Hombre		1998-2000	All	4WD	HB304x.598	F, Z, Y			HB305x.610	F, Z, Y, P		
I-280		2006-2006	All		HB554x.643	F, Y, Z, G, U						
I-290	LS	2007-2007	All		HB554x.643	F, Y, Z, G, U						
I-290	S	2007-2008	All		HB554x.643	F, Y, Z, G, U						
I-350		2006-2006	All		HB554x.643	F, Y, Z, G, U						
I-370	LS	2007-2008	All		HB554x.643	F, Y, Z, G, U						
Impulse	RS	1991-1992	All		HB148x.560	F, Z, N, G, W, S, E, M						
Impulse	XS	1991-1992	All		HB148x.560	F, Z, N, G, W, S, E, M						
Impulse		1990-1990	All		HB148x.560	F, Z, N, G, W, S, E, M						
Oasis		1996-1999	All		HB143x.680	F, Z, N, G, U, W, S, E	HUS528	HKx528143	HB572x.570	F, Z, Y, E, G, W		
Rodeo		1993-2001	All		HB422x.610	F						
Rodeo Sport		2001-2001	All		HB422x.610	F						
Trooper	LS	1992-1997	All		HB422x.610	F						
Trooper	Ltd	1997-1997	All		HB422x.610	F						
Trooper	RS	1993-1995	All		HB422x.610	F						
Trooper	S	1992-1997	All		HB422x.610	F						
Trooper	SE	1996-1996	All		HB422x.610	F						
Trooper		1998-2002	All		HB422x.610	F						
Vehicross		1999-2001	All		HB422x.610	F						
IVECO												
Z435T		1987-1988	All	8060 Turbo Diesel Hydraulic	HB588x.875	P						
Z450T		1987-1988	All	8060 Turbo Diesel Hydraulic	HB588x.875	P						
JAGUAR												
S-Type		2000-2004	All		HB376x.665	F			HB428x.650	F		
Vanden Plas		1990-2003	All		HB135x.642	F						
XJ12		1995-1996	All		HB135x.642	F						
XJ6	L	1997-1997	All		HB135x.642	F						
XJ6	Sovereign	1990-1993	All		HB135x.642	F						
XJ6		1990-1997	All		HB135x.642	F						
XJ8		2000-2003	All		HB135x.642	F						
XJR		1998-2001	All		HB135x.642	F						
XJR		2002-2003	All		HB193x.670	F, Z, N, U, G, W, V, S, E			HB194x.570	F, Z, Y, N, U, V, S, E, W		
XK8	Victory Edition	2006-2006	All		HB135x.642	F						
XK8		1997-2002	All		HB135x.642	F						
XK8		2003-2006	All		HB135x.642	F			HB194x.570	F, Z, Y, N, U, V, S, E, W		
XKR		2000-2006	All		HB193x.670	F, Z, N, U, G, W, V, S, E			HB194x.570	F, Z, Y, N, U, V, S, E, W		

APPLICATION GUIDE



RACE PAD COMPOUNDS

DTC-70 - U	DTC-05 - H	MT-4 - L	HP Plus - N
DTC-60 - G	HT-14 - V	Blue 9012 - E	
DTC-30 - W	HT-10 - S	Black - M	
DTC-15 - A	Metallic - MB	DR-97 - J	

STREET PAD COMPOUNDS

HPS Performance Street - F	LTS Light Truck & SUV - Y
Performance Ceramic - Z	SuperDuty - P

MAKE/ MODEL	SUBMODEL	ENGIN YRS. (LITER)	NOTE	FRONT				REAR			
				PADS	PAD COMPOUND	ROTOR S	PAD/ROTOR KIT	PADS	PAD COMPOUND	ROTOR S	PAD/ROTOR KIT
JEEP											
Cherokee	SJ	1974-1976	All	HB103x.590	F, Z, Y, P, N, U, G W, H, S, L, E, M, A						
Cherokee (XJ)		1990-1998	All 4WD	HB210x.677	F, Z, Y, P	HUS8722	HKx8722210				
Cherokee (XJ)		1990-2001	All 2WD	HB210x.677	F, Z, Y, P						
Cherokee (XJ)		1999-1999	All 4WD. w/78mm Hat Height	HB210x.677	F, Z, Y, P	HUS8742	HKx8742210				
Cherokee (XJ)		1999-1999	All 4WD. w/82mm Hat Height	HB210x.677	F, Z, Y, P	HUS8722	HKx8722210				
Cherokee (XJ)		2000-2002	All 4WD	HB210x.677	F, Z, Y, P	HUS8742	HKx8742210				
CJ5		1977-1978	All	HB292x.674	F, P						
CJ7		1977-1978	All	HB292x.674	F, P						
Comanche		1990-1992	All 2WD	HB210x.677	F, Z, Y, P						
Comanche		1990-1992	All 4WD	HB210x.677	F, Z, Y, P	HUS8722	HKx8722210				
Commander	Limited	2006-2010	All	HB558x.710	F, Z, Y			HB555x.678	F, Z, Y		
Commander	Overland	2007-2010	All	HB558x.710	F, Z, Y			HB555x.678	F, Z, Y		
Commander	Sport	2008-2010	All	HB558x.710	F, Z, Y			HB555x.678	F, Z, Y		
Commander		2006-2010	All	HB558x.710	F, Z, Y			HB555x.678	F, Z, Y		
Compass	Limited	2008-2010	All	HB435x.622	F, Y			HB457x.605	F, Z		
Compass	Sport	2008-2010	All	HB435x.622	F, Y			HB457x.605	F, Z		
Compass		2007-2007	All	HB435x.622	F, Y			HB457x.605	F, Z		
Grand Cherokee (WJ)	Laredo	1999-2002	All w/Akebono Front Caliper	HB446x.725	F, Y			HB381x.661	F, Y		
Grand Cherokee (WJ)	Laredo	2003-2004	All	HB446x.725	F, Y			HB381x.661	F, Y		
Grand Cherokee (WJ)	Limited	1999-2002	All w/Akebono Front Caliper	HB446x.725	F, Y			HB381x.661	F, Y		
Grand Cherokee (WJ)	Limited	2003-2004	All	HB446x.725	F, Y			HB381x.661	F, Y		
Grand Cherokee (WJ)	Overland	2002-2002	All w/Akebono Front Caliper	HB446x.725	F, Y			HB381x.661	F, Y		
Grand Cherokee (WJ)	Overland	2003-2004	All	HB446x.725	F, Y			HB381x.661	F, Y		
Grand Cherokee (WJ)	Special Edition	2004-2004	All	HB446x.725	F, Y			HB381x.661	F, Y		
Grand Cherokee (WJ)		2002-2002	All w/Akebono Front Caliper	HB446x.725	F, Y			HB381x.661	F, Y		
Grand Cherokee (WK)	65th Anniversary Edition	2006-2006	All	HB558x.710	F, Z, Y			HB555x.678	F, Z, Y		
Grand Cherokee (WK)	Laredo	2005-2010	All	HB558x.710	F, Z, Y			HB555x.678	F, Z, Y		
Grand Cherokee (WK)	Limited	2005-2010	All	HB558x.710	F, Z, Y			HB555x.678	F, Z, Y		
Grand Cherokee (WK)	Overland	2006-2010	All	HB558x.710	F, Z, Y			HB555x.678	F, Z, Y		
Grand Cherokee (WK)	Srt8	2006-2010	All	HB563x.656	F, Z, Y, N			HB194x.570	F, Z, Y, N, U, V, S, E, W		
Grand Cherokee (WK2)		2011-2014	All	HB701x.723	F, Z, Y			HB702x.662	F, Z, Y		
Grand Cherokee (WK2)		2011-2013	All 350mm front rotor	HB701x.723	F, Z, Y	HUS504		HB702x.662	F, Z, Y		
Grand Cherokee (WK2)		2011-2013	All 330mm front rotors	HB701x.723	F, Z, Y			HB702x.662	F, Z, Y	HUS505	
Grand Cherokee (WK2)	SRT8	2012-2014	All	HB649x.605	F, Z, U, G, W			HB194x.570	F, Z, Y, N, U, V, S, E, W		
Grand Cherokee (ZJ)	5.9 Limited	1998-1998	5.9	HB210x.677	F, Z, Y, P	HUS8722	HKx8722210	HB286x.591	F, Y		
Grand Cherokee (ZJ)	Laredo	1994-1994	All	HB210x.677	F, Z, Y, P	HUS8722	HKx8722210	HB285x.595	F		
Grand Cherokee (ZJ)	Laredo	1995-1998	All	HB210x.677	F, Z, Y, P	HUS8722	HKx8722210	HB286x.591	F, Y		
Grand Cherokee (ZJ)	Limited	1994-1994	All	HB210x.677	F, Z, Y, P	HUS8722	HKx8722210	HB285x.595	F		
Grand Cherokee (ZJ)	Limited	1995-1998	All	HB210x.677	F, Z, Y, P	HUS8722	HKx8722210	HB286x.591	F, Y		
Grand Cherokee (ZJ)	Orvis	1995-1995	All	HB210x.677	F, Z, Y, P	HUS8722	HKx8722210	HB286x.591	F, Y		
Grand Cherokee (ZJ)	Orvis	1997-1997	All	HB210x.677	F, Z, Y, P	HUS8722	HKx8722210	HB286x.591	F, Y		
Grand Cherokee (ZJ)	SE	1994-1994	All	HB210x.677	F, Z, Y, P	HUS8722	HKx8722210	HB285x.595	F		
Grand Cherokee (ZJ)	SE	1995-1995	All	HB210x.677	F, Z, Y, P	HUS8722	HKx8722210	HB286x.591	F, Y		
Grand Cherokee (ZJ)	TSI	1997-1998	All	HB210x.677	F, Z, Y, P	HUS8722	HKx8722210	HB286x.591	F, Y		
Grand Wagoneer		1984-1990	All	HB103x.590	F, Z, Y, P, N, U, G W, H, S, L, E, M, A						
J10		1974-1988	All	HB103x.590	F, Z, Y, P, N, U, G W, H, S, L, E, M, A						

BRAKE PAD CODE BREAKDOWN

H B **2 4 5** **x** **. 6 3 1**

HAWK BRAKE PAD SHAPE INSERT COMPOUND CODE PAD THICKNESS

PAD/ROTOR KIT CODE BREAKDOWN

H K **x** **4 2 8** **4 4 8**

HAWK KIT INSERT COMPOUND CODE ROTOR PAD SHAPE

MAKE/MODEL	SUBMODEL	YRS.	ENGINE (LITER)	NOTE	FRONT				REAR			
					PADS	PAD COMPOUND	ROTORS	PAD/ROTOR KIT	PADS	PAD COMPOUND	ROTORS	PAD/ROTOR KIT
JEEP CONTINUED												
J20		1974-1988	All		HB103x.590	F, Z, Y, P, N, U, G W, H, S, L, E, M, A						
Liberty (KJ)	65th Anniversary Edition	2006-2006	All		HB373x.689	F						
Liberty (KJ)	Limited	2002-2007	All		HB373x.689	F						
Liberty (KJ)	Limited	2008-2012	All	w/standard Brakes	HB569x.650	F, Z, Y			HB608x.630	F, Y		
Liberty (KJ)	Renegade	2003-2006	All		HB373x.689	F						
Liberty (KJ)	Rocky Mountain Edition	2005-2005	All		HB373x.689	F						
Liberty (KJ)	Sport	2002-2007	All		HB373x.689	F						
Liberty (KK)	Sport	2008-2012	All	w/standard Brakes	HB569x.650	F, Z, Y			HB608x.630	F, Y		
Liberty (KJ)		2002-2002	All	Rear drum brakes	HB373x.689	F						
Liberty (KJ)		2003-2003	All		HB373x.689	F			HB689x.550	F		
Liberty (KJ)		2004-2007	All		HB373x.689	F			HB690x.550	F		
Patriot	Limited	2007-2014	All		HB435x.622	F, Y			HB457x.605	F, Z		
Patriot	Sport	2008-2014	All		HB435x.622	F, Y			HB457x.605	F, Z		
Patriot		2007-2014	All		HB435x.622	F, Y			HB457x.605	F, Z		
Wagoneer	Custom	1974-1976	All		HB103x.590	F, Z, Y, P, N, U, G W, H, S, L, E, M, A						
Wagoneer	Limited	1990-1990	All		HB210x.677	F, Z, Y, P						
Wagoneer		1971-1985	All		HB103x.590	F, Z, Y, P, N, U, G W, H, S, L, E, M, A						
Wrangler (07-10JK)	Rubicon	2007-2014	All		HB569x.650	F, Z, Y	HUS678	HKx678569	HB608x.630	F, Y		
Wrangler (07-10JK)	Sahara	2007-2014	All		HB569x.650	F, Z, Y	HUS678	HKx678569	HB608x.630	F, Y		
Wrangler (07-10JK)	Unlimited Rubicon	2007-2014	All		HB569x.650	F, Z, Y	HUS678	HKx678569	HB608x.630	F, Y		
Wrangler (07-10JK)	Unlimited Sahara	2007-2014	All		HB569x.650	F, Z, Y	HUS678	HKx678569	HB608x.630	F, Y		
Wrangler (07-10JK)	Unlimited X	2007-2014	All		HB569x.650	F, Z, Y	HUS678	HKx678569	HB608x.630	F, Y		
Wrangler (07-10JK)	X	2007-2014	All		HB569x.650	F, Z, Y	HUS678	HKx678569	HB608x.630	F, Y		
Wrangler (87-95YJ)	Islander	1990-1992	All		HB210x.677	F, Z, Y, P	HUS8722	HKx8722210				
Wrangler (87-95YJ)	Laredo	1990-1990	All		HB210x.677	F, Z, Y, P	HUS8722	HKx8722210				
Wrangler (87-95YJ)	Renegade	1991-1994	All		HB210x.677	F, Z, Y, P	HUS8722	HKx8722210				
Wrangler (87-95YJ)	Rio Grande	1995-1995	All		HB210x.677	F, Z, Y, P	HUS8722	HKx8722210				
Wrangler (87-95YJ)	S	1991-1994	All		HB210x.677	F, Z, Y, P	HUS8722	HKx8722210				
Wrangler (87-95YJ)	SE	1994-1995	All		HB210x.677	F, Z, Y, P	HUS8722	HKx8722210				
Wrangler (97-06TJ)	65th Anniversary Edition	2006-2006	All		HB210x.677	F, Z, Y, P	HUS8742	HKx8742210				
Wrangler (97-06TJ)	Rubicon	2003-2006	All		HB210x.677	F, Z, Y, P	HUS8742	HKx8742210	HB689x.550	F		
Wrangler (97-06TJ)	Sahara	1997-1997	All		HB210x.677	F, Z, Y, P	HUS8722	HKx8722210				
Wrangler (97-06TJ)	Sahara	2002-2004	All		HB210x.677	F, Z, Y, P	HUS8742	HKx8742210				
Wrangler (97-06TJ)	Sport	1997-1997	All		HB210x.677	F, Z, Y, P	HUS8722	HKx8722210	HB286x.591	F, Y		
Wrangler (97-06TJ)	Sport	2002-2006	All		HB210x.677	F, Z, Y, P	HUS8742	HKx8742210				
Wrangler (97-06TJ)	Unlimited	2004-2006	All		HB210x.677	F, Z, Y, P			HB690x.550	F		
Wrangler (97-06TJ)	Unlimited Rubicon	2005-2006	All		HB210x.677	F, Z, Y, P			HB689x.550	F		
Wrangler (97-06TJ)	X	2002-2006	All		HB210x.677	F, Z, Y, P	HUS8742	HKx8742210				
Wrangler (97-06TJ)		1998-1998	All		HB210x.677	F, Z, Y, P	HUS8722	HKx8722210	HB286x.591	F, Y		
Wrangler (97-06TJ)		1999-2001	All		HB210x.677	F, Z, Y, P	HUS8742	HKx8742210				
KIA												
Amanti		2004-2006	All		HB461x.646	F, Y						
Optima	EX	2005-2010	All		HB368x.665	F, Z						
Optima	LX	2005-2010	All		HB368x.665	F, Z						
Optima		2003-2004	All		HB368x.665	F, Z						

RACE PAD COMPOUNDS

DTC-70 - U	DTC-05 - H	MT-4 - L	HP Plus - N
DTC-60 - G	HT-14 - V	Blue 9012 - E	
DTC-30 - W	HT-10 - S	Black - M	
DTC-15 - A	Metallic - MB	DR-97 - J	

STREET PAD COMPOUNDS

HPS Performance Street - F	LTS Light Truck & SUV - Y
Performance Ceramic - Z	SuperDuty - P

MAKE/ MODEL	SUBMODEL	YRS.	ENGINE (LITER)	NOTE	FRONT				REAR			
					PADS	PAD COMPOUND	ROTORS	PAD/ROTOR KIT	PADS	PAD COMPOUND	ROTORS	PAD/ROTOR KIT
KIA CONTINUED												
Optima		2011-2013	2.0L	2.0 I engine	HB661x.667	F,Z,N						
Sedona		2002-2004	All		HB461x.646	F,Y						
Sephia		1995-1997	All		HB597x.681	F						
Sephia		2000-2000	All		HB597x.681	F						
Sorento	EX	2005-2009	All		HB461x.646	F,Y						
Sorento	LX	2005-2009	All		HB461x.646	F,Y						
Sorento		2003-2004	All		HB461x.646	F,Y						
Soul		2010-2013	All		HB368x.665	F,Z						
Sportage	EX	2005-2010	All		HB368x.665	F,Z						
Sportage	LX	2005-2010	All		HB368x.665	F,Z						
LAND ROVER												
Discovery	Series li	1999-1999	All		HB469x.705	F,Y						
Discovery		1995-1995	All		HB469x.705	F,Y						
Discovery		1996-2004	All		HB469x.705	F,Y			HB195x.640	F,Z,N,G,S,E		
LR3		2005-2009	All		HB681x.686	Y,Z			HB682x.657	Y,Z		
LR4		2010-2013	All		HB684x.694	Y,Z			HB682x.657	Y,Z		
Range Rover	Classic	1995-1995	All		HB469x.705	F,Y						
Range Rover	Classic Lwb	1995-1995	All		HB469x.705	F,Y						
Range Rover	HSE	1996-1998	All		HB469x.705	F,Y						
Range Rover	HSE	2005-2005	All		HB454x.715	F			HB518x.642	F,Z,Y,N,U,G,S,E		
Range Rover	HSE	2006-2009	All		HB681x.686	Y,Z			HB682x.657	Y,Z		
Range Rover	SE	1995-1998	All		HB469x.705	F,Y						
Range Rover	Sport	2010-2013	All		HB684x.694	Y,Z			HB682x.657	Y,Z		
Range Rover	Sport LE	2008-2008	All		HB683x.651	Y,Z			HB682x.657	Y,Z		
Range Rover	Sport Supercharged	2006-2009	All		HB683x.651	Y,Z			HB682x.657	Y,Z		
Range Rover	Sport Supercharged	2010-2013	All		HB685x.610	Y,Z			HB686x.645	Y,Z		
Range Rover	Standard	2010-2012	All		HB684x.694	Y,Z			HB682x.657	Y,Z		
Range Rover	Supercharged	2006-2009	All		HB683x.651	Y,Z			HB682x.657	Y,Z		
Range Rover	Supercharged	2010-2012	All		HB685x.610	Y,Z			HB686x.645	Y,Z		
Range Rover		1999-2002	All		HB469x.705	F,Y						
Range Rover		2003-2004	All		HB454x.715	F			HB518x.642	F,Z,Y,N,U,G,S,E		
LEXUS												
CT200h		2011-2013	All		HB596x.690				HB629x.565			
ES300		1992-1996	All		HB318x.669	F,Z			HB401x.587	F		
ES300		1997-1999	All		HB320x.669	F,Z			HB401x.587	F		
ES300		2000-2001	All		HB320x.669	F,Z			HB610x.587	F,Z		
ES300		2002-2003	All		HB677x.685	Y,Z						
ES300h		2013	All		HB647x.692				HB648x.607			
ES330		2004-2006	All		HB677x.685	Y,Z						
ES350		2007-2013	All		HB647x.692	F,Z			HB648x.607	F,Z		
GS300		1993-1997	All		HB375x.669	F			HB670x.610	F		
GS300		1998-2005	All		HB375x.669	F			HB499x.610	F,Z		
GS300		2006-2006	All		HB474x.681	F,Z			HB562x.612	F,Z		
GS400		1998-2000	All		HB375x.669	F			HB499x.610	F,Z		
GS430		2001-2005	All		HB375x.669	F			HB499x.610	F,Z		
GX460		2010-2013	All		HB490x.665	F,Z,Y,P			HB477x.610	F,Y		
GX470		2003-2009	All		HB490x.665	F,Z,Y,P			HB477x.610	F,Y		

BRAKE PAD CODE BREAKDOWN

H B **2 4 5** **x** **. 6 3 1**
 HAWK BRAKE PAD SHAPE INSERT COMPOUND CODE PAD THICKNESS

PAD/ROTOR KIT CODE BREAKDOWN

H K **x** **4 2 8** **4 4 8**
 HAWK KIT INSERT COMPOUND CODE ROTOR PAD SHAPE

MAKE/MODEL	SUBMODEL	ENGINE YRS. (LITER)	NOTE	FRONT				REAR			
				PADS	PAD COMPOUND	ROTORS	PAD/ROTOR KIT	PADS	PAD COMPOUND	ROTORS	PAD/ROTOR KIT
LEXUS CONTINUED											
HS250H		2010-2012	All	HB627x.690	F, Z						
IS250		2006-2008	All	HB566x.688	F, Z			HB562x.612	F, Z		
IS250		2009-2013	All	HB474x.681	F, Z			HB562x.612	F, Z		
IS300	Sportcross	2002-2005	All	HB375x.669	F			HB499x.610	F, Z		
IS300		2001-2005	All	HB375x.669	F			HB499x.610	F, Z		
IS-F		2008-2013	All	HB616x.607	F, Z, G						
LX450		1996-1997	All	HB312x.591	F, Y, P			HB477x.610	F, Y		
LX470		1998-2007	All	HB313x.685	F, Y			HB427x.685	F, Y		
LX570		2008-2013	All	HB589x.704	Z, Y, P			HB590x.682	Z, Y, P		
RX300		1999-2001	All	HB320x.669	F, Z			HB401x.587	F		
SC300		1996-1998	All	HB318x.669	F, Z			HB670x.610	F		
SC430		2002-2006	All	HB375x.669	F			HB499x.610	F, Z		
SC430		2008-2010	All	HB375x.669	F			HB499x.610	F, Z		
LINCOLN											
Blackwood		2002-2002	All	HB266x.650	F, Z, Y, P			HB301x.630	F, Z, Y, P		
Continental	Executive	1991-1992	All	HB240x.620	F			HB580x.627	F, G, E		
Continental	Givenchy	1987-1987	All	HB125x.650	F, Z, E						
Continental	Signature	1988-1992	All	HB240x.620	F			HB580x.627	F, G, E		
Continental		1973-1979	All	HB292x.674	F, P						
Continental		1982-1987	All	HB125x.650	F, Z, E						
Continental		1988-1990	All	HB240x.620	F			HB580x.627	F, G, E		
Continental		1995-1995	All	HB416x.689	F			HB417x.659	F		
Continental		1997-2002	All	HB416x.689	F			HB417x.659	F		
LS	Sport	2006-2006	All	HB376x.665	F			HB428x.650	F		
LS		2000-2005	All	HB376x.665	F			HB428x.650	F		
Mark IV		1973-1976	All	HB292x.674	F, P						
Mark LT		2006-2008	All	HB455x.785	F, Z, Y			HB456x.705	F, Z, Y		
Mark V		1977-1979	All	HB292x.674	F, P						
Mark VI		1982-1983	All	HB125x.650	F, Z, E						
Mark VII	Bill Blass	1991-1992	All	HB125x.650	F, Z, E			HB580x.627	F, G, E		
Mark VII	LSC	1991-1992	All	HB125x.650	F, Z, E			HB580x.627	F, G, E		
Mark VII		1984-1987	All	HB125x.650	F, Z, E						
Mark VII	LSC	1995-1998	All	HB416x.689	F						
Mark VII		1993-1995	All	HB416x.689	F						
Mark VII		1997-1998	All	HB416x.689	F						
MKS		2009-2011	All	HB612x.690	Y, Z			HB674x.664	F, Z		
MKS		2012-2013	All	Standard brakes	HB710x.706	F, Z, Y, P		HB674x.664	F, Z		
MKT		2010-2011	All	HB612x.690	Y, Z			HB674x.664	F, Z		
MKT		2012-2013	All	Standard brakes	HB710x.706	F, Z, Y, P		HB674x.664	F, Z		
MKX		2007-2010	All	HB656x.684	F			HB657x.667	F		
MKX		2011-2013	All	HB656x.684	F			HB674x.664	F, Z		
MKZ		2007-2012	All	HB565x.688	F, Z			HB564x.567	F, Z		
Navigator	L	2008-2010	All	HB578x.735	Y			HB579x.785	Y		
Navigator	L Luxury	2007-2007	All	HB578x.735	Y			HB579x.785	Y		
Navigator	L Ultimate	2007-2007	All	HB578x.735	Y			HB579x.785	Y		
Navigator	Luxury	2006-2006	All	HB462x.827	F, Z, Y			HB463x.787	F, Z, Y		
Navigator	Luxury	2007-2007	All	HB578x.735	Y			HB579x.785	Y		
Navigator	Ultimate	2006-2006	All	HB462x.827	F, Z, Y			HB463x.787	F, Z, Y		

APPLICATION GUIDE

RACE PAD COMPOUNDS

DTC-70 - U	DTC-05 - H	MT-4 - L	HP Plus - N
DTC-60 - G	HT-14 - V	Blue 9012 - E	
DTC-30 - W	HT-10 - S	Black - M	
DTC-15 - A	Metallic - MB	DR-97 - J	

STREET PAD COMPOUNDS

HPS Performance Street - F	LTS Light Truck & SUV - Y
Performance Ceramic - Z	SuperDuty - P

MAKE/ MODEL	SUBMODEL	ENGINE YRS. (LITER)	NOTE	FRONT				REAR			
				PADS	PAD COMPOUND	ROTORS	PAD/ROTOR KIT	PADS	PAD COMPOUND	ROTORS	PAD/ROTOR KIT
LINCOLN CONTINUED											
Navigator	Ultimate	2007-2007	All		HB578x.735	Y			HB579x.785	Y	
Navigator		1998-2002	All		HB299x.650	F, Z, Y, P			HB301x.630	F, Z, Y, P	
Navigator		2003-2005	All		HB462x.827	F, Z, Y			HB463x.787	F, Z, Y	
Navigator		2008-2010	All		HB578x.735	Y			HB579x.785	Y	
Navigator		2010-2013	All		HB672x.714	Y, Z			HB579x.785	Y	
Town Car	Cartier	1987-1994	All		HB125x.650	F, Z, E					
Town Car	Cartier	2003-2003	All		HB433x.654	F			HB443x.614	F	
Town Car	Designer Series	2006-2007	All		HB433x.654	F			HB301x.630	F, Z, Y, P	
Town Car	Executive	1991-1994	All		HB125x.650	F, Z, E					
Town Car	Executive	2003-2004	All		HB433x.654	F			HB443x.614	F	
Town Car	Executive	2005-2007	All		HB433x.654	F			HB301x.630	F, Z, Y, P	
Town Car	Executive L	2005-2007	All		HB433x.654	F			HB301x.630	F, Z, Y, P	
Town Car	Jack Nicklaus	1993-1993	All		HB125x.650	F, Z, E					
Town Car	Limousine	2008-2011	All		HB433x.654	F			HB443x.614	F	
Town Car	Signature	1987-1994	All		HB125x.650	F, Z, E					
Town Car	Signature	2003-2004	All		HB433x.654	F			HB443x.614	F	
Town Car	Signature	2005-2007	All		HB433x.654	F			HB301x.630	F, Z, Y, P	
Town Car	Signature L	2005-2007	All		HB433x.654	F			HB301x.630	F, Z, Y, P	
Town Car	Signature Limited	2005-2007	All		HB433x.654	F			HB301x.630	F, Z, Y, P	
Town Car	Signature Se	1989-1989	All		HB125x.650	F, Z, E					
Town Car	Tournament Edition	1994-1994	All		HB125x.650	F, Z, E					
Town Car	Ultimate	2004-2004	All		HB433x.654	F			HB443x.614	F	
Town Car		1982-1990	All		HB125x.650	F, Z, E					
Town Car		1998-2002	All	with steel piston	HB294x.646	F			HB341x.618	F	
Town Car		1998-2002	All	with phenolic piston	HB294x.646	F			HB353x.618	F, Y	
Town Car		2008-2011	All		HB433x.654	F			HB443x.614	F	
Zephyr		2006-2006	All		HB565x.688	F, Z			HB564x.567	F, Z	
LOTUS											
Elise		2001-2005	All		HB180x.560	F, Z, N, U, G, W, S, E			HB278x.465	F, N, S, W	
Elise		2010-2011	All		HB180x.560	F, Z, N, U, G, W, S, E			HB278x.465	F, N, S, W	
Exige		2010-2011	All		HB180x.560	F, Z, N, U, G, W, S, E			HB278x.465	F, N, S, W	
MAZDA											
2	Sport	2011-2013	All		HB668x.567	F, N, Z, E, G, W					
2	Touring	2011-2013	All		HB668x.567	F, N, Z, E, G, W					
3	I	2004-2005	All		HB519x.682	F, N, G, V, S, E			HB571x.605	F, Z, N, E	
3	I	2006-2013	All		HB519x.682	F, N, G, V, S, E			HB478x.605	F, Z, N, G, U, S, E	
3	Mazdaspeed	2007-2013	All		HB549x.702	F, Z, N, G	HUS578	HKx578549	HB478x.605	F, Z, N, G, U, S, E	
3	S	2004-2005	All		HB519x.682	F, N, G, V, S, E			HB571x.605	F, Z, N, E	
3	S	2006-2011	All		HB519x.682	F, N, G, V, S, E			HB478x.605	F, Z, N, G, U, S, E	
3	SP23	2004-2005	All		HB519x.682	F, N, G, V, S, E			HB571x.605	F, Z, N, E	
5	Grand Touring	2006-2007	All		HB519x.682	F, N, G, V, S, E			HB571x.605	F, Z, N, E	
5	Grand Touring	2008-2013	All		HB519x.682	F, N, G, V, S, E			HB478x.605	F, Z, N, G, U, S, E	
5	Sport	2006-2007	All		HB519x.682	F, N, G, V, S, E			HB571x.605	F, Z, N, E	
5	Sport	2008-2013	All		HB519x.682	F, N, G, V, S, E			HB478x.605	F, Z, N, G, U, S, E	
5	Touring	2006-2007	All		HB519x.682	F, N, G, V, S, E			HB571x.605	F, Z, N, E	
5	Touring	2008-2013	All		HB519x.682	F, N, G, V, S, E			HB478x.605	F, Z, N, G, U, S, E	
6	I	2003-2005	All		HB459x.700	F, Z			HB158x.515	F, Z, N, G, W, S, E, M	

BRAKE PAD CODE BREAKDOWN

H B **2 4 5** **x** **.6 3 1**
 HAWK BRAKE PAD SHAPE INSERT COMPOUND CODE PAD THICKNESS

PAD/ROTOR KIT CODE BREAKDOWN

H K **x** **4 2 8** **4 4 8**
 HAWK KIT INSERT COMPOUND CODE ROTOR PAD SHAPE

MAKE/ MODEL	SUBMODEL	ENGINE YRS. (LITER)	NOTE	FRONT				REAR			
				PADS	PAD COMPOUND	ROTOR	PAD/ROTOR KIT	PADS	PAD COMPOUND	ROTOR	PAD/ROTOR KIT
MAZDA CONTINUED											
6	I	2008-2013	All	HB565x.688	F, Z			HB564x.567	F, Z		
6	Mazdaspeed	2006-2010	All	HB549x.702	F, Z, N, G			HB564x.567	F, Z		
6	S	2003-2005	All	HB459x.700	F, Z			HB158x.515	F, Z, N, G, W, S, E, M		
6	S	2006-2013	All	HB565x.688	F, Z			HB564x.567	F, Z		
323		1990-1991	All	HB246x.567	F, E, S						
626	DX	1993-1994	All	race material .634 thick	HB211x.606	F, Z, N, E	HUS577	HKx577211	HB212x.535	F, N, E	
626	DX	1995-1998	All	race material .634 thick	HB211x.606	F, Z, N, E	HUS577	HKx577211			
626	ES	1993-1997	All	race material .634 thick	HB211x.606	F, Z, N, E	HUS577	HKx577211	HB212x.535	F, N, E	
626	ES	1998-1998	All	w/Rear Disc Brakes.	HB489x.630	F	HUS577	HKx577489	HB212x.535	F, N, E	
626	ES	2002-2002	All	w/Rear Disc Brakes.	HB489x.630	F	HUS577	HKx577489	HB212x.535	F, N, E	
626	ES	2002-2002	All	race material .634 thick	HB211x.606	F, Z, N, E	HUS577	HKx577211			
626	LX	1993-1997	All	race material .634 thick	HB211x.606	F, Z, N, E	HUS577	HKx577211	HB212x.535	F, N, E	
626	LX	1998-1998	All	w/Rear Disc Brakes.	HB489x.630	F	HUS577	HKx577489	HB212x.535	F, N, E	
626	LX	1998-1998	All	race material .634 thick	HB211x.606	F, Z, N, E	HUS577	HKx577211			
626	LX	2002-2002	All	w/Rear Disc Brakes.	HB489x.630	F	HUS577	HKx577489	HB212x.535	F, N, E	
626	LX	2002-2002	All	race material .634 thick	HB211x.606	F, Z, N, E	HUS577	HKx577211			
626		1999-2001	All	w/Rear Disc Brakes.	HB489x.630	F	HUS577	HKx577489	HB212x.535	F, N, E	
626		1999-2001	All	race material .634 thick	HB211x.606	F, Z, N, E	HUS577	HKx577211			
929	S	1990-1991	All		HB407x.602	F, Y					
929		1988-1991	All		HB407x.602	F, Y					
B1800		1978-1978	All		HB150x.555	F, N, E					
B2000		1979-1984	All		HB150x.555	F, N, E					
B2300		1994-1994	All		HB279x.594	Y					
B2300		1995-1997	All		HB283x.650	F, Z, Y, P					
B2300		2003-2008	All		HB472x.650	F, Z, Y					
B2500		1998-2001	All		HB283x.650	F, Z, Y, P					
B3000	DS	2006-2007	All		HB472x.650	F, Z, Y					
B3000		1994-1994	All		HB279x.594	Y					
B3000		1995-1996	All		HB283x.650	F, Z, Y, P					
B3000		1998-2002	All		HB283x.650	F, Z, Y, P					
B3000		2003-2007	All		HB472x.650	F, Z, Y					
B4000	SE	2006-2008	All		HB472x.650	F, Z, Y					
B4000		1994-1994	All		HB279x.594	Y					
B4000		1995-2002	All		HB283x.650	F, Z, Y, P					
B4000		2003-2008	All		HB472x.650	F, Z, Y					
Cosmo		1976-1978	All		HB152x.540	F, N, G, E, M					
CX-7		2007-2012	All		HB656x.684	F			HB657x.667	F	
CX-9		2007-2013	All		HB656x.684	F			HB657x.667	F	
Miata	Mazdaspeed	2004-2005	All		HB431x.606	F, N, W, V, S, E			HB468x.492	F, N, S, E	
Miata		1990-1993	All		HB148x.560	F, Z, N, G, W, S, E, M			HB157x.484	F, N, G, W, E, M	
Miata		1994-1997	All		HB149x.505	F, Z, N, G, W, S, E, M	HUS579	HKx579149	HB159x.492	F, Z, N, G, W, S, E, M	
Miata		1999-2000	All		HB149x.505	F, Z, N, G, W, S, E, M	HUS579	HKx579149	HB159x.492	F, Z, N, G, W, S, E, M	
Miata		2001-2005	All	w/ Sport Suspension	HB431x.606	F, N, W, V, S, E			HB442x.496	F, N, W, S, E	
Miata		2001-2005	All	w/o Sport Suspension	HB149x.505	F, Z, N, G, W, S, E, M	HUS579	HKx579149	HB159x.492	F, Z, N, G, W, S, E, M	
MX-3	GS	1992-1994	All		HB246x.567	F, E, S					
MX-3		1992-1995	All		HB246x.567	F, E, S					
MX-5 Miata	Club Spec	2006-2006	All		HB522x.565	F, N, U, G, S, E	HUS585	HKx585522	HB523x.539	F, N, G, W, S, E	
MX-5 Miata	Grand Touring	2006-2013	All		HB522x.565	F, N, U, G, S, E	HUS585	HKx585522	HB523x.539	F, N, G, W, S, E	

APPLICATION GUIDE

RACE PAD COMPOUNDS

DTC-70 - U	DTC-05 - H	MT-4 - L	HP Plus - N
DTC-60 - G	HT-14 - V	Blue 9012 - E	
DTC-30 - W	HT-10 - S	Black - M	
DTC-15 - A	Metallic - MB	DR-97 - J	

STREET PAD COMPOUNDS

HPS Performance Street - F	LTS Light Truck & SUV - Y
Performance Ceramic - Z	SuperDuty - P

MAKE/ MODEL	SUBMODEL	ENGINE YRS. (LITER)	NOTE	FRONT				REAR			
				PADS	PAD COMPOUND	ROTORS	PAD/ROTOR KIT	PADS	PAD COMPOUND	ROTORS	PAD/ROTOR KIT
MAZDA CONTINUED											
MX-5 Miata	Sport	2006-2013	All	HB522x.565	F, N, U, G, S, E	HUS585	HKx585522	HB523x.539	F, N, G, W, S, E		
MX-5 Miata	SV	2006-2013	All	HB522x.565	F, N, U, G, S, E	HUS585	HKx585522	HB523x.539	F, N, G, W, S, E		
MX-5 Miata	Touring	2006-2013	All	HB522x.565	F, N, U, G, S, E	HUS585	HKx585522	HB523x.539	F, N, G, W, S, E		
MX-5 Miata		2006-2006	All	HB522x.565	F, N, U, G, S, E	HUS585	HKx585522	HB523x.539	F, N, G, W, S, E		
MX-5 Miata		2006-2012	All Modified front pads w/DTC-60 material only	HB691x.644	G	HUS585	HKx585691	HB523x.539	F, N, G, W, S, E		
MX-6	LS	1993-1997	All race material .634 thick	HB211x.606	F, Z, N, E	HUS577	HKx577211	HB212x.535	F, N, E		
MX-6	RS	1996-1997	All race material .634 thick	HB211x.606	F, Z, N, E	HUS577	HKx577211	HB212x.535	F, N, E		
MX-6		1993-1995	All race material .634 thick	HB211x.606	F, Z, N, E	HUS577	HKx577211	HB212x.535	F, N, E		
Navajo	DX	1992-1994	All	HB279x.594	Y						
Navajo	LX	1991-1994	All	HB279x.594	Y						
Protege	4wd	1990-1991	All	HB246x.567	F, E, S			HB157x.484	F, N, G, W, E, M		
Protege	DX	1991-1994	All	HB246x.567	F, E, S						
Protege	DX	1996-1998	All	HB246x.567	F, E, S						
Protege	DX	2002-2003	All race material .634 thick	HB211x.606	F, Z, N, E						
Protege	ES	1995-1998	All	HB246x.567	F, E, S			HB159x.492	F, Z, N, G, W, S, E, M		
Protege	ES	2002-2003	All race material .634 thick	HB211x.606	F, Z, N, E	HUS577	HKx577211	HB436x.535	F, Z, N		
Protege	LX	1990-1994	All	HB246x.567	F, E, S			HB157x.484	F, N, G, W, E, M		
Protege	LX	1996-1998	All	HB246x.567	F, E, S						
Protege	LX	2002-2003	All race material .634 thick	HB211x.606	F, Z, N, E						
Protege	Mazdaspeed	2003-2003	All	HB489x.630	F			HB158x.515	F, Z, N, G, W, S, E, M		
Protege	MP3	2001-2001	All race material .634 thick	HB211x.606	F, Z, N, E	HUS577	HKx577211	HB436x.535	F, Z, N		
Protege	Protégé 5	2002-2003	All race material .634 thick	HB211x.606	F, Z, N, E			HB436x.535	F, Z, N		
Protege	SE	1990-1990	All	HB246x.567	F, E, S						
Protege		1994-1995	All	HB246x.567	F, E, S						
Protege		1999-2001	1.8 race material .634 thick	HB211x.606	F, Z, N, E						
Rotary Pickup		1976-1976	All	HB150x.555	F, N, E						
RX-2		1970-1974	All	HB150x.555	F, N, E						
RX-3		1971-1978	All	HB156x.562	E						
RX-4		1974-1978	All	HB150x.555	F, N, E						
RX-7	GXL	1990-1990	All w/Electronic Adjustable Suspension	HB155x.580	F, N, G, S, E, M			HB158x.515	F, Z, N, G, W, S, E, M		
RX-7	GXL	1990-1990	All w/Standard Suspension	HB152x.540	F, N, G, E, M			HB158x.515	F, Z, N, G, W, S, E, M		
RX-7	U	1990-1990	All w/Electronic Adjustable Suspension	HB155x.580	F, N, G, S, E, M			HB158x.515	F, Z, N, G, W, S, E, M		
RX-7	U	1990-1990	All w/Standard Suspension	HB152x.540	F, N, G, E, M			HB158x.515	F, Z, N, G, W, S, E, M		
RX-7		1979-1980	All	HB150x.555	F, N, E						
RX-7		1981-1985	All	HB150x.555	F, N, E			HB151x.505	F, E, M		
RX-7		1984-1985	All fuel injected models	HB152x.540	F, N, G, E, M			HB158x.515	F, Z, N, G, W, S, E, M		
RX-7	Turbo	1986-1991	All Turbo	HB155x.580	F, N, G, S, E, M			HB158x.515	F, Z, N, G, W, S, E, M		
RX-7	Base	1986-1991	All 5-lug, excluding Turbo	HB155x.580	F, N, G, S, E, M			HB158x.515	F, Z, N, G, W, S, E, M		
RX-7	Base	1986-1991	All 4-lug, excluding Turbo	HB152x.540	F, N, G, E, M			HB158x.515	F, Z, N, G, W, S, E, M		
RX-7		1993-1995	All w/Electronic Adjustable Suspension	HB155x.580	F, N, G, S, E, M			HB158x.515	F, Z, N, G, W, S, E, M		
RX-8	Grand Touring	2004-2011	All	HB470x.643	F, Z, N, G, V, S, E	HUS764	HKx764470	HB378x.565	F, Z, N, S, E	HUS763	HKx763378
RX-8	Sport	2004-2011	All	HB470x.643	F, Z, N, G, V, S, E	HUS764	HKx764470	HB378x.565	F, Z, N, S, E	HUS763	HKx763378
RX-8	Touring	2004-2011	All	HB470x.643	F, Z, N, G, V, S, E	HUS764	HKx764470	HB378x.565	F, Z, N, S, E	HUS763	HKx763378
RX-8	Touring	2004-2008	All Standard suspension	HB470x.643	F, Z, N, G, V, S, E	HUS762	HKx762470	HB378x.565	F, Z, N, S, E	HUS763	HKx763378

BRAKE PAD CODE BREAKDOWN

H B 2 4 5 x . 6 3 1
 HAWK BRAKE PAD SHAPE INSERT COMPOUND CODE PAD THICKNESS

PAD/ROTOR KIT CODE BREAKDOWN

H K x 4 2 8 4 4 8
 HAWK KIT INSERT COMPOUND CODE ROTOR PAD SHAPE

MAKE/ MODEL	SUBMODEL	ENGINE YRS. (LITER)	NOTE	FRONT				REAR			
				PADS	PAD COMPOUND	ROTOR	PAD/ROTOR KIT	PADS	PAD COMPOUND	ROTOR	PAD/ROTOR KIT
MERCEDES-BENZ											
230		1977-1978	All					HB172x.595	F, Z, N, U, G, W, M, S, E		
280		1973-1975	All					HB172x.595	F, Z, N, U, G, W, M, S, E		
190D	2.2	1984-1985	2.2	HB195x.640	F, Z, N, G, S, E						
190D	2.5	1986-1989	2.5	HB195x.640	F, Z, N, G, S, E						
190DT		1987-1987	All	HB195x.640	F, Z, N, G, S, E						
190E	2.3	1984-1988	2.3	HB195x.640	F, Z, N, G, S, E						
190E	2.3	1991-1993	2.3	HB195x.640	F, Z, N, G, S, E						
190E	2.3-16	1986-1987	2.3	HB195x.640	F, Z, N, G, S, E						
190E	2.6	1987-1993	2.6	HB195x.640	F, Z, N, G, S, E						
240D		1974-1982	All					HB172x.595	F, Z, N, U, G, W, M, S, E		
280C		1973-1974	All					HB172x.595	F, Z, N, U, G, W, M, S, E		
280CE		1978-1979	All					HB172x.595	F, Z, N, U, G, W, M, S, E		
280S		1976-1976	All					HB172x.595	F, Z, N, U, G, W, M, S, E		
280SE	4.5	1973-1973	4.5					HB172x.595	F, Z, N, U, G, W, M, S, E		
280SE		1978-1979	All					HB172x.595	F, Z, N, U, G, W, M, S, E		
300CD		1978-1981	All					HB172x.595	F, Z, N, U, G, W, M, S, E		
300CDT		1982-1985	All					HB172x.595	F, Z, N, U, G, W, M, S, E		
300D		1966-1972	All	HB171x.590	F, Z, N, U, W, S, E						
300DT		1982-1985	All					HB172x.595	F, Z, N, U, G, W, M, S, E		
300SD		1978-1985	All					HB172x.595	F, Z, N, U, G, W, M, S, E		
300SE		1966-1966	All	HB171x.590	F, Z, N, U, W, S, E			HB172x.595	F, Z, N, U, G, W, M, S, E		
300SE		1990-1990	All					HB172x.595	F, Z, N, U, G, W, M, S, E		
300SEL		1968-1972	All	HB171x.590	F, Z, N, U, W, S, E			HB172x.595	F, Z, N, U, G, W, M, S, E		
300TDT		1982-1985	All					HB172x.595	F, Z, N, U, G, W, M, S, E		
350SD		1991-1991	All					HB172x.595	F, Z, N, U, G, W, M, S, E		
350SDL		1990-1991	All					HB172x.595	F, Z, N, U, G, W, M, S, E		
380SEL		1982-1982	All					HB172x.595	F, Z, N, U, G, W, M, S, E		
420SEL		1989-1990	All					HB172x.595	F, Z, N, U, G, W, M, S, E		
450SE		1973-1976	All					HB172x.595	F, Z, N, U, G, W, M, S, E		
450SEL	6.9	1977-1979	6.9					HB172x.595	F, Z, N, U, G, W, M, S, E		
450SEL		1973-1980	All					HB172x.595	F, Z, N, U, G, W, M, S, E		
450SL		1973-1980	All					HB172x.595	F, Z, N, U, G, W, M, S, E		
450SLC		1973-1980	All					HB172x.595	F, Z, N, U, G, W, M, S, E		
500SEC		1985-1985	All					HB172x.595	F, Z, N, U, G, W, M, S, E		
500SEL		1985-1985	All					HB172x.595	F, Z, N, U, G, W, M, S, E		
560SEC		1986-1991	All					HB172x.595	F, Z, N, U, G, W, M, S, E		
560SEL		1986-1991	All					HB172x.595	F, Z, N, U, G, W, M, S, E		
560SL		1986-1989	All	HB199x.702	F, N, U, S, E			HB172x.595	F, Z, N, U, G, W, M, S, E		
C230	Kompressor	2005-2005	All	HB504x.740	F, Z						
C230		2002-2003	All	HB504x.740	F, Z						
C230		2013	All	HB504x.740	F, Z						
C240	4Matic	2003-2005	All	HB504x.740	F, Z						
C240		2001-2005	All	HB504x.740	F, Z						
C280	Luxury	2006-2007	All	HB504x.740	F, Z						
C320	4Matic	2003-2005	All	HB504x.740	F, Z						
C320		2001-2005	All	HB504x.740	F, Z						
C350	Luxury	2006-2007	All	HB504x.740	F, Z						
C350	Sport	2006-2007	All	HB504x.740	F, Z						

RACE PAD COMPOUNDS

DTC-70 - U	DTC-05 - H	MT-4 - L	HP Plus - N
DTC-60 - G	HT-14 - V	Blue 9012 - E	
DTC-30 - W	HT-10 - S	Black - M	
DTC-15 - A	Metallic - MB	DR-97 - J	

STREET PAD COMPOUNDS

HPS Performance Street - F	LTS Light Truck & SUV - Y
Performance Ceramic - Z	SuperDuty - P

MAKE/ MODEL	SUBMODEL	ENGINE YRS. (LITER)	NOTE	FRONT				REAR				
				PADS	PAD COMPOUND	ROTORS	PAD/ROTOR KIT	PADS	PAD COMPOUND	ROTORS	PAD/ROTOR KIT	
MERCEDES-BENZ CONTINUED												
C43	AMG	1999-2000	All		HB497x.776	F, Z, U, S			HB371x.600	F		
CL55	AMG	2001-2003	All		HB497x.776	F, Z, U, S						
CLK320		1998-2002	All		HB495x.756	F, Z						
CLK320		2003-2005	All		HB504x.740	F, Z						
CLK350	except sport model	2006-2009	All		HB504x.740	F, Z						
CLK430		1999-2003	All		HB495x.756	F, Z						
CLK55	AMG	2005-2006	All		HB616x.607	F, Z, G						
CLK63	AMG	2007-2008	All		HB616x.607	F, Z, G						
E300D		1998-1999	All		HB495x.756	F, Z						
E320		1996-1999	All		HB495x.756	F, Z						
E350	4Matic	2006-2009	All		HB495x.756	F, Z						
E420		1997-1997	All		HB495x.756	F, Z						
E430	4Matic	2000-2002	All		HB497x.776	F, Z, U, S						
E430		2000-2002	All		HB495x.756	F, Z						
E55	AMG	1999-2002	All		HB497x.776	F, Z, U, S			HB371x.600	F		
G500		2002-2008	All						HB479x.700	P		
G55	AMG	2003-2004	All						HB479x.700	P		
G550		2009-2013	All						HB479x.700	P		
ML320		1998-2002	All		HB505x.654	Z						
ML350		2003-2005	All		HB505x.654	Z						
ML430		1998-1999	All		HB505x.654	Z						
S430	4Matic	2005-2006	All		HB497x.776	F, Z, U, S						
S430		2003-2004	All		HB497x.776	F, Z, U, S						
S500	4Matic	2005-2006	All		HB497x.776	F, Z, U, S						
S500		2003-2004	All		HB497x.776	F, Z, U, S						
SLK280		2006-2008	All		HB504x.740	F, Z						
SLK300		2009-2011	All		HB504x.740	F, Z						
SLK32	AMG	2002-2004	All		HB497x.776	F, Z, U, S			HB371x.600	F		
SLK55	AMG	2005-2006	All	w/o Performance Package	HB616x.607	F, Z, G						
SLK55	AMG	2007-2010	All	w/Performance Package	HB616x.607	F, Z, G						
Sprinter	2500	2002	All						HB479x.700	P		
Sprinter	2500	2004	All						HB479x.700	P		
MERCURY												
Colony Park		1981-1981	All		HB125x.650	F, Z, E						
Colony Park		1984-1991	All		HB125x.650	F, Z, E						
Cougar	Brougham	1977-1977	All		HB292x.674	F, P						
Cougar	Brougham Villager	1977-1977	All		HB292x.674	F, P						
Cougar	LS	1989-1992	All		HB240x.620	F						
Cougar	S	2001-2001	All		HB420x.724	F						
Cougar	XR-7	1974-1979	All		HB292x.674	F, P						
Cougar	XR-7	1987-1988	All		HB263x.650	F, Z, N, U, G, E						
Cougar	XR-7	1989-1992	All		HB240x.620	F			HB580x.627	F, G, E		
Cougar	XR-7	1993-1997	All		HB182x.660	F, Z, N, E						
Cougar		1968-1973	All		HB646x.526	F						
Cougar		1975-1979	All		HB292x.674	F, P						
Cougar		1996-1997	All	With Sport Package	HB416x.689	F						
Cougar		1999-2002	All		HB420x.724	F						
Grand Marquis	Colony Park	1983-1983	All		HB125x.650	F, Z, E						

BRAKE PAD CODE BREAKDOWN

H B 2 4 5 x . 6 3 1
 HAWK BRAKE PAD SHAPE INSERT COMPOUND CODE PAD THICKNESS

PAD/ROTOR KIT CODE BREAKDOWN

H K x 4 2 8 4 4 8
 HAWK KIT INSERT COMPOUND CODE ROTOR PAD SHAPE

MAKE/ MODEL	SUBMODEL	YRS.	ENGINE (LITER)	NOTE	FRONT				REAR			
					PADS	PAD COMPOUND	ROTOR	PAD/ROTOR KIT	PADS	PAD COMPOUND	ROTOR	PAD/ROTOR KIT
MERCURY CONTINUED												
Grand Marquis	GS	2006-2011	All		HB433x.654	F			HB443x.614	F		
Grand Marquis	LS	2006-2011	All		HB433x.654	F			HB443x.614	F		
Grand Marquis		1975-1978	All		HB292x.674	F, P						
Grand Marquis		1981-1991	All		HB125x.650	F, Z, E						
Grand Marquis		1992-1994	All		HB125x.650	F, Z, E						
Grand Marquis		1998-2002	All		HB294x.646	F			HB353x.618	F, Y		
Grand Marquis		2003-2011	All		HB433x.654	F			HB443x.614	F		
Marauder		2003-2004	All		HB433x.654	F			HB443x.614	F		
Marquis		1973-1975	All		HB292x.674	F, P						
Milan	Premier	2006-2011	All		HB565x.688	F, Z			HB564x.567	F, Z		
Milan		2006-2011	All		HB565x.688	F, Z			HB564x.567	F, Z		
Montego	GT	1972-1973	All		HB292x.674	F, P						
Montego	MX	1972-1976	All		HB292x.674	F, P						
Montego	MX Brougham	1972-1976	All		HB292x.674	F, P						
Montego	Villager	1972-1976	All		HB292x.674	F, P						
Montego		1968-1971	All		HB646x.526	F						
Montego		1972-1976	All		HB292x.674	F, P						
Mountaineer	Premier	2004-2004	All		HB472x.650	F, Z, Y			HB520x.575	F, Z, Y		
Mountaineer		1997-2001	All		HB283x.650	F, Z, Y, P			HB287x.571	F, Z		
Mountaineer		2002-2004	All		HB472x.650	F, Z, Y			HB520x.575	F, Z, Y		
Mountaineer		2005-2005	All		HB472x.650	F, Z, Y			HB613x.589	Y, Z		
Mountaineer		2006-2010	All		HB612x.690	Y, Z			HB613x.589	Y, Z		
Mystique	GS	1995-1998	All		HB420x.724	F			HB510x.580	F		
Mystique	LS	1995-1998	All		HB420x.724	F			HB510x.580	F		
Mystique	Young America	1995-1995	All		HB420x.724	F			HB510x.580	F		
Mystique		1999-2000	All		HB420x.724	F			HB510x.580	F		
Sable		1989-1993	All		HB240x.620	F						
Sable		1994-2000	All		HB347x.689	F, Z			HB417x.659	F		
Sable		2002-2005	All		HB416x.689	F			HB417x.659	F		
Tracer	LS	1997-1998	All		HB246x.567	F, E, S			HB159x.492	F, Z, N, G, W, S, E, M		
Tracer	LTS	1991-1996	All		HB246x.567	F, E, S			HB157x.484	F, N, G, W, E, M		
Tracer	Trio	1994-1996	All		HB246x.567	F, E, S						
Tracer	Trio	1997-1998	All		HB246x.567	F, E, S			HB159x.492	F, Z, N, G, W, S, E, M		
Tracer		1991-1993	All		HB246x.567	F, E, S			HB157x.484	F, N, G, W, E, M		
Villager		1993-2002	All		HB414x.622	F						
MG												
MGB	GT	1967-1974	All		HB132x.580	N, E, M						
MGB		1967-1980	All		HB132x.580	N, E, M						
Midget		1966-1979	All		HB123x.535	N, E, M						
MINI												
Cooper	Base	2009-2013	All	John Cooper Works	HB640x.550	F, Z, N			HB574x.636	F, Z, N, G, S		
Cooper	Clubman	2008-2012	All		HB570x.666	F, Z			HB574x.636	F, Z, N, G, S		
Cooper	Convertible	2007-2008	All	John Cooper Works	HB560x.677	F, Z, N, G			HB445x.610	F, Z, N, G, W, S, E		
Cooper	Convertible	2007-2009	All		HB570x.666	F, Z						
Cooper	Countryman	2011-2013	All		HB560x.677	F, Z, N, G						
Cooper	S	2002-2006	All		HB444x.685	F, Z, N, G, W, S, E	HUS627	HKx627444	HB445x.610	F, Z, N, G, W, S, E	HUS626	HKx626445
Cooper	S	2006-2008	All	John Cooper Works	HB560x.677	F, Z, N, G			HB574x.636	F, Z, N, G, S		

APPLICATION GUIDE



RACE PAD COMPOUNDS

DTC-70 - U	DTC-05 - H	MT-4 - L	HP Plus - N
DTC-60 - G	HT-14 - V	Blue 9012 - E	
DTC-30 - W	HT-10 - S	Black - M	
DTC-15 - A	Metallic - MB	DR-97 - J	

STREET PAD COMPOUNDS

HPS Performance Street	- F	LTS Light Truck & SUV	- Y
Performance Ceramic	- Z	SuperDuty	- P

MAKE/ MODEL	SUBMODEL	ENGINE YRS. (LITER)	NOTE	FRONT				REAR				
				PADS	PAD COMPOUND	ROTORS	PAD/ROTOR KIT	PADS	PAD COMPOUND	ROTORS	PAD/ROTOR KIT	
MINI CONTINUED												
Cooper	S	2007-2013	All		HB560x.677	F, Z, N, G			HB574x.636	F, Z, N, G, S		
Cooper	S Clubman	2008-2010	All		HB560x.677	F, Z, N, G			HB574x.636	F, Z, N, G, S		
Cooper	S Convertible	2007-2008	All	John Cooper Works	HB560x.677	F, Z, N, G			HB445x.610	F, Z, N, G, W, S, E		
Cooper	S Convertible	2007-2009	All		HB444x.685	F, Z, N, G, W, S, E			HB445x.610	F, Z, N, G, W, S, E		
Cooper		2002-2006	All		HB444x.685	F, Z, N, G, W, S, E	HUS627	HKx627444	HB445x.610	F, Z, N, G, W, S, E	HUS626	HKx626445
Cooper		2006-2006	All	John Cooper Works	HB560x.677	F, Z, N, G			HB445x.610	F, Z, N, G, W, S, E		
Cooper		2007-2013	All		HB570x.666	F, Z			HB574x.636	F, Z, N, G, S		
MITSUBISHI												
3000GT	SL	1991-1999	All		HB214x.618	F, Z, N, S, E, G	HUS583	HKx583214	HB367x.585	F, Z, N		
3000GT	Spyder SL	1995-1996	All		HB214x.618	F, Z, N, S, E, G	HUS583	HKx583214	HB367x.585	F, Z, N		
3000GT	VR-4	1991-1993	All		HB120x.560	F, Z, N, E			HB673x.602	F		
3000GT	VR-4	1994-1998	All		HB120x.560	F, Z, N, E			HB201x.620	F, N		
3000GT		1991-1999	All		HB214x.618	F, Z, N, S, E, G	HUS583	HKx583214	HB367x.585	F, Z, N		
Diamante	ES	1993-1996	All		HB214x.618	F, Z, N, S, E, G	HUS583	HKx583214	HB367x.585	F, Z, N		
Diamante	ES	1997-1998	All		HB214x.618	F, Z, N, S, E, G	HUS583	HKx583214				
Diamante	LS	1993-1995	All		HB214x.618	F, Z, N, S, E, G	HUS583	HKx583214	HB367x.585	F, Z, N		
Diamante	LS	1997-1998	All		HB214x.618	F, Z, N, S, E, G	HUS583	HKx583214				
Diamante		1992-1992	All		HB214x.618	F, Z, N, S, E, G	HUS583	HKx583214				
Diamante		1999-2001	All		HB214x.618	F, Z, N, S, E, G	HUS583	HKx583214				
Diamante		2003-2004	All		HB214x.618	F, Z, N, S, E, G	HUS583	HKx583214				
Eclipse	GS	2006-2012	All	4 Cyl	HB435x.622	F, Y	HUS589	HKx589435	HB367x.585	F, Z, N		
Eclipse	GT	2006-2010	All	6 Cyl	HB435x.622	F, Y	HUS589	HKx589435	HB673x.602	F		
Eclipse	Non-Turbo	1989-1991	All	To 1/1991	HB213x.626	F, Z, N, E	HUS518	HKx518213				
Eclipse	Non-Turbo	1991-1994	All	D21A. From 2/1991	HB213x.626	F, Z, N, E	HUS518	HKx518213				
Eclipse	Non-Turbo	1991-1994	All	D22A. From 2/1991	HB213x.626	F, Z, N, E	HUS518	HKx518213				
Eclipse	Non-Turbo	1994-1994	All	w/Rear Disc Brakes.	HB213x.626	F, Z, N, E	HUS518	HKx518213	HB367x.585	F, Z, N	HUS772	HKx772367
Eclipse	Non-Turbo	1995-1999	All		HB213x.626	F, Z, N, E	HUS518	HKx518213	HB367x.585	F, Z, N	HUS772	HKx772367
Eclipse	Non-Turbo	2000-2000	All	6 Cyl. Only	HB214x.618	F, Z, N, S, E, G	HUS583	HKx583214	HB367x.585	F, Z, N	HUS772	HKx772367
Eclipse	Non-Turbo	2000-2001	All	4 Cyl. Only	HB213x.626	F, Z, N, E	HUS518	HKx518213				
Eclipse	Non-Turbo	2001-2005	All	6 Cyl. Only	HB435x.622	F, Y	HUS586	HKx586435	HB367x.585	F, Z, N	HUS772	HKx772367
Eclipse	Non-Turbo	2002-2005	All	4 Cyl. Only	HB435x.622	F, Y	HUS586	HKx586435				
Eclipse	Non-Turbo GS	2006-2008	All	4 Cyl. Only	HB435x.622	F, Y	HUS589	HKx589435	HB367x.585	F, Z, N		
Eclipse	Non-Turbo GT	2006-2012	All	6 Cyl. Only	HB435x.622	F, Y	HUS589	HKx589435	HB673x.602	F		
Eclipse	SE	2008-2008	All		HB435x.622	F, Y	HUS589	HKx589435	HB367x.585	F, Z, N		
Eclipse	Spyder GS	2007-2008	All		HB435x.622	F, Y	HUS589	HKx589435	HB367x.585	F, Z, N		
Eclipse	Spyder GT	2007-2008	All		HB435x.622	F, Y	HUS589	HKx589435				
Eclipse	Turbo	1989-1992	All	4WD. To 5/1992	HB435x.622	F, Y	HUS518	HKx518435				
Eclipse	Turbo	1989-1994	All	2WD	HB213x.626	F, Z, N, E	HUS518	HKx518213				
Eclipse	Turbo	1995-1999	All	2WD	HB213x.626	F, Z, N, E	HUS518	HKx518213	HB367x.585	F, Z, N	HUS772	HKx772367
Eclipse	Turbo	1995-1999	All	4WD	HB214x.618	F, Z, N, S, E, G	HUS583	HKx583214	HB367x.585	F, Z, N	HUS772	HKx772367
Expo	SP	1992-1993	All		HB213x.626	F, Z, N, E			HB367x.585	F, Z, N		
Expo		1992-1995	All		HB213x.626	F, Z, N, E						
Expo LRV	Sport	1992-1994	All		HB213x.626	F, Z, N, E			HB367x.585	F, Z, N		
Expo LRV		1992-1994	All		HB213x.626	F, Z, N, E						
Galant	Non-Turbo	1989-1993	All		HB213x.626	F, Z, N, E						
Galant	Ralliart	2007-2010	3.8		HB435x.622	F, Y			HB673x.602	F		
Galant	Turbo	1990-1993	All		HB214x.618	F, Z, N, S, E, G						
Galant		1994-1998	All	To 1/1998	HB213x.626	F, Z, N, E			HB367x.585	F, Z, N		

BRAKE PAD CODE BREAKDOWN

H B 2 4 5 x .6 3 1
 HAWK BRAKE PAD SHAPE INSERT COMPOUND CODE PAD THICKNESS

PAD/ROTOR KIT CODE BREAKDOWN

H K x 4 2 8 4 4 8
 HAWK KIT INSERT COMPOUND CODE ROTOR PAD SHAPE

MAKE/ MODEL	SUBMODEL	ENGINE YRS. (LITER)	NOTE	FRONT				REAR			
				PADS	PAD COMPOUND	ROTORS	PAD/ROTOR KIT	PADS	PAD COMPOUND	ROTORS	PAD/ROTOR KIT
MITSUBISHI CONTINUED											
Galant		1998-2000	6 Cyl. Only. To 5/2000	HB214x.618	F, Z, N, S, E, G	HUS583	HKx583214	HB367x.585	F, Z, N	HUS772	HKx772367
Galant		1998-2001	4 Cyl. Only. From 2/1998	HB213x.626	F, Z, N, E	HUS518	HKx518213				
Galant		2000-2003	6 Cyl. Only. From 6/2000	HB435x.622	F, Y	HUS586	HKx586435	HB367x.585	F, Z, N	HUS772	HKx772367
Galant		2004-2007	3.8 6 Cyl. Only	HB435x.622	F, Y			HB367x.585	F, Z, N		
Galant		2004-2008	2.4 4 Cyl. Only	HB435x.622	F, Y	HUS586	HKx586435				
Galant		2010-2012	4 Cyl. Only	HB435x.622	F, Y	HUS586	HKx586435	HB367x.585	F, Z, N	HUS772	HKx772367
Galant		2010-2012	6 Cyl. Only	HB435x.622	F, Y			HB367x.585	F, Z, N		
Lancer	DE	2008-2011	All	HB435x.622	F, Y			HB457x.605	F, Z		
Lancer	ES	2005-2007	All	HB438x.606	F, Z						
Lancer	ES	2008-2013	All	HB435x.622	F, Y			HB457x.605	F, Z		
Lancer	Evolution	2003-2006	All	HB453x.585	F, Z, N, U, G, W, V, S, E	HUS581	HKx581453	HB180x.560	F, Z, N, U, G, W, S, E	HUS580	HKx580180
Lancer	Evolution	2008-2013	All 1-piece front rotor	HB453x.585	F, Z, N, U, G, W, V, S, E	HUS466	HKx466453	HB615x.535	F, Z, N, U, G, S, W	HUS467	HKx467615
Lancer	Evolution MR	2005-2006	All	HB453x.585	F, Z, N, U, G, W, V, S, E	HUS581	HKx581453	HB180x.560	F, Z, N, U, G, W, S, E	HUS580	HKx580180
Lancer	Evolution RS	2005-2006	All	HB453x.585	F, Z, N, U, G, W, V, S, E	HUS581	HKx581453	HB180x.560	F, Z, N, U, G, W, S, E	HUS580	HKx580180
Lancer	Evolution SE	2006-2006	All	HB453x.585	F, Z, N, U, G, W, V, S, E	HUS581	HKx581453	HB180x.560	F, Z, N, U, G, W, S, E	HUS580	HKx580180
Lancer	GTS	2008-2013	All	HB435x.622	F, Y	HUS463	HKx463435	HB675x.602	F, Y	HUS639	HKx639675
Lancer	LS	2002-2004	All	HB438x.606	F, Z						
Lancer	Oz Rally	2005-2006	All	HB438x.606	F, Z			HB457x.605	F, Z		
Lancer	Ralliart	2004-2006	All 5 Lug	HB435x.622	F, Y	HUS581	HKx581435	HB457x.605	F, Z	HUS772	HKx772457
Lancer	Ralliart	2009-2011	All	HB214x.618	F, Z, N, S, E, G			HB675x.602	F, Y		
Lancer	Sportback	2004-2004	All	HB435x.622	F, Y	HUS586	HKx586435	HB457x.605	F, Z	HUS772	HKx772457
Mighty Max	LWB	1989-1989	All	HB404x.642	F						
Mighty Max	LWB	1992-1992	All	HB404x.642	F						
Mighty Max	SPX	1987-1989	All	HB404x.642	F						
Mighty Max	SWB	1989-1989	All	HB404x.642	F						
Mighty Max	SWB	1992-1992	All	HB404x.642	F						
Mighty Max	SWB	1995-1995	All	HB404x.642	F						
Mighty Max		1985-1986	All	HB614x.600	U, W						
Mighty Max		1987-1989	All	HB404x.642	F						
Mighty Max		1990-1994	All	HB404x.642	F						
Mirage		2000-2002	All	HB213x.626	F, Z, N, E						
Montero	LS	1989-1995	All	HB404x.642	F						
Montero	RS	1991-1991	All	HB404x.642	F						
Montero	Sport	1988-1990	All	HB404x.642	F						
Montero		1999-1999	All	HB214x.618	F, Z, N, S, E, G						
Montero Sport		1999-2004	All	HB214x.618	F, Z, N, S, E, G						
Outlander	ES	2007-2008	All	HB435x.622	F, Y						
Outlander	Limited	2005-2006	All	HB214x.618	F, Z, N, S, E, G			HB457x.605	F, Z		
Outlander	LS	2005-2006	All	HB214x.618	F, Z, N, S, E, G			HB457x.605	F, Z		
Outlander	LS	2007-2008	All	HB435x.622	F, Y						
Outlander	SE	2006-2006	All	HB214x.618	F, Z, N, S, E, G			HB457x.605	F, Z		
Outlander	XLS	2005-2005	All	HB214x.618	F, Z, N, S, E, G			HB457x.605	F, Z		
Outlander	XLS	2007-2008	All	HB435x.622	F, Y						
Outlander		2003-2004	All	HB435x.622	F, Y	HUS586	HKx586435				
Outlander		2009-2012	All	HB435x.622	F, Y						
Raider	Durocross	2006-2010	All	HB559x.695	F, Y						
Raider	LS	2006-2010	All	HB559x.695	F, Y						
Raider	SE	2007-2010	All	HB559x.695	F, Y						

APPLICATION GUIDE

RACE PAD COMPOUNDS

DTC-70 - U	DTC-05 - H	MT-4 - L	HP Plus - N
DTC-60 - G	HT-14 - V	Blue 9012 - E	
DTC-30 - W	HT-10 - S	Black - M	
DTC-15 - A	Metallic - MB	DR-97 - J	

STREET PAD COMPOUNDS

HPS Performance Street - F	LTS Light Truck & SUV - Y
Performance Ceramic - Z	SuperDuty - P

MAKE/ MODEL	SUBMODEL	ENGINE YRS. (LITER)	NOTE	FRONT				REAR			
				PADS	PAD COMPOUND	ROTOR	PAD/ROTOR KIT	PADS	PAD COMPOUND	ROTOR	PAD/ROTOR KIT
MITSUBISHI CONTINUED											
Raider	XLS	2006-2006	All	HB559x.695	F, Y						
Van		1987-1990	All	HB404x.642	F						
NISSAN											
810		1977-1980	All	HB169x.560	F, N, U, W, S, E, M						
200SX	SE	1995-1998	All	HB236x.622	N, E			HB680x.583	F, N		
200SX	SE-R	1996-1998	All	HB236x.622	N, E						
200SX		1987-1988	All	HB475x.642	F, E			HB262x.540	F, Z, N, S, E		
200SX		1995-1998	All	HB236x.622	N, E						
240SX	LE	1991-1992	All	4-Wheel ABS HB235x.665	F, Z, N, E			HB262x.540	F, Z, N, S, E		
240SX	LE	1991-1992	All	Non-ABS HB231x.625	F, N, E			HB262x.540	F, Z, N, S, E		
240SX	LE	1997-1997	All	HB235x.665	F, Z, N, E			HB262x.540	F, Z, N, S, E		
240SX	SE	1989-1993	All	4-Wheel ABS HB235x.665	F, Z, N, E			HB262x.540	F, Z, N, S, E		
240SX	SE	1989-1993	All	Non-ABS HB231x.625	F, N, E			HB262x.540	F, Z, N, S, E		
240SX	SE	1994-1996	All	HB231x.625	F, N, E			HB262x.540	F, Z, N, S, E		
240SX	SE	1997-1997	All	HB235x.665	F, Z, N, E			HB262x.540	F, Z, N, S, E		
240SX		1991-1993	All	HB231x.625	F, N, E			HB262x.540	F, Z, N, S, E		
240SX		1995-1996	All	HB231x.625	F, N, E			HB262x.540	F, Z, N, S, E		
240SX		1997-1998	All	HB235x.665	F, Z, N, E			HB262x.540	F, Z, N, S, E		
240Z		1970-1973	All	HB169x.560	F, N, U, W, S, E, M						
260Z	2+2	1974-1975	All	HB169x.560	F, N, U, W, S, E, M						
260Z		1974-1975	All	HB169x.560	F, N, U, W, S, E, M						
280Z	2+2	1975-1978	All	HB169x.560	F, N, U, W, S, E, M						
280Z		1975-1978	All	HB169x.560	F, N, U, W, S, E, M						
300ZX	Base	1984-1986	All	HB475x.642	F, E			HB262x.540	F, Z, N, S, E		
300ZX	Base	1987-1989	All	TO 1/89, Excl. Turbo HB475x.642	F, E			HB262x.540	F, Z, N, S, E		
300ZX	Base	1989-1996	All	FROM 2/89, Excl. Turbo HB178x.564	F, Z, N, G, W, S, E			HB179x.630	F, Z, N, W, S, E		
300ZX	Turbo	1989-1996	All	FROM 7/89 HB178x.564	F, Z, N, G, W, S, E			HB179x.630	F, Z, N, W, S, E		
350Z	Enthusiast	2003-2009	All	w/Brembo Brakes and 18 in. Wheels HB545x.564	F, Z, N, U, G, W, E			HB180x.560	F, Z, N, U, G, W, S, E		
350Z	Enthusiast	2006-2009	All	w/o Brembo brakes w/o 18 in. Wheels HB387x.547	F, Z	HUS428	HKx428387	HB370x.559	F, Z, N, G, E	HUS427	HKx427370
350Z	Grand Touring	2003-2009	All	w/Brembo Brakes and 18 in. Wheels HB545x.564	F, Z, N, U, G, W, E			HB180x.560	F, Z, N, U, G, W, S, E		
350Z	Grand Touring	2006-2009	All	w/o Brembo brakes w/o 18 in. Wheels HB387x.547	F, Z	HUS428	HKx428387	HB370x.559	F, Z, N, G, E	HUS427	HKx427370
350Z	Touring	2003-2009	All	w/Brembo Brakes and 18 in. Wheels HB545x.564	F, Z, N, U, G, W, E			HB180x.560	F, Z, N, U, G, W, S, E		
350Z	Touring	2006-2009	All	w/o Brembo brakes w/o 18 in. Wheels HB387x.547	F, Z	HUS428	HKx428387	HB370x.559	F, Z, N, G, E	HUS427	HKx427370
350Z	Track	2003-2009	All	w/Brembo Brakes and 18 in. Wheels HB545x.564	F, Z, N, U, G, W, E			HB180x.560	F, Z, N, U, G, W, S, E		
350Z	Track	2006-2009	All	w/o Brembo brakes w/o 18 in. Wheels HB387x.547	F, Z	HUS428	HKx428387	HB370x.559	F, Z, N, G, E	HUS427	HKx427370
350Z		2003-2005	All	w/o Brembo brakes w/o 18 in. Wheels HB268x.665	F, Z, N, G			HB370x.559	F, Z, N, G, E		
370Z	Base	2009-2013	All	w/ Sport Brakes HB601x.626	F, Z, N, E, G, U, W	HUS421	HKx421601	HB602x.545	F, Z, N, E, G, U, W		
370Z	Base	2009-2013	All	w/o Sport Brakes HB387x.547	F, Z			HB600x.539	F, Z		
370Z	Touring	2009-2013	All	w/ Sport Brakes HB601x.626	F, Z, N, E, G, U, W	HUS421	HKx421601	HB602x.545	F, Z, N, E, G, U, W		
370Z	Touring	2009-2013	All	w/o Sport Brakes HB387x.547	F, Z			HB600x.539	F, Z		
620 Pickup		1978-1979	All	HB169x.560	F, N, U, W, S, E, M						
Altima	SE-R	2005-2006	All	HB448x.610	F, Z, Y	HUS428	HKx428448	HB370x.559	F, Z, N, G, E		

BRAKE PAD CODE BREAKDOWN

H B **2 4 5** **x** **.6 3 1**
 HAWK BRAKE PAD SHAPE INSERT COMPOUND CODE PAD THICKNESS

PAD/ROTOR KIT CODE BREAKDOWN

H K **x** **4 2 8** **4 4 8**
 HAWK KIT INSERT COMPOUND CODE ROTOR PAD SHAPE

MAKE/ MODEL	SUBMODEL	YRS.	ENGINE (LITER)	NOTE	FRONT				REAR			
					PADS	PAD COMPOUND	ROTORS	PAD/ROTOR KIT	PADS	PAD COMPOUND	ROTORS	PAD/ROTOR KIT
NISSAN CONTINUED												
Altima		1993-2001	All		HB268x.665	F, Z, N, G	HUS557	HKx557268	HB421x.622	F		
Altima		2002-2006	All		HB268x.665	F, Z, N, G	HUS705	HKx705268	HB370x.559	F, Z, N, G, E		
Altima		2007-2012	All		HB268x.665	F, Z, N, G			HB600x.539	F, Z		
Altima	Coupe	2013	All		HB268x.665	F, Z, N, G			HB370x.559	F, Z, N, G, E		
Altima	Sedan	2013	All						HB370x.559	F, Z, N, G, E		
Armada	LE	2005-2006	All		HB567x.694	F, Z, Y			HB555x.678	F, Z, Y		
Armada	SE	2005-2006	All		HB567x.694	F, Z, Y						
Armada	SE Off-Road	2005-2006	All		HB567x.694	F, Z, Y			HB555x.678	F, Z, Y		
Armada		2007-2011	All		HB620x.703	Y			HB555x.678	F, Z, Y		
Axxess		1990-1990	All		HB235x.665	F, Z, N, E						
Cube		2009-2013	All		HB268x.665	F, Z, N, G						
Frontier		2000-2002	All		HB402x.669	F, Y						
Frontier		2003-2004	All	4WD / V6	HB488x.629	F, Z, Y						
Frontier		2003-2004	All	4 Cylinder	HB402x.669	F, Y						
Frontier		2005-2013	All		HB618x.625	Y			HB619x.626	Y		
GT-R		2009-2014	All		HB650x.730	F, Z, N, W, G, U			HB193x.670	F, Z, N, U, G, W, V, S, E		
Juke		2011-2013	All		HB268x.665	F, Z, N, G			HB370x.559	F, Z, N, G, E		
Maxima	GLE	1995-1999	All		HB268x.665	F, Z, N, G			HB421x.622	F		
Maxima	GXE	1992-1994	All		HB268x.665	F, Z, N, G						
Maxima	GXE	1995-1999	All		HB268x.665	F, Z, N, G						
Maxima	SE	1991-1999	All		HB268x.665	F, Z, N, G			HB421x.622	F		
Maxima	SE	2006-2008	All		HB448x.610	F, Z, Y	HUS428	HKx428448	HB370x.559	F, Z, N, G, E		
Maxima	SE	2009-2013	All		HB660x.661	F, N, Z, G, W	HUS428	HKx428660	HB370x.559	F, Z, N, G, E		
Maxima	SL	2006-2008	All		HB448x.610	F, Z, Y	HUS428	HKx428448	HB370x.559	F, Z, N, G, E		
Maxima	SL	2009-2013	All		HB660x.661	F, N, Z, G, W	HUS428	HKx428660	HB370x.559	F, Z, N, G, E		
Maxima		1985-1988	All		HB475x.642	F, E			HB262x.540	F, Z, N, S, E		
Maxima		1989-1990	All		HB268x.665	F, Z, N, G			HB262x.540	F, Z, N, S, E		
Maxima		2000-2001	All		HB268x.665	F, Z, N, G						
Maxima		2002-2003	All		HB268x.665	F, Z, N, G	HUS705	HKx705268	HB378x.626	F		
Maxima		2004-2005	All		HB448x.610	F, Z, Y			HB370x.559	F, Z, N, G, E		
Murano	LE	2009-2014	All		HB448x.610	F, Z, Y	HUS428	HKx428448	HB370x.559	F, Z, N, G, E		
Murano	S	2005-2007	All		HB448x.610	F, Z, Y			HB370x.559	F, Z, N, G, E		
Murano	S	2009-2014	All		HB448x.610	F, Z, Y	HUS428	HKx428448	HB370x.559	F, Z, N, G, E		
Murano	SE	2005-2007	All		HB448x.610	F, Z, Y			HB370x.559	F, Z, N, G, E		
Murano	SL	2005-2007	All		HB448x.610	F, Z, Y			HB370x.559	F, Z, N, G, E		
Murano	SL	2009-2014	All		HB448x.610	F, Z, Y	HUS428	HKx428448	HB370x.559	F, Z, N, G, E		
Murano		2003-2004	All		HB448x.610	F, Z, Y			HB370x.559	F, Z, N, G, E		
Murano	Crosscabriolet	2011-2012	All		HB387x.547	F, Z						
NV1500		2012-2013	All		HB705x.776	Y, P			HB705x.776	Y, P		
NV2500		2012-2013	All		HB705x.776	Y, P			HB705x.776	Y, P		
NV3500		2012-2013	All		HB705x.776	Y, P			HB705x.776	Y, P		
Pathfinder	Armada	2004-2004	All		HB567x.694	F, Z, Y			HB555x.678	F, Z, Y		
Pathfinder	LE	1994-1995	All		HB402x.669	F, Y						
Pathfinder	LE	1996-1997	All		HB326x.646	F, Z, Y						
Pathfinder	SE	1990-1995	All		HB402x.669	F, Y						
Pathfinder	SE	1996-1997	All		HB326x.646	F, Z, Y						
Pathfinder	XE	1990-1995	All		HB402x.669	F, Y						
Pathfinder	XE	1996-1997	All		HB326x.646	F, Z, Y						

APPLICATION GUIDE

RACE PAD COMPOUNDS

DTC-70 - U	DTC-05 - H	MT-4 - L	HP Plus - N
DTC-60 - G	HT-14 - V	Blue 9012 - E	
DTC-30 - W	HT-10 - S	Black - M	
DTC-15 - A	Metallic - MB	DR-97 - J	

STREET PAD COMPOUNDS

HPS Performance Street - F	LTS Light Truck & SUV - Y
Performance Ceramic - Z	SuperDuty - P

MAKE/ MODEL	SUBMODEL	ENGINE YRS. (LITER)	NOTE	FRONT				REAR				
				PADS	PAD COMPOUND	ROTORS	PAD/ROTOR KIT	PADS	PAD COMPOUND	ROTORS	PAD/ROTOR KIT	
NISSAN CONTINUED												
Pathfinder		1987-1989	All		HB402x.669	F, Y						
Pathfinder		1998-2004	All		HB326x.646	F, Z, Y						
Pathfinder		2005-2007	All		HB618x.625	Y			HB619x.626	Y		
Pathfinder		2008-2012	4.0		HB618x.625	Y			HB619x.626	Y		
Pathfinder		2008-2012	5.6		HB387x.547	F, Z			HB619x.626	Y		
Pickup D21 (Hard Body)	SE	1991-1994	All		HB402x.669	F, Y						
Pickup D21 (Hard Body)	SE	1995-1997	All	4WD	HB402x.669	F, Y						
Pickup D21 (Hard Body)	SE	1996-1997	All	2WD	HB475x.642	F, E						
Pickup D21 (Hard Body)	Short Bed XE	1995-1997	All		HB402x.669	F, Y						
Pickup D21 (Hard Body)	XE	1994-1997	All	4WD	HB402x.669	F, Y						
Pickup D21 (Hard Body)	XE	1996-1997	All	2WD	HB475x.642	F, E						
Pickup D21 (Hard Body)		1986-1993	All	4WD	HB402x.669	F, Y						
Pulsar NX		1983-1986	All		HB475x.642	F, E						
Quest	GXE	1993-1998	All		HB414x.622	F						
Quest	S	2005-2008	All		HB326x.646	F, Z, Y			HB370x.559	F, Z, N, G, E		
Quest	SE	2005-2008	All		HB326x.646	F, Z, Y			HB370x.559	F, Z, N, G, E		
Quest	SL	2005-2008	All		HB326x.646	F, Z, Y			HB370x.559	F, Z, N, G, E		
Quest	XE	1993-1998	All		HB414x.622	F						
Quest		1999-2002	All		HB414x.622	F						
Quest		2004-2008	All		HB326x.646	F, Z, Y			HB370x.559	F, Z, N, G, E		
Quest		2009-2009	All		HB326x.646	F, Z, Y						
Rogue		2008-2013	All		HB660x.661	F, N, Z, G, W			HB600x.539	F, Z		
Sentra	E	1996-1996	All		HB236x.622	N, E						
Sentra	GLE	1995-1999	All		HB236x.622	N, E			HB680x.583	F, N		
Sentra	GXE	1995-1999	All		HB236x.622	N, E			HB680x.583	F, N		
Sentra	SE-R	2002-2006	All		HB268x.665	F, Z, N, G	HUS557	HKx557268	HB378x.626	F		
Sentra	SE-R	2007-2009	All		HB268x.665	F, Z, N, G			HB600x.539	F, Z		
Sentra	SE-R	2010-2012	All	w/CVT Trans	HB268x.665	F, Z, N, G			HB600x.539	F, Z		
Sentra	SE-R	2010-2012	All	w/Manual Trans	HB660x.661	F, N, Z, G, W	HUS710	HKx710660	HB600x.539	F, Z	HUS706	HKx706600
Sentra	SE-R Spec V	2003-2006	All	w/Brembo Front Calipers	HB545x.564	F, Z, N, U, G, W, E			HB378x.626	F		
Sentra	SE-R Spec V	2007-2012	All		HB660x.661	F, N, Z, G, W	HUS710	HKx710660	HB600x.539	F, Z	HUS706	HKx706600
Sentra	XE	1995-1997	All		HB236x.622	N, E						
Sentra		1995-1995	All		HB236x.622	N, E						
Sentra		1998-1999	All		HB236x.622	N, E						
Sentra		2000-2000	All		HB235x.665	F, Z, N, E						
Sentra		2001-2006	All	w/Rear Disc Brakes	HB268x.665	F, Z, N, G	HUS557	HKx557268	HB378x.626	F		
Sentra		2001-2006	All	w/Rear Drum Brakes	HB235x.665	F, Z, N, E						
Sentra		2007-2009	All		HB268x.665	F, Z, N, G			HB600x.539	F, Z		
Sentra		2012-2012	All	w/Rear Drum Brakes	HB268x.665	F, Z, N, G						
Skyline	GT-R	1989-1993	All	R32	HB178x.564	F, Z, N, G, W, S, E			HB179x.630	F, Z, N, W, S, E		
Skyline	GT-R	1992-1995	All	Fits the V-Spec only	HB181x.660	F, N, U, G, E			HB180x.560	F, Z, N, U, G, W, S, E		
Skyline	GT-R	1995-1997	All	R33	HB181x.660	F, N, U, G, E			HB180x.560	F, Z, N, U, G, W, S, E		
Skyline	GT-R	1997-2002	All	R34 twin turbo	HB181x.660	F, N, U, G, E			HB180x.560	F, Z, N, U, G, W, S, E		
Skyline	GTS	1989-1995	All	R32	HB268x.665	F, Z, N, G			HB179x.630			
Stanza	GL	1984-1985	All		HB475x.642	F, E						
Stanza	XE	1984-1985	All		HB475x.642	F, E						
Stanza		1986-1988	All		HB475x.642	F, E						
Stanza		1989-1989	All		HB475x.642	F, E						

BRAKE PAD CODE BREAKDOWN

H B **2 4 5** **x** **.6 3 1**

HAWK BRAKE PAD SHAPE INSERT COMPOUND CODE PAD THICKNESS

PAD/ROTOR KIT CODE BREAKDOWN

H K **x** **4 2 8** **4 4 8**

HAWK KIT INSERT COMPOUND CODE ROTOR PAD SHAPE

MAKE/ MODEL	SUBMODEL	ENGINE YRS. (LITER)	NOTE	FRONT				REAR			
				PADS	PAD COMPOUND	ROTORS	PAD/ROTOR KIT	PADS	PAD COMPOUND	ROTORS	PAD/ROTOR KIT
NISSAN CONTINUED											
Stanza		1990-1992	All	HB235x.665	F, Z, N, E			HB262x.540	F, Z, N, S, E		
Titan	LE	2005-2007	All	HB567x.694	F, Z, Y			HB555x.678	F, Z, Y		
Titan	SE	2005-2007	All	HB567x.694	F, Z, Y			HB555x.678	F, Z, Y		
Titan	XE	2005-2007	All	HB567x.694	F, Z, Y			HB555x.678	F, Z, Y		
Titan		2004-2004	All	HB567x.694	F, Z, Y			HB555x.678	F, Z, Y		
Titan		2008-2010	All	HB620x.703	Y			HB555x.678	F, Z, Y		
Versa	S	2007-2007	All	HB268x.665	F, Z, N, G						
Versa	S	2008-2008	All Non-ABS	HB268x.665	F, Z, N, G						
Versa	S	2009-2012	All	HB268x.665	F, Z, N, G						
Versa	SL	2007-2007	All	HB268x.665	F, Z, N, G						
Versa	SL	2008-2008	All Non-ABS	HB268x.665	F, Z, N, G						
Versa	SL	2009-2012	All	HB268x.665	F, Z, N, G						
Xterra		2000-2004	All	HB488x.629	F, Z, Y						
Xterra		2005-2013	All	HB618x.625	Y			HB619x.626	Y		
OLDSMOBILE											
98	Regency	1973-1983	All	HB103x.590	F, Z, Y, P, N, U, G W, H, S, L, E, M, A						
98	Regency	1994-1994	All	HB217x.681	F, Z, E						
98	Regency Brougham	1982-1984	All	HB103x.590	F, Z, Y, P, N, U, G W, H, S, L, E, M, A						
98	Regency Elite	1994-1996	All	HB217x.681	F, Z, E						
98		1968-1981	All	HB103x.590	F, Z, Y, P, N, U, G W, H, S, L, E, M, A						
442		1968-1971	6.6	HB103x.590	F, Z, Y, P, N, U, G W, H, S, L, E, M, A						
Achieva	S	1992-1995	All	HB390x.602	F						
Achieva	SC	1994-1994	All	HB390x.602	F						
Achieva	SC	1996-1997	All	HB390x.602	F						
Achieva	SL	1992-1997	All	HB390x.602	F						
Achieva		1996-1996	All	HB390x.602	F						
Alero		1999-2004	All	HB425x.661	F			HB359x.543	F, Z, G		
Aurora		1995-1996	All	HB217x.681	F, Z, E			HB359x.543	F, Z, G		
Aurora		1997-1999	All	HB360x.670	F, Z	HUS8664	HKx8664360	HB359x.543	F, Z, G		
Aurora		2001-2002	All	HB360x.670	F, Z	HUS8664	HKx8664360	HB359x.543	F, Z, G		
Bravada		1991-1994	All	HB119x.594	F, Z, Y, P, N, U, G W, H, S, L, E, M, A						
Bravada		1996-1996	All	HB119x.594	F, Z, Y, P, N, U, G W, H, S, L, E, M, A						
Bravada		1997-2001	All	HB304x.598	F, Z, Y			HB305x.610	F, Z, Y, P		
Bravada		2002-2004	All	HB382x.657	F, Y			HB383x.685	F, Y		
Calais	Supreme	1986-1987	All	HB400x.630	F						
Calais		1985-1987	All	HB400x.630	F						
Cutlass	Brougham	1980-1981	All	HB119x.594	F, Z, Y, P, N, U, G W, H, S, L, E, M, A						
Cutlass	GLS	1997-1997	All	HB425x.661	F						
Cutlass	LS	1980-1981	All	HB119x.594	F, Z, Y, P, N, U, G W, H, S, L, E, M, A						
Cutlass	S	1971-1977	All	HB103x.590	F, Z, Y, P, N, U, G W, H, S, L, E, M, A						
Cutlass	Salon	1975-1977	All	HB103x.590	F, Z, Y, P, N, U, G W, H, S, L, E, M, A						

RACE PAD COMPOUNDS

DTC-70 - U	DTC-05 - H	MT-4 - L	HP Plus - N
DTC-60 - G	HT-14 - V	Blue 9012 - E	
DTC-30 - W	HT-10 - S	Black - M	
DTC-15 - A	Metallic - MB	DR-97 - J	

STREET PAD COMPOUNDS

HPS Performance Street - F	LTS Light Truck & SUV - Y
Performance Ceramic - Z	SuperDuty - P

MAKE/ MODEL	SUBMODEL	ENGINE YRS. (LITER)	NOTE	FRONT				REAR			
				PADS	PAD COMPOUND	ROTORS	PAD/ROTOR KIT	PADS	PAD COMPOUND	ROTORS	PAD/ROTOR KIT
OLDSMOBILE CONTINUED											
Cutlass	Salon	1978-1987	All	HB119x.594	F, Z, Y, P, N, U, G W, H, S, L, E, M, A						
Cutlass	Salon Brougham	1978-1980	All	HB119x.594	F, Z, Y, P, N, U, G W, H, S, L, E, M, A						
Cutlass		1968-1977	All	HB103x.590	F, Z, Y, P, N, U, G W, H, S, L, E, M, A						
Cutlass		1979-1986	All	HB119x.594	F, Z, Y, P, N, U, G W, H, S, L, E, M, A						
Cutlass		1997-1999	All	HB425x.661	F						
Cutlass Calais	International	1988-1989	All	HB400x.630	F						
Cutlass Calais	International	1990-1990	All	w/o Performance Package	HB400x.630	F					
Cutlass Calais	International	1990-1990	All	w/Performance Package	HB390x.602	F					
Cutlass Calais	International	1991-1991	All		HB390x.602	F					
Cutlass Calais	S	1989-1989	All		HB400x.630	F					
Cutlass Calais	S	1990-1990	All	w/o Performance Package	HB400x.630	F					
Cutlass Calais	S	1990-1990	All	w/Performance Package	HB390x.602	F					
Cutlass Calais	S	1991-1991	All		HB390x.602	F					
Cutlass Calais	SL	1988-1989	All		HB400x.630	F					
Cutlass Calais	SL	1990-1991	All		HB390x.602	F					
Cutlass Calais		1982-1984	All		HB119x.594	F, Z, Y, P, N, U, G W, H, S, L, E, M, A					
Cutlass Calais		1985-1985	All		HB400x.630	F					
Cutlass Calais		1988-1989	All		HB400x.630	F					
Cutlass Calais		1990-1990	All	w/o Performance Package	HB400x.630	F					
Cutlass Calais		1990-1990	All	w/Performance Package	HB390x.602	F					
Cutlass Calais		1991-1991	All		HB390x.602	F					
Cutlass Ciera	Brougham	1982-1982	All		HB400x.630	F					
Cutlass Ciera	Brougham	1983-1988	All	w/Standard Brakes	HB400x.630	F					
Cutlass Ciera	Cruiser	1984-1989	All	w/Standard Brakes	HB400x.630	F					
Cutlass Ciera	Cruiser Brougham	1987-1988	All	w/Standard Brakes	HB400x.630	F					
Cutlass Ciera	Cruiser SL	1989-1989	All	w/Standard Brakes	HB400x.630	F					
Cutlass Ciera	International	1989-1989	All	w/Standard Brakes	HB400x.630	F					
Cutlass Ciera	LS	1983-1985	All	w/Standard Brakes	HB400x.630	F					
Cutlass Ciera	S	1987-1987	All	w/Standard Brakes	HB400x.630	F					
Cutlass Ciera	SL	1987-1988	All	w/Standard Brakes	HB400x.630	F					
Cutlass Ciera		1982-1982	All		HB400x.630	F					
Cutlass Ciera		1983-1989	All	w/Standard Brakes	HB400x.630	F					
Cutlass Supreme	Brougham	1976-1977	All		HB103x.590	F, Z, Y, P, N, U, G W, H, S, L, E, M, A					
Cutlass Supreme	Brougham	1978-1987	All		HB119x.594	F, Z, Y, P, N, U, G W, H, S, L, E, M, A					
Cutlass Supreme	Classic	1988-1988	All		HB119x.594	F, Z, Y, P, N, U, G W, H, S, L, E, M, A					
Cutlass Supreme	Classic Brougham	1988-1988	All		HB119x.594	F, Z, Y, P, N, U, G W, H, S, L, E, M, A					
Cutlass Supreme	Cruiser	1974-1975	All		HB103x.590	F, Z, Y, P, N, U, G W, H, S, L, E, M, A					
Cutlass Supreme	International	1988-1993	All		HB232x.681	F					
Cutlass Supreme	S	1992-1993	All		HB232x.681	F					
Cutlass Supreme	S	1994-1994	All		HB232x.681	F		HB359x.543	F, Z, G		
Cutlass Supreme	SL	1989-1991	All		HB232x.681	F					

BRAKE PAD CODE BREAKDOWN

H B 2 4 5 x . 6 3 1
 HAWK BRAKE PAD SHAPE INSERT COMPOUND CODE PAD THICKNESS

PAD/ROTOR KIT CODE BREAKDOWN

H K x 4 2 8 4 4 8
 HAWK KIT INSERT COMPOUND CODE ROTOR PAD SHAPE

MAKE/ MODEL	SUBMODEL	ENGINE YRS. (LITER)	NOTE	FRONT				REAR			
				PADS	PAD COMPOUND	ROTOR	PAD/ROTOR KIT	PADS	PAD COMPOUND	ROTOR	PAD/ROTOR KIT
OLDSMOBILE CONTINUED											
Cutlass Supreme	SL	1995-1997	All	HB232x.681	F			HB359x.543	F, Z, G		
Cutlass Supreme		1971-1977	All	HB103x.590	F, Z, Y, P, N, U, G W, H, S, L, E, M, A						
Cutlass Supreme		1978-1987	All	HB119x.594	F, Z, Y, P, N, U, G W, H, S, L, E, M, A						
Cutlass Supreme		1988-1993	All	HB232x.681	F						
Cutlass Supreme		1994-1997	All	HB232x.681	F			HB359x.543	F, Z, G		
Delmont 88		1968-1968	All	HB103x.590	F, Z, Y, P, N, U, G W, H, S, L, E, M, A						
Delta 88	Custom	1968-1971	All	HB103x.590	F, Z, Y, P, N, U, G W, H, S, L, E, M, A						
Delta 88	Royale	1970-1985	All	HB103x.590	F, Z, Y, P, N, U, G W, H, S, L, E, M, A						
Delta 88	Royale	1994-1998	All	HB217x.681	F, Z, E						
Delta 88	Royale Brougham	1980-1985	All	HB103x.590	F, Z, Y, P, N, U, G W, H, S, L, E, M, A						
Delta 88	Royale Brougham LS	1984-1985	All	HB103x.590	F, Z, Y, P, N, U, G W, H, S, L, E, M, A						
Delta 88	Royale LS	1994-1998	All	HB217x.681	F, Z, E						
Delta 88	Royale LSS	1995-1995	All	HB217x.681	F, Z, E						
Delta 88		1968-1983	All	HB103x.590	F, Z, Y, P, N, U, G W, H, S, L, E, M, A						
Delta 88		1999-1999	All	HB217x.681	F, Z, E						
F85		1968-1972	All	HB103x.590	F, Z, Y, P, N, U, G W, H, S, L, E, M, A						
Firenza	GT	1986-1987	All	HB400x.630	F						
Firenza	LC	1986-1987	All	HB400x.630	F						
Firenza	LX	1982-1987	All	HB400x.630	F						
Firenza	S	1982-1987	All	HB400x.630	F						
Firenza	SX	1982-1985	All	HB400x.630	F						
Firenza		1982-1986	All	HB400x.630	F						
Intrigue		1998-2002	All	JB9 Standard Brakes	F, Z	HUS8664	HKx8664360	HB359x.543	F, Z, G	HUS8258	HKx8258359
Intrigue		1998-2002	All	JA9 Heavy Duty Brakes	F, Z			HB359x.543	F, Z, G		
Lss		1997-1999	All	HB217x.681	F, Z, E						
Omega	Brougham	1976-1979	All	HB103x.590	F, Z, Y, P, N, U, G W, H, S, L, E, M, A						
Omega	Brougham	1980-1984	All	HB400x.630	F						
Omega	F85	1976-1977	All	HB103x.590	F, Z, Y, P, N, U, G W, H, S, L, E, M, A						
Omega	Salon	1975-1975	All	HB103x.590	F, Z, Y, P, N, U, G W, H, S, L, E, M, A						
Omega		1973-1979	All	HB103x.590	F, Z, Y, P, N, U, G W, H, S, L, E, M, A						
Omega		1980-1984	All	HB400x.630	F						
Regency		1997-1998	All	HB217x.681	F, Z, E						
Silhouette		1994-1996	All	HB217x.681	F, Z, E						
Silhouette		1997-2001	All	HB360x.670	F, Z						
Silhouette		2002-2003	All	w/Rear Drum Brakes	F, Z						
Silhouette		2004-2004	All		F, Z						
Toronado	Brougham	1975-1978	All	HB103x.590	F, Z, Y, P, N, U, G W, H, S, L, E, M, A						
Toronado	Brougham	1979-1985	All	HB119x.594	F, Z, Y, P, N, U, G W, H, S, L, E, M, A			HB119x.594	F, Z, Y, P, N, U, G W, H, S, L, E, M, A		

RACE PAD COMPOUNDS

DTC-70 - U	DTC-05 - H	MT-4 - L	HP Plus - N
DTC-60 - G	HT-14 - V	Blue 9012 - E	
DTC-30 - W	HT-10 - S	Black - M	
DTC-15 - A	Metallic - MB	DR-97 - J	

STREET PAD COMPOUNDS

HPS Performance Street - F	LTS Light Truck & SUV - Y
Performance Ceramic - Z	SuperDuty - P

MAKE/ MODEL	SUBMODEL	ENGINE YRS. (LITER)	NOTE	FRONT				REAR			
				PADS	PAD COMPOUND	ROTORS	PAD/ROTOR KIT	PADS	PAD COMPOUND	ROTORS	PAD/ROTOR KIT
OLDSMOBILE CONTINUED											
Toronado	XSR	1977-1977	All	HB103x.590	F, Z, Y, P, N, U, G W, H, S, L, E, M, A						
Toronado		1968-1976	All	HB103x.590	F, Z, Y, P, N, U, G W, H, S, L, E, M, A						
Toronado		1978-1978	All	HB103x.590	F, Z, Y, P, N, U, G W, H, S, L, E, M, A						
Toronado		1979-1981	All	HB119x.594	F, Z, Y, P, N, U, G W, H, S, L, E, M, A			HB119x.594	F, Z, Y, P, N, U, G W, H, S, L, E, M, A		
Toronado		1984-1985	All	HB119x.594	F, Z, Y, P, N, U, G W, H, S, L, E, M, A			HB119x.594	F, Z, Y, P, N, U, G W, H, S, L, E, M, A		
Vista Cruiser		1968-1977	All	HB103x.590	F, Z, Y, P, N, U, G W, H, S, L, E, M, A						
OPEL											
1900	Rallye	1971-1972	All	HB172x.595	F, Z, N, U, G, W, M, S, E						
1900		1973-1974	All	HB172x.595	F, Z, N, U, G, W, M, S, E						
Manta		1971-1974	All	HB172x.595	F, Z, N, U, G, W, M, S, E						
Manta		1975-1975	All	HB180x.560	F, Z, N, U, G, W, S, E						
PEUGEOT											
405	DL	1989-1989	All	HB195x.640	F, Z, N, G, S, E			HB364x.642	F, Z, N, E		
405	Mi16	1989-1989	All	HB195x.640	F, Z, N, G, S, E			HB364x.642	F, Z, N, E		
405	S	1989-1989	All	HB195x.640	F, Z, N, G, S, E			HB364x.642	F, Z, N, E		
504		1979-1982	All	HB199x.702	F, N, U, S, E						
505	DL	1988-1989	All	HB199x.702	F, N, U, S, E						
505	GL	1984-1987	All	HB199x.702	F, N, U, S, E						
505	GLS	1987-1988	All	HB199x.702	F, N, U, S, E						
505	GLX	1988-1988	All	HB199x.702	F, N, U, S, E						
505	Liberte	1987-1987	All	HB199x.702	F, N, U, S, E						
505	S	1986-1989	All	HB199x.702	F, N, U, S, E						
505	STI	1986-1988	All	HB199x.702	F, N, U, S, E						
505	STX	1987-1989	All	HB199x.702	F, N, U, S, E						
505	SW8	1989-1989	All	HB199x.702	F, N, U, S, E						
505	Turbo	1989-1989	All	HB199x.702	F, N, U, S, E						
505		1980-1987	All	HB199x.702	F, N, U, S, E						
604		1977-1982	All	HB199x.702	F, N, U, S, E						
PLYMOUTH											
Barracuda		1970-1974	All	HB643x.595	F						
Belvedere		1970-1970	All	HB643x.595	F						
Colt	Vista	1992-1994	All	HB213x.626	F, Z, N, E						
Colt	Vista SE	1992-1992	All	HB213x.626	F, Z, N, E						
Cuda		1970-1974	All	HB643x.595	F						
Fury		1969-1973	All	HB643x.595	F						
Fury		1975-1978	All	HB643x.595	F						
Gran Coupe		1970-1974	All	HB643x.595	F						
Grand Voyager	SE	1996-1997	All	HB177x.710	F						
Grand Voyager		1996-2000	All	HB177x.710	F						
Laser	RS	1990-1992	All	HB213x.626	F, Z, N, E						
Laser	RS	1993-1994	All	HB214x.618	F, Z, N, S, E, G						
Laser		1990-1992	All	HB213x.626	F, Z, N, E						
Laser		1993-1994	All	HB214x.618	F, Z, N, S, E, G						

BRAKE PAD CODE BREAKDOWN

H B **2 4 5** **x** **. 6 3 1**

HAWK BRAKE PAD SHAPE INSERT COMPOUND CODE PAD THICKNESS

PAD/ROTOR KIT CODE BREAKDOWN

H K **x** **4 2 8** **4 4 8**

HAWK KIT INSERT COMPOUND CODE ROTOR PAD SHAPE

MAKE/ MODEL	SUBMODEL	YRS.	ENGINE (LITER)	NOTE	FRONT				REAR			
					PADS	PAD COMPOUND	ROTORS	PAD/ROTOR KIT	PADS	PAD COMPOUND	ROTORS	PAD/ROTOR KIT
PLYMOUTH CONTINUED												
Neon	Highline	1995-1997	All		HB177x.630	F, N, G, S, E			HB176x.614	F, Z, N		
Neon	Sport	1995-1996	All		HB177x.630	F, N, G, S, E			HB176x.614	F, Z, N		
Neon		1995-1999	All		HB177x.630	F, N, G, S, E			HB176x.614	F, Z, N		
Prowler		1997-1997	All		HB260x.670	F, Z			HB260x.670	F, Z		
Prowler		1999-2001	All		HB260x.670	F, Z			HB260x.670	F, Z		
Roadrunner		1970-1975	All	w/Pin Type Calipers	HB643x.595	F						
Roadrunner Gtx		1970-1975	All	w/Pin Type Calipers	HB643x.595	F						
Satellite		1970-1975	All	w/Pin Type Calipers	HB643x.595	F						
Sebring		1970-1975	All	w/Pin Type Calipers	HB643x.595	F						
Sport Fury		1969-1973	All		HB643x.595	F						
Sport Fury		1975-1978	All		HB643x.595	F						
Suburban Wagon		1969-1973	All		HB643x.595	F						
Suburban Wagon		1975-1978	All		HB643x.595	F						
Valiant		1971-1972	All		HB471x.510	F, N, U, S						
Voyager	SE	1996-1997	All		HB177x.710	F						
Voyager		1996-2000	All		HB177x.710	F						
PONTIAC												
6000	LE	1982-1982	All		HB400x.630	F						
6000	LE	1983-1989	All	w/Standard Brakes	HB400x.630	F						
6000	SE	1986-1989	All	w/Standard Brakes	HB400x.630	F						
6000		1982-1982	All		HB400x.630	F						
6000		1983-1989	All	w/Standard Brakes	HB400x.630	F						
Aztek	GT	2001-2001	All		HB373x.689	F			HB359x.543	F, Z, G		
Aztek	Rally	2004-2004	All		HB373x.689	F			HB359x.543	F, Z, G		
Aztek		2001-2005	All		HB373x.689	F			HB359x.543	F, Z, G		
Bonneville	Brougham	1976-1981	All		HB103x.590	F, Z, Y, P, N, U, G W, H, S, L, E, M, A						
Bonneville	Brougham	1982-1986	All		HB119x.594	F, Z, Y, P, N, U, G W, H, S, L, E, M, A						
Bonneville	GXP	2004-2005	All		HB467x.540	F, Z			HB359x.543	F, Z, G		
Bonneville	LE	1984-1986	All		HB119x.594	F, Z, Y, P, N, U, G W, H, S, L, E, M, A						
Bonneville	Safari	1979-1981	All		HB103x.590	F, Z, Y, P, N, U, G W, H, S, L, E, M, A						
Bonneville	SE	1994-1998	All		HB217x.681	F, Z, E						
Bonneville	SE	2004-2005	All		HB360x.670	F, Z			HB359x.543	F, Z, G		
Bonneville	SLE	2004-2005	All		HB360x.670	F, Z	HUS8664	HKx8664360	HB359x.543	F, Z, G		
Bonneville	SSE	1994-1998	All		HB217x.681	F, Z, E						
Bonneville		1973-1981	All		HB103x.590	F, Z, Y, P, N, U, G W, H, S, L, E, M, A						
Bonneville		1982-1986	All		HB119x.594	F, Z, Y, P, N, U, G W, H, S, L, E, M, A						
Bonneville		1999-1999	All		HB217x.681	F, Z, E						
Bonneville		2000-2003	All		HB360x.670	F, Z			HB359x.543	F, Z, G		
Catalina	Safari	1973-1981	All		HB103x.590	F, Z, Y, P, N, U, G W, H, S, L, E, M, A						
Catalina		1973-1981	All		HB103x.590	F, Z, Y, P, N, U, G W, H, S, L, E, M, A						
Firebird	Esprit	1973-1978	All		HB103x.590	F, Z, Y, P, N, U, G W, H, S, L, E, M, A						

RACE PAD COMPOUNDS

DTC-70 - U	DTC-05 - H	MT-4 - L	HP Plus - N
DTC-60 - G	HT-14 - V	Blue 9012 - E	
DTC-30 - W	HT-10 - S	Black - M	
DTC-15 - A	Metallic - MB	DR-97 - J	

STREET PAD COMPOUNDS

HPS Performance Street - F	LTS Light Truck & SUV - Y
Performance Ceramic - Z	SuperDuty - P

MAKE/ MODEL	SUBMODEL	ENGINE YRS. (LITER)	NOTE	FRONT				REAR				
				PADS	PAD COMPOUND	ROTORS	PAD/ROTOR KIT	PADS	PAD COMPOUND	ROTORS	PAD/ROTOR KIT	
PONTIAC CONTINUED												
Firebird	Esprit	1979-1981	All	HB103x.590	F, Z, Y, P, N, U, G W, H, S, L, E, M, A			HB119x.594	F, Z, Y, P, N, U, G W, H, S, L, E, M, A			
Firebird	Firehawk	1998-1998	All	HB249x.575	F, Z, N, U, G, W, V, S	HUS8664	HKx8664249	HB250x.653	F, Z, N, U, G, S, E	HUS8258	HKx8258250	
Firebird	Formula	1973-1978	All	HB103x.590	F, Z, Y, P, N, U, G W, H, S, L, E, M, A							
Firebird	Formula	1979-1981	All	HB103x.590	F, Z, Y, P, N, U, G W, H, S, L, E, M, A			HB119x.594	F, Z, Y, P, N, U, G W, H, S, L, E, M, A			
Firebird	Formula	1989-1992	All	w/o Performance Package	HB119x.594	F, Z, Y, P, N, U, G W, H, S, L, E, M, A	HUS8213	HKx8213119	HB112x.540	F, Z, N, U, G, S, E, M		
Firebird	Formula	1989-1992	All	w/Performance Package	HB111x.610	F, Z, N, U, G, S, E, M			HB112x.540	F, Z, N, U, G, S, E, M		
Firebird	Formula	1994-1997	All		HB217x.681	F, Z, E			HB112x.540	F, Z, N, U, G, S, E, M		
Firebird	Formula	1998-2002	All		HB249x.575	F, Z, N, U, G, W, V, S	HUS8664	HKx8664249	HB250x.653	F, Z, N, U, G, S, E	HUS8265	HKx8265250
Firebird	Trans Am	1973-1978	All		HB103x.590	F, Z, Y, P, N, U, G W, H, S, L, E, M, A						
Firebird	Trans Am	1979-1981	All		HB103x.590	F, Z, Y, P, N, U, G W, H, S, L, E, M, A			HB119x.594	F, Z, Y, P, N, U, G W, H, S, L, E, M, A		
Firebird	Trans Am	1987-1992	All	w/o Performance Package	HB119x.594	F, Z, Y, P, N, U, G W, H, S, L, E, M, A	HUS8213	HKx8213119				
Firebird	Trans Am	1987-1992	All	w/o Performance Package	HB119x.594	F, Z, Y, P, N, U, G W, H, S, L, E, M, A	HUS8213	HKx8213119				
Firebird	Trans Am	1994-1997	All		HB217x.681	F, Z, E			HB112x.540	F, Z, N, U, G, S, E, M		
Firebird	Trans Am	1998-2002	All		HB249x.575	F, Z, N, U, G, W, V, S	HUS8664	HKx8664249	HB250x.653	F, Z, N, U, G, S, E	HUS8265	HKx8265250
Firebird	Trans Am GT	1994-1994	All		HB217x.681	F, Z, E			HB112x.540	F, Z, N, U, G, S, E, M		
Firebird	Trans Am GTA	1989-1992	All	w/Performance Package	HB111x.610	F, Z, N, U, G, S, E, M			HB112x.540	F, Z, N, U, G, S, E, M		
Firebird	Trans Am GTA	1989-1992	All	w/Performance Package	HB111x.610	F, Z, N, U, G, S, E, M			HB112x.540	F, Z, N, U, G, S, E, M		
Firebird	Trans Am GTA SE	1989-1989	All	w/Performance Package	HB111x.610	F, Z, N, U, G, S, E, M			HB112x.540	F, Z, N, U, G, S, E, M		
Firebird		1973-1978	All		HB103x.590	F, Z, Y, P, N, U, G W, H, S, L, E, M, A						
Firebird		1979-1981	All		HB103x.590	F, Z, Y, P, N, U, G W, H, S, L, E, M, A			HB119x.594	F, Z, Y, P, N, U, G W, H, S, L, E, M, A		
Firebird		1988-1992	All	w/Performance Package	HB111x.610	F, Z, N, U, G, S, E, M			HB112x.540	F, Z, N, U, G, S, E, M		
Firebird		1989-1992	All	w/o Performance Package	HB119x.594	F, Z, Y, P, N, U, G W, H, S, L, E, M, A	HUS8213	HKx8213119				
Firebird		1990-1992	All	w/Performance Package	HB111x.610	F, Z, N, U, G, S, E, M			HB112x.540	F, Z, N, U, G, S, E, M		
Firebird		1994-1997	All		HB217x.681	F, Z, E			HB112x.540	F, Z, N, U, G, S, E, M		
Firebird		1998-2002	All		HB249x.575	F, Z, N, U, G, W, V, S	HUS8664	HKx8664249	HB250x.653	F, Z, N, U, G, S, E	HUS8265	HKx8265250
G3		2009-2010	All		HB592x.665	F						
G5	GT	2007-2009	All	w/Rear Drum Brakes	HB517x.690	F, Z						
G5	GT	2007-2010	All	w/Rear Disc Brakes	HB524x.740	F, Z, N, U, G, S, E			HB525x.540	F, Z, N, G		
G5		2007-2010	All	w/Rear Disc Brakes	HB524x.740	F, Z, N, U, G, S, E			HB525x.540	F, Z, N, G		
G5		2007-2010	All	w/Rear Drum Brakes	HB517x.690	F, Z						
G6	Base	2005-2010	All		HB524x.740	F, Z, N, U, G, S, E			HB525x.540	F, Z, N, G		
G6	GT	2005-2005	All		HB554x.643	F, Y, Z, G, U						
G6	GT	2006-2010	All		HB524x.740	F, Z, N, U, G, S, E			HB525x.540	F, Z, N, G		
G6	GTP	2006-2010	All		HB524x.740	F, Z, N, U, G, S, E			HB525x.540	F, Z, N, G		
G8	Base	2008-2009	All		HB606x.650	F, Z, N			HB607x.616	F, Z, N		
G8	GT	2008-2009	All		HB606x.650	F, Z, N			HB607x.616	F, Z, N		
G8	GXP	2008-2009	All		HB453x.585	F, Z, N, U, G, W, V, S, E			HB607x.616	F, Z, N		
Grand Am	GT	1992-1997	All		HB390x.602	F						
Grand Am	GT	2005-2005	All		HB425x.661	F			HB359x.543	F, Z, G		
Grand Am	GT1	2005-2005	All		HB425x.661	F			HB359x.543	F, Z, G		

BRAKE PAD CODE BREAKDOWN

H B 2 4 5 x . 6 3 1
 HAWK BRAKE PAD SHAPE INSERT COMPOUND CODE PAD THICKNESS

PAD/ROTOR KIT CODE BREAKDOWN

H K x 4 2 8 4 4 8
 HAWK KIT INSERT COMPOUND CODE ROTOR PAD SHAPE

MAKE/ MODEL	SUBMODEL	ENGINE YRS. (LITER)	NOTE	FRONT				REAR			
				PADS	PAD COMPOUND	ROTORS	PAD/ROTOR KIT	PADS	PAD COMPOUND	ROTORS	PAD/ROTOR KIT
PONTIAC CONTINUED											
Grand Am	LE	1985-1989	All	HB400x.630	F						
Grand Am	LE	1990-1990	All w/o Performance Package	HB400x.630	F						
Grand Am	LE	1990-1990	All w/Performance Package	HB390x.602	F						
Grand Am	LE	1991-1991	All	HB390x.602	F						
Grand Am	SE	1986-1989	All	HB400x.630	F						
Grand Am	SE	1990-1990	All w/o Performance Package	HB400x.630	F						
Grand Am	SE	1990-1990	All w/Performance Package	HB390x.602	F						
Grand Am	SE	1991-1997	All	HB390x.602	F						
Grand Am	SE	2005-2005	All	HB425x.661	F			HB359x.543	F, Z, G		
Grand Am		1973-1975	All	HB103x.590	F, Z, Y, P, N, U, G W, H, S, L, E, M, A						
Grand Am		1985-1988	All	HB400x.630	F						
Grand Am		1991-1991	All	HB390x.602	F						
Grand Am		1999-2004	All	HB425x.661	F			HB359x.543	F, Z, G		
Grand Lemans	Safari	1975-1977	All	HB103x.590	F, Z, Y, P, N, U, G W, H, S, L, E, M, A						
Grand Lemans		1975-1977	All	HB103x.590	F, Z, Y, P, N, U, G W, H, S, L, E, M, A						
Grand Prix	Brougham	1981-1981	All	HB119x.594	F, Z, Y, P, N, U, G W, H, S, L, E, M, A						
Grand Prix	Brougham	1982-1987	All	HB119x.594	F, Z, Y, P, N, U, G W, H, S, L, E, M, A	HUS8213	HKx8213119				
Grand Prix	GT	1991-1993	All	HB232x.681	F						
Grand Prix	GT	1995-1996	All	HB232x.681	F			HB359x.543	F, Z, G		
Grand Prix	GT	1997-2003	All	HB360x.670	F, Z			HB359x.543	F, Z, G		
Grand Prix	GT	2006-2007	All					HB440x.606	F, Z		
Grand Prix	GTP	1995-1996	All	HB232x.681	F			HB359x.543	F, Z, G		
Grand Prix	GTP	1997-2003	All	HB360x.670	F, Z			HB359x.543	F, Z, G		
Grand Prix	GTP	2004-2004	All	HB451x.668	F, Z			HB450x.555	F, Z		
Grand Prix	GTP	2005-2005	All					HB450x.555	F, Z		
Grand Prix	GXP	2005-2008	All	HB439x.555	F, Z			HB440x.606	F, Z		
Grand Prix	LE	1984-1987	All	HB119x.594	F, Z, Y, P, N, U, G W, H, S, L, E, M, A	HUS8213	HKx8213119				
Grand Prix	LE	1988-1993	All	HB232x.681	F						
Grand Prix	LJ	1977-1977	All	HB103x.590	F, Z, Y, P, N, U, G W, H, S, L, E, M, A						
Grand Prix	LJ	1978-1983	All	HB119x.594	F, Z, Y, P, N, U, G W, H, S, L, E, M, A						
Grand Prix	McLaren	1990-1990	All	HB232x.681	F						
Grand Prix	SE	1988-1993	All	HB232x.681	F						
Grand Prix	SE	1994-1994	All w/Rear Disc Brakes.	HB232x.681	F			HB359x.543	F, Z, G		
Grand Prix	SE	1995-1996	All	HB232x.681	F			HB359x.543	F, Z, G		
Grand Prix	SE	1997-1998	All	HB360x.670	F, Z			HB359x.543	F, Z, G		
Grand Prix	SJ	1977-1980	All	HB103x.590	F, Z, Y, P, N, U, G W, H, S, L, E, M, A						
Grand Prix	STE	1990-1993	All	HB232x.681	F						
Grand Prix		1973-1977	All	HB103x.590	F, Z, Y, P, N, U, G W, H, S, L, E, M, A						
Grand Prix		1978-1981	All	HB119x.594	F, Z, Y, P, N, U, G W, H, S, L, E, M, A						
Grand Prix		1982-1987	All	HB119x.594	F, Z, Y, P, N, U, G W, H, S, L, E, M, A	HUS8213	HKx8213119				

RACE PAD COMPOUNDS

DTC-70 - U	DTC-05 - H	MT-4 - L	HP Plus - N
DTC-60 - G	HT-14 - V	Blue 9012 - E	
DTC-30 - W	HT-10 - S	Black - M	
DTC-15 - A	Metallic - MB	DR-97 - J	

STREET PAD COMPOUNDS

HPS Performance Street - F	LTS Light Truck & SUV - Y
Performance Ceramic - Z	SuperDuty - P

MAKE/ MODEL	SUBMODEL	YRS.	ENGINE (LITER)	NOTE	FRONT				REAR			
					PADS	PAD COMPOUND	ROTORS	PAD/ROTOR KIT	PADS	PAD COMPOUND	ROTORS	PAD/ROTOR KIT
PONTIAC CONTINUED												
Grand Prix		1988-1989	All		HB232x.681	F						
Grand Prix		1992-1993	All		HB232x.681	F						
Grand Prix		1996-1996	All		HB232x.681	F			HB359x.543	F, Z, G		
Grand Prix		1998-2003	All		HB360x.670	F, Z			HB359x.543	F, Z, G		
Grand Prix		2004-2004	All		HB451x.668	F, Z			HB450x.555	F, Z		
Grand Prix		2005-2005	All						HB440x.606	F, Z		
Grand Prix		2008-2008	All						HB450x.555	F, Z		
Grand Safari		1973-1977	All		HB103x.590	F, Z, Y, P, N, U, G W, H, S, L, E, M, A						
Grandville	Brougham	1975-1975	All		HB103x.590	F, Z, Y, P, N, U, G W, H, S, L, E, M, A						
Grandville		1973-1974	All		HB103x.590	F, Z, Y, P, N, U, G W, H, S, L, E, M, A						
GTO		1973-1973	All		HB103x.590	F, Z, Y, P, N, U, G W, H, S, L, E, M, A						
GTO		2004-2004	All		HB460x.580	F, Z			HB573x.615	F, Z, N		
GTO		2005-2006	All		HB247x.575	F, Z, N, U, G, W, V, S, E			HB573x.615	F, Z, N		
J2000	Sunbird	1984-1984	All		HB400x.630	F						
J2000	Sunbird LE	1984-1984	All		HB400x.630	F						
J2000	Sunbird SE	1984-1984	All		HB400x.630	F						
J2000		1982-1983	All		HB400x.630	F						
Lemans	Safari	1973-1977	All		HB103x.590	F, Z, Y, P, N, U, G W, H, S, L, E, M, A						
Lemans	Sport	1973-1977	All		HB103x.590	F, Z, Y, P, N, U, G W, H, S, L, E, M, A						
Lemans		1973-1977	All		HB103x.590	F, Z, Y, P, N, U, G W, H, S, L, E, M, A						
Montana	SV6	2005-2005	All	AWD	HB373x.689	F			HB359x.543	F, Z, G		
Montana	SV6	2005-2005	All	FWD	HB360x.670	F, Z			HB359x.543	F, Z, G		
Montana	SV6	2006-2006	All		HB360x.670	F, Z						
Montana		1999-2001	All		HB360x.670	F, Z						
Montana		2002-2004	All	AWD	HB373x.689	F			HB359x.543	F, Z, G		
Montana		2002-2004	All	FWD	HB360x.670	F, Z			HB359x.543	F, Z, G		
Montana		2005-2005	All		HB360x.670	F, Z						
Parisienne	Brougham	1983-1986	All		HB103x.590	F, Z, Y, P, N, U, G W, H, S, L, E, M, A						
Parisienne		1983-1986	All		HB103x.590	F, Z, Y, P, N, U, G W, H, S, L, E, M, A						
Phoenix	LJ	1981-1983	All		HB400x.630	F						
Phoenix	SJ	1982-1983	All		HB400x.630	F						
Phoenix		1981-1984	All		HB400x.630	F						
Safari		1987-1989	All		HB103x.590	F, Z, Y, P, N, U, G W, H, S, L, E, M, A						
Solstice	GXP	2007-2007	All		HB524x.740	F, Z, N, U, G, S, E			HB478x.605	F, Z, N, G, U, S, E		
Solstice		2006-2010	All		HB524x.740	F, Z, N, U, G, S, E			HB478x.605	F, Z, N, G, U, S, E		
Sunbird	GT	1986-1991	All		HB400x.630	F						
Sunbird	GT	1992-1993	All		HB390x.602	F						
Sunbird	LE	1985-1985	All		HB400x.630	F						
Sunbird	LE	1989-1991	All		HB400x.630	F						
Sunbird	LE	1993-1994	All		HB390x.602	F						
Sunbird	SE	1985-1991	All		HB400x.630	F						

BRAKE PAD CODE BREAKDOWN

H B 2 4 5 x .6 3 1
 HAWK BRAKE PAD SHAPE INSERT COMPOUND CODE PAD THICKNESS

PAD/ROTOR KIT CODE BREAKDOWN

H K x 4 2 8 4 4 8
 HAWK KIT INSERT COMPOUND CODE ROTOR PAD SHAPE

MAKE/ MODEL	SUBMODEL	YRS.	ENGINE (LITER)	NOTE	FRONT				REAR			
					PADS	PAD COMPOUND	ROTORS	PAD/ROTOR KIT	PADS	PAD COMPOUND	ROTORS	PAD/ROTOR KIT
PONTIAC CONTINUED												
Sunbird	SE	1992-1994	All		HB390x.602	F						
Sunbird		1985-1988	All		HB400x.630	F						
Sunbird		1991-1991	All		HB400x.630	F						
Sunfire	GT	1996-1997	All		HB393x.665	F, Y						
Sunfire	SE	1996-1997	All		HB393x.665	F, Y						
Sunfire		1998-2005	All		HB390x.602	F						
Torrent		2006-2006	All		HB472x.650	F, Z, Y						
Trans Sport		1994-1996	All		HB217x.681	F, Z, E						
Trans Sport		1997-1998	All		HB360x.670	F, Z						
Ventura	Custom	1973-1975	All		HB103x.590	F, Z, Y, P, N, U, G W, H, S, L, E, M, A						
Ventura	S	1975-1975	All		HB103x.590	F, Z, Y, P, N, U, G W, H, S, L, E, M, A						
Ventura	SJ	1975-1977	All		HB103x.590	F, Z, Y, P, N, U, G W, H, S, L, E, M, A						
Ventura		1973-1977	All		HB103x.590	F, Z, Y, P, N, U, G W, H, S, L, E, M, A						
Vibe	GT	2003-2005	All		HB441x.661	F, Z			HB329x.543	F		
Vibe	GT	2006-2006	All		HB441x.661	F, Z						
Vibe		2003-2008	All		HB441x.661	F, Z						
Vibe		2009-2010	All	Except GT and AWD	HB627x.690	F, Z			HB629x.565	F		
Vibe		2009-2010	1.8		HB627x.690	F, Z	HUS506		HB629x.565	F		
Vibe		2009-2010	2.4	GT and AWD	HB704x.692	F, Z, G			HB648x.607	F, Z		
Wave		2006-2006	All	(Canada)	HB592x.665	F						
Wave5		2009-2009	All		HB592x.665	F						
PORSCHE												
Lemans		1963-1965	All		HB172x.595	F, Z, N, U, G, W, M, S, E						
911	Carrera	1974-1977	All	With "S" series calipers	HB171x.590	F, Z, N, U, W, S, E			HB172x.595	F, Z, N, U, G, W, M, S, E		
911	Carrera	1975-1977	All	With "M" series calipers	HB172x.595	F, Z, N, U, G, W, M, S, E			HB172x.595	F, Z, N, U, G, W, M, S, E		
911	Carrera	1984-1989	All		HB171x.590	F, Z, N, U, W, S, E						
911	Carrera 2	1965-1968	All		HB172x.595	F, Z, N, U, G, W, M, S, E						
911	Carrera 2	1969-1969	All	With "M" series calipers	HB172x.595	F, Z, N, U, G, W, M, S, E			HB172x.595	F, Z, N, U, G, W, M, S, E		
911	Carrera 2	1969-1969	All	With "S" series calipers	HB171x.590	F, Z, N, U, W, S, E						
911	Carrera 2	1970-1973	All		HB172x.595	F, Z, N, U, G, W, M, S, E			HB172x.595	F, Z, N, U, G, W, M, S, E		
911	Carrera 2 Turbo Look	1991-1994	All		HB184x.650	F, S, E, G, U			HB141x.650	F, Z, N, U, G, W, V, S, E		
911	Carrera 2S	1991-1994	All		HB184x.650	F, S, E, G, U			HB141x.650	F, Z, N, U, G, W, V, S, E		
911	Carrera 4	1989-1994	All		HB170x.650	F, Z, N, U, G, S, E, M			HB170x.650	F, Z, N, U, G, S, E, M		
911	Carrera 4 Turbo Look	1991-1994	All		HB170x.650	F, Z, N, U, G, S, E, M			HB170x.650	F, Z, N, U, G, S, E, M		
911	Carrera 4S	1991-1994	All		HB170x.650	F, Z, N, U, G, S, E, M			HB170x.650	F, Z, N, U, G, S, E, M		
911	E	1970-1973	All	With "S" series calipers	HB171x.590	F, Z, N, U, W, S, E			HB172x.595	F, Z, N, U, G, W, M, S, E		
911	S	1970-1977	All	With "S" series calipers	HB171x.590	F, Z, N, U, W, S, E			HB172x.595	F, Z, N, U, G, W, M, S, E		
911	SC	1978-1983	All	exc Turbo Look	HB171x.590	F, Z, N, U, W, S, E			HB172x.595	F, Z, N, U, G, W, M, S, E		
911	SC	1979-1983	All	Turbo Look	HB170x.650	F, Z, N, U, G, S, E, M			HB170x.650	F, Z, N, U, G, S, E, M		
911	Targa	1998-1998	All		HB291x.642	F, N, U, G, S, E			HB290x.606	F, Z, N, W, U, H, E		
911	Targa	2009-2012	All		HB483x.635	F, U, G, S			HB664x.634	F, Z, G, U, W		
911	Targa 4	2008-2008	All		HB483x.635	F, U, G, S						
911	Targa 4S	2008-2012	All	W/ Ceramic disc	HB483x.635	F, U, G, S						
911		1969-1969	All	With "M" series calipers	HB172x.595	F, Z, N, U, G, W, M, S, E						
911		1970-1973	All		HB172x.595	F, Z, N, U, G, W, M, S, E			HB172x.595	F, Z, N, U, G, W, M, S, E		

APPLICATION GUIDE

RACE PAD COMPOUNDS

DTC-70 - U	DTC-05 - H	MT-4 - L	HP Plus - N
DTC-60 - G	HT-14 - V	Blue 9012 - E	
DTC-30 - W	HT-10 - S	Black - M	
DTC-15 - A	Metallic - MB	DR-97 - J	

STREET PAD COMPOUNDS

HPS Performance Street - F	LTS Light Truck & SUV - Y
Performance Ceramic - Z	SuperDuty - P

MAKE/ MODEL	SUBMODEL	ENGINE YRS. (LITER)	NOTE	FRONT				REAR				
				PADS	PAD COMPOUND	ROTOR	PAD/ROTOR KIT	PADS	PAD COMPOUND	ROTOR	PAD/ROTOR KIT	
PORSCHE CONTINUED												
911		1974-1977	All	With "S" series calipers	HB171x.590	F, Z, N, U, W, S, E			HB172x.595	F, Z, N, U, G, W, M, S, E		
911		1974-1977	All	With "M" series calipers	HB172x.595	F, Z, N, U, G, W, M, S, E			HB172x.595	F, Z, N, U, G, W, M, S, E		
911		1987-1989	All		HB170x.650	F, Z, N, U, G, S, E, M						
912	E	1964-1969	All		HB172x.595	F, Z, N, U, G, W, M, S, E			HB172x.595	F, Z, N, U, G, W, M, S, E		
912	E	1976-1976	All		HB172x.595	F, Z, N, U, G, W, M, S, E						
912		1964-1969	All		HB172x.595	F, Z, N, U, G, W, M, S, E			HB172x.595	F, Z, N, U, G, W, M, S, E		
912		1976-1976	All		HB172x.595	F, Z, N, U, G, W, M, S, E						
914	4	1970-1972	All	To 7/72	HB172x.595	F, Z, N, U, G, W, M, S, E						
914	6	1970-1972	All		HB172x.595	F, Z, N, U, G, W, M, S, E			HB172x.595	F, Z, N, U, G, W, M, S, E		
914		1972-1975	All		HB172x.595	F, Z, N, U, G, W, M, S, E						
924	S	1986-1988	All		HB199x.702	F, N, U, S, E			HB198x.685	F, N, G, S, E		
924	Sport	1977-1979	All		HB199x.702	F, N, U, S, E			HB198x.685	F, N, G, S, E		
924	Sport	1980-1980	All	w/Rear Disc Brakes	HB199x.702	F, N, U, S, E			HB198x.685	F, N, G, S, E		
924	Sport	1981-1984	All		HB199x.702	F, N, U, S, E			HB198x.685	F, N, G, S, E		
924	Turbo	1977-1979	All		HB199x.702	F, N, U, S, E			HB198x.685	F, N, G, S, E		
924	Turbo	1980-1980	All	w/Rear Drum Brakes	HB198x.685	F, N, G, S, E						
924	Turbo	1981-1984	All		HB199x.702	F, N, U, S, E			HB198x.685	F, N, G, S, E		
924	Turbo Sport	1980-1980	All	w/Rear Disc Brakes	HB199x.702	F, N, U, S, E			HB198x.685	F, N, G, S, E		
924		1976-1984	All		HB198x.685	F, N, G, S, E						
928	CS	1978-1981	All		HB199x.702	F, N, U, S, E			HB198x.685	F, N, G, S, E		
928	CS	1982-1985	All		HB137x.690	F, N, U, G, S			HB198x.685	F, N, G, S, E		
928	CS	1986-1991	All		HB141x.650	F, Z, N, U, G, W, V, S, E			HB170x.650	F, Z, N, U, G, S, E, M		
928	CS	1992-1995	All		HB184x.650	F, S, E, G, U			HB198x.685	F, N, G, S, E		
928	GT	1978-1981	All		HB199x.702	F, N, U, S, E			HB198x.685	F, N, G, S, E		
928	GT	1982-1985	All		HB137x.690	F, N, U, G, S			HB198x.685	F, N, G, S, E		
928	GT	1986-1991	All		HB141x.650	F, Z, N, U, G, W, V, S, E			HB170x.650	F, Z, N, U, G, S, E, M		
928	GT	1992-1995	All		HB184x.650	F, S, E, G, U			HB198x.685	F, N, G, S, E		
928	GTS	1978-1981	All		HB199x.702	F, N, U, S, E			HB198x.685	F, N, G, S, E		
928	GTS	1982-1985	All		HB137x.690	F, N, U, G, S			HB198x.685	F, N, G, S, E		
928	GTS	1986-1991	All		HB141x.650	F, Z, N, U, G, W, V, S, E			HB170x.650	F, Z, N, U, G, S, E, M		
928	GTS	1992-1995	All		HB184x.650	F, S, E, G, U			HB198x.685	F, N, G, S, E		
928	S	1978-1981	All		HB199x.702	F, N, U, S, E			HB198x.685	F, N, G, S, E		
928	S	1982-1985	All		HB137x.690	F, N, U, G, S			HB198x.685	F, N, G, S, E		
928	S	1986-1991	All		HB141x.650	F, Z, N, U, G, W, V, S, E			HB170x.650	F, Z, N, U, G, S, E, M		
928	S	1992-1995	All		HB184x.650	F, S, E, G, U			HB198x.685	F, N, G, S, E		
928	S4	1978-1981	All		HB199x.702	F, N, U, S, E			HB198x.685	F, N, G, S, E		
928	S4	1982-1985	All		HB137x.690	F, N, U, G, S			HB198x.685	F, N, G, S, E		
928	S4	1986-1991	All		HB141x.650	F, Z, N, U, G, W, V, S, E			HB170x.650	F, Z, N, U, G, S, E, M		
928	S4	1992-1995	All		HB184x.650	F, S, E, G, U			HB198x.685	F, N, G, S, E		
944	Base	1990-1991	All		HB170x.650	F, Z, N, U, G, S, E, M			HB170x.650	F, Z, N, U, G, S, E, M		
944	S	1987-1988	All	16 Valve	HB199x.702	F, N, U, S, E			HB198x.685	F, N, G, S, E		
944	S2	1989-1989	All		HB170x.650	F, Z, N, U, G, S, E, M			HB170x.650	F, Z, N, U, G, S, E, M		
944	S2 Cabriolet	1989-1989	All		HB170x.650	F, Z, N, U, G, S, E, M			HB170x.650	F, Z, N, U, G, S, E, M		
944	Turbo	1986-1988	All		HB170x.650	F, Z, N, U, G, S, E, M			HB170x.650	F, Z, N, U, G, S, E, M		
944	Turbo	1989-1991	All		HB141x.650	F, Z, N, U, G, W, V, S, E			HB170x.650	F, Z, N, U, G, S, E, M		
944		1983-1989	All		HB199x.702	F, N, U, S, E			HB198x.685	F, N, G, S, E		
944		1990-1991	All	Sport Suspension	HB141x.650	F, Z, N, U, G, W, V, S, E			HB198x.685	F, N, G, S, E		
968		1992-1992	All	w/o Sport Suspension	HB170x.650	F, Z, N, U, G, S, E, M						

BRAKE PAD CODE BREAKDOWN

PAD/ROTOR KIT CODE BREAKDOWN

H B 2 4 5 x . 6 3 1
 HAWK BRAKE PAD SHAPE INSERT COMPOUND CODE PAD THICKNESS

H K x 4 2 8 4 4 8
 HAWK KIT INSERT COMPOUND CODE ROTOR PAD SHAPE

MAKE/ MODEL	SUBMODEL	YRS.	ENGINE (LITER)	NOTE	FRONT				REAR			
					PADS	PAD COMPOUND	ROTOR	PAD/ROTOR KIT	PADS	PAD COMPOUND	ROTOR	PAD/ROTOR KIT
PORSCHE CONTINUED												
968		1992-1995	All	w/Sport Suspension	HB141x.650	F, Z, N, U, G, W, V, S, E						
968		1993-1993	All	w/o Sport Suspension	HB170x.650	F, Z, N, U, G, S, E, M			HB170x.650	F, Z, N, U, G, S, E, M		
968		1994-1994	All	w/o Sport Suspension	HB170x.650	F, Z, N, U, G, S, E, M						
968		1995-1995	All	w/o Sport Suspension	HB170x.650	F, Z, N, U, G, S, E, M			HB170x.650	F, Z, N, U, G, S, E, M		
911 (964)	Carrera	1991-1991	All		HB170x.650	F, Z, N, U, G, S, E, M						
911 (964)	Carrera 2	1992-1994	All		HB170x.650	F, Z, N, U, G, S, E, M			HB170x.650	F, Z, N, U, G, S, E, M		
911 (964)	Turbo	1991-1992	All		HB141x.650	F, Z, N, U, G, W, V, S, E			HB170x.650	F, Z, N, U, G, S, E, M		
911 (993)	Carrera 2	1994-1998	All		HB141x.650	F, Z, N, U, G, W, V, S, E			HB170x.650	F, Z, N, U, G, S, E, M		
911 (993)	Carrera 2 Turbo Look	1996-1998	All		HB184x.650	F, S, E, G, U			HB141x.650	F, Z, N, U, G, W, V, S, E		
911 (993)	Carrera 2s	1996-1998	All		HB184x.650	F, S, E, G, U			HB141x.650	F, Z, N, U, G, W, V, S, E		
911 (993)	Carrera 4	1995-1998	All		HB141x.650	F, Z, N, U, G, W, V, S, E			HB170x.650	F, Z, N, U, G, S, E, M		
911 (993)	Carrera 4 Turbo Look	1996-1998	All		HB184x.650	F, S, E, G, U			HB141x.650	F, Z, N, U, G, W, V, S, E		
911 (993)	Carrera 4S	1996-1998	All		HB184x.650	F, S, E, G, U			HB141x.650	F, Z, N, U, G, W, V, S, E		
911 (993)	Turbo	1993-1994	All		HB184x.650	F, S, E, G, U			HB170x.650	F, Z, N, U, G, S, E, M		
911 (993)	Turbo	1995-1998	All		HB184x.650	F, S, E, G, U			HB141x.650	F, Z, N, U, G, W, V, S, E		
911 (993)	Turbo 3.6	1993-1994	All		HB184x.650	F, S, E, G, U			HB170x.650	F, Z, N, U, G, S, E, M		
911 (996)	Carrera 2	1998-2005	All		HB550x.634	F, Z, N, U, G, S, E			HB290x.583	F, Z, N, U, G, S, E		
911 (996)	Carrera 4	1999-2005	All		HB550x.634	F, Z, N, U, G, S, E			HB290x.606	F, Z, N, W, U, H, E		
911	Targa 4S	2008-2012	All	W/ Iron Discs	HB667x.622	F, Z, G, U, W			HB664x.634	F, Z, G, U, W		
911 (996)	Carrera 4	2006-2008	All		HB664x.634	F, Z, G, U, W			HB290x.606	F, Z, N, W, U, H, E		
911 (996)	Carrera 4 Turbo Look	2002-2002	All		HB667x.622	F, Z, G, U, W			HB550x.634	F, Z, N, U, G, S, E		
911 (996)	Carrera 4 Turbo Look	2003-2005	All	w/Iron Discs	HB667x.622	F, Z, G, U, W			HB550x.634	F, Z, N, U, G, S, E		
911 (996)	Carrera 4S	2002-2002	All		HB667x.622	F, Z, G, U, W			HB550x.634	F, Z, N, U, G, S, E		
911 (996)	Carrera 4S	2003-2005	All	w/Iron Discs	HB667x.622	F, Z, G, U, W			HB550x.634	F, Z, N, U, G, S, E		
911 (996)	Gt2	2003-2005	All		HB483x.635	F, U, G, S			HB291x.642	F, U, G, S, E		
911 (996)	Gt3	2004-2005	All	w/Iron Discs	HB483x.635	F, U, G, S			HB291x.642	F, U, G, S, E		
911 (996)	Gt3	2007-2008	All		HB483x.635	F, U, G, S			HB651x.624	F, Z, G, U		
911 (996)	Gt3 Cup	1999-2001	All		HB667x.622	F, Z, G, U, W			HB291x.642	F, U, G, S, E		
911 (996)	Gt3 Cup	2002-2005	All		HB483x.635	F, U, G, S			HB291x.642	F, U, G, S, E		
911 (996)	Turbo	2001-2002	All		HB667x.622	F, Z, G, U, W			HB550x.634	F, Z, N, U, G, S, E		
911 (996)	Turbo	2003-2005	All	w/Iron Discs	HB667x.622	F, Z, G, U, W			HB550x.634	F, Z, N, U, G, S, E		
911 (997)	Carrera 2	2005-2005	All	Standard Brakes	HB550x.634	F, Z, N, U, G, S, E			HB290x.583	F, Z, N, U, G, S, E		
911 (997)	Carrera 2	2005-2005	All	Sport	HB664x.634	F, Z, G, U, W			HB665x.577	F, Z, G, U, W		
911 (997)	Carrera 2	2006-2010	All		HB664x.634	F, Z, G, U, W			HB290x.583	F, Z, N, U, G, S, E		
911 (997)	Carrera 2 Turbo Look	2005-2005	All	w/Iron Discs	HB667x.622	F, Z, G, U, W			HB550x.634	F, Z, N, U, G, S, E		
911 (997)	Carrera 2 Turbo Look	2006-2012	All	w/Iron Discs	HB667x.622	F, Z, G, U, W			HB664x.634	F, Z, G, U, W		
911 (997)	Carrera 2S	2005-2005	All	w/Iron Discs	HB667x.622	F, Z, G, U, W			HB550x.634	F, Z, N, U, G, S, E		
911 (997)	Carrera 2S	2006-2012	All	w/Iron Discs	HB667x.622	F, Z, G, U, W			HB664x.634	F, Z, G, U, W		
911 (997)	Carrera 2 Turbo Look	2006-2012	All	W/ Ceramic disc	HB483x.635	F, U, G, S			HB664x.634	F, Z, G, U, W		
911 (997)	Carrera 2S	2006-2012	All	W/ Ceramic disc	HB483x.635	F, U, G, S			HB664x.634	F, Z, G, U, W		
911 (997)	Carrera 2 Turbo Look	2006-2012	All	w/Iron Discs	HB667x.622	F, Z, G, U, W			HB664x.634	F, Z, G, U, W		
911 (997)	Carrera 4S	2006-2012	All	w/Iron Discs	HB667x.622	F, Z, G, U, W			HB664x.634	F, Z, G, U, W		
911 (997)	Carrera 4 Turbo Look	2006-2012	All	W/ Ceramic disc	HB483x.635	F, U, G, S			HB664x.634	F, Z, G, U, W		
911 (997)	Carrera 4S	2006-2012	All	W/ Ceramic disc	HB483x.635	F, U, G, S			HB664x.634	F, Z, G, U, W		
911 (997)	GT2	2008-2012	All		HB483x.635	F, U, G, S			HB651x.624	F, Z, G, U		
911 (997)	GT3	2007-2007	All		HB483x.635	F, U, G, S			HB651x.624	F, Z, G, U		
911 (997)	GT3	2010-2011	All		HB483x.635	F, U, G, S			HB651x.624	F, Z, G, U		
911 (997)	GT3 Cup	2007-2008	All		HB483x.635	F, U, G, S			HB651x.624	F, Z, G, U		

APPLICATION GUIDE

RACE PAD COMPOUNDS

DTC-70 - U	DTC-05 - H	MT-4 - L	HP Plus - N
DTC-60 - G	HT-14 - V	Blue 9012 - E	
DTC-30 - W	HT-10 - S	Black - M	
DTC-15 - A	Metallic - MB	DR-97 - J	

STREET PAD COMPOUNDS

HPS Performance Street - F	LTS Light Truck & SUV - Y
Performance Ceramic - Z	SuperDuty - P

MAKE/ MODEL	SUBMODEL	ENGINE YRS. (LITER)	NOTE	FRONT				REAR			
				PADS	PAD COMPOUND	ROTORS	PAD/ROTOR KIT	PADS	PAD COMPOUND	ROTORS	PAD/ROTOR KIT
PORSCHE CONTINUED											
911 (997)	GT3 RSR	2008-2008	All		HB483x.635	F, U, G, S					
911 (997)	Turbo	2007-2012	All		HB483x.635	F, U, G, S			HB651x.624	F, Z, G, U	
Boxster	S	2000-2007	All	w/Iron Discs	HB550x.634	F, Z, N, U, G, S, E			HB290x.606	F, Z, N, W, U, H, E	
Boxster	S	2008-2012	All	w/Iron Discs	HB664x.634	F, Z, G, U, W			HB290x.583	F, Z, N, U, G, S, E	
Boxster	S	2007-2012	3.4L	w/Ceramic Discs	HB483x.635	F, G, S, U					
Boxster		1997-2004	All		HB289x.610	F, Z, N, W, G, H, S, E			HB290x.606	F, Z, N, W, U, H, E	
Boxster		2005-2008	All		HB289x.610	F, Z, N, W, G, H, S, E					
Boxster		2009-2012	All		HB664x.634	F, Z, G, U, W			HB665x.577	F, Z, G, U, W	
Boxster		2013	All	W/ Iron Discs					HB665x.577	F, Z, G, U, W	
Carrera	GT	2004-2005	All		HB483x.635	F, U, G, S			HB483x.635	F, U, G, S	
Cayenne	GTS	2008-2008	All	17 in. Wheel	HB512x.605	F, Z, Y, W			HB502x.606	F, Z, Y	
Cayenne	GTS	2009-2010	All	18 in. Wheel	HB501x.625	F, Z, Y, G, E			HB502x.606	F, Z, Y	
Cayenne	S	2003-2008	All	18 in. Wheel	HB501x.625	F, Z, Y, G, E			HB502x.606	F, Z, Y	
Cayenne	Turbo	2008-2008	All	17 in. Wheel	HB512x.605	F, Z, Y, W			HB502x.606	F, Z, Y	
Cayenne	Turbo	2008-2008	All	18 in. Wheel	HB501x.625	F, Z, Y, G, E			HB502x.606	F, Z, Y	
Cayenne		2003-2010	All	17 in. Wheel	HB512x.605	F, Z, Y, W			HB502x.606	F, Z, Y	
Cayenne		2003-2010	All	18 in. Wheel	HB501x.625	F, Z, Y, G, E			HB502x.606	F, Z, Y	
Cayman	S	2006-2006	All	w/Iron Discs	HB550x.634	F, Z, N, U, G, S, E			HB290x.583	F, Z, N, U, G, S, E	
Cayman	S	2007-2008	All	w/Iron Discs	HB664x.634	F, Z, G, U, W			HB290x.583	F, Z, N, U, G, S, E	
Cayman	S	2009	All	w/Iron Discs	HB664x.634	F, Z, G, U, W			HB665x.577	F, Z, G, U, W	
Cayman	S	2010-2012	All	w/Iron Discs	HB664x.634	F, Z, G, U, W			HB290x.583	F, Z, N, U, G, S, E	
Cayman	R	2011-2012	All	W/ Iron Discs	HB664x.634	F, Z, G, U, W			HB290x.583	F, Z, N, U, G, S, E	
Cayman		2006-2006	All	w/Iron Discs	HB550x.634	F, Z, N, U, G, S, E			HB290x.583	F, Z, N, U, G, S, E	
Cayman		2007-2008	All	w/Iron Discs	HB289x.610	F, Z, N, W, G, H, S, E					
Cayman		2008-2012	All	w/Iron Discs	HB664x.634	F, Z, G, U, W			HB665x.577	F, Z, G, U, W	
RENAULT											
Koleos		2011-2012	All	Latin America	HB387x.547	F, Z			HB600x.539	F, Z	
Safrane		2011-2012	All	Latin America	HB268x.665	F, Z, N, G					
ROVER											
MG ZT 260		2003-2005	All		HB464x.764	F, Z, Y, N, U, G, V, S, E			HB180x.560	F, Z, N, U, G, W, S, E	
SAAB											
99		1969-1974	All		HB172x.595	F, Z, N, U, G, W, M, S, E			HB713x.590	F, Z, W, G	
900	S	1988-1988	All		HB195x.640	F, Z, N, G, S, E					
900		1988-1988	All		HB195x.640	F, Z, N, G, S, E					
9000		1989-1989	All		HB195x.640	F, Z, N, G, S, E					
9-3	Aero Xwd	2009-2010	All		HB515x.760	F, Z			HB478x.605	F, Z, N, G, U, S, E	
9-3	SE	1999-1999	All		HB388x.756	F					
9-3	SE	2001-2002	All		HB388x.756	F					
9-3	SE	2003-2003	All	w/288mm Front Rotors	HB388x.756	F			HB478x.605	F, Z, N, G, U, S, E	
9-3	Viggen	1999-2002	All		HB388x.756	F					
9-3		1999-2001	All		HB388x.756	F					
9-3X		2010-2011	All		HB515x.760	F, Z			HB478x.605	F, Z, N, G, U, S, E	
9-5	2.3t	2006-2009	All	w/Wear Sensor	HB354x.756A	F, Z			HB227x.630	F, Z, N, U, G, S, E	
9-5	Aero	2000-2005	All		HB388x.756	F			HB227x.630	F, Z, N, U, G, S, E	
9-5	Aero	2006-2009	All	w/Wear Sensor	HB354x.756A	F, Z			HB227x.630	F, Z, N, U, G, S, E	
9-5	Arc	2002-2005	All		HB388x.756	F			HB227x.630	F, Z, N, U, G, S, E	
9-5	Linear	2002-2005	All		HB388x.756	F			HB227x.630	F, Z, N, U, G, S, E	

APPLICATION GUIDE

BRAKE PAD CODE BREAKDOWN

H B **2 4 5** **x** **. 6 3 1**
 HAWK BRAKE PAD SHAPE INSERT COMPOUND CODE PAD THICKNESS

PAD/ROTOR KIT CODE BREAKDOWN

H K **x** **4 2 8** **4 4 8**
 HAWK KIT INSERT COMPOUND CODE ROTOR PAD SHAPE

MAKE/ MODEL	SUBMODEL	YRS.	ENGINE (LITER)	NOTE	FRONT				REAR				
					PADS	PAD COMPOUND	ROTORS	PAD/ROTOR KIT	PADS	PAD COMPOUND	ROTORS	PAD/ROTOR KIT	
SAAB CONTINUED													
9-5		1999-1999	All	From Serial # X3025752	HB388x.756	F				HB227x.630	F, Z, N, U, G, S, E		
9-5		1999-1999	All	To Serial # X3025751	HB388x.756	F							
9-5		2000-2000	All		HB388x.756	F							
9-5		2001-2001	All		HB388x.756	F				HB227x.630	F, Z, N, U, G, S, E		
9-2X	2.5i	2006-2006	All		HB432x.661	F, Z, N, G, W, S, E	HUS732	HKx732432		HB452x.545	F, Z, N, W, S, E	HUS359	HKx359452
9-2X	Aero	2005-2006	All		HB432x.661	F, Z, N, G, W, S, E	HUS732	HKx732432		HB452x.545	F, Z, N, W, S, E	HUS359	HKx359452
9-2X	Linear	2005-2005	All		HB432x.661	F, Z, N, G, W, S, E	HUS730	HKx730432		HB452x.545	F, Z, N, W, S, E	HUS359	HKx359452
9-7X	Arc	2005-2005	All		HB382x.657	F, Y				HB383x.685	F, Y		
9-7X	Linear	2005-2005	All		HB382x.657	F, Y				HB383x.685	F, Y		
9-7X		2006-2009	All		HB617x.630	Y, Z				HB383x.685	F, Y		
SATURN													
Aura		2007-2008	All		HB524x.740	F, Z, N, U, G, S, E				HB525x.540	F, Z, N, G		
Aura		2009-2010	All		HB524x.740	F, Z, N, U, G, S, E							
Ion	Red Line	2004-2007	All		HB524x.740	F, Z, N, U, G, S, E				HB525x.540	F, Z, N, G		
Ion		2003-2004	All		HB517x.690	F, Z							
Ion-1		2005-2005	All		HB517x.690	F, Z							
Ion-2		2005-2007	All		HB517x.690	F, Z							
Ion-3		2005-2007	All		HB517x.690	F, Z							
L Series		2002-2004	All		HB388x.756	F							
L300		2005-2005	All		HB388x.756	F							
LS1		2001-2001	All		HB388x.756	F							
LS2		2001-2001	All		HB388x.756	F							
Lw Series		2001-2003	All		HB388x.756	F							
Outlook		2007-2010	All		HB617x.630	Y, Z				HB383x.685	F, Y		
Relay-1		2007-2007	All		HB360x.670	F, Z							
Relay-2		2005-2007	All		HB360x.670	F, Z							
Relay-3		2005-2007	All		HB360x.670	F, Z							
SC2		1991-1992	All		HB409x.661	F				HB359x.543	F, Z, G		
Sky	Red Line	2007-2010	All		HB524x.740	F, Z, N, U, G, S, E				HB478x.605	F, Z, N, G, U, S, E		
Sky		2007-2010	All		HB524x.740	F, Z, N, U, G, S, E				HB478x.605	F, Z, N, G, U, S, E		
SL1		1991-1998	All		HB409x.661	F				HB359x.543	F, Z, G		
SL1		1999-2002	All		HB409x.661	F							
SL2		1991-1998	All		HB409x.661	F				HB359x.543	F, Z, G		
SL2		1999-2002	All		HB409x.661	F							
SW1		1993-1998	All		HB409x.661	F				HB359x.543	F, Z, G		
SW1		1999-1999	All		HB409x.661	F							
SW2		1993-1998	All		HB409x.661	F				HB359x.543	F, Z, G		
SW2		1999-2001	All		HB409x.661	F							
Vue	Green Line	2007-2007	All		HB472x.650	F, Z, Y							
Vue	Red Line	2004-2004	All		HB472x.650	F, Z, Y							
Vue	Red Line	2006-2006	All		HB472x.650	F, Z, Y							
Vue		2002-2007	All		HB472x.650	F, Z, Y							
SCION													
FR-S	Base 2dr Coupe	2013-2013	All		HB711x.661	F, Z, N, G, U, W	HUS732	HKx732711		HB671x.628	F, Z, N, G, U, W		
iQ		2012-2013	All		HB493x.560								
tC	Spec	2007-2008	All		HB328x.685	F, Z, N, S				HB610x.587	F, Z		
tC		2005-2010	All		HB328x.685	F, Z, N, S				HB610x.587	F, Z		

APPLICATION GUIDE

RACE PAD COMPOUNDS

DTC-70 - U	DTC-05 - H	MT-4 - L	HP Plus - N
DTC-60 - G	HT-14 - V	Blue 9012 - E	
DTC-30 - W	HT-10 - S	Black - M	
DTC-15 - A	Metallic - MB	DR-97 - J	

STREET PAD COMPOUNDS

HPS Performance Street - F	LTS Light Truck & SUV - Y
Performance Ceramic - Z	SuperDuty - P

MAKE/ MODEL	SUBMODEL	YRS.	ENGINE (LITER)	NOTE	FRONT				REAR			
					PADS	PAD COMPOUND	ROTOR	PAD/ROTOR KIT	PADS	PAD COMPOUND	ROTOR	PAD/ROTOR KIT
SCION CONTINUED												
tC		2011-2013	All		HB704x.692	F, Z, G			HB629x.565	F		
xA		2004-2004	All		HB493x.650	F, Z, E						
xA		2005-2007	All		HB628x.651	F						
xB		2004-2004	All		HB493x.650	F, Z, E						
xB		2005-2007	All		HB628x.651	F						
xB		2008-2013	All		HB627x.690	F, Z			HB629x.565	F		
xD		2008-2013	All		HB627x.690	F, Z	HUS506					
SUBARU												
Alcyone	Svx	1992-1997	All		HB402x.669	F, Y			HB367x.585	F, Z, N		
B9 Tribeca	Limited	2006-2007	All		HB533x.668	F, Z, N, U, G			HB671x.628	F, Z, N, G, U, W		
B9 Tribeca		2006-2007	All		HB533x.668	F, Z, N, U, G			HB671x.628	F, Z, N, G, U, W		
Baja	Sport	2004-2006	All		HB432x.661	F, Z, N, G, W, S, E	HUS732	HKx732432	HB434x.543	F, Z, N, U, G, S, E	HUS358	HKx358434
Baja	Turbo	2004-2006	All		HB432x.661	F, Z, N, G, W, S, E	HUS732	HKx732432	HB434x.543	F, Z, N, U, G, S, E	HUS358	HKx358434
Baja		2003-2004	All		HB432x.661	F, Z, N, G, W, S, E	HUS732	HKx732432	HB434x.543	F, Z, N, U, G, S, E	HUS358	HKx358434
Brat	DL	1982-1982	All		HB202x.580	F, N, E						
BRZ	Limited	2013-2013	All	277mm Front Disc; Solid Rear Disc	HB711x.661	F, Z, N, G, U, W	HUS730	HKx730711	HB557x.545	F, Z, N	HUS739	HKx739557
BRZ	Premium	2013-2013	All	292mm Front Disc; Vented Rear Disc	HB711x.661	F, Z, N, G, U, W	HUS732	HKx732711	HB671x.628	F, Z, N, G, U, W		
Cross Trek	Base	2013-2013	All		HB711x.661	F, Z, N, G, U, W			HB557x.545	F, Z, N		
XV Cross Trek		2013	All		HB711x.661	F, Z, N, G, U, W			HB557x.545	F, Z, N		
DL		1981-1983	All		HB202x.580	F, N, E						
Forester	L	1998-2002	All	To 02/2002 w/Rear Drum Brakes	HB352x.665	F, Z, N, S, E	HUS730	HKx730352				
Forester	S	1998-2002	All	To 02/2002 w/Rear Disc Brakes	HB352x.665	F, Z, N, S, E	HUS730	HKx730352	HB434x.543	F, Z, N, U, G, S, E	HUS359	HKx359434
Forester	Sports 2.5 X	2008-2008	All	w/Rear Drum Brakes	HB432x.661	F, Z, N, G, W, S, E	HUS732	HKx732432				
Forester	Sports 2.5 X	2009-2010	All		HB432x.661	F, Z, N, G, W, S, E			HB557x.545	F, Z, N		
Forester	Sports 2.5 Xt	2008-2008	All		HB432x.661	F, Z, N, G, W, S, E	HUS732	HKx732432	HB452x.545	F, Z, N, W, S, E	HUS359	HKx359452
Forester	Sports 2.5 Xt	2009-2010	All		HB432x.661	F, Z, N, G, W, S, E			HB557x.545	F, Z, N		
Forester	X	2002-2003	All	From 02/2002 to 02/2003 w/Rear Drum Brakes	HB432x.661	F, Z, N, G, W, S, E	HUS732	HKx732432				
Forester	X	2006-2008	All	w/Rear Drum Brakes	HB432x.661	F, Z, N, G, W, S, E	HUS732	HKx732432				
Forester	X	2009-2010	All		HB432x.661	F, Z, N, G, W, S, E			HB557x.545	F, Z, N		
Forester	X L.L. Bean Edition	2006-2008	All		HB432x.661	F, Z, N, G, W, S, E	HUS732	HKx732432	HB452x.545	F, Z, N, W, S, E	HUS359	HKx359452
Forester	X L.L. Bean Edition	2009-2010	All		HB432x.661	F, Z, N, G, W, S, E			HB557x.545	F, Z, N		
Forester	XS	2002-2003	All	From 02/2002 to 02/2003	HB432x.661	F, Z, N, G, W, S, E	HUS732	HKx732432	HB434x.543	F, Z, N, U, G, S, E	HUS359	HKx359434
Forester	XS	2003-2005	All	From 03/2003	HB432x.661	F, Z, N, G, W, S, E	HUS732	HKx732432	HB452x.545	F, Z, N, W, S, E	HUS359	HKx359452
Forester	XT	2003-2005	All	From 03/2003	HB432x.661	F, Z, N, G, W, S, E	HUS732	HKx732432	HB452x.545	F, Z, N, W, S, E	HUS359	HKx359452
Forester	XT Limited	2006-2008	All		HB432x.661	F, Z, N, G, W, S, E	HUS732	HKx732432	HB452x.545	F, Z, N, W, S, E	HUS359	HKx359452
Forester	XT Limited	2009-2010	All		HB432x.661	F, Z, N, G, W, S, E			HB557x.545	F, Z, N		
GL		1981-1983	All		HB202x.580	F, N, E						
Forester		2011-2013	All		HB711x.661	F, Z, N, G, U, W			HB557x.545	F, Z, N		
Forester		2014	2.5i		HB711x.661	F, Z, N, G, U, W			HB557x.545	F, Z, N		
Forester		2014	2.0t		HB533x.668	F, Z, N, U, G	771078					
Impreza	2.5i	2006-2007	All		HB432x.661	F, Z, N, G, W, S, E	HUS730	HKx730432	HB452x.545	F, Z, N, W, S, E	HUS359	HKx359452
Impreza	2.5i	2008-2010	All		HB432x.661	F, Z, N, G, W, S, E	HUS730	HKx730432	HB557x.545	F, Z, N	HUS739	HKx739557
Impreza	Brighton	1997-1997	All		HB424x.665	F	HUS730	HKx730424				
Impreza	LS	1993-1994	All				HUS730		HB367x.585	F, Z, N	HUS359	

APPLICATION GUIDE

BRAKE PAD CODE BREAKDOWN

H B 2 4 5 x . 6 3 1
 HAWK BRAKE PAD SHAPE INSERT COMPOUND CODE PAD THICKNESS

PAD/ROTOR KIT CODE BREAKDOWN

H K x 4 2 8 4 4 8
 HAWK KIT INSERT COMPOUND CODE ROTOR PAD SHAPE

MAKE/MODEL	SUBMODEL	YRS.	ENGINE (LITER)	NOTE	FRONT				REAR			
					PADS	PAD COMPOUND	ROTORS	PAD/ROTOR KIT	PADS	PAD COMPOUND	ROTORS	PAD/ROTOR KIT
SUBARU CONTINUED												
Impreza	LX	1995-1996	All				HUS730		HB367x.585	F, Z, N	HUS359	
Impreza	Outback	1995-1996	All				HUS730		HB367x.585	F, Z, N	HUS359	
Impreza	Outback	1997-1999	All		HB424x.665	F	HUS730	HKx730424				
Impreza	Outback	2000-2001	All		HB424x.665	F	HUS730	HKx730424	HB434x.543	F, Z, N, U, G, S, E	HUS359	HKx359434
Impreza	Outback	2002-2002	All	w/Rear Disc Brakes	HB432x.661	F, Z, N, G, W, S, E	HUS730	HKx730432				
Impreza	Outback	2002-2002	All	w/Rear Drum Brakes	HB352x.665	F, Z, N, S, E	HUS730	HKx730352				
Impreza	Outback	2003-2003	All		HB432x.661	F, Z, N, G, W, S, E	HUS730	HKx730432	HB434x.543	F, Z, N, U, G, S, E	HUS359	HKx359434
Impreza	Outback	2004-2004	All		HB432x.661	F, Z, N, G, W, S, E	HUS730	HKx730432	HB452x.545	F, Z, N, W, S, E	HUS359	HKx359452
Impreza	Outback Sport	2005-2007	All		HB432x.661	F, Z, N, G, W, S, E	HUS730	HKx730432	HB452x.545	F, Z, N, W, S, E	HUS359	HKx359452
Impreza	Outback Sport	2008-2010	All		HB432x.661	F, Z, N, G, W, S, E	HUS730	HKx730432	HB557x.545	F, Z, N	HUS359	HKx359557
Impreza	RS	1998-1999	All		HB352x.665	F, Z, N, S, E	HUS730	HKx730352	HB434x.543	F, Z, N, U, G, S, E	HUS359	HKx359434
Impreza	RS	2000-2001	All		HB352x.665	F, Z, N, S, E	HUS730	HKx730352	HB434x.543	F, Z, N, U, G, S, E	HUS359	HKx359434
Impreza	RS	2002-2003	All		HB432x.661	F, Z, N, G, W, S, E	HUS730	HKx730432	HB434x.543	F, Z, N, U, G, S, E	HUS359	HKx359434
Impreza	RS	2004-2005	All		HB432x.661	F, Z, N, G, W, S, E	HUS730	HKx730432	HB452x.545	F, Z, N, W, S, E	HUS359	HKx359452
Impreza	TS	2002-2003	All		HB432x.661	F, Z, N, G, W, S, E	HUS730	HKx730432	HB434x.543	F, Z, N, U, G, S, E	HUS359	HKx359434
Impreza	TS	2004-2004	All		HB432x.661	F, Z, N, G, W, S, E	HUS730	HKx730432	HB452x.545	F, Z, N, W, S, E	HUS359	HKx359452
Impreza	WRX	2002-2002	All		HB352x.665	F, Z, N, S, E	HUS732	HKx732352	HB434x.543	F, Z, N, U, G, S, E	HUS359	HKx359434
Impreza	WRX	2003-2003	All		HB432x.661	F, Z, N, G, W, S, E	HUS732	HKx732432	HB434x.543	F, Z, N, U, G, S, E	HUS359	HKx359434
Impreza	WRX	2004-2005	All		HB432x.661	F, Z, N, G, W, S, E	HUS732	HKx732432	HB452x.545	F, Z, N, W, S, E	HUS359	HKx359452
Impreza	WRX	2006-2007	All		HB700x.562	F, Z, N, G, W, S, E	HUS732	HKx732700	HB179x.630	F, Z, N, W, S, E	HUS741	HKx741179
Impreza		2011-2013	All		HB711x.661	F, Z, N, G, U, W	HUS730	HKx730432	HB557x.545	F, Z, N		
Impreza	WRX	2008-2012	All		HB432x.661	F, Z, N, G, W, S, E	HUS732	HKx732432	HB557x.545	F, Z, N	HUS739	HKx739557
Impreza	WRX STI	2004-2004	All		HB453x.585	F, Z, N, U, G, W, V, S, E	HUS735	HKx735453	HB180x.560	F, Z, N, U, G, W, S, E	HUS736	HKx736180
Impreza	WRX STI	2005-2007	All		HB453x.585	F, Z, N, U, G, W, V, S, E	HUS737	HKx737453	HB180x.560	F, Z, N, U, G, W, S, E	HUS738	HKx738180
Impreza	WRX STI	2008-2012	All		HB453x.585	F, Z, N, U, G, W, V, S, E	HUS737	HKx737453	HB180x.560	F, Z, N, U, G, W, S, E		
Impreza	WRZ STI Limited	2007-2007	All		HB453x.585	F, Z, N, U, G, W, V, S, E	HUS737	HKx737453	HB180x.560	F, Z, N, U, G, W, S, E	HUS738	HKx738180
Impreza		1998-2001	All	15 in. Wheel	HB352x.665	F, Z, N, S, E	HUS730	HKx730352				
Impreza		1998-2001	All	w/o 15 in. Wheel	HB424x.665	F	HUS730	HKx730424				
Legacy	2.5 GT	2005-2008	2.5	Turbo	HB533x.668	F, Z, N, U, G	HUS474	HKx474533	HB434x.543	F, Z, N, U, G, S, E	HUS741	HKx741434
Legacy	2.5 GT	2010-2012	2.5		HB533x.668	F, Z, N, U, G	HUS474	HKx474533	HB671x.628	F, Z, N, G, U, W		
Legacy	2.5 GT B Spec	2007-2008	2.5	Turbo	HB533x.668	F, Z, N, U, G	HUS474	HKx474533	HB434x.543	F, Z, N, U, G, S, E	HUS741	HKx741434
Legacy	2.5i	2005-2009	2.5		HB432x.661	F, Z, N, G, W, S, E	HUS730	HKx730432	HB557x.545	F, Z, N	HUS740	HKx740557
Legacy	2.5i	2010-2012	2.5		HB432x.661	F, Z, N, G, W, S, E	HUS730	HKx730432	HB557x.545	F, Z, N	HUS739	HKx739557
Legacy	2.5i	2013-2013	2.5		HB711x.661	F, Z, N, G, U, W			HB557x.545	F, Z, N		
Legacy	3.0 R Limited	2008-2009	3.0		HB533x.668	F, Z, N, U, G	HUS474	HKx474533	HB434x.543	F, Z, N, U, G, S, E	HUS741	HKx741434
Legacy	3.0 R	2009-2009	3.0		HB432x.661	F, Z, N, G, W, S, E	HUS730	HKx730432	HB557x.545	F, Z, N	HUS740	HKx740557
Legacy	3.6 R	2010-2012	3.6		HB533x.668	F, Z, N, U, G	HUS474	HKx474533	HB671x.628	F, Z, N, G, U, W		
Legacy	GT	1996-1996	All						HB367x.585	F, Z, N		
Legacy	GT	1997-1998	All		HB352x.665	F, Z, N, S, E	HUS732	HKx732352	HB367x.585	F, Z, N		
Legacy	GT	2001-2001	All		HB352x.665	F, Z, N, S, E	HUS730	HKx730352	HB434x.543	F, Z, N, U, G, S, E	HUS358	HKx358434
Legacy	GT	2002-2002	All	To 4/2002	HB432x.661	F, Z, N, G, W, S, E	HUS732	HKx732432	HB434x.543	F, Z, N, U, G, S, E	HUS358	HKx358434
Legacy	GT	2002-2004	All	From 5/2002	HB432x.661	F, Z, N, G, W, S, E	HUS732	HKx732432	HB434x.543	F, Z, N, U, G, S, E	HUS358	HKx358434
Legacy	GT Limited	2001-2001	All		HB352x.665	F, Z, N, S, E	HUS732	HKx732352	HB434x.543	F, Z, N, U, G, S, E	HUS358	HKx358434
Legacy	GT Limited	2002-2002	All	To 4/2002	HB432x.661	F, Z, N, G, W, S, E	HUS732	HKx732432	HB434x.543	F, Z, N, U, G, S, E	HUS358	HKx358434
Legacy	L	1997-1998	All	14 in. Wheel	HB424x.665	F			HB367x.585	F, Z, N		
Legacy	L	1997-1998	All	15 or 16 in. Wheels	HB352x.665	F, Z, N, S, E	HUS732	HKx732352	HB367x.585	F, Z, N		
Legacy	L	2001-2001	All		HB352x.665	F, Z, N, S, E	HUS730	HKx730352	HB434x.543	F, Z, N, U, G, S, E	HUS358	HKx358434
Legacy	L	2002-2002	All	To 4/2002	HB352x.665	F, Z, N, S, E	HUS730	HKx730352	HB434x.543	F, Z, N, U, G, S, E	HUS358	HKx358434

RACE PAD COMPOUNDS

DTC-70 - U	DTC-05 - H	MT-4 - L	HP Plus - N
DTC-60 - G	HT-14 - V	Blue 9012 - E	
DTC-30 - W	HT-10 - S	Black - M	
DTC-15 - A	Metallic - MB	DR-97 - J	

STREET PAD COMPOUNDS

HPS Performance Street - F	LTS Light Truck & SUV - Y
Performance Ceramic - Z	SuperDuty - P

MAKE/ MODEL	SUBMODEL	ENGINE YRS. (LITER)	NOTE	FRONT				REAR				
				PADS	PAD COMPOUND	ROTORS	PAD/ROTOR KIT	PADS	PAD COMPOUND	ROTORS	PAD/ROTOR KIT	
SUBARU CONTINUED												
Legacy	L	2002-2004	All	From 5/2002	HB432x.661	F, Z, N, G, W, S, E	HUS730	HKx730432	HB434x.543	F, Z, N, U, G, S, E	HUS358	HKx358434
Legacy	Limited	1997-1998	All		HB352x.665	F, Z, N, S, E	HUS732	HKx732352	HB367x.585	F, Z, N		
Legacy	L-S	2002-2002	All	To 4/2002	HB352x.665	F, Z, N, S, E	HUS730	HKx730352	HB434x.543	F, Z, N, U, G, S, E	HUS358	HKx358434
Legacy	L-S	2002-2004	All	From 5/2002	HB432x.661	F, Z, N, G, W, S, E	HUS730	HKx730432	HB434x.543	F, Z, N, U, G, S, E	HUS358	HKx358434
Legacy	LSI	1997-1997	All	14 in. Wheel	HB424x.665	F			HB367x.585	F, Z, N		
Legacy	LSI	1997-1997	All	15 or 16 in. Wheels	HB352x.665	F, Z, N, S, E	HUS732	HKx732352	HB367x.585	F, Z, N		
Legacy	Non-Turbo	1990-1994	All						HB367x.585	F, Z, N		
Legacy	Outback	1995-1996	All						HB367x.585	F, Z, N		
Legacy	Outback	1997-1998	All	14 in. Wheel	HB424x.665	F			HB367x.585	F, Z, N		
Legacy	Outback	1997-1998	All	15 or 16 in. Wheels	HB352x.665	F, Z, N, S, E	HUS732	HKx732352	HB367x.585	F, Z, N		
Legacy	Outback	1999-1999	All		HB352x.665	F, Z, N, S, E	HUS730	HKx730352	HB367x.585	F, Z, N	HUS359	HKx359367
Legacy	Postal	1997-1998	All	14 in. Wheel	HB424x.665	F						
Legacy	Postal	1997-1998	All	15 or 16 in. Wheels	HB352x.665	F, Z, N, S, E	HUS732	HKx732352				
Legacy		1990-1990	All						HB367x.585	F, Z, N		
Legacy		1990-1990	All						HB367x.585	F, Z, N		
Legacy		1991-1993	All						HB367x.585	F, Z, N		
Legacy		1991-1994	All						HB367x.585	F, Z, N		
Legacy		1991-1996	All						HB367x.585	F, Z, N		
Legacy		1994-1994	All						HB367x.585	F, Z, N		
Legacy		1994-1994	All						HB367x.585	F, Z, N		
Legacy		1994-1994	All						HB367x.585	F, Z, N		
Legacy		1994-1996	All						HB367x.585	F, Z, N		
Legacy		1999-1999	All		HB424x.665	F			HB367x.585	F, Z, N		
Legacy		2000-2000	All		HB352x.665	F, Z, N, S, E	HUS730	HKx730352	HB434x.543	F, Z, N, U, G, S, E	HUS358	HKx358434
Outback	2.5 XT	2005-2005	2.5		HB432x.661	F, Z, N, G, W, S, E			HB557x.545	F, Z, N		
Outback	2.5i	2005-2005	2.5		HB432x.661	F, Z, N, G, W, S, E	HUS732	HKx732432	HB557x.545	F, Z, N	HUS740	HKx740557
Outback	2.5i	2006-2011	All		HB432x.661	F, Z, N, G, W, S, E			HB557x.545	F, Z, N		
Outback	2.5i	2013-2013	2.5		HB711x.661	F, Z, N, G, U, W			HB557x.545	F, Z, N		
Outback	2.5i Basic	2007-2007	All		HB432x.661	F, Z, N, G, W, S, E			HB557x.545	F, Z, N		
Outback	2.5i LL.Bean Edition	2008-2010	All		HB432x.661	F, Z, N, G, W, S, E			HB557x.545	F, Z, N		
Outback	2.5i Limited	2007-2007	All		HB432x.661	F, Z, N, G, W, S, E			HB557x.545	F, Z, N		
Outback	3.0 R	2005-2005	3.0		HB432x.661	F, Z, N, G, W, S, E	HUS732	HKx732432	HB557x.545	F, Z, N	HUS740	HKx740557
Outback	3.6 R	2010-2013	All		HB533x.668	F, Z, N, U, G			HB671x.628	F, Z, N, G, U, W		
Outback	R	2006-2006	All		HB432x.661	F, Z, N, G, W, S, E			HB557x.545	F, Z, N		
Outback	R.L.L.Bean Edition	2006-2009	All		HB432x.661	F, Z, N, G, W, S, E			HB557x.545	F, Z, N		
Outback	R.VDC Limited	2006-2006	All		HB432x.661	F, Z, N, G, W, S, E			HB557x.545	F, Z, N		
Outback	XT	2006-2006	All		HB432x.661	F, Z, N, G, W, S, E			HB557x.545	F, Z, N		
Outback	XT Limited	2007-2010	All		HB432x.661	F, Z, N, G, W, S, E			HB557x.545	F, Z, N		
Outback		2001-2001	All		HB424x.665	F	HUS732	HKx732424	HB434x.543	F, Z, N, U, G, S, E	HUS358	HKx358434
Outback		2002-2004	All		HB432x.661	F, Z, N, G, W, S, E	HUS732	HKx732432	HB434x.543	F, Z, N, U, G, S, E	HUS358	HKx358434
Outback		2008-2012	All		HB432x.661	F, Z, N, G, W, S, E			HB557x.545	F, Z, N		
Outback		2013	All		HB711x.661	F, Z, N, G, U, W			HB557x.545	F, Z, N		
Tribeca	Limited	2008-2013	All		HB533x.668	F, Z, N, U, G						
Tribeca	Premiere	2008-2013	All		HB533x.668	F, Z, N, U, G			HB671x.628	F, Z, N, G, U, W		
Tribeca		2008-2013	All		HB533x.668	F, Z, N, U, G			HB671x.628	F, Z, N, G, U, W		

BRAKE PAD CODE BREAKDOWN

H B **2 4 5** **x** **. 6 3 1**
 HAWK BRAKE PAD SHAPE INSERT COMPOUND CODE PAD THICKNESS

PAD/ROTOR KIT CODE BREAKDOWN

H K **x** **4 2 8** **4 4 8**
 HAWK KIT INSERT COMPOUND CODE ROTOR PAD SHAPE

MAKE/ MODEL	SUBMODEL	YRS.	ENGINE (LITER)	NOTE	FRONT				REAR			
					PADS	PAD COMPOUND	ROTORS	PAD/ROTOR KIT	PADS	PAD COMPOUND	ROTORS	PAD/ROTOR KIT
SUZUKI												
Equator		2009-2011	All		HB618x.625	Y			HB619x.626	Y		
Equator		2012	4.0		HB618x.625	Y			HB619x.626	Y		
Equator		2012	2.5						HB619x.626	Y		
Forenza		2004-2006	All		HB592x.665	F						
Forenza		2007-2008	All		HB592x.665	F						
Kizashi		2010-2013	All		HB660x.661	F, N, Z, G, W			HB145x.570	F, Z, Y, N, G, U, W, S, E, M		
Reno		2005-2006	All		HB592x.665	F						
Reno		2007-2008	All		HB592x.665	F						
Sidekick	JLX	1992-1995	All		HB384x.587	F						
Sidekick	JS	1992-1998	All		HB384x.587	F						
Sidekick	JX	1992-1998	All		HB384x.587	F						
SX4	AWD	2009-2013	All		HB268x.665	F, Z, N, G			HB145x.570	F, Z, Y, N, G, U, W, S, E, M		
SX4		2009-2013	All		HB268x.665	F, Z, N, G						
Vitara		2000-2004	All		HB384x.587	F						
TOYOTA												
4Runner	Limited	1996-1997	All		HB315x.669	F, Z, Y, P						
4Runner	Limited	2003-2013	All		HB490x.665	F, Z, Y, P			HB477x.610	F, Y		
4Runner	Limited	2003-2009	All		HB490x.665	F, Z, Y, P	HUS502		HB477x.610	F, Y	HUS503	
4Runner	Sport	2003-2013	All		HB490x.665	F, Z, Y, P			HB477x.610	F, Y		
4Runner	Sport	2003-2009	All		HB490x.665	F, Z, Y, P	HUS502		HB477x.610	F, Y	HUS503	
4Runner	SR5	1990-1991	All		HB315x.669	F, Z, Y, P						
4Runner	SR5	1992-1995	All		HB311x.591	F, Y, E						
4Runner	SR5	1996-1997	All		HB315x.669	F, Z, Y, P						
4Runner	SR5	2003-2012	All		HB490x.665	F, Z, Y, P			HB477x.610	F, Y		
4Runner		1996-2002	All		HB315x.669	F, Z, Y, P						
4Runner		2003-2012	All		HB490x.665	F, Z, Y, P			HB477x.610	F, Y		
4Runner		2003-2009	All		HB490x.665	F, Z, Y, P	HUS502		HB477x.610	F, Y	HUS503	
Avalon	XL	1995-1997	All		HB318x.669	F, Z						
Avalon	XL	2002-2003	All		HB320x.669	F, Z						
Avalon	XLS	1995-1995	All		HB318x.669	F, Z						
Avalon	XLS	1997-1997	All		HB318x.669	F, Z						
Avalon	XLS	2002-2003	All		HB320x.669	F, Z						
Avalon		1998-2001	All		HB320x.669	F, Z						
Avalon		2005-2007	All		HB677x.685	Y, Z						
Avalon		2008-2013	All		HB647x.692	F, Z			HB648x.607	F, Z		
Camry	DLX	1984-1986	All		HB191x.590	F, N, S, E						
Camry	Hybrid	2007-2007	All		HB647x.692	F, Z			HB648x.607	F, Z		
Camry	Hybrid	2009-2009	All		HB647x.692	F, Z			HB648x.607	F, Z		
Camry	LE	1984-1986	All		HB191x.590	F, N, S, E						
Camry	LE	2002-2006	2.4	4 Cyl. Only	HB474x.681	F, Z						
Camry	LE	2002-2006	3.0	6 Cyl. Only	HB474x.681	F, Z						
Camry	LE	2007-2012	All		HB647x.692	F, Z			HB648x.607	F, Z		
Camry	SE	2002-2004	3.0	6 Cyl. Only	HB474x.681	F, Z						
Camry	SE	2002-2006	2.4	4 Cyl. Only	HB474x.681	F, Z						
Camry	SE	2007-2012	All		HB647x.692	F, Z			HB648x.607	F, Z		
Camry	XLE	2002-2004	3.0	6 Cyl. Only	HB474x.681	F, Z						
Camry	XLE	2002-2006	2.4	4 Cyl. Only	HB474x.681	F, Z						
Camry	XLE	2007-2013	All		HB647x.692	F, Z			HB648x.607	F, Z		

APPLICATION GUIDE

RACE PAD COMPOUNDS

DTC-70 - U	DTC-05 - H	MT-4 - L	HP Plus - N
DTC-60 - G	HT-14 - V	Blue 9012 - E	
DTC-30 - W	HT-10 - S	Black - M	
DTC-15 - A	Metallic - MB	DR-97 - J	

STREET PAD COMPOUNDS

HPS Performance Street - F	LTS Light Truck & SUV - Y
Performance Ceramic - Z	SuperDuty - P

MAKE/ MODEL	SUBMODEL	ENGINE YRS. (LITER)	NOTE	FRONT				REAR			
				PADS	PAD COMPOUND	ROTORS	PAD/ROTOR KIT	PADS	PAD COMPOUND	ROTORS	PAD/ROTOR KIT
TOYOTA CONTINUED											
Camry		1992-1996	2.2 4 Cyl. Only w/Rear Disc Brakes	HB310x.689	F, Z			HB401x.587	F		
Camry		1992-1996	2.2 4 Cyl. Only w/Rear Drum Brakes	HB310x.689	F, Z						
Camry		1992-1996	3.0 6 Cyl. Only	HB318x.669	F, Z			HB401x.587	F		
Camry		1997-1999	2.2 w/Rear Disc Brakes	HB310x.689	F, Z						
Camry		1997-1999	3.0	HB320x.669	F, Z			HB401x.587	F		
Camry		2000-2001	2.2 14 in. Wheel	HB310x.689	F, Z						
Camry		2000-2001	2.2 15 in. Wheel	HB318x.669	F, Z						
Camry		2000-2001	3.0	HB320x.669	F, Z						
Celica	GT	1986-1989	All	HB191x.590	F, N, S, E						
Celica	GT	1993-1993	All	HB191x.590	F, N, S, E						
Celica	GT	1994-1998	All	HB318x.669	F, Z			HB401x.587	F		
Celica	GT	2002-2005	All	HB328x.685	F, Z, N, S			HB329x.543	F		
Celica	GTS	2001-2005	All	HB328x.685	F, Z, N, S			HB329x.543	F		
Celica	GTS Sport	1986-1987	All	HB191x.590	F, N, S, E						
Celica	ST	1987-1989	All	HB191x.590	F, N, S, E						
Celica	ST	1993-1993	All	HB191x.590	F, N, S, E						
Celica	ST	1994-1997	All	HB310x.689	F, Z						
Celica	ST Sport	1986-1986	All	HB191x.590	F, N, S, E						
Celica	Supra	1981-1981	All	HB614x.600	U, W						
Celica		1981-1981	All	HB614x.600	U, W						
Celica		2000-2000	All	HB493x.650	F, Z, E						
Corolla	CE	2006-2008	All	HB441x.661	F, Z						
Corolla	DLX	1984-1992	All	HB191x.590	F, N, S, E						
Corolla	DLX All Trac	1988-1992	All	HB191x.590	F, N, S, E						
Corolla	DX	1993-1997	All	HB310x.689	F, Z						
Corolla	FX	1987-1988	All	HB191x.590	F, N, S, E						
Corolla	FX16	1987-1987	All	HB191x.590	F, N, S, E			HB203x.550	F, N, M		
Corolla	FX16 GTS	1988-1988	All	HB191x.590	F, N, S, E			HB401x.587	F		
Corolla	GTS	1985-1987	All	HB202x.580	F, N, E			HB203x.550	F, N, M		
Corolla	GTS	1988-1991	All	HB191x.590	F, N, S, E			HB401x.587	F		
Corolla	Latin America	2007-2011	All	HB693x.716	Z			HB694x.580	Z		
Corolla	LE	1984-1984	All	HB191x.590	F, N, S, E						
Corolla	LE	1993-1995	All	HB310x.689	F, Z						
Corolla	Latin America	2013	All	HB627x.690	F, Z			HB629x.565	f		
Corolla	LE	2006-2008	All	HB441x.661	F, Z						
Corolla	LE LTD	1985-1986	All	HB191x.590	F, N, S, E						
Corolla	S	2006-2008	All	HB441x.661	F, Z						
Corolla	Sport	2008-2008	All	HB441x.661	F, Z						
Corolla	Sport Dlx	1984-1984	All	HB191x.590	F, N, S, E						
Corolla	SR5	1988-1991	All	HB191x.590	F, N, S, E						
Corolla	SR5 All Trac	1988-1990	All	HB191x.590	F, N, S, E						
Corolla	XRS	2005-2006	All	HB441x.661	F, Z			HB329x.543	F		
Corolla	XRS	2009-2009	All Rear Disc	HB704x.692	F, Z, G	HUS506		HB629x.565	F		
Corolla	XRS	2010-2010	All Rear Disc	HB627x.690	F, Z	HUS506		HB629x.565	F		
Corolla		1990-1992	All	HB191x.590	F, N, S, E						
Corolla		1993-1997	All	HB310x.689	F, Z						
Corolla		1998-2002	All	HB321x.650	F						

BRAKE PAD CODE BREAKDOWN

H B 2 4 5 x . 6 3 1
 HAWK BRAKE PAD SHAPE INSERT COMPOUND CODE PAD THICKNESS

PAD/ROTOR KIT CODE BREAKDOWN

H K x 4 2 8 4 4 8
 HAWK KIT INSERT COMPOUND CODE ROTOR PAD SHAPE

MAKE/ MODEL	SUBMODEL	YRS.	ENGINE (LITER)	NOTE	FRONT				REAR			
					PADS	PAD COMPOUND	ROTORS	PAD/ROTOR KIT	PADS	PAD COMPOUND	ROTORS	PAD/ROTOR KIT
TOYOTA CONTINUED												
Corolla		2003-2004	All		HB441x.661	F, Z						
Corolla		2009-2013	All	Rear Drum	HB627x.690	F, Z	HUS506					
Corona	Custom	1977-1978	All		HB169x.560	F, N, U, W, S, E, M						
Corona	DLX	1975-1978	All		HB169x.560	F, N, U, W, S, E, M						
Corona	SR5	1975-1976	2.2		HB169x.560	F, N, U, W, S, E, M						
Corona		1973-1974	All		HB169x.560	F, N, U, W, S, E, M						
Corona		1979-1980	All		HB169x.560	F, N, U, W, S, E, M						
Cressida	Luxury	1989-1992	All		HB407x.602	F, Y						
Cressida		1978-1980	All		HB169x.560	F, N, U, W, S, E, M						
Crown		1968-1970	All		HB169x.560	F, N, U, W, S, E, M						
Echo		2001-2005	All		HB493x.650	F, Z, E						
FJ Cruiser	Trail Teams Special Edition	2008-2010	All		HB490x.665	F, Z, Y, P	HUS502		HB477x.610	F, Y		
FJ Cruiser	Trd Special Edition	2007-2007	All		HB490x.665	F, Z, Y, P	HUS502		HB477x.610	F, Y		
FJ Cruiser		2007-2009	All		HB490x.665	F, Z, Y, P	HUS502		HB477x.610	F, Y	HUS503	
FJ Cruiser		2007-2013	All		HB490x.665	F, Z, Y, P	HUS502		HB477x.610	F, Y		
Hilux		2005-2012	All	Latin America	HB703x.665	F, Y, P						
Land Cruiser		1991-1994	All		HB312x.591	F, Y, P						
Land Cruiser		1995-1997	All		HB312x.591	F, Y, P			HB477x.610	F, Y		
Land Cruiser		1998-2007	All		HB313x.685	F, Y			HB427x.685	F, Y		
Land Cruiser		2008-2013	All		HB589x.704	Z, Y, P			HB590x.682	Z, Y, P		
Matrix	XR	2003-2005	All		HB441x.661	F, Z			HB329x.543	F		
Matrix	XR	2006-2008	All		HB441x.661	F, Z						
Matrix	XRS	2003-2006	All		HB441x.661	F, Z			HB329x.543	F		
Matrix		2003-2005	All		HB441x.661	F, Z			HB329x.543	F		
Matrix		2006-2008	All		HB441x.661	F, Z						
Matrix		2009-2013	1.8		HB627x.690	F, Z			HB629x.565	F		
Matrix	S	2009-2013	2.4	FWD	HB704x.692	F, Z, G			HB629x.565	F		
Matrix	S	2009-2013	2.4	AWD	HB704x.692	F, Z, G			HB648x.607	F, Z		
Matrix	XRS	2009-2011	2.4		HB627x.690	F, Z			HB648x.607	F, Z		
MR2		1985-1989	All		HB191x.590	F, N, S, E						
MR2		1991-1995	All	Non-Turbo	HB191x.590	F, N, S, E						
MR2 Spyder		2000-2005	All		HB493x.650	F, Z, E						
Paseo	Convertible	1997-1997	All		HB191x.590	F, N, S, E						
Paseo		1992-1998	All		HB191x.590	F, N, S, E						
Pickup	DLX	1989-1992	All	2WD	HB407x.602	F, Y						
Pickup	DLX	1989-1992	All	4WD	HB315x.669	F, Z, Y, P						
Pickup	DLX	1993-1995	All		HB315x.669	F, Z, Y, P						
Pickup	Sht Bd Dlx Exc	1991-1992	All	2WD	HB407x.602	F, Y						
Pickup	Sht Bd Dlx Exc	1991-1992	All	4WD	HB315x.669	F, Z, Y, P						
Pickup	SR5	1989-1991	All	4WD	HB315x.669	F, Z, Y, P						
Pickup	SR5	1989-1991	All	2WD	HB407x.602	F, Y						
Pickup	SR5	1994-1995	All	4WD	HB315x.669	F, Z, Y, P						
Pickup		1976-1983	All		HB169x.560	F, N, U, W, S, E, M						
Pickup		1989-1992	All	2WD	HB407x.602	F, Y						
Prius	Touring	2007-2009	All		HB493x.650	F, Z, E						
Prius	C	2012-2013	All		HB596x.690	F						
Prius	V	2012-2013	All		HB627x.690	F, Z						

APPLICATION GUIDE

RACE PAD COMPOUNDS

DTC-70 - U	DTC-05 - H	MT-4 - L	HP Plus - N
DTC-60 - G	HT-14 - V	Blue 9012 - E	
DTC-30 - W	HT-10 - S	Black - M	
DTC-15 - A	Metallic - MB	DR-97 - J	

STREET PAD COMPOUNDS

HPS Performance Street - F	LTS Light Truck & SUV - Y
Performance Ceramic - Z	SuperDuty - P

MAKE/ MODEL	SUBMODEL	ENGINE YRS. (LITER)	NOTE	FRONT				REAR			
				PADS	PAD COMPOUND	ROTOR	PAD/ROTOR KIT	PADS	PAD COMPOUND	ROTOR	PAD/ROTOR KIT
TOYOTA CONTINUED											
Prius		2001-2009	All	HB493x.650	F, Z, E						
Prius		2010-2013	All	HB596x.690	F			HB629x.565	F		
Rav4		1996-2000	All	HB310x.689	F, Z						
Rav4		2001-2005	All	HB429x.681	F						
Rav4		2006-2013	2.4 w/o 3rd Row Seat	HB627x.690	F, Z			HB648x.607	F, Z		
Rav4		2006-2013	2.4 with 3rd Row Seat	HB704x.692	F, Z, G			HB648x.607	F, Z		
Sequoia	Limited	2005-2007	All	HB490x.665	F, Z, Y, P	HUS795	HKx795490	HB477x.610	F, Y	HUS503	
Sequoia	Limited	2008-2013	All	HB589x.704	Z, Y, P			HB590x.682	Z, Y, P		
Sequoia	Platinum	2008-2013	All	HB589x.704	Z, Y, P			HB590x.682	Z, Y, P		
Sequoia	SR5	2005-2007	All	HB490x.665	F, Z, Y, P	HUS795	HKx795490	HB477x.610	F, Y	HUS503	
Sequoia	SR5	2008-2013	All	HB589x.704	Z, Y, P			HB590x.682	Z, Y, P		
Sequoia		2001-2002	All	HB314x.665	F, Y, P	HUS795	HKx795314	HB477x.610	F, Y	HUS503	
Sequoia		2003-2004	All	HB490x.665	F, Z, Y, P	HUS795	HKx795490	HB477x.610	F, Y	HUS503	
Sienna		1998-2003	All	HB318x.669	F, Z						
Sienna		2004-2010	All	HB677x.685	Y, Z						
Solara		1999-2000	2.2	HB320x.669	F, Z			HB401x.587	F		
Solara		1999-2000	3.0	HB320x.669	F, Z						
Solara		2004-2008	All	HB677x.685	Y, Z						
Supra	Twin Turbo	1993-1998	All	HB215x.630	F, N, S			HB216x.590	F		
Supra		1993-1998	All Non-Turbo	HB375x.669	F			HB670x.610	F		
T100	SR5	1993-1995	All 4WD	HB311x.591	F, Y, E						
T100	SR5	1996-1997	All	HB311x.591	F, Y, E						
T100		1993-1993	All 4WD	HB311x.591	F, Y, E						
T100		1997-1998	All 4WD	HB311x.591	F, Y, E						
Tacoma	Pre Runner	1999-2001	All 2WD	HB316x.670	F, Z, Y, P						
Tacoma	Pre Runner	2005-2012	All 6 Lug Wheels Only	HB490x.665	F, Z, Y, P						
Tacoma	Regular Cab	1995-1997	All 2WD	HB407x.602	F, Y						
Tacoma	Regular Cab	1995-1997	All 4WD	HB315x.669	F, Z, Y, P						
Tacoma	SR5	1995-1997	All 4WD	HB315x.669	F, Z, Y, P						
Tacoma	X-Runner	2005-2012	All 2WD, 5 Lug wheels single piston caliper	HB677x.685	Y, Z						
Tacoma		1995-1997	All 2WD	HB407x.602	F, Y						
Tacoma		1995-1997	All 4WD	HB315x.669	F, Z, Y, P						
Tacoma		1998-2004	All 5 Lug, From 2/98	HB407x.602	F, Y						
Tacoma		1998-2004	All 6 Lug, From 2/98	HB315x.669	F, Z, Y, P						
Tacoma		2005-2013	All 5 Lug RWD With Single piston	HB677x.685	Y, Z						
Tacoma		2005-2013	All 6 Lug RWD and 4WD with 4 piston caliper	HB490x.665	F, Z, Y, P	HUS502					
Tercel	CE	1997-1998	All	HB191x.590	F, N, S, E						
Tercel	DLX	1983-1988	All	HB191x.590	F, N, S, E						
Tercel	DLX	1990-1994	All	HB191x.590	F, N, S, E						
Tercel	DX	1995-1996	All	HB191x.590	F, N, S, E						
Tercel	EZ	1988-1988	All	HB191x.590	F, N, S, E						
Tercel	EZ	1990-1990	All	HB191x.590	F, N, S, E						
Tercel	LE	1991-1993	All	HB191x.590	F, N, S, E						
Tercel	SR5	1983-1988	All	HB191x.590	F, N, S, E						
Tercel	Std	1983-1983	All	HB191x.590	F, N, S, E						
Tercel	Std	1986-1988	All	HB191x.590	F, N, S, E						

BRAKE PAD CODE BREAKDOWN

PAD/ROTOR KIT CODE BREAKDOWN

H B 2 4 5 x . 6 3 1
 HAWK BRAKE PAD SHAPE INSERT COMPOUND CODE PAD THICKNESS

H K x 4 2 8 4 4 8
 HAWK KIT INSERT COMPOUND CODE ROTOR PAD SHAPE

MAKE/ MODEL	SUBMODEL	YRS.	ENGINE (LITER)	NOTE	FRONT				REAR			
					PADS	PAD COMPOUND	ROTORS	PAD/ROTOR KIT	PADS	PAD COMPOUND	ROTORS	PAD/ROTOR KIT
TOYOTA CONTINUED												
Tercel		1984-1985	All		HB191x.590	F, N, S, E						
Tercel		1989-1996	All		HB191x.590	F, N, S, E						
Tundra	Limited	2005-2006	All		HB490x.665	F, Z, Y, P	HUS795	HKx795490				
Tundra	Limited	2007-2013	All		HB589x.704	Z, Y, P			HB590x.682	Z, Y, P		
Tundra	SR5	2005-2005	All		HB490x.665	F, Z, Y, P	HUS795	HKx795490				
Tundra	SR5	2007-2013	All		HB589x.704	Z, Y, P			HB590x.682	Z, Y, P		
Tundra		1999-2003	All	w/ 4.7 in. Brake Pad	HB314x.665	F, Y, P	HUS795	HKx795314				
Tundra		2003-2003	All	w/ 5.3 in. Brake Pad	HB490x.665	F, Z, Y, P	HUS795	HKx795490				
Tundra		2004-2006	All		HB490x.665	F, Z, Y, P	HUS795	HKx795490				
Tundra		2007-2013	All		HB589x.704	Z, Y, P			HB590x.682	Z, Y, P		
Yaris	S	2007-2011	All		HB596x.690	F						
Yaris		2007-2011	All		HB596x.690	F						
Yaris		2012-2013	All	excluding SE	HB596x.690	F						
TRIUMPH												
GT-6		1971-1966			HB169x.560	F,N,M,E,W,U,S						
SPITFIRE		1967-1980			HB118x.560	M,E,V						
MKIII		1967-1980			HB118x.560	M,E,V						
MK IV		1967-1980			HB118x.560	M,E,V						
STAG		1970-1973			HB229x.580	E,S						
TR250		1967-1968			HB169x.560	F,N,M,E,W,U,S						
TR3		1957-1962			HB169x.560	F,N,M,E,W,U,S						
TR4		1961-1967			HB169x.560	F,N,M,E,W,U,S						
TR6		1969-1972			HB169x.560	F,N,M,E,W,U,S						
TR7		1975-1980	All		HB123x.535	N, E, M						
TR8		1980-1981	All		HB229x.580	E,S						
VOLKSWAGEN												
411		1971-1972	All		HB172x.595	F, Z, N, U, G, W, M, S, E						
412		1973-1974	All		HB172x.595	F, Z, N, U, G, W, M, S, E						
Beetle	2.5	2006-2006	2.5	w/Wear Sensor	HB272x.763A	F, Z			HB364x.642	F, Z, N, E		
Beetle	2.5	2006-2006	2.5		HB272x.763	F, Z, N, E			HB364x.642	F, Z, N, E		
Beetle	GLS TDI	2005-2005	1.9	w/Electronic Wear Sensor	HB365x.728A	F, Z			HB364x.642	F, Z, N, E		
Beetle	GLS TDI	2005-2005	1.9		HB365x.728	F, Z, N			HB364x.642	F, Z, N, E		
Beetle	S	2008-2010	2.5	w/280mm Rotors	HB365x.728	F, Z, N			HB364x.642	F, Z, N, E		
Beetle	S	2008-2010	2.5	w/280mm Rotors, w/Electronic Wear Sensor	HB365x.728A	F, Z			HB364x.642	F, Z, N, E		
Beetle	S	2008-2010	2.5	w/288mm Rotors	HB272x.763	F, Z, N, E			HB364x.642	F, Z, N, E		
Beetle	S	2008-2010	2.5	w/288mm Rotors, w/Wear Sensor	HB272x.763A	F, Z			HB364x.642	F, Z, N, E		
Beetle	SE	2008-2010	2.5	w/280mm Rotors	HB365x.728	F, Z, N			HB364x.642	F, Z, N, E		
Beetle	SE	2008-2010	2.5	w/280mm Rotors, w/Electronic Wear Sensor	HB365x.728A	F, Z			HB364x.642	F, Z, N, E		
Beetle	SE	2008-2010	2.5	w/288mm Rotors	HB272x.763	F, Z, N, E			HB364x.642	F, Z, N, E		
Beetle	SE	2008-2010	2.5	w/288mm Rotors, w/Wear Sensor	HB272x.763A	F, Z			HB364x.642	F, Z, N, E		
Beetle	TDI	2006-2006	1.9	w/Electronic Wear Sensor	HB365x.728A	F, Z			HB364x.642	F, Z, N, E		
Beetle	TDI	2006-2006	1.9		HB365x.728	F, Z, N			HB364x.642	F, Z, N, E		
Beetle		1998-2004	1.9	w/Electronic Wear Sensor	HB365x.728A	F, Z			HB364x.642	F, Z, N, E		
Beetle		1998-2004	1.9		HB365x.728	F, Z, N			HB364x.642	F, Z, N, E		
Beetle		1999-2000	1.8	w/Electronic Wear Sensor	HB365x.728A	F, Z			HB364x.642	F, Z, N, E		

APPLICATION GUIDE

RACE PAD COMPOUNDS

DTC-70 - U	DTC-05 - H	MT-4 - L	HP Plus - N
DTC-60 - G	HT-14 - V	Blue 9012 - E	
DTC-30 - W	HT-10 - S	Black - M	
DTC-15 - A	Metallic - MB	DR-97 - J	

STREET PAD COMPOUNDS

HPS Performance Street - F	LTS Light Truck & SUV - Y
Performance Ceramic - Z	SuperDuty - P

MAKE/ MODEL	SUBMODEL	ENGINE YRS. (LITER)	NOTE	FRONT				REAR			
				PADS	PAD COMPOUND	ROTORS	PAD/ROTOR KIT	PADS	PAD COMPOUND	ROTORS	PAD/ROTOR KIT
VOLKSWAGEN CONTINUED											
Beetle		1999-2000	1.8	HB365x.728	F, Z, N			HB364x.642	F, Z, N, E		
Beetle		1999-2005	2.0	w/Wear Sensor HB272x.763A	F, Z			HB364x.642	F, Z, N, E		
Beetle		1999-2005	2.0	HB272x.763	F, Z, N, E			HB364x.642	F, Z, N, E		
Beetle		2001-2002	1.8	w/Wear Sensor HB272x.763A	F, Z			HB364x.642	F, Z, N, E		
Beetle		2001-2002	1.8	HB272x.763	F, Z, N, E			HB364x.642	F, Z, N, E		
Beetle		2012-2013	All	HB543x.760	F, Z, N, G			HB695x.609	F		
Cabriolet		1985-1990	All	HB189x.595	F, Z, N, W, E						
CC	VR6	2009-2011	All	HB515x.760	F, Z						
CC		2009-2013	2.0	Turbo FWD HB543x.760	F, Z, N, G	HUS498	HKx498543	HB544x.628	F, Z, N, S		
Corrado	SLC	1992-1993	All	w/Wear Sensor				HB364x.587	F, Z, N, E		
Corrado	SLC	1992-1993	All	HB190x.730	F, G, S, E			HB364x.587	F, Z, N, E		
Corrado		1990-1992	All	w/Wear Sensor				HB364x.587	F, Z, N, E		
Corrado		1990-1992	All	HB190x.730	F, G, S, E			HB364x.587	F, Z, N, E		
Eos	Komfort	2007-2010	All	HB543x.760	F, Z, N, G	HUS498	HKx498543	HB544x.628	F, Z, N, S		
Eos	Lux	2007-2010	All	HB543x.760	F, Z, N, G	HUS498	HKx498543	HB544x.628	F, Z, N, S		
Eos	Turbo	2007-2010	All	HB543x.760	F, Z, N, G	HUS498	HKx498543	HB544x.628	F, Z, N, S		
Eos	VR6	2008-2008	All	HB543x.760	F, Z, N, G	HUS498	HKx498543	HB544x.628	F, Z, N, S		
Eos		2011-2013	All	HB543x.760	F, Z, N, G	HUS498	HKx498543	HB695x.609	F		
Golf	GL	1987-1988	All	HB189x.595	F, Z, N, W, E						
Golf	GL	1995-1997	All	w/Wear Sensor HB190x.600A	F, Z						
Golf	GL	1995-1997	All	HB190x.600	F, N, E, W						
Golf	GL	1999-1999	All	w/Wear Sensor HB190x.600A	F, Z			HB364x.587	F, Z, N, E		
Golf	GL	1999-1999	All	HB190x.600	F, N, E, W			HB364x.587	F, Z, N, E		
Golf	GL	2000-2010	All	w/Electronic Wear Sensor HB365x.728A	F, Z			HB544x.628	F, Z, N, S		
Golf	GL	2000-2010	All	HB365x.728	F, Z, N			HB544x.628	F, Z, N, S		
Golf	GLS	2000-2010	All	w/Electronic Wear Sensor HB365x.728A	F, Z			HB544x.628	F, Z, N, S		
Golf	GLS	2000-2010	All	HB365x.728	F, Z, N			HB544x.628	F, Z, N, S		
Golf	GLS TDI	2002-2006	All	w/Electronic Wear Sensor. w/Solid Rear Disc HB365x.728A	F, Z			HB544x.628	F, Z, N, S		
Golf	GLS TDI	2002-2006	All	w/Solid Rear Disc HB365x.728	F, Z, N			HB544x.628	F, Z, N, S		
Golf	GT	1987-1988	All	HB189x.595	F, Z, N, W, E						
Golf	GTI	1985-1986	All	HB189x.595	F, Z, N, W, E						
Golf	GTI	1993-1993	2.0	w/Wear Sensor HB190x.600A	F, Z						
Golf	GTI	1993-1993	2.0	HB190x.600	F, N, E, W						
Golf	GTI	1994-1994	2.0	w/Wear Sensor				HB364x.587	F, Z, N, E		
Golf	GTI	1994-1994	2.0	HB190x.730	F, G, S, E			HB364x.587	F, Z, N, E		
Golf	GTI	1996-1999	2.0	w/Wear Sensor HB190x.600A	F, Z			HB364x.587	F, Z, N, E		
Golf	GTI	1996-1999	2.0	HB190x.600	F, N, E, W			HB364x.587	F, Z, N, E		
Golf	GTI	1999-2000	2.8	w/Wear Sensor HB272x.763A	F, Z			HB364x.642	F, Z, N, E		
Golf	GTI	1999-2000	2.8	HB272x.763	F, Z, N, E			HB364x.642	F, Z, N, E		
Golf	GTI	2001-2001	2.8	w/Wear Sensor HB272x.763A	F, Z			HB364x.587	F, Z, N, E		
Golf	GTI	2001-2001	2.8	HB272x.763	F, Z, N, E			HB364x.587	F, Z, N, E		
Golf	GTI	2002-2002	2.8	w/Wear Sensor HB272x.763A	F, Z			HB364x.642	F, Z, N, E		
Golf	GTI	2002-2002	2.8	HB272x.763	F, Z, N, E			HB364x.642	F, Z, N, E		
Golf	GTI	2003-2004	2.8	w/Wear Sensor. w/Solid Rear Disc HB272x.763A	F, Z	HUS614	HKx614272A	HB364x.642	F, Z, N, E	HUS618	HKx618364
Golf	GTI	2003-2004	2.8	w/Solid Rear Disc HB272x.763	F, Z, N, E	HUS614	HKx614272	HB364x.642	F, Z, N, E	HUS618	HKx618364
Golf	GTI	2004-2004	1.8	w/Wear Sensor w/Solid Rear Disc HB272x.763A	F, Z	HUS614	HKx614272A	HB364x.642	F, Z, N, E	HUS618	HKx618364

BRAKE PAD CODE BREAKDOWN

H B 2 4 5 x . 6 3 1
 HAWK BRAKE PAD SHAPE INSERT COMPOUND CODE PAD THICKNESS

PAD/ROTOR KIT CODE BREAKDOWN

H K x 4 2 8 4 4 8
 HAWK KIT INSERT COMPOUND CODE ROTOR PAD SHAPE

MAKE/ MODEL	SUBMODEL	YRS.	ENGINE (LITER)	NOTE	FRONT				REAR			
					PADS	PAD COMPOUND	ROTORS	PAD/ROTOR KIT	PADS	PAD COMPOUND	ROTORS	PAD/ROTOR KIT
VOLKSWAGEN CONTINUED												
Golf	GTI	2004-2004	1.8	w/Solid Rear Disc	HB272x.763	F, Z, N, E	HUS614	HKx614272	HB364x.642	F, Z, N, E	HUS618	HKx618364
Golf	GTI	2006-2009	2.0		HB543x.760	F, Z, N, G	HUS498	HKx498543	HB544x.628	F, Z, N, S	HUS499	HKx499544
Golf	GTI	2010-2010	2.0		HB543x.760	F, Z, N, G	HUS498	HKx498543	HB544x.628	F, Z, N, S		
Golf	GTI	2011-2013	2.0		HB543x.760	F, Z, N, G	HUS498	HKx498543	HB695x.609	F		
Golf	GTI 1.8t	2002-2005	1.8	w/Wear Sensor	HB272x.763A	F, Z			HB364x.587	F, Z, N, E		
Golf	GTI 1.8t	2002-2005	1.8		HB272x.763	F, Z, N, E			HB364x.587	F, Z, N, E		
Golf	GTI 1.8t	2006-2006	1.8		HB543x.760	F, Z, N, G			HB544x.628	F, Z, N, S		
Golf	GTI 16-Valve	1987-1987	1.8		HB189x.595	F, Z, N, W, E						
Golf	GTI 16-Valve	1988-1989	1.8		HB189x.595	F, Z, N, W, E			HB364x.587	F, Z, N, E		
Golf	GTI 16-Valve	1990-1992	2.0		HB189x.595	F, Z, N, W, E			HB364x.587	F, Z, N, E		
Golf	GTI 8-Valve	1989-1992	1.8		HB189x.595	F, Z, N, W, E						
Golf	GTI VR6	1995-1995	2.8	w/Wear Sensor	HB190x.600A	F, Z			HB364x.587	F, Z, N, E		
Golf	GTI VR6	1995-1995	2.8		HB190x.600	F, N, E, W			HB364x.587	F, Z, N, E		
Golf	GTI VR6	1996-1998	2.8	w/Wear Sensor	HB272x.763A	F, Z			HB364x.587	F, Z, N, E		
Golf	GTI VR6	1996-1998	2.8		HB272x.763	F, Z, N, E			HB364x.587	F, Z, N, E		
Golf	III Celebration Edition	1995-1995	2.0	w/Wear Sensor	HB190x.600A	F, Z						
Golf	III Celebration Edition	1995-1995	2.0		HB190x.600	F, N, E, W						
Golf	III City	1995-1995	2.0	w/Wear Sensor	HB190x.600A	F, Z						
Golf	III City	1995-1995	2.0		HB190x.600	F, N, E, W						
Golf	III GL	1993-1994	2.0	w/Wear Sensor	HB190x.600A	F, Z						
Golf	III GL	1993-1994	2.0		HB190x.600	F, N, E, W						
Golf	III Sport	1995-1995	2.0	w/Wear Sensor	HB190x.600A	F, Z						
Golf	III Sport	1995-1995	2.0		HB190x.600	F, N, E, W						
Golf	Jazz	1997-1997	2.0	w/Wear Sensor	HB190x.600A	F, Z						
Golf	Jazz	1997-1997	2.0		HB190x.600	F, N, E, W						
Golf	K2	1997-1998	2.0	w/Wear Sensor	HB190x.600A	F, Z						
Golf	K2	1997-1998	2.0		HB190x.600	F, N, E, W						
Golf	LE	1995-1997	2.0	w/Wear Sensor	HB190x.600A	F, Z						
Golf	LE	1995-1997	2.0		HB190x.600	F, N, E, W						
Golf	LE	1999-1999	2.0	w/Wear Sensor	HB190x.600A	F, Z			HB364x.587	F, Z, N, E		
Golf	LE	1999-1999	2.0		HB190x.600	F, N, E, W			HB364x.587	F, Z, N, E		
Golf	LE	2000-2010	2.0	w/Electronic Wear Sensor	HB365x.728A	F, Z			HB544x.628	F, Z, N, S		
Golf		2012-2013	All		HB543x.760	F, Z, N, G			HB695x.609	F		
Golf		2010	All	Latin America	HB365x.728A	F, Z			HB364x.642	F, Z, N, E		
Golf	LE	2000-2010	2.0		HB365x.728	F, Z, N			HB544x.628	F, Z, N, S		
Golf	R	2012-2013	2.0		HB625x.760	F, Z			HB544x.628	F, Z, N, S		
Golf	R32	2004-2005	3.2		HB497x.776	F, Z, U, S			HB364x.642	F, Z, N, E		
Golf		1985-1986	1.6		HB189x.595	F, Z, N, W, E						
Golf		1985-1986	1.8		HB189x.595	F, Z, N, W, E						
Golf		1988-1989	1.8		HB189x.595	F, Z, N, W, E						
Golf		1998-1998	2.0	w/Wear Sensor	HB190x.600A	F, Z						
Golf		1998-1998	2.0		HB190x.600	F, N, E, W						
Golf		2000-2001	1.8	w/Electronic Wear Sensor	HB365x.728A	F, Z			HB364x.642	F, Z, N, E		
Golf		2000-2001	1.8		HB365x.728	F, Z, N			HB364x.642	F, Z, N, E		
Golf		2000-2001	1.9	w/Electronic Wear Sensor	HB365x.728A	F, Z			HB364x.642	F, Z, N, E		
Golf		2000-2001	1.9		HB365x.728	F, Z, N			HB364x.642	F, Z, N, E		
Golf		2000-2001	2.0	w/Electronic Wear Sensor	HB365x.728A	F, Z			HB364x.642	F, Z, N, E		
Golf		2000-2001	2.0		HB365x.728	F, Z, N			HB364x.642	F, Z, N, E		

APPLICATION GUIDE

RACE PAD COMPOUNDS

DTC-70 - U	DTC-05 - H	MT-4 - L	HP Plus - N
DTC-60 - G	HT-14 - V	Blue 9012 - E	
DTC-30 - W	HT-10 - S	Black - M	
DTC-15 - A	Metallic - MB	DR-97 - J	

STREET PAD COMPOUNDS

HPS Performance Street - F	LTS Light Truck & SUV - Y
Performance Ceramic - Z	SuperDuty - P

MAKE/ MODEL	SUBMODEL	YRS.	ENGINE (LITER)	NOTE	FRONT				REAR			
					PADS	PAD COMPOUND	ROTORS	PAD/ROTOR KIT	PADS	PAD COMPOUND	ROTORS	PAD/ROTOR KIT
VOLKSWAGEN CONTINUED												
Golf		2002-2006	1.9	w/Electronic Wear Sensor	HB365x.728A	F, Z			HB364x.642	F, Z, N, E		
Golf		2002-2006	1.9		HB365x.728	F, Z, N			HB364x.642	F, Z, N, E		
Golf		2002-2010	2.0	w/Electronic Wear Sensor	HB365x.728A	F, Z			HB364x.642	F, Z, N, E		
Golf		2002-2010	2.0		HB365x.728	F, Z, N			HB364x.642	F, Z, N, E		
GTI		2006-2010	All		HB543x.760	F, Z, N, G	HUS498	HKx498543	HB544x.628	F, Z, N, S		
GTI		2011	All		HB543x.760	F, Z, N, G	HUS498	HKx498543	HB544x.628	F, Z, N, S		
GTI		2012-2013	All		HB543x.760	F, Z, N, G	HUS498	HKx498543	HB695x.609	F		
Jetta	2.0T	2006-2010	2.0	2.0L, Turbo, Gas; exc Wagon	HB543x.760	F, Z, N, G	HUS498	HKx498543	HB544x.628	F, Z, N, S	HUS499	HKx499544
Jetta	2.0T	2011-2012	2.0	2.0L, Turbo, Gas	HB543x.760	F, Z, N, G	HUS498	HKx498543	HB695x.609	F		
Jetta	2.0T	2011-2012	2.0	2.0L; Gas, exc Turbo	HB365x.728	F, Z, N						
Jetta	Carat	1988-1988	All		HB189x.595	F, Z, N, W, E						
Jetta	Carat	1990-1991	All		HB189x.595	F, Z, N, W, E						
Jetta	Deluxe	1981-1986	All		HB189x.595	F, Z, N, W, E						
Jetta	GL	1986-1986	1.6		HB189x.595	F, Z, N, W, E						
Jetta	GL	1991-1992	1.6		HB189x.595	F, Z, N, W, E						
Jetta	GL	1991-1992	1.8		HB189x.595	F, Z, N, W, E						
Jetta	GL	1993-1994	2.0		HB190x.730	F, G, S, E						
Jetta	GL	1996-1998	2.0	w/Wear Sensor	HB190x.600A	F, Z						
Jetta	GL	1996-1998	2.0		HB190x.600	F, N, E, W						
Jetta	GL	2000-2001	2.0	w/Electronic Wear Sensor	HB365x.728A	F, Z						
Jetta	GL	2000-2001	2.0		HB365x.728	F, Z, N						
Jetta	GL	2002-2003	2.0	w/Electronic Wear Sensor	HB365x.728A	F, Z			HB364x.642	F, Z, N, E		
Jetta	GL	2002-2003	2.0		HB365x.728	F, Z, N			HB364x.642	F, Z, N, E		
Jetta	GL	2003-2003	1.8	w/Electronic Wear Sensor	HB365x.728A	F, Z			HB364x.642	F, Z, N, E		
Jetta	GL	2003-2003	1.8		HB365x.728	F, Z, N			HB364x.642	F, Z, N, E		
Jetta	GLI	1985-1985	1.8		HB189x.595	F, Z, N, W, E						
Jetta	GLI	1987-1987	1.8		HB189x.595	F, Z, N, W, E						
Jetta	GLI	2004-2004	1.8	Turbo	HB272x.763	F, Z, N, E			HB364x.587	F, Z, N, E		
Jetta	GLI	2005-2010	2.0	2.0L, Turbo, Gas; exc Wagon	HB543x.760	F, Z, N, G	HUS498	HKx498543	HB544x.628	F, Z, N, S	HUS499	HKx499544
Jetta	GLI	2011-2012	2.0	2.0L, Turbo, Gas	HB543x.760	F, Z, N, G	HUS498	HKx498543	HB695x.609	F		
Jetta	GLI	2011-2012	2.0	2.0L; Gas, exc Turbo	HB365x.728	F, Z, N						
Jetta	GLI 16-Valve	1987-1989	1.8		HB189x.595	F, Z, N, W, E						
Jetta	GLS	1996-1998	2.0	w/Wear Sensor	HB190x.600A	F, Z			HB364x.587	F, Z, N, E		
Jetta	GLS	1996-1998	2.0		HB190x.600	F, N, E, W			HB364x.587	F, Z, N, E		
Jetta	GLS	2000-2001	1.8	w/Electronic Wear Sensor	HB365x.728A	F, Z			HB364x.587	F, Z, N, E		
Jetta	GLS	2000-2001	1.8		HB365x.728	F, Z, N			HB364x.587	F, Z, N, E		
Jetta	GLS	2000-2001	2.0	w/Electronic Wear Sensor	HB365x.728A	F, Z			HB364x.587	F, Z, N, E		
Jetta	GLS	2000-2001	2.0		HB365x.728	F, Z, N			HB364x.587	F, Z, N, E		
Jetta	GLS	2002-2004	1.8	w/Electronic Wear Sensor	HB365x.728A	F, Z			HB364x.642	F, Z, N, E		
Jetta	GLS	2002-2004	1.8		HB365x.728	F, Z, N			HB364x.642	F, Z, N, E		
Jetta	GLS	2002-2004	2.0	w/Electronic Wear Sensor	HB365x.728A	F, Z			HB364x.642	F, Z, N, E		
Jetta	GLS	2002-2004	2.0		HB365x.728	F, Z, N			HB364x.642	F, Z, N, E		
Jetta	GLX	1996-1999	2.8	w/Wear Sensor	HB272x.763A	F, Z			HB364x.587	F, Z, N, E		
Jetta	GLX	1996-1999	2.8		HB272x.763	F, Z, N, E			HB364x.587	F, Z, N, E		
Jetta	III GL	1993-1995	2.0	w/Wear Sensor	HB190x.600A	F, Z						
Jetta	III GL	1993-1995	2.0		HB190x.600	F, N, E, W						
Jetta	III GLS	1993-1995	2.0	w/Wear Sensor	HB190x.600A	F, Z						
Jetta	III GLS	1993-1995	2.0		HB190x.600	F, N, E, W						

APPLICATION GUIDE

BRAKE PAD CODE BREAKDOWN

H B 2 4 5 x . 6 3 1
 HAWK BRAKE PAD SHAPE INSERT COMPOUND CODE PAD THICKNESS

PAD/ROTOR KIT CODE BREAKDOWN

H K x 4 2 8 4 4 8
 HAWK KIT INSERT COMPOUND CODE ROTOR PAD SHAPE

MAKE/ MODEL	SUBMODEL	YRS.	ENGINE (LITER)	NOTE	FRONT				REAR			
					PADS	PAD COMPOUND	ROTORS	PAD/ROTOR KIT	PADS	PAD COMPOUND	ROTORS	PAD/ROTOR KIT
VOLKSWAGEN CONTINUED												
Jetta	S	2008-2010	2.5		HB543x.760	F, Z, N, G	HUS621	HKx621543	HB544x.628	F, Z, N, S	HUS620	HKx620544
Jetta	S	2011-2012	2.5		HB543x.760	F, Z, N, G	HUS621	HKx621543	HB695x.609	F		
Jetta	SE	2008-2010	2.5		HB543x.760	F, Z, N, G	HUS621	HKx621543	HB544x.628	F, Z, N, S	HUS620	HKx620544
Jetta	SE	2011-2012	2.5		HB543x.760	F, Z, N, G	HUS621	HKx621543	HB695x.609	F		
Jetta	SEL	2008-2010	2.5		HB543x.760	F, Z, N, G	HUS621	HKx621543	HB544x.628	F, Z, N, S	HUS620	HKx620544
Jetta	SEL	2011-2012	2.5		HB543x.760	F, Z, N, G	HUS621	HKx621543	HB695x.609	F		
Jetta	TDI	2000-2001	1.9	w/Electronic Wear Sensor	HB365x.728A	F, Z			HB364x.587	F, Z, N, E		
Jetta	TDI	2000-2001	1.9		HB365x.728	F, Z, N			HB364x.587	F, Z, N, E		
Jetta	TDI	2002-2004	1.9	w/Electronic Wear Sensor	HB365x.728A	F, Z			HB364x.642	F, Z, N, E		
Jetta	TDI	2002-2004	1.9		HB365x.728	F, Z, N			HB364x.642	F, Z, N, E		
Jetta	TDI	2005-2005	1.9	w/Electronic Wear Sensor	HB365x.728A	F, Z			HB544x.628	F, Z, N, S		
Jetta	TDI	2005-2005	1.9		HB365x.728	F, Z, N			HB544x.628	F, Z, N, S		
Jetta	TDI	2006-2009	1.9		HB543x.760	F, Z, N, G	HUS621	HKx621543	HB544x.628	F, Z, N, S	HUS620	HKx620544
Jetta	TDI	2010-2012	1.9		HB543x.760	F, Z, N, G			HB695x.609	F		
Jetta	VR6	1999-2004	All	w/Wear Sensor	HB272x.763A	F, Z			HB364x.587	F, Z, N, E		
Jetta	VR6	1999-2004	All		HB272x.763	F, Z, N, E			HB364x.587	F, Z, N, E		
Jetta		1987-1987	1.6		HB189x.595	F, Z, N, W, E						
Jetta		1987-1989	1.8		HB189x.595	F, Z, N, W, E						
Jetta		1989-1989	1.6		HB189x.595	F, Z, N, W, E						
Jetta		1998-1998	2.0	w/Wear Sensor	HB190x.600A	F, Z						
Jetta		1998-1998	2.0		HB190x.600	F, N, E, W						
Passat	4 Motion	2003-2004	2.8	w/Wear Sensor	HB354x.756A	F, Z			HB364x.642	F, Z, N, E		
Passat	4 Motion	2004-2004	1.8	w/Wear Sensor	HB354x.756A	F, Z			HB364x.642	F, Z, N, E		
Passat	4 Motion	2005-2005	1.8	w/Wear Sensor	HB354x.756A	F, Z			HB544x.628	F, Z, N, S		
Passat	4 Motion	2005-2005	2.8	w/Wear Sensor	HB354x.756A	F, Z			HB544x.628	F, Z, N, S		
Passat	4 Motion	2003-2005	4.0	w/Wear Sensor	HB354x.756A	F, Z			HB364x.642	F, Z, N, E		
Passat	4 Motion	2006-2009	All		HB538x.760	F, Z, N			HB544x.628	F, Z, N, S		
Passat	GL	1990-1991	2.0	w/Wear Sensor	HB190x.600A	F, Z						
Passat	GL	1990-1991	2.0		HB190x.600	F, N, E, W						
Passat	GL	1992-1993	2.0	w/Syncro Ring	HB190x.600	F, N, E, W			HB364x.587	F, Z, N, E		
Passat	GL	1992-1993	2.0	w/Syncro Ring	HB190x.730	F, G, S, E			HB364x.587	F, Z, N, E		
Passat	GL	1992-1993	2.0	w/Wear Sensor					HB364x.587	F, Z, N, E		
Passat	GL	1992-1993	2.0	w/Wear Sensor, w/Syncro Ring	HB190x.600A	F, Z			HB364x.587	F, Z, N, E		
Passat	GL	1992-1993	2.0	w/Wear Sensor, w/Syncro Ring					HB364x.587	F, Z, N, E		
Passat	GL	1992-1993	2.0		HB190x.730	F, G, S, E			HB364x.587	F, Z, N, E		
Passat	GLS	1995-1995	2.0	w/Syncro Ring	HB190x.600	F, N, E, W						
Passat	GLS	1995-1995	2.0	w/Syncro Ring	HB190x.730	F, G, S, E						
Passat	GLS	1995-1995	2.0	w/Wear Sensor, w/Syncro Ring	HB190x.600A	F, Z						
Passat	GLS	1995-1996	2.0	w/Wear Sensor					HB364x.587	F, Z, N, E		
Passat	GLS	1995-1996	2.0		HB190x.730	F, G, S, E			HB364x.587	F, Z, N, E		
Passat	GLS	1996-1996	2.0	w/Syncro Ring	HB190x.600	F, N, E, W						
Passat	GLS	1996-1996	2.0	w/Wear Sensor, w/Syncro Ring	HB190x.600A	F, Z						
Passat	GLS	1998-1998	1.8	w/Wear Sensor, w/Syncro Ring	HB269x.763B	F						
Passat	GLS	1998-1998	1.8	w/Oval Wear Sensor	HB269x.763A	F, Z						
Passat	GLS	1998-1998	1.8		HB269x.763	F, Z, E						
Passat	GLS	1998-1998	2.8	w/Wear Sensor	HB272x.763A	F, Z			HB364x.642	F, Z, N, E		
Passat	GLS	1998-1998	2.8		HB272x.763	F, Z, N, E			HB364x.642	F, Z, N, E		
Passat	GLS 4 Motion	2002-2002	2.8	w/Wear Sensor	HB354x.756A	F, Z			HB364x.642	F, Z, N, E		

APPLICATION GUIDE

RACE PAD COMPOUNDS

DTC-70 - U	DTC-05 - H	MT-4 - L	HP Plus - N
DTC-60 - G	HT-14 - V	Blue 9012 - E	
DTC-30 - W	HT-10 - S	Black - M	
DTC-15 - A	Metallic - MB	DR-97 - J	

STREET PAD COMPOUNDS

HPS Performance Street - F	LTS Light Truck & SUV - Y
Performance Ceramic - Z	SuperDuty - P

MAKE/ MODEL	SUBMODEL	YRS.	ENGINE (LITER)	NOTE	FRONT				REAR			
					PADS	PAD COMPOUND	ROTOR	PAD/ROTOR KIT	PADS	PAD COMPOUND	ROTOR	PAD/ROTOR KIT
VOLKSWAGEN CONTINUED												
Passat	GLX	1993-1995	2.8	w/Syncro Ring	HB190x.600	F, N, E, W			HB364x.587	F, Z, N, E		
Passat	GLX	1993-1995	2.8	w/Wear Sensor, w/Syncro Ring	HB190x.600A	F, Z			HB364x.587	F, Z, N, E		
Passat	GLX	1997-1997	2.8	w/Wear Sensor	HB354x.756A	F, Z			HB364x.587	F, Z, N, E		
Passat	GLX 4 Motion	2002-2002	2.8	w/Wear Sensor	HB354x.756A	F, Z			HB364x.642	F, Z, N, E		
Passat	Komfort	2008-2009	2.0		HB543x.760	F, Z, N, G	HUS498	HKx498543	HB544x.628	F, Z, N, S	HUS499	HKx499544
Passat	Komfort	2010-2010	2.0		HB543x.760	F, Z, N, G	HUS498	HKx498543	HB544x.628	F, Z, N, S		
Passat	Lux	2008-2009	2.0		HB543x.760	F, Z, N, G	HUS498	HKx498543	HB544x.628	F, Z, N, S	HUS499	HKx499544
Passat	Lux	2010-2010	2.0		HB543x.760	F, Z, N, G	HUS498	HKx498543	HB544x.628	F, Z, N, S		
Passat	TDI	1996-1997	1.9	w/Syncro Ring	HB190x.600	F, N, E, W						
Passat	TDI	1996-1997	1.9	w/Wear Sensor, w/Syncro Ring	HB190x.600A	F, Z						
Passat	Turbo	2006-2009	2.0		HB543x.760	F, Z, N, G	HUS498	HKx498543	HB544x.628	F, Z, N, S	HUS499	HKx499544
Passat	Turbo	2010-2010	2.0		HB543x.760	F, Z, N, G	HUS498	HKx498543	HB544x.628	F, Z, N, S		
Passat		2006-2007	All	Except 4-Motion	HB543x.760	F, Z, N, G	HUS498	HKx498543	HB544x.628	F, Z, N, S	HUS499	HKx499544
Passat		2008-2009	3.6	3.6L FWD	HB538x.760	F, Z, N			HB544x.628	F, Z, N, S		
Passat	Base	2010-2010	All		HB543x.760	F, Z, N, G	HUS498	HKx498543	HB544x.628	F, Z, N, S		
Passat	VR6	2008-2010	3.6	Except 4-Motion	HB543x.760	F, Z, N, G			HB544x.628	F, Z, N, S		
Passat	W8 4 Motion	2003-2005	4.0	4 pad front caliper (available with wear sensor)	HB363x.689	F, E			HB364x.642	F, Z, N, E		
Passat		1999-1999	1.8	w/Large Round Wear Sensor	HB269x.763B	F			HB364x.642	F, Z, N, E		
Passat		1999-1999	1.8	w/Oval Wear Sensor	HB269x.763A	F, Z			HB364x.642	F, Z, N, E		
Passat		1999-1999	1.8		HB269x.763	F, Z, E			HB364x.642	F, Z, N, E		
Passat		1999-1999	2.8	w/Wear Sensor	HB272x.763A	F, Z			HB364x.642	F, Z, N, E		
Passat		1999-1999	2.8		HB272x.763	F, Z, N, E			HB364x.642	F, Z, N, E		
Passat		2000-2001	1.8	w/Wear Sensor	HB354x.756A	F, Z			HB364x.642	F, Z, N, E		
Passat		2000-2001	2.8	w/Wear Sensor	HB354x.756A	F, Z			HB364x.642	F, Z, N, E		
Phaeton		2002-2003	All		HB609x.572	F, Z, N, E, G, S, U, W						
Phaeton		2004-2006	All		HB687x.750	F, N, Z			HB544x.628	F, Z, N, S		
Quantum	Custom	1982-1983	All		HB189x.595	F, Z, N, W, E						
Quantum	DLX	1982-1983	All		HB189x.595	F, Z, N, W, E						
Quantum	GL Custom	1984-1986	All		HB189x.595	F, Z, N, W, E						
Quantum	GL Deluxe	1984-1984	All		HB189x.595	F, Z, N, W, E						
Quantum	Syncro	1986-1988	All	w/Wear Sensor					HB364x.587	F, Z, N, E		
Quantum	Wolfsburg Edition	1984-1984	All		HB189x.595	F, Z, N, W, E						
Quantum		1985-1985	All		HB189x.595	F, Z, N, W, E						
Rabbit	GL DLX	1983-1983	All		HB189x.595	F, Z, N, W, E						
Rabbit	GTI Sport	1983-1983	All		HB189x.595	F, Z, N, W, E						
Rabbit	L	1983-1984	All		HB189x.595	F, Z, N, W, E						
Rabbit	L Custom	1981-1982	All		HB189x.595	F, Z, N, W, E						
Rabbit	LS Custom	1983-1983	All		HB189x.595	F, Z, N, W, E						
Rabbit	LS Deluxe	1981-1982	All		HB189x.595	F, Z, N, W, E						
Rabbit	S	2006-2009	All		HB543x.760	F, Z, N, G			HB544x.628	F, Z, N, S		
Rabbit		1979-1984	All		HB189x.595	F, Z, N, W, E						
Rabbit Convertible		1980-1984	All		HB189x.595	F, Z, N, W, E						
Scirocco	16-Valve	1987-1987	All		HB189x.595	F, Z, N, W, E						
Scirocco	16-Valve	1987-1988	All	w/Wear Sensor					HB364x.587	F, Z, N, E		
Scirocco		1979-1980	All		HB189x.595	F, Z, N, W, E						
Tiguan	S	2007-2010	2.0		HB543x.760	F, Z, N			HB544x.628	F, Z, N, S		
Tiguan	SE	2007-2010	2.0		HB543x.760	F, Z, N			HB544x.628	F, Z, N, S		

BRAKE PAD CODE BREAKDOWN

H B 2 4 5 x . 6 3 1
 HAWK BRAKE PAD SHAPE INSERT COMPOUND CODE PAD THICKNESS

PAD/ROTOR KIT CODE BREAKDOWN

H K x 4 2 8 4 4 8
 HAWK KIT INSERT COMPOUND CODE ROTOR PAD SHAPE

MAKE/ MODEL	SUBMODEL	YRS.	ENGINE (LITER)	NOTE	FRONT				REAR			
					PADS	PAD COMPOUND	ROTOR	PAD/ROTOR KIT	PADS	PAD COMPOUND	ROTOR	PAD/ROTOR KIT
VOLKSWAGEN CONTINUED												
Tiguan	SEL	2007-2010	2.0		HB543x.760	F, Z, N			HB544x.628	F, Z, N, S		
Touareg	TDI	2004-2004	4.9	17 in. Wheels, w/330mm Rotors	HB512x.605	F, Z, Y, W			HB502x.606	F, Z, Y		
Touareg	TDI	2004-2004	4.9	18 in. Wheel, w/350mm Rotors	HB501x.625	F, Z, Y, G, E			HB502x.606	F, Z, Y		
Touareg	TDI	2006-2009	5.0	w/350mm Rotors	HB501x.625	F, Z, Y, G, E			HB502x.606	F, Z, Y		
Touareg		2004-2005	3.2	17 in. Wheels, w/330mm Rotors	HB512x.605	F, Z, Y, W			HB502x.606	F, Z, Y		
Touareg		2004-2005	3.2	18 in. Wheel, w/350mm Rotors	HB501x.625	F, Z, Y, G, E						
Touareg		2004-2005	4.2	17 in. Wheels, w/330mm Rotors	HB512x.605	F, Z, Y, W			HB502x.606	F, Z, Y		
Touareg		2004-2005	4.2	18 in. Wheel, w/350mm Rotors	HB501x.625	F, Z, Y, G, E			HB502x.606	F, Z, Y		
Touareg		2006-2007	4.2	w/350mm Rotors	HB501x.625	F, Z, Y, G, E			HB502x.606	F, Z, Y		
Touareg		2006-2014	3.6	4 Piston Front Caliper; 330mm Front Disc	HB632x.586	F, Z, N						
Touareg		2008-2014	4.2	4 Piston Front Caliper; 330mm Front Disc	HB632x.586	F, Z, N						
Transporter	211	1971-1974	All		HB171x.590	F, Z, N, U, W, S, E						
Transporter	215	1971-1973	All		HB171x.590	F, Z, N, U, W, S, E						
Transporter	261	1971-1971	All		HB171x.590	F, Z, N, U, W, S, E						
Transporter	265	1971-1971	All		HB171x.590	F, Z, N, U, W, S, E						
Transporter		1971-1979	All		HB171x.590	F, Z, N, U, W, S, E						
Vanagon	Campmobile	1980-1985	All		HB171x.590	F, Z, N, U, W, S, E						
Vanagon	Kombi	1980-1981	All		HB171x.590	F, Z, N, U, W, S, E						
Vanagon	Transport	1981-1981	All		HB171x.590	F, Z, N, U, W, S, E						
Vanagon		1982-1985	All		HB171x.590	F, Z, N, U, W, S, E						
VOLVO												
142	E	1971-1972	All		HB204x.615	F, N, S, E, M						
142	GL	1974-1974	All		HB204x.615	F, N, S, E, M						
142	S	1969-1969	All		HB204x.615	F, N, S, E, M						
142		1970-1974	All		HB204x.615	F, N, S, E, M						
145	S	1969-1969	All		HB204x.615	F, N, S, E, M						
145		1971-1974	All		HB204x.615	F, N, S, E, M			HB172x.595	F, Z, N, U, G, W, M, S, E		
164	E	1973-1974	All		HB204x.615	F, N, S, E, M			HB172x.595	F, Z, N, U, G, W, M, S, E		
164		1972-1972	All		HB204x.615	F, N, S, E, M			HB172x.595	F, Z, N, U, G, W, M, S, E		
164		1975-1975	All		HB204x.615	F, N, S, E, M			HB172x.595	F, Z, N, U, G, W, M, S, E		
240	DL	1990-1990	All		HB204x.615	F, N, S, E, M			HB172x.595	F, Z, N, U, G, W, M, S, E		
240	GL	1992-1992	All		HB204x.615	F, N, S, E, M			HB172x.595	F, Z, N, U, G, W, M, S, E		
240	SE	1991-1991	All		HB204x.615	F, N, S, E, M			HB172x.595	F, Z, N, U, G, W, M, S, E		
240		1990-1993	All		HB204x.615	F, N, S, E, M			HB172x.595	F, Z, N, U, G, W, M, S, E		
242	GL	1975-1975	All		HB204x.615	F, N, S, E, M			HB172x.595	F, Z, N, U, G, W, M, S, E		
242		1976-1978	All		HB204x.615	F, N, S, E, M			HB172x.595	F, Z, N, U, G, W, M, S, E		
244	GL	1975-1975	All		HB204x.615	F, N, S, E, M			HB172x.595	F, Z, N, U, G, W, M, S, E		
244		1976-1978	All		HB204x.615	F, N, S, E, M			HB172x.595	F, Z, N, U, G, W, M, S, E		
245		1975-1978	All		HB204x.615	F, N, S, E, M			HB172x.595	F, Z, N, U, G, W, M, S, E		
262	C	1979-1979	All		HB204x.615	F, N, S, E, M			HB172x.595	F, Z, N, U, G, W, M, S, E		
262	GL	1976-1976	All		HB204x.615	F, N, S, E, M			HB172x.595	F, Z, N, U, G, W, M, S, E		
265	GL	1977-1978	All		HB204x.615	F, N, S, E, M			HB172x.595	F, Z, N, U, G, W, M, S, E		

RACE PAD COMPOUNDS

DTC-70 - U	DTC-05 - H	MT-4 - L	HP Plus - N
DTC-60 - G	HT-14 - V	Blue 9012 - E	
DTC-30 - W	HT-10 - S	Black - M	
DTC-15 - A	Metallic - MB	DR-97 - J	

STREET PAD COMPOUNDS

HPS Performance Street - F	LTS Light Truck & SUV - Y
Performance Ceramic - Z	SuperDuty - P

MAKE/ MODEL	SUBMODEL	YRS.	ENGINE (LITER)	NOTE	FRONT				REAR			
					PADS	PAD COMPOUND	ROTOR	PAD/ROTOR KIT	PADS	PAD COMPOUND	ROTOR	PAD/ROTOR KIT
VOLVO CONTINUED												
265		1976-1976	All		HB204x.615	F, N, S, E, M			HB172x.595	F, Z, N, U, G, W, M, S, E		
740	SE	1991-1991	All		HB413x.690	F						
740		1991-1992	All		HB413x.690	F						
850	GLT	1995-1997	All		HB492x.732	F, Z						
850	R	1997-1997	All		HB492x.732	F, Z						
850	T-5	1997-1997	All		HB492x.732	F, Z						
850	T-5R	1995-1995	All		HB492x.732	F, Z						
850	Turbo	1995-1996	All		HB492x.732	F, Z						
850		1993-1997	All		HB492x.732	F, Z			HB172x.595	F, Z, N, U, G, W, M, S, E		
940	GLE	1991-1991	All		HB413x.690	F						
940	SE	1991-1991	All		HB413x.690	F						
940		1991-1995	All		HB413x.690	F						
960		1992-1993	All	w/o ABS	HB413x.690	F						
960		1994-1997	All		HB413x.690	F						
1800	E	1970-1972	All		HB204x.615	F, N, S, E, M						
1800	ES	1972-1973	All		HB204x.615	F, N, S, E, M						
C30	T5	2008-2009	All		HB519x.682	F, N, G, V, S, E			HB478x.605	F, Z, N, G, U, S, E		
C30		2010-2013	All		HB519x.682	F, N, G, V, S, E			HB478x.605	F, Z, N, G, U, S, E		
C70	T5	2006-2006	All		HB519x.682	F, N, G, V, S, E			HB478x.605	F, Z, N, G, U, S, E		
C70	T5	2008-2009	All		HB519x.682	F, N, G, V, S, E			HB478x.605	F, Z, N, G, U, S, E		
C70		1999-2002	All		HB492x.732	F, Z			HB172x.595	F, Z, N, U, G, W, M, S, E		
C70		2010-2011	All	w/278mm Front Rotor	HB519x.682	F, N, G, V, S, E			HB478x.605	F, Z, N, G, U, S, E		
C70		2010-2013	All	w/300mm Front Rotor	HB519x.682	F, N, G, V, S, E			HB478x.605	F, Z, N, G, U, S, E		
C70		2010-2013	All	w/320mm Front Rotor	HB515x.760	F, Z			HB478x.605	F, Z, N, G, U, S, E		
S40	2.4i	2006-2007	All		HB519x.682	F, N, G, V, S, E						
S40	2.4i	2008-2009	All		HB519x.682	F, N, G, V, S, E			HB478x.605	F, Z, N, G, U, S, E		
S40	I	2005-2005	All		HB194x.570	F, Z, Y, N, U, V, S, E, W			HB478x.605	F, Z, N, G, U, S, E		
S40	T5	2004-2004	All						HB516x.626	F, Z		
S40	T5	2005-2005	All		HB519x.682	F, N, G, V, S, E			HB571x.605	F, Z, N, E		
S40		2000-2004	All						HB516x.626	F, Z		
S40		2004-2011	All	w/278mm Front Rotor	HB519x.682	F, N, G, V, S, E			HB478x.605	F, Z, N, G, U, S, E		
S40		2004-2011	All	w/300mm Front Rotor	HB519x.682	F, N, G, V, S, E			HB478x.605	F, Z, N, G, U, S, E		
S40		2004-2011	All	w/320mm Front Rotor	HB515x.760	F, Z			HB478x.605	F, Z, N, G, U, S, E		
S60	2.4	2005-2005	2.4		HB491x.693	F, Z			HB652x.634	F, Z		
S60	2.5T	2005-2007	2.5		HB491x.693	F, Z			HB652x.634	F, Z		
S60	2.5t AWD	2005-2005	2.5		HB491x.693	F, Z			HB652x.634	F, Z		
S60	R	2004-2007	All		HB453x.585	F, Z, N, U, G, W, V, S, E			HB194x.570	F, Z, Y, N, U, V, S, E, W		
S60	T5	2008-2008	All		HB491x.693	F, Z			HB652x.634	F, Z		
S60		2001-2004	All		HB491x.693	F, Z			HB652x.634	F, Z		
S70		1999-2000	All		HB492x.732	F, Z			HB172x.595	F, Z, N, U, G, W, M, S, E		
S80	2.5t	2004-2006	2.5		HB491x.693	F, Z			HB652x.634	F, Z		
S80	2.5T AWD	2004-2006	2.5		HB491x.693	F, Z			HB652x.634	F, Z		
S80	T6	2005-2005	All		HB491x.693	F, Z			HB652x.634	F, Z		
S80	T6 Premier	2005-2005	All		HB491x.693	F, Z			HB652x.634	F, Z		
S80		1999-2001	2.8		HB491x.693	F, Z			HB652x.634	F, Z		
S80		1999-2004	2.9		HB491x.693	F, Z			HB652x.634	F, Z		
S90		1998-1998	All		HB413x.690	F						
V40		2000-2004	All						HB516x.626	F, Z		

BRAKE PAD CODE BREAKDOWN

H B **2 4 5** **x** **.6 3 1**
 HAWK BRAKE PAD SHAPE INSERT COMPOUND CODE PAD THICKNESS

PAD/ROTOR KIT CODE BREAKDOWN

HK **x** **4 2 8** **4 4 8**
 HAWK KIT INSERT COMPOUND CODE ROTOR PAD SHAPE

MAKE/ MODEL	SUBMODEL	YRS.	ENGINE (LITER)	NOTE	FRONT				REAR			
					PADS	PAD COMPOUND	ROTOR	PAD/ROTOR KIT	PADS	PAD COMPOUND	ROTOR	PAD/ROTOR KIT
VOLVO CONTINUED												
V50	2.4i	2006-2009	2.4		HB519x.682	F, N, G, V, S, E			HB478x.605	F, Z, N, G, U, S, E		
V50	I	2005-2005	All		HB519x.682	F, N, G, V, S, E			HB478x.605	F, Z, N, G, U, S, E		
V50	T5	2005-2009	All		HB549x.702	F, Z, N, G			HB478x.605	F, Z, N, G, U, S, E		
V50		2010-2011	All	w/278mm Front Rotor	HB519x.682	F, N, G, V, S, E			HB478x.605	F, Z, N, G, U, S, E		
V50		2010-2011	All	w/305mm Front Rotor	HB519x.682	F, N, G, V, S, E			HB478x.605	F, Z, N, G, U, S, E		
V50		2010-2011	All	w/320mm Front Rotor	HB515x.760	F, Z			HB478x.605	F, Z, N, G, U, S, E		
V70	2.4	2005-2007	2.4		HB491x.693	F, Z			HB652x.634	F, Z		
V70	2.5T	2005-2007	2.5		HB491x.693	F, Z			HB652x.634	F, Z		
V70	R	2004-2007	All		HB453x.585	F, Z, N, U, G, W, V, S, E			HB194x.570	F, Z, Y, N, U, V, S, E, W		
V70	T5	2001-2007	All		HB491x.693	F, Z			HB652x.634	F, Z		
V70	X/C	2001-2002	All		HB491x.693	F, Z			HB652x.634	F, Z		
V70	X/C AWD	1999-2000	All		HB492x.732	F, Z			HB652x.634	F, Z		
V70		1999-2000	All	2WD	HB492x.732	F, Z			HB172x.595	F, Z, N, U, G, W, M, S, E		
V90		1997-1998	All		HB413x.690	F						
XC70		2003-2007	2.5		HB491x.693	F, Z			HB652x.634	F, Z		

APPLICATION GUIDE

MFG	CALIPER	PAD	MFG	CALIPER	PAD
Aerospace Components	2 Piston	HB104x.485	AP Racing	CP4219	HB110x.654
Aerospace Components	4 Piston	HB100x.480	AP Racing	CP4567	HB192x.620
Aerospace Components	GT	HB101x.800	AP Racing	CP4586	HB108x.560
Aerospace Components	Single Floater	HB104x.485	AP Racing	CP4596	HB108x.560
Alcon	Advantage 6	HB109x.710	AP Racing	CP5020	HB108x.560
Alcon	Advantage 6 GT	HB109x.980	AP Racing	CP5040-10/11/12/13S4	HB192x.620
Alcon	4 Piston H-Type	HB107x.620	AP Racing	CP5040-20/21/22/23S4	HB114x.980
Alcon	4 Piston K-Type	HB184x.787	AP Racing	CP5040-30/31/32/33S4	HB114x.980
Alcon	4R-Type	HB118x.560	AP Racing	CP5040-5S4	HB110x.654
Alcon	B-Type	HB105x.775	AP Racing	CP5045	HB184x.787
Alcon	CAR22 48mm Radial Depth	HB351x.620	AP Racing	CP5060-10/11/12/13ST	HB122x.710
Alcon	CAR89 51mm Radial Depth	HB122x.710	AP Racing	CP5060-10/11/12/13ST	HB688x.710
Alcon	CAR89 51mm Radial Depth	HB688x.710	AP Racing	CP5060-2/3/4/5ST	HB109x.710
Alcon	CAR71i10	HB105x.775	AP Racing	CP5060-2/3/4/5ST	HB109x.650
Alcon	CAR 32	HB130x.775	AP Racing	CP5070	HB688x.710
Alcon	CAR94	HB331x1.17	AP Racing	CP5095	HB688x.710
Alcon	CAR95	HB349x1.18	AP Racing	CP5100	HB192x.620
Alcon	DP83	HB105x.980	AP Racing	CP5104	HB107x.62
Alcon	DP88	HB349x1.18	AP Racing	CP5108	HB192x.620
Alcon	H-Type	HB192x.620	AP Racing	CP5119	HB180x.560
Alcon	L-Type	HB167x.778	AP Racing	CP5144	HB107x.620
Alcon	MB4	HB105x.775	AP Racing	CP5211	HB108x.560
Alcon	Mono 4	HB655x.620	AP Racing	CP5219	HB110x.654
Alcon	Mono 6, model 4497	HB709x.630	AP Racing	CP5260-8/9/10/11	HB688x.710
Alcon	RC4498X600	HB655x.620	AP Racing	CP5270-2/3/4/5	HB688x.710
Alcon	R-Type (short profile)	HB118x.560	AP Racing	CP5311	HB108x.560
Alcon	2 Piston R-Type	HB118x.560	AP Racing	CP5316	HB180x.560
Alcon	TA-4	HB184x.650	AP Racing	CP5317	HB180x.560
Alcon	TA-4	HB184x.710	AP Racing	CP5420	HB167x.778
Alcon	TA-6	HB109x.710	AP Racing	CP5421	HB167x.778
Alcon	TA-6	HB109x.650	AP Racing	CP5510	HB167x.778
Alcon	TA-6+	HB349x1.18	AP Racing	CP5515	HB167x.778
Alcon	4 Piston TPC	HB221x1.18	AP Racing	CP5555	HB109x.710
Alcon	4 Piston P-Type	HB170x.650	AP Racing	CP5555	HB109x.650
Alcon	XF-Type (Scalloped)	HB224x1.12	AP Racing	CP5570	HB122x.710
Alcon	XR-6	HB109x1.12	AP Racing	CP5570	HB688x.710
Alcon	XT	HB238x1.18	AP Racing	CP5610	HB167x.778
Alcon	XT-4	HB238x1.18	AP Racing	CP5779	HB130x.775
Alcon	XT-6	HB238x1.18	AP Racing	CP5780	HB130x.775
AP Racing	CP2279	HB110x.775	AP Racing	CP5788	HB130x.775
AP Racing	CP2361	HB107x.620	AP Racing	CP5789	HB130x.775
AP Racing	CP2485	HB108x.560	AP Racing	CP5810	HB109x.980
AP Racing	CP2505	HB117x.380	AP Racing	CP5835	HB110x.775
AP Racing	CP2561	HB108x.560	AP Racing	CP5836	HB130x.775
AP Racing	CP2576	HB108x.560	AP Racing	CP5842	HB331x1.17
AP Racing	CP2577	HB108x.560	AP Racing	CP5845	HB331x1.17
AP Racing	CP3176	HB108x.560	AP Racing	CP5845	HB331x.854
AP Racing	CP3177	HB108x.560	AP Racing	CP5846	HB105x.980
AP Racing	CP3178	HB108x.560	AP Racing	CP5847	HB105x.980
AP Racing	CP3228	HB107x.620	AP Racing	CP5880	HB110x.775
AP Racing	CP3307	HB110x.654	AP Racing	CP5890	HB109x.980
AP Racing	CP3676	HB108x.560	AP Racing	CP5895	HB109x.980
AP Racing	CP3677	HB108x.560	AP Racing	CP6056	HB688x.710
AP Racing	CP3696	HB117x.380	AP Racing	CP6070	HB105x.980
AP Racing	CP3696-6E0	HB117x.380	AP Racing	CP6078	HB109x.980
AP Racing	CP3788	HB110x.775	AP Racing	CP6120	HB171x.590
AP Racing	CP3789	HB110x.775	AP Racing	CP6121	HB171x.590
AP Racing	CP3799	HB110x.775	AP Racing	CP6126	HB180x.560

SPECIALTY CALIPER GUIDE

MFG	CALIPER	PAD
AP Racing	CP6270	HB105x.980
AP Racing	CP6271	HB105x.980
AP Racing	CP6470	HB105x.980
AP Racing	CP6480	HB105x.980
AP Racing	CP6600	HB585x.660
AP Racing	CP6760	HB192x.620
AP Racing	CP7040	HB586x.660
AP Racing	CP7600	HB587x.630
AP Racing	CP7606	HB587x.630
AP Racing	CP7613	HB587x.630
AP Racing	CP9040	HB586x.660
AP Racing (Essex)	CP4751 (SC200)	HB101x.800
AP Racing (Essex)	CP4761 (SC200)	HB101x.800
AP Racing (Essex)	CP5200 (SC250)	HB110x.654
AP Racing (Essex)	CP5260 (SC660)	HB109x.980
AP Racing (Essex)	CP5270 (SC670)	HB109x.980
AP Racing (Essex)	CP5410 (SC240)	HB167x.778
AP Racing (Essex)	CP5751 (SC300)	HB101x.800
AP Racing (Essex)	CP5755 (SC100)	HB237x.625
AP Racing (Essex)	CP5756 (SC100)	HB237x.625
AP Racing (Essex)	CP5757 (SC100)	HB237x.625
AP Racing (Essex)	CP5805 (SC360/560)	HB102x.800
AP Racing (Essex)	CP5810 (SC660)	HB109x.112
AP Racing (Essex)	CP5820 (SC680)	HB331x.117
AP Racing (Essex)	CP5830 (SC430)	HB110x.775
AP Racing (Essex)	CP5850 (SC675)	HB221x.110
AP Racing (Essex)	CP5890 (SC670)	HB109x.112
AP Racing (Essex)	CP6751 (SC275)	HB101x.800
AP Racing (Essex)	CP6761 (SC275)	HB101x.800
AP Racing (Essex)	CP7751 (SC400)	HB101x.800
Baer	S4	HB100x.480
Baer	T4	HB249x.575
Baer	6P	HB247x.575
Baer	6S	HB122x.710
Baer	6S	HB688x.710
Baer	Alumisport	HB509x.678
Baer	IronSport	HB183x.585
Baer	GT	HB247x.575
Baer	GT Plus	HB247x.575
Baer	Sport (Front)	HB111x.610
Baer	Sport (Rear)	HB112x.540
Baer	SS (Front)	HB111x.610
Baer	SS (Rear)	HB112x.540
Baer	Track (Front)	HB111x.610
Baer	Track (Rear)	HB112x.540
Brakeman	F1 Tornado	HB117x.380
Brakeman	F2 Tornado	HB108x.560
Brakeman	F3 Tornado	HB100x.480
Brakeman	F3 Tornado	HB100x.625
Brakeman	F4 Tornado	HB101x.800
Brakeman	F5 Tornado	HB101x.800
Brakeman	Replacement Metric Style Caliper	HB119x.594
Brembo	20.5272.12/22	HB194x.570
Brembo	20.7958.30/40	HB168x.770
Brembo	20.8271.10/40	HB130x1.018
Brembo	20.8330.10/20	HB130x1.018
Brembo	20.8330.30/40	HB130x1.097
Brembo	20.8643.23/28/29	HB193x.670

MFG	CALIPER	PAD
Brembo	20.8644.10/22/23	HB193x.670
Brembo	Big Red	HB184x.650
Brembo	F-40	HB193x.670
Brembo	GT3R 4 Piston	HB184x.710
Brembo	GT3 Wide Annulus	HB699x1.14
Brembo	GT3 Wide Annulus	HB699x.984
Brembo	NASCAR Front	HB221x1.18
Brembo	NASCAR Front	HB331x1.17
Brembo	NASCAR Front	HB486x.708
Brembo	NASCAR Front	HB486x1.094
Brembo	NASCAR Rear	HB167x.778
Brembo	S4	HB141x.650
Brembo	X2.023.21/24	HB130x.775
Brembo	X2.028.01/04	HB130x.775
Brembo	X2.029.21/24	HB167x.778
Brembo	X2.029.71/74	HB167x.778
Brembo	X2.040.01/04	HB351x.620
Brembo	X6.059.41/44	HB167x.778
Brembo	X6.L4.01/04	HB331x1.17
Brembo	X6.L4.01/04	HB486x.708
Brembo	X6.L4.01/04	HB486x1.094
Brembo	X9.011.01/04	HB167x.778
Brembo	X9.011.31/34	HB167x.778
Brembo	X9.060.51/54	HB130x1.018
Brembo	X9.060.71/74	HB130x.980
Brembo	X9.066.91/94	HB351x.620
Brembo	X93.45.11/14	HB221x1.18
Brembo	X94.75.11/14	HB351x.620
Brembo	X96.14.01/04	HB167x.778
Brembo	X97.24.01	HB172x.595
Brembo	X97.24.10	HB172x.595
Brembo	X97.24.21	HB172x.595
Brembo	X97.24.31	HB172x.595
Brembo	X97.24.51	HB172x.595
Brembo	X97.24.61	HB172x.595
Brembo	X97.60.21/24	HB168x.770
Brembo	X97.60.41/44	HB105x.620
Brembo	X97.60.81/84	HB105x.620
Brembo	X98.A8.41/44	HB105x.620
Brembo	X98.A8.41/44	HB208x.620
Brembo	XA0.80.51/54	HB105x.708
Brembo	XA0.80.51/54	HB208x.708
Brembo	XA1.37.11/14	HB208x.708
Brembo	XA2.30.11/14	HB167x.620
Brembo	XA2.30.21/24	HB167x.620
Brembo	XA2.86.31/34	HB167x.620
Brembo	XA2.86.83/84	HB348x1.14
Brembo	XA2.E5.01/04	HB105x.775
Brembo	XA2.E5.01/04	HB208x.787
Brembo	XA2.E5.11/14	HB105x.775
Brembo	XA2.E5.11/14	HB208x.787
Brembo	XA2.E6.11/14	HB105x.620
Brembo	XA2.E6.11/14	HB208x.620
Brembo	XA2.E6.31/34	HB105x.620
Brembo	XA2.E6.31/34	HB208x.620
Brembo	XA2.E6.51/54	HB105x.620
Brembo	XA2.E7.01/04	HB105x.980
Brembo	XA2.E7.11/14	HB105x.980

SPECIALTY CALIPER GUIDE

MFG	CALIPER	PAD	MFG	CALIPER	PAD
Brembo	XA3.02.11/12	HB348x1.14	CNC	630	HB102x.800
Brembo	XA3.02.21/22	HB348x1.14	CNC	631	HB102x.800
Brembo	XA3.02.31/32	HB348x1.14	CNC	633	HB102x.800
Brembo	XA3.02.41/42	HB348x1.14	CNC	636	HB101x.800
Brembo	XA3.A4.01/04	HB167x.778	CNC	642	HB100x.480
Brembo	XA3.A4.41/44	HB167x.778	CNC	643	HB100x.480
Brembo	XA3.B7.51/54	HB348x1.14	CNC	644	HB104x.485
Brembo	XA3.G2.11/14	HB167x.778	CNC	645	HB104x.485
Brembo	XA4.10.01/04	HB351x.620	CNC	648	HB100x.480
Brembo	XA4.67.51/54	HB208x.866	CNC	651	HB104x.485
Brembo	XA4.C6.11/14	HB208x.866	CNC	652	HB104x.485
Brembo	XA4.D3.01/04	HB130x.980	CNC	654	HB101x.800
Brembo	XA4.F1.01/02	HB348x1.14	CNC	664	HB100x.480
Brembo	XA4.F1.11/12	HB348x1.14	CNC	672	HB104x.485
Brembo	XA4.F1.21/22	HB348x1.14	CNC	674	HB100x.480
Brembo	XA4.F1.31/32	HB348x1.14	Coleman	GM Metric	HB119x.594
Brembo	XA5.09.01/04	HB208x.708	Coleman	Series I	HB101x.800
Brembo	XA5.90.01/04	HB105x.775	Coleman	Series II	HB101x.800
Brembo	XA5.C2.01/02	HB348x1.14	Coleman	Series III	HB105x.708
Brembo	XA5.TO.01/04	HB130X.684	Coleman	Series III	HB105x.775
Brembo	XA5.TO.01/04	HB221X.684	Coleman	Series III	HB105x.980
Brembo	XA6.61.01/04	HB348x1.14	Coleman	Series IV	HB109x.710
Brembo	XA6.61.21/24	HB348X.980	Coleman	Series IV	HB109x.650
Brembo	XA6.H7.01/02	HB348x1.14	Coleman	Series IV	HB109x.980
Brembo	XA6.H7.11/14	HB105x.775	Coleman	Series IV	HB109x1.12
Brembo	XA6.L6.11/14	HB180X.560	CompBrake	Pro Race One	HB521x.800
Brembo	XA6.S0.01/04	HB605x.625	CompBrake	Pro Race Two	HB237x.480
Brembo	XA6.S0.21/24	HB605x.625	CompBrake	Pro Race Two	HB237x.625
Brembo	XA7.G0.11/12	HB167x.778	CompBrake	Comp-B16	HB237x.480
Brembo	XA7.G1.53/54	HB167x.778	CompBrake	Comp-B16	HB237x.625
Brembo	XA8.30.11/14	HB105x.980	CompBrake	Pro Race Three	HB100x.480
Brembo	XA8.30.51/54	HB105x.980	CompBrake	Pro Race Four	HB180x.560
Brembo	XA8.31.11/12	HB348x1.14	CompBrake	Pro Race Five	HB110x.654
Brembo	XA8.31.21/22	HB699x1.14	CompBrake	Pro Race Six	HB110x.654
Brembo	XA8.31.31/32	HB699x1.14	CompBrake	Pro Race Seven	HB184x.650
Brembo	XA8.U2.01	HB172x.595	Hawk	HCAS101	HB119x.594
Brembo	XA8.Z4.01/04	HB486x1.17	Hawk	HCAS300	HB247x.575
Brembo	XA9.Y6.53/54	HB130x.684	Hawk	HCAS301	HB247x.575
Brembo	XA9.Y6.53/54	HB221x.684	Hawk	HCAS302	HB247x.575
Brembo	XB0.L2.11/14	HB105X.980	Hawk	HCAS303	HB385x.640
Brembo	Caliper Family A	HB194x.570	Hawk	HCAS304	HB247x.575
Brembo	Caliper Family B	HB193x.670	Hawk	HCAS305	HB247x.575
Brembo	Caliper Family C	HB194x.570	Hawk	HCAS306	HB247x.575
Brembo	Caliper Family E	HB194x.570	Hawk	HCAS307	HB247x.575
Brembo	Caliper Family F	HB194x.570	Mark Williams	81100	HB237x.625
Brembo	Caliper Family G	HB609x.572	Mark Williams	82100	HB237x.480
Brembo	Caliper Family H	HB193x.670	Mark Williams	83100	HB104x.485
Brembo	Caliper Family J	HB581x.660	Outlaw	1000	HB104x.485
Brembo	Caliper Family M	HB582x.660	Outlaw	2000	HB100x.480
Brembo	Caliper Family N	HB581x.660	Outlaw	2800	HB237x.625
Brembo	Caliper Family P	HB193x.670	Outlaw	3000	HB101x.800
Brembo	B10	HB605x.625	Outlaw	4000	HB101x.800
Carbone Lorraine	4012	HB653x.606	Outlaw	4000XD	HB101x.800
CNC	623	HB104x.485	Outlaw	GM	HB103x.590
CNC	624	HB100x.480	Outlaw	Inboard Sprint Car Caliper	HB237x.625
CNC	625	HB100x.480	Outlaw	M-16	HB237x.625
CNC	626	HB100x.480	PFC	ZR34	HB654x.748
CNC	627	HB101x.800	Red Devil	300 Series	HB101x.800

MFG	CALIPER	PAD
Red Devil	600 Series - Short Track	HB238x1.18
Red Devil	Single Piston Floater	HB104x.485
Red Devil	260 Caliper, Metallic pads	HB100MB.480
Red Devil	300 Series, Metallic pads	HB101MB.775
Red Devil	100 Series Floating Caliper, Metallic pads	HB104MB.435
Red Devil	100 Series Solid mount Caliper, Metallic pads	HB696MB.450
Red Devil	LW 200 & 270 Caliper, Metallic pads	HB697MB.630
Red Devil	230, 240, 250 Calipers, Metallic pads	HB698MB.450
Rotora	RF201	HB180x.560
Rotora	RF202	HB180x.560
Rotora	RF401	HB105x.708
Rotora	RF402	HB105x.708
Rotora	RF403	HB110x.654
Rotora	RF404	HB110x.654
Rotora	RF801	HB609x.572
Rotora	FC2	HB180x.560
Rotora	FC4	HB193x.610
Rotora	FF4	HB105x.620
Rotora	FC6	HB109x.710
Rotora	FC8	HB609x.572
Sierra / JFZ	GM Series	HB103x.590
Sierra / JFZ	GN Series	HB102x.800
Sierra / JFZ	MGN Dual	HB100x.480
Sierra / JFZ	MGN Single	HB104x.485
Sierra / JFZ	XL Series	HB101x.800
Stop Tech	ST-10	HB405x.543
Stop Tech	ST-20	HB266x.650
Stop Tech	ST-21	HB172x.595
Stop Tech	ST-22	HB180x.560
Stop Tech	ST-40 / STR-40	HB141x.650
Stop Tech	STR-40GT	HB221x1.10
Stop Tech	ST-41	HB170x.650
Stop Tech	ST-42	HB542x.600
Stop Tech	ST-43	HB521x.650
Stop Tech	ST-45	HB141x.650
Stop Tech	ST-50	HB141x.650
Stop Tech	ST-60	HB122x.710
Stop Tech	ST-60	HB688x.710
Stop Tech	STR-60	HB688x.710
Strange	2 Piston	HB104x.485
Strange	4 Piston - Cotter Pin	HB267x.480
Strange	S-Series Caliper	HB583x.480
US Brake	DL Single	HB104x.485
US Brake	F22i	HB237x.480
US Brake	F22i	HB237x.625
US Brake	F33i	HB100x.480
US Brake	F88i	HB101x.800
US Brake	Oversize Metric GM	HB119x.594
US Brake	Standard GM	HB103x.590
US Brake	Stock Metric GM	HB119x.594
Wilwood	Forged Billet Aluminum D8-4 Corvette (D8)	HB126x.505
Wilwood	Forged Billet Aluminum D8-6 Corvette (D8)	HB126x.506
Wilwood	Combination Parking Brake Calipers (D340)	HB364x.642
Wilwood	BDL w/ Bridgebolt	HB541x.490
Wilwood	BDL w/ Cotter pin (7112)	HB540x.490

MFG	CALIPER	PAD
Wilwood	Dynalite - Billet w/bridge bolt	HB541x.490
Wilwood	Dynalite - Billet Narrow (7216)	HB541x.630
Wilwood	Dynalite - Billet Radial Narrow (7216)	HB541x.630
Wilwood	DLSF	HB104x.485
Wilwood	Dynalite	HB100x.480
Wilwood	Dynalite Single	HB104x.485
Wilwood	Dynalite w/ Bridgebolt	HB237x.480
Wilwood	Dynalite w/ Bridgebolt	HB237x.625
Wilwood	DynaPro Lug Mount (7812)	HB542x.490
Wilwood	Dynapro Lug Mount Forged Billet (7812)	HB542x.490
Wilwood	Dynapro Narrow Mount (7816)	HB542x.600
Wilwood	DynaPro NDL (7816)	HB542x.600
Wilwood	Dynalite - Forged Narrow Mount w/ Bridgebolt (7816)	HB542x.600
Wilwood	Dynapro Radial Mount Billet (7816)	HB542x.600
Wilwood	DynaPro 6 (Type 6712)	HB645x.490
Wilwood	FDL (7112)	HB540x.490
Wilwood	Dynalite - Forged w/cotter pin (7112)	HB540x.490
Wilwood	GM Metric	HB119x.594
Wilwood	GM Metric Aluminum Racing Calipers	HB119x.594
Wilwood	GMII, GM III	HB103x.590
Wilwood	GMIII (7520)	HB102x.800
Wilwood	GT 6000 - Radius	HB224x1.12
Wilwood	GT III - Radius	HB224x1.12
Wilwood	GT4000	HB105x.708
Wilwood	Integra HP	HB221x1.10
Wilwood	Integra IP	HB130x.980
Wilwood	Integra LP (9725)	HB369x.980
Wilwood	IR-GT	HB351x.620
Wilwood	IR-GT (7620)	HB351x.778
Wilwood	IR-GTR4 (7620)	HB351x.778
Wilwood	LC-GT	HB101x.800
Wilwood	NDL (7216)	HB541x.630
Wilwood	Prolite (9930)	HB238x1.18
Wilwood	Superlite 4R (7420)	HB521x.800
Wilwood	Superlite 6R (7420)	HB521x.800
Wilwood	Superlite II, III LC-GT	HB101x.800
Wilwood	Superlite SL4R (7420)	HB521x.800
Wilwood	Superlite ST (7420)	HB521x.800
Wilwood	Superlite-4/6, Forged (7420)	HB521x.800
Wilwood	Superlite-4/6, Forged, Thin (7416)	HB521x.650
Wilwood	Dynalite Single Floating (6812)	HB622x.488
Wilwood	DynaPro Single (6812)	HB622x.489
Wilwood	Dynalite Single (6812)	HB622x.490



HAWKPERFORMANCE.COM

SPECIALTY CALIPER GUIDE

Pad thickness in inches (and millimeters) to include core and friction material

Carry-over column for industry reference numbers and pad thickness

Hawk Performance part number

Hawk Performance compound codes

Industry reference numbers (FMSI)

Length in inches (and millimeters)

Original equipment and/or aftermarket caliper manufacturer

Width in inches (and millimeters)

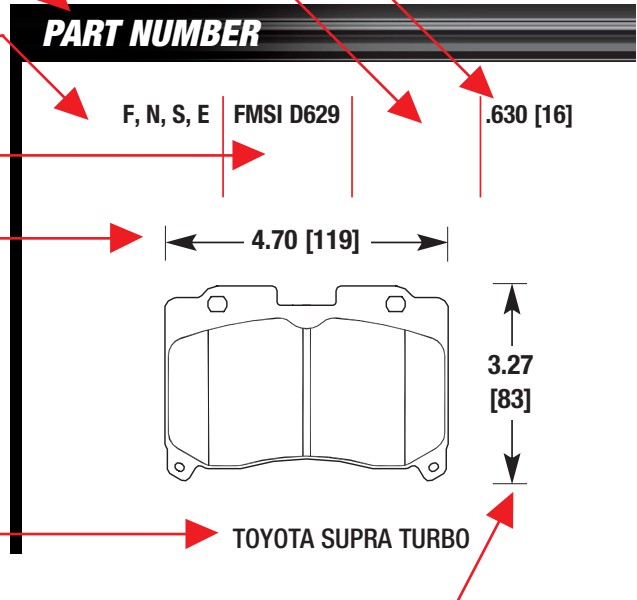

BRAKE PAD CODE BREAKDOWN			
H B	2 4 5	x	.6 3 1
HAWK BRAKE	PAD SHAPE	INSERT COMPOUND CODE	PAD THICKNESS

PAD/ROTOR KIT CODE BREAKDOWN			
H K	x	4 2 8	4 4 8
HAWK KIT	INSERT COMPOUND CODE	ROTOR	PAD SHAPE

STREET COMPOUNDS	
BRAKE PAD	COMPOUNDS
HPS Performance Street	F
Performance Ceramic	Z
LTS Light Truck & SUV	Y
SuperDuty	P



MOTORSPORTS COMPOUNDS	
BRAKE PAD	COMPOUNDS
DTC-70	U
DTC-60	G
DTC-30	W
DTC-15	A
DTC-05	H
HT-14	V
HT-10	S
Metallic	MB
MT-4	L
Blue 9012	E
Black	M
DR-97	J
HP Plus	N

BRAKE DIAGRAMS

HB100

F, N, E, G			.480 [12]
H, J, L, M			.625 [16]
MB, S, U, W			

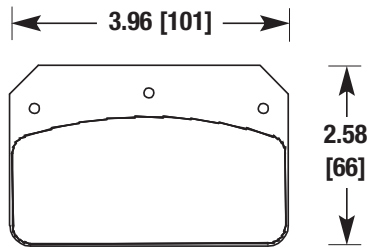

OUTLAW, SIERRA,
WILWOOD, RED DEVIL

HB103

F, N, P, Y, Z	FMSI D52		.590 [15]
A, E, G, H, L	FMSI D122		
M, S, U, W	FMSI D313		

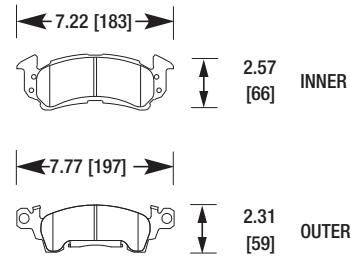

GM INTERMEDIATE

HB101

F, N, A, E			.800 [20]
G, H, L, M			
MB, S, U, W			

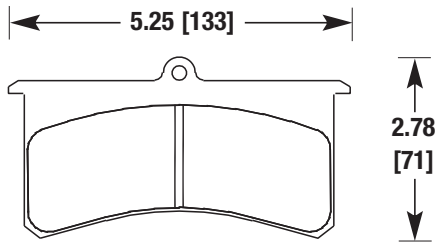

AP RACING, OUTLAW,
SIERRA, WILWOOD, RED DEVIL

HB104

F, N, E, H			.485 [12]
J, L, M, MB			
S, W			

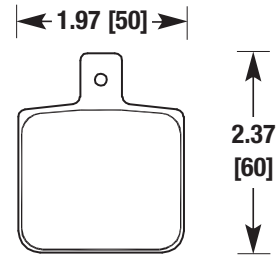

OUTLAW, SIERRA,
WILWOOD, RED DEVIL

HB102

F, N, E, G			.800 [20]
M, S, U, W			

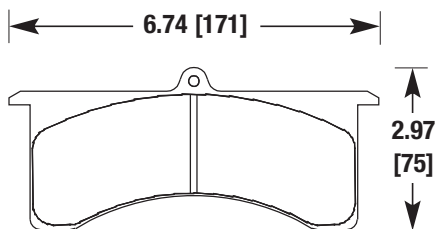

AP RACING, SIERRA,
WILWOOD

HB105

F, N, Z, E	.620 [16]		.980 [25]
G, U, W	.708 [18]		
	.775 [20]		

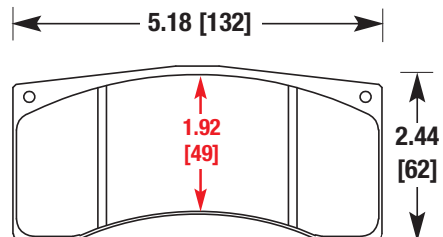

ALCON, BREMBO,
PORSCHE

BRAKE DIAGRAMS

HB107

E, G, S, U
V

.620 [16]

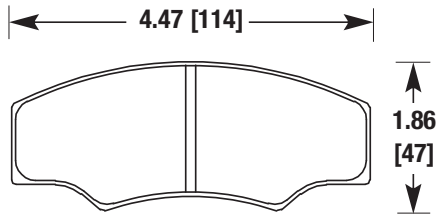

ALCON, AP RACING,
FORMULA ATLANTIC

HB110

F, N, Z, E
G, S, U, W

.654 [17]
.775 [20]

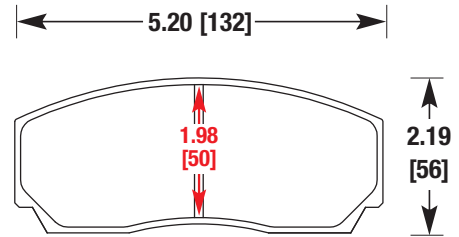

ALCON, AP RACING

HB108

E, G, M, S
V

FMSI D5	0.560 [14]
---------	------------

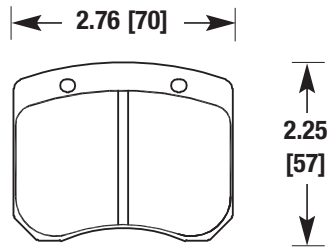

AP RACING,
FORMULA FORD 2000, LUCAS GIRLING

HB111

F, N, Z, E
G, M, S, U

FMSI D412	.610 [15]
-----------	-----------

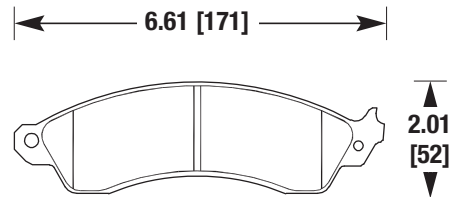

CAMARO, CORVETTE,
FIREBIRD, MUSTANG

HB109

F, Z, G, U

.650 [16]	1.120 [28]
.710 [18]	.800 [20]
.980 [25]	

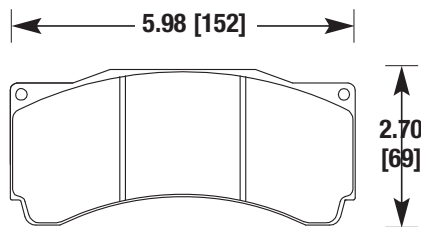

ALCON, AP RACING

HB112

F, N, Z, E
G, M, S, U

FMSI D213	.540 [14]
FMSI D295	
FMSI D413	

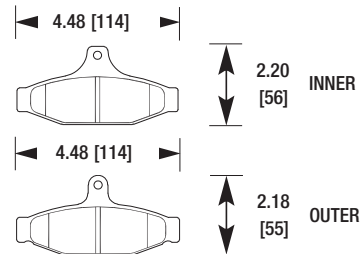

CAMARO, CORVETTE,
FIREBIRD (REAR)

HB113

F, N, E, G | FMSI D373 | .590 [15]

5.20 [132]

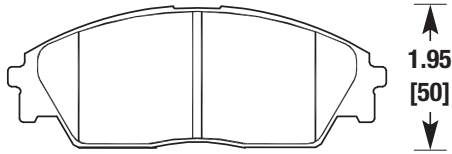

HONDA

HB117

E, M | | .380 [10]

2.34 [59]

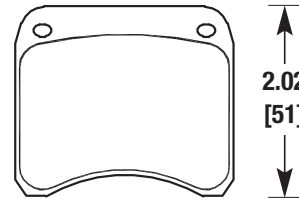

ALCON, AP RACING,
FORMULA FORD 1600

HB114

E | | .980 [25]

5.13 [130]

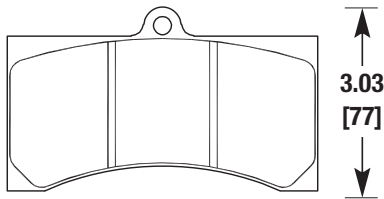

ALCON, AP RACING,
WILWOOD

HB118

E, M, V | FMSI D44 | .560 [14]

2.50 [64]

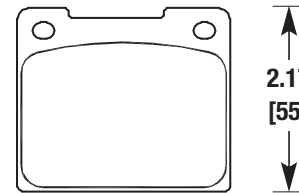

FORMULA MAZDA, LUCAS GIRLING

HB116

E, M, S | | .580 [15]

3.27 [83]

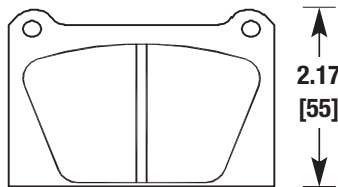

ALCON, LUCAS GIRLING

HB119

F, N, P, Y, Z | FMSI D138 | .594 [15]
A, E, G, H, L | FMSI D154 |
M, S, U, W | FMSI D202 |

6.00 [152]

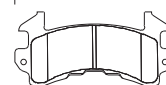

2.87 [73] INNER

4.83 [123]

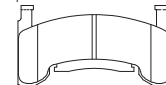

2.60 [66] OUTER

GM METRIC

HB120

F, N, Z, E | FMSI D531 | .560 [14]

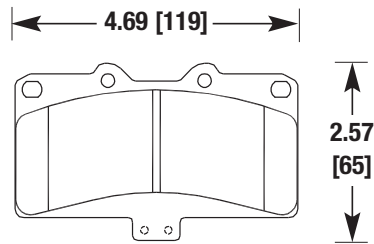

DODGE STEALTH, MITSUBISHI 3000GT

HB123

N, E, M | FMSI D61 | .535 [14]

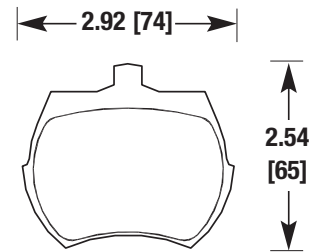

AUSTIN, MG,
MORRIS, TRIUMPH, WOLSELEY

HB121

S, U | .710 [18]
.980 [25]

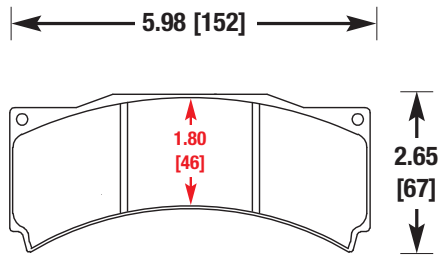

ALCON, AP RACING

HB125

F, Z, E | FMSI D199
FMSI D200
FMSI D499 | .650 [17]

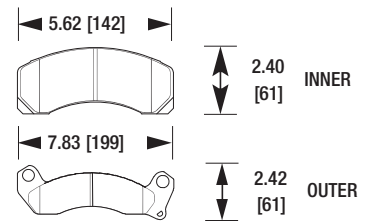

FORD, LINCOLN, MERCURY

HB122

N, Z, E, G | .710 [18]
U, W | .980 [25]

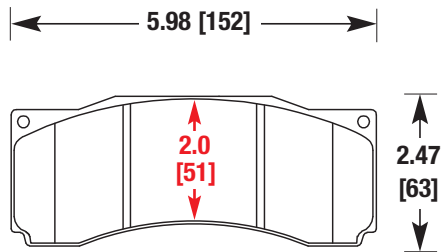

ALCON, AP RACING

HB126

F, N, Z, E | FMSI D8 | .505 [13]
S

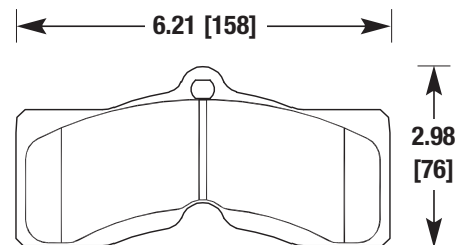

CHEVY, PONTIAC

HB128

F, E, S, U | .505 [13]

6.18 [157]

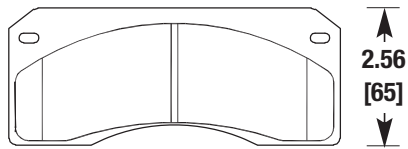

CORVETTE TWIN PIN

HB132

N, E, M | FMSI D27 | .580 [15]

3.50 [89]

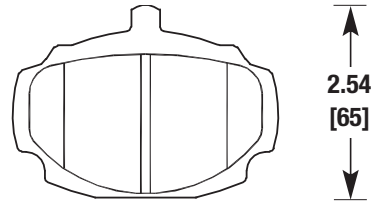

HUMBER, MG, SAAB, SINGER, VAUXHALL

HB130

G, U, W | 1.018 [26] | .684 [17]
1.097 [28] | .775 [20]
.980 [25]

5.47 [139]

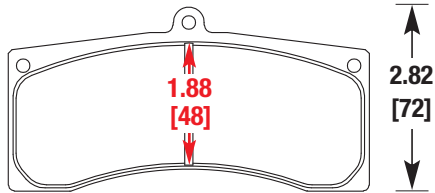

BREMBO, WILWOOD

HB135

F, N, Z, E | FMSI D394 | .642 [16]
G, S, U, V | FMSI D725 | .770 [20]

6.15 [156]

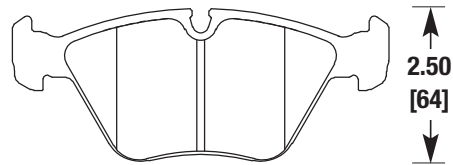

AUDI, BMW, JAGUAR

HB131

F, P, G, L | FMSI D153 | .595 [15]
M, U, W | FMSI D392
FMSI D614

7.21 [183]



INNER

7.77 [197]



OUTER

CHEVROLET IMPALA, CAPRICE, POLICE & HD

HB136

F, N, Z, E | FMSI D558 | .690 [18]
G, S, U

5.96 [151]

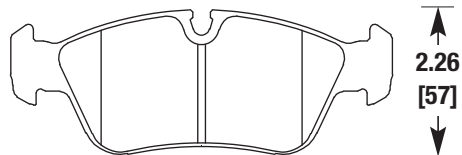

BMW

HB137

F, N, E, G	FMSI D253	.690 [18]
S, U	FMSI D395	

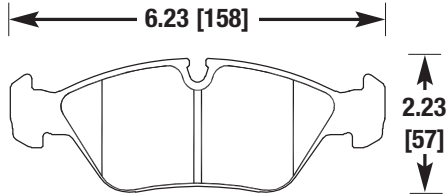

BMW, FERRARI, PORSCHE

HB143

F, N, Z, E	FMSI D503	.680 [17]
G, S, U, W		

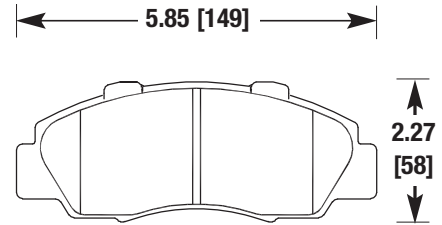

ACURA, HONDA, ISUZU

HB138

E, S		.690 [18]
------	--	-----------

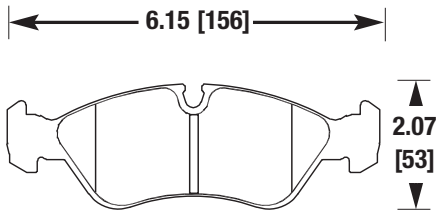

OPEL ASTRA

HB144

F, N, Z, E	FMSI D568	.690 [18]
U		.719

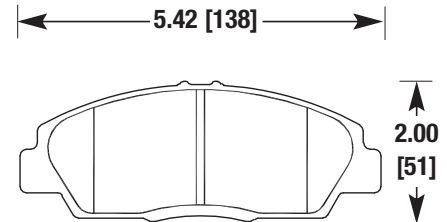

HONDA PRELUDE

HB141

F, N, Z, E	FMSI D372	.650 [17]
G, S, U, V	FMSI D447	.709
W	FMSI D609	

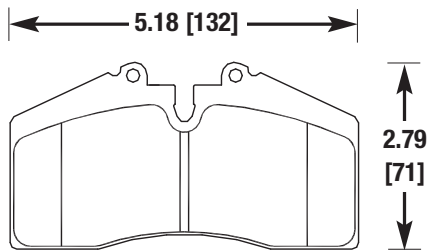

AUDI, FERRARI, PORSCHE

HB145

F, N, Y, Z	FMSI D537	.570 [14]
E, G, M, S		
U, W		

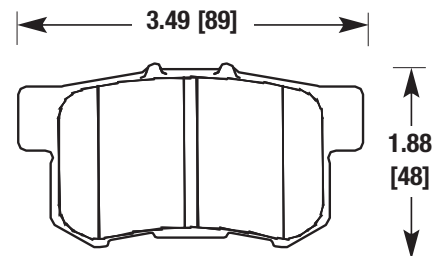

ACURA, HONDA, ISUZU (REAR)

HB148

F, N, Z, E | FMSI D457 | .560 [14]
 G, M, S, W | FMSI D468 |
 | FMSI D525 |

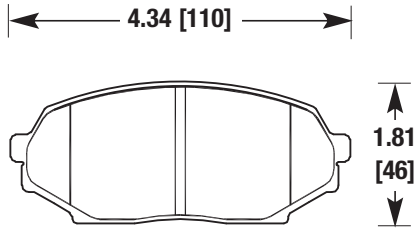

GEO, ISUZU, MAZDA, PONTIAC

HB151

F, E, M | FMSI D235 | .505 [13]

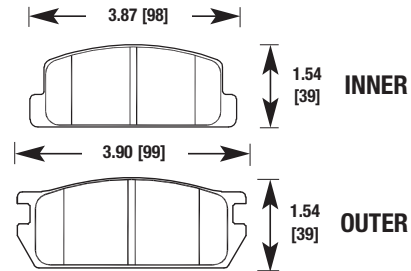

MAZDA RX-7 (REAR)

HB149

F, N, Z, E | FMSI D635 | .505 [13]
 G, M, S, W

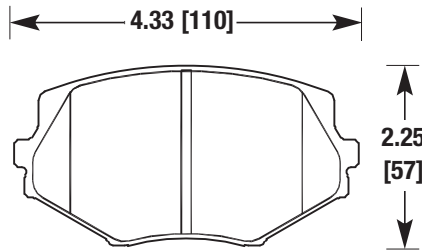

MAZDA MIATA

HB152

F, N, E, G | FMSI D131 | .540 [14]
 M

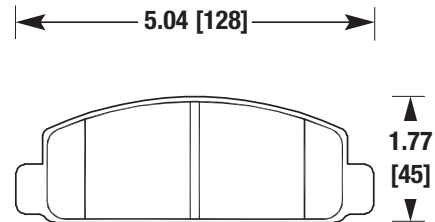

MAZDA RX-7

HB150

F, N, E | FMSI D76 | .555 [14]

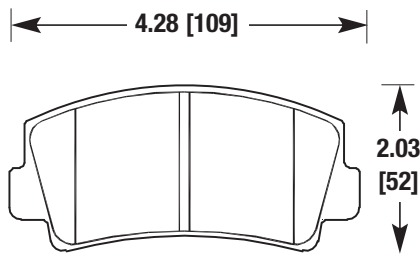

FORD, MAZDA

HB155

F, N, E, G | FMSI D331 | .580 [15]
 M, S | FMSI D463 |
 | FMSI D585 |

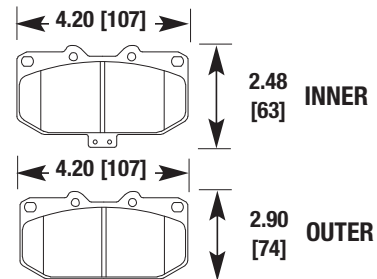

MAZDA RX-7

HB156

E	FMSI D94 FMSI D169 FMSI D172	.562 [14]
---	------------------------------------	-----------

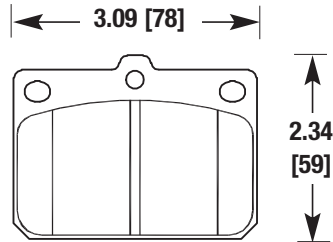

HYUNDAI, MAZDA, MITSUBISHI, TOYOTA

HB159

F, N, Z, E G, M, S, W	FMSI D636 FMSI D663	.492 [12]
--------------------------	------------------------	-----------

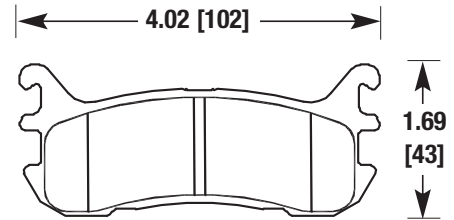

FORD, MAZDA, MERCURY (REAR)

HB157

F, N, E, G M, W	FMSI D458	.484 [12]
--------------------	-----------	-----------

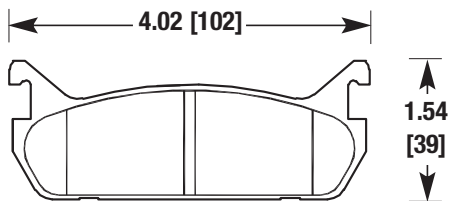

FORD, MAZDA, MERCURY (REAR)

HB167

G, U, W		.620 [16] .778 [20] .854 [22]
---------	--	-------------------------------------

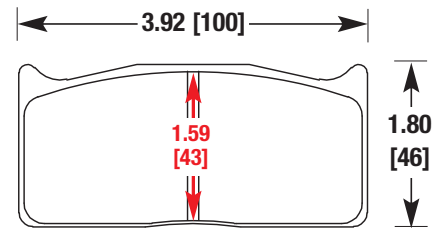

AP RACING, BREMBO, FORMULA ATLANTIC

HB158

F, N, Z, E G, M, S, W	FMSI D283 FMSI D332 FMSI D482	.515 [13]
--------------------------	-------------------------------------	-----------

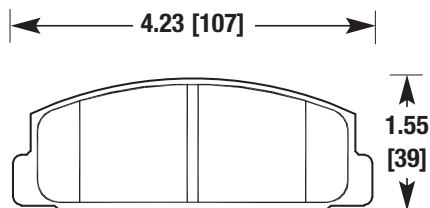

MAZDA RX-7 (REAR)

HB169

F, N, E, M S, U, W	FMSI D57 FMSI D114 FMSI D161	.560 [14]
-----------------------	------------------------------------	-----------

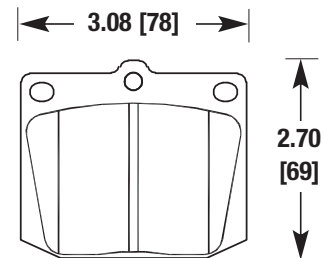

NISSAN

HB170

F, N, Z, E	FMSI D345	.650 [17]
G, M, S, U	FMSI D446	.710 [18]
	FMSI D608	

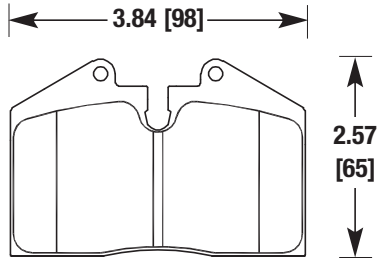

AUDI, FERRARI, PORSCHE

HB173

F, N, E	FMSI D294	.570 [14]
		.595 [15]

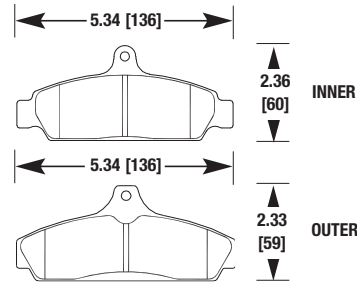

CORVETTE

HB171

F, N, Z, E	FMSI D45	.590 [15]
S, U, W	FMSI D287	.720

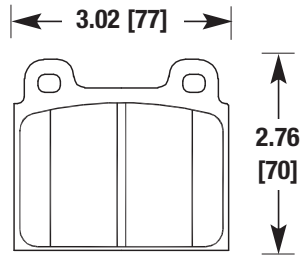

ALFA ROMEO, FERRARI, MERCEDES, OPEL, PORSCHE

HB176

F, N, Z, E	FMSI D415	FMSI D658	.614 [16]
M	FMSI D512	FMSI D759	.680 [17]
	FMSI D559	FMSI D782	
	FMSI D641		

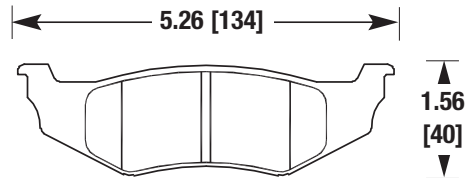

CHRYSLER, DODGE, EAGLE, PLYMOUTH (REAR)

HB172

F, N, Z, E	FMSI D31	.500 [13]
G, M, S, U	FMSI D58	.595 [15]
W	FMSI D861	

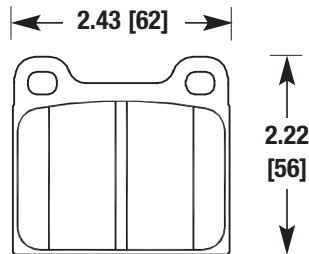

ALFA ROMEO, BMW, MERCEDES, PORSCHE, VOLVO

HB177

F, N, E, G	FMSI D642	.630 [16]
S		.710 [18]

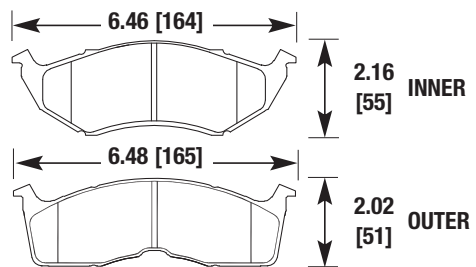

CHRYSLER, DODGE, EAGLE, PLYMOUTH

HB178

F, N, Z, E	FMSI D460	.564 [14]
G, S, W	FMSI D647	

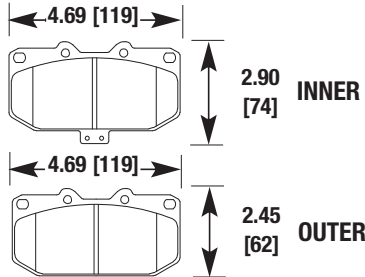

NISSAN 300ZX

HB181

F, N, Z, E	FMSI D639	.590 [15] .660 [17]
G, S, U	FMSI D960	

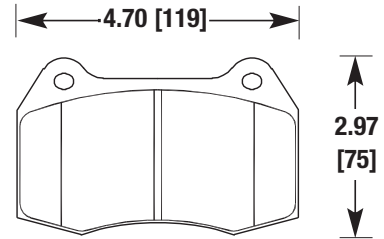

BMW, NISSAN

HB179

F, N, Z, E	FMSI D461	.630 [16]
S, W		

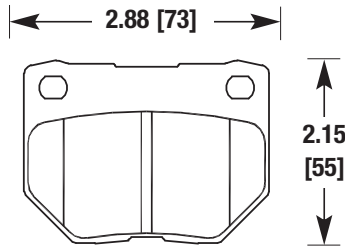

NISSAN 300ZX (REAR)

HB182

F, N, Z, E	FMSI D600	.660 [17]
------------	-----------	-----------

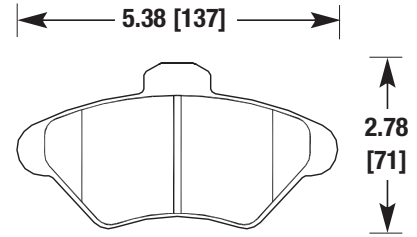

FORD, MERCURY

HB180

F, N, Z, E	FMSI D109	.560 [14]
G, S, U, W	FMSI D174	
	FMSI D961	

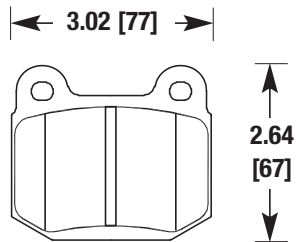

ALFA ROMEO, BMW, LOTUS,
NISSAN, OPEL

HB183

F, N, Z, E	FMSI D627	.585 [15] .660 [17]
G, M, U		

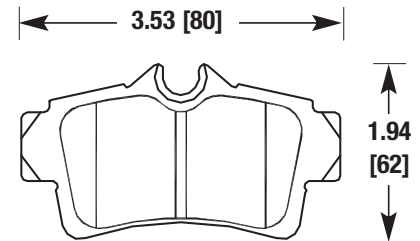

MUSTANG (REAR)

HB184

F, E, G, S U	FMSI D594	.650 [17] .710 [18] .787 [20]
-----------------	-----------	-------------------------------------

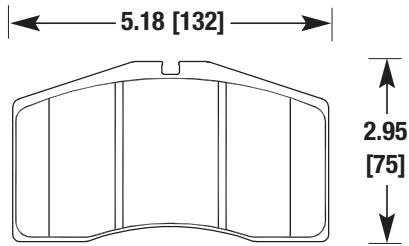

AUDI, BREMBO, PORSCHE

HB190

F, N, Z, E G, S, W	FMSI D227 FMSI D290 FMSI D684	FMSI D696	.600 [15] .730 [19]
-----------------------	-------------------------------------	-----------	------------------------

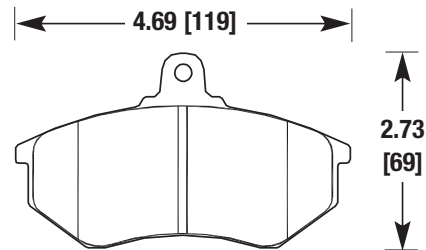

AUDI, VOLKSWAGEN

HB185

F, N, E	FMSI D504	.590 [15]
---------	-----------	-----------

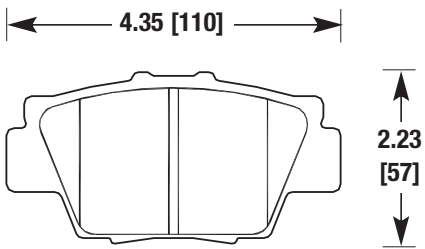

ACURA NSX (REAR)

HB191

F, N, E, S	FMSI D241 FMSI D242 FMSI D302	FMSI D539 FMSI D570	.590 [15]
------------	-------------------------------------	------------------------	-----------

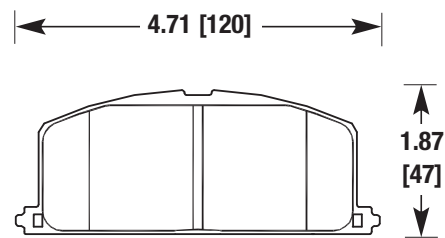

CHEVY, GEO, LEXUS, TOYOTA

HB189

N, Z, E, S W	FMSI D158 FMSI D206 FMSI D280	FMSI D307 FMSI D569	.550 [14] .595 [15]
-----------------	-------------------------------------	------------------------	------------------------

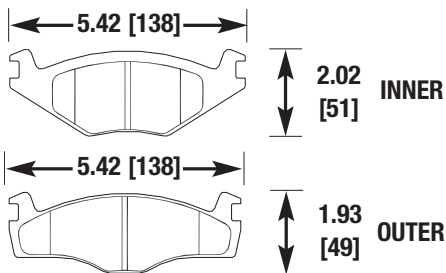

VOLKSWAGEN

HB192

G, S, U, W		.620 [16]
------------	--	-----------

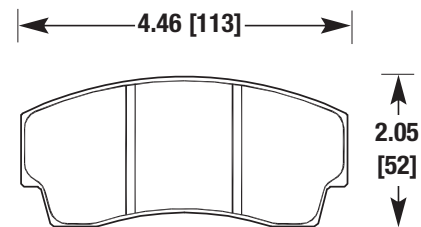

ALCON, AP RACING, FORMULA ATLANTIC

HB193

F, N, Z, E	FMSI D810	.610 [15]
G, S, U, V	FMSI D968	.670 [17]
W		.715 [18]

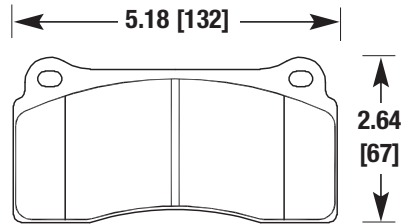

BREMBO F-40, DODGE, FERRARI,
JAGUAR, NISSAN

HB198

F, N, E, G	FMSI D252	.565 [14]
S	FMSI D254	.685 [17]
	FMSI D445	

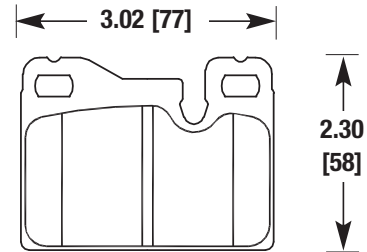

PORSCHE

HB194

F, N, Y, Z	FMSI D592	.570 [14]
E, G, S, U	FMSI D1053	.665 [17]
V, W		

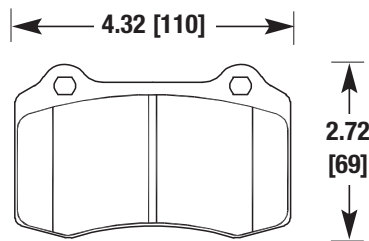

ESPIRIT, JAGUAR, MUSTANG, VIPER

HB199

F, N, E, G	FMSI D141	FMSI D443	.660 [17]
S, U	FMSI D251	FMSI D455	.702 [18]
	FMSI D424		

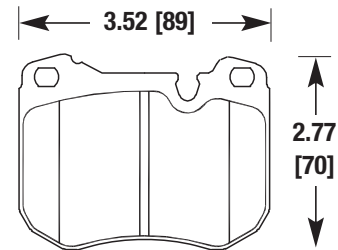

LAMBORGHINI, MERCEDES,
PEUGEOT, PORSCHE

HB195

F, N, Z, E	FMSI D278	FMSI D487	.640 [16]
G, S	FMSI D439	FMSI D493	
	FMSI D454		

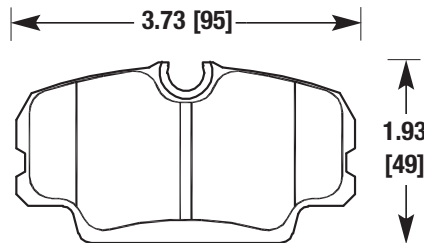

ALFA ROMEO, BMW, MERCEDES,
PEUGEOT, SAAB

HB201

F, N	FMSI D631	.620 [16]
------	-----------	-----------

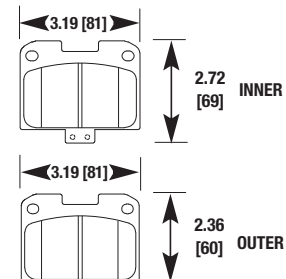

DODGE STEALTH, MITSUBISHI 3000GT (REAR)

HB202

F, N, E | FMSI D189 | .580 [15]
 FMSI D282

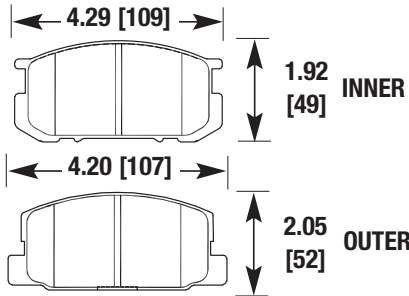

SUBARU, TOYOTA

HB206

E | FMSI D163 | .565 [14]

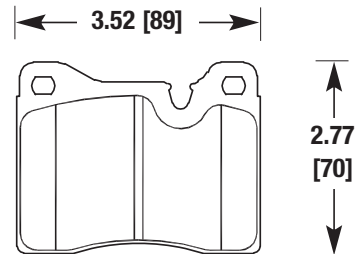

BMW, FERRARI, LAMBORGHINI, MASERATI

HB203

F, N, M | FMSI D305 | .550 [14]

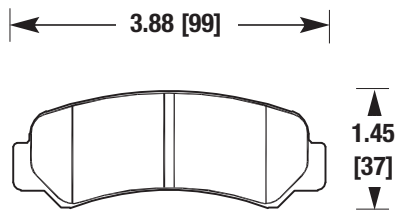

TOYOTA COROLLA (REAR)

HB208

G, U, V | .620 [16]
 .708 [18]
 .787 [20]
 .866 [22]

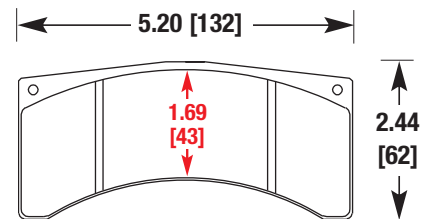

BREMBO F3000, WILWOOD

HB204

F, N, E, M | FMSI D43 | .615 [16]
 S

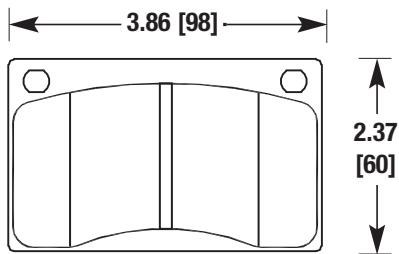

VOLVO

HB210

F, P, Y, Z | FMSI D477 | .677 [17]
 FMSI D712

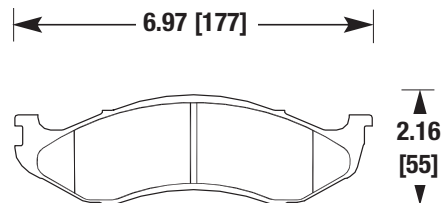

JEEP

HB211

F, N, Z, E | FMSI D583 | .606 [15]
 FMSI D637
 FMSI D893

5.18 [132]

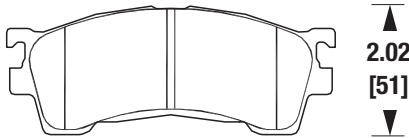

FORD, MAZDA

HB214

F, N, Z, E | FMSI D530 | .618 [16]
 G, S | FMSI D723

5.90 [150]

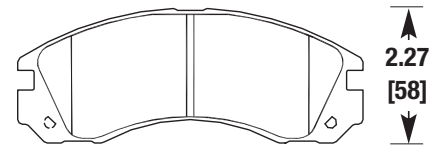

DODGE, EAGLE,
 MITSUBISHI, PLYMOUTH

HB212

F, N, E | FMSI D584 | .535 [14]

3.94 [100]

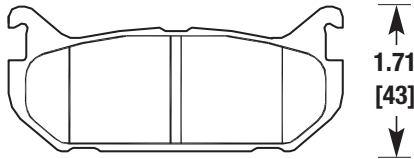

FORD, MAZDA (REAR)

HB215

F, N, S | FMSI D629 | .630 [16]

4.70 [119]

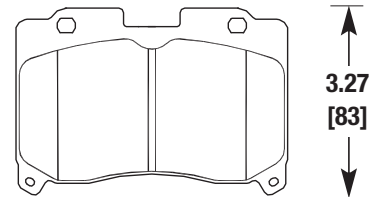

TOYOTA SUPRA TURBO

HB213

F, N, Z, E | FMSI D484 | .626 [16]

5.03 [128]

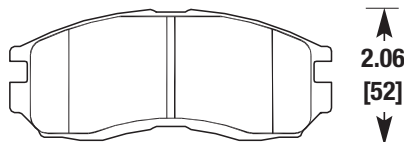

CHRYSLER, DODGE, EAGLE,
 MITSUBISHI, PLYMOUTH

HB216

F, E | FMSI D630 | .590 [15]

3.18 [81]

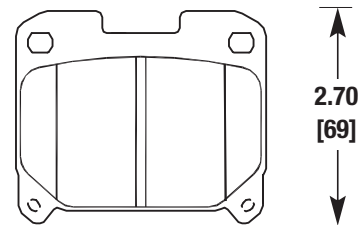

TOYOTA SUPRA TURBO (REAR)

HB217

F, Z, E | FMSI D623 | .681 [17]

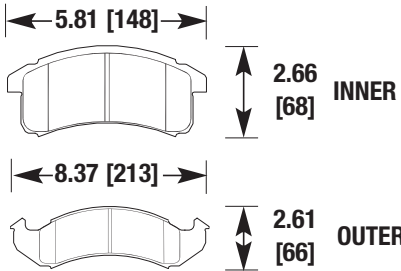

BUICK, CADILLAC, CHEVY, OLDS, PONTIAC

HB224

U | | 1.120 [28]

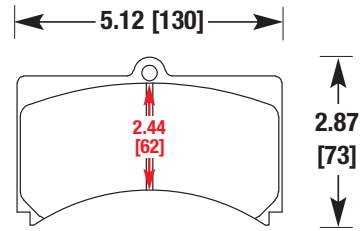

ALCON, WILWOOD

HB218

F, N, Z, E | FMSI D273 | .583 [15]
 G, S, U, W | FMSI D474 |
 | FMSI D560 |

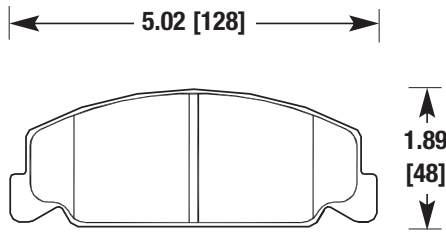

HONDA

HB227

F, N, Z, E | FMSI D396 | .630 [16]
 G, S, U | FMSI D692 |
 | FMSI D763 |

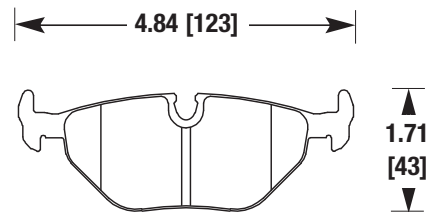

BMW, SAAB (REAR)

HB221

G, U | | .684 [17]
 | | 1.100 [28]
 | | 1.180 [30]

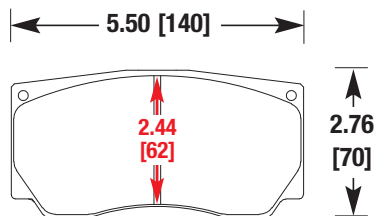

AP RACING, BREMBO, WILWOOD

HB229

E, S | FMSI D81 | .580 [15]

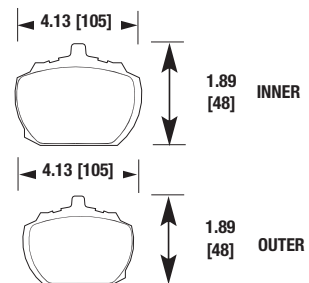

TRIUMPH

HB231

F, N, E | FMSI D422 | .575 [15]
.625 [16]

4.77 [121]

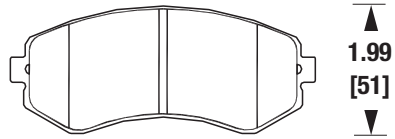

NISSAN 240SX

HB236

N, E | FMSI D668 | .622 [16]

4.27 [108]

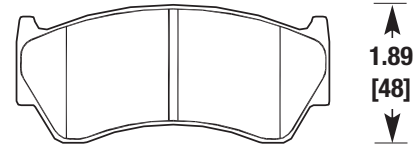

NISSAN

HB232

F, E | FMSI D376 | .681 [17]

5.52 [140]

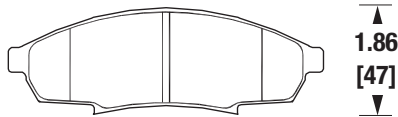

BUICK, CHEVY, OLDS, PONTIAC

HB237

F, N, Z, A | .480 [12]
E, G, H, L | .625 [16]
M, S, U, W

3.95 [100]

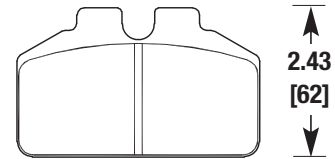

OUTLAW, SIERRA, WILWOOD

HB235

F, N, Z, E | FMSI D462 | .665 [17]
FMSI D485

5.40 [137]

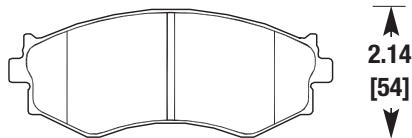

INFINITI, NISSAN

HB238

U | 1.180 [30]

5.98 [152]

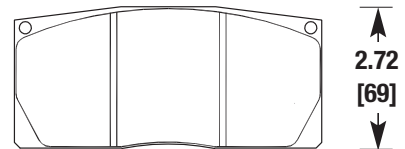

ALCON, WILWOOD

HB240

F, E | FMSI D417 | .620 [16]
 FMSI D421
 FMSI D597

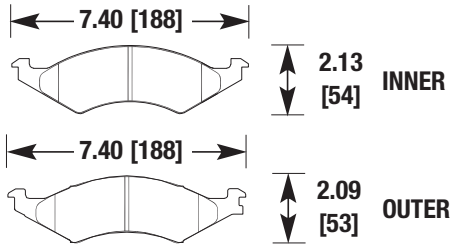

FORD, LINCOLN, MERCURY

HB245

F, N, Z, E | FMSI D617 | .631 [16]
 G, S

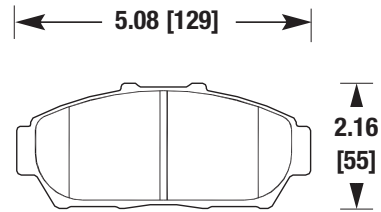

ACURA, HONDA

HB242

F, N, Z, E | FMSI D341 | .661 [17]
 G | FMSI D409

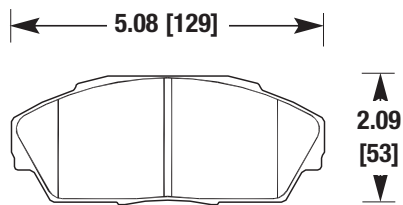

ACURA, HONDA

HB246

F, E, S | FMSI D473 | .567 [14]

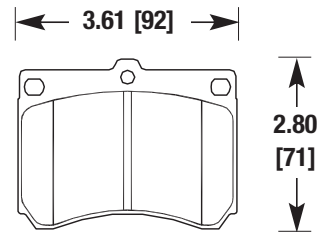

FORD, MAZDA, MERCURY

HB244

E, S | FMSI D4 | .624 [16]

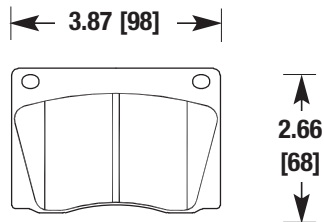

ALFA ROMEO, ASTON MARTIN,
 JAGUAR, LOTUS, VOLVO

HB247

F, N, Z, E | FMSI D731 | .575 [15]
 G, S, U, V
 W

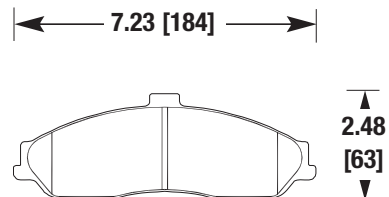

C-5 CORVETTE

HB248

F, N, Z, E | FMSI D732 | .650 [17]
G, S, U, W

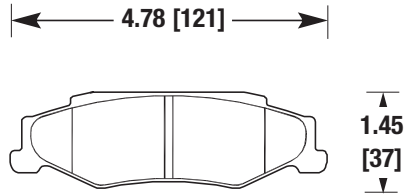

C-5 CORVETTE, CADILLAC XLR (REAR)

HB252

P, E | FMSI D184 | .860 [22]
FMSI D380
FMSI D717

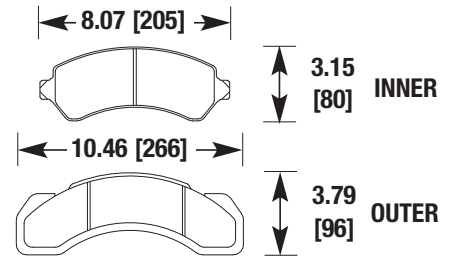

CHEVY/GMC TRUCK,
FREIGHTLINER, INTERNATIONAL

HB249

F, N, Z, G | FMSI D749 | .575 [15]
S, U, V, W

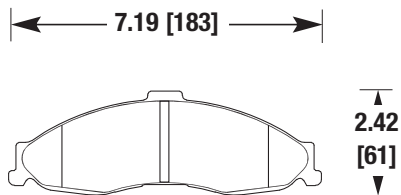

CAMARO, FIREBIRD

HB253

P, E | FMSI D224 | .750 [19]

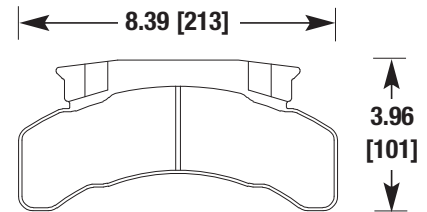

CHEVY/GMC TRUCK, FORD TRUCK

HB250

F, N, Z, E | FMSI D750 | .653 [17]
G, S, U

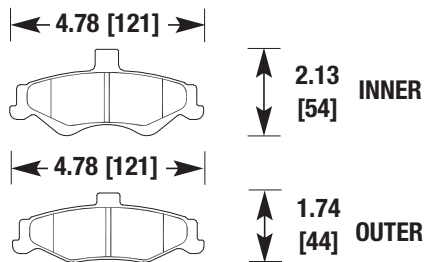

CAMARO, FIREBIRD (REAR)

HB254

P, E | FMSI D236 | 1.000 [25]

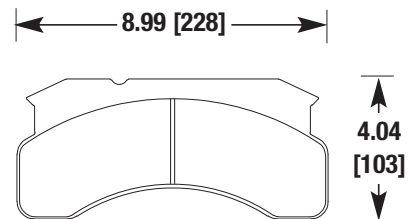

FORD MEDIUM DUTY

HB255

P, E | FMSI D120 | .655 [17]

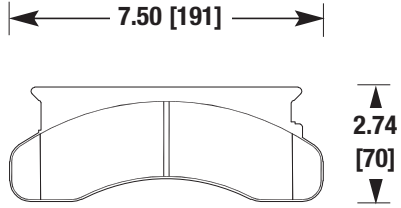

FORD TRUCK

HB263

F, N, Z, E | FMSI D431 | .650 [17]
G, U

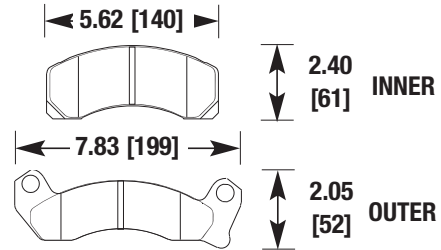

FORD

HB260

F, Z, E | FMSI D730 | .670 [17]

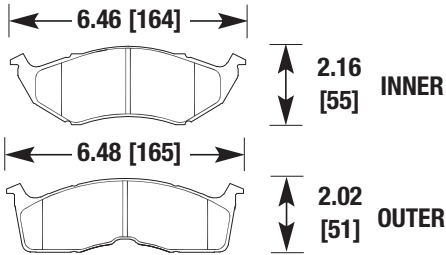

CHRYSLER, DODGE

HB266

F, P, Y, Z | FMSI D679 | .650 [17]

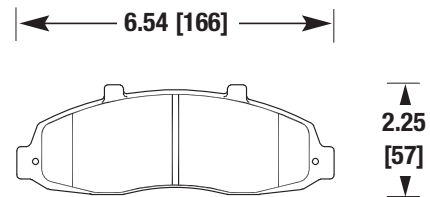

FORD F-150, LINCOLN BLACKWOOD

HB262

F, N, Z, E | FMSI D272 | FMSI D230 | .540 [14]
S | FMSI D323 | FMSI D231
FMSI D429 | FMSI D232
FMSI D464

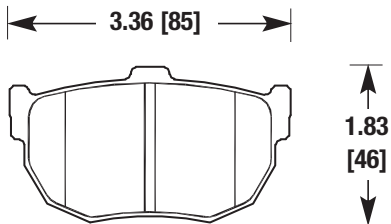

HYUNDAI, NISSAN (REAR)

HB267

J, W | RACE | .480 [12]

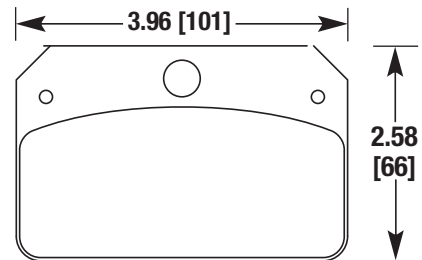

STRANGE W/ .438 CENTER HOLE

HB268

F, N, Z, G | FMSI D430 | .665 [17]
 FMSI D815
 FMSI D526

5.40 [137]

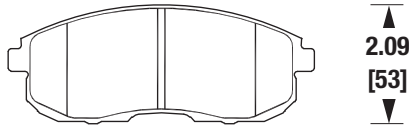

INFINITI, NISSAN

HB271

F, N, Z, E | FMSI D228 | .635 [16]
 FMSI D306
 FMSI D851

3.42 [87]

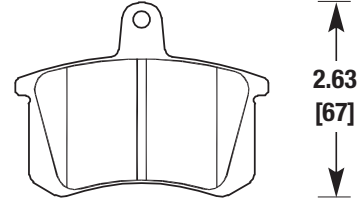

ALFA ROMEO, AUDI, VOLKSWAGEN (REAR)

HB269

F, Z, E | FMSI D555 | .763 [19]

6.15 [156]

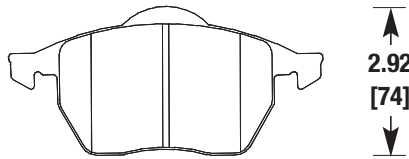

AUDI, VOLKSWAGEN

HB272

F, N, Z, E | FMSI D687 | .763 [19]

6.15 [156]

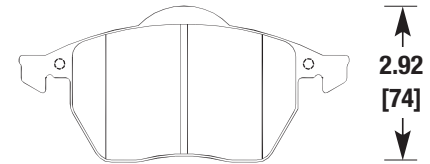

AUDI, VOLKSWAGEN

HB270

F, E | FMSI D362 | .724 [18]
 FMSI D419

5.70 [145]

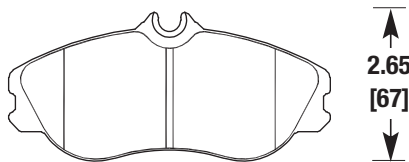

AUDI

HB274

F, N, Z, E | FMSI D804 | .610 [15]
 S

6.88 [175]

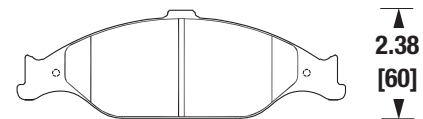

FORD MUSTANG

HB275

F, N, Z, E	FMSI D465	.620 [16]
G, S, U, W	FMSI D764	.660 [17]
		.720 [18]

← 5.43 [138] →

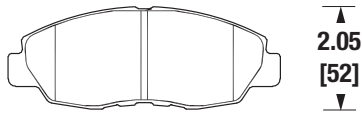

ACURA, HONDA

HB283

F, P, Y, Z	FMSI D652	.650 [17]
------------	-----------	-----------

← 6.06 [154] →

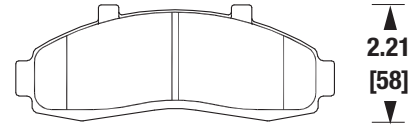

FORD TRUCK, MAZDA, MERCURY

HB278

F, N, E, S	FMSI D491	.465 [12]
W		.583 [15]

← 4.96 [126] →

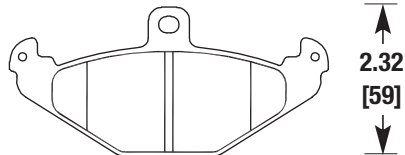

LOTUS ELISE, DODGE VIPER (REAR)

HB284

Z, E	FMSI D664	.575 [15]
------	-----------	-----------

← 5.52 [140] →



INNER

← 5.52 [140] →

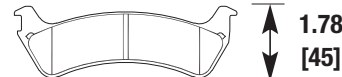

OUTER

FORD WINDSTAR (REAR)

HB279

Y, E	FMSI D205	FMSI D607	.594 [15]
	FMSI D249	FMSI D654	
	FMSI D387		

← 6.29 [160] →



INNER

← 6.77 [172] →



OUTER

FORD RANGER

HB285

F, E	FMSI D625	.595 [18]
------	-----------	-----------

← 5.52 [140] →

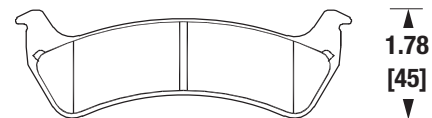

1.78

[45]

JEEP GRAND CHEROKEE

HB286

F, Y, E | FMSI D666 | .591 [15]
 FMSI D713

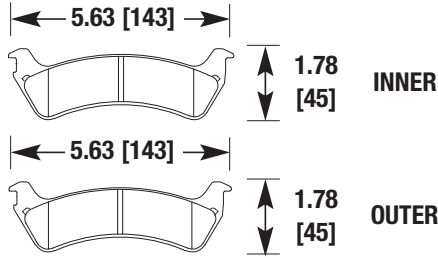

JEEP GRAND CHEROKEE (REAR)

HB290

F, N, Z, E | FMSI D738 | .583 [15]
 G, H, S, U
 W

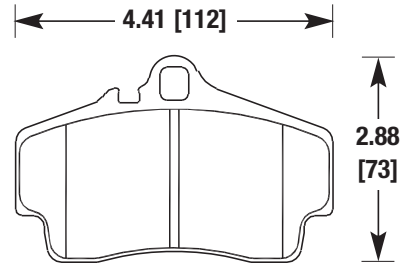

PORSCHE (REAR)

HB287

F, Z, E | FMSI D667 | .571 [15]

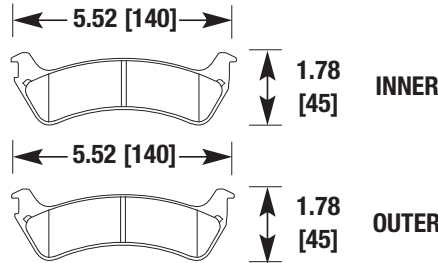

FORD EXPLORER, MERCURY MOUNTAINEER

HB291

F, E, G, S | FMSI D776 | .642 [16]
 U

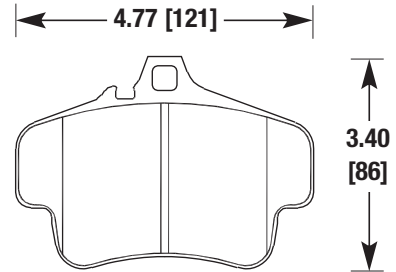

PORSCHE

HB289

F, N, Z, E | FMSI D737 | .610 [15]
 G, H, S, W

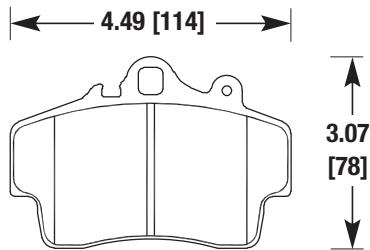

PORSCHE BOXSTER

HB292

F, P, E | FMSI D50 | .674 [17]
 FMSI D92

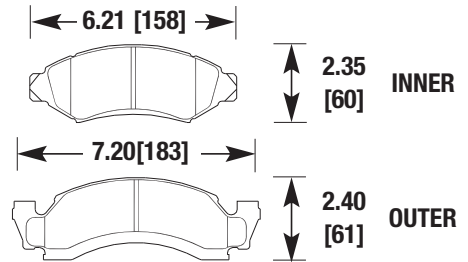

FORD, LINCOLN, MERCURY

HB293

F, E | FMSI D360 | .668 [17]
 FMSI D375

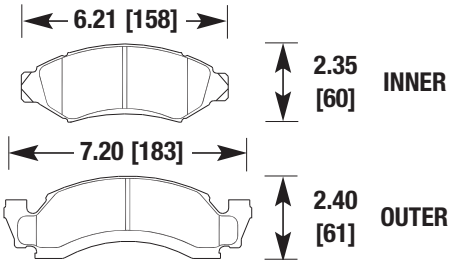

FORD TRUCK

HB296

F, P, Y, Z | FMSI D370 | .670 [17]
 FMSI D845

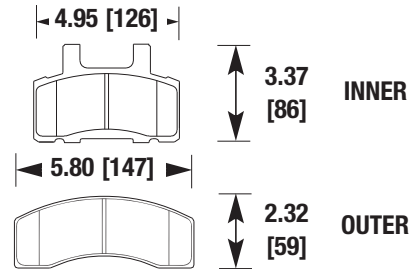

CHEVY/GMC TRUCK, DODGE TRUCK

HB294

F, E | FMSI D748 | .646 [16]

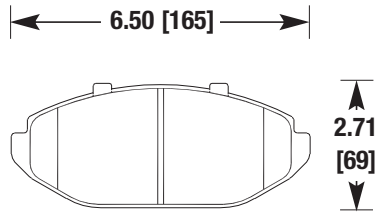

FORD, LINCOLN, MERCURY

HB298

F, Y, P, E | FMSI D459 | .787 [20]

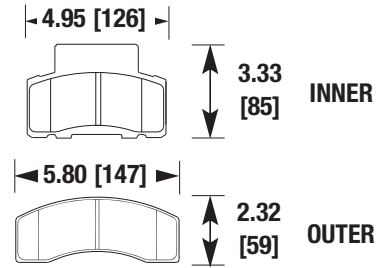

CHEVY/GMC TRUCK, DODGE TRUCK

HB295

F, Y, P, E | FMSI D626 | .630 [16]
 FMSI D632

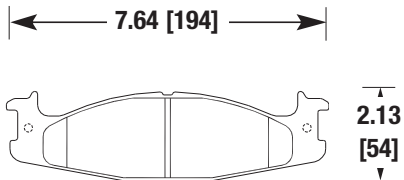

FORD TRUCK

HB299

F, P, Y, Z | FMSI D702 | .650 [17]

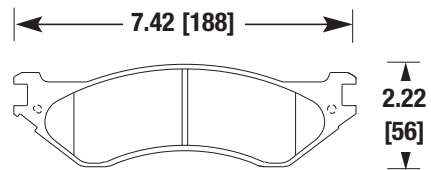

DODGE TRUCK, FORD TRUCK, LINCOLN

HB301

F, P, Y, Z | FMSI D711 | .630 [16]
 FMSI D879

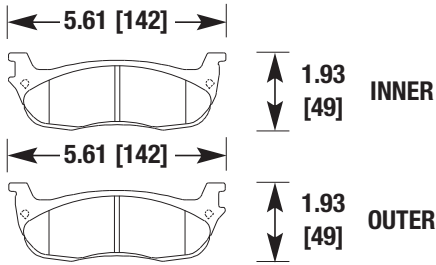

FORD TRUCK, LINCOLN (REAR)

HB304

F, Y, Z, E | FMSI D726 | .598 [15]

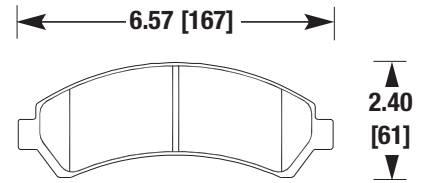

CHEVY/GMC TRUCK, ISUZU, OLDS

HB302

F, P, Y, Z | FMSI D756 | .700 [18]
 FMSI D824



FORD TRUCK

HB305

F, P, Y, Z | FMSI D729 | .610 [15]

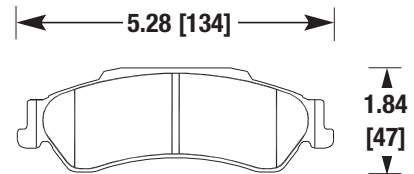

CHEVY/GMC TRUCK, ISUZU, OLDS (REAR)

HB303

F, P, Y, Z | FMSI D757 | .685 [17]

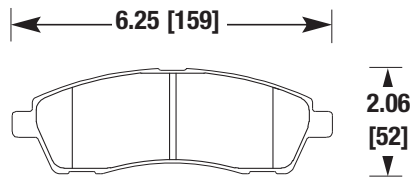

FORD TRUCK (REAR)

HB306

F, E | FMSI D746 | .795 [20]

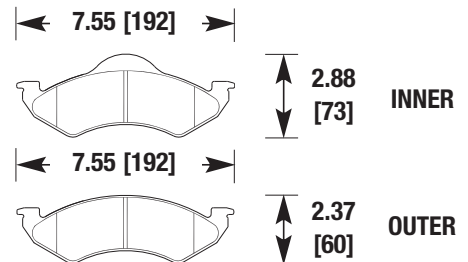

DODGE DAKOTA/DURANGO

HB307

F, P, Y, Z | FMSI D820 | .795 [20]

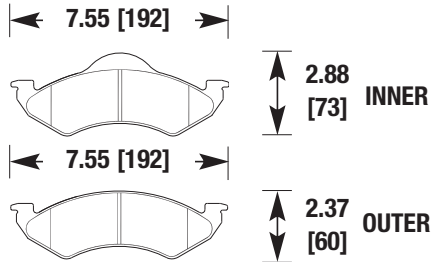

DODGE DAKOTA/DURANGO

HB312

F, P, Y, E | FMSI D502 | .591 [15]

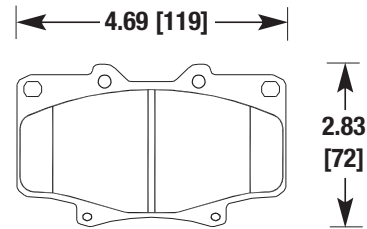

LEXUS LX450, TOYOTA LANDCRUISER

HB310

F, Z, E | FMSI D562 | .689 [18]
FMSI D695

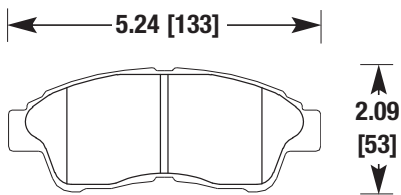

GEO, TOYOTA

HB313

F, Y, E | FMSI D772 | .685 [17]

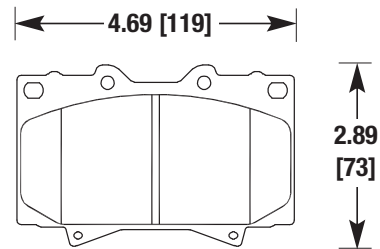

LEXUS LX470, TOYOTA LANDCRUISER

HB311

F, Y, E | FMSI D611 | .591 [15]

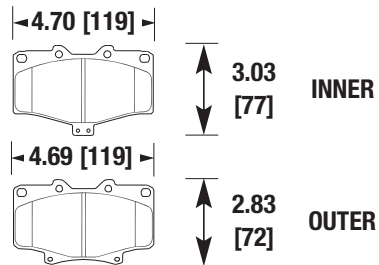

TOYOTA

HB314

F, Y, P, E | FMSI D812 | .665 [17]

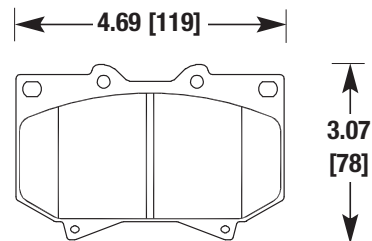

TOYOTA SEQUOIA/TUNDRA

HB315

F, P, Y, Z | FMSI D436 | .669 [17]

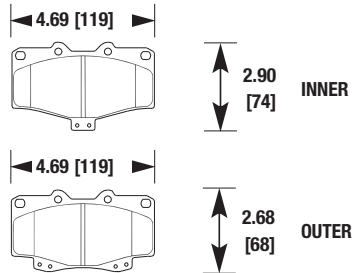

TOYOTA

HB320

F, Z, E | FMSI D707 | .669 [17]

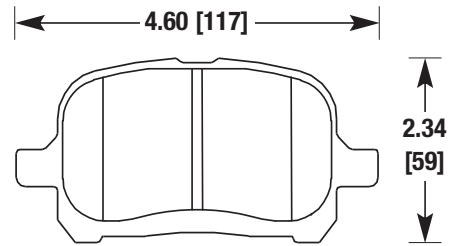

LEXUS, TOYOTA

HB316

F, P, Y, Z | FMSI D799 | .670 [17]

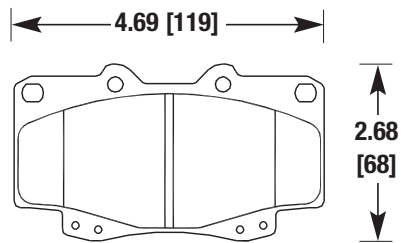

TOYOTA TACOMA

HB321

F, E | FMSI D741 | .650 [17]

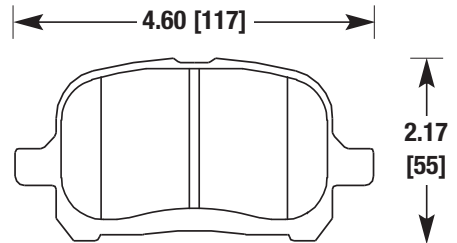

CHEVY, TOYOTA

HB318

F, Z, E | FMSI D697 | .669 [17]
 FMSI D718
 FMSI D744

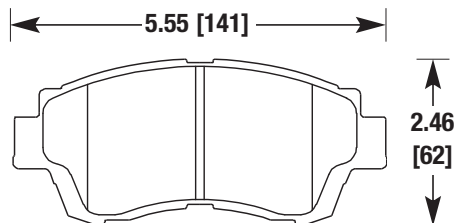

LEXUS, TOYOTA

HB322

F, P, Y, Z | FMSI D784 | .717 [18]

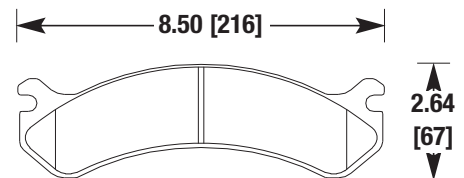

CADILLAC, CHEVY/GMC TRUCK,
 HUMMER H2

HB323

F, P, Y, Z | FMSI D785 | .724 [18]

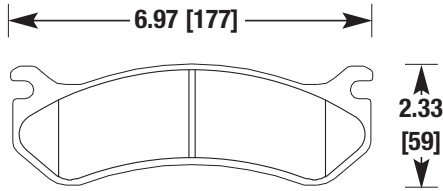

CADILLAC, CHEVY/GMC TRUCK,
HUMMER H2

HB326

F, Y, Z, E | FMSI D691
FMSI D855 | .646 [16]

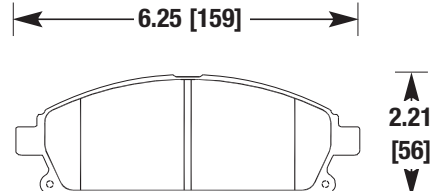

INFINITI, NISSAN

HB324

F, P, Y, Z | FMSI D792 | .673 [17]

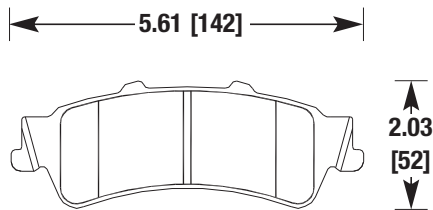

CADILLAC,
CHEVY/GMC TRUCK (REAR)

HB327

P, E | FMSI D786 | .799 [20]
1.050 [27]

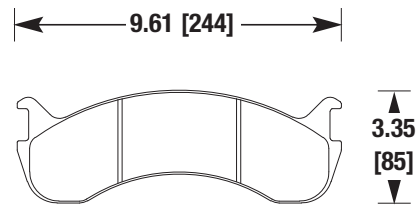

INTERNATIONAL

HB325

F, N, Y, Z | FMSI D547
S | FMSI D681 | .720 [18]

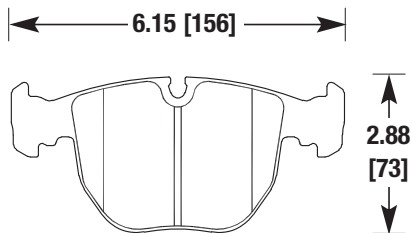

BMW

HB328

F, N, Z, S | FMSI D817 | .685 [17]

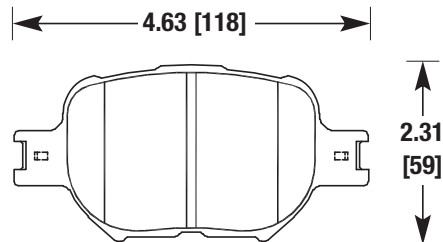

TOYOTA CELICA

HB329

F, E | FMSI D823 | .543 [14]

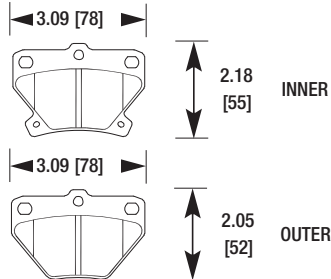

TOYOTA CELICA (REAR)

HB334

P, Y, E | FMSI D655 | .705 [18]
.736 [19]

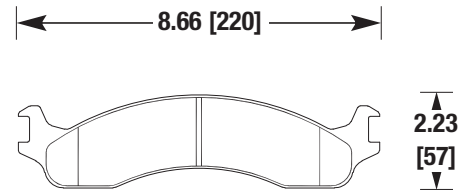

DODGE TRUCK, FORD TRUCK

HB331

G, U | .854 [22]
1.170 [30]

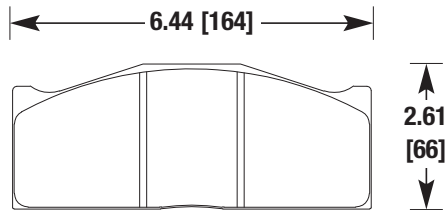

AP RACING, BREMBO
TRANS AM

HB335

P, E | FMSI D777 | .815 [21]

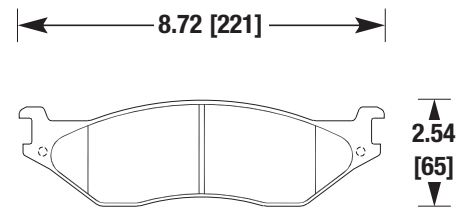

FORD TRUCK

HB332

F, P, Y, Z | FMSI D369
FMSI D789 | .654 [17]

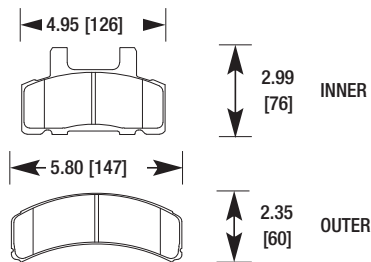

CADILLAC, CHEVY/GMC TRUCK,
DODGE TRUCK

HB336

Y, E | FMSI D450 | .655 [17]

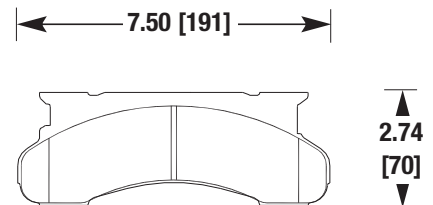

FORD TRUCK

HB340

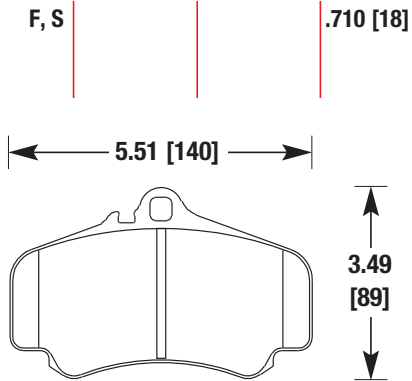

PORSCHE 996 GTR

HB347

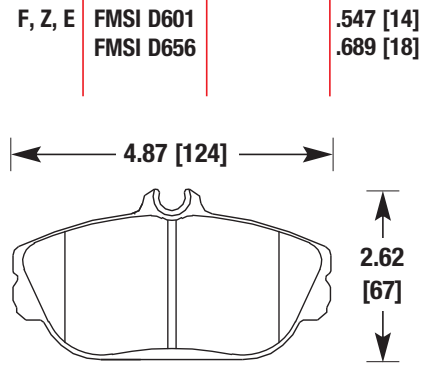

FORD, LINCOLN, MERCURY

HB341

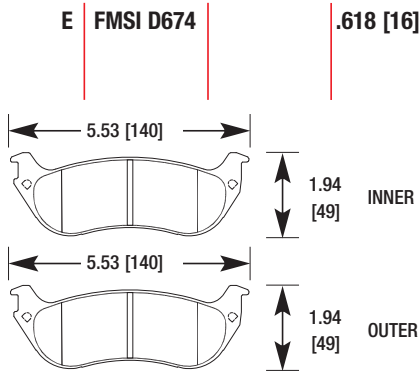

FORD, LINCOLN, MERCURY (REAR)

HB348

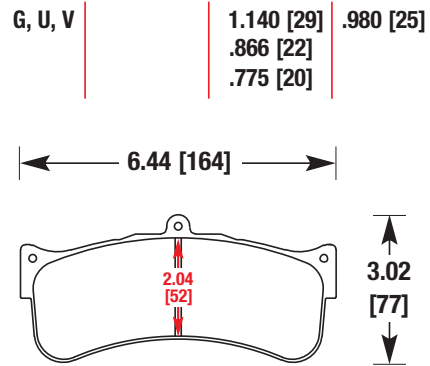

BREMBO

HB346

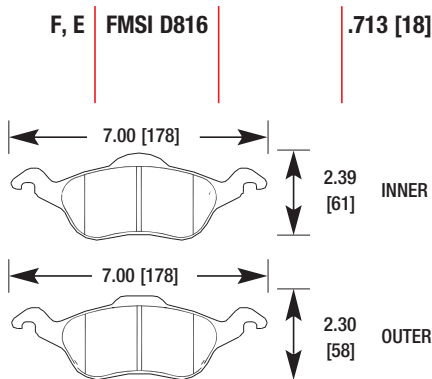

FORD FOCUS

HB349

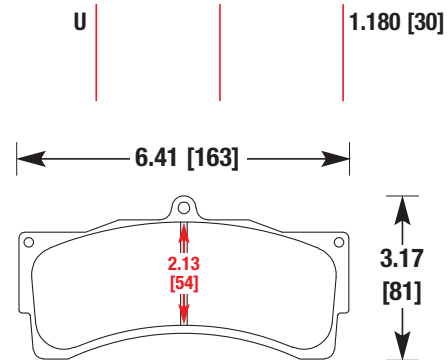

ALCON, AP RACING

HB350

F, N, Z, E	FMSI D339	.496 [13]
G, M, W	FMSI D374	.866 [22]
	FMSI D564	

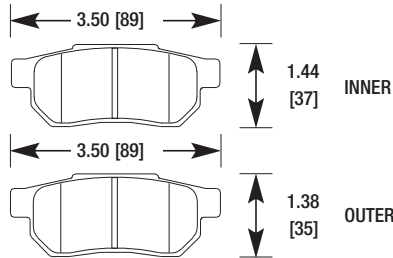

ACURA, HONDA (REAR)

HB353

F, Y	FMSI D690	.618 [16]
------	-----------	-----------

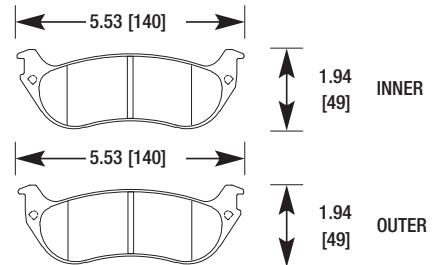

FORD, LINCOLN, MERCURY (REAR)

HB351

E, G, U, V		.620 [16]
S		.778 [20]

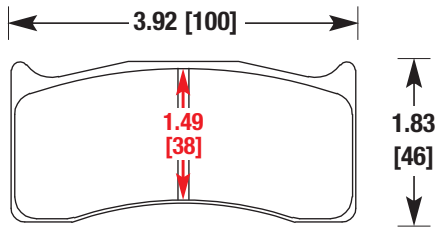

BREMBO, TOYOTA ATLANTIC, WILWOOD

HB354

F, Z, E	FMSI D836	.756 [19]
	FMSI D840	

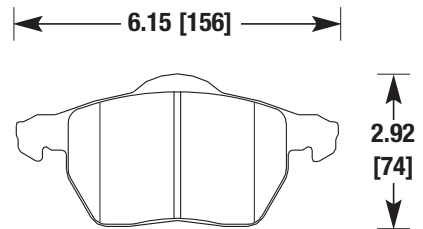

AUDI, VOLKSWAGEN

HB352

F, N, Z, E	FMSI D721	.665 [17]
S		

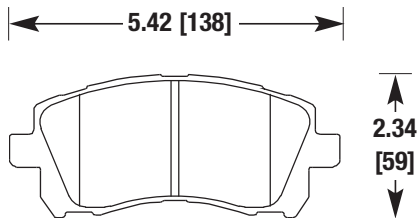

SUBARU

HB359

F, Z, G	FMSI D508	FMSI D754	.543 [14]
	FMSI D698	FMSI D814	
	FMSI D714		

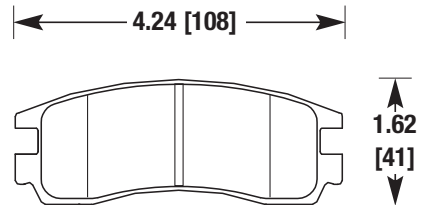

BUICK, CADILLAC, CHEVY, OLDS, PONTIAC (REAR)

HB360

F, Z, E | FMSI D699 | FMSI D1224 | .670 [17]
 FMSI D818
 FMSI D850

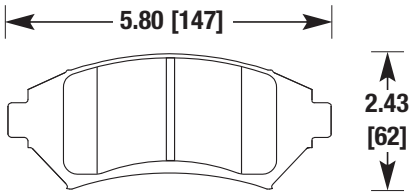

BUICK, CADILLAC, CHEVY,
 OLDS, PONTIAC

HB363

E | FMSI D839 | .689 [18]
 FMSI D912

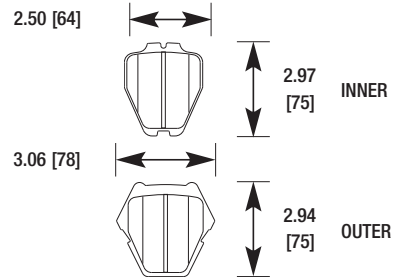

AUDI, VOLKSWAGEN

HB361

F, N, Z, E | FMSI D829 | .622 [16]
 G, S, U, W

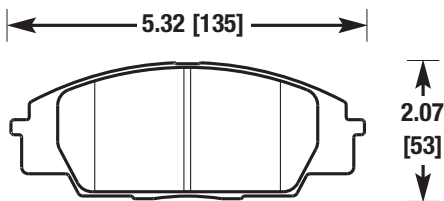

ACURA RSX, HONDA S2000

HB364

F, N, Z, E | FMSI D1017 | FMSI D340 | .587 [15]
 FMSI D1023 | FMSI D894 | .642 [16]
 FMSI D1112

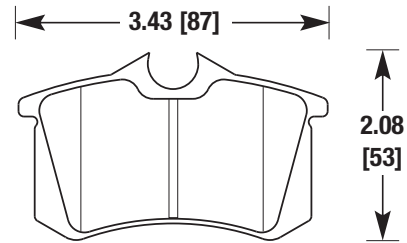

AUDI, PEUGEOT,
 VOLKSWAGEN (REAR)

HB362

F, N, Y, E | FMSI D548 | .642 [16]
 S

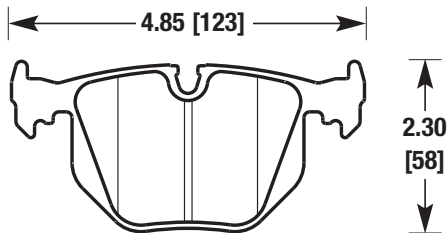

BMW (REAR)

HB365

F, N, Z, E | FMSI D768 | .728 [18]

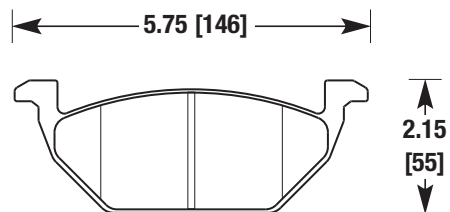

VOLKSWAGEN

HB366

F, Z, E, G | FMSI D787 | .681 [17]
U, W

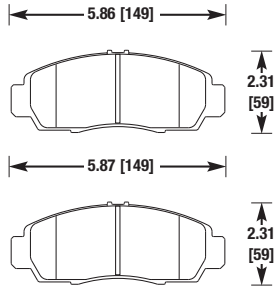

ACURA, HONDA

HB369

S,U | .775 [20]
.980 [25]

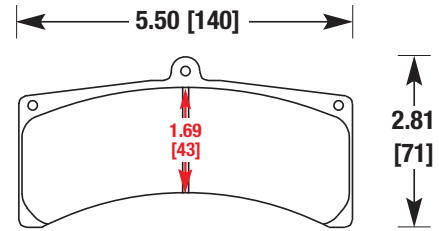

WILWOOD

HB367

F, N, Z, E | FMSI D383 | .585 [15]
FMSI D471

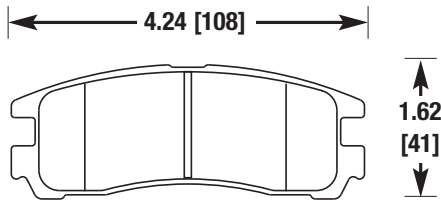

CHRYSLER, DODGE, EAGLE,
MITSUBISHI, SUBARU (REAR)

HB370

F, N, Z, E | FMSI D905 | .559 [14]
G

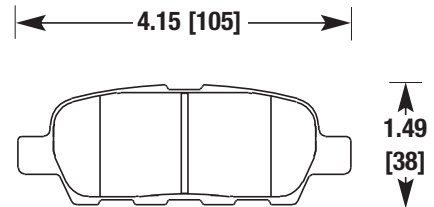

NISSAN (REAR)

HB368

F, Z, E | FMSI D924 | .665 [17]

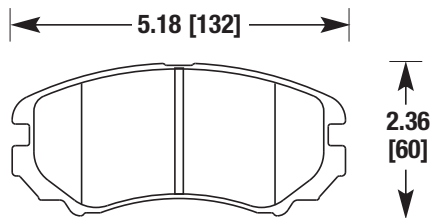

HYUNDAI, KIA

HB371

F, E | FMSI D603 | .600 [15]

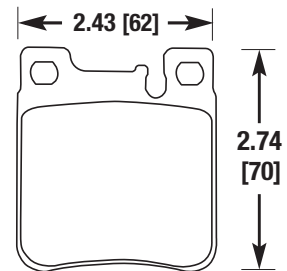

CHRYSLER, MERCEDES (REAR)

HB372

F, Y, E | FMSI D858 | .626 [16]

6.12 [155]

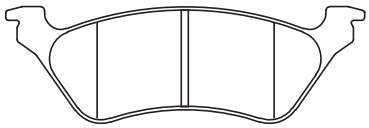

1.99
[51]

CHRYSLER, DODGE TRUCK (REAR)

HB375

F, E | FMSI D619 | .669 [17]

5.66 [144]

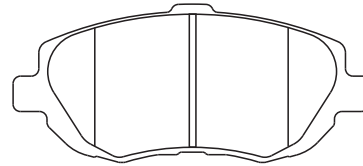

2.51
[64]

LEXUS, TOYOTA

HB373

F, E | FMSI D844
FMSI D856 | .689 [18]

5.77 [147]

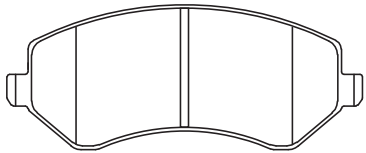

2.28
[58]

BUICK, CHRYSLER, DODGE TRUCK, JEEP

HB376

F, E | FMSI D805
FMSI D849 | .665 [17]

6.43 [163]

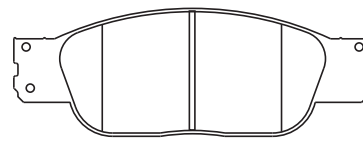

2.28
[58]

FORD, LINCOLN, JAGUAR

HB374

F, E | FMSI D857 | .700 [18]

6.79 [172]

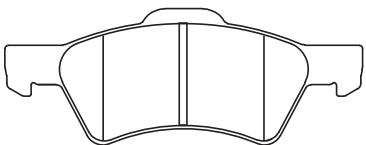

2.58
[66]

CHRYSLER, DODGE TRUCK

HB377

F, N, Z, E | FMSI D841 | .760 [19]
S, V

4.89 [124]

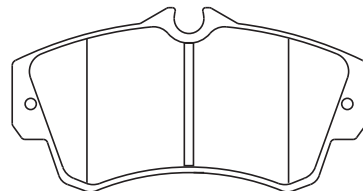

2.54
[65]

DODGE

HB378

F, N, Z, E	FMSI D900	.565 [14]
G, S, W	FMSI D1008	.626 [16]

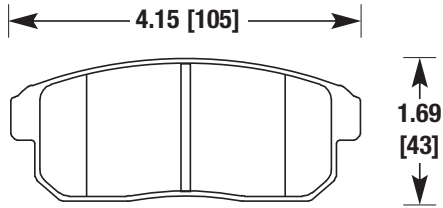

MAZDA RX-8, NISSAN (REAR)

HB383

F, Y, E	FMSI D883	.685 [17]
---------	-----------	-----------

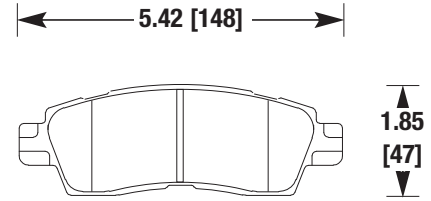

BUICK, CHEVYTRUCK, GMC, ISUZU, OLDS (REAR)

HB381

F, Y, E	FMSI D791	.661 [17]
---------	-----------	-----------

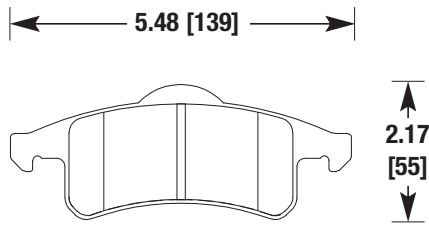

JEEP GRAND CHEROKEE (REAR)

HB384

F, E	FMSI D556 FMSI D807	.587 [15]
------	------------------------	-----------

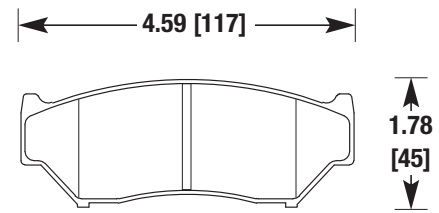

CHEVYTRUCK, GEO, SUZUKI

HB382

F, Y, E	FMSI D882	.657 [17]
---------	-----------	-----------

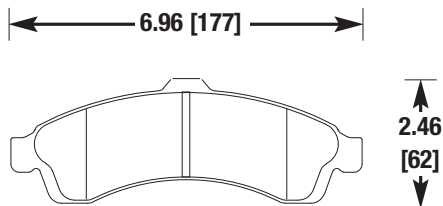

BUICK, CHEVYTRUCK, GMC, ISUZU, OLDS

HB385

F, Y, E	FMSI D834	.640 [16]
---------	-----------	-----------

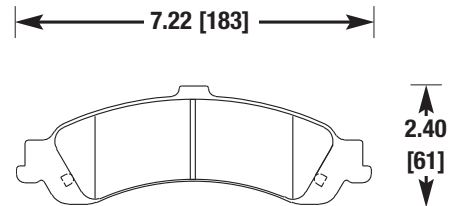

CADILLAC, CHEVY/GMC TRUCK (REAR)

HB387

F, Z, E | FMSI D888 | .547 [14]

6.18 [157]

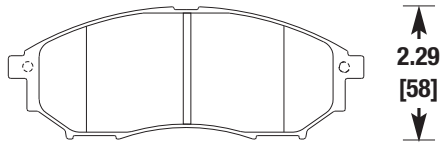

INFINITI

HB393

F, Y, E | FMSI D914
FMSI D943
FMSI D958 | .665 [17]

5.58 [142]

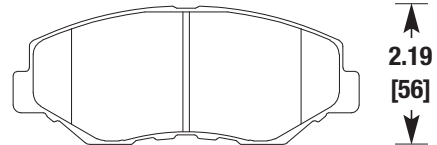

HONDA

HB388

F, E | FMSI D819
FMSI D936 | .756 [19]

6.11 [155]

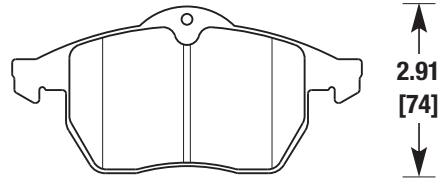

SAAB, SATURN

HB396

F, E | FMSI D215 | .630 [16]

4.95 [126]

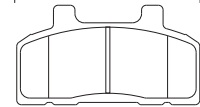

2.70 [69] INNER

5.83 [148]

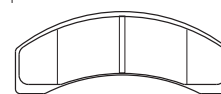

2.23 [57] OUTER

BUICK, CADILLAC, CHEVY, CHEVY TRUCK
OLDS, PONTIAC

HB390

F, E | FMSI D506
FMSI D673 | .602 [15]

5.81 [148]

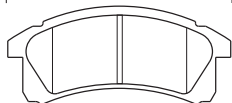

2.56 [65] INNER

7.50 [191]

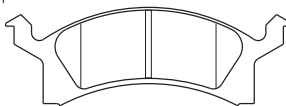

2.62 [67] OUTER

BUICK, CHEVROLET, OLDS, PONTIAC

HB397

F, E | FMSI D256 | .585 [15]

4.55 [116]

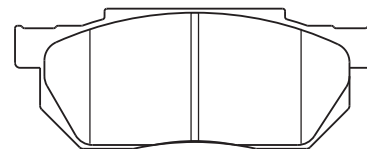

1.77 [45]

HONDA

HB398

F, E | FMSI D269 | .680 [17]

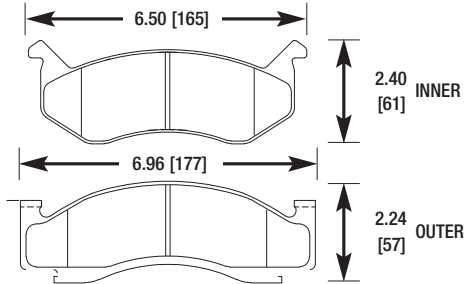

DODGE TRUCK

HB401

F, U | FMSI D325
FMSI D352
FMSI D685 | .587 [15]

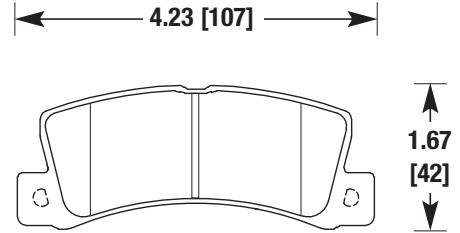

GEO, LEXUS, TOYOTA (REAR)

HB399

F, N, Z, E | FMSI D279 | .630 [16]
S, U

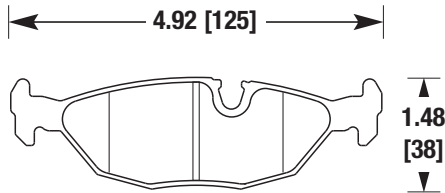

BMW (REAR)

HB402

F, Y, E | FMSI D333 | .669 [17]

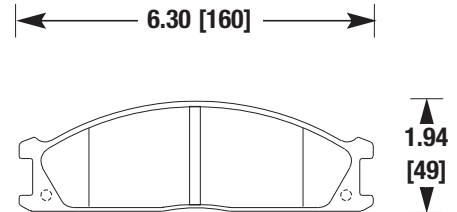

NISSAN TRUCK, SUBARU

HB400

F, U | FMSI D159 | FMSI D289 | .630 [16]
FMSI D183
FMSI D190

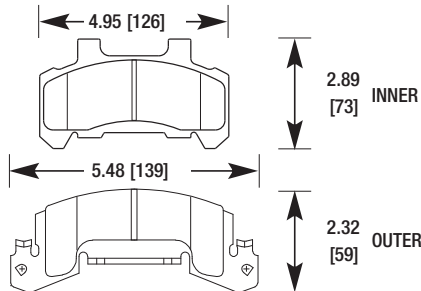

BUICK, CADILLAC, CHEVY, OLDS, PONTIAC

HB403

F, E | FMSI D334 | .587 [15]

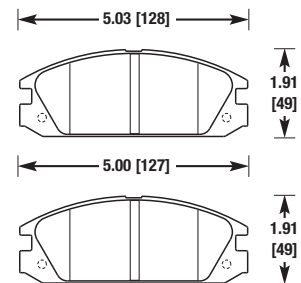

ACURA, HONDA

HB404

F, E | FMSI D349 | .642 [16]

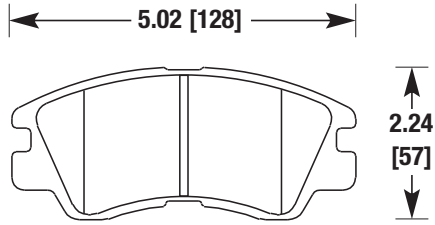

DODGE TRUCK, MITSUBISHI

HB413

F, E | FMSI D542 | .690 [18]

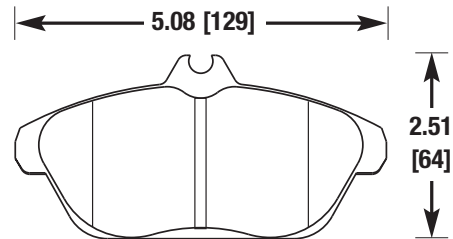

VOLVO

HB407

F, Y, E | FMSI D389
FMSI D433
FMSI D589 | .602 [15]

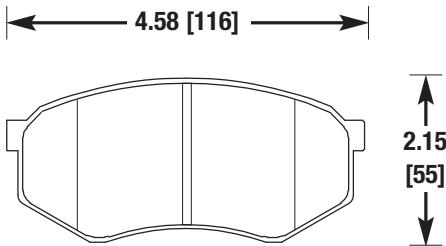

MAZDA, TOYOTA, TOYOTA TRUCK

HB414

F, E | FMSI D576 | .622 [16]

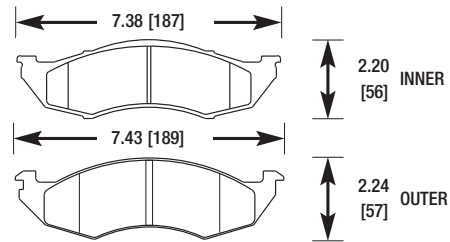

MERCURY, NISSAN TRUCK

HB409

F, E | FMSI D507
FMSI D728
FMSI D549 | .661 [17]

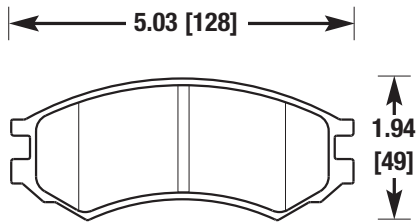

SATURN "S" SERIES

HB415

F, E | FMSI D587 | .583 [15]

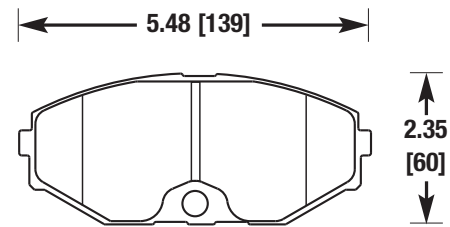

INFINITI

HB416

F, E | FMSI D598 | .689 [18]
 FMSI D765

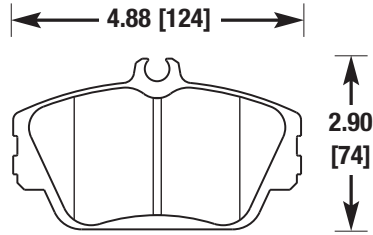

FORD, LINCOLN, MERCURY

HB420

F, E | FMSI D648 | .724 [18]
 FMSI D745
 FMSI D801

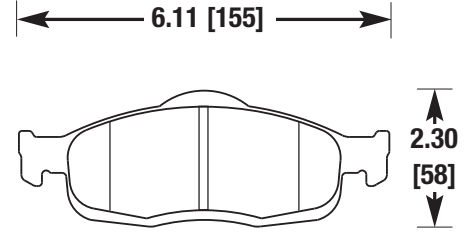

FORD, MERCURY

HB417

F, E | FMSI D610 | .659 [17]

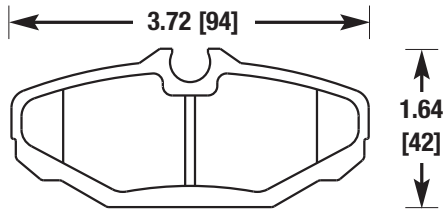

FORD, LINCOLN, MERCURY (REAR)

HB421

F, E | FMSI D540 | .622 [16]
 FMSI D595

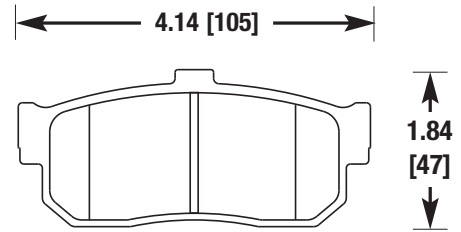

INFINITI, NISSAN (REAR)

HB418

F, N, Z, E | FMSI D621 | .646 [16]
 G, S, U | FMSI D948

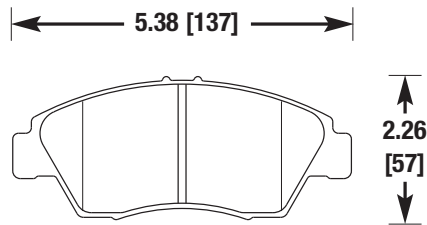

HONDA

HB422

F, E | FMSI D579 | .610 [15]

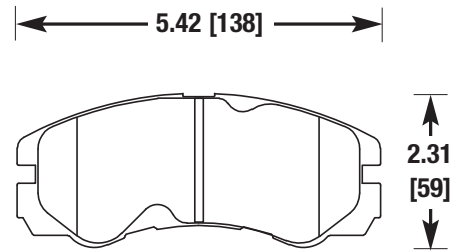

ACURA, HONDA, ISUZU

HB424

F, E | FMSI D722 | .665 [17]

← 5.42 [138] →

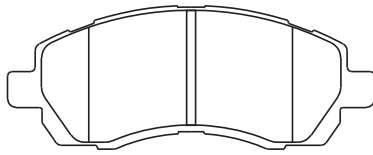

↑ 2.12 [54]
↓

SUBARU

HB428

F, E | FMSI D806
FMSI D944 | .650 [17]

← 4.40 [112] →

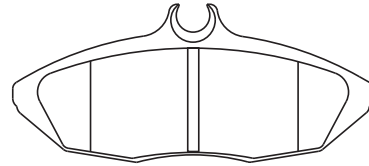

↑ 1.95 [50]
↓

DODGE, FORD, JAGUAR
LINCOLN (REAR)

HB425

F, E | FMSI D727
FMSI D752 | .661 [17]

← 6.35 [161] →

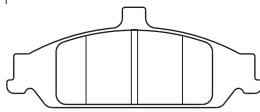

↑ 2.47 [63]
↓ INNER

← 6.35 [161] →

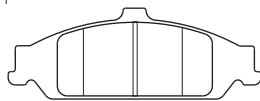

↑ 2.28 [58]
↓ OUTER

CHEVROLET, OLDS, PONTIAC

HB429

F, E | FMSI D862 | .681 [17]

← 4.85 [123] →

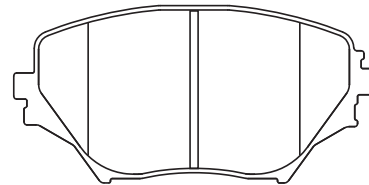

↑ 2.38 [60]
↓

TOYOTA RAV-4

HB427

F, Y, E | FMSI D773 | .685 [17]

← 4.84 [123] →

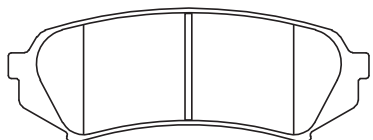

↑ 1.77 [45]
↓

LEXUS, TOYOTA TRUCK (REAR)

HB430

F, N, Z, E | FMSI D886 | .547 [14]

← 3.43 [87] →

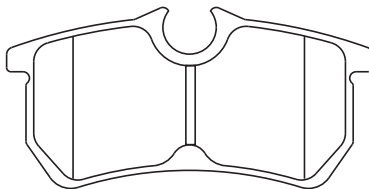

↑ 1.67 [42]
↓

FORD FOCUS (REAR)

HB431

F, N, E, S | FMSI D890 | .606 [15]
V, W

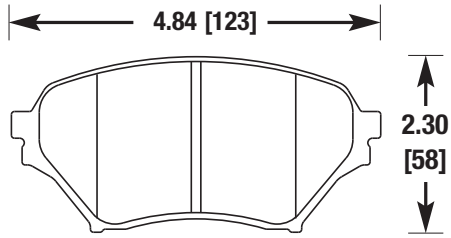

MAZDA MIATA

HB434

F, N, Z, E | FMSI D770 | .543 [14]
G, S, U

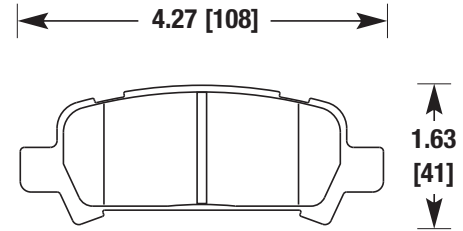

SUBARU (REAR)

HB432

F, N, E, G | FMSI D929 | .661 [17]
S, W

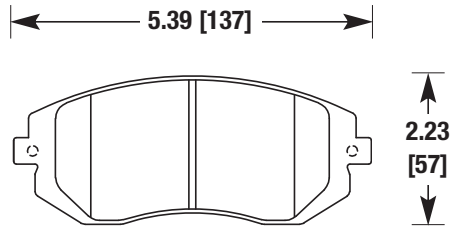

SUBARU

HB435

F, Y, E | FMSI D866 | .622 [16]

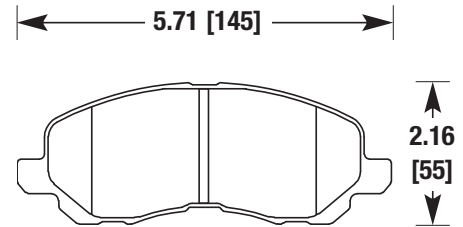

CHRYSLER, DODGE, MITSUBISHI

HB433

F, E | FMSI D931 | .654 [17]
FMSI D997

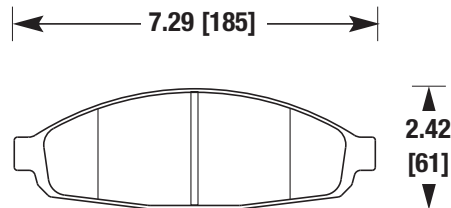

CHRYSLER, FORD, LINCOLN, MERCURY

HB436

F, N, Z, E | FMSI D892 | .535 [14]

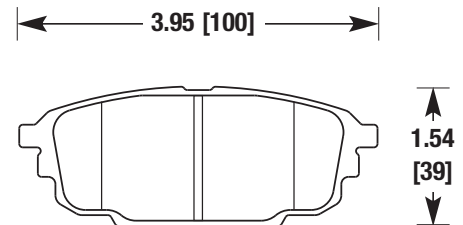

MAZDA PROTEGE (REAR)

HB437

F, E | FMSI D481 | .585 [15]
 FMSI D588

4.28 [109]

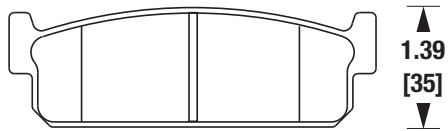

INFINITI (REAR)

HB440

F, Z, E | FMSI D922 | .606 [15]

4.82 [122]

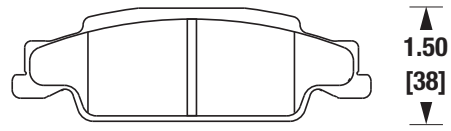

CADILLAC CTS, STS (REAR)

HB438

F, Z, E | FMSI D904 | .606 [15]

4.49 [114]

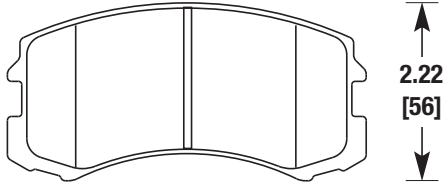

MITSUBISHI LANCER

HB441

F, Z, E | FMSI D923 | .661 [17]

4.83 [123]

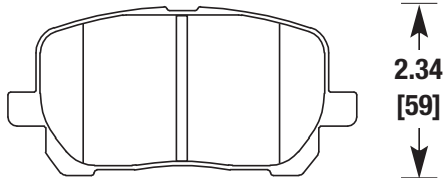

PONTIAC, TOYOTA

HB439

F, Z, E | FMSI D921 | .555 [14]
 FMSI D1110

7.18 [182]

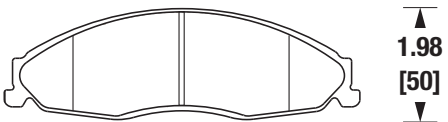

CADILLAC CTS, STS

HB442

F, N, E, S | FMSI D891 | .496 [13]
 W

4.01 [102]

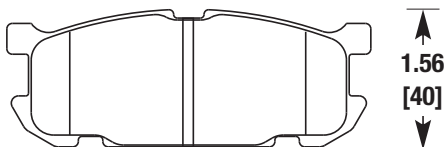

MAZDA MIATA (REAR)

HB443

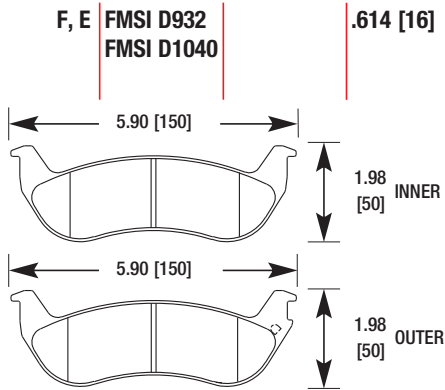

FORD, LINCOLN, MERCURY (REAR)

HB446

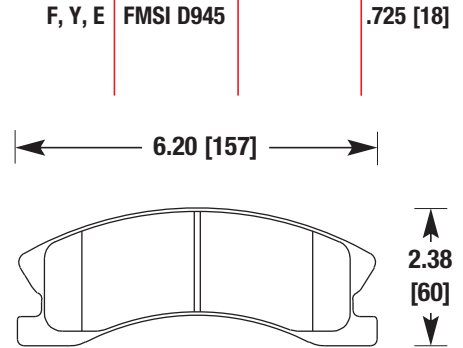

JEEP GRAND CHEROKEE

HB444

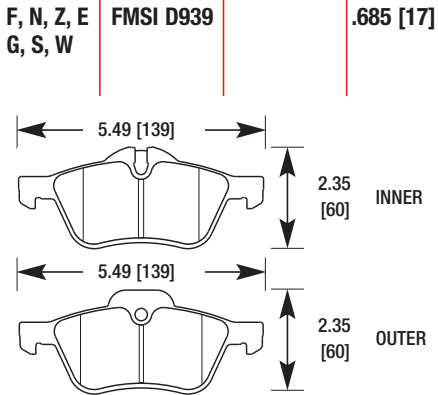

MINI COOPER

HB447

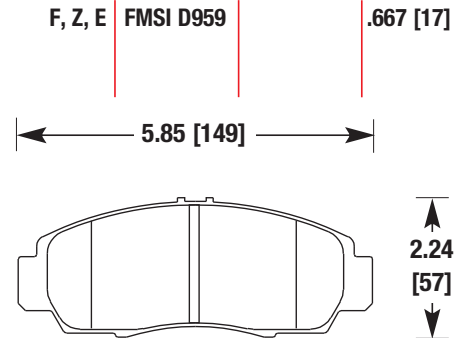

HONDA ACCORD

HB445

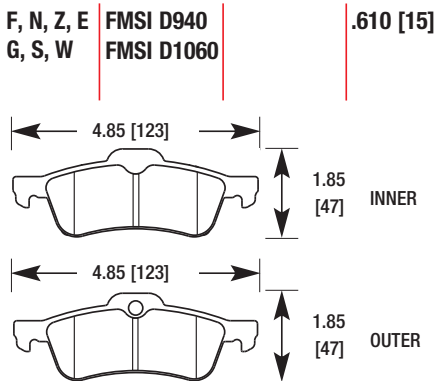

MINI COOPER (REAR)

HB448

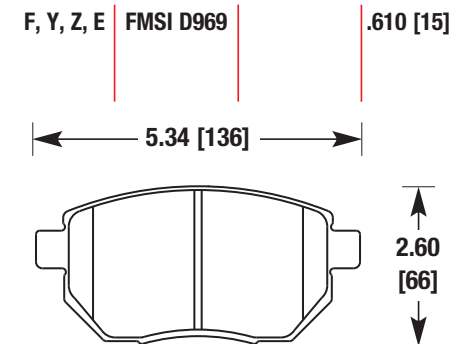

INFINITI, NISSAN, NISSAN TRUCK

HB449

F, N, Z, E | FMSI D970 | .679 [17]

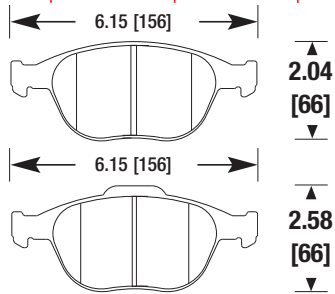

MAZDA

HB452

F, N, Z, E | FMSI D1004 | .545 [14]
S, W

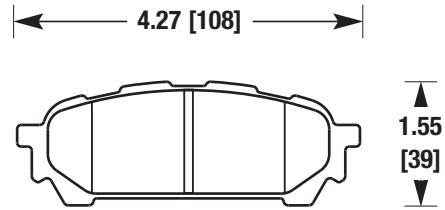

SUBARU (REAR)

HB450

F, Z, E | FMSI D999 | .555 [14]

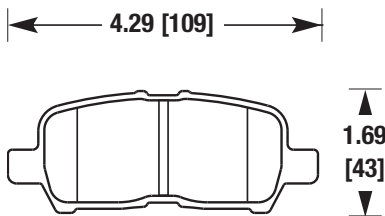

PONTIAC GRAND PRIX (REAR)

HB453

F, N, Z, G | FMSI D1001 | .585 [15]
S, U, V, W | FMSI D1016
E | FMSI D1050

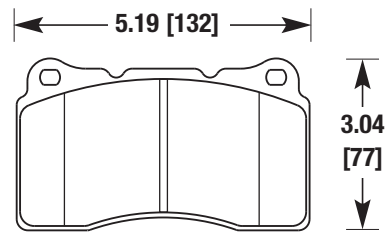

MITSUBISHI EVO, SUBARU IMPREZA

HB451

F, Z, E | FMSI D1000 | .668 [17]

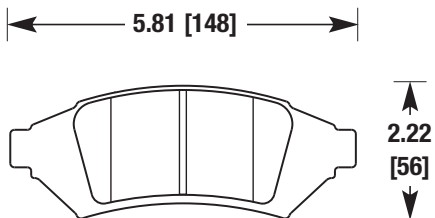

PONTIAC GRAND PRIX

HB454

F, E | FMSI D992 | .715 [18]

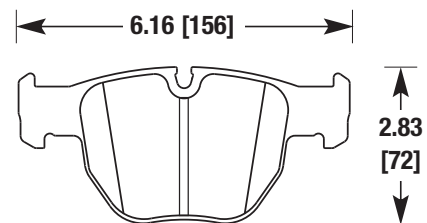

RANGE ROVER

HB455

F, Y, Z, E | FMSI D1011 | .785 [20]
 FMSI D1083

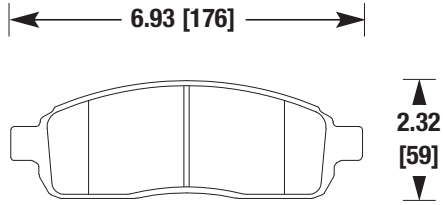

FORD TRUCK

HB458

F, Z, E | FMSI D1042 | .642 [16]

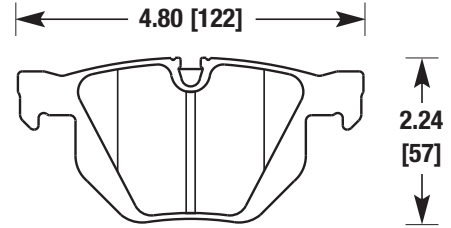

BMW 525i

HB456

F, Y, Z, E | FMSI D1012 | .705 [18]

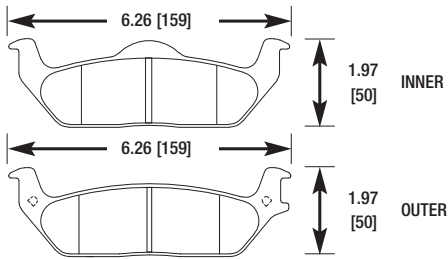

FORD F-150 (REAR)

HB459

F, Z, E | FMSI D957 | .700 [18]

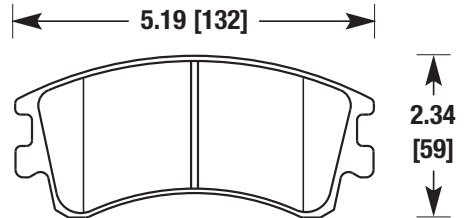

MAZDA 6

HB457

F, Z, E | FMSI D1037 | .605 [15]

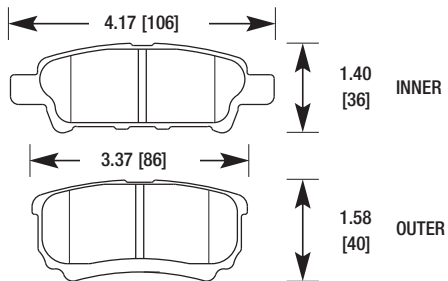

MITSUBISHI LANCER (REAR)

HB460

F, Z, E | FMSI D1043 | .580 [15]

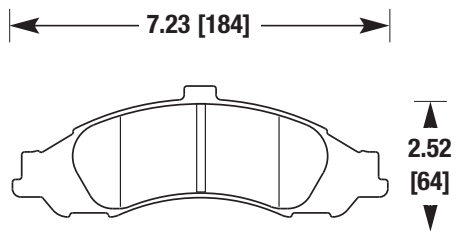

PONTIAC GTO

HB461

F, Y, E | FMSI D864 | FMSI D1013 | .646 [16]
 FMSI D903
 FMSI D955

5.86 [149]

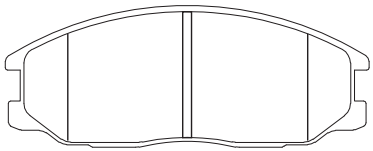

2.24
[57]

HYUNDAI, KIA

HB464

E, G, S, U | FMSI D946 | .764 [19]
 V

6.11 [155]

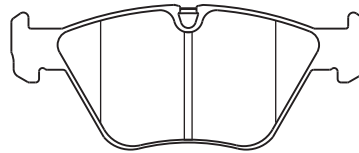

2.39
[61]

BMW

HB462

F, Y, Z, E | FMSI D934 | .827 [21]

8.27 [210]

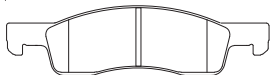

2.20
[56] INNER

8.27 [210]

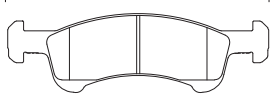

2.53
[64] OUTER

FORD TRUCK, LINCOLN

HB467

F, Z, E | FMSI D1019 | .540 [14]

7.11 [181]

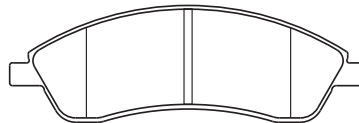

2.33
[59]

CADILLAC SRX

HB463

F, Y, Z, E | FMSI D935 | .787 [20]

5.49 [139]

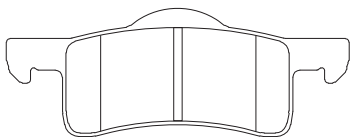

2.08
[53]

FORD TRUCK, LINCOLN (REAR)

HB468

F, N, E, S | FMSI D1002 | .492 [12]

4.02 [102]

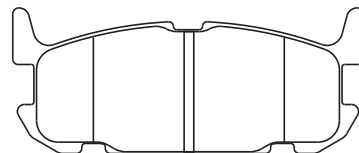

1.67
[42]

MAZDA MIATA

HB469

F, Y, E | FMSI D676 | .705 [18]

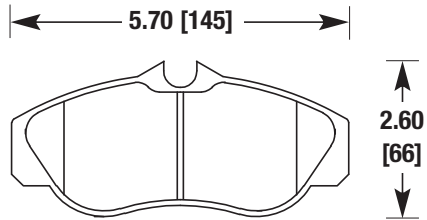

LAND ROVER DISCOVERY

HB472

F, Y, Z, E | FMSI D913 | .650 [17]
FMSI D833

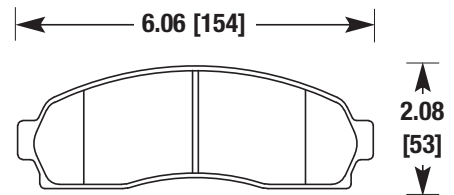

CHEVY TRUCK, FORD TRUCK, MAZDA TRUCK,
MERCURY, SATURN

HB470

F, N, Z, E | FMSI D1009 | .643 [16]
G, S, V

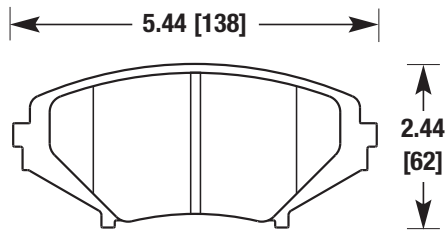

MAZDA RX-8

HB474

F, Z, E | FMSI D908 | .681 [17]

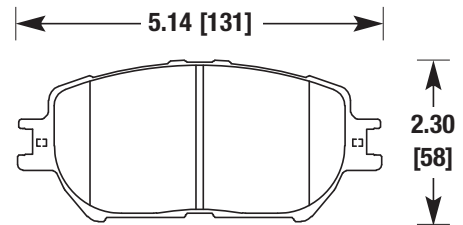

TOYOTA CAMRY

HB471

F, N, S, U | FMSI D11 | .510 [13]

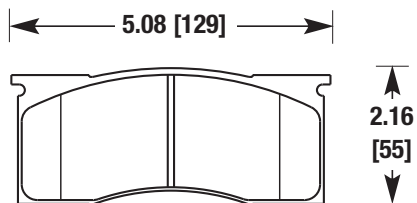

DODGE, PLYMOUTH

HB475

F, E | FMSI D266 | .642 [16]
FMSI D441

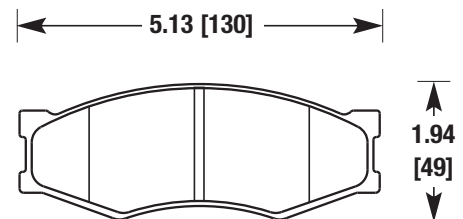

NISSAN

HB476

F, Y, E | FMSI D962 | .707 [18]

6.75 [171]

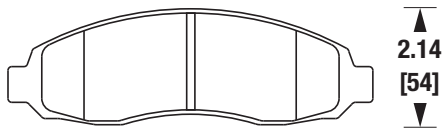

DODGE DAKOTA

HB479

P | FMSI D928 | .700 [18]

4.95 [126]

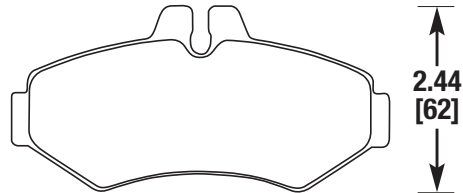

DODGE TRUCK, FREIGHTLINER (REAR)

HB477

F, Y, E | FMSI D606 | .610 [15]

4.58 [116]

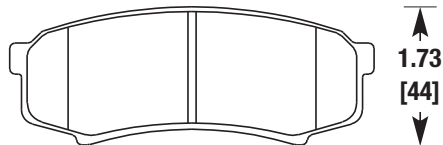

LEXUS, TOYOTA (REAR)

HB483

F, G, S, U | FMSI D991 | .635 [16]

7.49 [190]

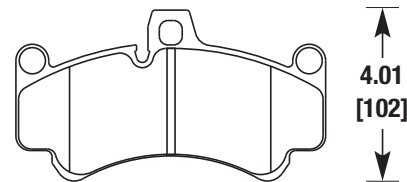

PORSCHE

HB478

F, N, Z, E | FMSI D1095 | .605 [15]
G, S, U

4.83 [123]

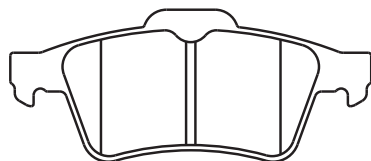

MAZDA 3, SOLSTICE (REAR)

HB484

F, N, Z, E | FMSI D1081 | .670 [17]
G, S, U, V

6.40 [163]

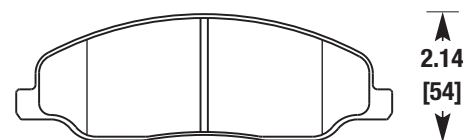

MUSTANG

HB485

F, N, Z, E | FMSI D1082 | .656 [17]
G, S

4.44 [113]

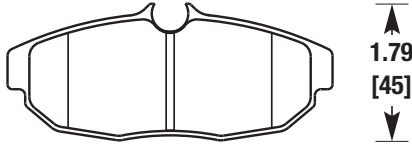

MUSTANG (REAR)

HB488

F, Y, Z, E | FMSI D830 | .629 [16]

6.46 [164]

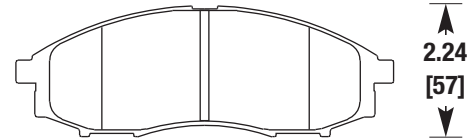

NISSAN TRUCK

HB486

G, U | 1.170 [30]

6.44 [164]

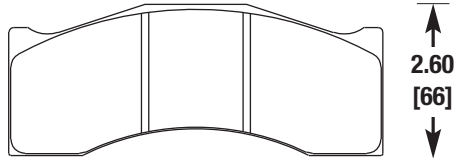

BREMBO

HB489

F, E | FMSI D755 | .630 [16]

5.18 [132]

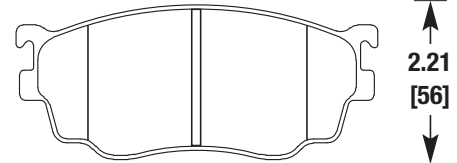

MAZDA 626

HB487

F, Y, E | FMSI D859 | .733 [19]
FMSI D821

8.66 [220]

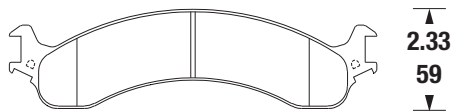

DODGE TRUCK

HB490

F, P, Y, Z | FMSI D976 | .665 [17]

5.30 [135]

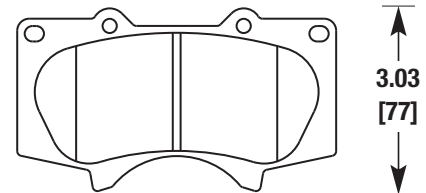

LEXUS, TOYOTA

HB491

F, Z, E | FMSI D794 | .693 [18]

6.10 [155]

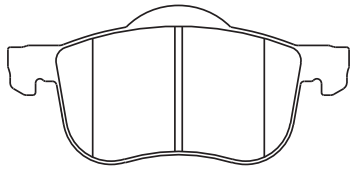

2.84
[72]

VOLVO

HB494

F, Y, Z, E | FMSI D974 | .670 [17]

6.80 [173]

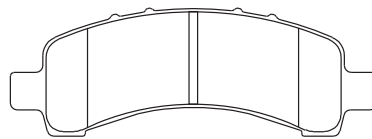

2.35
[60]

CADILLAC, CHEVY TRUCK, GMC TRUCK (REAR)

HB492

F, Z, E | FMSI D618 | .732 [19]

6.16 [156]

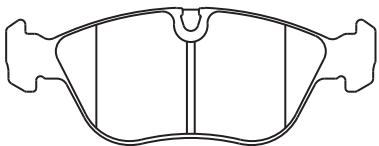

2.29
[58]

VOLVO

HB495

F, Z, E | FMSI D740
FMSI D853 | .756 [19]

6.10 [155]

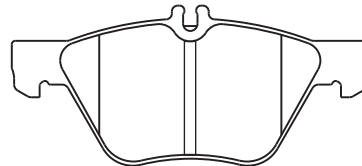

2.14
[54]

MERCEDES BENZ

HB493

F, Z, E | FMSI D822
FMSI D990 | .650 [17]

4.58 [116]

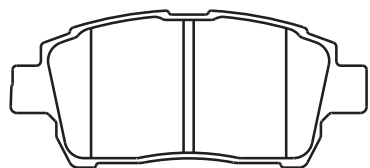

2.08
[53]

SCION, TOYOTA

HB496

F, Y, Z, E | FMSI D975 | .640 [16]

7.24 [184]

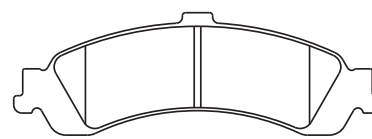

2.41
[61]

CADILLAC, CHEVY TRUCK, GMC TRUCK (REAR)

HB497

F, Z, S, U | FMSI D682 | .776 [20]

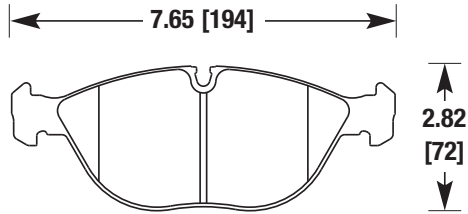

BMW

HB501

F, Y, Z, E | FMSI D977 | .625 [16]
G | FMSI D1014

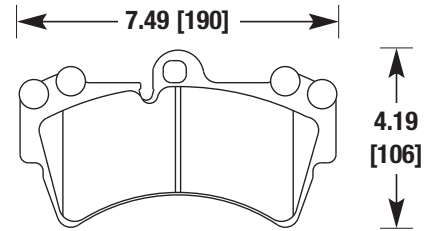

PORSCHE

HB498

F, E | FMSI D869 | .772 [20]

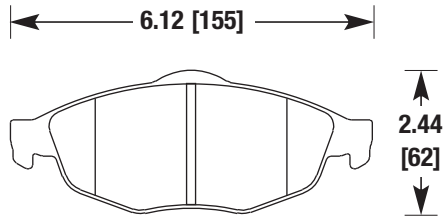

CHRYSLER, DODGE

HB502

F, Z, Y, E | FMSI D978 | .606 [15]

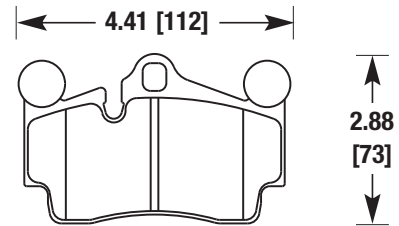

PORSCHE, VOLKSWAGEN

HB499

F, Z, E | FMSI D771 | .610 [15]

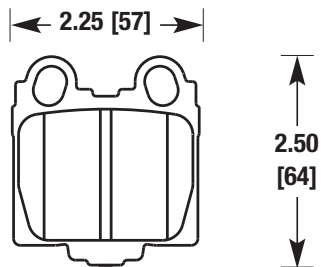

LEXUS (REAR)

HB503

Y, E | FMSI D963 | .790 [20]

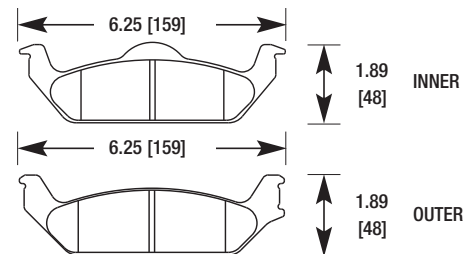

DODGE DAKOTA (REAR)

HB504

F, Z, E | FMSI D872 | .740 [19]

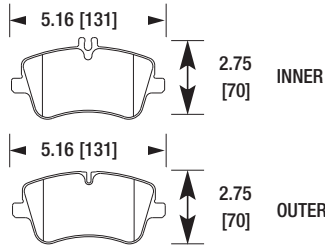

MERCEDES BENZ

HB507

F, Z, E | FMSI D1056 | .711 [18]

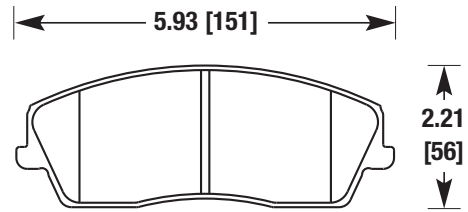

CHRYSLER, DODGE

HB505

Z, E | FMSI D760 | .654 [17]

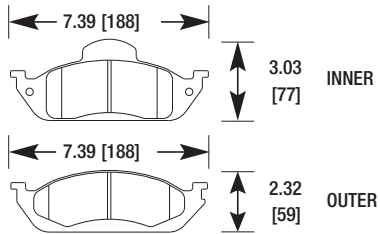

MERCEDES BENZ

HB508

F, Z, E | FMSI D1057 | .586 [15]
.675 [17]

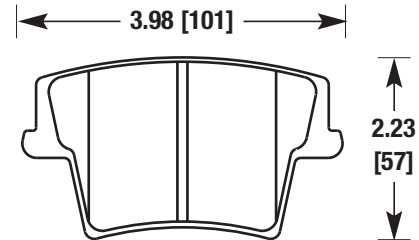

CHRYSLER, DODGE (REAR)

HB506

F, Z, E | FMSI D865 | .610 [15]

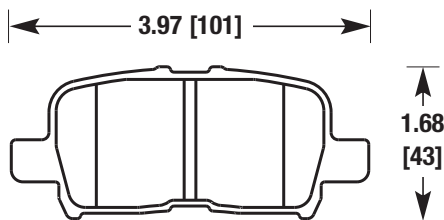

ACURA, HONDA (REAR)

HB509

F, Z, E | FMSI D1058 | .678 [17]

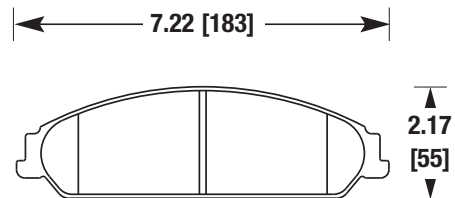

CHRYSLER, DODGE

HB510

F, E | FMSI D661 | .580 [15]

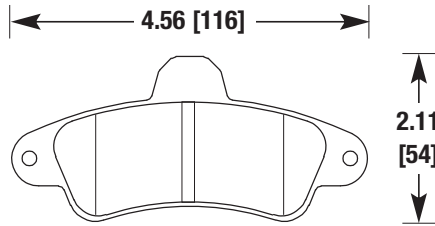

FORD MERCURY (REAR)

HB514

F, Y, E | FMSI D898 | .610 [15]

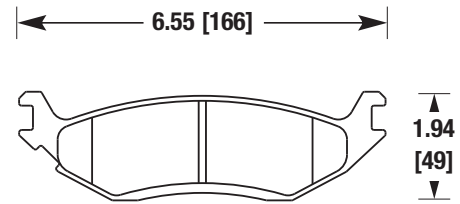

DODGE VAN (REAR)

HB512

F, Y, Z, W | FMSI D1007 | .605 [15]

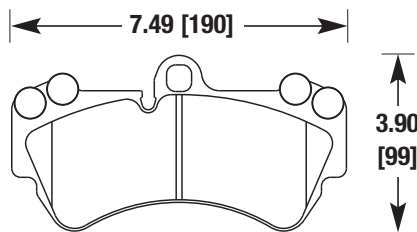

VOLKSWAGEN TOUAREG

HB515

F, Z, E | FMSI D915 | .760 [19]

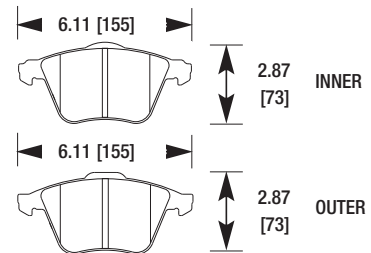

AUDI, VOLVO

HB513

F, Y, Z, E | FMSI D967 | .610 [15]

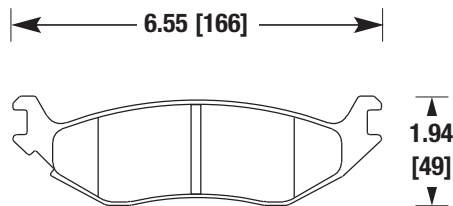

DODGE TRUCK (REAR)

HB517

F, Z, E | FMSI D956 | .690 [18]

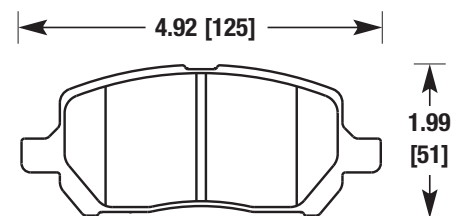

CHEVY, PONTIAC, SATURN

HB518

F, N, Y, Z | FMSI D683 | .642 [16]
E, G, S, U

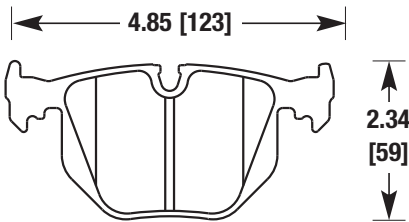

BMW (REAR)

HB521

F, N, A, G | .650 [17]
H, L, M, S | .800 [20]
U, W

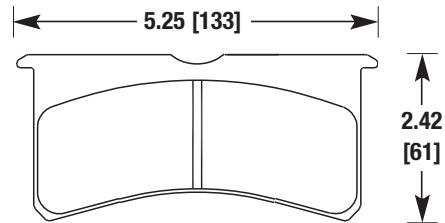

WILWOOD BRIDGE-BOLT SUPERLITE

HB519

F, N, E, G | FMSI D1044 | .682 [17]
S, V

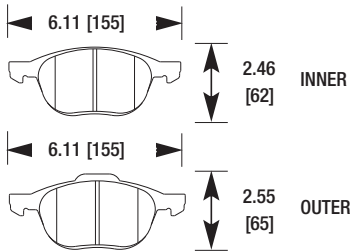

MAZDA 3

HB522

F, N, E, G | FMSI D1179 | .565 [14]
S, U

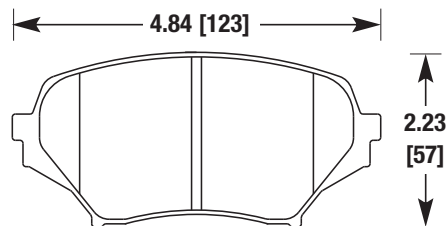

MAZDA MIATA MX-5

HB520

F, Y, Z, E | FMSI D881 | .618 [16]

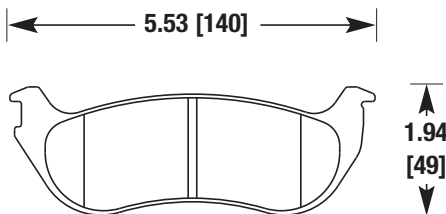

FORD EXPLORER (REAR)

HB523

F, N, E, G | FMSI D1180 | .539 [14]
S, W

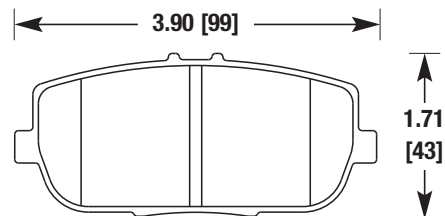

MAZDA MIATA MX-5 (REAR)

BRAKE DIAGRAMS

HB524

F, N, Z, E | FMSI D1028 | .740 [19]
 G, S, U | FMSI D1160

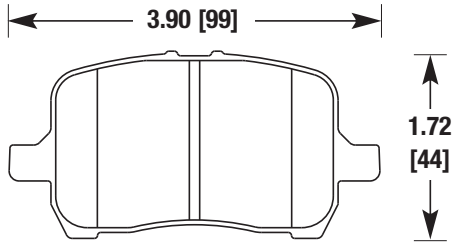

COBALT, SOLSTICE

HB527

Y, Z, E | FMSI D1120 | .604 [15]

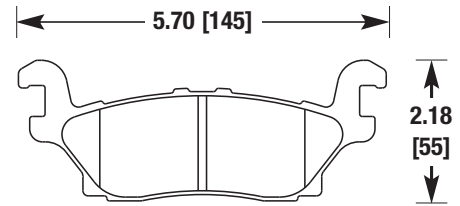

HUMMER H3 (REAR)

HB525

F, N, Z, G | FMSI D1033 | .540 [14]

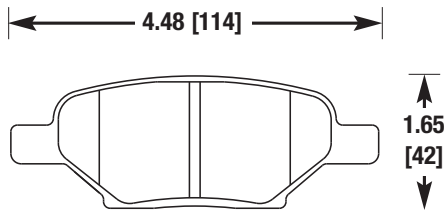

COBALT

HB528

P, Y, E | FMSI D1069 | .811 [21]

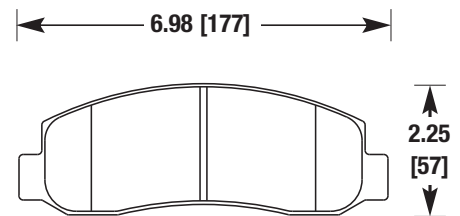

FORD F250/F350 SUPER DUTY

HB526

Y, Z, E | FMSI D1119 | .665 [17]

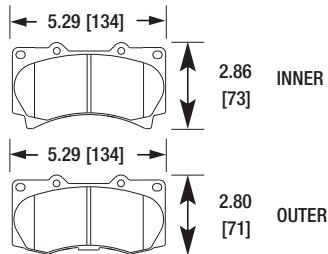

HUMMER H3

HB529

P, Y, E | FMSI D1068 | .710 [18]

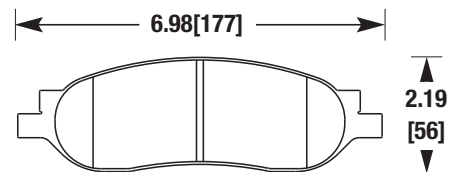

FORD TRUCK (REAR)

HB530

F, N, Z, G | FMSI D1049 | .570 [14]
U, W

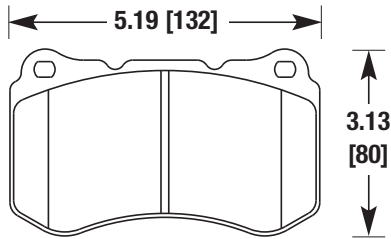

ACURA

HB533

F, N, Z, G | FMSI D1078 | .668 [17]
U

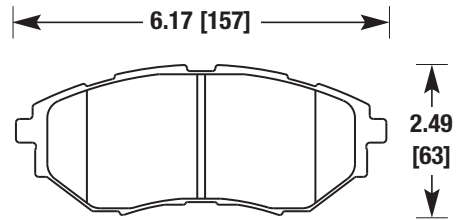

SUBARU

HB531

F, N, Z, U | FMSI D1185 | .570 [14]

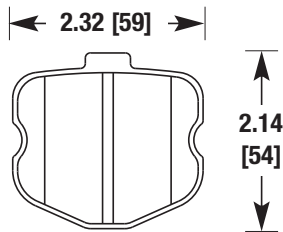

CORVETTE Z06 (FRONT)

HB534

F, N, Z, G | FMSI D1078 | .668 [17]
U

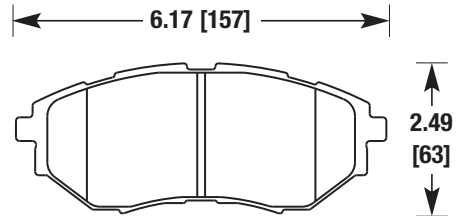

SUBARU

HB532

F, N, Z, G | FMSI D1185 | .570 [14]
U

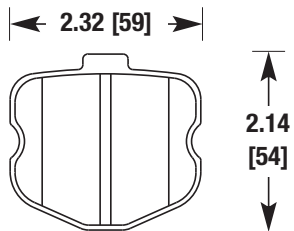

CORVETTE Z06 (REAR)

HB535

F, E | FMSI D1159 | .638 [16]

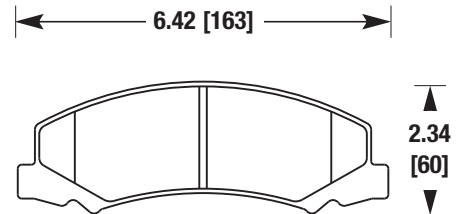

BUICK

BRAKE DIAGRAMS

HB536

F, E | FMSI D1076 | .704 [18]

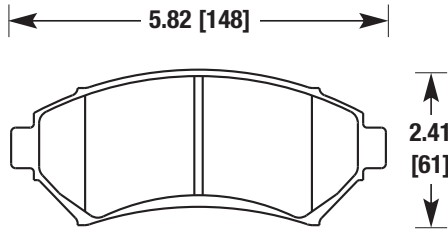

CADILLAC, CHEVY

HB540

F, E, G, H | | .490 [12]
M, S, U, W

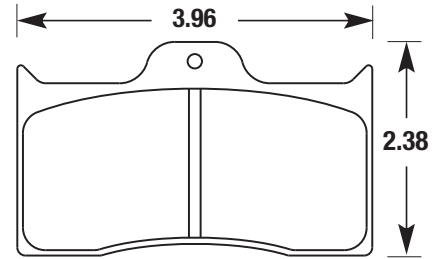

WILWOOD

HB538

F, N, Z, E | FMSI D1111 | .760 [19]

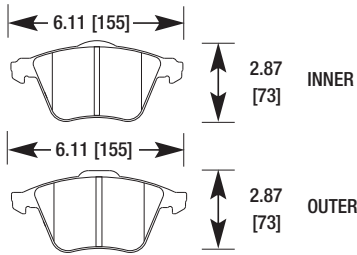

AUDI

HB541

F, E, G, H | | .630 [16]
S, U, W

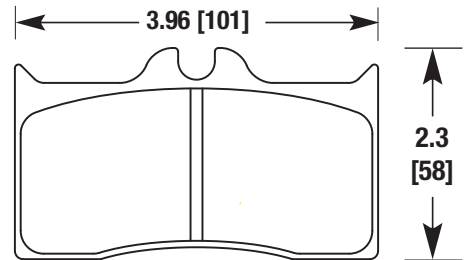

WILWOOD

HB539

Y, E | FMSI D0802 | .650 [17]

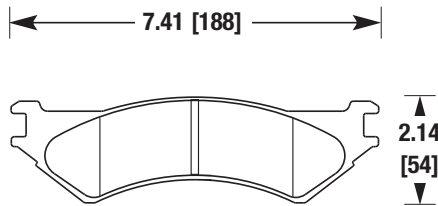

CHEVY IMPALA

HB542

F, E, G, S | | .600 [15]
U, W | | .490 [12]

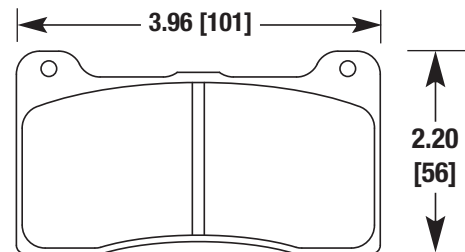

WILWOOD

HB543

F, N, Z, G | FMSI D1107 | .760 [19]

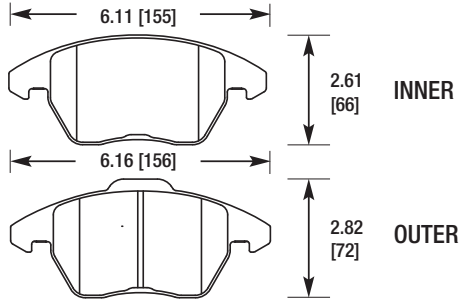

AUDI, VOLKSWAGEN

HB546

F, N, Z, S | FMSI D781 | .654 [17]
U

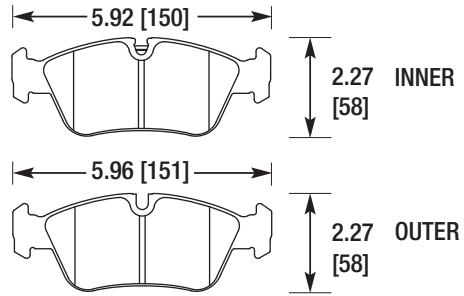

BMW Z4 ROADSTER, BMW 3 SERIES

HB544

F, N, Z, S | FMSI D1108 | .628 [16]

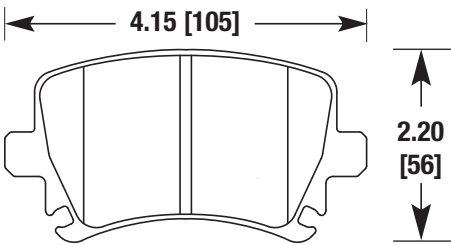

AUDI, VOLKSWAGEN (REAR)

HB547

P, Y, W | FMSI D1066 | .798 [20]

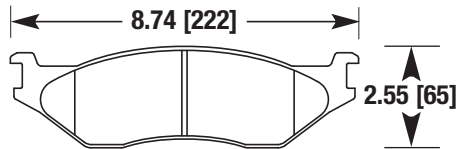

FORD F-450

HB545

F, N, Z, E | FMSI D960 | .564 [14]
G, U, W | .610 [15]

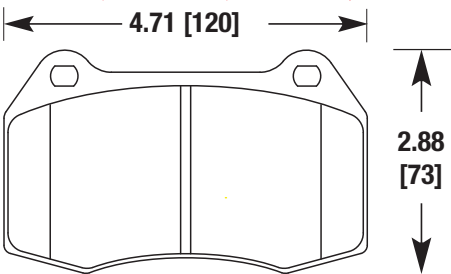

NISSAN 350Z W/BREMBO,
INFINITI G35 COUPE W/BREMBO

HB548

F, N, U, W | FMSI D1379 | .590 [15]

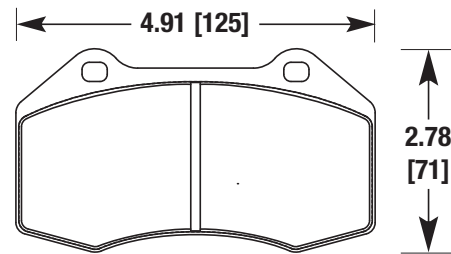

CHEVY COBALT SS

HB549

F, N, Z, G | FMSI D1186 | .702 [18]

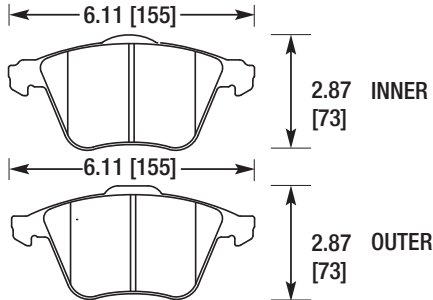

MAZDASPEED 3 AND 6

HB552

F, P, Y, E | FMSI D965 | .722 [18]

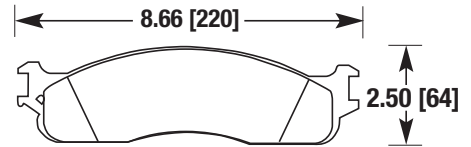

DODGE RAM PICKUP

HB550

F, N, Z, E | FMSI D917 | .634 [16]
G, S, U

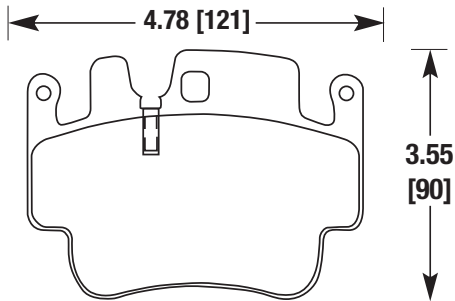

PORSCHE 911/BOXSTER/CAYMAN

HB553

F, N, Z, E | FMSI D1108 | .652 [17]

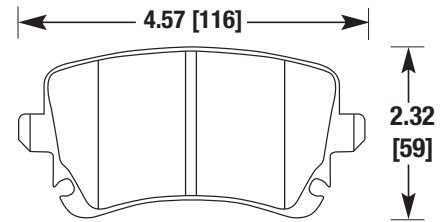

AUDI, VOLKSWAGEN

HB551

F, N, Z, E | FMSI D918 | .748 [19]
S, U | FMSI D1260

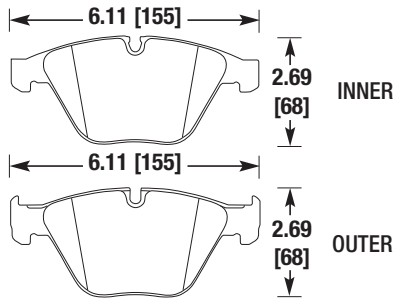

BMW

HB554

F, Y, Z, G | FMSI D1039 | .643 [16]
U

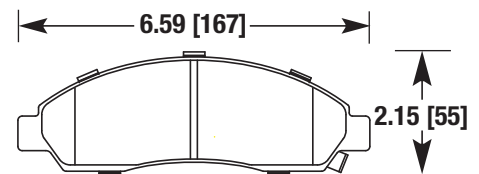

CHEVY COLORADO

HB555

F, Y, Z, E | FMSI D1041 | .678 [17]

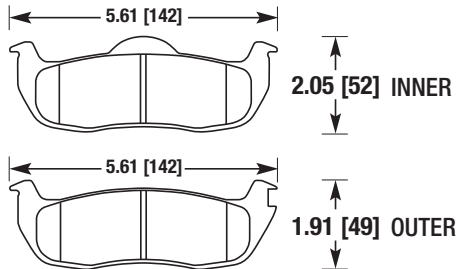

JEEP GRAND CHEROKEE (REAR)

HB558

F, Y, Z, E | FMSI D1080 | .710 [18]

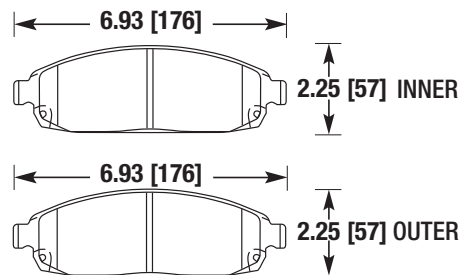

JEEP GRAND CHEROKEE

HB556

P, Y, E | FMSI D1067 | .710 [18]

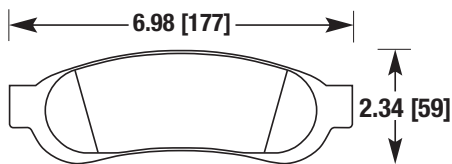

FORD F-350 SUPER DUTY PICKUP (REAR)

HB559

F, Y, E | FMSI D1084 | .695 [18]

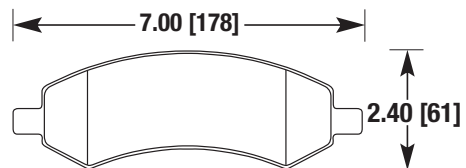

DODGE DAKOTA

HB557

F, N, Z, E | FMSI D1114 | .545 [14]

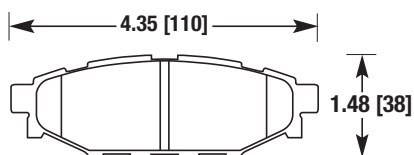

SUBARU LEGACY (REAR)

HB560

F, N, Z, G | FMSI D1204 | .677 [17]

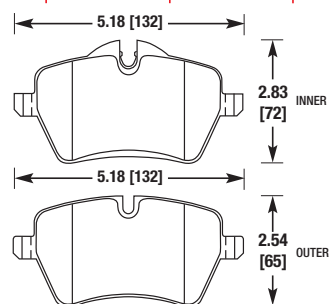

MINI COOPER (REAR)

HB561

F, P, Y, Z | FMSI D1092 | .710 [18]

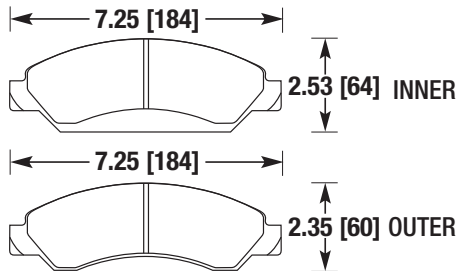

CHEVY SILVERADO

HB564

F, Z, E | FMSI D1161 | .567 [14]

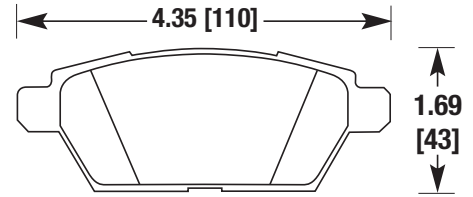

FORD FUSION (REAR)

HB562

F, Z, E | FMSI D1113 | .612 [16]

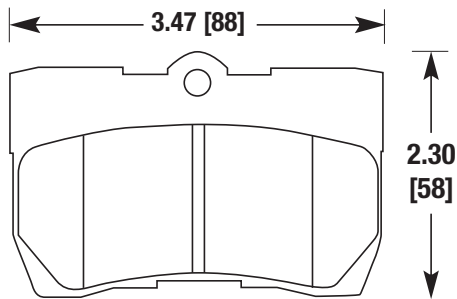

LEXUS IS250 (REAR)

HB565

F, Z, E | FMSI D1164 | .688 [17]

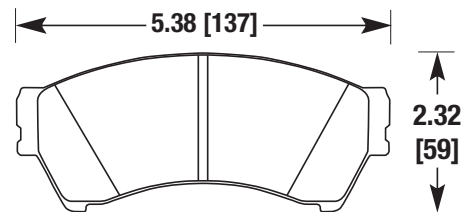

FORD FUSION

HB563

F, N, Y, Z | FMSI D1149 | .656 [17]

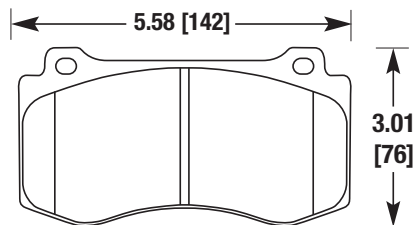

CHRYSLER, DODGE, JEEP

HB566

F, Z, E | FMSI D1178 | .688 [17]

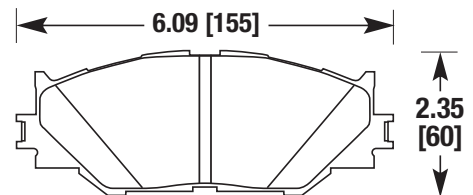

LEXUS IS250

HB567

F, Y, Z, E | FMSI D1183
FMSI D1063 | .694 [18]

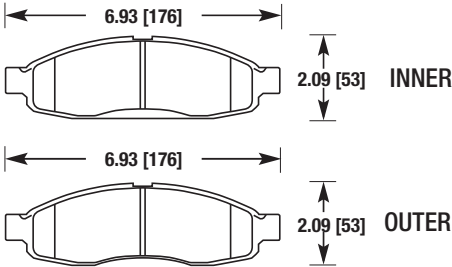

NISSAN TITAN

HB570

F, Z, E | FMSI D1308 | .666 [17]

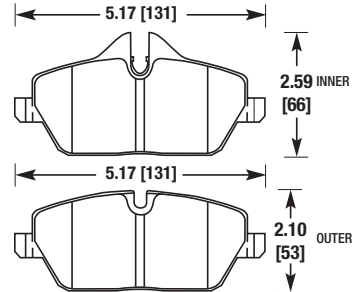

MINI COOPER STANDARD BRAKES

HB568

F, P, Y, Z | FMSI D1194 | .666 [17]

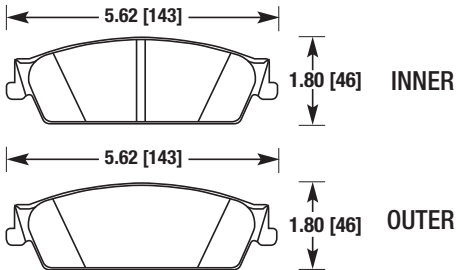

CADILLAC ESCALADE

HB571

F, N, Z, E | FMSI D973 | .605 [15]

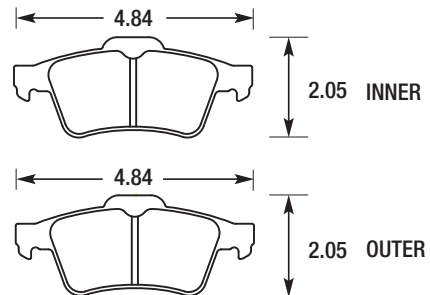

MAZDA 3 (REAR)

HB569

F, Y, Z, E | FMSI D1273 | .650 [17]

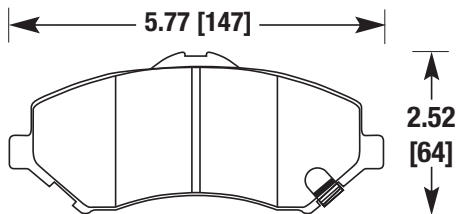

JEEP WRANGLER RUBICON

HB572

F, Y, Z, E | FMSI D536
G, W | FMSI D1086 | .570 [14]

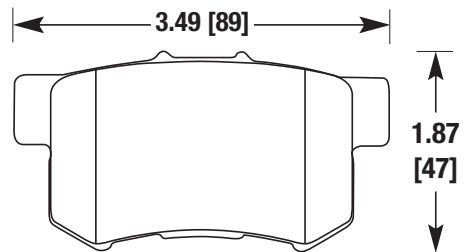

HONDA (REAR)

HB573

F, N, Z, E | FMSI D1048 | .615 [16]

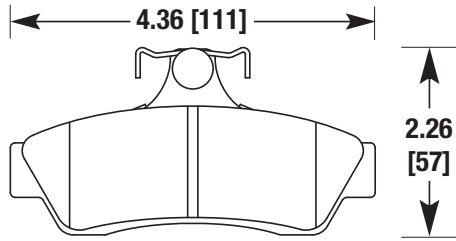

GTO (REAR)

HB579

Y, E | FMSI D1279 | .785 [20]

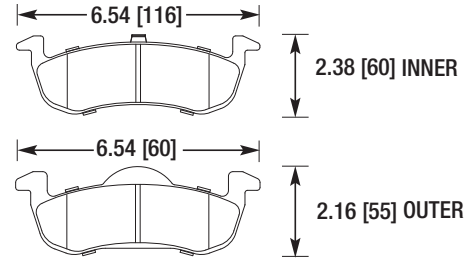

FORD EXPEDITION (REAR)

HB574

F, N, Z, G
S | FMSI D1309 | .636 [16]

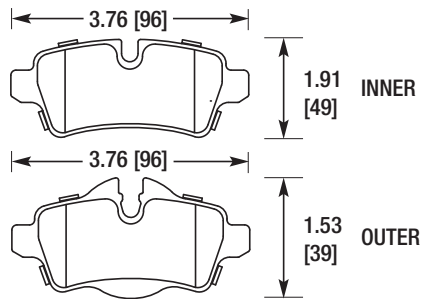

MINI COOPER (REAR)

HB580

F, E, G | FMSI D545
FMSI D347 | .627 [16]

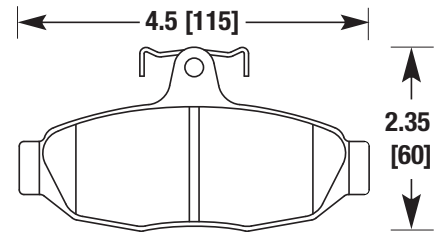

FORD, FACTORY 5 (REAR)

HB578

Y, E | FMSI D1278 | .735 [19]

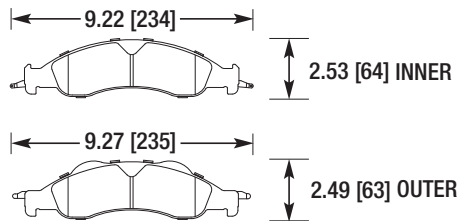

FORD EXPEDITION

HB581

F, Y, E, G
S, U, W | .660 [17]

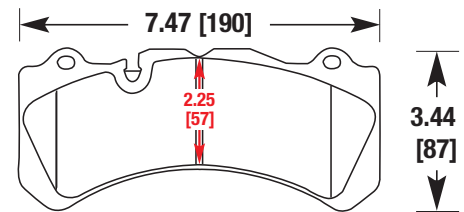

BREMBO SPORT BIG BRAKE KIT

HB582

F, E, G, U
W

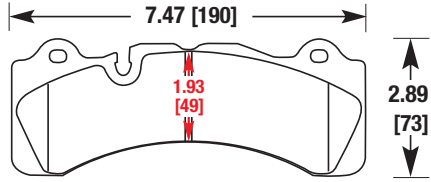

BREMBO SPORT BIG BRAKE KIT SCALLOPED

HB585

Z, U

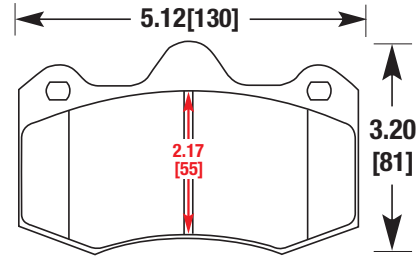

AP RACING CP6600D55

HB583

N, H, J, W

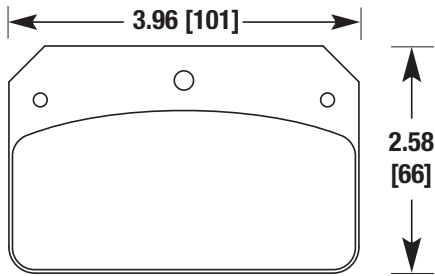

AEROSPACE DYNALITE

HB586

F, Z, U

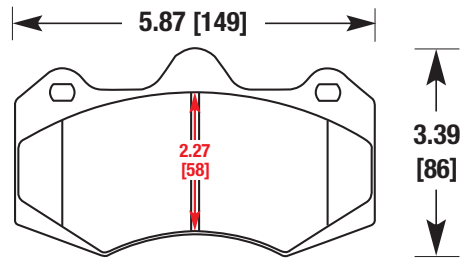

AP RACING CP7040D61

HB584

H, J, W

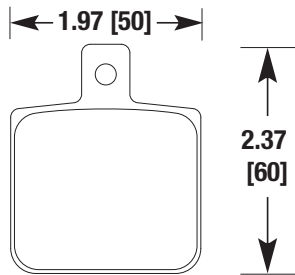

AEROSPACE SINGLE DYNALITE

HB587

F, Z, S, U

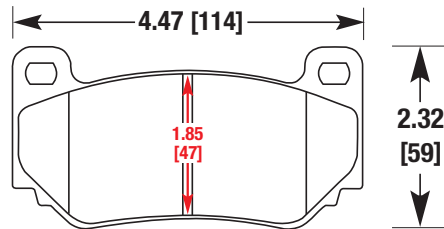

AP RACING CP7600D46

HB589

P, Y, Z, E | FMSI D1303 | .704 [18]

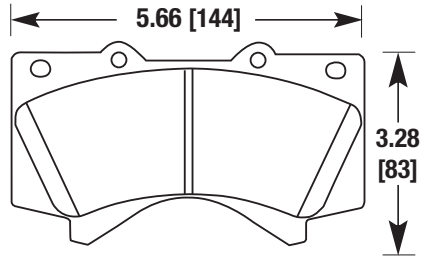

TOYOTA TUNDRA

HB596

F, E | FMSI D1184 | .690 [18]

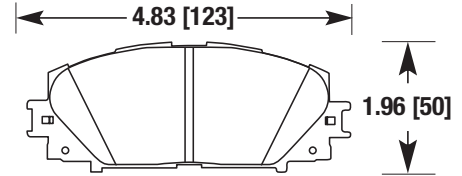

TOYOTA YARIS

HB590

P, Y, Z, E | FMSI D1304 | .682 [17]

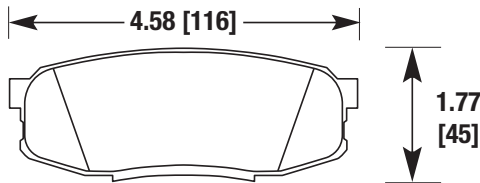

TOYOTA TUNDRA (REAR)

HB597

F, E | FMSI D766 | .681 [17]

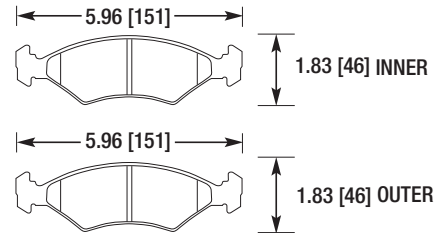

FORD FIESTA, KIA SEPHIA

HB592

F, E | FMSI D1035 | .665 [17]

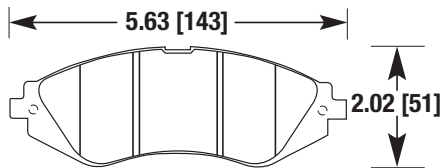

CHEVY OPTRA, AVEO

HB599

F, Z, E | FMSI D1287 | .616 [16]

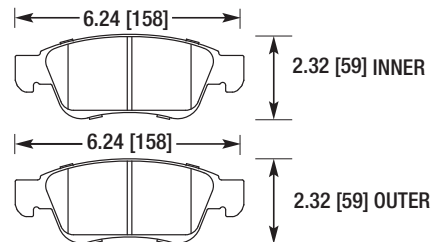

INFINITI G37

HB600

F, Z, E | FMSI D1288 | .539 [14]

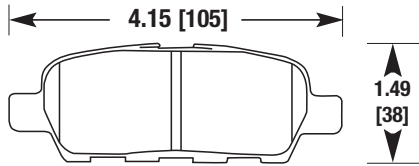

INFINITI G37 (REAR)

HB603

F, N, Z, G | FMSI D1371 | .616 [16]
S, U, W

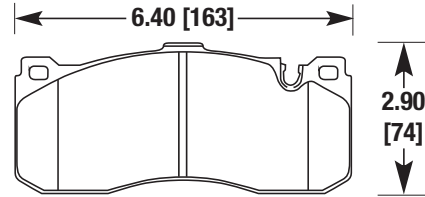

BMW 135i

HB601

F, N, Z, E | FMSI D1346 | .626 [16]
G, U, W

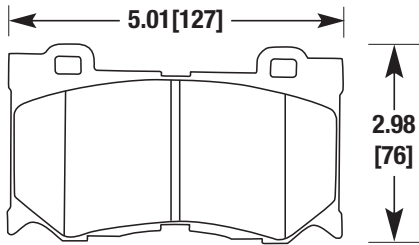

INFINITI G37 SPORT

HB604

F, N, Z, G | FMSI D1372 | .598 [15]
S, W

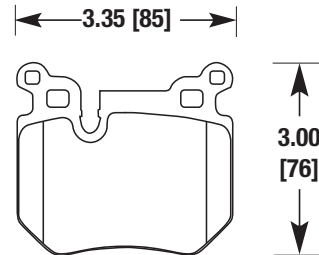

BMW 135i (REAR)

HB602

F, N, Z, E | FMSI D1347 | .545 [14]
G, U, W

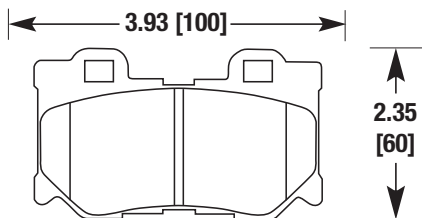

INFINITI G37 SPORT (REAR)

HB605

U, W | .625 [16]

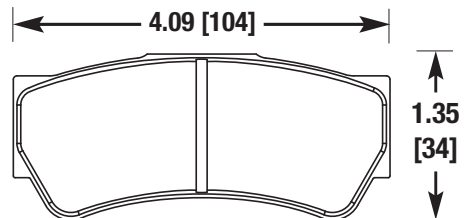

BREMBO

HB606

F, N, Z, E | FMSI D1351 | .650 [17]

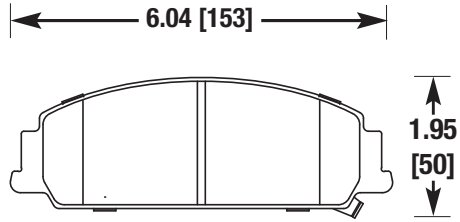

PONTIAC G8

HB609

F, N, Z, E | FMSI D1029 | .572 [15]
G, S, U, W

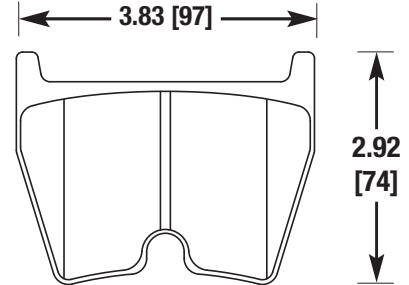

AUDI

HB607

F, N, Z, E | FMSI D1352 | .616 [16]

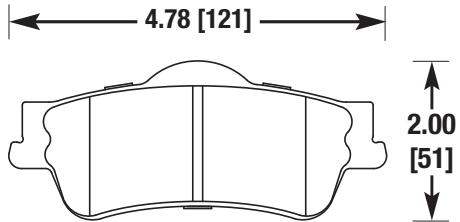

PONTIAC G8 (REAR)

HB610

F, E | FMSI D835 | .587 [15]

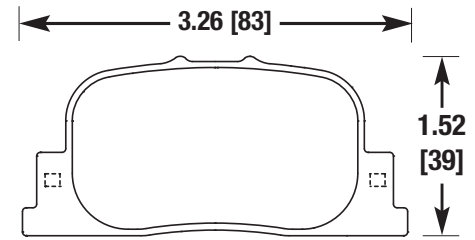

SCION, TOYOTA

HB608

F, Y, E | FMSI D1274 | .630 [16]

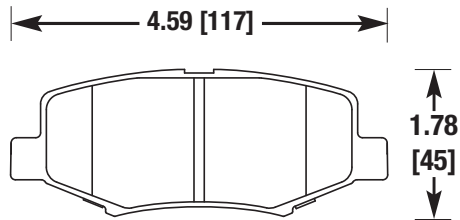

JEEP (REAR)

HB611

H, M, W | RACE | .490 [12]

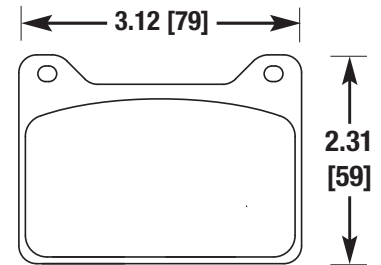

WILWOOD 7912

HB612

Y, Z, E | FMSI D1158 | .690 [18]

7.68 [195]

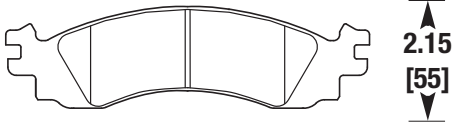

FORD EXPLORER

HB615

F, N, Z, G | FMSI D1368 | .535 [15]
S, U, W

3.41 [87]

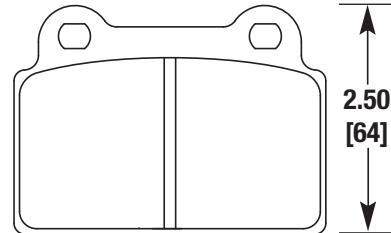

MINI (FRONT)

HB613

Y, Z, E | FMSI D1109 | .589 [15]

5.52 [140]

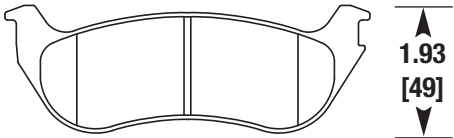

FORD EXPLORER (REAR)

HB616

F, Z, G | FMSI D1116 | .607 [15]
FMSI D1365

6.48 [165]

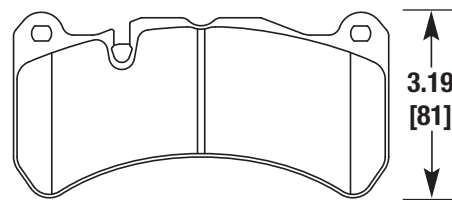

LEXUS, MERCEDES

HB614

U, W | FMSI D195 | .600 [15]

5.05 [128]

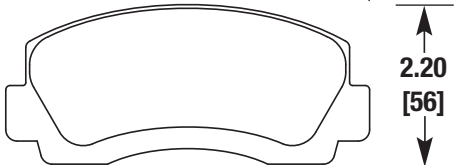

SWIFT

HB617

Y, Z, E | FMSI D1169 | .630 [16]

7.01 [178]



CHEVY

HB618

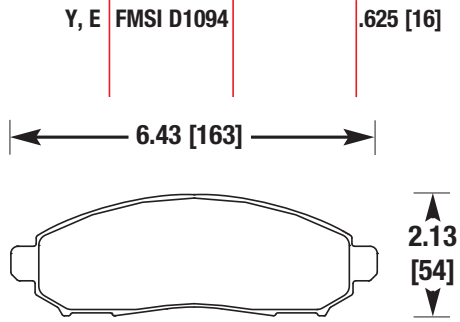

NISSAN

HB621

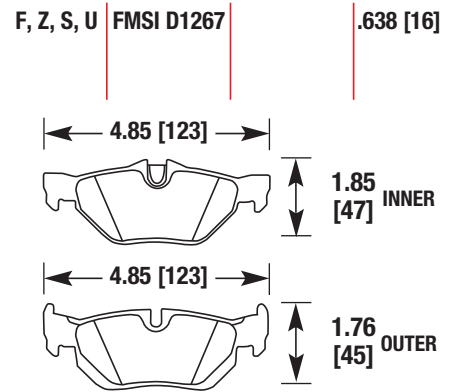

BMW (REAR)

HB619

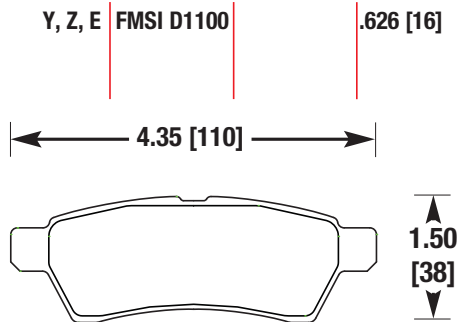

NISSAN (REAR)

HB622

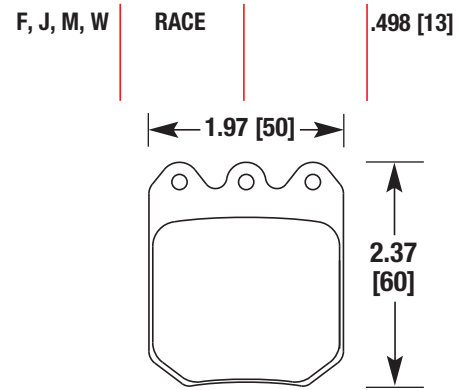

WILWOOD 6812

HB620

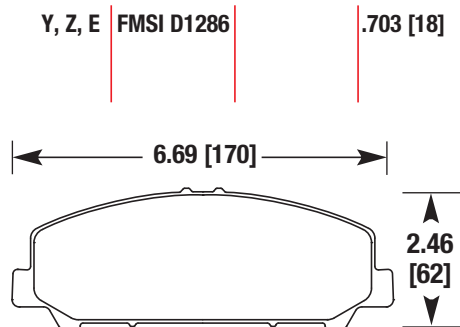

NISSAN

HB624

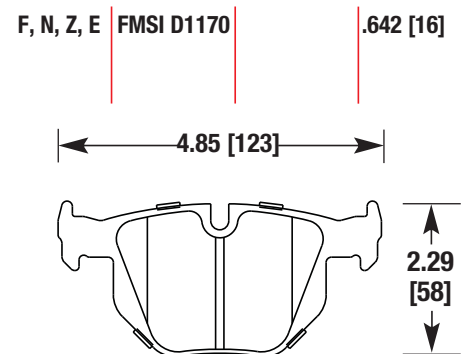

BMW (REAR)

HB625

F, Z, E | FMSI D1359 | .760 [19]

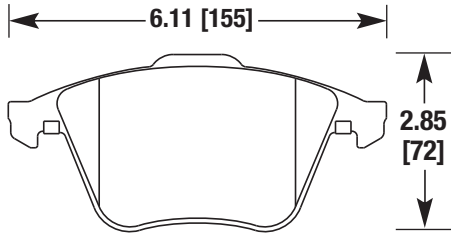

AUDI

HB628

F, E | FMSI D1249 | .651 [17]

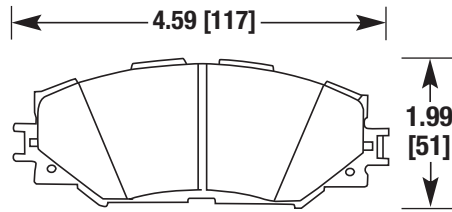

SCION

HB626

F, Z, E, G | FMSI D1336 | .577 [15]
W

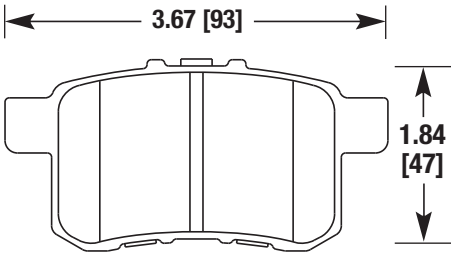

ACURA/HONDA (REAR)

HB629

F, E | FMSI D1354 | .565 [14]

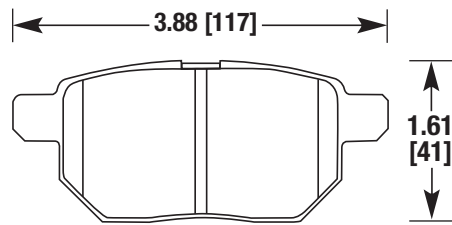

SCION (REAR)

HB627

F, Z, E | FMSI D1210 | .690 [18]

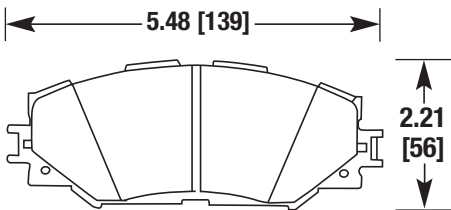

SCION

HB630

F, N, Z, U | FMSI D919 | .626 [16]

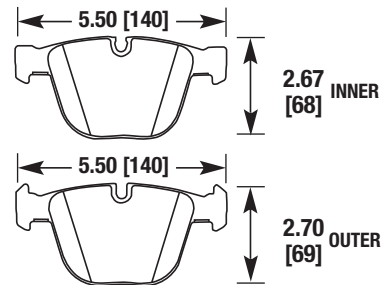

BMW (REAR)

HB631

F, N, Z, U | FMSI D1395 | .622 [17]

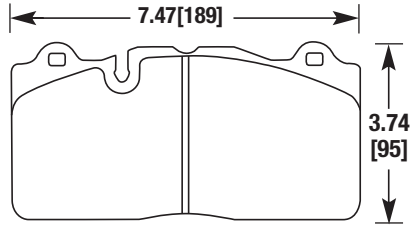

CORVETTE

HB634

P, E | FMSI D1400 | .750 [19]

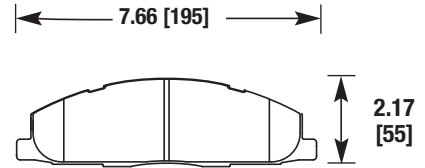

DODGE TRUCK (REAR)

HB632

F, N, Z, U | FMSI D1129 | .586 [15]

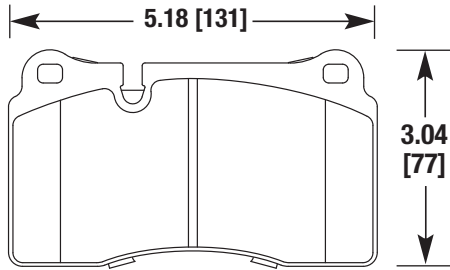

CORVETTE (REAR)

HB636

F, N, Z, E | FMSI D1396 | .644 [16]

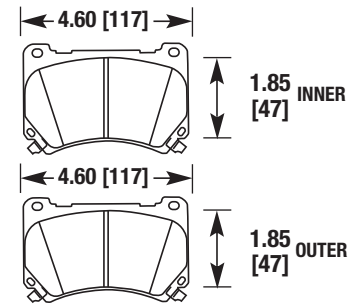

HYUNDAI

HB633

P, E | FMSI D1399 | .790 [19]

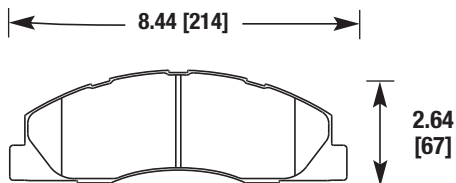

DODGE TRUCK

HB637

E | FMSI D1387 | .583 [15]

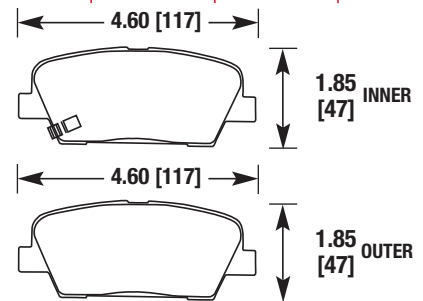

HYUNDAI (REAR)

HB638

F, N, Z, E | FMSI D1396 | .644 [16]

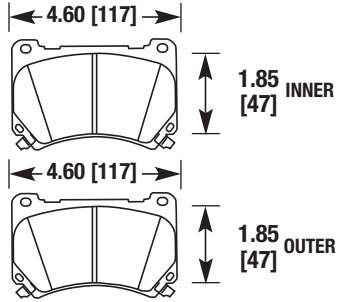

HYUNDAI

HB641

F, Z, E | FMSI D1322 | .696 [18]

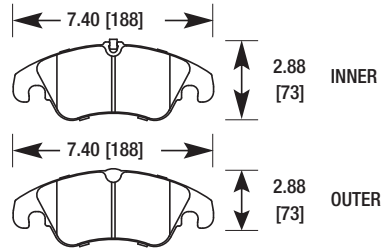

AUDI

HB639

F, N, Z, G | FMSI D1337 | .645 [16]

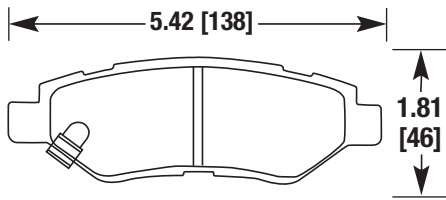

CAMARO (REAR)

HB642

F, Z, E | FMSI D1386 | .658 [17]

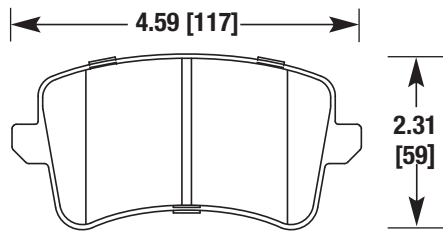

AUDI (REAR)

HB640

F, N, Z, E | FMSI D1403 | .550 [14]

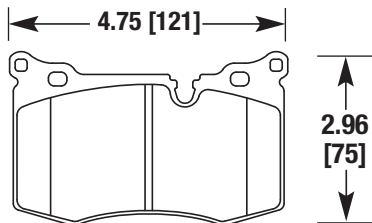

MINI COOPER JCW

HB643

F, E | FMSI D39 | .595 [15]

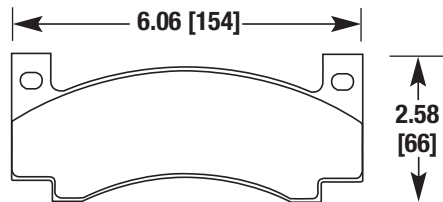

MOPAR

HB644

Y, Z, E | FSMI D1392 | .785 [20]

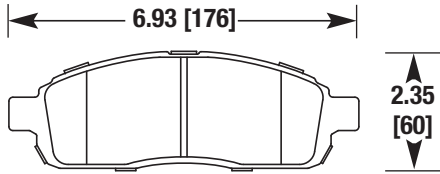

FORD TRUCK

HB647

F, Z, E | FSMI D1222
FSMI D1293 | .692 [43]

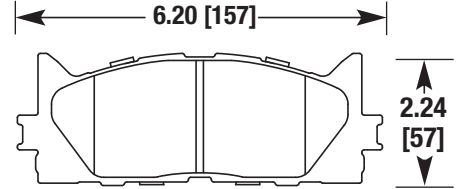

TOYOTA CAMRY

HB645

U, W | | .490 [12]

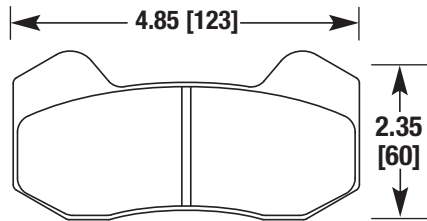

WILLWOOD 6712

HB648

F, Z, E | FSMI D1212 | .607 [15]

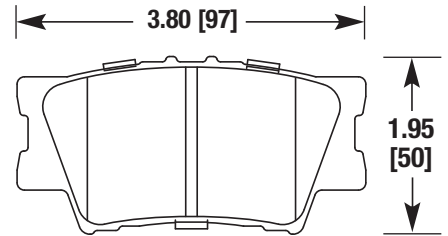

TOYOTA CAMRY (REAR)

HB646

F, E | FSMI D34 | .526 [13]

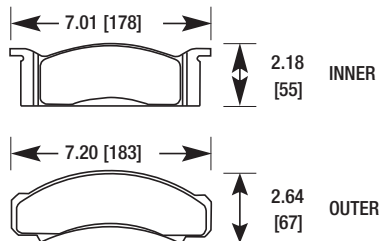

FORD, MERCURY

HB649

F, Z, G, U | FSMI D1405 | .605 [15]
W

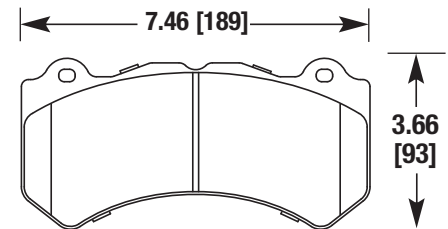

CADILLAC, CHEVY CAMARO

HB650

F, N, Z, G | FSMI D1382 | .730 [19]
U, W

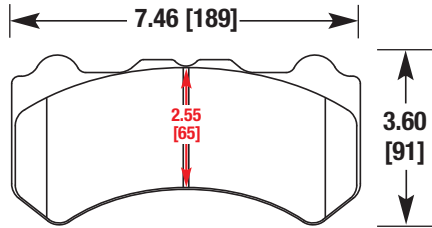

NISSAN

HB653

E | .606 [15]

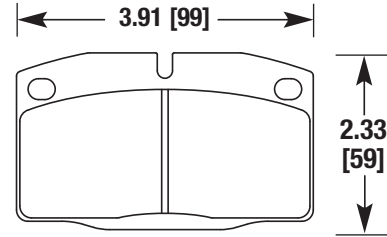

CARBONE LORRAINE 4012

HB651

F, Z, G, U | FSMI D1299 | .624 [16]
FSMI D1300

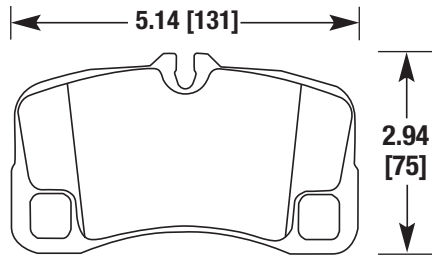

PORSCHE (REAR)

HB654

U | .748 [16]

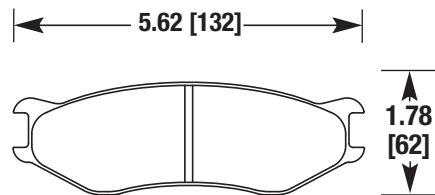

PFC ZR34

HB652

F, Z, E | FMSI D795 | .634 [16]

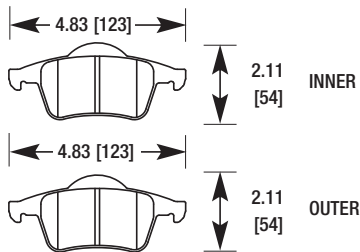

VOLVO (REAR)

HB655

F, N, U | .620 [16]

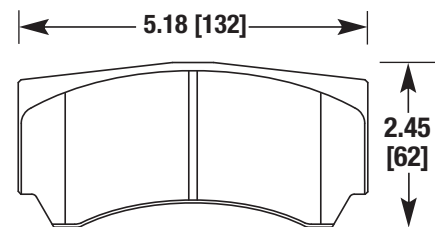

ALCON

HB656

F, E | FMSI D1258 | .684 [17]

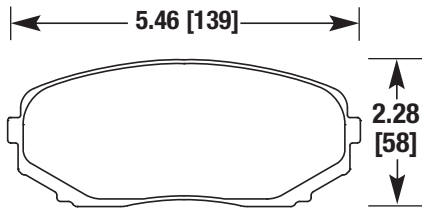

FORD

HB659

F, N, Z, G | FMSI D1185 | .570 [14]
U

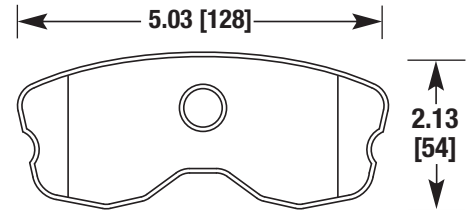

CORVETTE ONE-PIECE (REAR)

HB657

F, E | FMSI D1259 | .667 [17]

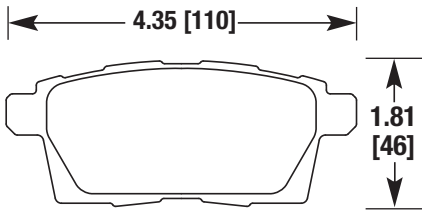

FORD (REAR)

HB660

F, N, Z, G | FMSI D1338 | .661 [17]
W | FMSI D1374

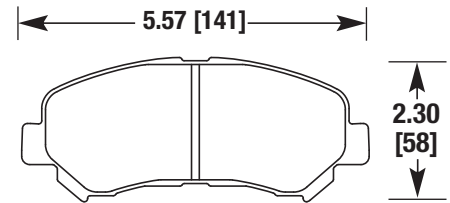

NISSAN SENTRA

HB658

F, N, Z, U | FMSI D1185 | .570 [14]

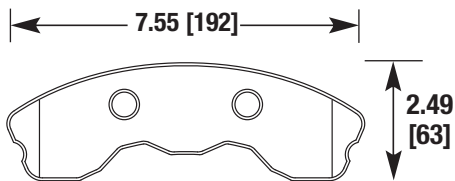

CORVETTE ONE-PIECE

HB661

F, N, Z, E | FMSI D1413 | .667 [17]

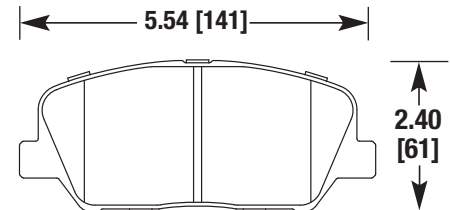

HYUNDAI

HB662

F, N, Z, E | FMSI D1284 | .587 [15]

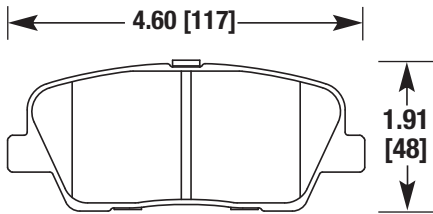

HYUNDAI (REAR)

HB665

F, Z, G, U | FMSI D1134 | .577 [15]
W

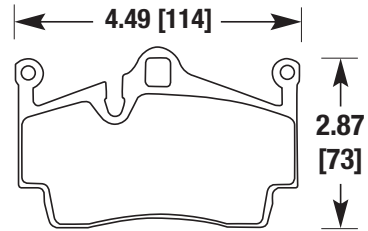

PORSCHE (REAR)

HB663

F, N, Z, G | FMSI D1428 | .557 [14]

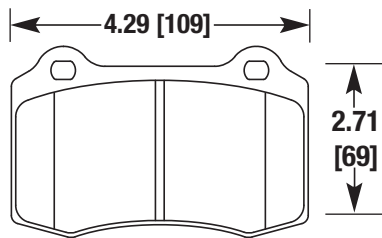

HYUNDAI (REAR)

HB667

F, Z, G, U | FMSI D916 | .622 [16]
W

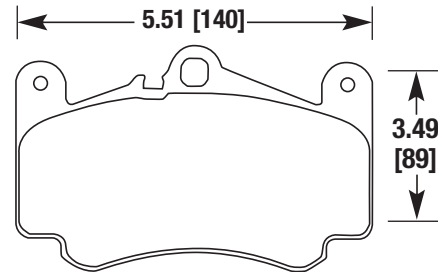

PORSCHE

HB664

F, Z, G, U | FMSI D1135 | .634 [16]
W

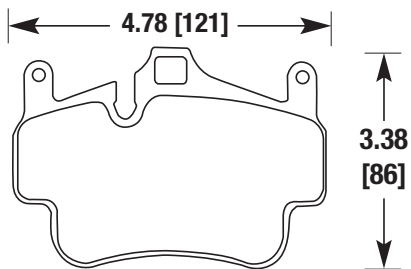

PORSCHE

HB668

F, N, Z, E | FMSI D1454 | .567 [14]
G, W

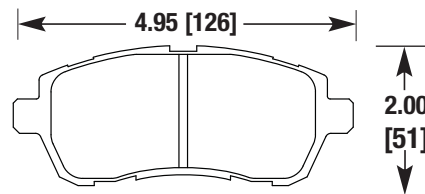

FORD FIESTA, MAZDA 2

HB669

F, N, Z, E | FMSI D1433 | .671 [17]

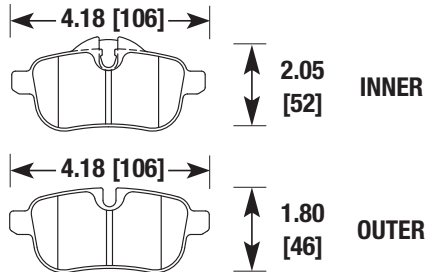

BMW (REAR)

HB672

Y, Z, E | FMSI D1414 | .714 [18]

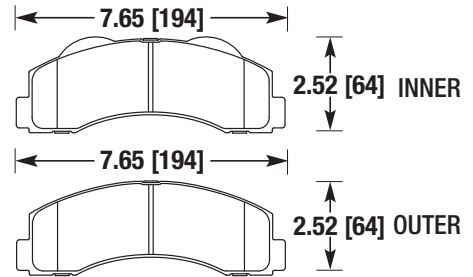

FORD TRUCK

HB670

F, E | FMSI D572 | .610 [15]

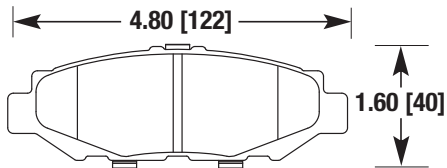

LEXUS, TOYOTA (REAR)

HB673

F, E | FMSI D532 | .602 [15]

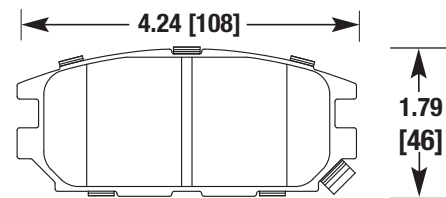

MITSUBISHI (REAR)

HB671

F, N, Z, G | FMSI D1124 | .628 [16]
U, W

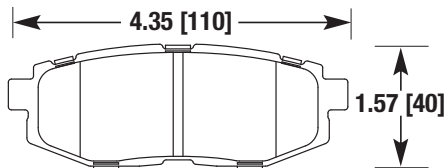

SUBARU / SCION (REAR)

HB674

F, Z, E | FMSI D1377 | .664 [17]

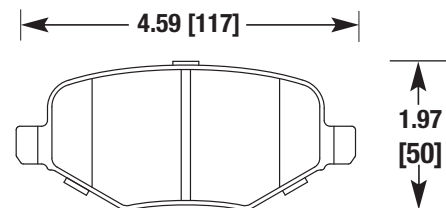

FORD, LINCOLN (REAR)

HB675

F, Y, E | FMSI D868 | .602 [15]

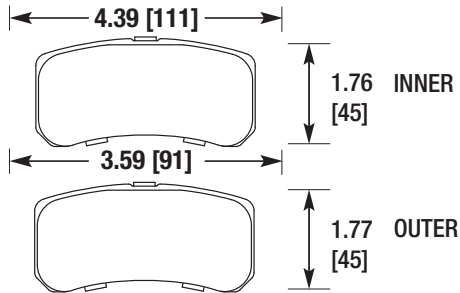

mitsubishi (REAR)

HB678

Y, Z, E | FMSI D1102 | .709 [18]

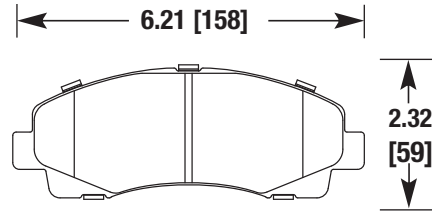

ACURA, HONDA

HB676

F, Z, E | FMSI D1151 | .780 [20]

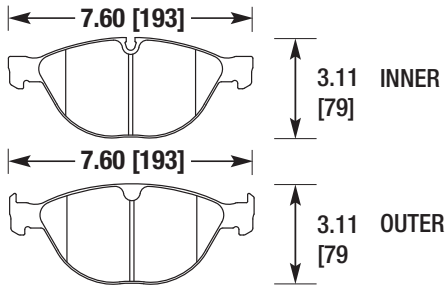

BMW M5, M6

HB679

Y, Z, E | FMSI D1103 | .600 [15]

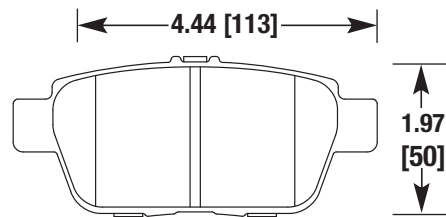

ACURA, HONDA (REAR)

HB677

Y, Z, E | FMSI D906 | .685 [17]

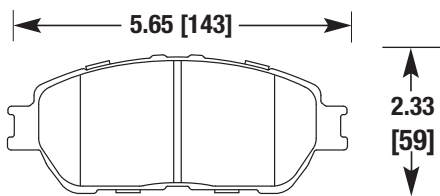

TOYOTA

HB680

F, N, E | FMSI D669 | .583 [15]

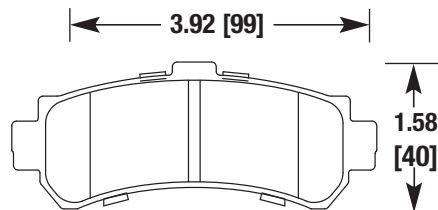

NISSAN (REAR)

HB681

Y, Z, E | FMSI D1098 | .686 [17]

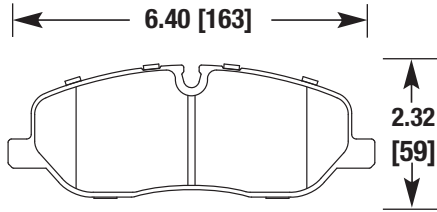

RANGE ROVER

HB684

Y, Z, E | FMSI D1425 | .694 [18]

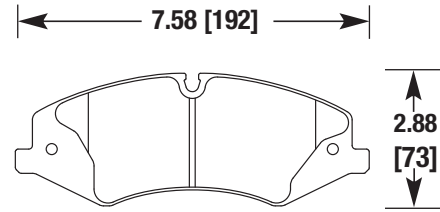

RANGE ROVER

HB682

Y, Z, E | FMSI D1099 | .657 [16]

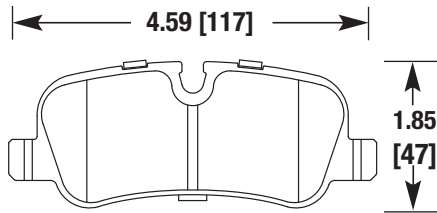

RANGE ROVER (REAR)

HB685

Y, Z, E | FMSI D1426 | .610 [15]

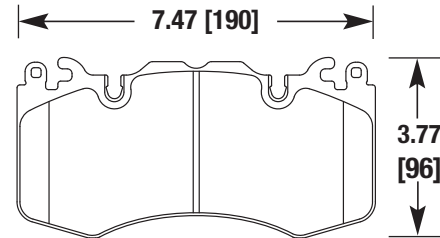

RANGE ROVER

HB683

Y, Z, E | FMSI D1165 | .651 [16]

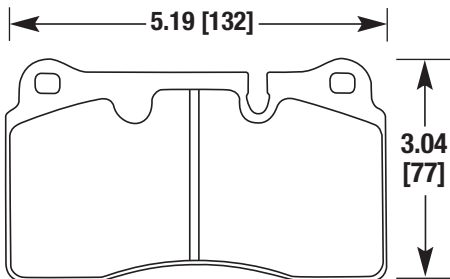

RANGE ROVER

HB686

Y, Z, E | FMSI D1427 | .645 [16]

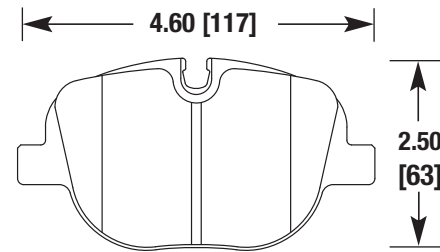

RANGE ROVER (REAR)

HB687

F, N, Z, E | FMSI D1117 | .750 [19]

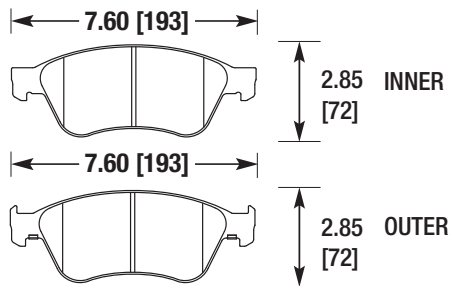

AUDI

HB690

F, E | FMSI D981 | .550 [14]

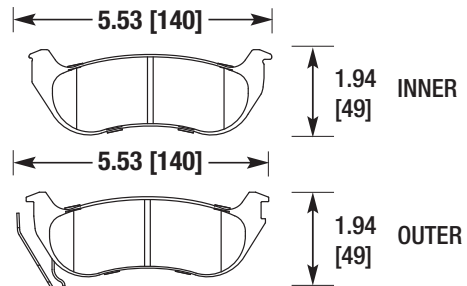

JEEP WRANGLER / LIBERTY (REAR)

HB688

F, N, Z, G
U, W | .710 [18]

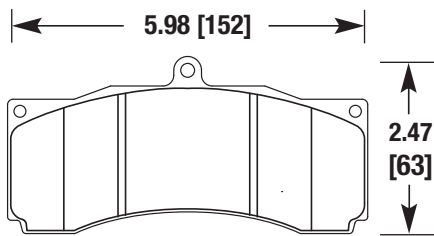

ALCON, AP RACING

HB691

G | .644 [16]

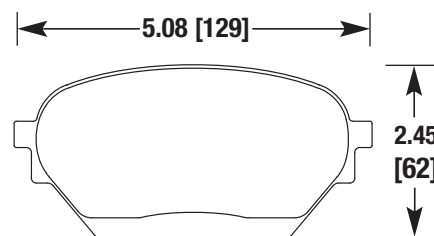

MAZDA MIATA MX5

HB689

F, E | FMSI D964 | .550 [14]

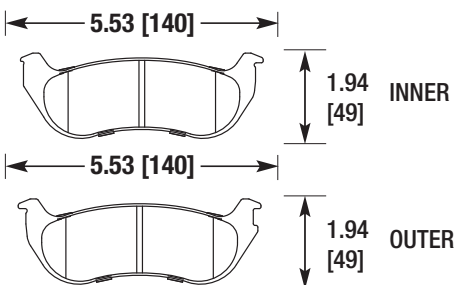

JEEP WRANGLER / LIBERTY (REAR)

HB693

Z, E | FMSI D1571 | .716 [18]

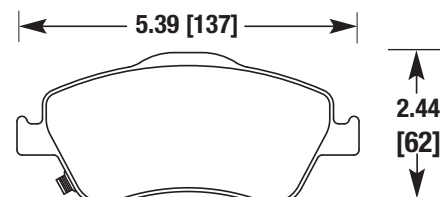

TOYOTA COROLLA (LATIN AMERICA)

HB694

Z, E | FMSI D1572 | .580 [18]

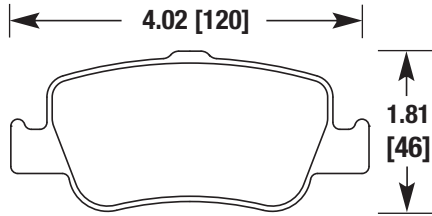

TOYOTA COROLLA (LATIN AMERICA, REAR)

HB697

MB | | .630 [16]

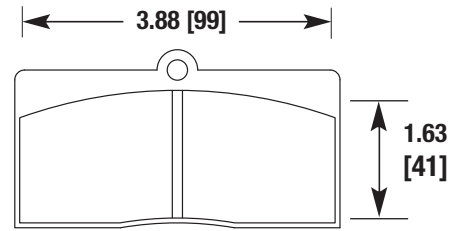

RED DEVIL

HB695

F, E | FMSI D1456 | .609 [15]

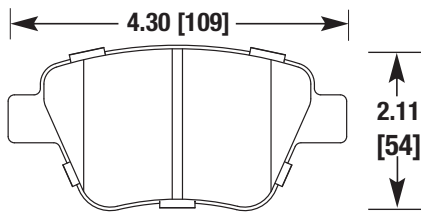

VOLKSWAGEN, AUDI (REAR)

HB698

MB | | .450 [11]

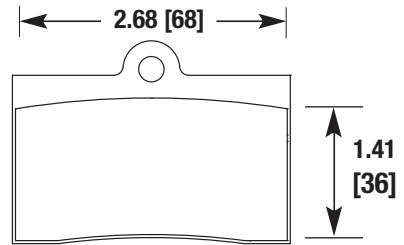

RED DEVIL

HB696

MB | | .450 [11]

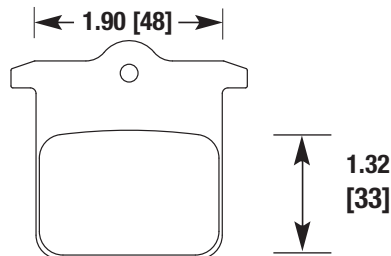

RED DEVIL

HB699

U | | 1.14 [29]

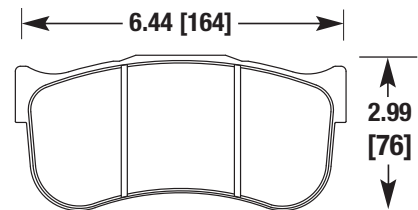

BREMBO

HB700

F, N, Z, E | FMSI D1182 | .562 [14]
G, S, W

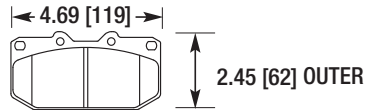
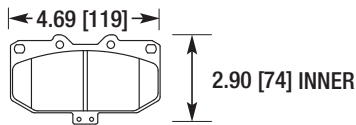

SUBARU WRX

HB703

F, P, Y, E | FMSI D1567 | .665 [17]

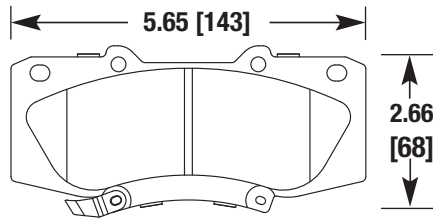

TOYOTA HILUX

HB701

F, Y, Z, E | FMSI D1455 | .723 [18]

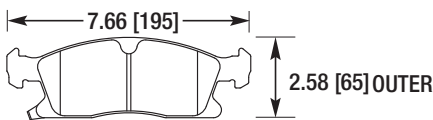
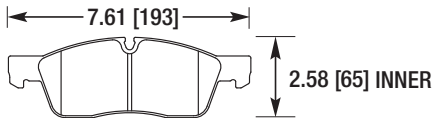

JEEP GRAND CHEROKEE

HB704

F, Z, G | FMSI D1211 | .692 [18]

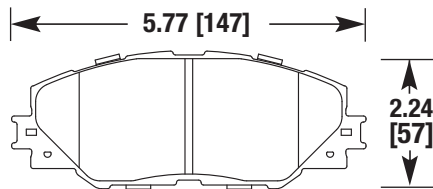

SCION

HB702

F, Y, Z, E | FMSI D1498 | .662 [17]

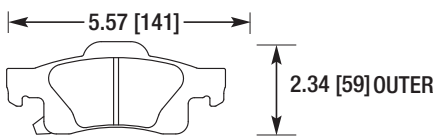
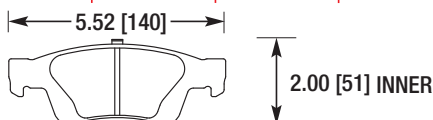

JEEP GRAND CHEROKEE (REAR)

HB705

P, Y, E | FMSI D1411 | .776 [20]

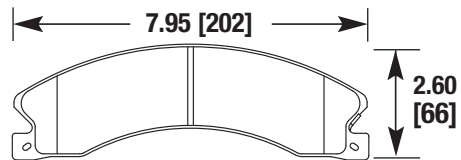

CHEVY/GMC TRUCK

HB706

F, N, Z, G | FMSI D1522 | .714 [18]
U, W

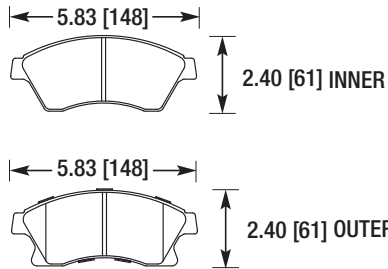

CHEVY CRUZE/SONIC

HB709

F, N, Z, G | | .630 [16]
U, W

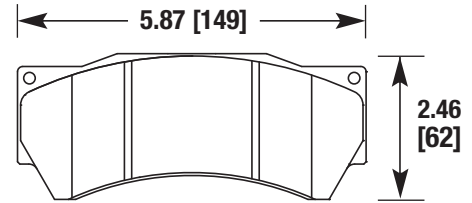

ALCON

HB707

F, N, Z, G | FMSI D1468 | .638 [16]
U, W

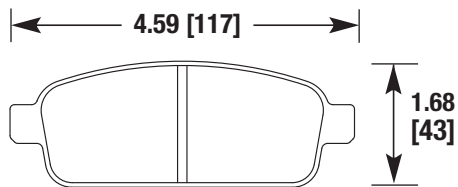

CHEVY CRUZE (REAR)

HB710

F, P, Y, Z | FMSI D1508 | .706 [18]

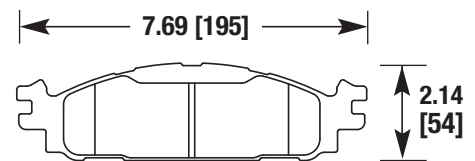

FORD EXPLORER

HB708

F, Z, E | FMSI D1294 | .738 [19]

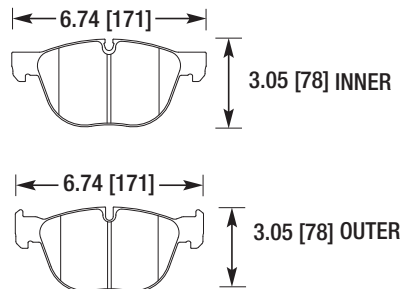

BMW X5/X6

HB711

F, N, Z, G | FMSI D1539 | .661 [17]
U, W

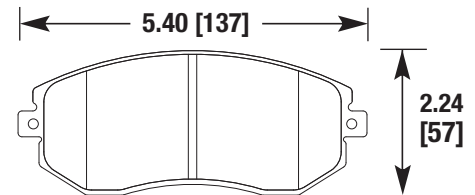

SUBARU, SCION

HB712

F, Z, N, W | FMSI D1567 | .680 [17]
G

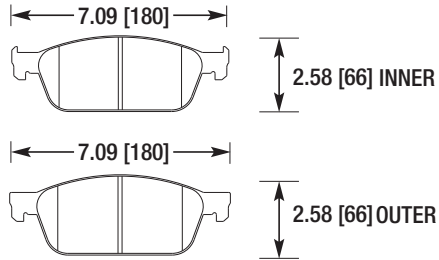

FORD FOCUS ST

ON THE ROAD OR ON THE TRACK...
CONTROL, COMAND AND CONQUER.



CROSS REFERENCE DATA SORTED BY FMSI NUMBER

FMSI No.	HAWK No.
D0004	HB244x.624
D0005	HB108x.560
D0008	HB126x.505
D0011	HB471x.510
D0027	HB132x.580
D0031	HB172x.500
D0031	HB172x.595
D0034	HB646x.362
D0039	HB643x.595
D0043	HB204x.615
D0044	HB118x.560
D0045	HB171x.590
D0045	HB171x.720
D0050	HB292x.674
D0052	HB103x.590
D0057	HB169x.560
D0058	HB172x.595
D0061	HB123x.535
D0076	HB150x.555
D0081	HB229x.580
D0092	HB292x.674
D0094	HB156x.562
D0100	HB207x.580
D0109	HB180x.560
D0109	HB180x.591
D0109	HB180x.640
D0114	HB169x.560
D0120	HB255x.655
D0122	HB103x.590
D0131	HB152x.540
D0138	HB119x.594
D0141	HB199x.702
D0145	HB207x.580
D0153	HB131x.595
D0154	HB119x.594
D0158	HB189x.595
D0159	HB400x.630
D0161	HB169x.560
D0163	HB206x.565
D0163	HB206x.700
D0169	HB156x.562

FMSI No.	HAWK No.
D0172	HB156x.562
D0174	HB180x.640
D0183	HB400x.630
D0184	HB252x.860
D0189	HB202x.580
D0190	HB400x.630
D0195	HB614x.600
D0199	HB125x.650
D0200	HB125x.650
D0202	HB119x.594
D0205	HB279x.594
D0206	HB189x.595
D0213	HB112x.540
D0215	HB396x.630
D0224	HB253x.750
D0225	HB251x1.14
D0227	HB190x.600
D0227	HB190x.730
D0228	HB271x.635
D0230	HB262x.540
D0231	HB262x.540
D0232	HB262x.540
D0235	HB151x.505
D0236	HB254x1.00
D0241	HB191x.590
D0242	HB191x.590
D0249	HB279x.594
D0251	HB199x.702
D0252	HB198x.685
D0253	HB137x.690
D0254	HB198x.685
D0256	HB397x.585
D0266	HB475x.642
D0269	HB398x.680
D0272	HB262x.540
D0273	HB218x.583
D0278	HB195x.640
D0279	HB399x.630
D0280	HB189x.550
D0280	HB189x.595
D0282	HB202x.580

FMSI CROSS REFERENCE

CROSS REFERENCE DATA SORTED BY FMSI NUMBER

FMSI No.	HAWK No.
D0283	HB158x.515
D0287	HB171x.590
D0289	HB400x.630
D0290	HB190x.730
D0292	HB134x.665
D0294	HB173x.570
D0295	HB112x.540
D0302	HB191x.590
D0305	HB203x.550
D0306	HB271x.605
D0307	HB189x.595
D0313	HB103x.590
D0321	HB195x.640
D0323	HB262x.540
D0325	HB401x.587
D0331	HB155x.580
D0332	HB158x.515
D0333	HB402x.669
D0334	HB403x.587
D0339	HB350x.496
D0340	HB364x.587
D0340	HB364x.642
D0341	HB242x.661
D0345	HB170x.650
D0347	HB580x.627
D0349	HB404x.642
D0352	HB401x.587
D0356	HB191x.590
D0360	HB293x.668
D0362	HB270x.724
D0364	HB350x.496
D0369	HB332x.654
D0370	HB296x.670
D0372	HB141x.650
D0373	HB113x.590
D0374	HB350x.496
D0375	HB293x.634
D0375	HB293x.668
D0376	HB232x.681
D0380	HB252x.860
D0383	HB367x.585

FMSI No.	HAWK No.
D0387	HB279x.594
D0389	HB407x.602
D0392	HB131x.595
D0394	HB135x.642
D0394	HB135x.770
D0395	HB137x.690
D0396	HB227x.630
D0409	HB242x.661
D0410	HB317x.591
D0412	HB111x.610
D0413	HB112x.540
D0415	HB176x.614
D0417	HB240x.620
D0419	HB270x.724
D0421	HB240x.620
D0422	HB231x.625
D0424	HB199x.660
D0429	HB262x.540
D0430	HB268x.665
D0431	HB263x.650
D0431	HB263x.670
D0433	HB407x.602
D0436	HB315x.669
D0439	HB195x.640
D0441	HB475x.642
D0443	HB199x.702
D0445	HB198x.685
D0446	HB170x.650
D0446	HB170x.710
D0447	HB141x.650
D0449	HB261x.665
D0450	HB336x.655
D0454	HB195x.640
D0455	HB199x.702
D0457	HB148x.560
D0458	HB157x.484
D0459	HB298x.787
D0460	HB178x.564
D0461	HB179x.630
D0462	HB235x.665
D0463	HB155x.580

CROSS REFERENCE DATA SORTED BY FMSI NUMBER

FMSI No.	HAWK No.
D0464	HB262x.540
D0465	HB275x.620
D0465	HB275x.720
D0468	HB148x.560
D0469	HB235x.665
D0470	HB408x.665
D0471	HB367x.585
D0473	HB246x.567
D0474	HB218x.583
D0476	HB318x.669
D0477	HB210x.677
D0481	HB437x.585
D0482	HB158x.515
D0484	HB213x.626
D0485	HB235x.665
D0487	HB195x.640
D0491	HB278x.465
D0491	HB278x.583
D0493	HB195x.640
D0499	HB125x.650
D0502	HB312x.591
D0503	HB143x.680
D0504	HB185x.590
D0506	HB390x.602
D0507	HB409x.661
D0508	HB359x.543
D0512	HB176x.614
D0521	HB411x.717
D0522	HB410x.721
D0524	HB411x.717
D0525	HB148x.560
D0526	HB268x.665
D0529	HB308x.689
D0530	HB214x.618
D0531	HB120x.560
D0532	HB673x.602
D0536	HB572x.570
D0537	HB145x.570
D0539	HB191x.590
D0540	HB421x.622
D0542	HB413x.690

FMSI No.	HAWK No.
D0545	HB580x.627
D0547	HB325x.720
D0548	HB362x.642
D0549	HB409x.661
D0551	HB379x.626
D0551	HB379x.626
D0555	HB269x.763
D0555	HB269x.763A
D0555	HB269x.763B
D0556	HB384x.587
D0558	HB136x.690
D0559	HB176x.614
D0560	HB218x.583
D0562	HB310x.689
D0564	HB350x.496
D0568	HB144x.719
D0569	HB189x.595
D0570	HB191x.590
D0572	HB670x.750
D0576	HB414x.622
D0579	HB422x.610
D0583	HB211x.634
D0584	HB212x.535
D0585	HB155x.580
D0587	HB415x.583
D0588	HB437x.585
D0589	HB407x.602
D0591	HB241x.710
D0592	HB194x.570
D0592	HB194x.665
D0593	HB308x.689
D0594	HB184x.650
D0594	HB184x.650A
D0594	HB184x.650B
D0594	HB184x.650C
D0595	HB421x.622
D0597	HB240x.620
D0598	HB416x.689
D0600	HB182x.660
D0601	HB347x.689
D0603	HB371x.600

CROSS REFERENCE DATA SORTED BY FMSI NUMBER

FMSI No.	HAWK No.
D0606	HB477x.610
D0607	HB279x.594
D0608	HB170x.650
D0609	HB141x.650
D0610	HB417x.659
D0611	HB311x.591
D0614	HB131x.595
D0617	HB245x.631
D0618	HB492x.732
D0619	HB375x.669
D0621	HB418x.646
D0623	HB217x.681
D0625	HB285x.595
D0626	HB295x.630
D0627	HB183x.585
D0627	HB183x.660
D0629	HB215x.630
D0630	HB216x.590
D0631	HB201x.620
D0632	HB295x.630
D0634	HB413x.690
D0635	HB149x.505
D0636	HB159x.492
D0637	HB211x.634
D0639	HB181x.660
D0641	HB176x.614
D0642	HB177x.630
D0642	HB177x.710
D0643	HB419x.634
D0647	HB178x.564
D0648	HB420x.724
D0650	HB233x.635
D0652	HB283x.650
D0654	HB279x.594
D0655	HB334x.705
D0655	HB334x.736
D0656	HB347x.689
D0658	HB176x.614
D0661	HB510x.580
D0663	HB159x.492
D0664	HB284x.575
D0666	HB286x.591

FMSI No.	HAWK No.
D0667	HB287x.571
D0668	HB236x.622
D0669	HB680x.583
D0673	HB390x.602
D0674	HB341x.618
D0676	HB469x.705
D0679	HB266x.650
D0681	HB325x.720
D0682	HB497x.776
D0683	HB518x.642
D0684	HB190x.730
D0685	HB401x.587
D0687	HB272x.763
D0687	HB272x.763A
D0690	HB353x.618
D0691	HB326x.646
D0692	HB227x.630
D0695	HB310x.689
D0696	HB190x.600
D0697	HB318x.669
D0698	HB359x.543
D0699	HB360x.670
D0700	HB261x.665
D0702	HB299x.650
D0707	HB320x.669
D0711	HB301x.630
D0712	HB210x.677
D0713	HB286x.591
D0714	HB359x.543
D0717	HB252x.860
D0718	HB318x.669
D0720	HB423x.709
D0721	HB352x.665
D0722	HB424x.665
D0723	HB214x.618
D0725	HB135x.770
D0726	HB304x.598
D0727	HB425x.661
D0728	HB409x.661
D0729	HB305x.610
D0730	HB260x.670

CROSS REFERENCE DATA SORTED BY FMSI NUMBER

FMSI No.	HAWK No.
D0731	HB247x.575
D0732	HB248x.650
D0737	HB289x.610
D0738	HB290x.583
D0738	HB290x.606
D0740	HB495x.756
D0741	HB321x.650
D0744	HB318x.669
D0745	HB420x.724
D0746	HB306x.795
D0747	HB261x.665
D0748	HB294x.646
D0749	HB249x.575
D0750	HB250x.653
D0752	HB425x.661
D0754	HB359x.543
D0755	HB489x.630
D0756	HB302x.700
D0757	HB303x.685
D0758	HB299x.650
D0759	HB176x.614
D0760	HB505x.654
D0763	HB227x.630
D0764	HB275x.620
D0764	HB275x.660
D0765	HB416x.689
D0766	HB597x.681
D0768	HB365x.728
D0769	HB344x.992
D0770	HB434x.543
D0771	HB499x.610
D0772	HB313x.685
D0773	HB427x.685
D0776	HB291x.642
D0777	HB335x.815
D0781	HB546x.654
D0782	HB176x.614
D0784	HB322x.717
D0785	HB323x.724
D0786	HB327x.799
D0786	HB327x1.05

FMSI No.	HAWK No.
D0787	HB366x.681
D0789	HB332x.654
D0791	HB381x.661
D0792	HB324x.673
D0794	HB491x.693
D0795	HB652x.634
D0799	HB316x.670
D0801	HB420x.724
D0802	HB539x.650
D0803	HB342x.701
D0804	HB274x.610
D0805	HB376x.665
D0806	HB428x.650
D0807	HB384x.587
D0810	HB193x.670
D0812	HB314x.665
D0814	HB359x.543
D0815	HB268x.665
D0816	HB346x.713
D0817	HB328x.685
D0818	HB360x.670
D0819	HB388x.756
D0820	HB307x.795
D0821	HB487x.733
D0822	HB493x.650
D0823	HB329x.543
D0824	HB302x.700
D0825	HB537x.783
D0829	HB361x.622
D0830	HB488x.629
D0833	HB472x.650
D0834	HB385x.640
D0835	HB610x.587
D0836	HB354x.756
D0837	HB500x.645
D0838	HB516x.626
D0839	HB363x.689
D0840	HB354x.756
D0841	HB377x.760
D0842	HB299x.650
D0843	HB473x.752

CROSS REFERENCE DATA SORTED BY FMSI NUMBER

FMSI No.	HAWK No.
D0844	HB373x.689
D0845	HB296x.670
D0849	HB376x.665
D0850	HB360x.670
D0851	HB271x.605
D0853	HB495x.756
D0855	HB326x.646
D0856	HB373x.689
D0857	HB374x.700
D0858	HB372x.626
D0859	HB487x.733
D0861	HB172x.595
D0862	HB429x.681
D0864	HB461x.646
D0865	HB506x.610
D0866	HB435x.622
D0868	HB675x.602
D0869	HB498x.772
D0872	HB504x.740
D0879	HB301x.630
D0881	HB520x.575
D0882	HB382x.657
D0883	HB383x.685
D0886	HB430x.547
D0888	HB387x.547
D0890	HB431x.606
D0891	HB442x.496
D0892	HB436x.535
D0893	HB211x.634
D0894	HB364x.642
D0897	HB299x.650
D0898	HB514x.610
D0900	HB378x.626
D0903	HB461x.646
D0904	HB438x.606
D0905	HB370x.559
D0906	HB677x.685
D0908	HB474x.681
D0909	HB322x.717
D0912	HB363x.689
D0913	HB472x.650

FMSI No.	HAWK No.
D0914	HB393x.665
D0915	HB515x.760
D0916	HB667x.622
D0917	HB550x.634
D0918	HB551x.748
D0919	HB630x.626
D0921	HB439x.555
D0922	HB440x.606
D0923	HB441x.661
D0924	HB368x.665
D0928	HB479x.700
D0929	HB432x.661
D0931	HB433x.654
D0932	HB443x.614
D0934	HB462x.827
D0935	HB463x.787
D0936	HB388x.756
D0939	HB444x.685
D0940	HB445x.610
D0943	HB393x.665
D0944	HB428x.650
D0945	HB446x.725
D0946	HB464x.764
D0947	HB465x.764
D0948	HB418x.646
D0955	HB461x.646
D0956	HB517x.690
D0957	HB459x.700
D0958	HB393x.665
D0959	HB447x.667
D0960	HB545x.564
D0961	HB180x.560
D0962	HB476x.707
D0963	HB503x.790
D0964	HB689x.550
D0965	HB552x.722
D0966	HB299x.650
D0967	HB513x.610
D0968	HB193x.670
D0969	HB448x.610
D0970	HB449x.679

CROSS REFERENCE DATA SORTED BY FMSI NUMBER

FMSI No.	HAWK No.
D0973	HB571x.605
D0974	HB494x.670
D0975	HB496x.640
D0976	HB490x.665
D0977	HB501x.625
D0978	HB502x.606
D0979	HB466x.780
D0981	HB690x.550
D0989	HB591x.760
D0990	HB493x.650
D0991	HB483x.635
D0992	HB454x.715
D0997	HB433x.654
D0999	HB450x.555
D1000	HB451x.668
D1001	HB453x.585
D1002	HB468x.492
D1003	HB466x.780
D1004	HB452x.545
D1007	HB512x.605
D1008	HB378x.565
D1009	HB470x.643
D1010	HB511x.790
D1011	HB455x.785
D1012	HB456x.705
D1013	HB461x.646
D1014	HB501x.625
D1016	HB453x.585
D1017	HB364x.642
D1018	HB553x.652
D1019	HB467x.540
D1023	HB364x.642
D1024	HB687x.750
D1027	HB588x.875
D1028	HB524x.740
D1029	HB609x.572
D1033	HB525x.540
D1035	HB592x.665
D1036	HB593x.548
D1037	HB457x.605
D1039	HB554x.643

FMSI No.	HAWK No.
D1040	HB443x.614
D1041	HB555x.678
D1042	HB458x.642
D1043	HB460x.580
D1044	HB519x.682
D1048	HB573x.615
D1049	HB530x.570
D1050	HB453x.585
D1053	HB194x.570
D1056	HB507x.711
D1057	HB508x.586
D1057	HB508x.675
D1058	HB509x.678
D1060	HB445x.610
D1061	HB534x.750
D1063	HB567x.694
D1066	HB547x.798
D1067	HB556x.710
D1068	HB529x.710
D1069	HB528x.811
D1075	HB360x.670
D1076	HB536x.704
D1077	HB299x.650
D1078	HB533x.668
D1079	HB299x.650
D1080	HB558x.710
D1081	HB484x.670
D1082	HB485x.656
D1083	HB455x.785
D1084	HB559x.695
D1087	HB555x.678
D1092	HB561x.710
D1094	HB618x.625
D1095	HB478x.605
D1096	HB299x.650
D1098	HB681x.686
D1099	HB682x.657
D1100	HB619x.626
D1101	HB619x.626
D1102	HB678x.709
D1103	HB679x.600

CROSS REFERENCE DATA SORTED BY FMSI NUMBER

FMSI No.	HAWK No.
D1107	HB543x.760
D1108	HB544x.628
D1109	HB613x.589
D1110	HB439x.555
D1111	HB538x.760
D1112	HB364x.587
D1113	HB562x.612
D1114	HB557x.545
D1116	HB616x.607
D1117	HB687x.750
D1119	HB526x.665
D1120	HB527x.604
D1124	HB671x.628
D1125	HB368x.665
D1129	HB632x.586
D1134	HB665x.577
D1135	HB664x.634
D1149	HB563x.656
D1151	HB676x.671
D1158	HB612x.690
D1159	HB535x.638
D1160	HB524x.740
D1161	HB564x.567
D1164	HB565x.688
D1169	HB617x.630
D1170	HB624x.642
D1178	HB566x.688
D1179	HB522x.565
D1180	HB523x.539
D1181	HB558x.710
D1182	HB700x.562
D1183	HB567x.694
D1184	HB596x.690
D1185	HB531x.570
D1185	HB532x.570
D1185	HB658x.570
D1185	HB659x.570
D1186	HB549x.702
D1192	HB565x.688
D1193	HB598x.606
D1194	HB568x.666

FMSI No.	HAWK No.
D1204	HB560x.677
D1210	HB627x.690
D1211	HB704x.692
D1212	HB648x.607
D1215	HB594x.657
D1216	HB595x.589
D1222	HB647x.692
D1224	HB360x.670
D1230	HB519x.682
D1244	HB128x.505
D1249	HB628x.651
D1258	HB656x.684
D1259	HB657x.667
D1260	HB551x.748
D1263	HB683x.651
D1267	HB621x.638
D1270	HB194x.570
D1273	HB569x.650
D1274	HB608x.630
D1278	HB578x.735
D1279	HB579x.785
D1284	HB662x.587
D1285	HB435x.622
D1286	HB620x.703
D1287	HB599x.616
D1288	HB600x.539
D1293	HB647x.692
D1294	HB708x.738
D1298	HB563x.656
D1299	HB651x.624
D1300	HB651x.624
D1303	HB589x.704
D1304	HB590x.682
D1308	HB570x.666
D1309	HB574x.636
D1319	HB543x.760
D1322	HB641x.696
D1333	HB528x.811
D1334	HB556x.710
D1336	HB626x.577
D1337	HB639x.645

CROSS REFERENCE DATA SORTED BY FMSI NUMBER

FMSI No.	HAWK No.
D1338	HB660x.661
D1346	HB601x.626
D1347	HB602x.545
D1351	HB606x.650
D1352	HB607x.616
D1353	HB547x.798
D1354	HB629x.565
D1359	HB625x.760
D1363	HB561x.710
D1364	HB525x.540
D1365	HB616x.607
D1367	HB561x.710
D1368	HB615x.535
D1371	HB603x.616
D1372	HB604x.598
D1374	HB660x.661
D1377	HB674x.664
D1379	HB548x.600
D1380	HB561x.710
D1382	HB650x.730
D1383	HB193x.670
D1384	HB635x.645
D1386	HB642x.658
D1387	HB637x.583
D1392	HB644x.785
D1393	HB370x.559
D1395	HB631x.622
D1396	HB636x.644
D1399	HB633x.790
D1400	HB634x.750
D1403	HB640x.550
D1404	HB638x.702
D1405	HB649x.605
D1411	HB705x.776
D1413	HB661x.667
D1414	HB672x.714
D1415	HB370x.559
D1419	HB531x.570
D1419	HB532x.570
D1419	HB658x.570
D1419	HB659x.570

FMSI No.	HAWK No.
D1423	HB629x.565
D1425	HB684x.694
D1426	HB685x.610
D1427	HB686x.645
D1428	HB663x.557
D1433	HB669x.671
D1451	HB626x.577
D1454	HB668x.567
D1455	HB701x.723
D1456	HB695x.609
D1463	HB484x.670
D1464	HB484x.670
D1465	HB485x.656
D1468	HB707x.638
D1474	HB453x.585
D1498	HB702x.662
D1506	HB366x.681
D1507	HB383x.685
D1508	HB710x.706
D1522	HB706x.714
D1539	HB711x.661
D1563	HB519x.682
D1565	HB705x.776
D1567	HB703x.665
D1571	HB693x.716
D1572	HB694x.580
D1578	HB275x.620
D1584	HB678x.709

FREQUENTLY ASKED STREET PAD QUESTIONS

Q: What compound is best for my application?

A: This is highly dependent on the vehicle and expectations of the customer. In most cases we recommend that you reference our product literature, website, or contact us at 440-528-4000.

Q: What causes brake noise?

A: There are literally hundreds of reasons why brake noise occurs and most have nothing to do with brake pads. Proper installation, brake system maintenance, rotor quality and debris tend to be the most common causes.

Sometimes brake squeal can be an indicator that there is a problem. Maintenance is required if you experience brake squeal for any of the following reasons:

- Lack of friction material (brakes need to be replaced)
- Loose fitting brake in the caliper
- Loose fitting or missing brake hardware (i.e. shims, anti-rattle clips)
- Loose lug nuts or caliper hardware
- Debris caught between the rotor and the surface of the brake pad
- Heat cracked or worn rotors
- Uneven finish on resurfaced rotors

In some cases, a user may experience brake noise when no maintenance is required. We call these NVH (Noise, Vibration and Harshness) issues. Brake squeal is typically caused by vibration between the brake pads, rotors and brake calipers. Some brands of semi-metallic brakes are more likely to experience brake squeal due to the metallic ingredients in the brake pads.

Hawk Performance has a great reputation for manufacturing low-noise, high-performance brake pads. All Hawk Performance products have an OE quality shim, severe duty powder coat surface treatment and "GearHead Grease Paks" to virtually eliminate the risk of brake noise. Below are the instructions for proper use of our "GearHead Grease Paks."

1. To silence brake noise – Apply 1-2 grams on the backside of the brake pad and evenly spread across the surface making sure to cover any areas where the pad contacts the caliper or piston.
2. To lubricate calipers – Clean and inspect all brake caliper parts making sure to inspect for damage or excessive corrosion. Apply to pins, slides, bushings, pistons, rubber sleeves and seals. **DO NOT APPLY TO THE ROTOR FACE OR THE BRAKING SURFACE OF THE PAD!**

Caution: For eye and skin contact, flush with water for 15 minutes. Wash skin with soap and water; call a physician if irritation persists. If swallowed do NOT induce vomiting; call a physician. **KEEP OUT OF REACH OF CHILDREN.**

Q: How do I break-in my new pads?

A: Brake Pad Burnishing/Bedding-In Instructions

1. After installing new brake pads, make 6-to-10 stops from approximately 30-35 MPH applying moderate pressure.
2. Make an additional 2-to-3 hard stops from approximately 40-45 MPH.
3. **DO NOT DRAG BRAKES!**
4. Allow at least 15 minutes for the brake system to cool down.
5. After step 4 is completed, your new Hawk Performance brake pads are ready for use.

Q: Why should I follow a break-in procedure on new brake pads?

A: Correct brake pad break-in (bedding) is important to assure quality braking performance over the life of the pad. This procedure allows the rubbing surface of the brake pad to be brought to temperatures, creating a transfer-film layer of friction material to be applied to the rotor surface. This allows the brake pad material to rub against itself rather than the bare rotor. This increases the stopping performance of the brake pad and can reduce pad and rotor wear.

Q: Can I run cross-drilled or slotted rotors with Hawk Performance brake pads?

A: Yes you can. We do suggest a slotted or solid faced rotor for performance applications. Cross drilled rotors are primarily for looks and as such some trade offs will occur, such as increased brake pad wear and increased dust.

Q: Where can I find an authorized distributor of Hawk Performance brake pads?

A: www.HawkPerformance.com. You can find an authorized distributor of Hawk Performance high performance brake pads by entering your zip code in the "Where to Buy" box on the left menu bar of our website. If you are looking for a distributor by name and not by location, simply use the "Advanced Search Options" feature of our website. You can also contact us at 440-528-4000.

Q: Does Hawk Performance have a part for my vehicle application?

A: We are constantly developing new applications, so if you do not see your application listed in the application guide of this catalog, please search for it on our website. To search for a part for your vehicle application, enter the year and make in the "Find Part Now" box on the left menu bar of our website and hit enter. Select the model of your vehicle from the drop down menu and hit enter. Hawk Performance part numbers for your specified application will be displayed, if available.

Q: What can I do during installation to ensure my brakes won't squeal?

A: First, choose Hawk Performance high performance disc brake pads as your upgrade over other aftermarket brake suppliers. The next best steps you can take to avoid having noisy brakes are:

- Turn / machine the rotors (machining off a small layer of the brake rotor to make it smooth again)
- Wash and dry the rotor to rid of debris
- Install the pads securely and according to instruction
- Properly bed-in the pads according to instruction
- Apply a thin layer of a silicone compound called anti-squeal brake lube on the back of the brake pads

Our standard installation procedures are outlined below. This information is printed on the box of every brake pad set we manufacture, and should be followed in accordance with the application-specific brake pad installation instructions provided by the vehicle manufacturer.

Brake Pad Installation Procedure

- Install brake pads properly. Be sure pads are securely positioned in the caliper.
- Flush system with fresh brake fluid.
- Check all hydraulic parts for excess wear and tear.
- Check disc for proper thickness, parallelism, and lateral runout.
- Check disc for scoring or grooves over .012" depth. If either applies, resurfacing is required.
- If discs do not need resurfacing, then contamination from the previous brake pads must be removed. Sand discs with 130-grit sandpaper using moderate pressure. Use soap and water to clean disc surface after sanding. Discs should be free and clear of oil, grease and brake fluid.
- Inspect calipers for freedom of movement. Lubricate where necessary.

LIMITED LIFETIME WARRANTY

Hawk Performance will warranty products to be free of defects from workmanship and materials. This warranty does not apply to normal wear or damage caused by negligence, lack of maintenance, accident, abnormal operations, or improper installation or service. Hawk Performance does not make any other warranty claims, either expressed or implied, including the implied warranties of merchantability or fitness for a particular purpose. In no event will Hawk Performance be liable for incident or consequential damages of any kind, whether such

damages are claimed on account of breach of warranty, breach of contract, negligence, or strict product liability. This includes without limitation, damage to property, or other economic losses that may be incurred. Any, and all, warranty claims must be processed through Hawk Performance. All valid warranty claims will be replaced/reimbursed with Hawk Performance products of equal or greater value.

FREQUENTLY ASKED MOTORSPORTS PAD QUESTIONS

Q: What are racing brake pads made from?

A: Racing brake pads are made from a variety of ingredients like metals, resins and fillers. The combination of ingredients and the size and weight of the ingredients used in the friction formula can create very different performance levels and characteristics.

Q: With all the different brake compounds available today, how do I make the proper choice of what to use on my racecar?

A: Choosing the proper brake pad compound that will provide the best performance for your Motorsports application can be made easier by following the guidelines outlined below:

- Determine what compounds and styles of brake pads are available for your calipers and type of racing.
- Determine the operating temperature of your car's brake system. Heat sensitive paint can be applied to the brake pads and rotors to help you gauge temperature. Tire pyrometers can be used, but due to the cool down time the temperature numbers may not be accurate.
- Upon learning your system's temperatures, or if you do not know your temperatures, contact Hawk Performance at 440-528-4000 for recommendations regarding proper brake material for your application.
- Other drivers that share your driving style will sometimes provide valuable information that may allow you to learn what brake pads other drivers have used and liked or disliked.
- Contact your local racing products dealer and inquire as to what brake pads they offer and recommend for your application.
- It's important to understand different types of racecars, racing surfaces and driving styles may require different levels of braking performance, and many drivers expect the brake system to have a certain feel that suits their individual needs. Because of this, it should not be assumed that what works for one driver would work for all. In some cases the best way to learn what is best for you is to experiment with a variety of friction compounds to determine how a particular pad differs from another regarding issues such as pedal feel, consistency and rotor and brake pad wear.

Q: What are some noticeable signs that I have made the wrong pad choice for my Motorsports racing application?

A: When a friction compound is used in a substantially higher temperature range than intended, the material can quickly lose its ability to perform correctly. Generally, an overheated brake pad will continue to provide a hard pedal but require more foot and pedal effort to achieve even marginal performance. Continued use during this type of circumstance can result in complete brake pad failure.

Q: What happens if I choose a brake pad compound that does not have a high enough temperature range for my application?

A: It's important to understand the chain of events that take place when a brake pad becomes too hot to work correctly. As the pad begins to lose performance effectiveness the driver may try to compensate by pushing harder and longer on the pedal. This may cause friction surface temperature to increase thereby increasing the brake problem. When this occurs, great stress is put on the friction material and the material can begin to crystallize. In extreme cases delaminating between the friction material and the pad's backing plate can sometimes occur. This type of situation may be corrected by choosing a friction compound designed to withstand higher temperature.

Q: Why should I perform a break-in procedure on new brake pads?

A: Correct brake pad break-in (bedding) is important to assure optimal braking performance over the life of the pad. This procedure allows the rubbing surface of the brake pad to slowly be brought up to racing temperatures. Proper bedding creates a transfer layer film of friction material to be applied to the rotor surface. This allows the brake pad material to rub against itself rather than the bare rotor. This increases the stopping performance of the brake pad and can reduce pad and rotor wear.

Q: What is the proper procedure for breaking in new brake pads?**A:** Brake pad break-in procedure:***Brake Pad Burnishing/Bedding-In Instructions***

1. After reaching medium speed engage brake pedal to slow car without coming to a complete stop. Release pedal quickly and do not drag brakes. Repeat four or five times.
2. At higher speeds engage brake pedal to slow car without coming to a complete stop. Release pedal quickly and do not drag brakes. Repeat five times.
3. At or near race speed engage brake pedal to slow car without coming to a complete stop. Release pedal quickly and do not drag brakes. Repeat three times. Allow a few seconds between brake engagements while car is in motion.
4. Do not hold brake pedal. Park car for approximately 20 minutes or until brake rotors are completely cool to the touch.
5. If during the above steps the brake pedal becomes soft or brake fade is noticed, park the car immediately for approximately 20 minutes. Do not hold brake pedal.

IMPORTANT REMINDERS WHEN BURNISHING/BEDDING BRAKE PADS

- Do not attempt to use badly worn or damaged rotors with new brake pads.
- Do not drag brakes while car is moving during break-in procedure.
- Do not engage pedal while car is stopped at any time following the break-in procedure.
- Upon completing the procedure, allow the brake system to completely cool before racing.
- Applying the pedal a few times before the start of the race will allow the brake pads to heat up before attempting to reach race speeds.
- Clean a used rotor surface with fine sand paper or steel wool, rinse with water, dry and install before bedding new pads.
- Some forms of racing don't allow time for the proper break-in procedure to be performed. However, it is still very important to attempt to perform at least the core of the procedure: Build up heat slowly and allow the system to completely cool down before racing if possible.

Q: What can happen to my brake pads if not bedded properly?**A:** Proper break-in will assure that small amounts of heat are introduced to the brake pad. Brake pads that are brought up to temperature too fast and not properly allowed to cool down may quickly become glazed and not perform as originally intended. The pad's rubbing surface reaches extreme heat levels during racing use. The surface needs slow temperature increases to help prepare the pad. Large amounts of heat all at one time can cause the brake pad rubbing surface to become somewhat liquified and coat the pad surface with a glaze. This will dramatically reduce stopping performance as certain ingredients in the friction compound breakdown and cause glazing of the rubbing surface of the brake pad.**Q: How can I tell by looking at the brake pad if my pads have been glazed over?****A:** When a brake pad glazes over, the friction surface develops a cloudy or glassy looking coating. It is possible to remove the glazed surface by using sand paper to grind away the damaged layer and expose a new layer that will require the proper bedding procedure.**Q: What is a pre-bedded brake pad?****A:** Some brake pad manufacturers offer a pre-bedded pad and/or a pre-bedding service. Pre-bedding involves placing pads in a caliper and running them against a mechanically driven rotor in a controlled environment. The rotor and pads are slowly brought up to temperature and allowed to cool down over several cycles. This process simulates on track situations while allowing the two surfaces to mate correctly in an optimum environment. While this process can be very expensive, it greatly reduces the break-in time prior to pad purchase. In most cases the rotor and the pad are, and should be, sold as a matched set.**Q: What is a pre-burnished brake pad?****A:** Some brake pads are pre-burnished during the manufacturing process. Pads that are pre-burnished have had high temperature applied to the rubbing surface to simulate the first few engagements on an actual race car. The process will allow the pad to break-in quickly and to begin working more effectively in a shorter time. Pre-burnished pads still need to be properly bedded to help assure that the pad and the rotor have an opportunity to mate correctly.

V-TWIN

PREMIUM QUALITY

METALLIC & ORGANIC COMPOUNDS

SINTERED METALLIC

Hawk Performance Sintered Metallic disc brake pads offer world-class braking performance for sport and heavy motorcycles. This product line combines the quality and fitment of Original Equipment with unsurpassed stopping power and quiet braking performance. In wet or dry braking conditions nothing beats Hawk's Sintered Metallic performance.

KEY FEATURES:

- Superior stopping power
HH+ RATED FRICTION MATERIAL, HIGHEST IN THE INDUSTRY
- Smooth, progressive engagement
- Extremely quiet
- Fade-Free performance
- Virtually dust free
- Lowest pad wear in the market
- Improved rotor life

N-A ORGANIC

Hawk Performance N-A Organic (Non-Asbestos Organic) disc brake pads offer "best in class" performance when compared to other leading aftermarket organic pads. Silent stops and progressive brake modulation characteristics maximize rider comfort and control. Ideal for bikes with polished or chrome rotors, but very effective on standard steel rotors.

KEY FEATURES:

- Excellent stopping power
GG RATED FRICTION MATERIAL
- Smooth, linear engagement
- Noise-Free performance
- Exceptional thermal stability
- Extremely gentle on rotors
- Extended pad life
- Low dust



BRAKE PAD CROSS REFERENCE

SINTERED METALLIC

HAWK NUMBER	EBC NUMBER	SBS NUMBER	VESRAH NUMBER	FERODO NUMBER
HMC5001	FA78	549	VD918	FDB335/R
HMC5002	FA94	579	VD919	FDB352/R
HMC5003	FA140	614	VD147	FDB531
HMC5004	FA196	700	VD156/3	FDB664
HMC5005	FA200	669	VD957	FDB521/2001
HMC5006	FA201	668	VD956	FDB485
HMC5007	FA209	674	VD958	FDB2006
HMC5008	FA216	662	VD944	N/A
HMC5009	FA244	706	VD262	FDB2042
HMC5010	FA261	721, 722, 735, 736	VD165/2	FDB2073 FDB2075
HMC5011	FA345	795	VD993	FDB2145
HMC5012	FA347	782	VD443	FDB2158
HMC5013	FA381	807	VD9009	N/A
HMC5014	FA387	808	VD9010	N/A
HMC5015	FA400	826	N/A	N/A
HMC5016	FA409	830	VD9025	N/A
HMC5017	FA424	N/A	N/A	N/A
HMC5018	FA434	N/A	N/A	N/A
HMC5019	FA457	853	N/A	N/A
HMC5020	FA458	854	N/A	N/A

N-A ORGANIC

HAWK NUMBER	EBC NUMBER	SBS NUMBER	VESRAH NUMBER	FERODO NUMBER
HMC1001	FA78	549	VD918	FDB335/R
HMC1002	FA94	579	VD919	FDB352/R
HMC1003	FA140	614	VD147	FDB531
HMC1004	FA196	700	VD156/3	FDB664
HMC1005	FA200	669	VD957	FDB521/2001
HMC1006	FA201	668	VD956	FDB485
HMC1007	FA209	674	VD958	FDB2006
HMC1008	FA216	662	VD944	N/A
HMC1009	FA244	706	VD262	FDB2042
HMC1013	FA381	807	VD9009	N/A
HMC1014	FA387	808	VD9010	N/A
HMC1015	FA400	826	N/A	N/A
HMC1016	FA409	830	VD9025	N/A
HMC1018	FA434	N/A	N/A	N/A
HMC1019	FA457	853	N/A	N/A
HMC1020	FA458	854	N/A	N/A





ON THE ROAD OR ON THE TRACK...
CONTROL, COMMAND AND CONQUER

HAWK
PERFORMANCE
RACE PROVEN. STREET LEGAL.™



HAWK
PERFORMANCE
RACE PROVEN. STREET LEGAL.



Hawk Performance is the brake supplier of choice for Sports Car Club of America, Skip Barber Racing School, the Richard Petty Driving Experience, NASA, Playboy Mazda MX-5 Cup, Pirelli World Challenge, Lucas Oil, and ARCA. Our superior brake products enable drivers to control, command and conquer the road or the race track for virtually any type of vehicle.



Hawk Performance Products Group

14345 Pipeline Avenue Chino, CA 91710

Toll Free: 1.855.465.7161 • Phone: 909.342.5200 • Fax: 909-342-5299 • info@HawkPerformance.com

www.HAWKPERFORMANCE.COM

DISTRIBUTED BY:

