



# STEERING AND SUSPENSION PARTS



**2013**  
**2014**







**NEW VEHICLES  
NUOVI VEICOLI ..... PAG. 4**

**PRODUCTS RANGE  
PRODUKTE IM SORTIMENT  
GAMME DE PRODUIT  
GAMA DE PRODUCTOS  
PRODOTTI IN GAMMA..... PAG. 6**

**MEASURES  
MASSNAHMEN  
MESURES  
MEDIDAS  
MISURE ..... PAG. 10**

**CHEVROLET ..... PAG. 12**

**CHRYSLER..... PAG. 20**

**DACIA ..... PAG. 26**

**DAEWOO-CHEVROLET ..... PAG. 30**

**DAIHATSU..... PAG. 39**

**HONDA..... PAG. 53**

**HYUNDAI ..... PAG. 88**

**ISUZU ..... PAG. 120**

**JEEP..... PAG. 126**

**KIA ..... PAG. 130**

**LAND ROVER..... PAG. 155**

**MAHINDRA..... PAG. 166**

**MAZDA ..... PAG. 167**

**MITSUBISHI ..... PAG. 198**

**NISSAN ..... PAG. 241**

**SMART ..... PAG. 288**

**SSANGYONG ..... PAG. 291**

**SUBARU ..... PAG. 296**

**SUZUKI..... PAG. 311**

**TATA..... PAG. 333**

**TOYOTA..... PAG. 337**

**CROSS REFERENCE LIST  
VERGLEICHSLISTE  
LISTA DE REFERENCIAS CRUZADES  
LISTE DE COMPARAISON  
LISTA DI COMPARAZIONE..... PAG. 403**

**BUMP RUBBER KIT UNIVERSAL TYPE  
UNIVERSALE DÄMPFERKAPPEN  
SOUFFLET DE CARDAN  
FUELLES AMTORIGUADORES UNIVERSALES  
CUFFIE AMMORTIZZATORI UNIVERSALI..... PAG. 441**

**RUBBER PARTS LIST  
MOTORAUFHÄNGUNG LISTE  
LISTE SILENT BLOCS  
LISTA TAPONES DE GOMA  
LISTA PARTI IN GOMMA ..... PAG. 452**







## NEW VEHICLES - NUOVI VEICOLI



### CHRYSLER

300C [2005 - ]

GRAND VOYAGER IV [2007 - ]

### CHEVROLET

CRUZE [2009 - ]

SPARK [2010 - ]

### DACIA

DUSTER [2010 - ]

LOGAN [2006 - ]

SANDERO [2008 - ]

SOLENZA [2003 - ]

### HONDA

ACCORD IX [2008 - ]

CR-V [2006 - ]

INSIGHT [2009 - ]

JAZZ III [2008 - ]

### HYUNDAI

H-1 [2008 - ]

I10 [2007 - ]

I20 [2008 - ]

I30 [2007 - ]

IX35 [2010 - ]

### JEEP

GRAND CHEROKEE III [2005 - ]

### KIA

SORENTO [2009 - ]

SOUL [2009 - ]

SPORTAGE [2010 - ]

VENGA [2010 - ]

### LANDROVER

FREELANDER [2006 - ]

### MAZDA

CX-7 [2007 - ]

2 [2007 - ]

5 [2005 - ]

6 [2007 - ]

### MITSUBISHI

ASX [2010 - ]

PAJERO IV [2007 - ]

### NISSAN

JUKE [2010 - ]

PIXO [2009 - ]

TIIDA [2007 - ]

X-TRAIL (T-31) [2007 - ]

### SMART

FORTWO [2007 - ]

### SSANGYONG

KYRON [2005 - ]

### SUBARU

FORESTER [2008 - ]

LEGACY [2003 - ]

LEGACY [2009 - ]

### SUZUKI

ALTO V [2009 - ]

SPLASH [2008 - ]

### TOYOTA

4 RUNNER [1996 - ]

AURIS [2007 - ]

AVENSIS (T27) [2009 - ]

CAMRY [2006 - ]

IQ [2009 - ]

PRIUS [2000 - 2003]

PRIUS [2003 - 2008]

PRIUS [2009 - ]

URBAN CRUISER [2009 - ]

VERSO [2009 - ]

| SOSPENSIONI / SUSPENSIONS<br>LENKUNGS UND-AUFHÄNGUNGSTEILE<br>SUSPENSION / SUSPENSIÓN |     |  |
|---|-----|--|
|   | MA  | AMMORTIZZATORI                         |
|   |     | SHOCK ABSORBERS                        |
|   |     | AMORTISSEURS                           |
|   |     | STOSSDÄMPFER                           |
|   |     | AMORTIZADORES                          |
|   |     | AMORTIZADORES                          |
|   | 44  | KIT CUSCINETTI RUOTA                   |
|   |     | WHEELBEARING KITS                      |
|   |     | KIT DE ROULEMENTS DE ROUES             |
|   |     | RADLAGERSÄTZE                          |
|   |     | KIT PROTECTORES ROTA                   |
|   | GOM | KIT COJINETES DE RUEDA                 |
|   |     | GOMMINI                                |
|   |     | RUBBERS                                |
|   |     | SILENT BLOCS                           |
|   |     | MOTORAUFHÄNGUNG                        |
|   | 72  | BORRACHAS                              |
|   |     | TAPONES DE GOMA                        |
|   |     | TRAPEZIO                               |
|   |     | SUSPENSION TRIANGLE                    |
|   |     | TRIANGLE DE SUSPENSION                 |
|   | 71  | TRAPEZ                                 |
|   |     | TRAPÉZIO                               |
|   |     | TRAPECIO                               |
|   |     | BRACCIO OSCILLANTE                     |
|   |     | SUSPENSION ARMS                        |
|   | 102 | BRAS OSCILLANTS                        |
|   |     | SCHWENKARME                            |
|   |     | BRAÇO OSCILADOR                        |
|   |     | BRAZO OSCILANTE                        |
|   |     | LEVE RINVIO STERZO                     |
|   | 59  | STEERING RELAY                         |
|   |     | LEVIERS DE RENVOI DE LA DIRECTION      |
|   |     | LENKRADHEBEL                           |
|   |     | MANOBRA LIGEIRA DE REGRESSO DO VOLANTE |
|   |     | LEVAS DE REENVÍO DE LA DIRECCIÓN       |
|   | 53  | TESTINE SOSPENSIONE                    |
|   |     | BALL JOINT                             |
|   |     | ROTULE (POUR SUSPENSION ET DIRECTION)  |
|   |     | AUFHÄNGEKÖPFE                          |
|   |     | CABEÇAS DE SUSPENSÃO                   |
|   | 105 | CABEZALES DE SUSPENSIÓN                |
|   |     | BARRE ACCOPIAMENTO                     |
|   |     | COUPLING BARS                          |
|   |     | BARRES D'ACCOUPEMENT                   |
|   |     | PLEUELSTANGEN                          |
|   | 105 | BARRAS DE JUNÇÃO                       |
|   |     | BARRAS DE ACOPLAMIENTO                 |

| SOSPENSIONI / SUSPENSIONS<br>LENKUNGS UND-AUFHÄNGUNGSTEILE<br>SUSPENSION / SUSPENSIÓN |     |  |
|---|-----|--|
|   | 111 | TESTA BARRA D'ACCOPIAMENTO                         |
|   |     | TIE-ROD END  |
|   |     | ROTULE DE BARRE DE CONNEXION                       |
|   |     | SPURSTANGENKOPF                                    |
|   |     | CABEÇA BARRA DE JUNÇÃO                             |
|   | 26  | CABEZA DE BARRA DE ACOPLAMIENTO                    |
|   |     | BRACCIO OSCILLANTE, SOSPENSIONE RUOTA              |
|   |     | TRACK CONTROL ARM                                  |
|   |     | BRAS DE LIAISON, SUSPENSION DE ROUE                |
|   |     | LENKER, RADAUFHÄNGUNG                              |
|   | 52  | BRAÇO OSCILADOR, SUSPENSÃO RODA                    |
|   |     | BRAZO OSCILANTE, SUSPENSIÓN DE RUEDA               |
|   |     | LEVE RINVIO STERZO                                 |
|   |     | STEERING RELAY                                     |
|   |     | LEVIERS DE RENVOI DE LA DIRECTION                  |
|   | 103 | LENKRADHEBEL                                       |
|   |     | MANOBRA LIGEIRA DE REGRESSO DO VOLANTE             |
|   |     | LEVAS DE REENVÍO DE LA DIRECCIÓN                   |
|   |     | GIUNTO ASSIALE, ASTA TRASVERSALE                   |
|   |     | AXIAL ROD, TIE ROD                                 |
|   | 106 | ROTULE DE DIRECTION INTÉRIEURE, BARRE DE CONNEXION |
|   |     | AXIALGELENK, SPURSTANGE                            |
|   |     | JUNTA AXIAL, FERRO TRANSVERSAL                     |
|   |     | JUNTA AXIAL, ASTA TRASVERSAL                       |
|   |     | STABILIZZATORE, CHASSIS                            |
|   | 27  | STABILISER, CHASSIS                                |
|   |     | STABILISATEUR, CHASSIS                             |
|   |     | STABILISATOR, FAHRWERK                             |
|   |     | ESTABILIZADOR, CHASSI                              |
|   |     | ESTABILIZADOR, CHASIS                              |
|   | 76  | BARRA D'ACCOPIAMENTO                               |
|   |     | TIE ROD, STEERING                                  |
|   |     | BARRE DE CONNEXION SPURSTANGE                      |
|   |     | BARRA DE JUNÇÃO                                    |
|   |     | BARRA DE ACOPLAMIENTO                              |
|   | 73  | GIUNTO ASSIALE, ASTA TRASVERSALE                   |
|   |     | AXIAL ROD, TIE ROD                                 |
|   |     | ROTULE DE DIRECTION INTÉRIEURE, BARRE DE CONNEXION |
|   |     | AXIALGELENK, SPURSTANGE                            |
|   |     | JUNTA AXIAL, FERRO TRANSVERSAL                     |
|   | 73  | JUNTA AXIAL, ASTA TRASVERSAL                       |
|   |     | GIUNTO DI SUPPORTO/GUIDA                           |
|   |     | SUPPORT/TEERING LINK                               |
|   |     | ROTULE DE SUSPENSION                               |
|   |     | TRAG/FÜHRUNGSGELENK                                |
|   | 73  | JUNTA DE SUPORTE /GUIA                             |
|   |     | JUNTA DE SOPORTE /GUIA                             |

The pictures as shown in the catalogue are not a reproduction of original drawings and are only mean for visual and identifying purposes and cannot be objected with the original parts at all, Ashika declines any responsibility following improper uses of these pictures and possible mistakes.

I disegni riportati nel catalogo non sono riproduzioni di disegni originali e sono a solo uso visivo ed identificativo e non potranno costituire oggetto di contestazione con i pezzi originali, in ogni caso Ashika declina ogni responsabilità sull'uso improprio degli stessi e non risponderà di eventuali errori e/o omissioni.

Copyright by Ashika - Verona

All rights of reproduction are reserved for Ashika

Les droits de reproduction sont réservés à Ashika

Todos los derechos de la reproducción son reservados para Ashika

I diritti di riproduzione sono riservati ad Ashika

### LETTURA DEL CODICE ASHIKA - THE KEY TO THE ASHIKA' CODE

#### ESEMPIO / EXAMPLE

**GOM- 9 10**

PARTE NUMERICA / COUNTING POSITION

COSTRUTTORE DEL VEICOLO / CAR MANUFACTURER

IDENTIFICA IL PRODOTTO / MAIN PRODUCT GROUP

- 0 = TATA - LADA - HUMMER
- 1 = NISSAN
- 2 = TOYOTA
- 3 = MAZDA
- 4 = HONDA
- 5 = MITSUBISHI
- 6 = DAIHATSU - PIAGGIO
- 7 = SUBARU
- 8 = SUZUKI - MARUTI
- 9 = ISUZU - JEEP - OPEL - CHRYSLER

- H = HYUNDAI
- K = KIA
- L = LAND ROVER
- M = SMART
- S = SSANGYONG
- W = DAEWOO-CHEVROLET

# WORLDWIDE QUALITY





NOTICE: Were you see European flag means complete range for european cars.

NOTA: Bandiera Europea significa gamma completa per auto europea.



|  <b>FILTRI - FILTERS<br/>FILTRES - FILTER<br/>FILTROS - FILTERS</b> |   |
|--|---|
|   | <b>10</b><br>Filtri olio - Oil filters<br>Filtres à huile - Ölfilter<br>Filtros do óleo - Filtros de aceite   |
|   | <b>20</b><br>Filtri aria - Air filters<br>Filtres à air - Luftfilter<br>Filtros de ar - Filtros de aire   |
|   | <b>21</b><br>Filtri abitacolo - Cabin filters<br>Filtres d'habitacle - Oollenfilter<br>Filtros de hanbitáculo - Filtros de purificación   |
|   | <b>30</b><br>Filtri carburante - Fuel filters<br>Filtres à carburant - Kraftstofffilter<br>Filtros de combustível - Filtros de carburante   |
|   | <b>10-ECO</b><br>Filtri olio eco - Eco oil filters<br>Filtres à huile eco - Ölfilter eco<br>Eco filtros do óleo - Eco filtros de aceite   |
|   | <b>30-ECO</b><br>Filtri carburante eco - Eco fuel filters<br>Filtres à carburant eco - Kraftstofffilter eco<br>Eco filtros de combustível - Eco filtros de carburante                       |
|   | <b>74</b><br>Kit filtri per tagliando - Service filter kit<br>Kit filtres entretien - Filter service satz<br>Kit de filtros da revisão - Kit filtros para revisão                           |
|   | <b>10-GAS</b><br>Filtro depurazione gpl - Gpl purification filter<br>Filtre purification gpl - ReinigungsfILTER gpl<br>Filtro gás para a filtragem do gpl<br>Gas filtro de purificación gpl |
|   | <b>99</b><br>Supporto filtro - Filter support<br>Filtre d'appui - Filtre halterung<br>Suporte do filtro - Soporte filtri  |















|  <b>FRENANTE - BRAKES<br/>BREMS - FREINAGE<br/>TRAVÕES - FRENOS</b> |  |
|--|--|
|   | <b>50</b><br>Pastiglie freno ant. - Brake pads front<br>Plaquettes de frein avant - Bremsklötse vorne<br>Pastilhas dos travões da frente - Pastillas de freno ant.               |
|   | <b>51</b><br>Pastiglie freno post. - Brake pads rear<br>Plaquettes de frein arrière - Bremsklötse hinten<br>Pastilhas dos travões de trás - Pastillas de freno post.             |
|   | <b>60</b><br>Dischi freno ant. - Brake discs front<br>Disques de frein avant - Bremsscheiben vorne<br>Discos dos travões da frente - Discos de freno ant.                        |
|   | <b>61</b><br>Dischi freno post. - Brake discs rear<br>Disques de frein arrière - Bremsscheiben hinten<br>Discos dos travões de trás - Discos de freno post.                      |
|   | <b>55</b><br>Ganasce freno - Brake shoes<br>Machaires de frein - Bremsbacken<br>Maxilas de travão - Zapatillas de freno  |
|   | <b>56</b><br>Tamburi freno - Brake drums<br>Tambours de frein - Bremstrommel<br>Tambores dos travões - Tambores de freno   |
|   | <b>65</b><br>Cilindretti freno dx - Rear wheel cylinder right<br>Cylindre de roue droit - Radbremszylinder, rechts<br>Cilindro de travão de trás direito - Cilindros de freno dx |
|   | <b>67</b><br>Cilindretti freno sx - Rear wheel cylinder left<br>Cylindre de roue gauche - Radbremszylinder, links<br>Cilindro de travão de trás esquerdo - Cilindros de freno sx |

|   |   |
|---|---|
|  | <b>68</b><br>Pompe freno - Brake master cylinders<br>Maitre cylindres - Hauptbremszylinder<br>Bombas dos travões - Bombas de freno  |
|  | <b>69</b><br>Tubi freno - Brake hoses<br>Fléxibles de frein - Bremsschläuche<br>Tubos dos travões - Tubos de freno  |
|  | <b>114</b><br>Kit riparazione pompa freno<br>Repair kit, brake master cylinder<br>Kit de réparation, maître cylindre de frein<br>Reparatursetz, hauptbremszylinder<br>Kit reparação da bomba dos travões<br>Kit reparación bomba de freno |
|  | <b>120-133</b><br>Kit riparazione pinza freno - Brake calipers repair kit<br>Kit de reparation etriers de frein<br>Reparatursetz bremsattel - Kit reparação pinça travão<br>Kit reparación pinza de freno                                 |
|  | <b>131</b><br>Cavi freno - Brake Cable<br>Câbles de frein - Bremskabel<br>Cabo de aço - Cable de freno  |



|  <b>FRIZIONI - CLUTCH<br/>KUPPLUNG - EMBRAYAGE<br/>EMBRAIAGEM - EMBRAGUE</b> |   |
|---|---|
|    | <b>92</b><br>Kit frizione - Clutch kits<br>Kit embrayages - Kupplungssätze<br>Kit embraiagem - Kit embrague   |
|    | <b>98</b><br>Kit frizione completo di volano - Clutch kit with flywheel<br>Kit embrayage avec volant - Kupplungssatz mit schwungrad<br>Kit de embraiagem com volante  |
|    | <b>80</b><br>Dischi frizione - Clutch discs<br>Disques d'embrayage - Kupplungsscheiben<br>Disco de embraiagem - Disco de embrague   |
|    | <b>70</b><br>Spingidisco frizione - Clutch cover<br>Mécanisme d'embrayage - Druckplattenkupplung<br>Prato de pressão da embraiagem - Prensa de embrague   |
|    | <b>91</b><br>Volani - Flywheels<br>Volants - Schwungräder<br>Volantes Bi-Massa - Volantes   |
|    | <b>90</b><br>Cuscinetti frizione - Clutch bearings<br>Butées d'embrayage - Kupplungs-ausrücklager<br>Rolamento de embraiagem - Cojinetes de embrague  |
|    | <b>54</b><br>Bullone, porta corona dentata volano<br>Bolt, flywheel ring gear<br>Carrier vis boulon au support du pignon pour volant d'inertie<br>Schraube, zahnkranzträgerschwungrad<br>Perno, soporte corona - Dentada, volante                                       |
|    | <b>95</b><br>Pompe frizione - Clutch master cylinders<br>Cylindre émetteur - Kupplungs-hauptzylinder<br>Bombas embraiagem - Bomba embrague  |
|    | <b>85</b><br>Cilindretti frizione - Clutch slave cylinders<br>Cylindre récepteur - Kupplungs-nehmerzylinder<br>Bomba secundária da embraiagem<br>Cilindros embrague   |
|    | <b>123</b><br>Kit riparazione pompa frizione<br>Repair kit, clutch master cylinder<br>Kit d'assemblage, cylindre émetteur d'embrayage<br>Reparatursetz, kupplungsgeberzylinder<br>Kit de reparação da bomba de embraiagem principal<br>Kit reparación bomba de embrague |

# GAMMA PRODOTTI

# PRODUCT RANGE

|   |            |  |
|---|------------|--|
|                   | <b>124</b> | <p>Kit riparazione cilindretto frizione<br/>                 Repair kit, clutch slave cylinder<br/>                 Kit d'assemblage, cylindre récepteur d'embrayage<br/>                 Reparatursatz, kupplungsnehmerzylinder<br/>                 Kit de reparação da bomba de embraiagem secundária<br/>                 Kit reparación cilindro embrague</p>   |
| <b>DISTRIBUZIONE - DISTRIBUTION<br/>VERTEILUNG - DISTRIBUTION<br/>DISTRIBUIÇÃO - DISTRIBUCIÓN</b> |            |  |
|                   | <b>KCK</b> | <p><b>new</b><br/>                 Kit distribuzione catena - Timing chain kit<br/>                 Kit chaines de distribution - Steuerkettensatz<br/>                 Kit da corrente de distribuição<br/>                 Kit distribución de cadena</p>  |
|                   | <b>KCT</b> | <p>Kit cinghia e tendicinghia - Timing belt kit<br/>                 Kit de distribution - Zahnriemensatz<br/>                 Kit de distribuição de correia - Kit correa y tensor de correa</p>  |
|                   | <b>SKC</b> | <p><b>new</b><br/>                 Pompa acqua + kit cinghie - Water pump &amp; timing belt kit<br/>                 Pompe à eau + kit de courroie de distribution<br/>                 Wasserpumpe + Zahnriemensatz<br/>                 Bomba de água + kit de correia dentada<br/>                 Bomba de agua + kit correa distribución</p>  |
|                  | <b>45</b>  | <p>Cuscinetti tendicinghia - Timing belt tensioners<br/>                 Galet tendeur - Spannrollen<br/>                 Tensores da correia de distribuição<br/>                 Cojinetes de tensor de correa</p>   |
|                 | <b>40</b>  | <p>Cinghie distribuzione - Timing belts<br/>                 Courroies de distribution - Zahnriemen<br/>                 Correia de distribuição - Correias de distribución</p>  |
|                 | <b>94</b>  | <p>Cinghia servizi - Fan belts<br/>                 Courroie - Keilriemen<br/>                 Correia de ventoinha - Correa de servicios</p>  |
|                 | <b>109</b> | <p>Cinghia servizi Mitsuboshi - Fan belt Mitsuboshi<br/>                 Courroie Mitsuboshi - Keilriemen Mitsuboshi<br/>                 Correia de ventoinha Mitsuboshi - Correa de servicios Mitsuboshi</p>   |
|                 | <b>96</b>  | <p>Cinghie servizi scanalate - Fan belts - Courroies<br/>                 Keilrippenriemen - Correia de ventoinha - Correa de servicios</p>  |
|                 | <b>112</b> | <p>Cinghia servizi scanalata Mitsuboshi - Fan belt Mitsuboshi<br/>                 Courroies Mitsuboshi - Keilrippenriemen Mitsuboshi<br/>                 Correia de ventoinha Mitsuboshi - Correa de servicios Mitsuboshi</p>  |
|                 | <b>41</b>  | <p>Catene distribuzione - Timing chains<br/>                 Chaines de distribution - Steuerketten<br/>                 Correntes de distribuição - Cadenas de distribución</p>   |
|                 | <b>128</b> | <p>Tenditore cinghia Poly-V - Timing belt tensioner<br/>                 Tendeur, courroie trapézoïdale - Spannarm, Keilrippenriemen<br/>                 Tensor, correia trapezoidal - Brazo tensor, correa Poly-V</p>  |
|                 | <b>129</b> | <p><b>new</b><br/>                 Galoppino/Guidacinghia, Cinghia Poly-V<br/>                 Deflection/Guide Pulley, V-ribbed belt - Poulie courroie trapézoïdale - Umlenk-/Führungsrolle, Keilrippenriemen<br/>                 Polea correa Poly-V - Polia correia trapezoidal</p>  |
|                 | <b>140</b> | <p><b>new</b><br/>                 Rullo tenditore, Cinghia Poly-V - Poly-V belt tensioner<br/>                 Poulie-tendeur, courroie trapézoïdale à nervures<br/>                 Spannrolle, Keilrippenriemen - Rolo tensor, correia trapezoidal estriada - Polea tensora, correa trapezoidal con dentado interior</p>  |
|                 | <b>146</b> | <p><b>new</b><br/>                 Smorzatore vibrazioni, Cinghia Poly-V<br/>                 Vibration damper V-ribbed belt<br/>                 Amortisseur de vibrations, courroie trapézoïdale à nervures<br/>                 Schwingungsdämpfer, Keilrippenriemen<br/>                 Amortecedor de vibrações, correia trapezoidal estriada<br/>                 Amortiguador vibraciones, correa trapez. Poly-V</p> |

|   |            |  |
|---|------------|--|
| <b>RAFFREDDAMENTO - COOLING<br/>ABKÜHLUNG - REFRIGERATION<br/>ARREFECIMENTO - REFRIGERACION</b> |            |  |
|                | <b>35</b>  | <p>Pompe acqua - Water pumps<br/>                 Pompes à eau - Wasserpumpen<br/>                 Bombas da água - Bombas de agua</p>   |
|                | <b>36</b>  | <p>Giunti viscosi - Viscous couplings<br/>                 Visco coupleur - Visco-kupplungen<br/>                 Juntas viscosas - Juntas viscosas</p>  |
|                | <b>38</b>  | <p>Valvole termostatiche - Thermostats<br/>                 Thermostates - Thermostate<br/>                 Termostatos - Válvulas termostáticas</p>   |
|                | <b>22</b>  | <p><b>new</b><br/>                 Valvola termostatica tama - Thermostate tama<br/>                 Vanne thermostatique tama - Thermostatventil tama<br/>                 Termostatos tama - Válvula termostática tama</p> |
|                | <b>RDA</b> | <p><b>new</b><br/>                 Radiatore - Radiator<br/>                 Radiateur - Kühler<br/>                 Radiador - Radiador</p>   |
|                | <b>33</b>  | <p>Tappi radiatore - Radiator caps<br/>                 Bouchons radiateurs - Kuhler versschluss kappe<br/>                 Tampões de radiator - Taponés radiador</p>   |
|                | <b>CMP</b> | <p><b>new</b><br/>                 Compressore - Compressor<br/>                 Compresseur - Kompressor<br/>                 Compresor - Compressor</p>  |
|              | <b>CND</b> | <p><b>new</b><br/>                 Condensatore - Condenser<br/>                 Condenseur - Kondensator<br/>                 Condensador - Condensador</p>   |
|              | <b>EVP</b> | <p><b>new</b><br/>                 Evaporatore - Evaporator<br/>                 Evaporateur - Verdampfer<br/>                 Evaporador - Evaporador</p>   |
|              | <b>RSD</b> | <p><b>new</b><br/>                 Riscaldatore - Heat Exchanger, interior heating<br/>                 Système de chauffage - Heizung<br/>                 Radiador de calefacción - Permutador de calor</p>                |
|              | <b>VNT</b> | <p><b>new</b><br/>                 Ventola, Raffreddamento motore - Fan, radiator<br/>                 Ventilateur - Lüfter<br/>                 Ventilador - Ventilador</p>   |



















|  |           |  |
|--|-----------|--|
| <b>GIUNTI E CUFFIE - JOINTS AND BOOTS<br/>KUPPLUNGEN UND ACHSMANSCHETTEN<br/>COUPLEUR, SOUFFLET DE CARDAN - JUNTAS DE<br/>TRANSMISSÃO E FOLAS - JUNTAS Y FUELLES</b> |           |  |
|   | <b>62</b> | <p>Giunti omocineticici lato ruota<br/>                 Costant velocity joints<br/>                 Joint homocinétique - Antriebswellen<br/>                 Juntas homocinéticas lado roda<br/>                 Juntas homocinéticas de lado de rueda</p> |
|   | <b>63</b> | <p>Kit cuffia - Boot kits<br/>                 Soufflet de cardana - Achsmanschetten<br/>                 Kit de folas - Kit de fuelles</p>  |
|   | <b>66</b> | <p>Crociere - Universal joints<br/>                 Croisillons de trans - Universal gelenke<br/>                 Cruzetas de cardan - Crucetas</p>  |

|   |           |   |
|---|-----------|---|
| <b>SOSPENSIONI - SUSPENSIONS<br/>LENKUNGS UND-AUFHÄNGUNGSTEILE<br/>SUSPENSION - SUSPENSÃO<br/>SUSPENSIONA</b> |           |   |
|                            | <b>44</b> | <p>Kit cuscinetti ruota - Wheelbearing kits<br/>                 Kit de roulements de roues - Radlagersätze<br/>                 Jogos de rolamentos das rodas - Kit cojinetes de rueda</p> |

# GAMME DES PRODUITS

# PRODUKTELINIE

|  |               |   |
|--|---------------|---|
|    | <b>MA</b>     | Ammortizzatori - Shock absorbers<br>Amortisseurs - Stossdämpfer<br>Amortecedores - Amortiguador   |
|    | <b>GOM</b>    | Gommini - Rubbers<br>Silent blocs - Motoraufhängung<br>Borrachas - Tapones de goma  |
|    | <b>72</b>     | Trapezio - Suspension triangle<br>Triangle de suspension - Trapez<br>Triângulo da suspensão - Trapecio  |
|    | <b>71-102</b> | Braccio oscillante - Suspension arms<br>Bras oscillants - Schwenkarme<br>Braços da suspensão - Brazo oscilante  |
|    | <b>59</b>     | Leve rinvio sterzo - Steering relay<br>Leviers de renvoi de la direction - Lenkradhebel<br>Pendural da barra de direcção<br>Levas de reenvío de la dirección  |
|    | <b>53</b>     | Testine sospensione - Ball joint<br>Rotule (pour suspension et direction)<br>Aufhängeköpfe - Rotula da suspensão<br>Cabezales de suspensión   |
|    | <b>105</b>    | Barre accoppiamento - Coupling bars<br>Barres d'accouplement - Pleuelstangen<br>Barras da direcção - Barras de acoplamiento   |
|    | <b>111</b>    | Testa barra d'accoppiamento - Tie-rod end<br>Rotule de barre de connexion<br>Spurstangenkopf - Terminal da direcção<br>Cabeza de barra de acoplamiento  |
|   | <b>106</b>    | Stabilizzatore, chassis - Stabilizer, chassis<br>Stabilisateur, chassis - Stabilisator, fahrwerk<br>Estabilizador, chassi - Estabilizador, chasis   |
|  | <b>103-76</b> | Giunto assiale, asta trasversale - Axial rod, tie rod<br>Rotule de direction intérieure, barre de connexion<br>Axialgelenk, spurstange - Rótula da direcção interior<br>Junta axial, asta transversal |
|  | <b>52</b>     | Leve rinvio sterzo - Steering relay<br>Leviers de renvoi de la direction - Lenkradhebel<br>Braço do pendural da direcção<br>Levas de reenvío de la dirección  |
|  | <b>26</b>     | Braccio oscillante, sospensione ruota<br>Track control arm<br>Bras de liaison, suspension de roue<br>Lenker, radaufhängung - Braço de suspensão<br>Brazo oscilante, suspensión de rueda               |
|  | <b>27</b>     | Barra d'accoppiamento - Tie rod, steering<br>Barre de connexion spurstange<br>Verbindungstange - Barra de junção<br>Barra de acoplamiento   |
|  | <b>73</b>     | Giunto di supporto/guida<br>Support/steering link<br>Rotule de suspension<br>Trag/führungsgelenk<br>Rótula da suspensão<br>Junta de soporte /guia   |
|  | <b>63-OA</b>  | Cuffie ammortizzatori universali<br>Universal bump rubber kit<br>Soufflet de cardan<br>Universale dämpferkappen<br>Kits de folas universais dos amortecedores<br>Fuelles amortiguadores universales   |



|   |  |  |
|---|--|--|
|    | <b>IMPIANTO ELETTRICO - ELECTRICAL PARTS<br/>ELEKTRISCHE TEILE - ÉLECTRIQUE PARTS<br/>MATERIAL ELÉCTRICO - PARTES ELECTRICAS</b> |  |
|    | <b>002</b>   | Alternatori - Alternators<br>Alternateurs - Lichtmaschinen<br>Alternadores - Alternadores  |
|    | <b>003</b>   | Motorini avviamento - Starters<br>Démarreurs - Anlasser<br>Motores de arranque - Arrancador  |
|    | <b>DENSO</b>   | Candele - Spark plugs<br>Bougies d'allumage - Kerzen<br>Denso velas - Denso bujías   |
|    | <b>01</b>  | Candelle - Glow plugs<br>Bougies de pré-chauffage - Gluhkerzen<br>Velas de incandescência - Bujías   |
|    | <b>HKT</b>   | Candelle hkt - Hkt glow plugs<br>Bougies de préchauffage hkt - Gluhkerzen hkt<br>Velas de incandescência hkt - Candelillas hkt   |
|    | <b>DENSO</b>   | Candelle denso - Denso glow plugs<br>Bougies de préchauffage denso - Gluhkerzen denso<br>Velas de incandescência denso - Candelillas denso   |
|    | <b>43</b>  | Sonde lambda - Oxigen sensors<br>Sonde lambda - Lambda sonde<br>Sondas lambda - Sensor oxigen  |
|  | <b>DENSO</b>   | Sonde lambda denso - Oxigen sensors denso<br>Sonde lambda denso - Lambda sonde denso<br>Sondas lambda denso - Sondas lambda  |
|  | <b>SA-X</b>  | Spazzole tergicristallo<br>Wiper blades - Balais essuie glaces<br>Wischerblätter - Escovas limpa vidros<br>Escobillas  |
|  | <b>SA-F</b>  | Spazzole tergicristallo universali - Universal wiper blades<br>Balais essuie-glaces universelles - Universale wischerblätter<br>Escovas limpa vidros universais -<br>Escobillas limpiaparabrisas universales   |
|  | <b>SA-R</b>  | Spazzole tergicristallo universali posteriori - Universal Rear wiper Blades<br>Balais d'essuie-glaces arrières universelles - Hintere universal Scheibenwischer<br>Escovas limpa vidros traseiras universales<br>Escobillas limpiaparabrisas traseras universales  |
|  | <b>SA-REG60C - SA-RE70C<br/>SA-RE70VL - SA-RE75BH</b>  | Refill universali per spazzole normali/flat<br>Universal refill for normal wiper blades/flat wiper blades<br>Refill universel pour balais essuie glace norm. et balais "flat"<br>Universal refill fuer normale/wischerblaetter<br>Und fuer flat wischerblaetter<br>Recargas universais para escovas flat normais<br>Recambios universales para escobillas normales |
|  | <b>HY</b>  | Spazzola ibrida - Hybrid wiper blade - Hybrid balai d'essuie-glace<br>Hybrid wischblatt - Und fuer flat wischerblaetter<br>Escova hybrida de limpa-vidros - Escobilla hybrida  |
|  | <b>HY-U</b>  | Spazzola Ibrida universale - Universal Hybrid wiper blade<br>Balais d'essuie-glaces hybrid universelles - Hybrid universal Scheibenwischer<br>Escovas limpa vidros Ibridadas universales - Escobillas limpiaparabrisas Ibridadas universales   |
|  | <b>64</b>  | Bulbi elettroventola - Temp. sensors<br>Capteur de température - Ventilkugeln<br>Sensores de temperatura - Sensor temperatura  |
|  | <b>05</b>  | Pompe benzina - Fuel pump<br>Pompe a carburant - Benzinpumpen<br>Bombas gasolina - Bombas de gasolina  |
|  | <b>77</b>  | Regolatori - Regulators<br>Regulateur de tension - Spannungsregler<br>Reguladores - Reguladores  |

## GAMA DE PRODUTOS

|  |          |  |
|--|----------|--|
|    | 97       | Spazzole accensione - Rotor arms<br>Rotors d'allumeurs - Verteilerfinger<br>Rotores - Rotor del distribuidor   |
|    | XX-C     | Kit cavi accensione - Electric-cable ignition kit<br>Kit câbles d'allumage - Zündkabel set<br>Jogo de fios de vela - Kit cables de encendido   |
|    | 78       | Bobina di accensione - Coil, ignition<br>Bobine d'allumage - Zündspule<br>Bobina de ignição - Bobina de encendido  |
|    | 13       | Condensatore - Condenser, ignition<br>Condenseur, système d'allumage<br>Kondensator, zündanlage<br>Condensador - Condensador   |
|    | 06       | Kit contatti accensione - Contact breaker<br>Distributor jeu de contacts d'allumage<br>Kontaktsatz, zündverteiler<br>Jogo de platinados - kit contactos de encendido   |
|    | 09 08 07 | Gruppo universale koito - Insert, headlight koito<br>Bloc-optique de phare koito<br>Scheinwerfereinsatz, hauptscheinwerfer koito<br>Óptica koito - Grupo universal koito   |
|    | 00       | Interruttore stop - Interrupteur des feux de freins<br>Brake light switch - Bremslichtschalter<br>Interruptor stop - Interruptor de luces de freno   |
|    | 12       | Interruttore temperatura, ventola radiatore<br>Temperature switch, radiator fan<br>Interrupteur de température, ventiateur de radiateur<br>Temperaturschalter, kühlerlüfter<br>Interruptor temperatura, ventoinha radiador<br>Interruptor temperatura, ventilador radiador |
|   | 11       | Pressostato olio - Oil pressure switch<br>Switch de pression d'huile - Öldruckschalter<br>Interruptor da pressão do óleo - Interruptor presión de aceite   |
|  | 06       | Spinterogeno - Distributor<br>Distributeur - Verteiler<br>Distribuidor - Distribuidor  |
|  | 02       | Sensore massa aria - Mass sensor<br>Capteur de masse - Sensorenmesser<br>Sensor massa ar - Sensor masa de aire   |
|  | 75       | Corpo farfallato elettrico - Throttle housing<br>Boîtier de papillon - Drosselklappenstutzen<br>Corpo de mariposa eléctrico<br>Cuerpo de mariposa eléctrico  |
|  | 130      | Puleggia alternatore - Freewheel Clutch, alternator<br>Poulie roue libre, alternateur - Generatorfreilauf<br>Rueda libre alternador - Roda livre do alternador   |
|  | 121      | Calotte spinterogeno - Distributor caps<br>Tête d'allumeur - Verteilekappen<br>Tampas do distribuidor - Tapa distribuidor  |



### MOTORE - ENGINE MOTOR - MOTEUR MOTOR - MOTOR

|  |     |   |
|--|-----|---|
|  | 16  | Alberi a camme - Camshafts - Arbres a cames<br>Nockenwellen - Árvores de cames - Árboles de levas                                   |
|  | 18  | Alberi motore - Crankshafts - Vilebrequins<br>Kurbelwellen - Cambotas - Árboles de moto   |
|  | 122 | Puleggia albero motore - Crank shaft pulleys<br>Poulie de vilebrequin - Motor-welle rolle<br>Polia da cambota - Polea del eje motor |

## GAMMA PRODUCTO

|   |       |   |
|---|-------|---|
|    | 47    | Guarnizioni coperchio valvole - Valves cover gaskets<br>Joint de couvre culbuteur - Dichtungen des klappendeckels<br>Juntas da cabeça - Tapa de culata de cilindro                                  |
|    | 46    | Guarnizioni testata - Head gaskets<br>Joints de culasses - Zylindercöpfe dichtung<br>Jogo de juntas da cabeça - Juntas de culata  |
|    | 48    | Kit guarnizioni testata - Head gaskets set<br>Kit joints de culasses - Zylinderkopfdichtungssatze<br>Kit guarnições cabeça - Kit juntas de culata   |
|    | 39    | Kit pistoni - Pistons kit - Kit pistons<br>Kolben rep. Sätze - Jogo de pistões - Kit pistones   |
|    | 49    | Kit guarnizioni motore - Full set gasket<br>Kit pochette joint moteur - Motor dichtungssatze<br>Jogo de juntas completo - Kit juntas de motor   |
|    | 15    | Valvole - Engine valves - Soupapes<br>Ventile - Válvulas - Válvulas   |
|    | 23    | Testate - Cylinder heads - Culasses<br>Zylinderköpfe - Cabeças - Culata del cilindro  |
|    | 88    | Bielle - Connecting roads - Bielle<br>Pleuel - Bielas - Bielas  |
|   | 88    | Boccola biella - Piston pin bushings - Bagues tête de bielle<br>Kolben-pleuel-buchse - Casquilhos de biela - Casq. de biela   |
|  | 34    | Fascia elastica - Piston ring<br>Segment de piston - Kolbenring<br>Segmento - Aros del pistón   |
|  | 86    | Bronzina banco - Main bearings<br>Coussinets de palier - Hauptlager<br>Bronzes de apoio - Cojinete de bancada   |
|  | 82    | Bronzina di biella - Big end bearings<br>Coussinet de bielle - Pleuellager<br>Bronzes de biela - Cojinete de biela  |
|  | 19    | Kit canne cilindro motore - Cylinder liner kits<br>Kit chemises - Laufbuchsensätze<br>Jogos de camisas - Kit barras de cilindro de motor  |
|  | 17    | Bilancieri valvole - Balances valves<br>Valves d'équilibres - Balancen ventile - Balancoen ventile<br>Martelos - Balancines de las válvulas   |
|  | 89 83 | Bronzina albero a camme - Camshaft bearings<br>Coussinets arbre à cames - Nockenwellenlager<br>Bronzes da árvore de cames - Cojinete de árbol de levas  |
|  | 79    | Rasamenti - Thrust washers<br>Cales latérale - Anlaufscheibe<br>Anilhas de folga da cambota - Enrases   |
|  | 115   | Bulloni testata - Cylinder head bolt<br>Boulon de culasse de cylindre - Zylinderkopfschraube<br>Pernos da cabeça - Pernos de cabezal  |
|  |       | Valvola ricircolo gas di scarico<br>Exhaust gas recirculation valve<br>Vanne egr ventil - Abgasrückführventil<br>Válvula de reciclo do gás de escape<br>Válvula de recirculación de gas de descarga |
|  |       | Pompa olio - Oil pump<br>Pompe à huile - Ölpumpe<br>Bomba óleo - Bomba de aceite  |
|  |       | Iniettore - Injector - Injecteur<br>Injektoren - Injector - Inyector  |
|  |       | Motore completo - Complete engine<br>Moteur complet - Motor komplett<br>Motor completo - Motor completo   |
|  |       | Turbina - Turbocharger - Turbocompresseur<br>Turbolader - Turbo - Turbina   |

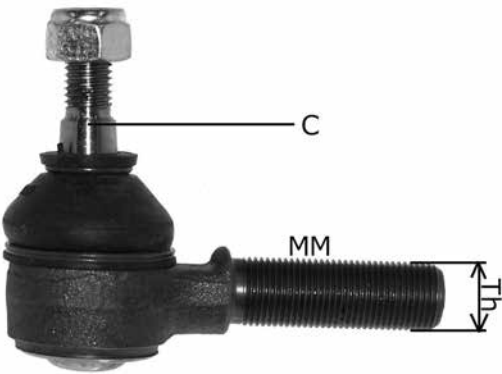
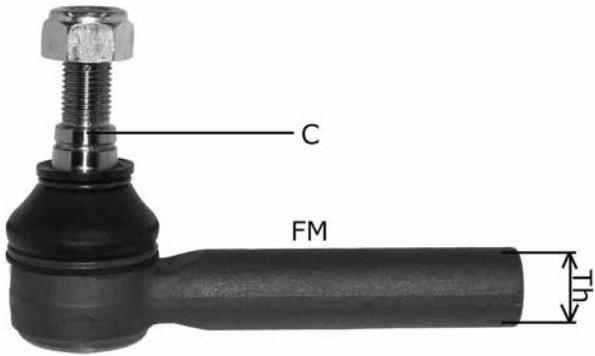

| IT                             | GB                       | D                            | F                            | ESP                         |
|--------------------------------|--------------------------|------------------------------|------------------------------|-----------------------------|
| L Lunghezza                    | L Length                 | L Länge                      | L Longueur                   | L Longitud                  |
| D Diametro                     | D Diameter               | D Durchmesser                | D Diamètre                   | D Diámetro                  |
| C Diametro cono piccolo        | C Smallest cone diameter | C Kleinster Konusdurchmesser | C Diamètre mineur du cône    | C Diámetro más pequeño cono |
| Th Caratteristiche filettatura | Th Thread features       | Th Gewindeabmessung          | Th Caractéristiques du filet | Th Características rosca    |
| FM Filettatura interna         | FM Internal thread       | FM Innengewinde              | FM Filetage intérieur        | FM Rosca interior           |
| MM Filettatura esterna         | MM External thread       | MM Aussengewinde             | MM Filetage extérieur        | MM Rosca externa            |

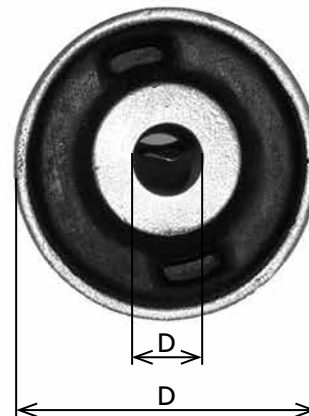

| IT                             | GB                       | D                            | F                            | ESP                         |
|--------------------------------|--------------------------|------------------------------|------------------------------|-----------------------------|
| L Lunghezza                    | L Length                 | L Länge                      | L Longueur                   | L Longitud                  |
| D Diametro                     | D Diameter               | D Durchmesser                | D Diamètre                   | D Diámetro                  |
| C Diametro cono piccolo        | C Smallest cone diameter | C Kleinster Konusdurchmesser | C Diamètre mineur du cône    | C Diámetro más pequeño cono |
| Th Caratteristiche filettatura | Th Thread features       | Th Gewindeabmessung          | Th Caractéristiques du filet | Th Características rosca    |
| FM Filettatura interna         | FM Internal thread       | FM Innengewinde              | FM Filetage intérieur        | FM Rosca interior           |
| MM Filettatura esterna         | MM External thread       | MM Aussengewinde             | MM Filetage extérieur        | MM Rosca externa            |



# CHEVROLET CAPTIVA



CAPTIVA

06/2006 ->

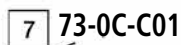
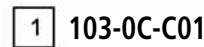
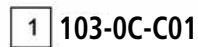
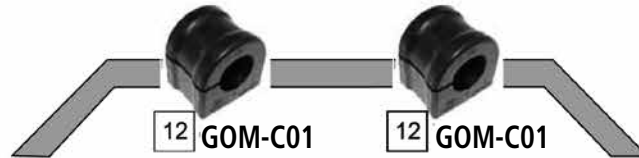

| Ref. | ASHIKA CODE | Description           | OEM       | Measures | Ref. | ASHIKA CODE | Description              | OEM                           | Measures               |
|------|-------------|-----------------------|-----------|----------|------|-------------|--------------------------|-------------------------------|------------------------|
| 1    | 103-0C-C01  | Axial Joint           | Part of   | -        | 7    | 73-0C-C01   | Ball Joint               | Part of 72-0C-C01 / 72-0C-C02 | c: 15,2                |
| 2    | 106-0C-C01  | Stabiliser Link Left  | 48 06 304 | L: 286   | 8    | 111-0C-C01  | Tie Rod End              | 96626667                      | c: 12,5 th: FM14X1.5 R |
| 3    | 106-0C-C02  | Stabiliser Link Right | 48 06 305 | L: 286   | 9    | GOM-C04     | Silentblock For Susp.Arm | Part of 72-0C-C01 / 72-0C-C02 | d: 14,2                |
| 4    | 106-0C-C03  | Stabiliser Link       | 96626150  | L: 165   | 10   | GOM-C02     | Silentblock For Susp.Arm | Part of 72-0C-C01             | d: 14,2                |
| 5    | 72-0C-C01   | Tca Left Wbj          | 96819161  | c: 15,2  | 11   | GOM-C03     | Silentblock For Susp.Arm | Part of 72-0C-C02             | d: 14,2                |
| 6    | 72-0C-C02   | Tca Right Wbj         | 48 06 301 | c: 15,2  | 12   | GOM-C01     | Stabiliser Mounting      | 96810751                      | d: 26                  |

CRUZE (J300)

05/2009 ->

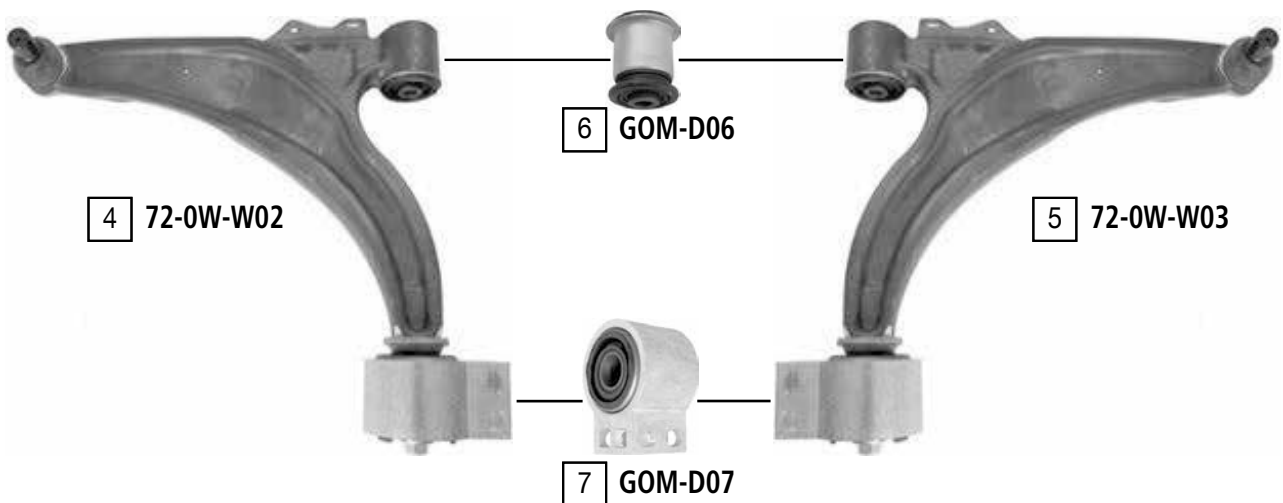
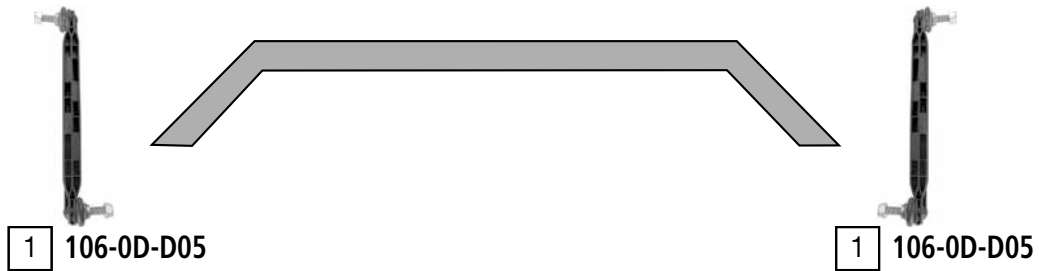

| Ref. | ASHIKA CODE | Description     | OEM      | Measures            | Ref. | ASHIKA CODE | Description         | OEM      | Measures        |
|------|-------------|-----------------|----------|---------------------|------|-------------|---------------------|----------|-----------------|
| 1    | 106-0D-D05  | Stabiliser Link | 13219141 | L:304               | 5    | 72-0W-W03   | TCA right wbj       | 13272606 | c:20            |
| 2    | 111-0W-W00  | Tie Rod End     | 13278359 | c:13.2 th:FM16x1.5R | 6    | GOM-D06     | Silentblock for TCA | 13219090 | di:12.4 do:40.4 |
| 3    | 103-0D-D04  | Axial Joint     | 13278358 | th:MM16x1.5R L:293  | 7    | GOM-D07     | Silentblock for TCA | 13230774 | di:22.3         |
| 4    | 72-0W-W02   | TCA Left Wbj    | 13272605 | c:20                |      |             |                     |          |                 |

# CHEVROLET EVANDA - EPICA



EVANDA / EPICA

03/2005 ->



| Ref. | ASHIKA CODE | Description          | OEM      | Measures           | Ref. | ASHIKA CODE | Description           | OEM      | Measures             |
|------|-------------|----------------------|----------|--------------------|------|-------------|-----------------------|----------|----------------------|
| 1    | 103-0C-C02  | Axial Joint          | 93740701 | th:MM16X1.5R L:358 | 3    | 106-0C-C05  | Stabiliser Link Right | 96225858 | L:79                 |
| 2    | 106-0C-C04  | Stabiliser Link Left | 96225859 | L:79               | 4    | 111-0C-C02  | Tie Rod End           | 93740710 | c: 13.2 th:FM14X1.5R |

KALOS

03/2005 ->

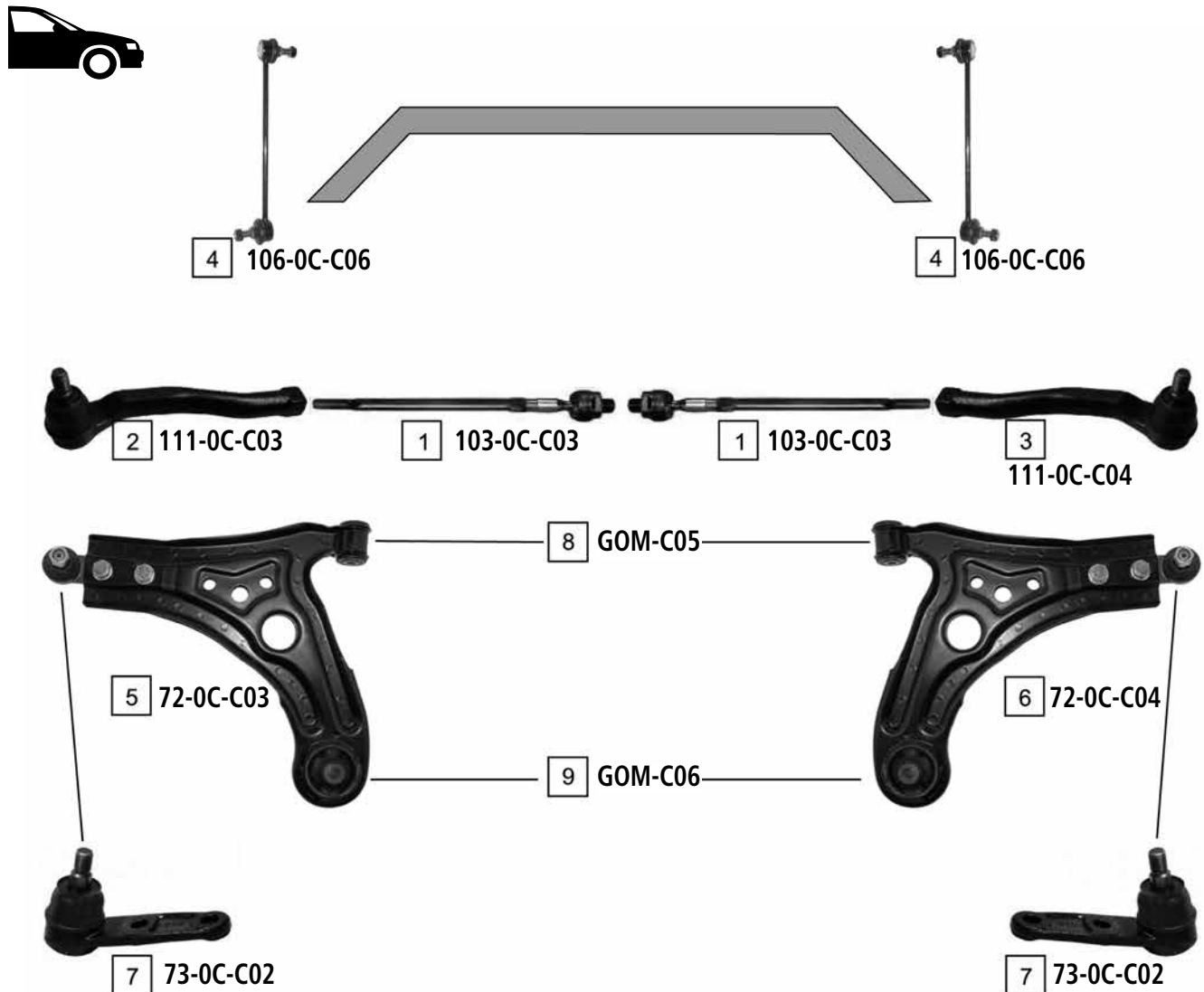

| Ref. | ASHIKA CODE | Description       | OEM       | Measures            | Ref. | ASHIKA CODE | Description              | OEM                           | Measures |
|------|-------------|-------------------|-----------|---------------------|------|-------------|--------------------------|-------------------------------|----------|
| 1    | 103-0C-C03  | Axial Joint       | No OE Ref | th: MM16X1.5R L:200 | 6    | 72-0C-C04   | TCA Right                | 96535082                      | c: 14.8  |
| 2    | 111-0C-C03  | Tie Rod End Left  | 9374-0722 | c:13.2 th:FM12X1.5R | 7    | 73-0C-C02   | Ball Joint               | 96535089                      | c: 14.8  |
| 3    | 111-0C-C04  | Tie Rod End Right | 9374-0723 | c:13.2 th:FM12X1.5R | 8    | GOM-C05     | Silentblock For Susp.Arm | Part of 72-0C-C03 / 72-0C-C04 | d: 28    |
| 4    | 106-0C-C06  | Stabiliser Link   | 96391875  | L: 260              | 9    | GOM-C06     | Silentblock For Susp.Arm | Part of 72-0C-C03 / 72-0C-C04 | d: 60    |
| 5    | 72-0C-C03   | TCA Left          | 96535081  | c: 14.8             |      |             |                          |                               |          |

# CHEVROLET LACETTI - NUBIRA



LACETTI - NUBIRA

03/2005 ->

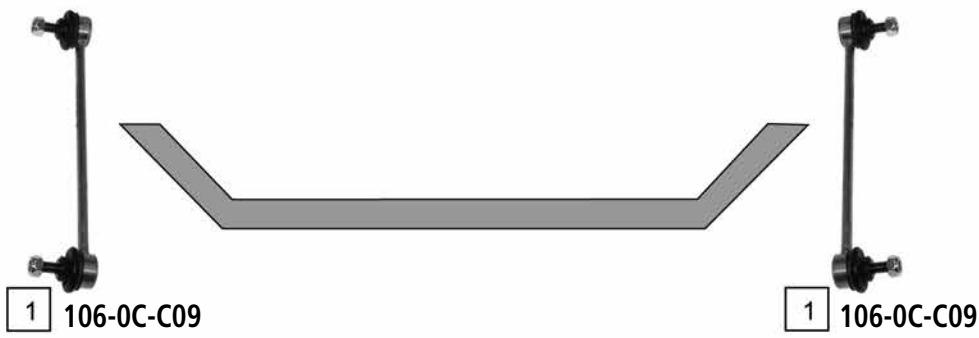

| Ref. | ASHIKA CODE | Description     | OEM       | Measures | Ref. | ASHIKA CODE | Description       | OEM       | Measures            |
|------|-------------|-----------------|-----------|----------|------|-------------|-------------------|-----------|---------------------|
| 1    | 106-0C-C09  | Stabiliser Link | 96391876  | L: 246   | 5    | 72-0C-C05   | TCA Right         | 9639 1851 | c: 18.2             |
| 2    | 106-0C-C07  | Stabiliser Link | 96403099  | L: 271   | 6    | 73-0C-C03   | Ball Joint        | 9649 0218 | c: 18               |
| 3    | 106-0C-C08  | Stabiliser Link | 96403100  | L: 271   | 7    | 111-0C-C06  | Tie Rod End Left  | 96407485  | c:13.3 th:FM14X1.5R |
| 4    | 72-0C-C06   | TCA Left        | 9639 1850 | c: 18.2  | 8    | 111-0C-C05  | Tie Rod End Right | 96407486  | c:13.3 th:FM14X1.5R |

MATIZ

03/2005 ->

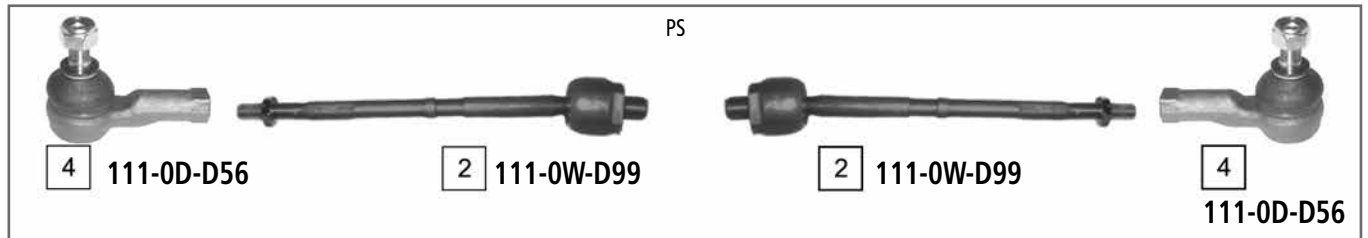
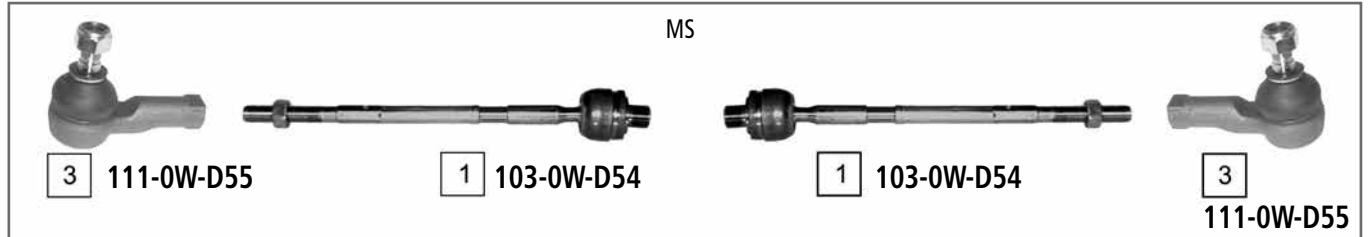

| Ref. | ASHIKA CODE | Description | OEM          | Measures            | Ref. | ASHIKA CODE | Description              | OEM       | Measures              |
|------|-------------|-------------|--------------|---------------------|------|-------------|--------------------------|-----------|-----------------------|
| 1    | 103-0W-D54  | Axial Joint | 9374 1074    | th: MM16X1.5R L:250 | 4    | 111-0D-D56  | Tie Rod End              | KBJ 029   | c: 12.5 th: FM12X1.5R |
| 2    | 111-0W-D99  | Axial Joint | 9374 1092    | th: MM16X1.5R L:251 | 5    | 71-08-803   | TCA                      | 9631-6765 | c:15                  |
| 3    | 111-0W-D55  | Tie Rod End | 48810-A78B00 | c:12.5 th:FM12X1.5R | 6    | GOM-C07     | Silentblock For Susp.Arm | 9638 0613 | d: 27.5               |

# CHEVROLET SPARK



SPARK (M300)

02/2010 ->

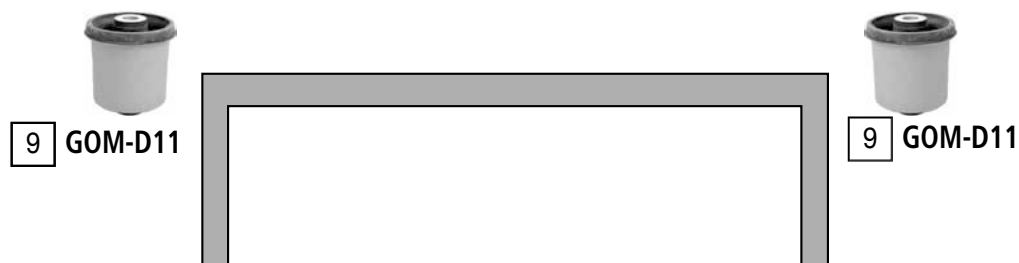
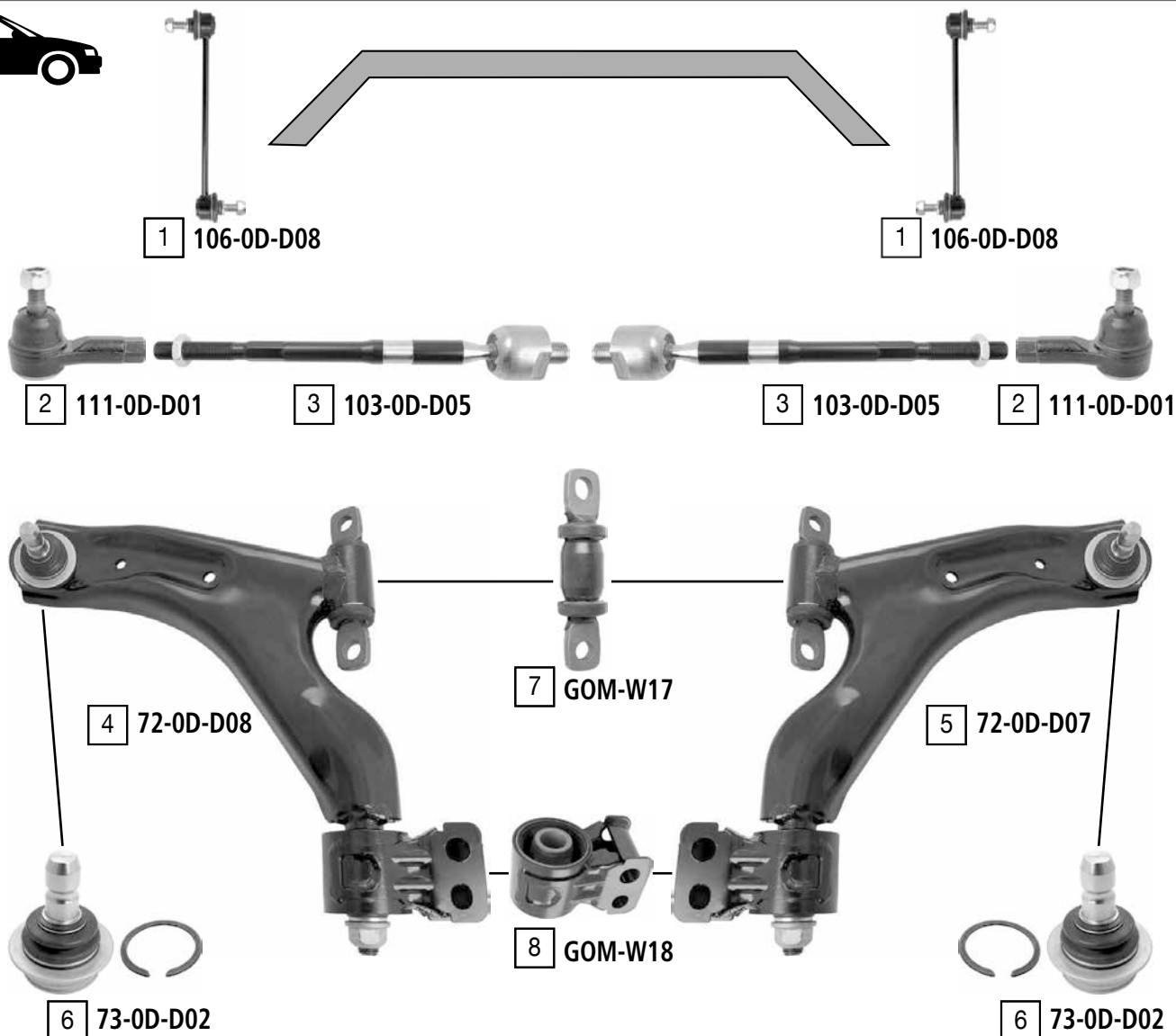

| Ref. | ASHIKA CODE | Description     | OEM      | Measures              | Ref. | ASHIKA CODE | Description         | OEM      | Measures      |
|------|-------------|-----------------|----------|-----------------------|------|-------------|---------------------|----------|---------------|
| 1    | 106-0D-D08  | Stabiliser Link | 95947829 | L:235                 | 6    | 73-0D-D02   | Ball Joint          | Part of  | c:16 do:42    |
| 2    | 111-0D-D01  | Tie Rod End     | 95967285 | c:13.25 th:FM12X1.25R | 7    | GOM-W17     | Silentblock For TCA | Part of  | do:31         |
| 3    | 103-0D-D05  | Axial Joint     | 95967294 | th:M14X1.5R L:244     | 8    | GOM-W18     | Silentblock For TCA | Part of  | di:18.1 do:51 |
| 4    | 72-0D-D08   | TCA left wbj    | 95952782 | c:15.95               | 9    | GOM-D11     | Mounting Axle Body  | 95020214 | do:69.35      |
| 5    | 72-0D-D07   | TCA right wbj   |          | c:15.95               |      |             |                     |          |               |

TACUMA - REZZO

03/2005 ->

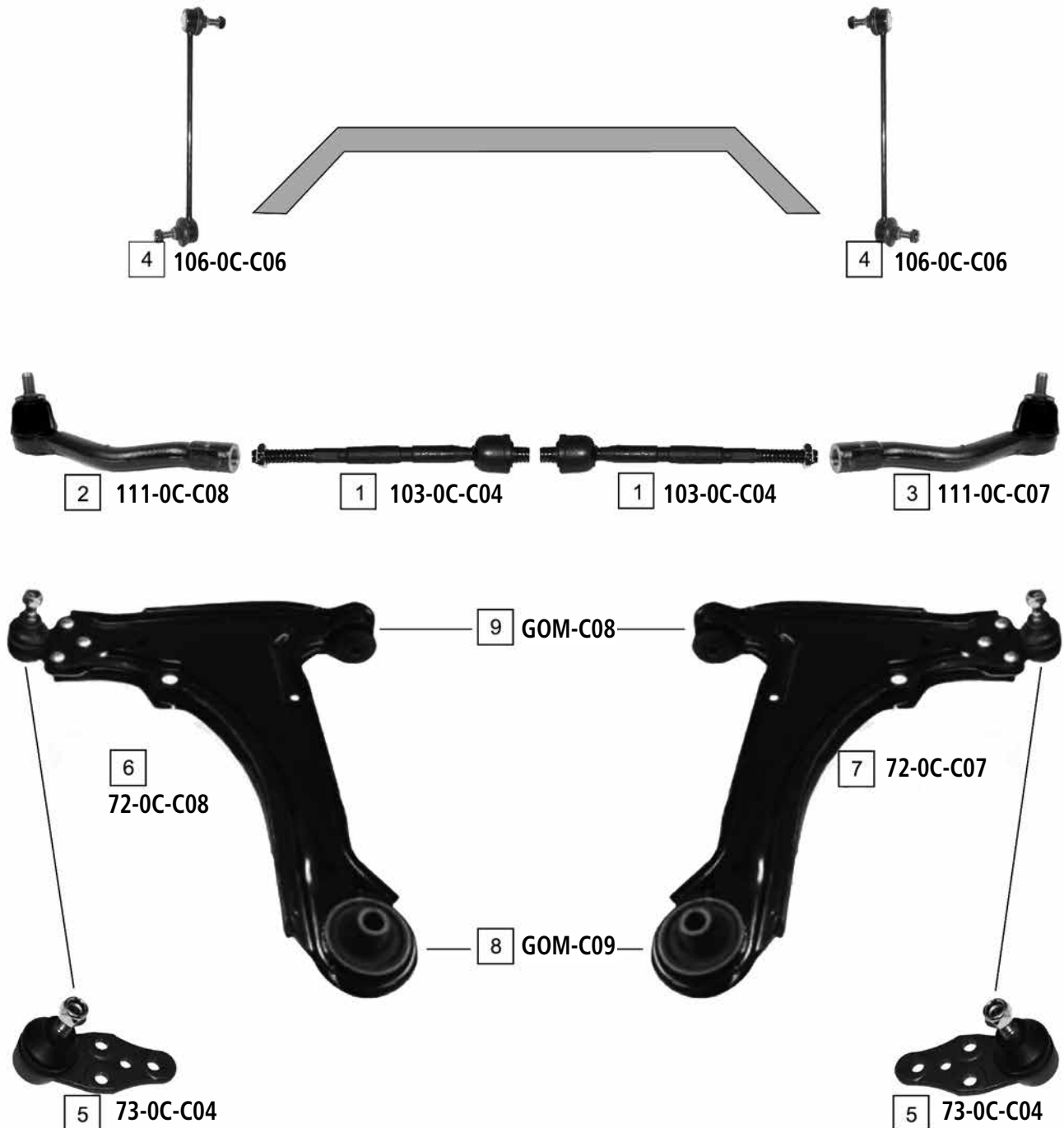

| Ref. | ASHIKA CODE | Description       | OEM      | Measures            | Ref. | ASHIKA CODE | Description              | OEM      | Measures |
|------|-------------|-------------------|----------|---------------------|------|-------------|--------------------------|----------|----------|
| 1    | 103-0C-C04  | Axial Joint       | 521564   | th: MM16X1.5R L:240 | 6    | 72-0C-C08   | TCA Left                 | 96378347 |          |
| 2    | 111-0C-C08  | Tie Rod End Left  | 96261378 | c:13.2 th:FM14X1.5R | 7    | 72-0C-C07   | TCA Right                | 96378348 |          |
| 3    | 111-0C-C07  | Tie Rod End Right | 96261379 | c:13.2 th:FM14X1.5R | 8    | GOM-C09     | Silentblock For Susp.Arm | 96261107 |          |
| 4    | 106-0C-C06  | Stabiliser Link   | 96391875 | L: 260              | 9    | GOM-C08     | Silentblock For Susp.Arm | 96378346 |          |
| 5    | 73-0C-C04   | Ball Joint        | 96261108 | c: 16               |      |             |                          |          |          |



300 C / 300 C TOURING

09/2004 ->



LOWER

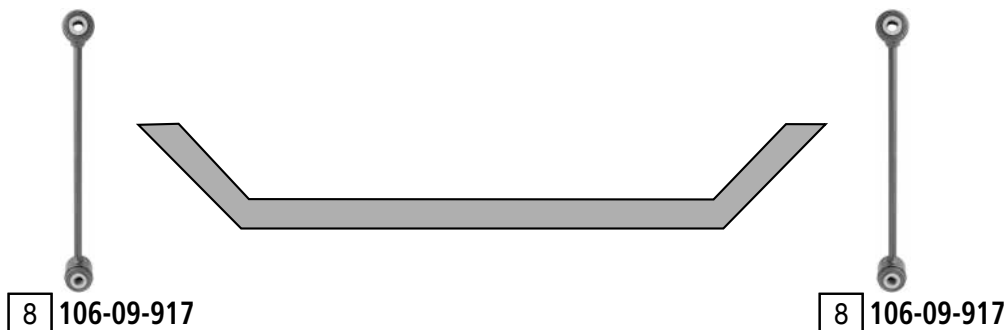

| Ref. | ASHIKA CODE | Description           | OEM         | Measures          | Ref. | ASHIKA CODE | Description               | OEM        | Measures |
|------|-------------|-----------------------|-------------|-------------------|------|-------------|---------------------------|------------|----------|
| 1    | 106-09-914  | stabiliser link left  | 4895 483AB  | L:214             | 5    | 71-09-900   | TCA left wbj              | 5180 607AB | c:16.85  |
| 2    | 106-09-915  | stabiliser link right | 4895 482AB  | L:214             | 6    | 71-09-901   | TCA right wbj             | 5180 606AB | c:16.85  |
| 3    | 111-09-916  | tie rod end           | 52013 468AD | c:15 th:FM15x1.5R | 7    | 71-09-902   | TCA wobj                  | 4782 561AE | c:14.3   |
| 4    | 103-09-908  | axial joint           | 68028 831AC | th:MM18x1.5 L:323 | 8    | 106-09-917  | stabiliser link rear axle | 4766 866AA | L:260    |

PT CRUISER

06/2000 ->



1 111-0C-C09



1 111-0C-C09



2 72-0C-C10



5 GOM-C10



3 72-0C-C09



4 73-0C-C05



6 GOM-C11



4 73-0C-C05

| Ref. | ASHIKA CODE | Description   | OEM        | Measures            | Ref. | ASHIKA CODE | Description              | OEM                           | Measures |
|------|-------------|---------------|------------|---------------------|------|-------------|--------------------------|-------------------------------|----------|
| 1    | 111-0C-C09  | Tie Rod End   | 4762861-AA | c:12.5 th:FM14X1.5R | 4    | 73-0C-C05   | Ball joint               | 4656 010                      | c: 18    |
| 2    | 72-0C-C10   | TCA Left Wbj  | 4656 731AH |                     | 5    | GOM-C10     | Silentblock For Susp.Arm | Part of 72-0C-C10 / 72-0C-C09 |          |
| 3    | 72-0C-C09   | TCA Right Wbj | 4656 730AH |                     | 6    | GOM-C11     | Silentblock For Susp.Arm | 4656 012AC                    |          |

VOYAGER I (ES)

01/1984 - 01/1995



1 111-0C-C10



1 111-0C-C10



2 72-0C-C12

5 GOM-C12



3 72-0C-C11

6 GOM-C13



4 73-0C-C06



4 73-0C-C06

| Ref. | ASHIKA CODE | Description   | OEM      | Measures            | Ref. | ASHIKA CODE | Description              | OEM      | Measures |
|------|-------------|---------------|----------|---------------------|------|-------------|--------------------------|----------|----------|
| 1    | 111-0C-C10  | Tie Rod End   | 52744700 | c:12.8 th:MM14X1.5R | 4    | 73-0C-C06   | Ball Joint               | 4694 747 | c: 18    |
| 2    | 72-0C-C12   | TCA Left Wbj  | 4728885  | c:18                | 5    | GOM-C12     | Silentblock For Susp.Arm | 272084   | d: 39    |
| 3    | 72-0C-C11   | TCA Right Wbj | 4728884  | c:18                | 6    | GOM-C13     | Silentblock For Susp.Arm | 5272098  | d: 58    |

VOYAGER II (GS)

01/1995 - 03/2001

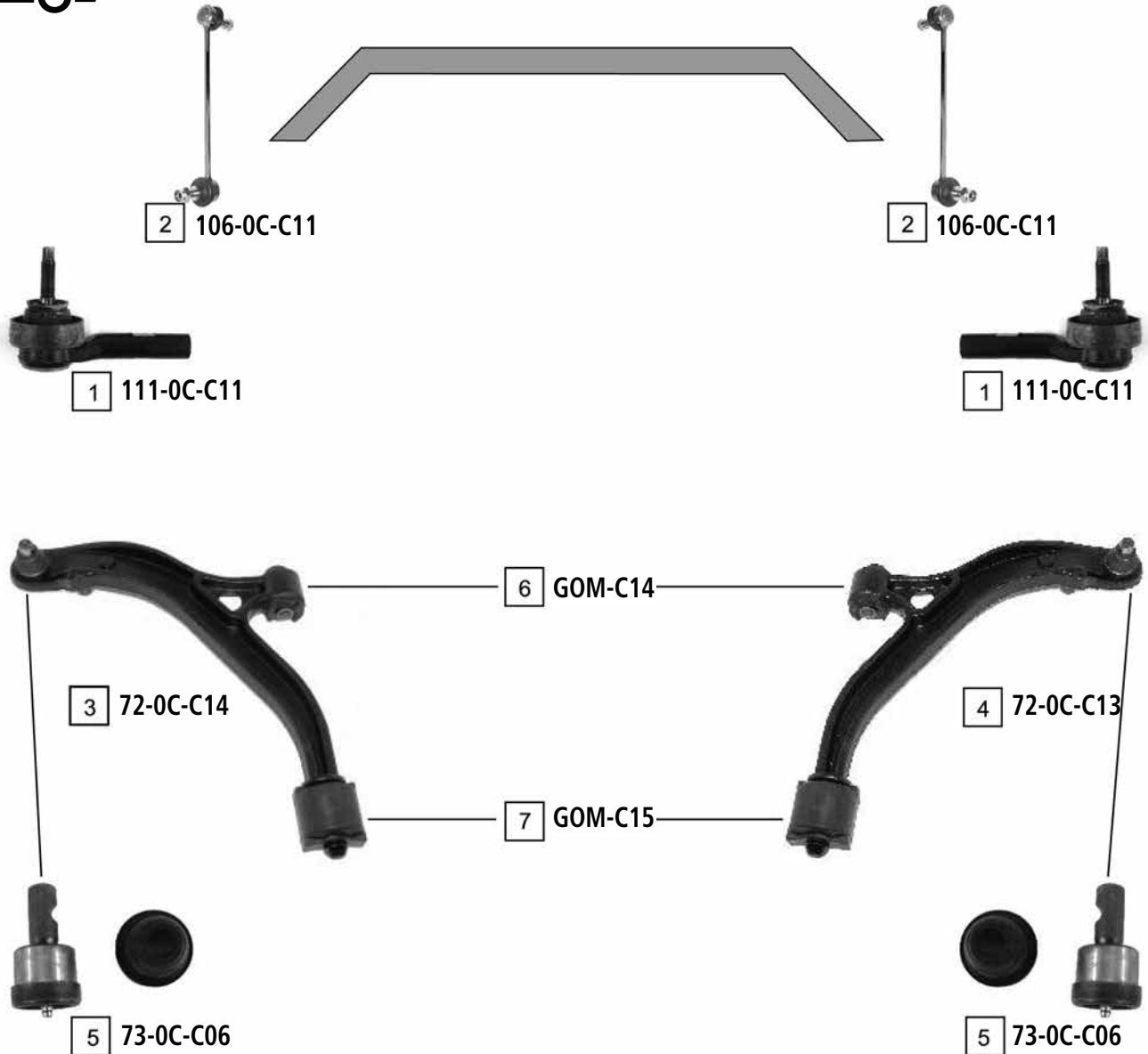

| Ref. | ASHIKA CODE | Description     | OEM        | Measures              | Ref. | ASHIKA CODE | Description              | OEM                           | Measures |
|------|-------------|-----------------|------------|-----------------------|------|-------------|--------------------------|-------------------------------|----------|
| 1    | 111-OC-C11  | Tie Rod End     | 4797706    | c: 12.5 th: FM14X1.5R | 5    | 73-OC-C06   | Ball Joint               | 4694 747                      | c: 18    |
| 2    | 106-OC-C11  | Stabiliser Link | 4743 669AA | L: 310                | 6    | GOM-C14     | Silentblock For Susp.Arm | Part of 72-OC-C14 / 72-OC-C13 | d: 39.3  |
| 3    | 72-OC-C14   | TCA Left        | 4694761-C  | c: 18                 | 7    | GOM-C15     | Silentblock For Susp.Arm | Part of 72-OC-C14 / 72-OC-C13 | d: 18.2  |
| 4    | 72-OC-C13   | TCA Right       | 4694760-C  | c: 18                 |      |             |                          |                               |          |

# CHRYSLER VOYAGER



VOYAGER III (RG)

02/2000->

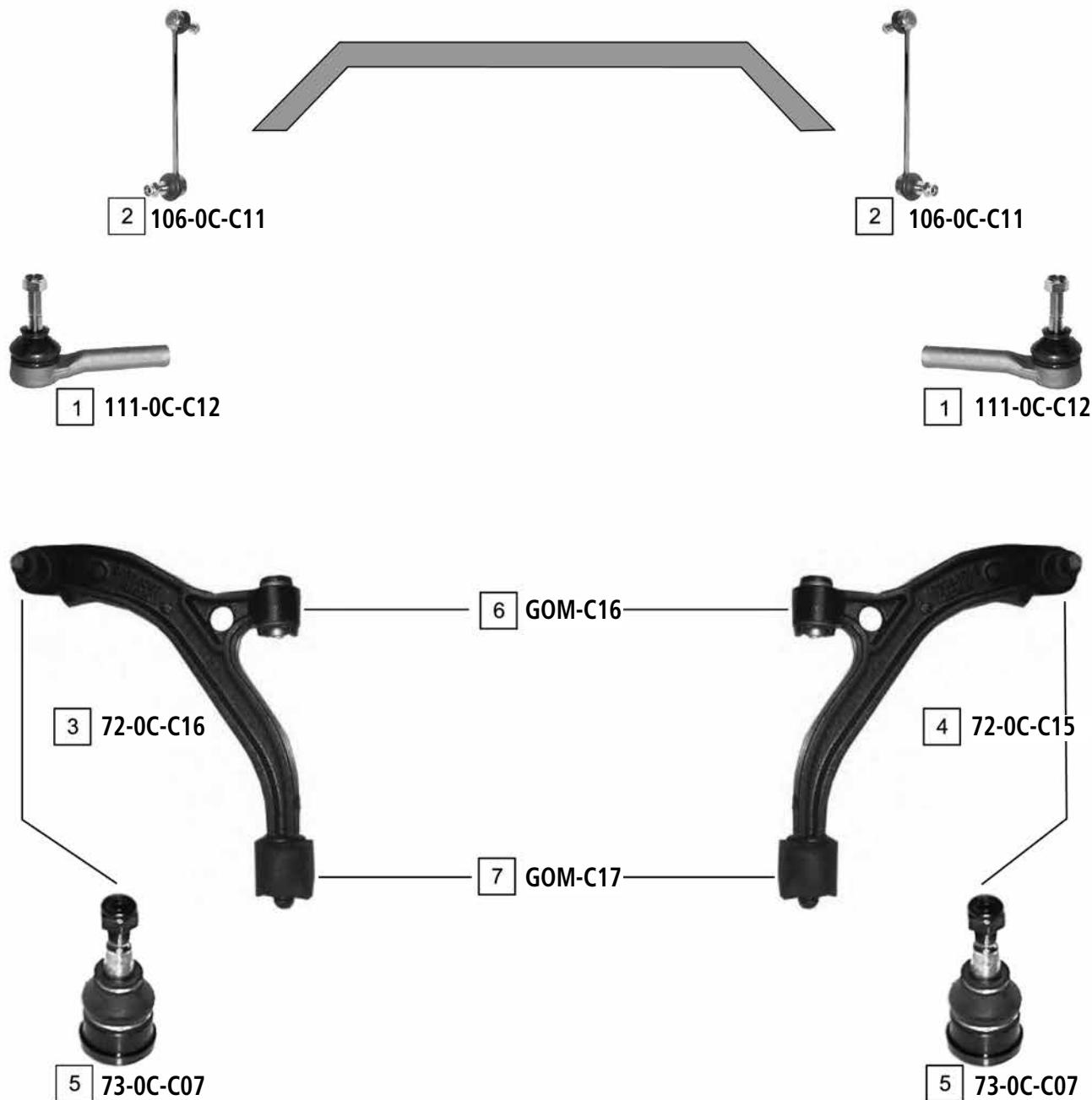

| Ref. | ASHIKA CODE | Description     | OEM        | Measures              | Ref. | ASHIKA CODE | Description              | OEM                         | Measures |
|------|-------------|-----------------|------------|-----------------------|------|-------------|--------------------------|-----------------------------|----------|
| 1    | 111-0C-C12  | Tie Rod End     | 5066 373AA | c: 12.5 th: FM14X1.5R | 5    | 73-0C-C07   | Ball Joint               | Part of 72-0C-C16/72-0C-C15 | c: 13.5  |
| 2    | 106-0C-C11  | Stabiliser Link | 4743 669AA | L: 310                | 6    | GOM-C16     | Silentblock For Susp.Arm | Part of 72-0C-C16/72-0C-C15 |          |
| 3    | 72-0C-C16   | TCA Left        | 4766543-AA | c: 13.5               | 7    | GOM-C17     | Silentblock For Susp.Arm | 4743095-AA                  |          |
| 4    | 72-0C-C15   | TCA Right       | 4766542-AA | c: 15.3               |      |             |                          |                             |          |

GRAND VOYAGER IV (RT)

10/2007 ->

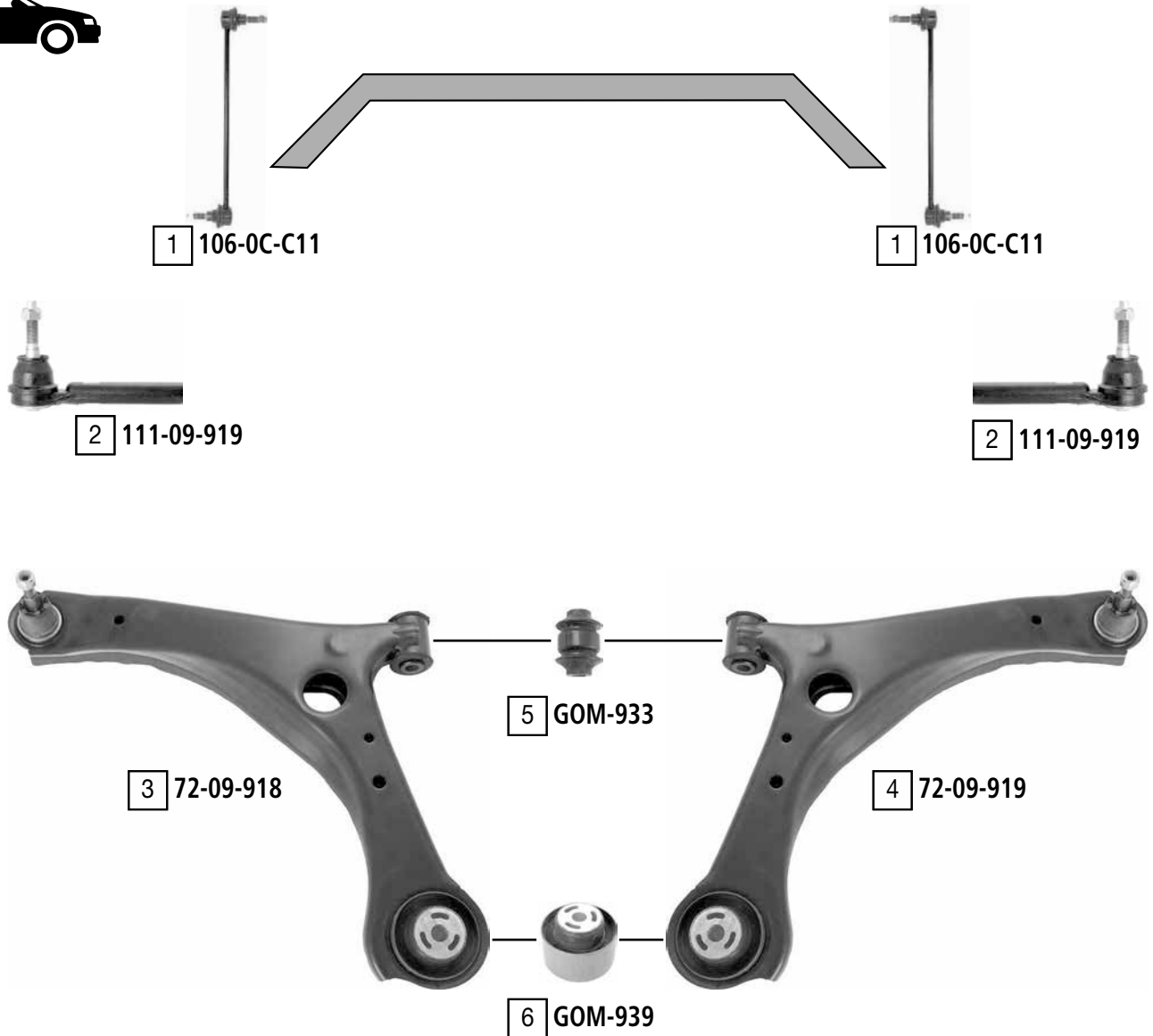

| Ref. | JAPANPARTS CODE | Description     | OEM         | Measures            | Ref. | JAPANPARTS CODE | Description        | OEM        | Measures         |
|------|-----------------|-----------------|-------------|---------------------|------|-----------------|--------------------|------------|------------------|
| 1    | 106-0C-C11      | stabiliser link | 4743 669AB  | L:310               | 4    | 72-09-919       | TCA right wbj      | 4766 910AG | c:14.8           |
| 2    | 111-09-919      | tie rod end     | 68033 171AB | c:12.55 th:FM14x1.5 | 5    | GOM-933         | silentblock forTCA | 5273 731AB | di:14.4 do:39.90 |
| 3    | 72-09-918       | TCA left wbj    | 4766 911AG  | c:14.8              | 6    | GOM-939         | silentblock forTCA | part of    | di:14.3 do:66.3  |

# DACIA DUSTER



DUSTER

04/2010 ->

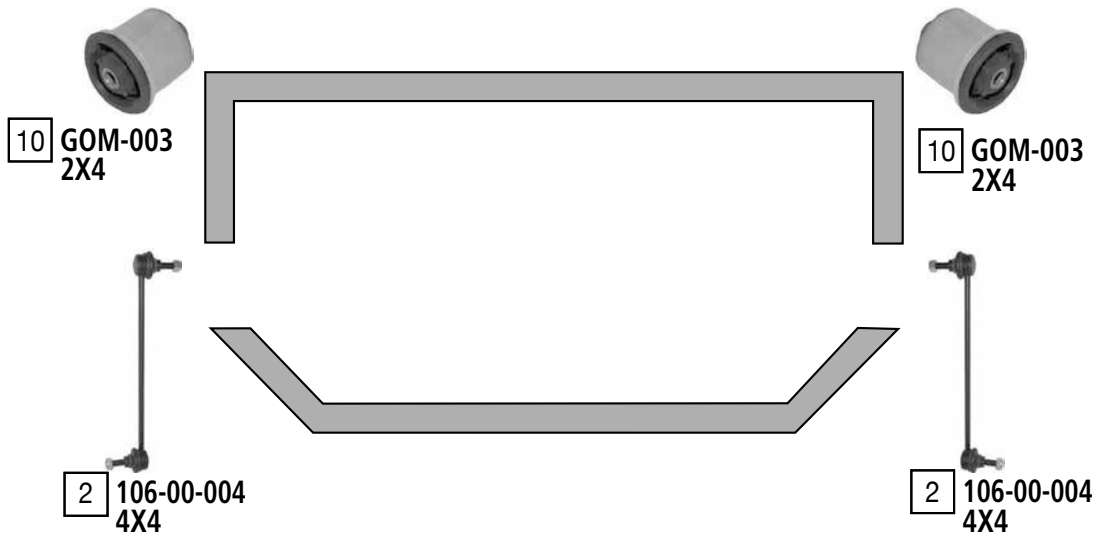
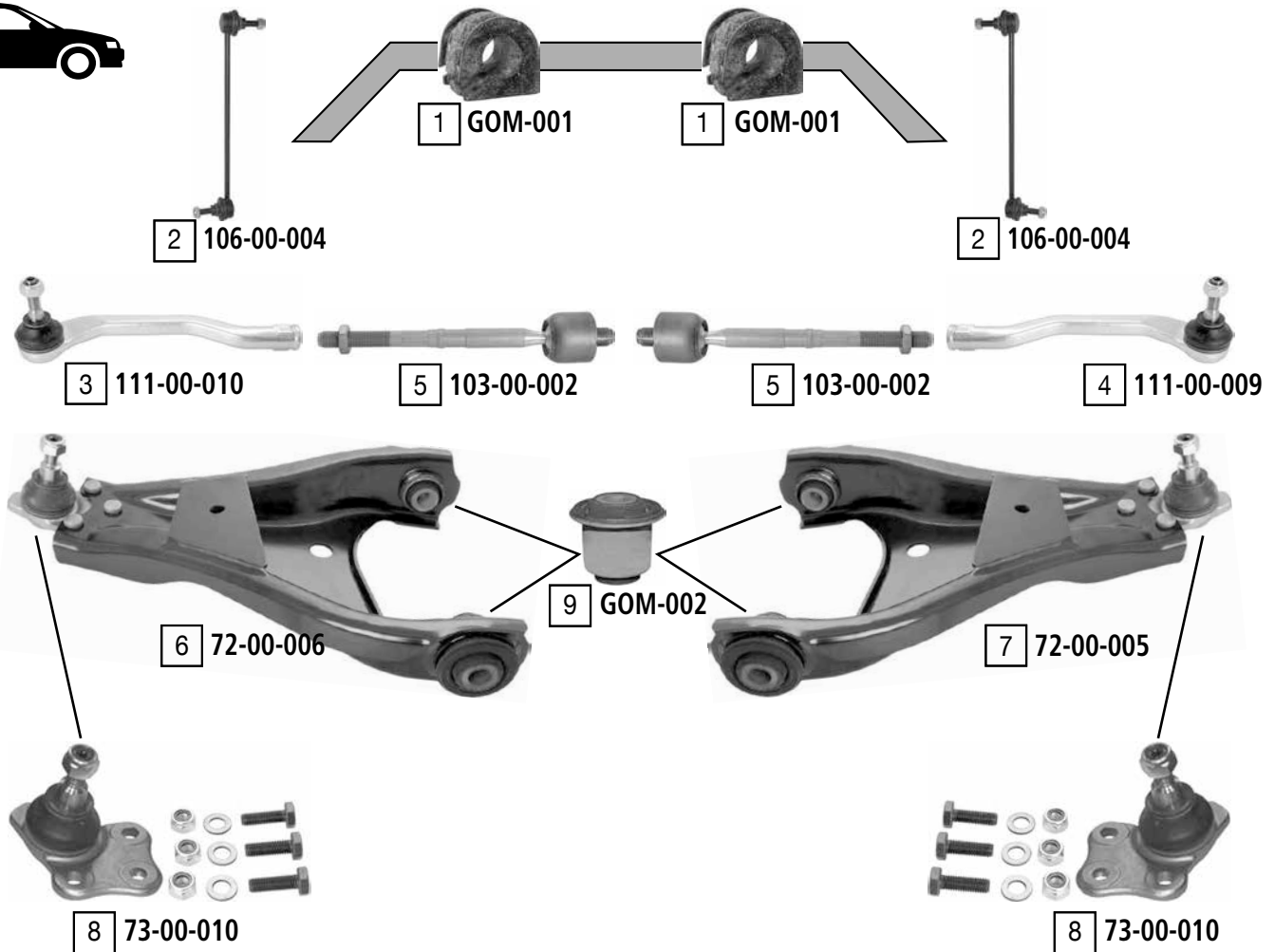

| Ref. | ASHIKA CODE | Description         | OEM           | Measures           | Ref. | ASHIKA CODE | Description         | OEM           | Measures        |
|------|-------------|---------------------|---------------|--------------------|------|-------------|---------------------|---------------|-----------------|
| 1    | GOM-001     | Stabiliser Mounting | 82 00 852 550 | di:18.5            | 6    | 72-00-006   | TCA Left Wbj        | 54 50 167 46R | c:17.2          |
| 2    | 106-00-004  | Stabiliser Link     | 82 00 814 411 | L:295              | 7    | 72-00-005   | TCA Right Wbj       | 54 50 065 42R | c:17.2          |
| 3    | 111-00-010  | Tie Rod End Left    | 82 01 108 339 | c:12 th:FM14x1.5R  | 8    | 73-00-010   | Ball Joint          | 40 16 023 08R | c:17.1          |
| 4    | 111-00-009  | Tie Rod End Right   | 82 01 108 332 | c:12 th:FM14x1.5R  | 9    | GOM-002     | Silentblock For TCA | Part of       | di:14.1 do:37.2 |
| 5    | 103-00-002  | Axial Joint         | 82 01 108 350 | th:MM16x1.5R L:204 | 10   | GOM-003     | Mounting Axle Body  | 60 01 549 989 | do:66.5         |

LOGAN  
LOGAN MCV  
LOGAN PICK-UP  
LOGAN VAN (EXPRESS)

09/2004 ->  
04/2007 ->  
03/2008 ->  
03/2009 ->

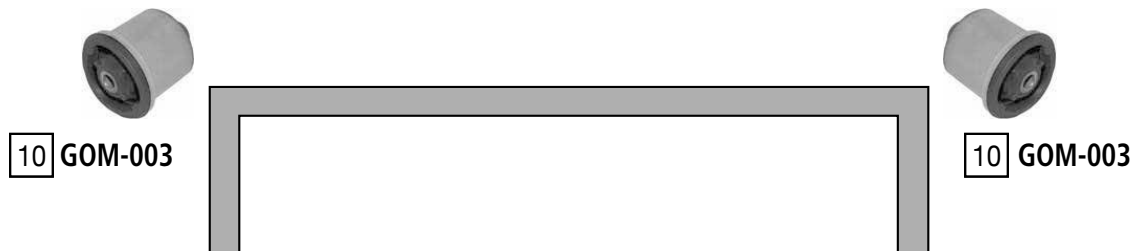
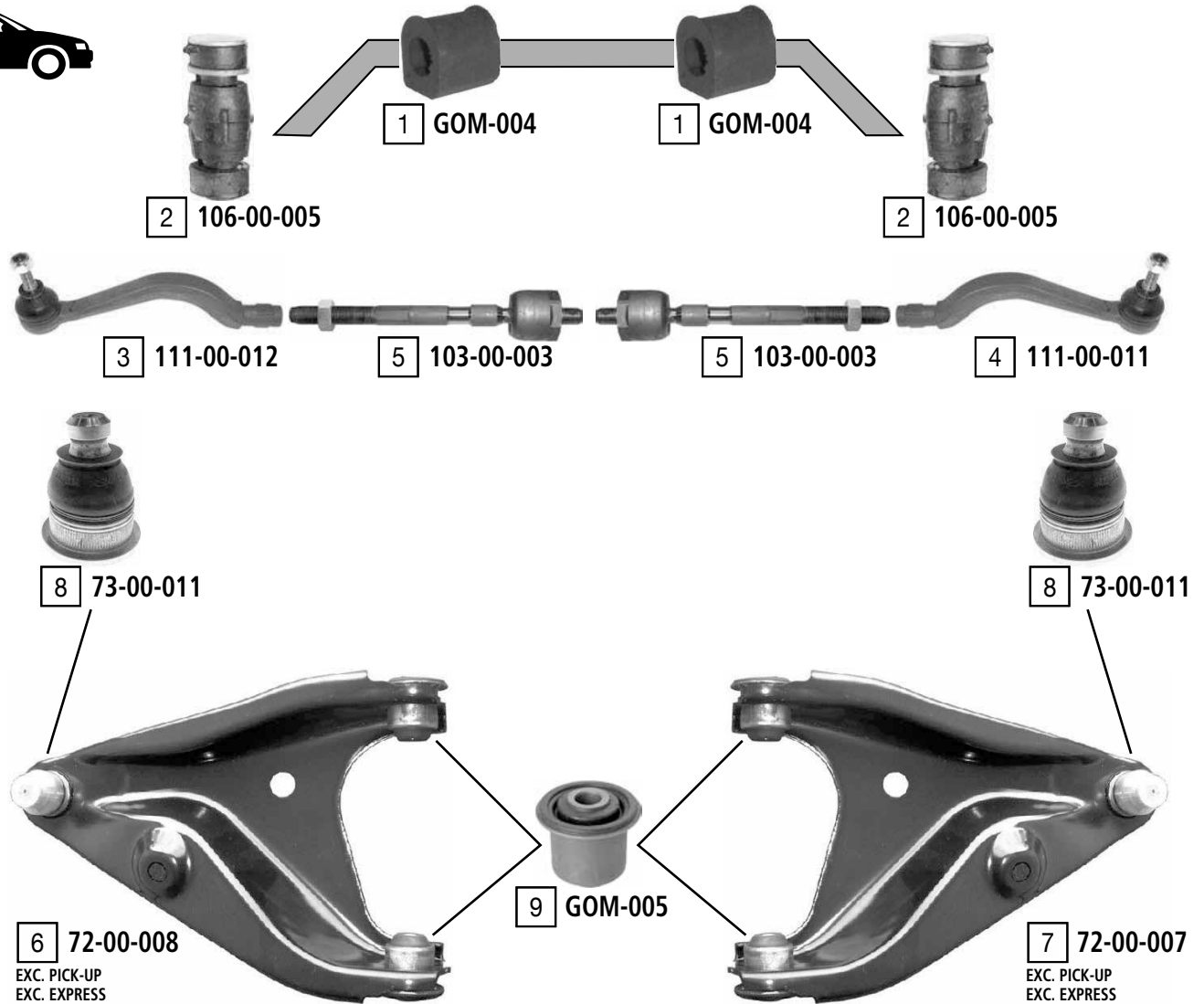

| Ref. | ASHIKA CODE | Description         | OEM           | Measures            | Ref. | ASHIKA CODE | Description         | OEM           | Measures        |
|------|-------------|---------------------|---------------|---------------------|------|-------------|---------------------|---------------|-----------------|
| 1    | GOM-004     | Stabiliser Mounting | 60 01 547 140 | di:23.5             | 6    | 72-00-008   | TCA left wbj        | 60 01 547 520 | c:18            |
| 2    | 106-00-005  | Stabiliser Mounting | 60 01 547 138 | -                   | 7    | 72-00-007   | TCA right wbj       | 60 01 547 519 | c:18            |
| 3    | 111-00-012  | Tie Rod End Left    | 60 01 547 610 | c:12.1 th:FM14X1.5R | 8    | 73-00-011   | Ball joint          | Part of       | c:18 do:38.3    |
| 4    | 111-00-011  | Tie Rod End Right   | 60 01 547 611 | c:12.1 th:FM14X1.5R | 9    | GOM-005     | Silentblock for TCA | Part of       | di:12.2 do:37.2 |
| 5    | 103-00-003  | Axial Joint         | 60 01 550 441 | th:MM12x1R L:193    | 10   | GOM-003     | Mounting axle body  | 60 01 549 989 | do:66.5         |



SANDERO

06/2008 ->

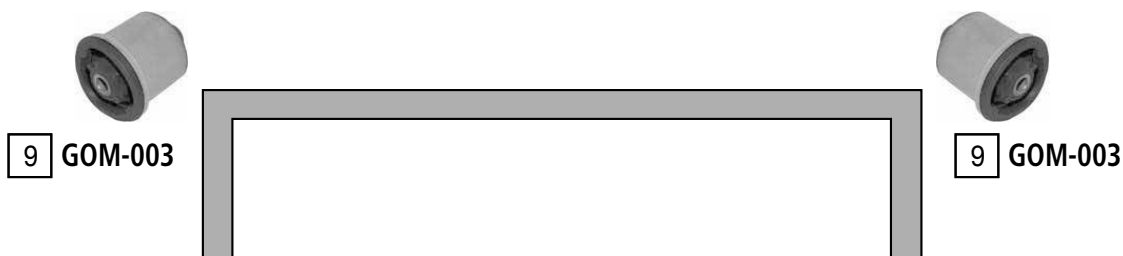
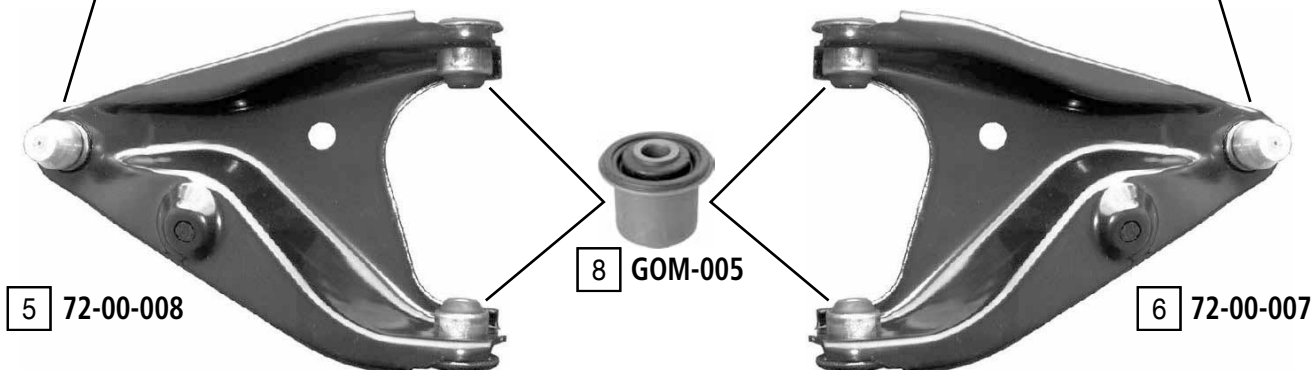

| Ref. | ASHIKA CODE | Description         | OEM           | Measures            | Ref. | ASHIKA CODE | Description         | OEM           | Measures        |
|------|-------------|---------------------|---------------|---------------------|------|-------------|---------------------|---------------|-----------------|
| 1    | 106-00-005  | Stabiliser Mounting | 60 01 547 138 | -                   | 6    | 72-00-007   | TCA right wbj       | 60 01 547 519 | c:18            |
| 2    | 111-00-012  | Tie Rod End Left    | 60 01 547 610 | c:12.1 th:FM14X1.5R | 7    | 73-00-011   | ball joint          | Part of       | c:18 do:38.3    |
| 3    | 111-00-011  | Tie Rod End Right   | 60 01 547 611 | c:12.1 th:FM14X1.5R | 8    | GOM-005     | silentblock for TCA | Part of       | di:12.2 do:37.2 |
| 4    | 103-00-003  | Axial Joint         | 60 01 550 441 | th:MM12x1R L:193    | 9    | GOM-003     | mounting axle body  | 60 01 549 989 | do:66.5         |
| 5    | 72-00-008   | TCA left wbj        | 60 01 547 520 | c:18                |      |             |                     |               |                 |

SOLENZA (B41\_)

02/2003 - 03/2005

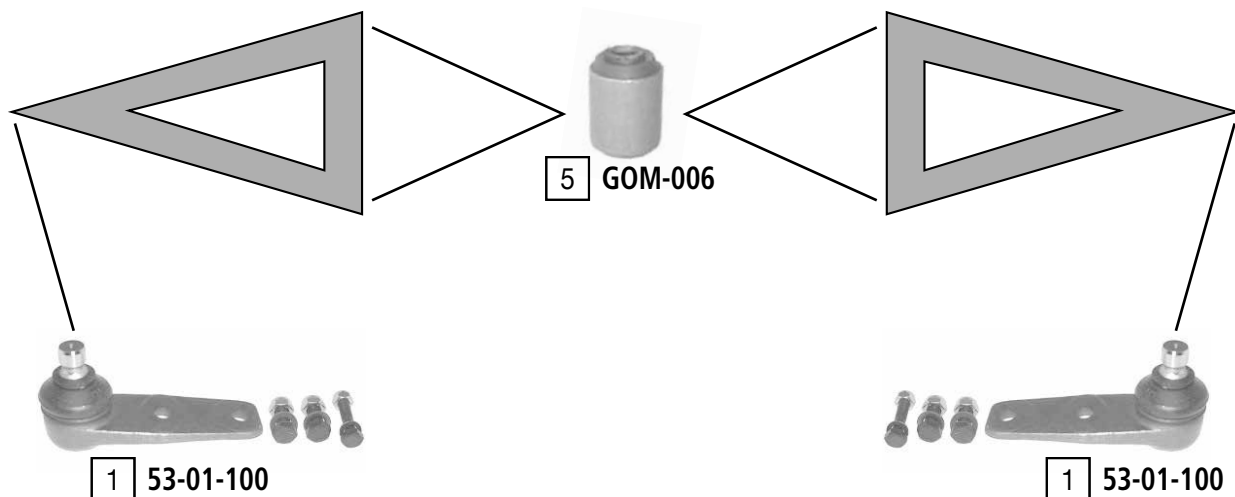
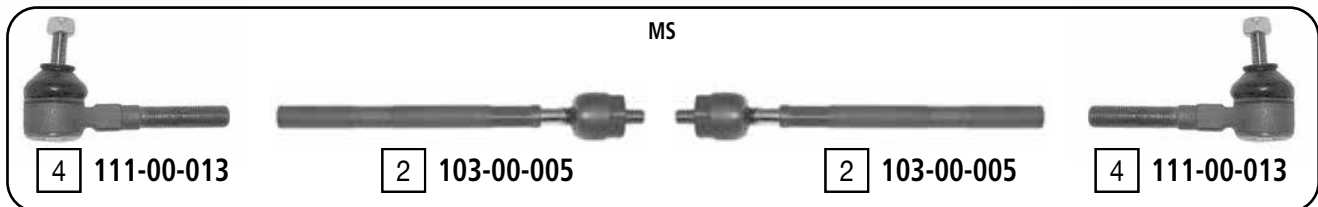
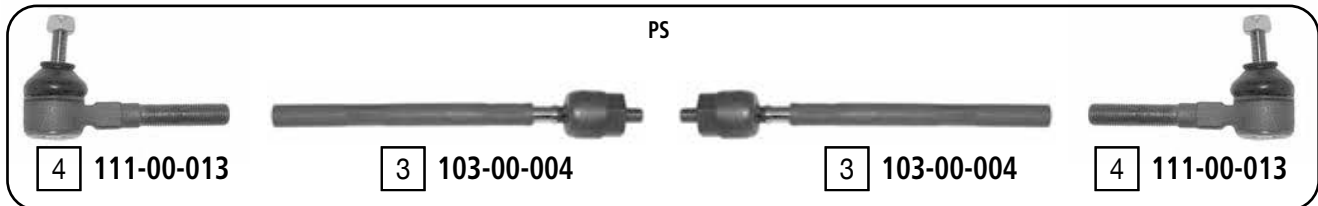
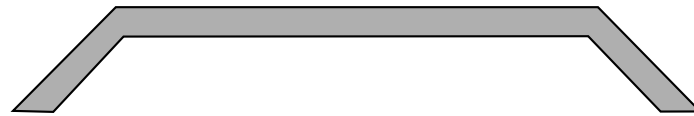

| Ref. | ASHIKA CODE | Description      | OEM           | Measures         | Ref. | ASHIKA CODE | Description         | OEM           | Measures            |
|------|-------------|------------------|---------------|------------------|------|-------------|---------------------|---------------|---------------------|
| 1    | 53-01-100   | Ball Joint Lower | 77 01 472 038 | c:16             | 4    | 111-00-013  | Tie Rod End         | 60 01 546 523 | c:11.9 th:MM14X1.5R |
| 2    | 103-00-005  | Axial Joint      | 60 01 542 724 | th:MM12X1R L:276 | 5    | GOM-006     | Silentblock For TCA | 77 04 000 681 | di:12.3 do:32.1     |
| 3    | 103-00-004  | Axial Joint      | 60 01 546 524 | th:MM12X1R L:285 |      |             |                     |               |                     |

KALOS (KLAS)

09/2002->

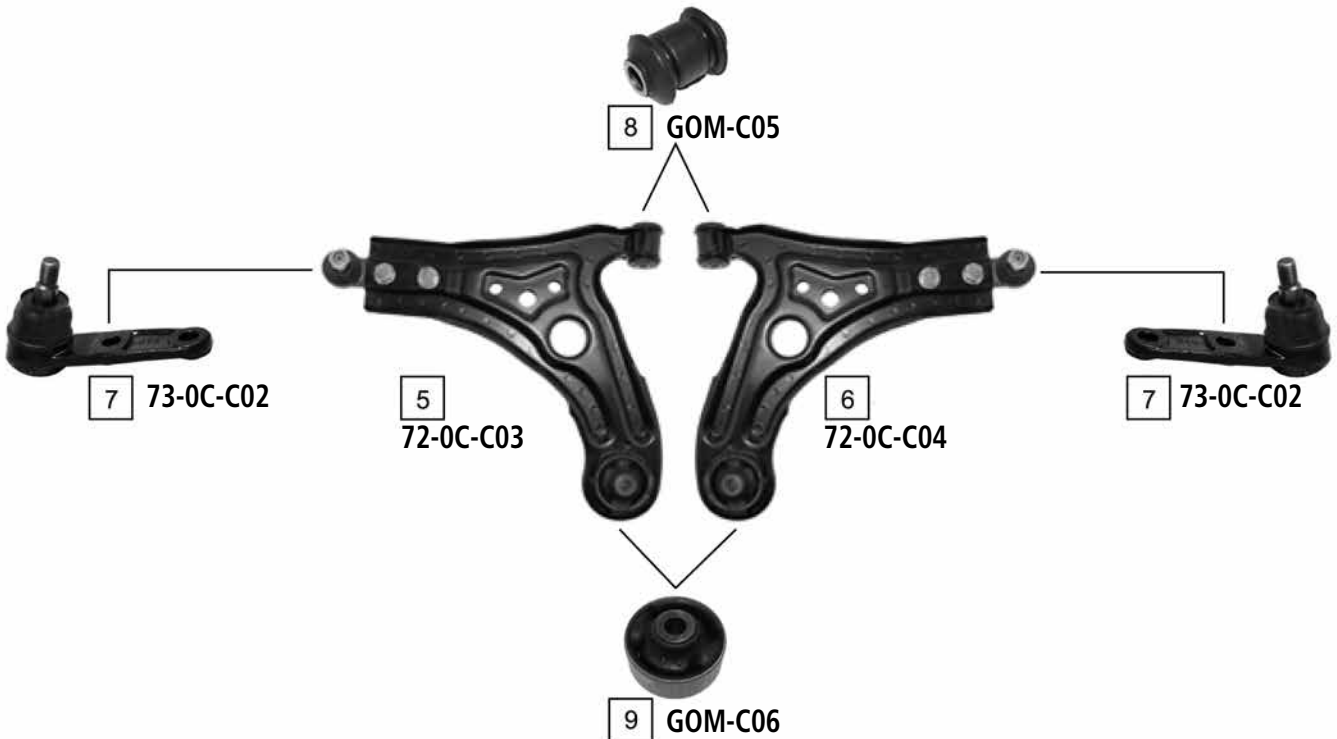

| Ref. | ASHIKA CODE | Description       | OEM       | Measures            | Ref. | ASHIKA CODE | Description              | OEM                           | Measures |
|------|-------------|-------------------|-----------|---------------------|------|-------------|--------------------------|-------------------------------|----------|
| 1    | 103-0C-C03  | Axial Joint       | -         | th: MM16X1.5R L:200 | 6    | 72-0C-C04   | TCA Right                | 96535082                      | c: 14.8  |
| 2    | 111-0C-C03  | Tie Rod End Left  | 9374-0722 | c:13.2 th:FM14X1.5R | 7    | 73-0C-C02   | Ball Joint               | 96535089                      | c: 14.8  |
| 3    | 111-0C-C04  | Tie Rod End Right | 9374-0723 | c:13.2 th:FM14X1.5R | 8    | GOM-C05     | Silentblock For Susp.Arm | Part of 72-0C-C03 / 72-0C-C04 | d: 28    |
| 4    | 106-0C-C06  | Stabiliser Link   | 96391875  | L: 260              | 9    | GOM-C06     | Silentblock For Susp.Arm | Part of 72-0C-C03 / 72-0C-C04 | d: 60    |
| 5    | 72-0C-C03   | TCA Left          | 96535081  | c: 14.8             |      |             |                          |                               |          |

KORANDO (KJ)

01/1999->

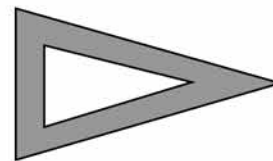
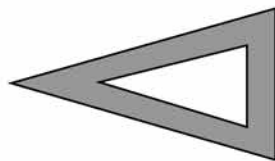
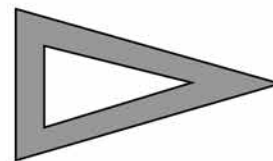
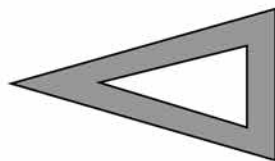

| Ref. | ASHIKA CODE | Description     | OEM        | Measures          | Ref. | ASHIKA CODE | Description | OEM        | Measures |
|------|-------------|-----------------|------------|-------------------|------|-------------|-------------|------------|----------|
| 1    | 111-05-S01  | Tie Rod End     | 4666005501 | c:16 th:FM14X1.5R | 4    | 73-05-S02   | Ball Joint  | 4450505001 | c:17.6   |
| 2    | 106-05-S01  | Stabiliser Link | 4475005001 |                   | 5    | 103-05-S02  | Axial Joint | Part of    |          |
| 3    | 73-05-S01   | Ball Joint      | 4443003011 | c:17.6            |      |             |             |            |          |

# DAEWOO LANOS-ESPERO-NEXIA



LANOS  
ARANOS  
EXPERO (KLEJ)  
NEXIA-RACER-CIELO (KLETN)

05/1997->  
01/1991-01/1995  
10/1991-09/1999  
02/1995-08/1997

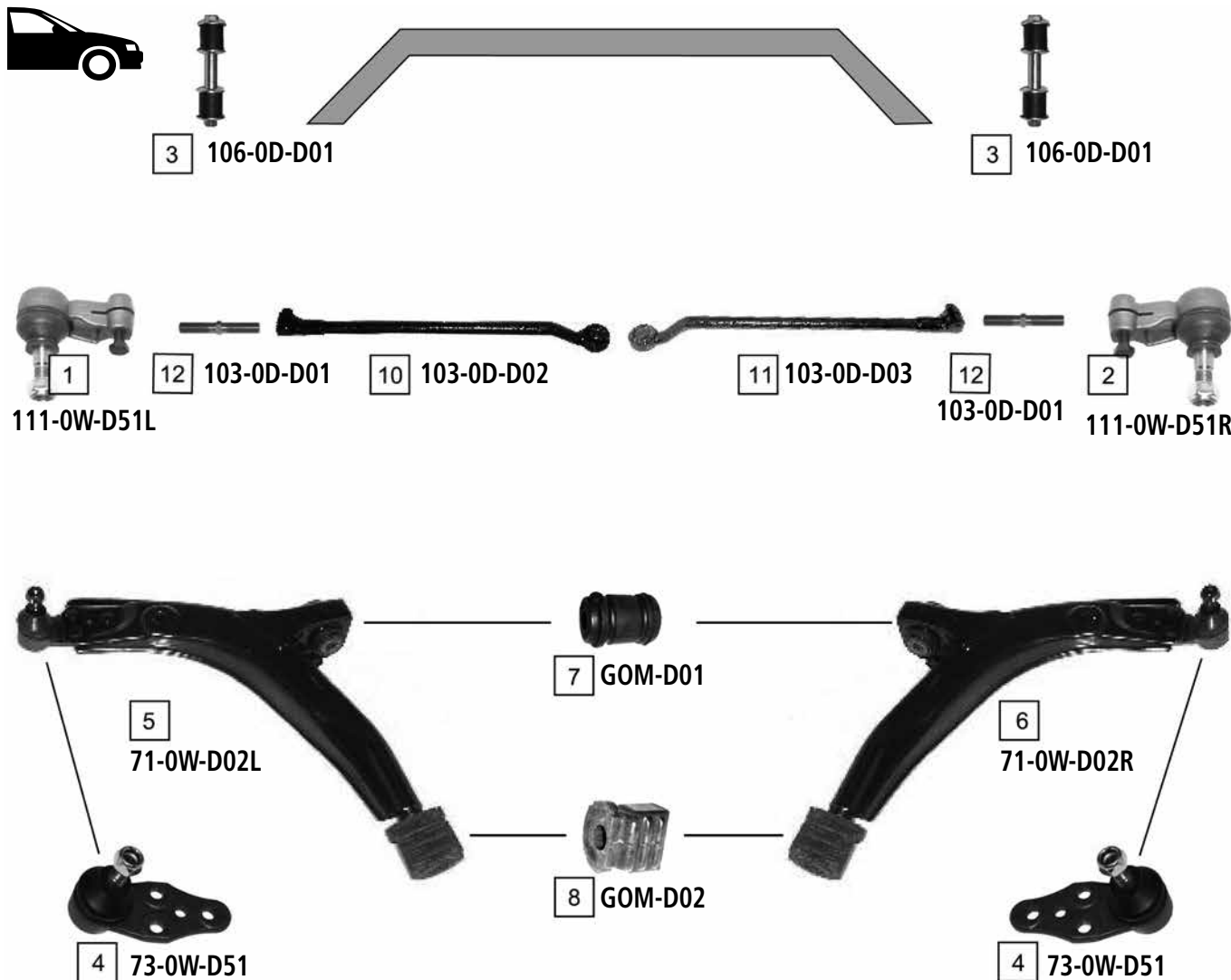

| Ref. | ASHIKA CODE | Description       | OEM       | Measures          | Ref. | ASHIKA CODE | Description              | OEM        | Measures |
|------|-------------|-------------------|-----------|-------------------|------|-------------|--------------------------|------------|----------|
| 1    | 111-0W-D51L | Tie Rod End Left  | 324.039   | c:13 th:FM16X1.5R | 7    | GOM-D01     | Silentblock For Susp.Arm | 352349     | d: 39.6  |
| 2    | 111-0W-D51R | Tie Rod End Right | 324.038   | c:13 th:FM16X1.5L | 8    | GOM-D02     | Silentblock For Susp.Arm | 352335     | d: 55.4  |
| 3    | 106-0D-D01  | Stabiliser Link   | 1603.148  | L:190             | 9    | GOM-D03     | Silentblock For Susp.Arm | 4 02 645   | d: 59.1  |
| 4    | 73-0W-D51   | Ball Joint Lower  | 1.603.120 | c: 13.4           | 10   | 103-0D-D02  | Axial Joint              | 078 48 281 |          |
| 5    | 71-0W-D02L  | TCA Left          | 352.123   | c: 13.4           | 11   | 103-0D-D03  | Axial Joint              | 078 48 282 |          |
| 6    | 71-0W-D02R  | TCA Right         | 352.124   | c: 13.4           | 12   | 103-0D-D01  | Adjusting Bolt           | 322575     | -        |

LEGANZA (KLAV)

06/1997-12/2002

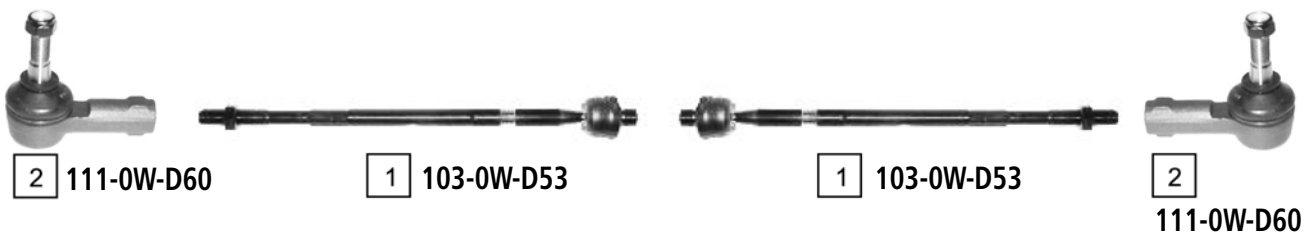
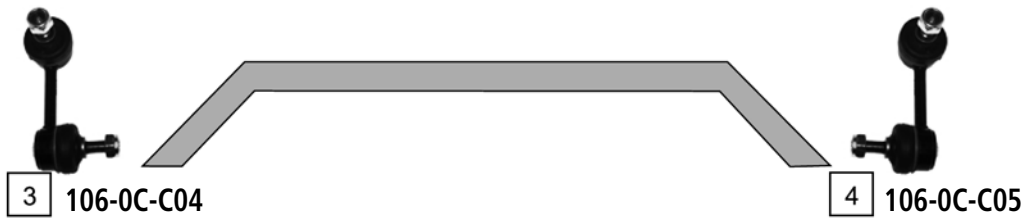

7 72-0D-D06

8 72-0D-D05

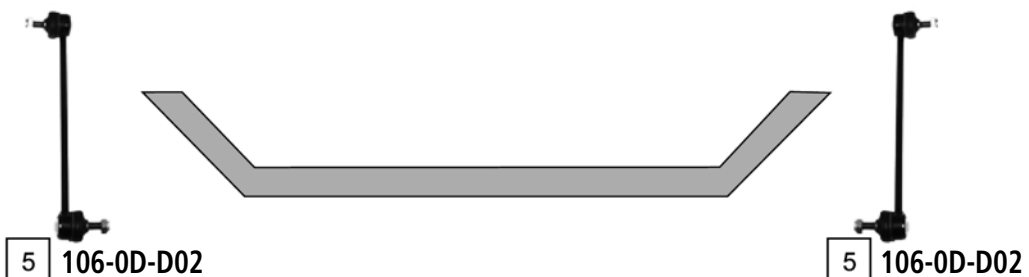
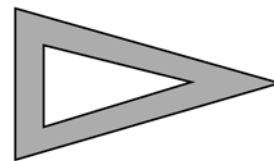
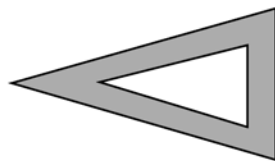

| Ref. | ASHIKA CODE | Description           | OEM       | Measures            | Ref. | ASHIKA CODE | Description     | OEM       | Measures |
|------|-------------|-----------------------|-----------|---------------------|------|-------------|-----------------|-----------|----------|
| 1    | 103-0W-D53  | Axial Joint           | 520898    | th:MM16X1.5R L:360  | 5    | 106-0D-D02  | Stabiliser Link | 96207628  | L:267    |
| 2    | 111-0W-D60  | Tie Rod End           | 9620 5809 | c:13.2 th:FM14X1.5R | 6    | 73-0W-D55   | Ball Joint      | 9621 3119 | c: 18    |
| 3    | 106-0C-C04  | Stabiliser Link Left  | 96225859  | L:79                | 7    | 72-0D-D06   | TCA Left        | 96213117  |          |
| 4    | 106-0C-C05  | Stabiliser Link Right | 96225858  | L:79                | 8    | 72-0D-D05   | TCA Right       | 96213118  |          |

MATIZ (KLYA)

09/1998->



MS



3 111-0W-D55



1 103-0W-D54



1 103-0W-D54



3 111-0W-D55

PS



4 111-0D-D56



2 111-0W-D99



2 111-0W-D99



4 111-0D-D56



5 71-08-803



6 GOM-C07



5 71-08-803

| Ref. | ASHIKA CODE | Description | OEM          | Measures            | Ref. | ASHIKA CODE | Description              | OEM       | Measures            |
|------|-------------|-------------|--------------|---------------------|------|-------------|--------------------------|-----------|---------------------|
| 1    | 103-0W-D54  | Axial Joint | 9374 1074    | th:MM16X1.5R L:250  | 4    | 111-0D-D56  | Tie Rod End              | KBJ 029   | c:12.5 th:FM12X1.5R |
| 2    | 111-0W-D99  | Axial Joint | 9374 1092    | th:MM16X1.5R L:251  | 5    | 71-08-803   | TCA                      | 9631-6765 | c: 15               |
| 3    | 111-0W-D55  | Tie Rod End | 48810-A78B00 | c:12.5 th:FM12X1.5R | 6    | GOM-C07     | Silentblock For Susp.Arm | 9638 0613 | d: 27.5             |

MUSSO (FJ)

01/1999->

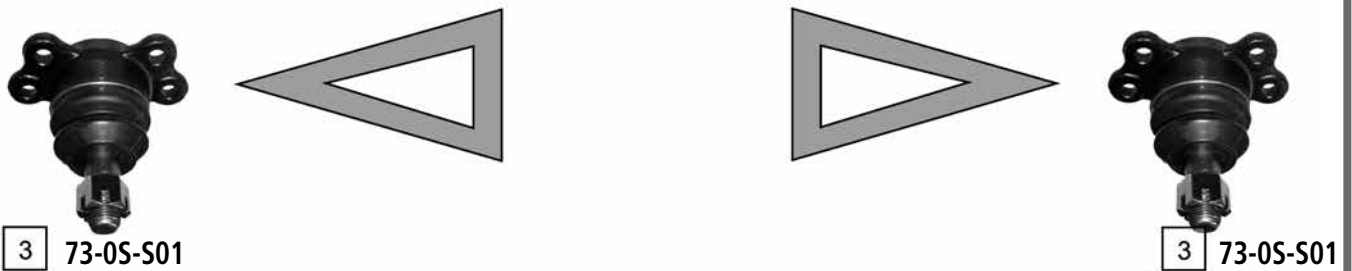

| Ref. | ASHIKA CODE | Description     | OEM        | Measures          | Ref. | ASHIKA CODE | Description | OEM        | Measures |
|------|-------------|-----------------|------------|-------------------|------|-------------|-------------|------------|----------|
| 1    | 111-05-S01  | Tie Rod End     | 4666005501 | c:16 th:FM14X1.5R | 4    | 73-05-S02   | Ball Joint  | 4450505001 | c:17.6   |
| 2    | 106-05-S01  | Stabiliser Link | 4475005001 |                   | 5    | 103-05-S02  | Axial Joint | Part of    |          |
| 3    | 73-05-S01   | Ball Joint      | 4443003011 | c:17.6            |      |             |             |            |          |



NUBIRA (KLAJ)

05/1997-07/2003

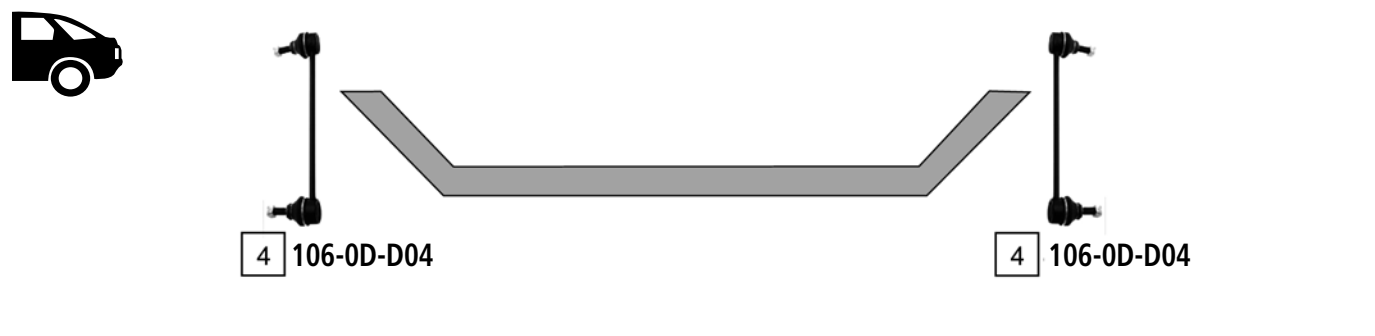
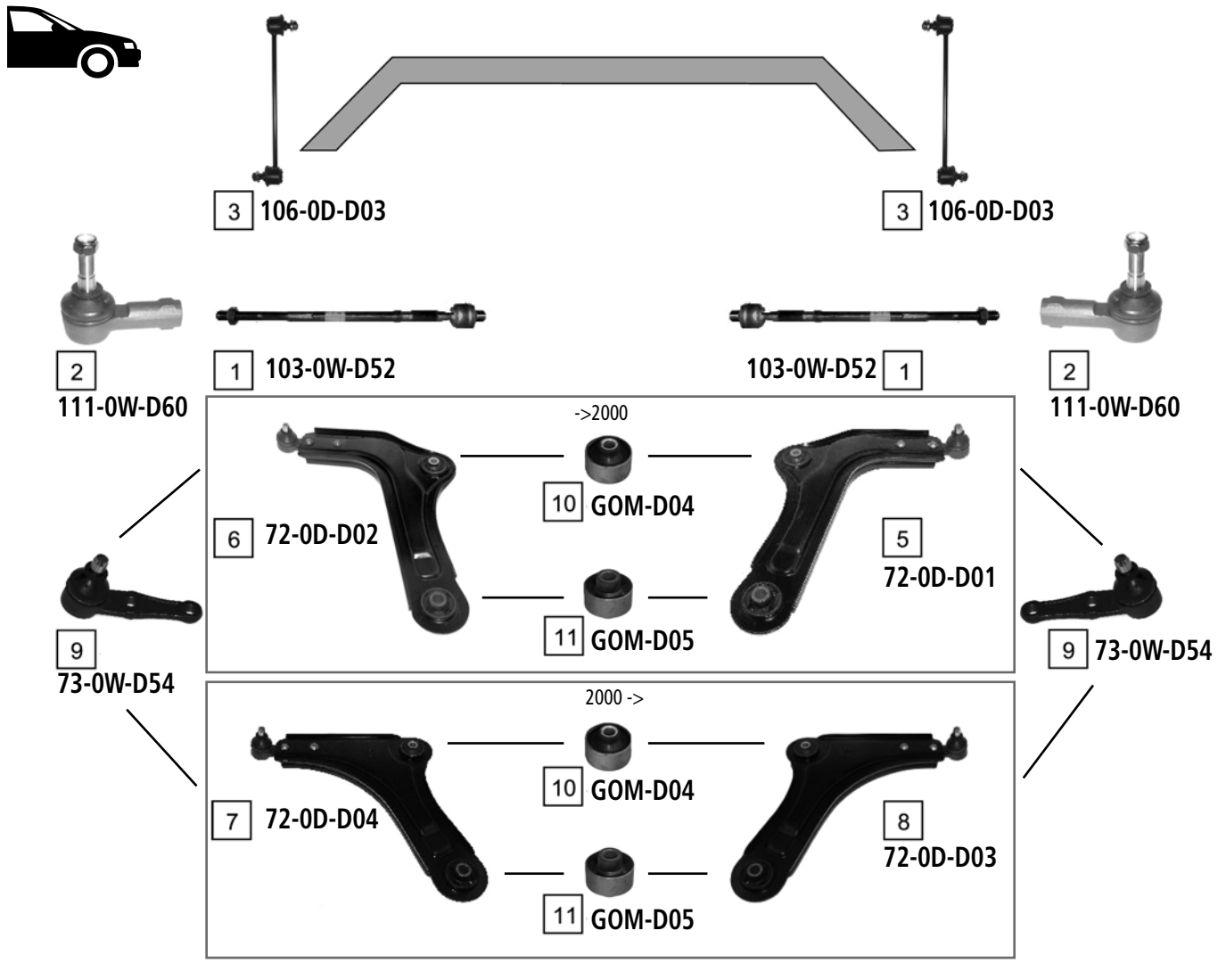

| Ref. | ASHIKA CODE | Description       | OEM        | Measures            | Ref. | ASHIKA CODE | Description              | OEM   | Measures |
|------|-------------|-------------------|------------|---------------------|------|-------------|--------------------------|---|----------|
| 1    | 103-0W-D52  | Axial Joint       | 520672     | th:MM16X1.5 L:345   | 7    | 72-0D-D04   | TCA Left                 | 96 268 454  |          |
| 2    | 111-0W-D60  | Tie Rod End       | 96205809   | c:13.2 th:FM14x1.5R | 8    | 72-0D-D03   | TCA Right                | 96 268 455  |          |
| 3    | 106-0D-D03  | Stabilisatorstang | 96300627   | L:268               | 9    | 73-0W-D54   | Ball Joint               | 9630 0648   | c:16     |
| 4    | 106-0D-D04  | Stabiliser link   | 9630 0222  | L:247               | 10   | GOM-D04     | Silentblock For Susp.Arm | Part of 72-0D-D02 / 72-0D-D01/<br>72-0D-D04/72-0D-D03 | d:49.3   |
| 5    | 72-0D-D01   | TCA Right         | 96 268 440 | c:16                | 11   | GOM-D05     | Silentblock For Susp.Arm | Part of 72-0D-D02 / 72-0D-D01/<br>72-0D-D04/72-0D-D03 | d:52.5   |
| 6    | 72-0D-D02   | TCA Left          | 96 268 439 | c:16                |      |             |                          |   |          |

REZZO (KLAU) - TACUMA

09/2000->

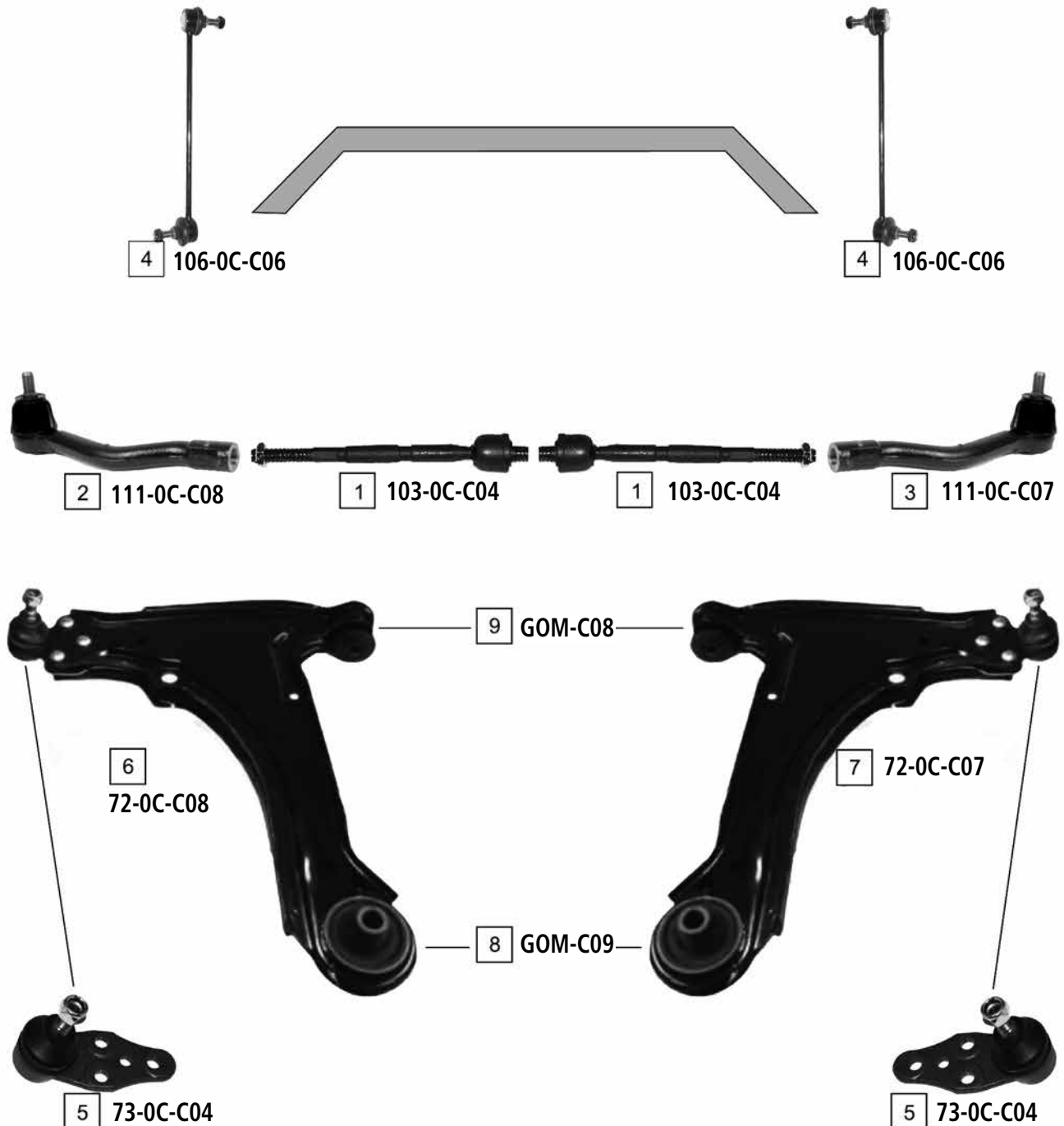

| Ref. | ASHIKA CODE | Description       | OEM      | Measures            | Ref. | ASHIKA CODE | Description              | OEM      | Measures |
|------|-------------|-------------------|----------|---------------------|------|-------------|--------------------------|----------|----------|
| 1    | 103-0C-C04  | Axial Joint       | 521564   | th: MM16X1.5R L:240 | 6    | 72-0C-C08   | TCA Left                 | 96378347 |          |
| 2    | 111-0C-C08  | Tie Rod End Left  | 96261378 | c:13.2 th:FM14X1.5R | 7    | 72-0C-C07   | TCA Right                | 96378348 |          |
| 3    | 111-0C-C07  | Tie Rod End Right | 96261379 | c:13.2 th:FM14X1.5R | 8    | GOM-C09     | Silentblock For Susp.Arm | 96261107 |          |
| 4    | 106-0C-C06  | Stabiliser Link   | 96391875 | L: 260              | 9    | GOM-C08     | Silentblock For Susp.Arm | 96378346 |          |
| 5    | 73-0C-C04   | Ball Joint        | 96261108 | c: 16               |      |             |                          |          |          |

TICO (KLY3)

02/1995-12/2000



| Ref. | ASHIKA CODE | Description | OEM       | Measures            | Ref. | ASHIKA CODE | Description              | OEM              | Measures           |
|------|-------------|-------------|-----------|---------------------|------|-------------|--------------------------|------------------|--------------------|
| 1    | 111-0W-D55  | Tie Rod End | 9612-9753 | c:12.6 th:FM12X1.5R | 3    | 103-0W-D51  | Axial Joint              | 48830 A78B00-000 | th:FM14X1.5R L:228 |
| 2    | 71-08-803   | TCA         | 96316765  | c: 15               | 4    | GOM-C07     | Silentblock For Susp.Arm | 96380613         | D: 27.5            |

APPLAUSE I - II (A101, A111)

06/1989-07/1997

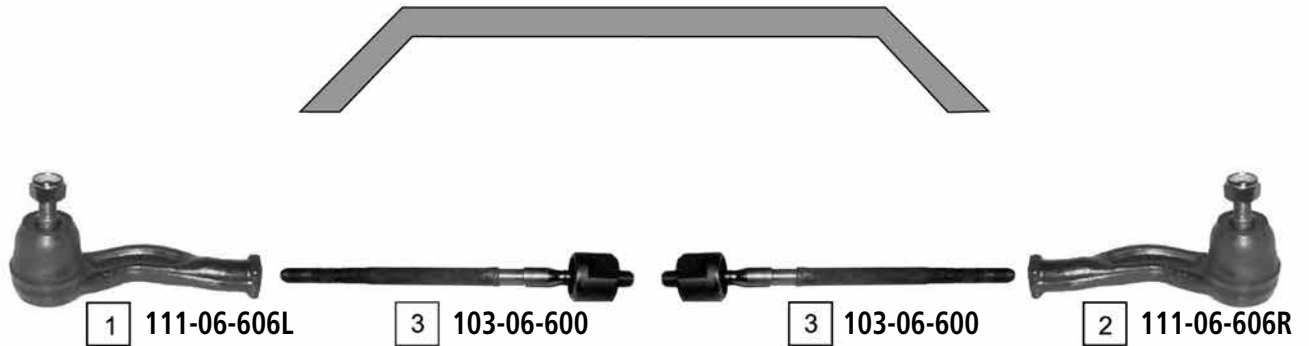

| Ref. | ASHIKA CODE | Description       | OEM         | Measures           | Ref. | ASHIKA CODE | Description | OEM         | Measures            |
|------|-------------|-------------------|-------------|--------------------|------|-------------|-------------|-------------|---------------------|
| 1    | 111-06-606L | Tie Rod End Left  | 4504787781  | c:12 th:FM12X1.25R | 3    | 103-06-600  | Axial Joint | 45503 87102 | th:MM12X1.25R L:252 |
| 2    | 111-06-606R | Tie Rod End Right | 45046-87781 | c:12 th:FM12X1.25R |      |             |             |             |                     |

CHARADE II (G11, G30)

01/1983-12/1986



**5** 103-06-603

**5** 103-06-603

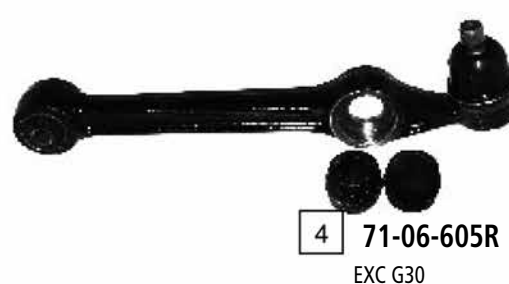
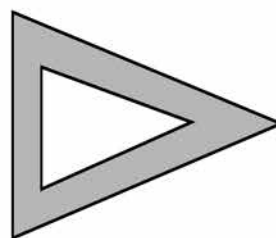
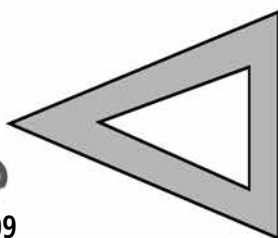

| Ref. | ASHIKA CODE | Description       | OEM         | Measures           | Ref. | ASHIKA CODE | Description | OEM         | Measures |
|------|-------------|-------------------|-------------|--------------------|------|-------------|-------------|-------------|----------|
| 1    | 53-06-609   | Ball Joint Lower  | 43308-12030 | c:14.5             | 4    | 71-06-605R  | TCA Upper   | 48068-87705 | c:15     |
| 2    | 111-06-609L | Tie Rod End Left  | 45047-87780 | c:12 th:FM12X1.25R | 5    | 103-06-603  |             |             |          |
| 3    | 111-06-609R | Tie Rod End Right | 45046-87282 | c:12 th:FM12X1.25R |      |             |             |             |          |

CHARADE III (G100, G101, G102)

01/1987 - 01/1993



MS 01/1989->



PS 01/1990->



1 71-06-698



2 71-06-699

| Ref. | ASHIKA CODE | Description | OEM         | Measures           | Ref. | ASHIKA CODE | Description       | OEM         | Measures            |
|------|-------------|-------------|-------------|--------------------|------|-------------|-------------------|-------------|---------------------|
| 1    | 71-06-698   | TCA Left    | 48069-87706 | c:16               | 4    | 103-06-606  | Axial Joint       | 45503-87706 | th:MM12X1.25R L:230 |
| 2    | 71-06-699   | TCA Right   | 48068-87706 | c:16               | 5    | 111-06-606L | Tie Rod End Left  | 4504787781  | c:12 th:FM12X1.25R  |
| 3    | 103-06-605  | Axial Joint | 45503-87708 | th:MM11X1.5R L:240 | 6    | 111-06-606R | Tie Rod End Right | 45046-87781 | c:12 th:FM12X1.25R  |

CHARADE IV (G200, G202, G203)

01/1993-12/1996

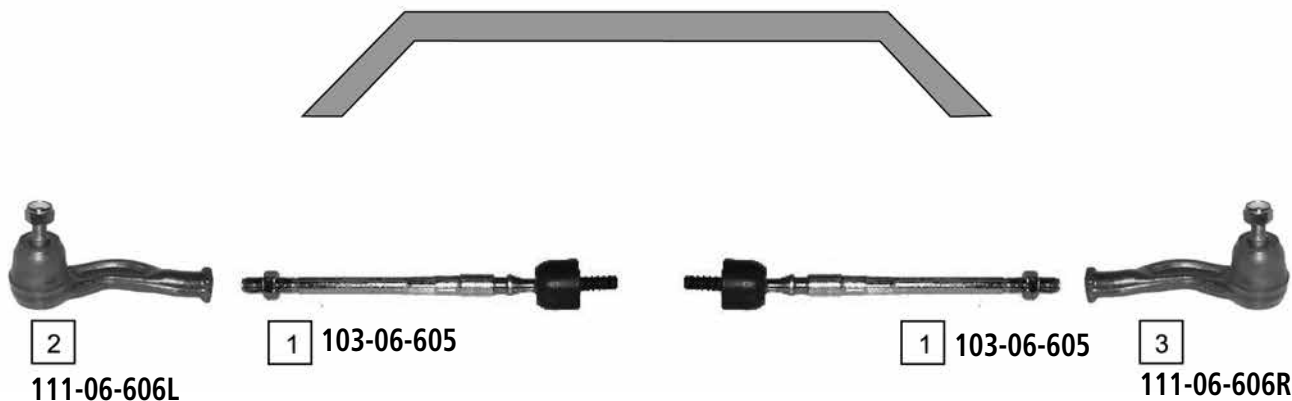

| Ref. | ASHIKA CODE | Description      | OEM         | Measures           | Ref. | ASHIKA CODE | Description       | OEM         | Measures           |
|------|-------------|------------------|-------------|--------------------|------|-------------|-------------------|-------------|--------------------|
| 1    | 103-06-605  | Axial Joint      | 45503-87708 | th:MM11X1.5R L:240 | 3    | 111-06-606R | Tie Rod End Right | 45046-87781 | c:12 th:FM12X1.25R |
| 2    | 111-06-606L | Tie Rod End Left | 4504787781  | c:12 th:FM12X1.25R |      |             |                   |             |                    |

CHARMANT (A)

11/1981 - 01/1989



A10, A20, A30, A40, A45



1 111-06-604



1  
111-06-604

A35, A55, A60



3 108-06-622



4 103-02-201



4 103-02-201



3  
108-06-622



2 53-06-609

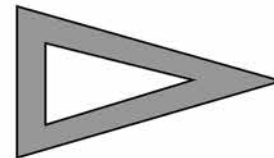
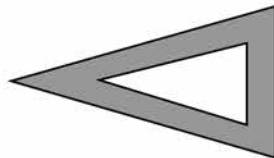

2  
53-06-609

| Ref. | ASHIKA CODE | Description      | OEM         | Measures            | Ref. | ASHIKA CODE | Description | OEM         | Measures           |
|------|-------------|------------------|-------------|---------------------|------|-------------|-------------|-------------|--------------------|
| 1    | 111-06-604  | Tie Rod End      | 45046 19065 | c:12.9 th:MM14X1.5L | 3    | 108-06-622  | Tie Rod     | 45460-19125 | -                  |
| 2    | 53-06-609   | Ball Joint Lower | 43308-12030 | c:14.5              | 4    | 103-02-201  | Axial Joint | 45503-10020 | th:MM14X1.5R L:146 |



CUORE II (L80, L81)  
CUORE III (L201)  
CUORE IV (L501)

09/1985-12/1990  
08/1990-12/1994  
01/1995-11/1996

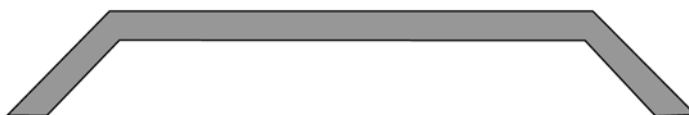

1 111-06-609L



2 111-06-609R

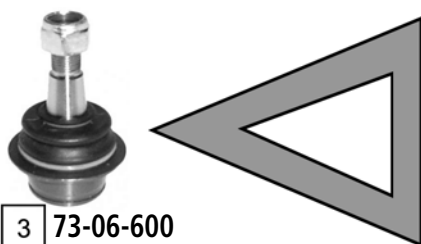

3 73-06-600

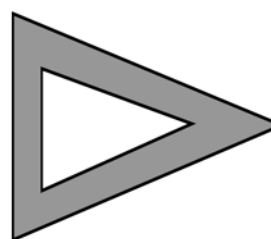

3 73-06-600

| Ref. | ASHIKA CODE | Description       | OEM         | Measures           | Ref. | ASHIKA CODE | Description | OEM         | Measures |
|------|-------------|-------------------|-------------|--------------------|------|-------------|-------------|-------------|----------|
| 1    | 111-06-609L | Tie Rod End Left  | 45047-87780 | c:12 th:FM12X1.25R | 3    | 73-06-600   | Ball Joint  | 48068 87206 |          |
| 2    | 111-06-609R | Tie Rod End Right | 45046-87282 | c:12 th:FM12X1.25R |      |             |             |             |          |

CUORE V (L5)

10/1996 - 10/1998



MS



3 111-06-609L



6 103-06-607



6 103-06-607



4 111-06-609R

PS



3 111-06-609L



5 103-06-608



5 103-06-608



4 111-06-609R



1 71-06-602



2 71-06-601

| Ref. | ASHIKA CODE | Description      | OEM         | Measures           | Ref. | ASHIKA CODE | Description       | OEM         | Measures           |
|------|-------------|------------------|-------------|--------------------|------|-------------|-------------------|-------------|--------------------|
| 1    | 71-06-602   | TCA Left Wbj     | 49069-97202 |                    | 4    | 111-06-609R | Tie Rod End Right | 45046-87282 | c:12 th:FM12X1.25R |
| 2    | 71-06-601   | TCA Right Wbj    | 49068-97202 |                    | 5    | 103-06-608  | Axial Joint       | 45503-97204 | th:MM14X1.5R L:224 |
| 3    | 111-06-609L | Tie Rod End Left | 45047-87780 | c:12 th:FM12X1.25R | 6    | 103-06-607  | Axial Joint       | 45503-97203 | th:MM14X1.5R L:224 |

CUORE VI - VII

10/1998 ->



-> 09/1999 MS

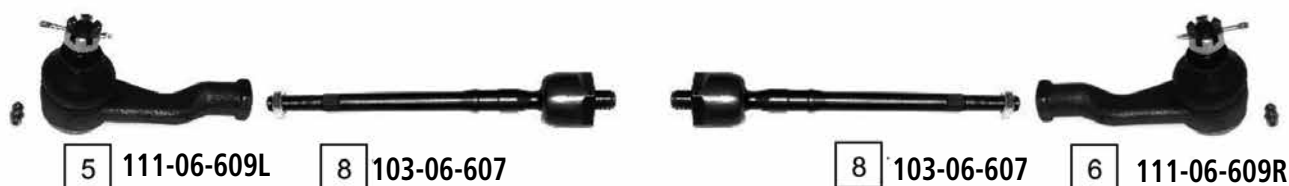

10/1999 -> PS



-> 03/2002



04/2002 ->



| Ref. | ASHIKA CODE | Description      | OEM         | Measures           | Ref. | ASHIKA CODE | Description       | OEM         | Measures           |
|------|-------------|------------------|-------------|--------------------|------|-------------|-------------------|-------------|--------------------|
| 1    | 71-06-606   | TCA Left         | 48069-97203 |                    | 6    | 111-06-609R | Tie Rod End Right | 45046-87282 | c:12 th:FM12X1.25R |
| 2    | 71-06-605   | TCA Right        | 48068-97203 |                    | 7    | 103-06-608  | Axial Joint       | 45503-97204 | th:MM14X1.5R L:224 |
| 3    | 71-06-604   | TCA Left         | 48069-97202 |                    | 8    | 103-06-607  | Axial Joint       | 45503-97203 | th:MM14X1.5R L:224 |
| 4    | 71-06-603   | TCA Right        | 48068-97202 |                    | 9    | 111-06-612  | Tie Rod End Left  | 45047-97203 |                    |
| 5    | 111-06-609L | Tie Rod End Left | 45047-87780 | c:12 th:FM12X1.25R | 10   | 111-06-611  | Tie Rod End Right | 45046-97203 |                    |

FEROZA (F300)

10-1988 ->

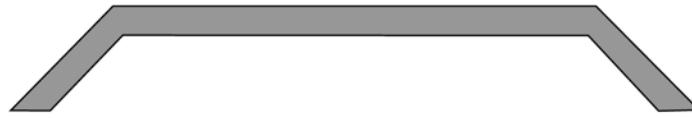

1 111-06-602L



2  
111-06-602R

| Ref. | ASHIKA CODE | Description      | OEM         | Measures            | Ref. | ASHIKA CODE | Description       | OEM         | Measures            |
|------|-------------|------------------|-------------|---------------------|------|-------------|-------------------|-------------|---------------------|
| 1    | 111-06-602L | Tie Rod End Left | 45047 87303 | c:16.4 th:MM20X1.5L | 2    | 111-06-602R | Tie Rod End Right | 45046 87680 | c:16.3 th:MM20X1.5L |

# DAIHATSU GRAN MOVE



GRAN MOVE (G3)

10/1996 - 07/2002



-> 06/1998



8 111-06-614

6 103-06-609



6 103-06-609

9 111-06-613

07/1998 ->



1 111-06-616

7 103-06-610



7 103-06-610

2 111-06-617



4 72-06-600  
-> 06/1998



5 72-06-601  
-> 06/1998



3 106-06-600



3 106-06-600

| Ref. | ASHIKA CODE | Description       | OEM             | Measures | Ref. | ASHIKA CODE | Description       | OEM         | Measures            |
|------|-------------|-------------------|-----------------|----------|------|-------------|-------------------|-------------|---------------------|
| 1    | 111-06-616  | Tie Rod End Left  | 45047-97204-000 |          | 6    | 103-06-609  | Axial Joint       | 45503-87710 | th:MM12X1.25R L:234 |
| 2    | 111-06-617  | Tie Rod End Right | 45046-97204-000 |          | 7    | 103-06-610  | Axial Joint       | 45503-87714 | th:MM12X1.25R L:234 |
| 3    | 106-06-600  | Stabiliser Link   | 48802-87703     | L:55.5   | 8    | 111-06-614  | Tie Rod End Left  | 45047-87706 |                     |
| 4    | 72-06-600   | TCA               | 48069-87710     |          | 9    | 111-06-613  | Tie Rod End Right | 45046-87707 |                     |
| 5    | 72-06-601   | TCA               | 48068-87711     |          |      |             |                   |             |                     |

HIJET

03/1982 ->



**1**  
111-06-607L



**2**  
111-06-607R

**3**

71-06-608

**4**

71-06-607

| Ref. | ASHIKA CODE | Description       | OEM         | Measures            | Ref. | ASHIKA CODE | Description | OEM             | Measures |
|------|-------------|-------------------|-------------|---------------------|------|-------------|-------------|-----------------|----------|
| 1    | 111-06-607L | Tie Rod End Left  | 4504687503  | c:11.8 th:FM14X1.5L | 3    | 71-06-608   |             | 48068-87501-000 |          |
| 2    | 111-06-607  | Tie Rod End Right | 45046-87503 | c:11.8 th:FM14X1.5R | 4    | 71-06-607   |             | 48069-87501-000 |          |

MOVE (L6, L9)

10/1996 ->



3 111-06-609L



5 103-06-611



5 103-06-611



4 111-06-609R



1 71-06-610



2 71-06-609

| Ref. | ASHIKA CODE | Description      | OEM         | Measures          | Ref. | ASHIKA CODE | Description       | OEM         | Measures           |
|------|-------------|------------------|-------------|-------------------|------|-------------|-------------------|-------------|--------------------|
| 1    | 71-06-610   | TCA              | 48069-87209 |                   | 4    | 111-06-609R | Tie Rod End Right | 45046-87282 | c:12th:FM12X1.25R  |
| 2    | 71-06-609   | TCA              | 48068-87209 |                   | 5    | 103-06-611  | Axial Joint       | 45503-87215 | th:MM11X1.2R L:202 |
| 3    | 111-06-609L | Tie Rod End Left | 45047-87780 | c:12th:FM12X1.25R |      |             |                   |             |                    |

ROCKY (F7, F8)  
WILDCAT/ROCKY (F70, F75)

02/1985 - 04/1993  
02/1985 - 04/1987



1

111-06-602L



2

111-06-602R

| Ref. | ASHIKA CODE | Description      | OEM         | Measures            | Ref. | ASHIKA CODE | Description       | OEM         | Measures            |
|------|-------------|------------------|-------------|---------------------|------|-------------|-------------------|-------------|---------------------|
| 1    | 111-06-602L | Tie Rod End Left | 45047 87303 | c:16.4 th:MM20X1.5L | 2    | 111-06-602R | Tie Rod End Right | 45046 87680 | c:16.3 th:MM20X1.5L |



TERIOS (J1)

10/1997-10/2005



4 111-06-610



3 103-06-612



3 103-06-612



4 111-06-610



1 72-06-602



2 72-06-603

| Ref. | ASHIKA CODE | Description | OEM         | Measures | Ref. | ASHIKA CODE | Description | OEM         | Measures            |
|------|-------------|-------------|-------------|----------|------|-------------|-------------|-------------|---------------------|
| 1    | 72-06-602   | TCA Left    | 43069-87401 | c: 15    | 3    | 103-06-612  | Axial Joint | 45460-87401 | th: MM14X1.5R L:295 |
| 2    | 72-06-603   | TCA Right   | 43068-87401 | c: 15    | 4    | 111-06-610  | Tie Rod End | 45046-87401 |                     |

ACCORD III (CA4 - CA5)

11/1985 - 12/1989



UPPER

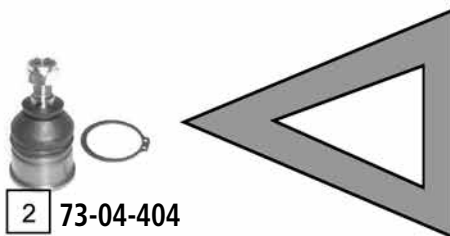

LOWER

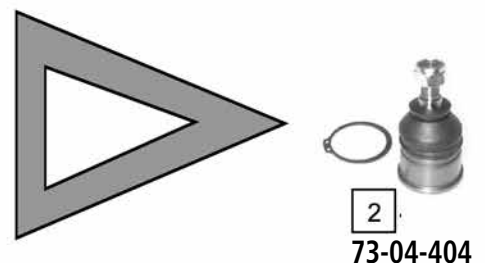

| Ref. | ASHIKA CODE | Description      | OEM           | Measures             | Ref. | ASHIKA CODE | Description     | OEM           | Measures |
|------|-------------|------------------|---------------|----------------------|------|-------------|-----------------|---------------|----------|
| 1    | 111-04-401  | Tie Rod End Left | 53540-611-010 | c: 13 th: FM12X1.25R | 4    | 26-04-492   | TCA Upper Right | 51459-SE0-000 | c:12.9   |
| 2    | 73-04-404   | Ball Joint Lower | 51220 SE0 000 | c:14.5               | 5    | 103-04-403  | Axial Joint     | 53521-SA0-003 |          |
| 3    | 26-04-491   | TCA Upper Left   | 51469-SE0-000 | c:12.9               |      |             |                 |               |          |

ACCORD IV (CB1-CB3-CB5-CB7)

01/1990 - 03/1993

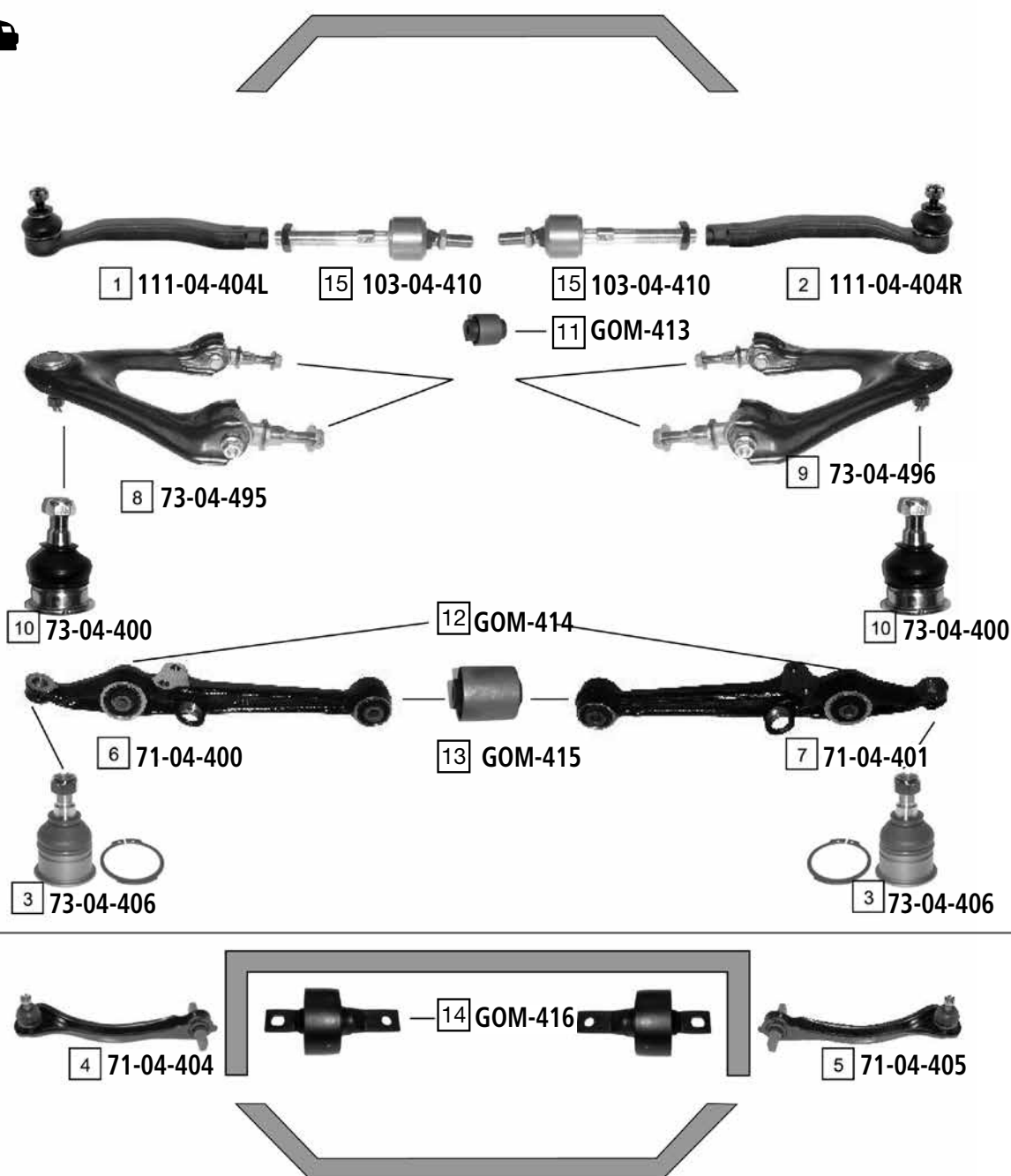

| Ref. | ASHIKA CODE | Description       | OEM           | Measures            | Ref. | ASHIKA CODE | Description              | OEM                            | Measures            |
|------|-------------|-------------------|---------------|---------------------|------|-------------|--------------------------|--------------------------------|---------------------|
| 1    | 111-04-404L | Tie Rod End Left  | 53560-SM4-003 | c:12.8 th:FM14X1.5R | 9    | 73-04-496   | TCA Right                | 51355 SM4 040                  | c:12.9              |
| 2    | 111-04-404R | Tie Rod End Right | 53540-SM4-003 | c:12.8 th:FM14X1.5R | 10   | 73-04-400   | Ball Joint               | Part of 73-04-495<br>73-04-496 | c:12.6              |
| 3    | 73-04-406   | Ball Joint Lower  | 51220-SM4-013 | c:16                | 11   | GOM-413     | Silentblock For Susp.Arm | 52365-SM4-005                  | d: 34               |
| 4    | 71-04-404   | TCA Left          | 52400 SM1 A03 | c:12.7              | 12   | GOM-414     | Silentblock For Susp.Arm | 51810-SM4-004                  | d: 42               |
| 5    | 71-04-405   | TCA Right         | 53390 SM1 A03 | c:12.7              | 13   | GOM-415     | Silentblock For Susp.Arm | 51393-SM4-013                  | d: 35               |
| 6    | 71-04-400   | TCA Left          | 51365-SM4-040 |                     | 14   | GOM-416     | Silentblock For Susp.Arm | 52370-SR3-J00                  | d: 80               |
| 7    | 71-04-401   | TCA Right         | 51355-SM4-040 |                     | 15   | 103-04-410  | Axial Joint              | 53521-SM4-013                  | th:MM12X1.25R L:140 |
| 8    | 73-04-495   | TCA Left          | 51460 SV4 000 | c:12.9              |      |             |                          |                                |                     |

ACCORD VI (CE-CF)

02/1996 - 10/1998

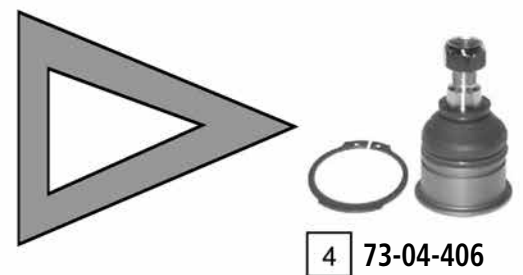
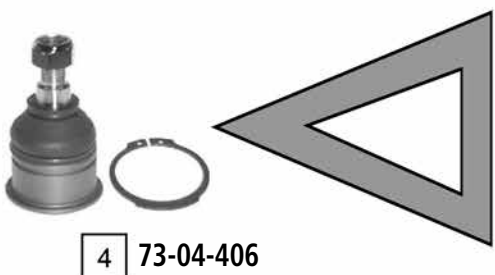
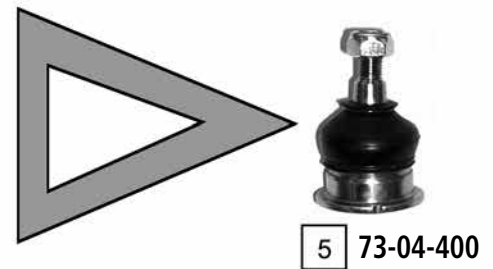
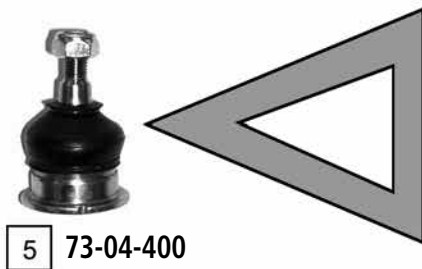
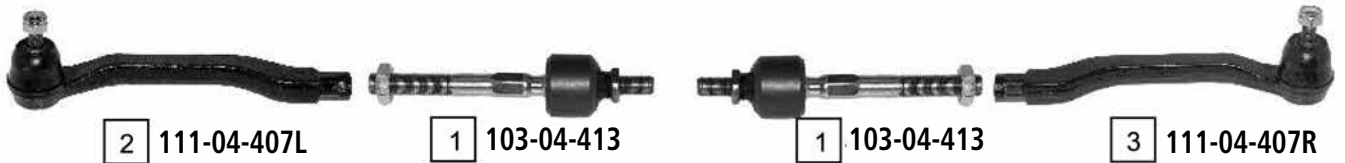

| Ref. | ASHIKA CODE | Description       | OEM           | Measures            | Ref. | ASHIKA CODE | Description      | OEM           | Measures |
|------|-------------|-------------------|---------------|---------------------|------|-------------|------------------|---------------|----------|
| 1    | 103-04-413  | Axial Joint       | 53010-SV4-000 | th:MM12X1.25R L:151 | 4    | 73-04-406   | Ball Joint Lower | 51220-SM4-013 | c:16     |
| 2    | 111-04-407L | Tie Rod End Left  | 53560-SV4-003 | c:12.6 th:FM14X1.5R | 5    | 73-04-400   | Ball Joint       |               | c:12.6   |
| 3    | 111-04-407R | Tie Rod End Right | 53540-SV4-003 | c:12.6 th:FM14X1.5R |      |             |                  |               |          |

ACCORD VII (CG)

02/1998 - 03/2002

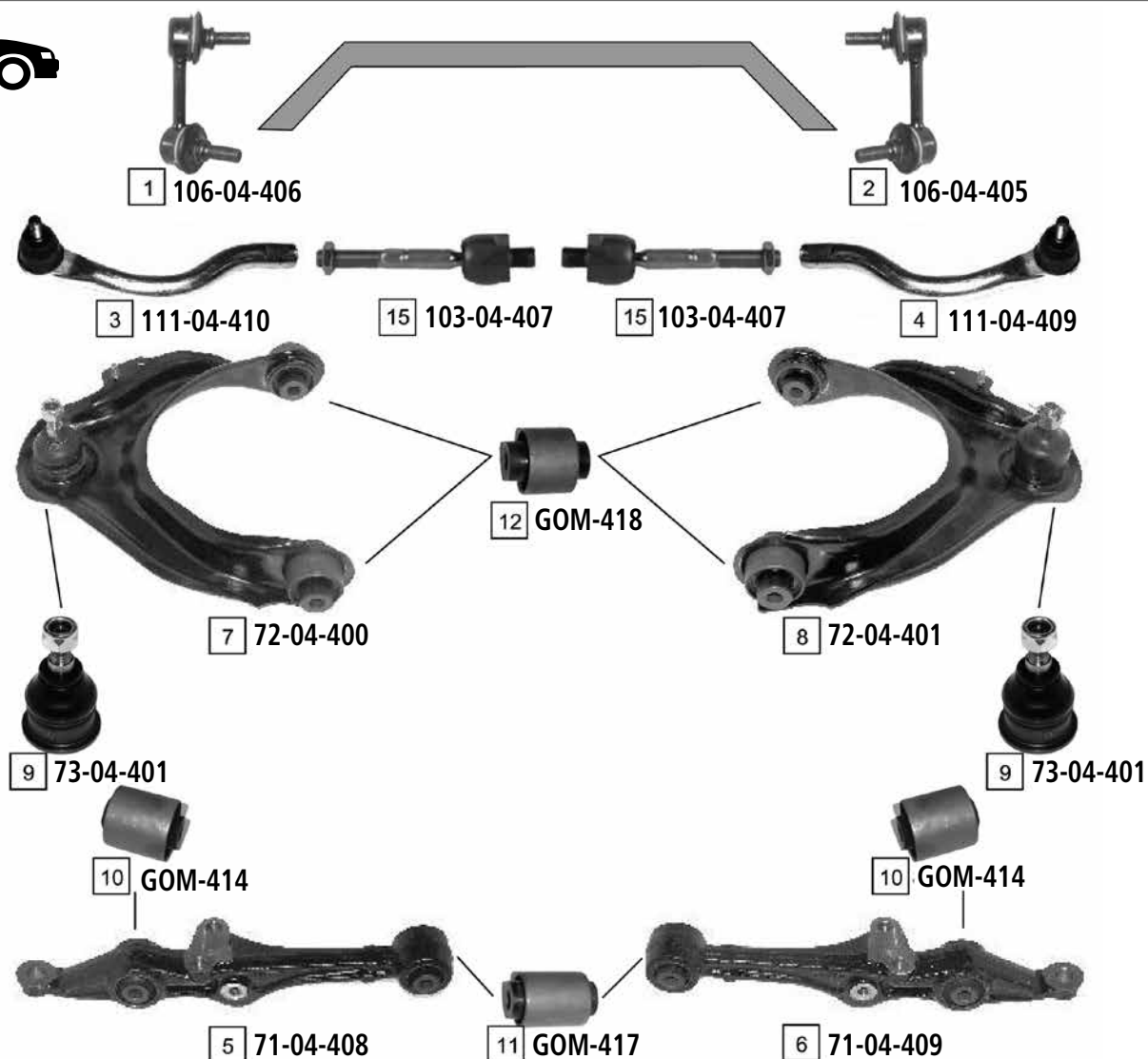

| Ref. | ASHIKA CODE | Description           | OEM           | Measures            | Ref. | ASHIKA CODE | Description              | OEM                            | Measures           |
|------|-------------|-----------------------|---------------|---------------------|------|-------------|--------------------------|--------------------------------|--------------------|
| 1    | 106-04-406  | Stabiliser Link Left  | 51321-S84-A01 | L:72                | 9    | 73-04-401   | Ball Joint               | Part of 72-04-400<br>72-04-401 | c:12.7             |
| 2    | 106-04-405  | Stabiliser Link Right | 51320-S84-A01 | L:72                | 10   | GOM-414     | Silentblock For Susp.Arm | 51810-SM4-004                  | d:42               |
| 3    | 111-04-410  | Tie Rod End Left      | 53560-S1A-E01 | c:12.6 th:MM14X1.5R | 11   | GOM-417     | Silentblock For Susp.Arm | 51810-S1A-E00                  |                    |
| 4    | 111-04-409  | Tie Rod End Right     | 53540-S1A-E01 | c:12.6 th:MM14X1.5R | 12   | GOM-418     | Silentblock For Susp.Arm | 51450-S1A-E01*                 | d:38.4             |
| 5    | 71-04-408   | TCA Left              | 51365-S1A-E00 | c:15.5              | 13   | 106-04-408  | Stabiliser Link Left     | 52325 S84 A01                  | L:113              |
| 6    | 71-04-409   | TCA Right             | 51355-S1A-E00 | c:15.5              | 14   | 106-04-407  | Stabiliser Link Right    | 52320 S84 A01                  | L:113              |
| 7    | 72-04-400   | TCA Left              | 51460 S1A E01 | c:12.7              | 15   | 103-04-407  | Axial Joint              | 53010 S84 A01                  | th:MM16X1.5R L:142 |
| 8    | 72-04-401   | TCA Right             | 51450-S1A-E01 | c:12.7              |      |             |                          |                                |                    |

ACCORD VIII (CL - CM)

02/2003 ->

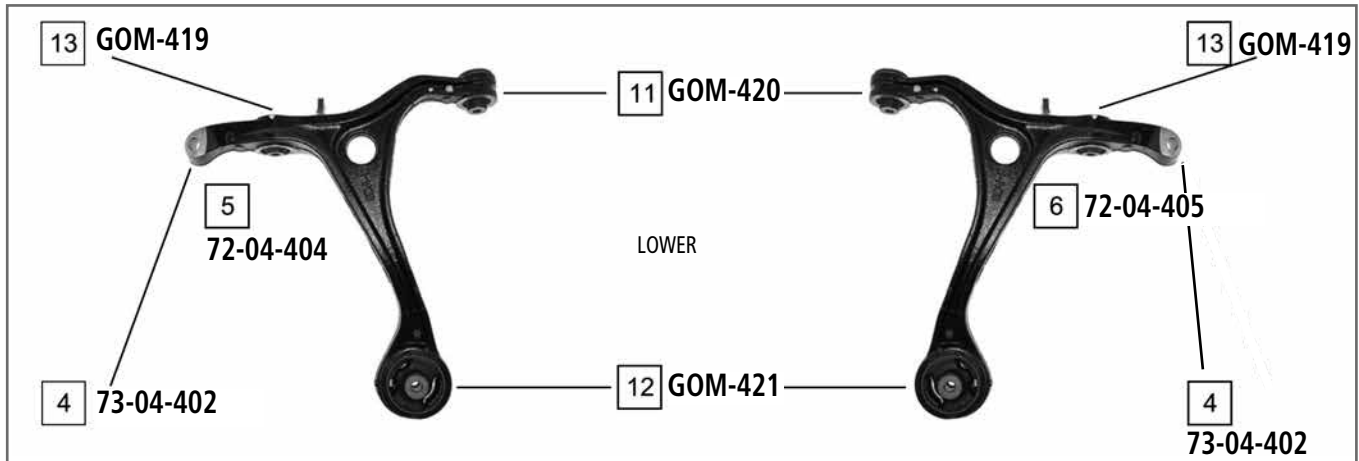
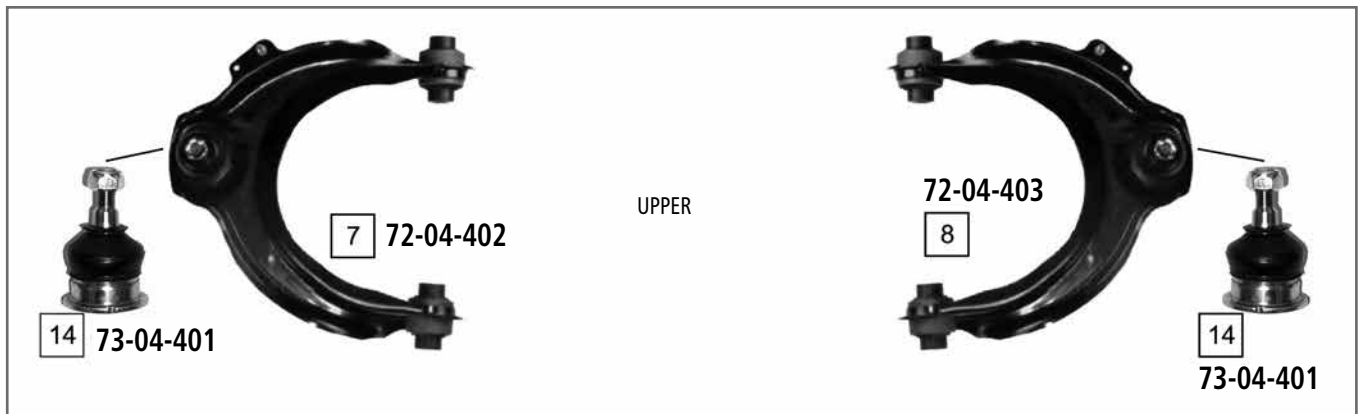
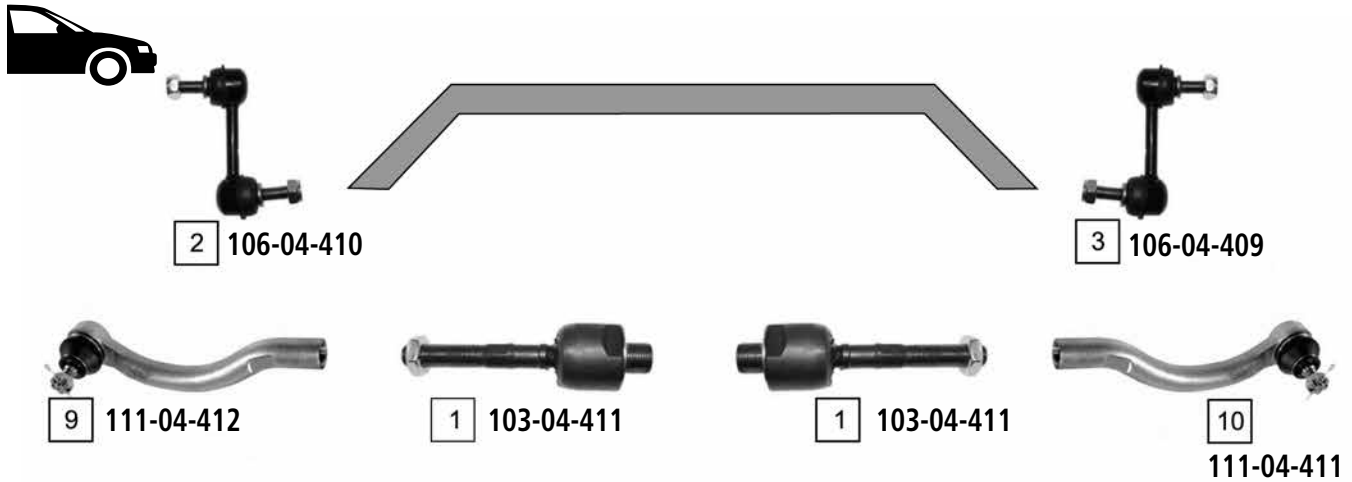

| Ref. | ASHIKA CODE | Description           | OEM                           | Measures           | Ref. | ASHIKA CODE | Description              | OEM           | Measures |
|------|-------------|-----------------------|-------------------------------|--------------------|------|-------------|--------------------------|---------------|----------|
| 1    | 103-04-411  | Axial Joint           | 53010 SDA A01                 | th:MM18X1.5R L:123 | 8    | 72-04-403   | TCA Right                | 51450 SDA A01 |          |
| 2    | 106-04-410  | Stabiliser Link Left  | 51321 SEA E01                 | L:80.5             | 9    | 111-04-412  | Tie Rod End Left         | 53560 SDA A01 |          |
| 3    | 106-04-409  | Stabiliser Link Right | 51320 SEA E01                 | L:80.5             | 10   | 111-04-411  | Tie Rod End Right        | 53540 SDA A01 |          |
| 4    | 73-04-402   | Ball Joint            | Part of 72-04-404 / 72-04-405 |                    | 11   | GOM-420     | Silentblock For Susp.Arm | 51391 SEA 004 |          |
| 5    | 73-04-404   | TCA Left              | 51360 SEA E01                 |                    | 12   | GOM-421     | Silentblock For Susp.Arm | 51393 SEA 004 |          |
| 6    | 72-04-405   | TCA Right             | 51350 SEA E01                 |                    | 13   | GOM-419     | Silentblock For Susp.Arm | 51810 SDA A01 |          |
| 7    | 72-04-402   | TCA Left              | 51460 SDA A01                 |                    | 14   | 73-04-401   | TCA Right                | 51355 SM4 040 | c:12.9   |

ACCORD IX  
ACCORD IX TOURER

07/2008 ->  
07/2008 ->

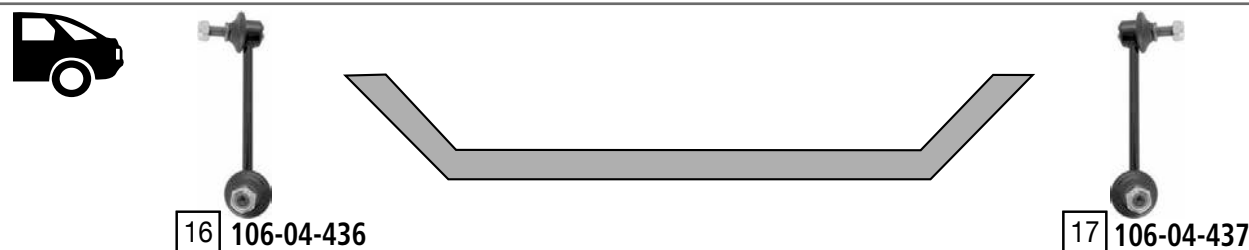
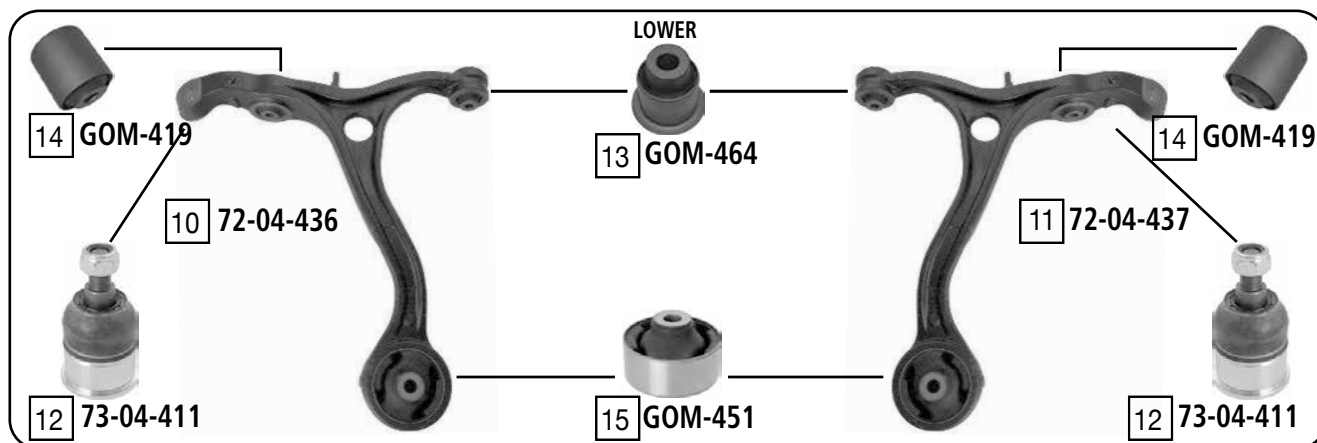
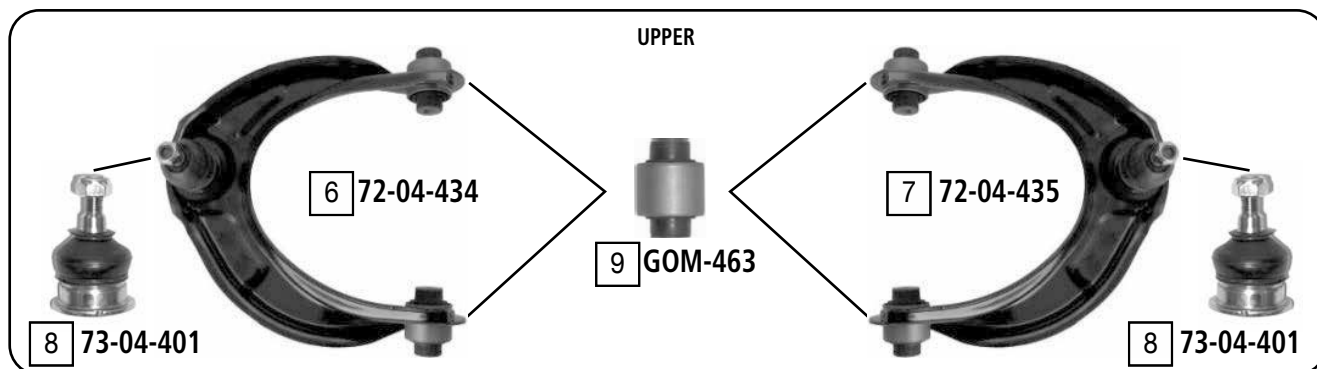
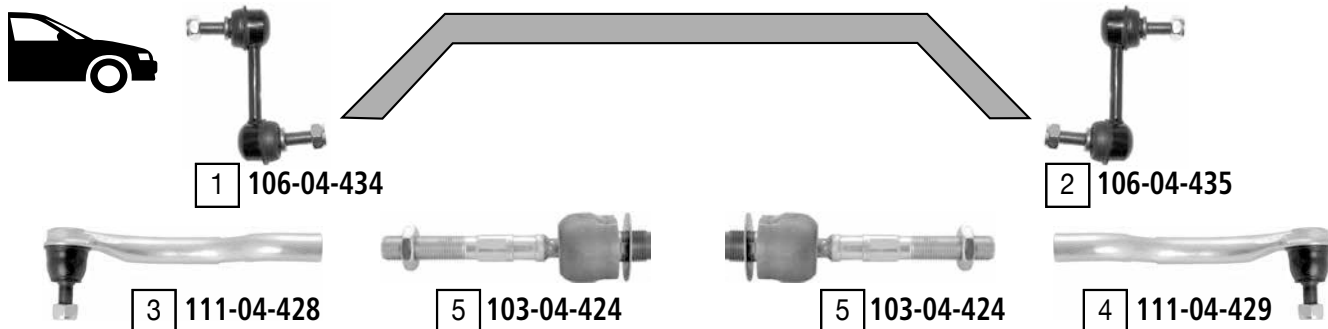

| Ref. | ASHIKA CODE | Description           | OEM           | Measures            | Ref | ASHIKA CODE | Description           | OEM           | Measures        |
|------|-------------|-----------------------|---------------|---------------------|-----|-------------|-----------------------|---------------|-----------------|
| 1    | 106-04-434  | Stabiliser link left  | 51321 SEA E01 | L:80.5              | 10  | 72-04-436   | TCA left wobj         | 51360 TA0 A00 | c:18.9          |
| 2    | 106-04-435  | Stabiliser link right | 51320 SEA E01 | L:80.5              | 11  | 72-04-437   | TCA right wobj        | 51350 TA0 A00 | c:18.9          |
| 3    | 111-04-428  | Tie rod end left      | 53560 TA0 A01 | c:13.7 th:FM14x1.5R | 12  | 73-04-411   | Ball joint            | 51220 TA0 A02 | c:19.3 do:48.6  |
| 4    | 111-04-429  | Tie rod end right     | 53540 TA0 A01 | c:13.7 th:FM14x1.5R | 13  | GOM-464     | Silentblock for TCA   | 51391 SEA 004 | di:12.2 do:38.2 |
| 5    | 103-04-424  | Axial joint           | 53610 TL1 G01 | th:MM18x1.5R L:131  | 14  | GOM-419     | Silentblock for TCA   | 51391 TA0 A01 | di:14.2 do:80   |
| 6    | 72-04-434   | TCA left wbj          | 51520 TA0 A03 | c:12.7              | 15  | GOM-451     | Silentblock for TCA   | 51810 SDA A01 | di:12.2 do:42.2 |
| 7    | 72-04-435   | TCA right wbj         | 51510 TA0 A03 | c:12.7              | 16  | 106-04-436  | Stabiliser link left  | 52325 TA0 A01 | L:145           |
| 8    | 73-04-401   | Ball joint            | Part of       | c:12.7 do:35.2      | 17  | 106-04-437  | Stabiliser link right | 52320 TA0 A01 | L:145           |
| 9    | GOM-463     | Silentblock for TCA   | Part of       | di:10.2 do:38.2     |     |             |                       |               |                 |

ACCORD COUPE (CD7-CD9)

09/1993 - 02/1998

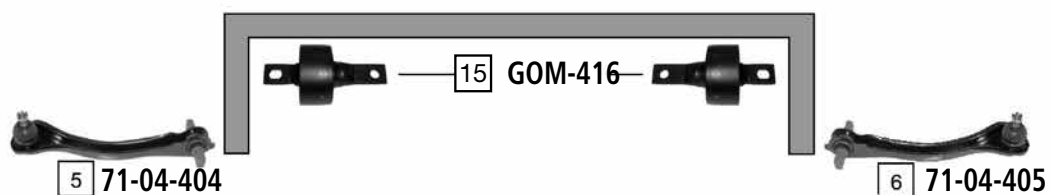
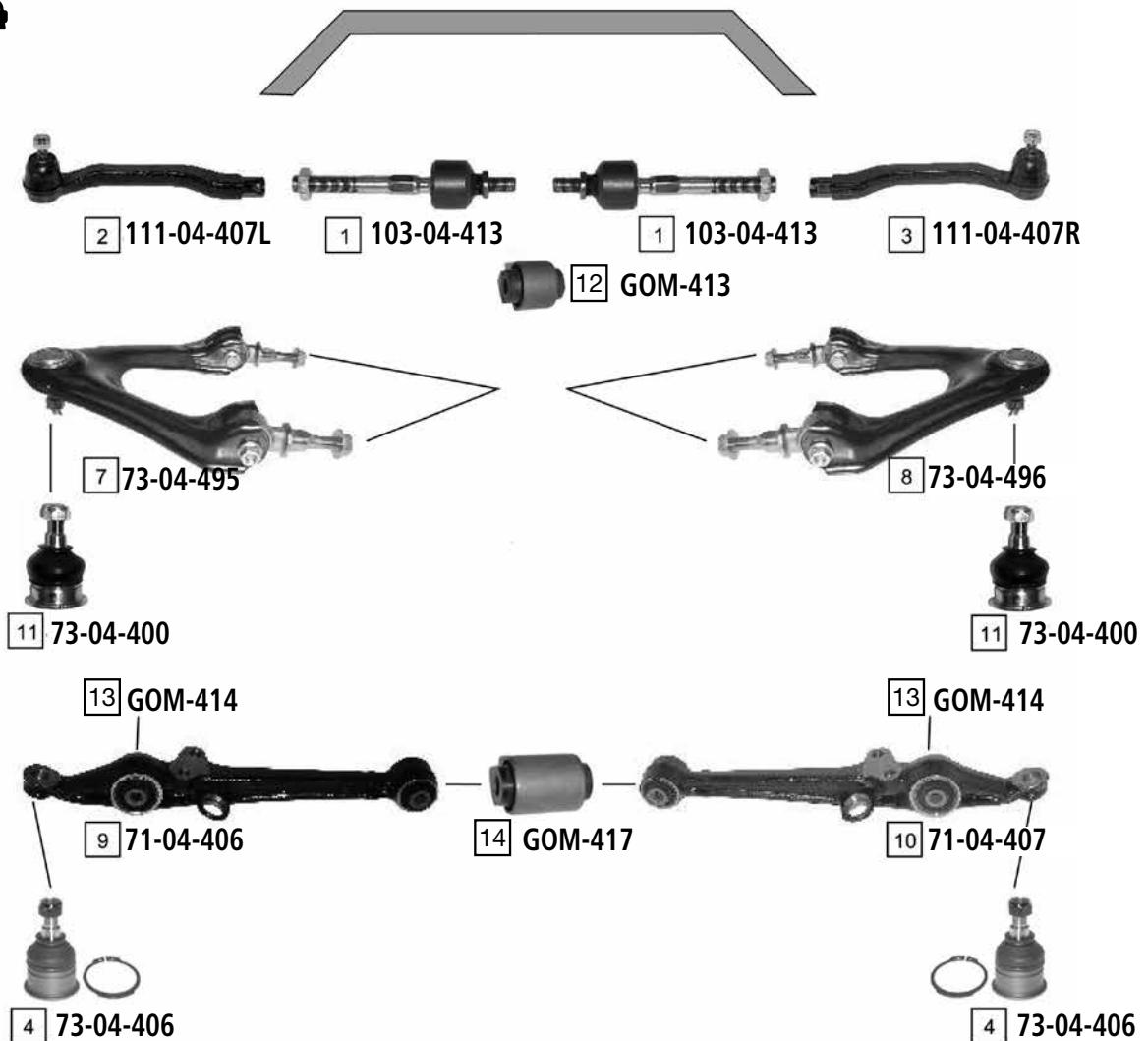

| Ref. | ASHIKA CODE | Description       | OEM           | Measures            | Ref. | ASHIKA CODE | Description              | OEM                         | Measures |
|------|-------------|-------------------|---------------|---------------------|------|-------------|--------------------------|-----------------------------|----------|
| 1    | 103-04-413  | Axial Joint       | 53010-SV4-000 | th:MM12X1.25R L:151 | 9    | 71-04-406   | TCA Left                 | 51365-SV7-A00               | c:15.5   |
| 2    | 111-04-407L | Tie Rod End Left  | 53560-SV4-003 | c:12.6 th:MM14X1.5R | 10   | 71-04-407   | TCA Right                | 51355-SV7-A00               | c:15.5   |
| 3    | 111-04-407R | Tie Rod End Right | 53540-SV4-003 | c:12.6 th:MM14X1.5R | 11   | 73-04-400   | Ball Joint               | Part of 73-04-495/73-04-496 | c:12.6   |
| 4    | 73-04-406   | Ball Joint Lower  | 51220-SM4-013 | c:16                | 12   | GOM-413     | Silentblock For Susp.Arm | 52365-SM4-005               | d:34     |
| 5    | 71-04-404   | TCA Left          | 52400 SM1 A03 | c:12.7              | 13   | GOM-414     | Silentblock For Susp.Arm | 51810-SM4-004               | d:42     |
| 6    | 71-04-405   | TCA Right         | 52390 SM1 A03 | c:12.7              | 14   | GOM-417     | Silentblock For Susp.Arm | 51355-S1A-E00               |          |
| 7    | 73-04-495   | TCA Left          | 51460 SV4 000 | c:12.9              | 15   | GOM-416     | Silentblock For Susp.Arm | 52370-SR3-J00               | d:80     |
| 8    | 73-04-496   | TCA Right         | 51355 SM4 040 | c:12.9              |      |             |                          |                             |          |



CIVIC II

09/1983 - 11/1987



| Ref. | ASHIKA CODE | Description | OEM           | Measures           | Ref. | ASHIKA CODE | Description | OEM           | Measures            |
|------|-------------|-------------|---------------|--------------------|------|-------------|-------------|---------------|---------------------|
| 1    | 111-04-401  | Tie Rod End | 53540-611-010 | c:13 th:FM12X1.25R | 3    | 26-04-495   | TCA Right   | 51351 SB2 013 | c:14.5              |
| 2    | 111-04-481  | TCA Left    | 51361-SB2-013 | c:14.5             | 4    | 103-04-405  | Axial Joint | 53521-SB2-003 | th:MM12X1.25R L:278 |

CIVIC III (EC-ED-EE)

09/1987 - 07/1991

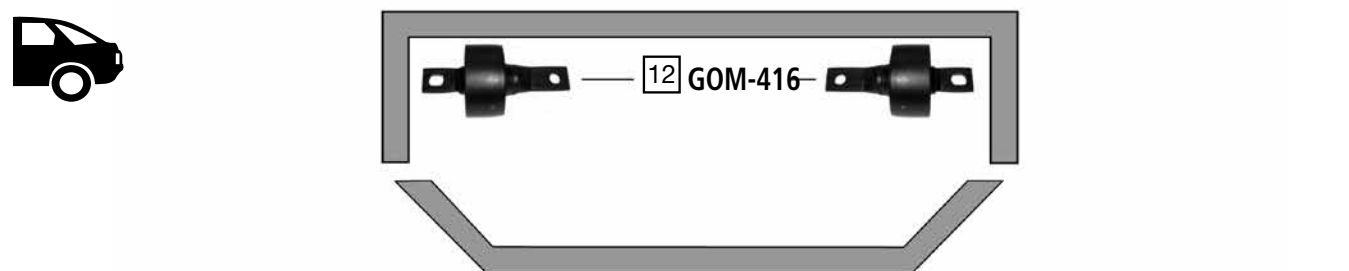
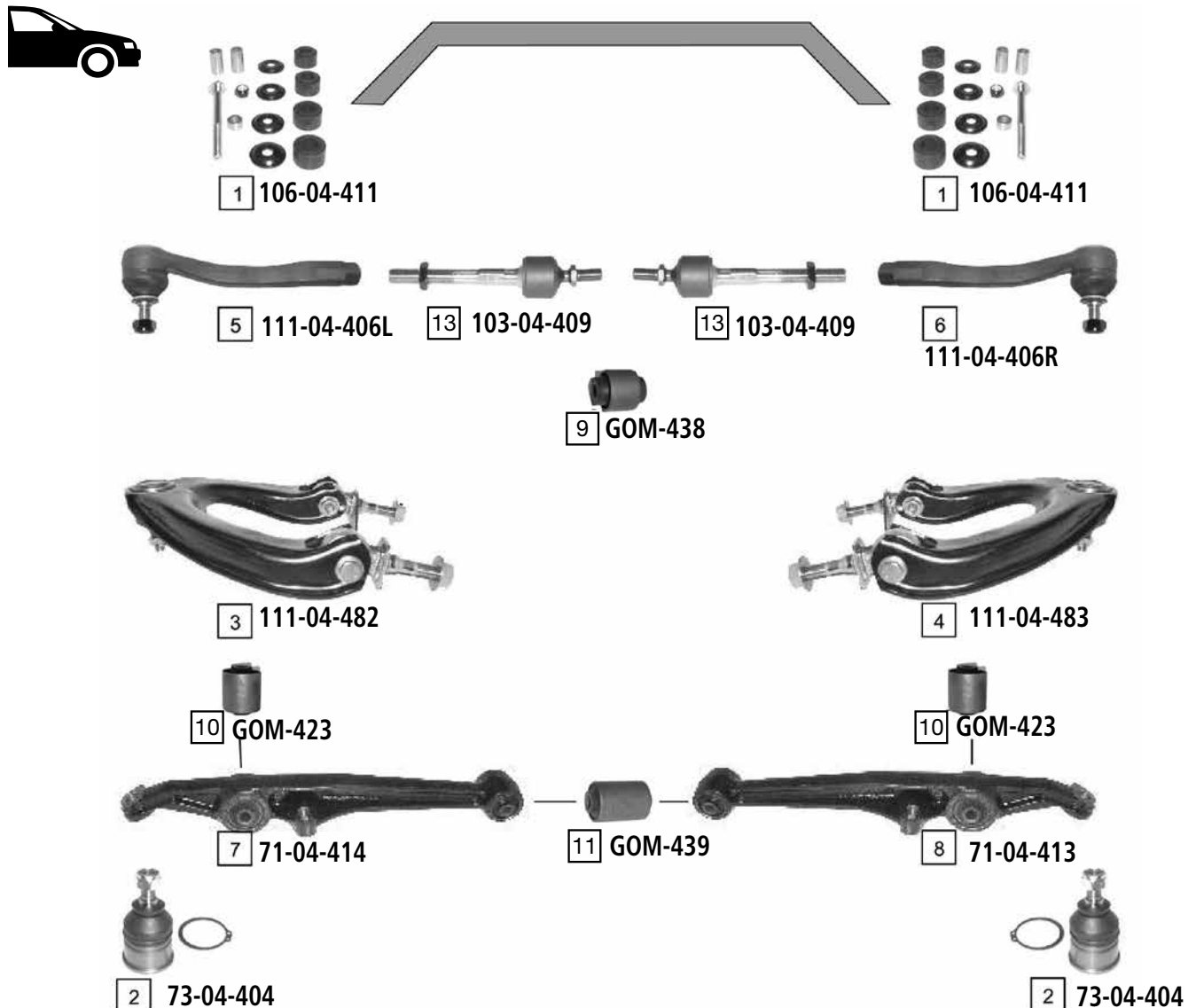

| Ref. | ASHIKA CODE | Description      | OEM           | Measures            | Ref. | ASHIKA CODE | Description              | OEM           | Measures            |
|------|-------------|------------------|---------------|---------------------|------|-------------|--------------------------|---------------|---------------------|
| 1    | 106-04-411  | Stabiliser Link  | 90112 SE0 000 | L:100               | 8    | 71-04-413   | TCA Right                | 51355-SH3-020 |                     |
| 2    | 73-04-404   | Ball Joint Lower | 51220 SE0 000 | c: 14.5             | 9    | GOM-438     | Silentblock For Susp.Arm | 51450-SH3-023 | d:29                |
| 3    | 111-04-482  | TCA Upper Left   | 51460-SH3-000 | c: 12.9             | 10   | GOM-423     | Silentblock For Susp.Arm | 51350-SR3-A02 | d:40                |
| 4    | 111-04-483  | TCA Upper Right  | 51450 SH3 020 | c: 12.9             | 11   | GOM-439     | Silentblock For Susp.Arm | 51355-SH3-020 | d:32.1              |
| 5    | 111-04-406L | Tie Rod End      | 53560-SH3-003 | c:12.9 th:FM14X1.5R | 12   | GOM-416     | Silentblock For Susp.Arm | 52370-SR3-J00 | d:80                |
| 6    | 111-04-406R | Tie Rod End      | 53540-SH3-003 | c:12.9 th:FM14X1.5R | 13   | 103-04-409  | Axial Joint              | 53521-SH3-003 | th:MM12x1,25R L:160 |
| 7    | 71-04-414   | TCA Left         | 51365-SH3-020 |                     |      |             |                          |               |                     |

CIVIC IV (MA-MB-EG-EH-EJ)

08/1991 - 01/1997

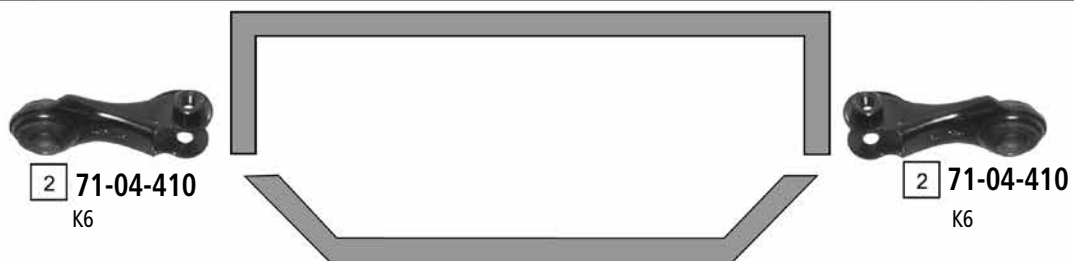
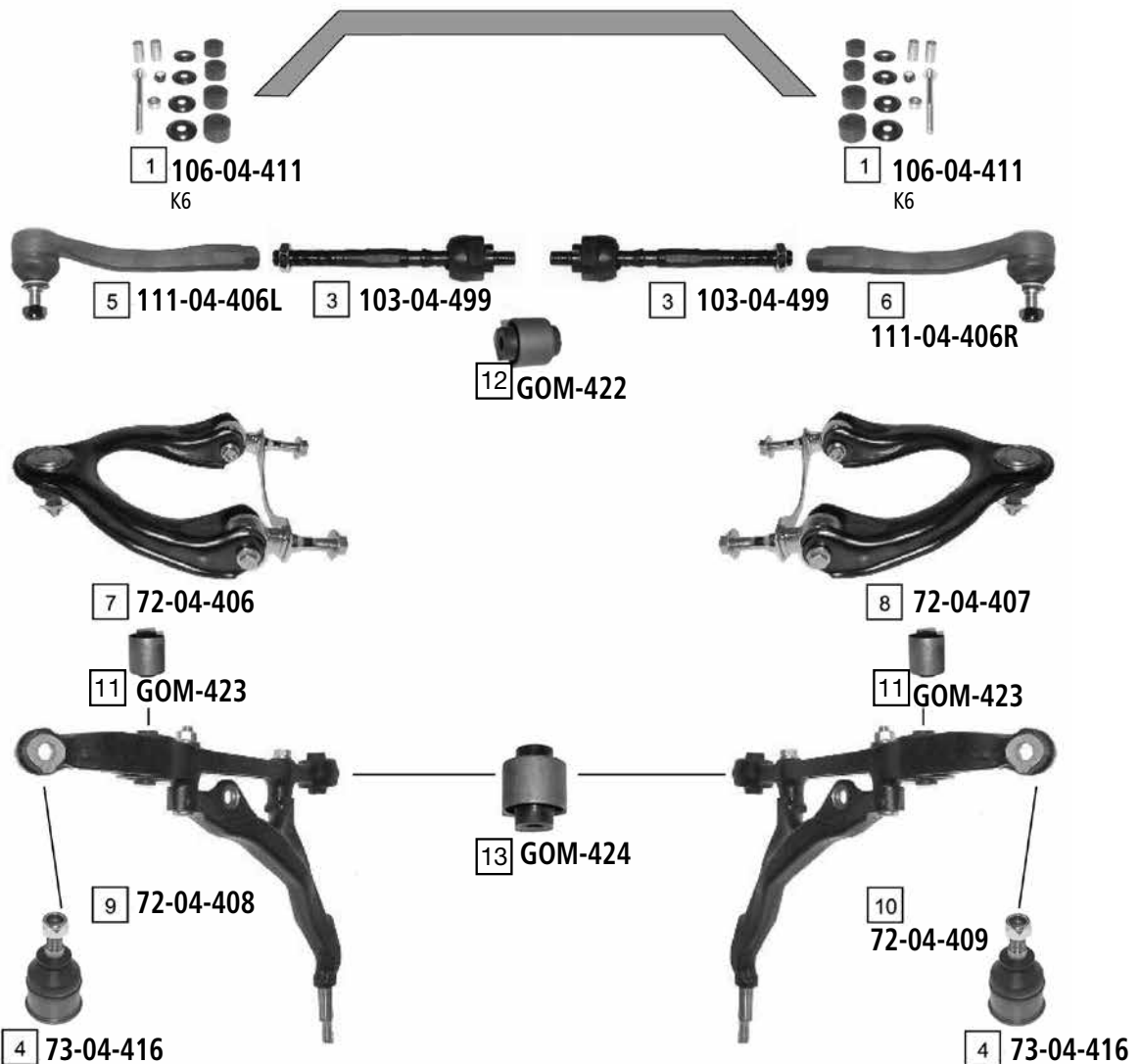

| Ref | ASHIKA CODE | Description       | OEM           | Measures            | Ref | ASHIKA CODE | Description              | OEM           | Measures |
|-----|-------------|-------------------|---------------|---------------------|-----|-------------|--------------------------|---------------|----------|
| 1   | 106-04-411  | Stabiliser Link   | 90112 SE0 000 | L:100               | 8   | 72-04-407   | TCA                      | 51450-SR3-023 | c:12.9   |
| 2   | 71-04-410   | Stabiliser Link   | 51312-SR3-000 | L:75                | 9   | 72-04-408   | TCA Left                 | 51360-SR3-020 | c:13.4   |
| 3   | 103-04-499  | Axial Joint       | 53010-SR3-010 | th:MM12X1.25R L:175 | 10  | 72-04-409   | TCA Right                | 51350-SR3-020 |          |
| 4   | 73-04-416   | Ball Joint        | 51220 S04 003 | c:14                | 12  | GOM-423     | Silentblock For Susp.Arm | 51350-SR3-A02 | d:40     |
| 5   | 111-04-406L | Tie Rod End Left  | 53560-S04-003 | c:12.9 th:FM14x1.5R | 13  | GOM-422     | Silentblock For Susp.Arm | 51450-SR3-023 | d:34     |
| 6   | 111-04-406R | Tie Rod End Right | 53540-S04-003 | c:12.9 th:FM14x1.5R | 15  | GOM-424     | Silentblock For Susp.Arm | 51360-SR3-A02 | d:37     |
| 7   | 72-04-406   | TCA               | 51460-SR3-023 | c:12.9              |     |             |                          |               |          |

CIVIC V (EJ9-EK1-EK3-EK4-MB-MC)

11/1995 - 02/2001

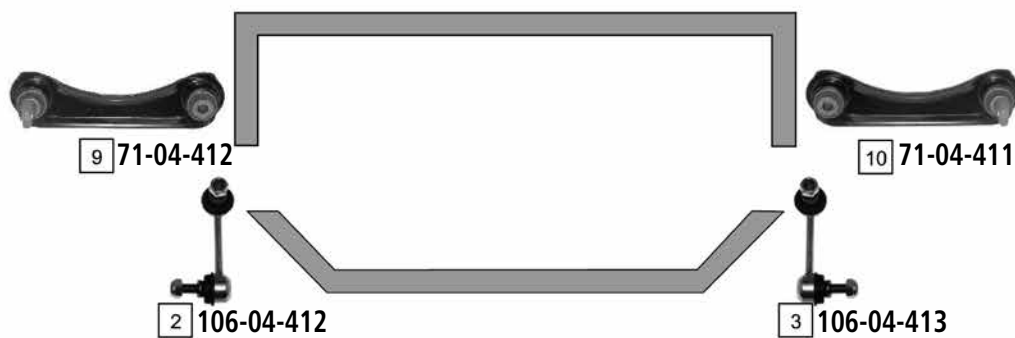
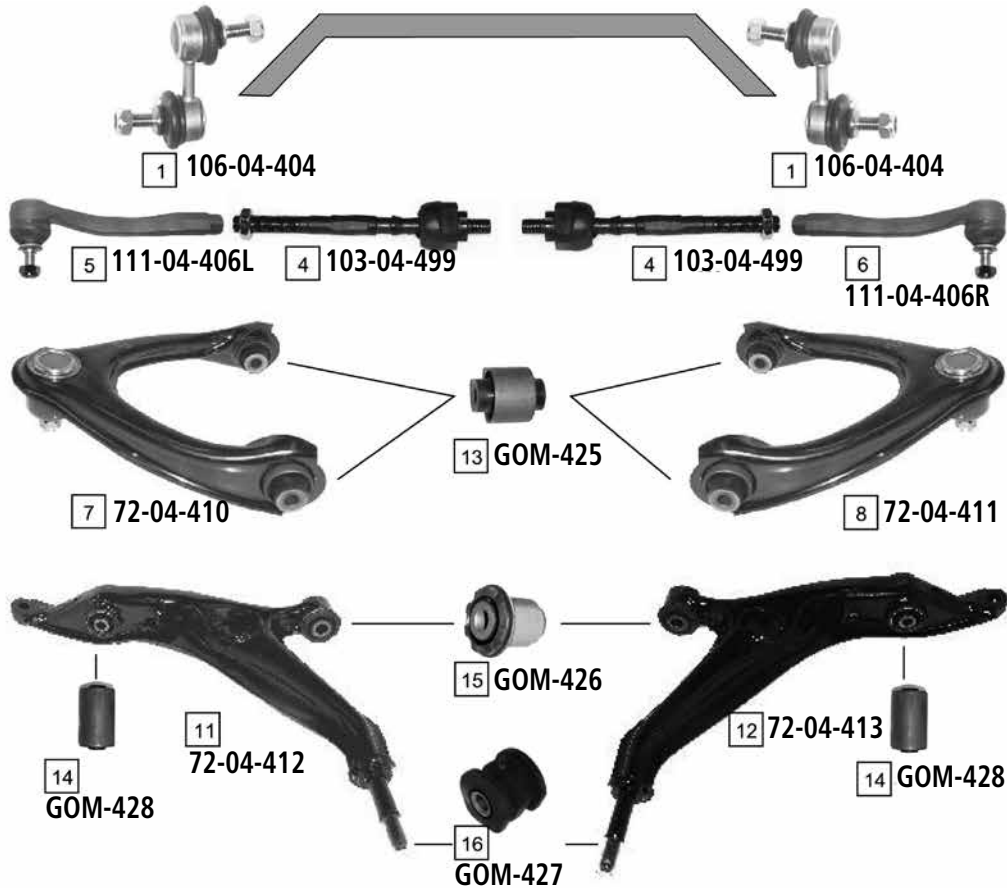

| Ref | ASHIKA CODE | Description           | OEM           | Measures            | Ref | ASHIKA CODE | Description              | OEM                           | Measures |
|-----|-------------|-----------------------|---------------|---------------------|-----|-------------|--------------------------|-------------------------------|----------|
| 1   | 106-04-404  | Stabiliser Link       | 51320-S04-003 |                     | 9   | 71-04-412   | TCA Left                 | 52390-SR3-000                 |          |
| 2   | 106-04-412  | Stabiliser Link Left  | 52321-S04-003 | L:90                | 10  | 71-04-411   | TCA Right                | 51460-SZ3-013                 |          |
| 3   | 106-04-413  | Stabiliser Link Right | 52320-S04-003 | L:90                | 11  | 72-04-412   | TCA Left                 | 51360 S04 G00                 | c:14     |
| 4   | 103-04-499  | Axial Joint           | 53010-SR3-010 | th:MM12X1.25R L:175 | 12  | 72-04-413   | TCA Right                | 51350 S04 000                 | c:13.5   |
| 5   | 111-04-406L | Tie Rod End Left      | 53560-S04-003 | c:12.9 th:FM14X1.5R | 13  | GOM-425     | Silentblock For Susp.Arm | 51450-S04-023                 | d:34     |
| 6   | 111-04-406R | Tie Rod End Right     | 53540-S04-003 | c:12.9 th:FM14X1.5R | 14  | GOM-428     | Silentblock For Susp.Arm | Part of 72-04-412 / 72-04-413 | d:40.1   |
| 7   | 72-04-410   | TCA Left              | 51450-S01-023 | c:12.8              | 15  | GOM-426     | Silentblock For Susp.Arm | 51350-S04-000                 | d:37     |
| 8   | 72-04-411   | TCA Right             | 52400-SR3-000 | c:12.8              | 16  | GOM-427     | Silentblock For Susp.Arm | 51391 S04 005                 |          |

CIVIC VI (EU-EP-EM)

02/2001 - 12/2005

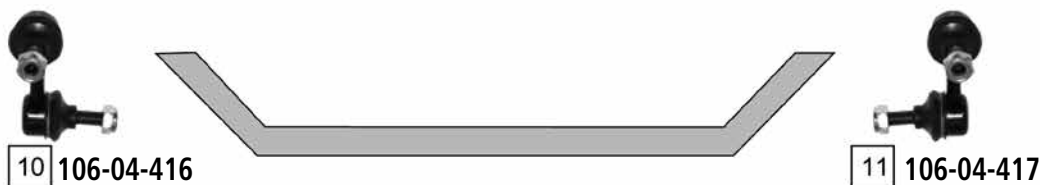
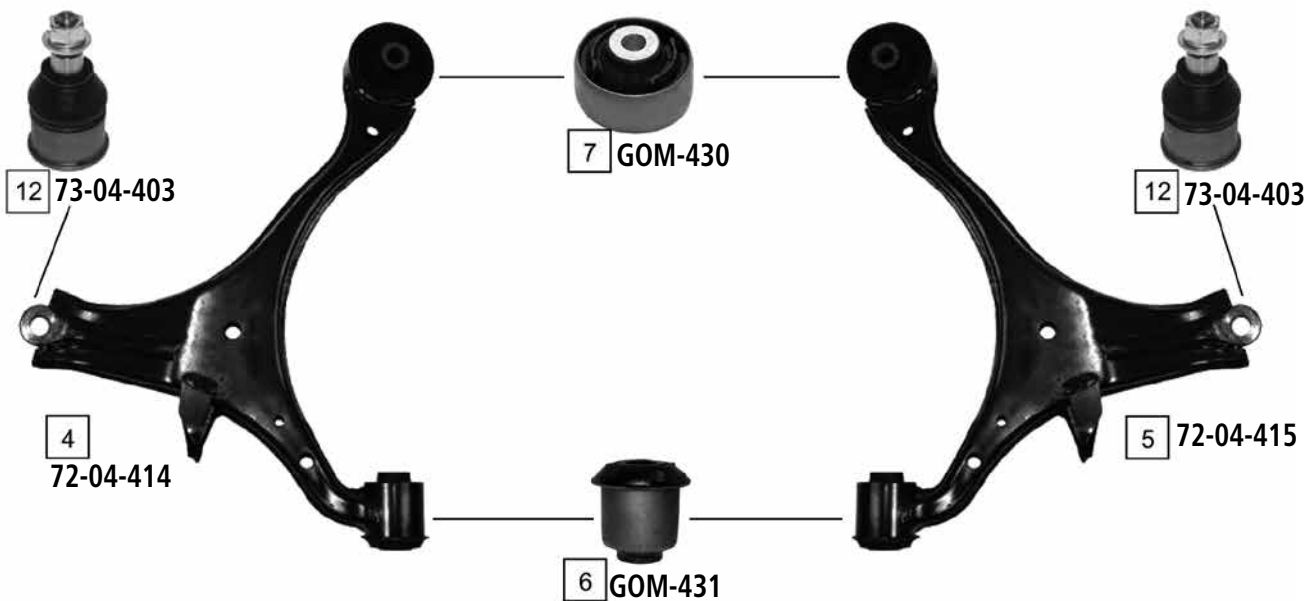
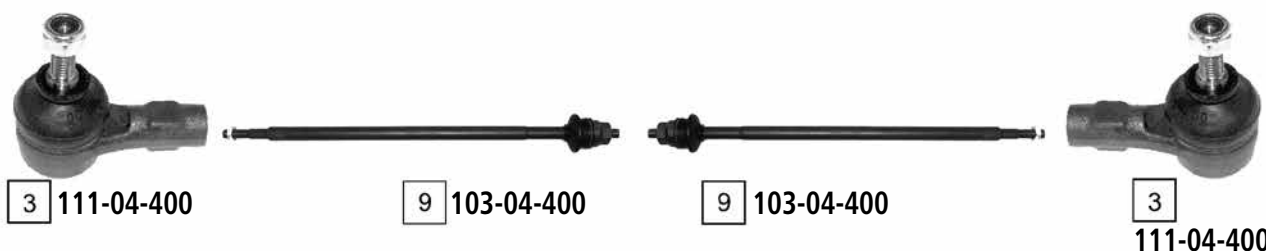
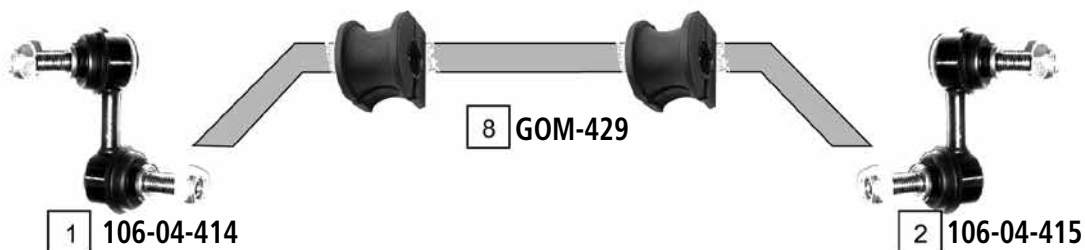

| Ref. | ASHIKA CODE | Description              | OEM           | Measures            | Ref. | ASHIKA CODE | Description              | OEM           | Measures            |
|------|-------------|--------------------------|---------------|---------------------|------|-------------|--------------------------|---------------|---------------------|
| 1    | 106-04-414  | Stabiliser Link Left     | 51321-S5A-003 | L:55.5              | 7    | GOM-430     | Silentblock For Susp.Arm | 51391 S5A 024 | d:65                |
| 2    | 106-04-415  | Stabiliser Link Right    | 51320-S5A-003 | L:55                | 8    | GOM-429     | Stabiliser Mounting      | 51306-S6D-005 | d:24.8              |
| 3    | 111-04-400  | Tie Rod End              | 53541-S5A-003 | c:12.7 th:FM14x1.5R | 9    | 103-04-400  | Axial Joint              | 53521 S5A 003 | th:MM14X1.25R L:502 |
| 4    | 72-04-414   | Tca Left Wobj            | 51360-S6D-G00 | c:15.5              | 10   | 106-04-416  | Stabiliser Link Left     | 52321 S5A 013 | L:72.5              |
| 5    | 72-04-415   | Tca Right Wobj           | 51350-S6D-G00 | c:15.5              | 11   | 106-04-417  | Stabiliser Link Right    | 52320 S5A 013 |                     |
| 6    | GOM-431     | Silentblock For Susp.Arm | 51392-S5A-004 | d:42.2              | 12   | 73-04-403   | Ball Joint               | 51220 S5A 003 | -                   |

CIVIC VII

01/2006->

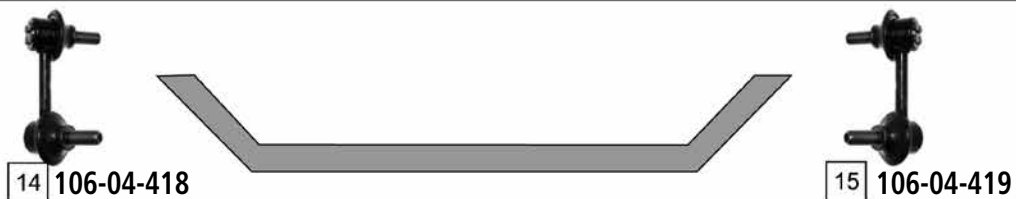
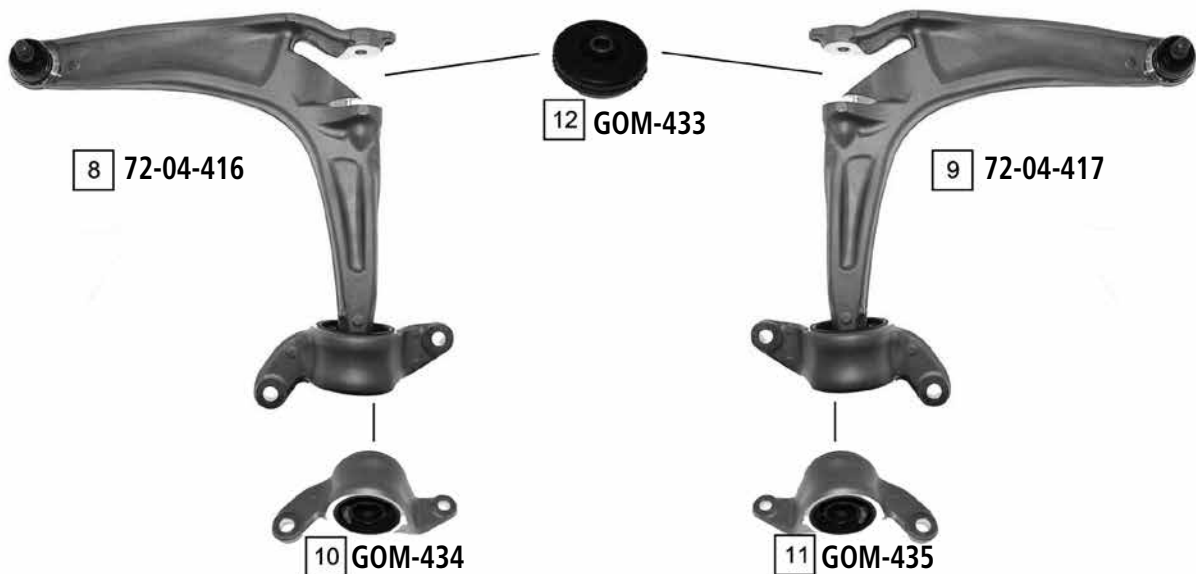
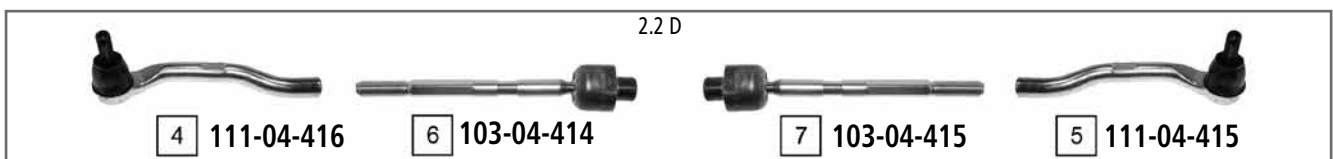
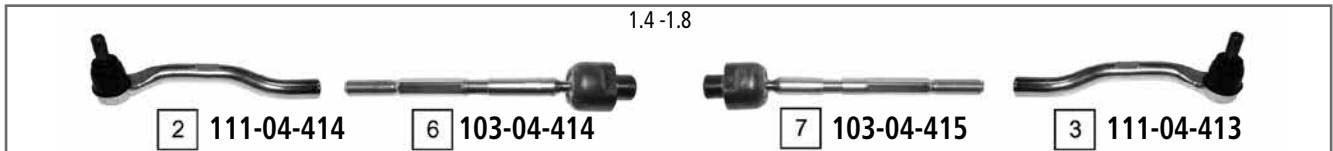
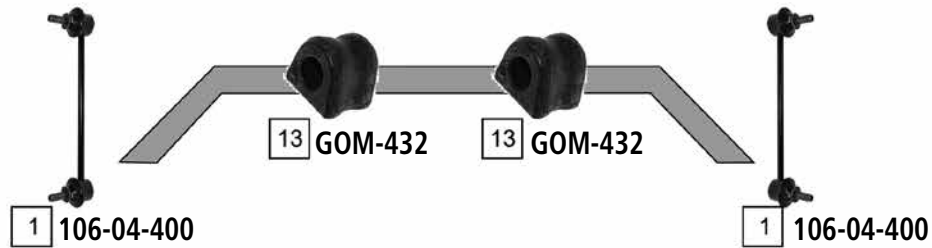

| Ref | ASHIKA CODE | Description       | OEM           | Measures | Ref | ASHIKA CODE | Description              | OEM           | Measures |
|-----|-------------|-------------------|---------------|----------|-----|-------------|--------------------------|---------------|----------|
| 1   | 106-04-400  | Stabiliser Link   | 51320 SMG E01 |          | 9   | 72-04-417   | TCA Right Wbj            | 51350 SMG E05 |          |
| 2   | 111-04-414  | Tie Rod End Left  | 53560 SMG 003 |          | 10  | GOM-434     | Silentblock For Susp.Arm | 51396 SMG E03 |          |
| 3   | 111-04-413  | Tie Rod End Right | 53540 SMG 003 |          | 11  | GOM-435     | Silentblock For Susp.Arm | 51395 SMG E03 |          |
| 4   | 111-04-416  | Tie Rod End Left  | 53560 SMJ 003 |          | 12  | GOM-433     | Silentblock For Susp.Arm | 51398 SMG E01 |          |
| 5   | 111-04-415  | Tie Rod End Right | 53540 SMJ 003 |          | 13  | GOM-432     | Stabiliser Mounting      | 51306 SMG E02 |          |
| 6   | 103-04-414  | Axial Joint       | 53010 SMG E01 |          | 14  | 106-04-418  | Stabiliser Link Left     | 52321 SNA A01 |          |
| 7   | 103-04-415  | Axial Joint       | 53011 SMG E01 |          | 15  | 106-04-419  | Stabiliser Link Right    | 52320 SNA A01 |          |
| 8   | 72-04-416   | TCA Left Wbj      | 51360 SMG E05 |          |     |             |                          |               |          |

# HONDA CONCERTO



CONCERTO (HW)

08/1989 - 10/1996

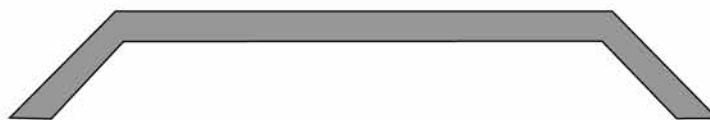

1 111-04-487



1 111-04-487



2 111-04-488



3 111-04-489

| Ref. | ASHIKA CODE | Description | OEM      | Measures            | Ref. | ASHIKA CODE | Description | OEM      | Measures |
|------|-------------|-------------|----------|---------------------|------|-------------|-------------|----------|----------|
| 1    | 111-04-487  | Tie Rod End | GSJ 1011 | c:12.9 th:FM14X1.5R | 3    | 111-04-489  | TCA Right   | GSJ 1086 | c:15     |
| 2    | 111-04-488  | TCA Left    | GSJ 1085 | c:15                |      |             |             |          |          |

CR-V I (RD)

10/1995 - 06/2002

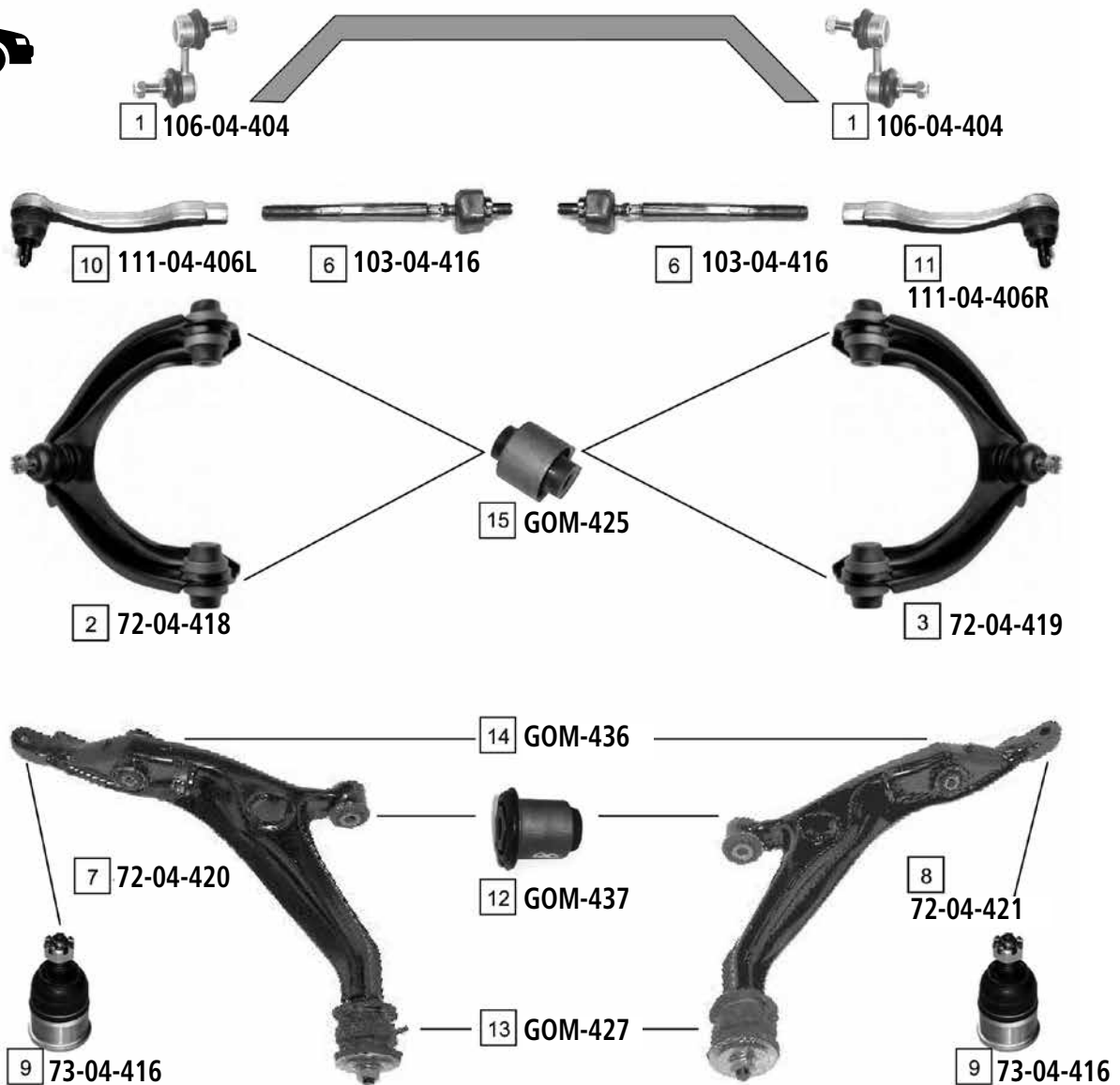

| Ref | ASHIKA CODE | Description           | OEM           | Measures            | Ref | ASHIKA CODE | Description              | OEM                           | Measures            |
|-----|-------------|-----------------------|---------------|---------------------|-----|-------------|--------------------------|-------------------------------|---------------------|
| 1   | 106-04-404  | Stabiliser Link       | 51320-S04-003 |                     | 9   | 73-04-416   | Ball Joint               | 51220-S04-003                 |                     |
| 2   | 72-04-418   | TCA Left              | 51460-S10-020 | c:12.7              | 10  | 111-04-406L | Tie Rod End Left         | 53560-S04-003                 | c:12.7 th:FM14X1.5R |
| 3   | 72-04-419   | TCA Right             | 51450-S10-020 | c:12.7              | 11  | 111-04-406R | Tie Rod End Right        | 53540-S04-003                 | c:12.7 th:FM14X1.5R |
| 4   | 106-04-420  | Stabiliser Link Left  | 52321 S10 003 | L:125               | 12  | GOM-437     | Silentblock For Susp.Arm | Part of 72-04-420 / 72-04-421 |                     |
| 5   | 106-04-421  | Stabiliser Link Right | 53320 S10 003 | L:125               | 13  | GOM-427     | Silentblock For Susp.Arm | 51391 S04 005                 |                     |
| 6   | 103-04-416  | Axial Joint           | 53010-S10-000 | th:MM12X1.25R L:202 | 14  | GOM-436     | Silentblock For Susp.Arm | Part of 72-04-420 / 72-04-421 |                     |
| 7   | 72-04-420   | TCA Left              | 51360-S10-G00 |                     | 15  | GOM-425     | Silentblock For Susp.Arm | 51450-S04-023                 | d:34                |
| 8   | 72-04-421   | TCA Right             | 51350-S10-G00 |                     |     |             |                          |                               |                     |



CR-V II

07/2002 - 09/2006

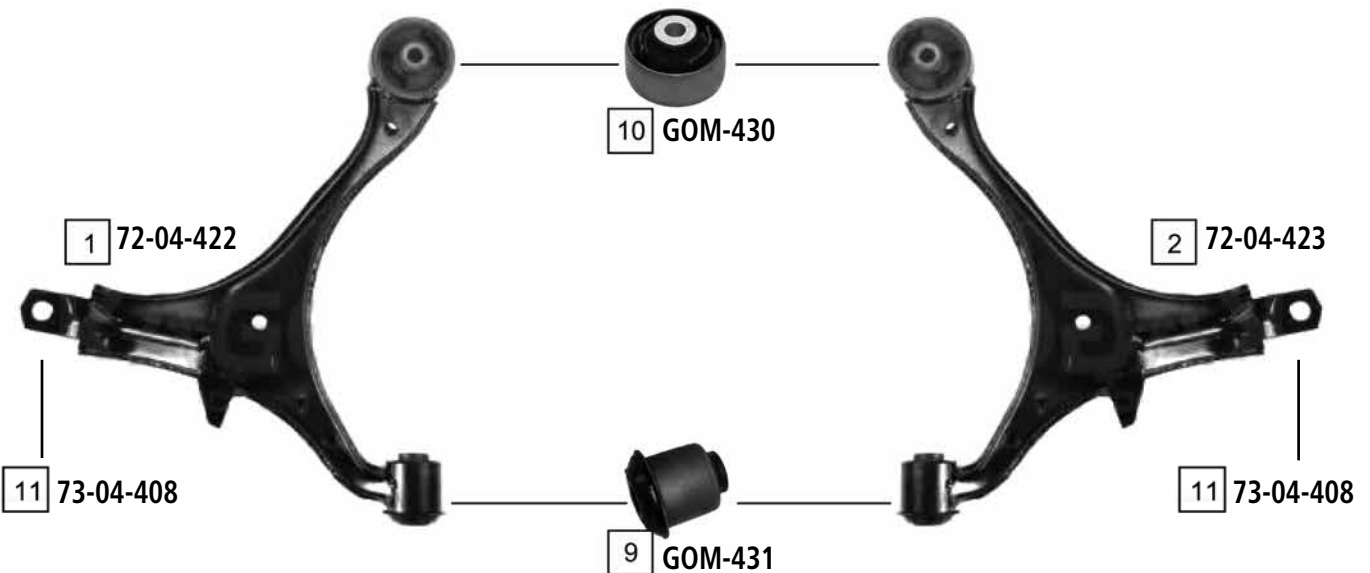

| Ref. | ASHIKA CODE | Description           | OEM           | Measures            | Ref. | ASHIKA CODE | Description              | OEM           | Measures |
|------|-------------|-----------------------|---------------|---------------------|------|-------------|--------------------------|---------------|----------|
| 1    | 72-04-422   | TCA Left              | 51360 S9A 010 | c:15                | 7    | 106-04-422  | Stabiliser Link Left     | 52321 S9A 003 | L:89.5   |
| 2    | 72-04-423   | TCA Right             | 51350 S9A 010 | c:15                | 8    | 106-04-423  | Stabiliser Link Right    | 52320 S9A 003 | L:89.5   |
| 3    | 103-04-417  | Axial Joint           | 53521-S9A-003 | th:MM14X1.25R L:547 | 9    | GOM-431     | Silentblock For Susp.Arm | 51392-S5A-004 | d:42.2   |
| 4    | 111-04-400  | Tie Rod End           | 53541-S5A-003 | c:12.7 th:FM14X1.5R | 10   | GOM-430     | Silentblock For Susp.Arm | 51391 S5A 024 | d :65    |
| 5    | 106-04-414  | Stabiliser Link Left  | 51321-S5A-003 | L:55.5              | 11   | 73-04-408   | Ball Joint               |               |          |
| 6    | 106-04-415  | Stabiliser Link Right | 51320-S5A-003 | L:55                |      |             |                          |               |          |

CR-V III

10/2006 ->

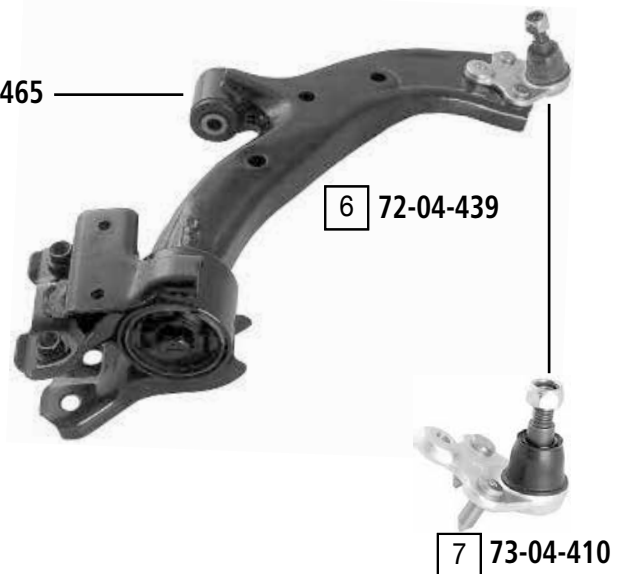
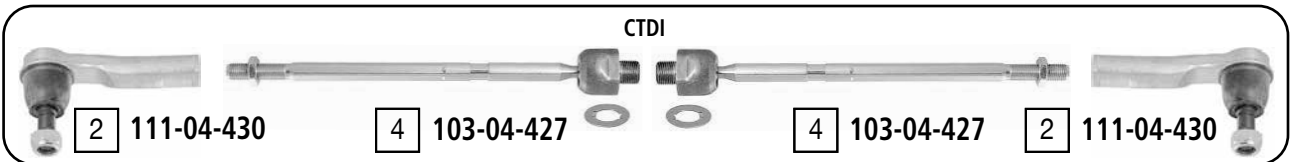
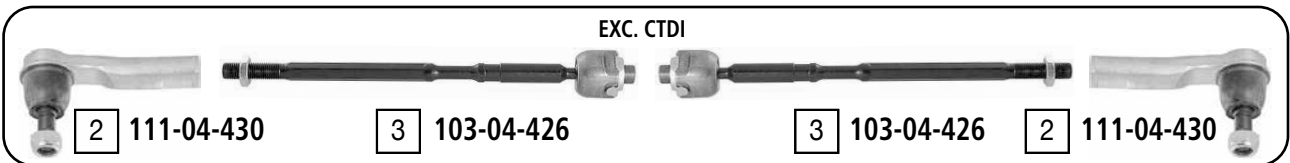
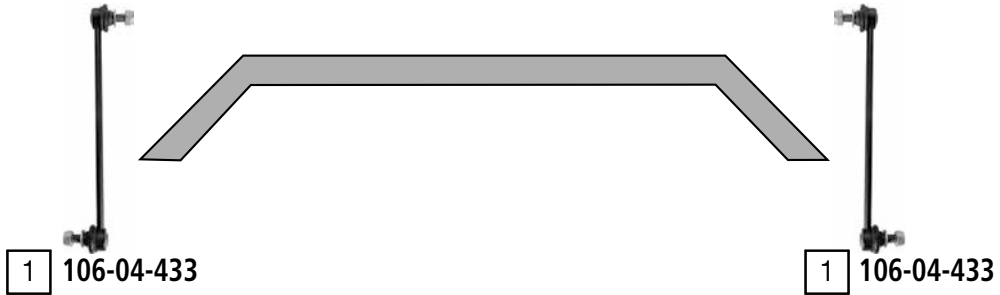

| Ref. | ASHIKA CODE | Description     | OEM           | Measures            | Ref. | ASHIKA CODE | Description           | OEM           | Measures |
|------|-------------|-----------------|---------------|---------------------|------|-------------|-----------------------|---------------|----------|
| 1    | 106-04-433  | Stabiliser Link | 51320 STK A01 | L:318               | 6    | 72-04-439   | TCA Right Wbj         | 51350 SWA E01 | c:17.5   |
| 2    | 111-04-430  | Tie Rod End     | 53540 SWA A02 | c:13.6 th:FM14x1.5R | 7    | 73-04-410   | Ball Joint            | 51220 STK A01 | c:17.5   |
| 3    | 103-04-426  | Axial Joint     | 53010 SWC G02 | th:MM16x1R L:317.5  | 8    | GOM-465     | Silentblock For TCA   | Part of       | di:14.3  |
| 4    | 103-04-427  | Axial Joint     | 53010 SWA A01 | th:MM20x1.5R L:319  | 9    | 106-04-442  | Stabiliser Link Left  | 52321 SWA A01 | L:85     |
| 5    | 72-04-438   | TCA Left Wbj    | 51360 SWA E01 | c:17.5              | 10   | 106-04-443  | Stabiliser Link Right | 52320 SWA A01 | L:85     |

CRX I (AF-AS)

07/1983 - 09/1987



1 111-04-401

4 103-04-405

4 103-04-405

1 111-04-401

2 111-04-481

3 26-04-495

| Ref | ASHIKA CODE | Description | OEM           | Measures           | Ref | ASHIKA CODE | Description | OEM           | Measures            |
|-----|-------------|-------------|---------------|--------------------|-----|-------------|-------------|---------------|---------------------|
| 1   | 111-04-401  | Tie Rod End | 53450-611-010 | c:13 th:FM12X1.25R | 3   | 26-04-495   | TCA Right   | 51351 SB2 013 | c:14.5              |
| 2   | 111-04-481  | TCA Left    | 51361-SB2-013 | c:14.5             | 4   | 103-04-405  | Axial Joint | 53521-SB2-003 | th:MM12X1.25R L:278 |

CRX II (ED-EE)

09/1987 - 02/1992

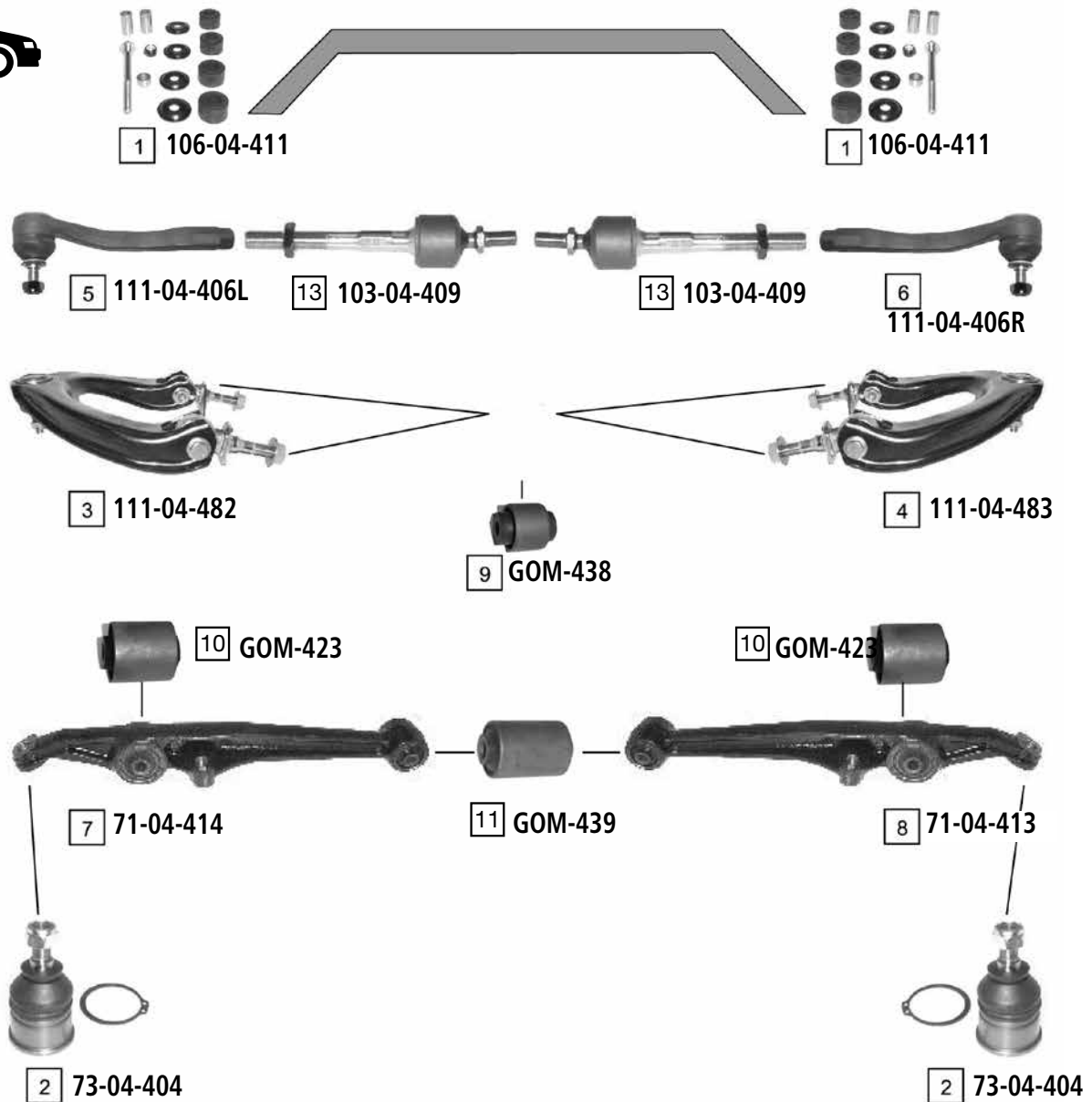

| Ref. | ASHIKA CODE | Description      | OEM           | Measures            | Ref. | ASHIKA CODE | Description              | OEM           | Measures            |
|------|-------------|------------------|---------------|---------------------|------|-------------|--------------------------|---------------|---------------------|
| 1    | 106-04-411  | Stabiliser Link  | 90112 SE0 000 | L:100               | 8    | 71-04-413   | TCA Right                | 51355-SH3-020 |                     |
| 2    | 73-04-404   | Ball Joint Lower | 51220 SE0 000 | c:14.5              | 9    | GOM-438     | Silentblock For Susp.Arm | 51450-SH3-023 | d:29                |
| 3    | 111-04-482  | TCA Upper Left   | 51460-SH3-000 | c:12.9              | 10   | GOM-423     | Silentblock For Susp.Arm | 51350-SR3-A02 | d:40                |
| 4    | 111-04-483  | TCA Upper Right  | 51450 SH3 020 | c:12.9              | 11   | GOM-439     | Silentblock For Susp.Arm | 51355-SH3-020 | d:32.1              |
| 5    | 111-04-406L | Tie Rod End      | 53560-SH3-003 | c:12.9 th:FM14X1.5R | 12   | GOM-416     | Silentblock For Susp.Arm | 52370-SR3-J00 | d:80                |
| 6    | 111-04-406R | Tie Rod End      | 53540-SH3-003 | c:12.9 th:FM14X1.5R | 13   | 103-04-409  | Axial Joint              | 53521-SH3-003 | th:MM12X1,25R L:160 |
| 7    | 71-04-414   | TCA Left         | 51365-SH3-020 |                     |      |             |                          |               |                     |

HR-V (GH)

03/1999 - 07/2006

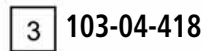

| Ref | ASHIKA CODE | Description           | OEM           | Measures           | Ref | ASHIKA CODE | Description | OEM           | Measures            |
|-----|-------------|-----------------------|---------------|--------------------|-----|-------------|-------------|---------------|---------------------|
| 1   | 106-04-424  | Stabiliser Link Left  | 51321-S2H-003 | L:148              | 4   | 72-04-424   | TCA         | 51360-S2H-G01 | c:16                |
| 2   | 106-04-425  | Stabiliser Link Right | 51320-S2H-003 | L:148              | 5   | 72-04-425   | TCA         | 51350-S2H-G01 | c:16                |
| 3   | 103-04-418  | Axial Joint           | 53010 S2H J01 | th:MM14X1.5R L:307 | 6   | 111-04-417  | Tie Rod End | 53540-SX8-T01 | c:13.5 th:FM12X1.25 |

INSIGHT (ZE2)

04/2009 ->

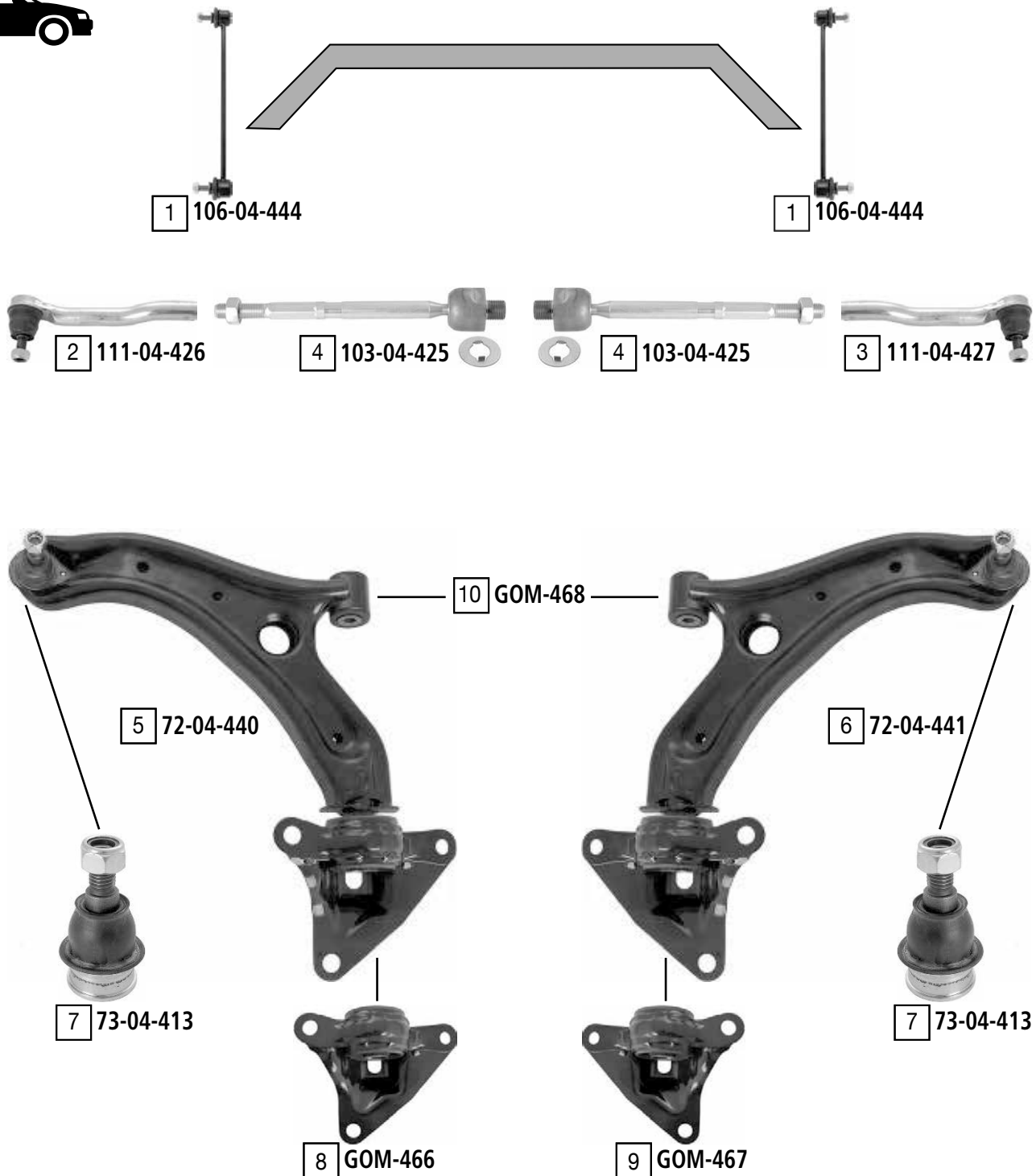

| Ref | ASHIKA CODE | Description       | OEM           | Measures            | Ref | ASHIKA CODE | Description         | OEM           | Measures        |
|-----|-------------|-------------------|---------------|---------------------|-----|-------------|---------------------|---------------|-----------------|
| 1   | 106-04-444  | Stabiliser Link   | 51320 TF0 003 | L:325               | 6   | 72-04-441   | TCA right wbj       | 51350 TF0 030 | c:17.5          |
| 2   | 111-04-426  | Tie Rod End Left  | 53560 TF0 003 | c:12.7 th:FM14X1.5R | 7   | 73-04-413   | Ball Joint Lower    | Part of       | c:17.5 do:36.25 |
| 3   | 111-04-427  | Tie Rod End Right | 53540 TF0 003 | c:12.7 th:FM14X1.5R | 8   | GOM-466     | Silentblock For TCA | Part of       | do:25.8         |
| 4   | 103-04-425  | Axial Joint       | 53010 TF0 003 | th:MM18x1.5R L:236  | 9   | GOM-467     | Silentblock For TCA | Part of       | do:25.8         |
| 5   | 72-04-440   | TCA Left Wbj      | 51360 TF0 030 | c:17.5              | 10  | GOM-468     | Silentblock For TCA | Part of       | di:14.2 do:33.9 |

INTEGRA (DA\_)

10/1985 - 08/1989



| Ref. | ASHIKA CODE | Description | OEM           | Measures            | Ref. | ASHIKA CODE | Description | OEM           | Measures            |
|------|-------------|-------------|---------------|---------------------|------|-------------|-------------|---------------|---------------------|
| 1    | 111-04-401  | Tie Rod End | 53540-611-010 | c:13 th: FM12X1.25R | 2    | 103-04-405  | Axial Joint | 53521-SB2-003 | th:MM12X1.25R L:278 |

JAZZ (AA)

10/1983 - 10/1986



| Ref | ASHIKA CODE | Description | OEM           | Measures           | Ref | ASHIKA CODE | Description | OEM           | Measures             |
|-----|-------------|-------------|---------------|--------------------|-----|-------------|-------------|---------------|----------------------|
| 1   | 111-04-401  | Tie Rod End | 53540-611-010 | c:13 th:FM12X1.25R | 3   | 26-04-495   | TCA Right   | 51351 SB2 013 | c:14.5               |
| 2   | 111-04-481  | TCA Left    | 51361-SB2-013 | c:14.5             | 4   | 103-04-405  | Axial Joint | 53521-SB2-003 | th: MM12X1.25R L:278 |



JAZZ (GD)

03/2002->

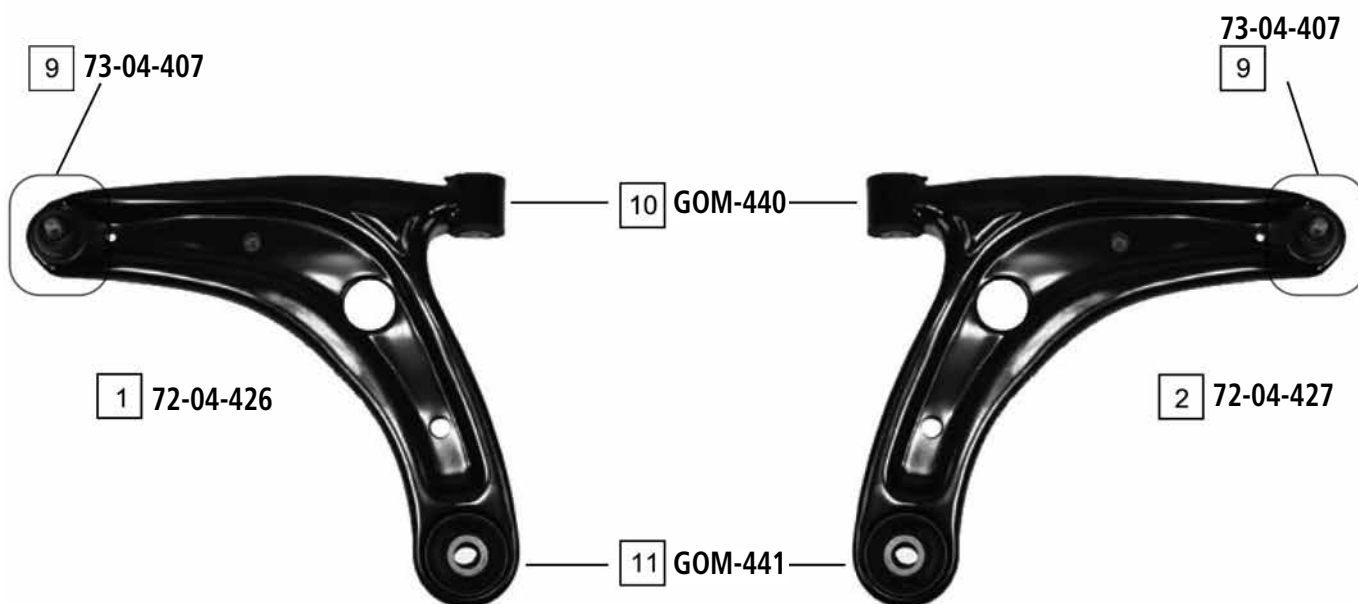
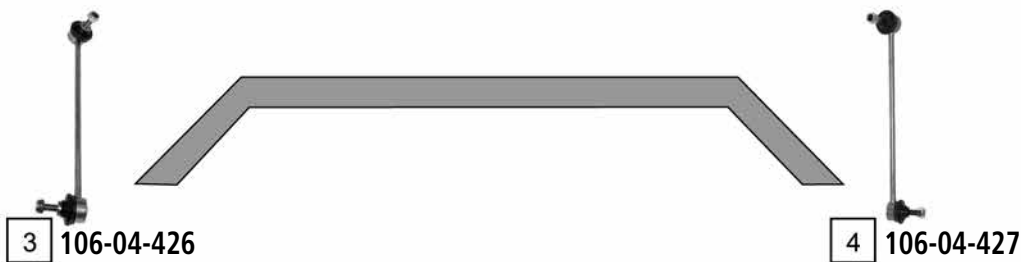

| Ref. | ASHIKA CODE | Description           | OEM           | Measures         | Ref. | ASHIKA CODE | Description              | OEM                           | Measures            |
|------|-------------|-----------------------|---------------|------------------|------|-------------|--------------------------|-------------------------------|---------------------|
| 1    | 72-04-426   | TCA Left              | 51360 SAA E01 |                  | 7    | 111-04-418  | Tie Rod End Left         | 53560-SAA-003                 | c:12.6 th:FM12X1.25 |
| 2    | 72-04-427   | TCA Right             | 51350 SAA E01 |                  | 8    | 111-04-419  | Tie Rod End Right        | 53540-SAA-003                 | c:12.6 th:FM12X1.25 |
| 3    | 106-04-426  | Stabiliser Link Left  | 51321-SAA-003 | L:300            | 9    | 73-04-407   | Ball Joint               | Part of 72-04-426 / 72-04-427 | c:16                |
| 4    | 106-04-427  | Stabiliser Link Right | 51320-SAA-003 |                  | 10   | GOM-440     | Silentblock For Susp.Arm | Part of 72-04-426 / 72-04-427 |                     |
| 5    | 103-04-420  | Axial Joint           | 53011-SAA-J01 | th:MM16X1R L:211 | 11   | GOM-441     | Silentblock For Susp.Arm | Part of 72-04-426 / 72-04-427 |                     |
| 6    | 103-04-419  | Axial Joint           | 53010-SAA-J01 | th:MM16X1R L:211 |      |             |                          |                               |                     |

JAZZ III (GE)

07/2008 ->

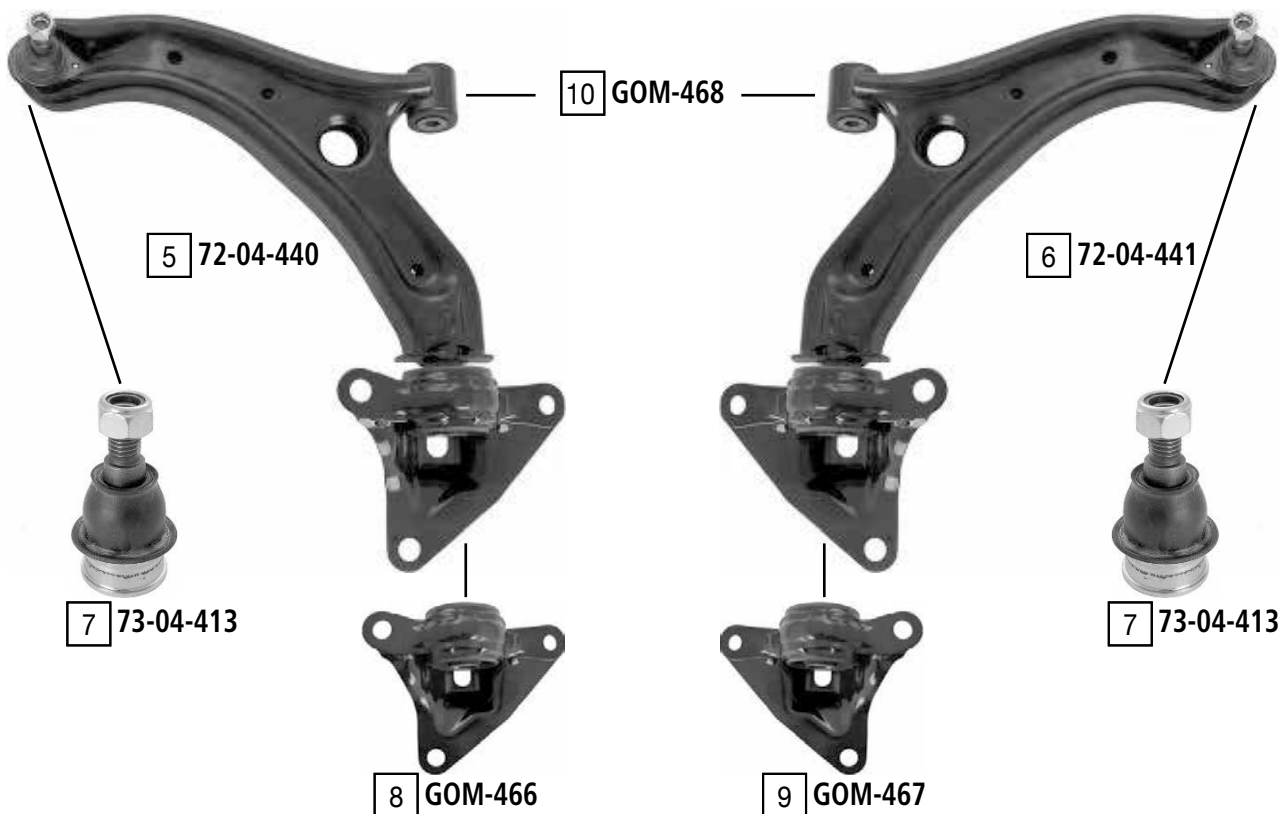
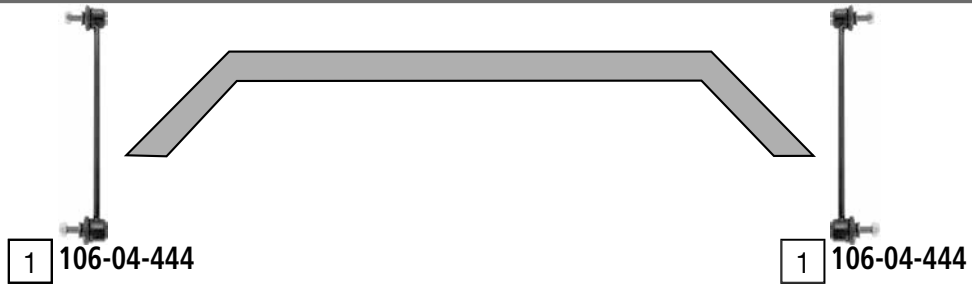

| Ref. | ASHIKA CODE | Description       | OEM           | Measures            | Ref. | ASHIKA CODE | Description         | OEM           | Measures        |
|------|-------------|-------------------|---------------|---------------------|------|-------------|---------------------|---------------|-----------------|
| 1    | 106-04-444  | Stabiliser Link   | 51320 TF0 003 | L:325               | 6    | 72-04-441   | TCA right wbj       | 51350 TF0 030 | c:17.5          |
| 2    | 111-04-426  | Tie Rod End Left  | 53560 TF0 003 | c:12.7 th:FM14X1.5R | 7    | 73-04-413   | Ball Joint Lower    | Part of       | c:17.5 do:36.25 |
| 3    | 111-04-427  | Tie Rod End Right | 53540 TF0 003 | c:12.7 th:FM14X1.5R | 8    | GOM-466     | Silentblock For TCA | Part of       | do:25.8         |
| 4    | 103-04-425  | Axial Joint       | 53010 TF0 003 | th:MM18x1.5R L:236  | 9    | GOM-467     | Silentblock For TCA | Part of       | do:25.8         |
| 5    | 72-04-440   | TCA left wbj      | 51360 TF0 030 | c:17.5              | 10   | GOM-468     | Silentblock For TCA | Part of       | di:14.2 do:33.9 |

LEGEND I (HS, KA)

01/1986 - 12/1990

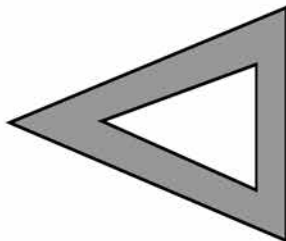

LOWER

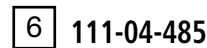
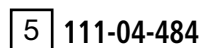
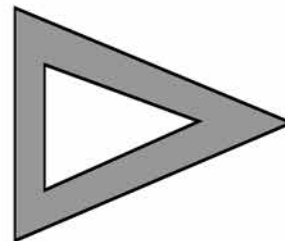

| Ref | ASHIKA CODE | Description      | OEM           | Measures           | Ref | ASHIKA CODE | Description | OEM           | Measures            |
|-----|-------------|------------------|---------------|--------------------|-----|-------------|-------------|---------------|---------------------|
| 1   | 111-04-405L | Tie Rod End      | 53560-SD4-003 | c:14 th:FM12X1.25R | 4   | 103-04-497  | Axial Joint | 53521-SD4-003 | th:MM12X1.25R L:136 |
| 2   | 111-04-405R | Tie Rod End      | 53540-SD4-003 | c:14 th:FM12X1.25R | 5   | 111-04-484  | Tie Rod End |               |                     |
| 3   | 73-04-499   | Ball Joint Lower | 51220-SD4-004 | c:18               | 6   | 111-04-485  | Tie Rod End |               |                     |

LEGEND II (KA7)

01/1991 - 02/1996

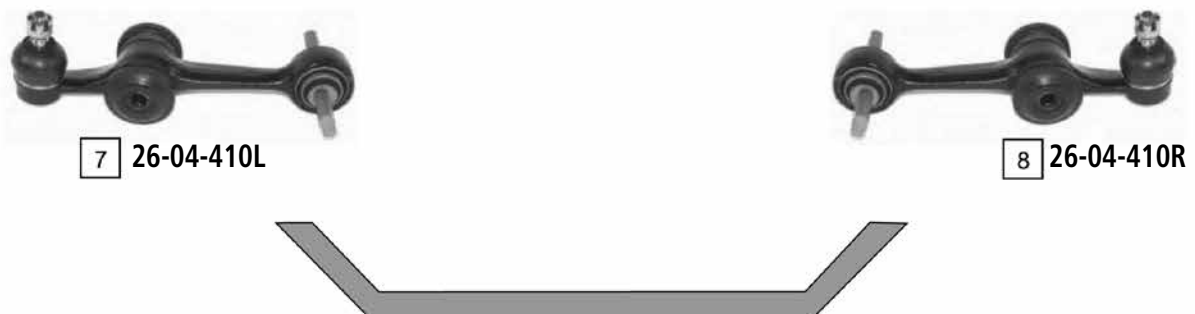
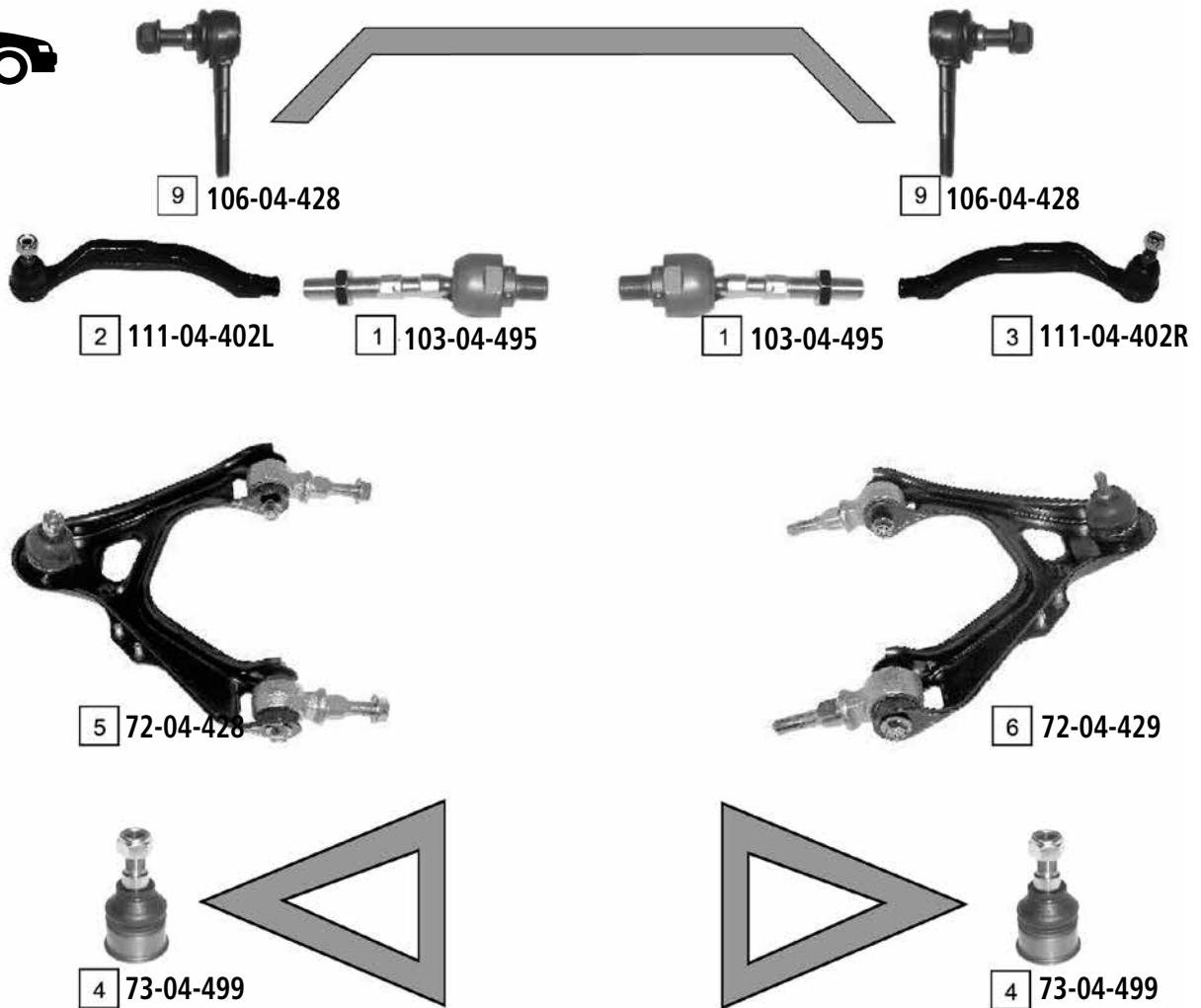

| Ref. | ASHIKA CODE | Description      | OEM           | Measures            | Ref. | ASHIKA CODE | Description     | OEM           | Measures |
|------|-------------|------------------|---------------|---------------------|------|-------------|-----------------|---------------|----------|
| 1    | 103-04-495  | Axial Joint      | 53521-SP0-004 | th:MM16X1.25R L:126 | 6    | 72-04-429   | TCA             | 51450-SP0-033 | c:12.8   |
| 2    | 111-04-402L | Tie Rod End      | 53560-SP0-013 |                     | 7    | 26-04-410L  | TCA             | 52400-SP0-013 | c:14     |
| 3    | 111-04-402R | Tie Rod End      | 53540-SP0-013 |                     | 8    | 26-04-410R  | TCA             | 51390-SP0-013 | c:14     |
| 4    | 73-04-499   | Ball Joint Lower | 51220-SD4-004 | c:18                | 9    | 106-04-428  | Stabiliser Link | 51320 SP0 003 | L:78.5   |
| 5    | 72-04-428   | TCA              | 51460-SP0-033 | c:12.8              |      |             |                 |               |          |

LEGEND III (KA9)

02/1996->



-> CHAS WC002641

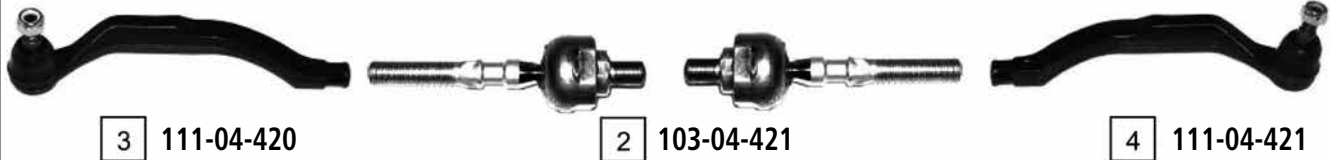

3 111-04-420

2 103-04-421

4 111-04-421

CHAS WC002642 ->



3 111-04-420

1 103-04-422

4 111-04-421



5 72-04-430



6 72-04-431

| Ref | ASHIKA CODE | Description | OEM           | Measures            | Ref | ASHIKA CODE | Description | OEM           | Measures |
|-----|-------------|-------------|---------------|---------------------|-----|-------------|-------------|---------------|----------|
| 1   | 103-04-422  | Axial Joint | 53010-SW5-003 | th:MM14X1.25R L:122 | 4   | 111-04-421  | Tie Rod End | 53540-SZ3-003 |          |
| 2   | 103-04-421  | Axial Joint | 53010-SW5-000 | th:MM14X1.25R L:122 | 5   | 72-04-430   | TCA         | 51450-SZ3-013 | c:12.8   |
| 3   | 111-04-420  | Tie Rod End | 53560-SZ3-003 |                     | 6   | 72-04-431   | TCA         | 51460-SZ3-901 | c:12.8   |

LOGO (GA3)

03/1999 - 03/2002

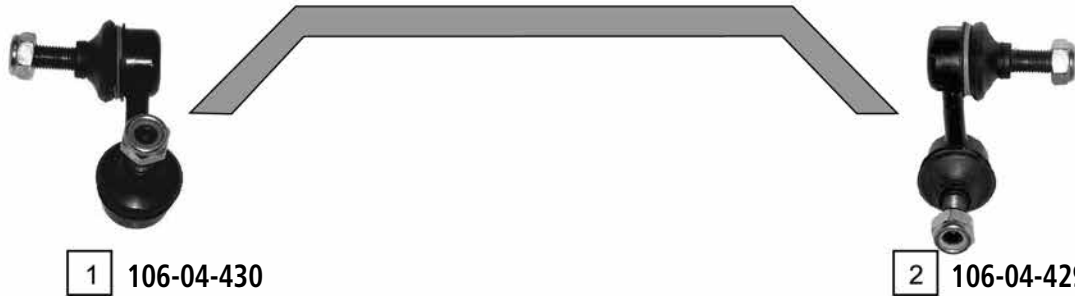

| Ref. | ASHIKA CODE | Description           | OEM           | Measures           | Ref. | ASHIKA CODE | Description              | OEM                           | Measures            |
|------|-------------|-----------------------|---------------|--------------------|------|-------------|--------------------------|-------------------------------|---------------------|
| 1    | 106-04-430  | Stabiliser Link Left  | 51321-S2G-003 | L:55               | 6    | 111-04-417  | Tie Rod End              | 53540-SX8-T01                 | c:13.5 th:FM12X1.25 |
| 2    | 106-04-429  | Stabiliser Link Right | 51320-S2G-003 | L:55               | 7    | GOM-442     | Silentblock For Susp.Arm | Part of 72-04-432 / 72-04-433 |                     |
| 3    | 103-04-423  | Axial Joint           | 53010-S50-003 | th:MM14X1.5R L:300 | 8    | GOM-443     | Silentblock For Susp.Arm | Part of 72-04-432 / 72-04-433 |                     |
| 4    | 72-04-432   | TCA Left              | 51360 S50 G01 | c:14.5             | 9    | 73-04-409   | Ball Joint               | Part of 72-04-432 / 72-04-433 |                     |
| 5    | 72-04-433   | TCA Right             | 51350 S50 G01 |                    |      |             |                          |                               |                     |

# HONDA PRELUDE



PRELUDE I (SN)

11/1978 - 10/1982

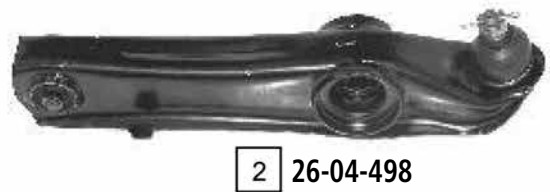

| Ref | ASHIKA CODE | Description | OEM           | Measures           | Ref | ASHIKA CODE | Description | OEM           | Measures |
|-----|-------------|-------------|---------------|--------------------|-----|-------------|-------------|---------------|----------|
| 1   | 111-04-401  | Tie Rod End | 53540-611-010 | c:13 th:FM12X1.25R | 3   | 103-04-403  | Axial Joint | 53521-SA0-003 |          |
| 2   | 26-04-498   | TCA         | 51350-692-000 | c:14.4             |     |             |             |               |          |

PRELUDE II (AB)

11/1983 - 04/1987

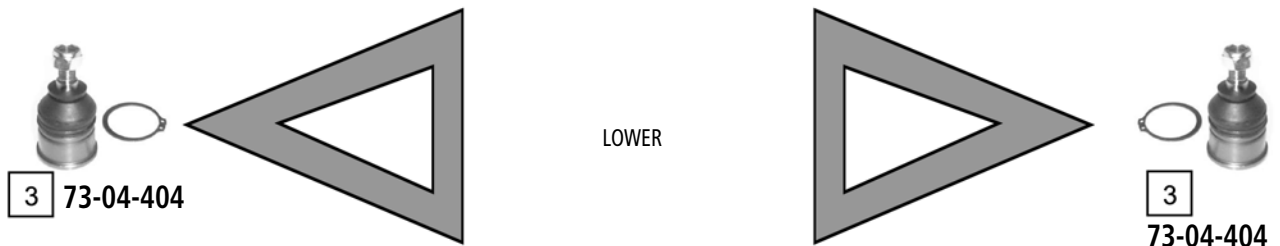

| Ref. | ASHIKA CODE | Description | OEM           | Measures           | Ref. | ASHIKA CODE | Description      | OEM           | Measures |
|------|-------------|-------------|---------------|--------------------|------|-------------|------------------|---------------|----------|
| 1    | 111-04-401  | Tie Rod End | 53540-611-010 | c:13 th:FM12X1.25R | 3    | 73-04-404   | Ball Joint Lower | 51220 SEO 000 | c:14.5   |
| 2    | 73-04-405   | Ball Joint  | 51270SB0003   | c:13               | 4    | 103-04-406  | Axial Joint      | 53540-SF1-004 |          |



# HONDA PRELUDE



PRELUDE III (BA)

04/1986 - 01/1992



2 111-04-499



4 103-04-406



4 103-04-406



2 111-04-499



3 111-04-486

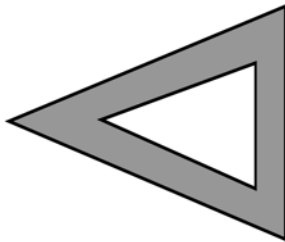

UPPER

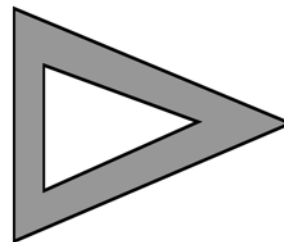

3 111-04-486



1 73-04-404

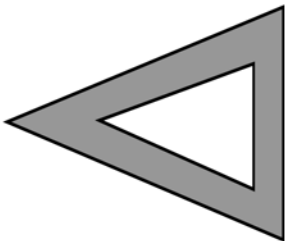

LOWER

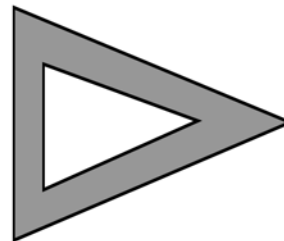

1 73-04-404

| Ref | ASHIKA CODE | Description      | OEM           | Measures           | Ref | ASHIKA CODE | Description      | OEM           | Measures |
|-----|-------------|------------------|---------------|--------------------|-----|-------------|------------------|---------------|----------|
| 1   | 73-04-404   | Ball Joint Lower | 51220 SEO 000 | c:14.5             | 3   | 111-04-486  | Ball Joint Upper | 51270-SF1-003 | c:13     |
| 2   | 111-04-499  | Tie Rod End      | 53540 SF1004  | c:14 th:FM12X1.25R | 4   | 103-04-406  | Axial Joint      | 53540-SF1-004 |          |

PRELUDE IV (BB)

02/1992 - 09/1996



THREAD HOUSING M14X1.5

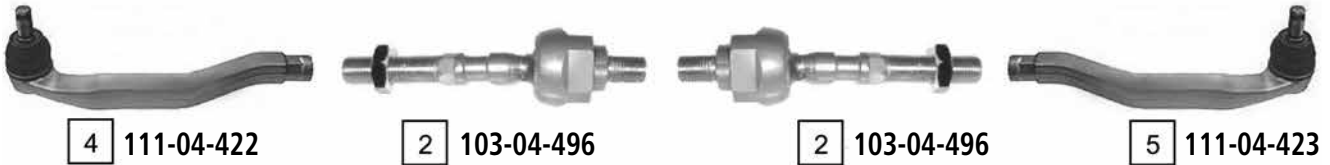

THREAD HOUSING M14X1.25

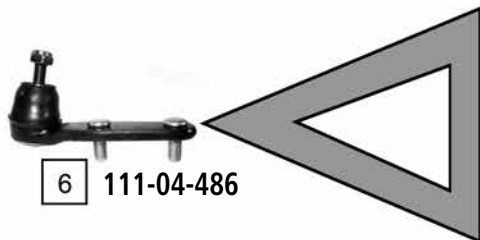

UPPER

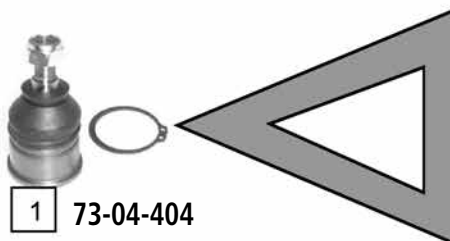
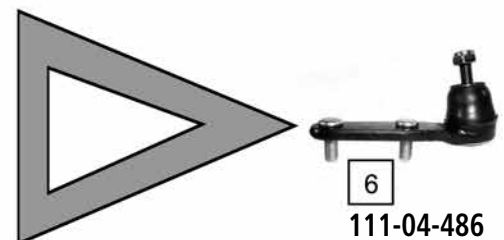

LOWER

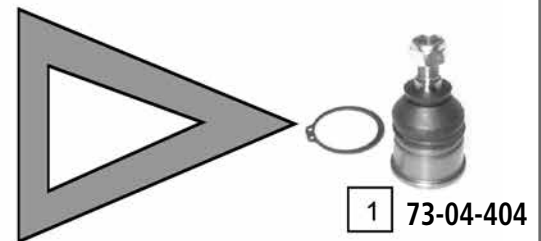

| Ref. | ASHIKA CODE | Description      | OEM           | Measures           | Ref. | ASHIKA CODE | Description       | OEM           | Measures |
|------|-------------|------------------|---------------|--------------------|------|-------------|-------------------|---------------|----------|
| 1    | 73-04-404   | Ball Joint Lower | 51220 SE0 000 | c:14.5             | 4    | 111-04-422  | Tie Rod End Left  | 53560 SSO 003 |          |
| 2    | 103-04-496  | Axial Joint      | 53010-SS0-000 | th:MM14X1,5R L:125 | 5    | 111-04-423  | Tie Rod End Right | 53540 SSO 003 |          |
| 3    | 103-04-498  | Axial Joint      | 53010-SS0-000 | th:MM14X1,5R L:125 | 6    | 111-04-486  | Ball Joint UPPER  | 51270-SF1-003 | c:13     |

# HONDA PRELUDE



PRELUDE V (BB)

10/1996 - 10/2000



1 106-04-431



1 106-04-431



3 111-04-424



6 103-04-421



6 103-04-421



4 111-04-425



5  
73-04-499

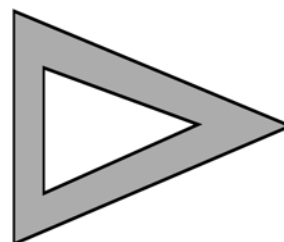
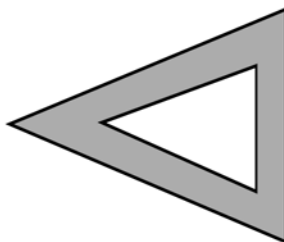

5  
73-04-499



2 106-04-432

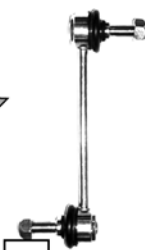

2 106-04-432

| Ref | ASHIKA CODE | Description     | OEM           | Measures | Ref | ASHIKA CODE | Description | OEM           | Measures            |
|-----|-------------|-----------------|---------------|----------|-----|-------------|-------------|---------------|---------------------|
| 1   | 106-04-431  | Stabiliser Link | 51320-S30-003 |          | 4   | 111-04-425  | Tie Rod End | 53540-S30-005 |                     |
| 2   | 106-04-432  | Stabiliser Link | 52320-S30-003 | L:165    | 5   | 73-04-499   | Ball Joint  | 51220-SL5-013 | c:18.5              |
| 3   | 111-04-424  | Tie Rod End     | 53560-S30-005 |          | 6   | 103-04-421  | Axial Joint | 53010-SW5-000 | th:MM14X1.25R L:122 |

QUINTET (SU)

02/1980 - 12/1984

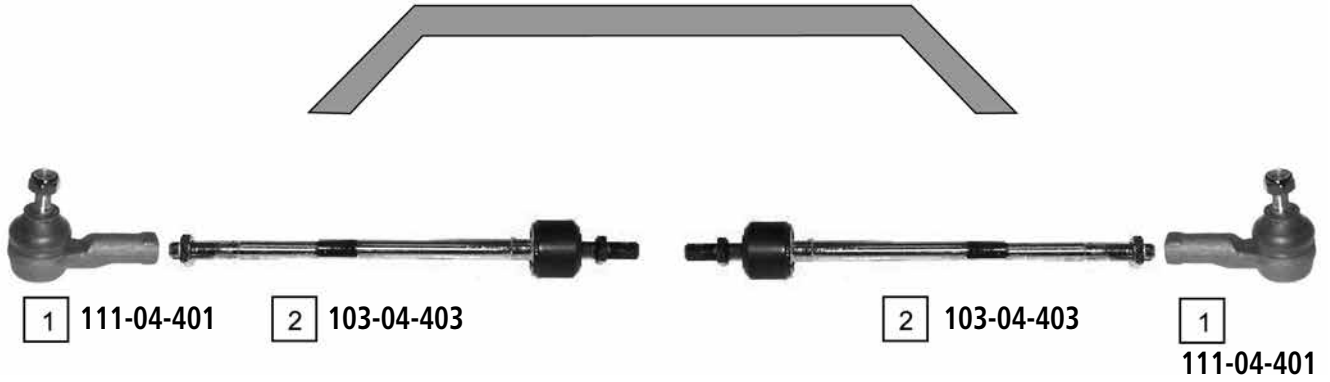

| Ref. | ASHIKA CODE | Description | OEM           | Measures           | Ref. | ASHIKA CODE | Description | OEM           | Measures |
|------|-------------|-------------|---------------|--------------------|------|-------------|-------------|---------------|----------|
| 1    | 111-04-401  | Tie Rod End | 53540-611-010 | c:13 th:FM12X1.25R | 2    | 103-04-403  | Axial Joint | 53521-SA0-003 |          |

# HYUNDAI ACCENT



ACCENT (X-3)

07/1994 - 01/2000



10 106-0H-H01



10 106-0H-H01



6 111-0H-H57

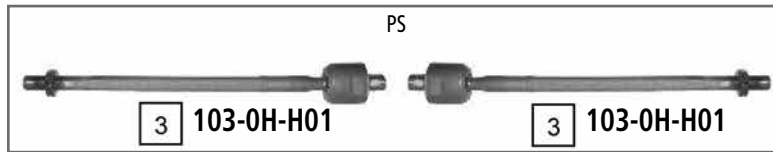

3 103-0H-H01

3 103-0H-H01

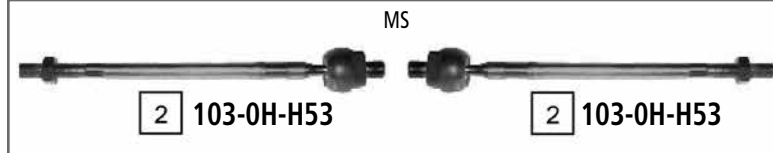

2 103-0H-H53

2 103-0H-H53



6 111-0H-H57



4 73-0H-H54L



7 GOM-H03

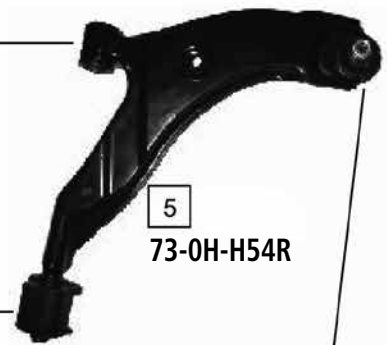

5 73-0H-H54R



8 GOM-H04



9 GOM-H05



1 73-0H-H57



1 73-0H-H57

| Ref | ASHIKA CODE | Description | OEM         | Measures            | Ref | ASHIKA CODE | Description              | OEM         | Measures            |
|-----|-------------|-------------|-------------|---------------------|-----|-------------|--------------------------|-------------|---------------------|
| 1   | 73-0H-H57   | Ball Joint  | 54520 31600 | c:15                | 6   | 111-0H-H57  | Tie Rod End              | 56820-28500 | c:13.6 th:FM14X1.5R |
| 2   | 103-0H-H53  | Axial Joint | 56540-22000 | th:MM16X1.5R L:296. | 7   | GOM-H03     | Silentblock For Susp.Arm | 54551 02000 | d:35                |
| 3   | 103-0H-H01  | Axial Joint | 57755-22000 | th:MM16X1.5R L:295  | 8   | GOM-H04     | Silentblock For Susp.Arm | 54555 22100 |                     |
| 4   | 73-0H-H54L  | TCA Left    | 54500-22200 |                     | 9   | GOM-H05     | Silentblock For Susp.Arm | 54556 22100 |                     |
| 5   | 73-0H-H54R  | TCA Right   | 54501-22200 |                     | 10  | 106-0H-H01  | Stabiliser Link          | 54825 22000 |                     |

ACCENT (LC)

01/2000 ->

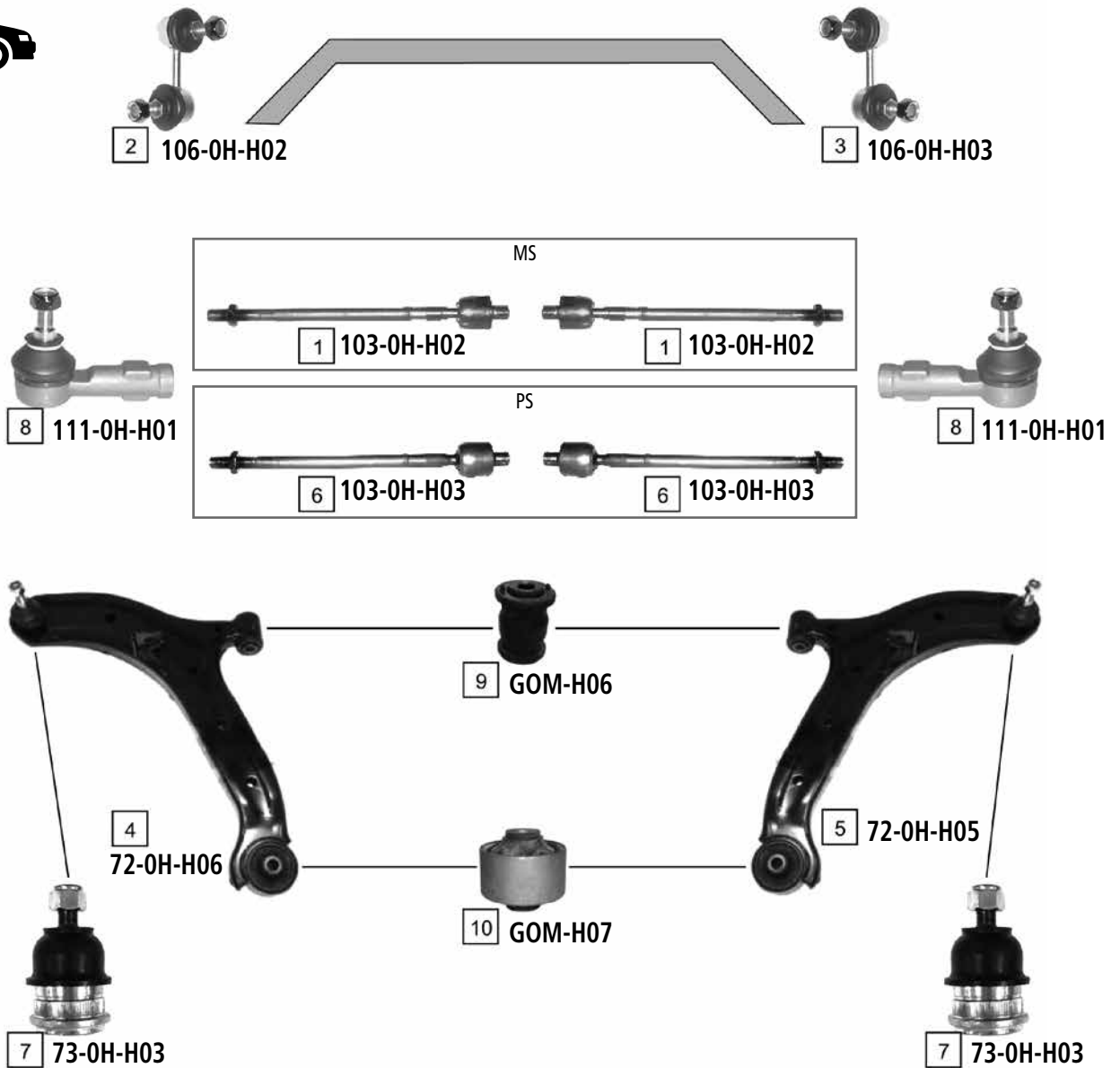

| Ref. | ASHIKA CODE | Description           | OEM         | Measures           | Ref. | ASHIKA CODE | Description              | OEM         | Measures            |
|------|-------------|-----------------------|-------------|--------------------|------|-------------|--------------------------|-------------|---------------------|
| 1    | 103-0H-H02  | Axial Joint           | 56540-25000 | th:MM16X1.5R L:305 | 7    | 73-0H-H03   | Ball Joint               | 54503-25A00 | c:15                |
| 2    | 106-0H-H02  | Stabiliser Link Left  | 54830-25010 | L:60               | 8    | 111-0H-H01  | Tie Rod End              | 56820-25000 | c:13.8 th:FM14X1.5R |
| 3    | 106-0H-H03  | Stabiliser Link Right | 54830-25020 | L:60               | 9    | GOM-H06     | Silentblock For Susp.Arm | 54551 25000 |                     |
| 4    | 72-0H-H06   | TCA Left              | 54500-25000 | c:15               | 10   | GOM-H07     | Silentblock For Susp.Arm | 54555 25000 |                     |
| 5    | 72-0H-H05   | TCA Right             | 54501-25000 | c:15               | 11   | 106-0H-H04  | Stabiliser Link          | 55830 25000 |                     |
| 6    | 103-0H-H03  | Axial Joint           | 57730 43010 | th:MM16X1.5R L:292 |      |             |                          |             |                     |

ACCENT (MC)

12/2005 ->

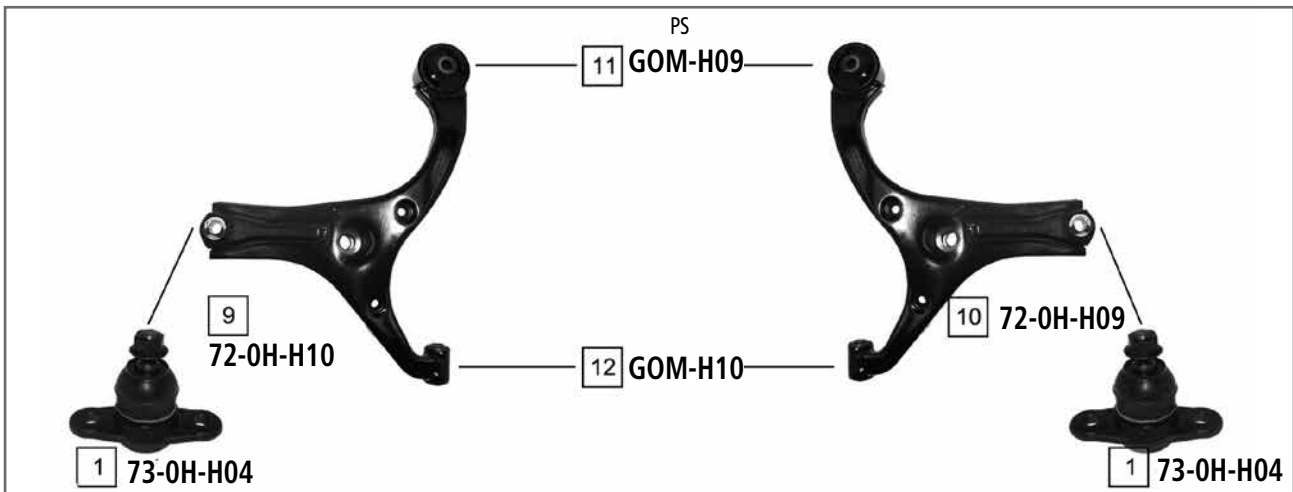
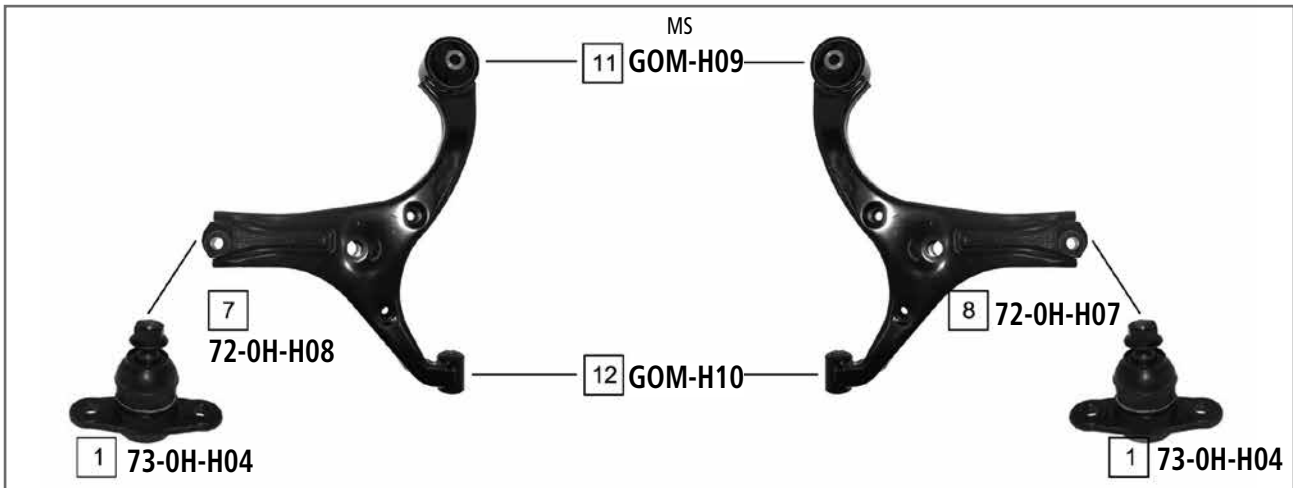
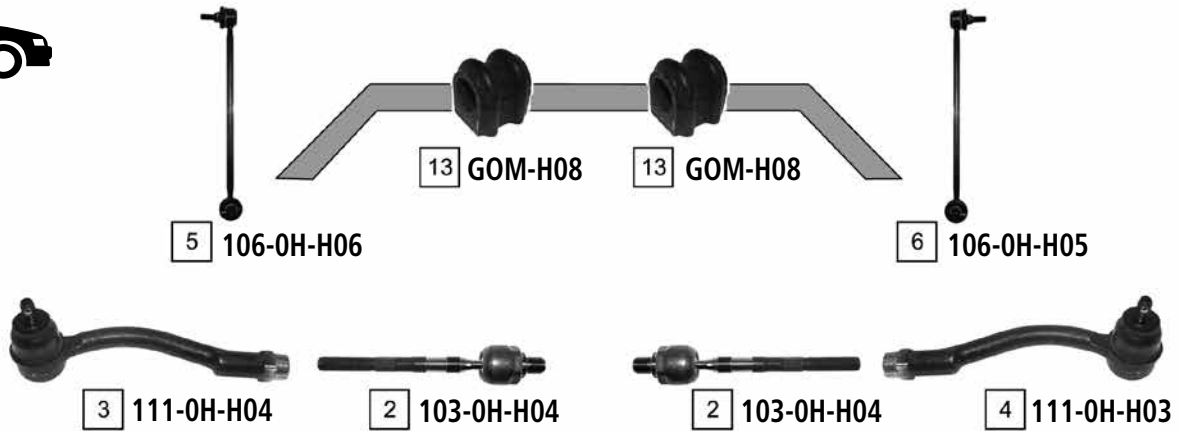

| Ref | ASHIKA CODE | Description           | OEM         | Measures           | Ref | ASHIKA CODE | Description              | OEM         | Measures |
|-----|-------------|-----------------------|-------------|--------------------|-----|-------------|--------------------------|-------------|----------|
| 1   | 73-0H-H04   | Ball Joint            | 51760 1G000 |                    | 8   | 72-0H-H07   | TCA Right                | 54501 1E100 |          |
| 2   | 103-0H-H04  | Axial Joint           | 57724 1E000 | th:MM16X1.5R L:195 | 9   | 72-0H-H10   | TCA Left                 | 54500 1E000 |          |
| 3   | 111-0H-H04  | Tie Rod End Left      | 56820 1E000 |                    | 10  | 72-0H-H09   | TCA Right                | 54501 1E000 |          |
| 4   | 111-0H-H03  | Tie Rod End Right     | 56820 1E900 |                    | 11  | GOM-H09     | Silentblock For Susp.Arm | 54584 1G000 |          |
| 5   | 106-0H-H06  | Stabiliser Link Left  | 54830 1G000 | L:285.5            | 12  | GOM-H10     | Silentblock For Susp.Arm | 54551 1E000 |          |
| 6   | 106-0H-H05  | Stabiliser Link Right | 54840 1G000 | L:285.5            | 13  | GOM-H08     | Stabiliser Mounting      | 54812 1G100 |          |
| 7   | 72-0H-H08   | TCA Left              | 54500 1E100 |                    |     |             |                          |             |          |

ATOS (MX)

02/1998 ->

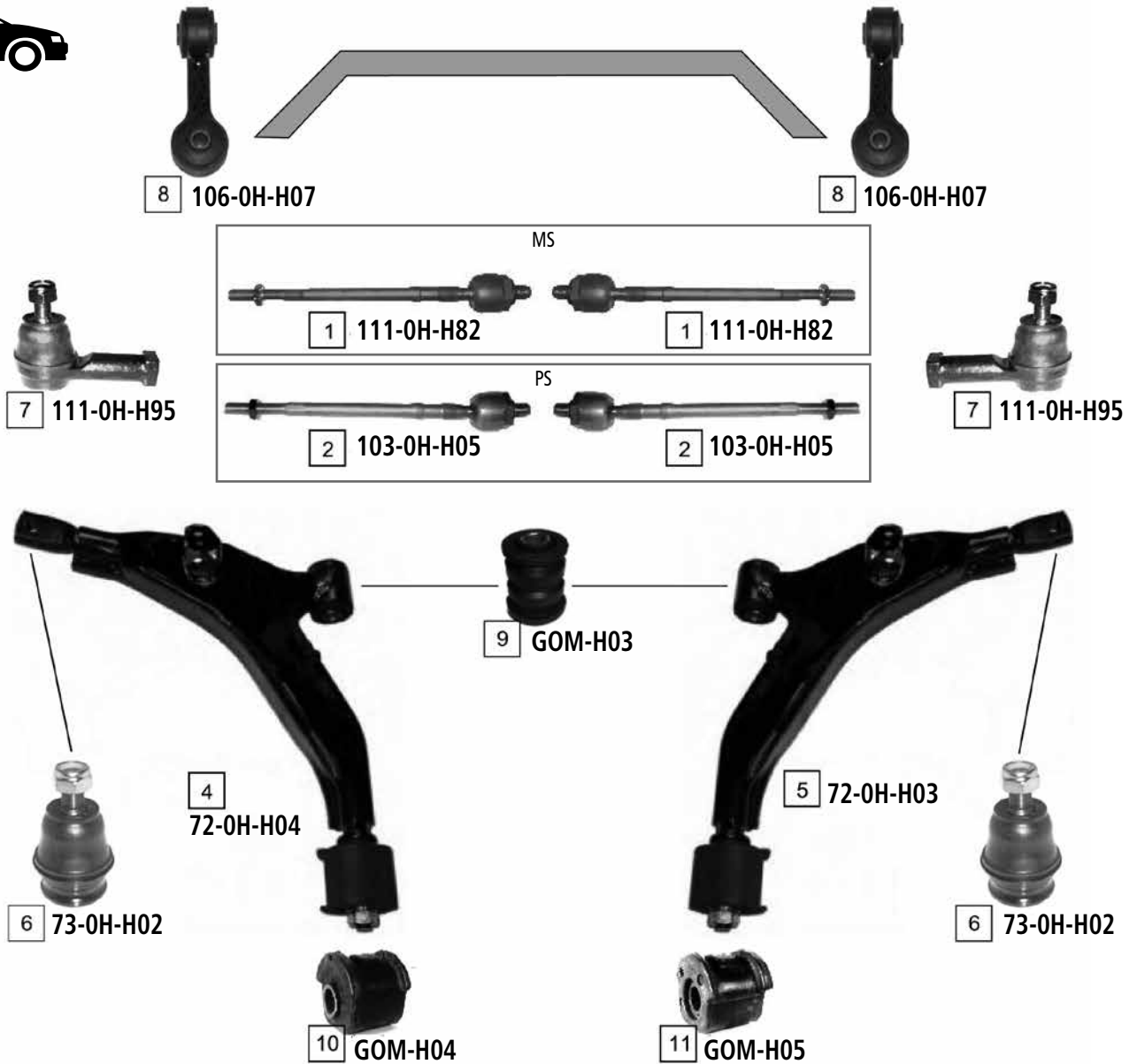

| Ref. | ASHIKA CODE | Description     | OEM         | Measures | Ref | ASHIKA CODE | Description              | OEM         | Measures            |
|------|-------------|-----------------|-------------|----------|-----|-------------|--------------------------|-------------|---------------------|
| 1    | 111-0H-H82  | Axial Joint     | 56540-02000 |          | 7   | 111-0H-H95  | Tie Rod End              | 56820-02500 | c:13.8 th:FM12X1.25 |
| 2    | 103-0H-H05  | Axial Joint     | 57755-02000 |          | 8   | 106-0H-H07  | Stabiliser Link          | 54820 02000 | L:70                |
| 3    | 111-0H-H91  | Stabiliser Link | 55530-29000 | L:130    | 9   | GOM-H03     | Silentblock For Susp.Arm | 54551 02000 | d:35                |
| 4    | 72-0H-H04   | TCA Left        | 54500 02050 | c:14.5   | 10  | GOM-H04     | Silentblock For Susp.Arm | 54555 22100 |                     |
| 5    | 72-0H-H03   | TCA Right       | 54501 02050 | c:14.5   | 11  | GOM-H05     | Silentblock For Susp.Arm | 54556 22100 |                     |
| 6    | 73-0H-H02   | Ball Joint      | 54530-02050 | c:13.35  |     |             |                          |             |                     |



# HYUNDAI COUPE



COUPE (RD)

08/1996 - 02/2002

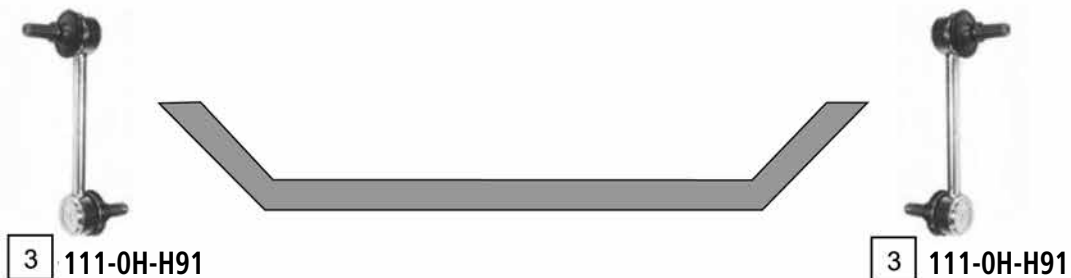

| Ref | ASHIKA CODE | Description     | OEM         | Measures            | Ref | ASHIKA CODE | Description | OEM         | Measures           |
|-----|-------------|-----------------|-------------|---------------------|-----|-------------|-------------|-------------|--------------------|
| 1   | 111-0H-H57  | Tie Rod End     | 56820-28500 | c:13.6 th:FM14X1.5R | 5   | 103-0H-H63  | Axial Joint | 57730 29000 | th:MM16X1.5R L:317 |
| 2   | 106-0H-H56  | Stabiliser Link | 54830-29000 | L:70.5              | 6   | 73-0H-H55L  | TCA         | 54500-29000 |                    |
| 3   | 111-0H-H91  | Stabiliser Link | 55530-29000 | L:130               | 7   | 73-0H-H55R  | TCA         | 54501-29000 |                    |
| 4   | 73-0H-H57   | Ball Joint      | 54520 31600 | c:15                |     |             |             |             |                    |

COUPE (GK)

03/2002 ->



| Ref. | ASHIKA CODE | Description     | OEM         | Measures            | Ref. | ASHIKA CODE | Description | OEM         | Measures |
|------|-------------|-----------------|-------------|---------------------|------|-------------|-------------|-------------|----------|
| 1    | 106-0H-H09  | Stabiliser Link | 54840-2C000 | L:286               | 5    | 72-0H-H12   | TCA Left    | 54500-2C000 |          |
| 2    | 106-0H-H08  | Stabiliser Link | 54830-2C000 | L:286               | 6    | 72-0H-H11   | TCA Right   | 54501-2C000 |          |
| 3    | 103-0H-H06  | Axial Joint     | 57724-2D000 | th:MM16X1.5R L:327  | 7    | 73-0H-H03   | Ball Joint  | 54503-25A00 | c:15     |
| 4    | 111-0H-H01  | Tie Rod End     | 56820-25000 | c:13.8 th:FM14X1.5R |      |             |             |             |          |

ELANTRA (XD)

06/2000 ->

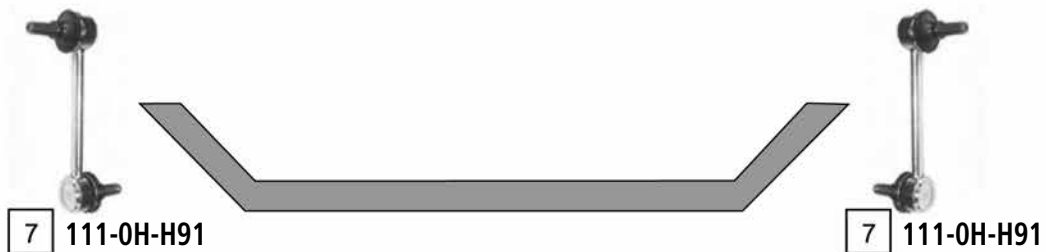

| Ref | ASHIKA CODE | Description     | OEM         | Measures           | Ref | ASHIKA CODE | Description     | OEM         | Measures            |
|-----|-------------|-----------------|-------------|--------------------|-----|-------------|-----------------|-------------|---------------------|
| 1   | 106-0H-H53  | Stabiliser Link | 54830 34500 | L:52               | 5   | 111-0H-H01  | Tie Rod End     | 56820-25000 | c:13.8 th:FM14X1.5R |
| 2   | 103-0H-H06  | Axial Joint     | 57724-2D000 | th:MM16X1.5R L:327 | 6   | 73-0H-H03   | Ball Joint      | 54503-25A00 | c:15                |
| 3   | 72-0H-H14   | TCA             | 54500 2D000 |                    | 7   | 111-0H-H91  | Stabiliser Link | 55530-29000 | L:130               |
| 4   | 72-0H-H13   | TCA             | 54501 2D000 |                    |     |             |                 |             |                     |

GALLOPER II (JK-01)

08/1998 ->

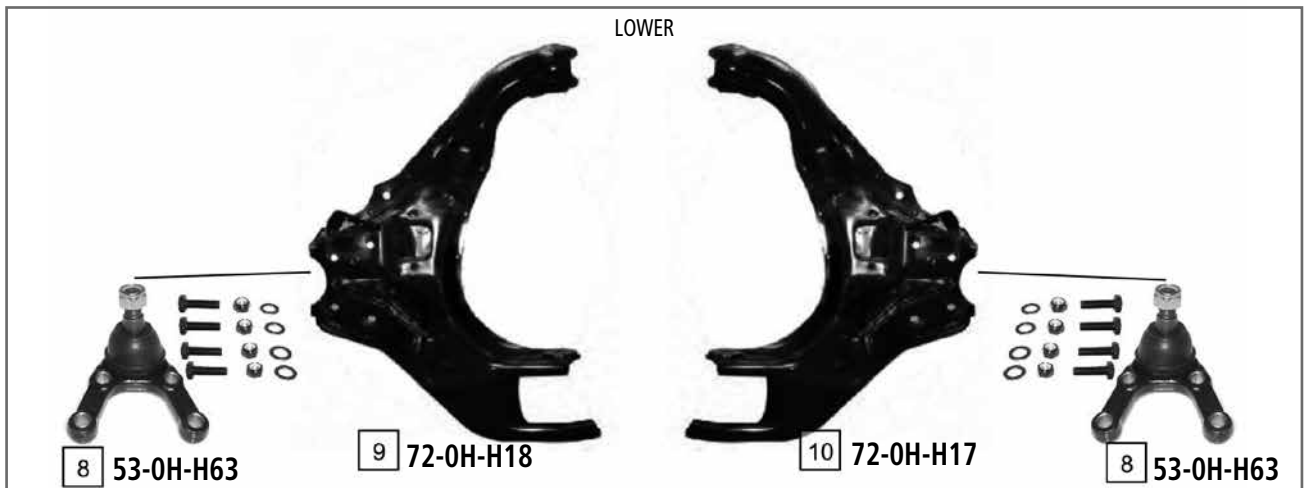
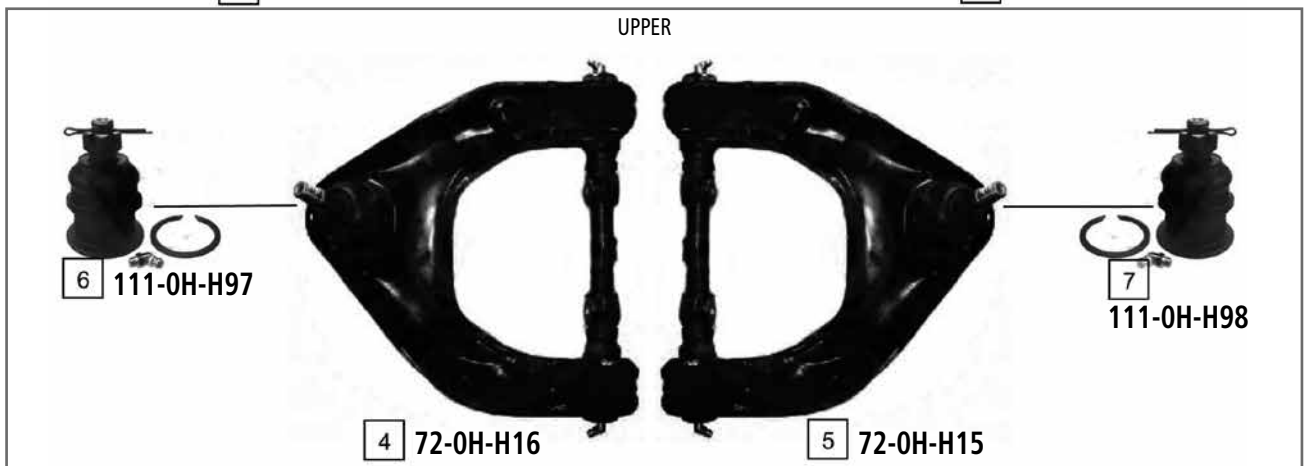
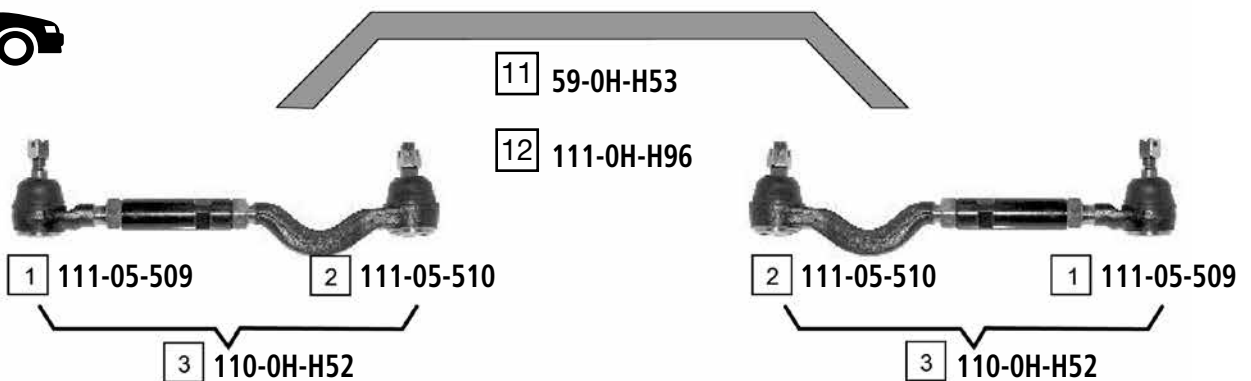

| Ref. | ASHIKA CODE | Description           | OEM         | Measures            | Ref. | ASHIKA CODE | Description            | OEM         | Measures |
|------|-------------|-----------------------|-------------|---------------------|------|-------------|------------------------|-------------|----------|
| 1    | 111-05-509  | Tie Rod End           | MB241171    | c:13.6 th:MM16X1.5L | 7    | 111-0H-H98  | Ball Joint UPPER Right | 54431-44000 |          |
| 2    | 111-05-510  | Tie Rod End           | MB241206    | c:13.8 th:MM16X1.5R | 8    | 53-0H-H63   | Ball Joint             | HB212-100   | c:19.5   |
| 3    | 110-0H-H52  | Tie Rod               | HB568-100   |                     | 9    | 72-0H-H18   | TCA Left               | HB212003    |          |
| 4    | 72-0H-H16   | TCA                   | MB109630A   |                     | 10   | 72-0H-H17   | TCA Right              | HB212004    |          |
| 5    | 72-0H-H15   | TCA                   | MB109631A   |                     | 11   | 59-0H-H53   |                        | MB673525B   |          |
| 6    | 111-0H-H97  | Ball Joint UPPER Left | 54417-44000 |                     | 12   | 59-0H-H96   |                        | MB673525A   |          |

GETZ (TB)

09/2002 ->

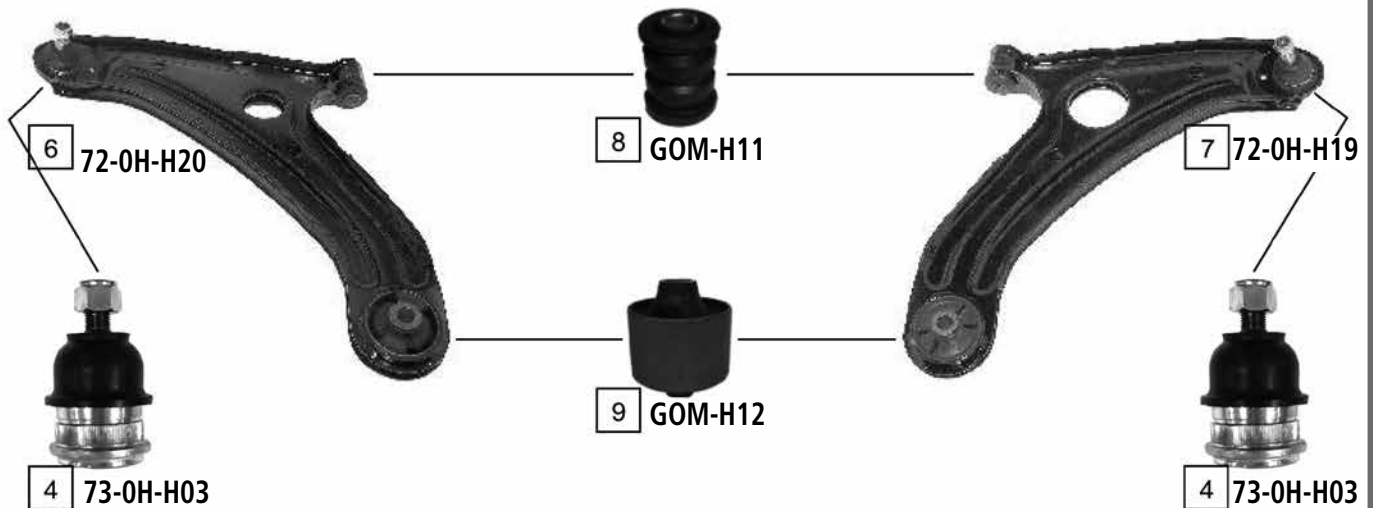

| Ref | ASHIKA CODE | Description           | OEM         | Measures            | Ref | ASHIKA CODE | Description              | OEM                           | Measures |
|-----|-------------|-----------------------|-------------|---------------------|-----|-------------|--------------------------|-------------------------------|----------|
| 1   | 106-0H-H10  | Stabiliser Link Left  | 54830-1C000 | L:198               | 6   | 72-0H-H20   | TCA Left                 | 54500-1C000                   | c:15     |
| 2   | 106-0H-H11  | Stabiliser Link Right | 54840-1C000 | L:198               | 7   | 72-0H-H19   | TCA Right                | 54501-1C000                   | c:15     |
| 3   | 103-0H-H07  | Axial Joint           | 57755-1C000 | th:MM16X1.5R L:316  | 8   | GOM-H11     | Silentblock For Susp.Arm | Part of 72-0H-H20 / 72-0H-H19 | d:32.8   |
| 4   | 73-0H-H03   | Ball Joint            | 54503-25A00 | c:15                | 9   | GOM-H12     | Silentblock For Susp.Arm | Part of 72-0H-H20 / 72-0H-H19 | d:63.3   |
| 5   | 111-0H-H05  | Tie Rod End           | 56820-3B000 | c:13.4 th:FM14X1.5R |     |             |                          |                               |          |

H1 / H200 / STAREX

01/1996 - 11/2002

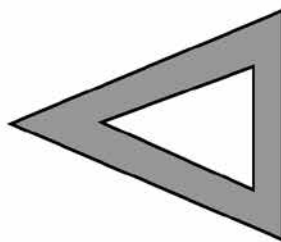

UPPER

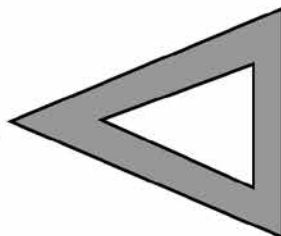
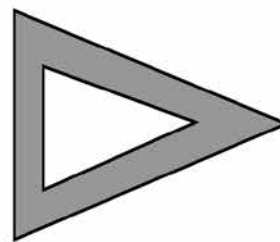

LOWER

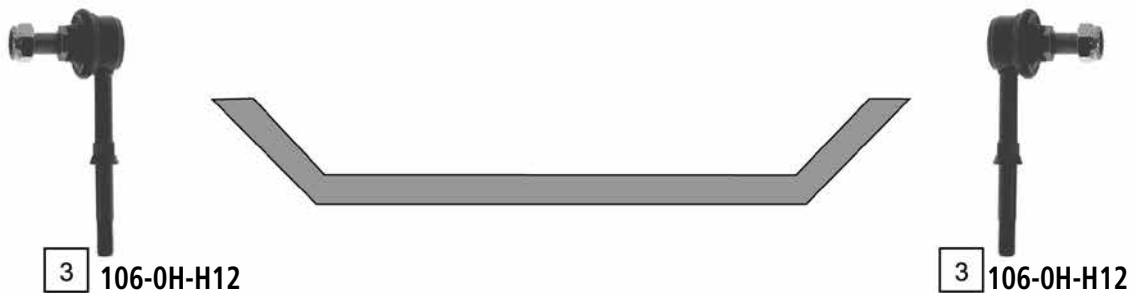
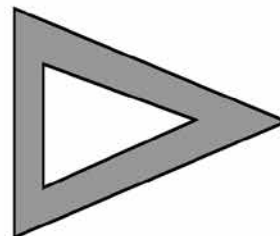

| Ref. | ASHIKA CODE | Description     | OEM         | Measures            | Ref. | ASHIKA CODE | Description      | OEM         | Measures           |
|------|-------------|-----------------|-------------|---------------------|------|-------------|------------------|-------------|--------------------|
| 1    | 111-0H-H59  | Tie Rod End     | 56872 43010 | c:13.7 th:FM14X1.5L | 4    | 53-0H-H77   | Ball Joint Upper | 54417 43A00 | c:17.6             |
| 2    | 106-0H-H58  | Stabiliser Link | 54830-4A003 | L:54                | 5    | 53-0H-H66   | Ball Joint       | 54530-4AA00 | c:19.5             |
| 3    | 106-0H-H12  | Stabiliser Link | 55530-4A001 |                     | 6    | 103-0H-H08  | Axial Joint      | 57729 4A000 | th:MM16X1.5R L:292 |

H1 (CARGO / TRAVEL)

02/2008 ->

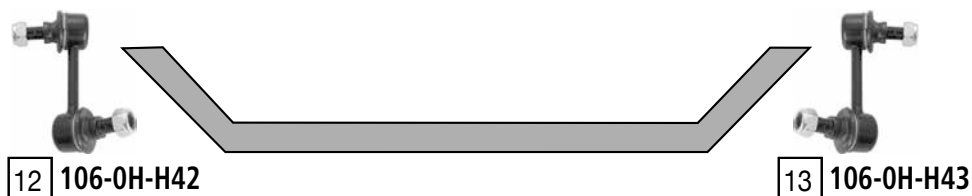
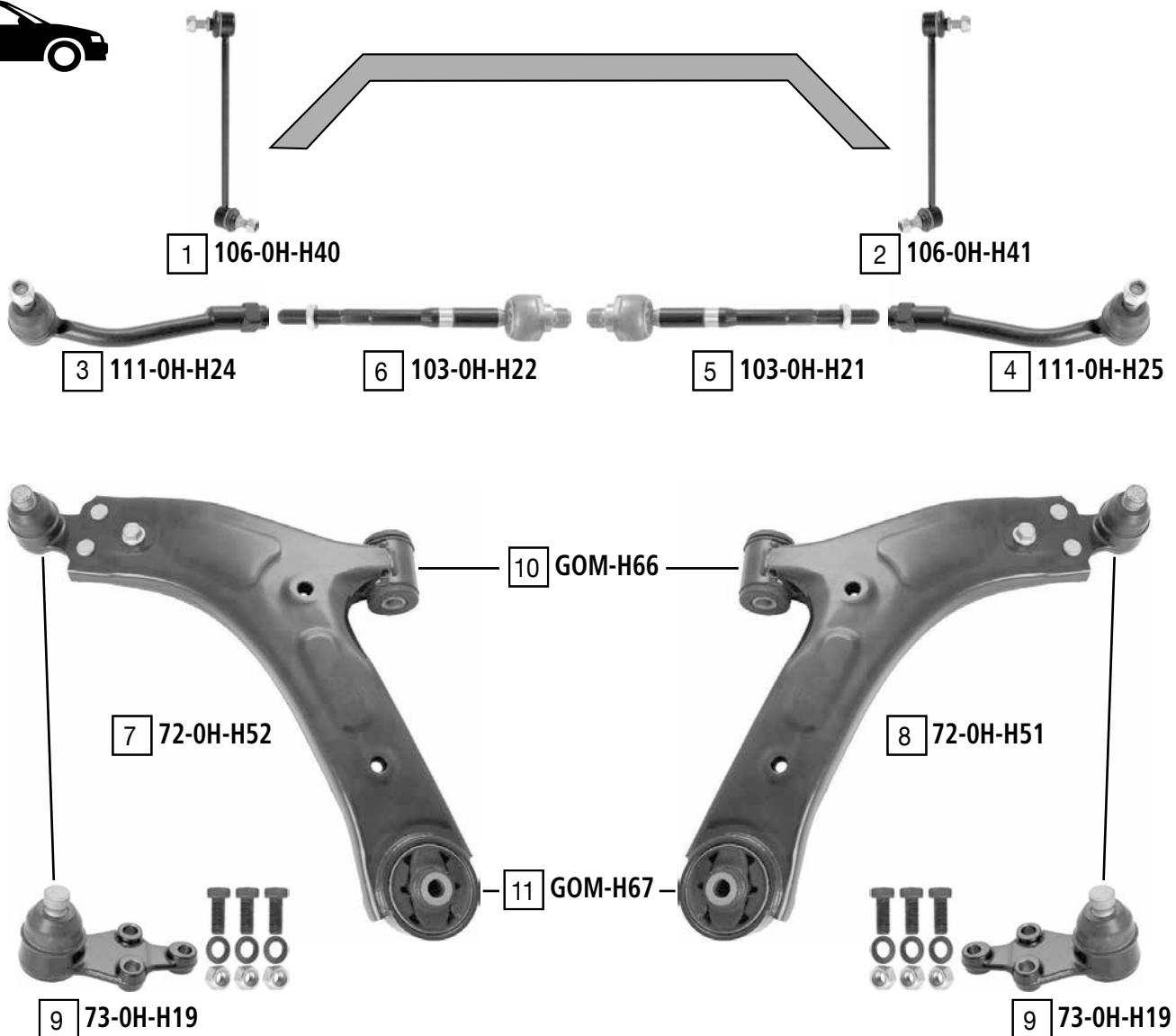

| Ref | ASHIKA CODE | Description           | OEM         | Measures            | Ref | ASHIKA CODE | Description           | OEM         | Measures        |
|-----|-------------|-----------------------|-------------|---------------------|-----|-------------|-----------------------|-------------|-----------------|
| 1   | 106-0H-H40  | Stabiliser Link Left  | 54830 4H200 | L:275               | 8   | 72-0H-H51   | TCA right wbj         | 54501 4H000 | c:19.9          |
| 2   | 106-0H-H41  | Stabiliser Link Right | 54840 4H200 | L:275               | 9   | 73-0H-H19   | Ball joint            | 54530 3J000 | c:20            |
| 3   | 111-0H-H24  | Tie Rod End Left      | 56820 4H000 | c:13.9 th:FM14X1.5R | 10  | GOM-H66     | Silentblock for TCA   | Part of     | di:14.5 do:42   |
| 4   | 111-0H-H25  | Tie Rod End Right     | 56820 4H100 | c:13.9 th:FM14X1.5R | 11  | GOM-H67     | Silentblock for TCA   | Part of     | di:14.4 do:69.5 |
| 5   | 103-0H-H21  | Axial Joint           | 57724 4H100 | th:MM18X1.5R L:241  | 12  | 106-0H-H42  | Stabiliser link left  | 55530 4H000 | L:84            |
| 6   | 103-0H-H22  | Axial Joint           | 57724 4H000 | th:MM18X1.5R L:241  | 13  | 106-0H-H43  | Stabiliser link right | 55540 4H000 | L:84            |
| 7   | 72-0H-H52   | TCA left wbj          | 54500 4H000 | c:20                |     |             |                       |             |                 |

H100

07/1993 - 02/2004

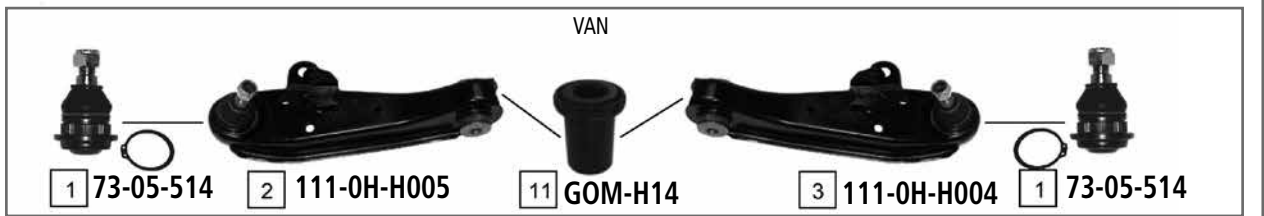
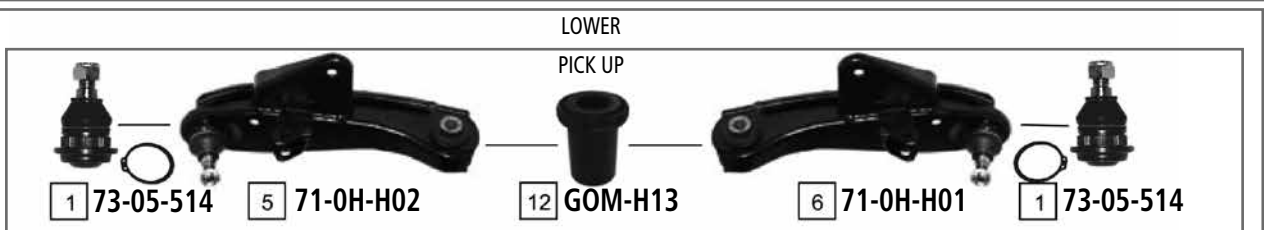
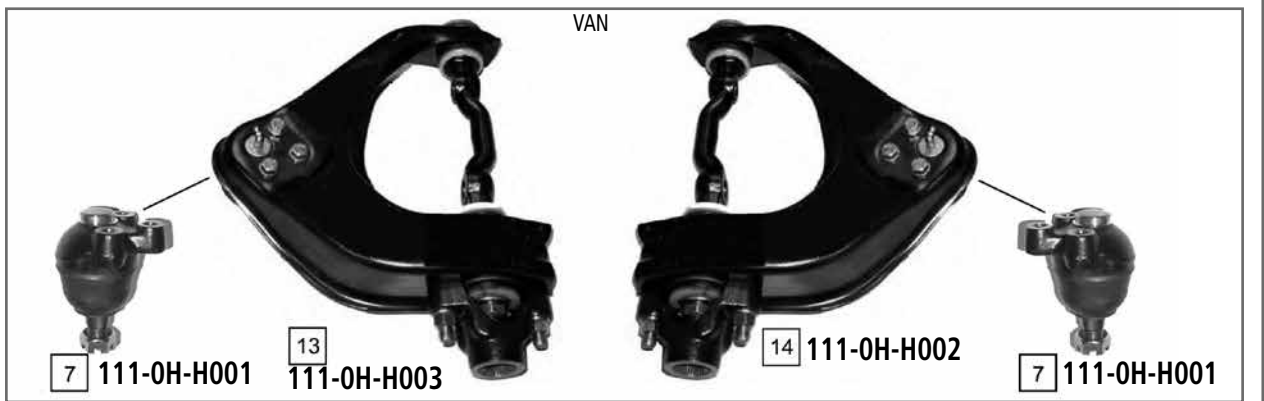
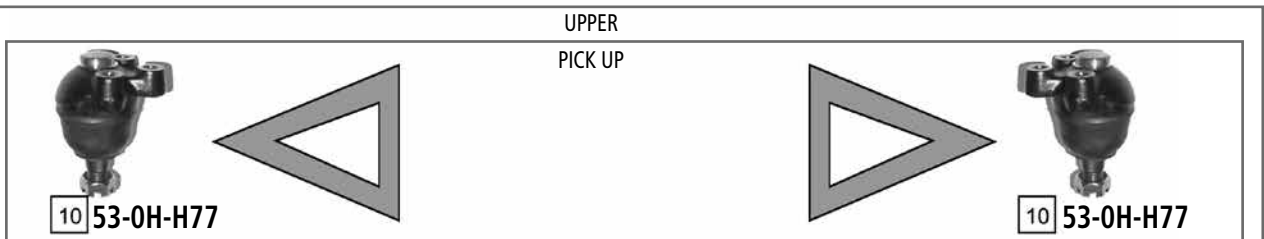
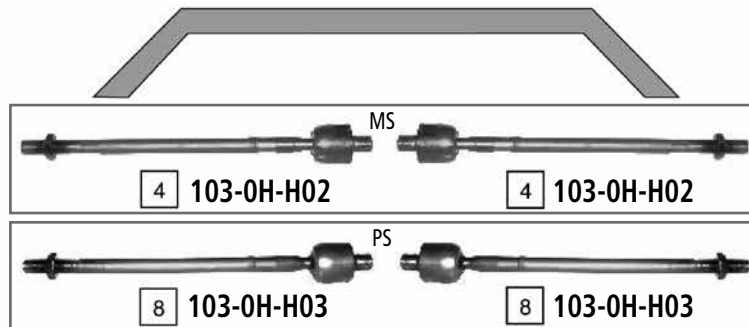

| Ref | ASHIKA CODE | Description      | OEM         | Measures           | Ref | ASHIKA CODE | Description              | OEM                             | Measures            |
|-----|-------------|------------------|-------------|--------------------|-----|-------------|--------------------------|---------------------------------|---------------------|
| 1   | 73-05-514   | Ball Joint Lower |             | c:19.6             | 8   | 103-0H-H03  | Axial Joint              | 57730 43010                     | th:MM16X1.5R L:292  |
| 2   | 111-0H-H005 | TCA              | 54510 43152 | c:19.5             | 9   | 111-0H-H59  | Tie Rod End              | 56872 43010                     | c:13.7 th:FM14X1.5R |
| 3   | 111-0H-H004 | TCA              | 54540 43152 | c:19.5             | 10  | 53-0H-H77   | Ball Joint Upper         | 54417 43A00                     | c:17.6              |
| 4   | 103-0H-H02  | Axial Joint      | 56540-25000 | th:MM16X1.5R L:305 | 11  | GOM-H14     | Silentblock For Susp.Arm | Part of 111-0H-H005/111-0H-H004 | d:45.8              |
| 5   | 71-0H-H02   | TCA Left         | 54510 48001 | c:19.6             | 12  | GOM-H13     | Silentblock For Susp.Arm | Part of 71-0H-H02/71-0H-H01     | d:42.3              |
| 6   | 71-0H-H01   | TCA Right        | 54540 48001 | c:19.6             | 13  | 111-0H-H003 | TCA Left                 | 54410 43004                     |                     |
| 7   | 111-0H-H001 | Ball Joint Upper | 54417 43000 |                    | 14  | 111-0H-H002 | TCA Right                | 54430 43004                     |                     |



i10

12/2007 ->



1 106-0H-H34

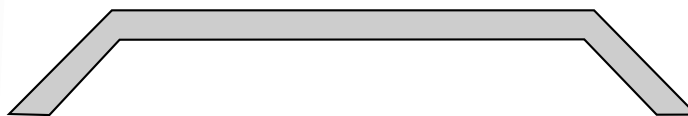

2 106-0H-H35



3 111-0H-H19



4 103-0H-H17



4 103-0H-H17



3 111-0H-H19

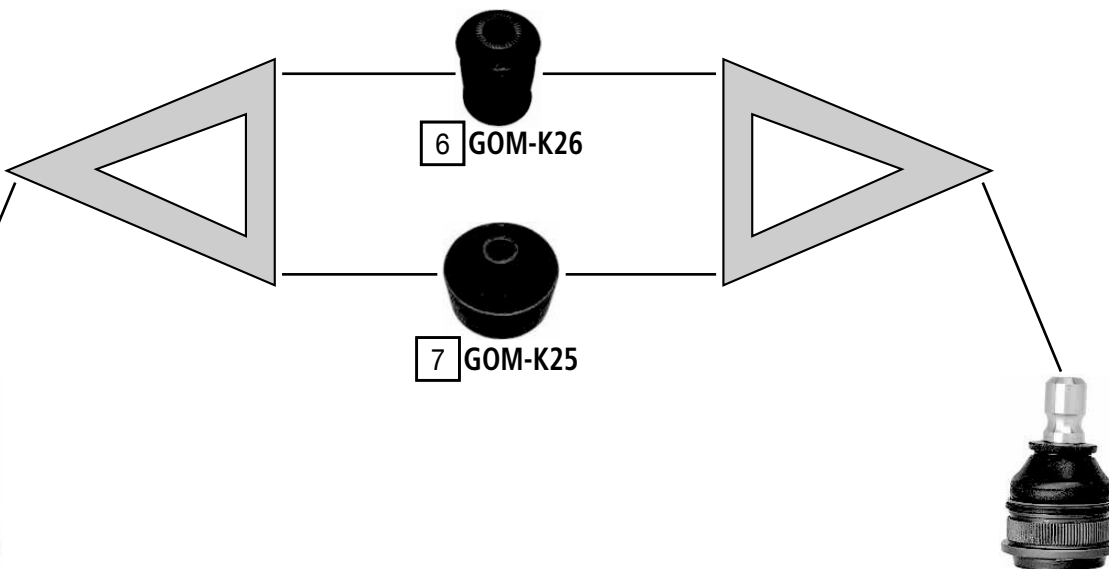

5 73-0K-K03

6 GOM-K26

7 GOM-K25



5 73-0K-K03

| Ref | ASHIKA CODE | Description           | OEM         | Measures             | Ref | ASHIKA CODE | Description         | OEM         | Measures        |
|-----|-------------|-----------------------|-------------|----------------------|-----|-------------|---------------------|-------------|-----------------|
| 1   | 106-0H-H34  | Stabiliser link left  | 54830 0X000 | L:230                | 5   | 73-0K-K03   | Ball Joint          | 54530 07000 | c:16 do:40      |
| 2   | 106-0H-H35  | Stabiliser link right | 54840 0X000 | L:230                | 6   | GOM-K26     | Silentblock For TCA | 54551 07000 | di:12.3 do:33   |
| 3   | 111-0H-H19  | Tie rod end           | 56820 0X010 | c:13.5 th:FM12x1.25R | 7   | GOM-K25     | Silentblock For TCA | 54584 0X000 | di:12.3 do:60.3 |
| 4   | 103-0H-H17  | Axial joint           | 57724 0X010 | th:MM16x1.5R L:295   |     |             |                     |             |                 |

i20

09/2008 ->

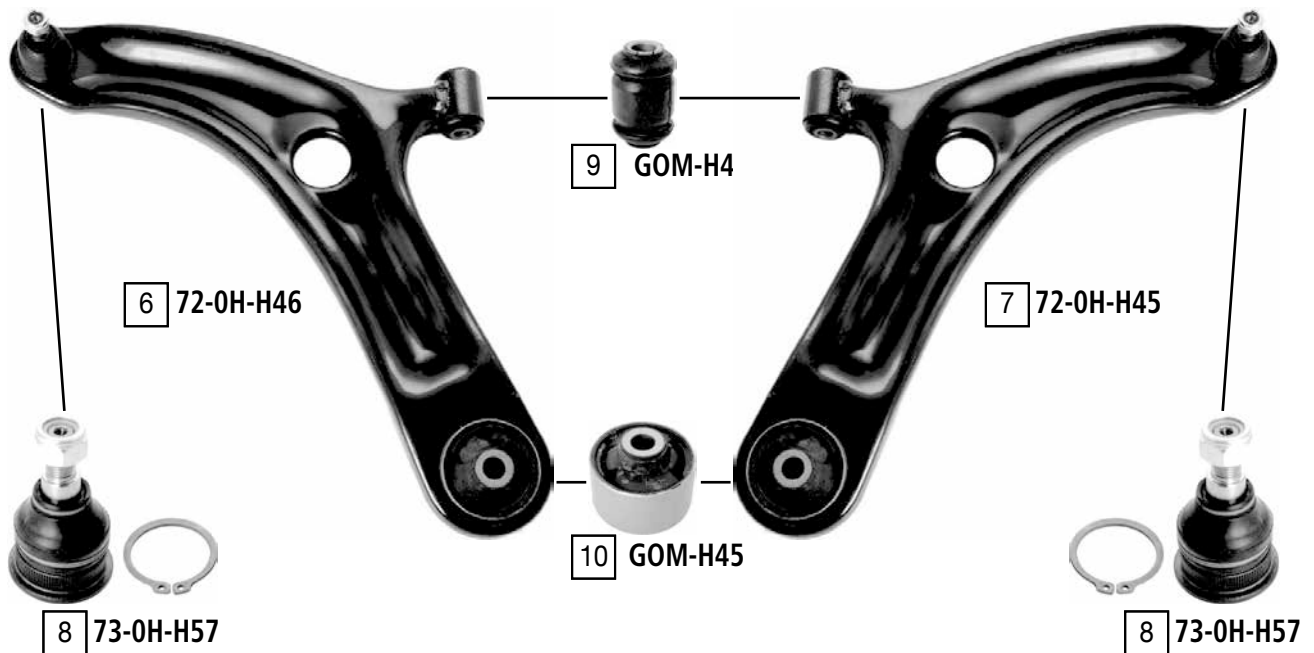
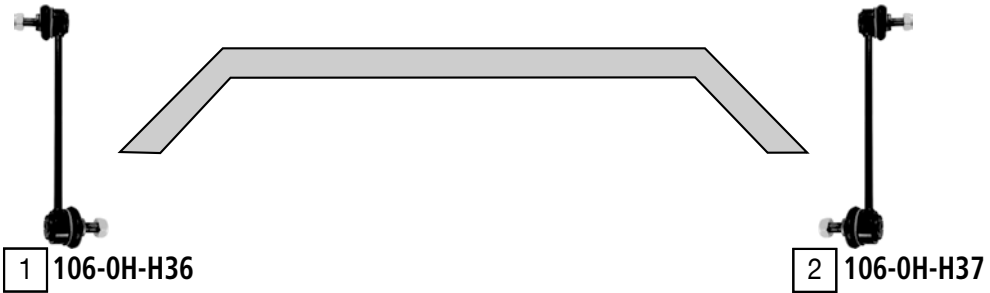

| Ref | ASHIKA CODE | Description           | OEM         | Measures            | Ref | ASHIKA CODE | Description         | OEM         | Measures         |
|-----|-------------|-----------------------|-------------|---------------------|-----|-------------|---------------------|-------------|------------------|
| 1   | 106-0H-H36  | Stabiliser Link Left  | 54830 1J000 | L:216               | 6   | 72-0H-H46   | TCA left wbj        | 54500 1J700 | c:15             |
| 2   | 106-0H-H37  | Stabiliser Link Right | 54840 1J000 | L:216               | 7   | 72-0H-H45   | TCA right wbj       | 54501 1J700 | c:15             |
| 3   | 111-0H-H20  | Tie Rod End Left      | 56820 2K000 | c:13.4 th:FM16X1.5R | 8   | 73-0H-H57   | Ball Joint          | 54530 31600 | c:15 do:40       |
| 4   | 111-0H-H21  | Tie Rod End Right     | 56820 2K050 | c:13.4 th:FM16X1.5R | 9   | GOM-H44     | Silentblock For TCA | 54551 1J000 | di:12.3 do:33.5  |
| 5   | 103-0H-H18  | Axial Joint           | 57724 1J000 | th:MM16X1.5R L:223  | 10  | GOM-H45     | Silentblock For TCA | 54584 1J000 | di:14.45 do:66.3 |

i30  
i30 CW ESTATE

10/2007 ->  
02/2008 ->

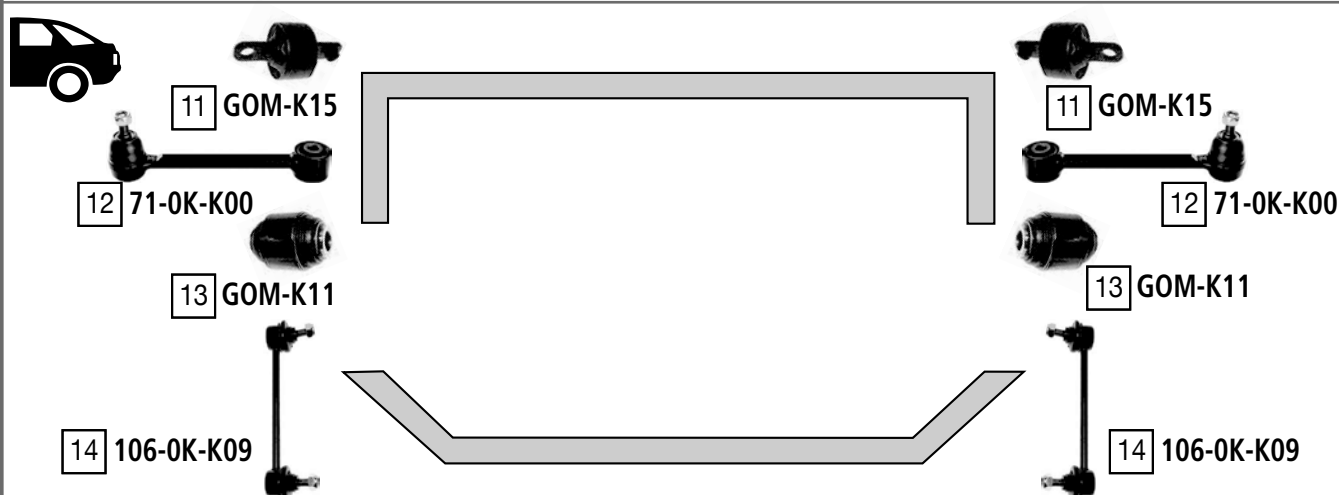
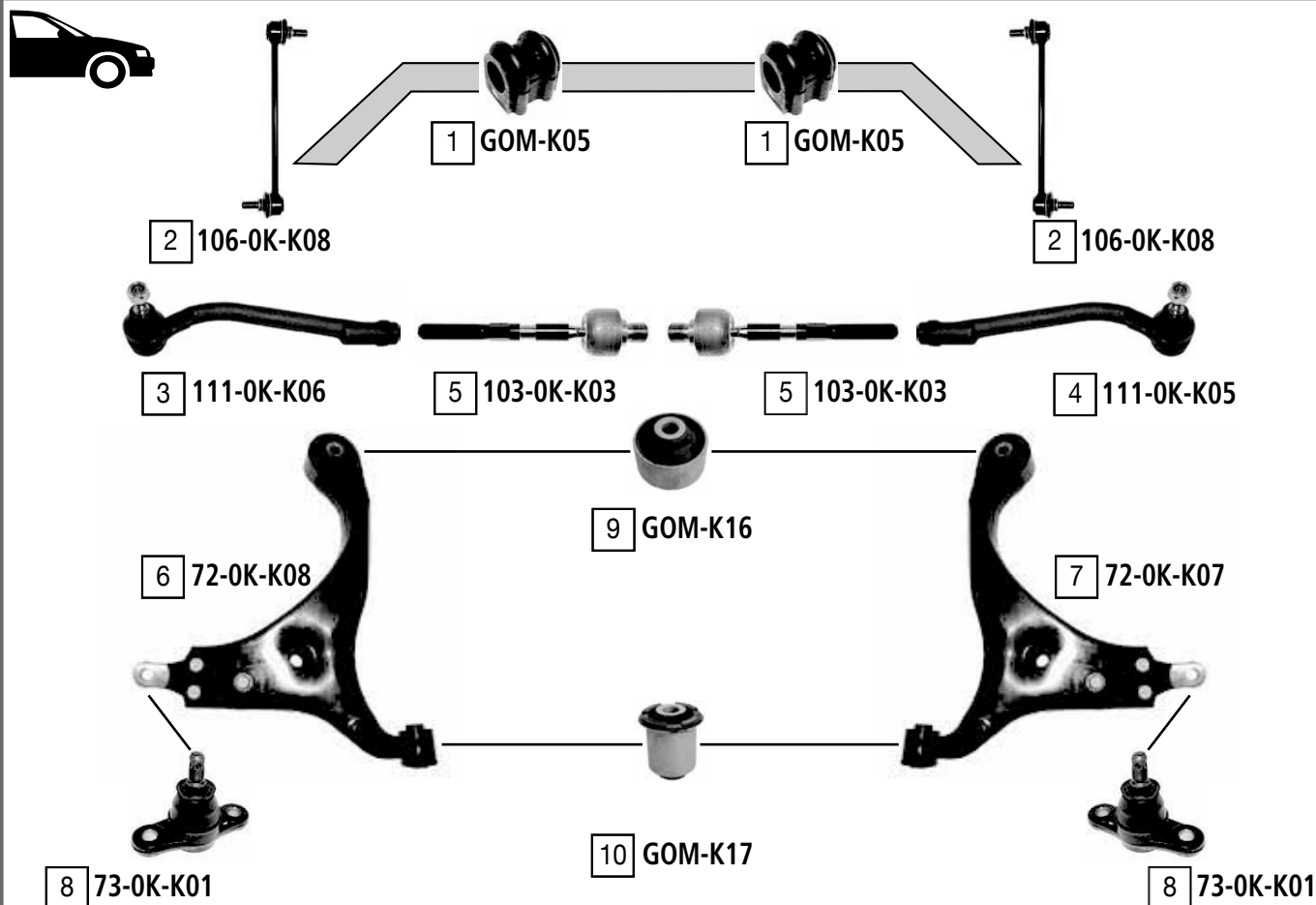

| Ref | ASHIKA CODE | Description         | OEM         | Measures            | Ref | ASHIKA CODE | Description               | OEM         | Measures      |
|-----|-------------|---------------------|-------------|---------------------|-----|-------------|---------------------------|-------------|---------------|
| 1   | GOM-K05     | Stabiliser Mounting | 54813 1H100 | di:23.4             | 8   | 73-0K-K01   | Ball Joint                | 51760 0Q000 | c:14.9        |
| 2   | 106-0K-K08  | Stabiliser Link     | 54830 2H100 | L:243               | 9   | GOM-K16     | Silentblock ForTCA        | 54584 2H000 | di:14 do:66   |
| 3   | 111-0K-K06  | Tie Rod End Left    | 56820 2H000 | c:13.3 th:FM14x1.5R | 10  | GOM-K17     | Silentblock ForTCA        | 54551 2H000 | di:12.4 do:38 |
| 4   | 111-0K-K05  | Tie Rod End Right   | 56820 2H090 | c:13.3 th:FM14x1.5R | 11  | GOM-K15     | Silentblock ForTCA        | 55543 2H000 | do:70.8       |
| 5   | 103-0K-K03  | Axial Joint         | 56540 2H000 | th:MM16x1.5R L:162  | 12  | 71-0K-K00   | TCA                       | 55250 2H000 | c:13.4        |
| 6   | 72-0K-K08   | TCA left wobj       | 54500 2H000 |                     | 13  | GOM-K11     | Ball Joint Rear           | 55130 4D000 | do:44         |
| 7   | 72-0K-K07   | TCA right wobj      | 54501 2H000 |                     | 14  | 106-0K-K09  | Stabiliser Link Rear Axle | 55530 1H100 | L:170         |

iX35 (LM)

01/2010 ->

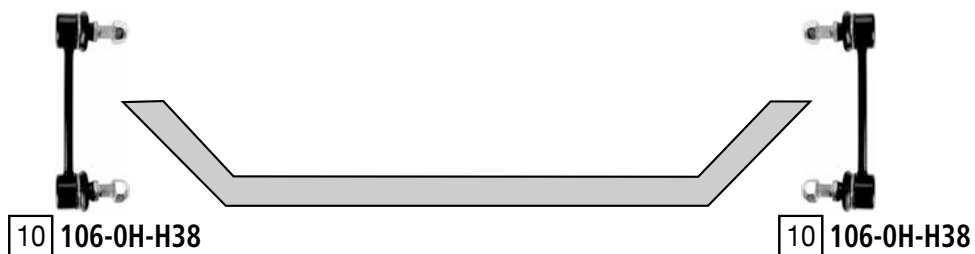
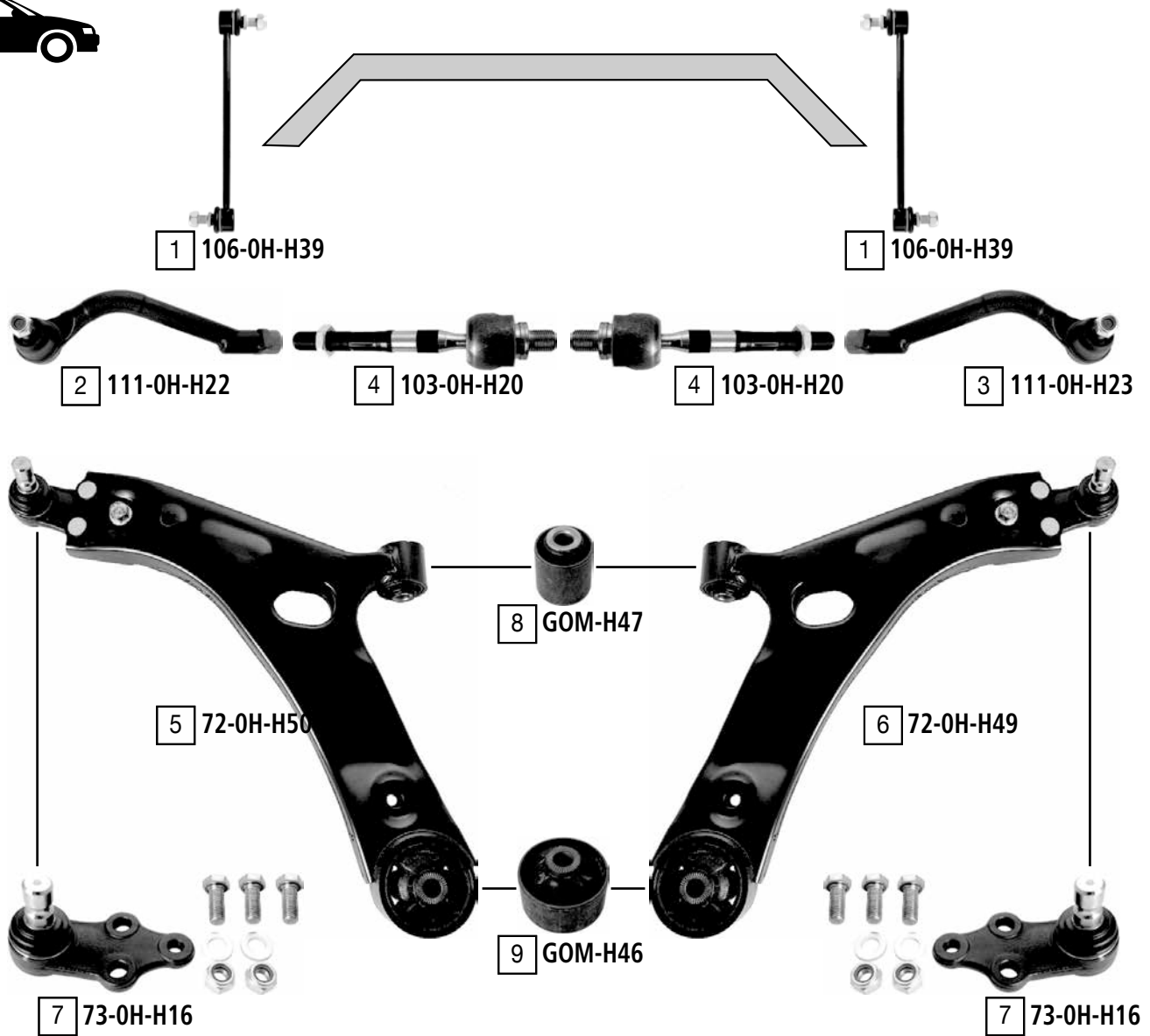

| Ref | ASHIKA CODE | Description       | OEM         | Measures            | Ref | ASHIKA CODE | Description               | OEM         | Measures         |
|-----|-------------|-------------------|-------------|---------------------|-----|-------------|---------------------------|-------------|------------------|
| 1   | 106-0H-H39  | stabiliser link   | 54830 2S000 | L:267               | 6   | 72-0H-H49   | TCA right wbj             | 54501 2Y000 | c:18             |
| 2   | 111-0H-H22  | tie rod end left  | 56820 2S000 | c:13.4 th:FM16X1.5R | 7   | 73-0H-H16   | Ball Joint                | 54530 3S000 | c:18             |
| 3   | 111-0H-H23  | tie rod end right | 56820 2S050 | c:13.4 th:FM16X1.5R | 8   | GOM-H47     | Silentblock For TCA       | 54551 2S000 | di:12.25 do:38.1 |
| 4   | 103-0H-H20  | axial joint       | 57724 2S000 | th:MM16X1.5R L:183  | 9   | GOM-H46     | Silentblock For TCA       | 54584 2S000 | di:14.35 do:70   |
| 5   | 72-0H-H50   | TCA left wbj      | 54500 2Y000 | c:18                | 10  | 106-0H-H38  | Stabiliser Link Rear Axle | 55530 2S100 | L:140            |

LANTRA I (J-1)

10/1990 - 11/1995

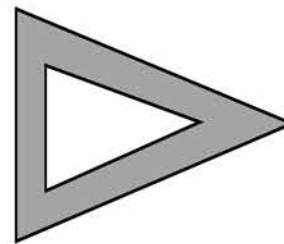
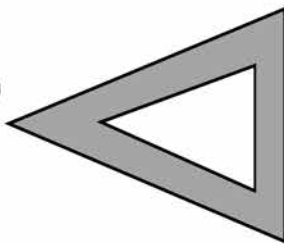
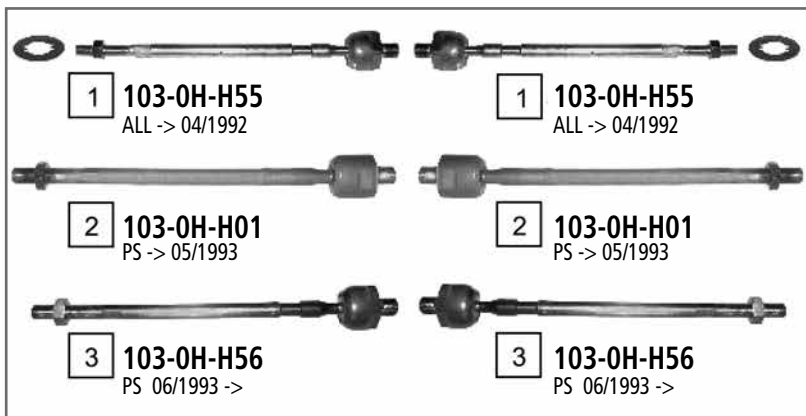
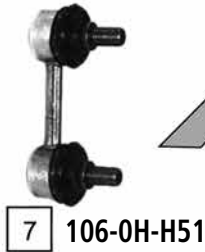

| Ref. | ASHIKA CODE | Description | OEM         | Measures            | Ref. | ASHIKA CODE | Description     | OEM         | Measures            |
|------|-------------|-------------|-------------|---------------------|------|-------------|-----------------|-------------|---------------------|
| 1    | 103-0H-H55  | Axial Joint | 57730-28000 |                     | 5    | 111-0H-H57  | Tie Rod End     | 56820-28500 | c:13.6 th:FM14X1.5R |
| 2    | 103-0H-H01  | Axial Joint | 57755-22000 | th:MM16X1.5R L:295  | 6    | 53-0H-H54   | Ball Joint      | 5453028000  | c:15                |
| 3    | 103-0H-H56  | Axial Joint | 56540 28020 | th:MM16X1.5R L:298  | 7    | 106-0H-H51  | Stabiliser Link | 54830 28000 | L:61                |
| 4    | 111-0H-H54  | Tie Rod End | 56820-28000 | c:13.4 th:FM12X1.25 |      |             |                 |             |                     |

LANTRA II (J-2)

11/1995 - 06/2000



| Ref | ASHIKA CODE | Description     | OEM         | Measures           | Ref | ASHIKA CODE | Description | OEM         | Measures            |
|-----|-------------|-----------------|-------------|--------------------|-----|-------------|-------------|-------------|---------------------|
| 1   | 103-0H-H63  | Axial Joint     | 57730 29000 | th:MM16X1.5R L:317 | 5   | 73-0H-H55L  | TCA         | 54500-29000 |                     |
| 2   | 106-0H-H56  | Stabiliser Link | 54830-29000 | L:70.5             | 6   | 73-0H-H55R  | TCA         | 54501-29000 |                     |
| 3   | 111-0H-H91  | Stabiliser Link | 55530-29000 | L:130              | 7   | 111-0H-H06  | Tie Rod End | 56820-22000 | c:13.6 th:FM14X1.5R |
| 4   | 73-0H-H57   | Ball Joint      | 54520 31600 | c:15               |     |             |             |             |                     |

MATRIX (FC)

06/2001 ->

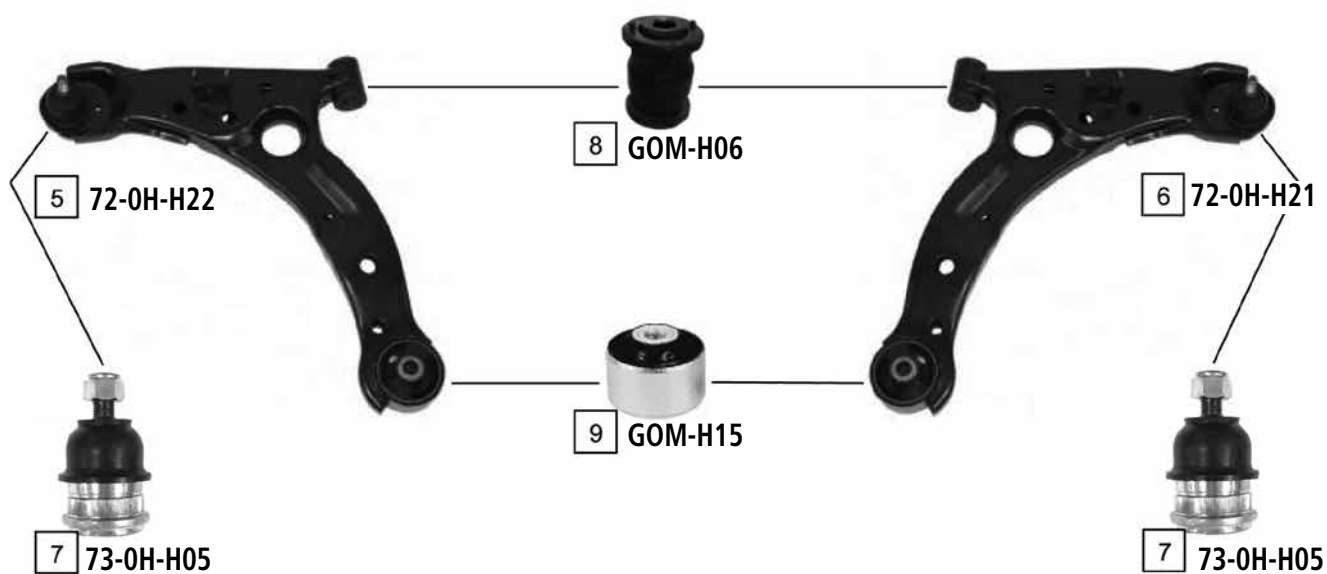

| Ref. | ASHIKA CODE | Description           | OEM         | Measures            | Ref. | ASHIKA CODE | Description              | OEM         | Measures |
|------|-------------|-----------------------|-------------|---------------------|------|-------------|--------------------------|-------------|----------|
| 1    | 106-0H-H02  | Stabiliser Link Left  | 54830-25010 | L:60                | 6    | 72-0H-H21   | TCA Right                | 54501-17000 |          |
| 2    | 106-0H-H03  | Stabiliser Link Right | 54830-25020 | L:60                | 7    | 73-0H-H05   | Ball Joint               | 54503-38A00 |          |
| 3    | 103-0H-H09  | Axial Joint           | 57755-17000 | th:MM16X1.5R L:322  | 8    | GOM-H06     | Silentblock For Susp.Arm | 54551 25000 |          |
| 4    | 111-0H-H01  | Tie Rod End           | 56820-25000 | c:13.8 th:FM14X1.5R | 9    | GOM-H15     | Silentblock For Susp.Arm | 54584-17000 |          |
| 5    | 72-0H-H22   | TCA Left              | 54500-17000 |                     | 10   | 106-0H-H13  | Stabiliser Link          | 55530 17000 | L:128.5  |

PONY  
EXCEL I

04/1974 - 01/1989

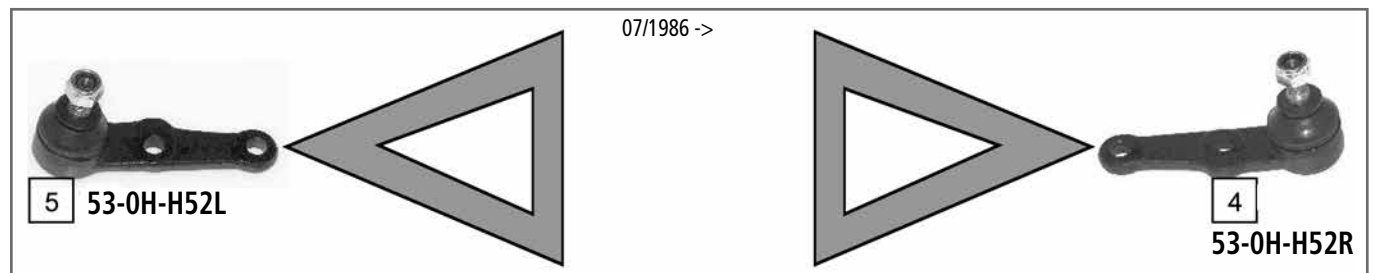
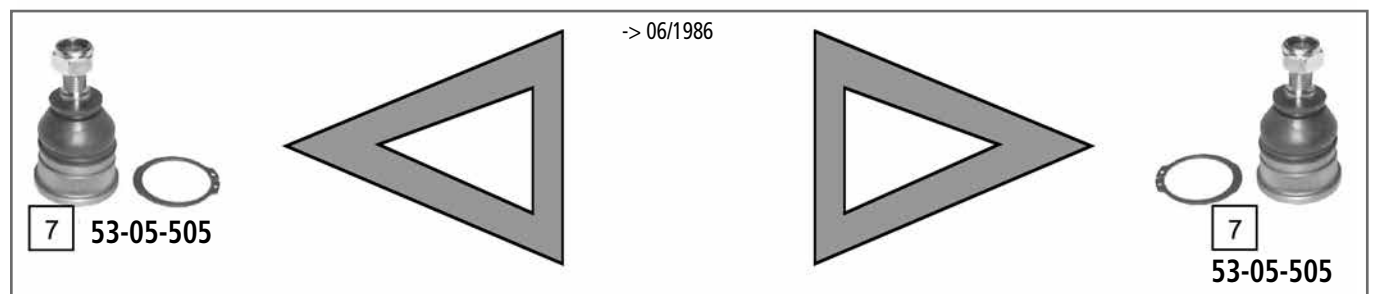
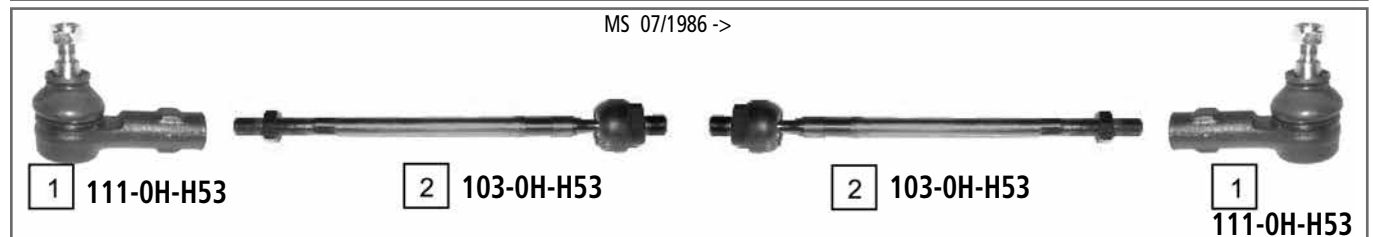

| Ref | ASHIKA CODE | Description            | OEM         | Measures            | Ref | ASHIKA CODE | Description           | OEM         | Measures            |
|-----|-------------|------------------------|-------------|---------------------|-----|-------------|-----------------------|-------------|---------------------|
| 1   | 111-0H-H53  | Tie Rod End            | 56820-21000 | c:13.45 th:FM14X1.5 | 5   | 53-0H-H52L  | Ball Joint Lower Left | 54530 21000 | c:13.5              |
| 2   | 103-0H-H53  | Axial Joint            | 56540-22000 | th:MM16X1.5R L:296  | 6   | 111-0H-H52  | Tie Rod End           | 56820 11060 | c:12.5 th:MM14X1.5L |
| 3   | 103-05-501  | Axial Joint            | MB122135    | th:FM18X1.5R L:297  | 7   | 53-05-505   | Ball Joint            | MB001696    | c:15                |
| 4   | 53-0H-H52R  | Ball Joint Lower Right | 54540 21000 | c:13.5              |     |             |                       |             |                     |



# HYUNDAI PONY - S COUPE



PONY (X-2)  
S COUPE (SLC)

10/1989 - 01/1995  
02/1990 - 05/1996

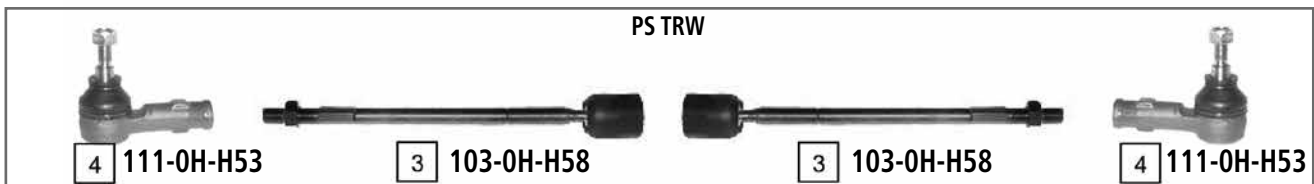
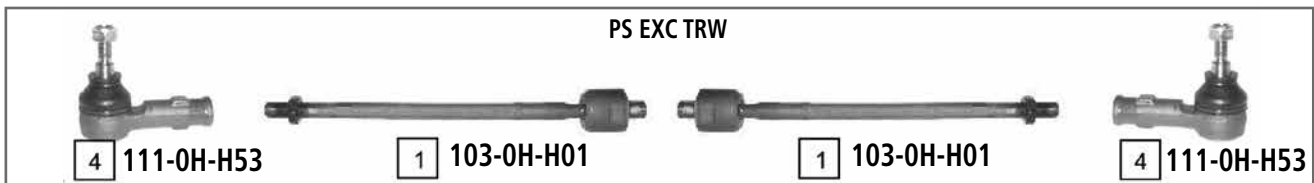
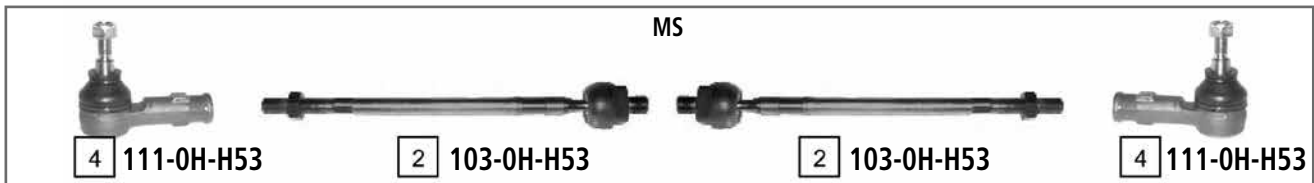

| Ref. | ASHIKA CODE | Description | OEM         | Measures            | Ref. | ASHIKA CODE | Description     | OEM         | Measures |
|------|-------------|-------------|-------------|---------------------|------|-------------|-----------------|-------------|----------|
| 1    | 103-0H-H01  | Axial Joint | 57755-22000 | th:MM16X1.5R L:295  | 5    | 73-0H-H53   | Ball Joint      | 54530-24A00 | c:15     |
| 2    | 103-0H-H53  | Axial Joint | 56540-22000 | th:MM16X1.5R L:296  | 6    | 106-05-501  | Stabiliser Link | 4056 A014   | L:60     |
| 3    | 103-0H-H58  | Axial Joint | 57730-24100 | th:FM14X1.5R L:303  | 7    | 72-0H-H24   | TCA Left        | 54502 24001 |          |
| 4    | 111-0H-H53  | Tie Rod End | 56820-21110 | c:13.3 th:FM14X1.5R | 8    | 72-0H-H23   | TCA Right       | 54503 24001 |          |

SANTA FE (SM)

01/2002 - 02/2006

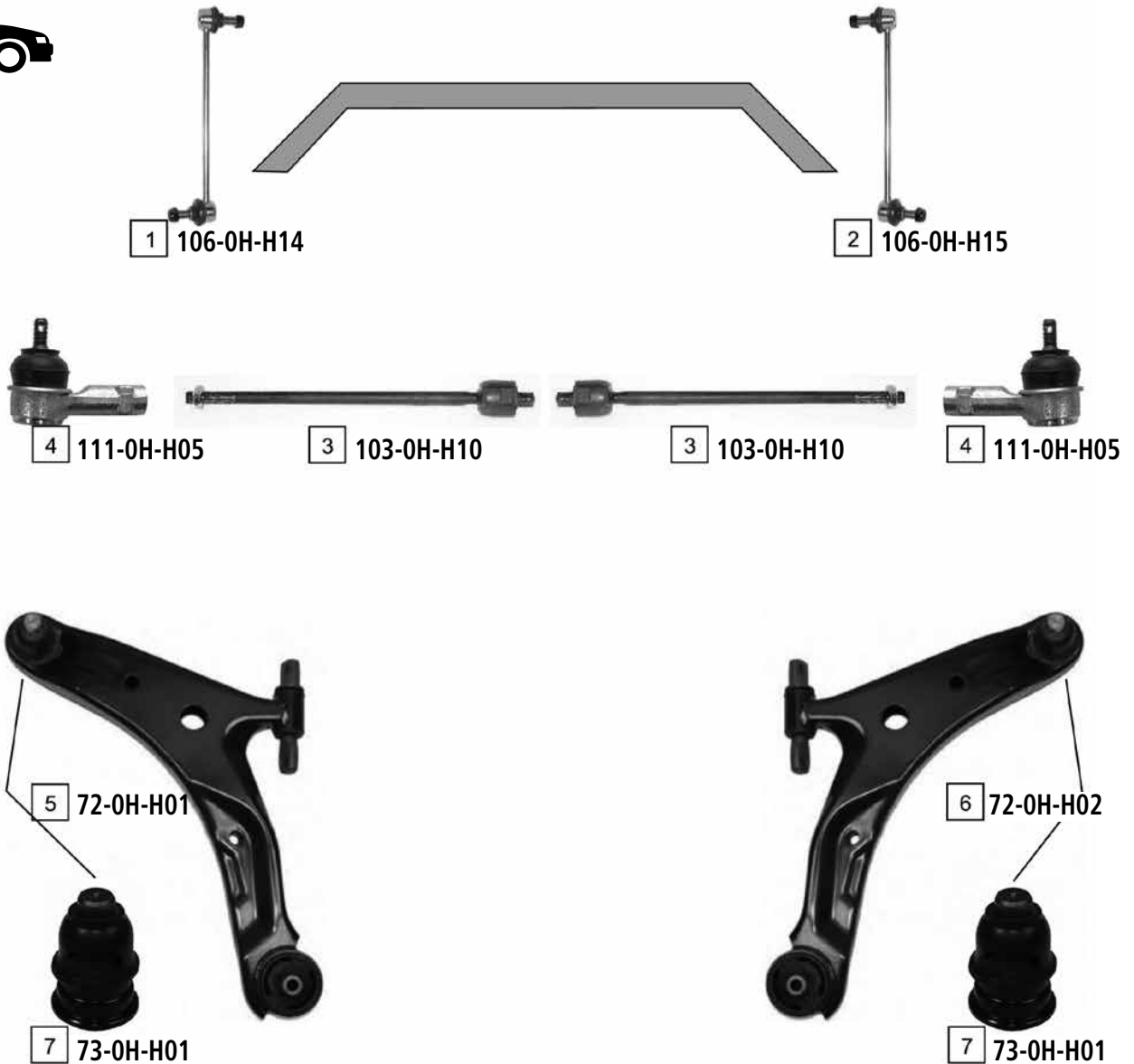

| Ref | ASHIKA CODE | Description           | OEM         | Measures            | Ref | ASHIKA CODE | Description          | OEM         | Measures |
|-----|-------------|-----------------------|-------------|---------------------|-----|-------------|----------------------|-------------|----------|
| 1   | 106-0H-H14  | Stabiliser Link Left  | 54830-26000 | L:264               | 6   | 72-0H-H02   | TCA Right Wbj        | 54502-26000 |          |
| 2   | 106-0H-H15  | Stabiliser Link Right | 54840-26000 | L:264               | 7   | 73-0H-H01   | Ball Joint           | 54503-3BA00 | c:20     |
| 3   | 103-0H-H10  | Axial Joint           | 57785-26200 | th:MM16X1.5R L:328  | 8   | 106-0H-H16  | Stabiliser Link Left | 55530 26600 | L:117    |
| 4   | 111-0H-H05  | Tie Rod End           | 56820-3B000 | c:13.4 th:FM14X1.5R | 9   | 106-0H-H17  | Stabiliser Link Left | 55540 26600 | L:117    |
| 5   | 72-0H-H01   | TCA Left Wbj          | 54501-26000 |                     |     |             |                      |             |          |

SANTA FE

03/2006 ->

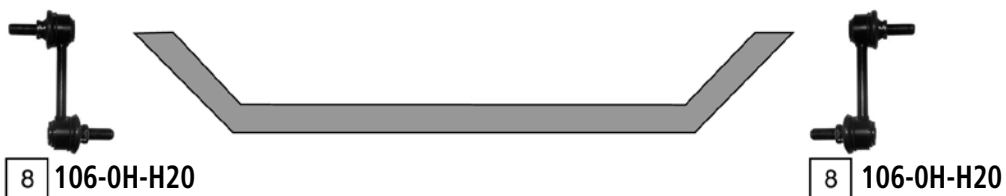
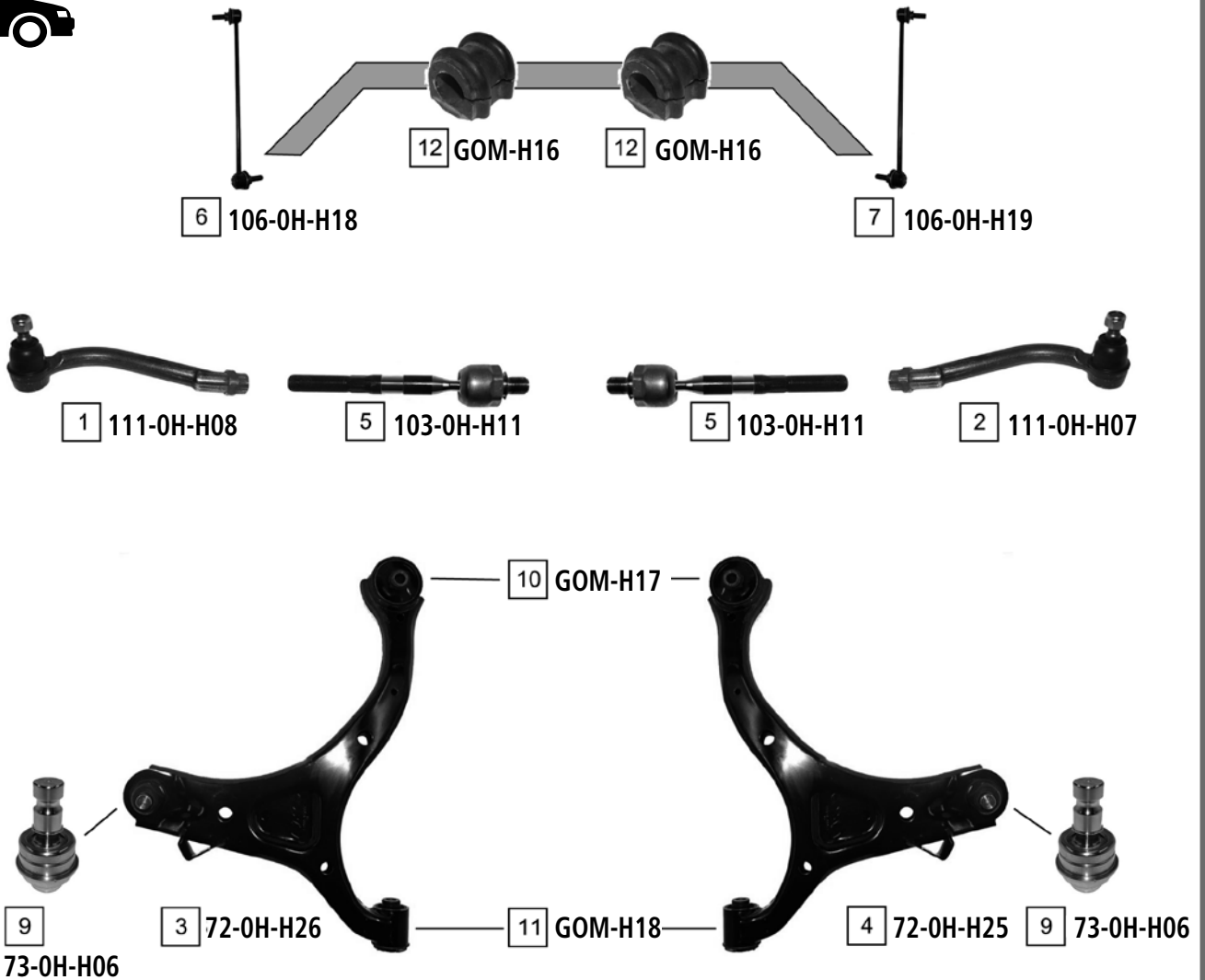

| Ref. | ASHIKA CODE | Description          | OEM         | Measures | Ref. | ASHIKA CODE | Description              | OEM         | Measures |
|------|-------------|----------------------|-------------|----------|------|-------------|--------------------------|-------------|----------|
| 1    | 111-0H-H08  | Tie Rod End Left     | 56820 2B000 |          | 7    | 106-0H-H19  | Stabiliser Link Right    | 54840 2B000 |          |
| 2    | 111-0H-H07  | Tie Rod End Right    | 56820 2B900 |          | 8    | 106-0H-H20  | Stabiliser Link          | 55530 2B000 |          |
| 3    | 72-0H-H26   | TCA Left Wbj         | 54500 2B100 |          | 9    | 73-0H-H06   | Ball Joint               | 54530 2B000 |          |
| 4    | 72-0H-H25   | TCA Right Wbj        | 54501 2B100 |          | 10   | GOM-H17     | Silentblock For Susp.Arm | 54584 2B000 |          |
| 5    | 103-0H-H11  | Axial Joint          | 57724 2B000 |          | 11   | GOM-H18     | Silentblock For Susp.Arm | 54551 2B000 |          |
| 6    | 106-0H-H18  | Stabiliser Link Left | 54830 2B000 |          | 12   | GOM-H16     | Stabiliser Mounting      | 54813 3K100 |          |

SONATA I (Y-2)

09/1988 - 10/1993

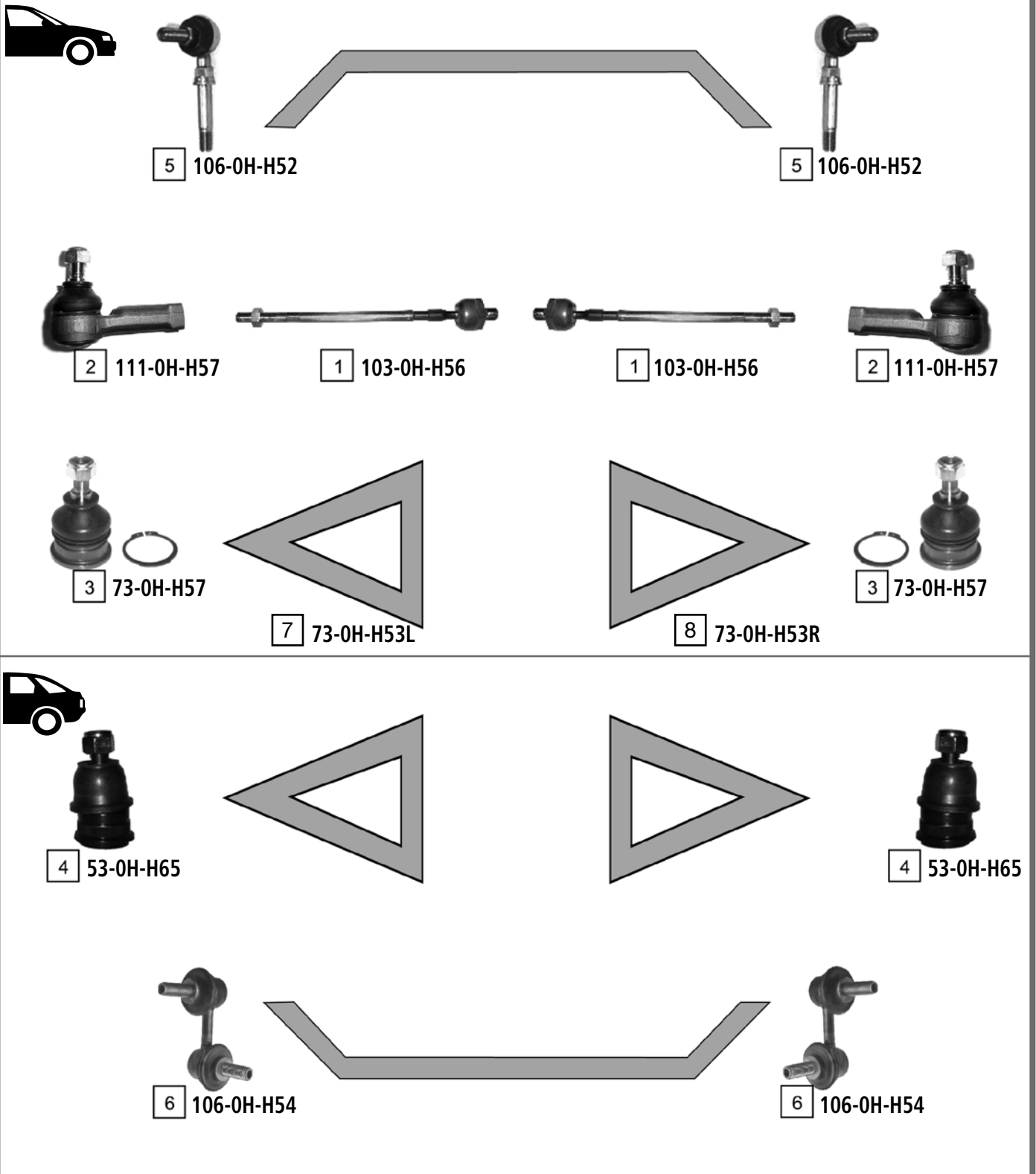

| Ref | ASHIKA CODE | Description | OEM         | Measures              | Ref | ASHIKA CODE | Description     | OEM         | Measures |
|-----|-------------|-------------|-------------|-----------------------|-----|-------------|-----------------|-------------|----------|
| 1   | 103-OH-H56  | Axial Joint | 56540 28020 | th:MM16X1.5R L:298    | 5   | 106-OH-H52  | Stabiliser Link | 54830 36000 | -        |
| 2   | 111-OH-H57  | Tie Rod End | 56820-28500 | c: 13,6 th: FM14X1.5R | 6   | 106-OH-H54  | Stabiliser Link | 55580-37020 | L:60     |
| 3   | 73-OH-H57   | Ball Joint  | 54520 31600 | c: 15                 | 7   | 73-OH-H53L  | Ball Joint      |             |          |
| 4   | 53-OH-H65   | Ball Joint  | 55130 34A00 | c:16.2                | 8   | 73-OH-H53R  | Ball Joint      |             |          |

# HYUNDAI SONATA



SONATA II (Y-3)

05/1993 - 06/1998

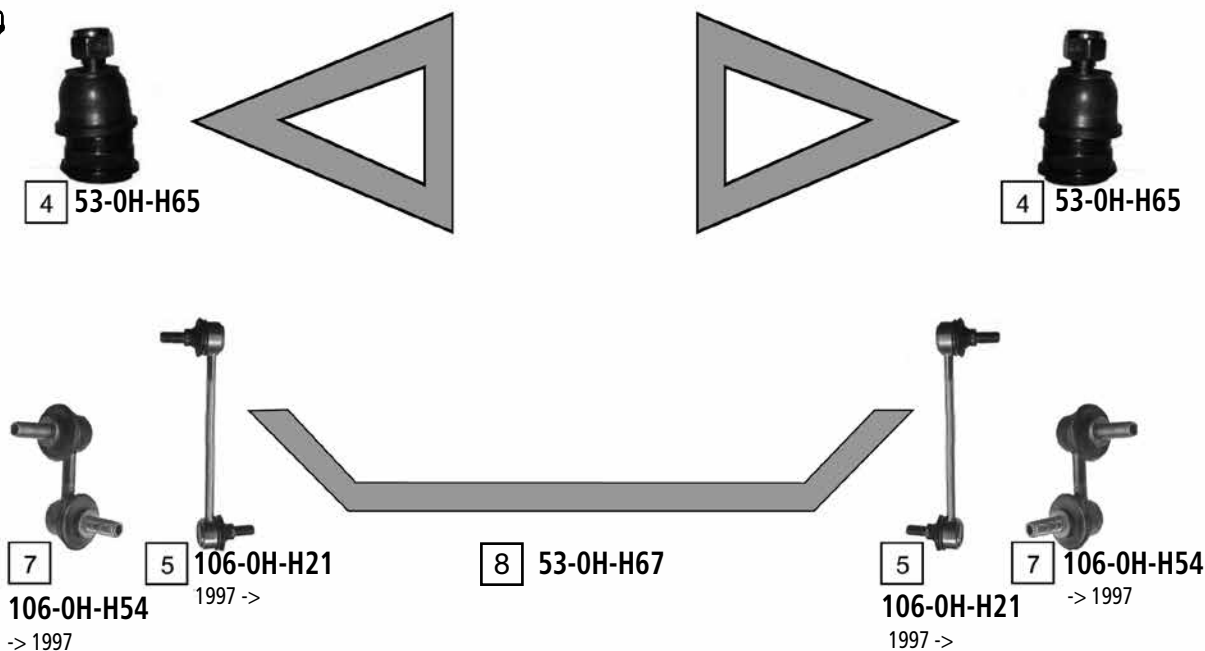
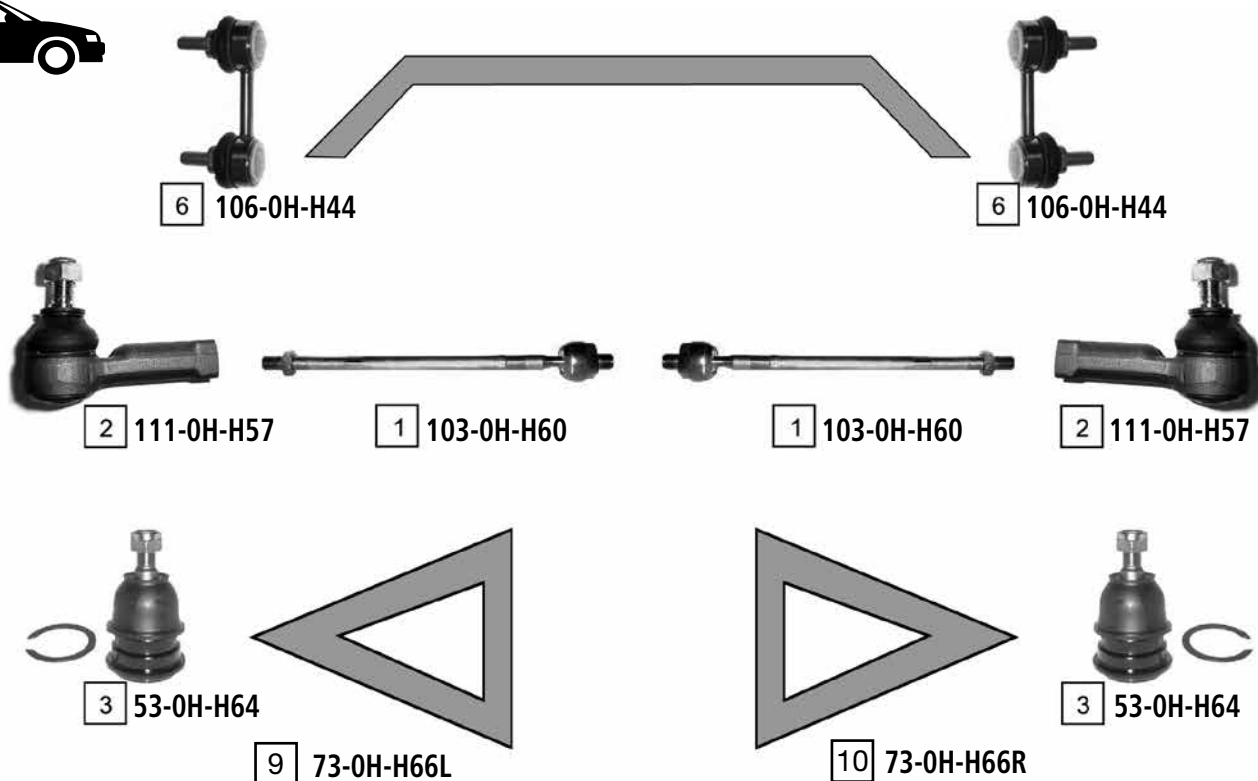

| Ref. | ASHIKA CODE | Description     | OEM         | Measures            | Ref. | ASHIKA CODE | Description     | OEM         | Measures |
|------|-------------|-----------------|-------------|---------------------|------|-------------|-----------------|-------------|----------|
| 1    | 103-0H-H60  | Axial Joint     | 57716 34000 | th:MM16X1.5R L:322  | 6    | 106-0H-H44  | Stabiliser Link | 54830 34000 | L:52     |
| 2    | 111-0H-H57  | Tie Rod End     | 56820-28500 | c:13.6 th:FM14X1.5R | 7    | 106-0H-H54  | Stabiliser Link | 55580-37020 | L:60     |
| 3    | 53-0H-H64   | Ball Joint      | 54503 34A00 | c:15                | 8    | 53-0H-H67   | Ball Joint      | 5520134000  |          |
| 4    | 53-0H-H65   | Ball Joint      | 55130 34A00 | c:16.2              | 9    | 73-0H-H66L  | Ball Joint      | 5450034000  |          |
| 5    | 106-0H-H21  | Stabiliser Link | 55530-38000 | L:180               | 10   | 73-0H-H66R  | Ball Joint      | 5450134000  |          |

SONATA III

03/1998 - 10/2001

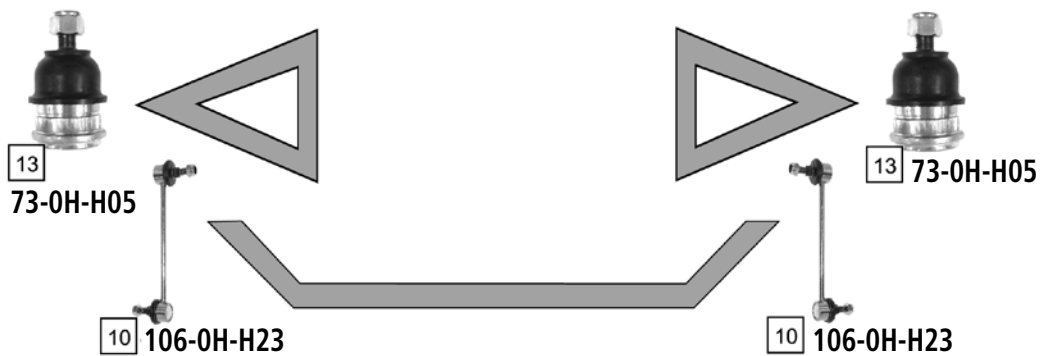
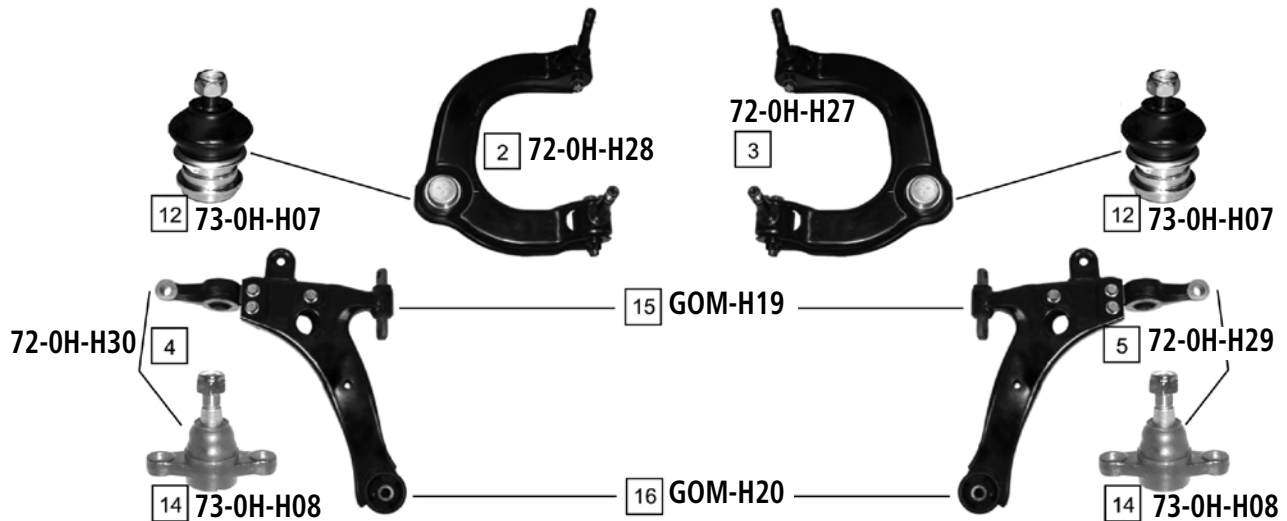
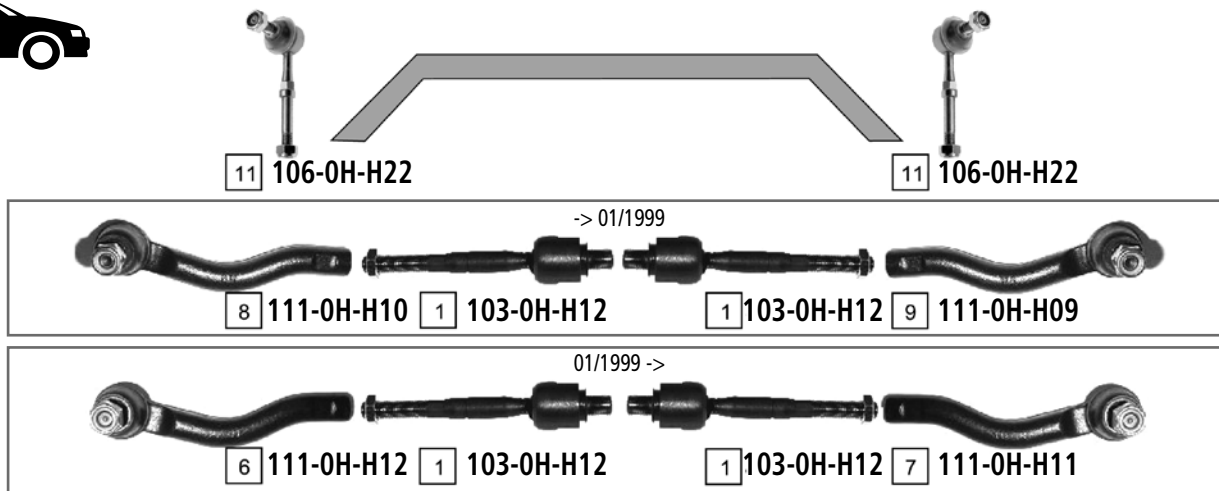

| Ref | ASHIKA CODE | Description       | OEM         | Measures     | Ref | ASHIKA CODE | Description              | OEM         | Measures |
|-----|-------------|-------------------|-------------|--------------|-----|-------------|--------------------------|-------------|----------|
| 1   | 103-0H-H12  | Axial Joint       | 57724-38000 |              | 9   | 111-0H-H09  | Tie Rod End Right        | 57780-38010 |          |
| 2   | 72-0H-H28   | TCA               | 54410-38000 | c:13.2       | 10  | 106-0H-H23  | Stabiliser Link          | 55530-38600 | L:193.5  |
| 3   | 72-0H-H27   | TCA               | 54420-38000 | c:13.2       | 11  | 106-0H-H22  | Stabiliser Link          | 54830-38100 |          |
| 4   | 72-0H-H30   | TCA               | 54500 38000 |              | 12  | 73-0H-H07   | Ball Joint               | 54403 38A00 | c:13.4   |
| 5   | 72-0H-H29   | TCA               | 54501 38000 |              | 13  | 73-0H-H05   | Ball Joint               | 54503-38A00 |          |
| 6   | 111-0H-H12  | Tie Rod End Left  | 56820-38000 | th:FM14X1.5R | 14  | 73-0H-H08   | Ball Joint               | 51760 38000 | c:18     |
| 7   | 111-0H-H11  | Tie Rod End Right | 56820-38900 | th:FM14X1.5R | 15  | GOM-H19     | Silentblock For Susp.Arm | 54551 38000 |          |
| 8   | 111-0H-H10  | Tie Rod End Left  | 57780-38000 |              | 16  | GOM-H20     | Silentblock For Susp.Arm | 54584 38000 |          |

SONATA IV

10/2001 - 01/2005

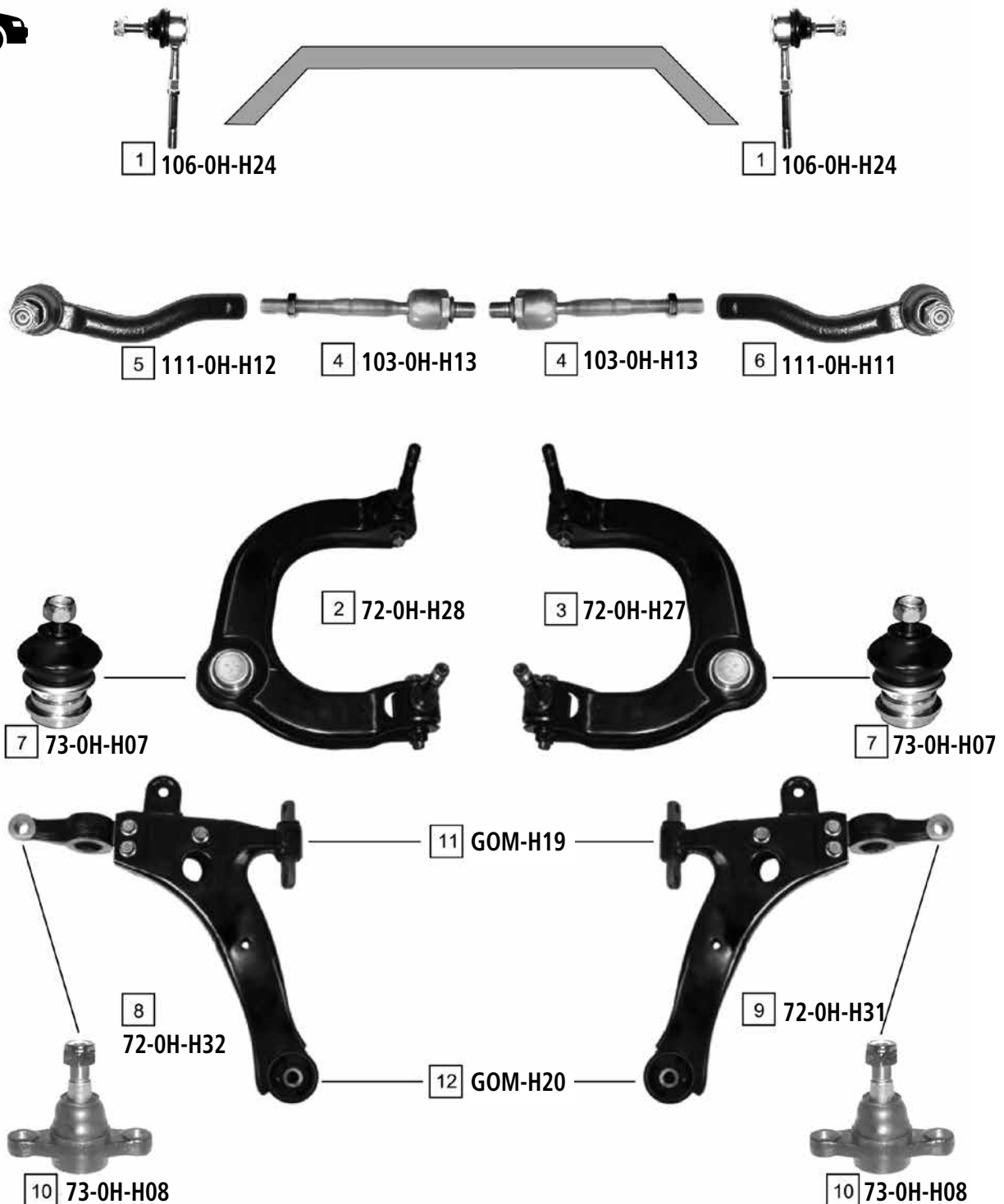

| Ref. | ASHIKA CODE | Description       | OEM         | Measures           | Ref. | ASHIKA CODE | Description              | OEM         | Measures |
|------|-------------|-------------------|-------------|--------------------|------|-------------|--------------------------|-------------|----------|
| 1    | 106-0H-H24  | Stabiliser Link   | 54830-38110 |                    | 7    | 73-0H-H07   | Ball Joint               | 54403 38A00 | c:13.4   |
| 2    | 72-0H-H28   | TCA               | 54410-38000 | c:13.2             | 8    | 72-0H-H32   | TCA Left                 | 54500-38011 |          |
| 3    | 72-0H-H27   | TCA               | 54420-38000 | c:13.2             | 9    | 72-0H-H31   | TCA Right                | 54501-38011 |          |
| 4    | 103-0H-H13  | Axial Joint       | 57724-38010 | th:MM16X1.5R L:171 | 10   | 73-0H-H08   | Ball Joint               | 51760 38000 | c:18     |
| 5    | 111-0H-H12  | Tie Rod End Left  | 56820-38000 | th:FM14X1.5R       | 11   | GOM-H19     | Silentblock For Susp.Arm | 54551 38000 | -        |
| 6    | 111-0H-H11  | Tie Rod End Right | 56820-38900 | th:FM14X1.5R       | 12   | GOM-H20     | Silentblock For Susp.Arm | 54584 38000 | -        |

SONATA V (NF)

01/2005 ->

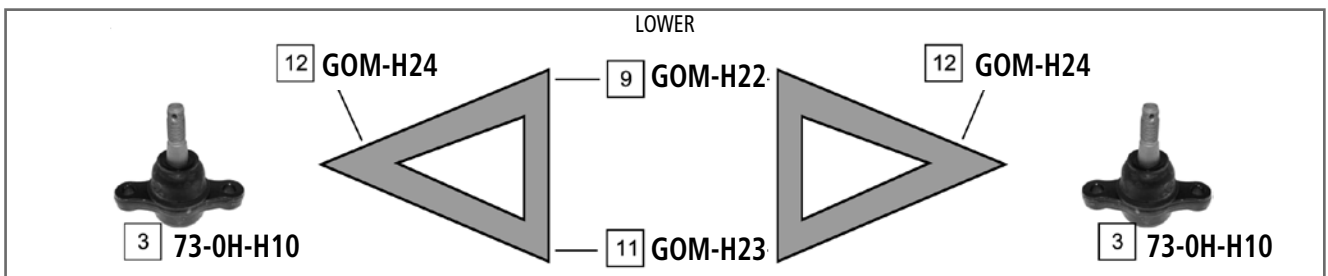
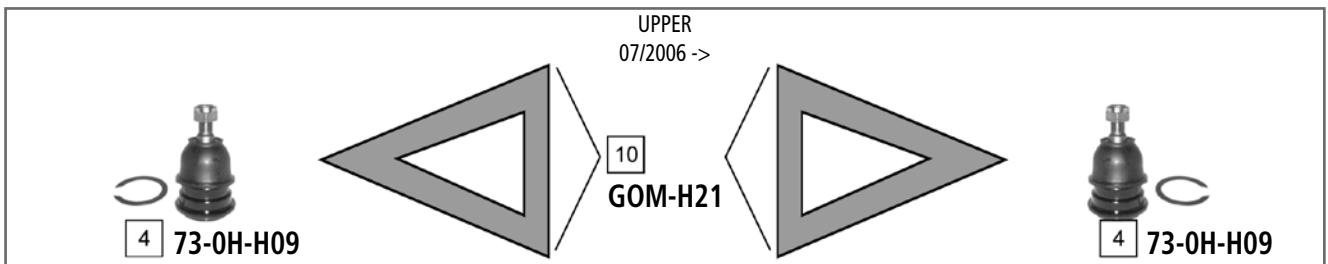
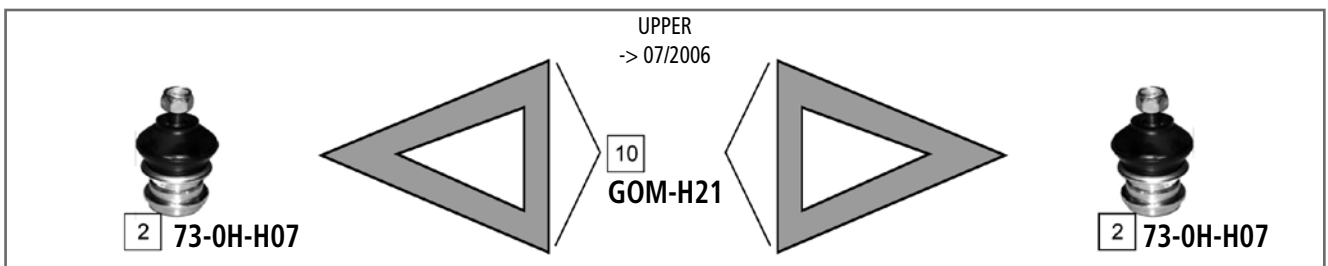
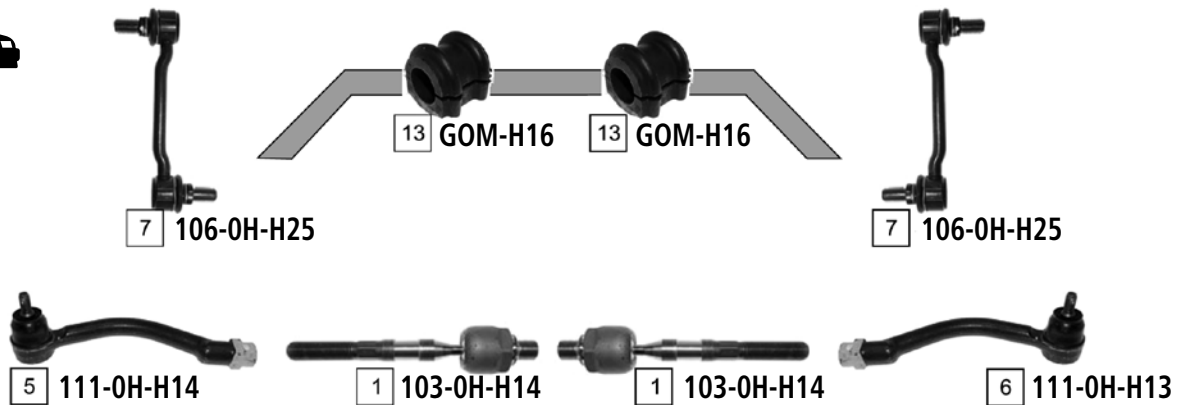

| Ref | ASHIKA CODE | Description       | OEM         | Measures            | Ref | ASHIKA CODE | Description               | OEM         | Measures |
|-----|-------------|-------------------|-------------|---------------------|-----|-------------|---------------------------|-------------|----------|
| 1   | 103-0H-H14  | Axial Joint       | 57724 3K000 | th:MM16X1.5R L:178  | 8   | 106-0H-H26  | Stabiliser Link           | 55530 3K001 | L:80     |
| 2   | 73-0H-H07   | Ball Joint        | 54403 38A00 | c:13.4              | 9   | GOM-H22     | Silientblock For Susp.Arm | 54584 3K000 |          |
| 3   | 73-0H-H10   | Ball Joint        | 51760 3K000 | c:15.1              | 10  | GOM-H21     | Silientblock For Susp.Arm | 54443 3K000 |          |
| 4   | 73-0H-H09   | Ball Joint        | 54430 3F600 | c:13.5              | 11  | GOM-H23     | Silientblock For Susp.Arm | 54551 3K000 |          |
| 5   | 111-0H-H14  | Tie Rod End Left  | 56820 3K000 | c:13.4 th:MM16X1.5R | 12  | GOM-H24     | Silientblock For Susp.Arm | 54552 3K000 |          |
| 6   | 111-0H-H13  | Tie Rod End Right | 56820 3K010 | c:13.4 th:MM16X1.5R | 13  | GOM-H16     | Satbiliser Mounting       | 54813 3K100 |          |
| 7   | 106-0H-H25  | Stabiliser Link   | 54830 3L000 | L:150               |     |             |                           |             |          |



TERRACAN (HP)

12/2001 ->

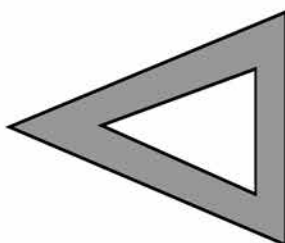
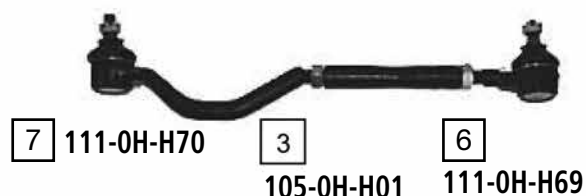
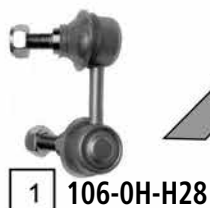

UPPER

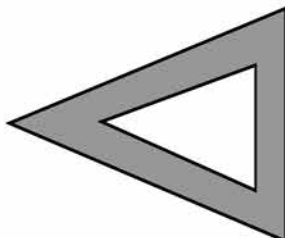
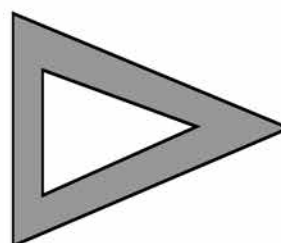

LOWER

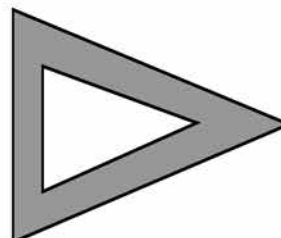

| Ref. | ASHIKA CODE | Description      | OEM         | Measures | Ref. | ASHIKA CODE | Description      | OEM         | Measures |
|------|-------------|------------------|-------------|----------|------|-------------|------------------|-------------|----------|
| 1    | 106-0H-H28  | Stabiliser Link  | 54822-H1000 | L:67     | 5    | 73-0H-H12   | Ball Joint Lower | 54550-H1000 |          |
| 2    | 106-0H-H27  | Stabiliser Link  | 54823-H1000 | L:67     | 6    | 111-0H-H69  | Tie Rod End      | 5B000037    |          |
| 3    | 105-0H-H01  | Tie Rod          | 56850-H1011 |          | 7    | 111-0H-H70  | Tie Rod End      | 5B000036    |          |
| 4    | 73-0H-H11   | Ball Joint UPPER | 54440-H1000 |          |      |             |                  |             |          |

TRAJET (FO)

03/2000 ->

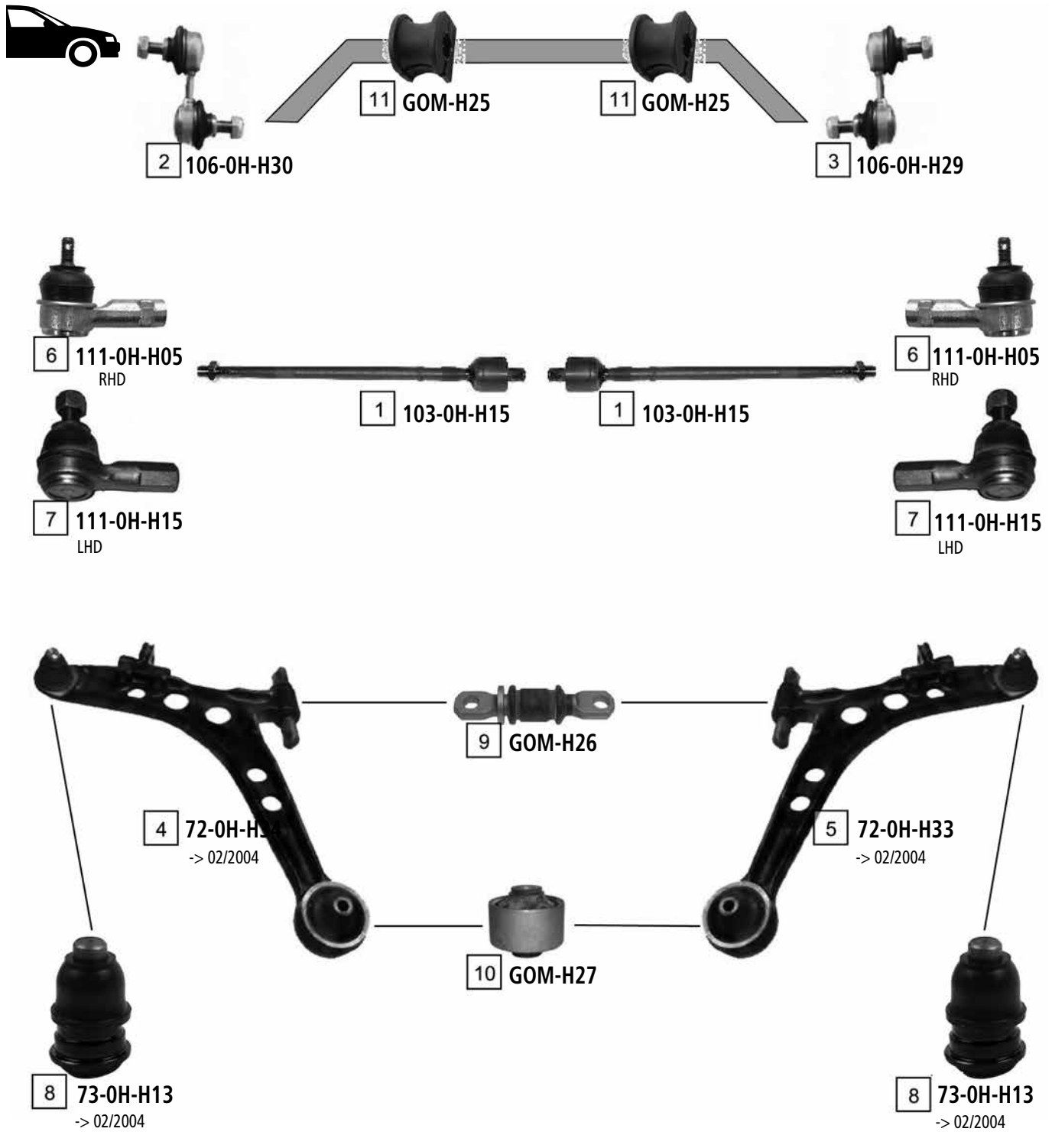

| Ref. | ASHIKA CODE | Description     | OEM         | Measures              | Ref. | ASHIKA CODE | Description               | OEM         | Measures |
|------|-------------|-----------------|-------------|-----------------------|------|-------------|---------------------------|-------------|----------|
| 1    | 103-0H-H15  | Axial Jpint     | 57724 3A000 | th: MM16X1.5R L:295   | 7    | 111-0H-H15  | Tie Rod End               | 57780-3B000 |          |
| 2    | 106-0H-H30  | Stabiliser Link | 54830 3A000 | L:60                  | 8    | 73-0H-H13   | Ball Joint                | 54530 3B000 | c: 19.9  |
| 3    | 106-0H-H29  | Stabiliser Link | 54840 3A000 | L:60                  | 9    | GOM-H26     | Silentblock For Susp. Arm | 54551 3A000 |          |
| 4    | 72-0H-H34   | TCA Left Wbj    | 54501 3A100 |                       | 10   | GOM-H27     | Silentblock For Susp. Arm | 54555 3A100 |          |
| 5    | 72-0H-H33   | TCA Right Wbj   | 54502 3A100 |                       | 11   | GOM-H25     | Stabiliser Mounting       | 54813-3A000 |          |
| 6    | 111-0H-H05  | Tie Rod End     | 56820-3B000 | c: 13.4 th: FM14X1.5R |      |             |                           |             |          |

TUCSON

09/2004 ->

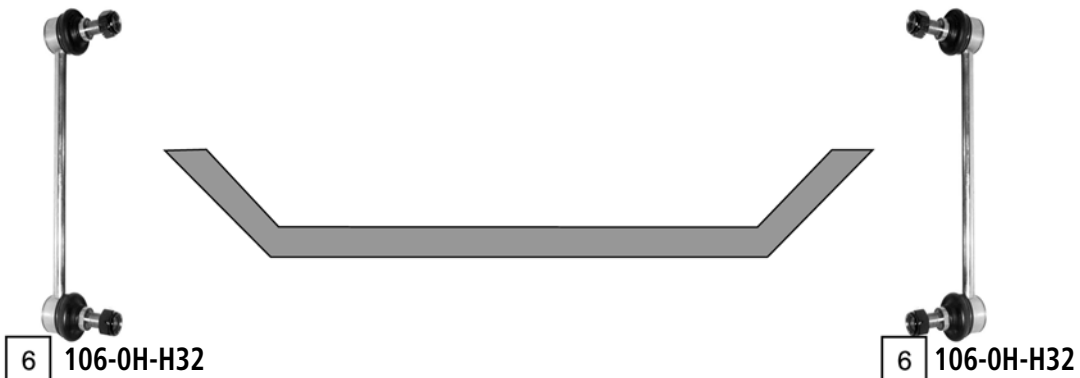
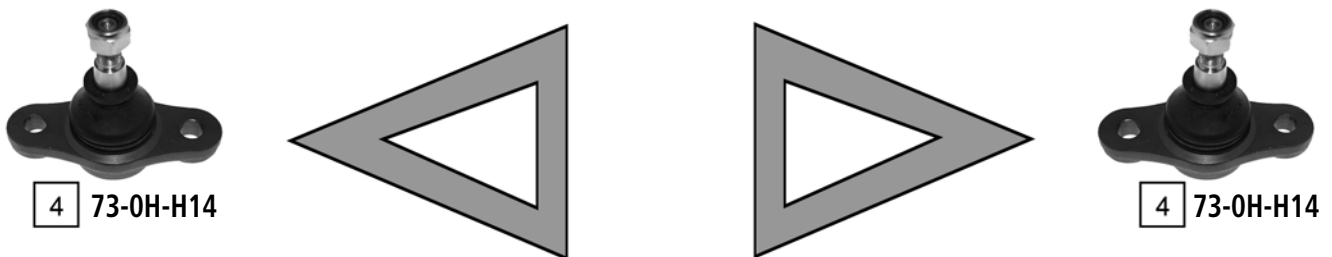
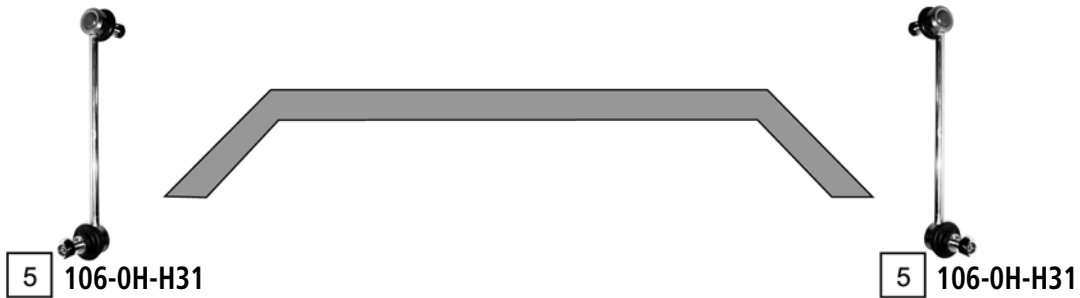

| Ref. | ASHIKA CODE | Description       | OEM         | Measures              | Ref. | ASHIKA CODE | Description     | OEM         | Measures |
|------|-------------|-------------------|-------------|-----------------------|------|-------------|-----------------|-------------|----------|
| 1    | 103-0H-H16  | Axial Joint       | 57724 2E000 | th: MM16X1.5R L:243   | 4    | 73-0H-H14   | Ball Joint      | 51760 2E000 | c: 14.5  |
| 2    | 111-0H-H17  | Tie Rod End Left  | 56820 2E000 | c: 13.3 th: FM10X1.5R | 5    | 106-0H-H31  | Stabiliser Link | 54830 2E000 | L:238    |
| 3    | 111-0H-H16  | Tie Rod End Right | 56820 2E900 | c: 13.3 th: FM10X1.5R | 6    | 106-0H-H32  | Stabiliser Link | 55530 2E000 | L:220    |

XG (25 - 30)

04/1999 ->



1 106-0H-H33



1 106-0H-H33



3 111-0H-H10

2 103-0H-H12

2 103-0H-H12

4 111-0H-H09



5 73-0H-H07

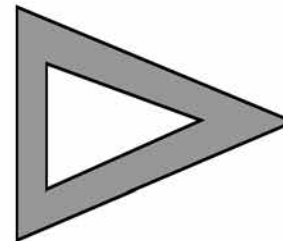
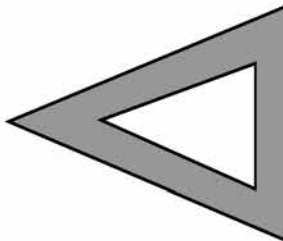

5 73-0H-H07



6 73-0H-H05

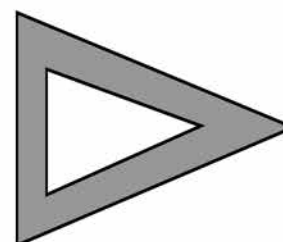
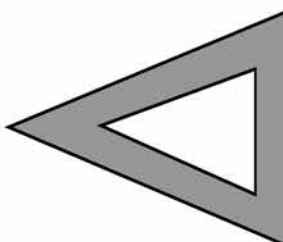

6 73-0H-H05



| Ref | ASHIKA CODE | Description      | OEM         | Measures | Ref | ASHIKA CODE | Description       | OEM         | Measures |
|-----|-------------|------------------|-------------|----------|-----|-------------|-------------------|-------------|----------|
| 1   | 106-0H-H33  | Stabiliser Link  | 54830-39000 |          | 4   | 111-0H-H09  | Tie Rod End Right | 57780-38010 |          |
| 2   | 103-0H-H12  | Axial Joint      | 57724-38000 |          | 5   | 73-0H-H07   | Ball Joint        | 54403 38A00 | c:13.4   |
| 3   | 111-0H-H10  | Tie Rod End Left | 57780-38000 |          | 6   | 73-0H-H05   | Ball Joint        | 54503-38A00 |          |

CAMPO (KB)

01/1983 - 12/1990



2 111-09-998



1 103-09-900



1 103-09-900



3  
111-09-999



4 73-09-914

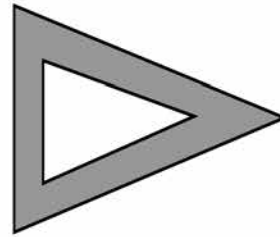
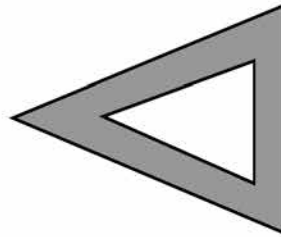

4  
73-09-914



5 73-09-999

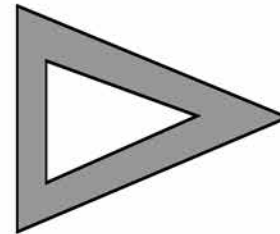
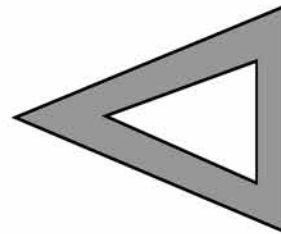

5  
73-09-999

| Ref. | ASHIKA CODE | Description       | OEM           | Measures           | Ref. | ASHIKA CODE | Description      | OEM           | Measures |
|------|-------------|-------------------|---------------|--------------------|------|-------------|------------------|---------------|----------|
| 1    | 103-09-900  | Axial Joint       | 8-94217-221-3 | th:FM14X1.5R L:267 | 4    | 73-09-914   | Ball Joint UPPER | 310 828       | c:17.5   |
| 2    | 111-09-998  | Tie Rod End Left  | 324 058       | c:16 th:FM14X1.5L  | 5    | 73-09-999   | Ball Joint UPPER | 8-94224-550-2 | c:17.4   |
| 3    | 111-09-999  | Tie Rod End Right | 324 057       | c:16 th:FM14X1.5R  |      |             |                  |               |          |

D-MAX

2002 ->



**5** 106-09-908  
4WD

**6** 106-09-909  
4WD

**1** 111-09-915    **2** 103-09-902

**2** 103-09-902

**1** 111-09-915

**7** 73-09-917  
4WD

**7** 73-09-917  
4WD

**3** 73-09-906  
4x2

**3** 73-09-906  
4x2

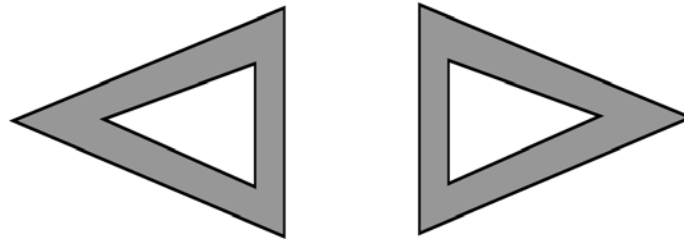

**4** 73-09-913  
4x2

**4** 73-09-913  
4x2

| Ref. | ASHIKA CODE | Description | OEM         | Measures | Ref. | ASHIKA CODE | Description     | OEM           | Measures |
|------|-------------|-------------|-------------|----------|------|-------------|-----------------|---------------|----------|
| 1    | 111-09-915  | Tie Rod End | 8-973048550 |          | 5    | 106-09-908  | Stabiliser Link | 8-97235-787-0 |          |
| 2    | 103-09-902  | Axial Joint | 8-973048510 |          | 6    | 106-09-909  | Stabiliser Link | 8-97235-786-1 |          |
| 3    | 73-09-906   | Ball Joint  | 8-972357770 |          | 7    | 73-09-917   | Ball Joint      | 8-94374-424-0 |          |
| 4    | 73-09-913   | Ball Joint  | 8-944521020 |          |      |             |                 |               |          |

# ISUZU PICK-UP FASTER



PICK-UP FASTER

06/1981 - 01/1998



1 111-09-904



2 103-09-900



2 103-09-900



1 111-09-904



3 73-09-999

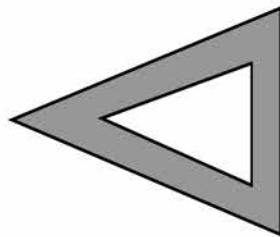

UPPER

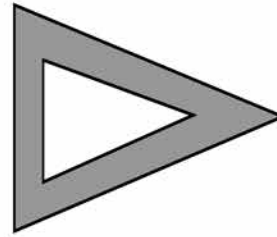

3 73-09-999



4 53-09-906

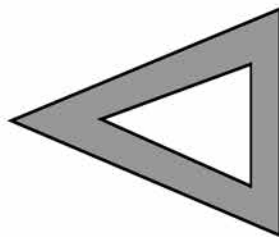

LOWER

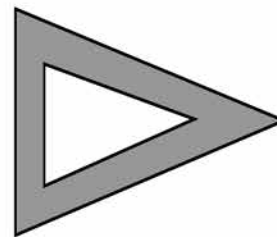

4 53-09-906



5 53-09-908L

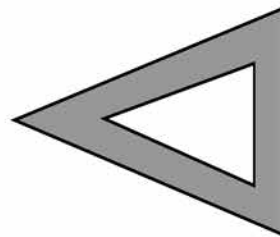

LOWER 4X4

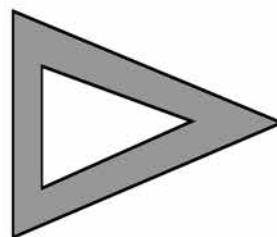

6 53-09-908R

| Ref | ASHIKA CODE | Description      | OEM           | Measures            | Ref | ASHIKA CODE | Description      | OEM           | Measures |
|-----|-------------|------------------|---------------|---------------------|-----|-------------|------------------|---------------|----------|
| 1   | 111-09-904  | Tie Rod End      | 8-94237-351-1 | c:13.2 th:FM14X1.5R | 4   | 53-09-906   | Ball Joint       | 8-94224-552-2 | c:17.6   |
| 2   | 103-09-900  | Axial Joint      | 8-94217-221-3 | th:FM14X1.5R L:267  | 5   | 53-09-908L  | Ball Joint Lower | 94109704      | c:17.6   |
| 3   | 73-09-999   | Ball Joint UPPER | 8-94224-550-2 | c:17.4              | 6   | 53-09-908R  | Ball Joint Lower | 8-94452-106-1 |          |

PICK-UP FASTER

05/1988 - 12/1990



2 111-09-998



3 111-09-999

UPPER



1 73-09-914

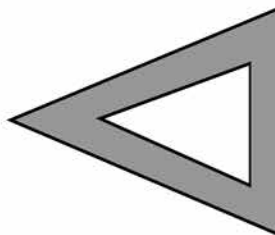

6 GOM-914

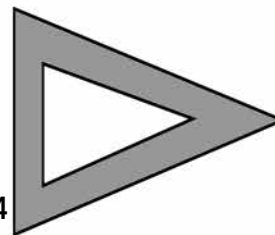

1 73-09-914

LOWER



4 73-09-915

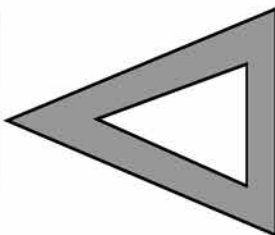

TFR

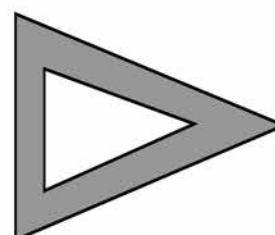

4 73-09-915



5 73-09-913

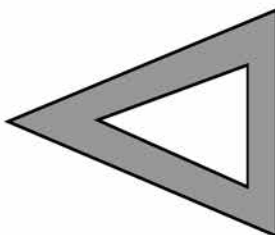

TFS

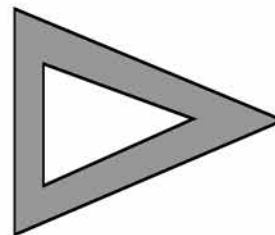

5 73-09-913

| Ref. | ASHIKA CODE | Description       | OEM     | Measures          | Ref. | ASHIKA CODE | Description              | OEM           | Measures |
|------|-------------|-------------------|---------|-------------------|------|-------------|--------------------------|---------------|----------|
| 1    | 73-09-914   | Ball Joint UPPER  | 310 828 | c:17.5            | 4    | 73-09-915   | Ball Joint UPPER         | 8 94459 464 1 | c:20.5   |
| 2    | 111-09-998  | Tie Rod End Left  | 324 058 | c:16 th:FM14X1.5L | 5    | 73-09-913   | Ball Joint UPPER         | 8-94452-102-1 | c:20.5   |
| 3    | 111-09-999  | Tie Rod End Right | 324 057 | c:16 th:FM14X1.5R | 6    | GOM-914     | Silentblock For Susp.Arm | 8-94226-557-0 |          |



# ISUZU TROOPER - BIGHORN



TROOPER (UBS)  
BIGHORN

10/1987 - 12/1991



1 111-09-998

8 103-09-999

8 103-09-999



2 111-09-999

UPPER

-> 11/1991



3 73-09-999

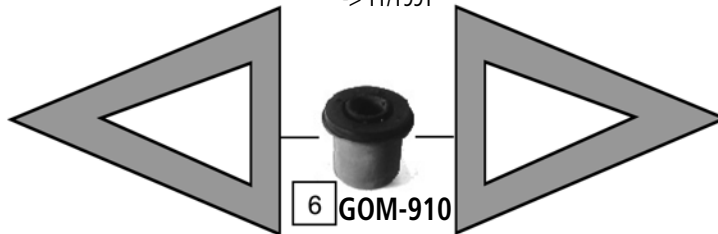

6 GOM-910



3 73-09-999

UPPER

12/1991 ->



5 73-09-917

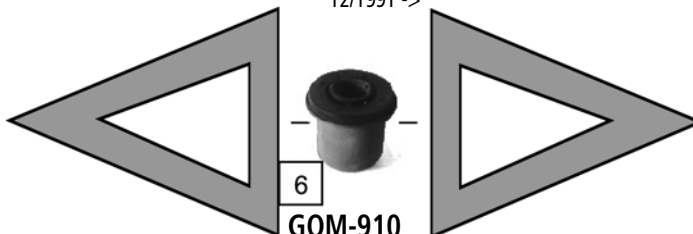

6 GOM-910



5 73-09-917

LOWER



4 73-09-913

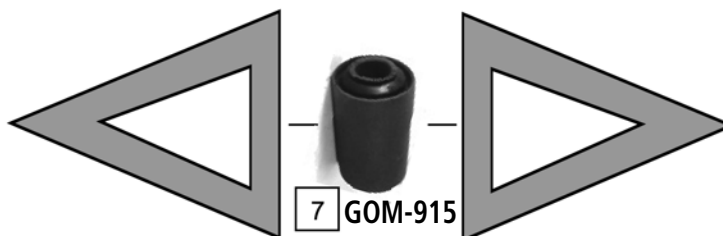

7 GOM-915



4 73-09-913

| Ref | ASHIKA CODE | Description       | OEM           | Measures          | Ref | ASHIKA CODE | Description              | OEM           | Measures |
|-----|-------------|-------------------|---------------|-------------------|-----|-------------|--------------------------|---------------|----------|
| 1   | 111-09-998  | Tie Rod End Left  | 324 058       | c:16 th:FM14X1.5L | 5   | 73-09-917   | Ball Joint               | 8-94374424-0  | c:17.6   |
| 2   | 111-09-999  | Tie Rod End Right | 324 057       | c:16 th:FM14X1.5R | 6   | GOM-910     | Silentblock For Susp.Arm | 8-94408-840-3 | d:38.2   |
| 3   | 73-09-999   | Ball Joint UPPER  | 8-94224-550-2 | c:17.4            | 7   | GOM-915     | Silentblock For Susp.Arm | 8-94408-842-0 | d:44.6   |
| 4   | 73-09-913   | Ball Joint UPPER  | 8-94452-102-1 | c:20.5            | 8   | 103-09-999  | Axial Joint              | 5-44352095-2  |          |

TROOPER (UB)  
BIGHORN

08/1991 - 07/1998

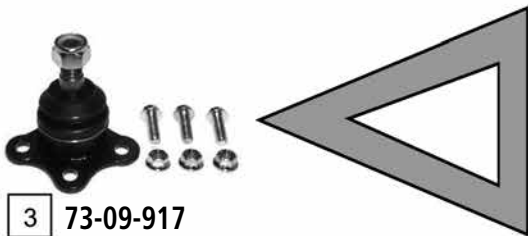

UPPER

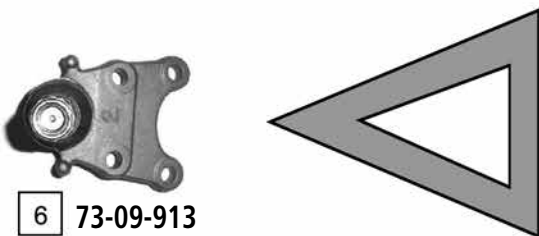
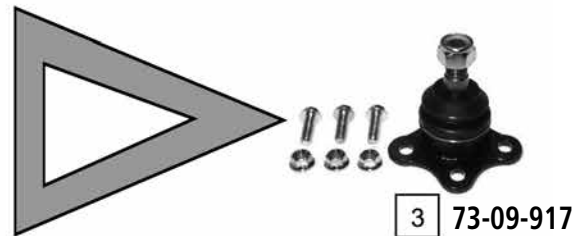

LOWER

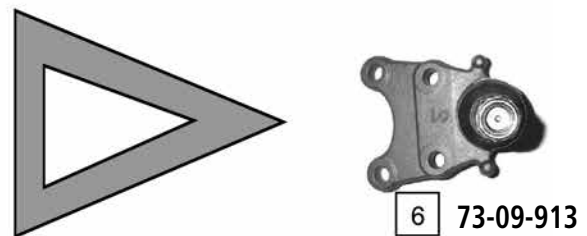

| Ref. | ASHIKA CODE | Description       | OEM          | Measures          | Ref. | ASHIKA CODE | Description           | OEM           | Measures |
|------|-------------|-------------------|--------------|-------------------|------|-------------|-----------------------|---------------|----------|
| 1    | 111-09-998  | Tie Rod End Left  | 324 058      | c:16 th:FM14X1.5L | 4    | 106-09-901  | Stabiliser Link Left  | 8-97018228-2  | L:148    |
| 2    | 111-09-999  | Tie Rod End Right | 324 057      | c:16 th:FM14X1.5R | 5    | 106-09-900  | Stabiliser Link Right | 8-97018227-2  |          |
| 3    | 73-09-917   | Ball Joint        | 8-94374424-0 | c:17.6            | 6    | 73-09-913   | Ball Joint Upper      | 8-94452-102-1 | c:20.5   |

4.0l - 2.1TD  
CHEROKEE (XJ)

10/1984 - 09/2001

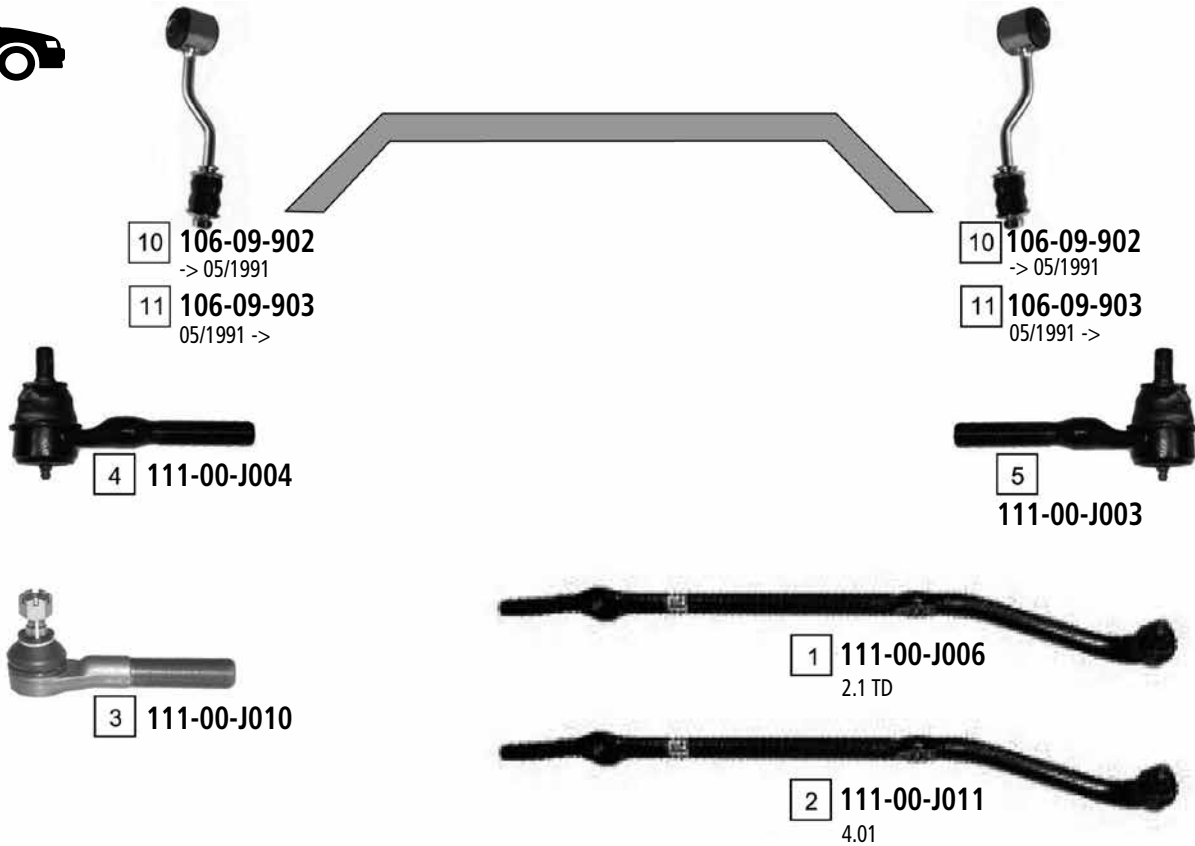

UPPER



LOWER

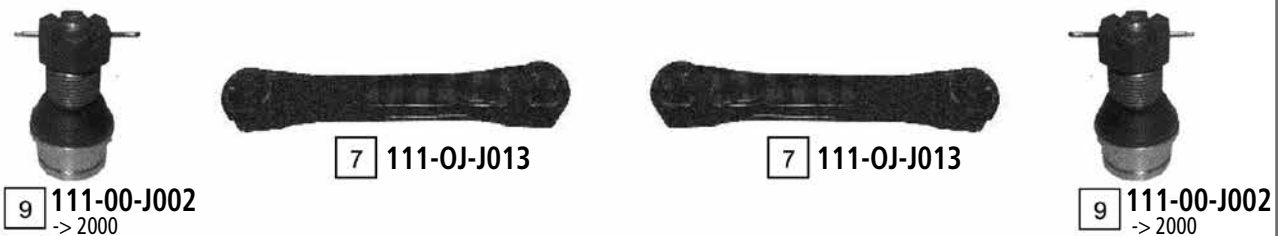

| Ref | ASHIKA CODE | Description | OEM      | Measures            | Ref | ASHIKA CODE | Description     | OEM       | Measures |
|-----|-------------|-------------|----------|---------------------|-----|-------------|-----------------|-----------|----------|
| 1   | 111-00-J006 | Tie Rod     | 52005738 |                     | 7   | 111-OJ-J013 | TCA             | 52001162  |          |
| 2   | 111-00-J011 | Tie Rod     | 52006592 |                     | 8   | 111-00-J001 | Ball Joint      | 83500 202 | c:15.8   |
| 3   | 111-00-J010 | Tie Rod End | 52005739 | c:14.2 th:MM22X1.5L | 9   | 111-00-J002 | Ball Joint      | 83500 202 | c:18.4   |
| 4   | 111-00-J004 | Tie Rod End | 52005741 |                     | 10  | 106-09-902  | Stabiliser Link | 52037 849 |          |
| 5   | 111-00-J003 | Tie Rod End | 52005740 |                     | 11  | 106-09-903  | Stabiliser Link | 52003 360 |          |
| 6   | 111-00-J007 | TCA         | 52087711 |                     |     |             |                 |           |          |

GRAND CHEROKEE I (ZJ / ZG)

01/1991 - 04/1999

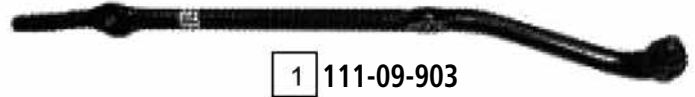
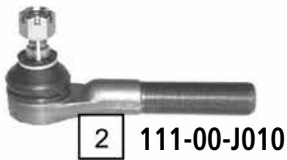

UPPER



5 111-00-J001

LOWER



6 111-00-J002

| Ref. | ASHIKA CODE | Description | OEM      | Measures            | Ref. | ASHIKA CODE | Description     | OEM       | Measures |
|------|-------------|-------------|----------|---------------------|------|-------------|-----------------|-----------|----------|
| 1    | 111-09-903  | Tie Rod     | 52037994 |                     | 5    | 111-00-J001 | Ball Joint      | 83500 202 | c:15.8   |
| 2    | 111-00-J010 | Tie Rod End | 52005739 | c:14.2 th:MM22X1.5L | 6    | 111-00-J002 | Ball Joint      | 83500 202 | c:18.4   |
| 3    | 111-00-J007 | TCA         | 52087711 |                     | 7    | 106-09-904  | Stabiliser Link | 52088437  |          |
| 4    | 111-00-J000 | TCA         | 52088312 |                     |      |             |                 |           |          |

# JEEP GRAND CHEROKEE



GRAND CHEROKEE II (WJ/WG)

01/1999 - 06/2005

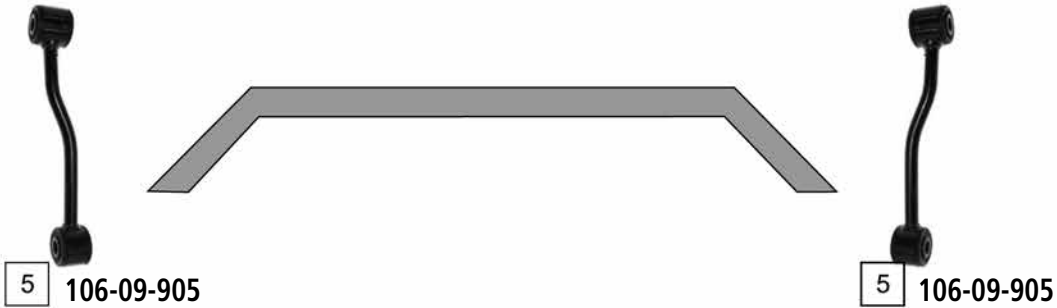

UPPER



LOWER

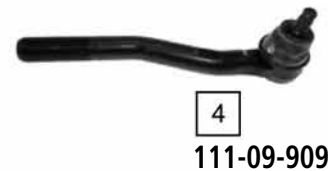

UPPER



LOWER



| Ref | ASHIKA CODE | Description       | OEM         | Measures            | Ref | ASHIKA CODE | Description | OEM         | Measures |
|-----|-------------|-------------------|-------------|---------------------|-----|-------------|-------------|-------------|----------|
| 1   | 111-09-908  | Tie Rod End Left  | 52088 511   | c:14.3 th:MM24X1.5L | 6   | 111-OJ-J014 | TCA         | 52088208-AC |          |
| 2   | 111-09-907  | Tie Rod End Right | 52088 461   | c:14.3 th:MM24x1.5R | 7   | 111-OJ-J012 | TCA         | 52088217-AB |          |
| 3   | 111-09-910  | Tie Rod End Left  | 52088 869AA | c:14.3 th:MM24X1.5L | 8   | 73-09-900   | Ball Joint  | 5012 432AA  | c:16     |
| 4   | 111-09-909  | Tie Rod End Right | 52088 870AA | c:14.3 th:MM24X1.5R | 9   | 73-09-902   | Ball Joint  | 5012 432AA  | c:17.7   |
| 5   | 106-09-905  | Stabiliser Link   | 52088 283   |                     |     |             |             |             |          |

GRAND CHEROKEE III (W2)

06/2005 ->

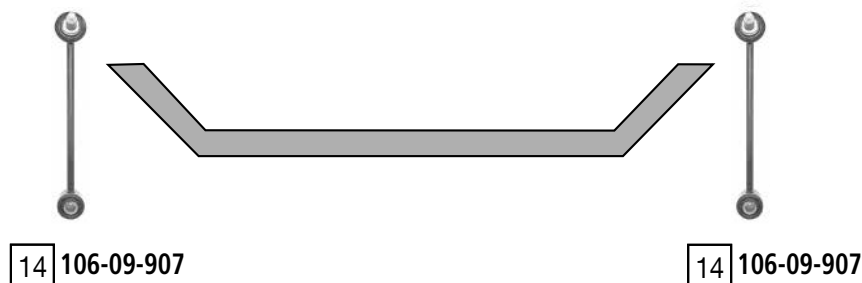
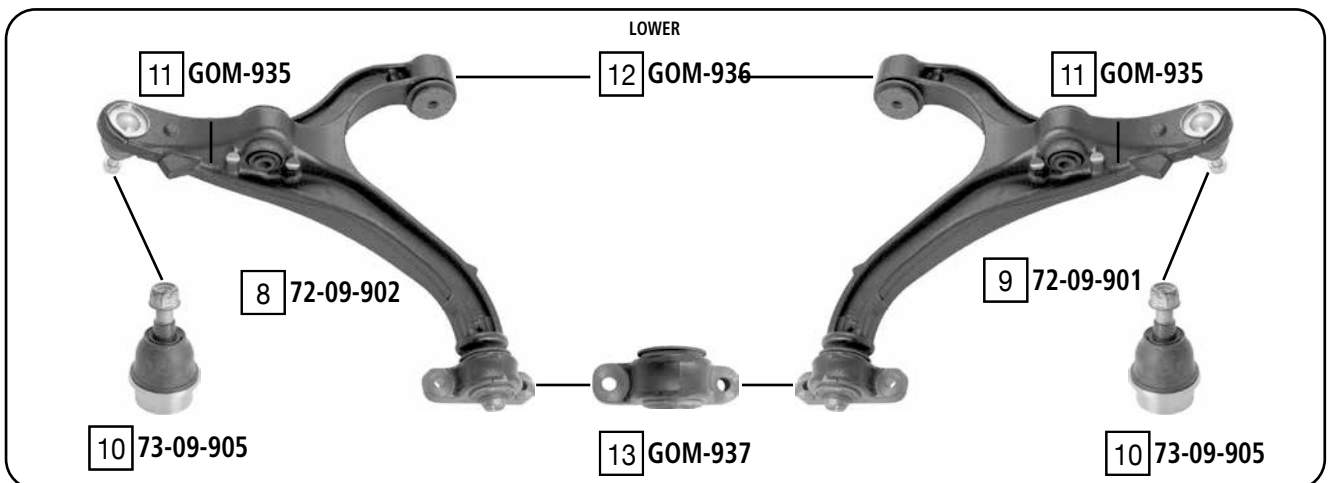
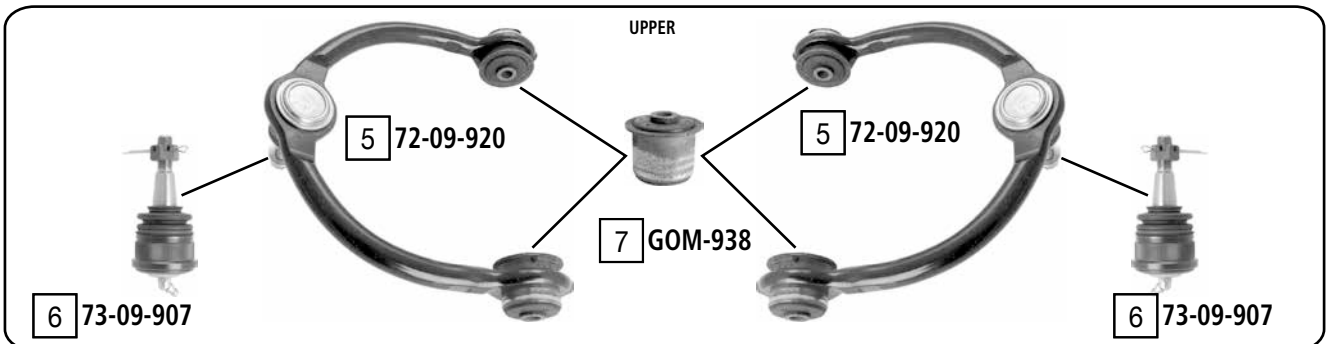
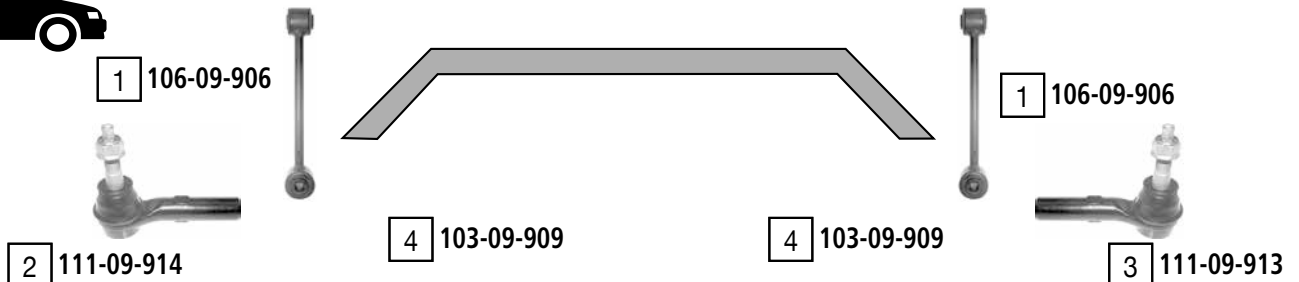

| Ref | ASHIKA CODE | Description         | OEM         | Measures           | Ref | ASHIKA CODE | Description               | OEM         | Measures        |
|-----|-------------|---------------------|-------------|--------------------|-----|-------------|---------------------------|-------------|-----------------|
| 1   | 106-09-906  | Stabiliser link     | 52089 467AB | L:230              | 8   | 72-09-902   | TCA left wbj              | 52089 981AI | c:17.3          |
| 2   | 111-09-914  | Tie rod end left    | 5143 555AC  | c:15 th:FM16X1.5R  | 9   | 72-09-901   | TCA right wbj             | 52089 980AI | c:17.3          |
| 3   | 111-09-913  | Tie rod end right   | 5143 556AC  | c:15 th:FM16X1.5R  | 10  | 73-09-905   | Ball joint lower          | 5135 651AD  | c:17.3 do:49.7  |
| 4   | 103-09-909  | Axial joint         | Part of     | th:MM14x1.5R L:354 | 11  | GOM-935     | Silentblock for TCA       | Part of     | di:16.3 do:49.3 |
| 5   | 72-09-920   | TCA wbj             | 52090 206AI | c:14.6             | 12  | GOM-936     | Silentblock for TCA       | Part of     | di:16.3 do:54.9 |
| 6   | 73-09-907   | Ball joint upper    | Part of     | c:14.6 do:43.9     | 13  | GOM-937     | Silentblock for TCA       | Part of     | di:26 do:26     |
| 7   | GOM-938     | Silentblock for TCA | Part of     | di:12.2 do:46      | 14  | 106-09-907  | Stabiliser link rear axle | 52089 486AE | L:240           |

CARENS I (FC)

11/2000 - 07/2002

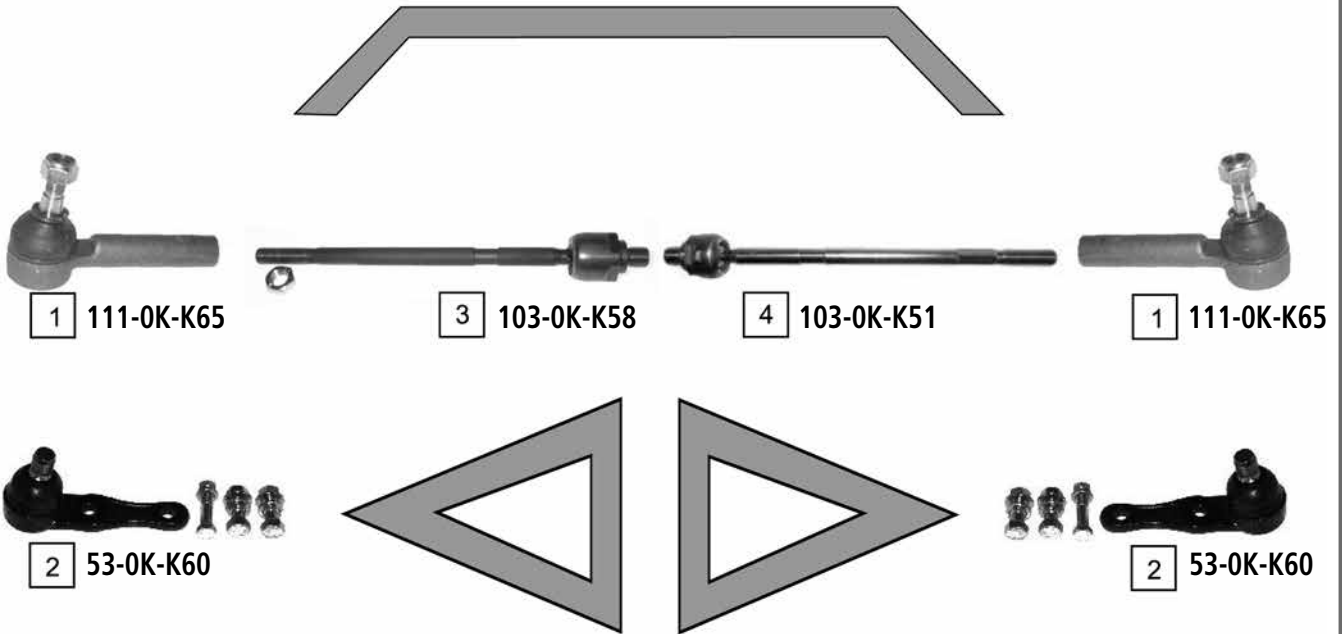

| Ref | ASHIKA CODE | Description | OEM          | Measures          | Ref | ASHIKA CODE | Description | OEM         | Measures           |
|-----|-------------|-------------|--------------|-------------------|-----|-------------|-------------|-------------|--------------------|
| 1   | 111-0K-K65  | Tie Rod End | 0K201 32280  | c:13 th:FM14X1.5R | 3   | 103-0K-K58  | Axial Joint | 0K2A1 32240 | th:MM16X1.5R L:282 |
| 2   | 53-0K-K60   | Ball Joint  | 0K2A1 34550A | c:18              | 4   | 103-0K-K51  | Axial Joint | 0K2A2 32240 |                    |

CARENS II (FJ)

07/2002 - 09/2006

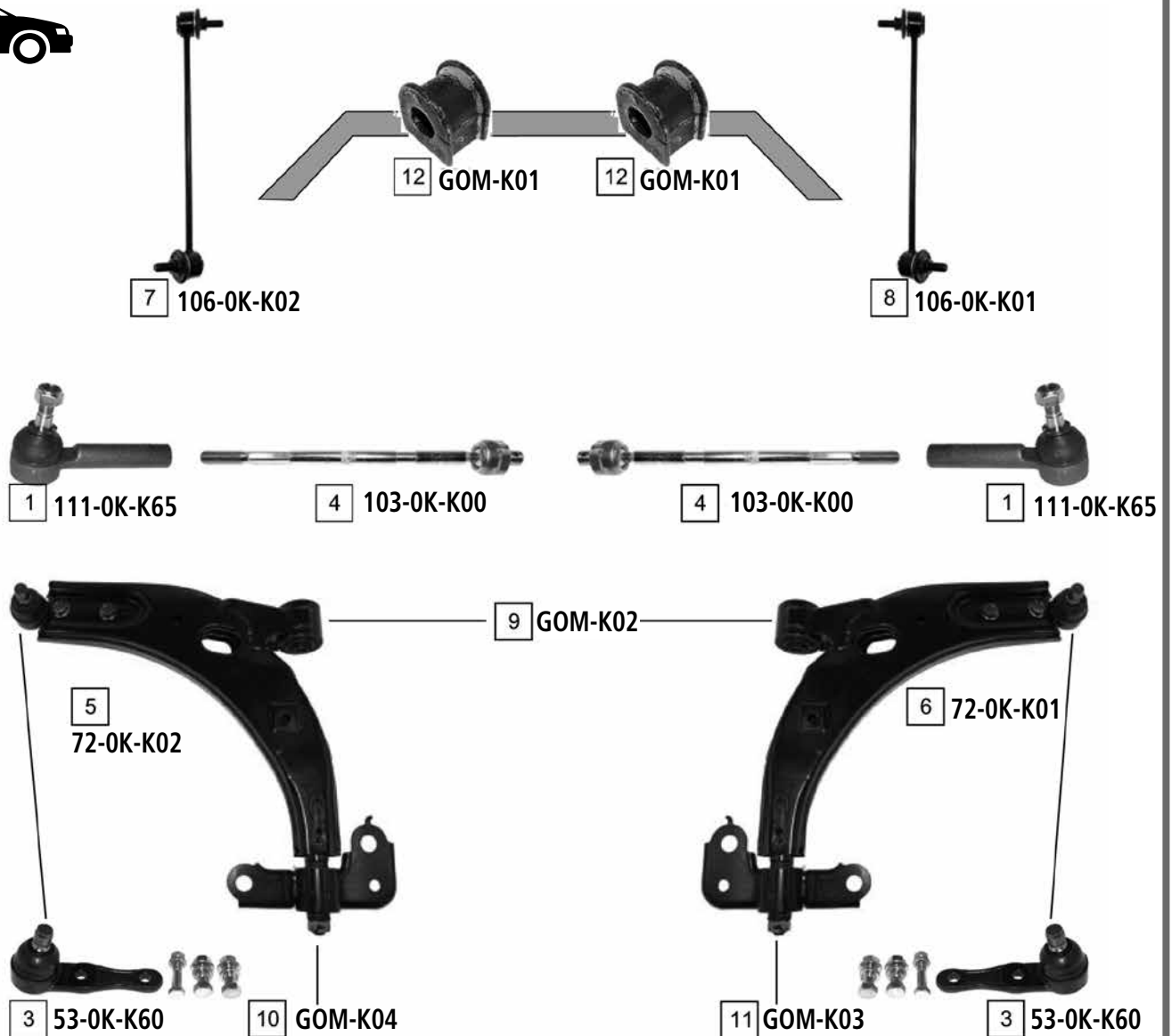

| Ref. | ASHIKA CODE | Description     | OEM          | Measures           | Ref. | ASHIKA CODE | Description              | OEM          | Measures |
|------|-------------|-----------------|--------------|--------------------|------|-------------|--------------------------|--------------|----------|
| 1    | 111-OK-K65  | Tie Rod End     | OK201 32280  | c:13 th:FM14X1.5R  | 7    | 106-OK-K02  | Stabiliser Link Left     | OK2FA 34170  | L:280    |
| 2    | 106-OK-K54  | Stabiliser Link | OK2A1 34150B | L:89               | 8    | 106-OK-K01  | Stabiliser Link Right    | OK2FA 34150  | L:280    |
| 3    | 53-OK-K60   | Ball Joint      | OK2A1 34550A | c:18               | 9    | GOM-K02     | Silentblock For Susp.Arm | OK2C034460   |          |
| 4    | 103-OK-K100 | Axial Joint     | OK2FK 32240  | th:MM16X1.5R L:304 | 10   | GOM-K04     | Silentblock For Susp.Arm | OK2A1 3446Y  |          |
| 5    | 72-OK-K02   | TCA Left        | OK2FA 34350  | c:18               | 11   | GOM-K03     | Silentblock For Susp.Arm | OK2A1 3446X  |          |
| 6    | 72-OK-K01   | TCA Right       | OK2FA 34340  | c:18               | 12   | GOM-K01     | Stabiliser Mounting      | OK2KB 34156A | d:20     |



# KIA CARENS



CARENS III

10/2006 ->

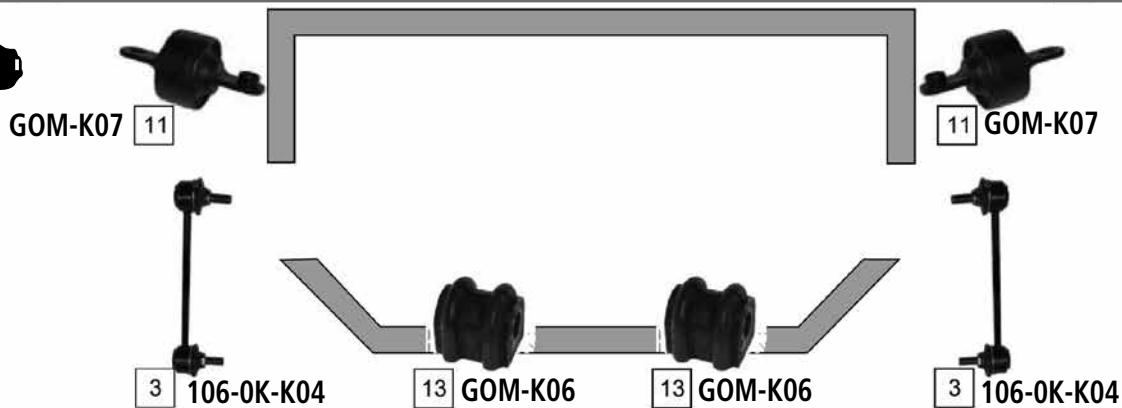
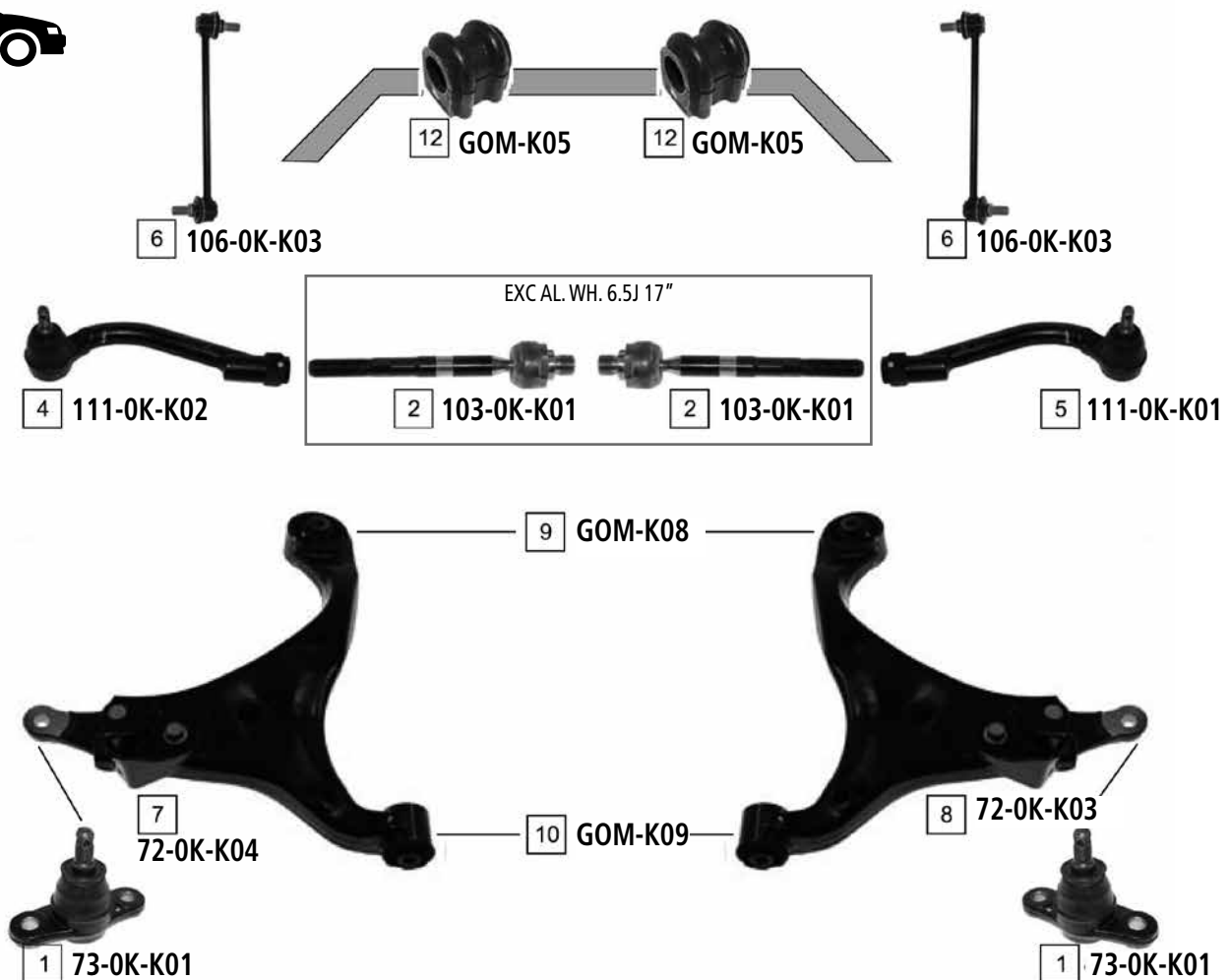

| Ref | ASHIKA CODE | Description       | OEM         | Measures            | Ref | ASHIKA CODE | Description              | OEM         | Measures |
|-----|-------------|-------------------|-------------|---------------------|-----|-------------|--------------------------|-------------|----------|
| 1   | 73-OK-K01   | Ball Joint        | 51760 2G000 | c:15                | 8   | 72-OK-K03   | TCA Right Wobj           | 54501 1D000 | -        |
| 2   | 103-OK-K01  | Axial Joint       | 57724 2G000 | th:MM18X1.5R L:199  | 9   | GOM-K08     | Silentblock For Susp.Arm | 54584 1D000 | d:14.3   |
| 3   | 106-OK-K04  | Stabiliser Link   | 55530 1D000 | L:180               | 10  | GOM-K09     | Silentblock For Susp.Arm | 54551 1D000 | d:12.2   |
| 4   | 111-OK-K02  | Tie Rod End Left  | 56820 2G000 | c:13.4 th:MM16X1.5R | 11  | GOM-K07     | Silentblock For Susp.Arm | 55543 2G000 | -        |
| 5   | 111-OK-K01  | Tie Rod End Right | 56820 2G900 | c:13.4 th:MM16X1.5R | 12  | GOM-K05     | Stabiliser Mounting      | 54813 1H100 | d:23.4   |
| 6   | 106-OK-K03  | Stabiliser Link   | 54830 2G000 | L:241               | 13  | GOM-K06     | Stabiliser Mounting      | 55513 2G000 | d:14     |
| 7   | 72-OK-K04   | TCA Left Wobj     | 54500 1D000 | -                   |     |             |                          |             |          |

CARNIVAL - SEDONA (UP)

08/1999 - 11/2005



| Ref. | ASHIKA CODE | Description       | OEM         | Measures         | Ref. | ASHIKA CODE | Description     | OEM          | Measures |
|------|-------------|-------------------|-------------|------------------|------|-------------|-----------------|--------------|----------|
| 1    | 111-0K-K95  | Axial Joint       | 0K522 32270 | th:MM17X1R L:246 | 5    | 26-0K-K55L  | TCA Left        | 0K552 34350B | c:21.9   |
| 2    | 111-0K-K96  | Axial Joint       | 0K522 32250 | th:MM17X1R L:308 | 6    | 26-0K-K55R  | TCA Right       | 0K552 34300B | c:21.9   |
| 3    | 111-0K-K94  | Tie Rod End Left  | 0K552 32240 |                  | 7    | 106-0K-K58  | Stabiliser Link | 0K552 34151B | L:64     |
| 4    | 111-0K-K93  | Tie Rod End Right | 0K552 32280 |                  |      |             |                 |              |          |

# KIA CARNIVAL



CARNIVAL III

04/2006 ->

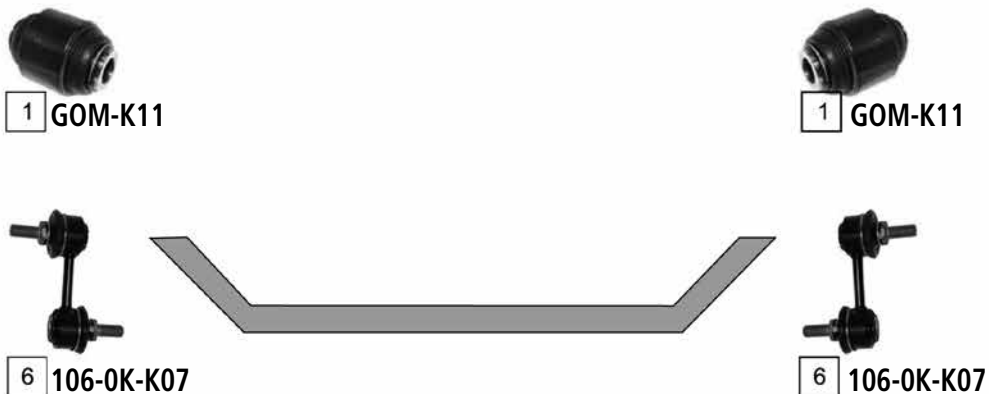
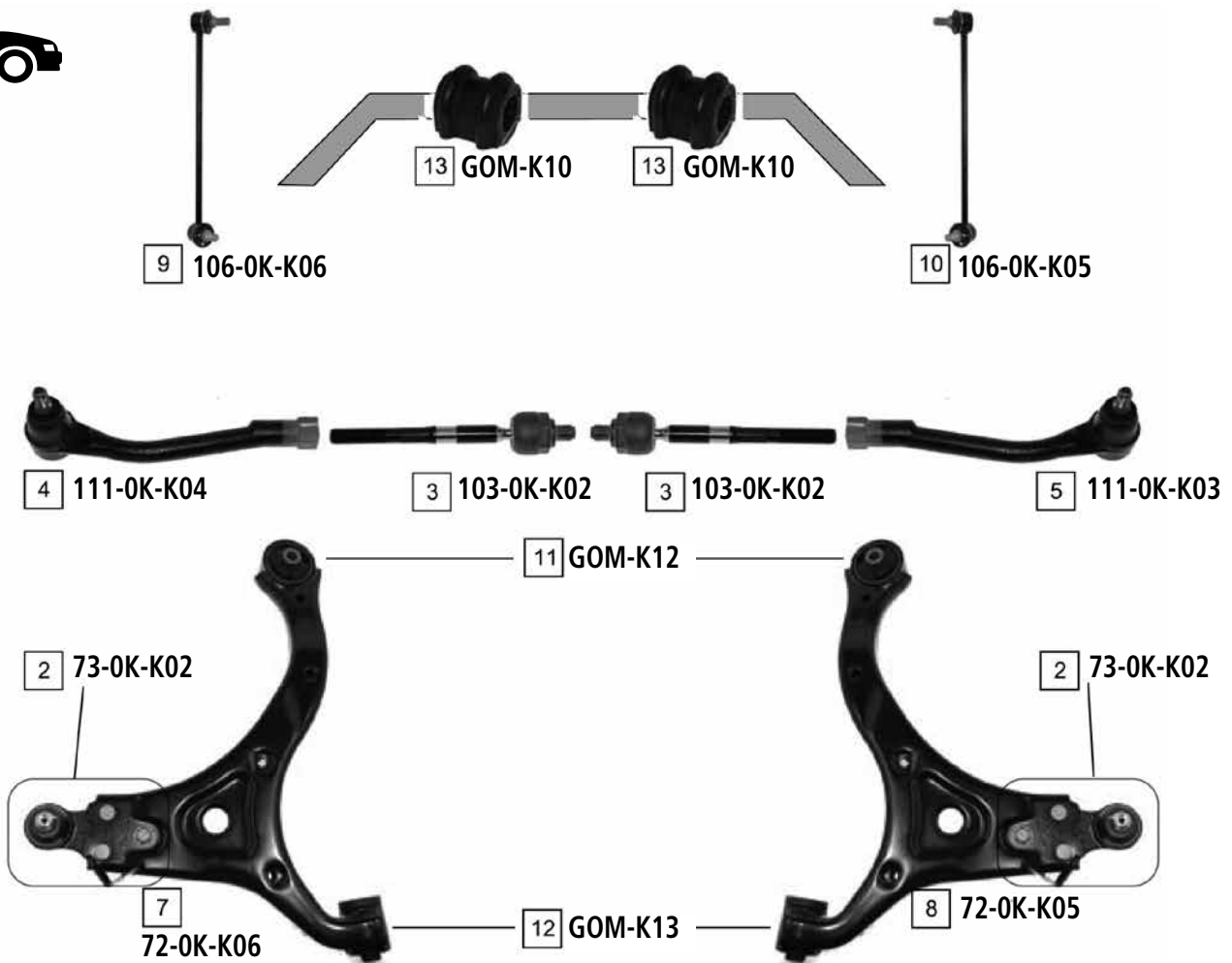

| Ref | ASHIKA CODE | Description       | OEM         | Measures           | Ref | ASHIKA CODE | Description              | OEM         | Measures |
|-----|-------------|-------------------|-------------|--------------------|-----|-------------|--------------------------|-------------|----------|
| 1   | GOM-K11     | Ball Joint        | 55130 4D000 | -                  | 8   | 72-0K-K05   | TCA Right Wbj            | 54501 4D001 | c:20     |
| 2   | 73-0K-K02   | Ball Joint        | 54530 4D000 | c:20               | 9   | 106-0K-K06  | Stabiliser Link Left     | 54830 4D000 | L:323    |
| 3   | 103-0K-K02  | Axial Joint       | 57724 4D000 | th:MM16X1.5R L:210 | 10  | 106-0K-K05  | Stabiliser Link Right    | 54840 4D000 | L:323    |
| 4   | 111-0K-K04  | Tie Rod End Left  | 56820 4D000 | c:14 th:FM16X1.5R  | 11  | GOM-K12     | Silentblock For Susp.Arm | 54584 4D000 | d:14.4   |
| 5   | 111-0K-K03  | Tie Rod End Right | 56820 4D100 | c:14 th:FM16X1.5R  | 12  | GOM-K13     | Silentblock For Susp.Arm | 54551 4D000 | d:14.1   |
| 6   | 106-0K-K07  | Stabiliser Link   | 55530 4D000 | L:72               | 13  | GOM-K10     | Stabiliser Mounting      | 54813 4D000 | d:26     |
| 7   | 72-0K-K06   | TCA Left Wbj      | 54500 4D001 | c:20               |     |             |                          |             |          |

CEE'D

12/2006 ->

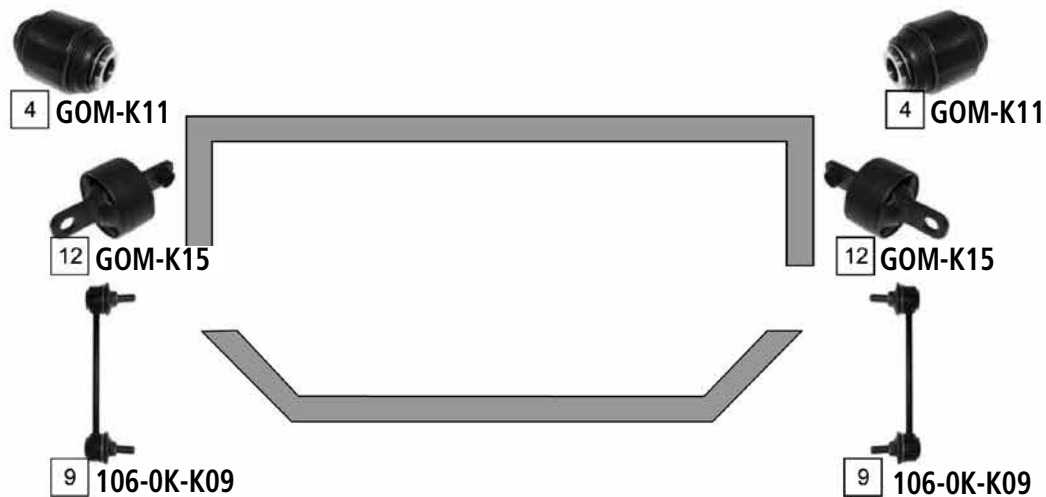
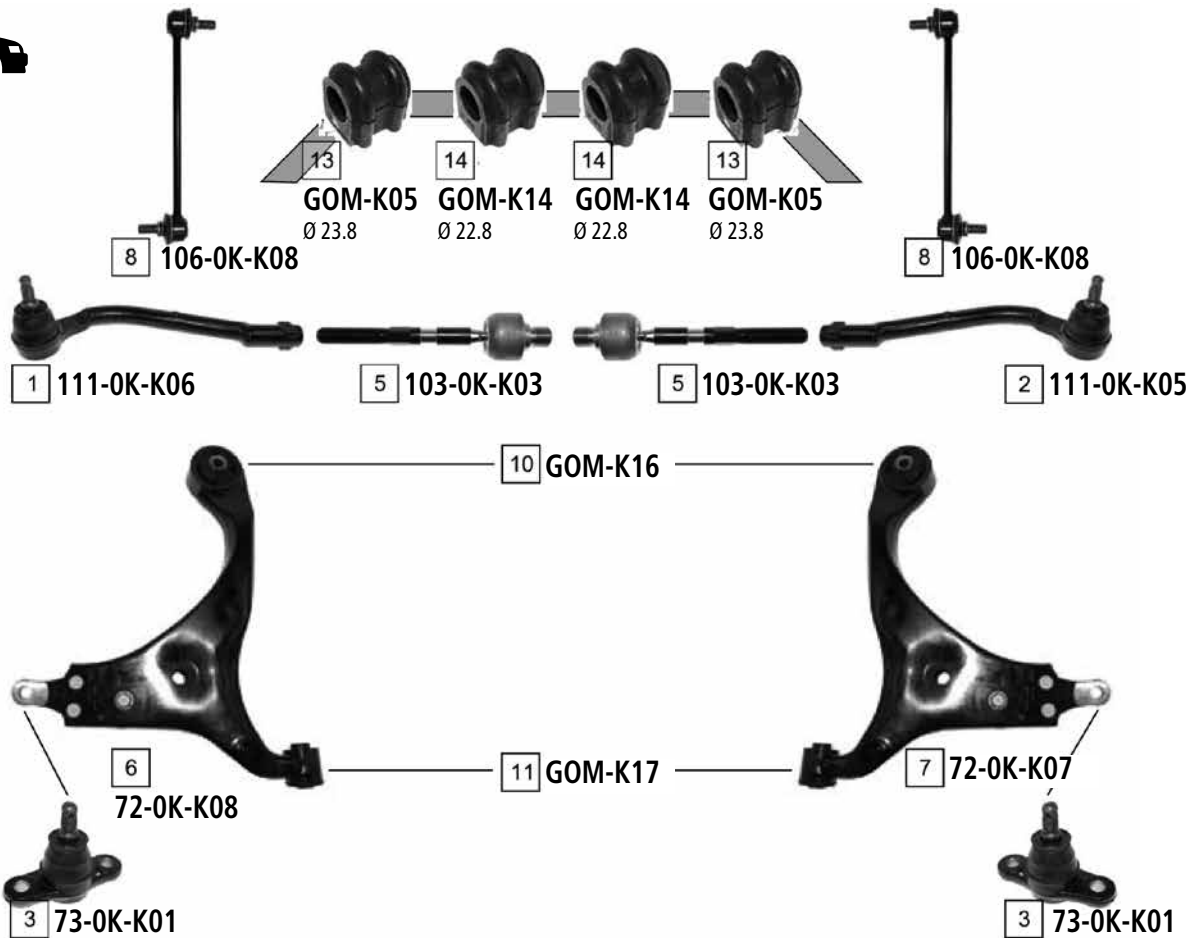

| Ref. | ASHIKA CODE | Description       | OEM         | Measures            | Ref. | ASHIKA CODE | Description              | OEM         | Measures |
|------|-------------|-------------------|-------------|---------------------|------|-------------|--------------------------|-------------|----------|
| 1    | 111-OK-K06  | Tie Rod End Left  | 56820 2H000 | c:13.4 th:FM14X1.5R | 8    | 106-OK-K08  | Stabiliser Link          | 54830 2H000 | L:245    |
| 2    | 111-OK-K05  | Tie Rod End Right | 56820 2H090 | c:13.4 th:FM14X1.5R | 9    | 106-OK-K09  | Stabiliser Link          | 55530 1H000 | L:171    |
| 3    | 73-OK-K01   | Ball Joint        | 51760 2G000 | c:15                | 10   | GOM-K16     | Silentblock For Susp.Arm | 54584 2H000 | d:14     |
| 4    | GOM-K11     | Ball Joint        | 55130 4D000 | -                   | 11   | GOM-K17     | Silentblock For Susp.Arm | 54551 2H000 | d:12.4   |
| 5    | 103-OK-K03  | Axial Joint       | 56540 2H000 | th:MM16X1.5R L:162  | 12   | GOM-K15     | Silentblock For Susp.Arm | 55543 1H000 | -        |
| 6    | 72-OK-K08   | TCA Left Wobj     | 54500 2H000 | -                   | 13   | GOM-K05     | Stabiliser Mounting      | 54813 1H100 | d:23.4   |
| 7    | 72-OK-K07   | TCA Right Wobj    | 54501 2H000 | -                   | 14   | GOM-K14     | Stabiliser Mounting      | 54813 2H000 | d:22.3   |

CERATO

04/2004 ->

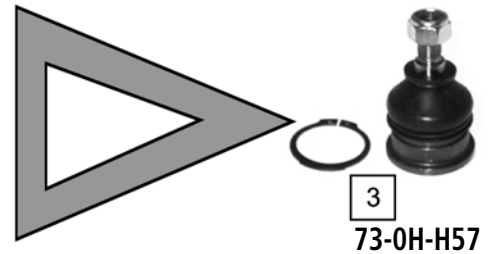
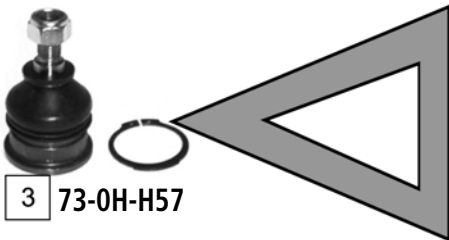
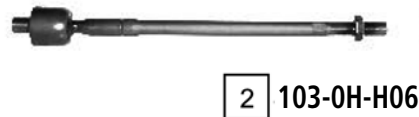
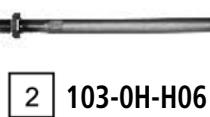

| Ref | ASHIKA CODE | Description     | OEM         | Measures            | Ref | ASHIKA CODE | Description           | OEM         | Measures |
|-----|-------------|-----------------|-------------|---------------------|-----|-------------|-----------------------|-------------|----------|
| 1   | 111-0H-H01  | Tie Rod End     | 56820-25000 | c:13.8 th:FM14X1.5R | 5   | 106-0K-K10  | Stabiliser Link Left  | 54830 2F000 | L:250    |
| 2   | 103-0H-H06  | Axial Joint     | 57724-2D000 | th:MM16X1.5R L:327  | 6   | 106-0K-K11  | Stabiliser Link Right | 54840 2F000 | L:250    |
| 3   | 73-0H-H57   | Ball Joint      | 54520 31600 | c:15                |     |             |                       |             |          |
| 4   | 106-0H-H13  | Stabiliser Link | 55530 17000 | L:128.5             |     |             |                       |             |          |

CLARUS (K9A)

07/1996 - 04/2000

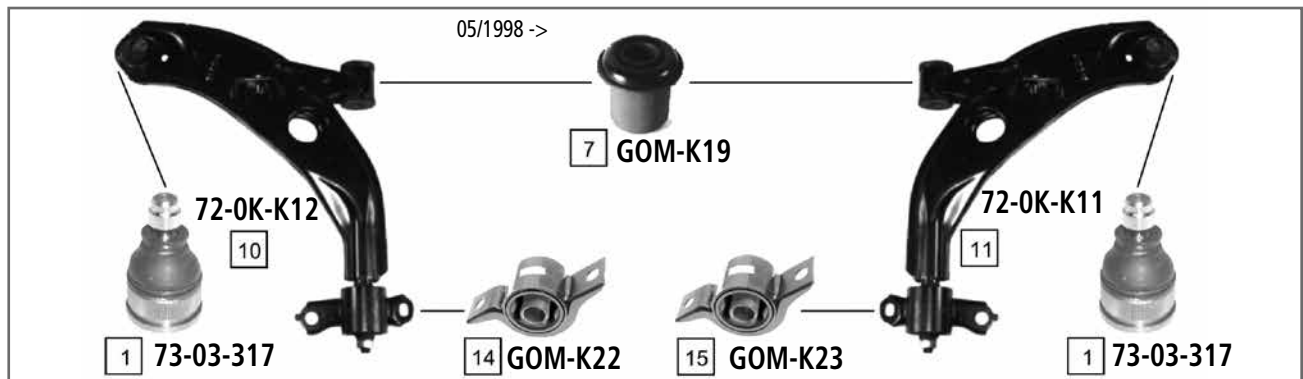
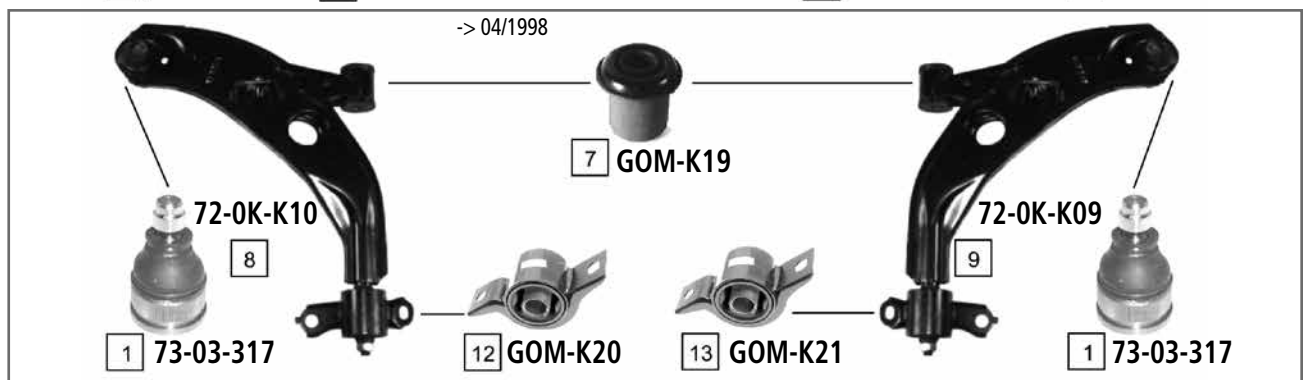
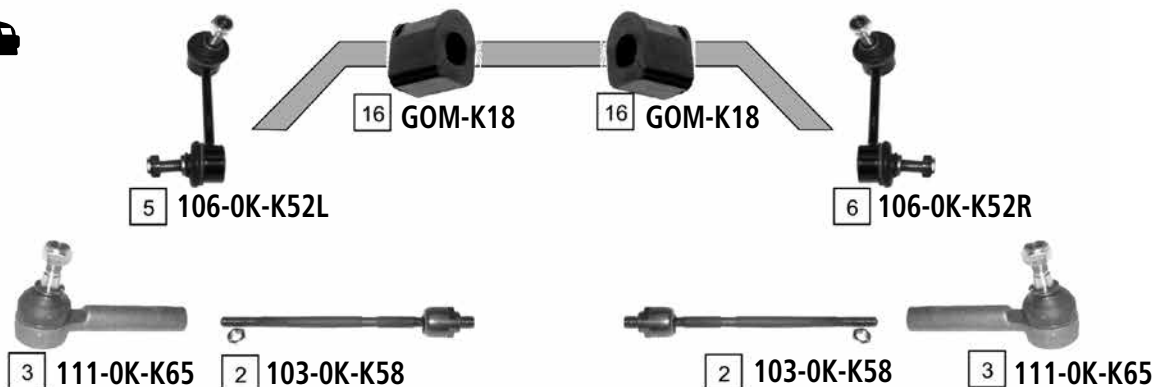

| Ref. | ASHIKA CODE | Description              | OEM          | Measures           | Ref. | ASHIKA CODE | Description              | OEM         | Measures |
|------|-------------|--------------------------|--------------|--------------------|------|-------------|--------------------------|-------------|----------|
| 1    | 73-03-317   | Ball Joint LOWER         | 0G030 34550B | c:18               | 9    | 72-0K-K09   | TCA Right                | 0K9A2-34300 |          |
| 2    | 103-0K-K58  | Axial Joint              | 0K2A1 32240  | th:MM16X1.5R L:282 | 10   | 72-0K-K12   | TCA Left                 | 0K9A6-34350 |          |
| 3    | 111-0K-K65  | Tie Rod End              | 0K201 32280  | c:13 th:FM14X1.5R  | 11   | 72-0K-K11   | TCA Right                | 0K9A6-34300 |          |
| 4    | 106-0K-K53  | Stabiliser Link          | 0K9A3 28170A | L:70               | 12   | GOM-K20     | Silentblock For Susp.Arm | 0K9A2-34464 |          |
| 5    | 106-0K-K52L | Stabiliser Link Left     | KGA2A 34170A | L:104              | 13   | GOM-K21     | Silentblock For Susp.Arm | 0K9A2-3446X |          |
| 6    | 106-0K-K52R | Stabiliser Link Right    | KGA2A 34150A | L:104              | 14   | GOM-K22     | Silentblock For Susp.Arm | 0K9A6-3446Y |          |
| 7    | GOM-K19     | Silentblock For Susp.Arm | 0K9A2-34470  |                    | 15   | GOM-K23     | Silentblock For Susp.Arm | 0K9A6-3446X |          |
| 8    | 72-0K-K10   | TCA Left                 | 0K9A2-34350  |                    | 16   | GOM-K18     | Stabiliser Mounting      | 0K9A2-34156 |          |

# KIA K2500 - 2700



K 2500 - 2700

01/1997 ->

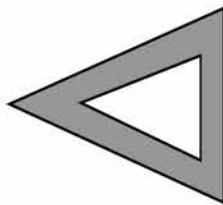
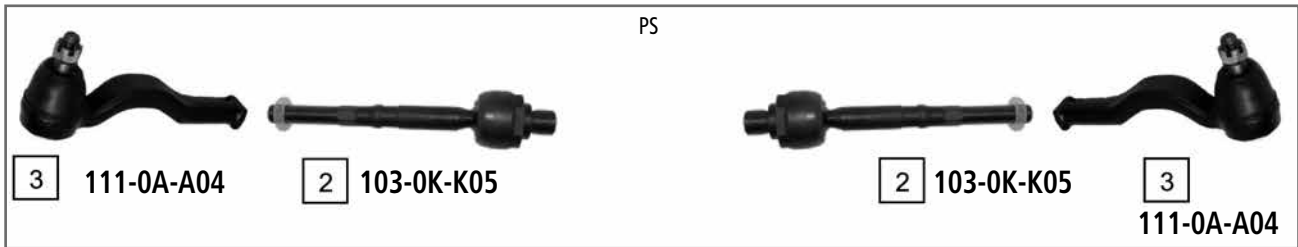
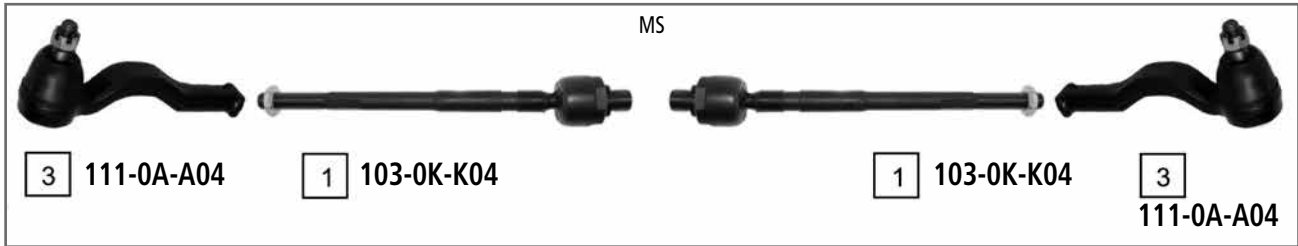

6 71-0K-K52L

8 71-0K-K52R

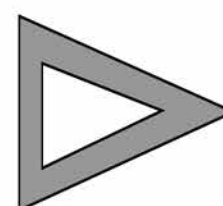
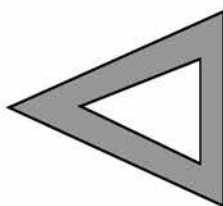
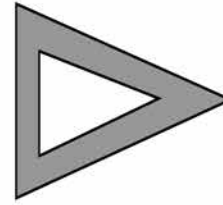

7 26-0K-K51L

9 26-0K-K51R

| Ref | ASHIKA CODE | Description | OEM          | Measures           | Ref | ASHIKA CODE | Description | OEM           | Measures |
|-----|-------------|-------------|--------------|--------------------|-----|-------------|-------------|---------------|----------|
| 1   | 103-0K-K04  | Axial Joint | 0K72A 32270  | th:MM17X1R L:275   | 6   | 71-0K-K52L  | TCA Left    | OSE46-34-200  |          |
| 2   | 103-0K-K05  | Axial Joint | 0K60A32270/A | th:MM18X1.5R L:183 | 7   | 26-0K-K51L  | TCA Left    | OS083-34-300B |          |
| 3   | 111-0A-A04  | Tie Rod End | 0K71032240   | c:14 th:FM14X1.5R  | 8   | 71-0K-K52R  | TCA Right   | OS046-34-250  |          |
| 4   | 73-0A-A01   | Ball Joint  | 0K710 34540  |                    | 9   | 26-0K-K51R  | TCA Right   | OS083-34-350B |          |
| 5   | 73-0A-A02   | Ball Joint  | 0K710 34510  |                    |     |             |             |               |          |

PICANTO

02/2004 ->

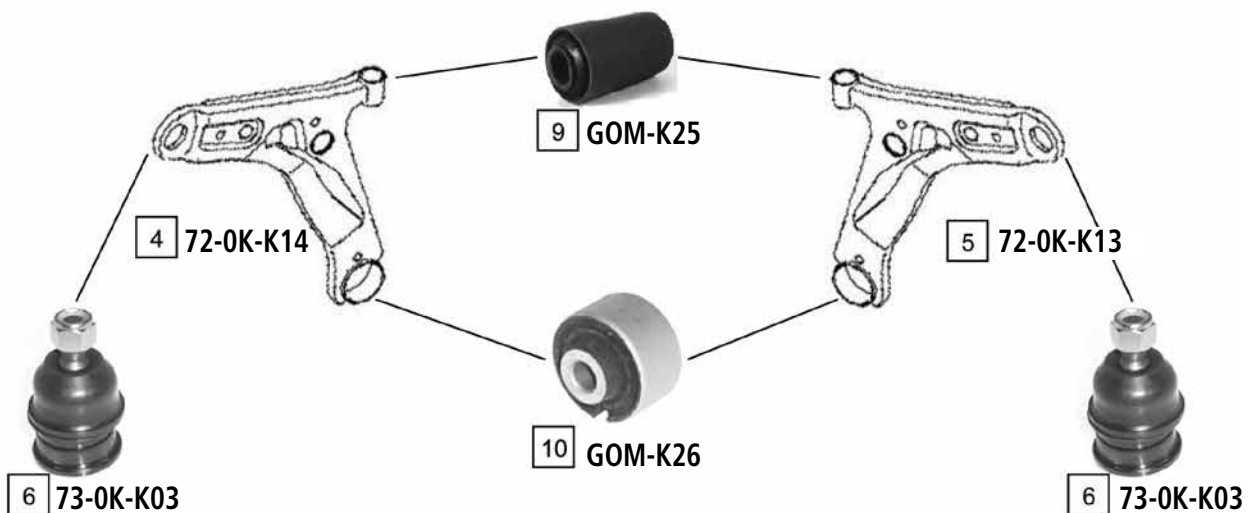
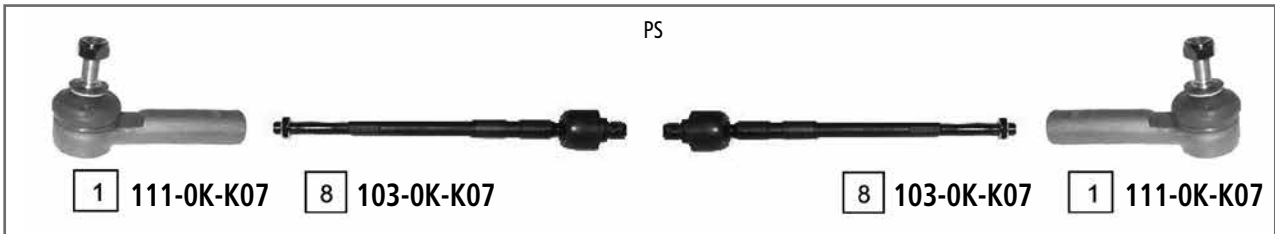
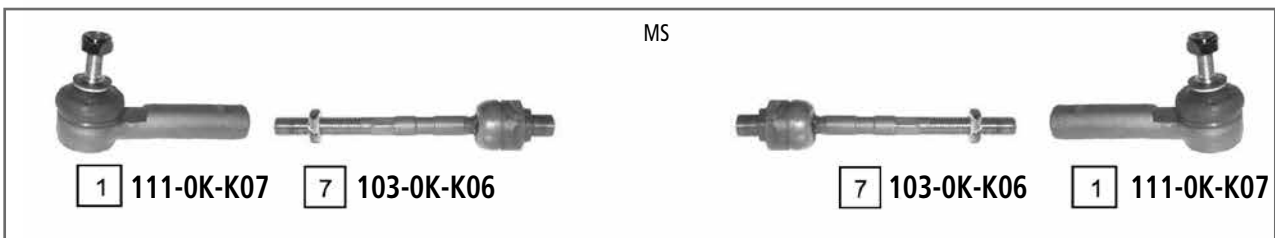

| Ref. | ASHIKA CODE | Description           | OEM           | Measures            | Ref. | ASHIKA CODE | Description              | OEM         | Measures           |
|------|-------------|-----------------------|---------------|---------------------|------|-------------|--------------------------|-------------|--------------------|
| 1    | 111-OK-K07  | Tie Rod End           | 568.20.07.000 | c:13.1 th:FM12X1.25 | 7    | 103-OK-K06  | Axial Joint              | 57724 07100 | th:MM16X1.5R L:290 |
| 2    | 106-OK-K12  | Stabiliser Link Left  | 54830 07000   | L:230               | 8    | 103-OK-K07  | Axial Joint              | 57724 07000 | th:MM16X1.5R L:290 |
| 3    | 106-OK-K13  | Stabiliser Link Right | 54840 07000   | L:230               | 9    | GOM-K25     | Silentblock For Susp.Arm | 54584 07000 |                    |
| 4    | 72-OK-K14   | TCA Left Wbj          | 54500 07200   |                     | 10   | GOM-K26     | Silentblock For Susp.Arm | 54551 07000 |                    |
| 5    | 72-OK-K13   | TCA Right Wbj         | 54501 07200   |                     | 11   | GOM-K24     | Stabiliser Mounting      | 54812 07100 |                    |
| 6    | 73-OK-K03   | Ball Joint            | 54530 07000   | c:16                |      |             |                          |             |                    |



PREGIO (TB)

01/1997 - 01/2005



4 106-0K-K14



4 106-0K-K14



2 111-0K-K68

3 103-0K-K04



3 103-0K-K04



2 111-0K-K68



1 73-0K-K04

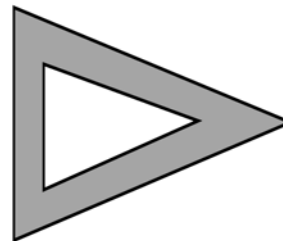
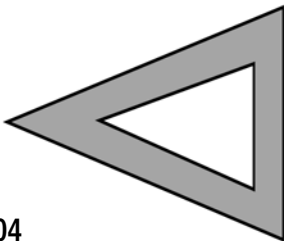

1 73-0K-K04

| Ref | ASHIKA CODE | Description | OEM          | Measures | Ref | ASHIKA CODE | Description     | OEM          | Measures         |
|-----|-------------|-------------|--------------|----------|-----|-------------|-----------------|--------------|------------------|
| 1   | 73-0K-K04   | Ball Joint  | OK72A 34510A | c:21.6   | 3   | 103-0K-K04  | Axial Joint     | OK72A 32270  | th:MM17X1R L:275 |
| 2   | 111-0K-K68  | Tie Rod End | OK72A 32240  |          | 4   | 106-0K-K14  | Stabiliser Link | OK72A 34150A | L:77             |

PRIDE (DA)

01/1990 - 05/2001



2 111-03-325 1 103-0K-K53



1 103-0K-K53 2 111-03-325



3 73-0K-K52



3 73-0K-K52

| Ref. | ASHIKA CODE | Description | OEM          | Measures            | Ref. | ASHIKA CODE | Description | OEM           | Measures |
|------|-------------|-------------|--------------|---------------------|------|-------------|-------------|---------------|----------|
| 1    | 103-0K-K53  | Axial Joint | KK150-32-240 | th:MM16X1.5R L:265  | 3    | 73-0K-K52   | TCA         | KKY01-34-390A | c:16     |
| 2    | 111-03-325  | Tie Rod End | 8AB1-32-280  | c:12.6 th:FM12X1.25 |      |             |             |               |          |

RETONA (CE)

06/1999 - 01/2003



2 111-0K-K66L



4 111-0K-K67L



5 111-0K-K67R



3 111-0K-K66R

8 105-0K-K51L

6 71-0K-K57

6 71-0K-K57

9 105-0K-K51R



1 53-0K-K58

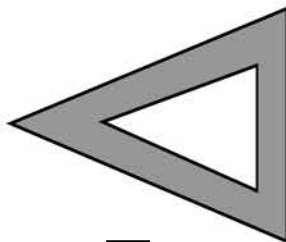

7 26-0K-K56

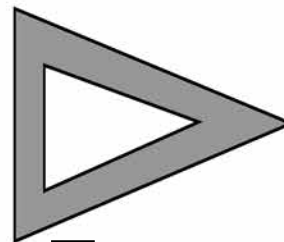

7 26-0K-K56



1 53-0K-K58

| Ref | ASHIKA CODE | Description       | OEM           | Measures            | Ref | ASHIKA CODE | Description | OEM           | Measures |
|-----|-------------|-------------------|---------------|---------------------|-----|-------------|-------------|---------------|----------|
| 1   | 53-0K-K58   | Ball Joint        | OK011-34-510B | c:18                | 6   | 71-0K-K57   |             | OK011-34-200  |          |
| 2   | 111-0K-K66L | Tie Rod End Outer | OK011-32-240A | c:13.4 th:FM18X1.5L | 7   | 26-0K-K56   |             | OK011-34-300D |          |
| 3   | 111-0K-K66R | Tie Rod End Outer | OK011-32-250A | c:13.4              | 8   | 105-0K-K51L |             | OK011-32-270A |          |
| 4   | 111-0K-K67L | Tie Rod End Inner | OK011-32-230  | c:14.6 th:FM18X1.5R | 9   | 105-0K-K51R |             | OK011-32-290A |          |
| 5   | 111-0K-K67R | Tie Rod End Inner | OK011-32-280  | c:14.6 th:FM18X1.5L |     |             |             |               |          |

RIO

09/2000 - 02/2005

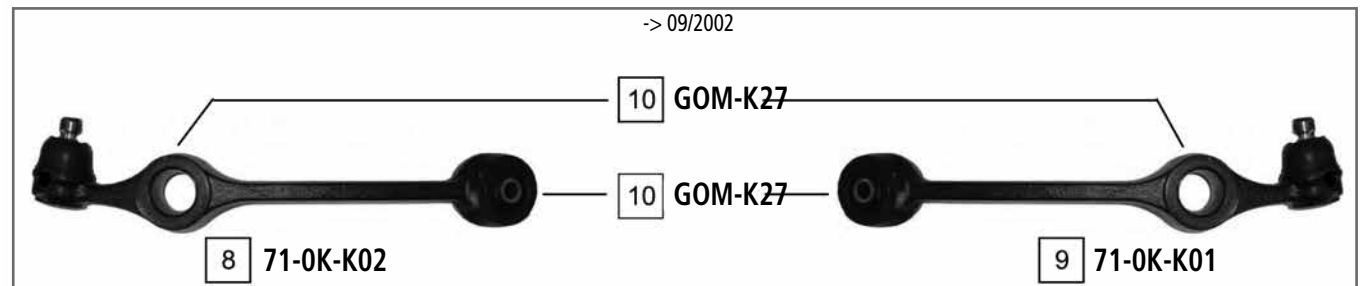
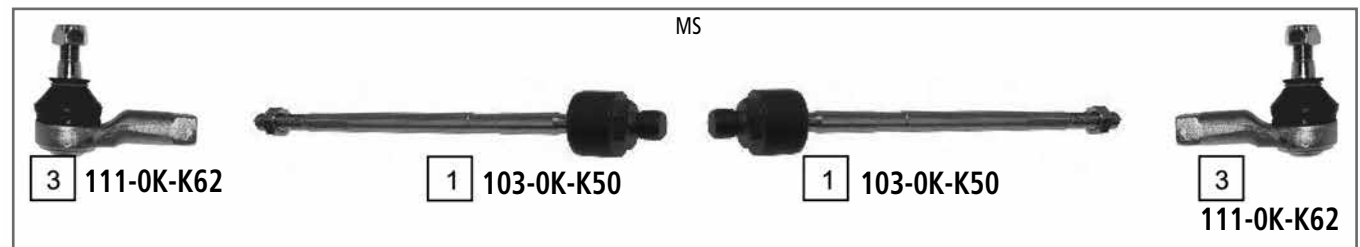
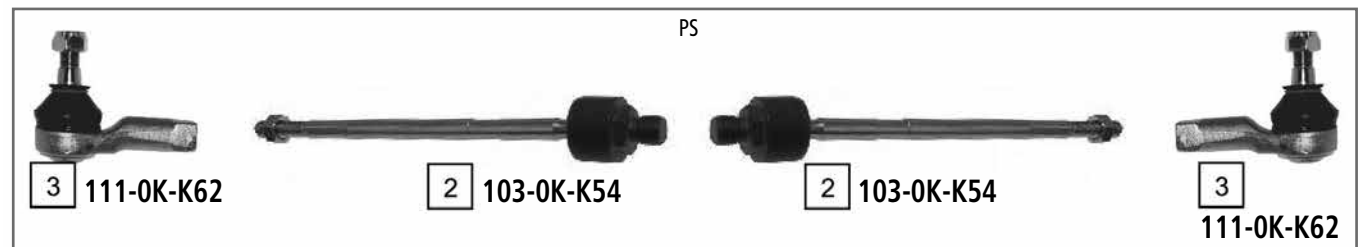
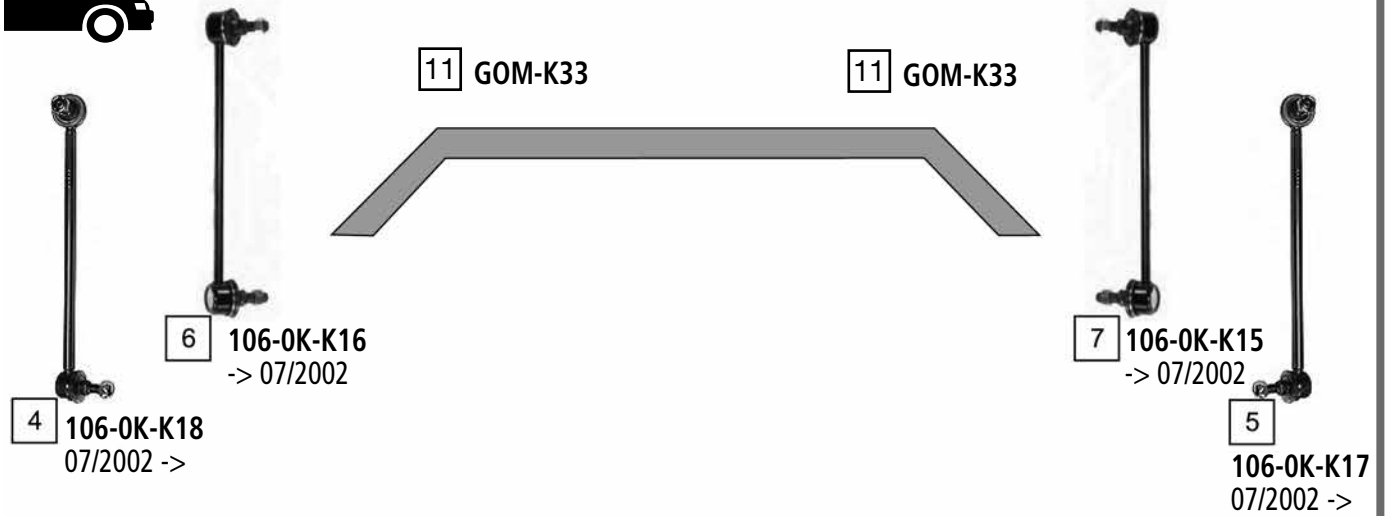

| Ref. | ASHIKA CODE | Description           | OEM          | Measures            | Ref. | ASHIKA CODE | Description              | OEM           | Measures |
|------|-------------|-----------------------|--------------|---------------------|------|-------------|--------------------------|---------------|----------|
| 1    | 103-0K-K50  | Axial Joint           | KDX5032240B  |                     | 7    | 106-0K-K15  | Stabiliser Link Right    | 0K33C 34150A  | L:240    |
| 2    | 103-0K-K54  | Axial Joint           | KDX53 32240B | th:MM16X1.5R L:279  | 8    | 71-0K-K01   | TCA Left                 | 0K30B 34350B  | -        |
| 3    | 111-0K-K62  | Tie Rod End           | MDX5032280   | c:13.2 th:FM12X1.25 | 9    | 71-0K-K02   | TCA Right                | 0K30B34300B   | -        |
| 4    | 106-0K-K18  | Stabiliser Link Left  | 54820 FD000  | L:218               | 10   | GOM-K27     | Silentblock For Susp.Arm | 0K30A 34480 C | -        |
| 5    | 106-0K-K17  | Stabiliser Link Right | 54830 FD000  |                     | 11   | GOM-K33     | Stabiliser Mounting      | 54813-FD000   |          |
| 6    | 106-0K-K16  | Stabiliser Link Left  | 0K33C 34160A | L:240               |      |             |                          |               |          |

RIO II

03/2005 ->

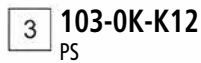

06/2006 ->

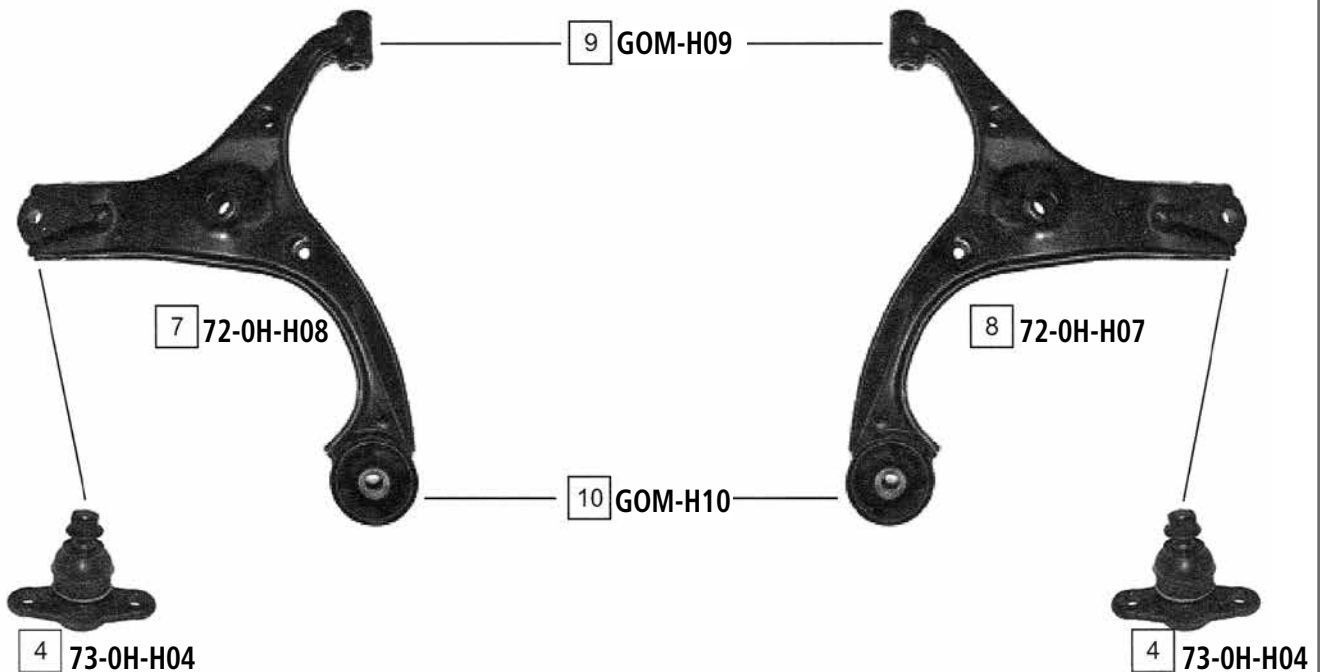

| Ref. | ASHIKA CODE | Description           | OEM         | Measures            | Ref. | ASHIKA CODE | Description              | OEM         | Measures |
|------|-------------|-----------------------|-------------|---------------------|------|-------------|--------------------------|-------------|----------|
| 1    | 111-0K-K10  | Tie Rod End Left      | 56820 1G900 | c:13.4 th:FM14X1.5R | 7    | 72-0H-H08   | TCA Left                 | 54500 1E100 | c:15     |
| 2    | 111-0K-K11  | Tie Rod End Right     | 56820 1G000 | c:13.4 th:FM14X1.5R | 8    | 72-0H-H07   | TCA Right                | 54501 1E100 | c:15     |
| 3    | 103-0K-K12  | Axial Joint           | 57724 1G100 | th:MM16X1.5R L:186  | 9    | GOM-H09     | Silentblock For Susp.Arm | 54584 1G000 | d:66.5   |
| 4    | 73-0H-H04   | Ball Joint            | 51760 1G000 | c:15                | 10   | GOM-H10     | Silentblock For Susp.Arm | 54551 1E000 | d:32.5   |
| 5    | 106-0H-H06  | Stabiliser Link Left  | 54830 1G000 | L: 285.5            | 11   | GOM-H08     | Stabiliser Mounting      | 54812 1G100 | -        |
| 6    | 106-0H-H05  | Stabiliser Link Right | 54840 1G000 | L: 285.5            |      |             |                          |             |          |

MENTOR I  
SEPHIA I (FA)  
SPECTRA

09/1993 - 05/1998

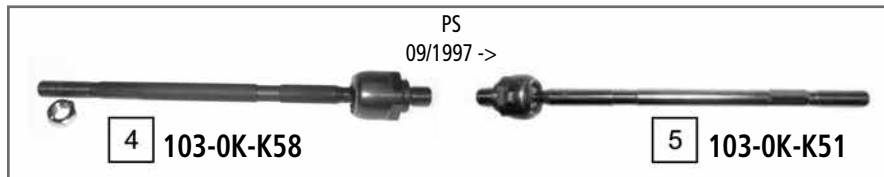
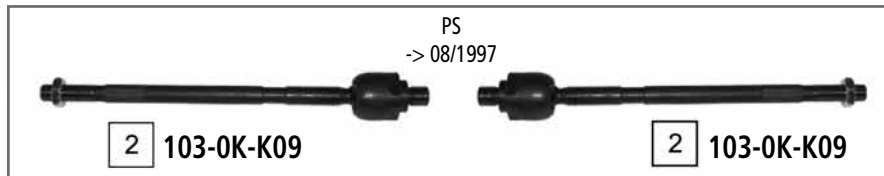
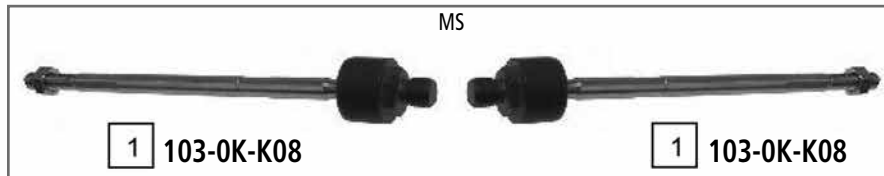

6 26-OK-K53L

7 26-OK-K53R

8 53-OK-K57

8 53-OK-K57

| Ref | ASHIKA CODE | Description | OEM         | Measures           | Ref | ASHIKA CODE | Description | OEM           | Measures |
|-----|-------------|-------------|-------------|--------------------|-----|-------------|-------------|---------------|----------|
| 1   | 103-OK-K08  | Axial Joint | 0K201 32240 |                    | 5   | 103-OK-K51  | Axial Joint | 0K2A2 32240   |          |
| 2   | 103-OK-K09  | Axial Joint | 0K203 32240 | th:MM16X1.5R L:284 | 6   | 26-OK-K53L  | TCA Left    | 0K201-34-350C |          |
| 3   | 111-OK-K65  | Tie Rod End | 0K201 32280 | c:13 th:FM14X1.5R  | 7   | 26-OK-K53R  | TCA Right   | 0K201-34-300C |          |
| 4   | 103-OK-K58  | Axial Joint | 0K2A1 32240 | th:MM16X1.5R L:282 | 8   | 53-OK-K57   | Ball Joint  | 0K201-34-550C |          |

SHUMA I (FB)

10/1997 - 03/2001



**5**  
**106-0K-K20**  
02/1999 ->



**3**  
**106-0K-K55**  
-> 01/1999



**3**  
**106-0K-K55**  
-> 01/1999



**6**  
**106-0K-K19**  
02/1999 ->



**1** 111-0K-K65

**7** 103-0K-K58

**7** 103-0K-K58



**1** 111-0K-K65



**4** 53-0K-K60

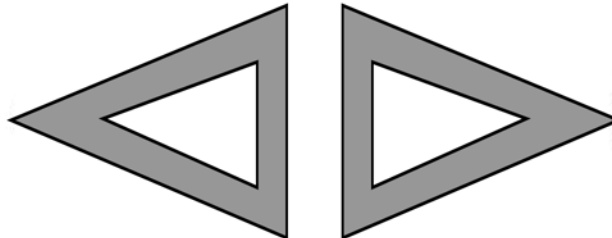

**4** 53-0K-K60



**2** 106-0K-K54



**2** 106-0K-K54

| Ref. | ASHIKA CODE | Description     | OEM          | Measures          | Ref. | ASHIKA CODE | Description           | OEM          | Measures |
|------|-------------|-----------------|--------------|-------------------|------|-------------|-----------------------|--------------|----------|
| 1    | 111-0K-K65  | Tie Rod End     | 0K201 32280  | c:13 th:FM14X1.5R | 5    | 106-0K-K20  | Stabiliser Link Left  | 0K2N1 34170A | L:274    |
| 2    | 106-0K-K54  | Stabiliser Link | 0K2A1 34150B | L:89              | 6    | 106-0K-K19  | Stabiliser Link Right | 0K2N1 34150A | L:274    |
| 3    | 106-0K-K55  | Stabiliser Link | 0K2A5 34150A | L:86              | 7    | 103-0K-K58  | Axial Joint           | 0K2A1-32-240 |          |
| 4    | 53-0K-K60   | Ball Joint      | 0K2A1 34550A | c:18              |      |             |                       |              |          |

SORENTO (JC)

05/2002 ->

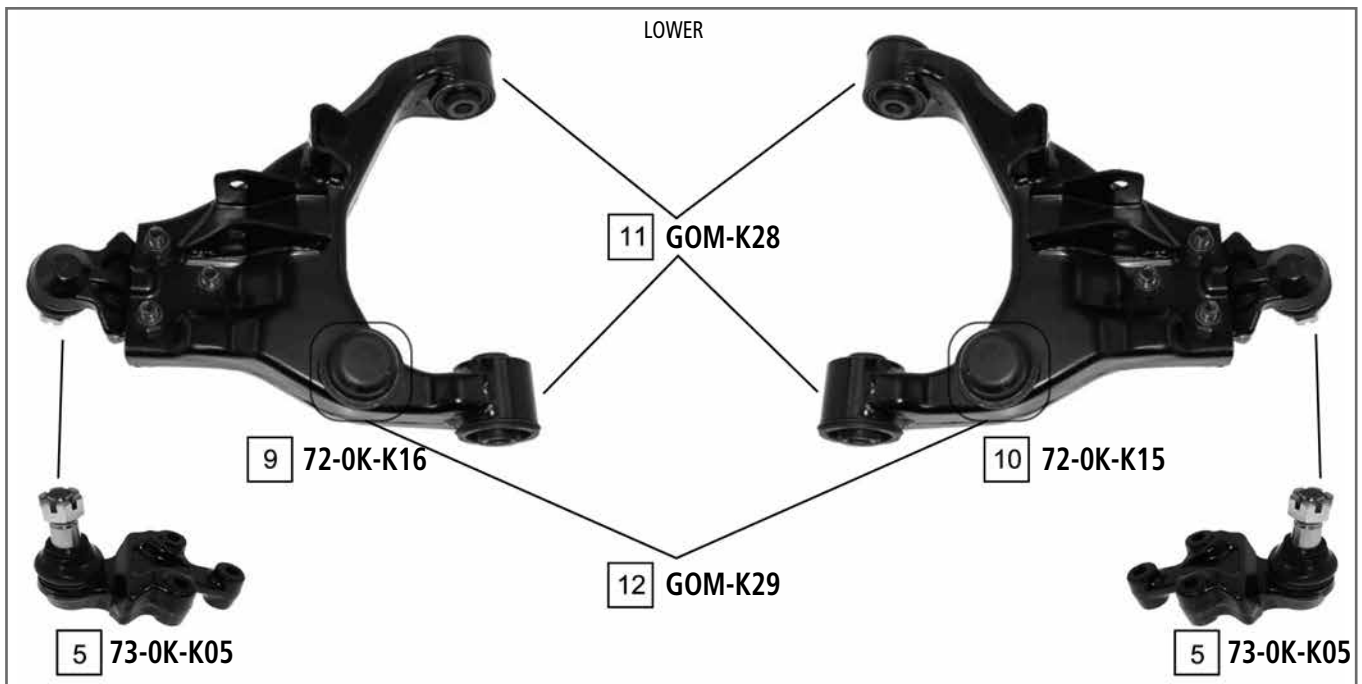
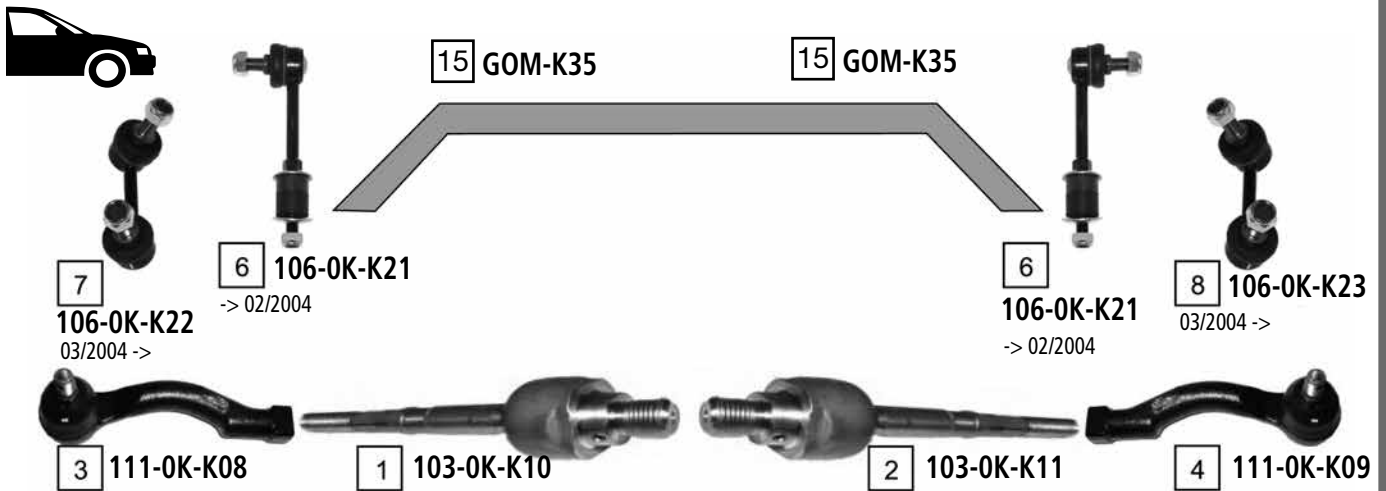

| Ref | ASHIKA CODE | Description           | OEM         | Measures            | Ref | ASHIKA CODE | Description              | OEM         | Measures |
|-----|-------------|-----------------------|-------------|---------------------|-----|-------------|--------------------------|-------------|----------|
| 1   | 103-OK-K10  | Axial Joint           | 57732 3E010 | th: MM18X1.5R L:172 | 9   | 72-OK-K16   | TCA Left                 | 54510 3E001 | c: 21.6  |
| 2   | 103-OK-K11  | Axial Joint           | 57731 3E010 | th: MM18X1.5R L:172 | 10  | 72-OK-K15   | TCA Right                | 54520 3E001 | c: 21.6  |
| 3   | 111-OK-K08  | Tie Rod End Left      | 56820 3E000 |                     | 11  | GOM-K28     | Silentblock For Susp.Arm | 54580 3E001 |          |
| 4   | 111-OK-K09  | Tie Rod End Right     | 56820 3E900 |                     | 12  | GOM-K29     | Silentblock For Susp.Arm | 54590 3E000 |          |
| 5   | 73-OK-K05   | Ball Joint            | 54570 3E000 | c: 21.6             | 13  | GOM-K31     | Stabiliser Mounting      | 55530-3E010 |          |
| 6   | 106-OK-K21  | Stabiliser Link       | 54810 3E000 |                     | 14  | GOM-K32     | Stabiliser Mounting      | 55530-3E020 |          |
| 7   | 106-OK-K22  | Stabiliser Link Left  | 54811 3E010 | L:85                | 15  | GOM-K35     | Stabiliser Mounting      | 54830-3E020 |          |
| 8   | 106-OK-K23  | Stabiliser Link Right | 54811 3E060 | L:85                |     |             |                          |             |          |



# KIA SORENTO



SORENTO (XM)

09/2009 ->

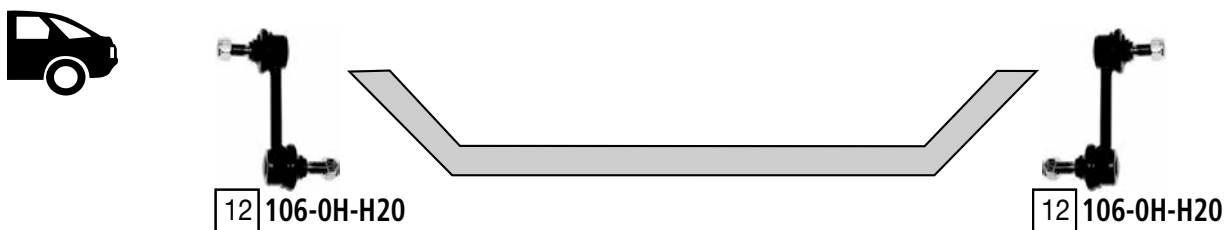
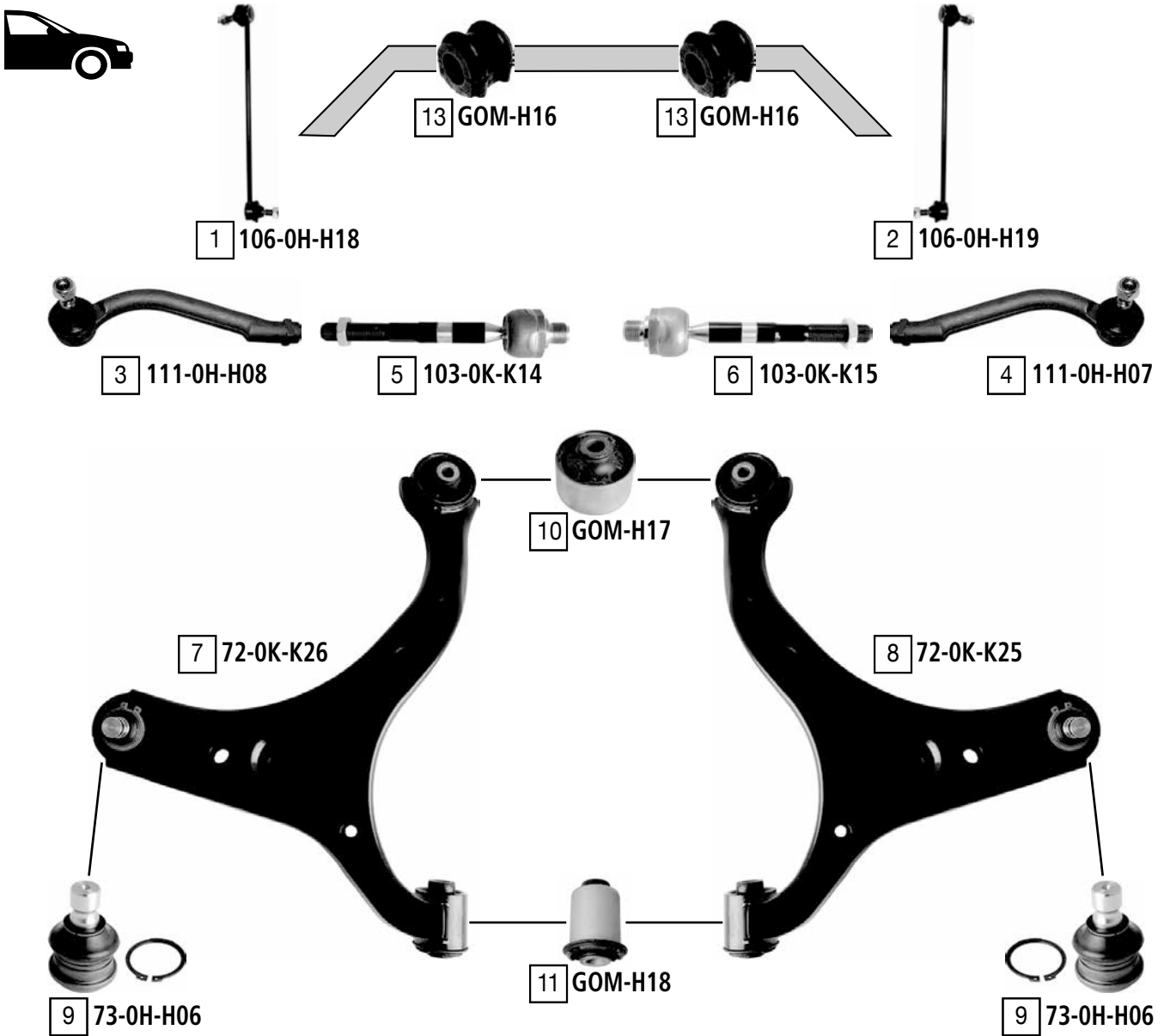

| Ref | ASHIKA CODE | Description           | OEM         | Measures            | Ref | ASHIKA CODE | Description               | OEM         | Measures        |
|-----|-------------|-----------------------|-------------|---------------------|-----|-------------|---------------------------|-------------|-----------------|
| 1   | 106-0H-H18  | Stabiliser link left  | 54830 2B200 | L:342               | 8   | 72-0K-K25   | TCA right wbj             | 54501 2P000 | c:20            |
| 2   | 106-0H-H19  | Stabiliser link right | 54840 2B200 | L:342               | 9   | 73-0H-H06   | Ball joint                | 54530 2B000 | c:20 do:42.7    |
| 3   | 111-0H-H08  | Tie rod end left      | 56820 2P900 | c:13.9 th:FM16X1.5R | 10  | GOM-H17     | Silentblock forTCA        | 54584 2B000 | di:14.3 do:66   |
| 4   | 111-0H-H07  | Tie rod end right     | 56820 2P000 | c:13.9 th:FM16X1.5R | 11  | GOM-H18     | Silentblock forTCA        | 54550 2P000 | di:14.3 do:42.2 |
| 5   | 103-0K-K14  | Axial joint           | 57724 2P100 | th:MM18X1.5R L:188  | 12  | 106-0H-H20  | Stabiliser link rear axle | 55530 2B200 | L:99            |
| 6   | 103-0K-K15  | Axial joint           | 57724 2P000 | th:MM18X1.5R L:188  | 13  | GOM-H16     | Stabiliser mounting       | 54813 3K100 | di:27           |
| 7   | 72-0K-K26   | TCA left wbj          | 54500 2P000 | c:20                |     |             |                           |             |                 |

SOUL (AM)

02/2009 ->

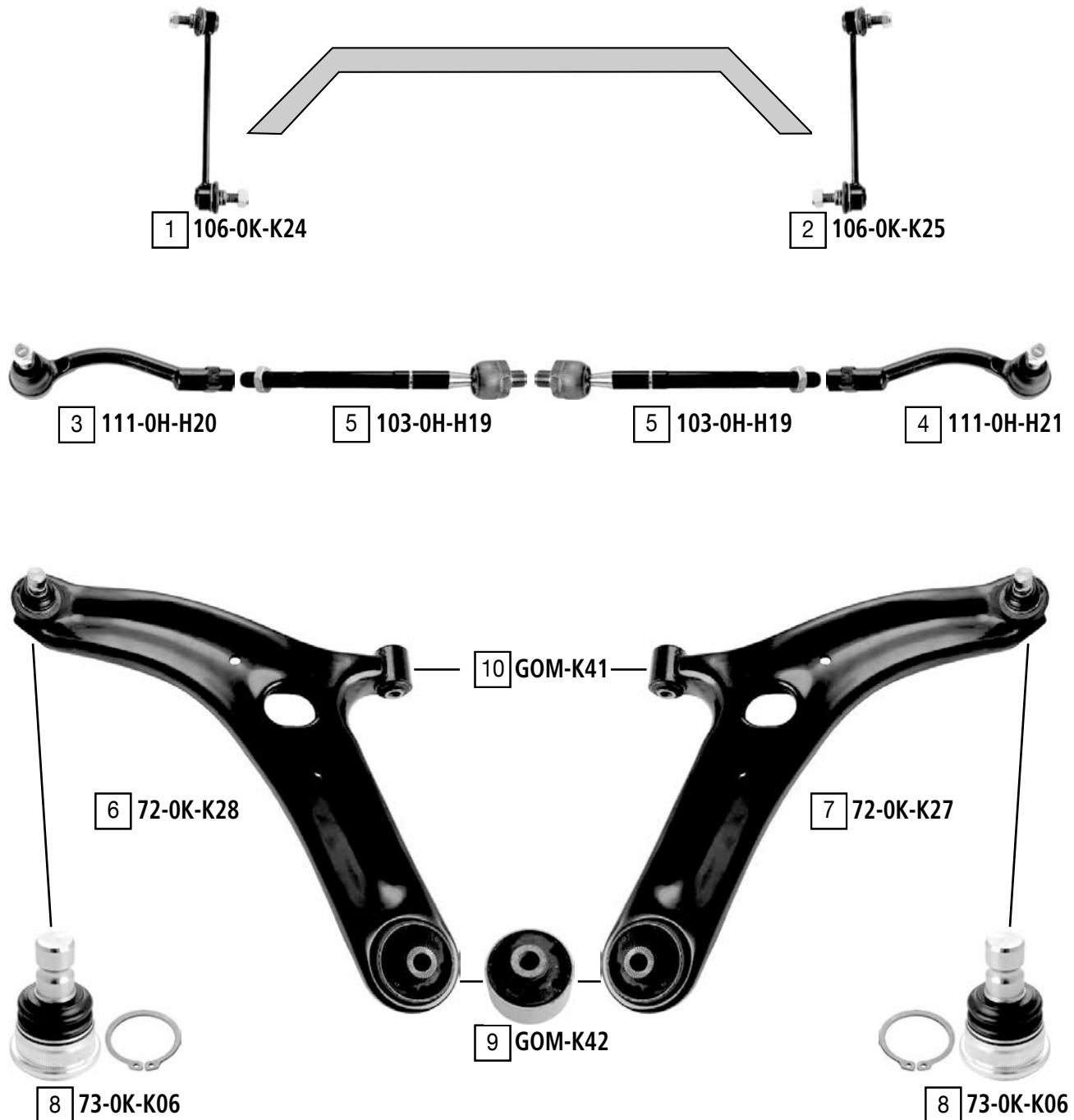

| Ref | ASHIKA CODE | Description           | OEM         | Measures            | Ref | ASHIKA CODE | Description        | OEM         | Measures       |
|-----|-------------|-----------------------|-------------|---------------------|-----|-------------|--------------------|-------------|----------------|
| 1   | 106-0K-K24  | Stabiliser Link Left  | 54830 2K000 | L:216               | 6   | 72-0K-K28   | TCA left wbj       | 54500 2K300 | c:18           |
| 2   | 106-0K-K25  | Stabiliser Link Right | 54840 2K000 | L:216               | 7   | 72-0K-K27   | TCA right wbj      | 54501 2K000 | c:18           |
| 3   | 111-0H-H20  | Tie Rod End Left      | 56820 2K000 | c:13.4 th:FM16X1.5R | 8   | 73-0K-K06   | Ball Joint         | 54530 2K000 | c:18 do:40     |
| 4   | 111-0H-H21  | Tie Rod End Right     | 56820 2K050 | c:13.4 th:FM16X1.5R | 9   | GOM-K42     | Silentblock ForTCA | 54584 2K000 | di:14.25 do:66 |
| 5   | 103-0H-H19  | Axial Joint           | 56540 2K000 | th:MM16X1.5R L:247  | 10  |             | Silentblock ForTCA | 54551 2K000 | di:12.2 do:33  |

# KIA SPECTRA - SHUMA - SEPHIA



MENTOR II  
SEPHIA II  
SHUMA II (FB)  
SPECTRA II

06/2000 - 02/2004

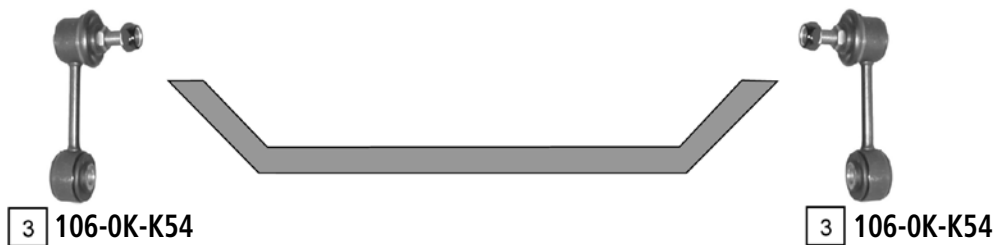
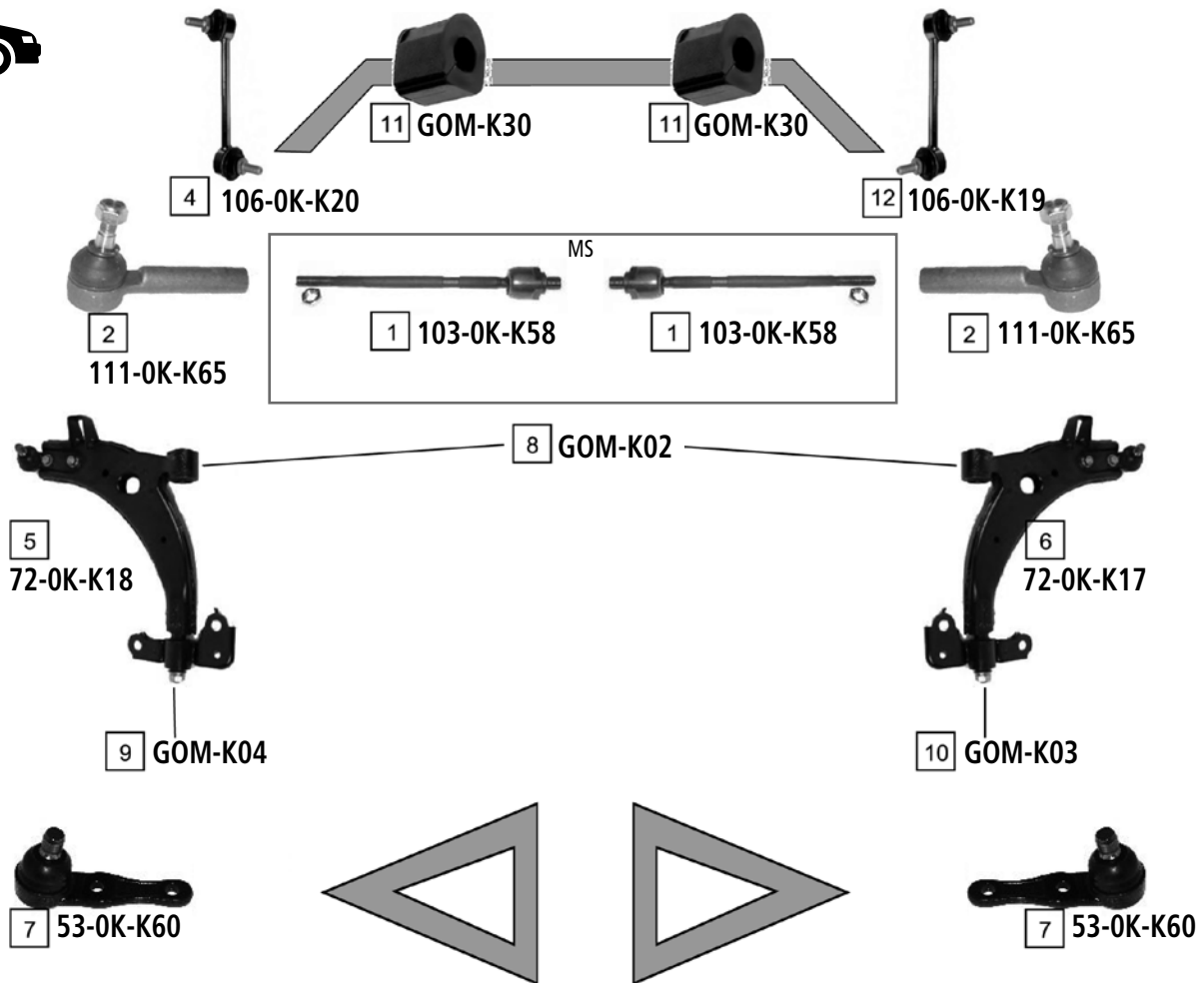

| Ref | ASHIKA CODE | Description          | OEM          | Measures            | Ref | ASHIKA CODE | Description              | OEM          | Measures |
|-----|-------------|----------------------|--------------|---------------------|-----|-------------|--------------------------|--------------|----------|
| 1   | 103-0K-K58  | Axial Joint          | 0K2A1 32240  | th: MM16X1.5R L:282 | 7   | 53-0K-K60   | Ball Joint               | 0K2A1 34550A | c:18     |
| 2   | 111-0K-K65  | Tie Rod End          | 0K201 32280  | c:13 th:FM14X1.5R   | 8   | GOM-K02     | Silentblock For Susp.Arm | 0K2C0 34460  |          |
| 3   | 106-0K-K54  | Stabiliser Link      | 0K2A1 34150B | L:89                | 9   | GOM-K04     | Silentblock For Susp.Arm | 0K2A1 3446Y  |          |
| 4   | 106-0K-K20  | Stabiliser Link Left | 0K2N1 34170A | L:274               | 10  | GOM-K03     | Silentblock For Susp.Arm | 0K2A1 3446X  |          |
| 5   | 72-0K-K18   | TCA Left             | 0K2NA 34350B |                     | 11  | GOM-K30     | Stabiliser Mounting      | 0K2NA 34156  |          |
| 6   | 72-0K-K17   | TCA Right            | 0K2NA 34300B |                     | 12  | 106-0K-K19  | Stabiliser Link Right    | 0K2N1 34150A | L:274    |

SPORTAGE (K00)

04/1994 - 08/2004

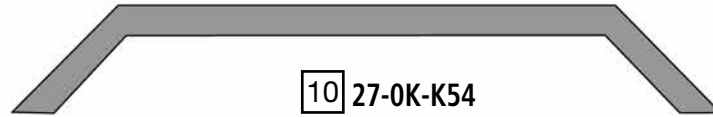

2 111-0K-K66L



4 111-0K-K67L



5 111-0K-K67R



3 111-0K-K66R

8 105-0K-K51L

6 71-0K-K57

6 71-0K-K57

9 105-0K-K51R



1 53-0K-K58

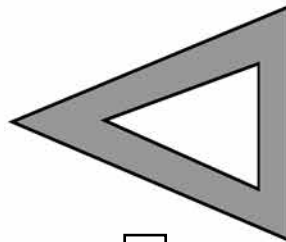

7 26-0K-K56

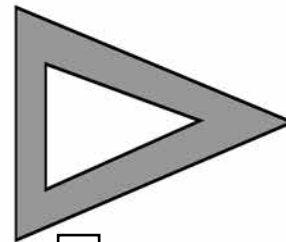

7 26-0K-K56



1 53-0K-K58

| Ref | ASHIKA CODE | Description       | OEM           | Measures            | Ref | ASHIKA CODE | Description | OEM           | Measures |
|-----|-------------|-------------------|---------------|---------------------|-----|-------------|-------------|---------------|----------|
| 1   | 53-0K-K58   | Ball Joint        | 0K011-34-510B | c:18                | 6   | 71-0K-K57   | TCA         | 0K011-34-200  |          |
| 2   | 111-0K-K66L | Tie Rod End Outer | 0K011-32-240A | c:13.4 th:FM18X1.5L | 7   | 26-0K-K56   | TCA         | 0K011-34-300D |          |
| 3   | 111-0K-K66R | Tie Rod End Outer | 0K011-32-250A | c:13.4              | 8   | 105-0K-K51L |             | 0K011-32-270A |          |
| 4   | 111-0K-K67L | Tie Rod End Inner | 0K011-32-230  | c:14.6 th:FM18X1.5R | 9   | 105-0K-K51R |             | 0K011-32-290A |          |
| 5   | 111-0K-K67R | Tie Rod End Inner | 0K011-32-280  | c:14.6 th:FM18X1.5L | 10  | 27-0K-K54   |             | 0K011-32-260A |          |

SPORTAGE

09/2004 ->

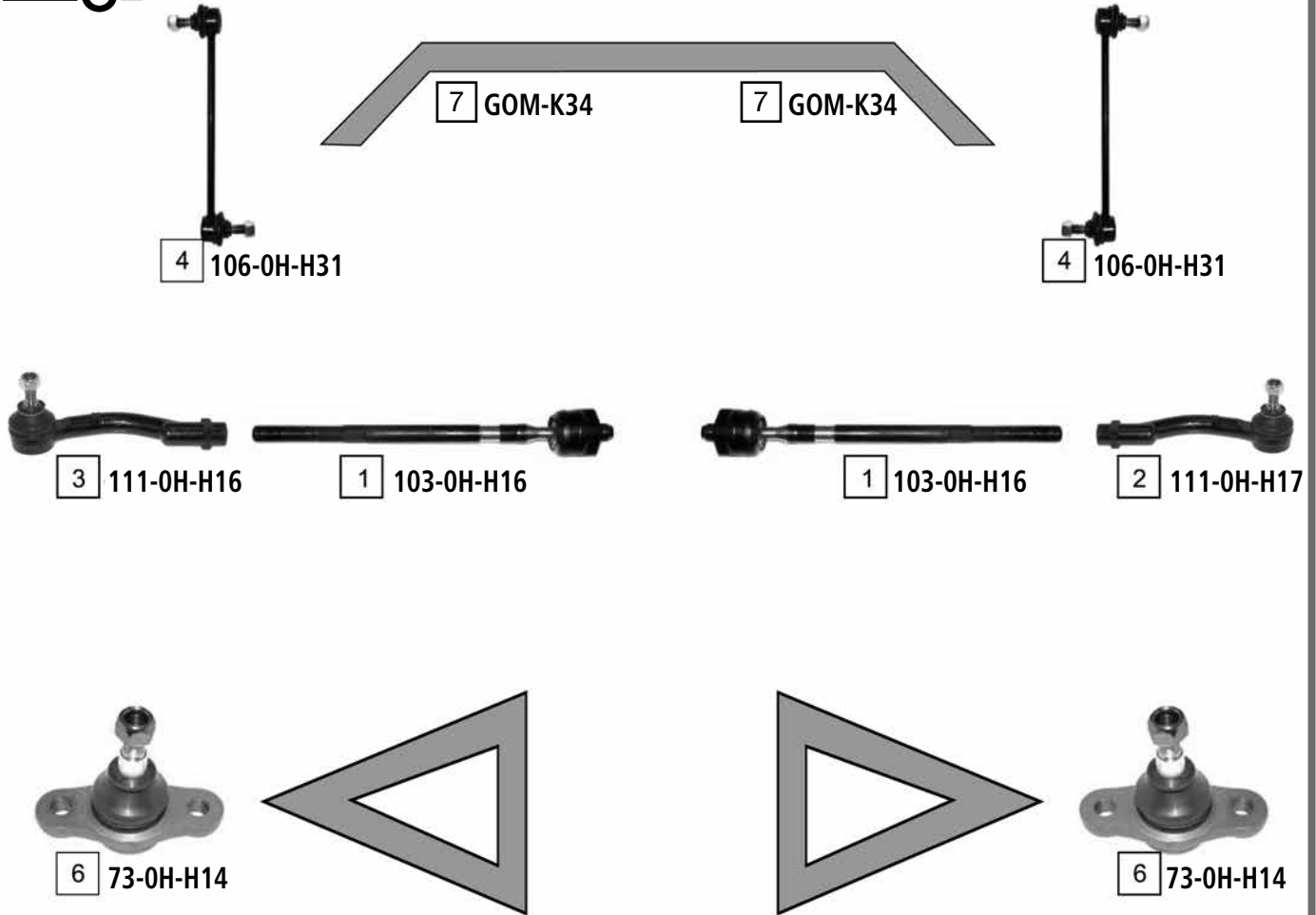

| Ref. | ASHIKA CODE | Description       | OEM         | Measures            | Ref. | ASHIKA CODE | Description         | OEM         | Measures |
|------|-------------|-------------------|-------------|---------------------|------|-------------|---------------------|-------------|----------|
| 1    | 103-0H-H16  | Axial Joint       | 57724 2E000 | th:MM16X1.5R L:243  | 5    | 106-0H-H32  | Stabiliser Link     | 55530 1F000 | L:220    |
| 2    | 111-0H-H17  | Tie Rod End Left  | 56820 2E000 | c:13.3 th:FM10X1.5R | 6    | 73-0H-H14   | Ball Joint          | 51760 2E000 | c:14.5   |
| 3    | 111-0H-H16  | Tie Rod End Right | 56820 2E900 | c:13.3 th:FM10X1.5R | 7    | GOM-K34     | Stabiliser Mounting | 54813-2E100 |          |
| 4    | 106-0H-H31  | Stabiliser Link   | 54830 2E000 | L:238               |      |             |                     |             |          |

SPORTAGE (SL)

07/2010 ->

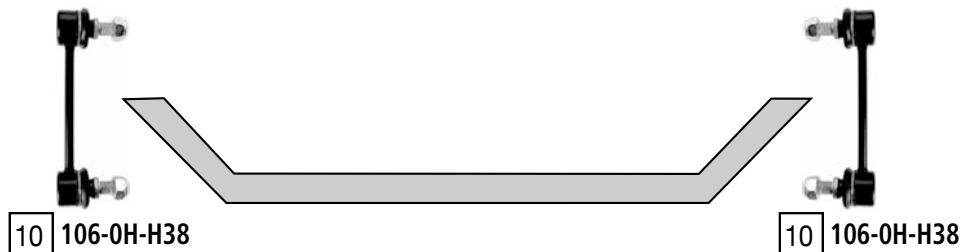
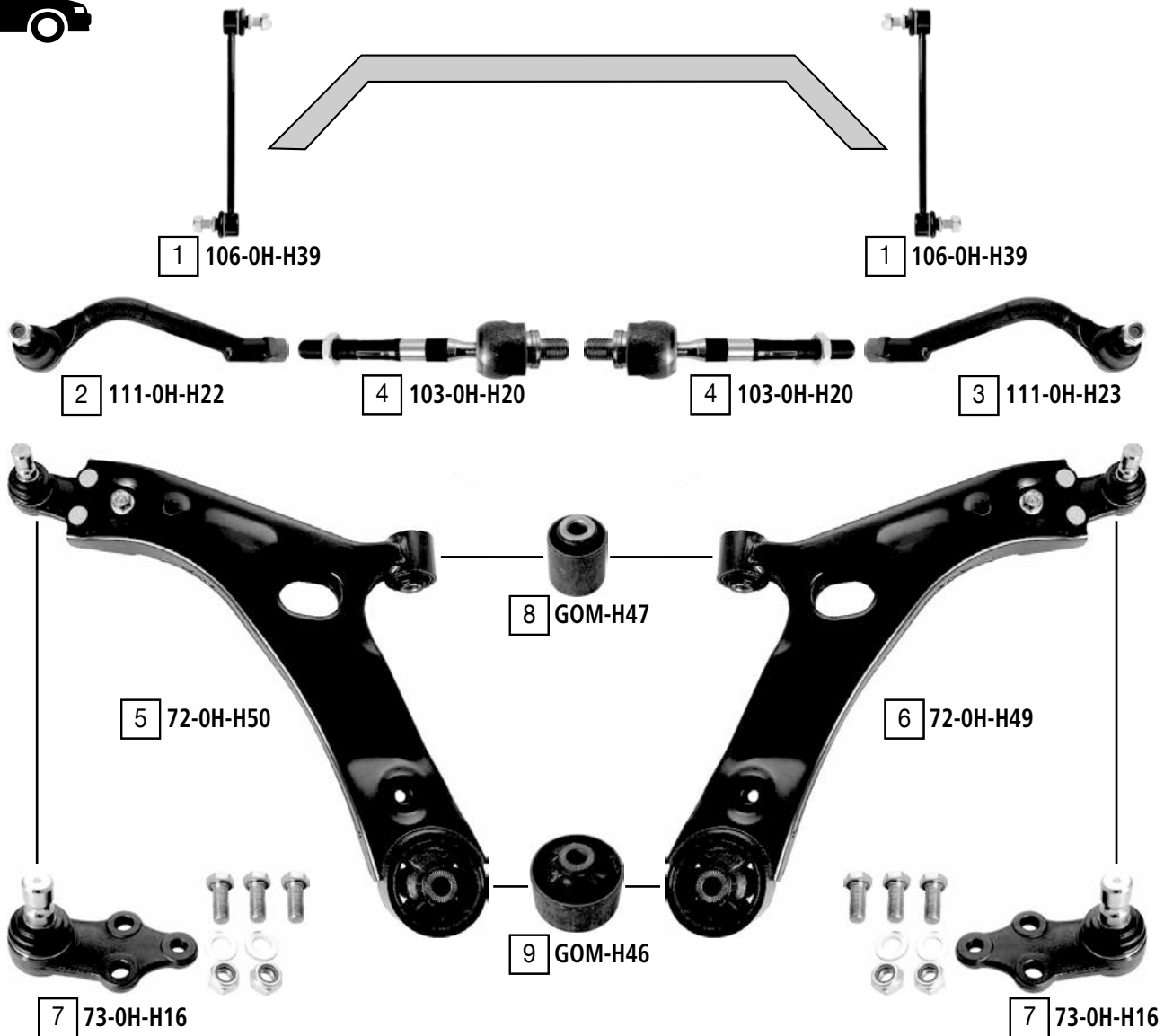

| Ref | ASHIKA CODE | Description       | OEM         | Measures            | Ref | ASHIKA CODE | Description               | OEM         | Measures         |
|-----|-------------|-------------------|-------------|---------------------|-----|-------------|---------------------------|-------------|------------------|
| 1   | 106-0H-H39  | Stabiliser link   | 54830 2S200 | L:267               | 6   | 72-0H-H49   | TCA right wbj             | 54501 2Y000 | c:18             |
| 2   | 111-0H-H22  | Tie rod end left  | 56820 2S000 | c:13.4 th:FM16X1.5R | 7   | 73-0H-H16   | Ball Joint                | 54530 3S000 | c:18             |
| 3   | 111-0H-H23  | Tie rod end right | 56820 2S050 | c:13.4 th:FM16X1.5R | 8   | GOM-H47     | Silentblock For TCA       | 54551 2S000 | di:12.25 do:38.1 |
| 4   | 103-0H-H20  | Axial joint       | 57724 2S000 | th:MM16X1.5R L:183  | 9   | GOM-H46     | Silentblock For TCA       | 54584 2S000 | di:14.35 do:70   |
| 5   | 72-0H-H50   | TCA left wbj      | 54500 2Y000 | c:18                | 10  | 106-0H-H38  | Stabiliser Link Rear Axle | 55530 2S200 | L:140            |

VENGA (YN)

02/2010 ->



1 106-0H-H36

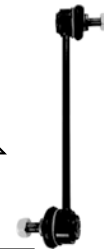
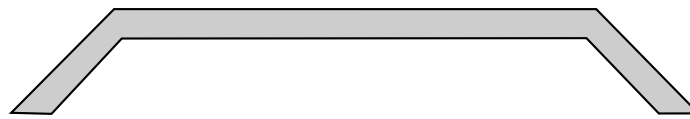

2 106-0H-H37



3 111-0H-H20



5 103-0H-H19



4 111-0H-H21



6 72-0H-H48



9 GOM-H10



7 72-0H-H47



10 GOM-K43



8 73-0H-H57



8 73-0H-H57

| Ref | ASHIKA CODE | Description           | OEM         | Measures            | Ref | ASHIKA CODE | Description        | OEM         | Measures        |
|-----|-------------|-----------------------|-------------|---------------------|-----|-------------|--------------------|-------------|-----------------|
| 1   | 106-0H-H36  | Stabiliser link left  | 54830 1J000 | L:216               | 6   | 72-0H-H48   | TCA left wbj       | 54500 1P000 | c:15            |
| 2   | 106-0H-H37  | Stabiliser link right | 54840 1J000 | L:216               | 7   | 72-0H-H47   | TCA right wbj      | 54501 1P000 | c:15            |
| 3   | 111-0H-H20  | Tie rod end left      | 56820 2K000 | c:13.4 th:FM16X1.5R | 8   | 73-0H-H57   | Ball Joint         | 54530 31600 | c:15 do:40      |
| 4   | 111-0H-H21  | Tie rod end right     | 56820 2K050 | c:13.4 th:FM16X1.5R | 9   | GOM-H10     | Silentblock ForTCA | 54551 1E000 | di:12.2 do:32.5 |
| 5   | 103-0H-H19  | Axial joint           | 56540 2K000 | th:MM16X1.5R L:247  | 10  | GOM-K43     | Silentblock ForTCA | 54584 1P000 | di:14.3 do:66   |

DEFENDER (LD)

09/1990 - 12/2000

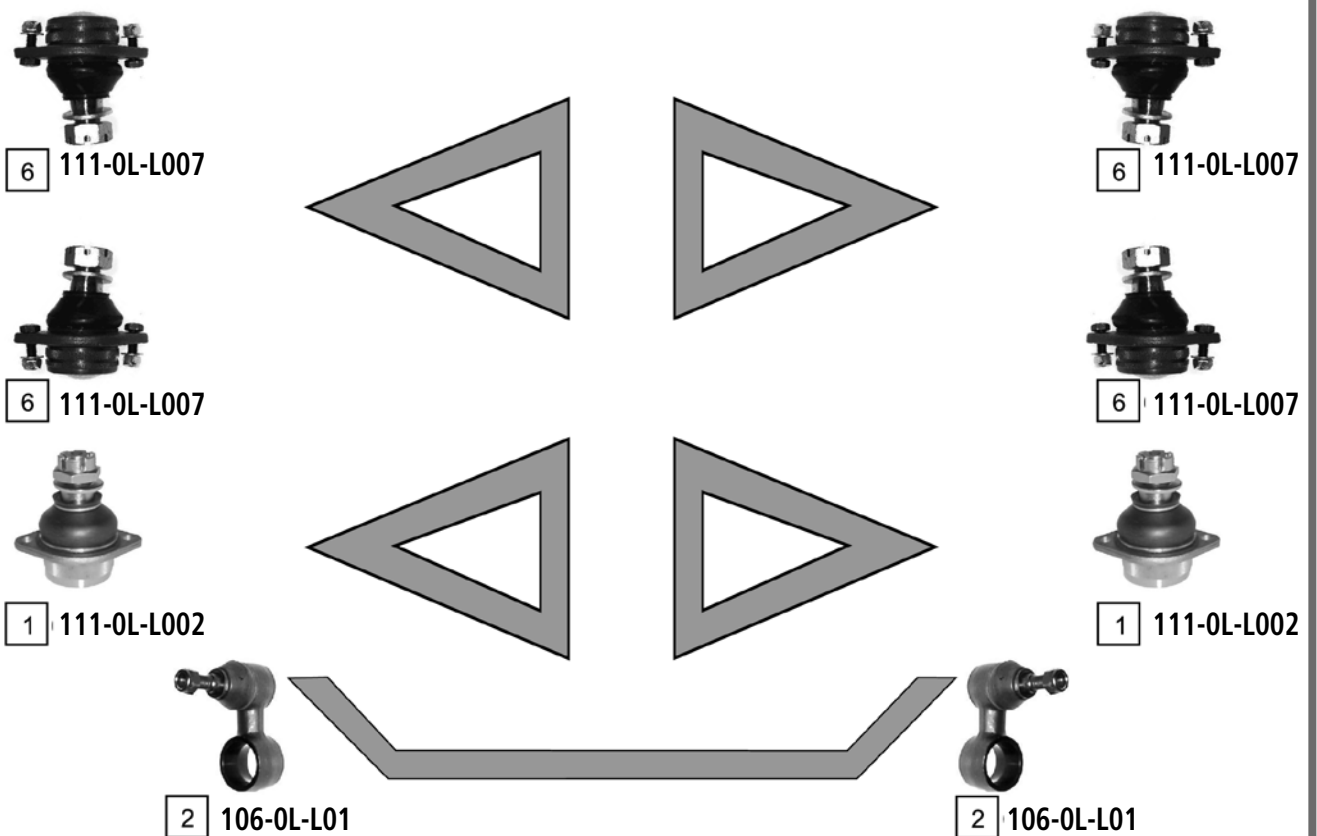
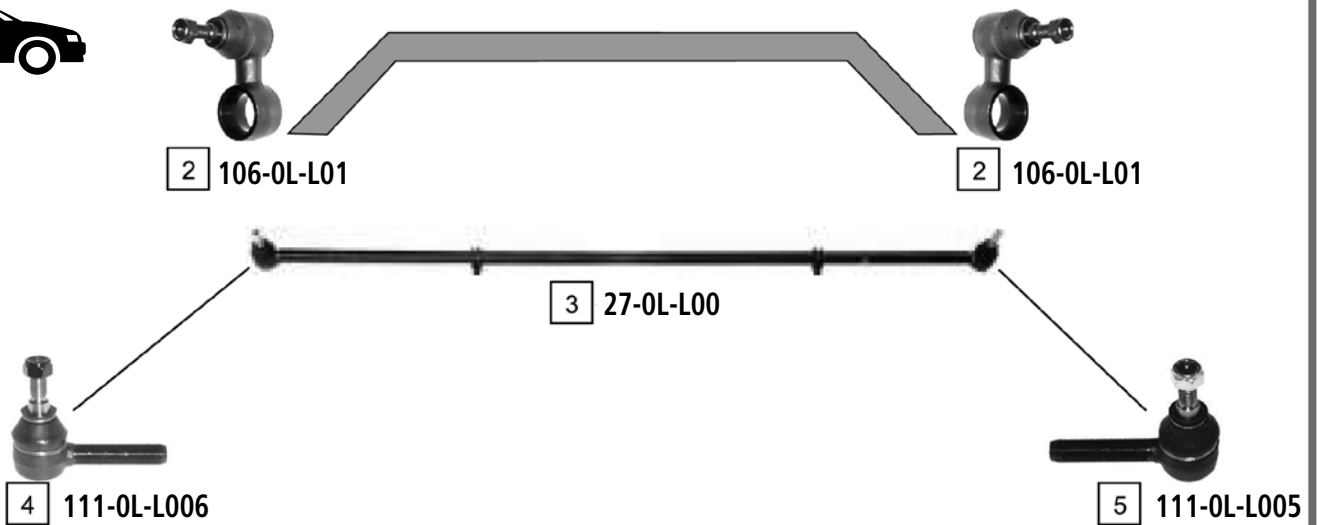

| Ref | ASHIKA CODE | Description     | OEM      | Measures | Ref | ASHIKA CODE | Description                | OEM      | Measures           |
|-----|-------------|-----------------|----------|----------|-----|-------------|----------------------------|----------|--------------------|
| 1   | 111-0L-L002 | Ball Joint      | ANR 1799 |          | 4   | 111-0L-L006 | Tie Rod End Left           | RTC 5870 | "c:15 th:11/16"x16 |
| 2   | 106-0L-L01  | Stabiliser Link | NTC 1888 | L:63     | 5   | 111-0L-L005 | Tie Rod End Right          | RTC 5869 | c:14.8 th:M17R 16G |
| 3   | 27-0L-L00   | Tie Rod         | NRC9743  |          | 6   | 111-0L-L007 | Ball Joint UPPER And LOWER | 575 882  | c:23.3             |



# LANDROVER DISCOVERY



DISCOVERY I

10/1989 - 06/1994

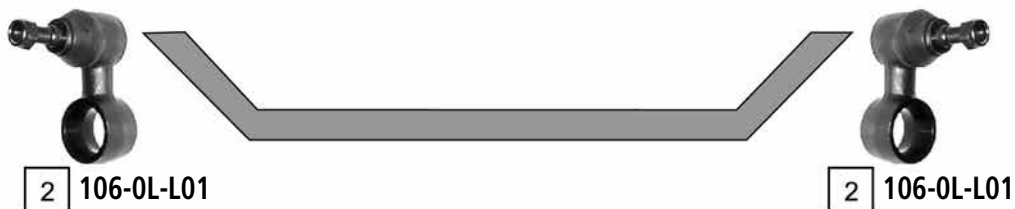
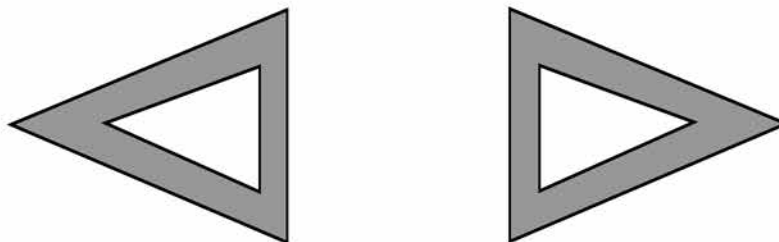
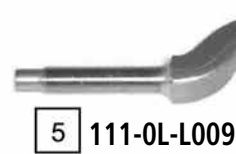
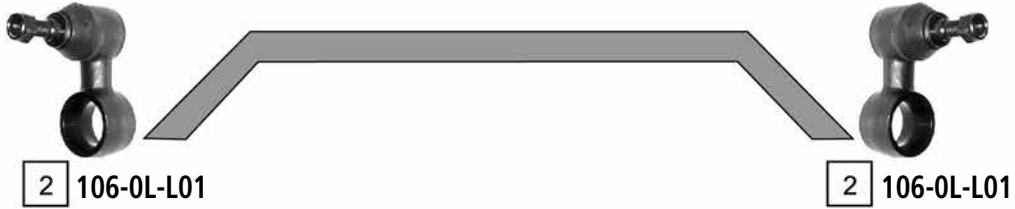

| Ref. | ASHIKA CODE | Description      | OEM      | Measures            | Ref. | ASHIKA CODE | Description       | OEM      | Measures           |
|------|-------------|------------------|----------|---------------------|------|-------------|-------------------|----------|--------------------|
| 1    | 111-0L-L002 | Ball Joint       | ANR 1799 |                     | 4    | 111-0L-L005 | Tie Rod End Right | RTC 5869 | c:14:8 th:M17R 16G |
| 2    | 106-0L-L01  | Stabiliser Link  | NTC 1888 | L:63                | 5    | 111-0L-L009 | Tie Rod End       | NRC 1823 |                    |
| 3    | 111-0L-L006 | Tie Rod End Left | RTC 5870 | "c:15 th:11/16" x16 |      |             |                   |          |                    |

DISCOVERY II (LJ,LT)

06/1994 - 09/2004

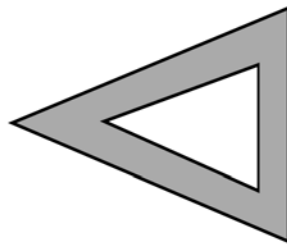
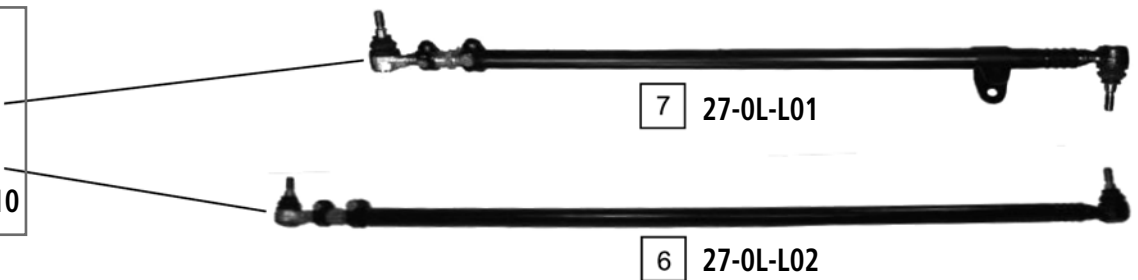
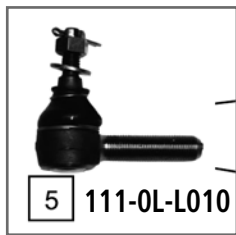
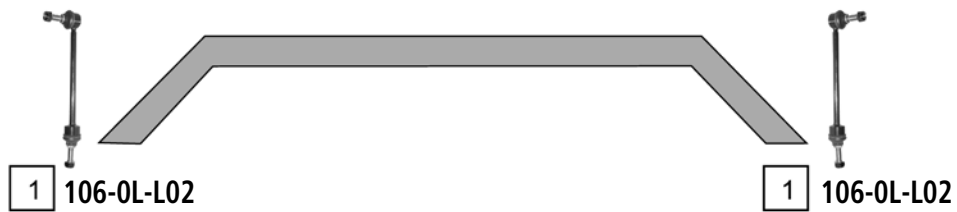

UPPER

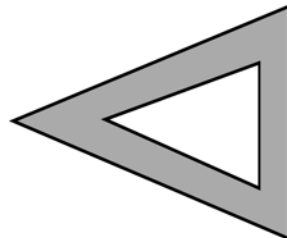
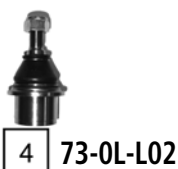
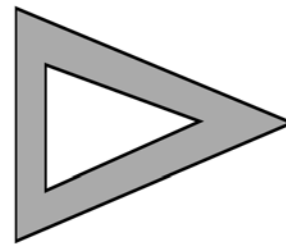

LOWER

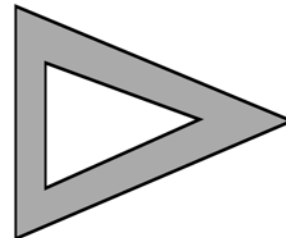

| Ref | ASHIKA CODE | Description     | OEM       | Measures | Ref | ASHIKA CODE | Description | OEM       | Measures |
|-----|-------------|-----------------|-----------|----------|-----|-------------|-------------|-----------|----------|
| 1   | 106-0L-L02  | Stabiliser Link | RBM100223 | L:243.5  | 5   | 111-0L-L010 | Tie Rod End | QFS000010 |          |
| 2   | 106-0L-L03  | Stabiliser Link | RDG100682 | L:158.5  | 6   | 27-0L-L02   | Track Rod   | TIQ000010 |          |
| 3   | 73-0L-L01   | Ball Joint      | FTC 3570  | c:16     | 7   | 27-0L-L01   | Track Rod   | QHG000050 | -        |
| 4   | 73-0L-L02   | Ball Joint      | FTC 3571  | c:18.9   |     |             |             |           |          |

DISCOVERY III

10/2004 ->

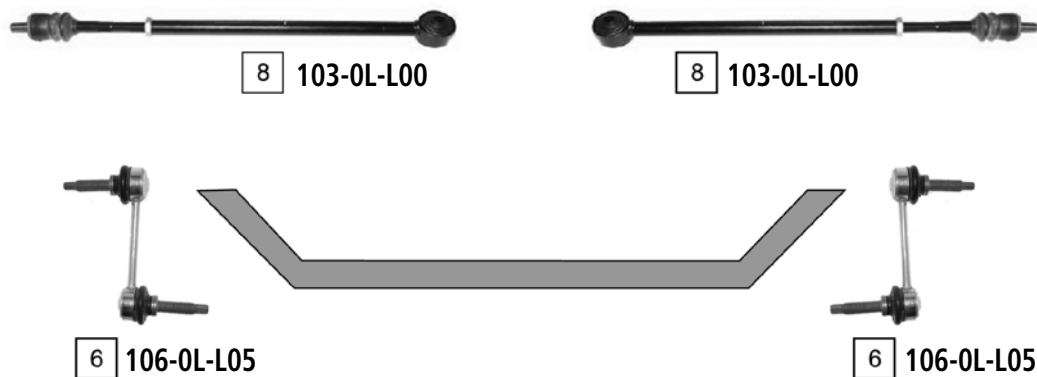
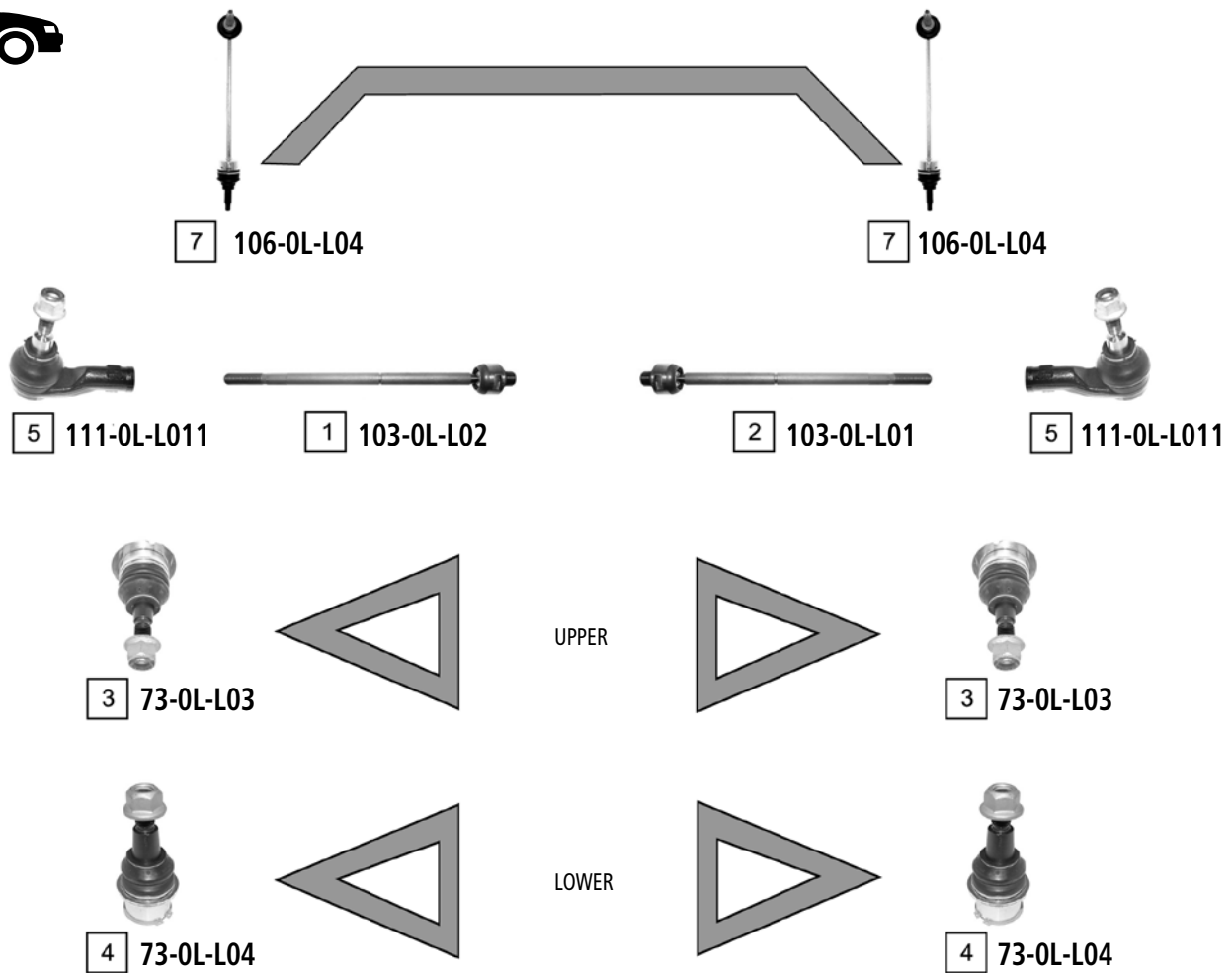

| Ref. | ASHIKA CODE | Description | OEM        | Measures | Ref. | ASHIKA CODE | Description     | OEM        | Measures |
|------|-------------|-------------|------------|----------|------|-------------|-----------------|------------|----------|
| 1    | 103-0L-L02  | Axial Joint | QFK 500020 | L:372    | 5    | 111-0L-L011 | Tie Rod End     | QJB 500010 | c:16.80  |
| 2    | 103-0L-L01  | Axial Joint | QFK 500010 | -        | 6    | 106-0L-L05  | Stabiliser Link | RGD 000311 | L:116    |
| 3    | 73-0L-L03   | Ball Joint  | RBK 500030 | c:13.85  | 7    | 106-0L-L04  | Stabiliser Link | RBM 500190 | -        |
| 4    | 73-0L-L04   | Ball Joint  | RBK 500040 | c:20.65  | 8    | 103-0L-L00  | Tie Rod         | RGD 500083 | -        |

FREELANDER

07/1997 - 01/2006

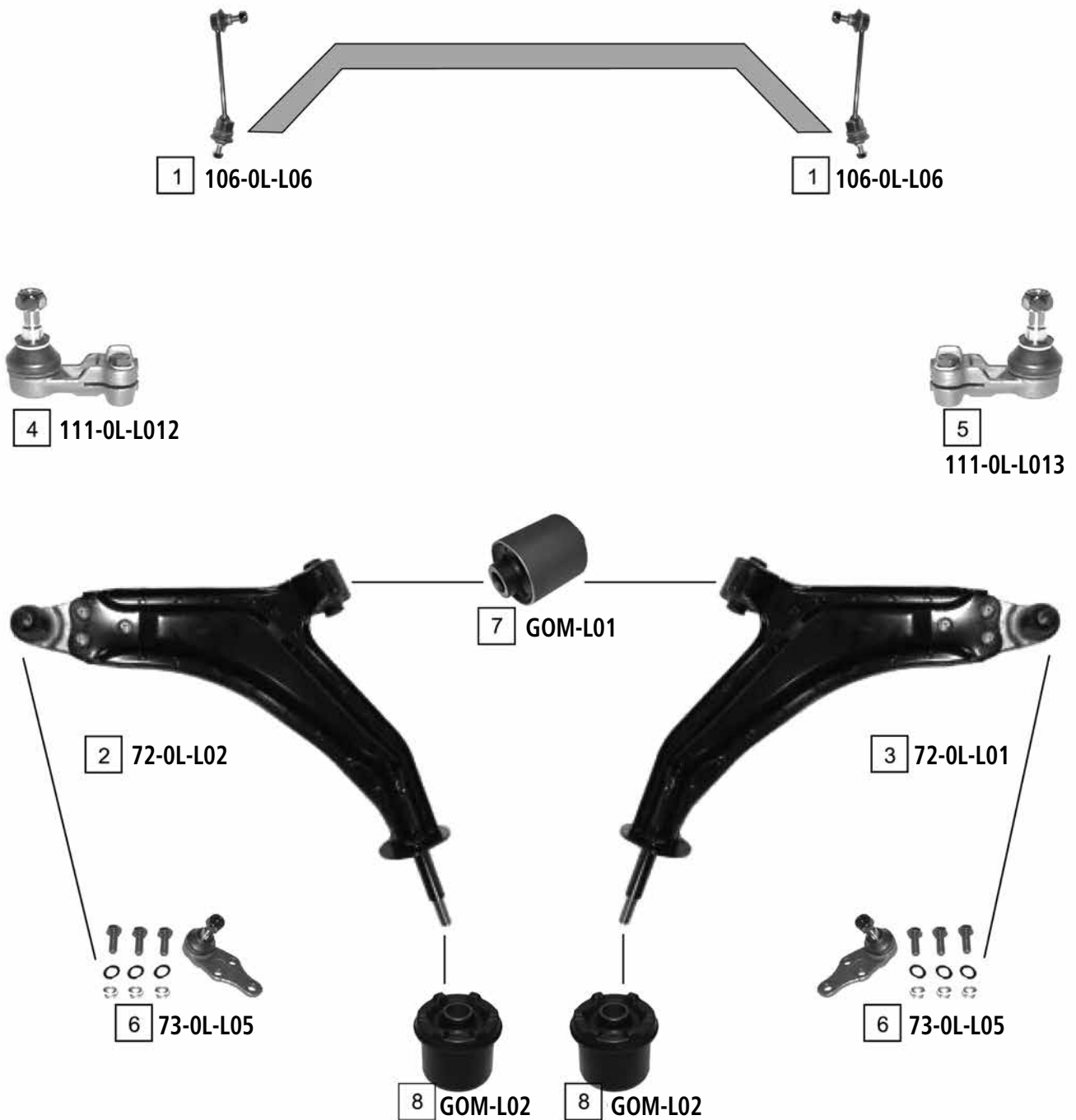

| Ref | ASHIKA CODE | Description      | OEM        | Measures            | Ref | ASHIKA CODE | Description              | OEM                         | Measures            |
|-----|-------------|------------------|------------|---------------------|-----|-------------|--------------------------|-----------------------------|---------------------|
| 1   | 106-0L-L06  | Stabiliser Link  | RBM 100170 | L:177               | 5   | 111-0L-L013 | Tie Rod End Right        | QJB 100220                  | c:14.7 th:FM16X1.5R |
| 2   | 72-0L-L02   | TCA Left         | RBJ 102450 | c:15.4              | 6   | 73-0L-L05   | Ball Joint LOWER         | Part of 72-0L-L02/72-0L-L01 | c:15                |
| 3   | 72-0L-L01   | TCA Right        | RBJ102440  | -                   | 7   | GOM-L01     | Silentblock For Susp.Arm | RBX 101160                  | d:45.4              |
| 4   | 111-0L-L012 | Tie Rod End Left | QJB 100230 | c:14.7 th:FM16X1.5L | 8   | GOM-L02     | Silentblock For Susp.Arm | RBX 101780                  | -                   |

# LANDROVER FREELANDER



FREELANDER II

10/2006 ->

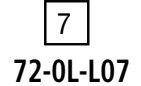
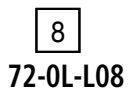
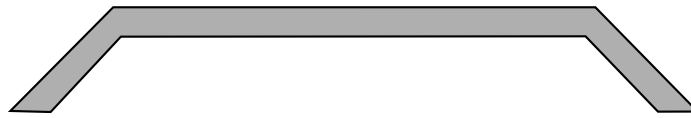

| Ref | ASHIKA CODE | Description        | OEM       | Measures            | Ref | ASHIKA CODE | Description               | OEM       | Measures |
|-----|-------------|--------------------|-----------|---------------------|-----|-------------|---------------------------|-----------|----------|
| 1   | 106-0L-L12  | Stabiliser link    | LR0 02626 | L:347               | 6   | 106-0L-L13  | Stabiliser link rear axle | LR0 02876 | L:229    |
| 2   | 111-0L-L018 | Tie rod end left   | LR0 02610 | c:16.7 th:FM18X1.5R | 7   | 72-0L-L07   |                           | LR0 07205 |          |
| 3   | 111-0L-L017 | Tie rod end right  | LR0 02609 | c:16.7 th:FM18X1.5R | 8   | 72-0L-L06   |                           | LR0 07206 |          |
| 4   | 73-0L-L08   | Ball joint         | Part of   | c:17.9              | 9   | GOM-L17     |                           |           |          |
| 5   | GOM-L18     | Silentblock forTCA | Part of   | di:14.2 do:60       | 10  | GOM-L16     |                           |           |          |

LANDROVER 88-109

01/1984 - 12/1986



2 111-0L-L001



1 111-0L-L000

| Ref. | ASHIKA CODE | Description        | OEM     | Measures            | Ref. | ASHIKA CODE | Description | OEM     | Measures            |
|------|-------------|--------------------|---------|---------------------|------|-------------|-------------|---------|---------------------|
| 1    | 111-0L-L000 | Spoorstangeind Rht | 320.901 | "c:15.2 th:11/16" x | 2    | 111-0L-L001 | Tie Rod End | 320.901 | "c:15.2 th:11/16" x |

# LANDROVER 90 - 110 - 130 - RANGE ROVER



LANDROVER 90-110-130  
RANGE ROVER I

03/1984 - 07/1990  
12/1970 - 07/1994

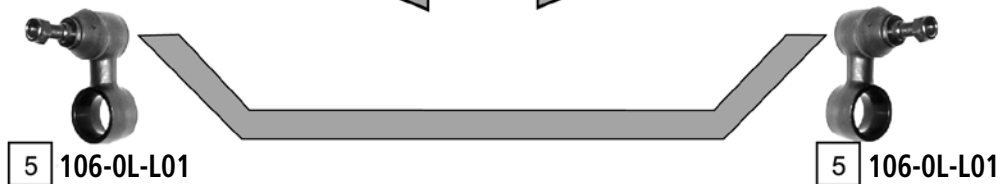
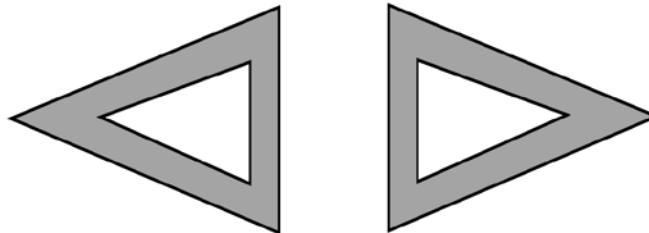
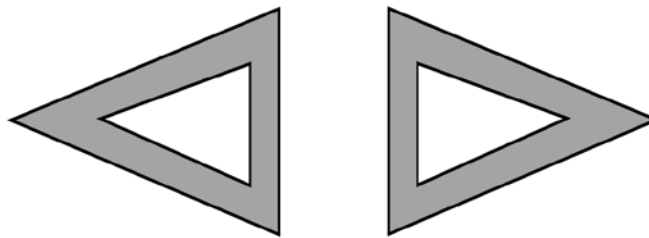
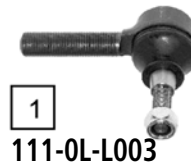

| Ref | ASHIKA CODE | Description     | OEM      | Measures           | Ref | ASHIKA CODE | Description                | OEM      | Measures |
|-----|-------------|-----------------|----------|--------------------|-----|-------------|----------------------------|----------|----------|
| 1   | 111-0L-L003 | Tie Rod End     | NRC 6007 | "c:15 th:11/16"x16 | 4   | 111-0L-L007 | Ball Joint UPPER And LOWER | 575 882  | c:23.3   |
| 2   | 111-0L-L004 | Tie Rod End     | NRC 4745 | "c:15 th:11/16"x16 | 5   | 106-0L-L01  | Stabiliser Link            | NTC 1888 | L:63     |
| 3   | 111-0L-L002 | Ball Joint Rear | ANR 1799 | c:23.4             |     |             |                            |          |          |

RANGE ROVER II (LP)

07/1994 - 03/2002

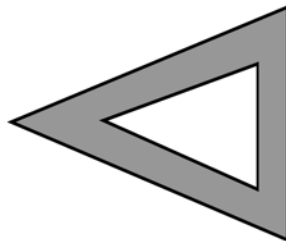
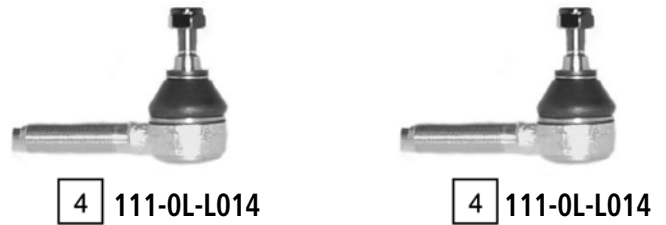

UPPER

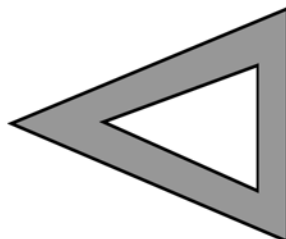
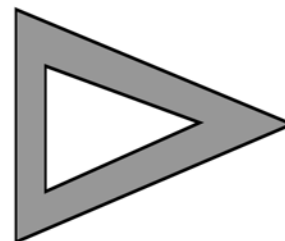

LOWER

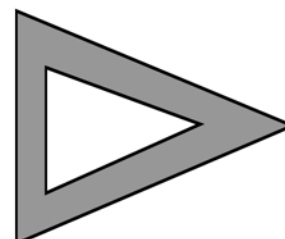

| Ref. | ASHIKA CODE | Description     | OEM      | Measures | Ref | ASHIKA CODE | Description | OEM      | Measures            |
|------|-------------|-----------------|----------|----------|-----|-------------|-------------|----------|---------------------|
| 1    | 106-0L-L07  | Stabiliser Link | ANR 3304 | L:97     | 3   | 73-0L-L02   | Ball Joint  | FTC 3571 | c:18.9              |
| 2    | 73-0L-L01   | Ball Joint      | FTC 3570 | c:16     | 4   | 111-0L-L014 | Tie Rod End | STC 1871 | c:14.1 th:MM18X1.5L |



# LANDROVER RANGE ROVER



RANGE ROVER III (LM)

03/2002 ->

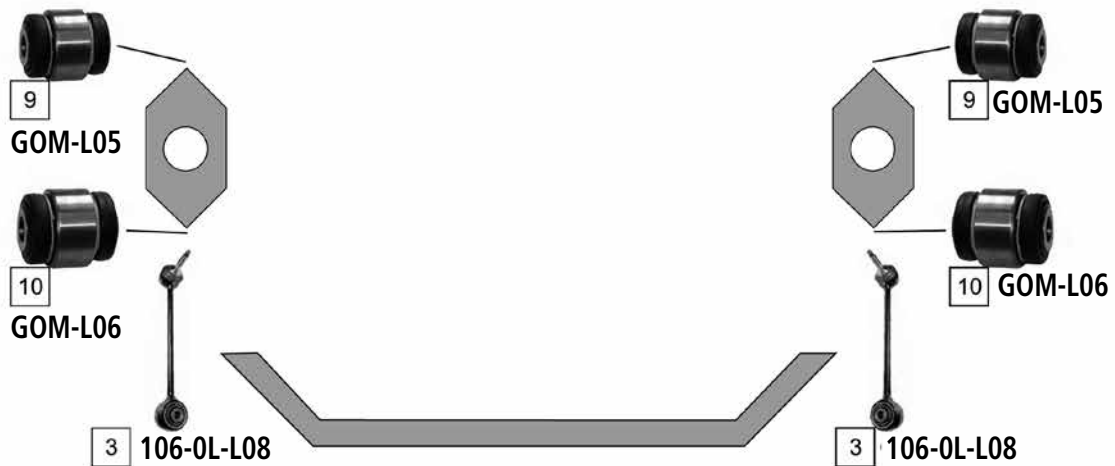
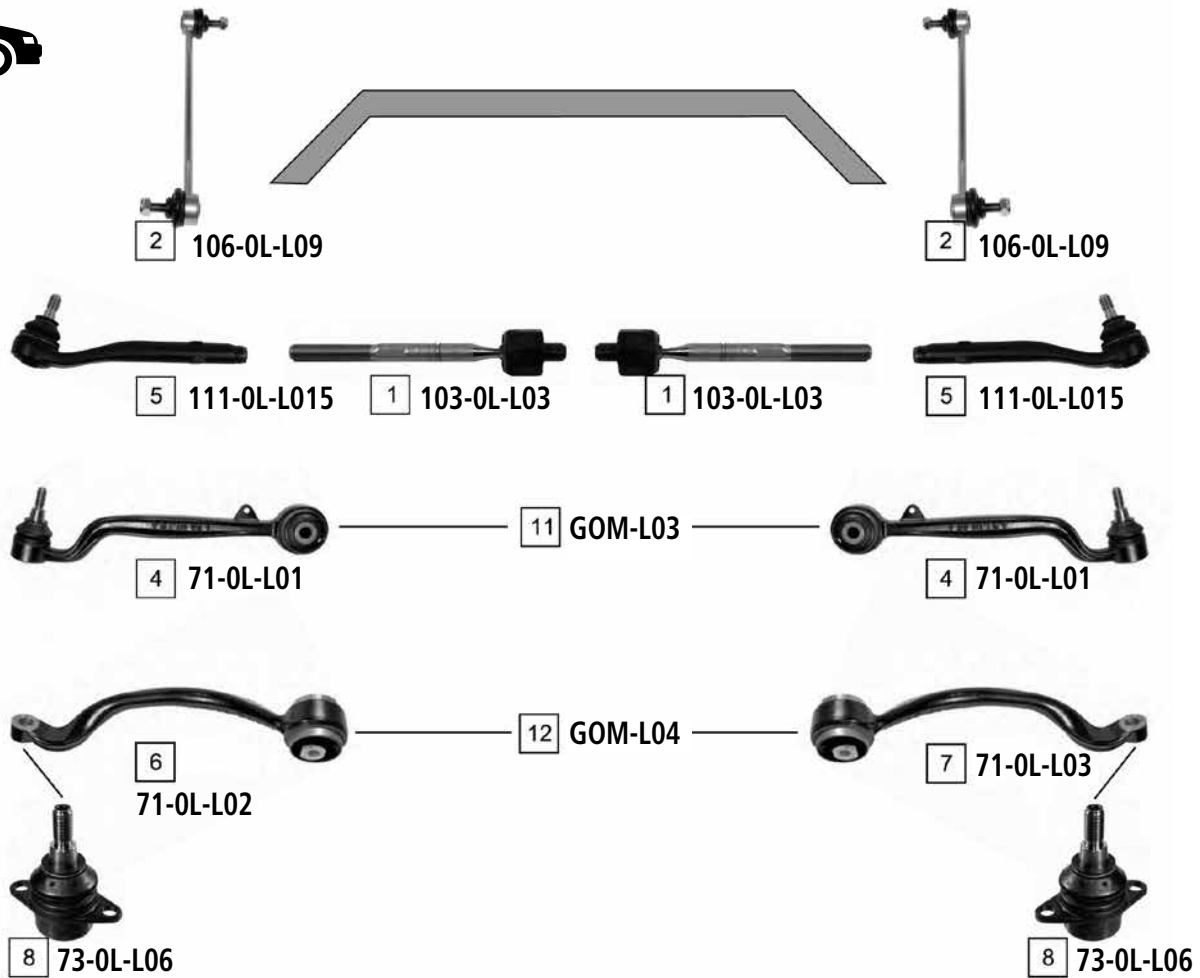

| Ref | ASHIKA CODE | Description     | OEM        | Measures | Ref | ASHIKA CODE | Description              | OEM        | Measures |
|-----|-------------|-----------------|------------|----------|-----|-------------|--------------------------|------------|----------|
| 1   | 103-0L-L03  | Axial Joint     | TIQ 000040 |          | 7   | 71-0L-L03   | TCA Right                | RBJ 000120 |          |
| 2   | 106-0L-L09  | Stabiliser Link | RBM 000011 | L:380    | 8   | 73-0L-L06   | Ball Joint               | RBK 500150 |          |
| 3   | 106-0L-L08  | Stabiliser Link | RGD 000180 |          | 9   | GOM-L05     | Ball Joint               | RHF 000260 |          |
| 4   | 71-0L-L01   | TCA             | RBJ 500710 |          | 10  | GOM-L06     | Ball Joint               | RBK 000042 |          |
| 5   | 111-0L-L015 | Tie Rod End     | TIQ 000030 |          | 11  | GOM-L03     | Silentblock For Susp.Arm | RBX 000070 |          |
| 6   | 71-0L-L02   | TCA Left        | RBJ 000130 | -        | 12  | GOM-L04     | Silentblock For Susp.Arm | RBX 000200 |          |

RANGE ROVER SPORT

02/2005 ->

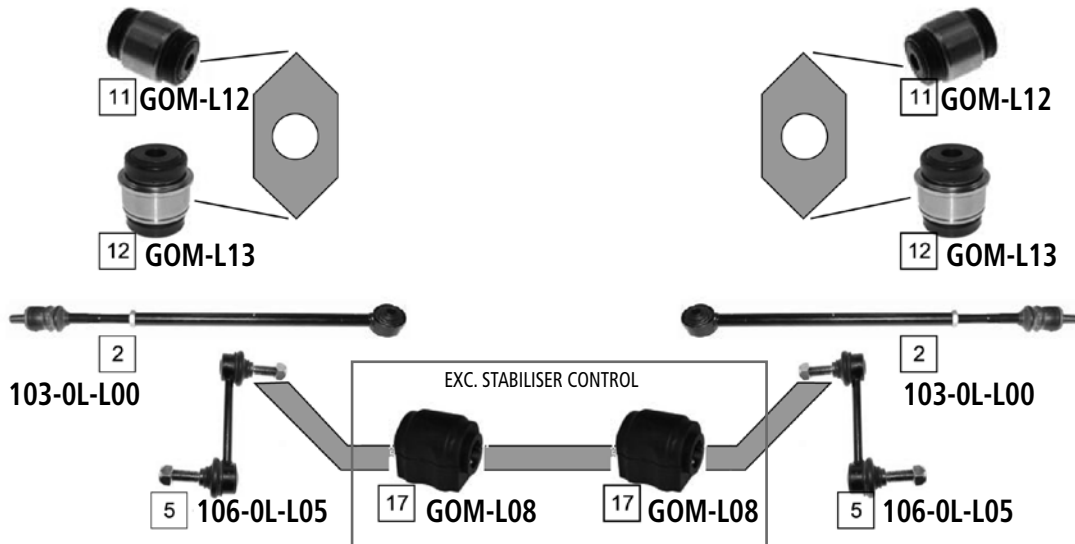
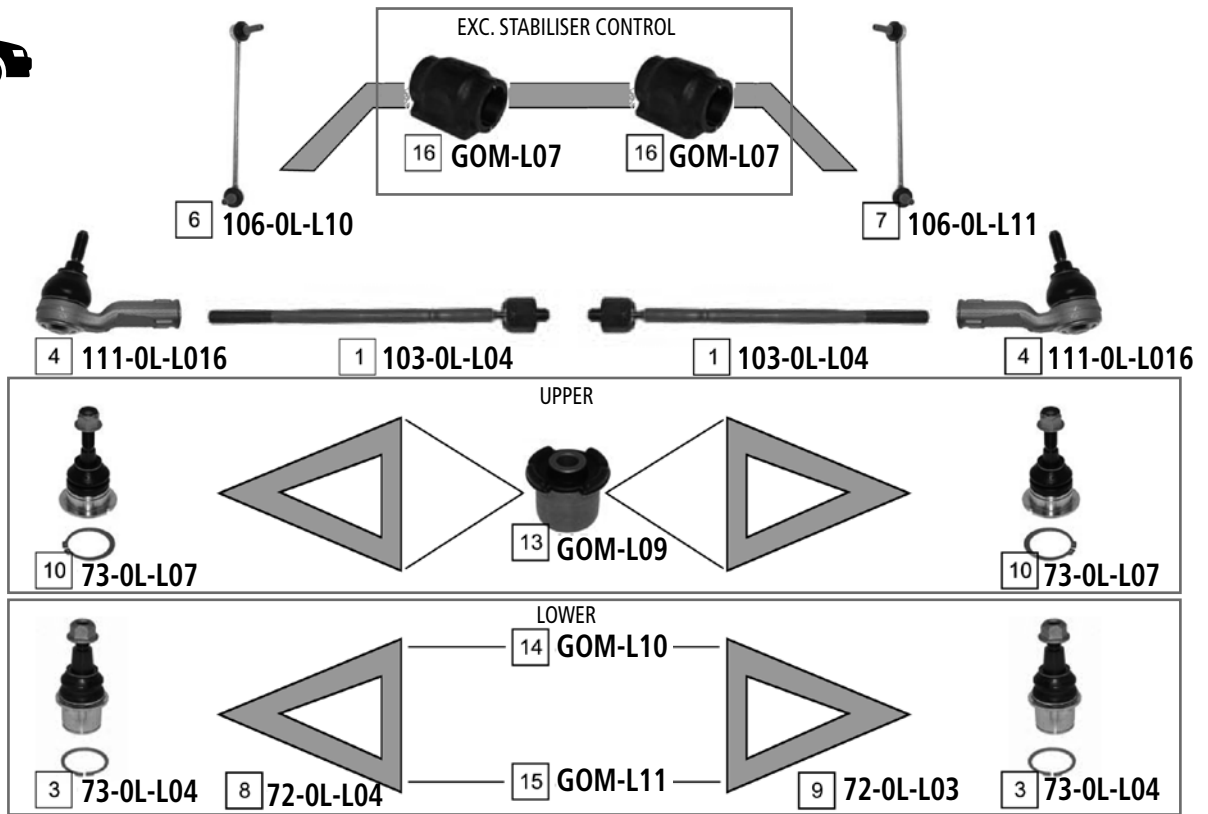

| Ref. | ASHIKA CODE | Description           | OEM        | Measures            | Ref. | ASHIKA CODE | Description              | OEM        | Measures |
|------|-------------|-----------------------|------------|---------------------|------|-------------|--------------------------|------------|----------|
| 1    | 103-0L-L04  | Axial Joint           | QFK 500030 | th:MM16X1.5R L:365  | 10   | 73-0L-L07   | Ball Joint               | RBK 500170 | c:13.8   |
| 2    | 103-0L-L00  | Tie Rod               | RGD 500083 | -                   | 11   | GOM-L12     | Ball Joint               | RHF 500031 | -        |
| 3    | 73-0L-L04   | Ball Joint            | RBK 500040 | c:20.65             | 12   | GOM-L13     | Ball Joint               | RBK 500012 | -        |
| 4    | 111-0L-L016 | Tie Rod End           | QJB 500040 | c:16.8 th:FM16X1.5R | 13   | GOM-L09     | Silentblock For Susp.Arm | RBX 500443 | d:14.3   |
| 5    | 106-0L-L05  | Stabiliser Link       | RGD 000311 | L:116               | 14   | GOM-L10     | Silentblock For Susp.Arm | RBX 500432 | -        |
| 6    | 106-0L-L10  | Stabiliser Link Left  | RBM 500150 | L:345               | 15   | GOM-L11     | Silentblock For Susp.Arm | RBX 500531 | -        |
| 7    | 106-0L-L11  | Stabiliser Link Right | RBM 500140 | L:345               | 16   | GOM-L07     | Stabiliser Mounting      | RBX 500280 | d:30     |
| 8    | 72-0L-L04   | TCA Left              | RBJ 500456 | -                   | 17   | GOM-L08     | Stabiliser Mounting      | RGX 500070 | d:23     |
| 9    | 72-0L-L03   | TCA Right             | RBJ 500446 | -                   |      |             |                          |            |          |

GOA

01/2007 ->



2 106-00-002

1 106-00-001

3 111-00-004

3 111-00-004

4 73-00-004

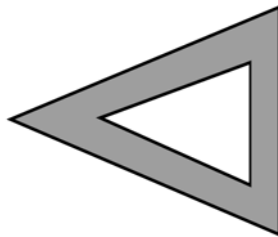

4 73-00-004

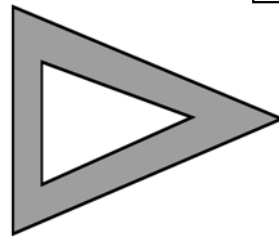

5 73-00-005

5 73-00-005

| Ref | ASHIKA CODE | Description           | OEM         | Measures | Ref | ASHIKA CODE | Description | OEM         | Measures |
|-----|-------------|-----------------------|-------------|----------|-----|-------------|-------------|-------------|----------|
| 1   | 106-00-001  | Stabiliser Link Right | 0401EA0360N |          | 4   | 73-00-004   | Ball Joint  | 0401BA0140N |          |
| 2   | 106-00-002  | Stabiliser Link Left  | 0401EA0370N |          | 5   | 73-00-005   | Ball Joint  | 0401BA0280N |          |
| 3   | 111-00-004  | Tie Rod End           |             |          |     |             |             |             |          |

121 I (DA)

10/1987 - 10/1990



1 111-03-325



2 103-0K-K53



2 103-0K-K53



1 111-03-325



3 73-0K-K52



3 73-0K-K52

| Ref | ASHIKA CODE | Description | OEM          | Measures            | Ref | ASHIKA CODE | Description | OEM           | Measures |
|-----|-------------|-------------|--------------|---------------------|-----|-------------|-------------|---------------|----------|
| 1   | 111-03-325  | Tie Rod End | 8AB1-32-280  | c:12.6 th:FM12X1.25 | 3   | 73-0K-K52   | TCA         | KKY01-34-390A | c:16     |
| 2   | 103-0K-K53  | Axial Joint | KK150-32-240 | th:MM16X1.5R L:265  |     |             |             |               |          |

# MAZDA 121



121 II (DB)

10/1990 - 03/1996

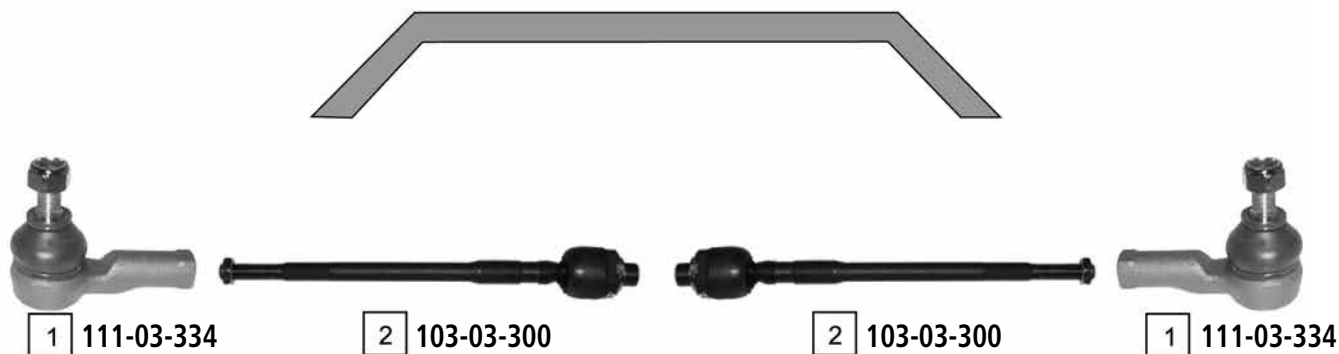

| Ref. | ASHIKA CODE | Description | OEM         | Measures            | Ref | ASHIKA CODE | Description | OEM        | Measures         |
|------|-------------|-------------|-------------|---------------------|-----|-------------|-------------|------------|------------------|
| 1    | 111-03-334  | Tie Rod End | 8AB2-32-280 | c:13.3 th:FM12X1.25 | 2   | 103-03-300  | Axial Joint | D06132248A | th:MM17X1R L:279 |

121 III (JASM,JBSM)

03/1996 - 10/2002

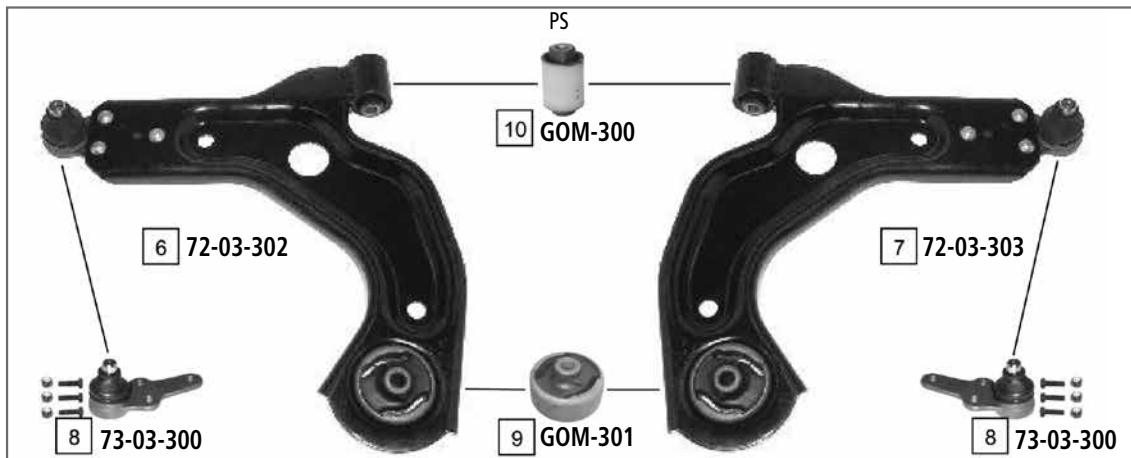
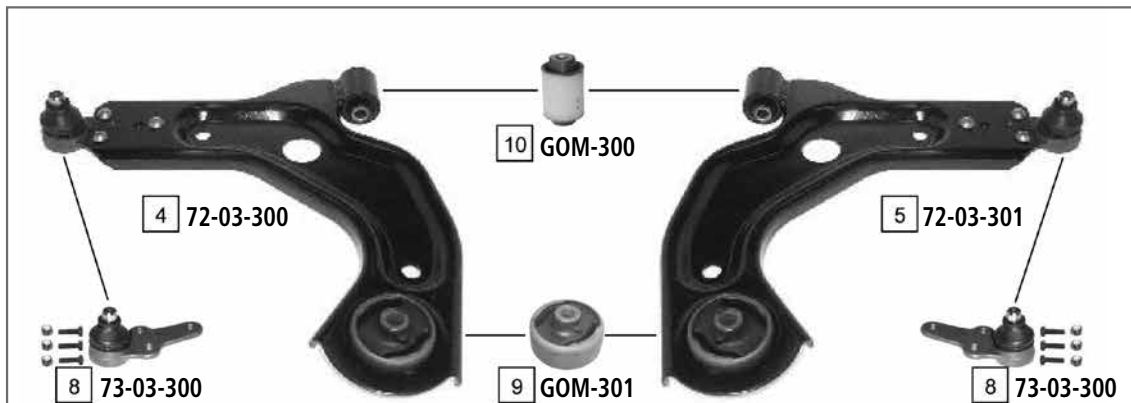
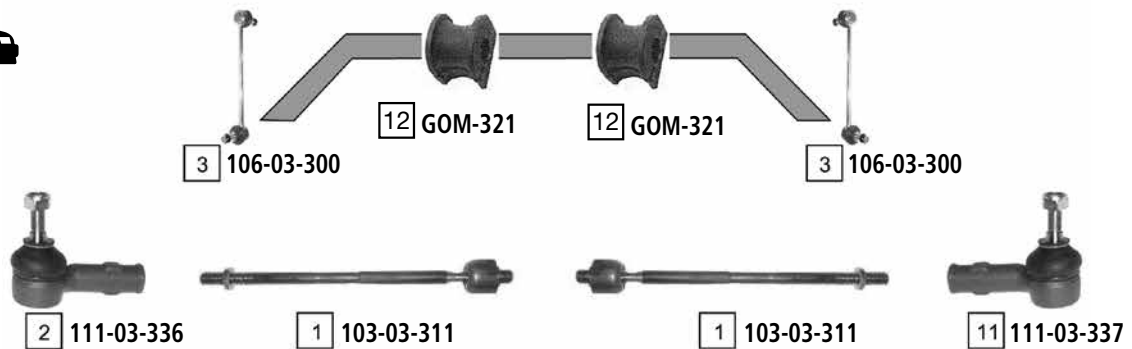

| Ref | ASHIKA CODE | Description      | OEM          | Measures           | Ref | ASHIKA CODE | Description              | OEM           | Measures         |
|-----|-------------|------------------|--------------|--------------------|-----|-------------|--------------------------|---------------|------------------|
| 1   | 103-03-311  | Axial Joint      | 1044014      | th:MM14X1.5R L:310 | 8   | 73-03-300   | Ball Joint               | 94FB 33 95A2B | c:16.5           |
| 2   | 111-03-336  | Tie Rod End Left | 1 020 174    | c:11.5 th:M14X2R   | 9   | GOM-301     | Silentblock For Susp.Arm | 1E01 34 153A  | d:66.1           |
| 3   | 106-03-300  | Stabiliser Link  | 1 015 265    | L:238              | 10  | GOM-300     | Silentblock For Susp.Arm | 1 010 037     | d:37.3           |
| 4   | 72-03-300   | TCA Left         | 1E00 34 350A | c:16.5             | 11  | 111-03-337  | Tie Rod End Right        | 1011857       | c:11.5 th:M14X2R |
| 5   | 72-03-301   | TCA Right        | 1E00 34 300A | c:17.45            | 12  | GOM-321     | Stabiliser Mounting      | 1E00-34-156   |                  |
| 6   | 72-03-302   | TCA Left         | 1 063 255    | c:16.5             | 13  | GOM-322     | Mounting Axle Body       | 1E00-28-460C  | -                |
| 7   | 72-03-303   | TCA Right        | 1 063 236    | c:16.5             |     |             |                          |               |                  |

# MAZDA 323



323 II (BD)

06/1980 - 04/1985

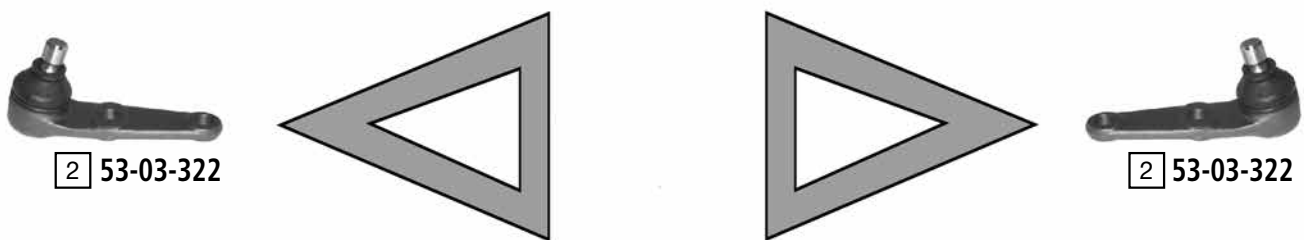
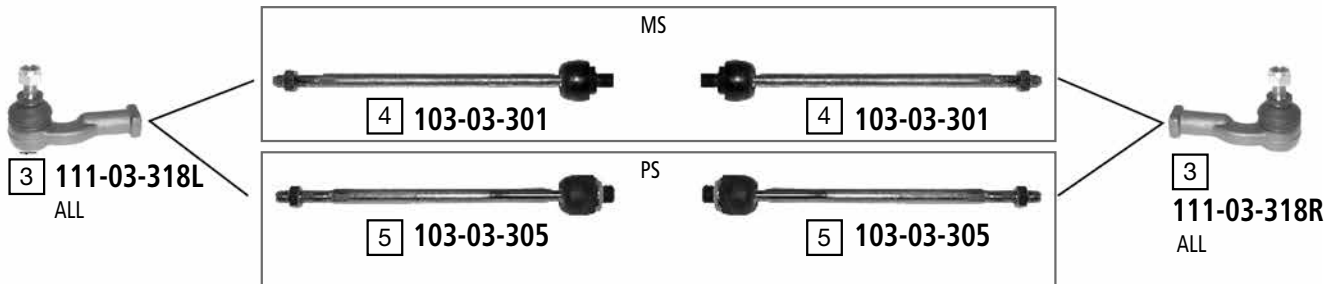
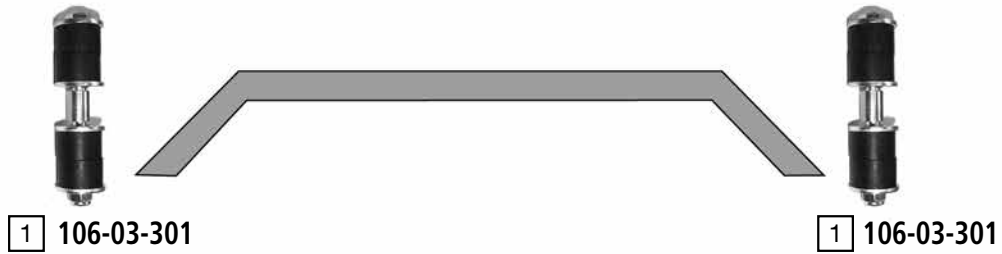

| Ref | ASHIKA CODE | Description      | OEM         | Measures            | Ref | ASHIKA CODE | Description       | OEM         | Measures |
|-----|-------------|------------------|-------------|---------------------|-----|-------------|-------------------|-------------|----------|
| 1   | 106-03-301  | Stabiliser Link  | B02934159   | L:110               | 4   | 103-03-301  | Axial Joint       | B001-32-135 |          |
| 2   | 53-03-322   | Ball Joint Lower | B092-34-550 | c:16                | 5   | 103-03-305  | Axial Joint       | BA2932-135  |          |
| 3   | 111-03-318L | Tie Rod End Left | B067-99-324 | c:12.7 th:FM12X1.25 | 6   | 111-03-318R | Tie Rod End Right | B001-99324  |          |

323 III (BF)  
323 III S.W. (BW)

05/1985 - 05/1989  
05/1986 - 10/1995

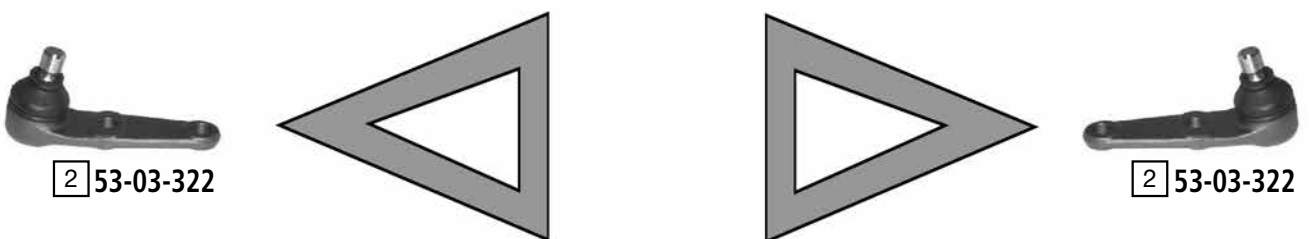
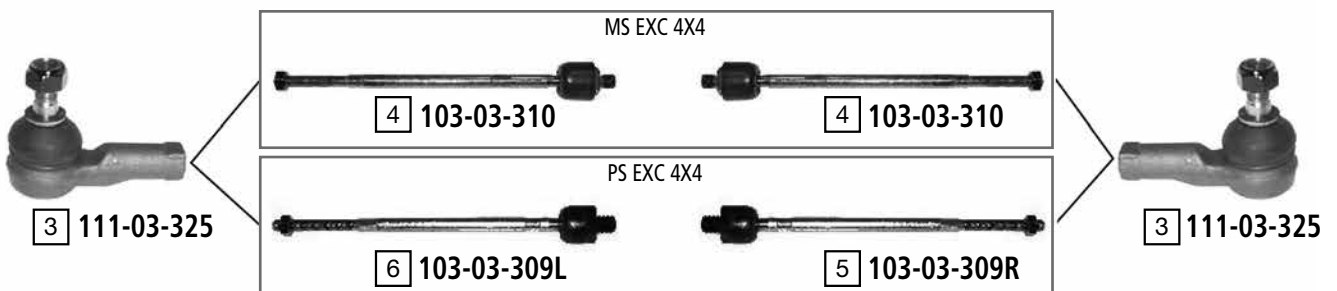
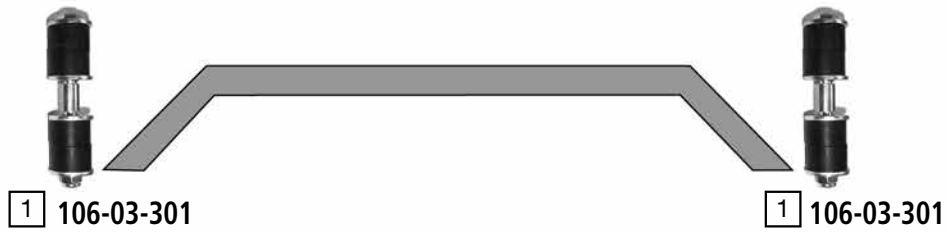

| Ref. | ASHIKA CODE | Description      | OEM         | Measures            | Ref. | ASHIKA CODE | Description | OEM         | Measures |
|------|-------------|------------------|-------------|---------------------|------|-------------|-------------|-------------|----------|
| 1    | 106-03-301  | Stabiliser Link  | B02934159   | L:110               | 4    | 103-03-310  | Axial Joint | BF67-32-24X |          |
| 2    | 53-03-322   | Ball Joint Lower | B092-34-550 | c:16                | 5    | 103-03-309R | Axial Joint | B093-32-240 |          |
| 3    | 111-03-325  | Tie Rod End      | 8AB1-32-280 | c:12.6 th:FM12X1.25 | 6    | 103-03-309L | Axial Joint |             |          |



323 IV (BG)

06/1989 - 08/1994

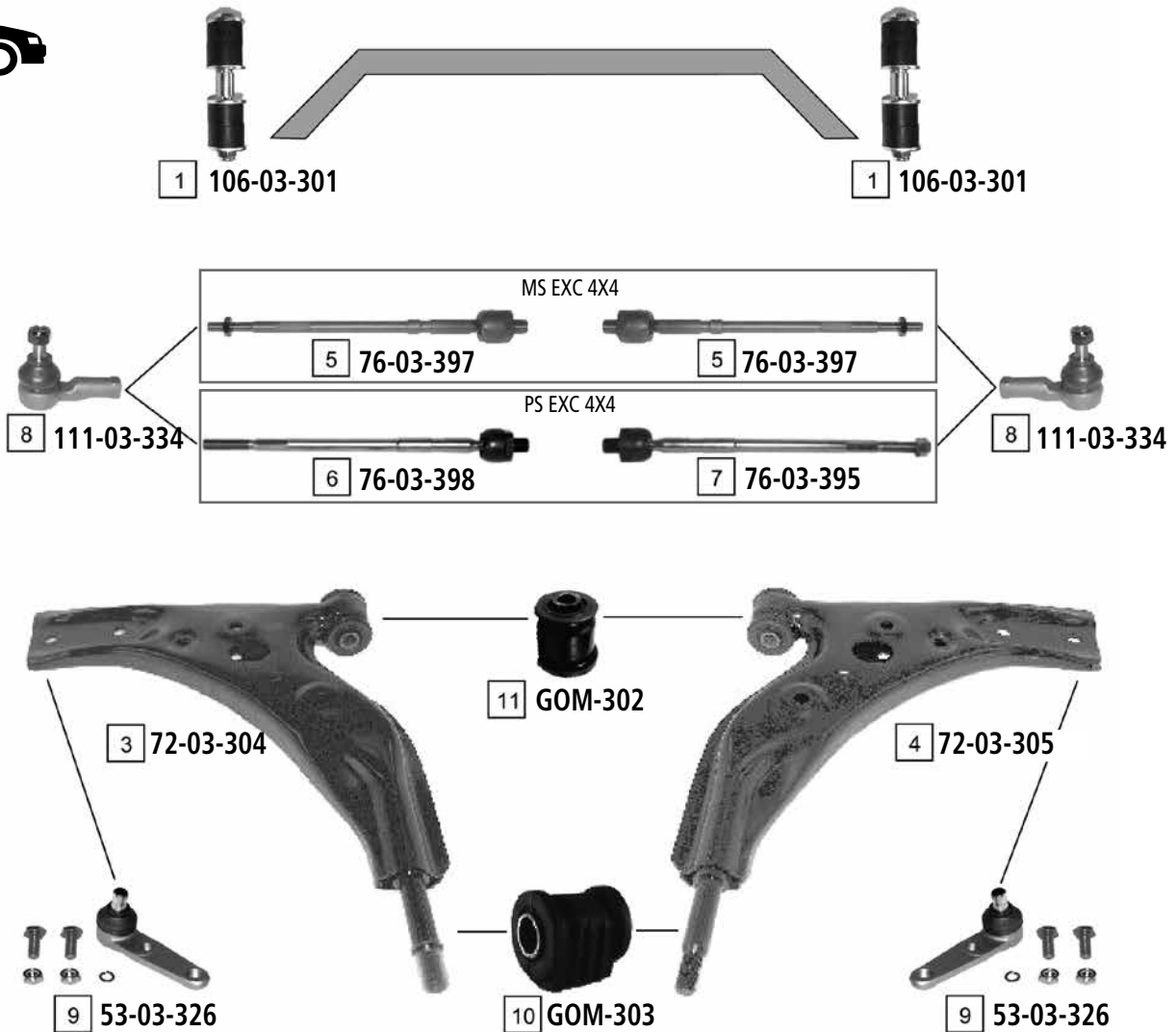

| Ref | ASHIKA CODE | Description     | OEM          | Measures         | Ref | ASHIKA CODE | Description              | OEM         | Measures            |
|-----|-------------|-----------------|--------------|------------------|-----|-------------|--------------------------|-------------|---------------------|
| 1   | 106-03-301  | Stabiliser Link | B02934159    | L:110            | 7   | 76-03-395   | Axial Joint              | B456-32-24X | th:MM16X1R L:324    |
| 2   | 106-03-302  | Stabiliser Link | 8AG1 28 100A | L:105            | 8   | 111-03-334  | Tie Rod End              | 8AB2-32-280 | c:13.3 th:FM12X1.25 |
| 3   | 72-03-304   | TCA Left        | B455-34350E  |                  | 9   | 53-03-326   | Ball Joint LOWER         | B455-34-550 | c:16                |
| 4   | 72-03-305   | TCA Right       | B455-34-300E |                  | 10  | GOM-303     | Silentblock For Susp.Arm | B001-34-470 |                     |
| 5   | 76-03-397   | Axial Joint     | B455-32-24X  | th:MM16X1R L:325 | 11  | GOM-302     | Silentblock For Susp.Arm | B459-34-470 |                     |
| 6   | 76-03-398   | Axial Joint     | B456-32-25X  | th:MM16X1R L:325 |     |             |                          |             |                     |

323 V (BA)

08/1994 - 09/1998

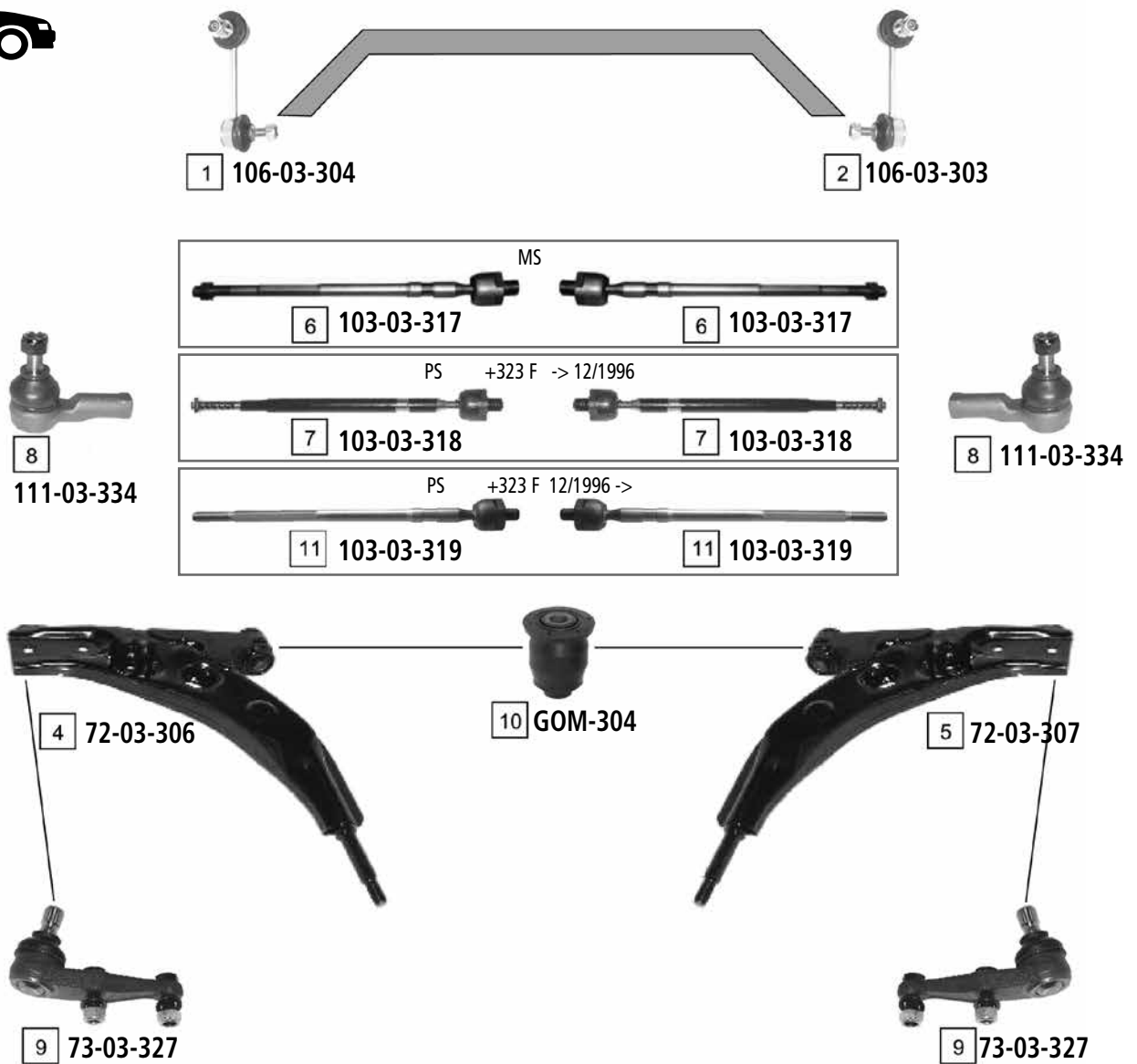

| Ref. | ASHIKA CODE | Description           | OEM          | Measures         | Ref. | ASHIKA CODE | Description              | OEM         | Measures            |
|------|-------------|-----------------------|--------------|------------------|------|-------------|--------------------------|-------------|---------------------|
| 1    | 106-03-304  | Stabiliser Link Left  | GA2A 34 170A | L:105            | 7    | 103-03-318  | Axial Joint              | E016 32 24X | th:MM16X1R L:334    |
| 2    | 106-03-303  | Stabiliser Link Right | GA2A 34 150A | L:105            | 8    | 111-03-334  | Tie Rod End              | 8AB2-32-280 | c:13.3 th:FM12X1.25 |
| 3    | 106-03-305  | Stabiliser Link       | BC1D 28 170A | L:255            | 9    | 73-03-327   | Ball Joint               | B01A 34 550 | c:18                |
| 4    | 72-03-306   | TCA                   | B01A 34 350  |                  | 10   | GOM-304     | Silentblock For Susp.Arm | BC1D 34 470 | d:40.5              |
| 5    | 72-03-307   | TCA                   | B01A 34 300  |                  | 11   | 103-03-319  | Axial Joint              | B21H 32 24X | th:MM14X1.5R L:335  |
| 6    | 103-03-317  | Axial Joint           | E016 32 250  | th:MM16X1R L:335 |      |             |                          |             |                     |

323 VI (BJ)

09/1998 - 05/2004

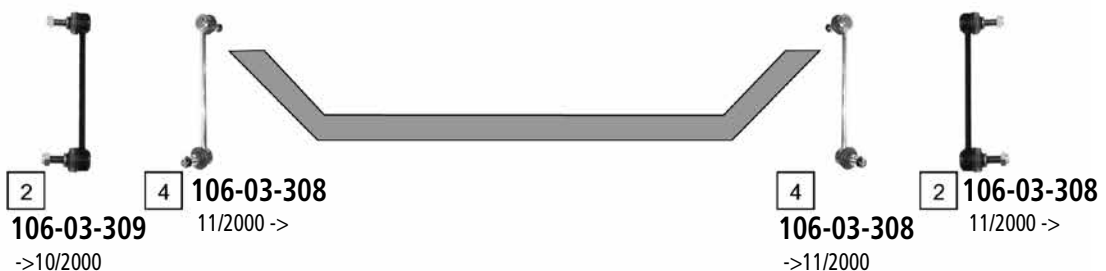
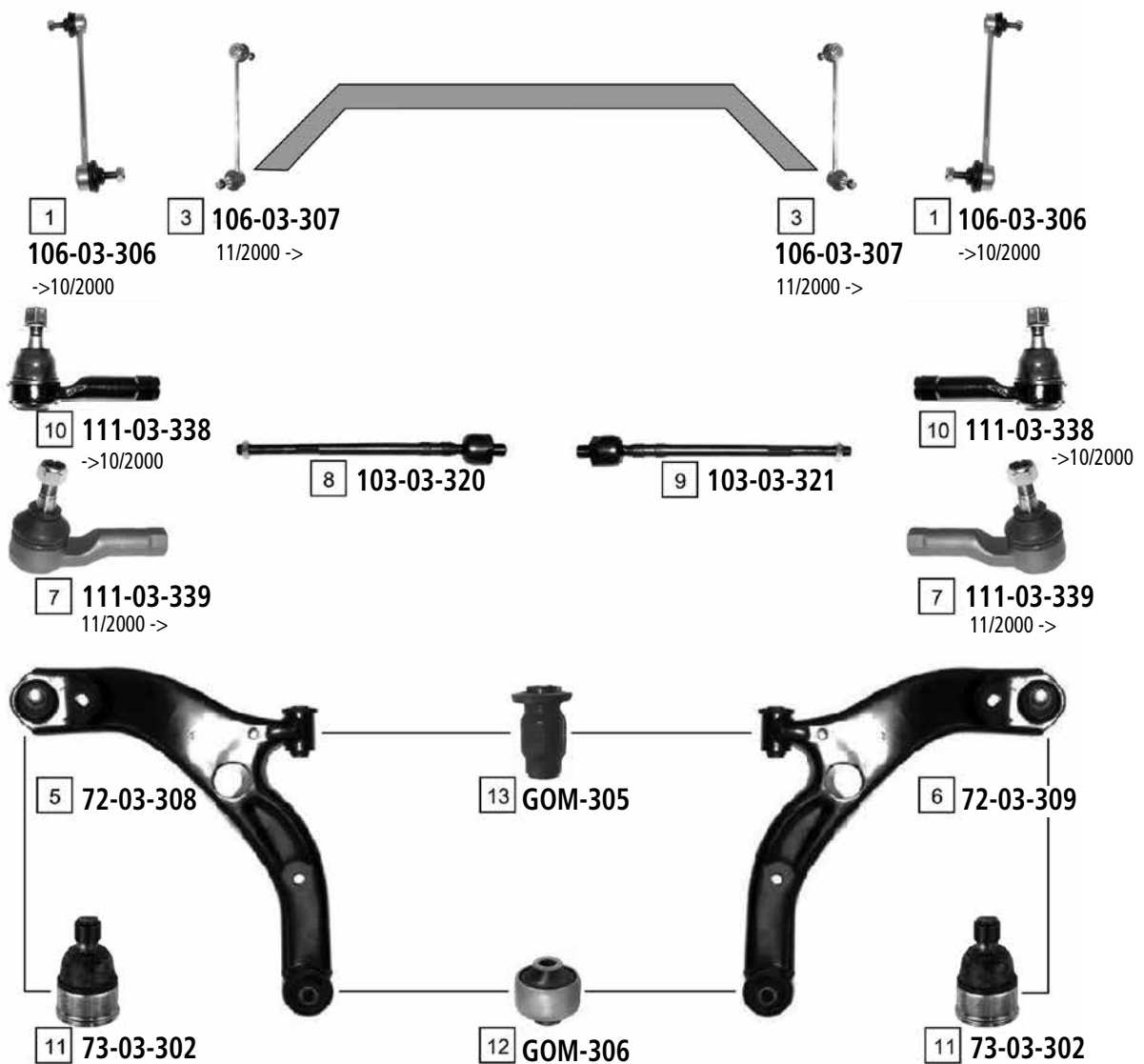

| Ref | ASHIKA CODE | Description     | OEM           | Measures            | Ref | ASHIKA CODE | Description              | OEM                           | Measures         |
|-----|-------------|-----------------|---------------|---------------------|-----|-------------|--------------------------|-------------------------------|------------------|
| 1   | 106-03-306  | Stabiliser Link | B26 R 34 170  | L:190               | 8   | 103-03-320  | Axial Joint              | B25D 32 240                   | th:MM16X1R L:310 |
| 2   | 106-03-309  | Stabiliser Link | B26R-28-170   | L:190               | 9   | 103-03-321  | Axial Joint              | B25D 32 250                   | th:MM16X1R L:310 |
| 3   | 106-03-307  | Stabiliser Link | LC62-34-170 A | L:266               | 10  | 111-03-338  | Tie Rod End              | 8AG4 32 280                   |                  |
| 4   | 106-03-308  | Stabiliser Link | B30H 28 170 B | L:160               | 11  | 73-03-302   | Ball Joint               | Part of 72-03-308 / 72-03-309 | c:18             |
| 5   | 72-03-308   | TCA Left        | B25D 34 350 A |                     | 12  | GOM-306     | Silentblock For Susp.Arm | B25D 34 460                   |                  |
| 6   | 72-03-309   | TCA Right       | B25D 34 300 A |                     | 13  | GOM-305     | Silentblock For Susp.Arm | B25D 34 470                   |                  |
| 7   | 111-03-339  | Tie Rod End     | 8AG3-32-280   | c:12.9 th:FM14X1.5R |     |             |                          |                               |                  |

626 III (GD)

07/1987 - 05/1992

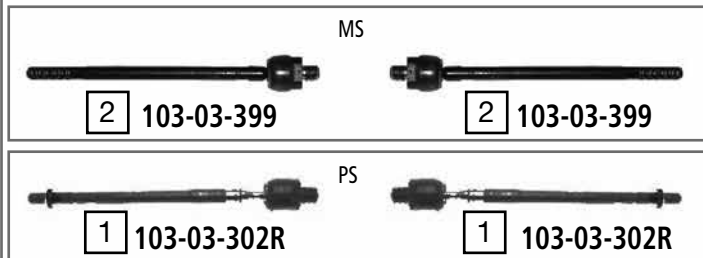

| Ref | ASHIKA CODE | Description | OEM          | Measures            | Ref | ASHIKA CODE | Description      | OEM          | Measures            |
|-----|-------------|-------------|--------------|---------------------|-----|-------------|------------------|--------------|---------------------|
| 1   | 103-03-302R | Axial Joint | GJ22-32-240  | th:MM18X1.5R L:285  | 4   | 111-03-339  | Tie Rod End      | 8AG3-32-280  | c:12.9 th:FM14X1.5R |
| 2   | 103-03-399  | Axial Joint | G030-32-250A | th:MM16X1R L:282    | 5   | 73-03-317   | Ball Joint Lower | 0G030 34550B | c:18                |
| 3   | 111-03-309  | Tie Rod End | H001-99-324  | c:13.6 th:FM14X1.5R | 6   | 106-03-302  | Stabiliser Link  | 8AG1 28 100A | L:105               |

# MAZDA 626



626 IV (GE)

08/1991 - 04/1997

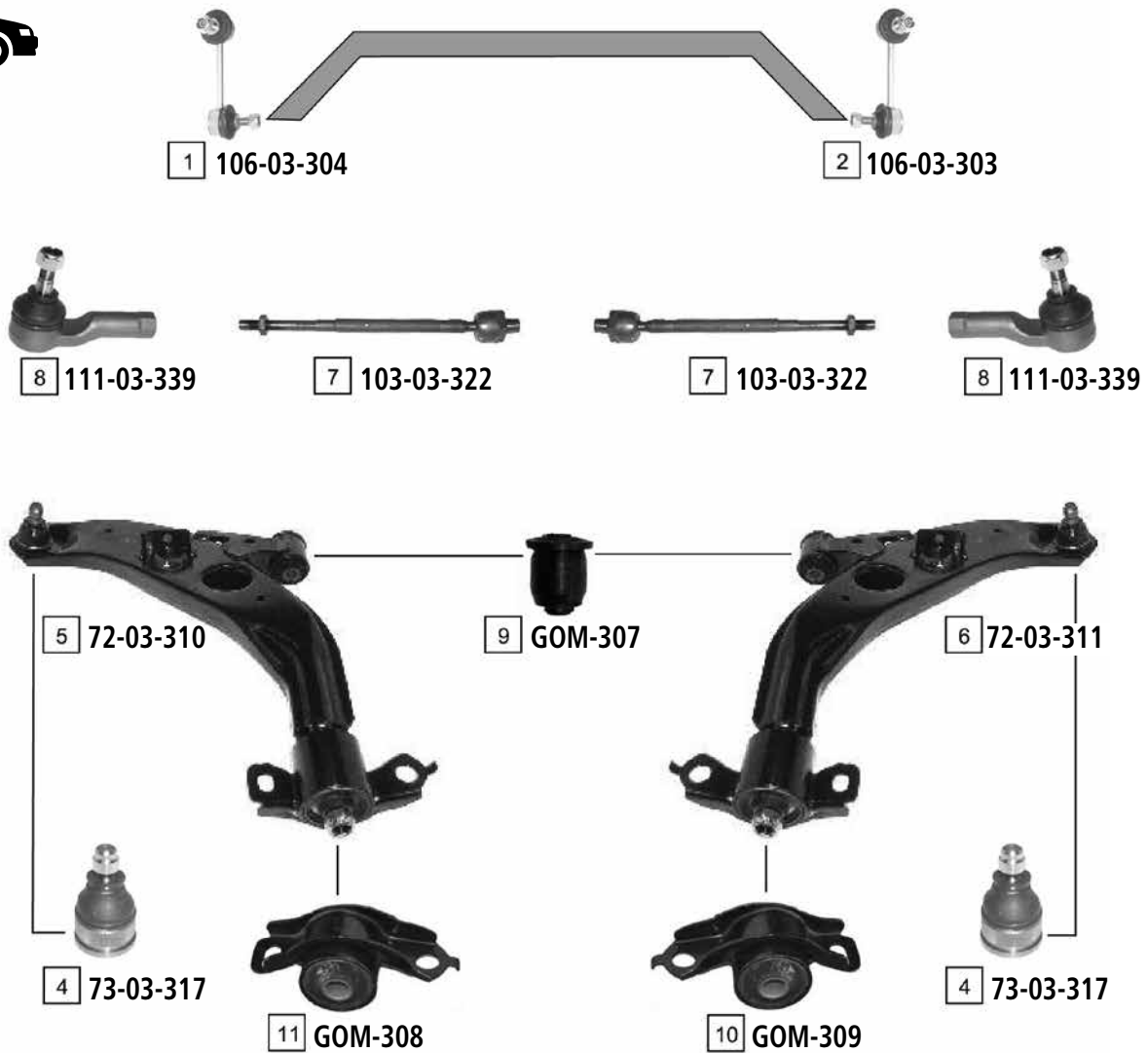

| Ref. | ASHIKA CODE | Description           | OEM          | Measures | Ref. | ASHIKA CODE | Description              | OEM          | Measures            |
|------|-------------|-----------------------|--------------|----------|------|-------------|--------------------------|--------------|---------------------|
| 1    | 106-03-304  | Stabiliser Link Left  | GA2A 34 170A | L:105    | 7    | 103-03-322  | Axial Joint              | GA2A-32-250  | th:MM18X1R L:300    |
| 2    | 106-03-303  | Stabiliser Link Right | GA2A 34 105A | L:105    | 8    | 111-03-339  | Tie Rod End              | 8AG3-32-280  | c:12.9 th:FM14X1.5R |
| 3    | 106-0K-K51  | Stabiliser Link       | GA2C-28-170B | L:88     | 9    | GOM-307     | Silentblock For Susp.Arm | GA2A 34 470  | d:38.5              |
| 4    | 73-03-317   | Ball Joint LOWER      | 0G030 34550B | c:18     | 10   | GOM-309     | Silentblock For Susp.Arm | GA2A 34 46XA |                     |
| 5    | 72-03-310   | TCA                   | GA2A-34-350  | c:18     | 11   | GOM-308     | Silentblock For Susp.Arm | GA2A 34 46YA |                     |
| 6    | 72-03-311   | TCA                   | GA2A-34-300  | c:18     |      |             |                          |              |                     |

626 V (GF)

05/1997 - 04/2002

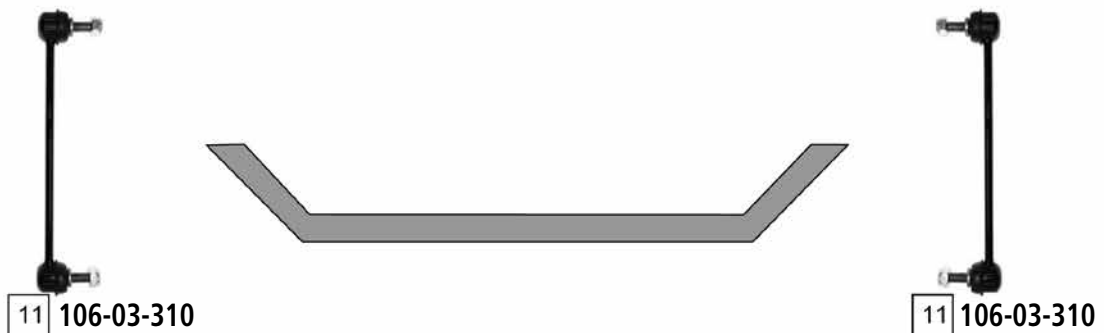
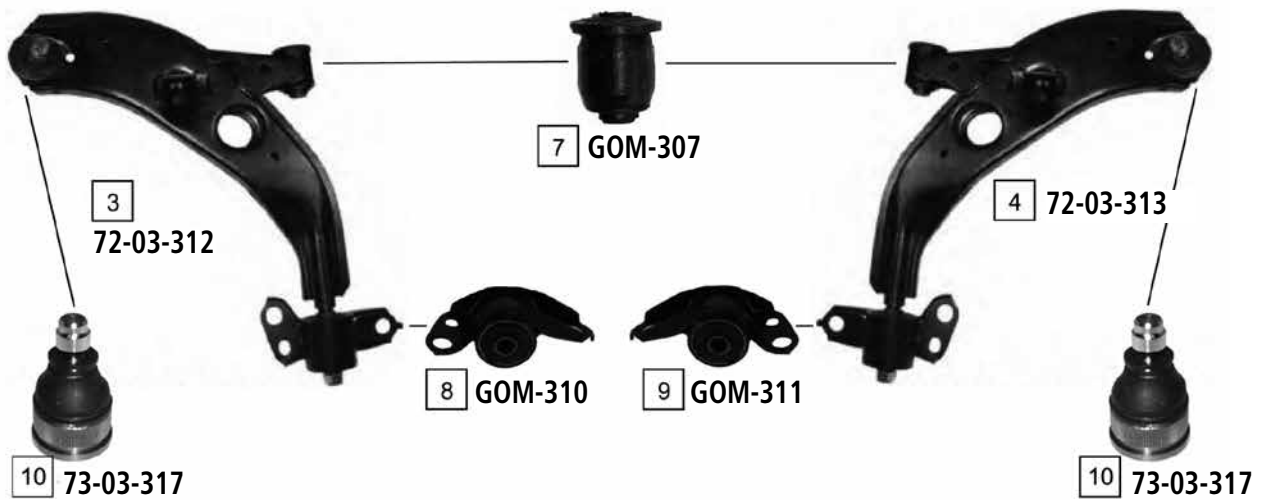
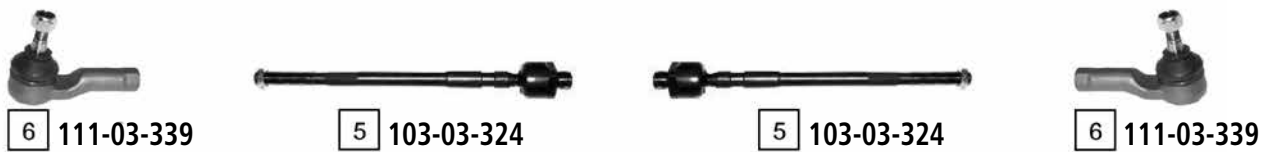

| Ref | ASHIKA CODE | Description           | OEM          | Measures            | Ref | ASHIKA CODE | Description              | OEM          | Measures |
|-----|-------------|-----------------------|--------------|---------------------|-----|-------------|--------------------------|--------------|----------|
| 1   | 106-03-304  | Stabiliser Link Left  | GA2A 34 170A | L:105               | 7   | GOM-307     | Silentblock For Susp.Arm | GA2A 34 470  | d:38.5   |
| 2   | 106-03-303  | Stabiliser Link Right | GA2A 34 150A | L:105               | 8   | GOM-310     | Silentblock For Susp.Arm | GE4T 34 46YD | d:18,5   |
| 3   | 72-03-312   | TCA                   | GE4T-34-350E | c:18                | 9   | GOM-311     | Silentblock For Susp.Arm | GE4T 34 46XD | d:18,5   |
| 4   | 72-03-313   | TCA                   | GE4T-34-300E | c:18                | 10  | 73-03-317   | Ball Joint Lower         | OG030 34550B | c:18     |
| 5   | 103-03-324  | Axial Joint           | GE4T-32-240  | th:MM18X1.5R L:307  | 11  | 106-03-310  | Stabiliser Link          | GE4T 28 170  | L:230    |
| 6   | 111-03-339  | Tie Rod End           | 8AG3-32-280  | c:12.9 th:FM14x1.5R |     |             |                          |              |          |

# MAZDA

## B1600 - 1800 - 2000 - 2200 - 2600



B1600 - 1800 (UD,UF)  
B2000 - 2200 - 2600

10/1981 - 12/1996

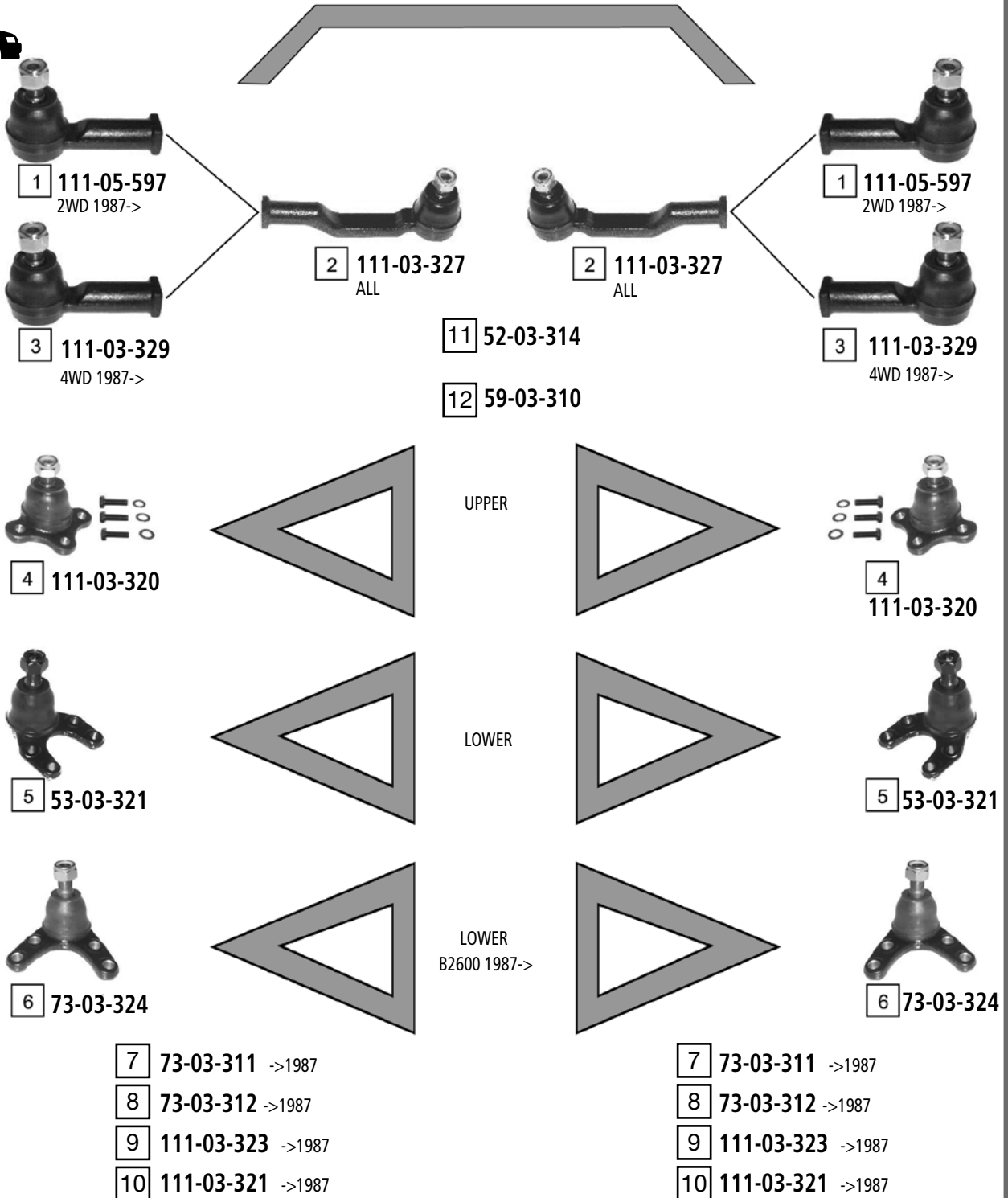

| Ref | ASHIKA CODE | Description       | OEM         | Measures              | Ref | ASHIKA CODE | Description | OEM          | Measures |
|-----|-------------|-------------------|-------------|-----------------------|-----|-------------|-------------|--------------|----------|
| 1   | 111-05-597  | Tie Rod End       | UB39-99-324 | c: 13.7 th: FM14X1.5L | 7   | 73-03-311   | Ball Joint  | VA01-99-354  |          |
| 2   | 111-03-327  | Tie Rod End Inner | UB39-99-322 | c: 13.8 th: FM14X1.5R | 8   | 73-03-312   | Ball Joint  | VA01-99-356  |          |
| 3   | 111-03-329  | Tie Rod End       | 8AU1-32-280 | c: 13.7 th: FM14X1.5L | 9   | 111-03-323  | Tie Rod End | 0662-99-324  |          |
| 4   | 111-03-320  | Ball Joint Upper  | 8AU1-34-540 | c: 13.7               | 10  | 111-03-321  | Tie Rod End | VA01-32-240  |          |
| 5   | 53-03-321   | Ball Joint Lower  | 8AU2-34-510 | c:17.6                | 11  | 52-03-314   |             | VB39-32-220B |          |
| 6   | 73-03-324   | Ball Joint Lower  | 8AU3-34-510 | c: 17.8               | 12  | 59-03-310   |             | VB39-32-320A |          |

B2200 - 2500 - 2600 (UN)

02/1999 ->

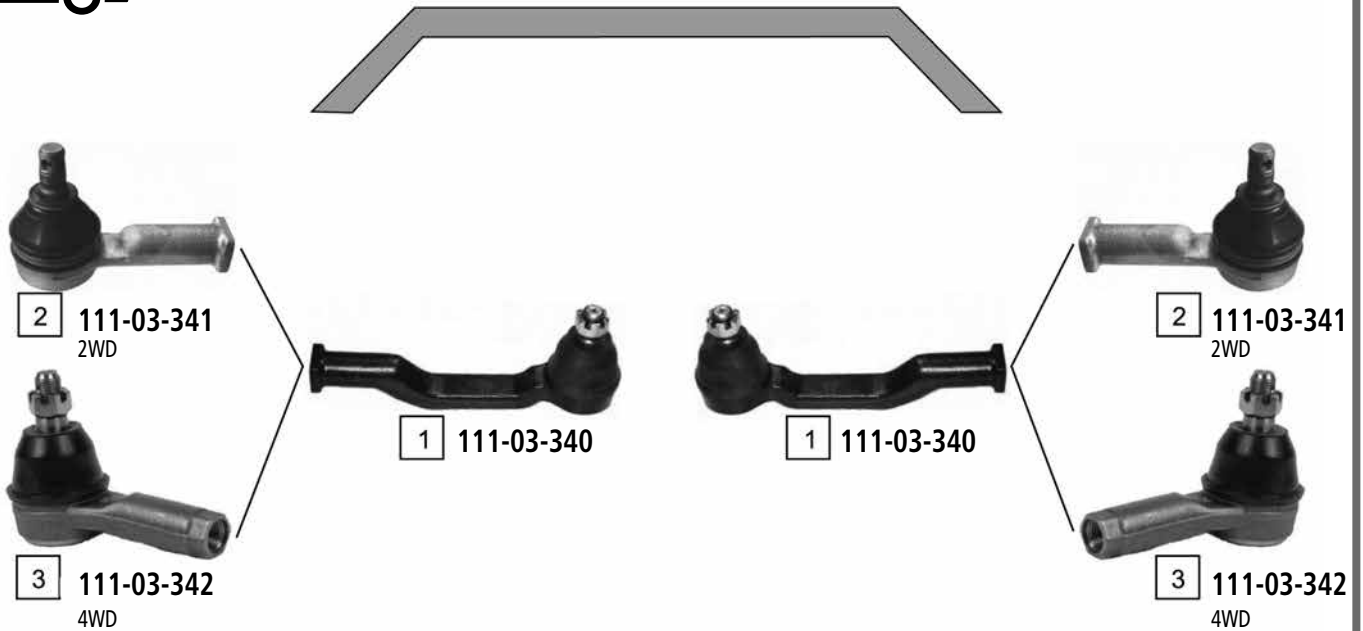

| Ref | ASHIKA CODE | Description | OEM         | Measures           | Ref | ASHIKA CODE | Description | OEM         | Measures |
|-----|-------------|-------------|-------------|--------------------|-----|-------------|-------------|-------------|----------|
| 1   | 111-03-340  | Tie Rod End | UH74-32-250 |                    | 3   | 111-03-342  | Tie Rod End | UH74-32-280 |          |
| 2   | 111-03-341  | Tie Rod End | UH71-32-280 | c:13.6 th:FM14X15L |     |             |             |             |          |



CX-7 (ER)

10/2007 ->

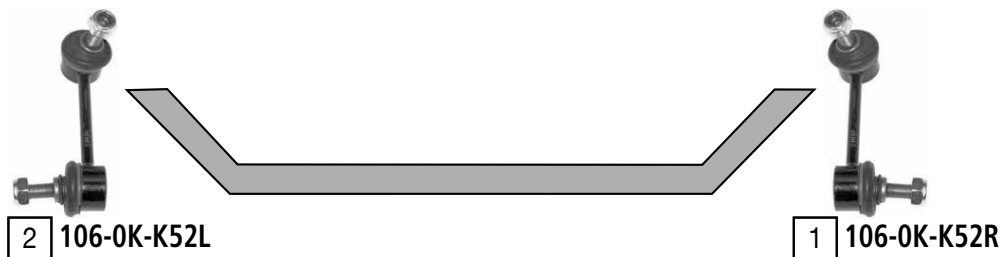
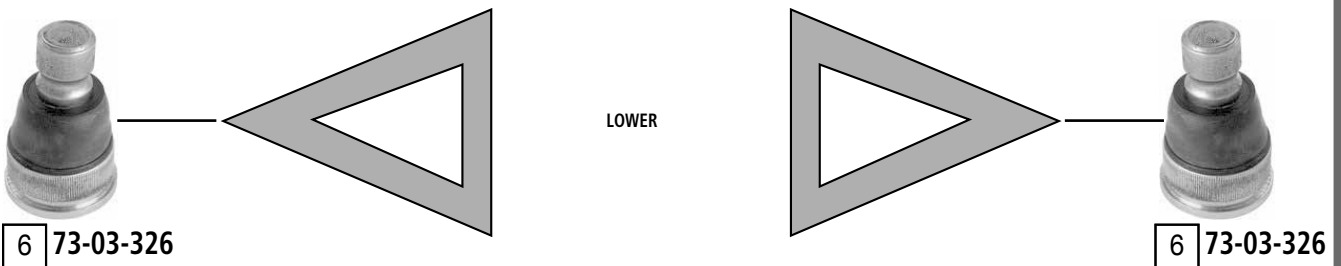
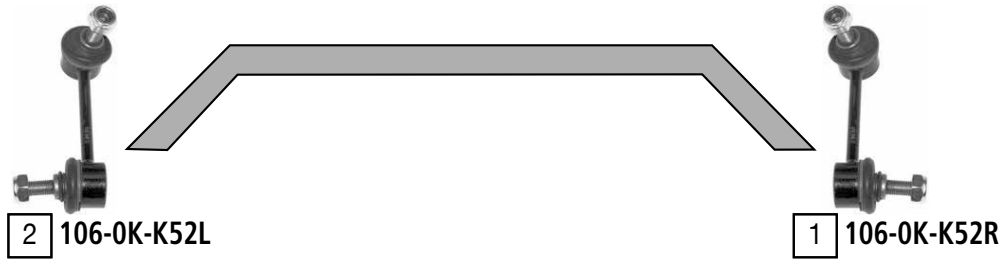

| Ref | ASHIKA CODE | Description      | OEM          | Measures            | Ref | ASHIKA CODE | Description       | OEM          | Measures            |
|-----|-------------|------------------|--------------|---------------------|-----|-------------|-------------------|--------------|---------------------|
| 1   | 106-0K-K52R | Stabiliser link  | L206 34 150A | L:104               | 4   | 111-03-357  | Tie rod end right | EG21 32 280A | c:14.9 th:FM14x1.5R |
| 2   | 106-0K-K52L | Stabiliser link  | L206 34 170A | L:104               | 5   | 103-03-336  | Axial joint       | EG21 32 240  | th:MM14x1.5R L:206  |
| 3   | 111-03-358  | Tie rod end left | EG21 32 290A | c:14.9 th:FM14x1.5R | 6   | 73-03-326   | Ball joint lower  | Part of      | c:22 do:44          |

DEMIO (DW)

08/1998 - 04/2003



| Ref | ASHIKA CODE | Description     | OEM          | Measures | Ref | ASHIKA CODE | Description | OEM         | Measures            |
|-----|-------------|-----------------|--------------|----------|-----|-------------|-------------|-------------|---------------------|
| 1   | 106-03-311  | Stabiliser Link | EA03-34-170A | L:55     | 4   | 111-03-334  | Tie Rod End | 8AB2-32-280 | c:13.3 th:FM12X1.25 |
| 2   | 71-03-300   | TCA             | D201 34 350A |          | 5   | 103-03-326  | Axial Joint | D102-32-240 | th:MM16X1.5R L:279  |
| 3   | 71-03-301   | TCA             | D201 34 300E |          | 6   | 103-03-325  | Axial Joint | D102-32-250 | th:MM16X1.5R L:280  |

# MAZDA E2000 - E2200



E2000 - E2200 (SD,SR)

01/1984 - 07/1999

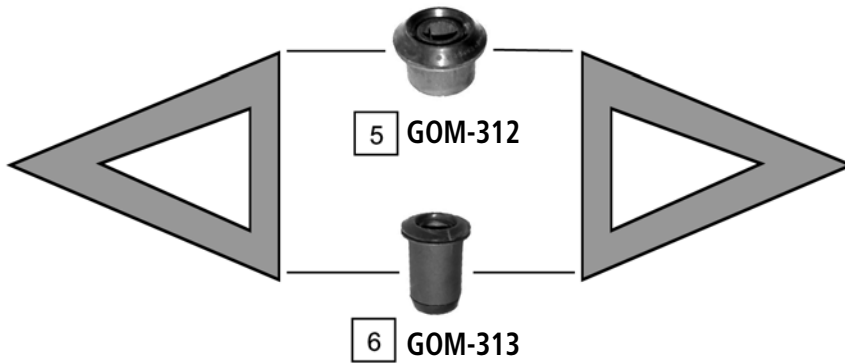

| Ref | ASHIKA CODE | Description      | OEM         | Measures            | Ref | ASHIKA CODE | Description              | OEM          | Measures |
|-----|-------------|------------------|-------------|---------------------|-----|-------------|--------------------------|--------------|----------|
| 1   | 103-03-304  | Axial Joint      | S083-32-115 | h:MM17X1R L:183     | 5   | GOM-312     | Silentblock For Susp.Arm | S083 34 840A | d:45.3   |
| 2   | 111-03-343  | Tie Rod End      | S083-99-324 | c:13.8 th:FM14X1.5R | 6   | GOM-313     | Silentblock For Susp.Arm | S083 34 830A | d:45.2   |
| 3   | 73-03-313   | Ball Joint Upper | S083 99 354 | c:17.8              | 7   | GOM-314     | Silentblock For Susp.Arm | S083-34-460  | d:45     |
| 4   | 73-03-314   | Ball Joint Lower | S083 99 356 | c:17.8              |     |             |                          |              |          |

MAZDA 2

04/2003 ->

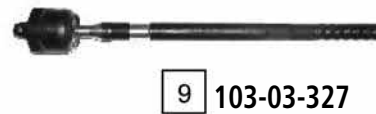
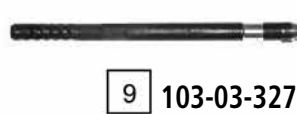
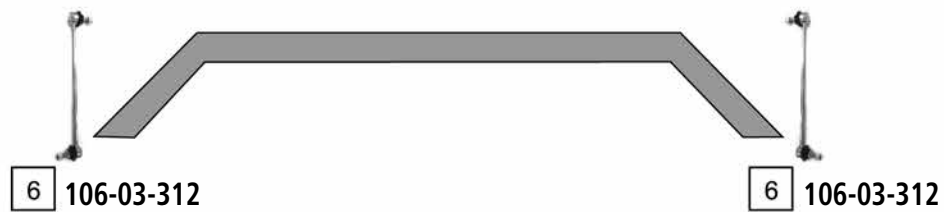

| Ref | ASHIKA CODE | Description       | OEM                   | Measures            | Ref | ASHIKA CODE | Description              | OEM                   | Measures           |
|-----|-------------|-------------------|-----------------------|---------------------|-----|-------------|--------------------------|-----------------------|--------------------|
| 1   | 111-03-344  | Tie Rod End Left  | 1202549               | c:11,6 th:FM14X1.5R | 6   | 106-03-312  | Stabiliser Link          | 1146150               | L:285              |
| 2   | 73-03--303  | Ball Joint        | Part of BS-314/BS-315 | c:17,5              | 7   | GOM-315     | Silentblock For Susp.Arm | Part of BS-314/BS-315 | d:40               |
| 3   | 72-03--314  | TCA Left          | DD32 34 350           | c:17,5              | 8   | GOM-316     | Silentblock For Susp.Arm | Part of BS-314/BS-315 |                    |
| 4   | 72-03--315  | TCA Right         | DD32 34 300           | c:17,5              | 9   | 103-03-327  | Axial Joint              | 4 342 539             | th:MM14X1,5R L:278 |
| 5   | 111-03-345  | Tie Rod End Right | 1202548               | c:11,6 th:FM14X1,5R |     |             |                          |                       |                    |

MAZDA 2

10/2007 ->

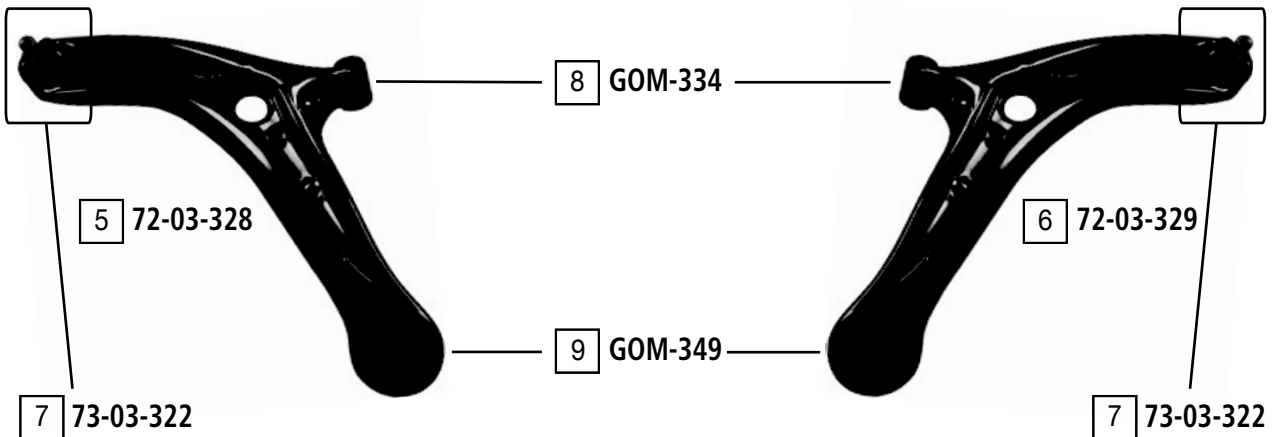
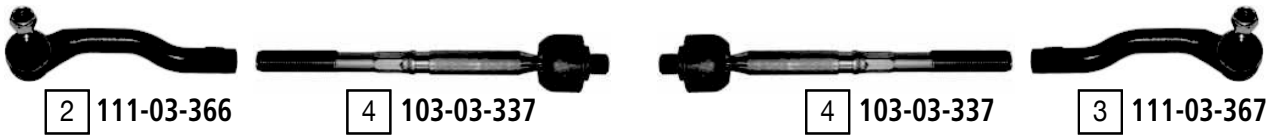
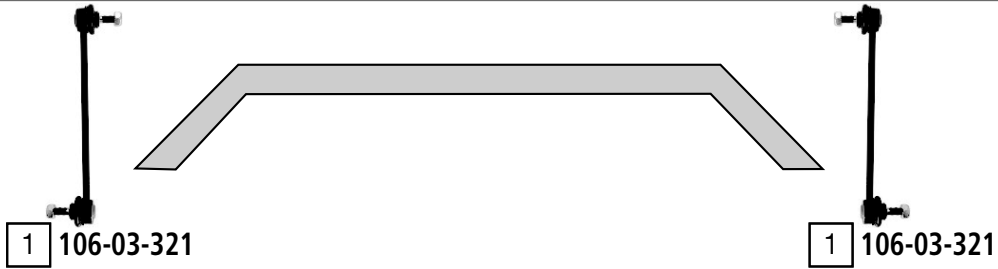

| Ref | ASHIKA CODE | Description       | OEM          | Measures           | Ref | ASHIKA CODE | Description         | OEM          | Measures       |
|-----|-------------|-------------------|--------------|--------------------|-----|-------------|---------------------|--------------|----------------|
| 1   | 106-03-321  | Stabiliser Link   | D651 34 170  | L:252              | 6   | 72-03-329   | TCA Right Wbj       | D651 34 300D | c:17.5         |
| 2   | 111-03-366  | Tie Rod End Left  | D653 32 290  | c:13 th:FM14x1.5R  | 7   | 73-03-322   | Ball Joint          | Part of      | c:17.5 do:38.7 |
| 3   | 111-03-367  | Tie Rod End Right | D651 32 280  | c:13 th:FM14x1.5R  | 8   | GOM-334     | Silentblock For TCA | D651 34 470  | di:12.2        |
| 4   | 103-03-337  | Axial Joint       | D653 32 240  | th:MM14x1.5R L:216 | 9   | GOM-349     | Silentblock For TCA | Part of      | di:12 do:60.9  |
| 5   | 72-03-328   | TCA Left Wbj      | D651 34 350E | c:17.5             |     |             |                     |              |                |

MAZDA 3 (BK)

06/2003 ->

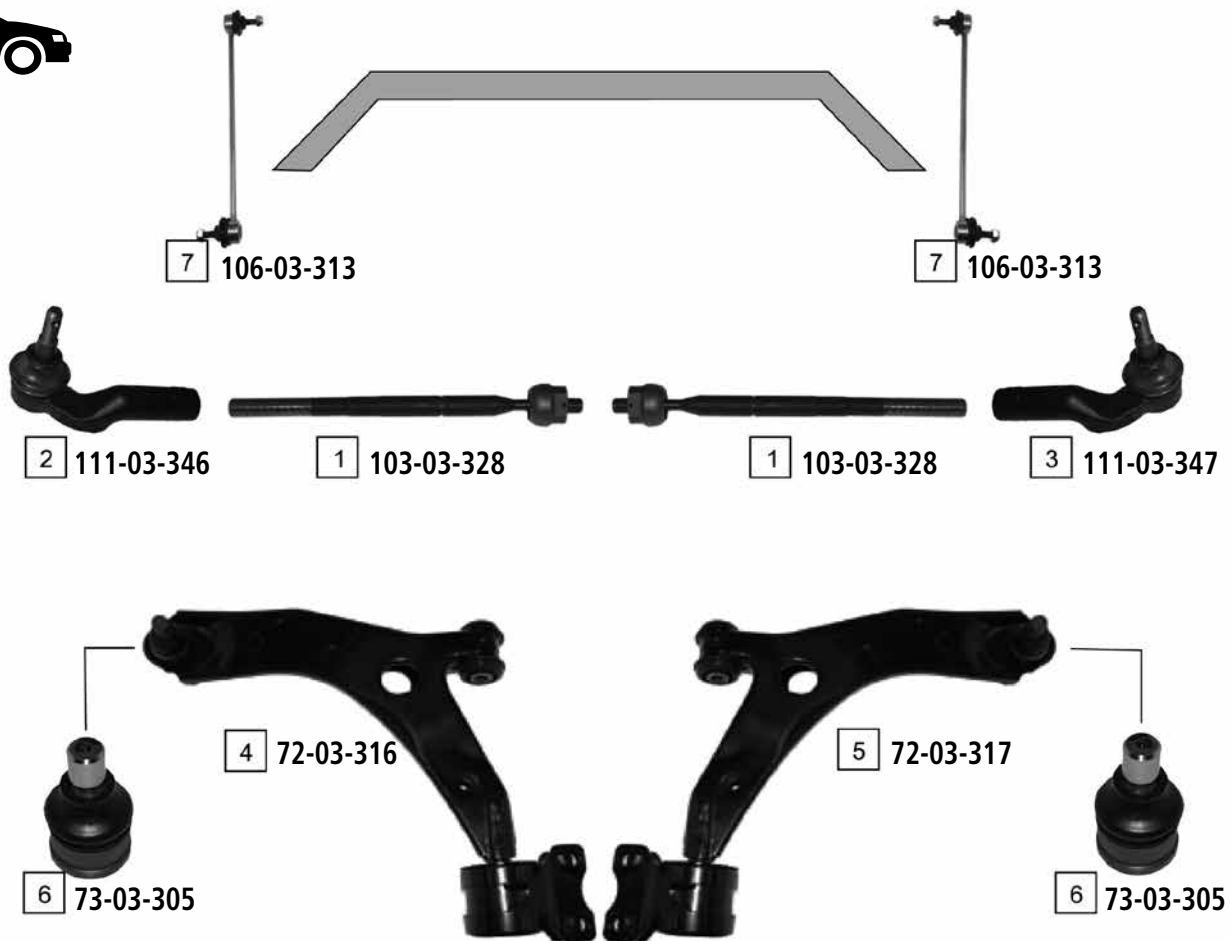

| Ref | ASHIKA CODE | Description       | OEM         | Measures            | Ref | ASHIKA CODE | Description           | OEM                           | Measures |
|-----|-------------|-------------------|-------------|---------------------|-----|-------------|-----------------------|-------------------------------|----------|
| 1   | 103-03-328  | Axial Joint       | BP4L 32 240 | th:MM14X1.5R L:292  | 6   | 73-03-305   | Ball Joint            | Part of 72-03-316 / 72-03-317 | c:18     |
| 2   | 111-03-346  | Tie Rod End Left  | BP4L 32 290 | c:12.2 th:FM17X1.5R | 7   | 106-03-313  | Stabiliser Link       | BP4K 34 170C                  | L:307    |
| 3   | 111-03-347  | Tie Rod End Right | BP4L 32 280 | c:12.2 th:FM17X1.5R | 8   | 71-03-303   | Track Rod             | BP4K 28 500C                  |          |
| 4   | 72-03-316   | TCA Left Wbj      | B32H 34 350 | c:18                | 9   | 71-03-302   | Track Rod             | BP4K 28 C 10B                 |          |
| 5   | 72-03-317   | TCA Right Wbj     | B32H 34 300 | C:18                | 10  | GOM-317     | Silentblock Axle Body | 30666821                      |          |

MAZDA 5

02/2005 ->

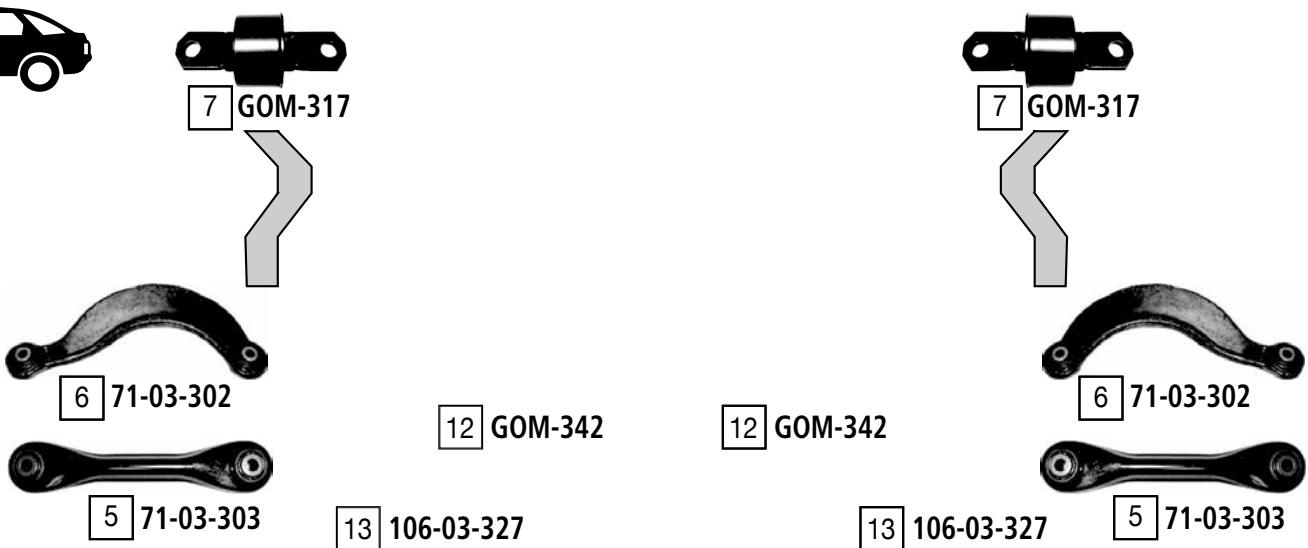
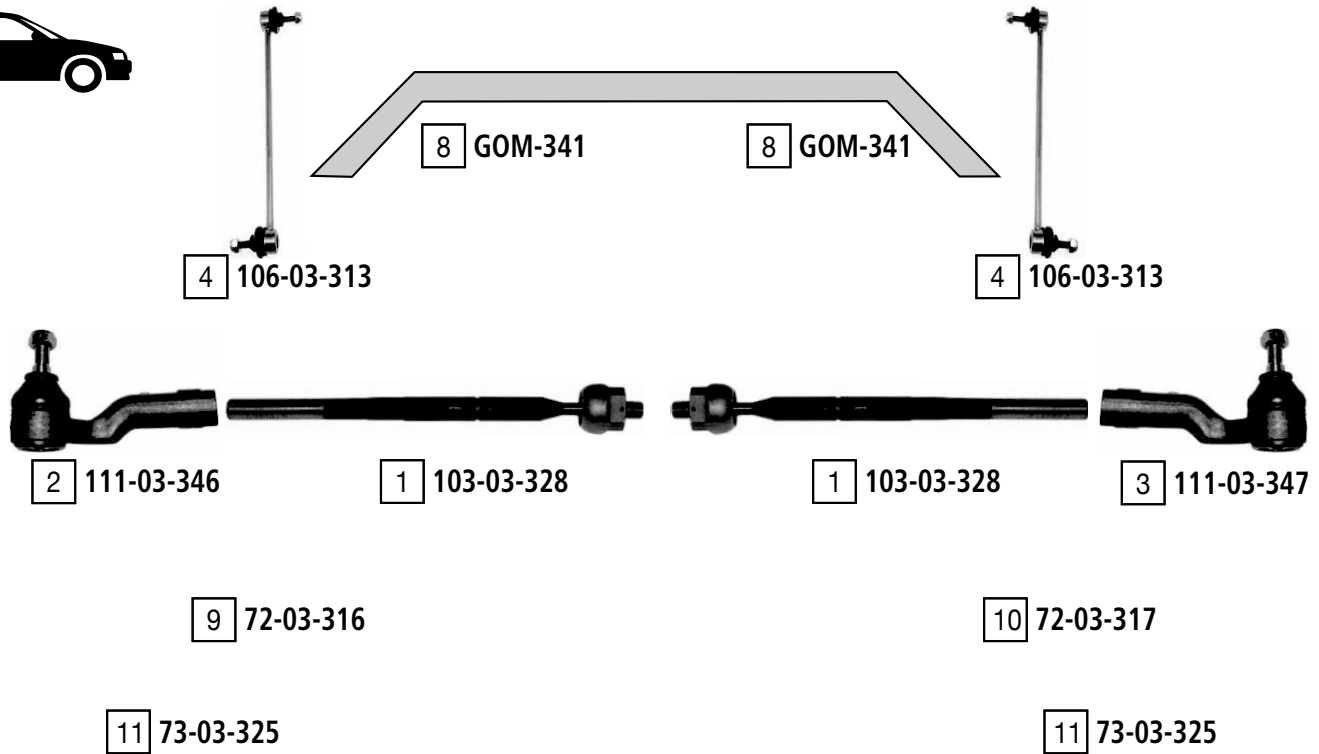

| Ref | ASHIKA CODE | Description        | OEM          | Measures            | Ref | ASHIKA CODE | Description         | OEM          | Measures |
|-----|-------------|--------------------|--------------|---------------------|-----|-------------|---------------------|--------------|----------|
| 1   | 103-03-328  | Axial Joint        | BP4L 32 240  | th:MM14X1.5R L:292  | 8   | GOM-341     | Stabiliser Mounting | CC29 34 156C |          |
| 2   | 111-03-346  | Tie Rod End Left   | BP4L 32 290  | c:12.2 th:FM17X1.5R | 9   | 72-03-316   | TCA Left Wbj        | B32H 34 350  |          |
| 3   | 111-03-347  | Tie Rod End Right  | BP4L 32 280  | c:12.2 th:FM17X1.5R | 10  | 72-03-317   | TCA Right Wbj       | B32H 34 300  |          |
| 4   | 106-03-313  | Stabiliser Link    | BP4K 34 170D | L:307               | 11  | 73-03-325   | Ball Joint          | BK3P 34 300D |          |
| 5   | 71-03-303   | Track Rod Rear     | BP4K 28 500E | L:223               | 12  | GOM-342     | Stabiliser Mounting | C24328156C   |          |
| 6   | 71-03-302   | Track Rod Rear     | BP4K 28 C10B | L:288               | 13  | 106-03-327  | Stabiliser Link     | BP4K28170C   |          |
| 7   | GOM-317     | Mounting Axle Body | Part of      | do:60.2             |     |             |                     |              |          |

MAZDA 6 (GG,GY)

01/2002 ->

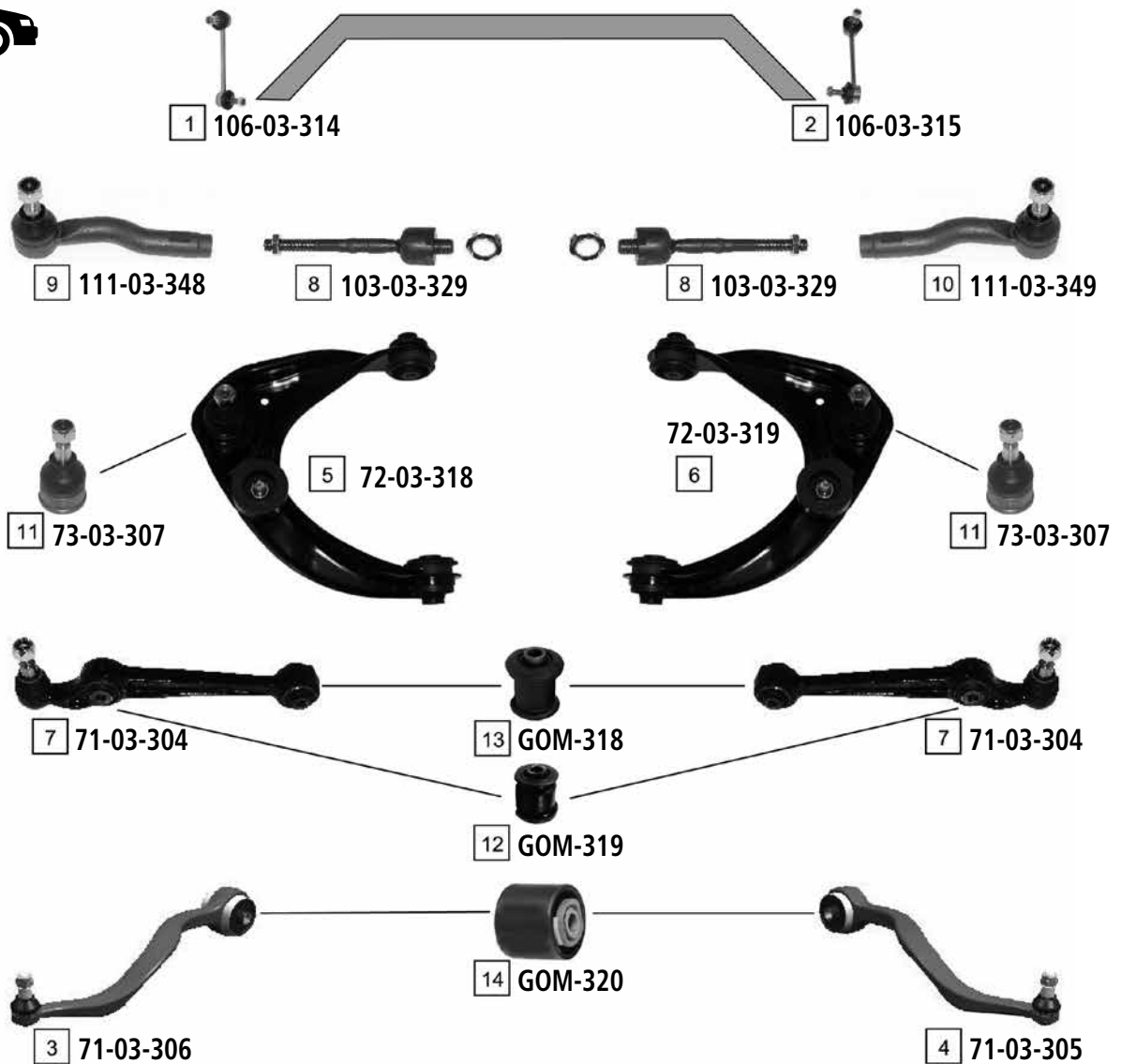

| Ref | ASHIKA CODE | Description           | OEM           | Measures           | Ref | ASHIKA CODE | Description              | OEM           | Measures            |
|-----|-------------|-----------------------|---------------|--------------------|-----|-------------|--------------------------|---------------|---------------------|
| 1   | 106-03-314  | Stabiliser Link Left  | GJ6A-34-170A  | L:154              | 9   | 111-03-348  | Tie Rod End Left         | GJ6E-32-290   | c:12.9 th:FM14X1.5R |
| 2   | 106-03-315  | Stabiliser Link Right | GJ6A-34-150A  | L:154              | 10  | 111-03-349  | Tie Rod End Right        | GJ6E-32-280   | c:12.9 th:FM14X1.5R |
| 3   | 71-03-306   | TCA Left              | GJ6A-34-J50 B | c:19.5             | 11  | 73-03-307   | Ball Joint               | GJ6A-34-540   | c:12.6              |
| 4   | 71-03-305   | TCA Right             | GJ6A-34-J00 B | c:19.5             | 12  | GOM-319     | Silentblock For Susp.Arm | GJ6A-34-710 A | d:44.2              |
| 5   | 72-03-318   | TCA Left              | GJ6A-34-250 B | c:12.8             | 13  | GOM-318     | Silentblock For Susp.Arm | GJ6A-34-470 A | d:40.2              |
| 6   | 72-03-319   | TCA Right             | GJ6A-34-200 B |                    | 14  | GOM-320     | Silentblock For Susp.Arm | GJ6A-34-460 A | d:62.3              |
| 7   | 71-03-304   | TCA                   | GA6A-34-300 B | c:18.5             | 15  | 106-03-316  | Stabiliser Link          | GJ6A 28 170A  |                     |
| 8   | 103-03-329  | Axial Joint           | GJ6E-32-240   | th:MM18X1.5R L:181 |     |             |                          |               |                     |



MAZDA 6 (GH) SALOON - ESTATE - HATCHBACK

08/2007 ->

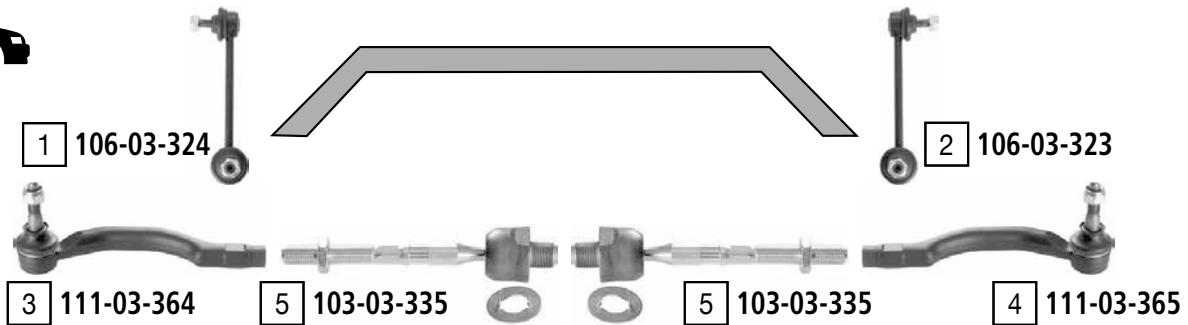

UPPER

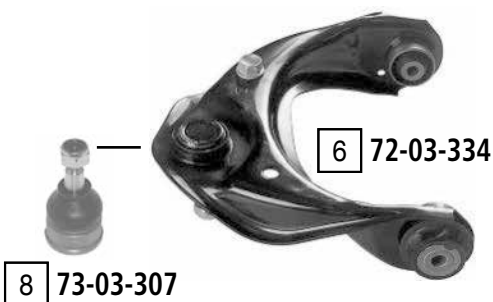

LOWER

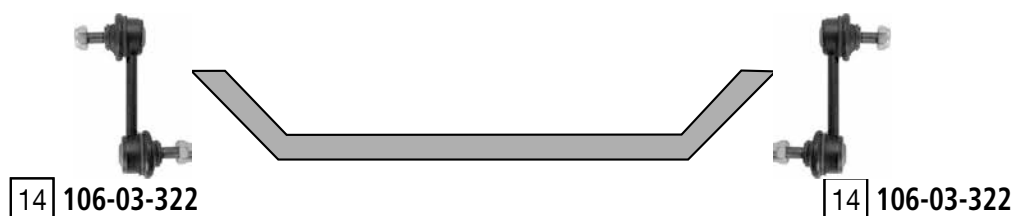
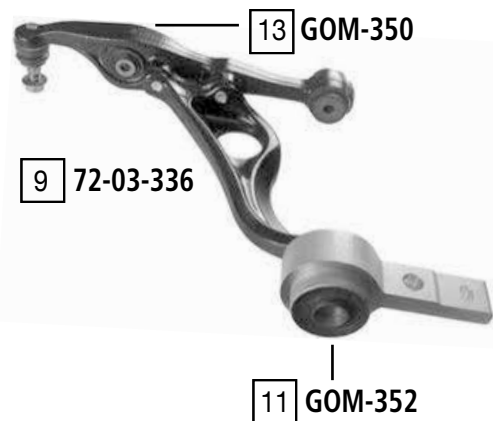

| Ref | ASHIKA CODE | Description           | OEM          | Measures            | Ref | ASHIKA CODE | Description               | OEM          | Measures        |
|-----|-------------|-----------------------|--------------|---------------------|-----|-------------|---------------------------|--------------|-----------------|
| 1   | 106-03-324  | Stabiliser link left  | GS1D 34 170  | L:160               | 8   | 73-03-307   | Ball joint                | GJ6A 34 540  | c:12.6          |
| 2   | 106-03-323  | Stabiliser link right | GS1D 34 150  | L:160               | 9   | 72-03-336   | TCA left wbj              | GS1D 34 350L | c:17.1          |
| 3   | 111-03-364  | Tie rod end left      | GS1D 32 290  | c:12.6 th:FM14x1.5R | 10  | 72-03-337   | TCA right wbj             | GS1D 34 300L | c:17.1          |
| 4   | 111-03-365  | Tie rod end right     | GS1D 32 280  | c:12.6 th:FM14x1.5R | 11  | GOM-352     | Silentblock forTCA        | Part of      | di:28.9         |
| 5   | 103-03-335  | Axial joint           | GS1D 32 240  | th:MM18x1.5R L:165  | 12  | GOM-353     | Silentblock forTCA        | Part of      | di:28.9         |
| 6   | 72-03-334   | TCA left wbj          | GS1D 34 250A | c:12.7              | 13  | GOM-350     | Silentblock forTCA        | Part of      | di:12.4 do:44.6 |
| 7   | 72-03-335   | TCA right wbj         | GS1D 34 200A | c:12.7              | 14  | 106-03-322  | Stabiliser link rear axle | GS1D 28 170  | L:96            |

MPV I (LV)

03/1995 - 09/1999



3 111-03-350



2 103-03-323



2 103-03-323



3 111-03-350



1 71-03-307



1 71-03-307

| Ref | ASHIKA CODE | Description | OEM         | Measures         | Ref | ASHIKA CODE | Description | OEM         | Measures            |
|-----|-------------|-------------|-------------|------------------|-----|-------------|-------------|-------------|---------------------|
| 1   | 71-03-307   | TCA         | LB82-34-300 | c:18             | 3   | 111-03-350  | Tie Rod End | 8AL1-32-280 | c:13.9 th:FM14X1.5R |
| 2   | 103-03-323  | Axial Joint | LA01-32-115 | th:MM17X1R L:170 |     |             |             |             |                     |

MPV II (LW)

09/1999 - 07/2005

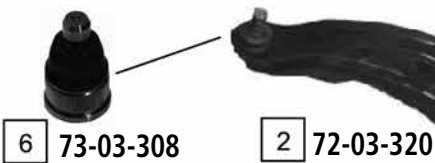

| Ref | ASHIKA CODE | Description     | OEM           | Measures | Ref | ASHIKA CODE | Description | OEM                           | Measures            |
|-----|-------------|-----------------|---------------|----------|-----|-------------|-------------|-------------------------------|---------------------|
| 1   | 106-03-307  | Stabiliser Link | LC62-34-170 A | L:266    | 4   | 103-03-330  | Axial Joint | LC62-32-240 B                 | th:MM16X1.5R L:316  |
| 2   | 72-03-320   | TCA Left Wbj    | LC62 34 350C  |          | 5   | 111-03-338  | Tie Rod End | 8AG4 32 280                   | c:12.9 th:FM14X1.5R |
| 3   | 72-03-321   | TCA Right Wbj   | LC62 34 300C  |          | 6   | 73-03-308   | Ball Joint  | Part of 72-03-320 / 72-03-321 |                     |

MX-3 (EC)

07/1991 - 09/1998

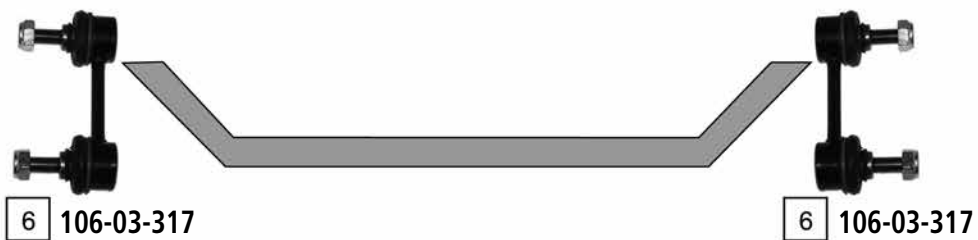
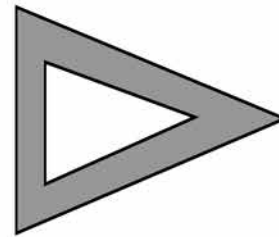
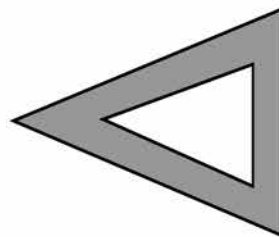
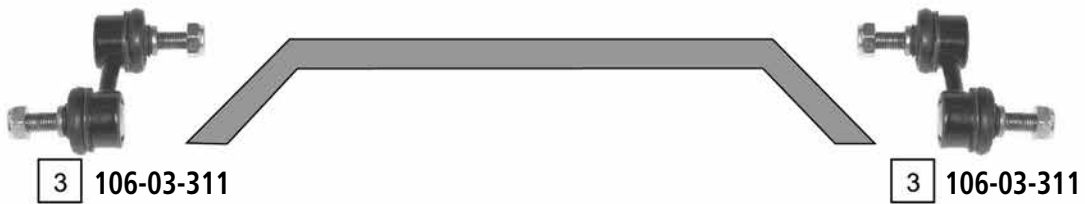

| Ref | ASHIKA CODE | Description      | OEM          | Measures            | Ref | ASHIKA CODE | Description     | OEM         | Measures         |
|-----|-------------|------------------|--------------|---------------------|-----|-------------|-----------------|-------------|------------------|
| 1   | 111-03-334  | Tie Rod End      | 8AB2-32-280  | c:13.3 th:FM12X1.25 | 4   | 76-03-398   | Axial Joint     | B456-32-25X | th:MM16X1R L:325 |
| 2   | 53-03-326   | Ball Joint Lower | B455-34-550  | c:16                | 5   | 76-03-395   | Axial Joint     | B456-32-24X | th:MM16X1R L:324 |
| 3   | 106-03-311  | Stabiliser Link  | EA03-34-170A | L:55                | 6   | 106-03-317  | Stabiliser Link | EA01 28 170 | L:80             |

# MAZDA MX-5



MX-5 I (NA)

09/1989 - 09/1998



4 106-03-318



4 106-03-318



2 111-03-300



1 103-03-331



1 103-03-331



2 111-03-300



3 73-03-320

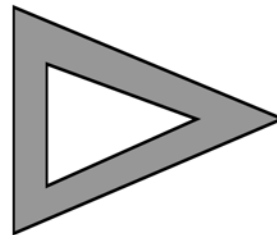
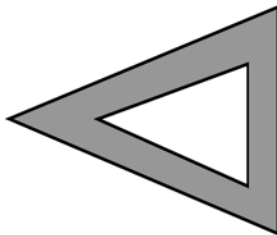

3 73-03-320



4 106-03-318



4 106-03-318

| Ref | ASHIKA CODE | Description | OEM         | Measures            | Ref | ASHIKA CODE | Description     | OEM         | Measures |
|-----|-------------|-------------|-------------|---------------------|-----|-------------|-----------------|-------------|----------|
| 1   | 103-03-331  | Axial Joint | NA01-32-240 | th:MM18X1.5R L:301  | 3   | 73-03-320   | Ball Joint      | NA01 34 550 | c:15.9   |
| 2   | 111-03-300  | Tie Rod End | 8AN1-32-280 | c:13.2 th:FM12X1.25 | 4   | 106-03-318  | Stabiliser Link | NA01 34 170 | L:107    |

MX-5 II (NB)

05/1998 - 02/2005



UPPER



LOWER



| Ref | ASHIKA CODE | Description           | OEM         | Measures | Ref | ASHIKA CODE | Description | OEM          | Measures            |
|-----|-------------|-----------------------|-------------|----------|-----|-------------|-------------|--------------|---------------------|
| 1   | 106-03-320  | Stabiliser Link Left  | NC10-34-170 | L:104    | 6   | 72-03-325   | TCA Right   | N066 34 310  |                     |
| 2   | 106-03-319  | Stabiliser Link Right | NC10-34-150 | L:104    | 7   | 73-03-320   | Ball Joint  | NA01 34 550  | c:15.9              |
| 3   | 72-03-322   | TCA Left              | N068-34-250 |          | 8   | 103-03-332  | Axial Joint | NC10-32-250A | th:MM16X1.5R L:303  |
| 4   | 72-03-323   | TCA Right             | N068-34-200 |          | 9   | 103-03-333  | Axial Joint | NC10-32-240A | th:MM16X1R L:303    |
| 5   | 72-03-324   | TCA Left              | N066 34 360 |          | 10  | 111-03-300  | Tie Rod End | 8AN1-32-280  | c:13.2 th:FM12X1.25 |



PREMACY (CP)

07/1999 ->

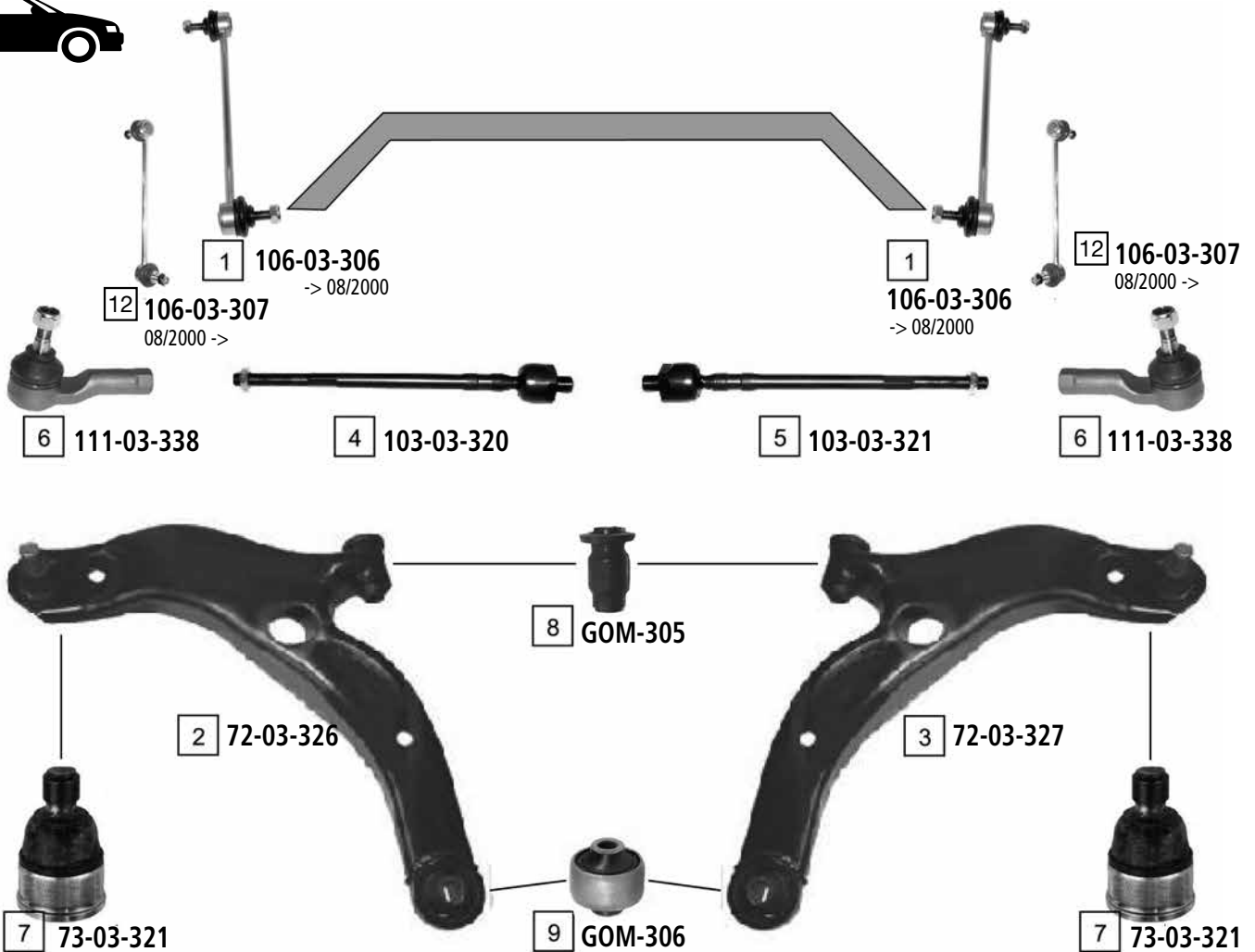

| Ref | ASHIKA CODE | Description     | OEM            | Measures            | Ref | ASHIKA CODE | Description              | OEM           | Measures |
|-----|-------------|-----------------|----------------|---------------------|-----|-------------|--------------------------|---------------|----------|
| 1   | 106-03-306  | Stabiliser Link | B26 R 34 170   | L:190               | 7   | 73-03-321   | Ball Joint               | LC62-34-550   |          |
| 2   | 72-03-326   | TCA             | C 100 34 350 A | c:18                | 8   | GOM-305     | Silentblock For Susp.Arm | B25D 34 470   |          |
| 3   | 72-03-327   | TCA             | C 100 34 300 A | c:18                | 9   | GOM-306     | Silentblock For Susp.Arm | B25D 34 460   |          |
| 4   | 103-03-320  | Axial Joint     | B25D 32 240    | th:MM16X1R L:310    | 10  | 106-03-309  | Stabiliser Link          | B26R-28-170   | L:190    |
| 5   | 103-03-321  | Axial Joint     | B25D 32 250    | th:MM16X1R L:310    | 11  | 106-03-308  | Stabiliser Link          | B30H 28 170 B | L:160    |
| 6   | 111-03-338  | Tie Rod End     | 8AG4 32 280    | c:12.9 th:FM14X1.5R | 12  | 106-03-307  | Stabiliser Link          | LC62-34-170 A | L:266    |



RX 7 II (FC) RX 7 III (FD)

11/1985 - 06/1996



**2** 111-03-334  
FD



**2** 111-03-334  
FD



**3** 103-03-304  
FC



**3** 103-03-304  
FC



**1** 53-03-307  
FC

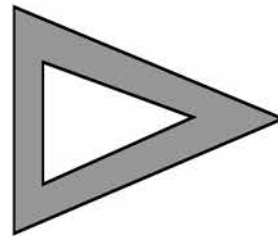
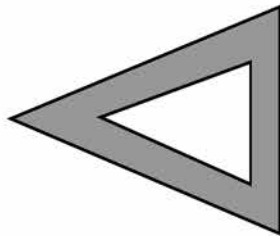

**1** 53-03-307  
FC

| Ref | ASHIKA CODE | Description      | OEM         | Measures            | Ref | ASHIKA CODE | Description | OEM         | Measures         |
|-----|-------------|------------------|-------------|---------------------|-----|-------------|-------------|-------------|------------------|
| 1   | 53-03-307   | Ball Joint Lower | 8531-99-356 | c:14.5              | 3   | 103-03-304  | Axial Joint | S083-32-115 | th:MM17X1R L:183 |
| 2   | 111-03-334  | Tie Rod End      | 8AB2-32-280 | c:13.3 th:FM12X1.25 |     |             |             |             |                  |

XEDOS 6 (CA)

07/1991 - 10/1999

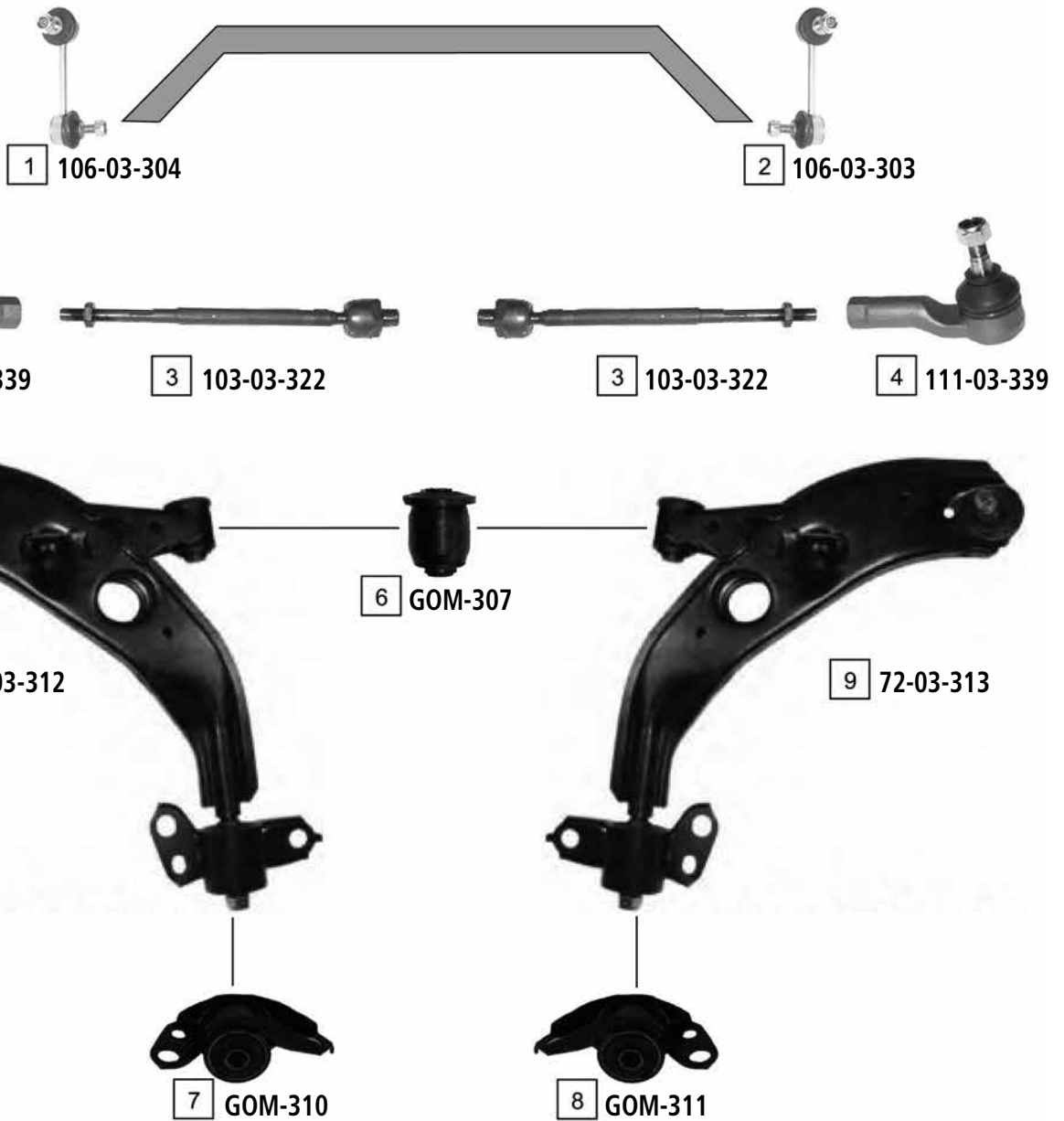

10 106-0K-K51

10 106-0K-K51

| Ref | ASHIKA CODE | Description           | OEM          | Measures            | Ref | ASHIKA CODE | Description              | OEM          | Measures |
|-----|-------------|-----------------------|--------------|---------------------|-----|-------------|--------------------------|--------------|----------|
| 1   | 106-03-304  | Stabiliser Link Left  | GA2A 34 170A | L:105               | 6   | GOM-307     | Silentblock For Susp.Arm | GA2A 34 470  | d:38.5   |
| 2   | 106-03-303  | Stabiliser Link Right | GA2A 34 150A | L:105               | 7   | GOM-310     | Silentblock For Susp.Arm | GE4T 34 46YD | d:18.5   |
| 3   | 103-03-322  | Axial Joint           | GA2A-32-250  | th:MM18X1R L:300    | 8   | GOM-311     | Silentblock For Susp.Arm | GE4T 34 46XD | d:18.5   |
| 4   | 111-03-339  | Tie Rod End           | 8AG3-32-280  | c:12.9 th:FM14X1.5R | 9   | 72-03-313   | TCA                      | GE4T-34-300E | c:18     |
| 5   | 72-03-312   | TCA                   | GE4T-34-350E | c:18                | 10  | 106-0K-K51  | Stabiliser Link          | GA2C-28-170B |          |

ASX (GA\_W\_)

05/2010 ->

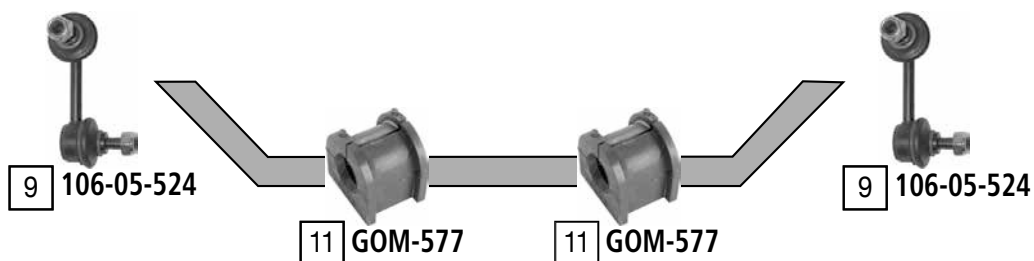
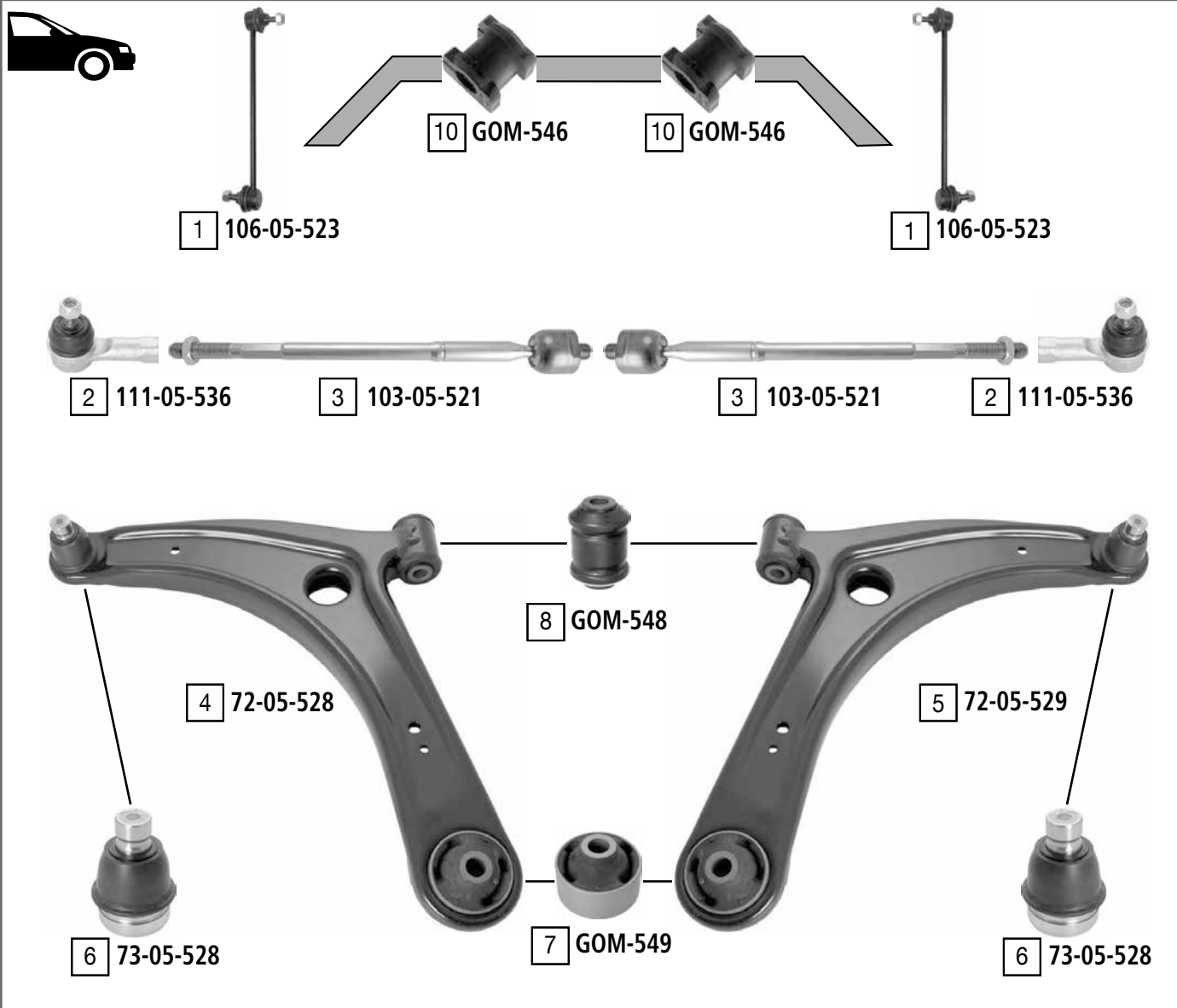

| Ref | ASHIKA CODE | Description     | OEM      | Measures            | Ref | ASHIKA CODE | Description               | OEM      | Measures      |
|-----|-------------|-----------------|----------|---------------------|-----|-------------|---------------------------|----------|---------------|
| 1   | 106-05-523  | Stabiliser link | MN101368 | L:265               | 7   | GOM-549     | Silentblock for TCA       | MN184133 | di:14.2 do:60 |
| 2   | 111-05-536  | Tie rod end     | 4422A052 | c:13.3 th:FM14X1.5R | 8   | GOM-548     | Silentblock for TCA       | Part of  | di:14.2 do:37 |
| 3   | 103-05-521  | Axial joint     | 4422A076 | th:MM14X1.5R L:339  | 9   | 106-05-524  | Stabiliser link rear axle | MN184194 | L:80          |
| 4   | 72-05-528   | TCA left wbj    | 4013A281 | c:20                | 10  | GOM-546     | Stabiliser mounting       | 4056A079 | di:22         |
| 5   | 72-05-529   | TCA right wbj   | 4013A282 | c:20                | 11  | GOM-577     | Stabiliser mounting       | MN101395 | di:17.5       |
| 6   | 73-05-528   | Ball joint      | Part of  | c:20 do:40.1        |     |             |                           |          |               |

CANTER (35FB,35FE,60FE,63FE)

01/1986 - 04/2002



2 111-05-507L



1 111-05-507R



1 111-05-507R



2  
111-05-507L

| Ref | ASHIKA CODE | Description | OEM      | Measures            | Ref | ASHIKA CODE | Description | OEM      | Measures            |
|-----|-------------|-------------|----------|---------------------|-----|-------------|-------------|----------|---------------------|
| 1   | 111-05-507R | Tie Rod End | MW033301 | c:16.2 th:MM20x1.5R | 2   | 111-05-507L | Tie Rod End | MW033300 | c:16.2 th:MM20x1.5L |

# MITSUBISHI CARISMA



CARISMA (DA\_)

05/1995 - 02/1999

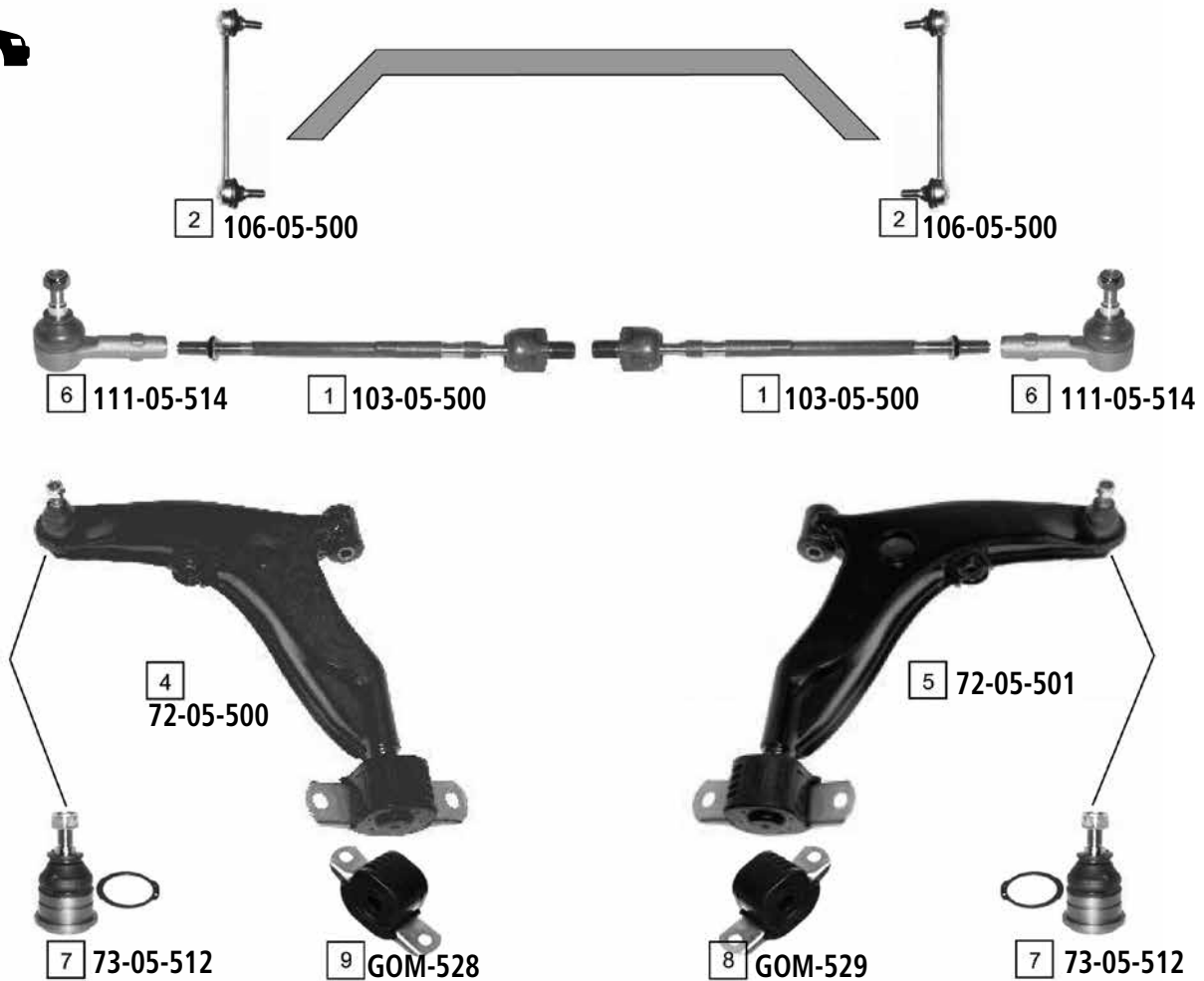

08/1997->

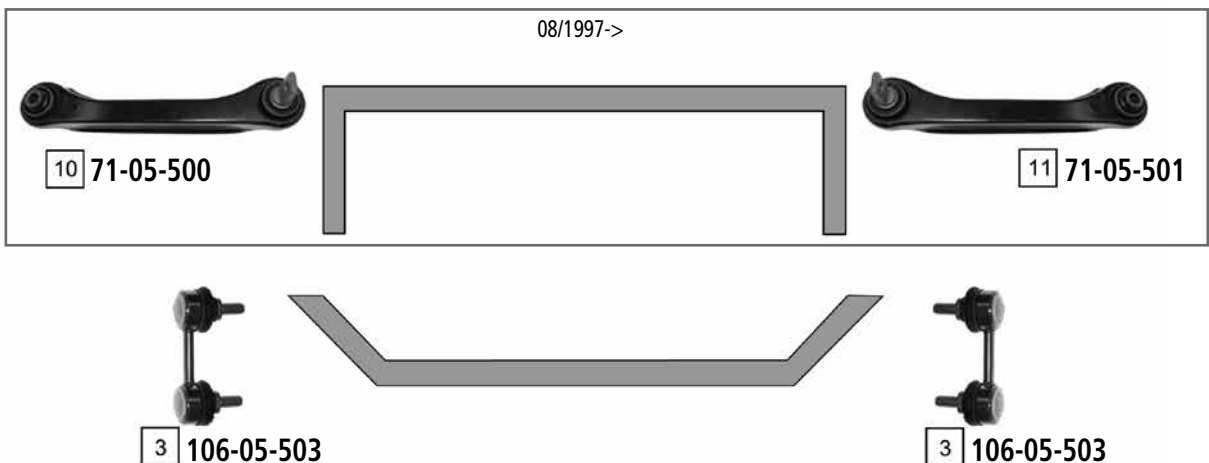

| Ref | ASHIKA CODE | Description     | OEM       | Measures            | Ref | ASHIKA CODE | Description              | OEM                           | Measures |
|-----|-------------|-----------------|-----------|---------------------|-----|-------------|--------------------------|-------------------------------|----------|
| 1   | 103-05-500  | Axial Joint     | MB244901  | th:MM16X1.5R L:304  | 7   | 73-05-512   | Ball Joint Lower         | Part of 72-05-500 / 72-05-501 | c:15     |
| 2   | 106-05-500  | Stabiliser Link | MR272116  |                     | 8   | GOM-529     | Silentblock For Susp.Arm | MB808910                      |          |
| 3   | 106-05-503  | Stabiliser Link | MR272117  | L:75.5              | 9   | GOM-528     | Silentblock For Susp.Arm | MB808909                      |          |
| 4   | 72-05-500   | TCA Left        | MR 179479 | c:15                | 10  | 71-05-500   | TCA Left                 | MR130479                      |          |
| 5   | 72-05-501   | TCA Left        | MR179480  | c:15                | 11  | 71-05-501   | TCA Right                | MR130480                      |          |
| 6   | 111-05-514  | Tie Rod End     | MB 527169 | c:13.3 th:FM12X1.25 |     |             |                          |                               |          |

CARISMA (DA\_)

03/1999 - 06/2006

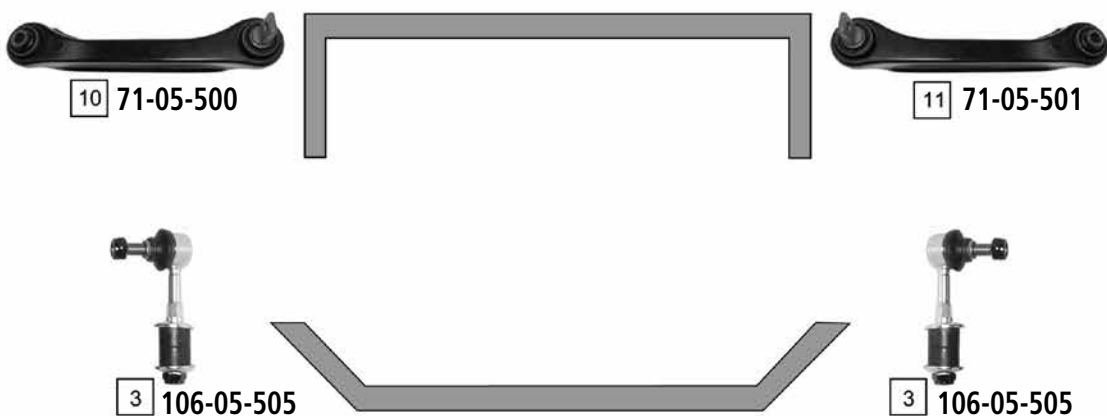
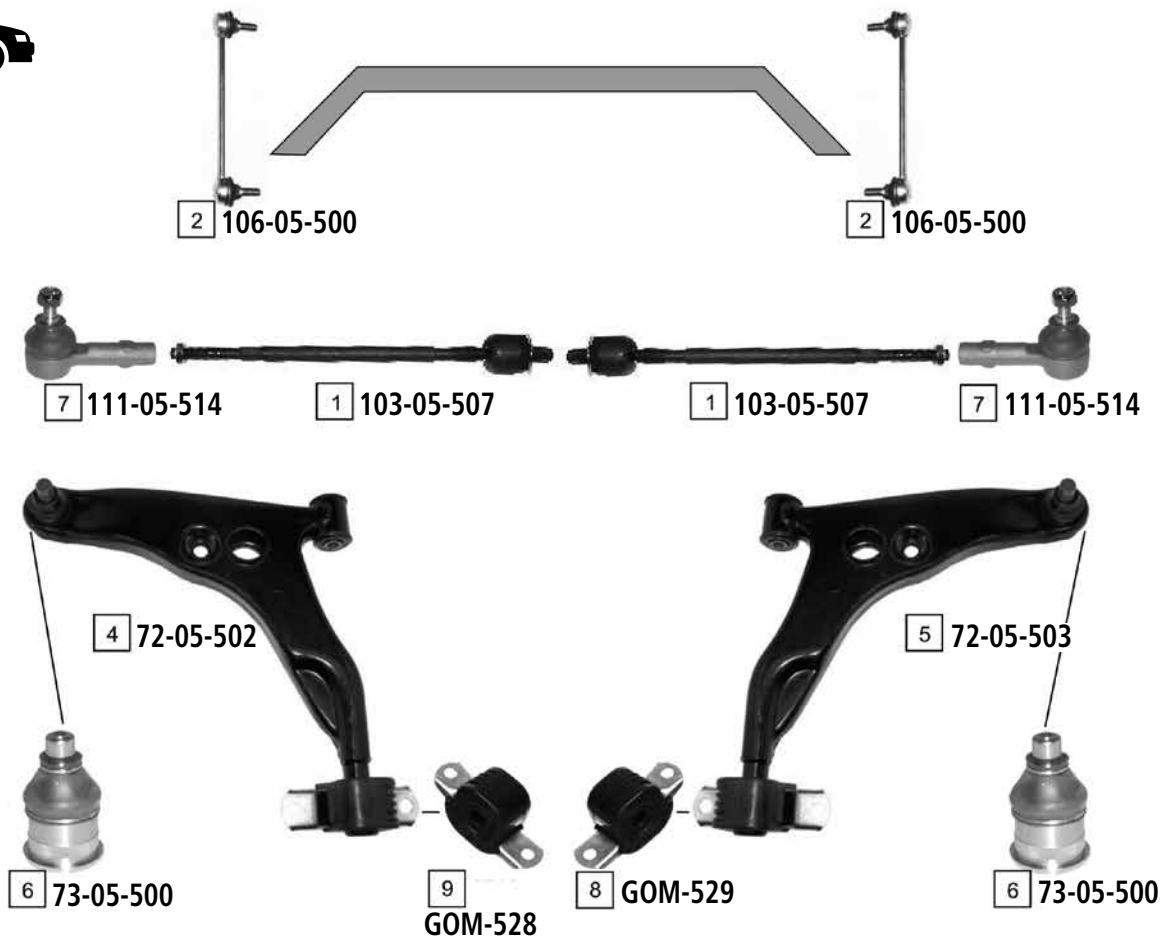

| Ref | ASHIKA CODE | Description     | OEM                           | Measures           | Ref | ASHIKA CODE | Description              | OEM       | Measures            |
|-----|-------------|-----------------|-------------------------------|--------------------|-----|-------------|--------------------------|-----------|---------------------|
| 1   | 103-05-507  | Axial Joint     | MR403027                      | th:MM16X1.5R L:316 | 7   | 111-05-514  | Tie Rod End              | MR 485672 | c:13.3 th:FM12X1.25 |
| 2   | 106-05-500  | Stabiliser Link | MR272116                      |                    | 8   | GOM-529     | Silentblock For Susp.Arm | MB808910  |                     |
| 3   | 106-05-505  | Stabiliser Link | MR-272118                     |                    | 9   | GOM-528     | Silentblock For Susp.Arm | MB808909  |                     |
| 4   | 72-05-502   | TCA             | MR911570                      | c:18               | 10  | 71-05-500   | TCA Left                 | MR130479  |                     |
| 5   | 72-05-503   | TCA             | MR911569                      | c:18               | 11  | 71-05-501   | TCA Right                | MR130480  |                     |
| 6   | 73-05-500   | Ball Joint      | Part of 72-05-502 / 72-05-503 | c:18               |     |             |                          |           |                     |

COLT I (A15\_A)

01/1997 - 01/1984



1 111-0H-H53



2 103-05-501

2 103-05-501



1 111-0H-H53



4 53-05-506L

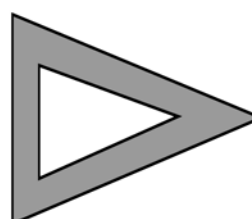
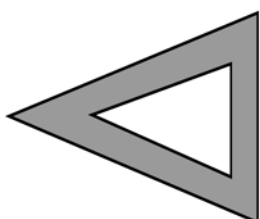

3 53-05-506R

| Ref | ASHIKA CODE | Description | OEM         | Measures            | Ref | ASHIKA CODE | Description            | OEM      | Measures |
|-----|-------------|-------------|-------------|---------------------|-----|-------------|------------------------|----------|----------|
| 1   | 111-0H-H53  | Tie Rod End | 56820-21000 | c:13.45 th:FM14X1.5 | 3   | 53-05-506R  | Ball Joint Lower Right | MB109169 | c:13.5   |
| 2   | 103-05-501  | Axial Joint | MB122135    | th:FM18X1.5R L:297  | 4   | 53-05-506L  | Ball Joint Lower Left  | MB109168 | c:13.5   |

COLT II (C1 A)

05/1984 - 04/1988



| Ref | ASHIKA CODE | Description     | OEM       | Measures            | Ref | ASHIKA CODE | Description      | OEM       | Measures            |
|-----|-------------|-----------------|-----------|---------------------|-----|-------------|------------------|-----------|---------------------|
| 1   | 106-05-501  | Stabiliser Link | 4056 A014 | L:60                | 4   | 103-05-504  | Axial Joint      | MB350718  |                     |
| 2   | 111-05-511  | Tie Rod End     | MB241982  | c:13.3 th:FM12X1.25 | 5   | 111-05-514  | Tie Rod End      | MB 527169 | c:13.4 th:FM12X1.25 |
| 3   | 103-05-502  | Axial Joint     | MB347666  | th:MM12X1.25R L:278 | 6   | 73-05-512   | Ball Joint Lower |           | c:15                |



COLT III (C5\_A)

04/1998 - 04/1992

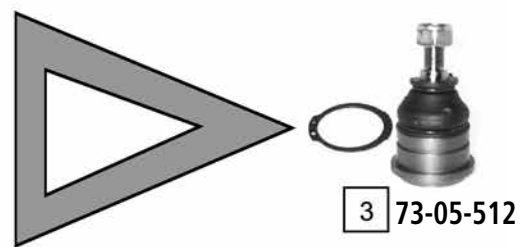
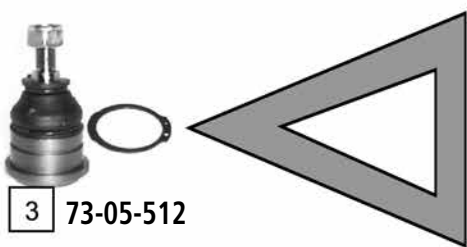
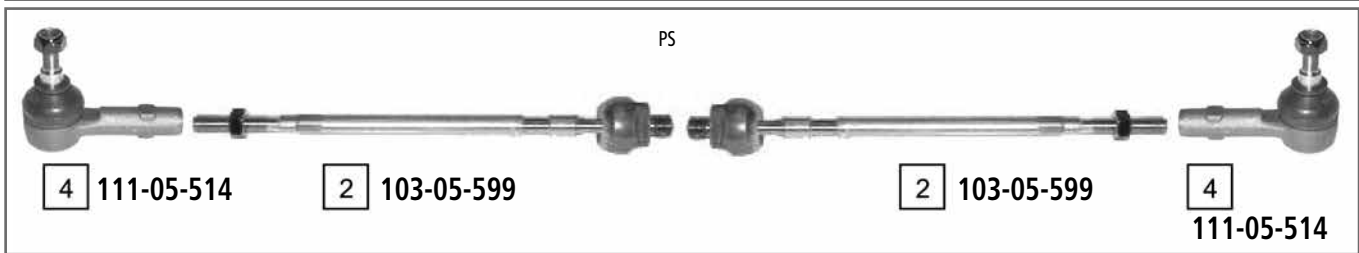
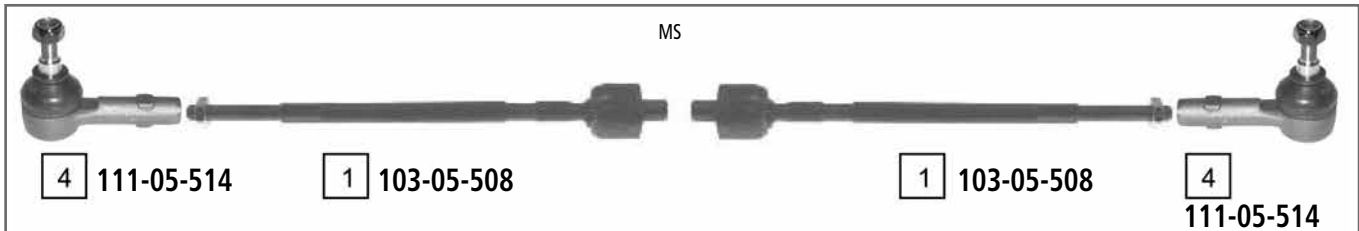

| Ref | ASHIKA CODE | Description      | OEM       | Measures           | Ref | ASHIKA CODE | Description     | OEM       | Measures            |
|-----|-------------|------------------|-----------|--------------------|-----|-------------|-----------------|-----------|---------------------|
| 1   | 103-05-508  | Axial Joint      | MB553249  | th:MM16X1.5R L:298 | 4   | 111-05-514  | Tie Rod End     | MB 527169 | c:13.4 th:FM12X1.25 |
| 2   | 103-05-599  | Axial Joint      | MB 910934 | th:MM16X1.5R L:309 | 5   | 106-05-501  | Stabiliser Link | 4056 A014 | L:60                |
| 3   | 73-05-512   | Ball Joint Lower |           | c:15               |     |             |                 |           |                     |

COLT IV (CA\_A)

04/1992 - 08/1995

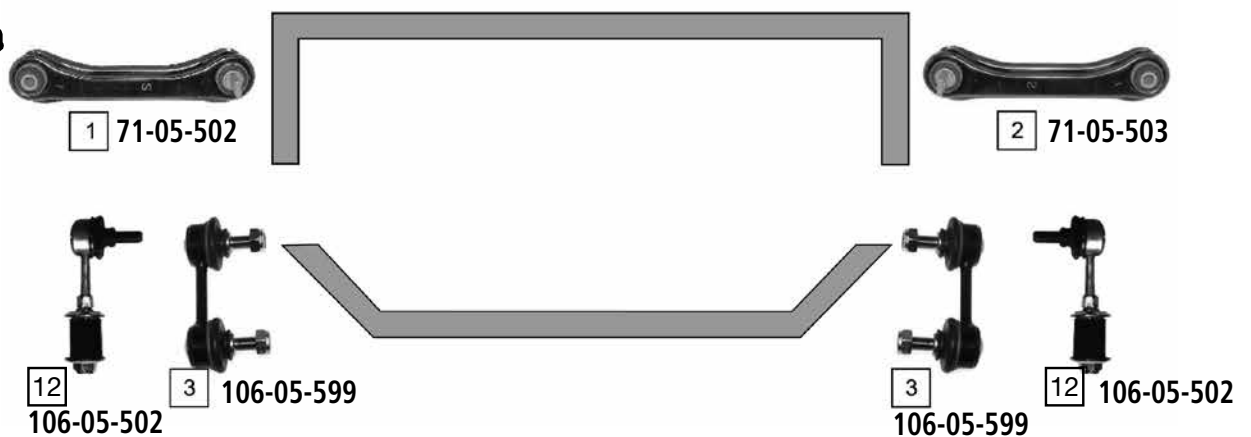
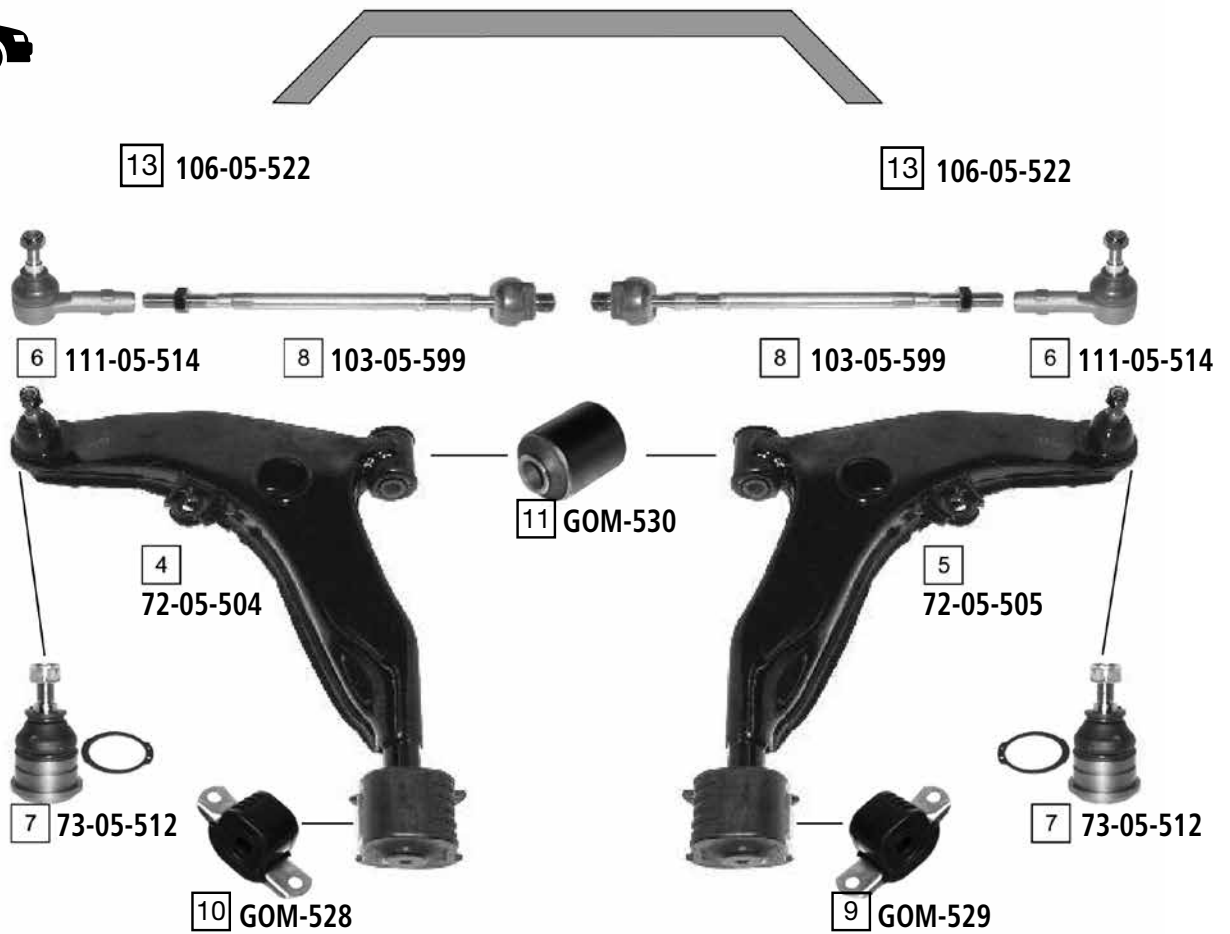

| Ref | ASHIKA CODE | Description      | OEM                             | Measures            | Ref | ASHIKA CODE | Description              | OEM                           | Measures           |
|-----|-------------|------------------|---------------------------------|---------------------|-----|-------------|--------------------------|-------------------------------|--------------------|
| 1   | 71-05-502   | TCA Left         | MB809220                        | c:15                | 8   | 103-05-599  | Axial Joint              | MB 910934                     | th:MM16X1.5R L:309 |
| 2   | 71-05-503   | TCA Right        | MB809221                        | c:15                | 9   | GOM-529     | Silentblock For Susp.Arm | MB808910                      |                    |
| 3   | 106-05-599  | Stabiliser Link  | MB 809354                       | L:75                | 10  | GOM-528     | Silentblock For Susp.Arm | MB808909                      |                    |
| 4   | 72-05-504   | TCA Left         | MB912077                        | c:15                | 11  | GOM-530     | Silentblock For Susp.Arm | Part of 72-05-504 / 72-05-505 |                    |
| 5   | 72-05-505   | TCA Right        | MB912078                        | c:15                | 12  | 106-05-502  | Stabiliser Link          | MB809355                      | L:105              |
| 6   | 111-05-514  | Tie Rod End      | MB 527169                       | c:13.4 th:FM12X1.25 | 13  | 106-05-522  | Stabiliser Link          | MB241974                      |                    |
| 7   | 73-05-512   | Ball Joint Lower | Part of 72-05-504/<br>72-05-505 | c:15                |     |             |                          |                               |                    |

COLT V (CJ\_A)

09/1995 - 07/2005



| Ref | ASHIKA CODE | Description   | OEM       | Measures           | Ref | ASHIKA CODE | Description              | OEM                            | Measures            |
|-----|-------------|---------------|-----------|--------------------|-----|-------------|--------------------------|--------------------------------|---------------------|
| 1   | 103-05-599  | Axial Joint   | MR297969  | th:MM16X1.5R L:309 | 5   | 111-05-514  | Tie Rod End              | MR 485672                      | c:13.3 th:FM12X1.25 |
| 2   | 72-05-506   | TCA Left Wbj  | MR439701  |                    | 6   | GOM-529     | Silentblock For Susp.Arm | MB808910                       |                     |
| 3   | 72-05-507   | TCA Right Wbj | MR439702  |                    | 7   | GOM-528     | Silentblock For Susp.Arm | MB808909                       |                     |
| 4   | 73-05-512   | Ball Joint    | MB-241883 | c:15               | 8   | GOM-530     | Silentblock For Susp.Arm | Part of 72-05-506<br>72-05-507 |                     |

COLT VI (Z30)

04/2004 ->



1 106-05-506



1 106-05-506



4 111-05-500



4 111-05-500

5 73-05-502

5 73-05-502



2 72-05-508

6 GOM-532



3 72-05-509

7 GOM-531

| Ref | ASHIKA CODE | Description     | OEM       | Measures | Ref | ASHIKA CODE | Description              | OEM                           | Measures |
|-----|-------------|-----------------|-----------|----------|-----|-------------|--------------------------|-------------------------------|----------|
| 1   | 106-05-506  | Stabiliser Link | 4056 A052 |          | 5   | 73-05-502   | Ball Joint               | Part of 72-05-508 / 72-05-509 |          |
| 2   | 72-05-508   | TCA Left Wbj    | MN 186217 |          | 6   | GOM-532     | Silentblock For Susp.Arm | Part of 72-05-508 / 72-05-509 |          |
| 3   | 72-05-509   | TCA Right Wbj   | MN 186218 |          | 7   | GOM-531     | Silentblock For Susp.Arm | Part of 72-05-508 / 72-05-509 |          |
| 4   | 111-05-500  | Tie Rod End     | MR 977606 |          |     |             |                          |                               |          |

# MITSUBISHI GALANT - SAPPORO



GALANT II (A16\_)  
SAPPORO II (A16\_A)

06/1980 - 06/1984



1.6



1 111-05-501



2 111-05-505



5 111-05-504



1 111-05-501

2.0-2.0 TURBO



1 111-05-501



2 111-05-505



4 111-05-508



1 111-05-501



3 53-05-505

1.6

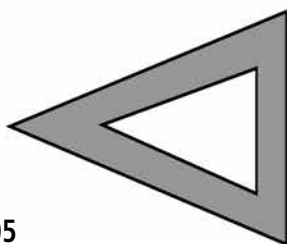

LOWER

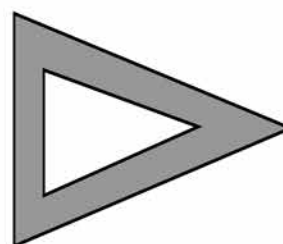

3 53-05-505

1.6

| Ref | ASHIKA CODE | Description            | OEM       | Measures            | Ref | ASHIKA CODE | Description             | OEM      | Measures            |
|-----|-------------|------------------------|-----------|---------------------|-----|-------------|-------------------------|----------|---------------------|
| 1   | 111-05-501  | Tie Rod End            | MA159984  | c:12.5 th:MM14X1.5L | 4   | 111-05-508  | Tie Rod End Inner Right | MB109858 | c:12.5 th:FM14X1.5L |
| 2   | 111-05-505  | Tie Rod End Inner Left | MB076003  | c:12.1 th:MM14X1.5R | 5   | 111-05-504  | Tie Rod End Inner Right | MB076004 | c:12.2 th:FM14X1.5L |
| 3   | 53-05-505   | Ball Joint Lower       | MB 001696 | c:15                |     |             |                         |          |                     |

GALANT III (E1 A)  
SAPPORO III (E16A)

06/1984 - 12/1987  
06/1987 - 08/1990



1 111-05-516



2 103-05-505  
PS



2 103-05-505  
PS



1 111-05-516

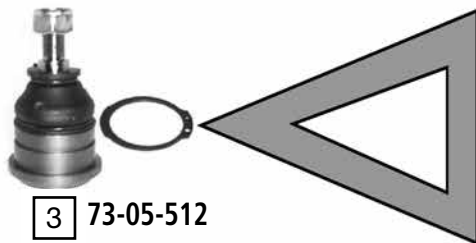

3 73-05-512

LOWER

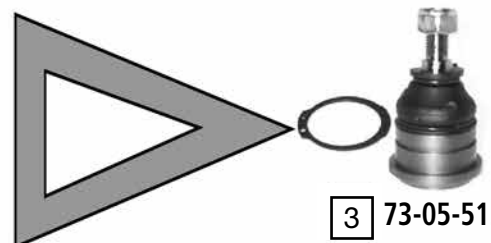

3 73-05-512

| Ref | ASHIKA CODE | Description | OEM       | Measures            | Ref | ASHIKA CODE | Description      | OEM | Measures |
|-----|-------------|-------------|-----------|---------------------|-----|-------------|------------------|-----|----------|
| 1   | 111-05-516  | Tie Rod End | MB192430  | c:13.45 th:FM14X1.5 | 3   | 73-05-512   | Ball Joint Lower |     | c:15     |
| 2   | 103-05-505  | Axial Joint | MB 266152 | th:MM16X1.5R L:296  |     |             |                  |     |          |

GALANT IV (E3\_A)

11/1987 - 10/1992

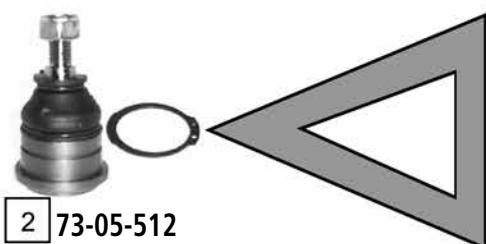

LOWER

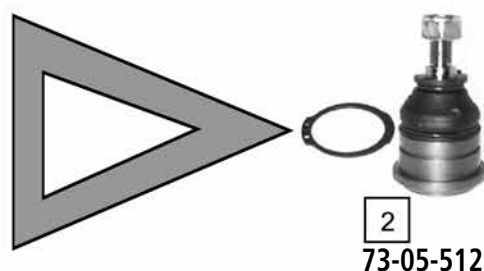

| Ref | ASHIKA CODE | Description      | OEM      | Measures          | Ref | ASHIKA CODE | Description | OEM      | Measures            |
|-----|-------------|------------------|----------|-------------------|-----|-------------|-------------|----------|---------------------|
| 1   | 103-05-509  | Axial Joint      | MB532281 | th:MM16X1.R L:314 | 3   | 111-05-516  | Tie Rod End | MB192430 | c:13.45 th:FM14X1.5 |
| 2   | 73-05-512   | Ball Joint Lower |          | c:15              |     |             |             |          |                     |

GALANT V (E5\_A,E7\_A,E8\_A)  
ECLIPSE I (D2\_A)

11/1992 - 08/1996  
04/1991 - 12/1995

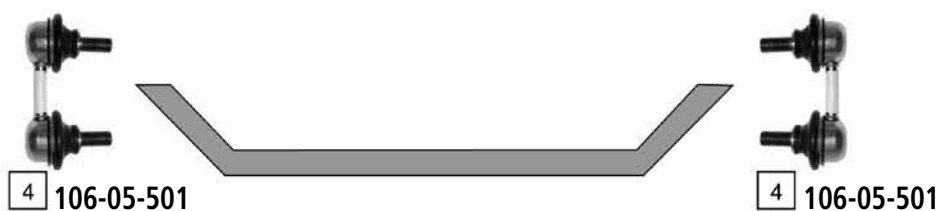
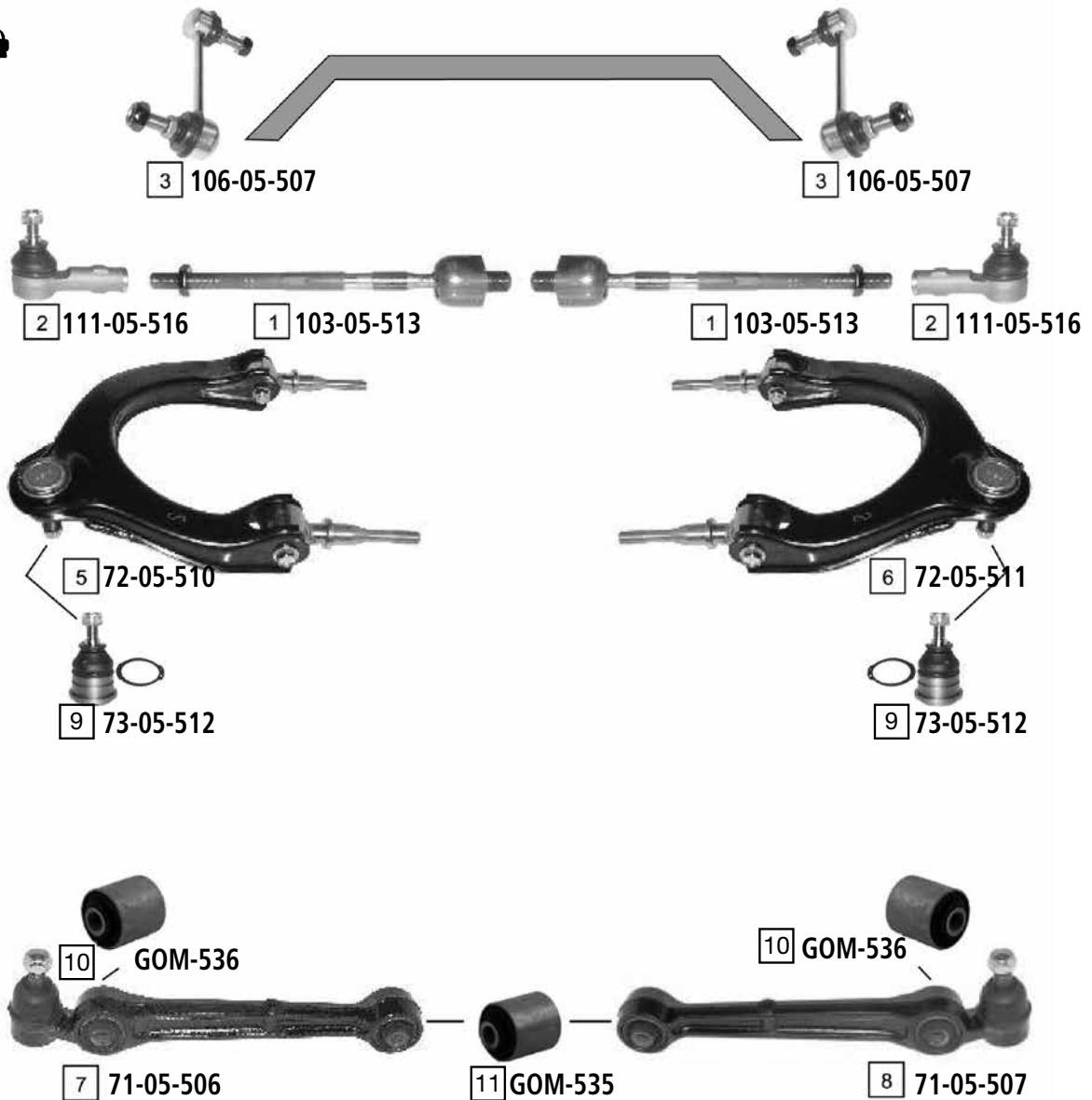

| Ref | ASHIKA CODE | Description     | OEM       | Measures            | Ref | ASHIKA CODE | Description              | OEM                          | Measures |
|-----|-------------|-----------------|-----------|---------------------|-----|-------------|--------------------------|------------------------------|----------|
| 1   | 103-05-513  | Axial Joint     | MB949343  | th:MM16X1.5R L.235  | 7   | 71-05-506   | TCA Left                 | MB912509                     | c:15.3   |
| 2   | 111-05-516  | Tie Rod End     | MB192430  | c:13.45 th:FM14X1.5 | 8   | 71-05-507   | TCA Right                | MB912510                     | c:16     |
| 3   | 106-05-507  | Stabiliser Link | MB892981  | L:120               | 9   | 73-05-512   | Ball Joint Lower         | MB-518961                    | c:15     |
| 4   | 106-05-501  | Stabiliser Link | 4056 A014 | L:60                | 10  | GOM-536     | Silentblock For Susp.Arm | Part of 71-05-506 /71-05-507 | d:40.2   |
| 5   | 72-05-510   | TCA Left Wbj    | MB912505  | c:12.5              | 11  | GOM-535     | Silentblock For Susp.Arm | Part of 71-05-506 /71-05-507 | d:40.2   |
| 6   | 72-05-511   | TCA Right Wbj   | MB912506  | c:12.5              |     |             |                          |                              |          |



GALANT VI (EA\_)

09/1996 - 10/2004

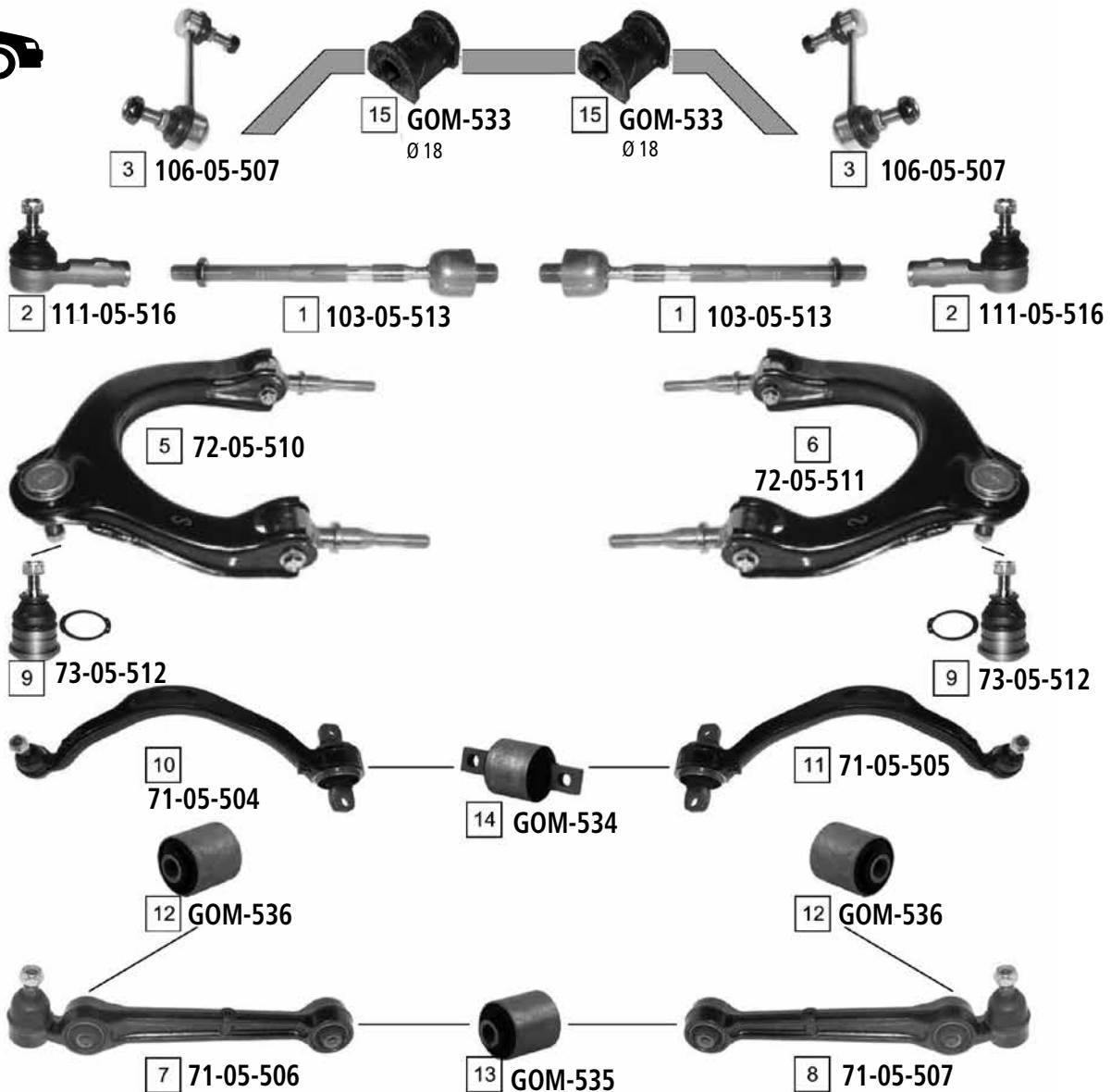

| Ref | ASHIKA CODE | Description     | OEM      | Measures            | Ref | ASHIKA CODE | Description              | OEM                           | Measures |
|-----|-------------|-----------------|----------|---------------------|-----|-------------|--------------------------|-------------------------------|----------|
| 1   | 103-05-513  | Axial Joint     | MB949343 | th:MM16X1.5R L.235  | 9   | 73-05-512   | Ball Joint Lower         | Part of 72-05-510 / 72-05-511 | c:15     |
| 2   | 111-05-516  | Tie Rod End     | MB192430 | c:13.45 th:FM14X1.5 | 10  | 71-05-504   | TCA Left                 | MR296293                      | c:15.3   |
| 3   | 106-05-507  | Stabiliser Link | MB892981 | L.120               | 11  | 71-05-505   | TCA Right                | MR296292                      | c:15.3   |
| 4   | 106-05-508  | Stabiliser Link | MR131732 | L:60                | 12  | GOM-536     | Silentblock For Susp.Arm | Part of 71-05-506 / 71-05-507 | d:40.2   |
| 5   | 72-05-510   | TCA Left Wbj    | MB912505 | c:12.5              | 13  | GOM-535     | Silentblock For Susp.Arm | Part of 71-05-506 / 71-05-507 | d:40.2   |
| 6   | 72-05-511   | TCA Right Wbj   | MB912506 | c:12.5              | 14  | GOM-534     | Silentblock For Susp.Arm | Part of 71-05-504 / 71-05-505 |          |
| 7   | 71-05-506   | TCA Left        | MB912509 | c:15.3              | 15  | GOM-533     | Stabiliser Mounting      | MR244116                      | d:18     |
| 8   | 71-05-507   | TCA Right       | MB912510 | c:16                |     |             |                          |                               |          |

L200 (L021P,L025P)

01/1979 - 12/1982

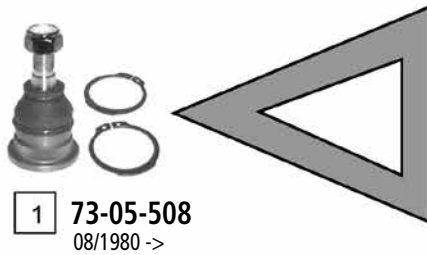

UPPER

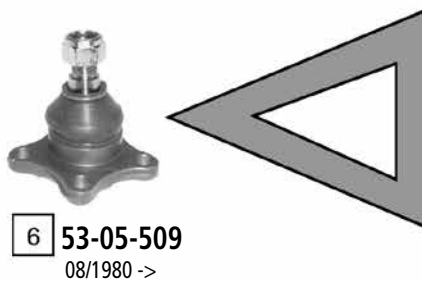
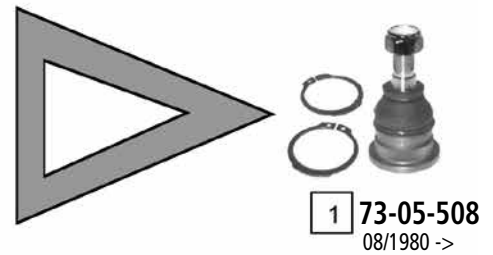

LOWER

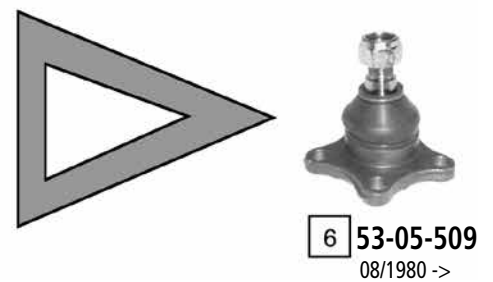

| Ref | ASHIKA CODE | Description            | OEM      | Measures            | Ref | ASHIKA CODE | Description | OEM      | Measures |
|-----|-------------|------------------------|----------|---------------------|-----|-------------|-------------|----------|----------|
| 1   | 73-05-508   | Ball Joint Upper       | MB176309 | c:15.9              | 4   | 52-05-503   | Pitman Arm  | MB076009 |          |
| 2   | 111-05-501  | Tie Rod End            | MA159984 | c:12.5 th:MM14X1.5L | 5   | 59-05-504   | Pitman Arm  | MB241420 |          |
| 3   | 111-05-505  | Tie Rod End Inner Left | MB076003 | c:12.1 th:14X1.5R   | 6   | 53-05-509   | Ball Joint  | MB176283 | c:19.4   |

L 200 2X4 (K\_T)

11/1986 - 08/1996

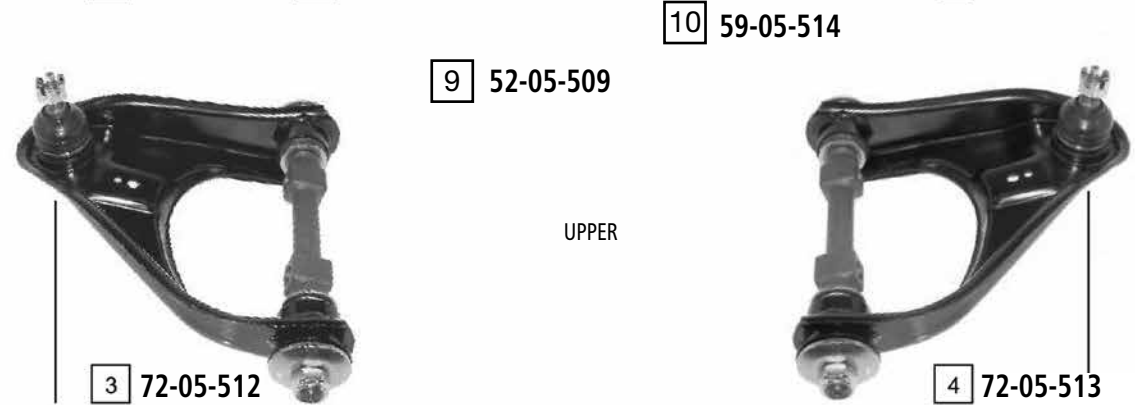

UPPER

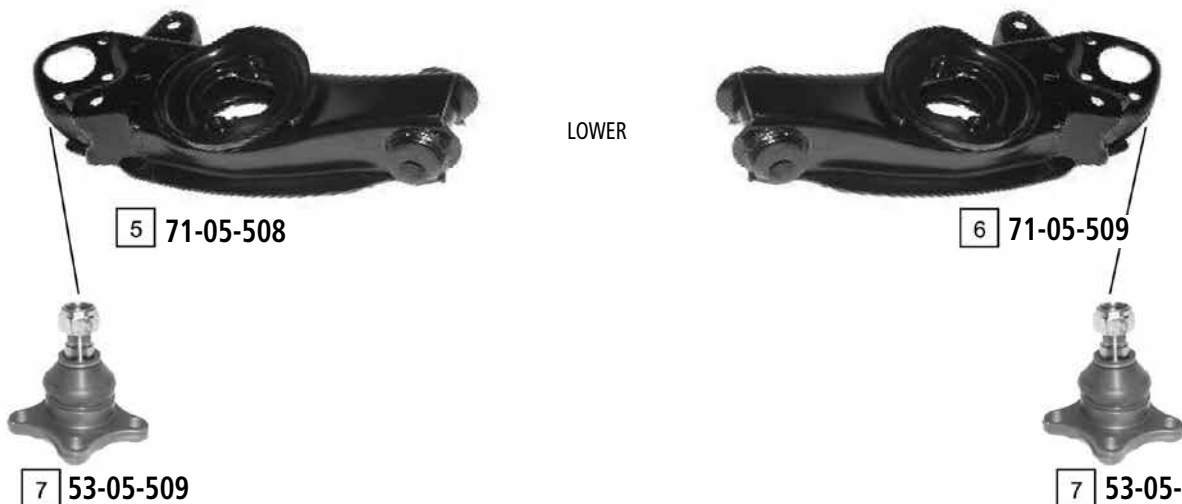

LOWER

| Ref | ASHIKA CODE | Description            | OEM      | Measures              | Ref | ASHIKA CODE | Description | OEM                           | Measures |
|-----|-------------|------------------------|----------|-----------------------|-----|-------------|-------------|-------------------------------|----------|
| 1   | 111-05-501  | Tie Rod End            | MA159984 | c: 12.5 th: MM14x1.5L | 6   | 71-05-509   | TCA Right   | MB109513                      |          |
| 2   | 111-05-505  | Tie Rod End Inner Left | MB076003 | c: 12.1 th: MM14x1.5R | 7   | 53-05-509   | Ball Joint  | MB176283                      | c:19.4   |
| 3   | 72-05-512   | TCA Left               | MB527159 | c: 16                 | 8   | 73-05-520   | Ball Joint  | Part of 72-05-512 / 72-05-513 | c:16     |
| 4   | 72-05-513   | TCA Right              | MB860408 | c: 16                 | 9   | 52-05-509   | Pitman Arm  | MB241166                      |          |
| 5   | 71-05-508   | TCA Left               | MB109512 |                       | 10  | 59-05-514   | Pitman Arm  | MB527228                      |          |

L 200 2X4 (K62T/K64T)

06/1996 ->



1 111-05-512



2 111-05-517



1 111-05-512

UPPER



7 73-05-504

10 52-05-509



7 73-05-504



5 72-05-514



6 72-05-515

LOWER



3 71-05-510



9 GOM-537



4 71-05-511



8 73-05-505



8 73-05-505

| Ref | ASHIKA CODE | Description       | OEM      | Measures              | Ref | ASHIKA CODE | Description              | OEM                           | Measures |
|-----|-------------|-------------------|----------|-----------------------|-----|-------------|--------------------------|-------------------------------|----------|
| 1   | 111-05-512  | Tie Rod End Outer | MR241032 | c: 13.6 th:MM 16x1.5R | 6   | 72-05-515   | TCA Right Wbj            | MR241024                      | c:16     |
| 2   | 111-05-517  | Tie Rod End Inner | MR241031 | c: 13.8 th:MM 16x1.5R | 7   | 73-05-504   | Ball Joint               | Part of 72-05-514 / 72-05-515 | c:16     |
| 3   | 71-05-510   | TCA Left Wbj      | MR241025 | c: 19.5               | 8   | 73-05-505   | Ball Joint               | MR241027                      | c:19.5   |
| 4   | 71-05-511   | TCA Right Wbj     | MR241026 | c: 19.5               | 9   | GOM-537     | Silentblock For Susp.Arm | MR234247                      |          |
| 5   | 72-05-514   | TCA Left Wbj      | MR241023 | c: 16                 | 10  | 52-05-509   | Pitman Arm               | MB241166                      |          |

L 200 4X4 (K\_T)

11/1986 - 08/1996

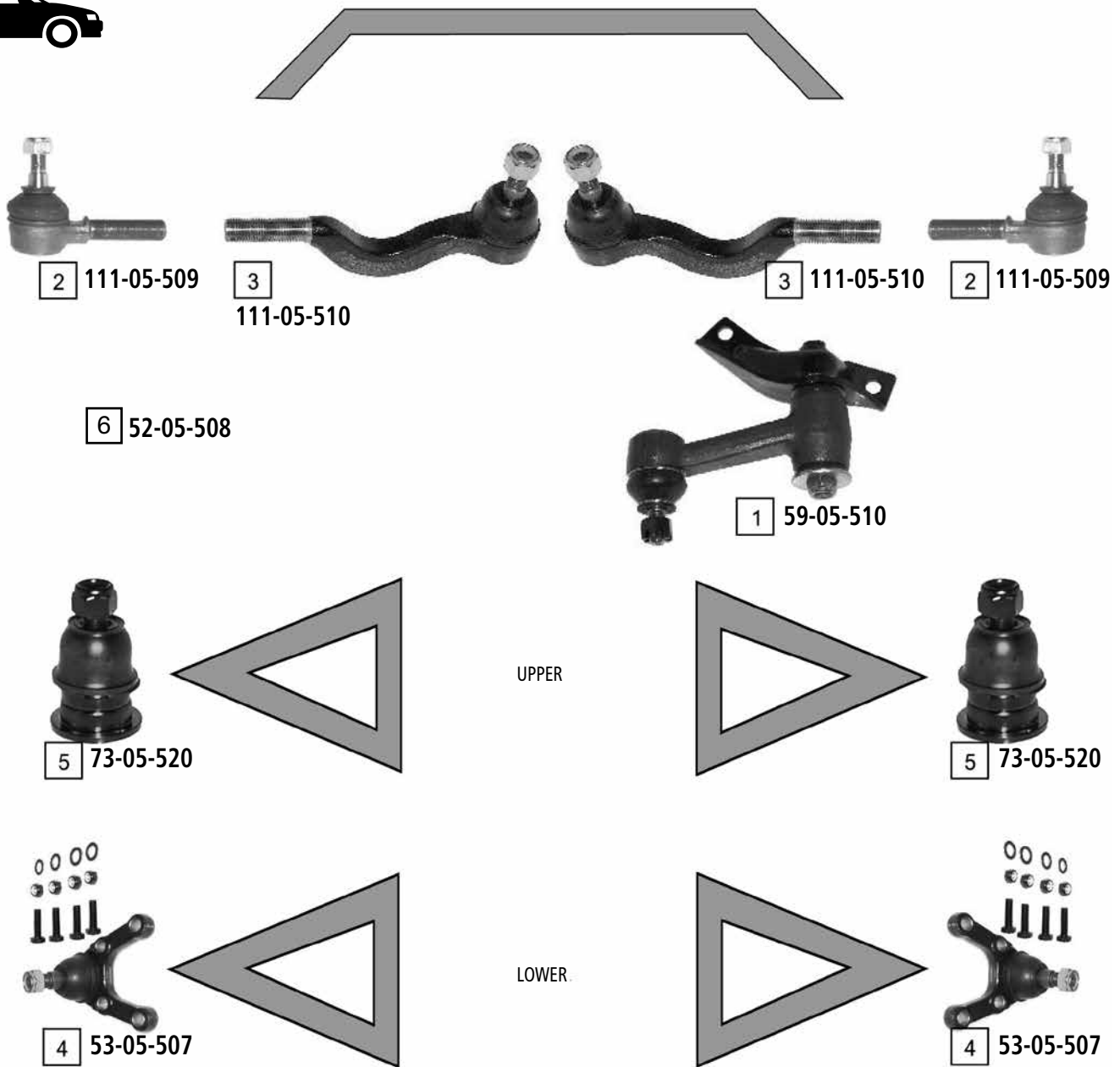

| Ref | ASHIKA CODE | Description | OEM      | Measures            | Ref | ASHIKA CODE | Description | OEM      | Measures |
|-----|-------------|-------------|----------|---------------------|-----|-------------|-------------|----------|----------|
| 1   | 59-05-510   | Pitman Arm  | MB241423 |                     | 4   | 53-05-507   | Ball Joint  | MB176308 | c:19.4   |
| 2   | 111-05-509  | Tie Rod End | MB241171 | c:13.6 th:MM16X1.5L | 5   | 73-05-520   | Ball Joint  |          | c:16     |
| 3   | 111-05-510  | Tie Rod End | MB241206 | c:13.8 th:M16X1.5R  | 6   | 52-05-508   | Pitman Arm  | MB241168 |          |

L 200 (K74T/K75T) 4X4

06/1996 ->



2 111-05-599



1 111-05-518

8 59-05-500



2  
111-05-599



3 73-05-522

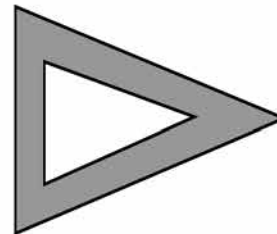
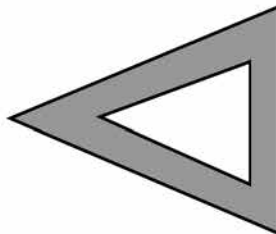

3 73-05-522



4 73-05-523L

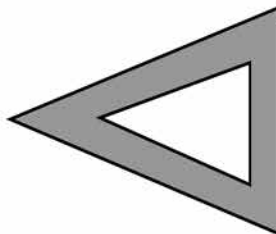

6 GOM-506

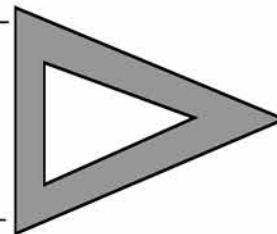

7 GOM-505



5  
73-05-523R

| Ref | ASHIKA CODE | Description           | OEM       | Measures              | Ref | ASHIKA CODE | Description              | OEM      | Measures |
|-----|-------------|-----------------------|-----------|-----------------------|-----|-------------|--------------------------|----------|----------|
| 1   | 111-05-518  | Tie Rod End Inner     | MR296274  | c: 13.6 th MM 16x1.5R | 5   | 73-05-523R  | Ball Joint Lower Right   | MB831038 | c:19.3   |
| 2   | 111-05-599  | Tie Rod End           | MB831043  | c: 13.6 th M 16x1.5L  | 6   | GOM-506     | Silentblock For Susp.Arm | MB109684 | d:40     |
| 3   | 73-05-522   | Ball Joint Upper      | MB-860830 | c:16.5                | 7   | GOM-505     | Silentblock For Susp.Arm | MB109662 | d:40.4   |
| 4   | 73-05-523L  | Ball Joint Lower Left | MB831037  | c:19.3                | 8   | 59-05-500   | Pitman Arm               | MR296272 |          |

L200 4X4 (KB4T)

12/2005 ->

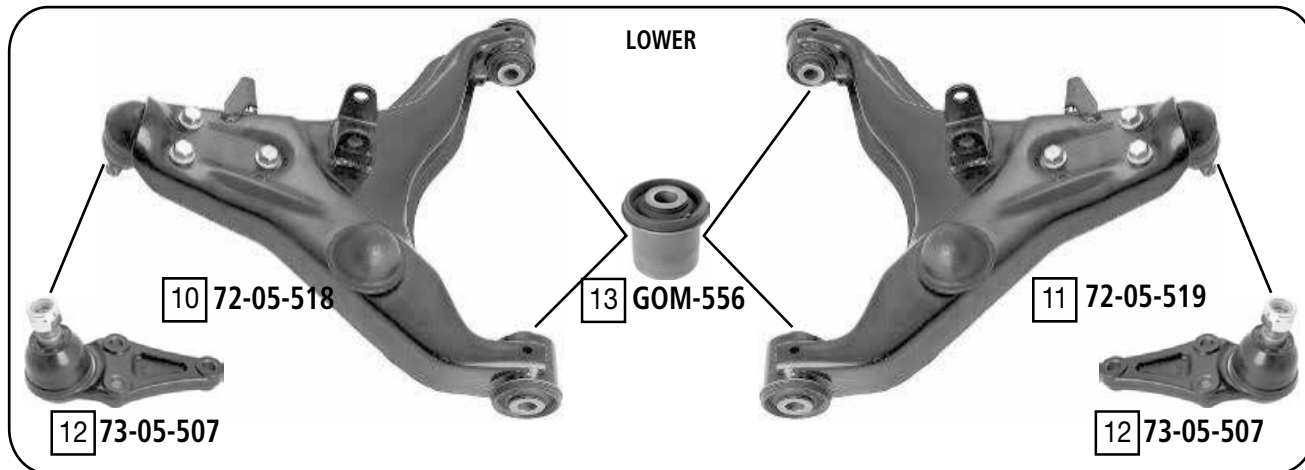
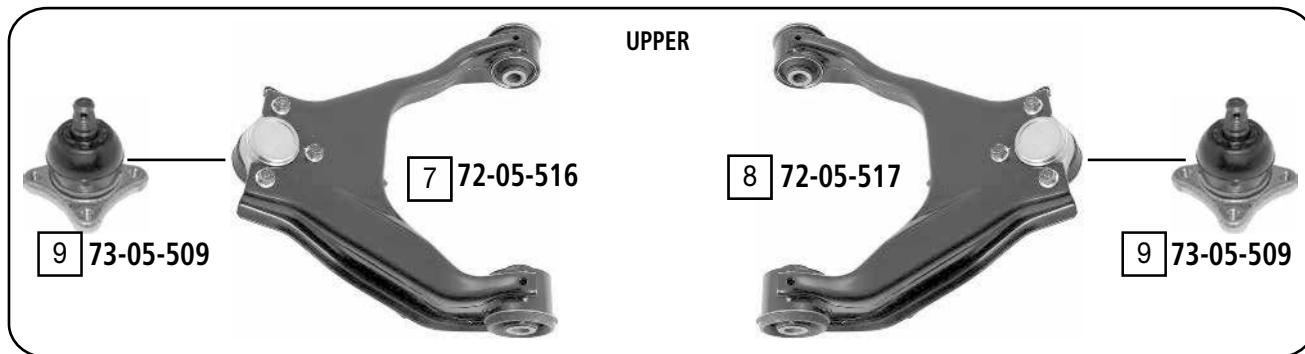
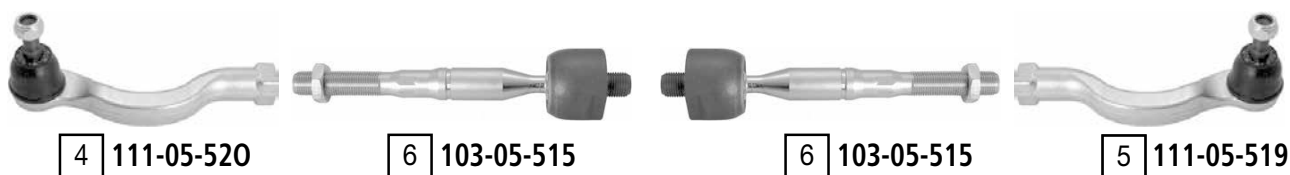
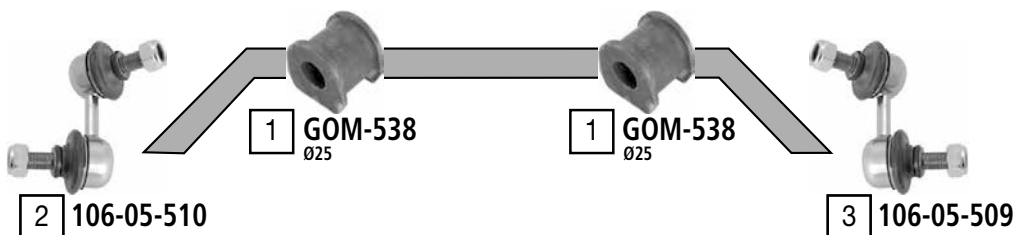

| Ref | JAPANPARTS CODE | Description           | OEM      | Measures            | Ref | JAPANPARTS CODE | Description         | OEM       | Measures        |
|-----|-----------------|-----------------------|----------|---------------------|-----|-----------------|---------------------|-----------|-----------------|
| 1   | GOM538          | Stabiliser mounting   | MR992317 | di:25               | 8   | 72-05-517       | TCA right           | 4010A014  | c:15.9          |
| 2   | 106-05-510      | Stabiliser link left  | MR992309 | L:65                | 9   | 73-05-509       | ball joint          | 4010 A015 | c:15.9          |
| 3   | 106-05-509      | Stabiliser link right | MR992310 | L:65                | 10  | 72-05-518       | TCA left            | 4013A087  | c:19.4          |
| 4   | 111-05-520      | Tie rod end left      | 4422A009 | c:13.6 th:FM16x1.5R | 11  | 72-05-519       | TCA right           | 4013A088  | c:19.4          |
| 5   | 111-05-519      | Tie rod end right     | 4422A010 | c:13.5 th:FM16x1.5R | 12  | 73-05-507       | ball joint          | 4013A090  | c:19.3          |
| 6   | 103-05-515      | Axial joint           | 4410A173 | th:MM16x1.5R L:200  | 13  | GOM556          | silentblock for TCA | MR992256  | di:16.4 do:50.1 |
| 7   | 72-05-516       | TCA left              | 4010A013 | c:15.9              |     |                 |                     |           |                 |

L300 (L03\_L06\_)

06/1979 - 04/1994



**2** 111-0H-H53  
ALL



**3** 111-05-522  
09/1982->



**3** 111-05-522  
09/1982->



**2** 111-0H-H53  
ALL



**1** 59-05-513  
LHD 1986->

**8** 59-05-511  
->1986

**7** 73-05-503  
->09/1983

**7** 73-05-503  
->09/1983



**4** 73-05-508  
->10/1983

**10** 52-05-599  
->12/1983

UPPER

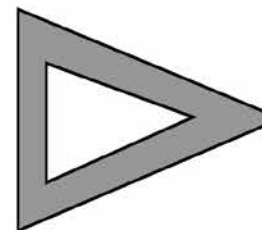

**9** 52-05-523  
->12/1983



**4** 73-05-508  
->10/1983



**5** 53-05-509  
10/1983 ->

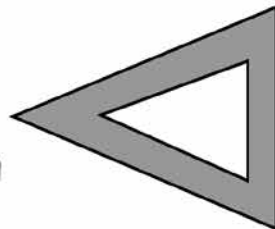

**6** 53-05-504  
-> 09/1983

LOWER

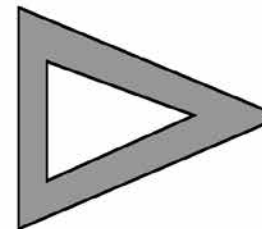

**6** 53-05-504  
-> 09/1983



**5** 53-05-509  
10/1983 ->

| Ref | ASHIKA CODE | Description      | OEM         | Measures            | Ref | ASHIKA CODE | Description | OEM      | Measures |
|-----|-------------|------------------|-------------|---------------------|-----|-------------|-------------|----------|----------|
| 1   | 59-05-513   | Pitman Arm       | MB315770    |                     | 6   | 53-05-504   | Ball Joint  | MB175544 |          |
| 2   | 111-0H-H53  | Tie Rod End      | 56820-21000 | c:13.45 th:FM14X1.5 | 7   | 73-05-503   | Ball Joint  | MB112477 |          |
| 3   | 111-05-522  | Tie Rod End      | MB288119    | c:13.8 th:FM14X1.5L | 8   | 59-05-511   | Pitman Arm  | MB166429 |          |
| 4   | 73-05-508   | Ball Joint Upper | MB176309    | c:15.9              | 9   | 52-05-523   | Pitman Arm  | MB166423 |          |
| 5   | 53-05-509   | Ball Joint       | MB176283    | c:19.4              | 10  | 52-05-599   | Pitman Arm  | MB166424 |          |



L300 (PO\_)

11/1986 - 05/1999

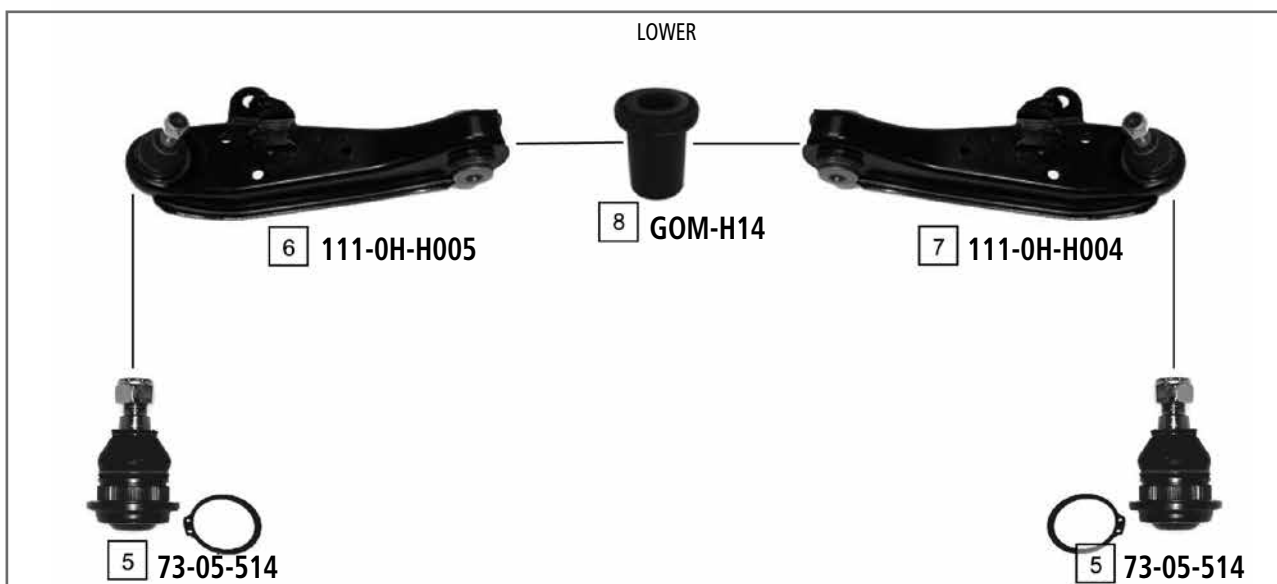
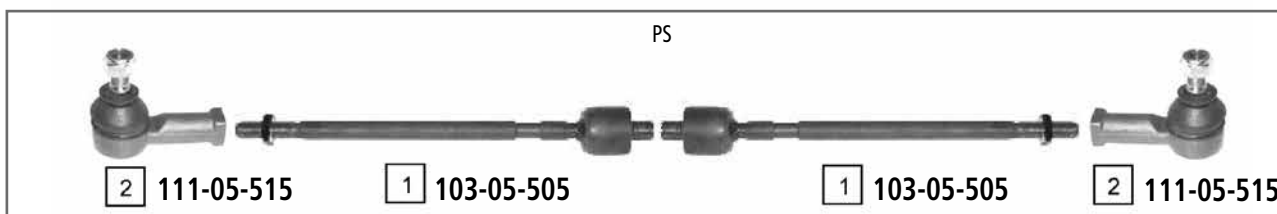
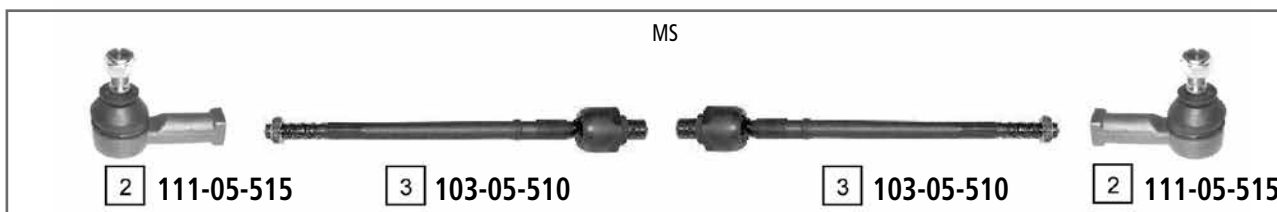

| Ref | ASHIKA CODE | Description      | OEM      | Measures            | Ref | ASHIKA CODE | Description              | OEM                               | Measures |
|-----|-------------|------------------|----------|---------------------|-----|-------------|--------------------------|-----------------------------------|----------|
| 1   | 103-05-505  | Axial Joint      | MB266152 | th:MM16X1.5R L:296  | 5   | 73-05-514   | Ball Joint Lower         | MB527384-01                       | c:19.6   |
| 2   | 111-05-515  | Tie Rod End      | MB527650 | c:13.7 th:FM14X1.5L | 6   | 111-0H-H005 | TCA                      | MB598017                          | c:19.5   |
| 3   | 103-05-510  | Axial Joint      | MB532971 | th:MM17X1R L:290    | 7   | 111-0H-H004 | TCA                      | MB598018                          | c:19.5   |
| 4   | 73-05-513   | Ball Joint Upper | MB527349 | c:17.6              | 8   | GOM-H14     | Silentblock For Susp.Arm | Part of 111-0H-H005 / 111-0H-H004 | d:45.8   |

L300 (L035GV/W,L037GV/W,L038GV/W)  
4X4

10/1982 - 06/19986

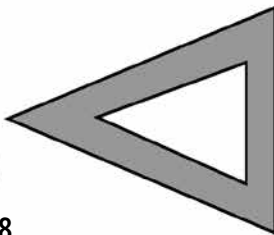

UPPER

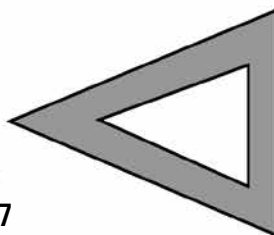
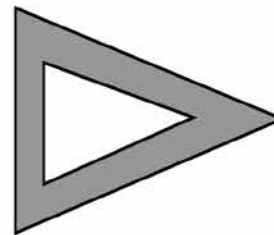

LOWER

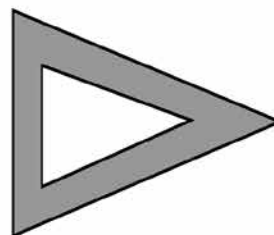

| Ref | ASHIKA CODE | Description | OEM      | Measures            | Ref | ASHIKA CODE | Description      | OEM      | Measures |
|-----|-------------|-------------|----------|---------------------|-----|-------------|------------------|----------|----------|
| 1   | 111-05-509  | Tie Rod End | MB241171 | c:13.6 th:MM16X1.5L | 3   | 73-05-508   | Ball Joint Upper | MB176309 | c:15.9   |
| 2   | 111-05-510  | Tie Rod End | MB241206 | c:13.8 th:MM16X1.5R | 4   | 53-05-507   | Ball Joint Lower | MB176308 | c:19.4   |

L300 (L2\_V,P45W) 4X4

06/1986 ->



1 111-05-515



1  
111-05-515



2 73-05-513

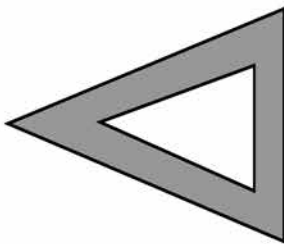

UPPER

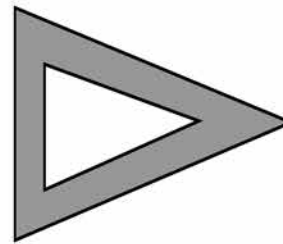

2  
73-05-513



3  
73-05-515L

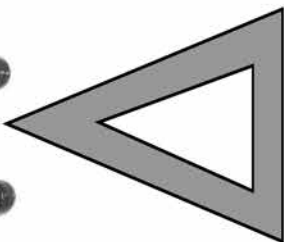

LOWER

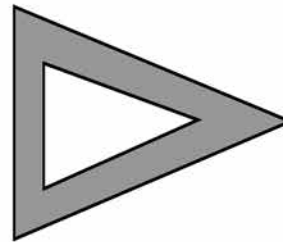

4  
73-05-515R

| Ref | ASHIKA CODE | Description      | OEM      | Measures            | Ref | ASHIKA CODE | Description      | OEM      | Measures |
|-----|-------------|------------------|----------|---------------------|-----|-------------|------------------|----------|----------|
| 1   | 111-05-515  | Tie Rod End      | MB527650 | c:13.7 th:FM14X1.5L | 3   | 73-05-515L  | Ball Joint Left  | MB527351 | c:19.4   |
| 2   | 73-05-513   | Ball Joint Upper | MB527349 | c:17.6              | 4   | 73-05-515R  | Ball Joint Right | MB527352 | c:19.4   |

LANCER I (A17\_)

04/1979 - 01/1984



EXC TURBO



1 111-05-501

2 111-05-505

3 111-05-504

1 111-05-501

TURBO



1 111-05-501

2 111-05-505

5 111-05-508

1 111-05-501



4 53-05-505  
EXC TURBO

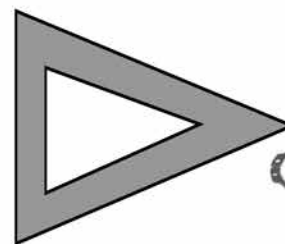
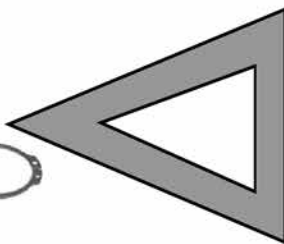

4 53-05-505  
EXC TURBO

| Ref | ASHIKA CODE | Description             | OEM      | Measures            | Ref | ASHIKA CODE | Description             | OEM       | Measures              |
|-----|-------------|-------------------------|----------|---------------------|-----|-------------|-------------------------|-----------|-----------------------|
| 1   | 111-05-501  | Tie Rod End             | MA159984 | c:12.5 th:MM14X1.5L | 4   | 53-05-505   | Ball Joint Lower        | MB 001696 | c: 15                 |
| 2   | 111-05-505  | Tie Rod End Inner Left  | MB076003 | c:12.1 th:MM14X1.5R | 5   | 111-05-508  | Tie Rod End Inner Right | MB109858  | c: 12.5 th: FM14X1.5L |
| 3   | 111-05-504  | Tie Rod End Inner Right | MB076004 | c:12.2 th:FM14X1.5L |     |             |                         |           |                       |

LANCER III (C1\_A, C6\_A)  
LANCER III S.W. (C1\_V, C3\_V)

02/1984 - 04/1989

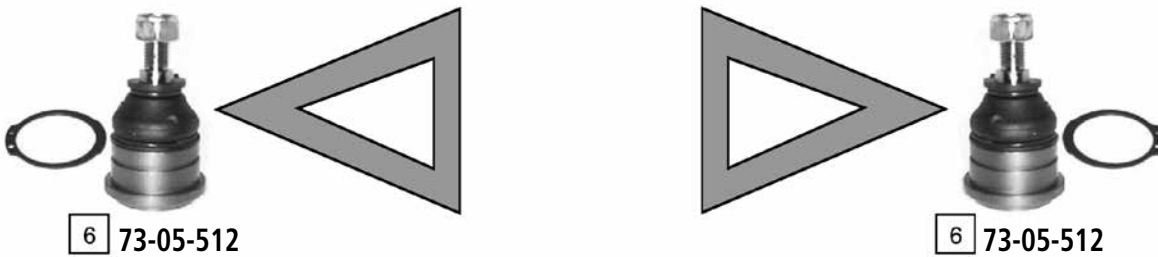
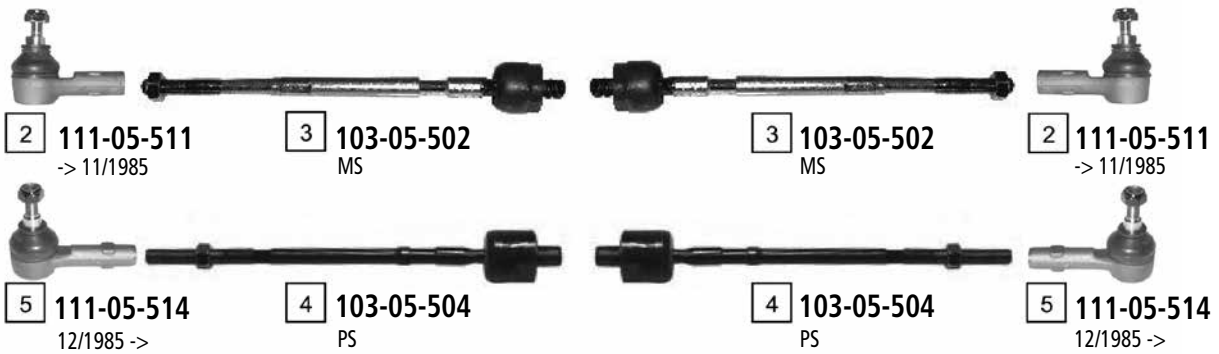

| Ref | ASHIKA CODE | Description     | OEM       | Measures            | Ref | ASHIKA CODE | Description      | OEM       | Measures            |
|-----|-------------|-----------------|-----------|---------------------|-----|-------------|------------------|-----------|---------------------|
| 1   | 106-05-501  | Stabiliser Link | 4056 A014 | L:60                | 4   | 103-05-504  | Axial Joint      | MB350718  |                     |
| 2   | 111-05-511  | Tie Rod End     | MB241982  | c:13.3 th:FM12X1.25 | 5   | 111-05-514  | Tie Rod End      | MB527169  | c:13.4 th:FM12X1.25 |
| 3   | 103-05-502  | Axial Joint     | MB347666  | th:MM12X1.25R L:278 | 6   | 73-05-512   | Ball Joint Lower | MB-518961 | c:15                |

LANCER IV (C6\_A, C7\_A)

05/1988 - 05/1992



MS

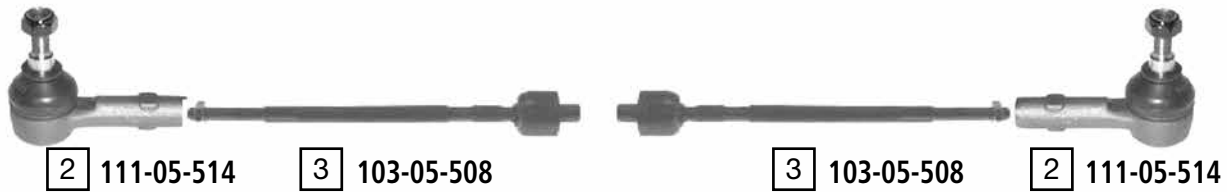

PS



| Ref      | ASHIKA CODE       | Description     | OEM      | Measures            | Ref      | ASHIKA CODE       | Description      | OEM       | Measures           |
|----------|-------------------|-----------------|----------|---------------------|----------|-------------------|------------------|-----------|--------------------|
| <b>1</b> | <b>106-05-504</b> | Stabiliser Link | MB518780 | L:88                | <b>4</b> | <b>103-05-599</b> | Axial Joint      | MB910934  | th:MM16X1.5R L:309 |
| <b>2</b> | <b>111-05-514</b> | Tie Rod End     | MB527169 | c:13.4 th:FM12X1.25 | <b>5</b> | <b>73-05-512</b>  | Ball Joint Lower | MB-518961 | c:15               |
| <b>3</b> | <b>103-05-508</b> | Axial Joint     | MB553249 | th:MM16X1.5R L:298  |          |                   |                  |           |                    |

# MITSUBISHI LANCER



LANCER V (CB/D\_A)  
LANCER VI (CK/P\_A)

06/1992 - 12/1995  
12/1995 - 08/2003

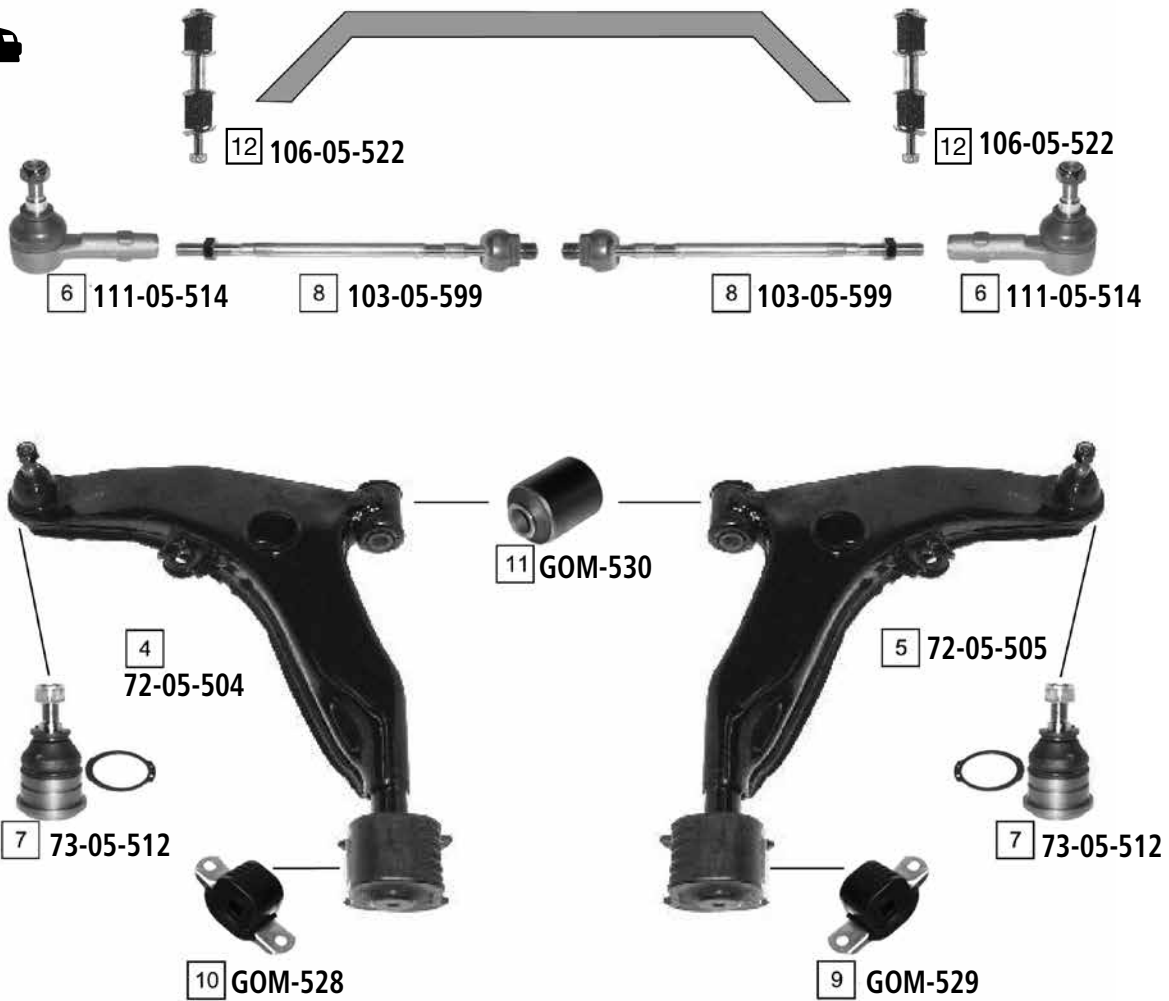

| Ref | ASHIKA CODE | Description     | OEM      | Measures            | Ref | ASHIKA CODE | Description              | OEM                          | Measures           |
|-----|-------------|-----------------|----------|---------------------|-----|-------------|--------------------------|------------------------------|--------------------|
| 1   | 71-05-502   | TCA Left        | MB809220 | c:15                | 7   | 73-05-512   | Ball Joint Lower         | Part of 72-05-504 /72-05-505 | c:15               |
| 2   | 71-05-503   | TCA Right       | MB809221 | c:15                | 8   | 103-05-599  | Axial Joint              | MB910934                     | th:MM16X1.5R L:309 |
| 3   | 106-05-599  | Stabiliser Link | MB809354 | L:75                | 9   | GOM-529     | Silentblock For Susp.Arm | MB808910                     |                    |
| 4   | 72-05-504   | TCA Left        | MB912077 | c:15                | 10  | GOM-528     | Silentblock For Susp.Arm | MB808909                     |                    |
| 5   | 72-05-505   | TCA Right       | MB912078 | c:15                | 11  | GOM-530     | Silentblock For Susp.Arm | Part of 72-05-504 /72-05-505 |                    |
| 6   | 111-05-514  | Tie Rod End     | MB527169 | c:13.4 th:FM12X1.25 | 12  | 106-05-522  | Stabiliser Link          | MB241974                     | L:131              |

LANCER VII (CS\_)

09/2003 ->

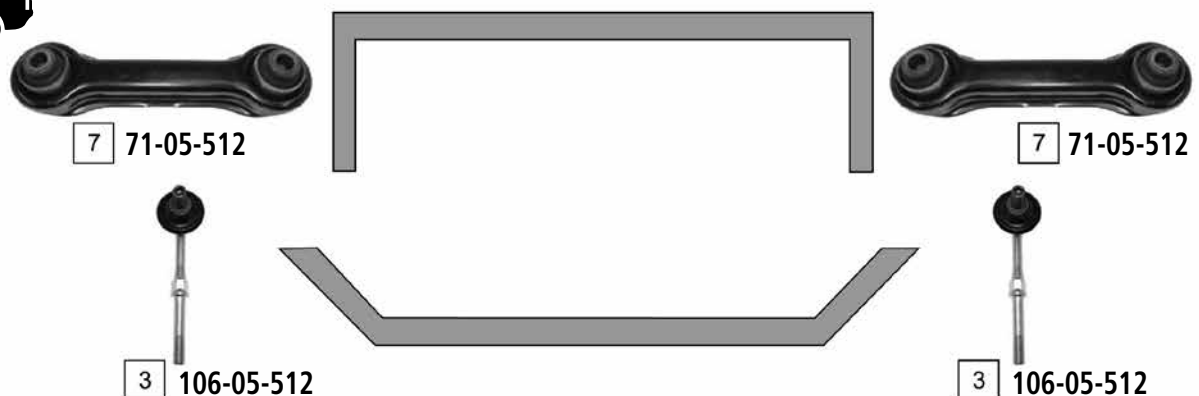
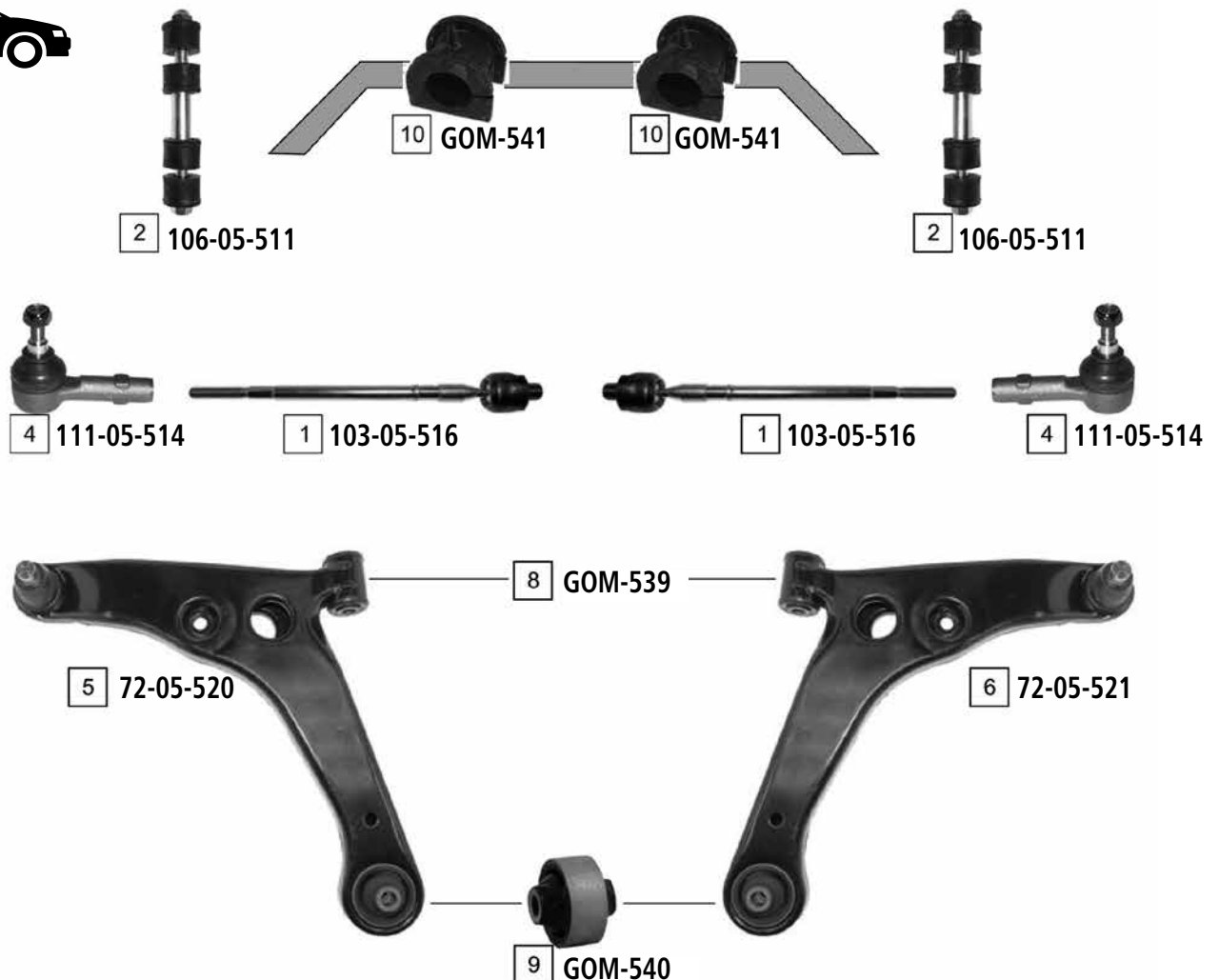

| Ref | ASHIKA CODE | Description     | OEM      | Measures            | Ref | ASHIKA CODE | Description              | OEM                           | Measures |
|-----|-------------|-----------------|----------|---------------------|-----|-------------|--------------------------|-------------------------------|----------|
| 1   | 103-05-516  | Axial Joint     | MR491358 | th:MM16X1.5R L:311  | 6   | 72-05-521   | TCA Right Wbj            | MR403420                      | c:20     |
| 2   | 106-05-511  | Stabiliser Link | MR954887 | L:136               | 7   | 71-05-512   | TCA                      | MR403485                      | -        |
| 3   | 106-05-512  | Stabiliser Link | MR403771 | L:115               | 8   | GOM-539     | Silentblock For Susp.Arm | Part of 72-05-520 / 72-05-521 | -        |
| 4   | 111-05-514  | Tie Rod End     | MB527169 | c:13.4 th:FM12X1.25 | 9   | GOM-540     | Silentblock For Susp.Arm | MR403441                      | -        |
| 5   | 72-05-520   | TCA Left Wbj    | MR403419 | c:20                | 10  | GOM-541     | Stabiliser Mounting      | MN100250                      | d:26     |



OUTLANDER

02/2007 ->

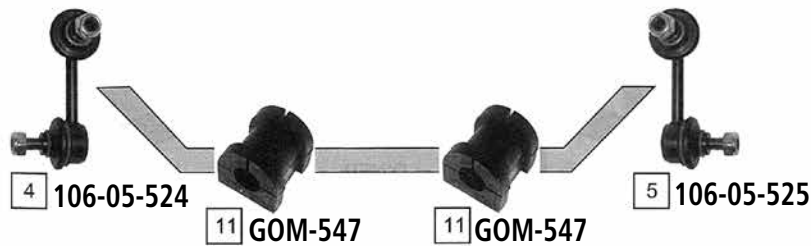
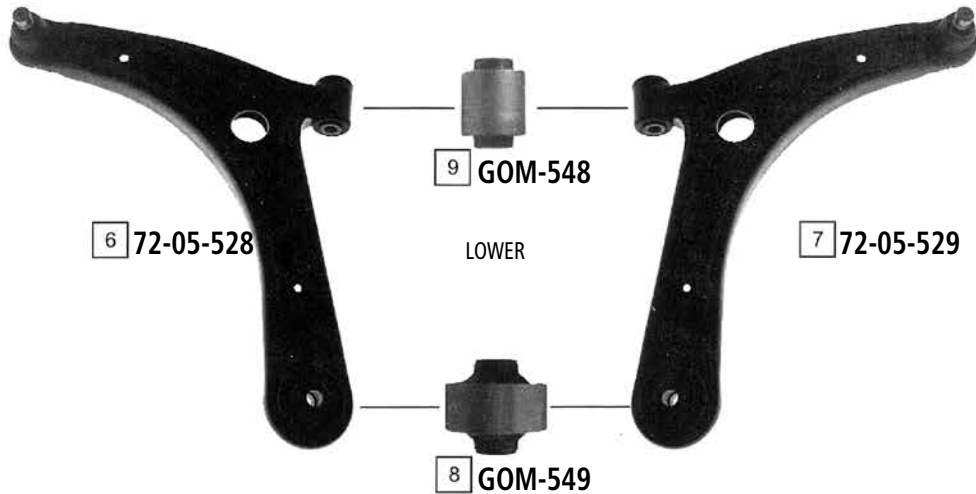
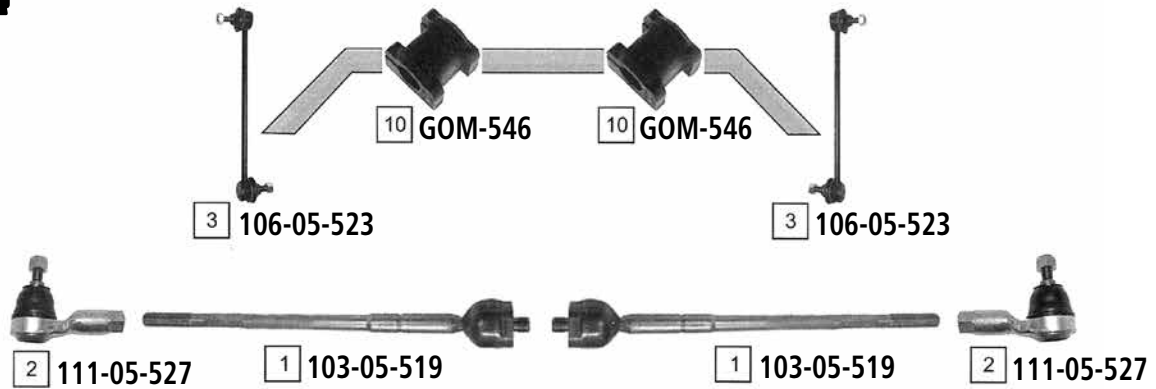

| Ref | ASHIKA CODE | Description           | OEM      | Measures            | Ref | ASHIKA CODE | Description              | OEM      | Measures |
|-----|-------------|-----------------------|----------|---------------------|-----|-------------|--------------------------|----------|----------|
| 1   | 103-05-519  | Axial Joint           | 4422A012 | -                   | 7   | 72-05-529   | TCA Right WBJ            | 4013A010 | c:20     |
| 2   | 111-05-527  | Tie Rod End           | 4422A018 | c:13.4 th:fm14x1.5R | 8   | GOM-549     | Silentblock For Susp.Arm | MN184133 | d:60     |
| 3   | 106-05-523  | Stabiliser Link       | MN101368 | L:265               | 9   | GOM-548     | Silentblock For Susp.Arm | MN125871 | -        |
| 4   | 106-05-524  | Stabiliser Link Left  | 4156A014 | L:80                | 10  | GOM-546     | Stabiliser Mounting      | 4056A079 | -        |
| 5   | 106-05-525  | Stabiliser Link Right | MN184194 | L:80                | 11  | GOM-547     | Stabiliser Mounting      | 4156A028 | -        |
| 6   | 72-05-528   | TCA Left WBJ          | 4013A009 | c:20                |     |             |                          |          |          |

PAJERO I (L04\_G, L14\_G)

03/1983 - 02/1991

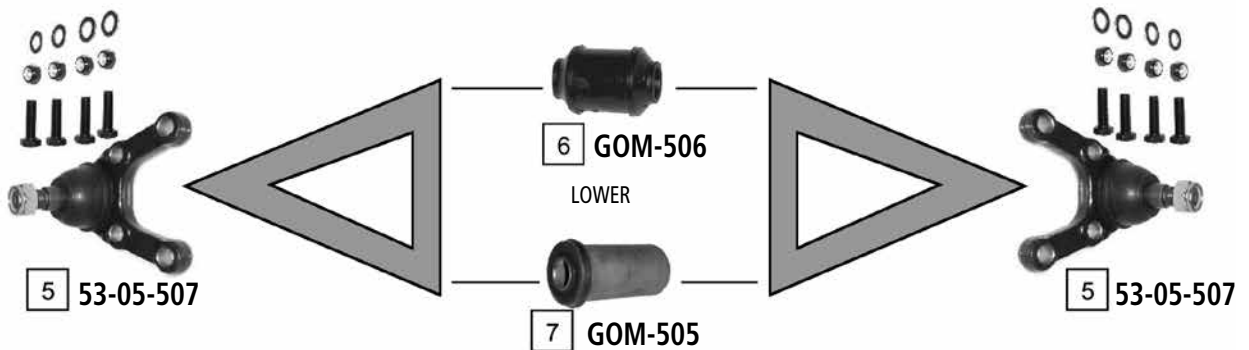
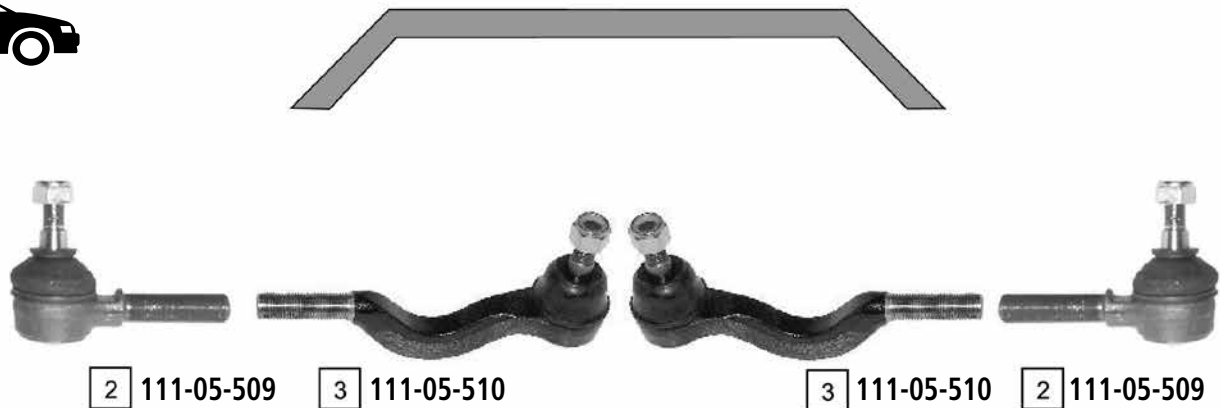

| Ref | ASHIKA CODE | Description      | OEM      | Measures            | Ref | ASHIKA CODE | Description              | OEM      | Measures |
|-----|-------------|------------------|----------|---------------------|-----|-------------|--------------------------|----------|----------|
| 1   | 59-05-508   | Pitman Arm       | MB241830 |                     | 5   | 53-05-507   | Ball Joint Lower         | MB176308 | c:19.4   |
| 2   | 111-05-509  | Tie Rod End      | MB241171 | c:13.6 th:MM16X1.5L | 6   | GOM-506     | Silentblock For Susp.Arm | MB109684 | d:40     |
| 3   | 111-05-510  | Tie Rod End      | MB241206 | c:13.8 th:MM16X1.5R | 7   | GOM-505     | Silentblock For Susp.Arm | MB109662 | d:40.4   |
| 4   | 73-05-508   | Ball Joint Upper | MB176309 | c:15.9              | 8   | 52-05-510   | Pitman Arm               | MB241973 |          |

# MITSUBISHI PAJERO



PAJERO II (V2\_W, V4\_W)  
PAJERO CLASSIC (V2\_W)

03/1991 - 04/2000  
07/2002 ->

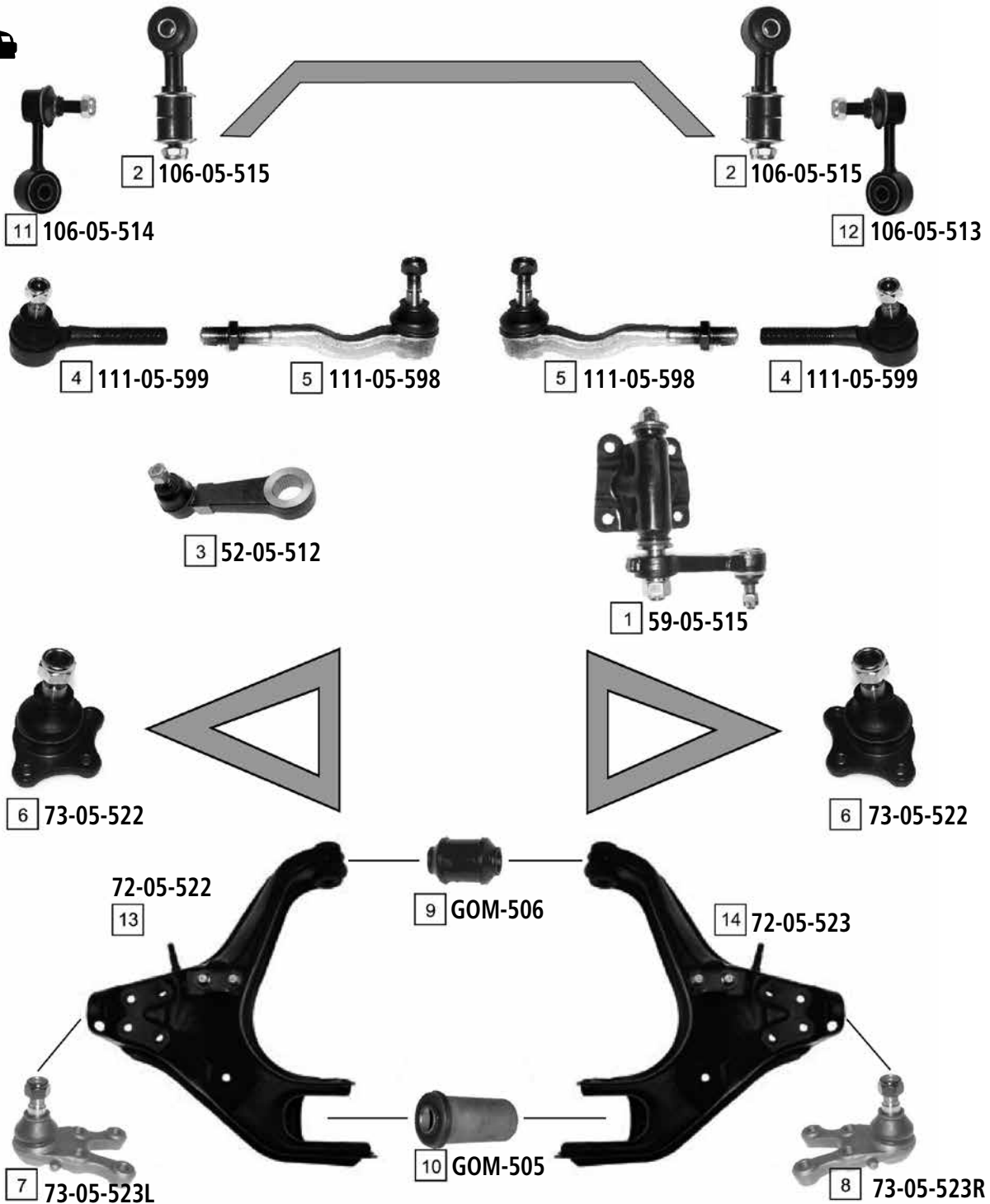

| Ref | ASHIKA CODE | Description           | OEM       | Measures           | Ref | ASHIKA CODE | Description              | OEM       | Measures |
|-----|-------------|-----------------------|-----------|--------------------|-----|-------------|--------------------------|-----------|----------|
| 1   | 59-05-515   | Pitman Arm            | MB831042  | -                  | 8   | 73-05-523R  | Ball Joint Lower Right   | MB831038  | c:19.3   |
| 2   | 106-05-515  | Stabiliser Link       | MB633926  | -                  | 9   | GOM-506     | Silentblock For Susp.Arm | MB109684  | d:40     |
| 3   | 52-05-512   | Pitman Arm            | MB831040  | -                  | 10  | GOM-505     | Silentblock For Susp.Arm | MB109662  | d:40.4   |
| 4   | 111-05-599  | Tie Rod End           | MB831043  | c:13.6 th:M16X1.5L | 11  | 106-05-514  | Stabiliser Link Left     | MR 132551 | L:79     |
| 5   | 111-05-598  | Tie Rod End Inner     | MB831044  | c:13.7 th:M16X1.5R | 12  | 106-05-513  | Stabiliser Link Right    | MR 132552 | L:79     |
| 6   | 73-05-522   | Ball Joint Upper      | MB-860830 | c:16.5             | 13  | 72-05-522   | Susp. Arm W/O Ball Joint | MB860381  |          |
| 7   | 73-05-523L  | Ball Joint Lower Left | MB831037  | c:19.3             | 14  | 72-05-523   | Susp. Arm W/O Ball Joint | MB860382  |          |

PAJERO III (V6\_W / V7\_W)

04/2000 - 10/2006

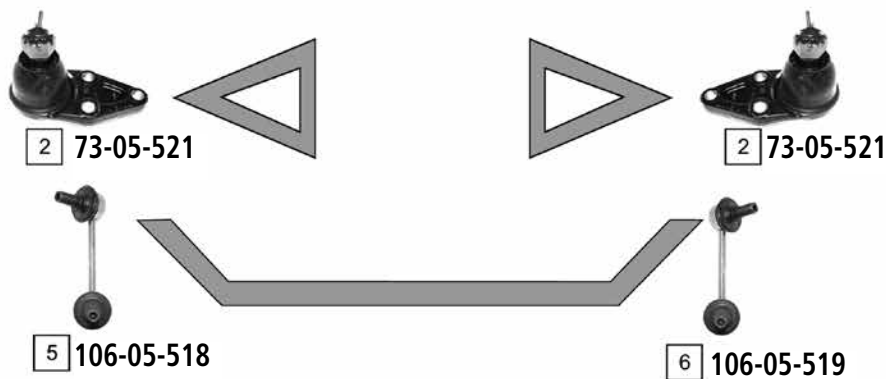
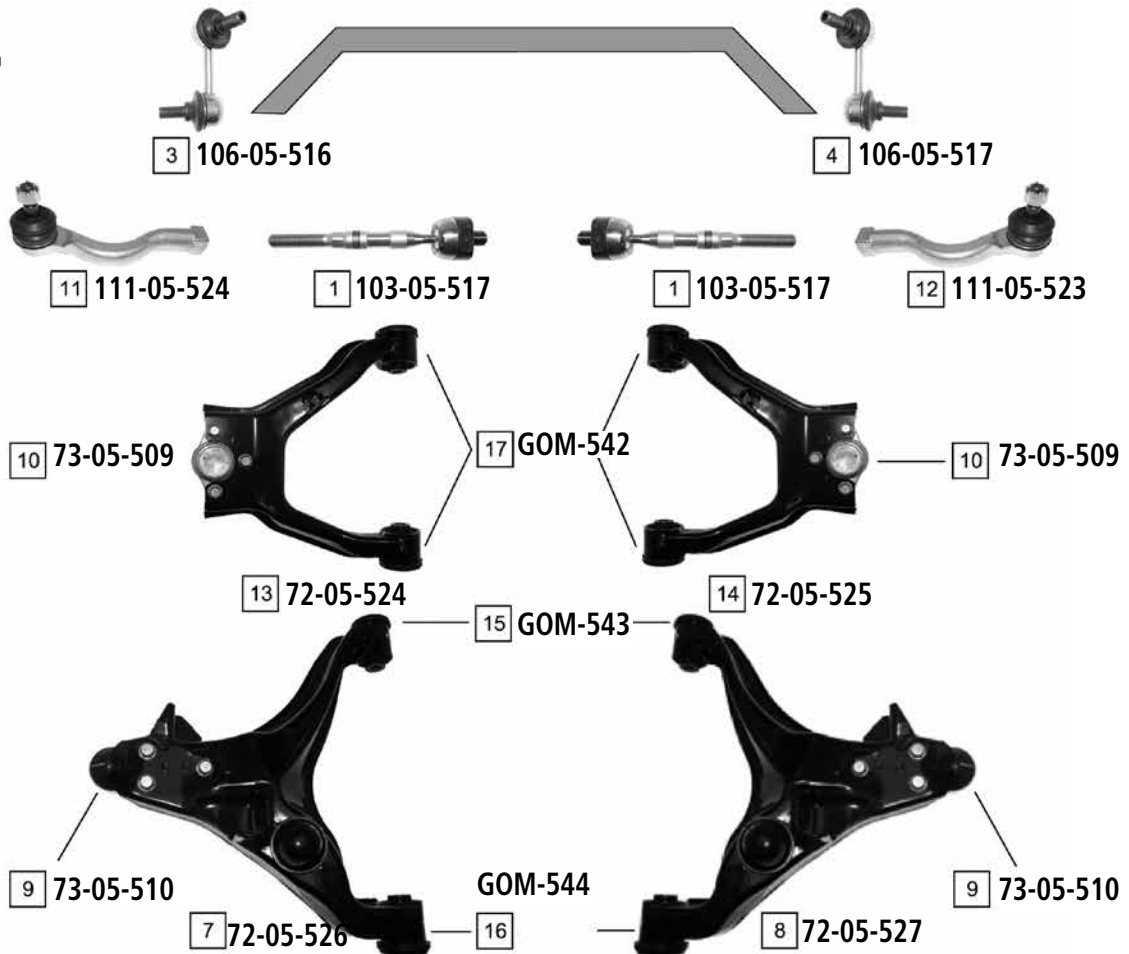

| Ref | ASHIKA CODE | Description           | OEM      | Measures | Ref | ASHIKA CODE | Description              | OEM                           | Measures |
|-----|-------------|-----------------------|----------|----------|-----|-------------|--------------------------|-------------------------------|----------|
| 1   | 103-05-517  | Axial Joint           | MR510267 |          | 10  | 73-05-509   | Ball Joint               | 4010 A015                     |          |
| 2   | 73-05-521   | Ball Joint            | MR508130 |          | 11  | 111-05-524  | Tie Rod End Left         | MR508135                      |          |
| 3   | 106-05-516  | Stabiliser Link Left  | MR374521 |          | 12  | 111-05-523  | Tie Rod End Right        | MR508136                      |          |
| 4   | 106-05-517  | Stabiliser Link Right | MR374522 |          | 13  | 72-05-524   | TCA Left                 | 4010 A037                     |          |
| 5   | 106-05-518  | Stabiliser Link Left  | MR418052 |          | 14  | 72-05-525   | TCA Right                | 4010 A038                     |          |
| 6   | 106-05-519  | Stabiliser Link Right | MR418053 |          | 15  | GOM-543     | Silentblock For Susp.Arm | Part of 72-05-526 / 72-05-527 |          |
| 7   | 72-05-526   | TCA Left              | MR496795 |          | 16  | GOM-544     | Silentblock For Susp.Arm | Part of 72-05-526 / 72-05-527 |          |
| 8   | 72-05-527   | TCA Right             | MR496796 |          | 17  | GOM-542     | Silentblock For Susp.Arm | Part of 72-05-524 / 72-05-525 |          |
| 9   | 73-05-510   | Ball Joint            | MR496799 |          |     |             |                          |                               |          |

PAJERO IV

09/2006 ->

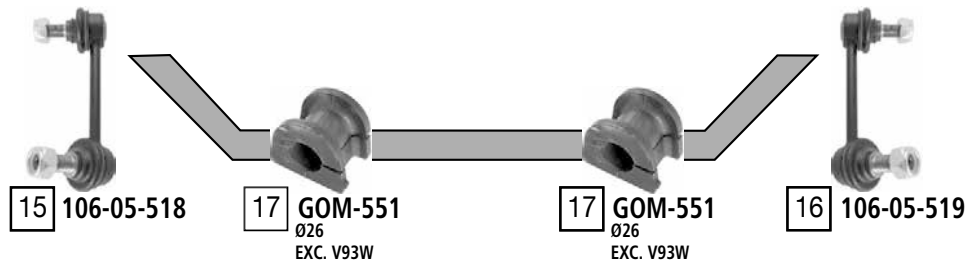
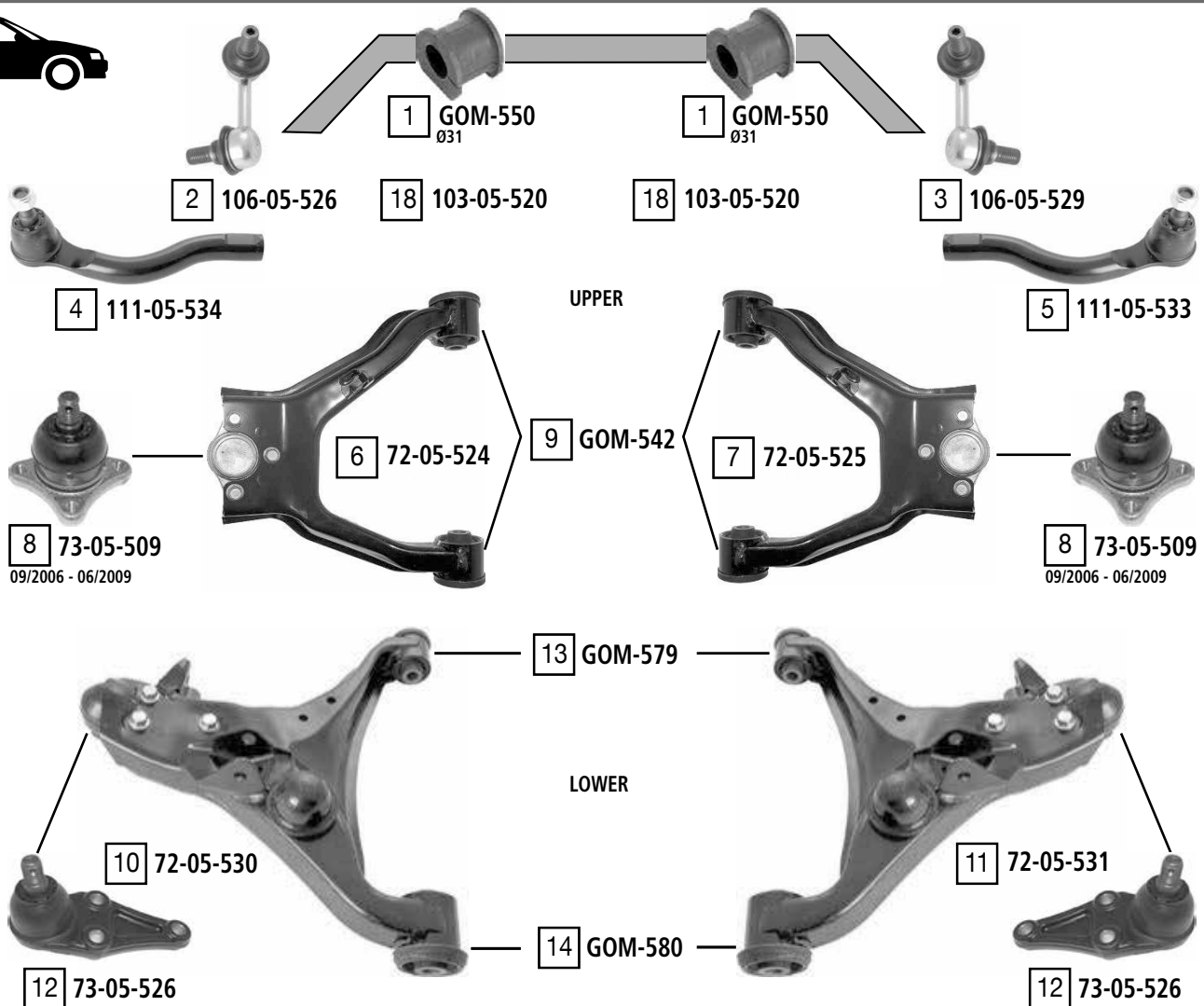

| Ref | ASHIKA CODE | Description           | OEM       | Measures            | Ref | ASHIKA CODE | Description           | OEM      | Measures      |
|-----|-------------|-----------------------|-----------|---------------------|-----|-------------|-----------------------|----------|---------------|
| 1   | GOM-550     | Stabiliser Mounting   | MR554271  | di:31               | 10  | 72-05-530   | TCA left wbj          | 4013A209 | c:19.3        |
| 2   | 106-05-526  | Stabiliser Link Left  | 4056A133  | L:78.5              | 11  | 72-05-531   | TCA right wbj         | 4013A210 | c:19.3        |
| 3   | 106-05-529  | Stabiliser Link Right | 4056A134  | L:78.5              | 12  | 73-05-526   | Ball Joint            | MR496799 | c:19.5        |
| 4   | 111-05-534  | Tie Rod End Left      | 4422A037  | c:13.7 th:FM16x1.5R | 13  | GOM-579     | Silentblock For TCA   | Part of  | di:16.3 do:48 |
| 5   | 111-05-533  | Tie Rod End Right     | 4422A038  | c:13.7 th:FM16x1.5R | 14  | GOM-580     | Silentblock For TCA   | Part of  | di:16.3 do:52 |
| 6   | 72-05-524   | TCA Left Wbj          | 4010 A037 |                     | 15  | 106-05-518  | Stabiliser Link Left  | 4056A111 | L:115         |
| 7   | 72-05-525   | TCA Right Wbj         | 4010 A038 |                     | 16  | 106-05-519  | Stabiliser Link Right | 4056A112 | L:115         |
| 8   | 73-05-509   | Ball Joint            | 4010 A015 | c:15.9              | 17  | GOM-551     | Stabiliser Mounting   | 4156A041 | di:26         |
| 9   | GOM-542     | Silentblock For TCA   | Part of   | di:14.4 do:46.2     | 18  | 103-05-520  | Axial Joint           | 4422A036 |               |

PAJERO PININ (H6\_W / H7\_W)

10/1999 - 03/2005

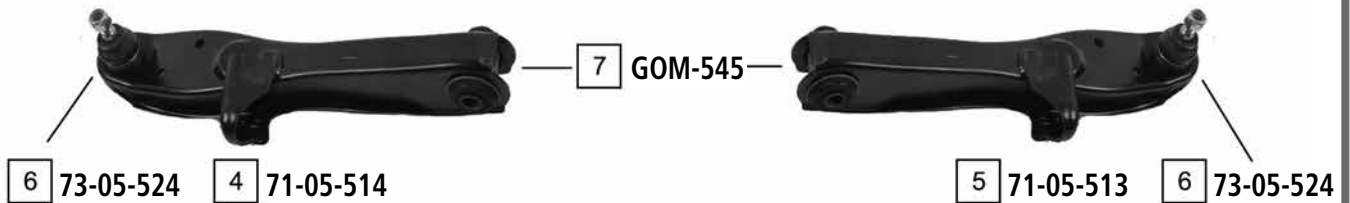

| Ref | ASHIKA CODE | Description     | OEM       | Measures            | Ref | ASHIKA CODE | Description              | OEM                           | Measures |
|-----|-------------|-----------------|-----------|---------------------|-----|-------------|--------------------------|-------------------------------|----------|
| 1   | 103-05-518  | Axial Joint     | MR448255  |                     | 5   | 71-05-513   | TCA Right                | MR414940                      |          |
| 2   | 111-05-516  | Tie Rod End     | MB192430  | c:13.45 th:FM14X1.5 | 6   | 73-05-524   | Ball Joint               | Part of 71-05-514 / 71-05-513 |          |
| 3   | 106-05-501  | Stabiliser Link | 4056 A014 | L:60                | 7   | GOM-545     | Silentblock For Susp.Arm | MR319067                      |          |
| 4   | 71-05-514   | TCA Left        | MR414939  |                     |     |             |                          |                               |          |

SIGMA (F16A)  
SIGMA S.W. (F07W)

12/1990 - 10/1996  
01/1993 - 07/1996

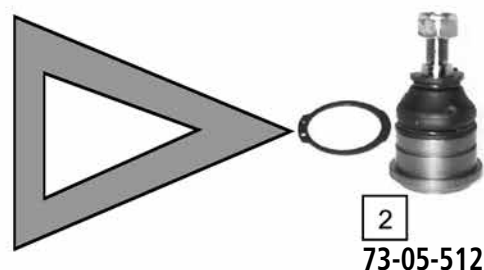
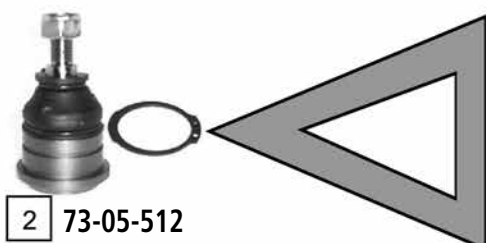
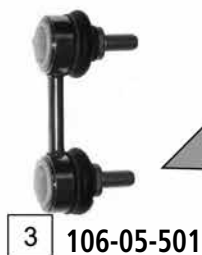

| Ref | ASHIKA CODE | Description      | OEM       | Measures            | Ref | ASHIKA CODE | Description     | OEM       | Measures |
|-----|-------------|------------------|-----------|---------------------|-----|-------------|-----------------|-----------|----------|
| 1   | 111-05-516  | Tie Rod End      | MB192430  | c:13.45 th:FM14X1.5 | 3   | 106-05-501  | Stabiliser Link | 4056 A014 | L:60     |
| 2   | 73-05-512   | Ball Joint Lower | MB-518961 | c:15                | 4   | 106-05-508  | Stabiliser Link | MR131732  | L:60     |

SPACE RUNNER (N1 W, N2 W)

10/1991 - 08/1999

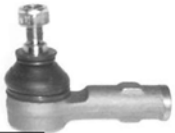

**1** 111-05-516

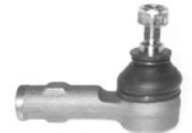

**1**  
111-05-516

**2** 73-05-512

**2** 73-05-512

| Ref | ASHIKA CODE | Description | OEM      | Measures            | Ref | ASHIKA CODE | Description | OEM      | Measures |
|-----|-------------|-------------|----------|---------------------|-----|-------------|-------------|----------|----------|
| 1   | 111-05-516  | Tie Rod End | MB192430 | c:13.45 th:FM14X1.5 | 2   | 73-05-512   | Ball Joint  | MB518961 |          |



SPACE STAR (DGO)

08/1998 - 03/2006

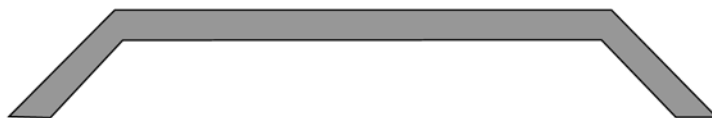

2 111-05-514



3 73-05-512

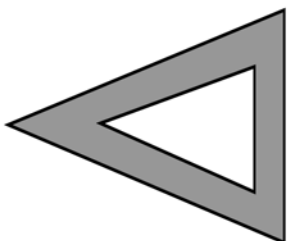

LOWER

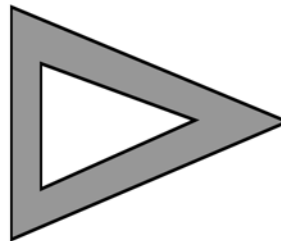

3  
73-05-512



4 71-05-500

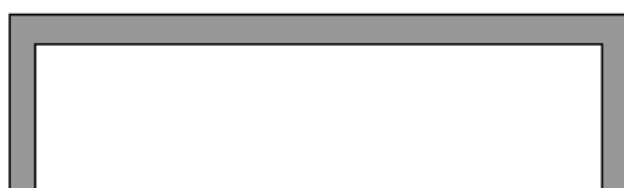

5 71-05-501



1 106-05-505



1 106-05-505

| Ref | ASHIKA CODE | Description      | OEM              | Measures            | Ref | ASHIKA CODE | Description | OEM      | Measures |
|-----|-------------|------------------|------------------|---------------------|-----|-------------|-------------|----------|----------|
| 1   | 106-05-505  | Stabiliser Link  | MR272118         |                     | 4   | 71-05-500   | TCA Left    | MR130479 |          |
| 2   | 111-05-514  | Tie Rod End      | MB527169         | c:13.4 th:FM12X1.25 | 5   | 71-05-501   | TCA Right   | MR130480 |          |
| 3   | 73-05-512   | Ball Joint Lower | Part of MB518961 | c:15                |     |             |             |          |          |

SPACE WAGON (DO\_V/W)

10/1983-04/1991



PS EXC 4X4



PS 4X4

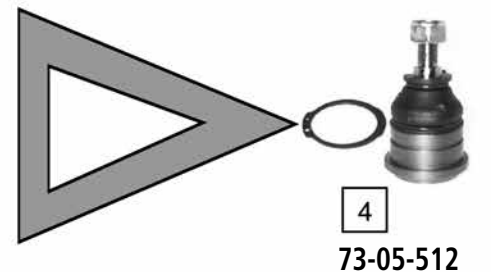
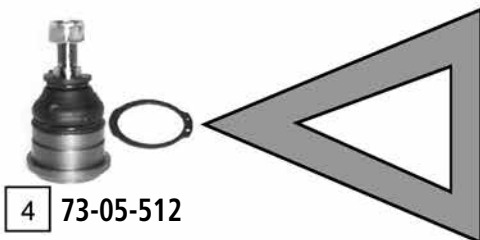

| Ref | ASHIKA CODE | Description | OEM       | Measures            | Ref | ASHIKA CODE | Description      | OEM      | Measures |
|-----|-------------|-------------|-----------|---------------------|-----|-------------|------------------|----------|----------|
| 1   | 111-05-516  | Tie Rod End | MB192430  | c:13.45 th:FM14X1.5 | 3   | 103-05-506  | Axial Joint      | MB243329 |          |
| 2   | 103-05-505  | Axial Joint | MB 266152 | th:MM16X1.5R L:296  | 4   | 73-05-512   | Ball Joint Lower | MB518961 |          |

# MITSUBISHI SPACE WAGON



SPACE WAGON (N3\_W, N4\_W)

05/1991 - 11/1998

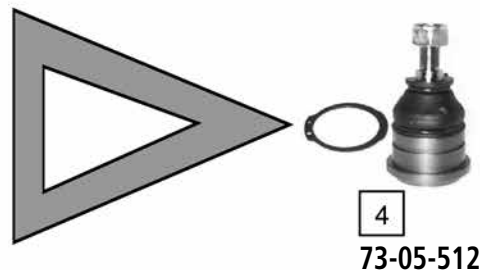
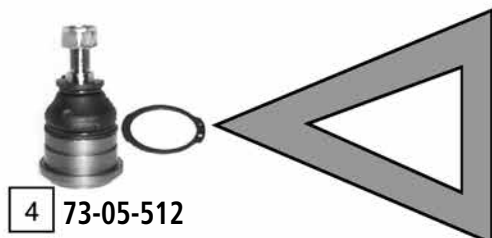
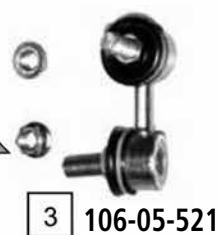
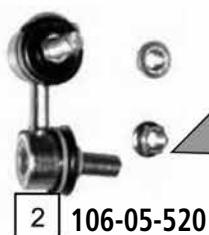

| Ref | ASHIKA CODE | Description          | OEM      | Measures            | Ref | ASHIKA CODE | Description           | OEM              | Measures |
|-----|-------------|----------------------|----------|---------------------|-----|-------------|-----------------------|------------------|----------|
| 1   | 111-05-516  | Tie Rod End          | MB192430 | c:13.45 th:FM14X1.5 | 3   | 106-05-521  | Stabiliser Link Right | MB808076         | L:51.5   |
| 2   | 106-05-520  | Stabiliser Link Left | MB672370 | L:51.5              | 4   | 73-05-512   | Ball Joint Lower      | Part of MB518961 | c:15     |

STARION (A18\_A)

01/1982 - 08/1990



**1** 111-05-501  
-> 05/1987



**2** 111-05-505  
ALL



**3** 111-05-508  
ALL



**1** 111-05-501  
-> 05/1987

**4** 53-05-510

**4** 53-05-510

| Ref | ASHIKA CODE | Description            | OEM      | Measures            | Ref | ASHIKA CODE | Description             | OEM       | Measures            |
|-----|-------------|------------------------|----------|---------------------|-----|-------------|-------------------------|-----------|---------------------|
| 1   | 111-05-501  | Tie Rod End            | MA159984 | c:12.5 th:MM14X1.5L | 3   | 111-05-508  | Tie Rod End Inner Right | MB109858  | c:12.5 th:FM14X1.5L |
| 2   | 111-05-505  | Tie Rod End Inner Left | MB076003 | c:12.1 th:MM14X1.5R | 4   | 53-05-510   | Ball Joint              | MB-185329 |                     |

# MITSUBISHI TREDIA - CORDIA



TREDIA (A21\_)  
CORDIA (A21\_A)

06/1982 - 03/1988  
10/1982 - 12/1986



MS



1 111-05-516



2 103-05-505



2 103-05-505



1 111-05-516

PS



1 111-05-516



3 103-05-506



3 103-05-506



1 111-05-516



4 73-05-512

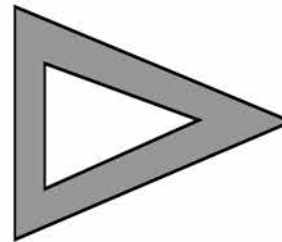
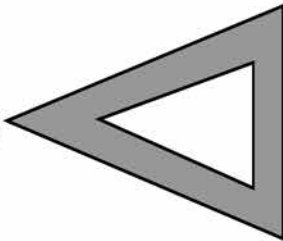

4 73-05-512

| Ref | ASHIKA CODE | Description | OEM       | Measures            | Ref | ASHIKA CODE | Description      | OEM       | Measures           |
|-----|-------------|-------------|-----------|---------------------|-----|-------------|------------------|-----------|--------------------|
| 1   | 111-05-516  | Tie Rod End | MB192430  | c:13.45 th:FM14X1.5 | 3   | 103-05-506  | Axial Joint      | MB243329  | th:MM16X1.5R L:295 |
| 2   | 103-05-505  | Axial Joint | MB 266152 | th:MM16X1.5R L:296  | 4   | 73-05-512   | Ball Joint Lower | MB-518961 | c:15               |

100 NX (B13)

08/1990 - 06/1995

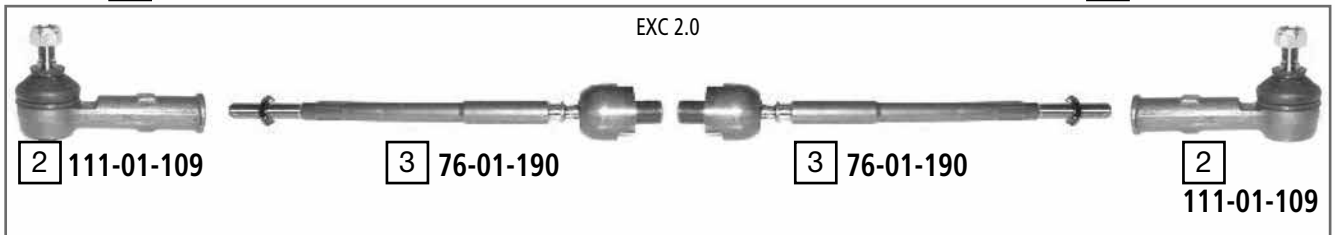

| Ref | ASHIKA CODE | Description     | OEM         | Measures           | Ref | ASHIKA CODE | Description              | OEM         | Measures |
|-----|-------------|-----------------|-------------|--------------------|-----|-------------|--------------------------|-------------|----------|
| 1   | 106-01-101  | Stabiliser Link | 54618 50Y00 | L:85.5             | 4   | GOM-139     | Silentblock For Susp.Arm | 54570-69Y10 |          |
| 2   | 111-01-109  | Tie Rod End     | 48520-01E00 | c:13 th:FM12X1.25R | 5   | 107-01-190  | Ball Joint               |             | c:14.7   |
| 3   | 76-01-190   | Axial Joint     | 48521-50400 | th:MM16X1R L:274.5 |     |             |                          |             |          |

# NISSAN ALMERA



ALMERA I (N15)

07/1995 - 07/2000

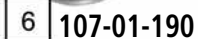
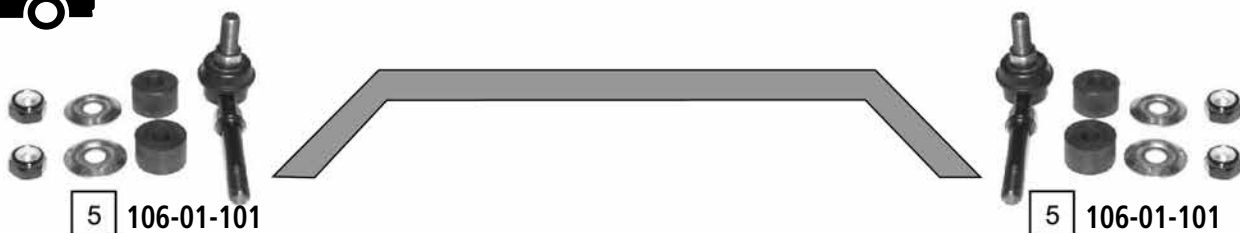

| Ref | ASHIKA CODE | Description     | OEM         | Measures            | Ref | ASHIKA CODE | Description              | OEM         | Measures            |
|-----|-------------|-----------------|-------------|---------------------|-----|-------------|--------------------------|-------------|---------------------|
| 1   | 111-01-109  | Tie Rod End     | 48520-0M025 | c:12.9 th:FM12X1.5R | 6   | 107-01-190  | Ball Joint               | 4016152910  | c:14.7              |
| 2   | 72-01-104   | TCA Left        | 54501-0M010 | c:14.9              | 7   | 76-01-190   | Axial Joint              | 48521-50400 | th:MM16X1R L.274.5  |
| 3   | 72-01-105   | TCA Right       | 54500-0M010 | c:14.9              | 8   | GOM-139     | Silentblock For Susp.Arm | 54570-69Y10 |                     |
| 4   | 76-01-191   | Axial Joint     | 48521-1M210 | th:MM16X1R L:275    | 9   | GOM-138     | Silentblock For Susp.Arm | 54560-50A00 | d:36.2              |
| 5   | 106-01-101  | Stabiliser Link | 54618 50Y00 | L:85.5              | 10  | 111-01-194  | Tie Rod End              | 48520-0M085 | c:12.85 th:FM14X1.5 |

ALMERA II (N16)

08/2000-03/2007



UK PRODUCTION



JAPAN PRODUCTION

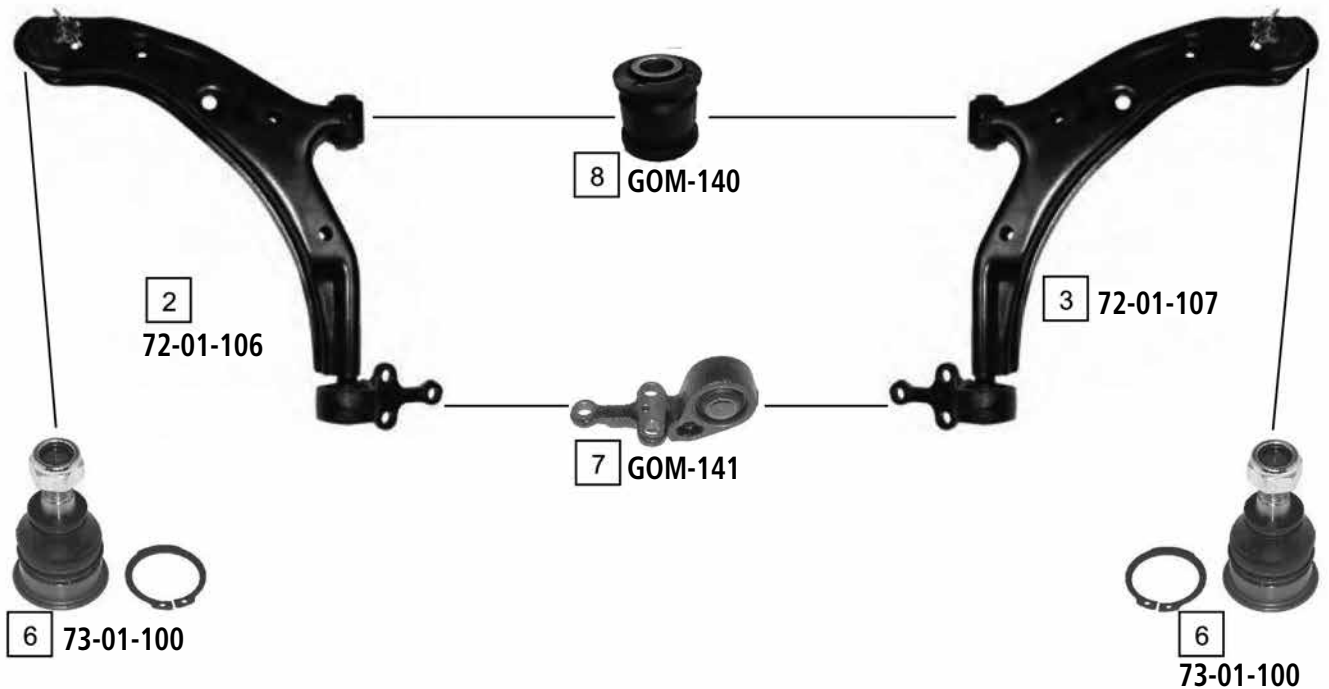

| Ref | ASHIKA CODE | Description     | OEM         | Measures            | Ref | ASHIKA CODE | Description              | OEM                           | Measures            |
|-----|-------------|-----------------|-------------|---------------------|-----|-------------|--------------------------|-------------------------------|---------------------|
| 1   | 111-01-100  | Tie Rod End     | 48520-BM425 | c:12.7 th:FM12X1.25 | 6   | 73-01-100   | Ball Joint               | -                             | c:14.7              |
| 2   | 72-01-106   | TCA Left        | 54501-BM400 | c:15                | 7   | GOM-141     | Silentblock For Susp.Arm | Part of 72-01-106 / 72-01-107 |                     |
| 3   | 72-01-107   | TCA Right       | 54500-BM300 | c:15                | 8   | GOM-140     | Silentblock For Susp.Arm | Part of 72-01-106 / 72-01-107 | d:32.2              |
| 4   | 103-01-108  | Axial Joint     | 48521 4M500 | th:MM16X1R L:284    | 9   | 103-01-100  | Axial Joint              | 48520-0C025                   | th:MM16X1R L:275    |
| 5   | 106-01-100  | Stabiliser Link | 54618-4M400 |                     | 10  | 111-01-101  | Tie Rod End              | 48520-15U25                   | c:12.8 th:FM14X1.5R |



ALMERA TINO (V10)

08/2000 - 12/2006



| Ref | ASHIKA CODE | Description          | OEM         | Measures         | Ref | ASHIKA CODE | Description           | OEM         | Measures            |
|-----|-------------|----------------------|-------------|------------------|-----|-------------|-----------------------|-------------|---------------------|
| 1   | 103-01-111  | Axial Joint          | 48521 4U000 | th:MM16X1R L:310 | 5   | 106-01-103  | Stabiliser Link Right | 54618-4U000 | L:65                |
| 2   | 72-01-108   | TCA Left Wbj         | 54501-5U300 |                  | 6   | 73-01-101   | Ball Joint            | 40160-2Y000 | c:15                |
| 3   | 72-01-109   | TCA Right Wbj        | 54500 5U300 |                  | 7   | 111-01-101  | Tie Rod End           | 48520-15U25 | c:12.8 th:FM14X1.5R |
| 4   | 106-01-104  | Stabiliser Link Left | 54668-4U000 | L:65             |     |             |                       |             |                     |

BLUEBIRD (910)

01/1980 - 12/1983

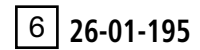
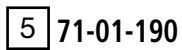
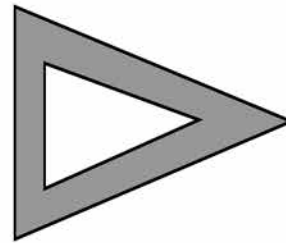
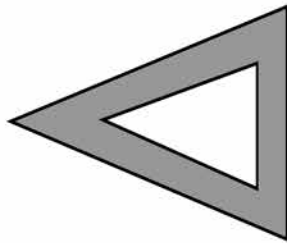
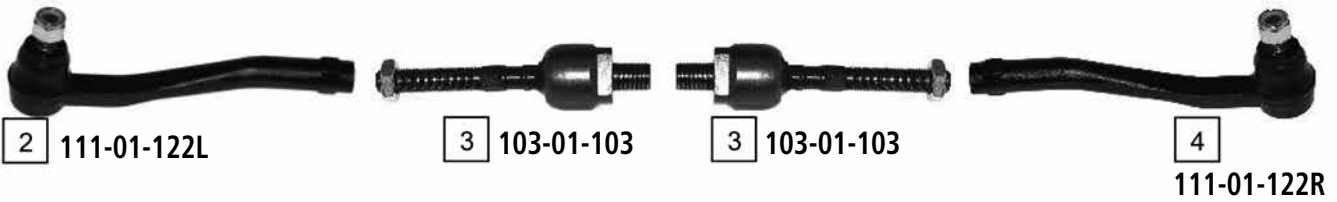

| Ref | ASHIKA CODE | Description      | OEM         | Measures            | Ref | ASHIKA CODE | Description       | OEM         | Measures            |
|-----|-------------|------------------|-------------|---------------------|-----|-------------|-------------------|-------------|---------------------|
| 1   | 53-01-126   | Ball Joint Lower | 40160-W1000 | c:16.2              | 4   | 111-01-122R | Tie Rod End Right | 48520-W1025 | c:13.4 th:FM14X1.5R |
| 2   | 111-01-122L | Tie Rod End      | 48640-W1025 | c:13.4 th:FM14X1.5R | 5   | 71-01-190   | TCA Left          |             |                     |
| 3   | 103-01-103  | Axial Joint      | 48521-01F00 |                     | 6   | 26-01-195   | TCA Right         |             |                     |

BLUEBIRD (U11,WU11,T72)

11/1983 - 05/1990



**2** 106-01-101  
01/1986 ->



**2** 106-01-101  
01/1986 ->



**4** 111-01-109



**3** 103-01-101



**3** 103-01-101



**4**  
111-01-109



**1** 73-01-124

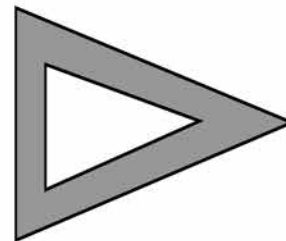
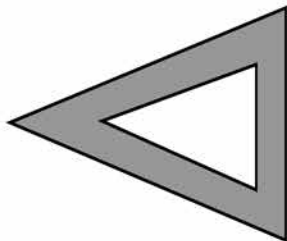

**1** 73-01-124

| Ref | ASHIKA CODE | Description      | OEM         | Measures | Ref | ASHIKA CODE | Description | OEM         | Measures           |
|-----|-------------|------------------|-------------|----------|-----|-------------|-------------|-------------|--------------------|
| 1   | 73-01-124   | Ball Joint Lower | 40160 01E00 | c: 14.9  | 3   | 103-01-101  | Axial Joint | 48521-35F00 | th:MM16X1R L:270   |
| 2   | 106-01-101  | Stabiliser Link  | 54618 50Y00 | L:85.5   | 4   | 111-01-109  | Tie Rod End | 48520-01E25 | c:13 th:FM12X1.25R |

CHERRY (F10,N10)

02/1975 - 05/1982



2 111-01-118

1 103-01-104

1 103-01-104



2  
111-01-118

F10



3 53-01-115

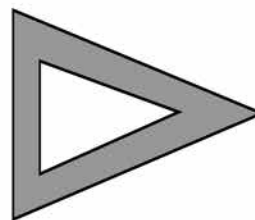
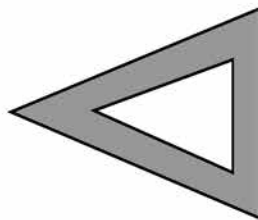

3  
53-01-115

N10



4 53-01-118

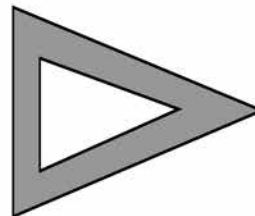
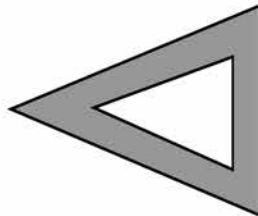

4  
53-01-118

| Ref | ASHIKA CODE | Description | OEM         | Measures            | Ref | ASHIKA CODE | Description      | OEM         | Measures |
|-----|-------------|-------------|-------------|---------------------|-----|-------------|------------------|-------------|----------|
| 1   | 103-01-104  | Axial Joint | -           | -                   | 3   | 53-01-115   | Ball Joint Lower | 40160-M3025 | c:13.2   |
| 2   | 111-01-118  | Tie Rod End | 48520-M0225 | c:13.7 th:FM12X1.25 | 4   | 53-01-118   | Ball Joint Lower | 40160-M7025 | c:13     |

CHERRY (N12)

06/1982 - 07/1987

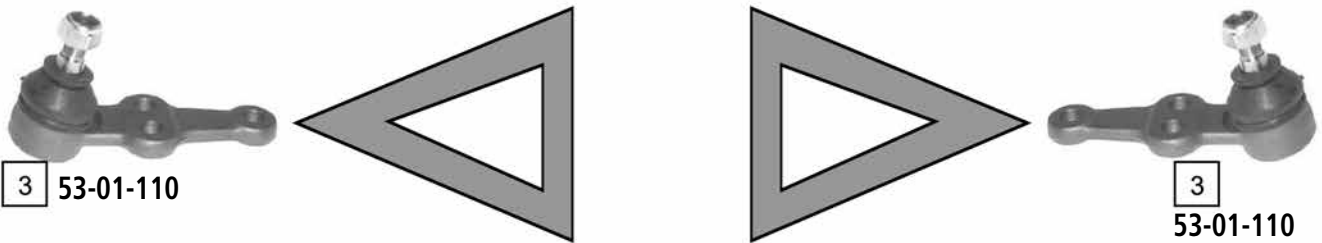
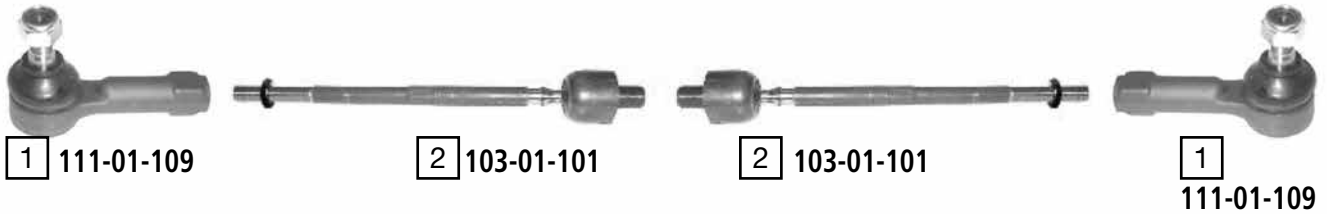

| Ref | ASHIKA CODE | Description | OEM         | Measures           | Ref | ASHIKA CODE | Description      | OEM         | Measures |
|-----|-------------|-------------|-------------|--------------------|-----|-------------|------------------|-------------|----------|
| 1   | 111-01-109  | Tie Rod End | 48520-D010  | c:13 th:FM12X1.25R | 3   | 53-01-110   | Ball Joint Lower | 40160-01A25 | c:13     |
| 2   | 103-01-101  | Axial Joint | 48521-35F00 | th:MM16X1R L:270   |     |             |                  |             |          |

INTERSTAR (X70)

07/2002 ->

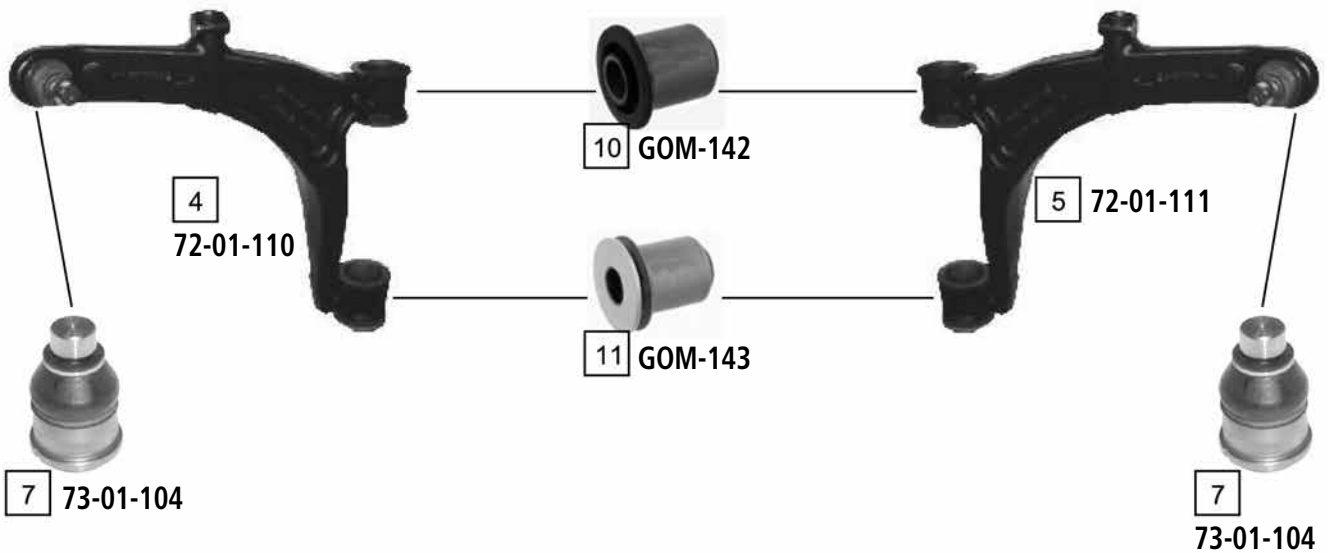

| Ref | ASHIKA CODE | Description           | OEM         | Measures           | Ref | ASHIKA CODE | Description              | OEM         | Measures            |
|-----|-------------|-----------------------|-------------|--------------------|-----|-------------|--------------------------|-------------|---------------------|
| 1   | 106-01-106  | Stabiliser Link Left  | 54616-00QAB | L:127              | 7   | 73-01-104   | Ball Joint Lower         | 54500-00QAC | c:22                |
| 2   | 106-01-105  | Stabiliser Link Right | 54618-00QAA | L:127              | 8   | 111-01-160  | Tie Rod End Left         | 48520-00QAH | c:16.4 th:FM16X1.5R |
| 3   | 103-01-112  | Axial Joint           | 48521-00QAF | th:MM14X1.5R L:175 | 9   | 111-01-161  | Tie Rod End Right        | 48520-00QAJ | c:16.4 th:FM16X1.5R |
| 4   | 72-01-110   | TCA Left              | 54501-00QAC | c:22               | 10  | GOM-142     | Silentblock For Susp.Arm | 54570 00QAA | d:55.2              |
| 5   | 72-01-111   | TCA Right             | 54500-00QAC | c:22               | 11  | GOM-143     | Silentblock For Susp.Arm | 54423 00QAA | d:55.2              |
| 6   | 73-01-103   | Ball Joint Upper      | 45 00 254   | c:16               |     |             |                          |             |                     |

JUKE (F15E)

10/2009 ->

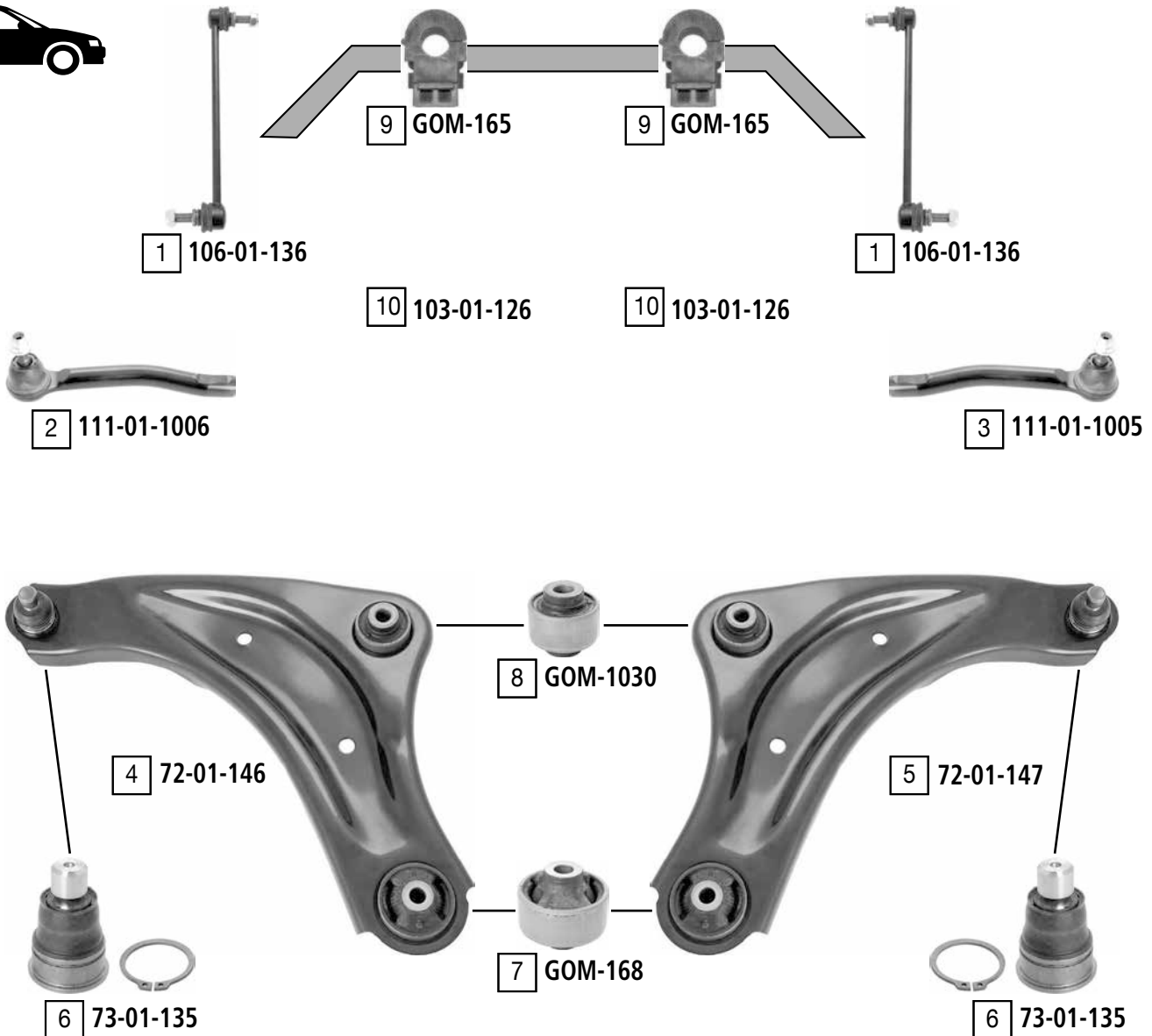

| Ref | ASHIKA CODE | Description       | OEM         | Measures             | Ref | ASHIKA CODE | Description         | OEM         | Measures        |
|-----|-------------|-------------------|-------------|----------------------|-----|-------------|---------------------|-------------|-----------------|
| 1   | 106-01-136  | Stabiliser Link   | 54618 CY00A | L:284                | 6   | 73-01-135   | Ball Joint          | Part of     | c:18 do:38.5    |
| 2   | 111-01-1006 | Tie Rod End Left  | D8640 1KA0A | c:11.9 th:FM12X1.25R | 7   | GOM-168     | Silentblock For TCA | Part of     | di:12.2 do:58   |
| 3   | 111-01-1005 | Tie Rod End Right | D8520 1KA0A | c:11.9 th:FM12X1.25R | 8   | GOM-1030    | Silentblock For TCA | part of     | di:14.2 do:50.1 |
| 4   | 72-01-146   | TCA Left Wbj      | 54501 1KA0B | c:18                 | 9   | GOM-165     | Stabiliser Mounting | 54613 JD03A | di:22.7         |
| 5   | 72-01-147   | TCA Right Wbj     | 54500 1KA0B | c:18                 | 10  | 103-01-126  |                     |             |                 |

KUBISTAR (X76)

07/2003 ->

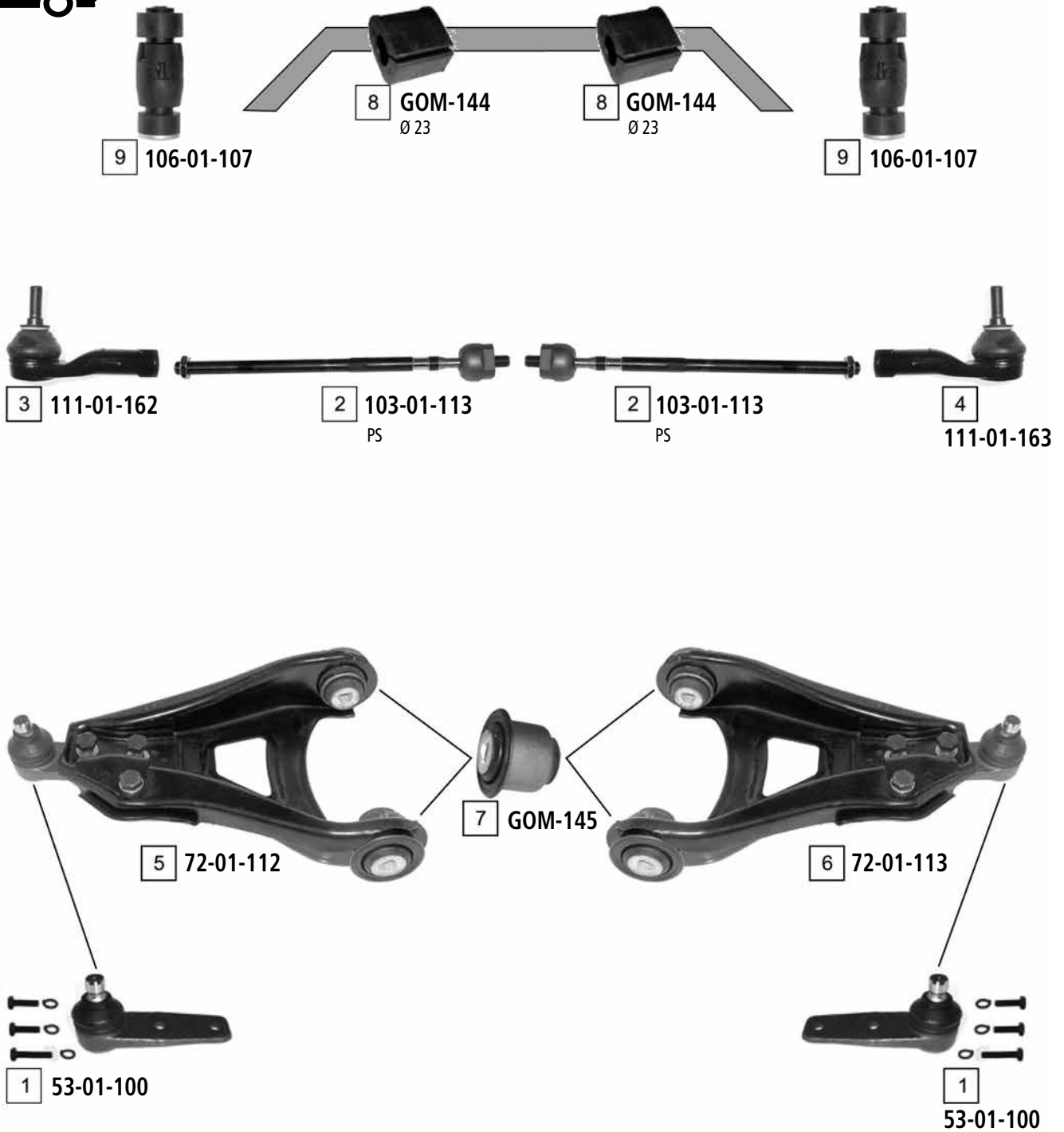

| Ref | ASHIKA CODE | Description      | OEM           | Measures         | Ref | ASHIKA CODE | Description              | OEM         | Measures |
|-----|-------------|------------------|---------------|------------------|-----|-------------|--------------------------|-------------|----------|
| 1   | 53-01-100   | Ball Joint Lower | 77 01 472 038 | c:16             | 6   | 72-01-113   | TCA Left Right           | 54500 00QAH | c:16     |
| 2   | 103-01-113  | Axial Joint      | 48521 00QAG   | th:MM12X1R L:303 | 7   | GOM-145     | Silentblock For Susp.Arm | 54560 00QAB | d:45.4   |
| 3   | 111-01-162  | Tie Rod End      | 48520 00QAN   |                  | 8   | GOM-144     | Stabiliser Mounting      | 54613 00QAD | d:21     |
| 4   | 111-01-163  | Tie Rod End      | 48520 00QAP   |                  | 9   | 106-01-107  | Stabiliser Mounting      | 54616 00QAA |          |
| 5   | 72-01-112   | TCA Left         | 54501 00QAH   | c:16             |     |             |                          |             |          |



LAUREL (C31, C32)

01/1981 - 06/1990



-> 10/1984



5 111-01-117

5 111-01-117



1 111-01-130

1  
111-01-130

11/1984 ->



3 111-01-148



2 103-01-103



2 103-01-103



3  
111-01-148



4 73-01-195

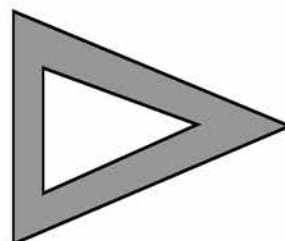
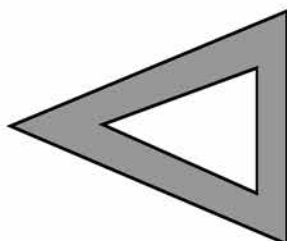

4  
73-01-195

| Ref | ASHIKA CODE | Description | OEM         | Measures            | Ref | ASHIKA CODE | Description      | OEM         | Measures |
|-----|-------------|-------------|-------------|---------------------|-----|-------------|------------------|-------------|----------|
| 1   | 111-01-130  | Tie Rod End | 48520-01L25 | c:13.5 th:MM14X1.5L | 4   | 73-01-195   | Ball Joint Lower | 40160-41L00 | c:16.2   |
| 2   | 103-01-103  | Axial Joint | 48521-01F00 |                     | 5   | 111-01-117  | Tie Rod End      |             |          |
| 3   | 111-01-148  | Tie Rod End | 48520-41L00 | c:13.6 th:FM14X1.5R |     |             |                  |             |          |

MAXIMA (J30)

10/1988 - 09/1994



4 106-01-101



4 106-01-101



3 111-01-174



2 111-01-180



2 111-01-180



3 111-01-174



1 73-01-124

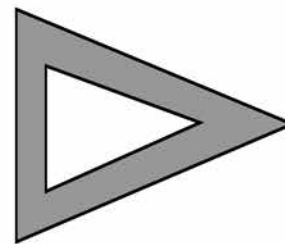
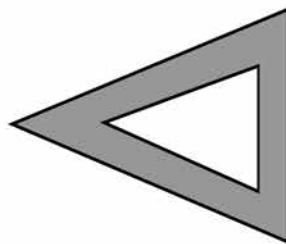

1 73-01-124

| Ref | ASHIKA CODE | Description      | OEM         | Measures         | Ref | ASHIKA CODE | Description     | OEM         | Measures          |
|-----|-------------|------------------|-------------|------------------|-----|-------------|-----------------|-------------|-------------------|
| 1   | 73-01-124   | Ball Joint Lower | 40160 01E00 | c:14.9           | 3   | 111-01-174  | Tie Rod End     | 48520-88E25 | c:11 th:FM14X1.5R |
| 2   | 111-01-180  | Axial Joint      | 48521-72E06 | th:MM16X1R L:260 | 4   | 106-01-101  | Stabiliser Link | 54618 50Y00 | L:85.5            |

# NISSAN MAXIMA



MAXIMA QX (A32)

10/1994 - 08/2000

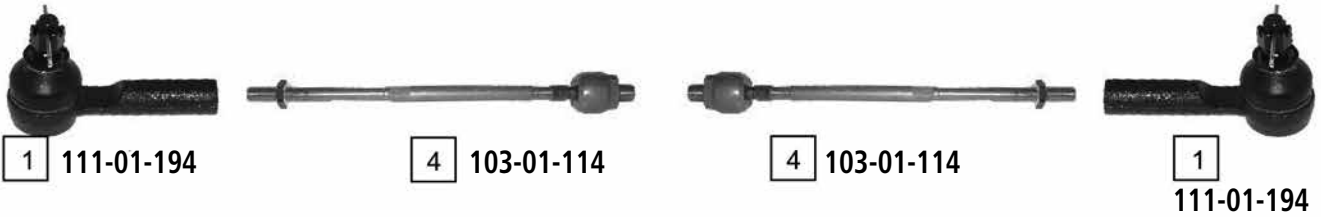

| Ref | ASHIKA CODE | Description | OEM         | Measures            | Ref | ASHIKA CODE | Description     | OEM         | Measures         |
|-----|-------------|-------------|-------------|---------------------|-----|-------------|-----------------|-------------|------------------|
| 1   | 111-01-194  | Tie Rod End | 48520-0M085 | c:12.85 th:FM14X1.5 | 4   | 103-01-114  | Axial Joint     | 48521-40U25 | th:MM16X1R L:312 |
| 2   | 72-01-114   | TCA Left    | 54501-41001 | c:17                | 5   | 106-01-108  | Stabiliser Link | 54618-0E000 | L:98             |
| 3   | 72-01-115   | TCA Right   | 54500-41000 | c:17                |     |             |                 |             |                  |

MICRA (K10)

12/1982 - 11/1992

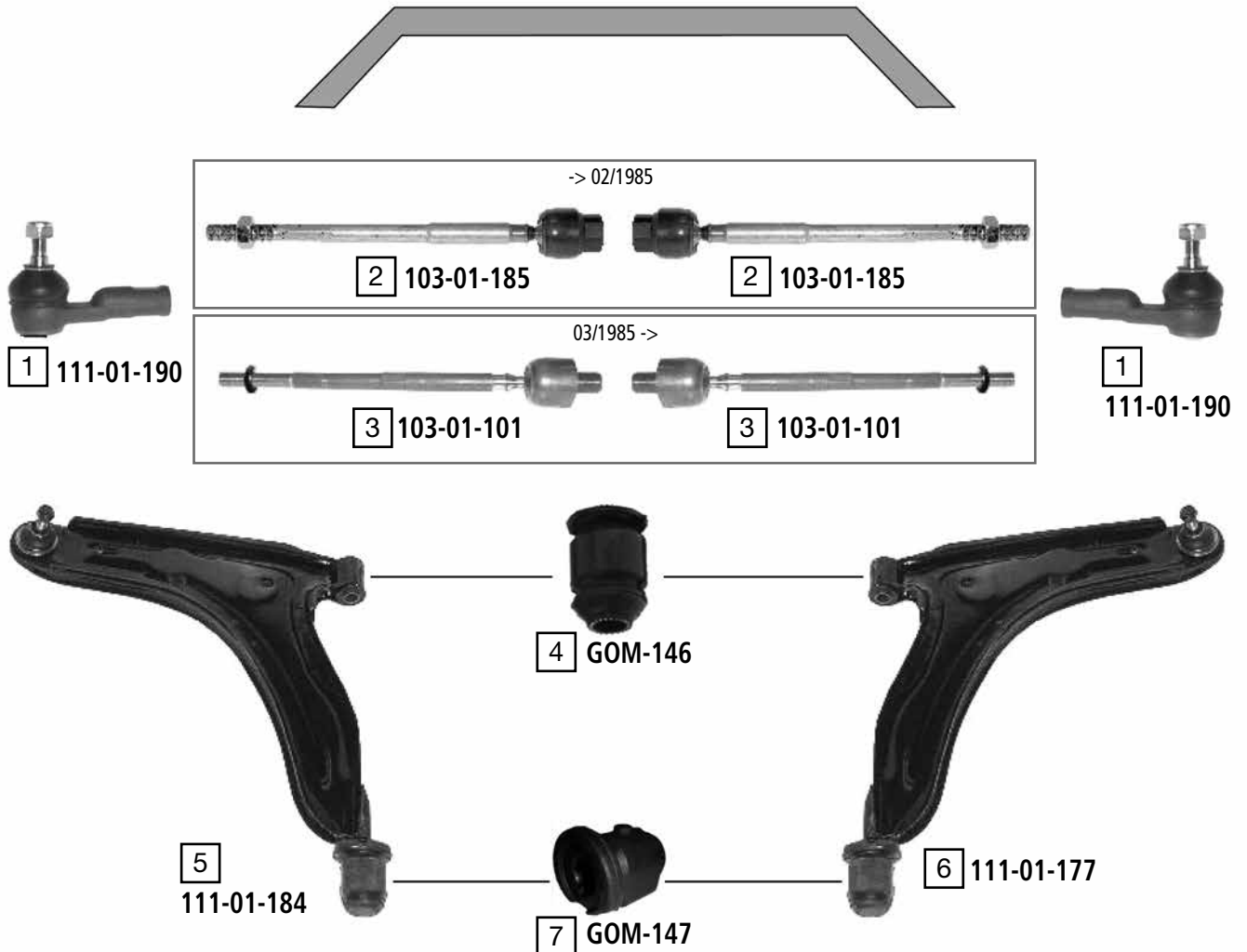

| Ref | ASHIKA CODE | Description              | OEM         | Measures           | Ref | ASHIKA CODE | Description              | OEM         | Measures |
|-----|-------------|--------------------------|-------------|--------------------|-----|-------------|--------------------------|-------------|----------|
| 1   | 111-01-190  | Tie Rod End              | 48520-01B25 | c:11 th:FM12X1.25R | 5   | 111-01-184  | TCA Left                 | 54501 21B00 | c:11.7   |
| 2   | 103-01-185  | Axial Joint              | 48521-17B00 | th:FM18X1R L:270   | 6   | 111-01-177  | TCA Right                | 54500 21B00 | c:11.7   |
| 3   | 103-01-101  | Axial Joint              | 48521-35F00 | th:MM16X1R L:270   | 7   | GOM-147     | Silentblock For Susp.Arm | 54476 01B00 |          |
| 4   | GOM-146     | Silentblock For Susp.Arm | 54535 01B00 | d:27.2             | 8   | 106-01-198  | Stabiliser Link          | 45261-4F702 | L:90     |

MICRA (K11)

03/1993 - 08/2002

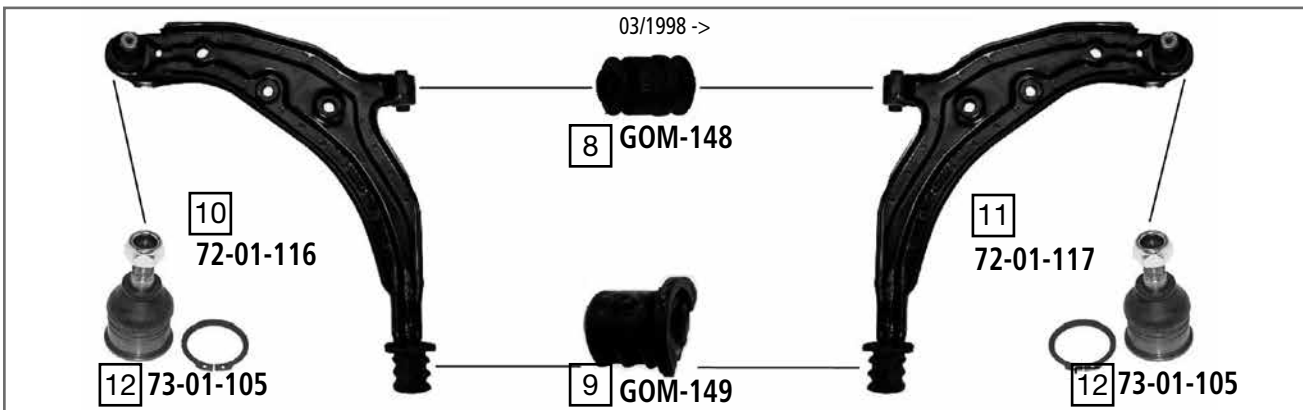
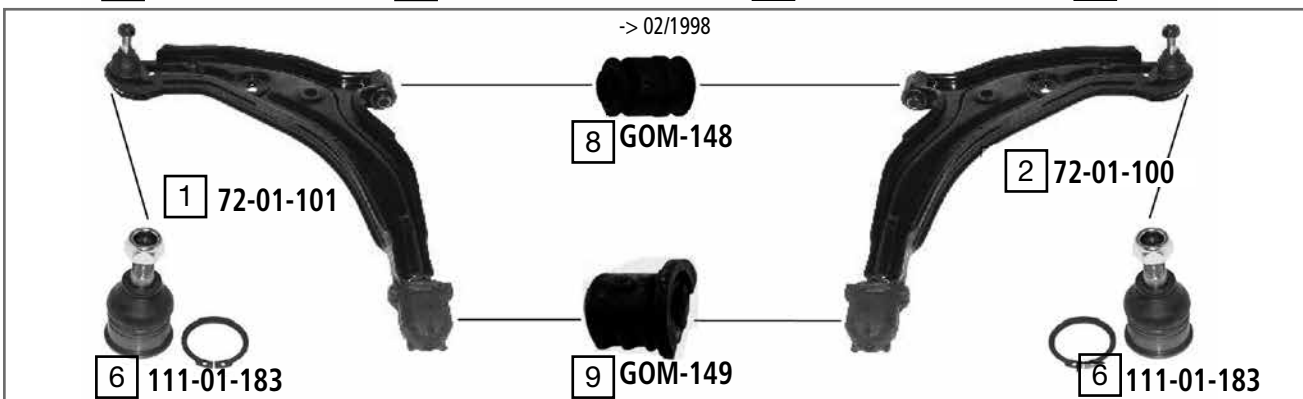

| Ref | ASHIKA CODE | Description     | OEM         | Measures            | Ref | ASHIKA CODE | Description              | OEM  | Measures         |
|-----|-------------|-----------------|-------------|---------------------|-----|-------------|--------------------------|--|------------------|
| 1   | 72-01-101   | TCA Left        | 54501 4F102 | c:12.4              | 7   | 103-01-101  | Axial Joint              | 48521-35F00  | th:MM16X1R L:270 |
| 2   | 72-01-100   | TCA Right       | 54500 4F102 | c:12.4              | 8   | GOM-148     | Silentblock For Susp.Arm | Part of 72-01-101/72-01-100<br>72-01-116/72-01-117 | d:28.3           |
| 3   | 111-01-181  | Tie Rod End     | 48520-4F125 | c:10.9 th:FM12X1.25 | 9   | GOM-149     | Silentblock For Susp.Arm | Part of 72-01-101/72-01-100<br>72-01-116/72-01-117 |                  |
| 4   | 106-01-198  | Stabiliser Link | 45261-4F702 | L:90                | 10  | 72-01-116   | TCA Left                 | 54501 6F600  | c:13.1           |
| 5   | 106-01-109  | Stabiliser Link | 56261-47B01 |                     | 11  | 72-01-117   | TCA Right                | 54500 6F600  | c:13.1           |
| 6   | 111-01-183  | Ball Joint      | 40160-4F100 | c:12.4              | 12  | 73-01-105   | Ball Joint               | Part of 72-01-116/72-01-117                        | c:13.1           |

MICRA (K12)

11/2002 ->

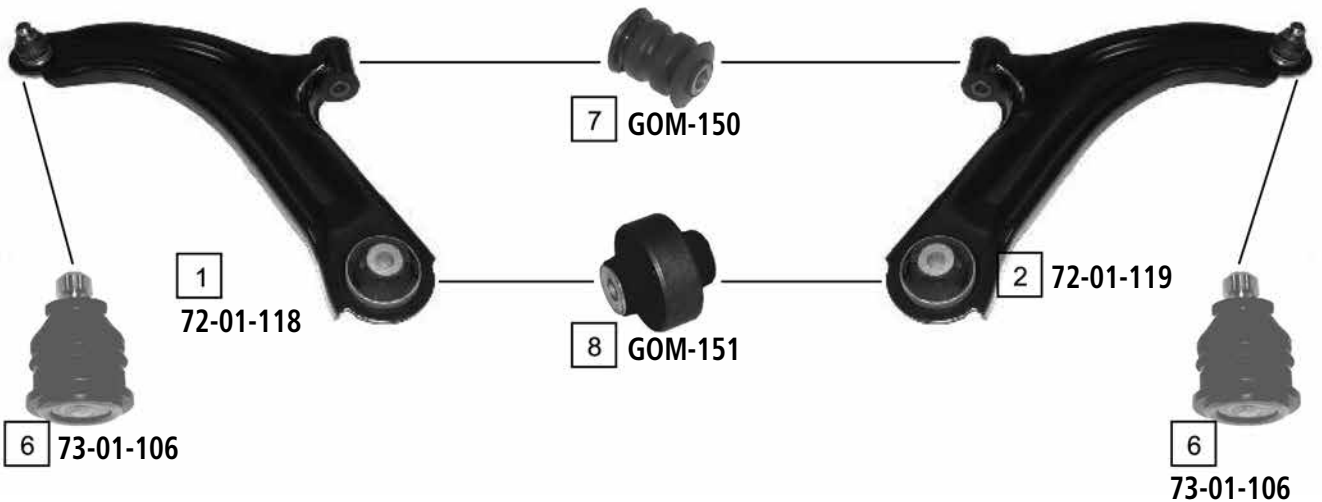
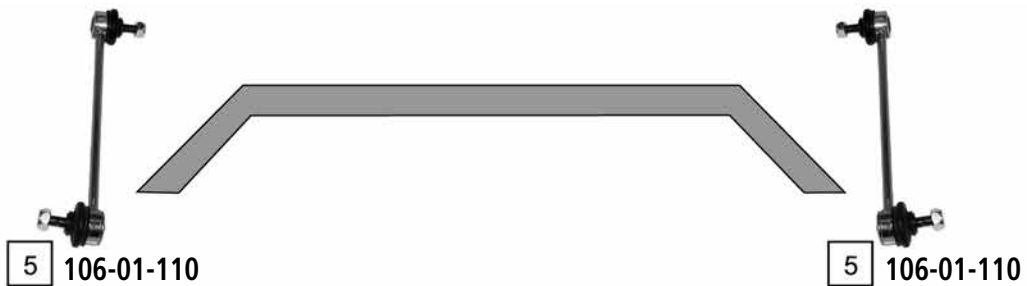

| Ref | ASHIKA CODE | Description       | OEM         | Measures            | Ref | ASHIKA CODE | Description              | OEM                         | Measures |
|-----|-------------|-------------------|-------------|---------------------|-----|-------------|--------------------------|-----------------------------|----------|
| 1   | 72-01-118   | TCA Left          | 54501 AX600 | c:16                | 5   | 106-01-110  | Stabiliser Link          | 54618-AX600                 | L:248    |
| 2   | 72-01-119   | TCA Right         | 54500 AX600 | c:16                | 6   | 73-01-106   | Ball Joint               | Part of 72-01-118/72-01-119 | c:16     |
| 3   | 111-01-164  | Tie Rod End Left  | 48640 AX600 | c:11.7 th:FM14X1.5R | 7   | GOM-150     | Silentblock For Susp.Arm | 54560 AX600                 | d:36.1   |
| 4   | 111-01-165  | Tie Rod End Right | 48520 AX600 | c:11.7 th:FM14X1.5R | 8   | GOM-151     | Silentblock For Susp.Arm | Part of 72-01-118/72-01-119 | d:58.4   |

NAVARA (D40M)

07/2005 ->

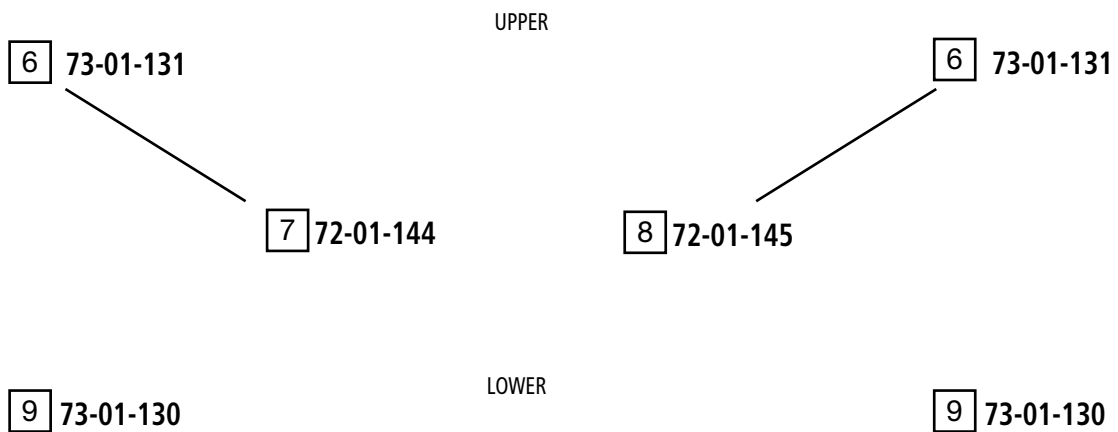
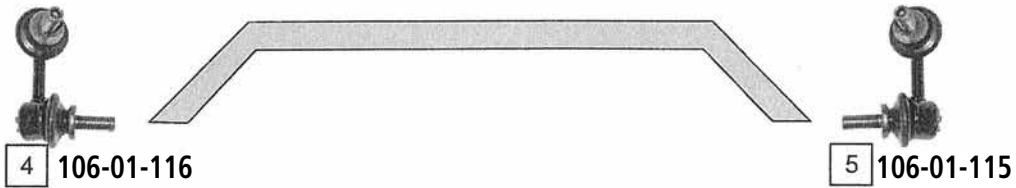

| Ref | ASHIKA CODE | Description           | OEM         | Measures            | Ref | ASHIKA CODE | Description | OEM         | Measures |
|-----|-------------|-----------------------|-------------|---------------------|-----|-------------|-------------|-------------|----------|
| 1   | 111-01-150  | Tie Rod End Left      | 48520 EA01J | c:14.9 th:FM16X1.5R | 6   | 73-01-131   | Ball Joint  | 40110 EB300 |          |
| 2   | 111-01-179  | Tie Rod End Right     | 48640 EA01J | c:14.9 th:FM16X1.5R | 7   | 72-01-144   | TCA Left    | 54525 EB300 |          |
| 3   | 103-01-116  | Axial Joint           | 48521 EA000 | th:MM20X1R          | 8   | 72-01-145   | TCA Right   | 54524 EB300 |          |
| 4   | 106-01-116  | Stabiliser Link Left  | 54668 EA010 | -                   | 9   | 73-01-130   | Ball Joint  | 40160 EA00A |          |
| 5   | 106-01-115  | Stabiliser Link Right | 54618 EA010 | -                   |     |             |             |             |          |

NOTE (E11)

03/2006 ->

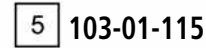
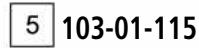

| Ref | ASHIKA CODE | Description      | OEM         | Measures            | Ref | ASHIKA CODE | Description              | OEM                         | Measures |
|-----|-------------|------------------|-------------|---------------------|-----|-------------|--------------------------|-----------------------------|----------|
| 1   | 72-01-118   | TCA Left         | 54501 AX600 | c:16                | 6   | 106-01-111  | Stabiliser Link          | 54618 9U00A                 | L:255    |
| 2   | 72-01-119   | TCA Right        | 54500 AX600 | c:16                | 7   | 73-01-106   | Ball Joint               | Part of 72-01-118/72-01-119 | c:16     |
| 3   | 111-01-166  | Tie Rod End Left | 486471U61A  | c:11.8 th:FM12X1.25 | 8   | GOM-150     | Silentblock For Susp.Arm | 54560-AX600                 | d:36.1   |
| 4   | 111-01-167  | Tie Rod End Left | 48527 1U61A | c:11.8 th:FM12X1.25 | 9   | GOM-151     | Silentblock For Susp.Arm | Part of 72-01-118/72-01-119 | d:58.4   |
| 5   | 103-01-115  | Axial Joint      | Part of     | -                   | 10  | GOM-152     | Stabiliser Mounting      | 54613 9U000                 | d:21     |



# NISSAN PATHFINDER



PATHFINDER (R50)

01/10/1997 ->

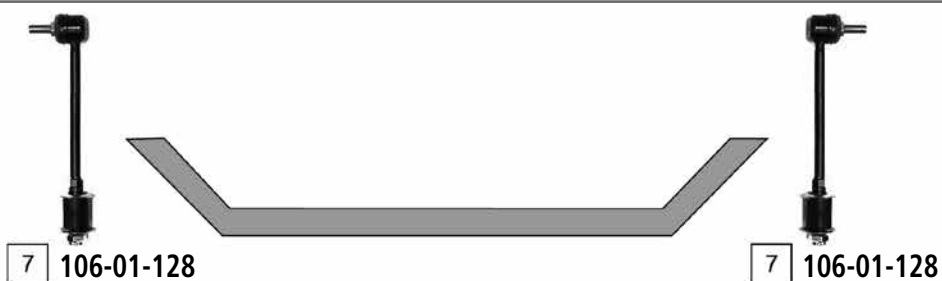
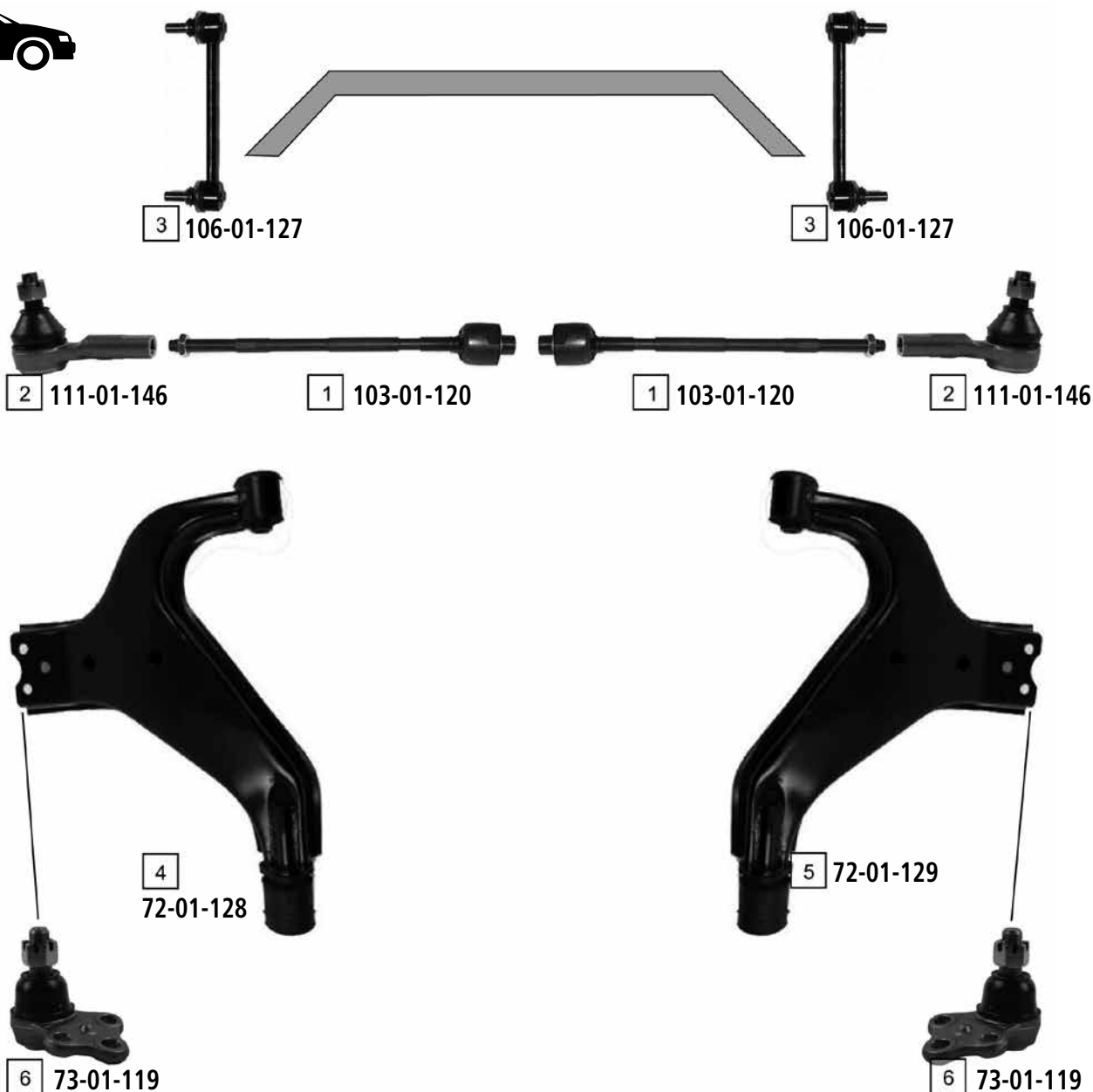

| Ref | ASHIKA CODE | Description     | OEM         | Measures            | Ref | ASHIKA CODE | Description     | OEM         | Measures |
|-----|-------------|-----------------|-------------|---------------------|-----|-------------|-----------------|-------------|----------|
| 1   | 103-01-120  | Axial Joint     | 48521 0W025 | th:MM20X1.5R L:328  | 5   | 72-01-129   | TCA Right       | 54500 0W001 |          |
| 2   | 111-01-146  | Tie Rod End     | 48520 0W025 | c:14.8 th:FM14X1.5R | 6   | 73-01-119   | Ball Joint      | 40160 0W025 | c:17     |
| 3   | 106-01-127  | Stabiliser Link | 54618 0W001 | L:190               | 7   | 106-01-128  | Stabiliser Link | 56260 0W001 | L:163    |
| 4   | 72-01-128   | TCA Left        | 54501 0W001 |                     |     |             |                 |             |          |

PATHFINDER (R51M)

01/2005 ->

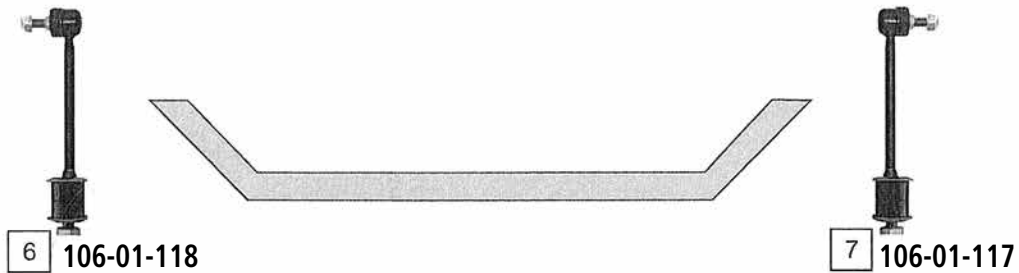
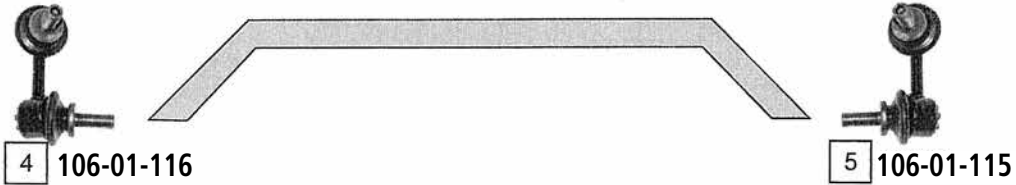

| Ref | ASHIKA CODE | Description          | OEM         | Measures            | Ref | ASHIKA CODE | Description           | OEM         | Measures |
|-----|-------------|----------------------|-------------|---------------------|-----|-------------|-----------------------|-------------|----------|
| 1   | 111-01-150  | Tie Rod End Left     | 48520 EA01J | c:14.9 th:FM16X1.5R | 5   | 106-01-115  | Stabiliser Link Right | 54618 EA010 | -        |
| 2   | 111-01-179  | Tie Rod End Right    | 48640 EA01J | c:14.9 th:FM16X1.5R | 6   | 106-01-118  | Stabiliser Link Left  | 56261 EA510 | -        |
| 3   | 103-01-116  | Axial Joint          | 48521 EA000 | th:MM20X1R          | 7   | 106-01-117  | Stabiliser Link Right | 56261 EA500 | -        |
| 4   | 106-01-116  | Stabiliser Link Left | 54668 EA010 | -                   |     |             |                       |             |          |

PATROL R (160)

11/1979 - 08/1988



**2**  
111-01-110L



**1**  
111-01-110R



**1**  
111-01-110R



**2**  
111-01-110L

**3** 111-01-152

**3** 111-01-152

**4** 111-0N-N006

**5** 111-0N-N005

**6** 111-0N-N007

**7** 111-0N-N008

**8** 111-0N-N010

**9** 111-0N-N009

| Ref | ASHIKA CODE | Description | OEM         | Measures            | Ref | ASHIKA CODE | Description | OEM         | Measures |
|-----|-------------|-------------|-------------|---------------------|-----|-------------|-------------|-------------|----------|
| 1   | 111-01-110R | Tie Rod End | 48580-J5100 | c:15.8 th:MM22X1.5L | 6   | 111-0N-N007 | Tie Rod End |             |          |
| 2   | 111-01-110L | Tie Rod End | 48570-J5100 | c:15.8 th:MM22X1.5R | 7   | 111-0N-N008 | Tie Rod End |             |          |
| 3   | 111-01-152  | Tie Rod End | 4857011J00  |                     | 8   | 111-0N-N010 | Tie Rod End | 48520-G9502 |          |
| 4   | 111-0N-N006 | Tie Rod End |             |                     | 9   | 111-0N-N009 | Tie Rod End | 48570-G9501 |          |
| 5   | 111-0N-N005 | Tie Rod End |             |                     |     |             |             |             |          |

PATROL GR (Y60)

08/1987 - 09/1997



**3** 106-01-112

**4** 111-01-158  
-> 06/1992



**3** 106-01-112

**4** 111-01-158  
-> 06/1992



**1** 111-01-172

**5** 111-0N-N011  
-> 07/1989

**6** 111-0N-N012  
08/1989 ->



**2**  
111-01-173



**3** 106-01-112



**3** 106-01-112

| Ref | ASHIKA CODE | Description       | OEM         | Measures | Ref | ASHIKA CODE | Description    | OEM        | Measures |
|-----|-------------|-------------------|-------------|----------|-----|-------------|----------------|------------|----------|
| 1   | 111-01-172  | Tie Rod End Left  | 48570 01J10 |          | 4   | 111-01-158  | Tie Rod End    | 4852001J00 |          |
| 2   | 111-01-173  | Tie Rod End Right | 48520 01J10 |          | 5   | 111-0N-N011 | Cross Rod Assi | 4856049502 |          |
| 3   | 106-01-112  | Stabiliser Link   | 56260 01J10 | L:130    | 6   | 111-0N-N012 | Cross Rod Assi |            |          |

PICK-UP 2X4 (D21)

08/1985 - 02/1998



UPPER

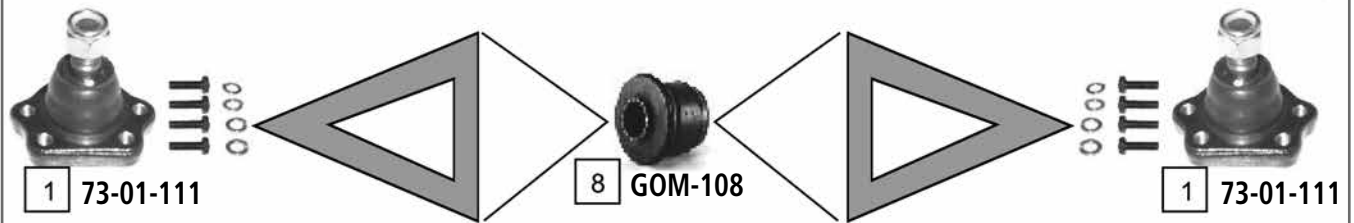

LOWER



| Ref | ASHIKA CODE | Description       | OEM         | Measures            | Ref | ASHIKA CODE | Description              | OEM         | Measures |
|-----|-------------|-------------------|-------------|---------------------|-----|-------------|--------------------------|-------------|----------|
| 1   | 73-01-111   | Ball Joint        | 40110 01G00 | c:16.1              | 7   | 71-01-101   | TCA Right                | 54502-01G90 | c:19.65  |
| 2   | 111-01-139  | Tie Rod End       | 48520-01G25 | c:13.3 th:MM18X1.5L | 8   | GOM-108     | Silentblock For Susp.Arm | 54506-B9500 | d:41.1   |
| 3   | 111-01-141  | Tie Rod End Inner | 48521-01G25 | c:13.2 th:MM18X1.5R | 9   | 27-01-113   | Cross Rod                | 4856009G25  |          |
| 4   | 106-01-113  | Stabiliser Link   | 54618 01G00 | L:195               | 10  | 59-01-118   | Pitman Arm               | 4853001G25  |          |
| 5   | 53-01-190   | Ball Joint Lower  | 40160 01G25 | c:19.5              | 11  | 105-01-115  | Tie Rod                  | 4851001G025 |          |
| 6   | 71-01-100   | TCA Left          | 54503-01G90 | c:19.65             |     |             |                          |             |          |

PICK-UP 4X4 (D21)

08/1985 - 02/1998

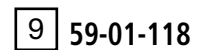
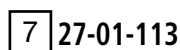
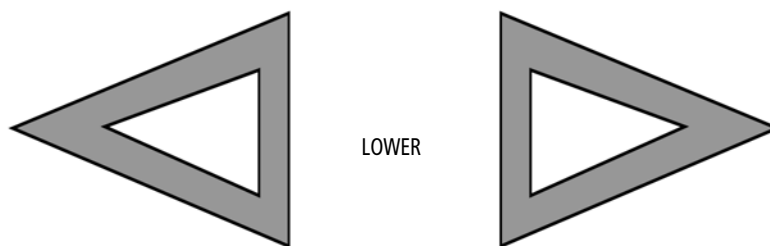
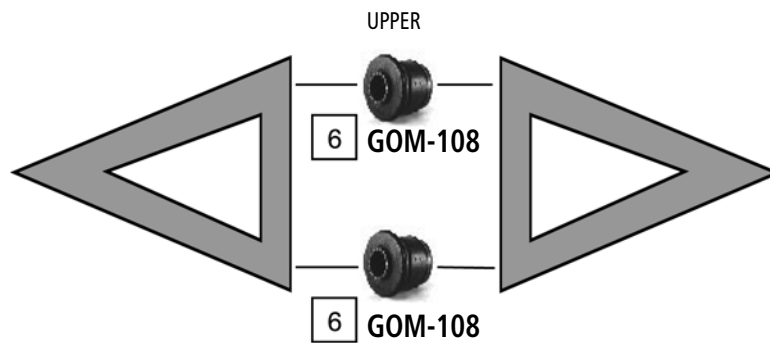
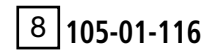
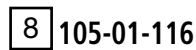
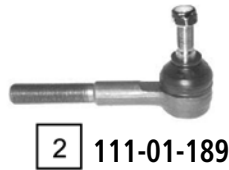
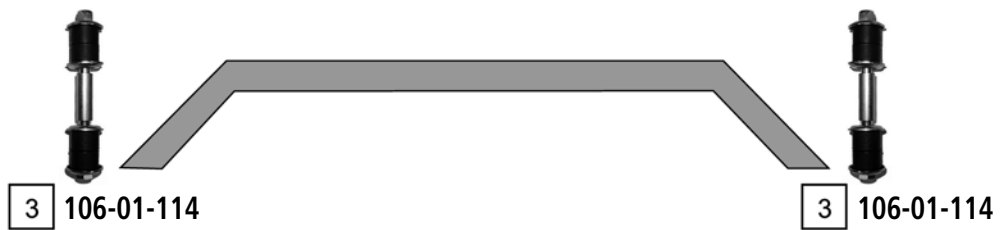

| Ref | ASHIKA CODE | Description       | OEM         | Measures            | Ref | ASHIKA CODE | Description              | OEM         | Measures |
|-----|-------------|-------------------|-------------|---------------------|-----|-------------|--------------------------|-------------|----------|
| 1   | 111-01-142  | Tie Rod End Outer | 48520 31G25 | c:13.2 th:MM16X1.5R | 6   | GOM-108     | Silentblock For Susp.Arm | 54506-B9500 | d:41.1   |
| 2   | 111-01-189  | Tie Rod End Inner | 48520 7F001 | c:13.3 th:MM16X1.5L | 7   | 27-01-113   | Cross Road               | 48560 09G25 |          |
| 3   | 106-01-114  | Stabiliser Link   | 54618 02E00 | L:140               | 8   | 105-01-116  | Tie Rod                  | 48510 31G25 |          |
| 4   | 53-01-121   | Ball Joint Lower  | 40160 0F000 | c:19.5              | 9   | 59-01-118   | Pitman Arm               | 48530 01G25 |          |
| 5   | 73-01-111   | Ball Joint        | 40110 01G00 | c:16.1              |     |             |                          |             |          |

PICK-UP (D22) KING CAB

09/1998 ->

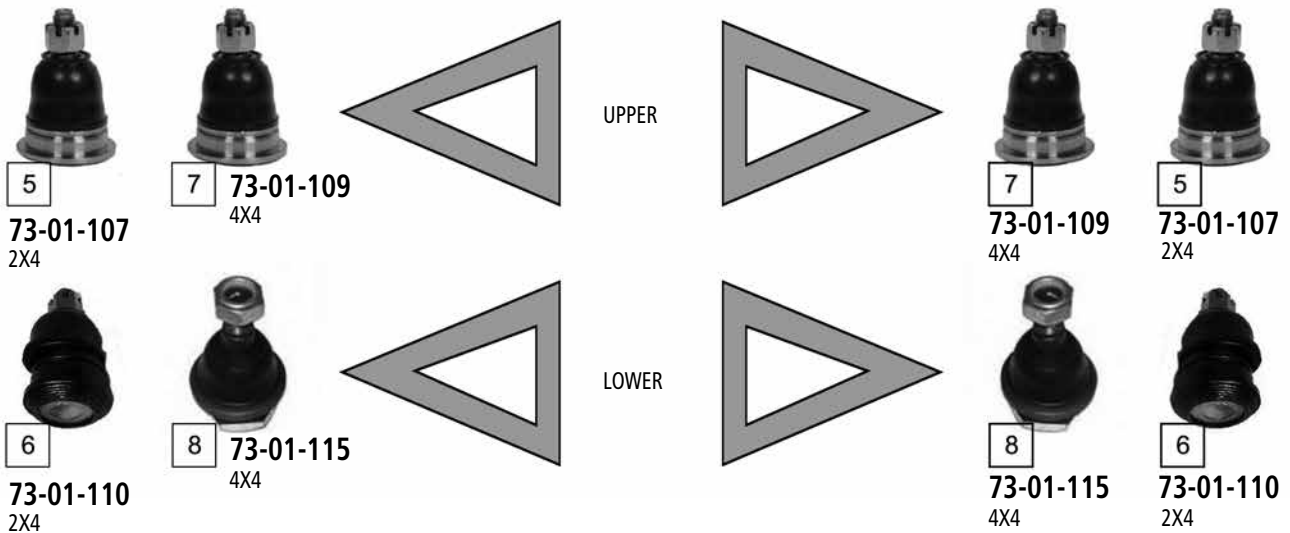
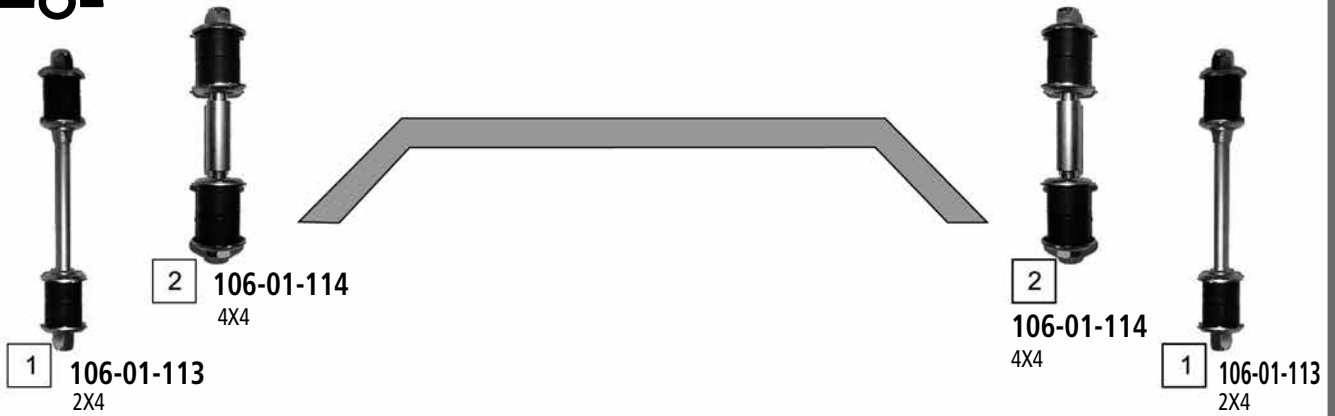

| Ref | ASHIKA CODE | Description       | OEM         | Measures             | Ref | ASHIKA CODE | Description       | OEM         | Measures |
|-----|-------------|-------------------|-------------|----------------------|-----|-------------|-------------------|-------------|----------|
| 1   | 106-01-113  | Stabiliser Link   | 54618 01G00 | L: 195               | 6   | 73-01-110   | Ball Joint        | 40160 2S485 | -        |
| 2   | 106-01-114  | Stabiliser Link   | 54618 02E00 | L: 140               | 7   | 73-01-109   | Ball Joint        | 40110 2S685 | -        |
| 3   | 111-01-146  | Tie Rod End       | 48520 0W025 | c: 14.8 th:FM14x1.5R | 8   | 73-01-115   | Ball Joint        | 40160 2S601 | -        |
| 4   | 111-01-123  | Tie Rod End Inner | 48570 3S525 | -                    | 9   | 111-01-111  | Tie Rod End Inner | 48521 2S425 | -        |
| 5   | 73-01-107   | Ball Joint        | 40110 2S485 | -                    | 10  | 111-01-138  | Tie Rod End Outer | 48520 2S425 | -        |

PIXO (UA0)

06/2009 ->

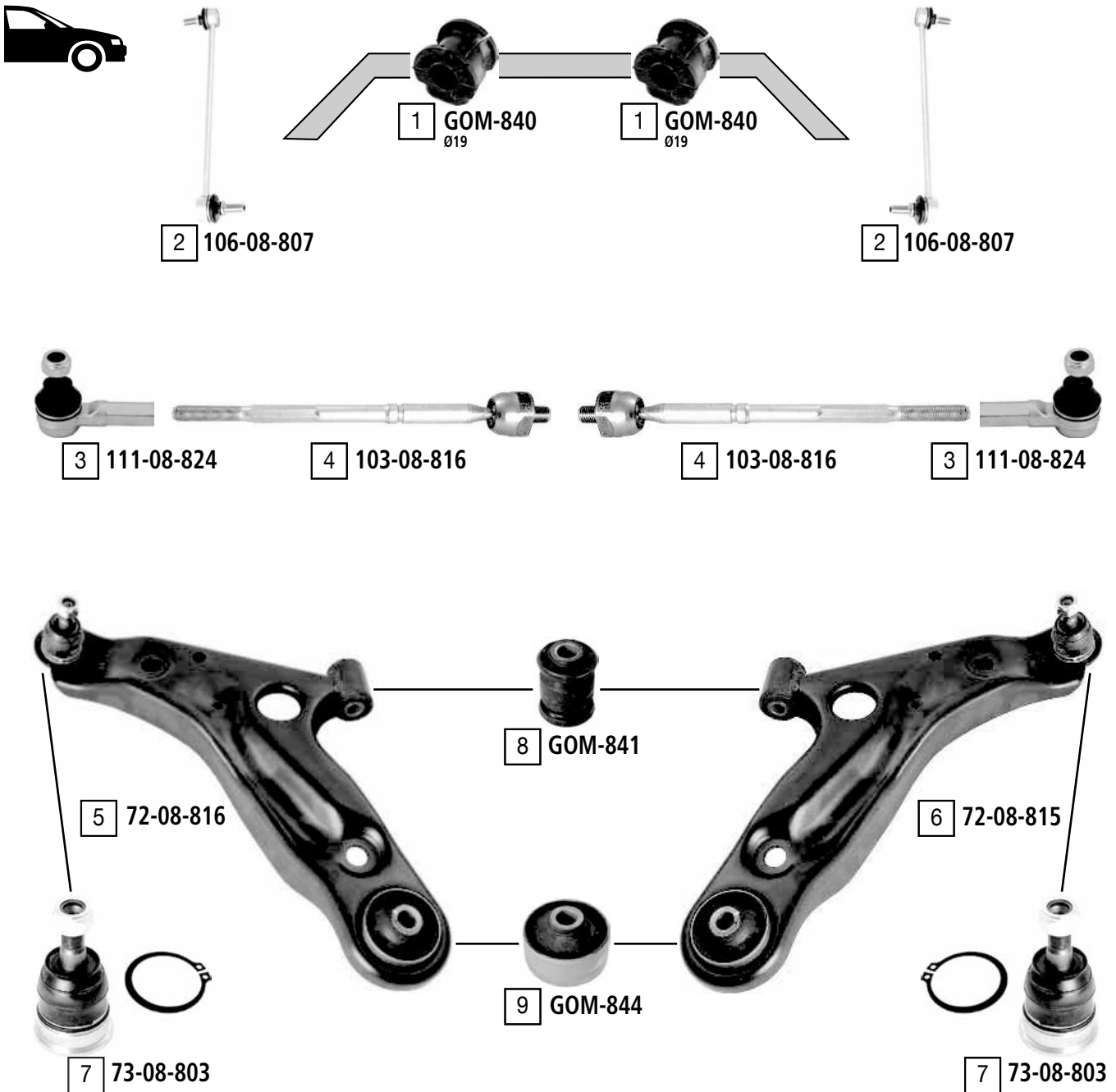

| Ref | ASHIKA CODE | Description         | OEM          | Measures             | Ref | ASHIKA CODE | Description         | OEM         | Measures        |
|-----|-------------|---------------------|--------------|----------------------|-----|-------------|---------------------|-------------|-----------------|
| 1   | GOM-840     | Stabiliser mounting | 54614M-4A00B | di:19                | 6   | 72-08-815   | TCA right wbj       | 54530 4A00D | c:13.4          |
| 2   | 106-08-807  | Stabiliser link     | 54616 4A00B  | L:282                | 7   | 73-08-803   | Ball joint          | 54529 4A00A | c:13.4 do:40.3  |
| 3   | 111-08-824  | Tie rod end         | 48520 4A00B  | c:13 th:FM12x1.25R   | 8   | GOM-841     | Silentblock for TCA | 54423 4A00B | di:12.1 do:33.4 |
| 4   | 103-08-816  | Axial joint         | 48510 4A00C  | th:MM14x1.5R L:272.5 | 9   | GOM-844     | Silentblock for TCA | part of     | di:12.4 do:54.1 |
| 5   | 72-08-816   | TCA left wbj        | 54529 4A00D  | c:13.4               |     |             |                     |             |                 |



PRAIRIE (M10, NM10)  
PRAIRIE PRO (M11)

01/1983 - 10/1998  
10/1988 - 07/1994



4X4



2X4



-> 10/1988

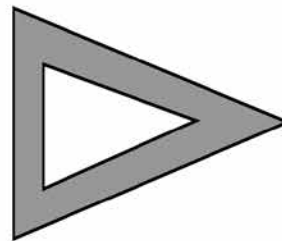
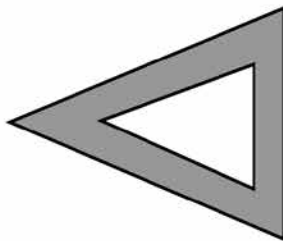

10/1988 ->

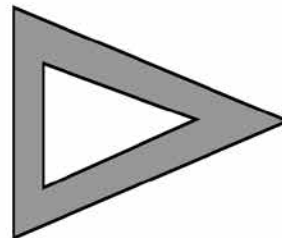
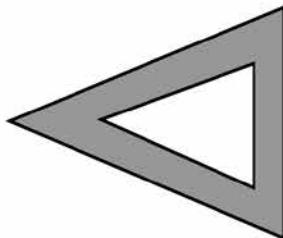

| Ref | ASHIKA CODE | Description      | OEM         | Measures         | Ref | ASHIKA CODE | Description      | OEM         | Measures           |
|-----|-------------|------------------|-------------|------------------|-----|-------------|------------------|-------------|--------------------|
| 1   | 111-01-180  | Axial Joint      | 48521-72E06 | th:MM16X1R L:260 | 4   | 111-01-185  | Tie Rod End      | 48520 53E25 | c:13 th:FM12X1.25R |
| 2   | 106-01-101  | Stabiliser Link  | 54618 50Y00 | L:85.5           | 5   | 73-01-124   | Ball Joint Lower | 40160 01E00 | c:14.9             |
| 3   | 53-01-110   | Ball Joint Lower | 40160-01A25 | c:13             | 6   | 103-01-101  | Axial Joint      | 48521-35F00 | th:MM16X1R L:270   |

PRIMASTAR (X83)

03/2001 ->

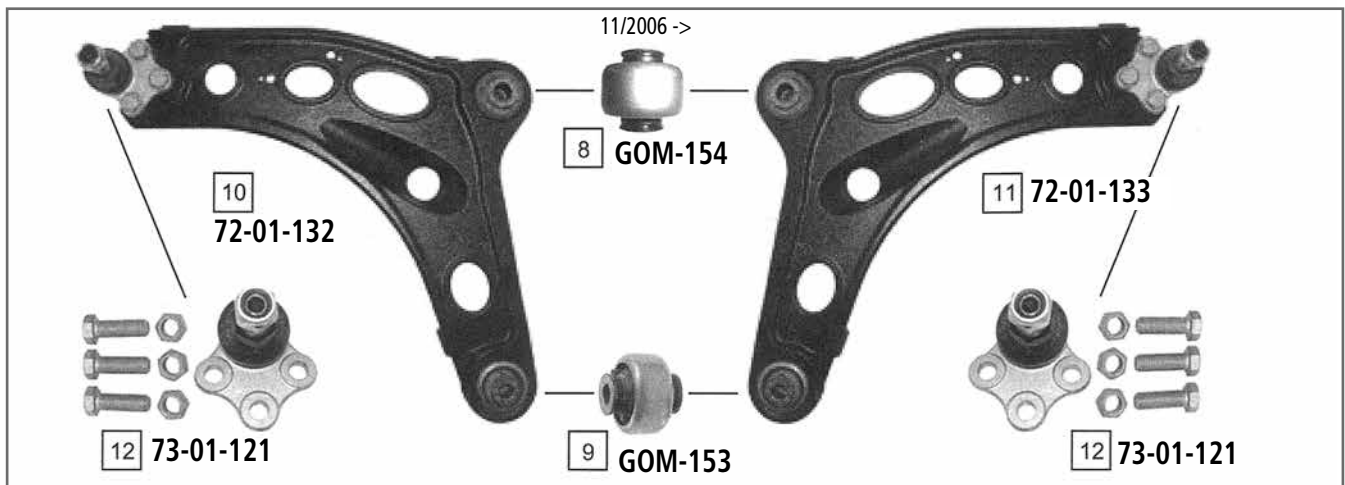
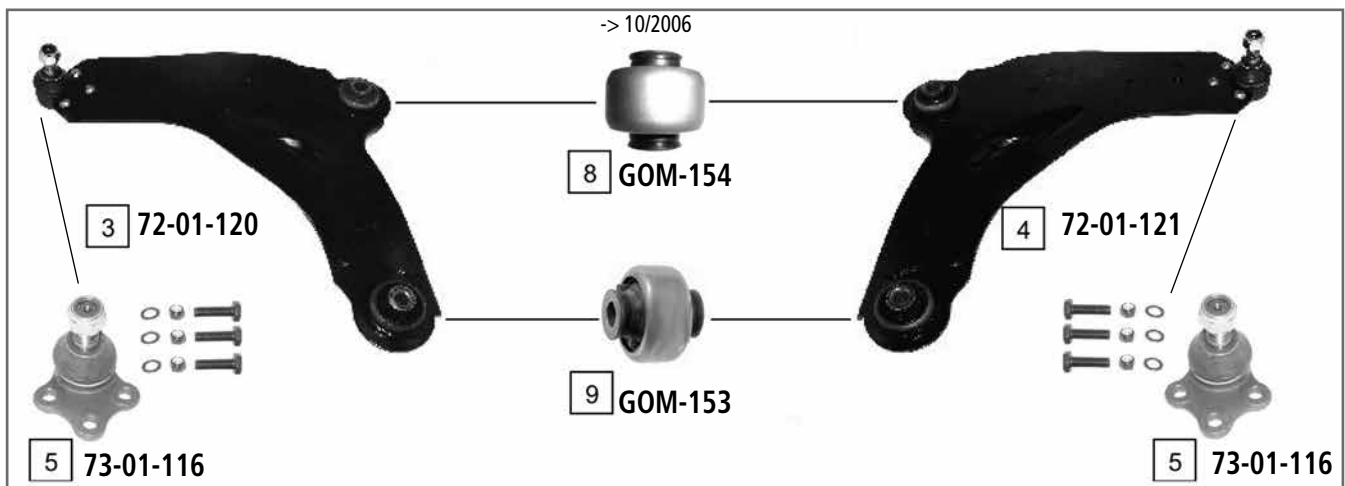
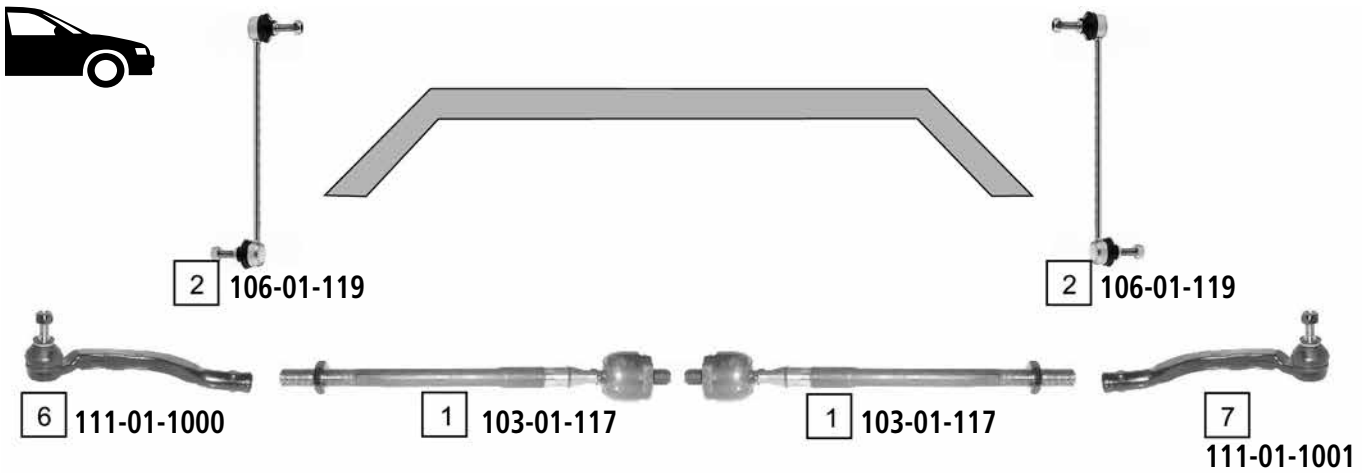

| Ref | ASHIKA CODE | Description      | OEM                   | Measures          | Ref | ASHIKA CODE | Description              | OEM                           | Measures          |
|-----|-------------|------------------|-----------------------|-------------------|-----|-------------|--------------------------|-------------------------------|-------------------|
| 1   | 103-01-117  | Axial Joint      | 48520-00QAM           | th:MM12X1R L:263  | 7   | 111-01-1001 | Tie Rod End Right        | 48520-00QAL                   | c:12 th:FM14X1.5R |
| 2   | 106-01-119  | Stabiliser Link  | 54616-00QAC           | L:366             | 8   | GOM-154     | Silentblock For Susp.Arm | Part of 72-01-120/121/132/133 | d:54              |
| 3   | 72-01-120   | TCA Left Wbj     | 54503-00QAA           | c:18              | 9   | GOM-153     | Silentblock For Susp.Arm | Part of 72-01-120/121/132/133 | d:54.6            |
| 4   | 72-01-121   | TCA Right Wbj    | 55502-00QAA           | c:18              | 10  | 72-01-132   | TCA Left Wbj             | 82 00 626 959                 | c:18              |
| 5   | 73-01-116   | Ball Joint Lower | Part of 72-01-120/121 | c:18              | 11  | 72-01-133   | TCA Right Wbj            | 82 00 565 079                 | c:18              |
| 6   | 111-01-1000 | Tie Rod End Left | 48520-00QAK           | c:12 th:FM14X1.5R | 12  | 73-01-121   | Ball Joint               | 40 160 00Q0A                  | c:18              |

PRIMERA (P10)

06/1990 - 06/1996

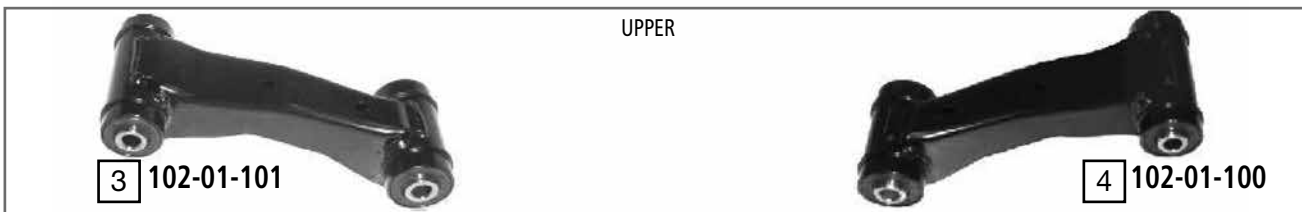
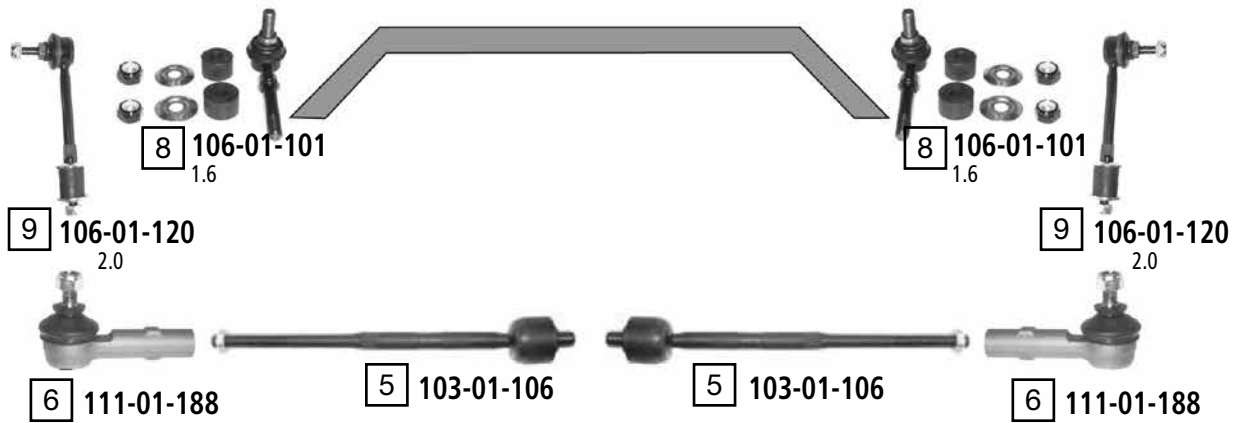

| Ref | ASHIKA CODE | Description | OEM         | Measures           | Ref | ASHIKA CODE | Description              | OEM                         | Measures |
|-----|-------------|-------------|-------------|--------------------|-----|-------------|--------------------------|-----------------------------|----------|
| 1   | 72-01-103   | TCA Left    | 54501-86J00 | c:15               | 7   | 106-01-199  | Stabiliser Link          | 56261-86J25                 | L:114.5  |
| 2   | 72-01-102   | TCA Right   | 54500-86J00 | c:15               | 8   | 106-01-101  | Stabiliser Link          | 5461850Y00                  | L:85.5   |
| 3   | 102-01-101  | TCA Left    | 54525-2F010 |                    | 9   | 106-01-120  | Stabiliser Link          | 54618-50J20                 | L:160    |
| 4   | 102-01-100  | TCA Right   | 54524-2F010 |                    | 10  | 53-01-130   | Ball Joint               | 40160 60Y60                 |          |
| 5   | 103-01-106  | Axial Joint | 48521-72E00 | th:MM14X1.5R L:273 | 11  | GOM-155     | Silentblock For Susp.Arm | Part of 72-01-102/72-01-103 | d:38.1   |
| 6   | 111-01-188  | Tie Rod End | 48520 73J25 | c:13 th:FM12X1.25R | 12  | GOM-156     | Silentblock For Susp.Arm | Part of 72-01-102/72-01-103 | d:20     |

PRIMERA (P11)

06/1996 - 12/2001



UPPER

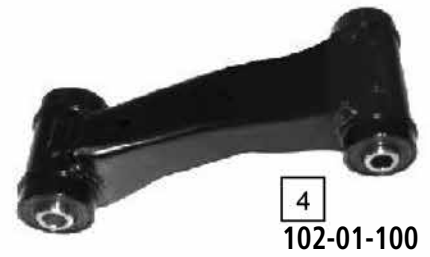

LOWER

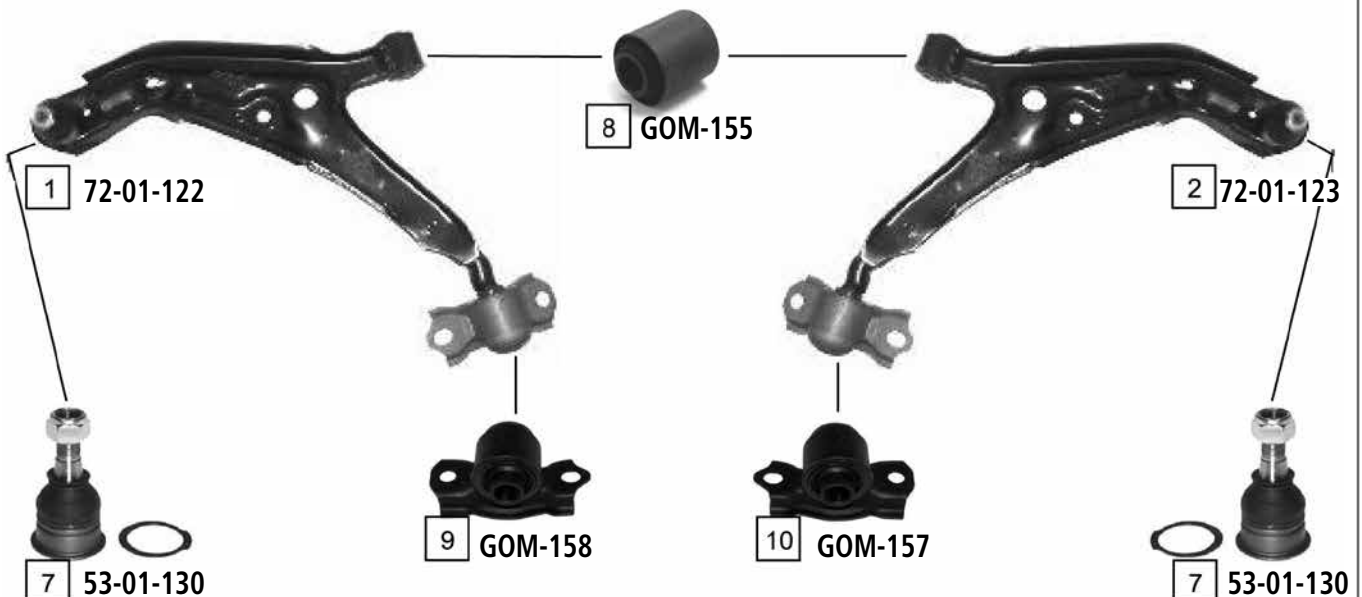

| Ref | ASHIKA CODE | Description | OEM         | Measures           | Ref | ASHIKA CODE | Description              | OEM                         | Measures           |
|-----|-------------|-------------|-------------|--------------------|-----|-------------|--------------------------|-----------------------------|--------------------|
| 1   | 72-01-122   | TCA Left    | 54501-2F500 | c:15               | 6   | 111-01-188  | Tie Rod End              | 48520 73J25                 | c:13 th:FM12X1.25R |
| 2   | 72-01-123   | TCA Right   | 54500-2F500 | c:15               | 7   | 53-01-130   | Ball Joint               | 40160-60Y60                 | c:15               |
| 3   | 102-01-101  | TCA Left    | 54525-2F010 |                    | 8   | GOM-155     | Silentblock For Susp.Arm | Part of 72-01-122/72-01-123 | d:38.1             |
| 4   | 102-01-100  | TCA Right   | 54524-2F010 |                    | 9   | GOM-158     | Silentblock For Susp.Arm | Part of 72-01-122           |                    |
| 5   | 103-01-106  | Axial Joint | 4852172E00  | th:MM14X1.5R L:273 | 10  | GOM-157     | Silentblock For Susp.Arm | Part of 72-01-122           |                    |

# NISSAN PRIMERA



PRIMERA (P12,WP12)

03/2002 ->

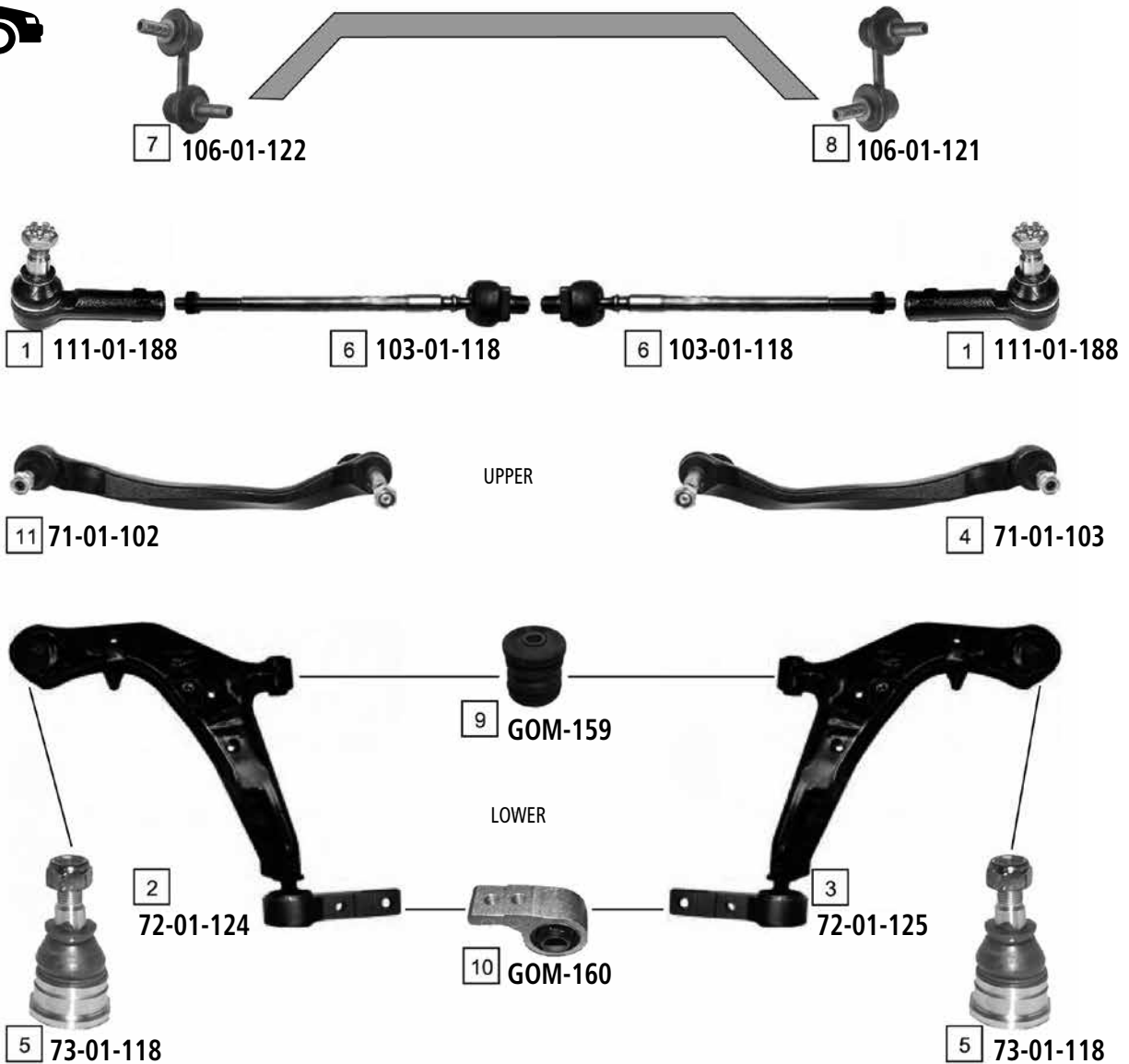

| Ref | ASHIKA CODE | Description          | OEM             | Measures            | Ref | ASHIKA CODE | Description              | OEM                         | Measures |
|-----|-------------|----------------------|-----------------|---------------------|-----|-------------|--------------------------|-----------------------------|----------|
| 1   | 111-01-188  | Tie Rod End          | 48520-73J25     | c:12.9 th:FM12X1.25 | 8   | 106-01-121  | Stabiliser Link Right    | 54618-AU000                 | L:65     |
| 2   | 72-01-124   | TCA Left             | 54501 AV605     |                     | 9   | GOM-159     | Silentblock For Susp.Arm | Part of 72-01-124/72-01-125 |          |
| 3   | 72-01-125   | TCA Right            | 54500-AV600     |                     | 10  | GOM-160     | Silentblock For Susp.Arm | Part of 72-01-124/72-01-125 |          |
| 4   | 71-01-103   | TCA Right            | 54524 AV600     | c:13                | 11  | 71-01-102   | TCA Left                 | 54525 AV600                 | c:13     |
| 5   | 73-01-118   | Ball Joint           | Part of 41170/1 | c:15.2              | 12  | 106-01-123  | Stabiliser Link          | 56261 AV610                 | L:90.5   |
| 6   | 103-01-118  | Axial Joint          | Part of         | th:MM18X1.5R L:280  | 13  | 106-01-124  | Stabiliser Link          | 56261 0E000                 | L:91     |
| 7   | 106-01-122  | Stabiliser Link Left | 54668-AU000     | L:65                |     |             |                          |                             |          |

PRIMERA TRAVELLER (WP11)

04/1998 - 12/2001

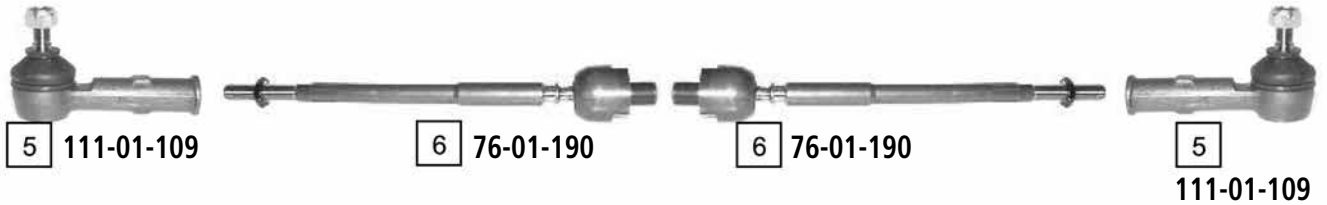

UPPER

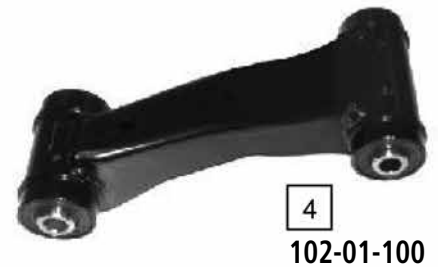

LOWER

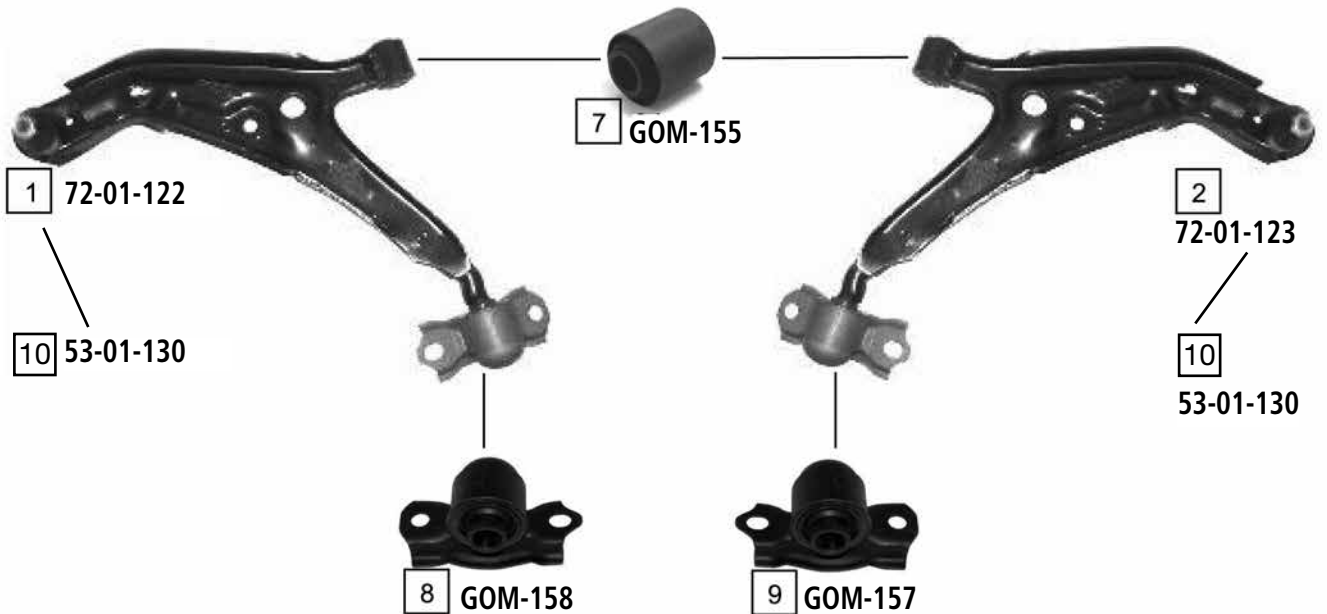

| Ref | ASHIKA CODE | Description | OEM         | Measures           | Ref | ASHIKA CODE | Description              | OEM                     | Measures           |
|-----|-------------|-------------|-------------|--------------------|-----|-------------|--------------------------|-------------------------|--------------------|
| 1   | 72-01-122   | TCA Left    | 54501-2F500 | c:15               | 6   | 76-01-190   | Axial Joint              | 48521-50400             | th:MM16X1R L:274.5 |
| 2   | 72-01-123   | TCA Right   | 54500-2F500 | c:15               | 7   | GOM-155     | Silentblock For Susp.Arm | Part of 72-01-122/BS123 | d:38.1             |
| 3   | 102-01-101  | TCA Left    | 54525-2F010 |                    | 8   | GOM-158     | Silentblock For Susp.Arm | Part of 72-01-122       |                    |
| 4   | 102-01-100  | TCA Right   | 54524-2F010 |                    | 9   | GOM-157     | Silentblock For Susp.Arm | Part of 72-01-123       |                    |
| 5   | 111-01-109  | Tie Rod End | 48520-01E25 | c:13 th:FM12X1.25R | 10  | 53-01-130   | Ball Joint               | 40160 60J60             |                    |

# NISSAN QASHQAI



QASHQAI (J10E)

02/2007 ->

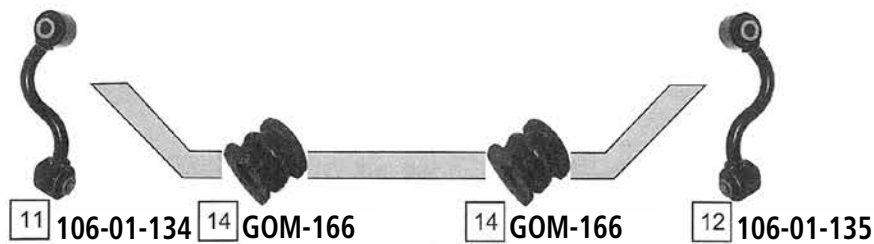
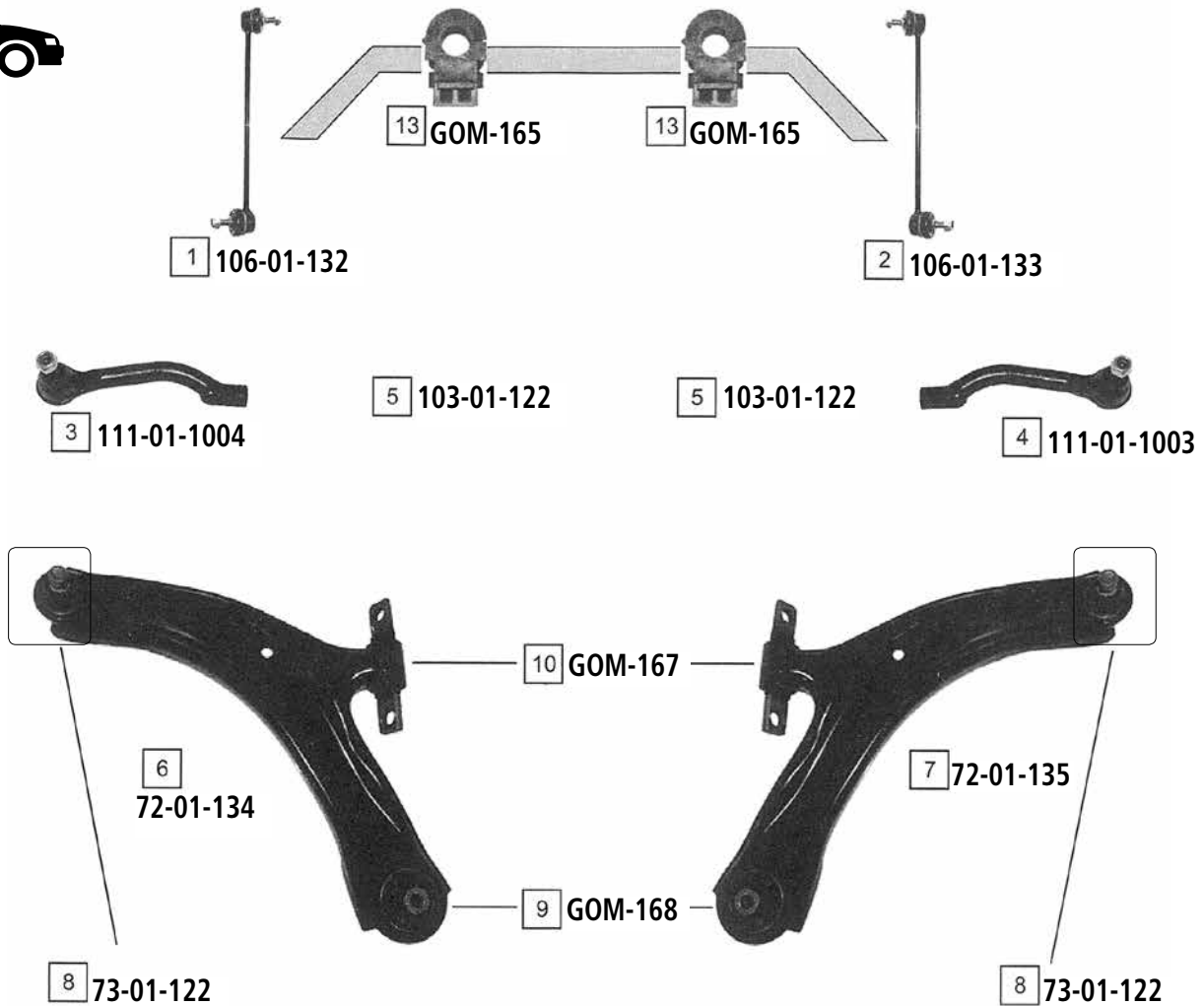

| Ref | ASHIKA CODE | Description           | OEM         | Measures          | Ref | ASHIKA CODE | Description               | OEM                         | Measures |
|-----|-------------|-----------------------|-------------|-------------------|-----|-------------|---------------------------|-----------------------------|----------|
| 1   | 106-01-132  | Stabiliser Link Left  | 54668 JD00A | L:300             | 8   | 73-01-122   | Ball Joint Left and Right | Part of 72-01-134/72-01-135 | c:20     |
| 2   | 106-01-133  | Stabiliser Link Right | 54618 JD00A | L:300             | 9   | GOM-168     | Silentblock For Susp.Arm  | Part of 72-01-134/72-01-135 | d:58     |
| 3   | 111-01-1004 | Tie Rod End Left      | 48647 JD01A | c:12 th:FM14X1.5R | 10  | GOM-167     | Silentblock For Susp.Arm  | Part of 72-01-134/72-01-135 | -        |
| 4   | 111-01-1003 | Tie Rod End Right     | 45527 JD01A | c:12 th:FM14X1.5R | 11  | 106-01-134  | Stabiliser Link Left      | 55619 JD00A                 | -        |
| 5   | 103-01-122  | Axial Joint           | Part of     | th:MM14X1.5R      | 12  | 106-01-135  | Stabiliser Link Right     | 55618 JD00A                 | -        |
| 6   | 72-01-134   | TCA Left WBJ          | 54501 JD000 | c:20              | 13  | GOM-165     | Stabiliser Mounting       | 54613 JD03A                 | L:22.7   |
| 7   | 72-01-135   | TCA Right WBJ         | 54500 JD000 | c:20              | 14  | GOM-166     | Stabiliser Mounting       | 54613 JD18C                 | d:18     |

SERENA (C23M)  
VANETTE CARGO (HC23)

10/1992 - 06/2001  
01/1995 - 06/2001



3 111-0N-N020



4 111-0N-N019



1 111-01-188



2 103-01-119



2 103-01-119



1  
111-01-188

09/1994 ->



5  
72-01-126



9 GOM-161



6  
72-01-127



10 GOM-162



7 111-0N-N017



8  
111-0N-N016

| Ref | ASHIKA CODE | Description           | OEM         | Measures            | Ref | ASHIKA CODE | Description              | OEM                         | Measures |
|-----|-------------|-----------------------|-------------|---------------------|-----|-------------|--------------------------|-----------------------------|----------|
| 1   | 111-01-188  | Tie Rod End           | 48520-73J25 | c:12.9 th:FM12X1.25 | 6   | 72-01-127   | TCA Right                | 54500 7C350                 |          |
| 2   | 103-01-119  | Axial Joint           | Part of     | th:MM14X1.5R L:319  | 7   | 111-0N-N017 | Ball Joint Left          | 40161 9C500                 | c:15     |
| 3   | 111-0N-N020 | Stabiliser Link Left  | 54668 9C000 | L:111               | 8   | 111-0N-N016 | Ball Joint Right         | 40160 9C500                 | c:15     |
| 4   | 111-0N-N019 | Stabiliser Link Right | 54618 9C002 | L:111               | 9   | GOM-161     | Silentblock For Susp.Arm | Part of 72-01-126/72-01-127 |          |
| 5   | 72-01-126   | TCA Left              | 54501 7C350 |                     | 10  | GOM-162     | Silentblock For Susp.Arm | Part of 72-01-126/72-01-127 |          |



STANZA (T11)

06/1981 - 12/1985

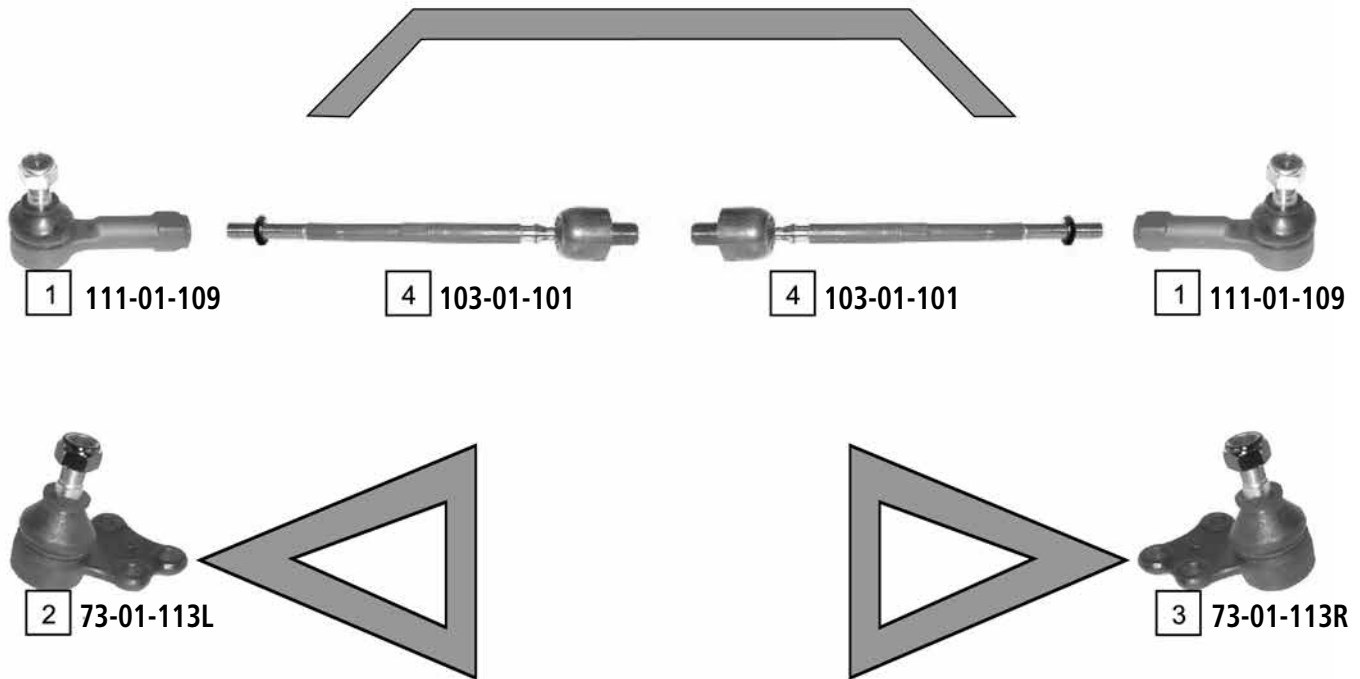

| Ref | ASHIKA CODE | Description           | OEM         | Measures           | Ref | ASHIKA CODE | Description            | OEM         | Measures         |
|-----|-------------|-----------------------|-------------|--------------------|-----|-------------|------------------------|-------------|------------------|
| 1   | 111-01-109  | Tie Rod End           | 48520-D010  | c:13 th:FM12X1.25R | 3   | 73-01-113R  | Ball Joint Lower Right | 40160-D0125 | c:14.5           |
| 2   | 73-01-113L  | Ball Joint Lower Left | 40161-D0125 | c:14.5             | 4   | 103-01-101  | Axial Joint            | 48521-35F00 | th:MM16X1R L:270 |

SUNNY II (B12,N13)

06/1986 - 09/1990

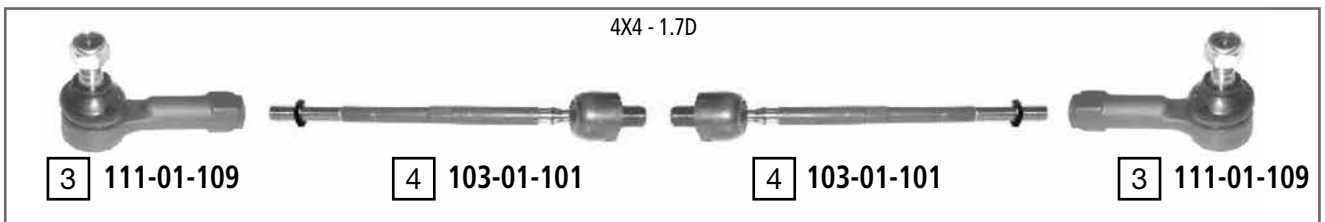
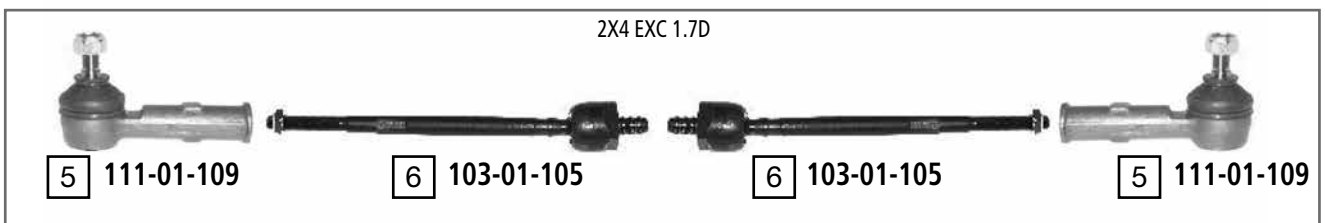

| Ref | ASHIKA CODE | Description      | OEM         | Measures           | Ref | ASHIKA CODE | Description              | OEM         | Measures           |
|-----|-------------|------------------|-------------|--------------------|-----|-------------|--------------------------|-------------|--------------------|
| 1   | 106-01-101  | Stabiliser Link  | 54618-50Y00 | L:87               | 5   | 111-01-109  | Tie Rod End              | 48520-01E25 | c:13 th:FM12X1.25R |
| 2   | 53-01-130   | Ball Joint Lower | 40160-60960 | c:15               | 6   | 103-01-105  | Axial Joint              | 48521-35A00 |                    |
| 3   | 111-01-109  | Tie Rod End      | 48520-D010  | c:13 th:FM12X1.25R | 7   | GOM-138     | Silentblock For Susp.Arm | 54560-50A00 | d:36.2             |
| 4   | 103-01-101  | Axial Joint      | 48521-35F00 | th:MM16X1R L:270   |     |             |                          |             |                    |

SUNNY III (N14 EXC. 2.0GTi-R)

10/1990 - 06/1995



| Ref | ASHIKA CODE | Description     | OEM         | Measures           | Ref | ASHIKA CODE | Description              | OEM         | Measures           |
|-----|-------------|-----------------|-------------|--------------------|-----|-------------|--------------------------|-------------|--------------------|
| 1   | 106-01-101  | Stabiliser Link | 54618 50Y00 | L: 85.5            | 4   | 76-01-190   | Axial Joint              | 48521-50400 | th:MM16X1R L:274.5 |
| 2   | 107-01-190  | Ball Joint      | 40161 52Y10 | c:14.7             | 5   | GOM-139     | Silentblock For Susp.Arm | 54570-69Y10 |                    |
| 3   | 111-01-109  | Tie Rod End     | 48520-01E00 | c:13 th:FM12X1.25R |     |             |                          |             |                    |

TERRANO I (WD21,VD21)

07/1986 - 02/1996



-> 08/1993



09/1993 ->

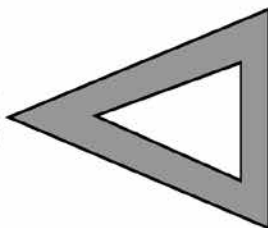
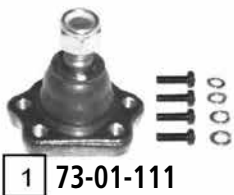
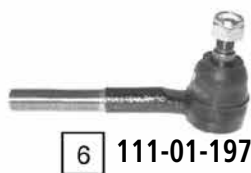

UPPER

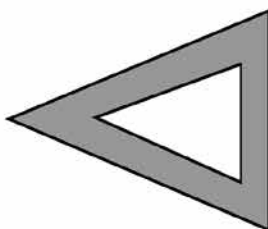
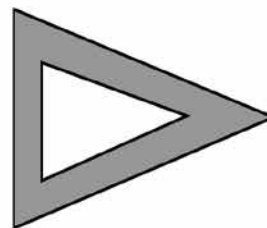

LOWER

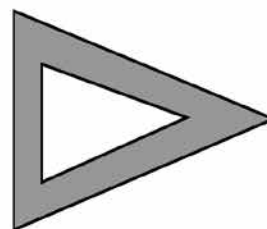

**8** 59-01-119

**9** 59-01-120

| Ref | ASHIKA CODE | Description       | OEM         | Measures            | Ref | ASHIKA CODE | Description       | OEM         | Measures            |
|-----|-------------|-------------------|-------------|---------------------|-----|-------------|-------------------|-------------|---------------------|
| 1   | 73-01-111   | Ball Joint        | 40110 01G00 | c:16.1              | 6   | 111-01-197  | Tie Rod End Inner | 48570 61G25 | c:14.3 th:MM16X1.5L |
| 2   | 53-01-121   | Ball Joint Lower  | 40160 0F000 | c:19.5              | 7   | 106-01-125  | Stabiliser Link   | 54618 0F000 |                     |
| 3   | 111-01-142  | Tie Rod End Outer | 48520 31G25 | c:13.2 th:MM16X1.5R | 8   | 59-01-119   | Pitman Arm        | 48530 35G25 |                     |
| 4   | 111-01-189  | Tie Rod End Inner | 48520 7F001 | c:13.3 th:MM16X1.5L | 9   | 59-01-120   | Pitman Arm        | 48530 31G25 |                     |
| 5   | 111-01-196  | Tie Rod End Outer | 48520 61G25 | c:14.3 th:MM16X1.5R |     |             |                   |             |                     |

# NISSAN TERRANO



TERRANO II (R20)

02/1993 - 09/1997

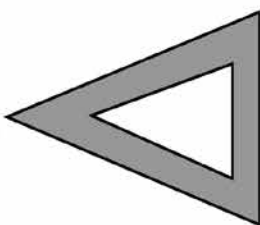
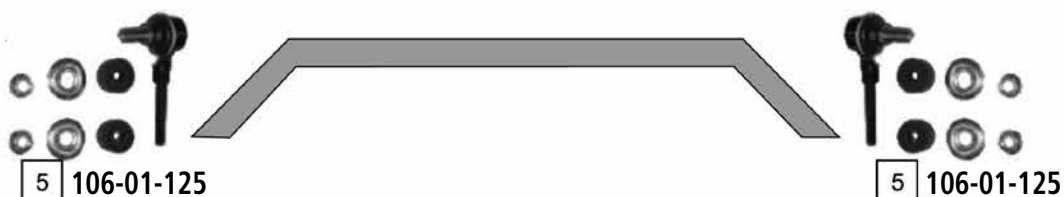

UPPER

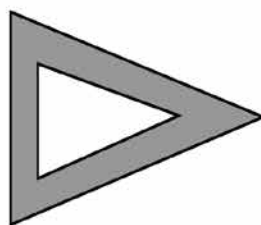

7 111-0N-N028

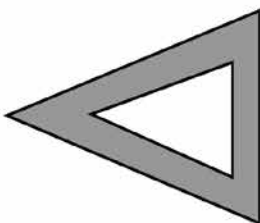

LOWER

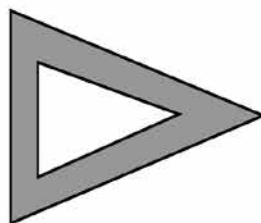

| Ref | ASHIKA CODE | Description       | OEM         | Measures            | Ref | ASHIKA CODE | Description       | OEM         | Measures |
|-----|-------------|-------------------|-------------|---------------------|-----|-------------|-------------------|-------------|----------|
| 1   | 73-01-111   | Ball Joint        | 40110 01G00 | c:16.1              | 5   | 106-01-125  | Stabiliser Link   | 54618 0F000 |          |
| 2   | 53-01-121   | Ball Joint Lower  | 40160 0F000 | c:19.5              | 6   | 106-01-126  | Stabiliser Link   | 56260 0F001 | L:207    |
| 3   | 111-01-142  | Tie Rod End Outer | 48520 31G25 | c:13.2 th:MM16X1.5R | 7   | 111-0N-N028 | Real Rod Steering | 48560 0F000 |          |
| 4   | 111-01-189  | Tie Rod End Inner | 48520 7F001 | c:13.3 th:MM16X1.5L |     |             |                   |             |          |

TIIDA HATCHBACK (C11X)  
TIIDA SALOON (SC11X)

09/2007 ->

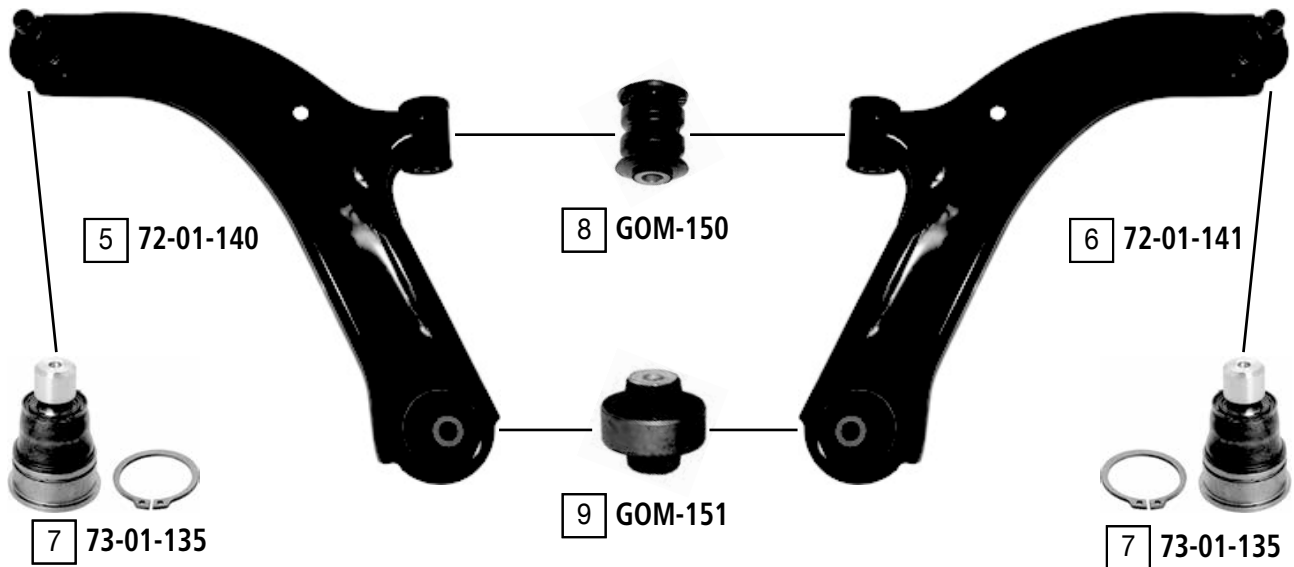

| Ref | ASHIKA CODE | Description       | OEM         | Measures             | Ref | ASHIKA CODE | Description         | OEM         | Measures        |
|-----|-------------|-------------------|-------------|----------------------|-----|-------------|---------------------|-------------|-----------------|
| 1   | 106-01-111  | Stabiliser link   | 54618 9U00A | L:255                | 6   | 72-01-141   | TCA right wbj       | 54500 EL000 | c:18            |
| 2   | 111-01-167  | Tie rod end right | 48647 1U61A | c:11.7 th:FM12x1.25R | 7   | 73-01-135   | Ball joint          | Part of     | c:18 do:38.5    |
| 3   | 111-01-166  | Tie rod end left  | 48527 1U61A | c:11.8 th:FM12x1.25R | 8   | GOM-150     | Silentblock for TCA | 54560 AX600 | di:12.1 do:36.1 |
| 4   | 103-01-123  | Axial joint       | 48521 3U025 | th:MM14x1.5R L:200   | 9   | GOM-151     | Silentblock for TCA | 54570 AX600 | di:12.2 do:58.4 |
| 5   | 72-01-140   | TCA left wbj      | 54501 EL000 | c:18                 |     |             |                     |             |                 |

URVAN (E23)

07/1980 - 05/1987



4 111-01-120

5 111-01-119



1 73-01-111

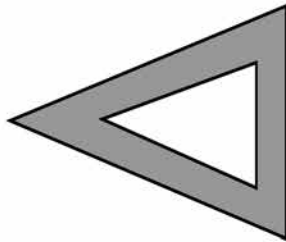

UPPER

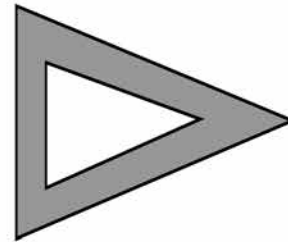

1 73-01-111



2 53-01-198

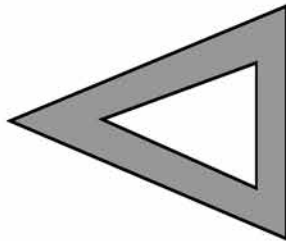

LOWER

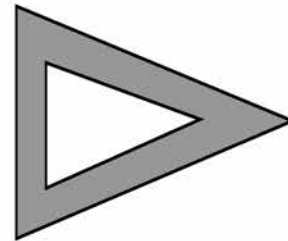

3 53-01-199

| Ref | ASHIKA CODE | Description      | OEM         | Measures | Ref | ASHIKA CODE | Description | OEM         | Measures |
|-----|-------------|------------------|-------------|----------|-----|-------------|-------------|-------------|----------|
| 1   | 73-01-111   | Ball Joint       | 40110 01G00 | c:16.1   | 4   | 111-01-120  | Tie Rod End | 48571-T3025 |          |
| 2   | 53-01-198   | Ball Joint Left  | 40160-48W00 | c:19.8   | 5   | 111-01-119  | Tie Rod End | 48561-T3025 |          |
| 3   | 53-01-199   | Ball Joint Right | 40160-T3060 | c:19.7   |     |             |             |             |          |

URVAN (E24)

02/1987 - 05/1997



-> 09/1988



4 111-01-195



5 111-01-193



5 111-01-193



4 111-01-195

10/1988 ->



6 111-01-175



3 103-01-109



3 103-01-109



6 111-01-175



1 73-01-111

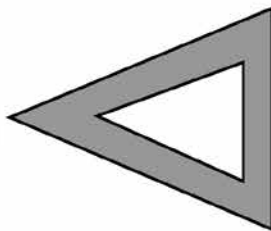

UPPER

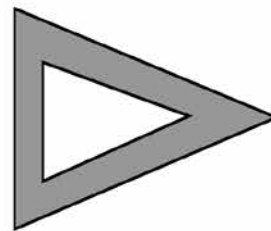

1 73-01-111



2 53-01-190

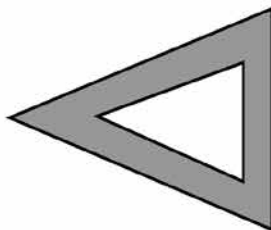

LOWER

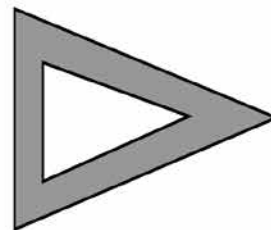

2 53-01-190

| Ref | ASHIKA CODE | Description      | OEM         | Measures         | Ref | ASHIKA CODE | Description | OEM         | Measures            |
|-----|-------------|------------------|-------------|------------------|-----|-------------|-------------|-------------|---------------------|
| 1   | 73-01-111   | Ball Joint       | 40110 01G00 | c:16.1           | 4   | 111-01-195  | Tie Rod End | 48640-01N25 | c:16.2 th:FM16X1.5L |
| 2   | 53-01-190   | Ball Joint Lower | 40160 01G25 | c:19.5           | 5   | 111-01-193  | Tie Rod End | 48641.01N25 | c:16.2 th:FM16X1.5R |
| 3   | 103-01-109  | Axial Joint      | 48521-27N00 | th:MM16X1R L:290 | 6   | 111-01-175  | Tie Rod End | 48520-27N25 | c:16.3 th:FM14X1.5R |



VANETTE (C120)

07/1981 - 06/1987

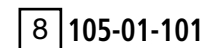
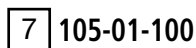
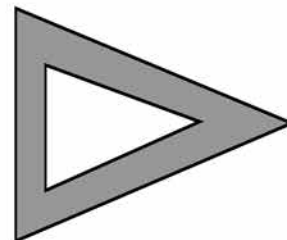
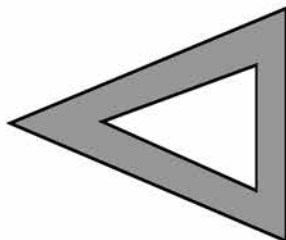
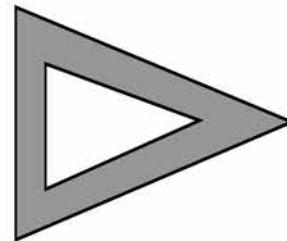
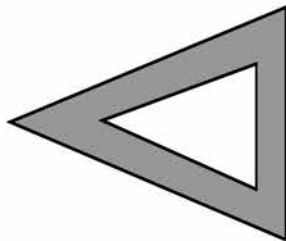
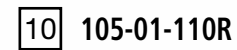
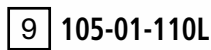

| Ref | ASHIKA CODE | Description | OEM         | Measures            | Ref | ASHIKA CODE | Description      | OEM         | Measures |
|-----|-------------|-------------|-------------|---------------------|-----|-------------|------------------|-------------|----------|
| 1   | 111-01-102L | Tie Rod End | 48520U0100  | c:13.3 th:FM14X1.5R | 6   | 53-01-109   | Ball Joint Lower | 40160-G2500 | c:19.5   |
| 2   | 111-01-102R | Tie Rod End | 48520-G2525 | c:13.3 th:FM14X1.5L | 7   | 105-01-100  | Pitman Arm       |             |          |
| 3   | 111-01-103R | Tie Rod End | 48641-G2525 | c:13.4 th:FM14X1.5L | 8   | 105-01-101  | Pitman Arm       | 48530-Y9500 |          |
| 4   | 111-01-103L | Tie Rod End | 48521-G2525 | c:13.4 th:FM14X1.5R | 9   | 105-01-110L | Tie Rod End      | 48630-G2525 |          |
| 5   | 73-01-123   | Ball Joint  | 40110-G3700 | c:13.5              | 10  | 105-01-110R | Tie Rod End      | 48510-G2525 |          |

VANETTE (C22)

09/1985 - 12/1995



3 111-01-155L



5 111-01-156L



6 111-01-156R



4 111-01-155R

8 105-01-124L

9 105-01-124R



1 73-01-123

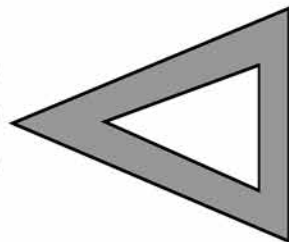

UPPER

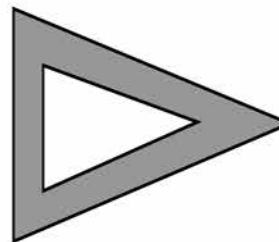

1 73-01-123



2 53-01-109

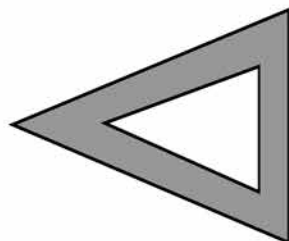

LOWER

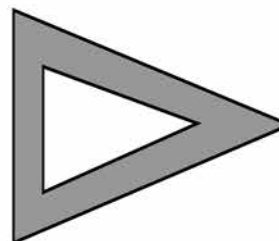

2 53-01-109

7 59-01-128

| Ref | ASHIKA CODE | Description       | OEM         | Measures            | Ref | ASHIKA CODE | Description             | OEM        | Measures            |
|-----|-------------|-------------------|-------------|---------------------|-----|-------------|-------------------------|------------|---------------------|
| 1   | 73-01-123   | Ball Joint        | 40110-G3700 | c:13.5              | 6   | 111-01-156R | Tie Rod End Inner Right | 4016050W00 | c:13.3 th:FM14X1.5R |
| 2   | 53-01-109   | Ball Joint Lower  | 40110-G3700 | c:19.5              | 7   | 59-01-128   | Pitman Arm              | 48530G5701 |                     |
| 3   | 111-01-155L | Tie Rod End Left  | 48520-G5101 | c:13.3 th:FM14X1.5R | 8   | 105-01-124L | Tie Rod End             | 48630G5101 |                     |
| 4   | 111-01-155R | Tie Rod End Right | 48520-G5101 | c:13.3 th:FM14X1.5L | 9   | 105-01-124R | Tie Rod End             | 48510G5101 |                     |
| 5   | 111-01-156L | Tie Rod End Left  | 48521G5101  | c:13.3 th:FM14X1.5L |     |             |                         |            |                     |

X-TRAIL (T30)

07/2001 - 05/2007

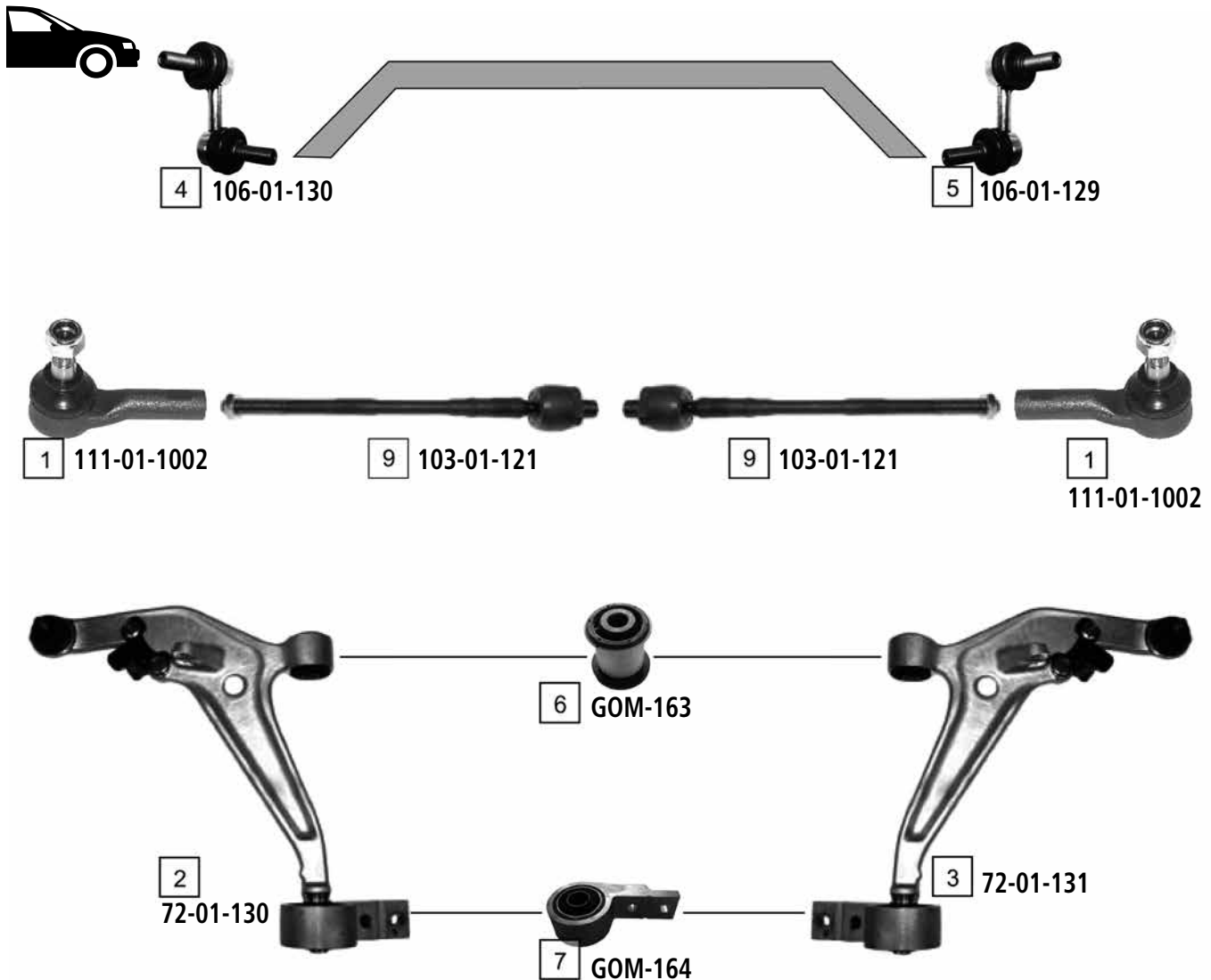

| Ref | ASHIKA CODE | Description           | OEM         | Measures            | Ref | ASHIKA CODE | Description              | OEM                         | Measures          |
|-----|-------------|-----------------------|-------------|---------------------|-----|-------------|--------------------------|-----------------------------|-------------------|
| 1   | 111-01-1002 | Tie Rod End           | 48520-0P725 | c:14.8 th:FM14X1.5R | 6   | GOM-163     | Silentblock For Susp.Arm | Part of 72-01-130/72-01-131 |                   |
| 2   | 72-01-130   | TCA Left              | 54501-8H310 | c:15.4              | 7   | GOM-164     | Silentblock For Susp.Arm | Part of 72-01-130/72-01-131 |                   |
| 3   | 72-01-131   | TCA Right             | 54500-8H310 | c:15.2              | 8   | 106-01-131  | Stabiliser Link          | 56261 EQ000                 | L:115             |
| 4   | 106-01-130  | Stabiliser Link Left  | 54668-8H300 | L:64                | 9   | 103-01-121  | Axial Joint              | 48521 8H325                 | th: MM16X1R L:287 |
| 5   | 106-01-129  | Stabiliser Link Right | 54618-8H300 | L:64                |     |             |                          |                             |                   |

X-TRAIL (T31)

06/2007 ->

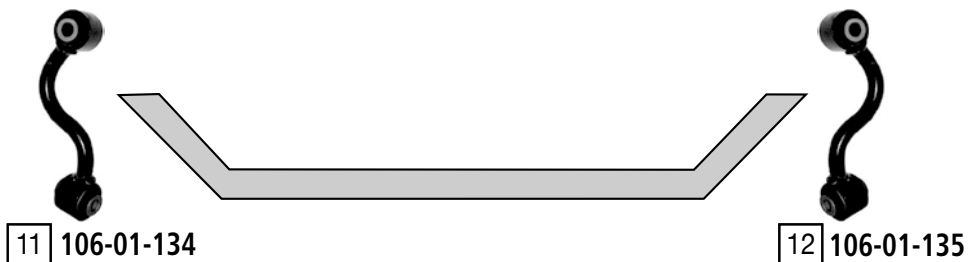
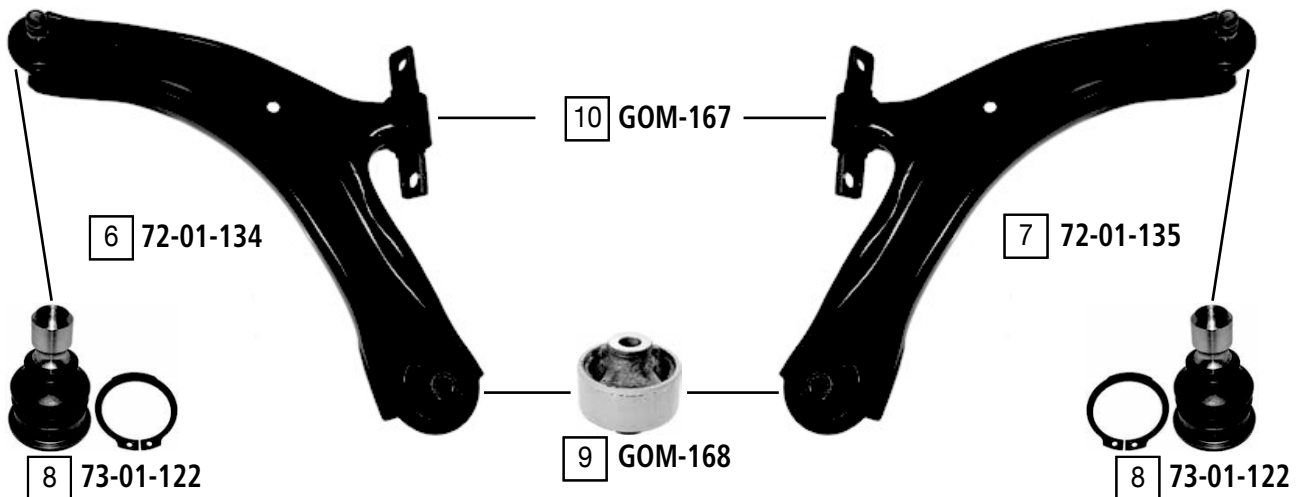
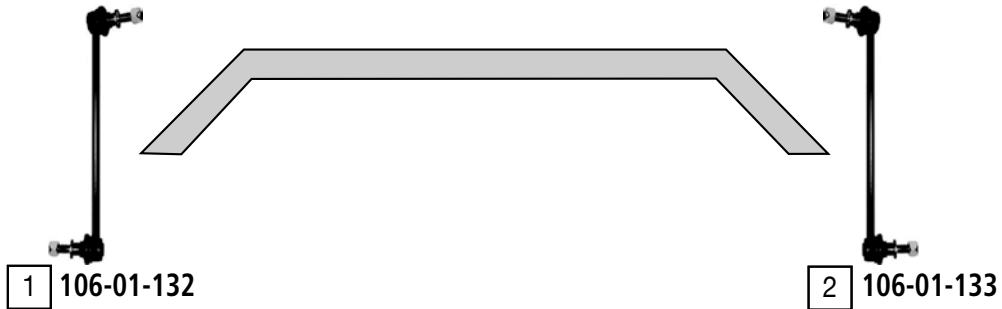

| Ref | ASHIKA CODE | Description           | OEM         | Measures            | Ref | ASHIKA CODE | Description           | OEM         | Measures      |
|-----|-------------|-----------------------|-------------|---------------------|-----|-------------|-----------------------|-------------|---------------|
| 1   | 106-01-132  | Stabiliser link left  | 54668 JD00A | L:300               | 7   | 72-01-135   | TCA right wbj         | 54500 JD000 | c:20          |
| 2   | 106-01-133  | Stabiliser link right | 54618 JD00A | L:300               | 8   | 73-01-122   | Ball joint            | Part of     | c:20 do:41.1  |
| 3   | 111-01-1004 | Tie rod end left      | 48647 JD01A | c:11.7 th:FM14x1.5R | 9   | GOM-168     | Silentblock for TCA   | Part of     | di:12.2 do:58 |
| 4   | 111-01-1003 | Tie rod end right     | 48527 JD01A | c:11.7 th:FM14x1.5R | 10  | GOM-167     | Silentblock for TCA   | Part of     |               |
| 5   | 103-01-122  | Axial joint           | D8521 JG00A | th:MM22x1.5R L:233  | 11  | 106-01-134  | Stabiliser link left  | 55619 JD00A | L:142         |
| 6   | 72-01-134   | TCA left wbj          | 54501 JD000 | c:20                | 12  | 106-01-135  | Stabiliser link right | 55618 JD00A | L:142         |

# SMART CITY COUPE - CABRIO



CITY COUPE - CABRIO

07/1998 - 02/2002

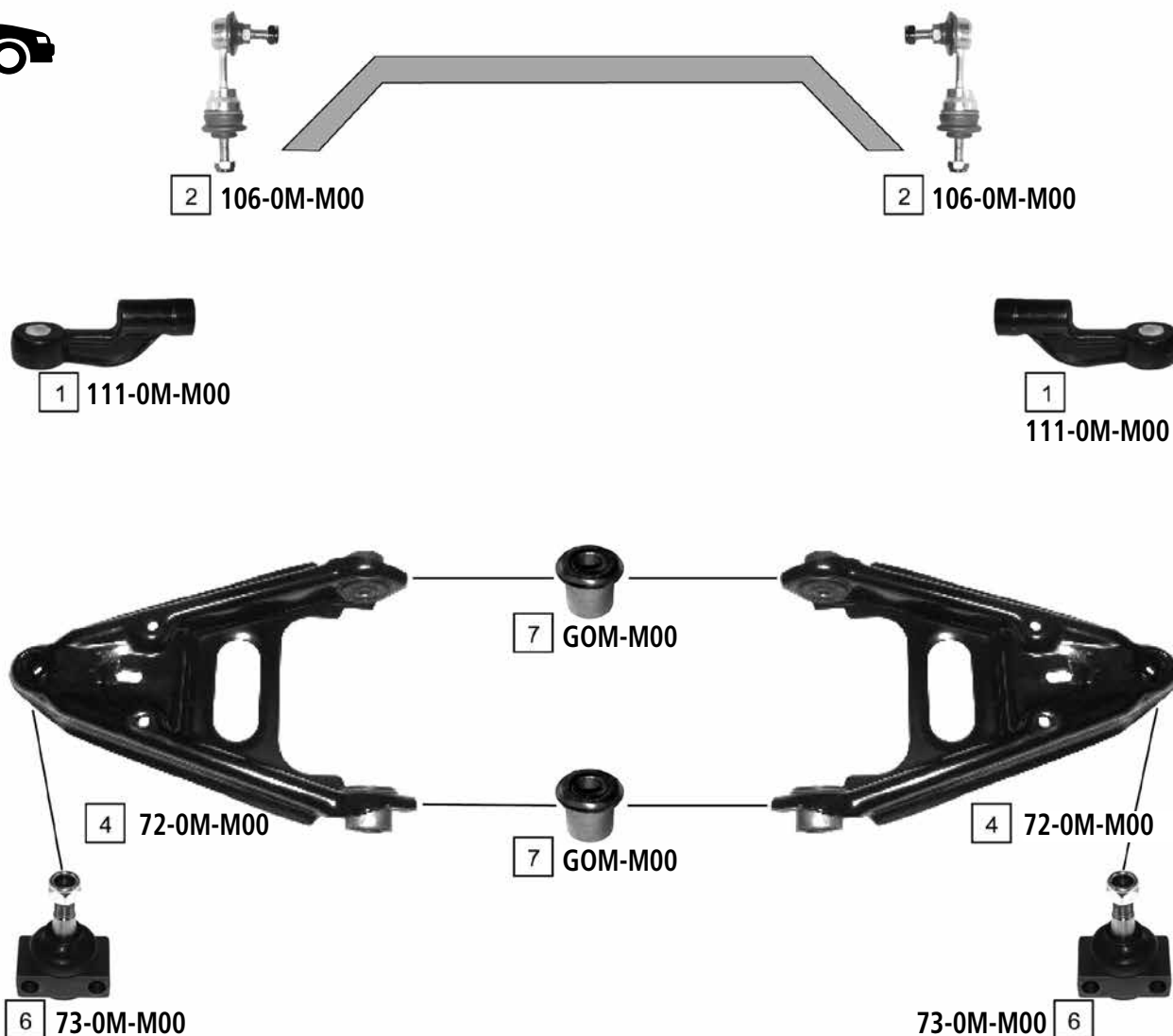

| Ref | ASHIKA CODE | Description     | OEM             | Measures | Ref | ASHIKA CODE | Description              | OEM               | Measures |
|-----|-------------|-----------------|-----------------|----------|-----|-------------|--------------------------|-------------------|----------|
| 1   | 111-0M-M00  | Tie Rod End     | 4887V002000000  |          | 5   | 71-0M-M00   | Thrust Rod               | 1765V005000000    | -        |
| 2   | 106-0M-M00  | Stabiliser Link | 5102V005000000  | L:93     | 6   | 73-0M-M00   | Ball Joint               | 2271V007000005    | c:13     |
| 3   | 106-0M-M01  | Stabiliser Link | 1802V004000000  | L:149    | 7   | GOM-M00     | Silentblock For Susp.Arm | Part of 72-0M-M00 | d:39.2   |
| 4   | 72-0M-M00   | TCA             | 07001V006000000 |          |     |             |                          |                   |          |

FORFOUR (454)

04/2004 ->

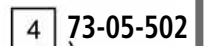
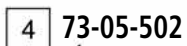

| Ref | ASHIKA CODE | Description   | OEM                         | Measures | Ref | ASHIKA CODE | Description              | OEM                         | Measures |
|-----|-------------|---------------|-----------------------------|----------|-----|-------------|--------------------------|-----------------------------|----------|
| 1   | 72-05-508   | TCA Left Wbj  | 454 330 07 07               |          | 5   | 106-0M-M02  | Stabiliser Link          | 454 320 00 10               |          |
| 2   | 72-05-509   | TCA Right Wbj | 454 330 08 07               |          | 6   | GOM-532     | Silentblock For Susp.Arm | Part of 72-05-508/72-05-509 |          |
| 3   | 111-05-500  | Tie Rod End   | 454 460 02 05               |          | 7   | GOM-531     | Silentblock For Susp.Arm | Part of 72-05-508/72-05-509 |          |
| 4   | 73-05-502   | Ball Joint    | Part of 72-05-508/72-05-509 |          |     |             |                          |                             |          |

FORTWO COUPE - CABRIO (451)

01/2007 ->

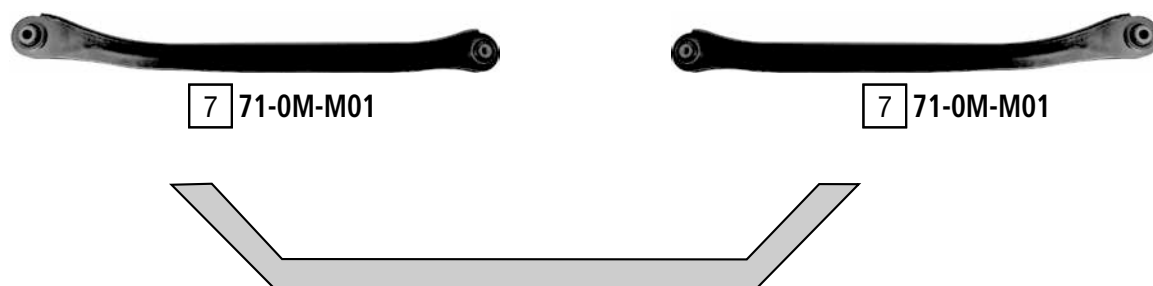
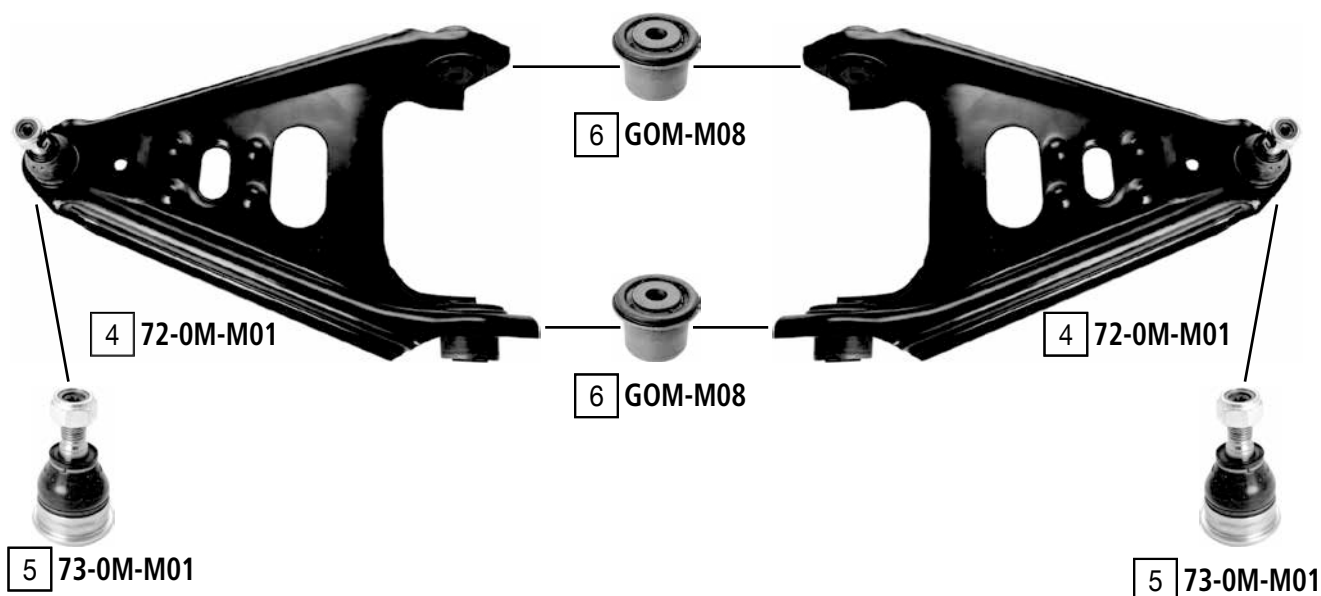
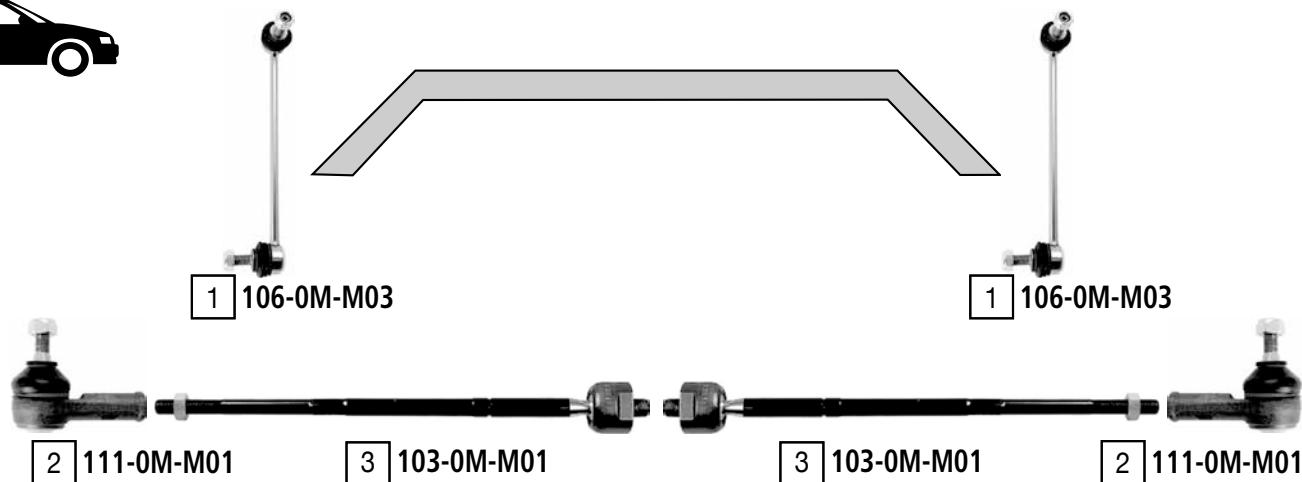

| Ref | ASHIKA CODE | Description     | OEM           | Measures            | Ref | ASHIKA CODE | Description         | OEM           | Measures        |
|-----|-------------|-----------------|---------------|---------------------|-----|-------------|---------------------|---------------|-----------------|
| 1   | 106-0M-M03  | Stabiliser link | 451 320 01 89 | L:227               | 5   | 73-0M-M01   | Ball joint          | part of       | c:12.9 do:36.7  |
| 2   | 111-0M-M01  | Tie rod end     | 451 338 01 37 | c:10.7 th:FM12x1.5R | 6   | GOM-M08     | Silentblock for TCA | part of       | di:12.2 do:39.5 |
| 3   | 103-0M-M01  | Axial joint     | part of       | th:MM14X1.5R L:378  | 7   | 71-0M-M01   | TCA                 | 451 350 01 29 |                 |
| 4   | 72-0M-M01   | TCA wbj         | 451 330 00 10 | c:13.1              |     |             |                     |               |                 |

KORANDO (KJ)

01/1996 ->



2 106-05-S01

2 106-05-S01

7 111-05-S02L  
-> 12/1998

8 111-05-S31  
-> 12/1998

9 111-05-S03R  
-> 12/1998



1 111-05-S01  
1/1999 ->



5 103-05-S02



5 103-05-S02



1 111-05-S01  
1/1999 ->



3 73-05-S01

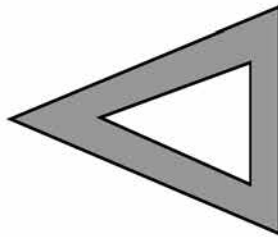

UPPER

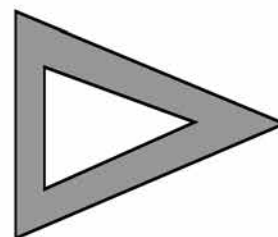

3 73-05-S01



4 73-05-S02

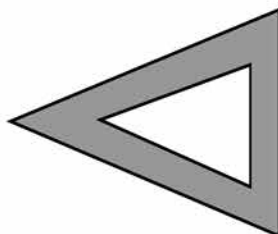

LOWER

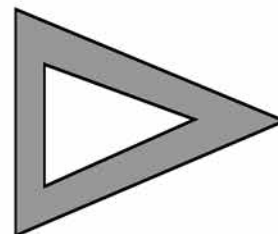

4 73-05-S02



10 101-05-S04 ->POST.



12 101-05-S06 ->POST.

6 52-05-S01



11 101-05-S05 ->POST.

13 101-05-S07 ->POST.



14 101-05-S09 ->LATO MONT. POST.

| Ref | ASHIKA CODE | Description     | OEM         | Measures          | Ref | ASHIKA CODE | Description | OEM         | Measures |
|-----|-------------|-----------------|-------------|-------------------|-----|-------------|-------------|-------------|----------|
| 1   | 111-00-J01  | Tie Rod End     | 4666005501  | c:16 th:FM14X1.5R | 8   | 111-05-S31  | Tie Rod End | 46620-01000 |          |
| 2   | 106-05-S01  | Stabiliser Link | 4475005001  |                   | 9   | 111-05-S03R | Tie Rod End | 46670-01010 |          |
| 3   | 73-05-S01   | Ball Joint      | 4443003011  | c:17.6            | 10  | 101-05-S04  | Upper Link  | 45401-05000 |          |
| 4   | 73-05-S02   | Ball Joint      | 4450505001  | c:17.6            | 11  | 101-05-S05  | Lower Link  | 45502-05004 |          |
| 5   | 103-05-S02  | Axial Joint     |             |                   | 12  | 101-05-S06  | Lower Link  | 45501-05302 |          |
| 6   | 52-05-S01   | Pitman Arm      | 4644901051  |                   | 13  | 101-05-S07  | Lower Link  | 45502-05102 |          |
| 7   | 111-05-S02L | Tie Rod End     | 46660-01010 |                   | 14  | 101-05-S09  | Lower Link  | 45601-05000 |          |



KYRON

05/2005 ->

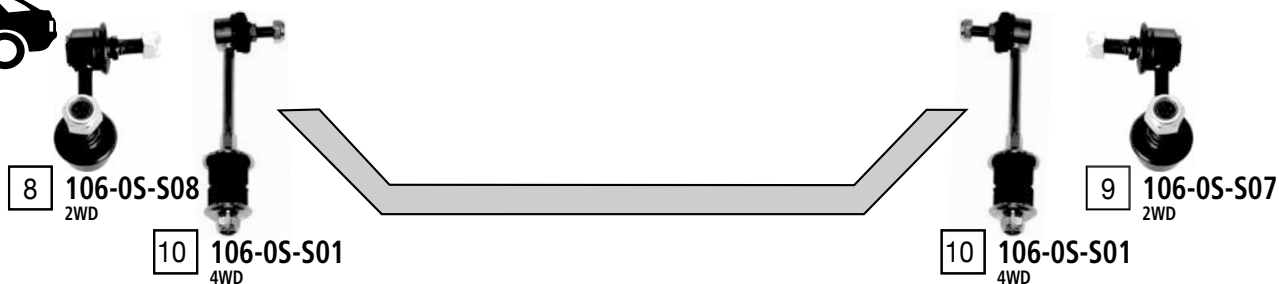
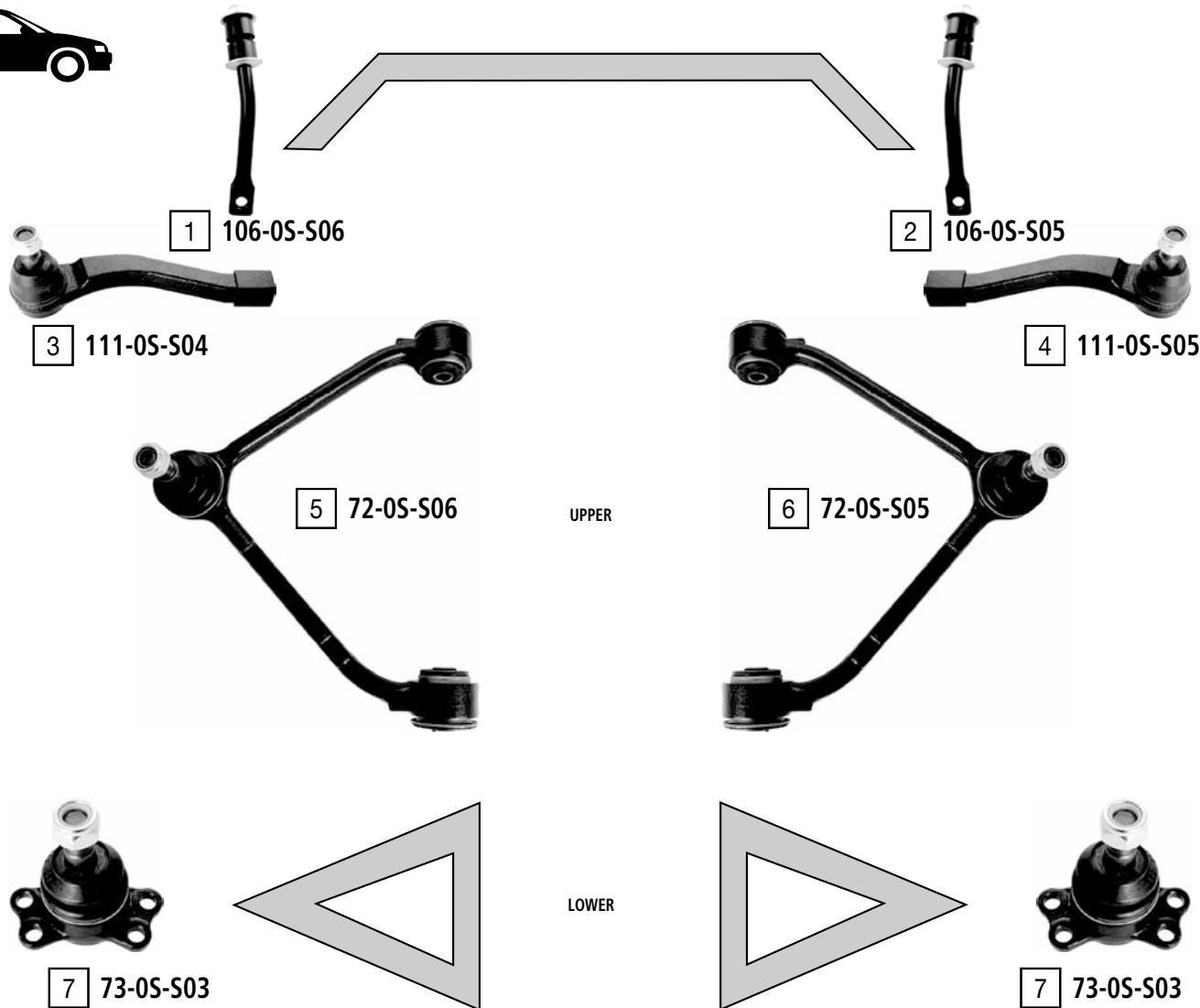

| Ref | ASHIKA CODE | Description           | OEM        | Measures             | Ref | ASHIKA CODE | Description           | OEM        | Measures |
|-----|-------------|-----------------------|------------|----------------------|-----|-------------|-----------------------|------------|----------|
| 1   | 106-05-S06  | stabiliser link left  | 4475109000 | L:170                | 6   | 72-05-S05   | TCA right wbj         | 4440209011 | c:17.6   |
| 2   | 106-05-S05  | stabiliser link right | 4475209000 | L:170                | 7   | 73-05-S03   | ball joint            | 4454109004 | c:17.4   |
| 3   | 111-05-S04  | tie rod end left      | 4666008001 | c:15.95 th:FM16X1.5R | 8   | 106-05-S08  | stabiliser link left  | 4575009001 | L:72     |
| 4   | 111-05-S05  | tie rod end right     | 4666008011 | c:15.95 th:FM16X1.5R | 9   | 106-05-S07  | stabiliser link right | 4575109001 | L:72     |
| 5   | 72-05-S06   | TCA left wbj          | 4440109011 | c:17.6               | 10  | 106-05-S01  | stabiliser link       | 4475005001 | L:171    |

MUSSO (FJ)

01/1999 ->

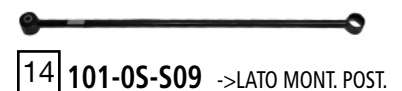
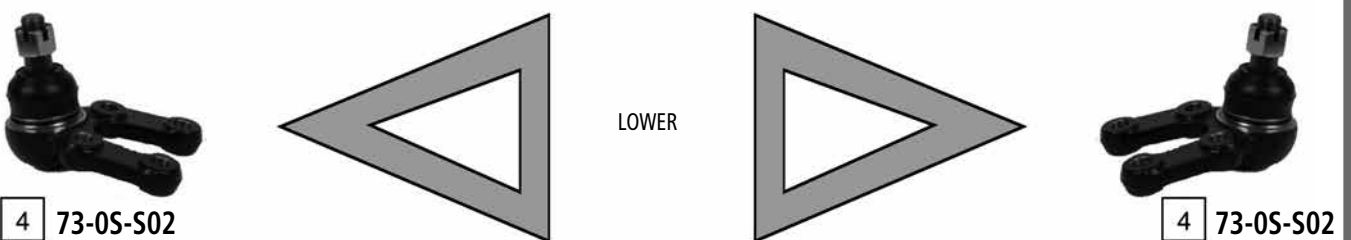
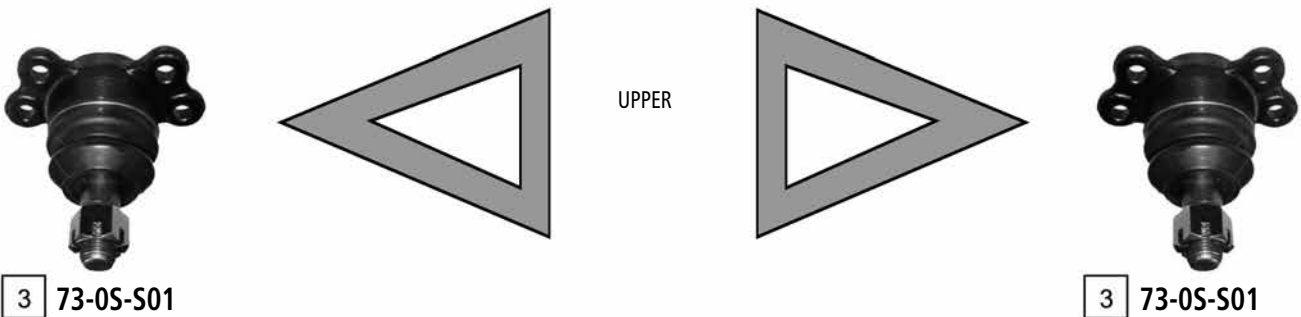
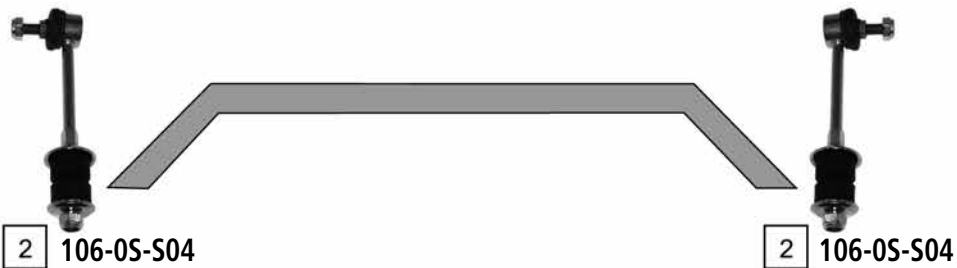

| Ref | ASHIKA CODE | Description     | OEM        | Measures          | Ref | ASHIKA CODE | Description | OEM         | Measures |
|-----|-------------|-----------------|------------|-------------------|-----|-------------|-------------|-------------|----------|
| 1   | 111-05-S01  | Tie Rod End     | 4666005501 | c:16 th:FM14X1.5R | 6   | 101-05-S04  | Upper Link  | 45401-05000 |          |
| 2   | 106-05-S04  | Stabiliser Link | 4475005001 |                   | 7   | 101-05-S05  | Lower Link  | 45502-05004 |          |
| 3   | 73-05-S01   | Ball Joint      | 4443003011 | c:17.6            | 8   | 101-05-S06  | Lower Link  | 45501-05302 |          |
| 4   | 73-05-S02   | Ball Joint      | 4450505001 | c:17.6            | 9   | 101-05-S07  | Lower Link  | 45502-05102 |          |
| 5   | 103-05-S02  | Axial Joint     | Part of    |                   | 10  | 101-05-S09  | Lower Link  | 45601-05000 |          |

REXTON

04/2002 ->

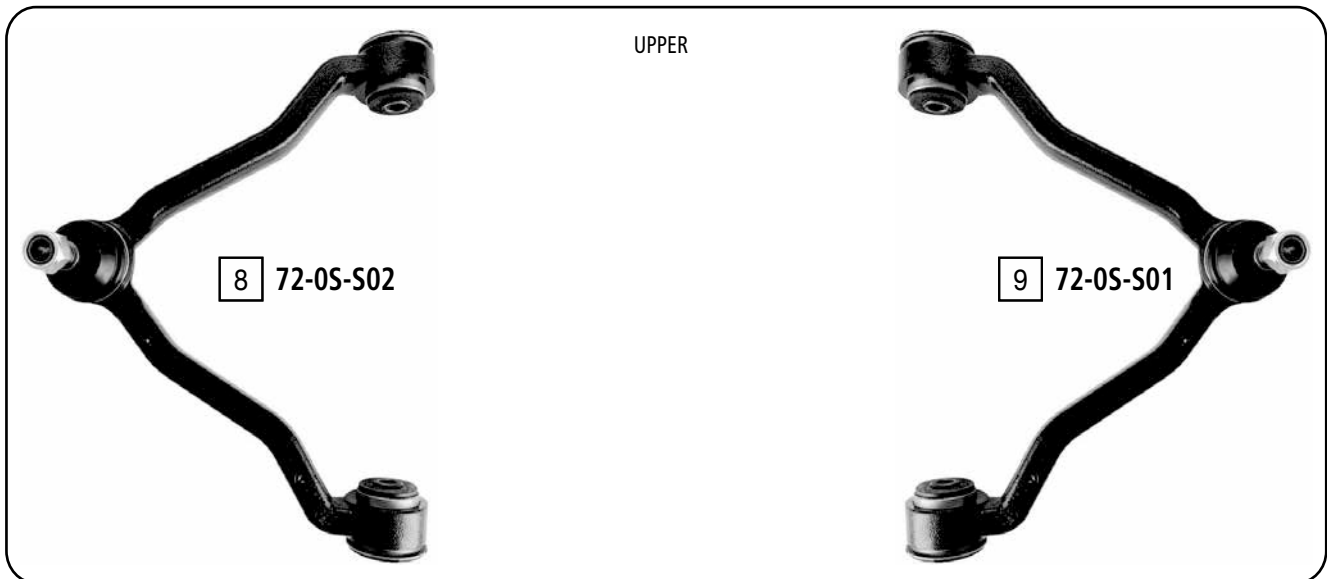
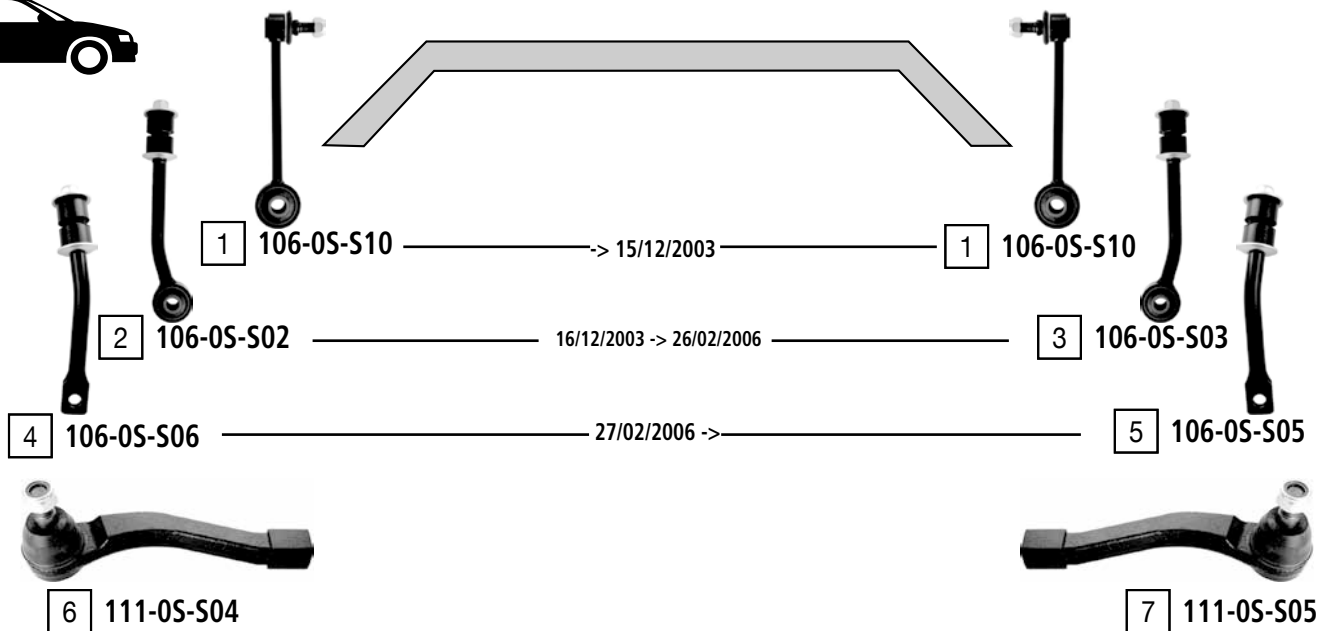

10 72-0S-S04

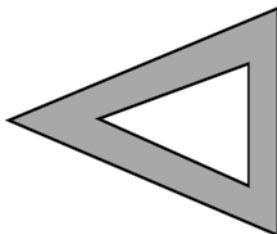

LOWER

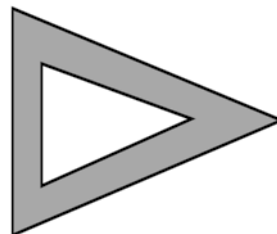

11 72-0S-S03

| Ref | ASHIKA CODE | Description           | OEM        | Measures             | Ref | ASHIKA CODE | Description       | OEM        | Measures             |
|-----|-------------|-----------------------|------------|----------------------|-----|-------------|-------------------|------------|----------------------|
| 1   | 106-0S-S10  | stabiliser link       | 4475008000 | L:185                | 7   | 111-0S-S05  | tie rod end right | 4666008011 | c:15.95 th:FM16X1.5R |
| 2   | 106-0S-S02  | stabiliser link left  | 4475008001 | L:200                | 8   | 72-0S-S02   | TCA left wbj      | 4440108000 | c:17.6               |
| 3   | 106-0S-S03  | stabiliser link right | 4475508000 | L:200                | 9   | 72-0S-S01   | TCA right wbj     | 4440208000 | c:17.6               |
| 4   | 106-0S-S06  | stabiliser link left  | 4475109000 | L:170                | 10  | 72-0S-S04   | TCA left          | 4450108005 |                      |
| 5   | 106-0S-S06  | stabiliser link right | 4475209000 | L:170                | 11  | 72-0S-S03   | TCA right         | 4450208005 |                      |
| 6   | 111-0S-S04  | tie rod end left      | 4666008001 | c:15.95 th:FM16X1.5R |     |             |                   |            |                      |

REXTON

04/2002 ->

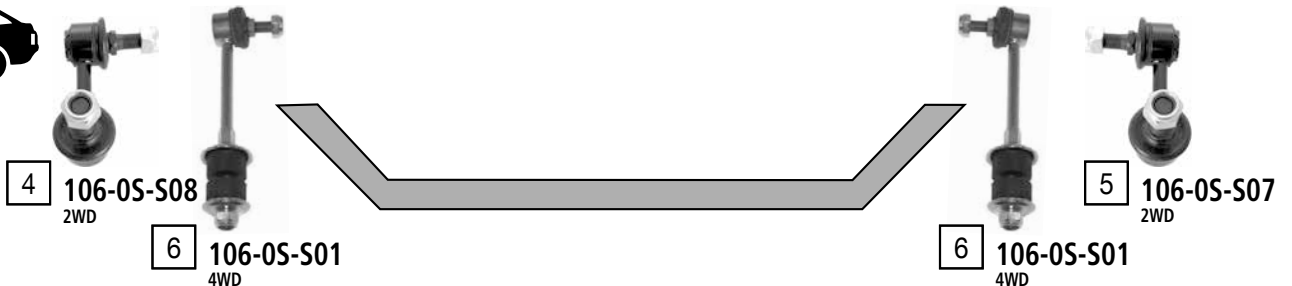
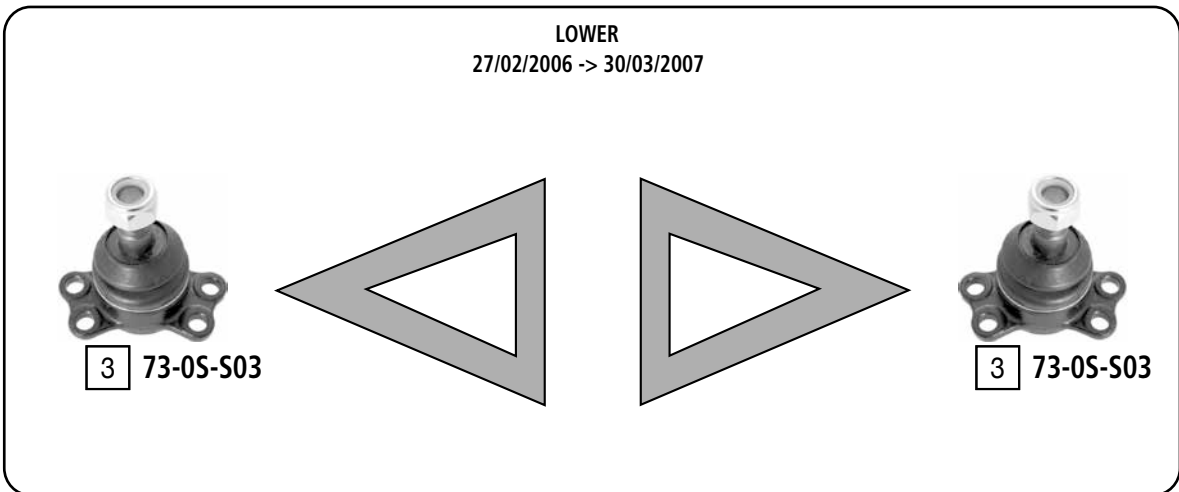
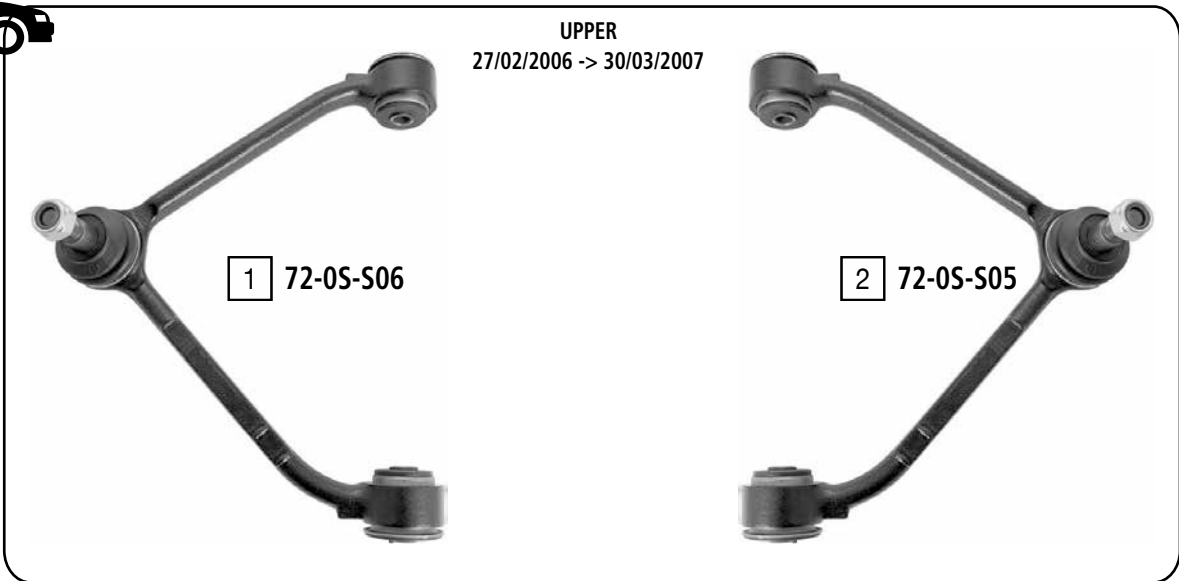

| Ref | ASHIKA CODE | Description   | OEM        | Measures | Ref | ASHIKA CODE | Description           | OEM        | Measures |
|-----|-------------|---------------|------------|----------|-----|-------------|-----------------------|------------|----------|
| 1   | 72-05-S06   | TCA left wbj  | 4440109011 | c:17.6   | 4   | 106-05-S08  | stabiliser link left  | 4575009001 | L:72     |
| 2   | 72-05-S05   | TCA right wbj | 4440209011 | c:17.6   | 5   | 106-05-S07  | stabiliser link right | 4575109001 | L:72     |
| 3   | 73-05-S03   | ball joint    | 4454109004 | c:17.4   | 6   | 106-05-S01  | stabiliser link       | 4475005001 | L:171    |

# SUBARU 1800 XT



1800 XT COUPÉ

11/1984 - 12/1990

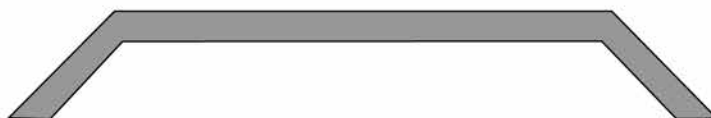

MS



2 111-07-703L



3 103-07-734



3 103-07-734



1  
111-07-703R

PS



2 111-07-703L



4 103-07-706



4 103-07-706



1  
111-07-703R



5 73-07-798

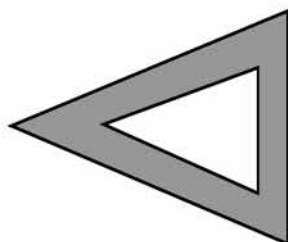

LOWER

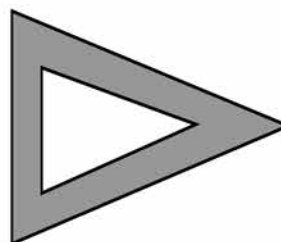

5  
73-07-798

| Ref | ASHIKA CODE | Description       | OEM         | Measures            | Ref | ASHIKA CODE | Description      | OEM         | Measures           |
|-----|-------------|-------------------|-------------|---------------------|-----|-------------|------------------|-------------|--------------------|
| 1   | 111-07-703R | Tie Rod End Left  | 31320-GA111 | c:12.3 th:FM14X1.5R | 4   | 103-07-706  | Axial Joint      | 31310-GA151 | th:MM14X1.5R L:280 |
| 2   | 111-07-703L | Tie Rod End Right | 31320-GA101 | c:12.3 th:FM14X1.5R | 5   | 73-07-798   | Ball Joint Lower | 721067003   | c:13.8             |
| 3   | 103-07-734  | Axial Joint       | 31310-GA170 |                     |     |             |                  |             |                    |

FORESTER (SF)

01/1997 - 05/2002

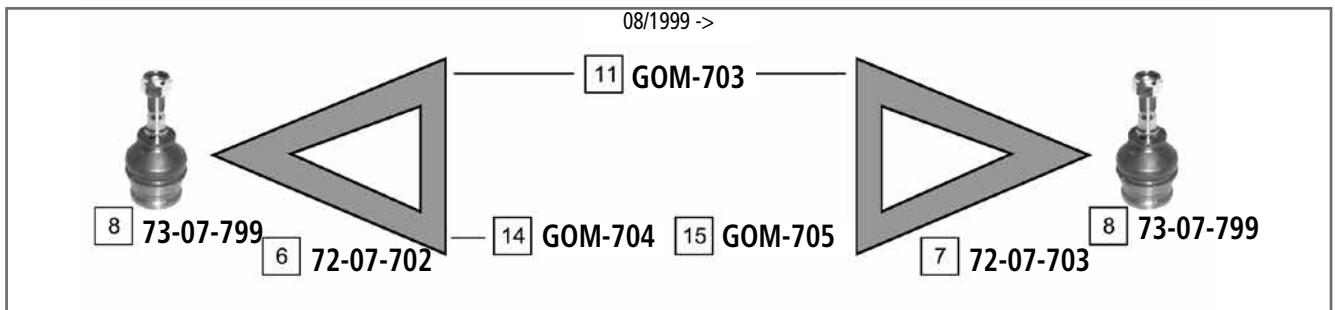
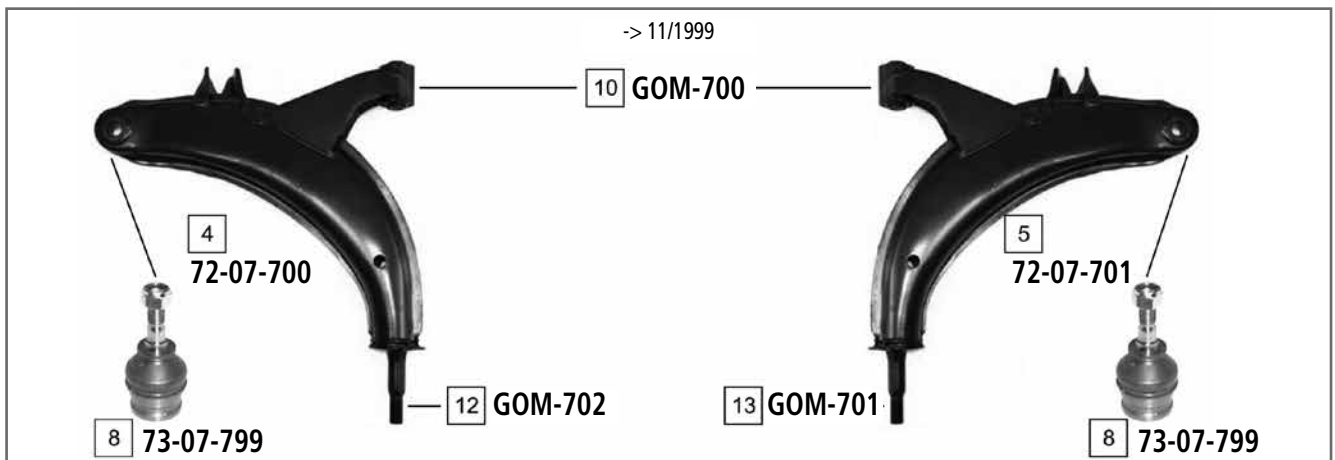
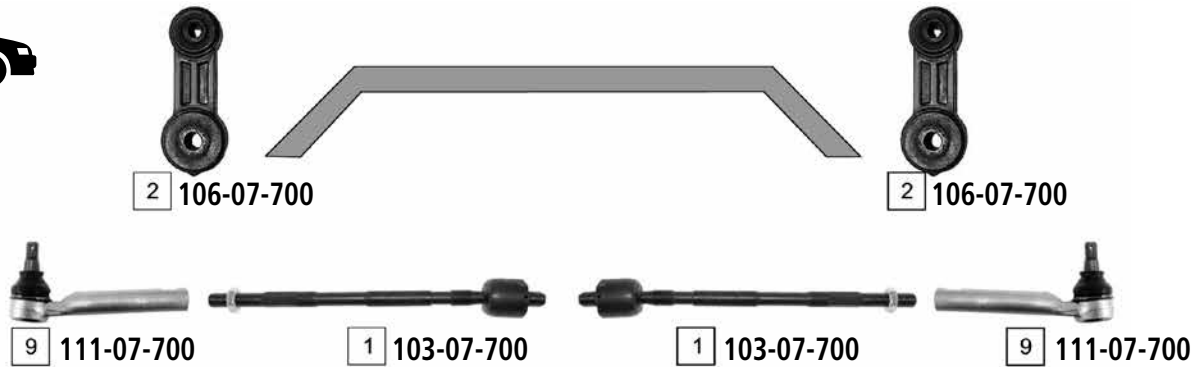

| Ref | ASHIKA CODE | Description      | OEM           | Measures           | Ref | ASHIKA CODE | Description              | OEM          | Measures |
|-----|-------------|------------------|---------------|--------------------|-----|-------------|--------------------------|--------------|----------|
| 1   | 103-07-700  | Axial Joint      | 34140 FC000   | th:MM14X1.5R L:292 | 9   | 111-07-700  | Tie Rod End              | 34141 AA 041 |          |
| 2   | 106-07-700  | Stabiliser Link  | 20420 AA003   |                    | 10  | GOM-700     | Silentblock For Susp.Arm | 20201 AA000  |          |
| 3   | 106-07-701  | Stabiliser Link  | 20481 AA001   |                    | 11  | GOM-703     | Silentblock For Susp.Arm | 20201 FC020  |          |
| 4   | 72-07-700   | TCA Left         | 20200 AA210   |                    | 12  | GOM-702     | Silentblock For Susp.Arm | 20201 AC110  |          |
| 5   | 72-07-701   | TCA Right        | 200200 AC200F |                    | 13  | GOM-701     | Silentblock For Susp.Arm | 20201 AC100  |          |
| 6   | 72-07-702   | TCA Left         | 20200 FC130   |                    | 14  | GOM-704     | Silentblock For Susp.Arm | 20201 FC110  |          |
| 7   | 72-07-703   | TCA Right        | 20200 FC120   |                    | 15  | GOM-705     | Silentblock For Susp.Arm | 20201 FC100  |          |
| 8   | 73-07-799   | Ball Joint Lower | 21067 GA050   | c:15.7             |     |             |                          |              |          |

FORESTER (SG)

02/2002 ->



2 106-07-702

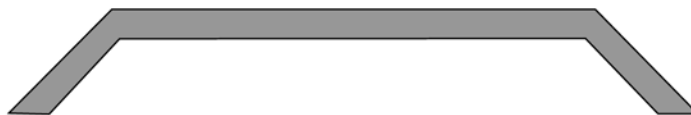

2 106-07-702



7 111-07-700

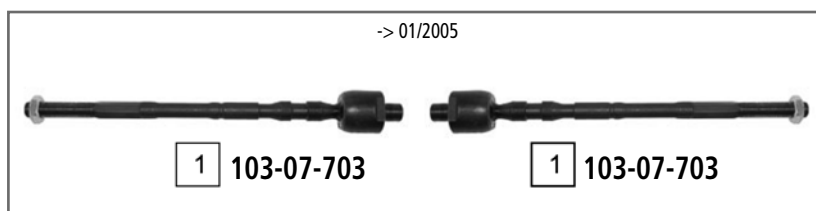

1 103-07-703

1 103-07-703



7 111-07-700



6 73-07-799

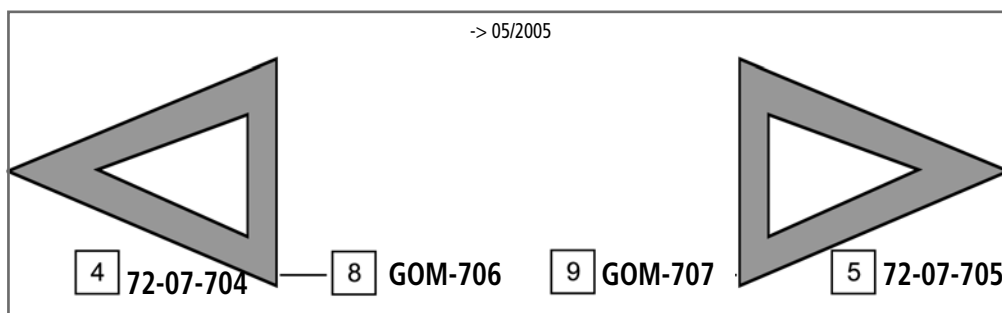

4 72-07-704

8 GOM-706

9 GOM-707

5 72-07-705



6 73-07-799



3 106-07-703



3 106-07-703

| Ref | ASHIKA CODE | Description     | OEM         | Measures           | Ref | ASHIKA CODE | Description              | OEM          | Measures |
|-----|-------------|-----------------|-------------|--------------------|-----|-------------|--------------------------|--------------|----------|
| 1   | 103-07-703  | Axial Joint     | 34160 AE000 | th:MM16X1.5R L:302 | 6   | 73-07-799   | Ball Joint Lower         | 21067 GA050  | c:15.7   |
| 2   | 106-07-702  | Stabiliser Link | 20470 SA000 |                    | 7   | 111-07-700  | Tie Rod End              | 34141 AA 041 |          |
| 3   | 106-07-703  | Stabiliser Link | 20470 SA010 | L:70               | 8   | GOM-706     | Silentblock For Susp.Arm | 20201 FC130  |          |
| 4   | 72-07-704   | TCA Left        | 20202 SA010 |                    | 9   | GOM-707     | Silentblock For Susp.Arm | 20201 FC120  |          |
| 5   | 72-07-705   | TCA Right       | 20202 SA000 |                    |     |             |                          |              |          |

FORESTER (S12)

01/2008 ->

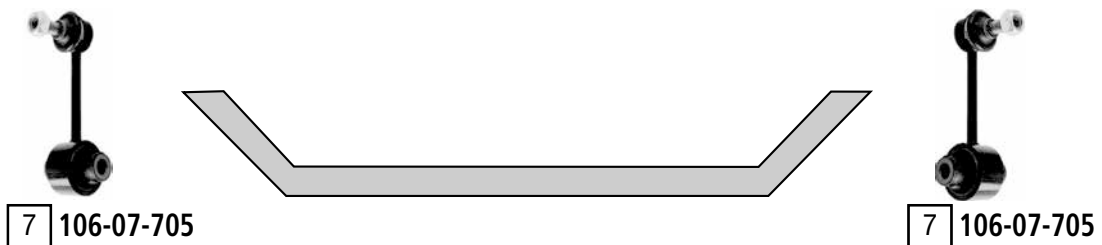
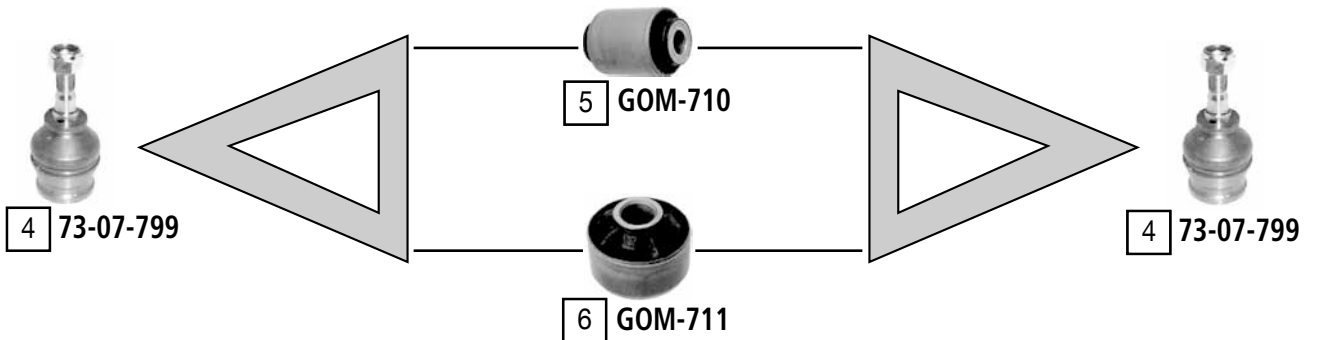

| Ref | ASHIKA CODE | Description      | OEM         | Measures           | Ref | ASHIKA CODE | Description               | OEM         | Measures        |
|-----|-------------|------------------|-------------|--------------------|-----|-------------|---------------------------|-------------|-----------------|
| 1   | 106-07-702  | stabiliser link  | 20470 SA000 | L:60               | 5   | GOM-710     | silentblock for TCA       | 20204 AJ000 | di:12.4 do:37.1 |
| 2   | 111-07-700  | tie rod end      | 34161 SA000 | c:13 th:FM14X1.5R  | 6   | GOM-711     | silentblock for TCA       | 20204 AG011 | di:19.2 do:60   |
| 3   | 103-07-708  | axial joint      | 34160 XA010 | th:MM16x1.5R L:325 | 7   | 106-07-705  | stabiliser link rear axle | 20470 AJ010 | L:107           |
| 4   | 73-07-799   | ball joint lower | 21067 GA050 | c:15.7 do:38       |     |             |                           |             |                 |



IMPREZA (GC-GF)

08/1992 - 12/2000

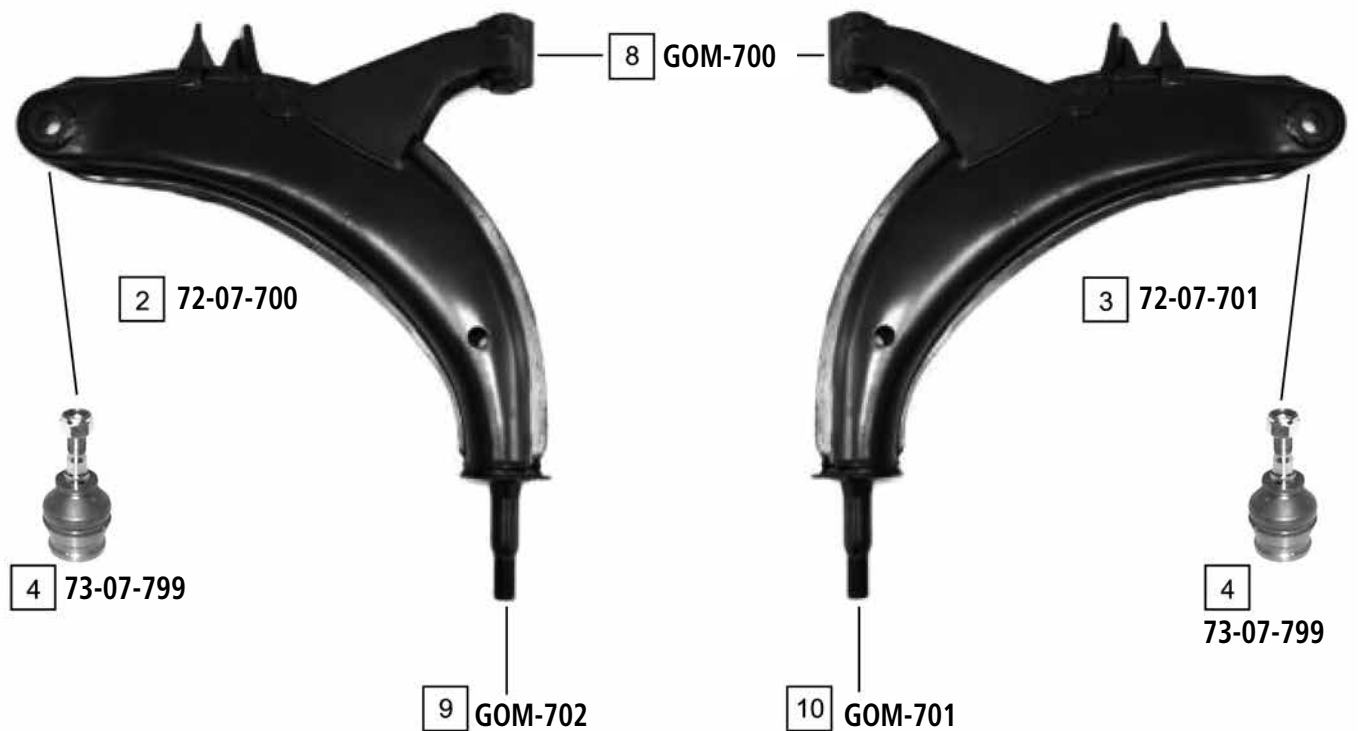
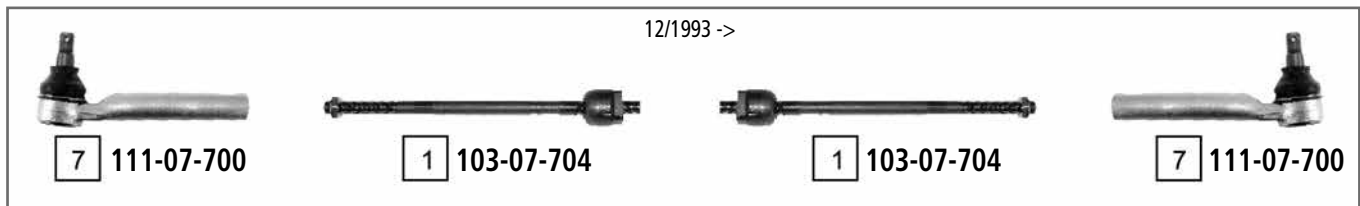
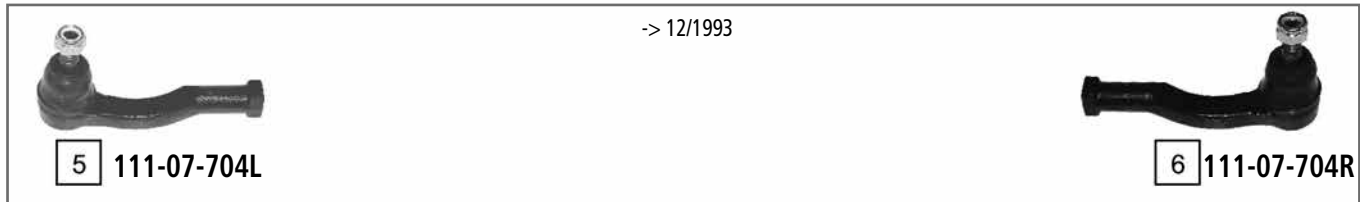

| Ref | ASHIKA CODE | Description      | OEM           | Measures           | Ref | ASHIKA CODE | Description              | OEM          | Measures |
|-----|-------------|------------------|---------------|--------------------|-----|-------------|--------------------------|--------------|----------|
| 1   | 103-07-704  | Axial Joint      | 34140-AA040   | th:MM14x1.5R L:292 | 6   | 111-07-704R | Tie Rod End Right        | 31320-GA190  |          |
| 2   | 72-07-700   | TCA Left         | 20200 AA210   |                    | 7   | 111-07-700  | Tie Rod End              | 34141 AA 041 |          |
| 3   | 72-07-701   | TCA Right        | 200200 AC200F |                    | 8   | GOM-700     | Silentblock For Susp.Arm | 20201 AA000  |          |
| 4   | 73-07-799   | Ball Joint Lower | 21067 GA050   | c:15.7             | 9   | GOM-702     | Silentblock For Susp.Arm | 20201 AC110  |          |
| 5   | 111-07-704L | Tie Rod End Left | 31320-GA200   |                    | 10  | GOM-701     | Silentblock For Susp.Arm | 20201 AC100  |          |

IMPREZA (GD-GG)

12/2000 ->

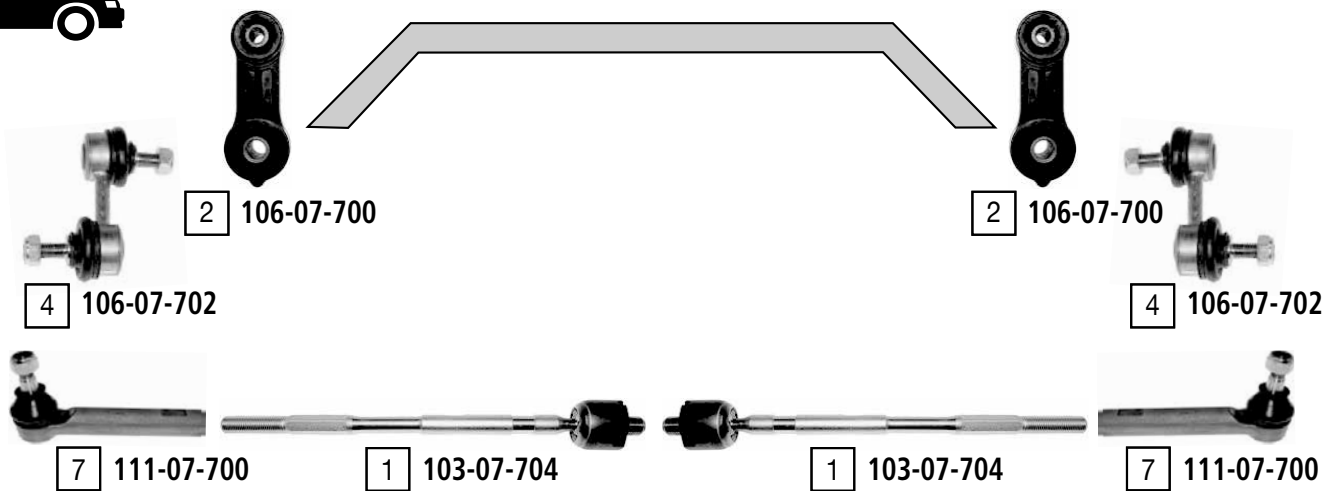

6 73-07-799  
ALL



6 73-07-799  
ALL

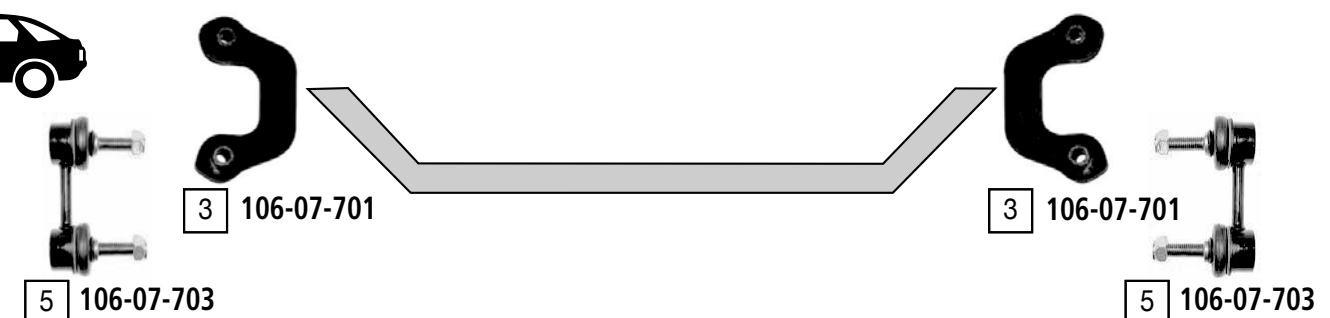

| Ref | ASHIKA CODE | Description               | OEM         | Measures           | Ref | ASHIKA CODE | Description               | OEM         | Measures          |
|-----|-------------|---------------------------|-------------|--------------------|-----|-------------|---------------------------|-------------|-------------------|
| 1   | 103-07-704  | axial joint               | 34140 AA040 | th:MM14X1.5R L:292 | 5   | 106-07-703  | stabiliser link rear axle | 20470 SA011 | L:70              |
| 2   | 106-07-700  | stabiliser link           | 20420 AA004 | L:65               | 6   | 73-07-799   | ball joint lower          | 21067 GA050 | c:15.7 do:38      |
| 3   | 106-07-701  | stabiliser link rear axle | 20481 AA001 | L:100              | 7   | 111-07-700  | tie rod end               | 34161 SA000 | c:13 th:FM14X1.5R |
| 4   | 106-07-702  | stabiliser link           | 20470 SA000 | L:60               |     |             |                           |             |                   |

IMPREZA (GR)

01/2008 ->



1 106-07-702



1 106-07-702



2 111-07-700



3 103-07-703



3 103-07-703



2 111-07-700



4 73-07-799



4 73-07-799



5 106-07-706



5 106-07-706

| Ref | ASHIKA CODE | Description     | OEM         | Measures           | Ref | ASHIKA CODE | Description               | OEM         | Measures     |
|-----|-------------|-----------------|-------------|--------------------|-----|-------------|---------------------------|-------------|--------------|
| 1   | 106-07-702  | stabiliser link | 20470 SA000 | L:60               | 4   | 73-07-799   | ball joint lower          | 21067 GA050 | c:15.7 do:38 |
| 2   | 111-07-700  | tie rod end     | 34161 SA000 | c:13 th:FM14X1.5R  | 5   | 106-07-706  | stabiliser link rear axle | 20470 FG000 | L:94         |
| 3   | 103-07-703  | axial joint     | 34160 AE001 | th:MM16X1.5R L:302 |     |             |                           |             |              |

JUSTY (KAD-JMA)

11/1984 - 09/2003



3 111-07-705



4 103-07-707



4 103-07-707



3 111-07-705

1987 - 1994



1 71-07-700



2 71-07-701



5 73-07-704



5 73-07-704

| Ref | ASHIKA CODE | Description | OEM        | Measures            | Ref | ASHIKA CODE | Description | OEM        | Measures           |
|-----|-------------|-------------|------------|---------------------|-----|-------------|-------------|------------|--------------------|
| 1   | 71-07-700   | TCA Left    | 7210-60530 |                     | 4   | 103-07-707  | Axial Joint | 7313-10140 | th:MM14X1.5R L:222 |
| 2   | 71-07-701   | TCA Right   | 7210-60520 | c:15                | 5   | 73-07-704   | Ball Joint  | 7210-67021 | c:13               |
| 3   | 111-07-705  | Tie Rod End | 7313-20020 | c:11.5 th:FM12X1.5R |     |             |             |            |                    |

LEGACY I (BC)

01/1989 - 08/1994



4 111-07-704L



5  
111-07-704R



1 72-07-700

3 73-07-799

6 GOM-702

8 GOM-700



2 72-07-701

3  
73-07-799

7 GOM-701

| Ref | ASHIKA CODE | Description      | OEM           | Measures | Ref | ASHIKA CODE | Description              | OEM         | Measures |
|-----|-------------|------------------|---------------|----------|-----|-------------|--------------------------|-------------|----------|
| 1   | 72-07-700   | TCA Left         | 20200 AA210   |          | 5   | 111-07-704R | Tie Rod End Right        | 31320-GA190 |          |
| 2   | 72-07-701   | TCA Right        | 200200 AC200F |          | 6   | GOM-702     | Silentblock For Susp.Arm | 20201 AC110 |          |
| 3   | 73-07-799   | Ball Joint Lower | 21067 GA050   | c:15.7   | 7   | GOM-701     | Silentblock For Susp.Arm | 20201 AC100 |          |
| 4   | 111-07-704L | Tie Rod End Left | 31320-GA200   |          | 8   | GOM-700     | Silentblock For Susp.Arm | 20201 AA000 |          |

LEGACY II (BD-BG)

01/1994 - 03/1999



5 111-07-700



1 103-07-704



1 103-07-704



5  
111-07-700



2 72-07-700

4 73-07-799

6 GOM-700

7 GOM-702



3 72-07-701

4  
73-07-799

8 GOM-701

| Ref | ASHIKA CODE | Description      | OEM           | Measures           | Ref | ASHIKA CODE | Description              | OEM          | Measures |
|-----|-------------|------------------|---------------|--------------------|-----|-------------|--------------------------|--------------|----------|
| 1   | 103-07-704  | Axial Joint      | 34140-AA040   | th:MM14X1.5R L:292 | 5   | 111-07-700  | Tie Rod End              | 34141 AA 041 |          |
| 2   | 72-07-700   | TCA Left         | 20200 AA210   |                    | 6   | GOM-700     | Silentblock For Susp.Arm | 20201 AA000  |          |
| 3   | 72-07-701   | TCA Right        | 200200 AC200F |                    | 7   | GOM-702     | Silentblock For Susp.Arm | 20201 AC110  |          |
| 4   | 73-07-799   | Ball Joint Lower | 21067 GA050   | c:15.7             | 8   | GOM-701     | Silentblock For Susp.Arm | 20201 AC100  |          |

LEGACY III (BE-BH)

04/1999 - 08/2003

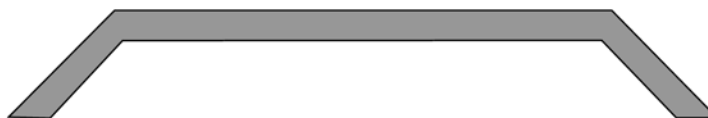

3 111-07-700



1 103-07-705



1 103-07-705



3  
111-07-700



2 73-07-799

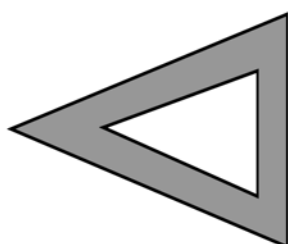

LOWER

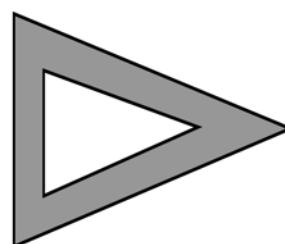

2  
73-07-799

| Ref | ASHIKA CODE | Description      | OEM         | Measures           | Ref | ASHIKA CODE | Description | OEM          | Measures |
|-----|-------------|------------------|-------------|--------------------|-----|-------------|-------------|--------------|----------|
| 1   | 103-07-705  | Axial Joint      | 31310-GA152 | th:MM14X1.5R L:292 | 3   | 111-07-700  | Tie Rod End | 34141 AA 041 |          |
| 2   | 73-07-799   | Ball Joint Lower | 21067 GA050 | c:15.7             |     |             |             |              |          |

LEGACY IV (B13)

09/2003 ->

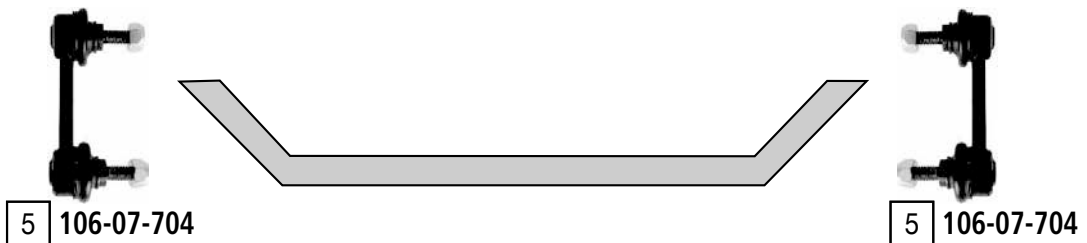
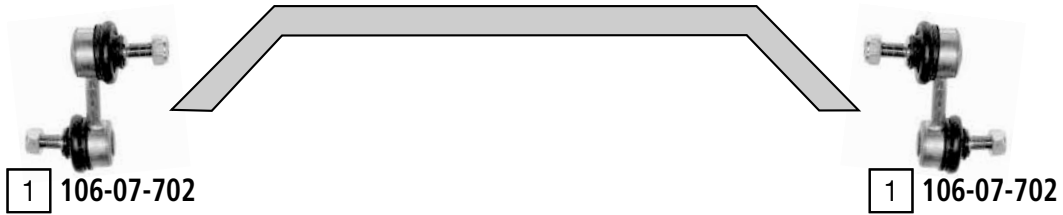

| Ref | ASHIKA CODE | Description     | OEM         | Measures           | Ref | ASHIKA CODE | Description               | OEM         | Measures     |
|-----|-------------|-----------------|-------------|--------------------|-----|-------------|---------------------------|-------------|--------------|
| 1   | 106-07-702  | stabiliser link | 20470 SA000 | L:60               | 4   | 73-07-799   | ball joint lower          | 21067 GA050 | c:15.7 do:38 |
| 2   | 111-07-700  | tie rod end     | 34161 SA000 | c:13 th:FM14X1.5R  | 5   | 106-07-704  | stabiliser link rear axle | 20470 AE001 | L:90         |
| 3   | 103-07-703  | axial joint     | 34160 AE001 | th:MM16X1.5R L:302 |     |             |                           |             |              |



LEGACY V (B14)

09/2009 ->

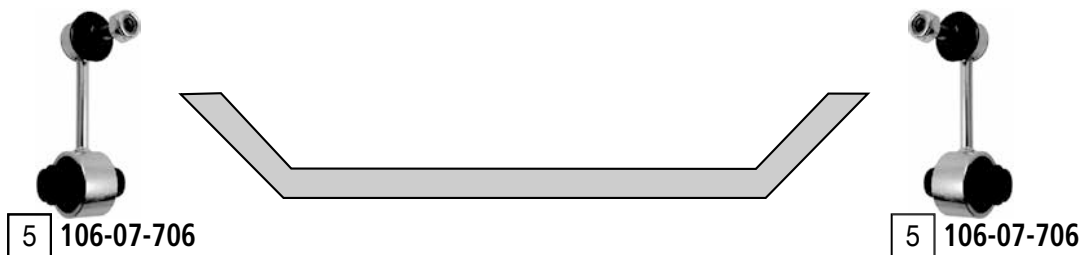
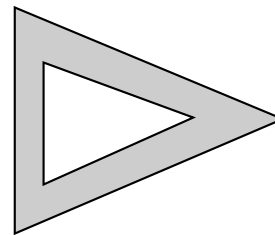
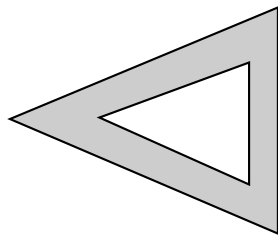

| Ref | ASHIKA CODE | Description     | OEM         | Measures           | Ref | ASHIKA CODE | Description               | OEM         | Measures     |
|-----|-------------|-----------------|-------------|--------------------|-----|-------------|---------------------------|-------------|--------------|
| 1   | 106-07-707  | stabiliser link | 20420 AJ000 | L:63               | 4   | 73-07-799   | ball joint lower          | 21067 GA050 | c:15.7 do:38 |
| 2   | 111-07-700  | tie rod end     | 34161 SA000 | c:13 th:FM14X1.5R  | 5   | 106-07-706  | stabiliser link rear axle | 20470 FG000 | L:94         |
| 3   | 103-07-703  | axial joint     | 34160 AE001 | th:MM16X1.5R L:302 |     |             |                           |             |              |

LEONE II

11/1984 - 02/1992



MS



2 111-07-703L



3 103-07-734



3 103-07-734



1 111-07-703R

PS



2 111-07-703L



4 103-07-706



4 103-07-706



1 111-07-703R



5 73-07-798

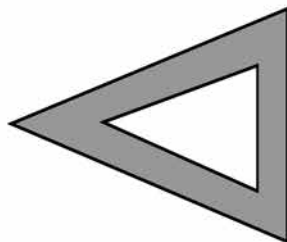

LOWER

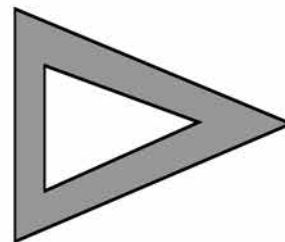

5 73-07-798

| Ref | ASHIKA CODE | Description       | OEM         | Measures            | Ref | ASHIKA CODE | Description      | OEM         | Measures           |
|-----|-------------|-------------------|-------------|---------------------|-----|-------------|------------------|-------------|--------------------|
| 1   | 111-07-703R | Tie Rod End Left  | 31320-GA111 | c:12.3 th:FM14X1.5R | 4   | 103-07-706  | Axial Joint      | 31310-GA151 | th:MM14X1.5R L:280 |
| 2   | 111-07-703L | Tie Rod End Right | 31320-GA101 | c:12.3 th:FM14X1.5R | 5   | 73-07-798   | Ball Joint Lower | 721067003   | c:13.8             |
| 3   | 103-07-734  | Axial Joint       | 31310-GA170 |                     |     |             |                  |             |                    |

LIBERO (E10-E12)

01/1983 - 02/2000



1 73-07-704

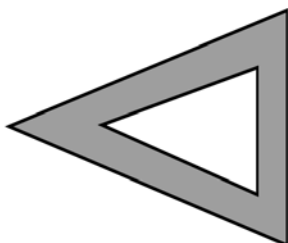

LOWER

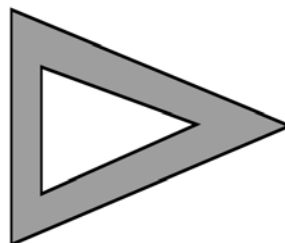

1  
73-07-704

| Ref | ASHIKA CODE | Description | OEM        | Measures | Ref | ASHIKA CODE | Description | OEM | Measures |
|-----|-------------|-------------|------------|----------|-----|-------------|-------------|-----|----------|
| 1   | 73-07-704   | Ball Joint  | 7210-67021 | c:13     |     |             |             |     |          |

ALTO I (SS80)

06/1982 - 12/1985



09/1984 ->



1 111-08-804



2 103-08-803



2 103-08-803



1 111-08-804



3 71-08-803



4 GOM-C07



3 71-08-803

| Ref | ASHIKA CODE | Description | OEM         | Measures            | Ref | ASHIKA CODE | Description              | OEM         | Measures |
|-----|-------------|-------------|-------------|---------------------|-----|-------------|--------------------------|-------------|----------|
| 1   | 111-08-804  | Tie Rod End | 48810 78000 | c:12.8 th:MM12X1.25 | 3   | 71-08-803   | TCA                      | 45200 69DV1 | c:15     |
| 2   | 103-08-803  | Axial Joint | 48830-84000 |                     | 4   | GOM-C07     | Silentblock For Susp.Arm | 45261 77A10 | d:27.5   |

ALTO II (EC)  
ALTO III (EF,SH410)

01/1986 - 11/1993  
04/1994 - 06/2002

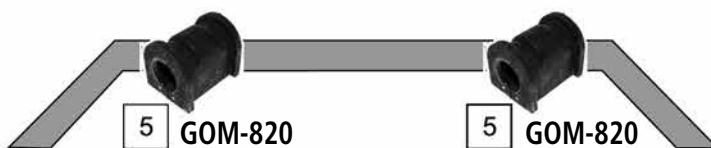

| Ref | ASHIKA CODE | Description | OEM         | Measures            | Ref | ASHIKA CODE | Description              | OEM         | Measures |
|-----|-------------|-------------|-------------|---------------------|-----|-------------|--------------------------|-------------|----------|
| 1   | 111-08-812  | Tie Rod End | 48810 84000 | c:12.7 th:MM12X1.25 | 4   | GOM-C07     | Silentblock For Susp.Arm | 45261 77A10 | d:27.5   |
| 2   | 103-08-803  | Axial Joint | 48830-84000 |                     | 5   | GOM-820     | Stabiliser Mountig       | 42431 70B42 | d:21.5   |
| 3   | 71-08-803   | TCA         | 45200 69DV1 | c:15                |     |             |                          |             |          |

ALTO IV (RF410)

03/2002 - 02/2007

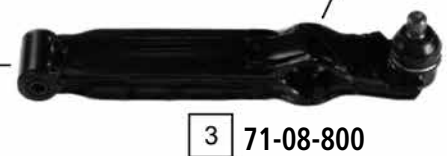

| Ref      | ASHIKA CODE       | Description | OEM          | Measures            | Ref      | ASHIKA CODE    | Description              | OEM          | Measures |
|----------|-------------------|-------------|--------------|---------------------|----------|----------------|--------------------------|--------------|----------|
| <b>1</b> | <b>103-08-800</b> | Axial Joint | 48830 M70F00 | th:FM14X1.5R L:236  | <b>4</b> | <b>GOM-C07</b> | Silentblock For Susp.Arm | 45261 77A10  | d:27.5   |
| <b>2</b> | <b>111-08-812</b> | Tie Rod End | 48810 84000  | c:12.7 th:MM12X1.25 | <b>5</b> | <b>GOM-821</b> | Silentblock For Susp.Arm | 42451 M76G00 |          |
| <b>3</b> | <b>71-08-800</b>  | TCA         | 45200 M79F00 | c:15                |          |                |                          |              |          |

ALTO V (GF)

01/2009 ->

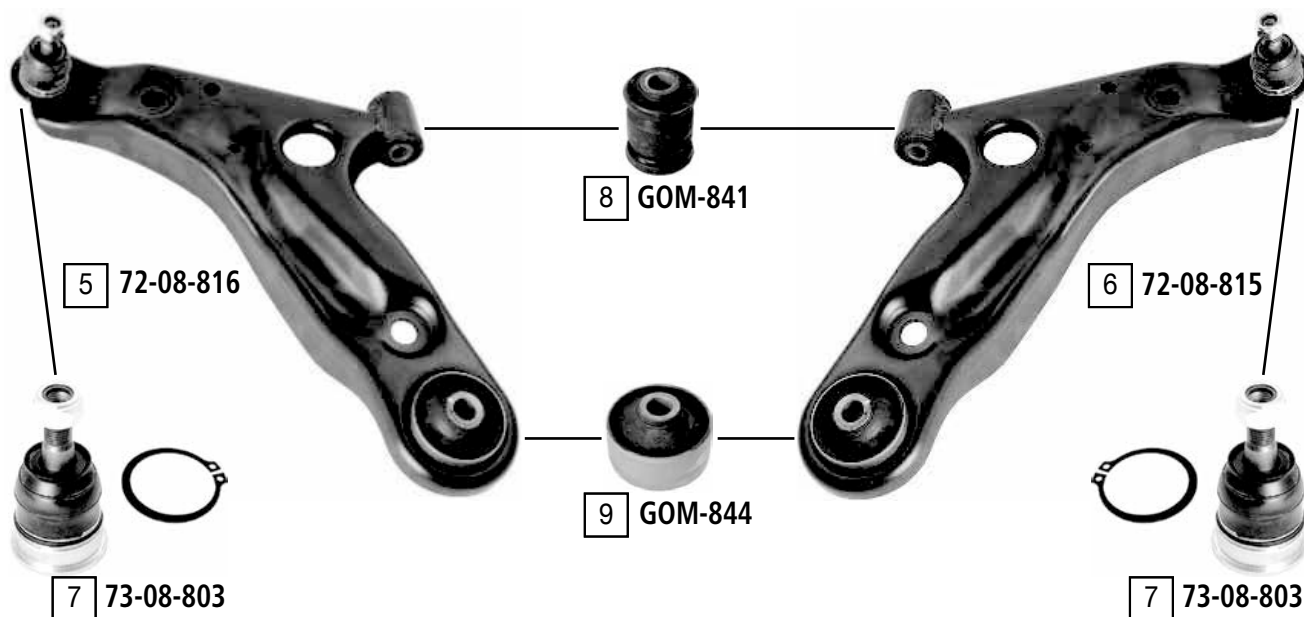
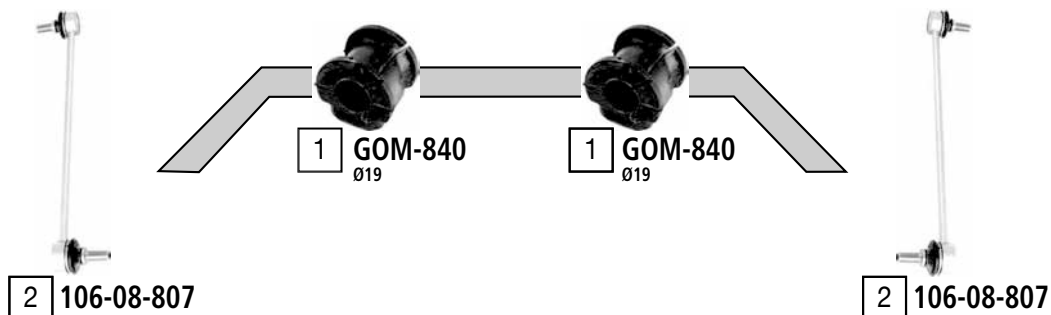

| Ref | ASHIKA CODE | Description         | OEM          | Measures               | Ref | ASHIKA CODE | Description         | OEM          | Measures        |
|-----|-------------|---------------------|--------------|------------------------|-----|-------------|---------------------|--------------|-----------------|
| 1   | GOM-840     | stabiliser mounting | 42431 M68K00 | di:19                  | 6   | 72-08-815   | TCA right wbj       | 45201 M68K00 | c:13.4          |
| 2   | 106-08-807  | stabiliser link     | 42420 M68K00 | L:282                  | 7   | 73-08-803   | ball joint          | Part of      | c:13.4 do:40.3  |
| 3   | 111-08-824  | tie rod end         | 48810 63J00  | c:13 th:FM12x1.25R     | 8   | GOM-841     | silentblock for TCA | 45430 M68K00 | di:12.1 do:33.4 |
| 4   | 103-08-816  | axial joint         | 48830 M68K00 | th:MM14x1.5R L:272.5 9 | 9   | GOM-844     | silentblock for TCA | Part of      | di:12.4 do:54.1 |
| 5   | 72-08-816   | TCA left wbj        | 45202 M68K00 | c:13.4                 |     |             |                     |              |                 |

BALENO (SY)

07/1995 - 11/2002

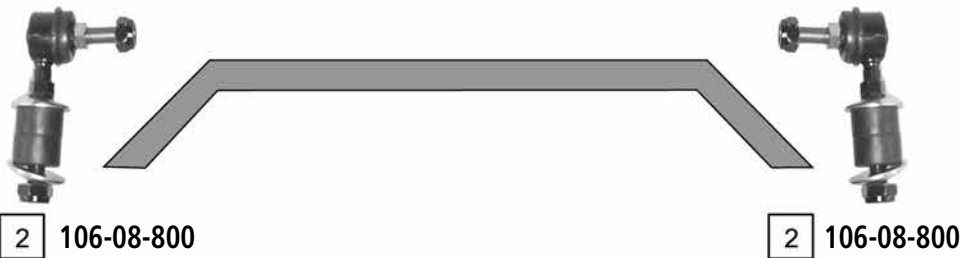

5 111-08-805



1 103-08-805



1 103-08-805



5 111-08-805



3  
72-08-800

9 GOM-822



4 72-08-801

8 GOM-823



6 106-08-802



7 106-08-801

| Ref | ASHIKA CODE | Description     | OEM         | Measures            | Ref | ASHIKA CODE | Description              | OEM         | Measures |
|-----|-------------|-----------------|-------------|---------------------|-----|-------------|--------------------------|-------------|----------|
| 1   | 103-08-805  | Axial Joint     | 48830-60G00 | th:MM14X1.5R L:307  | 6   | 106-08-802  | Stabiliser Link Left     | 46640 80F00 | L:178    |
| 2   | 106-08-800  | Stabiliser Link | 46630 60B01 |                     | 7   | 106-08-801  | Stabiliser Link Right    | 46630 80F00 | L:178    |
| 3   | 72-08-800   | TCA             | 45202-63G01 | c:16.5              | 8   | GOM-823     | Silentblock For Susp.Arm | 46420 60B02 |          |
| 4   | 72-08-801   | TCA             | 45201-63G01 | C:16.5              | 9   | GOM-822     | Silentblock For Susp.Arm | 45500 50800 |          |
| 5   | 111-08-805  | Tie Rod End     | 48810 76G00 | c:12.7 th:FM12X1.25 |     |             |                          |             |          |



CARRY (ST90V)

11/1980 - 10/1985



2 111-08-803L



3 111-08-803R



2 111-08-803L



3  
111-08-803R



1 71-08-802



1 71-08-802

4 73-08-801  
-> 02/1981

4 73-08-801  
-> 02/1981

| Ref | ASHIKA CODE | Description | OEM         | Measures            | Ref | ASHIKA CODE | Description | OEM         | Measures            |
|-----|-------------|-------------|-------------|---------------------|-----|-------------|-------------|-------------|---------------------|
| 1   | 71-08-802   | TCA Lower   | 45200-79001 |                     | 3   | 111-08-803R | Tie Rod End | 48810 79000 | c:12.7 th:MM14X1.5R |
| 2   | 111-08-803L | Tie Rod End | 48820-79000 | c:12.5 th:MM14X1.5L | 4   | 73-08-801   | Ball Joint  |             |                     |

CARRY (ED)

10/1985 - 03/1999



2 111-08-803L



3 111-08-803R



2 111-08-803L



3  
111-08-803R

-> 1991



1 71-08-805



1 71-08-805

| Ref | ASHIKA CODE | Description | OEM         | Measures            | Ref | ASHIKA CODE | Description | OEM         | Measures            |
|-----|-------------|-------------|-------------|---------------------|-----|-------------|-------------|-------------|---------------------|
| 1   | 71-08-805   | TCA Lower   | 45200-85001 |                     | 3   | 111-08-803R | Tie Rod End | 48810 79000 | c:12.7 th:MM14X1.5R |
| 2   | 111-08-803L | Tie Rod End | 48820-79000 | c:12.5 th:MM14X1.5L |     |             |             |             |                     |

CARRY (FD)

03/1999 ->

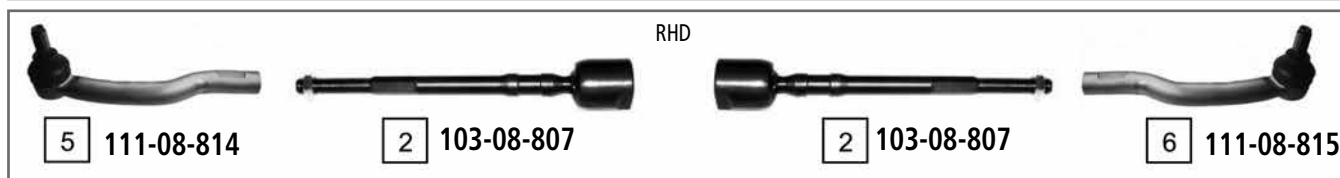
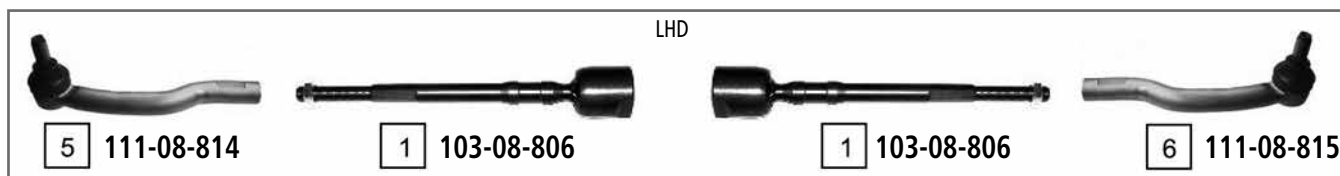

| Ref | ASHIKA CODE | Description | OEM         | Measures           | Ref | ASHIKA CODE | Description              | OEM         | Measures |
|-----|-------------|-------------|-------------|--------------------|-----|-------------|--------------------------|-------------|----------|
| 1   | 103-08-806  | Axial Joint | 48830-77A00 | th:FM14X1.5R L:240 | 5   | 111-08-814  | Tie Rod End              | 48820-78A00 |          |
| 2   | 103-08-807  | Axial Joint | 48830-78A00 | th:FM14X1.5R L:225 | 6   | 111-08-815  | Tie Rod End              | 48810-78A00 |          |
| 3   | 71-08-806   | TCA         | 45202-77A01 | c:15               | 7   | GOM-824     | Silentblock For Susp.Arm | 09319 10030 |          |
| 4   | 71-08-807   | TCA         | 45201-77A01 | c:15               |     |             |                          |             |          |

GRAND VITARA (FT-GT)

03/1998 - 04/2005



-> 06/2001



06/2001 ->

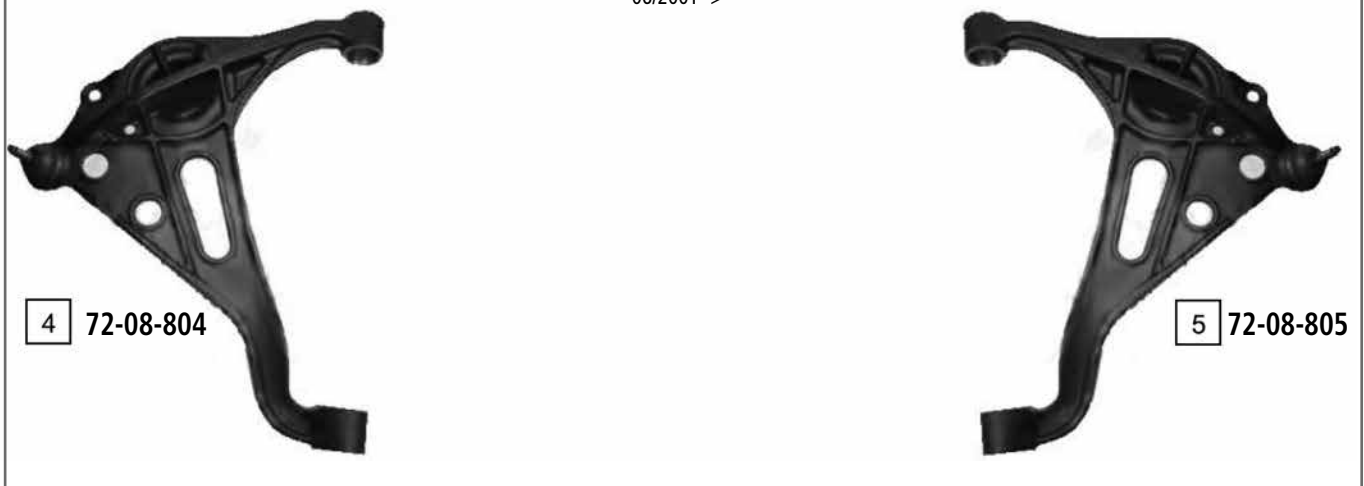

| Ref | ASHIKA CODE | Description | OEM         | Measures         | Ref | ASHIKA CODE | Description       | OEM         | Measures |
|-----|-------------|-------------|-------------|------------------|-----|-------------|-------------------|-------------|----------|
| 1   | 103-08-808  | Axial Joint | 48830-65D00 | th:MM16X1R L:227 | 5   | 72-08-805   | TCA               | 45201-65D01 |          |
| 2   | 72-08-802   | TCA         | 45202-65D00 |                  | 6   | 111-08-816  | Tie Rod End Left  | 48820 65D00 |          |
| 3   | 72-08-803   | TCA         | 45201-65D00 |                  | 7   | 111-08-817  | Tie Rod End Right | 48810 65D00 |          |
| 4   | 72-08-804   | TCA         | 45202 65D01 |                  |     |             |                   |             |          |

# SUZUKI GRAND VITARA



GRAND VITARA (JB416-419-420)

10/2005 ->

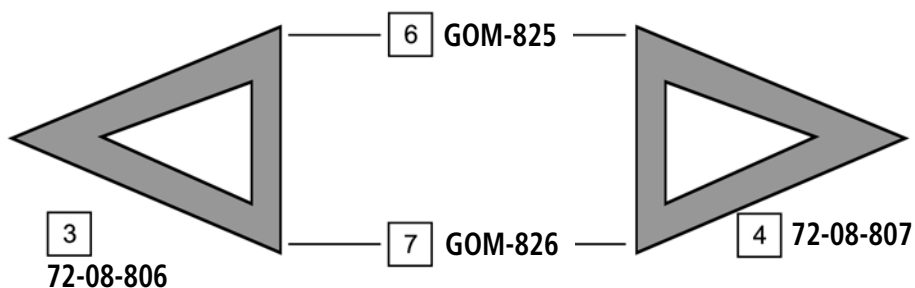

| Ref | ASHIKA CODE | Description     | OEM         | Measures           | Ref | ASHIKA CODE | Description              | OEM                         | Measures |
|-----|-------------|-----------------|-------------|--------------------|-----|-------------|--------------------------|-----------------------------|----------|
| 1   | 103-08-809  | Axial Joint     | 48830 65J00 | th:MM18X1.5R L:343 | 5   | 111-08-800  | Tie Rod End              | 48810 65J00                 |          |
| 2   | 106-08-803  | Stabiliser Link | 42420 65J00 |                    | 6   | GOM-825     | Silentblock For Susp.Arm | 45261 65J00                 |          |
| 3   | 72-08-806   | TCA Left        | 45202 65J00 |                    | 7   | GOM-826     | Silentblock For Susp.Arm | Part of 72-08-806/72-08-807 |          |
| 4   | 72-08-807   | TCA Right       | 45201 65J00 |                    |     |             |                          |                             |          |

IGNIS (FH-RG413-RG415)

10/2000 - 09/2003

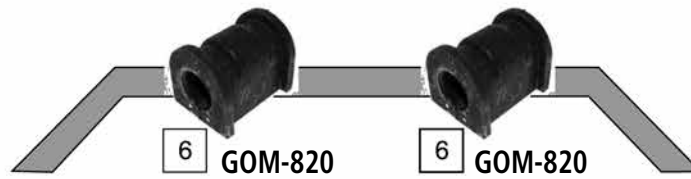

2 111-08-805



1 103-08-810



1 103-08-810



2  
111-08-805



| Ref | ASHIKA CODE | Description | OEM         | Measures            | Ref | ASHIKA CODE | Description              | OEM          | Measures |
|-----|-------------|-------------|-------------|---------------------|-----|-------------|--------------------------|--------------|----------|
| 1   | 103-08-810  | Axial Joint | 48830 75F00 | th:FM14X1.5R L:248  | 4   | GOM-C07     | Silentblock For Susp.Arm | 45261 77A10  | d:27.5   |
| 2   | 111-08-805  | Tie Rod End | 48810 76G00 | c:12.7 th:FM12X1.25 | 5   | GOM-821     | Silentblock For Susp.Arm | 42451 M76G00 |          |
| 3   | 71-08-801   | TCA         | 45200 76G20 | c:15                | 6   | GOM-820     | Stabiliser Mounting      | 42431 70B42  | d:21.5   |

IGNIS (RM413-415)

09/2003 ->



| Ref | ASHIKA CODE | Description | OEM         | Measures            | Ref | ASHIKA CODE | Description              | OEM          | Measures |
|-----|-------------|-------------|-------------|---------------------|-----|-------------|--------------------------|--------------|----------|
| 1   | 111-08-818  | Tie Rod End | 48810 83E02 | c:13.1 th:FM12X1.25 | 4   | GOM-C07     | Silentblock For Susp.Arm | 45261 77A10  | d:27.5   |
| 2   | 103-08-811  | Axial Joint | 48830 86G00 | th:MM14X1.5R L:247  | 5   | GOM-821     | Silentblock For Susp.Arm | 42451 M76G00 |          |
| 3   | 71-08-804   | TCA         | 45200 85E00 |                     |     |             |                          |              |          |

JIMNY (FJ)

09/1998 ->



**1** 111-08-820



**2**  
111-08-819

**3** 111-08-807

**4** 111-08-811

| Ref | ASHIKA CODE | Description | OEM         | Measures            | Ref | ASHIKA CODE | Description | OEM         | Measures |
|-----|-------------|-------------|-------------|---------------------|-----|-------------|-------------|-------------|----------|
| 1   | 111-08-820  | Tie Rod End | 48820-81A00 | c:12.5 th:MM16X1.5L | 3   | 111-08-807  | Tie Rod End | 48870 80002 |          |
| 2   | 111-08-819  | Tie Rod End | 48810-81A00 | c:12.5 th:MM16X1.5R | 4   | 111-08-811  | Tie Rod End | 48870 80060 |          |



SAMURAI (SJ)

11/1988 ->

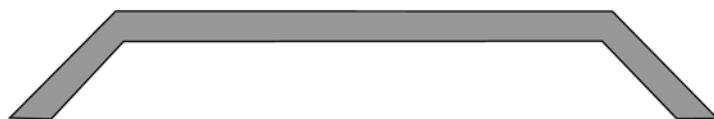

**2** 111-08-806L

**1** 111-08-806R

**3** 111-0N-N041

| Ref | ASHIKA CODE | Description | OEM         | Measures            | Ref | ASHIKA CODE | Description       | OEM | Measures |
|-----|-------------|-------------|-------------|---------------------|-----|-------------|-------------------|-----|----------|
| 1   | 111-08-806R | Tie Rod End | 48810 77E00 | c:12.5 th:MM16X1.5R | 3   | 111-0N-N041 | Rod Assy Steering |     |          |
| 2   | 111-08-806L | Tie Rod End | 48820-80000 | c:12.5 th:MM16X1.5L |     |             |                   |     |          |

SPLASH

01/2008 ->

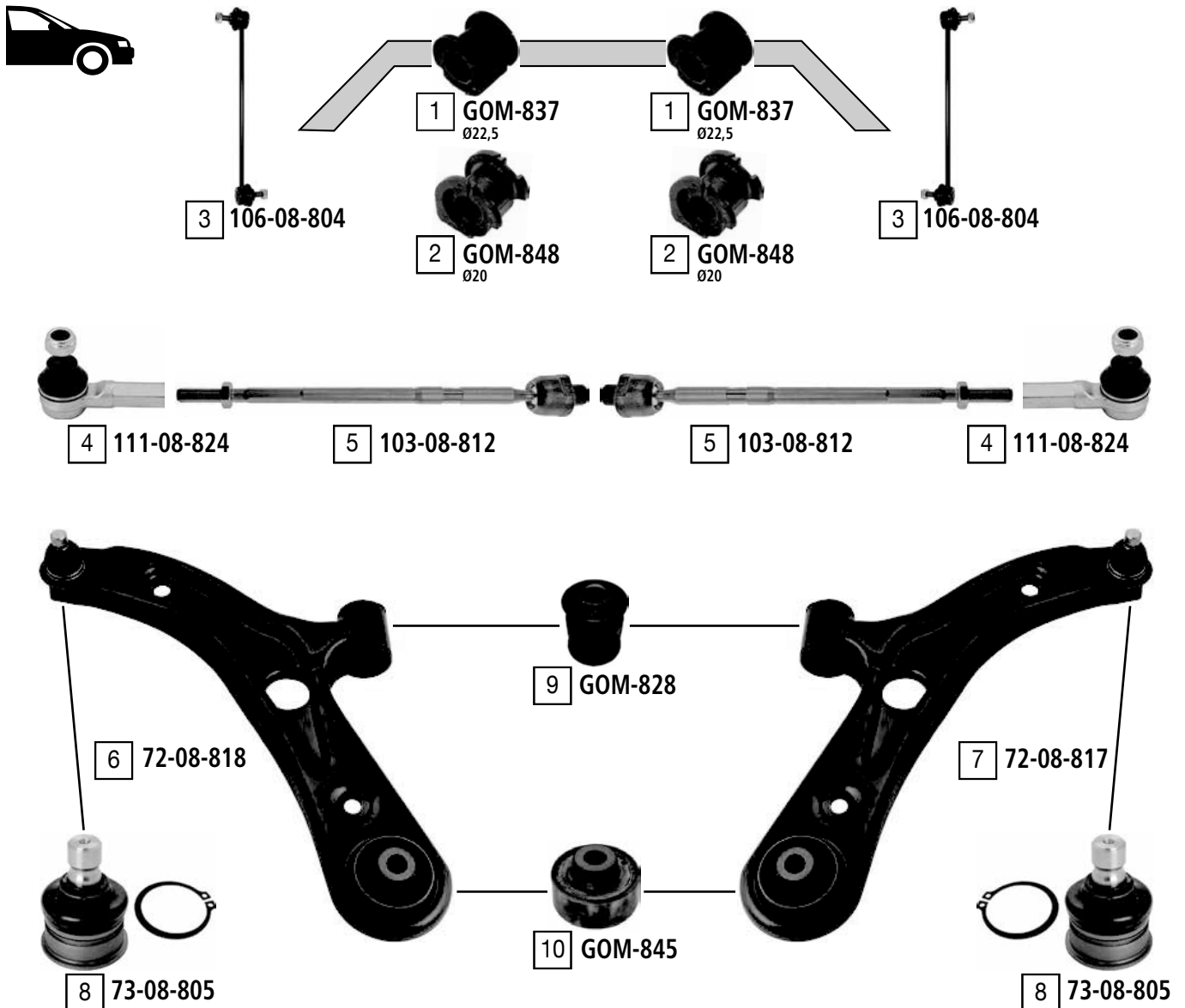

| Ref | ASHIKA CODE | Description         | OEM         | Measures           | Ref | ASHIKA CODE | Description         | OEM         | Measures        |
|-----|-------------|---------------------|-------------|--------------------|-----|-------------|---------------------|-------------|-----------------|
| 1   | GOM-837     | stabiliser mounting | 42431 51K40 | di:22.5            | 7   | 72-08-817   | TCA right wbj       | 45201 72K00 | c:16.5          |
| 2   | GOM-848     | stabiliser mounting | 42431 51K00 | di:20              | 8   | 73-08-805   | ball joint          | Part of     | c:16.5 do:40.2  |
| 3   | 106-08-804  | stabiliser link     | 42420 62J00 | L:300              | 9   | GOM-828     | silentblock for TCA | 45530 62J00 | di:14.2 do:43.5 |
| 4   | 111-08-824  | tie rod end         | 48810 63J00 | c:13 th:FM12x1.25R | 10  | GOM-845     | silentblock for TCA | Part of     | do:60           |
| 5   | 103-08-812  | axial joint         | 48830 63J00 | th:MM18X1.5R L:305 | 11  | GOM-842     | mounting axle body  | 46221 51K10 | do:55           |
| 6   | 72-08-818   | TCA left wbj        | 45202 72K00 | c:16.5             |     |             |                     |             |                 |

SWIFT I (AA)

10/1983 - 02/1989



| Ref | ASHIKA CODE | Description | OEM         | Measures            | Ref | ASHIKA CODE | Description | OEM         | Measures |
|-----|-------------|-------------|-------------|---------------------|-----|-------------|-------------|-------------|----------|
| 1   | 103-08-802  | Axial Joint | 48830-82000 | th:FM14X1.5R L:264  | 3   | 73-08-804   | TCA         | 45200-82000 | c:15     |
| 2   | 111-08-805  | Tie Rod End | 48810 60B00 | c:12.8 th:FM12X1.25 |     |             |             |             |          |

SWIFT II (AH, AJ)

03/1989 - 05/2001

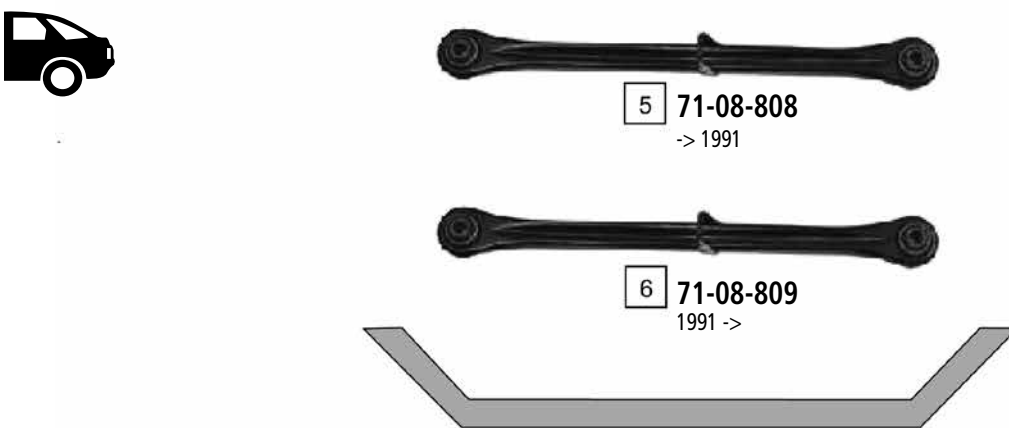
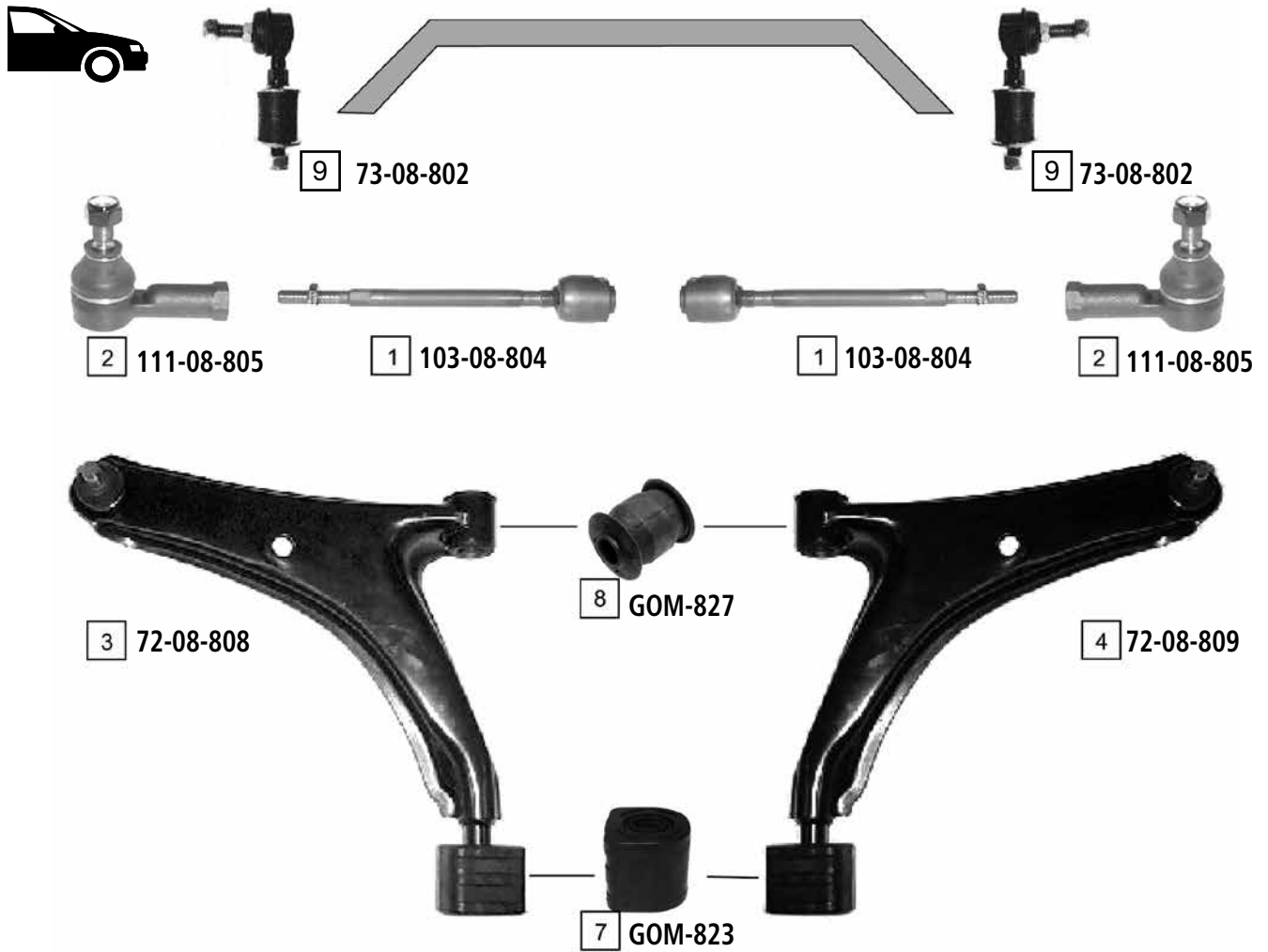

| Ref | ASHIKA CODE | Description | OEM         | Measures            | Ref | ASHIKA CODE | Description              | OEM         | Measures |
|-----|-------------|-------------|-------------|---------------------|-----|-------------|--------------------------|-------------|----------|
| 1   | 103-08-804  | Axial Joint | 48830-60B00 | th:FM14X1.5R L:288  | 6   | 71-08-809   | TCA                      | 46300 60B10 |          |
| 2   | 111-08-805  | Tie Rod End | 48810 60B00 | c:12.8 th:FM12X1.25 | 7   | GOM-823     | Silentblock For Susp.Arm | 46420 60B02 |          |
| 3   | 72-08-808   | TCA         | 45200 60820 | c:15                | 8   | GOM-827     | Silentblock For Susp.Arm | 45530 70C00 | d:34     |
| 4   | 72-08-809   | TCA         | 45200 60810 | c:15                | 9   | 73-08-802   | Stabiliser Link          | 46630-60B01 |          |
| 5   | 71-08-808   | TCA         | 46300 60B00 |                     |     |             |                          |             |          |

SWIFT III (RS413-415)

02/2005 ->

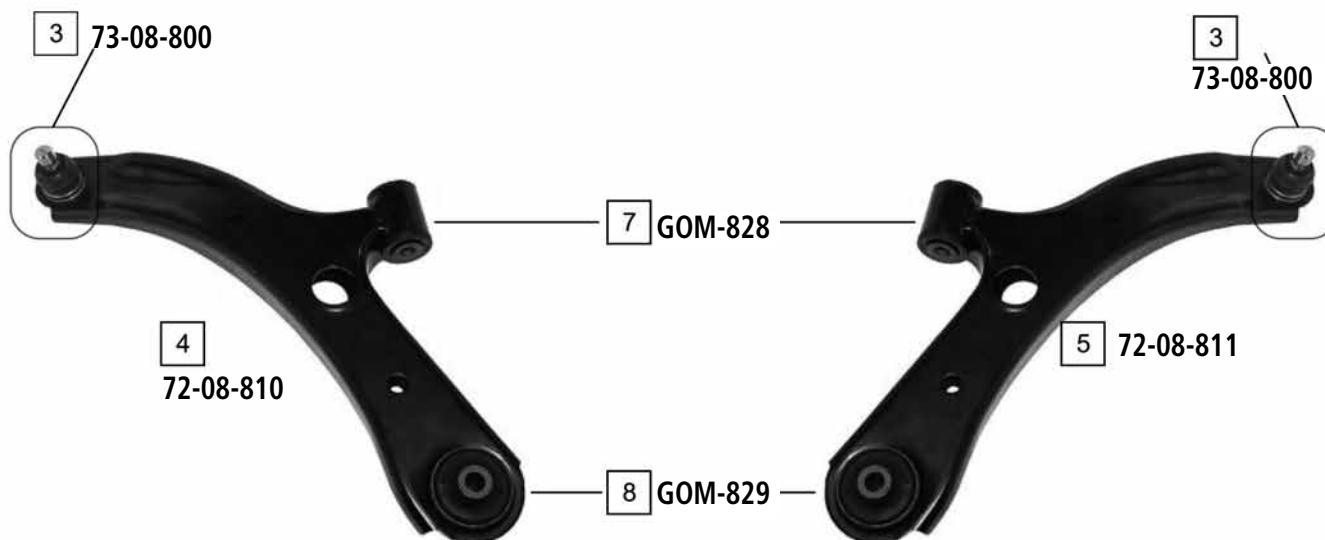
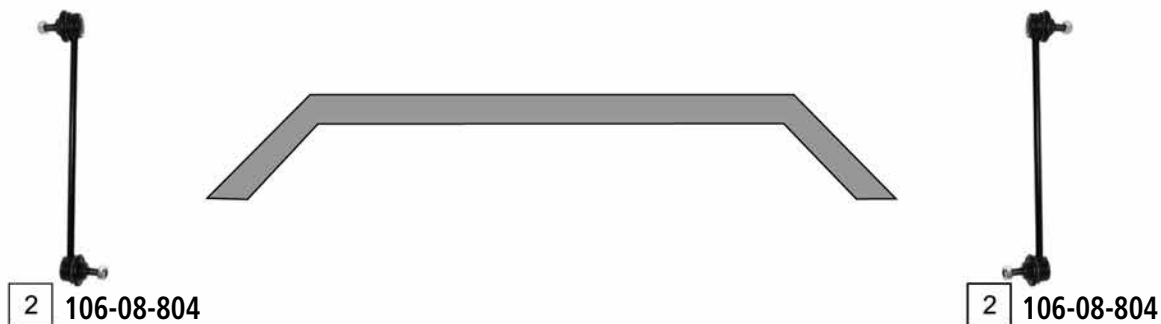

| Ref | ASHIKA CODE | Description     | OEM                            | Measures           | Ref | ASHIKA CODE | Description              | OEM                         | Measures            |
|-----|-------------|-----------------|--------------------------------|--------------------|-----|-------------|--------------------------|-----------------------------|---------------------|
| 1   | 103-08-812  | Axial Joint     | 48830 63J00                    | th:MM18X1.5R L:305 | 5   | 72-08-811   | TCA Right Wbj            | 45201 62J00                 | c:16.5              |
| 2   | 106-08-804  | Stabiliser Link | 42420 62J00                    | L:300              | 6   | 111-08-821  | Tie Rod End              | 48810 63J00                 | c:13.15 th:FM12X1.2 |
| 3   | 73-08-800   | Ball Joint      | Part of 72-08-810<br>72-08-811 |                    | 7   | GOM-828     | Silentblock For Susp.Arm | 45530 62J00                 |                     |
| 4   | 72-08-810   | TCA Left Wbj    | 45202 62J00                    | c:16.5             | 8   | GOM-829     | Silentblock For Susp.Arm | Part of 72-08-810/72-08-811 |                     |

SX4 (RW415-416-419)

06/2006 ->

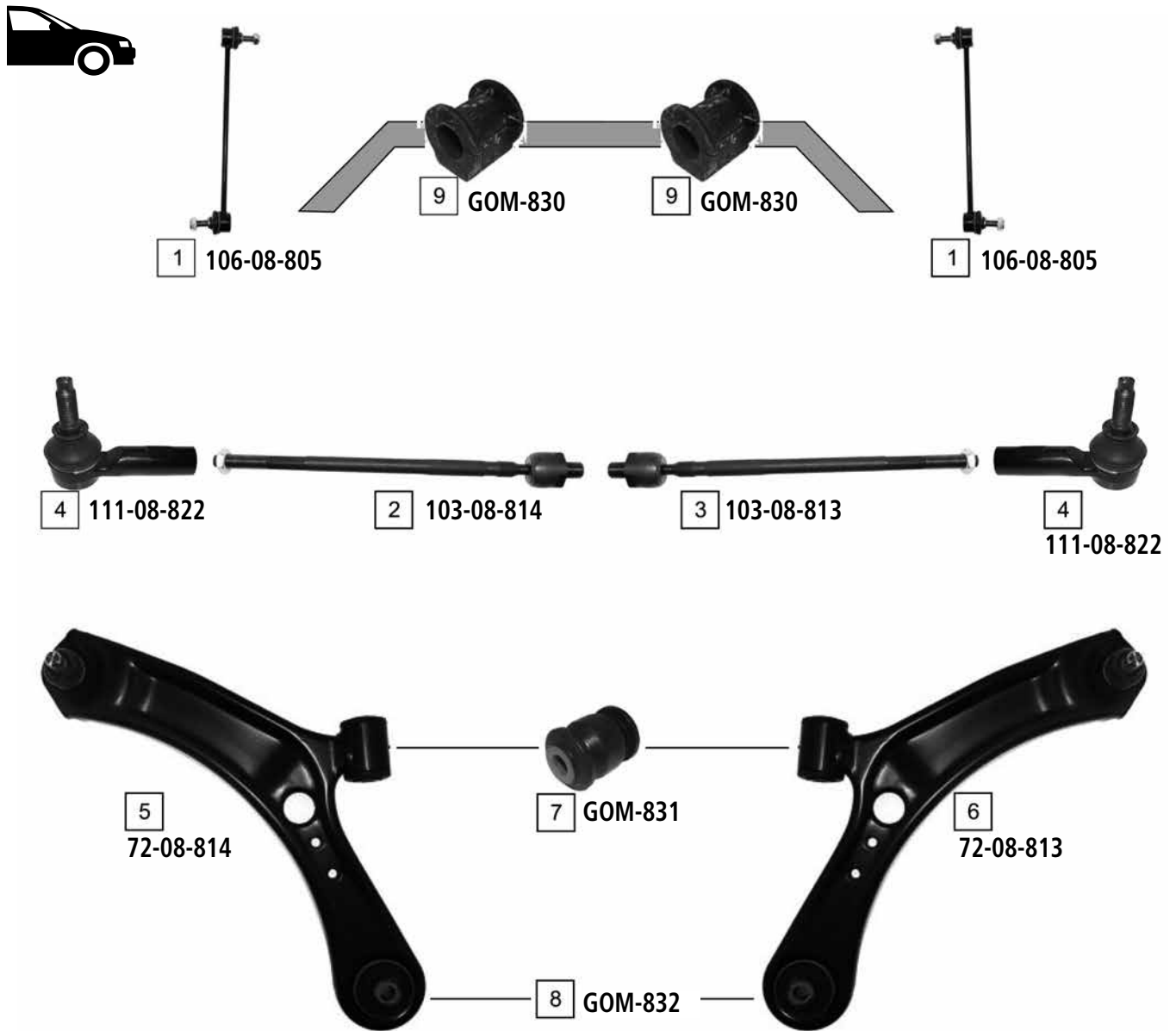

| Ref | ASHIKA CODE | Description     | OEM         | Measures         | Ref | ASHIKA CODE | Description              | OEM                         | Measures |
|-----|-------------|-----------------|-------------|------------------|-----|-------------|--------------------------|-----------------------------|----------|
| 1   | 106-08-805  | Stabiliser Link | 42420 80J00 | L:270            | 6   | 72-08-813   | TCA Right Wbj            | 45201 79J00                 |          |
| 2   | 103-08-814  | Axial Joint     | 48830 79J10 | th:MM16X1R L:334 | 7   | GOM-831     | Silentblock For Susp.Arm | 45261 79J00                 |          |
| 3   | 103-08-813  | Axial Joint     | 48830 79J00 | th:MM16X1R L:334 | 8   | GOM-832     | Silentblock For Susp.Arm | Part of 72-08-814/72-08-813 |          |
| 4   | 111-08-822  | Tie Rod End     | 48810 79J00 |                  | 9   | GOM-830     | Stabiliser Mounting      | 42431 79J00                 |          |
| 5   | 72-08-814   | TCA Left Wbj    | 45202 79J00 |                  |     |             |                          |                             |          |

VITARA (ESCUDO) (ET, TA)

05/1988 - 03/1998

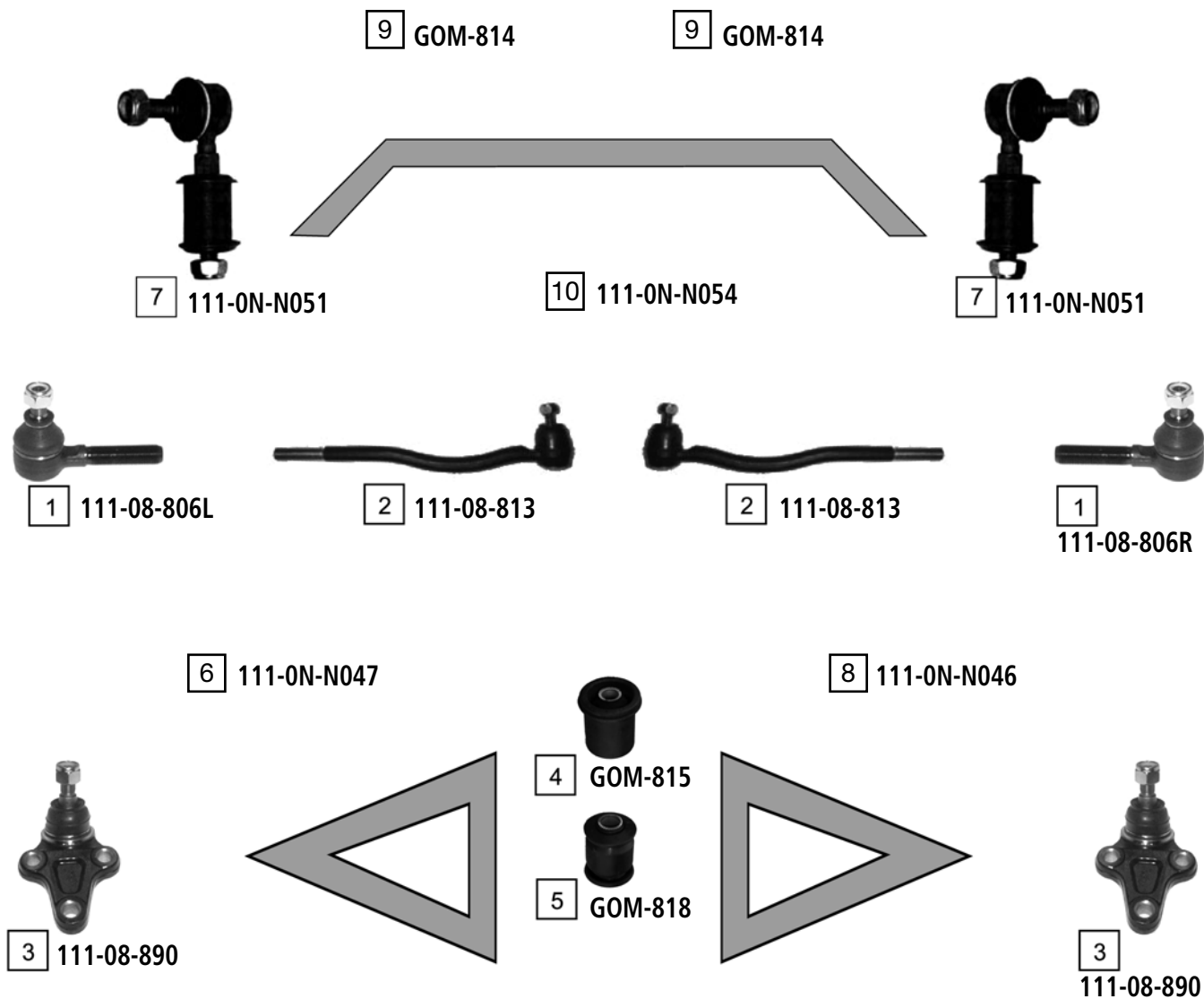

| Ref | ASHIKA CODE | Description              | OEM         | Measures            | Ref | ASHIKA CODE | Description         | OEM         | Measures |
|-----|-------------|--------------------------|-------------|---------------------|-----|-------------|---------------------|-------------|----------|
| 1   | 111-08-806R | Tie Rod End              | 48810 77E00 | c:12.5 th:MM16X1.5R | 6   | 111-0N-N047 | TCA Left            | 45202-56B00 |          |
| 2   | 111-08-813  | Tie Rod End              | 48820 77E00 | c:12.6 th:MM16X1.5L | 7   | 111-0N-N051 | Stabiliser Link     | 42420 60A00 |          |
| 3   | 111-08-890  | Ball Joint Lower         | 45700-60A00 | c:16                | 8   | 111-0N-N046 | TCA Right           | 45201-56B00 |          |
| 4   | GOM-815     | Silentblock For Susp.Arm | 09319-12044 |                     | 9   | GOM-814     | Stabiliser Mounting | 4241260A00  |          |
| 5   | GOM-818     | Silentblock For Susp.Arm | 09319-14007 |                     | 10  | 111-0N-N054 | Link Assy Steering  | 48850A60A00 |          |

WAGON R+ (EM)

02/1998 - 05/2000



3 111-08-823



1 103-08-810



1 103-08-810



3  
111-08-823



2 71-08-810



2 71-08-810

| Ref | ASHIKA CODE | Description | OEM         | Measures           | Ref | ASHIKA CODE | Description | OEM         | Measures            |
|-----|-------------|-------------|-------------|--------------------|-----|-------------|-------------|-------------|---------------------|
| 1   | 103-08-810  | Axial Joint | 48830 75F00 | th:FM14X1.5R L:248 | 3   | 111-08-823  | Tie Rod End | 48810-83E00 | c:12.5 th:FM12X1.25 |
| 2   | 71-08-810   | TCA         | 45200 75F00 | c:15               |     |             |             |             |                     |



# SUZUKI WAGON R



WAGON R+ (MM)

05/2000 ->



3 111-08-823



1 103-08-815



1 103-08-815



3 111-08-823



2 71-08-811



2 71-08-811

| Ref | ASHIKA CODE | Description | OEM         | Measures           | Ref | ASHIKA CODE | Description | OEM         | Measures            |
|-----|-------------|-------------|-------------|--------------------|-----|-------------|-------------|-------------|---------------------|
| 1   | 103-08-815  | Axial Joint | 48830-83E00 | th:MM14X1.5R L:243 | 3   | 111-08-823  | Tie Rod End | 48810-83E00 | c:12.5 th:FM12X1.25 |
| 2   | 71-08-811   | TCA         | 45200 76G00 |                    |     |             |             |             |                     |

2000 D / PICK UP

1998 ->



1 111-00-003L

2 111-00-003R

3 73-00-002

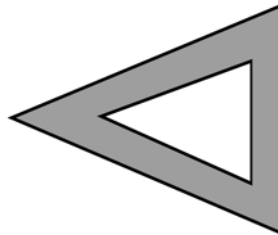

3 73-00-002

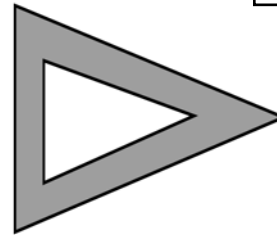

4 73-00-003

4 73-00-003

| Ref | ASHIKA CODE | Description       | OEM            | Measures | Ref | ASHIKA CODE | Description | OEM            | Measures |
|-----|-------------|-------------------|----------------|----------|-----|-------------|-------------|----------------|----------|
| 1   | 111-00-003L | Tie Rod End Left  | 2654-TELQ-0116 |          | 3   | 73-00-002   | Ball Joint  | 2654-3211-0156 |          |
| 2   | 111-00-003R | Tie Rod End Right | 2655-TELQ-0117 |          | 4   | 73-00-003   | Ball Joint  | 2654-3320-0113 |          |

INDICA

10/1998 ->



4 111-00-001

4 111-00-001

3 73-00-001

3 73-00-001

2 72-00-002

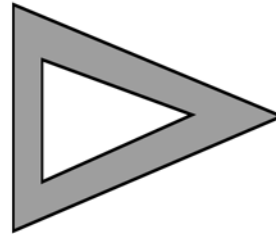
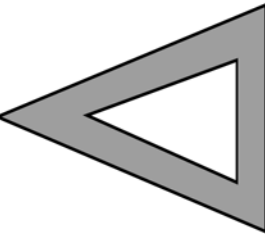

1 72-00-001

| Ref | ASHIKA CODE | Description | OEM            | Measures | Ref | ASHIKA CODE | Description | OEM            | Measures |
|-----|-------------|-------------|----------------|----------|-----|-------------|-------------|----------------|----------|
| 1   | 72-00-001   | TCA Right   | 2702-3211-0150 |          | 3   | 73-00-001   | Ball Joint  | 2702-3211-0106 |          |
| 2   | 72-00-002   | TCA Left    | 2702-3211-0149 |          | 4   | 111-00-001  | Tie Rod End | 2702-4660-3511 |          |



INDIGO

01/2003 ->



1 111-00-002

1 111-00-002

3 72-00-004

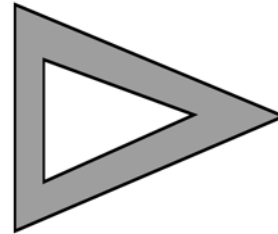
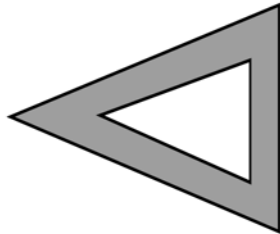

2 72-00-003

| Ref | ASHIKA CODE | Description | OEM            | Measures | Ref | ASHIKA CODE | Description | OEM            | Measures |
|-----|-------------|-------------|----------------|----------|-----|-------------|-------------|----------------|----------|
| 1   | 111-00-002  | Tie Rod End | 8855-4601-0001 |          | 3   | 72-00-004   | TCA Left    | 2779-3210-0183 |          |
| 2   | 72-00-003   | TCA Right   | 2779-3210-0182 |          |     |             |             |                |          |

SAFARI

01/1998 ->



2 111-00-006

1 111-00-005

3 73-00-002

3 73-00-002

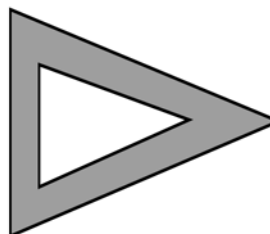
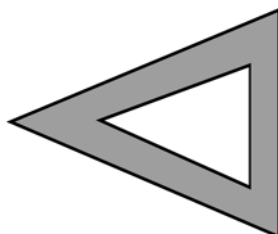

4 73-00-007

4 73-00-007

| Ref | ASHIKA CODE | Description | OEM            | Measures | Ref | ASHIKA CODE | Description | OEM            | Measures |
|-----|-------------|-------------|----------------|----------|-----|-------------|-------------|----------------|----------|
| 1   | 111-00-005  | Tie Rod End | 2699-4660-0121 |          | 3   | 73-00-002   | Ball Joint  | 2654-3211-0156 |          |
| 2   | 111-00-006  | Tie Rod End | 2699-4660-0113 |          | 4   | 73-00-007   | Ball Joint  | 2699-3210-0150 |          |

4 RUNNER

08/1987 - 03/1996



1 111-02-226



3 73-02-292



3 73-02-292



1  
111-02-226



2 73-02-227

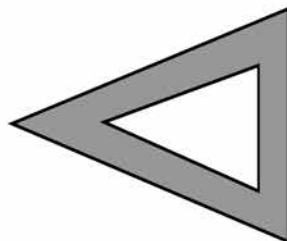

UPPER

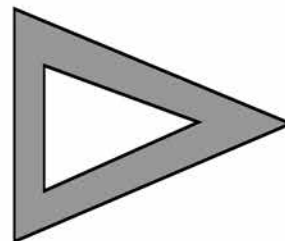

2 73-02-227

4 59-02-244

FOR VEHICLES WITHOUT POWER STEERING

5 59-02-245

6 52-02-235

| Ref | ASHIKA CODE | Description | OEM         | Measures            | Ref | ASHIKA CODE | Description | OEM         | Measures |
|-----|-------------|-------------|-------------|---------------------|-----|-------------|-------------|-------------|----------|
| 1   | 111-02-226  | Tie Rod End | 45064-29115 | c:14.8 th:MM17X1.5L | 4   | 59-02-244   | Pitman Arm  | 45490 39345 |          |
| 2   | 73-02-227   | Ball Joint  | 43350-39045 | c:17.1              | 5   | 59-02-245   | Pitman Arm  | 45490-39355 |          |
| 3   | 73-02-292   | Tie Rod End | 45406 39165 | c:14.7 th:FM17X1.5R | 6   | 52-02-235   | Tie Rod End | 45401 35220 |          |

# TOYOTA 4 RUNNER



4 RUNNER (RZN18\_,VZN18\_)

11/1995 ->

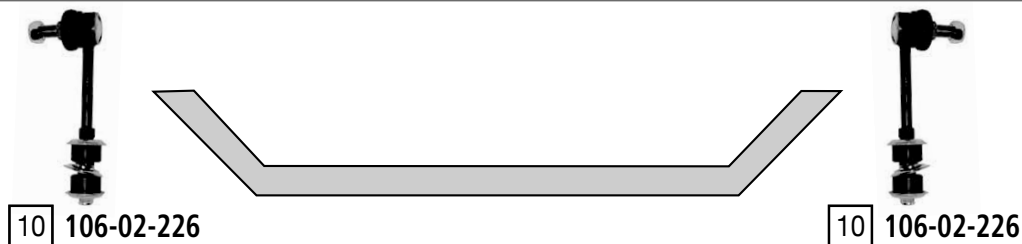
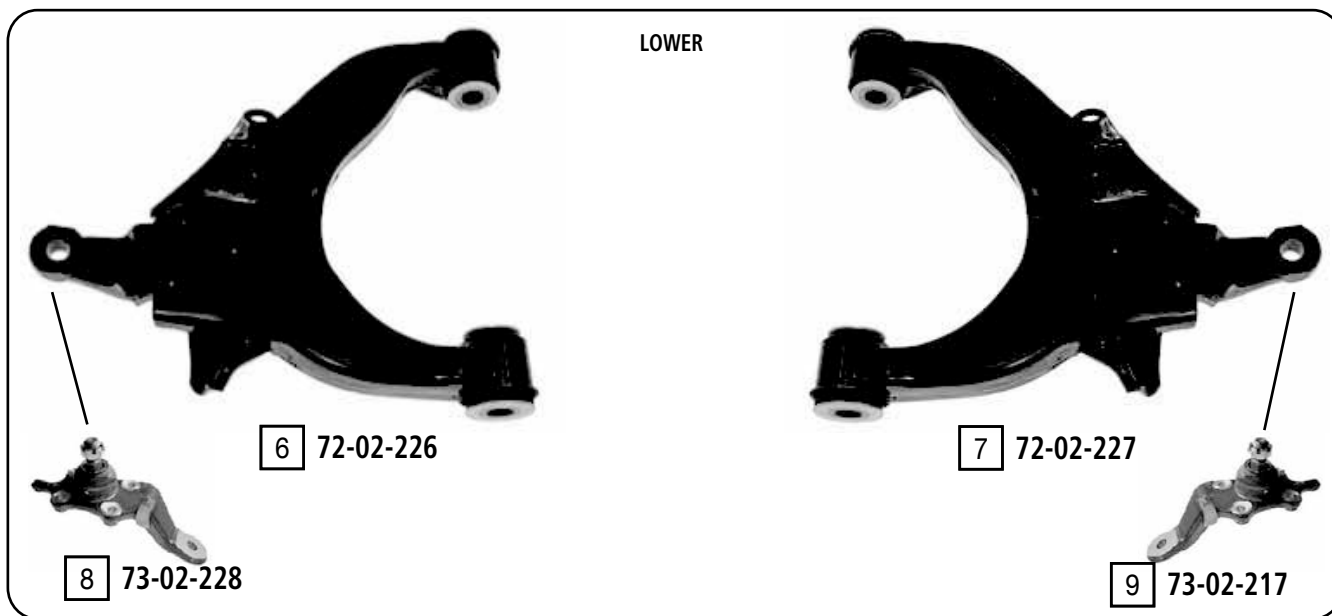
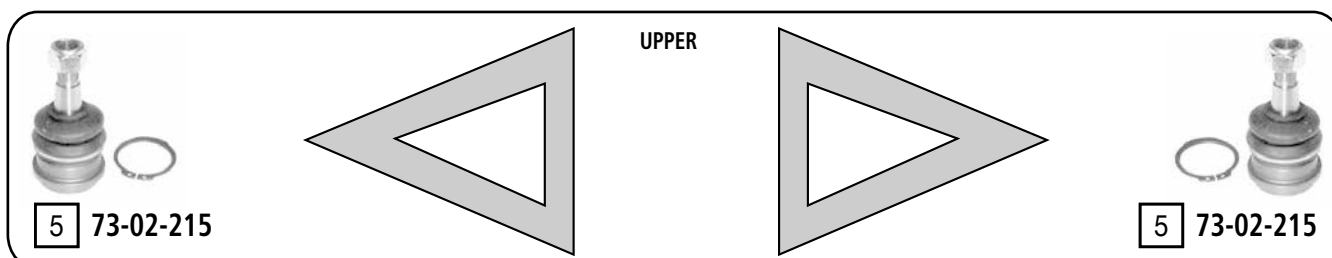
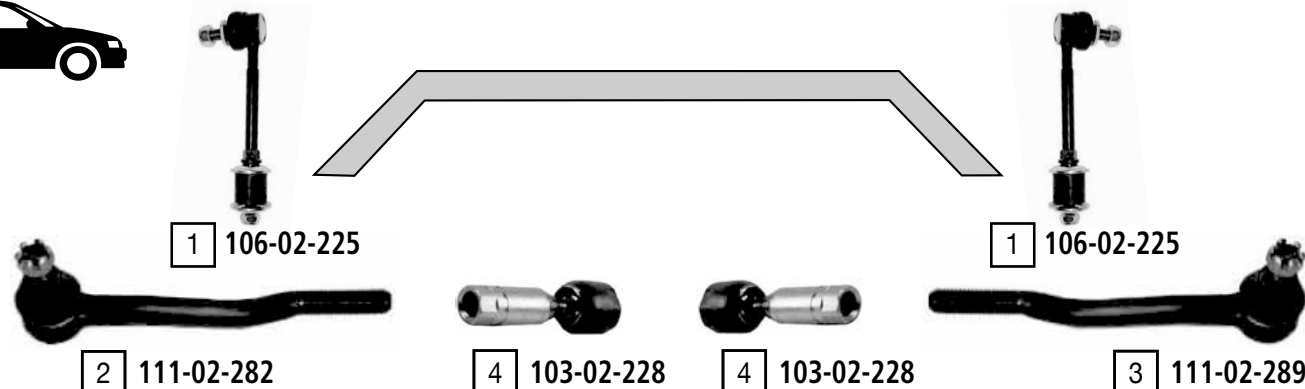

| Ref | ASHIKA CODE | Description       | OEM         | Measures            | Ref | ASHIKA CODE | Description               | OEM         | Measures |
|-----|-------------|-------------------|-------------|---------------------|-----|-------------|---------------------------|-------------|----------|
| 1   | 106-02-225  | stabiliser link   | 48820 AD010 | L:177.5             | 6   | 72-02-226   | TCA left wobj             | 48069 35081 |          |
| 2   | 111-02-282  | tie rod end left  | 45047 39215 | c:14.8 th:MM20x1.5R | 7   | 72-02-227   | TCA right wobj            | 48068 35081 |          |
| 3   | 111-02-289  | tie rod end right | 45046 39335 | c:14.8 th:MM20x1.5R | 8   | 73-02-228   | ball joint left           | 43340 39465 | c:17.6   |
| 4   | 103-02-228  | axial joint       | 45503 39075 | th:MM18X1.5R L:131  | 9   | 73-02-217   | ball joint right          | 43330 39585 | c:17.6   |
| 5   | 73-02-215   | ball joint        | 43310 39016 | c:15.75 do:43.3     | 10  | 106-02-226  | stabiliser link rear axle | 48830 35020 | L:152.5  |

AURIS (\_E15\_)

10/2006 ->

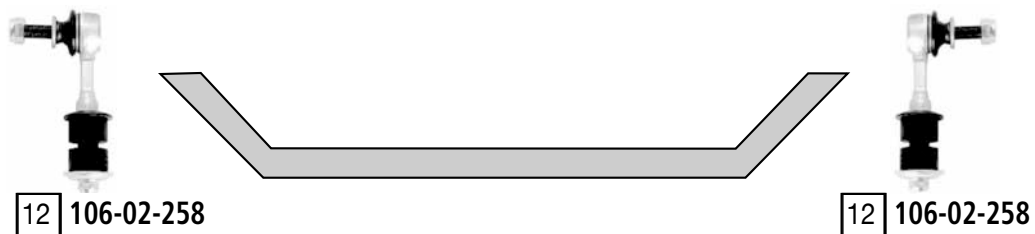
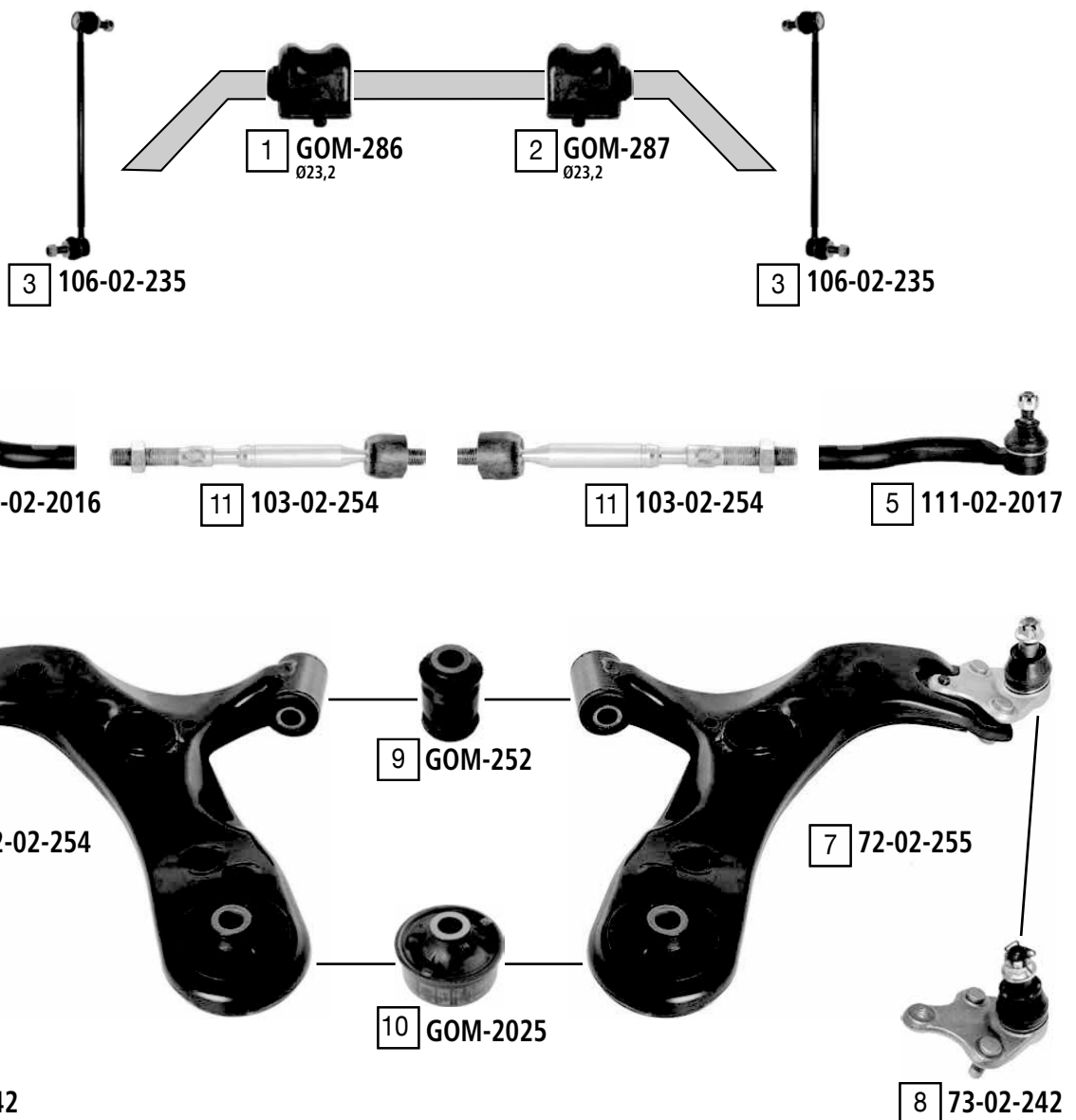

| Ref | ASHIKA CODE | Description         | OEM         | Measures            | Ref | ASHIKA CODE | Description               | OEM         | Measures           |
|-----|-------------|---------------------|-------------|---------------------|-----|-------------|---------------------------|-------------|--------------------|
| 1   | GOM-286     | stabiliser mounting | 48815 02140 | di:21               | 7   | 72-02-255   | TCA right wbj             | 48068 12300 | c:17.5             |
| 2   | GOM-287     | stabiliser mounting | 48815 02150 | di:21               | 8   | 73-02-242   | ball joint                | 43330 49095 | c:17.7             |
| 3   | 106-02-235  | stabiliser link     | 48820 02070 | L:360               | 9   | GOM-252     | silentblock for TCA       | Part of     | di:16.2 do:41      |
| 4   | 111-02-2016 | tie rod end left    | 45047 19215 | c:13.7 th:FM15x1.5R | 10  | GOM-2025    | silentblock for TCA       | Part of     | di:16.2 do:68      |
| 5   | 111-02-2017 | tie rod end right   | 45046 19415 | c:13.7 th:FM15x1.5R | 11  | 103-02-254  | axial joint               | Part of     | th:MM14x1.5R L:232 |
| 6   | 72-02-254   | TCA left wbj        | 48069 12300 | c:17.5              | 12  | 106-02-258  | stabiliser link rear axle | 48830 05030 | L:128.5            |



AVENSIS (\_T22\_)

09/1997 - 02/2003

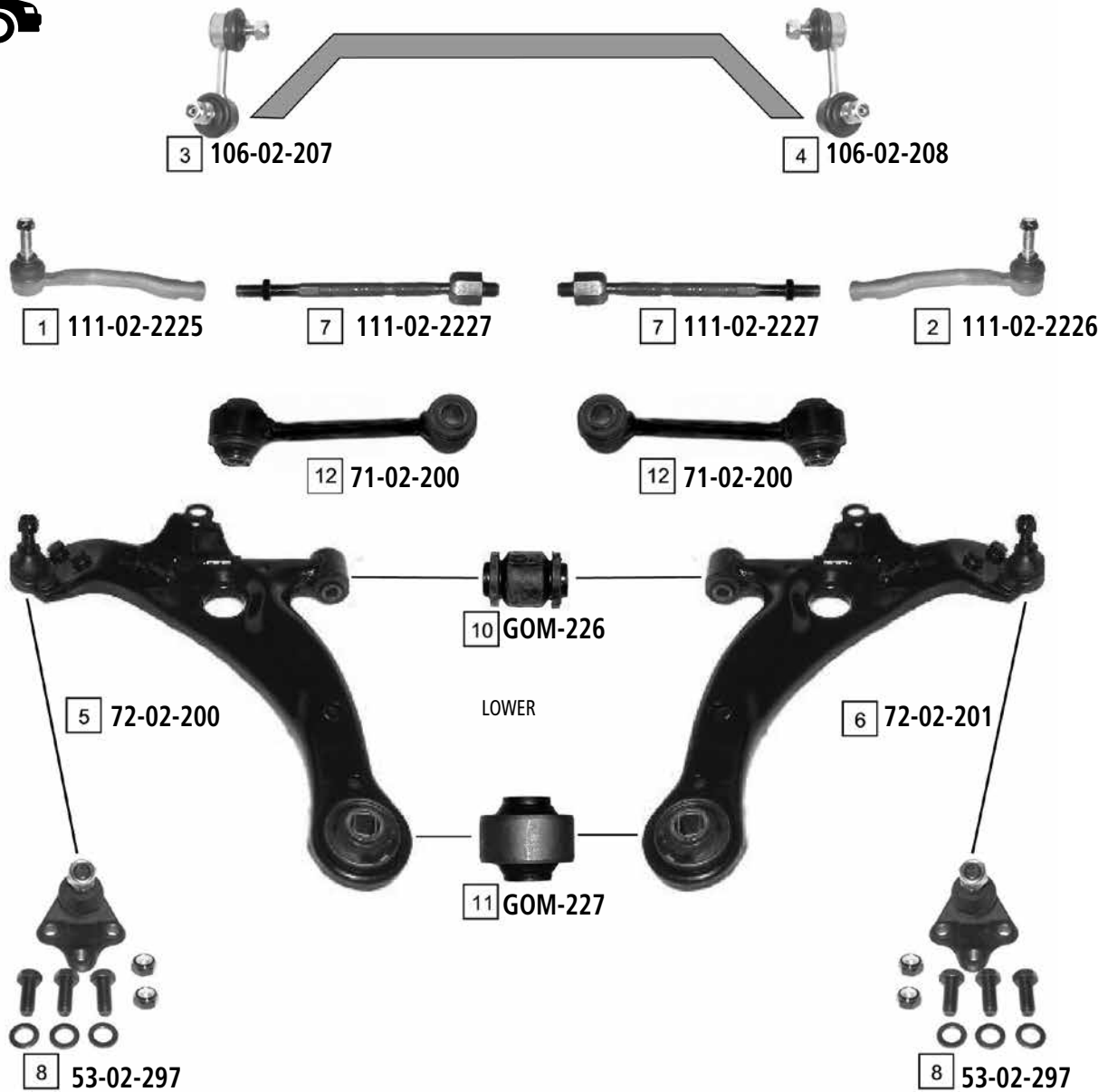

| Ref | ASHIKA CODE | Description           | OEM         | Measures            | Ref | ASHIKA CODE | Description              | OEM                         | Measures           |
|-----|-------------|-----------------------|-------------|---------------------|-----|-------------|--------------------------|-----------------------------|--------------------|
| 1   | 111-02-2225 | Tie Rod End Right     | 45046-29365 | c:12.7 th:FM14X1.5R | 7   | 111-02-2227 | Axial Joint              | 45503-05020                 | th:MM16X1.5R L:242 |
| 2   | 111-02-2226 | Tie Rod End Left      | 45047-29125 | c:12.7 th:FM14X1.5R | 8   | 53-02-297   | Ball Joint lower         | 43330 09030                 | c:15               |
| 3   | 106-02-207  | Stabiliser Link Left  | 48810 05012 | L:70                | 9   | 106-02-200  | Stabiliser Link          | 48830 05020                 | L:140              |
| 4   | 106-02-208  | Stabiliser Link Right | 48820 05012 | L:70                | 10  | GOM-226     | Silentblock For Susp.Arm | Part of 72-02-200/72-02-201 | d:38               |
| 5   | 72-02-200   | TCA Left              | 48068-05050 | c:15                | 11  | GOM-227     | Silentblock For Susp.Arm | 48061 05010                 | d:60.2             |
| 6   | 72-02-201   | TCA Right             | 48069-05050 | c:15                | 12  | 71-02-200   | Track Link               | 48650 20020                 |                    |

AVENSIS (\_T25\_) 03/2003 ->

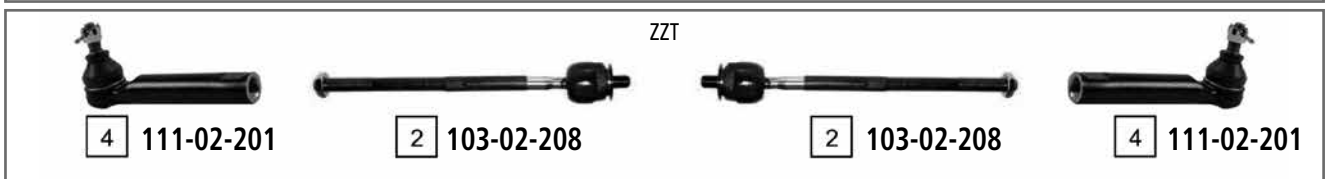
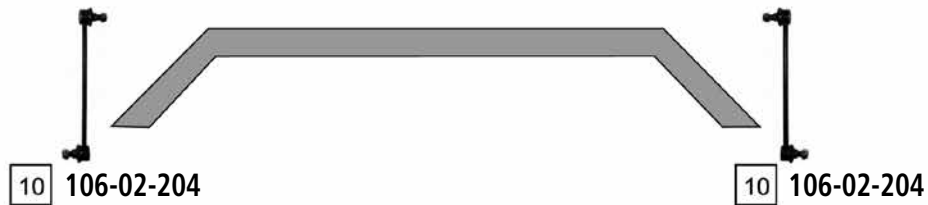

| Ref | ASHIKA CODE | Description | OEM         | Measures | Ref | ASHIKA CODE | Description              | OEM                         | Measures |
|-----|-------------|-------------|-------------|----------|-----|-------------|--------------------------|-----------------------------|----------|
| 1   | 103-02-200  | Axial Joint | 45503 0F010 |          | 7   | GOM-228     | Silentblock For Susp.Arm | Part of 72-02-202/72-02-203 |          |
| 2   | 103-02-208  | Axial Joint | Part of     |          | 8   | GOM-229     | Silentblock For Susp.Arm | Part of 72-02-202/72-02-203 |          |
| 3   | 111-02-200  | Tie Rod End | 45046 29425 |          | 9   | 73-02-200   | Ball Joint lower         | 43330 09210                 | c:15     |
| 4   | 111-02-201  | Tie Rod End | 45046 09230 |          | 10  | 106-02-204  | Stabiliser Link          | 48820 47010                 | L:285    |
| 5   | 72-02-202   | TCA Left    | 48069 05070 | c:15     | 11  | 106-02-212  | Stabiliser Link          | 48840 21010                 | L:100    |
| 6   | 72-02-203   | TCA Right   | 48068 05070 | c:15     | 12  | 106-02-213  | Stabiliser Link          | 48830 21020                 | L:100    |

AVENSIS (T27)

11/2008 ->

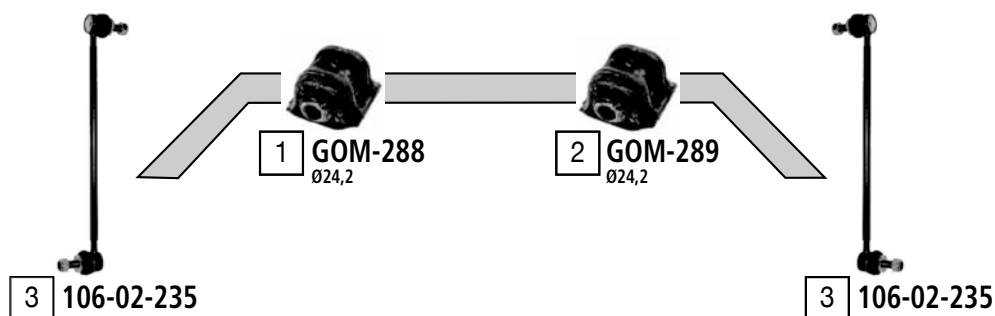

4 111-02-2024



5 111-02-2025

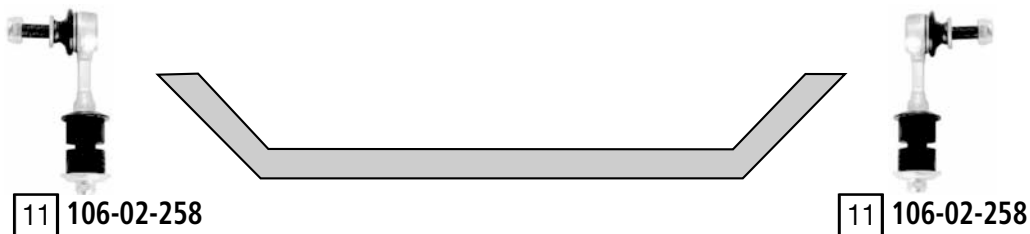
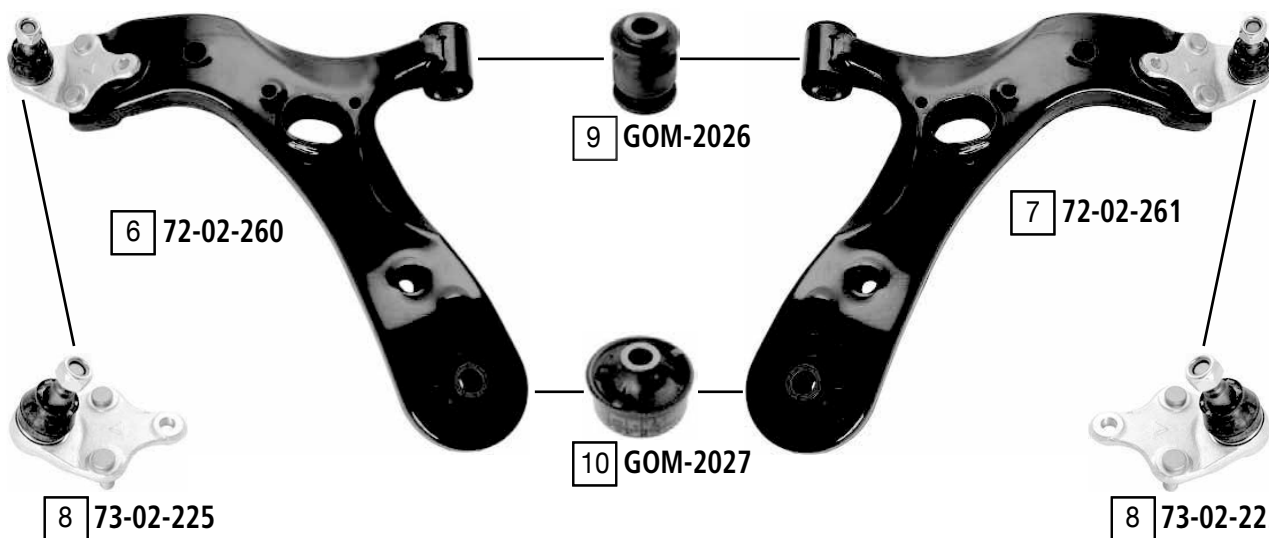

| Ref | ASHIKA CODE | Description         | OEM         | Measures            | Ref | ASHIKA CODE | Description               | OEM         | Measures      |
|-----|-------------|---------------------|-------------|---------------------|-----|-------------|---------------------------|-------------|---------------|
| 1   | GOM-288     | stabiliser mounting | 48815 05130 | di:24.2             | 7   | 72-02-261   | TCA right wbj             | 48068 05080 | c:17.6        |
| 2   | GOM-289     | stabiliser mounting | 48815 05120 | di:24.2             | 8   | 73-02-225   | ball joint lower          | 43330 09770 | c:17.5        |
| 3   | 106-02-235  | stabiliser link     | 48820 02070 | L:360               | 9   | GOM-2026    | silentblock for TCA       | Part of     | di:16.1 do:41 |
| 4   | 111-02-2024 | tie rod end left    | 45047 09320 | c:13.5 th:FM16x1.5R | 10  | GOM-2027    | silentblock for TCA       | Part of     | di:16.2 do:68 |
| 5   | 111-02-2025 | tie rod end right   | 45046 09660 | c:13.5 th:FM16x1.5R | 11  | 106-02-258  | stabiliser link rear axle | 48830 05030 | L:128.5       |
| 6   | 72-02-260   | TCA left wbj        | 48069 05080 | c:17.6              |     |             |                           |             |               |

AVENSIS VERSO (ACM20, CLM20)

05/2001 ->

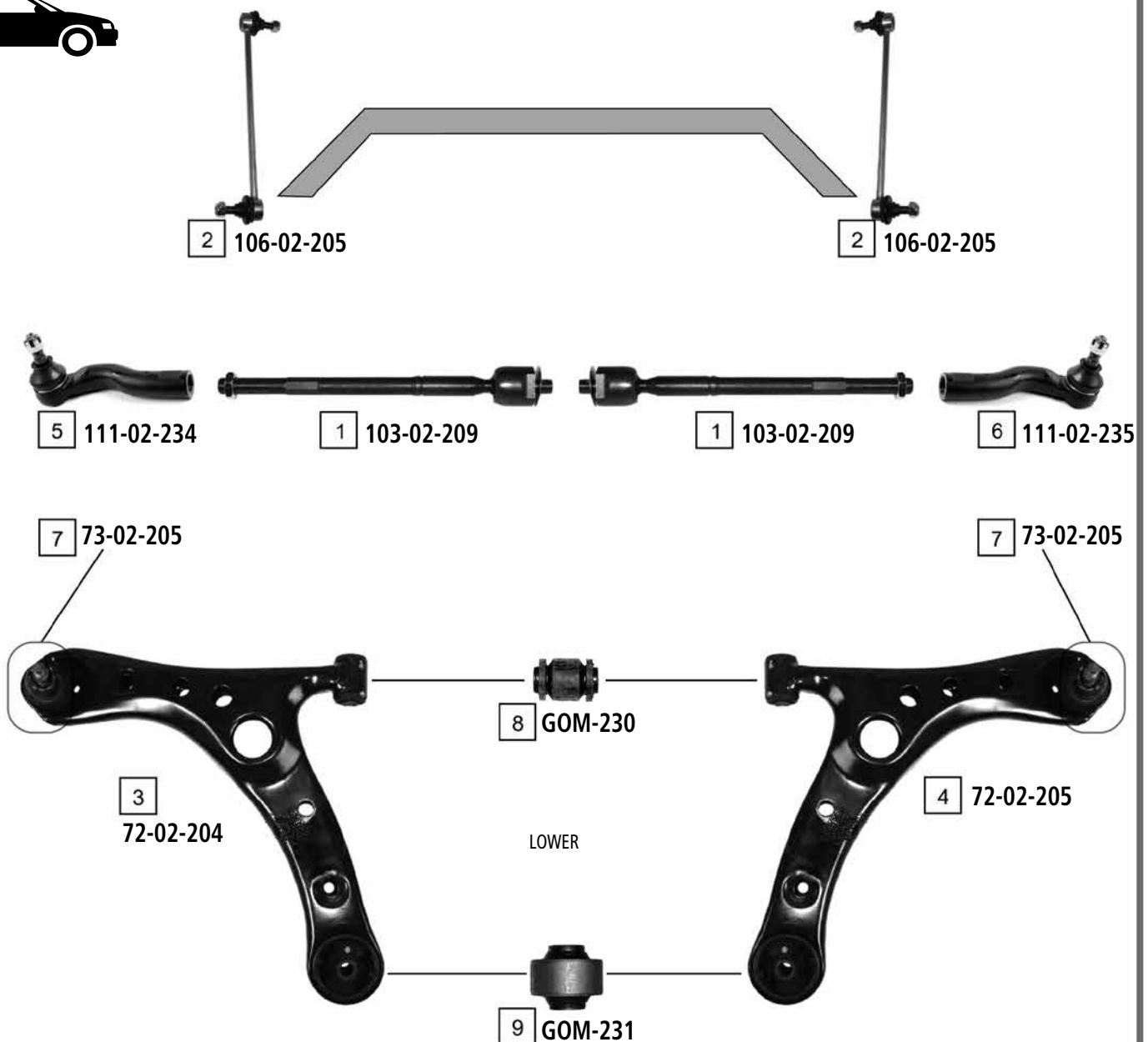

| Ref | ASHIKA CODE | Description      | OEM         | Measures            | Ref | ASHIKA CODE | Description              | OEM                         | Measures            |
|-----|-------------|------------------|-------------|---------------------|-----|-------------|--------------------------|-----------------------------|---------------------|
| 1   | 103-02-209  | Axial Joint      | 45503-49105 | th:MM14X1.5R L:290  | 6   | 111-02-235  | Tie Rod End Right        | 45047 49055                 | c:12.6 th:FM16X1.5R |
| 2   | 106-02-205  | Stabiliser Link  | 48820-44020 | L:280               | 7   | 73-02-205   | Ball Joint               | Part of 72-02-204/72-02-205 | c:17.5              |
| 3   | 72-02-204   | TCA Left Wbj     | 48069 49065 |                     | 8   | GOM-230     | Silentblock For Susp.Arm | Part of 72-02-204/72-02-205 |                     |
| 4   | 72-02-205   | TCA Right Wbj    | 48068 49065 |                     | 9   | GOM-231     | Silentblock For Susp.Arm | Part of 72-02-204/72-02-205 |                     |
| 5   | 111-02-234  | Tie Rod End Left | 45046 49125 | c:12.6 th:FM16X1.5R |     |             |                          |                             |                     |

AYGO

06/2005 ->

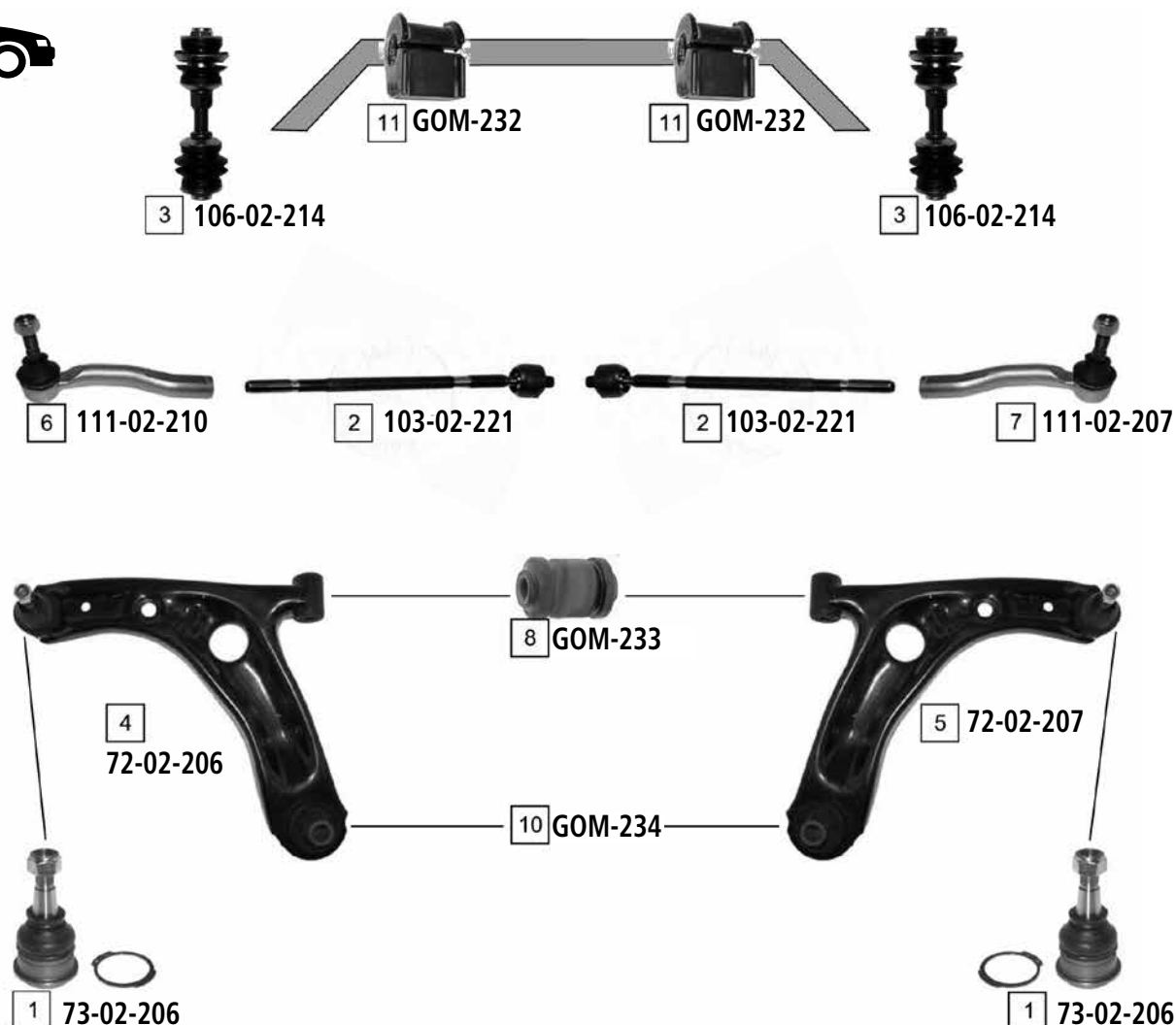

| Ref | ASHIKA CODE | Description      | OEM                         | Measures | Ref | ASHIKA CODE | Description              | OEM                         | Measures |
|-----|-------------|------------------|-----------------------------|----------|-----|-------------|--------------------------|-----------------------------|----------|
| 1   | 73-02-206   | Ball Joint Lower | Part of 72-02-206/72-02-207 | c:13.5   | 7   | 111-02-207  | Tie Rod End Right        | 3817 64                     |          |
| 2   | 103-02-221  | Axial Joint      | Part of                     |          | 8   | GOM-233     | Silentblock For Susp.Arm | Part of 72-02-206/72-02-207 | d:32     |
| 3   | 106-02-214  | Stabiliser Link  | 5091 10                     |          | 9   | GOM-235     | Mounting Axle Body       | 48725 0H010                 |          |
| 4   | 72-02-206   | TCA Left Wbj     | 48069 0H010                 |          | 10  | GOM-234     | Silentblock For Susp.Arm | Part of 72-02-206/72-02-207 |          |
| 5   | 72-02-207   | TCA Right Wbj    | 48068 0H010                 |          | 11  | GOM-232     | Stabiliser Mounting      | 5094 A8                     |          |
| 6   | 111-02-210  | Tie Rod End Left | 3817 63                     |          |     |             |                          |                             |          |

CAMRY (CV1\_, SV1\_)

10/1982 - 07/1988



1 110-02-282



1 110-02-282



2 73-02-216

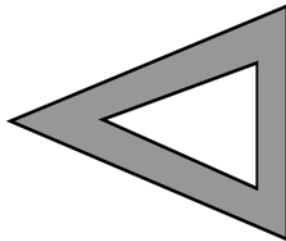

LOWER

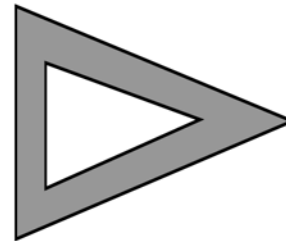

2 73-02-216

| Ref | ASHIKA CODE | Description | OEM         | Measures            | Ref | ASHIKA CODE | Description      | OEM         | Measures |
|-----|-------------|-------------|-------------|---------------------|-----|-------------|------------------|-------------|----------|
| 1   | 110-02-282  | Tie Rod End | 45460-39165 | c:12.6 th:FM14X1.5R | 2   | 73-02-216   | Ball Joint Lower | 43330-39135 | c:16     |

CAMRY (\_V2)

08/1986 - 05/1991



2 111-02-259



3 103-02-216



3 103-02-216



2 111-02-259



1 73-02-216

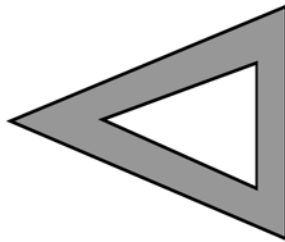

LOWER

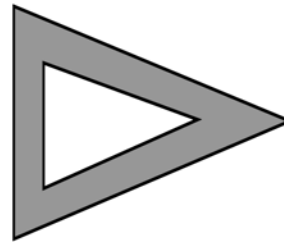

1 73-02-216

| Ref | ASHIKA CODE | Description      | OEM         | Measures            | Ref | ASHIKA CODE | Description | OEM         | Measures           |
|-----|-------------|------------------|-------------|---------------------|-----|-------------|-------------|-------------|--------------------|
| 1   | 73-02-216   | Ball Joint Lower | 43330-39135 | c:16                | 3   | 103-02-216  | Axial Joint | 45503-29105 | th:MM14X1.5R L:327 |
| 2   | 111-02-259  | Tie Rod End      | 45046 19175 | c:12.7 th:FM14X1.5R |     |             |             |             |                    |

CAMRY (\_V10)

06/1991 - 06/1997



2 111-02-283



3 103-02-291



3 103-02-291



2 111-02-283



1 73-02-239

LOWER



1 73-02-239



4 106-02-217



4 106-02-217

| Ref | ASHIKA CODE | Description | OEM         | Measures            | Ref | ASHIKA CODE | Description     | OEM         | Measures           |
|-----|-------------|-------------|-------------|---------------------|-----|-------------|-----------------|-------------|--------------------|
| 1   | 73-02-239   | Ball Joint  | 43330 39285 | c:17.5              | 3   | 103-02-291  | Axial Joint     | 45503-29355 | th:MM14X1.5R L:337 |
| 2   | 111-02-283  | Tie Rod End | 45046-29255 | c:12.7 th:FM15X1.5R | 4   | 106-02-217  | Stabiliser Link | 48830 33010 | L:192              |



CAMRY (\_V20)

08/1996 - 11/2001

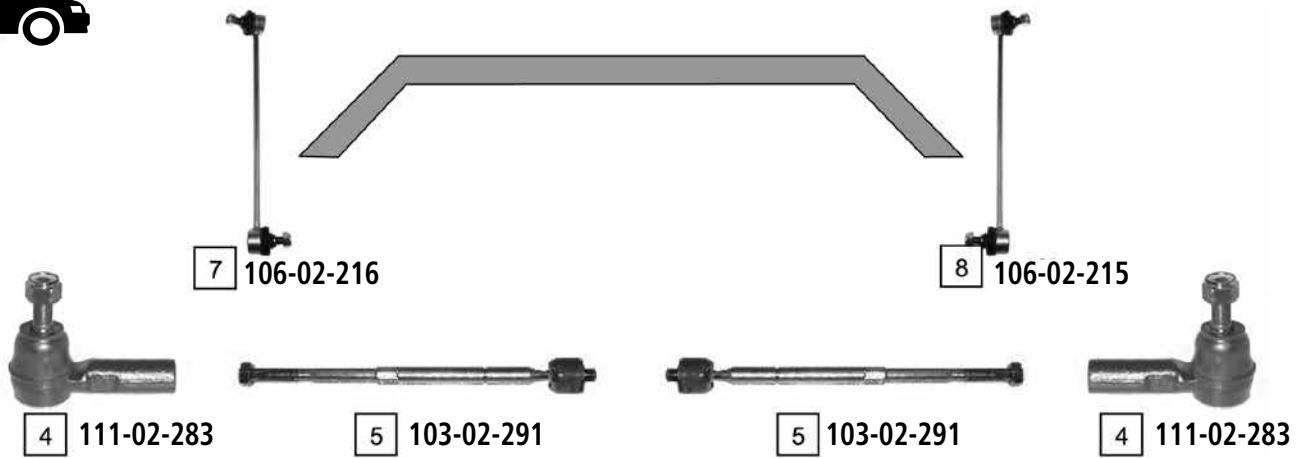

| Ref | ASHIKA CODE | Description | OEM         | Measures            | Ref | ASHIKA CODE | Description           | OEM         | Measures           |
|-----|-------------|-------------|-------------|---------------------|-----|-------------|-----------------------|-------------|--------------------|
| 1   | 72-02-208   | TCA Left    | 48069 33031 | c:17.5              | 5   | 103-02-291  | Axial Joint           | 45503-29355 | th:MM14X1.5R L:337 |
| 2   | 72-02-209   | TCA Right   | 48068 33031 | c:17.5              | 6   | 106-02-217  | Stabiliser Link       | 48830 33010 | L:192              |
| 3   | 73-02-239   | Ball Joint  | 43330 39285 | c:17.5              | 7   | 106-02-216  | Stabiliser Link Left  | 48810 33010 | L:285              |
| 4   | 111-02-283  | Tie Rod End | 45046-29255 | c:12.7 th:FM15X1.5R | 8   | 106-02-215  | Stabiliser Link Right | 48820 33020 | L:285              |

CAMRY (\_V30)

11/2001 - 01/2006

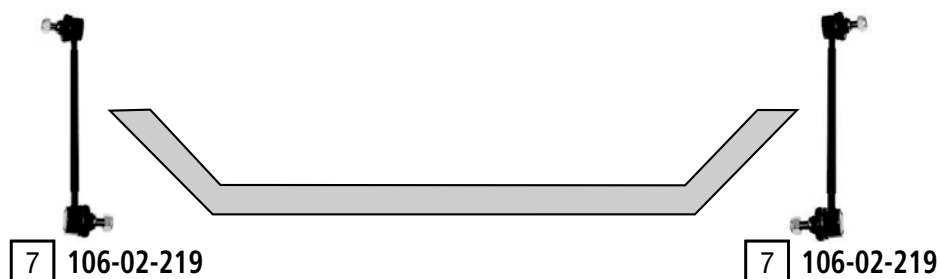
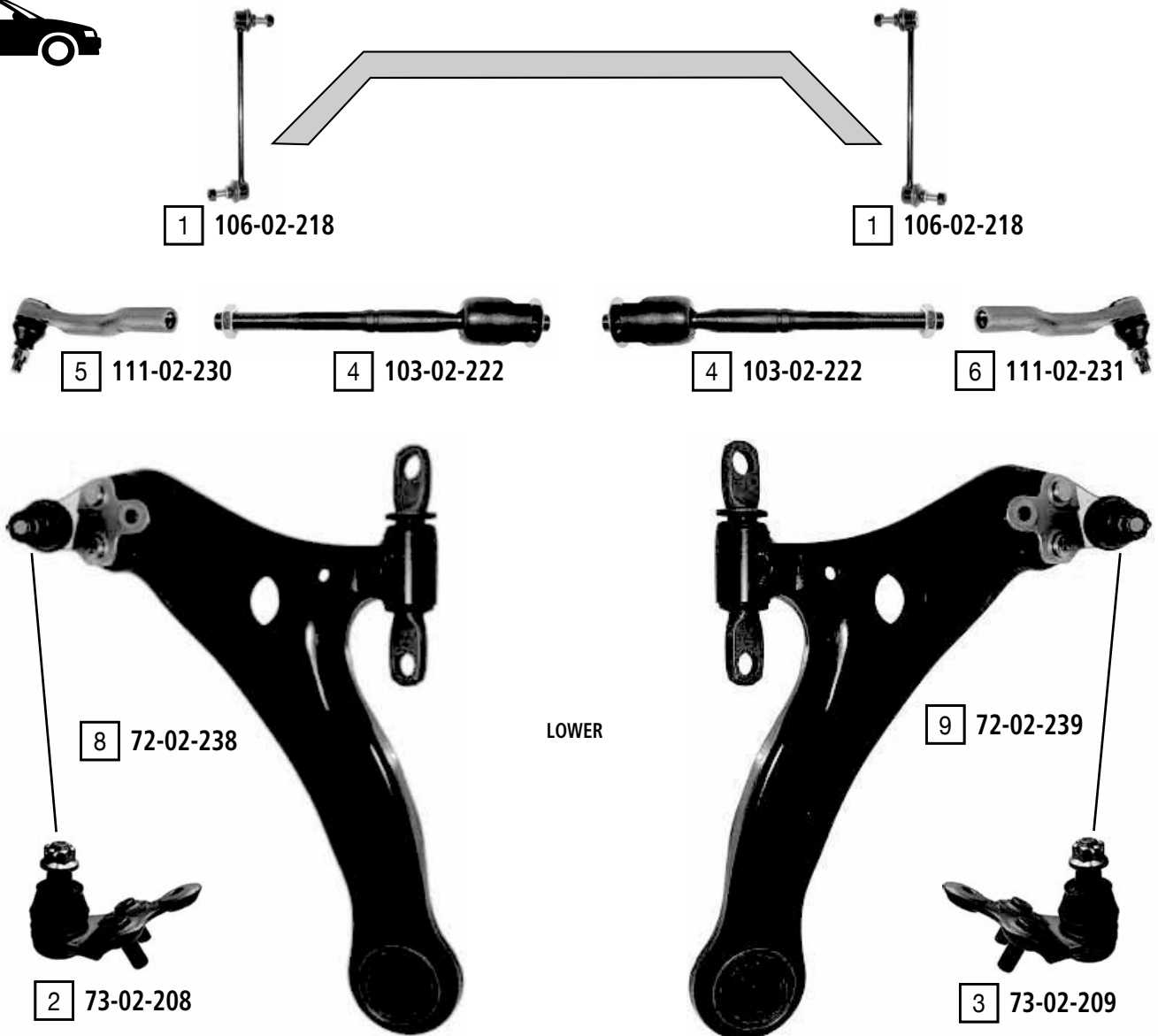

| Ref | ASHIKA CODE | Description      | OEM         | Measures            | Ref | ASHIKA CODE | Description               | OEM         | Measures            |
|-----|-------------|------------------|-------------|---------------------|-----|-------------|---------------------------|-------------|---------------------|
| 1   | 106-02-218  | stabiliser link  | 48820 28050 | L:260               | 6   | 111-02-231  | tie rod end right         | 45460 39615 | c:13.6 th:FM15X1.5R |
| 2   | 73-02-208   | ball joint left  | 43340 29215 | c:17.6              | 7   | 106-02-219  | stabiliser link rear axle | 48830 48010 | L:237               |
| 3   | 73-02-209   | ball joint right | 43330 29615 | c:17.6              | 8   | 72-02-238   | TCA left wbj              | 48069 28120 | c:17.6              |
| 4   | 103-02-222  | axial joint      | 45503 39225 | th:MM14X1.5R L:238  | 9   | 72-02-239   | TCA right wbj             | 48068 28120 | c:17.6              |
| 5   | 111-02-230  | tie rod end left | 45470 39215 | c:13.6 th:FM15X1.5R |     |             |                           |             |                     |

CAMRY (\_V40)

01/2006 ->



1 106-02-259

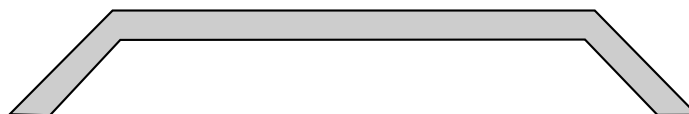

1 106-02-259

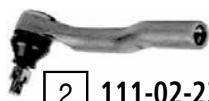

2 111-02-230



3 111-02-231



4 72-02-238

LOWER

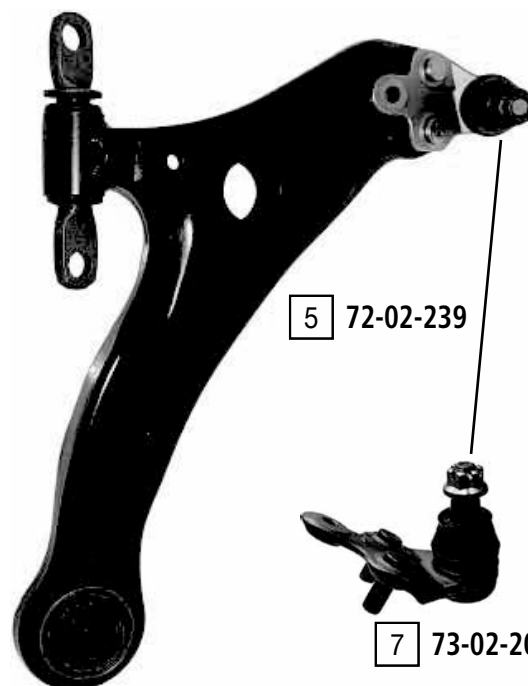

5 72-02-239

6 73-02-208

7 73-02-209



8 106-02-263



8 106-02-263

| Ref | ASHIKA CODE | Description       | OEM         | Measures            | Ref | ASHIKA CODE | Description               | OEM         | Measures |
|-----|-------------|-------------------|-------------|---------------------|-----|-------------|---------------------------|-------------|----------|
| 1   | 106-02-259  | stabiliser link   | 48820 33070 | L:260               | 5   | 72-02-239   | TCA right wbj             | 48068 28120 | c:17.6   |
| 2   | 111-02-230  | tie rod end left  | 45470 39215 | c:13.6 th:FM15X1.5R | 6   | 73-02-208   | ball joint left           | 43340 29215 | c:17.6   |
| 3   | 111-02-231  | tie rod end right | 45460 39615 | c:13.6 th:FM15X1.5R | 7   | 73-02-209   | ball joint right          | 43330 29615 | c:17.6   |
| 4   | 72-02-238   | TCA left wbj      | 48069 28120 | c:17.6              | 8   | 106-02-263  | stabiliser link rear axle | 48830 33040 | L:261    |

CARINA (CA60, TA60, TA62)  
CELICA (RA6)

09/1981-09/1983  
01/1982-10/1986



MS



1 110-02-235



1 110-02-235

PS



2 110-02-231



2 110-02-231



3 53-06-609  
EXC CELICA

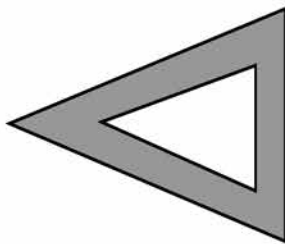

LOWER

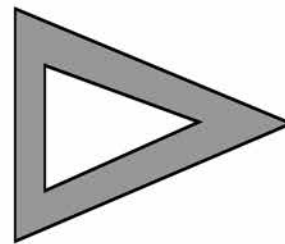

3 53-06-609  
EXC CELICA

| Ref | ASHIKA CODE | Description | OEM         | Measures | Ref | ASHIKA CODE | Description      | OEM         | Measures |
|-----|-------------|-------------|-------------|----------|-----|-------------|------------------|-------------|----------|
| 1   | 110-02-235  | Tie Rod     | 45460-19165 |          | 3   | 53-06-609   | Ball Joint Lower | 43308-12030 | c: 14.5  |
| 2   | 110-02-231  | Tie Rod     | 45460-19155 |          |     |             |                  |             |          |

CARINA E (\_T19\_)

04/1992 - 09/1997

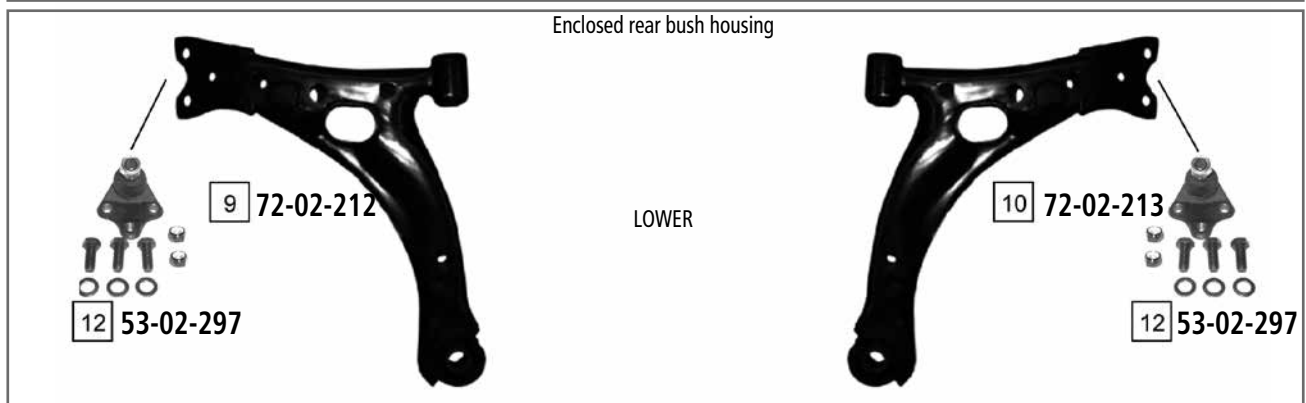
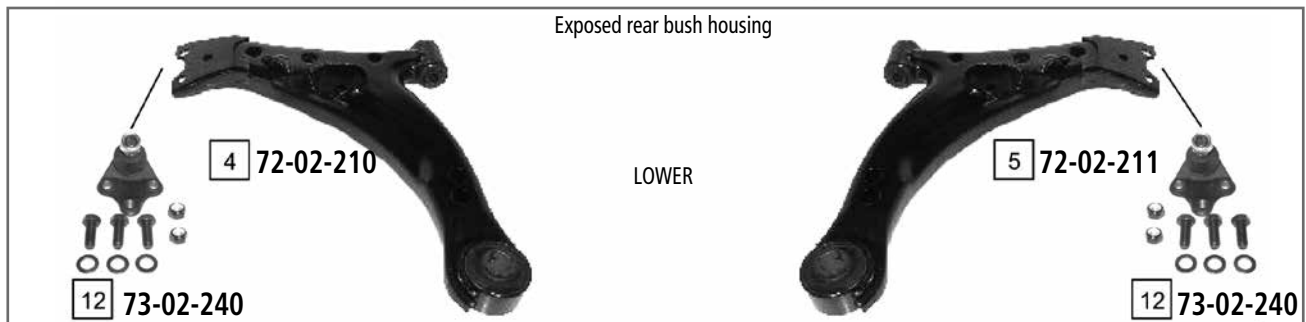
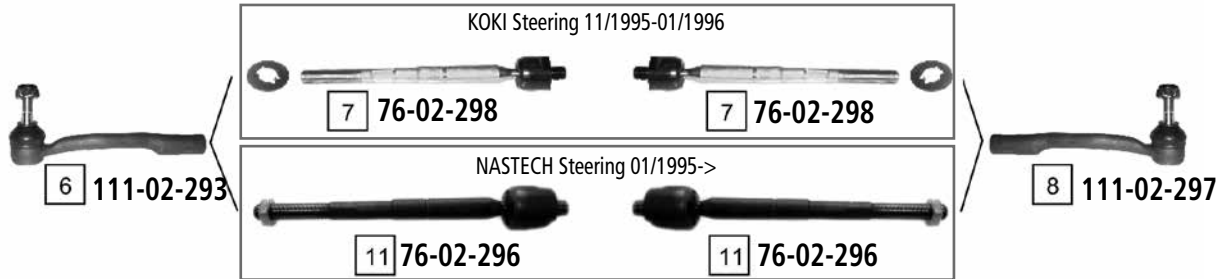
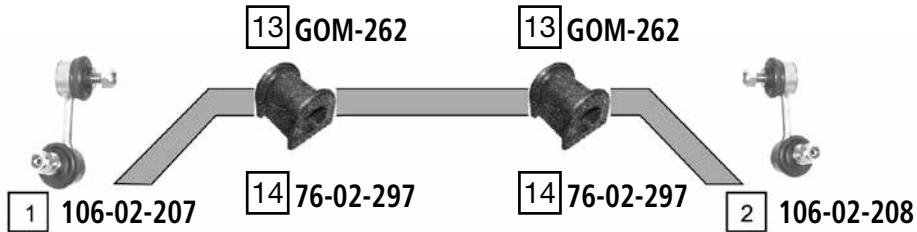

| Ref | ASHIKA CODE | Description           | OEM         | Measures            | Ref | ASHIKA CODE | Description         | OEM         | Measures            |
|-----|-------------|-----------------------|-------------|---------------------|-----|-------------|---------------------|-------------|---------------------|
| 1   | 106-02-207  | Stabiliser Link Left  | 48810 05012 | L:70                | 8   | 111-02-297  | Tie Rod End Right   | 45046-29275 | c:12.6 th:FM15X1.5R |
| 2   | 106-02-208  | Stabiliser Link Right | 48820 05012 | L:70                | 9   | 72-02-212   | TCA Left            | 48069-20221 |                     |
| 3   | 106-02-202  | Stabiliser Link       | 48830 12050 | L:105               | 10  | 72-02-213   | TCA Right           | 48068-20221 |                     |
| 4   | 72-02-210   | TCA Left              | 49069-20260 | c:15.9              | 11  | 76-02-296   | Axial Joint         | 45503-05010 | th:MM14X1.5R L:239  |
| 5   | 72-02-211   | TCA Right             | 48068-20260 | c:15.9              | 12  | 53-02-297   | Ball Joint Lower    | 43330 09030 | c:15                |
| 6   | 111-02-293  | Tie Rod End Left      | 45047-29075 | c:12.6 th:FM15X1.5R | 13  | GOM-262     | Stabiliser Mounting | 4881530040  | d:20                |
| 7   | 76-02-298   | Axial Joint           | 45503 29435 | th:MM14X1.5R L:240  | 14  | 76-02-297   | Axial Joint         | 4550329475  |                     |

CARINA II (\_T15\_)

10/1983 - 05/1988



MS -> 08/1984

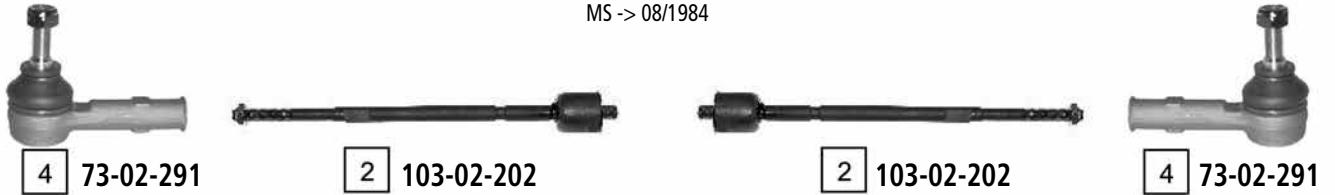

MS 09/1984 ->

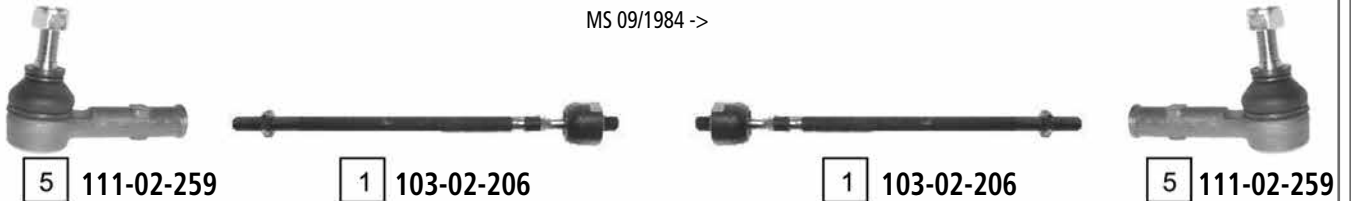

PS 09/1984 ->

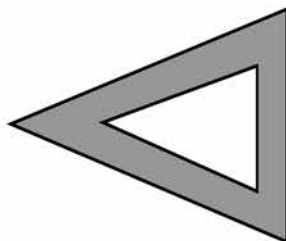
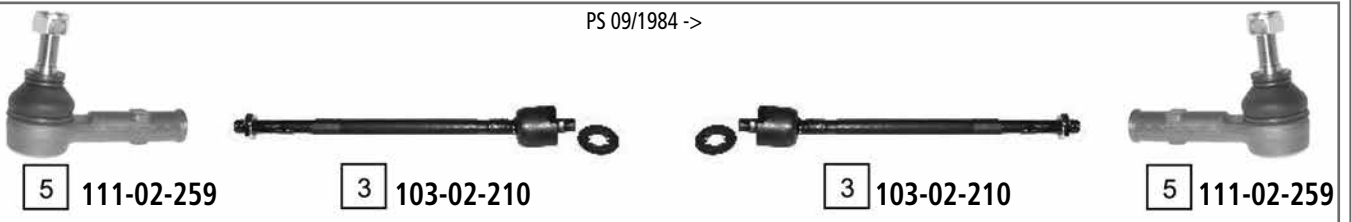

LOWER

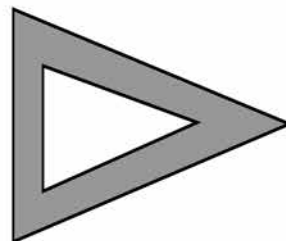

| Ref | ASHIKA CODE | Description | OEM         | Measures            | Ref | ASHIKA CODE | Description      | OEM         | Measures            |
|-----|-------------|-------------|-------------|---------------------|-----|-------------|------------------|-------------|---------------------|
| 1   | 103-02-206  | Axial Joint | 45503-19036 | th: MM14X1.5R L:315 | 4   | 73-02-291   | Tie Rod End      | 45046-29135 | c:12.6 th:FM12X1.25 |
| 2   | 103-02-202  | Axial Joint | 45503-19035 | th: MM14X1.5R L:317 | 5   | 111-02-259  | Tie Rod End      | 45046 19175 | c:12.7 th:FM14X1.5R |
| 3   | 103-02-210  | Axial Joint | 45503-19056 | th: MM14X1.5R L:297 | 6   | 53-02-296   | Ball Joint Lower | 43330-29136 | c:15.9              |

CARINA II (\_T17\_)

12/1987 - 06/1993

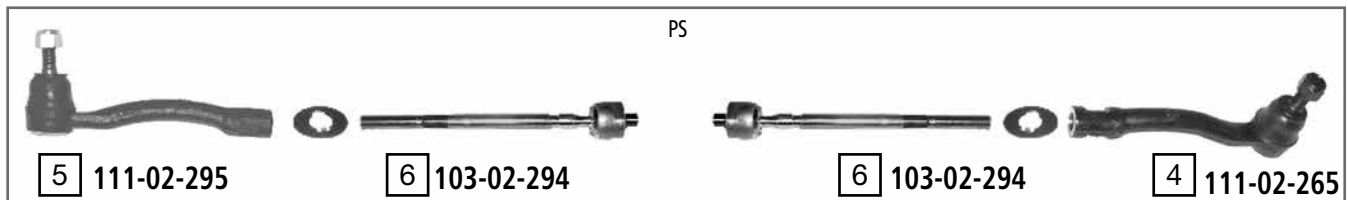
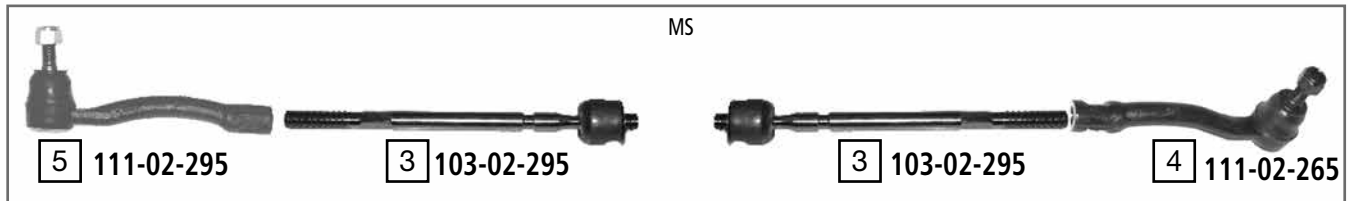
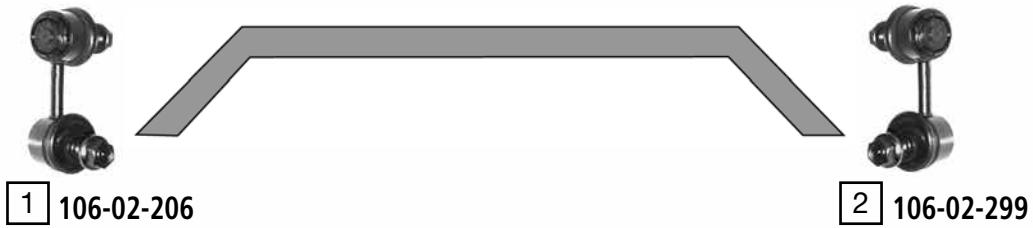

LOWER



| Ref | ASHIKA CODE | Description           | OEM         | Measures            | Ref | ASHIKA CODE | Description       | OEM         | Measures            |
|-----|-------------|-----------------------|-------------|---------------------|-----|-------------|-------------------|-------------|---------------------|
| 1   | 106-02-206  | Stabiliser Link Left  | 48810-20010 | L:58                | 5   | 111-02-295  | Tie Rod End Right | 45046-29165 | c.12.5 th:FM15X1.5R |
| 2   | 106-02-299  | Stabiliser Link Right | 48820-20030 | L:60.5              | 6   | 103-02-294  | Axial Joint       | 45503-29165 | th:MM14X1.5R L:250  |
| 3   | 103-02-295  | Axial Joint           | 45503-29155 | th:MM14X1.5R L:259  | 7   | 73-02-299   | Ball Joint Lower  | 43330-29145 | c.15.9              |
| 4   | 111-02-265  | Tie Rod End Left      | 45047-29045 | c.12.5 th:FM15X1.5R |     |             |                   |             |                     |

CELICA (ST16\_, AT16\_)

08/1985 - 08/1989



5 106-02-201

5 106-02-201



1 111-02-259



2 103-02-216



2 103-02-216

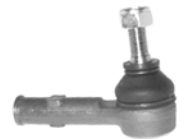

1 111-02-259



3 73-02-299

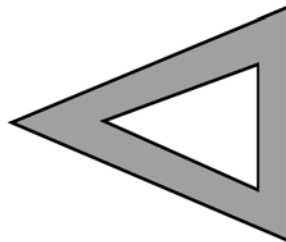

LOWER

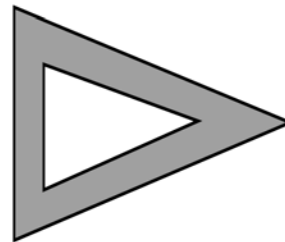

3 73-02-299



4 106-02-202

4 106-02-202

| Ref | ASHIKA CODE | Description      | OEM         | Measures            | Ref | ASHIKA CODE | Description     | OEM         | Measures |
|-----|-------------|------------------|-------------|---------------------|-----|-------------|-----------------|-------------|----------|
| 1   | 111-02-259  | Tie Rod End      | 45046 19175 | c:12.7 th:FM14X1.5R | 4   | 106-02-202  | Stabiliser Link | 48830 12050 | L:105    |
| 2   | 103-02-216  | Axial Joint      | 45503-29105 | th:MM14X1.5R L:327  | 5   | 106-02-201  | Stabiliser Link | 48820-20010 | L:69     |
| 3   | 73-02-299   | Ball Joint Lower | 43330-29145 | c:15.9              |     |             |                 |             |          |



# TOYOTA CELICA



CELICA (ST18\_ AT180)

09/1989 - 11/1993



1 106-02-201  
EXC 4X4

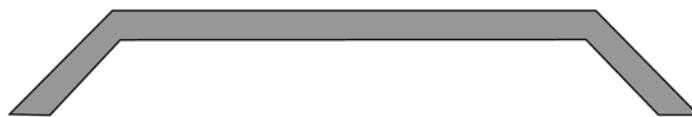

1 106-02-201  
EXC 4X4



4 111-02-259



5 103-02-292



5 103-02-292



4 111-02-259



3 73-02-241

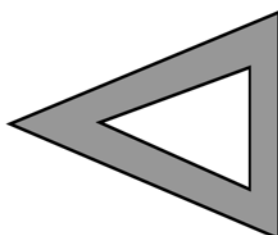

LOWER

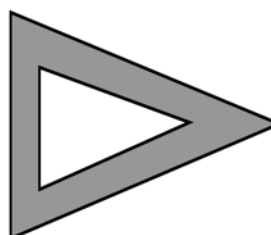

3 73-02-241



2 106-02-202



2 106-02-202

| Ref | ASHIKA CODE | Description     | OEM         | Measures | Ref | ASHIKA CODE | Description | OEM         | Measures            |
|-----|-------------|-----------------|-------------|----------|-----|-------------|-------------|-------------|---------------------|
| 1   | 106-02-201  | Stabiliser Link | 48820-20010 | L:69     | 4   | 111-02-259  | Tie Rod End | 45046 19175 | c:12.7 th:FM14X1.5R |
| 2   | 106-02-202  | Stabiliser Link | 48830 12050 | L:105    | 5   | 103-02-292  | Axial Joint | 45503 29245 | th:MM14X1.5R L:341  |
| 3   | 73-02-241   | Ball Joint      | 43330 29225 | c:18.2   |     |             |             |             |                     |

CELICA (\_T20\_)

11/1993 - 11/1999



1 106-02-298



1 106-02-298



4 111-02-259



4 111-02-259



3 53-02-297

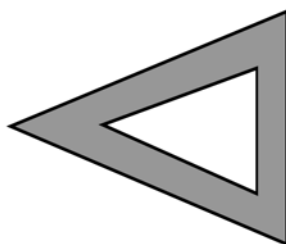

LOWER

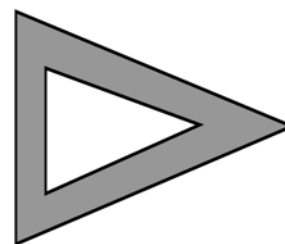

3 53-02-297



2 106-02-202



2 106-02-202

| Ref | ASHIKA CODE | Description     | OEM         | Measures | Ref | ASHIKA CODE | Description      | OEM         | Measures            |
|-----|-------------|-----------------|-------------|----------|-----|-------------|------------------|-------------|---------------------|
| 1   | 106-02-298  | Stabiliser Link | 48820 33010 | L:60.5   | 3   | 53-02-297   | Ball Joint Lower | 43330 09030 | c:15                |
| 2   | 106-02-202  | Stabiliser Link | 48830 12050 | L.105    | 4   | 111-02-259  | Tie Rod End      | 45046 19175 | c:12.7 th:FM14X1.5R |

CELICA (ZZT23\_)

11/1999 - 12/2005



LOWER

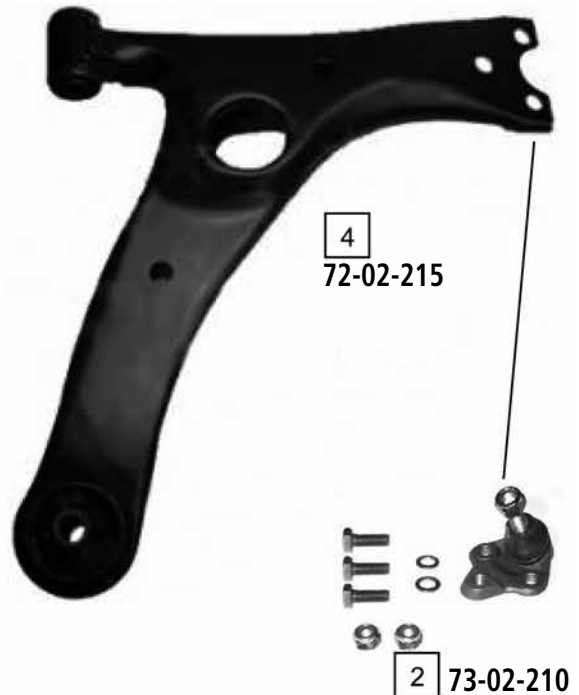

| Ref | ASHIKA CODE | Description     | OEM         | Measures | Ref | ASHIKA CODE | Description | OEM         | Measures           |
|-----|-------------|-----------------|-------------|----------|-----|-------------|-------------|-------------|--------------------|
| 1   | 106-02-220  | Stabiliser Link | 48820 32010 | L:285    | 5   | 111-02-252  | Tie Rod End | 45047-49015 |                    |
| 2   | 73-02-210   | Ball Joint      | 43330 19115 | c:15.3   | 6   | 111-02-237  | Tie Rod End | 45046-49085 |                    |
| 3   | 72-02-214   | TCA             | 48069 20381 |          | 7   | 103-02-223  | Axial Joint | 45503-49035 | th:MM14X1.5R L.303 |
| 4   | 72-02-215   | TCA             | 48068 20380 |          |     |             |             |             |                    |

COROLLA (\_E7\_)

09/1979 - 08/1987



2 108-06-622



3 103-02-201



3 103-02-201



2 108-06-622



1 53-06-609

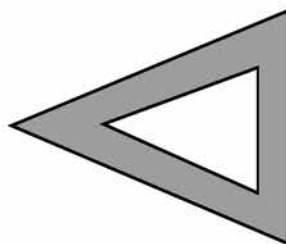

LOWER

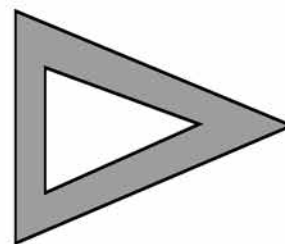

1 53-06-609

| Ref | ASHIKA CODE | Description      | OEM         | Measures | Ref | ASHIKA CODE | Description | OEM         | Measures           |
|-----|-------------|------------------|-------------|----------|-----|-------------|-------------|-------------|--------------------|
| 1   | 53-06-609   | Ball Joint Lower | 43308-12030 | c:14.5   | 3   | 103-02-201  | Axial Joint | 45503-10020 | th:MM14X1.5R L:146 |
| 2   | 108-06-622  | Tie Rod          | 45460-19125 |          |     |             |             |             |                    |

COROLLA (\_E8\_)

06/1983 - 05/1988

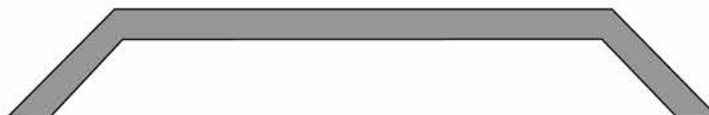

MS -> 09/1984



1 73-02-291



2 103-02-202



2 103-02-202



1 73-02-291

MS 10/1984 ->



4 111-02-259



103-02-206



5 103-02-206



4 111-02-259

PS 10/1984 ->



4 111-02-259



6 103-02-210



6 103-02-210



4 111-02-259



3 53-02-296

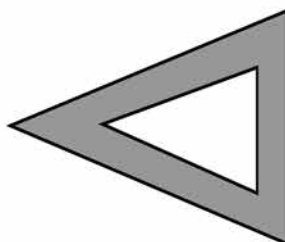

LOWER

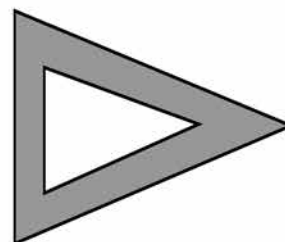

3 53-02-296

| Ref | ASHIKA CODE | Description      | OEM         | Measures            | Ref | ASHIKA CODE | Description | OEM         | Measures            |
|-----|-------------|------------------|-------------|---------------------|-----|-------------|-------------|-------------|---------------------|
| 1   | 73-02-291   | Tie Rod End      | 45046-29135 | c:12.6 th:FM12X1.25 | 4   | 111-02-259  | Tie Rod End | 45046 19175 | c:12.7 th:FM14X1.5R |
| 2   | 103-02-202  | Axial Joint      | 45503-19035 | th:MM14X1.5R L:317  | 5   | 103-02-206  | Axial Joint | 45503-19036 | th:MM14X1.5R L:315  |
| 3   | 53-02-296   | Ball Joint Lower | 43330-29136 | c:15.9              | 6   | 103-02-210  | Axial Joint | 45503-19056 | th:MM14X1.5R L:297  |

COROLLA (\_E9\_)

07/1987 - 06/1993

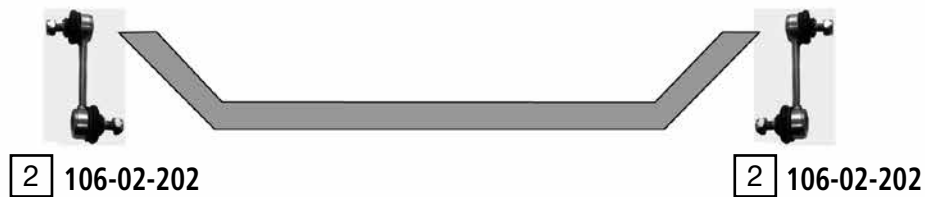
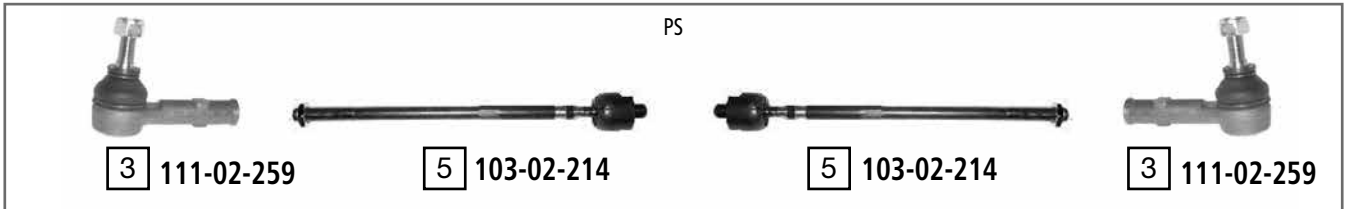
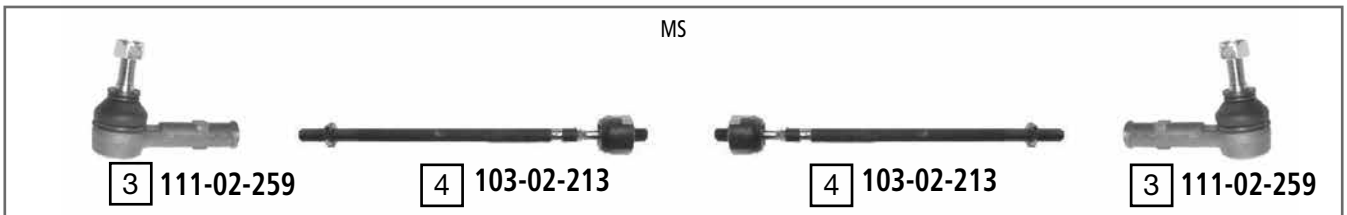

| Ref | ASHIKA CODE | Description     | OEM         | Measures            | Ref | ASHIKA CODE | Description            | OEM         | Measures           |
|-----|-------------|-----------------|-------------|---------------------|-----|-------------|------------------------|-------------|--------------------|
| 1   | 106-02-201  | Stabiliser Link | 48820-20010 | L:69                | 5   | 103-02-214  | Axial Joint            | 45503-19135 | th:MM14X1.5R L:309 |
| 2   | 106-02-202  | Stabiliser Link | 48830 12050 | L:105               | 6   | 73-02-290   | Ball Joint Lower Left  | 43340-19015 | c:15.6             |
| 3   | 111-02-259  | Tie Rod End     | 45046 19175 | c:12.7 th:FM14X1.5R | 7   | 73-02-232R  | Ball Joint Lower Right | 43330-19065 | c:15.6             |
| 4   | 103-02-213  | Axial Joint     | 45503-19125 | th:MM14X1.5R L:306  |     |             |                        |             |                    |

COROLLA (\_E10\_)

07/1992 - 04/1997

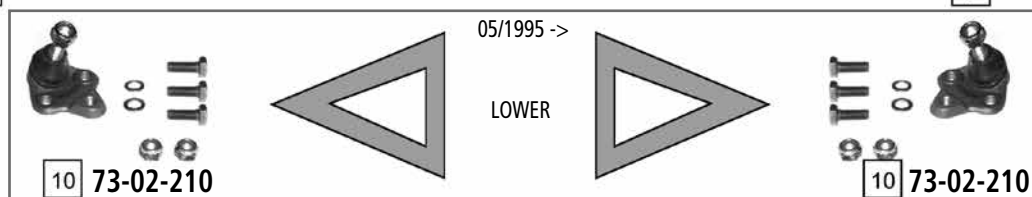
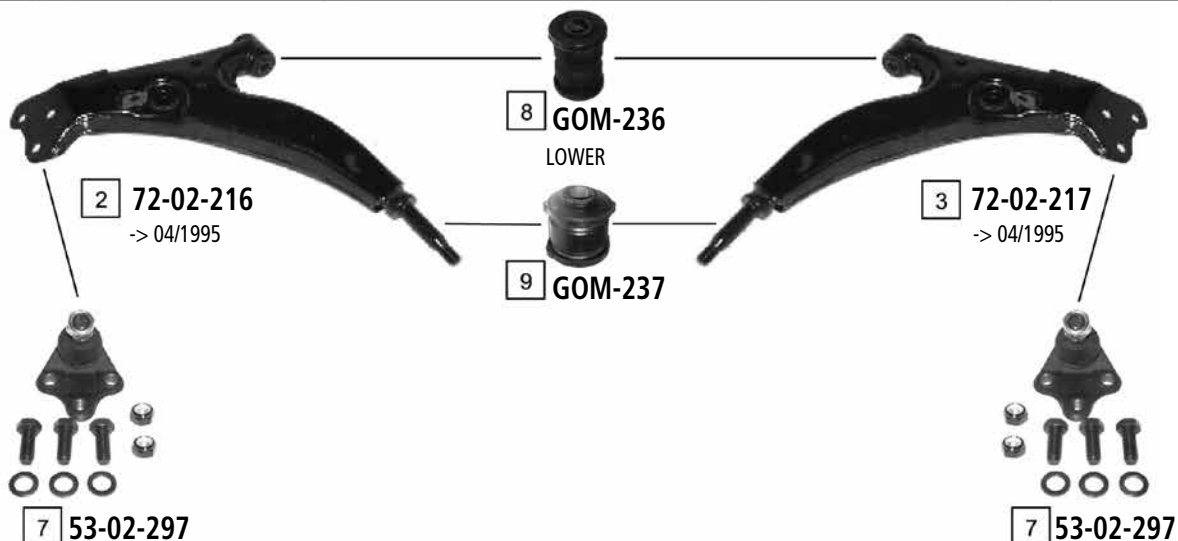
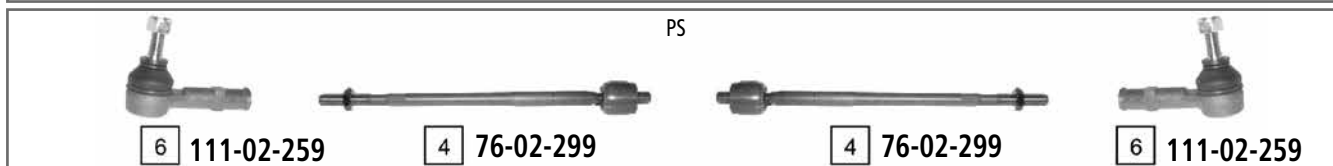
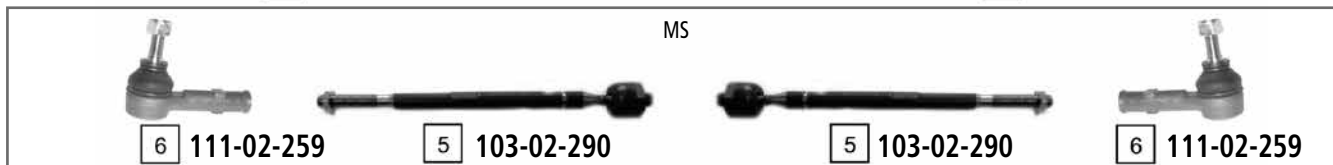

| Ref | ASHIKA CODE | Description     | OEM         | Measures            | Ref | ASHIKA CODE | Description              | OEM         | Measures |
|-----|-------------|-----------------|-------------|---------------------|-----|-------------|--------------------------|-------------|----------|
| 1   | 106-02-298  | Stabiliser Link | 48820 33010 | L:60.5              | 7   | 53-02-297   | Ball Joint Lower         | 43330 09030 | c:15     |
| 2   | 72-02-216   | TCA Left        | 48069-12130 |                     | 8   | GOM-236     | Silentblock For Susp.Arm | 48654-12070 | d:34.5   |
| 3   | 72-02-217   | TCA Right       | 48068-12130 |                     | 9   | GOM-237     | Silentblock For Susp.Arm | 48655-12050 | d:46     |
| 4   | 76-02-299   | Axial Joint     | 45503-19205 | th:MM14X1.5R L:330  | 10  | 73-02-210   | Ball Joint               | 43330 19115 | c.15.3   |
| 5   | 103-02-290  | Axial Joint     | 45503-29365 | th:MM14X1.5R L:315  | 11  | 106-02-202  | Stabiliser Link          | 48830 12050 | L:105    |
| 6   | 111-02-259  | Tie Rod End     | 45046 19175 | c:12.7 th:FM14X1.5R |     |             |                          |             |          |

COROLLA (\_E11\_)

04/1997 - 11/2001



LOWER

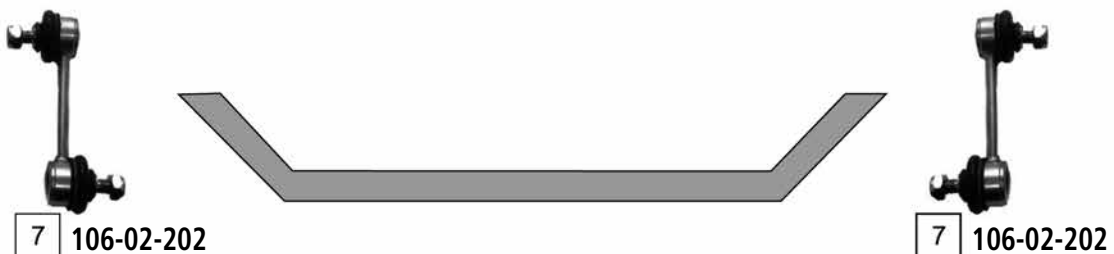

| Ref | ASHIKA CODE | Description     | OEM         | Measures | Ref | ASHIKA CODE | Description     | OEM         | Measures            |
|-----|-------------|-----------------|-------------|----------|-----|-------------|-----------------|-------------|---------------------|
| 1   | 106-02-298  | Stabiliser Link | 48820 33010 | L:60.5   | 5   | 76-02-299   | Axial Joint     | 45503-19205 | th:MM14X1.5R L:330  |
| 2   | 73-02-210   | Ball Joint      | 43330 19115 | c:15.3   | 6   | 111-02-259  | Tie Rod End     | 45046 19175 | c:12.7 th:FM14X1.5R |
| 3   | 72-02-218   | TCA Left        | 48069-12171 |          | 7   | 106-02-202  | Stabiliser Link | 48830 12050 | L:105               |
| 4   | 72-02-219   | TCA Right       | 48068-12171 |          |     |             |                 |             |                     |



COROLLA (\_E12\_)

12/2001 ->

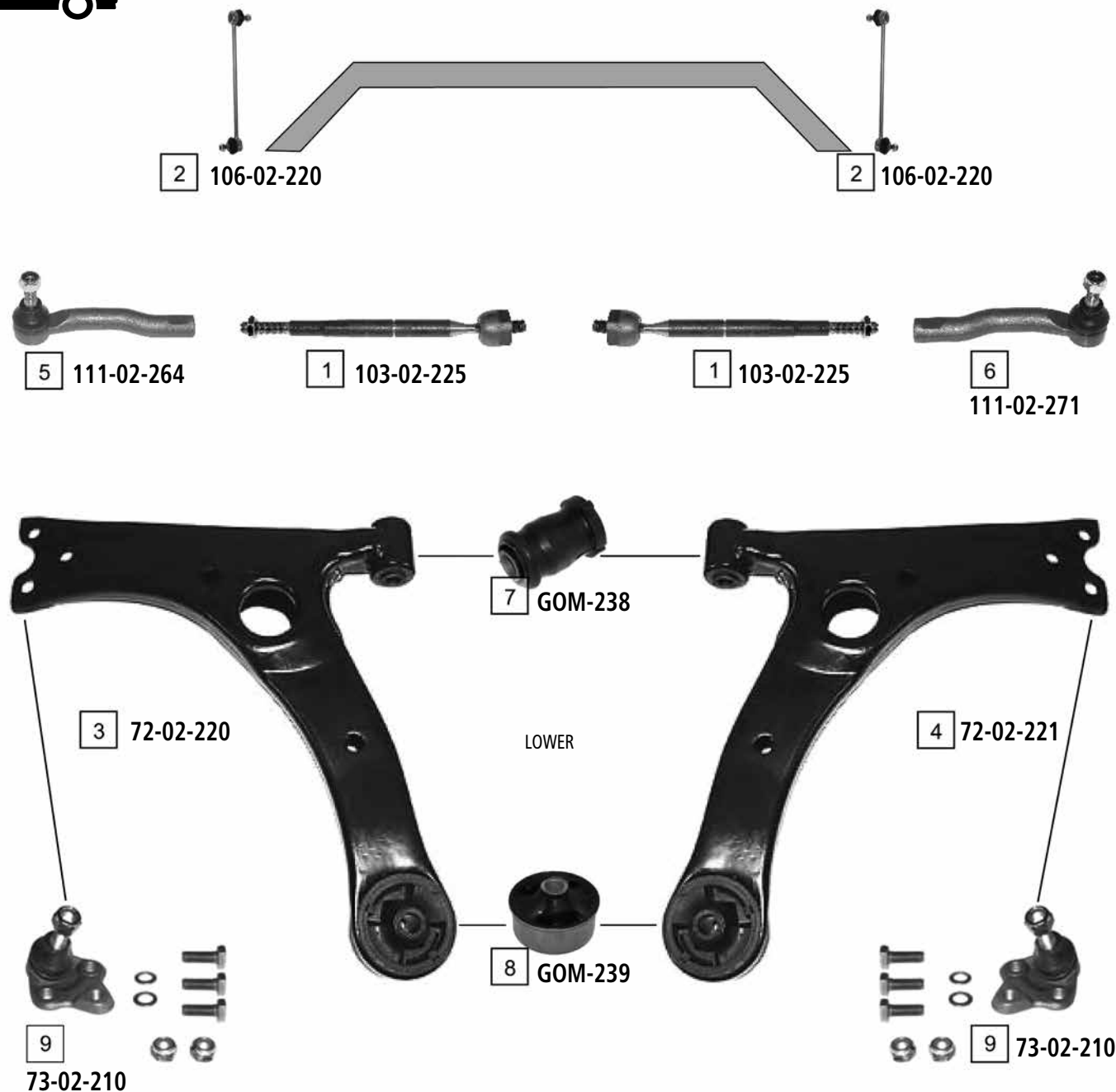

| Ref | ASHIKA CODE | Description      | OEM         | Measures            | Ref | ASHIKA CODE | Description              | OEM                         | Measures            |
|-----|-------------|------------------|-------------|---------------------|-----|-------------|--------------------------|-----------------------------|---------------------|
| 1   | 103-02-225  | Axial Joint      | 45503-12130 | th:MM14X1.5R L:272  | 6   | 111-02-271  | Tie Rod End Right        | 45046 19265                 | c:12.6 th.FM14X1.5R |
| 2   | 106-02-220  | Stabiliser Link  | 48820-32010 | L:285               | 7   | GOM-238     | Silentblock For Susp.Arm | Part of 72-02-220/72-02-221 | d:34.5              |
| 3   | 72-02-220   | TCA Left         | 48069-12260 | c:15                | 8   | GOM-239     | Silentblock For Susp.Arm | Part of 72-02-220/72-02-221 | d:68.3              |
| 4   | 72-02-221   | TCA Right        | 48068-12260 | c:15                | 9   | 73-02-210   | Ball Joint               | 43330 19115                 | c.15.3              |
| 5   | 111-02-264  | Tie Rod End Left | 45047 19115 | c:12.6 th:FM14X1.5R |     |             |                          |                             |                     |

COROLLA VERSO (\_E12J\_)

01/2002 - 05/2004

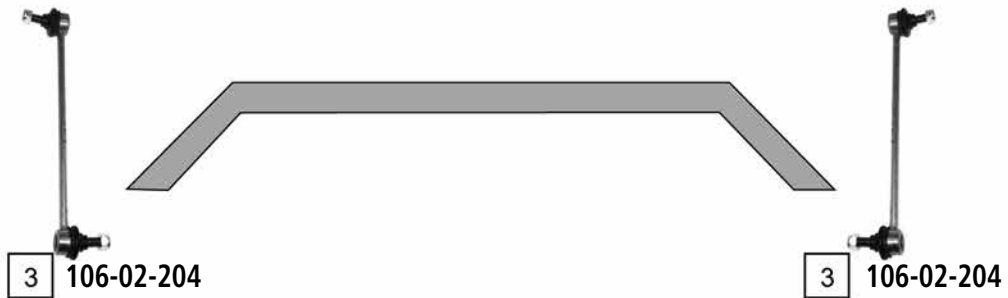

| Ref | ASHIKA CODE | Description     | OEM         | Measures           | Ref | ASHIKA CODE | Description              | OEM                         | Measures            |
|-----|-------------|-----------------|-------------|--------------------|-----|-------------|--------------------------|-----------------------------|---------------------|
| 1   | 103-02-226  | Axial Joint     | 45503-19255 | th:MM14X1.5R L:273 | 6   | 111-02-276  | Tie Rod End Left         | 45047-49045                 | c:12.6 th:FM14X1.5R |
| 2   | 73-02-210   | Ball Joint      | 43330 19115 | c:15.3             | 7   | 111-02-275  | Tie Rod End Right        | 45046-49115                 | c:12.6 th:FM14X1.5R |
| 3   | 106-02-204  | Stabiliser Link | 48820 47010 | L:285              | 8   | GOM-238     | Silentblock For Susp.Arm | Part of 72-02-220/72-02-221 | d:34.5              |
| 4   | 72-02-220   | TCA Left        | 48069-12260 | c:15               | 9   | GOM-239     | Silentblock For Susp.Arm | Part of 72-02-220/72-02-221 | d:68.3              |
| 5   | 72-02-221   | TCA Right       | 48068-12260 | c:15               |     |             |                          |                             |                     |

# TOYOTA COROLLA



COROLLA VERSO (AUR10-CUR10-ZNR1\_)

04/2004 ->

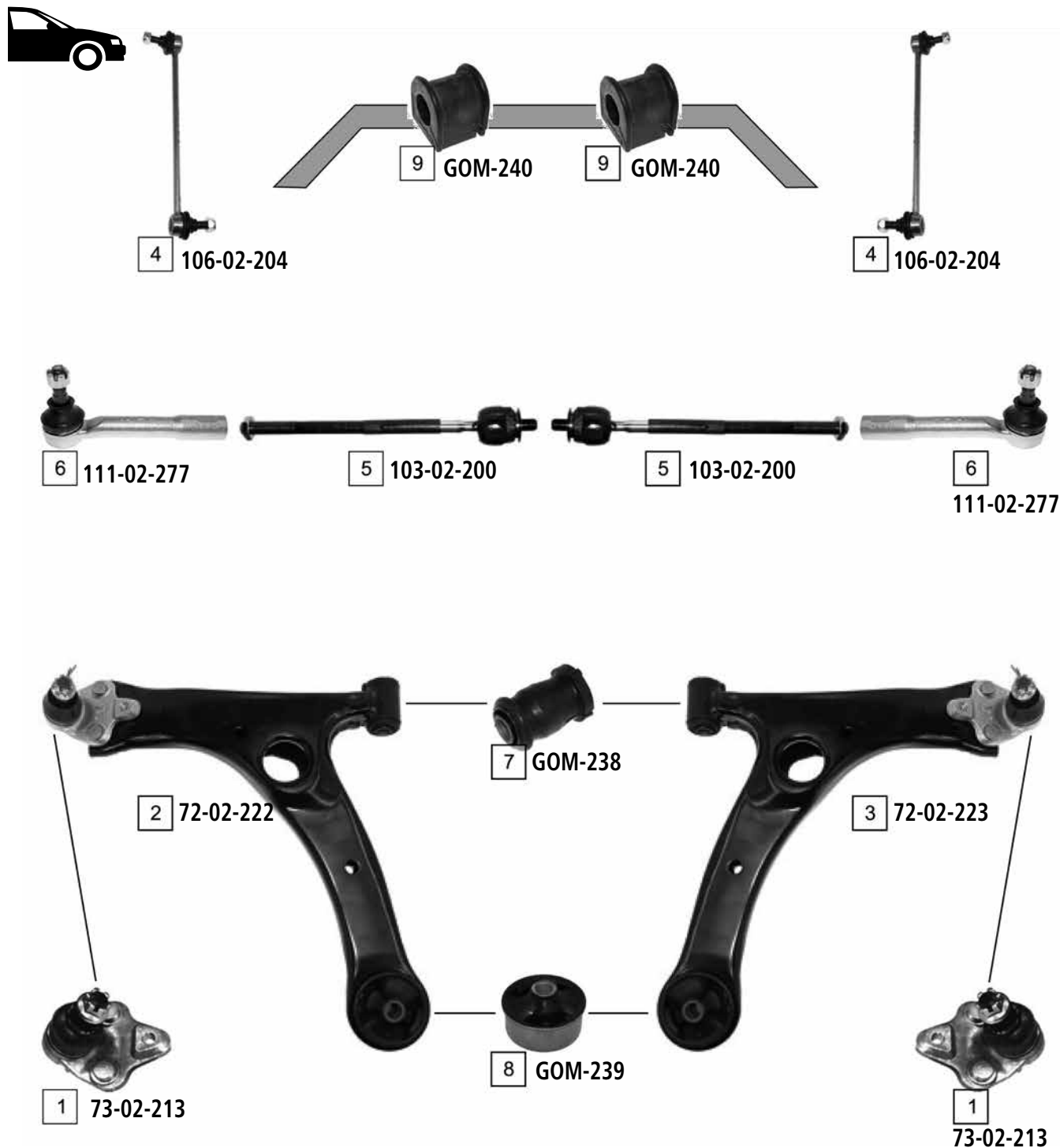

| Ref | ASHIKA CODE | Description     | OEM         | Measures | Ref | ASHIKA CODE | Description              | OEM                         | Measures            |
|-----|-------------|-----------------|-------------|----------|-----|-------------|--------------------------|-----------------------------|---------------------|
| 1   | 73-02-213   | Ball Joint      | 43330 09360 | c:17.6   | 6   | 111-02-277  | Tie Rod End              | 45046 09430                 | c:12.6 th:FM16X1.5R |
| 2   | 72-02-222   | TCA Left Wbj    | 48069 0F010 | c:17.6   | 7   | GOM-238     | Silentblock For Susp.Arm | Part of 72-02-222/72-02-223 | d:34.5              |
| 3   | 72-02-223   | TCA Right Wbj   | 48068 0F010 | c:17.6   | 8   | GOM-239     | Silentblock For Susp.Arm | Part of 72-02-222/72-02-223 | d:68.3              |
| 4   | 106-02-204  | Stabiliser Link | 48820 47010 | L:285    | 9   | GOM-240     | Stabiliser Mounting      | 48815 0F010                 | d:42                |
| 5   | 103-02-200  | Axial Joint     | 45503 0F010 |          |     |             |                          |                             |                     |

HIACE II (\_H5\_,\_H6\_,\_H7\_) 12/1982 - 07/1989



8 27-02-212

7 59-02-236



2 111-02-226



1 111-02-232



1 111-02-232



2 111-02-226

UPPER EXC 4X4



3 73-02-220

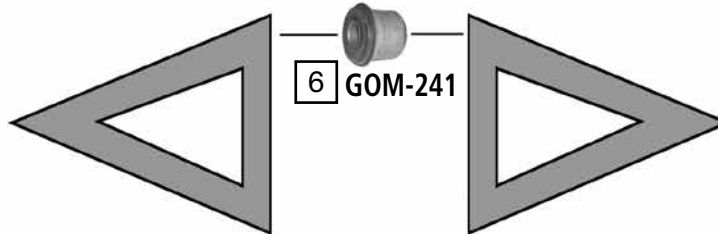

6 GOM-241



3 73-02-220

LOWER EXC 4X4



4 53-02-221



4 53-02-221

LOWER 4X4



5 53-02-228

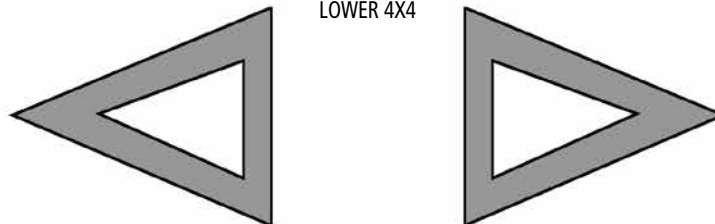

5 53-02-228

| Ref | ASHIKA CODE | Description | OEM         | Measures            | Ref | ASHIKA CODE | Description              | OEM         | Measures |
|-----|-------------|-------------|-------------|---------------------|-----|-------------|--------------------------|-------------|----------|
| 1   | 111-02-232  | Tie Rod End | 45406-29145 | c:14.7 th:MM17X1.5R | 5   | 53-02-228   | Ball Joint               | 43330-39195 | c:18.2   |
| 2   | 111-02-226  | Tie Rod End | 45046-29115 | c:14.8 th:MM17X1.5L | 6   | GOM-241     | Silentblock For Susp.Arm | 48632 26010 | d:46.2   |
| 3   | 73-02-220   | Ball Joint  | 43360-29076 | c:17.2              | 7   | 59-02-236   | Pitman Arm               | 45490-29465 |          |
| 4   | 53-02-221   | Ball Joint  | 43330 29125 | c:18                | 8   | 27-02-212   | Tie Rod End              | 45450-29155 |          |

HIACE III (\_H10\_,\_H11\_) 08/1989 - 07/1995



1 111-02-270



2 103-02-217



2 103-02-217



1 111-02-270



3 73-02-234

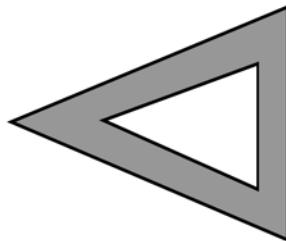

UPPER

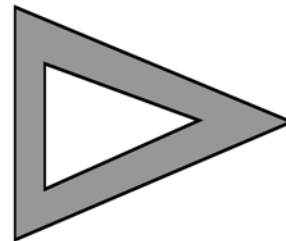

3 73-02-234



4 53-02-221

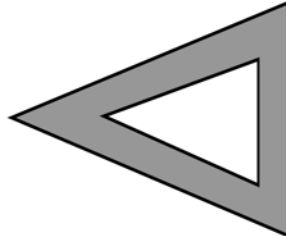

LOWER

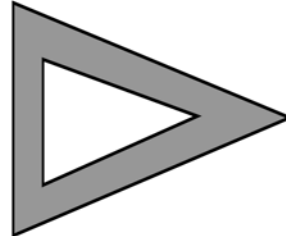

4 53-02-221

| Ref | ASHIKA CODE | Description | OEM         | Measures              | Ref | ASHIKA CODE | Description      | OEM         | Measures |
|-----|-------------|-------------|-------------|-----------------------|-----|-------------|------------------|-------------|----------|
| 1   | 111-02-270  | Tie Rod End | 45046-29215 | c: 14.7 th: FM17X1.5R | 3   | 73-02-234   | Ball Joint Upper | 43350-29065 | c:17.2   |
| 2   | 103-02-217  | Axial Joint | 45503-29255 | th:MM14X1.5R L:277    | 4   | 53-02-221   | Ball Joint       | 43330 29125 | c:18     |

HIACE IV (\_H1\_,\_H2\_,)

08/1995 - 01/2007

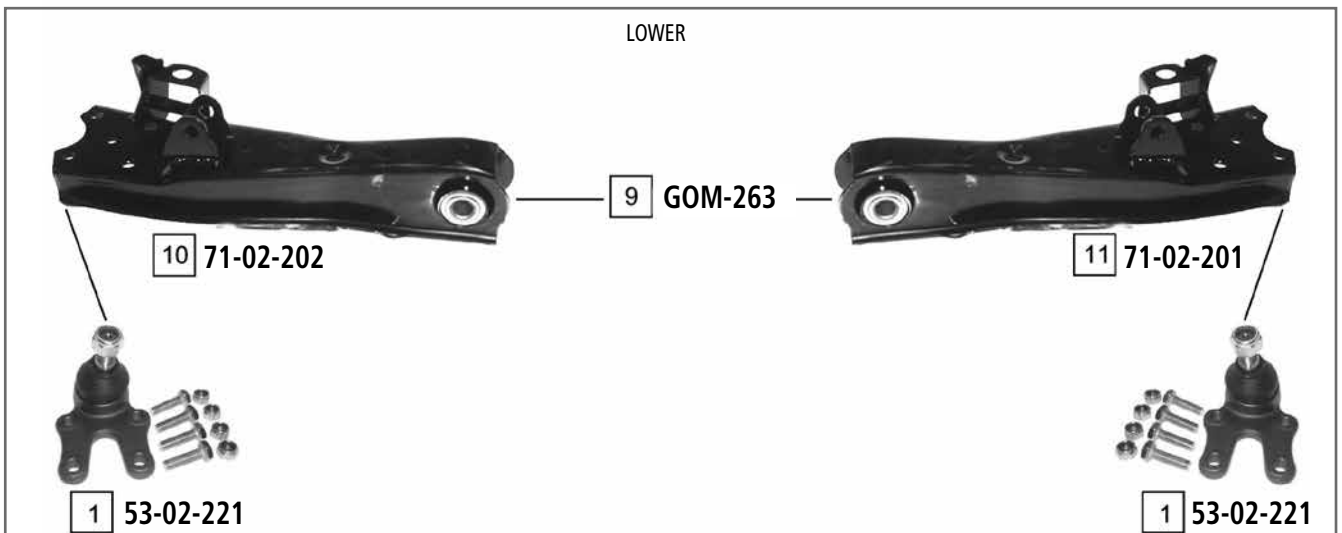
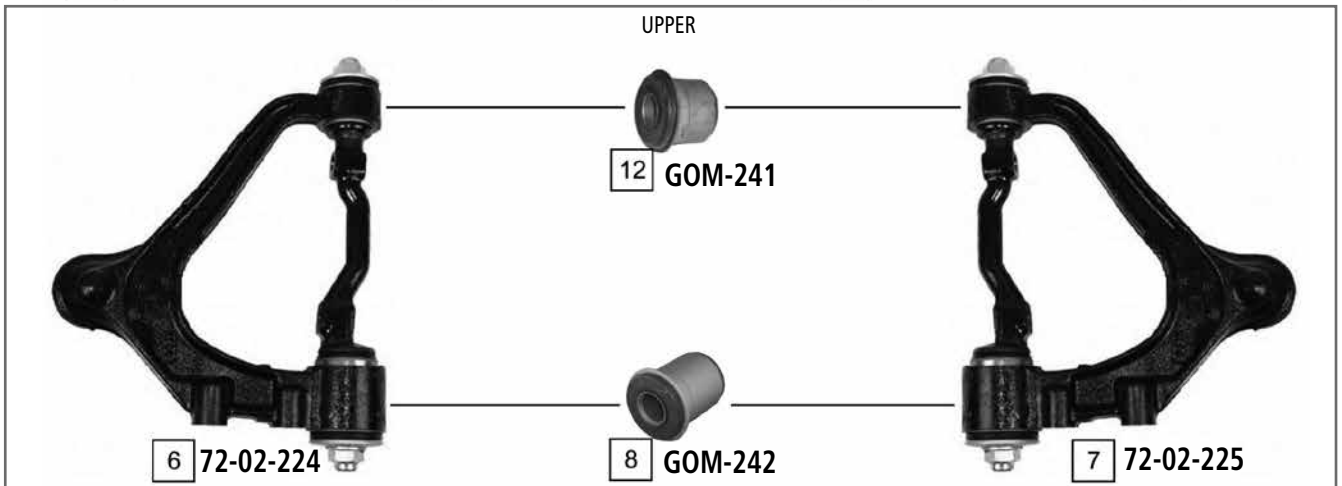
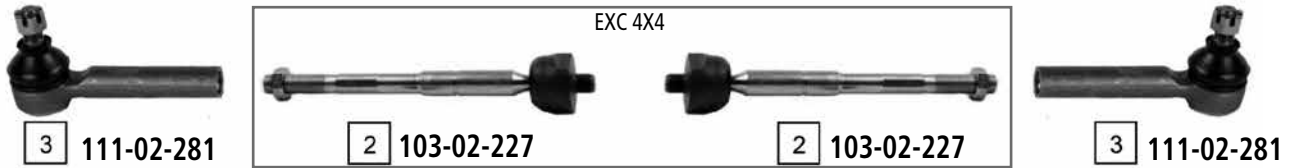

| Ref | ASHIKA CODE | Description           | OEM         | Measures           | Ref | ASHIKA CODE | Description              | OEM         | Measures |
|-----|-------------|-----------------------|-------------|--------------------|-----|-------------|--------------------------|-------------|----------|
| 1   | 53-02-221   | Ball Joint            | 43330 29125 | c:18               | 7   | 72-02-225   | TCA Right                | 48066 29075 | c:17     |
| 2   | 103-02-227  | Axial Joint           | 45503 29565 | th:MM14X1.5R L:275 | 8   | GOM-242     | Silentblock For Susp.Arm | 48635 26010 |          |
| 3   | 111-02-281  | Tie Rod End           | 45046 29325 |                    | 9   | GOM-263     | Silentblock For Susp.Arm | 48061 26050 |          |
| 4   | 106-02-222  | Stabiliser Link Left  | 48810 26020 | L:75               | 10  | 71-02-202   | TCA Left                 | 48069 26130 |          |
| 5   | 106-02-221  | Stabiliser Link Right | 48820 26020 | L:75               | 11  | 71-02-201   | TCA Right                | 48068 26130 |          |
| 6   | 72-02-224   | TCA Left              | 48067 29075 | c.17               | 12  | GOM-241     | Silentblock For Susp.Arm | 48632 26010 | d.46.2   |

HILUX (\_N3\_,\_N4\_,\_N5\_) 2X4

08/1978 - 07/1988



9 59-02-244

10 59-02-215

11 59-02-239



1 111-02-226



2 111-02-227



2 111-02-227



1  
111-02-226

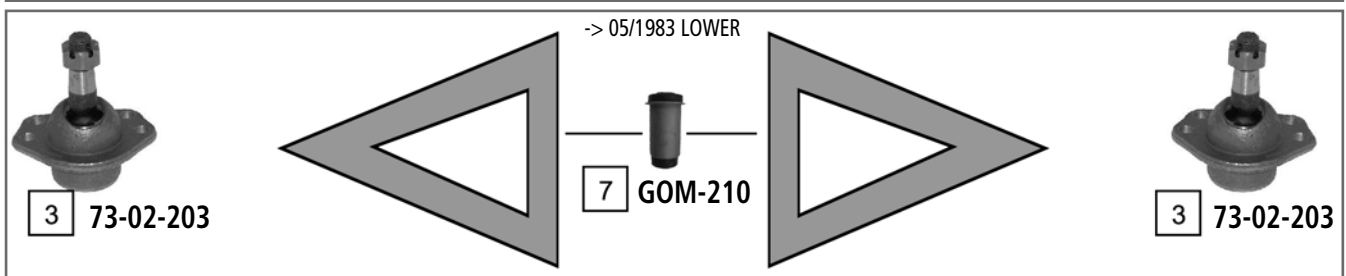
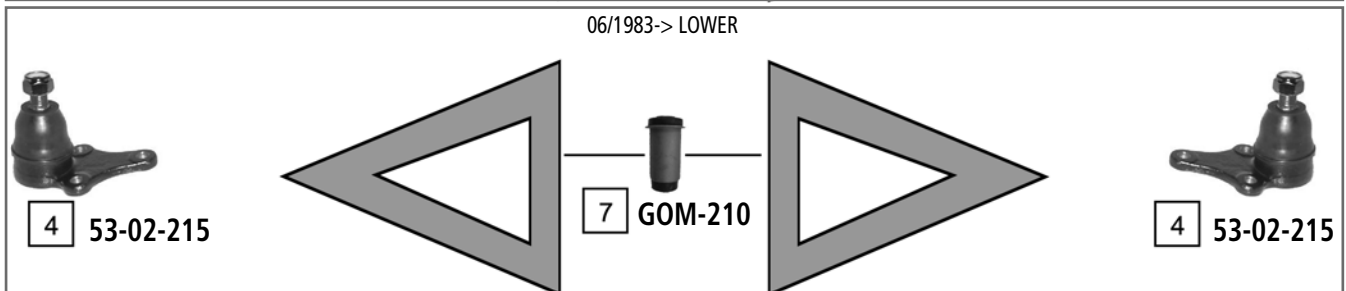
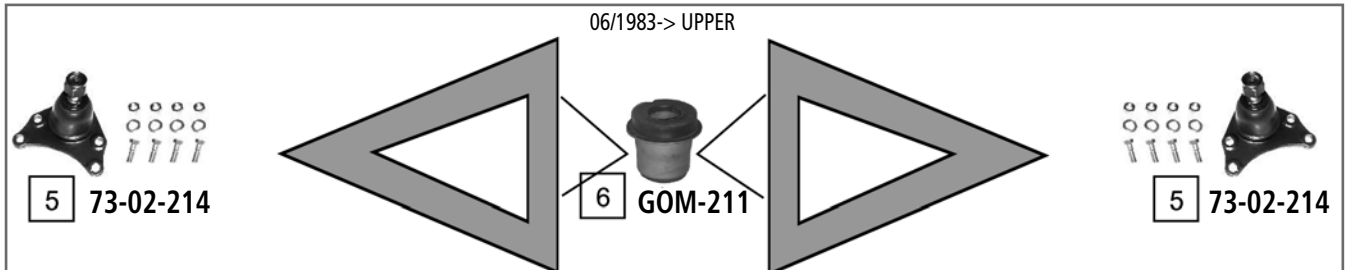

8 52-02-236

| Ref | ASHIKA CODE | Description              | OEM         | Measures            | Ref | ASHIKA CODE | Description              | OEM         | Measures |
|-----|-------------|--------------------------|-------------|---------------------|-----|-------------|--------------------------|-------------|----------|
| 1   | 111-02-226  | Tie Rod End              | 45046-29115 | c:14.8 th:MM17X1.5L | 7   | GOM-210     | Silentblock For Susp.Arm | 48654-35010 | d:40.5   |
| 2   | 111-02-227  | Tie Rod End              | 45406-29115 | c:14.8 th:MM17X1.5R | 8   | 52-02-236   | Tie Rod End              | 45401-35240 |          |
| 3   | 73-02-203   | Ball Joint               | 4335039016  | c:15                | 9   | 59-02-244   | Pitman Arm               | 45490-39255 |          |
| 4   | 53-02-215   | Ball Joint               | 43330 39145 | c:17.9              | 10  | 59-02-215   | Pitman Arm               | 45490-35140 |          |
| 5   | 73-02-214   | Ball Joint               | 43350-39035 | c:15                | 11  | 59-02-239   | Pitman Arm               | 45490-35130 |          |
| 6   | 73-02-214   | Silentblock For Susp.Arm | 48632-30020 | d:36.5 - 38         |     |             |                          |             |          |

HILUX (\_N8,\_N9,\_N11\_) 2X4

08/1988 - 07/1997



1 111-02-226



2 111-02-227



2 111-02-227



1 111-02-226

10 108-02-203

10 108-02-203



4 73-02-227

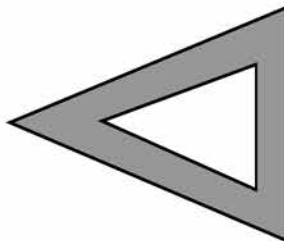

UPPER

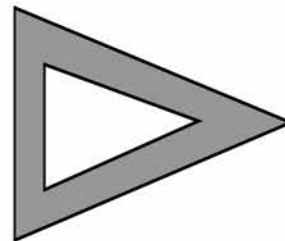

4 73-02-227



3 53-02-235

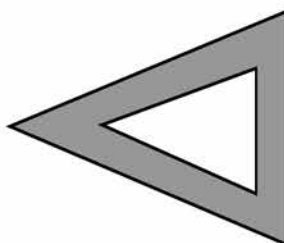

LOWER

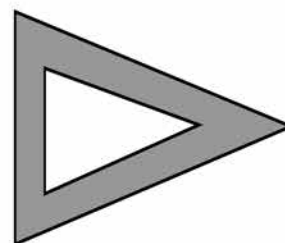

3 53-02-235

5 27-02-201  
03/1989 ->

6 27-02-210

7 59-02-215

8 59-02-239

9 59-02-240

| Ref | ASHIKA CODE | Description | OEM         | Measures            | Ref | ASHIKA CODE | Description | OEM         | Measures |
|-----|-------------|-------------|-------------|---------------------|-----|-------------|-------------|-------------|----------|
| 1   | 111-02-226  | Tie Rod End | 45046-29115 | c.14.8 th:MM17X1.5L | 6   | 27-02-210   | Tie Rod End | 45450-39165 |          |
| 2   | 111-02-227  | Tie Rod End | 45406-29115 | c.14.8 th:MM17X1.5R | 7   | 59-02-215   | Pitman Arm  | 45490-35140 |          |
| 3   | 53-02-235   | Ball Joint  | 43330-39295 | c.18.2              | 8   | 59-02-239   | Pitman Arm  | 45490-35130 |          |
| 4   | 73-02-227   | Ball Joint  | 43350-39045 | c.17.1              | 9   | 59-02-240   | Pitman Arm  | 45490-39315 |          |
| 5   | 27-02-201   | Tie Rod End | 45450-39065 |                     | 10  | 108-02-203  | Tie Rod End | 45490-39225 |          |



HILUX (\_N6,\_N10,\_N11,\_N12,\_N13\_) 4X4

08/1985 ->



1 111-02-226



2 73-02-292



2 73-02-292



1 111-02-226

08/1991 ->



4 73-02-227

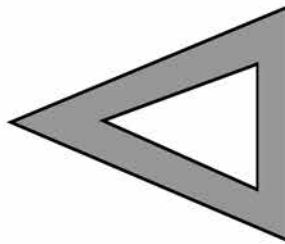

UPPER

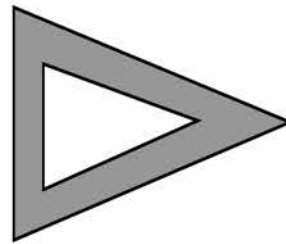

4 73-02-227



3 53-02-228

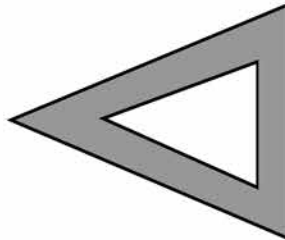

LOWER

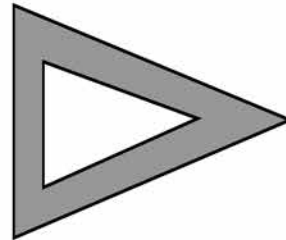

3 53-02-228

-> 03/1989



5 53-02-295

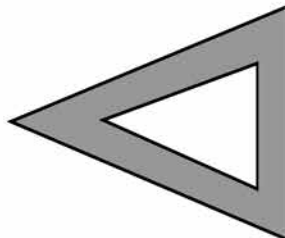

LOWER

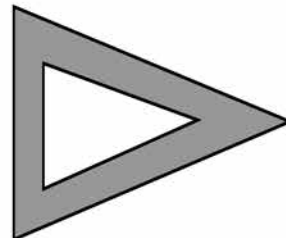

5 53-02-295

6 27-02-201

7 27-02-210

| Ref | ASHIKA CODE | Description | OEM         | Measures            | Ref | ASHIKA CODE | Description | OEM         | Measures |
|-----|-------------|-------------|-------------|---------------------|-----|-------------|-------------|-------------|----------|
| 1   | 111-02-226  | Tie Rod End | 45046-29115 | c:14.8 th:MM17X1.5L | 5   | 53-02-295   | Ball Joint  | 43330-39265 | c:18.1   |
| 2   | 73-02-292   | Tie Rod End | 45406 39165 | c:14.7 th:FM17X1.5R | 6   | 27-02-201   | Tie Rod End | 45450-39065 |          |
| 3   | 53-02-228   | Ball Joint  | 43330-39195 | c:18.2              | 7   | 27-02-210   | Tie Rod End | 45450-39165 |          |
| 4   | 73-02-227   | Ball Joint  | 43350-39045 | c:17.1              |     |             |             |             |          |

HILUX (KUN1\_ 2 x 4 / KUN2\_ 4 x 4)

09/2005 ->

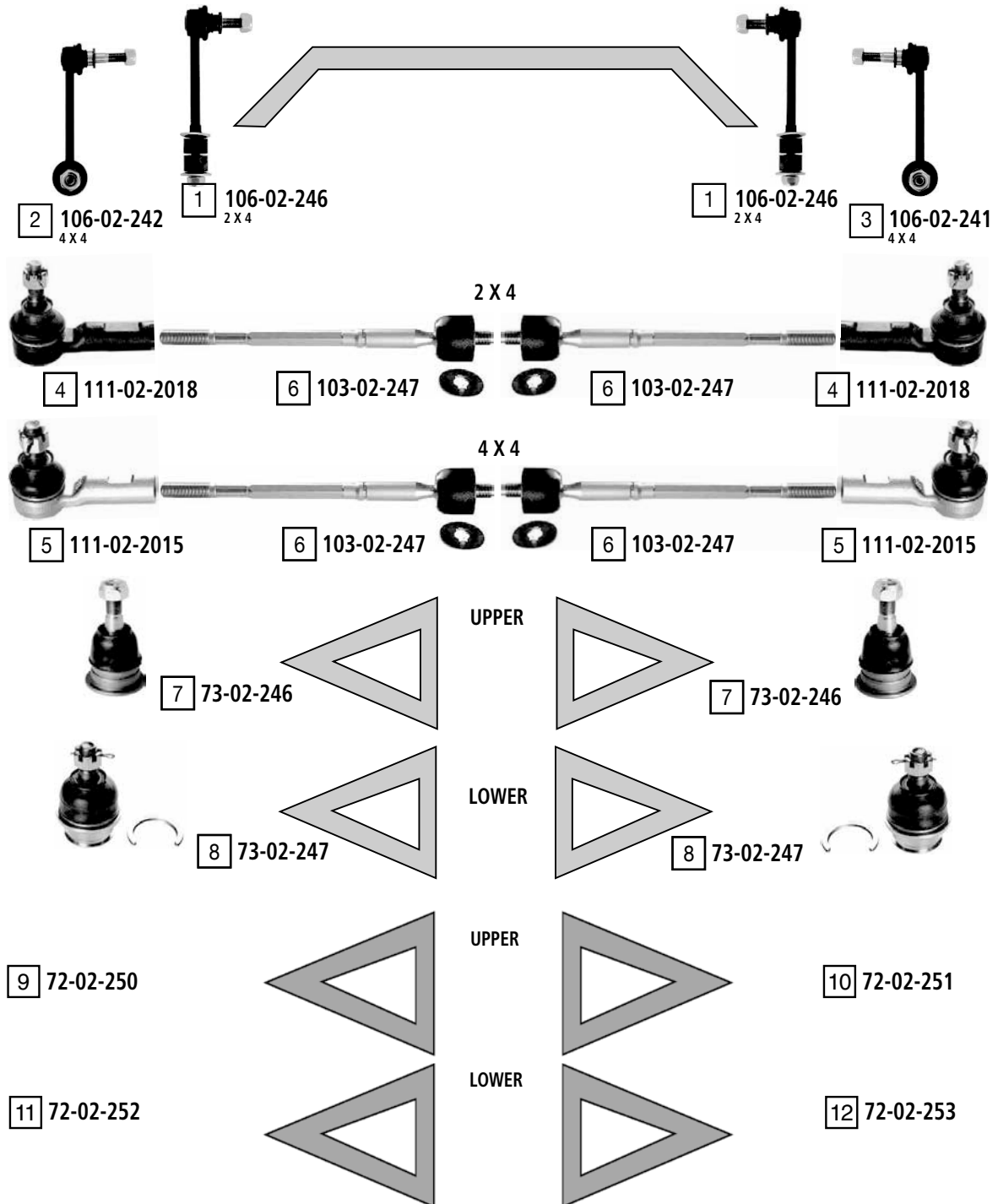

| Ref | ASHIKA CODE | Description           | OEM         | Measures            | Ref | ASHIKA CODE | Description | OEM         | Measures       |
|-----|-------------|-----------------------|-------------|---------------------|-----|-------------|-------------|-------------|----------------|
| 1   | 106-02-246  | stabiliser link       | 48820 0K010 |                     | 7   | 73-02-246   | ball joint  | 43310 09015 | c:15 do:43.85  |
| 2   | 106-02-242  | stabiliser link left  | 48810 0K010 | L:140               | 8   | 73-02-247   | ball joint  | 43330 09510 | c:16.5 do:47.3 |
| 3   | 106-02-241  | stabiliser link right | 48820 0K030 | L:140               | 9   | 72-02-250   | TCA Left    | 48630-0K040 |                |
| 4   | 111-02-2018 | tie rod end           | 45046 09261 | c:13.6 th:FM15x1.5R | 10  | 72-02-251   | TCA Right   | 48610-0K040 |                |
| 5   | 111-02-2015 | tie rod end           | 45046 09281 | c:15.2 th:FM15x1.5R | 11  | 72-02-252   | TCA Left    | 48069-0K040 |                |
| 6   | 103-02-247  | axial joint           | 45503 09331 | th:MM14x1.5R L:294  | 12  | 72-02-253   | TCA Right   | 48068-0K040 |                |

IQ (AJ1)

01/2009 ->

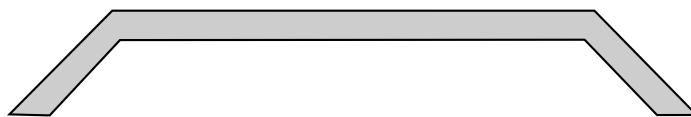

1 106-02-262

1 106-02-262



2 111-02-2029



3 103-02-255



3 103-02-255



2 111-02-2029



4 72-02-264

8 GOM-2031

5 72-02-265

7 GOM-2032



6 73-02-206



6 73-02-206

| Ref | ASHIKA CODE | Description     | OEM         | Measures            | Ref | ASHIKA CODE | Description         | OEM         | Measures        |
|-----|-------------|-----------------|-------------|---------------------|-----|-------------|---------------------|-------------|-----------------|
| 1   | 106-02-262  | stabiliser link | 48820 74010 | L:285               | 5   | 72-02-265   | TCA right wbj       | 48068 79015 | c:13.5          |
| 2   | 111-02-2029 | tie rod end     | 45046 79025 | c:13.9 th:MM14x1.5R | 6   | 73-02-206   | ball joint lower    | Part of     | c:13.5 do:36.7  |
| 3   | 103-02-255  | axial joint     | 45503 74010 | th:MM16x1.5R L:117  | 7   | GOM-2032    | silentblock for TCA | Part of     | di:14.2 do:34   |
| 4   | 72-02-264   | TCA left wbj    | 48069 79015 | c:13.5              | 8   | GOM-2031    | silentblock for TCA | Part of     | di:19.3 do:60.1 |

LANDCRUISER (FJ4\_, HJ45 , BJ4\_)

03/1969 - 04/1986



1 111-02-217L



2 111-02-217R



3 111-02-209



4 111-02-221R

5 111-02-221L

6 111-02-217L

| Ref | ASHIKA CODE | Description | OEM         | Measures            | Ref | ASHIKA CODE | Description | OEM         | Measures            |
|-----|-------------|-------------|-------------|---------------------|-----|-------------|-------------|-------------|---------------------|
| 1   | 111-02-217L | Tie Rod End | 45046 60033 | c:12.9 th:MM17X1.5R | 4   | 111-02-221R | Tie Rod End | 45046 69055 | c:12.7 th.MM21X1.5L |
| 2   | 111-02-217R | Tie Rod End | 45045 60013 | c:12.9 th:MM17X1.5L | 5   | 111-02-221L | Tie Rod End | 45046-69045 |                     |
| 3   | 111-02-209  | Tie Rod End | 45046 69035 | c:12.9 th.MM21X1.5R | 6   | 111-02-217L | Tie Rod End | 45045-69015 |                     |

LANDCRUISER (BJ60, HJ6\_, HJ45, FJ62)

08/1980 - 01/1990

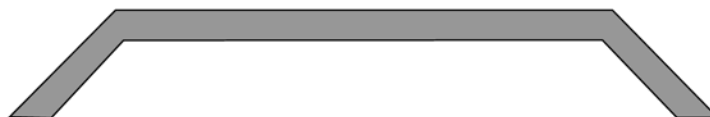

**1** 111-02-285  
05/1989-01/1990



**3** 111-02-248  
-> 05/1989



**4** 111-02-247



**2** 111-02-245



**5** 111-02-249

**6** 111-02-250

PER VEICOLI CON GUIDA A DX

| Ref | ASHIKA CODE | Description | OEM         | Measures            | Ref | ASHIKA CODE | Description | OEM         | Measures            |
|-----|-------------|-------------|-------------|---------------------|-----|-------------|-------------|-------------|---------------------|
| 1   | 111-02-285  | Tie Rod End | 45047 69066 | c:14.5 th:MM23X1.5R | 4   | 111-02-247  | Tie Rod End | 45046 69115 | c:14.8 th:MM23X1.5L |
| 2   | 111-02-245  | Tie Rod End | 45044 60H00 | c.16.8 th:MM21X1.5L | 5   | 111-02-249  | Tie Rod End | 45044-69065 |                     |
| 3   | 111-02-248  | Tie Rod End | 45047 69065 | c.14.6 th:MM23X1.5R | 6   | 111-02-250  | Tie Rod End | 45046-69105 |                     |

LANDCRUISER (RJ7\_, LJ7\_, BJ7\_)

11/1984 - 01/1990



1 111-02-254  
BJ7\_



5 111-02-279  
RJ7\_/LJ7\_

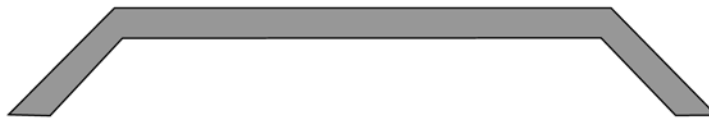

4 111-02-251  
RJ7\_/LJ7\_



6 111-02-248  
BJ7\_ -> 05/1989



2 111-02-285  
BJ7\_ 05/1989 ->



3 111-02-256  
RJ7\_/LJ7\_



7 111-02-247  
BJ7\_ 05/1989 ->



6 111-02-248  
RJ7\_/LJ7\_ -> 05/1989



2 111-02-285  
RJ7\_/LJ7\_ 05/1989 ->



8 GOM-209



9 GOM-243



| Ref | ASHIKA CODE | Description       | OEM         | Measures            | Ref | ASHIKA CODE | Description              | OEM         | Measures            |
|-----|-------------|-------------------|-------------|---------------------|-----|-------------|--------------------------|-------------|---------------------|
| 1   | 111-02-254  | Tie Rod End Left  | 45044 60H03 | c:16.65 th:MM21X1.5 | 6   | 111-02-248  | Tie Rod End              | 45047 69065 | c:14.6 th:MM23X1.5R |
| 2   | 111-02-285  | Tie Rod End       | 45047 69066 | c:14.5 th:MM23X1.5R | 7   | 111-02-247  | Tie Rod End              | 45046 69115 | c:14.8 th:MM23X1.5L |
| 3   | 111-02-256  | Tie Rod End Right | 45046 69135 | c:14.5 th:MM23X1.5L | 8   | GOM-209     | Silentblock For Susp.Arm | 48702 60020 | d:65.4              |
| 4   | 111-02-251  | Tie Rod End Left  | 45045 69065 | c:14.8 th:MM21X1.5R | 9   | GOM-243     | Silentblock For Susp.Arm | 48702-60010 | d:65.6              |
| 5   | 111-02-279  | Tie Rod End Right | 45044 69106 | c:14.7 th:MM21X1.5L |     |             |                          |             |                     |

LANDCRUISER (KZJ7\_,LJ7\_, RJ7\_)

01/1990 - 04/1996



5 106-02-224



6 106-02-223

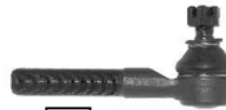

2 111-02-251



1 111-02-285



3 GOM-209



4 GOM-243



| Ref | ASHIKA CODE | Description              | OEM         | Measures            | Ref | ASHIKA CODE | Description              | OEM         | Measures |
|-----|-------------|--------------------------|-------------|---------------------|-----|-------------|--------------------------|-------------|----------|
| 1   | 111-02-285  | Tie Rod End              | 45047 69066 | c.14.5 th:MM23X1.5R | 4   | GOM-243     | Silentblock For Susp.Arm | 48702-60010 | d:65.6   |
| 2   | 111-02-251  | Tie Rod End Left         | 45045 69065 | c.14.8 th:MM21X1.5R | 5   | 106-02-224  | Stabiliser Link Left     | 48810 60010 |          |
| 3   | GOM-209     | Silentblock For Susp.Arm | 48702 60020 | d:65.4              | 6   | 106-02-223  | Stabiliser Link Right    | 48820 60010 |          |

LANDCRUISER 80 (FJ80, FZJ80, HDJ80, HZJ80)

01/1990 - 01/1998

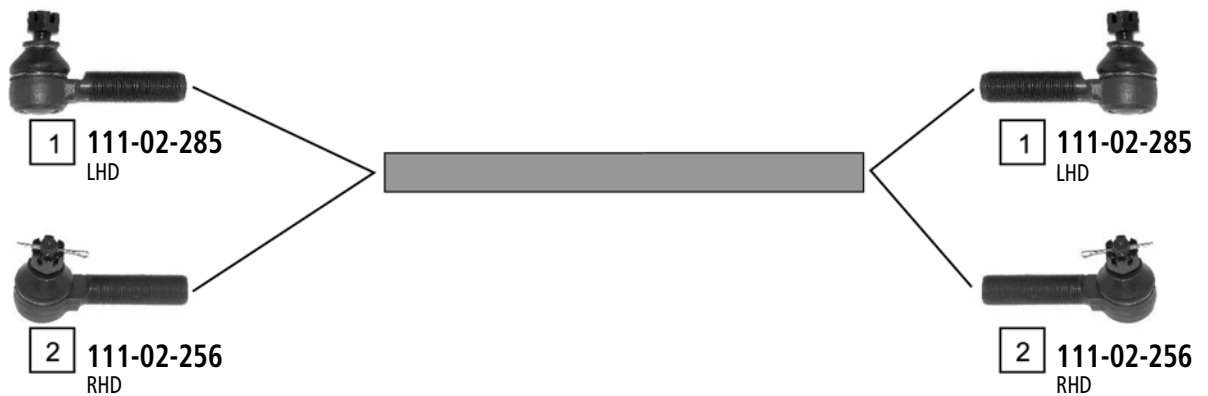

| Ref | ASHIKA CODE | Description       | OEM         | Measures            | Ref | ASHIKA CODE | Description       | OEM         | Measures            |
|-----|-------------|-------------------|-------------|---------------------|-----|-------------|-------------------|-------------|---------------------|
| 1   | 111-02-285  | Tie Rod End       | 45047 69066 | c.14.5 th:MM23X1.5R | 4   | 111-02-279  | Tie Rod End Right | 45044 69106 | c.14.7 th:MM21X1.5L |
| 2   | 111-02-256  | Tie Rod End Right | 45046 69135 | c.14.5 th:MM23X1.5L | 5   | 111-02-278  | Tie Rod End Right | 45044 69115 | c.14.6 th:MM21X1.5L |
| 3   | 111-02-251  | Tie Rod End Left  | 45045 69065 | c.14.8 th:MM21X1.5R |     |             |                   |             |                     |



# TOYOTA LANDCRUISER



LANDCRUISER 90 (KDJ9\_,KZJ9\_,VZJ9\_)

04/1996 - 09/2002

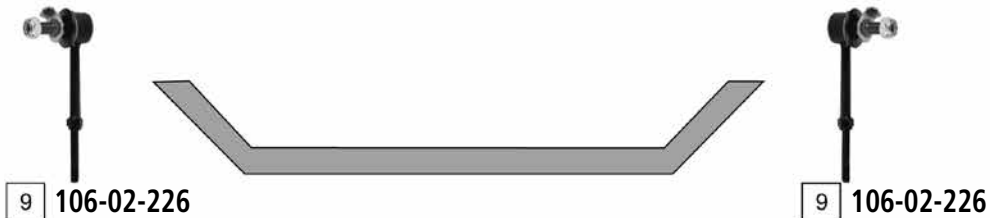
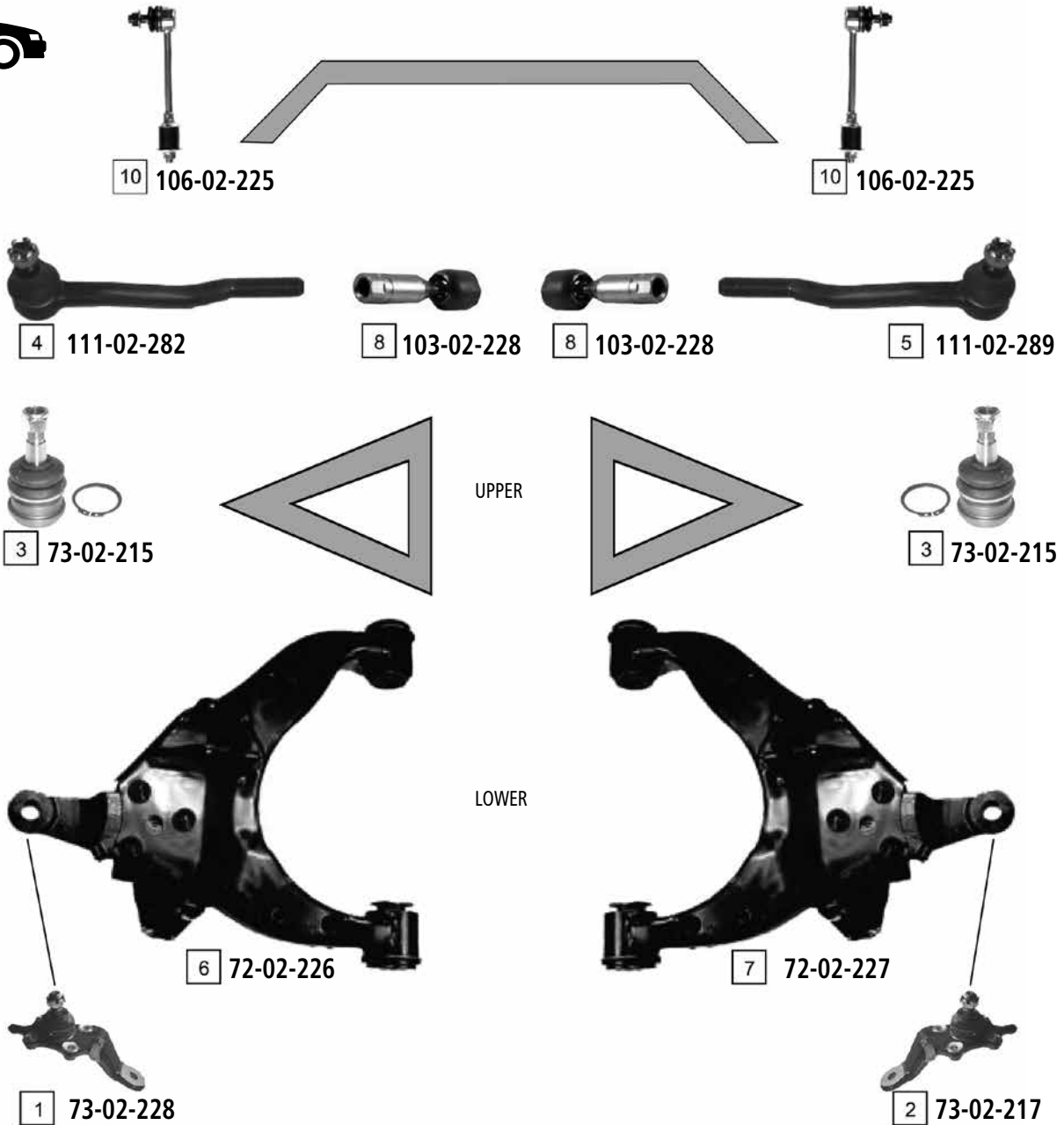

| Ref | ASHIKA CODE | Description       | OEM         | Measures            | Ref | ASHIKA CODE | Description     | OEM         | Measures           |
|-----|-------------|-------------------|-------------|---------------------|-----|-------------|-----------------|-------------|--------------------|
| 1   | 73-02-228   | Ball Joint Left   | 43340 39325 | c:17.6              | 6   | 72-02-226   | Tca Wobj        | 48069 35080 |                    |
| 2   | 73-02-217   | Ball Joint Right  | 43330 39415 | c:17.6              | 7   | 72-02-227   | Tca Wobj        | 48068 35080 |                    |
| 3   | 73-02-215   | Ball Joint        | 43310 39016 | c:15.75             | 8   | 103-02-228  | Axial Joint     | 45503 39075 | th:MM18X1.5R L.133 |
| 4   | 111-02-282  | Tie Rod End Left  | 45047 39215 | c:14.8 th:MM20X1.5R | 9   | 106-02-226  | Stabiliser Link | 48830 35020 |                    |
| 5   | 111-02-289  | Tie Rod End Right | 45046 39335 | c:14.8 th:MM20X1.5R | 10  | 106-02-225  | Stabiliser Link | 48820 35030 |                    |

LANDCRUISER 100 (HDJ100 , UZJ100)

01/1998 ->

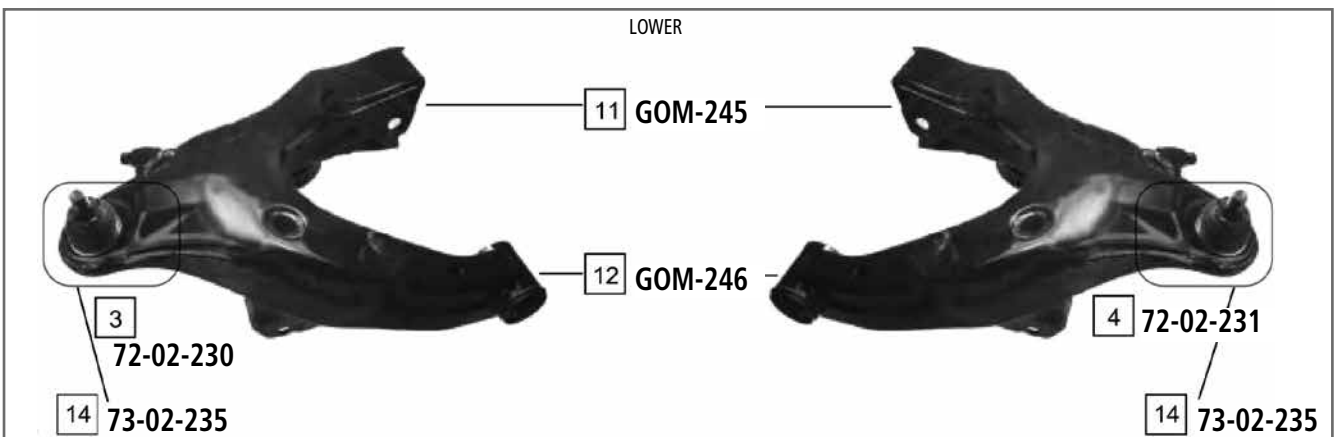
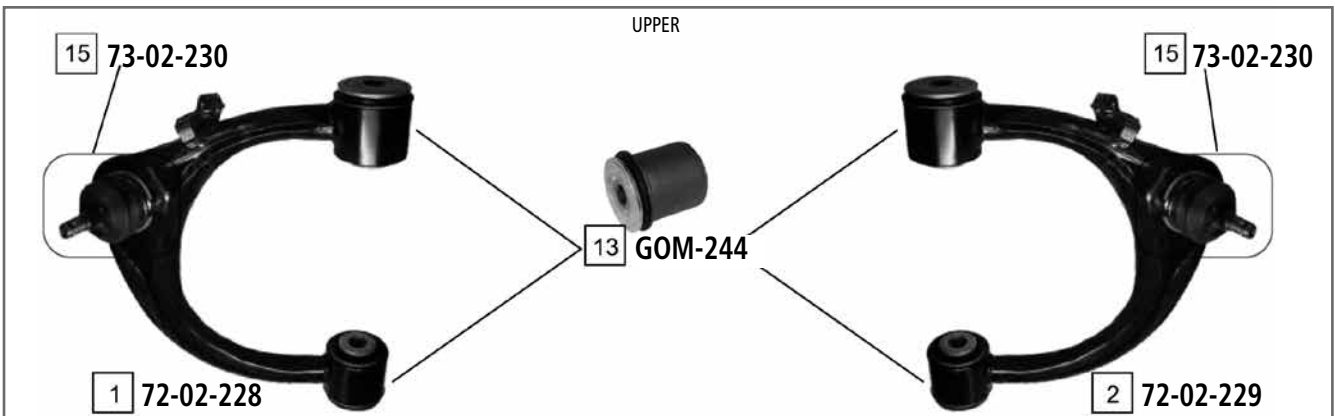
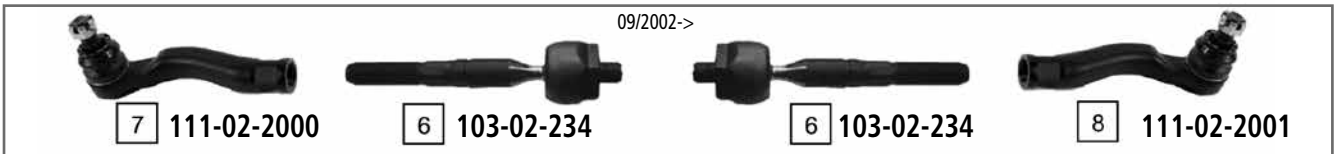
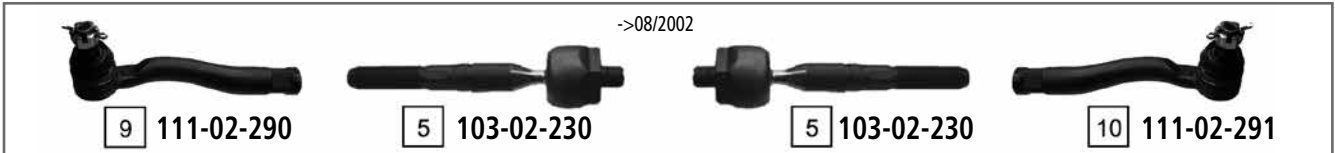

| Ref | ASHIKA CODE | Description       | OEM         | Measures           | Ref | ASHIKA CODE | Description              | OEM                         | Measures            |
|-----|-------------|-------------------|-------------|--------------------|-----|-------------|--------------------------|-----------------------------|---------------------|
| 1   | 72-02-228   | TCA               | 48630 60010 |                    | 9   | 111-02-290  | Tie Rod End              | 45047-69100                 | c:18.3 th:FM20X1.5R |
| 2   | 72-02-229   | TCA               | 48610 60030 |                    | 10  | 111-02-291  | Tie Rod End              | 45046-69195                 | c:18.3 th:FM20X1.5R |
| 3   | 72-02-230   | TCA               | 48640 60010 |                    | 11  | GOM-245     | Silentblock For Susp.Arm | 48655 60010                 |                     |
| 4   | 72-02-231   | TCA               | 48620 60010 |                    | 12  | GOM-246     | Silentblock For Susp.Arm | 48654 60010                 | d:48                |
| 5   | 103-02-230  | Axial Joint       | 45503-69015 | th:MM18X1.5R L:198 | 13  | GOM-244     | Silentblock For Susp.Arm | 48632 60010                 | d.52.1              |
| 6   | 103-02-234  | Axial Joint       | 45503 69025 |                    | 14  | 73-02-235   | Ball Joint               | Part of 72-02-230/72-02-231 |                     |
| 7   | 111-02-2000 | Tie Rod End Left  | 45047 69115 |                    | 15  | 73-02-230   | Ball Joint               | Part of 72-02-228/72-02-229 |                     |
| 8   | 111-02-2001 | Tie Rod End Right | 45046 69205 |                    |     |             |                          |                             |                     |

# TOYOTA LANDCRUISER



LANDCRUISER 120 (GRJ\_, KDJ\_)

09/2002 ->

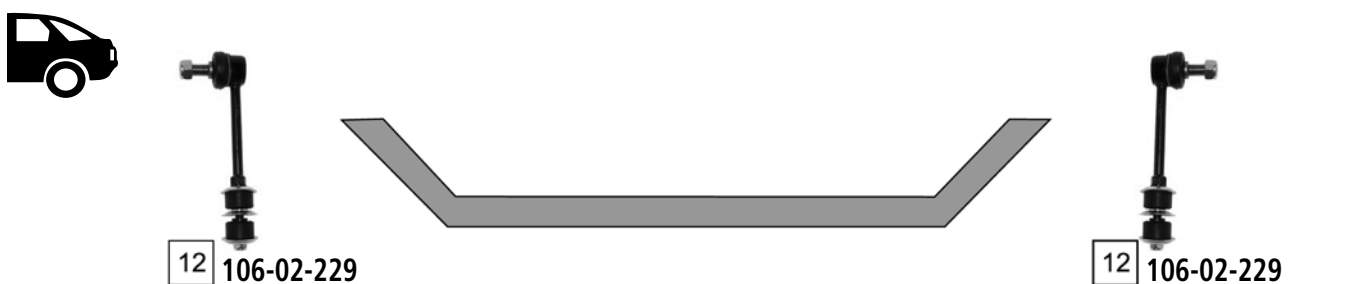
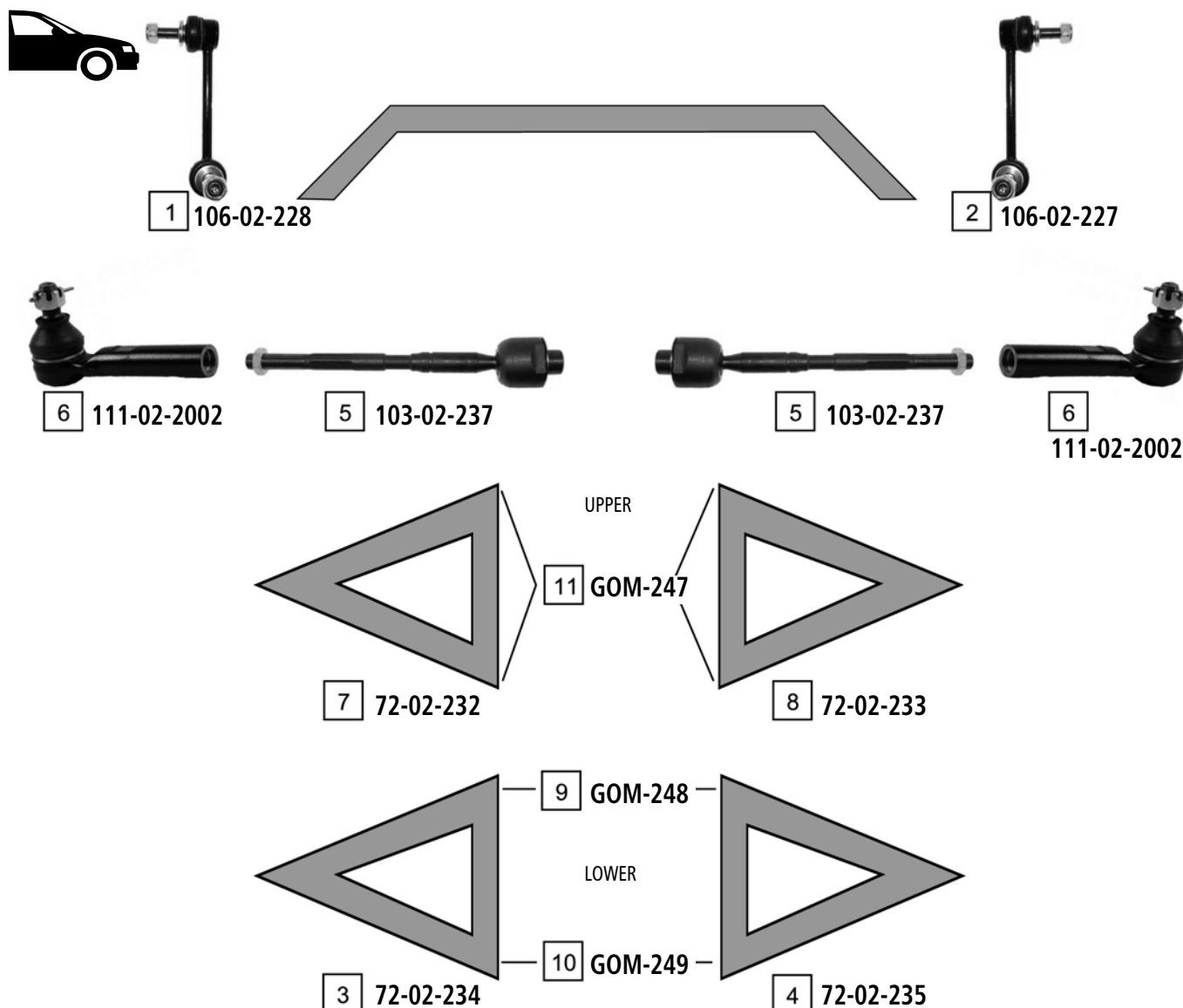

| Ref | ASHIKA CODE | Description           | OEM         | Measures           | Ref | ASHIKA CODE | Description              | OEM         | Measures |
|-----|-------------|-----------------------|-------------|--------------------|-----|-------------|--------------------------|-------------|----------|
| 1   | 106-02-228  | Stabiliser Link Left  | 48810 60040 | L:140              | 7   | 72-02-232   | TCA                      | 48630 60020 |          |
| 2   | 106-02-227  | Stabiliser Link Right | 48820 60050 | L:140              | 8   | 72-02-233   | TCA                      | 48610 60050 |          |
| 3   | 72-02-234   | TCA                   | 48069 60010 |                    | 9   | GOM-248     | Silentblock For Susp.Arm | 48654 60030 |          |
| 4   | 72-02-235   | TCA                   | 48068 60010 |                    | 10  | GOM-249     | Silentblock For Susp.Arm | 48655 60030 |          |
| 5   | 103-02-237  | Axial Joint           | 45503 39235 | th.MM22X1.5R L:260 | 11  | GOM-247     | Silentblock For Susp.Arm | 48632 60020 |          |
| 6   | 111-02-2002 | Tie Rod End           | 45046 39505 |                    | 12  | 106-02-229  | Stabiliser Link          | 48830 60030 |          |

LITEACE (\_M2\_)

10/1979 - 09/1986



**1** 111-02-205  
10/1982 ->



**1** 111-02-205  
10/1982 ->



**2** 73-02-229

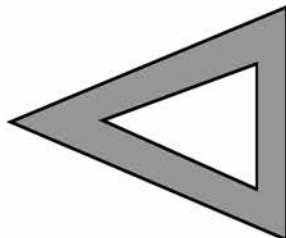

UPPER

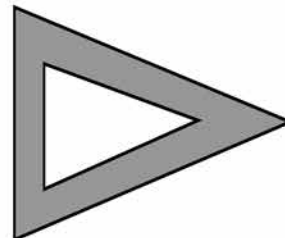

**2** 73-02-229



**4** 53-02-235

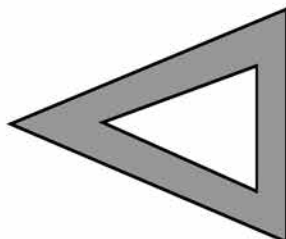

-> 09/1982

LOWER

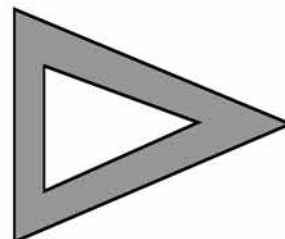

**4** 53-02-235



**3** 73-06-625

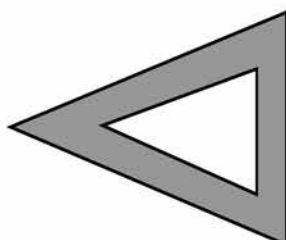

10/1982 ->

LOWER

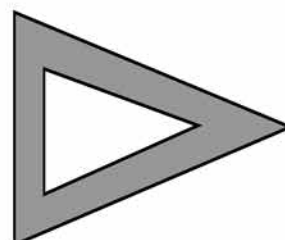

**3** 73-06-625

| Ref | ASHIKA CODE | Description | OEM         | Measures            | Ref | ASHIKA CODE | Description | OEM         | Measures |
|-----|-------------|-------------|-------------|---------------------|-----|-------------|-------------|-------------|----------|
| 1   | 111-02-205  | Tie Rod End | 45046 19065 | c:12.9 th:MM14X1.5L | 3   | 73-06-625   | Ball Joint  | 43340-29095 | c:16.8   |
| 2   | 73-02-229   | Ball Joint  | 43350 29076 | c:15.2              | 4   | 53-02-235   | Ball Joint  | 43330-39295 | c:18.2   |

LITEACE (\_M3\_)

09/1985 - 01/1992

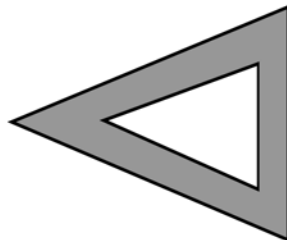
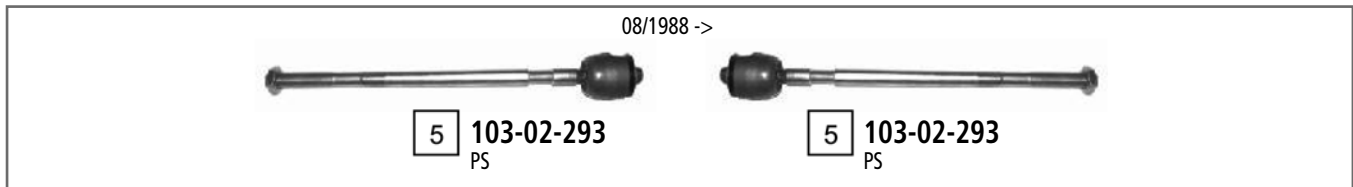
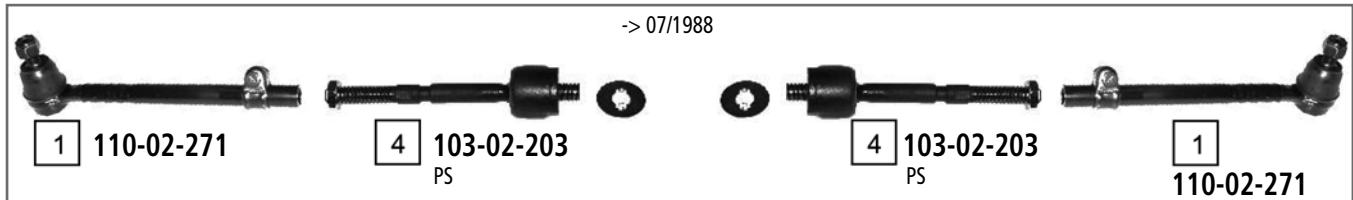

UPPER

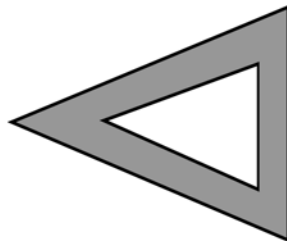
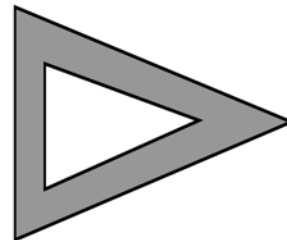

LOWER

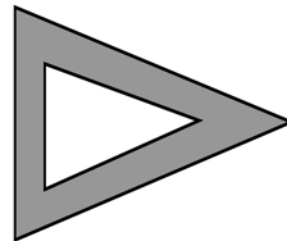

| Ref | ASHIKA CODE | Description | OEM         | Measures            | Ref | ASHIKA CODE | Description | OEM         | Measures           |
|-----|-------------|-------------|-------------|---------------------|-----|-------------|-------------|-------------|--------------------|
| 1   | 110-02-271  | Tie Rod End | 45460-29315 | c:12.9 th:FM14X1.5R | 4   | 103-02-203  | Axial Joint | 45503-29015 | th:MM14X1.5R L:175 |
| 2   | 73-02-229   | Ball Joint  | 43350 29076 | c:15.2              | 5   | 103-02-293  | Axial Joint | 45503-29215 | th:MM14X1.5R L:307 |
| 3   | 73-06-625   | Ball Joint  | 43340-29095 | c:16.8              |     |             |             |             |                    |

MR 2 (\_W1\_, \_W2\_)

06/1984 - 05/2000



**1** 73-02-291

**3** 103-02-238  
12/1989 ->

**3** 103-02-238  
12/1989 ->

**1**  
73-02-291



**2** 73-02-224

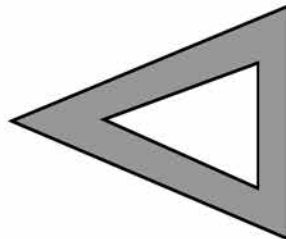

LOWER

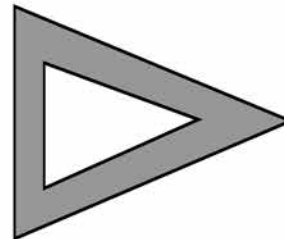

**2**  
73-02-224

| Ref | ASHIKA CODE | Description      | OEM         | Measures            | Ref | ASHIKA CODE | Description | OEM         | Measures            |
|-----|-------------|------------------|-------------|---------------------|-----|-------------|-------------|-------------|---------------------|
| 1   | 73-02-291   | Tie Rod End      | 45046-29135 | c:12.6 th:FM12X1.25 | 3   | 103-02-238  | Axial Joint | 45503 19145 | th.MM12X1.25R L:288 |
| 2   | 73-02-224   | Ball Joint Lower | 43330-19025 | c:14.3              |     |             |             |             |                     |

PASEO (EL54)

08/1995 - 07/1999



2 111-02-298



1 103-02-298



1 103-02-298



2 111-02-298



4 73-02-238L

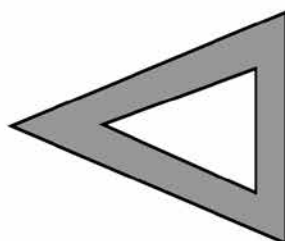

LOWER

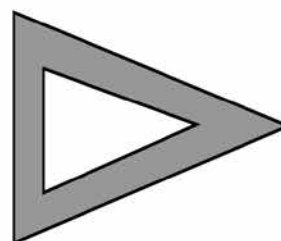

3 73-02-238R

| Ref | ASHIKA CODE | Description | OEM         | Measures            | Ref | ASHIKA CODE | Description | OEM         | Measures |
|-----|-------------|-------------|-------------|---------------------|-----|-------------|-------------|-------------|----------|
| 1   | 103-02-298  | Axial Joint | 45503 19155 | th:MM12X1.25R L:289 | 3   | 73-02-238R  | Ball Joint  | 43330 19085 | c:13.5   |
| 2   | 111-02-298  | Tie Rod End | 45046-19205 | c:12.7 th:FM12X1.25 | 4   | 73-02-238L  | Ball Joint  | 43340-19025 |          |

PICNIC (\_XM10)

05/1996 - 04/2001

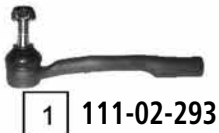

LOWER



| Ref | ASHIKA CODE | Description       | OEM         | Measures            | Ref | ASHIKA CODE | Description      | OEM         | Measures           |
|-----|-------------|-------------------|-------------|---------------------|-----|-------------|------------------|-------------|--------------------|
| 1   | 111-02-293  | Tie Rod End Left  | 45047-29075 | c:12.6 th:FM15X1.5R | 4   | 72-02-237   | TCA              | 48068-44010 |                    |
| 2   | 111-02-297  | Tie Rod End Right | 45046-29275 | c:12.6 th:FM15X1.5R | 5   | 53-02-297   | Ball Joint Lower | 43330 09030 | c:15               |
| 3   | 72-02-236   | TCA               | 48069-44010 |                     | 6   | 76-02-298   | Axial Joint      | 45503 29435 | th.MM14X1.5R L:240 |



PREVIA (TCR1\_ 2\_)

05/1990 - 08/2000

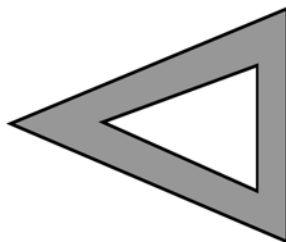
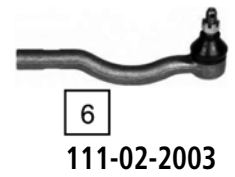
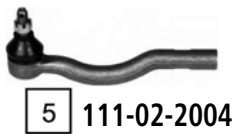
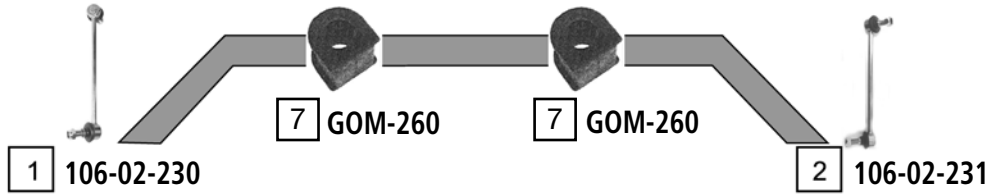

LOWER

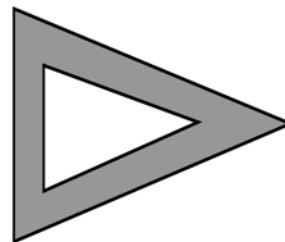

| Ref | ASHIKA CODE | Description           | OEM         | Measures           | Ref | ASHIKA CODE | Description         | OEM         | Measures            |
|-----|-------------|-----------------------|-------------|--------------------|-----|-------------|---------------------|-------------|---------------------|
| 1   | 106-02-230  | Stabiliser Link Left  | 48810 28020 | L:255              | 5   | 111-02-2004 | Tie Rod End         | 45047 29065 | c:12.4 th:FM14X1.5R |
| 2   | 106-02-231  | Stabiliser Link Right | 48820 28010 | L:255              | 6   | 111-02-2003 | Tie Rod End         | 45046 29235 | c:12.4 th:FM14X1.5R |
| 3   | 73-02-236   | Ball Joint            | 43330-29235 | c:17               | 7   | GOM-260     | Stabiliser Mounting | 48815 28061 | -                   |
| 4   | 103-02-239  | Axial Joint           | 45503-29295 | th:MM14X1.5R L.215 |     |             |                     |             |                     |

PREVIA ESTIMA (ACR3\_)

08/2000 - 04/2006



6 111-02-2006



8 103-02-240



8 103-02-240



7  
111-02-2005



4 72-02-238

LOWER



5 72-02-239



2 73-02-208



3 73-02-209

| Ref | ASHIKA CODE | Description             | OEM         | Measures | Ref | ASHIKA CODE | Description             | OEM         | Measures           |
|-----|-------------|-------------------------|-------------|----------|-----|-------------|-------------------------|-------------|--------------------|
| 1   | 106-02-218  | Stabiliser Link         | 48820 28050 | L:260    | 5   | 72-02-239   | Susp.Arm W/O Ball Joint | 48068-28120 |                    |
| 2   | 73-02-208   | Ball Joint Left         | 43340-29175 | c:17.6   | 6   | 111-02-2006 | Tie Rod End             | 45470-29185 |                    |
| 3   | 73-02-209   | Ball Joint Right        | 43330-29405 | c:17.6   | 7   | 111-02-2005 | Tie Rod End             | 45460-29425 |                    |
| 4   | 72-02-238   | Susp.Arm W/O Ball Joint | 48069-28120 |          | 8   | 103-02-240  | Axial Joint             | 45504-28030 | th:MM14X1.5R L:235 |

PRIUS (NHW11)

05/2000 - 08/2003

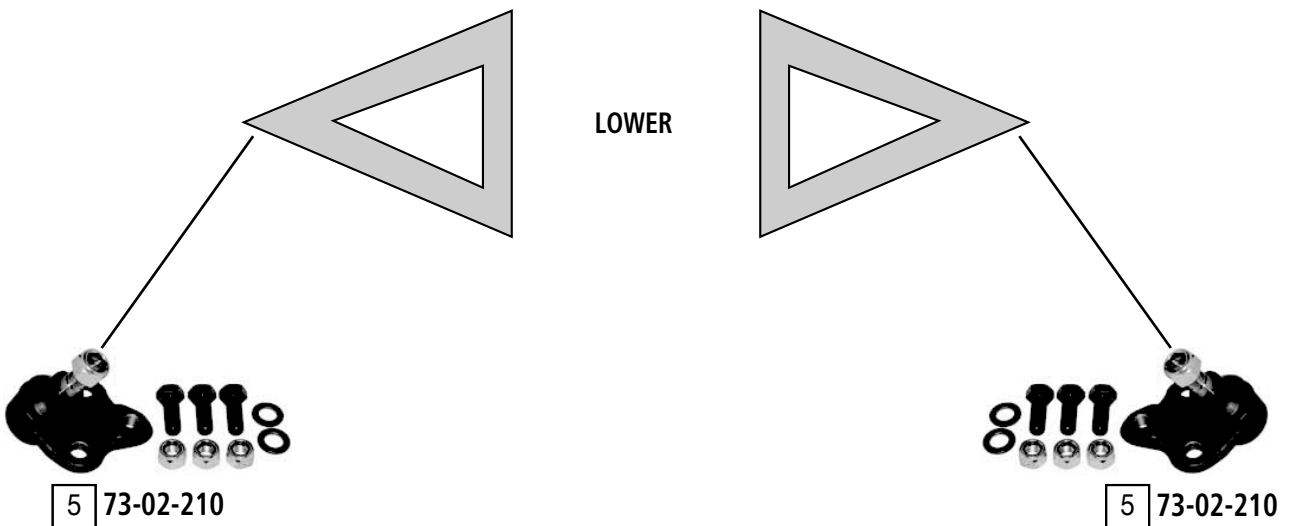
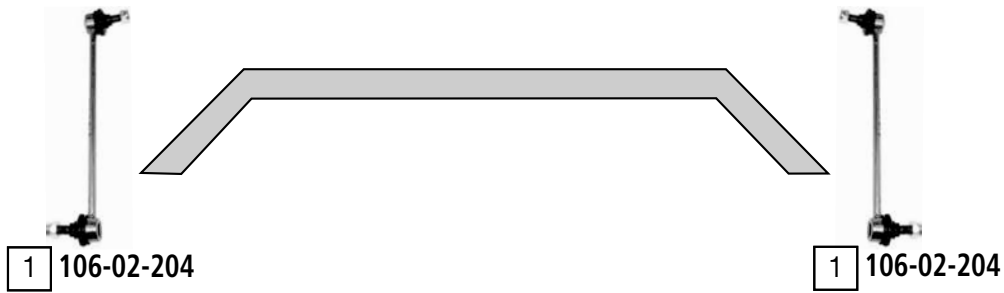

| Ref | ASHIKA CODE | Description       | OEM         | Measures            | Ref | ASHIKA CODE | Description | OEM         | Measures           |
|-----|-------------|-------------------|-------------|---------------------|-----|-------------|-------------|-------------|--------------------|
| 1   | 106-02-204  | stabiliser link   | 48820 47010 | L:285               | 4   | 103-02-249  | axial joint | 45503 49075 | th:MM18x1.5R L:265 |
| 2   | 111-02-264  | tie rod end left  | 45047 19115 | c:12.6 th:FM14x1.5R | 5   | 73-02-210   | ball joint  | 43330 19115 | c:15.3             |
| 3   | 111-02-271  | tie rod end right | 45046 19265 | c:12.6 th:FM14x1.5R |     |             |             |             |                    |

PRIUS (NHW20)

08/2003 - 12/2008

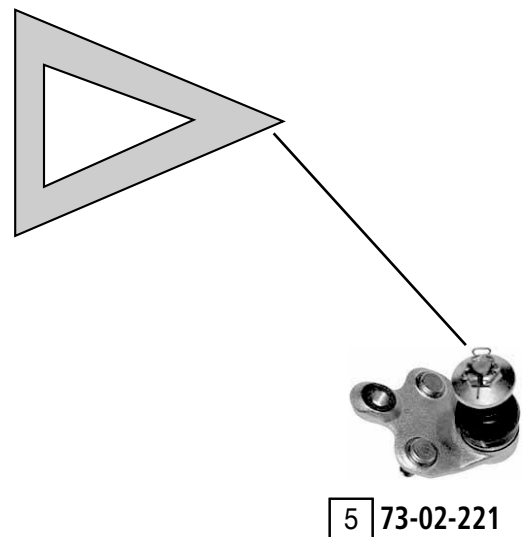
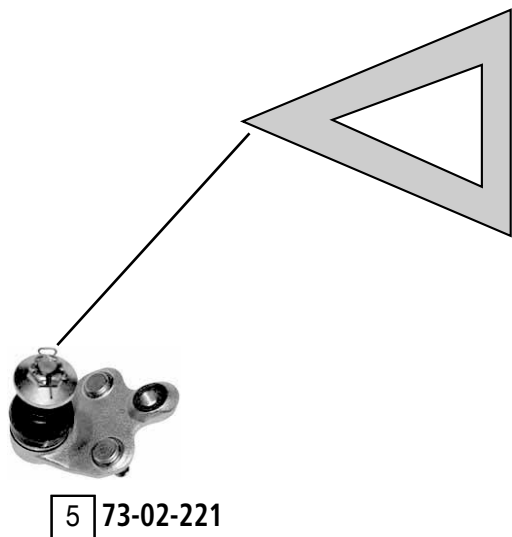
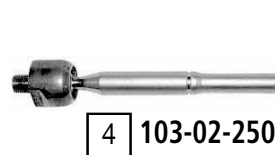
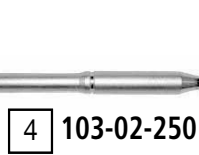
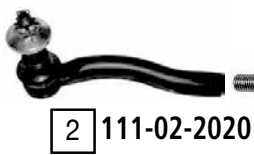
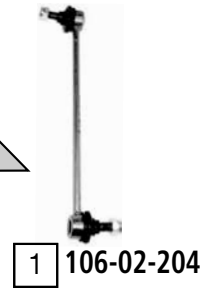
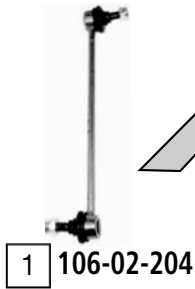

| Ref | ASHIKA CODE | Description       | OEM         | Measures          | Ref | ASHIKA CODE | Description | OEM         | Measures           |
|-----|-------------|-------------------|-------------|-------------------|-----|-------------|-------------|-------------|--------------------|
| 1   | 106-02-204  | stabiliser link   | 48820 47010 | L:285             | 4   | 103-02-250  | axial joint | 45503 47030 | th:MM14x1.5R L:280 |
| 2   | 111-02-2020 | tie rod end left  | 45047 49075 | c:12 th:FM14x1.5R | 5   | 73-02-221   | ball joint  | 43330 49055 | c:15               |
| 3   | 111-02-2021 | tie rod end right | 45046 49145 | c:12 th:FM14X1.5R |     |             |             |             |                    |

PRIUS (ZVW30)

01/2009 ->

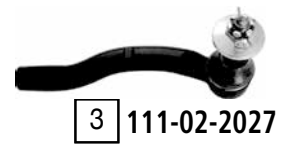

| Ref | ASHIKA CODE | Description       | OEM         | Measures            | Ref | ASHIKA CODE | Description         | OEM         | Measures      |
|-----|-------------|-------------------|-------------|---------------------|-----|-------------|---------------------|-------------|---------------|
| 1   | 106-02-235  | stabiliser link   | 48820 02070 | L:360               | 5   | 72-02-267   | TCA right wbj       | 48068 47050 | c:15          |
| 2   | 111-02-2028 | tie rod end left  | 45047 49165 | c:12.1 th:FM14X1.5R | 6   | 73-02-249   | ball joint          | 43330 49185 | c:15          |
| 3   | 111-02-2027 | tie rod end right | 45046 49225 | c:12.1 th:FM14X1.5R | 7   | GOM-252     | silentblock for TCA | Part of     | di:16.2 do:41 |
| 4   | 72-02-266   | TCA left wbj      | 48069 47050 | c:15                | 8   | GOM-2025    | silentblock for TCA | Part of     | di:16.2 do:68 |

RAV 4 I (SXA1\_)

04/1994 - 06/2000



8 GOM-220

8 GOM-220



LOWER



| Ref | ASHIKA CODE | Description     | OEM         | Measures | Ref | ASHIKA CODE | Description         | OEM         | Measures            |
|-----|-------------|-----------------|-------------|----------|-----|-------------|---------------------|-------------|---------------------|
| 1   | 106-02-298  | Stabiliser Link | 48820 33010 | L:60.5   | 5   | 72-02-241   | TCA Right           | 48068 42010 |                     |
| 2   | 106-02-232  | Stabiliser Link | 48820 42010 | L:63     | 6   | 103-02-290  | Axial Joint         | 45503-29365 | th:MM14X1.5R L:315  |
| 3   | 73-02-241   | Ball Joint      | 43330-49025 | c:17.5   | 7   | 111-02-259  | Tie Rod End         | 45046 19175 | c:12.7 th:FM14X1.5R |
| 4   | 72-02-240   | TCA Left        | 48069 42010 |          | 8   | GOM-220     | Stabiliser Mounting | 48815-10060 |                     |

RAV 4 II (XA2)

07/2000 - 03/2006

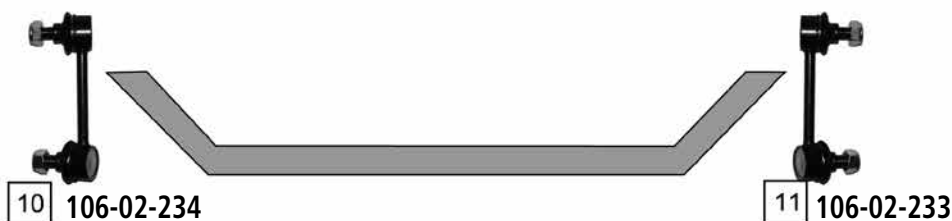
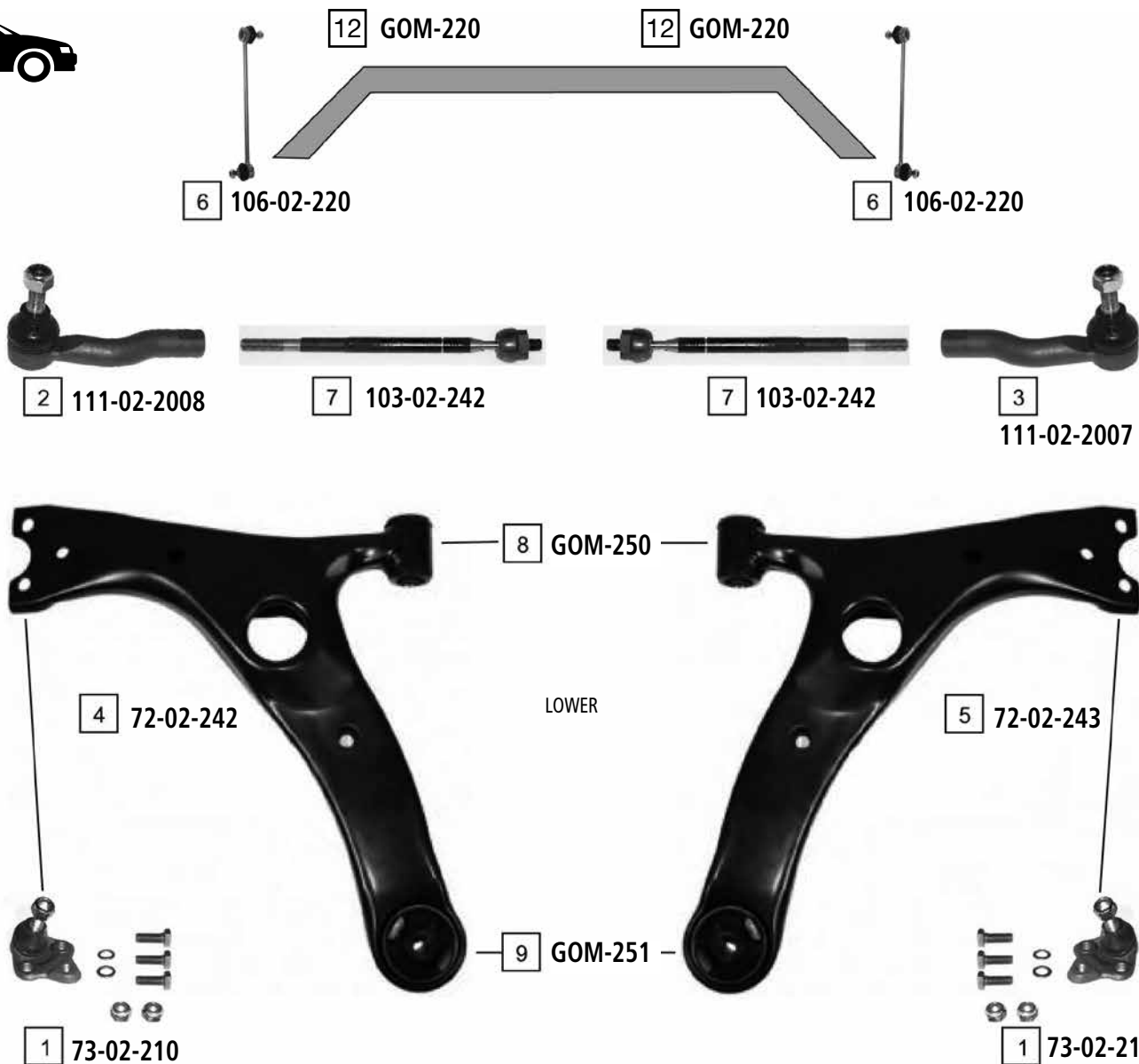

| Ref | ASHIKA CODE | Description       | OEM         | Measures            | Ref | ASHIKA CODE | Description              | OEM                         | Measures           |
|-----|-------------|-------------------|-------------|---------------------|-----|-------------|--------------------------|-----------------------------|--------------------|
| 1   | 73-02-210   | Ball Joint        | 43330 19115 | c:15.3              | 7   | 103-02-242  | Axial Joint              | 45503-49055                 | th:MM14X1.5R L:297 |
| 2   | 111-02-2008 | Tie Rod End Left  | 45047-49025 | c.12.7 th:FM15X1.25 | 8   | GOM-250     | Silentblock For Susp.Arm | Part of 72-02-242/72-02-243 |                    |
| 3   | 111-02-2007 | Tie Rod End Right | 45046-49095 | c.12.7 th:FM15X1.5R | 9   | GOM-251     | Silentblock For Susp.Arm | Part of 72-02-242/72-02-243 |                    |
| 4   | 72-02-242   | TCA Left Wbj      | 48069-42040 |                     | 10  | 106-02-234  | Stabiliser Link Left     | 48840 42010                 | L:100              |
| 5   | 72-02-243   | TCA Right Wbj     | 48068-42040 |                     | 11  | 106-02-233  | Stabiliser Link Right    | 48830 42010                 | L:100              |
| 6   | 106-02-220  | Stabiliser Link   | 48820 32010 | L:285               | 12  | GOM-220     | Stabiliser Mounting      | 48815-10060                 |                    |

RAV 4 III (ACA3\_,ALA30,GSA33)

03/2006 ->

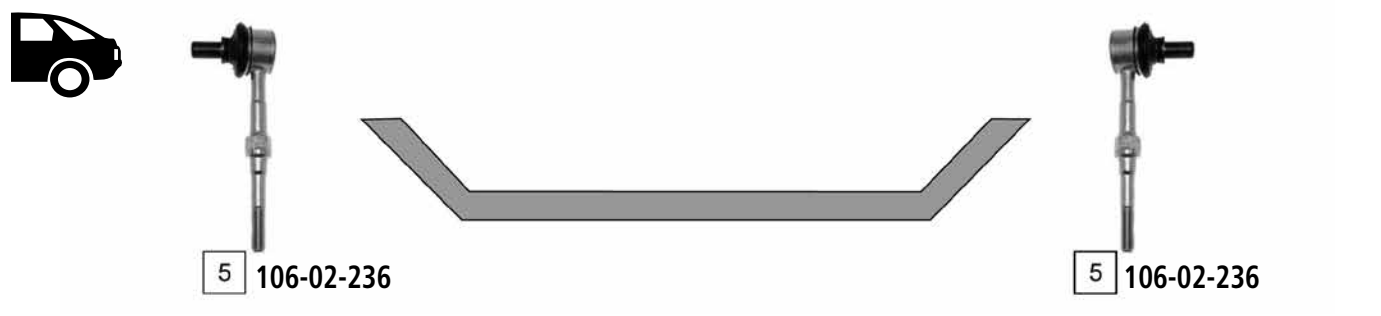
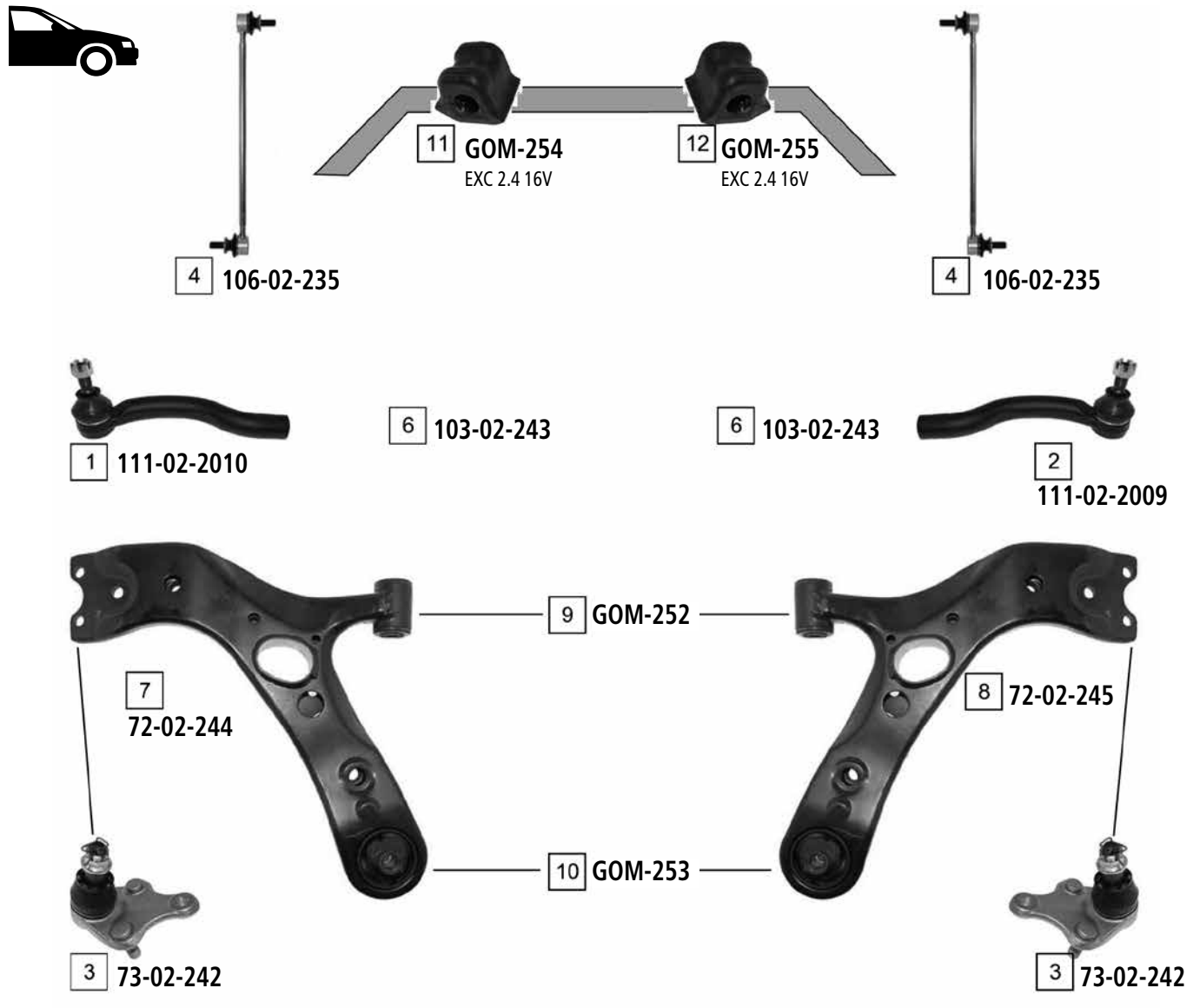

| Ref | ASHIKA CODE | Description       | OEM         | Measures            | Ref | ASHIKA CODE | Description              | OEM                         | Measures |
|-----|-------------|-------------------|-------------|---------------------|-----|-------------|--------------------------|-----------------------------|----------|
| 1   | 111-02-2010 | Tie Rod End Left  | 45047 49135 | c:16.3 th:FM16X1.5R | 7   | 72-02-244   | TCA Left Wbj             | 48069 42050                 |          |
| 2   | 111-02-2009 | Tie Rod End Right | 45046 49195 | c:16.3 th:FM16X1.5R | 8   | 72-02-245   | TCA Right Wbj            | 48068 42050                 |          |
| 3   | 73-02-242   | Ball Joint        | 43330 49095 | c:17.7              | 9   | GOM-252     | Silentblock For Susp.Arm | Part of 72-02-244/72-02-245 |          |
| 4   | 106-02-235  | Stabiliser Link   | 48820 42030 | L:360               | 10  | GOM-253     | Silentblock For Susp.Arm | Part of 72-02-244/72-02-245 |          |
| 5   | 106-02-236  | Stabiliser Link   | 48830 42020 |                     | 11  | GOM-254     | Stabiliser Mounting      | 48815 42090                 | d:23     |
| 6   | 103-02-243  | Axial Joint       | Part of     | th:MM16X1.5R        | 12  | GOM-255     | Stabiliser Mounting      | 48815 42100                 | d.23     |



STARLET (\_P7\_)

10/1984 - 12/1989



1 111-02-266



2 103-02-211



2 103-02-211



1 111-02-266



3 53-02-298

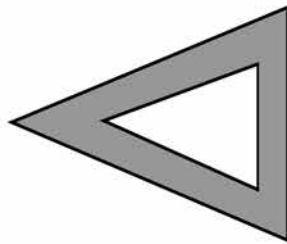

LOWER

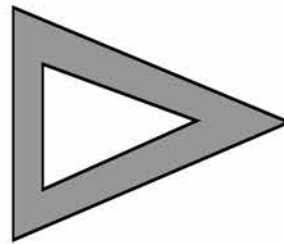

3 53-02-298

| Ref | ASHIKA CODE | Description | OEM         | Measures             | Ref | ASHIKA CODE | Description      | OEM         | Measures |
|-----|-------------|-------------|-------------|----------------------|-----|-------------|------------------|-------------|----------|
| 1   | 111-02-266  | Tie Rod End | 45504619165 | c:12.8 th:FM12X1.25  | 3   | 53-02-298   | Ball Joint Lower | 43330-19075 | c:14.1   |
| 2   | 103-02-211  | Axial Joint | 45503-19075 | th: MM12X1.25R L:271 |     |             |                  |             |          |

STARLET (\_P8\_)  
STARLET (EP91)

12/1989 - 03/1996  
04/1996 - 03/1999



2 111-02-298

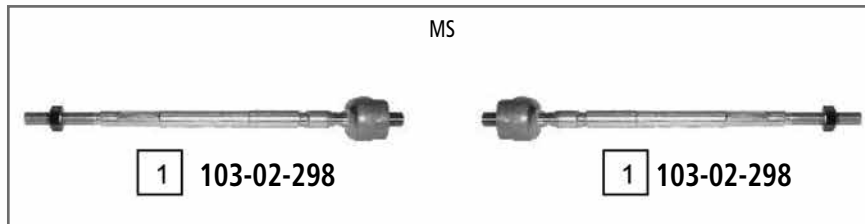

1 103-02-298

1 103-02-298



2 111-02-298



4 73-02-238L

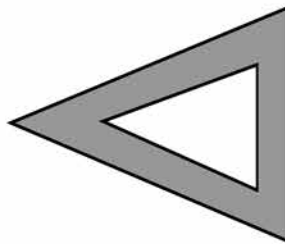

LOWER

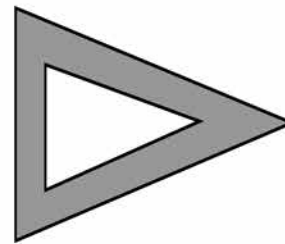

3 73-02-238R

| Ref | ASHIKA CODE | Description | OEM         | Measures            | Ref | ASHIKA CODE | Description | OEM         | Measures |
|-----|-------------|-------------|-------------|---------------------|-----|-------------|-------------|-------------|----------|
| 1   | 103-02-298  | Axial Joint | 45503 19155 | th.MM12X1.25R L.289 | 3   | 73-02-238R  | Ball Joint  | 43330 19085 | c.13.5   |
| 2   | 111-02-298  | Tie Rod End | 45046-19205 | c:12.7 th:FM12X1.25 | 4   | 73-02-238L  | Ball Joint  | 43340-19025 |          |

SUPRA (JZA80)

05/1993 - 08/1998



1 106-02-237



1 106-02-237



2 111-02-2012



3  
111-02-2011



4 106-02-238



4 106-02-238

| Ref | ASHIKA CODE | Description      | OEM         | Measures            | Ref | ASHIKA CODE | Description       | OEM         | Measures            |
|-----|-------------|------------------|-------------|---------------------|-----|-------------|-------------------|-------------|---------------------|
| 1   | 106-02-237  | Stabiliser Link  | 48810-28010 | L:111               | 3   | 111-02-2011 | Tie Rod End Right | 45460-19235 | c.12.9 th:MM17X1.5L |
| 2   | 111-02-2012 | Tie Rod End Left | 45470-19065 | c:12.9 th.MM17X1.5L | 4   | 106-02-238  | Stabiliser Link   | 48820-24010 | L:111               |

URBAN CRUISER (NCP11\_)

04/2009 ->



| Ref | ASHIKA CODE | Description     | OEM         | Measures            | Ref | ASHIKA CODE | Description         | OEM         | Measures |
|-----|-------------|-----------------|-------------|---------------------|-----|-------------|---------------------|-------------|----------|
| 1   | 106-02-240  | stabiliser link | 48820 0D010 | L:360               | 5   | 73-02-206   | ball joint lower    | Part of     |          |
| 2   | 111-02-201  | tie rod end     | 45046 09230 | c:12.6 th:FM15X1.5R | 6   | GOM-258     | silentblock for TCA | Part of     |          |
| 3   | 72-02-248   | TCA left wbj    | 48069 09040 | c:13.4              | 7   | GOM-259     | silentblock for TCA | Part of     |          |
| 4   | 72-02-249   | TCA right wbj   | 48068 09040 | c:13.4              | 8   | GOM-257     | stabiliser mounting | 48815 0D100 |          |

VERSO (AUR2\_ZGR2\_)

04/2009 ->



1 106-02-235

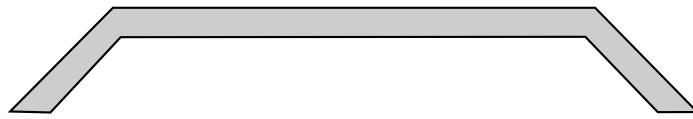

1 106-02-235



2 111-02-2024



3 111-02-2025



4 72-02-254



7 GOM-252



5 72-02-255



8 GOM-2025



6 73-02-242



6 73-02-242

| Ref | ASHIKA CODE | Description       | OEM         | Measures            | Ref | ASHIKA CODE | Description         | OEM         | Measures      |
|-----|-------------|-------------------|-------------|---------------------|-----|-------------|---------------------|-------------|---------------|
| 1   | 106-02-235  | stabiliser link   | 48820 02070 | L:360               | 5   | 72-02-255   | TCA right wbj       | 48068 12300 | c:17.5        |
| 2   | 111-02-2024 | tie rod end left  | 45047 09320 | c:13.5 th:FM16x1.5R | 6   | 73-02-242   | ball joint          | 43330 49095 | c:17.7        |
| 3   | 111-02-2025 | tie rod end right | 45046 09660 | c:13.5 th:FM16x1.5R | 7   | GOM-252     | silentblock for TCA | Part of     | di:16.2 do:41 |
| 4   | 72-02-254   | TCA left wbj      | 48069 12300 | c:17.5              | 8   | GOM-2025    | silentblock for TCA | Part of     | di:16.2 do:68 |

YARIS (\_CP10)  
YARIS VERSO (NC/LP2\_)

04/1999 - 12/2005  
11/1999 - 12/2005

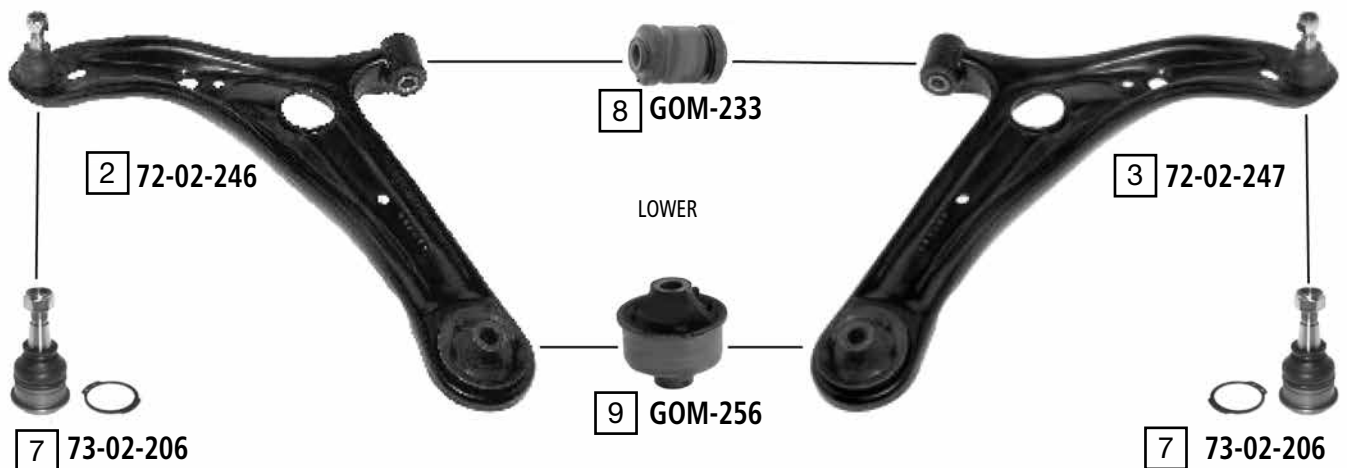
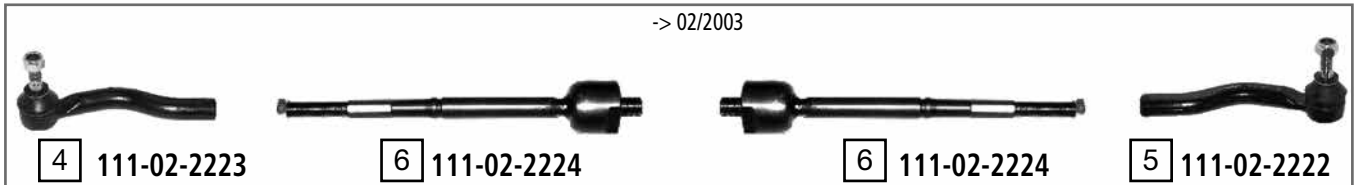

| Ref | ASHIKA CODE | Description       | OEM         | Measures             | Ref | ASHIKA CODE | Description              | OEM                         | Measures            |
|-----|-------------|-------------------|-------------|----------------------|-----|-------------|--------------------------|-----------------------------|---------------------|
| 1   | 106-02-239  | Stabiliser Link   | 48819 52010 | L:97                 | 7   | 73-02-206   | Ball Joint Lower         | Part of 72-02-246/72-02-247 | c:13.5              |
| 2   | 72-02-246   | TCA Left          | 48069-59035 | c:13.6               | 8   | GOM-233     | Silentblock For Susp.Arm | Part of 72-02-246/72-02-247 | d:32.5              |
| 3   | 72-02-247   | TCA Right         | 48068-59035 | c:13.6               | 9   | GOM-256     | Silentblock For Susp.Arm | Part of 72-02-246/72-02-247 | d:55                |
| 4   | 111-02-2223 | Tie Rod End Left  | 45047-59026 | c:12.7 th.FM12X1.25  | 10  | 111-02-259  | Tie Rod End              | 45046 19175                 | c:12.7 th.FM14X1.5R |
| 5   | 111-02-2222 | Tie Rod End Right | 45046-59026 | c:12.7 th.FM12X1.25R | 11  | 103-02-245  | Axial Joint              | 45503 59055                 | th.MM14X1.5R L:341  |
| 6   | 111-02-2224 | Axial Joint       | 45503-59045 | th.MM14X1.5R L.242   | 12  | 103-02-244  | Axial Joint              | 45503 0D030                 | th:MM14X1.5R L:248  |

YARIS II (KSP90,NLP90,SCP90)

11/2005 ->

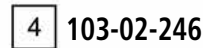
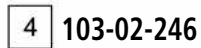
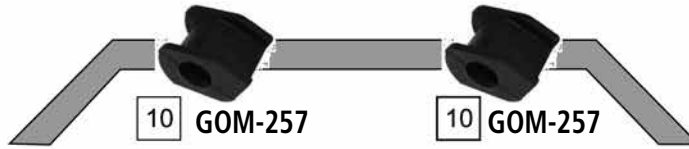

| Ref | ASHIKA CODE | Description       | OEM                 | Measures            | Ref | ASHIKA CODE | Description              | OEM                         | Measures |
|-----|-------------|-------------------|---------------------|---------------------|-----|-------------|--------------------------|-----------------------------|----------|
| 1   | 111-02-2014 | Tie Rod End Left  | 45047 09220         | c.12.7 th:FM14X1.5R | 6   | 72-02-249   | TCA Right Wbj            | 48068 09040                 |          |
| 2   | 111-02-2013 | Tie Rod End Right | 45046 09480         | c:12.7 th:FM14X1.5R | 7   | 73-02-206   | Ball Joint Lower         | Part of 72-02-248/72-02-249 | c.13.5   |
| 3   | 106-02-240  | Stabiliser Link   | 48820 0D010         | L:360               | 8   | GOM-258     | Silentblock For Susp.Arm | Part of 72-02-248/72-02-249 |          |
| 4   | 103-02-246  | Axial Joint       | Part of 45503-52070 |                     | 9   | GOM-259     | Silentblock For Susp.Arm | Part of 72-02-248/72-02-249 |          |
| 5   | 72-02-248   | TCA Left Wbj      | 48069 09040         |                     | 10  | GOM-257     | Stabiliser Mounting      | 48815 0D100                 | d:24     |



**CROSS REFERENCE LIST  
VERGLEICHSLISTE  
LISTA DE REFERENCIAS CRUZADES  
LISTE DE COMPARAISON  
LISTA DI COMPARAZIONE**

| ASIA MOTORS  | ASHIKA      |           |             |            |            |
|--------------|-------------|-----------|-------------|------------|------------|
| 0K550-32-450 | 111-0A-A03L | 96261378  | 111-0C-C08  | 96653351   | GOM-W14    |
| 0K550-32-510 | 111-0A-A03R | 96261379  | 111-0C-C07  | 96810751   | GOM-C01    |
| 0K710-32-240 | 111-0A-A04  | 96268439  | 72-0D-D02   | 96815893   | 72-0C-C03  |
| 0K710-34-510 | 73-03-314   | 96268440  | 72-0D-D01   | 96819161   | 72-0C-C01  |
| 0K710-34-540 | 73-03-313   | 96268454  | 72-0D-D04   | 96819162   | 72-0C-C02  |
| AA92A-59-032 | 73-03-314   | 96268455  | 72-0D-D03   | 96852964   | 73-0C-C01  |
| KJ01-32-631B | 111-0A-A51  | 96275018  | 111-0W-D51L | 96870465   | 72-0C-C03  |
| Z1G1-32-310  | 111-0A-A52  | 96275019  | 111-0W-D51R | 96970074   | GOM-D10    |
| CHEVROLET    | ASHIKA      | 9630-0048 | 73-0W-D54   | 96970075   | GOM-D09    |
| 13 272 606   | 72-0W-W03   | 96300222  | 106-0D-D04  | K9018-2694 | 71-0W-D02L |
| 13219090     | GOM-D06     | 96300222  | 106-0C-C09  | K9018-2695 | 71-0W-D02R |
| 13219141     | 106-0D-D05  | 96300627  | 106-0D-D03  | KBJ-R45    | 111-0W-D99 |
| 13230774     | GOM-D07     | 96300648  | 73-0W-D54   | KBJ029     | 111-0D-D56 |
| 13272605     | 72-0W-W02   | 96316765  | 71-08-803   | CHRYSLER   | ASHIKA     |
| 13278358     | 103-0D-D04  | 96328434  | GOM-D08     | 04656730AH | 72-0C-C09  |
| 13278359     | 111-0W-W00  | 96378346  | GOM-C08     | 04656731AH | 72-0C-C10  |
| 324038       | 111-0W-D51R | 96378347  | 72-0C-C08   | 04656932AA | GOM-927    |
| 352123       | 71-0W-D02L  | 96378348  | 72-0C-C07   | 04694760AA | 72-0C-C13  |
| 4806304      | 106-0C-C01  | 9639 1856 | GOM-W03     | 04743041AC | GOM-928    |
| 4806305      | 106-0C-C02  | 96391850  | 72-0C-C06   | 04743935AD | 103-09-907 |
| 520672       | 103-0W-D52  | 96391851  | 72-0C-C05   | 04762861AA | 111-0C-C09 |
| 520808       | 103-0C-C02  | 96391876  | 106-0C-C09  | 04895483AA | 106-09-914 |
| 520838       | 103-0W-D52  | 96403099  | 106-0C-C07  | 05093857AA | 111-0C-C09 |
| 520898       | 103-0W-D53  | 96403100  | 106-0C-C08  | 05272506AA | GOM-929    |
| 521136       | 111-0W-D55  | 96407485  | 111-0C-C06  | 272084     | GOM-C12    |
| 521564       | 103-0C-C04  | 96407486  | 111-0C-C05  | 4443405    | 73-0C-C06  |
| 5272098      | GOM-C13     | 96415063  | 72-0C-C06   | 4449553    | 73-0C-C06  |
| 93740621     | 103-0C-C04  | 96415064  | 72-0C-C05   | 4656 934AB | 106-09-911 |
| 93740701     | 103-0C-C02  | 96431044  | GOM-C09     | 4656010    | 73-0C-C05  |
| 93740710     | 111-0C-C02  | 96440010  | 72-0W-W00   | 4656010AB  | 73-0C-C05  |
| 93740722     | 111-0C-C03  | 96440011  | 72-0W-W01   | 4656010AE  | 73-0C-C05  |
| 93740723     | 111-0C-C04  | 96474040  | GOM-W09     | 4656012AB  | GOM-C11    |
| 93741092     | 111-0W-D99  | 96474041  | GOM-W10     | 4656012AC  | GOM-C11    |
| 94786917     | 73-0W-D51   | 96474042  | GOM-W11     | 4656730AH  | GOM-C10    |
| 95947829     | 106-0D-D08  | 96474043  | GOM-W12     | 4656730AH  | 72-0C-C09  |
| 95967285     | 111-0D-D01  | 96490218  | 73-0C-C03   | 4656731AH  | GOM-C10    |
| 95967294     | 103-0D-D05  | 96518121  | GOM-W00     | 4656731AH  | 72-0C-C10  |
| 9612-9753    | 111-0W-D60  | 96535081  | 72-0C-C03   | 4684120    | GOM-C16    |
| 96205809     | 111-0W-D60  | 96535082  | 72-0C-C04   | 4694 761AC | 72-0C-C14  |
| 96207628     | 106-0D-D02  | 96535089  | 73-0C-C02   | 4694747    | 73-0C-C06  |
| 96213117     | 72-0D-D06   | 96611265  | 71-08-803   | 4694760    | 72-0C-C13  |
| 96213118     | 72-0D-D05   | 96626150  | 106-0C-C03  | 4694760-C  | 72-0C-C13  |
| 96213119     | 73-0W-D55   | 96626247  | 106-0C-C01  | 4694760AC  | GOM-C15    |
| 96225858     | 106-0C-C04  | 96626248  | 106-0C-C02  | 4694760AC  | 72-0C-C13  |
| 96225859     | 106-0C-C05  | 96626667  | 111-0C-C01  | 4694760AC  | GOM-C14    |
| 96261107     | GOM-C09     | 96639904  | 106-0D-D06  | 4694761    | 72-0C-C14  |
| 96261108     | 73-0C-C04   | 96639905  | 106-0D-D07  | 4694761-C  | 72-0C-C14  |
|              |             | 96639918  | 73-0D-D01   | 4694761AC  | GOM-C15    |



**CROSS REFERENCE LIST**  
**VERGLEICHSLISTE**  
**LISTA DE REFERENCIAS CRUZADES**  
**LISTE DE COMPARAISON**  
**LISTA DI COMPARAZIONE**



|                |               |                |             |          |             |
|----------------|---------------|----------------|-------------|----------|-------------|
| 4694761AC      | GOM-C14       | 07846485       | 111-0W-D51R | 96225858 | 106-0C-C04  |
| 4728884        | 72-0C-C11     | 07846495       | 111-0W-D51L | 96225859 | 106-0C-C05  |
| 4728885        | 72-0C-C12     | 07848281       | 103-0D-D02  | 96261107 | GOM-C09     |
| 4743 094AA     | GOM-C18       | 07848282       | 103-0D-D03  | 96261108 | 73-0C-C04   |
| 4743095-AA     | GOM-C17       | 1603148        | 106-0D-D01  | 96261378 | 111-0C-C08  |
| 4743669AA      | 106-0C-C11    | 26001806       | 111-0W-D51R | 96261379 | 111-0C-C07  |
| 4743669AB      | 106-0C-C11    | 26001807       | 111-0W-D51L | 96268439 | 72-0D-D02   |
| 4762861-AA     | 111-0C-C09    | 352335         | GOM-D02     | 96268440 | 72-0D-D01   |
| 4766 866AA     | 106-09-917    | 352349         | GOM-D01     | 96268454 | 72-0D-D04   |
| 4766 910AG     | 72-09-919     | 402645         | GOM-D03     | 96268455 | 72-0D-D03   |
| 4766 911AG     | 72-09-918     | 4443003000     | 73-0S-S01   | 96275018 | 111-0W-D51L |
| 4766542-AA     | 72-0C-C15     | 4443003010     | 73-0S-S01   | 96275019 | 111-0W-D51R |
| 4766542AA      | 73-0C-C07     | 4443003011     | 73-0S-S01   | 96275798 | 106-0C-C06  |
| 4766543-AA     | 72-0C-C16     | 4450505000     | 73-0S-S02   | 96298000 | GOM-D05     |
| 4766543AA      | 73-0C-C07     | 4450505001     | 73-0S-S02   | 96300222 | 106-0D-D04  |
| 4782716AA      | 106-09-915    | 4475005000     | 106-0S-S01  | 96300627 | 106-0D-D03  |
| 4797706        | 111-0C-C11    | 4475005001     | 106-0S-S01  | 96300648 | 73-0W-D54   |
| 5066373AA      | 111-0C-C12    | 45200-A70B00   | 71-08-803   | 96305974 | 72-0D-D02   |
| 5066373AB      | 111-0C-C12    | 4666005500     | 111-0S-S01  | 96305975 | 72-0D-D01   |
| 5201-3468AB    | 111-09-916    | 4666005501     | 111-0S-S01  | 96316765 | 71-08-803   |
| 52088 636AD    | 72-09-917     | 48810-A78B00   | 111-0W-D55  | 96322618 | GOM-W02     |
| 52088437       | 106-09-904    | 48830-A78B00   | 103-0W-D51  | 96378346 | GOM-C08     |
| 52088520       | 111-0J-J015   | 48830A78B00000 | 103-0W-D51  | 96378347 | 72-0C-C08   |
| 52088636AG     | 72-09-917     | 520672         | 103-0W-D52  | 96378348 | 72-0C-C07   |
| 52088637AD     | 72-09-916     | 520838         | 103-0W-D52  | 96380613 | GOM-C07     |
| 52088637AG     | 72-09-916     | 520898         | 103-0W-D53  | 96391850 | 72-0C-C06   |
| 5272098        | GOM-C13       | 521255         | 103-0W-D54  | 96391851 | 72-0C-C05   |
| 5272190        | 106-09-912    | 521257         | 103-0W-D54  | 96403099 | 106-0C-C07  |
| 5272324AB      | 106-09-910    | 521564         | 103-0C-C04  | 96403100 | 106-0C-C08  |
| 5274470        | 111-0C-C10    | 56820-11000    | 111-05-502  | 96407485 | 111-0C-C06  |
| 68028 831AC    | 103-09-908    | 90 235 040     | GOM-D02     | 96407486 | 111-0C-C05  |
| 68033 171AB    | 111-09-919    | 90193117       | GOM-D01     | 96415063 | 72-0C-C06   |
| 83500202       | 111-00-J002   | 90250348       | GOM-W05     | 96415064 | 72-0C-C05   |
| 83500202       | 111-00-J001   | 90250437       | GOM-W07     | 96431044 | GOM-C09     |
| DA782561AE     | 71-09-902     | 90334546       | GOM-D02     | 96437817 | GOM-W13     |
| DA782612AC     | 71-09-901     | 93740621       | 103-0C-C04  | 96446586 | 111-0W-D60  |
| DA782613AC     | 71-09-900     | 93740722       | 111-0C-C03  | 96457360 | GOM-W08     |
| DA782665AB     | 72-09-914     | 93741074       | 103-0W-D54  | 96490218 | 73-0C-C03   |
| DA782666AB     | 72-09-915     | 94788122       | 73-00-051   | 96492383 | GOM-D05     |
| <b>CITROEN</b> | <b>ASHIKA</b> | 94788122       | 73-0W-D51   | 96535081 | 72-0C-C03   |
| 1813E2         | GOM-291       | 95994977       | 106-0C-C06  | 96535082 | 72-0C-C04   |
| 5131 C9        | GOM-235       | 96129839       | 106-0D-D01  | 96535087 | GOM-C05     |
| <b>DACIA</b>   | <b>ASHIKA</b> | 96205808       | 111-0W-D60  | 96535088 | GOM-C06     |
| 352124         | 71-0W-D02R    | 96205809       | 111-0W-D60  | 96535089 | 73-0C-C02   |
| 381763         | 111-02-210    | 96207628       | 106-0D-D02  | 96549921 | GOM-W04     |
| 381764         | 111-02-207    | 96213119       | 73-0W-D55   | 96568585 | GOM-W01     |
| <b>DAEWOO</b>  | <b>ASHIKA</b> | 96213130       | GOM-W15     | 96611265 | 71-08-803   |
| 04 02 642      | GOM-W06       | 96213131       | GOM-W16     | 96815893 | 72-0C-C03   |



**CROSS REFERENCE LIST**  
**VERGLEICHSLISTE**  
**LISTA DE REFERENCIAS CRUZADES**  
**LISTE DE COMPARAISON**  
**LISTA DI COMPARAZIONE**

|                 |               |                 |             |                 |             |
|-----------------|---------------|-----------------|-------------|-----------------|-------------|
| 96870465        | 72-0C-C03     | 45046-87503     | 111-06-607R | 4504787783      | 111-06-606L |
| D96422324       | 72-0C-C07     | 45046-87504     | 111-06-607R | 4504797203      | 111-06-609L |
| D96423220       | 72-0C-C08     | 45046-87580     | 111-06-607R | 4504797204000   | 111-06-614  |
| KBJ029          | 111-0D-D56    | 45046-87601     | 111-06-602R | 45047B9160      | 111-06-609L |
| <b>DAIHATSU</b> | <b>ASHIKA</b> | 45046-87680     | 111-06-602R | 45056-87501     | 111-06-601R |
| 12361-87306     | GOM-601       | 45046-87701     | 111-06-604  | 45056-87502     | 111-06-601R |
| 12361-87603     | GOM-602       | 45046-87707     | 111-06-613  | 45057-87501     | 111-06-601L |
| 12371-87607     | GOM-603       | 45046-87780     | 111-06-609R | 45057-87502     | 111-06-601L |
| 2001-4541       | 73-06-613R    | 45046-87781     | 111-06-606R | 45406-19016     | 111-06-624  |
| 2713-4741       | 111-06-601L   | 45046-97203     | 111-06-611  | 45406-19055     | 111-06-624  |
| 2713-4742       | 111-06-601R   | 45046-97204-000 | 111-06-617  | 45406-19065     | 111-06-624  |
| 2713-4751       | 111-06-601R   | 45046-B9080     | 111-06-619  | 45406-19075     | 111-06-624  |
| 2713-4752       | 111-06-601L   | 45046-B9320     | 111-06-619  | 45460-19125     | 108-06-622  |
| 42236-81400     | GOM-603       | 4504687285      | 111-06-609R | 45460-87401     | 103-06-612  |
| 43068-87401     | 72-06-603     | 4504687402      | 111-06-610  | 45503-10020     | 103-02-201  |
| 43069-87401     | 72-06-602     | 4504687707000   | 111-06-613  | 45503-19015     | 103-02-201  |
| 43308-12020     | 53-06-605     | 4504687782      | 111-06-606R | 45503-87102     | 103-06-600  |
| 4330812030      | 53-06-609     | 4504687783      | 111-06-606R | 45503-87210     | 103-06-611  |
| 4330819035      | 53-06-609     | 4504687784      | 111-06-606R | 45503-87215     | 103-06-611  |
| 43330-29115     | 73-06-625     | 4504697203      | 111-06-609R | 45503-87701     | 103-02-201  |
| 43330-87501     | 73-06-613R    | 4504697204000   | 111-06-613  | 45503-87702     | 103-06-602  |
| 43330-87580     | 73-06-613R    | 45046B9220      | 111-06-609R | 45503-87703     | 103-06-603  |
| 43330-87581     | 73-06-611     | 45047-19055     | 111-06-604  | 45503-87705     | 103-06-604  |
| 43330-87582     | 73-06-613R    | 45047-87280     | 111-06-609L | 45503-87706     | 103-06-606  |
| 43340-29075     | 53-06-699     | 45047-87281     | 111-06-609L | 45503-87708     | 103-06-605  |
| 43340-29095     | 73-06-625     | 45047-87303     | 111-06-602L | 45503-87709     | 103-06-606  |
| 43340-87581     | 73-06-611     | 45047-87380     | 111-06-602L | 45503-87710     | 103-06-609  |
| 43350-29035     | 73-06-629     | 45047-87501     | 111-06-601R | 45503-87711     | 103-06-605  |
| 43350-29036     | 73-06-625     | 45047-87502     | 111-06-601R | 45503-87714     | 103-06-610  |
| 43350-29036     | 73-06-629     | 45047-87503     | 111-06-607L | 45503-97201     | 103-06-613  |
| 43360-29055     | 73-06-629     | 45047-87580     | 111-06-607L | 45503-97203     | 103-06-607  |
| 43360-29056     | 73-06-629     | 45047-87583     | 111-06-607L | 45503-97203-000 | 103-06-607  |
| 45046-19065     | 111-02-205    | 45047-87584     | 111-06-607L | 45503-97204     | 103-06-608  |
| 45046-19095     | 111-02-205    | 45047-87680     | 111-06-615  | 45503-97204-000 | 103-06-608  |
| 45046-19135     | 111-02-205    | 45047-87685     | 111-06-608  | 45503-97401     | 103-06-615  |
| 45046-29075     | 111-02-205    | 45047-87706     | 111-06-614  | 45503-B1010     | 103-06-614  |
| 45046-29095     | 111-06-604    | 45047-87780     | 111-06-609L | 4550319045      | 103-02-201  |
| 45046-29095     | 111-06-605    | 45047-87781     | 111-06-606L | 4550387710000   | 103-06-609  |
| 45046-87203     | 111-06-699    | 45047-87782     | 111-06-606L | 48068-87208     | 71-06-600   |
| 45046-87280     | 111-06-604    | 45047-87784     | 111-06-606L | 48068-87209     | 71-06-609   |
| 45046-87281     | 111-06-604    | 45047-97203     | 111-06-612  | 48068-87403     | 72-06-603   |
| 45046-87282     | 111-06-609R   | 45047-97204-000 | 111-06-616  | 48068-87501-000 | 71-06-608   |
| 45046-87283     | 111-06-609R   | 45047-B9070     | 111-06-618  | 48068-87705     | 71-06-605R  |
| 45046-87302     | 111-06-603R   | 45047-B9270     | 111-06-618  | 48068-87706     | 71-06-699   |
| 45046-87303     | 111-06-602R   | 4504787282      | 111-06-609L | 48068-87711     | 72-06-601   |
| 45046-87401     | 111-06-610    | 4504787303      | 111-02-202L | 48068-97202     | 71-06-603   |
| 45046-87501     | 111-06-601L   | 4504787380      | 111-02-202L | 48068-97203     | 71-06-605   |
| 45046-87502     | 111-06-601L   | 4504787706000   | 111-06-614  | 48068-B1020     | 72-06-607   |

**CROSS REFERENCE LIST**  
**VERGLEICHSLISTE**  
**LISTA DE REFERENCIAS CRUZADES**  
**LISTE DE COMPARAISON**  
**LISTA DI COMPARAZIONE**



|                 |               |               |           |               |            |
|-----------------|---------------|---------------|-----------|---------------|------------|
| 48068-B1080     | 72-06-607     | 50805-S04-000 | GOM-460   | 51230SNAA02   | 73-04-420  |
| 48068-B4010     | 72-06-605     | 50805-SR3-951 | GOM-406   | 51230SNAA03   | 73-04-420  |
| 4806887711000   | 72-06-601     | 50810-SM4-000 | GOM-402   | 51270-SB0-003 | 73-04-405  |
| 48069-87209     | 71-06-610     | 50810-SR3-010 | GOM-402   | 51270-SBO-013 | 73-04-405  |
| 48069-87403     | 72-06-602     | 50810-SR3-030 | GOM-402   | 51270-SE0-043 | 73-04-400  |
| 48069-87501-000 | 71-06-607     | 50810-SR3-983 | GOM-461   | 51270-SF1-003 | 111-04-486 |
| 48069-87706     | 71-06-698     | 50820-SR3-J02 | GOM-403   | 51306 SMG E02 | GOM-432    |
| 48069-87710     | 72-06-600     | 50820-SR3-J11 | GOM-407   | 51306-S04-003 | GOM-462    |
| 48069-97202     | 71-06-604     | 50820-SR3-J11 | GOM-405   | 51306-S04-N01 | GOM-446    |
| 48069-97203     | 71-06-606     | 50824-S04-013 | GOM-459   | 51306-S6D-005 | GOM-429    |
| 48069-B1020     | 72-06-606     | 50841-SR3-030 | GOM-400   | 51306-S7B-014 | GOM-449    |
| 48069-B1080     | 72-06-606     | 50841-SR3-984 | GOM-457   | 51306SWAA01   | GOM-455    |
| 48069-B4010     | 72-06-604     | 50842-SR3-030 | GOM-401   | 51310-SP0-003 | 106-04-403 |
| 4806987710000   | 72-06-600     | 50842-SR3-030 | GOM-458   | 51312-SR3-000 | 71-04-410  |
| 48802-87703     | 106-06-600    | 50842-SR3-984 | GOM-458   | 51320 TF0 003 | 106-04-444 |
| 4880287703000   | 106-06-600    | 51210S6DG10   | 73-04-403 | 51320-S04-003 | 106-04-404 |
| 48815-20026     | GOM-607       | 51215S6DG10   | 73-04-403 | 51320-S2G-003 | 106-04-429 |
| 48815-87601     | GOM-608       | 51220 TA0 A02 | 73-04-411 | 51320-S2H-003 | 106-04-425 |
| 48820-B2010     | 106-06-605    | 51220-S04-003 | 73-04-416 | 51320-S30-003 | 106-04-431 |
| 48821-B1010     | 106-06-601    | 51220-S5A-003 | 73-04-403 | 51320-S5A-003 | 106-04-415 |
| 48821-B1030     | 106-06-601    | 51220-SAA-013 | 73-04-407 | 51320-S84-A01 | 106-04-405 |
| 48822-87401     | 106-06-603    | 51220-SB0-003 | 73-04-404 | 51320-SAA-003 | 106-04-427 |
| 4882287604      | 106-06-604    | 51220-SD4-004 | 73-04-499 | 51320-SAA-J01 | 106-04-439 |
| 48831-B1010     | 106-06-602    | 51220-SD4-013 | 73-04-499 | 51320-SEA-E01 | 106-04-409 |
| 48831-B1020     | 106-06-602    | 51220-SD4-023 | 73-04-499 | 51320-SMG-E01 | 106-04-400 |
| 49068-97202     | 71-06-601     | 51220-SE0-000 | 73-04-404 | 51320-SP0-003 | 106-04-428 |
| 49069-97202     | 71-06-602     | 51220-SK7-013 | 73-04-404 | 51320-ST7-003 | 106-04-401 |
| 90043-85046     | GOM-605       | 51220-SL5-003 | 73-04-499 | 51320-STK-A01 | 106-04-433 |
| 90043-85049     | GOM-606       | 51220-SL5-013 | 73-04-499 | 51320-TA0-A01 | 106-04-435 |
| 90045-40165     | GOM-609       | 51220-SM1-A01 | 73-04-406 | 51321-S2G-003 | 106-04-430 |
| <b>DR</b>       | <b>ASHIKA</b> | 51220-SM1-A02 | 73-04-406 | 51321-S2H-003 | 106-04-424 |
| 722010037       | 106-00-003    | 51220-SM4-003 | 73-04-406 | 51321-S5A-003 | 106-04-414 |
| <b>FORD</b>     | <b>ASHIKA</b> | 51220-SM4-013 | 73-04-406 | 51321-S84-A01 | 106-04-406 |
| 1020174         | 111-03-336    | 51220-SR3-003 | 73-04-416 | 51321-SAA-003 | 106-04-426 |
| 1044014         | 103-03-311    | 51220-STK-A01 | 73-04-410 | 51321-SAA-J01 | 106-04-438 |
| 1202548         | 111-03-345    | 51220S5AJ10   | 73-04-403 | 51321-SEA-E01 | 106-04-410 |
| 1202549         | 111-03-344    | 51220S84A01   | 73-04-406 | 51325-TA0-A01 | 106-04-434 |
| 13000384        | GOM-323       | 51220S84A02   | 73-04-406 | 51350 SWA E01 | 72-04-439  |
| 1540724         | 72-03-329     | 51220SB0023   | 73-04-404 | 51350 TA0 A00 | 72-04-437  |
| 1540725         | 72-03-328     | 51220SD4000   | 73-04-499 | 51350 TF0 030 | 72-04-441  |
| 1545338         | 111-03-355    | 51220SE0003   | 73-04-404 | 51350-000-010 | 71-04-403  |
| 1545339         | 111-03-356    | 51220SF1000   | 73-04-404 | 51350-634-003 | 26-04-401  |
| 1545457         | 103-03-334    | 51220SH3003   | 73-04-404 | 51350-659-010 | 71-04-402  |
| 1603120         | 73-0W-D51     | 51220SK7003   | 73-04-404 | 51350-659-325 | 71-04-402  |
| 8V51 3C437 AA   | 111-03-356    | 51220SM0003   | 73-04-406 | 51350-671-000 | 26-04-401  |
| 8V513C367AA     | 111-03-355    | 51220SNAA02   | 73-04-421 | 51350-671-003 | 26-04-401  |
| 8V513L519AA     | 103-03-334    | 51220SNAA03   | 73-04-421 | 51350-671-013 | 26-04-401  |
| <b>HONDA</b>    | <b>ASHIKA</b> | 51230-S2A-000 | 73-04-412 | 51350-671-033 | 26-04-401  |



**CROSS REFERENCE LIST**  
**VERGLEICHSLISTE**  
**LISTA DE REFERENCIAS CRUZADES**  
**LISTE DE COMPARAISON**  
**LISTA DI COMPARAZIONE**

|                |           |                  |            |               |            |
|----------------|-----------|------------------|------------|---------------|------------|
| 51350-671-405  | 26-04-401 | 51355-SH3-020    | 71-04-413  | 51360-SEA-E01 | 72-04-404  |
| 51350-692-000  | 26-04-498 | 51355-SK3-000    | 111-04-489 | 51360-SMG-E05 | 72-04-416  |
| 51350-692-010  | 26-04-498 | 51355-SM4-040    | 71-04-401  | 51360-SNA-A03 | 72-04-444  |
| 51350-692-020  | 26-04-498 | 51355-SV7-A00    | 71-04-407  | 51360-SR3-020 | 72-04-408  |
| 51350-692-030  | 26-04-498 | 51355S1AE00      | GOM-417    | 51360S04G00   | GOM-426    |
| 51350-692-040  | 26-04-498 | 51355S84A00      | 71-04-409  | 51360S04G00   | GOM-428    |
| 51350-692-050  | 26-04-498 | 51355SH3010      | 71-04-413  | 51360S10G00   | GOM-437    |
| 51350-692-640  | 26-04-498 | 51355SK7000      | 71-04-413  | 51360S10G00   | GOM-436    |
| 51350-S04-000  | 72-04-413 | 51355SK7010      | 71-04-413  | 51360S50G01   | 73-04-409  |
| 51350-S10-G00  | 72-04-421 | 51355SM4030      | 71-04-401  | 51360SAAE01   | 73-04-407  |
| 51350-S2H-G01  | 72-04-425 | 51355SN7010      | 73-04-400  | 51360SAAE01   | GOM-440    |
| 51350-S50-G01  | 72-04-433 | 51355SV4000      | 71-04-407  | 51360SAAE01   | GOM-441    |
| 51350-S6D-G00  | 72-04-415 | 51360 SWA E01    | 72-04-438  | 51360SK7000   | 71-04-414  |
| 51350-S9A-010  | 72-04-423 | 51360 TA0 A00    | 72-04-436  | 51360SR3A01   | 72-04-408  |
| 51350-S9A-020  | 72-04-423 | 51360 TF0 030    | 72-04-440  | 51360SR3A02   | 72-04-408  |
| 51350-SA0-00   | 71-04-403 | 51360-000-010    | 71-04-403  | 51360ST7010   | 72-04-408  |
| 51350-SA0-010  | 71-04-403 | 51360-634-003    | 26-04-401  | 51361-SB2-013 | 111-04-481 |
| 51350-SA0-020  | 71-04-403 | 51360-659-010    | 71-04-402  | 51361SB2672   | 111-04-481 |
| 51350-SA0-030  | 71-04-403 | 51360-659-325    | 71-04-402  | 51361SB6931   | 111-04-481 |
| 51350-SA0-325  | 71-04-403 | 51360-671-000    | 26-04-401  | 51365-S1A-E00 | 71-04-408  |
| 51350-SA5-000  | 26-04-489 | 51360-671-003    | 26-04-401  | 51365-S84-A00 | 71-04-408  |
| 51350-SA5-003  | 26-04-489 | 51360-671-013    | 26-04-401  | 51365-SH3-020 | 71-04-414  |
| 51350-SA5-010  | 26-04-496 | 51360-671-033    | 26-04-401  | 51365-SK3-000 | 111-04-488 |
| 51350-SA5-013  | 26-04-489 | 51360-671-405    | 26-04-401  | 51365-SM4-040 | 71-04-400  |
| 51350-SA5-013A | 73-04-498 | 51360-692-010    | 26-04-498  | 51365-SV7-A00 | 71-04-406  |
| 51350-SA5-020  | 26-04-496 | 51360-692-020    | 26-04-498  | 51365SH3010   | 71-04-414  |
| 51350-SAA-E01  | 72-04-427 | 51360-692-030    | 26-04-498  | 51365SK7010   | 71-04-414  |
| 51350-SCA-S00  | 72-04-423 | 51360-692-040    | 26-04-498  | 51365SM4030   | 71-04-400  |
| 51350-SEA-E01  | 72-04-405 | 51360-692-050    | 26-04-498  | 51365SV4000   | 71-04-406  |
| 51350-SMG-E05  | 72-04-417 | 51360-692-640    | 26-04-498  | 51391 S5A 024 | GOM-430    |
| 51350-SNA-A03  | 72-04-445 | 51360-S04-G00    | 72-04-412  | 51391 TA0 A01 | GOM-451    |
| 51350-SR3-020  | 72-04-409 | 51360-S04-G00 S2 | GOM-426    | 51391-S04-005 | GOM-427    |
| 51350S04000    | GOM-426   | 51360-S10-G00    | 72-04-420  | 51391-SEA-004 | GOM-420    |
| 51350S04000    | GOM-428   | 51360-S2H-G01    | 72-04-424  | 51391S7A005   | GOM-430    |
| 51350S04G00    | 72-04-413 | 51360-S2H-G02    | 72-04-424  | 51392 SR3 014 | GOM-424    |
| 51350S10G00    | GOM-437   | 51360-S50-G01    | 72-04-432  | 51392 SR3 024 | GOM-424    |
| 51350S10G00    | GOM-436   | 51360-S6D-G00    | 72-04-414  | 51392-S5A-004 | GOM-431    |
| 51350S50G01    | 73-04-409 | 51360-S9A-010    | 72-04-422  | 51392-SR3-004 | GOM-409    |
| 51350SAAE01    | GOM-440   | 51360-SA0-000    | 71-04-403  | 51393-SEA-004 | GOM-421    |
| 51350SAAE01    | 73-04-407 | 51360-SA0-010    | 71-04-403  | 51393-SM4-013 | GOM-415    |
| 51350SAAE01    | GOM-441   | 51360-SA0-020    | 71-04-403  | 51393SH3003   | GOM-439    |
| 51350SR3A01    | 72-04-409 | 51360-SA0-030    | 71-04-403  | 51395 SMG E03 | GOM-435    |
| 51350SR3A02    | 72-04-409 | 51360-SA5-003    | 26-04-494  | 51395-SR3-N02 | GOM-410    |
| 51350ST7010    | 72-04-409 | 51360-SA5-010    | 26-04-493  | 51395SMGE05   | GOM-435    |
| 51351-SB2-013  | 26-04-495 | 51360-SA5-013    | 26-04-494  | 51396 SMG E03 | GOM-434    |
| 51351-SB2-672  | 26-04-495 | 51360-SA5-020    | 26-04-493  | 51396-SR3-N02 | GOM-411    |
| 51351-SB6-931  | 26-04-495 | 51360-SAA-E01    | 72-04-426  | 51396SMGE05   | GOM-434    |
| 51355-S1A-E00  | 71-04-409 | 51360-SCA-S00    | 72-04-422  | 51398 SMG E01 | GOM-433    |

**CROSS REFERENCE LIST**  
**VERGLEICHSLISTE**  
**LISTA DE REFERENCIAS CRUZADES**  
**LISTE DE COMPARAISON**  
**LISTA DI COMPARAZIONE**



|                  |            |                  |            |               |            |
|------------------|------------|------------------|------------|---------------|------------|
| 51450-S04-023    | 72-04-411  | 51460-SH3-023-WA | 111-04-482 | 52321-S5A-013 | 106-04-416 |
| 51450-S10-020    | 72-04-419  | 51460-SP0-033    | 72-04-428  | 52321-S9A-003 | 106-04-422 |
| 51450-S1A-E01    | 72-04-401  | 51460-SR3-023    | 72-04-406  | 52321-SNA-A01 | 106-04-418 |
| 51450-S84-A01    | 72-04-401  | 51460-SV4-A00    | 73-04-495  | 52321-SWA-A01 | 106-04-422 |
| 51450-SDA-A01    | 72-04-403  | 51460-SZ3-013    | 72-04-430  | 52325-S84-A01 | 106-04-408 |
| 51450-SGO-020    | 111-04-485 | 51460S01023      | GOM-425    | 52325-TA0-A01 | 106-04-436 |
| 51450-SH3-000    | 111-04-483 | 51460S1AE01      | GOM-418    | 52335STRG01   | GOM-416    |
| 51450-SH3-010    | 111-04-483 | 51460SDAA01      | 73-04-401  | 52350-SEA-000 | 71-04-415  |
| 51450-SH3-023-WA | 111-04-482 | 51460SH3020      | 111-04-482 | 52365-SM4-005 | GOM-413    |
| 51450-SM4-023    | 73-04-496  | 51460SH3023      | 111-04-482 | 52370-SR3-J00 | GOM-416    |
| 51450-SP0-033    | 72-04-429  | 51460SH3030      | 111-04-482 | 52390 SH3 030 | 71-04-411  |
| 51450-SR3-023    | 72-04-407  | 51460SK7043      | 111-04-482 | 52390-S30-003 | 72-04-443  |
| 51450-SZ3-013    | 72-04-431  | 51460SR0A02      | 72-04-406  | 52390-SE0-013 | 26-04-490  |
| 51450S01023      | GOM-425    | 51460SR3003      | 72-04-406  | 52390-SE0-023 | 26-04-490  |
| 51450S01023      | 72-04-411  | 51460SR3013      | 72-04-406  | 52390-SE0-033 | 26-04-490  |
| 51450S01A02      | 72-04-411  | 51460SR3A02      | 72-04-406  | 52390-SE0-043 | 26-04-490  |
| 51450S04013      | 72-04-411  | 51460SV4A00      | 73-04-400  | 52390-SM1-A03 | 71-04-405  |
| 51450S1AE01      | GOM-418    | 51469-SE0-000    | 26-04-491  | 52390-SP0-013 | 26-04-410R |
| 51450SDAA01      | 73-04-401  | 51469-SE0-003    | 26-04-491  | 52390-SR3-000 | 71-04-412  |
| 51450SGO020      | 72-04-424  | 51510 TA0 A03    | 72-04-435  | 52390SM4A04   | 71-04-405  |
| 51450SH3020      | 111-04-483 | 51510TA0A03      | 73-04-401  | 52390SR3000   | 71-04-411  |
| 51450SH3023      | GOM-438    | 51520 TA0 A03    | 72-04-434  | 52393-SR0-004 | GOM-445    |
| 51450SH3023      | 111-04-483 | 51520TA0A03      | 73-04-401  | 52393-SR3-004 | GOM-445    |
| 51450SH3030      | 111-04-483 | 51810 SH3 004    | GOM-423    | 52400-S30-003 | 72-04-442  |
| 51450SK7043      | 111-04-483 | 51810-SDA-A01    | GOM-419    | 52400-SM1-A03 | 71-04-404  |
| 51450SR0A02      | 72-04-407  | 51810-SM4-003    | GOM-414    | 52400-SP0-013 | 26-04-410L |
| 51450SR3003      | 72-04-407  | 51810-SM4-004    | GOM-414    | 52400SH3030   | 71-04-412  |
| 51450SR3013      | 72-04-407  | 51810SH3003      | GOM-423    | 52400SM4A04   | 71-04-404  |
| 51450SR3A02      | 72-04-407  | 51810TA0A01      | GOM-419    | 52400SR3000   | 71-04-412  |
| 51450SV4000      | 73-04-496  | 51920-S6M-014    | GOM-447    | 52622-SH3-010 | GOM-444    |
| 51450SV4A00      | 73-04-496  | 51925-S6M-014    | GOM-448    | 53010 SWA A01 | 103-04-427 |
| 51455SR3003      | GOM-422    | 52303SH3020      | 71-04-410  | 53010 SWC G01 | 103-04-426 |
| 51455SR3004      | GOM-422    | 52306SDAA01      | GOM-456    | 53010 SWC G02 | 103-04-426 |
| 51459-SE0-000    | 26-04-492  | 52306SWAA01      | GOM-454    | 53010 TF0 003 | 103-04-425 |
| 51459-SE0-003    | 26-04-492  | 52320 S2H 003    | 106-04-441 | 53010-S04-000 | 103-04-409 |
| 51459-SEO-000    | 26-04-492  | 52320 SWA A01    | 106-04-443 | 53010-S04-J51 | 103-04-409 |
| 51460 S01 023    | 72-04-410  | 52320-S04-003    | 106-04-413 | 53010-S10-000 | 103-04-416 |
| 51460 S01 A02    | 72-04-410  | 52320-S10-003    | 106-04-421 | 53010-S2H-J01 | 103-04-418 |
| 51460 S04 010    | 72-04-410  | 52320-S30-003    | 106-04-432 | 53010-S50-003 | 103-04-423 |
| 51460 S04 023    | 72-04-410  | 52320-S5A-013    | 106-04-417 | 53010-S84-A01 | 103-04-407 |
| 51460 SV4 000    | 73-04-495  | 52320-S84-A01    | 106-04-407 | 53010-SAA-J01 | 103-04-419 |
| 51460-S10-020    | 72-04-418  | 52320-S9A-003    | 106-04-423 | 53010-SDA-A01 | 103-04-411 |
| 51460-S1A-E01    | 72-04-400  | 52320-SNA-A01    | 106-04-419 | 53010-SMG-E01 | 103-04-414 |
| 51460-S84-A01    | 72-04-400  | 52320-TA0-A01    | 106-04-437 | 53010-SR3-010 | 103-04-499 |
| 51460-SDA-A01    | 72-04-402  | 52321 S2H 003    | 106-04-440 | 53010-SS0-000 | 103-04-498 |
| 51460-SGO-020    | 111-04-484 | 52321 SWA A01    | 106-04-442 | 53010-SV4-000 | 103-04-413 |
| 51460-SH3-000    | 111-04-482 | 52321-S04-003    | 106-04-412 | 53010-SW5-000 | 103-04-421 |
| 51460-SH3-010    | 111-04-482 | 52321-S10-003    | 106-04-420 | 53010-SW5-003 | 103-04-422 |



**CROSS REFERENCE LIST**  
**VERGLEICHSLISTE**  
**LISTA DE REFERENCIAS CRUZADES**  
**LISTE DE COMPARAISON**  
**LISTA DI COMPARAZIONE**

|               |            |                |             |                |               |
|---------------|------------|----------------|-------------|----------------|---------------|
| 53010-TA0-A01 | 103-04-424 | 53540-SA0-003  | 111-04-401  | 53560-SP0-023  | 111-04-402L   |
| 53010S2HJ02   | 103-04-418 | 53540-SA0-004  | 111-04-401  | 53560-SR0-A01  | 111-04-406L   |
| 53010SEL003   | 103-04-419 | 53540-SAA-003  | 111-04-419  | 53560-SR3-003  | 111-04-406L   |
| 53010ST0000   | 103-04-499 | 53540-SB0-003  | 111-04-401  | 53560-SS0-003  | 111-04-422    |
| 53011-SAA-J01 | 103-04-420 | 53540-SB2-002  | 111-04-401  | 53560-ST7-003  | 111-04-406L   |
| 53011-SMG-E01 | 103-04-415 | 53540-SB2-003  | 111-04-401  | 53560-SV4-003  | 111-04-407L   |
| 53011SEL003   | 103-04-420 | 53540-SB2-013  | 111-04-401  | 53560-SX0-003  | 111-04-407L   |
| 53521-634-000 | 103-04-401 | 53540-SC2-003  | 111-04-401  | 53560-SZ3-003  | 111-04-420    |
| 53521-671-000 | 103-04-402 | 53540-SD4-003  | 111-04-405R | 53560S04003    | 73-04-416     |
| 53521-671-010 | 103-04-402 | 53540-SDA-A01  | 111-04-411  | 53560S04003    | 111-04-406L   |
| 53521-689-000 | 103-04-402 | 53540-SF1-004  | 111-04-499  | 53560S04013    | 111-04-406L   |
| 53521-689-003 | 103-04-402 | 53540-SH3-003  | 111-04-406R | 53560S04013    | 73-04-416     |
| 53521-692-003 | 103-04-403 | 53540-SH3-013  | 111-04-406R | 53560SELT01    | 111-04-418    |
| 53521-S5A-003 | 103-04-400 | 53540-SK3-E01  | 111-04-487  | 53560SS0004    | 111-04-422    |
| 53521-S9A-003 | 103-04-417 | 53540-SM4-003  | 111-04-404R | 551360-692-000 | 26-04-498     |
| 53521-SA0-003 | 103-04-403 | 53540-SM4-004  | 111-04-404R | 77014000       | 103-04-416    |
| 53521-SA5-000 | 103-04-404 | 53540-SMG-003  | 111-04-413  | 90112-SE0-000  | 106-04-411    |
| 53521-SA5-003 | 103-04-404 | 53540-SMJ-003  | 111-04-415  | GSJ 227        | 26-04-495     |
| 53521-SB0-000 | 103-04-406 | 53540-SP0-013  | 111-04-402R | GSJ 228        | 111-04-481    |
| 53521-SB0-003 | 103-04-406 | 53540-SP0-023  | 111-04-402R | GSJ 404        | 73-04-406     |
| 53521-SB2-003 | 103-04-405 | 53540-SR0-A01  | 111-04-406R | GSJ 424        | 73-04-496     |
| 53521-SB2-013 | 103-04-405 | 53540-SR3-003  | 111-04-406R | GSJ 499        | 73-04-416     |
| 53521-SD4-023 | 103-04-497 | 53540-SS0-003  | 111-04-423  | GSV 1211       | 103-04-410    |
| 53521-SE0-000 | 103-04-403 | 53540-ST7-003  | 111-04-406R | <b>HYUNDAI</b> | <b>ASHIKA</b> |
| 53521-SE0-003 | 103-04-403 | 53540-SV4-003  | 111-04-407R | 2181025700     | GOM-H51       |
| 53521-SE0-013 | 103-04-403 | 53540-SX0-003  | 111-04-407R | 2183025700     | GOM-H50       |
| 53521-SE0-951 | 103-04-403 | 53540-SX8-T01  | 111-04-417  | 26001806       | 111-0W-D51R   |
| 53521-SF1-003 | 103-04-406 | 53540-SZ3-003  | 111-04-421  | 26001807       | 111-0W-D51L   |
| 53521-SH3-003 | 103-04-409 | 535400-SC2-004 | 111-04-401  | 458303K000     | 106-0H-H25    |
| 53521-SK3-003 | 103-04-412 | 53540SC2004    | 111-04-401  | 51760-1G000    | 73-0H-H04     |
| 53521-SK7-003 | 103-04-412 | 53540SELT01    | 111-04-419  | 51760-2E000    | 73-0H-H14     |
| 53521-SL4-014 | 103-04-496 | 53540SS0004    | 111-04-423  | 51760-38000    | 73-0H-H08     |
| 53521-SM4-003 | 103-04-410 | 53541-S5A-003  | 111-04-400  | 51760-3K000    | 73-0H-H10     |
| 53521-SM4-013 | 103-04-410 | 53541-S7A-003  | 111-04-400  | 517600Q000     | 73-0K-K01     |
| 53521-SP0-004 | 103-04-495 | 53560 TA0 A01  | 111-04-428  | 517602H000     | 73-0K-K01     |
| 53540 SWA A01 | 111-04-430 | 53560 TF0 003  | 111-04-426  | 52773-25100    | GOM-H54       |
| 53540 SWA A02 | 111-04-430 | 53560-S1A-E01  | 111-04-410  | 53503-21000    | 53-0H-H52R    |
| 53540 TA0 A01 | 111-04-429 | 53560-S30-005  | 111-04-424  | 54400-4A000    | 72-0H-H38     |
| 53540 TF0 003 | 111-04-427 | 53560-SAA-003  | 111-04-418  | 54400-4A820    | 72-0H-H40     |
| 53540-611-010 | 111-04-401 | 53560-SD4-003  | 111-04-405L | 54401-4A000    | 72-0H-H37     |
| 53540-611-020 | 111-04-401 | 53560-SDA-A01  | 111-04-412  | 54401-4A820    | 72-0H-H39     |
| 53540-634-000 | 111-04-401 | 53560-SH3-003  | 111-04-406L | 54403-38A00    | 73-0H-H07     |
| 53540-659-003 | 111-04-401 | 53560-SH3-013  | 111-04-406L | 54410-38000    | 72-0H-H28     |
| 53540-671-010 | 111-04-401 | 53560-SM4-003  | 111-04-404L | 54410-43004    | 111-0H-H003   |
| 53540-679-004 | 111-04-401 | 53560-SM4-004  | 111-04-404L | 54410-43005    | 111-0H-H003   |
| 53540-S1A-E01 | 111-04-409 | 53560-SMG-003  | 111-04-414  | 54417-43000    | 111-0H-H001   |
| 53540-S30-005 | 111-04-425 | 53560-SMJ-003  | 111-04-416  | 54417-43A00    | 53-0H-H77     |
| 53540-SA0-002 | 111-04-401 | 53560-SP0-013  | 111-04-402L | 54417-44000    | 111-0H-H97    |

**CROSS REFERENCE LIST**  
**VERGLEICHSLISTE**  
**LISTA DE REFERENCIAS CRUZADES**  
**LISTE DE COMPARAISON**  
**LISTA DI COMPARAZIONE**



|             |             |             |            |             |             |
|-------------|-------------|-------------|------------|-------------|-------------|
| 54417-4A000 | 53-0H-H77   | 54500-4A801 | 72-0H-H44  | 545012Y000  | 72-0H-H49   |
| 5441743A00  | 73-05-513   | 5450002051  | 72-0H-H04  | 5450138010  | 72-0H-H29   |
| 5441743A01  | 73-05-513   | 545001C010  | 72-0H-H20  | 54502-21000 | 53-0H-H52L  |
| 5441743A01  | 53-0H-H77   | 5450022100  | 73-0H-H54L | 54502-24001 | 72-0H-H24   |
| 5441747000  | 73-05-513   | 5450029500  | 73-0H-H55L | 54502-26000 | 72-0H-H02   |
| 5441747000  | 53-0H-H77   | 545002C001  | 72-0H-H12  | 54502-3A100 | 72-0H-H33   |
| 544174A000  | 73-05-513   | 545002C002  | 72-0H-H12  | 54502-3A201 | 72-0H-H33   |
| 544174AA00  | 53-0H-H77   | 545002D002  | 72-0H-H14  | 54503-22A00 | 73-0H-H57   |
| 544174AA00  | 73-05-513   | 545002H000  | 72-0K-K08  | 54503-24001 | 72-0H-H23   |
| 544174BA00  | 73-05-513   | 545002Y000  | 72-0H-H50  | 54503-25A00 | 73-0H-H57   |
| 544174BA00  | 53-0H-H77   | 5450038010  | 72-0H-H30  | 54503-31600 | 73-0H-H57   |
| 54420-38000 | 72-0H-H27   | 54501 29500 | 73-0H-H55R | 54503-34A00 | 53-0H-H64   |
| 54430-31000 | 73-0H-H55   | 54501 2D002 | 72-0H-H13  | 54503-34A01 | 53-0H-H64   |
| 54430-31300 | 73-0H-H55   | 54501 4H000 | 72-0H-H51  | 54503-38A00 | 73-0H-H57   |
| 54430-3F600 | 73-0H-H09   | 54501-02050 | 72-0H-H03  | 54503-3BA00 | 73-0H-H01   |
| 54430-3K000 | 73-0H-H07   | 54501-02052 | 72-0H-H03  | 54503-DA000 | 73-0H-H01   |
| 54430-43004 | 111-0H-H002 | 54501-0X000 | 72-0H-H35  | 54510-43150 | 111-0H-H005 |
| 54430-43005 | 111-0H-H002 | 54501-0X200 | 72-0H-H35  | 54510-4B001 | 71-0H-H02   |
| 54431-44000 | 111-0H-H98  | 54501-17000 | 72-0H-H21  | 5451043150  | 73-05-514   |
| 54440-H1000 | 73-0H-H11   | 54501-1C000 | 72-0H-H19  | 5451043151  | 73-05-514   |
| 54443-3K000 | GOM-H21     | 54501-1E000 | 72-0H-H09  | 5451043151  | 111-0H-H005 |
| 54457-43000 | 111-0H-H001 | 54501-1E100 | 72-0H-H07  | 5451043152  | GOM-H14     |
| 5445743001  | 111-0H-H001 | 54501-1J500 | 72-0H-H45  | 5451043152  | 111-0H-H005 |
| 54500 4H000 | 72-0H-H52   | 54501-1J700 | 72-0H-H45  | 5451043152  | 73-05-514   |
| 54500-02050 | 72-0H-H04   | 54501-1P100 | 72-0H-H47  | 545104B001  | GOM-H13     |
| 54500-02052 | 72-0H-H04   | 54501-22000 | 73-0H-H54R | 54520-11011 | 53-0H-H51   |
| 54500-0X000 | 72-0H-H36   | 54501-22200 | 73-0H-H54R | 54520-14200 | 53-0H-H51   |
| 54500-0X200 | 72-0H-H36   | 54501-25000 | 72-0H-H05  | 54520-31600 | 73-0H-H57   |
| 54500-17000 | 72-0H-H22   | 54501-26000 | 72-0H-H01  | 54524-43000 | 53-0H-H60   |
| 54500-1C000 | 72-0H-H20   | 54501-29000 | 73-0H-H55R | 54524-43001 | 53-0H-H60   |
| 54500-1E000 | 72-0H-H10   | 54501-2B100 | 72-0H-H25  | 54528-4AA10 | 73-0H-H17   |
| 54500-1E100 | 72-0H-H08   | 54501-2C000 | 72-0H-H11  | 54530 3A200 | 73-0H-H00   |
| 54500-1J500 | 72-0H-H46   | 54501-2D000 | 72-0H-H13  | 54530 3J000 | 73-0H-H19   |
| 54500-1J700 | 72-0H-H46   | 54501-33000 | 73-0H-H53R | 54530-02050 | 73-0H-H02   |
| 54500-1P000 | 72-0H-H48   | 54501-34000 | 73-0H-H66R | 54530-14200 | 53-0H-H51   |
| 54500-22000 | 73-0H-H54L  | 54501-38000 | 72-0H-H29  | 54530-21000 | 53-0H-H52L  |
| 54500-22200 | 73-0H-H54L  | 54501-38011 | 72-0H-H31  | 54530-21100 | 53-0H-H52L  |
| 54500-25000 | 72-0H-H06   | 54501-3A100 | 72-0H-H34  | 54530-21A00 | 53-0H-H52L  |
| 54500-29000 | 73-0H-H55L  | 54501-3A201 | 72-0H-H34  | 54530-24000 | 73-0H-H53   |
| 54500-2B100 | 72-0H-H26   | 54501-4A000 | 72-0H-H41  | 54530-24A00 | 73-0H-H53   |
| 54500-2C000 | 72-0H-H12   | 54501-4A600 | 72-0H-H41  | 54530-28000 | 53-0H-H54   |
| 54500-2D000 | 72-0H-H14   | 54501-4A801 | 72-0H-H43  | 54530-28A00 | 53-0H-H54   |
| 54500-33000 | 73-0H-H53L  | 5450102051  | 72-0H-H03  | 54530-31000 | 53-0H-H56   |
| 54500-34000 | 73-0H-H66L  | 545011C010  | 72-0H-H19  | 54530-31300 | 53-0H-H56   |
| 54500-38000 | 72-0H-H30   | 5450122100  | 73-0H-H54R | 54530-31600 | 73-0H-H57   |
| 54500-38011 | 72-0H-H32   | 545012C001  | 72-0H-H11  | 54530-37000 | 53-0H-H64   |
| 54500-4A000 | 72-0H-H42   | 545012C002  | 72-0H-H11  | 54530-3B000 | 73-0H-H13   |
| 54500-4A600 | 72-0H-H42   | 545012H000  | 72-0K-K07  | 54530-3S000 | 73-0H-H16   |



**CROSS REFERENCE LIST**  
**VERGLEICHSLISTE**  
**LISTA DE REFERENCIAS CRUZADES**  
**LISTE DE COMPARAISON**  
**LISTA DI COMPARAZIONE**

|             |             |             |            |             |             |
|-------------|-------------|-------------|------------|-------------|-------------|
| 54530-4A000 | 53-0H-H66   | 54555-3A100 | GOM-H27    | 54830-2B200 | 106-0H-H18  |
| 54530-4AA00 | 53-0H-H66   | 5455522101  | GOM-H04    | 54830-2C000 | 106-0H-H08  |
| 54530-4AA10 | 73-0H-H18   | 54556-22100 | GOM-H05    | 54830-2E000 | 106-0H-H31  |
| 5453002000  | 73-0H-H02   | 5455622101  | GOM-H05    | 54830-34000 | 106-0H-H44  |
| 5453007000  | 73-0K-K03   | 54584 2B000 | GOM-H17    | 54830-34500 | 106-0H-H53  |
| 5453021000  | 53-05-506L  | 54584 2S000 | GOM-H46    | 54830-36010 | 106-0H-H53  |
| 5453021A00  | 53-05-506L  | 54584-17000 | GOM-H15    | 54830-38100 | 106-0H-H22  |
| 5453037010  | 53-0H-H64   | 54584-1C300 | GOM-H12    | 54830-38110 | 106-0H-H24  |
| 545303B000  | 73-0H-H06   | 54584-1G000 | GOM-H09    | 54830-39000 | 106-0H-H33  |
| 545303B000  | 73-0H-H01   | 54584-2E000 | GOM-K46    | 54830-3A000 | 106-0H-H30  |
| 54540-21000 | 53-0H-H52R  | 54584-3K000 | GOM-H22    | 54830-3L000 | 106-0H-H25  |
| 54540-21100 | 53-0H-H52R  | 545842H000  | GOM-K16    | 54830-4A000 | 106-0H-H58  |
| 54540-21A00 | 53-0H-H52R  | 5458438100  | GOM-H20    | 54830-4A003 | 106-0H-H58  |
| 54540-43150 | 111-0H-H004 | 54610-02010 | GOM-H29    | 54830-4A800 | 106-0H-H58  |
| 54540-4B001 | 71-0H-H01   | 54610-34010 | GOM-H31    | 54830-4A802 | 106-0H-H58  |
| 5454021000  | 53-05-506R  | 54712-44150 | GOM-H35    | 54830-4H000 | 106-0H-H40  |
| 5454021100  | 53-05-506R  | 54812-07000 | GOM-H64    | 54830-M2000 | 106-0H-H57L |
| 5454021A00  | 53-05-506R  | 54812-1G100 | GOM-H08    | 548301E000  | 106-0H-H06  |
| 5454043150  | 73-05-514   | 54813-25000 | GOM-H59    | 5483029500  | 106-0H-H56  |
| 5454043151  | 111-0H-H004 | 54813-26100 | GOM-H34    | 548302H000  | 106-0K-K08  |
| 5454043151  | 73-05-514   | 54813-2C100 | GOM-H62    | 548302H100  | 106-0K-K08  |
| 5454043152  | GOM-H14     | 54813-2F000 | GOM-K48    | 548302S000  | 106-0H-H39  |
| 5454043152  | 111-0H-H004 | 54813-3A000 | GOM-H25    | 548302S200  | 106-0H-H39  |
| 5454043152  | 73-05-514   | 54813-3A100 | GOM-H25    | 5483034000  | 106-0H-H53  |
| 545404B001  | GOM-H13     | 54813-3K100 | GOM-H16    | 5483034500  | 106-0H-H44  |
| 5454743001  | 111-0H-H001 | 5481302100  | GOM-H36    | 5483037010  | 106-0H-H51  |
| 54550-H1000 | 73-0H-H12   | 5481317100  | GOM-H39    | 5483037020  | 106-0H-H51  |
| 54550-H1010 | 73-0H-H12   | 548131H100  | GOM-K05    | 5483039000  | 106-0H-H22  |
| 54551 26000 | GOM-H32     | 548132D102  | GOM-H37    | 548303K000  | 106-0H-H25  |
| 54551 2B000 | GOM-H18     | 548132H000  | GOM-K14    | 54840 4H000 | 106-0H-H41  |
| 54551-02000 | GOM-H03     | 54820-02000 | 106-0H-H07 | 54840 4H200 | 106-0H-H41  |
| 54551-1E000 | GOM-H10     | 54822-H1000 | 106-0H-H28 | 54840-0X000 | 106-0H-H35  |
| 54551-22000 | GOM-H03     | 54823-H1000 | 106-0H-H27 | 54840-1C000 | 106-0H-H11  |
| 54551-25000 | GOM-H06     | 54825-22000 | 106-0H-H01 | 54840-1G000 | 106-0H-H05  |
| 54551-2D000 | GOM-K45     | 54830 4H200 | 106-0H-H40 | 54840-1J000 | 106-0H-H37  |
| 54551-2E000 | GOM-K47     | 54830-0X000 | 106-0H-H34 | 54840-26000 | 106-0H-H15  |
| 54551-38000 | GOM-H19     | 54830-17010 | 106-0H-H02 | 54840-2B000 | 106-0H-H19  |
| 54551-3A000 | GOM-H26     | 54830-17020 | 106-0H-H03 | 54840-2B200 | 106-0H-H19  |
| 54551-3K000 | GOM-H23     | 54830-1C000 | 106-0H-H10 | 54840-2C000 | 106-0H-H09  |
| 5455122100  | GOM-H03     | 54830-1G000 | 106-0H-H06 | 54840-3A000 | 106-0H-H29  |
| 5455122200  | GOM-H03     | 54830-1J000 | 106-0H-H36 | 54840-M2000 | 106-0H-H57R |
| 5455129000  | GOM-H55     | 54830-25010 | 106-0H-H02 | 548401E100  | 106-0H-H05  |
| 545512H000  | GOM-K17     | 54830-25020 | 106-0H-H03 | 5511629000  | GOM-H61     |
| 5455138010  | GOM-H19     | 54830-26000 | 106-0H-H14 | 55118-1D000 | GOM-H63     |
| 54552-3K000 | GOM-H24     | 54830-28000 | 106-0H-H51 | 55130-34A00 | 53-0H-H65   |
| 54555 26000 | GOM-H33     | 54830-29000 | 111-0H-H93 | 55130-34A01 | 53-0H-H65   |
| 54555-22100 | GOM-H04     | 54830-29000 | 106-0H-H56 | 55130-37000 | 53-0H-H65   |
| 54555-25000 | GOM-H07     | 54830-2B000 | 106-0H-H18 | 551304D000  | GOM-K11     |



**CROSS REFERENCE LIST**  
**VERGLEICHSLISTE**  
**LISTA DE REFERENCIAS CRUZADAS**  
**LISTE DE COMPARAISON**  
**LISTA DI COMPARAZIONE**



|             |            |             |             |             |             |
|-------------|------------|-------------|-------------|-------------|-------------|
| 55160-1C100 | GOM-H58    | 56540-43000 | 103-0H-H53  | 56872-43000 | 111-05-515  |
| 55201-34000 | 53-0H-H67  | 565402H000  | 103-0K-K03  | 56872-43010 | 111-05-515  |
| 55201-34010 | 53-0H-H67  | 56820 4H000 | 111-0H-H24  | 56872-44000 | 111-0H-H60L |
| 55215-22000 | GOM-H53    | 56820 4H100 | 111-0H-H25  | 56940-44000 | 59-0H-H54   |
| 55219-25100 | GOM-H56    | 56820-02500 | 111-0H-H95  | 57716-34000 | 103-0H-H60  |
| 55250-34000 | 73-0H-H68  | 56820-0X000 | 111-0H-H18  | 57724 4H000 | 103-0H-H22  |
| 55256-44000 | GOM-H28    | 56820-0X900 | 111-0H-H19  | 57724 4H100 | 103-0H-H21  |
| 55513-22500 | GOM-H60    | 56820-11060 | 111-0H-H52  | 57724-0X000 | 103-0H-H17  |
| 55513-2E100 | GOM-H30    | 56820-1E000 | 111-0H-H04  | 57724-1E000 | 103-0H-H04  |
| 55513-2L000 | GOM-H43    | 56820-1E900 | 111-0H-H03  | 57724-1J000 | 103-0H-H18  |
| 5551317000  | GOM-H40    | 56820-21000 | 111-0H-H53  | 57724-2B000 | 103-0H-H11  |
| 555132D100  | GOM-H38    | 56820-21100 | 111-0H-H53  | 57724-2D000 | 103-0H-H06  |
| 55530 2B200 | 106-0H-H20 | 56820-21110 | 111-0H-H53  | 57724-2E000 | 103-0H-H16  |
| 55530 4H000 | 106-0H-H42 | 56820-21120 | 111-0H-H53  | 57724-38000 | 103-0H-H12  |
| 55530-17000 | 106-0H-H13 | 56820-22000 | 111-0H-H06  | 57724-38010 | 103-0H-H13  |
| 55530-26600 | 106-0H-H16 | 56820-25000 | 111-0H-H01  | 57724-3A000 | 103-0H-H15  |
| 55530-29000 | 111-0H-H91 | 56820-28000 | 111-0H-H54  | 57724-3K000 | 103-0H-H14  |
| 55530-2B000 | 106-0H-H20 | 56820-28500 | 111-0H-H57  | 577242D020  | 103-0H-H06  |
| 55530-2E000 | 106-0H-H32 | 56820-2B000 | 111-0H-H08  | 577242S000  | 103-0H-H20  |
| 55530-38000 | 106-0H-H21 | 56820-2B900 | 111-0H-H07  | 57729-4A000 | 103-0H-H08  |
| 55530-38600 | 106-0H-H23 | 56820-2E000 | 111-0H-H16  | 57730-24000 | 103-0H-H54  |
| 55530-3K001 | 106-0H-H26 | 56820-2E900 | 111-0H-H17  | 57730-24100 | 103-0H-H58  |
| 55530-4A001 | 106-0H-H12 | 56820-2K000 | 111-0H-H20  | 57730-28000 | 103-0H-H55  |
| 5553017010  | 106-0H-H13 | 56820-2K050 | 111-0H-H21  | 57730-28020 | 103-0H-H56  |
| 555301H000  | 106-0K-K09 | 56820-31000 | 111-0H-H55  | 57730-29000 | 103-0H-H63  |
| 555301H100  | 106-0K-K09 | 56820-36000 | 111-0H-H56  | 57730-29001 | 103-0H-H63  |
| 5553029500  | 111-0H-H91 | 56820-38000 | 111-0H-H12  | 57730-33100 | 103-0H-H56  |
| 555302S100  | 106-0H-H38 | 56820-38900 | 111-0H-H11  | 57730-43010 | 103-0H-H03  |
| 5553038010  | 106-0H-H21 | 56820-3B000 | 111-0H-H05  | 5773043000  | 103-0H-H01  |
| 55540 4H000 | 106-0H-H43 | 56820-3K000 | 111-0H-H14  | 5773043010  | 103-0H-H01  |
| 55540-26600 | 106-0H-H17 | 56820-3K010 | 111-0H-H13  | 57755-02000 | 103-0H-H05  |
| 555431H000  | GOM-K15    | 56820-H1002 | 59-0H-H50   | 57755-17000 | 103-0H-H09  |
| 555432H000  | GOM-K15    | 5682011060  | 111-05-501  | 57755-22000 | 103-0H-H01  |
| 55577-26600 | GOM-H41    | 5682021000  | 111-05-503R | 577551C000  | 103-0H-H07  |
| 555773A010  | GOM-H42    | 5682021100  | 111-05-503R | 5775522000  | 103-0H-H58  |
| 55580-37020 | 106-0H-H54 | 5682022000  | 111-0H-H57  | 5775522000  | 103-0H-H54  |
| 5558037030  | 106-0H-H54 | 5682025000  | 111-0H-H57  | 5777525000  | 103-0H-H03  |
| 55830-25000 | 106-0H-H04 | 568202H000  | 111-0K-K06  | 57780-38000 | 111-0H-H10  |
| 56540-02000 | 111-0H-H82 | 568202H090  | 111-0K-K05  | 57780-38010 | 111-0H-H09  |
| 56540-21001 | 103-0H-H51 | 568202S000  | 111-0H-H22  | 57780-3B000 | 111-0H-H15  |
| 56540-21010 | 103-0H-H51 | 568202S050  | 111-0H-H23  | 5778038000  | 111-0H-H12  |
| 56540-21100 | 103-0H-H51 | 5682036000  | 111-05-516  | 5778038010  | 111-0H-H11  |
| 56540-22000 | 103-0H-H53 | 5682037000  | 111-0H-H57  | 57785-26200 | 103-0H-H10  |
| 56540-24000 | 103-0H-H53 | 5682037010  | 111-0H-H57  | HB212-100   | 53-05-507   |
| 56540-24001 | 103-0H-H53 | 56830-36000 | 106-0H-H52  | HB212003    | 72-0H-H18   |
| 56540-25000 | 103-0H-H02 | 56840-11200 | 59-0H-H52   | HB212004    | 72-0H-H17   |
| 56540-28020 | 103-0H-H56 | 56850-H1011 | 105-0H-H01  | HB568110    | 111-0H-H70  |
| 56540-2K000 | 103-0H-H19 | 56850H1001  | 105-0H-H01  | HB568110    | 111-05-510  |



**CROSS REFERENCE LIST**  
**VERGLEICHSLISTE**  
**LISTA DE REFERENCIAS CRUZADES**  
**LISTE DE COMPARAISON**  
**LISTA DI COMPARAZIONE**

|                |               |               |             |               |             |
|----------------|---------------|---------------|-------------|---------------|-------------|
| HB568120       | 111-05-509    | 8-94200-320-1 | 73-09-903   | 8-94408-842-0 | GOM-915     |
| MB109630A      | 72-0H-H16     | 8-94200-320-2 | 73-09-903   | 8-94419-406-1 | 110-09-905  |
| MB109631A      | 72-0H-H15     | 8-94217-221-3 | 103-09-900  | 8-94419-407-1 | 110-09-905  |
| MB122135       | 103-05-501    | 8-94223-168-0 | GOM-906     | 8-94419-407-2 | 110-09-905  |
| MB243425A      | 110-0H-H52    | 8-94223-366-0 | GOM-909     | 8-94419-408-0 | 111-09-999  |
| MB243426A      | 110-0H-H52    | 8-94224-550-1 | 73-09-999   | 8-94419-408-1 | 111-09-999  |
| MB518892       | 106-05-501    | 8-94224-550-2 | 73-09-999   | 8-94419-409-0 | 111-09-998  |
| MB673525A      | 111-0H-H96    | 8-94224-550-3 | 73-09-999   | 8-94419-409-1 | 111-09-998  |
| MB673525B      | 111-0H-H96    | 8-94224-550-4 | 73-09-999   | 8-94419-608-2 | 111-09-905R |
| SB000036       | 111-0H-H70    | 8-94224-550-5 | 73-09-999   | 8-94419-609-2 | 111-09-905L |
| SB000037       | 111-0H-H69    | 8-94224-551-0 | 53-09-908R  | 8-94452-102-0 | 73-09-913   |
| ZB212100       | 53-05-507     | 8-94224-551-1 | 53-09-908R  | 8-94452-102-1 | 73-09-913   |
| <b>ISUZU</b>   | <b>ASHIKA</b> | 8-94224-551-2 | 53-09-908R  | 8-94452-104-0 | 53-09-906   |
| 5-44350-095-0  | 103-09-999    | 8-94224-552-1 | 53-09-906   | 8-94452-104-1 | 53-09-906   |
| 5-44350-095-1  | 103-09-999    | 8-94224-552-2 | 53-09-906   | 8-94452-106-0 | 53-09-908R  |
| 5-44350-095-2  | 103-09-999    | 8-94225-550-0 | 73-09-999   | 8-94452-107-0 | 53-09-908R  |
| 5-44350-095-3  | 103-09-999    | 8-94226-557-0 | GOM-908     | 8-94452-107-1 | 53-09-908R  |
| 5-44352-015-0  | 111-09-902R   | 8-94226-557-2 | GOM-908     | 8-94452-110-1 | 73-09-909   |
| 5-44352-015-1  | 111-09-902R   | 8-94226-967-0 | 73-09-909   | 8-94452-110-2 | 73-09-909   |
| 5-44352-015-2  | 111-09-902R   | 8-94226-967-1 | 73-09-909   | 8-94459-453-1 | 73-09-914   |
| 5-44352-016-0  | 111-09-902L   | 8-94226-967-2 | 73-09-909   | 8-94459-453-2 | 73-09-914   |
| 5-44352-016-1  | 111-09-902L   | 8-94231-4610  | 59-09-901   | 8-94459-453-3 | 73-09-914   |
| 5-44352-016-2  | 111-09-902L   | 8-94233-475-1 | 111-09-906R | 8-94459-456-1 | 73-09-913   |
| 5-44352-026-0  | 111-09-904    | 8-94233-476-1 | 111-09-997  | 8-94459-464-0 | 73-09-915   |
| 5-44352-070-0  | 111-09-902R   | 8-94234-319-0 | GOM-907     | 8-94459-464-1 | 73-09-915   |
| 5-44352-602-0  | 111-09-902R   | 8-94237-351-0 | 111-09-904  | 8-94459-464-2 | 73-09-915   |
| 5-44352-629-0  | 111-09-902R   | 8-94237-351-1 | 111-09-904  | 8-94459-464-3 | 73-09-915   |
| 5-44352-639-0  | 111-09-902R   | 8-94237-366-0 | 27-09-902   | 8-94459-465-2 | 73-09-913   |
| 5-51220-003-0  | 73-09-901     | 8-94237-366-1 | 27-09-902   | 8-94459-475-0 | 27-09-904   |
| 5-51220-029-1  | 73-09-901     | 8-94237-367-0 | 27-09-902   | 8-94459-478-0 | 110-09-903  |
| 5-51220-029-2  | 73-09-901     | 8-94237-367-1 | 27-09-902   | 8-94459-478-1 | 110-09-903  |
| 5-51220-033-0  | 73-09-901     | 8-94237-800-0 | 59-09-901   | 8-94459-480-0 | 111-09-999  |
| 5-51227-033-0  | 53-09-908R    | 8-94241-767-0 | 52-09-912   | 8-94459-480-1 | 111-09-999  |
| 8 97 018 166 1 | GOM-915       | 8-94243-234-0 | 73-09-999   | 8-94459-480-2 | 111-09-999  |
| 8-64452-106-1  | 53-09-908R    | 8-94243-236-1 | 53-09-908R  | 8-94459-481-0 | 111-09-998  |
| 8-91733-866-0  | GOM-903       | 8-94246-236-0 | 53-09-908R  | 8-94459-481-1 | 111-09-998  |
| 8-92223-475-1  | 73-09-909     | 8-94246-475-0 | 53-09-906   | 8-94459-481-2 | 111-09-998  |
| 8-94103-222-2  | 111-09-905R   | 8-94246-475-1 | 53-09-906   | 8-94472-255-0 | 73-09-999   |
| 8-94103-223-2  | 111-09-905L   | 8-94250-316-0 | 73-09-903   | 8-94472-255-2 | 73-09-999   |
| 8-94109-041-1  | 111-09-912    | 8-94255-456-0 | 73-09-903   | 8-97018-125-2 | 106-09-916  |
| 8-94109-041-2  | 111-09-912    | 8-94328-799-0 | GOM-934     | 8-97018227-2  | 106-09-900  |
| 8-94109-041-3  | 111-09-912    | 8-94366-606-0 | 103-09-905  | 8-97018228-2  | 106-09-901  |
| 8-94109-704-1  | 53-09-908L    | 8-94369-924-0 | 111-09-997  | 8-97020-953-1 | 111-09-999  |
| 8-94109-704-1  | 53-09-908R    | 8-94369-925-0 | 111-09-906R | 8-97020-954-1 | 111-09-998  |
| 8-94124-585-1  | 111-09-906R   | 8-94374-424-0 | 73-09-917   | 8-97020-954-2 | 111-09-998  |
| 8-94124-586-0  | 111-09-997    | 8-94375282-5  | GOM-901     | 8-97025-752-0 | GOM-932     |
| 8-94124-586-1  | 111-09-997    | 8-94375283-2  | GOM-902     | 8-97025-753-0 | GOM-900     |
| 8-94200-320-0  | 73-09-903     | 8-94408-840-3 | GOM-910     | 8-97028-967-0 | 59-09-997   |

**CROSS REFERENCE LIST**  
**VERGLEICHSLISTE**  
**LISTA DE REFERENCIAS CRUZADAS**  
**LISTE DE COMPARAISON**  
**LISTA DI COMPARAZIONE**



|                 |             |               |               |             |             |
|-----------------|-------------|---------------|---------------|-------------|-------------|
| 8-97039-325-1   | 59-09-997   | 9-51151-023-0 | GOM-912       | 5135 651AB  | 73-09-905   |
| 8-97104-157-1RH | GOM-904     | 9-51227-704-0 | 53-09-908R    | 5143 555AB  | 111-09-914  |
| 8-97104-158-1LH | GOM-905     | 9-51227-704-1 | 53-09-908R    | 5143 556AB  | 111-09-913  |
| 8-97234-977-2   | GOM-917     | 9-51351-029-0 | GOM-913       | 5143555AC   | 111-09-914  |
| 8-972349762     | GOM-916     | 94020795      | 53-09-908R    | 5143556AC   | 111-09-913  |
| 8-97235-786-1   | 106-09-909  | 94021476      | 111-09-902R   | 5174185AB   | 106-09-913  |
| 8-97235-787-0   | 106-09-908  | 94021477      | 111-09-902L   | 5183761AA   | 111-09-911  |
| 8-972357760     | 73-09-913   | 94021716      | 73-09-901     | 52000598    | 111-00-J009 |
| 8-972357770     | 73-09-906   | 94025674      | 111-09-902R   | 52001145    | GOM-925     |
| 8-973048510     | 103-09-902  | 94025675      | 111-09-902L   | 52001162    | 111-0J-J013 |
| 8-973048550     | 111-09-915  | 94025980      | 111-09-902R   | 52003-360   | 106-09-903  |
| 8-973049280     | 111-09-915  | 94025981      | 111-09-902L   | 52003232    | GOM-921     |
| 8-97332-642-0   | GOM-918     | 94025984      | 73-09-901     | 52005738    | 111-00-J006 |
| 8-97357-492-0   | GOM-919     | 94027778      | 103-09-999    | 52005739    | 111-00-J010 |
| 8-97365-010-0   | 72-09-905   | 94028101      | 53-09-908R    | 52005740    | 111-00-J003 |
| 8-97365-011-0   | 72-09-904   | 94028225      | 111-09-904    | 52005741    | 111-00-J004 |
| 8-97365-012-0   | 72-09-907   | 94109704      | 53-09-908L    | 52006592    | 111-00-J011 |
| 8-97365-013-0   | 72-09-906   | 94200320      | 73-09-903     | 52037 849   | 106-09-902  |
| 8-97365-014-0   | 72-09-909   | 94200328      | 73-09-903     | 52037994    | 111-09-903  |
| 8-97365-015-0   | 72-09-908   | 94217221      | 111-09-904    | 52087710    | 111-00-J007 |
| 8-97365-016-0   | 72-09-911   | 94224550      | 73-09-999     | 52087711    | 111-00-J007 |
| 8-97365-017-0   | 72-09-910   | 94224551      | 53-09-908R    | 52088 283   | 106-09-905  |
| 8-97365-021-0   | 73-09-913   | 94224552      | 53-09-906     | 52088 461   | 111-09-907  |
| 8-973650180     | 73-09-906   | 94224701      | 111-09-904    | 52088 511   | 111-09-908  |
| 8-973672720     | GOM-916     | 94233475      | 111-09-906R   | 52088 869AA | 111-09-910  |
| 8-979445750     | 106-09-918  | 94237351      | 111-09-904    | 52088 870AA | 111-09-909  |
| 8942432360      | 53-09-908R  | 94243234      | 73-09-999     | 52088125    | GOM-926     |
| 8944521061      | 53-09-908R  | 94243236      | 53-09-908R    | 52088208-AC | 111-0J-J014 |
| 8944594532      | 73-09-999   | 94246475      | 53-09-906     | 52088217-AB | 111-0J-J012 |
| 8944594533      | 73-09-999   | 9445104       | 53-09-906     | 52088312    | 111-00-J000 |
| 8944594651      | 73-09-913   | 94452106      | 53-09-908R    | 52088355AB  | 72-09-903   |
| 8970209540      | 111-09-998  | 94452110      | 53-09-909     | 52088378    | GOM-924     |
| 8979406160      | 111-09-999  | 94459453      | 73-09-914     | 52088437    | 106-09-904  |
| 897956902A      | 111-09-999  | 94459464      | 73-09-915     | 52088523    | GOM-922     |
| 9-43150-038-0   | 111-09-901R | 94459480      | 111-09-999    | 52088524    | GOM-923     |
| 9-43150-039-0   | 111-09-901L | 94459481      | 111-09-998    | 52088778AB  | GOM-920     |
| 9-43150-053-0   | 111-09-901R | 97028967      | 59-09-997     | 52089 467AB | 106-09-906  |
| 9-43150-054-0   | 111-09-901L |               |               | 52089486AC  | 106-09-907  |
| 9-43150-601-0   | 111-09-901R | <b>JEEP</b>   | <b>ASHIKA</b> | 52089486AE  | 106-09-907  |
| 9-43150-602-0   | 111-09-901L | 05012432AA    | 73-09-902     | 52089980AF  | 72-09-901   |
| 9-43150-605-0   | 111-09-901R | 05012432AA    | 73-09-900     | 52089980AG  | 72-09-901   |
| 9-43150-606-0   | 111-09-901L | 051894419AA   | 111-09-918    | 52089981AF  | 72-09-902   |
| 9-43150-612-0   | 111-09-901R | 5012 432AA    | 73-09-900     | 52089981AG  | 72-09-902   |
| 9-43150-613-0   | 111-09-901L | 5012432AA     | 73-09-902     | 52124302AA  | GOM-930     |
| 9-44352-071-0   | 111-09-902L | 50724444AA    | 111-09-917    | 5289 486AC  | 106-09-907  |
| 9-44352-603-0   | 111-09-902L | 50724445AA    | 111-09-918    | 68003671AA  | 111-09-917  |
| 9-44352-630-0   | 111-09-902L | 5105040AB     | 72-09-913     | 83500 202   | 111-00-J001 |
| 9-44352-640-0   | 111-09-902L | 5105041AB     | 72-09-912     | 83500202    | 111-00-J002 |
|                 |             | 5105103AC     | GOM-931       |             |             |



**CROSS REFERENCE LIST**  
**VERGLEICHSLISTE**  
**LISTA DE REFERENCIAS CRUZADES**  
**LISTE DE COMPARAISON**  
**LISTA DI COMPARAZIONE**

|               |               |               |            |               |            |
|---------------|---------------|---------------|------------|---------------|------------|
| E6770TU       | 111-00-J008   | OK2FA34340    | 72-0K-K01  | OK9A2-34300   | 72-0K-K09  |
| <b>KIA</b>    | <b>ASHIKA</b> | OK2FK 32240   | 103-0K-K00 | OK9A2-34350   | 72-0K-K10  |
| 0G030-32-550A | 73-0K-K51     | OK2KB 34156A  | GOM-K01    | OK9A2-34464   | GOM-K20    |
| 0G030-34550B  | 73-03-317     | OK2M228150    | 106-0K-K54 | OK9A2-3446X   | GOM-K21    |
| OK011-32-230  | 111-0K-K66L   | OK2N1 34150A  | 106-0K-K19 | OK9A2-34470   | GOM-K19    |
| OK011-32-240A | 111-0K-K67L   | OK2N1 34170A  | 106-0K-K20 | OK9A232280    | 111-0K-K69 |
| OK011-32-250A | 111-0K-K67R   | OK2NA 34156   | GOM-K30    | OK9A232280    | 111-0K-K65 |
| OK011-32-260A | 27-0K-K54     | OK2NA 34300B  | 72-0K-K17  | OK9A3-28-170  | 106-0K-K53 |
| OK011-32-270A | 105-0K-K51L   | OK2NA 34350B  | 72-0K-K18  | OK9A3-28-170A | 106-0K-K53 |
| OK011-32-280  | 111-0K-K66R   | OK30A 34480 C | GOM-K27    | OK9A6-34300   | 72-0K-K11  |
| OK011-32-290A | 105-0K-K51R   | OK30B 34300B  | 71-0K-K01  | OK9A6-34350   | 72-0K-K12  |
| OK011-34-150A | 106-0K-K28    | OK30B 34350B  | 71-0K-K02  | OK9A6-3446X   | GOM-K23    |
| OK011-34-200  | 71-0K-K57     | OK33C 34150A  | 106-0K-K15 | OK9A6-3446Y   | GOM-K22    |
| OK011-34-300D | 26-0K-K56     | OK33C 34160A  | 106-0K-K16 | OS083-34-300B | 26-0K-K51L |
| OK011-34-510B | 53-0K-K58     | OK522-32-250  | 111-0K-K96 | OS083-34-350B | 26-0K-K51R |
| OK01132270A   | 111-0K-K67L   | OK522-32-270  | 111-0K-K95 | OSE46-34-200  | 71-0K-K52L |
| OK201 32240   | 103-0K-K08    | OK552-32-240  | 111-0K-K94 | OSE46-34-200A | 71-0K-K52L |
| OK201-32-280  | 111-0K-K65    | OK552-32-280  | 111-0K-K93 | OSE46-34-250  | 71-0K-K52R |
| OK201-32-280A | 111-0K-K65    | OK552-34-150B | 106-0K-K58 | 51760 2G000   | 73-0K-K01  |
| OK201-34-300C | 26-0K-K53R    | OK552-34-151B | 106-0K-K58 | 517600Q000    | 73-0K-K01  |
| OK201-34-350C | 26-0K-K53L    | OK552-34-160B | 106-0K-K58 | 517601G000    | 73-0H-H04  |
| OK201-34-550C | 53-0K-K57     | OK552-34-300A | 26-0K-K55R | 517602E000    | 73-0H-H14  |
| OK20132240    | 103-0K-K58    | OK552-34-300B | 26-0K-K55R | 517602H000    | 73-0K-K01  |
| OK20132280    | 111-0K-K69    | OK552-34-350A | 26-0K-K55L | 54410-3E000   | 72-0K-K24  |
| OK20132280A   | 111-0K-K69    | OK552-34-350B | 26-0K-K55L | 54410-3E001   | 72-0K-K24  |
| OK20134550D   | 53-03-322     | OK55232250    | 111-0K-K96 | 54410-3E002   | 72-0K-K24  |
| OK20134550E   | 53-03-322     | OK55232250A   | 111-0K-K96 | 544203E000    | 72-0K-K23  |
| OK203 32240   | 103-0K-K09    | OK55232270    | 111-0K-K95 | 544203E001    | 72-0K-K23  |
| OK20332240A   | 103-0K-K09    | OK55234300C   | 26-0K-K55R | 544203E002    | 72-0K-K23  |
| OK2A1 3446X   | GOM-K03       | OK55234350C   | 26-0K-K55L | 54480-3E001   | GOM-K49    |
| OK2A1 3446Y   | GOM-K04       | OK60A 32270   | 103-0K-K05 | 54480-3E002   | GOM-K50    |
| OK2A1-32-240  | 103-0K-K58    | OK60A32270A   | 103-0K-K05 | 54480-3E100   | GOM-K51    |
| OK2A1-34-150A | 106-0K-K54    | OK670-32-240  | 111-0K-K56 | 54500 07200   | 72-0K-K14  |
| OK2A1-34-150B | 106-0K-K54    | OK670-32-450  | 111-0K-K58 | 54500 1D000   | 72-0K-K04  |
| OK2A1-34-170A | 106-0K-K55    | OK670-32-510  | 111-0K-K57 | 54500 2F000   | 72-0K-K22  |
| OK2A1-34-550A | 53-0K-K60     | OK710-34-510  | 73-03-314  | 54500 2F001   | 72-0K-K22  |
| OK2A2 32240   | 103-0K-K51    | OK71032240    | 111-0A-A04 | 54500 2H000   | 72-0K-K08  |
| OK2A5-34-150  | 106-0K-K55    | OK71034540    | 73-03-313  | 54500 2P000   | 72-0K-K26  |
| OK2A5-34-150A | 106-0K-K55    | OK72A 32270   | 103-0K-K04 | 54500 4D001   | 72-0K-K06  |
| OK2A5-34-150B | 106-0K-K55    | OK72A 34150A  | 106-0K-K14 | 54500-07100   | 72-0K-K14  |
| OK2A5-34-150C | 106-0K-K55    | OK72A 34510A  | 73-0K-K04  | 54500-FD000   | 71-0K-K06  |
| OK2AA-28-500  | 71-0K-K03     | OK72A-32-240  | 111-0K-K68 | 545001E100    | 72-0H-H08  |
| OK2C0 34460   | GOM-K02       | OK72A-34-200  | 72-0K-K00  | 545001F000    | 72-0K-K20  |
| OK2FA 34150   | 106-0K-K01    | OK72A-34-200A | 72-0K-K00  | 54501 07200   | 72-0K-K13  |
| OK2FA 34170   | 106-0K-K02    | OK72A32240A   | 111-0K-K68 | 54501 1D000   | 72-0K-K03  |
| OK2FA 34300   | 72-0K-K01     | OK72A32270A   | 103-0K-K04 | 54501 2F000   | 72-0K-K21  |
| OK2FA 34350   | 72-0K-K02     | OK9A2-32-240  | 103-0K-K58 | 54501 2F001   | 72-0K-K21  |
| OK2FA-34-550  | 53-0K-K60     | OK9A2-34156   | GOM-K18    | 54501 2H000   | 72-0K-K07  |

**CROSS REFERENCE LIST**  
**VERGLEICHSLISTE**  
**LISTA DE REFERENCIAS CRUZADES**  
**LISTE DE COMPARAISON**  
**LISTA DI COMPARAZIONE**



|             |            |             |            |                   |               |
|-------------|------------|-------------|------------|-------------------|---------------|
| 54501 2P000 | 72-0K-K25  | 54830-2K000 | 106-0K-K24 | 57724 07100       | 103-0K-K06    |
| 54501 4D001 | 72-0K-K05  | 54830-3E000 | GOM-K38    | 57724 2G000       | 103-0K-K01    |
| 54501-07100 | 72-0K-K13  | 54830-3E020 | GOM-K35    | 57724 4D000       | 103-0K-K02    |
| 54501-FD000 | 71-0K-K05  | 548301E000  | 106-0H-H06 | 57724-1G000       | 103-0K-K12    |
| 545011E100  | 72-0H-H07  | 548301G000  | 106-0H-H06 | 57724-1G100       | 103-0K-K13    |
| 545011F100  | 72-0K-K19  | 548302H100  | 106-0K-K08 | 57724-2P000       | 103-0K-K15    |
| 54510 3E001 | 72-0K-K16  | 54840 07000 | 106-0K-K13 | 57724-2P100       | 103-0K-K14    |
| 545103E002  | 72-0K-K16  | 54840 2F000 | 106-0K-K11 | 577242D000        | 103-0H-H06    |
| 545103E003  | 72-0K-K16  | 54840 2K000 | 106-0K-K25 | 577242D020        | 103-0H-H06    |
| 54520-3E001 | 72-0K-K15  | 54840 4D000 | 106-0K-K05 | 577242E000        | 103-0H-H16    |
| 545203E002  | 72-0K-K15  | 548401E100  | 106-0H-H05 | 577242G010        | 103-0K-K01    |
| 545203E003  | 72-0K-K15  | 548401G000  | 106-0H-H05 | 57731 3E010       | 103-0K-K11    |
| 54530 07000 | 73-0K-K03  | 55130 4D000 | GOM-K11    | 57732 3E010       | 103-0K-K10    |
| 54530 4D000 | 73-0K-K02  | 55227-2D000 | GOM-K36    | F4BZ-3280A        | 103-0K-K54    |
| 5453031600  | 73-0H-H57  | 55250 1H000 | 71-0K-K00  | FMBZ-3A130-A      | 111-0K-K62    |
| 54551 07000 | GOM-K26    | 55250 2H000 | 71-0K-K00  | GA2C-28-170A      | 106-0K-K51    |
| 54551 1D000 | GOM-K09    | 55513 2G000 | GOM-K06    | KB092-32-280      | 111-0K-K61    |
| 54551 2H000 | GOM-K17    | 55513-3E000 | GOM-K52    | KB09232280        | 111-03-325    |
| 54551 4D000 | GOM-K13    | 55530 1D000 | 106-0K-K04 | KDX50 32240B      | 103-0K-K50    |
| 545514D001  | GOM-K13    | 55530 1F000 | 106-0H-H32 | KDX53-32-240      | 103-0K-K54    |
| 54570 3E000 | 73-0K-K05  | 55530 1H000 | 106-0K-K09 | KDX53-32-240A     | 103-0K-K54    |
| 54570 3E001 | 73-0K-K05  | 55530 4D000 | 106-0K-K07 | KDX5332240B       | 103-0K-K54    |
| 54580 3E001 | GOM-K28    | 55530-3E010 | GOM-K31    | KG2C-28-170A      | 106-0K-K51    |
| 545803E002  | GOM-K28    | 55530-3E020 | GOM-K32    | KGA2A-34-150      | 106-0K-K52R   |
| 54584 07000 | GOM-K25    | 5553017000  | 106-0H-H13 | KGA2A-34-150A     | 106-0K-K52R   |
| 54584 1D000 | GOM-K08    | 5553017010  | 106-0H-H13 | KGA2A-34-170      | 106-0K-K52L   |
| 54584 2H000 | GOM-K16    | 555301H100  | 106-0K-K09 | KGA2A-34-170A     | 106-0K-K52L   |
| 54584 4D000 | GOM-K12    | 55543 1H000 | GOM-K15    | KH380-28-170B     | 106-0K-K57    |
| 545844D001  | GOM-K12    | 55543 2G000 | GOM-K07    | KH380-34-170C     | 106-0K-K56    |
| 54590 3E000 | GOM-K29    | 555432H000  | GOM-K15    | KK150-32-240      | 103-0K-K53    |
| 54620-07000 | GOM-K37    | 55580-3E000 | 106-0K-K26 | KKY01-32-280      | 111-0K-K61    |
| 54810 3E000 | 106-0K-K21 | 55580-3E050 | 106-0K-K27 | KKY01-34-310      | 73-0K-K52     |
| 54811 3E010 | 106-0K-K22 | 56540 2H000 | 103-0K-K03 | KKY01-34-390A     | 73-0K-K52     |
| 54811 3E060 | 106-0K-K23 | 56820 07000 | 111-0K-K07 | KKY0132280        | 111-03-325    |
| 54812 07100 | GOM-K24    | 56820 2G000 | 111-0K-K02 | MB092-32-280      | 111-0K-K61    |
| 548121G100  | GOM-H08    | 56820 2G900 | 111-0K-K01 | MD00134153A       | GOM-K44       |
| 54813 1H100 | GOM-K05    | 56820 2H000 | 111-0K-K06 | MDX50-32-280      | 111-0K-K62    |
| 54813 2H000 | GOM-K14    | 56820 2H090 | 111-0K-K05 | OK20134550C       | 53-03-322     |
| 54813 4D000 | GOM-K10    | 56820 3E000 | 111-0K-K08 | OK552-32-250      | 111-0K-K96    |
| 54813-2E100 | GOM-K34    | 56820 3E900 | 111-0K-K09 | OK552-32-270      | 111-0K-K95    |
| 54813-FD000 | GOM-K33    | 56820 4D000 | 111-0K-K04 | OK9A2-32-280      | 111-0K-K65    |
| 54820 FD000 | 106-0K-K18 | 56820 4D100 | 111-0K-K03 | <b>LAND ROVER</b> | <b>ASHIKA</b> |
| 54830 07000 | 106-0K-K12 | 56820 4D101 | 111-0K-K03 | 572337            | 111-0L-L002   |
| 54830 2F000 | 106-0K-K10 | 56820-1G000 | 111-0K-K11 | 575 882           | 111-0L-L007   |
| 54830 2H000 | 106-0K-K08 | 56820-1G900 | 111-0K-K10 | ANR 1799          | 111-0L-L002   |
| 54830 4D000 | 106-0K-K06 | 56820-4D001 | 111-0K-K04 | ANR 3304          | 106-0L-L07    |
| 54830 FD000 | 106-0K-K17 | 5682025000  | 111-0H-H01 | FTC 3570          | 73-0L-L01     |
| 54830-2G000 | 106-0K-K03 | 57724 07000 | 103-0K-K07 | FTC 3571          | 73-0L-L02     |



**CROSS REFERENCE LIST**  
**VERGLEICHSLISTE**  
**LISTA DE REFERENCIAS CRUZADES**  
**LISTE DE COMPARAISON**  
**LISTA DI COMPARAZIONE**

|            |             |            |             |                 |               |
|------------|-------------|------------|-------------|-----------------|---------------|
| KKB000270  | GOM-L14     | RBJ102930  | 72-0L-L02   | TIQ 000040      | 103-0L-L03    |
| KKB000280  | GOM-L15     | RBK 500012 | GOM-L13     | TIQ000010       | 27-0L-L02     |
| LR0 02609  | 111-0L-L017 | RBK 500030 | 73-0L-L03   | TIQ100000       | 27-0L-L02     |
| LR0 02610  | 111-0L-L018 | RBK 500040 | 73-0L-L04   | <b>LEXUS</b>    | <b>ASHIKA</b> |
| LR0 02876  | 106-0L-L13  | RBK 500150 | 73-0L-L06   | 4333029405      | 73-02-209     |
| LR002624   | 72-0L-L07   | RBK 500170 | 73-0L-L07   | 4333029615      | 73-02-209     |
| LR002625   | 72-0L-L06   | RBK 500210 | 73-0L-L06   | 4333039435      | 73-02-239     |
| LR002626   | 106-0L-L12  | RBK500180  | 73-0L-L04   | 4334029175      | 73-02-208     |
| LR007205   | 72-0L-L07   | RBM 000011 | 106-0L-L09  | 4334029215      | 73-02-208     |
| LR007206   | 72-0L-L06   | RBM 100170 | 106-0L-L06  | 4504629255      | 111-02-283    |
| LR018343   | 71-0L-L03   | RBM 100223 | 106-0L-L02  | 45460 59035     | 111-02-2023   |
| LR018344   | 71-0L-L02   | RBM 500140 | 106-0L-L11  | 45470 59035     | 111-02-2022   |
| LR018345   | GOM-L04     | RBM 500150 | 106-0L-L10  | 45503 30070     | 103-02-251    |
| LR018347   | GOM-L07     | RBM 500190 | 106-0L-L04  | 45503 39105     | 103-02-248    |
| LR018354   | GOM-L08     | RBM100171  | 106-0L-L06  | 45503-29785     | 103-02-248    |
| NRC 1823   | 111-0L-L009 | RBM100172  | 106-0L-L06  | 48068 53010     | 71-02-203     |
| NRC 4745   | 111-0L-L004 | RBX 000070 | GOM-L03     | 48068 59025     | 71-02-203     |
| NRC 6007   | 111-0L-L003 | RBX 000200 | GOM-L04     | 48069 53010     | 71-02-204     |
| NRC 9743   | 27-0L-L00   | RBX 101160 | GOM-L01     | 48069 59025     | 71-02-204     |
| NTC 1888   | 106-0L-L01  | RBX 101780 | GOM-L02     | 48610 59025     | 72-02-259     |
| NTC1886    | 111-0L-L003 | RBX 500280 | GOM-L07     | 48630 59025     | 72-02-258     |
| NTC1887    | 111-0L-L004 | RBX 500432 | GOM-L10     | 48810 53010     | 106-02-256    |
| NTC4260    | 111-0L-L002 | RBX 500443 | GOM-L09     | 4881033010      | 106-02-216    |
| NTC8533    | 111-0L-L002 | RBX 500531 | GOM-L11     | 48820 22041     | 106-02-253    |
| NTC9932    | 111-0L-L002 | RBX101790  | GOM-L01     | 48820 53010     | 106-02-257    |
| QFK 500010 | 103-0L-L01  | RBX101860  | GOM-L02     | 4882028050      | 106-02-218    |
| QFK 500020 | 103-0L-L02  | RDG 100682 | 106-0L-L03  | 48830 30090     | 106-02-255    |
| QFK 500030 | 103-0L-L04  | RGD 000180 | 106-0L-L08  | 48830 51010     | 106-02-254    |
| QFK50040   | 27-0L-L00   | RGD 000311 | 106-0L-L05  | 4883048010      | 106-02-219    |
| QFS000010  | 111-0L-L010 | RGD 500083 | 103-0L-L00  | <b>MAHINDRA</b> | <b>ASHIKA</b> |
| QFS100060  | 111-0L-L010 | RGD 500140 | 106-0L-L14  | 0401BA0140N     | 73-00-004     |
| QHG000050  | 27-0L-L01   | RGD 500180 | 106-0L-L08  | 0401BA0280N     | 73-00-005     |
| QHG100010  | 27-0L-L01   | RGD000312  | 106-0L-L05  | 0401EA0360N     | 106-00-001    |
| QJB 100220 | 111-0L-L013 | RGD100682  | 106-0L-L03  | 0401EA0370N     | 106-00-002    |
| QJB 100230 | 111-0L-L012 | RGD500100  | 106-0L-L08  | <b>MAZDA</b>    | <b>ASHIKA</b> |
| QJB 500010 | 111-0L-L011 | RGX 500070 | GOM-L08     | 0131-34-540A    | 73-03-309     |
| QJB 500040 | 111-0L-L016 | RHF 000260 | GOM-L05     | 0305-99-324     | 111-03-303    |
| RBJ 000120 | 71-0L-L03   | RHF 500031 | GOM-L12     | 0305-99-324A    | 111-03-303    |
| RBJ 000130 | 71-0L-L02   | RHF 500100 | GOM-L12     | 0305-99-356     | 53-03-303     |
| RBJ 102440 | 72-0L-L01   | RHF500110  | 111-0L-L002 | 0603-99-324     | 111-03-302    |
| RBJ 102450 | 72-0L-L02   | RTC 5869   | 111-0L-L005 | 0603-99-325     | 111-03-302    |
| RBJ 500446 | 72-0L-L03   | RTC 5870   | 111-0L-L006 | 0662-99-322     | 111-03-334    |
| RBJ 500456 | 72-0L-L04   | RTC1800    | 111-0L-L003 | 0662-99-324     | 111-03-323    |
| RBJ 500710 | 71-0L-L01   | RTC5869    | 111-0L-L003 | 0866-32-320     | 59-03-308     |
| RBJ 500920 | 71-0L-L01   | RTC5870    | 111-0L-L004 | 0866-99-322     | 111-03-306    |
| RBJ102920  | 73-0L-L05   | STC 1871   | 111-0L-L010 | 0866-99-324     | 111-03-305    |
| RBJ102920  | 72-0L-L01   | STC1871    | 111-0L-L010 | 0866-99-324B    | 111-03-305    |
| RBJ102930  | 73-0L-L05   | TIQ 000030 | 111-0L-L015 | 1010037         | GOM-300       |

**CROSS REFERENCE LIST**  
**VERGLEICHSLISTE**  
**LISTA DE REFERENCIAS CRUZADES**  
**LISTE DE COMPARAISON**  
**LISTA DI COMPARAZIONE**



|              |             |               |             |               |             |
|--------------|-------------|---------------|-------------|---------------|-------------|
| 1011857      | 111-03-337  | 2370-99-324   | 111-03-303  | B01A 34 350   | 72-03-306   |
| 1015265      | 106-03-300  | 2469-99-324   | 111-03-303  | B01A-34-550   | 73-03-327   |
| 1063236      | 72-03-303   | 2541-99-324A  | 111-03-302  | B01A-34-550A  | 73-03-327   |
| 1063255      | 72-03-302   | 2L8Z3079AA    | 73-03-305   | B01C34380     | GOM-325     |
| 1130273      | 106-03-300  | 3625-99-322   | 111-03-306  | B029-34159    | 106-03-301  |
| 1146150      | 106-03-312  | 3874-99-324   | 111-03-302  | B037-32-280   | 111-0A-A04  |
| 1175-99-322  | 111-03-316  | 3958-99-324B  | 111-03-305  | B038-32-135   | 103-03-305  |
| 1175-99-322A | 111-03-316  | 4084-99-324B  | 111-03-305  | B06799325     | 111-03-318R |
| 1175-99-324  | 111-03-315  | 4342539       | 103-03-327  | B092-32-240   | 103-03-310  |
| 1175-99-324A | 111-03-315  | 8021-99-324   | 111-03-314  | B092-34-550   | 53-03-322   |
| 1175-99-324X | 105-03-301  | 8037-32-320   | 59-03-308   | B093-32-240   | 103-03-309R |
| 1177-99-324  | 111-03-305  | 8038-99-322   | 111-03-316  | B093-32-250   | 103-03-309L |
| 1177-99-324A | 111-03-305  | 8038-99-356   | 73-03-316   | B09332240     | 103-03-309L |
| 1363-99-322  | 111-03-310R | 8173-32-322   | 111-03-319  | B094-32-240   | 103-03-310  |
| 1363-99-323  | 111-03-310L | 8173-99-322   | 111-03-319  | B210-32-240   | 103-03-310  |
| 1391-99-322  | 111-03-309  | 8173-99-356   | 53-03-307   | B211-32-240   | 103-03-313R |
| 1391-99-354  | 73-03-309   | 8531-32-320   | 59-03-308   | B21H 32 24X   | 103-03-319  |
| 1391-99-354A | 73-03-309   | 8531-99-322   | 111-03-312  | B21H3225X     | 103-03-319  |
| 1513343      | 106-03-321  | 8531-99-322A  | 111-03-312  | B25D 32 240   | 103-03-320  |
| 1524-99-322  | 111-03-306  | 8531-99-324   | 73-03-399   | B25D 32 250   | 103-03-321  |
| 1524-99-324  | 111-03-305  | 8531-99-356   | 53-03-307   | B25D 34 300A  | 72-03-309   |
| 1907-99-324  | 111-03-314  | 8559-99-354   | 73-03-318   | B25D 34 350A  | 72-03-308   |
| 1907-99-324A | 111-03-314  | 8650-99-356   | 73-03-316   | B25D 34 460   | GOM-306     |
| 1E00 34 300A | 72-03-301   | 8AB1-32-280   | 111-03-325  | B25D 34 470   | GOM-305     |
| 1E00 34 350A | 72-03-300   | 8AB2-32-280   | 111-03-334  | B25D-28-380-B | GOM-343     |
| 1E00-28-460C | GOM-322     | 8AG1 28 100A  | 106-03-302  | B25D-28-390-B | GOM-344     |
| 1E00-34-156  | GOM-321     | 8AG1-32-280   | 111-03-330  | B25D-34-380A  | GOM-328     |
| 1E0028460B   | GOM-322     | 8AG3 32 280   | 111-03-339  | B25D32240     | 103-03-321  |
| 1E0032240    | 103-03-311  | 8AG4 32 280   | 111-03-338  | B25D34300B    | 72-03-309   |
| 1E0032280A   | 111-03-337  | 8AG432280     | 111-03-339  | B25D34300C    | 72-03-309   |
| 1E0034153A   | GOM-300     | 8AH1-32-280   | 111-03-322  | B25D34300D    | 72-03-309   |
| 1E0034300B   | 72-03-301   | 8AH132280     | 111-03-309  | B25D34300D    | 73-03-302   |
| 1E0034300D   | 72-03-301   | 8AH3-32-280   | 111-03-332  | B25D34350B    | 72-03-308   |
| 1E0034300E   | 72-03-301   | 8AL1-32-280   | 111-03-350  | B25D34350C    | 72-03-308   |
| 1E0034300F   | 72-03-301   | 8AN1-32-280   | 111-03-300  | B25D34350D    | 72-03-308   |
| 1E01 34 153A | GOM-301     | 8AU1-32-280   | 111-03-329  | B25D34350D    | 73-03-302   |
| 1E0132280A   | 111-03-336  | 8AU1-34-510   | 53-03-321   | B26 R 28 170  | 106-03-309  |
| 1E0134300A   | 72-03-303   | 8AU1-34-540   | 111-03-320  | B26 R 34 170  | 106-03-306  |
| 1E0134300B   | 72-03-303   | 8AU2-32-270   | 111-03-328  | B28V34470     | GOM-305     |
| 1E0134300D   | 72-03-303   | 8AU2-34-510   | 53-03-321   | B30H 28 170B  | 106-03-308  |
| 1E0134300E   | 72-03-303   | 8AU3-34-510   | 73-03-324   | B32H 34 300   | 72-03-317   |
| 1E0134300F   | 72-03-303   | 94FB 33 95A2B | 73-03-300   | B32H 34 350   | 72-03-316   |
| 1E0134350A   | 72-03-302   | B001-32-135   | 103-03-301  | B32H-34-300B  | 72-03-317   |
| 1E0134350B   | 72-03-302   | B001-34-470   | GOM-303     | B32H34300A    | 72-03-317   |
| 1E0134350D   | 72-03-302   | B001-34-550   | 53-03-322   | B32H34350A    | 72-03-316   |
| 1E0134350E   | 72-03-302   | B001-99-324   | 111-03-318R | B455-32-24X   | 76-03-397   |
| 1E0134350F   | 72-03-302   | B001-99-325   | 111-03-318R | B455-32-280   | 111-03-334  |
| 2113-99-324  | 111-03-303  | B01A 34 300   | 72-03-307   | B455-34-300 E | 72-03-305   |



**CROSS REFERENCE LIST  
VERGLEICHSLISTE  
LISTA DE REFERENCIAS CRUZADES  
LISTE DE COMPARAISON  
LISTA DI COMPARAZIONE**

|               |            |              |            |              |             |
|---------------|------------|--------------|------------|--------------|-------------|
| B455-34-350 E | 72-03-304  | C10034350B   | 72-03-326  | EA01-28-170  | 106-03-317  |
| B455-34-550   | 53-03-326  | C10034460B   | GOM-306    | EA0128170D   | 106-03-317  |
| B45534300B    | 72-03-305  | C10034470A   | GOM-305    | EA03-34-170A | 106-03-311  |
| B45534350B    | 72-03-304  | C10035350B   | 73-03-321  | EA0334170    | 106-03-311  |
| B456-32-24X   | 76-03-395  | C14534460    | GOM-306    | EC01-34-150A | 106-03-325  |
| B456-32-25X   | 76-03-398  | C23628500A   | 71-03-303  | EG21 32 240  | 103-03-336  |
| B459-34-470   | GOM-302    | C243-28-156C | GOM-342    | EG21 32 280  | 111-03-357  |
| BA29-32-135   | 103-03-305 | CC29-34-156C | GOM-341    | EG21 32 280A | 111-03-357  |
| BBM2-28-C10   | 71-03-302  | D0013224X    | 103-0K-K53 | EG21 32 290  | 111-03-358  |
| BBM2-34-170A  | 106-03-326 | D061-32-24XA | 103-03-300 | EG21 32 290A | 111-03-358  |
| BC1D 28 170A  | 106-03-305 | D102-32-240  | 103-03-326 | F15134150    | 106-0K-K52R |
| BC1D 34 470   | GOM-304    | D102-32-250  | 103-03-325 | F15134170    | 106-0K-K52L |
| BC1D-28-380   | GOM-327    | D10232240A   | 103-03-326 | F1CZ-32-80A  | 76-03-397   |
| BC1D-28-390   | GOM-326    | D10232250A   | 103-03-325 | FOZ-3A130A   | 111-03-332  |
| BF62-32-240   | 103-03-310 | D201-34-300E | 71-03-301  | G030-32-240  | 103-03-302L |
| BF667-32-240  | 103-03-310 | D201-34-350A | 71-03-300  | G030-32-240A | 103-03-302L |
| BF6732240     | 103-03-310 | D27Z-3A131A  | 111-03-302 | G030-32-250  | 103-03-399  |
| BF673224X     | 103-03-310 | D651 32 290  | 111-03-366 | G030-32-250A | 103-03-399  |
| BJ3A-39-040A  | GOM-346    | D651 34 170  | 106-03-321 | G030-34-300F | 26-03-399   |
| BJ3A-39-06Y   | GOM-345    | D651 34 470  | GOM-334    | G030-34-350F | 26-03-398   |
| BJ3D-28-200A  | 71-03-311  | D651-32-240  | 103-03-337 | G030-99-356  | 73-03-317   |
| BJ3D-28-250A  | 71-03-310  | D651-32-280  | 111-03-367 | G037-32-240  | 103-03-306R |
| BK3P-34-300D  | 73-03-325  | D651-34-300  | 72-03-329  | G037-32-240A | 103-03-306R |
| BL8D-28-200B  | 71-03-309  | D651-34-350  | 72-03-328  | G037-32-240B | 103-03-306R |
| BL8D28250B    | 71-03-308  | D65134300C   | 72-03-329  | G037-32-240C | 103-03-306R |
| BP4K 28 500C  | 71-03-303  | D653 32 240  | 103-03-337 | G037-32-250  | 103-03-306L |
| BP4K 28C 10B  | 71-03-302  | D653-32-290  | 111-03-366 | G037-32-250A | 103-03-306L |
| BP4K 34 170C  | 106-03-313 | D77Z-3A131A  | 111-03-302 | G037-32-250B | 103-03-306L |
| BP4K-28-170C  | 106-03-327 | DD32 34 300  | 72-03-315  | G037-32-250C | 103-03-306L |
| BP4K-28-C10A  | 71-03-302  | DD32 34 350  | 72-03-314  | G351-32-280  | 111-03-332  |
| BP4K-39-040C  | GOM-340    | DD3234170    | 106-03-312 | GA2A 34 150A | 106-03-303  |
| BP4K-39-040D  | GOM-340    | DD3234300    | 73-03-303  | GA2A 34 170A | 106-03-304  |
| BP4K-39-040E  | GOM-340    | DD3234300    | GOM-315    | GA2A 34 46XA | GOM-309     |
| BP4K28500D    | 71-03-303  | DD3234300    | GOM-316    | GA2A 34 46YA | GOM-308     |
| BP4K28500E    | 71-03-303  | DD3234350    | 73-03-303  | GA2A 34 470  | GOM-307     |
| BP4K34170D    | 106-03-313 | DD3234350    | GOM-315    | GA2A-32-250  | 103-03-322  |
| BP4K34300E    | 73-03-305  | DD3234350    | GOM-316    | GA2A-34-300  | 72-03-311   |
| BP4K34300E    | 72-03-317  | DE90-32-280  | 111-03-345 | GA2A-34-350  | 72-03-310   |
| BP4K34350E    | 72-03-316  | DE9032240    | 103-03-327 | GA2A32240    | 103-03-322  |
| BP4K34350E    | 73-03-305  | DE9032290    | 111-03-344 | GA2A32240A   | 103-03-322  |
| BP4L 32 240   | 103-03-328 | E016 32 24X  | 103-03-318 | GA2A32250A   | 103-03-322  |
| BP4L 32 280   | 111-03-347 | E016 32 250  | 103-03-317 | GA2A3446XB   | GOM-309     |
| BP4L 32 290   | 111-03-346 | E0163225X    | 103-03-318 | GA2A3446YB   | GOM-308     |
| BP4L-34-380   | GOM-348    | E17Z-3049A   | 73-03-311  | GA2B28170A   | 106-0K-K51  |
| C100-34-300A  | 72-03-327  | E17Z-3050A   | 73-03-312  | GA2B28170B   | 106-0K-K51  |
| C100-34-350A  | 72-03-326  | E17Z-3590A   | 52-03-304  | GA2B34470    | GOM-307     |
| C10034300B    | 73-03-321  | E17Z3A131A   | 111-05-597 | GA2B34470A   | GOM-307     |
| C10034300B    | 72-03-327  | E17Z3A131A   | 111-03-321 | GA2C-28-170B | 106-0K-K51  |



**CROSS REFERENCE LIST**  
**VERGLEICHSLISTE**  
**LISTA DE REFERENCIAS CRUZADES**  
**LISTE DE COMPARAISON**  
**LISTA DI COMPARAZIONE**



|              |             |               |             |              |            |
|--------------|-------------|---------------|-------------|--------------|------------|
| GA6A-34-300B | 71-03-304   | GJ6A34J50C    | 71-03-306   | LC6232246    | 103-03-330 |
| GA6A-99-356  | 73-03-317   | GJ6A34J50D    | 71-03-306   | LC6234170    | 106-03-307 |
| GA6B-99-356  | 73-03-317   | GJ6E-32-240   | 103-03-329  | M001-99-356  | 73-03-317  |
| GA6B-99-356A | 73-03-317   | GJ6E-32-280   | 111-03-349  | M001-99-356A | 73-03-317  |
| GA6B34300E   | 72-03-311   | GJ6E-32-280A  | 111-03-349  | M26R28170    | 106-03-309 |
| GA6B34350E   | 72-03-310   | GJ6E-32-290   | 111-03-348  | N066-34-310  | 72-03-325  |
| GA6BE34300   | 72-03-311   | GJ6E-32-290A  | 111-03-348  | N066-34-360  | 72-03-324  |
| GA6BE34350   | 72-03-310   | GP9A-34-250A  | 72-03-318   | N068-34-200  | 72-03-323  |
| GD7A-34-300A | 72-03-313   | GR1A-34-460   | GOM-320     | N068-34-250  | 72-03-322  |
| GD7A-34-350A | 72-03-312   | GS1D 32 240   | 103-03-335  | NA01-32-240  | 103-03-331 |
| GE4T 28 170  | 106-03-310  | GS1D 32 280   | 111-03-365  | NA01-34-170  | 106-03-318 |
| GE4T 34 46XD | GOM-311     | GS1D 32 290   | 111-03-364  | NA01-34-550  | 73-03-320  |
| GE4T 34 46YD | GOM-310     | GS1D 34 150   | 106-03-323  | NA0134550A   | 73-03-320  |
| GE4T-32-240  | 103-03-324  | GS1D 34 170   | 106-03-324  | NC10-32-240A | 103-03-333 |
| GE4T-34-300E | 72-03-313   | GS1D 34 200A  | 72-03-335   | NC10-32-250A | 103-03-332 |
| GE4T-34-350E | 72-03-312   | GS1D 34 250A  | 72-03-334   | NC10-34-150  | 106-03-319 |
| GE4T-34-46XC | GOM-311     | GS1D 34 300G  | 72-03-337   | NC10-34-170  | 106-03-320 |
| GE4T-34-46YB | GOM-310     | GS1D 34 300H  | 72-03-337   | NC1032240    | 103-03-333 |
| GE4T-34-46YC | GOM-310     | GS1D 34 300J  | 72-03-337   | NC1032250    | 103-03-332 |
| GE4T32240A   | 103-03-324  | GS1D 34 300L  | 72-03-337   | NE51-32-280A | 111-03-326 |
| GE4T34300B   | 72-03-313   | GS1D 34 350G  | 72-03-336   | S083 34 830A | GOM-313    |
| GE4T34300C   | 72-03-313   | GS1D 34 350H  | 72-03-336   | S083 34 840A | GOM-312    |
| GE4T34300D   | 72-03-313   | GS1D 34 350J  | 72-03-336   | S083-32-115  | 103-03-304 |
| GE4T34350B   | 72-03-312   | GS1D 34 350L  | 72-03-336   | S083-34-460  | GOM-314    |
| GE4T34350C   | 72-03-312   | GS1D-28-170   | 106-03-322  | S083-99-324  | 111-03-343 |
| GE4T34350D   | 72-03-312   | H001-32-240   | 103-03-303  | S083-99-354  | 73-03-313  |
| GJ21-32-240  | 103-03-302R | H001-32-240A  | 103-03-303  | S083-99-356  | 73-03-314  |
| GJ22-32-240  | 103-03-302R | H001-32-240X  | 105-03-303  | S08399356    | 73-03-314  |
| GJ6A 28 156  | GOM-336     | H001-32-324X  | 105-03-303  | S23134820    | GOM-314    |
| GJ6A 34 156  | GOM-335     | H001-99-324   | 111-03-309  | S47P-32-280  | 111-03-343 |
| GJ6A-28-170A | 106-03-316  | H001-99-356   | 73-03-319   | SA39-32-115  | 103-03-304 |
| GJ6A-34-150A | 106-03-315  | H002-32-240   | 103-03-307  | UA01-32-240  | 111-03-321 |
| GJ6A-34-170A | 106-03-314  | H002-32-240B  | 103-03-307  | UA01-99-354  | 73-03-311  |
| GJ6A-34-200B | 72-03-319   | H002-32-240C  | 103-03-307  | UA01-99-356  | 73-03-312  |
| GJ6A-34-250B | 72-03-318   | H260-32-240A  | 103-03-314L | UA0199322    | 111-03-327 |
| GJ6A-34-460A | GOM-320     | H261-32-240A  | 103-03-314R | UA0199323    | 111-03-327 |
| GJ6A-34-470A | GOM-318     | H2Y0-99-356   | 73-03-319   | UA0199324    | 111-05-597 |
| GJ6A-34-540  | 73-03-307   | HA14-32-240AX | 105-03-302  | UA04-32-220  | 52-03-304  |
| GJ6A-34-710A | GOM-319     | L20634150A    | 106-0K-K52R | UA3N-32-320A | 59-03-300  |
| GJ6A-34-J00B | 71-03-305   | L20634170A    | 106-0K-K52L | UB39-28-333  | GOM-332    |
| GJ6A-34-J50B | 71-03-306   | LA01-32-115   | 103-03-323  | UB39-32-220B | 52-03-314  |
| GJ6A34300B   | 71-03-304   | LB82-34-300   | 71-03-307   | UB39-32-320  | 59-03-310  |
| GJ6A34300C   | 71-03-304   | LC62-32-240B  | 103-03-330  | UB39-32-320A | 59-03-310  |
| GJ6A34300D   | 71-03-304   | LC62-32-280   | 73-03-305   | UB39-32-320B | 59-03-313  |
| GJ6A34460B   | GOM-320     | LC62-34-170A  | 106-03-307  | UB39-34-154  | 106-03-328 |
| GJ6A34470B   | GOM-318     | LC62-34-300C  | 72-03-321   | UB39-99-322  | 111-03-327 |
| GJ6A34J00C   | 71-03-305   | LC62-34-350C  | 72-03-320   | UB39-99-356  | 53-03-321  |
| GJ6A34J00D   | 71-03-305   | LC62-34-550   | 73-03-321   | UB3999324    | 111-05-597 |



**CROSS REFERENCE LIST  
VERGLEICHSLISTE  
LISTA DE REFERENCIAS CRUZADES  
LISTE DE COMPARAISON  
LISTA DI COMPARAZIONE**

|                   |               |               |            |             |             |
|-------------------|---------------|---------------|------------|-------------|-------------|
| UB3999324         | 111-03-321    | 4013A282      | 72-05-529  | MB001696    | 53-05-505   |
| UB40-28-333       | GOM-333       | 4056-A014     | 106-05-501 | MB001699    | 53-05-505   |
| UB71-34-156A      | GOM-347       | 4056A015      | 106-0H-H02 | MB001715    | 53-05-505   |
| UC86-34-210       | 72-03-331     | 4056A034      | 106-05-534 | MB002433    | 73-05-599   |
| UC86-34-260       | 72-03-330     | 4056A035      | 106-05-535 | MB002475    | 73-05-503   |
| UC86-34-510A      | 73-03-324     | 4056A037      | 106-05-512 | MB002476    | 73-05-503   |
| UE-38-32-320      | 59-03-313     | 4056A037      | 106-05-527 | MB002583-01 | 73-05-516   |
| UE39-32-320B      | 59-03-313     | 4056A038      | 106-05-504 | MB002584-01 | 73-05-516   |
| UH71-28-450       | GOM-329       | 4056A052      | 106-05-506 | MB005820    | 59-05-503   |
| UH71-28-470       | GOM-330       | 4056A079      | GOM-546    | MB006314    | 111-05-503R |
| UH71-28-480       | GOM-331       | 4056A105      | 106-05-517 | MB006314    | 111-0H-H53  |
| UH71-32-280       | 111-03-341    | 4056A106      | 106-05-516 | MB006315    | 111-05-503L |
| UH71-34-470       | GOM-324       | 4056A111      | 106-05-518 | MB006358    | 111-05-503R |
| UH74-32-250       | 111-03-340    | 4056A112      | 106-05-519 | MB006358    | 111-0H-H53  |
| UH74-32-280       | 111-03-342    | 4056A121      | GOM-550    | MB006359    | 111-05-503L |
| UH75-34-210A      | 72-03-333     | 4056A133      | 106-05-526 | MB006570    | 59-05-521   |
| UH75-34-260A      | 72-03-332     | 4056A134      | 106-05-529 | MB007023    | GOM-501     |
| UJ06-32-320       | 59-03-316     | 4056A161      | 106-05-533 | MB076001    | 105-05-502L |
| UR56-32-220       | 52-03-300     | 4110A072      | 73-05-527  | MB076002    | 105-05-502R |
| UR56-32-250       | 111-03-317    | 4156A014      | 106-05-524 | MB076003    | 111-05-505  |
| UR61-32-280       | 111-03-304    | 4156A028      | GOM-547    | MB076004    | 111-05-504  |
| UR61-34-550       | 73-03-328     | 4156A041      | GOM-551    | MB076010    | 52-05-502   |
| W023-99-323       | 111-03-310L   | 4410A173      | 103-05-515 | MB076531    | 111-0H-H53  |
| YL8Z-5K483-AA     | 106-03-325    | 4422A008      | 111-05-535 | MB076531    | 111-05-503R |
| <b>MG</b>         | <b>ASHIKA</b> | 4422A009      | 111-05-520 | MB076532    | 111-05-503L |
| GSJ 1011          | 111-04-487    | 4422A010      | 111-05-519 | MB076663    | 111-05-505  |
| GSJ 1085          | 111-04-488    | 4422A012      | 103-05-519 | MB076664    | 111-05-504  |
| GSJ 1086          | 111-04-489    | 4422A018      | 111-05-527 | MB109168    | 53-0H-H52L  |
| GSJ 495           | 111-04-406L   | 4422A036      | 103-05-520 | MB109168    | 53-05-506L  |
| GSJ 496           | 111-04-406R   | 4422A037      | 111-05-534 | MB109169    | 53-0H-H52R  |
| <b>MITSUBISHI</b> | <b>ASHIKA</b> | 4422A038      | 111-05-533 | MB109169    | 53-05-506R  |
| 1091A079          | GOM-554       | 4422A052      | 111-05-536 | MB109219    | GOM-521     |
| 1091A080          | GOM-555       | 4422A056      | 103-05-516 | MB109512    | 71-05-508   |
| 4010A013          | 72-05-516     | 4422A076      | 103-05-521 | MB109513    | 71-05-509   |
| 4010A014          | 72-05-517     | 51270-SR3-023 | 73-04-415  | MB109529    | GOM-516     |
| 4010A015          | 73-05-509     | 91255-04600   | 111-05-532 | MB109539    | 113-05-502  |
| 4010A037          | 72-05-524     | AW311699      | 73-05-512  | MB109539-01 | 58-05-503   |
| 4010A038          | 72-05-525     | AW330961      | 73-05-519  | MB109557    | GOM-517     |
| 4013A009          | 72-05-528     | MA150801      | 111-05-596 | MB109585    | 73-05-503   |
| 4013A010          | 72-05-529     | MA159982      | 111-05-502 | MB109586    | 113-05-502  |
| 4013A087          | 72-05-518     | MA159984      | 111-0H-H52 | MB109587    | 53-05-504   |
| 4013A088          | 72-05-519     | MA159984      | 111-05-501 | MB109588    | 53-05-504   |
| 4013A090          | 73-05-507     | MA169613      | 111-05-502 | MB109662    | GOM-505     |
| 4013A209          | 72-05-530     | MA169614      | 111-05-501 | MB109684    | GOM-506     |
| 4013A210          | 72-05-531     | MA169614      | 111-0H-H52 | MB109858    | 111-05-508  |
| 4013A211          | 73-05-510     | MB-584531     | GOM-511    | MB111070    | GOM-512     |
| 4013A211          | 73-05-526     | MB-633870     | GOM-505    | MB111071    | GOM-511     |
| 4013A281          | 72-05-528     | MB-892982     | 106-05-501 | MB111203    | GOM-510     |

**CROSS REFERENCE LIST**  
**VERGLEICHSLISTE**  
**LISTA DE REFERENCIAS CRUZADAS**  
**LISTE DE COMPARAISON**  
**LISTA DI COMPARAZIONE**



|          |             |          |             |             |             |
|----------|-------------|----------|-------------|-------------|-------------|
| MB112476 | 73-05-503   | MB185441 | 111-0H-H53  | MB303375    | 73-05-512   |
| MB112477 | 73-05-503   | MB192297 | 59-05-503   | MB315160    | 103-05-505  |
| MB122000 | 59-05-504   | MB192430 | 111-0H-H56  | MB315586    | 103-05-503  |
| MB122011 | 111-05-506  | MB192430 | 111-05-516  | MB315629    | 111-0H-H53  |
| MB122012 | 111-05-506  | MB192499 | 111-0H-H56  | MB315629    | 111-05-503R |
| MB122135 | 103-05-501  | MB192499 | 111-05-516  | MB315769    | 59-05-512   |
| MB122396 | 52-05-504   | MB241155 | 73-05-508   | MB315770    | 59-05-511   |
| MB122400 | 59-05-506   | MB241155 | 53-0H-H60   | MB315775    | 111-05-509  |
| MB122774 | 59-05-503   | MB241156 | 53-0H-H60   | MB315776    | 111-05-510  |
| MB122779 | 111-05-505  | MB241156 | 73-05-508   | MB338594    | GOM-566     |
| MB122781 | 111-0H-H52  | MB241165 | 52-05-502   | MB347599    | 111-05-515  |
| MB122781 | 111-05-501  | MB241166 | 52-05-509   | MB347666    | 103-05-502  |
| MB122782 | 111-0H-H52  | MB241168 | 52-05-508   | MB349475    | 53-0H-H60   |
| MB122782 | 111-05-501  | MB241171 | 111-05-509  | MB349475    | 73-05-508   |
| MB130807 | 103-05-599  | MB241172 | 111-0H-H53  | MB349575    | 53-0H-H60   |
| MB142181 | 111-05-503R | MB241172 | 111-05-503R | MB349575    | 73-05-508   |
| MB150095 | GOM-525     | MB241196 | 59-05-521   | MB349963    | 73-05-512   |
| MB154199 | GOM-500     | MB241206 | 111-05-510  | MB349964    | 73-05-512   |
| MB166281 | 52-05-509   | MB241207 | 111-05-503L | MB350577    | 103-05-505  |
| MB166284 | 59-05-505   | MB241420 | 59-05-504   | MB350718    | 103-05-504  |
| MB166420 | 24-05-504   | MB241421 | 59-05-505   | MB378701    | 111-05-505  |
| MB166422 | 24-05-599   | MB241422 | 59-05-505   | MB378702    | 111-05-504  |
| MB166424 | 52-05-599   | MB241423 | 59-05-510   | MB378703    | 111-05-508  |
| MB166425 | 52-05-521   | MB241425 | 59-05-509   | MB378704    | 111-05-501  |
| MB166426 | 111-0H-H53  | MB241448 | 52-05-504   | MB378704    | 111-0H-H52  |
| MB166426 | 111-05-503R | MB241449 | 52-05-501   | MB430350    | 73-05-512   |
| MB166427 | 111-05-503L | MB241495 | 59-05-503   | MB430351    | 73-05-512   |
| MB166428 | 59-05-507   | MB241496 | 59-05-521   | MB436444    | GOM-502     |
| MB166429 | 59-05-511   | MB241499 | 59-05-506   | MB489434    | 111-05-516  |
| MB166592 | 111-05-508  | MB241500 | 59-05-506   | MB489434    | 111-0H-H56  |
| MB166765 | 111-05-509  | MB241508 | 59-05-506   | MB489606    | 103-05-502  |
| MB166766 | 111-05-510  | MB241818 | 53-05-509   | MB501530    | 103-05-504  |
| MB166980 | 111-05-505  | MB241830 | 59-05-508   | MB518041    | 73-05-512   |
| MB166981 | 111-05-508  | MB241883 | 73-05-512   | MB518042    | 73-05-512   |
| MB166982 | 111-0H-H52  | MB241884 | 52-05-511   | MB518205    | 73-05-512   |
| MB166982 | 111-05-501  | MB241973 | 52-05-510   | MB518206    | 73-05-512   |
| MB175544 | 53-05-504   | MB241974 | 106-05-522  | MB518283    | 73-05-520   |
| MB175581 | GOM-520     | MB241982 | 111-05-511  | MB518712    | 73-05-512   |
| MB175804 | GOM-507     | MB241982 | 111-05-514  | MB518713    | 73-05-512   |
| MB175812 | 53-05-509   | MB243329 | 103-05-506  | MB518780    | 106-05-504  |
| MB176273 | 53-05-509   | MB243373 | 103-05-503  | MB518892    | 106-05-501  |
| MB176283 | 53-05-509   | MB244901 | 103-05-500  | MB518960    | 73-05-512   |
| MB176308 | 53-05-507   | MB260676 | GOM-503     | MB518961    | 73-05-512   |
| MB176309 | 73-05-508   | MB266152 | 103-05-505  | MB527157-01 | 73-05-520   |
| MB176309 | 53-0H-H60   | MB267685 | GOM-522     | MB527159    | 73-05-520   |
| MB176442 | GOM-519     | MB275632 | GOM-524     | MB527159    | 72-05-512   |
| MB185329 | 53-05-510   | MB288119 | 111-05-522  | MB527161-01 | 73-05-520   |
| MB185441 | 111-05-503R | MB303374 | 73-05-512   | MB527169    | 111-05-514  |



**CROSS REFERENCE LIST**  
**VERGLEICHSLISTE**  
**LISTA DE REFERENCIAS CRUZADES**  
**LISTE DE COMPARAISON**  
**LISTA DI COMPARAZIONE**

|             |             |          |            |          |            |
|-------------|-------------|----------|------------|----------|------------|
| MB527228    | 59-05-514   | MB809220 | 71-05-502  | MC891911 | 111-05-537 |
| MB527349    | 73-05-513   | MB809221 | 71-05-503  | MN100250 | GOM-541    |
| MB527350    | 73-05-513   | MB809230 | 71-05-516  | MN101368 | 106-05-523 |
| MB527351    | 73-05-515L  | MB809231 | 71-05-515  | MN101395 | GOM-577    |
| MB527352    | 73-05-515R  | MB809354 | 106-05-599 | MN125871 | GOM-548    |
| MB527383    | 111-0H-H004 | MB809355 | 106-05-502 | MN184133 | GOM-549    |
| MB527383-01 | 73-05-514   | MB809357 | GOM-569    | MN184194 | 106-05-525 |
| MB527384    | 111-0H-H005 | MB809388 | GOM-513    | MN186217 | 72-05-508  |
| MB527384-01 | 73-05-514   | MB809455 | 106-05-502 | MN186218 | 72-05-509  |
| MB527511-01 | 73-05-520   | MB831035 | 72-05-532  | MR102653 | GOM-528    |
| MB527512-01 | 73-05-520   | MB831036 | 72-05-533  | MR102654 | GOM-529    |
| MB527650    | 111-05-515  | MB831037 | 73-05-523L | MR130479 | 71-05-500  |
| MB532046    | 103-05-502  | MB831038 | 73-05-523R | MR130480 | 71-05-501  |
| MB532281    | 103-05-509  | MB831039 | 106-05-515 | MR130807 | 103-05-599 |
| MB532657    | 103-05-505  | MB831040 | 52-05-512  | MR131004 | GOM-575    |
| MB532971    | 103-05-510  | MB831042 | 59-05-515  | MR131732 | 106-05-508 |
| MB553249    | 103-05-508  | MB831043 | 111-05-599 | MR131830 | 103-05-514 |
| MB564991    | 111-05-516  | MB831044 | 111-05-598 | MR132551 | 106-05-514 |
| MB564991    | 111-0H-H56  | MB844456 | GOM-570    | MR132552 | 106-05-513 |
| MB573043    | 106-05-501  | MB860381 | 72-05-522  | MR150093 | GOM-563    |
| MB573783    | GOM-523     | MB860382 | 72-05-523  | MR150094 | GOM-527    |
| MB573784    | GOM-508     | MB860408 | 73-05-520  | MR150095 | GOM-527    |
| MB573885    | 111-0H-H56  | MB860408 | 72-05-513  | MR150767 | GOM-564    |
| MB573885    | 111-05-516  | MB860817 | 73-05-512  | MR162803 | 72-05-510  |
| MB576093    | 73-05-512   | MB860818 | 73-05-512  | MR162804 | 72-05-511  |
| MB576094    | 73-05-512   | MB860829 | 73-05-522  | MR165252 | GOM-576    |
| MB581845    | GOM-504     | MB860829 | 111-0H-H97 | MR171441 | GOM-567    |
| MB584021    | 106-05-528  | MB860830 | 73-05-522  | MR179479 | 72-05-500  |
| MB584146    | GOM-518     | MB860830 | 53-0H-H61  | MR179480 | 72-05-501  |
| MB597605    | 111-05-514  | MB860830 | 111-0H-H97 | MR197068 | GOM-574    |
| MB598017    | 111-0H-H005 | MB864164 | 111-05-515 | MR223119 | GOM-573    |
| MB598017    | 111-0H-H004 | MB879354 | 106-05-599 | MR234247 | GOM-537    |
| MB598017    | GOM-H14     | MB892981 | 106-05-507 | MR241023 | 72-05-514  |
| MB598018    | 111-0H-H005 | MB910859 | 111-0H-H56 | MR241024 | 72-05-515  |
| MB598018    | GOM-H14     | MB910859 | 111-05-516 | MR241025 | 71-05-510  |
| MB598018    | 111-0H-H004 | MB910934 | 103-05-599 | MR241026 | 71-05-511  |
| MB598023    | 111-05-514  | MB910961 | 103-05-599 | MR241027 | 73-05-505  |
| MB598097    | GOM-509     | MB912076 | 111-05-514 | MR241031 | 111-05-517 |
| MB598098    | 106-05-530  | MB912077 | 72-05-504  | MR241032 | 111-05-512 |
| MB616286    | 111-0H-H56  | MB912078 | 72-05-505  | MR241341 | 72-05-506  |
| MB616286    | 111-05-516  | MB912505 | 72-05-510  | MR241342 | 72-05-507  |
| MB631492    | GOM-514     | MB912506 | 72-05-511  | MR244116 | GOM-533    |
| MB633820    | GOM-578     | MB912509 | 71-05-506  | MR244901 | 103-05-500 |
| MB633926    | 106-05-515  | MB912510 | 71-05-507  | MR267649 | GOM-565    |
| MB672370    | 106-05-520  | MB912519 | 111-05-516 | MR267876 | 106-05-514 |
| MB808076    | 106-05-521  | MB912519 | 111-0H-H56 | MR267877 | 106-05-513 |
| MB808909    | GOM-528     | MB949343 | 103-05-513 | MR272116 | 106-05-500 |
| MB808910    | GOM-529     | MC891910 | 111-05-538 | MR272117 | 106-05-503 |

**CROSS REFERENCE LIST**  
**VERGLEICHSLISTE**  
**LISTA DE REFERENCIAS CRUZADES**  
**LISTE DE COMPARAISON**  
**LISTA DI COMPARAZIONE**



|          |            |          |            |               |               |
|----------|------------|----------|------------|---------------|---------------|
| MR272118 | 106-05-505 | MR418547 | GOM-560    | MR992309      | 106-05-510    |
| MR272646 | GOM-572    | MR439701 | 72-05-506  | MR992310      | 106-05-509    |
| MR296027 | 71-05-510  | MR439702 | 72-05-507  | MR992317      | GOM-538       |
| MR296028 | 71-05-511  | MR448255 | 103-05-518 | MR992670      | GOM-552       |
| MR296093 | 72-05-534  | MR455699 | GOM-568    | MR992713      | GOM-557       |
| MR296094 | 72-05-535  | MR476457 | 111-05-514 | MR992717      | GOM-558       |
| MR296267 | 72-02-268  | MR476595 | 106-05-512 | MT141175      | 73-05-599     |
| MR296268 | 72-02-269  | MR485672 | 111-05-514 | MT141176      | 73-05-599     |
| MR296269 | 73-05-523L | MR491345 | 71-05-502  | MT141196      | 73-05-501     |
| MR296270 | 73-05-523R | MR491346 | 71-05-503  | MT141247      | 58-05-501     |
| MR296272 | 59-05-500  | MR491358 | 103-05-516 | MT142181      | 111-05-503R   |
| MR296274 | 111-05-518 | MR496792 | 73-05-509  | MT142181      | 111-0H-H53    |
| MR296274 | 111-05-510 | MR496793 | 72-05-524  | MT142182      | 111-05-503L   |
| MR296292 | 71-05-505  | MR496794 | 72-05-525  | MT241449      | 52-05-501     |
| MR296292 | GOM-534    | MR496795 | GOM-544    | MT402860      | 59-05-521     |
| MR296293 | 71-05-504  | MR496795 | GOM-543    | MT402870      | 52-05-501     |
| MR296293 | GOM-534    | MR496795 | 72-05-526  | MT402871      | 52-05-501     |
| MR296295 | 71-05-506  | MR496796 | 72-05-527  | MW033300      | 111-05-507L   |
| MR296295 | GOM-535    | MR496796 | GOM-543    | MW033301      | 111-05-507R   |
| MR296295 | GOM-536    | MR496796 | GOM-544    | PW530031      | 103-05-512    |
| MR296296 | GOM-536    | MR496799 | 73-05-510  | UB39-99-324   | 111-05-597    |
| MR296296 | GOM-535    | MR508130 | 73-05-521  |               |               |
| MR296296 | 71-05-507  | MR508135 | 111-05-524 | <b>NISSAN</b> | <b>ASHIKA</b> |
| MR297500 | GOM-571    | MR508136 | 111-05-523 | 01225-00231   | GOM-1006      |
| MR297969 | 103-05-599 | MR510267 | 103-05-517 | 11200360 0    | 111-0N-N031   |
| MR316368 | 106-0H-H02 | MR510417 | GOM-544    | 11200361 0    | 111-0N-N032   |
| MR316435 | 106-05-534 | MR519398 | GOM-542    | 11210-01B01   | GOM-100       |
| MR316436 | 106-05-535 | MR554271 | GOM-550    | 11210-0F002   | GOM-176       |
| MR319067 | GOM-545    | MR554820 | GOM-562    | 11210-2F001   | GOM-198       |
| MR325576 | 71-05-507  | MR554820 | GOM-562    | 11210-2S710   | GOM-1015      |
| MR325577 | 71-05-506  | MR580647 | GOM-553    | 11210-35G00   | GOM-102       |
| MR333166 | 103-05-513 | MR589880 | GOM-561    | 11210-8H305   | GOM-177       |
| MR374521 | 106-05-516 | MR594282 | GOM-559    | 11210-8H30E   | GOM-177       |
| MR374522 | 106-05-517 | MR594339 | 106-05-532 | 11210-99B00   | GOM-170       |
| MR392730 | 106-05-522 | MR594340 | 106-05-531 | 112102F200    | GOM-199       |
| MR403027 | 103-05-507 | MR594674 | 103-05-513 | 112106F800    | GOM-1001      |
| MR403419 | 72-05-520  | MR911569 | 72-05-503  | 1121090J01    | GOM-196       |
| MR403420 | 72-05-521  | MR911570 | 72-05-502  | 1121093J00    | GOM-197       |
| MR403440 | GOM-539    | MR915770 | 72-05-501  | 11210AX600    | GOM-182       |
| MR403441 | GOM-540    | MR916133 | 72-05-502  | 11210AX60A    | GOM-182       |
| MR403485 | 71-05-512  | MR954887 | 106-05-533 | 11210AY600    | GOM-183       |
| MR403771 | 106-05-512 | MR954888 | 106-05-522 | 11210AY60A    | GOM-183       |
| MR414939 | 73-05-524  | MR961391 | 72-05-536  | 11210BN702    | GOM-187       |
| MR414939 | 71-05-514  | MR961392 | 72-05-537  | 11210BV000    | GOM-194       |
| MR414940 | 71-05-513  | MR961477 | 106-0M-M02 | 11220-10J00   | GOM-104       |
| MR414940 | 73-05-524  | MR977606 | 111-05-500 | 11220-2S710   | GOM-1016      |
| MR418052 | 106-05-518 | MR992191 | 106-05-526 | 11220-35G00   | GOM-101       |
| MR418053 | 106-05-519 | MR992192 | 106-05-529 | 11220-7F000   | GOM-178       |
|          |            | MR992256 | GOM-556    | 11220-99B11   | GOM-1026      |



**CROSS REFERENCE LIST**  
**VERGLEICHSLISTE**  
**LISTA DE REFERENCIAS CRUZADES**  
**LISTE DE COMPARAISON**  
**LISTA DI COMPARAZIONE**

|             |             |             |            |              |             |
|-------------|-------------|-------------|------------|--------------|-------------|
| 11220-99B20 | GOM-1003    | 40110-T6025 | 73-01-111  | 40160-60Y00  | 107-01-190  |
| 1122093J00  | GOM-1000    | 40110-V0100 | 73-01-111  | 40160-60Y10  | 107-01-190  |
| 1122099B01  | GOM-1002    | 4011000QAA  | 73-01-126  | 40160-60Y20  | 107-01-190  |
| 11220AX600  | GOM-180     | 4011000QAB  | 73-01-126  | 40160-60Y60  | 53-01-130   |
| 11270-00QAA | GOM-1012    | 401100F000  | 73-01-111  | 40160-67L00  | 73-01-195   |
| 11270-BU000 | GOM-192     | 40110EB300  | 73-01-131  | 40160-69Y00  | 107-01-190  |
| 11270BM500  | GOM-184     | 40110G5110  | 73-01-123  | 40160-69Y10  | 107-01-190  |
| 11270BN310  | GOM-193     | 40160 00Q0B | 73-01-132  | 40160-7F000  | 53-01-101   |
| 11320-01G00 | GOM-103     | 40160-01A00 | 53-01-110  | 40160-85E00  | 73-01-124   |
| 11320-06J00 | GOM-105     | 40160-01A25 | 53-01-110  | 40160-86M00  | 53-01-130   |
| 11320-2F020 | GOM-190     | 40160-01B25 | 73-01-134  | 40160-92G90  | 53-01-190   |
| 11320-2F320 | GOM-191     | 40160-01E00 | 73-01-124  | 40160-93G00  | 53-01-121   |
| 11320-31G0A | GOM-1017    | 40160-01E25 | 73-01-124  | 40160-93G25  | 53-01-121   |
| 11320-7F000 | GOM-173     | 40160-01G00 | 53-01-190  | 40160-93G26  | 53-01-121   |
| 11320-99B11 | GOM-1025    | 40160-01G25 | 53-01-190  | 40160-9C500  | 111-0N-N016 |
| 113200M002  | GOM-1010    | 40160-01G26 | 53-01-190  | 40160-A006G0 | 53-01-110   |
| 113206F800  | GOM-1004    | 40160-01G50 | 53-01-190  | 40160-A03G0  | 53-01-110   |
| 1132093J00  | GOM-188     | 40160-01G90 | 53-01-190  | 40160-A8600  | 53-01-103   |
| 1132093J20  | GOM-189     | 40160-01N25 | 53-01-190  | 40160-A8610  | 53-01-103   |
| 11320BM500  | GOM-185     | 40160-01P00 | 73-01-137  | 40160-A8625  | 53-01-103   |
| 11320BN301  | GOM-186     | 40160-01P81 | 73-01-137  | 40160-B9500  | 53-01-199   |
| 11340-02B04 | GOM-179     | 40160-0F000 | 53-01-121  | 40160-D0125  | 73-01-113R  |
| 1135041B00  | GOM-1011    | 40160-0M020 | 107-01-190 | 40160-EA00A  | 73-01-130   |
| 11360-BV000 | GOM-195     | 40160-0W025 | 73-01-119  | 40160-F1700  | 53-01-199   |
| 11360AY600  | GOM-181     | 40160-21P00 | 73-01-137  | 40160-F4200  | 107-01-190  |
| 119051300   | 111-0N-N029 | 40160-26P00 | 73-01-137  | 40160-G2500  | 53-01-109   |
| 119051310   | 111-0N-N030 | 40160-27N25 | 53-01-190  | 40160-G2525  | 53-01-109   |
| 20638-61500 | GOM-132     | 40160-2S485 | 73-01-110  | 40160-G4010  | 53-01-109   |
| 34140 AA030 | 103-07-705  | 40160-2S601 | 73-01-115  | 40160-G5100  | 53-01-109   |
| 37521-34G25 | GOM-106     | 40160-2Y000 | 73-01-101  | 40160-G5400  | 53-01-109   |
| 37521-36G25 | GOM-1014    | 40160-41L00 | 73-01-195  | 40160-H1000  | 53-01-104   |
| 37521-W1025 | GOM-171     | 40160-48W00 | 53-01-199  | 40160-H1001  | 53-01-104   |
| 40100-P0110 | 73-01-111   | 40160-48W25 | 53-01-199  | 40160-H7400  | 53-01-105   |
| 40110-01G00 | 73-01-111   | 40160-4F100 | 111-01-183 | 40160-H7427  | 53-01-105   |
| 40110-01G25 | 73-01-111   | 40160-50A00 | 53-01-130  | 40160-M3025  | 53-01-115   |
| 40110-01G26 | 73-01-111   | 40160-50J25 | 53-01-130  | 40160-M7025  | 53-01-118   |
| 40110-2S485 | 73-01-107   | 40160-50W00 | 53-01-121  | 40160-N8400  | 73-01-120   |
| 40110-2S685 | 73-01-109   | 40160-50W01 | 53-01-121  | 40160-P6525  | 53-01-119   |
| 40110-73000 | 73-01-111   | 40160-50W10 | 53-01-121  | 40160-S0104  | 53-01-119   |
| 40110-B9500 | 73-01-111   | 40160-50W25 | 53-01-121  | 40160-S0105  | 53-01-119   |
| 40110-E0100 | 73-01-111   | 40160-50Y00 | 107-01-190 | 40160-S0106  | 53-01-119   |
| 40110-F1700 | 73-01-111   | 40160-50Y10 | 107-01-190 | 40160-S0125  | 53-01-119   |
| 40110-G0300 | 73-01-108   | 40160-51E00 | 73-01-124  | 40160-S0126  | 53-01-119   |
| 40110-G3700 | 73-01-123   | 40160-52Y00 | 107-01-190 | 40160-S0127  | 53-01-119   |
| 40110-G5100 | 73-01-123   | 40160-52Y10 | 107-01-190 | 40160-S0128  | 53-01-119   |
| 40110-P0110 | 73-01-111   | 40160-55G90 | 53-01-190  | 40160-T3060  | 53-01-199   |
| 40110-T3060 | 73-01-111   | 40160-60T10 | 107-01-190 | 40160-U7000  | 53-01-103   |
| 40110-T6000 | 73-01-111   | 40160-60T20 | 107-01-190 | 40160-W1000  | 53-01-126   |

**CROSS REFERENCE LIST**  
**VERGLEICHSLISTE**  
**LISTA DE REFERENCIAS CRUZADES**  
**LISTE DE COMPARAISON**  
**LISTA DI COMPARAZIONE**



|             |             |             |             |             |             |
|-------------|-------------|-------------|-------------|-------------|-------------|
| 40160-W1001 | 53-01-126   | 48001JD900  | 103-01-122  | 48520 4A00B | 111-08-824  |
| 40160-W2200 | 53-01-126   | 48510 4A00C | 103-08-816  | 48520-00QAH | 111-01-160  |
| 40160-W2210 | 53-01-126   | 48510-01G25 | 105-01-115  | 48520-00QAJ | 111-01-161  |
| 40160-W5000 | 53-01-106   | 48510-01L25 | 105-01-106  | 48520-00QAK | 111-01-1000 |
| 40160-Y02G0 | 107-01-190  | 48510-01N25 | 110-01-190  | 48520-00QAL | 111-01-1001 |
| 40160-ZG90A | 73-01-130   | 48510-01W00 | 108-01-104  | 48520-00QAM | 103-01-117  |
| 4016000001  | 107-01-190  | 48510-11A27 | 105-01-199  | 48520-00QAN | 111-01-162  |
| 40160000AC  | 73-01-104   | 48510-20500 | 108-01-101R | 48520-00QAP | 111-01-163  |
| 40160000AD  | 73-01-104   | 48510-2T025 | 108-01-102R | 48520-01B25 | 111-01-190  |
| 4016000Q0A  | 73-01-121   | 48510-31G25 | 105-01-116  | 48520-01E00 | 111-01-109  |
| 4016000QAB  | 73-01-103   | 48510-35A26 | 105-01-199  | 48520-01E25 | 111-01-109  |
| 4016000QAC  | 73-01-104   | 48510-41W00 | 105-01-111  | 48520-01E26 | 111-01-109  |
| 4016000QAD  | 73-01-104   | 48510-50A25 | 105-01-126  | 48520-01F25 | 111-01-122R |
| 4016001E00  | 111-01-178  | 48510-50A26 | 105-01-125  | 48520-01G25 | 111-01-139  |
| 4016001E00  | 53-01-130   | 48510-50A27 | 105-01-125  | 48520-01G25 | 111-01-140  |
| 4016001E25  | 111-01-178  | 48510-50W00 | 105-01-114R | 48520-01J00 | 111-01-158  |
| 4016001E25  | 53-01-130   | 48510-50Y25 | 105-01-129  | 48520-01J10 | 111-01-173  |
| 401600M010  | 107-01-190  | 48510-51A25 | 105-01-126  | 48520-01L25 | 111-01-130  |
| 4016041L00  | 111-01-148  | 48510-53A25 | 105-01-126  | 48520-01P25 | 111-01-159  |
| 401604F105  | 111-01-183  | 48510-53A26 | 105-01-126  | 48520-01R25 | 111-01-186  |
| 4016050Y02  | 107-01-190  | 48510-70A25 | 105-01-199  | 48520-01W00 | 111-01-107  |
| 4016050Y0R  | 107-01-190  | 48510-B5000 | 108-01-101R | 48520-02E00 | 111-01-109  |
| 4016050Y20  | 107-01-190  | 48510-B9500 | 108-01-101R | 48520-02E25 | 111-01-109  |
| 4016051E00  | 111-01-178  | 48510-B9525 | 108-01-101R | 48520-02E26 | 111-01-109  |
| 4016051E00  | 53-01-130   | 48510-D0100 | 105-01-199  | 48520-0C025 | 111-01-101  |
| 4016052Y20  | 107-01-190  | 48510-D0125 | 105-01-199  | 48520-0M025 | 111-01-109  |
| 4016052Y60  | 107-01-190  | 48510-G2500 | 105-01-110R | 48520-0P725 | 111-01-1002 |
| 4016069C00  | 53-01-130   | 48510-G2525 | 105-01-110R | 48520-15U25 | 111-01-101  |
| 4016085E00  | 111-01-178  | 48510-G5101 | 105-01-124R | 48520-17B25 | 111-01-190  |
| 4016085E00  | 53-01-130   | 48510-G5125 | 105-01-124R | 48520-21P25 | 111-01-149  |
| 40160A06G0  | 53-01-110   | 48510-H1001 | 105-01-120R | 48520-27N25 | 111-01-175  |
| 40160BU000  | 73-01-101   | 48510-H1025 | 105-01-112R | 48520-2S425 | 111-01-138  |
| 40161-48W00 | 53-01-198   | 48510-H5025 | 105-01-112R | 48520-2S485 | 111-01-138  |
| 40161-48W25 | 53-01-199   | 48510-Q0125 | 105-01-107  | 48520-31C00 | 111-01-155L |
| 40161-48W25 | 53-01-198   | 48510-R8000 | 108-01-102R | 48520-31G25 | 111-01-142  |
| 40161-50W01 | 53-01-121   | 48510-R8025 | 108-01-102R | 48520-41L00 | 111-01-148  |
| 40161-52Y10 | 107-01-190  | 48510-S0125 | 105-01-107  | 48520-41L25 | 111-01-148  |
| 40161-9C500 | 111-0N-N017 | 48510-T3026 | 108-01-102R | 48520-41L26 | 111-01-148  |
| 40161-B9500 | 53-01-198   | 48510-T3060 | 108-01-102R | 48520-41L27 | 111-01-148  |
| 40161-D0125 | 73-01-113L  | 48510-T3065 | 108-01-102R | 48520-41W00 | 111-01-107  |
| 40161-F1700 | 53-01-198   | 48510-U0100 | 105-01-122R | 48520-4F125 | 111-01-181  |
| 40161-T3060 | 53-01-198   | 48510-V5001 | 105-01-108  | 48520-50A00 | 111-01-147  |
| 4500254     | 73-01-103   | 48510-V5025 | 105-01-108  | 48520-50A25 | 111-01-147  |
| 45261-4F702 | 106-01-198  | 48510-V6225 | 105-01-108  | 48520-50A26 | 111-01-147  |
| 45261-90J01 | 106-01-199  | 48510-V6600 | 105-01-108  | 48520-50W00 | 111-01-112  |
| 45527-JD1A  | 111-01-1003 | 48510-V6625 | 105-01-108  | 48520-50Y25 | 111-01-109  |
| 45527JD01A  | 111-01-1003 | 48510-W5000 | 105-01-103R | 48520-53E25 | 111-01-185  |
| 480019U100  | 103-01-115  | 48510-W5025 | 105-01-103R | 48520-61G25 | 111-01-196  |



**CROSS REFERENCE LIST**  
**VERGLEICHSLISTE**  
**LISTA DE REFERENCIAS CRUZADES**  
**LISTE DE COMPARAISON**  
**LISTA DI COMPARAZIONE**

|              |             |             |             |             |             |
|--------------|-------------|-------------|-------------|-------------|-------------|
| 48520-71L25  | 111-01-194  | 485200C000  | 111-01-101  | 48521-8H300 | 103-01-121  |
| 48520-73J25  | 111-01-188  | 485200W025  | 111-01-146  | 48521-8H325 | 103-01-121  |
| 48520-7F001  | 111-01-189  | 4852015U26  | 111-01-101  | 48521-8H385 | 103-01-121  |
| 48520-88E25  | 111-01-174  | 4852031C00  | 111-01-155R | 48521-A0600 | 111-01-103R |
| 48520-A0600  | 111-01-102R | 4852041W00  | 111-01-140  | 48521-D0100 | 103-01-101  |
| 48520-AX600  | 111-01-165  | 4852041W00  | 111-01-139  | 48521-EA000 | 103-01-116  |
| 48520-AX602  | 111-01-1007 | 4852050Y25  | 111-01-147  | 48521-G2525 | 111-01-126R |
| 48520-BM425  | 111-01-100  | 4852060Y25  | 111-01-194  | 48521-G5101 | 111-01-156R |
| 48520-C6079  | 111-0N-N010 | 4852060Y25  | 111-01-101  | 48521-G5125 | 111-01-156R |
| 48520-C8400  | 111-0N-N010 | 485206F625  | 111-01-181  | 48521-H1001 | 111-01-105R |
| 48520-C84100 | 111-0N-N010 | 485207F000  | 111-01-142  | 48521-H5025 | 111-01-105R |
| 48520-D0100  | 111-01-109  | 485209C000  | 111-01-188  | 48521-M3070 | 103-01-104  |
| 48520-D0125  | 111-01-109  | 485209C025  | 111-01-188  | 48521-M7000 | 103-01-104  |
| 48520-D0126  | 111-01-109  | 48520OM085  | 111-01-101  | 48521-N8425 | 111-01-154R |
| 48520-EA01J  | 111-01-150  | 48520OM085  | 111-01-194  | 48521-P9001 | 103-01-103  |
| 48520-G2525  | 111-01-102R | 48521-00QAF | 103-01-112  | 48521-Q0125 | 111-01-117  |
| 48520-G5101  | 111-01-155R | 48521-00QAG | 103-01-113  | 48521-S0101 | 111-01-117  |
| 48520-G5125  | 111-01-155R | 48521-01F00 | 103-01-103  | 48521-S0102 | 111-01-117  |
| 48520-G9502  | 111-0N-N010 | 48521-01G25 | 111-01-141  | 48521-S0103 | 111-01-117  |
| 48520-H1001  | 111-01-104R | 48521-01L25 | 111-01-131  | 48521-S0125 | 111-01-117  |
| 48520-H5025  | 111-01-106R | 48521-01N25 | 111-01-195  | 48521-S0126 | 111-01-117  |
| 48520-M0225  | 111-01-118  | 48521-01W00 | 111-01-108  | 48521-U0100 | 111-01-103R |
| 48520-M3025  | 111-01-118  | 48521-0W025 | 103-01-120  | 48521-U5200 | 111-01-103R |
| 48520-OP725  | 111-01-1002 | 48521-17B00 | 103-01-185  | 48521-W1000 | 103-01-103  |
| 48520-Q0125  | 111-01-116  | 48521-1M210 | 76-01-191   | 48521-W1001 | 103-01-103  |
| 48520-R8000  | 105-01-102L | 48521-27N00 | 103-01-109  | 48521-W5025 | 111-01-105R |
| 48520-R8025  | 105-01-102L | 48521-2S425 | 111-01-111  | 4852100Q0B  | 103-01-112  |
| 48520-S0101  | 111-01-116  | 48521-2S485 | 111-01-111  | 4852106R05  | 111-01-180  |
| 48520-S0102  | 111-01-116  | 48521-31G25 | 111-01-189  | 4852106R06  | 111-01-180  |
| 48520-S0125  | 111-01-116  | 48521-35A00 | 103-01-105  | 485210W026  | 103-01-120  |
| 48520-T3026  | 105-01-102L | 48521-35A06 | 103-01-105  | 485211M226  | 76-01-191   |
| 48520-T3060  | 105-01-102L | 48521-35F00 | 103-01-101  | 485214M588  | 103-01-108  |
| 48520-T3065  | 105-01-102L | 48521-3U025 | 103-01-123  | 485214U085  | 103-01-111  |
| 48520-U0100  | 111-01-102L | 48521-40U21 | 103-01-114  | 4852172E00  | 111-01-180  |
| 48520-U5200  | 111-01-102R | 48521-40U25 | 103-01-114  | 4852172L00  | 111-01-180  |
| 48520-V0100  | 111-01-122L | 48521-4M500 | 103-01-108  | 4852172V06  | 111-01-180  |
| 48520-V0125  | 111-01-199  | 48521-4M528 | 103-01-108  | 48527-1U61A | 111-01-167  |
| 48520-W1025  | 111-01-122R | 48521-4U000 | 103-01-111  | 48527-JD01A | 111-01-1003 |
| 48520-W5025  | 111-01-106R | 48521-50400 | 76-01-190   | 48530-01G00 | 59-01-118   |
| 4852001E00   | 111-01-147  | 48521-50W00 | 111-01-113R | 48530-01G25 | 59-01-118   |
| 4852001E25   | 111-01-147  | 48521-50Y00 | 76-01-190   | 48530-04C00 | 105-01-101  |
| 4852001E26   | 111-01-147  | 48521-50Y25 | 111-01-108  | 48530-18V00 | 59-01-126   |
| 4852001W00   | 111-01-139  | 48521-70A00 | 103-01-101  | 48530-20V00 | 59-01-126   |
| 4852001W00   | 111-01-140  | 48521-70A06 | 103-01-101  | 48530-21400 | 59-01-101   |
| 4852002E00   | 111-01-147  | 48521-71L00 | 103-01-106  | 48530-31G25 | 59-01-120   |
| 4852002E25   | 111-01-147  | 48521-71V06 | 111-01-180  | 48530-35G25 | 59-01-119   |
| 4852002E26   | 111-01-147  | 48521-72E00 | 103-01-106  | 48530-B9500 | 59-01-102   |
| 485200C000   | 111-01-194  | 48521-72E06 | 111-01-180  | 48530-B9510 | 59-01-102   |



**CROSS REFERENCE LIST**  
**VERGLEICHSLISTE**  
**LISTA DE REFERENCIAS CRUZADES**  
**LISTE DE COMPARAISON**  
**LISTA DI COMPARAZIONE**



|             |             |             |             |             |             |
|-------------|-------------|-------------|-------------|-------------|-------------|
| 48530-G3701 | 59-01-180   | 48630-G2525 | 105-01-110L | 48647-JD01A | 111-01-1004 |
| 48530-G3710 | 59-01-180   | 48630-G5101 | 105-01-124L | 48680-11J00 | 111-0N-N008 |
| 48530-G5101 | 59-01-127   | 48630-G5125 | 105-01-124L | 48680-C6061 | 111-0N-N008 |
| 48530-G5701 | 59-01-128   | 48630-H1000 | 105-01-120L | 54320-1F500 | GOM-169     |
| 48530-Y9500 | 105-01-101  | 48630-H1001 | 105-01-120L | 54320-40U00 | GOM-1005    |
| 48560-09G25 | 27-01-113   | 48630-Q0125 | 105-01-107  | 54320-4F102 | GOM-169     |
| 48560-0F000 | 111-0N-N028 | 48630-R8025 | 105-01-102L | 54320-50Y12 | GOM-1008    |
| 48560-31G25 | 27-01-114   | 48630-S0125 | 105-01-107  | 54320-65E00 | GOM-1006    |
| 48560-31G26 | 27-01-114   | 48630-U0100 | 105-01-122L | 54423 4A00B | GOM-841     |
| 48560-3S525 | 27-01-115   | 48630-V5001 | 105-01-108  | 54423-00QAA | GOM-143     |
| 48560-61G25 | 27-01-116   | 48630-V5025 | 105-01-108  | 54423-B9500 | GOM-107     |
| 48560-G9501 | 111-0N-N012 | 48630-V5026 | 105-01-108  | 54476-01B00 | GOM-147     |
| 48560-W5000 | 27-01-107   | 48630-V5401 | 105-01-108  | 54476-01G00 | GOM-118     |
| 48560-W5025 | 27-01-107   | 48630-V5425 | 105-01-108  | 54476-01J00 | GOM-126     |
| 48560-W5700 | 27-01-198   | 48630-V6625 | 105-01-108  | 54476-01W00 | GOM-115     |
| 48560-W5725 | 27-01-198   | 48630-W5025 | 105-01-103L | 54476-F0200 | GOM-114     |
| 48561-T3001 | 111-01-119  | 48640-01F25 | 111-01-122L | 54477-T6000 | GOM-115     |
| 48561-T3025 | 111-01-119  | 48640-01N25 | 111-01-195  | 54479-50W00 | GOM-115     |
| 48570-01J00 | 111-01-158  | 48640-31C00 | 111-01-155R | 54499-W2210 | 26-01-195   |
| 48570-01J10 | 111-01-172  | 48640-50W00 | 111-01-112L | 54500 BM400 | 72-01-107   |
| 48570-11J00 | 111-01-152  | 48640-A0600 | 111-01-102L | 54500 EL000 | 72-01-141   |
| 48570-11J25 | 111-01-152  | 48640-AX600 | 111-01-164  | 54500-00QAC | 72-01-111   |
| 48570-31G25 | 111-01-189  | 48640-AX602 | 111-01-1008 | 54500-00QAH | 72-01-113   |
| 48570-3S525 | 111-01-123  | 48640-EA01J | 111-01-179  | 54500-0M010 | 72-01-105   |
| 48570-61G25 | 111-01-197  | 48640-G5101 | 111-01-155L | 54500-0W001 | 72-01-129   |
| 48570-82100 | 111-01-110L | 48640-G5125 | 111-01-155L | 54500-21B00 | 111-01-177  |
| 48570-C6079 | 111-01-152  | 48640-H1001 | 111-01-104L | 54500-2F500 | 72-01-123   |
| 48570-C8410 | 111-01-152  | 48640-H5025 | 111-01-106L | 54500-30R10 | 111-01-178  |
| 48570-G9501 | 111-0N-N009 | 48640-N8425 | 111-01-153L | 54500-41U00 | 72-01-115   |
| 48570-J5100 | 111-01-110L | 48640-U0100 | 111-01-102L | 54500-44B00 | 72-01-100   |
| 48570-T3001 | 111-01-120  | 48640-U5200 | 111-01-102L | 54500-4F102 | 72-01-100   |
| 48571-T3025 | 111-01-120  | 48640-W1025 | 111-01-122L | 54500-4F105 | 72-01-100   |
| 48580-82100 | 111-01-110R | 48640-W5025 | 111-01-106L | 54500-50J10 | 72-01-102   |
| 48580-J5100 | 111-01-110R | 48640G5101  | 111-01-155R | 54500-5U300 | 72-01-109   |
| 48600-G2725 | 105-01-100  | 48641-01N25 | 111-01-193  | 54500-67L00 | 71-01-193   |
| 48630-01G25 | 105-01-115  | 48641-50W00 | 111-01-113L | 54500-6F600 | 72-01-117   |
| 48630-01L25 | 105-01-106  | 48641-A0600 | 111-01-103L | 54500-7C350 | 72-01-127   |
| 48630-01N25 | 110-01-190  | 48641-G2525 | 111-01-103R | 54500-86J00 | 72-01-102   |
| 48630-01W00 | 108-01-104  | 48641-G5125 | 111-01-156L | 54500-8H310 | 72-01-131   |
| 48630-20500 | 108-01-101L | 48641-H1001 | 111-01-105L | 54500-AV600 | 72-01-125   |
| 48630-2T025 | 105-01-102L | 48641-H5025 | 111-01-105L | 54500-AX600 | 72-01-119   |
| 48630-31G25 | 105-01-116  | 48641-N8425 | 111-01-154L | 54500-BM410 | 72-01-107   |
| 48630-41W00 | 105-01-111  | 48641-U0100 | 111-01-103L | 54500-JD000 | 72-01-135   |
| 48630-50W00 | 105-01-114L | 48641-U0100 | 111-01-191  | 54500-W2210 | 71-01-190   |
| 48630-B5000 | 108-01-101L | 48641-W5025 | 111-01-105L | 5450000QAD  | 72-01-111   |
| 48630-B9500 | 108-01-101L | 48641G5101  | 111-01-156L | 5450000QAE  | 72-01-111   |
| 48630-B9525 | 108-01-101L | 48647-1U61A | 111-01-166  | 5450000QAH  | 53-01-100   |
| 48630-G2500 | 105-01-110L | 48647-9X62A | 111-0N-N032 | 545000M020  | 72-01-105   |



**CROSS REFERENCE LIST**  
**VERGLEICHSLISTE**  
**LISTA DE REFERENCIAS CRUZADES**  
**LISTE DE COMPARAISON**  
**LISTA DI COMPARAZIONE**

|             |            |             |           |             |            |
|-------------|------------|-------------|-----------|-------------|------------|
| 545000M060  | 72-01-105  | 54501-AX600 | 72-01-118 | 54503-2S485 | 71-01-106  |
| 545000W000  | 72-01-129  | 54501-BM400 | 72-01-106 | 54503-55G90 | 71-01-100  |
| 545001KA0B  | 72-01-147  | 54501-JD000 | 72-01-134 | 54503-7F000 | 72-01-136  |
| 545002F500  | GOM-157    | 5450100QAD  | 72-01-110 | 5450300Q0C  | 72-01-132  |
| 5450041U01  | 72-01-115  | 5450100QAE  | 72-01-110 | 5450300QAA  | 73-01-116  |
| 5450041U02  | 72-01-115  | 5450100QAH  | 53-01-100 | 5450300QAB  | 72-01-120  |
| 545004F105  | GOM-149    | 545010M020  | 72-01-104 | 545032S485  | 73-01-110  |
| 545004F105  | GOM-148    | 545010M060  | 72-01-104 | 5450355G10  | 71-01-100  |
| 545006F600  | 73-01-105  | 545010W000  | 72-01-128 | 5450392G00  | 71-01-100  |
| 5450086J00  | GOM-156    | 545011KA0B  | 72-01-146 | 5450392G90  | 71-01-100  |
| 545008H310  | GOM-164    | 545012F500  | GOM-158   | 54506-B9500 | GOM-108    |
| 545008H310  | GOM-163    | 5450141U00  | 72-01-114 | 54524-2F010 | 102-01-100 |
| 54500AV606  | GOM-160    | 5450141U02  | 72-01-114 | 54524-2S486 | 72-01-139  |
| 54500AV606  | 73-01-118  | 545014F105  | GOM-148   | 54524-3J201 | 102-01-100 |
| 54500AV606  | 72-01-125  | 545014F105  | GOM-149   | 54524-86J10 | 102-01-100 |
| 54500AV606  | GOM-159    | 545016F600  | 73-01-105 | 54524-AV600 | 71-01-103  |
| 54500AV60C  | 72-01-125  | 5450186J00  | GOM-156   | 5452486J01  | 102-01-100 |
| 54500BC41A  | 72-01-119  | 545018H310  | GOM-163   | 54524AV601  | 71-01-103  |
| 54500BC42A  | 73-01-106  | 545018H310  | GOM-164   | 54524EB300  | 72-01-145  |
| 54500BC42A  | 72-01-119  | 54501AV600  | 72-01-124 | 54524EB30A  | 72-01-145  |
| 54500BM400  | 73-01-100  | 54501AV605  | 73-01-118 | 54524VK385  | 73-01-109  |
| 54500BM410  | 73-01-100  | 54501AV605  | GOM-159   | 54525-2F010 | 102-01-101 |
| 54500BM410  | GOM-140    | 54501AV605  | GOM-160   | 54525-2S486 | 72-01-138  |
| 54500BM410  | GOM-141    | 54501BC41A  | 72-01-118 | 54525-3J201 | 102-01-101 |
| 54500BU000  | 72-01-109  | 54501BC42A  | 73-01-106 | 54525-86J10 | 102-01-101 |
| 54500F4300  | 72-01-105  | 54501BC42A  | 72-01-118 | 54525-AV600 | 71-01-102  |
| 54500JG000  | 72-01-135  | 54501BM400  | 73-01-100 | 5452586J01  | 102-01-101 |
| 54501 BM410 | 72-01-106  | 54501BM410  | GOM-141   | 54525AV601  | 71-01-102  |
| 54501 EL000 | 72-01-140  | 54501BM410  | GOM-140   | 54525EB300  | 72-01-144  |
| 54501-00QAC | 72-01-110  | 54501BM410  | 73-01-100 | 54525EB30A  | 72-01-144  |
| 54501-00QAH | 72-01-112  | 54501BU000  | 72-01-108 | 54529 4A00A | 73-08-803  |
| 54501-0M010 | 72-01-104  | 54501JG000  | 72-01-134 | 54529 4A00D | 72-08-816  |
| 54501-0W001 | 72-01-128  | 54502-00Q0B | 72-01-133 | 54530 4A00D | 72-08-815  |
| 54501-21B00 | 111-01-184 | 54502-00QAA | 72-01-133 | 54535 01B00 | GOM-146    |
| 54501-2F500 | 72-01-122  | 54502-01G90 | 71-01-101 | 54542-2S610 | GOM-1013   |
| 54501-41U01 | 72-01-114  | 54502-2S485 | 71-01-105 | 54550-8H300 | GOM-164    |
| 54501-44B00 | 72-01-101  | 54502-55G90 | 71-01-101 | 54560 00QAB | GOM-145    |
| 54501-4F102 | 72-01-101  | 54502-7F000 | 72-01-137 | 54560-01G00 | GOM-110    |
| 54501-4F105 | 72-01-101  | 5450200Q0C  | 72-01-133 | 54560-01J00 | GOM-119    |
| 54501-50J10 | 72-01-103  | 5450200QAB  | 72-01-121 | 54560-50A00 | GOM-138    |
| 54501-5U300 | 72-01-108  | 5450201G00  | 71-01-101 | 54560-8H300 | GOM-163    |
| 54501-67L00 | 71-01-194  | 5450201G50  | 71-01-101 | 54560-AX600 | GOM-150    |
| 54501-6F600 | 72-01-116  | 545022S485  | 73-01-110 | 54570-00QAA | GOM-142    |
| 54501-7C350 | 72-01-126  | 5450255G10  | 71-01-101 | 54570-50A10 | GOM-1007   |
| 54501-86J00 | 72-01-103  | 5450292G00  | 71-01-101 | 54570-50J00 | GOM-156    |
| 54501-8H310 | 72-01-130  | 5450292G90  | 71-01-101 | 54570-69Y10 | GOM-139    |
| 54501-AV605 | 72-01-124  | 54503-00QAA | 72-01-120 | 54570-AX600 | GOM-151    |
| 54501-AV606 | 72-01-124  | 54503-01G90 | 71-01-100 | 54590-01E00 | GOM-155    |

**CROSS REFERENCE LIST**  
**VERGLEICHSLISTE**  
**LISTA DE REFERENCIAS CRUZADES**  
**LISTE DE COMPARAISON**  
**LISTA DI COMPARAZIONE**



|              |             |             |             |                |               |
|--------------|-------------|-------------|-------------|----------------|---------------|
| 54613 00QAD  | GOM-144     | 54618-OE000 | 106-01-108  | 56261-0E000    | 106-01-124    |
| 54613-01J11  | GOM-123     | 5461800Q0C  | 106-01-105  | 56261-0F600    | 106-01-198    |
| 54613-06J10  | GOM-124     | 5461801G0A  | 106-01-113  | 56261-4F725    | 106-01-198    |
| 54613-0F001  | GOM-125     | 546182F010  | 106-01-120  | 56261-6F600    | 111-01-182    |
| 54613-0X800  | GOM-172     | 546183W400  | 106-01-127  | 56261-86J25    | 106-01-199    |
| 54613-14900  | GOM-113     | 5461847B0A  | 106-01-109  | 56261-90J01    | 106-01-199    |
| 54613-2Y003  | GOM-174     | 5461858820  | 106-01-101  | 56261-EA500    | 106-01-117    |
| 54613-32G00  | GOM-128     | 5461886J00  | 106-01-120  | 56261-EA510    | 106-01-118    |
| 54613-43G00  | GOM-121     | 54618BC40A  | 106-01-111  | 56261-EQ000    | 106-01-131    |
| 54613-4U006  | GOM-174     | 54618BU00   | 106-01-103  | 562614F702     | 106-01-198    |
| 54613-8H518  | GOM-175     | 54618D5000  | 106-01-101  | 562616F600     | 106-01-198    |
| 54613-9U000  | GOM-152     | 54618D5010  | 106-01-101  | 56261AV611     | 106-01-123    |
| 54613-AU004  | GOM-174     | 54668-4U000 | 106-01-104  | 56261AW000     | 106-01-123    |
| 54613-JD03A  | GOM-165     | 54668-8H300 | 106-01-130  | 7700312852     | 73-01-104     |
| 54613-JD18C  | GOM-166     | 54668-9C000 | 111-0N-N020 | 7701472038     | 53-01-100     |
| 54613-W1410  | GOM-122     | 54668-AU000 | 106-01-122  | 8200565079     | 72-01-133     |
| 54614M-4A00B | GOM-840     | 54668-EA010 | 106-01-116  | 8200626959     | 72-01-132     |
| 54616 4A00B  | 106-08-807  | 54668-JD00A | 106-01-132  | D8520-1HJ0A    | 111-01-1009   |
| 54616-00QAA  | 106-01-107  | 54668BU00   | 106-01-104  | D8520-1KA0A    | 111-01-1005   |
| 54616-00QAB  | 106-01-106  | 54668CA000  | 106-01-138  | D85200W025     | 111-01-146    |
| 54616-00QAC  | 106-01-119  | 54668CA00E  | 106-01-138  | D8520EW00A     | 111-01-166    |
| 5461600Q0C   | 106-01-106  | 55045-07200 | GOM-131     | D8520JG00A     | 111-01-1003   |
| 54618-00QAA  | 106-01-105  | 55045-10W00 | GOM-116     | D8521 JG00A    | 103-01-122    |
| 54618-01G00  | 106-01-113  | 55045-31000 | GOM-134     | D8521-1HJ0A    | 103-01-125    |
| 54618-02E00  | 106-01-114  | 55045-G2500 | GOM-120     | D8560-VK90A    | 27-01-115     |
| 54618-02E0A  | 106-01-114  | 55045-G9500 | GOM-131     | D8570-VK90A    | 111-01-123    |
| 54618-0E000  | 106-01-108  | 55046-01600 | GOM-130     | D8640-1HJ0A    | 111-01-1010   |
| 54618-0F000  | 106-01-125  | 55046-01G00 | GOM-109     | D86401KA0A     | 111-01-1006   |
| 54618-0W001  | 106-01-127  | 55046-C6000 | GOM-117     | D8640EW00A     | 111-01-167    |
| 54618-47B00  | 106-01-109  | 55046-G9600 | GOM-117     | D8640JG00A     | 111-01-1004   |
| 54618-4M400  | 106-01-100  | 55135-01J00 | GOM-127     | D8E20JG00A     | 111-01-1003   |
| 54618-4U000  | 106-01-103  | 55320-50Y11 | GOM-1009    | D8F40JG00A     | 111-01-1004   |
| 54618-50J20  | 106-01-120  | 55502-00QAA | 72-01-121   | <b>OPEL</b>    | <b>ASHIKA</b> |
| 54618-50Y00  | 106-01-101  | 5550200QAA  | 73-01-116   | 15293924       | 73-0C-C01     |
| 54618-56511  | 106-01-102  | 55618-JD00A | 106-01-135  | 3 50 617       | 106-0D-D05    |
| 54618-86J25  | 106-01-120  | 55618JE20A  | 106-01-135  | 324039         | 111-0W-D51L   |
| 54618-8H300  | 106-01-129  | 55619-JD00A | 106-01-134  | 44 18 631      | 73-01-132     |
| 54618-90J11  | 106-01-120  | 55619JE20A  | 106-01-134  | 4401910        | 73-01-126     |
| 54618-9C002  | 111-0N-N019 | 56112-09400 | GOM-112     | 4500090        | 73-01-126     |
| 54618-9U00A  | 106-01-111  | 56112-0F000 | GOM-112     | 4500255        | 73-01-104     |
| 54618-AU000  | 106-01-121  | 56112-V0100 | GOM-112     | 47 08 299      | 72-08-817     |
| 54618-AX600  | 106-01-110  | 56113-60U05 | GOM-112     | 47 09 704      | GOM-837       |
| 54618-CA000  | 106-01-137  | 56260-01J10 | 106-01-112  | 9 20 007       | 103-0D-D04    |
| 54618-CA00E  | 106-01-137  | 56260-0F001 | 106-01-126  | 94452102       | 73-09-913     |
| 54618-CY00A  | 106-01-136  | 56260-0W001 | 106-01-128  | 94459465       | 73-09-913     |
| 54618-EA010  | 106-01-115  | 56260-41G11 | 106-01-128  | <b>PEUGEOT</b> | <b>ASHIKA</b> |
| 54618-JD00A  | 106-01-133  | 56260-VB010 | 106-01-112  | 180679         | GOM-290       |
| 54618-JX00A  | 106-01-139  | 56261 AV610 | 106-01-123  | <b>PIAGGIO</b> | <b>ASHIKA</b> |



**CROSS REFERENCE LIST**  
**VERGLEICHSLISTE**  
**LISTA DE REFERENCIAS CRUZADES**  
**LISTE DE COMPARAISON**  
**LISTA DI COMPARAZIONE**

|                  |               |                  |               |             |             |
|------------------|---------------|------------------|---------------|-------------|-------------|
| 322575           | 103-0D-D01    | 5102V005000000   | 106-0M-M00    | 20200AC210  | 72-07-700   |
| 45046-87581-000  | 111-0N-N034   | A4513380137      | 111-0M-M01    | 20200AC210F | 72-07-700   |
| 45046-87Z02      | 111-0N-N035   | <b>SSANGYONG</b> | <b>ASHIKA</b> | 20201-AA000 | GOM-700     |
| 45047-87581-000  | 111-0N-N033   | 4440108000       | 72-0S-S02     | 20201-AC100 | GOM-701     |
| 45047-87Z02      | 111-0N-N035   | 4440208000       | 72-0S-S01     | 20201-AC110 | GOM-702     |
| <b>RENAULT</b>   | <b>ASHIKA</b> | 44430-03000      | 73-0S-S02     | 20201-FA070 | GOM-709     |
| 77 01 070 154    | 73-01-132     | 44430-03011      | 73-0S-S01     | 20201-FA080 | GOM-708     |
| 7700302114       | 73-01-126     | 4443003000       | 73-0S-S01     | 20201-FC020 | GOM-703     |
| 7701056969       | 73-01-104     | 4443003010       | 73-0S-S01     | 20201-FC100 | GOM-705     |
| 7701056970       | 73-01-126     | 4450108005       | 72-0S-S04     | 20201-FC110 | GOM-704     |
| 7701475841       | 103-01-124    | 4450208005       | 72-0S-S03     | 20201-FC120 | GOM-707     |
| <b>ROVER</b>     | <b>ASHIKA</b> | 44505-05001      | 73-0S-S02     | 20201-FC130 | GOM-706     |
| GSJ 278          | 73-04-499     | 4450505000       | 73-0S-S02     | 20202-SA000 | 72-07-705   |
| GSJ 407          | 111-04-404L   | 44560-03000      | 73-0S-S05     | 20202-SA010 | 72-07-704   |
| GSJ 408          | 111-04-404R   | 44560-03010      | 73-0S-S05     | 20204 AG011 | GOM-711     |
| GSJ 423          | 73-04-495     | 44560-03011      | 73-0S-S05     | 20204 AJ000 | GOM-710     |
| RBX 100670       | GOM-424       | 44570-03012      | 73-0S-S05     | 20420 AA004 | 106-07-700  |
| <b>SANTANA</b>   | <b>ASHIKA</b> | 44570-05000      | 106-0S-S04    | 20420 AJ000 | 106-07-707  |
| 30005938         | GOM-835       | 4475005000       | 106-0S-S01    | 20420-AA003 | 106-07-700  |
| 4181077E00       | GOM-835       | 4475005001       | 106-0S-S01    | 20470 AE000 | 106-07-704  |
| <b>SIMPA</b>     | <b>ASHIKA</b> | 4475008001       | 106-0S-S02    | 20470 AE001 | 106-07-704  |
| FZ90340          | GOM-340       | 4475508000       | 106-0S-S03    | 20470 FG000 | 106-07-706  |
| <b>SMART</b>     | <b>ASHIKA</b> | 45401-05000      | 101-0S-S04    | 20470 SC000 | 106-07-705  |
| 0002271V0030000C | 73-0M-M00     | 45501-05000      | 101-0S-S06    | 20470-SA000 | 106-07-702  |
| 0002271V0070000C | 73-0M-M00     | 45501-05100      | 101-0S-S06    | 20470-SA010 | 106-07-703  |
| 0015642V001      | 73-0M-M00     | 45501-05302      | 101-0S-S06    | 20470SA011  | 106-07-703  |
| 0015642V0010000C | 73-0M-M00     | 45502-05004      | 101-0S-S05    | 20481-AA001 | 106-07-701  |
| 07001V006000000  | 72-0M-M00     | 45502-05102      | 101-0S-S07    | 21067-GA050 | 73-07-799   |
| 07001V006000000  | GOM-M00       | 45601-05000      | 101-0S-S09    | 31310-GA120 | 103-07-735  |
| 07001V007000000  | 72-0M-M00     | 45712-06000      | GOM-S00       | 31310-GA151 | 103-07-706  |
| 14141V001000000  | 72-0M-M00     | 46620-01000      | 111-0S-S31    | 31310-GA152 | 103-07-705  |
| 14141V002000000  | 72-0M-M00     | 46620-02010      | 24-0S-S01     | 31310-GA170 | 103-07-734  |
| 15642V001        | 73-0M-M00     | 46660-01000      | 111-0S-S02L   | 31320-GA101 | 111-07-703R |
| 15642V001000000  | 73-0M-M00     | 46660-01010      | 111-0S-S02L   | 31320-GA111 | 111-07-703L |
| 1765V005000000   | 71-0M-M00     | 46660-05500      | 111-0S-S01    | 31320-GA190 | 111-07-704R |
| 1802V004000000   | 106-0M-M01    | 46660-05501      | 111-0S-S01    | 31320-GA200 | 111-07-704L |
| 2271V0070000005  | 73-0M-M00     | 4666008001       | 111-0S-S04    | 34140-AA040 | 103-07-704  |
| 2271V009000000   | 73-0M-M00     | 4666008011       | 111-0S-S05    | 34140-FC000 | 103-07-700  |
| 451 320 01 89    | 106-0M-M03    | 4666009002       | 111-0S-S04    | 34140AA030  | 103-07-705  |
| 451 330 00 10    | 72-0M-M01     | 4666009011       | 111-0S-S05    | 34141-AA041 | 111-07-700  |
| 4543200010       | 106-0M-M02    | 46670-01000      | 111-0S-S03R   | 34141AA042  | 111-07-700  |
| 4543300707       | 72-05-508     | 46670-01010      | 111-0S-S03R   | 34160-AE000 | 103-07-703  |
| 4543300807       | 72-05-509     | <b>SUBARU</b>    | <b>ASHIKA</b> | 34160-XA010 | 103-07-708  |
| 4544600205       | 111-05-500    | 200200AC200F     | 72-07-701     | 34160AE001  | 103-07-703  |
| 4887V002000000   | 111-0M-M00    | 20200-AA200      | 72-07-701     | 34161SA000  | 111-07-700  |
| 4887V004000000   | 111-0M-M00    | 20200-AA210      | 72-07-700     | 4520060810  | 72-08-809   |
| 4887V005000000   | 111-0M-M00    | 20200-FC120      | 72-07-703     | 4520060812  | 72-08-809   |
| 4887V006000000   | 111-0M-M00    | 20200-FC130      | 72-07-702     | 4520060820  | 72-08-808   |

**CROSS REFERENCE LIST**  
**VERGLEICHSLISTE**  
**LISTA DE REFERENCIAS CRUZADES**  
**LISTE DE COMPARAISON**  
**LISTA DI COMPARAZIONE**



|                 |               |                 |             |                 |             |
|-----------------|---------------|-----------------|-------------|-----------------|-------------|
| 4520060822      | 72-08-808     | 11620-71C11     | GOM-801     | 45200-85001     | 71-08-805   |
| 4520150G10      | 72-08-809     | 11710-60A01     | GOM-808     | 45200-85002     | 71-08-805   |
| 4520160E01      | 72-08-809     | 11710-80010     | GOM-804     | 45200-85E00     | 71-08-804   |
| 4520170C00      | 72-08-809     | 11710-80011     | GOM-804     | 45200-M79F00    | 71-08-800   |
| 4520250G10      | 72-08-808     | 11720-80JA0-000 | GOM-839     | 4520060812      | 72-08-809   |
| 4520260B01      | 72-08-808     | 29610-82C00     | GOM-810     | 4520060822      | 72-08-808   |
| 4520260E01      | 72-08-808     | 29650-82C00     | GOM-805     | 4520060860      | 72-08-802   |
| 4520270C00      | 72-08-808     | 41331-62020     | GOM-811     | 4520075F20      | 71-08-810   |
| 4553050G00      | GOM-827       | 41710-60B00     | GOM-800     | 4520076G21      | 71-08-801   |
| 4553070C00      | GOM-827       | 41710-80G10     | GOM-843     | 45200M79F10     | 71-08-800   |
| 4642060B02      | GOM-823       | 41810-60A00     | GOM-809     | 45200M79F11     | 71-08-800   |
| 6232-20043      | 53-07-701     | 41810-60A01     | GOM-809     | 45201 77A10     | 71-08-807   |
| 6315-10070      | 111-07-722    | 41810-65D11     | GOM-836     | 45201 M68K00    | 72-08-815   |
| 7210-60520      | 71-07-701     | 41810-65DB0     | GOM-836     | 45201-54L20     | 72-08-813   |
| 7210-60530      | 71-07-700     | 42412-60A00     | GOM-814     | 45201-56B00     | 111-0N-N046 |
| 7210-67001      | 73-07-798     | 42420 M68K00    | 106-08-807  | 45201-60E01     | 72-08-809   |
| 7210-67002      | 73-07-798     | 42420-60A00     | 111-0N-N051 | 45201-62J00     | 72-08-811   |
| 7210-67003      | 73-07-798     | 42420-62J00     | 106-08-804  | 45201-63G01     | 72-08-801   |
| 7210-67020      | 73-07-704     | 42420-65D00     | 111-0N-N051 | 45201-65D00     | 72-08-803   |
| 7210-67021      | 73-07-704     | 42420-65J00     | 106-08-803  | 45201-65D01     | 72-08-805   |
| 7313-10010      | 103-07-733    | 42420-77A00     | 106-08-806  | 45201-65J00     | 72-08-807   |
| 7313-10011      | 103-07-733    | 42420-80J00     | 106-08-805  | 45201-72K01     | GOM-829     |
| 7313-10060      | 103-07-733    | 4242065D00      | 111-0N-N051 | 45201-72K01     | 72-08-811   |
| 7313-10140      | 103-07-707    | 42431 M68K00    | GOM-840     | 45201-72K01     | 73-08-800   |
| 7313-20000      | 111-07-701R   | 42431-51K40     | GOM-837     | 45201-77A01     | 71-08-807   |
| 7313-20010      | 111-07-701L   | 42431-70B42     | GOM-820     | 45201-77A11     | 71-08-807   |
| 7313-20020      | 111-07-705    | 42431-79J00     | GOM-830     | 45201-78K00     | 72-08-807   |
|                 | <b>SUZUKI</b> | 42451 M76G00    | GOM-821     | 45201-79J00     | 72-08-813   |
|                 | <b>ASHIKA</b> | 45200-50E00     | 71-08-803   | 45201-85C00     | 111-0N-N046 |
| 09305-13002     | GOM-812       | 45200-60810     | 72-08-809   | 4520150G10      | 72-08-809   |
| 09319-10030     | GOM-824       | 45200-60812     | 72-08-809   | 4520160E01      | 72-08-809   |
| 09319-12023     | GOM-813       | 45200-60820     | 72-08-808   | 4520162J00      | 73-08-800   |
| 09319-12044     | GOM-815       | 45200-60822     | 72-08-808   | 4520162J00      | GOM-829     |
| 09319-12045     | GOM-816       | 45200-60863     | 72-08-802   | 4520163J00      | 72-08-811   |
| 09319-14007     | GOM-818       | 45200-69DV1     | 71-08-803   | 4520167D01      | 72-08-805   |
| 0931910030      | GOM-C07       | 45200-75F00     | 71-08-810   | 4520170C00      | 72-08-809   |
| 09320-10024     | GOM-817       | 45200-75F21     | 71-08-810   | 45202 77A10     | 71-08-806   |
| 11610-58B01     | GOM-807       | 45200-76G00     | 71-08-804   | 45202 M68K00    | 72-08-816   |
| 11610-58B10     | GOM-807       | 45200-76G20     | 71-08-801   | 45202-56B00     | 111-0N-N047 |
| 11610-58B10     | GOM-806       | 45200-76G22     | 71-08-801   | 45202-60E01     | 72-08-808   |
| 11610-65D00-000 | GOM-846       | 45200-78002     | 71-08-803   | 45202-62J00     | 72-08-810   |
| 11610-67D00-000 | GOM-847       | 45200-79000     | 71-08-802   | 45202-63G01     | 72-08-800   |
| 11610-80000     | GOM-803       | 45200-79001     | 71-08-802   | 45202-65D00     | 72-08-802   |
| 11610-80020     | GOM-802       | 45200-79002     | 71-08-802   | 45202-65D01     | 72-08-804   |
| 11610-80JA0-000 | GOM-838       | 45200-81A10     | 72-08-812   | 45202-65J00     | 72-08-806   |
| 11610-82C00     | GOM-802       | 45200-81A12     | 72-08-812   | 45202-72K00-000 | 72-08-818   |
| 11610-82C00     | GOM-803       | 45200-82000     | 73-08-804   | 45202-72K01     | 72-08-810   |
| 11620-58B00     | GOM-806       | 45200-84000     | 71-08-803   | 45202-72K01     | GOM-829     |
| 11620-71C10     | GOM-801       |                 |             |                 |             |



**CROSS REFERENCE LIST  
VERGLEICHSLISTE  
LISTA DE REFERENCIAS CRUZADES  
LISTE DE COMPARAISON  
LISTA DI COMPARAZIONE**

|                 |             |                 |             |                     |               |
|-----------------|-------------|-----------------|-------------|---------------------|---------------|
| 45202-72K01     | 73-08-800   | 48810-77E00     | 111-08-806R | 48830-78A00         | 103-08-807    |
| 45202-77A01     | 71-08-806   | 48810-78000     | 111-08-804  | 48830-82000         | 103-08-802    |
| 45202-77A12     | 71-08-806   | 48810-78001     | 111-08-804  | 48830-83E00         | 103-08-811    |
| 45202-78K00     | 72-08-806   | 48810-78002     | 111-08-804  | 48830-84000         | 103-08-803    |
| 45202-79J00     | 72-08-814   | 48810-78A00     | 111-08-815  | 48830-86G00         | 103-08-811    |
| 4520250G10      | 72-08-808   | 48810-79000     | 111-08-803R | 48830-M70F00        | 103-08-800    |
| 4520260B01      | 72-08-808   | 48810-79J00     | 111-08-822  | 4883078F00          | 103-08-810    |
| 4520260E01      | 72-08-808   | 48810-80000     | 111-08-806R | 4883079J00          | 103-08-813    |
| 4520262J00      | GOM-829     | 48810-81A00     | 111-08-819  | 4883079J10          | 103-08-814    |
| 4520262J00      | 73-08-800   | 48810-81A01     | 111-08-806R | 4883083E00          | 103-08-811    |
| 4520263J00      | 72-08-810   | 48810-82000     | 111-08-805  | 48830M84000         | 111-08-8998   |
| 4520267D01      | 72-08-804   | 48810-83300     | 111-08-806R | 48830M84010         | 111-08-8998   |
| 4520270C00      | 72-08-808   | 48810-83E00     | 111-08-823  | 48850-73010         | 111-08-808    |
| 45261 77A10     | GOM-C07     | 48810-83E01     | 111-08-823  | 48850-A60A00        | 111-0N-N054   |
| 45261-65D01     | GOM-833     | 48810-83E02     | 111-08-818  | 48870-80000         | 111-08-807    |
| 45261-65J00     | GOM-825     | 48810-84000     | 111-08-812  | 48870-80001         | 111-08-807    |
| 45261-79J00     | GOM-831     | 48810-84001     | 111-08-8999 | 48870-80002         | 111-08-807    |
| 45262-65D01     | GOM-834     | 48810-84001     | 111-08-812  | 48870-80060         | 111-08-811    |
| 45500-50800     | GOM-822     | 4881063J00      | 111-08-818  | 48870-A80060        | 111-0N-N039   |
| 45530-62J00     | GOM-828     | 4881084001      | 111-08-812  | 48870-A80A60        | 111-0N-N039   |
| 45530-70C00     | GOM-827     | 48810M68K00     | 111-08-824  | 57755-1C000         | 103-0H-H07    |
| 45530-M68K00    | GOM-841     | 48810M84001     | 111-08-812  | 91174728            | GOM-836       |
| 4553050G00      | GOM-827     | 48810M84010     | 111-08-8999 | 94788122            | 73-0W-D51     |
| 45700-60A00     | 111-08-890  | 48810M84010     | 111-08-812  | <b>TATA (TELCO)</b> | <b>ASHIKA</b> |
| 45700-67001     | 73-08-801   | 48810M84020     | 111-08-8999 | 0305-99-356A        | 53-03-303     |
| 46221 51K10     | GOM-842     | 48820-60001     | 111-08-803L | 0G030-34-550A       | 73-0K-K51     |
| 46300-60B00     | 71-08-808   | 48820-60A00     | 111-08-813  | 2654 TELQ 0116      | 111-00-003L   |
| 46300-60B10     | 71-08-808   | 48820-63002     | 111-08-802L | 2654-3211-0156      | 73-00-002     |
| 46300-60B10     | 71-08-809   | 48820-65D00     | 111-08-816  | 2654-3320-0113      | 73-00-003     |
| 46300-60B10-000 | 71-08-808   | 48820-65D01-000 | 111-08-816  | 2655 TELQ 0117      | 111-00-003R   |
| 4630060B00      | 71-08-809   | 48820-68L00-000 | 111-08-826  | 2699-3210-01-50     | 73-00-006     |
| 46420-60B02     | GOM-823     | 48820-77E00     | 111-08-813  | 2699-3210-01-66     | 73-00-006     |
| 46630-60B01     | 73-08-802   | 48820-78A00     | 111-08-814  | 2699-3210-0185      | 73-00-006     |
| 46630-60B01-000 | 73-08-802   | 48820-79000     | 111-08-803L | 2699-4660-01-13     | 111-00-006    |
| 46630-60B10     | 73-08-802   | 48820-80000     | 111-08-806L | 2699-4660-01-21     | 111-00-005    |
| 46630-80F00     | 106-08-801  | 48820-80001     | 111-08-806L | 2702-3211-0105      | 73-00-008     |
| 46640-80F00     | 106-08-802  | 48820-81A00     | 111-08-820  | 2702-3211-0106      | 73-00-001     |
| 48721-60A00     | 52-08-800   | 48830 M68K00    | 103-08-816  | 2702-3211-0149      | 72-00-002     |
| 48810-60001     | 111-08-803R | 48830-60B00     | 103-08-804  | 2702-3211-0150      | 72-00-001     |
| 48810-60A00     | 111-08-806R | 48830-60G00     | 103-08-805  | 2702-4660-3511      | 103-00-001    |
| 48810-60B00     | 111-08-805  | 48830-63B00     | 103-08-802  | 2779-3210-0182      | 72-00-003     |
| 48810-63002     | 111-08-802R | 48830-63J00     | 103-08-812  | 2779-3210-0183      | 72-00-004     |
| 48810-63J00     | 111-08-821  | 48830-65D00     | 103-08-808  | 45601-05001         | 101-0S-S09    |
| 48810-65D00     | 111-08-817  | 48830-65J00     | 103-08-809  | 8855-4601-0001      | 111-00-002    |
| 48810-65D01-000 | 111-08-817  | 48830-75F00     | 103-08-810  | 90342316            | 73-00-051     |
| 48810-65J00     | 111-08-800  | 48830-77A00     | 103-08-806  | 90375505            | 73-00-051     |
| 48810-68L00-000 | 111-08-825  | 48830-78000     | 103-08-801  | 90375506            | 73-00-051     |
| 48810-76G00     | 111-08-805  | 48830-78001     | 103-08-801  | 94786917            | 73-00-051     |

**CROSS REFERENCE LIST**  
**VERGLEICHSLISTE**  
**LISTA DE REFERENCIAS CRUZADAS**  
**LISTE DE COMPARAISON**  
**LISTA DI COMPARAZIONE**



| TOWN LIFE   |               | ASHIKA    |               |             |            |             |            |
|-------------|---------------|-----------|---------------|-------------|------------|-------------|------------|
| 154011      |               | GOM-458   |               | 43330-19045 | 73-02-219  | 43330-39225 | 53-02-210  |
|             | <b>TOYOTA</b> |           | <b>ASHIKA</b> | 43330-19065 | 73-02-232R | 43330-39235 | 53-02-228  |
| 123050Q010  |               | GOM-291   |               | 43330-19066 | 73-02-232R | 43330-39235 | 53-02-210  |
| 12361-0L030 |               | GOM-283   |               | 43330-19075 | 53-02-298  | 43330-39245 | 53-02-235  |
| 12361-16040 |               | GOM-2015  |               | 43330-19085 | 73-02-238R | 43330-39255 | 53-02-228  |
| 12361-30080 |               | GOM-283   |               | 43330-19095 | 53-02-297  | 43330-39265 | 53-02-295  |
| 12361-54120 |               | GOM-202   |               | 43330-19115 | 73-02-210  | 43330-39285 | 73-02-239  |
| 12361-54121 |               | GOM-202   |               | 43330-19245 | 73-02-242  | 43330-39295 | 53-02-235  |
| 12361-60022 |               | GOM-200   |               | 43330-29045 | 53-02-297  | 43330-39315 | 53-02-295  |
| 12362-15130 |               | GOM-2016  |               | 43330-29046 | 53-02-297  | 43330-39415 | 73-02-217  |
| 12363-74120 |               | GOM-2022  |               | 43330-29055 | 53-02-297  | 43330-39585 | 73-02-217  |
| 123630Q010  |               | GOM-290   |               | 43330-29056 | 53-02-297  | 43330-49025 | 73-02-241  |
| 12371-15241 |               | GOM-2021  |               | 43330-29065 | 53-02-297  | 43330-49095 | 73-02-242  |
| 12371-64210 |               | GOM-2001  |               | 43330-29105 | 53-02-221  | 43330-49185 | 73-02-249  |
| 12371-68010 |               | GOM-201   |               | 43330-29115 | 73-06-625  | 4333009070  | 73-02-210  |
| 1237174312  |               | GOM-2002  |               | 43330-29125 | 53-02-221  | 4333009230  | 73-02-210  |
| 37230-0K011 |               | GOM-281   |               | 43330-29135 | 53-02-296  | 4333019085  | 73-02-238L |
| 37230-0K021 |               | GOM-282   |               | 43330-29136 | 53-02-296  | 4333029095  | 73-06-625  |
| 37230-26020 |               | GOM-294   |               | 43330-29137 | 53-02-296  | 4333029125  | 73-02-237  |
| 37230-35050 |               | GOM-203   |               | 43330-29138 | 53-02-296  | 4333029140  | 73-02-216  |
| 37230-35080 |               | GOM-204   |               | 43330-29139 | 53-02-296  | 4333029145  | 73-02-297  |
| 37230-35090 |               | GOM-261   |               | 43330-29145 | 73-02-299  | 4333029146  | 73-02-297  |
| 433029535   |               | 53-02-221 |               | 43330-29146 | 73-02-299  | 4333029185  | 73-02-299  |
| 433029535   |               | 73-02-237 |               | 43330-29155 | 73-02-237  | 4333029295  | 53-02-221  |
| 43308-12020 |               | 53-02-205 |               | 43330-29155 | 53-02-221  | 4333029295  | 73-02-237  |
| 43308-12030 |               | 53-06-609 |               | 43330-29165 | 73-06-625  | 4333029515  | 73-02-237  |
| 43308-16010 |               | 53-02-299 |               | 43330-29175 | 73-06-625  | 4333029515  | 53-02-221  |
| 43308-19035 |               | 53-02-209 |               | 43330-29185 | 73-02-297  | 4333029615  | 73-02-209  |
| 43308-29015 |               | 73-02-212 |               | 43330-29205 | 53-02-296  | 4333039195  | 53-02-210  |
| 43308-29115 |               | 73-02-212 |               | 43330-29225 | 73-02-241  | 4333039245  | 73-02-216  |
| 4330819035  |               | 53-06-609 |               | 43330-29235 | 73-02-236  | 4333039255  | 53-02-210  |
| 43310-09015 |               | 73-02-246 |               | 43330-29265 | 53-02-297  | 4333039265  | 73-02-227  |
| 43310-09030 |               | 73-02-246 |               | 43330-29275 | 73-02-244R | 4333039295  | 73-02-216  |
| 43310-0K010 |               | 73-02-246 |               | 43330-29315 | 53-02-297  | 4333039315  | 73-02-227  |
| 43310-0K040 |               | 73-02-246 |               | 43330-29325 | 73-02-241  | 4333039345  | 73-02-216  |
| 43310-39016 |               | 73-02-215 |               | 43330-29326 | 73-02-241  | 4333039435  | 73-02-239  |
| 43330 09770 |               | 73-02-225 |               | 43330-29375 | 53-02-297  | 4333039445  | 73-02-216  |
| 43330 49055 |               | 73-02-221 |               | 43330-29405 | 73-02-209  | 4333039445  | 53-02-235  |
| 43330-02020 |               | 53-02-297 |               | 43330-39045 | 53-02-206  | 4333039775  | 73-02-209  |
| 43330-06020 |               | 73-02-239 |               | 43330-39065 | 53-02-210  | 4333039835  | 53-02-295  |
| 43330-09030 |               | 53-02-297 |               | 43330-39075 | 53-02-206  | 4333039835  | 73-02-227  |
| 43330-09210 |               | 73-02-200 |               | 43330-39095 | 53-02-210  | 43340-19015 | 73-02-290  |
| 43330-09360 |               | 73-02-213 |               | 43330-39105 | 53-02-210  | 43340-19025 | 73-02-238L |
| 43330-09510 |               | 73-02-247 |               | 43330-39115 | 53-02-210  | 43340-29025 | 53-02-297  |
| 43330-09630 |               | 73-02-242 |               | 43330-39135 | 73-02-216  | 43340-29026 | 53-02-297  |
| 43330-0B020 |               | 73-06-625 |               | 43330-39165 | 53-02-215  | 43340-29036 | 53-02-297  |
| 43330-19025 |               | 73-02-224 |               | 43330-39175 | 53-02-228  | 43340-29045 | 53-02-297  |
|             |               |           |               | 43330-39195 | 53-02-228  | 43340-29075 | 53-02-297  |



**CROSS REFERENCE LIST**  
**VERGLEICHSLISTE**  
**LISTA DE REFERENCIAS CRUZADES**  
**LISTE DE COMPARAISON**  
**LISTA DI COMPARAZIONE**

|             |            |             |             |             |             |
|-------------|------------|-------------|-------------|-------------|-------------|
| 43340-29085 | 73-02-244L | 43360-29035 | 73-02-207   | 45046-19015 | 111-02-223  |
| 43340-29095 | 73-06-625  | 43360-29045 | 73-02-207   | 45046-19055 | 111-02-206  |
| 43340-29105 | 53-02-221  | 43360-29055 | 73-02-229   | 45046-19075 | 111-02-223  |
| 43340-29175 | 73-02-208  | 43360-29056 | 73-02-229   | 45046-19085 | 111-02-223  |
| 43340-39035 | 53-02-210  | 43360-29076 | 73-02-220   | 45046-19095 | 111-02-223  |
| 43340-39045 | 53-02-210  | 43360-39065 | 73-02-203   | 45046-19105 | 108-02-222  |
| 43340-39075 | 53-02-206  | 43360-39075 | 73-02-227   | 45046-19115 | 108-02-234  |
| 43340-39085 | 53-02-210  | 43360-39085 | 73-02-227   | 45046-19135 | 111-02-223  |
| 43340-39095 | 53-02-210  | 4336029065  | 73-02-220   | 45046-19165 | 111-02-266  |
| 43340-39125 | 53-02-210  | 4336039015  | 73-02-203   | 45046-19175 | 111-02-259  |
| 43340-39135 | 53-02-210  | 4336039025  | 73-02-203   | 45046-19205 | 111-02-298  |
| 43340-39145 | 53-02-215  | 4336039045  | 73-02-203   | 45046-19205 | 111-02-299  |
| 43340-39205 | 53-02-210  | 4336039055  | 73-02-203   | 45046-19206 | 111-02-298  |
| 43340-39225 | 53-02-235  | 45044 69086 | 111-02-254  | 45046-19206 | 111-02-299  |
| 43340-39245 | 53-02-295  | 45044-60H00 | 111-02-245  | 45046-19216 | 111-02-298  |
| 43340-39325 | 73-02-228  | 45044-60H01 | 111-02-249  | 45046-19265 | 111-02-271  |
| 43340-39465 | 73-02-228  | 45044-60H03 | 111-02-254  | 45046-19415 | 111-02-2017 |
| 4334019016  | 73-02-290  | 45044-69035 | 111-02-245  | 45046-20010 | 111-02-205  |
| 4334029105  | 73-02-237  | 45044-69045 | 111-02-249  | 45046-29045 | 111-02-205  |
| 4334029215  | 73-02-208  | 45044-69055 | 111-02-245  | 45046-29055 | 111-02-205  |
| 4334039175  | 53-02-210  | 45044-69065 | 111-02-249  | 45046-29056 | 111-02-205  |
| 4334039175  | 53-02-228  | 45044-69075 | 111-02-253  | 45046-29075 | 111-02-223  |
| 4334039225  | 73-02-216  | 45044-69076 | 111-02-253  | 45046-29095 | 111-02-205  |
| 4334039235  | 53-02-228  | 45044-69085 | 111-02-254  | 45046-29105 | 111-02-213L |
| 4334039235  | 53-02-210  | 45044-69095 | 111-02-236  | 45046-29115 | 111-02-226  |
| 4334039245  | 73-02-227  | 45044-69105 | 111-02-255  | 45046-29125 | 111-02-226  |
| 4334039545  | 73-02-208  | 45044-69106 | 111-02-279  | 45046-29135 | 73-02-291   |
| 4334060010  | 73-02-235  | 45044-69115 | 111-02-278  | 45046-29165 | 111-02-265  |
| 43350-29015 | 73-02-207  | 45044-69125 | 111-02-279  | 45046-29185 | 111-02-2026 |
| 43350-29026 | 73-02-211  | 45044-69135 | 111-02-253  | 45046-29205 | 111-02-267  |
| 43350-29035 | 73-02-229  | 45045-29035 | 111-02-213L | 45046-29215 | 111-02-270  |
| 43350-29036 | 73-02-229  | 45045-29045 | 111-02-295  | 45046-29235 | 111-02-2003 |
| 43350-29065 | 73-02-234  | 45045-60013 | 111-02-217L | 45046-29255 | 111-02-283  |
| 43350-29076 | 73-02-229  | 45045-60H04 | 111-02-246  | 45046-29275 | 111-02-297  |
| 43350-39016 | 73-02-203  | 45045-69015 | 111-02-217L | 45046-29305 | 111-02-259  |
| 43350-39035 | 73-02-214  | 45045-69035 | 111-02-246  | 45046-29325 | 111-02-281  |
| 43350-39045 | 73-02-227  | 45045-69045 | 111-02-246  | 45046-29335 | 111-02-297  |
| 43350-39085 | 73-02-227  | 45045-69065 | 111-02-251  | 45046-29365 | 111-02-2225 |
| 43350-39115 | 73-02-214  | 45046 09660 | 111-02-2025 | 45046-29425 | 111-02-200  |
| 43350-39125 | 73-02-227  | 45046 49145 | 111-02-2021 | 45046-35080 | 111-02-257  |
| 4335029045  | 73-02-220  | 45046 79025 | 111-02-2029 | 45046-39085 | 111-02-215R |
| 4335029055  | 73-02-220  | 45046-09230 | 111-02-201  | 45046-39095 | 111-02-203R |
| 4335029056  | 73-02-220  | 45046-09251 | 111-02-2018 | 45046-39105 | 111-02-226  |
| 4335029095  | 73-02-234  | 45046-09281 | 111-02-2015 | 45046-39106 | 111-02-226  |
| 4335039025  | 73-02-203  | 45046-09295 | 111-02-207  | 45046-39125 | 111-02-226  |
| 4335039075  | 73-02-214  | 45046-09430 | 111-02-277  | 45046-39155 | 111-02-239  |
| 43360-29015 | 73-02-207  | 45046-09480 | 111-02-2013 | 45046-39175 | 111-02-226  |
| 43360-29025 | 73-02-211  | 45046-09570 | 111-02-2017 | 45046-39185 | 111-02-263R |



**CROSS REFERENCE LIST**  
**VERGLEICHSLISTE**  
**LISTA DE REFERENCIAS CRUZADAS**  
**LISTE DE COMPARAISON**  
**LISTA DI COMPARAZIONE**



|             |             |             |             |             |             |
|-------------|-------------|-------------|-------------|-------------|-------------|
| 45046-39215 | 111-02-226  | 45047-19055 | 111-02-205  | 4504769026  | 111-02-217L |
| 45046-39235 | 111-02-226  | 45047-19056 | 108-02-234  | 4504769026  | 111-02-248  |
| 45046-39255 | 111-02-272  | 45047-19115 | 111-02-264  | 4504769067  | 111-02-285  |
| 45046-39256 | 111-02-272  | 45047-19215 | 111-02-2016 | 45401-19055 | 52-02-212   |
| 45046-39335 | 111-02-289  | 45047-20010 | 111-02-205  | 45401-19066 | 52-02-202   |
| 45046-39385 | 111-02-226  | 45047-29015 | 111-02-205  | 45401-19095 | 52-02-210   |
| 45046-39505 | 111-02-2002 | 45047-29035 | 111-02-203L | 45401-19125 | 52-02-202   |
| 45046-49085 | 111-02-237  | 45047-29045 | 111-02-295  | 45401-19135 | 52-02-202   |
| 45046-49095 | 111-02-2007 | 45047-29065 | 111-02-2004 | 45401-19175 | 52-02-215   |
| 45046-49115 | 111-02-275  | 45047-29075 | 111-02-293  | 45401-19185 | 52-02-216   |
| 45046-49125 | 111-02-234  | 45047-29105 | 111-02-294  | 45401-19195 | 52-02-216   |
| 45046-49195 | 111-02-2009 | 45047-29125 | 111-02-2226 | 45401-35190 | 52-02-235   |
| 45046-49225 | 111-02-2027 | 45047-35050 | 111-02-258  | 45401-35220 | 52-02-235   |
| 45046-59025 | 111-02-2222 | 45047-39025 | 111-02-203L | 45401-35240 | 52-02-236   |
| 45046-59026 | 111-02-2222 | 45047-39075 | 111-02-228  | 45406-19016 | 111-02-224  |
| 45046-60030 | 111-02-217R | 45047-39076 | 111-02-228  | 45406-19045 | 111-02-224  |
| 45046-60031 | 111-02-217R | 45047-39085 | 111-02-232  | 45406-19055 | 111-02-224  |
| 45046-60032 | 111-02-217R | 45047-39115 | 111-02-263L | 45406-19065 | 111-02-224  |
| 45046-60033 | 111-02-217R | 45047-39155 | 111-02-273  | 45406-19075 | 111-02-224  |
| 45046-60H01 | 111-02-221L | 45047-39156 | 111-02-273  | 45406-29055 | 111-02-219R |
| 45046-60H02 | 111-02-221R | 45047-39215 | 111-02-282  | 45406-29056 | 111-02-219R |
| 45046-69025 | 111-02-217R | 45047-49015 | 111-02-252  | 45406-29065 | 111-02-219R |
| 45046-69030 | 111-02-217R | 45047-49025 | 111-02-2008 | 45406-29075 | 111-02-244  |
| 45046-69035 | 111-02-209  | 45047-49045 | 111-02-276  | 45406-29095 | 111-02-214  |
| 45046-69045 | 111-02-221L | 45047-49055 | 111-02-235  | 45406-29105 | 111-02-233  |
| 45046-69055 | 111-02-221R | 45047-49135 | 111-02-2010 | 45406-29115 | 111-02-227  |
| 45046-69105 | 111-02-250  | 45047-49165 | 111-02-2028 | 45406-29135 | 111-02-260  |
| 45046-69115 | 111-02-247  | 45047-59025 | 111-02-2223 | 45406-29145 | 111-02-232  |
| 45046-69125 | 111-02-287  | 45047-59026 | 111-02-2223 | 45406-39075 | 111-02-220  |
| 45046-69155 | 111-02-247  | 45047-69035 | 111-02-248  | 45406-39085 | 111-02-227  |
| 45046-69195 | 111-02-291  | 45047-69065 | 111-02-248  | 45406-39086 | 111-02-227  |
| 45046-69205 | 111-02-2001 | 45047-69066 | 111-02-285  | 45406-39095 | 111-02-227  |
| 45046-8Y001 | 111-02-259  | 45047-69085 | 111-02-285  | 45406-39105 | 111-02-240  |
| 4504605070  | 111-02-2025 | 45047-69100 | 111-02-290  | 45406-39115 | 111-02-227  |
| 4504609050  | 111-02-2225 | 45047-69115 | 111-02-2000 | 45406-39125 | 111-02-227  |
| 4504609100  | 111-02-2225 | 45047-87303 | 111-02-202L | 45406-39135 | 73-02-292   |
| 4504609360  | 111-02-271  | 45047-87380 | 111-02-202L | 45406-39165 | 73-02-292   |
| 4504639165  | 111-02-226  | 4504705060  | 111-02-2024 | 45406-39175 | 73-02-292   |
| 4504649115  | 111-02-271  | 4504709010  | 111-02-2226 | 4540629115  | 111-02-232  |
| 4504669036  | 111-02-209  | 4504709030  | 111-02-2226 | 4540639085  | 111-02-232  |
| 4504669116  | 111-02-247  | 4504709150  | 111-02-264  | 4540639086  | 111-02-232  |
| 4504669135  | 111-02-287  | 4504729075  | 111-02-294  | 4540639115  | 111-02-232  |
| 45047 09320 | 111-02-2024 | 4504729105  | 111-02-293  | 4540639125  | 111-02-232  |
| 45047 49075 | 111-02-2020 | 4504749045  | 111-02-264  | 4540639155  | 111-02-232  |
| 45047-09125 | 111-02-210  | 4504760013  | 111-02-248  | 4540639155  | 111-02-227  |
| 45047-09220 | 111-02-2014 | 4504760013  | 111-02-217L | 4540639185  | 73-02-292   |
| 45047-09570 | 111-02-2016 | 4504769025  | 111-02-248  | 45407-29015 | 111-02-219L |
| 45047-19035 | 111-02-223  | 4504769025  | 111-02-217L | 45407-29016 | 111-02-219L |



**CROSS REFERENCE LIST**  
**VERGLEICHSLISTE**  
**LISTA DE REFERENCIAS CRUZADES**  
**LISTE DE COMPARAISON**  
**LISTA DI COMPARAZIONE**

|             |             |             |             |             |             |
|-------------|-------------|-------------|-------------|-------------|-------------|
| 45440-29045 | 28-02-297   | 45460-39215 | 108-02-203  | 45500-0H010 | 103-02-221  |
| 45440-29125 | 28-02-297   | 45460-39225 | 108-02-203  | 4550005030  | 103-02-208  |
| 45450-29085 | 28-02-297   | 45460-39245 | 105-02-224  | 45503 09331 | 103-02-247  |
| 45450-29155 | 27-02-212   | 45460-39615 | 111-02-231  | 45503 39265 | 103-02-237  |
| 45450-39015 | 27-02-201   | 4546039635  | 111-02-231  | 45503 47030 | 103-02-250  |
| 45450-39016 | 27-02-201   | 45470-19015 | 108-02-234  | 45503 49075 | 103-02-249  |
| 45450-39037 | 28-02-297   | 45470-19035 | 111-02-262L | 45503 74010 | 103-02-255  |
| 45450-39055 | 27-02-201   | 45470-19045 | 111-02-262L | 45503-02080 | 103-02-225  |
| 45450-39065 | 27-02-201   | 45470-19055 | 111-02-262L | 45503-05010 | 76-02-296   |
| 45450-39125 | 27-02-298   | 45470-19065 | 111-02-2012 | 45503-05020 | 111-02-2227 |
| 45450-39155 | 27-02-209   | 45470-29046 | 105-02-214  | 45503-06080 | 103-02-231  |
| 45450-39165 | 27-02-210   | 45470-29075 | 105-02-220  | 45503-09321 | 103-02-247  |
| 45460-19025 | 105-02-299  | 45470-29085 | 110-02-271  | 45503-0D030 | 103-02-244  |
| 45460-19055 | 105-02-204  | 45470-29185 | 111-02-2006 | 45503-0F010 | 103-02-200  |
| 45460-19056 | 105-02-299  | 45470-39055 | 105-02-224  | 45503-10020 | 103-02-201  |
| 45460-19065 | 105-02-204  | 45470-39215 | 111-02-230  | 45503-12130 | 103-02-225  |
| 45460-19085 | 105-02-204  | 4547039225  | 111-02-230  | 45503-17040 | 103-02-252  |
| 45460-19095 | 105-02-204  | 45490-19125 | 59-02-201   | 45503-19015 | 103-02-201  |
| 45460-19105 | 108-02-222  | 45490-19125 | 108-02-222  | 45503-19025 | 103-02-204  |
| 45460-19115 | 108-02-234  | 45490-19165 | 59-02-209   | 45503-19035 | 103-02-202  |
| 45460-19135 | 105-02-204  | 45490-19175 | 59-02-209   | 45503-19036 | 103-02-206  |
| 45460-19145 | 108-02-237  | 45490-19215 | 59-02-226   | 45503-19045 | 103-02-201  |
| 45460-19155 | 110-02-231  | 45490-19225 | 59-02-229   | 45503-19055 | 103-02-205  |
| 45460-19165 | 110-02-235  | 45490-19245 | 59-02-229   | 45503-19056 | 103-02-210  |
| 45460-19175 | 105-02-299  | 45490-29135 | 59-02-218   | 45503-19075 | 103-02-211  |
| 45460-19185 | 111-02-262R | 45490-29145 | 59-02-218   | 45503-19085 | 103-02-289  |
| 45460-19195 | 111-02-262R | 45490-29245 | 59-02-235   | 45503-19116 | 103-02-212  |
| 45460-19205 | 111-02-262R | 45490-29295 | 59-02-209   | 45503-19125 | 103-02-213  |
| 45460-19235 | 111-02-2011 | 45490-29305 | 59-02-209   | 45503-19135 | 103-02-214  |
| 45460-29066 | 105-02-208  | 45490-29335 | 59-02-209   | 45503-19145 | 103-02-238  |
| 45460-29085 | 105-02-201  | 45490-29355 | 59-02-209   | 45503-19155 | 103-02-298  |
| 45460-29125 | 105-02-208  | 45490-29365 | 59-02-209   | 45503-19195 | 103-02-298  |
| 45460-29135 | 105-02-299  | 45490-29405 | 59-02-209   | 45503-19205 | 76-02-299   |
| 45460-29145 | 105-02-299  | 45490-29425 | 59-02-209   | 45503-19215 | 103-02-290  |
| 45460-29185 | 105-02-208  | 45490-29465 | 59-02-236   | 45503-19255 | 103-02-225  |
| 45460-29205 | 110-02-230  | 45490-29475 | 59-02-243   | 45503-22010 | 103-02-203  |
| 45460-29215 | 108-02-203  | 45490-29515 | 59-02-246   | 45503-29015 | 103-02-203  |
| 45460-29225 | 110-02-230  | 45490-35130 | 59-02-239   | 45503-29016 | 103-02-203  |
| 45460-29265 | 105-02-209  | 45490-35140 | 59-02-215   | 45503-29025 | 103-02-207  |
| 45460-29285 | 105-02-220  | 45490-39245 | 59-02-245   | 45503-29035 | 103-02-219  |
| 45460-29315 | 110-02-271  | 45490-39255 | 59-02-244   | 45503-29075 | 103-02-215  |
| 45460-29425 | 111-02-2005 | 45490-39315 | 59-02-240   | 45503-29095 | 103-02-297  |
| 45460-39095 | 108-02-203  | 45490-39325 | 59-02-245   | 45503-29105 | 103-02-216  |
| 45460-39096 | 108-02-203  | 45490-39335 | 59-02-244   | 45503-29125 | 103-02-203  |
| 45460-39125 | 105-02-206  | 45490-39345 | 59-02-244   | 45503-29135 | 103-02-297  |
| 45460-39155 | 108-02-203  | 45490-39355 | 59-02-245   | 45503-29155 | 103-02-295  |
| 45460-39165 | 110-02-282  | 45490-39455 | 59-02-200   | 45503-29165 | 103-02-294  |
| 45460-39195 | 105-02-211  | 45490-405   | 59-02-209   | 45503-29215 | 103-02-293  |

**CROSS REFERENCE LIST**  
**VERGLEICHSLISTE**  
**LISTA DE REFERENCIAS CRUZADES**  
**LISTE DE COMPARAISON**  
**LISTA DI COMPARAZIONE**



|             |             |             |           |             |           |
|-------------|-------------|-------------|-----------|-------------|-----------|
| 45503-29245 | 103-02-292  | 48068-0F010 | 72-02-223 | 48069-05070 | 72-02-202 |
| 45503-29255 | 103-02-217  | 48068-0H010 | 72-02-207 | 48069-09040 | 72-02-248 |
| 45503-29265 | 103-02-218  | 48068-0K040 | 72-02-253 | 48069-0F010 | 72-02-222 |
| 45503-29295 | 103-02-239  | 48068-12130 | 72-02-217 | 48069-0H010 | 72-02-206 |
| 45503-29355 | 103-02-291  | 48068-12171 | 72-02-219 | 48069-0K040 | 72-02-252 |
| 45503-29365 | 103-02-290  | 48068-12260 | 72-02-221 | 48069-12130 | 72-02-216 |
| 45503-29385 | 76-02-299   | 48068-19045 | 28-02-297 | 48069-12171 | 72-02-218 |
| 45503-29395 | 103-02-253  | 48068-19095 | 73-02-222 | 48069-12260 | 72-02-220 |
| 45503-29435 | 76-02-298   | 48068-20221 | 72-02-213 | 48069-19045 | 71-02-291 |
| 45503-29475 | 76-02-297   | 48068-20260 | 72-02-211 | 48069-20221 | 72-02-212 |
| 45503-29565 | 103-02-227  | 48068-20380 | 72-02-215 | 48069-20381 | 72-02-214 |
| 45503-29615 | 76-02-298   | 48068-26130 | 71-02-201 | 48069-26130 | 71-02-202 |
| 45503-29765 | 103-02-240  | 48068-28120 | 72-02-239 | 48069-28120 | 72-02-238 |
| 45503-39015 | 103-02-289  | 48068-33031 | 72-02-209 | 48069-33031 | 72-02-208 |
| 45503-39025 | 103-02-216  | 48068-35080 | 72-02-227 | 48069-35080 | 72-02-226 |
| 45503-39075 | 103-02-228  | 48068-42010 | 72-02-241 | 48069-42010 | 72-02-240 |
| 45503-39135 | 103-02-291  | 48068-42040 | 72-02-243 | 48069-42040 | 72-02-242 |
| 45503-39225 | 103-02-222  | 48068-42041 | 72-02-243 | 48069-42041 | 72-02-242 |
| 45503-39235 | 103-02-237  | 48068-42050 | 72-02-245 | 48069-42050 | 72-02-244 |
| 45503-49035 | 103-02-223  | 48068-44010 | 72-02-237 | 48069-44010 | 72-02-236 |
| 45503-49055 | 103-02-242  | 48068-49045 | 72-02-205 | 48069-49045 | 72-02-204 |
| 45503-49105 | 103-02-209  | 48068-49065 | 72-02-205 | 48069-49065 | 72-02-204 |
| 45503-52010 | 111-02-2224 | 48068-59035 | 72-02-247 | 48069-59035 | 72-02-246 |
| 45503-52070 | 103-02-246  | 48068-60010 | 72-02-235 | 48069-60010 | 72-02-234 |
| 45503-59045 | 111-02-2224 | 48068-79015 | 72-02-265 | 4806905050  | GOM-226   |
| 45503-59055 | 103-02-245  | 4806805050  | GOM-226   | 4806905070  | GOM-228   |
| 45503-69015 | 103-02-230  | 4806805070  | GOM-228   | 4806905070  | GOM-229   |
| 45503-69025 | 103-02-234  | 4806805070  | GOM-229   | 480690H010  | GOM-233   |
| 45503-990DL | 103-02-224  | 480680H010  | GOM-234   | 480690H010  | GOM-234   |
| 4550305050  | 111-02-2227 | 480680H010  | GOM-233   | 4806912140  | 72-02-216 |
| 4550309230  | 103-02-222  | 4806812140  | 72-02-217 | 4806912160  | 72-02-218 |
| 45503990DL  | 76-02-296   | 4806820381  | 72-02-215 | 4806912170  | 72-02-218 |
| 45504-28030 | 103-02-240  | 4806826131  | 71-02-201 | 4806912190  | 72-02-218 |
| 48061-05010 | GOM-227     | 4806826132  | 71-02-201 | 4806912191  | 72-02-218 |
| 48061-26050 | GOM-263     | 4806829265  | 72-02-205 | 4806920260  | 72-02-210 |
| 48061-27010 | GOM-269     | 4806833030  | 72-02-209 | 4806920380  | 72-02-214 |
| 48061-27011 | GOM-269     | 4806833050  | 72-02-239 | 4806926131  | 71-02-202 |
| 48061-35040 | GOM-293     | 4806833060  | 72-02-239 | 4806926132  | 71-02-202 |
| 48061-60010 | GOM-274     | 4806835081  | 72-02-227 | 4806929265  | 72-02-204 |
| 48066-29075 | 72-02-225   | 4806842012  | 72-02-241 | 4806933030  | 72-02-208 |
| 48067-29075 | 72-02-224   | 4806842022  | 72-02-241 | 4806933050  | 72-02-238 |
| 48068 05080 | 72-02-261   | 4806849065  | 73-02-205 | 4806933060  | 72-02-238 |
| 48068 12300 | 72-02-255   | 48069 05080 | 72-02-260 | 4806935081  | 72-02-226 |
| 48068 33020 | 72-02-263   | 48069 12300 | 72-02-254 | 4806942012  | 72-02-240 |
| 48068-02070 | 72-02-221   | 48069 33020 | 72-02-262 | 4806942022  | 72-02-240 |
| 48068-05050 | 72-02-201   | 48069 79015 | 72-02-264 | 4806949065  | 73-02-205 |
| 48068-05070 | 72-02-203   | 48069-02080 | 72-02-220 | 48071-01010 | GOM-2024  |
| 48068-09040 | 72-02-249   | 48069-05050 | 72-02-200 | 4807112080  | GOM-2024  |



**CROSS REFERENCE LIST**  
**VERGLEICHSLISTE**  
**LISTA DE REFERENCIAS CRUZADES**  
**LISTE DE COMPARAISON**  
**LISTA DI COMPARAZIONE**

|             |           |               |            |             |            |
|-------------|-----------|---------------|------------|-------------|------------|
| 4807112140  | GOM-2024  | 4865442020    | GOM-276    | 48815-0D100 | GOM-257    |
| 4807201011  | GOM-2023  | 48655 12060   | GOM-295    | 48815-0F010 | GOM-240    |
| 4807212080  | GOM-2023  | 48655-12050   | GOM-237    | 48815-0K010 | GOM-264    |
| 4807212140  | GOM-2023  | 48655-12120   | GOM-267    | 48815-10060 | GOM-220    |
| 48075-42050 | GOM-292   | 48655-20030   | GOM-2009   | 48815-12220 | GOM-297    |
| 48603-33021 | GOM-2004  | 48655-20050RH | GOM-217    | 48815-12230 | GOM-2020   |
| 48609-01040 | GOM-2018  | 48655-20060LH | GOM-218    | 48815-20020 | GOM-214    |
| 48609-0K010 | GOM-2033  | 48655-20140   | GOM-231    | 48815-20030 | GOM-215    |
| 48609-0K040 | GOM-2034  | 48655-33010   | GOM-2010   | 48815-28061 | GOM-260    |
| 48609-12192 | GOM-2018  | 48655-52010   | GOM-2011   | 48815-30040 | GOM-262    |
| 48609-12211 | GOM-2003  | 48655-60010   | GOM-245    | 48815-30050 | GOM-219    |
| 48609-20050 | GOM-2014  | 48655-60030   | GOM-249    | 48815-42050 | GOM-220    |
| 48609-33011 | GOM-2017  | 48674 32090   | GOM-2006   | 48815-42090 | GOM-254    |
| 48609-33121 | GOM-2005  | 48674-60010   | GOM-223    | 48815-42100 | GOM-255    |
| 48609-42010 | GOM-275   | 48702-60010   | GOM-243    | 48815-42110 | GOM-254    |
| 48609-42011 | GOM-275   | 48702-60020   | GOM-209    | 48815-42120 | GOM-255    |
| 48609-42012 | GOM-275   | 48702-60031   | GOM-2012   | 48815-60010 | GOM-207    |
| 48609-52031 | GOM-265   | 48702-60040   | GOM-272    | 48815-60180 | GOM-2035   |
| 48609-52100 | GOM-266   | 48702-60050   | GOM-271    | 4881502040  | GOM-296    |
| 48610-0K040 | 72-02-251 | 48706-60030   | GOM-273    | 488150H010  | GOM-232    |
| 48610-35040 | 72-02-257 | 48710-35030   | 71-02-205  | 4881542040  | GOM-2000   |
| 48610-60030 | 72-02-229 | 48720-60011   | 27-02-200  | 4881552030  | GOM-298    |
| 48610-60050 | 72-02-233 | 48725-03010   | GOM-2013   | 48817-30010 | GOM-208    |
| 48610-60070 | 72-02-233 | 48725-0H010   | GOM-235    | 4881812160  | GOM-299    |
| 48620-60010 | 72-02-231 | 48750-16100   | GOM-2019   | 48819-26050 | 106-02-249 |
| 48630-0K040 | 72-02-250 | 4875016110    | GOM-2019   | 48819-35020 | 106-02-250 |
| 48630-35020 | 72-02-256 | 48802-60030   | 106-02-247 | 48819-52010 | 106-02-239 |
| 48630-60010 | 72-02-228 | 48802-60090   | 106-02-248 | 4881970010  | 106-02-214 |
| 48630-60020 | 72-02-232 | 48810-05012   | 106-02-207 | 48820 33070 | 106-02-259 |
| 48630-60040 | 72-02-232 | 48810-0K010   | 106-02-242 | 48820-02020 | 106-02-220 |
| 48632 26010 | GOM-241   | 48810-20010   | 106-02-206 | 48820-02070 | 106-02-235 |
| 48632 60010 | GOM-244   | 48810-20020   | 106-02-207 | 48820-05012 | 106-02-208 |
| 48632-30020 | GOM-211   | 48810-26020   | 106-02-222 | 48820-0D010 | 106-02-240 |
| 48632-60020 | GOM-247   | 48810-26030   | 106-02-244 | 48820-0D020 | 106-02-240 |
| 48635-26010 | GOM-242   | 48810-28010   | 106-02-237 | 48820-0K010 | 106-02-246 |
| 48635-28010 | GOM-2007  | 48810-28020   | 106-02-230 | 48820-0K030 | 106-02-241 |
| 48640-60010 | 72-02-230 | 48810-33010   | 106-02-216 | 48820-20010 | 106-02-201 |
| 48650-20020 | 71-02-200 | 48810-44010   | 106-02-207 | 48820-20030 | 106-02-299 |
| 4865020021  | 71-02-200 | 48810-50020   | 106-02-260 | 48820-20040 | 106-02-208 |
| 48654 12010 | GOM-2030  | 48810-60010   | 106-02-224 | 48820-24010 | 106-02-238 |
| 48654-05040 | GOM-230   | 48810-60040   | 106-02-228 | 48820-26020 | 106-02-221 |
| 48654-12070 | GOM-236   | 48815 02140   | GOM-286    | 48820-26030 | 106-02-245 |
| 48654-16110 | GOM-233   | 48815 02150   | GOM-287    | 48820-28010 | 106-02-231 |
| 48654-20150 | GOM-268   | 48815 05120   | GOM-289    | 48820-28050 | 106-02-218 |
| 48654-35010 | GOM-210   | 48815 05130   | GOM-288    | 48820-30010 | 106-02-203 |
| 48654-60010 | GOM-246   | 48815 12140   | GOM-2028   | 48820-32010 | 106-02-220 |
| 48654-60030 | GOM-248   | 48815 12160   | GOM-2029   | 48820-33010 | 106-02-298 |
| 4865420060  | GOM-2008  | 48815 14160   | GOM-270    | 48820-33020 | 106-02-215 |

**CROSS REFERENCE LIST**  
**VERGLEICHSLISTE**  
**LISTA DE REFERENCIAS CRUZADES**  
**LISTE DE COMPARAISON**  
**LISTA DI COMPARAZIONE**



|             |             |
|-------------|-------------|
| 48820-35010 | 106-02-243  |
| 48820-35030 | 106-02-225  |
| 48820-42010 | 106-02-232  |
| 48820-42030 | 106-02-235  |
| 48820-44010 | 106-02-208  |
| 48820-44020 | 106-02-205  |
| 48820-47010 | 106-02-204  |
| 48820-50030 | 106-02-261  |
| 48820-60010 | 106-02-223  |
| 48820-60050 | 106-02-227  |
| 48820-74010 | 106-02-262  |
| 48820-AD010 | 106-02-225  |
| 4882028030  | 106-02-231  |
| 48830 33040 | 106-02-263  |
| 48830-05020 | 106-02-200  |
| 48830-05030 | 106-02-258  |
| 48830-20010 | 106-02-202  |
| 48830-21020 | 106-02-213  |
| 48830-32010 | 106-02-209  |
| 48830-33010 | 106-02-217  |
| 48830-35020 | 106-02-226  |
| 48830-42010 | 106-02-233  |
| 48830-42020 | 106-02-236  |
| 48830-48010 | 106-02-219  |
| 48830-60030 | 106-02-229  |
| 4883006030  | 106-02-219  |
| 4883012060  | 106-02-202  |
| 4883042021  | 106-02-236  |
| 48840-21010 | 106-02-212  |
| 48840-42010 | 106-02-234  |
| 49069-20260 | 72-02-210   |
| 509110      | 106-02-214  |
| 5094 A8     | GOM-232     |
| 90101-08038 | 106-02-251  |
| 90101-10140 | 106-02-252  |
| 90140006    | 111-0W-D51R |
| 90140007    | 111-0W-D51L |
| 90342316    | 73-0W-D51   |
| 90375505    | 73-0W-D51   |
| 90375506    | 73-0W-D51   |
| 90385 T0001 | GOM-277     |
| 90385 T0002 | GOM-278     |
| 90385 T0003 | GOM-279     |
| 90385 T0008 | GOM-279     |
| 90385 T0009 | GOM-277     |
| 90385 T0010 | GOM-278     |
| 90385-18007 | GOM-213     |
| 90385-18009 | GOM-205     |

|                            |          |
|----------------------------|----------|
| 90385-18009                | GOM-222  |
| 90385-18019                | GOM-2037 |
| 90385-18020                | GOM-2036 |
| 90385-18023                | GOM-285  |
| 90385-18046                | GOM-212  |
| 90385-23037                | GOM-221  |
| 90389 14004                | GOM-280  |
| 90389 T0005                | GOM-280  |
| 90389-16026                | GOM-284  |
| 90389-18002                | GOM-206  |
| 90948-01002                | GOM-216  |
| <b>VOLVO</b> <b>ASHIKA</b> |          |
| 30 683 067                 | GOM-323  |
| 30666821                   | GOM-317  |



**BUMP RUBBER KIT UNIVERSAL TYPE  
UNIVERSALE DÄMPFERKAPPEN  
SOUFFLET DE CARDAN  
FUELLES AMTORGUADORES UNIVERSALES  
CUFFIE AMMORTIZZATORI UNIVERSALI**



| CODE/CODICE<br>ASHIKA | Shaft<br>diameter<br><i>Diametro<br/>dell'asse</i> | Cut dimensions (mm)<br><i>Dimensioni del taglio (mm)</i> |       |       |                               |
|-----------------------|--|--|-------|-------|-------------------------------|
|                       |  | number~C<br><i>numero~C</i>                              | C ~ B | B ~ A | no cut<br><i>non tagliato</i> |
| 63-0A-A10             | Ø 10   | 46   | 66    | 84    | 98                            |
| 63-0A-A12             | Ø 12   |  |       |       |                               |
| 63-0A-A16             | Ø 16   |  |       |       |                               |
| 63-0A-A18             | Ø 18   |  |       |       |                               |
| 63-0A-A20             | Ø 20   |  |       |       |                               |
| 63-0A-A22             | Ø 22   |  |       |       |                               |

|                               |  |
|-------------------------------|--|
| number/numero~C<br>L=46mm     |  |
| C ~ B<br>L=66mm               |  |
| B ~ A<br>L=84mm               |  |
| no cut/non tagliato<br>L=98mm |  |

! : All the attached dust boots become common with 63- (COD ASHIKA)

! : As for the cut dimensions, it is written the dimensions that do not include the base part sound stopper.



! : Per le dimensioni del taglio, sono scritte le dimensioni che non includono la base del bloccaggio di vibrazione.

# 63-0A-A10



| ASHIKA CODE | MANUFACTURER | CAR NAME      | MODEL   | YEAR            | ForR | REMARKS |
|-------------|--------------|---------------|---------|-----------------|------|---------|
| 63-0A-A10   | AUDI         | 50            |         |                 | R    |         |
|             | AUDI         | 80            | Variant | 1991-1995       | R    |         |
|             | AUDI         | 80            | Avant   | 1991-1995       | R    |         |
|             | HONDA        | LIFE          |         | 08.1998-09.2003 | R    |         |
|             | HONDA        | That's        |         | 02.2002-        | R    |         |
|             | MAZDA        | Demio         |         |                 | R    |         |
|             | SEAT         | Cordoba Vario |         |                 | R    |         |
|             | VOLKSWAGEN   | Derby         |         |                 | R    |         |
|             | VOLKSWAGEN   | Golf Cabrio   |         |                 | R    |         |
|             | VOLKSWAGEN   | Golf I        |         |                 | R    |         |
|             | VOLKSWAGEN   | Jetta I       |         |                 | R    |         |
|             | VOLKSWAGEN   | Polo          |         |                 | R    |         |
|             | VOLKSWAGEN   | Polo Variant  |         |                 | R    |         |
|             | VOLKSWAGEN   | Scirocco      |         |                 | R    |         |

# 63-0A-A12 (1)



| ASHIKA CODE | MANUFACTURER | CAR NAME         | MODEL | YEAR            | ForR | REMARKS           |
|-------------|--------------|------------------|-------|-----------------|------|-------------------|
| 63-0A-A12   | AUDI         | A4               |       |                 | R    |                   |
|             | AUDI         | A4 Avant         |       |                 | R    |                   |
|             | BMW          | 5 Series (E28)   |       |                 | R    |                   |
|             | BMW          | 6 Series (E24)   |       |                 | R    |                   |
|             | FORD         | Escort           |       |                 | R    |                   |
|             | FORD         | Mk VII           |       |                 | R    |                   |
|             | FORD         | RS               |       | 1995-02.1999    | R    |                   |
|             | FORD         | XR-3             |       |                 | R    |                   |
|             | HONDA        | ACCORD           |       | 07.1997-06.2002 | F    |                   |
|             | HONDA        | ACCORD           |       | 07.1997-06.2002 | R    |                   |
|             | HONDA        | ACCORD INSPIRE   |       | 12.2007-        | F    |                   |
|             | HONDA        | ACCORD INSPIRE   |       | 12.2007-        | R    |                   |
|             | HONDA        | ACCORD JP4Dr     |       | 09.2002-        | F    |                   |
|             | HONDA        | ACCORD JP4Dr     |       | 09.2002-        | R    |                   |
|             | HONDA        | ACCORD JPWGN     |       | 11.2002-        | F    |                   |
|             | HONDA        | ACCORD JPWGN     |       | 11.2002-        | R    |                   |
|             | HONDA        | ACCORD UA        |       | 07.2002-        | F    |                   |
|             | HONDA        | ACCORD UA        |       | 07.2002-        | R    |                   |
|             | HONDA        | AIRWAVE          |       | 05.2005-        | R    |                   |
|             | HONDA        | AVANCIER         |       | 2002            | F    |                   |
|             | HONDA        | AVANCIER         |       | 2002            | R    |                   |
|             | HONDA        | CIVIC            |       | 06.1995-05.2005 | R    |                   |
|             | HONDA        | CIVIC GSA/SIC    |       | 08.2005-        | R    |                   |
|             | HONDA        | CIVIC TYPE R     |       | 08.2001-        | R    |                   |
|             | HONDA        | CROSSROAD        |       | 02.2007-        | R    |                   |
|             | HONDA        | CR-V             |       | 09.1995-10.2001 | R    | JP/UK/Thailand    |
|             | HONDA        | CR-V             |       | 07.2006-        | R    | JP/US/UK/Thailand |
|             | HONDA        | Edix             |       | 06.2004-        | R    |                   |
|             | HONDA        | ELYSION          |       | 05.2004-        | F    |                   |
|             | HONDA        | ELYSION          |       | 05.2004-        | R    |                   |
|             | HONDA        | ELYSION PRESTIGE |       | 12.2006-        | F    |                   |
|             | HONDA        | ELYSION PRESTIGE |       | 12.2006-        | R    |                   |
|             | HONDA        | FCX              |       | 10.2002-        | R    |                   |

| ASHIKA CODE | MANUFACTURER | CAR NAME               | MODEL | YEAR            | ForR | REMARKS |  |
|-------------|--------------|------------------------|-------|-----------------|------|---------|--|
| 63-0A-A12   | HONDA        | Fit Rr:SSK Assy        |       | 08.2007-        | R    |         |  |
|             | HONDA        | Fit ARIA SSM           |       | 10.2002-        | R    |         |  |
|             | HONDA        | Fit EU/KQ              |       | 08.2002-        | R    |         |  |
|             | HONDA        | FREED Rr:SSK Assy      |       | 05.2008-        | R    |         |  |
|             | HONDA        | INSPIRE JP             |       | 05.2003-        | F    |         |  |
|             | HONDA        | INSPIRE JP             |       | 05.2003-        | R    |         |  |
|             | HONDA        | INTEGRA                |       | 03.1995-08.2006 | R    |         |  |
|             | HONDA        | INTEGRA R              |       | 06.2004-        | R    |         |  |
|             | HONDA        | LEGEND                 |       | 08.1998-02.2004 | F    |         |  |
|             | HONDA        | LEGEND                 |       | 08.1998-02.2004 | R    |         |  |
|             | HONDA        | LEGEND                 |       | 07.2004-        | F    |         |  |
|             | HONDA        | LEGEND                 |       | 07.2004-        | R    |         |  |
|             | HONDA        | LEGEND EU/GSA          |       | 05.2006-        | F    |         |  |
|             | HONDA        | LEGEND EU/GSA          |       | 05.2006-        | R    |         |  |
|             | HONDA        | LOGO                   |       | 08.1996-09.2001 | R    |         |  |
|             | HONDA        | MOBILIO Spike          |       | 12.2002-        | R    |         |  |
|             | HONDA        | NSX                    |       | 02.1993-11.2001 | F    |         |  |
|             | HONDA        | NSX                    |       | 02.1993-11.2001 | R    |         |  |
|             | HONDA        | ODYSSEY                |       | 09.1997-        | R    |         |  |
|             | HONDA        | ODYSSEY                |       | 10.2003-        | F    |         |  |
|             | HONDA        | ODYSSEY Absolute (4WD) |       | 04.2006-        | F    |         |  |
|             | HONDA        | ODYSSEY Absolute (4WD) |       | 04.2006-        | R    |         |  |
|             | HONDA        | ODYSSEY V6             |       | 09.1997-11.2003 | R    |         |  |
|             | HONDA        | OLTIA                  |       | 06.1995-07.2002 | R    |         |  |
|             | HONDA        | PRELUDE                |       | 09.1996-12.2001 | F    |         |  |
|             | HONDA        | PRELUDE                |       | 09.1996-12.2001 | R    |         |  |
|             | HONDA        | RD-X                   |       | 05.2006-        | R    |         |  |
|             | HONDA        | S2000                  |       | 03.1999-08.2004 | F    |         |  |
|             | HONDA        | S2000                  |       | 03.1999-08.2004 | R    |         |  |
|             | HONDA        | S-MX                   |       | 12.1996-04.2001 | R    |         |  |
|             | HONDA        | STEP WGN               |       | 03.1996-04.2001 | R    |         |  |
|             | HONDA        | STEP WGN               |       | 06.2005-        | R    |         |  |
|             | HONDA        | STREAM                 |       | 06.2006-        | R    |         |  |
|             | HONDA        | US ACCORD              |       | 07.2007-        | F    |         |  |
|             | HONDA        | US ACCORD              |       | 07.2007-        | R    |         |  |
|             | MAZDA        | 121                    |       |                 |      | R       |  |
|             | MAZDA        | 929                    |       |                 |      | R       |  |
|             | MAZDA        | 929L                   |       |                 |      | R       |  |
|             | MAZDA        | Luce                   |       |                 |      | R       |  |
|             | SEAT         | Toledo                 |       |                 |      | R       |  |
|             | SKODA        | Favorit                |       |                 |      | R       |  |
|             | WOLKSWAGEN   | Corrado                |       |                 |      | R       |  |
|             | WOLKSWAGEN   | Golf Cabrio            |       |                 |      | R       |  |
|             | WOLKSWAGEN   | Golf II                |       |                 |      | R       |  |
|             | WOLKSWAGEN   | Jetta II               |       |                 |      | R       |  |
| WOLKSWAGEN  | Golf III     |                        |       |                 | R    |         |  |
| WOLKSWAGEN  | Vento        |                        |       |                 | R    |         |  |
| WOLKSWAGEN  | Passat       |                        |       | -1996           | R    |         |  |
| WOLKSWAGEN  | Santana      |                        |       | -1988           | R    |         |  |



# 63-0A-A16



| ASHIKA CODE | MANUFACTURER  | CAR NAME         | MODEL   | YEAR | ForR      | REMARKS |
|-------------|---------------|------------------|---------|------|-----------|---------|
| 63-0A-A16   | AUDI          | 100              |         |      | R         |         |
|             | AUDI          | 100 Avant        |         |      | R         |         |
|             | AUDI          | A4               |         |      | F         |         |
|             | AUDI          | A4 Avant         |         |      | F         |         |
|             | AUDI          | A6               |         |      | R         |         |
|             | AUDI          | A6 Avant         |         |      | 1994-1997 | R       |
|             | FIAT          | Cinquecento      |         |      |           | F       |
|             | FIAT          | Seicento         |         |      |           | F       |
|             | MERCEDES BENZ | 190 Series (201) |         |      |           | F       |
|             | MERCEDES BENZ | E Series         |         |      |           | F       |
|             | MERCEDES BENZ | E-Class (124)    |         |      |           | F       |
|             | MITSUBISHI    | Carisma          |         |      |           | R       |
|             | NISSAN        | Sunny            |         |      |           | R       |
|             | VOLKSWAGEN    | Golf III         | Variant |      |           | R       |
|             | VOLKSWAGEN    | Passat           |         |      | 1997-     | F       |
|             | VOLVO         | S40              |         |      |           | R       |
| VOLVO       | V40           |                  |         |      | R         |         |

# 63-0A-A18 (1)



| ASHIKA CODE | MANUFACTURER | CAR NAME              | MODEL   | YEAR | ForR            | REMARKS |
|-------------|--------------|-----------------------|---------|------|-----------------|---------|
| 63-0A-A18   | AUTOBIANCHI  | Y10                   |         |      | F               |         |
|             | FIAT         | Regata Weekend (138R) |         |      | F               |         |
|             | FIAT         | Regata (138R)         |         |      | F               |         |
|             | FIAT         | Ritmo                 |         |      | F               |         |
|             | FIAT         | Strada (138)          |         |      | F               |         |
|             | FIAT         | Uno (146) Exc.CS      |         |      | F               |         |
|             | FORD         | Escort                | Express |      |                 | F       |
|             | FORD         | Escort                | Mk. V   |      |                 | F       |
|             | FORD         | Escort                | Mk. VI  |      |                 | F       |
|             | FORD         | Escort                | Mk. VII |      |                 | F       |
|             | FORD         | Escort                | MK III  |      |                 | F       |
|             | FORD         | Escort                | MK IV   |      |                 | F       |
|             | FORD         | Escort                | RS      |      | 1990-02.1999    | F       |
|             | FORD         | Escort                | Van     |      |                 | F       |
|             | FORD         | Escort                | XR-3    |      | 1980-1990       | F       |
|             | FORD         | Escort                | XR-3    |      |                 | F       |
|             | FORD         | Escort Turnier        | Mk. V   |      |                 | F       |
|             | FORD         | Escort Turnier        | Mk. VI  |      |                 | F       |
|             | FORD         | Escort Turnier        | Mk. VII |      | 1990-02.1999    | F       |
|             | FORD         | Escort Van            | Express |      |                 | F       |
|             | FORD         | Fiesta                | Courier |      |                 | F       |
|             | FORD         | Fiesta                | Van     |      |                 | F       |
|             | FORD         | Fiesta                | XR-2    |      | -1996           | F       |
|             | FORD         | Fiesta Van            | Courier |      |                 | F       |
|             | FORD         | Fiesta                |         |      | 1996-02.2002    | F       |
|             | FORD         | Ka                    |         |      |                 | F       |
|             | FORD         | Orion                 |         |      |                 | F       |
|             | HONDA        | VAMOS                 |         |      | 08.2001-08.2004 | F       |
|             | LANCIA       | Y10                   |         |      |                 | F       |
|             | MAZDA        | 121                   |         |      |                 | F       |



| ASHIKA CODE | MANUFACTURER         | CAR NAME          | MODEL     | YEAR            | ForR            | REMARKS |  |
|-------------|----------------------|-------------------|-----------|-----------------|-----------------|---------|--|
| 63-0A-A8    | MAZDA                | 626               |           |                 | R               |         |  |
|             | MAZDA                | 323               |           | 1980-1989       | F               |         |  |
|             | MAZDA                | 323               |           | 1986-1994       | R               |         |  |
|             | MAZDA                | Montrose          |           |                 | R               |         |  |
|             | NISSAN               | Cherry            |           |                 | R               |         |  |
|             | NISSAN               | Primera           |           |                 | F               |         |  |
|             | NISSAN               | Pulsar            |           |                 | R               |         |  |
|             | NISSAN               | Sunny             |           |                 | R               |         |  |
|             | NISSAN               | Sunny             | Traveller |                 | R               |         |  |
|             | OPEL                 | Corsa A           |           |                 | F               |         |  |
|             | OPEL                 | Corsa B           |           |                 | F               |         |  |
|             | OPEL                 | Corsa Combo       |           |                 | F               |         |  |
|             | RENAULT              | R5 (Super5)       | Express   |                 | F               |         |  |
|             | RENAULT              | R5 (Super5)       | Extra     |                 | F               |         |  |
|             | RENAULT              | R5 (Super5)       | Rapide    |                 | F               |         |  |
|             | SEAT                 | Arosa             |           |                 | F               |         |  |
|             | SEAT                 | Cordoba           |           |                 | F               |         |  |
|             | SEAT                 | Cordoba Vario     |           |                 | F               |         |  |
|             | SEAT                 | Ibiza             |           |                 | F               |         |  |
|             | SEAT                 | Malaga            |           |                 | F               |         |  |
|             | SEAT                 | Toledo            |           |                 | F               |         |  |
|             | SKODA                | Favorit           |           |                 | F               |         |  |
|             | SKODA                | Felicia           |           |                 | F               |         |  |
|             | TOYOTA               | CALDINA           | AZT241W   |                 | 09.2002-        |         |  |
|             | TOYOTA               | CALDINA           | AZT246W   |                 | 09.2002-        |         |  |
|             | TOYOTA               | CALDINA           | ZZT241W   |                 | 09.2002-        |         |  |
|             | TOYOTA               | CAMRY GRACIA      | MCV21     |                 | 12.1996-09.2001 |         |  |
|             | TOYOTA               | CAMRY GRACIA      | MCV21W    |                 | 12.1996-09.2001 |         |  |
|             | TOYOTA               | CAMRY GRACIA      | MCV25W    |                 | 06.1997-09.2001 |         |  |
|             | TOYOTA               | CAMRY GRACIA      | SXV20     |                 | 12.1996-09.2001 |         |  |
|             | TOYOTA               | CAMRY GRACIA      | SXV20W    |                 | 12.1996-09.2001 |         |  |
|             | TOYOTA               | CAMRY GRACIA      | SXV25     |                 | 08.1998-09.2001 |         |  |
|             | TOYOTA               | CAMRY GRACIA      | SXV25W    |                 | 06.1997-09.2001 |         |  |
|             | TOYOTA               | COROLLA RUNX/ALEX | NZE121    |                 | 01.2001-        |         |  |
|             | TOYOTA               | COROLLA RUNX/ALEX | ZZE122    |                 | 09.2002-        |         |  |
|             | TOYOTA               | COROLLA SPACIO    | NZE121N   |                 | 05.2001-04.2003 |         |  |
|             | TOYOTA               | COROLLA SPACIO    | ZZE122N   |                 | 05.2001-        |         |  |
|             | TOYOTA               | COROLLA/FIELDER   | CE121     |                 | 08.2000-04.2004 |         |  |
|             | TOYOTA               | COROLLA/FIELDER   | E121G     |                 | 08.2000-04.2004 |         |  |
|             | TOYOTA               | COROLLA/FIELDER   | NZE120    |                 | 08.2000-        |         |  |
|             | TOYOTA               | COROLLA/FIELDER   | NZE121    |                 | 08.2000-        |         |  |
|             | TOYOTA               | COROLLA/FIELDER   | NZE121G   |                 | 08.2000-        |         |  |
| TOYOTA      | COROLLA/FIELDER      | ZZE122            |           | 08.2000-        |                 |         |  |
| TOYOTA      | COROLLA/FIELDER      | ZZE122G           |           | 08.2000-        |                 |         |  |
| TOYOTA      | MARK II QUALIS WAGON | MCV20W            |           | 04.1997-12.2001 |                 |         |  |
| TOYOTA      | MARK II QUALIS WAGON | MCV21W            |           | 04.1997-12.2001 |                 |         |  |
| TOYOTA      | MARK II QUALIS WAGON | MCV25W            |           | 06.1997-12.2001 |                 |         |  |
| TOYOTA      | MARK II QUALIS WAGON | SXV20W            |           | 04.1997-12.2001 |                 |         |  |
| TOYOTA      | MARK II QUALIS WAGON | SXV25W            |           | 06.1997-12.2001 |                 |         |  |
| TOYOTA      | PORTE                | NNP10             |           | 07.2004-        |                 |         |  |
| TOYOTA      | PORTE                | NNP11             |           | 07.2004-        |                 |         |  |
| TOYOTA      | PORTE                | NNP15             |           | 01.2006-        |                 |         |  |
| TOYOTA      | RAV 4                | ACA31W            |           | 11.2005-        |                 |         |  |
| TOYOTA      | VITZ                 | NCP10             |           | 01.1999-01.2005 |                 |         |  |

# 63-0A-A18 (3)



| ASHIKA CODE | MANUFACTURER | CAR NAME         | MODEL | YEAR            | ForR | REMARKS   |
|-------------|--------------|------------------|-------|-----------------|------|-----------|
| 63-0A-A18   | TOYOTA       | VITZ             | NCP13 | 10.2000-12.2002 |      | 1.0B (AT) |
|             | TOYOTA       | VITZ             | NCP15 | 09.1999-01.2005 |      |           |
|             | TOYOTA       | VITZ             | SCP10 | 01.1999-01.2005 |      |           |
|             | TOYOTA       | VITZ             | SCP13 | 12.2002-01.2005 |      |           |
|             | TOYOTA       | WINDOM           | MCV20 | 08.1996-07.2001 |      |           |
|             | TOYOTA       | WINDOM           | MCV21 | 08.1996-07.2001 |      |           |
|             | VAUXHALL     | Corsa            |       |                 | F    |           |
|             | VAUXHALL     | Corsa Combo      |       |                 | F    |           |
|             | VAUXHALL     | Nova             |       |                 | F    |           |
|             | VOLKSWAGEN   | Corrado          |       |                 | F    |           |
|             | VOLKSWAGEN   | Golf II          |       |                 | F    |           |
|             | VOLKSWAGEN   | Golf III Variant |       |                 | F    |           |
|             | VOLKSWAGEN   | Golf III Vento   |       |                 | F    |           |
|             | VOLKSWAGEN   | Golf Cabrio      |       |                 | F    |           |
|             | VOLKSWAGEN   | Jetta II         |       |                 | F    |           |
|             | VOLKSWAGEN   | Lupo             |       |                 | F    |           |
|             | VOLKSWAGEN   | Passat           |       | 1988-1996       | F    |           |
|             | VOLKSWAGEN   | Polo Derby       |       |                 | F    |           |
|             | VOLKSWAGEN   | Polo Variant     |       |                 | F    |           |
|             | VOLVO        | 400 Series       |       |                 | F    |           |

# 63-0A-A20 (1)



| ASHIKA CODE | MANUFACTURER | CAR NAME              | MODEL        | YEAR | ForR | REMARKS |  |
|-------------|--------------|-----------------------|--------------|------|------|---------|--|
| 63-0A-A20   | ALFA ROMEO   | Alfa 155              |              |      | F    |         |  |
|             | ALFA ROMEO   | Alfa 164              |              |      | R    |         |  |
|             | CHRYSLER     | Chrysler Voyager      | Mini-Van     |      | F    |         |  |
|             | CHRYSLER     | Chrysler Voyager      | Town&Country |      | F    |         |  |
|             | CHRYSLER     | Chrysler Voyager      | Caravan      |      | F    |         |  |
|             | CITROËN      | Berlingo              |              |      | F    |         |  |
|             | CITROËN      | Visa                  |              |      | F    |         |  |
|             | CITROËN      | Xsara Picasso         |              |      | F    |         |  |
|             | CITROËN      | Xara (N2)             |              |      | F    |         |  |
|             | CITROËN      | ZX                    |              |      | F    |         |  |
|             | DAEWOO       | Aranos                |              |      | F    |         |  |
|             | DAEWOO       | Cielo                 |              |      | F    |         |  |
|             | DAEWOO       | Espero                |              |      | F    |         |  |
|             | DAEWOO       | Lanos                 |              |      | F    |         |  |
|             | DAEWOO       | Matiz                 |              |      | F    |         |  |
|             | DAEWOO       | Nexia                 |              |      | F    |         |  |
|             | DAEWOO       | Sens                  |              |      | F    |         |  |
|             | FIAT         | Brava                 |              |      | F    |         |  |
|             | FIAT         | Bravo                 |              |      | F    |         |  |
|             | FIAT         | Croma (154)           |              |      | F    |         |  |
|             | FIAT         | Croma (154)           |              |      | R    |         |  |
|             | FIAT         | Panda                 |              |      | F    |         |  |
|             | FIAT         | Tempra Familiia (159) |              |      | F    |         |  |
|             | FIAT         | Tempra Station Wagon  |              |      | F    |         |  |
|             | FIAT         | Tempra (159)          |              |      | F    |         |  |
|             | FIAT         | Tipo (160)            |              |      | F    |         |  |
|             | FORD         | Escort                |              | Mk V |      | F       |  |

| ASHIKA CODE | MANUFACTURER        | CAR NAME           | MODEL    | YEAR      | ForR     | REMARKS |  |
|-------------|---------------------|--------------------|----------|-----------|----------|---------|--|
| 63-0A-A20   | FORD                | Escort             | Mk VI    |           | F        |         |  |
|             | FORD                | Escort             | XR-3     |           | F        |         |  |
|             | FORD                | Escort             | RS       | 1990-1995 | F        |         |  |
|             | FORD                | Galaxy             |          |           | F        |         |  |
|             | FORD                | Granada (GAE/GGE)  |          |           | F        |         |  |
|             | FORD                | Mondeo             |          |           | F        |         |  |
|             | FORD                | Scorpio            |          |           | F        |         |  |
|             | FORD                | Sierra             | XR-4     |           | F        |         |  |
|             | FORD                | Sierra             | Cosworth |           | F        |         |  |
|             | FORD                | Sierra             |          |           | F        |         |  |
|             | HONDA               | AIRWAVE            |          |           | 05.2005- | F       |  |
|             | HONDA               | Ballade            |          |           |          | F       |  |
|             | HONDA               | Ballade CR-X       |          |           |          | F       |  |
|             | HONDA               | CIVIC              |          |           |          | F       |  |
|             | HONDA               | CIVIC CR-X         |          |           |          | F       |  |
|             | HONDA               | CIVIC GSA/SIC      |          |           | 08.2005- | F       |  |
|             | HONDA               | CROSSROAD          |          |           | 02.2007- | F       |  |
|             | HONDA               | Fit ARIA SSM       |          |           | 10.2002- | F       |  |
|             | HONDA               | Fit EU/KQ          |          |           | 11.2002- | F       |  |
|             | HONDA               | FREED Rr: SSK Assy |          |           | 05.2008- | F       |  |
|             | HONDA               | STREAM             |          |           | 06.2006- | F       |  |
|             | HYUNDAI             | Excel              |          |           |          | F       |  |
|             | HYUNDAI             | Pony               |          |           |          | F       |  |
|             | HYUNDAI             | S-Coupe            |          |           |          | F       |  |
|             | LADA SAMARA         | Diva               |          |           |          | F       |  |
|             | LADA SAMARA         | Forma              |          |           |          | F       |  |
|             | LADA SAMARA         | Riva               |          |           |          | F       |  |
|             | LADA SAMARA         | Sagona             |          |           |          | F       |  |
|             | LANCIA              | Dedra (835)        |          |           |          | F       |  |
|             | LANCIA              | Delta              |          |           |          | F       |  |
|             | LANCIA              | Delta (836)        |          |           |          | F       |  |
|             | LANCIA              | Prisma (831)       |          |           |          | F       |  |
|             | LANCIA              | Thema              |          |           |          | F       |  |
|             | LANCIA              | Thema              |          |           |          | R       |  |
|             | MAZDA               | Demio              | DE       |           | 2007-    |         |  |
|             | MERCEDES BENZ       | V-Class            |          |           |          | F       |  |
|             | MERCEDES BENZ       | Vito               |          |           |          | F       |  |
|             | MITSUBISHI          | Carisma            |          |           |          | F       |  |
|             | MITSUBISHI          | Colt               |          |           |          | F       |  |
|             | MITSUBISHI          | Cordia&Tredia      |          |           |          | F       |  |
|             | MITSUBISHI          | Eclipse            |          |           |          | F       |  |
|             | MITSUBISHI          | Expo               |          |           |          | F       |  |
|             | MITSUBISHI          | Galant             |          |           |          | F       |  |
|             | MITSUBISHI          | Lancer             | Estate   |           |          | F       |  |
|             | MITSUBISHI          | Lancer             |          |           |          | F       |  |
| MITSUBISHI  | Sapporo (Lambda)    |                    |          |           | F        |         |  |
| MITSUBISHI  | Sigma               |                    |          |           | F        |         |  |
| MITSUBISHI  | Space Wagon         |                    |          |           | F        |         |  |
| MITSUBISHI  | Space Van (chariot) |                    |          |           | F        |         |  |
| NISSAN      | Primera             |                    |          |           | R        |         |  |
| OPEL        | Aero                |                    |          |           | F        |         |  |
| OPEL        | Astra               |                    |          |           | F        |         |  |
| OPEL        | Commodore           |                    |          |           | F        |         |  |
| OPEL        | Corsa A             |                    |          |           | F        |         |  |
| OPEL        | Corsa B             |                    |          |           | F        |         |  |
| OPEL        | Kadett              |                    |          |           | F        |         |  |
| OPEL        | Monza               |                    |          |           | F        |         |  |
| OPEL        | Olympia             |                    |          |           | F        |         |  |
| OPEL        | Rekord              |                    |          |           | F        |         |  |



| ASHIKA CODE | MANUFACTURER | CAR NAME           | MODEL  | YEAR | ForR            | REMARKS |        |
|-------------|--------------|--------------------|--------|------|-----------------|---------|--------|
| 63-0A-A20   | OPEL         | Record Caravan     |        |      | F               |         |        |
|             | OPEL         | Senator            |        |      | F               |         |        |
|             | OPEL         | Tigra              |        |      | F               |         |        |
|             | OPEL         | Vectra B           |        |      | F               |         |        |
|             | PEUGEOT      | 106                |        |      | F               |         |        |
|             | PEUGEOT      | 205                |        |      | F               |         |        |
|             | PEUGEOT      | 305                |        |      | F               |         |        |
|             | PEUGEOT      | 306                |        |      | F               |         |        |
|             | PEUGEOT      | 309                |        |      | F               |         |        |
|             | PEUGEOT      | 405                |        |      | F               |         |        |
|             | PEUGEOT      | 505                |        |      | F               |         |        |
|             | PEUGEOT      | Kangoo             |        |      | F               |         |        |
|             | PEUGEOT      | Partner            |        |      | F               |         |        |
|             | RENAULT      | Ranch              |        |      | F               |         |        |
|             | ROVER        | 200 Series         |        |      | F               |         |        |
|             | SEAT         | Alhambra           |        |      | F               |         |        |
|             | SUBARU       | Justy,J Series     |        |      | F               |         |        |
|             | SUZUKI       | Swift              |        |      | F               |         |        |
|             | TOYOTA       | Camry              |        |      | F               |         |        |
|             | TOYOTA       | Celica             |        |      | F               |         |        |
|             | TOYOTA       | Corolla & Sprinter |        |      | 1970-04.1987    | F       |        |
|             | TOYOTA       | Corolla            |        |      | 05.1987-04.1997 | F       |        |
|             | TOYOTA       | PROBOX             | NCP59G |      | 06.2002-        |         | 1.5WGN |
|             | TOYOTA       | PROBOX/SUCCEED     | NCP50V |      | 06.2002-        |         |        |
|             | TOYOTA       | PROBOX/SUCCEED     | NCP51V |      | 06.2002-        |         |        |
|             | TOYOTA       | PROBOX/SUCCEED     | NCP52V |      | 04.2003-        |         |        |
|             | TOYOTA       | PROBOX/SUCCEED     | NCP55V |      | 06.2002-        |         |        |
|             | TOYOTA       | PROBOX/SUCCEED     | NCP58G |      | 06.2002-        |         |        |
|             | TOYOTA       | PROBOX/SUCCEED     | NCP59G |      | 06.2002-        |         |        |
|             | TOYOTA       | PROBOX/SUCCEED     | NLP51V |      | 06.2002-        |         |        |
|             | TOYOTA       | Starlet            |        |      |                 | F       |        |
|             | VAUXHALL     | Astra              |        |      |                 | F       |        |
|             | VAUXHALL     | Belmont            |        |      |                 | F       |        |
|             | VAUXHALL     | Carlton            |        |      |                 | F       |        |
|             | VAUXHALL     | Corsa              |        |      |                 | F       |        |
|             | VAUXHALL     | Nova               |        |      |                 | F       |        |
|             | VAUXHALL     | Omega              |        |      |                 | F       |        |
|             | VAUXHALL     | Royale             |        |      |                 | F       |        |
|             | VAUXHALL     | Senator            |        |      |                 | F       |        |
|             | VAUXHALL     | Tigra              |        |      |                 | F       |        |
|             | VAUXHALL     | Vectra B           |        |      |                 | F       |        |
|             | VAUXHALL     | Viceroy            |        |      |                 | F       |        |
|             | VOLKSWAGEN   | Golf I             |        |      |                 | F       |        |
|             | VOLKSWAGEN   | Golf Cabrio        |        |      |                 | F       |        |
|             | VOLKSWAGEN   | Golf Caddy         |        |      |                 | F       |        |
|             | VOLKSWAGEN   | Jetta I            |        |      |                 | F       |        |
|             | VOLKSWAGEN   | Scirocco           |        |      |                 | F       |        |
|             | VOLKSWAGEN   | Sharan (7M)        |        |      |                 | F       |        |
| VOLVO       | 850          |                    |        |      | F               |         |        |
| VOLVO       | 300 Series   |                    |        |      | F               |         |        |
| VOLVO       | C 70         |                    |        |      | F               |         |        |
| VOLVO       | S 40         |                    |        |      | F               |         |        |
| VOLVO       | S 70         |                    |        |      | F               |         |        |
| VOLVO       | V 40         |                    |        |      | F               |         |        |
| VOLVO       | V 70         |                    |        |      | F               |         |        |

| ASHIKA CODE | MANUFACTURER | CAR NAME            | MODEL     | YEAR            | ForR            | REMARKS |                   |
|-------------|--------------|---------------------|-----------|-----------------|-----------------|---------|-------------------|
| 63-0A-A22   | ALFA ROMEO   | Alfa 145            |           |                 | F               |         |                   |
|             | ALFA ROMEO   | Alfa 146            |           |                 | F               |         |                   |
|             | FIAT         | Marea               |           |                 | F               |         |                   |
|             | FORD         | Mondeo              |           |                 | R               |         |                   |
|             | HONDA        | CIVIC TYPE R        |           |                 | 08.2001-05.2005 | F       |                   |
|             | HONDA        | CIVIC TYPE R        |           |                 | 12.2006-        | F       |                   |
|             | HONDA        | CR-V                |           |                 | 07.2006-        | F       | JP/US/UK/Thailand |
|             | HONDA        | Fit                 | GE6       |                 | 2007-           |         |                   |
|             | HONDA        | HR-V                |           |                 | 08.1998-09.2003 | F       |                   |
|             | HONDA        | INTEGRA             |           |                 | 03.1995-08.2006 | F       |                   |
|             | HONDA        | INTEGRA R           |           |                 | 06.2004-        | F       |                   |
|             | HONDA        | OLTIA               |           |                 | 06.1995-07.2002 | F       |                   |
|             | HONDA        | RD-X                |           |                 | 05.2006-        | F       |                   |
|             | HONDA        | S-MX                |           |                 | 12.1996-04.2001 | F       |                   |
|             | MAZDA        | 323                 |           |                 | 1980-1989       | R       |                   |
|             | mitsubishi   | DELICA SPACE GEAR   | PA3V      |                 | 03.1994-        | R       |                   |
|             | mitsubishi   | DELICA SPACE GEAR   | PA4W      |                 | 03.1994-        | R       |                   |
|             | mitsubishi   | DELICA SPACE GEAR   | PD4W ECS  |                 | 03.1994-        | R       |                   |
|             | mitsubishi   | DELICA SPACE GEAR   | PD4W      |                 | 03.1994-        | R       |                   |
|             | mitsubishi   | DELICA SPACE GEAR   | PA5V      |                 | 03.1994-        | R       |                   |
|             | mitsubishi   | DELICA SPACE GEAR   | PB5V      |                 | 03.1994-        | R       |                   |
|             | mitsubishi   | DELICA SPACE GEAR   | PD5V      |                 | 03.1994-        | R       |                   |
|             | mitsubishi   | DELICA SPACE GEAR   | PA5W      |                 | 03.1994-        | R       |                   |
|             | mitsubishi   | DELICA SPACE GEAR   | PB5W      |                 | 03.1994-        | R       |                   |
|             | mitsubishi   | DELICA SPACE GEAR   | PC5W      |                 | 03.1994-        | R       |                   |
|             | mitsubishi   | DELICA SPACE GEAR   | PB6W      |                 | 03.1994-        | R       |                   |
|             | mitsubishi   | DELICA SPACE GEAR   | PD6W ECS  |                 | 03.1994-        | R       |                   |
|             | mitsubishi   | DELICA SPACE GEAR   | PF6W ECS  |                 | 03.1994-        | R       |                   |
|             | mitsubishi   | DELICA SPACE GEAR   | PF6W      |                 | 03.1994-        | R       |                   |
|             | mitsubishi   | DELICA SPACE GEAR   | PD8W ECS  |                 | 03.1994-        | R       |                   |
|             | mitsubishi   | DELICA SPACE GEAR   | PD8W      |                 | 03.1994-        | R       |                   |
|             | mitsubishi   | DELICA SPACE GEAR   | PE8W ECS  |                 | 03.1994-        | R       |                   |
|             | mitsubishi   | DELICA SPACE GEAR   | PE8W      |                 | 03.1994-        | R       |                   |
|             | mitsubishi   | DELICA SPACE GEAR   | PF8W ECS  |                 | 03.1994-        | R       |                   |
|             | mitsubishi   | DELICA SPACE GEAR   | PF8W      |                 | 03.1994-        | R       |                   |
|             | mitsubishi   | PAJERO              | V23C ECS  |                 | 10.1990-06.1994 | R       |                   |
|             | mitsubishi   | PAJERO              | V23W ECS  |                 | 10.1990-        | R       |                   |
|             | mitsubishi   | PAJERO              | V24C ECS  |                 | 10.1990-04.1995 | R       |                   |
|             | mitsubishi   | PAJERO              | V24W ECS  |                 | 10.1990-        | R       |                   |
|             | mitsubishi   | PAJERO              | V24WG ECS |                 | 10.1990-06.1994 | R       |                   |
|             | mitsubishi   | PAJERO              | V25C ECS  |                 | 07.1994-        | R       |                   |
|             | mitsubishi   | PAJERO              | V25W ECS  |                 | 07.1993-        | R       |                   |
|             | mitsubishi   | PAJERO              | V26W ECS  |                 | 07.1993-06.1994 | R       |                   |
|             | mitsubishi   | PAJERO              | V25WG ECS |                 | 07.1993-        | R       |                   |
|             | mitsubishi   | PAJERO              | V43W ECS  |                 | 10.1990-        | R       |                   |
|             | mitsubishi   | PAJERO              | V44W ECS  |                 | 10.1990-03.1992 | R       |                   |
|             | mitsubishi   | PAJERO              | V44WG ECS |                 | 10.1990-06.1993 | R       |                   |
|             | mitsubishi   | PAJERO              | V45W ECS  |                 | 07.1993-        | R       |                   |
|             | mitsubishi   | PAJERO              | V46W ECS  |                 | 07.1993-        | R       |                   |
|             | mitsubishi   | PAJERO              | V44WG ECS |                 | 07.1993-        | R       |                   |
| NISSAN      | TERRANO      | LBYD21 (Adjustable) |           | 08.1986-09-1989 | R               |         |                   |
| NISSAN      | TERRANO      | LR50                |           | 09.1995-        | R               |         |                   |
| NISSAN      | TERRANO      | LR50 (Adjustable)   |           | 09.1995-        | R               |         |                   |
| NISSAN      | TERRANO      | PR50                |           | 09.1995-        | R               |         |                   |
| NISSAN      | TERRANO      | PR50 (Adjustable)   |           | 09.1995-        | R               |         |                   |
| NISSAN      | TERRANO      | VBYD21 (Adjustable) |           | 08.1986-08.1995 | R               |         |                   |
| NISSAN      | TERRANO      | WBYD21 (Adjustable) |           | 08.1986-08.1995 | R               |         |                   |
| NISSAN      | TERRANO      | WHYD21 (Adjustable) |           | 08.1986-08.1995 | R               |         |                   |
| OPEL        | Ascona       |                     |           |                 | F               |         |                   |

# 63-0A-A22 (2)



| ASHIKA CODE | MANUFACTURER | CAR NAME            | MODEL        | YEAR            | ForR            | REMARKS |            |
|-------------|--------------|---------------------|--------------|-----------------|-----------------|---------|------------|
| 63-0A-A22   | OPEL         | Calibra             |              |                 | F               |         |            |
|             | OPEL         | Monta               |              |                 | F               |         |            |
|             | OPEL         | Vectra A            |              |                 | F               |         |            |
|             | PEUGEOT      | 206                 |              |                 | F               |         |            |
|             | TOYOTA       | ALPHARD G/V         |              | ANH10W          | 05.2002-        |         |            |
|             | TOYOTA       | ALPHARD G/V         |              | ANH15W          | 05.2002-        |         |            |
|             | TOYOTA       | ALPHARD G/V         |              | MNH10W          | 05.2002-08.2004 |         |            |
|             | TOYOTA       | ALPHARD G/V         |              | MNH15W          | 05.2002-04.2005 |         |            |
|             | TOYOTA       | bB                  |              | NCP30           | 01.2000-12.2005 |         |            |
|             | TOYOTA       | bB                  |              | NCP31           | 01.2000-04.2006 |         |            |
|             | TOYOTA       | bB                  |              | NCP34           | 06.2001-03.2003 |         |            |
|             | TOYOTA       | bB                  |              | NCP35           | 01.2000-12.2005 |         |            |
|             | TOYOTA       | CAMRY               |              | ACV30           | 09.2001-01.2006 |         |            |
|             | TOYOTA       | CAMRY               |              | ACV35           | 09.2001-01.2006 |         |            |
|             | TOYOTA       | CAMRY               |              | ACV40           | 01.2001-        |         |            |
|             | TOYOTA       | CAMRY               |              | ACV45           | 01.2001-        |         |            |
|             | TOYOTA       | CELICA              |              | ZZT230          | 08.1999-        |         |            |
|             | TOYOTA       | CELICA              |              | ZZT231          | 08.1999-04.2006 |         |            |
|             | TOYOTA       | COROLLA RUNX/ALEX   |              | NZE124          | 01.2001-        |         |            |
|             | TOYOTA       | COROLLA RUNX/ALEX   |              | ZZE124          | 09.2002-        |         |            |
|             | TOYOTA       | COROLLA SPACIO      |              | ZZE124N         | 08.2001-        |         |            |
|             | TOYOTA       | COROLLA/FIELDER     |              | NZE124          | 08.2000-        |         |            |
|             | TOYOTA       | COROLLA/FIELDER     |              | NZE124G         | 08.2000-        |         |            |
|             | TOYOTA       | COROLLA/FIELDER     |              | ZZE124          | 08.2000-        |         |            |
|             | TOYOTA       | COROLLA/FIELDER     |              | ZZE124G         | 08.2000-        |         |            |
|             | TOYOTA       | COROLLA/FIELDER     |              | ZZE124G         | 08.2000-09.2002 |         | 1.8WGN 4WD |
|             | TOYOTA       | CORONA PREMIO       |              | AT210           | 01.1996-12.2001 |         |            |
|             | TOYOTA       | CORONA PREMIO       |              | AT211           | 01.1996-12.2001 |         |            |
|             | TOYOTA       | CORONA PREMIO       |              | CT210           | 01.1996-12.1997 |         |            |
|             | TOYOTA       | CORONA PREMIO       |              | CT215           | 01.1996-12.1997 |         |            |
|             | TOYOTA       | CORONA PREMIO       |              | ST210           | 01.1996-12.2001 |         |            |
|             | TOYOTA       | CORONA PREMIO       |              | ST215           | 01.1996-12.2001 |         |            |
|             | TOYOTA       | ESTIMA              |              | TCR10W          | 02.1993-12.1999 |         |            |
|             | TOYOTA       | ESTIMA              |              | TCR11W          | 05.1990-12.1999 |         |            |
|             | TOYOTA       | ESTIMA              |              | TCR20W          | 02.1993-12.1999 |         |            |
|             | TOYOTA       | ESTIMA              |              | TCR21W          | 05.1990-12.1999 |         |            |
|             | TOYOTA       | ESTIMA EMINA/LUCIDA |              | CRX10G          | 01.1992-08.1999 |         |            |
|             | TOYOTA       | ESTIMA EMINA/LUCIDA |              | CRX11G          | 01.1992-08.1999 |         |            |
|             | TOYOTA       | ESTIMA EMINA/LUCIDA |              | CRX20G          | 01.1992-08.1999 |         |            |
|             | TOYOTA       | ESTIMA EMINA/LUCIDA |              | CRX21G          | 01.1992-08.1999 |         |            |
|             | TOYOTA       | ESTIMA EMINA/LUCIDA |              | TCR10G          | 01.1992-12.1999 |         |            |
|             | TOYOTA       | ESTIMA EMINA/LUCIDA |              | TCR11G          | 01.1992-12.1999 |         |            |
|             | TOYOTA       | ESTIMA EMINA/LUCIDA |              | TCR20G          | 01.1992-12.1999 |         |            |
|             | TOYOTA       | ESTIMA EMINA/LUCIDA |              | TCR21G          | 01.1992-12.1999 |         |            |
|             | TOYOTA       | ESTIMA T/L          |              | ACR30W          | 02.2000-08.2004 |         |            |
|             | TOYOTA       | ESTIMA T/L          |              | ACR30W          | 02.2000-08.2004 |         | 2.4 AERAS  |
|             | TOYOTA       | ESTIMA T/L          |              | ACR40W          | 02.2000-04.2003 |         |            |
|             | TOYOTA       | ESTIMA T/L          |              | MCR30W          | 12.1999-08.2004 |         |            |
|             | TOYOTA       | ESTIMA T/L          |              | MCR40W          | 12.1999-08.2004 |         |            |
|             | TOYOTA       | FUN CARGO           |              | NCP20           | 08.1999-09.2005 |         |            |
|             | TOYOTA       | FUN CARGO           |              | NCP21           | 08.1999-08.2001 |         |            |
|             | TOYOTA       | FUN CARGO           |              | NCP25           | 08.1999-09.2005 |         |            |
| TOYOTA      | HARRIER      |                     | ACU30W       | 02.2003-        |                 |         |            |
| TOYOTA      | HARRIER      |                     | ACU35W       | 02.2003-        |                 |         |            |
| TOYOTA      | HARRIER      |                     | MCU30W       | 02.2003-01.2006 |                 |         |            |
| TOYOTA      | HARRIER      |                     | MCU35W       | 02.2003-01.2006 |                 |         |            |
| TOYOTA      | Hilux        |                     | KZN130G TEMS | 08.1993-        | R               |         |            |
| TOYOTA      | Hilux        |                     | KZN130W TEMS | 08.1990-        | R               |         |            |
| TOYOTA      | Hilux        |                     | LN130G TEMS  | 04.1989-08.1993 | R               |         |            |



| ASHIKA CODE | MANUFACTURER | CAR NAME           | MODEL        | YEAR            | ForR | REMARKS |  |
|-------------|--------------|--------------------|--------------|-----------------|------|---------|--|
| 63-0A-A22   | TOYOTA       | Hilux              | LN130W TEMS  | 08.1990-08.1993 | R    |         |  |
|             | TOYOTA       | Hilux              | VZN130G TEMS | 08.1990-11.1995 | R    |         |  |
|             | TOYOTA       | Hilux              | YN130G TEMS  | 04.1989-08.1991 | R    |         |  |
|             | TOYOTA       | IPSUM              | ACM21W       | 05.2001-        |      |         |  |
|             | TOYOTA       | IPSUM              | ACM26W       | 05.2001-        |      |         |  |
|             | TOYOTA       | IST                | NCP60        | 04.2002-        |      |         |  |
|             | TOYOTA       | IST                | NCP61        | 04.2002-        |      |         |  |
|             | TOYOTA       | IST                | NCP65        | 04.2002-        |      |         |  |
|             | TOYOTA       | KLUGER LV          | ACU20W       | 11.2000-        |      |         |  |
|             | TOYOTA       | KLUGER LV          | ACU25W       | 11.2000-        |      |         |  |
|             | TOYOTA       | KLUGER LV          | MCU20W       | 11.2000-        |      |         |  |
|             | TOYOTA       | KLUGER LV          | MCU25W       | 11.2000-        |      |         |  |
|             | TOYOTA       | LAND CRUISER (BAN) | FZJ80G TEMS  | 08.1992-        |      |         |  |
|             | TOYOTA       | LAND CRUISER (BAN) | HDJ81V TEMS  | 08.1992-        |      |         |  |
|             | TOYOTA       | LAND CRUISER (BAN) | HZJ81V TEMS  | 08.1992-        |      |         |  |
|             | TOYOTA       | NOAH/VOXY          | AZR60G       | 11.2001-        |      |         |  |
|             | TOYOTA       | NOAH/VOXY          | AZR65G       | 11.2001-        |      |         |  |
|             | TOYOTA       | OPA                | ACT10        | 08.2000-04.2005 |      |         |  |
|             | TOYOTA       | OPA                | ZCT10        | 04.2000-04.2005 |      |         |  |
|             | TOYOTA       | OPA                | ZCT15        | 04.2000-04.2005 |      |         |  |
|             | TOYOTA       | PLATZ              | NCP12        | 08.1999-12.2005 |      |         |  |
|             | TOYOTA       | PLATZ              | NCP16        | 08.1999-12.2005 |      |         |  |
|             | TOYOTA       | PLATZ              | SCP11        | 08.1999-12.2005 |      |         |  |
|             | TOYOTA       | PREMIO/ALLION      | AZT240       | 12.2001-        |      |         |  |
|             | TOYOTA       | PREMIO/ALLION      | NZT240       | 12.2001-        |      |         |  |
|             | TOYOTA       | PREMIO/ALLION      | ZZT240       | 12.2001-        |      |         |  |
|             | TOYOTA       | PREMIO/ALLION      | ZZT245       | 12.2001-        |      |         |  |
|             | TOYOTA       | SIENTA             | NCP81G       | 09.2003-        |      |         |  |
|             | TOYOTA       | SIENTA             | NCP85G       | 09.2003-        |      |         |  |
|             | TOYOTA       | WILL CYPHA         | NCP70        | 09.2002-07.2005 |      |         |  |
|             | TOYOTA       | WILL CYPHA         | NCP75        | 09.2002-07.2005 |      |         |  |
|             | TOYOTA       | WILL VI            | NCP19        | 01.2000-12.2001 |      |         |  |
|             | TOYOTA       | WILL VS            | NZE127       | 04.2001-04.2004 |      |         |  |
|             | TOYOTA       | WILL VS            | ZZE127       | 04.2001-04.2004 |      |         |  |
|             | TOYOTA       | WILL VS            | ZZE128       | 04.2001-04.2004 |      |         |  |
|             | TOYOTA       | WILL VS            | ZZE129       | 04.2001-04.2004 |      |         |  |
|             | TOYOTA       | WINDOM             | MCV30        | 07.2001-07.2003 |      |         |  |
|             | TOYOTA       | WISH               | ANE10G       | 04.2003-        |      |         |  |
|             | TOYOTA       | WISH               | ANE11W       | 04.2003-        |      |         |  |
|             | TOYOTA       | WISH               | ZNE10G       | 01.2003-        |      |         |  |
|             | TOYOTA       | WISH               | ZNE14G       | 01.2003-        |      |         |  |
|             | VAUXHALL     | Calibra            |              |                 |      | F       |  |
|             | VAUXHALL     | Vectra             |              |                 |      | F       |  |
|             | VOLVO        | 740                |              |                 |      | F       |  |
|             | VOLVO        | 745                |              |                 |      | F       |  |
| VOLVO       | 760          |                    |              |                 | F    |         |  |
| VOLVO       | 780          |                    |              |                 | F    |         |  |
| VOLVO       | 940          |                    |              |                 | F    |         |  |
| VOLVO       | 960          |                    |              |                 | F    |         |  |
| VOLVO       | 240 series   |                    |              |                 | F    |         |  |
| VOLVO       | 242 series   |                    |              |                 | F    |         |  |
| VOLVO       | 244 series   |                    |              |                 | F    |         |  |
| VOLVO       | 245 series   |                    |              |                 | F    |         |  |
| VOLVO       | 260 series   |                    |              |                 | F    |         |  |
| VOLVO       | 264 series   |                    |              |                 | F    |         |  |
| VOLVO       | 265 series   |                    |              |                 | F    |         |  |



|                |                                |   |   |
|----------------|--------------------------------|---|---|
| <b>GOM-100</b> | <b>Engine Mounting</b>         | <b>NISSAN MICRA (K11)</b>                                   |    |
|                | <b>Supporto motore</b>         | 1.0 i 16V/1.3 i 16V/1.4 i 16V                               |   |
| NISSAN         | 11210-01B01                    |   |   |
|                | Length/Lunghezza [mm]          | 93  |   |
|                | Height/Altezza [mm]            | 84,5  |   |
|                | Width/Larghezza [mm]           | 64,5  |   |
|                | Inner Diam./Diam. Interno [mm] | 11  |   |
| <b>GOM-101</b> | <b>Engine Mounting</b>         | <b>NISSAN PICK UP/KING CAB (720)</b>                        |    |
|                | <b>Supporto motore</b>         | 1.8/2.2 4WD/2.2 D/2.3 D/2.5 D 4WD                           |   |
| NISSAN         | 11220-35G00                    | <b>NISSAN PICK UP/KING CAB (D21)</b>                        |   |
|                | Length/Lunghezza [mm]          | 135   |   |
|                | Height/Altezza [mm]            | 97  |   |
|                | Width/Larghezza [mm]           | 104   |   |
|                |                                | <b>NISSAN PICK UP/KING CAB/NAVARA (D22)</b>                 |   |
|                |                                | 2.4 i/2.4 i 4WD/2.5 D/2.5 D 4WD/2.5 Di/2.5 Di 4WD/3.2 D 4WD |   |
|                |                                | <b>NISSAN TERRANO I (WD21)</b>                              |   |
|                |                                | 2.4 i 4WD/2.7 TD 4WD/3.0 i 4WD                              |   |
|                |                                | <b>NISSAN TERRANO II (R20)</b>                              |   |
|                |                                | 2.4 4WD/2.4 i 12V 4WD/2.7 TD 4WD/2.7 TDi 4WD/3.0 Di 4WD     |   |
| <b>GOM-102</b> | <b>Engine Mounting</b>         | <b>NISSAN PICK UP/KING CAB (720)</b>                        |   |
|                | <b>Supporto motore</b>         | 1.8/2.2 4WD/2.2 D/2.3 D/2.5 D 4WD                           |   |
| NISSAN         | 11210-35G00                    | <b>NISSAN PICK UP/KING CAB (D21)</b>                        |   |
|                | Length/Lunghezza [mm]          | 133   |   |
|                | Height/Altezza [mm]            | 60  |   |
|                | Width/Larghezza [mm]           | 132   |   |
|                |                                | <b>NISSAN PICK UP/KING CAB/NAVARA (D22)</b>                 |   |
|                |                                | 2.4 i/2.4 i 4WD/2.5 D/2.5 D 4WD/2.5 Di/2.5 Di 4WD/3.2 D 4WD |   |
|                |                                | <b>NISSAN TERRANO I (WD21)</b>                              |   |
|                |                                | 2.4 i 4WD/2.7 TD 4WD/3.0 i 4WD                              |   |
| <b>GOM-103</b> | <b>Engine Mounting</b>         | <b>NISSAN PICK UP/KING CAB (720)</b>                        |  |
|                | <b>Supporto motore</b>         | 1.8/2.2 4WD/2.2 D/2.3 D/2.5 D 4WD                           |   |
| NISSAN         | 11320-01G00                    | <b>NISSAN PICK UP/KING CAB (D21)</b>                        |   |
|                | Length/Lunghezza [mm]          | 140   |   |
|                | Height/Altezza [mm]            | 64  |   |
|                | Width/Larghezza [mm]           | 102   |   |
|                |                                | <b>NISSAN PICK UP/KING CAB/NAVARA (D22)</b>                 |   |
|                |                                | 2.4 i/2.4 i 4WD/2.5 D/2.5 D 4WD/2.5 Di/2.5 Di 4WD/3.2 D 4WD |   |
|                |                                | <b>NISSAN TERRANO I (WD21)</b>                              |   |
|                |                                | 2.4 i 4WD/2.7 TD 4WD/3.0 i 4WD                              |   |
| <b>GOM-104</b> | <b>Engine Mounting</b>         | <b>NISSAN PATROL GR I (Y60)</b>                             |  |
|                | <b>Supporto motore</b>         | 2.8 TD (Y60A)/4.2 Cat./4.2 D (Y60GR)                        |   |
| NISSAN         | 11220-10J00                    | <b>NISSAN PATROL GR II (Y61)</b>                            |   |
|                | Length/Lunghezza [mm]          | 129   |   |
|                | Height/Altezza [mm]            | 59  |   |
|                | Width/Larghezza [mm]           | 121   |   |
|                |                                | <b>NISSAN PATROL Hardtop (K160)</b>                         |   |
|                |                                | 2.8 (K160)/3.2 TD (K160)/3.3 D (K160)                       |   |
|                |                                | <b>NISSAN PATROL Hardtop (K260)</b>                         |   |
|                |                                | 2.8/2.8 TD/3.2 D  |   |
|                |                                | <b>NISSAN PATROL SW (W160)</b>                              |   |
|                |                                | 2.8 (W160)/3.2 TD (W160)/3.3 D (W160)                       |   |
|                |                                | <b>NISSAN PATROL SW (W260)</b>                              |   |
|                |                                | 2.8 TD/3.2 D  |   |
| <b>GOM-105</b> | <b>Engine Mounting</b>         | <b>NISSAN PATROL GR I (Y60)</b>                             |  |
|                | <b>Supporto motore</b>         | 2.8 TD (Y60A)/4.2 Cat./4.2 D (Y60GR)                        |   |
| NISSAN         | 11320-06J00                    | <b>NISSAN PATROL GR II (Y61)</b>                            |   |
|                | Length/Lunghezza [mm]          | 135   |   |
|                | Height/Altezza [mm]            | 65  |   |
|                | Width/Larghezza [mm]           | 102,5   |   |
|                |                                | <b>NISSAN PATROL Hardtop (K160)</b>                         |   |
|                |                                | 2.8 (K160)/3.2 TD (K160)/3.3 D (K160)                       |   |
|                |                                | <b>NISSAN PATROL Hardtop (K260)</b>                         |   |
|                |                                | 2.8/2.8 TD/3.2 D  |   |
|                |                                | <b>NISSAN PATROL SW (W160)</b>                              |   |
|                |                                | 2.8 (W160)/3.2 TD (W160)/3.3 D (W160)                       |   |
|                |                                | <b>NISSAN PATROL SW (W260)</b>                              |   |
|                |                                | 2.8 TD/3.2 D  |   |

**GOM-106** Bearing,propshaft centre bearing  
 Supporto albero cardanico

|                                |             |
|--------------------------------|-------------|
| NISSAN                         | 37521-34G25 |
| Length/Lunghezza [mm]          | 117,5       |
| Height/Altezza [mm]            | 48          |
| Width/Larghezza [mm]           | 119         |
| Inner Diam./Diam. Interno [mm] | 30          |

|  |
|--|
| <b>NISSAN PICK UP/KING CAB (720)</b>   |
| 1.8/2.2 4WD/2.2 D/2.3 D/2.5 D 4WD  |
| <b>NISSAN PICK UP/KING CAB (D21)</b>   |
| 2.0/2.3 D/2.4 i 12V/2.4 i 12V 4WD/2.4 i 4WD/2.5 D/2.5 D 4WD/2.7 D 4WD/3.0 i V6 4WD |
| <b>NISSAN PICK UP/KING CAB/NAVARA (D22)</b>  |
| 2.4 i/2.4 i 4WD/2.5 D/2.5 D 4WD/2.5 Di/2.5 Di 4WD/2.5 TD 4WD/3.2 D 4WD             |
| <b>NISSAN TERRANO I (WD21)</b>   |
| 2.4 i 4WD/2.7 TD 4WD/3.0 i 4WD   |
| <b>NISSAN TERRANO II (R20)</b>   |
| 2.4 4WD/2.4 i 12V 4WD/2.7 TD 4WD/2.7 TDi 4WD/3.0 Di 4WD                            |



**GOM-107** Holder, control arm mounting  
 Silentblock

|                                |             |
|--------------------------------|-------------|
| NISSAN                         | 54423-B9500 |
| Length/Lunghezza [mm]          | 81          |
| Inner Diam./Diam. Interno [mm] | 18          |
| Outer Diam./Diam. esterno [mm] | 36          |

|  |
|--|
| <b>NISSAN PICK UP/KING CAB (720)</b>   |
| 1.8/2.2 4WD/2.2 D/2.3 D/2.5 D 4WD  |
| <b>NISSAN PICK UP/KING CAB (D21)</b>   |
| 2.0/2.3 D/2.4 i 12V/2.4 i 12V 4WD/2.4 i 4WD/2.5 D/2.5 D 4WD/2.7 D 4WD/3.0 i V6 4WD |
| <b>NISSAN PICK UP/KING CAB/NAVARA (D22)</b>  |
| 2.4 i/2.4 i 4WD/2.5 D/2.5 D 4WD/2.5 Di/2.5 Di 4WD/2.5 TD 4WD/3.2 D 4WD             |
| <b>NISSAN TERRANO I (WD21)</b>   |
| 2.4 i 4WD/2.7 TD 4WD/3.0 i 4WD   |
| <b>NISSAN TERRANO II (R20)</b>   |
| 2.4 4WD/2.4 i 12V 4WD/2.7 TD 4WD/2.7 TDi 4WD/3.0 Di 4WD                            |



**GOM-108** Holder, control arm mounting  
 Silentblock

|                                |             |
|--------------------------------|-------------|
| NISSAN                         | 54506-B9500 |
| Length/Lunghezza [mm]          | 48          |
| Inner Diam./Diam. Interno [mm] | 17,5        |
| Outer Diam./Diam. esterno [mm] | 41          |

|  |
|--|
| <b>NISSAN PICK UP/KING CAB (720)</b>   |
| 1.8/2.2 4WD/2.2 D/2.3 D/2.5 D 4WD  |
| <b>NISSAN PICK UP/KING CAB (D21)</b>   |
| 2.0/2.3 D/2.4 i 12V/2.4 i 12V 4WD/2.4 i 4WD/2.5 D/2.5 D 4WD/2.7 D 4WD/3.0 i V6 4WD |
| <b>NISSAN PICK UP/KING CAB/NAVARA (D22)</b>  |
| 2.4 i/2.4 i 4WD/2.5 D/2.5 D 4WD/2.5 Di/2.5 Di 4WD/2.5 TD 4WD/3.2 D 4WD             |
| <b>NISSAN TERRANO I (WD21)</b>   |
| 2.4 i 4WD/2.7 TD 4WD/3.0 i 4WD   |
| <b>NISSAN TERRANO II (R20)</b>   |
| 2.4 4WD/2.4 i 12V 4WD/2.7 TD 4WD/2.7 TDi 4WD/3.0 Di 4WD                            |



**GOM-109** Bush, leaf spring  
 Boccola balestra

|                                |             |
|--------------------------------|-------------|
| NISSAN                         | 55046-01G00 |
| Length/Lunghezza [mm]          | 37          |
| Inner Diam./Diam. Interno [mm] | 20          |
| Outer Diam./Diam. esterno [mm] | 32,5        |

|  |
|--|
| <b>NISSAN PICK UP/KING CAB (720)</b>   |
| 1.8/2.2 4WD/2.2 D/2.3 D/2.5 D 4WD  |
| <b>NISSAN PICK UP/KING CAB (D21)</b>   |
| 2.0/2.3 D/2.4 i 12V/2.4 i 12V 4WD/2.4 i 4WD/2.5 D/2.5 D 4WD/2.7 D 4WD/3.0 i V6 4WD |
| <b>NISSAN PICK UP/KING CAB/NAVARA (D22)</b>  |
| 2.4 i/2.4 i 4WD/2.5 D/2.5 D 4WD/2.5 Di/2.5 Di 4WD/2.5 TD 4WD/3.2 D 4WD             |
| <b>NISSAN TERRANO I (WD21)</b>   |
| 2.4 i 4WD/2.7 TD 4WD/3.0 i 4WD   |
| <b>NISSAN TERRANO II (R20)</b>   |
| 2.4 4WD/2.4 i 12V 4WD/2.7 TD 4WD/2.7 TDi 4WD/3.0 Di 4WD                            |



**GOM-110** Holder, control arm mounting  
 Silentblock

|                                |             |
|--------------------------------|-------------|
| NISSAN                         | 54560-01G00 |
| Length/Lunghezza [mm]          | 81          |
| Inner Diam./Diam. Interno [mm] | 18          |
| Outer Diam./Diam. esterno [mm] | 41          |

|  |
|--|
| <b>NISSAN PICK UP/KING CAB (720)</b>   |
| 1.8/2.2 4WD/2.2 D/2.3 D/2.5 D 4WD  |
| <b>NISSAN PICK UP/KING CAB (D21)</b>   |
| 2.0/2.3 D/2.4 i 12V/2.4 i 12V 4WD/2.4 i 4WD/2.5 D/2.5 D 4WD/2.7 D 4WD/3.0 i V6 4WD |
| <b>NISSAN PICK UP/KING CAB/NAVARA (D22)</b>  |
| 2.4 i/2.4 i 4WD/2.5 D/2.5 D 4WD/2.5 Di/2.5 Di 4WD/2.5 TD 4WD/3.2 D 4WD             |
| <b>NISSAN TERRANO I (WD21)</b>   |
| 2.4 i 4WD/2.7 TD 4WD/3.0 i 4WD   |
| <b>NISSAN TERRANO II (R20)</b>   |
| 2.4 4WD/2.4 i 12V 4WD/2.7 TD 4WD/2.7 TDi 4WD/3.0 Di 4WD                            |
| <b>NISSAN URVAN Autobus (E24)</b>  |
| 2.4 i/2.5 D  |
| <b>NISSAN URVAN Furgonato (E24)</b>  |
| 2.0/2.3 D/2.5 D  |



|                                |                                      |  |   |
|--------------------------------|--------------------------------------|--|---|
| <b>GOM-112</b>                 | <b>Bearing Bush, stabiliser</b>      | <b>NISSAN PATROL Hardtop (K160)</b>  |    |
|                                | <b>Boccola barra stabilizzatrice</b> | <b>NISSAN PATROL Hardtop (K260)</b>  |   |
| NISSAN                         | 56112-09400                          | 2.8 (K160)/3.2 TD (K160)/3.3 D (K160)  |   |
| Length/Lunghezza [mm]          | 16,5                                 | <b>NISSAN PATROL SW (W160)</b>   |   |
| Inner Diam./Diam. Interno [mm] | 10                                   | 2.8 (W160)/3.2 TD (W160)/3.3 D (W160)  |   |
| Outer Diam./Diam. esterno [mm] | 25                                   | <b>NISSAN PATROL SW (W260)</b>   |   |
|                                |                                      | 2.8 TD   |   |
|                                |                                      | <b>NISSAN PICK UP/KING CAB (720)</b>   |   |
|                                |                                      | 1.8/2.2 4WD/2.2 D/2.3 D/2.5 D 4WD  |   |
|                                |                                      | <b>NISSAN PICK UP/KING CAB (D21)</b>   |   |
|                                |                                      | 2.0/2.3 D/2.4 i 12V/2.4 i 12V 4WD/2.4 i 4WD/2.5 D/2.5 D 4WD/2.7 D 4WD/3.0 i V6 4WD |   |
|                                |                                      | <b>NISSAN PICK UP/KING CAB/NAVARA (D22)</b>  |   |
|                                |                                      | 2.4 i/2.4 i 4WD/2.5 D/2.5 D 4WD/2.5 Di/2.5 Di 4WD/2.5 TD 4WD/3.2 D 4WD             |   |
|                                |                                      | <b>NISSAN TERRANO I (WD21)</b>   |   |
|                                |                                      | 2.4 i 4WD/2.7 TD 4WD/3.0 i 4WD   |   |
|                                |                                      | <b>NISSAN TERRANO II (R20)</b>   |   |
|                                |                                      | 2.4 4WD/2.4 i 12V 4WD/2.7 TD 4WD/2.7 TDi 4WD/3.0 Di 4WD                            |   |
| <b>GOM-113</b>                 | <b>Bearing Bush, stabiliser</b>      | <b>NISSAN PICK UP/KING CAB (720)</b>   |   |
|                                | <b>Boccola barra stabilizzatrice</b> | <b>NISSAN PICK UP/KING CAB (D21)</b>   |   |
| NISSAN                         | 54613-14900                          | 1.8/2.2 4WD/2.2 D/2.3 D/2.5 D 4WD  |   |
| Length/Lunghezza [mm]          | 38                                   | <b>NISSAN PICK UP/KING CAB/NAVARA (D22)</b>  |   |
| Height/Altezza [mm]            | 35                                   | 2.0/2.3 D/2.4 i 12V/2.4 i 12V 4WD/2.4 i 4WD/2.5 D/2.5 D 4WD/2.7 D 4WD/3.0 i V6 4WD |   |
| Width/Larghezza [mm]           | 33                                   | <b>NISSAN TERRANO I (WD21)</b>   |   |
| Inner Diam./Diam. Interno [mm] | 20,5                                 | 2.4 i/2.4 i 4WD/2.5 D/2.5 D 4WD/2.5 Di/2.5 Di 4WD/2.5 TD 4WD/3.2 D 4WD             |   |
|                                |                                      | <b>NISSAN TERRANO II (R20)</b>   |   |
|                                |                                      | 2.4 4WD/2.4 i 12V 4WD/2.7 TD 4WD/2.7 TDi 4WD/3.0 Di 4WD                            |   |
| <b>GOM-114</b>                 | <b>Bearing Bush, stabiliser</b>      | <b>NISSAN PICK UP/KING CAB (720)</b>   |  |
|                                | <b>Boccola barra stabilizzatrice</b> | <b>NISSAN PICK UP/KING CAB (D21)</b>   |   |
| NISSAN                         | 54476-F0200                          | 1.8/2.2 4WD/2.2 D/2.3 D/2.5 D 4WD  |   |
| Length/Lunghezza [mm]          | 33                                   | <b>NISSAN PICK UP/KING CAB/NAVARA (D22)</b>  |   |
| Inner Diam./Diam. Interno [mm] | 22                                   | 2.0/2.3 D/2.4 i 12V/2.4 i 12V 4WD/2.4 i 4WD/2.5 D/2.5 D 4WD/2.7 D 4WD/3.0 i V6 4WD |   |
| Outer Diam./Diam. esterno [mm] | 50                                   | <b>NISSAN TERRANO I (WD21)</b>   |   |
|                                |                                      | 2.4 i/2.4 i 4WD/2.5 D/2.5 D 4WD/2.5 Di/2.5 Di 4WD/2.5 TD 4WD/3.2 D 4WD             |   |
|                                |                                      | <b>NISSAN TERRANO II (R20)</b>   |   |
|                                |                                      | 2.4 4WD/2.4 i 12V 4WD/2.7 TD 4WD/2.7 TDi 4WD/3.0 Di 4WD                            |   |
| <b>GOM-115</b>                 | <b>Bearing Bush, stabiliser</b>      | <b>NISSAN PICK UP/KING CAB (720)</b>   |  |
|                                | <b>Boccola barra stabilizzatrice</b> | <b>NISSAN PICK UP/KING CAB (D21)</b>   |   |
| NISSAN                         | 54476-01W00                          | 1.8/2.2 4WD/2.2 D/2.3 D/2.5 D 4WD  |   |
| Length/Lunghezza [mm]          | 34                                   | <b>NISSAN PICK UP/KING CAB/NAVARA (D22)</b>  |   |
| Inner Diam./Diam. Interno [mm] | 22                                   | 2.0/2.3 D/2.4 i 12V/2.4 i 12V 4WD/2.4 i 4WD/2.5 D/2.5 D 4WD/2.7 D 4WD/3.0 i V6 4WD |   |
| Outer Diam./Diam. esterno [mm] | 50                                   | <b>NISSAN TERRANO I (WD21)</b>   |   |
|                                |                                      | 2.4 i/2.4 i 4WD/2.5 D/2.5 D 4WD/2.5 Di/2.5 Di 4WD/2.5 TD 4WD/3.2 D 4WD             |   |
|                                |                                      | <b>NISSAN TERRANO II (R20)</b>   |   |
|                                |                                      | 2.4 4WD/2.4 i 12V 4WD/2.7 TD 4WD/2.7 TDi 4WD/3.0 Di 4WD                            |   |
| <b>GOM-116</b>                 | <b>Bush, leaf spring</b>             | <b>NISSAN PATROL GR I (Y60)</b>  |  |
|                                | <b>Boccola balestra</b>              | <b>NISSAN PATROL GR II (Y61)</b>   |   |
| NISSAN                         | 55045-10W00                          | 2.8 TD (Y60A)/4.2 Cat./4.2 D (Y60GR)   |   |
| Length/Lunghezza [mm]          | 37                                   | <b>NISSAN PATROL Hardtop (K160)</b>  |   |
| Inner Diam./Diam. Interno [mm] | 18                                   | 2.8 (K160)/3.2 TD (K160)/3.3 D (K160)  |   |
| Outer Diam./Diam. esterno [mm] | 40                                   | <b>NISSAN PATROL Hardtop (K260)</b>  |   |
|                                |                                      | 2.8/2.8 TD/3.2 D   |   |
|                                |                                      | <b>NISSAN PATROL SW (W160)</b>   |   |
|                                |                                      | 2.8 (W160)/3.2 TD (W160)/3.3 D (W160)  |   |
|                                |                                      | <b>NISSAN PATROL SW (W260)</b>   |   |

|                                |                          |
|--------------------------------|--------------------------|
| <b>GOM-117</b>                 | <b>Bush, leaf spring</b> |
|                                | <b>Boccola balestra</b>  |
| NISSAN                         | 55046-C6000              |
| Length/Lunghezza [mm]          | 51                       |
| Inner Diam./Diam. Interno [mm] | 18                       |
| Outer Diam./Diam. esterno [mm] | 33                       |

|  |
|--|
| 2.8 TD/3.2 D   |
| <b>NISSAN PICK UP/KING CAB (720)</b>                     |
| 1.8/2.2 4WD/2.2 D/2.3 D/2.5 D 4WD                        |
| <b>NISSAN PICK UP/KING CAB (D21)</b>                     |
| 2.0/2.3 D/2.4 i 12V/2.4 i 12V 4WD/2.4 i 4WD/2.5 D/2.5 D  |
| 4WD/2.7 D 4WD/3.0 i V6 4WD                               |
| <b>NISSAN PICK UP/KING CAB/NAVARA (D22)</b>              |
| 2.4 i/2.4 i 4WD/2.5 D/2.5 D 4WD/2.5 Di/2.5 Di 4WD/2.5 TD |
| 4WD/3.2 D 4WD  |
| <b>NISSAN TERRANO I (WD21)</b>                           |
| 2.4 i 4WD/2.7 TD 4WD/3.0 i 4WD                           |
| <b>NISSAN TERRANO II (R20)</b>                           |
| 2.4 4WD/2.4 i 12V 4WD/2.7 TD 4WD/2.7 TDi 4WD/3.0 Di 4WD  |

|                                       |
|---------------------------------------|
| <b>NISSAN PATROL GR I (Y60)</b>       |
| 2.8 TD (Y60A)/4.2 Cat./4.2 D (Y60GR)  |
| <b>NISSAN PATROL GR II (Y61)</b>      |
| 2.8 TD/3.0 DTi/4.2 TD/4.5 i           |
| <b>NISSAN PATROL Hardtop (K160)</b>   |
| 2.8 (K160)/3.2 TD (K160)/3.3 D (K160) |
| <b>NISSAN PATROL Hardtop (K260)</b>   |
| 2.8/2.8 TD/3.2 D                      |
| <b>NISSAN PATROL SW (W160)</b>        |
| 2.8 (W160)/3.2 TD (W160)/3.3 D (W160) |
| <b>NISSAN PATROL SW (W260)</b>        |
| 2.8 TD/3.2 D                          |



|                                |                                      |
|--------------------------------|--------------------------------------|
| <b>GOM-118</b>                 | <b>Bearing Bush, stabiliser</b>      |
|                                | <b>Boccola barra stabilizzatrice</b> |
| NISSAN                         | 54476-01G00                          |
| Length/Lunghezza [mm]          | 35                                   |
| Inner Diam./Diam. Interno [mm] | 21                                   |
| Outer Diam./Diam. esterno [mm] | 51                                   |

|                                       |
|---------------------------------------|
| <b>NISSAN PATROL GR I (Y60)</b>       |
| 2.8 TD (Y60A)/4.2 Cat./4.2 D (Y60GR)  |
| <b>NISSAN PATROL GR II (Y61)</b>      |
| 2.8 TD/3.0 DTi/4.2 TD/4.5 i           |
| <b>NISSAN PATROL Hardtop (K160)</b>   |
| 2.8 (K160)/3.2 TD (K160)/3.3 D (K160) |
| <b>NISSAN PATROL Hardtop (K260)</b>   |
| 2.8/2.8 TD/3.2 D                      |
| <b>NISSAN PATROL SW (W160)</b>        |
| 2.8 (W160)/3.2 TD (W160)/3.3 D (W160) |
| <b>NISSAN PATROL SW (W260)</b>        |
| 2.8 TD/3.2 D                          |



|                                |                                     |
|--------------------------------|-------------------------------------|
| <b>GOM-119</b>                 | <b>Holder, control arm mounting</b> |
|                                | <b>Silentblock</b>                  |
| NISSAN                         | 54560-01J00                         |
| Length/Lunghezza [mm]          | 50,2                                |
| Inner Diam./Diam. Interno [mm] | 16                                  |
| Outer Diam./Diam. esterno [mm] | 60,3                                |

|                                       |
|---------------------------------------|
| <b>NISSAN PATROL GR I (Y60)</b>       |
| 2.8 TD (Y60A)/4.2 Cat./4.2 D (Y60GR)  |
| <b>NISSAN PATROL GR II (Y61)</b>      |
| 2.8 TD/3.0 DTi/4.2 TD/4.5 i           |
| <b>NISSAN PATROL Hardtop (K160)</b>   |
| 2.8 (K160)/3.2 TD (K160)/3.3 D (K160) |
| <b>NISSAN PATROL Hardtop (K260)</b>   |
| 2.8/2.8 TD/3.2 D                      |
| <b>NISSAN PATROL SW (W160)</b>        |
| 2.8 (W160)/3.2 TD (W160)/3.3 D (W160) |
| <b>NISSAN PATROL SW (W260)</b>        |
| 2.8 TD/3.2 D                          |



|                                |                                      |
|--------------------------------|--------------------------------------|
| <b>GOM-120</b>                 | <b>Bearing Bush, stabiliser</b>      |
|                                | <b>Boccola barra stabilizzatrice</b> |
| NISSAN                         | 55045-G2500                          |
| Length/Lunghezza [mm]          | 38,5                                 |
| Inner Diam./Diam. Interno [mm] | 18                                   |
| Outer Diam./Diam. esterno [mm] | 45                                   |

|                                       |
|---------------------------------------|
| <b>NISSAN PATROL GR I (Y60)</b>       |
| 2.8 TD (Y60A)/4.2 Cat./4.2 D (Y60GR)  |
| <b>NISSAN PATROL GR II (Y61)</b>      |
| 2.8 TD/3.0 DTi/4.2 TD/4.5 i           |
| <b>NISSAN PATROL Hardtop (K160)</b>   |
| 2.8 (K160)/3.2 TD (K160)/3.3 D (K160) |
| <b>NISSAN PATROL Hardtop (K260)</b>   |
| 2.8/2.8 TD/3.2 D                      |
| <b>NISSAN PATROL SW (W160)</b>        |
| 2.8 (W160)/3.2 TD (W160)/3.3 D (W160) |
| <b>NISSAN PATROL SW (W260)</b>        |
| 2.8 TD/3.2 D                          |



|                                |                                      |   |   |
|--------------------------------|--------------------------------------|---|---|
| <b>GOM-121</b>                 | <b>Bearing Bush, stabiliser</b>      | <b>NISSAN PICK UP/KING CAB (D21)</b><br>2.0/2.3 D/2.4 i 12V/2.4 i 12V 4WD/2.4 i 4WD/2.5 D/2.5 D<br>4WD/2.7 D 4WD/3.0 i V6 4WD |    |
|                                | <b>Boccola barra stabilizzatrice</b> | <b>NISSAN TERRANO I (WD21)</b><br>2.4 i 4WD/2.7 TD 4WD/3.0 i 4WD  |   |
| NISSAN                         | 54613-43G00                          | <b>NISSAN TERRANO II (R20)</b><br>2.4 4WD/2.4 i 12V 4WD/2.7 TD 4WD/2.7 TDi 4WD/3.0 Di 4WD                                     |   |
| Length/Lunghezza [mm]          | 54                                   |   |   |
| Height/Altezza [mm]            | 35                                   |   |   |
| Width/Larghezza [mm]           | 37                                   |   |   |
| Inner Diam./Diam. Interno [mm] | 21                                   |   |   |
| <b>GOM-122</b>                 | <b>Bearing Bush, stabiliser</b>      | <b>NISSAN PICK UP/KING CAB (D21)</b><br>2.0/2.3 D/2.4 i 12V/2.4 i 12V 4WD/2.4 i 4WD/2.5 D/2.5 D<br>4WD/2.7 D 4WD/3.0 i V6 4WD |    |
|                                | <b>Boccola barra stabilizzatrice</b> | <b>NISSAN TERRANO I (WD21)</b><br>2.4 i 4WD/2.7 TD 4WD/3.0 i 4WD  |   |
| NISSAN                         | 54613-W1410                          |   |   |
| Length/Lunghezza [mm]          | 28,5                                 |   |   |
| Height/Altezza [mm]            | 38                                   |   |   |
| Width/Larghezza [mm]           | 32                                   |   |   |
| Inner Diam./Diam. Interno [mm] | 23                                   |   |   |
| <b>GOM-123</b>                 | <b>Bearing Bush, stabiliser</b>      | <b>NISSAN PATROL GR I (Y60)</b><br>2.8 TD (Y60A)/4.2 Cat./4.2 D (Y60GR)   |    |
|                                | <b>Boccola barra stabilizzatrice</b> | <b>NISSAN PATROL GR II (Y61)</b><br>2.8 TD/3.0 DTi/4.2 TD/4.5 i   |   |
| NISSAN                         | 54613-01J11                          | <b>NISSAN PATROL Hardtop (K160)</b><br>2.8 (K160)/3.2 TD (K160)/3.3 D (K160)  |   |
| Length/Lunghezza [mm]          | 34                                   | <b>NISSAN PATROL Hardtop (K260)</b><br>2.8/2.8 TD/3.2 D   |   |
| Height/Altezza [mm]            | 42                                   | <b>NISSAN PATROL SW (W160)</b><br>2.8 (W160)/3.2 TD (W160)/3.3 D (W160)   |   |
| Width/Larghezza [mm]           | 25                                   | <b>NISSAN PATROL SW (W260)</b><br>2.8 TD/3.2 D  |   |
| Inner Diam./Diam. Interno [mm] | 14                                   | <b>NISSAN PICK UP/KING CAB (D21)</b><br>2.0/2.3 D/2.4 i 12V/2.4 i 12V 4WD/2.4 i 4WD/2.5 D/2.5 D<br>4WD/2.7 D 4WD/3.0 i V6 4WD |   |
|                                |                                      | <b>NISSAN TERRANO I (WD21)</b><br>2.4 i 4WD/2.7 TD 4WD/3.0 i 4WD  |   |
| <b>GOM-124</b>                 | <b>Bearing Bush, stabiliser</b>      | <b>NISSAN PATROL GR I (Y60)</b><br>2.8 TD (Y60A)/4.2 Cat./4.2 D (Y60GR)   |  |
|                                | <b>Boccola barra stabilizzatrice</b> |   |   |
| NISSAN                         | 54613-06J10                          |   |   |
| Length/Lunghezza [mm]          | 46                                   |   |   |
| Height/Altezza [mm]            | 34                                   |   |   |
| Width/Larghezza [mm]           | 32                                   |   |   |
| Inner Diam./Diam. Interno [mm] | 17                                   |   |   |
| <b>GOM-125</b>                 | <b>Bearing Bush, stabiliser</b>      | <b>NISSAN PATROL GR I (Y60)</b><br>2.8 TD (Y60A)/4.2 Cat./4.2 D (Y60GR)   |  |
|                                | <b>Boccola barra stabilizzatrice</b> |   |   |
| NISSAN                         | 54613-0F001                          |   |   |
| Length/Lunghezza [mm]          | 36                                   |   |   |
| Height/Altezza [mm]            | 43,5                                 |   |   |
| Width/Larghezza [mm]           | 35                                   |   |   |
| Inner Diam./Diam. Interno [mm] | 23                                   |   |   |
| <b>GOM-126</b>                 | <b>Bearing Bush, stabiliser</b>      | <b>NISSAN PATROL GR I (Y60)</b><br>2.8 TD (Y60A)/4.2 Cat./4.2 D (Y60GR)   |  |
|                                | <b>Boccola barra stabilizzatrice</b> |   |   |
| NISSAN                         | 54476-01J00                          |   |   |
| Length/Lunghezza [mm]          | 40                                   |   |   |
| Inner Diam./Diam. Interno [mm] | 24                                   |   |   |
| Outer Diam./Diam. esterno [mm] | 37                                   |   |   |

|                                     |                                      |   |   |
|-------------------------------------|--------------------------------------|---|---|
| <b>GOM-127</b>                      | <b>Bearing Bush, stabiliser</b>      | <b>NISSAN PATROL GR I (Y60)</b><br>2.8 TD (Y60A)/4.2 Cat./4.2 D (Y60GR)   |    |
|                                     | <b>Boccola barra stabilizzatrice</b> |   |   |
| NISSAN 55135-01J00                  |                                      |   |   |
| Length/Lunghezza [mm] 27,5          |                                      |   |   |
| Inner Diam./Diam. Interno [mm] 25   |                                      |   |   |
| Outer Diam./Diam. esterno [mm] 47,5 |                                      |   |   |
| <b>GOM-128</b>                      | <b>Bearing Bush, stabiliser</b>      | <b>NISSAN PICK UP/KING CAB (D21)</b><br>2.0/2.3 D/2.4 i 12V/2.4 i 12V 4WD/2.4 i 4WD/2.5 D/2.5 D<br>4WD/2.7 D 4WD/3.0 i V6 4WD |    |
|                                     | <b>Boccola barra stabilizzatrice</b> | <b>NISSAN TERRANO I (WD21)</b><br>2.4 i 4WD/2.7 TD 4WD/3.0 i 4WD  |   |
| NISSAN 54613-32G00                  |                                      |   |   |
| Length/Lunghezza [mm] 47            |                                      |   |   |
| Height/Altezza [mm] 35,5            |                                      |   |   |
| Width/Larghezza [mm] 33             |                                      |   |   |
| Inner Diam./Diam. Interno [mm] 20   |                                      |   |   |
| <b>GOM-130</b>                      | <b>Bearing Bush, stabiliser</b>      | <b>NISSAN PATROL GR I (Y60)</b><br>2.8 TD (Y60A)/4.2 Cat./4.2 D (Y60GR)   |    |
|                                     | <b>Boccola barra stabilizzatrice</b> | <b>NISSAN PATROL GR II (Y61)</b><br>2.8 TD/3.0 DTi/4.2 TD/4.5 i   |   |
| NISSAN 55046-01600                  |                                      | <b>NISSAN PATROL Hardtop (K160)</b><br>2.8 (K160)/3.2 TD (K160)/3.3 D (K160)  |   |
| Length/Lunghezza [mm] 36,5          |                                      | <b>NISSAN PATROL Hardtop (K260)</b><br>2.8/2.8 TD/3.2 D   |   |
| Inner Diam./Diam. Interno [mm] 20   |                                      | <b>NISSAN PATROL SW (W160)</b><br>2.8 (W160)/3.2 TD (W160)/3.3 D (W160)   |   |
| Outer Diam./Diam. esterno [mm] 32   |                                      | <b>NISSAN PATROL SW (W260)</b><br>2.8 TD/3.2 D  |   |
| <b>GOM-131</b>                      | <b>Bush, leaf spring</b>             | <b>NISSAN PATROL GR I (Y60)</b><br>2.8 TD (Y60A)/4.2 Cat./4.2 D (Y60GR)   |   |
|                                     | <b>Boccola balestra</b>              | <b>NISSAN PATROL GR II (Y61)</b><br>2.8 TD/3.0 DTi/4.2 TD/4.5 i   |   |
| NISSAN 55045-07200                  |                                      | <b>NISSAN PATROL Hardtop (K160)</b><br>2.8 (K160)/3.2 TD (K160)/3.3 D (K160)  |   |
| Length/Lunghezza [mm] 64            |                                      | <b>NISSAN PATROL Hardtop (K260)</b><br>2.8/2.8 TD/3.2 D   |   |
| Inner Diam./Diam. Interno [mm] 16   |                                      | <b>NISSAN PATROL SW (W160)</b><br>2.8 (W160)/3.2 TD (W160)/3.3 D (W160)   |   |
| Outer Diam./Diam. esterno [mm] 33,2 |                                      | <b>NISSAN PATROL SW (W260)</b><br>2.8 TD/3.2 D  |   |
| <b>GOM-132</b>                      | <b>Bearing Bush, stabiliser</b>      | <b>NISSAN PATROL GR I (Y60)</b><br>2.8 TD (Y60A)/4.2 Cat./4.2 D (Y60GR)   |  |
|                                     | <b>Boccola barra stabilizzatrice</b> | <b>NISSAN PATROL GR II (Y61)</b><br>2.8 TD/3.0 DTi/4.2 TD/4.5 i   |   |
| NISSAN 20638-61500                  |                                      | <b>NISSAN PATROL Hardtop (K160)</b><br>2.8 (K160)/3.2 TD (K160)/3.3 D (K160)  |   |
| Length/Lunghezza [mm] 15            |                                      | <b>NISSAN PATROL Hardtop (K260)</b><br>2.8/2.8 TD/3.2 D   |   |
| Inner Diam./Diam. Interno [mm] 12   |                                      | <b>NISSAN PATROL SW (W160)</b><br>2.8 (W160)/3.2 TD (W160)/3.3 D (W160)   |   |
| Outer Diam./Diam. esterno [mm] 30   |                                      | <b>NISSAN PATROL SW (W260)</b><br>2.8 TD/3.2 D  |   |
|                                     |                                      | <b>NISSAN PICK UP/KING CAB (720)</b><br>1.8/2.2 4WD/2.2 D/2.3 D/2.5 D 4WD   |   |
|                                     |                                      | <b>NISSAN PICK UP/KING CAB (D21)</b><br>2.0/2.3 D/2.4 i 12V/2.4 i 12V 4WD/2.4 i 4WD/2.5 D/2.5 D<br>4WD/2.7 D 4WD/3.0 i V6 4WD |   |
|                                     |                                      | <b>NISSAN PICK UP/KING CAB/NAVARA (D22)</b><br>2.4 i/2.4 i 4WD/2.5 D/2.5 D 4WD/2.5 Di/2.5 Di 4WD/2.5 TD<br>4WD/3.2 D 4WD      |   |
|                                     |                                      | <b>NISSAN TERRANO I (WD21)</b><br>2.4 i 4WD/2.7 TD 4WD/3.0 i 4WD  |   |
|                                     |                                      | <b>NISSAN TERRANO II (R20)</b><br>2.4 4WD/2.4 i 12V 4WD/2.7 TD 4WD/2.7 TDi 4WD/3.0 Di 4WD                                     |   |

|                                |                                      |   |   |
|--------------------------------|--------------------------------------|---|---|
| <b>GOM-134</b>                 | <b>Bush, leaf spring</b>             | <b>NISSAN PATROL GR I (Y60)</b><br>2.8 TD (Y60A)/4.2 Cat./4.2 D (Y60GR)   |    |
|                                | <b>Boccola balestra</b>              | <b>NISSAN PATROL GR II (Y61)</b><br>2.8 TD/3.0 DTi/4.2 TD/4.5 i   |   |
| NISSAN                         | 55045-31000                          | <b>NISSAN PATROL Hardtop (K160)</b><br>2.8 (K160)/3.2 TD (K160)/3.3 D (K160)  |   |
| Length/Lunghezza [mm]          | 70                                   | <b>NISSAN PATROL Hardtop (K260)</b><br>2.8/2.8 TD/3.2 D   |   |
| Inner Diam./Diam. Interno [mm] | 18                                   | <b>NISSAN PATROL SW (W160)</b><br>2.8 (W160)/3.2 TD (W160)/3.3 D (W160)   |   |
| Outer Diam./Diam. esterno [mm] | 40                                   | <b>NISSAN PATROL SW (W260)</b><br>2.8 TD/3.2 D  |   |
|                                |                                      | <b>NISSAN PATROL Hardtop (K160)</b><br>2.8 (K160)/3.2 TD (K160)/3.3 D (K160)  |   |
|                                |                                      | <b>NISSAN PATROL Hardtop (K260)</b><br>2.8/2.8 TD   |   |
|                                |                                      | <b>NISSAN PATROL SW (W160)</b><br>2.8 (W160)/3.2 TD (W160)/3.3 D (W160)   |   |
|                                |                                      | <b>NISSAN PATROL SW (W260)</b><br>2.8 TD  |   |
| <b>GOM-136</b>                 | <b>Bearing Bush, stabiliser</b>      | <b>NISSAN PATROL Hardtop (K160)</b><br>2.8 (K160)/3.2 TD (K160)/3.3 D (K160)  |    |
|                                | <b>Boccola barra stabilizzatrice</b> | <b>NISSAN PATROL Hardtop (K260)</b><br>2.8/2.8 TD   |   |
| Length/Lunghezza [mm]          | 37                                   | <b>NISSAN PATROL SW (W160)</b><br>2.8 (W160)/3.2 TD (W160)/3.3 D (W160)   |   |
| Width/Larghezza [mm]           | 33                                   | <b>NISSAN PATROL SW (W260)</b><br>2.8 TD  |   |
| Inner Diam./Diam. Interno [mm] | 20                                   |   |   |
|                                |                                      |   |   |
| <b>GOM-137</b>                 | <b>Bush, leaf spring</b>             | <b>NISSAN PATROL Hardtop (K160)</b><br>2.8 (K160)/3.2 TD (K160)/3.3 D (K160)  |   |
|                                | <b>Boccola balestra</b>              | <b>NISSAN PATROL Hardtop (K260)</b><br>2.8/2.8 TD   |   |
| Length/Lunghezza [mm]          | 37                                   | <b>NISSAN PATROL SW (W160)</b><br>2.8 (W160)/3.2 TD (W160)/3.3 D (W160)   |   |
| Width/Larghezza [mm]           | 33                                   | <b>NISSAN PATROL SW (W260)</b><br>2.8 TD  |   |
| Inner Diam./Diam. Interno [mm] | 18                                   |   |   |
|                                |                                      |   |   |
| <b>GOM-138</b>                 | <b>Holder, control arm mounting</b>  | <b>NISSAN ALMERA I (N15)</b><br>1.4/1.4 GX,LX/1.6/1.6 SLX/2.0 D   |  |
|                                | <b>Silentblock</b>                   | <b>NISSAN ALMERA I Hatchback (N15)</b><br>1.4/1.4 S,GX,LX/1.6/1.6 SR,SLX/2.0 D/2.0 GTi  |   |
| NISSAN                         | 54560-50A00                          | <b>NISSAN SUNNY II (N13)</b><br>1.0/1.3/1.4/1.4 LX/1.5/1.6/1.6 4x4/1.6 GTI 16V/1.6 i/1.6 i  |   |
| Length/Lunghezza [mm]          | 60                                   | 12V/1.6 i 4x4 (A)/1.7 D   |   |
| Inner Diam./Diam. Interno [mm] | 14                                   | <b>NISSAN SUNNY II Coupe (B12)</b><br>1.5/1.6/1.6 GTI 16V/1.6 i/1.6 i 12V/1.8 GTI 16V   |   |
| Outer Diam./Diam. esterno [mm] | 36                                   | <b>NISSAN SUNNY II Hatchback (N13)</b><br>1.3/1.4/1.4 LX/1.5/1.6/1.6 GTI 16V/1.6 i/1.6 i 12V/1.7 D/1.8 GTI 16V                          |   |
|                                |                                      | <b>NISSAN SUNNY II Traveller (B12)</b><br>1.5/1.6/1.6 i/1.6 i 12V/1.6 i 12V 4x4/1.6 i 4x4 (A)/1.7 D                                     |   |
|                                |                                      |   |   |
|                                |                                      |   |   |
|                                |                                      |   |   |
| <b>GOM-139</b>                 | <b>Holder, control arm mounting</b>  | <b>NISSAN 100 NX (B13)</b><br>1.6/1.6 SR/2.0/2.0 GTi  |  |
|                                | <b>Silentblock</b>                   | <b>NISSAN ALMERA I (N15)</b><br>1.4/1.4 GX,LX/1.6/1.6 SLX/2.0 D   |   |
| NISSAN                         | 54570-69Y10                          | <b>NISSAN ALMERA I Hatchback (N15)</b><br>1.4/1.4 S,GX,LX/1.6/1.6 SR,SLX/2.0 D/2.0 GTi  |   |
| Length/Lunghezza [mm]          | 64                                   | <b>NISSAN SUNNY III (N14)</b><br>1.4/1.4 i/1.4 i 16V/1.6 i/1.6 i 16V/1.6 i 16V 4WD/1.6 SR 4x4/2.0 D                                     |   |
| Inner Diam./Diam. Interno [mm] | 24                                   | <b>NISSAN SUNNY III Hatchback (N14)</b><br>1.4 i/1.4 i 16V/1.5/1.6 i/1.6 i 16V/1.6 i 16V 4x4/1.6 SR 4x4/2.0 D/2.0 GTI 16V/2.0 GTI-R 4x4 |   |
| Outer Diam./Diam. esterno [mm] | 64                                   | <b>NISSAN SUNNY III Liftback (N14)</b><br>1.4/1.4 i/1.4 i 16V/1.6 i/1.6 i 16V/1.6 SR 4x4/2.0 D/2.0 i 16V                                |   |
|                                |                                      | <b>NISSAN SUNNY III Traveller (Y10)</b><br>1.6 16V 4x4/1.6 i/1.6 i 16V 4x4/2.0 D  |   |
|                                |                                      |   |   |
|                                |                                      |   |   |

|                                 |                                      |  |   |
|---------------------------------|--------------------------------------|--|---|
| <b>GOM-140</b>                  | <b>Holder, control arm mounting</b>  | <b>NISSAN ALMERA II (N16)</b><br>1.5/1.5 dCi/1.8/2.2 dCi/2.2 Di  |    |
|                                 | <b>Silentblock</b>                   | <b>NISSAN ALMERA II Hatchback (N16)</b><br>1.5/1.5 dCi/1.5 XL/1.8/2.2 dCi/2.2 Di   |   |
| NISSAN 54500BM410               |                                      |  |   |
| Length/Lunghezza [mm]           |                                      | 55   |   |
| Inner Diam./Diam. Interno [mm]  |                                      | 14   |   |
| Outer Diam./Diam. esterno [mm]  |                                      | 32,5   |   |
| <b>GOM-141</b>                  | <b>Holder, control arm mounting</b>  | <b>NISSAN ALMERA II (N16)</b><br>1.5/1.5 dCi/1.8/2.2 dCi/2.2 Di  |    |
|                                 | <b>Silentblock</b>                   | <b>NISSAN ALMERA II Hatchback (N16)</b><br>1.5/1.5 dCi/1.5 XL/1.8/2.2 dCi/2.2 Di   |   |
| NISSAN 54500BM410               |                                      |  |   |
| Inner Diam./Diam. Interno [mm]  |                                      | 21   |   |
| Overall Length/Lungh. Tot. [mm] |                                      | 163  |   |
| <b>GOM-142</b>                  | <b>Holder, control arm mounting</b>  | <b>NISSAN INTERSTAR</b><br>dCi 100/dCi 120/dCi 140/dCi 150/dCi 80/dCi 90   |    |
|                                 | <b>Silentblock</b>                   | <b>OPEL MOVANO (U9, E9, H9)</b><br>2.2 DTI/2.5 D/2.5 DTI/2.8 DTI   |   |
| NISSAN 54570-00QAA              |                                      | <b>OPEL MOVANO Combi (J9)</b><br>1.9 DTI/2.2 DTI/2.5 D/2.5 DTI/2.8 DTI/3.0 DTI   |   |
| Length/Lunghezza [mm]           |                                      | 74,2   |   |
| Inner Diam./Diam. Interno [mm]  |                                      | 28   |   |
| Outer Diam./Diam. esterno [mm]  |                                      | 55,3   |   |
|                                 |                                      | <b>OPEL MOVANO Furgonato (F9)</b><br>1.9 DTI/2.2 DTI/2.5 D/2.5 DTI/2.8 DTI/3.0 DTI   |   |
|                                 |                                      | <b>RENAULT MASTER II (FD, JD/ND)</b><br>1.9 dCi 80/1.9 dTi/2.2 dCi 90/2.5 D/2.5 dCi 100 (JDCV)/2.5 dCi 120/2.8 dTi/3.0 dCi 140 (JD0T)  |   |
| <b>GOM-143</b>                  | <b>Holder, control arm mounting</b>  | <b>NISSAN INTERSTAR</b><br>dCi 100/dCi 120/dCi 140/dCi 150/dCi 80/dCi 90   |  |
|                                 | <b>Silentblock</b>                   | <b>NISSAN INTERSTAR Pianale piatto/Telaio</b><br>dCi 140   |   |
| NISSAN 54423-00QAA              |                                      | <b>OPEL MOVANO (U9, E9, H9)</b><br>2.2 DTI/2.5 D/2.5 DTI/2.8 DTI   |   |
| Length/Lunghezza [mm]           |                                      | 79   |   |
| Inner Diam./Diam. Interno [mm]  |                                      | 28   |   |
| Outer Diam./Diam. esterno [mm]  |                                      | 55   |   |
|                                 |                                      | <b>OPEL MOVANO Combi (J9, F9)</b><br>1.9 DTI/2.2 DTI/2.5 D/2.5 DTI/2.8 DTI/3.0 DTI   |   |
|                                 |                                      | <b>RENAULT MASTER II (ED/HD/UD)</b><br>2.2 dCi 90/2.5 D/2.5 dCi 100 (ED4V, ED8V)/2.5 dCi 120/2.8 dTi/3.0 dCi 120/3.0 dCi 140 (ED0S, UD0S)/3.0 dCi 160  |   |
|                                 |                                      | <b>RENAULT MASTER II (JD/ND)</b><br>1.9 dCi 80/1.9 dTi/2.2 dCi 90/2.5 D/2.5 dCi 100 (JDCV)/2.5 dCi 120/2.8 dTi/3.0 dCi 140 (JD0T)  |   |
| <b>GOM-144</b>                  | <b>Bearing Bush, stabiliser</b>      | <b>NISSAN KUBISTAR</b><br>1.2/1.2 16V/1.5 dCi/1.5 dCi 70/1.5 dCi 85/1.6 16V  |  |
|                                 | <b>Boccola barra stabilizzatrice</b> | <b>RENAULT 19 I (B/C53_)</b><br>1.2/1.4/1.4 (B/C532) Cat./1.4 (B/C53P)/1.7/1.7 (B/C53B)/1.7 (B/C53C)/1.8 16V (B/C53D)/1.9 D (B/C534, B/C53J)/1.9 DT  |   |
| NISSAN 54613 00QAD              |                                      | <b>RENAULT 19 I Chamade (L53_)</b><br>1.1 TR/1.2/1.4/1.4 (L532, L53P)/1.7 (L53B)/1.7 (L53C)/1.7 (L53F)/1.8 16V (L53D)/1.9 D (L534, L53J)/1.9 DT/1.9 TD (L53K)  |   |
| Fitting Position/Lato Montaggio |                                      | Front  |   |
| Length/Lunghezza [mm]           |                                      | 42   |   |
| Height/Altezza [mm]             |                                      | 46   |   |
| Width/Larghezza [mm]            |                                      | 36,5   |   |
| Inner Diam./Diam. Interno [mm]  |                                      | 22   |   |
|                                 |                                      | <b>RENAULT 19 I Furgonato (S53_)</b><br>1.2/1.4/1.9 D  |   |
|                                 |                                      | <b>RENAULT 19 II (B/C53_)</b><br>1.2/1.4/1.4 (B/C532)/1.4 (B/C535)/1.7 (B/C53B)/1.7 (B/C53C)/1.8 (5/353A)/1.8 (5/353F, B/C538)/1.8 (B/C538)/1.8 (B/C53Y)/1.8 16V (B/C53D)/1.9 D (B/C53J)/1.9 dT (B/C53T) |   |
|                                 |                                      | <b>RENAULT 19 II Chamade (L53_)</b><br>1.2/1.4/1.4 (532)/1.4 (L535)/1.7 (L53B)/1.7 (L53C)/1.8 (453A/F)/1.8 (L538)/1.8 (L53V, L538)/1.8 (L53Y)/1.8 16V (L53D)/1.9 D (L53J)/1.9 dT (L53T)                  |   |
|                                 |                                      | <b>RENAULT 19 II Furgonato (S53_)</b><br>1.2/1.4/1.9 D/1.9 dT  |   |
|                                 |                                      | <b>RENAULT CLIO I (B/C57_, 5/357_)</b>   |   |



1.1/1.2 (5/357Y, 5/357K)/1.2 (B/C/S577)/1.2 (B/C/S57A, B/C57S, 5/357F, 5/357I, 5/357L, 5/357R)/1.2 (B/C57R)/1.4/1.4 (B/C57T, B/C57Y)/1.4 (B57I, C57J)/1.7 (B/C574)/1.8/1.8 (B/C578)/1.8 (B/C57C, B/C57U)/1.8 16V (C57D)/1.8 Rsi (B/C579)/1.8 Rsi (B/C5

**RENAULT CLIO II (B/C/B0/1\_, CB0/1/2\_)**

1.2 (B/CB0F, B/CB0A, B/CB10, B/CB1K, B/CB2D, B/CB2H)/1.2 16V (B/CB0S)/1.4 (B/CB0C)/1.4 16V (B/CB0L)/1.4 16V (B/CB0P)/1.5 dCi/1.5 dCi (B/CB07)/1.5 dCi (B/CB08)/1.6 (B/CB0D)/1.6 16V (CB0T, CB0H)/1.9 D (B/CB0E)/1.9 dTi (B/CB0U)/2.0 16V Sport/2.0 16V Sport

**RENAULT KANGOO (KCO\_)**

1.2 (KC0A, KC0K, KCOF, KC01)/1.2 16V (KC03, KC05, KC06, KC0T, KC0W)/1.4 (KC0C, KC0H, KC0B, KC0M)/1.5 dCi/1.5 dCi (KC07)/1.5 dCi (KC08, KC09)/1.6/1.6 16V/1.6 16V 4x4 (KC0P, KC0S, KC0L)/1.6 16V bivalent/1.9 dCi 4x4/1.9 dCi 4x4 (KCOV)/1.9 dTi (KCOU)/D 55 1

**RENAULT KANGOO Express (FCO\_)**

1.2 (FC01, FC0A, FCOF)/1.2 16V (FC05)/1.4 (FC0C, FC0B, FCOH, FCOM)/1.5 dCi/1.5 dCi (FC07)/1.5 dCi (FC08, FC09)/1.6 16V/1.6 16V 4x4 (FC0L, FC0P, FC0S)/1.9 dCi/1.9 dCi 4x4/1.9 dCi 4x4 (FC0V)/1.9 dTi (FC0U)/D 55 1.9 (FC0D)/D 65 1.9 (FC0E, FC02, FCOJ, FCON)

**RENAULT MEGANE Classic (LA)**

1.4 (LA0E, LA0V)/1.4 16V (LA0D, LA1H, IA0W, LA10)/1.6 e (LA0F, LA0S)/1.6 i (LA0L)/1.9 D (LA0A, LA0U)/2.0 i (LA07, LA0G)

**RENAULT MEGANE I (BA)**

1.4 e (BA0E, BAOV)/1.4 Eco (BA0T)/1.6 e (BA0F, BA0S)/1.6 i (BA0L)/1.9 D Eco (B/SA0U, BA0A)

**RENAULT MEGANE Scenic (JAO\_)**

1.6 e (JA0F)/1.6 i (JA0L)/1.9 dTi (JA0K, JA0Y)/1.9 dTi (JA0N)/2.0 i (JA0G)

**RENAULT SCENIC (JA)**

1.9 dTi (JA0N)

**RENAULT THALIA (LB0/1/2\_)**

1.2 16V/1.5 dCi

**NISSAN KUBISTAR**

1.2/1.2 16V/1.5 dCi/1.5 dCi 70/1.5 dCi 85/1.6 16V

**RENAULT CLIO II (B/C/B0/1\_, CB0/1/2\_)**

1.2 (B/CB0F, B/CB0A, B/CB10, B/CB1K, B/CB2D, B/CB2H)/1.2 16V (B/CB0S)/1.4 (B/CB0C)/1.4 16V (B/CB0L)/1.4 16V (B/CB0P)/1.5 dCi/1.5 dCi (B/CB07)/1.5 dCi (B/CB08)/1.6 (B/CB0D)/1.6 16V (CB0T, CB0H)/1.9 D (B/CB0E)/1.9 dTi (B/CB0U)/2.0 16V Sport/2.0 16V Sport

**RENAULT CLIO II Furgonato (SBO\_)**

1.1 (SB0A)/1.5 dCi/1.9 D (SB0E)

**RENAULT KANGOO (KCO\_)**

1.2 (KC0A, KC0K, KCOF, KC01)/1.2 16V (KC03, KC05, KC06, KC0T, KC0W)/1.4 (KC0C, KC0H, KC0B, KC0M)/1.5 dCi/1.5 dCi (KC07)/1.5 dCi (KC08, KC09)/1.6/1.6 16V/1.6 16V 4x4 (KC0P, KC0S, KC0L)/1.6 16V bivalent/1.9 dCi 4x4/1.9 dCi 4x4 (KCOV)/1.9 dTi (KCOU)/D 55 1

**RENAULT KANGOO Express (FCO\_)**

1.2 (FC01, FC0A, FCOF)/1.2 16V (FC05)/1.4 (FC0C, FC0B, FCOH, FCOM)/1.5 dCi/1.5 dCi (FC07)/1.5 dCi (FC08, FC09)/1.6 16V/1.6 16V 4x4 (FC0L, FC0P, FC0S)/1.9 dCi/1.9 dCi 4x4/1.9 dCi 4x4 (FC0V)/1.9 dTi (FC0U)/D 55 1.9 (FC0D)/D 65 1.9 (FC0E, FC02, FCOJ, FCON)

**RENAULT THALIA (LB0/1/2\_)**

1.2 16V/1.5 dCi

**RENAULT TWINGO**

1.2 (CN0D)/1.2 16V (CN0A)/1.2 Turbo (CN0C)/1.5 dCi (CN0E)/1.6 RS (CN0R)

**GOM-145**

Holder, control arm mounting

Silentblock

NISSAN 54560 00QAB

Length/Lunghezza [mm] 46,4

Inner Diam./Diam. Interno [mm] 15,5

Outer Diam./Diam. esterno [mm] 46



|                |                                     |   |   |
|----------------|-------------------------------------|---|---|
| <b>GOM-146</b> | <b>Holder, control arm mounting</b> | <b>NISSAN MICRA (K10)</b>   |    |
|                | <b>Silentblock</b>                  | 1.0/1.2   |   |
| NISSAN         | 54535 01B00                         |   |   |
|                | Length/Lunghezza [mm]               | 47,5  |   |
|                | Inner Diam./Diam. Interno [mm]      | 12  |   |
|                | Outer Diam./Diam. esterno [mm]      | 29  |   |
| <b>GOM-147</b> | <b>Holder, control arm mounting</b> | <b>NISSAN MICRA (K10)</b>   |    |
|                | <b>Silentblock</b>                  | 1.0/1.2   |   |
| NISSAN         | 54476-01B00                         |   |   |
|                | Length/Lunghezza [mm]               | 54,5  |   |
|                | Inner Diam./Diam. Interno [mm]      | 15  |   |
|                | Outer Diam./Diam. esterno [mm]      | 37  |   |
| <b>GOM-148</b> | <b>Holder, control arm mounting</b> | <b>NISSAN MICRA (K11)</b>   |    |
|                | <b>Silentblock</b>                  | 1.0 i 16V/1.3 i 16V/1.4 i 16V/1.5 D   |   |
| NISSAN         | 545004F105                          |   |   |
|                | Length/Lunghezza [mm]               | 47  |   |
|                | Inner Diam./Diam. Interno [mm]      | 12  |   |
|                | Outer Diam./Diam. esterno [mm]      | 28  |   |
| <b>GOM-149</b> | <b>Holder, control arm mounting</b> | <b>NISSAN MICRA (K11)</b>   |  |
|                | <b>Silentblock</b>                  | 1.0 i 16V/1.3 i 16V/1.4 i 16V/1.5 D   |   |
| NISSAN         | 545004F105                          |   |   |
|                | Length/Lunghezza [mm]               | 54  |   |
|                | Inner Diam./Diam. Interno [mm]      | 14  |   |
|                | Outer Diam./Diam. esterno [mm]      | 42  |   |
| <b>GOM-150</b> | <b>Holder, control arm mounting</b> | <b>NISSAN MICRA (K12)</b>   |  |
|                | <b>Silentblock</b>                  | 1.0 16V/1.2 16V/1.4 16V/1.5 dCi/160 SR  |   |
| NISSAN         | 54560-AX600                         | <b>NISSAN MICRA C+C</b>   |   |
|                | Length/Lunghezza [mm]               | 55  |   |
|                | Inner Diam./Diam. Interno [mm]      | 12  |   |
|                | Outer Diam./Diam. esterno [mm]      | 36  |   |
|                |                                     | <b>NISSAN NOTE</b>  |   |
|                |                                     | 1.4/1.5 dCi/1.6   |   |
|                |                                     | <b>NISSAN TIIDA 2 volumi (C11X)</b>   |   |
|                |                                     | 1.5 dCi/1.6/1.8   |   |
|                |                                     | <b>NISSAN TIIDA Tre volumi (SC11X)</b>  |   |
|                |                                     | 1.5 dCi/1.6/1.8   |   |
|                |                                     | <b>RENAULT CLIO III</b>   |   |
|                |                                     | 1.2 16V/1.4 16V/1.5 dCi/1.5 dCi (C/BR1G)/1.6 16V                                  |   |
|                |                                     | <b>RENAULT MODUS (F/JPO_)</b>   |   |
|                |                                     | 1.2/1.2 (JPOC, JP0K)/1.4 (JP01, JP0J)/1.5 dCi/1.5 dCi (JPOG, JP0H)/1.6/1.6 (JP0B) |   |
| <b>GOM-151</b> | <b>Holder, control arm mounting</b> | <b>NISSAN MICRA (K12)</b>   |  |
|                | <b>Silentblock</b>                  | 1.0 16V/1.2 16V/1.4 16V/1.5 dCi/160 SR  |   |
| NISSAN         | 54570-AX600                         | <b>NISSAN MICRA C+C</b>   |   |
|                | Length/Lunghezza [mm]               | 53  |   |
|                | Inner Diam./Diam. Interno [mm]      | 12  |   |
|                | Outer Diam./Diam. esterno [mm]      | 58  |   |
|                |                                     | <b>NISSAN NOTE</b>  |   |
|                |                                     | 1.4/1.5 dCi/1.6   |   |
|                |                                     | <b>NISSAN TIIDA 2 volumi (C11X)</b>   |   |
|                |                                     | 1.5 dCi/1.6/1.8   |   |
|                |                                     | <b>NISSAN TIIDA Tre volumi (SC11X)</b>  |   |
|                |                                     | 1.5 dCi/1.6/1.8   |   |
|                |                                     | <b>RENAULT CLIO III</b>   |   |
|                |                                     | 1.2 16V/1.4 16V/1.5 dCi/1.5 dCi (C/BR1G)/1.6 16V                                  |   |
|                |                                     | <b>RENAULT MODUS (F/JPO_)</b>   |   |
|                |                                     | 1.2/1.2 (JPOC, JP0K)/1.4 (JP01, JP0J)/1.5 dCi/1.5 dCi (JPOG, JP0H)/1.6/1.6 (JP0B) |   |

|                                 |                                      |
|---------------------------------|--------------------------------------|
| <b>GOM-152</b>                  | <b>Bearing Bush, stabiliser</b>      |
|                                 | <b>Boccola barra stabilizzatrice</b> |
| NISSAN                          | 54613-9U000                          |
| Fitting Position/Lato Montaggio | Front                                |
| Length/Lunghezza [mm]           | 39                                   |
| Height/Altezza [mm]             | 41,5                                 |
| Width/Larghezza [mm]            | 42                                   |
| Inner Diam./Diam. Interno [mm]  | 21                                   |

**NISSAN NOTE**  
 1.4/1.5 dCi/1.6



|                                |                                     |
|--------------------------------|-------------------------------------|
| <b>GOM-153</b>                 | <b>Holder, control arm mounting</b> |
|                                | <b>Silentblock</b>                  |
| Length/Lunghezza [mm]          | 54,5                                |
| Inner Diam./Diam. Interno [mm] | 15                                  |
| Outer Diam./Diam. esterno [mm] | 58,2                                |

**NISSAN PRIMASTAR Autobus**  
 2.0/dCi 100/dCi 140/dCi 80

**NISSAN PRIMASTAR Furgonato**  
 2.0/dCi 100/dCi 140/dCi 80

**RENAULT ESPACE IV (JKO\_)**  
 1.9 dCi (JKOU, JKOG)/2.0/2.0 (JKOKA6)/2.0 dCi/2.0 Turbo (JKOBA6, JKOBC6, JKOBAB, JKOBCB)/2.2 dCi/2.2 dCi (JKOHA6, JKOHC6, JKOHAB, JKOHCB)/3.0 dCi/3.0 dCi (JKOJAB, JKOJCB)/3.5 V6 (JKOFAB, JKOFAB)

**RENAULT LAGUNA II (BGO\_, BG1\_)**  
 1.6 16V/1.6 16V (BGOA, BGOL)/1.8 16V (BG06, BG0J, BGOM)/1.8 16V (BG0B, BGOM)/1.8 16V (BG0C, BG0V)/1.9 dCi/1.9 dCi (BG0E)/1.9 dCi (BG0G)/1.9 dCi (BG0R)/2.0 16V/2.0 16V (BG00, BG0K, BG0P, BG0W)/2.0 16V IDE (BG0N)/2.0 16V Turbo (BG0S, BG0Z, BG1L, BG1M)/2.0 d

**RENAULT LAGUNA II Grandtour (KGO\_, KG1\_)**  
 1.6 16V/1.6 16V (KGOA, KGOL)/1.8 16V/1.8 16V (KG0B, KG0M)/1.8 16V (KG0J)/1.9 dCi/1.9 dCi (KG0E)/1.9 dCi (KG0G)/1.9 dCi (KG0R)/2.0 16V/2.0 16V (KG00, KG0K, KG0W)/2.0 16V IDE (KG0N, KG0P)/2.0 16V Turbo (KG0S, KG0Z, KG1L, KG1M)/2.0 dCi/2.2 dCi/2.2 dCi (KG0F)

**RENAULT VEL SATIS (BJO)**  
 2.0 16 V Turbo/2.0 16V Turbo (BJOK)/2.0 dCi/2.2 dCi/2.2 dCi (BJ0E)/2.2 dCi (BJ0H)/3.0 dCi/3.0 dCi (BJ0J0B)/3.5 V6 (BJ0V, BJ0U)



|                                |                                     |
|--------------------------------|-------------------------------------|
| <b>GOM-154</b>                 | <b>Holder, control arm mounting</b> |
|                                | <b>Silentblock</b>                  |
| Length/Lunghezza [mm]          | 50,5                                |
| Inner Diam./Diam. Interno [mm] | 18                                  |
| Outer Diam./Diam. esterno [mm] | 55                                  |

**NISSAN PRIMASTAR Autobus**  
 2.0/dCi 100/dCi 120/dCi 140/dCi 150/dCi 80/dCi 90

**NISSAN PRIMASTAR Furgonato**  
 2.0/dCi 100/dCi 120/dCi 140/dCi 150/dCi 80/dCi 90

**OPEL VIVARO Combi**  
 1.9 DI/1.9 DTI/2.0 16V/2.0 CDTI/2.0 ECOTEC/2.5 CDTI/2.5 DTI

**OPEL VIVARO Furgonato**  
 1.9 DI/2.0 16V/2.0 CDTI/2.0 ECOTEC/2.5 CDTI/2.5 DTI

**RENAULT TRAFIC Autobus (JL)**  
 1.9 dCi 100/1.9 dCi 80/2.0 (JL0A)/2.0 dCi 115/2.0 dCi 90/2.5 dCi 135 (JL0D)/2.5 dCi 145

**RENAULT TRAFIC Furgonato (FL)**  
 1.9 dCi 100/1.9 dCi 80/2.0 (FL0A)/2.0 dCi 115/2.0 dCi 90/2.5 dCi 135 (FL0D)/2.5 dCi 145

**RENAULT TRAFIC II Pianale piatto/Telaio (EL)**  
 1.9 dCi 100 (ELOC)/1.9 dCi 80 (ELOB)/2.0 (ELOA)/2.0 dCi 115/2.0 dCi 90/2.5 dCi 135 (ELOD)/2.5 dCi 145



|                                |                                     |
|--------------------------------|-------------------------------------|
| <b>GOM-155</b>                 | <b>Holder, control arm mounting</b> |
|                                | <b>Silentblock</b>                  |
| NISSAN                         | 54590-01E00                         |
| Length/Lunghezza [mm]          | 50                                  |
| Inner Diam./Diam. Interno [mm] | 18                                  |
| Outer Diam./Diam. esterno [mm] | 38,7                                |

**NISSAN PRIMERA (P10)**  
 1.6/2.0/2.0 16V/2.0 16V 4x4/2.0 D/2.0 GT/2.0 GT 4x4/2.0 i

**NISSAN PRIMERA (P11)**  
 1.6 16V/1.8/1.8 16V/2.0/2.0 16V/2.0 TD

**NISSAN PRIMERA Hatchback (P10)**  
 1.6/2.0/2.0 16V/2.0 16V 4x4/2.0 D/2.0 GT 4x4/2.0 i

**NISSAN PRIMERA Hatchback (P11)**  
 1.6 16V/1.8 16V/2.0 16V/2.0 TD

**NISSAN PRIMERA Traveller (W10)**  
 1.6 i/2.0 D/2.0 i

**NISSAN PRIMERA Traveller (WP11)**  
 1.6 16V/1.8 16V/2.0 16V/2.0 TD



|                                 |                                     |   |   |
|---------------------------------|-------------------------------------|---|---|
| <b>GOM-156</b>                  | <b>Holder, control arm mounting</b> | <b>NISSAN PRIMERA (P10)</b><br>1.6/2.0/2.0 16V/2.0 16V 4x4/2.0 D/2.0 GT/2.0 GT 4x4/2.0 i    |    |
|                                 | <b>Silentblock</b>                  | <b>NISSAN PRIMERA Hatchback (P10)</b><br>1.6/2.0/2.0 16V/2.0 16V 4x4/2.0 D/2.0 GT 4x4/2.0 i |   |
| NISSAN                          | 5450086J00                          | <b>NISSAN PRIMERA Traveller (W10)</b><br>1.6 i/2.0 D/2.0 i                                  |   |
| Length/Lunghezza [mm]           | 70                                  |   |   |
| Height/Altezza [mm]             | 59                                  |   |   |
| Width/Larghezza [mm]            | 57                                  |   |   |
| Inner Diam./Diam. Interno [mm]  | 22                                  |   |   |
| <b>GOM-157</b>                  | <b>Holder, control arm mounting</b> | <b>NISSAN PRIMERA (P11)</b><br>1.6 16V/1.8/1.8 16V/2.0/2.0 16V/2.0 TD                       |    |
|                                 | <b>Silentblock</b>                  | <b>NISSAN PRIMERA Hatchback (P11)</b><br>1.6 16V/1.8 16V/2.0 16V/2.0 TD                     |   |
| NISSAN                          | 545002F500                          | <b>NISSAN PRIMERA Traveller (WP11)</b><br>1.6 16V/1.8 16V/2.0 16V/2.0 TD                    |   |
| Length/Lunghezza [mm]           | 151,7                               |   |   |
| Height/Altezza [mm]             | 84,5                                |   |   |
| Width/Larghezza [mm]            | 70,4                                |   |   |
| Inner Diam./Diam. Interno [mm]  | 22                                  |   |   |
| <b>GOM-158</b>                  | <b>Holder, control arm mounting</b> | <b>NISSAN PRIMERA (P11)</b><br>1.6 16V/1.8/1.8 16V/2.0/2.0 16V/2.0 TD                       |    |
|                                 | <b>Silentblock</b>                  | <b>NISSAN PRIMERA Hatchback (P11)</b><br>1.6 16V/1.8 16V/2.0 16V/2.0 TD                     |   |
| NISSAN                          | 545012F500                          | <b>NISSAN PRIMERA Traveller (WP11)</b><br>1.6 16V/1.8 16V/2.0 16V/2.0 TD                    |   |
| Length/Lunghezza [mm]           | 151,7                               |   |   |
| Height/Altezza [mm]             | 86                                  |   |   |
| Width/Larghezza [mm]            | 72                                  |   |   |
| Inner Diam./Diam. Interno [mm]  | 22,5                                |   |   |
| <b>GOM-159</b>                  | <b>Holder, control arm mounting</b> | <b>NISSAN PRIMERA (P12)</b><br>1.6/1.8/1.9 dCi/2.0/2.2 dCi/2.2 Di/2.5                       |  |
|                                 | <b>Silentblock</b>                  | <b>NISSAN PRIMERA Hatchback (P12)</b><br>1.6/1.8/1.9 dCi/2.0/2.2 dCi/2.2 Di/2.5             |   |
| NISSAN                          | 54500AV606                          | <b>NISSAN PRIMERA SW (WP12)</b><br>1.6 Visia/1.8/1.9 dCi/2.0/2.2 dCi/2.2 Di/2.5             |   |
| Length/Lunghezza [mm]           | 52,5                                |   |   |
| Inner Diam./Diam. Interno [mm]  | 18                                  |   |   |
| Outer Diam./Diam. esterno [mm]  | 38                                  |   |   |
| <b>GOM-160</b>                  | <b>Holder, control arm mounting</b> | <b>NISSAN PRIMERA (P12)</b><br>1.6/1.8/1.9 dCi/2.0/2.2 dCi/2.2 Di/2.5                       |  |
|                                 | <b>Silentblock</b>                  | <b>NISSAN PRIMERA Hatchback (P12)</b><br>1.6/1.8/1.9 dCi/2.0/2.2 dCi/2.2 Di/2.5             |   |
| NISSAN                          | 54500AV606                          | <b>NISSAN PRIMERA SW (WP12)</b><br>1.6 Visia/1.8/1.9 dCi/2.0/2.2 dCi/2.2 Di/2.5             |   |
| Width/Larghezza [mm]            | 54                                  |   |   |
| Inner Diam./Diam. Interno [mm]  | 21                                  |   |   |
| Overall Length/Lungh. Tot. [mm] | 193                                 |   |   |
| Outer Diam./Diam. esterno [mm]  | 75                                  |   |   |
| <b>GOM-161</b>                  | <b>Holder, control arm mounting</b> | <b>NISSAN SERENA (C23M)</b><br>1.6 16V/2.0 16V/2.0 D/2.3 D                                  |  |
|                                 | <b>Silentblock</b>                  | <b>NISSAN VANETTE CARGO Autobus (HC 23)</b><br>1.6 i/2.0 D/2.3 D                            |   |
|                                 |                                     | <b>NISSAN VANETTE CARGO Furgonato (HC 23)</b><br>1.6 i/2.0 D/2.3 D                          |   |
| Length/Lunghezza [mm]           | 60                                  |   |   |
| Inner Diam./Diam. Interno [mm]  | 14                                  |   |   |
| Outer Diam./Diam. esterno [mm]  | 43                                  |   |   |
| <b>GOM-162</b>                  | <b>Holder, control arm mounting</b> | <b>NISSAN SERENA (C23M)</b><br>1.6 16V/2.0 16V/2.0 D/2.3 D                                  |  |
|                                 | <b>Silentblock</b>                  | <b>NISSAN VANETTE CARGO Autobus (HC 23)</b><br>1.6 i/2.0 D/2.3 D                            |   |
|                                 |                                     | <b>NISSAN VANETTE CARGO Furgonato (HC 23)</b><br>1.6 i/2.0 D/2.3 D                          |   |
| Length/Lunghezza [mm]           | 68                                  |   |   |
| Height/Altezza [mm]             | 55                                  |   |   |
| Width/Larghezza [mm]            | 60                                  |   |   |
| Inner Diam./Diam. Interno [mm]  | 22                                  |   |   |

|                                |                                     |
|--------------------------------|-------------------------------------|
| <b>GOM-163</b>                 | <b>Holder, control arm mounting</b> |
|                                | <b>Silentblock</b>                  |
| NISSAN                         | 545008H310                          |
| Length/Lunghezza [mm]          | 55                                  |
| Inner Diam./Diam. Interno [mm] | 14,4                                |
| Outer Diam./Diam. esterno [mm] | 39                                  |

|  |
|--|
| <b>NISSAN X-TRAIL (T30)</b>                        |
| 2.0/2.0 4x4/2.2 dCi/2.2 dCi 4x4/2.2 Di 4x4/2.5 4x4 |



|                                 |                                     |
|---------------------------------|-------------------------------------|
| <b>GOM-164</b>                  | <b>Holder, control arm mounting</b> |
|                                 | <b>Silentblock</b>                  |
| NISSAN                          | 545008H310                          |
| Inner Diam./Diam. Interno [mm]  | 28                                  |
| Overall Length/Lungh. Tot. [mm] | 182                                 |

|  |
|--|
| <b>NISSAN X-TRAIL (T30)</b>                        |
| 2.0/2.0 4x4/2.2 dCi/2.2 dCi 4x4/2.2 Di 4x4/2.5 4x4 |



|                                 |                                      |
|---------------------------------|--------------------------------------|
| <b>GOM-165</b>                  | <b>Bearing Bush, stabiliser</b>      |
|                                 | <b>Boccola barra stabilizzatrice</b> |
| NISSAN                          | 54613-JD03A                          |
| Fitting Position/Lato Montaggio | Front                                |
| Length/Lunghezza [mm]           | 34                                   |
| Height/Altezza [mm]             | 75                                   |
| Width/Larghezza [mm]            | 47                                   |
| Inner Diam./Diam. Interno [mm]  | 23                                   |

|   |
|---|
| <b>NISSAN Juke</b>  |
| 1.5 dCi/1.6   |
| <b>NISSAN QASHQAI</b>   |
| 1.5 dCi/1.6/2.0/2.0 4 ruote motrici/2.0 dCi/2.0 dCi 4 ruote motrici |



|                                 |                                      |
|---------------------------------|--------------------------------------|
| <b>GOM-166</b>                  | <b>Bearing Bush, stabiliser</b>      |
|                                 | <b>Boccola barra stabilizzatrice</b> |
| NISSAN                          | 54613-JD18C                          |
| Fitting Position/Lato Montaggio | Rear                                 |
| Length/Lunghezza [mm]           | 38                                   |
| Height/Altezza [mm]             | 52                                   |
| Width/Larghezza [mm]            | 49                                   |
| Inner Diam./Diam. Interno [mm]  | 18                                   |

|   |
|---|
| <b>NISSAN QASHQAI</b>   |
| 1.5 dCi/1.6/2.0/2.0 4 ruote motrici/2.0 dCi/2.0 dCi 4 ruote motrici |



|                        |                                     |
|------------------------|-------------------------------------|
| <b>GOM-167</b>         | <b>Holder, control arm mounting</b> |
|                        | <b>Silentblock</b>                  |
| Length/Lunghezza [mm]  | 147,5                               |
| Diameter/Diametro [mm] | 32                                  |

|   |
|---|
| <b>NISSAN QASHQAI</b>   |
| 1.5 dCi/1.6/2.0/2.0 4 ruote motrici/2.0 dCi/2.0 dCi 4 ruote motrici |
| <b>NISSAN X-TRAIL (T31)</b>   |
| 2.0/2.0 dCi/2.0 dCi FWD/2.5   |

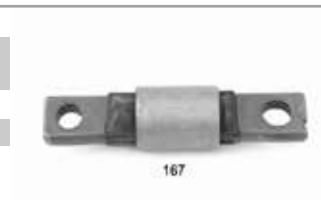

|                                |                                     |
|--------------------------------|-------------------------------------|
| <b>GOM-168</b>                 | <b>Holder, control arm mounting</b> |
|                                | <b>Silentblock</b>                  |
| Length/Lunghezza [mm]          | 53                                  |
| Inner Diam./Diam. Interno [mm] | 12                                  |
| Outer Diam./Diam. esterno [mm] | 58                                  |

|   |
|---|
| <b>NISSAN Juke</b>  |
| 1.5 dCi/1.6/1.6 4x4   |
| <b>NISSAN QASHQAI</b>   |
| 1.5 dCi/1.6/2.0/2.0 4 ruote motrici/2.0 dCi/2.0 dCi 4 ruote motrici |
| <b>NISSAN X-TRAIL (T31)</b>   |
| 2.0/2.0 dCi/2.0 dCi FWD/2.5   |



|                                 |   |
|---------------------------------|---|
| <b>GOM-169</b>                  | <b>Suspension Strut Support Bearing</b> |
|                                 | <b>Supporto ammortizzatore</b>          |
| NISSAN                          | 54320-1F500                             |
| Fitting Position/Lato Montaggio | Front Axle                              |
| Length/Lunghezza [mm]           | 123,7                                   |
| Height/Altezza [mm]             | 40                                      |
| Width/Larghezza [mm]            | 89                                      |
| Inner Diam./Diam. Interno [mm]  | 10                                      |

|                                     |
|-------------------------------------|
| <b>NISSAN MICRA (K11)</b>           |
| 1.0 i 16V/1.3 i 16V/1.4 i 16V/1.5 D |









|  |  |  |
|--|--|--|
| <b>GOM-170</b> <b>Engine Mounting</b><br><br><b>Supporto motore</b>  | <b>NISSAN MICRA (K11)</b><br>1.0 i 16V/1.3 i 16V   |  <p>170</p>   |
| NISSAN      11210-99B00<br>Height/Altezza [mm]      80<br>Inner Diam./Diam. Interno [mm]      10<br>Mount. Bores/Fori Fiss. Dist. [mm]      60   |  |  |
| <b>GOM-171</b> <b>Bearing,propshaft centre bearing</b><br><br><b>Supporto albero cardanico</b>   | <b>NISSAN BLUEBIRD (910)</b><br>1.6/2.0 D/2.0 i<br><b>NISSAN PICK UP/KING CAB/NAVARA (D22)</b><br>2.5 D 4WD  |  <p>171</p>   |
| NISSAN      37521-W1025<br>Height/Altezza [mm]      51<br>Inner Diam./Diam. Interno [mm]      30<br>Outer Diam./Diam. esterno [mm]      110  |  |  |
| <b>GOM-172</b> <b>Bearing Bush, stabiliser</b><br><br><b>Boccola barra stabilizzatrice</b>   | <b>NISSAN TERRANO II (R20)</b><br>2.4 4WD/2.4 i 12V 4WD/2.7 D/2.7 TD 4WD/2.7 TDi 4WD/3.0 Di 4WD  |  <p>172</p>   |
| NISSAN      54613-0X800<br>Fitting Position/Lato Montaggio      Front Axle<br>Length/Lunghezza [mm]      47<br>Height/Altezza [mm]      28<br>Width/Larghezza [mm]      48<br>Inner Diam./Diam. Interno [mm]      28       |  |  |
| <b>GOM-173</b> <b>Engine Mounting</b><br><br><b>Supporto motore</b>  | <b>NISSAN TERRANO II (R20)</b><br>2.7 D/2.7 TD 4WD/2.7 TDi 4WD/3.0 Di 4WD  |  <p>173</p> |
| NISSAN      11320-7F000<br>Length/Lunghezza [mm]      167<br>Height/Altezza [mm]      72<br>Height/Altezza 1 [mm]      66<br>Width/Larghezza [mm]      116   |  |  |
| <b>GOM-174</b> <b>Bearing Bush, stabiliser</b><br><br><b>Boccola barra stabilizzatrice</b>   | <b>NISSAN ALMERA TINO (V10)</b><br>1.8/2.0/2.2 dCi/2.2 Di<br><b>NISSAN PRIMERA (P12)</b><br>1.6/1.8/1.9 dCi/2.0/2.2 dCi/2.2 Di/2.5                                 |  <p>174</p> |
| NISSAN      54613-2Y003<br>Fitting Position/Lato Montaggio      Front Axle<br>Length/Lunghezza [mm]      36<br>Height/Altezza [mm]      45<br>Inner Diam./Diam. Interno [mm]      23                                       | <b>NISSAN PRIMERA Hatchback (P12)</b><br>1.6/1.8/1.9 dCi/2.0/2.2 dCi/2.2 Di/2.5<br><b>NISSAN PRIMERA SW (WP12)</b><br>1.6 Visia/1.8/1.9 dCi/2.0/2.2 dCi/2.2 Di/2.5 |  |
| <b>GOM-175</b> <b>Bearing Bush, stabiliser</b><br><br><b>Boccola barra stabilizzatrice</b>   | <b>NISSAN X-TRAIL (T30)</b><br>2.0/2.2 dCi/2.2 DCi FWD   |  <p>175</p> |
| NISSAN      54613-8H518<br>Fitting Position/Lato Montaggio      Front Axle<br>Length/Lunghezza [mm]      38<br>Height/Altezza [mm]      41<br>Width/Larghezza [mm]      41<br>Inner Diam./Diam. Interno [mm]      17,5     |  |  |
| <b>GOM-176</b> <b>Engine Mounting</b><br><br><b>Supporto motore</b>  | <b>NISSAN TERRANO II (R20)</b><br>2.7 TDi 4WD  |  <p>176</p> |
| NISSAN      11210-0F002<br>Fitting Position/Lato Montaggio      Front Axle<br>Fitting Position/Lato Montaggio      Right<br>Length/Lunghezza [mm]      152<br>Height/Altezza [mm]      61<br>Width/Larghezza [mm]      138 |  |  |

**RUBBER PARTS LIST**  
**MOTORAUFHÄNGUNG LISTE**  
**LISTE SILENT BLOCS**  
**LISTA TAPONES DE GOMA**  
**LISTA PARTI IN GOMMA**

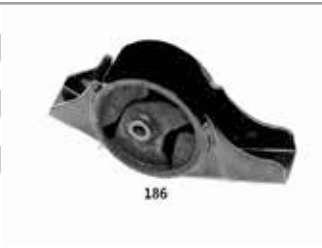

|                                 |                        |                                       |   |
|---------------------------------|------------------------|---------------------------------------|---|
| <b>GOM-177</b>                  | <b>Engine Mounting</b> | <b>NISSAN X-TRAIL (T30)</b>           |    |
|                                 | <b>Supporto motore</b> | 2.0                                   |   |
| NISSAN                          | 11210-8H305            |                                       |   |
| Fitting Position/Lato Montaggio |                        | Front Axle                            |   |
| <b>GOM-178</b>                  | <b>Engine Mounting</b> | <b>NISSAN TERRANO II (R20)</b>        |    |
|                                 | <b>Supporto motore</b> | 2.7 TDi 4WD                           |   |
| NISSAN                          | 11220-7F000            |                                       |   |
| Fitting Position/Lato Montaggio |                        | Front Axle Left                       |   |
| Length/Lunghezza [mm]           |                        | 132                                   |   |
| Height/Altezza [mm]             |                        | 103                                   |   |
| Width/Larghezza [mm]            |                        | 102                                   |   |
| <b>GOM-179</b>                  | <b>Engine Mounting</b> | <b>NISSAN MICRA (K10)</b>             |    |
|                                 | <b>Supporto motore</b> | 1.0/1.2                               |   |
| NISSAN                          | 11340-02B04            |                                       |   |
| Fitting Position/Lato Montaggio |                        | Rear                                  |   |
| Height/Altezza [mm]             |                        | 48                                    |   |
| Inner Diam./Diam. Interno [mm]  |                        | 11                                    |   |
| Overall Length/Lungh. Tot. [mm] |                        | 278                                   |   |
| <b>GOM-180</b>                  | <b>Engine Mounting</b> | <b>NISSAN MICRA (K12)</b>             |  |
|                                 | <b>Supporto motore</b> | 1.2 16V/1.4 16V                       |   |
| NISSAN                          | 11220AX600             |                                       |   |
| Fitting Position/Lato Montaggio |                        | Front Axle                            |   |
| Fitting Position/Lato Montaggio |                        | Left                                  |   |
| Length/Lunghezza [mm]           |                        | 153                                   |   |
| Height/Altezza [mm]             |                        | 50                                    |   |
| Inner Diam./Diam. Interno [mm]  |                        | 11                                    |   |
|                                 |                        | <b>NISSAN PRIMERA (P12)</b>           |   |
|                                 |                        | 1.9 dCi                               |   |
|                                 |                        | <b>NISSAN PRIMERA Hatchback (P12)</b> |   |
|                                 |                        | 1.9 dCi                               |   |
|                                 |                        | <b>NISSAN PRIMERA SW (WP12)</b>       |   |
|                                 |                        | 1.9 dCi                               |   |
| <b>GOM-181</b>                  | <b>Engine Mounting</b> | <b>NISSAN MICRA (K12)</b>             |  |
|                                 | <b>Supporto motore</b> | 1.5 dCi                               |   |
| NISSAN                          | 11360AY600             |                                       |   |
| Fitting Position/Lato Montaggio |                        | Front Axle                            |   |
| Fitting Position/Lato Montaggio |                        | Rear                                  |   |
| Length/Lunghezza [mm]           |                        | 183                                   |   |
| Inner Diam./Diam. Interno [mm]  |                        | 13                                    |   |
| Inner Diam./Diam. Int. 1 [mm]   |                        | 12                                    |   |
|                                 |                        | <b>NISSAN NOTE</b>                    |   |
|                                 |                        | 1.5 dCi                               |   |
|                                 |                        | <b>NISSAN NV200 Autobus</b>           |   |
|                                 |                        | 1.5 dci                               |   |
|                                 |                        | <b>NISSAN NV200 Furgonato</b>         |   |
|                                 |                        | 1.5 dci                               |   |
| <b>GOM-182</b>                  | <b>Engine Mounting</b> | <b>NISSAN MICRA (K12)</b>             |  |
|                                 | <b>Supporto motore</b> | 1.2 16V/1.4 16V                       |   |
| NISSAN                          | 11210AX600             |                                       |   |
| Fitting Position/Lato Montaggio |                        | Front Axle                            |   |
| Fitting Position/Lato Montaggio |                        | Right                                 |   |
| Length/Lunghezza [mm]           |                        | 208                                   |   |
| Height/Altezza [mm]             |                        | 105                                   |   |
|                                 |                        | <b>NISSAN MICRA C+C</b>               |   |
|                                 |                        | 1.4 16V                               |   |
|                                 |                        | <b>NISSAN NOTE</b>                    |   |
|                                 |                        | 1.4                                   |   |
| <b>GOM-183</b>                  | <b>Engine Mounting</b> | <b>NISSAN MICRA (K12)</b>             |  |
|                                 | <b>Supporto motore</b> | 1.5 dCi                               |   |
| NISSAN                          | 11210AY600             |                                       |   |
| Fitting Position/Lato Montaggio |                        | Front Axle                            |   |
| Fitting Position/Lato Montaggio |                        | Right                                 |   |
| Length/Lunghezza [mm]           |                        | 208                                   |   |
| Height/Altezza [mm]             |                        | 105                                   |   |
|                                 |                        | <b>NISSAN NOTE</b>                    |   |
|                                 |                        | 1.5 dCi                               |   |
|                                 |                        | <b>NISSAN NV200 Autobus</b>           |   |
|                                 |                        | 1.5 dci                               |   |
|                                 |                        | <b>NISSAN NV200 Furgonato</b>         |   |
|                                 |                        | 1.5 dci                               |   |

|                                 |                        |  |   |   |
|---------------------------------|------------------------|--|---|---|
| <b>GOM-184</b>                  | <b>Engine Mounting</b> | <b>NISSAN ALMERA II (N16)</b><br>1.5/1.8                               |    |   |
|                                 | <b>Supporto motore</b> | <b>NISSAN ALMERA II Hatchback (N16)</b><br>1.5/1.8                     |   |   |
| NISSAN                          | 11270BM500             |  |   |   |
| Fitting Position/Lato Montaggio | Front Axle             |  |   |   |
| Width/Larghezza [mm]            | 55                     |  |   |   |
| Inner Diam./Diam. Interno [mm]  | 10                     |  |   |   |
| Outer Diam./Diam. esterno [mm]  | 95                     |  |   |   |
| <b>GOM-185</b>                  | <b>Engine Mounting</b> | <b>NISSAN ALMERA II (N16)</b><br>1.5/1.8                               |   |    |
|                                 | <b>Supporto motore</b> | <b>NISSAN ALMERA II Hatchback (N16)</b><br>1.5/1.8                     |   |   |
| NISSAN                          | 11320BM500             |  |   |   |
| Fitting Position/Lato Montaggio | Front Axle             |  |   |   |
| Length/Lunghezza [mm]           | 141                    |  |   |   |
| Height/Altezza [mm]             | 91                     |  |   |   |
| Width/Larghezza [mm]            | 60                     |  |   |   |
| Inner Diam./Diam. Interno [mm]  | 10                     |  |   |   |
| <b>GOM-186</b>                  | <b>Engine Mounting</b> | <b>NISSAN ALMERA II (N16)</b><br>2.2 dCi/2.2 Di                        |   |   |
|                                 | <b>Supporto motore</b> | <b>NISSAN ALMERA II Hatchback (N16)</b><br>2.2 dCi/2.2 Di              |   |   |
| NISSAN                          | 11320BN301             |  |   |   |
| Fitting Position/Lato Montaggio | Front Axle             | 1.8/2.2 dCi/2.2 Di   |   |   |
| Length/Lunghezza [mm]           | 193                    |  |   |   |
| Height/Altezza [mm]             | 89                     |  |   |   |
| Width/Larghezza [mm]            | 55                     |  |   |   |
| Inner Diam./Diam. Interno [mm]  | 10,5                   |  |   |   |
| <b>GOM-187</b>                  | <b>Engine Mounting</b> | <b>NISSAN ALMERA II (N16)</b><br>1.5 dCi                               |   |  |
|                                 | <b>Supporto motore</b> | <b>NISSAN ALMERA II Hatchback (N16)</b><br>1.5 dCi                     |   |   |
| NISSAN                          | 11210BN702             |  |   |   |
| Fitting Position/Lato Montaggio | Front Axle             |  |   |   |
| Fitting Position/Lato Montaggio | Right                  |  |   |   |
| Length/Lunghezza [mm]           | 195                    |  |   |   |
| Height/Altezza [mm]             | 105                    |  |   |   |
| <b>GOM-188</b>                  | <b>Engine Mounting</b> | <b>NISSAN PRIMERA (P10)</b><br>2.0 16V/2.0 16V 4x4/2.0 GT              |  |   |
|                                 | <b>Supporto motore</b> | <b>NISSAN PRIMERA Hatchback (P10)</b><br>2.0/2.0 16V/2.0 16V 4x4/2.0 i |   |   |
| NISSAN                          | 1132093J00             |  |   |   |
| Fitting Position/Lato Montaggio | Front Axle             | 2.0 i  |   |   |
| Fitting Position/Lato Montaggio | Rear                   |  |   |   |
| <b>GOM-189</b>                  | <b>Engine Mounting</b> | <b>NISSAN PRIMERA (P10)</b><br>2.0 D                                   |   |  |
|                                 | <b>Supporto motore</b> | <b>NISSAN PRIMERA Hatchback (P10)</b><br>2.0 D                         |   |   |
| NISSAN                          | 1132093J20             |  |   |   |
| Fitting Position/Lato Montaggio | Front Axle             | 2.0 D  |   |   |
| Fitting Position/Lato Montaggio | Rear                   |  |   |   |
| <b>GOM-190</b>                  | <b>Engine Mounting</b> | <b>NISSAN PRIMERA (P11)</b><br>1.6 16V/2.0 TD                          |  |   |
|                                 | <b>Supporto motore</b> | <b>NISSAN PRIMERA Hatchback (P11)</b><br>1.6 16V/2.0 TD                |   |   |
| NISSAN                          | 11320-2F020            |  |   |   |
| Fitting Position/Lato Montaggio | Front Axle             | 1.6 16V/2.0 TD   |   |   |
| Fitting Position/Lato Montaggio | Left Rear              |  |   |   |
| Length/Lunghezza [mm]           | 178                    |  |   |   |
| Height/Altezza [mm]             | 98                     |  |   |   |
| Inner Diam./Diam. Interno [mm]  | 10                     |  |   |   |



|                                 |                        |   |   |   |
|---------------------------------|------------------------|---|---|---|
| <b>GOM-191</b>                  | <b>Engine Mounting</b> | <b>NISSAN PRIMERA (P11)</b><br>2.0 16V                                      |    |   |
|                                 | <b>Supporto motore</b> |   |   | <b>NISSAN PRIMERA Hatchback (P11)</b><br>2.0 16V                                      |
| NISSAN                          | 11320-2F320            | <b>NISSAN PRIMERA Traveller (WP11)</b><br>2.0 16V                           |   |   |
| Fitting Position/Lato Montaggio | Front Axle             |   |   |   |
| Fitting Position/Lato Montaggio | Left Rear              |   |   |   |
| Length/Lunghezza [mm]           | 177                    |   |   |   |
| Height/Altezza [mm]             | 98                     |   |   |   |
| Width/Larghezza [mm]            | 55                     |   |   |   |
| Inner Diam./Diam. Interno [mm]  | 10,5                   |   |   |   |
| <b>GOM-192</b>                  | <b>Engine Mounting</b> | <b>NISSAN ALMERA TINO (V10)</b><br>1.8                                      |   |    |
|                                 | <b>Supporto motore</b> | <b>NISSAN PRIMERA (P12)</b><br>1.6/1.8                                      |   |   |
| NISSAN                          | 11270-BU000            | <b>NISSAN PRIMERA Hatchback (P12)</b><br>1.6/1.8                            |   |   |
| Fitting Position/Lato Montaggio | Front Axle             |   |   |   |
| <b>GOM-193</b>                  | <b>Engine Mounting</b> | <b>NISSAN ALMERA II (N16)</b><br>2.2 dCi/2.2 Di                             |    |   |
|                                 | <b>Supporto motore</b> | <b>NISSAN ALMERA II Hatchback (N16)</b><br>2.2 dCi/2.2 Di                   |   |   |
| NISSAN                          | 11270BN310             | <b>NISSAN ALMERA TINO (V10)</b><br>2.2 dCi/2.2 Di                           |   |   |
| Fitting Position/Lato Montaggio | Front Axle             |   |   |   |
| Fitting Position/Lato Montaggio | Front                  |   |   |   |
| Length/Lunghezza [mm]           | 139                    |   |   |   |
| Height/Altezza [mm]             | 94                     |   |   |   |
| Inner Diam./Diam. Interno [mm]  | 10                     |   |   |   |
| <b>GOM-194</b>                  | <b>Engine Mounting</b> | <b>NISSAN PRIMERA (P12)</b><br>1.9 dCi                                      |   |  |
|                                 | <b>Supporto motore</b> | <b>NISSAN PRIMERA Hatchback (P12)</b><br>1.9 dCi                            |   |   |
| NISSAN                          | 11210BV000             | <b>NISSAN PRIMERA SW (WP12)</b><br>1.9 dCi                                  |   |   |
| Fitting Position/Lato Montaggio | Front Axle             |   |   |   |
| Fitting Position/Lato Montaggio | Front                  |   |   |   |
| Length/Lunghezza [mm]           | 194                    |   |   |   |
| Height/Altezza [mm]             | 105                    |   |   |   |
| <b>GOM-195</b>                  | <b>Engine Mounting</b> | <b>NISSAN PRIMERA (P12)</b><br>1.9 dCi                                      |  |   |
|                                 | <b>Supporto motore</b> | <b>NISSAN PRIMERA Hatchback (P12)</b><br>1.9 dCi                            |   |   |
| NISSAN                          | 11360-BV000            | <b>RENAULT CLIO III</b><br>1.2 16V/1.2 16V Hi-Flex/1.2 16V (C/BR1J, C/BR1Q) |   |   |
| Fitting Position/Lato Montaggio | Front Axle             | <b>RENAULT GRAND SCENIC</b><br>1.9 dCi                                      |   |   |
| Fitting Position/Lato Montaggio | Rear                   | <b>RENAULT MEGANE II (BMO_, CM0_)</b><br>1.5 dCi (BM0F, CM0F)               |   |   |
|                                 |                        | <b>RENAULT MODUS (F/JPO_)</b><br>1.2/1.2 (JPOC, JPOK)/1.2 16V Hi-Flex       |   |   |
|                                 |                        | <b>RENAULT SCENIC II (JM)</b><br>1.9 D/1.9 dCi/1.9 dCi (JM12)               |   |   |
| <b>GOM-196</b>                  | <b>Engine Mounting</b> | <b>NISSAN PRIMERA (P10)</b><br>1.6  |   |  |
|                                 | <b>Supporto motore</b> | <b>NISSAN PRIMERA Hatchback (P10)</b><br>1.6                                |   |   |
| NISSAN                          | 1121090J01             | <b>NISSAN PRIMERA Traveller (W10)</b><br>1.6 i                              |   |   |
| Fitting Position/Lato Montaggio | Front Axle             |   |   |   |
| Fitting Position/Lato Montaggio | Right                  |   |   |   |
| Length/Lunghezza [mm]           | 174                    |   |   |   |
| Height/Altezza [mm]             | 117,5                  |   |   |   |
| Width/Larghezza [mm]            | 80                     |   |   |   |
| Inner Diam./Diam. Interno [mm]  | 11                     |   |   |   |

|                                    |                        |
|------------------------------------|------------------------|
| <b>GOM-197</b>                     | <b>Engine Mounting</b> |
|                                    | <b>Supporto motore</b> |
| NISSAN                             | 1121093J00             |
| Fitting Position/Lato Montaggio    | Front Axle             |
| Fitting Position/Lato Montaggio    | Right                  |
| Height/Altezza [mm]                | 80                     |
| Inner Diam./Diam. Interno [mm]     | 10                     |
| Mount. Bores/Fori Fiss. Dist. [mm] | 120                    |

|                                       |
|---------------------------------------|
| <b>NISSAN PRIMERA (P10)</b>           |
| 2.0 16V/2.0 16V 4x4/2.0 GT/2.0 i      |
| <b>NISSAN PRIMERA Hatchback (P10)</b> |
| 2.0/2.0 16V/2.0 16V 4x4/2.0 i         |
| <b>NISSAN PRIMERA Traveller (W10)</b> |
| 2.0 i                                 |



|                                 |                        |
|---------------------------------|------------------------|
| <b>GOM-198</b>                  | <b>Engine Mounting</b> |
|                                 | <b>Supporto motore</b> |
| NISSAN                          | 11210-2F001            |
| Fitting Position/Lato Montaggio | Front Axle             |
| Fitting Position/Lato Montaggio | Right                  |
| Length/Lunghezza [mm]           | 172,5                  |
| Height/Altezza [mm]             | 116                    |
| Width/Larghezza [mm]            | 80,5                   |
| Inner Diam./Diam. Interno [mm]  | 11                     |

|  |
|--|
| <b>NISSAN PRIMERA (P11)</b>            |
| 1.6 16V                                |
| <b>NISSAN PRIMERA Hatchback (P11)</b>  |
| 1.6 16V                                |
| <b>NISSAN PRIMERA Traveller (WP11)</b> |
| 1.6 16V                                |



|                                    |                        |
|------------------------------------|------------------------|
| <b>GOM-199</b>                     | <b>Engine Mounting</b> |
|                                    | <b>Supporto motore</b> |
| NISSAN                             | 112102F200             |
| Fitting Position/Lato Montaggio    | Front Axle             |
| Fitting Position/Lato Montaggio    | Right                  |
| Length/Lunghezza [mm]              | 130                    |
| Height/Altezza [mm]                | 113                    |
| Width/Larghezza [mm]               | 80                     |
| Inner Diam./Diam. Interno [mm]     | 10                     |
| Mount. Bores/Fori Fiss. Dist. [mm] | 85                     |

|  |
|--|
| <b>NISSAN PRIMERA (P11)</b>            |
| 2.0 16V/2.0 TD                         |
| <b>NISSAN PRIMERA Hatchback (P11)</b>  |
| 2.0 16V/2.0 TD                         |
| <b>NISSAN PRIMERA Traveller (WP11)</b> |
| 2.0 16V/2.0 TD                         |



|                       |                        |
|-----------------------|------------------------|
| <b>GOM-200</b>        | <b>Engine Mounting</b> |
|                       | <b>Supporto motore</b> |
| TOYOTA                | 12361-60022            |
| Length/Lunghezza [mm] | 110                    |
| Height/Altezza [mm]   | 46                     |
| Width/Larghezza [mm]  | 77                     |

|   |
|---|
| <b>TOYOTA LAND CRUISER (_J4_)</b>   |
| 3.0 D (BJ40_V, BJ43_) / 3.4 D (BJ42_V, BJ45_V, BJ46_) / 3.6 D (HJ45_V) / 3.6 L / 3.9 (FJ40_, FJ43_, FJ45_, FJ55_V) / 4.0 D (HJ47_V) / 4.2 (FJ40_V, FJ43_, FJ45_V, FJ55_)                                |
| <b>TOYOTA LAND CRUISER (_J6_)</b>   |
| 3.4 Diesel (BJ60_V) / 4.0 (FJ62_G) / 4.0 (FJ62_V) / 4.0 Diesel (HJ60) / 4.0 Diesel (HJ60_V) / 4.0 Turbo-D (HJ61_V)  |
| <b>TOYOTA LAND CRUISER (_J7_)</b>   |
| 2.4 (RJ70_V, RJ73_V) / 2.4 (RJ70_, RJ73_) / 2.4 D (LJ70_) / 2.4 TD (LJ70) / 2.4 TD (LJ70_, LJ73_) / 3.0 TD (KZJ70_, KZJ73_, KZJ77_) / 3.4 D (BJ70_V, BJ73_) / 3.4 TD (BJ71_V) / 3.5 D / 4.2 TD (HZJ7_V) |
| <b>TOYOTA LAND CRUISER Hardtop (_J7_)</b>   |
| 2.4 TD (LJ77) / 3.0 TD  |
| <b>TOYOTA LAND CRUISER Pick-up (_J4_)</b>   |
| 3.4 D (BJ45_P) / 3.6 D (HJ45_P) / 3.9 (FJ45_P) / 4.0 D (HJ47_P) / 4.2 (FJ45_P)  |



|                       |                        |
|-----------------------|------------------------|
| <b>GOM-201</b>        | <b>Engine Mounting</b> |
|                       | <b>Supporto motore</b> |
| TOYOTA                | 12371-68010            |
| Length/Lunghezza [mm] | 280                    |
| Height/Altezza [mm]   | 47                     |
| Width/Larghezza [mm]  | 131                    |

|   |
|---|
| <b>TOYOTA LAND CRUISER (_J4_)</b>   |
| 3.0 D (BJ40_V, BJ43_) / 3.4 D (BJ42_V, BJ45_V, BJ46_) / 3.6 D (HJ45_V) / 3.6 L / 3.9 (FJ40_, FJ43_, FJ45_, FJ55_V) / 4.0 D (HJ47_V) / 4.2 (FJ40_V, FJ43_, FJ45_V, FJ55_)                                |
| <b>TOYOTA LAND CRUISER (_J6_)</b>   |
| 3.4 Diesel (BJ60_V) / 4.0 (FJ62_G) / 4.0 (FJ62_V) / 4.0 Diesel (HJ60) / 4.0 Diesel (HJ60_V) / 4.0 Turbo-D (HJ61_V) / 4.2 (FJ60_V)   |
| <b>TOYOTA LAND CRUISER (_J7_)</b>   |
| 2.4 (RJ70_V, RJ73_V) / 2.4 (RJ70_, RJ73_) / 2.4 D (LJ70_) / 2.4 TD (LJ70) / 2.4 TD (LJ70_, LJ73_) / 3.0 TD (KZJ70_, KZJ73_, KZJ77_) / 3.4 D (BJ70_V, BJ73_) / 3.4 TD (BJ71_V) / 3.5 D / 4.2 TD (HZJ7_V) |
| <b>TOYOTA LAND CRUISER Hardtop (_J7_)</b>   |
| 2.4 TD (LJ77) / 3.0 TD  |
| <b>TOYOTA LAND CRUISER Pick-up (_J4_)</b>   |
| 3.4 D (BJ45_P) / 3.6 D (HJ45_P) / 3.9 (FJ45_P) / 4.0 D (HJ47_P) / 4.2 (FJ45_P)  |



|                                |   |  |   |
|--------------------------------|---|--|---|
| <b>GOM-202</b>                 | <b>Engine Mounting</b>                  | <b>TOYOTA 4 RUNNER ( _N130)</b>  |    |
|                                | <b>Supporto motore</b>                  | 2.4 (RN61)/2.4 TD 4x4/2.7 i 4x4/3.0 Turbo-D (KZN 130)/3.0 V6 (VZN 130)/3.4 i 4x4   |   |
| TOYOTA                         | 12361-54120                             | <b>TOYOTA 4 RUNNER</b>   |   |
|                                |   | 3.0 Turbo-D  |   |
| Length/Lunghezza [mm]          | 122                                     | <b>TOYOTA HILUX Pick-up ( _N_ )</b>  |   |
| Height/Altezza [mm]            | 46                                      | 1.6 /1.8 (YN85_ , YN90_)/2.0/2.0 4WD/2.2 4WD (YN106_ , YN110_)/2.2 D/2.2 D 2WD/ 4WD/2.4 D/2.4 D 4WD/2.4 i 4WD/2.4 TD 4WD/2.5 D-4D/2.5 D-4D 4WD/2.8 D   |   |
| Width/Larghezza [mm]           | 122                                     | <b>TOYOTA LAND CRUISER ( _J_ )</b>   |   |
|                                |   | 2.4 D (LJ70_)/2.4 TD (LJ70)/2.4 TD (LJ70_ , LJ73_ )  |   |
| <b>GOM-203</b>                 | <b>Bearing,propshaft centre bearing</b> | <b>TOYOTA 4 RUNNER ( _N130)</b>  |    |
|                                | <b>Supporto albero cardanico</b>        | 2.4 (RN61)/2.4 TD 4x4/2.7 i 4x4/3.0 Turbo-D (KZN 130)/3.0 V6 (VZN 130)/3.4 i 4x4   |   |
| TOYOTA                         | 37230-35050                             | <b>TOYOTA 4 RUNNER</b>   |   |
|                                |   | 3.0 Turbo-D  |   |
| Length/Lunghezza [mm]          | 177                                     | <b>TOYOTA HILUX Pick-up ( _N_ )</b>  |   |
| Height/Altezza [mm]            | 106                                     | 1.6 /1.8 (YN85_ , YN90_)/2.0/2.0 4WD/2.2 4WD (YN106_ , YN110_)/2.2 D/2.2 D 2WD/ 4WD/2.4 D/2.4 D 4WD/2.4 i 4WD/2.4 TD 4WD/2.5 D-4D/2.5 D-4D 4WD/2.8 D   |   |
| Width/Larghezza [mm]           | 60                                      |  |   |
| Inner Diam./Diam. Interno [mm] | 30                                      |  |   |
| <b>GOM-204</b>                 | <b>Bearing,propshaft centre bearing</b> | <b>TOYOTA 4 RUNNER ( _N130)</b>  |   |
|                                | <b>Supporto albero cardanico</b>        | 2.4 (RN61)/2.4 TD 4x4/2.7 i 4x4/3.0 Turbo-D (KZN 130)/3.0 V6 (VZN 130)/3.4 i 4x4   |   |
| TOYOTA                         | 37230-35080                             | <b>TOYOTA 4 RUNNER</b>   |   |
|                                |   | 3.0 Turbo-D  |   |
| Length/Lunghezza [mm]          | 285                                     | <b>TOYOTA HILUX Pick-up ( _N_ )</b>  |   |
| Height/Altezza [mm]            | 120                                     | 1.6 /1.8 (YN85_ , YN90_)/2.0/2.0 4WD/2.2 4WD (YN106_ , YN110_)/2.2 D/2.2 D 2WD/ 4WD/2.4 D/2.4 D 4WD/2.4 i 4WD/2.4 TD 4WD/2.5 D-4D/2.5 D-4D 4WD/2.8 D   |   |
| Width/Larghezza [mm]           | 60                                      |  |   |
| Inner Diam./Diam. Interno [mm] | 30                                      |  |   |
| <b>GOM-205</b>                 | <b>Bush, leaf spring</b>                | <b>TOYOTA LAND CRUISER ( _J_ )</b>   |  |
|                                | <b>Boccola balestra</b>                 | 3.0 D (BJ40_ , BJ43_)/3.4 D (BJ42_ , BJ45_ , BJ46_)/3.6 D (HJ45_ , VJ)/3.6 L/3.9 (FJ40_ , FJ43_ , FJ45_ , FJ55_ , VJ)/4.0 D (HJ47_ , VJ)/4.2 (FJ40_ , FJ43_ , FJ45_ , VJ, FJ55_ )                                  |   |
| TOYOTA                         | 90385-18009                             | <b>TOYOTA LAND CRUISER ( _J_ )</b>   |   |
|                                |   | 3.4 Diesel (BJ60_ , VJ)/4.0 (FJ62_ , GJ)/4.0 (FJ62_ , VJ)/4.0 Diesel (HJ60)/4.0 Diesel (HJ60_ , VJ)/4.0 Turbo-D (HJ61_ , VJ)/4.2 (FJ60_ , VJ)  |   |
| Length/Lunghezza [mm]          | 44                                      | <b>TOYOTA LAND CRUISER ( _J_ )</b>   |   |
| Inner Diam./Diam. Interno [mm] | 18                                      | 2.4 (RJ70_ , VJ, RJ73_ , VJ)/2.4 (RJ70_ , RJ73_ )/2.4 D (LJ70_ )/2.4 TD (LJ70)/2.4 TD (LJ70_ , LJ73_ )/3.0 TD (KZJ70_ , KZJ73_ , KZJ77_ )/3.4 D (BJ70_ , VJ, BJ73_ )/3.4 TD (BJ71_ , VJ)/3.5 D/4.2 TD (HZJ7_ , VJ) |   |
| Outer Diam./Diam. esterno [mm] | 40                                      | <b>TOYOTA LAND CRUISER 80 ( _J_ )</b>  |   |
|                                |   | 4.0 (FJ80_ )/4.2 D (HZJ80_ )/4.2 TD (HDJ80)/4.2 TD 24V (HDJ80_ )/4.5 24V (FZJ80_ )   |   |
|                                |   | <b>TOYOTA LAND CRUISER 90 ( _J_ )</b>  |   |
|                                |   | 3.0 D-4D/3.0 TD (KZJ90_ , KZJ95_ )/3.4 i 24V (VZJ90_ , VZJ95_ )  |   |
|                                |   | <b>TOYOTA LAND CRUISER Hardtop ( _J_ )</b>   |   |
|                                |   | 2.4 TD (LJ77)/3.0 TD   |   |
|                                |   | <b>TOYOTA LAND CRUISER Pick-up ( _J_ )</b>   |   |
|                                |   | 3.4 D (BJ45_ , P)/3.6 D (HJ45_ , P)/3.9 (FJ45_ , P)/4.0 D (HJ47_ , P)/4.2 (FJ45_ , P)  |   |
| <b>GOM-206</b>                 | <b>Bush, leaf spring</b>                | <b>TOYOTA LAND CRUISER ( _J_ )</b>   |  |
|                                | <b>Boccola balestra</b>                 | 3.0 D (BJ40_ , BJ43_ )/3.4 D (BJ42_ , BJ45_ , BJ46_ )/3.6 D (HJ45_ , VJ)/3.6 L/3.9 (FJ40_ , FJ43_ , FJ45_ , FJ55_ , VJ)/4.0 D (HJ47_ , VJ)/4.2 (FJ40_ , FJ43_ , FJ45_ , VJ, FJ55_ )                                |   |
| TOYOTA                         | 90389-18002                             | <b>TOYOTA LAND CRUISER ( _J_ )</b>   |   |
|                                |   | 3.4 Diesel (BJ60_ , VJ)/4.0 (FJ62_ , GJ)/4.0 (FJ62_ , VJ)/4.0 Diesel (HJ60)/4.0 Diesel (HJ60_ , VJ)/4.0 Turbo-D (HJ61_ , VJ)/4.2 (FJ60_ , VJ)  |   |
| Length/Lunghezza [mm]          | 45                                      | <b>TOYOTA LAND CRUISER ( _J_ )</b>   |   |
| Inner Diam./Diam. Interno [mm] | 18                                      | 2.4 (RJ70_ , VJ, RJ73_ , VJ)/2.4 (RJ70_ , RJ73_ )/2.4 D (LJ70_ )/2.4 TD (LJ70)/2.4 TD (LJ70_ , LJ73_ )/3.0 TD (KZJ70_ , KZJ73_ , KZJ77_ )/3.4 D (BJ70_ , VJ, BJ73_ )/3.4 TD (BJ71_ , VJ)/3.5 D/4.2 TD (HZJ7_ , VJ) |   |
| Outer Diam./Diam. esterno [mm] | 35                                      | <b>TOYOTA LAND CRUISER 80 ( _J_ )</b>  |   |
|                                |   | 4.0 (FJ80_ )/4.2 D (HZJ80_ )/4.2 TD (HDJ80)/4.2 TD 24V (HDJ80_ )/4.5 24V (FZJ80_ )   |   |
|                                |   | <b>TOYOTA LAND CRUISER 90 ( _J_ )</b>  |   |
|                                |   | 3.0 D-4D/3.0 TD (KZJ90_ , KZJ95_ )/3.4 i 24V (VZJ90_ , VZJ95_ )  |   |
|                                |   | <b>TOYOTA LAND CRUISER Hardtop ( _J_ )</b>   |   |
|                                |   | 2.4 TD (LJ77)/3.0 TD   |   |

|                                |                                      |
|--------------------------------|--------------------------------------|
| <b>GOM-207</b>                 | <b>Bearing Bush, stabiliser</b>      |
|                                | <b>Boccola barra stabilizzatrice</b> |
| TOYOTA                         | 48815-60010                          |
| Length/Lunghezza [mm]          | 40,5                                 |
| Height/Altezza [mm]            | 40                                   |
| Width/Larghezza [mm]           | 41                                   |
| Inner Diam./Diam. Interno [mm] | 20                                   |

**TOYOTA LAND CRUISER Pick-up ( \_J4\_ )**  
 3.4 D (BJ45\_P)/3.6 D (HJ45\_P)/3.9 (FJ45\_P)/4.0 D (HJ47\_P)/4.2 (FJ45\_P)

**TOYOTA LAND CRUISER ( \_J4\_ )**  
 3.0 D (BJ40\_V, BJ43\_)/3.4 D (BJ42\_V, BJ45\_V, BJ46\_)/3.6 D (HJ45\_V)/3.6 L/3.9 (FJ40\_, FJ43\_, FJ45\_, FJ55\_V)/4.0 D (HJ47\_V)/4.2 (FJ40\_V, FJ43\_, FJ45\_V, FJ55\_)

**TOYOTA LAND CRUISER ( \_J6\_ )**  
 3.4 Diesel (BJ60\_V)/4.0 (FJ62\_G)/4.0 (FJ62\_V)/4.0 Diesel (HJ60)/4.0 Diesel (HJ60\_V)/4.0 Turbo-D (HJ61\_V)/4.2 (FJ60\_V)

**TOYOTA LAND CRUISER ( \_J7\_ )**  
 2.4 (RJ70\_V, RJ73\_V)/2.4 (RJ70\_, RJ73\_)/2.4 D (LJ70\_)/2.4 TD (LJ70)/2.4 TD (LJ70\_, LJ73\_)/3.0 TD (KZJ70\_, KZJ73\_, KZJ77\_)/3.4 D (BJ70\_V, BJ73\_)/3.4 TD (BJ71\_V)/3.5 D/4.2 TD (HZJ7\_V)

**TOYOTA LAND CRUISER 80 ( \_J8\_ )**  
 4.0 (FJ80\_)/4.2 D (HZJ80\_)/4.2 TD (HDJ80)/4.2 TD 24V (HDJ80\_)/4.5 24V (FZJ80\_)

**TOYOTA LAND CRUISER 90 ( \_J9\_ )**  
 3.0 D-4D/3.0 TD (KZJ90\_, KZJ95\_)/3.4 i 24V (VZJ90\_, VZJ95\_)

**TOYOTA LAND CRUISER Hardtop ( \_J7\_ )**  
 2.4 TD (LJ77)/3.0 TD

**TOYOTA LAND CRUISER Pick-up ( \_J4\_ )**  
 3.4 D (BJ45\_P)/3.6 D (HJ45\_P)/3.9 (FJ45\_P)/4.0 D (HJ47\_P)/4.2 (FJ45\_P)



|                                |                                      |
|--------------------------------|--------------------------------------|
| <b>GOM-208</b>                 | <b>Bearing Bush, stabiliser</b>      |
|                                | <b>Boccola barra stabilizzatrice</b> |
| TOYOTA                         | 48817-30010                          |
| Length/Lunghezza [mm]          | 21                                   |
| Inner Diam./Diam. Interno [mm] | 8                                    |
| Outer Diam./Diam. esterno [mm] | 27                                   |

**TOYOTA COROLLA ( \_E7\_ )**  
 1.3 (KE70)/1.6 (TE71)/1.8 D (CE70)

**TOYOTA COROLLA 2 volumi ( \_E7\_ )**  
 1.3 (KE70)/1.6 (TE71)/1.6 GT (TE71)/1.8 D (CE70)

**TOYOTA COROLLA Combi (KE)**  
 1.2 (KE36)

**TOYOTA COROLLA Coupe (KE)**  
 1.2 (KE35)

**TOYOTA HILUX Pick-up ( \_N\_ )**  
 2.4 D/2.4 D 4WD/2.4 TD 4WD

**TOYOTA LAND CRUISER ( \_J4\_ )**  
 3.0 D (BJ40\_V, BJ43\_)/3.4 D (BJ42\_V, BJ45\_V, BJ46\_)/3.6 D (HJ45\_V)/3.6 L/3.9 (FJ40\_, FJ43\_, FJ45\_, FJ55\_V)/4.0 D (HJ47\_V)/4.2 (FJ40\_V, FJ43\_, FJ45\_V, FJ55\_)

**TOYOTA LAND CRUISER ( \_J6\_ )**  
 3.4 Diesel (BJ60\_V)/4.0 (FJ62\_G)/4.0 (FJ62\_V)/4.0 Diesel (HJ60)/4.0 Diesel (HJ60\_V)/4.0 Turbo-D (HJ61\_V)/4.2 (FJ60\_V)

**TOYOTA LAND CRUISER ( \_J7\_ )**  
 2.4 (RJ70\_V, RJ73\_V)/2.4 (RJ70\_, RJ73\_)/2.4 D (LJ70\_)/2.4 TD (LJ70)/2.4 TD (LJ70\_, LJ73\_)/3.0 TD (KZJ70\_, KZJ73\_, KZJ77\_)/3.4 D (BJ70\_V, BJ73\_)/3.4 TD (BJ71\_V)/3.5 D/4.2 TD (HZJ7\_V)

**TOYOTA LAND CRUISER (J12)**  
 3.0 D-4D (KD120)/4.0 (GRJ12)

**TOYOTA LAND CRUISER 80 ( \_J8\_ )**  
 4.0 (FJ80\_)/4.2 D (HZJ80\_)/4.2 TD (HDJ80)/4.2 TD 24V (HDJ80\_)/4.5 24V (FZJ80\_)

**TOYOTA LAND CRUISER 90 ( \_J9\_ )**  
 3.0 D-4D/3.0 TD (KZJ90\_, KZJ95\_)/3.4 i 24V (VZJ90\_, VZJ95\_)

**TOYOTA LAND CRUISER Hardtop ( \_J7\_ )**  
 2.4 TD (LJ77)/3.0 TD

**TOYOTA LAND CRUISER Pick-up ( \_J4\_ )**  
 3.4 D (BJ45\_P)/3.6 D (HJ45\_P)/3.9 (FJ45\_P)/4.0 D (HJ47\_P)/4.2 (FJ45\_P)



|                                |                                       |
|--------------------------------|---------------------------------------|
| <b>GOM-209</b>                 | <b>Control Arm-/Trailing Arm Bush</b> |
|                                | <b>Supporto, Braccio oscillante</b>   |
| TOYOTA                         | 48702-60020                           |
| Length/Lunghezza [mm]          | 50                                    |
| Inner Diam./Diam. Interno [mm] | 16                                    |
| Outer Diam./Diam. esterno [mm] | 65,3                                  |

**TOYOTA LAND CRUISER ( \_J7\_ )**  
 2.4 (RJ70\_V, RJ73\_V)/2.4 (RJ70\_, RJ73\_)/2.4 D (LJ70\_)/2.4 TD (LJ70)/2.4 TD (LJ70\_, LJ73\_)/2.5 TD 4x4/3.0 TD (KZJ70\_, KZJ73\_, KZJ77\_)/3.4 D (BJ70\_V, BJ73\_)/3.4 TD (BJ71\_V)/3.5 D/3.5 D 4x4/4.2 TD (HZJ7\_V)

**TOYOTA LAND CRUISER Hardtop ( \_J7\_ )**  
 2.4 TD (LJ77)/3.0 TD



|                                |                                      |  |   |
|--------------------------------|--------------------------------------|--|---|
| <b>GOM-210</b>                 | <b>Holder, control arm mounting</b>  | <b>TOYOTA 4 RUNNER (_N130)</b>   |    |
|                                | <b>Silentblock</b>                   | 2.4 (RN61)/2.4 TD 4x4/2.7 i 4x4/3.0 Turbo-D (KZN 130)/3.0 V6 (VZN 130)/3.4 i 4x4   |   |
| TOYOTA                         | 48654-35010                          | <b>TOYOTA 4 RUNNER</b>   |   |
|                                |                                      | 3.0 Turbo-D  |   |
| Length/Lunghezza [mm]          | 92,5                                 | <b>TOYOTA HILUX Pick-up (_N_)</b>  |   |
| Inner Diam./Diam. Interno [mm] | 18                                   | 1.6 /1.8 (YN85_ ,YN90_)/2.0/2.0 4WD/2.2 4WD (YN106_ ,YN110_)/2.2 D/2.2 D 2WD/ 4WD/2.4 D/2.4 D 4WD/2.4 i 4WD/2.4 TD 4WD/2.5 D-4D/2.5 D-4D 4WD/2.8 D |   |
| Outer Diam./Diam. esterno [mm] | 40                                   |  |   |
| <b>GOM-211</b>                 | <b>Holder, control arm mounting</b>  | <b>TOYOTA 4 RUNNER (_N130)</b>   |    |
|                                | <b>Silentblock</b>                   | 2.4 (RN61)/2.4 TD 4x4/2.7 i 4x4/3.0 Turbo-D (KZN 130)/3.0 V6 (VZN 130)/3.4 i 4x4   |   |
| TOYOTA                         | 48632-30020                          | <b>TOYOTA 4 RUNNER</b>   |   |
|                                |                                      | 3.0 Turbo-D  |   |
| Length/Lunghezza [mm]          | 44,5                                 | <b>TOYOTA HILUX Pick-up (_N_)</b>  |   |
| Inner Diam./Diam. Interno [mm] | 18                                   | 1.6 /1.8 (YN85_ ,YN90_)/2.0/2.0 4WD/2.2 4WD (YN106_ ,YN110_)/2.2 D/2.2 D 2WD/ 4WD/2.4 D/2.4 D 4WD/2.4 i 4WD/2.4 TD 4WD/2.5 D-4D/2.5 D-4D 4WD/2.8 D |   |
| Outer Diam./Diam. esterno [mm] | 36,4                                 |  |   |
| <b>GOM-212</b>                 | <b>Bush, leaf spring</b>             | <b>TOYOTA 4 RUNNER (_N130)</b>   |    |
|                                | <b>Boccola balestra</b>              | 2.4 (RN61)/2.4 TD 4x4/2.7 i 4x4/3.0 Turbo-D (KZN 130)/3.0 V6 (VZN 130)/3.4 i 4x4   |   |
| TOYOTA                         | 90385-18046                          | <b>TOYOTA 4 RUNNER</b>   |   |
|                                |                                      | 3.0 Turbo-D  |   |
| Length/Lunghezza [mm]          | 34                                   | <b>TOYOTA HILUX Pick-up (_N_)</b>  |   |
| Inner Diam./Diam. Interno [mm] | 17                                   | 2.4 D/2.4 D 4WD  |   |
| Outer Diam./Diam. esterno [mm] | 29                                   |  |   |
| <b>GOM-213</b>                 | <b>Bush, leaf spring</b>             | <b>TOYOTA 4 RUNNER (_N130)</b>   |   |
|                                | <b>Boccola balestra</b>              | 2.4 (RN61)/2.4 TD 4x4/2.7 i 4x4/3.0 Turbo-D (KZN 130)/3.0 V6 (VZN 130)/3.4 i 4x4   |   |
| TOYOTA                         | 90385-18007                          | <b>TOYOTA 4 RUNNER</b>   |   |
|                                |                                      | 3.0 Turbo-D  |   |
| Length/Lunghezza [mm]          | 55                                   |  |   |
| Inner Diam./Diam. Interno [mm] | 18                                   |  |   |
| Outer Diam./Diam. esterno [mm] | 30                                   |  |   |
| <b>GOM-214</b>                 | <b>Bearing Bush, stabiliser</b>      | <b>TOYOTA 4 RUNNER (_N130)</b>   |  |
|                                | <b>Boccola barra stabilizzatrice</b> | 2.4 (RN61)/2.4 TD 4x4/2.7 i 4x4/3.0 Turbo-D (KZN 130)/3.0 V6 (VZN 130)/3.4 i 4x4   |   |
| TOYOTA                         | 48815-20020                          | <b>TOYOTA 4 RUNNER</b>   |   |
|                                |                                      | 3.0 Turbo-D  |   |
| Length/Lunghezza [mm]          | 40                                   | <b>TOYOTA HILUX Pick-up (_N_)</b>  |   |
| Height/Altezza [mm]            | 32                                   | 2.4 D/2.4 D 4WD  |   |
| Width/Larghezza [mm]           | 31                                   |  |   |
| Inner Diam./Diam. Interno [mm] | 16                                   |  |   |
| <b>GOM-215</b>                 | <b>Bearing Bush, stabiliser</b>      | <b>TOYOTA 4 RUNNER (_N130)</b>   |  |
|                                | <b>Boccola barra stabilizzatrice</b> | 2.4 (RN61)/2.4 TD 4x4/2.7 i 4x4/3.0 Turbo-D (KZN 130)/3.0 V6 (VZN 130)/3.4 i 4x4   |   |
| TOYOTA                         | 48815-20030                          | <b>TOYOTA 4 RUNNER</b>   |   |
|                                |                                      | 3.0 Turbo-D  |   |
| Length/Lunghezza [mm]          | 39                                   | <b>TOYOTA HILUX Pick-up (_N_)</b>  |   |
| Height/Altezza [mm]            | 31                                   | 2.4 D/2.4 D 4WD  |   |
| Width/Larghezza [mm]           | 30                                   |  |   |
| Inner Diam./Diam. Interno [mm] | 18                                   |  |   |
| <b>GOM-216</b>                 | <b>Bearing Bush, stabiliser</b>      | <b>TOYOTA 4 RUNNER (_N130)</b>   |  |
|                                | <b>Boccola barra stabilizzatrice</b> | 2.4 (RN61)/2.4 TD 4x4/2.7 i 4x4/3.0 Turbo-D (KZN 130)/3.0 V6 (VZN 130)/3.4 i 4x4   |   |
| TOYOTA                         | 90948-01002                          | <b>TOYOTA 4 RUNNER</b>   |   |
|                                |                                      | 3.0 Turbo-D  |   |
| Length/Lunghezza [mm]          | 16                                   | <b>TOYOTA HILUX Pick-up (_N_)</b>  |   |
| Inner Diam./Diam. Interno [mm] | 10                                   | 2.4 D/2.4 D 4WD  |   |
| Outer Diam./Diam. esterno [mm] | 25                                   |  |   |

|                |                                      |   |   |
|----------------|--------------------------------------|---|---|
| <b>GOM-217</b> | <b>Holder, control arm mounting</b>  | <b>TOYOTA CORONA (RX, RT)</b>   |    |
|                | <b>Silentblock</b>                   | 1.8 (TT1)/2.0 (RT104)/2.0 Mark II (RX12)  |   |
|                | TOYOTA 48655-20050RH                 | <b>TOYOTA CORONA SW (RT118)</b>   |   |
|                |                                      | 2.0   |   |
|                | Length/Lunghezza [mm]                | 145   |   |
|                | Height/Altezza [mm]                  | 57  |   |
|                | Width/Larghezza [mm]                 | 77  |   |
|                | Inner Diam./Diam. Interno [mm]       | 20  |   |
| <b>GOM-218</b> | <b>Holder, control arm mounting</b>  | <b>TOYOTA CORONA (RX, RT)</b>   |    |
|                | <b>Silentblock</b>                   | 1.8 (TT1)/2.0 (RT104)/2.0 Mark II (RX12)  |   |
|                | TOYOTA 48655-20060LH                 | <b>TOYOTA CORONA SW (RT118)</b>   |   |
|                |                                      | 2.0   |   |
|                | Length/Lunghezza [mm]                | 148   |   |
|                | Height/Altezza [mm]                  | 57  |   |
|                | Width/Larghezza [mm]                 | 81  |   |
|                | Inner Diam./Diam. Interno [mm]       | 18  |   |
| <b>GOM-219</b> | <b>Bearing Bush, stabiliser</b>      | <b>TOYOTA LAND CRUISER ( _J7_ )</b>   |    |
|                | <b>Boccola barra stabilizzatrice</b> | 2.4 D (LJ70_)/2.4 TD (LJ70)/2.4 TD (LJ70_, LJ73_)/3.0 TD (KZJ70_, KZJ73_, KZJ77_)/3.4 D (BJ70_V, BJ73_)/3.4 TD (BJ71_V)/3.5 D/4.2 TD (HZJ7_V) |   |
|                | TOYOTA 48815-30050                   | <b>TOYOTA LAND CRUISER Hardtop ( _J7_ )</b>   |   |
|                |                                      | 2.4 TD (LJ77)/3.0 TD  |   |
|                | Length/Lunghezza [mm]                | 40  |   |
|                | Height/Altezza [mm]                  | 32  |   |
|                | Width/Larghezza [mm]                 | 31  |   |
|                | Inner Diam./Diam. Interno [mm]       | 22.5  |   |
| <b>GOM-220</b> | <b>Bearing Bush, stabiliser</b>      | <b>TOYOTA RAV 4 II (XA2)</b>  |  |
|                | <b>Boccola barra stabilizzatrice</b> | 1.8 VVTi/2.0 D-4D 4WD/2.0 VVTi 4WD  |   |
|                | TOYOTA 48815-10060                   | <b>TOYOTA RAV 4 II</b>  |   |
|                |                                      | 2.4   |   |
|                | Fitting Position/Lato Montaggio      | Front Axle  |   |
|                | Length/Lunghezza [mm]                | 43  |   |
|                | Height/Altezza [mm]                  | 39  |   |
|                | Width/Larghezza [mm]                 | 31  |   |
|                | Inner Diam./Diam. Interno [mm]       | 22  |   |
| <b>GOM-221</b> | <b>Bearing Bush, stabiliser</b>      | <b>TOYOTA COASTER</b>   |  |
|                | <b>Boccola barra stabilizzatrice</b> | 4.1 D   |   |
|                | TOYOTA 90385-23037                   | <b>TOYOTA DYNA ( 4Y )</b>   |   |
|                |                                      | 2.2 ( YU210 )   |   |
|                | Length/Lunghezza [mm]                | 43  |   |
|                | Inner Diam./Diam. Interno [mm]       | 22  |   |
|                | Outer Diam./Diam. esterno [mm]       | 40  |   |
|                |                                      | <b>TOYOTA DYNA ( 3L )</b>   |   |
|                |                                      | 2.8 D ( LY60/61 )   |   |
|                |                                      | <b>TOYOTA DYNA ( 3RZ-FE )</b>   |   |
|                |                                      | 2.7 i ( RZU100 )  |   |
|                |                                      | <b>TOYOTA DYNA ( 3Y )</b>   |   |
|                |                                      | 2.0 ( YY211 ) /2.0 ( YY61 )   |   |
|                |                                      | <b>TOYOTA DYNA 100 ( 2Y )</b>   |   |
|                |                                      | 1.8 ( YY100 )/2.4 D ( LH80-LH81 )   |   |
|                |                                      | <b>TOYOTA DYNA 100 ( 2Y )</b>   |   |
|                |                                      | 1.8 ( Y81 )   |   |
|                |                                      | <b>TOYOTA DYNA 150 ( 3L / 5L )</b>  |   |
|                |                                      | 2.8 D ( LY211 / LY212 )   |   |
|                |                                      | <b>TOYOTA DYNA 150 ( Diesel )</b>   |   |
|                |                                      | 3.4 D ( LY61 )  |   |
|                |                                      | <b>TOYOTA DYNA 200 ( Diesel )</b>   |   |
|                |                                      | 3.4 D ( BU79/89 )/3.7 D   |   |
|                |                                      | <b>TOYOTA DYNA Autobus</b>  |   |
|                |                                      | 2.4 D/3.4 D   |   |
|                |                                      | <b>TOYOTA DYNA D ( 2L )</b>   |   |
|                |                                      | 2.8 D ( LY100 )   |   |
|                |                                      | <b>TOYOTA DYNA D ( 15BF )</b>   |   |
|                |                                      | 4.1 D ( BU10/11 )   |   |
|                |                                      | <b>TOYOTA DYNA D ( 15BF-15BFT )</b>   |   |
|                |                                      | 4.1 D 16V - Turbo ( BU21/142/22 )   |   |
|                |                                      | <b>TOYOTA DYNA D ( 3B )</b>   |   |

|                                 |                                      |  |   |
|---------------------------------|--------------------------------------|--|---|
|                                 |                                      | 3.0 D (BU)/3.4 D ( BU100/140 )   |   |
|                                 |                                      | <b>TOYOTA DYNA Pianale piatto/Telaio</b>   |   |
|                                 |                                      | 2.0/2.4 D/3.4 D  |   |
| <b>GOM-222</b>                  | <b>Bush, leaf spring</b>             | <b>TOYOTA LAND CRUISER ( _J7_ )</b>  |    |
|                                 | <b>Boccola balestra</b>              | 3.5 D/4.2 TD (HZJ7__V)   |   |
| TOYOTA                          | 90385-18009                          | <b>TOYOTA LAND CRUISER Hardtop ( _J7_ )</b>  |   |
|                                 |                                      | 3.0 TD   |   |
| Length/Lunghezza [mm]           | 44                                   |  |   |
| Inner Diam./Diam. Interno [mm]  | 18                                   |  |   |
| Outer Diam./Diam. esterno [mm]  | 40                                   |  |   |
| <b>GOM-223</b>                  | <b>Bush, leaf spring</b>             | <b>TOYOTA LAND CRUISER ( _J7_ )</b>  |    |
|                                 | <b>Boccola balestra</b>              | 2.4 D (LJ70_)/2.4 TD (LJ70)/2.4 TD (LJ70_ , LJ73_)/3.0 TD (KZJ70_ , KZJ73_ , KZJ77_)/3.4 D (BJ70_V , BJ73_)/3.4 TD (BJ71_V)/3.5 D/4.2 TD (HZJ7__V) |   |
| TOYOTA                          | 48674-60010                          | <b>TOYOTA LAND CRUISER Hardtop ( _J7_ )</b>  |   |
|                                 |                                      | 2.4 TD (LJ77)/3.0 TD   |   |
| Length/Lunghezza [mm]           | 40                                   |  |   |
| Inner Diam./Diam. Interno [mm]  | 25                                   |  |   |
| Outer Diam./Diam. esterno [mm]  | 37                                   |  |   |
| <b>GOM-224</b>                  | <b>Bearing Bush, stabiliser</b>      | <b>TOYOTA LAND CRUISER ( _J7_ )</b>  |   |
|                                 | <b>Boccola barra stabilizzatrice</b> | 2.4 D (LJ70_)/2.4 TD (LJ70_ , LJ73_)   |   |
| Length/Lunghezza [mm]           | 40                                   |  |   |
| Width/Larghezza [mm]            | 32                                   |  |   |
| Inner Diam./Diam. Interno [mm]  | 22,5                                 |  |   |
| <b>GOM-225</b>                  | <b>Bearing Bush, stabiliser</b>      | <b>TOYOTA LAND CRUISER ( _J7_ )</b>  |  |
|                                 | <b>Boccola barra stabilizzatrice</b> | 2.4 D (LJ70_)/2.4 TD (LJ70_ , LJ73_)   |   |
| Length/Lunghezza [mm]           | 21                                   |  |   |
| Width/Larghezza [mm]            | 26,5                                 |  |   |
| Inner Diam./Diam. Interno [mm]  | 8                                    |  |   |
| <b>GOM-226</b>                  | <b>Holder, control arm mounting</b>  | <b>TOYOTA AVENSIS ( _T22_ )</b>  |  |
|                                 | <b>Silentblock</b>                   | 1.6 (AT220_)/1.6 VVT-i/1.8 (AT221_)/1.8 VVT-i/2.0 (ST220_)/2.0 D-4D (CDT220_)/2.0 TD (CT220_)/2.0 VVT-i  |   |
| TOYOTA                          | 4806805050                           | <b>TOYOTA AVENSIS Liftback ( _T22_ )</b>   |   |
|                                 |                                      | 1.6 (AT220_)/1.6 VVT-i/1.8 (AT221_)/1.8 VVT-i/2.0 (ST220_)/2.0 D-4D (CDT220_)/2.0 TD (CT220_)/2.0 VVT-i  |   |
| Length/Lunghezza [mm]           | 59                                   | <b>TOYOTA AVENSIS SW ( _T22_ )</b>   |   |
| Inner Diam./Diam. Interno [mm]  | 14                                   | 1.6 (AT220_)/1.6 VVT-i/1.8 (AT221_)/1.8 VVT-i/2.0 (ST220_)/2.0 D-4D (CDT220_)/2.0 TD (CT220_)/2.0 VVT-i  |   |
| Outer Diam./Diam. esterno [mm]  | 39                                   |  |   |
| <b>GOM-227</b>                  | <b>Holder, control arm mounting</b>  | <b>TOYOTA AVENSIS ( _T22_ )</b>  |  |
|                                 | <b>Silentblock</b>                   | 1.6 (AT220_)/1.6 VVT-i/1.8 (AT221_)/1.8 VVT-i/2.0 (ST220_)/2.0 D-4D (CDT220_)/2.0 TD (CT220_)/2.0 VVT-i  |   |
| TOYOTA                          | 48061-05010                          | <b>TOYOTA AVENSIS Liftback ( _T22_ )</b>   |   |
|                                 |                                      | 1.6 (AT220_)/1.6 VVT-i/1.8 (AT221_)/1.8 VVT-i/2.0 (ST220_)/2.0 D-4D (CDT220_)/2.0 TD (CT220_)/2.0 VVT-i  |   |
| Inner Diam./Diam. Interno [mm]  | 18                                   | <b>TOYOTA AVENSIS SW ( _T22_ )</b>   |   |
| Overall Length/Lungh. Tot. [mm] | 54                                   | 1.6 (AT220_)/1.6 VVT-i/1.8 (AT221_)/1.8 VVT-i/2.0 (ST220_)/2.0 D-4D (CDT220_)/2.0 TD (CT220_)/2.0 VVT-i  |   |
| Outer Diam./Diam. esterno [mm]  | 60                                   |  |   |
| <b>GOM-228</b>                  | <b>Holder, control arm mounting</b>  | <b>TOYOTA AVENSIS (T25)</b>  |  |
|                                 | <b>Silentblock</b>                   | 1.6 VVT-i/1.8/2.0/2.0 D-4D/2.2 D-4D/2.2 D-CAT/2.4  |   |
| TOYOTA                          | 4806805070                           | <b>TOYOTA AVENSIS SW (T25)</b>   |   |
|                                 |                                      | 1.6 VVT-i/1.8/2.0/2.0 D-4D/2.2 D-4D/2.2 D-CAT/2.4  |   |
| Length/Lunghezza [mm]           | 60                                   | <b>TOYOTA AVENSIS Tre volumi (T25)</b>   |   |
| Inner Diam./Diam. Interno [mm]  | 14                                   | 1.6 VVT-i/1.8/2.0/2.0 D-4D/2.2 D-4D/2.2 D-CAT/2.4  |   |
| Outer Diam./Diam. esterno [mm]  | 38                                   |  |   |

|                                 |                                      |   |   |
|---------------------------------|--------------------------------------|---|---|
| <b>GOM-229</b>                  | <b>Holder, control arm mounting</b>  | <b>TOYOTA AVENSIS (T25)</b><br>1.6 VVT-i/1.8/2.0/2.0 D-4D/2.2 D-4D/2.2 D-CAT/2.4                                  |    |
|                                 | <b>Silentblock</b>                   | <b>TOYOTA AVENSIS SW (T25)</b><br>1.6 VVT-i/1.8/2.0/2.0 D-4D/2.2 D-4D/2.2 D-CAT/2.4                               |   |
| TOYOTA                          | 4806805070                           | <b>TOYOTA AVENSIS Tre volumi (T25)</b><br>1.6 VVT-i/1.8/2.0/2.0 D-4D/2.2 D-4D/2.2 D-CAT/2.4                       |   |
| Length/Lunghezza [mm]           | 59                                   |   |   |
| Inner Diam./Diam. Interno [mm]  | 14                                   |   |   |
| Outer Diam./Diam. esterno [mm]  | 68,5                                 |   |   |
| <b>GOM-230</b>                  | <b>Holder, control arm mounting</b>  | <b>TOYOTA AVENSIS VERSO</b><br>2.0 D-4D/2.0 VVT-i/2.4 VVTi GLS  |    |
|                                 | <b>Silentblock</b>                   |   |   |
| TOYOTA                          | 48654-05040                          |   |   |
| Length/Lunghezza [mm]           | 59                                   |   |   |
| Inner Diam./Diam. Interno [mm]  | 14                                   |   |   |
| Outer Diam./Diam. esterno [mm]  | 36                                   |   |   |
| <b>GOM-231</b>                  | <b>Holder, control arm mounting</b>  | <b>TOYOTA AVENSIS VERSO</b><br>2.0 D-4D/2.0 VVT-i/2.4 VVTi GLS  |    |
|                                 | <b>Silentblock</b>                   |   |   |
| TOYOTA                          | 48655-20140                          |   |   |
| Fitting Position/Lato Montaggio | Front Axle left and right            |   |   |
| Length/Lunghezza [mm]           | 54                                   |   |   |
| Inner Diam./Diam. Interno [mm]  | 22                                   |   |   |
| Outer Diam./Diam. esterno [mm]  | 60,5                                 |   |   |
| <b>GOM-232</b>                  | <b>Bearing Bush, stabiliser</b>      | <b>CITROEN C1</b><br>1.0/1.4 HDi  |  |
|                                 | <b>Boccola barra stabilizzatrice</b> | <b>PEUGEOT 107</b><br>1.0/1.4 HDi   |   |
| TOYOTA                          | 488150H010                           | <b>TOYOTA AYGO</b><br>1.0/1.4 HDi   |   |
| Fitting Position/Lato Montaggio | Front                                |   |   |
| Length/Lunghezza [mm]           | 56                                   |   |   |
| Height/Altezza [mm]             | 43,5                                 |   |   |
| Width/Larghezza [mm]            | 40                                   |   |   |
| Inner Diam./Diam. Interno [mm]  | 21,5                                 |   |   |
| <b>GOM-233</b>                  | <b>Holder, control arm mounting</b>  | <b>CITROEN C1</b><br>1.0/1.4 HDi  |  |
|                                 | <b>Silentblock</b>                   | <b>PEUGEOT 107</b><br>1.0/1.4 HDi   |   |
| TOYOTA                          | 480680H010                           | <b>TOYOTA AYGO</b><br>1.0/1.4 HDi   |   |
| Fitting Position/Lato Montaggio | Front Axle Left                      | <b>TOYOTA YARIS (_CP10)</b><br>1.0 16V/1.0 16V (SCP10_)/1.3/1.3 16V (NCP10_)/1.4 D-4D/1.5 TS (NCP13)/1.5 VVT-i TS |   |
| Length/Lunghezza [mm]           | 53                                   | <b>TOYOTA YARIS VERSO (NC/LP2_)</b><br>1.3 (NCP22)/1.4 D-4D (NLP22)/1.5 (NCP21)                                   |   |
| Inner Diam./Diam. Interno [mm]  | 12                                   |   |   |
| Outer Diam./Diam. esterno [mm]  | 32,7                                 |   |   |
| <b>GOM-234</b>                  | <b>Holder, control arm mounting</b>  | <b>CITROEN C1</b><br>1.0/1.4 HDi  |  |
|                                 | <b>Silentblock</b>                   | <b>PEUGEOT 107</b><br>1.0/1.4 HDi   |   |
| TOYOTA                          | 480680H010                           | <b>TOYOTA AYGO</b><br>1.0/1.4 HDi   |   |
| Fitting Position/Lato Montaggio | Lower Front Axle                     |   |   |
| Length/Lunghezza [mm]           | 62                                   |   |   |
| Inner Diam./Diam. Interno [mm]  | 19                                   |   |   |
| Outer Diam./Diam. esterno [mm]  | 56,5                                 |   |   |
| <b>GOM-235</b>                  | <b>Holder, control arm mounting</b>  | <b>CITROEN C1</b><br>1.0/1.4 HDi  |  |
|                                 | <b>Silentblock</b>                   | <b>PEUGEOT 107</b><br>1.0/1.4 HDi   |   |
| TOYOTA                          | 48725-0H010                          | <b>TOYOTA AYGO</b><br>1.0/1.4 HDi   |   |
| Length/Lunghezza [mm]           | 85                                   |   |   |
| Inner Diam./Diam. Interno [mm]  | 12                                   |   |   |
| Outer Diam./Diam. esterno [mm]  | 75                                   |   |   |



|                                |                                     |  |   |   |
|--------------------------------|-------------------------------------|--|---|---|
| <b>GOM-236</b>                 | <b>Holder, control arm mounting</b> | <b>TOYOTA COROLLA ( _E10_ )</b>  |    |   |
|                                | <b>Silentblock</b>                  | 1.3 12V (EE100_)/1.3 XLI (EE101_)/1.3 XLI 16V (EE101)/1.6 Si (AE101_)/2.0 D (CE100_)   |   |   |
| TOYOTA                         | 48654-12070                         | <b>TOYOTA COROLLA ( _E11_ )</b>  |   |   |
| Length/Lunghezza [mm]          | 60                                  | 1.3 16V/1.4 (EE111_)/1.4 16V (ZZE111_)/1.5/1.6 (AE111_)/1.6 16V (ZZE112_)/1.6 Aut. (AE111_)/1.8 Linea Terra/1.9 D (WZE110_)/2.0 D (CE110_)/2.0 D-4D/2.2 TD |   |   |
| Inner Diam./Diam. Interno [mm] | 14,5                                | <b>TOYOTA COROLLA Compact ( _E10_ )</b>  |   |   |
| Outer Diam./Diam. esterno [mm] | 33,5                                | 1.3 12V (EE100_)/1.3 XLI (EE101_)/1.3 XLI 16V (EE101)/1.6 Si (AE101_)/1.8 GT (AE102_)/2.0 D (CE100_)   |   |   |
|                                |                                     | <b>TOYOTA COROLLA Compact ( _E11_ )</b>  |   |   |
|                                |                                     | 1.4 (EE111_)/1.4 (ZZE111_)/1.5/1.6 (AE111_)/1.6 (ZZE112_)/1.6 Aut. (AE111_)/1.9 D (WZE110_)/2.0 D (CE110_)/2.0 D-4D/2.2 TD                                 |   |   |
|                                |                                     | <b>TOYOTA COROLLA Liftback ( _E10_ )</b>   |   |   |
|                                |                                     | 1.3 12V (EE100_)/1.3 XLI (EE101_)/1.6 GLI (AE101_)/1.8 GT (AE102_)/2.0 D (CE100_)  |   |   |
|                                |                                     | <b>TOYOTA COROLLA Liftback ( _E11_ )</b>   |   |   |
|                                |                                     | 1.4 (EE111_)/1.4 (ZZE111_)/1.6 (AE111_)/1.6 (ZZE112_)/1.6 Aut. (AE111_)/1.9 D (WZE110_)/2.0 D (CE110_)/2.0 D-4D  |   |   |
|                                |                                     | <b>TOYOTA COROLLA Wagon ( _E11_ )</b>  |   |   |
|                                |                                     | 1.4 (EE111_)/1.4 16V (ZZE111_)/1.6 (AE111_)/1.6 16V (ZZE112_)/1.6 Aut. (AE111_)/1.8 AWD (AE115_)/1.9 D (WZE110_)/2.0 D (CE110_)/2.0 D-4D                   |   |   |
|                                |                                     | <b>TOYOTA COROLLA Wagon ( _E10_ )</b>  |   |   |
|                                |                                     | 1.3 12V (EE100_)/1.3 XLI (EE101_)/1.3 XLI 16V (EE101_)/1.6 Si (AE101_)/1.8 16V 4WD (AE103_)/2.0 D (CE100_)   |   |   |
| <b>GOM-237</b>                 | <b>Holder, control arm mounting</b> | <b>TOYOTA COROLLA ( _E10_ )</b>  |   |   |
|                                | <b>Silentblock</b>                  | 1.3 12V (EE100_)/1.3 XLI (EE101_)/1.3 XLI 16V (EE101)/1.6 Si (AE101_)/2.0 D (CE100_)   |   |   |
| TOYOTA                         | 48655-12050                         | <b>TOYOTA COROLLA Compact ( _E10_ )</b>  |   |   |
| Length/Lunghezza [mm]          | 60                                  | 1.3 12V (EE100_)/1.3 XLI (EE101_)/1.3 XLI 16V (EE101)/1.6 Si (AE101_)/1.8 GT (AE102_)/2.0 D (CE100_)   |   |   |
| Inner Diam./Diam. Interno [mm] | 18,5                                | <b>TOYOTA COROLLA Liftback ( _E10_ )</b>   |   |   |
| Outer Diam./Diam. esterno [mm] | 46                                  | 1.3 12V (EE100_)/1.3 XLI (EE101_)/1.6 GLI (AE101_)/1.8 GT (AE102_)/2.0 D (CE100_)  |   |   |
|                                |                                     | <b>TOYOTA COROLLA Wagon ( _E10_ )</b>  |   |   |
|                                |                                     | 1.3 12V (EE100_)/1.3 XLI (EE101_)/1.3 XLI 16V (EE101_)/1.6 Si (AE101_)/1.8 16V 4WD (AE103_)/1.8 XL/1.8 XL 4x4/2.0 D (CE100_)                               |   |   |
| <b>GOM-238</b>                 | <b>Holder, control arm mounting</b> | <b>TOYOTA COROLLA ( _E12U_ )</b>   |   |  |
|                                | <b>Silentblock</b>                  | 1.4 D/1.4 VVT-i/1.6 VVT-i/1.8/1.8 VVTL-i TS/2.0 D-4D   |   |   |
|                                |                                     | <b>TOYOTA COROLLA MPV / Space Wagon</b>  |   |   |
|                                |                                     | 2.2 D-4D   |   |   |
|                                |                                     | <b>TOYOTA COROLLA SW ( _E12J_ )</b>  |   |   |
| Length/Lunghezza [mm]          | 60                                  | 1.4 D/1.4 VVT-i/1.6 VVT-i/1.8/2.0 D-4D   |   |   |
| Inner Diam./Diam. Interno [mm] | 14                                  | <b>TOYOTA COROLLA Tre volumi ( _E12_ )</b>   |   |   |
| Outer Diam./Diam. esterno [mm] | 35                                  | 1.4 D/1.4 VVT-i/1.5/1.6 VVT-i/1.8/2.0 D-4D/2.0 D4d   |   |   |
|                                |                                     | <b>TOYOTA COROLLA Verso ( _E12J_ )</b>   |   |   |
|                                |                                     | 1.4 VVT-i/1.6 VVT-i/1.8 VVT-i/2.0 D-4D   |   |   |
|                                |                                     | <b>TOYOTA COROLLA Verso</b>  |   |   |
|                                |                                     | 1.6/1.8/2.0 D-4D/2.2 D-4D  |   |   |
| <b>GOM-239</b>                 | <b>Holder, control arm mounting</b> | <b>TOYOTA COROLLA ( _E12U_ )</b>   |  |   |
|                                | <b>Silentblock</b>                  | 1.4 D/1.4 VVT-i/1.6 VVT-i/1.8/1.8 VVTL-i TS/2.0 D-4D   |   |   |
|                                |                                     | <b>TOYOTA COROLLA MPV / Space Wagon</b>  |   |   |
|                                |                                     | 2.2 D-4D   |   |   |
|                                |                                     | <b>TOYOTA COROLLA SW ( _E12J_ )</b>  |   |   |
| Length/Lunghezza [mm]          | 60                                  | 1.4 D/1.4 VVT-i/1.6 VVT-i/1.8/2.0 D-4D   |   |   |
| Inner Diam./Diam. Interno [mm] | 14                                  | <b>TOYOTA COROLLA Tre volumi ( _E12_ )</b>   |   |   |
| Outer Diam./Diam. esterno [mm] | 68                                  | 1.4 D/1.4 VVT-i/1.5/1.6 VVT-i/1.8/2.0 D-4D/2.0 D4d   |   |   |
|                                |                                     | <b>TOYOTA COROLLA Verso ( _E12J_ )</b>   |   |   |
|                                |                                     | 1.4 VVT-i/1.6 VVT-i/1.8 VVT-i/2.0 D-4D   |   |   |
|                                |                                     | <b>TOYOTA COROLLA Verso</b>  |   |   |
|                                |                                     | 1.6/1.8/2.0 D-4D/2.2 D-4D  |   |   |

|                                 |                                      |
|---------------------------------|--------------------------------------|
| <b>GOM-240</b>                  | <b>Bearing Bush, stabiliser</b>      |
|                                 | <b>Boccola barra stabilizzatrice</b> |
| TOYOTA                          | 48815-0F010                          |
| Fitting Position/Lato Montaggio | Front                                |
| Length/Lunghezza [mm]           | 41                                   |
| Height/Altezza [mm]             | 49                                   |
| Width/Larghezza [mm]            | 44                                   |
| Inner Diam./Diam. Interno [mm]  | 24                                   |

|                             |
|-----------------------------|
| <b>TOYOTA COROLLA Verso</b> |
| 1.6/1.8/2.0 D-4D/2.2 D-4D   |



|                                |                                     |
|--------------------------------|-------------------------------------|
| <b>GOM-241</b>                 | <b>Holder, control arm mounting</b> |
|                                | <b>Silentblock</b>                  |
| TOYOTA                         | 48632 26010                         |
| Length/Lunghezza [mm]          | 48                                  |
| Inner Diam./Diam. Interno [mm] | 20,5                                |
| Outer Diam./Diam. esterno [mm] | 48                                  |

|  |
|--|
| <b>TOYOTA HIACE II Furgonato (H5_)</b>   |
| 1.8/2.0/2.2 D/2.4 D  |
| <b>TOYOTA HIACE II Wagon (H5_)</b>   |
| 1.8 (H5G)/2.0 (H5G)/2.2 D (H5G)/2.4 D (H5G)/2.4 D 4WD (H5F)  |
| <b>TOYOTA HIACE IV Furgonato (_H1_, _H2_)</b>  |
| 2.4 (RCH12_, RCH22_)/2.4 4WD (RCH18_, RCH28_)/2.4 D (LXH12_, LXH22_)/2.4 TD (LXH12_, LXH22_)/2.4 TD 4WD (LXH18_, LXH28_)/2.5 D-4D/2.5 D-4D 4WD/2.7 (RCH13_, RCH23_)/2.7 4WD (RCH19_, RCH29_)/3.0 D |
| <b>TOYOTA HIACE IV Wagon (_H1_, _H2_)</b>  |
| 2.4 (RCH12_, RCH22_)/2.4 4WD (RCH18_)/2.4 D/2.4 TD (LXH12_, LXH22_)/2.4 TD 4WD (H18/28)/2.5 D-4D/2.7/2.7 (RCH13_, RCH23_)/2.7 4WD (RCH19_)/3.0 D   |



|                                |                                     |
|--------------------------------|-------------------------------------|
| <b>GOM-242</b>                 | <b>Holder, control arm mounting</b> |
|                                | <b>Silentblock</b>                  |
| TOYOTA                         | 48635-26010                         |
| Length/Lunghezza [mm]          | 75                                  |
| Inner Diam./Diam. Interno [mm] | 26,5                                |
| Outer Diam./Diam. esterno [mm] | 57                                  |

|  |
|--|
| <b>TOYOTA HIACE IV Furgonato (_H1_, _H2_)</b>  |
| 2.4 (RCH12_, RCH22_)/2.4 4WD (RCH18_, RCH28_)/2.4 D (LXH12_, LXH22_)/2.4 TD (LXH12_, LXH22_)/2.4 TD 4WD (LXH18_, LXH28_)/2.5 D-4D/2.5 D-4D 4WD/2.7 (RCH13_, RCH23_)/2.7 4WD (RCH19_, RCH29_)/3.0 D |
| <b>TOYOTA HIACE IV Wagon (_H1_, _H2_)</b>  |
| 2.4 (RCH12_, RCH22_)/2.4 4WD (RCH18_)/2.4 D/2.4 TD (LXH12_, LXH22_)/2.4 TD 4WD (H18/28)/2.5 D-4D/2.7/2.7 (RCH13_, RCH23_)/2.7 4WD (RCH19_)/3.0 D   |



|                                 |                       |
|---------------------------------|-----------------------|
| <b>GOM-243</b>                  | <b>GummiParts</b>     |
|                                 | <b>Parti in gomma</b> |
| TOYOTA                          | 48702-60010           |
| Fitting Position/Lato Montaggio | Rear Axle Right       |
| Length/Lunghezza [mm]           | 50                    |
| Inner Diam./Diam. Interno [mm]  | 16                    |
| Outer Diam./Diam. esterno [mm]  | 65                    |

|  |
|--|
| <b>TOYOTA LAND CRUISER (_J7_)</b>  |
| 2.4 (RJ70_V, RJ73_V)/2.4 (RJ70_, RJ73_)/2.4 D (LJ70_)/2.4 TD (LJ70)/2.4 TD (LJ70_, LJ73_)/2.5 TD 4x4/3.0 TD (KZJ70_, KZJ73_, KZJ77_)/3.4 D (BJ70_V, BJ73_)/3.4 TD (BJ71_V)/3.5 D/3.5 D 4x4/4.2 TD (HZJ7_V) |
| <b>TOYOTA LAND CRUISER Hardtop (_J7_)</b>  |
| 2.4 TD (LJ77)/3.0 TD   |



|                                |                                     |
|--------------------------------|-------------------------------------|
| <b>GOM-244</b>                 | <b>Holder, control arm mounting</b> |
|                                | <b>Silentblock</b>                  |
| TOYOTA                         | 48632 60010                         |
| Length/Lunghezza [mm]          | 66                                  |
| Inner Diam./Diam. Interno [mm] | 15                                  |
| Outer Diam./Diam. esterno [mm] | 52,5                                |

|  |
|--|
| <b>TOYOTA LAND CRUISER 100 (_J10_)</b> |
| 4.2 TD (HDJ100_)/4.7/4.7 (UZJ100_)     |



|                                |                                     |
|--------------------------------|-------------------------------------|
| <b>GOM-245</b>                 | <b>Holder, control arm mounting</b> |
|                                | <b>Silentblock</b>                  |
| TOYOTA                         | 48655-60010                         |
| Length/Lunghezza [mm]          | 90                                  |
| Inner Diam./Diam. Interno [mm] | 18                                  |
| Outer Diam./Diam. esterno [mm] | 47                                  |

|  |
|--|
| <b>TOYOTA LAND CRUISER 100 (_J10_)</b> |
| 4.2 TD (HDJ100_)/4.7/4.7 (UZJ100_)     |



|                                |                                     |   |   |
|--------------------------------|-------------------------------------|---|---|
| <b>GOM-246</b>                 | <b>Holder, control arm mounting</b> | <b>TOYOTA LAND CRUISER 100 (_J10_)</b>                                    |    |
|                                | <b>Silentblock</b>                  | 4.2 TD (HDJ100_)/4.7/4.7 (UZJ100_)  |   |
| TOYOTA                         | 48654-60010                         |   |   |
| Length/Lunghezza [mm]          | 84                                  |   |   |
| Inner Diam./Diam. Interno [mm] | 18                                  |   |   |
| Outer Diam./Diam. esterno [mm] | 59                                  |   |   |
| <b>GOM-247</b>                 | <b>Holder, control arm mounting</b> | <b>TOYOTA LAND CRUISER (J12)</b>  |    |
|                                | <b>Silentblock</b>                  | 3.0 D-4D (KDJ120)/4.0 (GRJ12)   |   |
| TOYOTA                         | 48632-60020                         |   |   |
| Length/Lunghezza [mm]          | 62                                  |   |   |
| Inner Diam./Diam. Interno [mm] | 15,5                                |   |   |
| Outer Diam./Diam. esterno [mm] | 46                                  |   |   |
| <b>GOM-248</b>                 | <b>Holder, control arm mounting</b> | <b>TOYOTA LAND CRUISER (J12)</b>  |    |
|                                | <b>Silentblock</b>                  | 3.0 D-4D (KDJ120)/4.0 (GRJ12)   |   |
| TOYOTA                         | 48654-60030                         |   |   |
| Length/Lunghezza [mm]          | 72                                  |   |   |
| Inner Diam./Diam. Interno [mm] | 19                                  |   |   |
| Outer Diam./Diam. esterno [mm] | 62                                  |   |   |
| <b>GOM-249</b>                 | <b>Holder, control arm mounting</b> | <b>TOYOTA LAND CRUISER (J12)</b>  |   |
|                                | <b>Silentblock</b>                  | 3.0 D-4D (KDJ120)/4.0 (GRJ12)   |   |
| TOYOTA                         | 48655-60030                         |   |   |
| Length/Lunghezza [mm]          | 89,5                                |   |   |
| Inner Diam./Diam. Interno [mm] | 14,5                                |   |   |
| Outer Diam./Diam. esterno [mm] | 56                                  |   |   |
| <b>GOM-250</b>                 | <b>Holder, control arm mounting</b> | <b>TOYOTA RAV 4 II (XA2)</b>  |  |
|                                | <b>Silentblock</b>                  | 1.8 VVTi/2.0 D-4D 4WD/2.0 VVTi 4WD/2.4 VVTi 4x4                           |   |
|                                |                                     | <b>TOYOTA RAV 4 II</b>  |   |
|                                |                                     | 2.4   |   |
| Length/Lunghezza [mm]          | 59                                  |   |   |
| Inner Diam./Diam. Interno [mm] | 14                                  |   |   |
| Outer Diam./Diam. esterno [mm] | 34                                  |   |   |
| <b>GOM-251</b>                 | <b>Holder, control arm mounting</b> | <b>TOYOTA RAV 4 II (XA2)</b>  |  |
|                                | <b>Silentblock</b>                  | 1.8 VVTi/2.0 D-4D 4WD/2.0 VVTi 4WD/2.4 VVTi 4x4                           |   |
|                                |                                     | <b>TOYOTA RAV 4 II</b>  |   |
|                                |                                     | 2.4   |   |
| Length/Lunghezza [mm]          | 60                                  |   |   |
| Inner Diam./Diam. Interno [mm] | 14                                  |   |   |
| Outer Diam./Diam. esterno [mm] | 60                                  |   |   |
| <b>GOM-252</b>                 | <b>Holder, control arm mounting</b> | <b>TOYOTA AURIS</b>   |  |
|                                | <b>Silentblock</b>                  | 1.33 Dual-VVTi/1.4 D-4D/1.4 VVTi/1.6/1.6 VVTi/1.8/1.8 VVTi/2.0 D-4D/2.2 D |   |
|                                |                                     | <b>TOYOTA PRIUS</b>   |   |
|                                |                                     | 1.8 HSD   |   |
| Length/Lunghezza [mm]          | 65,5                                | <b>TOYOTA RAV 4 III</b>   |   |
| Inner Diam./Diam. Interno [mm] | 16                                  | 2.0 VVT-i/2.2 D-4D/2.2 D-CAT  |   |
| Outer Diam./Diam. esterno [mm] | 41                                  | <b>TOYOTA VERSO</b>   |   |
|                                |                                     | 1.6/1.8/2.0 D-4D/2.2 D-4D/2.2 D-CAT                                       |   |

|                |                                      |  |   |
|----------------|--------------------------------------|--|---|
| <b>GOM-253</b> | <b>Holder, control arm mounting</b>  | <b>TOYOTA RAV 4 III</b>  |    |
|                | <b>Silentblock</b>                   | 2.0 VVT-i/2.2 D-4D/2.2 D-CAT   |   |
|                | Length/Lunghezza [mm]                | 60   |   |
|                | Inner Diam./Diam. Interno [mm]       | 16   |   |
|                | Outer Diam./Diam. esterno [mm]       | 68   |   |
| <b>GOM-254</b> | <b>Bearing Bush, stabiliser</b>      | <b>TOYOTA RAV 4 III</b>  |    |
|                | <b>Boccola barra stabilizzatrice</b> | 2.0 VVT-i/2.2 D-4D/2.2 D-CAT   |   |
| TOYOTA         | 48815-42090                          |  |   |
|                | Fitting Position/Lato Montaggio      | Left Front   |   |
|                | Length/Lunghezza [mm]                | 58   |   |
|                | Height/Altezza [mm]                  | 52   |   |
|                | Width/Larghezza [mm]                 | 62   |   |
|                | Inner Diam./Diam. Interno [mm]       | 17   |   |
| <b>GOM-255</b> | <b>Bearing Bush, stabiliser</b>      | <b>TOYOTA RAV 4 III</b>  |    |
|                | <b>Boccola barra stabilizzatrice</b> | 2.0 VVT-i/2.2 D-4D/2.2 D-CAT   |   |
| TOYOTA         | 48815-42100                          |  |   |
|                | Fitting Position/Lato Montaggio      | Right Front  |   |
|                | Length/Lunghezza [mm]                | 58   |   |
|                | Height/Altezza [mm]                  | 52   |   |
|                | Width/Larghezza [mm]                 | 62   |   |
|                | Inner Diam./Diam. Interno [mm]       | 17   |   |
| <b>GOM-256</b> | <b>Holder, control arm mounting</b>  | <b>TOYOTA YARIS (_ CP10)</b>   |   |
|                | <b>Silentblock</b>                   | 1.0 16V/1.0 16V (SCP10_)/1.3/1.3 16V (NCP10_)/1.4 D-4D/1.5 TS (NCP13)/1.5 VVT-i TS |   |
|                |                                      | <b>TOYOTA YARIS VERSO (NC/LP2_)</b>  |   |
|                |                                      | 1.3 (NCP22)/1.4 D-4D (NLP22)/1.5 (NCP21)   |   |
|                | Length/Lunghezza [mm]                | 58   |   |
|                | Inner Diam./Diam. Interno [mm]       | 12,5   |   |
|                | Outer Diam./Diam. esterno [mm]       | 55   |   |
| <b>GOM-257</b> | <b>Bearing Bush, stabiliser</b>      | <b>CITROEN JUMPER Autobus (230P)</b>   |  |
|                | <b>Boccola barra stabilizzatrice</b> | 2.8 D  |   |
| TOYOTA         | 48815-0D100                          | <b>TOYOTA URBAN CRUISER</b>  |   |
|                |                                      | 1.3 VVT-i/1.33/1.4 D-4D/1.4 D-4D 4x4   |   |
|                |                                      | <b>TOYOTA YARIS</b>  |   |
|                |                                      | 1.0 VVT-i/1.3 VVT-i/1.8 VVTi/D-4D  |   |
|                | Fitting Position/Lato Montaggio      | Front  |   |
|                | Length/Lunghezza [mm]                | 43   |   |
|                | Height/Altezza [mm]                  | 42   |   |
|                | Width/Larghezza [mm]                 | 67   |   |
|                | Inner Diam./Diam. Interno [mm]       | 24   |   |
| <b>GOM-258</b> | <b>Holder, control arm mounting</b>  | <b>TOYOTA URBAN CRUISER</b>  |  |
|                | <b>Silentblock</b>                   | 1.3 VVT-i/1.33/1.4 D-4D/1.4 D-4D 4x4   |   |
|                |                                      | <b>TOYOTA YARIS</b>  |   |
|                |                                      | 1.0 VVT-i/1.3 VVT-i/1.8 VVTi/D-4D  |   |
|                | Length/Lunghezza [mm]                | 53   |   |
|                | Inner Diam./Diam. Interno [mm]       | 14   |   |
|                | Outer Diam./Diam. esterno [mm]       | 33   |   |
| <b>GOM-259</b> | <b>Holder, control arm mounting</b>  | <b>TOYOTA URBAN CRUISER</b>  |  |
|                | <b>Silentblock</b>                   | 1.3 VVT-i/1.33/1.4 D-4D/1.4 D-4D 4x4   |   |
|                |                                      | <b>TOYOTA YARIS</b>  |   |
|                |                                      | 1.0 VVT-i/1.3 VVT-i/1.8 VVTi/D-4D  |   |
|                | Fitting Position/Lato Montaggio      | Lower Front Axle   |   |
|                | Length/Lunghezza [mm]                | 62   |   |
|                | Inner Diam./Diam. Interno [mm]       | 21   |   |
|                | Outer Diam./Diam. esterno [mm]       | 60   |   |

|  |   |   |
|--|---|---|
| <b>GOM-260</b><br><b>Bearing Bush, stabiliser</b><br><br><b>Boccola barra stabilizzatrice</b>  | <b>TOYOTA PREVIA (TCR1_, 2_)</b><br>2.4/2.4 4WD/2.4 GX  |    |
|  | <b>TOYOTA PREVIA</b><br>2.2 D (3CT)   |   |
| TOYOTA 48815-28061<br>Fitting Position/Lato Montaggio Front<br>Length/Lunghezza [mm] 42,5<br>Height/Altezza [mm] 47<br>Width/Larghezza [mm] 40<br>Inner Diam./Diam. Interno [mm] 25        |   |   |
| <b>GOM-261</b><br><b>Bearing,propshaft centre bearing</b><br><b>Supporto albero cardanico</b>  | <b>TOYOTA 4 RUNNER (_N130)</b><br>2.4 (RN61)/2.4 TD 4x4/2.7 i 4x4/3.0 Turbo-D (KZN 130)/3.0 V6 (VZN 130)/3.4 i 4x4  |    |
|  | <b>TOYOTA 4 RUNNER</b><br>3.0 Turbo-D   |   |
| TOYOTA 37230-35090<br>Length/Lunghezza [mm] 177<br>Height/Altezza [mm] 106<br>Width/Larghezza [mm] 60<br>Inner Diam./Diam. Interno [mm] 30   | <b>TOYOTA HILUX Pick-up (_N_)</b><br>1.6 /1.8 (YN85_, YN90_)/2.0/2.0 4WD/2.2 4WD (YN106_, YN110_)/2.2 D/2.2 D 2WD/ 4WD/2.4 D/2.4 D 4WD/2.4 i 4WD/2.4 TD 4WD/2.5 D-4D/2.5 D-4D 4WD/2.8 D   |   |
| <b>GOM-262</b><br><b>Bearing Bush, stabiliser</b><br><br><b>Boccola barra stabilizzatrice</b>  | <b>TOYOTA CARINA E (_T19_)</b><br>1.6 (AT190)/1.6 16V/1.6 GLI (AT190)/1.8 (AT191)/1.8 GL/2.0 D (CT190)/2.0 GLI (ST191)/2.0 GTi (ST191)/2.0 GTi 16V (ST191_)/2.0 i (ST191)/2.0 TD (CT190)  |   |
|  | <b>TOYOTA CARINA E Sportswagon (_T19_)</b><br>1.6 GLI (AT190_)/1.6 i (AT190_)/1.8 GL/1.8 i (AT191_)/2.0 D (CT190_)/2.0 GLI (ST191_)/2.0 i (ST191_)/2.0 TD (CT190_)  |   |
| TOYOTA 48815-30040<br>Fitting Position/Lato Montaggio Front<br>Length/Lunghezza [mm] 39,5<br>Height/Altezza [mm] 32<br>Width/Larghezza [mm] 30<br>Inner Diam./Diam. Interno [mm] 20        | <b>TOYOTA CARINA E Tre volumi (_T19_)</b><br>1.5 SG/1.6 (AT190)/1.6 16V (AT190_)/1.6 GLI (AT190)/1.8/1.8 GL/1.8 i 16V (AT191)/2.0 (ST191)/2.0 D (CT190)/2.0 GLI (ST191)/2.0 GTi (ST191_)/2.0 GTi 16V (ST191_)/2.0 i (ST191)/2.0 TD (CT190_)         |   |
| <b>GOM-263</b><br><b>Holder, control arm mounting</b><br><br><b>Silentblock</b>  | <b>TOYOTA HIACE IV Furgonato (_H1_, _H2_)</b><br>2.4 (RCH12_, RCH22_)/2.4 4WD (RCH18_, RCH28_)/2.4 D (LXH12_, LXH22_)/2.4 TD (LXH12_, LXH22_)/2.4 TD 4WD (LXH18_, LXH28_)/2.5 D-4D/2.5 D-4D 4WD/2.7 (RCH13_, RCH23_)/2.7 4WD (RCH19_, RCH29_)/3.0 D |  |
|  | <b>TOYOTA HIACE IV Wagon (_H1_, _H2_)</b><br>2.4 (RCH12_, RCH22_)/2.4 4WD (RCH18_)/2.4 D/2.4 TD (LXH12_, LXH22_)/2.4 TD 4WD (H18/28)/2.5 D-4D/2.7/2.7 (RCH13_, RCH23_)/2.7 4WD (RCH19_)/3.0 D   |   |
| TOYOTA 48061-26050<br>Fitting Position/Lato Montaggio Front<br>Height/Altezza [mm] 68<br>Inner Diam./Diam. Interno [mm] 17<br>Outer Diam./Diam. esterno [mm] 44                            | <b>TOYOTA HILUX Pick-up</b><br>2.5 D/2.5 D 4x4/3.0 D 4x4  |   |
| <b>GOM-264</b><br><b>Bearing Bush, stabiliser</b><br><br><b>Boccola barra stabilizzatrice</b>  | <b>TOYOTA YARIS (_CP10)</b><br>1.0 16V (SCP10_)/1.3/1.3 16V (NCP10_)/1.4 D-4D/1.5 VVT-i TS  |  |
|  | <b>TOYOTA YARIS VERSO (NC/LP2_)</b><br>1.3 (NCP22)/1.4 D-4D (NLP22)/1.5 (NCP21)   |   |
| TOYOTA 48815-0K010<br>Fitting Position/Lato Montaggio Front<br>Length/Lunghezza [mm] 49<br>Height/Altezza [mm] 57<br>Width/Larghezza [mm] 52<br>Inner Diam./Diam. Interno [mm] 30          |   |   |
| <b>GOM-265</b><br><b>Suspension Strut Support Bearing</b><br><b>Supporto ammortizzatore</b>  | <b>TOYOTA YARIS (_CP10)</b><br>1.0 16V (SCP10_)/1.3/1.3 16V (NCP10_)/1.4 D-4D/1.5 VVT-i TS  |  |
|  | <b>TOYOTA YARIS VERSO (NC/LP2_)</b><br>1.3 (NCP22)/1.4 D-4D (NLP22)/1.5 (NCP21)   |   |
| TOYOTA 48609-52031<br>Fitting Position/Lato Montaggio Front Axle<br>Length/Lunghezza [mm] 140<br>Height/Altezza [mm] 43<br>Width/Larghezza [mm] 124,5<br>Inner Diam./Diam. Interno [mm] 14 |   |   |

|   |  |  |
|---|--|--|
| <b>GOM-266</b><br><b>Suspension Strut Support Bearing</b><br><b>Supporto ammortizzatore</b>   | <b>TOYOTA YARIS</b><br>1.0 VVT-i/1.3 VVT-i/1.8 VVTi/D-4D   |  <p>266</p>   |
| TOYOTA 48609-52100<br>Fitting Position/Lato Montaggio Front Axle<br>Length/Lunghezza [mm] 51<br>Inner Diam./Diam. Interno [mm] 20<br>Outer Diam./Diam. esterno [mm] 91  |  |  |
| <b>GOM-267</b><br><b>Holder, control arm mounting</b><br><b>Silentblock</b>   | <b>TOYOTA COROLLA (_ E11_)</b><br>1.3 16V/1.4 (EE111_)/1.4 16V (ZZE111_)/1.5/1.6 (AE111_)/1.6 16V (ZZE112_)/1.6 Aut. (AE111_)/1.8 Linea Terra/1.9 D (WZE110_)/2.0 D (CE110_)/2.0 D-4D/2.2 TD                 |  <p>267</p>   |
| TOYOTA 48655-12120<br>Length/Lunghezza [mm] 61<br>Inner Diam./Diam. Interno [mm] 20,5<br>Outer Diam./Diam. esterno [mm] 52,5  | <b>TOYOTA COROLLA Compact (_ E11_)</b><br>1.4 (EE111_)/1.4 (ZZE111_)/1.5/1.6 (AE111_)/1.6 (ZZE112_)/1.6 Aut. (AE111_)/1.9 D (WZE110_)/2.0 D (CE110_)/2.0 D-4D/2.2 TD   |  |
|   | <b>TOYOTA COROLLA Liftback (_ E11_)</b><br>1.4 (EE111_)/1.4 (ZZE111_)/1.6 (AE111_)/1.6 (ZZE112_)/1.6 Aut. (AE111_)/1.9 D (WZE110_)/2.0 D (CE110_)/2.0 D-4D   |  |
|   | <b>TOYOTA COROLLA Wagon (_ E11_)</b><br>1.4 (EE111_)/1.4 16V (ZZE111_)/1.6 (AE111_)/1.6 16V (ZZE112_)/1.6 Aut. (AE111_)/1.8 AWD (AE115_)/1.9 D (WZE110_)/2.0 D (CE110_)/2.0 D-4D                             |  |
|   |  |  |
| <b>GOM-268</b><br><b>Holder, control arm mounting</b><br><b>Silentblock</b>   | <b>TOYOTA CARINA E (_ T19_)</b><br>1.6 (AT190)/1.6 16V/1.6 GLi (AT190)/1.8 (AT191)/1.8 GL/2.0 D (CT190)/2.0 GLi (ST191)/2.0 GTi (ST191)/2.0 GTi 16V (ST191_)/2.0 i (ST191)/2.0 TD (CT190)                    |  <p>268</p>  |
| TOYOTA 48654-20150<br>Fitting Position/Lato Montaggio Front Axle<br>Length/Lunghezza [mm] 60<br>Inner Diam./Diam. Interno [mm] 14<br>Outer Diam./Diam. esterno [mm] 36  | <b>TOYOTA CARINA E Sportswagon (_ T19_)</b><br>1.6 GLi (AT190_)/1.6 i (AT190_)/1.8 GL/1.8 i (AT191_)/2.0 D (CT190_)/2.0 GLi (ST191_)/2.0 i (ST191_)/2.0 TD (CT190_)  |  |
|   | <b>TOYOTA CARINA E Tre volumi (_ T19_)</b><br>1.5 SG/1.6 (AT190)/1.6 16V (AT190_)/1.8/1.8 GL/1.8 i 16V (AT191)/2.0 (ST191)/2.0 D (CT190)/2.0 GTi (ST191_)/2.0 GTi 16V (ST191_)/2.0 i (ST191)/2.0 TD (CT190_) |  |
|   | <b>TOYOTA LITEACE Autobus (_ R2_LG)</b><br>1.5 (KR21LG)/2.0 D (CR21LG)/2.2 (YR22LG)  |  <p>269</p> |
| <b>GOM-269</b><br><b>Holder, control arm mounting</b><br><b>Silentblock</b>   | <b>TOYOTA LITEACE Autobus (CM30_G, KM30_G)</b><br>1.5 (KM30LG)/2.0 D (CM30LG)  |  |
| TOYOTA 48061-27010<br>Technical Information Number Silentblock Sup. tra<br>Fitting Position/Lato Montaggio Lower Front Axle<br>Length/Lunghezza [mm] 69<br>Inner Diam./Diam. Interno [mm] 14<br>Outer Diam./Diam. esterno [mm] 39 | <b>TOYOTA LITEACE Furgonato (_ R2_V)</b><br>1.5 (KR27_V)   |  |
|   | <b>TOYOTA LITEACE Furgonato (CM3_V, KM3_V)</b><br>1.5 (KM31_V, KM36_V)/2.0 D (CM36_V)  |  |
|   | <b>TOYOTA LITEACE Furgonato (M2_V)</b><br>1.3  |  |
|   | <b>TOYOTA MODELL F Autobus (_ R2_ 31)</b><br>1.8 De Luxe (YR20)/2.0 (YR21_G)/2.0 Super (YR21)/2.2 (YR22LG, YR31LG)   |  |
|   |  |  |
|   |  |  |
| <b>GOM-270</b><br><b>Bearing Bush, stabiliser</b><br><b>Boccola barra stabilizzatrice</b>   | <b>TOYOTA HILUX Pick-up (_ N_)</b><br>2.4 D/2.4 i 4WD/2.4 TD 4WD/2.5 D-4D/2.5 D-4D 4WD   |  <p>270</p> |
| TOYOTA 48815 14160<br>Fitting Position/Lato Montaggio Front Axle<br>Length/Lunghezza [mm] 40<br>Height/Altezza [mm] 40<br>Inner Diam./Diam. Interno [mm] 24   | <b>TOYOTA LAND CRUISER (_ J6_)</b><br>4.0 (FJ62_G)   |  |
| <b>GOM-271</b><br><b>Control Arm-/Trailing Arm Bush</b><br><b>Supporto, Braccio oscillante</b>  | <b>TOYOTA LAND CRUISER 80 (_ J8_)</b><br>4.0 (FJ80_)/4.2 TD (HDJ80)/4.2 TD 24V (HDJ80_)  |  <p>271</p> |
| TOYOTA 48702-60050<br>Fitting Position/Lato Montaggio Rear Axle left and right<br>Length/Lunghezza [mm] 50<br>Inner Diam./Diam. Interno [mm] 16<br>Outer Diam./Diam. esterno [mm] 60  |  |  |

|  |   |  |
|--|---|--|
| <p><b>GOM-272</b>      <b>Control Arm-/Trailing Arm Bush</b><br/> <b>Supporto, Braccio oscillante</b></p> <p>TOYOTA      48702-60040</p> <p>Fitting Position/Lato Montaggio      Rear Axle left and right<br/> Fitting Position/Lato Montaggio      Lower<br/> Length/Lunghezza [mm]      60<br/> Inner Diam./Diam. Interno [mm]      18<br/> Outer Diam./Diam. esterno [mm]      55</p> | <p><b>TOYOTA LAND CRUISER (_J6_)</b><br/> 4.0 (FJ62_G)</p> <p><b>TOYOTA LAND CRUISER 80 (_J8_)</b><br/> 4.0 (FJ80_)/4.2 TD (HDJ80)/4.2 TD 24V (HDJ80_)</p>  |  <p>272</p>   |
| <p><b>GOM-273</b>      <b>Control Arm-/Trailing Arm Bush</b><br/> <b>Supporto, Braccio oscillante</b></p> <p>TOYOTA      48706-60030</p> <p>Fitting Position/Lato Montaggio      Rear Axle left and right<br/> Length/Lunghezza [mm]      50<br/> Inner Diam./Diam. Interno [mm]      16<br/> Outer Diam./Diam. esterno [mm]      40</p>   | <p><b>TOYOTA LAND CRUISER (_J7_)</b><br/> 4.2 TD (HZJ7__V)</p> <p><b>TOYOTA LAND CRUISER 100 (_J10_)</b><br/> 4.2 TD (HDJ100_)</p> <p><b>TOYOTA LAND CRUISER 80 (_J8_)</b><br/> 4.2 D (HZJ80_)/4.5 24V (FZJ80_)</p> <p><b>TOYOTA LAND CRUISER Hardtop (_J7_)</b><br/> 4.2 D 4 ruote motrici</p>   |  <p>273</p>   |
| <p><b>GOM-274</b>      <b>Holder, control arm mounting</b><br/> <b>Silentblock</b></p> <p>TOYOTA      48061-60010</p> <p>Fitting Position/Lato Montaggio      Front Axle left and right<br/> Fitting Position/Lato Montaggio      Lower<br/> Length/Lunghezza [mm]      60<br/> Inner Diam./Diam. Interno [mm]      18<br/> Outer Diam./Diam. esterno [mm]      54</p>                   | <p><b>TOYOTA LAND CRUISER (_J6_)</b><br/> 4.0 (FJ62_G)</p> <p><b>TOYOTA LAND CRUISER (_J7_)</b><br/> 4.2 TD (HZJ7__V)</p> <p><b>TOYOTA LAND CRUISER 100 (_J10_)</b><br/> 4.2 TD (HDJ100_)</p> <p><b>TOYOTA LAND CRUISER 80 (_J8_)</b><br/> 4.0 (FJ80_)/4.2 D (HZJ80_)/4.2 TD (HDJ80)/4.2 TD 24V (HDJ80_)/4.5 24V (FZJ80_)</p> <p><b>TOYOTA LAND CRUISER Hardtop (_J7_)</b><br/> 4.2 D 4 ruote motrici</p> |  <p>274</p>   |
| <p><b>GOM-275</b>      <b>Suspension Strut Support Bearing</b><br/> <b>Supporto ammortizzatore</b></p> <p>TOYOTA      48609-42010</p> <p>Fitting Position/Lato Montaggio      Front Axle<br/> Length/Lunghezza [mm]      142<br/> Height/Altezza [mm]      44<br/> Width/Larghezza [mm]      131<br/> Inner Diam./Diam. Interno [mm]      14</p>   | <p><b>TOYOTA RAV 4 II (XA2)</b><br/> 1.8 VVTi/2.0 D-4D 4WD/2.0 VVTi 4WD/2.4 VVTi 4x4</p>  |  <p>275</p> |
| <p><b>GOM-276</b>      <b>Holder, control arm mounting</b><br/> <b>Silentblock</b></p> <p>TOYOTA      4865442020</p> <p>Height/Altezza [mm]      56<br/> Inner Diam./Diam. Interno [mm]      14,2<br/> Outer Diam./Diam. esterno [mm]      44,5<br/> Mounting Type/Tipo supporto</p>   | <p><b>TOYOTA RAV 4 I/ FUNCRUISER (XA1_)</b><br/> 2.0 16V</p>  |  <p>276</p> |
| <p><b>GOM-277</b>      <b>Bush, leaf spring</b><br/> <b>Boccola balestra</b></p> <p>TOYOTA      90385 T0001</p> <p>Fitting Position/Lato Montaggio      Rear Axle<br/> Length/Lunghezza [mm]      52,5<br/> Inner Diam./Diam. Interno [mm]      19</p>   | <p><b>TOYOTA HILUX Pick-up</b><br/> 2.5 D/2.5 D 4x4/2.5 D4d/3.0 D 4x4</p>   |  <p>277</p> |

|   |  |   |
|---|--|---|
| <b>GOM-278</b> Bush, leaf spring<br><b>Boccola balestra</b>   | <b>TOYOTA HILUX Pick-up</b><br>2.5 D/2.5 D 4x4/2.5 D4d/3.0 D 4x4 |    |
| TOYOTA 90385 T0002<br>Fitting Position/Lato Montaggio Rear Axle<br>Length/Lunghezza [mm] 38<br>Inner Diam./Diam. Interno [mm] 19  |  |   |
| <b>GOM-279</b> Bush, leaf spring<br><b>Boccola balestra</b>   | <b>TOYOTA HILUX Pick-up</b><br>2.5 D/2.5 D 4x4/2.5 D4d/3.0 D 4x4 |    |
| TOYOTA 90385 T0003<br>Fitting Position/Lato Montaggio Front<br>Fitting Position/Lato Montaggio Rear Axle<br>Length/Lunghezza [mm] 39<br>Inner Diam./Diam. Interno [mm] 23 |  |   |
| <b>GOM-280</b> Bush, leaf spring<br><b>Boccola balestra</b>   | <b>TOYOTA HILUX Pick-up</b><br>2.5 D/2.5 D 4x4/2.5 D4d/3.0 D 4x4 |    |
| TOYOTA 90389 14004<br>Fitting Position/Lato Montaggio Rear Axle<br>Length/Lunghezza [mm] 73<br>Inner Diam./Diam. Interno [mm] 14,2  |  |   |
| <b>GOM-281</b> Bearing,propshaft centre bearing<br><b>Supporto albero cardanico</b>   | <b>TOYOTA HILUX Pick-up</b><br>2.5 D/2.5 D4d                     |  |
| TOYOTA 37230-0K011<br>Length/Lunghezza [mm] 176<br>Height/Altezza [mm] 110<br>Width/Larghezza [mm] 57<br>Inner Diam./Diam. Interno [mm] 30                                |  |   |
| <b>GOM-282</b> Bearing,propshaft centre bearing<br><b>Supporto albero cardanico</b>   | <b>TOYOTA HILUX Pick-up</b><br>2.5 D 4x4/3.0 D 4x4               |  |
| TOYOTA 37230-0K021<br>Length/Lunghezza [mm] 179<br>Height/Altezza [mm] 110<br>Width/Larghezza [mm] 54<br>Inner Diam./Diam. Interno [mm] 30                                |  |   |
| <b>GOM-283</b> Engine Mounting<br><b>Supporto motore</b>  | <b>TOYOTA HILUX Pick-up</b><br>2.5 D/2.5 D 4x4/3.0 D 4x4         |  |
| TOYOTA 12361-0L030<br>Fitting Position/Lato Montaggio Front<br>Length/Lunghezza [mm] 160<br>Height/Altezza [mm] 94<br>Width/Larghezza [mm] 131                            |  |   |
| <b>GOM-284</b> Bush, leaf spring<br><b>Boccola balestra</b>   | <b>TOYOTA DYNA</b><br>2.5 D4d/3.0 D4d                            |  |
| TOYOTA 90389-16026<br>Fitting Position/Lato Montaggio Front Axle<br>Length/Lunghezza [mm] 43<br>Inner Diam./Diam. Interno [mm] 16<br>Outer Diam./Diam. esterno [mm] 40,5  |  |   |



**RUBBER PARTS LIST**  
**MOTORAUFHÄNGUNG LISTE**  
**LISTE SILENT BLOCS**  
**LISTA TAPONES DE GOMA**  
**LISTA PARTI IN GOMMA**





|                                 |                                      |  |   |
|---------------------------------|--------------------------------------|--|---|
| <b>GOM-285</b>                  | <b>Bush, leaf spring</b>             | <b>TOYOTA DYNA</b>   |    |
|                                 | <b>Boccola balestra</b>              | 2.5 D4d/3.0 D4d  |   |
| TOYOTA                          | 90385-18023                          |  |   |
| Fitting Position/Lato Montaggio | Rear Axle                            |  |   |
| Length/Lunghezza [mm]           | 42                                   |  |   |
| Inner Diam./Diam. Interno [mm]  | 18                                   |  |   |
| Outer Diam./Diam. esterno [mm]  | 30                                   |  |   |
| <b>GOM-286</b>                  | <b>Bearing Bush, stabiliser</b>      | <b>TOYOTA AURIS</b>  |    |
|                                 | <b>Boccola barra stabilizzatrice</b> | 1.33 Dual-VVTi/1.4 D-4D/1.4 VVTi/1.6/1.6 VVTi/2.0 D-4D/2.2 D |   |
| TOYOTA                          | 48815 02140                          |  |   |
| Fitting Position/Lato Montaggio | Front Axle Left                      |  |   |
| Length/Lunghezza [mm]           | 53                                   |  |   |
| Height/Altezza [mm]             | 61                                   |  |   |
| Inner Diam./Diam. Interno [mm]  | 23                                   |  |   |
| <b>GOM-287</b>                  | <b>Bearing Bush, stabiliser</b>      | <b>TOYOTA AURIS</b>  |    |
|                                 | <b>Boccola barra stabilizzatrice</b> | 1.33 Dual-VVTi/1.4 D-4D/1.4 VVTi/1.6/1.6 VVTi/2.0 D-4D/2.2 D |   |
| TOYOTA                          | 48815 02150                          |  |   |
| Fitting Position/Lato Montaggio | Front Axle Right                     |  |   |
| Length/Lunghezza [mm]           | 53                                   |  |   |
| Height/Altezza [mm]             | 61                                   |  |   |
| Inner Diam./Diam. Interno [mm]  | 23                                   |  |   |
| <b>GOM-288</b>                  | <b>Bearing Bush, stabiliser</b>      | <b>TOYOTA AVENSIS</b>  |  |
|                                 | <b>Boccola barra stabilizzatrice</b> | 1.6/1.6 VVT-i/1.8/2.0 D/2.2 D/2.2 D-CAT                      |   |
| TOYOTA                          | 48815 05130                          | <b>TOYOTA AVENSIS SW (T27)</b>                               |   |
| Fitting Position/Lato Montaggio | Front Axle Left                      | 1.6/1.8/2.0/2.2 D  |   |
| Length/Lunghezza [mm]           | 53                                   | <b>TOYOTA AVENSIS Tre volumi (T27)</b>                       |   |
| Height/Altezza [mm]             | 53                                   | 2.0/2.2 D  |   |
| Width/Larghezza [mm]            | 64,5                                 |  |   |
| Inner Diam./Diam. Interno [mm]  | 23                                   |  |   |
| <b>GOM-289</b>                  | <b>Bearing Bush, stabiliser</b>      | <b>TOYOTA AVENSIS</b>  |  |
|                                 | <b>Boccola barra stabilizzatrice</b> | 1.6/1.6 VVT-i/1.8/2.0 D/2.2 D/2.2 D-CAT                      |   |
| TOYOTA                          | 48815 05120                          | <b>TOYOTA AVENSIS SW (T27)</b>                               |   |
| Fitting Position/Lato Montaggio | Front Axle Right                     | 1.6/1.8/2.0/2.2 D  |   |
| Length/Lunghezza [mm]           | 53                                   | <b>TOYOTA AVENSIS Tre volumi (T27)</b>                       |   |
| Height/Altezza [mm]             | 53                                   | 2.0/2.2 D  |   |
| Width/Larghezza [mm]            | 64,5                                 |  |   |
| Inner Diam./Diam. Interno [mm]  | 23                                   |  |   |
| <b>GOM-290</b>                  | <b>Engine Mounting</b>               | <b>CITROEN C1</b>  |  |
|                                 | <b>Supporto motore</b>               | 1.0  |   |
| TOYOTA                          | 123630Q010                           | <b>PEUGEOT 107</b>   |   |
| Fitting Position/Lato Montaggio | Front Axle & Rear                    | 1.0  |   |
| Length/Lunghezza [mm]           | 185                                  | <b>TOYOTA AYGO</b>   |   |
| Inner Diam./Diam. Interno [mm]  | 15                                   | 1.0/1.0 GPL  |   |
| Inner Diam./Diam. Int. 1 [mm]   | 12                                   |  |   |
| Inner Diam./Diam. Interno [mm]  | 14,5                                 |  |   |
| <b>GOM-291</b>                  | <b>Engine Mounting</b>               | <b>CITROEN C1</b>  |  |
|                                 | <b>Supporto motore</b>               | 1.0  |   |
| TOYOTA                          | 123050Q010                           | <b>PEUGEOT 107</b>   |   |
| Fitting Position/Lato Montaggio | Front Axle Right                     | 1.0  |   |
| Length/Lunghezza [mm]           | 171                                  | <b>TOYOTA AYGO</b>   |   |
| Height/Altezza [mm]             | 89                                   | 1.0/1.0 GPL  |   |

|  |   |  |
|--|---|--|
| <p><b>GOM-292</b>      <b>Control Arm-/Trailing Arm Bush</b><br/> <b>Supporto, Braccio oscillante</b></p> <p>TOYOTA      48075-42050</p>   | <p><b>TOYOTA RAV 4 I Cabrio/ FUNCRUISER (SXA1_)</b><br/> 2.0 16V<br/> <b>TOYOTA RAV 4 I/ FUNCRUISER (SXA1_)</b><br/> 2.0/2.0 4x4/2.0 16V</p>  |               |
| <p><b>GOM-293</b>      <b>Control Arm-/Trailing Arm Bush</b><br/> <b>Supporto, Braccio oscillante</b></p> <p>TOYOTA      48061-35040</p> <p>Fitting Position/Lato Montaggio      Upper Front Axle<br/> Length/Lunghezza [mm]      66<br/> Inner Diam./Diam. Interno [mm]      20<br/> Outer Diam./Diam. esterno [mm]      49</p>               | <p><b>TOYOTA LAND CRUISER 90 ( _J9_ )</b><br/> 3.0 D-4D/3.0 TD (KZJ90_ , KZJ95_)/3.4 i 24V (VZJ90_ , VZJ95_)/4.2 TD</p>   |  <p>293</p>   |
| <p><b>GOM-294</b>      <b>Bearing,propshaft centre bearing</b><br/> <b>Supporto albero cardanico</b></p> <p>TOYOTA      37230-26020</p> <p>Length/Lunghezza [mm]      172<br/> Height/Altezza [mm]      56<br/> Inner Diam./Diam. Interno [mm]      30</p>   | <p><b>TOYOTA HIACE IV Furgonato ( _H1_ , _H2_ )</b><br/> 2.4 (RCH12_ , RCH22_)/2.4 D (LXH12_ , LXH22_)/2.4 TD (LXH12_ , LXH22_)/2.4 TD 4WD (LXH18_ , LXH28_)/2.5 D-4D/2.5 D-4D 4WD/2.5 D4d 4x4/2.7 (RCH13_ , RCH23_ )</p> <p><b>TOYOTA HIACE IV Wagon ( _H1_ , _H2_ )</b><br/> 2.4 (RCH12_ , RCH22_)/2.4 D/2.4 TD (LXH12_ , LXH22_)/2.4 TD 4WD (H18/28)/2.5 D-4D/2.5 D4d 4x4/2.7 (RCH13_ , RCH23_ )</p>   |  <p>294</p>   |
| <p><b>GOM-295</b>      <b>Control Arm-/Trailing Arm Bush</b><br/> <b>Supporto, Braccio oscillante</b></p> <p>TOYOTA      48655 12060</p> <p>Fitting Position/Lato Montaggio      Lower Front Axle<br/> Length/Lunghezza [mm]      60,5<br/> Height/Altezza [mm]      59<br/> Inner Diam./Diam. Interno [mm]      18,5</p>                      | <p><b>TOYOTA COROLLA ( _E9_ )</b><br/> 1.3 i (EE90)/1.5/1.5 4x4/1.6 (AE92)/1.6 GL 4x4/1.6 i/1.6 i 4WD/1.6 XL/1.8 D</p> <p><b>TOYOTA COROLLA Compact ( _E9_ )</b><br/> 1.3 (EE90)/1.3 i (EE90)/1.5/1.5 4x4/1.6 (AE92)/1.6 GL 4x4/1.6 GTI /1.6 XL/1.8 D</p> <p><b>TOYOTA COROLLA Liftback ( _E9_ )</b><br/> 1.3 i (EE90)/1.5/1.5 4x4/1.6/1.6 (AE92)/1.6 GTI/1.8 D (CE90)</p> <p><b>TOYOTA COROLLA SW ( _E9_ )</b><br/> 1.3 (EE90)/1.3 i (EE90)/1.6 (AE92)/1.6 XLI/1.6 XLI 4x4/1.8 D</p> |  <p>295</p> |
| <p><b>GOM-296</b>      <b>Bearing Bush, stabiliser</b><br/> <b>Boccola barra stabilizzatrice</b></p> <p>TOYOTA      4881502040</p> <p>Fitting Position/Lato Montaggio      Front Axle<br/> Length/Lunghezza [mm]      40<br/> Height/Altezza [mm]      37<br/> Width/Larghezza [mm]      39<br/> Inner Diam./Diam. Interno [mm]      20</p>    | <p><b>TOYOTA COROLLA ( _E11_ )</b><br/> 1.8/2.0 D (CE110_)/2.0 D-4D</p> <p><b>TOYOTA COROLLA Compact ( _E11_ )</b><br/> 1.4 (EE111_)/1.6 (AE111_)/1.6 Aut. (AE111_)</p>   |  <p>296</p> |
| <p><b>GOM-297</b>      <b>Bearing Bush, stabiliser</b><br/> <b>Boccola barra stabilizzatrice</b></p> <p>TOYOTA      48815-12220</p> <p>Fitting Position/Lato Montaggio      Front Axle<br/> Length/Lunghezza [mm]      39<br/> Height/Altezza [mm]      36<br/> Width/Larghezza [mm]      43<br/> Inner Diam./Diam. Interno [mm]      25,5</p> | <p><b>TOYOTA COROLLA ( _E10_ )</b><br/> 2.0 D (CE100_)</p> <p><b>TOYOTA COROLLA Compact ( _E10_ )</b><br/> 2.0 D (CE100_)</p> <p><b>TOYOTA COROLLA Liftback ( _E10_ )</b><br/> 1.3 XLI (EE101_)/2.0 D (CE100_)</p> <p><b>TOYOTA COROLLA Wagon ( _E10_ )</b><br/> 2.0 D (CE100_)</p>   |  <p>297</p> |
| <p><b>GOM-298</b>      <b>Bearing Bush, stabiliser</b><br/> <b>Boccola barra stabilizzatrice</b></p> <p>TOYOTA      4881552030</p> <p>Fitting Position/Lato Montaggio      Front Axle<br/> Length/Lunghezza [mm]      40<br/> Height/Altezza [mm]      36<br/> Width/Larghezza [mm]      32<br/> Inner Diam./Diam. Interno [mm]      25</p>    | <p><b>TOYOTA YARIS ( _CP10)</b><br/> 1.0 16V/1.0 16V (SCP10_)/1.3/1.3 16V (NCP10_)/1.4 D-4D/1.5 TS (NCP13)/1.5 VVT-i TS</p> <p><b>TOYOTA YARIS VERSO (NC/LP2_)</b><br/> 1.3 (NCP22)/1.4 D-4D (NLP22)/1.5 (NCP21)</p>  |  <p>298</p> |

|   |  |   |
|---|--|---|
| <p><b>GOM-299</b>      <b>Bearing Bush, stabiliser</b></p> <p><b>Boccola barra stabilizzatrice</b></p> <p>TOYOTA      4881812160</p>  | <p><b>TOYOTA COROLLA ( _E11_ )</b><br/> 1.3/1.4 (EE111_)/1.4 16V (ZZE111_)/1.4 D4d/1.5/1.6<br/> (AE111_)/1.6 16V (ZZE112_)/1.6 Aut. (AE111_)/1.8/1.8 Linea<br/> Terra/1.9 D (WZE110_)/2.0 D (CE110_)/2.0 D-4D/2.2 TD</p>   |  <p>299</p>      |
| <p><b>GOM-300</b>      <b>Holder, control arm mounting</b></p> <p><b>Silentblock</b></p> <p>MAZDA      1010037</p> <p>Length/Lunghezza [mm]      62</p> <p>Inner Diam./Diam. Interno [mm]      12</p> <p>Outer Diam./Diam. esterno [mm]      37</p>         | <p><b>FORD FIESTA Furgonato (J5_ J3_ )</b><br/> 1.3/1.4 i/1.8 D/1.8 DI</p> <p><b>FORD FIESTA Furgonato (JV_ )</b><br/> D 1.8/TD 1.8</p> <p><b>FORD FIESTA IV (JA_ JB_ )</b><br/> 1.0 i/1.25 i 16V/1.3 i/1.4 i 16V/1.6 16V Sport/1.8 D/1.8 DI</p> <p><b>FORD PUMA (EC_ )</b><br/> 1.4 16V/1.6 16V/1.7 16V/ST 160</p> <p><b>MAZDA 121 III (JASM, JBSM)</b><br/> 1.25/1.3/1.3i 16V CABRIO (JJA)/1.8 D</p> |  <p>300</p>      |
| <p><b>GOM-301</b>      <b>Holder, control arm mounting</b></p> <p><b>Silentblock</b></p> <p>MAZDA      1E01 34 153A</p> <p>Length/Lunghezza [mm]      50</p> <p>Inner Diam./Diam. Interno [mm]      12</p> <p>Outer Diam./Diam. esterno [mm]      66</p>    | <p><b>FORD FIESTA Furgonato (J5_ J3_ )</b><br/> 1.3/1.4 i/1.8 D/1.8 DI</p> <p><b>FORD FIESTA Furgonato (JV_ )</b><br/> D 1.8/TD 1.8</p> <p><b>FORD FIESTA IV (JA_ JB_ )</b><br/> 1.0 i/1.25 i 16V/1.3 i/1.4 i 16V/1.6 16V Sport/1.8 D/1.8 DI</p> <p><b>FORD PUMA (EC_ )</b><br/> 1.4 16V/1.6 16V/1.7 16V/ST 160</p> <p><b>MAZDA 121 III (JASM, JBSM)</b><br/> 1.25/1.3/1.3i 16V CABRIO (JJA)/1.8 D</p> |  <p>301</p>     |
| <p><b>GOM-302</b>      <b>Holder, control arm mounting</b></p> <p><b>Silentblock</b></p> <p>MAZDA      B459-34-470</p> <p>Length/Lunghezza [mm]      57</p> <p>Inner Diam./Diam. Interno [mm]      12</p> <p>Outer Diam./Diam. esterno [mm]      40</p>     | <p><b>MAZDA 323 F IV (BG)</b><br/> 1.6/1.6 16V/1.8 4WD/1.8 16V/1.8 16V GT</p> <p><b>MAZDA 323 IV C (BG)</b><br/> 1.3/1.3 16V/1.6/1.6 16V/1.7 D/1.8 16V/1.8 16V 4WD/1.8 16V<br/> GT/1.8 16V Turbo 4WD/1.9 16V 2WD/4WD</p> <p><b>MAZDA 323 IV S (BG)</b><br/> 1.3/1.3 16V/1.6/1.6 16V/1.7 D/1.8 16V/1.8 16V 4WD/1.8 16V<br/> GT/1.8 16V Turbo 4WD</p>  |  <p>RU-302</p> |
| <p><b>GOM-303</b>      <b>Holder, control arm mounting</b></p> <p><b>Silentblock</b></p> <p>MAZDA      B001-34-470</p> <p>Length/Lunghezza [mm]      52</p> <p>Inner Diam./Diam. Interno [mm]      18</p> <p>Outer Diam./Diam. esterno [mm]      32,5</p>   | <p><b>MAZDA 323 F IV (BG)</b><br/> 1.6/1.6 16V/1.8 4WD/1.8 16V/1.8 16V GT</p> <p><b>MAZDA 323 IV C (BG)</b><br/> 1.3/1.3 16V/1.6/1.6 16V/1.7 D/1.8 16V/1.8 16V 4WD/1.8 16V<br/> GT/1.8 16V Turbo 4WD/1.9 16V 2WD/4WD</p> <p><b>MAZDA 323 IV S (BG)</b><br/> 1.3/1.3 16V/1.6/1.6 16V/1.7 D/1.8 16V/1.8 16V 4WD/1.8 16V<br/> GT/1.8 16V Turbo 4WD</p>  |  <p>RU-303</p> |
| <p><b>GOM-304</b>      <b>Holder, control arm mounting</b></p> <p><b>Silentblock</b></p> <p>MAZDA      BC1D 34 470</p> <p>Length/Lunghezza [mm]      57</p> <p>Inner Diam./Diam. Interno [mm]      12</p> <p>Outer Diam./Diam. esterno [mm]      47</p>     | <p><b>MAZDA 323 F V (BA)</b><br/> 1.5 16V/1.8 16V/2.0 24V</p> <p><b>MAZDA 323 V C (BA)</b><br/> 1.3 16V/1.5 16V/1.8 16V</p> <p><b>MAZDA 323 V P (BA)</b><br/> 1.3 16V/1.5 16V/2.0 D</p> <p><b>MAZDA 323 V S (BA)</b><br/> 1.3 16V/1.5 16V/1.6 TD/1.8 16V/2.0 D</p>   |  <p>304</p>    |
| <p><b>GOM-305</b>      <b>Holder, control arm mounting</b></p> <p><b>Silentblock</b></p> <p>MAZDA      B25D 34 470</p> <p>Length/Lunghezza [mm]      60,5</p> <p>Inner Diam./Diam. Interno [mm]      12</p> <p>Outer Diam./Diam. esterno [mm]      29,5</p> | <p><b>MAZDA 323 F VI (BJ)</b><br/> 1.4 16V/1.5 16V/1.6/1.9 16V/2.0 D/2.0 TD</p> <p><b>MAZDA 323 VI P (BJ)</b><br/> 1.4 16V/1.5 16V</p> <p><b>MAZDA 323 VI S (BJ)</b><br/> 1.4/1.4 16V/1.5 16V/1.6/1.9 16V/2.0/2.0 Astina/2.0 D/2.0<br/> DiTD/2.0 TD</p> <p><b>MAZDA PREMACY (CP)</b><br/> 1.8/1.9/2.0/2.0 TD/2.3 SVT</p>   |  <p>305</p>    |

|                                |   |  |   |   |
|--------------------------------|---|--|---|---|
| <b>GOM-306</b>                 | <b>Holder, control arm mounting</b>   | <b>MAZDA 323 F VI (BJ)</b><br>1.4 16V/1.5 16V/1.6/1.9 16V/2.0 D/2.0 TD                             |  <p>RU-306</p> |   |
|                                | <b>Silentblock</b>  | <b>MAZDA 323 VI P (BJ)</b><br>1.4 16V/1.5 16V  |   |   |
| MAZDA                          | B25D 34 460   | <b>MAZDA 323 VI S (BJ)</b><br>1.4/1.4 16V/1.5 16V/1.6/1.9 16V/2.0/2.0 Astina/2.0 D/2.0 DiTD/2.0 TD |   |   |
| Length/Lunghezza [mm]          | 48  | <b>MAZDA PREMACY (CP)</b><br>1.8/1.9/2.0/2.0 TD/2.3 SVT  |   |   |
| Inner Diam./Diam. Interno [mm] | 16  | <b>MAZDA 626 IV (GE)</b><br>1.8 i/2.0 D GLX Comprex/2.0 i/2.0 i 4WD                                |   |   |
| Outer Diam./Diam. esterno [mm] | 48,5  | <b>MAZDA 626 IV Hatchback (GE)</b><br>1.8/2.0 D GLX Comprex/2.0 i/2.0 i 4WD/2.5 24V                |   |   |
| <b>GOM-307</b>                 | <b>Holder, control arm mounting</b>   | <b>MAZDA 626 V (GF)</b><br>1.8/2.0/2.0 DiTD/2.0 TD/2.0 Turbo DI                                    |   |  <p>RU-307</p> |
| <b>Silentblock</b>             | <b>MAZDA 626 V Hatchback (GF)</b><br>1.8/2.0/2.0 DiTD/2.0 H.P./2.0 TD/2.0 Turbo DI  |  |   |   |
| MAZDA                          | GA2A 34 470   | <b>MAZDA 626 V SW (GW)</b><br>1.8/2.0/2.0 DiTD/2.0 H.P./2.0 TD/2.0 Turbo DI                        |   |   |
| Length/Lunghezza [mm]          | 60  | <b>MAZDA XEDOS 6 (CA)</b><br>1.6 16V/2.0 V6  |   |   |
| Inner Diam./Diam. Interno [mm] | 13  | <b>MAZDA 626 IV (GE)</b><br>1.8 i/2.0 D GLX Comprex/2.0 i/2.0 i 4WD                                |   |   |
| Outer Diam./Diam. esterno [mm] | 39  | <b>MAZDA 626 IV Hatchback (GE)</b><br>1.8/2.0 D GLX Comprex/2.0 i/2.0 i 4WD/2.5 24V                |   |   |
| <b>GOM-308</b>                 | <b>Holder, control arm mounting</b>   | <b>MAZDA 626 IV (GE)</b><br>1.8 i/2.0 D GLX Comprex/2.0 i/2.0 i 4WD                                |  <p>308</p>   |   |
| <b>Silentblock</b>             | <b>MAZDA 626 IV Hatchback (GE)</b><br>1.8/2.0 D GLX Comprex/2.0 i/2.0 i 4WD/2.5 24V |  |   |   |
| MAZDA                          | GA2A 34 46YA  | <b>MAZDA 626 V (GF)</b><br>1.8/2.0/2.0 DiTD/2.0 TD/2.0 Turbo DI                                    |   |   |
| Length/Lunghezza [mm]          | 168   | <b>MAZDA 626 V Hatchback (GF)</b><br>1.8/2.0/2.0 DiTD/2.0 H.P./2.0 TD/2.0 Turbo DI                 |   |   |
| Height/Altezza [mm]            | 65,5  | <b>MAZDA 626 V SW (GW)</b><br>1.8/2.0/2.0 DiTD/2.0 H.P./2.0 TD/2.0 Turbo DI                        |   |   |
| Width/Larghezza [mm]           | 70  | <b>MAZDA XEDOS 6 (CA)</b><br>1.6 16V/2.0 V6  |   |   |
| <b>GOM-309</b>                 | <b>Holder, control arm mounting</b>   | <b>MAZDA 626 IV (GE)</b><br>1.8 i/2.0 D GLX Comprex/2.0 i/2.0 i 4WD                                |  <p>309</p>  |   |
| <b>Silentblock</b>             | <b>MAZDA 626 IV Hatchback (GE)</b><br>1.8/2.0 D GLX Comprex/2.0 i/2.0 i 4WD/2.5 24V |  |   |   |
| MAZDA                          | GA2A 34 46XA  | <b>MAZDA 626 V (GF)</b><br>1.8/2.0/2.0 DiTD/2.0 TD/2.0 Turbo DI                                    |   |   |
| Length/Lunghezza [mm]          | 168   | <b>MAZDA 626 V Hatchback (GF)</b><br>1.8/2.0/2.0 DiTD/2.0 H.P./2.0 TD/2.0 Turbo DI                 |   |   |
| Height/Altezza [mm]            | 65,5  | <b>MAZDA 626 V SW (GW)</b><br>1.8/2.0/2.0 DiTD/2.0 H.P./2.0 TD/2.0 Turbo DI                        |   |   |
| Width/Larghezza [mm]           | 70  | <b>MAZDA XEDOS 6 (CA)</b><br>1.6 16V/2.0 V6  |   |   |
| <b>GOM-310</b>                 | <b>Holder, control arm mounting</b>   | <b>MAZDA 626 V (GF)</b><br>1.8/2.0/2.0 DiTD/2.0 TD/2.0 Turbo DI                                    |  <p>310</p>  |   |
| <b>Silentblock</b>             | <b>MAZDA 626 V Hatchback (GF)</b><br>1.8/2.0/2.0 DiTD/2.0 H.P./2.0 TD/2.0 Turbo DI  |  |   |   |
| MAZDA                          | GE4T 34 46YD  | <b>MAZDA 626 V SW (GW)</b><br>1.8/2.0/2.0 DiTD/2.0 H.P./2.0 TD/2.0 Turbo DI                        |   |   |
| Length/Lunghezza [mm]          | 167   | <b>MAZDA XEDOS 6 (CA)</b><br>1.6 16V/2.0 V6  |   |   |
| Height/Altezza [mm]            | 71  | <b>MAZDA 626 V (GF)</b><br>1.8/2.0/2.0 DiTD/2.0 TD/2.0 Turbo DI                                    |   |   |
| Width/Larghezza [mm]           | 70  | <b>MAZDA 626 V Hatchback (GF)</b><br>1.8/2.0/2.0 DiTD/2.0 H.P./2.0 TD/2.0 Turbo DI                 |   |   |
| <b>GOM-311</b>                 | <b>Holder, control arm mounting</b>   | <b>MAZDA 626 V (GF)</b><br>1.8/2.0/2.0 DiTD/2.0 TD/2.0 Turbo DI                                    |  <p>311</p>  |   |
| <b>Silentblock</b>             | <b>MAZDA 626 V Hatchback (GF)</b><br>1.8/2.0/2.0 DiTD/2.0 H.P./2.0 TD/2.0 Turbo DI  |  |   |   |
| MAZDA                          | GE4T 34 46XD  | <b>MAZDA 626 V SW (GW)</b><br>1.8/2.0/2.0 DiTD/2.0 H.P./2.0 TD/2.0 Turbo DI                        |   |   |
| Length/Lunghezza [mm]          | 167   | <b>MAZDA XEDOS 6 (CA)</b><br>1.6 16V/2.0 V6  |   |   |
| Height/Altezza [mm]            | 71  | <b>MAZDA 626 V (GF)</b><br>1.8/2.0/2.0 DiTD/2.0 TD/2.0 Turbo DI                                    |   |   |
| Width/Larghezza [mm]           | 70  | <b>MAZDA 626 V Hatchback (GF)</b><br>1.8/2.0/2.0 DiTD/2.0 H.P./2.0 TD/2.0 Turbo DI                 |   |   |
| <b>GOM-312</b>                 | <b>Holder, control arm mounting</b>   | <b>MAZDA E 2000,2200 Autobus (SR1)</b><br>2.0/2.0 4WD/2.2 D  |  <p>312</p>  |   |
| <b>Silentblock</b>             | <b>MAZDA E 2000,2200 Furgonato (SR2)</b><br>2.0/2.2 D/2.2 D 4WD                     |  |   |   |
| MAZDA                          | S083 34 840A  |  |   |   |

|                                |                                     |  |   |
|--------------------------------|-------------------------------------|--|---|
| <b>GOM-313</b>                 | <b>Holder, control arm mounting</b> | <b>MAZDA E 2000,2200 Autobus (SR1)</b><br>2.0/2.0 4WD/2.2 D  |    |
|                                | <b>Silentblock</b>                  | <b>MAZDA E 2000,2200 Furgonato (SR2)</b><br>2.0/2.2 D/2.2 D 4WD  |   |
| MAZDA                          | S083 34 830A                        |  |   |
| Length/Lunghezza [mm]          |                                     | 72,5   |   |
| Inner Diam./Diam. Interno [mm] |                                     | 24,4   |   |
| Outer Diam./Diam. esterno [mm] |                                     | 45   |   |
| <b>GOM-314</b>                 | <b>Holder, control arm mounting</b> | <b>MAZDA E 2000,2200 Autobus (SR1)</b><br>2.0/2.0 4WD/2.2 D  |    |
|                                | <b>Silentblock</b>                  | <b>MAZDA E 2000,2200 Furgonato (SR2)</b><br>2.0/2.2 D/2.2 D 4WD  |   |
| MAZDA                          | S083-34-460                         |  |   |
| Length/Lunghezza [mm]          |                                     | 79   |   |
| Inner Diam./Diam. Interno [mm] |                                     | 16,5   |   |
| Outer Diam./Diam. esterno [mm] |                                     | 45,5   |   |
| <b>GOM-315</b>                 | <b>Holder, control arm mounting</b> | <b>FORD FIESTA V (JH_)</b><br>1.25 16V/1.3/1.4 16V/1.4 TDCi/1.6 16V/1.6 TDCi/ST150                               |    |
|                                | <b>Silentblock</b>                  | <b>FORD FUSION (JU_)</b><br>1.25/1.4/1.4 TDCi/1.6/1.6 TDCi   |   |
| MAZDA                          | DD3234300                           | <b>MAZDA 2</b><br>1.25/1.3 L/1.4/1.4 CD/1.5/1.6  |   |
| Length/Lunghezza [mm]          |                                     | 55   |   |
| Inner Diam./Diam. Interno [mm] |                                     | 12   |   |
| Outer Diam./Diam. esterno [mm] |                                     | 40,4   |   |
| <b>GOM-316</b>                 | <b>Holder, control arm mounting</b> | <b>FORD FIESTA V (JH_)</b><br>1.25 16V/1.3/1.4 16V/1.4 TDCi/1.6 16V/1.6 TDCi/ST150                               |   |
|                                | <b>Silentblock</b>                  | <b>FORD FUSION (JU_)</b><br>1.25/1.4/1.4 TDCi/1.6/1.6 TDCi   |   |
| MAZDA                          | DD3234300                           | <b>MAZDA 2</b><br>1.25/1.3 L/1.4/1.4 CD/1.5/1.6  |   |
| Length/Lunghezza [mm]          |                                     | 148,5  |   |
| Width/Larghezza [mm]           |                                     | 65   |   |
| Inner Diam./Diam. Interno [mm] |                                     | 22   |   |
| Inner Diam./Diam. Int. 1 [mm]  |                                     | 21   |   |
| Outer Diam./Diam. esterno [mm] |                                     | 72,4   |   |
| <b>GOM-317</b>                 | <b>Holder, control arm mounting</b> | <b>FORD FOCUS (DAW, DBW)</b><br>1.4 16V/1.6 16V/1.8 16V/1.8 DI / TDDi/1.8 TDCi/1.8 Turbo DI / TDDi/2.0 16V/ST170 |  |
|                                | <b>Silentblock</b>                  | <b>FORD FOCUS C-MAX</b><br>1.6/1.6 TDCi/1.6 Ti/1.8/1.8 Flexifuel/1.8 TDCi/2.0/2.0 TDCi                           |   |
| VOLVO                          | 30666821                            | <b>FORD FOCUS II</b><br>1.4/1.6/1.6 TDCi/1.6 Ti/1.8 Flexifuel/1.8 TDCi/2.0/2.0 TDCi/2.5 ST                       |   |
| Length/Lunghezza [mm]          |                                     | 142  |   |
| Diameter/Diametro [mm]         |                                     | 60,5   |   |
|                                |                                     | <b>FORD FOCUS II Cabriolet</b><br>1.6/2.0/2.0 TDCi   |   |
|                                |                                     | <b>FORD FOCUS II Tre volumi</b><br>1.4/1.6/1.6 TDCi/1.6 Ti/1.8 Flexifuel/1.8 TDCi/2.0/2.0 TDCi                   |   |
|                                |                                     | <b>FORD FOCUS II Turnier</b><br>1.4/1.6/1.6 TDCi/1.6 Ti/1.8 Flexifuel/1.8 TDCi/2.0/2.0 TDCi                      |   |
|                                |                                     | <b>FORD FOCUS SW (DNW)</b><br>1.4 16V/1.6 16V/1.8 16V/1.8 DI / TDDi/1.8 TDCi/1.8 Turbo DI / TDDi/2.0 16V/ST170   |   |
|                                |                                     | <b>FORD FOCUS Tre volumi (DFW)</b><br>1.4 16V/1.6 16V/1.8 16V/1.8 TDCi/1.8 Turbo DI / TDDi/2.0 16V               |   |
|                                |                                     | <b>MAZDA 3</b><br>1.4/1.6/1.6 DI Turbo/2.0/2.3 DiSi Turbo MPS/2.3 MPS/2.3 MZR/2.3 MZR Sport                      |   |
|                                |                                     | <b>MAZDA 3 Tre volumi</b><br>1.6/1.6 DI Turbo/2.0  |   |
|                                |                                     | <b>MAZDA 5</b><br>1.8/2.0/2.0 CD/2.3   |   |
|                                |                                     | <b>VOLVO C30</b><br>1.6/1.6 D/1.8/1.8 FlexFuel/2.0/2.0 D/2.4 D5/2.4 i/D5/T5                                      |   |
|                                |                                     | <b>VOLVO S40 II</b><br>1.6/1.6 D/1.8/2.0/2.0 D/2.4/2.4 D5/T5/T5 AWD  |   |
|                                |                                     | <b>VOLVO V50</b>   |   |

|                                 |                                      |   |   |   |
|---------------------------------|--------------------------------------|---|---|---|
|                                 |                                      | 1.6/1.6 D/1.8/2.0/2.0 D/2.4/2.4 D5/T5/T5 AWD                    |   |   |
| <b>GOM-318</b>                  | <b>Holder, control arm mounting</b>  | <b>MAZDA 6 (GG)</b>   |  |   |
|                                 | <b>Silentblock</b>                   | 1.8/2.0/2.0 DI/2.3  |   |   |
| MAZDA                           | GJ6A-34-470A                         | <b>MAZDA 6 Hatchback (GG)</b>                                   |   |   |
|                                 |                                      | 1.8/2.0/2.0 DI/2.3  |   |   |
|                                 |                                      | <b>MAZDA 6 SW (GY)</b>  |   |   |
| Length/Lunghezza [mm]           | 57,2                                 | 1.8/2.0/2.0 DI/2.3/2.3 AWD                                      |   |   |
| Inner Diam./Diam. Interno [mm]  | 12                                   |   |   |   |
| Outer Diam./Diam. esterno [mm]  | 40,2                                 |   |   |   |
| <b>GOM-319</b>                  | <b>Holder, control arm mounting</b>  | <b>MAZDA 6 (GG)</b>   |   |    |
|                                 | <b>Silentblock</b>                   | 1.8/2.0/2.0 DI/2.3  |   |   |
| MAZDA                           | GJ6A-34-710A                         | <b>MAZDA 6 Hatchback (GG)</b>                                   |   |   |
|                                 |                                      | 1.8/2.0/2.0 DI/2.3  |   |   |
|                                 |                                      | <b>MAZDA 6 SW (GY)</b>  |   |   |
| Length/Lunghezza [mm]           | 49,5                                 | 1.8/2.0/2.0 DI/2.3/2.3 AWD                                      |   |   |
| Inner Diam./Diam. Interno [mm]  | 12,5                                 |   |   |   |
| Outer Diam./Diam. esterno [mm]  | 44,2                                 |   |   |   |
| <b>GOM-320</b>                  | <b>Holder, control arm mounting</b>  | <b>MAZDA 6 (GG)</b>   |  |   |
|                                 | <b>Silentblock</b>                   | 1.8/2.0/2.0 DI/2.3  |   |   |
| MAZDA                           | GJ6A-34-460A                         | <b>MAZDA 6 Hatchback (GG)</b>                                   |   |   |
|                                 |                                      | 1.8/2.0/2.0 DI/2.3  |   |   |
|                                 |                                      | <b>MAZDA 6 SW (GY)</b>  |   |   |
| Length/Lunghezza [mm]           | 79,4                                 | 1.8/2.0/2.0 DI/2.3/2.3 AWD                                      |   |   |
| Inner Diam./Diam. Interno [mm]  | 12                                   |   |   |   |
| Outer Diam./Diam. esterno [mm]  | 62,5                                 |   |   |   |
| <b>GOM-321</b>                  | <b>Bearing Bush, stabiliser</b>      | <b>FORD ESCORT '91 Express (AVL)</b>                            |   |  |
|                                 | <b>Boccola barra stabilizzatrice</b> | 1.3/1.4/1.8 D   |   |   |
| MAZDA                           | 1E00-34-156                          | <b>FORD ESCORT '95 Furgonato (AVL)</b>                          |   |   |
|                                 |                                      | 1.4/1.8 D/1.8 Turbo D   |   |   |
| Fitting Position/Lato Montaggio | Front                                | <b>FORD ESCORT CLASSIC (AAL, ABL)</b>                           |   |   |
| Length/Lunghezza [mm]           | 30                                   | 1.6 16V   |   |   |
| Height/Altezza [mm]             | 30                                   | <b>FORD ESCORT CLASSIC Turnier (ANL)</b>                        |   |   |
| Width/Larghezza [mm]            | 40                                   | 1.6 16V/1.8 TD  |   |   |
| Inner Diam./Diam. Interno [mm]  | 14                                   | <b>FORD ESCORT II (ATH)</b>                                     |   |   |
|                                 |                                      | 1.1/1.3/1.6 RS/2.0 RS (BATN)/2.0 RS Trazione posteriore/RS 1800 |   |   |
|                                 |                                      | <b>FORD ESCORT II SW</b>  |   |   |
|                                 |                                      | 1.1/1.3 (BADR)/1.3 (CADR)                                       |   |   |
|                                 |                                      | <b>FORD ESCORT III (GAA)</b>                                    |   |   |
|                                 |                                      | 1.1/1.3/1.6/1.6 D/1.6 i (GAA)/1.6 RS Turbo/1.6 XR3i/1.7 Turbo   |   |   |
|                                 |                                      | RS/RS 1600i   |   |   |
|                                 |                                      | <b>FORD ESCORT III Cabriolet (ALD)</b>                          |   |   |
|                                 |                                      | 1.3/1.6/1.6 i   |   |   |
|                                 |                                      | <b>FORD ESCORT III SW (AWA)</b>                                 |   |   |
|                                 |                                      | 1.1/1.3/1.6/1.6 D   |   |   |
|                                 |                                      | <b>FORD ESCORT V (GAL)</b>                                      |   |   |
|                                 |                                      | 1.3/1.4/1.6/1.8 16V XR3i/1.8 D                                  |   |   |
|                                 |                                      | <b>FORD ESCORT V Cabriolet (ALL)</b>                            |   |   |
|                                 |                                      | 1.4/1.6/1.8 16V XR3i  |   |   |
|                                 |                                      | <b>FORD ESCORT V SW (GAL, AVL)</b>                              |   |   |
|                                 |                                      | 1.3/1.4/1.6/1.8 16V/1.8 D                                       |   |   |
|                                 |                                      | <b>FORD ESCORT VI (GAL)</b>                                     |   |   |
|                                 |                                      | 1.3/1.4/1.6 i 16V/1.8 16V XR3i/1.8 D/1.8 i 16V/1.8 TD/1.8 XR3i  |   |   |
|                                 |                                      | 16V 4x4   |   |   |
|                                 |                                      | <b>FORD ESCORT VI Cabriolet (ALL)</b>                           |   |   |
|                                 |                                      | 1.6 16V XR3i/1.6 i 16V/1.8 16V XR3i                             |   |   |
|                                 |                                      | <b>FORD ESCORT VI SW (GAL)</b>                                  |   |   |
|                                 |                                      | 1.3/1.4/1.6 i 16V/1.8 D/1.8 i 16V/1.8 TD                        |   |   |
|                                 |                                      | <b>FORD ESCORT VI Tre volumi (GAL)</b>                          |   |   |
|                                 |                                      | 1.3/1.4/1.6 i 16V/1.8 i 16V/1.8 TD                              |   |   |
|                                 |                                      | <b>FORD ESCORT VII (GAL, AAL, ABL)</b>                          |   |   |
|                                 |                                      | 1.3/1.4/1.6 16V/1.6 16V 4x4/1.6 i 16V/1.8 16V/1.8 D/1.8 TD/1.8  |   |   |
|                                 |                                      | Turbo D/RS Cosworth 4x4   |   |   |
|                                 |                                      | <b>FORD ESCORT VII Cabriolet (ALL)</b>                          |   |   |
|                                 |                                      | 1.4/1.6 16V XR3i/1.8 16V XR3i/1.8 TD/1.8 Turbo D                |   |   |
|                                 |                                      | <b>FORD ESCORT VII SW (GAL, ANL)</b>                            |   |   |

|                                |                                     |
|--------------------------------|-------------------------------------|
| <b>GOM-322</b>                 | <b>Holder, control arm mounting</b> |
|                                | <b>Silentblock</b>                  |
| MAZDA                          | 1E00-28-460C                        |
| Length/Lunghezza [mm]          | 70                                  |
| Inner Diam./Diam. Interno [mm] | 12,5                                |
| Outer Diam./Diam. esterno [mm] | 64                                  |

|  |
|--|
| 1.3/1.4/1.6 16V/1.6 i 16V/1.8 16V/1.8 D/1.8 TD/1.8 Turbo D                             |
| <b>FORD ESCORT VII Tre volumi (GAL, AFL)</b>   |
| 1.3/1.4/1.6 i 16V/1.8 16V/1.8 D/1.8 TD/1.8 Turbo D                                     |
| <b>FORD FIESTA Furgonato (J5_, J3_)</b>  |
| 1.3/1.4 i/1.8 D/1.8 DI   |
| <b>FORD FIESTA Furgonato (JV_)</b>   |
| D 1.8/TD 1.8   |
| <b>FORD FIESTA III (GFJ)</b>   |
| 1.1/1.3/1.3 Cat./1.4/1.4 Cat./1.6/1.6 XR2i/1.8 16V/1.8 D                               |
| <b>FORD FIESTA IV (JA_, JB_)</b>   |
| 1.0 i/1.25 i 16V/1.3 i/1.4 i 16V/1.6 16V Sport/1.8 D/1.8 DI                            |
| <b>FORD ORION III (GAL)</b>  |
| 1.3/1.4/1.6/1.6 i/1.6 i 16V/1.8 D/1.8 i 16V/1.8 TD                                     |
| <b>MAZDA 121 III (JASM, JBSM)</b>  |
| 1.25/1.3/1.3i 16V CABRIO (JJA)/1.8 D   |
| <b>SAAB 9-3 Cabriolet (YS3D)</b>   |
| 2.0 Turbo  |
| <b>SUBARU JUSTY II (JMA, MS)</b>   |
| 1.3 4x4  |
| <b>FORD ESCORT '91 Express (AVL)</b>   |
| 1.3/1.4/1.8 D  |
| <b>FORD ESCORT '95 Furgonato (AVL)</b>   |
| 1.4/1.8 D/1.8 Turbo D  |
| <b>FORD ESCORT V (GAL)</b>   |
| 1.3/1.4/1.6/1.8 16V XR3i/1.8 D   |
| <b>FORD ESCORT V Cabriolet (ALL)</b>   |
| 1.4/1.6/1.8 16V XR3i   |
| <b>FORD ESCORT V SW (GAL, AVL)</b>   |
| 1.3/1.4/1.6/1.8 16V/1.8 D  |
| <b>FORD ESCORT VI (GAL)</b>  |
| 1.3/1.4/1.6 i 16V/1.8 16V XR3i/1.8 D/1.8 i 16V/1.8 TD/1.8 XR3i 16V 4x4                 |
| <b>FORD ESCORT VI Cabriolet (ALL)</b>  |
| 1.6 16V XR3i/1.6 i 16V/1.8 16V XR3i  |
| <b>FORD ESCORT VI SW (GAL)</b>   |
| 1.3/1.4/1.6 i 16V/1.8 D/1.8 i 16V/1.8 TD   |
| <b>FORD ESCORT VI Tre volumi (GAL)</b>   |
| 1.3/1.4/1.6 i 16V/1.8 i 16V/1.8 TD   |
| <b>FORD ESCORT VII (GAL, AAL, ABL)</b>   |
| 1.3/1.4/1.6 16V/1.6 16V 4x4/1.6 i 16V/1.8 16V/1.8 D/1.8 TD/1.8 Turbo D/RS Cosworth 4x4 |
| <b>FORD ESCORT VII Cabriolet (ALL)</b>   |
| 1.4/1.6 16V XR3i/1.8 16V XR3i/1.8 TD/1.8 Turbo D                                       |
| <b>FORD ESCORT VII SW (GAL, ANL)</b>   |
| 1.3/1.4/1.6 16V/1.6 i 16V/1.8 16V/1.8 D/1.8 TD/1.8 Turbo D                             |
| <b>FORD ESCORT VII Tre volumi (GAL, AFL)</b>   |
| 1.3/1.4/1.6 i 16V/1.8 16V/1.8 D/1.8 TD/1.8 Turbo D                                     |
| <b>MAZDA 121 III (JASM, JBSM)</b>  |
| 1.25/1.3/1.3i 16V CABRIO (JJA)/1.8 D   |



|                                 |                                     |
|---------------------------------|-------------------------------------|
| <b>GOM-323</b>                  | <b>Holder, control arm mounting</b> |
|                                 | <b>Silentblock</b>                  |
| FORD                            | 13000384                            |
| Fitting Position/Lato Montaggio | Rear                                |
| Length/Lunghezza [mm]           | 35                                  |
| Inner Diam./Diam. Interno [mm]  | 12                                  |
| Outer Diam./Diam. esterno [mm]  | 36                                  |

|  |
|--|
| <b>FORD FOCUS (DAW, DBW)</b>   |
| 1.4 16V/1.6 16V/1.8 16V/1.8 DI / TDDi/1.8 TDCi/1.8 Turbo DI / TDDi/2.0 16V/ST170 |
| <b>FORD FOCUS SW (DNW)</b>   |
| 1.4 16V/1.6 16V/1.8 16V/1.8 DI / TDDi/1.8 TDCi/1.8 Turbo DI / TDDi/2.0 16V/ST170 |
| <b>FORD FOCUS Tre volumi (DFW)</b>   |
| 1.4 16V/1.6 16V/1.8 16V/1.8 TDCi/1.8 Turbo DI / TDDi/2.0 16V                     |
| <b>MAZDA 3</b>   |
| 1.4/1.6/1.6 DI Turbo/2.0/2.3 DiSi Turbo MPS/2.3 MPS/2.3 MZR/2.3 MZR Sport        |
| <b>MAZDA 3 Tre volumi</b>  |
| 1.6/1.6 DI Turbo/2.0   |
| <b>VOLVO C30</b>   |
| 1.6/1.6 D/1.8/1.8 FlexFuel/2.0/2.0 D/2.4 D5/2.4 i/D5/T5                          |
| <b>VOLVO S40 II</b>  |
| 1.6/1.6 D/1.8/2.0/2.0 D/2.4 D5/T5/T5 AWD   |
| <b>VOLVO V50</b>   |



|                                    |   |  |   |
|------------------------------------|---|--|---|
|                                    |   | 1.6/1.6 D/1.8/2.0/2.0 D/2.4/2.4 D5/T5/T5 AWD   |   |
| <b>GOM-324</b>                     | <b>Holder, control arm mounting</b>     | <b>FORD RANGER</b>                             |    |
|                                    | <b>Silentblock</b>                      | 2.5 D/2.5 D 4x4/2.5 TD/2.5 TD 4x4              |   |
|                                    |   | <b>MAZDA B-SERIE (UN)</b>                      |   |
|                                    |   | 2.5 D/2.5 D 4WD/2.5 TD 4WD                     |   |
| MAZDA                              | UH71-34-470                             |  |   |
| Fitting Position/Lato Montaggio    |   | Upper Front Axle                               |   |
| Length/Lunghezza [mm]              |   | 50   |   |
| Inner Diam./Diam. Interno [mm]     |   | 18   |   |
| Outer Diam./Diam. esterno [mm]     |   | 49   |   |
| <b>GOM-325</b>                     | <b>Suspension Strut Support Bearing</b> | <b>MAZDA 323 F V (BA)</b>                      |    |
|                                    | <b>Supporto ammortizzatore</b>          | 1.5 16V/1.8 16V                                |   |
|                                    |   | <b>MAZDA 323 V C (BA)</b>                      |   |
|                                    |   | 1.3 16V/1.5 16V/1.8 16V                        |   |
| MAZDA                              | B01C34380                               | <b>MAZDA 323 V S (BA)</b>                      |   |
| Fitting Position/Lato Montaggio    |   | 1.3 16V/1.5 16V/1.6 TD/1.8 16V/2.0 D           |   |
| Length/Lunghezza [mm]              |   | 139  |   |
| Height/Altezza [mm]                |   | 54   |   |
| Width/Larghezza [mm]               |   | 122  |   |
| Inner Diam./Diam. Interno [mm]     |   | 9  |   |
| <b>GOM-326</b>                     | <b>Suspension Strut Support Bearing</b> | <b>MAZDA 323 F V (BA)</b>                      |   |
|                                    | <b>Supporto ammortizzatore</b>          | 1.5 16V/1.8 16V/2.0 24V                        |   |
|                                    |   | <b>MAZDA 323 V C (BA)</b>                      |   |
|                                    |   | 1.3 16V/1.5 16V/1.8 16V                        |   |
| MAZDA                              | BC1D-28-390                             | <b>MAZDA 323 V P (BA)</b>                      |   |
| Fitting Position/Lato Montaggio    |   | 1.3 16V/1.5 16V/2.0 D                          |   |
| Height/Altezza [mm]                |   | 64   |   |
| Inner Diam./Diam. Interno [mm]     |   | 13   |   |
|                                    |   | 1.3 16V/1.5 16V/1.6 TD/1.8 16V/2.0 D           |   |
| <b>GOM-327</b>                     | <b>Suspension Strut Support Bearing</b> | <b>MAZDA 323 F V (BA)</b>                      |  |
|                                    | <b>Supporto ammortizzatore</b>          | 1.5 16V/1.8 16V/2.0 24V                        |   |
|                                    |   | <b>MAZDA 323 V C (BA)</b>                      |   |
|                                    |   | 1.3 16V/1.5 16V/1.8 16V                        |   |
| MAZDA                              | BC1D-28-380                             | <b>MAZDA 323 V P (BA)</b>                      |   |
| Fitting Position/Lato Montaggio    |   | 1.3 16V/1.5 16V/2.0 D                          |   |
| Height/Altezza [mm]                |   | 64   |   |
| Inner Diam./Diam. Interno [mm]     |   | 13   |   |
|                                    |   | 1.3 16V/1.5 16V/1.6 TD/1.8 16V/2.0 D           |   |
| <b>GOM-328</b>                     | <b>Suspension Strut Support Bearing</b> | <b>MAZDA 323 F VI (BJ)</b>                     |  |
|                                    | <b>Supporto ammortizzatore</b>          | 1.5 16V/1.6/2.0/2.0 D/2.0 TD                   |   |
|                                    |   | <b>MAZDA 323 VI S (BJ)</b>                     |   |
|                                    |   | 1.5 16V/1.6/2.0 D/2.0 TD                       |   |
| MAZDA                              | B25D-34-380A                            |  |   |
| Fitting Position/Lato Montaggio    |   | Front Axle                                     |   |
| Height/Altezza [mm]                |   | 31   |   |
| Inner Diam./Diam. Interno [mm]     |   | 12   |   |
| Mount. Bores/Fori Fiss. Dist. [mm] |   | 97   |   |
| <b>GOM-329</b>                     | <b>Bush, leaf spring</b>                | <b>FORD RANGER</b>                             |  |
|                                    | <b>Boccola balestra</b>                 | 2.5 D/2.5 D 4x4/2.5 TD/2.5 TD 4x4              |   |
|                                    |   | <b>MAZDA B-SERIE (UN)</b>                      |   |
|                                    |   | 2.5 D/2.5 D 4WD/2.5 TD 4WD                     |   |
| MAZDA                              | UH71-28-450                             |  |   |
| Fitting Position/Lato Montaggio    |   | Front Axle                                     |   |
| Length/Lunghezza [mm]              |   | 37   |   |
| Inner Diam./Diam. Interno [mm]     |   | 17,5   |   |
| Outer Diam./Diam. esterno [mm]     |   | 32   |   |
| <b>GOM-330</b>                     | <b>Bush, leaf spring</b>                | <b>FORD RANGER</b>                             |  |
|                                    | <b>Boccola balestra</b>                 | 2.5 D/2.5 D 4x4/2.5 TD/2.5 TD 4x4/3.0 TDCi 4x4 |   |
|                                    |   | <b>MAZDA B-SERIE (UN)</b>                      |   |
|                                    |   | 2.5 D/2.5 D 4WD/2.5 TD 4WD                     |   |
| MAZDA                              | UH71-28-470                             |  |   |
| Fitting Position/Lato Montaggio    |   | Rear Axle Upper                                |   |
| Length/Lunghezza [mm]              |   | 46   |   |
| Inner Diam./Diam. Interno [mm]     |   | 19   |   |
| Outer Diam./Diam. esterno [mm]     |   | 32   |   |





**RUBBER PARTS LIST**  
**MOTORAUFHÄNGUNG LISTE**  
**LISTE SILENT BLOCS**  
**LISTA TAPONES DE GOMA**  
**LISTA PARTI IN GOMMA**



|                                 |                                      |  |   |
|---------------------------------|--------------------------------------|--|---|
| <b>GOM-331</b>                  | <b>Bush, leaf spring</b>             | <b>FORD RANGER</b>                             |    |
|                                 | <b>Boccola balestra</b>              | 2.5 D/2.5 D 4x4/2.5 TD/2.5 TD 4x4/3.0 TDCi 4x4 |   |
| MAZDA                           | UH71-28-480                          | <b>MAZDA B-SERIE (UN)</b>                      |   |
|                                 |                                      | 2.5 D/2.5 D 4WD/2.5 TD 4WD                     |   |
| Fitting Position/Lato Montaggio |                                      | Rear Axle Lower                                |   |
| <b>GOM-332</b>                  | <b>Bush, leaf spring</b>             | <b>MAZDA B-SERIE (UF)</b>                      |    |
|                                 | <b>Boccola balestra</b>              | 2.5 D/2.5 D 4WD                                |   |
| MAZDA                           | UB39-28-333                          |  |   |
| Fitting Position/Lato Montaggio |                                      | Rear Axle Upper                                |   |
| Length/Lunghezza [mm]           |                                      | 46   |   |
| Inner Diam./Diam. Interno [mm]  |                                      | 18   |   |
| Outer Diam./Diam. esterno [mm]  |                                      | 32,5   |   |
| <b>GOM-333</b>                  | <b>Bush, leaf spring</b>             | <b>MAZDA B-SERIE (UF)</b>                      |    |
|                                 | <b>Boccola balestra</b>              | 2.5 D/2.5 D 4WD                                |   |
| MAZDA                           | UB40-28-333                          |  |   |
| Fitting Position/Lato Montaggio |                                      | Rear Axle Lower                                |   |
| <b>GOM-334</b>                  | <b>Holder, control arm mounting</b>  | <b>MAZDA 2</b>                                 |   |
|                                 | <b>Silentblock</b>                   | 1.3/1.4 MZR-CD/1.5                             |   |
| MAZDA                           | D651 34 470                          |  |   |
| Length/Lunghezza [mm]           |                                      | 53   |   |
| Inner Diam./Diam. Interno [mm]  |                                      | 12   |   |
| Outer Diam./Diam. esterno [mm]  |                                      | 33   |   |
| <b>GOM-335</b>                  | <b>Bearing Bush, stabiliser</b>      | <b>MAZDA 6 (GG)</b>                            |  |
|                                 | <b>Boccola barra stabilizzatrice</b> | 1.8/2.0/2.0 DI/2.3/3.0                         |   |
| MAZDA                           | GJ6A 34 156                          | <b>MAZDA 6 Hatchback (GG)</b>                  |   |
|                                 |                                      | 1.8/2.0/2.0 DI/2.3                             |   |
|                                 |                                      | <b>MAZDA 6 SW (GY)</b>                         |   |
|                                 |                                      | 1.8/2.0/2.0 CITD 4x4/2.0 DI/2.3/2.3 AWD        |   |
| Fitting Position/Lato Montaggio |                                      | Front Axle                                     |   |
| Length/Lunghezza [mm]           |                                      | 48   |   |
| Height/Altezza [mm]             |                                      | 42   |   |
| Width/Larghezza [mm]            |                                      | 33   |   |
| Inner Diam./Diam. Interno [mm]  |                                      | 22,5   |   |
| <b>GOM-336</b>                  | <b>Bearing Bush, stabiliser</b>      | <b>MAZDA 6 (GG)</b>                            |  |
|                                 | <b>Boccola barra stabilizzatrice</b> | 1.8/2.0/2.0 DI/2.3/3.0                         |   |
| MAZDA                           | GJ6A 28 156                          | <b>MAZDA 6 Hatchback (GG)</b>                  |   |
|                                 |                                      | 1.8/2.0/2.0 DI/2.3                             |   |
|                                 |                                      | <b>MAZDA 6 SW (GY)</b>                         |   |
|                                 |                                      | 1.8/2.0/2.0 CITD 4x4/2.0 DI/2.3/2.3 AWD        |   |
| Fitting Position/Lato Montaggio |                                      | Rear Axle                                      |   |
| Length/Lunghezza [mm]           |                                      | 41,5   |   |
| Height/Altezza [mm]             |                                      | 36   |   |
| Width/Larghezza [mm]            |                                      | 33   |   |
| Inner Diam./Diam. Interno [mm]  |                                      | 19   |   |
| <b>GOM-340</b>                  | <b>Engine Mounting</b>               | <b>MAZDA 3</b>                                 |  |
|                                 | <b>Supporto motore</b>               | 1.4/1.6/1.6 DI Turbo/2.0/2.0 MZR-CD            |   |
| MAZDA                           | BP4K-39-040C                         | <b>MAZDA 3 Tre volumi</b>                      |   |
|                                 |                                      | 1.6/1.6 DI Turbo/2.0/2.0 MZR-CD                |   |
| Height/Altezza [mm]             |                                      | 44   |   |
| Inner Diam./Diam. Interno [mm]  |                                      | 12,5   |   |

|                                |                        |  |   |
|--------------------------------|------------------------|--|---|
| <b>GOM-400</b>                 | <b>Engine Mounting</b> | <b>HONDA CIVIC IV (EG, EH)</b>   |    |
|                                | <b>Supporto motore</b> | 1.5 i 16V (EG8)/1.6 16V Vtec (EH9)/1.6 VTI (EG9)                               |   |
| HONDA                          | 50841-SR3-030          | <b>HONDA CIVIC IV Coupe (EJ)</b>   |   |
| Length/Lunghezza [mm]          | 145                    | 1.5 i LSi (EJ2)/1.6 i (EJ6)/1.6 i Vtec/1.6 i Vtec (EJ1)                        |   |
| Height/Altezza [mm]            | 80                     | <b>HONDA CIVIC IV Fastback (MA, MB)</b>  |   |
| Width/Larghezza [mm]           | 49                     | 1.4 i (MA8)/1.5 i Vtec-E (MA9)/1.6 i (MB1)/1.6 i Vtec (MB1)                    |   |
| Inner Diam./Diam. Interno [mm] | 20                     | <b>HONDA CIVIC IV Hatchback (EG)</b>   |   |
|                                |                        | 1.3 16V (EG3)/1.5 i 16V/1.5 i 16V (EG4)/1.6 16V Vtec (EG5)/1.6 VTI 16V (EG6)   |   |
|                                |                        | <b>HONDA CIVIC V (EJ9, EK3/4)</b>  |   |
|                                |                        | 1.4 i (EJ9)/1.5 i (EK3)/1.6 i Vtec/1.6 VTI (EK4)                               |   |
|                                |                        | <b>HONDA CIVIC V Coupe (EJ6, EJ8)</b>  |   |
|                                |                        | 1.6 i/1.6 i Vtec   |   |
|                                |                        | <b>HONDA CIVIC V Fastback (MB)</b>   |   |
|                                |                        | 1.4 16V (MB2)/1.5 16V (MB3)/1.6 16V (MB4)/1.6 VTI/1.8 16V (MB6)/2.0 i TD (MB7) |   |
|                                |                        | <b>HONDA CIVIC VI Aerodeck (MB,MC)</b>   |   |
|                                |                        | 1.4 16V (MB8)/1.5 16V (MB9)/1.6 16V (MC1)/1.8 16V (MC2)/2.0 i D (MC3)          |   |
|                                |                        | <b>HONDA CIVIC VI Hatchback (EJ,EK)</b>  |   |
|                                |                        | 1.4 i (EJ9)/1.4 i S (EJ9)/1.5 i (EK3)/1.6 i (EK1)/1.6 VTI (EK4)                |   |
|                                |                        | <b>HONDA CRX III (EH, EG)</b>  |   |
|                                |                        | 1.6 ESi (EH6)/1.6 i VTI (EG2)  |   |
| <b>GOM-401</b>                 | <b>Engine Mounting</b> | <b>HONDA CIVIC IV (EG, EH)</b>   |   |
|                                | <b>Supporto motore</b> | 1.5 i 16V (EG8)/1.6 16V Vtec (EH9)/1.6 VTI (EG9)                               |   |
| HONDA                          | 50842-SR3-030          | <b>HONDA CIVIC IV Coupe (EJ)</b>   |   |
| Length/Lunghezza [mm]          | 145                    | 1.5 i LSi (EJ2)/1.6 i (EJ6)/1.6 i Vtec/1.6 i Vtec (EJ1)                        |   |
| Height/Altezza [mm]            | 80                     | <b>HONDA CIVIC IV Fastback (MA, MB)</b>  |   |
| Width/Larghezza [mm]           | 58                     | 1.4 i (MA8)/1.5 i Vtec-E (MA9)/1.6 i (MB1)/1.6 i Vtec (MB1)                    |   |
| Inner Diam./Diam. Interno [mm] | 20                     | <b>HONDA CIVIC IV Hatchback (EG)</b>   |   |
|                                |                        | 1.3 16V (EG3)/1.5 i 16V/1.5 i 16V (EG4)/1.6 16V Vtec (EG5)/1.6 VTI 16V (EG6)   |   |
|                                |                        | <b>HONDA CIVIC V (EJ9, EK3/4)</b>  |   |
|                                |                        | 1.4 i (EJ9)/1.5 i (EK3)/1.6 i Vtec/1.6 VTI (EK4)                               |   |
|                                |                        | <b>HONDA CIVIC V Coupe (EJ6, EJ8)</b>  |   |
|                                |                        | 1.6 i/1.6 i Vtec   |   |
|                                |                        | <b>HONDA CIVIC V Fastback (MB)</b>   |   |
|                                |                        | 1.4 16V (MB2)/1.5 16V (MB3)/1.6 16V (MB4)/1.6 VTI/1.8 16V (MB6)/2.0 i TD (MB7) |   |
|                                |                        | <b>HONDA CIVIC VI Aerodeck (MB,MC)</b>   |   |
|                                |                        | 1.4 16V (MB8)/1.5 16V (MB9)/1.6 16V (MC1)/1.8 16V (MC2)/2.0 i D (MC3)          |   |
|                                |                        | <b>HONDA CIVIC VI Hatchback (EJ,EK)</b>  |   |
|                                |                        | 1.4 i (EJ9)/1.4 i S (EJ9)/1.5 i (EK3)/1.6 i (EK1)/1.6 VTI (EK4)                |   |
|                                |                        | <b>HONDA CRX III (EH, EG)</b>  |   |
|                                |                        | 1.6 ESi (EH6)/1.6 i VTI (EG2)  |   |
| <b>GOM-402</b>                 | <b>Engine Mounting</b> | <b>HONDA CIVIC IV (EG, EH)</b>   |  |
|                                | <b>Supporto motore</b> | 1.5 i 16V (EG8)/1.6 16V Vtec (EH9)/1.6 VTI (EG9)                               |   |
| HONDA                          | 50810-SM4-000          | <b>HONDA CIVIC IV Coupe (EJ)</b>   |   |
| Length/Lunghezza [mm]          | 139                    | 1.5 i LSi (EJ2)/1.6 i (EJ6)/1.6 i Vtec/1.6 i Vtec (EJ1)                        |   |
| Height/Altezza [mm]            | 88                     | <b>HONDA CIVIC IV Fastback (MA, MB)</b>  |   |
| Width/Larghezza [mm]           | 104                    | 1.4 i (MA8)/1.5 i Vtec-E (MA9)/1.6 i (MB1)/1.6 i Vtec (MB1)                    |   |
| Inner Diam./Diam. Interno [mm] | 12                     | <b>HONDA CIVIC IV Hatchback (EG)</b>   |   |
|                                |                        | 1.3 16V (EG3)/1.5 i 16V/1.5 i 16V (EG4)/1.6 16V Vtec (EG5)/1.6 VTI 16V (EG6)   |   |
|                                |                        | <b>HONDA CIVIC V (EJ9, EK3/4)</b>  |   |
|                                |                        | 1.4 i (EJ9)/1.5 i (EK3)/1.6 i Vtec/1.6 VTI (EK4)                               |   |
|                                |                        | <b>HONDA CIVIC V Coupe (EJ6, EJ8)</b>  |   |
|                                |                        | 1.6 i/1.6 i Vtec   |   |
|                                |                        | <b>HONDA CIVIC V Fastback (MB)</b>   |   |
|                                |                        | 1.4 16V (MB2)/1.5 16V (MB3)/1.6 16V (MB4)/1.6 VTI/1.8 16V (MB6)/2.0 i TD (MB7) |   |
|                                |                        | <b>HONDA CIVIC VI Aerodeck (MB,MC)</b>   |   |
|                                |                        | 1.4 16V (MB8)/1.5 16V (MB9)/1.6 16V (MC1)/1.8 16V (MC2)/2.0 i D (MC3)          |   |
|                                |                        | <b>HONDA CIVIC VI Hatchback (EJ,EK)</b>  |   |
|                                |                        | 1.4 i (EJ9)/1.4 i S (EJ9)/1.5 i (EK3)/1.6 i (EK1)/1.6 VTI (EK4)                |   |
|                                |                        | <b>HONDA CRX III (EH, EG)</b>  |   |
|                                |                        | 1.6 ESi (EH6)/1.6 i VTI (EG2)  |   |
| <b>GOM-403</b>                 | <b>Engine Mounting</b> | <b>HONDA CIVIC IV (EG, EH)</b>   |  |
|                                | <b>Supporto motore</b> | 1.5 i 16V (EG8)/1.6 16V Vtec (EH9)/1.6 VTI (EG9)                               |   |
| HONDA                          | 50820-SR3-J02          | <b>HONDA CIVIC IV Coupe (EJ)</b>   |   |
| Length/Lunghezza [mm]          | 137                    | 1.5 i LSi (EJ2)/1.6 i (EJ6)/1.6 i Vtec/1.6 i Vtec (EJ1)                        |   |
| Height/Altezza [mm]            | 106                    | <b>HONDA CIVIC IV Fastback (MA, MB)</b>  |   |
| Width/Larghezza [mm]           | 93                     | 1.4 i (MA8)/1.5 i Vtec-E (MA9)/1.6 i (MB1)/1.6 i Vtec (MB1)                    |   |
| Inner Diam./Diam. Interno [mm] | 12                     | <b>HONDA CIVIC IV Hatchback (EG)</b>   |   |
|                                |                        | 1.3 16V (EG3)/1.5 i 16V/1.5 i 16V (EG4)/1.6 16V Vtec (EG5)/1.6 VTI 16V (EG6)   |   |
|                                |                        | <b>HONDA CIVIC V (EJ9, EK3/4)</b>  |   |
|                                |                        | 1.4 i (EJ9)/1.5 i (EK3)/1.6 i Vtec/1.6 VTI (EK4)                               |   |
|                                |                        | <b>HONDA CIVIC V Coupe (EJ6, EJ8)</b>  |   |
|                                |                        | 1.6 i/1.6 i Vtec   |   |
|                                |                        | <b>HONDA CIVIC V Fastback (MB)</b>   |   |
|                                |                        | 1.4 16V (MB2)/1.5 16V (MB3)/1.6 16V (MB4)/1.6 VTI/1.8 16V (MB6)/2.0 i TD (MB7) |   |
|                                |                        | <b>HONDA CIVIC VI Aerodeck (MB,MC)</b>   |   |
|                                |                        | 1.4 16V (MB8)/1.5 16V (MB9)/1.6 16V (MC1)/1.8 16V (MC2)/2.0 i D (MC3)          |   |
|                                |                        | <b>HONDA CIVIC VI Hatchback (EJ,EK)</b>  |   |
|                                |                        | 1.4 i (EJ9)/1.4 i S (EJ9)/1.5 i (EK3)/1.6 i (EK1)/1.6 VTI (EK4)                |   |
|                                |                        | <b>HONDA CRX III (EH, EG)</b>  |   |
|                                |                        | 1.6 ESi (EH6)/1.6 i VTI (EG2)  |   |

|                                |                        |  |   |
|--------------------------------|------------------------|--|---|
| <b>GOM-405</b>                 | <b>Engine Mounting</b> | <b>HONDA CIVIC IV (EG, EH)</b>   |    |
|                                | <b>Supporto motore</b> | 1.5 i 16V (EG8)/1.6 16V Vtec (EH9)/1.6 VTI (EG9)   |   |
| HONDA                          | 50820-SR3-J11          | <b>HONDA CIVIC IV Coupe (EJ)</b>   |   |
| Length/Lunghezza [mm]          | 134                    | 1.5 i LSi (EJ2)/1.6 i (EJ6)/1.6 i Vtec/1.6 i Vtec (EJ1)  |   |
| Height/Altezza [mm]            | 103                    | <b>HONDA CIVIC IV Fastback (MA, MB)</b>  |   |
| Width/Larghezza [mm]           | 85,5                   | 1.4 i (MA8)/1.5 i Vtec-E (MA9)/1.6 i (MB1)/1.6 i Vtec (MB1)  |   |
| Inner Diam./Diam. Interno [mm] | 12                     | <b>HONDA CIVIC IV Hatchback (EG)</b>   |   |
| <b>GOM-406</b>                 | <b>Engine Mounting</b> | <b>HONDA CIVIC I (SL)</b>  |    |
|                                | <b>Supporto motore</b> | 1300 L/1300 S  |   |
| HONDA                          | 50805-SR3-951          | <b>HONDA CIVIC I Hatchback (SB, SS)</b>  |   |
| Length/Lunghezza [mm]          | 124                    | 1200 (SB1)/1200 (SB2)/1300 L (SS)  |   |
| Height/Altezza [mm]            | 128                    | <b>HONDA CIVIC I Wagon (WC)</b>  |   |
| Width/Larghezza [mm]           | 118                    | 1300   |   |
| Inner Diam./Diam. Interno [mm] | 12                     | <b>HONDA CIVIC II</b>  |   |
|                                |                        | 1.2/1.3/1.5 GL/1.5 GT/1.5 GTi  |   |
|                                |                        | <b>HONDA CIVIC II Hatchback (AL, AJ, AG, AH)</b>   |   |
|                                |                        | 1.2 (AL)/1.3 (AG)/1.5 GL (AH)/1.5 GT (AH)/1.5 GTi (AH)   |   |
|                                |                        | <b>HONDA CIVIC III Hatchback (EC, ED, EE)</b>  |   |
|                                |                        | 1.3 (EC8)/1.3 16 V (EC8) Cat./1.4 L (EC9)/1.5 i 16V/1.5 i 16V (ED6)/1.6 i 16V/1.6 i 16V (ED7)/1.6 i 16V Vtec (EE9) |   |
|                                |                        | <b>HONDA CIVIC III Tre volumi (ED)</b>   |   |
|                                |                        | 1.3/1.3 16V (D13B1)/1.4 L (ED2)/1.5 i 16V/1.5 i 16V (ED3)/1.6 i 16V/1.6 i 16V (ED4)/1.6 i 16V 4x4                  |   |
|                                |                        | <b>HONDA CIVIC IV (EG, EH)</b>   |   |
|                                |                        | 1.5 i 16V (EG8)/1.6 16V Vtec (EH9)/1.6 VTI (EG9)   |   |
|                                |                        | <b>HONDA CIVIC IV Coupe (EJ)</b>   |   |
|                                |                        | 1.5 i LSi (EJ2)/1.6 i (EJ6)/1.6 i Vtec/1.6 i Vtec (EJ1)  |   |
|                                |                        | <b>HONDA CIVIC IV Fastback (MA, MB)</b>  |   |
|                                |                        | 1.4 i (MA8)/1.5 i Vtec-E (MA9)/1.6 i (MB1)/1.6 i Vtec (MB1)  |   |
|                                |                        | <b>HONDA CIVIC IV Hatchback (EG)</b>   |   |
|                                |                        | 1.3 16V (EG3)/1.5 i 16V/1.5 i 16V (EG4)/1.6 16V Vtec (EG5)/1.6 VTI 16V (EG6)                                       |   |
|                                |                        | <b>HONDA CIVIC Shuttle I (AN, AR)</b>  |   |
|                                |                        | 1.5 (AN)/1.5 4WD (AR)  |   |
|                                |                        | <b>HONDA CIVIC Shuttle II (EE)</b>   |   |
|                                |                        | 1.4 i 16V (EE1)/1.5 i 16V (EE2)/1.6 16V 4WD D16Z2/1.6 i 16V 4WD (EE4)  |   |
|                                |                        | <b>HONDA CIVIC V (EJ9, EK3/4)</b>  |   |
|                                |                        | 1.4 i (EJ9)/1.5 i (EK3)/1.6 i Vtec/1.6 VTI (EK4)   |   |
|                                |                        | <b>HONDA CIVIC V Coupe (EJ6, EJ8)</b>  |   |
|                                |                        | 1.6 i/1.6 i Vtec   |   |
|                                |                        | <b>HONDA CIVIC V Fastback (MB)</b>   |   |
|                                |                        | 1.4 16V (MB2)/1.5 16V (MB3)/1.6 16V (MB4)/1.6 VTI/1.8 16V (MB6)/2.0 i TD (MB7)                                     |   |
|                                |                        | <b>HONDA CIVIC VI Aerodeck (MB,MC)</b>   |   |
|                                |                        | 1.4 16V (MB8)/1.5 16V (MB9)/1.6 16V (MC1)/1.8 16V (MC2)/2.0 i D (MC3)  |   |
|                                |                        | <b>HONDA CIVIC VI Hatchback (EJ,EK)</b>  |   |
|                                |                        | 1.4 i (EJ9)/1.4 i S (EJ9)/1.5 i (EK3)/1.6 i (EK1)/1.6 VTI (EK4)  |   |
| <b>GOM-407</b>                 | <b>Engine Mounting</b> | <b>HONDA CIVIC IV (EG, EH)</b>   |  |
|                                | <b>Supporto motore</b> | 1.5 i 16V (EG8)/1.6 16V Vtec (EH9)/1.6 VTI (EG9)   |   |
| HONDA                          | 50820-SR3-J11          | <b>HONDA CIVIC IV Coupe (EJ)</b>   |   |
| Length/Lunghezza [mm]          | 132                    | 1.5 i LSi (EJ2)/1.6 i (EJ6)/1.6 i Vtec/1.6 i Vtec (EJ1)  |   |
| Height/Altezza [mm]            | 115                    | <b>HONDA CIVIC IV Fastback (MA, MB)</b>  |   |
| Width/Larghezza [mm]           | 93                     | 1.4 i (MA8)/1.5 i Vtec-E (MA9)/1.6 i (MB1)/1.6 i Vtec (MB1)  |   |
| Inner Diam./Diam. Interno [mm] | 12                     | <b>HONDA CIVIC IV Hatchback (EG)</b>   |   |
|                                |                        | 1.3 16V (EG3)/1.5 i 16V/1.5 i 16V (EG4)/1.6 16V Vtec (EG5)/1.6 VTI 16V (EG6)                                       |   |

|                                |                                     |  |   |   |
|--------------------------------|-------------------------------------|--|---|---|
| <b>GOM-409</b>                 | <b>Holder, control arm mounting</b> | <b>HONDA CIVIC I (SL)</b>  |  |   |
|                                | <b>Silentblock</b>                  | 1300 L/1300 S  |   |   |
| HONDA                          | 51392-SR3-004                       | <b>HONDA CIVIC I Hatchback (SB, SS)</b>  |   |   |
| Length/Lunghezza [mm]          | 50                                  | 1200 (SB1)/1200 (SB2)/1300 L (SS)  |   |   |
| Inner Diam./Diam. Interno [mm] | 12                                  | <b>HONDA CIVIC I Wagon (WC)</b>  |   |   |
| Outer Diam./Diam. esterno [mm] | 37                                  | 1300   |   |   |
|                                |                                     | <b>HONDA CIVIC II</b>  |   |   |
|                                |                                     | 1.2/1.3/1.5 GL/1.5 GT/1.5 GTI  |   |   |
|                                |                                     | <b>HONDA CIVIC II Hatchback (AL, AJ, AG, AH)</b>   |   |   |
|                                |                                     | 1.2 (AL)/1.3 (AG)/1.5 GL (AH)/1.5 GT (AH)/1.5 GTI (AH)   |   |   |
|                                |                                     | <b>HONDA CIVIC III Hatchback (EC, ED, EE)</b>  |   |   |
|                                |                                     | 1.3 (EC8)/1.3 16 V (EC8) Cat./1.4 L (EC9)/1.5 i 16V/1.5 i 16V (ED6)/1.6 i 16V/1.6 i 16V (ED7)/1.6 i 16V Vtec (EE9) |   |   |
|                                |                                     | <b>HONDA CIVIC III Tre volumi (ED)</b>   |   |   |
|                                |                                     | 1.3/1.3 16V (D13B1)/1.4 L (ED2)/1.5 i 16V/1.5 i 16V (ED3)/1.6 i 16V/1.6 i 16V (ED4)/1.6 i 16V 4x4                  |   |   |
|                                |                                     | <b>HONDA CIVIC Shuttle II (EE)</b>   |   |   |
|                                |                                     | 1.5 i 16V (EE2)/1.6 i 16V 4WD (EE4)  |   |   |
| <b>GOM-410</b>                 | <b>Holder, control arm mounting</b> | <b>HONDA CIVIC I (SL)</b>  |   |  |
|                                | <b>Silentblock</b>                  | 1300 L/1300 S  |   |   |
| HONDA                          | 51395-SR3-N02                       | <b>HONDA CIVIC I Hatchback (SB, SS)</b>  |   |   |
| Length/Lunghezza [mm]          | 155                                 | 1200 (SB1)/1200 (SB2)/1300 L (SS)  |   |   |
| Height/Altezza [mm]            | 73                                  | <b>HONDA CIVIC I Wagon (WC)</b>  |   |   |
| Width/Larghezza [mm]           | 86,5                                | 1300   |   |   |
| Inner Diam./Diam. Interno [mm] | 18                                  | <b>HONDA CIVIC II</b>  |   |   |
|                                |                                     | 1.2/1.3/1.5 GL/1.5 GT/1.5 GTI  |   |   |
|                                |                                     | <b>HONDA CIVIC II Hatchback (AL, AJ, AG, AH)</b>   |   |   |
|                                |                                     | 1.2 (AL)/1.3 (AG)/1.5 GL (AH)/1.5 GT (AH)/1.5 GTI (AH)   |   |   |
|                                |                                     | <b>HONDA CIVIC III Hatchback (EC, ED, EE)</b>  |   |   |
|                                |                                     | 1.3 (EC8)/1.3 16 V (EC8) Cat./1.4 L (EC9)/1.5 i 16V/1.5 i 16V (ED6)/1.6 i 16V/1.6 i 16V (ED7)/1.6 i 16V Vtec (EE9) |   |   |
|                                |                                     | <b>HONDA CIVIC III Tre volumi (ED)</b>   |   |   |
|                                |                                     | 1.3/1.3 16V (D13B1)/1.4 L (ED2)/1.5 i 16V/1.5 i 16V (ED3)/1.6 i 16V/1.6 i 16V (ED4)/1.6 i 16V 4x4                  |   |   |
|                                |                                     | <b>HONDA CIVIC IV (EG, EH)</b>   |   |   |
|                                |                                     | 1.5 i 16V (EG8)/1.6 16V Vtec (EH9)/1.6 VTI (EG9)   |   |   |
|                                |                                     | <b>HONDA CIVIC IV Coupe (EJ)</b>   |   |   |
|                                |                                     | 1.5 i LSi (EJ2)/1.6 i (EJ6)/1.6 i Vtec/1.6 i Vtec (EJ1)  |   |   |
|                                |                                     | <b>HONDA CIVIC IV Fastback (MA, MB)</b>  |   |   |
|                                |                                     | 1.4 i (MA8)/1.5 i Vtec-E (MA9)/1.6 i (MB1)/1.6 i Vtec (MB1)  |   |   |
|                                |                                     | <b>HONDA CIVIC IV Hatchback (EG)</b>   |   |   |
|                                |                                     | 1.3 16V (EG3)/1.5 i 16V/1.5 i 16V (EG4)/1.6 16V Vtec (EG5)/1.6 VTI 16V (EG6)                                       |   |   |
|                                |                                     | <b>HONDA CIVIC Shuttle I (AN, AR)</b>  |   |   |
|                                |                                     | 1.5 (AN)/1.5 4WD (AR)  |   |   |
|                                |                                     | <b>HONDA CIVIC Shuttle II (EE)</b>   |   |   |
|                                |                                     | 1.4 i 16V (EE1)/1.5 i 16V (EE2)/1.6 16V 4WD D16Z2/1.6 i 16V 4WD (EE4)  |   |   |
|                                |                                     | <b>HONDA CIVIC V (EJ9, EK3/4)</b>  |   |   |
|                                |                                     | 1.4 i (EJ9)/1.5 i (EK3)/1.6 i Vtec/1.6 VTI (EK4)   |   |   |
|                                |                                     | <b>HONDA CIVIC V Coupe (EJ6, EJ8)</b>  |   |   |
|                                |                                     | 1.6 i/1.6 i Vtec   |   |   |
|                                |                                     | <b>HONDA CIVIC V Fastback (MB)</b>   |   |   |
|                                |                                     | 1.4 16V (MB2)/1.5 16V (MB3)/1.6 16V (MB4)/1.6 VTI/1.8 16V (MB6)/2.0 i TD (MB7)                                     |   |   |
|                                |                                     | <b>HONDA CIVIC VI Aerodeck (MB,MC)</b>   |   |   |
|                                |                                     | 1.4 16V (MB8)/1.5 16V (MB9)/1.6 16V (MC1)/1.8 16V (MC2)/2.0 i D (MC3)  |   |   |
|                                |                                     | <b>HONDA CIVIC VI Hatchback (EJ,EK)</b>  |   |   |
|                                |                                     | 1.4 i (EJ9)/1.4 i S (EJ9)/1.5 i (EK3)/1.6 i (EK1)/1.6 VTI (EK4)  |   |   |
|                                |                                     | <b>HONDA CRX III (EH, EG)</b>  |   |   |
|                                |                                     | 1.6 ESi (EH6)/1.6 i VTI (EG2)  |   |   |

|                                 |                                     |
|---------------------------------|-------------------------------------|
| <b>GOM-411</b>                  | <b>Holder, control arm mounting</b> |
|                                 | <b>Silentblock</b>                  |
| HONDA                           | 51396-SR3-N02                       |
| Height/Altezza [mm]             | 58                                  |
| Width/Larghezza [mm]            | 73                                  |
| Inner Diam./Diam. Interno [mm]  | 18,5                                |
| Overall Length/Lungh. Tot. [mm] | 161                                 |













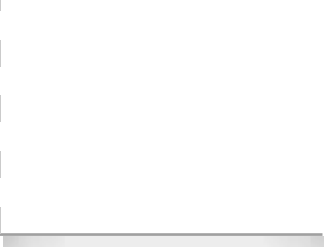



|  |
|--|
| <b>HONDA CIVIC I (SL)</b>  |
| 1300 L/1300 S  |
| <b>HONDA CIVIC I Hatchback (SB, SS)</b>  |
| 1200 (SB1)/1200 (SB2)/1300 L (SS)  |
| <b>HONDA CIVIC I Wagon (WC)</b>  |
| 1300   |
| <b>HONDA CIVIC II</b>  |
| 1.2/1.3/1.5 GL/1.5 GT/1.5 GTI  |
| <b>HONDA CIVIC II Hatchback (AL, AJ, AG, AH)</b>   |
| 1.2 (AL)/1.3 (AG)/1.5 GL (AH)/1.5 GT (AH)/1.5 GTI (AH)   |
| <b>HONDA CIVIC III Hatchback (EC, ED, EE)</b>  |
| 1.3 (EC8)/1.3 16 V (EC8) Cat./1.4 L (EC9)/1.5 i 16V/1.5 i 16V (ED6)/1.6 i 16V/1.6 i 16V (ED7)/1.6 i 16V Vtec (EE9) |
| <b>HONDA CIVIC III Tre volumi (ED)</b>   |
| 1.3/1.3 16V (D13B1)/1.4 L (ED2)/1.5 i 16V/1.5 i 16V (ED3)/1.6 i 16V/1.6 i 16V (ED4)/1.6 i 16V 4x4                  |
| <b>HONDA CIVIC IV (EG, EH)</b>   |
| 1.5 i 16V (EG8)/1.6 16V Vtec (EH9)/1.6 VTI (EG9)   |
| <b>HONDA CIVIC IV Coupe (EJ)</b>   |
| 1.5 i LSi (EJ2)/1.6 i (EJ6)/1.6 i Vtec/1.6 i Vtec (EJ1)  |
| <b>HONDA CIVIC IV Fastback (MA, MB)</b>  |
| 1.4 i (MA8)/1.5 i Vtec-E (MA9)/1.6 i (MB1)/1.6 i Vtec (MB1)  |
| <b>HONDA CIVIC IV Hatchback (EG)</b>   |
| 1.3 16V (EG3)/1.5 i 16V/1.5 i 16V (EG4)/1.6 16V Vtec (EG5)/1.6 VTI 16V (EG6)                                       |
| <b>HONDA CIVIC Shuttle I (AN, AR)</b>  |
| 1.5 (AN)/1.5 4WD (AR)  |
| <b>HONDA CIVIC Shuttle II (EE)</b>   |
| 1.4 i 16V (EE1)/1.5 i 16V (EE2)/1.6 16V 4WD D16Z2/1.6 i 16V 4WD (EE4)  |
| <b>HONDA CIVIC V (EJ9, EK3/4)</b>  |
| 1.4 i (EJ9)/1.5 i (EK3)/1.6 i Vtec/1.6 VTI (EK4)   |
| <b>HONDA CIVIC V Coupe (EJ6, EJ8)</b>  |
| 1.6 i/1.6 i Vtec   |
| <b>HONDA CIVIC V Fastback (MB)</b>   |
| 1.4 16V (MB2)/1.5 16V (MB3)/1.6 16V (MB4)/1.6 VTI/1.8 16V (MB6)/2.0 i TD (MB7)                                     |
| <b>HONDA CIVIC VI Aerodeck (MB, MC)</b>  |
| 1.4 16V (MB8)/1.5 16V (MB9)/1.6 16V (MC1)/1.8 16V (MC2)/2.0 i D (MC3)  |
| <b>HONDA CIVIC VI Hatchback (EJ, EK)</b>   |
| 1.4 i (EJ9)/1.4 i S (EJ9)/1.5 i (EK3)/1.6 i (EK1)/1.6 VTI (EK4)  |
| <b>HONDA CRX III (EH, EG)</b>  |
| 1.6 ESi (EH6)/1.6 i VTI (EG2)  |

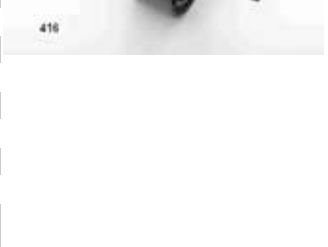

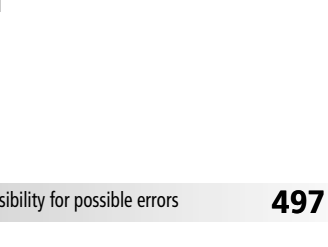
|                                 |                                     |
|---------------------------------|-------------------------------------|
| <b>GOM-413</b>                  | <b>Holder, control arm mounting</b> |
|                                 | <b>Silentblock</b>                  |
| HONDA                           | 52365-SM4-005                       |
| Inner Diam./Diam. Interno [mm]  | 12                                  |
| Overall Length/Lungh. Tot. [mm] | 40                                  |
| Outer Diam./Diam. esterno [mm]  | 36                                  |

|   |
|---|
| <b>HONDA ACCORD IV (CB3, CB7)</b>   |
| 1.8/2.0 16V (CB3)/2.0 i 16V (CB3)/2.2 i 16V (CB7)/2.2 i 16V Automatic (CB7) |
| <b>HONDA ACCORD IV Aerodeck (CB8, CC)</b>                                   |
| 2.0 i 16V (CC9)/2.2 i 16V (CB8)   |
| <b>HONDA ACCORD IV Coupe (CC1)</b>  |
| 2.0 i 16V   |
| <b>HONDA ACCORD V (CC7)</b>   |
| 2.0 i/2.0 i S/2.3 i SR  |
| <b>HONDA ACCORD V Aerodeck (CE)</b>   |
| 2.0 i LS 16V (CE2)/2.2 i ES (CE1)   |
| <b>HONDA ACCORD V Coupe (CD7, CD9)</b>                                      |
| 2.0 (DC9)/2.2 i ES  |
| <b>MERCEDES-BENZ Tre volumi (W123)</b>                                      |
| 240 D (123.123)   |
| <b>ROVER 600 (RH)</b>   |
| 618 i/Si/620 i/620 Sdi/620 Si/620 Ti Vitesse/623 Si                         |

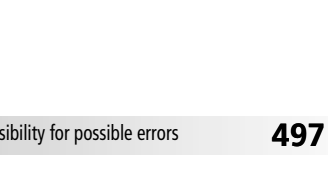

|                                 |                                     |  |   |
|---------------------------------|-------------------------------------|--|---|
| <b>GOM-414</b>                  | <b>Holder, control arm mounting</b> | <b>HONDA ACCORD IV (CB3, CB7)</b><br>1.8/2.0 16V (CB3)/2.0 i 16V (CB3)/2.2 i 16V (CB7)/2.2 i 16V<br>Automatik (CB7)  |    |
|                                 | <b>Silentblock</b>                  | <b>HONDA ACCORD IV Aerodeck (CB8, CC)</b><br>2.0 i 16V (CC9)/2.2 i 16V (CB8)   |   |
| HONDA                           | 51810-SM4-003                       | <b>HONDA ACCORD IV Coupe (CC1)</b><br>2.0 i 16V  |    |
| Inner Diam./Diam. Interno [mm]  | 12,4                                | <b>HONDA ACCORD V (CC7)</b><br>2.0 i/2.0 i S/2.3 i SR  |   |
| Overall Length/Lungh. Tot. [mm] | 53                                  | <b>HONDA ACCORD V Aerodeck (CE)</b><br>2.0 i LS 16V (CE2)/2.2 i ES (CE1)   |    |
| Outer Diam./Diam. esterno [mm]  | 42,5                                | <b>HONDA ACCORD V Coupe (CD7, CD9)</b><br>2.0 (DC9)/2.2 i ES   |   |
|                                 |                                     | <b>HONDA ACCORD VII (CG)</b><br>1.6 i/1.6 LS/1.8 i/2.0 i/2.0 Turbo DI/2.2 Type-R/2.3/2.4 Vtec E/3.0 Vtec   |   |
|                                 |                                     | <b>HONDA ACCORD VII Aerodeck</b><br>2.3 16 V   |   |
|                                 |                                     | <b>HONDA ACCORD VII Coupe (CG)</b><br>2.0 i 16V/3.0 V6 24V   |  |
|                                 |                                     | <b>HONDA ACCORD VII Hatchback (CH)</b><br>1.8 i (CH6)/2.0 (CH7)/2.0 TDi/2.3 (CL4)  |   |
|                                 |                                     | <b>MERCEDES-BENZ Tre volumi (W123)</b><br>240 D (123.123)  |  |
|                                 |                                     | <b>ROVER 600 (RH)</b><br>618 i/Si/620 i/620 Sdi/620 Si/620 Ti Vitesse/623 Si   |   |
| <b>GOM-415</b>                  | <b>Holder, control arm mounting</b> | <b>HONDA ACCORD IV (CB3, CB7)</b><br>1.8/2.0 16V (CB3)/2.0 i 16V (CB3)/2.2 i 16V (CB7)/2.2 i 16V<br>Automatik (CB7)  |   |
|                                 | <b>Silentblock</b>                  | <b>HONDA ACCORD IV Aerodeck (CB8, CC)</b><br>2.0 i 16V (CC9)/2.2 i 16V (CB8)   |   |
| HONDA                           | 51393-SM4-013                       | <b>HONDA ACCORD IV Coupe (CC1)</b><br>2.0 i 16V  |  |
| Inner Diam./Diam. Interno [mm]  | 12,6                                | <b>MERCEDES-BENZ Tre volumi (W123)</b><br>240 D (123.123)  |   |
| Overall Length/Lungh. Tot. [mm] | 53                                  | <b>ROVER 600 (RH)</b><br>618 i/Si/620 i/620 Sdi/620 Si/620 Ti Vitesse/623 Si   |  |
| Outer Diam./Diam. esterno [mm]  | 35,3                                | <b>HONDA ACCORD IV (CB3, CB7)</b><br>1.8/2.0 16V (CB3)/2.0 i 16V (CB3)/2.2 i 16V (CB7)/2.2 i 16V<br>Automatik (CB7)  |   |
|                                 |                                     | <b>HONDA ACCORD IV Aerodeck (CB8, CC)</b><br>2.0 i 16V (CC9)/2.2 i 16V (CB8)   |  |
|                                 |                                     | <b>HONDA ACCORD IV Coupe (CC1)</b><br>2.0 i 16V  |   |
|                                 |                                     | <b>MERCEDES-BENZ Tre volumi (W123)</b><br>240 D (123.123)  |  |
|                                 |                                     | <b>ROVER 600 (RH)</b><br>618 i/Si/620 i/620 Sdi/620 Si/620 Ti Vitesse/623 Si   |   |
| <b>GOM-416</b>                  | <b>Holder, control arm mounting</b> | <b>HONDA ACCORD IV (CB3, CB7)</b><br>1.8/2.0 16V (CB3)/2.0 i 16V (CB3)/2.2 i 16V (CB7)/2.2 i 16V<br>Automatik (CB7)  |  |
|                                 | <b>Silentblock</b>                  | <b>HONDA ACCORD IV Aerodeck (CB8, CC)</b><br>2.0 i 16V (CC9)/2.2 i 16V (CB8)   |   |
| HONDA                           | 52335STRG01                         | <b>HONDA ACCORD IV Coupe (CC1)</b><br>2.0 i 16V  |  |
| Length/Lunghezza [mm]           | 160                                 | <b>HONDA ACCORD V (CC7)</b><br>2.0 i/2.0 i S/2.3 i SR  |   |
| Width/Larghezza [mm]            | 40                                  | <b>HONDA ACCORD V Aerodeck (CE)</b><br>2.0 i LS 16V (CE2)/2.2 i ES (CE1)   |  |
| Diameter/Diametro [mm]          | 80                                  | <b>HONDA ACCORD V Coupe (CD7, CD9)</b><br>2.0 (DC9)/2.2 i ES   |   |
|                                 |                                     | <b>HONDA CIVIC III Hatchback (EC, ED, EE)</b><br>1.3 (EC8)/1.3 16 V (EC8) Cat./1.4 L (EC9)/1.5/1.5 i 16V/1.5 i 16V<br>(ED6)/1.6 i 16V/1.6 i 16V (ED7)/1.6 i 16V Vtec (EE9) |  |
|                                 |                                     | <b>HONDA CIVIC III Tre volumi (ED)</b><br>1.3/1.3 16V (D13B1)/1.4 L (ED2)/1.5/1.5 i 16V/1.5 i 16V<br>(ED3)/1.6 i 16V/1.6 i 16V (ED4)/1.6 i 16V 4x4                         |   |
|                                 |                                     | <b>HONDA CRX II (ED, EE)</b><br>1.4 GL/1.6 i 16V/1.6 i 16V (ED9)/1.6 i 16V Vtec (EE8)  |  |
|                                 |                                     | <b>MERCEDES-BENZ Tre volumi (W123)</b><br>240 D (123.123)  |   |
|                                 |                                     | <b>ROVER 600 (RH)</b><br>618 i/Si/620 i/620 Sdi/620 Si/620 Ti Vitesse/623 Si   |   |

|                                 |                                     |  |   |
|---------------------------------|-------------------------------------|--|---|
| <b>GOM-417</b>                  | <b>Holder, control arm mounting</b> | <b>HONDA ACCORD V (CC7)</b>  |    |
|                                 | <b>Silentblock</b>                  | 2.0 i/2.0 i S/2.3 i SR   |   |
| HONDA                           | 51355S1AE00                         | <b>HONDA ACCORD V Aerodeck (CE)</b>  |   |
| Length/Lunghezza [mm]           | 56                                  | 2.0 i LS 16V (CE2)/2.2 i ES (CE1)  |   |
| Inner Diam./Diam. Interno [mm]  | 12                                  | <b>HONDA ACCORD V Coupe (CD7, CD9)</b>                                       |   |
| Outer Diam./Diam. esterno [mm]  | 35                                  | 2.0 (DC9)/2.2 i ES   |   |
|                                 |                                     | <b>HONDA ACCORD VII (CG)</b>   |   |
|                                 |                                     | 1.6 i/1.6 LS/1.8 i/2.0 i/2.0 Turbo Di/2.2 Type-R/2.3/2.4 Vtec E/3.0 Vtec     |   |
|                                 |                                     | <b>HONDA ACCORD VII Aerodeck</b>   |   |
|                                 |                                     | 2.3 16 V   |   |
| <b>GOM-418</b>                  | <b>Holder, control arm mounting</b> | <b>HONDA ACCORD VII (CG)</b>   |    |
|                                 | <b>Silentblock</b>                  | 1.6 i/1.6 LS/1.8 i/2.0 i/2.0 Turbo Di/2.2 Type-R/2.3/2.4 Vtec E/3.0 Vtec     |   |
| HONDA                           | 51450S1AE01                         | <b>HONDA ACCORD VII Aerodeck</b>   |   |
| Length/Lunghezza [mm]           | 48                                  | 2.3 16 V   |   |
| Inner Diam./Diam. Interno [mm]  | 10                                  | <b>HONDA ACCORD VII Coupe (CG)</b>   |   |
| Outer Diam./Diam. esterno [mm]  | 38,5                                | 2.0 i 16V/3.0 V6 24V   |   |
|                                 |                                     | <b>HONDA ACCORD VII Hatchback (CH)</b>                                       |   |
|                                 |                                     | 1.8 i (CH6)/2.0 (CH7)/2.0 TDi/2.3 (CL4)                                      |   |
|                                 |                                     | <b>HONDA ACCORD IX</b>   |   |
|                                 |                                     | 2.0/2.2 i-DTEC/2.4   |   |
| <b>GOM-419</b>                  | <b>Holder, control arm mounting</b> | <b>HONDA ACCORD SW</b>   |   |
|                                 | <b>Silentblock</b>                  | 2.0/2.2 i-DTEC/2.4   |   |
| HONDA                           | 51810-SDA-A01                       | <b>HONDA ACCORD VIII</b>   |   |
| Inner Diam./Diam. Interno [mm]  | 12,6                                | 2.0 (CL7)/2.0 4 ruote motrici (CL8)/2.2 i-CTDi/2.4/2.4 (CL9)/3.0             |   |
| Overall Length/Lungh. Tot. [mm] | 52,5                                | <b>HONDA ACCORD VIII Tourer</b>  |   |
| Outer Diam./Diam. esterno [mm]  | 42,5                                | 2.0 (CM1)/2.2 i-CTDi/2.4 (CM2)/2.4 Vtec E/2.4 Vtec T                         |   |
|                                 |                                     | <b>HONDA ACCORD VIII</b>   |   |
|                                 |                                     | 2.0 (CL7)/2.0 4 ruote motrici (CL8)/2.2 i-CTDi/2.4/2.4 (CL9)/3.0             |   |
|                                 |                                     | <b>HONDA ACCORD VIII Tourer</b>  |   |
|                                 |                                     | 2.0 (CM1)/2.2 i-CTDi/2.4 (CM2)/2.4 Vtec E/2.4 Vtec T                         |   |
| <b>GOM-420</b>                  | <b>Holder, control arm mounting</b> | <b>HONDA ACCORD VIII</b>   |  |
|                                 | <b>Silentblock</b>                  | 2.0 (CM1)/2.2 i-CTDi/2.4 (CM2)/2.4 Vtec E/2.4 Vtec T                         |   |
| HONDA                           | 51391-SEA-004                       | <b>HONDA ACCORD VIII</b>   |   |
| Inner Diam./Diam. Interno [mm]  | 14,4                                | 2.0 (CL7)/2.0 4 ruote motrici (CL8)/2.2 i-CTDi/2.4/2.4 (CL9)/3.0             |   |
| Overall Length/Lungh. Tot. [mm] | 60,5                                | <b>HONDA ACCORD VIII Tourer</b>  |   |
| Outer Diam./Diam. esterno [mm]  | 74,5                                | 2.0 (CM1)/2.2 i-CTDi/2.4 (CM2)/2.4 Vtec E/2.4 Vtec T                         |   |
|                                 |                                     | <b>HONDA ACCORD VIII</b>   |   |
|                                 |                                     | 2.0 (CL7)/2.0 4 ruote motrici (CL8)/2.2 i-CTDi/2.4/2.4 (CL9)/3.0             |   |
|                                 |                                     | <b>HONDA ACCORD VIII Tourer</b>  |   |
|                                 |                                     | 2.0 (CM1)/2.2 i-CTDi/2.4 (CM2)/2.4 Vtec E/2.4 Vtec T                         |   |
| <b>GOM-421</b>                  | <b>Holder, control arm mounting</b> | <b>HONDA ACCORD VIII</b>   |  |
|                                 | <b>Silentblock</b>                  | 2.0 (CM1)/2.2 i-CTDi/2.4 (CM2)/2.4 Vtec E/2.4 Vtec T                         |   |
| HONDA                           | 51393-SEA-004                       | <b>HONDA ACCORD VIII</b>   |   |
| Inner Diam./Diam. Interno [mm]  | 12,5                                | 2.0 (CL7)/2.0 4 ruote motrici (CL8)/2.2 i-CTDi/2.4/2.4 (CL9)/3.0             |   |
| Overall Length/Lungh. Tot. [mm] | 56,6                                | <b>HONDA ACCORD VIII Tourer</b>  |   |
| Outer Diam./Diam. esterno [mm]  | 38,4                                | 2.0 (CM1)/2.2 i-CTDi/2.4 (CM2)/2.4 Vtec E/2.4 Vtec T                         |   |
|                                 |                                     | <b>HONDA ACCORD VIII</b>   |   |
|                                 |                                     | 2.0 (CL7)/2.0 4 ruote motrici (CL8)/2.2 i-CTDi/2.4/2.4 (CL9)/3.0             |   |
|                                 |                                     | <b>HONDA ACCORD VIII Tourer</b>  |   |
|                                 |                                     | 2.0 (CM1)/2.2 i-CTDi/2.4 (CM2)/2.4 Vtec E/2.4 Vtec T                         |   |
| <b>GOM-422</b>                  | <b>Holder, control arm mounting</b> | <b>HONDA CIVIC IV (EG, EH)</b>   |  |
|                                 | <b>Silentblock</b>                  | 1.5/1.5 i 16V (EG8)/1.6 16V Vtec (EH9)/1.6 EX/1.6 VTI (EG9)                  |   |
| HONDA                           | 51455SR3003                         | <b>HONDA CIVIC IV Coupe (EJ)</b>   |   |
| Length/Lunghezza [mm]           | 40                                  | 1.5 i LSi (EJ2)/1.6 i (EJ6)/1.6 i Vtec/1.6 i Vtec (EJ1)                      |   |
| Inner Diam./Diam. Interno [mm]  | 10                                  | <b>HONDA CIVIC IV Fastback (MA, MB)</b>                                      |   |
| Outer Diam./Diam. esterno [mm]  | 34                                  | 1.4 i (MA8)/1.5 i Vtec-E (MA9)/1.6 i (MB1)/1.6 i Vtec (MB1)                  |   |
|                                 |                                     | <b>HONDA CIVIC IV Hatchback (EG)</b>   |   |
|                                 |                                     | 1.3 16V (EG3)/1.5 i 16V/1.5 i 16V (EG4)/1.6 16V Vtec (EG5)/1.6 VTI 16V (EG6) |   |
|                                 |                                     | <b>HONDA CRX III (EH, EG)</b>  |   |
|                                 |                                     | 1.6 Esi (EH6)/1.6 i VTI (EG2)  |   |

|                                 |                                     |  |   |
|---------------------------------|-------------------------------------|--|---|
| <b>GOM-423</b>                  | <b>Holder, control arm mounting</b> | <b>HONDA CIVIC III Hatchback (EC, ED, EE)</b><br>1.3 (EC8)/1.3 16V (EC8) Cat./1.4 L (EC9)/1.5/1.5 i 16V/1.5 i 16V (ED6)/1.6 i 16V/1.6 i 16V (ED7)/1.6 i 16V Vtec (EE9) |    |
|                                 | <b>Silentblock</b>                  | <b>HONDA CIVIC III Tre volumi (ED)</b><br>1.3/1.3 16V (D13B1)/1.4 L (ED2)/1.5/1.5 i 16V/1.5 i 16V (ED3)/1.6 i 16V/1.6 i 16V (ED4)/1.6 i 16V 4x4                        |   |
| HONDA                           | 51810 SH3 004                       | <b>HONDA CIVIC IV (EG, EH)</b><br>1.5/1.5 i 16V (EG8)/1.6 16V Vtec (EH9)/1.6 EX/1.6 VTI (EG9)  | <b>423</b>  |
| Inner Diam./Diam. Interno [mm]  | 12,3                                | <b>HONDA CIVIC IV Coupe (EJ)</b><br>1.5 i LSi (EJ2)/1.6 i (EJ6)/1.6 i Vtec/1.6 i Vtec (EJ1)  |   |
| Overall Length/Lungh. Tot. [mm] | 51                                  | <b>HONDA CIVIC IV Fastback (MA, MB)</b><br>1.4 i (MA8)/1.5 i Vtec-E (MA9)/1.6 i (MB1)/1.6 i Vtec (MB1)   | <b>423</b>  |
| Outer Diam./Diam. esterno [mm]  | 40,5                                | <b>HONDA CIVIC IV Hatchback (EG)</b><br>1.3 16V (EG3)/1.5 i 16V/1.5 i 16V (EG4)/1.6 16V Vtec (EG5)/1.6 VTI 16V (EG6)   |   |
|                                 |                                     | <b>HONDA CRX II (ED, EE)</b><br>1.4 GL/1.6 i 16V/1.6 i 16V (ED9)/1.6 i 16V Vtec (EE8)  | <b>423</b>  |
|                                 |                                     | <b>HONDA CRX III (EH, EG)</b><br>1.6 ESi (EH6)/1.6 i VTI (EG2)   |   |
| <b>GOM-424</b>                  | <b>Holder, control arm mounting</b> | <b>HONDA CIVIC IV (EG, EH)</b><br>1.5/1.5 i 16V (EG8)/1.6 16V Vtec (EH9)/1.6 EX/1.6 VTI (EG9)  |    |
|                                 | <b>Silentblock</b>                  | <b>HONDA CIVIC IV Coupe (EJ)</b><br>1.5 i LSi (EJ2)/1.6 i (EJ6)/1.6 i Vtec/1.6 i Vtec (EJ1)  |   |
| HONDA                           | 51392 SR3 014                       | <b>HONDA CIVIC IV Fastback (MA, MB)</b><br>1.4 i (MA8)/1.5 i Vtec-E (MA9)/1.6 i (MB1)/1.6 i Vtec (MB1)   | <b>424</b>  |
| Length/Lunghezza [mm]           | 50                                  | <b>HONDA CIVIC IV Hatchback (EG)</b><br>1.3 16V (EG3)/1.5 i 16V/1.5 i 16V (EG4)/1.6 16V Vtec (EG5)/1.6 VTI 16V (EG6)   |   |
| Inner Diam./Diam. Interno [mm]  | 12                                  | <b>HONDA CRX III (EH, EG)</b><br>1.6 ESi (EH6)/1.6 i VTI (EG2)   | <b>424</b>  |
| Outer Diam./Diam. esterno [mm]  | 37                                  | <b>HONDA CIVIC V (EJ9, EK3/4)</b><br>1.4/1.4 i (EJ9)/1.5 i (EK3)/1.6 i Vtec/1.6 VTI (EK4)  |   |
|                                 |                                     | <b>HONDA CIVIC V Coupe (EJ6, EJ8)</b><br>1.6 i/1.6 i Vtec  |  |
|                                 |                                     | <b>HONDA CIVIC V Fastback (MB)</b><br>1.4 16V (MB2)/1.5 16V (MB3)/1.6/1.6 16V (MB4)/1.6 VTI/1.8 16V (MB6)/2.0 i TD (MB7)   |   |
| <b>GOM-425</b>                  | <b>Holder, control arm mounting</b> | <b>HONDA CIVIC VI Aerodeck (MB,MC)</b><br>1.4 16V (MB8)/1.5 16V (MB9)/1.6 16V (MC1)/1.8 16V (MC2)/2.0 i D (MC3)  |  |
|                                 | <b>Silentblock</b>                  | <b>HONDA CIVIC VI Hatchback (EJ,EK)</b><br>1.4 i (EJ9)/1.4 i S (EJ9)/1.5 i (EK3)/1.6/1.6 i (EK1)/1.6 VTI (EK4)   |   |
| HONDA                           | 51450S01023                         | <b>HONDA CR-V I (RD)</b><br>2.0 16V (RD1, RD3)   | <b>425</b>  |
| Length/Lunghezza [mm]           | 47,5                                | <b>HONDA CIVIC V (EJ9, EK3/4)</b><br>1.4/1.4 i (EJ9)/1.5 i (EK3)/1.6 i Vtec/1.6 VTI (EK4)  |   |
| Inner Diam./Diam. Interno [mm]  | 11                                  | <b>HONDA CIVIC V Coupe (EJ6, EJ8)</b><br>1.6 i/1.6 i Vtec  |  |
| Outer Diam./Diam. esterno [mm]  | 34                                  | <b>HONDA CIVIC V Fastback (MB)</b><br>1.4 16V (MB2)/1.5 16V (MB3)/1.6/1.6 16V (MB4)/1.6 VTI/1.8 16V (MB6)/2.0 i TD (MB7)   |   |
|                                 |                                     | <b>HONDA CIVIC VI Aerodeck (MB,MC)</b><br>1.4 16V (MB8)/1.5 16V (MB9)/1.6 16V (MC1)/1.8 16V (MC2)/2.0 i D (MC3)  | <b>426</b>  |
|                                 |                                     | <b>HONDA CIVIC VI Hatchback (EJ,EK)</b><br>1.4 i (EJ9)/1.4 i S (EJ9)/1.5 i (EK3)/1.6/1.6 i (EK1)/1.6 VTI (EK4)   |   |
| <b>GOM-426</b>                  | <b>Holder, control arm mounting</b> | <b>HONDA CIVIC V (EJ9, EK3/4)</b><br>1.4/1.4 i (EJ9)/1.5 i (EK3)/1.6 i Vtec/1.6 VTI (EK4)  |  |
|                                 | <b>Silentblock</b>                  | <b>HONDA CIVIC V Coupe (EJ6, EJ8)</b><br>1.6 i/1.6 i Vtec  |   |
| HONDA                           | 51350S04000                         | <b>HONDA CIVIC V Fastback (MB)</b><br>1.4 16V (MB2)/1.5 16V (MB3)/1.6/1.6 16V (MB4)/1.6 VTI/1.8 16V (MB6)/2.0 i TD (MB7)   | <b>426</b>  |
| Inner Diam./Diam. Interno [mm]  | 14,5                                | <b>HONDA CIVIC VI Aerodeck (MB,MC)</b><br>1.4 16V (MB8)/1.5 16V (MB9)/1.6 16V (MC1)/1.8 16V (MC2)/2.0 i D (MC3)  |   |
| Overall Length/Lungh. Tot. [mm] | 50                                  | <b>HONDA CIVIC VI Hatchback (EJ,EK)</b><br>1.4 i (EJ9)/1.4 i S (EJ9)/1.5 i (EK3)/1.6/1.6 i (EK1)/1.6 VTI (EK4)   |  |
| Outer Diam./Diam. esterno [mm]  | 38                                  | <b>HONDA CIVIC V (EJ9, EK3/4)</b><br>1.4/1.4 i (EJ9)/1.5 i (EK3)/1.6 i Vtec/1.6 VTI (EK4)  |   |
|                                 |                                     | <b>HONDA CIVIC V Coupe (EJ6, EJ8)</b><br>1.6 i/1.6 i Vtec  | <b>427</b>  |
|                                 |                                     | <b>HONDA CIVIC V Fastback (MB)</b><br>1.4 16V (MB2)/1.5 16V (MB3)/1.6/1.6 16V (MB4)/1.6 VTI/1.8 16V (MB6)/2.0 i TD (MB7)   |   |
| <b>GOM-427</b>                  | <b>Holder, control arm mounting</b> | <b>HONDA CIVIC VI Aerodeck (MB,MC)</b><br>1.4 16V (MB8)/1.5 16V (MB9)/1.6 16V (MC1)/1.8 16V (MC2)/2.0 i D (MC3)  |  |
|                                 | <b>Silentblock</b>                  | <b>HONDA CIVIC VI Hatchback (EJ,EK)</b><br>1.4 i (EJ9)/1.4 i S (EJ9)/1.5 i (EK3)/1.6/1.6 i (EK1)/1.6 VTI (EK4)   |   |
| HONDA                           | 51391-S04-005                       |  | <b>427</b>  |
| Inner Diam./Diam. Interno [mm]  | 18                                  |  |   |
| Overall Length/Lungh. Tot. [mm] | 61                                  |  | <b>427</b>  |
| Outer Diam./Diam. esterno [mm]  | 60                                  |  |   |



|                                |                                     |  |
|--------------------------------|-------------------------------------|--|
| <b>GOM-428</b>                 | <b>Holder, control arm mounting</b> | 1.4 i (EJ9)/1.4 i S (EJ9)/1.5 i (EK3)/1.6/1.6 i (EK1)/1.6 VTI (EK4)  |
|                                | <b>Silentblock</b>                  | <b>HONDA CR-V I (RD)</b><br>2.0 16V (RD1, RD3)   |
| HONDA                          | 51350S04000                         | <b>HONDA CIVIC V (EJ9, EK3/4)</b><br>1.4/1.4 i (EJ9)/1.5 i (EK3)/1.6 i Vtec/1.6 VTI (EK4)                                |
| Length/Lunghezza [mm]          | 72                                  | <b>HONDA CIVIC V Coupe (EJ6, EJ8)</b><br>1.6 i/1.6 i Vtec  |
| Inner Diam./Diam. Interno [mm] | 12,5                                | <b>HONDA CIVIC V Fastback (MB)</b><br>1.4 16V (MB2)/1.5 16V (MB3)/1.6/1.6 16V (MB4)/1.6 VTI/1.8 16V (MB6)/2.0 i TD (MB7) |
| Outer Diam./Diam. esterno [mm] | 40,5                                | <b>HONDA CIVIC VI Aerodeck (MB,MC)</b><br>1.4 16V (MB8)/1.5 16V (MB9)/1.6 16V (MC1)/1.8 16V (MC2)/2.0 i D (MC3)          |



|                                 |                                      |  |
|---------------------------------|--------------------------------------|--|
| <b>GOM-429</b>                  | <b>Bearing Bush, stabiliser</b>      | <b>HONDA CIVIC VI</b><br>1.4 i (EJ9)/1.4 i S (EJ9)/1.5 i (EK3)/1.6/1.6 i (EK1)/1.6 VTI (EK4)           |
|                                 | <b>Boccola barra stabilizzatrice</b> | <b>HONDA CIVIC VI</b><br>1.3 IMA/1.4 (ES4)/1.6/1.7   |
| HONDA                           | 51306-S6D-005                        | <b>HONDA CIVIC VI Coupe (EM)</b><br>1.6 i/1.7 i/1.7 i VTEC   |
| Fitting Position/Lato Montaggio | Front                                | <b>HONDA CIVIC VI Hatchback (EU_, EP_)</b><br>1.4 i/1.4 iS (EP1)/1.6 i/1.7 CTDi/2.0 i Sport/2.0 Type-R |
| Height/Altezza [mm]             | 36                                   |  |
| Width/Larghezza [mm]            | 35,5                                 |  |
| Inner Diam./Diam. Interno [mm]  | 25                                   |  |
| Overall Length/Lungh. Tot. [mm] | 45,7                                 |  |



|                                 |                                     |  |
|---------------------------------|-------------------------------------|--|
| <b>GOM-430</b>                  | <b>Holder, control arm mounting</b> | <b>HONDA CIVIC VI</b><br>1.3 IMA/1.4 (ES4)/1.6/1.7   |
|                                 | <b>Silentblock</b>                  | <b>HONDA CIVIC VI Coupe (EM)</b><br>1.6 i/1.7 i/1.7 i VTEC   |
| HONDA                           | 51391 S5A 024                       | <b>HONDA CIVIC VI Hatchback (EU_, EP_)</b><br>1.4 i/1.4 iS (EP1)/1.6 i/1.7 CTDi/2.0 i Sport/2.0 Type-R |
| Inner Diam./Diam. Interno [mm]  | 14,7                                | <b>HONDA CR-V II</b><br>2.0/2.2 CTDi   |
| Overall Length/Lungh. Tot. [mm] | 63                                  |  |
| Outer Diam./Diam. esterno [mm]  | 65,5                                |  |



|                                 |                                     |  |
|---------------------------------|-------------------------------------|--|
| <b>GOM-431</b>                  | <b>Holder, control arm mounting</b> | <b>HONDA CIVIC VI</b><br>1.3 IMA/1.4 (ES4)/1.6/1.7   |
|                                 | <b>Silentblock</b>                  | <b>HONDA CIVIC VI Coupe (EM)</b><br>1.6 i/1.7 i/1.7 i VTEC   |
| HONDA                           | 51392-S5A-004                       | <b>HONDA CIVIC VI Hatchback (EU_, EP_)</b><br>1.4 i/1.4 iS (EP1)/1.6 i/1.7 CTDi/2.0 i Sport/2.0 Type-R |
| Inner Diam./Diam. Interno [mm]  | 14,7                                | <b>HONDA CR-V II</b><br>2.0/2.2 CTDi   |
| Overall Length/Lungh. Tot. [mm] | 63,3                                |  |
| Outer Diam./Diam. esterno [mm]  | 43,3                                |  |



|                                 |                                      |  |
|---------------------------------|--------------------------------------|--|
| <b>GOM-432</b>                  | <b>Bearing Bush, stabiliser</b>      | <b>HONDA CIVIC VII</b><br>1.3/1.4/1.8/2.2 CTDi |
|                                 | <b>Boccola barra stabilizzatrice</b> |  |
| HONDA                           | 51306 SMG E02                        |  |
| Fitting Position/Lato Montaggio | Front                                |  |
| Length/Lunghezza [mm]           | 47                                   |  |
| Height/Altezza [mm]             | 51                                   |  |
| Width/Larghezza [mm]            | 51                                   |  |
| Inner Diam./Diam. Interno [mm]  | 19                                   |  |



|                                |                                     |  |
|--------------------------------|-------------------------------------|--|
| <b>GOM-433</b>                 | <b>Holder, control arm mounting</b> | <b>HONDA CIVIC VII</b><br>1.3/1.4/1.8/2.2 CTDi |
|                                | <b>Silentblock</b>                  |  |
| HONDA                          | 51398 SMG E01                       |  |
| Inner Diam./Diam. Interno [mm] | 10                                  |  |
| Outer Diam./Diam. esterno [mm] | 59                                  |  |





|   |   |   |
|---|---|---|
| <p><b>GOM-434</b>      <b>Holder, control arm mounting</b></p> <p><b>Silentblock</b></p> <p>HONDA      51396 SMG E03</p> <p>Inner Diam./Diam. Interno [mm]      29</p> <p>Overall Length/Lungh. Tot. [mm]      215</p>  | <p><b>HONDA CIVIC VII</b><br/>1.3/1.4/1.8/2.2 CTDi</p>  |    |
| <p><b>GOM-435</b>      <b>Holder, control arm mounting</b></p> <p><b>Silentblock</b></p> <p>HONDA      51395 SMG E03</p> <p>Inner Diam./Diam. Interno [mm]      29</p> <p>Overall Length/Lungh. Tot. [mm]      215</p>  | <p><b>HONDA CIVIC VII</b><br/>1.3/1.4/1.8/2.2 CTDi</p>  |    |
| <p><b>GOM-436</b>      <b>Holder, control arm mounting</b></p> <p><b>Silentblock</b></p> <p>HONDA      51350S10G00</p> <p>Length/Lunghezza [mm]      72</p> <p>Inner Diam./Diam. Interno [mm]      12</p> <p>Outer Diam./Diam. esterno [mm]      40,5</p>           | <p><b>HONDA CR-V I (RD)</b><br/>2.0 16V (RD1, RD3)</p>  |    |
| <p><b>GOM-437</b>      <b>Holder, control arm mounting</b></p> <p><b>Silentblock</b></p> <p>HONDA      51350S10G00</p> <p>Inner Diam./Diam. Interno [mm]      14,5</p> <p>Overall Length/Lungh. Tot. [mm]      50</p> <p>Outer Diam./Diam. esterno [mm]      38</p> | <p><b>HONDA CR-V I (RD)</b><br/>2.0 16V (RD1, RD3)</p>  |  |
| <p><b>GOM-438</b>      <b>Holder, control arm mounting</b></p> <p><b>Silentblock</b></p> <p>HONDA      51450SH3023</p> <p>Length/Lunghezza [mm]      39</p> <p>Inner Diam./Diam. Interno [mm]      10</p> <p>Outer Diam./Diam. esterno [mm]      29</p>             | <p><b>HONDA CIVIC III Hatchback (EC, ED, EE)</b><br/>1.3 (EC8)/1.3 16 V (EC8) Cat./1.4 L (EC9)/1.5/1.5 i 16V/1.5 i 16V (ED6)/1.6 i 16V/1.6 i 16V (ED7)/1.6 i 16V Vtec (EE9)</p> <p><b>HONDA CIVIC III Tre volumi (ED)</b><br/>1.3/1.3 16V (D13B1)/1.4 L (ED2)/1.5/1.5 i 16V/1.5 i 16V (ED3)/1.6 i 16V/1.6 i 16V (ED4)/1.6 i 16V 4x4</p> <p><b>HONDA CRX II (ED, EE)</b><br/>1.4 GL/1.6 i 16V/1.6 i 16V (ED9)/1.6 i 16V Vtec (EE8)</p> |  |
| <p><b>GOM-439</b>      <b>Holder, control arm mounting</b></p> <p><b>Silentblock</b></p> <p>HONDA      51393SH3003</p> <p>Length/Lunghezza [mm]      52</p> <p>Inner Diam./Diam. Interno [mm]      10</p> <p>Outer Diam./Diam. esterno [mm]      32</p>             | <p><b>HONDA CIVIC III Hatchback (EC, ED, EE)</b><br/>1.3 (EC8)/1.3 16 V (EC8) Cat./1.4 L (EC9)/1.5/1.5 i 16V/1.5 i 16V (ED6)/1.6 i 16V/1.6 i 16V (ED7)/1.6 i 16V Vtec (EE9)</p> <p><b>HONDA CIVIC III Tre volumi (ED)</b><br/>1.3/1.3 16V (D13B1)/1.4 L (ED2)/1.5/1.5 i 16V/1.5 i 16V (ED3)/1.6 i 16V/1.6 i 16V (ED4)/1.6 i 16V 4x4</p> <p><b>HONDA CRX II (ED, EE)</b><br/>1.4 GL/1.6 i 16V/1.6 i 16V (ED9)/1.6 i 16V Vtec (EE8)</p> |  |
| <p><b>GOM-440</b>      <b>Holder, control arm mounting</b></p> <p><b>Silentblock</b></p> <p>HONDA      51350SAAE01</p> <p>Length/Lunghezza [mm]      46</p> <p>Inner Diam./Diam. Interno [mm]      12</p> <p>Outer Diam./Diam. esterno [mm]      40</p>             | <p><b>HONDA JAZZ (GD)</b><br/>1.2/1.4</p>   |  |

|                                 |                                      |                  |  |   |
|---------------------------------|--------------------------------------|------------------|--|---|
| <b>GOM-441</b>                  | <b>Holder, control arm mounting</b>  |                  | <b>HONDA JAZZ (GD)</b>   |    |
|                                 | <b>Silentblock</b>                   |                  | 1.2/1.4  |   |
| HONDA                           |                                      | 51350SAAE01      |  |   |
| Length/Lunghezza [mm]           |                                      | 50               |  |   |
| Inner Diam./Diam. Interno [mm]  |                                      | 19               |  |   |
| Outer Diam./Diam. esterno [mm]  |                                      | 61,5             |  |   |
| <b>GOM-444</b>                  | <b>Holder, control arm mounting</b>  |                  | <b>HONDA CIVIC III Hatchback (EC, ED, EE)</b>  |    |
|                                 | <b>Silentblock</b>                   |                  | 1.3 (EC8)/1.3 16 V (EC8) Cat./1.4 L (EC9)/1.5 i 16V/1.5 i 16V (ED6)/1.6 i 16V (ED7)/1.6 i 16V Vtec (EE9) |   |
| HONDA                           |                                      | 52622-SH3-010    | <b>HONDA CIVIC III Tre volumi (ED)</b>   |   |
| Fitting Position/Lato Montaggio |                                      | Rear Axle        | 1.4 L (ED2)/1.5 i 16V/1.5 i 16V (ED3)/1.6 i 16V/1.6 i 16V (ED4)  |   |
| Fitting Position/Lato Montaggio |                                      | inner            | <b>HONDA CIVIC IV (EG, EH)</b>   |   |
| Length/Lunghezza [mm]           |                                      | 50               | 1.5 i 16V (EG8)/1.6 16V Vtec (EH9)/1.6 VTI (EG9)   |   |
| Inner Diam./Diam. Interno [mm]  |                                      | 10               | <b>HONDA CIVIC IV Coupe (EJ)</b>   |   |
| Outer Diam./Diam. esterno [mm]  |                                      | 37               | 1.5 i LSi (EJ2)/1.6 i (EJ6)/1.6 i Vtec (EJ1)   |   |
|                                 |                                      |                  | <b>HONDA CIVIC IV Hatchback (EG)</b>   |   |
|                                 |                                      |                  | 1.3 16V (EG3)/1.5 i 16V/1.5 i 16V (EG4)/1.6 16V Vtec (EG5)/1.6 VTI 16V (EG6)                             |   |
|                                 |                                      |                  | <b>HONDA CRX II (ED, EE)</b>   |   |
|                                 |                                      |                  | 1.6 i 16V/1.6 i 16V (ED9)/1.6 i 16V Vtec (EE8)   |   |
|                                 |                                      |                  | <b>HONDA CRX III (EH, EG)</b>  |   |
|                                 |                                      |                  | 1.6 ESi (EH6)  |   |
|                                 |                                      |                  | <b>HONDA HR-V (GH)</b>   |   |
|                                 |                                      |                  | 1.6 16V/1.6 16V 4WD  |   |
|                                 |                                      |                  | <b>HONDA LOGO (GA3)</b>  |   |
|                                 |                                      |                  | 1.3  |   |
| <b>GOM-445</b>                  | <b>Holder, control arm mounting</b>  |                  | <b>HONDA CIVIC IV (EG, EH)</b>   |  |
|                                 | <b>Silentblock</b>                   |                  | 1.6 16V Vtec (EH9)/1.6 VTI (EG9)   |   |
| HONDA                           |                                      | 52393-SR0-004    | <b>HONDA CIVIC IV Coupe (EJ)</b>   |   |
| Fitting Position/Lato Montaggio |                                      | Rear Axle        | 1.5 i LSi (EJ2)/1.6 i Vtec (EJ1)   |   |
| Diameter/Diametro [mm]          |                                      | 31,5             | <b>HONDA CIVIC IV Fastback (MA, MB)</b>  |   |
| Overall Length/Lungh. Tot. [mm] |                                      | 106              | 1.4 i (MA8)/1.5 i Vtec-E (MA9)/1.6 i (MB1)/1.6 i Vtec (MB1)  |   |
|                                 |                                      |                  | <b>HONDA CIVIC IV Hatchback (EG)</b>   |   |
|                                 |                                      |                  | 1.3 16V (EG3)/1.5 i 16V (EG4)/1.6 16V Vtec (EG5)/1.6 VTI 16V (EG6)                                       |   |
|                                 |                                      |                  | <b>HONDA CIVIC V (EJ9, EK3/4)</b>  |   |
|                                 |                                      |                  | 1.4 i (EJ9)/1.5 i (EK3)/1.6 i Vtec/1.6 VTI (EK4)   |   |
|                                 |                                      |                  | <b>HONDA CIVIC V Coupe (EJ6, EJ8)</b>  |   |
|                                 |                                      |                  | 1.6 i/1.6 i Vtec   |   |
|                                 |                                      |                  | <b>HONDA CIVIC VI Hatchback (EJ,EK)</b>  |   |
|                                 |                                      |                  | 1.4 i (EJ9)/1.4 i S (EJ9)/1.5 i (EK3)/1.6 i (EK1)/1.6 VTI (EK4)  |   |
| <b>GOM-446</b>                  | <b>Bearing Bush, stabiliser</b>      |                  | <b>HONDA CIVIC V (EJ9, EK3/4)</b>  |  |
|                                 | <b>Boccola barra stabilizzatrice</b> |                  | 1.6 VTI (EK4)  |   |
| HONDA                           |                                      | 51306-S04-N01    | <b>HONDA CIVIC VI Hatchback (EJ,EK)</b>  |   |
| Fitting Position/Lato Montaggio |                                      | Front Axle       | 1.6 VTI (EK4)  |   |
| Length/Lunghezza [mm]           |                                      | 40               | <b>HONDA CR-V I (RD)</b>   |   |
| Height/Altezza [mm]             |                                      | 42               | 2.0 16V (RD1, RD3)   |   |
| Width/Larghezza [mm]            |                                      | 45               |  |   |
| Inner Diam./Diam. Interno [mm]  |                                      | 25               |  |   |
| <b>GOM-447</b>                  | <b>Suspension Strut Support</b>      |                  | <b>HONDA CR-V II</b>   |  |
|                                 | <b>Bearing</b>                       |                  | 2.0/2.4 Vtec   |   |
| HONDA                           |                                      | 51920-S6M-014    |  |   |
| Fitting Position/Lato Montaggio |                                      | Front Axle Right |  |   |
| Height/Altezza [mm]             |                                      | 36               |  |   |
| Inner Diam./Diam. Interno [mm]  |                                      | 12               |  |   |

|   |   |  |
|---|---|--|
| <b>GOM-448</b><br><b>Suspension Strut Support Bearing</b><br><b>Supporto ammortizzatore</b>   | <b>HONDA CR-V II</b><br>2.0/2.4 Vtec  |  <p>448</p>   |
| HONDA 51925-S6M-014<br>Fitting Position/Lato Montaggio Front Axle Left<br>Height/Altezza [mm] 36<br>Inner Diam./Diam. Interno [mm] 12   |   |  |
| <b>GOM-449</b><br><b>Bearing Bush, stabiliser</b><br><b>Boccola barra stabilizzatrice</b>   | <b>HONDA CR-V II</b><br>2.0/2.2 CTDi/2.4 Vtec   |  <p>449</p>   |
| HONDA 51306-S7B-014<br>Fitting Position/Lato Montaggio Front Axle<br>Bore n°/Fori nr. [mm] 27,2<br>Quantity per Axle 2  |   |  |
| <b>GOM-450</b><br><b>Holder, control arm mounting</b><br><b>Silentblock</b>   | <b>HONDA ACCORD VIII</b><br>2.0 (CL7)/2.0 4 ruote motrici (CL8)/2.2 i-CTDi/2.4/2.4 (CL9)/3.0<br><b>HONDA ACCORD VIII Tourer</b><br>2.0 (CM1)/2.2 i-CTDi/2.4 (CM2)/2.4 Vtec E/2.4 Vtec T |  <p>450</p>   |
| Fitting Position/Lato Montaggio Upper Front Axle<br>Length/Lunghezza [mm] 53,2<br>Inner Diam./Diam. Interno [mm] 10,2<br>Outer Diam./Diam. esterno [mm] 38,3                            |   |  |
| <b>GOM-451</b><br><b>Holder, control arm mounting</b><br><b>Silentblock</b>   | <b>HONDA ACCORD IX</b><br>2.0/2.2 i-DTEC/2.4<br><b>HONDA ACCORD SW</b><br>2.0/2.2 i-DTEC/2.4  |  <p>451</p> |
| HONDA 51391 TA0 A01<br>Height/Altezza [mm] 66<br>Inner Diam./Diam. Interno [mm] 14<br>Outer Diam./Diam. esterno [mm] 80   |   |  |
| <b>GOM-452</b><br><b>Holder, control arm mounting</b><br><b>Silentblock</b>   | <b>HONDA CR-V II</b><br>2.0 i-VTEC/2.2 i-CTDi<br><b>HONDA CR-V III</b><br>2.2 i-DTEC/2.4/2.4 iVtec 4 ruote motrici  |  <p>452</p> |
| Inner Diam./Diam. Interno [mm] 21<br>Overall Length/Lungh. Tot. [mm] 57,5<br>Outer Diam./Diam. esterno [mm] 71  |   |  |
| <b>GOM-454</b><br><b>Bearing Bush, stabiliser</b><br><b>Boccola barra stabilizzatrice</b>   | <b>HONDA CR-V II</b><br>2.0 i-VTEC/2.2 i-CTDi<br><b>HONDA CR-V III</b><br>2.2 i-DTEC/2.4/2.4 iVtec 4 ruote motrici  |  <p>454</p> |
| HONDA 52306SWAA01<br>Fitting Position/Lato Montaggio Rear Axle<br>Length/Lunghezza [mm] 35<br>Height/Altezza [mm] 31<br>Inner Diam./Diam. Interno [mm] 19                               |   |  |
| <b>GOM-455</b><br><b>Bearing Bush, stabiliser</b><br><b>Boccola barra stabilizzatrice</b>   | <b>HONDA CR-V II</b><br>2.0 i-VTEC/2.2 i-CTDi<br><b>HONDA CR-V III</b><br>2.2 i-DTEC/2.4/2.4 iVtec 4 ruote motrici  |  <p>455</p> |
| HONDA 51306SWAA01<br>Fitting Position/Lato Montaggio Front Axle<br>Length/Lunghezza [mm] 42<br>Height/Altezza [mm] 39<br>Width/Larghezza [mm] 38,5<br>Inner Diam./Diam. Interno [mm] 20 |   |  |

|                                 |                                      |  |   |
|---------------------------------|--------------------------------------|--|---|
| <b>GOM-456</b>                  | <b>Bearing Bush, stabiliser</b>      | <b>HONDA ACCORD VII (CG)</b>   |  |
|                                 | <b>Boccola barra stabilizzatrice</b> | 2.4 Vtec E   |   |
| HONDA                           | 52306SDAA01                          | <b>HONDA ACCORD VIII</b>   |   |
| Fitting Position/Lato Montaggio | Rear Axle                            | 2.0 (CL7)/2.0 4 ruote motrici (CL8)/2.2 i-CTDi/2.4/2.4 (CL9)/2.4 Vtec/2.4 Vtec E (CM5)/3.0 |   |
| Length/Lunghezza [mm]           | 35                                   | <b>HONDA ACCORD VIII Tourer</b>  |   |
| Height/Altezza [mm]             | 31                                   | 2.0 (CM1)/2.2 i-CTDi/2.4 (CM2)/2.4 Vtec E/2.4 Vtec T                                       |   |
| Inner Diam./Diam. Interno [mm]  | 13                                   |  |   |

|                                |                        |   |   |
|--------------------------------|------------------------|---|---|
| <b>GOM-457</b>                 | <b>Engine Mounting</b> | <b>HONDA CIVIC IV (EG, EH)</b>          |  |
|                                | <b>Supporto motore</b> | 1.6/1.6 16V Vtec (EH9)                  |   |
| HONDA                          | 50841-SR3-984          | <b>HONDA CIVIC IV Coupe (EJ)</b>        |   |
| Length/Lunghezza [mm]          | 146                    | 1.6 i (EJ6)/1.6 i Vtec (EJ1)            |   |
| Height/Altezza [mm]            | 79                     | <b>HONDA CIVIC IV Hatchback (EG)</b>    |   |
| Width/Larghezza [mm]           | 47                     | 1.6 16V Vtec (EG5)                      |   |
| Inner Diam./Diam. Interno [mm] | 20                     | <b>HONDA CIVIC V (EJ9, EK3/4)</b>       |   |
|                                |                        | 1.5 i (EK3)/1.6 i Vtec                  |   |
|                                |                        | <b>HONDA CIVIC V Coupe (EJ6, EJ8)</b>   |   |
|                                |                        | 1.6 i/1.6 i Vtec                        |   |
|                                |                        | <b>HONDA CIVIC VI Hatchback (EJ,EK)</b> |   |
|                                |                        | 1.5 i (EK3)/1.6 i (EK1)                 |   |
|                                |                        | <b>HONDA CR-V I (RD)</b>                |   |
|                                |                        | 2.0 16V (RD1, RD3)                      |   |
|                                |                        | <b>HONDA CRX III (EH, EG)</b>           |   |
|                                |                        | 1.6 ESi (EH6)                           |   |
|                                |                        | <b>HONDA HR-V (GH)</b>                  |   |
|                                |                        | 1.6 16V 4WD                             |   |

|                                |                        |  |   |
|--------------------------------|------------------------|--|---|
| <b>GOM-460</b>                 | <b>Engine Mounting</b> | <b>HONDA CIVIC IV Coupe (EJ)</b>                 |  |
|                                | <b>Supporto motore</b> | 1.6 i (EJ6)/1.6 i Vtec                           |   |
| HONDA                          | 50805-S04-000          | <b>HONDA CIVIC V (EJ9, EK3/4)</b>                |   |
| Length/Lunghezza [mm]          | 125                    | 1.4 i (EJ9)/1.5 i (EK3)/1.6 i Vtec/1.6 VTI (EK4) |   |
| Height/Altezza [mm]            | 89                     | <b>HONDA CIVIC V Coupe (EJ6, EJ8)</b>            |   |
| Width/Larghezza [mm]           | 130                    | 1.6 i/1.6 i Vtec                                 |   |
| Inner Diam./Diam. Interno [mm] | 12                     | <b>HONDA CIVIC V Fastback (MB)</b>               |   |
|                                |                        | 1.6 VTI  |   |
|                                |                        | <b>HONDA CIVIC VI Hatchback (EJ,EK)</b>          |   |
|                                |                        | 1.4 i (EJ9)/1.5 i (EK3)/1.6 VTI (EK4)            |   |
|                                |                        | <b>HONDA CR-V I (RD)</b>                         |   |
|                                |                        | 2.0 16V (RD1, RD3)                               |   |

|                                 |                                      |   |   |
|---------------------------------|--------------------------------------|---|---|
| <b>GOM-462</b>                  | <b>Bearing Bush, stabiliser</b>      | <b>HONDA CIVIC V (EJ9, EK3/4)</b>       |  |
|                                 | <b>Boccola barra stabilizzatrice</b> | 1.6 i Vtec                              |   |
| HONDA                           | 51306-S04-003                        | <b>HONDA CIVIC V Coupe (EJ6, EJ8)</b>   |   |
| Fitting Position/Lato Montaggio | Front Axle                           | 1.6 i/1.6 i Vtec                        |   |
| Length/Lunghezza [mm]           | 39                                   | <b>HONDA CIVIC VI Hatchback (EJ,EK)</b> |   |
| Height/Altezza [mm]             | 35                                   | 1.4 i (EJ9)/1.6 i (EK1)                 |   |
| Width/Larghezza [mm]            | 30                                   |   |   |
| Inner Diam./Diam. Interno [mm]  | 22                                   |   |   |

|                                    |   |   |   |
|------------------------------------|---|---|---|
| <b>GOM-500</b>                     | <b>Bearing,propshaft centre bearing</b> | <b>HYUNDAI GALLOPER I</b>   |  |
|                                    | <b>Supporto albero cardanico</b>        | 2.5 TD/2.5 TD intercooler/3.0 V6  |   |
| MITSUBISHI                         | MB154199                                | <b>HYUNDAI GALLOPER II (JK-01)</b>  |   |
| Height/Altezza [mm]                | 115                                     | 2.5 Tci D/2.5 TD/2.5 TD intercooler/3.0 V6  |   |
| Width/Larghezza [mm]               | 58                                      | <b>MITSUBISHI L 200 (K_T)</b>   |   |
| Inner Diam./Diam. Interno [mm]     | 30                                      | 1.6 K11 (AG32)/2.0 (K62T)/2.0 4G63/2.4 4x4 (K75T)/2.5 D (K14T)/2.5 D (K64T)/2.5 D 4WD (K24T)/2.5 TD 4WD (K34T)/2.6 4WD (K33T) |   |
| Mount. Bores/Fori Fiss. Dist. [mm] | 160                                     | <b>MITSUBISHI PAJERO I (L04_G)</b>  |   |
|                                    |   | 2.3 TD (L043G, L048G)/2.5 TD (L044G, L049G)/2.6 (L042G, L047G)  |   |
|                                    |   | <b>MITSUBISHI PAJERO I (L04_G, L14_G)</b>   |   |
|                                    |   | 2.0 4WD/2.5 TD (L044G, L049G)/3.0 V6 (L141G, L146G)   |   |
|                                    |   | <b>MITSUBISHI PAJERO II (V2_W, V4_W)</b>  |   |
|                                    |   | 2.4/2.5 TD (V24C, V24W)/2.8 TD (V46W)/3.0 V6 (V23W, V43W, V23C)/3.0 V6 24V/3.5 V6 24V/3.5 V6 24V (V25W, V45W)                 |   |
|                                    |   | <b>MITSUBISHI PAJERO II Fuoristrada aperto (V2_W, V4_W)</b>   |   |

|                       |                        |
|-----------------------|------------------------|
| <b>GOM-501</b>        | <b>Engine Mounting</b> |
|                       | <b>Supporto motore</b> |
| mitsubishi            | MB007023               |
| Length/Lunghezza [mm] | 119                    |
| Height/Altezza [mm]   | 57                     |
| Width/Larghezza [mm]  | 126                    |

|  |
|--|
| 1.8 GDI/2.4/2.5 TD (V24C, V24W)/3.0 V6 (V23W, v43W, V23C)/3.0 V6 24V   |
| <b>mitsubishi pajero iii (V60)</b>   |
| 3.2 DI-D (V68W, V78W)  |
| <b>mitsubishi pajero pinin (H6_W, H7_W)</b>  |
| 1.8/1.8 GDI (H66W)/2.0 GDI (H67W, H77W)  |
| <b>mitsubishi pajero sport (K90)</b>   |
| 2.5 TD/3.0 V6  |
| <b>HYUNDAI GALLOPER I</b>  |
| 2.5 TD/2.5 TD intercooler/3.0 V6   |
| <b>HYUNDAI GALLOPER II (JK-01)</b>   |
| 2.5 TCI D/2.5 TD/2.5 TD intercooler/3.0 V6   |
| <b>mitsubishi L 200 (K_T)</b>  |
| 1.6 K11 (AG32)/2.0 (K62T)/2.0 4G63/2.4 4x4 (K75T)/2.5 D (K14T)/2.5 D (K64T)/2.5 D 4WD (K24T)/2.5 TD 4WD (K34T)/2.5 TD 4x4/2.5 TD 4x4 (K74T)/2.6 4WD (K33T) |
| <b>mitsubishi pajero classic (V2_W)</b>  |
| 2.5 TD   |
| <b>mitsubishi pajero i (L04_G)</b>   |
| 2.3 TD (L043G, L048G)/2.5 TD (L044G, L049G)/2.6 (L042G, L047G)   |
| <b>mitsubishi pajero i (L04_G, L14_G)</b>  |
| 2.0 4WD/2.5 TD (L044G, L049G)/3.0 V6 (L141G, L146G)  |
| <b>mitsubishi pajero ii (V2_W, V4_W)</b>   |
| 2.4/2.5 TD (V24C, V24W)/2.8 TD (V46W)/3.0 V6 (V23W, V43W, V23C)/3.0 V6 24V/3.5 V6 24V/3.5 V6 24V (V25W, V45W)  |
| <b>mitsubishi pajero ii Fuoristrada aperto (V2_W, V4_W)</b>  |
| 1.8 GDI/2.4/2.5 TD (V24C, V24W)/3.0 V6 (V23W, v43W, V23C)/3.0 V6 24V   |
| <b>mitsubishi pajero iii (V60)</b>   |
| 3.2 DI-D (V68W, V78W)/3.5 V6 GDI (V65W, V75W)  |
| <b>mitsubishi pajero pinin (H6_W, H7_W)</b>  |
| 1.8/1.8 GDI (H66W)/2.0 GDI (H67W, H77W)  |
| <b>mitsubishi pajero sport (K90)</b>   |
| 2.5 TD/3.0 V6  |



|                       |                        |
|-----------------------|------------------------|
| <b>GOM-502</b>        | <b>Engine Mounting</b> |
|                       | <b>Supporto motore</b> |
| mitsubishi            | MB436444               |
| Length/Lunghezza [mm] | 128                    |
| Height/Altezza [mm]   | 72                     |
| Width/Larghezza [mm]  | 124                    |

|                                      |
|--------------------------------------|
| <b>HYUNDAI GALLOPER I</b>            |
| 2.5 TD intercooler                   |
| <b>HYUNDAI GALLOPER II (JK-01)</b>   |
| 2.5 TD intercooler                   |
| <b>mitsubishi pajero sport (K90)</b> |
| 2.5 TD                               |



|                                |                        |
|--------------------------------|------------------------|
| <b>GOM-503</b>                 | <b>Engine Mounting</b> |
|                                | <b>Supporto motore</b> |
| mitsubishi                     | MB260676               |
| Length/Lunghezza [mm]          | 80                     |
| Height/Altezza [mm]            | 30,3                   |
| Width/Larghezza [mm]           | 49                     |
| Inner Diam./Diam. Interno [mm] | 25                     |

|  |
|--|
| <b>mitsubishi L 200 (K_T)</b>                                  |
| 1.6 K11 (AG32)/2.0 4G63/2.5 D (K14T)/2.5 D 4WD (K24T)          |
| <b>mitsubishi pajero i (L04_G)</b>                             |
| 2.3 TD (L043G, L048G)/2.5 TD (L044G, L049G)/2.6 (L042G, L047G) |
| <b>mitsubishi pajero i (L04_G, L14_G)</b>                      |
| 2.5 TD (L044G, L049G)/3.0 V6 (L141G, L146G)                    |



|                                |                        |
|--------------------------------|------------------------|
| <b>GOM-504</b>                 | <b>Engine Mounting</b> |
|                                | <b>Supporto motore</b> |
| mitsubishi                     | MB581845               |
| Length/Lunghezza [mm]          | 82                     |
| Height/Altezza [mm]            | 48                     |
| Width/Larghezza [mm]           | 55                     |
| Inner Diam./Diam. Interno [mm] | 11                     |

|  |
|--|
| <b>HYUNDAI GALLOPER I</b>  |
| 2.5 TD/2.5 TD intercooler/3.0 V6   |
| <b>HYUNDAI GALLOPER II (JK-01)</b>   |
| 2.5 TCI D/2.5 TD/2.5 TD intercooler/3.0 V6   |
| <b>mitsubishi L 200 (K_T)</b>  |
| 2.0 (K62T)/2.4 4x4 (K75T)/2.5 D (K14T)/2.5 D 4WD (K24T)/2.5 TD 4WD (K34T)/2.5 TD 4x4 (K74T)/2.6 4WD (K33T) |
| <b>mitsubishi pajero classic (V2_W)</b>  |
| 2.5 TD   |
| <b>mitsubishi pajero i (L04_G, L14_G)</b>  |
| 2.5 TD (L044G, L049G)  |
| <b>mitsubishi pajero ii (V2_W, V4_W)</b>   |
| 2.4/2.8 TD (V46W)/3.0 V6 (V23W, V43W, V23C)/3.0 V6 24V/3.5 V6 24V/3.5 V6 24V (V25W, V45W)                  |



|                                |           |                                     |
|--------------------------------|-----------|-------------------------------------|
| <b>GOM-505</b>                 |           | <b>Holder, control arm mounting</b> |
|                                |           | <b>Silentblock</b>                  |
| mitsubishi                     | MB-633870 |                                     |
| Length/Lunghezza [mm]          | 89,2      |                                     |
| Inner Diam./Diam. Interno [mm] | 19        |                                     |
| Outer Diam./Diam. esterno [mm] | 40        |                                     |

**MITSUBISHI PAJERO II Fuoristrada aperto (V2\_W, V4\_W)**

1.8 GDI/2.4/2.5 TD (V24C, V24W)/3.0 V6 (V23W, v43W, V23C)/3.0 V6 24V

**MITSUBISHI PAJERO III (V60)**

3.2 DI-D (V68W, V78W)/3.5 V6 GDI (V65W, V75W)

**MITSUBISHI PAJERO PININ (H6\_W, H7\_W)**

1.8/1.8 GDI (H66W)/2.0 GDI (H67W, H77W)

**MITSUBISHI PAJERO SPORT (K90)**

2.5 TD/3.0 V6

**HYUNDAI GALLOPER I**

2.5 TD/2.5 TD intercooler/3.0 V6

**HYUNDAI GALLOPER II (JK-01)**

2.5 TCI D/2.5 TD/2.5 TD intercooler/3.0 V6

**MITSUBISHI L 200 (K\_T)**

1.6 K11 (AG32)/2.0 (K62T)/2.0 4G63/2.4 4x4 (K75T)/2.5 D (K14T)/2.5 D (K64T)/2.5 D 4WD (K24T)/2.5 TD 4WD/2.5 TD 4WD (K34T)/2.5 TD 4WD (K74T)/2.5 TD 4x4/2.5 TD 4x4 (K74T)/2.6 4WD (K33T)

**MITSUBISHI PAJERO CLASSIC (V2\_W)**

2.5 TD/3.2 DI-D

**MITSUBISHI PAJERO I (L04\_G)**

2.3 TD (L043G, L048G)/2.5 TD (L044G, L049G)/2.6 (L042G, L047G)

**MITSUBISHI PAJERO I (L04\_G, L14\_G)**

2.0 4x4/2.0 4WD/2.0 Turbo 4x4/2.5 TD (L044G, L049G)/3.0 V6 (L141G, L146G)

**MITSUBISHI PAJERO II (V2\_W, V4\_W)**

2.4/2.5 TD (V24C, V24W)/2.8 TD (V46W)/3.0 V6 (V23W, V43W, V23C)/3.0 V6 24V/3.5 V6 24V/3.5 V6 24V (V25W, V45W)

**MITSUBISHI PAJERO II Fuoristrada aperto (V2\_W, V4\_W)**

1.8 GDI/2.4/2.5 TD (V24C, V24W)/3.0 V6 (V23W, v43W, V23C)/3.0 V6 24V

**MITSUBISHI PAJERO PININ (H6\_W, H7\_W)**

1.8/1.8 GDI (H66W)/2.0 GDI (H67W, H77W)

**MITSUBISHI PAJERO SPORT (K90)**

2.5 TD/3.0 V6

**HYUNDAI GALLOPER I**

2.5 TD/2.5 TD intercooler/3.0 V6

**HYUNDAI GALLOPER II (JK-01)**

2.5 TCI D/2.5 TD/2.5 TD intercooler/3.0 V6

**MITSUBISHI L 200 (K\_T)**

1.6 K11 (AG32)/2.0 (K62T)/2.0 4G63/2.4 4x4 (K75T)/2.5 D (K14T)/2.5 D (K64T)/2.5 D 4WD (K24T)/2.5 TD 4WD/2.5 TD 4WD (K34T)/2.5 TD 4WD (K74T)/2.5 TD 4x4/2.5 TD 4x4 (K74T)/2.6 4WD (K33T)

**MITSUBISHI PAJERO CLASSIC (V2\_W)**

2.5 TD/3.2 DI-D

**MITSUBISHI PAJERO I (L04\_G)**

2.3 TD (L043G, L048G)/2.5 TD (L044G, L049G)/2.6 (L042G, L047G)

**MITSUBISHI PAJERO I (L04\_G, L14\_G)**

2.0 4x4/2.0 4WD/2.0 Turbo 4x4/2.5 TD (L044G, L049G)/3.0 V6 (L141G, L146G)

**MITSUBISHI PAJERO II (V2\_W, V4\_W)**

2.4/2.5 TD (V24C, V24W)/2.8 TD (V46W)/3.0 V6 (V23W, V43W, V23C)/3.0 V6 24V/3.5 V6 24V/3.5 V6 24V (V25W, V45W)

**MITSUBISHI PAJERO II Fuoristrada aperto (V2\_W, V4\_W)**

1.8 GDI/2.4/2.5 TD (V24C, V24W)/3.0 V6 (V23W, v43W, V23C)/3.0 V6 24V

**MITSUBISHI PAJERO PININ (H6\_W, H7\_W)**

1.8/1.8 GDI (H66W)/2.0 GDI (H67W, H77W)



**MITSUBISHI PAJERO SPORT (K90)**

2.5 TD/3.0 V6



|                                |          |                                     |
|--------------------------------|----------|-------------------------------------|
| <b>GOM-506</b>                 |          | <b>Holder, control arm mounting</b> |
|                                |          | <b>Silentblock</b>                  |
| mitsubishi                     | MB109684 |                                     |
| Length/Lunghezza [mm]          | 64       |                                     |
| Inner Diam./Diam. Interno [mm] | 14,5     |                                     |
| Outer Diam./Diam. esterno [mm] | 39,4     |                                     |



|                                |                                      |  |   |
|--------------------------------|--------------------------------------|--|---|
| <b>GOM-507</b>                 | <b>Bearing Bush, stabiliser</b>      | <b>HYUNDAI GALLOPER I</b>  |    |
|                                | <b>Boccola barra stabilizzatrice</b> | <b>HYUNDAI GALLOPER II (JK-01)</b>   |   |
| MITSUBISHI                     | MB175804                             | 2.5 TD/2.5 TD intercooler/3.0 V6   |   |
| Length/Lunghezza [mm]          | 40                                   | <b>HYUNDAI GALLOPER II (JK-01)</b>   |   |
| Height/Altezza [mm]            | 35                                   | 2.5 TCI D/2.5 TD/2.5 TD intercooler/3.0 V6   |   |
| Width/Larghezza [mm]           | 35                                   | <b>MITSUBISHI L 200 (K__T)</b>   |   |
| Inner Diam./Diam. Interno [mm] | 23                                   | 1.6 K11 (AG32)/2.0 (K62T)/2.0 4G63/2.4 4x4 (K75T)/2.5 D (K14T)/2.5 D (K64T)/2.5 D 4WD (K24T)/2.5 TD 4WD (K34T)/2.5 TD 4WD (K74T)/2.5 TD 4x4/2.5 TD 4x4 (K74T)/2.6 4WD (K33T) |   |
|                                |                                      | <b>MITSUBISHI PAJERO CLASSIC (V2_W)</b>  |   |
|                                |                                      | 2.5 TD   |   |
|                                |                                      | <b>MITSUBISHI PAJERO I (L04_G)</b>   |   |
|                                |                                      | 2.3 TD (L043G, L048G)/2.5 TD (L044G, L049G)/2.6 (L042G, L047G)   |   |
|                                |                                      | <b>MITSUBISHI PAJERO I (L04_G, L14_G)</b>  |   |
|                                |                                      | 2.0 4WD/2.5 TD (L044G, L049G)/3.0 V6 (L141G, L146G)  |   |
|                                |                                      | <b>MITSUBISHI PAJERO II (V2_W, V4_W)</b>   |   |
|                                |                                      | 2.4/2.5 TD (V24C, V24W)/2.8 TD (V46W)/3.0 V6 (V23W, V43W, V23C)/3.0 V6 24V/3.5 V6 24V/3.5 V6 24V (V25W, V45W)  |   |
|                                |                                      | <b>MITSUBISHI PAJERO II Fuoristrada aperto (V2_W, V4_W)</b>  |   |
|                                |                                      | 1.8 GDI/2.4/2.5 TD (V24C, V24W)/3.0 V6 (V23W, v43W, V23C)/3.0 V6 24V   |   |
|                                |                                      | <b>MITSUBISHI PAJERO III (V60)</b>   |   |
|                                |                                      | 3.2 DI-D (V68W, V78W)/3.5 V6 GDI (V65W, V75W)  |   |
|                                |                                      | <b>MITSUBISHI PAJERO PININ (H6_W, H7_W)</b>  |   |
|                                |                                      | 1.8/1.8 GDI (H66W)/2.0 GDI (H67W, H77W)  |   |
|                                |                                      | <b>MITSUBISHI PAJERO SPORT (K90)</b>   |   |
|                                |                                      | 2.5 TD/3.0 V6  |   |
| <b>GOM-508</b>                 | <b>Bearing Bush, stabiliser</b>      | <b>HYUNDAI GALLOPER I</b>  |   |
|                                | <b>Boccola barra stabilizzatrice</b> | <b>HYUNDAI GALLOPER II (JK-01)</b>   |   |
| MITSUBISHI                     | MB573784                             | 2.5 TD/2.5 TD intercooler/3.0 V6   |   |
| Length/Lunghezza [mm]          | 39                                   | <b>HYUNDAI GALLOPER II (JK-01)</b>   |   |
| Height/Altezza [mm]            | 42                                   | 2.5 TCI D/2.5 TD/2.5 TD intercooler/3.0 V6   |   |
| Width/Larghezza [mm]           | 42                                   | <b>MITSUBISHI L 200 (K__T)</b>   |   |
| Inner Diam./Diam. Interno [mm] | 24                                   | 1.6 K11 (AG32)/2.0 (K62T)/2.0 4G63/2.4 4x4 (K75T)/2.5 D (K14T)/2.5 D (K64T)/2.5 D 4WD (K24T)/2.5 TD 4WD (K34T)/2.5 TD 4WD (K74T)/2.5 TD 4x4/2.5 TD 4x4 (K74T)/2.6 4WD (K33T) |   |
|                                |                                      | <b>MITSUBISHI PAJERO CLASSIC (V2_W)</b>  |   |
|                                |                                      | 2.5 TD   |   |
|                                |                                      | <b>MITSUBISHI PAJERO I (L04_G)</b>   |   |
|                                |                                      | 2.3 TD (L043G, L048G)/2.5 TD (L044G, L049G)/2.6 (L042G, L047G)   |   |
|                                |                                      | <b>MITSUBISHI PAJERO I (L04_G, L14_G)</b>  |   |
|                                |                                      | 2.0 4WD/2.5 TD (L044G, L049G)/3.0 V6 (L141G, L146G)  |   |
|                                |                                      | <b>MITSUBISHI PAJERO II (V2_W, V4_W)</b>   |   |
|                                |                                      | 2.4/2.5 TD (V24C, V24W)/2.8 TD (V46W)/3.0 V6 (V23W, V43W, V23C)/3.0 V6 24V/3.5 V6 24V/3.5 V6 24V (V25W, V45W)  |   |
|                                |                                      | <b>MITSUBISHI PAJERO II Fuoristrada aperto (V2_W, V4_W)</b>  |   |
|                                |                                      | 1.8 GDI/2.4/2.5 TD (V24C, V24W)/3.0 V6 (V23W, v43W, V23C)/3.0 V6 24V   |   |
|                                |                                      | <b>MITSUBISHI PAJERO III (V60)</b>   |   |
|                                |                                      | 3.2 DI-D (V68W, V78W)/3.5 V6 GDI (V65W, V75W)  |   |
|                                |                                      | <b>MITSUBISHI PAJERO PININ (H6_W, H7_W)</b>  |   |
|                                |                                      | 1.8/1.8 GDI (H66W)/2.0 GDI (H67W, H77W)  |   |
|                                |                                      | <b>MITSUBISHI PAJERO SPORT (K90)</b>   |   |
|                                |                                      | 2.5 TD/3.0 V6  |   |
| <b>GOM-509</b>                 | <b>Bearing Bush, stabiliser</b>      | <b>HYUNDAI GALLOPER I</b>  |  |
|                                | <b>Boccola barra stabilizzatrice</b> | <b>HYUNDAI GALLOPER II (JK-01)</b>   |   |
| MITSUBISHI                     | MB598097                             | 2.5 TD/2.5 TD intercooler/3.0 V6   |   |
| Diameter/Diametro [mm]         | 25                                   | <b>HYUNDAI GALLOPER II (JK-01)</b>   |   |
|                                |                                      | 2.5 TCI D/2.5 TD/2.5 TD intercooler/3.0 V6   |   |
|                                |                                      | <b>MITSUBISHI L 200 (K__T)</b>   |   |
|                                |                                      | 1.6 K11 (AG32)/2.0 (K62T)/2.0 4G63/2.4 4x4 (K75T)/2.5 D (K14T)/2.5 D (K64T)/2.5 D 4WD (K24T)/2.5 TD 4WD (K34T)/2.5 TD 4WD (K74T)/2.5 TD 4x4/2.5 TD 4x4 (K74T)/2.6 4WD (K33T) |   |
|                                |                                      | <b>MITSUBISHI PAJERO CLASSIC (V2_W)</b>  |   |
|                                |                                      | 2.5 TD   |   |
|                                |                                      | <b>MITSUBISHI PAJERO I (L04_G)</b>   |   |
|                                |                                      | 2.3 TD (L043G, L048G)/2.5 TD (L044G, L049G)/2.6 (L042G, L047G)   |   |
|                                |                                      | <b>MITSUBISHI PAJERO I (L04_G, L14_G)</b>  |   |



|                                |                          |
|--------------------------------|--------------------------|
| <b>GOM-510</b>                 | <b>Bush, leaf spring</b> |
|                                | <b>Boccola balestra</b>  |
| mitsubishi                     | MB111203                 |
| Length/Lunghezza [mm]          | 44                       |
| Inner Diam./Diam. Interno [mm] | 18                       |
| Outer Diam./Diam. esterno [mm] | 31,5                     |

2.0 4WD/2.5 TD (L044G, L049G)/3.0 V6 (L141G, L146G)  
**mitsubishi pajero II (V2\_W, V4\_W)**  
 2.4/2.5 TD (V24C, V24W)/2.8 TD (V46W)/3.0 V6 (V23W, V43W, V23C)/3.0 V6 24V/3.5 V6 24V/3.5 V6 24V (V25W, V45W)  
**mitsubishi pajero II Fuoristrada aperto (V2\_W, V4\_W)**  
 1.8 GDI/2.4/2.5 TD (V24C, V24W)/3.0 V6 (V23W, v43W, V23C)/3.0 V6 24V  
**mitsubishi pajero III (V60)**  
 3.2 DI-D (V68W, V78W)/3.5 V6 GDI (V65W, V75W)  
**mitsubishi pajero PININ (H6\_W, H7\_W)**  
 1.8/1.8 GDI (H66W)/2.0 GDI (H67W, H77W)  
**mitsubishi pajero SPORT (K90)**  
 2.5 TD/3.0 V6

**HYUNDAI GALLOPER I**  
 2.5 TD/2.5 TD intercooler/3.0 V6  
**HYUNDAI GALLOPER II (JK-01)**  
 2.5 TCI D/2.5 TD/2.5 TD intercooler/3.0 V6  
**mitsubishi L 200 (K\_T)**  
 1.6 K11 (AG32)/2.0 (K62T)/2.0 4G63/2.4 4x4 (K75T)/2.5 D (K14T)/2.5 D (K64T)/2.5 D 4WD (K24T)/2.5 TD 4WD (K34T)/2.5 TD 4WD (K74T)/2.5 TD 4x4/2.5 TD 4x4 (K74T)/2.6 4WD (K33T)  
**mitsubishi pajero CLASSIC (V2\_W)**  
 2.5 TD  
**mitsubishi pajero I (L04\_G)**  
 2.3 TD (L043G, L048G)/2.5 TD (L044G, L049G)/2.6 (L042G, L047G)  
**mitsubishi pajero I (L04\_G, L14\_G)**  
 2.0 4WD/2.5 TD (L044G, L049G)/3.0 V6 (L141G, L146G)  
**mitsubishi pajero II (V2\_W, V4\_W)**  
 2.4/2.5 TD (V24C, V24W)/2.8 TD (V46W)/3.0 V6 (V23W, V43W, V23C)/3.0 V6 24V/3.5 V6 24V/3.5 V6 24V (V25W, V45W)  
**mitsubishi pajero II Fuoristrada aperto (V2\_W, V4\_W)**  
 1.8 GDI/2.4/2.5 TD (V24C, V24W)/3.0 V6 (V23W, v43W, V23C)/3.0 V6 24V  
**mitsubishi pajero III (V60)**  
 3.2 DI-D (V68W, V78W)/3.5 V6 GDI (V65W, V75W)  
**mitsubishi pajero PININ (H6\_W, H7\_W)**  
 1.8/1.8 GDI (H66W)/2.0 GDI (H67W, H77W)  
**mitsubishi pajero SPORT (K90)**  
 2.5 TD/3.0 V6



|                                |                          |
|--------------------------------|--------------------------|
| <b>GOM-511</b>                 | <b>Bush, leaf spring</b> |
|                                | <b>Boccola balestra</b>  |
| mitsubishi                     | MB-584531                |
| Length/Lunghezza [mm]          | 53                       |
| Inner Diam./Diam. Interno [mm] | 16                       |
| Outer Diam./Diam. esterno [mm] | 28                       |

**HYUNDAI GALLOPER I**  
 2.5 TD/2.5 TD intercooler/3.0 V6  
**HYUNDAI GALLOPER II (JK-01)**  
 2.5 TCI D/2.5 TD/2.5 TD intercooler/3.0 V6  
**mitsubishi L 200 (K\_T)**  
 1.6 K11 (AG32)/2.0 (K62T)/2.0 4G63/2.4 4x4 (K75T)/2.5 D (K14T)/2.5 D (K64T)/2.5 D 4WD (K24T)/2.5 TD 4WD (K34T)/2.5 TD 4WD (K74T)/2.5 TD 4x4/2.5 TD 4x4 (K74T)/2.6 4WD (K33T)  
**mitsubishi pajero CLASSIC (V2\_W)**  
 2.5 TD  
**mitsubishi pajero I (L04\_G)**  
 2.3 TD (L043G, L048G)/2.5 TD (L044G, L049G)/2.6 (L042G, L047G)  
**mitsubishi pajero I (L04\_G, L14\_G)**  
 2.0 4WD/2.5 TD (L044G, L049G)/3.0 V6 (L141G, L146G)  
**mitsubishi pajero II (V2\_W, V4\_W)**  
 2.4/2.5 TD (V24C, V24W)/2.8 TD (V46W)/3.0 V6 (V23W, V43W, V23C)/3.0 V6 24V/3.5 V6 24V/3.5 V6 24V (V25W, V45W)  
**mitsubishi pajero II Fuoristrada aperto (V2\_W, V4\_W)**  
 1.8 GDI/2.4/2.5 TD (V24C, V24W)/3.0 V6 (V23W, v43W, V23C)/3.0 V6 24V  
**mitsubishi pajero III (V60)**  
 3.2 DI-D (V68W, V78W)/3.5 V6 GDI (V65W, V75W)  
**mitsubishi pajero PININ (H6\_W, H7\_W)**  
 1.8/1.8 GDI (H66W)/2.0 GDI (H67W, H77W)  
**mitsubishi pajero SPORT (K90)**  
 2.5 TD/3.0 V6



|                                |                          |
|--------------------------------|--------------------------|
| <b>GOM-512</b>                 | <b>Bush, leaf spring</b> |
|                                | <b>Boccola balestra</b>  |
| mitsubishi                     | MB111070                 |
| Length/Lunghezza [mm]          | 45                       |
| Inner Diam./Diam. Interno [mm] | 16                       |
| Outer Diam./Diam. esterno [mm] | 27                       |

|  |
|--|
| <b>HYUNDAI GALLOPER I</b>  |
| 2.5 TD/2.5 TD intercooler/3.0 V6   |
| <b>HYUNDAI GALLOPER II (JK-01)</b>   |
| 2.5 Tci D/2.5 TD/2.5 TD intercooler/3.0 V6   |
| <b>mitsubishi L 200 (K_T)</b>  |
| 1.6 K11 (AG32)/2.0 (K62T)/2.0 4G63/2.4 4x4 (K75T)/2.5 D (K14T)/2.5 D (K64T)/2.5 D 4WD (K24T)/2.5 TD 4WD (K34T)/2.5 TD 4WD (K74T)/2.5 TD 4x4/2.5 TD 4x4 (K74T)/2.6 4WD (K33T) |
| <b>mitsubishi PAJERO CLASSIC (V2_W)</b>  |
| 2.5 TD   |
| <b>mitsubishi PAJERO I (L04_G)</b>   |
| 2.3 TD (L043G, L048G)/2.5 TD (L044G, L049G)/2.6 (L042G, L047G)   |
| <b>mitsubishi PAJERO I (L04_G, L14_G)</b>  |
| 2.0 4WD/2.5 TD (L044G, L049G)/3.0 V6 (L141G, L146G)  |
| <b>mitsubishi PAJERO II (V2_W, V4_W)</b>   |
| 2.4/2.5 TD (V24C, V24W)/2.8 TD (V46W)/3.0 V6 (V23W, V43W, V23C)/3.0 V6 24V/3.5 V6 24V/3.5 V6 24V (V25W, V45W)  |
| <b>mitsubishi PAJERO II Fuoristrada aperto (V2_W, V4_W)</b>  |
| 1.8 GDI/2.4/2.5 TD (V24C, V24W)/3.0 V6 (V23W, v43W, V23C)/3.0 V6 24V   |
| <b>mitsubishi PAJERO III (V60)</b>   |
| 3.2 DI-D (V68W, V78W)/3.5 V6 GDI (V65W, V75W)  |
| <b>mitsubishi PAJERO PININ (H6_W, H7_W)</b>  |
| 1.8/1.8 GDI (H66W)/2.0 GDI (H67W, H77W)  |
| <b>mitsubishi PAJERO SPORT (K90)</b>   |
| 2.5 TD/3.0 V6  |



|                                |                          |
|--------------------------------|--------------------------|
| <b>GOM-513</b>                 | <b>Bush, leaf spring</b> |
|                                | <b>Boccola balestra</b>  |
| mitsubishi                     | MB809388                 |
| Length/Lunghezza [mm]          | 27                       |
| Inner Diam./Diam. Interno [mm] | 24                       |
| Outer Diam./Diam. esterno [mm] | 59,5                     |

|   |
|---|
| <b>mitsubishi PAJERO II (V2_W, V4_W)</b>  |
| 2.4/2.5 TD (V24C, V24W)/2.8 TD (V46W)/3.0 V6 (V23W, V43W, V23C)/3.0 V6 24V/3.5 V6 24V/3.5 V6 24V (V25W, V45W) |
| <b>mitsubishi PAJERO II Fuoristrada aperto (V2_W, V4_W)</b>   |
| 1.8 GDI/2.4/2.5 TD (V24C, V24W)/3.0 V6 (V23W, v43W, V23C)/3.0 V6 24V  |
| <b>mitsubishi PAJERO III (V60)</b>  |
| 3.2 DI-D (V68W, V78W)/3.5 V6 GDI (V65W, V75W)   |
| <b>mitsubishi PAJERO PININ (H6_W, H7_W)</b>   |
| 1.8/1.8 GDI (H66W)/2.0 GDI (H67W, H77W)   |
| <b>mitsubishi PAJERO SPORT (K90)</b>  |
| 2.5 TD/3.0 V6   |



|                                |                                     |
|--------------------------------|-------------------------------------|
| <b>GOM-514</b>                 | <b>Holder, control arm mounting</b> |
|                                | <b>Silentblock</b>                  |
| mitsubishi                     | MB631492                            |
| Length/Lunghezza [mm]          | 60                                  |
| Inner Diam./Diam. Interno [mm] | 16                                  |
| Outer Diam./Diam. esterno [mm] | 65                                  |

|  |
|--|
| <b>HYUNDAI GALLOPER I</b>  |
| 2.5 TD/2.5 TD intercooler/3.0 V6   |
| <b>HYUNDAI GALLOPER II (JK-01)</b>   |
| 2.5 Tci D/2.5 TD/2.5 TD intercooler/3.0 V6   |
| <b>mitsubishi L 200 (K_T)</b>  |
| 1.6 K11 (AG32)/2.0 (K62T)/2.0 4G63/2.4 4x4 (K75T)/2.5 D (K14T)/2.5 D (K64T)/2.5 D 4WD (K24T)/2.5 TD 4WD (K34T)/2.5 TD 4WD (K74T)/2.5 TD 4x4/2.5 TD 4x4 (K74T)/2.6 4WD (K33T) |
| <b>mitsubishi PAJERO CLASSIC (V2_W)</b>  |
| 2.5 TD   |
| <b>mitsubishi PAJERO I (L04_G)</b>   |
| 2.3 TD (L043G, L048G)/2.5 TD (L044G, L049G)/2.6 (L042G, L047G)   |
| <b>mitsubishi PAJERO I (L04_G, L14_G)</b>  |
| 2.0 4WD/2.5 TD (L044G, L049G)/3.0 V6 (L141G, L146G)  |
| <b>mitsubishi PAJERO II (V2_W, V4_W)</b>   |
| 2.4/2.5 TD (V24C, V24W)/2.8 TD (V46W)/3.0 V6 (V23W, V43W, V23C)/3.0 V6 24V/3.5 V6 24V/3.5 V6 24V (V25W, V45W)  |
| <b>mitsubishi PAJERO II Fuoristrada aperto (V2_W, V4_W)</b>  |
| 1.8 GDI/2.4/2.5 TD (V24C, V24W)/3.0 V6 (V23W, v43W, V23C)/3.0 V6 24V   |
| <b>mitsubishi PAJERO III (V60)</b>   |
| 3.2 DI-D (V68W, V78W)/3.5 V6 GDI (V65W, V75W)  |
| <b>mitsubishi PAJERO PININ (H6_W, H7_W)</b>  |
| 1.8/1.8 GDI (H66W)/2.0 GDI (H67W, H77W)  |
| <b>mitsubishi PAJERO SPORT (K90)</b>   |
| 2.5 TD/3.0 V6  |



|                                       |                                      |  |   |   |
|---------------------------------------|--------------------------------------|--|---|---|
| <b>GOM-515</b>                        | <b>GummiParts</b>                    | <b>HYUNDAI GALLOPER I</b><br>2.5 TD/2.5 TD intercooler/3.0 V6  |    |   |
|                                       | <b>Parti in gomma</b>                | <b>HYUNDAI GALLOPER II (JK-01)</b><br>2.5 TCI D/2.5 TD/2.5 TD intercooler/3.0 V6   |   |   |
|                                       |                                      | <b>mitsubishi L 200 (K__T)</b><br>1.6 K11 (AG32)/2.0 (K62T)/2.0 4G63/2.4 4x4 (K75T)/2.5 D (K14T)/2.5 D (K64T)/2.5 D 4WD (K24T)/2.5 TD 4WD (K34T)/2.5 TD 4WD (K74T)/2.5 TD 4x4/2.5 TD 4x4 (K74T)/2.6 4WD (K33T) |   |   |
|                                       |                                      | <b>MITSUBISHI PAJERO CLASSIC (V2_W)</b><br>2.5 TD  |   |   |
|                                       |                                      | <b>MITSUBISHI PAJERO I (L04_G)</b><br>2.3 TD (L043G, L048G)/2.5 TD (L044G, L049G)/2.6 (L042G, L047G)   |   |   |
|                                       |                                      | <b>MITSUBISHI PAJERO I (L04_G, L14_G)</b><br>2.0 4WD/2.5 TD (L044G, L049G)/3.0 V6 (L141G, L146G)   |   |   |
|                                       |                                      | <b>MITSUBISHI PAJERO II (V2_W, V4_W)</b><br>2.4/2.5 TD (V24C, V24W)/2.8 TD (V46W)/3.0 V6 (V23W, V43W, V23C)/3.0 V6 24V/3.5 V6 24V/3.5 V6 24V (V25W, V45W)  |   |   |
|                                       |                                      | <b>MITSUBISHI PAJERO II Fuoristrada aperto (V2_W, V4_W)</b><br>1.8 GDI/2.4/2.5 TD (V24C, V24W)/3.0 V6 (V23W, V43W, V23C)/3.0 V6 24V  |   |   |
|                                       |                                      | <b>MITSUBISHI PAJERO III (V60)</b><br>3.2 DI-D (V68W, V78W)/3.5 V6 GDI (V65W, V75W)  |   |   |
|                                       |                                      | <b>MITSUBISHI PAJERO PININ (H6_W, H7_W)</b><br>1.8/1.8 GDI (H66W)/2.0 GDI (H67W, H77W)   |   |   |
|                                       |                                      | <b>MITSUBISHI PAJERO SPORT (K90)</b><br>2.5 TD/3.0 V6  |   |   |
| <b>GOM-516</b>                        | <b>Bearing Bush, stabiliser</b>      | <b>HYUNDAI GALLOPER I</b><br>2.5 TD/2.5 TD intercooler/3.0 V6  |   |   |
|                                       | <b>Boccola barra stabilizzatrice</b> | <b>HYUNDAI GALLOPER II (JK-01)</b><br>2.5 TCI D/2.5 TD/2.5 TD intercooler/3.0 V6   |   |   |
| <b>mitsubishi</b>                     | <b>MB109529</b>                      | <b>mitsubishi L 200 (K__T)</b><br>1.6 K11 (AG32)/2.0 (K62T)/2.0 4G63/2.4 4x4 (K75T)/2.5 D (K14T)/2.5 D (K64T)/2.5 D 4WD (K24T)/2.5 TD 4WD (K34T)/2.5 TD 4WD (K74T)/2.5 TD 4x4/2.5 TD 4x4 (K74T)/2.6 4WD (K33T) |   |   |
| <b>Length/Lunghezza [mm]</b>          | <b>44</b>                            | <b>MITSUBISHI PAJERO I (L04_G)</b><br>2.5 TD (L044G, L049G)  |   |   |
| <b>Inner Diam./Diam. Interno [mm]</b> | <b>18</b>                            | <b>MITSUBISHI PAJERO I (L04_G, L14_G)</b><br>2.5 TD (L044G, L049G)   |   |   |
| <b>Outer Diam./Diam. esterno [mm]</b> | <b>28</b>                            |  |   |   |
|                                       |                                      | <b>HYUNDAI GALLOPER I</b><br>2.5 TD/2.5 TD intercooler/3.0 V6  |   |   |
|                                       |                                      | <b>HYUNDAI GALLOPER II (JK-01)</b><br>2.5 TCI D/2.5 TD/2.5 TD intercooler/3.0 V6   |   |   |
|                                       |                                      | <b>mitsubishi L 200 (K__T)</b><br>1.6 K11 (AG32)/2.0 (K62T)/2.0 4G63/2.4 4x4 (K75T)/2.5 D (K14T)/2.5 D (K64T)/2.5 D 4WD (K24T)/2.5 TD 4WD (K34T)/2.5 TD 4WD (K74T)/2.5 TD 4x4/2.5 TD 4x4 (K74T)/2.6 4WD (K33T) |   |   |
|                                       |                                      | <b>MITSUBISHI PAJERO I (L04_G)</b><br>2.5 TD (L044G, L049G)  |   |   |
|                                       |                                      | <b>MITSUBISHI PAJERO I (L04_G, L14_G)</b><br>2.5 TD (L044G, L049G)   |   |   |
| <b>GOM-517</b>                        | <b>Bearing Bush, stabiliser</b>      | <b>HYUNDAI GALLOPER I</b><br>2.5 TD/2.5 TD intercooler/3.0 V6  |  |   |
|                                       | <b>Boccola barra stabilizzatrice</b> | <b>HYUNDAI GALLOPER II (JK-01)</b><br>2.5 TCI D/2.5 TD/2.5 TD intercooler/3.0 V6   |   |   |
| <b>mitsubishi</b>                     | <b>MB109557</b>                      | <b>mitsubishi L 200 (K__T)</b><br>1.6 K11 (AG32)/2.0 (K62T)/2.0 4G63/2.4 4x4 (K75T)/2.5 D (K14T)/2.5 D (K64T)/2.5 D 4WD (K24T)/2.5 TD 4WD (K34T)/2.5 TD 4WD (K74T)/2.5 TD 4x4/2.5 TD 4x4 (K74T)/2.6 4WD (K33T) |   |   |
| <b>Length/Lunghezza [mm]</b>          | <b>35,5</b>                          | <b>MITSUBISHI PAJERO I (L04_G)</b><br>2.5 TD (L044G, L049G)  |   |   |
| <b>Height/Altezza [mm]</b>            | <b>37</b>                            | <b>MITSUBISHI PAJERO I (L04_G, L14_G)</b><br>2.5 TD (L044G, L049G)   |   |   |
| <b>Width/Larghezza [mm]</b>           | <b>36</b>                            |  |   |   |
| <b>Inner Diam./Diam. Interno [mm]</b> | <b>25</b>                            |  |   |   |
|                                       |                                      | <b>HYUNDAI GALLOPER I</b><br>2.5 TD/2.5 TD intercooler/3.0 V6  |   |   |
|                                       |                                      | <b>HYUNDAI GALLOPER II (JK-01)</b><br>2.5 TCI D/2.5 TD/2.5 TD intercooler/3.0 V6   |   |   |
|                                       |                                      | <b>mitsubishi L 200 (K__T)</b><br>1.6 K11 (AG32)/2.0 (K62T)/2.0 4G63/2.4 4x4 (K75T)/2.5 D (K14T)/2.5 D (K64T)/2.5 D 4WD (K24T)/2.5 TD 4WD (K34T)/2.5 TD 4WD (K74T)/2.5 TD 4x4/2.5 TD 4x4 (K74T)/2.6 4WD (K33T) |   |   |
|                                       |                                      | <b>MITSUBISHI PAJERO I (L04_G)</b><br>2.5 TD (L044G, L049G)  |   |   |
|                                       |                                      | <b>MITSUBISHI PAJERO I (L04_G, L14_G)</b><br>2.5 TD (L044G, L049G)   |   |   |
| <b>GOM-518</b>                        | <b>Bearing Bush, stabiliser</b>      | <b>HYUNDAI GALLOPER I</b><br>2.5 TD/2.5 TD intercooler/3.0 V6  |   |  |
|                                       | <b>Boccola barra stabilizzatrice</b> | <b>HYUNDAI GALLOPER II (JK-01)</b><br>2.5 TCI D/2.5 TD/2.5 TD intercooler/3.0 V6   |   |   |
| <b>mitsubishi</b>                     | <b>MB584146</b>                      | <b>mitsubishi L 200 (K__T)</b><br>1.6 K11 (AG32)/2.0 (K62T)/2.0 4G63/2.4 4x4 (K75T)/2.5 D (K14T)/2.5 D (K64T)/2.5 D 4WD (K24T)/2.5 TD 4WD (K34T)/2.5 TD 4WD (K74T)/2.5 TD 4x4/2.5 TD 4x4 (K74T)/2.6 4WD (K33T) |   |   |
| <b>Length/Lunghezza [mm]</b>          | <b>34</b>                            | <b>MITSUBISHI PAJERO I (L04_G)</b><br>2.5 TD (L044G, L049G)  |   |   |
| <b>Inner Diam./Diam. Interno [mm]</b> | <b>24</b>                            | <b>MITSUBISHI PAJERO I (L04_G, L14_G)</b><br>2.5 TD (L044G, L049G)   |   |   |
| <b>Outer Diam./Diam. esterno [mm]</b> | <b>37</b>                            |  |   |   |
|                                       |                                      | <b>HYUNDAI GALLOPER I</b><br>2.5 TD/2.5 TD intercooler/3.0 V6  |   |   |
|                                       |                                      | <b>HYUNDAI GALLOPER II (JK-01)</b><br>2.5 TCI D/2.5 TD/2.5 TD intercooler/3.0 V6   |   |   |
|                                       |                                      | <b>mitsubishi L 200 (K__T)</b><br>1.6 K11 (AG32)/2.0 (K62T)/2.0 4G63/2.4 4x4 (K75T)/2.5 D (K14T)/2.5 D (K64T)/2.5 D 4WD (K24T)/2.5 TD 4WD (K34T)/2.5 TD 4WD (K74T)/2.5 TD 4x4/2.5 TD 4x4 (K74T)/2.6 4WD (K33T) |   |   |
|                                       |                                      | <b>MITSUBISHI PAJERO I (L04_G)</b><br>2.5 TD (L044G, L049G)  |   |   |
|                                       |                                      | <b>MITSUBISHI PAJERO I (L04_G, L14_G)</b><br>2.5 TD (L044G, L049G)   |   |   |

|                                |                                      |  |   |
|--------------------------------|--------------------------------------|--|---|
| <b>GOM-519</b>                 | <b>Bearing Bush, stabiliser</b>      | <b>HYUNDAI GALLOPER I</b>  |    |
|                                | <b>Boccola barra stabilizzatrice</b> | 2.5 TD/2.5 TD intercooler/3.0 V6   |   |
| mitsubishi                     | MB176442                             | <b>HYUNDAI GALLOPER II (JK-01)</b>   |   |
| Length/Lunghezza [mm]          | 38                                   | 2.5 Tci D/2.5 TD/2.5 TD intercooler/3.0 V6   |   |
| Height/Altezza [mm]            | 35                                   | <b>mitsubishi L 200 (K__T)</b>   |   |
| Width/Larghezza [mm]           | 36                                   | 1.6 K11 (AG32)/2.0 (K62T)/2.0 4G63/2.4 4x4 (K75T)/2.5 D (K14T)/2.5 D (K64T)/2.5 D 4WD (K24T)/2.5 TD 4WD (K34T)/2.5 TD 4WD (K74T)/2.5 TD 4x4/2.5 TD 4x4 (K74T)/2.6 4WD (K33T) |   |
| Inner Diam./Diam. Interno [mm] | 22                                   | <b>mitsubishi PAJERO I (L04_G)</b>   |   |
|                                |                                      | 2.5 TD (L044G, L049G)  |   |
|                                |                                      | <b>mitsubishi PAJERO I (L04_G, L14_G)</b>  |   |
|                                |                                      | 2.5 TD (L044G, L049G)  |   |
| <b>GOM-520</b>                 | <b>Bearing Bush, stabiliser</b>      | <b>HYUNDAI GALLOPER I</b>  |    |
|                                | <b>Boccola barra stabilizzatrice</b> | 2.5 TD/2.5 TD intercooler/3.0 V6   |   |
| mitsubishi                     | MB175581                             | <b>HYUNDAI GALLOPER II (JK-01)</b>   |   |
| Length/Lunghezza [mm]          | 39                                   | 2.5 Tci D/2.5 TD/2.5 TD intercooler/3.0 V6   |   |
| Height/Altezza [mm]            | 39                                   | <b>mitsubishi L 200 (K__T)</b>   |   |
| Width/Larghezza [mm]           | 33                                   | 1.6 K11 (AG32)/2.0 (K62T)/2.0 4G63/2.4 4x4 (K75T)/2.5 D (K14T)/2.5 D (K64T)/2.5 D 4WD (K24T)/2.5 TD 4WD (K34T)/2.5 TD 4WD (K74T)/2.5 TD 4x4/2.5 TD 4x4 (K74T)/2.6 4WD (K33T) |   |
| Inner Diam./Diam. Interno [mm] | 22                                   | <b>mitsubishi PAJERO II (V2_W, V4_W)</b>   |   |
|                                |                                      | 2.5 TD (V24C, V24W)  |   |
|                                |                                      | <b>mitsubishi PAJERO II Fuoristrada aperto (V2_W, V4_W)</b>  |   |
|                                |                                      | 2.5 TD (V24C, V24W)  |   |
| <b>GOM-521</b>                 | <b>Bearing Bush, stabiliser</b>      | <b>HYUNDAI GALLOPER I</b>  |   |
|                                | <b>Boccola barra stabilizzatrice</b> | 2.5 TD/2.5 TD intercooler/3.0 V6   |   |
| mitsubishi                     | MB109219                             | <b>HYUNDAI GALLOPER II (JK-01)</b>   |   |
| Length/Lunghezza [mm]          | 36                                   | 2.5 Tci D/2.5 TD/2.5 TD intercooler/3.0 V6   |   |
| Height/Altezza [mm]            | 37,5                                 | <b>mitsubishi L 200 (K__T)</b>   |   |
| Width/Larghezza [mm]           | 40                                   | 1.6 K11 (AG32)/2.0 (K62T)/2.0 4G63/2.4 4x4 (K75T)/2.5 D (K14T)/2.5 D (K64T)/2.5 D 4WD (K24T)/2.5 TD 4WD (K34T)/2.5 TD 4WD (K74T)/2.5 TD 4x4/2.5 TD 4x4 (K74T)/2.6 4WD (K33T) |   |
| Inner Diam./Diam. Interno [mm] | 20                                   | <b>mitsubishi PAJERO II (V2_W, V4_W)</b>   |   |
|                                |                                      | 2.5 TD (V24C, V24W)  |   |
|                                |                                      | <b>mitsubishi PAJERO II Fuoristrada aperto (V2_W, V4_W)</b>  |   |
|                                |                                      | 2.5 TD (V24C, V24W)  |   |
| <b>GOM-522</b>                 | <b>Bearing Bush, stabiliser</b>      | <b>HYUNDAI GALLOPER I</b>  |  |
|                                | <b>Boccola barra stabilizzatrice</b> | 2.5 TD/2.5 TD intercooler/3.0 V6   |   |
| mitsubishi                     | MB267685                             | <b>HYUNDAI GALLOPER II (JK-01)</b>   |   |
| Length/Lunghezza [mm]          | 42                                   | 2.5 Tci D/2.5 TD/2.5 TD intercooler/3.0 V6   |   |
| Height/Altezza [mm]            | 35                                   | <b>mitsubishi L 200 (K__T)</b>   |   |
| Width/Larghezza [mm]           | 40                                   | 1.6 K11 (AG32)/2.0 (K62T)/2.0 4G63/2.4 4x4 (K75T)/2.5 D (K14T)/2.5 D (K64T)/2.5 D 4WD (K24T)/2.5 TD 4WD (K34T)/2.5 TD 4WD (K74T)/2.5 TD 4x4/2.5 TD 4x4 (K74T)/2.6 4WD (K33T) |   |
| Inner Diam./Diam. Interno [mm] | 24                                   | <b>mitsubishi PAJERO II (V2_W, V4_W)</b>   |   |
|                                |                                      | 2.5 TD (V24C, V24W)  |   |
|                                |                                      | <b>mitsubishi PAJERO II Fuoristrada aperto (V2_W, V4_W)</b>  |   |
|                                |                                      | 2.5 TD (V24C, V24W)  |   |
| <b>GOM-523</b>                 | <b>Bearing Bush, stabiliser</b>      | <b>HYUNDAI GALLOPER I</b>  |  |
|                                | <b>Boccola barra stabilizzatrice</b> | 2.5 TD/2.5 TD intercooler/3.0 V6   |   |
| mitsubishi                     | MB573783                             | <b>HYUNDAI GALLOPER II (JK-01)</b>   |   |
| Length/Lunghezza [mm]          | 39                                   | 2.5 Tci D/2.5 TD/2.5 TD intercooler/3.0 V6   |   |
| Height/Altezza [mm]            | 41                                   | <b>mitsubishi L 200 (K__T)</b>   |   |
| Width/Larghezza [mm]           | 40                                   | 1.6 K11 (AG32)/2.0 (K62T)/2.0 4G63/2.4 4x4 (K75T)/2.5 D (K14T)/2.5 D (K64T)/2.5 D 4WD (K24T)/2.5 TD 4WD (K34T)/2.5 TD 4WD (K74T)/2.5 TD 4x4/2.5 TD 4x4 (K74T)/2.6 4WD (K33T) |   |
| Inner Diam./Diam. Interno [mm] | 26                                   | <b>mitsubishi PAJERO II (V2_W, V4_W)</b>   |   |
|                                |                                      | 2.5 TD (V24C, V24W)  |   |
|                                |                                      | <b>mitsubishi PAJERO II Fuoristrada aperto (V2_W, V4_W)</b>  |   |
|                                |                                      | 2.5 TD (V24C, V24W)  |   |
| <b>GOM-524</b>                 | <b>Bearing Bush, stabiliser</b>      | <b>HYUNDAI GALLOPER I</b>  |  |
|                                | <b>Boccola barra stabilizzatrice</b> | 2.5 TD/2.5 TD intercooler/3.0 V6   |   |
| mitsubishi                     | MB275632                             | <b>HYUNDAI GALLOPER II (JK-01)</b>   |   |
| Length/Lunghezza [mm]          | 34,5                                 | 2.5 Tci D/2.5 TD/2.5 TD intercooler/3.0 V6   |   |
| Inner Diam./Diam. Interno [mm] | 17                                   | <b>mitsubishi L 200 (K__T)</b>   |   |
| Outer Diam./Diam. esterno [mm] | 49                                   | 1.6 K11 (AG32)/2.0 (K62T)/2.0 4G63/2.4 4x4 (K75T)/2.5 D (K14T)/2.5 D (K64T)/2.5 D 4WD (K24T)/2.5 TD 4WD (K34T)/2.5 TD 4WD (K74T)/2.5 TD 4x4/2.5 TD 4x4 (K74T)/2.6 4WD (K33T) |   |
|                                |                                      | <b>mitsubishi PAJERO II (V2_W, V4_W)</b>   |   |
|                                |                                      | 2.5 TD (V24C, V24W)  |   |
|                                |                                      |  |   |
|                                |                                      |  |   |

|   |   |  |  |  |   |
|---|---|--|--|--|---|
| <b>GOM-525</b><br><b>Bearing Bush, stabiliser</b><br><b>Boccola barra stabilizzatrice</b> | <b>MITSUBISHI</b> MB150095  | <b>MITSUBISHI PAJERO II Fuoristrada aperto (V2_W, V4_W)</b><br>2.5 TD (V24C, V24W)   |   |  |   |
|   | Length/Lunghezza [mm] 46  | <b>HYUNDAI GALLOPER I</b><br>2.5 TD/2.5 TD intercooler/3.0 V6  |  |  |   |
|   | Height/Altezza [mm] 41  | <b>HYUNDAI GALLOPER II (JK-01)</b><br>2.5 TCI D/2.5 TD/2.5 TD intercooler/3.0 V6   |  |  |   |
|   | Width/Larghezza [mm] 45,5   | <b>MITSUBISHI L 200 (K__T)</b><br>1.6 K11 (AG32)/2.0 (K62T)/2.0 4G63/2.4 4x4 (K75T)/2.5 D (K14T)/2.5 D (K64T)/2.5 D 4WD (K24T)/2.5 TD 4WD (K34T)/2.5 TD 4WD (K74T)/2.5 TD 4x4/2.5 TD 4x4 (K74T)/2.6 4WD (K33T) |  |  |   |
|   | Inner Diam./Diam. Interno [mm] 29   | <b>MITSUBISHI PAJERO II (V2_W, V4_W)</b><br>2.5 TD (V24C, V24W)  |  |  |   |
| <b>GOM-527</b><br><b>Bearing Bush, stabiliser</b><br><b>Boccola barra stabilizzatrice</b> | <b>MITSUBISHI</b> MR150094  | <b>MITSUBISHI PAJERO II Fuoristrada aperto (V2_W, V4_W)</b><br>2.5 TD (V24C, V24W)   |   |  |   |
|   | Length/Lunghezza [mm] 45,3  | <b>HYUNDAI GALLOPER I</b><br>2.5 TD/2.5 TD intercooler/3.0 V6  |  |  |   |
|   | Height/Altezza [mm] 41  | <b>HYUNDAI GALLOPER II (JK-01)</b><br>2.5 TCI D/2.5 TD/2.5 TD intercooler/3.0 V6   |  |  |   |
|   | Width/Larghezza [mm] 43,5   | <b>MITSUBISHI L 200 (K__T)</b><br>1.6 K11 (AG32)/2.0 (K62T)/2.0 4G63/2.4 4x4 (K75T)/2.5 D (K14T)/2.5 D (K64T)/2.5 D 4WD (K24T)/2.5 TD 4WD (K34T)/2.5 TD 4WD (K74T)/2.5 TD 4x4/2.5 TD 4x4 (K74T)/2.6 4WD (K33T) |  |  |   |
|   | Inner Diam./Diam. Interno [mm] 27   | <b>MITSUBISHI PAJERO II (V2_W, V4_W)</b><br>2.5 TD (V24C, V24W)  |  |  |   |
| <b>GOM-528</b><br><b>Holder, control arm mounting</b><br><b>Silentblock</b>               | <b>MITSUBISHI</b> MB808909  | <b>MITSUBISHI PAJERO II Fuoristrada aperto (V2_W, V4_W)</b><br>2.5 TD (V24C, V24W)   |  |  |   |
|   | Width/Larghezza [mm] 53   | <b>MITSUBISHI CARISMA (DA_)</b><br>1.6/1.8/1.8 16V/1.8 16V GDI/1.8 GDI/1.9 DI-D/1.9 TD   |  |  |   |
|   | Inner Diam./Diam. Interno [mm] 21   | <b>MITSUBISHI CARISMA Tre volumi (DA_)</b><br>1.6/1.8/1.8 16V GDI/1.8 GDI/1.9 DI-D/1.9 TD/2.0 16V GT EVO VI/VII  |  |  |   |
|   | Outer Diam./Diam. esterno [mm] 64   | <b>MITSUBISHI COLT IV (CA_A)</b><br>1.3 GLi 12V (CA1A)/1.6/1.6 4x4/1.6 GLXi 16V (CA4A)/1.8 GTi 16V (CA5A)/2.0 D (4D68)   |  |  |   |
|   |   | <b>MITSUBISHI COLT V (CJ_A)</b><br>1.3/1.5/1300/1300 GL, GLX (CJ1A)/1500 (CJ2A)/1600/1600 GLX (CJ4A)   |  |  |   |
|   |   | <b>MITSUBISHI LANCER V (CB/D_A)</b><br>1.3 (CB1A)/1.6/1.6 16V (CB4A)/1.6 16V 4WD (CD4A)/1.8 16V (CB5A)/1.8 GTi/2.0 Diesel (CB8A)   |  |  |   |
|   |   | <b>MITSUBISHI LANCER V SW (CB_W, CD_W)</b><br>1.6 16V (CB4W)/1.6 16V 4WD (CD4W)/2.0 D (CB8W)   |  |  |   |
|   |   | <b>MITSUBISHI LANCER VI (CK/P_A)</b><br>1.3 12V (CK1A)/1.5 16V (CK2A)/1.6 16V (CK4A)/2.0 16V EVO VI / VII (CP9A)   |  |  |   |
|   |   | <b>VOLVO S40 I (VS)</b><br>1.6/1.8/1.8 i/1.9 DI/1.9 T4/1.9 TD/2.0/2.0 T/2.0 T4   |  |  |   |
|   |   | <b>VOLVO V40 SW (VW)</b><br>1.6/1.8/1.8 i/1.9 DI/1.9 T4/1.9 TD/2.0/2.0 T/2.0 T4  |  |  |   |
|   | <b>GOM-529</b><br><b>Holder, control arm mounting</b><br><b>Silentblock</b> | <b>MITSUBISHI</b> MB808910   |  | <b>MITSUBISHI CARISMA (DA_)</b><br>1.6/1.8/1.8 16V/1.8 16V GDI/1.8 GDI/1.9 DI-D/1.9 TD   |  |
|   |   | Width/Larghezza [mm] 53  |  | <b>MITSUBISHI CARISMA Tre volumi (DA_)</b><br>1.6/1.8/1.8 16V GDI/1.8 GDI/1.9 DI-D/1.9 TD/2.0 16V GT EVO VI/VII                  |   |
|   |   | Inner Diam./Diam. Interno [mm] 21  |  | <b>MITSUBISHI COLT IV (CA_A)</b><br>1.3 GLi 12V (CA1A)/1.6/1.6 4x4/1.6 GLXi 16V (CA4A)/1.8 GTi 16V (CA5A)/2.0 D (4D68)           |   |
|   |   | Outer Diam./Diam. esterno [mm] 64  |  | <b>MITSUBISHI COLT V (CJ_A)</b><br>1.3/1.5/1300/1300 GL, GLX (CJ1A)/1500 (CJ2A)/1600/1600 GLX (CJ4A)                             |   |
|   |   |  |  | <b>MITSUBISHI LANCER V (CB/D_A)</b><br>1.3 (CB1A)/1.6/1.6 16V (CB4A)/1.6 16V 4WD (CD4A)/1.8 16V (CB5A)/1.8 GTi/2.0 Diesel (CB8A) |   |
|   |   | <b>MITSUBISHI LANCER V SW (CB_W, CD_W)</b><br>1.6 16V (CB4W)/1.6 16V 4WD (CD4W)/2.0 D (CB8W)   |  |  |   |
|   |   | <b>MITSUBISHI LANCER VI (CK/P_A)</b><br>1.3 12V (CK1A)/1.5 16V (CK2A)/1.6 16V (CK4A)/2.0 16V EVO VI / VII (CP9A)   |  |  |   |

|                                 |                                      |   |   |
|---------------------------------|--------------------------------------|---|---|
|                                 |                                      | <b>VOLVO S40 I (VS)</b>   |   |
|                                 |                                      | 1.6/1.8/1.8 i/1.9 DI/1.9 T4/1.9 TD/2.0/2.0 T/2.0 T4   |   |
|                                 |                                      | <b>VOLVO V40 SW (VW)</b>  |   |
|                                 |                                      | 1.6/1.8/1.8 i/1.9 DI/1.9 T4/1.9 TD/2.0/2.0 T/2.0 T4   |   |
| <b>GOM-530</b>                  | <b>Holder, control arm mounting</b>  | <b>MITSUBISHI COLT IV (CA_A)</b>  |    |
|                                 | <b>Silentblock</b>                   | 1.3 GLi 12V (CA1A)/1.6/1.6 GLXi 16V (CA4A)/1.8 GTi 16V (CA5A)/2.0 D (4D68)  |   |
|                                 |                                      | <b>MITSUBISHI COLT V (CJ_A)</b>   |   |
|                                 |                                      | 1300/1300 GL, GLX (CJ1A)/1500 (CJ2A)/1600/1600 GLX (CJ4A)   |   |
| Length/Lunghezza [mm]           | 60                                   | <b>MITSUBISHI LANCER V (CB/D_A)</b>   |   |
| Inner Diam./Diam. Interno [mm]  | 12                                   | 1.3 (CB1A)/1.6/1.6 16V (CB4A)/1.6 16V 4WD (CD4A)/1.8 16V (CB5A)/2.0 Diesel (CB8A)                                     |   |
| Outer Diam./Diam. esterno [mm]  | 32,6                                 | <b>MITSUBISHI LANCER V SW (CB_W, CD_W)</b>  |   |
|                                 |                                      | 1.6 16V (CB4W)/1.6 16V 4WD (CD4W)/2.0 D (CB8W)  |   |
|                                 |                                      | <b>MITSUBISHI LANCER VI (CK/P_A)</b>  |   |
|                                 |                                      | 1.3 12V (CK1A)/1.5 16V (CK2A)/1.6 16V (CK4A)/2.0 16V EVO VI / VII (CP9A)  |   |
| <b>GOM-531</b>                  | <b>Holder, control arm mounting</b>  | <b>MITSUBISHI COLT CZC Cabriolet</b>  |    |
|                                 | <b>Silentblock</b>                   | 1.5   |   |
|                                 |                                      | <b>MITSUBISHI COLT VI</b>   |   |
|                                 |                                      | 1.1/1.3/1.5/1.5 CZT/1.5 DI-D  |   |
|                                 |                                      | <b>SMART FORFOUR</b>  |   |
| Length/Lunghezza [mm]           | 54                                   | 1.1 (454.030)/1.3 (454.031)/1.5/1.5 (454.032)/1.5 BRABUS (454.034)/1.5 CDI (454.000)/1.5 CDI (454.001)                |   |
| Inner Diam./Diam. Interno [mm]  | 14                                   |   |   |
| Outer Diam./Diam. esterno [mm]  | 60                                   |   |   |
| <b>GOM-532</b>                  | <b>Holder, control arm mounting</b>  | <b>MITSUBISHI COLT CZC Cabriolet</b>  |   |
|                                 | <b>Silentblock</b>                   | 1.5   |   |
|                                 |                                      | <b>MITSUBISHI COLT VI</b>   |   |
|                                 |                                      | 1.1/1.3/1.5/1.5 CZT/1.5 DI-D  |   |
|                                 |                                      | <b>SMART FORFOUR</b>  |   |
| Length/Lunghezza [mm]           | 59                                   | 1.1 (454.030)/1.3 (454.031)/1.5/1.5 (454.032)/1.5 BRABUS (454.034)/1.5 CDI (454.000)/1.5 CDI (454.001)                |   |
| Inner Diam./Diam. Interno [mm]  | 14                                   |   |   |
| Outer Diam./Diam. esterno [mm]  | 41                                   |   |   |
| <b>GOM-533</b>                  | <b>Bearing Bush, stabiliser</b>      | <b>MITSUBISHI GALANT VI (EA_)</b>   |  |
|                                 | <b>Boccola barra stabilizzatrice</b> | 2.0/2.0 (EA2A)/2.0 TDI (EA6A)/2.4 GDI/2.5 V6 24V/2.5 V6 24V (EA5A)  |   |
| MITSUBISHI                      | MR244116                             | <b>MITSUBISHI GALANT VI SW (EA_)</b>  |   |
| Fitting Position/Lato Montaggio | Front                                | 2.0/2.0 (EA2W)/2.0 TDI (EA6W)/2.4 GDI/2.5 V6 24V/2.5 V6 24V (EA5W)  |   |
|                                 |                                      | <b>VW TRANSPORTER III Autobus</b>   |   |
|                                 |                                      | 1.9   |   |
| <b>GOM-534</b>                  | <b>Holder, control arm mounting</b>  | <b>MITSUBISHI GALANT VI (EA_)</b>   |  |
|                                 | <b>Silentblock</b>                   | 2.0/2.0 (EA2A)/2.0 TDI (EA6A)/2.4 GDI/2.5 V6 24V/2.5 V6 24V (EA5A)  |   |
| MITSUBISHI                      | MR296292                             | <b>MITSUBISHI GALANT VI SW (EA_)</b>  |   |
| Length/Lunghezza [mm]           | 132                                  | 2.0/2.0 (EA2W)/2.0 TDI (EA6W)/2.4 GDI/2.5 V6 24V/2.5 V6 24V (EA5W)  |   |
| Diameter/Diametro [mm]          | 56,5                                 |   |   |
| <b>GOM-535</b>                  | <b>Holder, control arm mounting</b>  | <b>MITSUBISHI ECLIPSE I (D2_A)</b>  |  |
|                                 | <b>Silentblock</b>                   | 1.8/2.0 i 16V (D22A)/2.0 i 16V 4x4  |   |
|                                 |                                      | <b>MITSUBISHI GALANT V (E5_A, E7_A, E8_A)</b>   |   |
|                                 |                                      | 1.8 (E52A)/1.8 GLSi (E52A)/2.0 GLSi (E55A)/2.0 GLSi 4x4 (E75A)/2.0 GLSTD (E57A)/2.0 V6-24 (E54A)/2.5 V6-24 4x4 (E88A) |   |
| Length/Lunghezza [mm]           | 55                                   | <b>MITSUBISHI GALANT V Tre volumi (E5_A, E7_A, E8_A)</b>  |   |
| Inner Diam./Diam. Interno [mm]  | 12,5                                 | 1.8 (E52A)/1.8 GLSi (E52A)/2.0 GLSi (E55A)/2.0 GLSi 4x4 (E75A)/2.0 GLSTD (E57A)/2.0 V6-24 (E54A)/2.5 V6-24 4x4 (E88A) |   |
| Outer Diam./Diam. esterno [mm]  | 40                                   | <b>MITSUBISHI GALANT VI (EA_)</b>   |   |
|                                 |                                      | 2.0/2.0 (EA2A)/2.0 TDI (EA6A)/2.4 GDI/2.5 V6 24V/2.5 V6 24V (EA5A)  |   |
|                                 |                                      | <b>MITSUBISHI GALANT VI SW (EA_)</b>  |   |
|                                 |                                      | 2.0/2.0 (EA2W)/2.0 TDI (EA6W)/2.4 GDI/2.5 V6 24V/2.5 V6 24V (EA5W)  |   |

|                                 |                                      |   |   |
|---------------------------------|--------------------------------------|---|---|
| <b>GOM-536</b>                  | <b>Holder, control arm mounting</b>  | <b>MITSUBISHI ECLIPSE I (D2_A)</b><br>1.8/2.0 i 16V (D22A)/2.0 i 16V 4x4  |    |
|                                 | <b>Silentblock</b>                   | <b>MITSUBISHI GALANT V (E5_A, E7_A, E8_A)</b><br>1.8 (E52A)/1.8 GLSI (E52A)/2.0 GLSI (E55A)/2.0 GLSI 4x4 (E75A)/2.0 GLSTD (E57A)/2.0 V6-24 (E54A)/2.5 V6-24 4x4 (E88A)            |   |
| MITSUBISHI                      | MR296295                             |   |   |
| Length/Lunghezza [mm]           | 50                                   | <b>MITSUBISHI GALANT V Tre volumi (E5_A, E7_A, E8_A)</b><br>1.8 (E52A)/1.8 GLSI (E52A)/2.0 GLSI (E55A)/2.0 GLSI 4x4 (E75A)/2.0 GLSTD (E57A)/2.0 V6-24 (E54A)/2.5 V6-24 4x4 (E88A) |   |
| Inner Diam./Diam. Interno [mm]  | 12,5                                 | <b>MITSUBISHI GALANT VI (EA_)</b><br>2.0/2.0 (EA2A)/2.0 TDI (EA6A)/2.4 GDI/2.5 V6 24V/2.5 V6 24V (EA5A)   |   |
| Outer Diam./Diam. esterno [mm]  | 40                                   | <b>MITSUBISHI GALANT VI SW (EA_)</b><br>2.0/2.0 (EA2W)/2.0 TDI (EA6W)/2.4 GDI/2.5 V6 24V/2.5 V6 24V (EA5W)  |   |
| <b>GOM-537</b>                  | <b>Holder, control arm mounting</b>  | <b>MITSUBISHI L 200 (K_T)</b><br>2.0 (K62T)/2.5 D (K64T)  |    |
|                                 | <b>Silentblock</b>                   |   |   |
| MITSUBISHI                      | MR234247                             |   |   |
| Height/Altezza [mm]             | 31                                   |   |   |
| Height/Altezza 1 [mm]           | 25                                   |   |   |
| Inner Diam./Diam. Interno [mm]  | 19                                   |   |   |
| <b>GOM-538</b>                  | <b>Bearing Bush, stabiliser</b>      | <b>MITSUBISHI L 200 (K_T)</b><br>2.5 Di-D   |   |
|                                 | <b>Boccola barra stabilizzatrice</b> | <b>MITSUBISHI L 200</b><br>2.5 DiD [RWD]  |   |
| MITSUBISHI                      | MR992317                             |   |   |
| Fitting Position/Lato Montaggio | Front                                |   |   |
| Length/Lunghezza [mm]           | 48                                   |   |   |
| Height/Altezza [mm]             | 57                                   |   |   |
| Width/Larghezza [mm]            | 58                                   |   |   |
| Inner Diam./Diam. Interno [mm]  | 25                                   |   |   |
| <b>GOM-539</b>                  | <b>Holder, control arm mounting</b>  | <b>MITSUBISHI LANCER SW</b><br>1.6/2.0  |  |
|                                 | <b>Silentblock</b>                   | <b>MITSUBISHI LANCER Tre volumi</b><br>1.3/1.6/2.0  |   |
| MITSUBISHI                      | MR403440                             | <b>MITSUBISHI LANCER VI (CK/P_A)</b><br>2.0 16V EVO IX/2.0 16V EVO VIII   |   |
| <b>GOM-540</b>                  | <b>Holder, control arm mounting</b>  | <b>MITSUBISHI LANCER SW</b><br>1.6/2.0  |  |
|                                 | <b>Silentblock</b>                   | <b>MITSUBISHI LANCER Tre volumi</b><br>1.3/1.6/2.0  |   |
| MITSUBISHI                      | MR403441                             | <b>MITSUBISHI LANCER VI (CK/P_A)</b><br>2.0 16V EVO IX/2.0 16V EVO VIII   |   |
| Length/Lunghezza [mm]           | 54                                   |   |   |
| Inner Diam./Diam. Interno [mm]  | 14                                   |   |   |
| Outer Diam./Diam. esterno [mm]  | 61                                   |   |   |
| <b>GOM-541</b>                  | <b>Bearing Bush, stabiliser</b>      | <b>MITSUBISHI LANCER SW</b><br>1.6/2.0  |  |
|                                 | <b>Boccola barra stabilizzatrice</b> | <b>MITSUBISHI LANCER Tre volumi</b><br>1.3/1.6/2.0  |   |
| MITSUBISHI                      | MN100250                             | <b>MITSUBISHI LANCER VI (CK/P_A)</b><br>2.0 16V EVO IX/2.0 16V EVO VIII   |   |
| Fitting Position/Lato Montaggio | Front                                |   |   |

|                |                                      |                                      |  |   |
|----------------|--------------------------------------|--------------------------------------|--|---|
| <b>GOM-542</b> | <b>Holder, control arm mounting</b>  | <b>Holder, control arm mounting</b>  | <b>MITSUBISHI PAJERO III (V60)</b>                                 |    |
|                | <b>Silentblock</b>                   | <b>Silentblock</b>                   | 2.5 TDi (V64W, V74W)/3.2 DI-D (V68W, V78W)/3.5 V6 GDI (V65W, V75W) |   |
| MITSUBISHI     | MR519398                             |                                      | <b>MITSUBISHI PAJERO IV (V80)</b>                                  |   |
|                |                                      |                                      | 3.2 DI-D (V88W, V98W)/3.8 V6 (V87W, V97W)                          |   |
|                | Inner Diam./Diam. Interno [mm]       | 14                                   |  | 542   |
|                | Overall Length/Lungh. Tot. [mm]      | 54                                   |  |   |
|                | Outer Diam./Diam. esterno [mm]       | 45                                   |  |   |
| <b>GOM-543</b> | <b>Holder, control arm mounting</b>  | <b>Holder, control arm mounting</b>  | <b>MITSUBISHI PAJERO III (V60)</b>                                 |    |
|                | <b>Silentblock</b>                   | <b>Silentblock</b>                   | 2.5 TDi (V64W, V74W)/3.2 DI-D (V68W, V78W)/3.5 V6 GDI (V65W, V75W) |   |
| MITSUBISHI     | MR496795                             |                                      |  |   |
|                | Inner Diam./Diam. Interno [mm]       | 16,5                                 |  | 543   |
|                | Overall Length/Lungh. Tot. [mm]      | 77                                   |  |   |
|                | Outer Diam./Diam. esterno [mm]       | 48,5                                 |  |   |
| <b>GOM-544</b> | <b>Holder, control arm mounting</b>  | <b>Holder, control arm mounting</b>  | <b>MITSUBISHI PAJERO III (V60)</b>                                 |    |
|                | <b>Silentblock</b>                   | <b>Silentblock</b>                   | 2.5 TDi (V64W, V74W)/3.2 DI-D (V68W, V78W)/3.5 V6 GDI (V65W, V75W) |   |
| MITSUBISHI     | MR496795                             |                                      |  |   |
|                | Inner Diam./Diam. Interno [mm]       | 16                                   |  | 544   |
|                | Overall Length/Lungh. Tot. [mm]      | 77                                   |  |   |
|                | Outer Diam./Diam. esterno [mm]       | 53                                   |  |   |
| <b>GOM-545</b> | <b>Holder, control arm mounting</b>  | <b>Holder, control arm mounting</b>  | <b>MITSUBISHI PAJERO PININ (H6_W, H7_W)</b>                        |  |
|                | <b>Silentblock</b>                   | <b>Silentblock</b>                   | 1.8/1.8 GDI (H66W)/2.0 GDI (H67W, H77W)                            |   |
| MITSUBISHI     | MR319067                             |                                      |  |   |
|                | Length/Lunghezza [mm]                | 62                                   |  | <b>RU-545</b>   |
|                | Inner Diam./Diam. Interno [mm]       | 12                                   |  |   |
|                | Outer Diam./Diam. esterno [mm]       | 32                                   |  |   |
| <b>GOM-546</b> | <b>Bearing Bush, stabiliser</b>      | <b>Bearing Bush, stabiliser</b>      | <b>CITROEN C-CROSSER</b>   |  |
|                | <b>Boccola barra stabilizzatrice</b> | <b>Boccola barra stabilizzatrice</b> | 2.2 HDi  |   |
| MITSUBISHI     | 4056A079                             |                                      | <b>MITSUBISHI ASX</b>  | 546   |
|                | Fitting Position/Lato Montaggio      | Front                                | 1.6/1.8/1.8 4WD/1.8 DI-D/1.8 DI-D 4WD/2.0 i/2.0 i 4WD              |   |
|                | Height/Altezza [mm]                  | 43                                   | <b>MITSUBISHI OUTLANDER</b>  |   |
|                | Width/Larghezza [mm]                 | 46                                   | 2.0 DI-D/2.2 DI-D/2.4 Mivec  |   |
|                | Width/Larghezza [mm]                 | 50                                   | <b>PEUGEOT 4007</b>  |   |
|                | Inner Diam./Diam. Interno [mm]       | 19                                   | 2.2 HDi/2.4 16V  |   |
| <b>GOM-547</b> | <b>Bearing Bush, stabiliser</b>      | <b>Bearing Bush, stabiliser</b>      | <b>CITROEN C-CROSSER</b>   |  |
|                | <b>Boccola barra stabilizzatrice</b> | <b>Boccola barra stabilizzatrice</b> | 2.2 HDi  |   |
| MITSUBISHI     | 4156A028                             |                                      | <b>MITSUBISHI OUTLANDER</b>  | 547   |
|                | Fitting Position/Lato Montaggio      | Rear                                 | 2.0 DI-D/2.2 DI-D/2.4 Mivec  |   |
|                |                                      |                                      | <b>PEUGEOT 4007</b>  |   |
|                |                                      |                                      | 2.2 HDi/2.4 16V  |   |
| <b>GOM-548</b> | <b>Holder, control arm mounting</b>  | <b>Holder, control arm mounting</b>  | <b>CITROEN C-CROSSER</b>   |  |
|                | <b>Silentblock</b>                   | <b>Silentblock</b>                   | 2.2 HDi  |   |
| MITSUBISHI     | MN125871                             |                                      | <b>MITSUBISHI ASX</b>  |   |
|                | Length/Lunghezza [mm]                | 60                                   | 1.6/1.8/1.8 4WD/1.8 DI-D/1.8 DI-D 4WD/2.0 i/2.0 i 4WD              |   |
|                | Inner Diam./Diam. Interno [mm]       | 14                                   | <b>MITSUBISHI OUTLANDER</b>  |   |
|                | Outer Diam./Diam. esterno [mm]       | 37                                   | 2.0 DI-D/2.2 DI-D/2.4 Mivec  |   |
|                |                                      |                                      | <b>PEUGEOT 4007</b>  |   |
|                |                                      |                                      | 2.2 HDi/2.4 16V  | 548   |





|                                |                                     |   |   |
|--------------------------------|-------------------------------------|---|---|
| <b>GOM-549</b>                 | <b>Holder, control arm mounting</b> | <b>CITROEN C-CROSSER</b>                              |  |
|                                | <b>Silentblock</b>                  | 2.2 HDi   |   |
| MITSUBISHI                     | MN184133                            | <b>MITSUBISHI ASX</b>                                 | 549   |
| Length/Lunghezza [mm]          | 54                                  | 1.6/1.8/1.8 4WD/1.8 DI-D/1.8 DI-D 4WD/2.0 i/2.0 i 4WD |   |
| Inner Diam./Diam. Interno [mm] | 14                                  | <b>MITSUBISHI OUTLANDER</b>                           |   |
| Outer Diam./Diam. esterno [mm] | 60                                  | 2.0 DI-D/2.2 DI-D/2.4 Mivec                           |   |
|                                |                                     | <b>PEUGEOT 4007</b>                                   |   |
|                                |                                     | 2.2 HDi/2.4 16V                                       |   |

|                                 |                                      |   |   |
|---------------------------------|--------------------------------------|---|---|
| <b>GOM-550</b>                  | <b>Bearing Bush, stabiliser</b>      | <b>MITSUBISHI PAJERO IV (V80)</b>         |  |
|                                 | <b>Boccola barra stabilizzatrice</b> | 3.2 DI-D (V88W, V98W)/3.8 V6 (V87W, V97W) |   |
| MITSUBISHI                      | 4056A121                             |   |   |
| Fitting Position/Lato Montaggio | Front                                |   |   |
| Length/Lunghezza [mm]           | 50                                   |   |   |
| Height/Altezza [mm]             | 56                                   |   |   |
| Width/Larghezza [mm]            | 52                                   |   |   |
| Inner Diam./Diam. Interno [mm]  | 30                                   |   |   |

|                                 |                                      |   |  |
|---------------------------------|--------------------------------------|---|--|
| <b>GOM-551</b>                  | <b>Bearing Bush, stabiliser</b>      | <b>MITSUBISHI PAJERO IV (V80)</b>         |  |
|                                 | <b>Boccola barra stabilizzatrice</b> | 3.2 DI-D (V88W, V98W)/3.8 V6 (V87W, V97W) |  |
| MITSUBISHI                      | 4156A041                             |   |  |
| Fitting Position/Lato Montaggio | Rear                                 |   |  |
| Length/Lunghezza [mm]           | 43                                   |   |  |
| Height/Altezza [mm]             | 48                                   |   |  |
| Width/Larghezza [mm]            | 59                                   |   |  |
| Inner Diam./Diam. Interno [mm]  | 25                                   |   |  |

|                                    |                        |                                |   |
|------------------------------------|------------------------|--------------------------------|---|
| <b>GOM-552</b>                     | <b>Engine Mounting</b> | <b>MITSUBISHI L 200 (K__T)</b> |  |
|                                    | <b>Supporto motore</b> | 2.5 DI-D                       |   |
| MITSUBISHI                         | MR992670               | <b>MITSUBISHI L 200</b>        | 552   |
| Fitting Position/Lato Montaggio    | Front                  | 2.5 DiD [RWD]                  |   |
| Length/Lunghezza [mm]              | 117,5                  |                                |   |
| Height/Altezza [mm]                | 66                     |                                |   |
| Width/Larghezza [mm]               | 71                     |                                |   |
| Mount. Bores/Fori Fiss. Dist. [mm] | 100                    |                                |   |

|                                    |   |                                |   |
|------------------------------------|---|--------------------------------|---|
| <b>GOM-553</b>                     | <b>Bearing,propshaft centre bearing</b> | <b>MITSUBISHI L 200 (K__T)</b> |  |
|                                    | <b>Supporto albero cardanico</b>        | 2.5 DI-D                       |   |
| MITSUBISHI                         | MR580647                                | <b>MITSUBISHI L 200</b>        | 553   |
| Height/Altezza [mm]                | 125                                     | 2.5 DiD [RWD]                  |   |
| Width/Larghezza [mm]               | 60                                      |                                |   |
| Inner Diam./Diam. Interno [mm]     | 30                                      |                                |   |
| Mount. Bores/Fori Fiss. Dist. [mm] | 188                                     |                                |   |

|                                 |                        |                                |   |
|---------------------------------|------------------------|--------------------------------|---|
| <b>GOM-554</b>                  | <b>Engine Mounting</b> | <b>MITSUBISHI L 200 (K__T)</b> |  |
|                                 | <b>Supporto motore</b> | 2.5 DI-D                       |   |
| MITSUBISHI                      | 1091A079               | <b>MITSUBISHI L 200</b>        | 554   |
| Fitting Position/Lato Montaggio | Left Front             | 2.5 DiD [RWD]                  |   |

|                                 |                        |                                |   |
|---------------------------------|------------------------|--------------------------------|---|
| <b>GOM-555</b>                  | <b>Engine Mounting</b> | <b>MITSUBISHI L 200 (K__T)</b> |  |
|                                 | <b>Supporto motore</b> | 2.5 DI-D                       |   |
| MITSUBISHI                      | 1091A080               | <b>MITSUBISHI L 200</b>        | 555   |
| Fitting Position/Lato Montaggio | Right Front            | 2.5 DiD [RWD]                  |   |

|  |  |  |
|--|--|--|
| <b>GOM-556</b><br><b>Holder, control arm mounting</b><br><b>Silentblock</b>  | <b>mitsubishi L 200 (K__T)</b><br>2.5 Di-D   |  <p>556</p>   |
| MITSUBISHI MR992256<br>Fitting Position/Lato Montaggio Lower Front Axle<br>Length/Lunghezza [mm] 66<br>Inner Diam./Diam. Interno [mm] 16<br>Outer Diam./Diam. esterno [mm] 61            |  |  |
| <b>GOM-557</b><br><b>Engine Mounting</b><br><b>Supporto motore</b>   | <b>mitsubishi L 200</b><br>2.5 Di-D [RWD] (KA4T)/2.5 DiD [RWD]                     |  <p>557</p>   |
| MITSUBISHI MR992713<br>Fitting Position/Lato Montaggio Rear<br>Length/Lunghezza [mm] 295<br>Height/Altezza [mm] 124<br>Width/Larghezza [mm] 104  |  |  |
| <b>GOM-558</b><br><b>Engine Mounting</b><br><b>Supporto motore</b>   | <b>mitsubishi L 200</b><br>2.5 Di-D [RWD] (KA4T)/2.5 DiD [RWD]                     |  <p>558</p>   |
| MITSUBISHI MR992717<br>Fitting Position/Lato Montaggio Rear<br>Height/Altezza [mm] 108<br>Width/Larghezza [mm] 86<br>Overall Length/Lungh. Tot. [mm] 279                                 |  |  |
| <b>GOM-559</b><br><b>Bearing Bush, stabiliser</b><br><b>Boccola barra stabilizzatrice</b>  | <b>mitsubishi PAJERO III (V60)</b><br>2.5 TDi (V64W, V74W)/3.2 Di-D (V68W, V78W)   |  <p>559</p> |
| MITSUBISHI MR594282<br>Fitting Position/Lato Montaggio Rear Axle<br>Length/Lunghezza [mm] 43,5<br>Height/Altezza [mm] 39<br>Width/Larghezza [mm] 40<br>Inner Diam./Diam. Interno [mm] 26 |  |  |
| <b>GOM-560</b><br><b>Bearing Bush, stabiliser</b><br><b>Boccola barra stabilizzatrice</b>  | <b>mitsubishi PAJERO III (V60)</b><br>2.5 TDi (V64W, V74W)/3.2 Di-D (V68W, V78W)   |  <p>560</p> |
| MITSUBISHI MR418547<br>Fitting Position/Lato Montaggio Rear Axle   |  |  |
| <b>GOM-561</b><br><b>Bearing Bush, stabiliser</b><br><b>Boccola barra stabilizzatrice</b>  | <b>mitsubishi LANCER VI (CK/P_A)</b><br>2.0 16V EVO IX/2.0 16V EVO VI / VII (CP9A) |  <p>561</p> |
| MITSUBISHI MR589880<br>Fitting Position/Lato Montaggio Rear Axle<br>Length/Lunghezza [mm] 40<br>Height/Altezza [mm] 30<br>Width/Larghezza [mm] 28<br>Inner Diam./Diam. Interno [mm] 22   |  |  |
| <b>GOM-562</b><br><b>Bearing Bush, stabiliser</b><br><b>Boccola barra stabilizzatrice</b>  | <b>mitsubishi LANCER VI (CK/P_A)</b><br>2.0 16V EVO IX/2.0 16V EVO VI / VII (CP9A) |  <p>562</p> |
| MITSUBISHI MR554820<br>Fitting Position/Lato Montaggio Front Axle<br>Length/Lunghezza [mm] 36<br>Height/Altezza [mm] 34<br>Width/Larghezza [mm] 34<br>Inner Diam./Diam. Interno [mm] 24  |  |  |

|  |  |  |
|--|--|--|
| <p><b>GOM-563</b>      <b>Bearing Bush, stabiliser</b></p> <p><b>Boccola barra stabilizzatrice</b></p>   | <p><b>MITSUBISHI L 400 Furgonato (PAOV)</b><br/>2500 TD</p>  |  <p>563</p>   |
| <p>MITSUBISHI      MR150093</p> <p>Fitting Position/Lato Montaggio      Front Axle</p> <p>Length/Lunghezza [mm]      45,5</p> <p>Height/Altezza [mm]      40,5</p> <p>Width/Larghezza [mm]      44,5</p> <p>Inner Diam./Diam. Interno [mm]      28</p>   | <p><b>MITSUBISHI L 200 (K__T)</b><br/>2.5 TD 4x4 (K74T)</p> <p><b>MITSUBISHI PAJERO SPORT (K90)</b><br/>2.5 TD/3.0 V6</p>                                      |  |
| <p><b>GOM-564</b>      <b>Bearing Bush, stabiliser</b></p> <p><b>Boccola barra stabilizzatrice</b></p>   |  |  |
| <p>MITSUBISHI      MR150767</p> <p>Fitting Position/Lato Montaggio      Front Axle</p> <p>Fitting Position/Lato Montaggio      Outer</p> <p>Length/Lunghezza [mm]      40</p> <p>Height/Altezza [mm]      35</p> <p>Width/Larghezza [mm]      42</p> <p>Inner Diam./Diam. Interno [mm]      20</p> | <p><b>MITSUBISHI PAJERO SPORT (K90)</b><br/>2.5 TD/3.0 V6</p>  |  <p>565</p>  |
| <p><b>GOM-565</b>      <b>Bearing Bush, stabiliser</b></p> <p><b>Boccola barra stabilizzatrice</b></p>   |  |  |
| <p>MITSUBISHI      MR267649</p> <p>Fitting Position/Lato Montaggio      Front Axle</p> <p>Fitting Position/Lato Montaggio      inner</p> <p>Length/Lunghezza [mm]      40</p> <p>Height/Altezza [mm]      40</p> <p>Width/Larghezza [mm]      49</p> <p>Inner Diam./Diam. Interno [mm]      28</p> | <p><b>MITSUBISHI PAJERO SPORT (K90)</b><br/>2.5 TD/3.0 V6</p>  |  <p>566</p> |
| <p><b>GOM-566</b>      <b>Bearing Bush, stabiliser</b></p> <p><b>Boccola barra stabilizzatrice</b></p>   |  |  |
| <p>MITSUBISHI      MB338594</p> <p>Fitting Position/Lato Montaggio      Rear Axle</p> <p>Length/Lunghezza [mm]      43</p> <p>Height/Altezza [mm]      37</p> <p>Width/Larghezza [mm]      40</p> <p>Inner Diam./Diam. Interno [mm]      22</p>  | <p><b>MITSUBISHI COLT V (CJ_A)</b><br/>1300/1300 GL, GLX (CJ1A)/1500 (CJ2A)/1600/1600 GLX (CJ4A)</p>   |  <p>567</p> |
| <p><b>GOM-567</b>      <b>Bearing Bush, stabiliser</b></p> <p><b>Boccola barra stabilizzatrice</b></p>   | <p><b>MITSUBISHI PAJERO II Fuoristrada aperto (V2_W, V4_W)</b><br/>1.8 GDI</p> <p><b>MITSUBISHI PAJERO PININ (H6_W, H7_W)</b><br/>1.8/2.0 GDI (H67W, H77W)</p> |  |
| <p><b>GOM-568</b>      <b>Bearing Bush, stabiliser</b></p> <p><b>Boccola barra stabilizzatrice</b></p>   |  |  |
| <p>MITSUBISHI      MR455699</p> <p>Fitting Position/Lato Montaggio      Front Axle</p> <p>Length/Lunghezza [mm]      40</p> <p>Height/Altezza [mm]      38</p> <p>Width/Larghezza [mm]      41</p> <p>Inner Diam./Diam. Interno [mm]      23</p>   |  |  |

|                |                                      |   |   |
|----------------|--------------------------------------|---|---|
| <b>GOM-569</b> | <b>Bearing Bush, stabiliser</b>      | <b>MITSUBISHI COLT IV (CA_A)</b>                          |    |
|                | <b>Boccola barra stabilizzatrice</b> | 1.3 GLi 12V (CA1A)/1.6 GLXi 16V (CA4A)/1.8 GTI 16V (CA5A) |   |
| MITSUBISHI     | MB809357                             | <b>MITSUBISHI LANCER V (CB/D_A)</b>                       |   |
|                |                                      | 1.3 (CB1A)/2.0 Diesel (CB8A)                              |   |
|                | Fitting Position/Lato Montaggio      | Rear Axle   |   |
|                | Length/Lunghezza [mm]                | 36,5  |   |
|                | Height/Altezza [mm]                  | 33  |   |
|                | Width/Larghezza [mm]                 | 28  |   |
|                | Inner Diam./Diam. Interno [mm]       | 15  |   |
| <b>GOM-570</b> | <b>Bearing Bush, stabiliser</b>      | <b>MITSUBISHI COLT IV (CA_A)</b>                          |    |
|                | <b>Boccola barra stabilizzatrice</b> | 1.3 GLi 12V (CA1A)/1.6 GLXi 16V (CA4A)/1.8 GTI 16V (CA5A) |   |
| MITSUBISHI     | MB844456                             | <b>MITSUBISHI LANCER V (CB/D_A)</b>                       |   |
|                |                                      | 1.3 (CB1A)/2.0 Diesel (CB8A)                              |   |
|                | Fitting Position/Lato Montaggio      | Front Axle  |   |
|                | Length/Lunghezza [mm]                | 35  |   |
|                | Height/Altezza [mm]                  | 30  |   |
|                | Width/Larghezza [mm]                 | 30  |   |
|                | Inner Diam./Diam. Interno [mm]       | 22  |   |
| <b>GOM-572</b> | <b>Bearing Bush, stabiliser</b>      | <b>MITSUBISHI GALANT VI (EA_)</b>                         |   |
|                | <b>Boccola barra stabilizzatrice</b> | 2.5 V6 24V (EA5A)   |   |
| MITSUBISHI     | MR272646                             | <b>MITSUBISHI GALANT VI SW (EA_)</b>                      |   |
|                |                                      | 2.5 V6 24V (EA5W)   |   |
|                | Fitting Position/Lato Montaggio      | Front Axle  |   |
|                | Length/Lunghezza [mm]                | 47  |   |
|                | Height/Altezza [mm]                  | 42  |   |
|                | Width/Larghezza [mm]                 | 41  |   |
|                | Inner Diam./Diam. Interno [mm]       | 20  |   |
| <b>GOM-601</b> | <b>Engine Mounting</b>               | <b>DAIHATSU FERENZA Hard Top (F300)</b>                   |  |
|                | <b>Supporto motore</b>               | 1.6 16V/1.6 i 16V   |   |
| DAIHATSU       | 12361-87306                          | <b>DAIHATSU FERENZA Soft Top (F300)</b>                   |   |
|                |                                      | 1.6 16V/1.6 i 16V   |   |
|                | Length/Lunghezza [mm]                | 133   |   |
|                | Height/Altezza [mm]                  | 45  |   |
|                | Width/Larghezza [mm]                 | 98  |   |
| <b>GOM-602</b> | <b>Engine Mounting</b>               | <b>DAIHATSU ROCKY Hard Top (F7, F8)</b>                   |  |
|                | <b>Supporto motore</b>               | 2.0/2.2/2.8 D/2.8 TD                                      |   |
| DAIHATSU       | 12361-87603                          | <b>DAIHATSU ROCKY Soft Top (F7, F8)</b>                   |   |
|                |                                      | 2.0/2.2 4x4/2.8 D/2.8 TD                                  |   |
|                | Length/Lunghezza [mm]                | 134   |   |
|                | Height/Altezza [mm]                  | 47  |   |
|                | Width/Larghezza [mm]                 | 90  |   |
| <b>GOM-603</b> | <b>Engine Mounting</b>               | <b>DAIHATSU FERENZA Hard Top (F300)</b>                   |  |
|                | <b>Supporto motore</b>               | 1.6 16V/1.6 i 16V   |   |
| DAIHATSU       | 12371-87607                          | <b>DAIHATSU FERENZA Soft Top (F300)</b>                   |   |
|                |                                      | 1.6 16V/1.6 i 16V   |   |
|                | Length/Lunghezza [mm]                | 112   |   |
|                | Height/Altezza [mm]                  | 35  |   |
|                | Width/Larghezza [mm]                 | 102   |   |
|                |                                      | <b>DAIHATSU ROCKY Hard Top (F7, F8)</b>                   |   |
|                |                                      | 2.0/2.2/2.8 D/2.8 TD                                      |   |
|                |                                      | <b>DAIHATSU ROCKY Soft Top (F7, F8)</b>                   |   |
|                |                                      | 2.0/2.2 4x4/2.8 D/2.8 TD                                  |   |
|                |                                      | <b>DAIHATSU WILDCAT/ROCKY (F70)</b>                       |   |
|                |                                      | 2.8 D/2.8 TD  |   |
|                |                                      | <b>DAIHATSU WILDCAT/ROCKY (F75)</b>                       |   |
|                |                                      | 2.8 D/2.8 TD  |   |

|                                 |                                      |  |   |
|---------------------------------|--------------------------------------|--|---|
| <b>GOM-605</b>                  | <b>Bush, leaf spring</b>             | <b>DAIHATSU FEROZA Hard Top (F300)</b>                     |    |
|                                 |                                      | 1.6 16V/1.6 i 16V  |   |
|                                 | <b>Boccola balestra</b>              | <b>DAIHATSU FEROZA Soft Top (F300)</b>                     |   |
|                                 |                                      | 1.6 16V/1.6 i 16V  |   |
| DAIHATSU                        | 90043-85046                          | <b>DAIHATSU ROCKY Hard Top (F7, F8)</b>                    |   |
| Fitting Position/Lato Montaggio | Front                                | 2.0/2.2/2.8 D/2.8 TD                                       |   |
| Length/Lunghezza [mm]           | 74                                   | <b>DAIHATSU ROCKY Soft Top (F7, F8)</b>                    |   |
| Inner Diam./Diam. Interno [mm]  | 16                                   | 2.0/2.2 4x4/2.8 D/2.8 TD                                   |   |
| Outer Diam./Diam. esterno [mm]  | 36,2                                 | <b>DAIHATSU WILDCAT/ROCKY (F70)</b>                        |   |
|                                 |                                      | 2.8 D/2.8 TD   |   |
|                                 |                                      | <b>DAIHATSU WILDCAT/ROCKY (F75)</b>                        |   |
|                                 |                                      | 2.8 D/2.8 TD   |   |
| <b>GOM-606</b>                  | <b>Bush, leaf spring</b>             | <b>DAIHATSU FEROZA Hard Top (F300)</b>                     |    |
|                                 |                                      | 1.6 16V/1.6 i 16V  |   |
|                                 | <b>Boccola balestra</b>              | <b>DAIHATSU FEROZA Soft Top (F300)</b>                     |   |
|                                 |                                      | 1.6 16V/1.6 i 16V  |   |
| DAIHATSU                        | 90043-85049                          | <b>DAIHATSU ROCKY Hard Top (F7, F8)</b>                    |   |
| Length/Lunghezza [mm]           | 55                                   | 2.0/2.2/2.8 D/2.8 TD                                       |   |
| Inner Diam./Diam. Interno [mm]  | 30                                   | <b>DAIHATSU ROCKY Soft Top (F7, F8)</b>                    |   |
| Outer Diam./Diam. esterno [mm]  | 45                                   | 2.0/2.2 4x4/2.8 D/2.8 TD                                   |   |
|                                 |                                      | <b>DAIHATSU WILDCAT/ROCKY (F70)</b>                        |   |
|                                 |                                      | 2.8 D/2.8 TD   |   |
|                                 |                                      | <b>DAIHATSU WILDCAT/ROCKY (F75)</b>                        |   |
|                                 |                                      | 2.8 D/2.8 TD   |   |
| <b>GOM-607</b>                  | <b>Bearing Bush, stabiliser</b>      | <b>DAIHATSU ROCKY Hard Top (F7, F8)</b>                    |   |
|                                 |                                      | 2.0/2.2/2.8 D/2.8 TD                                       |   |
|                                 | <b>Boccola barra stabilizzatrice</b> | <b>DAIHATSU ROCKY Soft Top (F7, F8)</b>                    |   |
|                                 |                                      | 2.0/2.2 4x4/2.8 D/2.8 TD                                   |   |
| DAIHATSU                        | 48815-20026                          | <b>DAIHATSU WILDCAT/ROCKY (F70)</b>                        |   |
| Length/Lunghezza [mm]           | 39,5                                 | 2.8 D/2.8 TD   |   |
| Height/Altezza [mm]             | 31,2                                 | <b>DAIHATSU WILDCAT/ROCKY (F75)</b>                        |   |
| Width/Larghezza [mm]            | 30                                   | 2.8 D/2.8 TD   |   |
| Inner Diam./Diam. Interno [mm]  | 16                                   |  |   |
|                                 |                                      | <b>DAIHATSU FEROZA Hard Top (F300)</b>                     |   |
|                                 |                                      | 1.6 16V/1.6 i 16V  |   |
|                                 |                                      | <b>DAIHATSU FEROZA Soft Top (F300)</b>                     |   |
|                                 |                                      | 1.6 16V/1.6 i 16V  |   |
| <b>GOM-608</b>                  | <b>Bearing Bush, stabiliser</b>      | <b>DAIHATSU FEROZA Hard Top (F300)</b>                     |  |
|                                 |                                      | 1.6 16V/1.6 i 16V  |   |
|                                 | <b>Boccola barra stabilizzatrice</b> | <b>DAIHATSU FEROZA Soft Top (F300)</b>                     |   |
|                                 |                                      | 1.6 16V/1.6 i 16V  |   |
| DAIHATSU                        | 48815-87601                          |  |   |
| Length/Lunghezza [mm]           | 40                                   |  |   |
| Height/Altezza [mm]             | 34,3                                 |  |   |
| Width/Larghezza [mm]            | 32                                   |  |   |
| Inner Diam./Diam. Interno [mm]  | 23                                   |  |   |
|                                 |                                      | <b>DAIHATSU FEROZA Hard Top (F300)</b>                     |   |
|                                 |                                      | 1.6 16V/1.6 i 16V  |   |
|                                 |                                      | <b>DAIHATSU FEROZA Soft Top (F300)</b>                     |   |
|                                 |                                      | 1.6 16V/1.6 i 16V  |   |
| <b>GOM-609</b>                  | <b>Bearing Bush, stabiliser</b>      | <b>DAIHATSU FEROZA Hard Top (F300)</b>                     |  |
|                                 |                                      | 1.6 16V/1.6 i 16V  |   |
|                                 | <b>Boccola barra stabilizzatrice</b> | <b>DAIHATSU FEROZA Soft Top (F300)</b>                     |   |
|                                 |                                      | 1.6 16V/1.6 i 16V  |   |
| DAIHATSU                        | 90045-40165                          |  |   |
| Length/Lunghezza [mm]           | 16,2                                 |  |   |
| Inner Diam./Diam. Interno [mm]  | 10                                   |  |   |
| Outer Diam./Diam. esterno [mm]  | 25                                   |  |   |
|                                 |                                      | <b>SUBARU FORESTER (SF)</b>                                |   |
|                                 |                                      | 2.0/2.0 S Turbo  |   |
|                                 |                                      | <b>SUBARU IMPREZA (GC)</b>                                 |   |
|                                 |                                      | 1.6 i/1.6 i 4WD/1.6 i 4WD/1.8 i 4WD/2.0 i 4WD/2.0 Turbo GT |   |
|                                 |                                      | 4WD/2.2 GX AWD   |   |
|                                 |                                      | <b>SUBARU IMPREZA Coupe (GFC)</b>                          |   |
|                                 |                                      | 1.6/1.6 4WD/2.0 4WD/2.0 Turbo 4WD                          |   |
|                                 |                                      | <b>SUBARU IMPREZA SW (GF)</b>                              |   |
|                                 |                                      | 1.5 L/1.6/1.6 i/1.6 i 4WD/1.6 i 4WD/1.8 i 4WD/2.0 4WD/2.0  |   |
|                                 |                                      | 16V AWD/2.0 i Turbo 4WD/2.0 Turbo GT 4WD/2.2 GX AWD        |   |
|                                 |                                      | <b>SUBARU LEGACY I (BC)</b>                                |   |
|                                 |                                      | 1.6/1.6i 16V/1800/1800 4WD/2.0 GL/2000 4WD/2000 Turbo      |   |
|                                 |                                      | 4WD/2200 4WD   |   |
|                                 |                                      | <b>SUBARU LEGACY I SW (BIF)</b>                            |   |
|                                 |                                      | 1.6 GL/1800/1800 4WD/2.2 GX/2000/2000 4WD/2000 Turbo       |   |
|                                 |                                      | Super 4WD/2200 Super 4WD                                   |   |
| <b>GOM-700</b>                  | <b>Holder, control arm mounting</b>  | <b>SUBARU FORESTER (SF)</b>                                |  |
|                                 |                                      | 2.0/2.0 S Turbo  |   |
|                                 | <b>Silentblock</b>                   | <b>SUBARU IMPREZA (GC)</b>                                 |   |
|                                 |                                      | 1.6 i/1.6 i 4WD/1.6 i 4WD/1.8 i 4WD/2.0 i 4WD/2.0 Turbo GT |   |
| DAIHATSU                        | 20201-AA000                          | 4WD/2.2 GX AWD   |   |
| Length/Lunghezza [mm]           | 55                                   | <b>SUBARU IMPREZA Coupe (GFC)</b>                          |   |
| Inner Diam./Diam. Interno [mm]  | 12,5                                 | 1.6/1.6 4WD/2.0 4WD/2.0 Turbo 4WD                          |   |
| Outer Diam./Diam. esterno [mm]  | 37,5                                 | <b>SUBARU IMPREZA SW (GF)</b>                              |   |
|                                 |                                      | 1.5 L/1.6/1.6 i/1.6 i 4WD/1.6 i 4WD/1.8 i 4WD/2.0 4WD/2.0  |   |
|                                 |                                      | 16V AWD/2.0 i Turbo 4WD/2.0 Turbo GT 4WD/2.2 GX AWD        |   |
|                                 |                                      | <b>SUBARU LEGACY I (BC)</b>                                |   |
|                                 |                                      | 1.6/1.6i 16V/1800/1800 4WD/2.0 GL/2000 4WD/2000 Turbo      |   |
|                                 |                                      | 4WD/2200 4WD   |   |
|                                 |                                      | <b>SUBARU LEGACY I SW (BIF)</b>                            |   |
|                                 |                                      | 1.6 GL/1800/1800 4WD/2.2 GX/2000/2000 4WD/2000 Turbo       |   |
|                                 |                                      | Super 4WD/2200 Super 4WD                                   |   |

|                                |                                     |
|--------------------------------|-------------------------------------|
| <b>GOM-701</b>                 | <b>Holder, control arm mounting</b> |
|                                | <b>Silentblock</b>                  |
| SUBARU                         | 20201-AC100                         |
| Length/Lunghezza [mm]          | 51                                  |
| Inner Diam./Diam. Interno [mm] | 20                                  |
| Inner Diam./Diam. Int. 1 [mm]  | 25                                  |

|   |
|---|
| <b>SUBARU LEGACY II (BD, BG)</b>  |
| 2.0 i/2.0 i 4WD/2.2 i 4WD/2.5 i 4WD   |
| <b>SUBARU LEGACY II SW (BD, BG)</b>   |
| 2.0 i/2.0 i 4WD/2.2 i 4WD/2.5 i 4WD   |
| <b>SUBARU FORESTER (SF)</b>   |
| 2.0/2.0 S Turbo   |
| <b>SUBARU IMPREZA (GC)</b>  |
| 1.6 i/1.6 i 4WD/1.6 i 4WD/1.8 i 4WD/2.0 i 4WD/2.0 Turbo GT 4WD/2.2 GX AWD                                     |
| <b>SUBARU IMPREZA Coupe (GFC)</b>   |
| 1.6/1.6 4WD/2.0 4WD/2.0 Turbo 4WD   |
| <b>SUBARU IMPREZA SW (GF)</b>   |
| 1.5 L/1.6/1.6 i/1.6 i 4WD/1.6 i 4WD/1.8 i 4WD/2.0 4WD/2.0 16V AWD/2.0 i Turbo 4WD/2.0 Turbo GT 4WD/2.2 GX AWD |
| <b>SUBARU LEGACY I (BC)</b>   |
| 1.6/1.6i 16V/1800/1800 4WD/2.0 GL/2000 4WD/2000 Turbo 4WD/2200 4WD  |
| <b>SUBARU LEGACY I SW (BJF)</b>   |
| 1.6 GL/1800/1800 4WD/2.2 GX/2000/2000 4WD/2000 Turbo Super 4WD/2200 Super 4WD                                 |
| <b>SUBARU LEGACY II (BD, BG)</b>  |
| 2.0 i/2.0 i 4WD/2.2 i 4WD/2.5 i 4WD   |
| <b>SUBARU LEGACY II SW (BD, BG)</b>   |
| 2.0 i/2.0 i 4WD/2.2 i 4WD/2.5 i 4WD   |



|                                |                                     |
|--------------------------------|-------------------------------------|
| <b>GOM-702</b>                 | <b>Holder, control arm mounting</b> |
|                                | <b>Silentblock</b>                  |
| SUBARU                         | 20201-AC110                         |
| Width/Larghezza [mm]           | 51                                  |
| Inner Diam./Diam. Interno [mm] | 20                                  |
| Inner Diam./Diam. Int. 1 [mm]  | 25                                  |

|   |
|---|
| <b>SUBARU FORESTER (SF)</b>   |
| 2.0/2.0 S Turbo   |
| <b>SUBARU IMPREZA (GC)</b>  |
| 1.6 i/1.6 i 4WD/1.6 i 4WD/1.8 i 4WD/2.0 i 4WD/2.0 Turbo GT 4WD/2.2 GX AWD                                     |
| <b>SUBARU IMPREZA Coupe (GFC)</b>   |
| 1.6/1.6 4WD/2.0 4WD/2.0 Turbo 4WD   |
| <b>SUBARU IMPREZA SW (GF)</b>   |
| 1.5 L/1.6/1.6 i/1.6 i 4WD/1.6 i 4WD/1.8 i 4WD/2.0 4WD/2.0 16V AWD/2.0 i Turbo 4WD/2.0 Turbo GT 4WD/2.2 GX AWD |
| <b>SUBARU LEGACY I (BC)</b>   |
| 1.6/1.6i 16V/1800/1800 4WD/2.0 GL/2000 4WD/2000 Turbo 4WD/2200 4WD  |
| <b>SUBARU LEGACY I SW (BJF)</b>   |
| 1.6 GL/1800/1800 4WD/2.2 GX/2000/2000 4WD/2000 Turbo Super 4WD/2200 Super 4WD                                 |
| <b>SUBARU LEGACY II (BD, BG)</b>  |
| 2.0 i/2.0 i 4WD/2.2 i 4WD/2.5 i 4WD   |
| <b>SUBARU LEGACY II SW (BD, BG)</b>   |
| 2.0 i/2.0 i 4WD/2.2 i 4WD/2.5 i 4WD   |



|                                |                                     |
|--------------------------------|-------------------------------------|
| <b>GOM-703</b>                 | <b>Holder, control arm mounting</b> |
|                                | <b>Silentblock</b>                  |
| SUBARU                         | 20201-FC020                         |
| Length/Lunghezza [mm]          | 55                                  |
| Inner Diam./Diam. Interno [mm] | 12,5                                |
| Outer Diam./Diam. esterno [mm] | 37                                  |







|                             |
|-----------------------------|
| <b>SUBARU FORESTER (SF)</b> |
| 2.0/2.0 S Turbo             |



|                                |                                     |
|--------------------------------|-------------------------------------|
| <b>GOM-704</b>                 | <b>Holder, control arm mounting</b> |
|                                | <b>Silentblock</b>                  |
| SUBARU                         | 20201-FC110                         |
| Width/Larghezza [mm]           | 51                                  |
| Inner Diam./Diam. Interno [mm] | 20                                  |
| Inner Diam./Diam. Int. 1 [mm]  | 25                                  |

|                             |
|-----------------------------|
| <b>SUBARU FORESTER (SF)</b> |
| 2.0/2.0 S Turbo             |



|   |  |  |
|---|--|--|
| <p><b>GOM-705</b>      <b>Holder, control arm mounting</b></p> <p><b>Silentblock</b></p>  | <p><b>SUBARU FORESTER (SF)</b><br/>2.0/2.0 S Turbo</p>   |  <p>705</p>   |
| <p>SUBARU      20201-FC100</p> <p>Width/Larghezza [mm]      51</p> <p>Inner Diam./Diam. Interno [mm]      20</p> <p>Inner Diam./Diam. Int. 1 [mm]      25</p>   |  |  |
| <p><b>GOM-706</b>      <b>Holder, control arm mounting</b></p> <p><b>Silentblock</b></p>  | <p><b>SUBARU FORESTER (SG)</b><br/>2.0/2.0 S Turbo/2.0 X/2.5/2.5 RX Nato AWD/2.5 XT</p>  |  <p>706</p>   |
| <p>SUBARU      20201-FC130</p> <p>Width/Larghezza [mm]      51</p> <p>Inner Diam./Diam. Interno [mm]      20</p> <p>Inner Diam./Diam. Int. 1 [mm]      25</p>   |  |  |
| <p><b>GOM-707</b>      <b>Holder, control arm mounting</b></p> <p><b>Silentblock</b></p>  | <p><b>SUBARU FORESTER (SG)</b><br/>2.0/2.0 S Turbo/2.0 X/2.5/2.5 RX Nato AWD/2.5 XT</p>  |  <p>707</p>   |
| <p>SUBARU      20201-FC120</p> <p>Width/Larghezza [mm]      51</p> <p>Inner Diam./Diam. Interno [mm]      25</p> <p>Inner Diam./Diam. Int. 1 [mm]      20</p>   |  |  |
| <p><b>GOM-708</b>      <b>Holder, control arm mounting</b></p> <p><b>Silentblock</b></p>  | <p><b>SUBARU IMPREZA (GD, GG)</b><br/>1.5/1.6/1.6 AWD/2.0/2.0 4 ruote motrici/2.0 AWD/2.0 R/2.0 WRX STi/2.0 WRX Turbo/2.2/2.5 4 ruote motrici/2.5 AWD/2.5 WRX/2.5 WRX ST1</p>  |  <p>708</p>  |
| <p>SUBARU      20201-FA080</p> <p>Width/Larghezza [mm]      68</p> <p>Inner Diam./Diam. Interno [mm]      20</p> <p>Inner Diam./Diam. Int. 1 [mm]      25</p>   | <p><b>SUBARU IMPREZA SW (GD, GG)</b><br/>1.5/1.6/2.0/2.0 AWD/2.0 R/2.0 Turbo/2.0 WRX STi AWD/2.0 WRX Turbo/2.2/2.5 AWD/2.5 WRX</p>   |  |
| <p><b>GOM-709</b>      <b>Holder, control arm mounting</b></p> <p><b>Silentblock</b></p>  | <p><b>SUBARU IMPREZA (GD, GG)</b><br/>1.5/1.6/1.6 AWD/2.0/2.0 4 ruote motrici/2.0 AWD/2.0 R/2.0 WRX STi/2.0 WRX Turbo/2.2/2.5 4 ruote motrici/2.5 AWD/2.5 WRX/2.5 WRX ST1</p>  |  <p>709</p> |
| <p>SUBARU      20201-FA070</p> <p>Width/Larghezza [mm]      68</p> <p>Inner Diam./Diam. Interno [mm]      20</p> <p>Inner Diam./Diam. Int. 1 [mm]      25</p>   | <p><b>SUBARU IMPREZA SW (GD, GG)</b><br/>1.5/1.6/2.0/2.0 AWD/2.0 R/2.0 Turbo/2.0 WRX STi AWD/2.0 WRX Turbo/2.2/2.5 AWD/2.5 WRX</p>   |  |
| <p><b>GOM-800</b>      <b>Suspension Strut Support Bearing</b></p> <p><b>Supporto ammortizzatore</b></p>  | <p><b>SUZUKI SWIFT II (AH, AJ)</b><br/>1.3 (SF413, AH35)/1.3 (SF413, AH35, MA)/1.6 (SF416, AH14)/1.6 4WD (SF416, AJ14)/1.6 i (SF416, AH14)/1.6 i 4WD (SF416, AJ14)</p>   |  <p>800</p> |
| <p>SUZUKI      41710-60B00</p> <p>Fitting Position/Lato Montaggio      Front Axle</p> <p>Length/Lunghezza [mm]      133</p> <p>Height/Altezza [mm]      132</p> <p>Width/Larghezza [mm]      47</p> <p>Inner Diam./Diam. Interno [mm]      34</p> | <p><b>SUZUKI SWIFT II 2 volumi (EA, MA)</b><br/>1.0 (SF310, AA44)/1.0 i (SF310, AA44)/1.3 (SF413, AB35)/1.3 4WD (SF413, AA35)/1.3 4WD (SF413, AF35)/1.3 GTi (SF413, AA34)</p>  |  |
| <p><b>GOM-801</b>      <b>Base</b></p> <p><b>Supporto cambio</b></p>  | <p><b>SUZUKI SWIFT Cabriolet (SF413)</b><br/>1.3 (SF413, AK35)</p>   |  <p>801</p> |
| <p>SUZUKI      11620-71C10</p> <p>Length/Lunghezza [mm]      86,2</p> <p>Height/Altezza [mm]      103,5</p> <p>Width/Larghezza [mm]      56</p> <p>Inner Diam./Diam. Interno [mm]      10</p>   | <p><b>SUZUKI SWIFT II (AH, AJ)</b><br/>1.6 i (SF416, AH14)/1.6 i 4WD (SF416, AJ14)</p> <p><b>SUZUKI SWIFT II 2 volumi (EA, MA)</b><br/>1.0 (SF310, AA44)/1.0 i (SF310, AA44)/1.3 (SF413, AB35)/1.3 4WD (SF413, AA35)/1.3 GTi (SF413, AA34)</p> |  |

|                                |                        |  |   |
|--------------------------------|------------------------|--|---|
| <b>GOM-802</b>                 | <b>Engine Mounting</b> | <b>SUZUKI SJ 410</b>   |    |
|                                |                        | 1.0  |   |
|                                | <b>Supporto motore</b> | <b>SUZUKI SJ 410 Cabrio</b>  |   |
|                                |                        | 1.0  |   |
| SUZUKI                         | 11610-80020            | <b>SUZUKI SJ 413</b>   |   |
|                                |                        | 1.3  |   |
| Length/Lunghezza [mm]          | 110                    |  |   |
| Height/Altezza [mm]            | 44                     |  |   |
| Width/Larghezza [mm]           | 74                     |  |   |
|                                |                        |  |   |
| <b>GOM-803</b>                 | <b>Engine Mounting</b> | <b>SUZUKI SJ 410</b>   |    |
|                                |                        | 1.0  |   |
|                                | <b>Supporto motore</b> | <b>SUZUKI SJ 410 Cabrio</b>  |   |
|                                |                        | 1.0  |   |
| SUZUKI                         | 11610-80000            | <b>SUZUKI SJ 413</b>   |   |
|                                |                        | 1.3  |   |
| Length/Lunghezza [mm]          | 91,5                   |  |   |
| Height/Altezza [mm]            | 45                     |  |   |
| Width/Larghezza [mm]           | 60                     |  |   |
|                                |                        |  |   |
| <b>GOM-804</b>                 | <b>Engine Mounting</b> | <b>SUZUKI SJ 410</b>   |    |
|                                |                        | 1.0  |   |
|                                | <b>Supporto motore</b> | <b>SUZUKI SJ 410 Cabrio</b>  |   |
|                                |                        | 1.0  |   |
| SUZUKI                         | 11710-80010            | <b>SUZUKI SJ 413</b>   |   |
|                                |                        | 1.3  |   |
| Length/Lunghezza [mm]          | 111                    |  |   |
| Height/Altezza [mm]            | 41                     |  |   |
| Width/Larghezza [mm]           | 81,5                   |  |   |
| Inner Diam./Diam. Interno [mm] | 10                     |  |   |
|                                |                        |  |   |
| <b>GOM-805</b>                 | <b>GummiParts</b>      | <b>SUZUKI SJ 410</b>   |   |
|                                |                        | 1.0  |   |
|                                | <b>Parti in gomma</b>  | <b>SUZUKI SJ 410 Cabrio</b>  |   |
|                                |                        | 1.0  |   |
| SUZUKI                         | 29650-82C00            | <b>SUZUKI SJ 413</b>   |   |
|                                |                        | 1.3  |   |
| Length/Lunghezza [mm]          | 52,5                   |  |   |
| Height/Altezza [mm]            | 27,5                   |  |   |
| Width/Larghezza [mm]           | 51                     |  |   |
|                                |                        |  |   |
| <b>GOM-806</b>                 | <b>Engine Mounting</b> | <b>SUZUKI VITARA (ET, TA)</b>  |  |
|                                |                        | 1.6 (ET)/1.6 (TA)/1.6 16V (ET)/1.9 D (ET)/2.0 16V (ET)/2.0 TD (ET)/2.0 TD Intercooler (ET)/2.0 V6 24V (ET)/2.5 V6 24V (FT) |   |
|                                | <b>Supporto motore</b> | <b>SUZUKI VITARA Cabrio (ET, TA)</b>   |   |
|                                |                        | 1.6 (TA)/1.6 16V (ET)/1.9 D (ET)/2.0 16V (ET)  |   |
| SUZUKI                         | 11610-58B10            |  |   |
|                                |                        |  |   |
| Length/Lunghezza [mm]          | 130                    |  |   |
| Height/Altezza [mm]            | 62                     |  |   |
| Width/Larghezza [mm]           | 87                     |  |   |
|                                |                        |  |   |
| <b>GOM-807</b>                 | <b>Engine Mounting</b> | <b>SUZUKI VITARA (ET, TA)</b>  |  |
|                                |                        | 1.6 (ET)/1.6 (TA)/1.6 16V (ET)/1.9 D (ET)/2.0 16V (ET)/2.0 TD (ET)/2.0 TD Intercooler (ET)/2.0 V6 24V (ET)/2.5 V6 24V (FT) |   |
|                                | <b>Supporto motore</b> | <b>SUZUKI VITARA Cabrio (ET, TA)</b>   |   |
|                                |                        | 1.6 (TA)/1.6 16V (ET)/1.9 D (ET)/2.0 16V (ET)  |   |
| SUZUKI                         | 11610-58B01            |  |   |
|                                |                        |  |   |
| Length/Lunghezza [mm]          | 152                    |  |   |
| Height/Altezza [mm]            | 58                     |  |   |
| Width/Larghezza [mm]           | 87                     |  |   |
|                                |                        |  |   |
| <b>GOM-808</b>                 | <b>Engine Mounting</b> | <b>SUZUKI VITARA (ET, TA)</b>  |  |
|                                |                        | 1.6 (ET)/1.6 (TA)/1.6 16V (ET)/1.9 D (ET)/2.0 16V (ET)/2.0 TD (ET)/2.0 TD Intercooler (ET)/2.0 V6 24V (ET)/2.5 V6 24V (FT) |   |
|                                | <b>Supporto motore</b> | <b>SUZUKI VITARA Cabrio (ET, TA)</b>   |   |
|                                |                        | 1.6 (TA)/1.6 16V (ET)/1.9 D (ET)/2.0 16V (ET)  |   |
| SUZUKI                         | 11710-60A01            |  |   |
|                                |                        |  |   |
| Length/Lunghezza [mm]          | 114                    |  |   |
| Height/Altezza [mm]            | 56                     |  |   |
| Width/Larghezza [mm]           | 61                     |  |   |
| Inner Diam./Diam. Interno [mm] | 25                     |  |   |
|                                |                        |  |   |



|   |   |           |   |
|---|---|-----------|---|
| <b>GOM-809</b><br><b>Suspension Strut Support Bearing</b><br><b>Supporto ammortizzatore</b> | <b>SUZUKI VITARA (ET, TA)</b><br>1.6 (ET)/1.6 (TA)/1.6 16V (ET)/1.9 D (ET)/2.0 16V (ET)/2.0 TD (ET)/2.0 TD Intercooler (ET)/2.0 V6 24V (ET)/2.5 V6 24V (FT) |           |    |
|   | <b>SUZUKI VITARA Cabrio (ET, TA)</b><br>1.6 (TA)/1.6 16V (ET)/1.9 D (ET)/2.0 16V (ET)   |           |   |
| SUZUKI  | 41810-60A00   |           |   |
| Fitting Position/Lato Montaggio   |   | Rear Axle |   |
| Length/Lunghezza [mm]   |   | 104       |   |
| Height/Altezza [mm]   |   | 106       |   |
| Width/Larghezza [mm]  |   | 38        |   |
| Inner Diam./Diam. Interno [mm]  |   | 17        |   |
| <b>GOM-810</b><br><b>GummiParts</b><br><b>Parti in gomma</b>                                | <b>SUZUKI SJ 410</b><br>1.0   |           |    |
|   | <b>SUZUKI SJ 410 Cabrio</b><br>1.0  |           |   |
| SUZUKI  | 29610-82C00   |           |   |
| Length/Lunghezza [mm]   |   | 50        |   |
| Height/Altezza [mm]   |   | 29        |   |
| Width/Larghezza [mm]  |   | 49        |   |
| <b>GOM-811</b><br><b>Bush, leaf spring</b><br><b>Boccola balestra</b>                       | <b>SUZUKI SAMURAI (SJ)</b><br>1.0 (SJ 410)/1.3 (SJ 413)/1.9 TD  |           |   |
|   | <b>SUZUKI SANTANA</b><br>1.0 (SJ410) F10A/1.0 (SJ410) F10A MADE IN SPAIN/1.3 (SJ413)  |           |   |
| SUZUKI  | 41331-62020   |           |   |
| Length/Lunghezza [mm]   |   | 33,2      |   |
| Height/Altezza [mm]   |   | 15,4      |   |
| Width/Larghezza [mm]  |   | 41        |   |
| <b>GOM-812</b><br><b>Bush, leaf spring</b><br><b>Boccola balestra</b>                       | <b>SUZUKI SAMURAI (SJ)</b><br>1.0 (SJ 410)/1.3 (SJ 413)/1.9 TD  |           |  |
|   | <b>SUZUKI SANTANA</b><br>1.0 (SJ410) F10A/1.0 (SJ410) F10A MADE IN SPAIN/1.3 (SJ413)  |           |   |
| SUZUKI  | 09305-13002   |           |   |
| Length/Lunghezza [mm]   |   | 32        |   |
| Inner Diam./Diam. Interno [mm]  |   | 13        |   |
| Outer Diam./Diam. esterno [mm]  |   | 30        |   |
| <b>GOM-813</b><br><b>Bush, leaf spring</b><br><b>Boccola balestra</b>                       | <b>SUZUKI SJ 410</b><br>1.0   |           |  |
|   | <b>SUZUKI SJ 410 Cabrio</b><br>1.0  |           |   |
| SUZUKI  | 09319-12023   |           |   |
| Length/Lunghezza [mm]   |   | 65        |   |
| Inner Diam./Diam. Interno [mm]  |   | 12        |   |
| Outer Diam./Diam. esterno [mm]  |   | 41        |   |
| <b>GOM-814</b><br><b>Bearing Bush, stabiliser</b><br><b>Boccola barra stabilizzatrice</b>   | <b>SUZUKI VITARA (ET, TA)</b><br>1.6 (ET)/1.6 (TA)/1.6 16V (ET)/1.9 D (ET)/2.0 16V (ET)/2.0 TD (ET)/2.0 TD Intercooler (ET)/2.0 V6 24V (ET)/2.5 V6 24V (FT) |           |  |
|   | <b>SUZUKI VITARA Cabrio (ET, TA)</b><br>1.6 (TA)/1.6 16V (ET)/1.9 D (ET)/2.0 16V (ET)   |           |   |
| SUZUKI  | 42412-60A00   |           |   |
| Length/Lunghezza [mm]   |   | 43,2      |   |
| Height/Altezza [mm]   |   | 40        |   |
| Width/Larghezza [mm]  |   | 33        |   |
| Inner Diam./Diam. Interno [mm]  |   | 24        |   |



|                |                                      |   |   |
|----------------|--------------------------------------|---|---|
| <b>GOM-815</b> | <b>Holder, control arm mounting</b>  | <b>SUZUKI VITARA (ET, TA)</b><br>1.6 (ET)/1.6 (TA)/1.6 16V (ET)/1.9 D (ET)/2.0 16V (ET)/2.0 TD (ET)/2.0 TD Intercooler (ET)/2.0 V6 24V (ET)/2.5 V6 24V (FT) |    |
|                | <b>Silentblock</b>                   | <b>SUZUKI VITARA Cabrio (ET, TA)</b><br>1.6 (TA)/1.6 16V (ET)/1.9 D (ET)/2.0 16V (ET)   |   |
| SUZUKI         | 09319-12044                          |   | 815   |
|                | Length/Lunghezza [mm]                | 65  |   |
|                | Inner Diam./Diam. Interno [mm]       | 13  |   |
|                | Outer Diam./Diam. esterno [mm]       | 45  |   |
| <b>GOM-816</b> | <b>Holder, control arm mounting</b>  | <b>SUZUKI VITARA (ET, TA)</b><br>1.6 (ET)/1.6 (TA)/1.6 16V (ET)/1.9 D (ET)/2.0 16V (ET)/2.0 TD (ET)/2.0 TD Intercooler (ET)/2.0 V6 24V (ET)/2.5 V6 24V (FT) |    |
|                | <b>Silentblock</b>                   | <b>SUZUKI VITARA Cabrio (ET, TA)</b><br>1.6 (TA)/1.6 16V (ET)/1.9 D (ET)/2.0 16V (ET)   |   |
| SUZUKI         | 09319-12045                          |   | 816   |
|                | Length/Lunghezza [mm]                | 64  |   |
|                | Inner Diam./Diam. Interno [mm]       | 14  |   |
|                | Outer Diam./Diam. esterno [mm]       | 42,4  |   |
| <b>GOM-817</b> | <b>Bearing Bush, stabiliser</b>      | <b>SUZUKI VITARA (ET, TA)</b><br>1.6 (ET)/1.6 (TA)/1.6 16V (ET)/1.9 D (ET)/2.0 16V (ET)/2.0 TD (ET)/2.0 TD Intercooler (ET)/2.0 V6 24V (ET)/2.5 V6 24V (FT) |    |
|                | <b>Boccola barra stabilizzatrice</b> | <b>SUZUKI VITARA Cabrio (ET, TA)</b><br>1.6 (TA)/1.6 16V (ET)/1.9 D (ET)/2.0 16V (ET)   |   |
| SUZUKI         | 09320-10024                          |   | 817   |
|                | Length/Lunghezza [mm]                | 16  |   |
|                | Inner Diam./Diam. Interno [mm]       | 10  |   |
|                | Outer Diam./Diam. esterno [mm]       | 25  |   |
| <b>GOM-818</b> | <b>Holder, control arm mounting</b>  | <b>SUZUKI VITARA (ET, TA)</b><br>1.6 (ET)/1.6 (TA)/1.6 16V (ET)/1.9 D (ET)/2.0 16V (ET)/2.0 TD (ET)/2.0 TD Intercooler (ET)/2.0 V6 24V (ET)/2.5 V6 24V (FT) |  |
|                | <b>Silentblock</b>                   | <b>SUZUKI VITARA Cabrio (ET, TA)</b><br>1.6 (TA)/1.6 16V (ET)/1.9 D (ET)/2.0 16V (ET)   |   |
| SUZUKI         | 09319-14007                          |   | 818   |
|                | Length/Lunghezza [mm]                | 64  |   |
|                | Inner Diam./Diam. Interno [mm]       | 14  |   |
|                | Outer Diam./Diam. esterno [mm]       | 41  |   |
| <b>GOM-820</b> | <b>Bearing Bush, stabiliser</b>      | <b>SUZUKI ALTO II (EC)</b><br>0.8 (SB308/CA)  |  |
|                | <b>Boccola barra stabilizzatrice</b> | <b>SUZUKI ALTO III (EF)</b><br>0.8 i cat. ( SB308 ) /1.0  |   |
| SUZUKI         | 42431-70B42                          | <b>SUZUKI IGNIS (FH)</b><br>1.3/1.3 4WD   | 820   |
|                | Fitting Position/Lato Montaggio      | Front   |   |
|                | Length/Lunghezza [mm]                | 51  |   |
|                | Height/Altezza [mm]                  | 39  |   |
|                | Inner Diam./Diam. Interno [mm]       | 21  |   |
|                | Inner Width/Larghezza interna [mm]   | 40  |   |
| <b>GOM-821</b> | <b>Holder, control arm mounting</b>  | <b>OPEL AGILA (H00)</b><br>1.0/1.0 12V/1.2 16V/1.2 16V Twinport/1.3 CDTI  |  |
|                | <b>Silentblock</b>                   | <b>SUZUKI ALTO IV (FF)</b><br>1.1   |   |
| SUZUKI         | 42451 M76G00                         | <b>SUZUKI IGNIS (FH)</b><br>1.3/1.3 4WD   | 821   |
|                | Length/Lunghezza [mm]                | 32  |   |
|                | Inner Diam./Diam. Interno [mm]       | 16  |   |
|                | Outer Diam./Diam. esterno [mm]       | 48,5  |   |
| <b>GOM-822</b> | <b>Holder, control arm mounting</b>  | <b>SUZUKI BALENO (EG)</b><br>1.3/1.3 i 16V/1.6 i 16V/1.6 i 16V 4x4/1.8 GT/1.9 TD  |  |
|                | <b>Silentblock</b>                   | <b>SUZUKI BALENO 2 volumi (EG)</b><br>1.3/1.3 i 16V/1.6 i 16V/1.6 i 16V 4x4/1.8 GT/1.9 TD   |   |
| SUZUKI         | 45500-50800                          | <b>SUZUKI BALENO SW (EG)</b><br>1.3 16V/1.6 i 16V/1.6 i 16V 4x4/1.8 i 16V/1.9 TD  | 822   |
|                | Length/Lunghezza [mm]                | 60  |   |
|                | Inner Diam./Diam. Interno [mm]       | 14  |   |
|                | Outer Diam./Diam. esterno [mm]       | 33  |   |





|                                |                                     |   |   |
|--------------------------------|-------------------------------------|---|---|
| <b>GOM-823</b>                 | <b>Holder, control arm mounting</b> | <b>SUZUKI BALENO (EG)</b><br>1.3/1.3 i 16V/1.6 i 16V/1.6 i 16V 4x4/1.8 GT/1.9 TD  |    |
|                                | <b>Silentblock</b>                  | <b>SUZUKI BALENO 2 volumi (EG)</b><br>1.3/1.3 i 16V/1.6 i 16V/1.6 i 16V 4x4/1.8 GT/1.9 TD   |   |
| SUZUKI                         | 46420-60B02                         | <b>SUZUKI BALENO SW (EG)</b><br>1.3 16V/1.6 i 16V/1.6 i 16V 4x4/1.8 i 16V/1.9 TD  |   |
| Length/Lunghezza [mm]          | 50                                  | <b>SUZUKI SWIFT II (AH, AJ)</b><br>1.3 (SF413, AH35)/1.3 (SF413, AH35, MA)/1.6 (SF416, AH14)/1.6 4WD (SF416, AJ14)/1.6 i (SF416, AH14)/1.6 i 4WD (SF416, AJ14)        |   |
| Height/Altezza [mm]            | 55                                  | <b>SUZUKI SWIFT II 2 volumi (EA, MA)</b><br>1.0 (SF310, AA44)/1.0 i (SF310, AA44)/1.3 (SF413, AB35)/1.3 4WD (SF413, AA35)/1.3 4WD (SF413, AF35)/1.3 GTi (SF413, AA34) |   |
| Width/Larghezza [mm]           | 60                                  |   |   |
| Inner Diam./Diam. Interno [mm] | 21                                  |   |   |
| Outer Diam./Diam. esterno [mm] |                                     |   |   |
| <b>GOM-824</b>                 | <b>Holder, control arm mounting</b> | <b>OPEL AGILA (H00)</b><br>1.0/1.0 12V/1.2 16V/1.2 16V Twinport/1.3 CDTi  |    |
|                                | <b>Silentblock</b>                  | <b>SUZUKI CARRY Furgonato (FD)</b><br>1.3/1.3 16 V  |   |
| SUZUKI                         | 09319-10030                         |   |   |
| Length/Lunghezza [mm]          | 51,5                                |   |   |
| Inner Diam./Diam. Interno [mm] | 10                                  |   |   |
| Outer Diam./Diam. esterno [mm] | 28                                  |   |   |
| <b>GOM-825</b>                 | <b>Holder, control arm mounting</b> | <b>SUZUKI GRAND VITARA</b><br>1.6 4 ruote motrici/1.9 DDiS/2.0 4 ruote motrici  |   |
|                                | <b>Silentblock</b>                  |   |   |
| SUZUKI                         | 45261-65J00                         |   |   |
| Length/Lunghezza [mm]          | 70                                  |   |   |
| Inner Diam./Diam. Interno [mm] | 14                                  |   |   |
| Outer Diam./Diam. esterno [mm] | 35                                  |   |   |
| <b>GOM-826</b>                 | <b>Holder, control arm mounting</b> | <b>SUZUKI GRAND VITARA</b><br>1.6 4 ruote motrici/1.9 DDiS/2.0 4 ruote motrici  |  |
|                                | <b>Silentblock</b>                  |   |   |
| SUZUKI                         |                                     |   |   |
| Length/Lunghezza [mm]          | 60                                  |   |   |
| Inner Diam./Diam. Interno [mm] | 14                                  |   |   |
| Outer Diam./Diam. esterno [mm] | 65,5                                |   |   |
| <b>GOM-827</b>                 | <b>Holder, control arm mounting</b> | <b>SUZUKI SWIFT II (AH, AJ)</b><br>1.3 (SF413, AH35)/1.3 (SF413, AH35, MA)/1.6 (SF416, AH14)/1.6 4WD (SF416, AJ14)/1.6 i (SF416, AH14)/1.6 i 4WD (SF416, AJ14)        |  |
|                                | <b>Silentblock</b>                  | <b>SUZUKI SWIFT II 2 volumi (EA, MA)</b><br>1.0 (SF310, AA44)/1.0 i (SF310, AA44)/1.3 (SF413, AB35)/1.3 4WD (SF413, AA35)/1.3 4WD (SF413, AF35)/1.3 GTi (SF413, AA34) |   |
| SUZUKI                         | 45530-70C00                         |   |   |
| Length/Lunghezza [mm]          | 50                                  |   |   |
| Inner Diam./Diam. Interno [mm] | 16,5                                |   |   |
| Outer Diam./Diam. esterno [mm] | 34                                  |   |   |
| <b>GOM-828</b>                 | <b>Holder, control arm mounting</b> | <b>SUZUKI SPLASH</b><br>1.0/1.2/1.3 CDTi  |  |
|                                | <b>Silentblock</b>                  | <b>SUZUKI SWIFT III (SG)</b><br>1.3/1.3 4x4/1.3 DDiS/1.5/1.6  |   |
| SUZUKI                         | 45530-62J00                         |   |   |
| Length/Lunghezza [mm]          | 64                                  |   |   |
| Inner Diam./Diam. Interno [mm] | 14,5                                |   |   |
| Outer Diam./Diam. esterno [mm] | 42                                  |   |   |
| <b>GOM-829</b>                 | <b>Holder, control arm mounting</b> | <b>SUZUKI SWIFT III (SG)</b><br>1.3/1.3 4x4/1.3 DDiS/1.5/1.6  |  |
|                                | <b>Silentblock</b>                  |   |   |
| SUZUKI                         | 45201-72K01                         |   |   |
| Length/Lunghezza [mm]          | 51                                  |   |   |
| Inner Diam./Diam. Interno [mm] | 14                                  |   |   |
| Outer Diam./Diam. esterno [mm] | 60                                  |   |   |

|  |   |  |
|--|---|--|
| <p><b>GOM-830</b>      <b>Bearing Bush, stabiliser</b></p> <p><b>Boccola barra stabilizzatrice</b></p> <p>SUZUKI      42431-79J00</p> <p>Fitting Position/Lato Montaggio      Front</p> <p>Length/Lunghezza [mm]      42</p> <p>Height/Altezza [mm]      47</p> <p>Width/Larghezza [mm]      45</p> <p>Inner Diam./Diam. Interno [mm]      22</p>                        | <p><b>FIAT SEDICI</b></p> <p>1.6 16V 4x4/1.9 D Multijet</p> <p><b>SUZUKI SX4</b></p> <p>1.5/1.6 DDiS/1.6 VVT/1.6 VVT 4x4/1.9 DDiS/1.9 DDiS 4x4/2.0 DDiS/2.0 DDiS 4x4</p>  |  <p>830</p>   |
| <p><b>GOM-831</b>      <b>Holder, control arm mounting</b></p> <p><b>Silentblock</b></p> <p>SUZUKI      45261-79J00</p> <p>Length/Lunghezza [mm]      64</p> <p>Inner Diam./Diam. Interno [mm]      14</p> <p>Outer Diam./Diam. esterno [mm]      45</p>   | <p><b>FIAT SEDICI</b></p> <p>1.6 16V 4x4/1.9 D Multijet</p> <p><b>SUZUKI SX4</b></p> <p>1.5/1.6 DDiS/1.6 VVT/1.6 VVT 4x4/1.9 DDiS/1.9 DDiS 4x4/2.0 DDiS/2.0 DDiS 4x4</p>  |  <p>831</p>   |
| <p><b>GOM-832</b>      <b>Holder, control arm mounting</b></p> <p><b>Silentblock</b></p>   | <p><b>FIAT SEDICI</b></p> <p>1.6 16V 4x4/1.9 D Multijet</p> <p><b>SUZUKI SX4</b></p> <p>1.5/1.6 DDiS/1.6 VVT/1.6 VVT 4x4/1.9 DDiS/1.9 DDiS 4x4/2.0 DDiS/2.0 DDiS 4x4</p>  |  <p>832</p>   |
| <p><b>GOM-833</b>      <b>Holder, control arm mounting</b></p> <p><b>Silentblock</b></p> <p>SUZUKI      45261-65D01</p> <p>Length/Lunghezza [mm]      65</p> <p>Inner Diam./Diam. Interno [mm]      12</p> <p>Outer Diam./Diam. esterno [mm]      56</p>   | <p><b>SUZUKI GRAND VITARA (FT, GT)</b></p> <p>1.6/2.0/2.0 HDI 110/2.0 TD Intercooler/2.5 V6 24V/2.5 V6 24V (FT)/2.7 XL-7</p> <p><b>SUZUKI GRAND VITARA</b></p> <p>1.9 TD</p>  |  <p>833</p> |
| <p><b>GOM-834</b>      <b>Holder, control arm mounting</b></p> <p><b>Silentblock</b></p> <p>SUZUKI      45262-65D01</p> <p>Length/Lunghezza [mm]      65</p> <p>Inner Diam./Diam. Interno [mm]      14</p> <p>Outer Diam./Diam. esterno [mm]      50</p>   | <p><b>SUZUKI GRAND VITARA (FT, GT)</b></p> <p>1.6/2.0/2.0 HDI 110/2.0 TD Intercooler/2.5 V6 24V/2.5 V6 24V (FT)/2.7 XL-7</p> <p><b>SUZUKI GRAND VITARA</b></p> <p>1.9 TD</p>  |  <p>834</p> |
| <p><b>GOM-835</b>      <b>Suspension Strut Support</b></p> <p><b>Bearing</b></p> <p><b>Supporto ammortizzatore</b></p> <p>SANTANA      30005938</p> <p>Fitting Position/Lato Montaggio      Front Axle</p> <p>Height/Altezza [mm]      35</p> <p>Inner Diam./Diam. Interno [mm]      17</p> <p>Mount. Bores/Fori Fiss. Dist. [mm]      79</p>                            | <p><b>SUZUKI VITARA (ET, TA)</b></p> <p>1.6 (ET)/1.6 (TA)/1.6 16V (ET)/2.0 16V (ET)</p> <p><b>SUZUKI VITARA Cabrio (ET, TA)</b></p> <p>1.6 (TA)/1.6 16V (ET)/2.0 16V (ET)</p> <p><b>SUZUKI X-90 (EL)</b></p> <p>1.6 i 16V/1.6 i 16V 4x4</p> |  <p>835</p> |
| <p><b>GOM-836</b>      <b>Suspension Strut Support</b></p> <p><b>Bearing</b></p> <p><b>Supporto ammortizzatore</b></p> <p>SUZUKI      41810-65D11</p> <p>Fitting Position/Lato Montaggio      Front Axle</p> <p>Length/Lunghezza [mm]      150</p> <p>Height/Altezza [mm]      80</p> <p>Width/Larghezza [mm]      150</p> <p>Inner Diam./Diam. Interno [mm]      17</p> | <p><b>SUZUKI GRAND VITARA (FT, GT)</b></p> <p>2.0/2.0 4 ruote motrici/2.0 HDI 110/2.0 TD Intercooler/2.5 V6 24V/2.5 V6 24V (FT)/2.7/2.7 XL-7</p>  |  <p>836</p> |

|                                    |   |   |   |
|------------------------------------|---|---|---|
| <b>GOM-837</b>                     | <b>Bearing Bush, stabiliser</b>         | <b>OPEL AGILA</b>                                 |    |
|                                    | <b>Boccola barra stabilizzatrice</b>    | 1.0/1.0 LPG/1.2/1.2 LPG/1.3 CDTI                  |   |
| SUZUKI                             | 42431-51K40                             | <b>SUZUKI SPLASH</b>                              |    |
|                                    |   | 1.0/1.2/1.3 CDTI                                  |   |
|                                    |   | <b>VAUXHALL AGILA</b>                             |    |
| Fitting Position/Lato Montaggio    | Front Axle                              | 1.0/1.2/1.3 CDTI                                  |   |
| Length/Lunghezza [mm]              | 34                                      |   |  |
| Height/Altezza [mm]                | 38                                      |   |   |
| Width/Larghezza [mm]               | 30                                      |   |  |
| Inner Diam./Diam. Interno [mm]     | 23                                      |   |   |
| <b>GOM-839</b>                     | <b>Engine Mounting</b>                  | <b>SUZUKI SX4</b>                                 |  |
|                                    | <b>Supporto motore</b>                  | 1.5/1.6/1.6 VVT/1.6 VVT 4x4/1.9 DDIS/1.9 DDIS 4x4 |   |
| SUZUKI                             | 11720-80JA0-000                         |   |  |
| Length/Lunghezza [mm]              | 56                                      |   |   |
| Inner Diam./Diam. Interno [mm]     | 10                                      |   |  |
| Outer Diam./Diam. esterno [mm]     | 88                                      |   |   |
| Mount. Bores/Fori Fiss. Dist. [mm] | 62                                      |   |  |
| <b>GOM-840</b>                     | <b>Bearing Bush, stabiliser</b>         | <b>NISSAN PIXO</b>                                |   |
|                                    | <b>Boccola barra stabilizzatrice</b>    | 1.0   |   |
| SUZUKI                             | 42431 M68K00                            | <b>SUZUKI ALTO V (GF)</b>                         |  |
|                                    |   | 1.0   |   |
| Fitting Position/Lato Montaggio    | Front Axle                              |   |  |
| Length/Lunghezza [mm]              | 34                                      |   |   |
| Height/Altezza [mm]                | 39                                      |   |  |
| Width/Larghezza [mm]               | 30                                      |   |   |
| Inner Diam./Diam. Interno [mm]     | 18                                      |   |  |
| <b>GOM-841</b>                     | <b>Holder, control arm mounting</b>     | <b>NISSAN PIXO</b>                                |   |
|                                    | <b>Silentblock</b>                      | 1.0   |   |
| SUZUKI                             | 45530-M68K00                            | <b>SUZUKI ALTO V (GF)</b>                         |  |
|                                    |   | 1.0   |   |
| Length/Lunghezza [mm]              | 53                                      |   |  |
| Inner Diam./Diam. Interno [mm]     | 12                                      |   |   |
| Outer Diam./Diam. esterno [mm]     | 33                                      |   |  |
| <b>GOM-842</b>                     | <b>Holder, control arm mounting</b>     | <b>SUZUKI SPLASH</b>                              |   |
|                                    | <b>Silentblock</b>                      | 1.0/1.2/1.3 CDTI                                  |   |
| SUZUKI                             | 46221 51K10                             |   |  |
| Fitting Position/Lato Montaggio    | Rear Axle                               |   |   |
| Height/Altezza [mm]                | 90                                      |   |  |
| Inner Diam./Diam. Interno [mm]     | 12                                      |   |   |
| Outer Diam./Diam. esterno [mm]     | 55                                      |   |  |
| <b>GOM-900</b>                     | <b>Bearing,propshaft centre bearing</b> | <b>ISUZU TROOPER (UBS)</b>                        |   |
|                                    | <b>Supporto albero cardanico</b>        | 2.2 D 4x4/2.8 TD (UBS55)                          |   |
| ISUZU                              | 8-97025-753-0                           |   |  |
| Length/Lunghezza [mm]              | 146,5                                   |   |   |
| Height/Altezza [mm]                | 138                                     |   |  |
| Width/Larghezza [mm]               | 59                                      |   |   |
| Inner Diam./Diam. Interno [mm]     | 30                                      |   |  |
| <b>GOM-901</b>                     | <b>Engine Mounting</b>                  | <b>ISUZU TROOPER (UB)</b>                         |   |
|                                    | <b>Supporto motore</b>                  | 3.1 TD/3.2  |   |
| ISUZU                              | 8-94375282-5                            | <b>ISUZU TROOPER (UB)</b>                         |  |
|                                    |   | 3.1 TD/3.2  |   |
| Length/Lunghezza [mm]              | 145                                     | <b>OPEL MONTEREY A (UBS_)</b>                     |  |
| Height/Altezza [mm]                | 86                                      | 3.1 TD (UBS69_)/3.2 (UBS25_)                      |   |
| Width/Larghezza [mm]               | 143                                     |   |  |

|                                |                          |  |   |  |
|--------------------------------|--------------------------|--|---|--|
| <b>GOM-902</b>                 | <b>Engine Mounting</b>   | <b>ISUZU TROOPER (UB)</b><br>3.1 TD/3.2  |    |  |
|                                | <b>Supporto motore</b>   | <b>ISUZU TROOPER (UB)</b><br>3.1 TD/3.2  |   |  |
| ISUZU                          | 8-94375283-2             | <b>OPEL MONTEREY A (UBS_)</b><br>3.1 TD (UBS69_)/3.2 (UBS25_)  |   |  |
| Length/Lunghezza [mm]          | 145                      |  |   |  |
| Height/Altezza [mm]            | 89                       |  |   |  |
| Width/Larghezza [mm]           | 143                      |  |   |  |
| <b>GOM-903</b>                 | <b>Engine Mounting</b>   | <b>ISUZU TROOPER (UB)</b><br>3.1 TD/3.2  |   |   |
|                                | <b>Supporto motore</b>   | <b>ISUZU TROOPER (UB)</b><br>3.1 TD/3.2  |   |  |
| ISUZU                          | 8-91733-866-0            | <b>OPEL MONTEREY A (UBS_)</b><br>3.1 TD (UBS69_)/3.2 (UBS25_)  |   |  |
| Length/Lunghezza [mm]          | 157                      |  |   |  |
| Height/Altezza [mm]            | 54                       |  |   |  |
| Width/Larghezza [mm]           | 89,5                     |  |   |  |
| <b>GOM-904</b>                 | <b>Engine Mounting</b>   | <b>ISUZU TROOPER (UB)</b><br>3.1 TD/3.2  |    |  |
|                                | <b>Supporto motore</b>   | <b>ISUZU TROOPER (UB)</b><br>3.1 TD/3.2  |   |  |
| ISUZU                          | 8-97104-157-1RH          | <b>OPEL MONTEREY A (UBS_)</b><br>3.1 TD (UBS69_)/3.2 (UBS25_)  |   |  |
| Length/Lunghezza [mm]          | 142                      |  |   |  |
| Height/Altezza [mm]            | 88                       |  |   |  |
| Width/Larghezza [mm]           | 112                      |  |   |  |
| <b>GOM-905</b>                 | <b>Engine Mounting</b>   | <b>ISUZU TROOPER (UB)</b><br>3.1 TD/3.2  |   |  |
|                                | <b>Supporto motore</b>   | <b>ISUZU TROOPER (UB)</b><br>3.1 TD/3.2  |   |  |
| ISUZU                          | 8-97104-158-1LH          | <b>OPEL MONTEREY A (UBS_)</b><br>3.1 TD (UBS69_)/3.2 (UBS25_)  |   |  |
| Length/Lunghezza [mm]          | 142                      |  |   |  |
| Height/Altezza [mm]            | 89                       |  |   |  |
| Width/Larghezza [mm]           | 112                      |  |   |  |
| <b>GOM-906</b>                 | <b>Bush, leaf spring</b> | <b>ISUZU TROOPER (UB)</b><br>3.1 TD/3.2  |  |  |
|                                | <b>Boccola balestra</b>  | <b>ISUZU TROOPER (UB)</b><br>3.1 TD/3.2  |   |  |
| ISUZU                          | 8-94223-168-0            | <b>ISUZU TROOPER (UBS)</b><br>2.2 (UBS13)/2.2 D (UBS52)/2.2 D 4x4/2.2 TD (UBS52)/2.3 (UBS16)/2.6 i (UBS17) |   |  |
| Length/Lunghezza [mm]          | 36                       |  |   |  |
| Inner Diam./Diam. Interno [mm] | 18                       |  |   |  |
| Outer Diam./Diam. esterno [mm] | 40,5                     |  |   |  |
|                                |                          | <b>ISUZU TROOPER (UBS)</b><br>2.2 D 4x4/2.8 TD (UBS55)   |   |  |
|                                |                          | <b>ISUZU TROOPER</b><br>3.0 DTI/3.5 V6 24V   |   |  |
|                                |                          | <b>ISUZU TROOPER Fuoristrada aperto</b><br>3.0 DTI/3.5 V6 24V  |   |  |
|                                |                          | <b>OPEL MONTEREY A (UBS_)</b><br>3.1 TD (UBS69_)/3.2 (UBS25_)  |   |  |
|                                |                          | <b>OPEL MONTEREY B</b><br>3.0 DTI/3.5 V6 24V   |   |  |
| <b>GOM-907</b>                 | <b>Bush, leaf spring</b> | <b>ISUZU TROOPER (UB)</b><br>3.1 TD/3.2  |  |  |
|                                | <b>Boccola balestra</b>  | <b>ISUZU TROOPER (UB)</b><br>3.1 TD/3.2  |   |  |
| ISUZU                          | 8-94234-319-0            | <b>ISUZU TROOPER (UBS)</b><br>2.2 (UBS13)/2.2 D (UBS52)/2.2 D 4x4/2.2 TD (UBS52)/2.3 (UBS16)/2.6 i (UBS17) |   |  |
| Length/Lunghezza [mm]          | 35                       |  |   |  |
| Inner Diam./Diam. Interno [mm] | 19                       |  |   |  |
| Outer Diam./Diam. esterno [mm] | 29                       |  |   |  |
|                                |                          | <b>ISUZU TROOPER (UBS)</b><br>2.2 D 4x4/2.8 TD (UBS55)   |   |  |
|                                |                          | <b>ISUZU TROOPER</b><br>3.0 DTI/3.5 V6 24V   |   |  |
|                                |                          | <b>ISUZU TROOPER Fuoristrada aperto</b><br>3.0 DTI/3.5 V6 24V  |   |  |
|                                |                          | <b>OPEL MONTEREY A (UBS_)</b>  |   |  |

|                                |                                     |      |  |   |
|--------------------------------|-------------------------------------|------|--|---|
| <b>GOM-908</b>                 | <b>Holder, control arm mounting</b> |      | 3.1 TD (UBS69_)/3.2 (UBS25_)   |    |
|                                | <b>Silentblock</b>                  |      | <b>OPEL MONTEREY B</b><br>3.0 DTI/3.5 V6 24V   |   |
| ISUZU                          | 8-94226-557-0                       |      | <b>ISUZU CAMPO (KB)</b><br>2.0 (KB28)/2.0 4WD (KB41, KB45)/2.0 4WD (KB48)/2.0 D (KBD23, KBD28)/2.0 D 4WD (KBD42, KBD46)/2.2 (TFS)/2.2 D (KBD27)/2.2 D 4WD (KBD42, KBD47)/2.5 D (KBD27)/2.5 D 4WD (KBD47) |   |
| Length/Lunghezza [mm]          |                                     | 45   | <b>ISUZU PICK UP</b><br>2.3/2.3 4x4/2.6 4x4/2.6 LS   |   |
| Inner Diam./Diam. Interno [mm] |                                     | 18   | <b>ISUZU TROOPER (UB)</b><br>3.1 TD/3.2  |   |
| Outer Diam./Diam. esterno [mm] |                                     | 36   | <b>ISUZU TROOPER (UB)</b><br>3.1 TD/3.2  |   |
|                                |                                     |      | <b>ISUZU TROOPER (UBS)</b><br>2.2 (UBS13)/2.2 D (UBS52)/2.2 D 4x4/2.2 TD (UBS52)/2.3 (UBS16)/2.6 i (UBS17)   |   |
|                                |                                     |      | <b>ISUZU TROOPER (UBS)</b><br>2.2 D 4x4/2.8 TD (UBS55)   |   |
|                                |                                     |      | <b>ISUZU TROOPER</b><br>3.0 DTI/3.5 V6 24V   |   |
|                                |                                     |      | <b>ISUZU TROOPER Fuoristrada aperto</b><br>3.0 DTI/3.5 V6 24V  |   |
|                                |                                     |      | <b>OPEL MONTEREY A (UBS_)</b><br>3.1 TD (UBS69_)/3.2 (UBS25_)  |   |
|                                |                                     |      | <b>OPEL MONTEREY B</b><br>3.0 DTI/3.5 V6 24V   |   |
| <b>GOM-909</b>                 | <b>Holder, control arm mounting</b> |      | <b>ISUZU TROOPER (UB)</b><br>3.1 TD/3.2  |  |
|                                | <b>Silentblock</b>                  |      | <b>ISUZU TROOPER (UB)</b><br>3.1 TD/3.2  |   |
| ISUZU                          | 8-94223-366-0                       |      | <b>ISUZU TROOPER (UBS)</b><br>2.2 (UBS13)/2.2 D (UBS52)/2.2 D 4x4/2.2 TD (UBS52)/2.3 (UBS16)/2.6 i (UBS17)   |   |
| Length/Lunghezza [mm]          |                                     | 63,5 | <b>ISUZU TROOPER (UBS)</b><br>2.2 D 4x4/2.8 TD (UBS55)   |   |
| Inner Diam./Diam. Interno [mm] |                                     | 14   | <b>ISUZU TROOPER</b><br>3.0 DTI/3.5 V6 24V   |   |
| Outer Diam./Diam. esterno [mm] |                                     | 35   | <b>ISUZU TROOPER Fuoristrada aperto</b><br>3.0 DTI/3.5 V6 24V  |   |
|                                |                                     |      | <b>OPEL MONTEREY A (UBS_)</b><br>3.1 TD (UBS69_)/3.2 (UBS25_)  |   |
|                                |                                     |      | <b>OPEL MONTEREY B</b><br>3.0 DTI/3.5 V6 24V   |   |
| <b>GOM-910</b>                 | <b>Holder, control arm mounting</b> |      | <b>ISUZU TROOPER (UB)</b><br>3.1 TD/3.2  |  |
|                                | <b>Silentblock</b>                  |      | <b>ISUZU TROOPER (UB)</b><br>3.1 TD/3.2  |   |
| ISUZU                          | 8-94408-840-3                       |      | <b>ISUZU TROOPER (UBS)</b><br>2.2 (UBS13)/2.2 D (UBS52)/2.2 D 4x4/2.2 TD (UBS52)/2.3 (UBS16)/2.6 i (UBS17)   |   |
| Length/Lunghezza [mm]          |                                     | 45   | <b>ISUZU TROOPER (UBS)</b><br>2.2 D 4x4/2.6 CLS Plane 4x4/2.8 TD (UBS55)   |   |
| Inner Diam./Diam. Interno [mm] |                                     | 18   | <b>ISUZU TROOPER</b><br>3.0 DTI/3.5 V6 24V   |   |
| Outer Diam./Diam. esterno [mm] |                                     | 38   | <b>ISUZU TROOPER Fuoristrada aperto</b><br>3.0 DTI/3.5 V6 24V  |   |
|                                |                                     |      | <b>OPEL CAMPO (TF_)</b><br>2.2 D (TFR52)/2.2 D 4x4 (TFS52)/2.3 (TFR16)/2.3 4x4 (TFS16)/2.5 D (TFR54)/2.5 D 4x4 (TFS54)/2.5 TD (TFR54)/2.5 TD 4x4 (TFS54)/3.1 TD (TFR69)/3.1 TD 4x4 (TFS69)               |   |
|                                |                                     |      | <b>OPEL FRONTERA A (5_MWL4)</b><br>2.2 i (54MWL4)/2.3 TD (5JMWL4)/2.4 i (53MWL4)/2.5 TDS/2.8 TD (5BMWL4)   |   |
|                                |                                     |      | <b>OPEL FRONTERA A Sport (5_SUD2)</b><br>2.0 i (52SUD2, 55SUD2)/2.5 TDS/2.8 TD (53SUD2)  |   |







|                                 |                                     |  |  |  |
|---------------------------------|-------------------------------------|--|--|--|
| <b>GOM-911</b>                  | <b>Holder, control arm mounting</b> | <b>ISUZU TROOPER (UB)</b><br>3.1 TD/3.2  |  <p>911</p>   |  |
|                                 | <b>Silentblock</b>                  | <b>ISUZU TROOPER (UB)</b><br>3.1 TD/3.2  |  |  |
|                                 |                                     | <b>ISUZU TROOPER (UBS)</b><br>2.2 (UBS13)/2.2 D (UBS52)/2.2 D 4x4/2.2 TD (UBS52)/2.3 (UBS16)/2.6 i (UBS17) |  |  |
| Length/Lunghezza [mm]           | 56                                  |  |  |  |
| Inner Diam./Diam. Interno [mm]  | 16,5                                |  |  |  |
| Outer Diam./Diam. esterno [mm]  | 36                                  |  |  |  |
|                                 |                                     | <b>ISUZU TROOPER (UBS)</b><br>2.2 D 4x4/2.8 TD (UBS55)   |  |  |
|                                 |                                     | <b>ISUZU TROOPER</b><br>3.0 DTI/3.5 V6 24V   |  |  |
|                                 |                                     | <b>ISUZU TROOPER Fuoristrada aperto</b><br>3.0 DTI/3.5 V6 24V  |  |  |
| <b>GOM-912</b>                  | <b>Holder, control arm mounting</b> | <b>ISUZU TROOPER (UB)</b><br>3.1 TD/3.2  |  |  <p>912</p>   |
|                                 | <b>Silentblock</b>                  | <b>ISUZU TROOPER (UB)</b><br>3.1 TD/3.2  |  |  |
| ISUZU                           | 9-51151-023-0                       | <b>ISUZU TROOPER (UBS)</b><br>2.2 (UBS13)/2.2 D (UBS52)/2.2 D 4x4/2.2 TD (UBS52)/2.3 (UBS16)/2.6 i (UBS17) |  |  |
| Length/Lunghezza [mm]           | 68                                  |  |  |  |
| Inner Diam./Diam. Interno [mm]  | 16                                  |  |  |  |
| Outer Diam./Diam. esterno [mm]  | 38                                  |  |  |  |
|                                 |                                     | <b>ISUZU TROOPER (UBS)</b><br>2.2 D 4x4/2.8 TD (UBS55)   |  |  |
|                                 |                                     | <b>ISUZU TROOPER</b><br>3.0 DTI/3.5 V6 24V   |  |  |
|                                 |                                     | <b>ISUZU TROOPER Fuoristrada aperto</b><br>3.0 DTI/3.5 V6 24V  |  |  |
|                                 |                                     | <b>OPEL MONTEREY A (UBS_)</b><br>3.1 TD (UBS69_)/3.2 (UBS25_)  |  |  |
| <b>GOM-913</b>                  | <b>Holder, control arm mounting</b> | <b>ISUZU TROOPER (UB)</b><br>3.1 TD/3.2  |  <p>913</p> |  |
|                                 | <b>Silentblock</b>                  | <b>ISUZU TROOPER (UB)</b><br>3.1 TD/3.2  |  |  |
| ISUZU                           | 9-51351-029-0                       | <b>ISUZU TROOPER (UBS)</b><br>2.2 (UBS13)/2.2 D (UBS52)/2.2 D 4x4/2.2 TD (UBS52)/2.3 (UBS16)/2.6 i (UBS17) |  |  |
| Length/Lunghezza [mm]           | 81                                  |  |  |  |
| Inner Diam./Diam. Interno [mm]  | 16                                  |  |  |  |
| Outer Diam./Diam. esterno [mm]  | 42                                  |  |  |  |
|                                 |                                     | <b>ISUZU TROOPER (UBS)</b><br>2.2 D 4x4/2.8 TD (UBS55)   |  |  |
|                                 |                                     | <b>ISUZU TROOPER</b><br>3.0 DTI/3.5 V6 24V   |  |  |
|                                 |                                     | <b>ISUZU TROOPER Fuoristrada aperto</b><br>3.0 DTI/3.5 V6 24V  |  |  |
|                                 |                                     | <b>OPEL MONTEREY A (UBS_)</b><br>3.1 TD (UBS69_)/3.2 (UBS25_)  |  |  |
| <b>GOM-915</b>                  | <b>Holder, control arm mounting</b> | <b>ISUZU TROOPER (UBS)</b><br>2.2 (UBS13)/2.2 D (UBS52)/2.2 D 4x4/2.2 TD (UBS52)/2.3 (UBS16)/2.6 i (UBS17) |  <p>915</p> |  |
|                                 | <b>Silentblock</b>                  | <b>ISUZU TROOPER (UBS)</b><br>2.2 D 4x4/2.6 CLS Plane 4x4/2.8 TD (UBS55)                                   |  |  |
| ISUZU                           | 8 97 018 166 1                      |  |  |  |
| Length/Lunghezza [mm]           | 85                                  |  |  |  |
| Inner Diam./Diam. Interno [mm]  | 18                                  |  |  |  |
| Outer Diam./Diam. esterno [mm]  | 44                                  |  |  |  |
| <b>GOM-916</b>                  | <b>Engine Mounting</b>              | <b>ISUZU D-MAX</b><br>3.0 DiTD/3.0 DiTD 4x4  |  |  <p>916</p> |
|                                 | <b>Supporto motore</b>              |  |  |  |
| ISUZU                           | 8-972349762                         |  |  |  |
| Fitting Position/Lato Montaggio | Right Front                         |  |  |  |
| Length/Lunghezza [mm]           | 126                                 |  |  |  |
| Width/Larghezza [mm]            | 87                                  |  |  |  |



|  |  |  |
|--|--|--|
| <p><b>GOM-917</b>      <b>Engine Mounting</b></p> <p><b>Supporto motore</b></p>  | <p><b>ISUZU D-MAX</b><br/>3.0 DiTD/3.0 DiTD 4x4</p>  | <br>917   |
| <p>ISUZU      8-97234-977-2</p> <p>Fitting Position/Lato Montaggio      Left Front</p> <p>Length/Lunghezza [mm]      179</p> <p>Height/Altezza [mm]      112</p> <p>Width/Larghezza [mm]      117</p>  |  |  |
| <p><b>GOM-918</b>      <b>Bush, leaf spring</b></p> <p><b>Boccola balestra</b></p>   | <p><b>ISUZU D-MAX</b><br/>2.5 D/2.5 DiTD 4x4/3.0 D 4x4/3.0 DiTD 4x4</p>  | <br>918   |
| <p>ISUZU      8-97332-642-0</p> <p>Fitting Position/Lato Montaggio      Front Axle</p> <p>Length/Lunghezza [mm]      69</p> <p>Inner Diam./Diam. Interno [mm]      14</p> <p>Outer Diam./Diam. esterno [mm]      40</p>                      |  |  |
| <p><b>GOM-920</b>      <b>Bearing Bush, stabiliser</b></p> <p><b>Boccola barra stabilizzatrice</b></p>   | <p><b>JEEP CHEROKEE (KJ)</b><br/>2.4</p>   | <br>920   |
| <p>JEEP      52088778AB</p> <p>Fitting Position/Lato Montaggio      Front Axle</p> <p>Length/Lunghezza [mm]      55</p> <p>Height/Altezza [mm]      63</p> <p>Width/Larghezza [mm]      58</p> <p>Inner Diam./Diam. Interno [mm]      30</p> |  |  |
| <p><b>GOM-921</b>      <b>Bearing Bush, stabiliser</b></p> <p><b>Boccola barra stabilizzatrice</b></p>   | <p><b>JEEP CHEROKEE (XJ)</b><br/>2.1 D 4x4/2.5/2.5 i 4x4/2.5 TD/4.0 i</p>                                      | <br>921 |
| <p>JEEP      52003232</p> <p>Fitting Position/Lato Montaggio      Front Axle</p> <p>Length/Lunghezza [mm]      45</p> <p>Height/Altezza [mm]      38</p> <p>Width/Larghezza [mm]      38</p> <p>Inner Diam./Diam. Interno [mm]      25</p>   |  |  |
| <p><b>GOM-922</b>      <b>Bearing Bush, stabiliser</b></p> <p><b>Boccola barra stabilizzatrice</b></p>   | <p><b>JEEP CHEROKEE (XJ)</b><br/>2.5 i/2.5 Tdi 4x4/4.0 i</p> <p><b>JEEP GRAND CHEROKEE I (Z)</b><br/>5.9 i</p> | <br>922 |
| <p>JEEP      52088523</p> <p>Fitting Position/Lato Montaggio      Front Axle</p> <p>Length/Lunghezza [mm]      45</p> <p>Height/Altezza [mm]      38</p> <p>Width/Larghezza [mm]      39</p> <p>Inner Diam./Diam. Interno [mm]      23</p>   |  |  |
| <p><b>GOM-923</b>      <b>Bearing Bush, stabiliser</b></p> <p><b>Boccola barra stabilizzatrice</b></p>   | <p><b>JEEP GRAND CHEROKEE I (Z)</b><br/>2.5 TD (Z)/2.5 TD Laredo/4.0 i (Z)/4.0 Laredo/5.9 i</p>                | <br>923 |
| <p>JEEP      52088524</p> <p>Fitting Position/Lato Montaggio      Front Axle</p> <p>Length/Lunghezza [mm]      45</p> <p>Height/Altezza [mm]      38,5</p> <p>Width/Larghezza [mm]      39</p> <p>Inner Diam./Diam. Interno [mm]      28</p> |  |  |

|                                 |                                      |  |   |
|---------------------------------|--------------------------------------|--|---|
| <b>GOM-924</b>                  | <b>Bearing Bush, stabiliser</b>      | <b>JEEP WRANGLER II (TJ)</b>                 |    |
|                                 | <b>Boccola barra stabilizzatrice</b> | 2.4/2.5/4.0                                  |   |
| JEEP                            | 52088378                             |  |   |
| Fitting Position/Lato Montaggio |                                      | Front Axle                                   |   |
| Length/Lunghezza [mm]           |                                      | 55   |   |
| Height/Altezza [mm]             |                                      | 53   |   |
| Width/Larghezza [mm]            |                                      | 59   |   |
| Inner Diam./Diam. Interno [mm]  |                                      | 30   |   |
| <b>GOM-925</b>                  | <b>Bearing Bush, stabiliser</b>      | <b>JEEP CHEROKEE (XJ)</b>                    |    |
|                                 | <b>Boccola barra stabilizzatrice</b> | 2.5/2.5 i/2.5 i 4x4/2.5 TD/2.5 Tdi 4x4/4.0 i |   |
| JEEP                            | 52001145                             |  |   |
| Fitting Position/Lato Montaggio |                                      | Rear Axle                                    |   |
| Length/Lunghezza [mm]           |                                      | 45   |   |
| Height/Altezza [mm]             |                                      | 38,5   |   |
| Width/Larghezza [mm]            |                                      | 38,5   |   |
| Inner Diam./Diam. Interno [mm]  |                                      | 15   |   |
| <b>GOM-926</b>                  | <b>Bearing Bush, stabiliser</b>      | <b>JEEP WRANGLER II (TJ)</b>                 |   |
|                                 | <b>Boccola barra stabilizzatrice</b> | 2.4/2.5/4.0                                  |   |
| JEEP                            | 52088125                             |  |   |
| Fitting Position/Lato Montaggio |                                      | Rear Axle                                    |   |
| Length/Lunghezza [mm]           |                                      | 41   |   |
| Height/Altezza [mm]             |                                      | 37   |   |
| Width/Larghezza [mm]            |                                      | 37   |   |
| Inner Diam./Diam. Interno [mm]  |                                      | 14   |   |
| <b>GOM-928</b>                  | <b>Bearing Bush, stabiliser</b>      | <b>CHRYSLER VOYAGER III (GS)</b>             |  |
|                                 | <b>Boccola barra stabilizzatrice</b> | 2.5 TDiC AWD                                 |   |
| CHRYSLER                        | 04743041AC                           |  |   |
| Fitting Position/Lato Montaggio |                                      | Front Axle                                   |   |
| Length/Lunghezza [mm]           |                                      | 46,5   |   |
| Height/Altezza [mm]             |                                      | 54   |   |
| Width/Larghezza [cm]            |                                      | 50   |   |
| Inner Diam./Diam. Interno [mm]  |                                      | 25   |   |
| <b>GOM-929</b>                  | <b>Bearing Bush, stabiliser</b>      | <b>CHRYSLER NEON II</b>                      |  |
|                                 | <b>Boccola barra stabilizzatrice</b> | 1.6/2.0 16V/2.0 16V R/T                      |   |
| CHRYSLER                        | 05272506AA                           |  |   |
| Fitting Position/Lato Montaggio |                                      | Front Axle                                   |   |
| Length/Lunghezza [mm]           |                                      | 28   |   |
| Inner Diam./Diam. Interno [mm]  |                                      | 21   |   |
| Outer Diam./Diam. esterno [mm]  |                                      | 44   |   |
| <b>GOM-930</b>                  | <b>Bearing Bush, stabiliser</b>      | <b>JEEP COMMANDER</b>                        |  |
|                                 | <b>Boccola barra stabilizzatrice</b> | 3.0 CRD/4.7 V8/5.7 V8                        |   |
| JEEP                            | 52124302AA                           |  |   |
| Fitting Position/Lato Montaggio |                                      | Rear Axle                                    |   |
| Length/Lunghezza [mm]           |                                      | 46   |   |
| Height/Altezza [mm]             |                                      | 40   |   |
| Width/Larghezza [mm]            |                                      | 39   |   |
| Inner Diam./Diam. Interno [mm]  |                                      | 19   |   |

|                                 |   |                                       |   |
|---------------------------------|---|---------------------------------------|---|
| <b>GOM-931</b>                  | <b>Bearing Bush, stabiliser</b>         | <b>DODGE CALIBER</b>                  |    |
|                                 | <b>Boccola barra stabilizzatrice</b>    | 1.8/2.0/2.0 CRD/2.4                   |   |
| JEEP                            | 5105103AC                               | <b>JEEP COMPASS</b>                   |    |
| Fitting Position/Lato Montaggio | Front Axle                              | 2.0 CRD/2.0 CRD 4x4/2.4/2.4 4x4       |   |
| Length/Lunghezza [mm]           | 52                                      | <b>JEEP PATRIOT</b>                   |    |
| Height/Altezza [mm]             | 43                                      | 2.0 CRD/2.4                           |   |
| Width/Larghezza [mm]            | 50                                      | <b>ISUZU TROOPER (UBS)</b>            |  |
| Inner Diam./Diam. Interno [mm]  | 23                                      | 2.2 D 4x4/2.8 TD (UBS55)              |   |
| <b>GOM-932</b>                  | <b>Bearing,propshaft centre bearing</b> | <b>NISSAN PRIMERA (P10)</b>           |    |
|                                 | <b>Supporto albero cardanico</b>        | 2.0 16V/2.0 16V 4x4/2.0 i             |   |
| ISUZU                           | 8-97025-752-0                           | <b>NISSAN PRIMERA Hatchback (P10)</b> |  |
| Length/Lunghezza [mm]           | 146                                     | 2.0/2.0 16V/2.0 16V 4x4/2.0 i         |   |
| Height/Altezza [mm]             | 157                                     | <b>NISSAN PRIMERA Traveller (W10)</b> |  |
| Width/Larghezza [mm]            | 60                                      | 2.0 i                                 |   |
| Inner Diam./Diam. Interno [mm]  | 30                                      | <b>NISSAN MICRA (K11)</b>             |  |
| <b>GOM-1000</b>                 | <b>Engine Mounting</b>                  | 1.5 D                                 |   |
|                                 | <b>Supporto motore</b>                  |                                       |   |
| NISSAN                          | 1122093J00                              | <b>NISSAN MICRA (K11)</b>             |  |
| Fitting Position/Lato Montaggio | Front Axle Left                         | 1.0 i 16V                             |   |
| Length/Lunghezza [mm]           | 204                                     | <b>NISSAN MICRA (K11)</b>             |  |
| Height/Altezza [mm]             | 107                                     | 1.0 i 16V/1.3 i 16V                   |   |
| Width/Larghezza [mm]            | 80                                      | <b>NISSAN MICRA (K11)</b>             |  |
| Inner Diam./Diam. Interno [mm]  | 11                                      | 1.5 D                                 |   |
| <b>GOM-1001</b>                 | <b>Engine Mounting</b>                  |                                       |  |
|                                 | <b>Supporto motore</b>                  |                                       |   |
| NISSAN                          | 112106F800                              |                                       |   |
| Fitting Position/Lato Montaggio | Front Axle                              |                                       |   |
| Fitting Position/Lato Montaggio | Right                                   |                                       |   |
| Length/Lunghezza [mm]           | 145                                     |                                       |   |
| <b>GOM-1002</b>                 | <b>Engine Mounting</b>                  |                                       |  |
|                                 | <b>Supporto motore</b>                  |                                       |   |
| NISSAN                          | 1122099B01                              |                                       |   |
| Fitting Position/Lato Montaggio | Front Axle                              |                                       |   |
| Fitting Position/Lato Montaggio | Transmission End                        |                                       |   |
| Inner Diam./Diam. Interno [mm]  | 11                                      |                                       |   |
| <b>GOM-1003</b>                 | <b>Engine Mounting</b>                  |                                       |  |
|                                 | <b>Supporto motore</b>                  |                                       |   |
| NISSAN                          | 11220-99B20                             |                                       |   |
| Fitting Position/Lato Montaggio | Front Axle                              |                                       |   |
| Fitting Position/Lato Montaggio | Left Rear                               |                                       |   |
| Width/Larghezza [mm]            | 50                                      |                                       |   |
| Inner Diam./Diam. Interno [mm]  | 11                                      |                                       |   |
| <b>GOM-1004</b>                 | <b>Engine Mounting</b>                  |                                       |  |
|                                 | <b>Supporto motore</b>                  |                                       |   |
| NISSAN                          | 113206F800                              |                                       |   |
| Fitting Position/Lato Montaggio | Front Axle                              |                                       |   |
| Length/Lunghezza [mm]           | 125                                     |                                       |   |
| Height/Altezza [mm]             | 74                                      |                                       |   |
| Width/Larghezza [mm]            | 53                                      |                                       |   |
| Inner Diam./Diam. Interno [mm]  | 11                                      |                                       |   |

|   |  |   |
|---|--|---|
| <b>GOM-1006</b> Suspension Strut Support<br>Bearing<br>Supporto ammortizzatore  | <b>NISSAN PRIMERA Traveller (W10)</b><br>1.6 i/2.0 D/2.0 i   |  <p>1006</p>   |
| NISSAN 01225-00231<br>Fitting Position/Lato Montaggio Front Axle<br>Height/Altezza [mm] 47<br>Inner Diam./Diam. Interno [mm] 15<br>Inner Diam./Diam. Int. 1 [mm] 33,7               |  |   |
| <b>GOM-1007</b> Holder, control arm mounting<br>Silentblock   | <b>NISSAN SUNNY II (N13)</b><br>1.3/1.4/1.4 LX/1.6/1.6 i/1.6 i 12V/1.6 i 4x4 (A)/1.7 D<br><b>NISSAN SUNNY II Coupe (B12)</b><br>1.6/1.6 i/1.6 i 12V  |  <p>1007</p>   |
| NISSAN 54570-50A10<br>Fitting Position/Lato Montaggio Lower Front Axle<br>Length/Lunghezza [mm] 68<br>Height/Altezza [mm] 58<br>Inner Diam./Diam. Interno [mm] 18                   | <b>NISSAN SUNNY II Hatchback (N13)</b><br>1.3/1.4/1.4 LX/1.6/1.6 i/1.6 i 12V/1.7 D<br><b>NISSAN SUNNY II Traveller (B12)</b><br>1.6/1.6 i/1.6 i 12V/1.6 i 4x4 (A)/1.7 D<br><b>NISSAN SUNNY III (N14)</b><br>1.6 i/1.6 i 16V<br><b>NISSAN SUNNY III Hatchback (N14)</b><br>1.6 i/1.6 i 16V<br><b>NISSAN SUNNY III Liftback (N14)</b><br>1.6 i/1.6 i 16V |   |
| <b>GOM-1008</b> Suspension Strut Support<br>Bearing<br>Supporto ammortizzatore  | <b>NISSAN ALMERA I (N15)</b><br>1.4/1.4 GX,LX/1.6/1.6 SLX/2.0 D<br><b>NISSAN ALMERA I Hatchback (N15)</b><br>1.4/1.4 S,GX,LX/1.6/1.6 SR,SLX/2.0 D/2.0 GTI  |  <p>1008</p>  |
| NISSAN 54320-50Y12<br>Fitting Position/Lato Montaggio Front Axle<br>Height/Altezza [mm] 24<br>Inner Diam./Diam. Interno [mm] 12<br>Outer Diam./Diam. esterno [mm] 70,5              |  |   |
| <b>GOM-1010</b> Engine Mounting<br>Supporto motore  | <b>NISSAN ALMERA I (N15)</b><br>1.4/1.4 GX,LX/2.0 D<br><b>NISSAN ALMERA I Hatchback (N15)</b><br>1.4/1.4 S,GX,LX/2.0 D/2.0 GTI   |  <p>1010</p> |
| NISSAN 113200M002<br>Fitting Position/Lato Montaggio Front<br>Length/Lunghezza [mm] 153<br>Height/Altezza [mm] 79,5<br>Inner Diam./Diam. Interno [mm] 11,5                          |  |   |
| <b>GOM-1011</b> Engine Mounting<br>Supporto motore  | <b>NISSAN ALMERA I (N15)</b><br>1.4/1.6/1.6 SLX/2.0 D<br><b>NISSAN ALMERA I Hatchback (N15)</b><br>1.4/1.6/1.6 SR,SLX/2.0 D/2.0 GTI  |  <p>1011</p> |
| NISSAN 1135041B00<br>Fitting Position/Lato Montaggio Front<br>Length/Lunghezza [mm] 124,5<br>Height/Altezza [mm] 58<br>Width/Larghezza [mm] 44<br>Inner Diam./Diam. Interno [mm] 11 |  |   |
| <b>GOM-1012</b> Engine Mounting<br>Supporto motore  | <b>NISSAN KUBISTAR</b><br>1.2/1.2 16V/1.6 16V<br><b>RENAULT CLIO II (B/C/B0/1_, CB0/1/2_)</b><br>1.2/1.2 (B/CB0F, B/CB0A, B/CB10, B/CB1K, B/CB2D, B/CB2H)/1.2 16V (B/CB05)/1.4 16V (B/CB0L)/1.4 16V (B/CB0P)/1.6 16V (CB0T, CB0H)  |  <p>1012</p> |
| NISSAN 11270-00QAA<br>Fitting Position/Lato Montaggio Right<br>Length/Lunghezza [mm] 170<br>Height/Altezza [mm] 80<br>Width/Larghezza [mm] 99<br>Inner Diam./Diam. Interno [mm] 13  | <b>RENAULT CLIO II Furgonato (SB0_)</b><br>1.2<br><b>RENAULT KANGOO (KC0_)</b><br>1.2 (KC0A, KC0K, KCOF, KC01)/1.2 16V (KC03, KC05, KC06, KC0T, KC0W)/1.5 dCi/1.6 16V/1.6 16V 4x4 (KC0P, KC0S, KC0L)/1.6 16V bivalent  |   |
|   | <b>RENAULT KANGOO</b><br>1.6 16V/1.6 16V Hi-Flex<br><b>RENAULT KANGOO Express (FC0_)</b>   |   |

1.2/1.2 (FC01, FCOA, FCOF)/1.2 16V (FC05)/1.5 dCi/1.6 16V/1.6 16V 4x4 (FC0L, FCOP, FCOS)/1.6 16V bivalent/D 55 1.9 (FCOD)

**RENAULT KANGOO Express**

1.6 16V/1.6 16V LPG

**GOM-1014** Bearing,propshaft centre bearing  
**Supporto albero cardanico**

NISSAN 37521-36G25

Length/Lunghezza [mm] 118,5  
 Height/Altezza [mm] 119  
 Width/Larghezza [mm] 50  
 Inner Diam./Diam. Interno [mm] 30

**NISSAN PICK UP/KING CAB (D21)**

2.4 4x4/2.5 D 4WD



1014

**GOM-1015** Engine Mounting  
**Supporto motore**

NISSAN 11210-2S710

Length/Lunghezza [mm] 144  
 Height/Altezza [mm] 69  
 Width/Larghezza [mm] 153

**NISSAN PICK UP/KING CAB/NAVARA (D22)**

2.5 TD 4WD



1015

**GOM-1016** Engine Mounting  
**Supporto motore**

NISSAN 11220-2S710

Length/Lunghezza [mm] 143  
 Height/Altezza [mm] 108  
 Width/Larghezza [mm] 104

**NISSAN PICK UP/KING CAB/NAVARA (D22)**

2.5 TD 4WD



1016

**GOM-1025**

NISSAN 11320-99B11

**NISSAN MICRA (K11)**

1.0 i 16V/1.3 i 16V/1.4 i 16V



1025

**GOM-1026**

NISSAN 11220-99B11

**NISSAN MICRA (K11)**

1.0 i 16V/1.3 i 16V



1026

**GOM-2000** Bearing Bush, stabiliser

**Boccola barra stabilizzatrice**

TOYOTA 4881542040

Fitting Position/Lato Montaggio Rear Axle  
 Length/Lunghezza [mm] 40  
 Height/Altezza [mm] 31  
 Width/Larghezza [mm] 30  
 Inner Diam./Diam. Interno [mm] 20

**TOYOTA RAV 4 II (XA2)**

1.8 VVTi/2.0 D-4D 4WD/2.0 VVTi 4WD





**TOYOTA RAV 4 II**

2.4



2000

|                 |                                     |   |   |
|-----------------|-------------------------------------|---|---|
| <b>GOM-2002</b> | <b>Engine Mounting</b>              | <b>TOYOTA CAMRY ( _V1_ )</b>  |    |
|                 | <b>Supporto motore</b>              | 2.2 (SXV10)   |   |
|                 |                                     | <b>TOYOTA CAMRY SW ( _V10_ )</b>  |   |
|                 |                                     | 2.2 (SXV10)   |   |
|                 | TOYOTA                              | 1237174312  |   |
|                 | Fitting Position/Lato Montaggio     | Right Rear  |   |
|                 | Overall Length/Lungh. Tot. [mm]     | 228   |   |
|                 | Fitted Diam./Diam. Mont. [mm]       | 32  |   |
| <b>GOM-2003</b> | <b>Suspension Strut Support</b>     | <b>TOYOTA COROLLA ( _E11_ )</b>   |    |
|                 | <b>Bearing</b>                      | 1.3/1.4 (EE111_)/1.4 16V (ZZE111_)/1.6 (AE111_)/1.6 16V (ZZE112_)/1.6 Aut. (AE111_)/1.9 D (WZE110_)/2.0 D (CE110_)              |   |
|                 | <b>Supporto ammortizzatore</b>      | <b>TOYOTA COROLLA Compact ( _E10_ )</b>   |   |
|                 |                                     | 1.8 GT (AE102_)/1.8 GTi 4x4   |   |
|                 | TOYOTA                              | 48609-12211   |   |
|                 | Fitting Position/Lato Montaggio     | Front Axle  |   |
|                 | Height/Altezza [mm]                 | 50  |   |
|                 | Inner Diam./Diam. Interno [mm]      | 15  |   |
|                 | Outer Diam./Diam. esterno [mm]      | 100   |   |
|                 |                                     | <b>TOYOTA COROLLA Compact ( _E11_ )</b>   |   |
|                 |                                     | 1.4 (EE111_)/1.6 (AE111_)/1.6 Aut. (AE111_)/2.0 D (CE110_)  |   |
|                 |                                     | <b>TOYOTA COROLLA Liftback ( _E10_ )</b>  |   |
|                 |                                     | 1.8 GT (AE102_)/1.8 GTi 4x4   |   |
|                 |                                     | <b>TOYOTA COROLLA Liftback ( _E11_ )</b>  |   |
|                 |                                     | 1.4 (EE111_)/1.6 (AE111_)/1.6 Aut. (AE111_)/2.0 D (CE110_)  |   |
|                 |                                     | <b>TOYOTA COROLLA Wagon ( _E11_ )</b>   |   |
|                 |                                     | 1.4 (EE111_)/1.4 16V (ZZE111_)/1.6 (AE111_)/1.6 16V (ZZE112_)/1.6 Aut. (AE111_)/1.8 AWD (AE115_)/1.9 D (WZE110_)/2.0 D (CE110_) |   |
|                 |                                     | <b>TOYOTA COROLLA Wagon ( _E10_ )</b>   |   |
|                 |                                     | 1.8 16V 4WD (AE103_)/1.8 XL/1.8 XL 4x4  |   |
| <b>GOM-2007</b> | <b>Holder, control arm mounting</b> | <b>TOYOTA LITEACE Autobus ( _R2_LG_ )</b>   |   |
|                 | <b>Silentblock</b>                  | 1.5 (KR21LG)/2.0 D (CR21LG)/2.2 (YR22LG)  |   |
|                 |                                     | <b>TOYOTA LITEACE Autobus (CM30_G, KM30_G)</b>  |   |
|                 |                                     | 1.5 (KM30LG)/2.0 D (CM30LG)   |   |
|                 | TOYOTA                              | 48635-28010   |   |
|                 | Fitting Position/Lato Montaggio     | Upper Front Axle  |   |
|                 | Fitting Position/Lato Montaggio     | inner   |   |
|                 | Length/Lunghezza [mm]               | 75,5  |   |
|                 | Inner Diam./Diam. Interno [mm]      | 23  |   |
|                 | Outer Diam./Diam. esterno [mm]      | 47  |   |
|                 |                                     | <b>TOYOTA LITEACE Furgonato ( _R2_V_ )</b>  |   |
|                 |                                     | 1.5 (KR27_V)  |   |
|                 |                                     | <b>TOYOTA LITEACE Furgonato (CM3_V, KM3_V)</b>  |   |
|                 |                                     | 1.5 (KM31_V, KM36_V)/2.0 D (CM36_V)   |   |
|                 |                                     | <b>TOYOTA LITEACE Furgonato (M2_V)</b>  |   |
|                 |                                     | 1.3   |   |
|                 |                                     | <b>TOYOTA MODELL F Autobus ( _R2_ , 31_ )</b>   |   |
|                 |                                     | 1.8 De Luxe (YR20)/2.0 (YR21_G)/2.0 Super (YR21)/2.2 (YR22LG, YR31LG)   |   |
| <b>GOM-2011</b> | <b>Holder, control arm mounting</b> | <b>TOYOTA YARIS ( _CP10_ )</b>  |  |
|                 | <b>Silentblock</b>                  | 1.0 16V/1.0 16V (SCP10_)/1.3/1.3 16V (NCP10_)/1.4 D-4D/1.5 TS (NCP13)/1.5 VVT-i TS  |   |
|                 |                                     | <b>TOYOTA YARIS VERSO (NC/LP2_)</b>   |   |
|                 |                                     | 1.3 (NCP22)/1.4 D-4D (NLP22)/1.5 (NCP21)  |   |
|                 | TOYOTA                              | 48655-52010   |   |
|                 | Fitting Position/Lato Montaggio     | Rear Axle   |   |
|                 | Length/Lunghezza [mm]               | 58  |   |
|                 | Inner Diam./Diam. Interno [mm]      | 12,5  |   |
|                 | Outer Diam./Diam. esterno [mm]      | 55,5  |   |
| <b>GOM-2015</b> | <b>Engine Mounting</b>              | <b>TOYOTA COROLLA ( _E9_ )</b>  |  |
|                 | <b>Supporto motore</b>              | 1.3 i (EE90)/1.6 (AE92)/1.6 i/1.6 i 4WD   |   |
|                 |                                     | <b>TOYOTA COROLLA Compact ( _E9_ )</b>  |   |
|                 |                                     | 1.3 (EE90)/1.3 i (EE90)/1.6 (AE92)/1.6 GTi (AE92)   |   |
|                 | TOYOTA                              | 12361-16040   |   |
|                 | Fitting Position/Lato Montaggio     | Left Front  |   |
|                 | Height/Altezza [mm]                 | 121,5   |   |
|                 | Width/Larghezza [mm]                | 56  |   |
|                 | Inner Diam./Diam. Interno [mm]      | 12,5  |   |
|                 |                                     | <b>TOYOTA COROLLA Liftback ( _E9_ )</b>   |   |
|                 |                                     | 1.3 i (EE90)/1.6/1.6 (AE92)/1.6 GTi   |   |
|                 |                                     | <b>TOYOTA COROLLA SW ( _E9_ )</b>   |   |
|                 |                                     | 1.3 (EE90)/1.3 i (EE90)/1.6 (AE92)/1.6 XLI/1.6 XLI 4x4 (AE95)   |   |
| <b>GOM-2018</b> | <b>Suspension Strut Support</b>     | <b>TOYOTA COROLLA ( _E9_ )</b>  |  |
|                 | <b>Bearing</b>                      | 1.3 i (EE90)/1.4/1.5/1.5 4x4/1.5 DX/1.6/1.6 (AE92)/1.6 GL 4x4/1.6 i/1.6 i 4WD/1.6 XL/1.8 D                                      |   |
|                 | <b>Supporto ammortizzatore</b>      | <b>TOYOTA COROLLA Compact ( _E9_ )</b>  |   |
|                 |                                     | 1.3 (EE90)/1.3 i (EE90)/1.5/1.5 4x4/1.6 (AE92)/1.6 GL 4x4/1.6 GTi (AE92)/1.6 XL/1.8 D (CE90)                                    |   |
|                 | TOYOTA                              | 48609-01040   |   |
|                 | Fitting Position/Lato Montaggio     | Front Axle  |   |
|                 | Inner Diam./Diam. Interno [mm]      | 15  |   |
|                 | Fitted Diam./Diam. Mont. [mm]       | 88  |   |
|                 |                                     | <b>TOYOTA COROLLA Liftback ( _E9_ )</b>   |   |
|                 |                                     | 1.3 i (EE90)/1.5/1.5 4x4/1.6/1.6 (AE92)/1.6 4x4/1.6 GTi/1.8 D (CE90)  |   |
|                 |                                     | <b>TOYOTA COROLLA SW ( _E9_ )</b>   |   |

|                                 |   |  |   |
|---------------------------------|---|--|---|
|                                 |   | 1.3 (EE90)/1.3 i (EE90)/1.6 (AE92)/1.6 XLI/1.6 XLI 4x4 (AE95)/1.8 D (CE90)   |   |
| <b>GOM-2019</b>                 | <b>Suspension Strut Support Bearing</b><br><b>Supporto ammortizzatore</b> | <b>TOYOTA PASEO (EL54)</b><br>1.5 16V<br><b>TOYOTA PASEO Cabriolet (EL54)</b><br>1.5 16V<br><b>TOYOTA STARLET (_P8_)</b><br>1.3 12V (EP81) Cat./1.5 D (NP80_)  |    |
| TOYOTA                          | 48750-16100   |  | 2019  |
| Fitting Position/Lato Montaggio |   | Front Axle   |   |
| Height/Altezza [mm]             |   | 36   |   |
| Inner Diam./Diam. Interno [mm]  |   | 10   |   |
| Outer Diam./Diam. esterno [mm]  |   | 106,5  |   |
| <b>GOM-2020</b>                 | <b>Bearing Bush, stabiliser</b><br><b>Boccola barra stabilizzatrice</b>   | <b>TOYOTA COROLLA Compact (_E10_)</b><br>1.8 GT (AE102_)<br><b>TOYOTA COROLLA Liftback (_E10_)</b><br>1.8 GT (AE102_)<br><b>TOYOTA COROLLA Wagon (_E10_)</b><br>1.8 XL   |    |
| TOYOTA                          | 48815-12230   |  | 2020  |
| Fitting Position/Lato Montaggio |   | Front Axle   |   |
| Length/Lunghezza [mm]           |   | 38,5   |   |
| Height/Altezza [mm]             |   | 37   |   |
| Width/Larghezza [mm]            |   | 42   |   |
| Inner Diam./Diam. Interno [mm]  |   | 25   |   |
| <b>GOM-2021</b>                 | <b>Engine Mounting</b><br><b>Supporto motore</b>                          | <b>TOYOTA COROLLA (_E10_)</b><br>1.3 XLI (EE101_)/1.3 XLI 16V (EE101)<br><b>TOYOTA COROLLA Compact (_E10_)</b><br>1.3 XLI (EE101_)/1.3 XLI 16V (EE101)<br><b>TOYOTA COROLLA Liftback (_E10_)</b><br>1.3 XLI (EE101_)<br><b>TOYOTA COROLLA Wagon (_E10_)</b><br>1.3 XLI (EE101_)/1.3 XLI 16V (EE101_)   |   |
| TOYOTA                          | 12371-15241   |  | 2021  |
| Fitting Position/Lato Montaggio |   | Right  |   |
| Length/Lunghezza [mm]           |   | 134  |   |
| Height/Altezza [mm]             |   | 175  |   |
| Width/Larghezza [mm]            |   | 56   |   |
| Inner Diam./Diam. Interno [mm]  |   | 12,5   |   |
| <b>GOM-2023</b>                 | <b>Suspension Strut Support Bearing</b><br><b>Supporto ammortizzatore</b> | <b>TOYOTA COROLLA (_E10_)</b><br>1.3 12V (EE100_)/1.3 XLI (EE101_)/1.3 XLI 16V (EE101)/1.6/1.6 Si (AE101_)/1.8/1.8 4 ruote motrici/2.0 D (CE100_)<br><b>TOYOTA COROLLA (_E11_)</b><br>1.3/1.3 16V/1.4 (EE111_)/1.4 16V (ZZE111_)/1.4 D4d/1.5/1.6 (AE111_)/1.6 16V (ZZE112_)/1.6 Aut. (AE111_)/1.8/1.8 Linea Terra/1.9 D (WZE110_)/2.0 D (CE110_)/2.0 D-4D/2.2 TD<br><b>TOYOTA COROLLA (_E9_)</b><br>1.3 i (EE90)/1.4/1.5/1.5 4x4/1.5 DX/1.6/1.6 (AE92)/1.6 4 ruote motrici/1.6 GL 4x4/1.6 i/1.6 i 4WD/1.6 XL/1.8 D<br><b>TOYOTA COROLLA Compact (_E10_)</b><br>1.3 12V (EE100_)/1.3 XLI (EE101_)/1.3 XLI 16V (EE101)/1.6 Si (AE101_)/1.8 GT (AE102_)/1.8 GTi 4x4/2.0 D (CE100_)<br><b>TOYOTA COROLLA Compact (_E11_)</b><br>1.4 (EE111_)/1.4 (ZZE111_)/1.5/1.6 (AE111_)/1.6 (ZZE112_)/1.6 Aut. (AE111_)/1.9 D (WZE110_)/2.0 D (CE110_)/2.0 D-4D/2.2 TD |  |
| TOYOTA                          | 4807201011  |  | 2023  |
| Fitting Position/Lato Montaggio |   | Rear Axle Right  |   |
| Fitted Diam./Diam. Mont. [mm]   |   | 68   |   |
| <b>GOM-2024</b>                 | <b>Suspension Strut Support Bearing</b><br><b>Supporto ammortizzatore</b> | <b>TOYOTA COROLLA (_E10_)</b><br>1.3 12V (EE100_)/1.3 XLI (EE101_)/1.3 XLI 16V (EE101)/1.6/1.6 Si (AE101_)/1.8/1.8 4 ruote motrici/2.0 D (CE100_)<br><b>TOYOTA COROLLA (_E11_)</b><br>1.3/1.3 16V/1.4 (EE111_)/1.4 16V (ZZE111_)/1.4 D4d/1.5/1.6 (AE111_)/1.6 16V (ZZE112_)/1.6 Aut. (AE111_)/1.8/1.8 Linea Terra/1.9 D (WZE110_)/2.0 D (CE110_)/2.0 D-4D/2.2 TD<br><b>TOYOTA COROLLA (_E9_)</b><br>1.3 i (EE90)/1.4/1.5/1.5 4x4/1.5 DX/1.6/1.6 (AE92)/1.6 4 ruote motrici/1.6 GL 4x4/1.6 i/1.6 i 4WD/1.6 XL/1.8 D<br><b>TOYOTA COROLLA Compact (_E10_)</b><br>1.3 12V (EE100_)/1.3 XLI (EE101_)/1.3 XLI 16V (EE101)/1.6 Si (AE101_)/1.8 GT (AE102_)/1.8 GTi 4x4/2.0 D (CE100_)<br><b>TOYOTA COROLLA Compact (_E11_)</b><br>1.4 (EE111_)/1.4 (ZZE111_)/1.5/1.6 (AE111_)/1.6 (ZZE112_)/1.6 Aut. (AE111_)/1.9 D (WZE110_)/2.0 D (CE110_)/2.0 D-4D/2.2 TD |  |
| TOYOTA                          | 48071-01010   |  | 2024  |
| Fitting Position/Lato Montaggio |   | Rear Axle Left   |   |
| Fitted Diam./Diam. Mont. [mm]   |   | 68   |   |

|                |                                      |   |   |
|----------------|--------------------------------------|---|---|
| <b>GOM-C01</b> | <b>Bearing Bush, stabiliser</b>      | <b>CHEVROLET CAPTIVA</b>                      |    |
|                | <b>Boccola barra stabilizzatrice</b> | 2.0 D/2.0 D 4WD/2.4/2.4 4WD/3.2 4WD           |   |
| CHEVROLET      | 96810751                             | <b>OPEL ANTARA</b>                            |   |
|                |                                      | 2.0 CDTI/2.4/3.2 V6                           |   |
|                | Fitting Position/Lato Montaggio      | Front   |   |
|                | Height/Altezza [mm]                  | 54  |   |
|                | Width/Larghezza [mm]                 | 40  |   |
|                | Width/Larghezza [mm]                 | 49,5  |   |
|                | Inner Diam./Diam. Interno [mm]       | 26  |   |
| <b>GOM-C02</b> | <b>Holder, control arm mounting</b>  | <b>CHEVROLET CAPTIVA</b>                      |    |
|                | <b>Silentblock</b>                   | 2.0 D/2.0 D 4WD/2.4/2.4 4WD/3.2 4WD           |   |
|                |                                      | <b>OPEL ANTARA</b>                            |   |
|                |                                      | 2.0 CDTI/2.4/3.2 V6                           |   |
|                | Fitting Position/Lato Montaggio      | Left  |   |
|                | Height/Altezza [mm]                  | 95,5  |   |
|                | Width/Larghezza [mm]                 | 55  |   |
|                | Inner Diam./Diam. Interno [mm]       | 19  |   |
| <b>GOM-C04</b> | <b>Holder, control arm mounting</b>  | <b>CHEVROLET CAPTIVA</b>                      |   |
|                | <b>Silentblock</b>                   | 2.0 D/2.0 D 4WD/2.4/2.4 4WD/3.2 4WD           |   |
|                |                                      | <b>OPEL ANTARA</b>                            |   |
|                |                                      | 2.0 CDTI/2.4/3.2 V6                           |   |
|                | Length/Lunghezza [mm]                | 60  |   |
|                | Inner Diam./Diam. Interno [mm]       | 14  |   |
|                | Outer Diam./Diam. esterno [mm]       | 38  |   |
| <b>GOM-C05</b> | <b>Holder, control arm mounting</b>  | <b>CHEVROLET AVEO</b>                         |  |
|                | <b>Silentblock</b>                   | 1.2/1.4/1.5                                   |   |
|                |                                      | <b>CHEVROLET KALOS</b>                        |   |
|                |                                      | 1.2/1.4/1.4 16V                               |   |
|                |                                      | <b>CHEVROLET KALOS Tre volumi</b>             |   |
|                |                                      | 1.4 16V                                       |   |
|                |                                      | <b>DAEWOO KALOS (KLAS)</b>                    |   |
|                |                                      | 1.2/1.4/1.4 16V                               |   |
|                | DAEWOO                               | 96535087                                      |   |
|                | Inner Diam./Diam. Interno [mm]       | 12  |   |
|                | Overall Length/Lungh. Tot. [mm]      | 47  |   |
|                | Outer Diam./Diam. esterno [mm]       | 34  |   |
| <b>GOM-C06</b> | <b>Holder, control arm mounting</b>  | <b>CHEVROLET AVEO</b>                         |  |
|                | <b>Silentblock</b>                   | 1.2/1.4/1.5                                   |   |
|                |                                      | <b>CHEVROLET KALOS</b>                        |   |
|                |                                      | 1.2/1.4/1.4 16V                               |   |
|                |                                      | <b>CHEVROLET KALOS Tre volumi</b>             |   |
|                |                                      | 1.4 16V                                       |   |
|                |                                      | <b>DAEWOO KALOS (KLAS)</b>                    |   |
|                |                                      | 1.2/1.4/1.4 16V                               |   |
|                | DAEWOO                               | 96535088                                      |   |
|                | Length/Lunghezza [mm]                | 46  |   |
|                | Inner Diam./Diam. Interno [mm]       | 12  |   |
|                | Outer Diam./Diam. esterno [mm]       | 60  |   |
| <b>GOM-C07</b> | <b>Holder, control arm mounting</b>  | <b>CHEVROLET MATIZ</b>                        |  |
|                | <b>Silentblock</b>                   | 0.8/1.0                                       |   |
|                |                                      | <b>DAEWOO MATIZ (KLYA)</b>                    |   |
|                |                                      | 0.8/1.0                                       |   |
|                |                                      | <b>DAEWOO TICO (KLY3)</b>                     |   |
|                |                                      | 0.8   |   |
|                |                                      | <b>OPEL AGILA (H00)</b>                       |   |
|                |                                      | 1.0/1.0 12V/1.2 16V/1.2 16V Twinport/1.3 CDTI |   |
|                |                                      | <b>SUZUKI ALTO I (SS80)</b>                   |   |
|                |                                      | 0.8 (SS80F, SS80G)                            |   |
|                |                                      | <b>SUZUKI ALTO II (EC)</b>                    |   |
|                |                                      | 0.8 (SB308/CA)                                |   |
|                |                                      | <b>SUZUKI ALTO III (EF)</b>                   |   |
|                |                                      | 0.8 i cat. (SB308) /1.0                       |   |
|                |                                      | <b>SUZUKI ALTO IV (FF)</b>                    |   |
|                |                                      | 1.1   |   |
|                |                                      | <b>SUZUKI IGNIS (FH)</b>                      |   |
|                |                                      | 1.3/1.3 4WD                                   |   |
|                |                                      | <b>SUZUKI IGNIS II</b>                        |   |
|                |                                      | 1.3/1.3 DDiS/1.5/1.5 4x4/1.5 Sport            |   |
|                | SUZUKI                               | 0931910030                                    |   |
|                | Length/Lunghezza [mm]                | 52,5  |   |
|                | Inner Diam./Diam. Interno [mm]       | 10  |   |
|                | Outer Diam./Diam. esterno [mm]       | 28,5  |   |



|                                |                                     |  |   |
|--------------------------------|-------------------------------------|--|---|
| <b>GOM-C08</b>                 | <b>Holder, control arm mounting</b> | <b>CHEVROLET LACETTI</b>               |    |
|                                | <b>Silentblock</b>                  | 1.4 16V/1.6/1.8/2.0 D                  |   |
| CHEVROLET                      | 96378346                            | <b>CHEVROLET NUBIRA SW</b>             |   |
| Length/Lunghezza [mm]          | 59,5                                | 1.6/1.8/2.0 D                          |   |
| Inner Diam./Diam. Interno [mm] | 12                                  | <b>CHEVROLET NUBIRA Tre volumi</b>     |   |
| Outer Diam./Diam. esterno [mm] | 38                                  | 1.4/1.6/1.8                            |   |
|                                |                                     | <b>CHEVROLET REZZO</b>                 |   |
|                                |                                     | 1.6/2.0                                |   |
|                                |                                     | <b>DAEWOO LACETTI (KLAN)</b>           |   |
|                                |                                     | 1.4/1.6/1.8                            |   |
|                                |                                     | <b>DAEWOO NUBIRA Tre volumi (KLAN)</b> |   |
|                                |                                     | 1.4                                    |   |
|                                |                                     | <b>DAEWOO TACUMA (KLAU)</b>            |   |
|                                |                                     | 1.6/1.6 SX/1.8/2.0                     |   |
| <b>GOM-C09</b>                 | <b>Holder, control arm mounting</b> | <b>CHEVROLET REZZO</b>                 |    |
|                                | <b>Silentblock</b>                  | 1.6/2.0                                |   |
| CHEVROLET                      | 96261107                            | <b>DAEWOO TACUMA (KLAU)</b>            |   |
| Length/Lunghezza [mm]          | 54                                  | 1.6/1.6 SX/1.8/2.0                     |   |
| Outer Diam./Diam. esterno [mm] | 72                                  |  |   |
| <b>GOM-C10</b>                 | <b>Holder, control arm mounting</b> | <b>CHRYSLER PT CRUISER</b>             |   |
|                                | <b>Silentblock</b>                  | 1.6/2.0/2.2 CRD/2.4/GT 2.4             |   |
| CHRYSLER                       | 4656730AH                           | <b>CHRYSLER PT CRUISER Cabriolet</b>   |   |
| Length/Lunghezza [mm]          | 69                                  | 2.4/2.4 GT                             |   |
| Outer Diam./Diam. esterno [mm] | 34                                  |  |   |
| <b>GOM-C11</b>                 | <b>Holder, control arm mounting</b> | <b>CHRYSLER PT CRUISER</b>             |  |
|                                | <b>Silentblock</b>                  | 1.6/2.0/2.2 CRD/2.4/GT 2.4             |   |
| CHRYSLER                       | 4656012AB                           | <b>CHRYSLER PT CRUISER Cabriolet</b>   |   |
| Length/Lunghezza [mm]          | 62                                  | 2.4/2.4 GT                             |   |
| Outer Diam./Diam. esterno [mm] | 55                                  |  |   |
| <b>GOM-C12</b>                 | <b>Holder, control arm mounting</b> | <b>CHRYSLER VOYAGER I (AS)</b>         |  |
|                                | <b>Silentblock</b>                  | 2.5 D/3.0                              |   |
| CHRYSLER                       | 272084                              | <b>CHRYSLER VOYAGER II (ES)</b>        |   |
| Length/Lunghezza [mm]          | 68                                  | 2.5 i/2.5 TD/3.0 i/3.3 i/3.3 i AWD     |   |
| Outer Diam./Diam. esterno [mm] | 39                                  |  |   |
| <b>GOM-C13</b>                 | <b>Holder, control arm mounting</b> | <b>CHRYSLER VOYAGER I (AS)</b>         |  |
|                                | <b>Silentblock</b>                  | 2.5 D/3.0                              |   |
| CHEVROLET                      | 5272098                             | <b>CHRYSLER VOYAGER II (ES)</b>        |   |
| Length/Lunghezza [mm]          | 66                                  | 2.5 i/2.5 TD/3.0 i/3.3 i/3.3 i AWD     |   |
| Outer Diam./Diam. esterno [mm] | 58,5                                |  |   |
| <b>GOM-C14</b>                 | <b>Holder, control arm mounting</b> | <b>CHRYSLER VOYAGER III (GS)</b>       |  |
|                                | <b>Silentblock</b>                  | 2.0 i/2.4 i/2.5 TD/3.0/3.3 i/3.8 i AWD |   |
| CHRYSLER                       | 4694760AC                           |  |   |
| Length/Lunghezza [mm]          | 68                                  |  |   |
| Outer Diam./Diam. esterno [mm] | 40                                  |  |   |

|   |                                     |  |   |
|---|-------------------------------------|--|---|
| <b>GOM-C15</b>                              | <b>Holder, control arm mounting</b> | <b>CHRYSLER VOYAGER III (GS)</b>   |    |
|   | <b>Silentblock</b>                  | 2.0 i/2.4 i/2.5 TD/3.0/3.3 i/3.8 i AWD   |   |
| CHRYSLER 4694760AC                          |                                     |  |   |
| Length/Lunghezza [mm] 65                    |                                     |  |   |
| Inner Diam./Diam. Interno [mm] 23           |                                     |  |   |
| Outer Diam./Diam. esterno [mm] 66,5         |                                     |  |   |
| <b>GOM-C16</b>                              | <b>Holder, control arm mounting</b> | <b>CHRYSLER VOYAGER IV (RG)</b>  |    |
|   | <b>Silentblock</b>                  | 2.4/2.5 CRD/2.8 CRD/3.3/3.3 AWD/3.8/3.8 AWD  |   |
| CHRYSLER 4684120                            |                                     |  |   |
| Length/Lunghezza [mm] 68                    |                                     |  |   |
| Inner Diam./Diam. Interno [mm] 14,5         |                                     |  |   |
| Outer Diam./Diam. esterno [mm] 39,4         |                                     |  |   |
| <b>GOM-C17</b>                              | <b>Holder, control arm mounting</b> | <b>CHRYSLER VOYAGER IV (RG)</b>  |    |
|   | <b>Silentblock</b>                  | 2.4/2.5 CRD/2.8 CRD/3.3/3.3 AWD/3.8/3.8 AWD  |   |
| CHRYSLER 4743095-AA                         |                                     |  |   |
| Fitting Position/Lato Montaggio Left Front  |                                     |  |   |
| Length/Lunghezza [mm] 63                    |                                     |  |   |
| Inner Diam./Diam. Interno [mm] 25           |                                     |  |   |
| Outer Diam./Diam. esterno [mm] 62           |                                     |  |   |
| <b>GOM-C18</b>                              | <b>Holder, control arm mounting</b> | <b>CHRYSLER VOYAGER IV (RG)</b>  |  |
|   | <b>Silentblock</b>                  | 2.4/2.5 CRD/2.8 CRD/3.3/3.3 AWD/3.8/3.8 AWD  |   |
| CHRYSLER 4743 094AA                         |                                     |  |   |
| Fitting Position/Lato Montaggio Right Front |                                     |  |   |
| Length/Lunghezza [mm] 63                    |                                     |  |   |
| Inner Diam./Diam. Interno [mm] 25           |                                     |  |   |
| Outer Diam./Diam. esterno [mm] 62           |                                     |  |   |
| <b>GOM-D01</b>                              | <b>Holder, control arm mounting</b> | <b>DAEWOO ESPERO (KLEJ)</b>  |  |
|   | <b>Silentblock</b>                  | 1.5/1.5 16V/1.8/2.0  |   |
| DAEWOO 352349                               |                                     | <b>DAEWOO LANOS (KLAT)</b>   |   |
|   |                                     | 1.3 (A13SM)/1.4/1.5/1.6 16V  |   |
|   |                                     | <b>DAEWOO LANOS Tre volumi (KLAT)</b>  |   |
|   |                                     | 1.4/1.5/1.6 16V  |   |
|   |                                     | <b>DAEWOO NEXIA (KLETN)</b>  |   |
|   |                                     | 1.5/1.5 16V/1.8  |   |
|   |                                     | <b>DAEWOO NEXIA Tre volumi (KLETN)</b>   |   |
|   |                                     | 1.5/1.5 16V/1.8  |   |
|   |                                     | <b>OPEL KADETT D (31_34_41_44_)</b>  |   |
|   |                                     | 1.2/1.2 S/1.3 N/1.3 S/1.6 D/1.6 S/1.8 GT/E   |   |
|   |                                     | <b>OPEL KADETT D (32_37_39_42)</b>   |   |
|   |                                     | 1.2 S/1.3 N/1.3 S/1.6 D  |   |
|   |                                     | <b>OPEL KADETT D SW (35_36_45_46_)</b>   |   |
|   |                                     | 1.2/1.2 S/1.3 N/1.3 S/1.6 D/1.6 S  |   |
|   |                                     | <b>OPEL KADETT E (39_49_)</b>  |   |
|   |                                     | 1.2/1.3 i Cat./1.3 N/1.3 S/1.4 i/1.4 S/1.5 TD/1.6/1.6 D/1.6 i/1.6 i                          |   |
|   |                                     | Cat./1.6 S/1.7 D/1.8/1.8 i/1.8 S/2.0 i/2.0 i Cat.  |   |
|   |                                     | <b>OPEL KADETT E 2 volumi (33_34_43_)</b>  |   |
|   |                                     | 1.2/1.3 i Cat./1.3 N/1.3 S/1.4 i/1.4 S/1.5 TD/1.6 D/1.6 i/1.6 i                              |   |
|   |                                     | Cat./1.6 S/1.7 D/1.8 E/1.8 GSI/1.8 i/1.8 S/2.0 GSI/2.0 GSI 16V/2.0 GSI 16V Cat./2.0 GSI Cat. |   |
|   |                                     | <b>OPEL KADETT E Cabriolet (43B_)</b>  |   |
|   |                                     | 1.3 S/1.4 i/1.4 S/1.6 i/1.6 i Cat./2.0 i/2.0 i Cat.  |   |
|   |                                     | <b>OPEL KADETT E Combo (38_48_)</b>  |   |
|   |                                     | 1.3 N/1.3 S/1.4 i/1.4 S/1.6/1.6 D/1.6 i/1.7 D  |   |
|   |                                     | <b>OPEL KADETT E Furgonato (37_47_)</b>  |   |
|   |                                     | 1.2/1.3 N/1.4 i/1.6 D/1.6 i/1.7 D/1.8 i  |   |
|   |                                     | <b>OPEL KADETT E SW (35_36_45_46_)</b>   |   |

|                                |                                     |
|--------------------------------|-------------------------------------|
| <b>GOM-D02</b>                 | <b>Holder, control arm mounting</b> |
|                                | <b>Silentblock</b>                  |
| DAEWOO                         | 352335                              |
| Length/Lunghezza [mm]          | 54                                  |
| Height/Altezza [mm]            | 56                                  |
| Width/Larghezza [mm]           | 63                                  |
| Inner Diam./Diam. Interno [mm] | 20                                  |

1.2/1.3 i Cat./1.3 N/1.3 S/1.4 i/1.4 S/1.5 TD/1.6/1.6 D/1.6 i/1.6 i  
 Cat./1.6 S/1.7 D/1.8 E/1.8 i/1.8 S/2.0 i/2.0 i Cat.

**DAEWOO ESPERO (KLEJ)**

1.5/1.5 16V/1.8/2.0

**DAEWOO LANOS (KLAT)**

1.3 (A13SM)/1.4/1.5/1.6 16V

**DAEWOO LANOS Tre volumi (KLAT)**

1.4/1.5/1.6 16V

**DAEWOO NEXIA (KLETN)**

1.5/1.5 16V/1.8

**DAEWOO NEXIA Tre volumi (KLETN)**

1.5/1.5 16V/1.8

**OPEL KADETT D (31\_34\_, 41\_44\_)**

1.2/1.2 S/1.3 N/1.3 S/1.6 D/1.6 S/1.8 GT/E

**OPEL KADETT D (32\_37\_,39\_, 42)**

1.2 S/1.3 N/1.3 S/1.6 D

**OPEL KADETT D SW (35\_, 36\_, 45\_, 46\_)**

1.2/1.2 S/1.3 N/1.3 S/1.6 D/1.6 S

**OPEL KADETT E (39\_, 49\_)**

1.2/1.3 i Cat./1.3 N/1.3 S/1.4 i/1.4 S/1.5 TD/1.6/1.6 D/1.6 i/1.6 i

Cat./1.6 S/1.7 D/1.8/1.8 i/1.8 S

**OPEL KADETT E 2 volumi (33\_, 34\_, 43\_)**

1.2/1.3 i Cat./1.3 N/1.3 S/1.4 i/1.4 S/1.5 TD/1.6 D/1.6 i/1.6 i

Cat./1.6 S/1.7 D/1.8 E/1.8 GSI/1.8 i/1.8 S/2.0 GSI 16V

**OPEL KADETT E Cabriolet (43B\_)**

1.3 S/1.4 i/1.4 S/1.6 i/1.6 i Cat.

**OPEL KADETT E Combo (38\_, 48\_)**

1.3 N/1.3 S/1.4 i/1.4 S/1.6/1.6 D/1.6 i/1.7 D

**OPEL KADETT E Furgonato (37\_, 47\_)**

1.2/1.3 N/1.4 i/1.6 D/1.6 i/1.7 D/1.8 i

**OPEL KADETT E SW (35\_, 36\_, 45\_, 46\_)**

1.2/1.3 i Cat./1.3 N/1.3 S/1.4 i/1.4 S/1.5 TD/1.6/1.6 D/1.6 i/1.6 i

Cat./1.6 S/1.7 D/2.0 i/2.0 i Cat.



|                                 |                                     |
|---------------------------------|-------------------------------------|
| <b>GOM-D03</b>                  | <b>Holder, control arm mounting</b> |
|                                 | <b>Silentblock</b>                  |
| DAEWOO                          | 402645                              |
| Fitting Position/Lato Montaggio | Rear Axle                           |
| Length/Lunghezza [mm]           | 74,7                                |
| Inner Diam./Diam. Interno [mm]  | 12                                  |
| Outer Diam./Diam. esterno [mm]  | 59                                  |

**DAEWOO ESPERO (KLEJ)**

1.5/1.5 16V/1.8/2.0

**DAEWOO LANOS (KLAT)**

1.3 (A13SM)/1.4/1.5/1.6 16V

**DAEWOO LANOS Tre volumi (KLAT)**

1.4/1.5/1.6 16V

**DAEWOO NEXIA (KLETN)**

1.5/1.5 16V/1.8

**DAEWOO NEXIA Tre volumi (KLETN)**

1.5/1.5 16V/1.8

**OPEL ASCONA C (81\_, 86\_, 87\_, 88\_)**

1.3 N/1.3 S/1.6/1.6 D/1.6 i/1.6 i Cat./1.6 S/1.8/1.8 E/1.8 i/2.0  
 i/2.0 i Cat./2.0 i GT

**OPEL ASCONA C 2 volumi (84\_, 89\_)**

1.3 N/1.3 S/1.6/1.6 D/1.6 i/1.6 i Cat./1.6 S/1.8/1.8 E/1.8 i/2.0  
 i/2.0 i Cat./2.0 i GT

**OPEL ASTRA F (56\_, 57\_)**

1.4/1.4 i/1.4 i 16V/1.4 Si/1.6/1.6 i/1.6 i 16V/1.6 Si/1.7 D/1.7  
 TD/1.7 TDS/1.8 i/1.8 i 16V/2.0 i/2.0 i 16V

**OPEL ASTRA F 2 volumi (53\_, 54\_, 58\_, 5)**

1.4/1.4 i/1.4 i 16V/1.4 Si/1.6/1.6 i/1.6 i 16V/1.6 Si/1.7 D/1.7  
 TD/1.7 TDS/1.8 i/1.8 i 16V/2.0 GSI 16V/2.0 i/2.0 i 16V

**OPEL ASTRA F Cabriolet (53\_B)**

1.4 i 16V/1.4 Si/1.6 i/1.8 i 16V/2.0 i

**OPEL ASTRA F CLASSIC 2 volumi**

1.4 i/1.6 i/1.6 i 16V

**OPEL ASTRA F CLASSIC SW**

1.4 Comfort/1.4 i/1.6 i/1.6 i 16V

**OPEL ASTRA F CLASSIC Tre volumi**

1.4 i/1.6 i/1.6 i 16V

**OPEL ASTRA F SW (51\_, 52\_)**

1.4/1.4 i/1.4 i 16V/1.4 Si/1.6/1.6 i/1.6 i 16V/1.6 Si/1.7 D/1.7  
 TD/1.7 TDS/1.8 i/1.8 i 16V/2.0 i 16V

**OPEL ASTRA F Van (55\_)**

1.4 i/1.6 i/1.7 D/1.7 TD



**OPEL KADETT E (39\_, 49\_)**

1.2/1.3 i Cat./1.3 N/1.3 S/1.4 i/1.4 S/1.5 TD/1.6/1.6 D/1.6 i/1.6 i  
 Cat./1.6 S/1.7 D/1.8/1.8 i/1.8 S/2.0 i/2.0 i Cat.

**OPEL KADETT E 2 volumi (33\_, 34\_, 43\_)**

1.2/1.3 i Cat./1.3 N/1.3 S/1.4 i/1.4 S/1.5 TD/1.6 D/1.6 i/1.6 i  
 Cat./1.6 S/1.7 D/1.8 E/1.8 GSI/1.8 i/1.8 S/2.0 GSI/2.0 GSI 16V/2.0  
 GSI 16V Cat./2.0 GSI Cat.

**OPEL KADETT E Cabriolet (43B\_)**

1.3 S/1.4 i/1.4 S/1.6 i/1.6 i Cat./2.0 i/2.0 i Cat.

**OPEL KADETT E Combo (38\_, 48\_)**

1.3 N/1.3 S/1.4 i/1.4 S/1.6/1.6 D/1.6 i/1.7 D

**OPEL KADETT E Furgonato (37\_, 47\_)**

1.2/1.3 N/1.4 i/1.6 D/1.6 i/1.7 D/1.8 i

**OPEL KADETT E SW (35\_, 36\_, 45\_, 46\_)**

1.2/1.3 i Cat./1.3 N/1.3 S/1.4 i/1.4 S/1.5 TD/1.6/1.6 D/1.6 i/1.6 i  
 Cat./1.6 S/1.7 D/1.8 E/1.8 i/1.8 S/2.0 i/2.0 i Cat.

**OPEL VECTRA A (86\_, 87\_)**

1.4 S/1.6/1.6 i/1.6 i Cat./1.7 D/1.7 TD/1.8 i Cat./1.8 S/1.8 S  
 4x4/2.0/2.0 i/2.0 i 16V/2.0 i 16V 4x4/2.0 i 4x4/2.0 i 4x4 Cat./2.0 i  
 Cat./2.0 i Turbo 4x4/2.5 V6/2000 16V 4x4/2000/GT 16V/2000/GT  
 16V 4x4 Cat./2000/GT 16V Cat.

**OPEL VECTRA A 2 volumi (88\_, 89\_)**

1.4 S/1.6 i/1.6 i Cat./1.6 S/1.7 D/1.7 TD/1.8 i/1.8 i Cat./1.8  
 S/2.0/2.0 i/2.0 i 16V/2.0 i 16V Cat./2.0 i Cat./2.0 i GT/2.5 V6

**GOM-D04 Holder, control arm mounting**

**Silentblock**

|                                |      |
|--------------------------------|------|
| Length/Lunghezza [mm]          | 44   |
| Inner Diam./Diam. Interno [mm] | 12,5 |
| Outer Diam./Diam. esterno [mm] | 49   |

**DAEWOO NUBIRA (KLAJ)**

1.6 16V/2.0 16V/2.0 CDX

**DAEWOO NUBIRA Tre volumi (KLAJ)**

1.5 SE/1.6 16V/2.0/2.0 16V

**DAEWOO NUBIRA Tre volumi (KLAN)**

1.6/1.8

**DAEWOO NUBIRA Wagon (KLAJ)**

1.6 16V/2.0 16V

**DAEWOO NUBIRA Wagon (KLAN)**

1.6/1.8



**GOM-D05 Holder, control arm mounting**

**Silentblock**

|                                |          |
|--------------------------------|----------|
| DAEWOO                         | 96298000 |
| Length/Lunghezza [mm]          | 49       |
| Inner Diam./Diam. Interno [mm] | 16       |
| Outer Diam./Diam. esterno [mm] | 53       |

**DAEWOO NUBIRA (KLAJ)**

1.6 16V/2.0 16V/2.0 CDX

**DAEWOO NUBIRA Tre volumi (KLAJ)**

1.5 SE/1.6 16V/2.0/2.0 16V

**DAEWOO NUBIRA Tre volumi (KLAN)**

1.6/1.8

**DAEWOO NUBIRA Wagon (KLAJ)**

1.6 16V/2.0 16V

**DAEWOO NUBIRA Wagon (KLAN)**

1.6/1.8



**GOM-H03 Holder, control arm mounting**

**Silentblock**

|                                |             |
|--------------------------------|-------------|
| HYUNDAI                        | 54551-02000 |
| Length/Lunghezza [mm]          | 56          |
| Inner Diam./Diam. Interno [mm] | 12          |
| Outer Diam./Diam. esterno [mm] | 35,5        |

**HYUNDAI ACCENT/EXCEL (X-3)**

1.3/1.3 i 12V/1.5 i 12V/1.5 i 16V

**HYUNDAI ACCENT/EXCEL Tre volumi (X-3)**

1.3/1.3 i 12V/1.5 i 12V/1.5 i 16V

**HYUNDAI ATOS (MX)**

0.8/1.0 i/1.1

**HYUNDAI ATOS PRIME (MX)**

1.0 i/1.1



**GOM-H04 Holder, control arm mounting**

**Silentblock**

|                                |             |
|--------------------------------|-------------|
| HYUNDAI                        | 54555-22100 |
| Length/Lunghezza [mm]          | 56          |
| Height/Altezza [mm]            | 58          |
| Width/Larghezza [mm]           | 65          |
| Inner Diam./Diam. Interno [mm] | 18,8        |

**HYUNDAI ACCENT/EXCEL (X-3)**

1.3/1.3 i 12V/1.5 i 12V/1.5 i 16V

**HYUNDAI ACCENT/EXCEL Tre volumi (X-3)**

1.3/1.3 i 12V/1.5 i 12V/1.5 i 16V

**HYUNDAI ATOS (MX)**

0.8/1.0 i/1.1

**HYUNDAI ATOS PRIME (MX)**

1.0 i/1.1





|                                 |                                      |   |  |   |
|---------------------------------|--------------------------------------|---|--|---|
| <b>GOM-H05</b>                  | <b>Holder, control arm mounting</b>  | <b>HYUNDAI ACCENT/EXCEL (X-3)</b><br>1.3/1.3 i 12V/1.5 i 12V/1.5 i 16V            | <br><b>H05</b>      |   |
|                                 | <b>Silentblock</b>                   | <b>HYUNDAI ACCENT/EXCEL Tre volumi (X-3)</b><br>1.3/1.3 i 12V/1.5 i 12V/1.5 i 16V |  |   |
| HYUNDAI                         | 54556-22100                          | <b>HYUNDAI ATOS (MX)</b><br>0.8/1.0 i/1.1   |  |   |
| Length/Lunghezza [mm]           | 56                                   | <b>HYUNDAI ATOS PRIME (MX)</b><br>1.0 i/1.1                                       |  |   |
| Height/Altezza [mm]             | 58                                   |   |  |   |
| Width/Larghezza [mm]            | 65                                   |   |  |   |
| Inner Diam./Diam. Interno [mm]  | 18,8                                 |   |  |   |
| <b>GOM-H06</b>                  | <b>Holder, control arm mounting</b>  | <b>HYUNDAI ACCENT (LC)</b><br>1.3/1.5/1.5 CRDi/1.6                                |  | <br><b>H06</b>     |
|                                 | <b>Silentblock</b>                   | <b>HYUNDAI ACCENT Tre volumi (LC)</b><br>1.3/1.5/1.5 CRDi/1.6                     |  |   |
| HYUNDAI                         | 54551-25000                          | <b>HYUNDAI MATRIX (FC)</b><br>1.5 CRDi/1.5 CRDi VGT/1.6/1.8                       |  |   |
| Length/Lunghezza [mm]           | 53,5                                 |   |  |   |
| Inner Diam./Diam. Interno [mm]  | 13                                   |   |  |   |
| Outer Diam./Diam. esterno [mm]  | 33                                   |   |  |   |
| <b>GOM-H07</b>                  | <b>Holder, control arm mounting</b>  | <b>HYUNDAI ACCENT (LC)</b><br>1.3/1.5/1.5 CRDi/1.6                                | <br><b>H07</b>      |   |
|                                 | <b>Silentblock</b>                   | <b>HYUNDAI ACCENT Tre volumi (LC)</b><br>1.3/1.5/1.5 CRDi/1.6                     |  |   |
| HYUNDAI                         | 54555-25000                          |   |  |   |
| Length/Lunghezza [mm]           | 54                                   |   |  |   |
| Inner Diam./Diam. Interno [mm]  | 12,5                                 |   |  |   |
| Outer Diam./Diam. esterno [mm]  | 52,5                                 |   |  |   |
| <b>GOM-H08</b>                  | <b>Bearing Bush, stabiliser</b>      | <b>HYUNDAI ACCENT (MC)</b><br>1.4 GL/1.5 CRDi GLS/1.6 GLS                         |  | <br><b>RU-H08</b> |
|                                 | <b>Boccola barra stabilizzatrice</b> | <b>HYUNDAI ACCENT Tre volumi (MC)</b><br>1.4 GL/1.5 CRDi GLS/1.6 GLS              |  |   |
| HYUNDAI                         | 54812-1G100                          | <b>KIA RIO</b><br>1.3   |  |   |
| Fitting Position/Lato Montaggio | Front                                | <b>KIA RIO II</b><br>1.4 16V/1.5 CRDi/1.6 16V                                     |  |   |
| Length/Lunghezza [mm]           | 45                                   | <b>KIA RIO II Tre volumi</b><br>1.4 16V/1.5 CRDi/1.6 16V                          |  |   |
| Height/Altezza [mm]             | 48                                   |   |  |   |
| Width/Larghezza [mm]            | 44                                   |   |  |   |
| Inner Diam./Diam. Interno [mm]  | 24                                   |   |  |   |
| <b>GOM-H09</b>                  | <b>Holder, control arm mounting</b>  | <b>HYUNDAI ACCENT (MC)</b><br>1.4 GL/1.5 CRDi GLS/1.6 GLS                         | <br><b>RU-H09</b> |   |
|                                 | <b>Silentblock</b>                   | <b>HYUNDAI ACCENT Tre volumi (MC)</b><br>1.4 GL/1.5 CRDi GLS/1.6 GLS              |  |   |
| HYUNDAI                         | 54584-1G000                          | <b>KIA RIO</b><br>1.3   |  |   |
| Length/Lunghezza [mm]           | 60                                   | <b>KIA RIO II</b><br>1.4 16V/1.5 CRDi/1.6 16V                                     |  |   |
| Inner Diam./Diam. Interno [mm]  | 14,5                                 | <b>KIA RIO II Tre volumi</b><br>1.4 16V/1.5 CRDi/1.6 16V                          |  |   |
| Outer Diam./Diam. esterno [mm]  | 66,3                                 |   |  |   |
| <b>GOM-H10</b>                  | <b>Holder, control arm mounting</b>  | <b>HYUNDAI ACCENT (MC)</b><br>1.4 GL/1.5 CRDi GLS/1.6 GLS                         |  | <br><b>H10</b>   |
|                                 | <b>Silentblock</b>                   | <b>HYUNDAI ACCENT Tre volumi (MC)</b><br>1.4 GL/1.5 CRDi GLS/1.6 GLS              |  |   |
| HYUNDAI                         | 54551-1E000                          | <b>HYUNDAI GETZ (TB)</b><br>1.1/1.3/1.4/1.5 CRDi/1.5 CRDi GLS/1.6                 |  |   |
| Length/Lunghezza [mm]           | 54                                   | <b>KIA RIO</b><br>1.3   |  |   |
| Inner Diam./Diam. Interno [mm]  | 12,5                                 | <b>KIA RIO II</b><br>1.4 16V/1.5 CRDi/1.6 16V                                     |  |   |
| Outer Diam./Diam. esterno [mm]  | 35                                   | <b>KIA RIO II Tre volumi</b><br>1.4 16V/1.5 CRDi/1.6 16V                          |  |   |
|                                 |                                      | <b>KIA VENGA</b><br>1.4 16V/1.4 CRDi/1.6 16V/1.6 CRDi                             |  |   |

|                                 |                                      |   |   |
|---------------------------------|--------------------------------------|---|---|
| <b>GOM-H12</b>                  | <b>Holder, control arm mounting</b>  | <b>HYUNDAI GETZ (TB)</b><br>1.1/1.3/1.4/1.5 CRDi/1.5 CRDi GLS/1.6   |    |
|                                 | <b>Silentblock</b>                   |   |   |
| HYUNDAI                         | 54584-1C300                          |   |   |
| Length/Lunghezza [mm]           | 55                                   |   |   |
| Inner Diam./Diam. Interno [mm]  | 14                                   |   |   |
| Outer Diam./Diam. esterno [mm]  | 63,5                                 |   |   |
| <b>GOM-H13</b>                  | <b>Holder, control arm mounting</b>  | <b>HYUNDAI H100 Furgonato</b><br>2.5 D  |    |
|                                 | <b>Silentblock</b>                   |   |   |
| HYUNDAI                         | 545104B001                           |   |   |
| Length/Lunghezza [mm]           | 77                                   |   |   |
| Inner Diam./Diam. Interno [mm]  | 16                                   |   |   |
| Outer Diam./Diam. esterno [mm]  | 42                                   |   |   |
| <b>GOM-H14</b>                  | <b>Holder, control arm mounting</b>  | <b>HYUNDAI H100 Autobus (P)</b><br>2.4/2.5 D/2.5 TD/2.6 D   |    |
|                                 | <b>Silentblock</b>                   | <b>MITSUBISHI L 300 Autobus (P0_W, P1_W, P2_W)</b><br>1.6 (P02V, P12V)/2.0 (P00W)/2.0 (P03W)/2.0 (P03W, P03V, P13V)/2.4 (P04W, P14V, P04V)/2.5 D (P05W, P05V, P15V)/2.5 TD 4WD (P25W, P25V) |   |
| HYUNDAI                         | 5451043152                           | <b>MITSUBISHI L 300 Furgonato (P0_W, P1_W)</b><br>1.4 G33B/1.6 (P12V, P02V)/2.0 (P03V, P13V)/2.5 D (P05V, P05W, P15V)/2.5 TD  |   |
| Length/Lunghezza [mm]           | 69,5                                 | <b>MITSUBISHI L 300 Pianale piatto/Telaio (P1_T)</b><br>2.0 (P13T)/2.5 D (P15T)   |   |
| Inner Diam./Diam. Interno [mm]  | 16                                   |   |   |
| Outer Diam./Diam. esterno [mm]  | 46                                   |   |   |
| <b>GOM-H15</b>                  | <b>Holder, control arm mounting</b>  | <b>HYUNDAI MATRIX (FC)</b><br>1.5 CRDi/1.5 CRDi VGT/1.6/1.8   |  |
|                                 | <b>Silentblock</b>                   |   |   |
| HYUNDAI                         | 54584-17000                          |   |   |
| Length/Lunghezza [mm]           | 54,5                                 |   |   |
| Inner Diam./Diam. Interno [mm]  | 14                                   |   |   |
| Outer Diam./Diam. esterno [mm]  | 63,5                                 |   |   |
| <b>GOM-H16</b>                  | <b>Bearing Bush, stabiliser</b>      | <b>HYUNDAI SANTA FE' (SM)</b><br>2.2 CRDi/2.2 CRDi 4x4/2.7/2.7 4x4  |  |
|                                 | <b>Boccola barra stabilizzatrice</b> | <b>HYUNDAI SANTA FÉ</b><br>2.2 CRDi/2.2 CRDi 4x4/2.2 CRDi GLS/2.2 CRDi GLS 4x4/2.7/2.7 4x4/2.7 V6 GLS/2.7 V6 GLS 4x4  |   |
| HYUNDAI                         | 54813-3K100                          | <b>HYUNDAI SONATA V</b><br>2.0 CRDi/2.4/3.3   |   |
| Fitting Position/Lato Montaggio | Front                                | <b>KIA SORENTO</b><br>2.0 CRDi/2.0 CRDi 4WD/2.2 CRDi/2.4 16V  |   |
| Length/Lunghezza [mm]           | 47,5                                 |   |   |
| Height/Altezza [mm]             | 47,5                                 |   |   |
| Width/Larghezza [mm]            | 52                                   |   |   |
| Inner Diam./Diam. Interno [mm]  | 26                                   |   |   |
| <b>GOM-H17</b>                  | <b>Holder, control arm mounting</b>  | <b>HYUNDAI SANTA FÉ</b><br>2.2 CRDi/2.2 CRDi 4x4/2.2 CRDi GLS/2.2 CRDi GLS 4x4/2.7/2.7 4x4/2.7 V6 GLS/2.7 V6 GLS 4x4  |  |
|                                 | <b>Silentblock</b>                   | <b>KIA SORENTO</b><br>2.0 CRDi/2.0 CRDi 4WD/2.2 CRDi/2.4 16V  |   |
| HYUNDAI                         | 54584 2B000                          |   |   |
| Length/Lunghezza [mm]           | 60                                   |   |   |
| Inner Diam./Diam. Interno [mm]  | 14                                   |   |   |
| Outer Diam./Diam. esterno [mm]  | 67                                   |   |   |
| <b>GOM-H18</b>                  | <b>Holder, control arm mounting</b>  | <b>HYUNDAI SANTA FÉ</b><br>2.2 CRDi/2.2 CRDi 4x4/2.2 CRDi GLS/2.2 CRDi GLS 4x4/2.7/2.7 4x4/2.7 V6 GLS/2.7 V6 GLS 4x4  |  |
|                                 | <b>Silentblock</b>                   | <b>KIA SORENTO</b><br>2.0 CRDi/2.0 CRDi 4WD/2.2 CRDi/2.4 16V  |   |
| HYUNDAI                         | 54551 2B000                          |   |   |
| Length/Lunghezza [mm]           | 70                                   |   |   |
| Inner Diam./Diam. Interno [mm]  | 14                                   |   |   |
| Outer Diam./Diam. esterno [mm]  | 42                                   |   |   |





**RUBBER PARTS LIST**  
**MOTORAUFHÄNGUNG LISTE**  
**LISTE SILENT BLOCS**  
**LISTA TAPONES DE GOMA**  
**LISTA PARTI IN GOMMA**



|                |                                      |  |  |
|----------------|--------------------------------------|--|--|
| <b>GOM-H19</b> | <b>Holder, control arm mounting</b>  | <b>HYUNDAI SONATA III (EF)</b><br>2.0 16V/2.4 16V/2.5 V6 24V | <br>H19   |
|                | <b>Silentblock</b>                   | <b>HYUNDAI SONATA IV/ SONICA</b><br>2.0/2.0 VVTi GLS/2.7 V6  |  |
|                | HYUNDAI 54551-38000                  |  |  |
|                | Overall Length/Lungh. Tot. [mm]      | 130  |  |
|                | Outer Diam./Diam. esterno [mm]       | 31   |  |
| <b>GOM-H20</b> | <b>Holder, control arm mounting</b>  | <b>HYUNDAI SONATA IV/ SONICA</b><br>2.7 V6                   | <br>H20   |
|                | <b>Silentblock</b>                   |  |  |
|                | HYUNDAI 5458438100                   |  |  |
|                | Length/Lunghezza [mm]                | 60   |  |
|                | Inner Diam./Diam. Interno [mm]       | 14   |  |
|                | Outer Diam./Diam. esterno [mm]       | 66   |  |
| <b>GOM-H21</b> | <b>Holder, control arm mounting</b>  | <b>HYUNDAI SONATA V</b><br>2.0 CRDi/2.4/3.3                  | <br>H21   |
|                | <b>Silentblock</b>                   |  |  |
|                | HYUNDAI 54443-3K000                  |  |  |
|                | Length/Lunghezza [mm]                | 45,7   |  |
|                | Inner Diam./Diam. Interno [mm]       | 10   |  |
|                | Outer Diam./Diam. esterno [mm]       | 40   |  |
| <b>GOM-H22</b> | <b>Holder, control arm mounting</b>  | <b>HYUNDAI SONATA V</b><br>2.0 CRDi/2.4/3.3                  | <br>H22 |
|                | <b>Silentblock</b>                   |  |  |
|                | HYUNDAI 54584-3K000                  |  |  |
|                | Length/Lunghezza [mm]                | 60   |  |
|                | Inner Diam./Diam. Interno [mm]       | 14   |  |
|                | Outer Diam./Diam. esterno [mm]       | 66,7   |  |
| <b>GOM-H23</b> | <b>Holder, control arm mounting</b>  | <b>HYUNDAI SONATA V</b><br>2.0 CRDi/2.4/3.3                  | <br>H23 |
|                | <b>Silentblock</b>                   |  |  |
|                | HYUNDAI 54551-3K000                  |  |  |
|                | Length/Lunghezza [mm]                | 58,5   |  |
|                | Inner Diam./Diam. Interno [mm]       | 14   |  |
|                | Outer Diam./Diam. esterno [mm]       | 45   |  |
| <b>GOM-H24</b> | <b>Holder, control arm mounting</b>  | <b>HYUNDAI SONATA V</b><br>2.0 CRDi/2.4/3.3                  | <br>H24 |
|                | <b>Silentblock</b>                   |  |  |
|                | HYUNDAI 54552-3K000                  |  |  |
|                | Length/Lunghezza [mm]                | 59,6   |  |
|                | Inner Diam./Diam. Interno [mm]       | 14   |  |
|                | Outer Diam./Diam. esterno [mm]       | 42   |  |
| <b>GOM-H25</b> | <b>Bearing Bush, stabiliser</b>      | <b>HYUNDAI TRAJET (FO)</b><br>2.0/2.0 CRDi/2.7 V6            | <br>H25 |
|                | <b>Boccola barra stabilizzatrice</b> |  |  |
|                | HYUNDAI 54813-3A000                  |  |  |
|                | Fitting Position/Lato Montaggio      | Front  |  |
|                | Length/Lunghezza [mm]                | 48   |  |
|                | Height/Altezza [mm]                  | 44   |  |
|                | Width/Larghezza [mm]                 | 49   |  |
|                | Inner Diam./Diam. Interno [mm]       | 29   |  |

|                |                                      |   |   |
|----------------|--------------------------------------|---|---|
| <b>GOM-H26</b> | <b>Holder, control arm mounting</b>  | <b>HYUNDAI TRAJET (FO)</b>  |    |
|                | <b>Silentblock</b>                   | 2.0/2.0 CRDi/2.7 V6   |   |
|                | HYUNDAI 54551-3A000                  |   |   |
|                | Overall Length/Lungh. Tot. [mm]      | 140   |   |
|                | Outer Diam./Diam. esterno [mm]       | 31  |   |
| <b>GOM-H27</b> | <b>Holder, control arm mounting</b>  | <b>HYUNDAI TRAJET (FO)</b>  |    |
|                | <b>Silentblock</b>                   | 2.0/2.0 CRDi/2.7 V6   |   |
|                | HYUNDAI 54555-3A100                  |   |   |
|                | Length/Lunghezza [mm]                | 82,5  |   |
|                | Inner Diam./Diam. Interno [mm]       | 12  |   |
|                | Outer Diam./Diam. esterno [mm]       | 64,5  |   |
| <b>GOM-H28</b> | <b>Bearing Bush, stabiliser</b>      | <b>HYUNDAI H-1/H-200/SATELLITE Autobus</b>                                    |    |
|                | <b>Boccola barra stabilizzatrice</b> | 2.4/2.4 4WD/2.5 D/2.5 TD  |   |
|                | HYUNDAI 55256-44000                  | <b>HYUNDAI H100 Autobus (P)</b>   |   |
|                | Length/Lunghezza [mm]                | 45,5  |   |
|                | Inner Diam./Diam. Interno [mm]       | 16,5  |   |
|                | Outer Diam./Diam. esterno [mm]       | 27  |   |
| <b>GOM-H29</b> | <b>Suspension Strut Support</b>      | <b>HYUNDAI ATOS (MX)</b>  |  |
|                | <b>Bearing</b>                       | 1.0 i   |   |
|                | <b>Supporto ammortizzatore</b>       | <b>HYUNDAI ATOS PRIME (MX)</b>  |   |
|                | HYUNDAI 54610-02010                  | 1.0 i/1.1   |   |
|                | Length/Lunghezza [mm]                | 129   |   |
|                | Height/Altezza [mm]                  | 53,5  |   |
|                | Width/Larghezza [mm]                 | 136   |   |
|                | Inner Diam./Diam. Interno [mm]       | 12  |   |
| <b>GOM-H30</b> | <b>Bearing Bush, stabiliser</b>      | <b>HYUNDAI TUCSON (JM)</b>  |  |
|                | <b>Boccola barra stabilizzatrice</b> | 2.0/2.0 4 ruote motrici/2.0 CRDi/2.0 CRDi 4 ruote motrici/2.7 4 ruote motrici |   |
|                | HYUNDAI 55513-2E100                  |   |   |
|                | Fitting Position/Lato Montaggio      | Rear Axle   |   |
|                | Length/Lunghezza [mm]                | 48  |   |
|                | Height/Altezza [mm]                  | 49  |   |
|                | Width/Larghezza [mm]                 | 53  |   |
|                | Inner Diam./Diam. Interno [mm]       | 15  |   |
| <b>GOM-H31</b> | <b>Suspension Strut Support</b>      | <b>HYUNDAI SANTA FE' (SM)</b>   |  |
|                | <b>Bearing</b>                       | 2.0/2.0 CRDi/2.0 CRDi 4x4/2.2 CRDi/2.2 CRDi 4x4/2.4 16V/2.4                   |   |
|                | <b>Supporto ammortizzatore</b>       | 16V 4x4/2.7/2.7 4x4/2.7 V6 4x4  |   |
|                | HYUNDAI 54610-34010                  |   |   |
|                | Fitting Position/Lato Montaggio      | Front Axle left and right   |   |
|                | Height/Altezza [mm]                  | 48  |   |
|                | Inner Diam./Diam. Interno [mm]       | 15  |   |
| <b>GOM-H32</b> | <b>Holder, control arm mounting</b>  | <b>HYUNDAI SANTA FE' (SM)</b>   |  |
|                | <b>Silentblock</b>                   | 2.0/2.0 CRDi/2.0 CRDi 4x4/2.2 CRDi/2.2 CRDi 4x4/2.4 16V/2.4                   |   |
|                | HYUNDAI 54551 26000                  | 16V 4x4/2.7/2.7 4x4/2.7 V6 4x4/3.5/3.5 4x4                                    |   |
|                | Fitting Position/Lato Montaggio      | Front Axle  |   |
|                | Overall Length/Lungh. Tot. [mm]      | 140   |   |
|                | Outer Diam./Diam. esterno [mm]       | 34  |   |



|  |  |   |
|--|--|---|
| <p><b>GOM-H33</b>      <b>Holder, control arm mounting</b></p> <p><b>Silentblock</b></p>   | <p><b>HYUNDAI SANTA FE' (SM)</b><br/>                 2.0/2.0 CRDi/2.0 CRDi 4x4/2.2 CRDi/2.2 CRDi 4x4/2.4 16V/2.4 16V 4x4/2.7/2.7 4x4/2.7 V6 4x4/3.5/3.5 4x4</p>                             |    |
| <p>HYUNDAI      54555 26000</p> <p>Fitting Position/Lato Montaggio      Lower Front Axle</p> <p>Length/Lunghezza [mm]      62</p> <p>Width/Larghezza [mm]      63</p> <p>Inner Diam./Diam. Interno [mm]      12</p>                              |  |   |
| <p><b>GOM-H34</b>      <b>Bearing Bush, stabiliser</b></p> <p><b>Boccola barra stabilizzatrice</b></p>   | <p><b>HYUNDAI SANTA FE' (SM)</b><br/>                 2.0/2.0 CRDi 4x4/2.4 16V/2.4 16V 4x4/2.7 V6 4x4</p>  |    |
| <p>HYUNDAI      54813-26100</p> <p>Fitting Position/Lato Montaggio      Front Axle</p> <p>Length/Lunghezza [mm]      48</p> <p>Height/Altezza [mm]      48</p> <p>Width/Larghezza [mm]      51</p> <p>Inner Diam./Diam. Interno [mm]      21</p> |  |   |
| <p><b>GOM-H35</b>      <b>Bearing Bush, stabiliser</b></p> <p><b>Boccola barra stabilizzatrice</b></p>   | <p><b>HYUNDAI H100 TRUCK Pianale piatto/Telaio</b><br/>                 2.5 D</p>  |   |
| <p>HYUNDAI      54712-44150</p> <p>Fitting Position/Lato Montaggio      Front Axle</p> <p>Length/Lunghezza [mm]      39</p> <p>Height/Altezza [mm]      35</p> <p>Width/Larghezza [mm]      36</p> <p>Inner Diam./Diam. Interno [mm]      23</p> |  |   |
| <p><b>GOM-H37</b>      <b>Bearing Bush, stabiliser</b></p> <p><b>Boccola barra stabilizzatrice</b></p>   | <p><b>HYUNDAI ELANTRA (XD)</b><br/>                 1.6/1.8/2.0/2.0 CRDi/CRDi</p>  |  |
| <p>HYUNDAI      548132D102</p> <p>Fitting Position/Lato Montaggio      Front Axle</p> <p>Length/Lunghezza [mm]      44</p> <p>Height/Altezza [mm]      47</p> <p>Width/Larghezza [mm]      38</p> <p>Inner Diam./Diam. Interno [mm]      22</p>  |  |   |
| <p><b>GOM-H38</b>      <b>Bearing Bush, stabiliser</b></p> <p><b>Boccola barra stabilizzatrice</b></p>   | <p><b>HYUNDAI ELANTRA (XD)</b><br/>                 1.6/1.8/2.0/2.0 CRDi/CRDi</p> <p><b>HYUNDAI LANTRA II (J-2)</b><br/>                 1.5 12V/1.6 16V/1.6 i/1.8 16V/1.9 D/2.0/2.0 16V</p> |  |
| <p>HYUNDAI      555132D100</p> <p>Fitting Position/Lato Montaggio      Rear Axle</p> <p>Length/Lunghezza [mm]      44</p> <p>Height/Altezza [mm]      36</p> <p>Width/Larghezza [mm]      34</p> <p>Inner Diam./Diam. Interno [mm]      14</p>   |  |   |
| <p><b>GOM-H39</b>      <b>Bearing Bush, stabiliser</b></p> <p><b>Boccola barra stabilizzatrice</b></p>   | <p><b>HYUNDAI MATRIX (FC)</b><br/>                 1.5 CRDi/1.5 CRDi VGT/1.6/1.8</p>   |  |
| <p>HYUNDAI      5481317100</p> <p>Fitting Position/Lato Montaggio      Front Axle</p> <p>Length/Lunghezza [mm]      41</p> <p>Height/Altezza [mm]      41</p> <p>Width/Larghezza [mm]      32</p> <p>Inner Diam./Diam. Interno [mm]      22</p>  |  |   |

|                                 |                                      |  |   |
|---------------------------------|--------------------------------------|--|---|
| <b>GOM-H40</b>                  | <b>Bearing Bush, stabiliser</b>      | <b>HYUNDAI MATRIX (FC)</b>   |    |
|                                 | <b>Boccola barra stabilizzatrice</b> | 1.5 CRDi/1.5 CRDi VGT/1.6/1.8  |   |
| HYUNDAI                         | 5551317000                           |  |   |
| Fitting Position/Lato Montaggio | Rear Axle                            |  |   |
| Length/Lunghezza [mm]           | 44                                   |  |   |
| Height/Altezza [mm]             | 33                                   |  |   |
| Width/Larghezza [mm]            | 30                                   |  |   |
| Inner Diam./Diam. Interno [mm]  | 14                                   |  |   |
| <b>GOM-H43</b>                  | <b>Bearing Bush, stabiliser</b>      | <b>HYUNDAI i30</b>   |    |
|                                 | <b>Boccola barra stabilizzatrice</b> | 1.4/1.6/1.6 CRDi/2.0/2.0 CRDi<br><b>HYUNDAI i30 CW SW</b><br>1.4/1.6/1.6 CRDi/2.0/2.0 CRDi |   |
| HYUNDAI                         | 55513-2L000                          | <b>KIA CEE'D</b>   |   |
| Fitting Position/Lato Montaggio | Rear Axle                            | 1.4/1.6/1.6 CRDi 115/1.6 CRDi 90/2.0/2.0 CRDi  |   |
| Length/Lunghezza [mm]           | 44                                   | <b>KIA CEE'D SW</b>  |   |
| Height/Altezza [mm]             | 41                                   | 1.4/1.6/1.6 CRDi 115/1.6 CRDi 90/2.0/2.0 CRDi  |   |
| Width/Larghezza [mm]            | 43                                   | <b>KIA PRO CEE'D</b>   |   |
| Inner Diam./Diam. Interno [mm]  | 16                                   | 1.4/1.6/1.6 CRDi 115/1.6 CRDi 90/2.0/2.0 CRDi  |   |
| <b>GOM-K01</b>                  | <b>Bearing Bush, stabiliser</b>      | <b>KIA CARENS II</b>   |   |
|                                 | <b>Boccola barra stabilizzatrice</b> | 1.6/1.8/2.0 CRDi/2.0 CVVT  |   |
| KIA                             | OK2KB 34156A                         |  |   |
| Fitting Position/Lato Montaggio | Front                                |  |   |
| Length/Lunghezza [mm]           | 32                                   |  |   |
| Inner Diam./Diam. Interno [mm]  | 20                                   |  |   |
| Outer Diam./Diam. esterno [mm]  | 39                                   |  |   |
| <b>GOM-K02</b>                  | <b>Holder, control arm mounting</b>  | <b>KIA CARENS II</b>   |  |
|                                 | <b>Silentblock</b>                   | 1.6/1.8/2.0 CRDi/2.0 CVVT<br><b>KIA SEPHIA (FA)</b><br>1.6 16V/1.8 16V                     |   |
| KIA                             | OK2C0 34460                          | <b>KIA SHUMA (FB)</b>  |   |
| Length/Lunghezza [mm]           | 59                                   | 1.5 i 16V/1.8 i 16V  |   |
| Inner Diam./Diam. Interno [mm]  | 12                                   | <b>KIA SHUMA II (FB)</b>   |   |
| Outer Diam./Diam. esterno [mm]  | 47                                   | 1.6/1.8  |   |
|                                 |                                      | <b>KIA SHUMA II Tre volumi (FB)</b>  |   |
|                                 |                                      | 1.6  |   |
|                                 |                                      | <b>KIA SHUMA Tre volumi (FB)</b>   |   |
|                                 |                                      | 1.5/1.5 i 16V/1.8 GX   |   |
| <b>GOM-K03</b>                  | <b>Holder, control arm mounting</b>  | <b>KIA CARENS II</b>   |  |
|                                 | <b>Silentblock</b>                   | 1.6/1.8/2.0 CRDi/2.0 CVVT<br><b>KIA SEPHIA (FA)</b><br>1.6 16V/1.8 16V                     |   |
| KIA                             | OK2A1 3446X                          | <b>KIA SHUMA (FB)</b>  |   |
| Length/Lunghezza [mm]           | 187                                  | 1.5 i 16V/1.8 i 16V  |   |
| Height/Altezza [mm]             | 54                                   | <b>KIA SHUMA II (FB)</b>   |   |
| Inner Diam./Diam. Interno [mm]  | 18                                   | 1.6/1.8  |   |
| Width/Larghezza [mm]            | 56                                   | <b>KIA SHUMA II Tre volumi (FB)</b>  |   |
|                                 |                                      | 1.6  |   |
|                                 |                                      | <b>KIA SHUMA Tre volumi (FB)</b>   |   |
|                                 |                                      | 1.5/1.5 i 16V/1.8 GX   |   |
| <b>GOM-K04</b>                  | <b>Holder, control arm mounting</b>  | <b>KIA CARENS II</b>   |  |
|                                 | <b>Silentblock</b>                   | 1.6/1.8/2.0 CRDi/2.0 CVVT<br><b>KIA SEPHIA (FA)</b><br>1.6 16V/1.8 16V                     |   |
| KIA                             | OK2A1 3446Y                          | <b>KIA SHUMA (FB)</b>  |   |
| Length/Lunghezza [mm]           | 187                                  | 1.5 i 16V/1.8 i 16V  |   |
| Height/Altezza [mm]             | 54                                   | <b>KIA SHUMA II (FB)</b>   |   |
| Inner Diam./Diam. Interno [mm]  | 18                                   | 1.6/1.8  |   |
| Width/Larghezza [mm]            | 56                                   | <b>KIA SHUMA II Tre volumi (FB)</b>  |   |
|                                 |                                      | 1.6  |   |
|                                 |                                      | <b>KIA SHUMA Tre volumi (FB)</b>   |   |
|                                 |                                      | 1.5/1.5 i 16V/1.8 GX   |   |

|                                 |                                      |   |   |
|---------------------------------|--------------------------------------|---|---|
| <b>GOM-K05</b>                  | <b>Bearing Bush, stabiliser</b>      | <b>HYUNDAI i30</b>                            |    |
|                                 | <b>Boccola barra stabilizzatrice</b> | 1.4/1.6/1.6 CRDi/2.0/2.0 CRDi                 |   |
| KIA                             | 54813 1H100                          | <b>HYUNDAI i30 CW SW</b>                      |   |
|                                 |                                      | 1.4/1.6/1.6 CRDi/2.0/2.0 CRDi                 |   |
| Fitting Position/Lato Montaggio | Front                                | <b>KIA CARENS III</b>                         |   |
| Length/Lunghezza [mm]           | 44                                   | 2.0 CRDi/2.0 CVVT                             |   |
| Height/Altezza [mm]             | 47                                   | <b>KIA CEE'D</b>                              |   |
| Width/Larghezza [mm]            | 44                                   | 1.4/1.6/1.6 CRDi 115/1.6 CRDi 90/2.0/2.0 CRDi |   |
| Inner Diam./Diam. Interno [mm]  | 23                                   | <b>KIA CEE'D SW</b>                           |   |
|                                 |                                      | 1.4/1.6/1.6 CRDi 115/1.6 CRDi 90/2.0/2.0 CRDi |   |
|                                 |                                      | <b>KIA PRO CEE'D</b>                          |   |
|                                 |                                      | 1.6/1.6 CRDi 115/1.6 CRDi 90/2.0 CRDi         |   |
| <b>GOM-K06</b>                  | <b>Bearing Bush, stabiliser</b>      | <b>KIA CARENS III</b>                         |    |
|                                 | <b>Boccola barra stabilizzatrice</b> | 2.0 CRDi/2.0 CVVT                             |   |
| KIA                             | 55513 2G000                          |   |   |
| Fitting Position/Lato Montaggio | Rear                                 |   |   |
| Length/Lunghezza [mm]           | 44                                   |   |   |
| Height/Altezza [mm]             | 40                                   |   |   |
| Width/Larghezza [mm]            | 44,5                                 |   |   |
| Inner Diam./Diam. Interno [mm]  | 14                                   |   |   |
| <b>GOM-K07</b>                  | <b>Holder, control arm mounting</b>  | <b>KIA CARENS III</b>                         |   |
|                                 | <b>Silentblock</b>                   | 2.0 CRDi/2.0 CVVT                             |   |
| KIA                             | 55543 2G000                          |   |   |
| Overall Length/Lungh. Tot. [mm] | 146                                  |   |   |
| Outer Diam./Diam. esterno [mm]  | 70                                   |   |   |
| <b>GOM-K08</b>                  | <b>Holder, control arm mounting</b>  | <b>KIA CARENS III</b>                         |  |
|                                 | <b>Silentblock</b>                   | 2.0 CRDi/2.0 CVVT                             |   |
| KIA                             | 54584 1D000                          |   |   |
| Length/Lunghezza [mm]           | 60                                   |   |   |
| Inner Diam./Diam. Interno [mm]  | 14                                   |   |   |
| Outer Diam./Diam. esterno [mm]  | 66                                   |   |   |
| <b>GOM-K09</b>                  | <b>Holder, control arm mounting</b>  | <b>KIA CARENS III</b>                         |  |
|                                 | <b>Silentblock</b>                   | 2.0 CRDi                                      |   |
| KIA                             | 54551 1D000                          |   |   |
| Length/Lunghezza [mm]           | 55                                   |   |   |
| Inner Diam./Diam. Interno [mm]  | 12                                   |   |   |
| Outer Diam./Diam. esterno [mm]  | 38                                   |   |   |
| <b>GOM-K10</b>                  | <b>Bearing Bush, stabiliser</b>      | <b>KIA CARNIVAL II</b>                        |  |
|                                 | <b>Boccola barra stabilizzatrice</b> | 2.7 V6/2.9 CRDi                               |   |
| KIA                             | 54813 4D000                          |   |   |
| Fitting Position/Lato Montaggio | Front                                |   |   |
| Length/Lunghezza [mm]           | 48                                   |   |   |
| Inner Diam./Diam. Interno [mm]  | 25                                   |   |   |
| Outer Diam./Diam. esterno [mm]  | 47                                   |   |   |
| <b>GOM-K11</b>                  | <b>Holder, control arm mounting</b>  | <b>HYUNDAI i30</b>                            |  |
|                                 | <b>Silentblock</b>                   | 1.4/1.6/1.6 CRDi/2.0/2.0 CRDi                 |   |
| KIA                             | 55130 4D000                          | <b>HYUNDAI i30 CW SW</b>                      |   |
|                                 |                                      | 1.4/1.6/1.6 CRDi/2.0/2.0 CRDi                 |   |
| Length/Lunghezza [mm]           | 59                                   | <b>KIA CARNIVAL II</b>                        |   |
| Inner Diam./Diam. Interno [mm]  | 14                                   | 2.7 V6/2.9 CRDi                               |   |
| Outer Diam./Diam. esterno [mm]  | 44                                   | <b>KIA CEE'D</b>                              |   |
|                                 |                                      | 1.4/1.6/1.6 CRDi 115/1.6 CRDi 90/2.0/2.0 CRDi |   |
|                                 |                                      | <b>KIA CEE'D SW</b>                           |   |



|                                 |                                      |   |   |
|---------------------------------|--------------------------------------|---|---|
|                                 |                                      | 1.4/1.6/1.6 CRDi 115/1.6 CRDi 90/2.0/2.0 CRDi |   |
|                                 |                                      | <b>KIA PRO CEE'D</b>                          |   |
|                                 |                                      | 1.6/1.6 CRDi 115/1.6 CRDi 90/2.0 CRDi         |   |
| <b>GOM-K12</b>                  | <b>Holder, control arm mounting</b>  | <b>KIA CARNIVAL II</b>                        |   |
|                                 | <b>Silentblock</b>                   | 2.7 V6/2.9 CRDi                               |   |
| KIA                             | 54584 4D000                          |   |    |
| Length/Lunghezza [mm]           | 60                                   |   |   |
| Inner Diam./Diam. Interno [mm]  | 14                                   |   |   |
| Outer Diam./Diam. esterno [mm]  | 66                                   |   |   |
| <b>GOM-K13</b>                  | <b>Holder, control arm mounting</b>  | <b>KIA CARNIVAL II</b>                        |   |
|                                 | <b>Silentblock</b>                   | 2.7 V6/2.9 CRDi                               |   |
| KIA                             | 54551 4D000                          |   |    |
| Length/Lunghezza [mm]           | 69,5                                 |   |   |
| Inner Diam./Diam. Interno [mm]  | 14                                   |   |   |
| Outer Diam./Diam. esterno [mm]  | 42                                   |   |   |
| <b>GOM-K14</b>                  | <b>Bearing Bush, stabiliser</b>      | <b>KIA CEE'D</b>                              |   |
|                                 | <b>Boccola barra stabilizzatrice</b> | 1.4/1.6/1.6 CRDi 115/1.6 CRDi 90/2.0/2.0 CRDi |   |
| KIA                             | 54813 2H000                          | <b>KIA CEE'D SW</b>                           |   |
| Fitting Position/Lato Montaggio | Front                                | 1.4/1.6/1.6 CRDi 115/1.6 CRDi 90/2.0/2.0 CRDi |   |
| Length/Lunghezza [mm]           | 45                                   | <b>KIA PRO CEE'D</b>                          |   |
| Height/Altezza [mm]             | 47,5                                 | 1.6/1.6 CRDi 115/1.6 CRDi 90/2.0 CRDi         |   |
| Width/Larghezza [mm]            | 44,5                                 |   |   |
| Inner Diam./Diam. Interno [mm]  | 22                                   |   |   |
| <b>GOM-K15</b>                  | <b>Holder, control arm mounting</b>  | <b>HYUNDAI i30</b>                            |   |
|                                 | <b>Silentblock</b>                   | 1.4/1.6/1.6 CRDi/2.0/2.0 CRDi                 |   |
| KIA                             | 55543 1H000                          | <b>HYUNDAI i30 CW SW</b>                      |   |
| Diameter/Diametro [mm]          | 70                                   | 1.4/1.6/1.6 CRDi/2.0/2.0 CRDi                 |   |
| Overall Length/Lungh. Tot. [mm] | 146                                  | <b>KIA CEE'D</b>                              |   |
|                                 |                                      | 1.4/1.6/1.6 CRDi 115/1.6 CRDi 90/2.0/2.0 CRDi |  |
|                                 |                                      | <b>KIA CEE'D SW</b>                           |   |
|                                 |                                      | 1.4/1.6/1.6 CRDi 115/1.6 CRDi 90/2.0/2.0 CRDi |   |
|                                 |                                      | <b>KIA PRO CEE'D</b>                          |   |
|                                 |                                      | 1.6/1.6 CRDi 115/1.6 CRDi 90/2.0 CRDi         |   |
| <b>GOM-K16</b>                  | <b>Holder, control arm mounting</b>  | <b>HYUNDAI i30</b>                            |   |
|                                 | <b>Silentblock</b>                   | 1.4/1.6/1.6 CRDi                              |   |
| KIA                             | 54584 2H000                          | <b>HYUNDAI i30 CW SW</b>                      |   |
| Length/Lunghezza [mm]           | 60                                   | 1.6/1.6 CRDi                                  |   |
| Inner Diam./Diam. Interno [mm]  | 14,3                                 | <b>KIA CEE'D</b>                              |   |
| Outer Diam./Diam. esterno [mm]  | 66,5                                 | 1.4/1.6/1.6 CRDi 115/1.6 CRDi 90/2.0/2.0 CRDi |  |
|                                 |                                      | <b>KIA CEE'D SW</b>                           |   |
|                                 |                                      | 1.4/1.6/1.6 CRDi 115/1.6 CRDi 90/2.0/2.0 CRDi |   |
|                                 |                                      | <b>KIA PRO CEE'D</b>                          |   |
|                                 |                                      | 1.6/1.6 CRDi 115/1.6 CRDi 90/2.0 CRDi         |   |
| <b>GOM-K17</b>                  | <b>Holder, control arm mounting</b>  | <b>HYUNDAI i30</b>                            |   |
|                                 | <b>Silentblock</b>                   | 1.4/1.6/1.6 CRDi                              |   |
| KIA                             | 54551 2H000                          | <b>HYUNDAI i30 CW SW</b>                      |   |
| Length/Lunghezza [mm]           | 55                                   | 1.6/1.6 CRDi                                  |   |
| Inner Diam./Diam. Interno [mm]  | 12                                   | <b>KIA CEE'D</b>                              |   |
| Outer Diam./Diam. esterno [mm]  | 38                                   | 1.4/1.6/1.6 CRDi 115/1.6 CRDi 90/2.0/2.0 CRDi |  |
|                                 |                                      | <b>KIA CEE'D SW</b>                           |   |
|                                 |                                      | 1.4/1.6/1.6 CRDi 115/1.6 CRDi 90/2.0/2.0 CRDi |   |
|                                 |                                      | <b>KIA PRO CEE'D</b>                          |   |
|                                 |                                      | 1.6/1.6 CRDi 115/1.6 CRDi 90/2.0 CRDi         |   |







**RUBBER PARTS LIST**  
**MOTORAUFHÄNGUNG LISTE**  
**LISTE SILENT BLOCS**  
**LISTA TAPONES DE GOMA**  
**LISTA PARTI IN GOMMA**



|                                 |                                      |                           |   |
|---------------------------------|--------------------------------------|---------------------------|---|
| <b>GOM-K18</b>                  | <b>Bearing Bush, stabiliser</b>      | <b>KIA CLARUS (K9A)</b>   |    |
|                                 | <b>Boccola barra stabilizzatrice</b> | <b>KIA CLARUS SW (GC)</b> |   |
| KIA                             | OK9A2-34156                          | 1.8 i 16V/2.0 i 16V       |   |
|                                 |                                      | 1.8 i 16V/2.0 i 16V       |   |
| Fitting Position/Lato Montaggio |                                      | Front                     |   |
| Length/Lunghezza [mm]           |                                      | 32                        |   |
| Inner Diam./Diam. Interno [mm]  |                                      | 25                        |   |
| Outer Diam./Diam. esterno [mm]  |                                      | 40                        |   |
| <b>GOM-K19</b>                  | <b>Holder, control arm mounting</b>  | <b>KIA CLARUS (K9A)</b>   |    |
|                                 | <b>Silentblock</b>                   | <b>KIA CLARUS SW (GC)</b> |   |
| KIA                             | OK9A2-34470                          | 1.8 i 16V/2.0 i 16V       |   |
|                                 |                                      | 1.8 i 16V/2.0 i 16V       |   |
| Length/Lunghezza [mm]           |                                      | 60                        |   |
| Inner Diam./Diam. Interno [mm]  |                                      | 12                        |   |
| Outer Diam./Diam. esterno [mm]  |                                      | 40                        |   |
| <b>GOM-K20</b>                  | <b>Holder, control arm mounting</b>  | <b>KIA CLARUS (K9A)</b>   |    |
|                                 | <b>Silentblock</b>                   | <b>KIA CLARUS SW (GC)</b> |   |
| KIA                             | OK9A2-34464                          | 1.8 i 16V/2.0 i 16V       |   |
|                                 |                                      | 1.8 i 16V/2.0 i 16V       |   |
| Length/Lunghezza [mm]           |                                      | 156                       |   |
| Height/Altezza [mm]             |                                      | 68                        |   |
| Width/Larghezza [mm]            |                                      | 70                        |   |
| Inner Diam./Diam. Interno [mm]  |                                      | 18,4                      |   |
| <b>GOM-K21</b>                  | <b>Holder, control arm mounting</b>  | <b>KIA CLARUS (K9A)</b>   |  |
|                                 | <b>Silentblock</b>                   | <b>KIA CLARUS SW (GC)</b> |   |
| KIA                             | OK9A2-3446X                          | 1.8 i 16V/2.0 i 16V       |   |
|                                 |                                      | 1.8 i 16V/2.0 i 16V       |   |
| Length/Lunghezza [mm]           |                                      | 156                       |   |
| Height/Altezza [mm]             |                                      | 68                        |   |
| Width/Larghezza [mm]            |                                      | 70                        |   |
| Inner Diam./Diam. Interno [mm]  |                                      | 18                        |   |
| <b>GOM-K22</b>                  | <b>Holder, control arm mounting</b>  | <b>KIA CLARUS (K9A)</b>   |  |
|                                 | <b>Silentblock</b>                   | <b>KIA CLARUS SW (GC)</b> |   |
| KIA                             | OK9A6-3446Y                          | 1.8 i 16V/2.0 i 16V       |   |
|                                 |                                      | 1.8 i 16V/2.0 i 16V       |   |
| Length/Lunghezza [mm]           |                                      | 163                       |   |
| Height/Altezza [mm]             |                                      | 69                        |   |
| Inner Diam./Diam. Interno [mm]  |                                      | 18                        |   |
| Width/Larghezza [mm]            |                                      | 70                        |   |
| <b>GOM-K23</b>                  | <b>Holder, control arm mounting</b>  | <b>KIA CLARUS (K9A)</b>   |  |
|                                 | <b>Silentblock</b>                   | <b>KIA CLARUS SW (GC)</b> |   |
| KIA                             | OK9A6-3446X                          | 1.8 i 16V/2.0 i 16V       |   |
|                                 |                                      | 1.8 i 16V/2.0 i 16V       |   |
| Length/Lunghezza [mm]           |                                      | 163                       |   |
| Height/Altezza [mm]             |                                      | 69                        |   |
| Inner Diam./Diam. Interno [mm]  |                                      | 18                        |   |
| Width/Larghezza [mm]            |                                      | 70                        |   |
| <b>GOM-K24</b>                  | <b>Bearing Bush, stabiliser</b>      | <b>KIA PICANTO (TA)</b>   |  |
|                                 | <b>Boccola barra stabilizzatrice</b> | <b>KIA PICANTO</b>        |   |
| KIA                             | 54812 07100                          | 1.2                       |   |
|                                 |                                      | 1.0/1.1/1.1 CRDi          |   |
| Fitting Position/Lato Montaggio |                                      | Front                     |   |

|                                 |                                      |                                     |   |
|---------------------------------|--------------------------------------|-------------------------------------|---|
| <b>GOM-K25</b>                  | <b>Holder, control arm mounting</b>  | <b>HYUNDAI i10</b>                  |    |
|                                 | <b>Silentblock</b>                   | 1.1/1.1 CRDi/1.2                    |   |
| KIA                             | 54584 07000                          | <b>KIA PICANTO</b>                  |   |
|                                 |                                      | 1.0/1.1/1.1 CRDi                    |   |
| Length/Lunghezza [mm]           | 54,5                                 |                                     |   |
| Inner Diam./Diam. Interno [mm]  | 12                                   |                                     |   |
| Outer Diam./Diam. esterno [mm]  | 60                                   |                                     |   |
| <b>GOM-K26</b>                  | <b>Holder, control arm mounting</b>  | <b>HYUNDAI i10</b>                  |    |
|                                 | <b>Silentblock</b>                   | 1.1/1.1 CRDi/1.2                    |   |
| KIA                             | 54551 07000                          | <b>KIA PICANTO</b>                  |   |
|                                 |                                      | 1.0/1.1/1.1 CRDi                    |   |
| Length/Lunghezza [mm]           | 53,8                                 |                                     |   |
| Inner Diam./Diam. Interno [mm]  | 12                                   |                                     |   |
| Outer Diam./Diam. esterno [mm]  | 33                                   |                                     |   |
| <b>GOM-K27</b>                  | <b>Holder, control arm mounting</b>  | <b>KIA RIO</b>                      |    |
|                                 | <b>Silentblock</b>                   | 1.3/1.5                             |   |
| KIA                             | OK30A 34480 C                        | <b>KIA RIO SW (DC)</b>              |   |
|                                 |                                      | 1.3/1.5                             |   |
| Length/Lunghezza [mm]           | 37,5                                 |                                     |   |
| Inner Diam./Diam. Interno [mm]  | 16                                   |                                     |   |
| Outer Diam./Diam. esterno [mm]  | 38                                   |                                     |   |
| <b>GOM-K28</b>                  | <b>Holder, control arm mounting</b>  | <b>KIA SORENTO (JC)</b>             |  |
|                                 | <b>Silentblock</b>                   | 2.4/2.5 CRDi/3.3 V6/3.5 V6          |   |
| KIA                             | 54580 3E001                          |                                     |   |
| Length/Lunghezza [mm]           | 69                                   |                                     |   |
| Inner Diam./Diam. Interno [mm]  | 18                                   |                                     |   |
| Outer Diam./Diam. esterno [mm]  | 51,5                                 |                                     |   |
| <b>GOM-K29</b>                  | <b>Holder, control arm mounting</b>  | <b>KIA SORENTO (JC)</b>             |  |
|                                 | <b>Silentblock</b>                   | 2.4/2.5 CRDi/3.3 V6/3.5 V6          |   |
| KIA                             | 54590 3E000                          |                                     |   |
| Height/Altezza [mm]             | 44                                   |                                     |   |
| Outer Diam./Diam. esterno [mm]  | 66                                   |                                     |   |
| Outer Thread/Filett. Est. [mm]  | 10X1,25                              |                                     |   |
| <b>GOM-K30</b>                  | <b>Bearing Bush, stabiliser</b>      | <b>KIA SEPHIA (FA)</b>              |  |
|                                 | <b>Boccola barra stabilizzatrice</b> | 1.6 16V/1.8 16V                     |   |
| KIA                             | OK2NA 34156                          | <b>KIA SHUMA (FB)</b>               |   |
|                                 |                                      | 1.5 i 16V/1.8 i 16V                 |   |
| Fitting Position/Lato Montaggio | Front                                | <b>KIA SHUMA II (FB)</b>            |   |
| Length/Lunghezza [mm]           | 32                                   | <b>KIA SHUMA II Tre volumi (FB)</b> |   |
| Inner Diam./Diam. Interno [mm]  | 17                                   | 1.6                                 |   |
| Outer Diam./Diam. esterno [mm]  | 28                                   | <b>KIA SHUMA Tre volumi (FB)</b>    |   |
|                                 |                                      | 1.5/1.5 i 16V/1.8 GX                |   |
| <b>GOM-K31</b>                  | <b>Bearing Bush, stabiliser</b>      | <b>KIA SORENTO (JC)</b>             |  |
|                                 | <b>Boccola barra stabilizzatrice</b> | 2.4/2.5 CRDi/3.5 V6                 |   |
| KIA                             | 55530-3E010                          |                                     |   |
| Fitting Position/Lato Montaggio | Rear                                 |                                     |   |
| Length/Lunghezza [mm]           | 38                                   |                                     |   |
| Height/Altezza [mm]             | 44                                   |                                     |   |
| Width/Larghezza [mm]            | 42                                   |                                     |   |
| Inner Diam./Diam. Interno [mm]  | 25                                   |                                     |   |

|                |                                      |   |   |
|----------------|--------------------------------------|---|---|
| <b>GOM-K32</b> | <b>Bearing Bush, stabiliser</b>      | <b>KIA SORENTO (JC)</b>   |    |
|                | <b>Boccola barra stabilizzatrice</b> | 2.4/2.5 CRDi/3.5 V6   |   |
| KIA            | 55530-3E020                          |   |   |
|                | Fitting Position/Lato Montaggio      | Rear  |   |
|                | Length/Lunghezza [mm]                | 38  |   |
|                | Height/Altezza [mm]                  | 44,5  |   |
|                | Width/Larghezza [mm]                 | 51  |   |
|                | Inner Diam./Diam. Interno [mm]       | 19  |   |
| <b>GOM-K33</b> | <b>Bearing Bush, stabiliser</b>      | <b>KIA RIO</b>  |    |
|                | <b>Boccola barra stabilizzatrice</b> | 1.3/1.5   |   |
| KIA            | 54813-FD000                          | <b>KIA RIO SW (DC)</b>  |   |
|                | Fitting Position/Lato Montaggio      | Front   |   |
|                | Length/Lunghezza [mm]                | 32  |   |
|                | Height/Altezza [mm]                  | 30  |   |
|                | Width/Larghezza [mm]                 | 30  |   |
|                | Inner Diam./Diam. Interno [mm]       | 19  |   |
| <b>GOM-K34</b> | <b>Bearing Bush, stabiliser</b>      | <b>HYUNDAI TUCSON (JM)</b>  |   |
|                | <b>Boccola barra stabilizzatrice</b> | 2.0/2.0 4 ruote motrici/2.0 CRDi/2.0 CRDi 4 ruote motrici/2.7 4 ruote motrici |   |
| KIA            | 54813-2E100                          | <b>KIA SPORTAGE</b>   |   |
|                | Fitting Position/Lato Montaggio      | Front   |   |
|                | Length/Lunghezza [mm]                | 48  |   |
|                | Height/Altezza [mm]                  | 47  |   |
|                | Width/Larghezza [mm]                 | 51  |   |
|                | Inner Diam./Diam. Interno [mm]       | 25  |   |
| <b>GOM-K35</b> | <b>Bearing Bush, stabiliser</b>      | <b>KIA SORENTO (JC)</b>   |  |
|                | <b>Boccola barra stabilizzatrice</b> | 2.4/2.5 CRDi/3.5 V6   |   |
| KIA            | 54830-3E020                          |   |   |
|                | Fitting Position/Lato Montaggio      | Front   |   |
|                | Length/Lunghezza [mm]                | 47  |   |
|                | Height/Altezza [mm]                  | 48  |   |
|                | Width/Larghezza [mm]                 | 51  |   |
|                | Inner Diam./Diam. Interno [mm]       | 28  |   |
| <b>GOM-K36</b> | <b>Holder, control arm mounting</b>  | <b>KIA SPORTAGE</b>   |  |
|                | <b>Silentblock</b>                   | 2.0 16V 4WD/2.0 CRDi 4WD/2.7 V6 4WD   |   |
| KIA            | 55227-2D000                          |   |   |
|                | Fitting Position/Lato Montaggio      | Rear Axle   |   |
|                | Length/Lunghezza [mm]                | 43  |   |
|                | Inner Diam./Diam. Interno [mm]       | 14  |   |
|                | Outer Diam./Diam. esterno [mm]       | 30  |   |
| <b>GOM-K37</b> | <b>Suspension Strut Support</b>      | <b>KIA PICANTO</b>  |  |
|                | <b>Bearing</b>                       | 1.0/1.1/1.1 CRDi  |   |
| KIA            | 54620-07000                          |   |   |
|                | Fitting Position/Lato Montaggio      | Front Axle  |   |
|                | Inner Diam./Diam. Interno [mm]       | 19  |   |
|                | Outer Diam./Diam. esterno [mm]       | 155   |   |

|                |                                      |  |   |
|----------------|--------------------------------------|--|---|
| <b>GOM-L01</b> | <b>Holder, control arm mounting</b>  | <b>LAND ROVER FREELANDER (LN)</b><br>1.8 16V/1.8 i 16V/2.0 DI/2.0 Td4/2.5 V6 |    |
|                | <b>Silentblock</b>                   | <b>LAND ROVER FREELANDER Soft Top</b><br>1.8 i 16V/2.0 DI                    |   |
| LAND ROVER     | RBX 101160                           |  | L01   |
|                | Length/Lunghezza [mm]                | 66   |   |
|                | Inner Diam./Diam. Interno [mm]       | 14   |   |
|                | Outer Diam./Diam. esterno [mm]       | 45,5   |   |
| <b>GOM-L02</b> | <b>Holder, control arm mounting</b>  | <b>LAND ROVER FREELANDER (LN)</b><br>1.8 16V/1.8 i 16V/2.0 DI/2.0 Td4/2.5 V6 |    |
|                | <b>Silentblock</b>                   | <b>LAND ROVER FREELANDER Soft Top</b><br>1.8 i 16V/2.0 DI                    |   |
| LAND ROVER     | RBX 101780                           |  | L02   |
|                | Length/Lunghezza [mm]                | 80   |   |
|                | Inner Diam./Diam. Interno [mm]       | 20   |   |
|                | Outer Diam./Diam. esterno [mm]       | 78   |   |
| <b>GOM-L03</b> | <b>Holder, control arm mounting</b>  | <b>LAND ROVER RANGE ROVER III (LM)</b><br>3.0 TD 6/3.6 TD 8/4.2/4.4          |    |
|                | <b>Silentblock</b>                   |  |   |
| LAND ROVER     | RBX 000070                           |  | L03   |
|                | Length/Lunghezza [mm]                | 68   |   |
|                | Inner Diam./Diam. Interno [mm]       | 14   |   |
|                | Outer Diam./Diam. esterno [mm]       | 52,6   |   |
| <b>GOM-L04</b> | <b>Holder, control arm mounting</b>  | <b>LAND ROVER RANGE ROVER III (LM)</b><br>3.0 TD 6/3.6 TD 8/4.2/4.4          |  |
|                | <b>Silentblock</b>                   |  |   |
| LAND ROVER     | LR018345                             |  | L04   |
|                | Length/Lunghezza [mm]                | 76   |   |
|                | Inner Diam./Diam. Interno [mm]       | 14   |   |
|                | Outer Diam./Diam. esterno [mm]       | 66   |   |
| <b>GOM-L05</b> | <b>Holder, control arm mounting</b>  | <b>LAND ROVER RANGE ROVER III (LM)</b><br>3.0 TD 6/3.6 TD 8/4.2/4.4          |  |
|                | <b>Silentblock</b>                   |  |   |
| LAND ROVER     | RHF 000260                           |  | L05   |
|                | Length/Lunghezza [mm]                | 53,5   |   |
|                | Inner Diam./Diam. Interno [mm]       | 14   |   |
|                | Outer Diam./Diam. esterno [mm]       | 45   |   |
| <b>GOM-L07</b> | <b>Bearing Bush, stabiliser</b>      | <b>LAND ROVER RANGE ROVER SPORT</b><br>2.7 TDVM/3.6 TD 8/4.2/4.4             |  |
|                | <b>Boccola barra stabilizzatrice</b> |  |   |
| LAND ROVER     | LR018347                             |  | L07   |
|                | Fitting Position/Lato Montaggio      | Front  |   |
|                | Length/Lunghezza [mm]                | 64   |   |
|                | Height/Altezza [mm]                  | 48   |   |
|                | Width/Larghezza [mm]                 | 50   |   |
|                | Inner Diam./Diam. Interno [mm]       | 30   |   |
| <b>GOM-L08</b> | <b>Bearing Bush, stabiliser</b>      | <b>LAND ROVER RANGE ROVER SPORT</b><br>2.7 TDVM/3.6 TD 8/4.2/4.4             |  |
|                | <b>Boccola barra stabilizzatrice</b> |  |   |
| LAND ROVER     | LR018354                             |  | L08   |
|                | Fitting Position/Lato Montaggio      | Rear   |   |
|                | Length/Lunghezza [mm]                | 64   |   |
|                | Height/Altezza [mm]                  | 56   |   |
|                | Width/Larghezza [mm]                 | 51   |   |
|                | Inner Diam./Diam. Interno [mm]       | 23   |   |



**RUBBER PARTS LIST**  
**MOTORAUFHÄNGUNG LISTE**  
**LISTE SILENT BLOCS**  
**LISTA TAPONES DE GOMA**  
**LISTA PARTI IN GOMMA**







|  |  |  |
|--|--|--|
| <p><b>GOM-L09</b>      <b>Holder, control arm mounting</b></p> <p><b>Silentblock</b></p>   | <p><b>LAND ROVER RANGE ROVER SPORT</b><br/>2.7 TDVM/3.6 TD 8/4.2/4.4</p>   |  <p>L09</p>   |
| <p>LAND ROVER      RBX 500443</p> <p>Length/Lunghezza [mm]      53</p> <p>Inner Diam./Diam. Interno [mm]      14</p> <p>Outer Diam./Diam. esterno [mm]      56</p> |  |  |
| <p><b>GOM-L10</b>      <b>Holder, control arm mounting</b></p> <p><b>Silentblock</b></p>   | <p><b>LAND ROVER RANGE ROVER SPORT</b><br/>2.7 TDVM/3.6 TD 8/4.2/4.4</p>   |  <p>L10</p>   |
| <p>LAND ROVER      RBX 500432</p> <p>Length/Lunghezza [mm]      77</p> <p>Inner Diam./Diam. Interno [mm]      16</p> <p>Outer Diam./Diam. esterno [mm]      53</p> |  |  |
| <p><b>GOM-L11</b>      <b>Holder, control arm mounting</b></p> <p><b>Silentblock</b></p>   | <p><b>LAND ROVER RANGE ROVER SPORT</b><br/>2.7 TDVM/3.6 TD 8/4.2/4.4</p>   |  <p>L11</p>   |
| <p>LAND ROVER      RBX 500531</p> <p>Length/Lunghezza [mm]      83</p> <p>Inner Diam./Diam. Interno [mm]      16</p> <p>Outer Diam./Diam. esterno [mm]      88</p> |  |  |
| <p><b>GOM-L12</b>      <b>Holder, control arm mounting</b></p> <p><b>Silentblock</b></p>   | <p><b>LAND ROVER DISCOVERY III</b><br/>3.0 TD</p> <p><b>LAND ROVER RANGE ROVER SPORT</b><br/>2.7 TDVM/3.6 TD 8/4.2/4.4</p> |  <p>L12</p> |
| <p>LAND ROVER      RHF 500031</p> <p>Length/Lunghezza [mm]      62</p> <p>Inner Diam./Diam. Interno [mm]      13</p> <p>Outer Diam./Diam. esterno [mm]      47</p> |  |  |
| <p><b>GOM-L13</b>      <b>Holder, control arm mounting</b></p> <p><b>Silentblock</b></p>   | <p><b>LAND ROVER RANGE ROVER SPORT</b><br/>2.7 TDVM/3.6 TD 8/4.2/4.4</p>   |  <p>L13</p> |
| <p>LAND ROVER      RBK 500012</p> <p>Length/Lunghezza [mm]      65</p> <p>Inner Diam./Diam. Interno [mm]      16</p> <p>Outer Diam./Diam. esterno [mm]      59</p> |  |  |
| <p><b>GOM-L14</b>      <b>Engine Mounting</b></p> <p><b>Supporto motore</b></p>  | <p><b>LAND ROVER RANGE ROVER III (LM)</b><br/>4.4</p>  |  <p>L14</p> |
| <p>LAND ROVER      KKB000270</p> <p>Fitting Position/Lato Montaggio      Left Front</p>  |  |  |
| <p><b>GOM-L15</b>      <b>Engine Mounting</b></p> <p><b>Supporto motore</b></p>  | <p><b>LAND ROVER RANGE ROVER III (LM)</b><br/>4.4</p>  |  <p>L15</p> |
| <p>LAND ROVER      KKB000280</p> <p>Fitting Position/Lato Montaggio      Right Front</p>   |  |  |

|                                 |                                      |  |   |
|---------------------------------|--------------------------------------|--|---|
| <b>GOM-M00</b>                  | <b>Holder, control arm mounting</b>  | <b>SMART CABRIO</b><br>0.6/0.6 (S1OLA1)/0.6 (S1OLD2)/0.7/0.8 CDI (S1OLC1)                |    |
|                                 | <b>Silentblock</b>                   | <b>SMART CITY-COUPE (MC01)</b><br>0.6/0.6 (S1CLA1)/0.6 (S1CLB1)/0.7/0.8 CDI (S1CLC1)     |   |
| SMART                           | 07001V006000000                      | <b>SMART FORTWO cabrio</b><br>0.7 (450.432)/0.7 (450.433)/0.8 CDI (450.400)              |   |
| Length/Lunghezza [mm]           | 37                                   | <b>SMART FORTWO Coupe</b><br>0.7 (450.330)/0.7 (450.332)/0.7 (450.333)/0.8 CDI (450.300) |   |
| Inner Diam./Diam. Interno [mm]  | 12                                   | <b>VOLVO XC 90</b><br>2.5 T  |   |
| Outer Diam./Diam. esterno [mm]  | 39                                   |  |   |
| <b>GOM-S00</b>                  | <b>Bearing Bush, stabiliser</b>      | <b>SSANGYONG ACTYON</b><br>2.3 4x4/200 Xdi 4WD   |    |
|                                 | <b>Boccola barra stabilizzatrice</b> | <b>SSANGYONG KYRON</b><br>2.7 Xdi  |   |
| SSANGYONG                       | 45712-06000                          | <b>SSANGYONG REXTON</b><br>2.7 Xdi   |   |
| Fitting Position/Lato Montaggio | Rear Axle                            |  |   |
| Length/Lunghezza [mm]           | 50                                   |  |   |
| Height/Altezza [mm]             | 41                                   |  |   |
| Width/Larghezza [mm]            | 38                                   |  |   |
| Inner Diam./Diam. Interno [mm]  | 20                                   |  |   |
| <b>GOM-W00</b>                  | <b>Suspension Strut Support</b>      | <b>DAEWOO MATIZ (KLYA)</b><br>0.8  |   |
|                                 | <b>Bearing</b>                       |  |   |
| <b>Supporto ammortizzatore</b>  |                                      |  |   |
| CHEVROLET                       | 96518121                             |  |   |
| Fitting Position/Lato Montaggio | Front Axle                           |  |   |
| Height/Altezza [mm]             | 30                                   |  |   |
| Inner Diam./Diam. Interno [mm]  | 32                                   |  |   |
| Outer Diam./Diam. esterno [mm]  | 84                                   |  |   |
| <b>GOM-W01</b>                  | <b>Suspension Strut Support</b>      | <b>DAEWOO MATIZ (KLYA)</b><br>1.0  |  |
|                                 | <b>Bearing</b>                       |  |   |
| <b>Supporto ammortizzatore</b>  |                                      |  |   |
| DAEWOO                          | 96568585                             |  |   |
| Length/Lunghezza [mm]           | 141,5                                |  |   |
| Height/Altezza [mm]             | 40                                   |  |   |
| Inner Diam./Diam. Interno [mm]  | 32                                   |  |   |
| <b>GOM-W02</b>                  | <b>Bearing Bush, stabiliser</b>      | <b>CHEVROLET MATIZ</b><br>0.8/1.0  |  |
|                                 | <b>Boccola barra stabilizzatrice</b> | <b>DAEWOO MATIZ (KLYA)</b><br>0.8/1.0  |   |
| DAEWOO                          | 96322618                             |  |   |
| Fitting Position/Lato Montaggio | Front Axle                           |  |   |
| Length/Lunghezza [mm]           | 51                                   |  |   |
| Height/Altezza [mm]             | 40                                   |  |   |
| Width/Larghezza [mm]            | 32                                   |  |   |
| Inner Diam./Diam. Interno [mm]  | 22                                   |  |   |
| <b>GOM-W03</b>                  | <b>Holder, control arm mounting</b>  | <b>CHEVROLET LACETTI</b><br>1.4 16V/1.6/1.8/2.0 D  |  |
|                                 | <b>Silentblock</b>                   | <b>CHEVROLET NUBIRA SW</b><br>1.6/1.8/2.0 D  |   |
| CHEVROLET                       | 9639 1856                            | <b>CHEVROLET NUBIRA Tre volumi</b><br>1.4/1.6/1.8  |   |
| Length/Lunghezza [mm]           | 54,5                                 | <b>DAEWOO LACETTI (KLAN)</b><br>1.4/1.6/1.8  |   |
| Inner Diam./Diam. Interno [mm]  | 12                                   | <b>DAEWOO NUBIRA Tre volumi (KLAN)</b><br>1.4/1.6/1.8                                    |   |
| Outer Diam./Diam. esterno [mm]  | 60                                   | <b>DAEWOO NUBIRA Wagon (KLAN)</b><br>1.6/1.8   |   |

**RUBBER PARTS LIST**  
**MOTORAUFHÄNGUNG LISTE**  
**LISTE SILENT BLOCS**  
**LISTA TAPONES DE GOMA**  
**LISTA PARTI IN GOMMA**



|                                 |                                 |   |   |
|---------------------------------|---------------------------------|---|---|
| <b>GOM-W04</b>                  | <b>Suspension Strut Support</b> | <b>CHEVROLET LACETTI</b><br>1.4 16V/1.6/1.8/2.0 D               |    |
|                                 | <b>Bearing</b>                  |   |   |
|                                 | <b>Supporto ammortizzatore</b>  | <b>CHEVROLET NUBIRA Tre volumi</b><br>1.4/1.5/1.6/1.8/2.0/2.0 D |   |
| DAEWOO                          | 96549921                        |   |   |
| Fitting Position/Lato Montaggio | Upper Front Axle                |   |   |
| Height/Altezza [mm]             | 44                              |   |   |
| Inner Diam./Diam. Interno [mm]  | 14,5                            |   |   |
| Outer Diam./Diam. esterno [mm]  | 114                             |   |   |
| <b>GOM-W05</b>                  | <b>Engine Mounting</b>          | <b>DAEWOO LANOS (KLAT)</b><br>1.4/1.5/1.6 16V                   |    |
|                                 | <b>Supporto motore</b>          | <b>DAEWOO LANOS Tre volumi (KLAT)</b><br>1.4/1.5/1.6 16V        |   |
| DAEWOO                          | 90250348                        |   |   |
| Fitting Position/Lato Montaggio | Right Front                     |   |   |
| Length/Lunghezza [mm]           | 115                             |   |   |
| Height/Altezza [mm]             | 99                              |   |   |
| Width/Larghezza [mm]            | 51                              |   |   |
| <b>GOM-W07</b>                  | <b>Engine Mounting</b>          | <b>DAEWOO LANOS (KLAT)</b><br>1.4/1.5/1.6 16V                   |    |
|                                 | <b>Supporto motore</b>          | <b>DAEWOO LANOS Tre volumi (KLAT)</b><br>1.4/1.5/1.6 16V        |   |
| DAEWOO                          | 90250437                        |   |   |
| Fitting Position/Lato Montaggio | Rear Axle Left                  |   |   |
| Length/Lunghezza [mm]           | 150                             |   |   |
| Height/Altezza [mm]             | 89                              |   |   |
| Width/Larghezza [mm]            | 59                              |   |   |
| <b>GOM-W08</b>                  | <b>Suspension Strut Support</b> | <b>CHEVROLET LACETTI</b><br>1.4 16V/1.6/1.8/2.0 D               |  |
|                                 | <b>Bearing</b>                  | <b>CHEVROLET NUBIRA SW</b><br>1.5/1.6/1.8/2.0/2.0 D             |   |
|                                 | <b>Supporto ammortizzatore</b>  | <b>CHEVROLET NUBIRA Tre volumi</b><br>1.4/1.5/1.6/1.8/2.0/2.0 D |   |
| DAEWOO                          | 96457360                        |   |   |
| Fitting Position/Lato Montaggio | Rear Axle Upper                 |   |   |
| Height/Altezza [mm]             | 46,5                            |   |   |
| Inner Diam./Diam. Interno [mm]  | 32                              |   |   |
| Inner Diam./Diam. Int. 1 [mm]   | 15                              |   |   |

# Rechtliche Hinweise - Disclaimer - Avvertenze Legali Information juridique - Advertencias/Juridische Informatie



**DE** Wir haben uns um die weitestgehende Richtigkeit der in diesem Katalog enthaltenen Angaben bemüht. Wir haften indes nicht für eventuelle Unrichtigkeiten. Dieser Katalog enthält Produkte, die dem Erstausstattungsstandard entsprechen. Wir behalten uns jederzeit technische Änderungen vor. Die im Katalog angeführten Originalnummern und Herstellernamen dienen ausschließlich der Identifizierung des Bauteils und sind nicht auf Lieferscheinen und Rechnungen verwendbar. Die vollständige und auch teilweise Reproduktion unserer Referenzangaben und unseres Katalogs ist verboten.

**EN** We have made every effort to ensure that the data in this catalogue are as accurate as possible. However, we decline all responsibility for any inaccuracies.  
This catalogue contains products of "initial equipment" quality. We reserve the right to make technical changes at any time. The original numbers and manufacturers' names mentioned in this catalogue are provided solely to allow identification of the component and may not be used on delivery notes and invoices.  
Even partial reproduction of our references and catalogue is forbidden.

**I** Ci siamo adoperati affinché i dati contenuti in questo catalogo siano i più esatti possibili. Tuttavia decliniamo ogni responsabilità per eventuali inesattezze.  
Questo catalogo contiene prodotti di qualità "primo equipaggiamento". Ci riserviamo il diritto di apportare modifiche tecniche in qualsiasi momento. I numeri originali e i nomi dei fabbricanti citati in questo catalogo servono esclusivamente a scopo identificativo del componente e non possono essere utilizzati sulle bolle di accompagnamento e fatture.  
La riproduzione, anche parziale dei nostri riferimenti e del nostro catalogo è vietata.

**FR** Nous avons fait tout notre possible pour que les données de ce catalogue soient exactes. Toutefois, nous déclinons toute responsabilité pour d'éventuelles inexactitudes.  
Ce catalogue contient des produits de qualité "équipement standard". Nous nous réservons le droit d'apporter à tout moment des modifications techniques. Les numéros originaux et les noms des fabricants cités dans ce catalogue servent exclusivement à identifier le composant et ne peuvent pas être utilisés sur les bulletins d'accompagnement et les factures.  
La reproduction, même partielle, de nos références et de notre catalogue est rigoureusement interdite.

**ES** Hemos procurado que los datos que figuran en este catálogo sean lo más exactos posible. No obstante declinamos toda responsabilidad por eventuales imprecisiones.  
Este catálogo incluye productos de calidad de "equipos de serie". Nos reservamos el derecho de introducir modificaciones técnicas en cualquier momento.  
Los números originales y los nombres de los fabricantes citados en este catálogo se ofrecen exclusivamente a efectos de identificación del componente y no podrán ser empleados en las cartas de porte ni en las facturas.  
Queda prohibida la reproducción total o parcial de nuestros códigos de referencia y nuestro catálogo.

**NL** Wij hebben ons ingespannen om ervoor te zorgen dat de gegevens in deze catalogus zo exact mogelijk zouden zijn. Wij kunnen echter niet aansprakelijk worden gesteld voor eventuele onnauwkeurigheden.  
Deze catalogus bevat producten van "standaarduitrusting" kwaliteit. Wij behouden ons het recht voor om op ieder gewenst ogenblik technische wijzigingen aan te brengen. De in deze catalogus genoemde oorspronkelijke nummers en namen van de fabrikanten dienen uitsluitend ter identificatie van de component en kunnen niet worden gebruikt op de geleidebrieven en facturen. De, ook gedeeltelijke, reproductie van ons referentiemateriaal en de catalogus is verboden.

# Certificate of Registration



The Governing Board of  
Q.A. International Certification Limited  
hereby grants to:

**JAPANPARTS S.r.l.**

Registration No. : QAIC / IT / 90039 - A

*(hereinafter called the Registered Company) the right to be listed in the Directory of Registered Companies in respect of the services listed below. These services shall be offered by the Registered Company at or from only the address given below in accordance with the quality management system in compliance with ISO 9001:2008.*

Address to which this Certificate refers :

**Via Della Meccanica, 1/A - 37139 VERONA - Italy**

Approved Scope to which this Certificate refers  
(Scopo della Certificazione cui il Certificato riferisce)

**Commercialisation of Automotive Parts and Accessories  
(Commercializzazione di Ricambi per Autoveicoli)**

(Further clarification regarding the Scope of this Certificate and the applicability of ISO 9001:2008 requirements may be obtained by consulting the organisation)

Signed for and on behalf of the Board

CHAIRMAN  
A. J. Duffield

SCHEME MANAGER  
A. Carter

Certificate Issue Date : 5th March 2013 - Certificate Expiry Date : 24th January 2014  
Date of Initial Registration : 25th January 2000 - Re-assessment Date : 24th January 2015  
This Certificate of Registration is granted subject to the Regulations approved by the Board.

**QA INTERNATIONAL**

Q.A. International Certification Ltd.  
Dudley Court  
Dudley Road  
Darlington  
Co. Durham  
DL1 4GG

Tel: +44 (0)1325 384272  
Fax: +44 (0)1325 480980  
www.qai.co.uk



The use of the Accredited Mark reflects  
commitment in respect of these services covered  
by the corresponding certificate number 90039.