

# AVANTECH

Запчасти, которым доверяют.

каталог 2014/2015



щетки стеклоочистителей



## Предисловие

### Уважаемые партнёры!

Мы благодарим Вас за выбор продукции под брендом AVANTECH. Ассортимент товаров постоянно расширяется, следить за новинками Вы можете на нашем сайте [www.avantechparts.ru](http://www.avantechparts.ru).

Данный каталог предназначен для подбора автомобильных щеток стеклоочистителей и носит рекомендательный характер. Указанная в каталоге информация получена на основе последних данных, актуальных на дату печати каталога.

Мы предприняли все усилия, чтобы содержащаяся в каталоге информация была максимально корректной. Однако не несем ответственности за возможные неточности. Наиболее достоверную информацию по подбору запасных частей на автомобиль можно получить, используя оригинальные каталоги автопроизводителей.

## СОДЕРЖАНИЕ

Общая информация.....	4	DODGE.....	72
<b>Каталог применяемости щеток стеклоочистителей для праворульных авто.....</b>	<b>14</b>	FIAT.....	73
DAIHATSU.....	14	FORD.....	75
HINO.....	16	GEELY.....	77
HONDA.....	17	GREAT WALL.....	77
ISUZU.....	21	HONDA.....	77
MAZDA.....	22	HYUNDAI.....	79
MITSUBISHI.....	26	INFINITI.....	81
NISSAN.....	31	ISUZU.....	82
NISSAN DIESEL.....	37	JAGUAR.....	82
SUBARU.....	38	JEEP.....	82
SUZUKI.....	40	KIA.....	83
TOYOTA.....	42	LADA.....	85
LEXUS.....	52	LANCIA.....	85
<b>Каталог щеток стеклоочистителей для заднего стекла.....</b>	<b>53</b>	LAND ROVER.....	86
DAIHATSU.....	53	LEXUS.....	86
HONDA.....	53	LIFAN.....	87
MAZDA.....	54	MAZDA.....	87
MITSUBISHI.....	55	MERCEDES.....	89
NISSAN.....	55	MG.....	92
SUBARU.....	56	MINI.....	92
SUZUKI.....	56	MITSUBISHI.....	92
TOYOTA.....	57	NISSAN.....	94
<b>Каталог применяемости щеток стеклоочистителей для леворульных авто.....</b>	<b>59</b>	OPEL.....	96
ACURA.....	59	PEUGEOT.....	98
ALFA ROMEO.....	59	PORSCHE.....	100
ASTON MARTIN.....	60	RENAULT.....	101
AUDI.....	60	ROVER.....	103
BMW.....	63	SAAB.....	104
BYD.....	66	SEAT.....	105
CADILLAC.....	66	SKODA.....	106
CHERY.....	66	SMART.....	106
CHEVROLET.....	67	SSANGYONG.....	107
CHRYSLER.....	68	SUBARU.....	107
CITROEN.....	69	SUZUKI.....	108
DAEWOO.....	71	TOYOTA.....	110
DAIHATSU.....	71	VOLKSWAGEN.....	113
		VOLVO.....	116
		Инструкции по установке щеток на авто.....	118
		Расшифровка значений артикулов.....	126



# AVANTECH

## SMART NEO

### БЕСКАРКАСНЫЕ ЩЕТКИ НОВОГО ПОКОЛЕНИЯ

Бескаркасные щетки нового поколения Smart Neo. Щетки имеют широкую применимость креплений на 95% автомобилей производства Японии, Кореи, США, Европы и России. Современные технологии производства обеспечивают равномерное нажатие щетки в независимости от кривизны стекла, а использование синтетической резины и графитового покрытия обеспечивает бесшумную работу и идеальное удаление влаги. Высокие аэродинамические характеристики обеспечивают спойлер и монолитность конструкции щетки, уменьшая воздействия ветра при движении на высоких скоростях.

Щетки Smart Neo обладают универсальностью использования, за счет симметричного спойлера их можно устанавливать на автомобили с левым и правым расположением руля, без необходимости менять спойлеры местами.

Возможность всесезонного использования. В регионах с обильными осадками в зимний период рекомендуем использовать зимние щетки серии AVANTECH Snowguard.

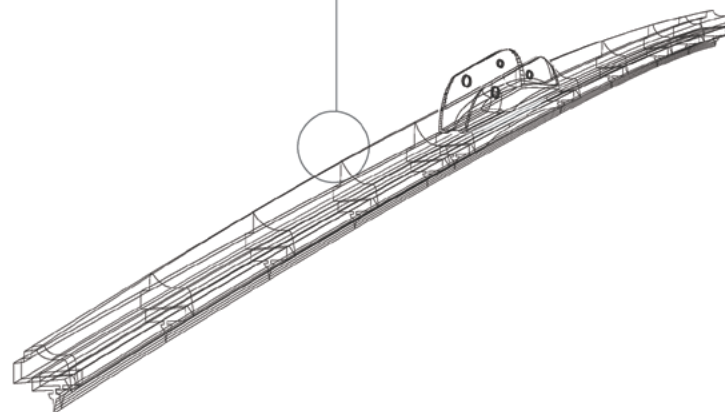

# AVANTECH HYBRID

### ГИБРИДНЫЕ ЩЁТКИ

Щетки премиум-класса AVANTECH Hybrid, сочетание современного дизайна и технологий производства. В данной серии удачно сочетаются все достоинства каркасных щеток и их бескаркасных аналогов:

- Модный современный дизайн, позволяет не только гармонично дополнять внешний облик автомобиля, но и выгодно подчеркивает его солидность.
- Надежная аэродинамическая конструкция, плотно прижимающая щетку к стеклу.
- Эффективное удаление влаги и бесшумная работа. Высокое качество очистки, бесшумная работа.
- Длительность эксплуатации. Резиновая лента изготавливается по специальной технологии, что гарантирует устойчивость к возможным неблагоприятным воздействиям окружающей среды. Лезвие ленты обработано покрытием (графитовая основа), обеспечивающим первоначальные свойства на протяжении всего срока службы.

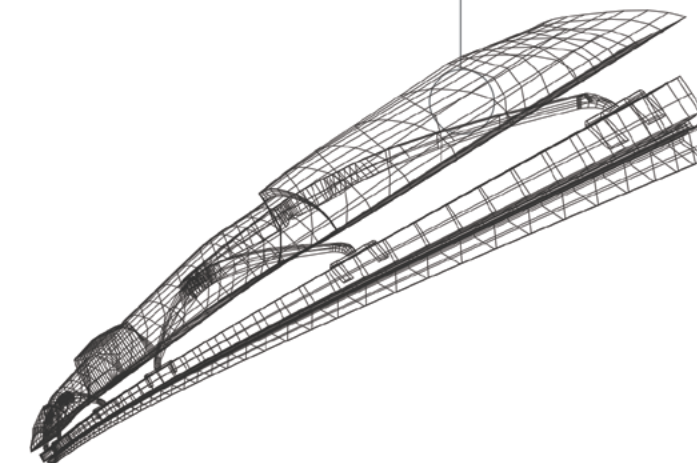

# AVANTECH

## SPOILER

### ЛЕТНИЕ ЩЁТКИ СО СПОЙЛЕРОМ



Серия щеток AVANTECH Spoiler сохраняет традиционную надежность классических щеток Aerodynamic, но в отличие от последних имеют новый конструктивный элемент – спойлер.

На скорости свыше 80 км/ч встречный поток воздуха приподнимает щетки стеклоочистителей, благодаря аэродинамической конструкции каркаса и наличию спойлера, щетки AVANTECH Spoiler обеспечивают надежный прижим к стеклу на высоких скоростях.

Продолжительный срок эксплуатации и бесшумная работа щетки за счет нанесения графитового покрытия на резинку щетки.

Конструкция щеток AVANTECH Spoiler идентична конструкции данного типа щеток, устанавливаемых на многих автомобилестроительных заводах.

AVANTECH Spoiler могут использоваться на автомобилях как с левым, так и с правым расположением руля. Для этого достаточно снять коннектор и поставить его противоположной стороной.

Примечание: установка щетки должна производиться спойлером вниз (по отношению к капоту).

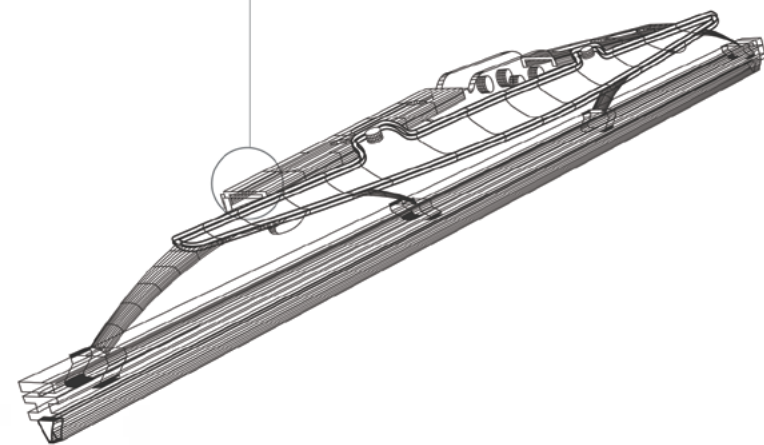

# AVANTECH

## AERODYNAMIC

### ЛЕТНИЕ ЩЁТКИ



Щетки серии AVANTECH Aerodynamic. Щетки доступные каждому автоводителю, обладающие всеми необходимыми для этого продукта потребительскими качествами. Корпус щетки полностью металлический с антикоррозийным покрытием. Хорошая подвижность элементов каркаса за счет металлических клепок, вкручивающихся в соединяемые части, конструкция щетки не позволяет резинке вылезать из корпуса при эксплуатации. Работают в широком диапазоне скоростей движения автомобиля. В производстве использованы высококачественные резинки из натурального каучука с графитовым покрытием, обеспечивают плотный контакт щеток со стеклом.

Подходят для большинства зарубежных и отечественных автомобилей, диапазон размеров от 300 до 700 мм.

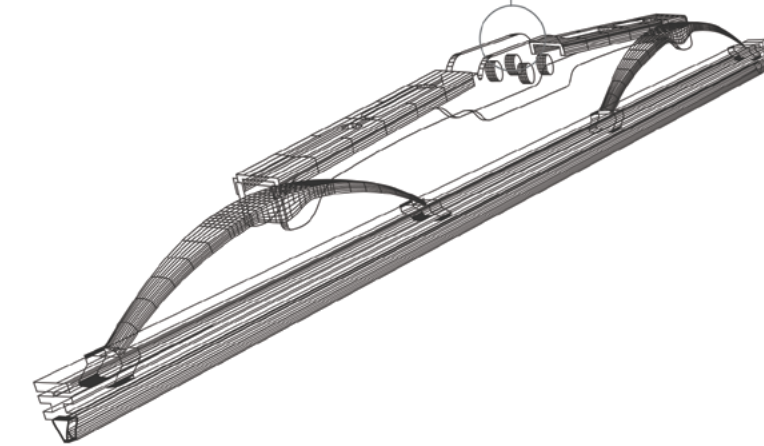



# AVANTECH

## SNOWGUARD

### ЗИМНЯЯ ЩЕТКА



Замена щеток на зимние является неотъемлемым элементом подготовки автомобиля к зиме. Обычные летние щетки не могут эффективно работать в холодное время года. Снег и лёд постоянно налипают на каркас и резинку, щетка теряет свою эластичность и перестаёт очищать стекло. Поэтому рекомендуем использовать в зимний период AVANTECH Snowguard.

Все подвижные элементы щетки скрыты под надежным и полностью герметичным резиновым чехлом.

Резинки обладают особой эластичностью для работы в холодное время года.

В зимнюю непогоду щетки плотно прилегают к стеклу, не обмерзают и исключают появление разводов.

Конструкция и технология производства разработана в Японии.

Выпускаются в широком диапазоне размеров – от 280 до 700 мм.

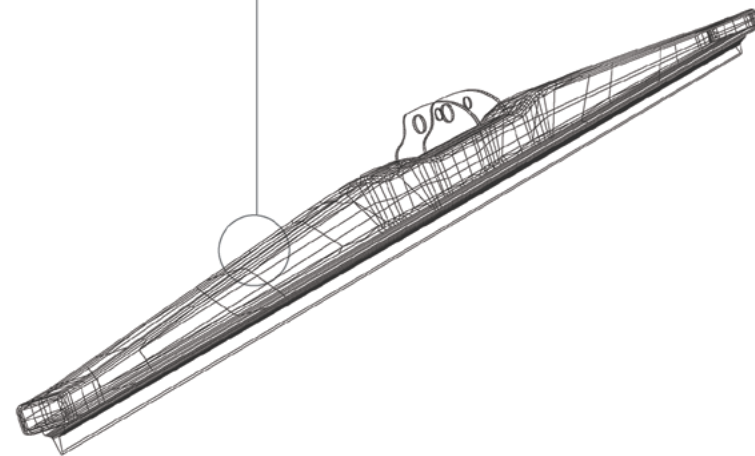

# AVANTECH

## SNOWGUARD POLAR

### ЗИМНЯЯ ЩЕТКА ДЛЯ ЕВРОПЕЙСКИХ АВТОМОБИЛЕЙ



6 коннекторов в комплекте, с помощью которых можно устанавливать щетку на значительную часть европейских автомобилей.

Все подвижные элементы щетки скрыты под надежным и полностью герметичным резиновым чехлом.

Графитовое покрытие резинки обеспечивает бесшумную работу щетки в течение продолжительного периода времени.

Резинки обладают особой эластичностью для работы в холодное время года.

В зимнюю непогоду щетки плотно прилегают к стеклу, не обмерзают и исключают появление разводов.

Конструкция и технология производства разработана в Японии.

Выпускаются в широком диапазоне размеров – от 350 – 700 мм. Маркировка SE.

Рычаги с коннекторами устанавливаются на следующие марки автомобилей: ALFA ROMEO, AUDI, BMW, CITROEN, FIAT, FORD, MERCEDES-BENZ, PEUGEOT, OPEL, VOLKSWAGEN, SKODA, RENAULT, VOLVO.

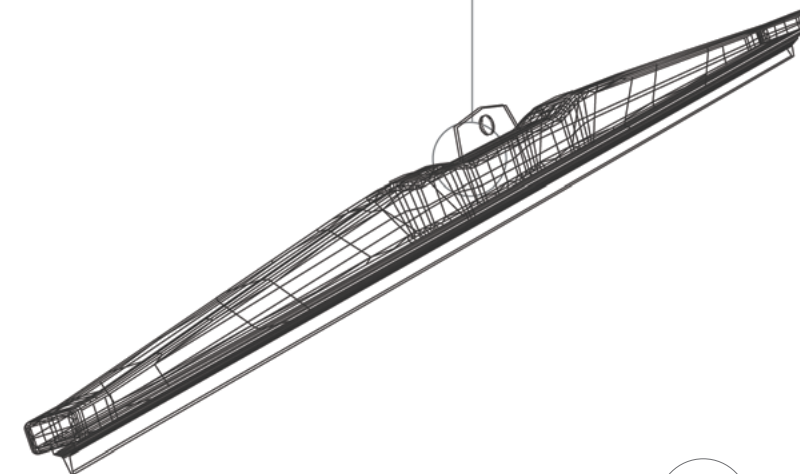



# AVANTECH

## SNOWGUARD REAR

### ЗИМНЯЯ ЩЕТКА ДЛЯ ЗАДНЕГО СТЕКЛА



Все подвижные части щетки покрыты непроницаемым для снега, льда и воды чехлом из прочной и эластичной резины.

В результате в любую зимнюю погоду щетка не обмерзает и плотно прилегает к стеклу.

Резинка выполнена из специальной мягкой резины, которая не дубеет на морозе и прекрасно очищает стекло.

Графитовое покрытие резинки обеспечивает бесшумную работу щетки в течение продолжительного периода времени.

Щетка комплектуется двумя коннекторами, что гарантирует 100% установку на Ваш авто, за место штатной пластиковой щетки.

Кронштейн под установку коннектора тип А



Кронштейн под установку коннектора тип В



# AVANTECH REAR

### ПЛАСТИКОВАЯ ЩЕТКА ЗАДНЕГО СТЕКЛА



Конструкция щетки стеклоочистителя AVANTECH REAR аналогична оригинальной.

Графитовое покрытие резинки обеспечивает бесшумную работу щетки в течение продолжительного периода времени.

Конструкция щетки в виде прочного пластикового каркаса обеспечивает надежное прилегание щетки к стеклу, за счет чего достигается идеальное удаление влаги со стекла автомобиля.

На упаковке щеток стеклоочистителей AVANTECH REAR представлен перечень автомобилей, куда может устанавливаться данная щетка, а также подробная инструкция по снятию и установке щетки.

Типы крепления щёток:

Серия AR



Серия AR2

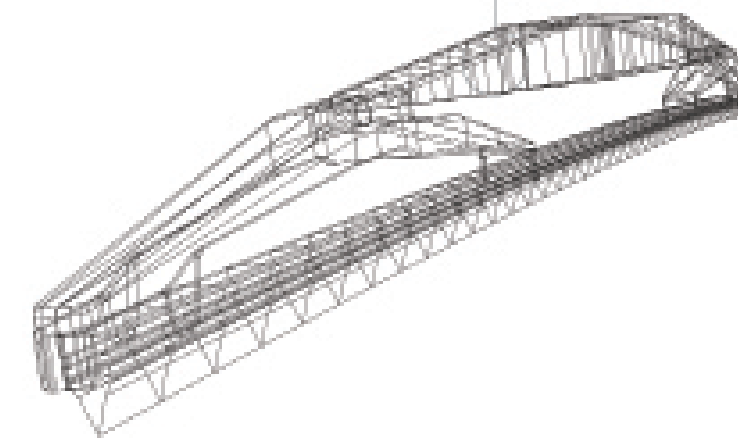



## ПРИМЕНЯЕМОСТЬ ЛИНЕЕК ЩЕТОК AVANTECH К РЫЧАГАМ РАЗНЫХ ТИПОВ

Название рычага	Название рычага	AERODYNAMIC	SPOILER	SMART	SMART NEO	HYBRID	SNOWGUARD	SNOWGUARD POLAR	Номер коннектора SNOWGUARD POLAR под рычаг
1	Крючок U-Hook	✓	✓	✓	✓	✓	✓	✗	✗
2	Кнопка Top Lock	✗	✗	✗	✓	✗	✗	✓	<b>E, G</b> E под ширину рычага 19 мм G под ширину рычага 16 мм
3	Штырь P&H	✗	✗	✗	✓	✓	✗	✓	<b>F</b>
4	Ласточкин хвост M-Lock	✗	✗	✗	✓	✗	✗	✓	<b>A</b>

Название рычага	Название рычага	AERODYNAMIC	SPOILER	SMART	SMART NEO	HYBRID	SNOWGUARD	SNOWGUARD POLAR	Номер коннектора SNOWGUARD POLAR под рычаг
5	Клешня Claw	✗	✗	✗	✗	✗	✗	✓	<b>D</b>
6	Штыковой замок Bayonet	✓	✓	✗	✓	✗	✓	✗	✗
7	Пинч Тэб Баттон Pinch Tab Button	✗	✗	✗	✗	✗	✗	✓	<b>B</b>
8	Пин Лок Pin Lock	✗	✗	✗	✗	✗	✗	✗	✗



КАТАЛОГ ПРИМЕНЯЕМОСТИ ЩЕТОК СТЕКЛОЧИСТИТЕЛЕЙ ДЛЯ ПРАВУЛЬНЫХ АВТО

DAIHATSU

HINO

HONDA

ISUZU

MAZDA

MINI

NISSAN

NISSAN DIESEL

SUBARU

SUZUKI

TOYOTA

LEXUS

Марка	Модель	Кузов	Расположение руля	Период выпуска	Место водителя					Место пассажира					Заднее стекло					
					Aerodynamic	Snowguard	Smart neo	Spoiler	Hybrid	Aerodynamic	Snowguard	Smart neo	Spoiler	Hybrid	Aerodynamic	Snowguard	Smart neo	Spoiler	Hybrid	
DAIHATSU																				
DAIHATSU	Altis	SXV2	Правый	мар 00	сен 01	A21	S21	SN21	SP21	H21	A19	S19	SN19	SP19	H19	A18	S18	SN18	SP18	H18
DAIHATSU	Altis	ACV3	Правый	сен 01	дек 05	A24	S24	SN24	SP24	H24	A19	S19	SN19	SP19	H19					
DAIHATSU	Altis	ACV40N, ACV45N	Правый	янв 06		A24	S24	SN24	SP24	H24	A20	S20	SN20	SP20	H20					
DAIHATSU	Applause	A101,111	Правый	июл 89	мар 98	A19	S19	SN19	SP19	H19	A17	S17	SN17			A18	S18	SN18	SP18	H18
DAIHATSU	Applause	A101,111	Правый	апр 98	май 00	A19	S19	SN19	SP19	H19	A17	S17	SN17			A18	S18	SN18	SP18	H18
DAIHATSU	Atrai	S8	Правый	сен 88	дек 93	A16	S16	SN16	SP16	H16	A15	S15	SN15			A13	S13			
DAIHATSU	Atrai	S120, S130	Правый	янв 94	дек 98	A16	S16	SN16	SP16	H16	A16	S16	SN16	SP16	H16	A13	S13			
DAIHATSU	Atrai	S220, S230	Правый	янв 99	апр 05	A19	S19	SN19	SP19	H19	A15	S15	SN15			A15	S15	SN15		
DAIHATSU	Atrai	S320G, S330G	Правый	май 05		A20	S20	SN20	SP20	H20	A14	S14	SN14							
DAIHATSU	Atrai 7	S221, S231	Правый	июл 00	дек 04	A19	S19	SN19	SP19	H19	A15	S15	SN15			A15	S15	SN15		
DAIHATSU	Be-Go	J200G, J210G	Правый	янв 06		A21	S21	SN21	SP21	H21	A18	S18	SN18	SP18	H18					
DAIHATSU	Boon	M300,M301S,M310S	Правый	июн 04	фев 10	A20	S20	SN20	SP20	H20	A16	S16	SN16	SP16	H16					
DAIHATSU	Boon	M60 S/M61 S	Правый	фев 10		A21	S21	SN21	SP21	H21	A17	S17	SN17							
DAIHATSU	Boon Luminas	M50, M51	Правый	дек 08		A24	S24	SN24	SP24	H24	A17	S17	SN17							
DAIHATSU	Charade	G10	Правый	янв 87	дек 92	A18	S18	SN18	SP18	H18	A17	S17	SN17			A13	S13			
DAIHATSU	Charade	G20	Правый	янв 93	май 00	A18	S18	SN18	SP18	H18	A18	S18	SN18	SP18	H18	A15	S15	SN15		
DAIHATSU	Coo	M401S, M402S, M411S	Правый	май 06		A20	S20	SN20	SP20	H20	A19	S19	SN19	SP19	H19					
DAIHATSU	Copen	L880K	Правый	июн 02		A18	S18	SN18	SP18	H18	A16	S16	SN16	SP16	H16					
DAIHATSU	Delta	V5,78,98,118	Правый	сен 84	апр 95	A17	S17	SN17			A17	S17	SN17							
DAIHATSU	Delta	V75,76,79,99,115,116,119	Правый	сен 84	апр 95	A18	S18	SN18	SP18	H18	A18	S18	SN18	SP18	H18					
DAIHATSU	Delta	BU10,BU212	Правый	май 95	окт 96	A17	S17	SN17			A17	S17	SN17			A16	S16	SN16	SP16	H16
DAIHATSU	Delta	KR, SR, CR	Правый	окт 96	дек 97	A21	S21	SN21	SP21	H21	A17	S17	SN17			A16	S16	SN16	SP16	H16
DAIHATSU	Delta	SR, BU, XZU	Правый	янв 98	окт 01	A21	S21	SN21	SP21	H21	A17	S17	SN17			A16	S16	SN16	SP16	H16
DAIHATSU	Delta Wide	YB, KB, CB	Правый	ноя 82	дек 91	A18	S18	SN18	SP18	H18	A18	S18	SN18	SP18	H18					
DAIHATSU	Delta Wide	YB, KB, CB	Правый	янв 92	окт 96	A18	S18	SN18	SP18	H18	A18	S18	SN18	SP18	H18	A16	S16	SN16	SP16	H16
DAIHATSU	Esse	L235S, L245S	Правый	дек 05		A18	S18	SN18	SP18	H18	A18	S18	SN18	SP18	H18					
DAIHATSU	HIJET	S8	Правый	сен 88	дек 93	A16	S16	SN16	SP16	H16	A15	S15	SN15			A13	S13			
DAIHATSU	HIJET	S100, S110	Правый	янв 94	дек 98	A16	S16	SN16	SP16	H16	A16	S16	SN16	SP16	H16	A13	S13			
DAIHATSU	HIJET Truck	S200P, S210P	Правый	янв 99		A16	S16	SN16	SP16	H16	A16	S16	SN16	SP16	H16					
DAIHATSU	HIJET	S200V, S210V	Правый	янв 99	дек 04	A19	S19	SN19	SP19	H19	A15	S15	SN15			A15	S15	SN15		

Марка	Модель	Кузов	Расположение руля	Период выпуска	Место водителя					Место пассажира					Заднее стекло					
					Aerodynamic	Snowguard	Smart neo	Spoiler	Hybrid	Aerodynamic	Snowguard	Smart neo	Spoiler	Hybrid	Aerodynamic	Snowguard	Smart neo	Spoiler	Hybrid	
DAIHATSU																				
DAIHATSU	HIJET	S320V, S330V	Правый	дек 04		A20	S20	SN20	SP20	H20	A14	S14	SN14							
DAIHATSU	Leeza	L100, L111	Правый	ноя 86	янв 92	A18	S18	SN18	SP18	H18	A16	S16	SN16	SP16	H16	A13	S13			
DAIHATSU	MAX	L95,L96 S	Правый	ноя 01	дек 05	A21	S21	SN21	SP21	H21	A14	S14	SN14							
DAIHATSU	Midget II	K100P	Правый	мар 96	авг 99	A16	S16	SN16	SP16	H16						A12	S11			
DAIHATSU	Midget II	K100#	Правый	сен 99	июл 01	A19	S19	SN19	SP19	H19						A12	S11			
DAIHATSU	Mira	LA300S, LA310S	Правый	сен 11		A20	S20	SN20	SP20	H20	A14	S14	SN14							
DAIHATSU	Mira	L2##	Правый	мар 90	авг 94	A18	S18	SN18	SP18	H18	A16	S16	SN16	SP16	H16	A12	S11			
DAIHATSU	Mira	L5##	Правый	авг 94	авг 98	A18	S18	SN18	SP18	H18	A16	S16	SN16	SP16	H16	A12	S11			
DAIHATSU	Mira	L7##	Правый	ноя 98	ноя 02	A18	S18	SN18	SP18	H18	A15	S15	SN15			A12	S11			
DAIHATSU	Mira	L250, L260	Правый	дек 02	ноя 06	A21	S21	SN21	SP21	H21	A12	S11								
DAIHATSU	Mira	L275S, L285S	Правый	дек 06		A22	S22	SN22	SP22	H22	A12	S11								
DAIHATSU	Mira Jino	L700S, L710S	Правый	мар 99	окт 04	A18	S18	SN18	SP18	H18	A14	S14	SN14							
DAIHATSU	Mira Jino	L650S, L660S	Правый	ноя 04		A20	S20	SN20	SP20	H20	A16	S16	SN16	SP16	H16					
DAIHATSU	Move	L600, L602, L610	Правый	авг 95	сен 98	A17	S17	SN17			A15	S15	SN15			A12	S11			
DAIHATSU	Move	L90#, L91#	Правый	окт 98	окт 99	A19	S19	SN19	SP19	H19	A17	S17	SN17			A12	S11			
DAIHATSU	Move	L90#, L91#	Правый	ноя 99	сен 02	A19	S19	SN19	SP19	H19	A17	S17	SN17							
DAIHATSU	Move	L150S, L160S	Правый	окт 02	сен 06	A20	S20	SN20	SP20	H20	A16	S16	SN16	SP16	H16					
DAIHATSU	Move	L175S, L185S	Правый	окт 06		A22	S22	SN22	SP22	H22	A16	S16	SN16	SP16	H16					
DAIHATSU	Move Conte	L57, L58	Правый	авг 08		A18	S18	SN18	SP18	H18	A18	S18	SN18	SP18	H18					
DAIHATSU	Move Latte	L550S, L560S	Правый	авг 04		A19	S19	SN19	SP19	H19	A17	S17	SN17							
DAIHATSU	Naked	L750,760	Правый	ноя 99	дек 04	A18	S18	SN18	SP18	H18	A17	S17	SN17			A12	S11			
DAIHATSU	Opti	L3##	Правый	фев 92	окт 98	A18	S18	SN18	SP18	H18	A14	S14	SN14			A13	S13			
DAIHATSU	Opti	L8##	Правый	ноя 98	авг 02	A18	S18	SN18	SP18	H18	A15	S15	SN15							
DAIHATSU	Sonica	L4	Правый	июн 06		A24	S24	SN24	SP24	H24	A14	S14	SN14							
DAIHATSU	Tanto	L35,36	Правый	ноя 03	дек 07	A20	S20	SN20	SP20	H20	A17	S17	SN17							
DAIHATSU	Tanto	L37, L38	Правый	дек 07		A20	S20	SN20	SP20	H20	A17	S17	SN17							
DAIHATSU	Terios	J100G	Правый	мар 97	апр 00	A20	S20	SN20	SP20	H20	A14	S14	SN14			A12	S11			
DAIHATSU	Terios	J102G, J122G	Правый	май 00	дек 05	A22	S22	SN22	SP22	H22	A12	S11				A12	S11			
DAIHATSU	Terios Kid	J111G, J131G	Правый	окт 98	окт 00	A20	S20	SN20	SP20	H20	A14	S14	SN14			A12	S11			
DAIHATSU	Terios Kid	J111G, J131G	Правый	ноя 00		A22	S22	SN22	SP22	H22	A12	S11				A12	S11			

DAIHATSU

HINO

HONDA

ISUZU

MAZDA

MINI

NISSAN

NISSAN DIESEL

SUBARU

SUZUKI

TOYOTA

LEXUS



DAIHATSU

HINO

HONDA

ISUZU

MAZDA

MITSUBISHI

NISSAN

NISSAN DIESEL

SUBARU

SUZUKI

TOYOTA

LEXUS

Марка	Модель	Кузов	Расположение руля	Период выпуска	Место водителя					Место пассажира					Заднее стекло				
					Aerodynamic	Snowguard	Smart neo	Spoiler	Hybrid	Aerodynamic	Snowguard	Smart neo	Spoiler	Hybrid	Aerodynamic	Snowguard	Smart neo	Spoiler	Hybrid
DAIHATSU																			
DAIHATSU	YRV	M200G, M201G, M211G	Правый	авг 00	июл 05	A21	S21	SN21	SP21	H21	A14	S14	SN14						
DAIHATSU	Tanto	L350,360S	Правый	ноя 03		A20	S20	SN20	SP20	H20	A17	S17	SN17						
DAIHATSU	Terios	J100G	Правый	мар 97	апр 00	A20	S20	SN20	SP20	H20	A14	S14	SN14			A12	S11		
DAIHATSU	Terios	J102G, J122G	Правый	май 00	дек 05	A22	S22	SN22	SP22	H22	A12	S11				A12	S11		
DAIHATSU	Terios Kid	J111G, J131G	Правый	окт 98	окт 00	A20	S20	SN20	SP20	H20	A14	S14	SN14			A12	S11		
DAIHATSU	Terios Kid	J111G, J131G	Правый	ноя 00		A22	S22	SN22	SP22	H22	A12	S11				A12	S11		
DAIHATSU	YRV	M200G, M201G, M211G	Правый	авг 00	июл 05	A21	S21	SN21	SP21	H21	A14	S14	SN14						

HINO																				
Марка	Модель	Кузов	Расположение руля	Период выпуска	Период выпуска	Aerodynamic	Snowguard	Smart neo	Spoiler	Hybrid	Aerodynamic	Snowguard	Smart neo	Spoiler	Hybrid	Aerodynamic	Snowguard	Smart neo	Spoiler	Hybrid
HINO	Dutro	BU3,XZU3	Правый	май 99	июн 11	A20	S20	SN20	SP20	H20	A20	S20	SN20	SP20	H20					
HINO	Dutro	KCKU/ZC/ZU/TRC/TRU/BZU	Правый	июн 11		A20	S20	SN20	SP20	H20										
HINO	Dutro	KU/ZC/ZU7	Правый	июн 11		A20	S20	SN20	SP20	H20										
HINO	Ranger	U-FB, FC, FD, FF, FG, FT, GD, GK, SD, W-SD	Правый	авг 89		A26	S26	SN26	SP26	H26	A26	S26	SN26	SP26	H26					
HINO	Ranger	KC	Правый			A20	S20	SN20	SP20	H20	A20	S20	SN20	SP20	H20					
HINO	Ranger	KC-FH, FN, FP, FQ, FR, FS, FW, SH, SS	Правый	апр 95		A22	S22	SN22	SP22	H22	A22	S22	SN22	SP22	H22	A22	S22	SN22	SP22	H22
HINO	Ranger	U-FH, FN, FP, FR, FS, FW, GN, W-SH, SS	Правый	окт 89		A22	S22	SN22	SP22	H22	A22	S22	SN22	SP22	H22	A22	S22	SN22	SP22	H22
HINO	Ranger	KC-FN, FQ, FR, FS, FW, GN	Правый	июн 98		A22	S22	SN22	SP22	H22	A22	S22	SN22	SP22	H22	A22	S22	SN22	SP22	H22
HINO	Ranger	KK-FC, FD, FE, FG, FT, FX, GD, GK, GX	Правый	мар 99		A26	S26	SN26	SP26	H26	A26	S26	SN26	SP26	H26					
HINO	Ranger	KC-FB, FC, FD, FE, FF, FG, FT, FX, GD, GK	Правый	окт 94		A26	S26	SN26	SP26	H26	A26	S26	SN26	SP26	H26					
HINO	Ranger	RX4JFAT	Правый	авг 95		A26	S26	SN26	SP26	H26	A26	S26	SN26	SP26	H26					
HINO	Ranger	RX4JFET	Правый	июн 99		A26	S26	SN26	SP26	H26	A26	S26	SN26	SP26	H26					
HINO	Ranger	KP	Правый	фев 79		A20	S20	SN20	SP20	H20	A20	S20	SN20	SP20	H20					
HINO	Ranger	4D,4E,4L,4S,4W,5,7D,7E,KG	Правый			A20	S20	SN20	SP20	H20	A20	S20	SN20	SP20	H20					
HINO	Ranger	HV78,78D,98,98D,118,118D	Правый	сен 84	апр 95	A17	S17	SN17			A17	S17	SN17							
HINO	Ranger	HV75,76,79,99,115,116,119	Правый	сен 84	апр 95	A18	S18	SN18	SP18	H18	A18	S18	SN18	SP18	H18					

Марка	Модель	Кузов	Расположение руля	Период выпуска	Период выпуска	Место водителя					Место пассажира					Заднее стекло				
						Aerodynamic	Snowguard	Smart neo	Spoiler	Hybrid	Aerodynamic	Snowguard	Smart neo	Spoiler	Hybrid	Aerodynamic	Snowguard	Smart neo	Spoiler	Hybrid
HINO																				
HINO	Ranger	BU1,2,XZU130X	Правый	май 95	окт 96	A17	S17	SN17			A17	S17	SN17			A16	S16	SN16	SP16	H16
HINO	Ranger	BU1,2,XZU130X	Правый	окт 96		A17	S17	SN17			A17	S17	SN17			A16	S16	SN16	SP16	H16

HONDA																				
Марка	Модель	Кузов	Расположение руля	Период выпуска	Период выпуска	Aerodynamic	Snowguard	Smart neo	Spoiler	Hybrid	Aerodynamic	Snowguard	Smart neo	Spoiler	Hybrid	Aerodynamic	Snowguard	Smart neo	Spoiler	Hybrid
HONDA	Accord	CB1, CB2, CB3, CB4	Правый	сен 89	авг 93	A24	S24	SN24	SP24	H24	A19	S19	SN19	SP19	H19					
HONDA	Accord	CD3, CD4, CD5, CD6	Правый	сен 93	авг 97	A24	S24	SN24	SP24	H24	A20	S20	SN20	SP20	H20	A16	S16	SN16	SP16	H16
HONDA	Accord	CF3, CF4, CF5	Правый	сен 97	сен 02	A21	S21	SN21	SP21	H21	A18	S18	SN18	SP18	H18	A15	S15	SN15		
HONDA	Accord	CL7, CL8, CL9	Правый	окт 02	дек 08	A26	S26	SN26	SP26	H26	A15	S15	SN15							
HONDA	Accord	CU2	Правый	дек 08		A24	S24	SN24	SP24	H24	A22	S22	SN22	SP22	H22					
HONDA	Accord Coupe	GB6, GB7	Правый	апр 89	янв 94	A24	S24	SN24	SP24	H24	A19	S19	SN19	SP19	H19					
HONDA	Accord Coupe	CD7, CD8	Правый	янв 94	янв 99	A24	S24	SN24	SP24	H24	A20	S20	SN20	SP20	H20					
HONDA	Accord Wagon	CB9	Правый	апр 91	янв 94	A24	S24	SN24	SP24	H24	A19	S19	SN19	SP19	H19					
HONDA	Accord Wagon	CE1	Правый	фев 94	авг 97	A24	S24	SN24	SP24	H24	A20	S20	SN20	SP20	H20	A15	S15	SN15		
HONDA	Accord Wagon	CF6, CF7, CH9	Правый	сен 97	окт 02	A21	S21	SN21	SP21	H21	A18	S18	SN18	SP18	H18	A17	S17	SN17		
HONDA	Accord Wagon	CM2, CM3	Правый	окт 02	окт 05	A26	S26	SN26	SP26	H26	A15	S15	SN15							
HONDA	Accord Wagon	CM1, CM2, CM3	Правый	ноя 05	дек 08	A26	S26	SN26	SP26	H26	A14	S14	SN14							
HONDA	Accord Wagon	CW2	Правый	дек 08		A24	S24	SN24	SP24	H24	A22	S22	SN22	SP22	H22					
HONDA	Acty	HA1, HA2, HA3, HA4, HA5, HH1, HH2, HH3, HH4	Правый	май 88	апр 99	A16	S16	SN16	SP16	H16	A15	S15	SN15			A14	S14	SN14		
HONDA	Acty	HA6, HA7, HH5, HH6	Правый	июн 99		A17	S17	SN17			A15	S15	SN15			A12	S11			
HONDA	Airwave	GJ1, GJ2	Правый	апр 05	апр 08	A24	S24	SN24	SP24	H24	A14	S14	SN14							
HONDA	Ascot	CB1, CB2, CB3, CB4	Правый	сен 89	сен 93	A24	S24	SN24	SP24	H24	A19	S19	SN19	SP19	H19					
HONDA	Ascot	CE4, CE5	Правый	окт 93	мар 98	A22	S22	SN22	SP22	H22	A19	S19	SN19	SP19	H19					
HONDA	Ascot Innova	CB3, CB4, CC4	Правый	мар 92	дек 96	A24	S24	SN24	SP24	H24	A19	S19	SN19	SP19	H19					
HONDA	Avancier	TA1,2,3	Правый	сен 99	дек 03	A24	S24	SN24	SP24	H24	A18	S18	SN18	SP18	H18					
HONDA	Beat	PP1	Правый	мар 91	дек 96	A17	S17	SN17			A17	S17	SN17							
HONDA	Capa	GA4, GA6	Правый	апр 98	янв 02	A19	S19	SN19	SP19	H19	A17	S17	SN17			A12	S11			
HONDA	City	GA1, GA2	Правый	ноя 86	мар 94	A20	S20	SN20	SP20	H20	A18	S18	SN18	SP18	H18	A13	S13			
HONDA	Civic	EF	Правый	сен 87	сен 91	A20	S20	SN20	SP20	H20	A19	S19	SN19	SP19	H19	A16	S16	SN16	SP16	H16

DAIHATSU

HINO

HONDA

ISUZU

MAZDA

MITSUBISHI

NISSAN

NISSAN DIESEL

SUBARU

SUZUKI

TOYOTA

LEXUS

DAIHATSU

HINO

HONDA

ISUZU

MAZDA

MITSUBISHI

NISSAN

NISSAN DIESEL

SUBARU

SUZUKI

TOYOTA

LEXUS

Марка	Модель	Кузов	Расположение руля	Период выпуска	Место водителя					Место пассажира					Заднее стекло					
					Aerodynamic	Snowguard	Smart neo	Spoiler	Hybrid	Aerodynamic	Snowguard	Smart neo	Spoiler	Hybrid	Aerodynamic	Snowguard	Smart neo	Spoiler	Hybrid	
HONDA																				
HONDA	Civic	EG3, EG4, EG5, EG6, EG7, EG8, EG9, EH1, EJ3	Правый	сен 91	авг 95	A22	S22	SN22	SP22	H22	A18	S18	SN18	SP18	H18					
HONDA	Civic	EK2, EK3, EK4, EK9, EK2, EK3, EK4, EK5, EK8	Правый	сен 95	авг 00	A20	S20	SN20	SP20	H20	A18	S18	SN18	SP18	H18	A15	S15	SN15		
HONDA	Civic	EU1, EU2, EU3, EU4	Правый	сен 00	авг 05	A24	S24	SN24	SP24	H24	A15	S15	SN15							
HONDA	Civic	ES1, ES2, ES3, ES9	Правый	сен 00	сен 05	A21	S21	SN21	SP21	H21	A19	S19	SN19	SP19	H19					
HONDA	Civic Ferio	ES1,2,3	Правый	сен 00		A21	S21	SN21	SP21	H21	A19	S19	SN19	SP19	H19					
HONDA	Civic Shuttle	EF2, EF5, EY2, EY4, EY5	Правый	сен 87	фев 97	A20	S20	SN20	SP20	H20	A19	S19	SN19	SP19	H19					
HONDA	Concerto	MA1, MA2, MA3	Правый	фев 91	сен 92	A20	S20	SN20	SP20	H20	A19	S19	SN19	SP19	H19	A18	S18	SN18	SP18	H18
HONDA	Crossroad	RT1, 2, 3, 4	Правый	фев 07		A22	S22	SN22	SP22	H22	A19	S19	SN19	SP19	H19					
HONDA	CR-V	RD1,RD2	Правый	окт 95	авг 01	A20	S20	SN20	SP20	H20	A19	S19	SN19	SP19	H19	A12	S11			
HONDA	CR-V	RD4,5	Правый	сен 01	сен 06	A21	S21	SN21	SP21	H21	A20	S20	SN20	SP20	H20					
HONDA	CR-V	RE3, RE4	Правый	окт 06		A26	S26	SN26	SP26	H26	A17	S17	SN17							
HONDA	CR-X	EF6, EF7, EF8	Правый	июн 87	янв 92	A20	S20	SN20	SP20	H20	A20	S20	SN20	SP20	H20	A18	S18	SN18	SP18	H18
HONDA	CR-X	EG1, EG2, EJ4	Правый	фев 92	дек 98	A22	S22	SN22	SP22	H22	A19	S19	SN19	SP19	H19					
HONDA	CR-Z	ZF1	Правый	фев 10		A26	S26	SN26	SP26	H26	A20	S20	SN20	SP20	H20					
HONDA	Domani	MA4,MA5,MA6,MA7	Правый	окт 92	янв 97	A22	S22	SN22	SP22	H22	A18	S18	SN18	SP18	H18					
HONDA	Domani	MB3,MB4,MB5	Правый	янв 97	авг 00	A20	S20	SN20	SP20	H20	A18	S18	SN18	SP18	H18					
HONDA	Horizon	UBS69, UBS73	Правый	фев 94	июл 99	A20	S20	SN20	SP20	H20	A22	S22	SN22	SP22	H22	A15	S15	SN15		
HONDA	Edix (FR-V)	BE1,BE2,BE3,BE4	Правый	июл 04		A26	S26	SN26	SP26	H26	A19	S19	SN19	SP19	H19					
HONDA	Element	YH2	Правый	апр 03	июл 05	A20	S20	SN20	SP20	H20	A20	S20	SN20	SP20	H20					
HONDA	ElySION	RR1,RR2	Правый	май 04		A26	S26	SN26	SP26	H26	A24	S24	SN24	SP24	H24					
HONDA	Fit (Jazz)	UCS69	Правый	окт 93	дек 96	A18	S18	SN18	SP18	H18	A18	S18	SN18	SP18	H18	A12	S11			
HONDA	Fit (Jazz)	GD1,2	Правый	июн 01	окт 07	A20	S20	SN20	SP20	H20	A15	S15	SN15							
HONDA	Fit (Jazz)	GE5-9	Правый	окт 07		A26	S26	SN26	SP26	H26	A14	S14	SN14							
HONDA	Fit Aria	GD6, GD7, GD8, GD9	Правый	дек 02		A21	S21	SN21	SP21	H21	A14	S14	SN14							
HONDA	Fit Shuttle	GG7, 8/GP2	Правый	июн 11		A26	S26	SN26	SP26	H26	A14	S14	SN14							
HONDA	Freed	GB3, GB4	Правый	май 08	окт 11	A26	S26	SN26	SP26	H26	A14	S14	SN14							
HONDA	Freed	GB3, 4/GP3	Правый	окт 11		A26	S26	SN26	SP26	H26	A14	S14	SN14							

Марка	Модель	Кузов	Расположение руля	Период выпуска	Место водителя					Место пассажира					Заднее стекло					
					Aerodynamic	Snowguard	Smart neo	Spoiler	Hybrid	Aerodynamic	Snowguard	Smart neo	Spoiler	Hybrid	Aerodynamic	Snowguard	Smart neo	Spoiler	Hybrid	
HONDA																				
HONDA	HR-V	GH1, GH2, GH3, GH4	Правый	сен 98	фев 06	A20	S20	SN20	SP20	H20	A17	S17	SN17							
HONDA	Insight	ZE1	Правый	дек 99	июл 06	A20	S20	SN20	SP20	H20	A18	S18	SN18	SP18	H18	A16	S16	SN16	SP16	H16
HONDA	Insight	ZE2	Правый	фев 09	окт 11	A26	S26	SN26	SP26	H26	A17	S17	SN17							
HONDA	Insight	ZE2, ZE3	Правый	окт 11		A26	S26	SN26	SP26	H26	A17	S17	SN17							
HONDA	Inspire	CB5, UA1, UA2, UA3	Правый	май 91	окт 98	A22	S22	SN22	SP22	H22	A19	S19	SN19	SP19	H19					
HONDA	Inspire	UA4,UA5	Правый	окт 98	май 03	A24	S24	SN24	SP24	H24	A19	S19	SN19	SP19	H19					
HONDA	Inspire	UC1	Правый	июн 03	дек 07	A26	S26	SN26	SP26	H26	A18	S18	SN18	SP18	H18					
HONDA	Inspire	CP3	Правый	дек 07		A26	S26	SN26	SP26	H26	A19	S19	SN19	SP19	H19					
HONDA	Integra	DA5, DA6, DA7, DA8, DB1	Правый	мар 89	апр 93	A20	S20	SN20	SP20	H20	A19	S19	SN19	SP19	H19					
HONDA	Integra	DB6, DB7, DB8, DB9, DC1, DC2	Правый	июл 93	июн 01	A22	S22	SN22	SP22	H22	A18	S18	SN18	SP18	H18	A19	S19	SN19	SP19	H19
HONDA	Integra	DC5	Правый	июл 01	июл 06	A24	S24	SN24	SP24	H24	A20	S20	SN20	SP20	H20	A20	S20	SN20	SP20	H20
HONDA	Integra SJ	EK3	Правый	мар 96	дек 01	A20	S20	SN20	SP20	H20	A18	S18	SN18	SP18	H18					
HONDA	Lagreat	RL1	Правый	июн 99	дек 04	A24	S24	SN24	SP24	H24	A21	S21	SN21	SP21	H21	A17	S17	SN17		
HONDA	Legend	KA7, KA8, KA9	Правый	окт 90	сен 04	A22	S22	SN22	SP22	H22	A19	S19	SN19	SP19	H19					
HONDA	Life	JA4	Правый	апр 97	сен 98	A22	S22	SN22	SP22	H22						A15	S15	SN15		
HONDA	Life	JB1, JB2, JB3	Правый	окт 98	авг 03	A19	S19	SN19	SP19	H19	A14	S14	SN14			A15	S15	SN15		
HONDA	Life	JB5, JB6, JB7, JB8	Правый	сен 03	ноя 08	A21	S21	SN21	SP21	H21	A12	S11								
HONDA	Life	JC1, JC2	Правый	ноя 08		A21	S21	SN21	SP21	H21	A12	S11								
HONDA	Life Dunk	JB5,6,7,8	Правый	дек 00	авг 03	A19	S19	SN19	SP19	H19	A14	S14	SN14			A15	S15	SN15		
HONDA	Logo	GA3	Правый	окт 96	ноя 98	A19	S19	SN19	SP19	H19	A17	S17	SN17			A12	S11			
HONDA	Logo	GA3, GA5	Правый	янв 99	июн 01	A19	S19	SN19	SP19	H19	A17	S17	SN17							
HONDA	MDX	YD1	Правый	мар 03	дек 06	A24	S24	SN24	SP24	H24	A21	S21	SN21	SP21	H21					
HONDA	Mobilio	GB1,2	Правый	дек 01		A22	S22	SN22	SP22	H22	A18	S18	SN18	SP18	H18					
HONDA	Mobilio Spike	JB1,JB2	Правый	окт 98		A19	S19	SN19	SP19	H19	A14	S14	SN14			A15	S15	SN15		
HONDA	Mobilio Spike	GK1,2	Правый	сен 02		A22	S22	SN22	SP22	H22	A18	S18	SN18	SP18	H18					
HONDA	Mobilio Spike	JB5,6,7,8	Правый	сен 03		A21	S21	SN21	SP21	H21	A12	S11								
HONDA	N Box	JF1, JF2	Правый	ноя 11		A18	S18	SN18	SP18	H18	A17	S17	SN17							
HONDA	NSX	NA1,NA2	Правый	авг 90		A22	S22	SN22	SP22	H22	A22	S22	SN22	SP22	H22					
HONDA	Odyssey	RA1,RA2	Правый	окт 94	июл 97	A24	S24	SN24	SP24	H24	A24	S24	SN24	SP24	H24	A15	S15	SN15		

DAIHATSU

HINO

HONDA

ISUZU

MAZDA

MITSUBISHI

NISSAN

NISSAN DIESEL

SUBARU

SUZUKI

TOYOTA

LEXUS



DAIHATSU

HINO

HONDA

ISUZU

MAZDA

MITSUBISHI

NISSAN

NISSAN DIESEL

SUBARU

SUZUKI

TOYOTA

LEXUS

Марка	Модель	Кузов	Расположение руля	Период выпуска	Место водителя					Место пассажира					Заднее стекло					
					Aerodynamic	Snowguard	Smart neo	Spoiler	Hybrid	Aerodynamic	Snowguard	Smart neo	Spoiler	Hybrid	Aerodynamic	Snowguard	Smart neo	Spoiler	Hybrid	
HONDA																				
HONDA	Odyssey	RA3,RA4,RA5	Правый	авг 97	ноя 99	A24	S24	SN24	SP24	H24	A24	S24	SN24	SP24	H24	A15	S15	SN15		
HONDA	Odyssey	RA6,RA7,RA8	Правый	дек 99	сен 03	A24	S24	SN24	SP24	H24	A24	S24	SN24	SP24	H24					
HONDA	Odyssey	RB1, RB2	Правый	окт 03	окт 08	A28	S28	SN28			A14	S14	SN14							
HONDA	Odyssey	RB3, RB4	Правый	окт 08		A26	S26	SN26	SP26	H26	A17	S17	SN17							
HONDA	Orthia	EL1,EL2,EL3	Правый	мар 96	янв 02	A20	S20	SN20	SP20	H20	A18	S18	SN18	SP18	H18	A12	S11			
HONDA	Partner	EY6,EY7,EY8,EY9	Правый	мар 96	фев 06	A20	S20	SN20	SP20	H20	A18	S18	SN18	SP18	H18	A15	S15	SN15		
HONDA	Partner	GJ3, GJ4	Правый	мар 06		A24	S24	SN24	SP24	H24	A14	S14	SN14							
HONDA	Prelude	BA4, BA5	Правый	май 87	авг 91	A20	S20	SN20	SP20	H20	A19	S19	SN19	SP19	H19					
HONDA	Prelude	BA8,BA9,BB1,BB4	Правый	июл 91	окт 96	A22	S22	SN22	SP22	H22	A19	S19	SN19	SP19	H19	A19	S19	SN19	SP19	H19
HONDA	Prelude	BB5,BB6,BB7,BB8	Правый	ноя 96	авг 00	A21	S21	SN21	SP21	H21	A19	S19	SN19	SP19	H19	A15	S15	SN15		
HONDA	Rafaga	CB1, CB2, CB3, CB4	Правый	сен 89	сен 93	A24	S24	SN24	SP24	H24	A19	S19	SN19	SP19	H19					
HONDA	Rafaga	CE4,CE5	Правый	окт 93	мар 98	A22	S22	SN22	SP22	H22	A19	S19	SN19	SP19	H19					
HONDA	S2000	AP1	Правый	апр 99		A20	S20	SN20	SP20	H20	A16	S16	SN16	SP16	H16					
HONDA	Saber	UA1,UA2,UA3	Правый	фев 95	окт 98	A22	S22	SN22	SP22	H22	A19	S19	SN19	SP19	H19					
HONDA	Saber	UA4,UA5	Правый	окт 98	июн 03	A24	S24	SN24	SP24	H24	A19	S19	SN19	SP19	H19					
HONDA	S-MX	RH1,RH2	Правый	янв 96	янв 02	A19	S19	SN19	SP19	H19	A18	S18	SN18	SP18	H18	A15	S15	SN15		
HONDA	Stepwgn	RF1,RF2	Правый	май 96	мар 01	A20	S20	SN20	SP20	H20	A19	S19	SN19	SP19	H19	A15	S15	SN15		
HONDA	Stepwgn	RF3,4	Правый	апр 01	май 03	A24	S24	SN24	SP24	H24	A16	S16	SN16	SP16	H16					
HONDA	Stepwgn	RF3,4,5,6,7,8	Правый	окт 03	апр 05	A24	S24	SN24	SP24	H24	A17	S17	SN17							
HONDA	Stepwgn	RG1, RG2	Правый	май 05		A26	S26	SN26	SP26	H26										
HONDA	Stream	RN1,2,3,4	Правый	окт 00	июн 06	A24	S24	SN24	SP24	H24	A14	S14	SN14							
HONDA	Stream	RN6-9	Правый	июл 06		A26	S26	SN26	SP26	H26	A14	S14	SN14							
HONDA	That's	JD1,2	Правый	фев 02		A19	S19	SN19	SP19	H19	A14	S14	SN14							
HONDA	Today	JA2, JA3, JW3, JW4	Правый	сен 85	дек 92	A22	S22	SN22	SP22	H22						A12	S11			
HONDA	Today	JA4, JA5	Правый	янв 93	сен 98	A22	S22	SN22	SP22	H22										
HONDA	Tomeo	CF3,CF4,CF5	Правый	сен 97	сен 02	A21	S21	SN21	SP21	H21	A18	S18	SN18	SP18	H18	A15	S15	SN15		
HONDA	Vamos	HM1,HM2	Правый	май 99	мар 03	A17	S17	SN17			A15	S15	SN15			A14	S14	SN14		
HONDA	Vamos	n/a	Правый	апр 03		A17	S17	SN17			A15	S15	SN15							
HONDA	Vamos-Hobio	HM3, HM4, HJ1, HJ2	Правый	апр 03		A17	S17	SN17			A15	S15	SN15							
HONDA	Vigor	CC2,CC3	Правый	янв 92		A22	S22	SN22	SP22	H22	A19	S19	SN19	SP19	H19					

Марка	Модель	Кузов	Расположение руля	Период выпуска	Место водителя					Место пассажира					Заднее стекло					
					Aerodynamic	Snowguard	Smart neo	Spoiler	Hybrid	Aerodynamic	Snowguard	Smart neo	Spoiler	Hybrid	Aerodynamic	Snowguard	Smart neo	Spoiler	Hybrid	
HONDA																				
HONDA	Z	PA1	Правый	окт 98	янв 02	A19	S19	SN19	SP19	H19	A14	S14	SN14			A12	S11			
HONDA	ZEST	JE1, JE2	Правый	фев 06		A21	S21	SN21	SP21	H21	A19	S19	SN19	SP19	H19					

ISUZU																				
Марка	Модель	Кузов	Расположение руля	Период выпуска	Место водителя					Место пассажира					Заднее стекло					
					Aerodynamic	Snowguard	Smart neo	Spoiler	Hybrid	Aerodynamic	Snowguard	Smart neo	Spoiler	Hybrid	Aerodynamic	Snowguard	Smart neo	Spoiler	Hybrid	
ISUZU	Aska	CJ	Правый	мар 94	сен 97	A24	S24	SN24	SP24	H24	A20	S20	SN20	SP20	H20					
ISUZU	Aska	CT	Правый	сен 97		A21	S21	SN21	SP21	H21	A18	S18	SN18	SP18	H18	A15	S15	SN15		
ISUZU	BigHom	UBS	Правый	дек 91	апр 95	A20	S20	SN20	SP20	H20	A20	S20	SN20	SP20	H20	A15	S15	SN15		
ISUZU	BigHom	UBS	Правый	май 95		A20	S20	SN20	SP20	H20	A22	S22	SN22	SP22	H22	A15	S15	SN15		
ISUZU	Como	PE25,GE25	Правый	май 01		A19	S19	SN19	SP19	H19	A19	S19	SN19	SP19	H19	A19	S19	SN19	SP19	H19
ISUZU	Elf	NHR,NHS,NKR,NKS (150,250)	Правый	апр 93		A19	S19	SN19	SP19	H19	A19	S19	SN19	SP19	H19					
ISUZU	Elf	NPR,NPS (350)	Правый	май 93		A20	S20	SN20	SP20	H20	A20	S20	SN20	SP20	H20					
ISUZU	Elf	VHR,VKR	Правый	ноя 96		A24	S24	SN24	SP24	H24	A20	S20	SN20	SP20	H20					
ISUZU	Elf	WHR,WKR	Правый	мар 85	май 95	A18	S18	SN18	SP18	H18	A18	S18	SN18	SP18	H18	A16	S16	SN16	SP16	H16
ISUZU	Elf	WHR,WKR	Правый	июн 95	дек 06	A18	S18	SN18	SP18	H18	A18	S18	SN18	SP18	H18	A16	S16	SN16	SP16	H16
ISUZU	Elf	NKR, NHR	Правый	дек 06		A19	S19	SN19	SP19	H19	A19	S19	SN19	SP19	H19					
ISUZU	Fargo	WFR,WFS	Правый	июл 93	июл 95	A18	S18	SN18	SP18	H18	A18	S18	SN18	SP18	H18	A16	S16	SN16	SP16	H16
ISUZU	Fargo	E24	Правый	авг 95	май 97	A19	S19	SN19	SP19	H19	A19	S19	SN19	SP19	H19	A16	S16	SN16	SP16	H16
ISUZU	Fargo	E24	Правый	май 97		A19	S19	SN19	SP19	H19	A19	S19	SN19	SP19	H19	A16	S16	SN16	SP16	H16
ISUZU	Fargo Free	E50	Правый	июл 97		A26	S26	SN26	SP26	H26	A18	S18	SN18	SP18	H18	A18	S18	SN18	SP18	H18
ISUZU	Fargo Truck	NFR,NFS	Правый	июл 93	июн 95	A18	S18	SN18	SP18	H18	A18	S18	SN18	SP18	H18					
ISUZU	Fargo Truck	F23	Правый	июн 95		A18	S18	SN18	SP18	H18	A18	S18	SN18	SP18	H18					
ISUZU	Fastar-Rodeo	TFR,TRS	Правый	май 88		A18	S18	SN18	SP18	H18	A18	S18	SN18	SP18	H18					
ISUZU	Forward	FRR, FSR	Правый	фев 94	май 07	A22	S22	SN22	SP22	H22	A22	S22	SN22	SP22	H22					
ISUZU	Forward	FRR, FSR	Правый	май 07		A22	S22	SN22	SP22	H22	A22	S22	SN22	SP22	H22					
ISUZU	Forward	NR	Правый	июн 94		A20	S20	SN20	SP20	H20	A20	S20	SN20	SP20	H20					
ISUZU	Forward	FTR	Правый	фев 94	май 07	A20	S20	SN20	SP20	H20	A19	S19	SN19	SP19	H19	A19	S19	SN19	SP19	H19
ISUZU	Forward	FRR, FSR	Правый	май 07		A20	S20	SN20	SP20	H20	A19	S19	SN19	SP19	H19	A19	S19	SN19	SP19	H19
ISUZU	Journey	W40	Правый	авг 93		A22	S22	SN22	SP22	H22	A22	S22	SN22	SP22	H22	A16	S16	SN16	SP16	H16
ISUZU	Journey	W41	Правый	фев 99		A24	S24	SN24	SP24	H24	A24	S24	SN24	SP24	H24	A16	S16	SN16	SP16	H16
ISUZU	Mu	UCS	Правый	фев 89	июл 98	A18	S18	SN18	SP18	H18	A18	S18	SN18	SP18	H18					

DAIHATSU

HINO

HONDA

ISUZU

MAZDA

MITSUBISHI

NISSAN

NISSAN DIESEL

SUBARU

SUZUKI

TOYOTA

LEXUS

- DAIHATSU
- HINO
- HONDA
- ISUZU
- MAZDA
- MITSUBISHI
- NISSAN
- NISSAN DIESEL
- SUBARU
- SUZUKI
- TOYOTA
- LEXUS

Марка	Модель	Кузов	Расположение руля	Период выпуска	Место водителя					Место пассажира					Заднее стекло					
					Aerodynamic	Snowguard	Smart neo	Spoiler	Hybrid	Aerodynamic	Snowguard	Smart neo	Spoiler	Hybrid	Aerodynamic	Snowguard	Smart neo	Spoiler	Hybrid	
<b>ISUZU</b>																				
ISUZU	Mu	UES	Правый	мар 98		A19	S19	SN19	SP19	H19	A19	S19	SN19	SP19	H19	A13	S13			
ISUZU	New Aska	CJ1	Правый	янв 94	сен 97	A24	S24	SN24	SP24	H24	A20	S20	SN20	SP20	H20	A16	S16	SN16	SP16	H16
ISUZU	New Aska	CJ2,3	Правый	сен 97		A21	S21	SN21	SP21	H21	A18	S18	SN18	SP18	H18	A15	S15	SN15		
ISUZU	New Forward	FR	Правый	дек 93	сен 96	A22	S22	SN22	SP22	H22	A22	S22	SN22	SP22	H22					
ISUZU	New Forward	FR	Правый	окт 96		A20	S20	SN20	SP20	H20	A19	S19	SN19	SP19	H19	A19	S19	SN19	SP19	H19
ISUZU	New Forward	FR	Правый	дек 93	сен 96	A22	S22	SN22	SP22	H22	A22	S22	SN22	SP22	H22					
ISUZU	New Forward	FR	Правый	дек 93	сен 96	A20	S20	SN20	SP20	H20	A19	S19	SN19	SP19	H19					
ISUZU	New Forward	FR	Правый	окт 96		A22	S22	SN22	SP22	H22	A22	S22	SN22	SP22	H22					
ISUZU	New Gemini	MJ1,2,3	Правый	сен 93	дек 96	A22	S22	SN22	SP22	H22	A18	S18	SN18	SP18	H18					
ISUZU	New Gemini	MJ4,5	Правый	янв 97		A20	S20	SN20	SP20	H20	A18	S18	SN18	SP18	H18					
ISUZU	New Gemini	MJ6	Правый	янв 97		A20	S20	SN20	SP20	H20	A18	S18	SN18	SP18	H18	A15	S15	SN15		
ISUZU	Truck	CX,CV,EX	Правый	авг 83		A18	S18	SN18	SP18	H18	A18	S18	SN18	SP18	H18	A18	S18	SN18	SP18	H18
ISUZU	Truck	CX,CV (810 EX)	Правый	май 92		A18	S18	SN18	SP18	H18	A18	S18	SN18	SP18	H18	A18	S18	SN18	SP18	H18
ISUZU	Truck	CX,CV,EX	Правый	сен 94		A22	S22	SN22	SP22	H22	A20	S20	SN20	SP20	H20	A20	S20	SN20	SP20	H20
ISUZU	VehiCROSS	UGS	Правый	мар 97		A24	S24	SN24	SP24	H24	A17	S17	SN17							
ISUZU	Wizard	UCS	Правый	ноя 95	июл 98	A18	S18	SN18	SP18	H18	A18	S18	SN18	SP18	H18					
ISUZU	Wizard	UES	Правый	мар 98		A19	S19	SN19	SP19	H19	A19	S19	SN19	SP19	H19	A13	S13			

<b>MAZDA</b>																				
MAZDA	Astina	BG	Правый	янв 91	июл 93	A21	S21	SN21	SP21	H21	A18	S18	SN18	SP18	H18					
MAZDA	Atenza	GG3S	Правый	май 02		A22	S22	SN22	SP22	H22	A18	S18	SN18	SP18	H18	A20	S20	SN20	SP20	H20
MAZDA	Atenza Sedan	GGEP,GG3P	Правый	май 02	янв 08	A22	S22	SN22	SP22	H22	A18	S18	SN18	SP18	H18					
MAZDA	Atenza Sedan	GH	Правый	янв 08		A24	S24	SN24	SP24	H24	A16	S16	SN16	SP16	H16					
MAZDA	Atenza Sport	GGES,GG3S	Правый	май 02	янв 08	A22	S22	SN22	SP22	H22	A18	S18	SN18	SP18	H18	A20	S20	SN20	SP20	H20
MAZDA	Atenza Sport	GH	Правый	янв 08							A16	S16	SN16	SP16	H16					
MAZDA	Atenza Wagon	GYES,GY3W	Правый	июн 02	янв 08	A22	S22	SN22	SP22	H22	A18	S18	SN18	SP18	H18					
MAZDA	Atenza Wagon	GH	Правый	янв 08		A24	S24	SN24	SP24	H24	A16	S16	SN16	SP16	H16					
MAZDA	Axela (Mazda 3)	BK3P,5P,EP	Правый	окт 03		A21	S21	SN21	SP21	H21	A19	S19	SN19	SP19	H19					
MAZDA	Axela Sport (Mazda 3)	BK3P,5P,EP	Правый	окт 03		A21	S21	SN21	SP21	H21	A19	S19	SN19	SP19	H19					
MAZDA	Axela (Mazda 3)	BL	Правый	июн 09		A24	S24	SN24	SP24	H24	A21	S21	SN21	SP21	H21					

Марка	Модель	Кузов	Расположение руля	Период выпуска	Место водителя					Место пассажира					Заднее стекло					
					Aerodynamic	Snowguard	Smart neo	Spoiler	Hybrid	Aerodynamic	Snowguard	Smart neo	Spoiler	Hybrid	Aerodynamic	Snowguard	Smart neo	Spoiler	Hybrid	
<b>MAZDA</b>																				
MAZDA	AZ-1	PG6SA	Правый	авг 92	окт 95	A22	S22	SN22	SP22	H22										
MAZDA	AZ-3	EC5SA	Правый	июн 91	янв 98	A21	S21	SN21	SP21	H21	A18	S18	SN18	SP18	H18	A21	S21	SN21	SP21	H21
MAZDA	AZ-OFFROAD	JM23W	Правый	окт 98		A18	S18	SN18	SP18	H18	A16	S16	SN16	SP16	H16	A12	S11			
MAZDA	AZ-Wagon	CY,CZ	Правый	апр 97	сен 98	A18	S18	SN18	SP18	H18	A16	S16	SN16	SP16	H16	A14	S14	SN14		
MAZDA	AZ-Wagon	MD	Правый	окт 98	сен 03	A18	S18	SN18	SP18	H18	A15	S15	SN15			A14	S14	SN14		
MAZDA	AZ-Wagon	MJ21S	Правый	окт 03	июл 04	A19	S19	SN19	SP19	H19	A16	S16	SN16	SP16	H16					
MAZDA	AZ-Wagon	MJ22S	Правый	май 07	сен 08	A19	S19	SN19	SP19	H19	A16	S16	SN16	SP16	H16					
MAZDA	AZ-Wagon	MJZ35	Правый	сен 08		A20	S20	SN20	SP20	H20	A16	S16	SN16	SP16	H16					
MAZDA	Biante	CC	Правый	июл 08		A26	S26	SN26	SP26	H26	A14	S14	SN14							
MAZDA	Bongo	SS	Правый	ноя 88	дек 92	A16	S16	SN16	SP16	H16	A16	S16	SN16	SP16	H16	A15	S15	SN15		
MAZDA	Bongo	SE	Правый	июл 90	май 99	A16	S16	SN16	SP16	H16	A16	S16	SN16	SP16	H16					
MAZDA	Bongo	SK	Правый	май 99		A18	S18	SN18	SP18	H18	A18	S18	SN18	SP18	H18	A16	S16	SN16	SP16	H16
MAZDA	Bongo Browny	SR, SS, SD	Правый	авг 90	май 99	A16	S16	SN16	SP16	H16	A16	S16	SN16	SP16	H16	A15	S15	SN15		
MAZDA	Bongo Browny	SK	Правый	июн 99		A18	S18	SN18	SP18	H18	A18	S18	SN18	SP18	H18	A16	S16	SN16	SP16	H16
MAZDA	Bongo Friendee	SG	Правый	май 95	ноя 05	A24	S24	SN24	SP24	H24	A16	S16	SN16	SP16	H16	A16	S16	SN16	SP16	H16
MAZDA	Capella	GD	Правый	май 87	июл 94	A19	S19	SN19	SP19	H19	A19	S19	SN19	SP19	H19	A18	S18	SN18	SP18	H18
MAZDA	Capella	CG	Правый	авг 94	июл 97	A21	S21	SN21	SP21	H21	A20	S20	SN20	SP20	H20					
MAZDA	Capella	GF	Правый	авг 97	дек 02	A21	S21	SN21	SP21	H21	A19	S19	SN19	SP19	H19					
MAZDA	Capella Wagon	GV	Правый	май 87	сен 94	A19	S19	SN19	SP19	H19	A19	S19	SN19	SP19	H19	A16	S16	SN16	SP16	H16
MAZDA	Capella Wagon	GV	Правый	окт 94	окт 97	A19	S19	SN19	SP19	H19	A19	S19	SN19	SP19	H19	A16	S16	SN16	SP16	H16
MAZDA	Capella Wagon	GW	Правый	ноя 97	дек 02	A21	S21	SN21	SP21	H21	A19	S19	SN19	SP19	H19					
MAZDA	Carol	AA	Правый	окт 89	окт 95	A18	S18	SN18	SP18	H18	A16	S16	SN16	SP16	H16	A15	S15	SN15		
MAZDA	Carol	AC	Правый	окт 95	окт 98	A18	S18	SN18	SP18	H18	A16	S16	SN16	SP16	H16	A15	S15	SN15		
MAZDA	Carol	HB	Правый	окт 98	авг 04	A18	S18	SN18	SP18	H18	A16	S16	SN16	SP16	H16	A12	S11			
MAZDA	Carol	HB24S	Правый	сен 04	дек 09	A18	S18	SN18	SP18	H18	A16	S16	SN16	SP16	H16					
MAZDA	Carol	HB25S	Правый	дек 09		A20	S20	SN20	SP20	H20	A14	S14	SN14							
MAZDA	Clef	GE	Правый	апр 92	апр 94	A21	S21	SN21	SP21	H21	A20	S20	SN20	SP20	H20					
MAZDA	Cosmo	JC	Правый	апр 90	мар 95	A20	S20	SN20	SP20	H20	A18	S18	SN18	SP18	H18					
MAZDA	Cronos	GE	Правый	сен 91	янв 96	A21	S21	SN21	SP21	H21	A20	S20	SN20	SP20	H20	A22	S22	SN22	SP22	H22
MAZDA	Custom-Cab	HB	Правый	янв 93	янв 96	A18	S18	SN18	SP18	H18	A18	S18	SN18	SP18	H18					

- DAIHATSU
- HINO
- HONDA
- ISUZU
- MAZDA
- MITSUBISHI
- NISSAN
- NISSAN DIESEL
- SUBARU
- SUZUKI
- TOYOTA
- LEXUS



Марка	Модель	Кузов	Расположение руля	Период выпуска	Место водителя					Место пассажира					Заднее стекло					
					Aerodynamic	Snowguard	Smart neo	Spoiler	Hybrid	Aerodynamic	Snowguard	Smart neo	Spoiler	Hybrid	Aerodynamic	Snowguard	Smart neo	Spoiler	Hybrid	
MAZDA																				
MAZDA	CX-7	ER3P	Правый	дек 06		A26	S26	SN26	SP26	H26	A16	S16	SN16	SP16	H16					
MAZDA	Demio (Mazda 2)	DW	Правый	июл 96	ноя 09	A20	S20	SN20	SP20	H20	A16	S16	SN16	SP16	H16	A16	S16	SN16	SP16	H16
MAZDA	Demio (Mazda 2)	DW3,5W	Правый	дек 99	июл 02	A20	S20	SN20	SP20	H20	A16	S16	SN16	SP16	H16					
MAZDA	Demio (Mazda 2)	DY3W, DY3R, DY5W	Правый	авг 02	июн 07	A24	S24	SN24	SP24	H24	A16	S16	SN16	SP16	H16					
MAZDA	Demio (Mazda 2)	DE3AS, DE3FS, DE5FS	Правый	июл 07		A24	S24	SN24	SP24	H24	A14	S14	SN14							
MAZDA	E fini MS 8	MB	Правый	янв 92	фев 98	A21	S21	SN21	SP21	H21	A18	S18	SN18	SP18	H18					
MAZDA	Efini RX7	FD	Правый	окт 91		A20	S20	SN20	SP20	H20	A20	S20	SN20	SP20	H20	A18	S18	SN18	SP18	H18
MAZDA	Eunos 100	BG	Правый	янв 91	апр 94	A21	S21	SN21	SP21	H21	A18	S18	SN18	SP18	H18					
MAZDA	Eunos 300	MA	Правый	окт 88	дек 92	A21	S21	SN21	SP21	H21	A18	S18	SN18	SP18	H18					
MAZDA	Eunos 500	CA	Правый	дек 91	янв 96	A21	S21	SN21	SP21	H21	A20	S20	SN20	SP20	H20					
MAZDA	Eunos 800	TA	Правый	сен 93	май 97	A21	S21	SN21	SP21	H21	A20	S20	SN20	SP20	H20					
MAZDA	Eunos Cosmo	JC	Правый	фев 90	окт 95	A20	S20	SN20	SP20	H20	A18	S18	SN18	SP18	H18					
MAZDA	Eunos Presso	EC	Правый	апр 91		A21	S21	SN21	SP21	H21	A18	S18	SN18	SP18	H18	A21	S21	SN21	SP21	H21
MAZDA	Eunos Roadster	NA,NB	Правый	июн 89		A18	S18	SN18	SP18	H18	A18	S18	SN18	SP18	H18					
MAZDA	Familia	BG	Правый	дек 89	май 94	A21	S21	SN21	SP21	H21	A18	S18	SN18	SP18	H18	A16	S16	SN16	SP16	H16
MAZDA	Familia	BH	Правый	июн 94	май 98	A21	S21	SN21	SP21	H21	A18	S18	SN18	SP18	H18	A20	S20	SN20	SP20	H20
MAZDA	Familia	BJ	Правый	июн 98	авг 03	A21	S21	SN21	SP21	H21	A19	S19	SN19	SP19	H19					
MAZDA	Familia S-Wagon	BJ5W, BJ8W, BJFW	Правый	июн 98	авг 03	A21	S21	SN21	SP21	H21	A19	S19	SN19	SP19	H19	A14	S14	SN14		
MAZDA	Familia Van	#Y10	Правый	авг 94	апр 99	A21	S21	SN21	SP21	H21	A18	S18	SN18	SP18	H18	A12	S11			
MAZDA	Familia Van	#Y11	Правый	май 99		A21	S21	SN21	SP21	H21	A16	S16	SN16	SP16	H16	A12	S11			
MAZDA	Familia Van	BVAY12, BVY12, BVJY12	Правый	янв 07		A21	S21	SN21	SP21	H21	A16	S16	SN16	SP16	H16	A14	S14	SN14		
MAZDA	Festiva	D23,25	Правый	ноя 92	окт 97	A20	S20	SN20	SP20	H20	A16	S16	SN16	SP16	H16	A21	S21	SN21	SP21	H21
MAZDA	Festiva	DW	Правый	июл 96		A20	S20	SN20	SP20	H20	A16	S16	SN16	SP16	H16	A16	S16	SN16	SP16	H16
MAZDA	Freda	SG	Правый	июн 95		A24	S24	SN24	SP24	H24	A16	S16	SN16	SP16	H16	A16	S16	SN16	SP16	H16
MAZDA	Freda	BG,BH	Правый	мар 89	окт 98	A21	S21	SN21	SP21	H21	A18	S18	SN18	SP18	H18					
MAZDA	Freda	BH	Правый	апр 94	окт 98	A21	S21	SN21	SP21	H21	A18	S18	SN18	SP18	H18	A21	S21	SN21	SP21	H21
MAZDA	Ixion	CP	Правый	апр 99		A24	S24	SN24	SP24	H24	A16	S16	SN16	SP16	H16	A14	S14	SN14		
MAZDA	J100	SD	Правый	авг 90		A16	S16	SN16	SP16	H16	A16	S16	SN16	SP16	H16					
MAZDA	J100	SR	Правый	авг 90		A16	S16	SN16	SP16	H16	A16	S16	SN16	SP16	H16	A15	S15	SN15		
MAZDA	Lantis	CB	Правый	июн 93	июн 97	A21	S21	SN21	SP21	H21	A19	S19	SN19	SP19	H19					

DAIHATSU

HINO

HONDA

ISUZU

MAZDA

MITSUBISHI

NISSAN

NISSAN DIESEL

SUBARU

SUZUKI

TOYOTA

LEXUS

Марка	Модель	Кузов	Расположение руля	Период выпуска	Место водителя					Место пассажира					Заднее стекло					
					Aerodynamic	Snowguard	Smart neo	Spoiler	Hybrid	Aerodynamic	Snowguard	Smart neo	Spoiler	Hybrid	Aerodynamic	Snowguard	Smart neo	Spoiler	Hybrid	
MAZDA																				
MAZDA	Lantis	CB	Правый	июн 93	июн 97	A21	S21	SN21	SP21	H21	A19	S19	SN19	SP19	H19	A19	S19	SN19	SP19	H19
MAZDA	Laputa	HP	Правый	мар 99	янв 06	A19	S19	SN19	SP19	H19	A16	S16	SN16	SP16	H16	A12	S11			
MAZDA	Leser Lidea	BJ	Правый	ноя 98		A21	S21	SN21	SP21	H21	A19	S19	SN19	SP19	H19					
MAZDA	Leser Lidea	BJ	Правый	ноя 98		A21	S21	SN21	SP21	H21	A19	S19	SN19	SP19	H19	A12	S11			
MAZDA	Luce	HC (Taxi)	Правый	июл 86	янв 96	A20	S20	SN20	SP20	H20	A19	S19	SN19	SP19	H19					
MAZDA	Luce	HC	Правый	авг 91	июл 95	A20	S20	SN20	SP20	H20	A19	S19	SN19	SP19	H19					
MAZDA	Millenia	TA	Правый	май 97	авг 03	A21	S21	SN21	SP21	H21	A20	S20	SN20	SP20	H20					
MAZDA	MPV	LV#	Правый	авг 91	май 99	A22	S22	SN22	SP22	H22	A20	S20	SN20	SP20	H20	A16	S16	SN16	SP16	H16
MAZDA	MPV	LWEW,LW5W	Правый	май 99	янв 06	A24	S24	SN24	SP24	H24	A24	S24	SN24	SP24	H24	A16	S16	SN16	SP16	H16
MAZDA	MPV	LY3P	Правый	фев 06		A26	S26	SN26	SP26	H26	A16	S16	SN16	SP16	H16					
MAZDA	MS-6	GE	Правый	сен 91	дек 96	A21	S21	SN21	SP21	H21	A20	S20	SN20	SP20	H20	A22	S22	SN22	SP22	H22
MAZDA	MS-8	MB	Правый	мар 92	фев 98	A21	S21	SN21	SP21	H21	A18	S18	SN18	SP18	H18					
MAZDA	MX-6	GE	Правый	май 94	янв 96	A20	S20	SN20	SP20	H20	A20	S20	SN20	SP20	H20					
MAZDA	MX-5	NA#	Правый	сен 89	дек 97	A18	S18	SN18	SP18	H18	A18	S18	SN18	SP18	H18					
MAZDA	MX-5	NB#	Правый	янв 98	июл 05	A18	S18	SN18	SP18	H18	A18	S18	SN18	SP18	H18					
MAZDA	MX-5	NCEC	Правый	авг 05		A18	S18	SN18	SP18	H18	A18	S18	SN18	SP18	H18					
MAZDA	Parkway	WV	Правый	май 84	июн 95	A18	S18	SN18	SP18	H18	A18	S18	SN18	SP18	H18	A17	S17	SN17		
MAZDA	Persona	MA	Правый	окт 88	дек 92	A21	S21	SN21	SP21	H21	A18	S18	SN18	SP18	H18					
MAZDA	Premacy	CP	Правый	фев 99	янв 05	A24	S24	SN24	SP24	H24	A16	S16	SN16	SP16	H16	A14	S14	SN14		
MAZDA	Premacy	CREW, CR3W	Правый	фев 05	июл 10	A24	S24	SN24	SP24	H24	A16	S16	SN16	SP16	H16					
MAZDA	Premacy	CWEFW	Правый	июл 10		A26	S26	SN26	SP26	H26	A16	S16	SN16	SP16	H16					
MAZDA	Presso	EC	Правый	июн 91	дек 98	A21	S21	SN21	SP21	H21	A18	S18	SN18	SP18	H18	A21	S21	SN21	SP21	H21
MAZDA	Proceed	UF, UV	Правый	ноя 89	окт 90	A18	S18	SN18	SP18	H18	A18	S18	SN18	SP18	H18	A12	S11			
MAZDA	Proceed Levante	TF,TJ	Правый	фев 95	ноя 97	A17	S17	SN17			A17	S17	SN17			A15	S15	SN15		
MAZDA	Proceed Levante	TF,TJ	Правый	ноя 97	сен 99	A19	S19	SN19	SP19	H19	A19	S19	SN19	SP19	H19	A15	S15	SN15		
MAZDA	Revue	DB	Правый	авг 90	июн 99	A20	S20	SN20	SP20	H20	A16	S16	SN16	SP16	H16					
MAZDA	RX-7	FC3S	Правый	сен 85	окт 91	A20	S20	SN20	SP20	H20	A20	S20	SN20	SP20	H20	A22	S22	SN22	SP22	H22
MAZDA	RX-7	FD3S	Правый	ноя 91		A20	S20	SN20	SP20	H20	A20	S20	SN20	SP20	H20	A18	S18	SN18	SP18	H18
MAZDA	RX-8	SE3P	Правый	апр 03		A20	S20	SN20	SP20	H20	A18	S18	SN18	SP18	H18					
MAZDA	Scrum	DG, DF51	Правый	мар 90	сен 91	A15	S15	SN15			A14	S14	SN14			A14	S14	SN14		

DAIHATSU

HINO

HONDA

ISUZU

MAZDA

MITSUBISHI

NISSAN

NISSAN DIESEL

SUBARU

SUZUKI

TOYOTA

LEXUS





DAIHATSU

HINO

HONDA

ISUZU

MAZDA

**MITSUBISHI**

NISSAN

NISSAN DIESEL

SUBARU

SUZUKI

TOYOTA

LEXUS

Марка	Модель	Кузов	Расположение руля	Период выпуска	Место водителя					Место пассажира					Заднее стекло					
					Aerodynamic	Snowguard	Smart neo	Spoiler	Hybrid	Aerodynamic	Snowguard	Smart neo	Spoiler	Hybrid	Aerodynamic	Snowguard	Smart neo	Spoiler	Hybrid	
MITSUBISHI																				
MITSUBISHI	Dion	CR9W	Правый	янв 00	апр 02	A22	S22	SN22	SP22	H22	A18	S18	SN18	SP18	H18	A15	S15	SN15		
MITSUBISHI	Dion	CR5W,CR6W	Правый	май 02	дек 06	A22	S22	SN22	SP22	H22	A18	S18	SN18	SP18	H18					
MITSUBISHI	Eclipse	D32A	Правый	июл 95	авг 99	A24	S24	SN24	SP24	H24	A22	S22	SN22	SP22	H22	A19	S19	SN19	SP19	H19
MITSUBISHI	Eclipse-Spider	D38A	Правый	дек 95	ноя 99	A24	S24	SN24	SP24	H24	A22	S22	SN22	SP22	H22					
MITSUBISHI	ekWagon	H81W	Правый	окт 01	авг 06	A19	S19	SN19	SP19	H19	A14	S14	SN14							
MITSUBISHI	ekWagon	H82W	Правый	сен 06		A19	S19	SN19	SP19	H19	A14	S14	SN14							
MITSUBISHI	Emeraude	E52A,53A,54A,74A, 84A	Правый	июл 92	авг 96	A21	S21	SN21	SP21	H21	A18	S18	SN18	SP18	H18	A18	S18	SN18	SP18	H18
MITSUBISHI	Emeraude	E53A,54A,64A,74A, 84A	Правый	июл 92	авг 96	A21	S21	SN21	SP21	H21	A18	S18	SN18	SP18	H18	A20	S20	SN20	SP20	H20
MITSUBISHI	Eterna	E3#A	Правый	янв 89	апр 92	A19	S19	SN19	SP19	H19	A18	S18	SN18	SP18	H18	A14	S14	SN14		
MITSUBISHI	Eterna	E5#, E6#, E7#, E8#	Правый	май 92	июл 96	A21	S21	SN21	SP21	H21	A18	S18	SN18	SP18	H18	A18	S18	SN18	SP18	H18
MITSUBISHI	FTO	DE2F,3A	Правый	сен 94	дек 99	A21	S21	SN21	SP21	H21	A20	S20	SN20	SP20	H20	A17	S17	SN17		
MITSUBISHI	Galant	E12A	Правый	авг 89	ноя 95	A19	S19	SN19	SP19	H19	A17	S17	SN17							
MITSUBISHI	Galant	E52A,53A,54A,74A,84A	Правый	фев 92	авг 96	A21	S21	SN21	SP21	H21	A18	S18	SN18	SP18	H18	A18	S18	SN18	SP18	H18
MITSUBISHI	Galant	E52A,53A,54A,64A,74A,84A	Правый	фев 92	авг 96	A21	S21	SN21	SP21	H21	A18	S18	SN18	SP18	H18	A20	S20	SN20	SP20	H20
MITSUBISHI	Galant	E54A,74A	Правый	авг 94	авг 96	A21	S21	SN21	SP21	H21	A18	S18	SN18	SP18	H18	A20	S20	SN20	SP20	H20
MITSUBISHI	Galant	E19A(Taxi)	Правый	дек 95		A19	S19	SN19	SP19	H19	A17	S17	SN17							
MITSUBISHI	Galant	EA1A,3A,EC1A,3A,5A	Правый	июл 96	ноя 05	A22	S22	SN22	SP22	H22	A18	S18	SN18	SP18	H18	A17	S17	SN17		
MITSUBISHI	Galant Fortis	CX4A	Правый	авг 07		A24	S24	SN24	SP24	H24	A17	S17	SN17							
MITSUBISHI	Grandis	N8#W, N9#W	Правый	окт 97	апр 03	A26	S26	SN26	SP26	H26	A16	S16	SN16	SP16	H16	A15	S15	SN15		
MITSUBISHI	Grandis	NA4W	Правый	май 03		A28	S28	SN28			A22	S22	SN22	SP22	H22					
MITSUBISHI	GTO	Z15A,16A	Правый	сен 90	авг 01	A21	S21	SN21	SP21	H21	A20	S20	SN20	SP20	H20	A22	S22	SN22	SP22	H22
MITSUBISHI	I	HA1W	Правый	янв 06		A28	S28	SN28												
MITSUBISHI	Lancer	C6#, 7#	Правый	июн 88	сен 91	A19	S19	SN19	SP19	H19	A17	S17	SN17							
MITSUBISHI	Lancer	CB,CD	Правый	окт 91	авг 95	A20	S20	SN20	SP20	H20	A17	S17	SN17			A17	S17	SN17		
MITSUBISHI	Lancer	CB,CD,CE	Правый	окт 91	авг 95	A20	S20	SN20	SP20	H20	A17	S17	SN17			A18	S18	SN18	SP18	H18
MITSUBISHI	Lancer	CK,CM	Правый	окт 95	янв 97	A20	S20	SN20	SP20	H20	A17	S17	SN17			A17	S17	SN17		
MITSUBISHI	Lancer	CK,CM	Правый	фев 97	апр 00	A20	S20	SN20	SP20	H20	A17	S17	SN17			A16	S16	SN16	SP16	H16
MITSUBISHI	Lancer	CS2V	Правый	дек 02		A24	S24	SN24	SP24	H24	A18	S18	SN18	SP18	H18	A14	S14	SN14		
MITSUBISHI	Lancer	CS#A	Правый	фев 03		A24	S24	SN24	SP24	H24	A18	S18	SN18	SP18	H18	A17	S17	SN17		
MITSUBISHI	Lancer	CS5W	Правый	фев 03		A24	S24	SN24	SP24	H24	A18	S18	SN18	SP18	H18					

Марка	Модель	Кузов	Расположение руля	Период выпуска	Место водителя					Место пассажира					Заднее стекло					
					Aerodynamic	Snowguard	Smart neo	Spoiler	Hybrid	Aerodynamic	Snowguard	Smart neo	Spoiler	Hybrid	Aerodynamic	Snowguard	Smart neo	Spoiler	Hybrid	
MITSUBISHI																				
MITSUBISHI	Lancer Cedia	CS#A	Правый	май 00	янв 03	A24	S24	SN24	SP24	H24	A18	S18	SN18	SP18	H18	A17	S17	SN17		
MITSUBISHI	Lancer Cedia Wagon	CS#W	Правый	ноя 00	фев 03	A24	S24	SN24	SP24	H24	A18	S18	SN18	SP18	H18					
MITSUBISHI	Lancer Cargo	CVY12	Правый	дек 08		A24	S24	SN24	SP24	H24	A18	S18	SN18	SP18	H18					
MITSUBISHI	Lancer Evolution	CN9A	Правый	авг 96	янв 97	A20	S20	SN20	SP20	H20	A17	S17	SN17			A17	S17	SN17		
MITSUBISHI	Lancer Evolution	CN9A	Правый	фев 97	июн 97	A20	S20	SN20	SP20	H20	A17	S17	SN17			A16	S16	SN16	SP16	H16
MITSUBISHI	Lancer Evolution	CP9A	Правый	янв 98	янв 01	A20	S20	SN20	SP20	H20	A17	S17	SN17			A16	S16	SN16	SP16	H16
MITSUBISHI	Lancer Evolution	CT9A	Правый	фев 01	фев 02	A24	S24	SN24	SP24	H24	A18	S18	SN18	SP18	H18	A17	S17	SN17		
MITSUBISHI	Lancer Evolution X	C24A	Правый	окт 07		A24	S24	SN24	SP24	H24	A17	S17	SN17							
MITSUBISHI	Lancer Evolution Wagon	CT9W	Правый	сен 05		A24	S24	SN24	SP24	H24	A18	S18	SN18	SP18	H18					
MITSUBISHI	Legnum	EA1W,3W,4W,5W,EC1W, 3W,4W,5W	Правый	июн 96	авг 02	A22	S22	SN22	SP22	H22	A18	S18	SN18	SP18	H18	A16	S16	SN16	SP16	H16
MITSUBISHI	Libero	CB, CD	Правый	апр 92	мар 98	A20	S20	SN20	SP20	H20	A17	S17	SN17			A16	S16	SN16	SP16	H16
MITSUBISHI	Libero	CB, CD	Правый	апр 98	дек 02	A20	S20	SN20	SP20	H20	A17	S17	SN17			A16	S16	SN16	SP16	H16
MITSUBISHI	Minica	H2A, H2V, H2VW	Правый	янв 89	сен 93	A18	S18	SN18	SP18	H18	A15	S15	SN15			A14	S14	SN14		
MITSUBISHI	Minica	H3A, H3V	Правый	окт 93	сен 98	A18	S18	SN18	SP18	H18	A14	S14	SN14			A14	S14	SN14		
MITSUBISHI	Minica	H42A, H47A, H42V, H47V	Правый	окт 98		A18	S18	SN18	SP18	H18	A15	S15	SN15			A14	S14	SN14		
MITSUBISHI	Minica Toppo	H22A, H22V, H27A, H27V	Правый	фев 90	сен 93	A20	S20	SN20	SP20	H20	A15	S15	SN15			A14	S14	SN14		
MITSUBISHI	Minica Toppo	H3A, H3V	Правый	авг 93	сен 98	A20	S20	SN20	SP20	H20	A14	S14	SN14			A14	S14	SN14		
MITSUBISHI	Minica Toppo BJ	H4A	Правый	окт 98	янв 01	A20	S20	SN20	SP20	H20	A15	S15	SN15			A14	S14	SN14		
MITSUBISHI	Minica Toppo BJ	H4A	Правый	фев 01	дек 04	A20	S20	SN20	SP20	H20	A15	S15	SN15							
MITSUBISHI	Minica Toppo BJ	H43A,48A	Правый	янв 99		A20	S20	SN20	SP20	H20	A15	S15	SN15			A14	S14	SN14		
MITSUBISHI	Minicab	U1T	Правый	апр 84	дек 90	A15	S15	SN15			A15	S15	SN15			A14	S14	SN14		
MITSUBISHI	Minicab	U4T, U4V, U42PV	Правый	янв 91	дек 99	A15	S15	SN15			A15	S15	SN15							
MITSUBISHI	Minicab	U6W, U6T	Правый	янв 99	ноя 05	A17	S17	SN17			A15	S15	SN15							
MITSUBISHI	Minicab	U6W	Правый	дек 05		A17	S17	SN17			A15	S15	SN15							
MITSUBISHI	Mirage	C5, C6, C7, C8	Правый	май 90	сен 91	A20	S20	SN20	SP20	H20	A15	S15	SN15							
MITSUBISHI	Mirage	CA,CC	Правый	июл 91	сен 95	A20	S20	SN20	SP20	H20	A17	S17	SN17			A14	S14	SN14		
MITSUBISHI	Mirage	CB,CD	Правый	июл 91	сен 95	A20	S20	SN20	SP20	H20	A17	S17	SN17			A17	S17	SN17		
MITSUBISHI	Mirage	CB,CD	Правый	июл 91	сен 95	A20	S20	SN20	SP20	H20	A17	S17	SN17			A18	S18	SN18	SP18	H18
MITSUBISHI	Mirage	CJ,CL	Правый	авг 95	янв 97	A20	S20	SN20	SP20	H20	A17	S17	SN17			A14	S14	SN14		

DAIHATSU

HINO

HONDA

ISUZU

MAZDA

**MITSUBISHI**

NISSAN

NISSAN DIESEL

SUBARU

SUZUKI

TOYOTA

LEXUS

DAIHATSU

HINO

HONDA

ISUZU

MAZDA

MITSUBISHI

NISSAN

NISSAN DIESEL

SUBARU

SUZUKI

TOYOTA

LEXUS

Марка	Модель	Кузов	Расположение руля	Период выпуска	Место водителя					Место пассажира					Заднее стекло					
					Aerodynamic	Snowguard	Smart neo	Spoiler	Hybrid	Aerodynamic	Snowguard	Smart neo	Spoiler	Hybrid	Aerodynamic	Snowguard	Smart neo	Spoiler	Hybrid	
MITSUBISHI																				
MITSUBISHI	Mirage	CK,CM	Правый	авг 95	янв 97	A20	S20	SN20	SP20	H20	A17	S17	SN17			A16	S16	SN16	SP16	H16
MITSUBISHI	Mirage	CJ,CL	Правый	фев 97	дек 99	A20	S20	SN20	SP20	H20	A17	S17	SN17			A14	S14	SN14		
MITSUBISHI	Mirage	CK,CM	Правый	фев 97	май 00	A20	S20	SN20	SP20	H20	A17	S17	SN17			A16	S16	SN16	SP16	H16
MITSUBISHI	Mirage Dingo	CQ2A	Правый	дек 98	авг 02	A22	S22	SN22	SP22	H22	A18	S18	SN18	SP18	H18	A16	S16	SN16	SP16	H16
MITSUBISHI	Outlander	CW5W	Правый	окт 05		A24	S24	SN24	SP24	H24	A20	S20	SN20	SP20	H20					
MITSUBISHI	Pajero	L04G, L14G	Правый	окт 87	дек 90	A16	S16	SN16	SP16	H16	A16	S16	SN16	SP16	H16					
MITSUBISHI	Pajero	V2, V3, V4	Правый	янв 90	авг 99	A19	S19	SN19	SP19	H19	A19	S19	SN19	SP19	H19	A15	S15	SN15		
MITSUBISHI	Pajero	V78, V75, V68, V65	Правый	сен 99	сен 06	A20	S20	SN20	SP20	H20	A20	S20	SN20	SP20	H20	A16	S16	SN16	SP16	H16
MITSUBISHI	Pajero	V83, V87, V93, V97	Правый	окт 06		A22	S22	SN22	SP22	H22	A20	S20	SN20	SP20	H20					
MITSUBISHI	Pajero io	H66W,71W,76W	Правый	мар 98	июн 07	A18	S18	SN18	SP18	H18	A18	S18	SN18	SP18	H18	A16	S16	SN16	SP16	H16
MITSUBISHI	Pajero Junior	H57A	Правый	окт 95	май 98	A18	S18	SN18	SP18	H18	A16	S16	SN16	SP16	H16	A14	S14	SN14		
MITSUBISHI	Pajero Mini	H51A,56A	Правый	ноя 95	сен 98	A18	S18	SN18	SP18	H18	A16	S16	SN16	SP16	H16	A14	S14	SN14		
MITSUBISHI	Pajero Mini	H53A,58A	Правый	авг 98	сен 08	A18	S18	SN18	SP18	H18	A16	S16	SN16	SP16	H16	A14	S14	SN14		
MITSUBISHI	Pajero Mini	H53A,58A	Правый	сен 08		A18	S18	SN18	SP18	H18	A16	S16	SN16	SP16	H16	A12	S11			
MITSUBISHI	Proudia	S32A,33A	Правый	фев 00							A21	S21	SN21	SP21	H21					
MITSUBISHI	Rosa	BE4, BG4	Правый	май 86	мар 95	A19	S19	SN19	SP19	H19	A18	S18	SN18	SP18	H18	A16	S16	SN16	SP16	H16
MITSUBISHI	Rosa	BE4, BG4	Правый	апр 95		A19	S19	SN19	SP19	H19	A18	S18	SN18	SP18	H18	A16	S16	SN16	SP16	H16
MITSUBISHI	Rosa	BE6, BG6	Правый	авг 97		A22	S22	SN22	SP22	H22	A21	S21	SN21	SP21	H21	A16	S16	SN16	SP16	H16
MITSUBISHI	RVR	N11W,13W,21W,21WG,23W,3WG,28W,28WG	Правый	май 91	мар 97	A22	S22	SN22	SP22	H22	A18	S18	SN18	SP18	H18	A16	S16	SN16	SP16	H16
MITSUBISHI	RVR	N61W,64WG,71W,73WG,74WG	Правый	сен 97	авг 02	A26	S26	SN26	SP26	H26	A16	S16	SN16	SP16	H16	A16	S16	SN16	SP16	H16
MITSUBISHI	RVR	GA3W, GA4W	Правый	фев 10		A24	S24	SN24	SP24	H24	A20	S20	SN20	SP20	H20					
MITSUBISHI	Sigma	F11A,12A,13A,15A,17A,25A,27A	Правый	дек 94	сен 95	A20	S20	SN20	SP20	H20	A19	S19	SN19	SP19	H19					
MITSUBISHI	Sigma	F13AK	Правый	авг 91	мар 96	A20	S20	SN20	SP20	H20	A19	S19	SN19	SP19	H19					
MITSUBISHI	Strada	K34T	Правый	апр 92	май 97	A18	S18	SN18	SP18	H18	A17	S17	SN17							
MITSUBISHI	Strada	K74T	Правый	дек 96		A19	S19	SN19	SP19	H19	A19	S19	SN19	SP19	H19					
MITSUBISHI	Toppo	HB2A	Правый	сен 08		A20	S20	SN20	SP20	H20	A15	S15	SN15							
MITSUBISHI	Town Box	U61W,62W,63W,64W	Правый	апр 99		A17	S17	SN17			A15	S15	SN15			A14	S14	SN14		
MITSUBISHI	Town Box	U65W,66W	Правый	июн 99		A17	S17	SN17			A15	S15	SN15			A14	S14	SN14		
MITSUBISHI	Triton	KB9T	Правый	сен 06		A22	S22	SN22	SP22	H22	A19	S19	SN19	SP19	H19					

Марка	Модель	Кузов	Расположение руля	Период выпуска	Место водителя					Место пассажира					Заднее стекло					
					Aerodynamic	Snowguard	Smart neo	Spoiler	Hybrid	Aerodynamic	Snowguard	Smart neo	Spoiler	Hybrid	Aerodynamic	Snowguard	Smart neo	Spoiler	Hybrid	
MITSUBISHI																				
MITSUBISHI	Truck	FH2	Правый	янв 95		A21	S21	SN21	SP21	H21	A21	S21	SN21	SP21	H21					
MITSUBISHI	Truck	FK3	Правый	фев 86		A17	S17	SN17			A17	S17	SN17							
MITSUBISHI	Truck	FK4,FL4	Правый	дек 83	фев 95	A20	S20	SN20	SP20	H20	A20	S20	SN20	SP20	H20					
MITSUBISHI	Truck	FK4,FL4	Правый	мар 95		A20	S20	SN20	SP20	H20	A20	S20	SN20	SP20	H20					
MITSUBISHI	Truck	FK5#,FM5	Правый	дек 83	фев 95	A20	S20	SN20	SP20	H20										
MITSUBISHI	Truck	FK5,FM5	Правый	мар 95		A20	S20	SN20	SP20	H20	A18	S18	SN18	SP18	H18	A18	S18	SN18	SP18	H18
MITSUBISHI	Truck	FK6,FL6,FM6, FN6	Правый	июн 92		A26	S26	SN26	SP26	H26	A26	S26	SN26	SP26	H26					
MITSUBISHI	Truck	FN4,FP4,FT4, FU4, FV4	Правый	июн 83	фев 95	A20	S20	SN20	SP20	H20	A20	S20	SN20	SP20	H20	A20	S20	SN20	SP20	H20
MITSUBISHI	Truck	FN4,FP4,FT4, FU4, FV4	Правый	мар 95		A20	S20	SN20	SP20	H20	A20	S20	SN20	SP20	H20	A20	S20	SN20	SP20	H20
MITSUBISHI	Truck	FP5,FS5,FT5, FV5, FU5,FY5	Правый	апр 96		A22	S22	SN22	SP22	H22	A20	S20	SN20	SP20	H20	A22	S22	SN22	SP22	H22

NISSAN																				
NISSAN	180SX	RS13, RPS13	Правый	мар 89	дек 98	A20	S20	SN20	SP20	H20	A20	S20	SN20	SP20	H20	A20	S20	SN20	SP20	H20
NISSAN	AD	Y10	Правый	окт 90	мар 94	A21	S21	SN21	SP21	H21	A18	S18	SN18	SP18	H18	A12	S11			
NISSAN	AD	Y10	Правый	мар 94	апр 99	A21	S21	SN21	SP21	H21	A18	S18	SN18	SP18	H18	A12	S11			
NISSAN	AD	Y10X	Правый	июл 93	янв 96	A21	S21	SN21	SP21	H21	A18	S18	SN18	SP18	H18	A14	S14	SN14		
NISSAN	AD	Y10X	Правый	янв 96	май 99	A21	S21	SN21	SP21	H21	A18	S18	SN18	SP18	H18	A12	S11			
NISSAN	AD	Y11(Van)	Правый	май 99	апр 04	A22	S22	SN22	SP22	H22	A16	S16	SN16	SP16	H16	A12	S11			
NISSAN	AD	Y11(Van)	Правый	май 04		A22	S22	SN22	SP22	H22	A16	S16	SN16	SP16	H16	A12	S11			
NISSAN	AD Expert	VAY12, VY12	Правый	дек 06		A21	S21	SN21	SP21	H21	A19	S19	SN19	SP19	H19	A13	S13			
NISSAN	Atlas	H41	Правый	окт 91		A18	S18	SN18	SP18	H18	A18	S18	SN18	SP18	H18					
NISSAN	Atlas	F23	Правый	янв 92		A18	S18	SN18	SP18	H18	A18	S18	SN18	SP18	H18					
NISSAN	Atlas	AKR,AKS	Правый	июн 95		A19	S19	SN19	SP19	H19	A19	S19	SN19	SP19	H19					
NISSAN	Atlas	H41	Правый	янв 92		A20	S20	SN20	SP20	H20	A20	S20	SN20	SP20	H20					
NISSAN	Atlas	APR,APS	Правый	июн 95		A20	S20	SN20	SP20	H20	A20	S20	SN20	SP20	H20					
NISSAN	Atlas Max	AHR,AKR	Правый	дек 98		A24	S24	SN24	SP24	H24	A20	S20	SN20	SP20	H20					
NISSAN	Avenir	W10, VW10	Правый	май 90	апр 91	A21	S21	SN21	SP21	H21	A18	S18	SN18	SP18	H18	A15	S15	SN15		
NISSAN	Avenir	W10, VW10	Правый	май 91	мар 94	A21	S21	SN21	SP21	H21	A18	S18	SN18	SP18	H18	A14	S14	SN14		
NISSAN	Avenir	W10, VW10	Правый	мар 94	авг 95	A21	S21	SN21	SP21	H21	A18	S18	SN18	SP18	H18	A14	S14	SN14		
NISSAN	Avenir	W10	Правый	авг 95	авг 98	A21	S21	SN21	SP21	H21	A18	S18	SN18	SP18	H18	A12	S11			

DAIHATSU

HINO

HONDA

ISUZU

MAZDA

MITSUBISHI

NISSAN

NISSAN DIESEL

SUBARU

SUZUKI

TOYOTA

LEXUS



- DAIHATSU
- HINO
- HONDA
- ISUZU
- MAZDA
- MAZDA
- MITSUBISHI
- NISSAN
- NISSAN DIESEL
- SUBARU
- SUZUKI
- TOYOTA
- LEXUS

Марка	Модель	Кузов	Расположение руля	Период выпуска	Место водителя					Место пассажира					Заднее стекло					
					Aerodynamic	Snowguard	Smart neo	Spoiler	Hybrid	Aerodynamic	Snowguard	Smart neo	Spoiler	Hybrid	Aerodynamic	Snowguard	Smart neo	Spoiler	Hybrid	
NISSAN																				
NISSAN	Avenir	W11	Правый	авг 98		A21	S21	SN21	SP21	H21	A19	S19	SN19	SP19	H19	A13	S13			
NISSAN	Bassara	JU30	Правый	ноя 99	мар 06	A26	S26	SN26	SP26	H26	A21	S21	SN21	SP21	H21	A16	S16	SN16	SP16	H16
NISSAN	Bluebird	U12	Правый	сен 87	авг 91	A20	S20	SN20	SP20	H20	A20	S20	SN20	SP20	H20	A18	S18	SN18	SP18	H18
NISSAN	Bluebird	U13	Правый	сен 91	дек 95	A21	S21	SN21	SP21	H21	A20	S20	SN20	SP20	H20	A16	S16	SN16	SP16	H16
NISSAN	Bluebird	U14	Правый	янв 96	июл 00	A21	S21	SN21	SP21	H21	A19	S19	SN19	SP19	H19	A17	S17	SN17		
NISSAN	Bluebird Sylphy	TG10, QG10, FG10, QNG10	Правый	авг 00	окт 05	A22	S22	SN22	SP22	H22	A16	S16	SN16	SP16	H16					
NISSAN	Bluebird Sylphy	G11, KG11	Правый	дек 05		A22	S22	SN22	SP22	H22	A17	S17	SN17							
NISSAN	Caravan	QGE25	Правый	апр 01		A19	S19	SN19	SP19	H19	A19	S19	SN19	SP19	H19	A19	S19	SN19	SP19	H19
NISSAN	Caravan/Homy	E24, E24	Правый	сен 86	май 93	A19	S19	SN19	SP19	H19	A19	S19	SN19	SP19	H19	A16	S16	SN16	SP16	H16
NISSAN	Caravan/Homy	E24, E24	Правый	май 93	май 97	A19	S19	SN19	SP19	H19	A19	S19	SN19	SP19	H19	A16	S16	SN16	SP16	H16
NISSAN	Caravan/Homy	E24, E24	Правый	май 97	апр 01	A19	S19	SN19	SP19	H19	A19	S19	SN19	SP19	H19	A16	S16	SN16	SP16	H16
NISSAN	Caravan/Homy	E25, E25	Правый	май 01	апр 03	A19	S19	SN19	SP19	H19	A19	S19	SN19	SP19	H19	A19	S19	SN19	SP19	H19
NISSAN	Caravan/Homy	E25, E25	Правый	май 03		A19	S19	SN19	SP19	H19	A19	S19	SN19	SP19	H19					
NISSAN	Cedric/Gloria	Y30	Правый	июн 85	авг 97	A19	S19	SN19	SP19	H19	A18	S18	SN18	SP18	H18	A16	S16	SN16	SP16	H16
NISSAN	Cedric/Gloria	Y31	Правый	окт 87	май 91	A20	S20	SN20	SP20	H20	A19	S19	SN19	SP19	H19					
NISSAN	Cedric/Gloria	SY31	Правый	июн 91	апр 98	A20	S20	SN20	SP20	H20	A20	S20	SN20	SP20	H20					
NISSAN	Cedric/Gloria	Y32	Правый	июн 91	июн 95	A22	S22	SN22	SP22	H22	A20	S20	SN20	SP20	H20					
NISSAN	Cedric/Gloria	Y33	Правый	июн 95	янв 98	A22	S22	SN22	SP22	H22	A20	S20	SN20	SP20	H20					
NISSAN	Cedric/Gloria	Y33	Правый	янв 98	июн 99	A22	S22	SN22	SP22	H22	A20	S20	SN20	SP20	H20					
NISSAN	Cedric/Gloria	Y34	Правый	июн 99	сен 04	A21	S21	SN21	SP21	H21	A19	S19	SN19	SP19	H19					
NISSAN	Cefiro	A31	Правый	сен 88	июл 94	A20	S20	SN20	SP20	H20	A18	S18	SN18	SP18	H18	A19	S19	SN19	SP19	H19
NISSAN	Cefiro	A32	Правый	авг 94	янв 97	A22	S22	SN22	SP22	H22	A21	S21	SN21	SP21	H21	A17	S17	SN17		
NISSAN	Cefiro	A32	Правый	янв 97	авг 98	A22	S22	SN22	SP22	H22	A21	S21	SN21	SP21	H21	A18	S18	SN18	SP18	H18
NISSAN	Cefiro	A32	Правый	авг 98	ноя 98	A22	S22	SN22	SP22	H22	A21	S21	SN21	SP21	H21	A18	S18	SN18	SP18	H18
NISSAN	Cefiro	CA33	Правый	дек 98	фев 03	A26	S26	SN26	SP26	H26	A17	S17	SN17			A18	S18	SN18	SP18	H18
NISSAN	Cefiro Wagon	WA32	Правый	июн 97	авг 98	A22	S22	SN22	SP22	H22	A21	S21	SN21	SP21	H21	A16	S16	SN16	SP16	H16
NISSAN	Cefiro Wagon	WA32	Правый	авг 98	июл 03	A22	S22	SN22	SP22	H22	A21	S21	SN21	SP21	H21	A16	S16	SN16	SP16	H16
NISSAN	Cima	FPAY31, FPY31	Правый	янв 88	июл 91	A20	S20	SN20	SP20	H20	A19	S19	SN19	SP19	H19					
NISSAN	Cima	FGY32	Правый	авг 91	май 96	A22	S22	SN22	SP22	H22	A20	S20	SN20	SP20	H20					
NISSAN	Cima	FGY33	Правый	июн 96	янв 98	A22	S22	SN22	SP22	H22	A20	S20	SN20	SP20	H20					

Марка	Модель	Кузов	Расположение руля	Период выпуска	Место водителя					Место пассажира					Заднее стекло					
					Aerodynamic	Snowguard	Smart neo	Spoiler	Hybrid	Aerodynamic	Snowguard	Smart neo	Spoiler	Hybrid	Aerodynamic	Snowguard	Smart neo	Spoiler	Hybrid	
NISSAN																				
NISSAN	Cima	FGY33	Правый	янв 98	дек 00	A22	S22	SN22	SP22	H22	A20	S20	SN20	SP20	H20					
NISSAN	Cima	HF,GF,GNF50	Правый	янв 01		A26	S26	SN26	SP26	H26	A18	S18	SN18	SP18	H18					
NISSAN	Civilian	W40	Правый	ноя 91	янв 99	A22	S22	SN22	SP22	H22	A22	S22	SN22	SP22	H22	A16	S16	SN16	SP16	H16
NISSAN	Civilian	W41	Правый	фев 99		A24	S24	SN24	SP24	H24	A24	S24	SN24	SP24	H24	A16	S16	SN16	SP16	H16
NISSAN	Clipper	U71T, U71TP, U72T, U72TP, U71V	Правый	сен 03	дек 05	A17	S17	SN17			A15	S15	SN15			A14	S14	SN14		
NISSAN	Clipper	U71T, U71TP, U72T, U72TP, U71V, U72V, U71W, U72W	Правый	янв 06		A17	S17	SN17			A15	S15	SN15							
NISSAN	Crew	K30, K30S	Правый	июл 93		A19	S19	SN19	SP19	H19	A18	S18	SN18	SP18	H18					
NISSAN	Cube	Z10	Правый	фев 98	мар 99	A24	S24	SN24	SP24	H24	A16	S16	SN16	SP16	H16	A12	S11			
NISSAN	Cube	Z10	Правый	апр 99	ноя 99	A24	S24	SN24	SP24	H24	A16	S16	SN16	SP16	H16	A12	S11			
NISSAN	Cube	Z10	Правый	сен 00	сен 02	A22	S22	SN22	SP22	H22	A15	S15	SN15			A12	S11			
NISSAN	Cube	BZ11	Правый	окт 02	ноя 08	A19	S19	SN19	SP19	H19	A18	S18	SN18	SP18	H18					
NISSAN	Cube	BZ12	Правый	ноя 08		A20	S20	SN20	SP20	H20	A20	S20	SN20	SP20	H20					
NISSAN	Datsun	D21	Правый	авг 85	янв 97	A19	S19	SN19	SP19	H19	A19	S19	SN19	SP19	H19					
NISSAN	Datsun	D22	Правый	янв 97	май 99	A19	S19	SN19	SP19	H19	A19	S19	SN19	SP19	H19					
NISSAN	Datsun	D22	Правый	июн 99	июл 02	A19	S19	SN19	SP19	H19	A19	S19	SN19	SP19	H19					
NISSAN	Dualis (Quasqai)	J10, NJ10	Правый	май 07																
NISSAN	Elgrand	E50	Правый	май 97	апр 02	A26	S26	SN26	SP26	H26	A18	S18	SN18	SP18	H18	A18	S18	SN18	SP18	H18
NISSAN	Elgrand	E51	Правый	май 02		A26	S26	SN26	SP26	H26	A16	S16	SN16	SP16	H16					
NISSAN	Elgrand	E52	Правый	авг 10		A26	S26	SN26	SP26	H26	A17	S17	SN17	SP17						
NISSAN	Expert	VW11	Правый	июн 99	дек 06	A21	S21	SN21	SP21	H21	A19	S19	SN19	SP19	H19	A13	S13			
NISSAN	Fairlady	Z32	Правый	июл 89	дек 93	A21	S21	SN21	SP21	H21	A21	S21	SN21	SP21	H21	A19	S19	SN19	SP19	H19
NISSAN	Fairlady	Z32	Правый	дек 93	июн 02	A21	S21	SN21	SP21	H21	A21	S21	SN21	SP21	H21	A16	S16	SN16	SP16	H16
NISSAN	Fairlady	Z33	Правый	июл 02		A20	S20	SN20	SP20	H20	A18	S18	SN18	SP18	H18	A18	S18	SN18	SP18	H18
NISSAN	Figaro	FK10	Правый	фев 91	дек 91	A19	S19	SN19	SP19	H19	A19	S19	SN19	SP19	H19					
NISSAN	Fuga	Y50,PY50,PNY50	Правый	окт 04		A24	S24	SN24	SP24	H24	A19	S19	SN19	SP19	H19					
NISSAN	Infiniti Q45	G50	Правый	окт 89	сен 96	A21	S21	SN21	SP21	H21	A21	S21	SN21	SP21	H21					
NISSAN	Kix	H59	Правый	окт 08		A18	S18	SN18	SP18	H18	A16	S16	SN16	SP16	H16	A12	S11			
NISSAN	Lafesta	A30, B30, NB30	Правый	дек 04		A26	S26	SN26	SP26	H26	A12	S11				A12	S11			
NISSAN	Lafesta	CWFEWVN	Правый	июн 11		A26	S26	SN26	SP26	H26	A16	S16	SN16	SP16	H16					

DAIHATSU

HINO

HONDA

ISUZU

MAZDA

MITSUBISHI

NISSAN

NISSAN DIESEL

SUBARU

SUZUKI

TOYOTA

LEXUS

- DAIHATSU
- HINO
- HONDA
- ISUZU
- MAZDA
- MITSUBISHI
- NISSAN**
- NISSAN DIESEL
- SUBARU
- SUZUKI
- TOYOTA
- LEXUS

Марка	Модель	Кузов	Расположение руля	Период выпуска	Место водителя					Место пассажира					Заднее стекло					
					Aerodynamic	Snowguard	Smart neo	Spoiler	Hybrid	Aerodynamic	Snowguard	Smart neo	Spoiler	Hybrid	Aerodynamic	Snowguard	Smart neo	Spoiler	Hybrid	
NISSAN																				
NISSAN	Langley	N13P	Правый	окт 86	авг 90	A20	S20	SN20	SP20	H20	A20	S20	SN20	SP20	H20	A19	S19	SN19	SP19	H19
NISSAN	Largo	GC22	Правый	май 86	апр 93	A22	S22	SN22	SP22	H22	A19	S19	SN19	SP19	H19					
NISSAN	Largo	W30	Правый	май 93	июн 99	A26	S26	SN26	SP26	H26	A19	S19	SN19	SP19	H19	A16	S16	SN16	SP16	H16
NISSAN	Laurel	C33	Правый	янв 89	дек 92	A20	S20	SN20	SP20	H20	A18	S18	SN18	SP18	H18					
NISSAN	Laurel	C34	Правый	янв 93	май 97	A20	S20	SN20	SP20	H20	A20	S20	SN20	SP20	H20	A16	S16	SN16	SP16	H16
NISSAN	Laurel	C35	Правый	июн 97	дек 02	A21	S21	SN21	SP21	H21	A19	S19	SN19	SP19	H19	A20	S20	SN20	SP20	H20
NISSAN	Leopard/J.Farie	F31	Правый	фев 86	май 92	A20	S20	SN20	SP20	H20	A20	S20	SN20	SP20	H20					
NISSAN	Leopard/J.Farie	JPY32	Правый	июн 92	фев 96	A21	S21	SN21	SP21	H21	A20	S20	SN20	SP20	H20					
NISSAN	Leopard/J.Farie	JPY33	Правый	мар 96	июн 99	A22	S22	SN22	SP22	H22	A20	S20	SN20	SP20	H20					
NISSAN	Liberty	M12	Правый	ноя 98	ноя 04	A26	S26	SN26	SP26	H26	A15	S15	SN15			A14	S14	SN14		
NISSAN	Lucino	N15	Правый	янв 95		A21	S21	SN21	SP21	H21	A19	S19	SN19	SP19	H19	A14	S14	SN14		
NISSAN	March	K10	Правый	янв 87	дек 91	A18	S18	SN18	SP18	H18	A18	S18	SN18	SP18	H18	A18	S18	SN18	SP18	H18
NISSAN	March	K11	Правый	янв 92	июн 94	A21	S21	SN21	SP21	H21	A18	S18	SN18	SP18	H18	A16	S16	SN16	SP16	H16
NISSAN	March	K11	Правый	июн 94	дек 95	A21	S21	SN21	SP21	H21	A18	S18	SN18	SP18	H18	A14	S14	SN14		
NISSAN	March	K11	Правый	дек 95	фев 02	A21	S21	SN21	SP21	H21	A18	S18	SN18	SP18	H18	A16	S16	SN16	SP16	H16
NISSAN	March	K,AK,BK12	Правый	мар 02	ноя 03	A22	S22	SN22	SP22	H22	A16	S16	SN16	SP16	H16					
NISSAN	March	YK12, AK12, BNK12	Правый	дек 03	июл 10	A22	S22	SN22	SP22	H22	A16	S16	SN16	SP16	H16					
NISSAN	March	K13	Правый	июл 10		A22	S22	SN22	SP22	H22	A16	S16	SN16	SP16	H16					
NISSAN	Maxima	J30	Правый	ноя 88	июл 94	A21	S21	SN21	SP21	H21	A20	S20	SN20	SP20	H20					
NISSAN	Mistral	R20	Правый	фев 94	фев 99	A21	S21	SN21	SP21	H21	A20	S20	SN20	SP20	H20					
NISSAN	Moco	MG21S	Правый	апр 02	мар 04	A21	S21	SN21	SP21	H21	A12	S11				A12	S11			
NISSAN	Moco	MG21S	Правый	апр 04	янв 06	A21	S21	SN21	SP21	H21	A12	S11								
NISSAN	Moco	MG22S	Правый	фев 06	фев 11	A20	S20	SN20	SP20	H20										
NISSAN	Moco	MG33S	Правый	фев 11		A20	S20	SN20	SP20	H20	A17	S17	SN17							
NISSAN	Murano	TZ50, PZ50, PNZ50	Правый	сен 04	сен 08	A26	S26	SN26	SP26	H26	A18	S18	SN18	SP18	H18	A14	S14	SN14		
NISSAN	Note	E11, NE11	Правый	янв 05		A24	S24	SN24	SP24	H24	A14	S14	SN14			A12	S11			
NISSAN	Otti	H91W	Правый	июн 05	сен 06	A19	S19	SN19	SP19	H19	A14	S14	SN14							
NISSAN	Otti	H92W	Правый	окт 06		A19	S19	SN19	SP19	H19	A14	S14	SN14							
NISSAN	Pao	PK10	Правый	янв 89	июн 90	A17	S17	SN17			A16	S16	SN16	SP16	H16					
NISSAN	Passat	319A	Правый	окт 89		A21	S21	SN21	SP21	H21	A21	S21	SN21	SP21	H21					

Марка	Модель	Кузов	Расположение руля	Период выпуска	Место водителя					Место пассажира					Заднее стекло					
					Aerodynamic	Snowguard	Smart neo	Spoiler	Hybrid	Aerodynamic	Snowguard	Smart neo	Spoiler	Hybrid	Aerodynamic	Snowguard	Smart neo	Spoiler	Hybrid	
NISSAN																				
NISSAN	Pino	HC24S	Правый	янв 07		A18	S18	SN18	SP18	H18	A16	S16	SN16	SP16	H16					
NISSAN	Prairie	M11	Правый	сен 88	дек 94	A26	S26	SN26	SP26	H26	A22	S22	SN22	SP22	H22	A16	S16	SN16	SP16	H16
NISSAN	Prairie	M11	Правый	дек 94	ноя 98	A26	S26	SN26	SP26	H26	A22	S22	SN22	SP22	H22	A14	S14	SN14		
NISSAN	Prairie	M12	Правый	ноя 98	ноя 04	A28	S28				A15	S15	SN15			A14	S14	SN14		
NISSAN	Presage	U30	Правый	июн 98	июл 00	A26	S26	SN26	SP26	H26	A21	S21	SN21	SP21	H21	A16	S16	SN16	SP16	H16
NISSAN	Presage	U30	Правый	авг 00	июн 03	A26	S26	SN26	SP26	H26	A21	S21	SN21	SP21	H21	A16	S16	SN16	SP16	H16
NISSAN	Presage	TU31	Правый	июл 03		A26	S26	SN26	SP26	H26	A16	S16	SN16	SP16	H16	A12	S11			
NISSAN	Presea	R10	Правый	июн 90	янв 95	A20	S20	SN20	SP20	H20	A20	S20	SN20	SP20	H20	A18	S18	SN18	SP18	H18
NISSAN	Presea	R11	Правый	янв 95	авг 00	A21	S21	SN21	SP21	H21	A19	S19	SN19	SP19	H19	A18	S18	SN18	SP18	H18
NISSAN	President	JHG50	Правый	окт 90		A21	S21	SN21	SP21	H21	A21	S21	SN21	SP21	H21					
NISSAN	President	PGF50	Правый	окт 03		A26	S26	SN26	SP26	H26	A18	S18	SN18	SP18	H18					
NISSAN	Primera	P10	Правый	фев 90	сен 95	A21	S21	SN21	SP21	H21	A19	S19	SN19	SP19	H19					
NISSAN	Primera	P10E	Правый	июл 91	ноя 96	A21	S21	SN21	SP21	H21	A19	S19	SN19	SP19	H19	A21	S21	SN21	SP21	H21
NISSAN	Primera	P11	Правый	сен 95	дек 00	A21	S21	SN21	SP21	H21	A19	S19	SN19	SP19	H19	A17	S17	SN17		
NISSAN	Primera	P12	Правый	янв 01	дек 05	A26	S26	SN26	SP26	H26	A19	S19	SN19	SP19	H19					
NISSAN	Primera UK	P11E	Правый	ноя 96		A21	S21	SN21	SP21	H21	A19	S19	SN19	SP19	H19	A21	S21	SN21	SP21	H21
NISSAN	Primera Wagon	WP11,WHF11,WHNP11,WQP11	Правый	сен 97	дек 00	A21	S21	SN21	SP21	H21	A19	S19	SN19	SP19	H19	A18	S18	SN18	SP18	H18
NISSAN	Primera Wagon	WTP12,WNTP12,WRP12,WQP12	Правый	янв 01	дек 05	A26	S26	SN26	SP26	H26	A19	S19	SN19	SP19	H19	A14	S14	SN14		
NISSAN	Primera	P11	Правый	сен 95	дек 00	A21	S21	SN21	SP21	H21	A19	S19	SN19	SP19	H19	A17	S17	SN17		
NISSAN	Primera	TP,RP12	Правый	янв 01		A26	S26	SN26	SP26	H26	A19	S19	SN19	SP19	H19					
NISSAN	Primera Wagon	WP11	Правый	сен 97	дек 00	A21	S21	SN21	SP21	H21	A19	S19	SN19	SP19	H19	A14	S14	SN14		
NISSAN	Primera Wagon	WP11	Правый	янв 00		A21	S21	SN21	SP21	H21	A19	S19	SN19	SP19	H19	A14	S14	SN14		
NISSAN	Pulsar	N13	Правый	окт 86	июл 90	A20	S20	SN20	SP20	H20	A20	S20	SN20	SP20	H20	A18	S18	SN18	SP18	H18
NISSAN	Pulsar	N14	Правый	авг 90	янв 95	A21	S21	SN21	SP21	H21	A19	S19	SN19	SP19	H19	A12	S11			
NISSAN	Pulsar	N14	Правый	авг 90	янв 95	A21	S21	SN21	SP21	H21	A19	S19	SN19	SP19	H19	A20	S20	SN20	SP20	H20
NISSAN	Pulsar	N14	Правый	авг 90	янв 95	A21	S21	SN21	SP21	H21	A19	S19	SN19	SP19	H19					
NISSAN	Pulsar	N15	Правый	янв 95	авг 00	A21	S21	SN21	SP21	H21	A19	S19	SN19	SP19	H19	A14	S14	SN14		
NISSAN	Pulsar	N15	Правый	янв 95	авг 00	A21	S21	SN21	SP21	H21	A19	S19	SN19	SP19	H19	A14	S14	SN14		
NISSAN	Pulsar	N15	Правый	янв 95	авг 00	A21	S21	SN21	SP21	H21	A19	S19	SN19	SP19	H19	A18	S18	SN18	SP18	H18
NISSAN	Pulsar	N15	Правый	май 96	авг 00	A21	S21	SN21	SP21	H21	A19	S19	SN19	SP19	H19	A14	S14	SN14		

- DAIHATSU
- HINO
- HONDA
- ISUZU
- MAZDA
- MITSUBISHI
- NISSAN**
- NISSAN DIESEL
- SUBARU
- SUZUKI
- TOYOTA
- LEXUS

- DAIHATSU
- HINO
- HONDA
- ISUZU
- MAZDA
- MITSUBISHI
- NISSAN
- NISSAN DIESEL
- SUBARU
- SUZUKI
- TOYOTA
- LEXUS

Марка	Модель	Кузов	Расположение руля	Период выпуска	Место водителя					Место пассажира					Заднее стекло					
					Aerodynamic	Snowguard	Smart neo	Spoiler	Hybrid	Aerodynamic	Snowguard	Smart neo	Spoiler	Hybrid	Aerodynamic	Snowguard	Smart neo	Spoiler	Hybrid	
<b>NISSAN</b>																				
NISSAN	Rasheen	RB14	Правый	дек 94	авг 00	A21	S21	SN21	SP21	H21	A20	S20	SN20	SP20	H20	A12	S11			
NISSAN	Roox	ML21S	Правый	дек 09		A21	S21	SN21	SP21	H21	A16	S16	SN16	SP16	H16					
NISSAN	R'nessa	N30	Правый	окт 97	ноя 98	A22	S22	SN22	SP22	H22	A18	S18	SN18	SP18	H18	A14	S14	SN14		
NISSAN	R'nessa	N30	Правый	ноя 98	июл 01	A24	S24	SN24	SP24	H24	A17	S17	SN17			A14	S14	SN14		
NISSAN	Safari	Y60	Правый	окт 87	окт 91	A18	S18	SN18	SP18	H18	A18	S18	SN18	SP18	H18	A12	S11			
NISSAN	Safari	Y60	Правый	окт 91	авг 95	A19	S19	SN19	SP19	H19	A19	S19	SN19	SP19	H19	A12	S11			
NISSAN	Safari	Y60	Правый	авг 95	сен 97	A19	S19	SN19	SP19	H19	A19	S19	SN19	SP19	H19	A12	S11			
NISSAN	Safari	WFGY61	Правый	окт 97	июн 07	A19	S19	SN19	SP19	H19	A20	S20	SN20	SP20	H20	A14	S14	SN14		
NISSAN	Serena	C23	Правый	июн 91	май 99	A26	S26	SN26	SP26	H26	A26	S26	SN26	SP26	H26	A16	S16	SN16	SP16	H16
NISSAN	Serena	C24	Правый	июн 99	ноя 01	A26	S26	SN26	SP26	H26	A14	S14	SN14			A18	S18	SN18	SP18	H18
NISSAN	Serena	C24	Правый	ноя 01	апр 05	A26	S26	SN26	SP26	H26	A14	S14	SN14							
NISSAN	Serena	C25	Правый	май 05	ноя 10	A26	S26	SN26	SP26	H26	A12	S11				A16	S16	SN16	SP16	H16
NISSAN	Serena	C26	Правый	ноя 10		A26	S26	SN26	SP26	H26	A12	S11								
NISSAN	Silvia	S13	Правый	июн 88	сен 93	A20	S20	SN20	SP20	H20	A20	S20	SN20	SP20	H20					
NISSAN	Silvia	S14	Правый	окт 93	дек 98	A21	S21	SN21	SP21	H21	A20	S20	SN20	SP20	H20	A18	S18	SN18	SP18	H18
NISSAN	Silvia	S15	Правый	янв 99	авг 02	A21	S21	SN21	SP21	H21	A20	S20	SN20	SP20	H20	A17	S17	SN17		
NISSAN	Skyline	R32	Правый	май 89	июл 93	A20	S20	SN20	SP20	H20	A19	S19	SN19	SP19	H19	A18	S18	SN18	SP18	H18
NISSAN	Skyline	R33	Правый	авг 93	апр 98	A21	S21	SN21	SP21	H21	A21	S21	SN21	SP21	H21	A18	S18	SN18	SP18	H18
NISSAN	Skyline	R34	Правый	май 98	янв 00	A21	S21	SN21	SP21	H21	A21	S21	SN21	SP21	H21	A18	S18	SN18	SP18	H18
NISSAN	Skyline	R34	Правый	янв 00	май 01	A21	S21	SN21	SP21	H21	A21	S21	SN21	SP21	H21	A18	S18	SN18	SP18	H18
NISSAN	Skyline	VHV35	Правый	июн 01	окт 06	A21	S21	SN21	SP21	H21	A18	S18	SN18	SP18	H18	A15	S15	SN15		
NISSAN	Skyline	V36, NV36, PV36	Правый	ноя 06		A24	S24	SN24	SP24	H24	A17	S17	SN17							
NISSAN	Skyline Coupe	CPV35	Правый	фев 03		A24	S24	SN24	SP24	H24	A17	S17	SN17							
NISSAN	Stagea	C34	Правый	сен 96	сен 99	A21	S21	SN21	SP21	H21	A19	S19	SN19	SP19	H19	A12	S11			
NISSAN	Stagea	C34	Правый	окт 99	сен 01	A21	S21	SN21	SP21	H21	A19	S19	SN19	SP19	H19	A12	S11			
NISSAN	Stagea	M35, PM35, NM35, PNM35	Правый	окт 01	июн 07	A21	S21	SN21	SP21	H21	A18	S18	SN18	SP18	H18					
NISSAN	Sunny	B13	Правый	янв 90	дек 93	A20	S20	SN20	SP20	H20	A19	S19	SN19	SP19	H19	A20	S20	SN20	SP20	H20
NISSAN	Sunny	B14	Правый	янв 94		A21	S21	SN21	SP21	H21	A19	S19	SN19	SP19	H19	A18	S18	SN18	SP18	H18
NISSAN	Sunny	B15	Правый	окт 98	сен 04	A22	S22	SN22	SP22	H22	A16	S16	SN16	SP16	H16	A17	S17	SN17		
NISSAN	Sunny California	CY10	Правый	окт 90	мар 94	A21	S21	SN21	SP21	H21	A18	S18	SN18	SP18	H18	A14	S14	SN14		

Марка	Модель	Кузов	Расположение руля	Период выпуска	Место водителя					Место пассажира					Заднее стекло					
					Aerodynamic	Snowguard	Smart neo	Spoiler	Hybrid	Aerodynamic	Snowguard	Smart neo	Spoiler	Hybrid	Aerodynamic	Snowguard	Smart neo	Spoiler	Hybrid	
<b>NISSAN</b>																				
NISSAN	Sunny California	CY10	Правый	мар 94	май 96	A21	S21	SN21	SP21	H21	A18	S18	SN18	SP18	H18	A12	S11			
NISSAN	Sunny Lucino	B14	Правый	май 94	апр 99	A21	S21	SN21	SP21	H21	A19	S19	SN19	SP19	H19	A20	S20	SN20	SP20	H20
NISSAN	Sunny Lucino Hatchback	FN15, HN15	Правый	янв 95	авг 00	A21	S21	SN21	SP21	H21	A19	S19	SN19	SP19	H19	A18	S18	SN18	SP18	H18
NISSAN	Sunny Lucino SR-V	JN15	Правый	май 96	авг 00	A21	S21	SN21	SP21	H21	A19	S19	SN19	SP19	H19	A18	S18	SN18	SP18	H18
NISSAN	Sunny Truck	B120	Правый	окт 89	дек 94	A15	S15	SN15			A15	S15	SN15							
NISSAN	Teana	PJ31, J31, TNJ31	Правый	фев 03	июн 08	A24	S24	SN24	SP24	H24	A19	S19	SN19	SP19	H19					
NISSAN	Terrano	WD21	Правый	авг 86	сен 95	A19	S19	SN19	SP19	H19	A19	S19	SN19	SP19	H19	A12	S11			
NISSAN	Terrano	R50	Правый	сен 95	авг 02	A22	S22	SN22	SP22	H22	A21	S21	SN21	SP21	H21	A12	S11			
NISSAN	Terrano-Regulus	JR50	Правый	авг 96	авг 02	A22	S22	SN22	SP22	H22	A21	S21	SN21	SP21	H21	A12	S11			
NISSAN	Tiida	C11, NC11	Правый	сен 04		A22	S22	SN22	SP22	H22	A16	S16	SN16	SP16	H16	A12	S11			
NISSAN	Tiida Latio	SC11, SNC11	Правый	окт 04		A22	S22	SN22	SP22	H22	A16	S16	SN16	SP16	H16					
NISSAN	Tino	V10	Правый	дек 98	мар 03	A26	S26	SN26	SP26	H26	A19	S19	SN19	SP19	H19	A19	S19	SN19	SP19	H19
NISSAN	Vanette	C22	Правый	сен 85	мар 94	A19	S19	SN19	SP19	H19	A18	S18	SN18	SP18	H18	A16	S16	SN16	SP16	H16
NISSAN	Vanette	S20	Правый	апр 94	июн 99	A16	S16	SN16	SP16	H16	A16	S16	SN16	SP16	H16	A15	S15	SN15		
NISSAN	Vanette	S21	Правый	июн 99		A18	S18	SN18	SP18	H18	A18	S18	SN18	SP18	H18	A17	S17	SN17		
NISSAN	Vanette Serena	C23	Правый	июн 91	июн 99	A26	S26	SN26	SP26	H26	A26	S26	SN26	SP26	H26	A16	S16	SN16	SP16	H16
NISSAN	Vanette	M20	Правый	май 09		A22	S22	SN22	SP22	H22	A16	S16	SN16	SP16	H16					
NISSAN	Wingroad	CY10	Правый	май 96	апр 99	A21	S21	SN21	SP21	H21	A18	S18	SN18	SP18	H18	A12	S11			
NISSAN	Wingroad	Y11	Правый	май 99	сен 01	A22	S22	SN22	SP22	H22	A16	S16	SN16	SP16	H16	A12	S11			
NISSAN	Wingroad	WHY, WFY, WHNY, WFNY10	Правый	окт 01	окт 05	A22	S22	SN22	SP22	H22	A16	S16	SN16	SP16	H16	A12	S11			
NISSAN	Wingroad	Y12, NY12, JY12	Правый	ноя 05		A22	S22	SN22	SP22	H22	A16	S16	SN16	SP16	H16	A14	S14	SN14		
NISSAN	X-trail	T, NT, PN30	Правый	ноя 00	авг 07	A24	S24	SN24	SP24	H24	A15	S15	SN15			A17	S17	SN17		
NISSAN	X-trail	T31	Правый	авг 07		A24	S24	SN24	SP24	H24	A16	S16	SN16	SP16	H16					
<b>NISSAN DIESEL</b>																				
NISSAN DIESEL	Condor	F23	Правый	янв 92		A18	S18	SN18	SP18	H18	A18	S18	SN18	SP18	H18					
NISSAN DIESEL	Condor	H41	Правый	окт 91	май 95	A18	S18	SN18	SP18	H18	A18	S18	SN18	SP18	H18					
NISSAN DIESEL	Condor	H41	Правый	янв 92	май 95	A20	S20	SN20	SP20	H20	A20	S20	SN20	SP20	H20					
NISSAN DIESEL	Condor	H42	Правый	май 95		A19	S19	SN19	SP19	H19	A19	S19	SN19	SP19	H19					
NISSAN DIESEL	Condor	H42	Правый			A20	S20	SN20	SP20	H20	A20	S20	SN20	SP20	H20					
NISSAN DIESEL	Condor	NK110	Правый	авг 98		A18	S18	SN18	SP18	H18	A18	S18	SN18	SP18	H18					

- DAIHATSU
- HINO
- HONDA
- ISUZU
- MAZDA
- MITSUBISHI
- NISSAN
- NISSAN DIESEL
- SUBARU
- SUZUKI
- TOYOTA
- LEXUS



- DAIHATSU
- HINO
- HONDA
- ISUZU
- MAZDA
- MITSUBISHI
- NISSAN
- NISSAN DIESEL
- SUBARU
- SUZUKI
- TOYOTA
- LEXUS

Марка	Модель	Кузов	Расположение руля	Период выпуска	Место водителя					Место пассажира					Заднее стекло				
					Aerodynamic	Snowguard	Smart neo	Spoiler	Hybrid	Aerodynamic	Snowguard	Smart neo	Spoiler	Hybrid	Aerodynamic	Snowguard	Smart neo	Spoiler	Hybrid
<b>NISSAN DIESEL</b>																			
NISSAN DIESEL	Condor	BHR, BKR	Правый	дек 98		A24	S24	SN24	SP24	H24	A20	S20	SN20	SP20	H20				
NISSAN DIESEL	Condor	U-CM87 Short body	Правый	апр 90		A18	S18	SN18	SP18	H18	A18	S18	SN18	SP18	H18				
NISSAN DIESEL	Condor	U-CM89 Short Cab	Правый	апр 90		A20	S20	SN20	SP20	H20	A20	S20	SN20	SP20	H20				
NISSAN DIESEL	Condor	U-MK210, LK210, PK250.	Правый	окт 92		A26	S26	SN26	SP26	H26	A26	S26	SN26	SP26	H26				
NISSAN DIESEL	Condor	U-MK210, LK210, PK210, 250.	Правый	окт 92		A20	S20	SN20	SP20	H20	A20	S20	SN20	SP20	H20				
NISSAN DIESEL	Condor	W-CL88BT	Правый	апр 90		A26	S26	SN26	SP26	H26	A26	S26	SN26	SP26	H26				
NISSAN DIESEL	Condor	W-CL88BT	Правый	апр 90		A20	S20	SN20	SP20	H20	A20	S20	SN20	SP20	H20				
NISSAN DIESEL	Condor	KC-MF211, LF211, LK211, 251, 260, MK130, 210, 211, 251, 260, KC-PK211, 251, 260	Правый	сен 94		A26	S26	SN26	SP26	H26	A26	S26	SN26	SP26	H26				
NISSAN DIESEL	Condor	KC-LK211, 251, 260, MK130, 210, 211, 251, 260, KC-PK211, 251, 260	Правый	сен 94		A20	S20	SN20	SP20	H20	A20	S20	SN20	SP20	H20				
NISSAN DIESEL	Condor	KC-MK120, 211.. Short Cab		окт 95		A20	S20	SN20	SP20	H20	A20	S20	SN20	SP20	H20				

<b>SUBARU</b>																				
Марка	Модель	Кузов	Расположение руля	Период выпуска	Период выпуска	Место водителя					Место пассажира					Заднее стекло				
						Aerodynamic	Snowguard	Smart neo	Spoiler	Hybrid	Aerodynamic	Snowguard	Smart neo	Spoiler	Hybrid	Aerodynamic	Snowguard	Smart neo	Spoiler	Hybrid
SUBARU	Alcyone SVX	CXW, CXD	Правый	сен 91	ноя 96	A22	S22	SN22	SP22	H22	A20	S20	SN20	SP20	H20					
SUBARU	Dex	M401, M411	Правый	ноя 08		A20	S20	SN20	SP20	H20	A19	S19	SN19	SP19	H19					
SUBARU	Dias	S321N/S331N	Правый	сен 09		A20	S20	SN20	SP20	H20	A14	S14	SN14							
SUBARU	Domingo	KJ	Правый	сен 83	май 94	A15	S15	SN15			A15	S15	SN15			A15	S15	SN15		
SUBARU	Domingo	FA	Правый	июн 94	ноя 98	A16	S16	SN16	SP16	H16	A16	S16	SN16	SP16	H16	A15	S15	SN15		
SUBARU	Exiga	YA	Правый	май 08		A24	S24	SN24	SP24	H24	A18	S18	SN18	SP18	H18					
SUBARU	Forester	SF5	Правый	фев 97	май 97	A21	S21	SN21	SP21	H21	A19	S19	SN19	SP19	H19	A15	S15	SN15		
SUBARU	Forester	SF5	Правый	июн 97	дек 99	A21	S21	SN21	SP21	H21	A19	S19	SN19	SP19	H19	A15	S15	SN15		
SUBARU	Forester	SF5	Правый	янв 00	янв 02	A21	S21	SN21	SP21	H21	A19	S19	SN19	SP19	H19	A15	S15	SN15		
SUBARU	Forester	SG5	Правый	фев 02	июл 03	A22	S22	SN22	SP22	H22	A19	S19	SN19	SP19	H19	A15	S15	SN15		
SUBARU	Forester	SG5	Правый	авг 03	янв 05	A22	S22	SN22	SP22	H22	A19	S19	SN19	SP19	H19					
SUBARU	Forester	SG5, SG9	Правый	фев 05	дек 07	A22	S22	SN22	SP22	H22	A19	S19	SN19	SP19	H19					
SUBARU	Forester	SH	Правый	дек 07		A24	S24	SN24	SP24	H24	A18	S18	SN18	SP18	H18					
SUBARU	Impreza XV	GH	Правый	июн 10	дек 11	A24	S24	SN24	SP24	H24	A16	S16	SN16	SP16	H16					
SUBARU	Impreza	GC	Правый	ноя 92	янв 95	A21	S21	SN21	SP21	H21	A18	S18	SN18	SP18	H18	A17	S17	SN17		

<b>SUBARU</b>																				
Марка	Модель	Кузов	Расположение руля	Период выпуска	Период выпуска	Место водителя					Место пассажира					Заднее стекло				
						Aerodynamic	Snowguard	Smart neo	Spoiler	Hybrid	Aerodynamic	Snowguard	Smart neo	Spoiler	Hybrid	Aerodynamic	Snowguard	Smart neo	Spoiler	Hybrid
SUBARU	Impreza	GD	Правый	авг 00	июн 04	A22	S22	SN22	SP22	H22	A17	S17	SN17			A15	S15	SN15		
SUBARU	Impreza	GD	Правый	июн 04	июн 07	A22	S22	SN22	SP22	H22	A17	S17	SN17			A15	S15	SN15		
SUBARU	Impreza	GJ	Правый	дек 11		A26	S26	SN26	SP26	H26	A16	S16	SN16	SP16	H16					
SUBARU	Impreza	GF	Правый	ноя 92	янв 95	A21	S21	SN21	SP21	H21	A18	S18	SN18	SP18	H18	A15	S15	SN15		
SUBARU	Impreza	GC	Правый	янв 95		A21	S21	SN21	SP21	H21	A18	S18	SN18	SP18	H18	A17	S17	SN17		
SUBARU	Impreza	GF	Правый	дек 98		A21	S21	SN21	SP21	H21	A18	S18	SN18	SP18	H18	A15	S15	SN15		
SUBARU	Impreza	GDA, GDB, GGA, GGB	Правый	авг 00	май 07	A22	S22	SN22	SP22	H22	A17	S17	SN17			A15	S15	SN15		
SUBARU	Impreza	GH2, GH3, GH7, GH8	Правый	июн 07	дек 11	A24	S24	SN24	SP24	H24	A16	S16	SN16	SP16	H16					
SUBARU	Impreza	GH	Правый	дек 11		A26	S26	SN26	SP26	H26	A16	S16	SN16	SP16	H16					
SUBARU	Justy	KA	Правый	окт 88	мар 94	A18	S18	SN18	SP18	H18	A17	S17	SN17			A15	S15	SN15		
SUBARU	Legacy	BF, BC	Правый	ноя 88	сен 93	A20	S20	SN20	SP20	H20	A18	S18	SN18	SP18	H18	A17	S17	SN17		
SUBARU	Legacy	BD, BG	Правый	окт 93	ноя 98	A21	S21	SN21	SP21	H21	A19	S19	SN19	SP19	H19	A17	S17	SN17		
SUBARU	Legacy B4	BE5, BE9, BEE	Правый	дек 98	окт 01	A22	S22	SN22	SP22	H22	A20	S20	SN20	SP20	H20	A18	S18	SN18	SP18	H18
SUBARU	Legacy B4	BE5, BE9, BEE	Правый	ноя 01	май 03	A22	S22	SN22	SP22	H22	A20	S20	SN20	SP20	H20	A18	S18	SN18	SP18	H18
SUBARU	Legacy B4	BL5	Правый	июн 03	май 09	A24	S24	SN24	SP24	H24	A18	S18	SN18	SP18	H18					
SUBARU	Legacy B4	BM	Правый	май 09		A26	S26	SN26	SP26	H26	A19	S19	SN19	SP19	H19					
SUBARU	Legacy Wagon	BF, BC	Правый	ноя 88	сен 93	A20	S20	SN20	SP20	H20	A18	S18	SN18	SP18	H18	A15	S15	SN15		
SUBARU	Legacy Wagon	BD, BG	Правый	окт 93	май 98	A21	S21	SN21	SP21	H21	A19	S19	SN19	SP19	H19	A15	S15	SN15		
SUBARU	Legacy Wagon	BH5, BH9, BHC, BHE	Правый	июн 98	апр 03	A22	S22	SN22	SP22	H22	A20	S20	SN20	SP20	H20	A15	S15	SN15		
SUBARU	Legacy Wagon	BP5	Правый	май 03	май 09	A24	S24	SN24	SP24	H24	A18	S18	SN18	SP18	H18					
SUBARU	Legacy Wagon	BR	Правый	май 09		A26	S26	SN26	SP26	H26	A19	S19	SN19	SP19	H19					
SUBARU	Leone Van	CV	Правый	апр 94	апр 99	A21	S21	SN21	SP21	H21	A18	S18	SN18	SP18	H18	A12	S11			
SUBARU	Leone Van	Y	Правый	май 99		A22	S22	SN22	SP22	H22	A16	S16	SN16	SP16	H16					
SUBARU	Lucra	L455F, L465F	Правый	апр 10		A22	S22	SN22	SP22	H22	A14	S14	SN14							
SUBARU	Pleo	RA, RV	Правый	окт 98	окт 00	A20	S20	SN20	SP20	H20	A17	S17	SN17			A14	S14	SN14		
SUBARU	Pleo	RA, RV	Правый	окт 00		A20	S20	SN20	SP20	H20	A17	S17	SN17			A14	S14	SN14		
SUBARU	Pleo	L275/L285	Правый	апр 10		A22	S22	SN22	SP22	H22	A12	S17	SN17							
SUBARU	R1	RJ, R2	Правый	дек 04		A22	S22	SN22	SP22	H22	A14	S11								
SUBARU	R2	RC1,2	Правый	дек 03		A22	S22	SN22	SP22	H22	A14	S14	SN14							
SUBARU	Rex	KG, KN, KP, KH	Правый	июн 89	фев 92	A19	S19	SN19	SP19	H19	A15	S15	SN15			A13	S13			

- DAIHATSU
- HINO
- HONDA
- ISUZU
- MAZDA
- MITSUBISHI
- NISSAN
- NISSAN DIESEL
- SUBARU
- SUZUKI
- TOYOTA
- LEXUS



DAIHATSU

HINO

HONDA

ISUZU

MAZDA

MITSUBISHI

NISSAN

NISSAN DIESEL

SUBARU

SUZUKI

TOYOTA

LEXUS

Марка	Модель	Кузов	Расположение руля	Период выпуска	Место водителя					Место пассажира					Заднее стекло				
					Aerodynamic	Snowguard	Smart neo	Spoiler	Hybrid	Aerodynamic	Snowguard	Smart neo	Spoiler	Hybrid	Aerodynamic	Snowguard	Smart neo	Spoiler	Hybrid

SUZUKI																			
SUZUKI	Solio	MA34S	Правый	авг 05	дек 10	A20	S20	SN20	SP20	H20	A18	S18	SN18	SP18	H18				
SUZUKI	Solio	MA15S	Правый	дек 10		A22	S22	SN22	SP22	H22	A17	S17	SN17						
SUZUKI	Palette	MK21S	Правый	янв 08		A21	S21	SN21	SP21	H21	A16	S16	SN16	SP16	H16				
SUZUKI	Splash	XB32S	Правый	окт 08		A22	S22	SN22	SP22	H22	A16	S16	SN16	SP16	H16				
SUZUKI	Swift	HT51S	Правый	фев 00	май 03	A19	S19	SN19	SP19	H19	A18	S18	SN18	SP18	H18	A14	S14	SN14	
SUZUKI	Swift	HT51S, HT81S	Правый	июн 03	мар 06	A19	S19	SN19	SP19	H19	A18	S18	SN18	SP18	H18				
SUZUKI	Swift	ZC11S, ZC21S, ZD11S, ZD21S, ZC31S, ZC71S	Правый	ноя 04		A21	S21	SN21	SP21	H21	A18	S18	SN18	SP18	H18				
SUZUKI	SX-4	YA11S, YB11S, YA41S, YB41S	Правый	июл 06		A26	S26	SN26	SP26	H26	A14	S14	SN14						
SUZUKI	Twin	EC22S	Правый	янв 03	дек 05	A18	S18	SN18	SP18	H18	A16	S16	SN16	SP16	H16				
SUZUKI	Wagon R	CT21, CV21	Правый	авг 93	сен 98	A18	S18	SN18	SP18	H18	A16	S16	SN16	SP16	H16	A14	S14	SN14	
SUZUKI	Wagon R	MC11, MC21, MC22S	Правый	окт 98	авг 03	A18	S18	SN18	SP18	H18	A15	S15	SN15			A14	S14	SN14	
SUZUKI	Wagon R	MH21S, MH22S	Правый	сен 03	апр 07	A19	S19	SN19	SP19	H19	A16	S16	SN16	SP16	H16	A14	S14	SN14	
SUZUKI	Wagon R	MH	Правый	апр 07	сен 08	A19	S19	SN19	SP19	H19	A16	S16	SN16	SP16	H16				
SUZUKI	Wagon R	MH23S	Правый	сен 08		A20	S20	SN20	SP20	H20	A16	S16	SN16	SP16	H16				
SUZUKI	Wagon R Plus	MA63S	Правый	май 99	ноя 00	A20	S20	SN20	SP20	H20	A18	S18	SN18	SP18	H18	A14	S14	SN14	
SUZUKI	Wagon R Solio	MA34S, MA64S	Правый	дек 00		A20	S20	SN20	SP20	H20	A18	S18	SN18	SP18	H18	A14	S14	SN14	
SUZUKI	Wagon R Wide	MA61S/MB61S	Правый	янв 97	май 99	A20	S20	SN20	SP20	H20	A18	S18	SN18	SP18	H18	A12	S11		
SUZUKI	X-90	LB11S	Правый	окт 95	дек 98	A17	S17	SN17			A18	S18	SN18	SP18	H18				

TOYOTA																			
TOYOTA	Allex	NZE121,124,ZZE123	Правый	май 02		A24	S24	SN24	SP24	H24	A16	S16	SN16	SP16	H16				
TOYOTA	Allion	NZT240, ZZT24, AZT240	Правый	дек 01		A24	S24	SN24	SP24	H24	A16	S16	SN16	SP16	H16				
TOYOTA	Allion	ZRT260, ZRT265, NZT260	Правый	июн 07		A24	S24	SN24	SP24	H24	A16	S16	SN16	SP16	H16				
TOYOTA	Alphard	MNH10W	Правый	фев 05		A26	S26	SN26	SP26	H26	A16	S16	SN16	SP16	H16				
TOYOTA	Altezza Gita	GXE10W, JCE10W	Правый	июл 01		A22	S22	SN22	SP22	H22	A19	S19	SN19	SP19	H19				
TOYOTA	Altezza	GZE10,SXE10	Правый	окт 98		A22	S22	SN22	SP22	H22	A19	S19	SN19	SP19	H19				
TOYOTA	Aristo	JZS147,UZS143	Правый	окт 91	авг 97	A20	S20	SN20	SP20	H20	A19	S19	SN19	SP19	H19				
TOYOTA	Aristo	JZS147,F/M	Правый	окт 91	авг 95	A21	S21	SN21	SP21	H21	A19	S19	SN19	SP19	H19				
TOYOTA	Aristo	JZS16	Правый	авг 97	дек 04	A24	S24	SN24	SP24	H24	A20	S20	SN20	SP20	H20				

Марка	Модель	Кузов	Расположение руля	Период выпуска	Место водителя					Место пассажира					Заднее стекло				
					Aerodynamic	Snowguard	Smart neo	Spoiler	Hybrid	Aerodynamic	Snowguard	Smart neo	Spoiler	Hybrid	Aerodynamic	Snowguard	Smart neo	Spoiler	Hybrid

TOYOTA																				
TOYOTA	Auris	NZE151,NZE154,ZRE152,ZRE154	Правый	окт 06		A26	S26	SN26	SP26	H26	A16	S16	SN16	SP16	H16					
TOYOTA	Avalon	MCX10	Правый	мар 95	мар 00	A21	S21	SN21	SP21	H21	A19	S19	SN19	SP19	H19					
TOYOTA	Avensis	AZT250, 250W, 255, 255W	Правый	окт 03		A24	S24	SN24	SP24	H24	A18	S18	SN18	SP18	H18					
TOYOTA	bB	NCP3	Правый	янв 00	ноя 05	A20	S20	SN20	SP20	H20	A19	S19	SN19	SP19	H19	A14	S14	SN14		
TOYOTA	bB	QNC2	Правый	дек 05		A20	S20	SN20	SP20	H20	A19	S19	SN19	SP19	H19					
TOYOTA	bB	NC2	Правый	дек 05		A20	S20	SN20	SP20	H20	A19	S19	SN19	SP19	H19					
TOYOTA	Belta	SCP92, KSP92	Правый	ноя 05		A24	S24	SN24	SP24	H24	A14	S14	SN14							
TOYOTA	Blade	AZE154H, AZE156H	Правый	дек 06		A26	S26	SN26	SP26	H26	A16	S16	SN16	SP16	H16					
TOYOTA	Brevis	JCG10,11,JCU15	Правый	июн 01	июн 07	A24	S24	SN24	SP24	H24	A18	S18	SN18	SP18	H18					
TOYOTA	Caldina	AT191,CT19,ET196, ST19	Правый	ноя 92	янв 96	A21	S21	SN21	SP21	H21	A18	S18	SN18	SP18	H18	A16	S16	SN16	SP16	H16
TOYOTA	Caldina	AT191,CT19,ET196, ST19	Правый	янв 96	июл 97	A21	S21	SN21	SP21	H21	A18	S18	SN18	SP18	H18	A16	S16	SN16	SP16	H16
TOYOTA	Caldina	AT211,CT216,ST21	Правый	авг 97	авг 02	A21	S21	SN21	SP21	H21	A18	S18	SN18	SP18	H18	A14	S14	SN14		
TOYOTA	Caldina	ST,AZT,ZZT24W	Правый			A24	S24	SN24	SP24	H24	A16	S16	SN16	SP16	H16					
TOYOTA	Cami	J100E	Правый	май 99	апр 00	A20	S20	SN20	SP20	H20	A14	S14	SN14			A12	S11			
TOYOTA	Cami	J102E,J122E	Правый	май 00	янв 06	A22	S22	SN22	SP22	H22	A12	S11				A12	S11			
TOYOTA	Camry	CV, SV, VZV3	Правый	июл 90	июн 94	A21	S21	SN21	SP21	H21	A19	S19	SN19	SP19	H19					
TOYOTA	Camry	CV, SV	Правый	июл 94	май 96	A21	S21	SN21	SP21	H21	A19	S19	SN19	SP19	H19					
TOYOTA	Camry	CV, SV	Правый	июн 96	авг 01	A21	S21	SN21	SP21	H21	A19	S19	SN19	SP19	H19					
TOYOTA	Camry	ACV30,35	Правый	сен 01	дек 05	A24	S24	SN24	SP24	H24	A19	S19	SN19	SP19	H19					
TOYOTA	Camry	ACV40, ACV45	Правый	янв 06		A24	S24	SN24	SP24	H24	A20	S20	SN20	SP20	H20					
TOYOTA	Camry	AVV50	Правый	сен 11		A26	S26	SN26	SP26	H26	A18	S18	SN18	SP18	H18					
TOYOTA	Camry Gracia	MCV21,SVX2D,25	Правый	дек 96	июл 99	A21	S21	SN21	SP21	H21	A19	S19	SN19	SP19	H19	A18	S18	SN18	SP18	H18
TOYOTA	Camry Gracia	MCV21W,25W,SVX20W, 25W	Правый	дек 96	дек 01	A21	S21	SN21	SP21	H21	A19	S19	SN19	SP19	H19	A14	S14	SN14		
TOYOTA	Camry	CV4,SV4	Правый	июн 94	май 96	A21	S21	SN21	SP21	H21	A19	S19	SN19	SP19	H19	A20	S20	SN20	SP20	H20
TOYOTA	Camry	CV4,SV4	Правый	май 96	июн 98	A21	S21	SN21	SP21	H21	A19	S19	SN19	SP19	H19	A20	S20	SN20	SP20	H20
TOYOTA	Camry	CV4,SV4	Правый	июн 94	май 96	A21	S21	SN21	SP21	H21	A19	S19	SN19	SP19	H19	A18	S18	SN18	SP18	H18
TOYOTA	Camry	CV4,SV4	Правый	май 96	мар 98	A21	S21	SN21	SP21	H21	A19	S19	SN19	SP19	H19	A18	S18	SN18	SP18	H18
TOYOTA	Carina ED	ST18	Правый	сен 89	сен 93	A20	S20	SN20	SP20	H20										
TOYOTA	Carina ED	ST20	Правый	сен 93	апр 98	A21	S21	SN21	SP21	H21	A19	S19	SN19	SP19	H19	A16	S16	SN16	SP16	H16
TOYOTA	Carina FF	AT, ST, CT, ET17	Правый	сен 88	июл 92	A20	S20	SN20	SP20	H20	A18	S18	SN18	SP18	H18					

DAIHATSU

HINO

HONDA

ISUZU

MAZDA

MITSUBISHI

NISSAN

NISSAN DIESEL

SUBARU

SUZUKI

TOYOTA

LEXUS



- DAIHATSU
- HINO
- HONDA
- ISUZU
- MAZDA
- MITSUBISHI
- NISSAN
- NISSAN DIESEL
- SUBARU
- SUZUKI
- TOYOTA
- LEXUS

Марка	Модель	Кузов	Расположение руля	Период выпуска	Место водителя					Место пассажира					Заднее стекло					
					Aerodynamic	Snowguard	Smart neo	Spoiler	Hybrid	Aerodynamic	Snowguard	Smart neo	Spoiler	Hybrid	Aerodynamic	Snowguard	Smart neo	Spoiler	Hybrid	
TOYOTA																				
TOYOTA	Carina FF	AT19,CT19,ST19	Правый	авг 92	авг 96	A21	S21	SN21	SP21	H21	A18	S18	SN18	SP18	H18	A16	S16	SN16	SP16	H16
TOYOTA	Carina FF	AT21CT21,ST215	Правый	авг 96	ноя 01	A21	S21	SN21	SP21	H21	A19	S19	SN19	SP19	H19	A18	S18	SN18	SP18	H18
TOYOTA	Cavalier	TJG00	Правый	янв 96	дек 00	A22	S22	SN22	SP22	H22	A17	S17	SN17							
TOYOTA	Celica	ST18	Правый	сен 83	сен 93	A20	S20	SN20	SP20	H20						A21	S21	SN21	SP21	H21
TOYOTA	Celica	ST20	Правый	сен 93	авг 99	A21	S21	SN21	SP21	H21	A19	S19	SN19	SP19	H19	A20	S20	SN20	SP20	H20
TOYOTA	Celica	ZZT23	Правый	авг 99	апр 06	A26	S26	SN26	SP26	H26	A16	S16	SN16	SP16	H16	A20	S20	SN20	SP20	H20
TOYOTA	Celsior	UCF1	Правый	окт 89	сен 94	A22	S22	SN22	SP22	H22	A16	S16	SN16	SP16	H16					
TOYOTA	Celsior	UCF2	Правый	окт 94	июл 00	A22	S22	SN22	SP22	H22	A16	S16	SN16	SP16	H16					
TOYOTA	Celsior	UCF30,31	Правый	авг 00	июн 06	A24	S24	SN24	SP24	H24	A16	S16	SN16	SP16	H16					
TOYOTA	Century	VG4	Правый	окт 82	июл 92	A18	S18	SN18	SP18	H18	A18	S18	SN18	SP18	H18					
TOYOTA	Century	VG4	Правый	дек 92	янв 97	A18	S18	SN18	SP18	H18	A18	S18	SN18	SP18	H18					
TOYOTA	Century	GZG50	Правый	апр 97		A22	S22	SN22	SP22	H22	A21	S21	SN21	SP21	H21					
TOYOTA	Chaser	GX, LX, SX, YX, JZX8	Правый	авг 90	окт 92	A21	S21	SN21	SP21	H21	A18	S18	SN18	SP18	H18	A17	S17	SN17		
TOYOTA	Chaser	GX90,JZX9,LX90,SX90	Правый	окт 92	сен 96	A21	S21	SN21	SP21	H21	A19	S19	SN19	SP19	H19	A18	S18	SN18	SP18	H18
TOYOTA	Chaser	GX10,JZX10,LX100, SX100	Правый	сен 96	июн 01	A22	S22	SN22	SP22	H22	A19	S19	SN19	SP19	H19	A19	S19	SN19	SP19	H19
TOYOTA	Coaster	BB4, 5, HDB5, HZB4, 5	Правый	янв 93	май 97	A21	S21	SN21	SP21	H21	A21	S21	SN21	SP21	H21	A16	S16	SN16	SP16	H16
TOYOTA	Coaster	BB4,5 ,HDB5, HZB4, 5	Правый	май 97		A21	S21	SN21	SP21	H21	A21	S21	SN21	SP21	H21	A16	S16	SN16	SP16	H16
TOYOTA	Coaster R	RX4JFAT,RX4JFET	Правый	июн 96		A26	S26	SN26	SP26	H26	A26	S26	SN26	SP26	H26					
TOYOTA	Corolla	EE, CE, AE9	Правый	май 87	май 91	A20	S20	SN20	SP20	H20	A18	S18	SN18	SP18	H18					
TOYOTA	Corolla	AE10,CE10,EE10	Правый	июн 91	май 95	A20	S20	SN20	SP20	H20	A18	S18	SN18	SP18	H18	A18	S18	SN18	SP18	H18
TOYOTA	Corolla	AE11,CE11,EE111	Правый	май 95	апр 97	A20	S20	SN20	SP20	H20	A18	S18	SN18	SP18	H18					
TOYOTA	Corolla	AE11,CE11,EE111	Правый	апр 97	июл 00	A20	S20	SN20	SP20	H20	A18	S18	SN18	SP18	H18					
TOYOTA	Corolla	Ce121,NZE12,ZZE12	Правый	авг 00	сен 06	A24	S24	SN24	SP24	H24	A16	S16	SN16	SP16	H16					
TOYOTA	Corolla	AE10,CE10,EE10	Правый	сен 91	апр 97	A20	S20	SN20	SP20	H20	A18	S18	SN18	SP18	H18	A16	S16	SN16	SP16	H16
TOYOTA	Corolla	AE10,CE10,EE10	Правый	апр 97	июл 00	A20	S20	SN20	SP20	H20	A18	S18	SN18	SP18	H18	A16	S16	SN16	SP16	H16
TOYOTA	Corolla Axio	NZE141,NZE144,ZRE142,ZRE144	Правый	окт 06		A26	S26	SN26	SP26	H26	A14	S14	SN14							
TOYOTA	Corolla Ceres	AE10	Правый	май 92	авг 98	A20	S20	SN20	SP20	H20	A18	S18	SN18	SP18	H18	A18	S18	SN18	SP18	H18
TOYOTA	Corolla Fielder	NZE12,ZZE12,CE121G	Правый	авг 00	сен 06	A24	S24	SN24	SP24	H24	A16	S16	SN16	SP16	H16					
TOYOTA	Corolla Fielder	NZE141G, NZE144G, ZRE142G, ZRE144G	Правый	окт 06		A26	S26	SN26	SP26	H26	A14	S14	SN14							

Марка	Модель	Кузов	Расположение руля	Период выпуска	Место водителя					Место пассажира					Заднее стекло					
					Aerodynamic	Snowguard	Smart neo	Spoiler	Hybrid	Aerodynamic	Snowguard	Smart neo	Spoiler	Hybrid	Aerodynamic	Snowguard	Smart neo	Spoiler	Hybrid	
TOYOTA																				
TOYOTA	Corolla II	EL, NL4	Правый	сен 90	авг 94	A20	S20	SN20	SP20	H20	A18	S18	SN18	SP18	H18	A18	S18	SN18	SP18	H18
TOYOTA	Corolla II	EL5,NL50	Правый	сен 94	июл 99	A20	S20	SN20	SP20	H20	A18	S18	SN18	SP18	H18	A18	S18	SN18	SP18	H18
TOYOTA	Corolla Levin	AE9	Правый	май 87	май 91	A20	S20	SN20	SP20	H20	A18	S18	SN18	SP18	H18	A18	S18	SN18	SP18	H18
TOYOTA	Corolla Levin	AE10(3D)	Правый	июн 91	май 95	A20	S20	SN20	SP20	H20	A18	S18	SN18	SP18	H18	A18	S18	SN18	SP18	H18
TOYOTA	Corolla Levin	AE11(3D)	Правый	май 95	апр 97	A20	S20	SN20	SP20	H20	A18	S18	SN18	SP18	H18	A18	S18	SN18	SP18	H18
TOYOTA	Corolla Levin	AE11(3D)	Правый	апр 97	июл 00	A20	S20	SN20	SP20	H20	A18	S18	SN18	SP18	H18	A18	S18	SN18	SP18	H18
TOYOTA	Corolla Rumion	E15	Правый	окт 07		A22	S22	SN22	SP22	H22	A20	S20	SN20	SP20	H20					
TOYOTA	Corolla Runx	NZE12,ZZE12	Правый	авг 00	сен 06	A24	S24	SN24	SP24	H24	A16	S16	SN16	SP16	H16					
TOYOTA	Corolla Spacio	AE11	Правый	янв 97	апр 01	A24	S24	SN24	SP24	H24	A18	S18	SN18	SP18	H18	A16	S16	SN16	SP16	H16
TOYOTA	Corolla Spacio	NZE121N,ZZE122N	Правый	май 01	июн 07	A26	S26	SN26	SP26	H26	A16	S16	SN16	SP16	H16					
TOYOTA	Corona	AT, CT, ET, ST17	Правый	янв 88	янв 92	A20	S20	SN20	SP20	H20	A18	S18	SN18	SP18	H18	A18	S18	SN18	SP18	H18
TOYOTA	Corona	AT190,CT19,ST19	Правый	фев 92	янв 96	A21	S21	SN21	SP21	H21	A18	S18	SN18	SP18	H18	A16	S16	SN16	SP16	H16
TOYOTA	Corona	AT190,CT19	Правый	фев 92	янв 96	A21	S21	SN21	SP21	H21	A18	S18	SN18	SP18	H18	A20	S20	SN20	SP20	H20
TOYOTA	Corona Exiv	ST18	Правый	сен 89	сен 93	A20	S20	SN20	SP20	H20										
TOYOTA	Corona Exiv	ST20	Правый	сен 93	апр 98	A21	S21	SN21	SP21	H21	A19	S19	SN19	SP19	H19	A18	S18	SN18	SP18	H18
TOYOTA	Corona Premio	AT21,CT21,ST21	Правый	янв 96	ноя 01	A21	S21	SN21	SP21	H21	A18	S18	SN18	SP18	H18	A16	S16	SN16	SP16	H16
TOYOTA	Corsa Tercel	EL, NL4	Правый	сен 90	авг 94	A20	S20	SN20	SP20	H20	A18	S18	SN18	SP18	H18	A18	S18	SN18	SP18	H18
TOYOTA	Corsa Tercel	EL5,NL50	Правый	сен 94	июл 99	A20	S20	SN20	SP20	H20	A18	S18	SN18	SP18	H18					
TOYOTA	Corsa Tercel	EL5,NL50	Правый	сен 94	июл 99	A20	S20	SN20	SP20	H20	A18	S18	SN18	SP18	H18	A18	S18	SN18	SP18	H18
TOYOTA	Cresta	GX,MX,SX,YX,JZX8	Правый	авг 90	окт 92	A21	S21	SN21	SP21	H21	A18	S18	SN18	SP18	H18	A17	S17	SN17		
TOYOTA	Cresta	GX90,JZX9,LX90,SX90	Правый	окт 92	сен 96	A21	S21	SN21	SP21	H21	A19	S19	SN19	SP19	H19	A18	S18	SN18	SP18	H18
TOYOTA	Cresta	GX100,JZX10,LX100	Правый	июн 96	июн 01	A22	S22	SN22	SP22	H22	A19	S19	SN19	SP19	H19	A19	S19	SN19	SP19	H19
TOYOTA	Crown	YS,LS,LS12,GS,MS, MS12	Правый	авг 83	сен 91	A19	S19	SN19	SP19	H19	A18	S18	SN18	SP18	H18	A12	S11			
TOYOTA	Crown	GS13,JZS13,LS13, YS130	Правый	окт 91	дек 95	A20	S20	SN20	SP20	H20	A18	S18	SN18	SP18	H18	A12	S11			
TOYOTA	Crown	GS13,JZS13,LS13, YS130	Правый	дек 95	апр 99	A20	S20	SN20	SP20	H20	A18	S18	SN18	SP18	H18	A12	S11			
TOYOTA	Crown	JZS17,GS171	Правый	сен 99	июл 01	A22	S22	SN22	SP22	H22	A18	S18	SN18	SP18	H18					
TOYOTA	Crown	JZS171, 173, 175, 177, 179, JKS175	Правый	авг 01	ноя 03	A22	S22	SN22	SP22	H22	A18	S18	SN18	SP18	H18					
TOYOTA	Crown	GRS180, GRS181, GRS182, GRS183	Правый	дек 03	фев 08	A24	S24	SN24	SP24	H24	A18	S18	SN18	SP18	H18					
TOYOTA	Crown	S20	Правый	фев 08		A24	S24	SN24	SP24	H24	A18	S18	SN18	SP18	H18					

- DAIHATSU
- HINO
- HONDA
- ISUZU
- MAZDA
- MITSUBISHI
- NISSAN
- NISSAN DIESEL
- SUBARU
- SUZUKI
- TOYOTA
- LEXUS

DAIHATSU

HINO

HONDA

ISUZU

MAZDA

MAZDA

MAZDA

MAZDA

MAZDA

MAZDA

MAZDA

MAZDA

Марка	Модель	Кузов	Расположение руля	Период выпуска	Место водителя					Место пассажира					Заднее стекло					
					Aerodynamic	Snowguard	Smart neo	Spoiler	Hybrid	Aerodynamic	Snowguard	Smart neo	Spoiler	Hybrid	Aerodynamic	Snowguard	Smart neo	Spoiler	Hybrid	
TOYOTA																				
TOYOTA	Crown Comfort	GZS10,LXS11,SXS11, YXS1	Правый	дек 95	июл 01	A20	S20	SN20	SP20	H20	A20	S20	SN20	SP20	H20					
TOYOTA	Crown Comfort	YXS10, YXS11, SXS13Y	Правый	авг 01		A20	S20	SN20	SP20	H20	A20	S20	SN20	SP20	H20					
TOYOTA	Crown Estate	JZS17	Правый	дек 99		A22	S22	SN22	SP22	H22	A18	S18	SN18	SP18	H18	A12	S11			
TOYOTA	Crown Estate	JZA17W	Правый	авг 01	июн 07	A22	S22	SN22	SP22	H22	A18	S18	SN18	SP18	H18					
TOYOTA	Crown Majesta	GS141,JZS141,143,145,LS141	Правый	окт 91	авг 95	A20	S20	SN20	SP20	H20	A18	S18	SN18	SP18	H18					
TOYOTA	Crown Majesta	JZS147,149,UZS14	Правый	окт 91	авг 95	A20	S20	SN20	SP20	H20	A19	S19	SN19	SP19	H19					
TOYOTA	Crown Majesta	GS151,JZS15,LS151,UZS15	Правый	авг 95	авг 99	A20	S20	SN20	SP20	H20	A18	S18	SN18	SP18	H18					
TOYOTA	Crown Majesta	GS171,JZS171,173,175, 179	Правый	сен 99	июн 04	A22	S22	SN22	SP22	H22	A18	S18	SN18	SP18	H18					
TOYOTA	Crown Majesta	JZS177,UZS17	Правый	сен 99	июн 04	A22	S22	SN22	SP22	H22	A19	S19	SN19	SP19	H19					
TOYOTA	Crown Majesta	UZS186,UZS187	Правый	июл 04		A24	S24	SN24	SP24	H24	A18	S18	SN18	SP18	H18					
TOYOTA	Curren	ST20	Правый	фев 94		A21	S21	SN21	SP21	H21	A19	S19	SN19	SP19	H19	A16	S16	SN16	SP16	H16
TOYOTA	Cynos	EL44	Правый	янв 91	авг 95	A21	S21	SN21	SP21	H21	A18	S18	SN18	SP18	H18	A19	S19	SN19	SP19	H19
TOYOTA	Cynos	EL5	Правый	авг 95	июл 99	A21	S21	SN21	SP21	H21	A18	S18	SN18	SP18	H18	A20	S20	SN20	SP20	H20
TOYOTA	Deliboy	CXC10,KXC10	Правый	июн 90	ноя 95	A18	S18	SN18	SP18	H18	A18	S18	SN18	SP18	H18	A16	S16	SN16	SP16	H16
TOYOTA	Duet	M100A,110A	Правый	сен 98	май 04	A19	S19	SN19	SP19	H19	A18	S18	SN18	SP18	H18	A12	S11			
TOYOTA	Dyna/ToyoAce	BU6,8,9,YU6,70,80, WU75,85,9	Правый	сен 84	май 95	A17	S17	SN17			A17	S17	SN17							
TOYOTA	Dyna/ToyoAce	BU1,2,RZU100,140,XZU130,140	Правый	май 95	окт 96	A17	S17	SN17			A17	S17	SN17							
TOYOTA	Dyna/ToyoAce	BU1,2,RZU100,140,XZU130,140	Правый	окт 96	апр 99	A17	S17	SN17			A17	S17	SN17							
TOYOTA	Dyna/ToyoAce	BU6,7,9,YU6,70,80,WU75,85,9	Правый	сен 84	май 95	A17	S17	SN17			A16	S16	SN16	SP16	H16	A16	S16	SN16	SP16	H16
TOYOTA	Dyna/ToyoAce	BU1,2,RZU100,140, XZU130,140	Правый	май 95	окт 96	A17	S17	SN17			A16	S16	SN16	SP16	H16	A16	S16	SN16	SP16	H16
TOYOTA	Dyna/ToyoAce	BU1,2,RZU100,140,XZU130,140	Правый	окт 96	апр 99	A17	S17	SN17			A16	S16	SN16	SP16	H16	A16	S16	SN16	SP16	H16
TOYOTA	Dyna/ToyoAce	BU3,XZU3	Правый	май 99	май 01	A20	S20	SN20	SP20	H20	A20	S20	SN20	SP20	H20					
TOYOTA	Dyna/ToyoAce	FB(3)	Правый	май 95		A26	S26	SN26	SP26	H26	A26	S26	SN26	SP26	H26					
TOYOTA	Dyna/ToyoAce	LY1,2,YY1, 2	Правый	май 95	окт 96	A17	S17	SN17			A17	S17	SN17							
TOYOTA	Dyna/ToyoAce	LY1,2,YY1, 2	Правый	окт 96	апр 99	A17	S17	SN17			A17	S17	SN17							
TOYOTA	Dyna/ToyoAce	Bu306,XZU307(Van)	Правый	май 99	май 01	A20	S20	SN20	SP20	H20	A20	S20	SN20	SP20	H20	A17	S17	SN17		
TOYOTA	Dyna/ToyoAce	BU4,XZU382,4	Правый	май 99	май 01	A20	S20	SN20	SP20	H20	A20	S20	SN20	SP20	H20					
TOYOTA	Dyna/ToyoAce	TRY20,KDY20, RZY21H	Правый	июн 01		A20	S20	SN20	SP20	H20	A20	S20	SN20	SP20	H20					
TOYOTA	Dyna/ToyoAce Quick	BU60	Правый	янв 86	май 95	A18	S18	SN18	SP18	H18	A18	S18	SN18	SP18	H18	A18	S18	SN18	SP18	H18
TOYOTA	Estima	TCR1,2	Правый	авг 93	ноя 97											A16	S16	SN16	SP16	H16

Марка	Модель	Кузов	Расположение руля	Период выпуска	Место водителя					Место пассажира					Заднее стекло							
					Aerodynamic	Snowguard	Smart neo	Spoiler	Hybrid	Aerodynamic	Snowguard	Smart neo	Spoiler	Hybrid	Aerodynamic	Snowguard	Smart neo	Spoiler	Hybrid			
TOYOTA																						
TOYOTA	Estima	TCR1,2	Правый	дек 97	дек 99													A16	S16	SN16	SP16	H16
TOYOTA	Estima	ACR, TCR30W,40W	Правый	янв 00	янв 06	A28	S28	SN28			A18	S18	SN18	SP18	H18							
TOYOTA	Estima	n/a	Правый	янв 06		A26	S26	SN26	SP26	H26	A16	S16	SN16	SP16	H16							
TOYOTA	Estima Hybrid	AHR34	Правый	июн 01		A28	S28	SN28			A18	S18	SN18	SP18	H18							
TOYOTA	Estima/Lucida/Emina	CXR1,2,TCR1,2	Правый	янв 92	дек 96											A16	S16	SN16	SP16	H16		
TOYOTA	Estima/Lucida/Emina	CXR1,2,TCR1,2	Правый	дек 96	дек 99											A16	S16	SN16	SP16	H16		
TOYOTA	FJ Cruiser	GSJ15W	Правый	дек 10		A16	S16	SN16	SP16	H16	A14	S14	SN14									
TOYOTA	FunCargo	NCP2	Правый	авг 99	июл 02	A22	S22	SN22	SP22	H22	A16	S16	SN16	SP16	H16	A16	S16	SN16	SP16	H16		
TOYOTA	FunCargo	NCP2	Правый	авг 02		A22	S22	SN22	SP22	H22	A16	S16	SN16	SP16	H16							
TOYOTA	Gaia	CXM10,SXM1	Правый	май 98	июл 02	A26	S26	SN26	SP26	H26	A14	S14	SN14			A16	S16	SN16	SP16	H16		
TOYOTA	Gaia	CXM10G, ACM10G, ACM15G	Правый	авг 02	авг 04	A26	S26	SN26	SP26	H26	A14	S14	SN14									
TOYOTA	Grand Hiace	KCH1,RCH1,VCH1,2	Правый	авг 99	май 02	A24	S24	SN24	SP24	H24	A21	S21	SN21	SP21	H21	A18	S18	SN18	SP18	H18		
TOYOTA	Granvia	KCH1,RCH11,VCH1,2	Правый	авг 95	авг 96	A21	S21	SN21	SP21	H21	A21	S21	SN21	SP21	H21	A18	S18	SN18	SP18	H18		
TOYOTA	Granvia	KCH1,RCH11,VCH1,2	Правый	авг 96	апр 98	A21	S21	SN21	SP21	H21	A21	S21	SN21	SP21	H21	A18	S18	SN18	SP18	H18		
TOYOTA	Granvia	KCH1,RCH11,VCH1,2	Правый	апр 98	май 02	A24	S24	SN24	SP24	H24	A21	S21	SN21	SP21	H21	A18	S18	SN18	SP18	H18		
TOYOTA	Harrier	ACU1,MCU1,SXU1	Правый	дек 97	янв 03	A24	S24	SN24	SP24	H24	A21	S21	SN21	SP21	H21	A16	S16	SN16	SP16	H16		
TOYOTA	Harrier	MCU30,31,35,36, ACU30,35	Правый	фев 03		A26	S26	SN26	SP26	H26	A22	S22	SN22	SP22	H22							
TOYOTA	Hiace	YH81, LH8, LH9	Правый	авг 87	май 95	A17	S17	SN17			A17	S17	SN17									
TOYOTA	Hiace	LY101,11,151,161, YY101	Правый	май 95	окт 96	A17	S17	SN17			A17	S17	SN17									
TOYOTA	Hiace	LH1,RZH10,11,12,133,KZH11	Правый	авг 89	авг 96	A19	S19	SN19	SP19	H19	A19	S19	SN19	SP19	H19	A17	S17	SN17				
TOYOTA	Hiace	LH1,RZH10,11,12,133,KZH11	Правый	авг 96	июл 04	A19	S19	SN19	SP19	H19	A19	S19	SN19	SP19	H19	A17	S17	SN17				
TOYOTA	Hiace	TRH200,KDH200,KDH205	Правый	авг 04		A20	S20	SN20	SP20	H20	A20	S20	SN20	SP20	H20	A17	S17	SN17				
TOYOTA	Hiace	TRH22,KDH22	Правый	авг 04		A22	S22	SN22	SP22	H22	A22	S22	SN22	SP22	H22	A17	S17	SN17				
TOYOTA	Hiace Regius	KCH4, RCH4	Правый	апр 97	апр 98	A24	S24	SN24	SP24	H24	A18	S18	SN18	SP18	H18	A18	S18	SN18	SP18	H18		
TOYOTA	Hiace Regius	KCH4, RCH4	Правый	май 98	май 02	A26	S26	SN26	SP26	H26	A18	S18	SN18	SP18	H18	A18	S18	SN18	SP18	H18		
TOYOTA	Hilux	KNZ130,LN10,112,13, VZN130,YN10,130	Правый	авг 91	авг 97	A18	S18	SN18	SP18	H18	A19	S19	SN19	SP19	H19							
TOYOTA	Hilux	LN8,LY8	Правый	авг 92	авг 97	A18	S18	SN18	SP18	H18	A19	S19	SN19	SP19	H19							
TOYOTA	Hilux	LN147,16,17,RZN147,152, 16,174	Правый	авг 97	июл 04	A18	S18	SN18	SP18	H18	A19	S19	SN19	SP19	H19							
TOYOTA	Hilux Surf	YN, LN8, 10, 13	Правый	сен 88	авг 91	A18	S18	SN18	SP18	H18	A17	S17	SN17									

DAIHATSU

HINO

HONDA

ISUZU

MAZDA

MAZDA

MAZDA

MAZDA

MAZDA

MAZDA

MAZDA

MAZDA

- DAIHATSU
- HINO
- HONDA
- ISUZU
- MAZDA
- MAZDA
- MITSUBISHI
- NISSAN
- NISSAN DIESEL
- SUBARU
- SUZUKI
- TOYOTA
- LEXUS

Марка	Модель	Кузов	Расположение руля	Период выпуска	Место водителя					Место пассажира					Заднее стекло					
					Aerodynamic	Snowguard	Smart neo	Spoiler	Hybrid	Aerodynamic	Snowguard	Smart neo	Spoiler	Hybrid	Aerodynamic	Snowguard	Smart neo	Spoiler	Hybrid	
TOYOTA																				
TOYOTA	Hilux Surf	YN, LN, KZN, VZN13	Правый	сен 91	ноя 95	A18	S18	SN18	SP18	H18	A19	S19	SN19	SP19	H19					
TOYOTA	Hilux Surf	KZN185,RZN18,VZN18	Правый	ноя 95	сен 02	A18	S18	SN18	SP18	H18	A19	S19	SN19	SP19	H19					
TOYOTA	Hilux Surf	VZN,RZN,KDN215W,210W	Правый	окт 02		A22	S22	SN22	SP22	H22	A20	S20	SN20	SP20	H20					
TOYOTA	Ipsum	CXM10, SXM1	Правый	май 96	апр 98	A24	S24	SN24	SP24	H24	A16	S16	SN16	SP16	H16	A15	S15	SN15		
TOYOTA	Ipsum	CXM10, SXM1	Правый	апр 98	апр 01	A24	S24	SN24	SP24	H24	A14	S14	SN14			A16	S16	SN16	SP16	H16
TOYOTA	Ipsum	ACM21W,26W	Правый	май 01		A26	S26	SN26	SP26	H26	A16	S16	SN16	SP16	H16					
TOYOTA	IQ	KGJ10	Правый	окт 08		A22	S22	SN22	SP22	H22	A18	S18	SN18	SP18	H18					
TOYOTA	Isis	ANM10, ANM15, ZNM10	Правый	сен 04		A24	S24	SN24	SP24	H24	A16	S16	SN16	SP16	H16					
TOYOTA	Ist	NCP6	Правый	янв 01	июл 07	A22	S22	SN22	SP22	H22	A16	S16	SN16	SP16	H16					
TOYOTA	Ist	ZSP 11, NCP11	Правый	июл 07		A24	S24	SN24	SP24	H24	A14	S14	SN14							
TOYOTA	Kluger V	ACU2,MCU2	Правый	ноя 00		A22	S22	SN22	SP22	H22	A19	S19	SN19	SP19	H19					
TOYOTA	Land Cruiser	FJ75,LJ7,HZJ7,KZJ7	Правый	авг 92		A17	S17	SN17			A20	S20	SN20	SP20	H20					
TOYOTA	Land Cruiser	FJ75,LJ7,HZJ7,KZJ7	Правый	авг 92		A17	S17	SN17			A19	S19	SN19	SP19	H19	A14	S14	SN14		
TOYOTA	Land Cruiser Prado	KZJ9,RZJ9,VZJ9	Правый	апр 96		A19	S19	SN19	SP19	H19	A18	S18	SN18	SP18	H18	A14	S14	SN14		
TOYOTA	Land Cruiser	FJ80,FZJ80,HDJ81, HZJ81	Правый	авг 92	янв 98	A18	S18	SN18	SP18	H18	A20	S20	SN20	SP20	H20	A14	S14	SN14		
TOYOTA	Land Cruiser	FJ80,FZJ80,HDJ81, HZJ81	Правый	авг 92	янв 98	A18	S18	SN18	SP18	H18	A20	S20	SN20	SP20	H20	A16	S16	SN16	SP16	H16
TOYOTA	Land Cruiser	HDJ101,UZJ100	Правый	янв 98	июл 99	A20	S20	SN20	SP20	H20	A20	S20	SN20	SP20	H20	A16	S16	SN16	SP16	H16
TOYOTA	Land Cruiser	HDJ101,UZJ100	Правый	июл 99	сен 07	A24	S24	SN24	SP24	H24	A22	S22	SN22	SP22	H22	A16	S16	SN16	SP16	H16
TOYOTA	Land Cruiser	J200	Правый	сен 07		A24	S24	SN24	SP24	H24	A22	S22	SN22	SP22	H22	A16	S16	SN16	SP16	H16
TOYOTA	Land Cruiser Prado	PZJ, LJ7	Правый	окт 84	июл 92	A17	S17	SN17			A16	S16	SN16	SP16	H16					
TOYOTA	Land Cruiser Prado	FJ, HDJ, HZJ8	Правый	фев 90	июл 92	A17	S17	SN17			A17	S17	SN17							
TOYOTA	Land Cruiser Prado	HZJ	Правый	авг 92	апр 96	A17	S17	SN17			A19	S19	SN19	SP19	H19	A14	S14	SN14		
TOYOTA	Land Cruiser Prado	KZJ90, 95, VZJ90, 95	Правый	май 96	сен 02	A19	S19	SN19	SP19	H19	A18	S18	SN18	SP18	H18	A14	S14	SN14		
TOYOTA	Land Cruiser Prado	VZJ121W	Правый	окт 02		A21	S21	SN21	SP21	H21	A22	S22	SN22	SP22	H22	A18	S18	SN18	SP18	H18
TOYOTA	Land Cruiser Prado	TRJ150W	Правый	сен 09		A26	S26	SN26	SP26	H26	A20	S20	SN20	SP20	H20	A12	S11	SN11		
TOYOTA	LiteAce/Town Ace	YR, CR, KR2, 3	Правый	окт 82	дек 91	A18	S18	SN18	SP18	H18	A18	S18	SN18	SP18	H18	A16	S16	SN16	SP16	H16
TOYOTA	LiteAce/Town Ace	CM5,6,KM5,YM55, 6	Правый	окт 86	июн 99	A22	S22	SN22	SP22	H22	A14	S14	SN14							
TOYOTA	LiteAce/Town Ace	CM7,8,KM7,8	Правый	июн 99		A22	S22	SN22	SP22	H22	A14	S14	SN14							
TOYOTA	LiteAce/Town Ace	CR4,CR5,KR4,SR40, 50	Правый	окт 96	янв 98	A21	S21	SN21	SP21	H21	A17	S17	SN17			A16	S16	SN16	SP16	H16
TOYOTA	LiteAce/Town Ace	CR4,CR5,KR4,SR40, 50	Правый	янв 98	окт 01	A24	S24	SN24	SP24	H24	A17	S17	SN17			A16	S16	SN16	SP16	H16

Марка	Модель	Кузов	Расположение руля	Период выпуска	Место водителя					Место пассажира					Заднее стекло					
					Aerodynamic	Snowguard	Smart neo	Spoiler	Hybrid	Aerodynamic	Snowguard	Smart neo	Spoiler	Hybrid	Aerodynamic	Snowguard	Smart neo	Spoiler	Hybrid	
TOYOTA																				
TOYOTA	LiteAce/Town Ace	KR27,YR2,30,CR2, 3	Правый	янв 92	окт 96	A18	S18	SN18	SP18	H18	A18	S18	SN18	SP18	H18	A16	S16	SN16	SP16	H16
TOYOTA	Mark II	LX80Y,SX80Y,YX80Y	Правый	авг 88	дек 95	A21	S21	SN21	SP21	H21	A18	S18	SN18	SP18	H18					
TOYOTA	Mark II	GX81,LX80,MX83,SX80,YX80, JZX81	Правый	авг 90	дек 95	A21	S21	SN21	SP21	H21	A18	S18	SN18	SP18	H18	A18	S18	SN18	SP18	H18
TOYOTA	Mark II	GX90,LX90,SX90,JZX9	Правый	окт 92	сен 96	A21	S21	SN21	SP21	H21	A19	S19	SN19	SP19	H19	A18	S18	SN18	SP18	H18
TOYOTA	Mark II	GX70,LX76,YX7	Правый	ноя 92	апр 97	A20	S20	SN20	SP20	H20	A18	S18	SN18	SP18	H18	A14	S14	SN14		
TOYOTA	Mark II	GX10,JZX10,LX100	Правый	сен 96	сен 00	A22	S22	SN22	SP22	H22	A18	S18	SN18	SP18	H18	A19	S19	SN19	SP19	H19
TOYOTA	Mark II	GX11,JZX11	Правый	окт 00	окт 04	A22	S22	SN22	SP22	H22	A18	S18	SN18	SP18	H18	A19	S19	SN19	SP19	H19
TOYOTA	Mark II Blit	JZX110W	Правый	янв 02	июн 07	A22	S22	SN22	SP22	H22	A18	S18	SN18	SP18	H18					
TOYOTA	Mark II Qualis	MCV2,SXV2	Правый	апр 97	янв 02	A21	S21	SN21	SP21	H21	A19	S19	SN19	SP19	H19	A14	S14	SN14		
TOYOTA	Mark X	GRX120,GRX121, GRX125	Правый	ноя 04		A22	S22	SN22	SP22	H22	A19	S19	SN19	SP19	H19					
TOYOTA	Mark X	GRX13	Правый	окт 09		A24	S24	SN24	SP24	H24	A16	S16	SN16	SP16	H16					
TOYOTA	Mark X ZIO	GGA10, ANA10	Правый	июн 07		A22	S22	SN22	SP22	H22	A16	S16	SN16	SP16	H16					
TOYOTA	Master Ace Surf	YR, CR2, 3	Правый	ноя 82	дек 91	A18	S18	SN18	SP18	H18	A18	S18	SN18	SP18	H18	A16	S16	SN16	SP16	H16
TOYOTA	MegaCruiser	BXD20	Правый	янв 96	дек 02	A16	S16	SN16	SP16	H16	A12	S11				A16	S16	SN16	SP16	H16
TOYOTA	MR2	SW20	Правый	окт 89	сен 92	A20	S20	SN20	SP20	H20										
TOYOTA	MR2	SW20	Правый	янв 93	сен 99	A20	S20	SN20	SP20	H20	A19	S19	SN19	SP19	H19					
TOYOTA	MR-Spyder	ZZW30	Правый	окт 99	апр 07	A20	S20	SN20	SP20	H20	A19	S19	SN19	SP19	H19					
TOYOTA	Nadia	SXN1	Правый	июл 98	авг 03	A26	S26	SN26	SP26	H26	A14	S14	SN14			A17	S17	SN17		
TOYOTA	Noah	AZR60G,65G	Правый	ноя 01	май 07	A26	S26	SN26	SP26	H26	A14	S14	SN14							
TOYOTA	Noah	ZRR7W, ZRR7G	Правый	июн 07		A26	S26	SN26	SP26	H26	A16	S16	SN16	SP16	H16					
TOYOTA	Opa	ACT10,ZCT10,15	Правый	май 00	авг 05	A26	S26	SN26	SP26	H26	A17	S17	SN17							
TOYOTA	Passo	QNC10,KGC10,KGC15	Правый	июн 04		A20	S20	SN20	SP20	H20	A16	S16	SN16	SP16	H16					
TOYOTA	Passo Sette	M502E	Правый	фев 08		A24	S24	SN24	SP24	H24	A17	S17	SN17							
TOYOTA	Pixis Space	L575A/L585A	Правый	сен 11		A18	S18	SN18	SP18	H18	A18	S18	SN18	SP18	H18					
TOYOTA	Pixis Van	S321M/S331M	Правый	дек 11		A20	S20	SN20	SP20	H20	A14	S14	SN14							
TOYOTA	Pixis Truck	S201U/S211U	Правый			A16	S16	SN16	SP16	H16	A16	S16	SN16	SP16	H16					
TOYOTA	Platz	NCP1,SCP11	Правый	авг 99	окт 05	A21	S21	SN21	SP21	H21	A14	S14	SN14							
TOYOTA	Porte	NNP10,NNP11	Правый	июл 04		A24	S24	SN24	SP24	H24	A14	S14	SN14							
TOYOTA	Premio	NZT240, ZZT24, AZT240	Правый	дек 01	май 07	A24	S24	SN24	SP24	H24	A16	S16	SN16	SP16	H16					
TOYOTA	Premio	ZRT260, ZRT265, NZT260	Правый	июн 07		A24	S24	SN24	SP24	H24	A16	S16	SN16	SP16	H16					

- DAIHATSU
- HINO
- HONDA
- ISUZU
- MAZDA
- MAZDA
- MITSUBISHI
- NISSAN
- NISSAN DIESEL
- SUBARU
- SUZUKI
- TOYOTA
- LEXUS



DAIHATSU

HINO

HONDA

ISUZU

MAZDA

MITSUBISHI

NISSAN

NISSAN DIESEL

SUBARU

SUZUKI

TOYOTA

LEXUS

Марка	Модель	Кузов	Расположение руля	Период выпуска	Место водителя					Место пассажира					Заднее стекло					
					Aerodynamic	Snowguard	Smart neo	Spoiler	Hybrid	Aerodynamic	Snowguard	Smart neo	Spoiler	Hybrid	Aerodynamic	Snowguard	Smart neo	Spoiler	Hybrid	
TOYOTA																				
TOYOTA	Previa	TCR1W, 2W	Правый	май 90	июл 93											A16	S16	SN16	SP16	H16
TOYOTA	Previa	TCR1W, 2W	Правый	авг 93	ноя 97											A16	S16	SN16	SP16	H16
TOYOTA	Previa	TCR1W, 2W	Правый	дек 97	дек 99											A16	S16	SN16	SP16	H16
TOYOTA	Previa	MCR30W, MCR40W, AHR10W	Правый	янв 00	дек 05						A18	S18	SN18	SP18	H18					
TOYOTA	Previa	GSR50W, ACR50W	Правый	янв 06		A26	S26	SN26	SP26	H26	A16	S16	SN16	SP16	H16					
TOYOTA	Prius	NHW1	Правый	дек 97	авг 03	A24	S24	SN24	SP24	H24	A16	S16	SN16	SP16	H16					
TOYOTA	Prius	NHW2	Правый	сен 03		A26	S26	SN26	SP26	H26	A16	S16	SN16	SP16	H16					
TOYOTA	Prius	NHP10	Правый	дек 12		A26	S26	SN26	SP26	H26	A14	S14	SN14							
TOYOTA	Prius	ZVW30	Правый	май 09		A26	S26	SN26	SP26	H26	A16	S16	SN16	SP16	H16					
TOYOTA	Probox	NCP50,51,55V,NLP51V	Правый	июл 02		A20	S20	SN20	SP20	H20	A18	S18	SN18	SP18	H18					
TOYOTA	Probox	NZ,ND	Правый	июл 02		A20	S20	SN20	SP20	H20	A18	S18	SN18	SP18	H18					
TOYOTA	Progres	JCG1	Правый	май 98	июн 07	A24	S24	SN24	SP24	H24	A17	S17	SN17							
TOYOTA	Pronard	MCX20	Правый	апр 00	май 03	A24	S24	SN24	SP24	H24	A16	S16	SN16	SP16	H16					
TOYOTA	Quick Delivery	BU68	Правый	май 00	окт 96	A21	S21	SN21	SP21	H21	A21	S21	SN21	SP21	H21	A18	S18	SN18	SP18	H18
TOYOTA	Quick Delivery	BU68,RZU68	Правый	окт 96		A21	S21	SN21	SP21	H21	A21	S21	SN21	SP21	H21	A18	S18	SN18	SP18	H18
TOYOTA	Quick Delivery	LH81,LY151	Правый	май 95	май 99	A17	S17	SN17			A17	S17	SN17			A18	S18	SN18	SP18	H18
TOYOTA	Ractis	NCP100,105, SCP100	Правый	окт 05		A24	S24	SN24	SP24	H24	A14	S14	SN14							
TOYOTA	Raum	EXZ10,15	Правый	май 97	апр 03	A22	S22	SN22	SP22	H22	A18	S18	SN18	SP18	H18	A16	S16	SN16	SP16	H16
TOYOTA	Raum	NCZ20,25	Правый	май 03		A22	S22	SN22	SP22	H22	A18	S18	SN18	SP18	H18					
TOYOTA	RAV4	SXA1	Правый	апр 94	авг 96	A20	S20	SN20	SP20	H20	A18	S18	SN18	SP18	H18	A14	S14	SN14		
TOYOTA	RAV4	SXA1	Правый	авг 96	апр 00	A20	S20	SN20	SP20	H20	A18	S18	SN18	SP18	H18	A14	S14	SN14		
TOYOTA	RAV4	ACA,ZCA2	Правый	май 00	окт 05	A24	S24	SN24	SP24	H24	A19	S19	SN19	SP19	H19					
TOYOTA	RAV4	ACA31W, ACA36W	Правый	ноя 05		A24	S24	SN24	SP24	H24	A17	S17	SN17							
TOYOTA	Regius	KCH4,LXH4,RCH4	Правый	апр 97	июл 99	A24	S24	SN24	SP24	H24	A18	S18	SN18	SP18	H18	A18	S18	SN18	SP18	H18
TOYOTA	Regius	KCH4,RCH4	Правый	авг 99		A26	S26	SN26	SP26	H26	A18	S18	SN18	SP18	H18	A18	S18	SN18	SP18	H18
TOYOTA	Regius Ace	LH1,RZH10,11,12,133, KZH11	Правый	апр 97		A19	S19	SN19	SP19	H19	A19	S19	SN19	SP19	H19	A17	S17	SN17		
TOYOTA	Rush	J200E, J210E	Правый	янв 06		A21	S21	SN21	SP21	H21	A18	S18	SN18	SP18	H18					
TOYOTA	Sai	AZK10	Правый	дек 09		A26	S26	SN26	SP26	H26	A16	S16	SN16	SP16	H16					
TOYOTA	Sera	EXY10	Правый	мар 90	дек 95	A21	S21	SN21	SP21	H21	A18	S18	SN18	SP18	H18					
TOYOTA	Sienta	NCP81G,85G	Правый	сен 03	май 11	A22	S22	SN22	SP22	H22	A17	S17	SN17							

DAIHATSU

HINO

HONDA

ISUZU

MAZDA

MITSUBISHI

NISSAN

NISSAN DIESEL

SUBARU

SUZUKI

TOYOTA

LEXUS

Марка	Модель	Кузов	Расположение руля	Период выпуска	Место водителя					Место пассажира					Заднее стекло					
					Aerodynamic	Snowguard	Smart neo	Spoiler	Hybrid	Aerodynamic	Snowguard	Smart neo	Spoiler	Hybrid	Aerodynamic	Snowguard	Smart neo	Spoiler	Hybrid	
TOYOTA																				
TOYOTA	Soarer	GZ, MZ2	Правый	фев 86	апр 91	A20	S20	SN20	SP20	H20	A18	S18	SN18	SP18	H18	A18	S18	SN18	SP18	H18
TOYOTA	Soarer	JZZ3,UZZ3	Правый	май 91	мар 01	A21	S21	SN21	SP21	H21	A20	S20	SN20	SP20	H20	A18	S18	SN18	SP18	H18
TOYOTA	Soarer	UZZ40	Правый	апр 01	май 07	A24	S24	SN24	SP24	H24	A20	S20	SN20	SP20	H20					
TOYOTA	Sparky	S221E,231E	Правый	сен 00	мар 03	A19	S19	SN19	SP19	H19	A15	S15	SN15			A15	S15	SN15		
TOYOTA	Sprinter	EE, CE, AE9	Правый	май 87	май 91	A20	S20	SN20	SP20	H20	A18	S18	SN18	SP18	H18					
TOYOTA	Sprinter	AE10,CE10,EE10	Правый	июн 91	май 95	A20	S20	SN20	SP20	H20	A18	S18	SN18	SP18	H18					
TOYOTA	Sprinter	AE11,CE11,EE11	Правый	май 95	апр 97	A20	S20	SN20	SP20	H20	A18	S18	SN18	SP18	H18					
TOYOTA	Sprinter	AE11,CE11,EE11	Правый	апр 97	июл 00	A20	S20	SN20	SP20	H20	A18	S18	SN18	SP18	H18					
TOYOTA	Sprinter	AE109,CE10,EE10	Правый	сен 91	апр 97	A20	S20	SN20	SP20	H20	A18	S18	SN18	SP18	H18	A16	S16	SN16	SP16	H16
TOYOTA	Sprinter	AE109,CE10,EE10	Правый	апр 97		A20	S20	SN20	SP20	H20	A18	S18	SN18	SP18	H18	A16	S16	SN16	SP16	H16
TOYOTA	Sprinter	AE109,CE10,EE10	Правый	сен 91	апр 97	A20	S20	SN20	SP20	H20	A18	S18	SN18	SP18	H18	A16	S16	SN16	SP16	H16
TOYOTA	Sprinter	AE109,CE10,EE10	Правый	апр 97		A20	S20	SN20	SP20	H20	A18	S18	SN18	SP18	H18	A16	S16	SN16	SP16	H16
TOYOTA	Sprinter Carib	AE95	Правый	фев 88	авг 95	A20	S20	SN20	SP20	H20	A18	S18	SN18	SP18	H18	A14	S14	SN14		
TOYOTA	Sprinter Carib	AE11	Правый	авг 95	апр 97	A20	S20	SN20	SP20	H20	A18	S18	SN18	SP18	H18	A14	S14	SN14		
TOYOTA	Sprinter Carib	AE11	Правый	апр 97	авг 02	A20	S20	SN20	SP20	H20	A18	S18	SN18	SP18	H18	A14	S14	SN14		
TOYOTA	Sprinter Trueno	AE9	Правый	май 87	май 91	A20	S20	SN20	SP20	H20	A18	S18	SN18	SP18	H18	A18	S18	SN18	SP18	H18
TOYOTA	Sprinter Trueno	AE11(3D)	Правый	май 95	апр 97	A20	S20	SN20	SP20	H20	A18	S18	SN18	SP18	H18	A18	S18	SN18	SP18	H18
TOYOTA	Sprinter Trueno	AE11(3D)	Правый	апр 97		A20	S20	SN20	SP20	H20	A18	S18	SN18	SP18	H18	A18	S18	SN18	SP18	H18
TOYOTA	Sprinter Marino	AE10	Правый	май 92	авг 98	A20	S20	SN20	SP20	H20	A18	S18	SN18	SP18	H18	A18	S18	SN18	SP18	H18
TOYOTA	Scepter	SXV10,VCV10	Правый	ноя 92	авг 96	A21	S21	SN21	SP21	H21	A19	S19	SN19	SP19	H19					
TOYOTA	Scepter	SXV15,VCV15	Правый	окт 93	июл 96	A21	S21	SN21	SP21	H21	A19	S19	SN19	SP19	H19					
TOYOTA	Scepter	SXV15W,VCV15W	Правый	июл 92	июл 96	A21	S21	SN21	SP21	H21	A19	S19	SN19	SP19	H19	A12	S11			
TOYOTA	Starlet	EP8,NP8	Правый	дек 89	янв 96	A20	S20	SN20	SP20	H20	A17	S17	SN17							
TOYOTA	Starlet	EP9,NP90	Правый	янв 96	июл 99	A20	S20	SN20	SP20	H20	A17	S17	SN17			A16	S16	SN16	SP16	H16
TOYOTA	Succeed	NCP51,55V,58,59G	Правый	июл 02		A20	S20	SN20	SP20	H20	A18	S18	SN18	SP18	H18					
TOYOTA	Supra	GA, MA70	Правый	сен 88	апр 93	A20	S20	SN20	SP20	H20	A18	S18	SN18	SP18	H18	A18	S18	SN18	SP18	H18
TOYOTA	Supra	JZA80	Правый	май 93	авг 02	A21	S21	SN21	SP21	H21	A20	S20	SN20	SP20	H20	A18	S18	SN18	SP18	H18
TOYOTA	Touring Hiace	KCH4,LXH4,RCH4	Правый	авг 99		A26	S26	SN26	SP26	H26	A18	S18	SN18	SP18	H18	A18	S18	SN18	SP18	H18
TOYOTA	Town Ace	S402M/S402U	Правый	янв 08		A19	S19	SN19	SP19	H19	A19	S19	SN19	SP19	H19					
TOYOTA	Vanguard	GSA/ACA33W	Правый	июл 07		A24	S24	SN24	SP24	H24	A17	S17	SN17	SP16	H16					

DAIHATSU

HINO

HONDA

ISUZU

MAZDA

MITSUBISHI

NISSAN

NISSAN DIESEL

SUBARU

SUZUKI

TOYOTA

LEXUS

Марка	Модель	Кузов	Расположение руля	Период выпуска	Место водителя					Место пассажира					Заднее стекло						
					Aerodynamic	Snowguard	Smart neo	Spoiler	Hybrid	Aerodynamic	Snowguard	Smart neo	Spoiler	Hybrid	Aerodynamic	Snowguard	Smart neo	Spoiler	Hybrid		
<b>TOYOTA</b>																					
TOYOTA	Vellfire	GGH2, W	Правый	май 08	сен 11						A14	S14	SN14								
TOYOTA	Verossa	GX11, JZX110	Правый	июл 01	апр 04	A22	S22	SN22	SP22	H22	A18	S18	SN18	SP18	H18	A19	S19	SN19	SP19	H19	
TOYOTA	Vista	CV3, SV3, VZV3	Правый	июл 90	июн 94	A21	S21	SN21	SP21	H21	A19	S19	SN19	SP19	H19						
TOYOTA	Vista	CV4, SV4	Правый	июл 94	июн 98	A21	S21	SN21	SP21	H21	A19	S19	SN19	SP19	H19						
TOYOTA	Vista	SV5, ZZV50	Правый	июн 98	июн 03	A24	S24	SN24	SP24	H24	A14	S14	SN14			A19	S19	SN19	SP19	H19	
TOYOTA	Vista Ardeo	SV5, ZZV50	Правый	июн 98	июн 03	A24	S24	SN24	SP24	H24	A14	S14	SN14			A14	S14	SN14			
TOYOTA	Vitz (Yaris)	SCP10, SCP13, NCP10, NCP13, NCP15	Правый	янв 99	янв 05	A21	S21	SN21	SP21	H21	A14	S14	SN14			A12	S11				
TOYOTA	Vitz (Yaris)	SCP90, NCP91, NCP95, KSP90	Правый	фев 05		A24	S24	SN24	SP24	H24	A14	S14	SN14								
TOYOTA	Voltz	ZZE136, 137, 138	Правый	авг 02	апр 04	A21	S21	SN21	SP21	H21	A17	S17	SN17								
TOYOTA	Voxy/NOAH	AZR60G, 65G	Правый	ноя 01	май 07	A26	S26	SN26	SP26	H26	A14	S14	SN14								
TOYOTA	Voxy/NOAH	ZRR7W, ZRR7G	Правый	июн 07		A26	S26	SN26	SP26	H26	A16	S16	SN16	SP16	H16						
TOYOTA	Will Cypha	NCP70, 75	Правый	окт 02	авг 05	A22	S22	SN22	SP22	H22	A14	S14	SN14								
TOYOTA	Will Vi	NCP19	Правый	янв 00		A19	S19	SN19	SP19	H19	A18	S18	SN18	SP18	H18						
TOYOTA	Will VS	ZZE12, NZE127	Правый	апр 01	апр 04	A24	S24	SN24	SP24	H24	A16	S16	SN16	SP16	H16						
TOYOTA	Windom	VCV10, 11	Правый	сен 91	авг 96	A21	S21	SN21	SP21	H21	A19	S19	SN19	SP19	H19	A19	S19	SN19	SP19	H19	
TOYOTA	Windom	MCV2	Правый	авг 96	авг 01	A22	S22	SN22	SP22	H22	A18	S18	SN18	SP18	H18	A20	S20	SN20	SP20	H20	
TOYOTA	Windom	MCV3	Правый	сен 01	фев 06	A24	S24	SN24	SP24	H24	A20	S20	SN20	SP20	H20						
TOYOTA	Wish	ZNE	Правый	янв 03	авг 05	A26	S26	SN26	SP26	H26	A14	S14	SN14								
TOYOTA	Wish	ZNE10, 14G	Правый	сен 05	апр 09	A26	S26	SN26	SP26	H26	A14	S14	SN14								
TOYOTA	Wish	ZGE2	Правый	апр 09		A26	S26	SN26	SP26	H26	A14	S14	SN14								
<b>LEXUS</b>																					
LEXUS	SC	UZZ40	Правый	авг 05	июн 06	A24	S24	SN24	SP24	H24	A20	S20	SN20	SP20	H20						
LEXUS	SC	UZZ40	Правый	июн 06	июл 10	A24	S24	SN24	SP24	H24	A20	S20	SN20	SP20	H20						

Производитель	Модель	Период выпуска	Кузов	REAR	SNOWGUARD REAR	Примечания
<b>DAIHATSU</b>						
DAIHATSU	Atrai	05.05-	S320G S330G	AR2-14	RR-14	
DAIHATSU	Be-Go	01.06-	J200G J210G	AR-12	RR-12	
DAIHATSU	Boon	06.04-	M300 301 310S	AR-14	RR-14	
DAIHATSU	Boon Luminas	12.08-	M502 512G	AR-12	RR-12	
DAIHATSU	Coo	05.06-	M401S M402S M411S	AR-12	RR-12	
DAIHATSU	Esse	12.05-	L235S L245S	AR-12	RR-12	
DAIHATSU	Hijet Van	12.04-	S320V S330V	AR2-14	RR-14	
DAIHATSU	MAX	11.01-	L95#S L96#S	AR-12	RR-12	
DAIHATSU	Mira	12.02-11.06	L250 L260	AR-12	RR-12	
DAIHATSU	Mira	12.06-	L275S L285S	AR-12	RR-12	
DAIHATSU	Move / Move Custom	10.02-09.06	L150S L160S	AR-12	RR-12	
DAIHATSU	Move / Move Custom	10.06-	L175S L185S	AR-12	RR-12	
DAIHATSU	Move Conte	08.08-	L575S L585S	AR-11	RR-11	Комплектуется щеткой типа AR длиной 275 мм
DAIHATSU	Sonica	06.06-	L405S L415S	AR-12	RR-12	
DAIHATSU	Tanto	11.03-10.07	L350S L360S	AR-12	RR-12	
DAIHATSU	Tanto	12.07-	L375S L385S	AR-12	RR-12	
DAIHATSU	YRV	08.00-	M200G M201G M211G	AR-12	RR-12	
<b>HONDA</b>						
HONDA	Accord Wagon	12.08-	CW2	AR2-12	RR-12	
HONDA	Accord Wagon	11.02-10.05	CM2 CM3	AR2-12	RR-12	
HONDA	Accord Wagon	11.05-	CM1 CM2 CM3	AR2-12	RR-12	
HONDA	Airwave	04.08-	CJ1 CJ2	AR2-12	RR-12	
HONDA	Avancier	09.99-	TA1 TA2 TA3	AR2-14	RR-14	
HONDA	Elysion	05.04-	RR1 RR2	AR2-14	RR-14	
HONDA	Odyssey	12.99-09.03	RA6 RA7 RA8	AR2-12	RR-12	
HONDA	Odyssey	10.03-09.08	RB1	AR2-12	RR-12	
HONDA	Odyssey	10.08-	RB3 RB4	AR2-12	RR-12	
HONDA	Crossroad	02.07-	RT1 2 3 4	AR2-12	RR-12	
HONDA	CR-V	10.06-	RE3 RE4	AR2-14	RR-14	

Производитель	Модель	Период выпуска	Кузов	REAR	SNOWGUARD REAR	Примечания
<b>HONDA</b>						
HONDA	Fit	06.01-09.07	GD1 GD2 GD3 GD4	AR2-14	RR-14	
HONDA	Fit	10.07-	GE6 GE7 GE8 GE9	AR2-14	RR-14	
HONDA	Freed	05.08-	GB3 GB4	AR2-14	RR-14	
HONDA	Mobilio	12.01-	GB1 GB2	AR2-14	RR-14	
HONDA	Life	09.03-10.20	JB5 JB6 JB7 JB8	AR2-14	RR-14	
HONDA	Life	11.08-	JC1 JC2	AR2-14	RR-14	
HONDA	Stepwagon	04.01-05.03	RF3 RF4	AR2-14	RR-14	
HONDA	Stepwagon	06.03-04.05	RF3 RF4	AR2-14	RR-14	
HONDA	Stepwagon	05.05-10.07	RG1 RG2	AR2-14	RR-14	
HONDA	Stepwagon	11.07-	RG1 RG2 RG3 RG4	AR2-14	RR-14	
HONDA	Stream	10.00-06.06	RN1 RN2 RN3 RN4	AR2-12	RR-12	
HONDA	Stream	07.06-	RN6 7 8 9	AR2-12	RR-12	
HONDA	Zest	02.06-	JE1 JE2	AR2-14	RR-14	

<b>MAZDA</b>						
MAZDA	Atenza Sport Wagon	06.02-	GYEW GY3W	AR-12	RR-12	
MAZDA	Atenza Sport Wagon	01.08-	GHEFW GH5AW GH5FW	AR-14	RR-14	
MAZDA	Atenza Sedan	05.02-12.07	GGEP GG3P	AR-14	RR-14	
MAZDA	Atenza Sedan	01.08-	GHEFP GH5AP GH5FP	AR-14	RR-14	
MAZDA	AZ Wagon	10.03-04.07	MJ21S	AR-12	RR-12	
MAZDA	AZ Wagon	05.07-08.08	MJ22S	AR-14	RR-14	
MAZDA	AZ Wagon	09.08-	MJ23S	AR-14	RR-14	
MAZDA	Biante	07.08-	CC3FW CCEAW CCEFW	AR-14	RR-14	
MAZDA	Carol	09.04-	HB24S	AR-14	RR-14	
MAZDA	CX7	12.06-	ER3P	AR-14	RR-14	
MAZDA	Demio	12.99-09.02	DW3W DW5W	AR-16	RR-16	
MAZDA	Demio	08.02-06.07	DY3W DY5W	AR2-14	RR-14	
MAZDA	Demio	07.07-	DE3AS DE3FS DE5FS	AR2-14	RR-14	
MAZDA	Premacy	02.05-	CREW CR3W	AR-12	RR-12	
MAZDA	Verisa	06.04-	DC5W	AR2-16	RR-16	

Производитель	Модель	Период выпуска	Кузов	REAR	SNOWGUARD REAR	Примечания
<b>MITSUBISHI</b>						
MITSUBISHI	Airtrek	06.01-	CU2W CU4W	AR-14	RR-14	
MITSUBISHI	Colt	11.02-	Z25A Z26A Z27A Z28A	AR-12	RR-12	
MITSUBISHI	Delica D:5	01.07-	CV5W	AR2-14	RR-14	
MITSUBISHI	ek Wagon	10.01-08.06	H81W	AR2-12	RR-12	
MITSUBISHI	ek Wagon	09.06-	H82W	AR2-12	RR-12	
MITSUBISHI	Galant Fortis	12.08-	CX4A	AR2-14	RR-14	
MITSUBISHI	Grandis	05.03-	NA4W	AR2-12	RR-12	
MITSUBISHI	Minicab	12.05-	U6#W	AR-14	RR-14	
MITSUBISHI	Pajero	10.06-	V83 V87 N93 V97	AR2-14	RR-14	
MITSUBISHI	Outlander	10.05-	CW5W	AR-12	RR-12	
MITSUBISHI	Toppo BJ	02.01-	H4#A	AR2-14	RR-14	
MITSUBISHI	Town Box	12.05-	U6#W	AR-14	RR-14	

<b>NISSAN</b>						
NISSAN	AD Van / Wagon	05.04-	Y11	AR2-14	RR-14	
NISSAN	Cube	11.08-	Z12 NZ12	AR2-12	RR-12	
NISSAN	Elgrand	05.02-	E51 #E51	AR2-14	RR-14	
NISSAN	Lafesta	12.04-	A30 B30 NB30	AR2-12	RR-12	
NISSAN	Murano	09.08-	TNZ51 PNZ51	AR2-14	RR-14	
NISSAN	Moco	04.04-01.06	MG21S	AR2-12	RR-12	
NISSAN	Moco	02.06-	MG22S	AR2-12	RR-12	
NISSAN	Note	01.05-	E11 NE11	AR2-12	RR-12	
NISSAN	Otti	06.05-09.06	H91W	AR2-12	RR-12	
NISSAN	Otti	10.06-	H92W	AR2-12	RR-12	
NISSAN	Presage	07.03-	U31	AR2-12	RR-12	
NISSAN	Stagea	10.01-	M35	AR2-12	RR-12	
NISSAN	Serena	05.05-	C25 NC25	AR2-16	RR-16	Комплектуется щеткой типа AR2 длиной 250 мм
NISSAN	Tiida	09.04-	C11 NC11	AR2-12	RR-12	
NISSAN	Wingroad	11.05-	Y12 NY12 JY12	AR2-14	RR-14	



Производитель	Модель	Период выпуска	Кузов	REAR	SNOWGUARD REAR	Примечания
<b>SUBARU</b>						
SUBARU	R1	12.04-	RJ1 RJ2	AR2-12	RR-12	
SUBARU	R2	10.03-	RC1 RC2	AR2-12	RR-12	
SUBARU	Impreza	06.07-	GH2 GH3 GH7 GH8	AR2-16	RR-16	
SUBARU	Exiga	06.08-	YA4 YA5	AR2-14	RR-14	
SUBARU	Stella	06.06-	RN1 RN2	AR2-14	RR-14	
SUBARU	Dex	11.08-	M401F M411F	AR-12	RR-12	
SUBARU	Forester	08.03-01.05	SG5	AR2-16	RR-16	
SUBARU	Forester	02.05-11.07	SG5 SG9	AR2-14	RR-14	
SUBARU	Forester	12.07-	SH5	AR2-14	RR-14	
SUBARU	Legacy B4	06.03-	BL5	AR2-14	RR-14	
SUBARU	Legacy Wagon	05.03-	BP5	AR2-14	RR-14	

<b>SUZUKI</b>						
SUZUKI	Alto	09.04-	HA24S	AR-14	RR-14	
SUZUKI	Alto Lapin	11.08-	HE22S	AR-11	RR-11	
SUZUKI	Aerio	07.04-	RA21S RC51S RB21S RD51S	AR2-12	RR-12	
SUZUKI	Cervo	11.06-	HG21S	AR2-12	RR-12	
SUZUKI	Kei	04.06-	HN22S	AR2-12	RR-12	
SUZUKI	Escudo	04.05-	TD54W TD94W	AR-12	RR-12	
SUZUKI	Every Wagon	08.05-	DA64W	AR-12	RR-12	
SUZUKI	MR Wagon	02.04-12.05	MF21S	AR2-12	RR-12	
SUZUKI	MR Wagon	01.06-	MF22S	AR2-12	RR-12	
SUZUKI	Landy	01.07-	SC25 SNC25	AR2-16	RR-16	
SUZUKI	SX4	07.06-	YA11S YB11S YA41S YB41S	AR2-12	RR-12	Комплектуется щеткой типа AR2 длиной 250 мм
SUZUKI	Swift	06.03-10.04	HT51S	AR2-12	RR-12	
SUZUKI	Swift	11.04-	ZC11S ZC21S ZD11S ZD21S	AR2-12	RR-12	Комплектуется щеткой типа AR2 длиной 250 мм
SUZUKI	Splash	10.08-	XB32S	AR2-14	RR-14	
SUZUKI	Palette	01.08-	MK21S	AR2-12	RR-12	
SUZUKI	Wagon R	09.03-04.07	MH21S	AR-12	RR-12	
SUZUKI	Wagon R	05.07-08.08	MH22S	AR-14	RR-14	
SUZUKI	Wagon R	09.08-	MH23S	AR-14	RR-14	

Производитель	Модель	Период выпуска	Кузов	REAR	SNOWGUARD REAR	Примечания
<b>TOYOTA</b>						
TOYOTA	RX350	01.09-	GGL10 15 16W	AR-16	RR-16	Lexus
TOYOTA	Avensis	10.03-	AZT250W AZT255W	AR-12	RR-12	
TOYOTA	Allion	12.01-05.07	NZT240 ZT24# AZT240	AR-16	RR-16	
TOYOTA	Allion	06.07-	ZRT260 ZRT265 NZT260	AR-14	RR-14	
TOYOTA	Altezza Gita	07.01-	GXE10 JCE10W GXE15W JCE15W	AR-14	RR-14	
TOYOTA	Alphard	05.02-04.08	MNH10W ANH10W MNH15W ANH15W	AR-16	RR-16	
TOYOTA	Alphard	05.08-	ANH20W ANH25W GGN20W GGH25W	AR-16	RR-16	
TOYOTA	Allex	07.01-	NZE12# ZZE12#	AR2-14	RR-14	
TOYOTA	Auris	10.06-	NZE151 NZE154 ZRE152 ZRE154	AR2-12	RR-12	
TOYOTA	bB	12.05-	NC20 NC21 NC25	AR-12	RR-12	
TOYOTA	Blade	12.06-	AZE154HAZE156H	AR2-12	RR-12	
TOYOTA	Caldina	09.02-	ST246W AZT24#W ZT241W	AR-12	RR-12	
TOYOTA	Corolla Spacio	05.01-	NZE121N ZZE122N	AR-14	RR-14	
TOYOTA	Corolla Fielder	08.00-09.06	NZE12# ZZE12# CE121	AR-14	RR-14	
TOYOTA	Corolla Fielder	10.06-	NZE141G NZE144G ZRE142G ZRE144G	AR-12	RR-12	
TOYOTA	Corolla Runx	01.01-	NZE12# ZZE12#	AR2-14	RR-14	
TOYOTA	Corolla Rumion	10.07-	NZE151N ZRE152N ZRE154N	AR-14	RR-14	
TOYOTA	Gaia	08.02-	CXM10G ACM10G ACM15G	AR-16	RR-16	
TOYOTA	Fun Cargo	08.02-	NCP20 NCP21 NCP25	AR-16	RR-16	
TOYOTA	IQ	11.08-	KGJ10	AR-11	RR-11	
TOYOTA	Isis	09.04-	ANM10# ANM15# ZNM10#	AR-14	RR-14	
TOYOTA	Ist	05.02-06.07	NCP60 NCP61 NCP65	AR-12	RR-12	
TOYOTA	Ist	07.07-	NCP110 115	AR-11	RR-11	Комплектуется щеткой типа AR длиной 200 мм
TOYOTA	Ipsium	05.01-	ACM21W ACM26W	AR-16	RR-16	
TOYOTA	Estima	01.00-12.05	#CR30W #CR40W #HR10W	AR-16	RR-16	
TOYOTA	Estima	01.06-	GSR50W ACR50W	AR-12	RR-12	
TOYOTA	Kluger V	11.00-	ACU Z## MCU2##	AR-12	RR-12	
TOYOTA	Mark II	01.02-	GX110W JZX110W JZX115W	AR-12	RR-12	
TOYOTA	Mark X Zio	09.07-	ANA10 ANA15 GGA10	AR-12	RR-12	
TOYOTA	Land Cruiser	09.07-	UZJ200W	AR-12	RR-12	
TOYOTA	Lite Ace	01.08-	S402M S402U	AR-14	RR-14	

Производитель	Модель	Период выпуска	Кузов	REAR	SNOWGUARD REAR	Примечания
<b>TOYOTA</b>						
TOYOTA	Hilux Surf	10.02-	VZN21#W RZN215W KDN215W			Комплектуется щеткой длиной 305 мм с особым типом крепления
TOYOTA	Harrier	02.03-	ACU3#MCU3#	AR-14	RR-14	
TOYOTA	Noah	11.01-05.07	AZR60GAZR65G	AR-16	RR-16	
TOYOTA	Noah	06.07-	ZRR7#W ZRR7#G	AR-16	RR-16	
TOYOTA	Opa	05.00-	ACT10ZCT10ZCT15	AR-14	RR-14	
TOYOTA	Passo	06.04-	QNC10 KGC10 KGC15	AR-14	RR-14	
TOYOTA	Prius	09.03-	NHW20	AR-16	RR-16	
TOYOTA	Premio	11.01-05.07	NZT240 ZT24#AZT240	AR-16	RR-16	
TOYOTA	Premio	06.07-	ZRT260 ZRT265 NZT260	AR-14	RR-14	
TOYOTA	Probox	06.02-	NCP50V NCP51V NCP55V NLP51V	AR-12	RR-12	
TOYOTA	Porte	07.04-	NNP10 NNP11	AR-16	RR-16	
TOYOTA	Raum	05.03-	NCZ20 NCZ25	AR-14	RR-14	
TOYOTA	Ractis	10.05-	NCP100,105 SCP100	AR-14	RR-14	
TOYOTA	Rush	01.06-	J200E J210E	AR-12	RR-12	
TOYOTA	RAV4	05.00-10.05	ACAZ#W ZCAZ#W	AR-12	RR-12	
TOYOTA	RAV4	11.05-	ACA31W ACA36W	AR-12	RR-12	
TOYOTA	Succeed	06.02-	NCP51V NCP55V NLP51V	AR-12	RR-12	
TOYOTA	Sienta	09.03-	NCP81G NCP85G	AR-12	RR-12	
TOYOTA	Town Ace	01.08-	S402M S402U	AR-14	RR-14	
TOYOTA	Vitz	02.05-	SCP90 NCP91 NCP95 KSP90	AR-12	RR-12	
TOYOTA	Vellfire	05.08-	ANH20W ANH25W GGN20W GGH25W	AR-16	RR-16	
TOYOTA	Voxy	11.01-05.07	AZR60GAZR65G	AR-16	RR-16	
TOYOTA	Voxy	06.07-	ZRR7#W ZRR7#G	AR-16	RR-16	
TOYOTA	Voltz	08.02-	ZZE136 ZZE137	AR-11	RR-11	
TOYOTA	Will Cypha	10.02-	NCP70 NCP75	AR-14	RR-14	
TOYOTA	Will VS	04.01-	ZZE12# NZE127	AR-14	RR-14	
TOYOTA	Wish	01.03-08.05	ANE10GANE11W ZNE10G ZNE14G	AR-12	RR-12	
TOYOTA	Wish	09.05-	ANE10GANE11W ZNE10G ZNE14G	AR-12	RR-12	

## КАТАЛОГ ПРИМЕНЯЕМОСТИ ЩЕТОК СТЕКЛОЧИСТИТЕЛЕЙ ДЛЯ ЛЕВОРУЛЬНЫХ АВТО

Производитель	Модель	Период выпуска	Сторона водителя (размер в мм)											Сторона пассажира (размер в мм)											Тип рычага для крепления щеток*	Заднее стекло (размер в мм)										
				AERODYNAMIC	SPOILER	SMART	SMART NEO	HYBRID	SNOWGUARD	SNOWGUARD POLAR	AERODYNAMIC	SPOILER	SMART		SMART NEO	HYBRID	SNOWGUARD	SNOWGUARD POLAR	AERODYNAMIC	SPOILER	SMART	SMART NEO	HYBRID	SNOWGUARD			SNOWGUARD POLAR									
<b>ACURA</b>																																				
ACURA	MDX [YD1]	01→06	600	A-24	SP24	SM24	SN24	H24	S-24	-	530	A-21	SP21	SM21	SN21	H21	S-21	-	1	-	-	-	-	-	-	-	-	-	-	-						
ACURA	MDX [YD2]	06→	650	A-26	SP26	SM26	SN26		S-26	-	530	A-21	SP21	SM21	SN21	H21	S-21	-	1	-	-	-	-	-	-	-	-	-	-	-						
ACURA	RDX	06→	650	A-26	SP26	SM26	SN26	H26	S-26	-	400	A-16	-	SM16	SN16	H16	S-16	-	1	-	-	-	-	-	-	-	-	-	-	-						
ACURA	TSX [CL]	03→	650	A-26	SP26	SM26	SN26	H26	S-26	-	400	A-16	-	SM16	SN16	H16	S-16	-	1	-	-	-	-	-	-	-	-	-	-	-						
ACURA	ZDX	09→	650	A-26	SP26	SM26	SN26	H26	S-26	-	480	A-19	SP19	SM19	SN19	H19	S-19	-	1	-	-	-	-	-	-	-	-	-	-	-						

<b>ALFA ROMEO</b>																														
ALFA ROMEO	145 [930 MY99]	99→01	550	A-22	SP22	SM22	SN22	H22	S-22	-	480	A-19	SP19	SM19	SN19	H19	S-19	-	1	-	-	-	-	-	-	-	-	-	-	-
ALFA ROMEO	146 [930 MY99]	99→01	550	A-22	SP22	SM22	SN22	H22	S-22	-	480	A-19	SP19	SM19	SN19	H19	S-19	-	1	-	-	-	-	-	-	-	-	-	-	-
ALFA ROMEO	147 [937]	00→05	550	A-22	SP22	SM22	SN22	H22	S-22	-	400	A-16	-	SM16	SN16	H16	S-16	-	1	-	-	-	-	-	-	-	-	-	-	-
ALFA ROMEO	147 [937]	05→	550	-	-	-	SN22	H22	-	SE22	400	-	-	-	SN16	H16	-	SE16	3	-	-	-	-	-	-	-	-	-	-	-
ALFA ROMEO	156 Berlina [932]	97→05	550	A-22	SP22	SM22	SN22	H22	S-22	-	500	A-20	SP20	SM20	SN20	H20	S-20	-	1	-	-	-	-	-	-	-	-	-	-	-
ALFA ROMEO	156 Cross Wagon Q4	04→05	550	A-22	SP22	SM22	SN22	H22	S-22	-	500	A-20	SP20	SM20	SN20	H20	S-20	-	1	-	-	-	-	-	-	-	-	-	-	-
ALFA ROMEO	156 Sport Wagon	00→05	550	A-22	SP22	SM22	SN22	H22	S-22	-	500	A-20	SP20	SM20	SN20	H20	S-20	-	1	-	-	-	-	-	-	-	-	-	-	-
ALFA ROMEO	156 Sport Wagon Q4 [932]	04→05	550	A-22	SP22	SM22	SN22	H22	S-22	-	500	A-20	SP20	SM20	SN20	H20	S-20	-	1	-	-	-	-	-	-	-	-	-	-	-
ALFA ROMEO	159 Berlina [939]	05→	580	-	-	-	SN24	H24	-	SE24	450	-	-	-	SN18	H18	-	SE18	3	-	-	-	-	-	-	-	-	-	-	-
ALFA ROMEO	159 Berlina Q4 [939]	06→	580	-	-	-	SN24	H24	-	SE24	450	-	-	-	SN18	H18	-	SE18	3	-	-	-	-	-	-	-	-	-	-	-
ALFA ROMEO	159 Sport Wagon Q4 [939]	06→	580	-	-	-	SN24	H24	-	SE24	450	-	-	-	SN18	H18	-	SE18	3	-	-	-	-	-	-	-	-	-	-	-
ALFA ROMEO	159 Sport Wagon [939]	06→	580	-	-	-	SN24	H24	-	SE24	450	-	-	-	SN18	H18	-	SE18	3	-	-	-	-	-	-	-	-	-	-	-
ALFA ROMEO	166 [936]	98→07	530	A-21	SP21	SM21	SN21	H21	S-21	-	480	A-19	SP19	SM19	SN19	H19	S-19	-	1	-	-	-	-	-	-	-	-	-	-	-
ALFA ROMEO	Brera [939]	06→	580	-	-	-	SN24	H24	-	SE24	450	-	-	-	SN18	H18	-	SE18	3	-	-	-	-	-	-	-	-	-	-	-
ALFA ROMEO	Giulietta [940]	10→	580	-	-	-	SN24	-	-	SE24	450	-	-	-	SN18	-	-	SE18	2	350	-	-	-	-	-	-	-	-	-	-
ALFA ROMEO	GT [937]	03→05	550	A-22	SP22	SM22	SN22	H22	S-22	-	400	A-16	-	SM16	SN16	H16	S-16	-	1	-	-	-	-	-	-	-	-	-	-	-

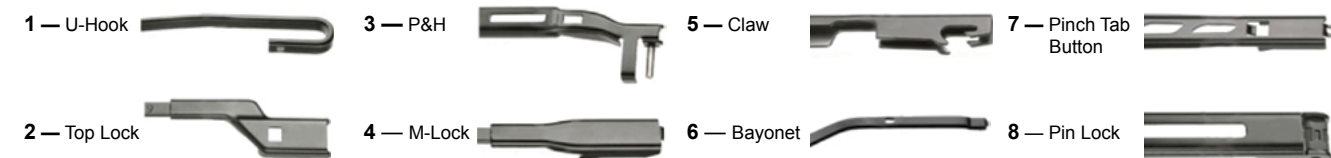





Производитель	Модель	Период выпуска	Сторона водителя (размер в мм)	AERODYNAMIC	SPOILER	SMART	SMART NEO	HYBRID	SNOWGUARD	SNOWGUARD POLAR	Сторона пассажира (размер в мм)	AERODYNAMIC	SPOILER	SMART	SMART NEO	HYBRID	SNOWGUARD	SNOWGUARD POLAR	Тип рычага для крепления щеток*	Заднее стекло (размер в мм)	AERODYNAMIC	SPOILER	SMART	SMART NEO	HYBRID	SNOWGUARD	SNOWGUARD POLAR
<b>AUDI</b>																											
AUDI	A6 Avant Allroad [4BH,C5]	01→05	550	-	-	-	-	-	-	-	550	-	-	-	-	-	-	-	8	380	-	-	-	-	-	-	-
AUDI	A6 Avant Allroad [4FH,C6]	06→	550	-	-	-	-	-	-	SE22	550	-	-	-	-	-	-	SE22	5	340	-	-	-	-	-	-	-
AUDI	A7 Sportback	10→	600	-	-	-	SN24	-	-	SE24	500	-	-	-	SN20	-	-	SE20	2	-	-	-	-	-	-	-	-
AUDI	A8 [4D2,D2]	94→02	550	A-22	SP22	SM22	SN22	H22	S-22	-	500	A-20	SP20	SM20	SN20	H20	S-20	-	1	-	-	-	-	-	-	-	-
AUDI	A8 [4E]	02→10	590	-	-	-	-	-	-	-	580	-	-	-	-	-	-	-	8	-	-	-	-	-	-	-	-
AUDI	A8 [4H]	09→	680	-	-	-	-	-	-	SE28	520	-	-	-	SN21	-	-	SE21	2	-	-	-	-	-	-	-	-
AUDI	Cabriolet [8G7,B4]	97→00	550	A-22	SP22	SM22	SN22	H22	S-22	-	550	A-22	SP22	SM22	SN22	H22	S-22	-	1	-	-	-	-	-	-	-	-
AUDI	Q5 [8RB]	08→	600	-	-	-	SN24	-	-	SE24	500	-	-	-	SN20	-	-	SE20	2	-	-	-	-	-	-	-	-
AUDI	Q7 [4LB]	06→	650	-	-	-	SN26	-	-	SE26	600	-	-	-	SN24	-	-	SE24	4	340	-	-	-	-	-	-	-
AUDI	RS4 [8EC,B7]	05→	550	-	-	-	-	-	-	-	550	-	-	-	-	-	-	-	8	-	-	-	-	-	-	-	-
AUDI	RS4 Avant [8D5,B5]	00→01	530	A-21	SP21	SM21	SN21	H21	S-21	-	530	A-21	SP21	SM21	SN21	H21	S-21	-	1	380	A-15	-	SM16	SN16	H16	S-16	-
AUDI	RS4 Avant [8ED,B7]	06→	550	-	-	-	-	-	-	-	550	-	-	-	-	-	-	-	8	-	-	-	-	-	-	-	-
AUDI	RS4 Cabriolet [8HE,B7]	06→	550	-	-	-	-	-	-	-	550	-	-	-	-	-	-	-	8	-	-	-	-	-	-	-	-
AUDI	S3 [8L1]	98→03	530	A-21	SP21	SM21	SN21	H21	S-21	-	480	A-19	SP19	SM19	SN19	H19	S-19	-	1	380	A-15	-	SM16	SN16	H16	S-16	-
AUDI	S3 [8P1]	06→08	600	-	-	-	SN24	-	-	SE24	480	-	-	-	SN19	-	-	SE19	4	-	-	-	-	-	-	-	-
AUDI	S4 [8D2,B5]	98→00	530	A-21	SP21	SM21	SN21	H21	S-21	-	530	A-21	SP21	SM21	SN21	H21	S-21	-	1	-	-	-	-	-	-	-	-
AUDI	S4 [8D2,B5]	00→01	550	-	-	-	-	-	-	-	550	-	-	-	-	-	-	-	8	-	-	-	-	-	-	-	-
AUDI	S4 [8E2,B6]	03→03	550	-	-	-	-	-	-	-	550	-	-	-	-	-	-	-	8	-	-	-	-	-	-	-	-
AUDI	S4 [8E2,B6]	03→04	550	-	-	-	-	-	-	-	550	-	-	-	-	-	-	-	8	-	-	-	-	-	-	-	-
AUDI	S4 [8EC,B7]	04→08	550	-	-	-	-	-	-	-	550	-	-	-	-	-	-	-	8	-	-	-	-	-	-	-	-
AUDI	S4 [8K2,B8]	08→	600	-	-	-	SN24	-	-	SE24	550	-	-	-	SN22	-	-	SE22	2	-	-	-	-	-	-	-	-
AUDI	S4 Avant [8D5,B5]	97→01	530	A-21	SP21	SM21	SN21	H21	S-21	-	530	A-21	SP21	SM21	SN21	H21	S-21	-	1	380	A-15	-	SM16	SN16	H16	S-16	-
AUDI	S4 Avant [8E5,B6]	03→03	550	-	-	-	-	-	-	-	550	-	-	-	-	-	-	-	8	340	-	-	-	-	-	-	-

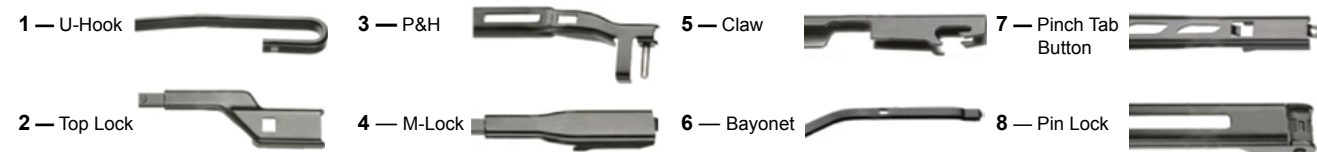

Производитель	Модель	Период выпуска	Сторона водителя (размер в мм)	AERODYNAMIC	SPOILER	SMART	SMART NEO	HYBRID	SNOWGUARD	SNOWGUARD POLAR	Сторона пассажира (размер в мм)	AERODYNAMIC	SPOILER	SMART	SMART NEO	HYBRID	SNOWGUARD	SNOWGUARD POLAR	Тип рычага для крепления щеток*	Заднее стекло (размер в мм)	AERODYNAMIC	SPOILER	SMART	SMART NEO	HYBRID	SNOWGUARD	SNOWGUARD POLAR
<b>AUDI</b>																											
AUDI	S4 Avant [8E5,B6]	03→04	550	-	-	-	-	-	-	-	550	-	-	-	-	-	-	-	8	340	-	-	-	-	-	-	-
AUDI	S4 Avant [8ED,B7]	04→	550	-	-	-	-	-	-	-	550	-	-	-	-	-	-	-	8	340	-	-	-	-	-	-	-
AUDI	S4 Cabriolet [8HE,B7,8H7,B7]	04→	550	-	-	-	-	-	-	-	550	-	-	-	-	-	-	-	8	-	-	-	-	-	-	-	-
AUDI	S5 Coupe [8T3]	07→	600	-	-	-	SN24	-	-	SE24	500	-	-	-	SN20	-	-	SE20	2	-	-	-	-	-	-	-	-
AUDI	S6 [4B4,C5]	99→01	550	A-22	SP22	SM22	SN22	H22	S-22	-	530	A-21	SP21	SM21	SN21	H21	S-21	-	1	-	-	-	-	-	-	-	-
AUDI	S6 [4F2,C6]	06→	550	-	-	-	-	-	-	SE22	550	-	-	-	-	-	-	SE22	5	-	-	-	-	-	-	-	-
AUDI	S6 Avant [4B6,C5]	99→01	550	A-22	SP22	SM22	SN22	H22	S-22	-	530	A-21	SP21	SM21	SN21	H21	S-21	-	1	380	A-15	-	SM16	SN16	H16	S-16	-
AUDI	S6 Avant [4F5,C6]	06→	550	-	-	-	-	-	-	SE22	550	-	-	-	-	-	-	SE22	5	340	-	-	-	-	-	-	-
AUDI	S8 [4D2]	96→02	550	A-22	SP22	SM22	SN22	H22	S-22	-	530	A-21	SP21	SM21	SN21	H21	S-21	-	1	-	-	-	-	-	-	-	-
AUDI	S8 [4E]	06→10	590	-	-	-	-	-	-	-	580	-	-	-	-	-	-	-	8	-	-	-	-	-	-	-	-
AUDI	TT Coupe [8N3]	98→03	550	A-22	SP22	SM22	SN22	H22	S-22	-	530	A-21	SP21	SM21	SN21	H21	S-21	-	1	-	-	-	-	-	-	-	-
AUDI	TT Coupe [8N3]	03→06	530	-	-	-	SN21	H21	-	SE21	530	-	-	-	SN21	H21	-	SE21	3	-	-	-	-	-	-	-	-
AUDI	TT Coupe [8J3]	06→	550	-	-	-	SN22	-	-	SE22	530	-	-	-	SN21	-	-	SE21	4	-	-	-	-	-	-	-	-
AUDI	TT Roadster [8N9]	99→03	550	A-22	SP22	SM22	SN22	H22	S-22	-	530	A-21	SP21	SM21	SN21	H21	S-21	-	1	-	-	-	-	-	-	-	-
AUDI	TT Roadster [8N9]	03→06	530	-	-	-	SN21	H21	-	SE21	530	-	-	-	SN21	H21	-	SE21	3	-	-	-	-	-	-	-	-
AUDI	TT Roadster [8J9]	07→	550	-	-	-	SN22	-	-	SE22	530	-	-	-	SN21	-	-	SE21	4	-	-	-	-	-	-	-	-
<b>BMW</b>																											
BMW	Series 1 [E81,E87]	04→	500	-	-	-	SN20	-	-	SE20	500	-	-	-	SN20	-	-	SE20	4	280	-	-	-	-	-	-	-
BMW	Series 1 Cabrio [E88]	08→	500	-	-	-	SN20	-	-	SE20	500	-	-	-	SN20	-	-	SE20	4	280	-	-	-	-	-	-	-
BMW	Series 1 Coupe [E82]	07→	500	-	-	-	SN20	-	-	SE20	500	-	-	-	SN20	-	-	SE20	4	280	-	-	-	-	-	-	-
BMW	Series 3 [E46]	98→05	580	A-24	SP24	SM24	SN24	H24	S-24	-	500	A-20	SP20	SM20	SN20	H20	S-20	-	1	-	-	-	-	-	-	-	-
BMW	Series 3 [E90]	05→09	600	-	-	-	SN24	H24	-	SE24	480	-	-	-	SN19	H19	-	SE19	3	-	-	-	-	-	-	-	-

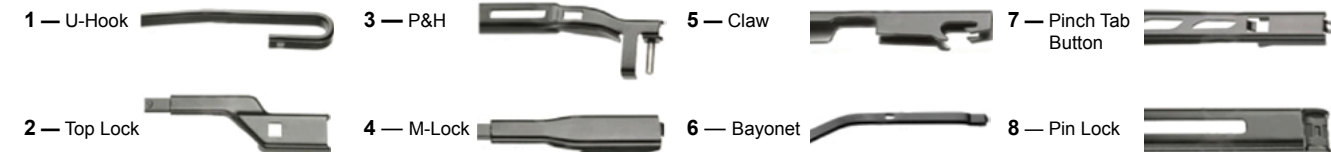

Производитель	Модель	Период выпуска	Сторона водителя (размер в мм)	AERODYNAMIC	SPOILER	SMART	SMART NEO	HYBRID	SNOWGUARD	SNOWGUARD POLAR	Сторона пассажира (размер в мм)	AERODYNAMIC	SPOILER	SMART	SMART NEO	HYBRID	SNOWGUARD	SNOWGUARD POLAR	Тип рычага для крепления щеток*	Заднее стекло (размер в мм)	AERODYNAMIC	SPOILER	SMART	SMART NEO	HYBRID	SNOWGUARD	SNOWGUARD POLAR
BMW																											
BMW	Serie 3 [E90]	09→	600	-	-	-	SN24	-	-	SE24	480	-	-	-	SN19	-	-	SE19	4	-	-	-	-	-	-	-	-
BMW	Serie 3 Cabrio [E46]	00→06	580	A-24	SP24	SM24	SN24	H24	S-24	-	500	A-20	SP20	SM20	SN20	H20	S-20	-	1	-	-	-	-	-	-	-	-
BMW	Serie 3 Cabrio [E93]	06→09	600	-	-	-	SN24	H24	-	SE24	450	-	-	-	SN18	H18	-	SE18	3	-	-	-	-	-	-	-	-
BMW	Serie 3 Cabrio [E93]	09→	590	-	-	-	SN24	-	-	SE24	400	-	-	-	SN16	-	-	SE16	4	-	-	-	-	-	-	-	-
BMW	Serie 3 Compact [E36]	94→00	530	A-21	SP21	SM21	SN21	H21	S-21	-	500	A-20	SP20	SM20	SN20	H20	S-20	-	1	-	-	-	-	-	-	-	-
BMW	Serie 3 Compact [E46]	01→04	580	A-24	SP24	SM24	SN24	H24	S-24	-	500	A-20	SP20	SM20	SN20	H20	S-20	-	1	-	-	-	-	-	-	-	-
BMW	Serie 3 Coupe [E46]	98→06	580	A-24	SP24	SM24	SN24	H24	S-24	-	500	A-20	SP20	SM20	SN20	H20	S-20	-	1	-	-	-	-	-	-	-	-
BMW	Serie 3 Coupe [E92]	06→09	600	-	-	-	SN24	H24	-	SE24	450	-	-	-	SN18	H18	-	SE18	3	-	-	-	-	-	-	-	-
BMW	Serie 3 Coupe [E92]	09→	590	-	-	-	SN24	-	-	SE24	400	-	-	-	SN16	-	-	SE16	4	-	-	-	-	-	-	-	-
BMW	Serie 3 Touring [E46]	99→05	580	A-24	SP24	SM24	SN24	H24	S-24	-	500	A-20	SP20	SM20	SN20	H20	S-20	-	1	-	-	-	-	-	-	-	-
BMW	Serie 3 Touring [E91]	05→09	600	-	-	-	SN24	H24	-	SE24	480	-	-	-	SN19	H19	-	SE19	3	-	-	-	-	-	-	-	-
BMW	Serie 3 Touring [E91]	09→	600	-	-	-	SN24	-	-	SE24	480	-	-	-	SN19	-	-	SE19	4	-	-	-	-	-	-	-	-
BMW	Serie 5 [E34]	89→98	600	A-24	SP24	SM24	SN24	H24	S-24	-	600	A-24	SP24	SM24	SN24	H24	S-24	-	1	-	-	-	-	-	-	-	-
BMW	Serie 5 [E39]	95→03	650	-	-	-	-	-	-	-	550	-	-	-	-	-	-	-	8	-	-	-	-	-	-	-	-
BMW	Serie 5 [E60]	03→10	600	-	-	-	-	-	-	SE24	580	-	-	-	-	-	-	SE22	7	-	-	-	-	-	-	-	-
BMW	Serie 5 GT [F07GT]	09→	650	-	-	-	SN26	H26	-	SE26	450	-	-	-	SN18	H18	-	SE18	3	-	-	-	-	-	-	-	-
BMW	Serie 5 [F10]	10→	650	-	-	-	SN26	H26	-	SE26	450	-	-	-	SN18	H18	-	SE18	3	-	-	-	-	-	-	-	-
BMW	Serie 5 Touring [E34]	89→95	600	A-24	SP24	SM24	SN24	H24	S-24	-	600	A-24	SP24	SM24	SN24	H24	S-24	-	1	-	-	-	-	-	-	-	-
BMW	Serie 5 Touring [E39]	96→04	650	-	-	-	-	-	-	-	550	-	-	-	-	-	-	-	8	430	-	-	-	-	-	-	-
BMW	Serie 5 Touring [E61]	04→10	600	-	-	-	-	-	-	SE24	580	-	-	-	-	-	-	SE22	7	350	-	-	-	-	-	-	-
BMW	Serie 5 Touring [F11]	10→	650	-	-	-	SN26	H26	-	SE26	450	-	-	-	SN18	H18	-	SE18	3	350	-	-	-	-	-	-	-
BMW	Serie 6 [E63]	04→10	600	-	-	-	-	-	-	SE24	580	-	-	-	-	-	-	SE22	7	-	-	-	-	-	-	-	-
BMW	Serie 6 Cabrio [E64]	04→10	600	-	-	-	-	-	-	SE24	580	-	-	-	-	-	-	SE22	7	-	-	-	-	-	-	-	-

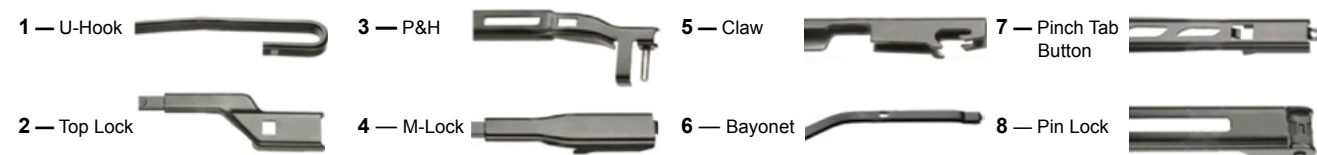

Производитель	Модель	Период выпуска	Сторона водителя (размер в мм)	AERODYNAMIC	SPOILER	SMART	SMART NEO	HYBRID	SNOWGUARD	SNOWGUARD POLAR	Сторона пассажира (размер в мм)	AERODYNAMIC	SPOILER	SMART	SMART NEO	HYBRID	SNOWGUARD	SNOWGUARD POLAR	Тип рычага для крепления щеток*	Заднее стекло (размер в мм)	AERODYNAMIC	SPOILER	SMART	SMART NEO	HYBRID	SNOWGUARD	SNOWGUARD POLAR
BMW																											
BMW	Serie 7 [E38]	94→01	600	A-24	SP24	SM24	SN24	H24	S-24	-	630	A-26	SP26	SM26	SN26	H26	S-26	-	1	-	-	-	-	-	-	-	-
BMW	Serie 7 [E65, E66]	01→08	630	A-26	SP26	SM26	SN26	H26	S-26	-	630	A-26	SP26	SM26	SN26	H26	S-26	-	1	-	-	-	-	-	-	-	-
BMW	Serie 7 [F01, F02, F04]	08→	650	-	-	-	SN26	H26	-	SE26	450	-	-	-	SN18	H18	-	SE18	3	-	-	-	-	-	-	-	-
BMW	Serie M [E39]	98→03	650	-	-	-	-	-	-	-	550	-	-	-	-	-	-	-	8	-	-	-	-	-	-	-	-
BMW	Serie M [E60, E63]	04→	600	-	-	-	-	-	-	SE24	580	-	-	-	-	-	-	SE22	7	-	-	-	-	-	-	-	-
BMW	Serie M Cabrio [E46]	01→06	550	A-22	SP22	SM22	SN22	H22	S-22	-	480	A-19	SP19	SM19	SN19	H19	S-19	-	1	-	-	-	-	-	-	-	-
BMW	Serie M Cabrio [E64]	06→	600	-	-	-	-	-	-	SE24	580	-	-	-	-	-	-	SE22	7	-	-	-	-	-	-	-	-
BMW	Serie M Cabrio [E93]	08→	600	-	-	-	SN24	H24	-	SE24	450	-	-	-	SN18	H18	-	SE18	3	-	-	-	-	-	-	-	-
BMW	Serie M Coupe [E46]	00→06	550	A-22	SP22	SM22	SN22	H22	S-22	-	480	A-19	SP19	SM19	SN19	H19	S-19	-	1	-	-	-	-	-	-	-	-
BMW	Serie M Coupe [E92]	07→	600	-	-	-	SN24	H24	-	SE24	450	-	-	-	SN18	H18	-	SE18	3	-	-	-	-	-	-	-	-
BMW	X1 [E84]	09→	600	-	-	-	SN24	-	-	SE24	480	-	-	-	SN19	-	-	SE19	4	300	-	-	-	-	-	-	-
BMW	X3 [E83]	04→10	530	A-21	SP21	SM21	SN21	H21	S-21	-	500	A-20	SP20	SM20	SN20	H20	S-20	-	1	350	A-14	-	SM14	SN14	-	S-14	-
BMW	X3 [F25]	10→	650	-	-	-	SN26	H26	-	SE26	500	-	-	-	SN20	H20	-	SE20	3	330	-	-	-	-	-	-	-
BMW	X5 [E53]	99→06	600	A-24	SP24	SM24	SN24	H24	S-24	-	530	A-21	SP21	SM21	SN21	H21	S-21	-	1	430	A-17	-	SM17	SN17	-	S-17	-
BMW	X5 [E70]	06→	600	-	-	-	SN24	H24	-	SE24	500	-	-	-	SN20	H20	-	SE20	3	380	-	-	-	-	-	-	-
BMW	X6 [E71, E72]	08→	600	-	-	-	SN24	H24	-	SE24	500	-	-	-	SN20	H20	-	SE20	3	-	-	-	-	-	-	-	-
BMW	Z3 [E36, E37]	95→02	500	A-20	SP20	SM20	SN20	H20	S-20	-	480	A-19	SP19	SM19	SN19	H19	S-19	-	1	-	-	-	-	-	-	-	-
BMW	Z3 Coupe [E36, E38]	97→02	500	A-20	SP20	SM20	SN20	H20	S-20	-	480	A-19	SP19	SM19	SN19	H19	S-19	-	1	-	-	-	-	-	-	-	-
BMW	Z4 [E85]	02→09	530	A-21	SP21	SM21	SN21	H21	S-21	-	500	A-20	SP20	SM20	SN20	H20	S-20	-	1	-	-	-	-	-	-	-	-
BMW	Z4 [E89]	09→	530	A-21	SP21	SM21	SN21	H21	S-21	-	530	A-21	SP21	SM21	SN21	H21	S-21	-	1	-	-	-	-	-	-	-	-
BMW	Z4 Coupe [E86]	06→09	530	A-21	SP21	SM21	SN21	H21	S-21	-	500	A-20	SP20	SM20	SN20	H20	S-20	-	1	-	-	-	-	-	-	-	-

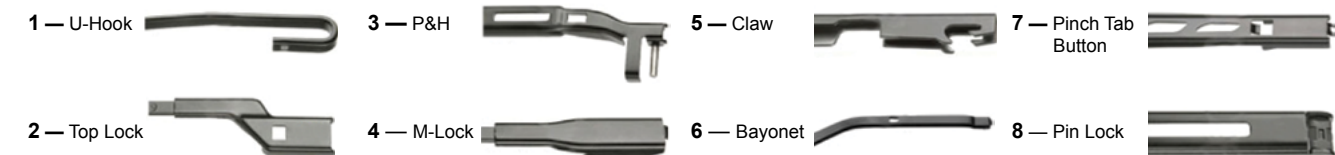

Производитель	Модель	Период выпуска	Сторона водителя (размер в мм)	AERODYNAMIC	SPOILER	SMART	SMART NEO	HYBRID	SNOWGUARD	SNOWGUARD POLAR	Сторона пассажира (размер в мм)	AERODYNAMIC	SPOILER	SMART	SMART NEO	HYBRID	SNOWGUARD	SNOWGUARD POLAR	Тип рычага для крепления щеток*	Заднее стекло (размер в мм)	AERODYNAMIC	SPOILER	SMART	SMART NEO	HYBRID	SNOWGUARD	SNOWGUARD POLAR
<b>BYD</b>																											
BYD	F0	08→	600	A-24	SP24	SM24	SN24	H24	S-24	-	-	-	-	-	-	-	-	-	-	1	-	-	-	-	-	-	-
BYD	F3	05→	600	A-24	SP24	SM24	SN24	H24	S-24	-	400	A-16	-	SM16	SN16	H16	S-16	-	1	-	-	-	-	-	-	-	-

<b>CADILLAC</b>																											
CADILLAC	BLS	05→	580	A-24	SP24	SM24	SN24	H24	S-24	-	580	A-24	SP24	SM24	SN24	H24	S-24	-	1	-	-	-	-	-	-	-	-
CADILLAC	BLS	08→	600	-	-	-	SN24	-	-	SE24	580	-	-	-	SN24	-	-	SE24	4	-	-	-	-	-	-	-	
CADILLAC	BLS Wagon	08→	600	-	-	-	SN24	-	-	SE24	580	-	-	-	SN24	-	-	SE24	4	300	-	-	-	-	-	-	
CADILLAC	CTS I	02→07	550	A-22	SP22	SM22	SN22	H22	S-22	-	530	A-21	SP21	SM21	SN21	H21	S-21	-	1	-	-	-	-	-	-	-	
CADILLAC	CTS II	07→	550	A-22	SP22	SM22	SN22	H22	S-22	-	480	A-19	SP19	SM19	SN19	H19	S-19	-	1	-	-	-	-	-	-	-	
CADILLAC	Escalade II	98→06	650	-	-	-	SN26	-	-	SE26	650	-	-	-	SN26	-	-	SE26	4	-	-	-	-	-	-	-	
CADILLAC	Escalade III	06→	650	-	-	-	SN26	-	-	SE26	650	-	-	-	SN26	-	-	SE26	4	300	-	-	-	-	-	-	
CADILLAC	SRX	03→08	550	A-22	SP22	SM22	SN22	H22	S-22	-	500	A-20	SP20	SM20	SN20	H20	S-20	-	1	340	A-14	-	SM14	SN14	-	S-14	
CADILLAC	SRX	09→	650	-	-	-	SN26	-	-	SE26	430	-	-	-	SN17	-	-	SE17	2	-	-	-	-	-	-	-	
CADILLAC	STS	04→	550	-	-	-	SN22	-	-	SE22	530	-	-	-	SN21	-	-	SE21	4	-	-	-	-	-	-	-	
CADILLAC	XLR	03→	500	A-20	SP20	SM20	SN20	H20	S-20	-	500	A-20	SP20	SM20	SN20	H20	S-20	-	1	-	-	-	-	-	-	-	

<b>CHERY</b>																											
CHERY	Amulet [A15]	03→	500	A-20	SP20	SM20	SN20	H20	S-20	-	500	A-20	SP20	SM20	SN20	H20	S-20	-	1	-	-	-	-	-	-	-	-
CHERY	Amulet [A21]	06→	550	A-22	SP22	SM22	SN22	H22	S-22	-	500	A-20	SP20	SM20	SN20	H20	S-20	-	1	-	-	-	-	-	-	-	-
CHERY	CrossEaster [B14]	06→	550	A-22	SP22	SM22	SN22	H22	S-22	-	500	A-20	SP20	SM20	SN20	H20	S-20	-	1	-	-	-	-	-	-	-	-
CHERY	Kimo [A1]	06→	550	A-22	SP22	SM22	SN22	H22	S-22	-	400	A-16	-	SM16	SN16	H16	S-16	-	1	-	-	-	-	-	-	-	
CHERY	M11 Hatchback	07→	530	A-21	SP21	SM21	SN21	H21	S-21	-	480	A-19	SP19	SM19	SN19	H19	S-19	-	1	-	-	-	-	-	-	-	
CHERY	M11 Sedan	08→	530	A-21	SP21	SM21	SN21	H21	S-21	-	480	A-19	SP19	SM19	SN19	H19	S-19	-	1	-	-	-	-	-	-	-	

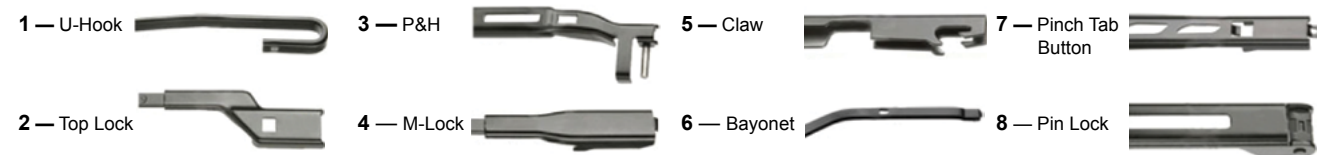

Производитель	Модель	Период выпуска	Сторона водителя (размер в мм)	AERODYNAMIC	SPOILER	SMART	SMART NEO	HYBRID	SNOWGUARD	SNOWGUARD POLAR	Сторона пассажира (размер в мм)	AERODYNAMIC	SPOILER	SMART	SMART NEO	HYBRID	SNOWGUARD	SNOWGUARD POLAR	Тип рычага для крепления щеток*	Заднее стекло (размер в мм)	AERODYNAMIC	SPOILER	SMART	SMART NEO	HYBRID	SNOWGUARD	SNOWGUARD POLAR
<b>CHERY</b>																											
CHERY	QQ3 [S11]	01→	530	A-21	SP21	SM21	SN21	H21	S-21	-	500	A-20	SP20	SM20	SN20	H20	S-20	-	1	-	-	-	-	-	-	-	
CHERY	QQ6 [S21]	06→	500	A-20	SP20	SM20	SN20	H20	S-20	-	500	A-20	SP20	SM20	SN20	H20	S-20	-	1	-	-	-	-	-	-	-	
CHERY	Sweet [QQ]	03→	530	A-21	SP21	SM21	SN21	H21	S-21	-	500	A-20	SP20	SM20	SN20	H20	S-20	-	1	-	-	-	-	-	-	-	
CHERY	Tiggo [T11]	05→	600	A-24	SP24	SM24	SN24	H24	S-24	-	480	A-19	SP19	SM19	SN19	H19	S-19	-	1	-	-	-	-	-	-	-	

<b>CHEVROLET</b>																											
CHEVROLET	Aveo [KL1S,T250]	06→	550	A-22	SP22	SM22	SN22	H22	S-22	-	400	A-16	-	SM16	SN16	H16	S-16	-	1	-	-	-	-	-	-	-	-
CHEVROLET	Aveo Hatchback [KL1S,T250]	08→	550	A-22	SP22	SM22	SN22	H22	S-22	-	400	A-16	-	SM16	SN16	H16	S-16	-	1	450	A-18	SP18	SM18	SN18	H18	S-18	-
CHEVROLET	Captiva [KL1C]	06→	600	A-24	SP24	SM24	SN24	H24	S-24	-	400	A-16	-	SM16	SN16	H16	S-16	-	1	-	-	-	-	-	-	-	
CHEVROLET	Corvette 97	97→04	580	A-24	SP24	SM24	SN24	H24	S-24	-	580	A-24	SP24	SM24	SN24	H24	S-24	-	1	-	-	-	-	-	-	-	
CHEVROLET	Corvette [C6]	04→	530	A-21	SP21	SM21	SN21	H21	S-21	-	530	A-21	SP21	SM21	SN21	H21	S-21	-	1	-	-	-	-	-	-	-	
CHEVROLET	Corvette Coupe	97→03	580	A-24	SP24	SM24	SN24	H24	S-24	-	580	A-24	SP24	SM24	SN24	H24	S-24	-	1	-	-	-	-	-	-	-	
CHEVROLET	Cruze	09→	600	A-24	SP24	SM24	SN24	H24	S-24	-	450	A-18	SP18	SM18	SN18	H18	S-18	-	1	-	-	-	-	-	-	-	
CHEVROLET	Epica [KL1L]	06→	550	A-22	SP22	SM22	SN22	H22	S-22	-	500	A-20	SP20	SM20	SN20	H20	S-20	-	1	-	-	-	-	-	-	-	
CHEVROLET	Lacetti SW [KL1N,J200]	05→	550	A-22	SP22	SM22	SN22	H22	S-22	-	480	A-19	SP19	SM19	SN19	H19	S-19	-	1	450	A-18	SP18	SM18	SN18	H18	S-18	
CHEVROLET	Lacetti [KL1N,J200]	05→	550	A-22	SP22	SM22	SN22	H22	S-22	-	480	A-19	SP19	SM19	SN19	H19	S-19	-	1	-	-	-	-	-	-	-	
CHEVROLET	Lanos	04→	480	A-19	SP19	SM19	SN19	H19	S-19	-	480	A-19	SP19	SM19	SN19	H19	S-19	-	1	-	-	-	-	-	-	-	
CHEVROLET	Nubira [KL1N,J200]	05→	550	A-22	SP22	SM22	SN22	H22	S-22	-	480	A-19	SP19	SM19	SN19	H19	S-19	-	1	-	-	-	-	-	-	-	
CHEVROLET	Nubira Station Wagon [KL1N,J200]	05→	550	A-22	SP22	SM22	SN22	H22	S-22	-	480	A-19	SP19	SM19	SN19	H19	S-19	-	1	450	A-18	SP18	SM18	SN18	H18	S-18	
CHEVROLET	Orlando	10→	600	A-24	SP24	SM24	SN24	H24	S-24	-	480	A-19	SP19	SM19	SN19	H19	S-19	-	1	-	-	-	-	-	-	-	
CHEVROLET	Prizm	98→02	500	A-20	SP20	SM20	SN20	H20	S-20	-	450	A-18	SP18	SM18	SN18	H18	S-18	-	1	-	-	-	-	-	-	-	
CHEVROLET	Rezzo [KL1U,U100]	05→	600	A-24	SP24	SM24	SN24	H24	S-24	-	450	A-18	SP18	SM18	SN18	H18	S-18	-	1	380	A-15	-	SM16	SN16	H16	S-16	
CHEVROLET	Spark	05→	550	A-22	SP22	SM22	SN22	H22	S-22	-	340	A-14	-	SM14	SN14	-	S-14	-	1	-	-	-	-	-	-	-	

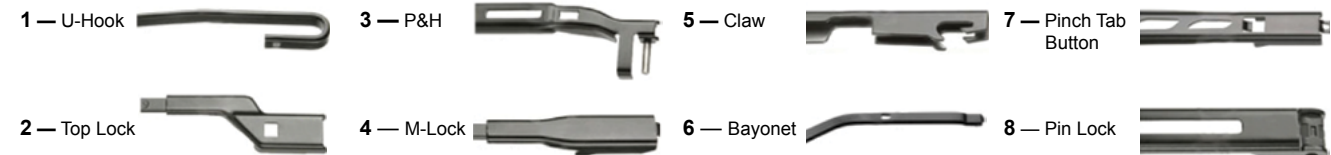



Производитель	Модель	Период выпуска	Сторона водителя (размер в мм)	AERODYNAMIC	SPOILER	SMART	SMART NEO	HYBRID	SNOWGUARD	SNOWGUARD POLAR	Сторона пассажира (размер в мм)	AERODYNAMIC	SPOILER	SMART	SMART NEO	HYBRID	SNOWGUARD	SNOWGUARD POLAR	Тип рычага для крепления щеток*	Заднее стекло (размер в мм)	AERODYNAMIC	SPOILER	SMART	SMART NEO	HYBRID	SNOWGUARD	SNOWGUARD POLAR
<b>CHEVROLET</b>																											
CHEVROLET	Spark	10→	580	A-24	SP24	SM24	SN24	H24	S-24	-	380	A-15	-	SM15	SN15	-	S-15	-	1	-	-	-	-	-	-	-	-
CHEVROLET	Suburban [GMT400]	91→00	450	A-18	SP18	SM18	SN18	H18	S-18	-	450	A-18	SP18	SM18	SN18	H18	S-18	-	1	-	-	-	-	-	-	-	-
CHEVROLET	Suburban [GMT800]	00→07	550	A-22	SP22	SM22	SN22	H22	S-22	-	550	A-22	SP22	SM22	SN22	H22	S-22	-	1	-	-	-	-	-	-	-	
CHEVROLET	Suburban [GMT900]	05→	550	-	-	-	SN22	-	-	SE22	550	-	-	-	SN22	-	-	SE22	4	300	-	-	-	-	-	-	
CHEVROLET	Tahoe [GMT410]	94→99	450	A-18	SP18	SM18	SN18	H18	S-18	-	450	A-18	SP18	SM18	SN18	H18	S-18	-	1	-	-	-	-	-	-	-	
CHEVROLET	Tahoe [GMT840]	99→07	550	A-22	SP22	SM22	SN22	H22	S-22	-	550	A-22	SP22	SM22	SN22	H22	S-22	-	1	-	-	-	-	-	-	-	
CHEVROLET	Tahoe [GMT900]	08→	550	-	-	-	SN22	-	-	SE22	550	-	-	-	SN22	-	-	SE22	4	300	-	-	-	-	-	-	
CHEVROLET	Tracker	98→04	480	A-19	SP19	SM19	SN19	H19	S-19	-	480	A-19	SP19	SM19	SN19	H19	S-19	-	1	380	A-15	-	SM16	SN16	H16	S-16	
CHEVROLET	Trailblazer [KC, GMT800]	01→	550	A-22	SP22	SM22	SN22	H22	S-22	-	550	A-22	SP22	SM22	SN22	H22	S-22	-	1	400	A-16	-	SM16	SN16	H16	S-16	
CHEVROLET	Viva	04→08	500	A-20	SP20	SM20	SN20	H20	S-20	-	480	A-19	SP19	SM19	SN19	H19	S-19	-	1	-	-	-	-	-	-	-	

<b>CHRYSLER</b>																											
CHRYSLER	300 [LX]	04→	550	A-22	SP22	SM22	SN22	H22	S-22	-	530	A-21	SP21	SM21	SN21	H21	S-21	-	1	-	-	-	-	-	-	-	
CHRYSLER	300C [LE]	04→	550	A-22	SP22	SM22	SN22	H22	S-22	-	530	A-21	SP21	SM21	SN21	H21	S-21	-	1	-	-	-	-	-	-	-	
CHRYSLER	300C Touring [LE]	04→	550	A-22	SP22	SM22	SN22	H22	S-22	-	530	A-21	SP21	SM21	SN21	H21	S-21	-	1	-	-	-	-	-	-	-	
CHRYSLER	300M [LH]	98→04	600	A-24	SP24	SM24	SN24	H24	S-24	-	480	A-19	SP19	SM19	SN19	H19	S-19	-	1	-	-	-	-	-	-	-	
CHRYSLER	Concorde	97→04	600	A-24	SP24	SM24	SN24	H24	S-24	-	550	A-22	SP22	SM22	SN22	H22	S-22	-	1	-	-	-	-	-	-	-	
CHRYSLER	Crossfire Coupe [ZH]	02→	500	A-20	SP20	SM20	SN20	H20	S-20	-	530	A-21	SP21	SM21	SN21	H21	S-21	-	1	-	-	-	-	-	-	-	
CHRYSLER	Crossfire Roadster [ZH]	02→	500	A-20	SP20	SM20	SN20	H20	S-20	-	530	A-21	SP21	SM21	SN21	H21	S-21	-	1	-	-	-	-	-	-	-	
CHRYSLER	Grand Voyager [RS]	07→	650	A-26	SP26	SM26	SN26	H26	S-26	-	550	A-22	SP22	SM22	SN22	H22	S-22	-	1	400	A-16	-	SM16	SN16	H16	S-16	
CHRYSLER	Neon [PL]	99→05	550	A-22	SP22	SM22	SN22	H22	S-22	-	480	A-19	SP19	SM19	SN19	H19	S-19	-	1	-	-	-	-	-	-	-	
CHRYSLER	PT Cruiser [PT]	00→	500	A-20	SP20	SM20	SN20	H20	S-20	-	530	A-21	SP21	SM21	SN21	H21	S-21	-	1	400	A-16	-	SM16	SN16	H16	S-16	
CHRYSLER	PT Cruiser Cabrio [PT]	00→	500	A-20	SP20	SM20	SN20	H20	S-20	-	530	A-21	SP21	SM21	SN21	H21	S-21	-	1	-	-	-	-	-	-	-	

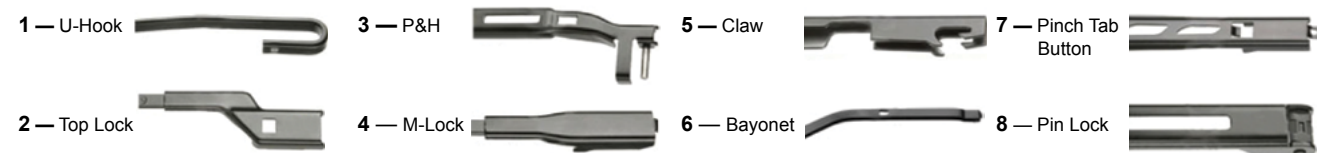

Производитель	Модель	Период выпуска	Сторона водителя (размер в мм)	AERODYNAMIC	SPOILER	SMART	SMART NEO	HYBRID	SNOWGUARD	SNOWGUARD POLAR	Сторона пассажира (размер в мм)	AERODYNAMIC	SPOILER	SMART	SMART NEO	HYBRID	SNOWGUARD	SNOWGUARD POLAR	Тип рычага для крепления щеток*	Заднее стекло (размер в мм)	AERODYNAMIC	SPOILER	SMART	SMART NEO	HYBRID	SNOWGUARD	SNOWGUARD POLAR
<b>CHRYSLER</b>																											
CHRYSLER	Sebring [JR]	00→06	550	A-22	SP22	SM22	SN22	H22	S-22	-	550	A-22	SP22	SM22	SN22	H22	S-22	-	1	-	-	-	-	-	-	-	
CHRYSLER	Sebring [JS]	07→	600	A-24	SP24	SM24	SN24	H24	S-24	-	550	A-22	SP22	SM22	SN22	H22	S-22	-	1	-	-	-	-	-	-	-	
CHRYSLER	Sebring Cabrio [JR]	01→06	550	A-22	SP22	SM22	SN22	H22	S-22	-	530	A-21	SP21	SM21	SN21	H21	S-21	-	1	-	-	-	-	-	-	-	
CHRYSLER	Sebring Cabrio [JS]	07→	600	A-24	SP24	SM24	SN24	H24	S-24	-	530	A-21	SP21	SM21	SN21	H21	S-21	-	1	-	-	-	-	-	-	-	
CHRYSLER	Stratus [JA]	95→01	550	A-22	SP22	SM22	SN22	H22	S-22	-	550	A-22	SP22	SM22	SN22	H22	S-22	-	1	-	-	-	-	-	-	-	
CHRYSLER	Stratus Cabrio [JA]	95→01	550	A-22	SP22	SM22	SN22	H22	S-22	-	550	A-22	SP22	SM22	SN22	H22	S-22	-	1	-	-	-	-	-	-	-	
CHRYSLER	Voyager [GS]	95→00	700	A-28	-	-	-	-	S-28	-	700	A-28	-	-	-	-	S-28	-	1	450	A-18	SP18	SM18	SN18	H18	S-18	
CHRYSLER	Voyager [NS]	96→00	700	A-28	-	-	-	-	S-28	-	650	A-26	SP26	SM26	SN26	H26	S-26	-	1	-	-	-	-	-	-	-	
CHRYSLER	Voyager [RG]	01→	700	A-28	-	-	-	-	S-28	-	650	A-26	SP26	SM26	SN26	H26	S-26	-	1	450	A-18	SP18	SM18	SN18	H18	S-18	

<b>CITROEN</b>																											
CITROEN	Berlingo [M49,M59]	96→08	550	A-22	SP22	SM22	SN22	H22	S-22	-	530	A-21	SP21	SM21	SN21	H21	S-21	-	1	340	A-14	-	SM14	SN14	-	S-14	
CITROEN	Berlingo [B9]	08→	650	-	-	-	SN26	-	-	SE26	400	-	-	-	SN16	-	-	SE16	2	350	-	-	-	-	-	-	
CITROEN	C 15	87→05	480	A-19	SP19	SM19	SN19	H19	S-19	-	-	-	-	-	-	-	-	-	1	-	-	-	-	-	-		
CITROEN	C-Crosser [EP,I4]	07→	600	A-24	SP24	SM24	SN24	H24	S-24	-	530	A-21	SP21	SM21	SN21	H21	S-21	-	1	300	A-12	-	-	-	-	S-11	
CITROEN	C1 [B0]	05→	650	A-26	SP26	SM26	SN26	H26	S-26	-	-	-	-	-	-	-	-	-	1	300	A-12	-	-	-	-	S-11	
CITROEN	C2 [A6]	03→	600	A-24	SP24	SM24	SN24	H24	S-24	-	450	A-18	SP18	SM18	SN18	H18	S-18	-	1	290	A-12	-	-	-	-	S-11	
CITROEN	C3 [A8,A31]	02→09	600	A-24	SP24	SM24	SN24	H24	S-24	-	450	A-18	SP18	SM18	SN18	H18	S-18	-	1	350	A-14	-	SM14	SN14	-	S-14	
CITROEN	C3 [A51]	09→	650	A-26	SP26	-	SN26	-	S-26	-	400	A-16	-	-	SN16	-	S-16	-	6	300	A-12	-	-	-	-	S-11	
CITROEN	C3 Picasso [A58]	09→10	600	-	-	-	SN24	-	-	SE24	400	-	-	-	SN16	-	-	SE16	2	290	-	-	-	-	-		
CITROEN	C3 Picasso [A58]	10→	600	A-24	SP24	-	SN24	-	S-24	-	400	A-16	-	-	SN16	-	S-16	-	6	290	A-12	-	-	-	-	S-11	
CITROEN	C3-Pluriel [A42]	03→	550	A-22	SP22	SM22	SN22	H22	S-22	-	450	A-18	SP18	SM18	SN18	H18	S-18	-	1	-	-	-	-	-	-		
CITROEN	C4 [B5, LC]	04→	700	-	-	-	-	-	-	SE28	600	-	-	-	SN24	-	-	SE24	4	300	-	-	-	-	-	-	

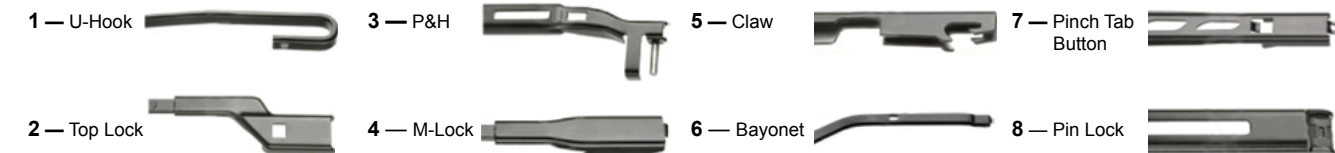

Производитель	Модель	Период выпуска	Сторона водителя (размер в мм)	AERODYNAMIC	SPOILER	SMART	SMART NEO	HYBRID	SNOWGUARD	SNOWGUARD POLAR	Сторона пассажира (размер в мм)	AERODYNAMIC	SPOILER	SMART	SMART NEO	HYBRID	SNOWGUARD	SNOWGUARD POLAR	Тип рычага для крепления щеток*	Заднее стекло (размер в мм)	AERODYNAMIC	SPOILER	SMART	SMART NEO	HYBRID	SNOWGUARD	SNOWGUARD POLAR
CITROEN																											
CITROEN	C4 II [B7]	09→	750	-	-	-	-	-	-	-	650	-	-	-	SN26	-	-	SE26	<b>2</b>	290	-	-	-	-	-	-	-
CITROEN	C4 Coupe [B5, LA]	04→	700	-	-	-	-	-	-	SE28	600	-	-	-	SN24	-	-	SE24	<b>4</b>	180	-	-	-	-	-	-	-
CITROEN	C4 Grand Picasso [B58]	06→08	800	-	-	-	-	-	-	-	750	-	-	-	-	-	-	-	<b>3</b>	350	-	-	-	-	-	-	-
CITROEN	C4 Grand Picasso [UA]	08→	800	-	-	-	-	-	-	-	750	-	-	-	-	-	-	-	<b>6</b>	350	A-14	-	-	SN14	-	S-14	-
CITROEN	C4 Picasso [B58]	07→08	800	-	-	-	-	-	-	-	750	-	-	-	-	-	-	-	<b>3</b>	350	-	-	-	-	-	-	-
CITROEN	C4 Picasso [UD]	08→	800	-	-	-	-	-	-	-	750	-	-	-	-	-	-	-	<b>6</b>	350	A-14	-	-	SN14	-	S-14	-
CITROEN	C5 [DC]	01→03	650	A-26	SP26	SM26	SN26	H26	S-26	-	450	A-18	SP18	SM18	SN18	H18	S-18	-	<b>1</b>	500	A-20	SP19	SM19	SN19	H19	S-19	-
CITROEN	C5 [DC]	03→04	650	-	-	-	SN26	H26	-	SE26	480	-	-	-	SN19	H19	-	SE19	<b>3</b>	400	-	-	-	-	-	-	-
CITROEN	C5 [RC]	04→08	650	-	-	-	SN26	H26	-	SE26	480	-	-	-	SN19	H19	-	SE19	<b>3</b>	400	-	-	-	-	-	-	-
CITROEN	C5 [RD]	08→	700	-	-	-	-	-	-	SE28	550	-	-	-	SN22	-	-	SE22	<b>4</b>	-	-	-	-	-	-	-	-
CITROEN	C5 Break [DE]	01→03	650	A-26	SP26	SM26	SN26	H26	S-26	-	450	A-18	SP18	SM18	SN18	H18	S-18	-	<b>1</b>	290	A-12	-	-	-	-	S-11	-
CITROEN	C5 Break [DE]	03→04	650	-	-	-	SN26	H26	-	SE26	480	-	-	-	SN19	H19	-	SE19	<b>3</b>	290	-	-	-	-	-	-	-
CITROEN	C5 Break [RE]	04→08	650	-	-	-	SN26	H26	-	SE26	480	-	-	-	SN19	H19	-	SE19	<b>3</b>	290	-	-	-	-	-	-	-
CITROEN	C5 Break [TD]	08→	700	-	-	-	-	-	-	SE28	550	-	-	-	SN22	-	-	SE22	<b>4</b>	250	-	-	-	-	-	-	-
CITROEN	C5 Tourer [TD]	08→	700	-	-	-	-	-	-	SE28	550	-	-	-	SN22	-	-	SE22	<b>4</b>	250	-	-	-	-	-	-	-
CITROEN	C6 [X6, TD]	05→	700	-	-	-	-	-	-	SE28	700	-	-	-	-	-	-	SE28	<b>3</b>	-	-	-	-	-	-	-	-
CITROEN	C8 [V3]	02→05	650	A-26	SP26	SM26	SN26	H26	S-26	-	650	A-26	SP26	SM26	SN26	H26	S-26	-	<b>1</b>	350	A-14	-	SM14	SN14	-	S-14	-
CITROEN	C8 [V3]	05→	650	A-26	SP26	SM26	SN26	H26	S-26	-	650	A-26	SP26	SM26	SN26	H26	S-26	-	<b>1</b>	350	A-14	-	SM14	SN14	-	S-14	-
CITROEN	DS3	10→	650	A-26	SP26	-	SN26	-	S-26	-	400	A-16	-	-	SN16	-	S-16	-	<b>6</b>	300	A-12	-	-	-	-	S-11	-
CITROEN	DS4	11→	750	-	-	-	-	-	-	-	650	-	-	-	SN26	-	-	SE26	<b>2</b>	300	-	-	-	-	-	-	-
CITROEN	Evasion [U60]	94→02	650	A-26	SP26	SM26	SN26	H26	S-26	-	500	A-20	SP20	SM20	SN20	H20	S-20	-	<b>1</b>	400	A-16	-	SM16	SN16	H16	S-16	-
CITROEN	Jumper [Z3]	94→02	550	A-22	SP22	SM22	SN22	H22	S-22	-	530	A-21	SP21	SM21	SN21	H21	S-21	-	<b>1</b>	-	-	-	-	-	-	-	-
CITROEN	Jumper [U5]	02→	550	A-22	SP22	SM22	SN22	H22	S-22	-	530	A-21	SP21	SM21	SN21	H21	S-21	-	<b>1</b>	-	-	-	-	-	-	-	-

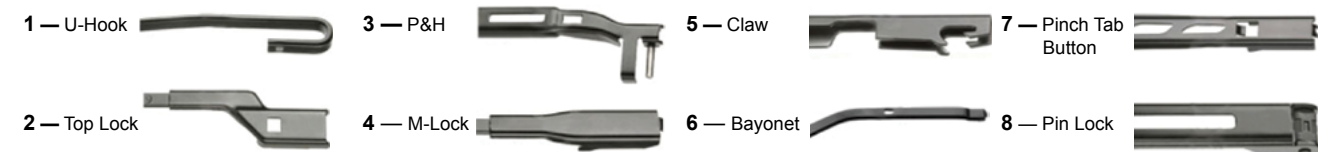

Производитель	Модель	Период выпуска	Сторона водителя (размер в мм)	AERODYNAMIC	SPOILER	SMART	SMART NEO	HYBRID	SNOWGUARD	SNOWGUARD POLAR	Сторона пассажира (размер в мм)	AERODYNAMIC	SPOILER	SMART	SMART NEO	HYBRID	SNOWGUARD	SNOWGUARD POLAR	Тип рычага для крепления щеток*	Заднее стекло (размер в мм)	AERODYNAMIC	SPOILER	SMART	SMART NEO	HYBRID	SNOWGUARD	SNOWGUARD POLAR
CITROEN																											
CITROEN	Jumper [U9]	06→	650	-	-	-	SN26	-	-	SE26	530	-	-	-	SN21	-	-	SE21	<b>2</b>	-	-	-	-	-	-	-	-
CITROEN	Jumpy [U64]	95→06	650	A-26	SP26	SM26	SN26	H26	S-26	-	450	A-18	SP18	SM18	SN18	H18	S-18	-	<b>1</b>	400	A-16	-	SM16	SN16	H16	S-16	-
CITROEN	Jumpy [G9]	07→	650	A-26	SP26	SM26	SN26	H26	S-26	-	500	A-20	SP20	SM20	SN20	H20	S-20	-	<b>1</b>	350	A-14	-	SM14	SN14	-	S-14	-
CITROEN	Nemo [A9]	08→	650	A-26	SP26	-	SN26	-	S-26	-	480	A-19	SP19	-	SN19	-	S-19	-	<b>6</b>	-	-	-	-	-	-	-	-
CITROEN	Saxo [S8]	96→03	500	A-20	SP20	SM20	SN20	H20	S-20	-	450	A-18	SP18	SM18	SN18	H18	S-18	-	<b>1</b>	350	A-14	-	SM14	SN14	-	S-14	-
CITROEN	Xantia [X2]	97→01	600	A-24	SP24	SM24	SN24	H24	S-24	-	500	A-20	SP20	SM20	SN20	H20	S-20	-	<b>1</b>	450	A-18	SP18	SM18	SN18	H18	S-18	-
CITROEN	Xantia Break [X2]	97→01	600	A-24	SP24	SM24	SN24	H24	S-24	-	500	A-20	SP20	SM20	SN20	H20	S-20	-	<b>1</b>	350	A-14	-	SM14	SN14	-	S-14	-
CITROEN	XM [Y4]	94→00	550	A-22	SP22	SM22	SN22	H22	S-22	-	550	A-22	SP22	SM22	SN22	H22	S-22	-	<b>1</b>	400	A-16	-	SM16	SN16	H16	S-16	-
CITROEN	Xsara [N6,N7]	97→05	550	A-22	SP22	SM22	SN22	H22	S-22	-	550	A-22	SP22	SM22	SN22	H22	S-22	-	<b>1</b>	450	A-18	SP18	SM18	SN18	H18	S-18	-
CITROEN	Xsara Break [N6, N7]	97→05	550	A-22	SP22	SM22	SN22	H22	S-22	-	500	A-20	SP20	SM20	SN20	H20	S-20	-	<b>1</b>	400	A-16	-	SM16	SN16	H16	S-16	-
CITROEN	Xsara Coupe [N6,N7]	97→05	550	A-22	SP22	SM22	SN22	H22	S-22	-	500	A-20	SP20	SM20	SN20	H20	S-20	-	<b>1</b>	450	A-18	SP18	SM18	SN18	H18	S-18	-
CITROEN	Xsara Picasso [N68]	00→05	650	A-26	SP26	SM26	SN26	H26	S-26	-	650	A-26	SP26	SM26	SN26	H26	S-26	-	<b>1</b>	400	A-16	-	SM16	SN16	H16	S-16	-
CITROEN	Xsara Picasso [N68]	05→	650	-	-	-	SN26	H26	-	SE26	650	-	-	-	SN26	H26	-	SE26	<b>3</b>	400	-	-	-	-	-	-	-

DAEWOO																											
DAEWOO	Matiz [KLYA]	98→05	550	A-22	SP22	SM22	SN22	H22	S-22	-	350	A-14	-	SM14	SN14	-	S-14	-	<b>1</b>	-	-	-	-	-	-	-	-
DAEWOO	Nexia [KLETN]	94→	450	A-18	SP18	SM18	SN18	H18	S-18	-	450	A-18	SP18	SM18	SN18	H18	S-18	-	<b>1</b>	-	-	-	-	-	-	-	-

DAIHATSU																											
DAIHATSU	Charade [G2]	93→03	480	A-19	SP19	SM19	SN19	H19	S-19	-	430	A-17	-	SM17	SN17	-	S-17	-	<b>1</b>	-	-	-	-	-	-	-	-
DAIHATSU	Charade [L2]	03→	530	A-21	SP21	SM21	SN21	H21	S-21	-	280	A-12	-	-	-	-	S-11	-	<b>1</b>	-	-	-	-	-	-	-	-
DAIHATSU	Charade Hatchback [G2]	93→00	480	A-19	SP19	SM19	SN19	H19	S-19	-	430	A-17	-	SM17	SN17	-	S-17	-	<b>1</b>	380	A-15	-	SM16	SN16	H16	S-16	-
DAIHATSU	Cuore [L7]	98→03	450	A-18	SP18	SM18	SN18	H18	S-18	-	380	A-15	-	SM15	SN15	-	S-15	-	<b>1</b>	-	-	-	-	-	-	-	-

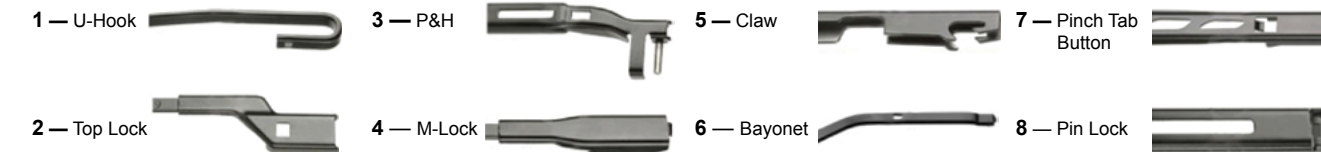

Производитель	Модель	Период выпуска	Сторона водителя (размер в мм)	AERODYNAMIC	SPOILER	SMART	SMART NEO	HYBRID	SNOWGUARD	SNOWGUARD POLAR	Сторона пассажира (размер в мм)	AERODYNAMIC	SPOILER	SMART	SMART NEO	HYBRID	SNOWGUARD	SNOWGUARD POLAR	Тип рычага для крепления щеток*	Заднее стекло (размер в мм)	AERODYNAMIC	SPOILER	SMART	SMART NEO	HYBRID	SNOWGUARD	SNOWGUARD POLAR
<b>DAIHATSU</b>																											
DAIHATSU	Cuore [L2]	03→	530	A-21	SP21	SM21	SN21	H21	S-21	-	280	A-12	-	-	-	-	S-11	-	1	-	-	-	-	-	-	-	-
DAIHATSU	Cuore VII	07→	530	A-21	SP21	SM21	SN21	H21	S-21	-	280	A-12	-	-	-	-	S-11	-	1	-	-	-	-	-	-	-	-
DAIHATSU	Materia [M4]	06→	500	A-20	SP20	SM20	SN20	H20	S-20	-	280	A-19	SP19	SM19	SN19	H19	S-19	-	1	-	-	-	-	-	-	-	-
DAIHATSU	Sirion I [M1]	98→04	480	A-19	SP19	SM19	SN19	H19	S-19	-	280	A-17	-	SM17	SN17	-	S-17	-	1	-	-	-	-	-	-	-	-
DAIHATSU	Sirion II [M3]	04→	500	A-20	SP20	SM20	SN20	H20	S-20	-	280	A-16	-	SM16	SN16	H16	S-16	-	1	350	A-14	-	SM14	SN14	-	S-14	-
DAIHATSU	Terios [J1]	97→05	500	A-20	SP20	SM20	SN20	H20	S-20	-	280	A-15	-	SM15	SN15	-	S-15	-	1	-	-	-	-	-	-	-	-
DAIHATSU	Terios [J2]	03→	530	A-21	SP21	SM21	SN21	H21	S-21	-	280	A-18	SP18	SM18	SN18	H18	S-18	-	1	-	-	-	-	-	-	-	-
DAIHATSU	Trevis [L6]	06→	500	A-20	SP20	SM20	SN20	H20	S-20	-	280	A-16	-	SM16	SN16	H16	S-16	-	1	-	-	-	-	-	-	-	-

<b>DODGE</b>																											
DODGE	Avenger [JS]	07→	600	A-24	SP24	SM24	SN24	H24	S-24	-	280	A-21	SP21	SM21	SN21	H21	S-21	-	1	-	-	-	-	-	-	-	-
DODGE	Caliber [P3]	06→	600	A-24	SP24	SM24	SN24	H24	S-24	-	280	A-16	-	SM16	SN16	H16	S-16	-	1	-	-	-	-	-	-	-	-
DODGE	Caliber [PM]	06→	600	A-24	SP24	SM24	SN24	H24	S-24	-	280	A-16	-	SM16	SN16	H16	S-16	-	1	-	-	-	-	-	-	-	-
DODGE	Caravan [NS]	95→03	650	A-26	SP26	SM26	SN26	H26	S-26	-	280	A-26	SP26	SM26	SN26	H26	S-26	-	1	400	A-16	-	SM16	SN16	H16	S-16	-
DODGE	Grand Caravan [NS]	95→00	-	-	-	-	-	-	-	-	280	-	-	-	-	-	-	-	1	400	A-16	-	SM16	SN16	H16	S-16	-
DODGE	Grand Caravan [RS]	00→07	650	A-26	SP26	SM26	SN26	H26	S-26	-	280	A-26	SP26	SM26	SN26	H26	S-26	-	1	-	-	-	-	-	-	-	-
DODGE	Grand Caravan [RT]	07→	650	A-26	SP26	SM26	SN26	H26	S-26	-	280	A-20	SP20	SM20	SN20	H20	S-20	-	1	400	A-16	-	SM16	SN16	H16	S-16	-
DODGE	Intrapid	97→04	600	A-24	SP24	SM24	SN24	H24	S-24	-	280	A-22	SP22	SM22	SN22	H22	S-22	-	1	-	-	-	-	-	-	-	-
DODGE	Journey [JC]	08→	600	A-24	SP24	SM24	SN24	H24	S-24	-	280	A-18	SP18	SM18	SN18	H18	S-18	-	1	-	-	-	-	-	-	-	-
DODGE	Magnum [LX]	05→	550	A-22	SP22	SM22	SN22	H22	S-22	-	280	A-21	SP21	SM21	SN21	H21	S-21	-	1	-	-	-	-	-	-	-	-
DODGE	Nitro [KA]	07→	480	A-19	SP19	SM19	SN19	H19	S-19	-	280	A-19	SP19	SM19	SN19	H19	S-19	-	1	300	A-12	-	-	-	-	S-11	-

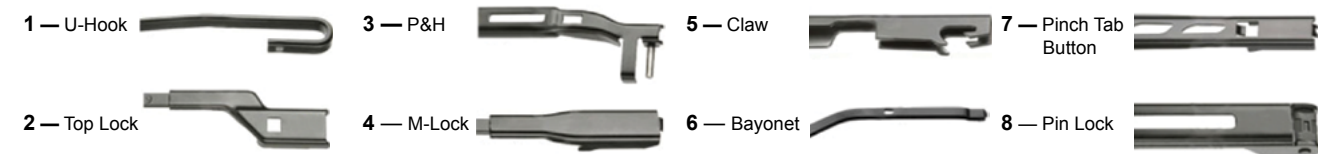

Производитель	Модель	Период выпуска	Сторона водителя (размер в мм)	AERODYNAMIC	SPOILER	SMART	SMART NEO	HYBRID	SNOWGUARD	SNOWGUARD POLAR	Сторона пассажира (размер в мм)	AERODYNAMIC	SPOILER	SMART	SMART NEO	HYBRID	SNOWGUARD	SNOWGUARD POLAR	Тип рычага для крепления щеток*	Заднее стекло (размер в мм)	AERODYNAMIC	SPOILER	SMART	SMART NEO	HYBRID	SNOWGUARD	SNOWGUARD POLAR
<b>FIAT</b>																											
FIAT	500 [150..]	07→	600	-	-	-	SN24	-	-	SE24	280	-	-	-	SN14	-	-	SE14	2	290	-	-	-	-	-	-	
FIAT	Albea [172..]	02→	550	A-22	SP22	SM22	SN22	H22	S-22	-	280	A-18	SP18	SM18	SN18	H18	S-18	-	1	-	-	-	-	-	-	-	
FIAT	Barchetta [183..]	95→05	480	A-19	SP19	SM19	SN19	H19	S-19	-	280	A-19	SP19	SM19	SN19	H19	S-19	-	1	-	-	-	-	-	-	-	
FIAT	Brava [182..]	95→01	550	A-22	SP22	SM22	SN22	H22	S-22	-	280	A-19	SP19	SM19	SN19	H19	S-19	-	1	-	-	-	-	-	-	-	
FIAT	Bravo [182..]	95→01	550	A-22	SP22	SM22	SN22	H22	S-22	-	280	A-19	SP19	SM19	SN19	H19	S-19	-	1	400	A-16	-	SM16	SN16	H16	S-16	
FIAT	Bravo [198]	07→	600	-	-	-	SN24	-	-	SE24	280	-	-	-	SN18	-	-	SE18	2	290	-	-	-	-	-	-	
FIAT	Coupe [175..]	94→00	530	A-21	SP21	SM21	SN21	H21	S-21	-	280	A-19	SP19	SM19	SN19	H19	S-19	-	1	500	A-20	SP19	SM19	SN19	H19	S-19	
FIAT	Croma [194..]	05→	630	-	-	-	SN26	H26	-	SE26	280	-	-	-	SN17	-	-	SE17	3	-	-	-	-	-	-	-	
FIAT	Doblo [119..]	00→	550	A-22	SP22	SM22	SN22	H22	S-22	-	280	A-18	SP18	SM18	SN18	H18	S-18	-	1	-	-	-	-	-	-	-	
FIAT	Doblo [152..]	10→	600	-	-	-	SN24	-	-	SE24	280	-	-	-	SN16	-	-	SE16	2	300	-	-	-	-	-	-	
FIAT	Doblo Cargo [223..]	00→	550	A-22	SP22	SM22	SN22	H22	S-22	-	280	A-18	SP18	SM18	SN18	H18	S-18	-	1	-	-	-	-	-	-	-	
FIAT	Doblo Cargo [263..]	10→	600	-	-	-	SN24	-	-	SE24	280	-	-	-	SN16	-	-	SE16	2	-	-	-	-	-	-	-	
FIAT	Ducato [230..234]	94→02	550	A-22	SP22	SM22	SN22	H22	S-22	-	280	A-21	SP21	SM21	SN21	H21	S-21	-	1	-	-	-	-	-	-	-	
FIAT	Ducato [243..247]	02→06	550	A-22	SP22	SM22	SN22	H22	S-22	-	280	A-21	SP21	SM21	SN21	H21	S-21	-	1	-	-	-	-	-	-	-	
FIAT	Ducato [243..247]	06→	650	-	-	-	SN26	-	-	SE26	280	-	-	-	SN21	-	-	SE21	2	-	-	-	-	-	-	-	
FIAT	Ducato Russia	08→	550	A-22	SP22	SM22	SN22	H22	S-22	-	280	A-22	SP22	SM22	SN22	H22	S-22	-	1	-	-	-	-	-	-	-	
FIAT	Fiorino [255..]	93→01	450	A-18	SP18	SM18	SN18	H18	S-18	-	280	-	-	-	-	-	-	-	1	330	A-13	-	-	-	-	S-13	
FIAT	Fiorino [225..]	07→	650	A-26	SP26	-	SN26	-	S-26	-	280	A-19	SP19	-	SN19	-	S-19	-	6	-	-	-	-	-	-	-	
FIAT	Fiorino Qubo [300..]	08→	650	A-26	SP26	-	SN26	-	S-26	-	280	A-19	SP19	-	SN19	-	S-19	-	6	-	-	-	-	-	-	-	
FIAT	Idea [135..]	04→08	550	A-22	SP22	SM22	SN22	H22	S-22	-	280	A-16	-	SM16	SN16	H16	S-16	-	1	-	-	-	-	-	-	-	
FIAT	Idea [135..]	08→	580	-	-	-	SN24	-	-	SE24	280	-	-	-	SN15	-	-	SE15	2	-	-	-	-	-	-	-	
FIAT	Linea [110..]	07→	650	A-26	SP26	SM26	SN26	H26	S-26	SE26	280	A-15	-	SM15	SN15	-	S-15	SE15	4	-	-	-	-	-	-	-	
FIAT	Marea [185..]	96→	550	A-22	SP22	SM22	SN22	H22	S-22	-	280	A-19	SP19	-	SN19	-	S-19	-	1	-	-	-	-	-	-	-	

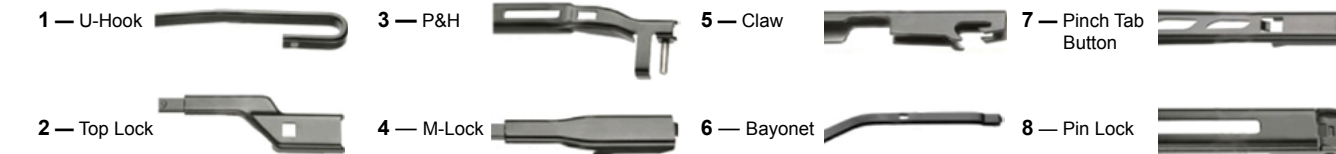



Производитель	Модель	Период выпуска	Сторона водителя (размер в мм)	AERODYNAMIC	SPOILER	SMART	SMART NEO	HYBRID	SNOWGUARD	SNOWGUARD POLAR	Сторона пассажира (размер в мм)	AERODYNAMIC	SPOILER	SMART	SMART NEO	HYBRID	SNOWGUARD	SNOWGUARD POLAR	Тип рычага для крепления щеток*	Заднее стекло (размер в мм)	AERODYNAMIC	SPOILER	SMART	SMART NEO	HYBRID	SNOWGUARD	SNOWGUARD POLAR
FIAT																											
FIAT	Marengo [285..]	97→02	550	A-22	SP22	SM22	SN22	H22	S-22	-	280	A-19	SP19	-	SN19	-	S-19	-	1	-	-	-	-	-	-	-	-
FIAT	Multipla [186..]	99→05	600	A-24	SP24	SM24	SN24	H24	S-24	-	280	A-22	SP22	SM22	SN22	H22	S-22	-	1	-	-	-	-	-	-	-	-
FIAT	Multipla [186..]	06→	600	-	-	-	SN24	-	-	SE24	280	-	-	-	SN22	-	-	SE22	4	-	-	-	-	-	-	-	-
FIAT	Palio [178..]	98→01	550	A-22	SP22	SM22	SN22	H22	S-22	-	280	A-18	SP18	SM18	SN18	H18	S-18	-	1	-	-	-	-	-	-	-	-
FIAT	Palio [171..]	01→	550	A-22	SP22	SM22	SN22	H22	S-22	-	280	A-18	SP18	SM18	SN18	H18	S-18	-	1	-	-	-	-	-	-	-	-
FIAT	Panda [141,153]	90→03	400	A-16	-	SM16	SN16	H16	S-16	-	280	-	-	-	-	-	-	-	1	330	A-13	-	-	-	-	S-13	-
FIAT	Panda [169..]	03→	550	A-22	SP22	SM22	SN22	H22	S-22	-	280	A-16	-	SM16	SN16	H16	S-16	-	1	-	-	-	-	-	-	-	-
FIAT	Punto [188..]	99→06	530	A-21	SP21	SM21	SN21	H21	S-21	-	280	A-18	SP18	SM18	SN18	H18	S-18	-	1	-	-	-	-	-	-	-	-
FIAT	Punto Grande [199..]	05→	650	-	-	-	SN26	-	-	SE26	280	-	-	-	SN15	-	-	SE15	4	300	-	-	-	-	-	-	-
FIAT	Punto VAN [288..]	99→	530	A-21	SP21	SM21	SN21	H21	S-21	-	280	A-18	SP18	SM18	SN18	H18	S-18	-	1	-	-	-	-	-	-	-	-
FIAT	Qubo	08→	650	A-26	SP26	-	SN26	-	S-26	-	280	A-16	-	SM16	SN16	H16	S-16	-	6	-	-	-	-	-	-	-	-
FIAT	Scudo [222..]	95→07	650	A-26	SP26	SM26	SN26	H26	S-26	-	280	A-20	SP20	SM20	SN20	H20	S-20	-	1	400	A-16	-	SM16	SN16	H16	S-16	-
FIAT	Scudo [272..]	07→	650	A-26	SP26	SM26	SN26	H26	S-26	-	280	A-20	SP20	SM20	SN20	H20	S-20	-	1	350	A-14	-	SM14	SN14	-	S-14	-
FIAT	Sedici [189..]	06→	650	A-26	SP26	SM26	SN26	H26	S-26	-	280	-	-	-	SN14	-	-	SE14	1	-	-	-	-	-	-	-	-
FIAT	Seicento [187..]	98→	480	A-19	SP19	SM19	SN19	H19	S-19	-	280	A-19	SP19	SM19	SN19	H19	S-19	-	1	-	-	-	-	-	-	-	-
FIAT	Siena [178..]	98→01	550	A-22	SP22	SM22	SN22	H22	S-22	-	280	A-18	SP18	SM18	SN18	H18	S-18	-	1	-	-	-	-	-	-	-	-
FIAT	Stilo [192..]	01→05	530	A-21	SP21	SM21	SN21	H21	S-21	-	280	A-18	SP18	SM18	SN18	H18	S-18	-	1	-	-	-	-	-	-	-	-
FIAT	Stilo [192..]	05→	550								280	-	-	-	SN19	-	-	SE19	4	-	-	-	-	-	-	-	-
FIAT	Stilo Multi Wagon [192..]	02→05	530	A-21	SP21	SM21	SN21	H21	S-21	-	280	A-19	SP19	SM19	SN19	H19	S-19	-	1	350	A-14	-	SM14	SN14	-	S-14	-
FIAT	Stilo Multi Wagon [192..]	05→	550	A-22	SP22	SM22	SN22	H22	S-22	-	280	A-19	SP19	SM19	SN19	H19	S-19	-	1	350	A-14	-	SM14	SN14	-	S-14	-
FIAT	Strada [278]	99→	550	A-22	SP22	SM22	SN22	H22	S-22	-	280	A-18	SP18	SM18	SN18	H18	S-18	-	1	-	-	-	-	-	-	-	-
FIAT	Ulysse [121..]	94→02	650	A-26	SP26	SM26	SN26	H26	S-26	-	280	A-20	SP20	SM20	SN20	H20	S-20	-	1	400	A-16	-	SM16	SN16	H16	S-16	-
FIAT	Ulysse [179..]	02→05	650	A-26	SP26	SM26	SN26	H26	S-26	-	280	A-26	SP26	SM26	SN26	H26	S-26	-	1	350	A-14	-	SM14	SN14	-	S-14	-
FIAT	Ulysse [179..]	05→	650	A-26	SP26	SM26	SN26	H26	S-26	-	280	A-26	SP26	SM26	SN26	H26	S-26	-	1	350	A-14	-	SM14	SN14	-	S-14	-

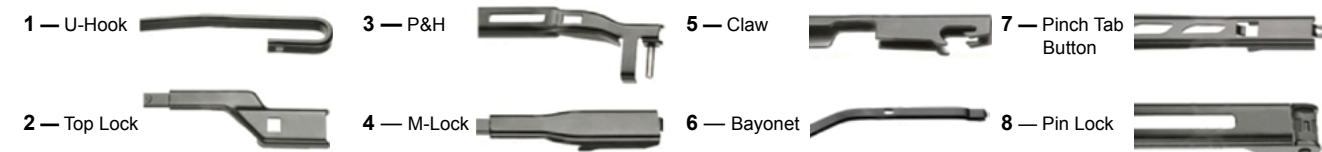

Производитель	Модель	Период выпуска	Сторона водителя (размер в мм)	AERODYNAMIC	SPOILER	SMART	SMART NEO	HYBRID	SNOWGUARD	SNOWGUARD POLAR	Сторона пассажира (размер в мм)	AERODYNAMIC	SPOILER	SMART	SMART NEO	HYBRID	SNOWGUARD	SNOWGUARD POLAR	Тип рычага для крепления щеток*	Заднее стекло (размер в мм)	AERODYNAMIC	SPOILER	SMART	SMART NEO	HYBRID	SNOWGUARD	SNOWGUARD POLAR
FORD																											
FORD	C-MAX	03→07	650	-	-	-	SN26	H26	-	SE26	280	-	-	-	SN19	H19	-	SE19	3	280	-	-	-	-	-	-	-
FORD	C-MAX	07→	650	-	-	-	SN26	H26	-	SE26	280	-	-	-	SN19	H19	-	SE19	3	280	-	-	-	-	-	-	-
FORD	C-MAX	10→	700	-	-	-	-	-	-	SE28	280	-	-	-	SN26	-	-	SE26	4	300	-	-	-	-	-	-	-
FORD	Cougar	98→00	550	A-22	SP22	SM22	SN22	H22	S-22	-	280	A-20	SP20	SM20	SN20	H20	S-20	-	1	-	-	-	-	-	-	-	-
FORD	Escape	01→07	480	A-19	SP19	SM19	SN19	H19	S-19	-	280	A-19	SP19	SM19	SN19	H19	S-19	-	1	280	A-12	-	-	-	-	S-11	-
FORD	Escape USA	07→	500	-	-	-	SN20	-	-	SE20	280	-	-	-	SN20	-	-	SE20	4	-	-	-	-	-	-	-	-
FORD	Escort Wagon	96→03	500	A-20	SP20	SM20	SN20	H20	S-20	-	280	A-20	SP20	SM20	SN20	H20	S-20	-	1	290	A-12	-	-	-	-	S-11	-
FORD	Expedition	96→04	500	A-20	SP20	SM20	SN20	H20	S-20	-	280	A-20	SP20	SM20	SN20	H20	S-20	-	1	-	-	-	-	-	-	-	-
FORD	Explorer	91→01	450	A-18	SP18	SM18	SN18	H18	S-18	-	280	A-18	SP18	SM18	SN18	H18	S-18	-	1	340	A-14	-	SM14	SN14	-	S-14	-
FORD	Fiesta IV Courier [96/99]	95→02	480	A-19	SP19	SM19	SN19	H19	S-19	-	280	A-19	SP19	SM19	SN19	H19	S-19	-	1	-	-	-	-	-	-	-	-
FORD	Fiesta IV [96/99]	95→02	480	A-19	SP19	SM19	SN19	H19	S-19	-	280	A-19	SP19	SM19	SN19	H19	S-19	-	1	400	A-16	-	SM16	SN16	H16	S-16	-
FORD	Fiesta V [02/05]	01→08	550	A-22	SP22	SM22	SN22	H22	S-22	-	280	A-16	-	SM16	SN16	H16	S-16	-	1	280	A-12	-	-	-	-	S-11	-
FORD	Fiesta VI [08]	08→	650	-	-	-	SN26	-	-	SE26	280	-	-	-	SN15	-	-	SE15	2	300	-	-	-	-	-	-	-
FORD	Five Hundred	04→05	600	-	-	-	SN24	H24	-	SE24	280	-	-	-	SN20	H20	-	SE20	3	-	-	-	-	-	-	-	-
FORD	Focus [DFW]	98→05	550	A-22	SP22	SM22	SN22	H22	S-22	-	280	A-19	SP19	SM19	SN19	H19	S-19	-	1	340	A-14	-	SM14	SN14	-	S-14	-
FORD	Focus 2 [DA]	04→	650	-	-	-	SN26	H26	-	SE26	280	-	-	-	SN17	-	-	SE17	3	350	-	-	-	-	-	-	-
FORD	Focus 3 [DA]	11→	650	-	-	-	SN26	H26	-	SE26	280	-	-	-	SN17	-	-	SE17	3	300	-	-	-	-	-	-	-
FORD	Focus 2 Cabriolet	06→	650	-	-	-	SN26	H26	-	SE26	280	-	-	-	SN17	-	-	SE17	3	-	-	-	-	-	-	-	-
FORD	Focus [DNW] Turnier	98→05	550	A-22	SP22	SM22	SN22	H22	S-22	-	280	A-19	SP19	SM19	SN19	H19	S-19	-	1	280	A-12	-	-	-	-	S-11	-
FORD	Focus 2 [DAW] Turnier	04→	650	-	-	-	SN26	H26	-	SE26	280	-	-	-	SN17	-	-	SE17	3	280	-	-	-	-	-	-	-
FORD	Focus 3 Turnier	11→	650	-	-	-	SN26	H26	-	SE26	280	-	-	-	SN17	-	-	SE17	3	300	-	-	-	-	-	-	-
FORD	Freestyle	04→06	600	-	-	-	SN24	H24	-	SE24	280	-	-	-	SN20	H20	-	SE20	3	-	-	-	-	-	-	-	-
FORD	Fusion [02/05]	02→	550	A-22	SP22	SM22	SN22	H22	S-22	-	280	A-16	-	SM16	SN16	H16	S-16	-	1	280	A-12	-	-	-	-	S-11	-
FORD	Galaxy [00,95]	95→01	700	A-28	-	-	-	-	S-28	-	280	A-26	SP26	SM26	SN26	H26	S-26	-	1	400	A-16	-	SM16	SN16	H16	S-16	-

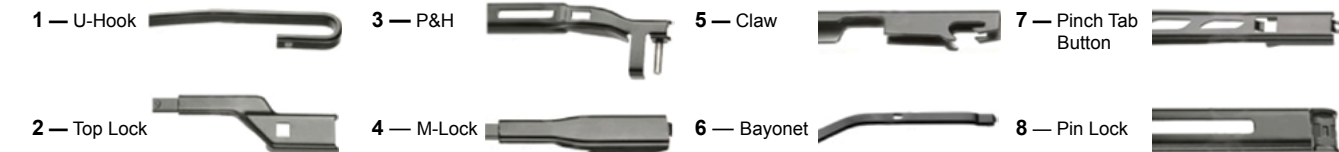

Производитель	Модель	Период выпуска	Сторона водителя (размер в мм)	AERODYNAMIC	SPOILER	SMART	SMART NEO	HYBRID	SNOWGUARD	SNOWGUARD POLAR	Сторона пассажира (размер в мм)	AERODYNAMIC	SPOILER	SMART	SMART NEO	HYBRID	SNOWGUARD	SNOWGUARD POLAR	Тип рычага для крепления щеток*	Заднее стекло (размер в мм)	AERODYNAMIC	SPOILER	SMART	SMART NEO	HYBRID	SNOWGUARD	SNOWGUARD POLAR
<b>FORD</b>																											
FORD	Galaxy [00]	01→06	700	-	-	-	-	-	-	SE28	280	-	-	-	-	-	-	SE28	3	400	-	-	-	-	-	-	-
FORD	Galaxy [06]	06→	750	-	-	-	-	-	-	-	280	-	-	-	SN26	-	-	SE26	2	350	-	-	-	-	-	-	-
FORD	Ka [RB]	96→08	480	A-19	SP19	SM19	SN19	H19	S-19	-	280	A-19	SP19	SM19	SN19	H19	S-19	-	1	380	A-15	-	SM16	SN16	H16	S-16	-
FORD	Ka II	08→10	600	A-24	SP24	SM24	SN24	H24	S-24	-	280	A-14	-	SM14	SN14	-	S-14	-	1	290	A-12	-	-	-	-	S-11	-
FORD	Ka II	10→	600	-	-	-	SN24	-	-	SE24	280	-	-	-	SN14	-	-	SE14	2	290	-	-	-	-	-	-	-
FORD	Kuga	08→	600	-	-	-	SN24	-	-	SE24	280	-	-	-	SN16	-	-	SE16	2	330	-	-	-	-	-	-	-
FORD	Maverick [UDS, UNS]	93→98	530	A-21	SP21	SM21	SN21	H21	S-21	-	280	A-20	SP20	SM20	SN20	H20	S-20	-	1	340	A-14	-	SM14	SN14	-	S-14	-
FORD	Maverick [1EZ, 1N2]	00→07	480	A-19	SP19	SM19	SN19	H19	S-19	-	280	A-19	SP19	SM19	SN19	H19	S-19	-	1	280	A-12	-	-	-	-	S-11	-
FORD	Mondeo II [97]	96→00	530	A-21	SP21	SM21	SN21	H21	S-21	-	280	A-20	SP20	SM20	SN20	H20	S-20	-	1	500	A-20	SP19	SM19	SN19	H19	S-19	-
FORD	Mondeo III [01]	00→07	550	A-22	SP22	SM22	SN22	H22	S-22	-	280	A-20	SP20	SM20	SN20	H20	S-20	-	1	480	A-19	SP19	SM19	SN19	H19	S-19	-
FORD	Mondeo IV [07]	08→	650	-	-	-	SN26	-	-	SE26	280	-	-	-	SN19	-	-	SE19	2	480	-	-	-	-	-	-	-
FORD	Mondeo II Turnier [97]	96→00	530	A-21	SP21	SM21	SN21	H21	S-21	-	280	A-20	SP20	SM20	SN20	H20	S-20	-	1	340	A-14	-	SM14	SN14	-	S-14	-
FORD	Mondeo III Turnier [01]	00→07	550	A-22	SP22	SM22	SN22	H22	S-22	-	280	A-20	SP20	SM20	SN20	H20	S-20	-	1	280	A-12	-	-	-	-	S-11	-
FORD	Mondeo IV Turnier [07]	07→	650	-	-	-	SN26	-	-	SE26	280	-	-	-	SN19	-	-	SE19	2	300	-	-	-	-	-	-	-
FORD	Puma	97→01	480	A-19	SP19	SM19	SN19	H19	S-19	-	280	A-19	SP19	SM19	SN19	H19	S-19	-	1	-	-	-	-	-	-	-	-
FORD	Ranger	02→06	450	A-18	SP18	SM18	SN18	H18	S-18	-	280	A-18	SP18	SM18	SN18	H18	S-18	-	1	-	-	-	-	-	-	-	-
FORD	Ranger	06→	450	A-18	SP18	SM18	SN18	H18	S-18	-	280	A-18	SP18	SM18	SN18	H18	S-18	-	1	-	-	-	-	-	-	-	-
FORD	S-MAX	06→	750	-	-	-	-	-	-	-	280	-	-	-	SN26	-	-	SE26	2	340	-	-	-	-	-	-	-
FORD	Street Ka	02→05	480	A-19	SP19	SM19	SN19	H19	S-19	-	280	A-18	SP18	SM18	SN18	H18	S-18	-	1	-	-	-	-	-	-	-	-
FORD	Taurus	99→06	600	-	-	-	SN24	H24	-	SE24	280	-	-	-	SN20	H20	-	SE20	3	-	-	-	-	-	-	-	
FORD	Taurus Wagon	99→05	600	-	-	-	SN24	H24	-	SE24	280	-	-	-	SN20	H20	-	SE20	3	-	-	-	-	-	-	-	
FORD	Tourneo Connect [02]	05→	550	A-22	SP22	SM22	SN22	H22	S-22	-	280	A-20	SP20	SM20	SN20	H20	S-20	-	1	340	A-14	-	SM14	SN14	-	S-14	-
FORD	Transit [E_] ]	91→00	550	A-22	SP22	SM22	SN22	H22	S-22	-	280	A-21	SP21	SM21	SN21	H21	S-21	-	1	340	A-14	-	SM14	SN14	-	S-14	-

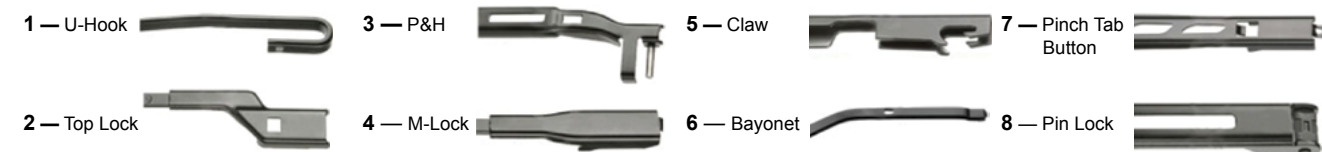

Производитель	Модель	Период выпуска	Сторона водителя (размер в мм)	AERODYNAMIC	SPOILER	SMART	SMART NEO	HYBRID	SNOWGUARD	SNOWGUARD POLAR	Сторона пассажира (размер в мм)	AERODYNAMIC	SPOILER	SMART	SMART NEO	HYBRID	SNOWGUARD	SNOWGUARD POLAR	Тип рычага для крепления щеток*	Заднее стекло (размер в мм)	AERODYNAMIC	SPOILER	SMART	SMART NEO	HYBRID	SNOWGUARD	SNOWGUARD POLAR
<b>FORD</b>																											
FORD	Transit [F_ _ _]	00→06	650	A-26	SP26	SM26	SN26	H26	S-26	-	280	A-24	SP24	SM24	SN24	H24	S-24	-	1	400	A-16	-	SM16	SN16	H16	S-16	-
FORD	Transit	06→	650	A-26	SP26	SM26	SN26	H26	S-26	-	280	A-24	SP24	SM24	SN24	H24	S-24	-	1	400	A-16	-	SM16	SN16	H16	S-16	-
FORD	Transit Connect [02]	02→	550	A-22	SP22	SM22	SN22	H22	S-22	-	280	A-20	SP20	SM20	SN20	H20	S-20	-	1	340	A-14	-	SM14	SN14	-	S-14	-
FORD	Windstar	94→03	600	A-24	SP24	SM24	SN24	H24	S-24	-	280	A-20	SP20	SM20	SN20	H20	S-20	-	1	400	A-16	-	SM16	SN16	H16	S-16	-

<b>GEELY</b>																											
GEELY	MK	08→	550	A-22	SP22	SM22	SN22	H22	S-22	-	280	A-19	SP19	SM19	SN19	H19	S-19	-	1	-	-	-	-	-	-	-	-
GEELY	Otaka [CK-1]	08→	530	A-21	SP21	SM21	SN21	H21	S-21	-	280	A-18	SP18	SM18	SN18	H18	S-18	-	1	-	-	-	-	-	-	-	-
GEELY	Vision [FC]	06→	600	A-24	SP24	SM24	SN24	H24	S-24	-	280	A-16	-	SM16	SN16	H16	S-16	-	1	-	-	-	-	-	-	-	

<b>GREAT WALL</b>																											
GREAT WALL	Hover	05→	600	A-24	SP24	SM24	SN24	H24	S-24	-	280	A-20	SP20	SM20	SN20	H20	S-20	-	1	-	-	-	-	-	-	-	-
GREAT WALL	Wingle	06→	550	A-22	SP22	SM22	SN22	H22	S-22	-	280	A-19	SP19	SM19	SN19	H19	S-19	-	1	-	-	-	-	-	-	-	-

<b>HONDA</b>																											
HONDA	Accord [CG/CH/CL]	98→03	550	A-22	SP22	SM22	SN22	H22	S-22	-	280	A-19	SP19	SM19	SN19	H19	S-19	-	1	400	A-16	-	SM16	SN16	H16	S-16	-
HONDA	Accord [CL/CN/CM]	03→08	650	A-26	SP26	SM26	SN26	H26	S-26	-	280	A-16	-	SM16	SN16	H16	S-16	-	1	-	-	-	-	-	-	-	
HONDA	Accord [CU/CW]	08→	600	A-24	SP24	SM24	SN24	H24	S-24	-	280	A-22	SP22	SM22	SN22	H22	S-22	-	1	-	-	-	-	-	-	-	
HONDA	Accord Tourer [CL/CN/CM]	03→08	650	A-26	SP26	SM26	SN26	H26	S-26	-	280	A-16	-	SM16	SN16	H16	S-16	-	1	-	-	-	-	-	-	-	
HONDA	Accord Tourer [CU/CW]	08→	600	A-24	SP24	SM24	SN24	H24	S-24	-	280	A-22	SP22	SM22	SN22	H22	S-22	-	1	300	A-12	-	-	-	-	S-11	-
HONDA	Civic [EJ/EK/EM]	95→01	500	A-20	SP20	SM20	SN20	H20	S-20	-	280	A-18	SP18	SM18	SN18	H18	S-18	-	1	380	A-15	-	SM16	SN16	H16	S-16	-
HONDA	Civic [EU/EP/EM/ES]	01→05	600	A-24	SP24	SM24	SN24	H24	S-24	-	280	A-14	-	SM14	SN14	-	S-14	-	1	300	A-12	-	-	-	-	S-11	-
HONDA	Civic 4D [FA/FD]	06→	650	A-26	SP26	SM26	SN26	H26	S-26	-	280	A-24	SP24	SM24	SN24	H24	S-24	-	1	-	-	-	-	-	-	-	

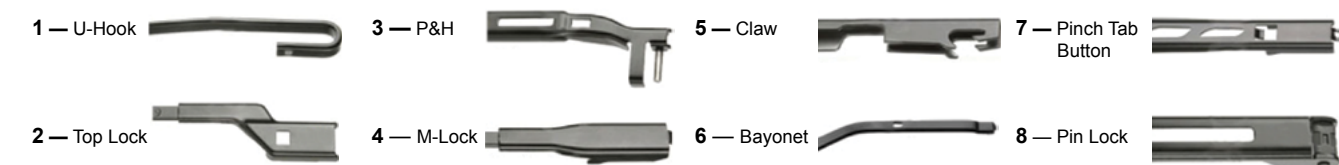

Производитель	Модель	Период выпуска	Сторона водителя (размер в мм)	AERODYNAMIC	SPOILER	SMART	SMART NEO	HYBRID	SNOWGUARD	SNOWGUARD POLAR	Сторона пассажира (размер в мм)	AERODYNAMIC	SPOILER	SMART	SMART NEO	HYBRID	SNOWGUARD	SNOWGUARD POLAR	Тип рычага для крепления щеток*	Заднее стекло (размер в мм)	AERODYNAMIC	SPOILER	SMART	SMART NEO	HYBRID	SNOWGUARD	SNOWGUARD POLAR
<b>HONDA</b>																											
HONDA	Civic 5D Hatchback [FK/FN]	06→	700	A-28	-	-	-	-	S-28	-	280	A-24	SP24	SM24	SN24	H24	S-24	-	1	-	-	-	-	-	-	-	-
HONDA	Civic 5D Hybrid [FD]	08→	650	A-26	SP26	SM26	SN26	H26	S-26	-	280	A-22	SP22	SM22	SN22	H22	S-22	-	1	-	-	-	-	-	-	-	-
HONDA	CR-V I	97→02	480	A-19	SP19	SM19	SN19	H19	S-19	-	280	A-19	SP19	SM19	SN19	H19	S-19	-	1	280	A-12	-	-	-	-	S-11	-
HONDA	CR-V II [RD]	02→06	530	A-21	SP21	SM21	SN21	H21	S-21	-	280	A-20	SP20	SM20	SN20	H20	S-20	-	1	380	A-15	-	SM16	SN16	H16	S-16	-
HONDA	CR-V III [RE]	07→	650	A-26	SP26	SM26	SN26	H26	S-26	-	280	A-16	-	SM16	SN16	H16	S-16	-	1	350	A-14	-	SM14	SN14	-	S-14	-
HONDA	CR-Z [ZF1]	10→	650	A-26	SP26	SM26	SN26	H26	S-26	-	280	A-20	SP20	SM20	SN20	H20	S-20	-	1	-	-	-	-	-	-	-	-
HONDA	Crosstour	10→	650	A-26	SP26	SM26	SN26	H26	S-26	-	280	A-19	SP19	SM19	SN19	H19	S-19	-	1	-	-	-	-	-	-	-	-
HONDA	Element	02→	530	A-21	SP21	SM21	SN21	H21	S-21	-	280	A-20	SP20	SM20	SN20	H20	S-20	-	1	-	-	-	-	-	-	-	-
HONDA	FR-V [BE]	05→	650	A-26	SP26	SM26	SN26	H26	S-26	-	280	A-19	SP19	SM19	SN19	H19	S-19	-	1	-	-	-	-	-	-	-	-
HONDA	HR-V [GH]	98→05	500	A-20	SP20	SM20	SN20	H20	S-20	-	280	A-18	SP18	SM18	SN18	H18	S-18	-	1	-	-	-	-	-	-	-	-
HONDA	Insight [ZE]	00→06	500	A-20	SP20	SM20	SN20	H20	S-20	-	280	A-18	SP18	SM18	SN18	H18	S-18	-	1	400	A-16	-	SM16	SN16	H16	S-16	-
HONDA	Insight	09→	650	A-26	SP26	SM26	SN26	H26	S-26	-	280	A-16	-	SM16	SN16	H16	S-16	-	1	-	-	-	-	-	-	-	-
HONDA	Integra [DC2, DC4]	98→01	500	A-20	SP20	SM20	SN20	H20	S-20	-	280	A-18	SP18	SM18	SN18	H18	S-18	-	1	480	A-19	SP19	SM19	SN19	H19	S-19	-
HONDA	Integra [DC5]	02→	500	A-20	SP20	SM20	SN20	H20	S-20	-	280	A-18	SP18	SM18	SN18	H18	S-18	-	1	-	-	-	-	-	-	-	-
HONDA	Jazz [GD]	02→08	500	A-20	SP20	SM20	SN20	H20	S-20	-	280	A-15	-	SM15	SN15	-	S-15	-	1	350	A-14	-	SM14	SN14	-	S-14	-
HONDA	Jazz [GE/GG]	08→	500	A-20	SP20	SM20	SN20	H20	S-20	-	280	A-15	-	SM15	SN15	-	S-15	-	1	350	A-14	-	SM14	SN14	-	S-14	-
HONDA	Legend [KA9]	96→04	500	A-20	SP20	SM20	SN20	H20	S-20	-	280	A-19	SP19	SM19	SN19	H19	S-19	-	1	-	-	-	-	-	-	-	-
HONDA	Logo	96→	500	A-20	SP20	SM20	SN20	H20	S-20	-	280	A-17	-	SM17	SN17	-	S-17	-	1	-	-	-	-	-	-	-	-
HONDA	NSX Coupe [NA]	90→05	500	A-20	SP20	SM20	SN20	H20	S-20	-	280	A-20	SP20	SM20	SN20	H20	S-20	-	1	-	-	-	-	-	-	-	-
HONDA	Odyssey [RA]	00→	600	A-24	SP24	SM24	SN24	H24	S-24	-	280	A-22	SP22	SM22	SN22	H22	S-22	-	1	-	-	-	-	-	-	-	-
HONDA	Pilot	05→08	600	A-24	SP24	SM24	SN24	H24	S-24	-	280	A-21	SP21	SM21	SN21	H21	S-21	-	1	350	A-14	-	SM14	SN14	-	S-14	-
HONDA	Pilot	08→	550	A-22	SP22	SM22	SN22	H22	S-22	-	280	A-21	SP21	SM21	SN21	H21	S-21	-	1	-	-	-	-	-	-	-	-
HONDA	Prelude [BB]	96→02	500	A-20	SP20	SM20	SN20	H20	S-20	-	280	A-18	SP18	SM18	SN18	H18	S-18	-	1	-	-	-	-	-	-	-	-

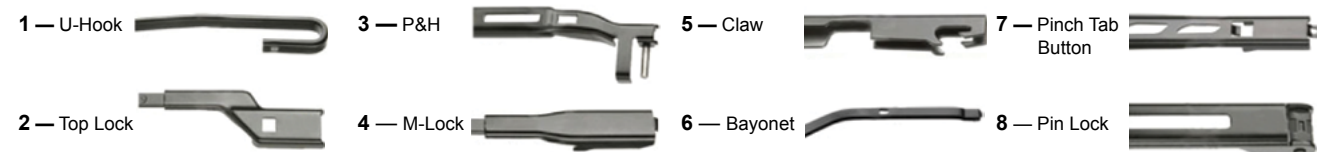

Производитель	Модель	Период выпуска	Сторона водителя (размер в мм)	AERODYNAMIC	SPOILER	SMART	SMART NEO	HYBRID	SNOWGUARD	SNOWGUARD POLAR	Сторона пассажира (размер в мм)	AERODYNAMIC	SPOILER	SMART	SMART NEO	HYBRID	SNOWGUARD	SNOWGUARD POLAR	Тип рычага для крепления щеток*	Заднее стекло (размер в мм)	AERODYNAMIC	SPOILER	SMART	SMART NEO	HYBRID	SNOWGUARD	SNOWGUARD POLAR
<b>HONDA</b>																											
HONDA	S2000	99→	500	A-20	SP20	SM20	SN20	H20	S-20	-	280	A-16	-	SM16	SN16	H16	S-16	-	1	-	-	-	-	-	-	-	-
HONDA	Shuttle	95→01	550	A-22	SP22	SM22	SN22	H22	S-22	-	280	A-22	SP22	SM22	SN22	H22	S-22	-	1	380	A-15	-	SM16	SN16	H16	S-16	-
HONDA	Stream [RN]	01→	600	A-24	SP24	SM24	SN24	H24	S-24	-	280	A-14	-	SM14	SN14	-	S-14	-	1	-	-	-	-	-	-	-	-
<b>HYUNDAI</b>																											
HYUNDAI	Accent [LC]	99→06	500	A-20	SP20	SM20	SN20	H20	S-20	-	280	A-18	SP18	SM18	SN18	H18	S-18	-	1	-	-	-	-	-	-	-	-
HYUNDAI	Accent [MC]	06→10	550	A-22	SP22	SM22	SN22	H22	S-22	-	280	A-16	-	SM16	SN16	H16	S-16	-	1	-	-	-	-	-	-	-	-
HYUNDAI	Accent Hatchback [LC]	99→06	500	A-20	SP20	SM20	SN20	H20	S-20	-	280	A-18	SP18	SM18	SN18	H18	S-18	-	1	450	A-18	SP18	SM18	SN18	H18	S-18	-
HYUNDAI	Accent Hatchback [MC]	06→10	550	A-22	SP22	SM22	SN22	H22	S-22	-	280	A-16	-	SM16	SN16	H16	S-16	-	1	350	A-14	-	SM14	SN14	-	S-14	-
HYUNDAI	Atos [MX]	97→03	500	A-20	SP20	SM20	SN20	H20	S-20	-	280	A-16	-	SM16	SN16	H16	S-16	-	1	340	A-14	-	SM14	SN14	-	S-14	-
HYUNDAI	Atos Prime [MX]	99→08	500	A-20	SP20	SM20	SN20	H20	S-20	-	280	A-16	-	SM16	SN16	H16	S-16	-	1	340	A-14	-	SM14	SN14	-	S-14	-
HYUNDAI	Azera	06→	600	A-24	SP24	SM24	SN24	H24	S-24	-	280	A-20	SP20	SM20	SN20	H20	S-20	-	1	-	-	-	-	-	-	-	-
HYUNDAI	Coupe [FX]	96→	550	A-22	SP22	SM22	SN22	H22	S-22	-	280	A-18	SP18	SM18	SN18	H18	S-18	-	1	-	-	-	-	-	-	-	-
HYUNDAI	Elantra [J2]	95→00	500	A-20	SP20	SM20	SN20	H20	S-20	-	280	A-18	SP18	SM18	SN18	H18	S-18	-	1	500	A-20	SP19	SM19	SN19	H19	S-19	-
HYUNDAI	Elantra [XD]	00→06	500	A-20	SP20	SM20	SN20	H20	S-20	-	280	A-18	SP18	SM18	SN18	H18	S-18	-	1	-	-	-	-	-	-	-	-
HYUNDAI	Elantra [HD]	06→	600	A-24	SP24	SM24	SN24	H24	S-24	-	280	A-18	SP18	SM18	SN18	H18	S-18	-	1	-	-	-	-	-	-	-	-
HYUNDAI	Elantra [MD]	10→	650	A-26	SP26	SM26	SN26	H26	S-26	-	280	A-14	-	SM14	SN14	-	S-14	-	1	-	-	-	-	-	-	-	-
HYUNDAI	Elantra Hatchback [XD]	00→06	500	A-20	SP20	SM20	SN20	H20	S-20	-	280	A-18	SP18	SM18	SN18	H18	S-18	-	1	350	A-14	-	SM14	SN14	-	S-14	-
HYUNDAI	Elantra Hatchback [HD]	06→	600	A-24	SP24	SM24	SN24	H24	S-24	-	280	A-18	SP18	SM18	SN18	H18	S-18	-	1	-	-	-	-	-	-	-	-
HYUNDAI	Equus	09→	600	-	-	-	SN24	-	-	SE24	280	-	-	-	SN19	-	-	SE19	4	-	-	-	-	-	-	-	-
HYUNDAI	Genesis [BH]	08→	600	-	-	-	SN24	-	-	SE24	280	-	-	-	SN20	-	-	SE20	4	-	-	-	-	-	-	-	-
HYUNDAI	Genesis Coupe [DK]	09→	600	A-24	SP24	SM24	SN24	H24	S-24	-	280	A-20	SP20	SM20	SN20	H20	S-20	-	1	-	-	-	-	-	-	-	-
HYUNDAI	Getz [TB]	02→	550	A-22	SP22	SM22	SN22	H22	S-22	-	280	A-14	-	SM14	SN14	-	S-14	-	1	340	A-14	-	SM14	SN14	-	S-14	-

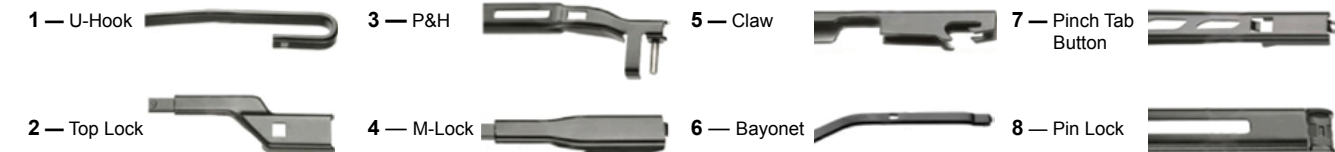



Производитель	Модель	Период выпуска	Сторона водителя (размер в мм)	AERODYNAMIC	SPOILER	SMART	SMART NEO	HYBRID	SNOWGUARD	SNOWGUARD POLAR	Сторона пассажира (размер в мм)	AERODYNAMIC	SPOILER	SMART	SMART NEO	HYBRID	SNOWGUARD	SNOWGUARD POLAR	Тип рычага для крепления щеток*	Заднее стекло (размер в мм)	AERODYNAMIC	SPOILER	SMART	SMART NEO	HYBRID	SNOWGUARD	SNOWGUARD POLAR
HYUNDAI																											
HYUNDAI	Grandeur [TG]	05→	600	A-24	SP24	SM24	SN24	H24	S-24	-	280	A-19	SP19	SM19	SN19	H19	S-19	-	1	-	-	-	-	-	-	-	-
HYUNDAI	Grandeur XG New [XG]	02→05	550	A-22	SP22	SM22	SN22	H22	S-22	-	280	A-20	SP20	SM20	SN20	H20	S-20	-	1	-	-	-	-	-	-	-	-
HYUNDAI	H-1	97→07	650	A-26	SP26	SM26	SN26	H26	S-26	-	280	A-20	SP20	SM20	SN20	H20	S-20	-	1	400	A-16	-	SM16	SN16	H16	S-16	-
HYUNDAI	H-1	08→	600	A-24	SP24	SM24	SN24	H24	S-24	-	280	A-20	SP20	SM20	SN20	H20	S-20	-	1	350	A-14	-	SM14	SN14	-	S-14	-
HYUNDAI	H100	93→00	450	A-18	SP18	SM18	SN18	H18	S-18	-	280	A-18	SP18	SM18	SN18	H18	S-18	-	1	-	-	-	-	-	-	-	-
HYUNDAI	i10	08→	550	A-22	SP22	SM22	SN22	H22	S-22	-	280	A-16	-	SM16	SN16	H16	S-16	-	1	-	-	-	-	-	-	-	-
HYUNDAI	i20	09→	600	A-24	SP24	SM24	SN24	H24	S-24	-	280	A-16	-	SM16	SN16	H16	S-16	-	1	300	A-12	-	-	-	-	S-11	-
HYUNDAI	i30	07→10	600	-	-	-	SN24	-	-	SE24	280	-	-	-	SN18	-	-	SE18	2	-	-	-	-	-	-	-	-
HYUNDAI	i30	10→	600	A-24	SP24	SM24	SN24	H24	S-24	-	280	A-18	SP18	SM18	SN18	H18	S-18	-	1	300	A-12	-	-	-	-	S-11	-
HYUNDAI	i30 CW Kombi	08→	600	-	-	-	SN24	-	-	SE24	280	-	-	-	SN18	-	-	SE18	2	300	-	-	-	-	-	-	-
HYUNDAI	ix20 [JC]	10→	650	-	-	-	SN26	-	-	SE26	280	-	-	-	SN14	-	-	SE14	2	300	-	-	-	-	-	-	-
HYUNDAI	ix35 [LM]	10→	600	A-24	SP24	SM24	SN24	H24	S-24	-	280	A-16	-	SM16	SN16	H16	S-16	-	1	300	A-12	-	-	-	-	S-11	-
HYUNDAI	ix55	09→	600	-	-	-	SN24	-	-	SE24	280	-	-	-	SN20	-	-	SE20	2	-	-	-	-	-	-	-	-
HYUNDAI	Lantra [J2]	95→00	500	A-20	SP20	SM20	SN20	H20	S-20	-	280	A-18	SP18	SM18	SN18	H18	S-18	-	1	-	-	-	-	-	-	-	-
HYUNDAI	Lantra Station Wagon [J2]	95→00	500	A-20	SP20	SM20	SN20	H20	S-20	-	280	A-18	SP18	SM18	SN18	H18	S-18	-	1	380	A-15	-	SM16	SN16	H16	S-16	-
HYUNDAI	Matrix [FC]	01→	550	A-22	SP22	SM22	SN22	H22	S-22	-	280	A-16	-	SM16	SN16	H16	S-16	-	1	350	A-14	-	SM14	SN14	-	S-14	-
HYUNDAI	Porter	94→04	450	A-18	SP18	SM18	SN18	H18	S-18	-	280	A-18	SP18	SM18	SN18	H18	S-18	-	1	-	-	-	-	-	-	-	-
HYUNDAI	Porter	04→	450	A-18	SP18	SM18	SN18	H18	S-18	-	280	A-18	SP18	SM18	SN18	H18	S-18	-	1	-	-	-	-	-	-	-	-
HYUNDAI	Santa Fe I [SM, Classic]	99→	550	A-22	SP22	SM22	SN22	H22	S-22	-	280	A-20	SP20	SM20	SN20	H20	S-20	-	1	340	A-14	-	SM14	SN14	-	S-14	-
HYUNDAI	Santa Fe II [CM]	06→	600	A-24	SP24	SM24	SN24	H24	S-24	-	280	A-18	SP18	SM18	SN18	H18	S-18	-	1	350	A-14	-	SM14	SN14	-	S-14	-
HYUNDAI	Satellite	97→07	650	A-26	SP26	SM26	SN26	H26	S-26	-	280	A-20	SP20	SM20	SN20	H20	S-20	-	1	400	A-16	-	SM16	SN16	H16	S-16	-
HYUNDAI	Solaris [RB]	11→	650	A-26	SP26	SM26	SN26	H26	S-26	-	280	A-16	-	SM16	SN16	H16	S-16	-	1	-	-	-	-	-	-	-	-
HYUNDAI	Sonata IV [EF]	98→01	500	A-20	SP20	SM20	SN20	H20	S-20	-	280	A-19	SP19	SM19	SN19	H19	S-19	-	1	-	-	-	-	-	-	-	-

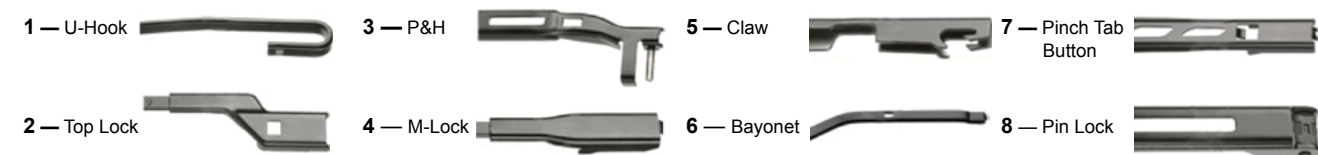

Производитель	Модель	Период выпуска	Сторона водителя (размер в мм)	AERODYNAMIC	SPOILER	SMART	SMART NEO	HYBRID	SNOWGUARD	SNOWGUARD POLAR	Сторона пассажира (размер в мм)	AERODYNAMIC	SPOILER	SMART	SMART NEO	HYBRID	SNOWGUARD	SNOWGUARD POLAR	Тип рычага для крепления щеток*	Заднее стекло (размер в мм)	AERODYNAMIC	SPOILER	SMART	SMART NEO	HYBRID	SNOWGUARD	SNOWGUARD POLAR
HYUNDAI																											
HYUNDAI	Sonata V [EU]	01→04	550	A-22	SP22	SM22	SN22	H22	S-22	-	280	A-20	SP20	SM20	SN20	H20	S-20	-	1	-	-	-	-	-	-	-	-
HYUNDAI	Sonata VI [NF]	04→	600	A-24	SP24	SM24	SN24	H24	S-24	-	280	A-20	SP20	SM20	SN20	H20	S-20	-	1	-	-	-	-	-	-	-	-
HYUNDAI	Sonata VII [YF]	10→	650	A-26	SP26	SM26	SN26	H26	S-26	-	280	A-18	SP18	SM18	SN18	H18	S-18	-	1	-	-	-	-	-	-	-	-
HYUNDAI	Starex	97→07	650	A-26	SP26	SM26	SN26	H26	S-26	-	280	A-20	SP20	SM20	SN20	H20	S-20	-	1	-	-	-	-	-	-	-	-
HYUNDAI	Stellar	89→01	450	A-18	SP18	SM18	SN18	H18	S-18	-	280	A-18	SP18	SM18	SN18	H18	S-18	-	1	-	-	-	-	-	-	-	-
HYUNDAI	Terracan [HP]	01→	550	A-22	SP22	SM22	SN22	H22	S-22	-	280	A-20	SP20	SM20	SN20	H20	S-20	-	1	400	A-16	-	SM16	SN16	H16	S-16	-
HYUNDAI	Tiburon [RD]	96→	550	A-22	SP22	SM22	SN22	H22	S-22	-	280	A-18	SP18	SM18	SN18	H18	S-18	-	1	-	-	-	-	-	-	-	-
HYUNDAI	Trajet [FO]	00→07	650	A-26	SP26	SM26	SN26	H26	S-26	-	280	A-22	SP22	SM22	SN22	H22	S-22	-	1	400	A-16	-	SM16	SN16	H16	S-16	-
HYUNDAI	Tucson [JM]	04→	600	A-24	SP24	SM24	SN24	H24	S-24	-	280	A-16	-	SM16	SN16	H16	S-16	-	1	-	-	-	-	-	-	-	-
HYUNDAI	Veracruz	06→	600	-	-	-	SN24	-	-	SE24	280	-	-	-	SN20	-	-	SE20	2	-	-	-	-	-	-	-	-
HYUNDAI	Verna [MC]	05→	550	A-22	SP22	SM22	SN22	H22	S-22	-	280	A-16	-	SM16	SN16	H16	S-16	-	1	350	A-14	-	SM14	SN14	-	S-14	-
HYUNDAI	XG [F]	98→05	550	A-22	SP22	SM22	SN22	H22	S-22	-	280	A-20	SP20	SM20	SN20	H20	S-20	-	1	-	-	-	-	-	-	-	-

INFINITY																											
INFINITY	EX35/37	08→	600	A-24	SP24	SM24	SN24	H24	S-24	-	280	A-18	SP18	SM18	SN18	H18	S-18	-	1	-	-	-	-	-	-	-	-
INFINITY	FX35/45 [S50]	03→08	550	A-22	SP22	SM22	SN22	H22	S-22	-	280	A-20	SP20	SM20	SN20	H20	S-20	-	1	-	-	-	-	-	-	-	-
INFINITY	FX37/50 [S51]	08→	600	A-24	SP24	SM24	SN24	H24	S-24	-	280	A-19	SP19	SM19	SN19	H19	S-19	-	1	-	-	-	-	-	-	-	-
INFINITY	G 25/35 USA	03→06	550	A-22	SP22	SM22	SN22	H22	S-22	-	280	A-18	SP18	SM18	SN18	H18	S-18	-	1	-	-	-	-	-	-	-	-
INFINITY	G 25/35/37	08→	650	A-26	SP26	SM26	SN26	H26	S-26	-	280	A-16	-	SM16	SN16	H16	S-16	-	1	-	-	-	-	-	-	-	-
INFINITY	M35/45	05→10	600	A-24	SP24	SM24	SN24	H24	S-24	-	280	A-19	SP19	SM19	SN19	H19	S-19	-	1	-	-	-	-	-	-	-	-
INFINITY	Q45 [F50]	01→	600	A-24	SP24	SM24	SN24	H24	S-24	-	280	A-18	SP18	SM18	SN18	H18	S-18	-	1	-	-	-	-	-	-	-	-
INFINITY	QX56 [JA60]	03→10	600	A-24	SP24	SM24	SN24	H24	S-24	-	280	A-20	SP20	SM20	SN20	H20	S-20	-	1	-	-	-	-	-	-	-	-
INFINITY	QX56 [JA60]	11→	600	A-24	SP24	SM24	SN24	H24	S-24	-	280	A-20	SP20	SM20	SN20	H20	S-20	-	1	-	-	-	-	-	-	-	-

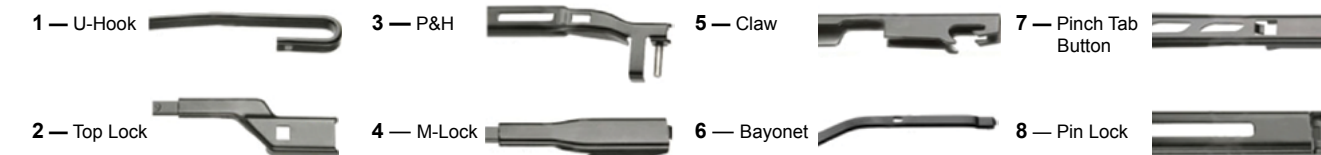



Производитель	Модель	Период выпуска	Сторона водителя (размер в мм)	AERODYNAMIC	SPOILER	SMART	SMART NEO	HYBRID	SNOWGUARD	SNOWGUARD POLAR	Сторона пассажира (размер в мм)	AERODYNAMIC	SPOILER	SMART	SMART NEO	HYBRID	SNOWGUARD	SNOWGUARD POLAR	Тип рычага для крепления щеток*	Заднее стекло (размер в мм)	AERODYNAMIC	SPOILER	SMART	SMART NEO	HYBRID	SNOWGUARD	SNOWGUARD POLAR
<b>KIA</b>																											
KIA	Mohave	09→	600	A-24	SP24	SM24	SN24	H24	S-24	-	280	A-20	SP20	SM20	SN20	H20	S-20	-	1	350	A-14	-	SM14	SN14	-	S-14	-
KIA	Opirus [LD]	03→	600	A-24	SP24	SM24	SN24	H24	S-24	-	280	A-18	SP18	SM18	SN18	H18	S-18	-	1	-	-	-	-	-	-	-	-
KIA	Picanto [BA]	04→	550	A-22	SP22	SM22	SN22	H22	S-22	-	280	A-16	-	SM16	SN16	H16	S-16	-	1	300	A-12	-	-	-	-	S-11	-
KIA	Picanto [TA]	11→	550	A-22	SP22	SM22	SN22	H22	S-22	-	280	A-16	-	SM16	SN16	H16	S-16	-	1	-	-	-	-	-	-	-	-
KIA	Pro Ceed	08→	600	-	-	-	SN24	-	-	SE24	280	-	-	-	SN18	-	-	SE18	2	-	-	-	-	-	-	-	-
KIA	Rio [DC]	00→05	530	A-21	SP21	SM21	SN21	H21	S-21	-	280	A-18	SP18	SM18	SN18	H18	S-18	-	1	350	A-14	-	SM14	SN14	-	S-14	-
KIA	Rio [DE, JB]	05→	550	A-22	SP22	SM22	SN22	H22	S-22	-	280	A-16	-	SM16	SN16	H16	S-16	-	1	350	A-14	-	SM14	SN14	-	S-14	-
KIA	Rio [UB]	11→	650	A-26	SP26	SM26	SN26	H26	S-26	-	280	A-16	-	SM16	SN16	H16	S-16	-	1	-	-	-	-	-	-	-	-
KIA	Rio Hatchback [DC]	00→	530	A-21	SP21	SM21	SN21	H21	S-21	-	280	A-18	SP18	SM18	SN18	H18	S-18	-	1	350	A-14	-	SM14	SN14	-	S-14	-
KIA	Hatchback [DE, JB]	05→	550	A-22	SP22	SM22	SN22	H22	S-22	-	280	A-16	-	SM16	SN16	H16	S-16	-	1	350	A-14	-	SM14	SN14	-	S-14	-
KIA	Rio Kombi [DC]	02→05	530	A-21	SP21	SM21	SN21	H21	S-21	-	280	A-18	SP18	SM18	SN18	H18	S-18	-	1	350	A-14	-	SM14	SN14	-	S-14	-
KIA	Sephia I [FA]	92→00	530	A-21	SP21	SM21	SN21	H21	S-21	-	280	A-19	SP19	SM19	SN19	H19	S-19	-	1	-	-	-	-	-	-	-	-
KIA	Sephia I Hatchback [FA]	96→00	530	A-21	SP21	SM21	SN21	H21	S-21	-	280	A-19	SP19	SM19	SN19	H19	S-19	-	1	450	A-18	SP18	SM18	SN18	H18	S-18	-
KIA	Shuma I [FB]	98→00	530	A-21	SP21	SM21	SN21	H21	S-21	-	280	A-19	SP19	SM19	SN19	H19	S-19	-	1	-	-	-	-	-	-	-	-
KIA	Shuma II [FB]	01→04	530	A-21	SP21	SM21	SN21	H21	S-21	-	280	A-19	SP19	SM19	SN19	H19	S-19	-	1	-	-	-	-	-	-	-	-
KIA	Shuma I Hatchback [FB]	98→00	530	A-21	SP21	SM21	SN21	H21	S-21	-	280	A-19	SP19	SM19	SN19	H19	S-19	-	1	450	A-18	SP18	SM18	SN18	H18	S-18	-
KIA	Shuma II Hatchback [FB]	01→04	530	A-21	SP21	SM21	SN21	H21	S-21	-	280	A-19	SP19	SM19	SN19	H19	S-19	-	1	480	A-19	SP19	SM19	SN19	H19	S-19	-
KIA	Sorento [JC]	02→	600	A-24	SP24	SM24	SN24	H24	S-24	-	280	A-18	SP18	SM18	SN18	H18	S-18	-	1	350	A-14	-	SM14	SN14	-	S-14	-
KIA	Sorento [XM]	09→	600	A-24	SP24	SM24	SN24	H24	S-24	-	280	A-20	SP20	SM20	SN20	H20	S-20	-	1	280	A-12	-	-	-	-	S-11	-
KIA	Soul	08→	600	A-24	SP24	SM24	SN24	H24	S-24	-	280	A-20	SP20	SM20	SN20	H20	S-20	-	1	280	A-12	-	-	-	-	S-11	-
KIA	Spectra	01→06	530	A-21	SP21	SM21	SN21	H21	S-21	-	280	A-20	SP20	SM20	SN20	H20	S-20	-	1	-	-	-	-	-	-	-	-
KIA	Spectra	06→	600	A-24	SP24	SM24	SN24	H24	S-24	-	280	A-16	-	SM16	SN16	H16	S-16	-	1	-	-	-	-	-	-	-	-
KIA	Sportage [JA]	93→04	500	A-20	SP20	SM20	SN20	H20	S-20	-	280	A-19	SP19	SM19	SN19	H19	S-19	-	1	400	A-16	-	SM16	SN16	H16	S-16	-

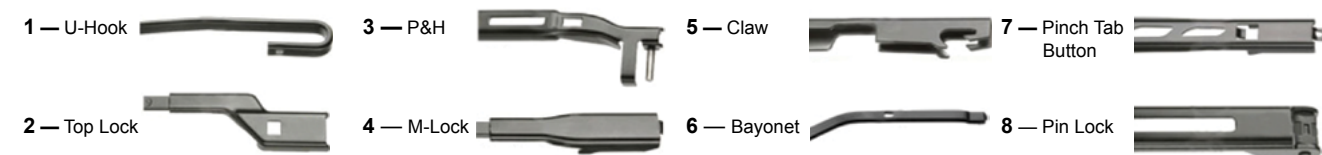

Производитель	Модель	Период выпуска	Сторона водителя (размер в мм)	AERODYNAMIC	SPOILER	SMART	SMART NEO	HYBRID	SNOWGUARD	SNOWGUARD POLAR	Сторона пассажира (размер в мм)	AERODYNAMIC	SPOILER	SMART	SMART NEO	HYBRID	SNOWGUARD	SNOWGUARD POLAR	Тип рычага для крепления щеток*	Заднее стекло (размер в мм)	AERODYNAMIC	SPOILER	SMART	SMART NEO	HYBRID	SNOWGUARD	SNOWGUARD POLAR
<b>KIA</b>																											
KIA	Sportage [KM, JE]	04→10	600	A-24	SP24	SM24	SN24	H24	S-24	-	280	A-16	-	SM16	SN16	H16	S-16	-	1	-	-	-	-	-	-	-	-
KIA	Sportage [SL]	10→	600	A-24	SP24	SM24	SN24	H24	S-24	-	280	A-18	SP18	SM18	SN18	H18	S-18	-	1	-	-	-	-	-	-	-	-
KIA	Venga [YN]	10→	650	-	-	-	SN26	-	-	SE26	280	-	-	-	SN14	-	-	SE14	2	300	-	-	-	-	-	-	-

<b>LADA</b>																											
LADA	2110	96→	510	A-20	SP20	SM20	SN20	H20	S-20	-	280	A-20	SP20	SM20	SN20	H20	S-20	-	1	-	-	-	-	-	-	-	-
LADA	2119, 2120	96→	500	A-20	SP20	SM20	SN20	H20	S-20	-	280	A-20	SP20	SM20	SN20	H20	S-20	-	1	-	-	-	-	-	-	-	-
LADA	Kalina	05→	600	A-24	SP24	SM24	SN24	H24	S-24	-	280	A-16	-	SM16	SN16	H16	S-16	-	1	-	-	-	-	-	-	-	-
LADA	Niva Chevrolet	03→	500	A-20	SP20	SM20	SN20	H20	S-20	-	280	A-20	SP20	SM20	SN20	H20	S-20	-	1	-	-	-	-	-	-	-	-
LADA	Samara - 2109	86→	500	A-20	SP20	SM20	SN20	H20	S-20	-	280	A-20	SP20	SM20	SN20	H20	S-20	-	1	-	-	-	-	-	-	-	-
LADA	Samara - 2115	96→	500	A-20	SP20	SM20	SN20	H20	S-20	-	280	A-20	SP20	SM20	SN20	H20	S-20	-	1	-	-	-	-	-	-	-	-
LADA	2101-2107	71→	330	A-13	-	-	-	-	S-13	-	280	A-13	-	-	-	-	S-13	-	1	-	-	-	-	-	-	-	-
LADA	2121 Niva	78→	330	A-13	-	-	-	-	S-13	-	280	A-13	-	-	-	-	S-13	-	1	280	A-12	-	-	-	-	S-11	-

<b>LANCIA</b>																													
LANCIA	Delta [844]	08→	600	-	-	-	SN24	-	-	SE24	280	-	-	-	SN17	-	-	SE17	2	300	-	-	-	-	-	-	-		
LANCIA	Kappa Berlina [838]	94→00	600	-	-	-	SP24	SM24	SN24	H24	S-24	-	280	A-21	SP21	SM21	SN21	H21	S-21	-	1	-	-	-	-	-	-		
LANCIA	Kappa Coupe [838]	97→00	600	-	-	-	SP24	SM24	SN24	H24	S-24	-	280	A-21	SP21	SM21	SN21	H21	S-21	-	1	-	-	-	-	-	-		
LANCIA	Kappa Station Wagon [838]	94→00	600	-	-	-	SP24	SM24	SN24	H24	S-24	-	280	A-21	SP21	SM21	SN21	H21	S-21	-	1	-	-	-	-	-	-		
LANCIA	Lybra Berlina [839]	99→06	550	-	-	-	SP22	SM22	SN22	H22	S-22	-	280	A-21	SP21	SM21	SN21	H21	S-21	-	1	-	-	-	-	-	-		
LANCIA	Lybra Station Wagon [839]	99→06	550	-	-	-	SP22	SM22	SN22	H22	S-22	-	280	A-21	SP21	SM21	SN21	H21	S-21	-	1	-	-	-	-	-	-		
LANCIA	Musa [184]	04→07	580	-	-	-	SP24	SM24	SN24	H24	S-24	-	280	A-15	-	SM15	SN15	-	S-15	-	1	400	A-16	-	SM16	SN16	H16	S-16	-
LANCIA	Phedra [180]	02→05	650	-	-	-	SP26	SM26	SN26	H26	S-26	-	280	A-26	SP26	SM26	SN26	H26	S-26	-	1	350	A-14	-	SM14	SN14	-	S-14	-

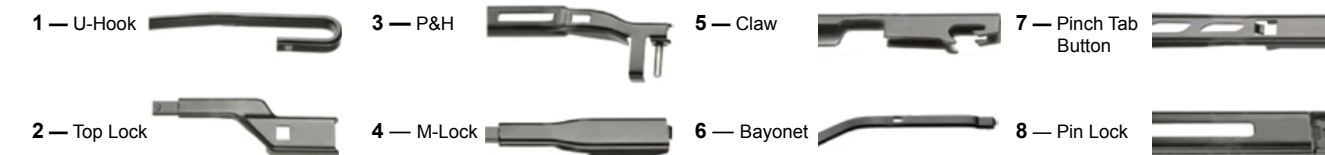



Производитель	Модель	Период выпуска	Сторона водителя (размер в мм)	AERODYNAMIC	SPOILER	SMART	SMART NEO	HYBRID	SNOWGUARD	SNOWGUARD POLAR	Сторона пассажира (размер в мм)	AERODYNAMIC	SPOILER	SMART	SMART NEO	HYBRID	SNOWGUARD	SNOWGUARD POLAR	Тип рычага для крепления щеток*	Заднее стекло (размер в мм)	AERODYNAMIC	SPOILER	SMART	SMART NEO	HYBRID	SNOWGUARD	SNOWGUARD POLAR
<b>LANCIA</b>																											
LANCIA	Phedra [180]	05→	650	A-26	SP26	SM26	SN26	H26	S-26	-	280	A-26	SP26	SM26	SN26	H26	S-26	-	1	350	A-14	-	SM14	SN14	-	S-14	-
LANCIA	Thesis [841]	02→	650	A-26	SP26	SM26	SN26	H26	S-26	-	280	A-21	SP21	SM21	SN21	H21	S-21	-	1	-	-	-	-	-	-	-	-
LANCIA	Y [840]	96→03	550	A-22	SP22	SM22	SN22	H22	S-22	-	280	A-16	-	SM16	SN16	H16	S-16	-	1	-	-	-	-	-	-	-	-
LANCIA	Ypsilon [843]	03→	600	A-24	SP24	SM24	SN24	H24	S-24	-	280	A-16	-	SM16	SN16	H16	S-16	-	1	-	-	-	-	-	-	-	-
LANCIA	ZETA [122]	94→02	650	A-26	SP26	SM26	SN26	H26	S-26	-	280	A-20	SP20	SM20	SN20	H20	S-20	-	1	450	A-18	SP18	SM18	SN18	H18	S-18	-

<b>LAND ROVER</b>																											
LAND ROVER	Defender	90→	350	A-14	-	SM14	SN14	-	S-14	-	280	A-14	-	SM14	SN14	-	S-14	-	1	340	A-14	-	SM14	SN14	-	S-14	-
LAND ROVER	Discovery II	98→04	530	A-21	SP21	SM21	SN21	H21	S-21	-	280	A-21	SP21	SM21	SN21	H21	S-21	-	1	340	A-14	-	SM14	SN14	-	S-14	-
LAND ROVER	Discovery III	04→	550	A-22	SP22	SM22	SN22	H22	S-22	-	280	A-21	SP21	SM21	SN21	H21	S-21	-	1	400	A-16	-	SM16	SN16	H16	S-16	-
LAND ROVER	Freelander I	97→07	550	A-22	SP22	SM22	SN22	H22	S-22	-	280	A-20	SP20	SM20	SN20	H20	S-20	-	1	350	A-14	-	SM14	SN14	-	S-14	-
LAND ROVER	Freelander II	06→	600	-	-	-	SN24	-	-	SE24	280	-	-	-	SN19	-	-	SE19	4	340	-	-	-	-	-	-	-
LAND ROVER	Range Rover II	94→02	550	A-22	SP22	SM22	SN22	H22	S-22	-	280	A-22	SP22	SM22	SN22	H22	S-22	-	1	480	A-19	SP19	SM19	SN19	H19	S-19	-
LAND ROVER	Range Rover III [LM]	02→	650	-	-	-	-	-	-	-	280	-	-	-	-	-	-	-	8	480	-	-	-	-	-	-	-
LAND ROVER	Range Rover Sport	05→	550	A-22	SP22	SM22	SN22	H22	S-22	-	280	A-22	SP22	SM22	SN22	H22	S-22	-	1	400	A-16	-	SM16	SN16	H16	S-16	-

<b>LEXUS</b>																											
LEXUS	CT 200h	10→	650	A-26	SP26	SM26	SN26	H26	S-26	-	280	A-18	SP18	SM18	SN18	H18	S-18	-	1	-	-	-	-	-	-	-	-
LEXUS	GS [S1]	97→05	600	A-24	SP24	SM24	SN24	H24	S-24	-	280	A-20	SP20	SM20	SN20	H20	S-20	-	1	-	-	-	-	-	-	-	-
LEXUS	GS [GRS,UZS]	05→	600	A-24	SP24	SM24	SN24	H24	S-24	-	280	A-20	SP20	SM20	SN20	H20	S-20	-	1	-	-	-	-	-	-	-	-
LEXUS	GX [UZJ120]	02→09	550	A-22	SP22	SM22	SN22	H22	S-22	-	280	A-21	SP21	SM21	SN21	H21	S-21	-	1	-	-	-	-	-	-	-	-
LEXUS	GX [URJ150]	09→	650	A-26	SP26	SM26	SN26	H26	S-26	-	280	A-20	SP20	SM20	SN20	H20	S-20	-	1	-	-	-	-	-	-	-	-
LEXUS	IS [E1]	99→05	550	A-22	SP22	SM22	SN22	H22	S-22	-	280	A-19	SP19	SM19	SN19	H19	S-19	-	1	350	A-14	-	SM14	SN14	-	S-14	-
LEXUS	IS [E2]	05→	550	A-22	SP22	SM22	SN22	H22	S-22	-	280	A-20	SP20	SM20	SN20	H20	S-20	-	1	-	-	-	-	-	-	-	-

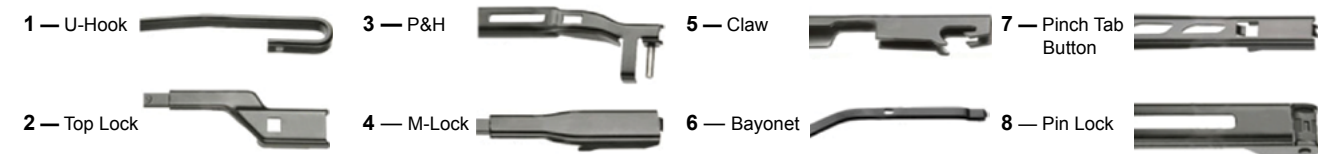

Производитель	Модель	Период выпуска	Сторона водителя (размер в мм)	AERODYNAMIC	SPOILER	SMART	SMART NEO	HYBRID	SNOWGUARD	SNOWGUARD POLAR	Сторона пассажира (размер в мм)	AERODYNAMIC	SPOILER	SMART	SMART NEO	HYBRID	SNOWGUARD	SNOWGUARD POLAR	Тип рычага для крепления щеток*	Заднее стекло (размер в мм)	AERODYNAMIC	SPOILER	SMART	SMART NEO	HYBRID	SNOWGUARD	SNOWGUARD POLAR
<b>LEXUS</b>																											
LEXUS	IS C 250 [GSE2_]	04→	550	A-22	SP22	SM22	SN22	H22	S-22	-	280	A-20	SP20	SM20	SN20	H20	S-20	-	1	-	-	-	-	-	-	-	-
LEXUS	IS Wagon [E1]	01→05	550	A-22	SP22	SM22	SN22	H22	S-22	-	280	A-19	SP19	SM19	SN19	H19	S-19	-	1	350	A-14	-	SM14	SN14	-	S-14	-
LEXUS	LS 400 [F1/2]	89→00	500	A-20	SP20	SM20	SN20	H20	S-20	-	280	A-16	-	SM16	SN16	H16	S-16	-	1	-	-	-	-	-	-	-	-
LEXUS	LS 430 [FE]	00→06	600	A-24	SP24	SM24	SN24	H24	S-24	-	280	A-16	-	SM16	SN16	H16	S-16	-	1	-	-	-	-	-	-	-	-
LEXUS	LS 460/600h [USF]	06→	600	A-24	SP24	SM24	SN24	H24	S-24	-	280	A-17	-	SM17	SN17	-	S-17	-	1	-	-	-	-	-	-	-	-
LEXUS	LX 470 [UZJ100]	98→07	600	A-24	SP24	SM24	SN24	H24	S-24	-	280	A-22	SP22	SM22	SN22	H22	S-22	-	1	400	A-16	-	SM16	SN16	H16	S-16	-
LEXUS	LX 570 [URJ200]	07→	600	A-24	SP24	SM24	SN24	H24	S-24	-	280	A-22	SP22	SM22	SN22	H22	S-22	-	1	350	A-14	-	SM14	SN14	-	S-14	-
LEXUS	RX 300 [XU10]	98→03	600	A-24	SP24	SM24	SN24	H24	S-24	-	280	A-21	SP21	SM21	SN21	H21	S-21	-	1	400	A-16	-	SM16	SN16	H16	S-16	-
LEXUS	RX 300/350/400h [XU30]	03→	650	A-26	SP26	SM26	SN26	H26	S-26	-	280	A-22	SP22	SM22	SN22	H22	S-22	-	1	350	A-14	-	SM14	SN14	-	S-14	-
LEXUS	RX 270/350/450h [AL10]	09→	650	A-26	SP26	SM26	SN26	H26	S-26	-	280	A-22	SP22	SM22	SN22	H22	S-22	-	1	350	A-14	-	SM14	SN14	-	S-14	-
LEXUS	SC 430	01→10	600	A-24	SP24	SM24	SN24	H24	S-24	-	280	A-20	SP20	SM20	SN20	H20	S-20	-	1	-	-	-	-	-	-	-	-

<b>LIFAN</b>																											
LIFAN	Breeze [520] HB	07→	600	A-24	SP24	SM24	SN24	H24	S-24	-	280	A-16	-	SM16	SN16	H16	S-16	-	1	-	-	-	-	-	-	-	-
LIFAN	Breeze [520] SD	06→	600	A-24	SP24	SM24	SN24	H24	S-24	-	280	A-16	-	SM16	SN16	H16	S-16	-	1	-	-	-	-	-	-	-	-
LIFAN	Smily [320]	09→	450	A-18	SP18	SM18	SN18	H18	S-18	-	280	A-18	SP18	SM18	SN18	H18	S-18	-	1	-	-	-	-	-	-	-	-
LIFAN	Solano [620]	08→	600	A-24	SP24	SM24	SN24	H24	S-24	-	280	A-16	-	SM16	SN16	H16	S-16	-	1	-	-	-	-	-	-	-	-

<b>MAZDA</b>																											
MAZDA	121 [Soho]	97→04	480	A-19	SP19	SM19	SN19	H19	S-19	-	280	A-19	SP19	SM19	SN19	H19	S-19	-	1	-	-	-	-	-	-	-	-
MAZDA	2 [DY]	03→07	600	A-24	SP24	SM24	SN24	H24	S-24	-	280	A-16	-	SM16	SN16	H16	S-16	-	1	350	A-14	-	SM14	SN14	-	S-14	-
MAZDA	2 [DE]	07→	650	A-26	SP26	SM26	SN26	H26	S-26	-	280	A-14	-	SM14	SN14	-	S-14	-	1	350	A-14	-	SM14	SN14	-	S-14	-
MAZDA	3 Hatchback [BK]	03→08	530	-	-	-	SN21	H21	-	SE21	280	-	-	-	SN19	H19	-	SE19	3	350	-	-	-	-	-	-	

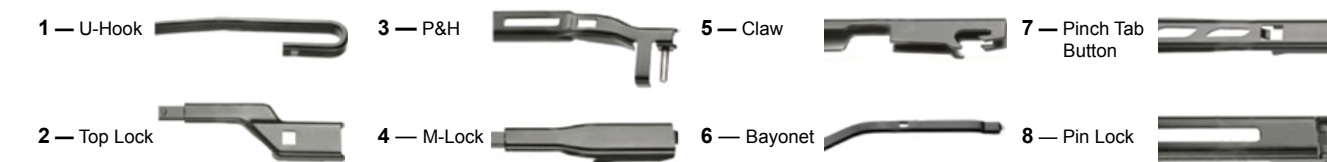

Производитель	Модель	Период выпуска	Сторона водителя (размер в мм)	AERODYNAMIC	SPOILER	SMART	SMART NEO	HYBRID	SNOWGUARD	SNOWGUARD POLAR	Сторона пассажира (размер в мм)	AERODYNAMIC	SPOILER	SMART	SMART NEO	HYBRID	SNOWGUARD	SNOWGUARD POLAR	Тип рычага для крепления щеток*	Заднее стекло (размер в мм)	AERODYNAMIC	SPOILER	SMART	SMART NEO	HYBRID	SNOWGUARD	SNOWGUARD POLAR
<b>MAZDA</b>																											
MAZDA	3 Hatchback [BL]	08→	600	A-24	SP24	SM24	SN24	H24	S-24	-	280	A-19	SP19	SM19	SN19	H19	S-19	-	1	350	A-14	-	SM14	SN14	-	S-14	-
MAZDA	3 [BK]	03→08	530	-	-	-	SN21	H21	-	SE21	280	-	-	-	SN19	H19	-	SE19	3	-	-	-	-	-	-	-	-
MAZDA	3 [BL]	08→	600	A-24	SP24	SM24	SN24	H24	S-24	-	280	A-19	SP19	SM19	SN19	H19	S-19	-	1	-	-	-	-	-	-	-	-
MAZDA	323 [BJ]	98→03	530	A-21	SP21	SM21	SN21	H21	S-21	-	280	A-18	SP18	SM18	SN18	H18	S-18	-	1	-	-	-	-	-	-	-	-
MAZDA	323 Hatchback [BA]	94→00	530	A-21	SP21	SM21	SN21	H21	S-21	-	280	A-18	SP18	SM18	SN18	H18	S-18	-	1	400	A-16	-	SM16	SN16	H16	S-16	-
MAZDA	323 Hatchback [BJ]	98→03	530	A-21	SP21	SM21	SN21	H21	S-21	-	280	A-18	SP18	SM18	SN18	H18	S-18	-	1	340	A-14	-	SM14	SN14	-	S-14	-
MAZDA	5 [CR]	05→	650	A-26	SP26	SM26	SN26	H26	S-26	-	280	A-16	-	SM16	SN16	H16	S-16	-	1	300	A-12	-	-	-	-	S-11	-
MAZDA	5 [CW]	10→	650	A-26	SP26	SM26	SN26	H26	S-26	-	280	A-16	-	SM16	SN16	H16	S-16	-	1	-	-	-	-	-	-	-	-
MAZDA	6 Sedan [GG/GY]	02→07	550	A-22	SP22	SM22	SN22	H22	S-22	-	280	A-19	SP19	SM19	SN19	H19	S-19	-	1	-	-	-	-	-	-	-	-
MAZDA	6 [GH]	07→	600	A-24	SP24	SM24	SN24	H24	S-24	-	280	A-16	-	SM16	SN16	H16	S-16	-	1	-	-	-	-	-	-	-	-
MAZDA	6 Fastback [GG/GY]	02→07	550	A-22	SP22	SM22	SN22	H22	S-22	-	280	A-19	SP19	SM19	SN19	H19	S-19	-	1	500	A-20	SP19	SM19	SN19	H19	S-19	-
MAZDA	6 Fastback [GH]	07→	600	A-24	SP24	SM24	SN24	H24	S-24	-	280	A-16	-	SM16	SN16	H16	S-16	-	1	500	A-20	SP19	SM19	SN19	H19	S-19	-
MAZDA	6 Wagon [GG/GY]	02→07	550	A-22	SP22	SM22	SN22	H22	S-22	-	280	A-19	SP19	SM19	SN19	H19	S-19	-	1	300	A-12	-	-	-	-	S-11	-
MAZDA	6 Wagon [GH]	07→	600	A-24	SP24	SM24	SN24	H24	S-24	-	280	A-16	-	SM16	SN16	H16	S-16	-	1	350	A-14	-	SM14	SN14	-	S-14	-
MAZDA	626 Fastback [GF]	99→02	530	A-21	SP21	SM21	SN21	H21	S-21	-	280	A-18	SP18	SM18	SN18	H18	S-18	-	1	500	A-20	SP19	SM19	SN19	H19	S-19	-
MAZDA	B2500 [UF,UN]	96→06	450	A-18	SP18	SM18	SN18	H18	S-18	-	280	A-18	SP18	SM18	SN18	H18	S-18	-	1	-	-	-	-	-	-	-	-
MAZDA	BT-50 [J97M]	06→11	450	A-18	SP18	SM18	SN18	H18	S-18	-	280	A-18	SP18	SM18	SN18	H18	S-18	-	1	-	-	-	-	-	-	-	-
MAZDA	CX-7 [ER]	06→	650	A-26	SP26	SM26	SN26	H26	S-26	-	280	A-16	-	SM16	SN16	H16	S-16	-	1	350	A-14	-	SM14	SN14	-	S-14	-
MAZDA	CX-9	07→	650	A-26	SP26	SM26	SN26	H26	S-26	-	280	A-16	-	SM16	SN16	H16	S-16	-	1	350	A-14	-	SM14	SN14	-	S-14	-
MAZDA	Demio [DW]	96→03	500	A-20	SP20	SM20	SN20	H20	S-20	-	280	A-16	-	SM16	SN16	H16	S-16	-	1	-	-	-	-	-	-	-	-
MAZDA	MPV [LW]	99→04	600	A-24	SP24	SM24	SN24	H24	S-24	-	280	A-24	SP24	SM24	SN24	H24	S-24	-	1	400	A-16	-	SM16	SN16	H16	S-16	-
MAZDA	MX-5 [NB]	98→05	450	A-18	SP18	SM18	SN18	H18	S-18	-	280	A-18	SP18	SM18	SN18	H18	S-18	-	1	-	-	-	-	-	-	-	-
MAZDA	MX-5 [NC]	05→	450	A-18	SP18	SM18	SN18	H18	S-18	-	280	A-18	SP18	SM18	SN18	H18	S-18	-	1	-	-	-	-	-	-	-	-

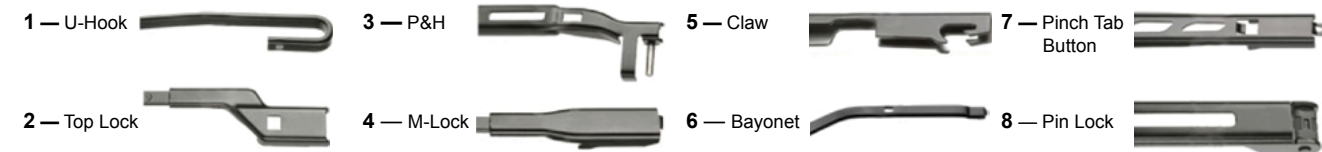

Производитель	Модель	Период выпуска	Сторона водителя (размер в мм)	AERODYNAMIC	SPOILER	SMART	SMART NEO	HYBRID	SNOWGUARD	SNOWGUARD POLAR	Сторона пассажира (размер в мм)	AERODYNAMIC	SPOILER	SMART	SMART NEO	HYBRID	SNOWGUARD	SNOWGUARD POLAR	Тип рычага для крепления щеток*	Заднее стекло (размер в мм)	AERODYNAMIC	SPOILER	SMART	SMART NEO	HYBRID	SNOWGUARD	SNOWGUARD POLAR
<b>MAZDA</b>																											
MAZDA	Premacy [CP]	99→05	600	A-24	SP24	SM24	SN24	H24	S-24	-	280	A-16	-	SM16	SN16	H16	S-16	-	1	340	A-14	-	SM14	SN14	-	S-14	-
MAZDA	RX-8 [FE,SE]	03→	500	A-20	SP20	SM20	SN20	H20	S-20	-	280	A-18	SP18	SM18	SN18	H18	S-18	-	1	-	-	-	-	-	-	-	-
MAZDA	Tribute [EP]	01→07	480	A-19	SP19	SM19	SN19	H19	S-19	-	280	A-19	SP19	SM19	SN19	H19	S-19	-	1	280	A-12	-	-	-	-	S-11	-
MAZDA	Tribute	08→11	500	-	-	-	SN20	-	-	SE20	280	-	-	-	SN20	-	-	SE20	4	-	-	-	-	-	-	-	-
MAZDA	Xedos-9 [TA]	93→02	530	A-21	SP21	SM21	SN21	H21	S-21	-	280	A-20	SP20	SM20	SN20	H20	S-20	-	1	-	-	-	-	-	-	-	-

<b>MERCEDES BENZ</b>																											
MERCEDES BENZ	A-Class [168]	97→04	650	A-26	SP26	SM26	SN26	H26	S-26	-	280	A-24	SP24	SM24	SN24	H24	S-24	-	1	350	A-14	-	SM14	SN14	-	S-14	-
MERCEDES BENZ	A-Class [169]	04→	650	-	-	-	SN26	-	-	SE26	280	-	-	-	SN24	-	-	SE24	4	300	-	-	-	-	-	-	-
MERCEDES BENZ	B-Class [245]	05→	650	-	-	-	SN26	-	-	SE26	280	-	-	-	SN22	-	-	SE22	4	300	-	-	-	-	-	-	-
MERCEDES BENZ	C-Class [202]	93→00	600	A-24	SP24	SM24	SN24	H24	S-24	-	280	-	-	-	-	-	-	-	1	-	-	-	-	-	-	-	-
MERCEDES BENZ	C-Class [203]	00→03	600	A-24	SP24	SM24	SN24	H24	S-24	-	280	A-22	SP22	SM22	SN22	H22	S-22	-	1	-	-	-	-	-	-	-	-
MERCEDES BENZ	C-Class [203]	03→07	550	-	-	-	-	-	-	-	280	-	-	-	-	-	-	-	8	-	-	-	-	-	-	-	-
MERCEDES BENZ	C-Class [W204]	07→08	600	-	-	-	SN24	H24	-	SE24	280	-	-	-	SN24	H24	-	SE24	3	-	-	-	-	-	-	-	-
MERCEDES BENZ	C-Class [W204]	08→	600	-	-	-	SN24	H24	-	SE24	280	-	-	-	SN24	H24	-	SE24	3	-	-	-	-	-	-	-	-
MERCEDES BENZ	C-Class Sportcoupe [203]	01→03	600	A-24	SP24	SM24	SN24	H24	S-24	-	280	A-22	SP22	SM22	SN22	H22	S-22	-	1	-	-	-	-	-	-	-	-
MERCEDES BENZ	C-Class Sportcoupe [203]	03→08	550	-	-	-	-	-	-	-	280	-	-	-	-	-	-	-	8	-	-	-	-	-	-	-	-
MERCEDES BENZ	C-Class Sportcoupe [204]	11→	600	-	-	-	SN24	H24	-	SE24	280	-	-	-	SN24	H24	-	SE24	3	-	-	-	-	-	-	-	-
MERCEDES BENZ	C-Class T-Modell [202]	96→01	600	A-24	SP24	SM24	SN24	H24	S-24	-	280	-	-	-	-	-	-	-	1	400	A-16	-	SM16	SN16	H16	S-16	-
MERCEDES BENZ	C-Class T-Modell [203]	01→03	600	A-24	SP24	SM24	SN24	H24	S-24	-	280	A-22	SP22	SM22	SN22	H22	S-22	-	1	400	A-16	-	SM16	SN16	H16	S-16	-
MERCEDES BENZ	C-Class T-Modell [203]	03→07	550	-	-	-	-	-	-	-	280	-	-	-	-	-	-	-	8	-	-	-	-	-	-	-	-
MERCEDES BENZ	C-Class T-Modell [S204]	07→08	600	-	-	-	SN24	H24	-	SE24	280	-	-	-	SN24	H24	-	SE24	3	290	-	-	-	-	-	-	-

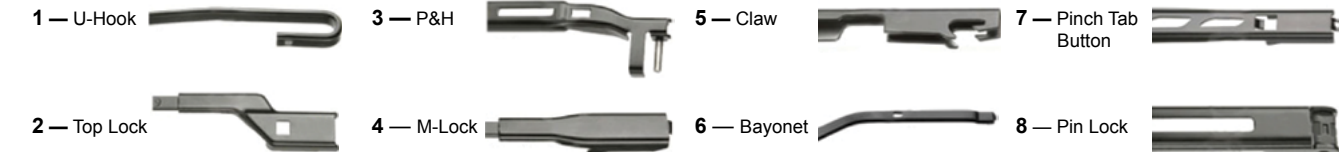

Производитель	Модель	Период выпуска	Сторона водителя (размер в мм)	AERODYNAMIC	SPOILER	SMART	SMART NEO	HYBRID	SNOWGUARD	SNOWGUARD POLAR	Сторона пассажира (размер в мм)	AERODYNAMIC	SPOILER	SMART	SMART NEO	HYBRID	SNOWGUARD	SNOWGUARD POLAR	Тип рычага для крепления щеток*	Заднее стекло (размер в мм)	AERODYNAMIC	SPOILER	SMART	SMART NEO	HYBRID	SNOWGUARD	SNOWGUARD POLAR
MERCEDES																											
MERCEDES BENZ	C-Class T-Modell [S204]	08→	600	-	-	-	-	-	-	-	280	-	-	-	-	-	-	-	-	8	290	-	-	-	-	-	-
MERCEDES BENZ	CL-Class [215]	99→06	680	-	-	-	-	-	-	SE28	280	-	-	-	-	-	-	SE28	3	-	-	-	-	-	-	-	-
MERCEDES BENZ	CL-Class [216]	06→	680	-	-	-	-	-	-	SE28	280	-	-	-	-	-	-	SE28	3	-	-	-	-	-	-	-	-
MERCEDES BENZ	CLC-Class [203]	08→	550	-	-	-	-	-	-	-	280	-	-	-	-	-	-	-	8	-	-	-	-	-	-	-	-
MERCEDES BENZ	CLK-Class [208]	97→02	600	A-24	SP24	SM24	SN24	H24	S-24	-	280	-	-	-	-	-	-	-	1	-	-	-	-	-	-	-	-
MERCEDES BENZ	CLK-Class [209]	02→	550	-	-	-	-	-	-	-	280	-	-	-	-	-	-	-	8	-	-	-	-	-	-	-	-
MERCEDES BENZ	CLK-Class Cabrio [208]	96→03	600	A-24	SP24	SM24	SN24	H24	S-24	-	280	-	-	-	-	-	-	-	1	-	-	-	-	-	-	-	-
MERCEDES BENZ	CLK-Class Cabrio [209]	03→	550	-	-	-	-	-	-	-	280	-	-	-	-	-	-	-	8	-	-	-	-	-	-	-	-
MERCEDES BENZ	CLS-Class [C219]	04→	650	-	-	-	SN26	H26	-	SE26	280	-	-	-	SN26	H26	-	SE26	3	-	-	-	-	-	-	-	-
MERCEDES BENZ	CLS-Class [C218]	11→	600	-	-	-	SN24	H24	-	SE24	280	-	-	-	SN24	H24	-	SE24	3	-	-	-	-	-	-	-	-
MERCEDES BENZ	E-Class [124]	93→96	600	A-24	SP24	SM24	SN24	H24	S-24	-	280	-	-	-	-	-	-	-	1	-	-	-	-	-	-	-	-
MERCEDES BENZ	E-Class [210]	95→03	600	A-24	SP24	SM24	SN24	H24	S-24	-	280	-	-	-	-	-	-	-	1	-	-	-	-	-	-	-	-
MERCEDES BENZ	E-Class [211]	02→	650	-	-	-	SN26	H26	-	SE26	280	-	-	-	SN26	H26	-	SE26	3	-	-	-	-	-	-	-	-
MERCEDES BENZ	E-Class [212]	08→	600	-	-	-	SN24	H24	-	SE24	280	-	-	-	SN24	H24	-	SE24	3	-	-	-	-	-	-	-	-
MERCEDES BENZ	E-Class Cabrio [A207]	10→	600	-	-	-	SN24	H24	-	SE24	280	-	-	-	SN24	H24	-	SE24	3	-	-	-	-	-	-	-	-
MERCEDES BENZ	E-Class Coupe [C207]	09→	600	-	-	-	SN24	H24	-	SE24	280	-	-	-	SN24	H24	-	SE24	3	-	-	-	-	-	-	-	-
MERCEDES BENZ	E-Class T-Model [210]	96→03	600	A-24	SP24	SM24	SN24	H24	S-24	-	280	-	-	-	-	-	-	-	1	400	A-16	-	SM16	SN16	H16	S-16	-
MERCEDES BENZ	E-Class T-Model [211]	03→	650	-	-	-	SN26	H26	-	SE26	280	-	-	-	SN26	H26	-	SE26	3	400	-	-	-	-	-	-	-
MERCEDES BENZ	G-Class [463]	89→	400	A-16	-	SM16	SN16	H16	S-16	-	280	A-16	-	SM16	SN16	H16	S-16	-	1	380	A-15	-	SM16	SN16	H16	S-16	-
MERCEDES BENZ	GL-Class [164]	06→	700	-	-	-	-	-	-	SE28	280	-	-	-	SN21	-	-	SE21	4	300	-	-	-	-	-	-	-
MERCEDES BENZ	GLK-Class [X204]	08→	550	-	-	-	SN22	H22	-	SE22	280	-	-	-	SN19	H19	-	SE19	3	300	-	-	-	-	-	-	-
MERCEDES BENZ	ML-Class [163]	98→05	550	A-22	SP22	SM22	SN22	H22	S-22	-	280	A-22	SP22	SM22	SN22	H22	S-22	-	1	400	A-16	-	SM16	SN16	H16	S-16	-

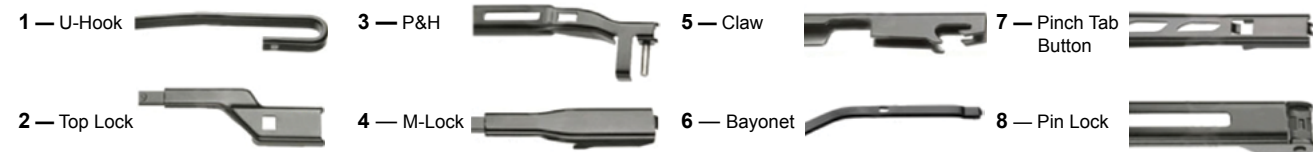

Производитель	Модель	Период выпуска	Сторона водителя (размер в мм)	AERODYNAMIC	SPOILER	SMART	SMART NEO	HYBRID	SNOWGUARD	SNOWGUARD POLAR	Сторона пассажира (размер в мм)	AERODYNAMIC	SPOILER	SMART	SMART NEO	HYBRID	SNOWGUARD	SNOWGUARD POLAR	Тип рычага для крепления щеток*	Заднее стекло (размер в мм)	AERODYNAMIC	SPOILER	SMART	SMART NEO	HYBRID	SNOWGUARD	SNOWGUARD POLAR
MERCEDES																											
MERCEDES BENZ	ML-Class [164]	05→	700	-	-	-	-	-	-	SE28	280	-	-	-	SN21	-	-	SE21	4	300	-	-	-	-	-	-	-
MERCEDES BENZ	R-Class [251]	06→	700	-	-	-	-	-	-	SE28	280	-	-	-	SN21	-	-	SE21	4	300	-	-	-	-	-	-	-
MERCEDES BENZ	S-Class [140]	91→98	700	A-28	-	-	-	-	S-28	-	280	A-26	SP26	SM26	SN26	H26	S-26	-	1	-	-	-	-	-	-	-	-
MERCEDES BENZ	S-Class [220]	98→05	650	-	-	-	SN26	H26	-	SE26	280	-	-	-	SN26	H26	-	SE26	3	-	-	-	-	-	-	-	-
MERCEDES BENZ	S-Class [221]	05→	680	-	-	-	-	-	-	SE28	280	-	-	-	-	-	-	SE28	3	-	-	-	-	-	-	-	-
MERCEDES BENZ	SL-Class [129]	93→01	600	A-24	SP24	SM24	SN24	H24	S-24	-	280	-	-	-	-	-	-	-	1	-	-	-	-	-	-	-	-
MERCEDES BENZ	SL-Class [230]	01→	650	-	-	-	SN26	H26	-	SE26	280	-	-	-	SN26	H26	-	SE26	3	-	-	-	-	-	-	-	-
MERCEDES BENZ	SLK-Class [170]	96→04	550	A-22	SP22	SM22	SN22	H22	S-22	-	280	A-22	SP22	SM22	SN22	H22	S-22	-	1	-	-	-	-	-	-	-	-
MERCEDES BENZ	SLK-Class [171]	04→	550	-	-	-	SN22	-	-	SE22	280	-	-	-	SN22	-	-	SE22	4	-	-	-	-	-	-	-	-
MERCEDES BENZ	SLK-Class [172]	11→	550	-	-	-	SN22	-	-	SE22	280	-	-	-	SN22	-	-	SE22	4	-	-	-	-	-	-	-	-
MERCEDES BENZ	SLR-Class [199]	04→	650	-	-	-	SN26	H26	-	SE26	280	-	-	-	SN26	H26	-	SE26	3	-	-	-	-	-	-	-	-
MERCEDES BENZ	Sprinter [T1N]	95→06	600	A-24	SP24	SM24	SN24	H24	S-24	-	280	A-22	SP22	SM22	SN22	H22	S-22	-	1	-	-	-	-	-	-	-	-
MERCEDES BENZ	Sprinter [w609,NCV3]	06→	650	-	-	-	SN26	-	-	SE26	280	-	-	-	SN24	-	-	SE24	4	-	-	-	-	-	-	-	-
MERCEDES BENZ	V-Class [638 T0N]	96→03	650	A-26	SP26	SM26	SN26	H26	S-26	-	280	A-22	SP22	SM22	SN22	H22	S-22	-	1	-	-	-	-	-	-	-	-
MERCEDES BENZ	Vaneo [414]	02→04	650	A-26	SP26	SM26	SN26	H26	S-26	-	280	A-24	SP24	SM24	SN24	H24	S-24	-	1	380	A-15	-	SM16	SN16	H16	S-16	-
MERCEDES BENZ	Vaneo [414]	04→05	650	-	-	-	SN26	-	-	SE26	280	-	-	-	SN24	-	-	SE24	4	380	-	-	-	-	-	-	-
MERCEDES BENZ	Vario [T2W]	96→	600	A-24	SP24	SM24	SN24	H24	S-24	-	280	-	-	-	-	-	-	-	1	-	-	-	-	-	-	-	-
MERCEDES BENZ	Viano [639 T0N]	03→05	700	A-28	-	-	-	-	S-28	-	280	A-26	SP26	SM26	SN26	H26	S-26	-	1	400	A-16	-	SM16	SN16	H16	S-16	-
MERCEDES BENZ	Viano [639 T0N]	05→	700	-	-	-	-	-	-	SE28	280	-	-	-	SN26	-	-	SE26	4	400	-	-	-	-	-	-	-
MERCEDES BENZ	Vito [638 T0N]	95→03	650	A-26	SP26	SM26	SN26	H26	S-26	-	280	A-22	SP22	SM22	SN22	H22	S-22	-	1	450	A-18	SP18	SM18	SN18	H18	S-18	-
MERCEDES BENZ	Vito [639 T0N]	03→05	700	A-28	-	-	-	-	S-28	-	280	A-26	SP26	SM26	SN26	H26	S-26	-	1	400	A-16	-	SM16	SN16	H16	S-16	-
MERCEDES BENZ	Vito [639 T0N]	05→	700	-	-	-	-	-	-	SE28	280	-	-	-	SN26	-	-	SE26	4	340	-	-	-	-	-	-	-

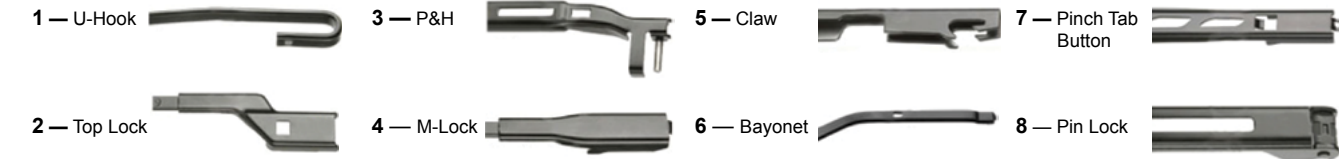







Производитель	Модель	Период выпуска	Сторона водителя (размер в мм)	AERODYNAMIC	SPOILER	SMART	SMART NEO	HYBRID	SNOWGUARD	SNOWGUARD POLAR	Сторона пассажира (размер в мм)	AERODYNAMIC	SPOILER	SMART	SMART NEO	HYBRID	SNOWGUARD	SNOWGUARD POLAR	Тип рычага для крепления цеток*	Заднее стекло (размер в мм)	AERODYNAMIC	SPOILER	SMART	SMART NEO	HYBRID	SNOWGUARD	SNOWGUARD POLAR
NISSAN																											
NISSAN	Primera Sedan [P11E]	96→01	530	A-21	SP21	SM21	SN21	H21	S-21	-	500	A-20	SP20	SM20	SN20	H20	S-20	-	1	300	A-12	-	-	-	-	S-11	-
NISSAN	Primera Sedan [P12E]	01→	650	A-26	SP26	SM26	SN26	H26	S-26	-	450	A-18	SP18	SM18	SN18	H18	S-18	-	1	-	-	-	-	-	-	-	-
NISSAN	Primera Wagon [WP11E]	98→01	530	A-21	SP21	SM21	SN21	H21	S-21	-	500	A-20	SP20	SM20	SN20	H20	S-20	-	1	400	A-16	-	SM16	SN16	H16	S-16	-
NISSAN	Primera Wagon [WP12E]	01→	650	A-26	SP26	SM26	SN26	H26	S-26	-	450	A-18	SP18	SM18	SN18	H18	S-18	-	1	400	A-16	-	SM16	SN16	H16	S-16	-
NISSAN	Qashqai [J10]	06→	600	-	-	-	SN24	-	-	-	380	-	-	-	SN15	-	-	SE15	4	300	-	-	-	-	-	-	-
NISSAN	Qashqai +2 [J10]	08→	600	-	-	-	SN24	-	-	-	380	-	-	-	SN15	-	-	SE15	4	300	-	-	-	-	-	-	-
NISSAN	Teana [J31]	03→08	600	A-24	SP24	SM24	SN24	H24	S-24	-	480	A-19	SP19	SM19	SN19	H19	S-19	-	1	-	-	-	-	-	-	-	-
NISSAN	Teana [J32]	08→	650	A-26	SP26	SM26	SN26	H26	S-26	-	450	A-18	SP18	SM18	SN18	H18	S-18	-	1	-	-	-	-	-	-	-	-
NISSAN	Terrano II [R20]	96→06	530	A-21	SP21	SM21	SN21	H21	S-21	-	500	A-20	SP20	SM20	SN20	H20	S-20	-	1	340	A-14	-	SM14	SN14	-	S-14	-
NISSAN	Tiida Sedan [C11]	07→	600	A-24	SP24	SM24	SN24	H24	S-24	-	350	A-14	-	SM14	SN14	-	S-14	-	1	-	-	-	-	-	-	-	-
NISSAN	Tiida Hatchback [C11]	07→	600	A-24	SP24	SM24	SN24	H24	S-24	-	350	A-14	-	SM14	SN14	-	S-14	-	1	350	A-14	-	SM14	SN14	-	S-14	-
NISSAN	Tiida Latio	04→	600	A-24	SP24	SM24	SN24	H24	S-24	-	350	A-14	-	SM14	SN14	-	S-14	-	1	-	-	-	-	-	-	-	-
NISSAN	X-Trail [T30]	01→	600	A-24	SP24	SM24	SN24	H24	S-24	-	400	A-16	-	SM16	SN16	H16	S-16	-	1	350	A-14	-	SM14	SN14	-	S-14	-
NISSAN	X-Trail [T31]	07→	600	A-24	SP24	SM24	SN24	H24	S-24	-	400	A-16	-	SM16	SN16	H16	S-16	-	1	350	A-14	-	SM14	SN14	-	S-14	-

OPEL																											
OPEL	Agila [A]	00→08	500	A-20	SP20	SM20	SN20	H20	S-20	-	450	A-18	SP18	SM18	SN18	H18	S-18	-	1	340	A-14	-	SM14	SN14	-	S-14	-
OPEL	Agila [B]	08→	550	A-22	SP22	SM22	SN22	H22	S-22	-	400	A-16	-	SM16	SN16	H16	S-16	-	1	-	-	-	-	-	-	-	-
OPEL	Antara	06→	600	A-24	SP24	SM24	SN24	H24	S-24	-	400	A-16	-	SM16	SN16	H16	S-16	-	1	300	A-12	-	-	-	-	S-11	-
OPEL	Astra Classic [F-Classiс]	97→00	500	A-20	SP20	SM20	SN20	H20	S-20	-	480	A-19	SP19	SM19	SN19	H19	S-19	-	1	400	A-16	-	SM16	SN16	H16	S-16	-
OPEL	Astra [G]	97→05	500	A-20	SP20	SM20	SN20	H20	S-20	-	480	A-19	SP19	SM19	SN19	H19	S-19	-	1	400	A-16	-	SM16	SN16	H16	S-16	-

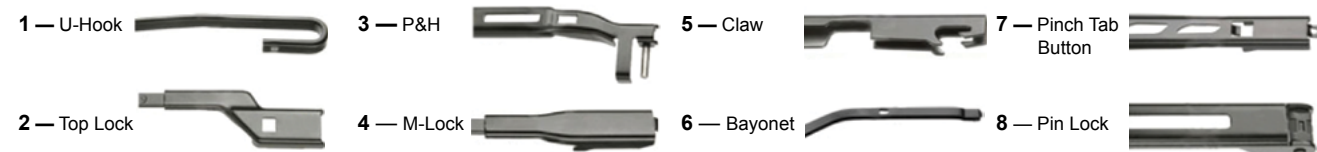

Производитель	Модель	Период выпуска	Сторона водителя (размер в мм)	AERODYNAMIC	SPOILER	SMART	SMART NEO	HYBRID	SNOWGUARD	SNOWGUARD POLAR	Сторона пассажира (размер в мм)	AERODYNAMIC	SPOILER	SMART	SMART NEO	HYBRID	SNOWGUARD	SNOWGUARD POLAR	Тип рычага для крепления цеток*	Заднее стекло (размер в мм)	AERODYNAMIC	SPOILER	SMART	SMART NEO	HYBRID	SNOWGUARD	SNOWGUARD POLAR
OPEL																											
OPEL	Astra [H]	04→	550	-	-	-	SN22	H22	-	SE22	450	-	-	-	SN18	H18	-	SE18	3	290	-	-	-	-	-	-	-
OPEL	Astra [J]	09→	650	-	-	-	SN26	-	-	SE26	600	-	-	-	SN24	-	-	SE24	2	-	-	-	-	-	-	-	-
OPEL	Astra Cabrio [G]	97→05	500	A-20	SP20	SM20	SN20	H20	S-20	-	480	A-19	SP19	SM19	SN19	H19	S-19	-	1	-	-	-	-	-	-	-	-
OPEL	Astra Caravan Classic [F-Classiс]	97→00	500	A-20	SP20	SM20	SN20	H20	S-20	-	480	A-19	SP19	SM19	SN19	H19	S-19	-	1	400	A-16	-	SM16	SN16	H16	S-16	-
OPEL	Astra Caravan [G]	97→04	500	A-20	SP20	SM20	SN20	H20	S-20	-	480	A-19	SP19	SM19	SN19	H19	S-19	-	1	290	A-12	-	-	-	-	S-11	-
OPEL	Astra Caravan [H]	04→	550	A-22	SP22	SM22	SN22	H22	S-22	-	450	A-18	SP18	SM18	SN18	H18	S-18	-	1	290	A-12	-	-	-	-	S-11	-
OPEL	Astra Coupe [G]	97→05	500	A-20	SP20	SM20	SN20	H20	S-20	-	480	A-19	SP19	SM19	SN19	H19	S-19	-	1	400	A-16	-	SM16	SN16	H16	S-16	-
OPEL	Astra GTC [H]	05→	550	-	-	-	SN22	H22	-	SE22	450	-	-	-	SN18	H18	-	SE18	3	230	-	-	-	-	-	-	-
OPEL	Astra GTC [J]	11→	730	-	-	-	-	-	-	SE28	630	-	-	-	SN26	-	-	SE26	4	-	-	-	-	-	-	-	-
OPEL	Astra Sports Tourer [J]	10→	680	-	-	-	-	-	-	SE28	630	-	-	-	SN26	-	-	SE26	2	-	-	-	-	-	-	-	-
OPEL	Astra TwinTop [H]	05→	550	-	-	-	SN22	H22	-	SE22	450	-	-	-	SN18	H18	-	SE18	3	-	-	-	-	-	-	-	-
OPEL	Combo	94→01	450	A-18	SP18	SM18	SN18	H18	S-18	-	450	A-18	SP18	SM18	SN18	H18	S-18	-	1	340	A-14	-	SM14	SN14	-	S-14	-
OPEL	Combo [Tour]	01→	450	A-18	SP18	SM18	SN18	H18	S-18	-	450	A-18	SP18	SM18	SN18	H18	S-18	-	1	340	A-14	-	SM14	SN14	-	S-14	-
OPEL	Corsa [C]	00→06	500	A-20	SP20	SM20	SN20	H20	S-20	-	450	A-18	SP18	SM18	SN18	H18	S-18	-	1	400	A-16	-	SM16	SN16	H16	S-16	-
OPEL	Corsa [D]	06→	650	-	-	-	SN26	-	-	SE26	400	-	-	-	SN16	-	-	SE16	4	300	-	-	-	-	-	-	-
OPEL	Frontera [A,B]	91→04	480	A-19	SP19	SM19	SN19	H19	S-19	-	480	A-19	SP19	SM19	SN19	H19	S-19	-	1	-	-	-	-	-	-	-	-
OPEL	GT [B]	07→	550	A-22	SP22	SM22	SN22	H22	S-22	-	400	A-16	-	SM16	SN16	H16	S-16	-	1	-	-	-	-	-	-	-	-
OPEL	Insignia Hatchback [69]	08→	600	-	-	-	SN24	-	-	SE24	450	-	-	-	SN18	-	-	SE18	4	500	-	-	-	-	-	-	-
OPEL	Insignia Sedan [68]	08→	600	A-24	SP24	SM24	SN24	H24	S-24	-	450	A-18	SP18	SM18	SN18	H18	S-18	-	1	-	-	-	-	-	-	-	-
OPEL	Insignia Sports Tourer [35]	09→	600	A-24	SP24	SM24	SN24	H24	S-24	-	450	A-18	SP18	SM18	SN18	H18	S-18	-	1	300	A-12	-	-	-	-	S-11	-
OPEL	Meriva	03→	600	A-24	SP24	SM24	SN24	H24	S-24	-	600	A-24	SP24	SM24	SN24	H24	S-24	-	1	400	A-16	-	SM16	SN16	H16	S-16	-
OPEL	Meriva [B]	10→	680	-	-	-	-	-	-	SE28	580	-	-	-	SN24	-	-	SE24	2	400	-	-	-	-	-	-	-
OPEL	Movano	98→	600	A-24	SP24	SM24	SN24	H24	S-24	-	600	A-24	SP24	SM24	SN24	H24	S-24	-	1	-	-	-	-	-	-	-	-

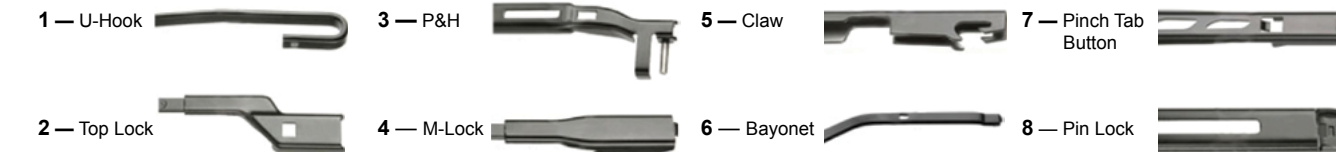



Производитель	Модель	Период выпуска	Сторона водителя (размер в мм)	AERODYNAMIC	SPOILER	SMART	SMART NEO	HYBRID	SNOWGUARD	SNOWGUARD POLAR	Сторона пассажира (размер в мм)	AERODYNAMIC	SPOILER	SMART	SMART NEO	HYBRID	SNOWGUARD	SNOWGUARD POLAR	Тип рычага для крепления щеток*	Заднее стекло (размер в мм)	AERODYNAMIC	SPOILER	SMART	SMART NEO	HYBRID	SNOWGUARD	SNOWGUARD POLAR
<b>OPEL</b>																											
OPEL	Movano [B]	10→	650	A-26	SP26	SM26	SN26	H26	S-26	-	650	A-26	SP26	SM26	SN26	H26	S-26	-	1	-	-	-	-	-	-	-	-
OPEL	Omega [B]	93→03	600	A-24	SP24	SM24	SN24	H24	S-24	-	480	A-19	SP19	SM19	SN19	H19	S-19	-	1	340	A-14	-	SM14	SN14	-	S-14	-
OPEL	Signum	03→08	600	A-24	SP24	SM24	SN24	H24	S-24	-	480	A-19	SP19	SM19	SN19	H19	S-19	-	1	-	-	-	-	-	-	-	-
OPEL	Tigra TwinTop [B]	04→	500	A-20	SP20	SM20	SN20	H20	S-20	-	450	A-18	SP18	SM18	SN18	H18	S-18	-	1	-	-	-	-	-	-	-	-
OPEL	Vectra [B]	95→03	480	A-19	SP19	SM19	SN19	H19	S-19	-	480	A-19	SP19	SM19	SN19	H19	S-19	-	1	480	A-19	SP19	SM19	SN19	H19	S-19	-
OPEL	Vectra [C]	01→08	600	A-24	SP24	SM24	SN24	H24	S-24	-	480	A-19	SP19	SM19	SN19	H19	S-19	-	1	400	A-16	-	SM16	SN16	H16	S-16	-
OPEL	Vectra Caravan [B]	95→03	480	A-19	SP19	SM19	SN19	H19	S-19	-	480	A-19	SP19	SM19	SN19	H19	S-19	-	1	340	A-14	-	SM14	SN14	-	S-14	-
OPEL	Vectra Caravan [C]	03→08	600	A-24	SP24	SM24	SN24	H24	S-24	-	480	A-19	SP19	SM19	SN19	H19	S-19	-	1	380	A-15	-	SM16	SN16	H16	S-16	-
OPEL	Vivaro	01→	600	A-24	SP24	SM24	SN24	H24	S-24	-	530	A-21	SP21	SM21	SN21	H21	S-21	-	1	400	A-16	-	SM16	SN16	H16	S-16	-
OPEL	Zafira [A]	99→05	600	A-24	SP24	SM24	SN24	H24	S-24	-	550	A-22	SP22	SM22	SN22	H22	S-22	-	1	400	A-16	-	SM16	SN16	H16	S-16	-
OPEL	Zafira [B]	05→	700	-	-	-	-	-	SE28	550	-	-	-	SN22	H22	-	SE22	3	350	-	-	-	-	-	-	-	-

<b>PEUGEOT</b>																												
PEUGEOT	1007 [A8]	05→	600	A-24	SP24	SM24	SN24	H24	S-24	-	450	A-18	SP18	SM18	SN18	H18	S-18	-	1	300	A-12	-	-	-	-	S-11	-	
PEUGEOT	106 [S2]	95→05	500	A-20	SP20	SM20	SN20	H20	S-20	-	450	A-18	SP18	SM18	SN18	H18	S-18	-	1	350	A-14	-	SM14	SN14	-	S-14	-	
PEUGEOT	107 [B0]	05→	650	A-26	SP26	SM26	SN26	H26	S-26	-	-	-	-	-	-	-	-	-	1	300	A-12	-	-	-	-	S-11	-	
PEUGEOT	206 [T1]	98→09	650	A-26	SP26	SM26	SN26	H26	S-26	-	400	A-16	-	SM16	SN16	H16	S-16	-	1	350	A-14	-	SM14	SN14	-	S-14	-	
PEUGEOT	206 CC [T1]	00→07	650	A-26	SP26	SM26	SN26	H26	S-26	-	400	A-16	-	SM16	SN16	H16	S-16	-	1	-	-	-	-	-	-	-	-	
PEUGEOT	206 SW [T1]	02→06	650	-	-	-	SN26	H26	-	SE26	400	-	-	-	SN16	H16	-	SE16	3	350	-	-	-	-	-	-	-	
PEUGEOT	206+ [T3]	09→	650	-	-	-	SN26	-	-	SE26	400	-	-	-	SN16	-	-	SE16	2	350	-	-	-	-	-	-	-	
PEUGEOT	207 [A7]	06→	650	-	-	-	SN26	H26	-	SE26	430	-	-	-	SN17	-	-	SE17	3	400	-	-	-	-	-	-	-	
PEUGEOT	207 CC [A7]	07→	650	-	-	-	SN26	H26	-	SE26	430	-	-	-	SN17	-	-	SE17	3	-	-	-	-	-	-	-	-	
PEUGEOT	207 SW [A7]	07→	650	-	-	-	SN26	H26	-	SE26	430	-	-	-	SN17	-	-	SE17	3	300	-	-	-	-	-	-	-	-

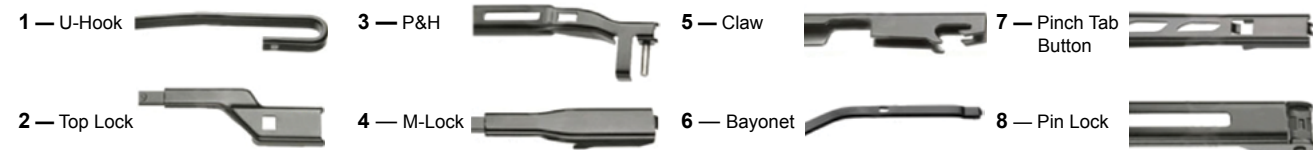

Производитель	Модель	Период выпуска	Сторона водителя (размер в мм)	AERODYNAMIC	SPOILER	SMART	SMART NEO	HYBRID	SNOWGUARD	SNOWGUARD POLAR	Сторона пассажира (размер в мм)	AERODYNAMIC	SPOILER	SMART	SMART NEO	HYBRID	SNOWGUARD	SNOWGUARD POLAR	Тип рычага для крепления щеток*	Заднее стекло (размер в мм)	AERODYNAMIC	SPOILER	SMART	SMART NEO	HYBRID	SNOWGUARD	SNOWGUARD POLAR
<b>PEUGEOT</b>																											
PEUGEOT	3008 [T8]	09→	800	-	-	-	-	-	-	-	680	-	-	-	-	-	-	SE28	2	300	-	-	-	-	-	-	-
PEUGEOT	306 [N5]	97→03	550	A-22	SP22	SM22	SN22	H22	S-22	-	500	A-20	SP20	SM20	SN20	H20	S-20	-	1	400	A-16	-	SM16	SN16	H16	S-16	-
PEUGEOT	306 Break [N5]	97→02	550	A-22	SP22	SM22	SN22	H22	S-22	-	500	A-20	SP20	SM20	SN20	H20	S-20	-	1	400	A-16	-	SM16	SN16	H16	S-16	-
PEUGEOT	306 Cabriolet [N3,N5]	93→03	550	A-22	SP22	SM22	SN22	H22	S-22	-	500	A-20	SP20	SM20	SN20	H20	S-20	-	1	-	-	-	-	-	-	-	-
PEUGEOT	307 [T5]	00→05	700	A-28	-	-	-	-	S-28	-	650	A-26	SP26	SM26	SN26	H26	S-26	-	1	350	A-14	-	SM14	SN14	-	S-14	-
PEUGEOT	307 [T5]	04→05	700	-	-	-	-	-	-	SE28	650	-	-	-	SN26	-	-	SE26	4	350	-	-	-	-	-	-	-
PEUGEOT	307 [T6]	05→07	700	-	-	-	-	-	-	SE28	650	-	-	-	SN26	-	-	SE26	4	350	-	-	-	-	-	-	-
PEUGEOT	307 Break/SW [T5]	02→05	700	A-28	-	-	-	-	S-28	-	650	A-26	SP26	SM26	SN26	H26	S-26	-	1	350	A-14	-	SM14	SN14	-	S-14	-
PEUGEOT	307 Break/SW [T5]	04→05	700	-	-	-	-	-	-	SE28	650	-	-	-	SN26	-	-	SE26	4	350	-	-	-	-	-	-	-
PEUGEOT	307 Break/SW [T6]	05→08	700	-	-	-	-	-	-	SE28	650	-	-	-	SN26	-	-	SE26	4	350	-	-	-	-	-	-	-
PEUGEOT	307 CC [T5]	03→05	700	-	-	-	-	-	-	SE28	600	-	-	-	SN24	-	-	SE24	4	-	-	-	-	-	-	-	-
PEUGEOT	307 CC [T6]	05→	700	-	-	-	-	-	-	SE28	650	-	-	-	SN26	-	-	SE26	4	-	-	-	-	-	-	-	-
PEUGEOT	308 [T7]	07→	750	-	-	-	-	-	-	-	650	-	-	-	SN26	-	-	SE26	2	300	-	-	-	-	-	-	-
PEUGEOT	308 CC [T7]	09→	750	-	-	-	-	-	-	-	650	-	-	-	SN26	-	-	SE26	2	-	-	-	-	-	-	-	-
PEUGEOT	308 SW [T7]	08→	750	-	-	-	-	-	-	-	650	-	-	-	SN26	-	-	SE26	2	300	-	-	-	-	-	-	-
PEUGEOT	4007 [I3]	07→	600	A-24	SP24	SM24	SN24	H24	S-24	-	530	A-21	SP21	SM21	SN21	H21	S-21	-	1	300	A-12	-	-	-	-	S-11	-
PEUGEOT	406 [D8,D9]	95→04	600	A-24	SP24	SM24	SN24	H24	S-24	-	530	A-21	SP21	SM21	SN21	H21	S-21	-	1	450	A-18	SP18	SM18	SN18	H18	S-18	-
PEUGEOT	406 Break [D9]	99→04	600	A-24	SP24	SM24	SN24	H24	S-24	-	530	A-21	SP21	SM21	SN21	H21	S-21	-	1	350	A-14	-	SM14	SN14	-	S-14	-
PEUGEOT	406 Coupe [D8,D9]	97→05	650	A-26	SP26	SM26	SN26	H26	S-26	-	450	A-18	SP18	SM18	SN18	H18	S-18	-	1	-	-	-	-	-	-	-	-
PEUGEOT	407 [D2]	04→	700	-	-	-	-	-	-	SE28	700	-	-	-	-	-	-	SE28	3	-	-	-	-	-	-	-	-
PEUGEOT	407 Coupe [D2]	05→	700	-	-	-	-	-	-	SE28	700	-	-	-	-	-	-	SE28	3	-	-	-	-	-	-	-	-
PEUGEOT	407 SW [D2]	04→	700	-	-	-	-	-	-	SE28	700	-	-	-	-	-	-	SE28	3	290	-	-	-	-	-	-	-
PEUGEOT	5008	09→	800	-	-	-	-	-	-	-	680	-	-	-	-	-	-	SE28	2	290	-	-	-	-	-	-	-

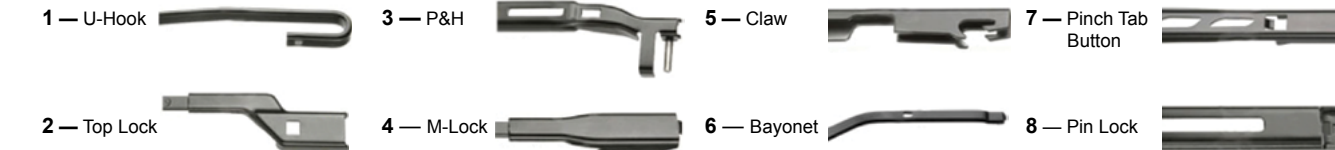

Производитель	Модель	Период выпуска	Сторона водителя (размер в мм)	AERODYNAMIC	SPOILER	SMART	SMART NEO	HYBRID	SNOWGUARD	SNOWGUARD POLAR	Сторона пассажира (размер в мм)	AERODYNAMIC	SPOILER	SMART	SMART NEO	HYBRID	SNOWGUARD	SNOWGUARD POLAR	Тип рычага для крепления щеток*	Заднее стекло (размер в мм)	AERODYNAMIC	SPOILER	SMART	SMART NEO	HYBRID	SNOWGUARD	SNOWGUARD POLAR
<b>PEUGEOT</b>																											
PEUGEOT	508	10→	650	-	-	-	SN26	-	-	SE26	650	-	-	-	SN26	-	-	SE26	2	-	-	-	-	-	-	-	-
PEUGEOT	508 SW	10→	650	-	-	-	SN26	-	-	SE26	650	-	-	-	SN26	-	-	SE26	2	300	-	-	-	-	-	-	-
PEUGEOT	607 [Z8,Z9]	00→	650	A-26	SP26	-	SN26	-	S-26	-	530	A-21	SP21	-	SN21	-	S-21	-	6	-	-	-	-	-	-	-	-
PEUGEOT	806 [U60]	94→02	650	A-26	SP26	SM26	SN26	H26	S-26	-	500	A-20	SP20	SM20	SN20	H20	S-20	-	1	400	A-16	-	SM16	SN16	H16	S-16	-
PEUGEOT	807 [V2]	02→05	650	A-26	SP26	SM26	SN26	H26	S-26	-	650	A-26	SP26	SM26	SN26	H26	S-26	-	1	350	A-14	-	SM14	SN14	-	S-14	-
PEUGEOT	807 [V2]	05→	650	A-26	SP26	SM26	SN26	H26	S-26	-	650	A-26	SP26	SM26	SN26	H26	S-26	-	1	350	A-14	-	SM14	SN14	-	S-14	-
PEUGEOT	Bipper [AA]	08→	650	A-26	SP26	-	SN26	-	S-26	-	480	A-19	SP19	-	SN19	-	S-19	-	6	-	-	-	-	-	-	-	-
PEUGEOT	Boxer [U3]	94→02	550	A-22	SP22	SM22	SN22	H22	S-22	-	530	A-21	SP21	SM21	SN21	H21	S-21	-	1	-	-	-	-	-	-	-	-
PEUGEOT	Boxer [U5]	02→	550	A-22	SP22	SM22	SN22	H22	S-22	-	530	A-21	SP21	SM21	SN21	H21	S-21	-	1	-	-	-	-	-	-	-	-
PEUGEOT	Boxer [U9]	06→	650	-	-	-	SN26	-	-	SE26	530	-	-	-	SN21	-	-	SE21	2	-	-	-	-	-	-	-	-
PEUGEOT	Expert [U64]	95→06	650	A-26	SP26	SM26	SN26	H26	S-26	-	450	A-18	SP18	SM18	SN18	H18	S-18	-	1	-	-	-	-	-	-	-	-
PEUGEOT	Expert [G9]	07→	650	A-26	SP26	SM26	SN26	H26	S-26	-	500	A-20	SP20	SM20	SN20	H20	S-20	-	1	350	A-14	-	SM14	SN14	-	S-14	-
PEUGEOT	Partner [M4]	96→02	550	A-22	SP22	SM22	SN22	H22	S-22	-	530	A-21	SP21	SM21	SN21	H21	S-21	-	1	400	A-16	-	SM16	SN16	H16	S-16	-
PEUGEOT	Partner [M5]	02→	550	A-22	SP22	SM22	SN22	H22	S-22	-	530	A-21	SP21	SM21	SN21	H21	S-21	-	1	350	A-14	-	SM14	SN14	-	S-14	-
PEUGEOT	Partner [B9]	08→	650	-	-	-	SN26	-	-	SE26	400	-	-	-	SN16	-	-	SE16	2	350	-	-	-	-	-	-	-
PEUGEOT	RCZ	10→	650	-	-	-	SN26	-	-	SE26	650	-	-	-	SN26	-	-	SE26	2	-	-	-	-	-	-	-	-
<b>PORSCHE</b>																											
PORSCHE	911 [996]	97→04	550	A-22	SP22	SM22	SN22	H22	S-22	-	530	A-21	SP21	SM21	SN21	H21	S-21	-	1	550	A-22	SP22	SM22	SN22	H22	S-22	-
PORSCHE	911 [996T/GT2,3]	99→05	550	A-22	SP22	SM22	SN22	H22	S-22	-	530	A-21	SP21	SM21	SN21	H21	S-21	-	1	550	A-22	SP22	SM22	SN22	H22	S-22	-
PORSCHE	911 [997,997 GT3]	04→	550	A-22	SP22	SM22	SN22	H22	S-22	-	530	A-21	SP21	SM21	SN21	H21	S-21	-	1	-	-	-	-	-	-	-	-
PORSCHE	Boxster [986,987]	96→09	550	A-22	SP22	SM22	SN22	H22	S-22	-	530	A-21	SP21	SM21	SN21	H21	S-21	-	1	-	-	-	-	-	-	-	-
PORSCHE	Cayenne [955, 9PA]	02→07	650	A-26	SP26	SM26	SN26	H26	S-26	-	650	A-26	SP26	SM26	SN26	H26	S-26	-	1	340	A-14	-	SM14	SN14	-	S-14	-
PORSCHE	Cayenne [957, 9PA]	07→	650	-	-	-	SN26	H26	-	SE26	650	-	-	-	SN26	H26	-	SE26	3	340	-	-	-	-	-	-	-

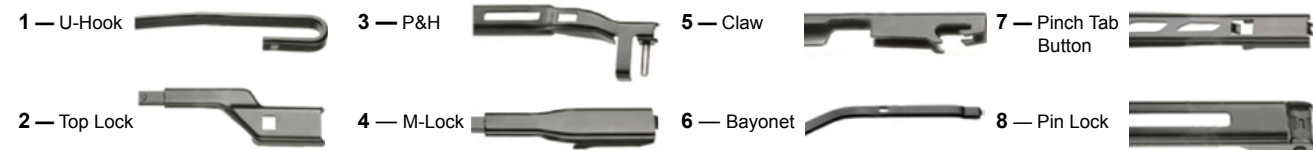

Производитель	Модель	Период выпуска	Сторона водителя (размер в мм)	AERODYNAMIC	SPOILER	SMART	SMART NEO	HYBRID	SNOWGUARD	SNOWGUARD POLAR	Сторона пассажира (размер в мм)	AERODYNAMIC	SPOILER	SMART	SMART NEO	HYBRID	SNOWGUARD	SNOWGUARD POLAR	Тип рычага для крепления щеток*	Заднее стекло (размер в мм)	AERODYNAMIC	SPOILER	SMART	SMART NEO	HYBRID	SNOWGUARD	SNOWGUARD POLAR
<b>PORSCHE</b>																											
PORSCHE	Cayenne [958]	10→	650	-	-	-	SN26	H26	-	SE26	650	-	-	-	SN26	H26	-	SE26	3	-	-	-	-	-	-	-	-
PORSCHE	Cayman [987C]	05→09	550	A-22	SP22	SM22	SN22	H22	S-22	-	550	A-22	SP22	SM22	SN22	H22	S-22	-	1	-	-	-	-	-	-	-	-
PORSCHE	Panamera	09→	600	A-24	SP24	SM24	SN24	H24	S-24	-	530	A-21	SP21	SM21	SN21	H21	S-21	-	1	-	-	-	-	-	-	-	-
<b>RENAULT</b>																											
RENAULT	19 [X53]	89→01	500	A-20	SP20	SM20	SN20	H20	S-20	-	500	A-20	SP20	SM20	SN20	H20	S-20	-	1	-	-	-	-	-	-	-	-
RENAULT	Avantime [XEO]	01→03	650	A-26	SP26	SM26	SN26	H26	S-26	-	450	A-18	SP18	SM18	SN18	H18	S-18	-	1	450	A-18	SP18	SM18	SN18	H18	S-18	-
RENAULT	Clio II [BB/CB/SB]	98→07	530	A-21	SP21	SM21	SN21	H21	S-21	-	400	A-16	-	SM16	SN16	H16	S-16	-	1	300	A-12	-	-	-	-	S-11	-
RENAULT	Clio III [BR/CR]	05→07	600	A-24	SP24	-	SN24	-	S-24	-	400	A-16	-	-	SN16	-	S-16	-	6	350	A-14	-	-	SN14	-	S-14	-
RENAULT	Clio III [BR/CR]	07→	600	A-24	SP24	-	SN24	-	S-24	-	400	A-16	-	-	SN16	-	S-16	-	6	300	A-12	-	-	-	-	S-11	-
RENAULT	Clio III Grandtour [KR]	07→	600	A-24	SP24	-	SN24	-	S-24	-	400	A-16	-	-	SN16	-	S-16	-	6	300	A-12	-	-	-	-	S-11	-
RENAULT	Espace III [JE0]	96→02	650	A-26	SP26	SM26	SN26	H26	S-26	-	450	A-18	SP18	SM18	SN18	H18	S-18	-	1	400	A-16	-	SM16	SN16	H16	S-16	-
RENAULT	Espace IV [JK0]	02→	750	-	-	-	-	-	-	-	680	-	-	-	-	-	-	SE28	3	350	-	-	-	-	-	-	-
RENAULT	Fluence [L30]	10→	650	A-26	SP26	-	SN26	-	S-26	-	400	A-16	-	-	SN16	-	S-16	-	6	-	-	-	-	-	-	-	-
RENAULT	Kangoo I [FC/KC]	97→07	500	A-20	SP20	SM20	SN20	H20	S-20	-	500	A-20	SP20	SM20	SN20	H20	S-20	-	1	340	A-14	-	SM14	SN14	-	S-14	-
RENAULT	Kangoo II [FW/KW]	08→	550	A-22	SP22	SM22	SN22	H22	S-22	-	530	A-21	SP21	SM21	SN21	H21	S-21	-	1	350	A-14	-	SM14	SN14	-	S-14	-
RENAULT	Koleos [HY]	08→	600	-	-	-	SN24	-	-	SE24	480	-	-	-	SN19	-	-	SE19	4	400	-	-	-	-	-	-	-
RENAULT	Laguna I [B56,556]	94→01	600	A-24	SP24	SM24	SN24	H24	S-24	-	450	A-18	SP18	SM18	SN18	H18	S-18	-	1	550	A-22	SP22	SM22	SN22	H22	S-22	-
RENAULT	Laguna II [BG]	01→07	600	A-24	SP24	SM24	SN24	H24	S-24	-	500	A-20	SP20	SM20	SN20	H20	S-20	-	1	500	A-20	SP19	SM19	SN19	H19	S-19	-
RENAULT	Laguna III [BT]	07→	-	-	-	-	-	-	-	-	-	-	-	-	-	-	-	-	1	350	A-14	-	SM14	SN14	-	S-14	-
RENAULT	Laguna Coupe III [DT]	08→	650	A-26	SP26	-	SN26	-	S-26	-	400	A-16	-	-	SN16	-	S-16	-	6	-	-	-	-	-	-	-	-
RENAULT	Laguna I Grandtour [A56,K56,S56]	95→01	600	A-24	SP24	SM24	SN24	H24	S-24	-	450	A-18	SP18	SM18	SN18	H18	S-18	-	1	340	A-14	-	SM14	SN14	-	S-14	-
RENAULT	Laguna II Grandtour [KG]	01→07	600	A-24	SP24	SM24	SN24	H24	S-24	-	500	A-20	SP20	SM20	SN20	H20	S-20	-	1	350	A-14	-	SM14	SN14	-	S-14	-

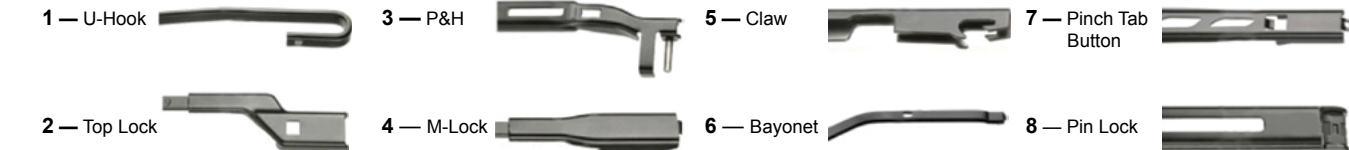







Производитель	Модель	Период выпуска	Сторона водителя (размер в мм)	AERODYNAMIC	SPOILER	SMART	SMART NEO	HYBRID	SNOWGUARD	SNOWGUARD POLAR	Сторона пассажира (размер в мм)	AERODYNAMIC	SPOILER	SMART	SMART NEO	HYBRID	SNOWGUARD	SNOWGUARD POLAR	Тип рычага для крепления щеток*	Заднее стекло (размер в мм)	AERODYNAMIC	SPOILER	SMART	SMART NEO	HYBRID	SNOWGUARD	SNOWGUARD POLAR
<b>SKODA</b>																											
SKODA	Fabia [6Y2]	99→08	530	A-21	SP21	SM21	SN21	H21	S-21	-	480	A-19	SP19	SM19	SN19	H19	S-19	-	1	350	A-14	-	SM14	SN14	-	S-14	-
SKODA	Fabia [5J2]	06→	530	-	-	-	SN21	-	-	SE21	530	-	-	-	SN21	-	-	SE21	2	330	-	-	-	-	-	-	-
SKODA	Fabia Combi [6Y5]	99→07	530	A-21	SP21	SM21	SN21	H21	S-21	-	480	A-19	SP19	SM19	SN19	H19	S-19	-	1	350	A-14	-	SM14	SN14	-	S-14	-
SKODA	Fabia Combi [5J5]	06→	530	-	-	-	SN21	-	-	SE21	530	-	-	-	SN21	-	-	SE21	2	400	-	-	-	-	-	-	-
SKODA	Fabia [6Y3]	99→07	530	A-21	SP21	SM21	SN21	H21	S-21	-	480	A-19	SP19	SM19	SN19	H19	S-19	-	1	-	-	-	-	-	-	-	-
SKODA	Felicia [6U1]	94→01	500	A-20	SP20	SM20	SN20	H20	S-20	-	480	A-19	SP19	SM19	SN19	H19	S-19	-	1	400	A-16	-	SM16	SN16	H16	S-16	-
SKODA	Felicia Combi [6U5]	94→01	500	A-20	SP20	SM20	SN20	H20	S-20	-	480	A-19	SP19	SM19	SN19	H19	S-19	-	1	400	A-16	-	SM16	SN16	H16	S-16	-
SKODA	Octavia [1U2]	96→	530	A-21	SP21	SM21	SN21	H21	S-21	-	480	A-19	SP19	SM19	SN19	H19	S-19	-	1	-	-	-	-	-	-	-	-
SKODA	Octavia [A5, 1Z3]	04→	600	-	-	-	SN24	H24	-	SE24	480	-	-	-	SN19	H19	-	SE19	3	400	-	-	-	-	-	-	-
SKODA	Octavia Combi [1U5]	96→	530	A-21	SP21	SM21	SN21	H21	S-21	-	480	A-19	SP19	SM19	SN19	H19	S-19	-	1	340	A-14	-	SM14	SN14	-	S-14	-
SKODA	Octavia Combi [1Z5]	04→	600	-	-	-	SN24	H24	-	SE24	480	-	-	-	SN19	H19	-	SE19	3	400	-	-	-	-	-	-	-
SKODA	Octavia Tour [1U]	96→10	530	A-21	SP21	SM21	SN21	H21	S-21	-	480	A-19	SP19	SM19	SN19	H19	S-19	-	1	340	A-14	-	SM14	SN14	-	S-14	-
SKODA	Praktik	07→	530	-	-	-	SN21	-	-	SE21	530	-	-	-	SN21	-	-	SE21	2	330	-	-	-	-	-	-	-
SKODA	Roomster [5J7]	06→	530	-	-	-	SN21	-	-	SE21	530	-	-	-	SN21	-	-	SE21	2	330	-	-	-	-	-	-	-
SKODA	Superb [B5, 3U4]	01→04	530	-	-	-	SN21	H21	-	SE21	530	-	-	-	SN21	H21	-	SE21	3	-	-	-	-	-	-	-	-
SKODA	Superb [B5, 3U4]	04→08	530	A-21	SP21	SM21	SN21	H21	S-21	-	530	A-21	SP21	SM21	SN21	H21	S-21	-	1	-	-	-	-	-	-	-	-
SKODA	Superb [B6, 3T4]	08→	600	-	-	-	SN24	-	-	SE24	450	-	-	-	SN18	-	-	SE18	2	-	-	-	-	-	-	-	-
SKODA	Superb Combi [B6, 3T5]	09→	600	-	-	-	SN24	-	-	SE24	450	-	-	-	SN18	-	-	SE18	2	-	-	-	-	-	-	-	-
SKODA	Yeti	09→	600	-	-	-	SN24	-	-	SE24	480	-	-	-	SN19	-	-	SE19	2	280	-	-	-	-	-	-	-

<b>SMART</b>																											
SMART	Forfour [454]	04→07	650	A-26	SP26	SM26	SN26	H26	S-26	-	450	A-18	SP18	SM18	SN18	H18	S-18	-	1	350	A-14	-	SM14	SN14	-	S-14	-
SMART	Fortwo Cabrio [450]	04→07	530	A-21	SP21	SM21	SN21	H21	S-21	-	530	A-21	SP21	SM21	SN21	H21	S-21	-	1	350	A-14	-	SM14	SN14	-	S-14	-

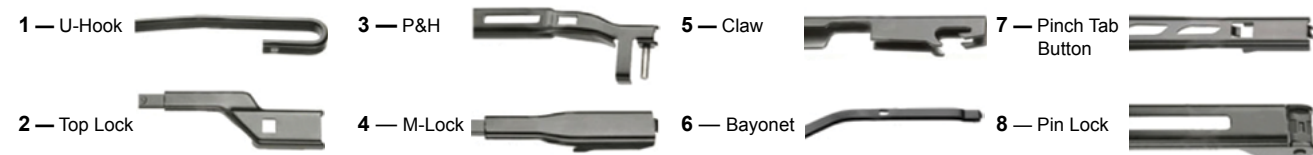

Производитель	Модель	Период выпуска	Сторона водителя (размер в мм)	AERODYNAMIC	SPOILER	SMART	SMART NEO	HYBRID	SNOWGUARD	SNOWGUARD POLAR	Сторона пассажира (размер в мм)	AERODYNAMIC	SPOILER	SMART	SMART NEO	HYBRID	SNOWGUARD	SNOWGUARD POLAR	Тип рычага для крепления щеток*	Заднее стекло (размер в мм)	AERODYNAMIC	SPOILER	SMART	SMART NEO	HYBRID	SNOWGUARD	SNOWGUARD POLAR
<b>SMART</b>																											
SMART	Fortwo Cabrio [451]	07→	600	-	-	-	SN24	-	-	SE24	550	-	-	-	SN22	-	-	SE22	4	-	-	-	-	-	-	-	-
SMART	Fortwo Coupe [450]	04→07	530	A-21	SP21	SM21	SN21	H21	S-21	-	530	A-21	SP21	SM21	SN21	H21	S-21	-	1	340	A-14	-	SM14	SN14	-	S-14	-
SMART	Fortwo Coupe [451]	07→	600	-	-	-	SN24	-	-	SE24	550	-	-	-	SN22	-	-	SE22	4	260	-	-	-	-	-	-	-
SMART	Roadster [452]	03→05	500	A-20	SP20	SM20	SN20	H20	S-20	-	450	A-18	SP18	SM18	SN18	H18	S-18	-	1	-	-	-	-	-	-	-	-
SMART	Roadster Coupe [452]	03→05	500	A-20	SP20	SM20	SN20	H20	S-20	-	450	A-18	SP18	SM18	SN18	H18	S-18	-	1	-	-	-	-	-	-	-	-
SMART	Smart Cabrio [450]	00→04	530	A-21	SP21	SM21	SN21	H21	S-21	-	530	A-21	SP21	SM21	SN21	H21	S-21	-	1	-	-	-	-	-	-	-	-
SMART	Smart Coupe [450]	98→04	530	A-21	SP21	SM21	SN21	H21	S-21	-	530	A-21	SP21	SM21	SN21	H21	S-21	-	1	340	A-14	-	SM14	SN14	-	S-14	-

<b>SSANGYONG</b>																											
SSANGYONG	Actyon	07→	530	A-21	SP21	SM21	SN21	H21	S-21	-	480	A-19	SP19	SM19	SN19	H19	S-19	-	1	500	A-20	SP19	SM19	SN19	H19	S-19	-
SSANGYONG	Actyon	11→	600	A-24	SP24	SM24	SN24	H24	S-24	-	400	A-16	-	SM16	SN16	H16	S-16	-	1	-	-	-	-	-	-	-	-
SSANGYONG	Actyon Sports	07→	530	A-21	SP21	SM21	SN21	H21	S-21	-	480	A-19	SP19	SM19	SN19	H19	S-19	-	1	-	-	-	-	-	-	-	-
SSANGYONG	Chairman	97→03	600	A-24	SP24	SM24	SN24	H24	S-24	-	-	-	-	-	-	-	-	-	1	-	-	-	-	-	-	-	-
SSANGYONG	Chairman New	03→08	600	A-24	SP24	SM24	SN24	H24	S-24	-	-	-	-	-	-	-	-	-	1	-	-	-	-	-	-	-	-
SSANGYONG	Korando [KJ]	96→05	450	A-18	SP18	SM18	SN18	H18	S-18	-	450	A-18	SP18	SM18	SN18	H18	S-18	-	1	280	A-12	-	-	-	-	S-11	-
SSANGYONG	Kyron	05→	550	A-22	SP22	SM22	SN22	H22	S-22	-	480	A-19	SP19	SM19	SN19	H19	S-19	-	1	300	A-12	-	-	-	-	S-11	-
SSANGYONG	Musso [MJ]	93→05	500	A-20	SP20	SM20	SN20	H20	S-20	-	450	A-18	SP18	SM18	SN18	H18	S-18	-	1	280	A-12	-	-	-	-	S-11	-
SSANGYONG	Rexton	02→	500	A-20	SP20	SM20	SN20	H20	S-20	-	480	A-19	SP19	SM19	SN19	H19	S-19	-	1	340	A-14	-	SM14	SN14	-	S-14	-
SSANGYONG	Rodius	04→	600	A-24	SP24	SM24	SN24	H24	S-24	-	450	A-18	SP18	SM18	SN18	H18	S-18	-	1	280	A-12	-	-	-	-	S-11	-

<b>SUBARU</b>																											
SUBARU	Forester [SF,SG]	97→07	530	A-21	SP21	SM21	SN21	H21	S-21	-	480	A-19	SP19	SM19	SN19	H19	S-19	-	1	350	A-14	-	SM14	SN14	-	S-14	-
SUBARU	Forester [SH]	07→	600	A-24	SP24	SM24	SN24	H24	S-24	-	450	A-18	SP18	SM18	SN18	H18	S-18	-	1	350	A-14	-	SM14	SN14	-	S-14	-

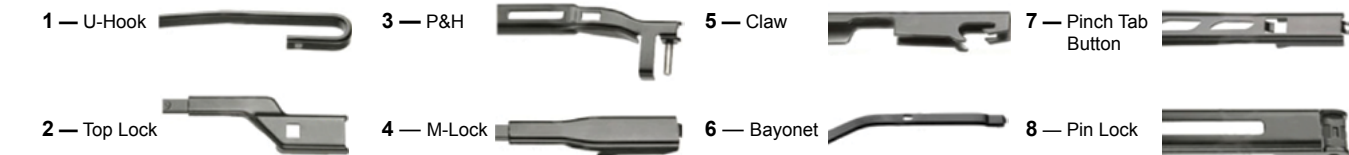

Производитель	Модель	Период выпуска	Сторона водителя (размер в мм)	AERODYNAMIC	SPOILER	SMART	SMART NEO	HYBRID	SNOWGUARD	SNOWGUARD POLAR	Сторона пассажира (размер в мм)	AERODYNAMIC	SPOILER	SMART	SMART NEO	HYBRID	SNOWGUARD	SNOWGUARD POLAR	Тип рычага для крепления щеток*	Заднее стекло (размер в мм)	AERODYNAMIC	SPOILER	SMART	SMART NEO	HYBRID	SNOWGUARD	SNOWGUARD POLAR
---------------	--------	----------------	--------------------------------	-------------	---------	-------	-----------	--------	-----------	-----------------	---------------------------------	-------------	---------	-------	-----------	--------	-----------	-----------------	---------------------------------	-----------------------------	-------------	---------	-------	-----------	--------	-----------	-----------------

SUBARU																											
SUBARU	Impreza Hatchback [GC,GF]	93→00	530	A-21	SP21	SM21	SN21	H21	S-21	-	450	A-18	SP18	SM18	SN18	H18	S-18	-	1	-	-	-	-	-	-	-	-
SUBARU	Impreza Hatchback	02→07	550	A-22	SP22	SM22	SN22	H22	S-22	-	430	A-17	-	SM17	SN17	-	S-17	-	1	-	-	-	-	-	-	-	-
SUBARU	Impreza Hatchback [GE, GH, GR]	07→	600	A-24	SP24	SM24	SN24	H24	S-24	-	400	A-16	-	SM16	SN16	H16	S-16	-	1	-	-	-	-	-	-	-	-
SUBARU	Impreza Kombi [GC,GF]	93→00	530	A-21	SP21	SM21	SN21	H21	S-21	-	450	A-18	SP18	SM18	SN18	H18	S-18	-	1	400	A-16	-	SM16	SN16	H16	S-16	-
SUBARU	Impreza Kombi [GD,GG]	00→07	550	A-22	SP22	SM22	SN22	H22	S-22	-	430	A-17	-	SM17	SN17	-	S-17	-	1	380	A-15	-	SM16	SN16	H16	S-16	-
SUBARU	Impreza Outback [GD,GG]	55→40	550	A-22	SP22	SM22	SN22	H22	S-22	-	400	A-16	-	SM16	SN16	H16	S-16	-	1	380	A-15	-	SM16	SN16	H16	S-16	-
SUBARU	Impreza Sedan [GC,GF]	93→00	530	A-21	SP21	SM21	SN21	H21	S-21	-	450	A-18	SP18	SM18	SN18	H18	S-18	-	1	-	-	-	-	-	-	-	-
SUBARU	Impreza Sedan [GD,GG]	00→07	550	A-22	SP22	SM22	SN22	H22	S-22	-	400	A-16	-	SM16	SN16	H16	S-16	-	1	-	-	-	-	-	-	-	-
SUBARU	Justy [MS]	96→	530	A-21	SP21	SM21	SN21	H21	S-21	-	450	A-18	SP18	SM18	SN18	H18	S-18	-	1	380	A-15	-	SM16	SN16	H16	S-16	-
SUBARU	Justy	03→	480	A-19	SP19	SM19	SN19	H19	S-19	-	430	A-17	-	SM17	SN17	-	S-17	-	1	330	A-13	-	-	-	-	S-13	-
SUBARU	Legacy [BL/BP]	03→09	600	A-24	SP24	SM24	SN24	H24	S-24	-	450	A-18	SP18	SM18	SN18	H18	S-18	-	1	-	-	-	-	-	-	-	-
SUBARU	Legacy [BM/BR]	09→	600	A-24	SP24	SM24	SN24	H24	S-24	-	480	A-19	SP19	SM19	SN19	H19	S-19	-	1	-	-	-	-	-	-	-	-
SUBARU	Legacy Kombi [BE/BH]	98→03	550	A-22	SP22	SM22	SN22	H22	S-22	-	550	A-22	SP22	SM22	SN22	H22	S-22	-	1	380	A-15	-	SM16	SN16	H16	S-16	-
SUBARU	Legacy Kombi [BL/BP]	03→	600	A-24	SP24	SM24	SN24	H24	S-24	-	450	A-18	SP18	SM18	SN18	H18	S-18	-	1	350	A-14	-	SM14	SN14	-	S-14	-
SUBARU	Legacy [BM/BR]	09→	650	A-26	SP26	SM26	SN26	H26	S-26	-	480	A-19	SP19	SM19	SN19	H19	S-19	-	1	350	A-14	-	SM14	SN14	-	S-14	-
SUBARU	Legacy Outback [BE/BH]	09→	550	A-22	SP22	SM22	SN22	H22	S-22	-	500	A-20	SP20	SM20	SN20	H20	S-20	-	1	380	A-15	-	SM16	SN16	H16	S-16	-
SUBARU	Legacy Outback [BL/BP]	03→	600	A-24	SP24	SM24	SN24	H24	S-24	-	450	A-18	SP18	SM18	SN18	H18	S-18	-	1	350	A-14	-	SM14	SN14	-	S-14	-
SUBARU	Legacy Outback [BM/BR]	09→	600	A-24	SP24	SM24	SN24	H24	S-24	-	480	A-19	SP19	SM19	SN19	H19	S-19	-	1	350	A-14	-	SM14	SN14	-	S-14	-
SUBARU	Legacy Sedan [BE/BH]	98→03	550	A-22	SP22	SM22	SN22	H22	S-22	-	500	A-20	SP20	SM20	SN20	H20	S-20	-	1	-	-	-	-	-	-	-	-
SUBARU	Tribeca [B9]	06→	650	A-26	SP26	SM26	SN26	H26	S-26	-	500	A-20	SP20	SM20	SN20	H20	S-20	-	1	350	A-14	-	SM14	SN14	-	S-14	-

SUZUKI																											
SUZUKI	Alto [EF]	94→02	480	A-19	SP19	SM19	SN19	H19	S-19	-	430	A-17	-	SM17	SN17	-	S-17	-	1	340	A-14	-	SM14	SN14	-	S-14	-

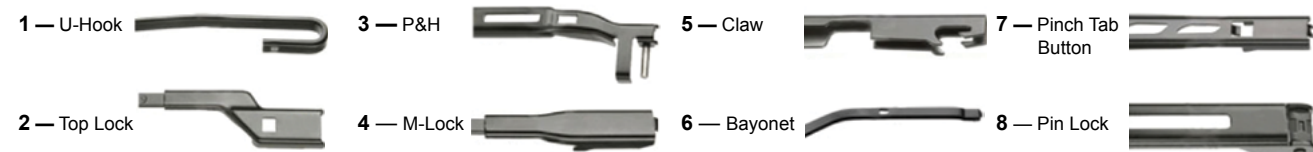

Производитель	Модель	Период выпуска	Сторона водителя (размер в мм)	AERODYNAMIC	SPOILER	SMART	SMART NEO	HYBRID	SNOWGUARD	SNOWGUARD POLAR	Сторона пассажира (размер в мм)	AERODYNAMIC	SPOILER	SMART	SMART NEO	HYBRID	SNOWGUARD	SNOWGUARD POLAR	Тип рычага для крепления щеток*	Заднее стекло (размер в мм)	AERODYNAMIC	SPOILER	SMART	SMART NEO	HYBRID	SNOWGUARD	SNOWGUARD POLAR
---------------	--------	----------------	--------------------------------	-------------	---------	-------	-----------	--------	-----------	-----------------	---------------------------------	-------------	---------	-------	-----------	--------	-----------	-----------------	---------------------------------	-----------------------------	-------------	---------	-------	-----------	--------	-----------	-----------------

SUZUKI																											
SUZUKI	Alto [FF]	02→06	450	A-18	SP18	SM18	SN18	H18	S-18	-	400	A-16	-	SM16	SN16	H16	S-16	-	1	340	A-14	-	SM14	SN14	-	S-14	-
SUZUKI	Alto [GF]	09→	550	A-22	SP22	SM22	SN22	H22	S-22	-	350	A-14	-	SM14	SN14	-	S-14	-	1	-	-	-	-	-	-	-	-
SUZUKI	Alto Hatchback [EF]	94→02	480	A-19	SP19	SM19	SN19	H19	S-19	-	430	A-17	-	SM17	SN17	-	S-17	-	1	340	A-14	-	SM14	SN14	-	S-14	-
SUZUKI	Baleno Hatchback	95→05	500	A-20	SP20	SM20	SN20	H20	S-20	-	450	A-18	SP18	SM18	SN18	H18	S-18	-	1	380	A-15	-	SM16	SN16	H16	S-16	-
SUZUKI	Baleno Sedan	95→05	500	A-20	SP20	SM20	SN20	H20	S-20	-	450	A-18	SP18	SM18	SN18	H18	S-18	-	1	-	-	-	-	-	-	-	-
SUZUKI	Baleno Wagon	96→07	500	A-20	SP20	SM20	SN20	H20	S-20	-	450	A-18	SP18	SM18	SN18	H18	S-18	-	1	340	A-14	-	SM14	SN14	-	S-14	-
SUZUKI	Carry [FD]	99→09	400	A-16	-	SM16	SN16	H16	S-16	-	400	A-16	-	SM16	SN16	H16	S-16	-	1	380	A-15	-	SM16	SN16	H16	S-16	-
SUZUKI	Grand Vitara Cabrio [GT]	98→08	480	A-19	SP19	SM19	SN19	H19	S-19	-	480	A-19	SP19	SM19	SN19	H19	S-19	-	1	-	-	-	-	-	-	-	-
SUZUKI	Grand Vitara [FT]	98→05	480	A-19	SP19	SM19	SN19	H19	S-19	-	480	A-19	SP19	SM19	SN19	H19	S-19	-	1	380	A-15	-	SM16	SN16	H16	S-16	-
SUZUKI	Grand Vitara 2 [JB, JT]	05→	480	A-19	SP19	SM19	SN19	H19	S-19	-	480	A-19	SP19	SM19	SN19	H19	S-19	-	1	300	A-12	-	-	-	-	S-11	-
SUZUKI	Ignis Hatchback	00→07	450	A-18	SP18	SM18	SN18	H18	S-18	-	450	A-18	SP18	SM18	SN18	H18	S-18	-	1	280	A-12	-	-	-	-	S-11	-
SUZUKI	Jimny	98→08	400	A-16	-	SM16	SN16	H16	S-16	-	400	A-16	-	SM16	SN16	H16	S-16	-	1	280	A-12	-	-	-	-	S-11	-
SUZUKI	Kizashi [FR]	10→	600	A-24	SP24	SM24	SN24	H24	S-24	-	500	A-20	SP20	SM20	SN20	H20	S-20	-	1	-	-	-	-	-	-	-	-
SUZUKI	Liana Hatchback	01→08	550	A-22	SP22	SM22	SN22	H22	S-22	-	480	A-19	SP19	SM19	SN19	H19	S-19	-	1	280	A-12	-	-	-	-	S-11	-
SUZUKI	Liana Sedan	02→07	550	A-22	SP22	SM22	SN22	H22	S-22	-	480	A-19	SP19	SM19	SN19	H19	S-19	-	1	-	-	-	-	-	-	-	-
SUZUKI	Samurai	84→04	280	-	-	-	-	-	S-11	-	-	-	-	-	-	-	-	-	1	340	A-14	-	SM14	SN14	-	S-14	-
SUZUKI	Splash	08→	550	A-22	SP22	SM22	SN22	H22	S-22	-	400	A-16	-	SM16	SN16	H16	S-16	-	1	-	-	-	-	-	-	-	-
SUZUKI	Swift Hatchback [MA]	96→04	530	A-21	SP21	SM21	SN21	H21	S-21	-	450	A-18	SP18	SM18	SN18	H18	S-18	-	1	380	A-15	-	SM16	SN16	H16	S-16	-
SUZUKI	Swift Hatchback [MZ/EZ]	04→	530	A-21	SP21	SM21	SN21	H21	S-21	-	450	A-18	SP18	SM18	SN18	H18	S-18	-	1	-	-	-	-	-	-	-	-
SUZUKI	Swift Hatchback	10→	530	A-21	SP21	SM21	SN21	H21	S-21	-	450	A-18	SP18	SM18	SN18	H18	S-18	-	1	-	-	-	-	-	-	-	-
SUZUKI	Swift Sedan [MA]	96→04	530	A-21	SP21	SM21	SN21	H21	S-21	-	450	A-18	SP18	SM18	SN18	H18	S-18	-	1	-	-	-	-	-	-	-	-
SUZUKI	SX4 Hatchback	06→	650	A-26	SP26	SM26	SN26	H26	S-26	-	350	A-14	-	SM14	SN14	-	S-14	-	1	300	A-12	-	-	-	-	S-11	-
SUZUKI	SX4 Sedan	07→	650	A-26	SP26	SM26	SN26	H26	S-26	-	350	A-14	-	SM14	SN14	-	S-14	-	1	-	-	-	-	-	-	-	-

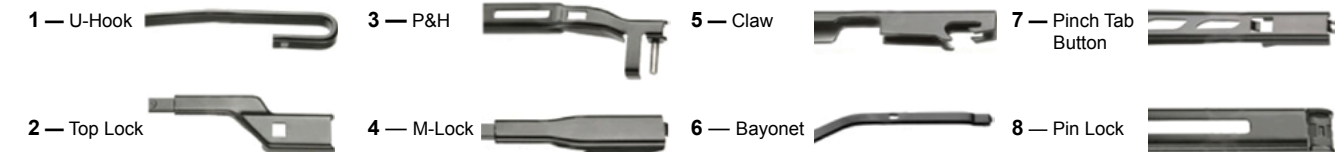





Производитель	Модель	Период выпуска	Сторона водителя (размер в мм)	AERODYNAMIC	SPOILER	SMART	SMART NEO	HYBRID	SNOWGUARD	SNOWGUARD POLAR	Сторона пассажира (размер в мм)	AERODYNAMIC	SPOILER	SMART	SMART NEO	HYBRID	SNOWGUARD	SNOWGUARD POLAR	Тип рычага для крепления щеток*	Заднее стекло (размер в мм)	AERODYNAMIC	SPOILER	SMART	SMART NEO	HYBRID	SNOWGUARD	SNOWGUARD POLAR
TOYOTA	Land Cruiser Prado 90 [J9]	96→02	480	A-19	SP19	SM19	SN19	H19	S-19	-	450	A-18	SP18	SM18	SN18	H18	S-18	-	1	-	-	-	-	-	-	-	-
TOYOTA	Land Cruiser Prado120 [J12]	02→09	550	A-22	SP22	SM22	SN22	H22	S-22	-	530	A-21	SP21	SM21	SN21	H21	S-21	-	1	450	A-18	SP18	SM18	SN18	H18	S-18	-
TOYOTA	Land Cruiser Prado150	09→	650	A-26	SP26	SM26	SN26	H26	S-26	-	500	A-20	SP20	SM20	SN20	H20	S-20	-	1	-	-	-	-	-	-	-	-
TOYOTA	Matrix [E130]	02→08	530	A-21	SP21	SM21	SN21	H21	S-21	-	450	A-18	SP18	SM18	SN18	H18	S-18	-	1	-	-	-	-	-	-	-	-
TOYOTA	Matrix [E140]	08→	650	A-26	SP26	SM26	SN26	H26	S-26	-	430	A-17	-	SM17	SN17	-	S-17	-	1	-	-	-	-	-	-	-	-
TOYOTA	MR2 Cabrio [W3]	99→05	500	A-20	SP20	SM20	SN20	H20	S-20	-	480	A-19	SP19	SM19	SN19	H19	S-19	-	1	-	-	-	-	-	-	-	-
TOYOTA	Picnic	96→01	600	A-24	SP24	SM24	SN24	H24	S-24	-	400	A-16	-	SM16	SN16	H16	S-16	-	1	340	A-14	-	SM14	SN14	-	S-14	-
TOYOTA	Previa [ACR3]	00→06	700	A-28	-	-	-	-	S-28	-	450	A-18	SP18	SM18	SN18	H18	S-18	-	1	-	-	-	-	-	-	-	-
TOYOTA	Prius [W11]	97→03	600	A-24	SP24	SM24	SN24	H24	S-24	-	400	A-16	-	SM16	SN16	H16	S-16	-	1	-	-	-	-	-	-	-	-
TOYOTA	Prius [W20]	03→08	650	A-26	SP26	SM26	SN26	H26	S-26	-	450	A-18	SP18	SM18	SN18	H18	S-18	-	1	400	A-16	-	SM16	SN16	H16	S-16	-
TOYOTA	Prius [W30,W35]	09→	650	A-26	SP26	SM26	SN26	H26	S-26	-	450	A-18	SP18	SM18	SN18	H18	S-18	-	1	400	A-16	-	SM16	SN16	H16	S-16	-
TOYOTA	RAV4 [A1]	94→00	500	A-20	SP20	SM20	SN20	H20	S-20	-	450	A-18	SP18	SM18	SN18	H18	S-18	-	1	340	A-14	-	SM14	SN14	-	S-14	-
TOYOTA	RAV4 [A2]	00→05	600	A-24	SP24	SM24	SN24	H24	S-24	-	480	A-19	SP19	SM19	SN19	H19	S-19	-	1	280	A-12	-	-	-	-	S-11	-
TOYOTA	RAV4 [A3]	05→	600	A-24	SP24	SM24	SN24	H24	S-24	-	400	A-16	-	SM16	SN16	H16	S-16	-	1	300	A-12	-	-	-	-	S-11	-
TOYOTA	Sequoia II	07→	650	-	-	-	SN26	-	-	SE26	600	-	-	-	SN24	-	-	SE24	4	-	-	-	-	-	-	-	-
TOYOTA	Solara [V20]	98→03	550	A-22	SP22	SM22	SN22	H22	S-22	-	530	A-21	SP21	SM21	SN21	H21	S-21	-	1	-	-	-	-	-	-	-	-
TOYOTA	Solara [V30,V31]	04→08	650	A-26	SP26	SM26	SN26	H26	S-26	-	480	A-19	SP19	SM19	SN19	H19	S-19	-	1	-	-	-	-	-	-	-	-
TOYOTA	Tundra I [K30,K40]	00→06	480	A-19	SP19	SM19	SN19	H19	S-19	-	480	A-19	SP19	SM19	SN19	H19	S-19	-	1	-	-	-	-	-	-	-	-
TOYOTA	Tundra II [K5]	07→	650	-	-	-	SN26	-	-	SE26	550	-	-	-	SN22	-	-	SE22	4	-	-	-	-	-	-	-	-
TOYOTA	Urban Cruiser [P1]	09→	600	A-24	SP24	SM24	SN24	H24	S-24	-	350	A-14	-	SM14	SN14	-	S-14	-	1	-	-	-	-	-	-	-	-
TOYOTA	Verso [R2]	09→	650	A-26	SP26	SM26	SN26	H26	S-26	-	400	A-16	-	SM16	SN16	H16	S-16	-	1	-	-	-	-	-	-	-	-
TOYOTA	Yaris [P1]	99→06	500	A-20	SP20	SM20	SN20	H20	S-20	-	400	A-16	-	SM16	SN16	H16	S-16	-	1	300	A-12	-	-	-	-	S-11	-
TOYOTA	Yaris [P9]	05→	600	A-24	SP24	SM24	SN24	H24	S-24	-	350	A-14	-	SM14	SN14	-	S-14	-	1	300	A-12	-	-	-	-	S-11	-
TOYOTA	Yaris Verso [P2]	99→05	550	A-22	SP22	SM22	SN22	H22	S-22	-	400	A-16	-	SM16	SN16	H16	S-16	-	1	400	A-16	-	SM16	SN16	H16	S-16	-

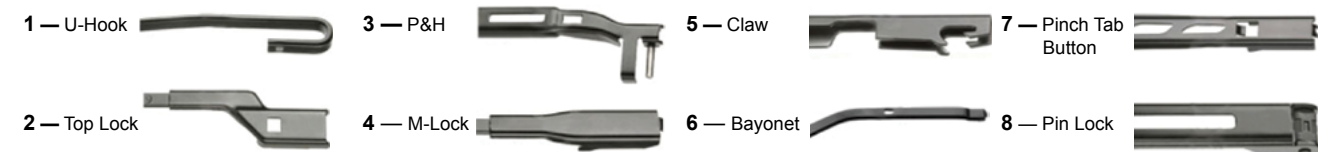

Производитель	Модель	Период выпуска	Сторона водителя (размер в мм)	AERODYNAMIC	SPOILER	SMART	SMART NEO	HYBRID	SNOWGUARD	SNOWGUARD POLAR	Сторона пассажира (размер в мм)	AERODYNAMIC	SPOILER	SMART	SMART NEO	HYBRID	SNOWGUARD	SNOWGUARD POLAR	Тип рычага для крепления щеток*	Заднее стекло (размер в мм)	AERODYNAMIC	SPOILER	SMART	SMART NEO	HYBRID	SNOWGUARD	SNOWGUARD POLAR
VOLKSWAGEN	Amarok	10→	600	A-24	SP24	SM24	SN24	H24	S-24	-	580	A-24	SP24	SM24	SN24	H24	S-24	-	1	-	-	-	-	-	-	-	-
VOLKSWAGEN	Bora [1J2]	98→02	530	A-21	SP21	SM21	SN21	H21	S-21	-	480	A-19	SP19	SM19	SN19	H19	S-19	-	1	-	-	-	-	-	-	-	-
VOLKSWAGEN	Bora [1J2]	02→05	530	-	-	-	SN21	H21	-	SE21	480	-	-	-	SN19	H19	-	SE19	3	-	-	-	-	-	-	-	-
VOLKSWAGEN	Bora Variant [1J6]	98→02	530	A-21	SP21	SM21	SN21	H21	S-21	-	480	A-19	SP19	SM19	SN19	H19	S-19	-	1	380	A-15	-	SM16	SN16	H16	S-16	-
VOLKSWAGEN	Bora Variant [1J6]	02→05	530	-	-	-	SN21	H21	-	SE21	480	-	-	-	SN19	H19	-	SE19	3	380	-	-	-	-	-	-	-
VOLKSWAGEN	Caddy [9K9]	95→03	530	-	-	-	SN21	H21	-	SE21	450	-	-	-	SN18	H18	-	SE18	3	450	-	-	-	-	-	-	-
VOLKSWAGEN	Caddy [2K]	04→06	600	-	-	-	SN24	H24	-	SE24	450	-	-	-	SN18	H18	-	SE18	3	400	-	-	-	-	-	-	-
VOLKSWAGEN	Caddy [2K]	06→	600	-	-	-	SN24	-	-	SE24	480	-	-	-	SN19	-	-	SE19	2	400	-	-	-	-	-	-	-
VOLKSWAGEN	Crafter 30 [2E]	06→	650	-	-	-	SN26	-	-	SE26	600	-	-	-	SN24	-	-	SE24	4	-	-	-	-	-	-	-	-
VOLKSWAGEN	Crafter 35 [2E]	06→	650	-	-	-	SN26	-	-	SE26	600	-	-	-	SN24	-	-	SE24	4	-	-	-	-	-	-	-	-
VOLKSWAGEN	Crafter 50 [2E]	06→	650	-	-	-	SN26	-	-	SE26	600	-	-	-	SN24	-	-	SE24	4	-	-	-	-	-	-	-	-
VOLKSWAGEN	Eos [1F7]	06→	600	-	-	-	SN24	-	-	SE24	480	-	-	-	SN19	-	-	SE19	2	-	-	-	-	-	-	-	-
VOLKSWAGEN	Eurovan [70]	92→00	530	A-21	SP21	SM21	SN21	H21	S-21	-	530	A-21	SP21	SM21	SN21	H21	S-21	-	1	-	-	-	-	-	-	-	-
VOLKSWAGEN	Fox [5Z1]	05→	530	A-21	SP21	SM21	SN21	H21	S-21	-	380	A-15	-	SM15	SN15	-	S-15	-	1	-	-	-	-	-	-	-	-
VOLKSWAGEN	Golf IV [1J1]	97→02	530	A-21	SP21	SM21	SN21	H21	S-21	-	450	A-18	SP18	SM18	SN18	H18	S-18	-	1	340	A-14	-	SM14	SN14	-	S-14	-
VOLKSWAGEN	Golf IV [1J1]	02→05	530	-	-	-	SN21	H21	-	SE21	480	-	-	-	SN19	H19	-	SE19	3	340	-	-	-	-	-	-	-
VOLKSWAGEN	Golf V [1K1]	03→05	600	-	-	-	SN24	H24	-	SE24	480	-	-	-	SN19	H19	-	SE19	3	330	-	-	-	-	-	-	-
VOLKSWAGEN	Golf V [1K1]	05→08	600	-	-	-	SN24	-	-	SE24	480	-	-	-	SN19	-	-	SE19	2	330	-	-	-	-	-	-	-
VOLKSWAGEN	Golf VI [5K1]	08→	600	-	-	-	SN24	-	-	SE24	480	-	-	-	SN19	-	-	SE19	2	280	-	-	-	-	-	-	-
VOLKSWAGEN	Golf IV Cabriolet [1E7]	98→02	530	A-21	SP21	SM21	SN21	H21	S-21	-	480	A-19	SP19	SM19	SN19	H19	S-19	-	1	-	-	-	-	-	-	-	-
VOLKSWAGEN	Golf VI Cabriolet	11→	600	-	-	-	SN24	-	-	SE24	480	-	-	-	SN19	-	-	SE19	2	-	-	-	-	-	-	-	-
VOLKSWAGEN	Golf Plus [5M1]	05→08	700	-	-	-	-	-	-	SE28	700	-	-	-	-	-	-	SE28	3	330	-	-	-	-	-	-	-
VOLKSWAGEN	Golf Plus [521]	09→	700	-	-	-	-	-	-	SE28	700	-	-	-	-	-	-	SE28	3	330	-	-	-	-	-	-	-
VOLKSWAGEN	Golf IV Variant [1J5]	99→02	530	A-21	SP21	SM21	SN21	H21	S-21	-	480	A-19	SP19	SM19	SN19	H19	S-19	-	1	380	A-15	-	SM16	SN16	H16	S-16	-

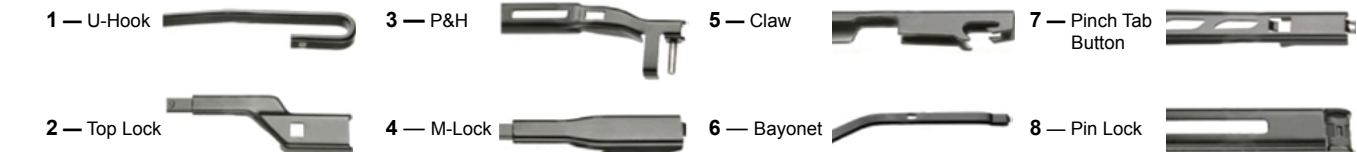

Производитель	Модель	Период выпуска	Сторона водителя (размер в мм)	AERODYNAMIC	SPOILER	SMART	SMART NEO	HYBRID	SNOWGUARD	SNOWGUARD POLAR	Сторона пассажира (размер в мм)	AERODYNAMIC	SPOILER	SMART	SMART NEO	HYBRID	SNOWGUARD	SNOWGUARD POLAR	Тип рычага для крепления щеток*	Заднее стекло (размер в мм)	AERODYNAMIC	SPOILER	SMART	SMART NEO	HYBRID	SNOWGUARD	SNOWGUARD POLAR
VOLKSWAGEN																											
VOLKSWAGEN	Golf IV Variant [1J5]	99→06	530	-	-	-	SN21	H21	-	SE21	480	-	-	-	SN19	H19	-	SE19	<b>3</b>	380	-	-	-	-	-	-	-
VOLKSWAGEN	Golf V Variant [1K5]	07→	600	-	-	-	SN24	-	-	SE24	480	-	-	-	SN19	-	-	SE19	<b>2</b>	330	-	-	-	-	-	-	-
VOLKSWAGEN	Golf VI Variant [5K1]	08→	600	-	-	-	SN24	-	-	SE24	480	-	-	-	SN19	-	-	SE19	<b>2</b>	330	-	-	-	-	-	-	-
VOLKSWAGEN	Jetta [1H2]	92→	530	A-21	SP21	SM21	SN21	H21	S-21	-	480	A-19	SP19	SM19	SN19	H19	S-19	-	<b>1</b>	-	-	-	-	-	-	-	-
VOLKSWAGEN	Jetta [1K2]	05→05	600	-	-	-	SN24	H24	-	SE24	480	-	-	-	SN19	H19	-	SE19	<b>3</b>	-	-	-	-	-	-	-	-
VOLKSWAGEN	Jetta [1K2]	05→	600	-	-	-	SN24	-	-	SE24	480	-	-	-	SN19	-	-	SE19	<b>2</b>	-	-	-	-	-	-	-	-
VOLKSWAGEN	Jetta [162]	10→	600	-	-	-	SN24	-	-	SE24	480	-	-	-	SN19	-	-	SE19	<b>2</b>	-	-	-	-	-	-	-	-
VOLKSWAGEN	LT [2D,2H]	96→06	600	A-24	SP24	SM24	SN24	H24	S-24	-	550	A-22	SP22	SM22	SN22	H22	S-22	-	<b>1</b>	-	-	-	-	-	-	-	-
VOLKSWAGEN	Lupo [6X1]	98→05	530	A-21	SP21	SM21	SN21	H21	S-21	-	480	A-19	SP19	SM19	SN19	H19	S-19	-	<b>1</b>	280	A-12	-	-	-	-	S-11	-
VOLKSWAGEN	New Beetle [1C1/9C1]	98→	530	A-21	SP21	SM21	SN21	H21	S-21	-	530	A-21	SP21	SM21	SN21	H21	S-21	-	<b>1</b>	-	-	-	-	-	-	-	-
VOLKSWAGEN	Passat B5 [3B2]	96→02	530	A-21	SP21	SM21	SN21	H21	S-21	-	530	A-21	SP21	SM21	SN21	H21	S-21	-	<b>1</b>	-	-	-	-	-	-	-	-
VOLKSWAGEN	Passat B5.5 [3B3]	00→01	530	A-21	SP21	SM21	SN21	H21	S-21	-	530	A-21	SP21	SM21	SN21	H21	S-21	-	<b>1</b>	-	-	-	-	-	-	-	-
VOLKSWAGEN	Passat B5.5 [3B3]	01→05	530	A-21	SP21	SM21	SN21	H21	S-21	-	530	A-21	SP21	SM21	SN21	H21	S-21	-	<b>1</b>	-	-	-	-	-	-	-	-
VOLKSWAGEN	Passat B6 [3C2]	05→	600	-	-	-	SN24	-	-	SE24	480	-	-	-	SN19	-	-	SE19	<b>2</b>	-	-	-	-	-	-	-	-
VOLKSWAGEN	Passat B7 [362]	10→	600	-	-	-	SN24	-	-	SE24	480	-	-	-	SN19	-	-	SE19	<b>2</b>	-	-	-	-	-	-	-	-
VOLKSWAGEN	Passat CC B6 [357]	08→	600	-	-	-	SN24	-	-	SE24	480	-	-	-	SN19	-	-	SE19	<b>4</b>	-	-	-	-	-	-	-	-
VOLKSWAGEN	Passat Variant B5 [3B5]	94→00	530	A-21	SP21	SM21	SN21	H21	S-21	-	530	A-21	SP21	SM21	SN21	H21	S-21	-	<b>1</b>	380	A-15	-	SM16	SN16	H16	S-16	-
VOLKSWAGEN	Passat Variant B5.5 [3B6]	00→05	530	A-21	SP21	SM21	SN21	H21	S-21	-	530	A-21	SP21	SM21	SN21	H21	S-21	-	<b>1</b>	380	A-15	-	SM16	SN16	H16	S-16	-
VOLKSWAGEN	Passat Variant B6 [3C5]	05→	600	-	-	-	SN24	-	-	SE24	480	-	-	-	SN19	-	-	SE19	<b>2</b>	280	-	-	-	-	-	-	-
VOLKSWAGEN	Passat Variant B7 [362]	10→	600	-	-	-	SN24	H24	-	SE24	480	-	-	-	SN19	H19	-	SE19	<b>3</b>	300	-	-	-	-	-	-	-
VOLKSWAGEN	Phaeton [3D2]	02→	600	-	-	-	SN24	H24	-	SE24	530	-	-	-	SN21	H21	-	SE21	<b>3</b>	-	-	-	-	-	-	-	-
VOLKSWAGEN	Pointer	04→	530	A-21	SP21	SM21	SN21	H21	S-21	-	480	A-19	SP19	SM19	SN19	H19	S-19	-	<b>1</b>	-	-	-	-	-	-	-	-
VOLKSWAGEN	Polo [6N2]	98→01	480	A-19	SP19	SM19	SN19	H19	S-19	-	480	A-19	SP19	SM19	SN19	H19	S-19	-	<b>1</b>	280	A-12	-	-	-	-	S-11	-

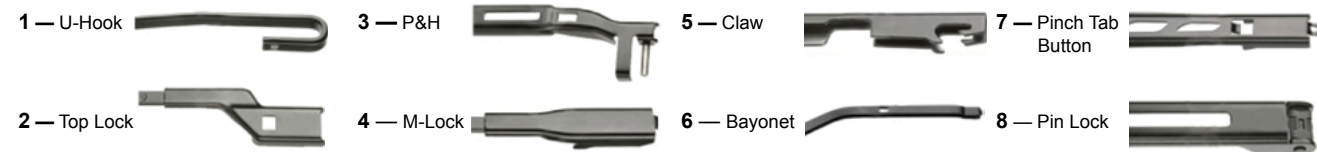

Производитель	Модель	Период выпуска	Сторона водителя (размер в мм)	AERODYNAMIC	SPOILER	SMART	SMART NEO	HYBRID	SNOWGUARD	SNOWGUARD POLAR	Сторона пассажира (размер в мм)	AERODYNAMIC	SPOILER	SMART	SMART NEO	HYBRID	SNOWGUARD	SNOWGUARD POLAR	Тип рычага для крепления щеток*	Заднее стекло (размер в мм)	AERODYNAMIC	SPOILER	SMART	SMART NEO	HYBRID	SNOWGUARD	SNOWGUARD POLAR
VOLKSWAGEN																											
VOLKSWAGEN	Polo [9N1]	01→05	530	-	-	-	SN21	H21	-	SE21	480	-	-	-	SN19	H19	-	SE19	<b>3</b>	330	-	-	-	-	-	-	-
VOLKSWAGEN	Polo [9N2]	03→	530	-	-	-	SN21	H21	-	SE21	480	-	-	-	SN19	H19	-	SE19	<b>3</b>	330	-	-	-	-	-	-	-
VOLKSWAGEN	Polo [9N3]	05→	530	-	-	-	SN21	-	-	SE21	480	-	-	-	SN19	-	-	SE19	<b>2</b>	330	-	-	-	-	-	-	-
VOLKSWAGEN	Polo [6R1]	09→	600	-	-	-	SN24	-	-	SE24	400	-	-	-	SN16	-	-	SE16	<b>2</b>	280	-	-	-	-	-	-	-
VOLKSWAGEN	Polo Classic [9V8,9V8 2C4]	94→03	500	A-20	SP20	SM20	SN20	H20	S-20	-	450	A-18	SP18	SM18	SN18	H18	S-18	-	<b>1</b>	-	-	-	-	-	-	-	-
VOLKSWAGEN	Polo Classic [6V2]	95→01	530	A-21	SP21	SM21	SN21	H21	S-21	-	450	A-18	SP18	SM18	SN18	H18	S-18	-	<b>1</b>	-	-	-	-	-	-	-	-
VOLKSWAGEN	Polo Playa [9V4]	98→02	500	A-20	SP20	SM20	SN20	H20	S-20	-	450	A-18	SP18	SM18	SN18	H18	S-18	-	<b>1</b>	-	-	-	-	-	-	-	-
VOLKSWAGEN	Polo Sedan [612]	10→	600	A-24	SP24	SM24	SN24	H24	S-24	-	400	A-16	-	SM16	SN16	H16	S-16	-	<b>1</b>	-	-	-	-	-	-	-	-
VOLKSWAGEN	Polo Variant [6V5]	97→01	530	A-21	SP21	SM21	SN21	H21	S-21	-	480	A-19	SP19	SM19	SN19	H19	S-19	-	<b>1</b>	280	A-12	-	-	-	-	S-11	-
VOLKSWAGEN	Scirocco [137]	08→	600	-	-	-	SN24	-	-	SE24	480	-	-	-	SN19	-	-	SE19	<b>2</b>	-	-	-	-	-	-	-	-
VOLKSWAGEN	Sharan [7M8]	95→00	700	A-28	-	-	-	-	S-28	-	650	A-26	SP26	SM26	SN26	H26	S-26	-	<b>1</b>	400	A-16	-	SM16	SN16	H16	S-16	-
VOLKSWAGEN	Sharan [7M9,7M6]	00→01	700	A-28	-	-	-	-	S-28	-	650	A-26	SP26	SM26	SN26	H26	S-26	-	<b>1</b>	400	A-16	-	SM16	SN16	H16	S-16	-
VOLKSWAGEN	Sharan [7M9,7M6]	01→	700	-	-	-	-	-	-	SE28	700	-	-	-	-	-	-	SE28	<b>3</b>	400	-	-	-	-	-	-	-
VOLKSWAGEN	Sharan [7N]	10→	700	-	-	-	-	-	-	SE28	400	-	-	-	SN16	-	-	SE16	<b>2</b>	330	-	-	-	-	-	-	-
VOLKSWAGEN	California T4 [70,7D]	90→03	530	A-21	SP21	SM21	SN21	H21	S-21	-	530	A-21	SP21	SM21	SN21	H21	S-21	-	<b>1</b>	-	-	-	-	-	-	-	-
VOLKSWAGEN	Caravelle T4 [70,7D]	90→03	530	A-21	SP21	SM21	SN21	H21	S-21	-	530	A-21	SP21	SM21	SN21	H21	S-21	-	<b>1</b>	-	-	-	-	-	-	-	-
VOLKSWAGEN	Multivan T4 [70,7D]	90→03	530	A-21	SP21	SM21	SN21	H21	S-21	-	530	A-21	SP21	SM21	SN21	H21	S-21	-	<b>1</b>	-	-	-	-	-	-	-	-
VOLKSWAGEN	Transporter T4 [70,7D]	90→03	530	A-21	SP21	SM21	SN21	H21	S-21	-	530	A-21	SP21	SM21	SN21	H21	S-21	-	<b>1</b>	400	A-16	-	SM16	SN16	H16	S-16	-
VOLKSWAGEN	California T5 [7H]	03→	600	-	-	-	SN24	H24	-	SE24	600	-	-	-	SN24	H24	-	SE24	<b>3</b>	-	-	-	-	-	-	-	-
VOLKSWAGEN	Caravelle T5 [7H]	03→	600	-	-	-	SN24	H24	-	SE24	600	-	-	-	SN24	H24	-	SE24	<b>3</b>	-	-	-	-	-	-	-	-
VOLKSWAGEN	Multivan T5 [7H]	03→	600	-	-	-	SN24	H24	-	SE24	600	-	-	-	SN24	H24	-	SE24	<b>3</b>	400	-	-	-	-	-	-	-
VOLKSWAGEN	Transporter T5 [7H, 7J]	03→	600	-	-	-	SN24	H24	-	SE24	600	-	-	-	SN24	H24	-	SE24	<b>3</b>	400	-	-	-	-	-	-	-
VOLKSWAGEN	Touareg [7LA]	02→06	650	-	-	-	SN26	H26	-	SE26	650	-	-	-	SN26	H26	-	SE26	<b>3</b>	330	-	-	-	-	-	-	-

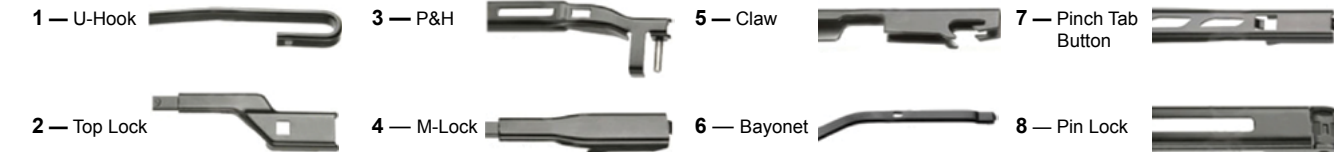



Производитель	Модель	Период выпуска	Сторона водителя (размер в мм)	AERODYNAMIC	SPOILER	SMART	SMART NEO	HYBRID	SNOWGUARD	SNOWGUARD POLAR	Сторона пассажира (размер в мм)	AERODYNAMIC	SPOILER	SMART	SMART NEO	HYBRID	SNOWGUARD	SNOWGUARD POLAR	Тип рычага для крепления щеток*	Заднее стекло (размер в мм)	AERODYNAMIC	SPOILER	SMART	SMART NEO	HYBRID	SNOWGUARD	SNOWGUARD POLAR
<b>VOLKSWAGEN</b>																											
VOLKSWAGEN	Touareg [7L6]	06→	650	-	-	-	SN26	H26	-	SE26	650	-	-	-	SN26	H26	-	SE26	<b>3</b>	330	-	-	-	-	-	-	-
VOLKSWAGEN	Touareg [7P5]	10→	650	-	-	-	SN26	H26	-	SE26	650	-	-	-	SN26	H26	-	SE26	<b>3</b>	-	-	-	-	-	-	-	-
VOLKSWAGEN	Touran [1T1]	03→06	700	-	-	-	-	-	-	SE28	700	-	-	-	-	-	-	SE28	<b>3</b>	400	-	-	-	-	-	-	-
VOLKSWAGEN	Touran [1T2]	06→	600	-	-	-	SN24	-	-	SE24	480	-	-	-	SN19	-	-	SE19	<b>2</b>	400	-	-	-	-	-	-	-

<b>VOLVO</b>																											
VOLVO	C30	06→	650	-	-	-	SN26	-	-	SE26	500	-	-	-	SN20	-	-	SE20	<b>2</b>	400	-	-	-	-	-	-	-
VOLVO	C70 I Cabrio	98→06	530	A-21	SP21	SM21	SN21	H21	S-21	-	530	A-21	SP21	SM21	SN21	H21	S-21	-	<b>1</b>	-	-	-	-	-	-	-	-
VOLVO	C70 II Cabrio	06→	650	-	-	-	SN26	-	-	SE26	500	-	-	-	SN20	-	-	SE20	<b>2</b>	-	-	-	-	-	-	-	-
VOLVO	C70 Coupe	97→02	530	A-21	SP21	SM21	SN21	H21	S-21	-	530	A-21	SP21	SM21	SN21	H21	S-21	-	<b>1</b>	-	-	-	-	-	-	-	-
VOLVO	S40 I	95→04	530	A-21	SP21	SM21	SN21	H21	S-21	-	500	A-20	SP20	SM20	SN20	H20	S-20	-	<b>1</b>	-	-	-	-	-	-	-	-
VOLVO	S40 II [P 11]	03→05	650	-	-	-	SN26	H26	-	SE26	480	-	-	-	SN19	H19	-	SE19	<b>3</b>	-	-	-	-	-	-	-	-
VOLVO	S40 II [P 11]	05→	650	-	-	-	SN26	-	-	SE26	500	-	-	-	SN20	-	-	SE20	<b>2</b>	-	-	-	-	-	-	-	-
VOLVO	S60 [P 24]	00→04	600	A-24	SP24	SM24	SN24	H24	S-24	-	530	A-21	SP21	SM21	SN21	H21	S-21	-	<b>1</b>	-	-	-	-	-	-	-	-
VOLVO	S60 [P 24]	04→	600	-	-	-	SN24	-	-	SE24	550	-	-	-	SN22	-	-	SE22	<b>4</b>	-	-	-	-	-	-	-	-
VOLVO	S60 II [P 24]	10→	650	-	-	-	SN26	-	-	SE26	500	-	-	-	SN20	-	-	SE20	<b>2</b>	-	-	-	-	-	-	-	-
VOLVO	S70	97→00	530	A-21	SP21	SM21	SN21	H21	S-21	-	530	A-21	SP21	SM21	SN21	H21	S-21	-	<b>1</b>	-	-	-	-	-	-	-	-
VOLVO	S80 I [P 23]	98→04	600	A-24	SP24	SM24	SN24	H24	S-24	-	530	A-21	SP21	SM21	SN21	H21	S-21	-	<b>1</b>	-	-	-	-	-	-	-	-
VOLVO	S80 I [P 23]	04→06	600	-	-	-	SN24	-	-	SE24	550	-	-	-	SN22	-	-	SE22	<b>4</b>	-	-	-	-	-	-	-	-
VOLVO	S80 II	06→	650	-	-	-	SN26	-	-	SE26	500	-	-	-	SN20	-	-	SE20	<b>2</b>	-	-	-	-	-	-	-	-
VOLVO	V40	95→04	530	A-21	SP21	SM21	SN21	H21	S-21	-	500	A-20	SP20	SM20	SN20	H20	S-20	-	<b>1</b>	400	A-16	-	SM16	SN16	H16	S-16	-
VOLVO	V50 [P 12]	04→05	650	-	-	-	SN26	H26	-	SE26	500	-	-	-	SN20	H20	-	SE20	<b>3</b>	340	-	-	-	-	-	-	-
VOLVO	V50 [P 12]	05→	650	-	-	-	SN26	-	-	SE26	480	-	-	-	SN19	-	-	SE19	<b>2</b>	340	-	-	-	-	-	-	-

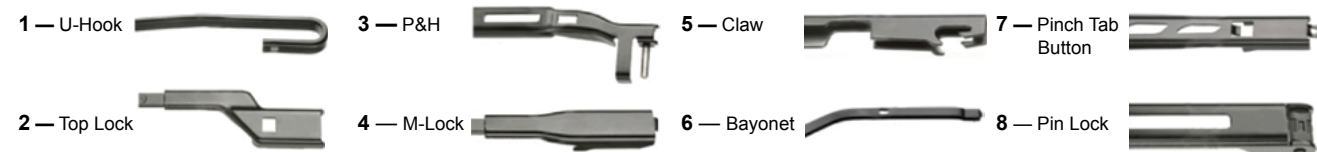

Производитель	Модель	Период выпуска	Сторона водителя (размер в мм)	AERODYNAMIC	SPOILER	SMART	SMART NEO	HYBRID	SNOWGUARD	SNOWGUARD POLAR	Сторона пассажира (размер в мм)	AERODYNAMIC	SPOILER	SMART	SMART NEO	HYBRID	SNOWGUARD	SNOWGUARD POLAR	Тип рычага для крепления щеток*	Заднее стекло (размер в мм)	AERODYNAMIC	SPOILER	SMART	SMART NEO	HYBRID	SNOWGUARD	SNOWGUARD POLAR
<b>VOLVO</b>																											
VOLVO	V60	10→	650	-	-	-	SN26	-	-	SE26	500	-	-	-	SN20	-	-	SE20	<b>2</b>	300	-	-	-	-	-	-	-
VOLVO	V70 I	97→00	530	A-21	SP21	SM21	SN21	H21	S-21	-	530	A-21	SP21	SM21	SN21	H21	S-21	-	<b>1</b>	430	A-17	-	SM17	SN17	-	S-17	-
VOLVO	V70 II	00→04	600	A-24	SP24	SM24	SN24	H24	S-24	-	530	A-21	SP21	SM21	SN21	H21	S-21	-	<b>1</b>	370	A-15	-	SM15	SN15	-	S-15	-
VOLVO	V70 II	04→07	600	-	-	-	SN24	-	-	SE24	530	-	-	-	SN21	-	-	SE21	<b>4</b>	380	-	-	-	-	-	-	-
VOLVO	V70 III	07→	650	-	-	-	SN26	-	-	SE26	500	-	-	-	SN20	-	-	SE20	<b>2</b>	350	-	-	-	-	-	-	-
VOLVO	XC60	09→	650	-	-	-	SN26	-	-	SE26	500	-	-	-	SN20	-	-	SE20	<b>2</b>	380	-	-	-	-	-	-	-
VOLVO	XC70 I	02→04	600	A-24	SP24	SM24	SN24	H24	S-24	-	530	A-21	SP21	SM21	SN21	H21	S-21	-	<b>1</b>	400	A-16	-	SM16	SN16	H16	S-16	-
VOLVO	XC70 I	04→07	600	-	-	-	SN24	-	-	SE24	530	-	-	-	SN21	-	-	SE21	<b>4</b>	400	-	-	-	-	-	-	-
VOLVO	XC70 II	07→	650	-	-	-	SN26	-	-	SE26	500	-	-	-	SN20	-	-	SE20	<b>2</b>	350	-	-	-	-	-	-	-
VOLVO	XC90	02→04	600	A-24	SP24	SM24	SN24	H24	S-24	-	530	A-21	SP21	SM21	SN21	H21	S-21	-	<b>1</b>	400	A-16	-	SM16	SN16	H16	S-16	-
VOLVO	XC90	04→	600	-	-	-	SN24	-	-	SE24	530	-	-	-	SN21	-	-	SE21	<b>4</b>	380	-	-	-	-	-	-	-

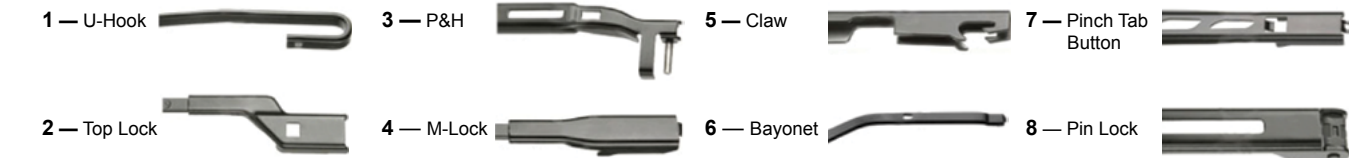

**SMART NEO**

**U-Hook**

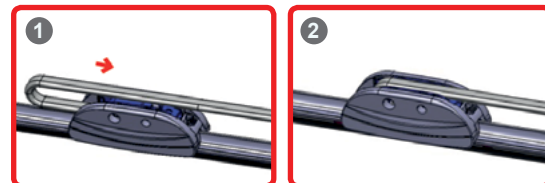

**Bayonet**

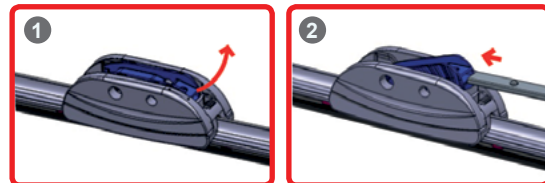

**P&H**

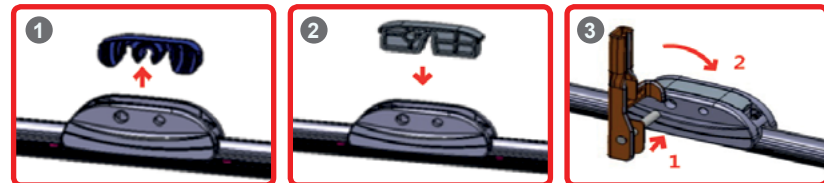

Снимите U-Hook коннектор. Установите P&H коннектор. Вставьте штырь кронштейна в большее отверстие. Поверните кронштейн.

**Pin Small**

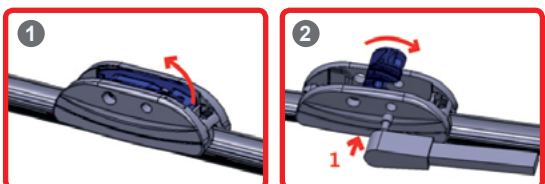

**Pin Large**

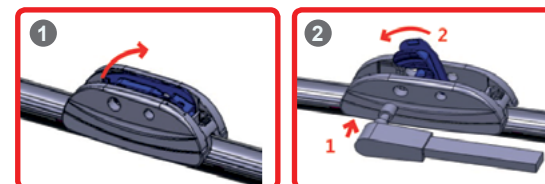

**Top-lock / M-lock**

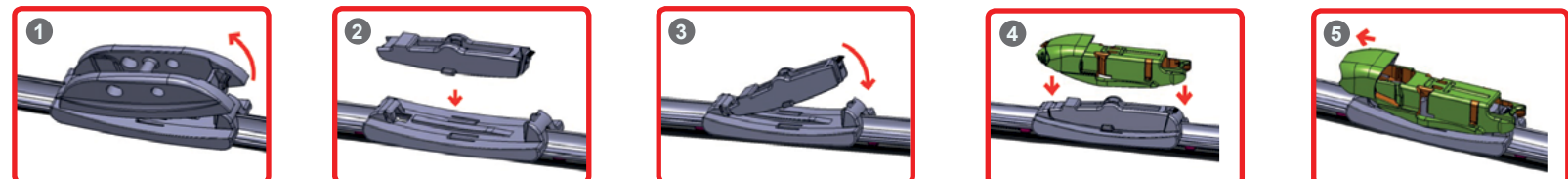

Снимите фиксатор. Установите фиксатор 2, который идет в комплекте. Защелкните фиксатор 2, как показано на рисунке. Установите коннектор. Зафиксируйте щетку в кронштейне.

**Top-lock**

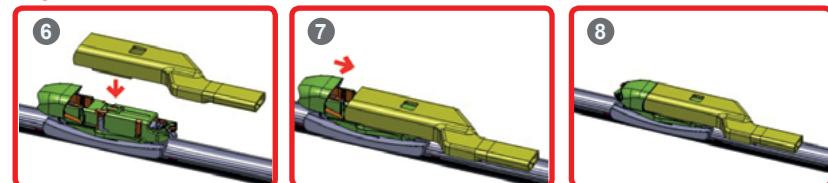

Зафиксируйте щетку в кронштейне

**M-lock**

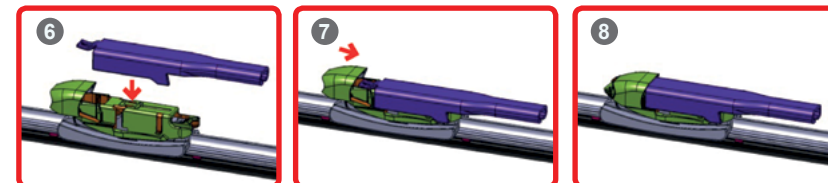

Зафиксируйте щетку в кронштейне

**Внимание!** Перед использованием необходимо снять защитный чехол.

**HYBRID**

Устанавливаются на кронштейны типа «U-Hook» (крючок) и разновидности кронштейнов боковой штырь следующих типов «P&H», Side pin 1/4" и 3/16".

**U-Hook**

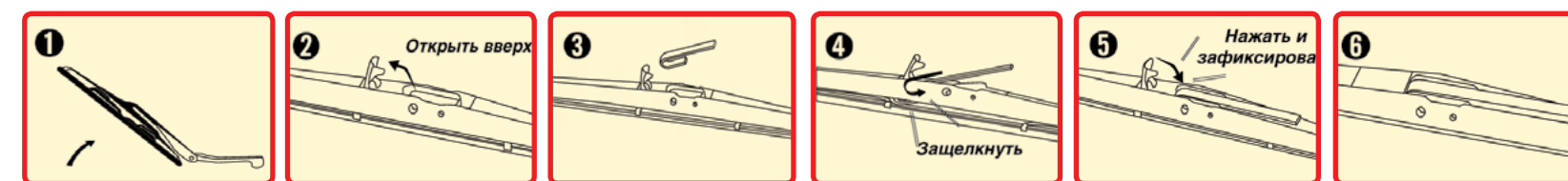

**«P&H»**

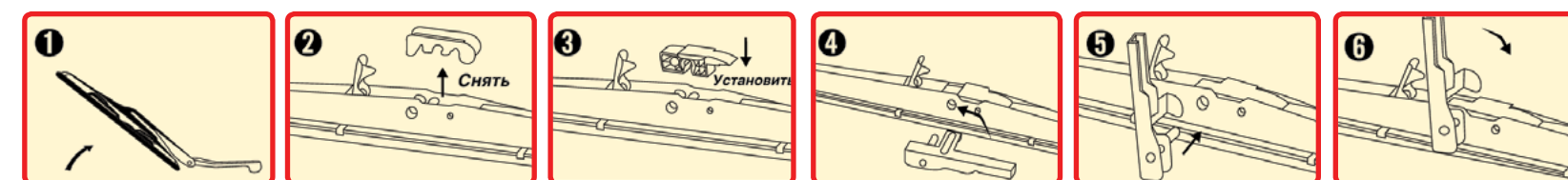

**Pin Small & Pin Large**



**Внимание!** Перед использованием необходимо снять защитный чехол.

## AERODYNAMIC

Устанавливаются на кронштейны типа «U-Hook» (крючок) и на кронштейны с отверстиями под винты.

### Наименование деталей



### Снятие щётки стеклоочистителя



1. Поднимите стеклоочистители вверх, отведя их от стекла



2. Возьмите одной рукой щетку и слегка поверните ее относительно кронштейна. Другой рукой возьмитесь за кронштейн и пальцем надавите на зажим коннектора.

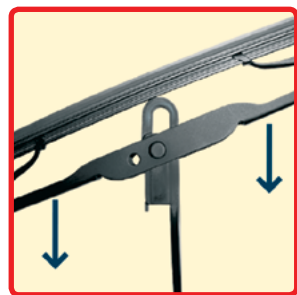

3. Потяните щетку, как показано на рисунке, и снимите ее.

### Установка щётки стеклоочистителя

При установке щетки должны быть отведены от стекла.



1. Расположите щетку и кронштейн так, как показано на рисунке.  
2. Вставьте в U-образное крепление кронштейна коннектор щетки. Удостоверьтесь, что коннектор плотно зашел в крепление и защелкнулся.



3. Аккуратно опустите кронштейн с щеткой на стекло.

### Установка щётки на кронштейны с отверстиями под винты



Снимите коннектор установленный на щетке. Закрепите коннектор 2 на кронштейне с помощью винта. Установите щетку на кронштейне, вставив поперечный стержень на щетке в паз коннектора.

### Для щёток с другими креплениями приобретайте переходники

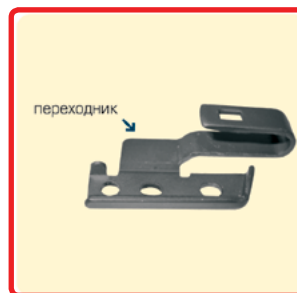

На некоторых автомобилях используется крепление на винтах с боковым выносом. Применяйте такой переходник (приобретается отдельно).  
При использовании этого переходника применяется коннектор, установленный на щетке. Закрепите переходник на кронштейне с помощью винтов. Установите щетку на кронштейне, вставив коннектор в U-образный паз переходника.

## SPOILER

Устанавливаются на кронштейны типа «U-Hook» (крючок) на кронштейны с отверстиями под винты

### Наименование деталей

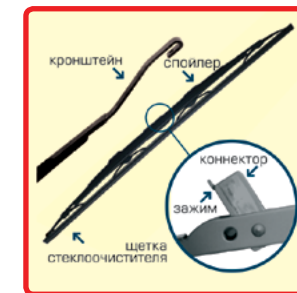

### Снятие щётки стеклоочистителя

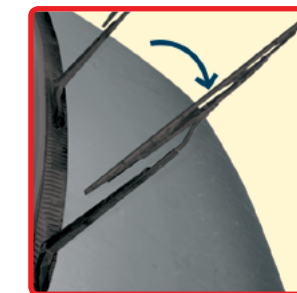

1. При снятии/установке щеток стеклоочистителя должны быть отведены от стекла.

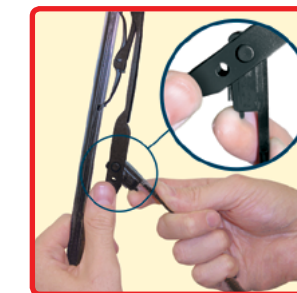

2. Возьмите одной рукой щетку и слегка поверните ее относительно кронштейна. Другой рукой возьмитесь за кронштейн и пальцем надавите на зажим коннектора.

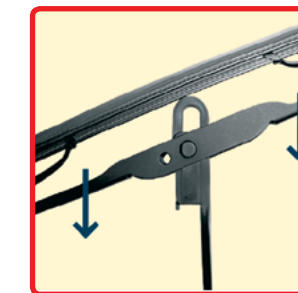

3. Потяните щетку, как показано на рисунке, и снимите ее.

### Установка щётки стеклоочистителя

При установке щетки должны быть отведены от стекла.



1. Расположите щетку и кронштейн так, как показано на рисунке.



2. Вставьте в U-образное крепление кронштейна коннектор щетки. Удостоверьтесь, что коннектор плотно зашел в крепление и защелкнулся.  
3. Аккуратно опустите кронштейн с щеткой на стекло.

### Установка щётки на кронштейны с отверстиями под винты



Снимите коннектор установленный на щетке. Закрепите коннектор 2 на кронштейне с помощью винта. Установите щетку на кронштейне, вставив поперечный стержень на щетке в паз коннектора.

### Для щёток с другими креплениями приобретайте переходники

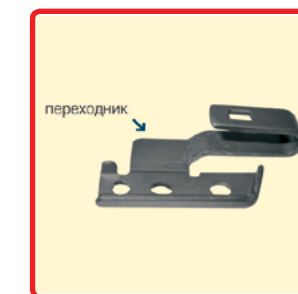

На некоторых автомобилях используется крепление на винтах с боковым выносом. Применяйте такой переходник (приобретается отдельно).  
При использовании этого переходника применяется коннектор, установленный на щетке. Закрепите переходник на кронштейне с помощью винтов. Установите щетку на кронштейне, вставив коннектор в U-образный паз переходника.

**Примечание: установка щетки должна производиться спойлером вниз (по отношению к капоту).**



## SNOWGUARD

Устанавливаются на кронштейны типа «U-Hook» (крючок) и на кронштейны с отверстиями под винты.

### Наименование деталей



### Снятие щётки стеклоочистителя

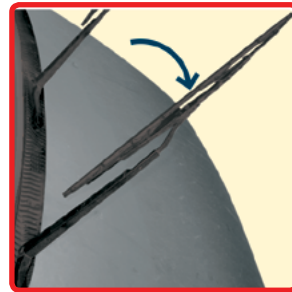

1. При снятии/установке щеток стеклоочистителя должны быть отведены от стекла.



2. Возьмите одной рукой щетку и слегка поверните ее относительно кронштейна. Другой рукой возьмитесь за кронштейн и пальцем надавите на зажим коннектора.

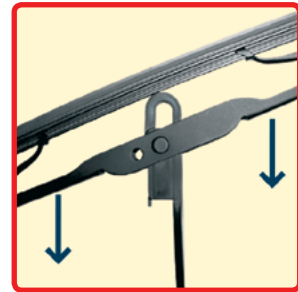

3. Потяните щетку, как показано на рисунке, и снимите ее.

### Установка щётки стеклоочистителя

Установка на кронштейны с U-образным креплением



1. Установите коннектор 1 на стержень щетки и расположите щетку и кронштейн так, как



2. Вставьте в U-образное крепление кронштейна коннектор щетки. Удостоверьтесь, что коннектор плотно зашел в крепление и защелкнулся.  
3. Аккуратно опустите кронштейн с щеткой на стекло.

### Установка щётки на кронштейны с отверстиями под винты



Установите коннектор 2 на кронштейне с помощью винта. Установите щетку на кронштейне, вставив поперечный стержень на щетке в паз коннектора 2.

### Для щёток с другими креплениями приобретайте переходники



На некоторых автомобилях используется крепление на винтах с боковым выносом. При использовании этого переходника применяется коннектор 1. Установите коннектор 1 на щетку. Закрепите переходник на кронштейне с помощью винтов. Установите щетку на кронштейне, вставив коннектор 1 в U-образный паз переходника.

## SNOWGUARD POLAR

### Коннектор тип A/M-Lock

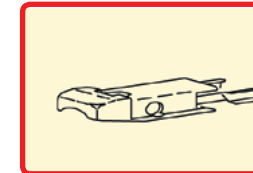

Коннектор тип А

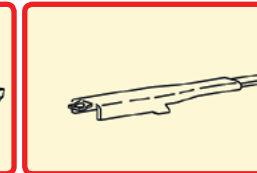

Рычаг под установку коннектора типа А

### Коннектор тип B/Pinch Tab Button

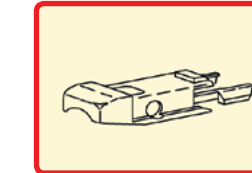

Коннектор тип В

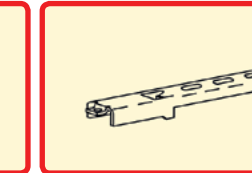

Рычаг под установку коннектора типа В

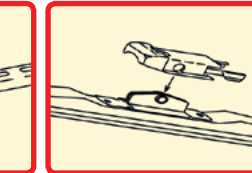

1. Установите коннектор на щетку, как указано на рисунке

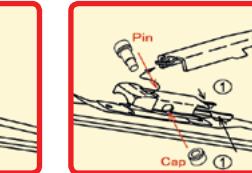

2. Вставьте стержень и заглушку (находится в индивидуальной упаковке) в пазы коннектора. Вставьте рычаг коннектора, как показано на рисунке и поверните в указанном направлении, чтобы зафиксировать щетку

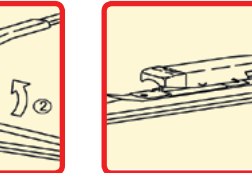

3. Проверьте, что щетка прочно держится в рычаге

### Коннектор тип D/Claw

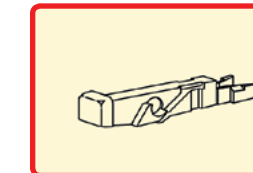

Коннектор тип F

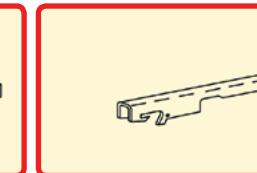

Рычаги под установку коннектора типа F

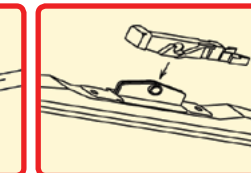

1. Установите коннектор на щетку, как указано на рисунке

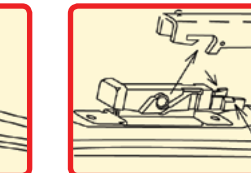

2. Вставьте щетку в рычаг, как отмечено на рисунке, нажмите на коннектор и поверните в указанном направлении, чтобы зафиксировать щетку.

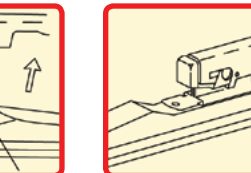

3. Проверьте, что щетка прочно держится в рычаге

### Коннектор тип F/P&N

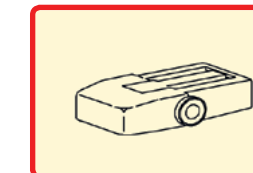

Коннектор тип F

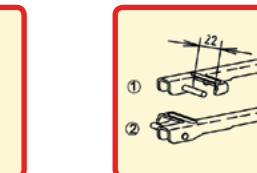

1. Широкий (правый руль)  
2. Широкий (левый руль)

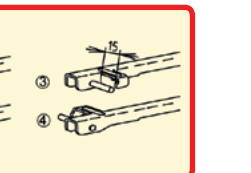

3. Узкий (правый руль)  
4. Узкий (левый руль)

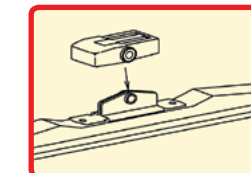

1. Установите коннектор на щетку, как указано на рисунке

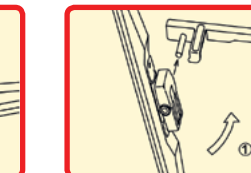

2. Вставьте щетку в рычаг, как отмечено на рисунке, и поверните в указанном направлении

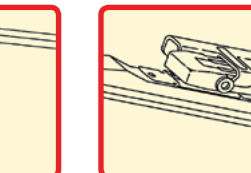

3. Проверьте, что щетка прочно держится в рычаге

### Коннектор тип E/Top-Loc (19 мм)

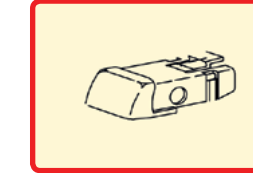

Коннектор тип E

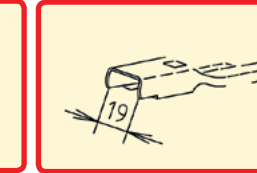

Рычаг под установку коннектора типа E

### Коннектор тип G/Top-Loc (16 мм)

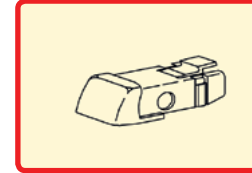

Коннектор тип G

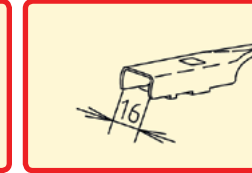

Рычаг под установку коннектора типа G

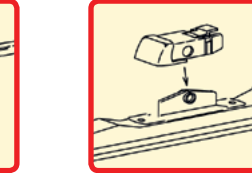

Установите коннектор на щетку, как указано на рисунке

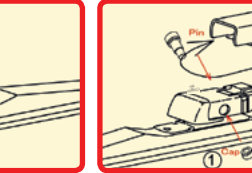

Вставьте стержень и заглушку в пазы коннектора. Вставьте рычаг в коннектор и сдвиньте щетку в указанном направлении.

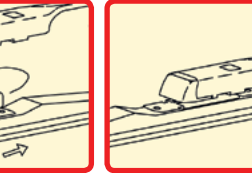

Проверьте, что щетка прочно держится в рычаге

Проверьте, что ширина рычага стеклоочистителя соответствует указанной на картинке

**Внимание!** Стержень и заглушка для коннектора E находятся в индивидуальной упаковке вместе с коннектором E. Стержень и заглушка для коннектора G находятся в отдельной индивидуальной упаковке

## REAR

Устанавливается на рычаги двух типов.

### Снятие щётки стеклоочистителя

#### Серия AR

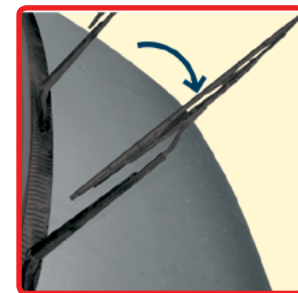

1. При снятии/установке щеток стеклоочистителя должны быть отведены от стекла.

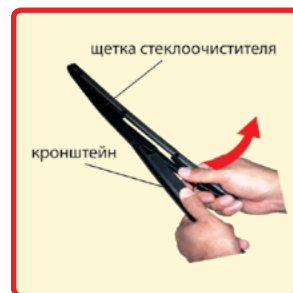

2. Поднимите кронштейн  
3. Поверните щетку и потяните с небольшим усилием, как показано на рисунке

#### Серия AR2

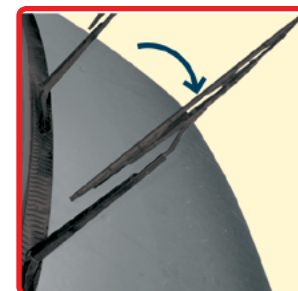

1. При снятии/установке щеток стеклоочистителя должны быть отведены от стекла.

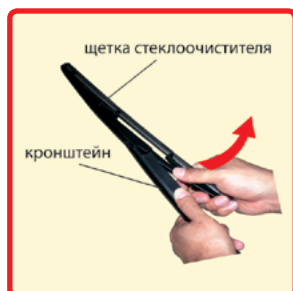

2. Поднимите кронштейн  
3. Поверните щетку и потяните с небольшим усилием, как показано на рисунке

### Установка щетки стеклоочистителя



Вставьте поперечный стержень щетки в паз кронштейна, как показано на рисунке.  
Обратите внимание, что правильное положение щетки в кронштейне – ограничителями вниз.



Поверните щетку, как показано на рисунке. Проверьте, что щетка зафиксирована на кронштейне.



Вставьте поперечный стержень щетки в паз кронштейна, как показано на рисунке.  
Обратите внимание, что правильное положение щетки в кронштейне – ограничителями вниз.



Поверните щетку, как показано на рисунке. Проверьте, что щетка зафиксирована на кронштейне.

## SNOWGUARD REAR

Устанавливается на рычаги двух типов.

### Типы коннекторов



Кронштейн под установку коннектора тип А



Кронштейн под установку коннектора тип В

### Снятие щетки стеклоочистителя

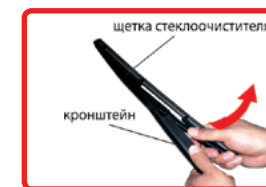

1. Поднимите кронштейн  
2. Поверните щетку и потяните с небольшим усилием, как показано на рисунке

### Установка щетки стеклоочистителя Коннектор тип А



1. Установите коннектор на щетку, как показано на рисунке



2. Защёлкните коннектор, как показано на рисунке  
3. Установите щетку на кронштейн

### Установка щетки стеклоочистителя Коннектор тип А



1. Поднимите кронштейн  
2. Поверните щетку и потяните с небольшим усилием, как показано на рисунке



1. Поднимите кронштейн  
2. Поверните щетку и потяните с небольшим усилием, как показано на рисунке

AERODYNAMIC

Артикул	Размер в мм
A11	275
A12	300
A13	325
A14	350
A15	375
A16	400
A17	425
A18	450
A19	475
A20	500
A21	525
A22	550
A24	600
A26	650
A28	700

SMART NEO

Артикул	Размер в мм
SN14	350
SN15	375
SN16	400
SN17	425
SN18	450
SN19	475
SN20	500
SN21	525
SN22	550
SN24	600
SN26	650

SNOWGUARD

Артикул	Размер в мм
S11	280
S12	300
S13	330
S14	350
S15	380
S16	400
S17	430
S18	450
S19	475
S20	500
S21	525
S22	550
S24	600
S26	650
S28	700

SNOWGUARD POLAR

Артикул	Размер в мм
SE14	350
SE15	380
SE16	400
SE17	430
SE18	450
SE19	475
SE20	500
SE21	525
SE22	550
SE24	600
SE26	650
SE28	700

REAR

Артикул	Размер в мм
AR11	275
AR12	300
AR14	350
AR16	400
AR2-12	300
AR2-14	350
AR2-16	400

SPOILER

Артикул	Размер в мм
SP16	400
SP18	450
SP19	475
SP20	500
SP21	525
SP22	550
SP24	600
SP26	650

HYBRID

Артикул	Размер в мм
H16	400
H18	450
H19	475
H20	500
H21	525
H22	550
H24	600
H26	650

SNOWGUARD REAR

Артикул	Размер в мм
RR11	275
RR12	300
RR14	350
RR16	400

---

---

---

---

---

---

---

---

---

---

---

---

---

---

---

---

---

---

---

---

---

---

---

---



## КОНТАКТНАЯ ИНФОРМАЦИЯ

Авантек Партс Групп Ко., ЛТД.  
21/Ф, Сеул Файненс Центр, Таэпонго  
1-га, Джун-гу, Сеул, 100-768, Корея  
Тел.: 02-892-8988, Факс: 02-893-8988

Эксклюзивным дистрибьютором  
продукции бренда AVANTECH в России  
является компания ЮНИКОМ.



**Москва**  
105082, г. Москва, ул. Большая  
Почтовая, д. 34, стр. 8, офис 601  
Тел./Факс: (495) 775-45-01, 775-89-01  
E-Mail: office@msk.uniqom.ru

**Екатеринбург**  
620050, г. Екатеринбург,  
ул. Ангарская, 77А  
Тел.: (343) 351-08-41  
E-Mail: office@ekb.uniqom.ru

**Краснодар**  
350005, г. Краснодар  
ул. Дзержинского, 98/5.  
Тел.: (861) 258-38-24, 258-38-36  
E-Mail: office@krd.uniqom.ru

**Новосибирск**  
630024, г. Новосибирск, ул. Мира, 58  
Тел./Факс: (383) 363-18-89  
E-Mail: office@nsk.uniqom.ru

**Иркутск**  
66414. г. Иркутск, ул. Олега Кошевого, 63  
Тел./Факс: (3952) 706-241, 706-245, 734-568  
E-Mail: office@irk.uniqom.ru

**Красноярск**  
660093, г. Красноярск,  
ул. Академика Вавилова, д. 1, стр. 9  
Тел.: (391) 240-98-83  
E-Mail: office@krs.uniqom.ru

**Хабаровск**  
680006, г. Хабаровск,  
ул. Индустриальная, 19Б  
Тел./Факс: (4212) 54-34-62  
E-Mail: office@khv.uniqom.ru

**Владивосток**  
690089, г. Владивосток, ул. Тухачевского, 48А  
Тел.: (423) 279-0-279 (многоканальный),  
Факс: (423) 237-84-95,  
E-Mail: vladivostok@uniqom.ru

[www.avantechparts.ru](http://www.avantechparts.ru)