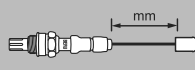
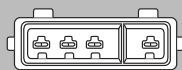

Lambda-Sonden

Lambda Sensors
Sondes Lambda
Lambdasondes
Sondas Lambda
Sonde Lambda
Лямбда-зонды
Sondy Lambda
Αισθητήρες λάμδα
Lambdaszondák
Sondas Lambda
Lambda sensörü

20

Nm

120

Herstellerbezogene Sortimente
Product ranges acc. to manufacturer
Assortiments en fonction du fabricant
Fabrikantgerelateerde sortimenten
Surtidos clasificados por marcas
Assortimenti riferiti ai produttori

Ассортимент в соответствии с изготовителем
Asortyment w odniesieniu do producentów
Γκάμα προϊόντων του κατασκευαστή
Gyártófűggő választékok
Sortidos ordenados por fabricantes
Üreticiyi baz alan çeşitler

181

Ersatztypen
Cross reference list
Types de remplacement
Reservetypes

Tipos de recambio
Sistemi di vendita
Запасные типы
Zamienniki

Ανταλλακτικοί τύποι
Ρόττίpusok
Modelos de substituição
Yedek tipler

184

184

Mit Erscheinen dieser Ausgabe werden alle seitherigen Ausgaben ungültig.

Con la publicación de esta edición pierden su validez todas las ediciones publicadas hasta ahora.

Με την κυκλοφορία της παρούσας έκδοσης ακυρώ-νται όλες οι προηγούμενες εκδόσεις.

Ausgabe
3/12

With the publication of this issue, all previous issues become invalid.

Con la comparsa della presente-edizione tutte le edizioni precedenti non sono più valide.

Ennek a kiadásnak a megjelenésé val az összes korábban közölt adat elveszti érvényességét.

Cette nouvelle édition rend caduques les éditions précédentes

С опубликованием данного издания все предыдущие издания теряют силу.

Com o surgimento desta edição, todas as anteriores deixam de ser válidas

Met het verschijnen van deze uitgave worden alle voorgaande uitgaven ongeldig

Wraz z ukazaniem się niniejszego wydania wszystkie poprzednie tracą ważność.

Bu baskýnyn ganymlanmasý ile birlikte önceki tüm baskýlar geçerliliđini kaybeder.

Weitere Anwendungen siehe auch

For further applications see
 Pour déterminer les autres affectations
 veuillez vous référer à

Zie voor verdere toepassingen ook
 Para más aplicaciones véase también
 Altre applicazioni vedi



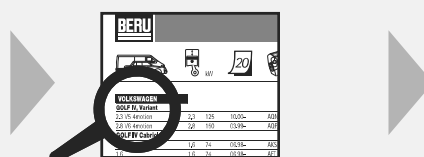





Дальнейшие использования см. также
 Pozostałe zastosowanie patrz również
 Περαιτέρω εφαρμογές βλέπε επίσης στο
 További alkalmazásokat lásd-nál
 Para outras aplicações, ver também
 Dider uygulamalar için ayrıca bkz.





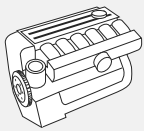

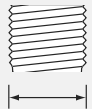

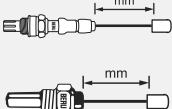

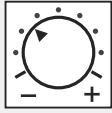
www.beru.com/produktfinder

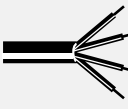

www.tecdoc.net

	<p>Hubraum Capacity Cylindrée Motorinhoud Cilindrada Cilindrata Рабочий объем pojemnosć skokowa Κυβισμός Lökettérfogat Cilindrada Silindir hacmi</p>		<p>Linkslenker Left-hand drive Volant à gauche Besturing links Volante a la izquierda Veicolo con guida a sinistra левостороннее рулевое управление Kierownica z lewej strony Αριστεροτίμονο Balkormányos condução à esquerda Soldan direksiyonlu araç</p>
	<p>Baujahr Year Année de fabrication Bouwjaar Año de modelo Anno di costr. Год изготовления rok produkcji Ετος κατασκευής Gyártási év Ano de construção Üretim yılı</p>		<p>Automatische Schaltung Automatic transmission Boîte automatique Automatische schakeling Conexión automática Comando automatico Автоматическое переключение Automatyczna skrzynia biegów Αυτόματο κιβώτιο ταχυτήτων Automatikus kapcsolás Ligação automática Otomatik geçiş</p>
	<p>Motorbezeichnung Engine type Désignation du moteur Motoraand. Designación del motor Denom. Motore Обозн. двигателя ozn. silnika Όνομ. κινητήρα Motormegj Designação do motor Motor tanımı</p>		<p>Manuelle Schaltung Manual transmission Boîte manuelle Handmatige schakeling Conexión manual Comando manuale Ручное переключение Manualna skrzynia biegów Συμβατικό κιβώτιο ταχυτήτων Kézi kapcsolás Ligação manual Mekanik geçiş</p>
	<p>Zylinder Cylinder Cylindre Cilinder Cilindro Cilindro цилиндр Cylinder κύλινδρος Henger Cilindro Silindir</p>		<p>Gewindedurchmesser Thread diameter Diamètre du filetage Schroefdraaddiameter Diámetro de la rosca Diametro filetto Диаметр резьбы Średnica gwintu Σταθεροί κινητήρες Menetátméro diâmetro da rosca Diş çapı</p>
	<p>Schlüsselweite Across flats Ouverture de clé Sleutelbreedte Boca de llave Grandezza chiave Раствор ключа Rozmiar klucza Ανοιγμα κλειδιού kulcsnyílás Abertura da chave Anahtar agzi</p>	<p>Nm</p>	<p>Anzugsdrehmoment in Newtonmeter Tightening torque in Newtonmeters (Nm) Couple de serrage en Nm Koppel in Nm Par de apriete en metro Newton Coppia di serraggio in Newton/metro Момент затяжки в ньютон-метре Moment dociągania w Nm Ροπή σύσφιξης σε Newtonmeter Forgatónyomaték Newton méterben binário de aperto em metros newton Newtonmetre cinsinden sikma torqu</p>
	<p>Rechtslenker Right-hand drive Volant à droite Besturing rechts Volante a la derecha Veicolo con guida a destra правостороннее рулевое управление Kierownica z prawej strony Δεξιοτίμονο Jobbkormányos condução à direita Sağdan direksiyonlu araç</p>		<p>Länge Anschlußleitung Cable length Longueur de câble Leidingslengte Longitud de cable Lunghezza cavi Длина кабеля Długość przewodu Μήκος αγωγού Vezeték hossza comprimento do cabo de ligação Bağlantı hattının uzunluğu</p>

	<p>Einbauposition Lambda-Sonde Oxygen sensor installation position Position de montage de la sonde lambda Inbouwpositie lambdasonde Posición de montaje de la sonda lambda Posizione di montaggio della sonda Lambda: позиция установки лямбда-зонда Ροζυζια montaζowa sondy lambda Θέση εγκατάστασης αισθητήρα λάμδα A lambda-szonda beépítési pozíciója posição de montagem da sonda Lambda Lambda sensörünün montaj pozisyonu</p>		<p>Regelsonde Control sensor Sonde de réglage Regelsonde Sonda de regulaci3n Sonda di regolazione регулирующий датчик Sonda regulacyjna Αισθητήρας ρύθμισης Szabályzó szonda sonda de regulac3o Kontrol sensörü</p>
	<p>Mit Anhängavorrichtung With clutch device Avec dispositif d'attache Met trekhaak Con dispositivo de suspensi3n Con dispositivo di agganciamento С прицеπным устройством Z zawieszaniem Με διάταξη ρυμούλκησης Vonóhoroggal Com dispositivo de acoplamento Asma tertibatli</p>		<p>Diagnosesonde Diagnosis sensor Sonde de diagnostic Diagnosesonde Sonda de diagnóstico Sonda di diagnosi диагностический датчик Sonda diagnostyczna Αισθητήρας διάγνωσης Diagnosztikai szonda sonda de diagnóstico Diyagnoz sensörü</p>
	<p>ohne Katalysator without catalytic converter sans catalyseur zonder katalysator sin catalizador senza catalizzatore без катализатора bez katalizatora χωρίς καταλύτη katalizátor nélkül sem catalisador Katalitik konvertörsüz</p>		<p>Kabelanzahl Number of cables Nombre de câbles Aantal kabel Número de cable Numero cavo Количество проводов Ilość kabli Αριθμός καλωδίων Kábelek száma número de cabos Kablo sayısı</p>
	<p>Einschränkungen Restrictions Restrictions Bepërkingen Limitaciones Restrizioni Ограничения Ograniczenia Περιορισμοί Korlátozások Limitaçöes Sinirlamalar</p>		<p>Lambda-Sonden Lambda Sensors Sondes lambda Lambdasondes Sondas Lambda Sonde Lambda Λямбда-зонды Sondy lambda Αισθητήρες λάμδα Lambdaszondák Sonda Lambda Lambda sensörü</p>
	<p>Am Fahrzeug ermitteln determine on the vehicle évaluer au niveau du véhicule aan het voertuig bepalen determinar en el vehículo rilevamento sul veicolo определить на автомобиле ustalić na samochodzie προσδιορισμός στο αυτοκίνητο meghatározás a járműn determinar no veículo Kablo rakoruyla</p>		

Кислородные датчики BorgWarner BERU Systems: Качество завода-изготовителя для автомастерских и специализированной торговли

Постоянно ужесточаемые нормы/предельные значения по отработавшим газам привели к тому, что кислородные датчики в автомобилях стали незаменимыми, а в новейших автомобилях устанавливаются даже два кислородных датчика как минимум (перед и после катализатора). Они позволяют контролировать как работу катализатора, так и самих кислородных датчиков (регулирующего и контрольного датчика).

Таким образом кислородные датчики в автомобилях с регулируемым катализатором гарантируют оптимальную создаваемую мощность, экологически чистый выброс вредных веществ и экономный расход топлива. BorgWarner BERU Systems имеет в программе ассортимент из 290 циркониевых кислородных датчиков, отвечающих спросу.

Сниженные выбросы ОГ, повышенная эффективность: Современные системы зажигания делают двигатели экологичными. В связи с этим BorgWarner BERU Systems предлагает автомастерским и специализированной торговле программу кислородных датчиков с качеством завода-изготовителя. Ими можно квалифицированно оборудовать европейский автопарк при постоянно растущем спросе на запасные части.

Кислородные датчики являются быстроизнашивающимися деталями – из-за сильных нагрузок в потоке ОГ, механических нагрузок (например, дорожного щебня), температурных перепадов, влияний окружающей среды (соль для посыпания дорог, грязь), функционирование которых следует проверять регулярно, а не только в рамках контроля токсичности ОГ. Чтобы своевременно заметить превышение допустимого законом выброса вредных веществ, повышение расхода топлива и снижение мощности двигателя. BorgWarner BERU Systems рекомендует контролировать кислородные датчики примерно через каждые 30000 километров пробега и заменять необогреваемые датчики после 50000 километров пробега; обогреваемые датчики следует менять после 100000 километров пробега.

Для этого BorgWarner BERU Systems предлагает своим партнерам в автомастерских и специализированной торговле свыше 290 циркониевых кислородных датчиков, из них свыше 90 датчиков, изготовленных по планарной технологии. Все датчики имеют индивидуальную упаковку и информативную инструкцию по монтажу.

Циркониевые кислородные датчики BorgWarner BERU Systems: принцип работы и конструкция

Планарный кислородный датчик представляет собой усовершенствованный циркониевый/стержневой датчик. Принцип работы соответствует традиционным стержневым/циркониевым датчикам, однако элемент датчика в форме вытянутой в длину пластинки состоит из нескольких слоев пленки и проводящих полосок, в которые интегрирован кроме измерительной ячейки также нагреватель, чтобы добиться еще более высокой эксплуатационной готовности и сократить нерегулируемую фазу работы непрогретого двигателя.

Тип стержневого датчика

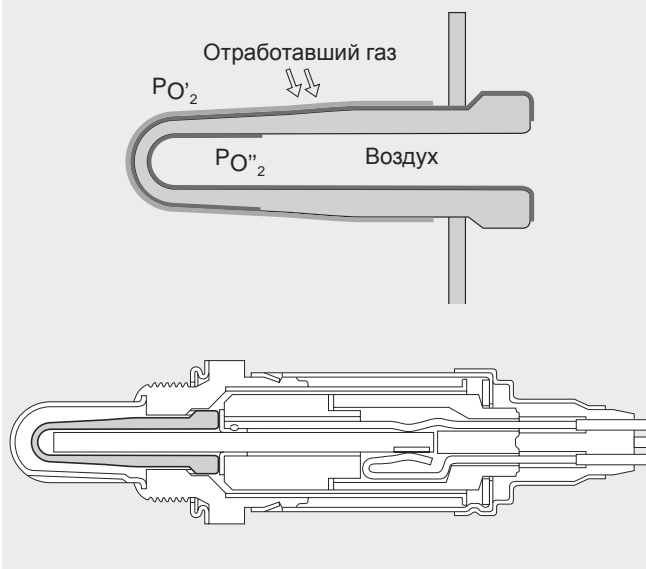

Тип планарного датчика

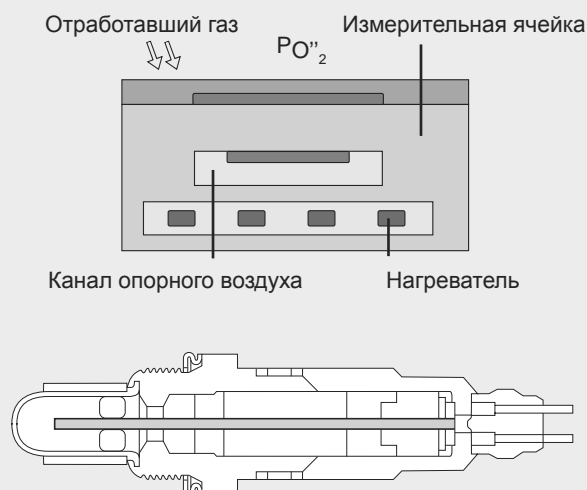

Sondy lambda firmy BorgWarner BERU Systems: Jakość pierwszego wyposażenia dla warsztatów i handlu

Coraz surowsze normy spalin/ wartości graniczne doprowadziły do tego, że sondy lambda stały się nieodłączną częścią samochodów, a w nowszych pojazdach zamontowane są nawet przynajmniej dwie sondy lambda (przed i za katalizatorem). Przy ich pomocy możliwa jest zarówno kontrola katalizatora, jak też sond lambda (sonda regulacyjna i monitorująca).

Tym samym sondy lambda są w samochodach z regulowanym katalizatorem gwarantem optymalnej mocy silnika, bezpiecznej dla środowiska emisji spalin i oszczędnego zużycia paliwa. BorgWarner BERU Systems ma w programie dostosowany do potrzeb asortyment 290 cyrkonowych sond lambda.

Mniejsza emisja, poprawa wydajności: Nowoczesne systemy zapłonowe sprawiają, że silniki są bezpieczniejsze dla środowiska. BorgWarner BERU Systems oferuje w tym zakresie warszatom i handlowi program sond lambda o jakości fabrycznego wyposażenia. Wraz z ciągle wzrastającym zapotrzebowaniem można w nie fachowo wyposażać europejski park maszynowy.

Sondy lambda to części zużywalne – ze względu na duże obciążenie w strumieniu spalin, obciążenia mechaniczne (np. żwir, odpryski z drogi), szoki termiczne, wpływy środowiska (sól do posypywania drogi, brud), ich działanie należy sprawdzać regularnie, nie tylko w ramach dopuszczającego badania technicznego. Należy je sprawdzać, aby odpowiednio wcześniej wykryć przekroczenie ustawowych wartości emisji substancji szkodliwych, wzrost zużycia paliwa, obniżenie mocy silnika. BorgWarner BERU Systems zaleca sprawdzanie sond lambda co około 30.000 kilometrów i wymianę nieogrzewanych sond przy 50.000 kilometrów; sondy ogrzewane należy wymieniać co 100.000 kilometrów.

BorgWarner BERU Systems oferuje do tego celu swoim partnerom w warsztatach i w specjalistycznym handlu aktualnie ponad 290 cyrkonowych sond lambda, z czego ponad 90 w technice planarnej. Wszystkie w opakowaniach jednostkowych z rzeczowo-informacyjną instrukcją montażu.

Cyrkonowe sondy lambda firmy BorgWarner BERU Systems: Działanie i budowa

Kolejnym etapem rozwoju cyrkonowej sondy palcowej jest planarna sonda lambda. Zasada działania odpowiada zwykłemu palcowemu/cyrkonowemu sondom, ale element czujnikowy ma kształt długiej płytki składającej się z wielu warstw folii i ścieżek przewodzących, w których oprócz komory pomiarowej zintegrowany jest dodatkowo grzejnik, aby jeszcze szybciej osiągnąć gotowość roboczą i skrócić nieregulowaną fazę nagrzewania.

Typ sondy palcowej

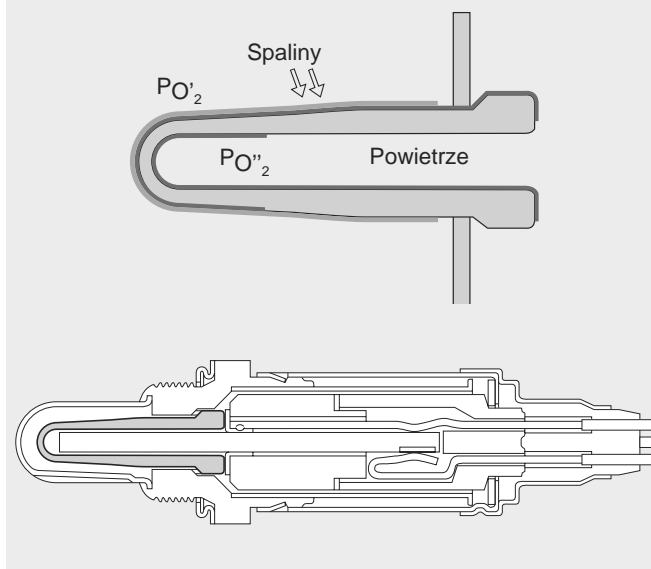

Typ sondy planarnej

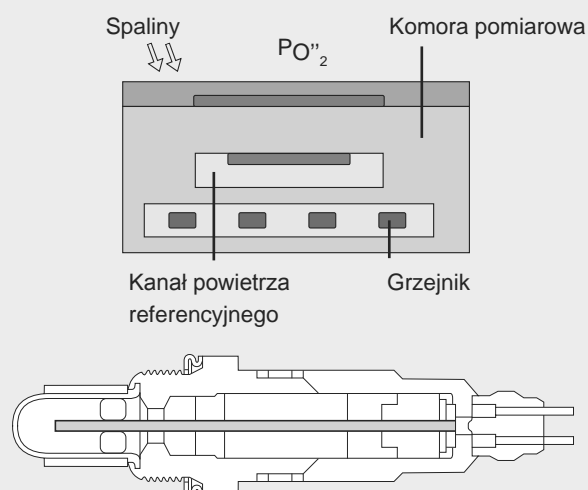

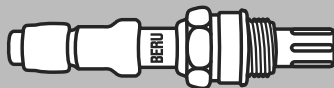

OZH 113	0 824 010 147	158
OZH 114	0 824 010 148	158
OZH 115	0 824 010 149	158
OZH 118	0 824 010 152	158
OZH 120	0 824 010 154	158
OZH 121	0 824 010 155	159
OZH 122	0 824 010 156	159
OZH 123	0 824 010 157	159
OZH 124	0 824 010 158	159
OZH 125	0 824 010 159	159
OZH 127	0 824 010 161	160
OZH 128	0 824 010 162	160
OZH 130	0 824 010 164	160
OZH 131	0 824 010 165	160
OZH 132	0 824 010 166	160
OZH 134	0 824 010 168	161
OZH 135	0 824 010 169	161
OZH 136	0 824 010 170	161
OZH 137	0 824 010 171	161
OZH 138	0 824 010 172	161
OZH 139	0 824 010 173	162
OZH 140	0 824 010 174	162
OZH 141	0 824 010 175	162
OZH 142	0 824 010 176	162
OZH 143	0 824 010 177	162
OZH 144	0 824 010 178	163
OZH 145	0 824 010 179	163
OZH 146	0 824 010 180	163
OZH 147	0 824 010 181	163
OZH 148	0 824 010 182	163
OZH 150	0 824 010 184	164
OZH 151	0 824 010 185	164
OZH 152	0 824 010 186	164
OZH 153	0 824 010 187	164
OZH 154	0 824 010 188	164
OZH 155	0 824 010 189	165
OZH 156	0 824 010 190	165
OZH 157	0 824 010 191	165
OZH 158	0 824 010 192	165
OZH 159	0 824 010 193	165
OZH 160	0 824 010 194	166
OZH 161	0 824 010 195	166
OZH 163	0 824 010 197	166
OZH 164	0 824 010 198	166
OZH 165	0 824 010 199	166
OZH 166	0 824 010 200	167
OZH 167	0 824 010 201	167
OZH 168	0 824 010 202	167
OZH 169	0 824 010 203	167
OZH 173	0 824 010 207	167
OZH 176	0 824 010 210	168
OZH 177	0 824 010 211	168
OZH 178	0 824 010 212	168
OZH 179	0 824 010 213	168
OZH 180	0 824 010 214	168
OZH 181	0 824 010 215	169
OZH 182	0 824 010 216	169
OZH 184	0 824 010 218	169
OZH 190	0 824 010 224	169
OZH 192	0 824 010 226	169
OZH 193	0 824 010 227	170
OZH 194	0 824 010 228	170
OZH 196	0 824 010 230	170

OZH 198	0 824 010 232	170
OZH 199	0 824 010 233	170
OZH 200	0 824 010 234	171
OZH 201	0 824 010 235	171
OZH 203	0 824 010 237	171
OZH 204	0 824 010 238	171
OZH 205	0 824 010 239	171
OZH 206	0 824 010 240	172
OZH 207	0 824 010 241	172
OZH 208	0 824 010 242	172
OZH 209	0 824 010 243	172
OZH 210	0 824 010 244	172
OZH 211	0 824 010 245	173
OZH 212	0 824 010 246	173
OZH 213	0 824 010 247	173
OZH 215	0 824 010 249	173
OZH 216	0 824 010 250	173
OZH 217	0 824 010 251	174
OZH 218	0 824 010 252	174
OZH 219	0 824 010 253	174
OZH 220	0 824 010 254	174
OZH 222	0 824 010 256	174
OZH 223	0 824 010 257	175
OZH 224	0 824 010 258	175
OZH 225	0 824 010 259	175
OZH 226	0 824 010 260	175
OZH 227	0 824 010 261	175
OZH 228	0 824 010 262	176
OZH 229	0 824 010 263	176
OZH 231	0 824 010 265	176
OZH 232	0 824 010 266	176
OZH 233	0 824 010 267	176
OZH 234	0 824 010 268	177
OZH 235	0 824 010 269	177
OZH 236	0 824 010 270	177
OZU 001	0 824 010 001	178
OZU 003	0 824 010 053	178
OZU 004	0 824 010 054	178
OZU 005	0 824 010 055	178
OZU 006	0 824 010 064	178
OZU 007	0 824 010 141	179
OZU 010	0 824 010 090	179
OZU 012	0 824 010 096	179
OZU 014	0 824 010 104	179
OZU 015	0 824 010 111	179
OZU 021	0 824 010 131	180
OZU 022	0 824 010 094	180
OZU 023	0 824 010 136	180
OZU 024	0 824 010 133	180
OZU 025	0 824 010 143	180

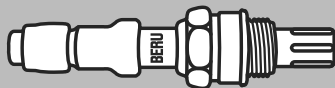

0 824 010 147	OZH 113	158
0 824 010 148	OZH 114	158
0 824 010 149	OZH 115	158
0 824 010 152	OZH 118	158
0 824 010 154	OZH 120	158
0 824 010 155	OZH 121	159
0 824 010 156	OZH 122	159
0 824 010 157	OZH 123	159
0 824 010 158	OZH 124	159
0 824 010 159	OZH 125	159
0 824 010 161	OZH 127	160
0 824 010 162	OZH 128	160
0 824 010 164	OZH 130	160
0 824 010 165	OZH 131	160
0 824 010 166	OZH 132	160
0 824 010 168	OZH 134	161
0 824 010 169	OZH 135	161
0 824 010 170	OZH 136	161
0 824 010 171	OZH 137	161
0 824 010 172	OZH 138	161
0 824 010 173	OZH 139	162
0 824 010 174	OZH 140	162
0 824 010 175	OZH 141	162
0 824 010 176	OZH 142	162
0 824 010 177	OZH 143	162
0 824 010 178	OZH 144	163
0 824 010 179	OZH 145	163
0 824 010 180	OZH 146	163
0 824 010 181	OZH 147	163
0 824 010 182	OZH 148	163
0 824 010 184	OZH 150	164
0 824 010 185	OZH 151	164
0 824 010 186	OZH 152	164
0 824 010 187	OZH 153	164
0 824 010 188	OZH 154	164
0 824 010 189	OZH 155	165
0 824 010 190	OZH 156	165
0 824 010 191	OZH 157	165
0 824 010 192	OZH 158	165
0 824 010 193	OZH 159	165
0 824 010 194	OZH 160	166
0 824 010 195	OZH 161	166
0 824 010 197	OZH 163	166
0 824 010 198	OZH 164	166
0 824 010 199	OZH 165	166
0 824 010 200	OZH 166	167
0 824 010 201	OZH 167	167
0 824 010 202	OZH 168	167
0 824 010 203	OZH 169	167
0 824 010 207	OZH 173	167
0 824 010 210	OZH 176	168
0 824 010 211	OZH 177	168
0 824 010 212	OZH 178	168
0 824 010 213	OZH 179	168
0 824 010 214	OZH 180	168
0 824 010 215	OZH 181	169
0 824 010 216	OZH 182	169
0 824 010 218	OZH 184	169
0 824 010 224	OZH 190	169
0 824 010 226	OZH 192	169
0 824 010 227	OZH 193	170
0 824 010 228	OZH 194	170
0 824 010 230	OZH 196	170

0 824 010 232	OZH 198	170
0 824 010 233	OZH 199	170
0 824 010 234	OZH 200	171
0 824 010 235	OZH 201	171
0 824 010 237	OZH 203	171
0 824 010 238	OZH 204	171
0 824 010 239	OZH 205	171
0 824 010 240	OZH 206	172
0 824 010 241	OZH 207	172
0 824 010 242	OZH 208	172
0 824 010 243	OZH 209	172
0 824 010 244	OZH 210	172
0 824 010 245	OZH 211	173
0 824 010 246	OZH 212	173
0 824 010 247	OZH 213	173
0 824 010 249	OZH 215	173
0 824 010 250	OZH 216	173
0 824 010 251	OZH 217	174
0 824 010 252	OZH 218	174
0 824 010 253	OZH 219	174
0 824 010 254	OZH 220	174
0 824 010 256	OZH 222	174
0 824 010 257	OZH 223	175
0 824 010 258	OZH 224	175
0 824 010 259	OZH 225	175
0 824 010 260	OZH 226	175
0 824 010 261	OZH 227	175
0 824 010 262	OZH 228	176
0 824 010 263	OZH 229	176
0 824 010 265	OZH 231	176
0 824 010 266	OZH 232	176
0 824 010 267	OZH 233	176
0 824 010 268	OZH 234	177
0 824 010 269	OZH 235	177
0 824 010 270	OZH 236	177
0 824 010 001	OZU 001	178
0 824 010 053	OZU 003	178
0 824 010 054	OZU 004	178
0 824 010 055	OZU 005	178
0 824 010 064	OZU 006	178
0 824 010 141	OZU 007	179
0 824 010 090	OZU 010	179
0 824 010 096	OZU 012	179
0 824 010 104	OZU 014	179
0 824 010 111	OZU 015	179
0 824 010 131	OZU 021	180
0 824 010 094	OZU 022	180
0 824 010 136	OZU 023	180
0 824 010 133	OZU 024	180
0 824 010 143	OZU 025	180

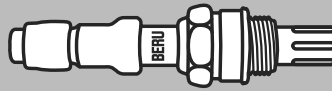

kW

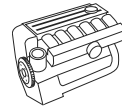

 Zyl.
Cyl.
Cil.

ALFA ROMEO

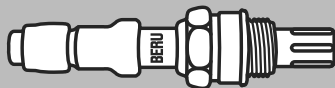
33							
1.4 i.e.	1,4	R	65	09.91-12.91	AR 30755	4	OZH 003
1.4 i.e.	1,4	R	66	06.91-12.91	AR 30755	4	OZH 003
1.5 i.e.	1,5	R	71	01.90-03.92	AR 30751	4	OZH 003
1.5 i.e.	1,5	R	71	04.92-09.94	AR 30751	4	OZH 067
1.7 i.e.	1,7	R	77	09.88-12.89	AR 30558	4	OZH 003
1.7 i.e.	1,7	R	77	04.92-09.94	AR 30737 A	4	OZH 067
1.7 i.e.	1,7	R	79	01.90-03.92	AR 30737	4	OZH 003
1.7 i.e. 4x4	1,7	R	79	01.90-03.92	AR 30737	4	OZH 003
1.7 16V	1,7	R	95	01.90-09.94	AR 30747	4	OZH 003
1.7 16V 4x4	1,7	R	95	01.90-09.94	AR 30747	4	OZH 003
1.7 16V	1,7	R	97	01.90-03.92	AR 30747	4	OZH 003
1.7 16V 4x4	1,7	R	97	06.90-09.94	AR 30747	4	OZH 003
33 Sportwagon							
1.4 i.e.	1,4	R	65	09.91-12.91	AR 30755	4	OZH 003
1.4 i.e.	1,4	R	66	06.91-12.91	AR 30755	4	OZH 003
1.4 i.e. 4x4	1,4	R	66	06.91-12.91	AR 30755	4	OZH 003
1.5 i.e.	1,5	R	71	01.90-03.92	AR 30751	4	OZH 003
1.5 i.e.	1,5	R	71	04.92-09.94	AR 30751	4	OZH 067
1.7 i.e.	1,7	R	77	09.88-12.89	AR 30558	4	OZH 003
1.7 i.e.	1,7	R	77	04.92-09.94	AR 30737	4	OZH 067
1.7 i.e. 4x4	1,7	R	77	09.88-12.89	AR 30558	4	OZH 003
1.7 i.e.	1,7	R	79	07.90-03.92	AR 30737	4	OZH 003
1.7 i.e. 4x4	1,7	R	79	07.90-03.92	AR 30737	4	OZH 003
1.7 16V	1,7	R	95	01.90-09.94	AR 30747	4	OZH 003
1.7 16V 4x4	1,7	R	95	06.90-09.94	AR 30747	4	OZH 003
1.7 16V	1,7	R	97	01.90-09.94	AR 30747	4	OZH 003
1.7 16V 4x4	1,7	R	97	01.90-03.92	AR 30747	4	OZH 003
75							
1.6 KAT	1,6	R	81	05.89-02.92	AR 61101	4	OZH 037
1.8	1,8	R	90	08.89-02.92	AR 61201	4	OZH 037
2.0 T.S.	2,0	R	107	01.87-05.90	AR 06166	4	OZH 046
2.5 V6 KAT	2,5	R	113	09.86-04.89	AR 01648	6	OZH 192
2.5 V6	2,5	R	115	02.86-08.86	AR 01911	6	OZH 192
3.0 V6 KAT	3,0	R	136	01.87-02.92	AR 06124	6	OZH 037
3.0 V6	3,0	R	141	02.90-02.92	AR 61503	6	OZH 037
90							
2.0 i.e.	2,0	R	97	05.85-01.87	AR 06210	6	OZH 192
2.5 i.e. V6	2,5	R	110	02.86-07.87	AR 01911	6	OZH 192
2.5 i.e. V6	2,5	R	114	10.84-07.87	AR 01911	6	OZH 192
145							
1.4 i.e.	1,4	R	66	07.94-12.96	AR 33501	4	OZH 054
1.4 i.e. 16V T.S.	1,4	R, 1	76	12.96-01.01	AR 33503, VET # 165088 →	4	OPH 028
1.4 i.e. 16V T.S.	1,4	R	76	02.99-10.99	AR 33503	4	OZH 052
1.4 i.e. 16V T.S.	1,4	R	76	02.99-10.99	AR 38501	4	OZH 052
1.4 i.e. 16V T.S.	1,4	R	76	12.96-01.99	AR 33503	4	OZH 056
1.6 i.e.	1,6	R	76	10.94-12.94	AR 33201	4	OZH 056
1.6 i.e. 16V T.S.	1,6	R, 1	88	02.99-01.01	AR 67601	4	OPH 028
1.6 i.e. 16V T.S.	1,6	R	88	02.99-01.01	AR 67601	4	OZH 056
1.7 i.e. 16V	1,7	R	95	10.94-11.96	AR 33401	4	OZH 056
1.8 i.e. 16V	1,8	R, 1	106	03.98-01.01	AR 32201	4	OPH 028
1.8 i.e. 16V T.S.	1,8	R	103	12.96-12.98	AR 38401/AR 67106	4	OZH 056
2.0 16V Quadrifoglio	2,0	R, 1	114	03.98-01.01	AR 32301	4	OPH 028
2.0 16V Quadrifoglio	2,0	R	114	03.98-01.01	AR 32301	4	OZH 056
2.0 16V T.S.	2,0	R	110	10.95-01.01	AR 67204	4	OZH 056
146							
1.4 i.e.	1,4	R	66	12.94-12.96	AR 33501	4	OZH 054
1.4 i.e. 16V T.S.	1,4	R, 1	76	11.96-01.01	AR 33503, VET # 0165088 →	4	OPH 028
1.4 i.e. 16V T.S.	1,4	R	76	11.96-01.01	AR 33503	4	OZH 052
1.4 i.e. 16V T.S.	1,4	R	76	11.96-01.01	AR 38501	4	OZH 056
1.6 i.e. 16V T.S.	1,6	R, 1	88	11.96-01.01	AR 67601, VET # 0165088 →	4	OPH 028
1.6 i.e. 16V T.S.	1,6	R	88	11.96-01.01	AR 67601/AR 38201	4	OZH 056

**BERU**

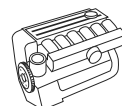
kW

Zyl.
Cyl.
Cil.**ALFA ROMEO****146**

1.7 i.e. 16V	1,7	R	96	12.94-11.96	AR 33401	4	OZH 056
1.8 i.e. 16V T.S.	1,7	R	103	11.96-01.01	AR 38401/AR 67106	4	OZH 056
1.8 i.e. 16V T.S.	1,7	R, 1	106	03.98-01.01	AR 32201	4	OPH 028
2.0 16V Quadrifoglio	2,0	R, 1	114	03.98-12.99	AR 32301	4	OPH 028
2.0 16V Quadrifoglio	2,0	R	114	03.98-01.01	AR 32301	4	OZH 056
2.0 16V T.S.	2,0	R	110	10.95-01.01	AR 67204	4	OZH 056

147

1.6 16V T.SPARK ECO	1,6	R, 1	77	01.01-	AR 37203	4	OPH 025
1.6 16V T.SPARK ECO	1,6	D, 1	77	01.01-	AR 37203	4	OPH 027
1.6 16V T.SPARK	1,6	R, 1	88	01.01-	AR 32104	4	OPH 026
2.0 16V T.SPARK	2,0	R, 1	110	01.01-	AR 32310	4	OPH 026
3.2 GTA	3,2	R, 1	184	02.03-	932 A.000	6	OPH 025

155

1.6 16V T.S.	1,6	R	88	05.96-12.97	AR 67601	4	OZH 056
1.7 T.S.	1,7	R	85	04.93-04.96	AR 67105	4	OZH 055
1.7 T.S. 16V	1,7	R	103	05.96-12.97	AR 67106	4	OZH 056
1.8 T.S.	1,8	R	77	02.92-04.96	AR 67402	4	OZH 055
1.8 T.S.	1,8	R	95	02.92-03.93	AR 67101	4	OZH 055
1.8 T.S. Sport	1,8	R	93	01.92-04.96	AR 67101/AR 67102	4	OZH 055
2.0 T.S.	2,0	R	104	04.93-02.95	AR 67202	4	OZH 055
2.0 T.S. 16V	2,0	R	110	05.96-10.97	AR 67204	4	OZH 056
2.0 16V Turbo Q4	2,0	R	137	01.92-12.97	AR 67203	4	OZH 037
2.0 16V Turbo Q4	2,0	R	140	01.92-12.97	AR 67203	4	OZH 037
2.5 V6	2,5	R	120	05.96-12.97	AR 67303	6	OZH 035
2.5 V6	2,5	R	121	02.92-04.96	AR 67301	6	OZH 055

156

1.6 16V T.SPARK	1,6	R, 1	88	09.97-09.05	AR 32104	4	OPH 026
1.6 16V T.SPARK	1,6	R	88	09.97-09.00	AR 67 601, → VET # 0023372, VET # 0012329 →	4	OZH 217
1.6 16V T.SPARK	1,6	R	88	09.97-09.00	AR 67 601, VET # 0023373 →	4	OZH 056
1.8 16V T.SPARK	1,7	R, 1	103	10.00-09.05	AR 32205	4	OPH 026
1.8 16V T.SPARK	1,7	R, 1	106	09.97-10.00	AR 32201	4	OPH 028
1.8 16V T.SPARK	1,7	R	106	09.97-10.00	AR 32201	4	OZH 056
2.0 16V T.SPARK	2,0	R, 1	110	10.00-03.02	AR 32310	4	OPH 026
2.0 16V T.SPARK	2,0	R, 1	114	09.97-10.00	AR 32301	4	OPH 028
2.0 16V T.SPARK	2,0	R	114	09.97-10.00	AR 32301	4	OZH 056
2.0 Twin Spark	2,0	R, 1	118	11.97-04.00	AR 32303	4	OPH 028
2.5 V6 24V	2,5	R, 1	140	09.97-12.01	AR 32401/AR 32402	6	OPH 028
2.5 V6 24V	2,5	R, 1	141	10.00-09.05	AR 32405	6	OPH 026
3.2 GTA	3,2	R, 1	184	03.02-09.05	932 A.000	6	OPH 026

156 Sportwagon

1.6 16V T.SPARK.	1,6	R, 1	88	05.00-05.06	AR 32104	4	OPH 026
1.8 16V T.SPARK	1,7	R, 1	103	10.00-05.06	AR 32205	4	OPH 026
1.8 16V T.SPARK	1,7	R, 1	106	05.00-10.00	AR 32201	4	OPH 028
2.0 16V T.SPARK	2,0	R, 1	110	10.00-03.02	AR 32310	4	OPH 026
2.0 16V T.SPARK	2,0	R, 1	114	05.00-10.00	AR 32301	4	OPH 028
2.5 V6 24V	2,5	R, 1	140	05.00-10.00	AR 32401	6	OPH 028
2.5 V6 24V	2,5	R, 1	141	10.00-05.06	AR 32405	6	OPH 026
3.2 GTA	3,2	R, 1	184	03.02-05.06	932 A.000	6	OPH 026

164

2.0 T.S.	2,0	R	105	06.87-09.92	AR 06416	4	OZH 037
2.0 T.S.	2,0	R	106	12.93-09.98	AR 64103	4	OZH 035
2.0 V6 Turbo	2,0	R	148	09.92-09.98	AR 64102	6	OZH 046
3.0 V6	3,0	R	132	09.92-09.98	AR 66303/AR 64305	6	OZH 055
3.0 V6	3,0	R	135	06.91-09.92	AR 06412	6	OZH 046
3.0 V6	3,0	R	135	06.87-05.91	AR 06412	6	OZH 037
3.0 i.e. QV	3,0	R	147	09.90-05.91	AR 64301/AR 06430	6	OZH 037
3.0 i.e. QV	3,0	R	147	06.91-09.92	AR 64301/AR 06430	6	OZH 046
3.0 24V	3,0	R	155	09.92-09.98	AR 66301/AR 66302	6	OZH 055
3.0	3,0	R	168	12.93-02.95	AR 64304	6	OZH 035
3.0 24V Q4	3,0	R	170	02.94-09.98	AR 64308/AR 64307	6	OZH 035



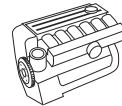

kW

 Zyl.
Cyl.
Cil.

ALFA ROMEO

164							
3.0 24V QV	3,0	R	171	12.93–09.98	AR 64304	6	OZH 035
166							
2.0 T.Spark	2,0	R, 1	110	10.00–	AR 36301	4	OPH 026
2.0 T.Spark	2,0	D, 1	110	10.00–	AR 36301	4	OPH 029
2.0 T.Spark	2,0	R	114	09.98–10.00	AR 34103	4	OZH 056
2.0 V6	2,0	R, 1	151	09.98–12.07	AR 34102	6	OPH 028
2.0 V6	2,0	R	151	09.98–	AR 34102	6	OZH 056
2.5 V6 24V	2,5	R, 1	138	10.00–10.07	AR 36201	6	OPH 025
2.5 V6 24V	2,5	R, 1	140	09.98–10.00	AR 34201	6	OPH 028
2.5 V6 24V	2,5	R	140	09.98–10.00	AR 34201	6	OZH 056
3.0 V6 24V	3,0	R, 1	162	10.00–10.07	AR 36101	6	OPH 025
3.0 V6 24V	3,0	R	166	09.98–10.00	AR 34301	6	OZH 056
3.0 V6 24V	3,0	R, 1	166	09.98–10.00	AR 34301	6	OPH 028
3.2 V6 24V	3,2	R, 1	176	10.03–10.07	936 A.000	6	OPH 025

ALFASUD Sprint

1.7 i.e.	1,7	R	77	10.87–12.89	AR 30558	4	OZH 003
----------	-----	---	----	-------------	----------	---	----------------

BRERA

1.8 TBi	1,7	R, 1	147	05.09–	939 B1.000	4	OPH 028
---------	-----	------	-----	--------	------------	---	----------------

GIULIETTA

1.4 TB	1,4	R, 1	88	04.10–	198 A4.000	4	OPH 025
--------	-----	------	----	--------	------------	---	----------------

GT

1.8 TS	1,7	R, 1	103	11.03–	AR 32205	4	OPH 026
3.2 GTA	3,2	R, 1	176	11.03–	936 A.000	6	OPH 025

GTV

1.8 16V	1,7	R, 1	106	05.98–	AR 32201	4	OPH 028
1.8 16V	1,7	R	106	05.98–	AR 32201	4	OZH 056
2.0 JTS	2,0	D, 1	121	04.03–12.05	937 A1.000	4	OPH 027
2.0 T.SPARK 16V	2,0	R, 1	110	01.98–12.05	AR 32310	4	OPH 026
2.0 T.SPARK 16V	2,0	R	110	06.95–	AR 16201/AR 32310	4	OZH 056
2.0 T.SPARK 16V	2,0	R, 1	114	05.98–08.00	AR 32301	4	OPH 028
2.0 V6 Turbo	2,0	R	148	06.95–	AR 16202, Chassis # 6003389 →	6	OZH 052
3.0 V6 24V	3,0	R, 1	160	10.00–12.05	AR 16105	6	OPH 025
3.0 V6 24V	3,0	R, 1	162	10.96–10.00	AR 16102	6	OPH 028
3.0 V6 24V	3,0	R	162	10.96–10.00	AR 16102	6	OZH 056
3.2 V6 24V	3,2	R, 1	176	04.03–12.05	936 A6.000	6	OPH 025

MITO

1.4	1,4	R + D, 1	58	09.08–	955 A1.000	4	OPH 025
1.4 TB	1,4	D, 1	114	09.08–	199 A8.000	4	OPH 027

SPIDER

1.8 16V	1,7	R, 1	106	05.98–04.05	AR 32201	4	OPH 028
1.8 16V	1,7	R	106	05.98–04.05	AR 32201	4	OZH 056
2000	2,0	R	85	08.86–12.89	AR 01544	4	OZH 192
2000	2,0	R	88	01.90–12.93	AR 01588	4	OZH 037
2.0 JTS	2,0	R, 1	121	04.03–04.05	937 A1.000	4	OPH 026
2.0 JTS	2,0	D, 1	121	04.03–04.05	937 A1.000	4	OPH 027
2.0 T.SPARK 16V	2,0	R, 1	110	06.95–04.05	AR 32310	4	OPH 026
2.0 T.SPARK 16V	2,0	R	110	06.95–04.05	AR 16201/AR 32310	4	OZH 052
2.0 T.SPARK 16V	2,0	R, 1	114	05.98–08.00	AR 32301	4	OPH 028
3.0 V6	3,0	R	141	06.95–04.05	AR 16101	6	OZH 052
3.2 V6 24V	3,2	R, 1	176	04.03–04.05	936 A6.000	6	OPH 025

ALPINA
ROADSTER

4.8 V8	4,8	R	280	06.02–		8	OZH 173
--------	-----	---	-----	--------	--	---	----------------

ALPINE

A610							
3.0 TURBO	3,0	R	184	03.91–04.95		6	OZH 033
V6							
2.5 TURBO	2,5	R	136	06.87–12.90	Z7U-734	6	OZH 044

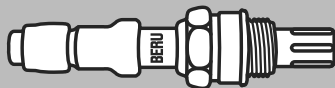

BERU



kW

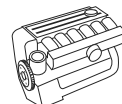

Zyl.
Cyl.
Cil.



AUDI

A3 (8L1)

1.6	1,6	R, 1, 2	74	08.97-07.98	AKL, → Chassis # 8L-W-150 000	4	OPH 070
1.6	1,6	D, 1	74	06.99-08.00	APF	4	OPH 094
1.6	1,6	R, 3	74	04.97-07.98	AKL, AEH, → Chassis # 8L-W-150 000, Chassis # 8L-V-095 001 →	4	OZH 169
1.8	1,8	R	92	05.97-	AGN	4	OZH 128
1.8	1,8	R	92	09.96-04.97	AGN	4	OZH 177
1.8 T	1,8	R, 1	110	08.98-04.01	AQA	4	OPH 065
1.8 T	1,8	R, 1	110	07.99-04.00	ARZ	4	OPH 065
1.8 T	1,8	R	110	12.96-07.97	AGU, → Chassis # 8L.V..150 000	4	OZH 152
1.8 T	1,8	R	110	08.97-06.03	AGU, → Chassis # 8L.W..000 000, Chassis # 8L.V..150 001 →	4	OZH 128
1.8 T	1,8	R	110	12.96-	AGU, Chassis # 8L.W.. 000 001 →	4	OZH 177
1.8 T	1,8	R, 1	132	07.99-08.00	AJQ	4	OPH 065
1.8 T	1,8	R, 1	132	07.99-05.00	APP	4	OPH 065
1.8 T quattro	1,8	D, 1	110	09.00-06.03	ARX, → Chassis # 8L-21050 000, 8L-2-150 000, Chassis # 8L-11000 001, 8L-1-060 001 →	4	OPH 066
1.8 T quattro	1,8	R, 1	110	08.98-08.00	AQA	4	OPH 068
1.8 T quattro	1,8	R	110	12.96-	AGU	4	OZH 128
1.8 T quattro	1,8	R	110	12.96-	ARX/AQA/AGU	4	OZH 177
1.8 T quattro	1,8	R, 1	132	10.98-08.00	AJQ	4	OPH 065
1.8 T quattro	1,8	D, 1	132	09.00-06.03	ARY, → Chassis # 8L-21050 000, 8L-2-150 000, Chassis # 8L-1-060 001, 8L-11000 001 →	4	OPH 066
1.8 T quattro	1,8	R, 1	132	10.98-08.00	AJQ	4	OPH 068
S3 quattro	1,8	D, 1	154	09.00-04.02	AMK, → Chassis # 8L-1-060 000	4	OPH 056
S3 quattro	1,8	D, 1	154	09.00-04.01	AUL, → Chassis # 8L-1-060 000	4	OPH 056
S3 quattro	1,8	R, 1	154	03.99-04.01	AUL, APY	4	OPH 061
S3 quattro	1,8	D, 1	154	09.00-04.02	AMK, → Chassis # 8L-2-150 000, 8L-21050 000, Chassis # 8L-1-060 001, 8L-11000 001 →	4	OPH 066
S3 quattro	1,8	D, 1	154	09.00-04.01	AUL, → Chassis # 8L-2-150 000, 8L-21050 000, Chassis # 8L-1-060 001, 8L-11000 001 →	4	OPH 066
S3 quattro	1,8	D, 1	165	10.01-06.03	BAM, → Chassis # 8L-2-150 000, 8L-21050 000, Chassis # 8L-11000 001, 8L-1-060 001 →	4	OPH 066
A3 (8P1)							
2.0 TFSI	2,0	D, 1	147	09.04-10.05	AXX	4	OPH 085
2.0 TFSI	2,0	D, 1	147	09.05-05.07	BWA	4	OPH 085
2.0 TFSI quattro	2,0	D, 1	147	09.04-10.05	AXX	4	OPH 085
2.0 TFSI quattro	2,0	D, 1	147	09.05-05.07	BWA	4	OPH 085
S3 quattro	2,0	D, 1	195	11.06-05.07	BHZ	4	OPH 085
A3 Sportback (8PA)							
2.0 TFSI	2,0	D, 1	147	09.04-10.05	AXX	4	OPH 085
2.0 TFSI quattro	2,0	D, 1	147	09.04-10.05	AXX	4	OPH 085
2.0 TFSI quattro	2,0	D, 1	147	06.07-06.08	BWA	4	OPH 085
A4 (8D2, B5)							
1.6	1,6	R	74	01.95-10.96	ADP	4	OZH 069
1.6	1,6	R	74	07.99-07.00	ANA	4	OZH 178
1.6	1,6	D	74	07.99-07.00	ANA	4	OZH 190
1.8 quattro	1,8	R	92	01.95-11.00	ADR/APT/ARG	4	OZH 069
1.8 T	1,8	R, 1	110	01.95-07.97	AEB, → Chassis # 8D-T-400 000	4	OPH 006
1.8 T	1,8	R	110	07.96-07.97	AEB, → Chassis # 8D-V-400 000, Chassis # 8D-V-000 001 →	4	OZH 152

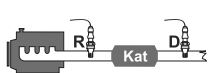

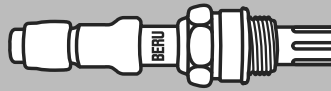

kW

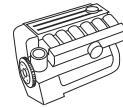

Zyl.
Cyl.
Cil.

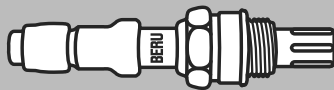

AUDI						
A4 (8D2, B5)						
1.8 T	1,8	R	110	01.95-11.00	APU, Chassis # 8D-W-000001 →	4 OZH 153
1.8 T	1,8	R	132	12.97-11.00	AJL	4 OZH 153
1.8 T quattro	1,8	R, 1	110	01.95-07.97	AEB, → Chassis # 8D-T-400 000	4 OPH 006
1.8 T quattro	1,8	D, 1	110	01.95-11.00	ANB	4 OPH 052
1.8 T quattro	1,8	R	110	07.96-07.97	AEB, → Chassis # 8D-V-400 000, Chassis # 8D-V-000 001 →	4 OZH 152
1.8 T quattro	1,8	R	110	01.95-11.00	APU, Chassis # 8D-W-000001 →	4 OZH 153
1.8 T quattro	1,8	R	132	12.97-11.00	AJL	4 OZH 153
2.4	2,4	R, 1	120	02.99-06.00	APZ	6 OPH 004
2.4	2,4	R, 1	121	06.00-11.00	AML	6 OPH 004
2.4	2,4	R, 1	121	02.99-06.00	ARJ	6 OPH 004
2.4	2,4	R, 1	121	02.99-11.00	APS	6 OPH 004
2.4	2,4	D, 1	121	06.00-11.00	AML	6 OPH 023
2.4 quattro	2,4	R, 1	120	02.99-06.00	APZ	6 OPH 004
2.4 quattro	2,4	R, 1	121	06.00-11.00	AML	6 OPH 004
2.4 quattro	2,4	R, 1	121	02.99-06.00	ARJ	6 OPH 004
2.4 quattro	2,4	R, 1	121	02.99-11.00	APS	6 OPH 004
2.4 quattro	2,4	D, 1	121	06.00-11.00	AML	6 OPH 023
2.6	2,6	R	110	01.95-11.00	ABC	6 OZH 103
2.6 quattro	2,6	R	110	01.95-11.00	ABC	6 OZH 103
2.8	2,8	R	128	09.95-07.97	AAH	6 OZH 103
2.8	2,8	R, 1	142	07.98-06.00	AMX	6 OPH 004
2.8	2,8	R, 1	142	02.99-06.00	AQD, APR	6 OPH 004
2.8	2,8	D, 1	142	06.00-11.00	AMX	6 OPH 023
2.8	2,8	R	142	10.96-11.00	ACK, ALG	6 OZH 071
2.8 quattro	2,8	R	128	01.95-07.97	AAH	6 OZH 103
2.8 quattro	2,8	R, 1	142	07.98-06.00	AMX	6 OPH 004
2.8 quattro	2,8	R, 1	142	02.99-06.00	APR, AQD	6 OPH 004
2.8 quattro	2,8	D, 1	142	06.00-11.00	AMX	6 OPH 023
2.8 quattro	2,8	R	142	08.97-11.00	ACK, ALG	6 OZH 071
S4 quattro	2,7	R, 1	195	09.97-12.98	AGB	6 OPH 004
S4 quattro	2,7	D, 1	195	02.99-11.00	AGB	6 OPH 023
A4 Avant (8D5, B5)						
1.6	1,6	R	74	03.96-07.00	AHL/ADP/ARM/ANA	4 OZH 068
1.8	1,8	R	92	02.96-12.98	ADR	4 OZH 069
1.8 quattro	1,8	R	92	01.96-01.99	ADR	4 OZH 069
1.8 T	1,8	R, 1	110	03.96-07.97	AEB, → Chassis # 8D-T-400 000	4 OPH 006
1.8 T	1,8	R	110	07.96-07.97	AEB, → Chassis # 8D-V-400 000, Chassis # 8D-V-000 001 →	4 OZH 152
1.8 T	1,8	R	110	03.96-09.01	APU, Chassis # 8D-W-000001 →	4 OZH 153
1.8 T	1,8	R	132	12.97-09.01	AJL	4 OZH 153
1.8 T quattro	1,8	R, 1	110	01.96-07.97	AEB, → Chassis # 8D-T-400 000	4 OPH 006
1.8 T quattro	1,8	D, 1	110	01.96-09.01	ANB	4 OPH 052
1.8 T quattro	1,8	R	110	07.96-07.97	AEB, → Chassis # 8D-V-400 000, Chassis # 8D-V-000 001 →	4 OZH 152
1.8 T quattro	1,8	R	110	01.96-09.01	APU, Chassis # 8D-W-000001 →	4 OZH 153
1.8 T quattro	1,8	R	132	12.97-09.01	AJL	4 OZH 153
2.4	2,4	R, 1	120	02.99-06.00	APZ	6 OPH 004
2.4	2,4	R, 1	121	06.00-09.01	AML	6 OPH 004
2.4	2,4	R, 1	121	02.99-09.01	APS	6 OPH 004
2.4	2,4	R, 1	121	02.99-06.00	ARJ	6 OPH 004
2.4	2,4	D, 1	121	06.00-09.01	AML	6 OPH 023
2.4	2,4	D, 1	121	06.00-09.01	AML	6 OPH 008
2.4	2,4	R	121	08.97-09.01	AGA, ALF	6 OZH 071
2.4 quattro	2,4	R, 1	120	02.99-06.00	APZ	6 OPH 004
2.4 quattro	2,4	R, 1	121	06.00-09.01	AML	6 OPH 004
2.4 quattro	2,4	R, 1	121	02.99-09.01	APS	6 OPH 004
2.4 quattro	2,4	R, 1	121	02.99-06.00	ARJ	6 OPH 004
2.4 quattro	2,4	D, 1	121	06.00-09.01	AML	6 OPH 023
2.4 quattro	2,4	D, 1	121	06.00-09.01	AML, Chassis # 8D-X-200 001 →	6 OPH 008
2.4 quattro	2,4	R	121	08.97-09.01	AGA, ALF	6 OZH 071

**BERU**

kW

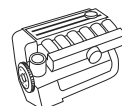
Zyl.
Cyl.
Cil.**AUDI**

A4 Avant (8D5, B5)							
2.6	2,6	R	110	02.96-09.01	ABC	6	OZH 103
2.6 quattro	2,6	R	110	01.96-09.01	ABC	6	OZH 103
2.8	2,8	R	128	03.96-09.96	AAH	6	OZH 103
2.8	2,8	R, 1	142	07.98-06.00	AMX	6	OPH 004
2.8	2,8	R, 1	142	02.99-06.00	APR, AQD	6	OPH 004
2.8	2,8	D, 1	142	10.96-09.01	AMX, Chassis # 8D-X-200 001 →	6	OPH 023
2.8	2,8	D, 1	142	10.96-09.01	AMX, Chassis # 8D-X-200 001 →	6	OPH 008
2.8	2,8	R	142	10.96-09.01	ACK, ALG	6	OZH 071
2.8 quattro	2,8	R	128	01.96-09.96	AAH	6	OZH 103
2.8 quattro	2,8	R, 1	140	09.99-09.00	ATX	6	OPH 004
2.8 quattro	2,8	R, 1	142	07.98-06.00	AMX	6	OPH 004
2.8 quattro	2,8	R, 1	142	02.99-06.00	AQD, APR	6	OPH 004
2.8 quattro	2,8	D, 1	142	06.00-09.01	AMX, Chassis # 8D-X-200 001 →	6	OPH 008
2.8 quattro	2,8	R	142	10.96-09.01	ACK, ALG	6	OZH 071
RS4 quattro	2,7	R, 1	280	05.00-09.01	AZR/ASJ	6	OPH 004
RS4 quattro	2,7	D, 1	280	05.00-10.00	ASJ	6	OPH 023
RS4 quattro	2,7	D, 1	280	10.00-09.01	AZR	6	OPH 023
S4 quattro	2,7	R, 1	195	09.97-12.98	AGB	6	OPH 004
S4 quattro	2,7	D, 1	195	02.99-09.01	AGB, Chassis # 8D-X-200 001 →	6	OPH 008
S4 quattro	2,7	D, 1	195	11.00-09.01	AZB, Chassis # 8D-X-200 001 →	6	OPH 008
S4 quattro	2,7	D, 1	195	02.99-09.01	AGB, Chassis # 8D-X-200 001 →	6	OPH 023
S4 quattro	2,7	D, 1	195	11.00-09.01	AZB, Chassis # 8D-X-200 001 →	6	OPH 023
A4 Avant (8E5, B6)							
2.0	2,0	D, 1	96	09.01-12.04	ALT	4	OPH 052
A4 Avant (8ED)							
2.0	2,0	D, 1	96	11.04-	ALT	4	OPH 052
A4 Cabriolet (8H7, 8HE)							
1.8 T	1,8	D, 1	120	07.02-	BFB	4	OPH 052
2.0	2,0	D, 1	96	09.04-12.05	ALT	4	OPH 052
A6 (4A, C4)							
1.8	1,8	R	92	12.95-10.97	ADR	4	OZH 070
1.8 quattro	1,8	R	92	12.95-10.97	ADR	4	OZH 070
2.0	2,0	R	74	06.94-08.96	AAE	4	OZH 027
2.0	2,0	R	85	06.94-10.97	ABK	4	OZH 037
2.0 16V	2,0	R	103	06.94-10.97	ACE	4	OZH 037
2.0 16V quattro	2,0	R	103	06.94-10.97	ACE	4	OZH 037
2.3	2,3	R	98	06.94-12.95	AAR	5	OZH 046
2.3 quattro	2,3	R	98	06.94-07.95	AAR	5	OZH 046
2.6	2,6	R	110	06.94-07.95	ABC	6	OZH 017
2.6	2,6	R	110	06.94-10.97	ABC	6	OZH 044
2.6 quattro	2,6	R	110	09.94-10.97	ABC, Chassis # 4A-S-026 715 →	6	OZH 017
2.8	2,8	R	128	06.94-10.97	AEJ/AAH/AFC	6	OZH 017
2.8	2,8	R	142	12.95-10.97	ACK	6	OZH 071
2.8 quattro	2,8	R	128	06.94-10.97	AEJ/AAH	6	OZH 017
2.8 quattro	2,8	R	142	12.95-10.97	ACK	6	OZH 071
S6 4.2 quattro	4,2	R	213	06.94-10.97	AEC	8	OZH 139
S6 Plus quattro	4,2	R	240	04.96-10.97	AHK	8	OZH 181
A6 (4B, C5)							
1.8 T	1,8	R	110	01.97-01.05	AEB	4	OZH 153
1.8 T	1,8	R	132	12.97-01.05	AJL	4	OZH 153
1.8 T quattro	1,8	R	110	02.97-01.05	AEB	4	OZH 153
1.8 T quattro	1,8	R	132	12.97-01.05	AJL	4	OZH 153
2.4	2,4	R, 1	100	07.98-01.99	ALW, Chassis # 4B-X-067 801 →	6	OPH 004
2.4	2,4	R, 1	100	02.99-05.00	ARN	6	OPH 004
2.4	2,4	R, 1	100	06.00-04.01	ASM	6	OPH 004
2.4	2,4	R, 1	115	04.98-04.01	APC, Chassis # 4B-X-067 801 →	6	OPH 004
2.4	2,4	R, 1	120	04.97-01.99	AJG	6	OPH 004
2.4	2,4	R, 1	120	06.00-04.01	AMM	6	OPH 004
2.4	2,4	R, 1	120	01.98-05.00	APZ, Chassis # 4B-X-067 801 →	6	OPH 004
2.4	2,4	R, 1	121	04.97-01.99	AGA, Chassis # 4B-X-067 801 →	6	OPH 004
2.4	2,4	R, 1	121	06.97-09.01	ALF, Chassis # 4B-X-067 801 →	6	OPH 004





kW

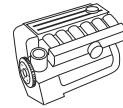

Zyl.
Cyl.
Cil.

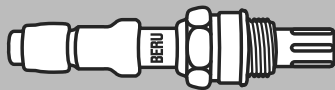

AUDI						
A6 (4B, C5)						
2.4	2.4	R, 1	121	06.00-05.01	AML	6 OPH 004
2.4	2.4	R, 1	121	11.98-04.01	APS, Chassis # 4B-X-067 801 →	6 OPH 004
2.4	2.4	R, 1	121	11.98-09.01	ARJ, Chassis # 4B-X-067 801 →	6 OPH 004
2.4	2.4	D, 1	121	06.00-05.01	AML	6 OPH 023
2.4 quattro	2.4	R, 1	115	08.98-07.99	APC, Chassis # 4B-X-067 801 →	6 OPH 004
2.4 quattro	2.4	R, 1	120	04.97-01.99	AJG	6 OPH 004
2.4 quattro	2.4	R, 1	120	11.98-05.00	APZ, Chassis # 4B-X-067 801 →	6 OPH 004
2.4 quattro	2.4	R, 1	121	04.97-01.99	AGA, Chassis # 4B-X-067 801 →	6 OPH 004
2.4 quattro	2.4	R, 1	121	06.97-09.01	ALF, Chassis # 4B-X-067 801 →	6 OPH 004
2.4 quattro	2.4	R, 1	121	06.00-05.01	AML	6 OPH 004
2.4 quattro	2.4	R, 1	121	11.98-04.01	APS, Chassis # 4B-X-067 801 →	6 OPH 004
2.4 quattro	2.4	R, 1	121	11.98-09.01	ARJ, Chassis # 4B-X-067 801 →	6 OPH 004
2.4 quattro	2.4	D, 1	121	06.00-05.01	AML	6 OPH 023
2.4 quattro	2.4	R	121	02:1997-01.05	AGA	6 OZH 086
2.7 T	2.7	R, 1	169	02.99-08.00	AJK, Chassis # 4B-X-067 801 →	6 OPH 004
2.7 T quattro	2.7	R, 1	169	02.99-08.00	AJK, Chassis # 4B-X-067 801 →	6 OPH 004
2.8	2.8	R	132	10.97-07.98	AGE	6 OZH 071
2.8	2.8	R, 1	140	07.99-04.01	ATX, Chassis # 4B-X-067 801 →	6 OPH 004
2.8	2.8	R, 1	140	06.02-	BBG, Chassis # 4B-X-067 801 →	6 OPH 004
2.8	2.8	R, 1	142	06.97-01.99	ACK, ALG, Chassis # 4B-X-067 801 →	6 OPH 004
2.8	2.8	R, 1	142	02.98-09.01	AMX, Chassis # 4B-X-067 801 →	6 OPH 004
2.8	2.8	R, 1	142	11.98-04.01	APR, Chassis # 4B-X-067 801 →	6 OPH 004
2.8	2.8	R, 1	142	11.98-09.01	AQD, Chassis # 4B-X-067 801 →	6 OPH 004
2.8	2.8	D, 1	142	02.98-09.01	AMX	6 OPH 023
2.8 quattro	2.8	R, 1	132	01.98-04.00	AGE, Chassis # 4B-X-067 801 →	6 OPH 004
2.8 quattro	2.8	R, 1	140	07.99-04.01	ATX, Chassis # 4B-X-067 801 →	6 OPH 004
2.8 quattro	2.8	R, 1	142	06.97-01.99	ACK, ALG, Chassis # 4B-X-067 801 →	6 OPH 004
2.8 quattro	2.8	R, 1	142	02.98-09.01	AMX, Chassis # 4B-X-067 801 →	6 OPH 004
2.8 quattro	2.8	R, 1	142	11.98-04.01	APR, Chassis # 4B-X-067 801 →	6 OPH 004
2.8 quattro	2.8	R, 1	142	11.98-09.01	AQD, Chassis # 4B-X-067 801 →	6 OPH 004
2.8 quattro	2.8	D, 1	142	02.98-09.01	AMX	6 OPH 023
4.2 quattro	4.2	R, 1	220	04.99-05.01	ARS	8 OPH 004
4.2 quattro	4.2	R, 1	220	06.00-05.01	ASG	8 OPH 004
4.2 quattro	4.2	D, 1	220	06.01-01.05	ASG	8 OPH 023
4.2 quattro	4.2	D, 1	220	06.01-01.05	ASG	8 OPH 007
RS6 quattro	4.2	D, 1	331	07.02-04.04	BCY	8 OPH 023
S6 quattro	4.2	R, 1	250	09.00-05.01	ANK	8 OPH 004
S6 quattro	4.2	R, 1	250	09.99-05.01	AQJ	8 OPH 004
S6 quattro	4.2	D, 1	250	09.00-06.01	ANK	8 OPH 024
A6 (4F2)						
2.4	2.4	D	130	05.04-10.08	BDW	6 OZH 234
2.4	2.4	D	130	05.04-10.08	BDW	6 OZH 233
3.0 quattro	3.0	D, 1	160	05.04-05.06	BBJ	6 OPH 053
3.2 FSI	3.1	D	188	05.04-10.08	AUK/BKH	6 OZH 234
3.2 FSI	3.1	D	188	05.04-10.08	AUK/BKH	6 OZH 233
3.2 FSI quattro	3.1	D	188	05.04-10.08	AUK/BKH	6 OZH 234
3.2 FSI quattro	3.1	D	188	05.04-10.08	AUK/BKH	6 OZH 233
4.2 quattro	4.2	D, 1	246	05.04-05.06	BAT	8 OPH 053
A6 Avant (4A, C4)						
1.8	1.8	R	92	12.95-12.97	ADR	4 OZH 070
1.8 quattro	1.8	R	92	12.95-12.97	ADR	4 OZH 070
2.0	2.0	R	74	06.94-08.96	AAE	4 OZH 027
2.0	2.0	R	85	06.94-12.97	ABK	4 OZH 037
2.0 16V	2.0	R	103	06.94-12.97	ACE	4 OZH 037
2.0 16V quattro	2.0	R	103	06.94-12.97	ACE	4 OZH 037
S6 Turbo quattro	2.2	R, 6	169	06.94-12.97	AAN	5 OZH 027
2.3	2.3	R	98	06.94-12.95	AAR	5 OZH 046
2.3 quattro	2.3	R	98	06.94-07.95	AAR	5 OZH 046
2.6	2.6	R	110	06.94-07.95	ABC	6 OZH 017

**BERU**

kW

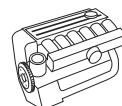
Zyl.
Cyl.
Cil.**AUDI****A6 Avant (4A, C4)**

2.6	2,6	R	110	06.94-12.97	ABC	6	OZH 044
2.6 quattro	2,6	R	110	09.94-12.97	ABC, Chassis # 4A-S-026715 →	6	OZH 017
2.8	2,8	R	128	06.94-12.97	AEJ/AAH	6	OZH 017
2.8 quattro	2,8	R	128	06.94-12.97	AEJ/AAH	6	OZH 017
2.8	2,8	R	142	12.95-12.97	ACK	6	OZH 071
2.8 quattro	2,8	R	142	12.95-12.97	ACK	6	OZH 071
S6 4.2 quattro	4,2	R	213	06.94-12.97	AEC	8	OZH 139
S6 Plus quattro	4,2	R	240	04.96-12.97	AHK	8	OZH 181

A6 Avant (4B, C5)

1.8 T	1,8	D, 1	110	12.97-01.05	ANB	4	OPH 052
1.8 T	1,8	R	110	12.97-01.05	AEB	4	OZH 153
1.8 T	1,8	R	132	04.99-01.05	AJL	4	OZH 153
1.8 T quattro	1,8	D, 1	110	12.97-01.05	ANB	4	OPH 052
1.8 T quattro	1,8	R	110	12.97-01.05	AEB	4	OZH 153
1.8 T quattro	1,8	R	132	12.97-01.05	AJL	4	OZH 153
2.4	2,4	R, 1	100	07.98-01.99	ALW, Chassis # 4B-X-067 801 →	6	OPH 004
2.4	2,4	R, 1	100	02.99-05.00	ARN	6	OPH 004
2.4	2,4	R, 1	100	06.00-04.01	ASM	6	OPH 004
2.4	2,4	D, 1	100	06.00-04.01	ASM	6	OPH 008
2.4	2,4	R, 1	120	04.97-01.99	AJG	6	OPH 004
2.4	2,4	R, 1	120	06.00-04.01	AMM	6	OPH 004
2.4	2,4	R, 1	120	01.98-05.00	APZ, Chassis # 4B-X-067 801 →	6	OPH 004
2.4	2,4	D, 1	120	06.00-04.01	AMM	6	OPH 008
2.4	2,4	R, 1	121	12.97-01.99	AGA, Chassis # 4B-X-067 801 →	6	OPH 004
2.4	2,4	R, 1	121	12.97-09.01	ALF, Chassis # 4B-X-067 801 →	6	OPH 004
2.4	2,4	R, 1	121	06.00-05.01	AML	6	OPH 004
2.4	2,4	R, 1	121	11.98-04.01	APS, Chassis # 4B-X-067 801 →	6	OPH 004
2.4	2,4	R, 1	121	11.98-09.01	ARJ, Chassis # 4B-X-067 801 →	6	OPH 004
2.4	2,4	D, 1	121	06.00-05.01	AML	6	OPH 008
2.4 quattro	2,4	R, 1	120	12.97-01.99	AJG	6	OPH 004
2.4 quattro	2,4	R, 1	120	11.98-05.00	APZ, Chassis # 4B-X-067 801 →	6	OPH 004
2.4 quattro	2,4	R, 1	121	12.97-01.99	AGA, Chassis # 4B-X-067 801 →	6	OPH 004
2.4 quattro	2,4	R, 1	121	12.97-09.01	ALF, Chassis # 4B-X-067 801 →	6	OPH 004
2.4 quattro	2,4	R, 1	121	06.00-05.01	AML	6	OPH 004
2.4 quattro	2,4	R, 1	121	11.98-04.01	APS, Chassis # 4B-X-067 801 →	6	OPH 004
2.4 quattro	2,4	R, 1	121	11.98-09.01	ARJ, Chassis # 4B-X-067 801 →	6	OPH 004
2.4 quattro	2,4	D, 1	121	06.00-05.01	AML	6	OPH 023
2.4 quattro	2,4	D, 1	121	06.00-05.01	AML	6	OPH 008
2.7 T	2,7	R, 1	169	02.99-08.00	AJK, Chassis # 4B-X-067 801 →	6	OPH 004
2.7 T quattro	2,7	R, 1	169	02.99-08.00	AJK, Chassis # 4B-X-067 801 →	6	OPH 004
2.7 T quattro	2,7	R, 1	169	09.00-05.01	AZA, Chassis # 4B-X-067 801 →	6	OPH 004
2.7 T quattro	2,7	D, 1	169	09.00-05.01	AZA	6	OPH 023
2.7 T quattro	2,7	D, 1	169	09.00-05.01	AZA	6	OPH 008
2.8	2,8	R	132	02.98-07.98	AGE	6	OZH 071
2.8	2,8	R, 1	140	07.99-01.05	ATX, Chassis # 4B-X-067 801 →	6	OPH 004
2.8	2,8	R, 1	142	12.97-07.98	ACK	6	OPH 004
2.8	2,8	R, 1	142	12.97-01.99	ALG, Chassis # 4B-X-067 801 →	6	OPH 004
2.8	2,8	R, 1	142	11.98-04.01	APR, AQD, Chassis # 4B-X-067 801 →	6	OPH 004
2.8	2,8	D, 1	142	02.98-09.01	AMX	6	OPH 008
2.8 quattro	2,8	R, 1	142	12.97-07.98	ACK	6	OPH 004
2.8 quattro	2,8	R, 1	142	12.97-01.99	ALG, Chassis # 4B-X-067 801 →	6	OPH 004
2.8 quattro	2,8	R, 1	142	11.98-04.01	AQD, APR, Chassis # 4B-X-067 801 →	6	OPH 004
2.8 quattro	2,8	D, 1	142	08.99-05.01	AMX	6	OPH 023
2.8 quattro	2,8	D, 1	142	08.99-05.01	AMX	6	OPH 008
2.8 quattro	2,8	R	142	12.97-01.05	ACK, ALG	6	OZH 086
4.2 quattro	4,2	R, 1	220	04.99-05.01	ARS	8	OPH 004
4.2 quattro	4,2	R, 1	220	06.00-05.01	ASG	8	OPH 004
4.2 quattro	4,2	D, 1	220	06.01-01.05	ASG	8	OPH 023
4.2 quattro	4,2	D, 1	220	06.01-01.05	ASG	8	OPH 007



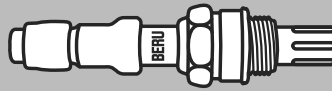

kW

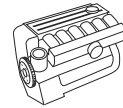

Zyl.
Cyl.
Cil.

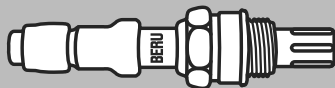

AUDI							
A6 Avant (4B, C5)							
RS6 plus quattro	4,2	D, 1	353	04.04-09.04	BRV	8	OPH 023
RS6 quattro	4,2	D, 1	331	07.02-09.04	BCY	8	OPH 023
S6 quattro	4,2	R, 1	250	09.00-05.01	ANK	8	OPH 004
S6 quattro	4,2	R, 1	250	09.99-05.01	AQJ	8	OPH 004
S6 quattro	4,2	D, 1	250	09.00-06.01	ANK	8	OPH 024
A6 Avant (4F5)							
3.0	3,0	D, 1	160	03.05-05.06	BBJ	6	OPH 053
3.0 quattro	3,0	D, 1	160	03.05-05.06	BBJ	6	OPH 053
4.2 quattro	4,2	D, 1	246	03.05-05.06	BAT	8	OPH 053
A8 (4D2, 4D8)							
2.8	2,8	R	120	07.95-03.96	AEJ	6	OZH 017
2.8	2,8	R	128	03.94-03.96	AAH	6	OZH 017
2.8	2,8	R, 1	142	05.00-02.01	AMX	6	OPH 004
2.8	2,8	R, 1	142	01.99-02.01	AQD, APR	6	OPH 004
2.8	2,8	R	142	04.96-09.02	ACK, ALG	6	OZH 071
2.8 quattro	2,8	R	120	07.95-03.96	AEJ	6	OZH 017
2.8 quattro	2,8	R	128	03.94-03.96	AAH	6	OZH 017
2.8 quattro	2,8	R, 1	142	05.00-02.01	AMX	6	OPH 004
2.8 quattro	2,8	R, 1	142	01.99-02.01	AQD APR	6	OPH 004
2.8 quattro	2,8	R	142	04.96-12.98	ACK, → Chassis # 4D-X-004999	6	OZH 071
3.7	3,7	R	169	07.95-12.98	AEW, → Chassis # 4B..X..004 999	8	OZH 151
3.7	3,7	R, 1	191	11.98-02.01	AQG	8	OPH 003
3.7	3,7	D, 1	191	05.00-09.02	AKC, Chassis # 4D-X-005 001 →	8	OPH 009
3.7	3,7	D, 1	191	05.00-09.02	AKC, Chassis # 4D-X-005 001 →	8	OPH 008
3.7 quattro	3,7	R	169	07.95-11.98	AKJ/AEW, → Chassis # 4B..X..004 999	8	OZH 151
3.7 quattro	3,7	R, 1	191	11.98-09.02	AKC/AQG	8	OPH 003
3.7 quattro	3,7	D, 1	191	05.00-09.02	AKC, Chassis # 4D-X-005 001 →	8	OPH 009
3.7 quattro	3,7	D, 1	191	05.00-09.02	AKC, Chassis # 4D-X-005 001 →	8	OPH 008
4.2 quattro	4,2	R, 1	175	02.99-04.00	ARU	8	OPH 003
4.2 quattro	4,2	D, 1	175	02.99-04.00	ARU, Chassis # 4D-X-005 001 →	8	OPH 009
4.2 quattro	4,2	D, 1	175	02.99-04.00	ARU, Chassis # 4D-X-005 001 →	8	OPH 008
4.2 quattro	4,2	R, 1	228	11.98-09.02	AUW, AQF	8	OPH 003
4.2 quattro	4,2	D, 1	228	05.00-09.02	AUW, Chassis # 4D-X-005 001 →	8	OPH 009
4.2 quattro	4,2	D, 1	228	05.00-09.02	AUW, Chassis # 4D-X-005 001 →	8	OPH 008
S 8 quattro	4,2	R, 1	265	06.99-09.02	AQH/AVP	8	OPH 003
S 8 quattro	4,2	D, 1	265	09.00-09.02	AVP	8	OPH 005
A8 (4E.)							
3.7 quattro	3,7	D, 1	206	10.02-05.06	BFL, Chassis # 4E-3-000 001 →	8	OPH 054
4.2 quattro	4,2	D, 1	246	10.02-05.06	BFM, Chassis # 4E-3-000 001 →	8	OPH 054
6.0 W12 quattro	6,0	D, 1	331	02.04-07.10	BHT	12	OPH 060
6.0 W12 quattro	6,0	D, 1	331	09.07-07.10	BTE	12	OPH 060
6.0 W12 quattro	6,0	D, 1	331	12.03-07.10	BTE/BSB/BHT	12	OPH 072
ALLROAD (4BH)							
2.7 T quattro	2,7	R, 1	184	05.00-06.02	ARE, → Chassis # 4B-1-200 000	6	OPH 004
2.7 T quattro	2,7	D, 1	184	05.00-06.02	ARE, → Chassis # 4B-1-200 000	6	OPH 023
2.7 T quattro	2,7	D, 1	184	05.00-06.02	ARE, → Chassis # 4B-1-200 000	6	OPH 008
CABRIOLET (8G7, B4)							
1.8	1,8	R	92	01.97-08.00	ADR	4	OZH 068
2.0 16V	2,0	R	103	06.95-07.96	ACE	4	OZH 037
2.0 E	2,0	R, 6	85	01.93-07.98	ABK	4	OZH 027
2.0 E	2,0	R	85	01.93-07.98	ABK	4	OZH 037
2.3 E	2,3	R	98	05.91-07.94	NG	5	OZH 046
2.6	2,6	R	110	06.93-08.00	ABC	6	OZH 017
2.6	2,6	R	110	06.93-08.00	ABC	6	OZH 044
2.8	2,8	R	128	11.92-08.00	AAH	6	OZH 017
COUPE (81, 85)							
1.8 GT	1,8	R	68	01.85-07.88	JN	4	OZU 022
1.8 GT	1,8	R	79	08.86-10.87	PV	4	OZH 037
2.2 GT	2,2	R	85	01.84-10.87	KX	5	OZU 022
2.2 quattro	2,2	R	88	08.85-10.88	JT	5	OZH 037

**BERU**

kW

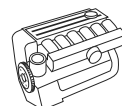
Zyl.
Cyl.
Cil.**AUDI****COUPE (81, 85)**

2.3	2,3	R	100	01.87-10.88	NG	5	OZH 003
2.3 quattro	2,3	R	100	01.87-10.88	NG	5	OZH 003

COUPE (89, 8B)

2.0	2,0	R	85	05.89-12.96	ABK/AAD	4	OZH 037
2.0 16 V	2,0	R	101	01.92-07.92	6A	4	OZH 037
2.0 16 V	2,0	R	103	08.92-12.96	ACE	4	OZH 037
2.3	2,3	R	98	03.90-07.94	NG	5	OZH 046
2.3	2,3	R	100	10.88-07.89	NG	5	OZH 003
2.3	2,3	R	100	08.89-07.94	NG	5	OZH 046
2.3 quattro	2,3	R	98	05.90-07.94	NG	5	OZH 046
2.3 quattro	2,3	R	100	11.88-07.89	NG	5	OZH 003
2.3 quattro	2,3	R	100	08.89-12.92	NG	5	OZH 046
2.3 20V	2,3	R	123	08.90-07.91	7A, Chassis # 8B-L-000 001 →	5	OZH 046
2.3 20V	2,3	R	125	08.89-07.91	7A, Chassis # 8B-L-000001 →	5	OZH 046
2.3 20V quattro	2,3	R	123	05.90-07.91	7A, Chassis # 8B-L-000001 →	5	OZH 046
2.3 20V quattro	2,3	R	125	11.88-07.91	7A	5	OZH 046
2.6	2,6	R	110	08.92-12.96	ABC	6	OZH 017
2.6	2,6	R	110	08.92-12.96	ABC	6	OZH 044
2.6 quattro	2,6	R	110	08.92-12.96	ABC	6	OZH 017
2.6 quattro	2,6	R	110	08.92-12.96	ABC	6	OZH 044
2.8	2,8	R	128	01.93-12.96	AAH	6	OZH 017
2.8	2,8	R	128	09.91-12.92	AAH	6	OZH 044
2.8 quattro	2,8	R	128	01.93-12.96	AAH	6	OZH 017
2.8 quattro	2,8	R	128	08.91-12.92	AAH	6	OZH 044
S2 quattro	2,2	R	162	09.90-09.92	3B	5	OZH 037
S2 quattro	2,2	R, 6	169	10.92-12.96	ABY	5	OZH 027
S2 quattro	2,2	R	169	10.92-12.96	ABY	5	OZH 037

QUATTRO (85)

2.2 20V	2,2	R	162	08.90-07.91	RR	5	OZH 037
2.2 20V	2,2	R	162	08.89-07.90	RR	5	OZH 046

TT (8N3)

1.8 T	1,8	R, 1	132	09.99-09.00	AJQ, APP	4	OPH 065
1.8 T quattro	1,8	D, 1	132	09.00-08.02	ARY	4	OPH 066
1.8 T quattro	1,8	R, 1	132	10.98-08.00	AJQ	4	OPH 068
1.8 T quattro	1,8	D, 1	165	09.00-08.02	BAM, → Chassis # 8N-1-010 100	4	OPH 056
1.8 T quattro	1,8	R, 1	165	10.98-08.01	APX	4	OPH 061
1.8 T quattro	1,8	D, 1	165	09.00-08.02	BAM, Chassis # 8N-1-010 101 →	4	OPH 066
3.2 VR6 quattro	3,2	D, 1	184	07.03-06.06	BHE	6	OPH 055
3.2 VR6 quattro	3,2	D, 1	184	07.03-06.06	BHE	6	OPH 064

TT Roadster (8N9)

1.8 T	1,8	R, 1	132	10.99-08.00	AJQ APP	4	OPH 065
1.8 T quattro	1,8	D, 1	132	09.00-08.02	ARY	4	OPH 066
1.8 T quattro	1,8	R, 1	132	02.00-08.00	AJQ	4	OPH 068
1.8 T quattro	1,8	D, 1	165	09.00-08.02	BAM, → Chassis # 8N-1-010 100	4	OPH 056
1.8 T quattro	1,8	R, 1	165	10.99-08.01	APX	4	OPH 061
1.8 T quattro	1,8	D, 1	165	09.00-08.02	BAM, Chassis # 8N-1-010 101 →	4	OPH 066
3.2 VR6 quattro	3,2	D, 1	184	07.03-06.06	BHE	6	OPH 055
3.2 VR6 quattro	3,2	D, 1	184	07.03-06.06	BHE	6	OPH 064

V8 (44, 4C)

3.6 quattro	3,6	R, 6	180	04.93-02.94	PT	8	OZH 027
3.6 quattro	3,6	R	180	04.93-02.94	PT	8	OZH 037
3.6 quattro	3,6	R, 6	184	10.88-02.94	PT	8	OZH 027
3.6 quattro	3,6	R	184	10.88-02.94	PT	8	OZH 037
4.2 quattro	4,2	R, 6	206	10.91-02.94	ABH	8	OZH 027
4.2 quattro	4,2	R	206	10.91-02.94	ABH	8	OZH 037

80 (81, 85, B2)

1.8	1,8	R	68	08.83-08.86	JN	4	OZU 001
1.8 CC quattro (85Q)	1,8	R	68	08.85-08.86	JN	4	OZH 037
1.8 GTE	1,8	R	81	08.85-07.86	PV	4	OZH 037
1.8 GTE	1,8	R	82	10.84-08.86	DZ	4	OZU 001
1.8 GTE quattro (85Q)	1,8	R	81	03.85-08.86	PV	4	OZH 037



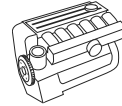

kW

 Zyl.
Cyl.
Cil.

AUDI						
80 (89, 89Q, 8A, B3)						
1.8	1,8	R	83	09.87-07.88	SD	4 OZH 037
1.8	1,8	R	83	09.86-08.87	SD	4 OZH 046
1.8 quattro	1,8	R	83	09.86-08.90	SD	4 OZH 046
1.8 S	1,8	R, 6	66	03.88-10.91	JN, NE	4 OZH 027
1.8 S	1,8	R	66	03.88-10.91	PM	4 OZU 022
1.8 S quattro	1,8	R, 6	66	03.88-08.91	NE/PM/JN	4 OZH 027
1.8 S quattro	1,8	R	66	03.88-08.91	PM	4 OZU 022
2.0	2,0	R	82	10.90-08.91	AAD	4 OZH 037
2.0 quattro	2,0	R	82	10.90-08.91	3A	4 OZH 046
2.0 quattro	2,0	R	85	10.90-08.91	AAD	4 OZH 037
2.0 E	2,0	R	83	08.88-10.90	3A	4 OZH 037
2.0 E quattro	2,0	R	83	08.88-09.90	3A	4 OZH 037
2.0 E 16V	2,0	R	101	03.90-09.91	6A	4 OZH 037
2.0 E 16V quattro	2,0	R	101	03.90-08.91	6A	4 OZH 037
2.3 quattro	2,3	R	98	10.87-07.89	NG	5 OZH 046
80 (8C, B4)						
1.6	1,6	R	52	01.92-12.94	ABM	4 OZH 017
1.6 E	1,6	R	74	06.93-12.94	ADA	4 OZH 037
2.0	2,0	R	66	09.91-12.94	ABT	4 OZH 017
2.0	2,0	R	66	09.91-12.94	ABT	4 OZH 044
2.0 E	2,0	R, 6	85	09.91-12.94	ABK	4 OZH 027
2.0 E	2,0	R	85	09.91-12.94	ABK	4 OZH 037
2.0 E quattro	2,0	R, 6	85	09.91-12.94	ABK	4 OZH 027
2.0 E quattro	2,0	R	85	09.91-12.94	ABK	4 OZH 037
2.0 E 16V	2,0	R	103	08.92-12.94	ACE	4 OZH 037
2.0 E 16V quattro	2,0	R	103	04.92-12.94	ACE	4 OZH 037
2.3 E	2,3	R	98	09.91-12.94	NG	5 OZH 046
2.3 E quattro	2,3	R	98	09.91-12.94	NG	5 OZH 046
2.6	2,6	R	110	07.92-12.94	ABC	6 OZH 017
2.6	2,6	R	110	07.92-12.94	ABC	6 OZH 044
2.6 quattro	2,6	R	110	06.92-12.94	ABC	6 OZH 017
2.6 quattro	2,6	R	110	06.92-12.94	ABC	6 OZH 044
2.8	2,8	R	128	08.92-12.94	AAH	6 OZH 017
2.8 quattro	2,8	R	128	08.92-12.94	AAH	6 OZH 017
S2 quattro	2,2	R	169	02.93-12.94	ABY	5 OZH 037
80 Avant (8C, B4)						
1.6 E	1,6	R	74	06.93-01.96	ADA	4 OZH 037
2.0	2,0	R	66	07.92-01.96	ABT	4 OZH 017
2.0	2,0	R	66	07.92-01.96	ABT	4 OZH 044
2.0 E	2,0	R, 6	85	07.92-01.96	ABK	4 OZH 027
2.0 E	2,0	R	85	07.92-01.96	ABK	4 OZH 037
2.0 E 16V	2,0	R	103	02.93-01.96	ACE	4 OZH 037
2.0 E 16V quattro	2,0	R	103	12.92-07.95	ACE	4 OZH 037
2.3 E	2,3	R	98	07.92-01.96	NG	5 OZH 046
2.3 E quattro	2,3	R	98	09.91-11.94	NG	5 OZH 046
2.6	2,6	R	110	07.92-01.96	ABC	6 OZH 017
2.6	2,6	R	110	07.92-01.96	ABC	6 OZH 044
2.6 quattro	2,6	R	110	07.92-07.95	ABC	6 OZH 017
2.6 quattro	2,6	R	110	07.92-07.95	ABC	6 OZH 044
2.8	2,8	R	128	08.92-01.96	AAH	6 OZH 017
2.8 quattro	2,8	R	128	08.92-07.95	AAH	6 OZH 017
S2 quattro	2,2	R	169	02.93-07.95	ABY	5 OZH 037
RS2 quattro (P1)	2,2	R	232	03.94-05.95	ADU	5 OZH 037
90 (81, 85, B2)						
2.0	2,0	R	83	03.86-03.87	SK	5 OZU 022
2.2	2,2	R	85	01.85-03.87	KX	5 OZU 022
2.2 E quattro	2,2	R	88	08.85-03.87	JT	5 OZH 037
90 (89, 89Q, 8A, B3)						
2.0	2,0	R	85	07.88-09.91	PS	5 OZH 046
2.0 quattro	2,0	R	101	08.89-07.90	6A	4 OZH 037
2.3 E	2,3	R	98	04.87-09.91	NG	5 OZH 046

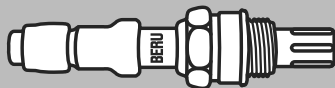
**BERU**

kW

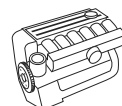
Zyl.
Cyl.
Cil.**AUDI****90 (89, 89Q, 8A, B3)**

2.3 E	2,3	R	100	04.87-07.91	NG	5	OZH 046
2.3 E quattro	2,3	R	98	04.87-07.91	NG	5	OZH 046
2.3 E quattro	2,3	R	100	04.87-07.91	NG	5	OZH 046
2.3 E 20V	2,3	R	123	04.90-07.91	7A	5	OZH 037
2.3 E 20V	2,3	R	125	08.88-07.91	7A	5	OZH 037
2.3 E 20V quattro	2,3	R	123	04.90-09.91	7A	5	OZH 037
2.3 E 20V quattro	2,3	R	125	06.88-09.91	7A	5	OZH 037

100 (44, 44Q, C3)

1.8	1,8	R	66	08.83-07.89	PH	4	OZU 001
1.8 KAT	1,8	R	66	03.85-07.88	4B, PH	4	OZU 022
1.8 quattro KAT	1,8	R	66	08.85-07.88	PH, 4B	4	OZU 022
2.0 KAT	2,0	R	85	01.88-11.90	RT	5	OZH 037
2.2	2,2	R	85	10.84-09.86	KZ	5	OZU 022
2.2 E quattro	2,2	R	88	08.85-07.86	PX	5	OZH 037
2.2 E Turbo quattro	2,2	R	121	08.86-11.88	MC, → Chassis # K-038261	5	OZH 037
2.2 E Turbo quattro	2,2	R	121	11.88-11.90	MC, Chassis # K-038262 →	5	OZH 046
2.2 Turbo	2,2	R	121	08.86-11.90	MC	5	OZH 037
2.3 E	2,3	R	100	10.86-07.89	NF, → Chassis # 44-K-300000	5	OZH 003
2.3 E	2,3	R	100	07.89-11.90	NF, Chassis # 44-L-000001 →	5	OZH 046
2.3 E quattro	2,3	R	100	08.86-07.89	NF, → Chassis # 44-K-300000	5	OZH 003
2.3 E quattro	2,3	R	100	07.89-11.90	NF, Chassis # 44-L-000001 →	5	OZH 046

100 (4A, C4)

2.0	2,0	R	74	12.90-06.94	AAE	4	OZH 027
2.0	2,0	R	74	12.90-06.94	AAE	4	OZH 044
2.0 E	2,0	R, 6	85	12.90-06.94	AAD	4	OZH 027
2.0 E	2,0	R	85	12.90-06.94	ABK	4	OZH 037
2.0 E quattro	2,0	R, 6	85	12.90-07.92	AAD	4	OZH 027
2.0 E quattro	2,0	R	85	12.90-07.92	AAD	4	OZH 037
2.0 E 16V	2,0	R	103	01.92-06.94	ACE	4	OZH 037
2.0 E 16V quattro	2,0	R	103	07.92-06.94	ACE	4	OZH 037
2.3 E	2,3	R	98	12.90-06.94	AAR	5	OZH 046
2.3 E quattro	2,3	R	98	12.90-06.94	AAR	5	OZH 046
2.6	2,6	R	110	03.92-06.94	ABC	6	OZH 017
2.6	2,6	R	110	03.92-06.94	ABC	6	OZH 044
2.6 quattro	2,6	R	110	04.92-06.94	ABC	6	OZH 017
2.6 quattro	2,6	R	110	04.92-06.94	ABC	6	OZH 044
2.8 E	2,8	R	128	09.92-06.94	AAH, Chassis # 4A-P-022307 →	6	OZH 017
2.8 E	2,8	R	128	12.90-08.92	AAH, → Chassis # 4A-P-022-306	6	OZH 044
2.8 E quattro	2,8	R	128	12.90-06.94	AAH	6	OZH 017
2.8 E quattro	2,8	R	128	12.90-06.94	AAH	6	OZH 044
S4 Turbo quattro	2,2	R, 6	169	08.91-06.94	AAN	5	OZH 027
S4 Turbo quattro	2,2	R	169	08.91-06.94	AAN	5	OZH 046
S4 V8 quattro	4,2	R	206	10.92-06.94	ABH	8	OZH 139

100 Avant (44, 44Q, C3)

1.8	1,8	R	66	04.85-07.89	PH	4	OZU 022
1.8 KAT	1,8	R	66	03.85-07.88	4B, PH	4	OZU 022
1.8 quattro	1,8	R	66	04.85-07.88	PH	4	OZU 022
1.8 quattro KAT	1,8	R	66	08.85-07.88	4B, PH	4	OZU 022
2.0 E KAT	2,0	R	85	01.88-11.90	RT	5	OZH 037
2.2	2,2	R	85	10.84-09.86	KZ	5	OZU 022
2.2 E quattro	2,2	R	88	08.85-07.86	PX	5	OZH 037
2.2 Turbo	2,2	R	121	08.86-11.90	MC	5	OZH 037
2.2 Turbo quattro	2,2	R	121	08.86-11.88	MC, → Chassis # K-038261	5	OZH 037
2.2 Turbo quattro	2,2	R	121	11.88-11.90	MC, Chassis # K-038262 →	5	OZH 046
2.3	2,3	R	98	03.90-11.90	AAR	5	OZH 046
2.3	2,3	R	100	08.86-07.89	NF, → Chassis # 44-K-300000	5	OZH 003
2.3	2,3	R	100	07.89-11.90	NF, Chassis # 44-L-000001 →	5	OZH 046
2.3 quattro	2,3	R	98	01.90-11.90	AAR	5	OZH 046
2.3 E quattro	2,3	R	100	08.86-07.89	NF, → Chassis # 44-K-300000	5	OZH 003
2.3 E quattro	2,3	R	100	07.89-11.90	NF, Chassis # 44-L-000001 →	5	OZH 046

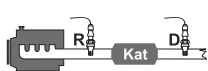

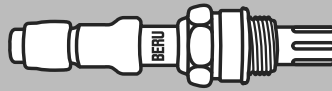

kW

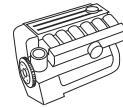
Zyl.
Cyl.
Cil.

AUDI							
100 Avant (4A, C4)							
2.0 E	2,0	R, 6	74	09.91-06.94	AAE	4	OZH 027
2.0 E	2,0	R	74	09.91-06.94	AAE	4	OZH 044
2.0 E	2,0	R, 6	85	09.91-06.94	AAD	4	OZH 027
2.0 E	2,0	R	85	09.91-12.92	AAD, ABK	4	OZH 037
2.0 E quattro	2,0	R, 6	85	12.90-07.92	AAD	4	OZH 027
2.0 E quattro	2,0	R	85	12.90-07.92	AAD	4	OZH 037
2.0 E 16V	2,0	R	103	07.92-06.94	ACE	4	OZH 037
2.0 E 16V quattro	2,0	R	103	07.92-06.94	ACE	4	OZH 037
2.3 E	2,3	R	98	09.91-06.94	AAR	5	OZH 046
2.3 E quattro	2,3	R	98	09.91-06.94	AAR	5	OZH 046
2.6	2,6	R	110	03.92-06.94	ABC	6	OZH 017
2.6	2,6	R	110	03.92-06.94	ABC	6	OZH 044
2.6 quattro	2,6	R	110	07.92-06.94	ABC	6	OZH 017
2.6 quattro	2,6	R	110	07.92-06.94	ABC	6	OZH 044
2.8 E	2,8	R	128	09.91-06.94	AAH	6	OZH 017
2.8 E	2,8	R	128	09.91-06.94	AAH	6	OZH 044
2.8 E quattro	2,8	R	128	09.91-06.94	AAH	6	OZH 017
2.8 E quattro	2,8	R	128	09.91-06.94	AAH	6	OZH 044
S4 Turbo quattro	2,2	R, 6	169	09.91-06.94	AAN	5	OZH 027
S4 Turbo quattro	2,2	R	169	09.91-06.94	AAN	5	OZH 046
200 (44, 44Q)							
2.2 Turbo	2,2	R	121	08.85-09.91	MC	5	OZH 037
2.2 Turbo quattro	2,2	R	121	01.85-11.88	MC, → Chassis # 44-K-038261	5	OZH 035
2.2 Turbo quattro	2,2	R	121	11.88-12.90	MC, Chassis # 44-K-038262 →	5	OZH 046
2.2 20V Turbo quattro	2,2	R	162	03.89-12.90	3B	5	OZH 046
200 Avant (44, 44Q)							
2.2 Turbo	2,2	R	121	08.85-09.91	MC	5	OZH 037
2.2 Turbo quattro	2,2	R	121	09.83-11.88	MC, → Chassis # 44-K-038261	5	OZH 035
2.2 Turbo quattro	2,2	R	121	11.88-12.90	MC, Chassis # 44-K-038262 →	5	OZH 046
2.2 20V Turbo quattro	2,2	R	162	07.89-12.90	3B	5	OZH 037
2.2 20V Turbo quattro	2,2	R	162	07.89-12.90	3B	5	OZH 046
BERTONE							
FREECLIMBER 2							
1.6	1,6	R	74	03.92-	BMW 161 E1	4	OZH 036
BMW							
3 (E30)							
316 i	1,6	R	73	09.88-12.90	M40 B16 (Kat.)	4	OZH 039
316 i	1,6	R	75	09.88-10.90	M40 B16	4	OZH 039
316 i	1,8	R	75	08.87-08.88	M10 B18	4	OZH 001
318 i	1,8	R	75	05.86-08.87	M10 B18	4	OZH 001
318 i	1,8	R	77	05.86-08.87	M10 B18	4	OZH 001
318 i	1,8	R	83	09.87-06.91	M40 B18	4	OZH 039
318 i	1,8	R	85	09.87-06.91	M40 B18	4	OZH 039
318 is	1,8	R	100	09.89-08.90	M42 B18	4	OZH 039
318 is	1,8	R	100	09.90-08.91	M42 B18	4	OZH 231
320 i	2,0	R	95	10.87-06.91	M20 B20	6	OZH 036
325 i	2,5	R	125	10.87-06.91	M20 B25	6	OZH 036
325 i	2,5	R	126	10.87-11.89	M20 B25	6	OZH 036
325 i X	2,5	R	125	10.87-08.91	M20 B25	6	OZH 036
325 i X	2,5	R	126	10.87-12.87	M20 B25	6	OZH 036
325 e 2.7	2,7	R	90	10.87-12.88	M20 B27	6	OZH 036
325 e 2.7	2,7	R	90	10.83-09.87	M20 B27	6	OZH 039
3 (E36)							
316 i	1,6	R	73	12.90-09.93	M40 B16 (Kat.)	4	OZH 036
316 i	1,6	R	75	07.93-09.95	M43 B16	4	OZH 004
316 i	1,6	R	75	10.95-02.98	M43 B16	4	OZH 023
316 i	1,6	R	75	12.90-09.93	M40 B16	4	OZH 036
318 i	1,8	R	83	12.90-10.93	M40 B18	4	OZH 036
318 i	1,8	R	85	10.93-09.95	M43 B18	4	OZH 023

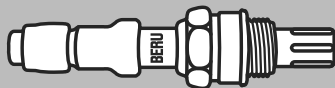
**BERU**

kW

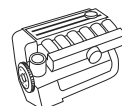
Zyl.
Cyl.
Cil.**BMW****3 (E36)**

318 i	1,8	R	85	10.95-02.98	M43 B18	4	OZH 036
318 is	1,8	R	103	09.93-02.98	M42 B18	4	OZH 036
318 is	1,9	R	103	09.95-02.98	M44 B19	4	OZH 173
320 i	2,0	R	110	09.90-08.92	M52 B(20 6 S3) Vanos/ M50 B(20 6 S2) Vanos/ M50 B20/M50 B(20 6 S1)/ M52 B20/M50 B20 TU	6	OZH 036
325 i	2,5	R	141	09.90-09.95	M50 B25/M50 B25 TU/ M50 B25 (Vanos)	6	OZH 036
M3 3.0	3,0	R	210	08.94-09.95	S50 B30	6	OZH 036

3 (E46)

316 i	1,6	R	77	04.00-02.05	M43 B16/M43 B16 (16 4 E3)	4	OZH 173
316 i	1,6	D	77	04.00-09.02	M43 B16/M43 B16 (16 4 E3)	4	OZH 199
316 i	1,6	D	85	06.02-03.04	N45 B16/N45 B16 A	4	OZH 223
316 i	1,8	D	85	02.02-03.04	N46 B18/N46 B18 A/N42 B18	4	OZH 224
316 i	1,8	D	85	02.02-03.04	N46 B18/N46 B18 A/N42 B18, (Euro 4)	4	OZH 223
316 i	1,9	R	77	09.98-02.05	M43 B19 TU/M43 164 E3	4	OZH 173
316 i	1,9	D	77	09.98-09.02	M43 B19 TU/M43 164 E3	4	OZH 199
318 i	1,9	R	87	02.98-09.01	M43 B19/M43 B19 TU	4	OZH 173
318 i	1,9	D	87	02.98-09.01	M43 B19/M43 B19 TU	4	OZH 199
318 i	2,0	D	105	09.01-03.04	N42 B20/N46 B20 A/N46 B20	4	OZH 224
318 i	2,0	D	105	09.01-03.04	N42 B20/N46 B20 A/N46 B20, (Euro 4)	4	OZH 223
320 i	2,0	D	110	03.98-09.00	M52 B(20 6 S3) Vanos/M52 B20	6	OZH 168
320 i	2,0	R	110	03.98-09.00	M52 B(20 6 S3) Vanos/M52 B20	6	OZH 173
320 i	2,0	D, 4	110	03.98-09.00	M52 B(20 6 S3) Vanos/M52 B20	6	OZH 199
320 i	2,0	R, 4	110	03.98-09.00	M52 B(20 6 S3) Vanos/M52 B20	6	OZH 218
320 i	2,2	D	125	09.00-02.05	M54 226 S1/M54 B22	6	OZH 168
320 i	2,2	R	125	09.00-02.05	M54 226 S1/M54 B22	6	OZH 173
320 i	2,2	R, 4	125	09.00-02.05	M54 226 S1/M54 B22	6	OZH 218
320 i	2,2	R, 4	125	09.00-02.05	M54 226 S1/M54 B22	6	OZH 222
323 i	2,5	D	125	03.98-09.00	M52 B25 TU/M52 B25 (Vanos)	6	OZH 168
323 i	2,5	R	125	03.98-09.00	M52 B25 TU/M52 B25 (Vanos)	6	OZH 173
323 i	2,5	D, 4	125	03.98-09.00	M52 B25 TU/M52 B25 (Vanos)	6	OZH 199
323 i	2,5	R, 4	125	03.98-09.00	M52 B25 TU/M52 B25 (Vanos)	6	OZH 218
325 i	2,5	D	141	09.00-02.05	M54 256 S5/M54 B25	6	OZH 168
325 i	2,5	R	141	09.00-02.05	M54 256 S5/M54 B25	6	OZH 173
325 i	2,5	R, 4	141	09.00-02.05	M54 256 S5/M54 B25	6	OZH 218
325 xi	2,5	D	141	09.00-02.05	M54 256 S5	6	OZH 168
325 xi	2,5	R	141	09.00-02.05	M54 256 S5	6	OZH 173
328 i	2,8	D	142	02.98-06.00	M52 B28	6	OZH 168
328 i	2,8	R	142	02.98-06.00	M52 B28	6	OZH 173
328 i	2,8	D, 4	142	02.98-06.00	M52 B28	6	OZH 199
328 i	2,8	R, 4	142	02.98-06.00	M52 B28	6	OZH 218
330 i	3,0	D	170	06.00-02.05	M54 B30 /M54 306 S3	6	OZH 168
330 i	3,0	R	170	06.00-02.05	M54 B30 /M54 306 S3	6	OZH 173
330 i	3,0	D, 4	170	06.00-09.00	M54 B30 /M54 306 S3	6	OZH 199
330 i	3,0	R, 4	170	06.00-02.05	M54 B30 /M54 306 S3	6	OZH 218
330 i	3,0	R, 4	170	10.00-02.05	M54 B30 /M54 306 S3	6	OZH 222
330 xi	3,0	D	170	06.00-02.05	M54 306 S3	6	OZH 168
330 xi	3,0	R	170	06.00-02.05	M54 306 S3	6	OZH 173

3 Cabriolet (E30)

318 i	1,8	R	83	09.90-10.93	M40 B18	4	OZH 039
318i	1,8	R	103	06.88-08.90	M40 B18 C	4	OZH 039
318i	1,8	R	103	09.90-02.92	M40 B18 C	4	OZH 231
320 i	2,0	R	95	10.87-10.93	M20 B20	6	OZH 036
325 i	2,5	R	125	09.87-10.93	M20 B25	6	OZH 036

3 Cabriolet (E36)

318 i	1,8	R	85	01.94-09.95	M43 B18	4	OZH 023
318 i	1,8	R	85	10.95-04.99	M43 B18	4	OZH 036



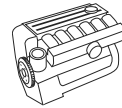

kW

 Zyl.
Cyl.
Cil.

BMW							
3 Cabriolet (E36)							
325 i	2,5	R	141	03.93–03.95	M50 B25/M50 B25 TU	6	OZH 036
M3 3.0	3,0	R	210	01.94–10.95	S50 B30	6	OZH 036
3 Cabriolet (E46)							
318 Ci	2,0	D	105	09.01–03.04	N42 B20/N46 B20	4	OZH 224
318 Ci	2,0	D	105	09.01–03.04	N42 B20/N46 B20, (Euro 4)	4	OZH 223
318 Ci	2,0	D	110	02.05–	N46 B20 B, (Euro 4)	4	OZH 224
318 Ci	2,0	D	110	02.05–	N46 B20 B, (Euro 4)	4	OZH 223
320 Ci	2,2	D	125	09.00–	M54 226 S1/M54 B22	6	OZH 168
320 Ci	2,2	R	125	09.00–	M54 226 S1/M54 B22	6	OZH 173
320 Ci	2,2	R, 4	125	09.00–	M54 226 S1/M54 B22	6	OZH 218
320 Ci	2,2	R, 4	125	09.00–	M54 226 S1/M54 B22	6	OZH 222
323 Ci	2,5	D	125	04.00–09.00	M52 B25 (Vanos)	6	OZH 168
323 Ci	2,5	R	125	04.00–09.00	M52 B25 (Vanos)	6	OZH 173
323 Ci	2,5	D, 4	125	04.00–09.00	M52 B25 (Vanos)	6	OZH 199
323 Ci	2,5	R, 4	125	04.00–09.00	M52 B25 (Vanos)	6	OZH 218
325 Ci	2,5	D	141	09.00–	M54 256 S5	6	OZH 168
325 Ci	2,5	R	141	09.00–	M54 256 S5	6	OZH 173
325 Ci	2,5	R, 4	141	09.00–	M54 256 S5	6	OZH 218
325 Ci	2,5	R, 4	141	09.00–	M54 256 S5	6	OZH 222
330 Ci	3,0	D	170	06.00–	M54 306 S3	6	OZH 168
330 Ci	3,0	R	170	06.00–	M54 306 S3	6	OZH 173
330 Ci	3,0	D, 4	170	06.00–	M54 306 S3	6	OZH 199
330 Ci	3,0	R, 4	170	06.00–	M54 306 S3	6	OZH 218
330 Ci	3,0	R, 4	170	10.00–	M54 306 S3	6	OZH 222
3 Compact (E36)							
316 g	1,6	R	75	12.95–08.00		4	OZH 023
316 i	1,6	R	75	10.95–08.00	M43 B16	4	OZH 023
316 i	1,6	R	75	03.94–09.95	M43 B16	4	OZH 036
316 i	1,9	R	77	12.98–08.00	M43 B19 TU/M43 164 E3	4	OZH 173
318 ti	1,8	R	103	11.94–08.95	M42 B18	4	OZH 036
318 ti	1,9	R	103	07.95–08.00	M44 B19	4	OZH 173
318 ti	1,9	D	103	12.95–08.00	M44 B19	4	OZH 199
3 Compact (E46)							
316 ti	1,8	D	85	06.01–03.04	N46 B18 A/N42 B18	4	OZH 224
316 ti	1,8	D	85	06.01–03.04	N46 B18 A/N42 B18, (Euro 4)	4	OZH 223
318 ti	2,0	D	105	09.01–03.04	N42 B20/N46 B20 A	4	OZH 224
318 ti	2,0	D	105	09.01–03.04	N42 B20/N46 B20 A, (Euro 4)	4	OZH 223
325 ti	2,5	D	141	06.01–02.05	M54 256 S5/M54 B25	6	OZH 168
325 ti	2,5	R	141	06.01–02.05	M54 256 S5/M54 B25	6	OZH 173
325 ti	2,5	R, 4	141	06.01–12.04	M54 256 S5/M54 B25	6	OZH 218
325 ti	2,5	R, 4	141	06.01–02.05	M54 256 S5/M54 B25	6	OZH 222
3 Coupe (E36)							
316 i	1,6	R	75	10.95–04.99	M43 B16	4	OZH 023
316 i	1,6	R	75	09.93–09.95	M43 B16	4	OZH 036
318 is	1,8	R	103	03.92–10.95	M42 B18	4	OZH 036
318 is	1,9	R	103	09.95–04.99	M44 B19	4	OZH 173
318 is	1,9	D	103	09.95–04.99	M44 B19	4	OZH 199
320 i	2,0	R	110	03.92–08.92	M52 B(20 6 S3) Vanos/ M50 B(20 6 S2) Vanos/ M50 B20/M50 B(20 6 S1)/ M52 B20/M50 B20 TU	6	OZH 036
325 i	2,5	R	141	03.92–04.99	M50 B25/M50 B25 TU/M50 B25 (Vanos)	6	OZH 036
M3 3.0	3,0	R	210	10.92–01.95	S50 B30	6	OZH 036
M3 3.0	3,0	R	217	01.95–10.95	S50 B30	6	OZH 036
3 Coupe (E46)							
316 Ci	1,6	R	77	04.00–	M43 B16 (16 4 E3)	4	OZH 173
316 Ci	1,6	D	77	04.00–09.02	M43 B16 (16 4 E3)	4	OZH 199
316 Ci	1,6	D	85	06.02–03.04	N45 B16 A	4	OZH 223
318 Ci	1,9	R	87	11.99–09.01	M43 B19	4	OZH 173
318 Ci	1,9	D	87	11.99–09.01	M43 B19	4	OZH 199

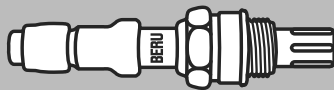
**BERU**

kW

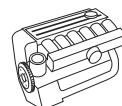
Zyl.
Cyl.
Cil.**BMW****3 Coupe (E46)**

318 Ci	2,0	D	105	09.01-03.04	N42 B20/N46 B20	4	OZH 224
318 Ci	2,0	D	105	09.01-03.04	N42 B20/N46 B20, (Euro 4)	4	OZH 223
320 Ci	2,0	D	110	08.99-09.00	M52 B(20 6 S4)/M52 B20	6	OZH 168
320 Ci	2,0	R	110	08.99-09.00	M52 B(20 6 S4)/M52 B20	6	OZH 173
320 Ci	2,2	D	125	09.00-	M54 226 S1/M54 B22	6	OZH 168
320 Ci	2,2	R	125	09.00-	M54 226 S1/M54 B22	6	OZH 173
320 Ci	2,2	R, 4	125	09.00-09.06	M54 226 S1/M54 B22	6	OZH 218
320 Ci	2,2	R, 4	125	09.00-09.06	M54 226 S1/M54 B22	6	OZH 222
323 Ci	2,5	D	125	04.99-09.00	M52 B25 (Vanos)	6	OZH 168
323 Ci	2,5	R	125	04.99-09.00	M52 B25 (Vanos)	6	OZH 173
323 Ci	2,5	D, 4	125	04.99-09.00	M52 B25 (Vanos)	6	OZH 199
323 Ci	2,5	R, 4	125	04.99-09.00	M52 B25 (Vanos)	6	OZH 218
325 Ci	2,5	D	141	09.00-	M54 256 S5	6	OZH 168
325 Ci	2,5	R	141	09.00-	M54 256 S5	6	OZH 173
325 Ci	2,5	R, 4	141	09.00-09.06	M54 256 S5	6	OZH 218
325 Ci	2,5	R, 4	141	09.00-09.06	M54 256 S5	6	OZH 222
328 Ci	2,8	D	142	04.99-06.00	M52 B28	6	OZH 168
328 Ci	2,8	R	142	04.99-06.00	M52 B28	6	OZH 173
328 Ci	2,8	D, 4	142	04.99-06.00	M52 B28	6	OZH 199
328 Ci	2,8	R, 4	142	04.99-06.00	M52 B28	6	OZH 218
330 xi	3,0	D	170	06.00-	M54 306 S3	6	OZH 168
330 xi	3,0	R	170	06.00-	M54 306 S3	6	OZH 173
330 xi	3,0	D, 4	170	06.00-	M54 306 S3	6	OZH 199
330 xi	3,0	R, 4	170	06.00-09.06	M54 306 S3	6	OZH 218
330 xi	3,0	R, 4	170	10.00-09.06	M54 306 S3	6	OZH 222

3 Touring (E30)

316 i	1,6	R	73	09.91-12.93	M40 B16 (Kat.)	4	OZH 039
316 i	1,6	R	75	09.91-06.94	M40 B16	4	OZH 039
318 i	1,8	R	83	04.89-06.94	M40 B18	4	OZH 039
318 i	1,8	R	85	04.89-06.91	M40 B18	4	OZH 039
320 i	2,0	R	95	01.88-12.91	M20 B20	6	OZH 036
325 i	2,5	R	125	10.87-03.93	M20 B25	6	OZH 036
325 i X	2,5	R	125	06.88-10.93	M20 B25	6	OZH 036

3 Touring (E36)

316 i	1,6	R	75	02.97-10.99	M43 B16	4	OZH 023
318 i	1,8	R	85	10.95-10.99	M43 B18	4	OZH 023
318 i	1,8	R	85	07.95-09.95	M43 B18	4	OZH 036

3 Touring (E46)

316 i	1,8	D	85	03.02-03.04	N46 B18/N46 B18 A/N42 B18	4	OZH 224
316 i	1,8	D	85	03.02-03.04	N46 B18/N46 B18 A/N42 B18, (Euro 4)	4	OZH 223
318 i	1,9	R	87	10.99-09.01	M43 B19/M43 B19 TU	4	OZH 173
318 i	1,9	D	87	10.99-09.01	M43 B19/M43 B19 TU	4	OZH 199
318 i	2,0	D	105	09.01-03.04	N42 B20/N46 B20 A/N46 B20	4	OZH 224
318 i	2,0	D	105	09.01-03.04	N42 B20/N46 B20 A/N46 B20, (Euro 4)	4	OZH 223
320 i	2,0	D	110	10.99-09.00	M52 B(20 6 S3) Vanos/M52 B20	6	OZH 168
320 i	2,0	R	110	10.99-09.00	M52 B(20 6 S3) Vanos/M52 B20	6	OZH 173
320 i	2,2	D	125	09.00-02.05	M54 226 S1/M54 B22	6	OZH 168
320 i	2,2	R	125	09.00-02.05	M54 226 S1/M54 B22	6	OZH 173
320 i	2,2	R, 4	125	09.00-02.05	M54 226 S1/M54 B22	6	OZH 218
320 i	2,2	R, 4	125	09.00-02.05	M54 226 S1/M54 B22	6	OZH 222
325 i	2,5	D	141	09.00-02.05	M54 256 S5/M54 B25	6	OZH 168
325 i	2,5	R	141	09.00-02.05	M54 256 S5/M54 B25	6	OZH 173
325 i	2,5	R, 4	141	09.00-02.05	M54 256 S5/M54 B25	6	OZH 218
325 i	2,5	R, 4	141	09.00-02.05	M54 256 S5/M54 B25	6	OZH 222
325 xi	2,5	D	141	09.00-02.05	M54 256 S5	6	OZH 168
325 xi	2,5	R	141	09.00-02.05	M54 256 S5	6	OZH 173
328 i	2,8	D	142	10.99-06.00	M52 B28	6	OZH 168
328 i	2,8	R	142	10.99-06.00	M52 B28	6	OZH 173
328 i	2,8	D, 4	142	10.99-06.00	M52 B28	6	OZH 199



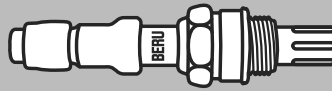

kW

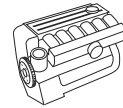
 Zyl.
Cyl.
Cil.

BMW							
3 Touring (E46)							
328 i	2,8	R, 4	142	10.99–06.00	M52 B28	6	OZH 218
330 i	3,0	D	170	06.00–02.05	M54 B30 /M54 306 S3	6	OZH 168
330 i	3,0	R	170	06.00–02.05	M54 B30 /M54 306 S3	6	OZH 173
330 i	3,0	D, 4	170	06.00–09.02	M54 B30 /M54 306 S3	6	OZH 199
330 i	3,0	R, 4	170	06.00–02.05	M54 B30 /M54 306 S3	6	OZH 218
330 i	3,0	R	170	10.00–02.05	M54 B30 /M54 306 S3	6	OZH 222
330 xi	3,0	D	170	06.00–02.05	M54 306 S3	6	OZH 168
330 xi	3,0	R	170	06.00–02.05	M54 306 S3	6	OZH 173
5 (E28)							
525 e 2.7	2,7	R	90	12.84–11.86	M20 B27	6	OZU 001
525 e 2.7	2,7	R	95	12.84–11.86	M20 B27	6	OZU 001
5 (E34)							
518 i	1,8	R	83	08.89–06.94	M40 B18	4	OZH 039
518 i	1,8	R	85	12.93–09.95	M43 B18	4	OZH 039
520 i	2,0	R	95	01.88–12.90	M20 B20	6	OZH 004
520 i 24V	2,0	R	110	09.89–06.92	M50 B(20 6 S2) Vanos/M50 B20/ M50 B(20 6 S1)/M50 B20 TU	6	OZH 030
525 i	2,5	R	125	01.88–12.90	M20 B25	6	OZH 004
525 i 24V	2,5	R	141	09.89–09.95	M50B25	6	OZH 030
525 i X 24V	2,5	R	141	10.91–09.95	M52 B25 (Vanos)	6	OZH 030
530 i	3,0	R	138	01.88–12.90	M30 B30	6	OZH 002
530 i V8	3,0	R	160	07.94–09.95	M60 B30	8	OZH 023
530 i V8	3,0	R	160	09.92–06.94	M60 B30	8	OZH 036
535 i	3,4	R	155	01.88–12.93	M30 B35	6	OZH 002
540 i V8	4,0	R	210	07.94–09.95	M60 B40	8	OZH 023
540 i V8	4,0	R	210	09.92–06.94	M60 B40	8	OZH 036
M5 3.6	3,5	R	232	10.88–05.92	S38 B36 (Kat.)	6	OZH 002
M5 3.8	3,8	R	250	03.92–09.95	S38 B38	6	OZH 002
5 (E39)							
520 i	2,0	D	110	01.96–09.00	M52 B(20 6 S3) Vanos/ M52 B(20 6 S4)/M52 B20	6	OZH 168
520 i	2,0	R	110	10.98–09.00	M52 B(20 6 S3) Vanos/ M52 B(20 6 S4)/M52 B20	6	OZH 173
520 i	2,0	R, 4	110	10.98–09.00	M52 B(20 6 S3) Vanos/ M52 B(20 6 S4)/M52 B20	6	OZH 218
520 i	2,2	D	125	09.00–06.03	M54 B22	6	OZH 168
520 i	2,2	R	125	09.00–06.03	M54 B22	6	OZH 173
520 i	2,2	R, 4	125	09.00–06.03	M54 B22	6	OZH 222
523 i	2,5	D	125	11.95–09.00	M52 B25 TU/M52 B25 (Vanos)	6	OZH 168
523 i	2,5	R	125	11.95–09.00	M52 B25 TU/M52 B25 (Vanos)	6	OZH 173
523 i	2,5	R, 4	125	10.98–09.00	M52 B25 TU/M52 B25 (Vanos)	6	OZH 218
525 i	2,5	D	141	09.00–06.03	M54 256 S5/M54 B25	6	OZH 168
525 i	2,5	R	141	09.00–06.03	M54 256 S5/M54 B25	6	OZH 173
525 i	2,5	R, 4	141	09.00–06.03	M54 256 S5/M54 B25	6	OZH 222
528 i	2,8	D	142	11.95–09.00	M52 B28/M52 B28 TU	6	OZH 168
528 i	2,8	R	142	10.98–09.00	M52 B28/M52 B28 TU	6	OZH 173
528 i	2,8	R, 4	142	10.98–09.00	M52 B28/M52 B28 TU	6	OZH 218
530 i	3,0	D	170	09.00–06.03	M54 B30 /M54 306 S3	6	OZH 168
530 i	3,0	R	170	09.00–06.03	M54 B30 /M54 306 S3	6	OZH 173
530 i	3,0	R, 4	170	09.00–06.03	M54 B30 /M54 306 S3	6	OZH 222
535 i	3,5	D	173	09.98–03.99	M62 B(35 8 S1)/M62 B35	8	OZH 167
535 i	3,5	R	173	09.98–03.99	M62 B(35 8 S1)/M62 B35	8	OZH 173
535 i	3,5	D	180	04.99–06.03	M62 B(35 8 S2)/M62 B35 TU	8	OZH 167
535 i	3,5	R	180	04.99–06.03	M62 B(35 8 S2)/M62 B35 TU	8	OZH 173
540 i	4,4	D	210	09.98–06.03	M62 B44/M62 B44 TU/ M62 448 S2	8	OZH 167
540 i	4,4	R	210	09.98–06.03	M62 B44/M62 B44 TU/ M62 448 S2	8	OZH 173
M5	4,9	D	294	10.98–06.03	S38 B49	8	OZH 167
M5	4,9	R	294	10.98–06.03	S38 B49	8	OZH 173

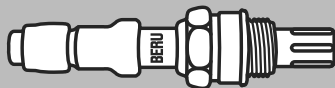
BERU

kW

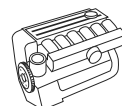
 Zyl.
Cyl.
Cil.

BMW
5 (E60)

520i	2,2	R	125	07.03-	M54 226 S1/M54 B22	6	OZH 173
520i	2,2	R, 4	125	07.03-03.05	M54 226 S1/M54 B22	6	OZH 222
523i	2,5	D, 1, 7	130	07.05-	N52 B25/N52 B25 A	6	OPH 044
525i	2,5	R	141	09.03-	M54 256 S5/M54 B25	6	OZH 173
525i	2,5	R, 4	141	09.03-03.05	M54 256 S5/M54 B25	6	OZH 222
525i	2,5	D, 1, 7	160	07.05-	N52 B25/N52 B25 A	6	OPH 044
525xi	2,5	D, 1, 7	160	07.05-	N52 B25 A	6	OPH 044
530i	3,0	R	170	07.03-	M54 B30 /M54 306 S3	6	OZH 173
530i	3,0	R, 4	170	07.03-03.05	M54 B30 /M54 306 S3	6	OZH 222
530i	3,0	D, 1, 7	190	07.05-	N52 B30 A/N52 B30	6	OPH 044
530xi	3,0	D, 1, 7	190	07.05-	N52 B30 A	6	OPH 044

5 Touring (E34)

518 g	1,8	R	85	11.95-06.96	M43 B18	4	OZH 039
518 i	1,8	R	83	03.93-09.94	M40 B18	4	OZH 039
520 i	2,0	R	110	11.91-06.92	M50 B(20 6 S2) Vanos/M50 B20/ M50 B(20 6 S1)/M50 B20 TU	6	OZH 030
525 i	2,5	R	141	11.91-01.97	M50 B25/M50 B25 TU	6	OZH 030
525 i X	2,5	R	141	02.92-01.97	M50B25	6	OZH 030
530 i V8	3,0	R	160	07.94-01.97	M60 B30	8	OZH 023
530 i V8	3,0	R	160	09.92-06.94	M60 B30	8	OZH 036
540 i	4,0	R	210	07.94-01.97	M60 B40	8	OZH 023
540 i	4,0	R	210	09.93-06.94	M60 B40	8	OZH 036
M5 3.8	3,8	R	250	09.94-12.95	S38 B38	6	OZH 002

5 Touring (E39)

520 i	2,0	D	110	01.97-09.00	M52 B(20 6 S3) Vanos/ M52 B(20 6 S4)/M52 B20	6	OZH 168
520 i	2,0	R	110	10.98-09.00	M52 B(20 6 S3) Vanos/ M52 B(20 6 S4)/M52 B20	6	OZH 173
520 i	2,0	R, 4	110	10.98-09.00	M52 B(20 6 S3) Vanos/ M52 B(20 6 S4)/M52 B20	6	OZH 218
520 i	2,2	D	125	09.00-05.04	M54 B22	6	OZH 168
520 i	2,2	R	125	09.00-05.04	M54 B22	6	OZH 173
520 i	2,2	R, 4	125	09.00-05.04	M54 B22	6	OZH 222
523 i	2,5	D	125	01.97-09.00	M52 B25 TU/M52 B25 (Vanos)	6	OZH 168
523 i	2,5	R	125	01.97-09.00	M52 B25 TU/M52 B25 (Vanos)	6	OZH 173
523 i	2,5	R, 4	125	10.98-09.00	M52 B25 TU/M52 B25 (Vanos)	6	OZH 218
525 i	2,5	D	141	09.00-05.04	M54 256 S5/M54 B25	6	OZH 168
525 i	2,5	R	141	09.00-05.04	M54 256 S5/M54 B25	6	OZH 173
525 i	2,5	R, 4	141	09.00-05.04	M54 256 S5/M54 B25	6	OZH 222
528 i	2,8	D	142	01.97-09.00	M52 B28/M52 B28 TU	6	OZH 168
528 i	2,8	R	142	01.97-09.00	M52 B28/M52 B28 TU	6	OZH 173
528 i	2,8	R, 4	142	10.98-09.00	M52 B28/M52 B28 TU	6	OZH 218
530 i	3,0	D	170	09.00-05.04	M54 B30 /M54 306 S3	6	OZH 168
530 i	3,0	R	170	09.00-05.04	M54 B30 /M54 306 S3	6	OZH 173
530 i	3,0	R, 4	170	09.00-05.04	M54 B30 /M54 306 S3	6	OZH 222
540 i	4,4	D	210	09.98-05.04	M62 B44/M62 B44 TU/ M62 448 S2	8	OZH 167
540 i	4,4	R	210	09.98-05.04	M62 B44/M62 B44 TU/ M62 448 S2	8	OZH 173

5 Touring (E61)

523i	2,5	D, 1, 7	130	07.05-	N52 B25/N52 B25 A	6	OPH 044
525i	2,5	R, 4	141	06.04-03.05	M54 256 S5/M54 B25	6	OZH 222
525i	2,5	D, 1, 7	160	07.05-	N52 B25/N52 B25 A	6	OPH 044
525xi	2,5	D, 1, 7	160	07.05-	N52 B25 A	6	OPH 044
530i	3,0	D, 1, 7	190	07.05-	N52 B30 A/N52 B30	6	OPH 044
530xi	3,0	D, 1, 7	190	07.05-	N52 B30 A	6	OPH 044

6 (E24)

635 CSi	3,4	R	136	01.88-05.89	M30 B35 (Motronic, 8:1, Kat.)	6	OZH 002
635 CSi	3,4	R	141	01.88-04.89	M30 B35	6	OZH 002
635 CSi	3,4	R	155	01.88-04.89	M30 B35	6	OZH 002





kW

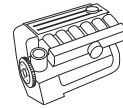

Zyl.
Cyl.
Cil.

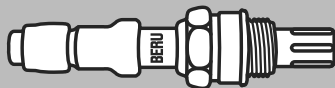

BMW							
7 (E32)							
730 i,iL	3,0	R	138	10.87–09.94	M30 B30	6	OZH 002
730 i,iL	3,0	R	138	12.86–09.87	M30 B30	6	OZH 193
730 i,iL	3,0	R	145	10.87–09.94	M30 B30	6	OZH 002
730 i,iL	3,0	R	145	12.86–09.87	M30 B30	6	OZH 193
730 i,iL V8	3,0	R	160	04.92–09.94	M60 B30	8	OZH 036
735 i,iL	3,4	R	155	10.87–09.92	M30 B35	6	OZH 002
735 i,iL	3,4	R	155	09.86–09.87	M30 B35	6	OZH 193
735 i,iL	3,4	R	162	09.86–12.87	M30 B35 (Motronic, 9.2:1)	6	OZH 193
740 i,iL V8	4,0	R	210	04.92–09.94	M60 B40	8	OZH 036
750 i,iL V12	5,0	R	220	09.87–09.94	M70 B50	12	OZH 036
7 (E38)							
740 i,iL	4,0	R	210	10.94–11.01	M60 B40	8	OZH 023
7 (E65, E66)							
730 i,Li	3,0	R	170	03.03–	M54 B30 /M54 306 S3	6	OZH 173
730 i,Li	3,0	R, 4	170	03.03–03.05	M54 B30 /M54 306 S3	6	OZH 222
730 i,Li	3,0	D, 1, 7	190	03.05–	N52 B30 A/N52 B30	6	OPH 044
8 (E31)							
840 i	4,0	R	210	04.93–09.93	M60 B40	8	OZH 023
840 i	4,0	R	210	04.93–02.96	M60 B40	8	OZH 036
850 i,Ci	5,0	R	220	04.90–10.94	M70 B50	12	OZH 036
850 CSi	5,6	R	280	04.93–12.96	M70 B56	12	OZH 039
X3 (E83)							
2.5 i	2,5	R	141	01.04–	M54 256 S5/M54 B25	6	OZH 173
3.0 i	3,0	R	170	01.04–	M54 B30 /M54 306 S3	6	OZH 173
X5 (E53)							
3.0 i	3,0	D	163	05.00–	M54 306 S3	6	OZH 168
3.0 i	3,0	R	163	05.00–	M54 306 S3	6	OZH 173
3.0 i	3,0	R	170	05.00–	M54 B30 /M54 306 S3	6	OZH 173
4.4 i	4,4	R	210	05.00–	M62 B44/M62 B44 TU	8	OZH 173
4.4 i	4,4	D	235	12.03–	N62 B44/N62 B44 A	8	OZH 224
4.6 is	4,6	R	255	02.02–	M67 468 S1/M62 B46	8	OZH 173
4.6 is	4,6	D	255	02.02–09.03	M67 468 S1/M62 B46	8	OZH 199
4.8 is	4,8	D	265	04.04–	N62 B48 A	8	OZH 224
Z1							
2.5	2,5	R	125	06.88–06.91	M20 B25	6	OZH 036
Z3 (E36)							
1.8	1,8	R	85	01.96–10.98	M43 B18	4	OZH 023
1.9	1,9	R	87	07.98–01.03	M43 B19/M43 B19 TU/ M43 194 E1	4	OZH 173
1.9	1,9	R	103	10.95–03.99	M44 B19	4	OZH 173
2.0	2,0	D	110	04.99–01.03	M52 B(20 6 S4)/M52 B20	6	OZH 168
2.0	2,0	R	110	04.99–01.03	M52 B(20 6 S4)/M52 B20	6	OZH 173
2.0	2,0	D, 4	110	04.99–12.00	M52 B(20 6 S4)/M52 B20	6	OZH 199
2.0	2,0	R, 4	110	04.99–12.00	M52 B(20 6 S4)/M52 B20	6	OZH 218
2.2	2,2	D	125	08.00–01.03	M54 226 S1/M54 B22	6	OZH 168
2.2	2,2	R	125	08.00–01.03	M54 226 S1/M54 B22	6	OZH 173
2.2	2,2	R, 4	125	08.00–12.02	M54 226 S1/M54 B22	6	OZH 218
2.2	2,2	R, 4	125	08.00–12.02	M54 226 S1/M54 B22	6	OZH 222
2.8	2,8	D	141	04.97–06.00	M52 B28/M52 B28 TU	6	OZH 168
2.8	2,8	R	141	04.97–06.00	M52 B28/M52 B28 TU	6	OZH 173
2.8	2,8	D, 4	141	10.98–06.00	M52 B28/M52 B28 TU	6	OZH 199
2.8	2,8	R, 4	141	10.98–06.00	M52 B28/M52 B28 TU	6	OZH 218
3.0	3,0	D	170	06.00–01.03	M54 B30 /M54 306 S3	6	OZH 168
3.0	3,0	R	170	06.00–01.03	M54 B30 /M54 306 S3	6	OZH 173
3.0	3,0	D, 4	170	06.00–09.00	M54 B30 /M54 306 S3	6	OZH 199
3.0	3,0	R, 4	170	06.00–12.02	M54 B30 /M54 306 S3	6	OZH 218
3.0	3,0	R, 4	170	06.00–12.02	M54 B30 /M54 306 S3	6	OZH 222
Z3 Coupe (E36)							
2.8	2,8	D	141	07.97–06.00	M52 B28	6	OZH 168
2.8	2,8	R	141	07.97–06.00	M52 B28	6	OZH 173
3.0	3,0	D	170	06.00–06.03	M54 306 S3	6	OZH 168

**BERU**

kW

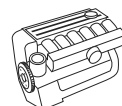
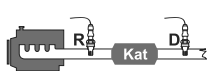
Zyl.
Cyl.
Cil.**BMW****Z3 Coupe (E36)**3.0 3,0 R 170 06.00-06.03 M54 306 S3 6 **OZH 173****Z4 (E85)**2.2 i 2,2 R 125 10.03- M54 226 S1/M54 B22 6 **OZH 173**2.2 i 2,2 R, 4 125 10.03-01.06 M54 226 S1/M54 B22 6 **OZH 218**2.2 i 2,2 R, 4 125 10.03-01.06 M54 226 S1/M54 B22 6 **OZH 222**2.5 i 2,5 D, 1 130 01.06- N52 B25 A 6 **OPH 036**2.5 i 2,5 R 141 02.03- M54 256 S5/M54 B25 6 **OZH 173**2.5 i 2,5 R, 4 141 02.03-01.06 M54 256 S5/M54 B25 6 **OZH 218**2.5 i 2,5 R, 4 141 02.03-01.06 M54 256 S5/M54 B25 6 **OZH 222**2.5 si 2,5 D, 1 160 01.06- N52 B25 A 6 **OPH 036**3.0 i 3,0 R 170 02.03- M54 B30 /M54 306 S3 6 **OZH 173**3.0 i 3,0 R, 4 170 02.03-01.06 M54 B30 /M54 306 S3 6 **OZH 218**3.0 i 3,0 R, 4 170 02.03-01.06 M54 B30 /M54 306 S3 6 **OZH 222**3.0 si 3,0 D, 1 195 01.06- N52 B30 A/N52 B30 6 **OPH 036****Z4 (E89)**sDrive23i 2,5 D, 1 150 10.09- N52 B25 A 6 **OPH 036**sDrive30i 3,0 D, 1 190 10.09- N52 B30 A 6 **OPH 036****Z4 Coupe (E86)**3.0 si 3,0 D, 1 195 03.06- N52 B30 A/N52 B30 6 **OPH 036****Z8 (E52)**4.9 4,9 R 294 06.00-06.03 S62 B50/S38 B49 8 **OZH 173****CADILLAC****CTS**3.2 3,2 R, 1 160 09.02-08.04 LA3 6 **OPH 074****CHEVROLET****CORVETTE '83 Convertible**5.6 5,7 R 179 08.88-08.91 8 **OZH 033**5.7 5,7 R 182 01.89-08.91 L98 8 **OZH 033****CHRYSLER****CROSSFIRE**3.2 3,2 D, 1, 3 160 07.03-08.08 EGX 6 **OPH 034**SRT-6 3,2 D, 1, 3 246 09.04-08.06 EGZ 6 **OPH 034****NEON II**1.6 1,6 R, 1 85 11.01-12.05 EJD 4 **OPH 030****STRATUS Cabriolet**2.0 LE 2,0 R 96 01.98-12.99 420X 4 **OZH 024****STRATUS Cabriolet C1750**2.5 LX 2,5 R 120 01.98-12.99 625H 6 **OZH 044****CITROËN****AX**10 1,0 R 33 07.92-01.95 CDY (TU9M), → Org. # 6629 4 **OZH 034**10 1,0 R 33 02.95-12.98 CDY (TU9M), → Org. # 6630 4 **OZH 079**10 1,0 R 37 02.87-01.95 CDZ (TU9M), → Org. # 6629 4 **OZH 034**10 1,0 R 37 02.95-12.98 CDZ (TU9M), → Org. # 6630 4 **OZH 079**11 1,1 R 44 09.86-05.91 HDZ (TU1M)/H1B, → Org. # 5292 4 **OZH 005**11 1,1 R 44 06.91-04.92 HDZ → Org. # 6629, → Org. # 5293 4 **OZH 034**11 1,1 R 44 02.95-12.97 HDZ (TU1M)/H1B, → Org. # 6630 4 **OZH 079**14 1,4 R 55 06.90-05.91 KDY, → Org. # 5292 4 **OZH 005**14 1,4 R 55 01.93-01.95 KDX → Org. # 6629, → Org. # 5293 4 **OZH 034**14 1,4 R 55 06.91-01.95 KDY, → Org. # 6629, → Org. # 5293 4 **OZH 034**14 1,4 R 55 02.95-04.97 KDX, KDY, → Org. # 6630 4 **OZH 079**1.4 GTi 1,4 R 66 08.91-01.95 KFY (TU3FJ2), → Org. # 6629 4 **OZH 038**1.4 GTi 1,4 R 66 02.95-12.96 KFY (TU3FJ2), → Org. # 6630 4 **OZH 079**1.4 GTi 1,4 R 69 06.91-01.95 KFZ (TU3FJ2), → Org. # 6629 4 **OZH 038**

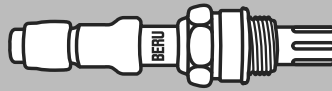

kW

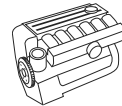
 Zyl.
Cyl.
Cil.

CITROËN

AX							
1.4 GTi	1,4	R	69	02.95–12.96	KFZ (TU3FJ2), → Org. # 6630	4	OZH 079
1.4 GTi	1,4	R	74	06.91–12.92	KFZ (TU3FJ2), → Org. # 6629	4	OZH 038
14 4x4	1,4	R	55	01.93–01.95	KDX, KDY → Org. # 6629, → Org. # 5293	4	OZH 034
14 4x4	1,4	R	55	02.95–12.96	KDX, KDY → Org. # 6630	4	OZH 079
BERLINGO							
1.1 i	1,1	R	44	07.96–	HDZ (TU1M)/HFX (TU1JP)	4	OZH 074
1.1 i	1,1	R, 1	44	06.00–04.08	HFX (TU1JP)	4	OPH 012
1.1 i	1,1	D, 1	44	06.00–11.02	HFX (TU1JP)	4	OPH 012
1.4 i	1,4	R, 1	55	07.98–11.02	KFX (TU3JP), (Euro 3)	4	OPH 010
1.4 i	1,4	D, 1	55	07.96–11.02	KFX (TU3JP), (Euro 3)	4	OPH 020
1.4 i	1,4	R	55	07.96–06.98	KFX (TU3JP)/KFW (TU3JP), → Org. # 7874	4	OZH 074
1.6	1,6	R, 1	66	04.08–	NFR (TU5JP4B)	4	OPH 010
1.6	1,6	D, 1	66	04.08–	NFR (TU5JP4B)	4	OPH 012
1.6	1,6	R, 1	80	04.08–	NFU (TU5JP4)	4	OPH 010
1.6	1,6	D, 1	80	04.08–	NFU (TU5JP4)	4	OPH 012
1.6 16V	1,6	R + D, 1	80	10.00–11.02	NFU (TU5JP4)	4	OPH 012
1.6 16V	1,6	R + D, 1	81	11.02–	NFU (TU5JP4)	4	OPH 012
BX							
14	1,4	R	55	01.89–02.93	KDZ (TU3M/Z)/KDY (TU3M)	4	OZH 005
16 E	1,6	R	65	05.89–10.91	BDY (XU5M)/BDZ (XU5M)	4	OZH 005
19 E	1,9	R	80	06.88–02.93	DDZ (XU9M)	4	OZH 005
19 GTi	1,9	R	88	06.88–02.93	DKZ (XU9JA)	4	OZH 005
19 GTi 4x4	1,9	R	88	06.88–02.93	DKZ (XU9JA)	4	OZH 005
19 GTi 16V	1,9	R	108	03.88–02.93	DFW (XU9J4)	4	OZH 005
BX Break							
14	1,4	R	55	06.90–02.93	KDY (TU3M)	4	OZH 005
16	1,6	R	65	05.89–10.91	BDY (XU5M)/BDZ (XU5M)	4	OZH 005
19	1,9	R	80	06.88–12.94	DDZ (XU9M)	4	OZH 005
19	1,9	R	88	06.88–03.93	DKZ (XU9JA)	4	OZH 005
19 4x4	1,9	R	80	10.90–05.91	DDZ (XU9M)	4	OZH 005
19 KAT	1,9	R	75	07.86–12.94	DFZ (XU9J1)	4	OZH 005
C15							
1.1 i	1,1	R	44	06.89–04.92	HDZ (TU1M), → Org. # 5656	4	OZH 005
1.1 i	1,1	R	44	04.92–12.96	HDZ (TU1M), → Org. # 5657	4	OZH 034
1.4 E	1,4	R	40	07.87–12.96	K3A	4	OZH 005
1.4 i	1,4	R	55	01.92–04.92	KDY (TU3FM)/KDY (TU3M), → Org. # 5656	4	OZH 005
1.4 i	1,4	R	55	04.92–12.96	KDY (TU3FM)/KDY (TU3M), → Org. # 5657	4	OZH 034
C15 Kombi							
1.1	1,1	R	44	06.89–04.92	HDZ (TU1M), → Org. # 5656	4	OZH 005
1.1	1,1	R	44	04.92–07.96	HDZ (TU1M), → Org. # 5657	4	OZH 034
1.4	1,4	R	55	01.92–04.92	KDY (TU3M), → Org. # 5656	4	OZH 005
1.4	1,4	R	55	04.92–07.96	KDY (TU3M), → Org. # 5657	4	OZH 034
C2							
1.1	1,1	R, 1	44	09.03–02.05	HFX (TU1JP), → Org. # 10381	4	OPH 012
1.6	1,6	R + D, 1	80	09.03–	NFU (TU5JP4)	4	OPH 012
1.6 VTS	1,6	R + D, 1	90	01.05–05.09	NFS (TU5JP4S)	4	OPH 012
C3							
1.1 i	1,1	R, 1	44	02.02–08.05	HFX (TU1JP)	4	OPH 012
1.6 16V	1,6	R, 1	80	02.02–08.05	NFU (TU5JP4)	4	OPH 012
1.6 16V	1,6	D, 1	80	02.02–05.09	NFU (TU5JP4)	4	OPH 012
C3 Pluriel							
1.6	1,6	R + D, 1	80	05.03–	NFU (TU5JP4)	4	OPH 012
C4							
1.6 16V	1,6	R + D, 1	80	11.04–07.08	NFU (TU5JP4)	4	OPH 012
1.6 16V Bio-Flex	1,6	D, 1	80	09.07–07.08	NFU (TU5JP4)	4	OPH 012
2.0 16V	2,0	D, 1	100	11.04–10.05	RFN (EW10J4)	4	OPH 020

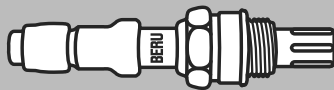

BERU



kW

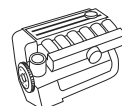

Zyl.
Cyl.
Cil.



CITROËN

C4 Coupe

1.6 16V	1,6	R + D, 1	80	11.04-07.08	NFU (TU5JP4)	4	OPH 012
2.0 16V	2,0	D, 1	100	11.04-10.05	RFN (EW10J4)	4	OPH 020
2.0 16V	2,0	D, 1	130	11.04-03.08	EW10J4S/RFK (EW10J4S)	4	OPH 020

C5

1.8 16V	1,7	R, 1	85	09.04-09.05	6FZ (EW7J4)	4	OPH 012
2.0 16V	2,0	R, 1	100	03.01-08.04	RFN (EW10J4)	4	OPH 012
3.0 V6	2,9	R + D, 1	152	03.01-08.04	XFX (ES9J4S)	6	OPH 012
3.0 V6	2,9	R + D, 1	152	09.04-04.07	XFV (ES9A), XFV (ES9A)	6	OPH 012
3.0 V6	2,9	R + D, 1	155	02.08-	XFU (ES9A)	6	OPH 012

C5 Break

1.8 16V	1,7	R, 1	85	09.04-08.05	6FZ (EW7J4)	4	OPH 012
2.0 16V	2,0	R, 1	100	06.01-08.04	RFN (EW10J4)	4	OPH 012
3.0 V6	2,9	R + D, 1	152	09.04-04.07	XFV (ES9A)	6	OPH 012
3.0 V6	2,9	R + D, 1	152	06.01-08.04	XFX (ES9J4S)	6	OPH 012
3.0 V6	2,9	R + D, 1	155	02.08-	XFU (ES9A)	6	OPH 012

C6

3.0 V6	2,9	R + D, 1	155	09.05-	ES9J4S/XFV (ES9A)	6	OPH 012
--------	-----	----------	-----	--------	-------------------	---	----------------

C8

2.0	2,0	R + D, 1	100	07.02-	RFN (EW10J4)	4	OPH 010
2.2	2,2	R + D, 1	116	07.02-	3FZ (EW12J4)	4	OPH 010
3.0 V6	2,9	R + D, 1	150	10.02-05.06	XFX (ES9J4S)	6	OPH 012

CX II

25 GTi	2,5	R	89	05.86-12.92	M25-668	4	OZH 005
--------	-----	---	----	-------------	---------	---	----------------

CX II Break

25 i	2,5	R	89	05.86-12.92	M25-668	4	OZH 005
------	-----	---	----	-------------	---------	---	----------------

EVASION

1.8	1,8	R	73	05.97-07.02	LFZ (XU7JP)	4	OZH 159
2.0	2,0	R	89	05.97-07.02	RFU (XU10J2/C)	4	OZH 159
2.0 16V	2,0	R, 1	97	05.98-04.00	RFV (XU10J4R)	4	OPH 020
2.0 16V	2,0	R + D, 1	100	05.00-07.02	RFN (EW10J4)	4	OPH 010
2.0 Turbo C.T.	2,0	R	108	05.97-07.02	RGX (XU10J2TE)	4	OZH 159

JUMPY

1.6	1,6	R	58	10.95-	220 A2.000/1580 SPI	4	OZH 159
2.0	2,0	R + D, 1	100	04.00-12.06	RFN (EW10J4)	4	OPH 010
2.0 i 16V	2,0	R + D, 1	102	03.00-		4	OPH 010

SAXO

1.0 X	1,0	R	33	05.96-11.98	CDZ (TU9M)	4	OZH 074
1.1 X,SX	1,1	R	40	05.96-09.03	HDZ (TU1M)	4	OZH 074
1.1 X,SX	1,1	R + D, 1	44	03.00-09.03	HFX (TU1JP)	4	OPH 012
1.1 X,SX	1,1	R	44	05.96-02.00	HDZ (TU1M)/HFX (TU1JP)	4	OZH 074
1.4 VTS	1,4	R, 1	55	05.96-06.03	KFX (TU3JP), (Euro 3)	4	OPH 010
1.4 VTS	1,4	D, 1	55	05.96-06.03	KFX (TU3JP)	4	OPH 010
1.4 VTS	1,4	R + D, 1, 2	55	06.00-06.03	KFW (TU3JP)	4	OPH 012
1.4 VTS	1,4	R	55	05.96-06.03	KFX (TU3JP)/KFW (TU3JP)	4	OZH 074
1.6	1,6	R, 1	66	02.98-06.03	NFZ (TU5JP), (Euro 2), → Org. # 7728	4	OPH 010

1.6	1,6	R	66	02.96-01.98	NFZ (TU5JP)	4	OZH 074
-----	-----	---	----	-------------	-------------	---	----------------

1.6	1,6	R + D, 1	74	02.01-09.03	NFT	4	OPH 012
-----	-----	----------	----	-------------	-----	---	----------------

1.6 VTL,VTR	1,6	R, 1	65	02.98-06.03	NFZ (TU5JP), (Euro 2), → Org. # 7728	4	OPH 010
-------------	-----	------	----	-------------	---	---	----------------

1.6 VTL,VTR	1,6	R	65	05.96-01.98	NFZ (TU5JP)	4	OZH 074
-------------	-----	---	----	-------------	-------------	---	----------------

1.6 VTS	1,6	R + D, 1	72	09.00-09.03	NFT	4	OPH 012
---------	-----	----------	----	-------------	-----	---	----------------

1.6 VTS	1,6	R	72	09.00-09.03	NFT	4	OZH 104
---------	-----	---	----	-------------	-----	---	----------------

XANTIA

1.6 i	1,6	R	65	03.93-05.95	BFZ (XU5JP), → Org. # 6779	4	OZH 038
-------	-----	---	----	-------------	----------------------------	---	----------------

1.6 i	1,6	R	65	06.95-01.98	BFZ (XU5JP), → Org. # 6780	4	OZH 104
-------	-----	---	----	-------------	----------------------------	---	----------------

1.8 i	1,8	R	74	03.93-05.95	LFZ (XU7JP), → Org. # 6779	4	OZH 038
-------	-----	---	----	-------------	----------------------------	---	----------------

1.8 i	1,8	R	74	06.95-01.98	LFZ (XU7JP), → Org. # 6780	4	OZH 104
-------	-----	---	----	-------------	----------------------------	---	----------------

1.8 i 16V	1,8	R	81	06.95-10.96	LFY (XU7JP4), → Org. # 7250	4	OZH 104
-----------	-----	---	----	-------------	-----------------------------	---	----------------

1.8 i 16V	1,8	R, 1	81	01.98-12.01	LFY (XU7JP4), (Euro 3)	4	OPH 010
-----------	-----	------	----	-------------	------------------------	---	----------------

2.0 i	2,0	R	89	03.93-05.95	RFX (XU10J2C), → Org. # 6779	4	OZH 038
-------	-----	---	----	-------------	------------------------------	---	----------------



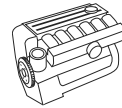

kW

Zyl.
Cyl.
Cil.**CITROËN****XANTIA**

2.0 i	2,0	R	89	06.95–01.98	RFX (XU10J2C), → Org. # 6780	4	OZH 107
2.0 i	2,0	R	89	01.98–04.03	RFX (XU10J2C)	4	OZH 104
2.0 i 16V	2,0	R	97	06.95–01.98	RFV (XU10J4R)	4	OZH 159
2.0 i 16V	2,0	R	110	06.94–12.96	RFT (XU10J4/Z)	4	OZH 034
2.0 i 16V	2,0	R	112	03.93–12.96	RFY (XU10J4/Z)	4	OZH 034
2.0 Turbo	2,0	R	108	06.95–01.98	RGX (XU10J2TE)	4	OZH 104
2.0 Turbo	2,0	R	108	01.98–04.03	RGX (XU10J2TE)	4	OZH 104

XANTIA Break

1.8 i	1,8	R	74	06.95–01.98	LFZ (XU7JP), → Org. # 6780	4	OZH 104
1.8 i 16V	1,8	R, 1	81	01.98–12.01	LFY (XU7JP4), (Euro 3)	4	OPH 010
2.0 i	2,0	R	89	06.95–01.98	RFX (XU10J2C), → Org. # 6780	4	OZH 104
2.0 i	2,0	R	89	01.98–04.03	RFX (XU10J2C)	4	OZH 104
2.0 i 16V	2,0	R	97	06.95–01.98	RFV (XU10J4R)	4	OZH 159
2.0 Turbo	2,0	R	108	06.95–01.98	RGX (XU10J2TE)	4	OZH 104
2.0 Turbo	2,0	R	108	01.98–04.03	RGX (XU10J2TE)	4	OZH 104

XM

2.0 i	2,0	R	79	05.89–04.94	RDZ (XU10MZ)	4	OZH 194
2.0 i	2,0	R	89	05.91–06.94	RFZ (XU10J2), → Org. # 5337	4	OZH 034
2.0 i	2,0	R	89	05.89–05.91	RFZ (XU10J2)	4	OZH 194
2.0 i 16V	2,0	R	97	05.94–10.00	RFV	4	OZH 034
2.0 i 16V	2,0	R	97	05.94–10.00	RFV (XU10J4R)	4	OZH 159
2.0 i Turbo	2,0	R	104	09.92–06.94	RGY (XU10J2TE/Z)	4	OZH 034
2.0 Turbo	2,0	R	108	05.94–10.00	RGX (XU10J2TE)	4	OZH 159
3.0 V6	3,0	R	123	05.89–05.91	UFZ (ZPJ/Z)/SFZ (ZPJ/Z)	6	OZH 166
3.0 V6 24V	3,0	R	147	07.90–05.91	UKZ (ZPJ4/Z)/SKZ (ZPJ4/Z)	6	OZH 166

XM Break

2.0 i	2,0	R	79	11.91–04.94	RDZ (XU10MZ)/XU102C, → Org. # 5337	4	OZH 034
2.0 i	2,0	R	89	11.91–04.94	RFZ (XU10J2), → Org. # 5337	4	OZH 034
2.0 i 16V	2,0	R	97	05.94–10.00	RFV	4	OZH 034
2.0 i 16V	2,0	R	97	05.94–10.00	RFV (XU10J4R)	4	OZH 159
2.0 Turbo	2,0	R	104	09.92–04.94	RGY (XU10J2TE/Z)	4	OZH 034
2.0 Turbo	2,0	R	108	05.94–10.00	RGX	4	OZH 159

XSARA

1.4 i	1,4	R, 1	55	06.98–08.00	KFX (TU3JP), (Euro 3)	4	OPH 010
1.4 i	1,4	D, 1	55	06.98–08.00	KFX (TU3JP)	4	OPH 020
1.4 i	1,4	R	55	04.97–05.98	KFX (TU3JP)/KFW (TU3JP)	4	OZH 074
1.6 16V	1,6	R + D, 1	80	09.00–03.05	NFU (TU5JP4)	4	OPH 012
1.6 i	1,6	R, 1	65	01.98–08.00	NFZ (TU5JP), → Org. # 7707	4	OPH 010
1.6 i	1,6	R	65	04.97–12.97	NFZ (TU5JP)	4	OZH 074
1.8 i Aut.	1,8	R	74	04.97–09.00	LFZ (XU7JP)	4	OZH 079
2.0 16V	2,0	R	97	07.98–09.00	RFV (XU10J4R)	4	OZH 104
2.0 16V	2,0	R, 1	100	09.00–03.05	RFN (EW10J4)	4	OPH 012
2.0 16V	2,0	R	120	04.97–09.00	RFS (XU10J4RS)	4	OZH 079

XSARA Break

1.4 i	1,4	R, 1	55	06.98–08.00	KFX (TU3JP), (Euro 3)	4	OPH 010
1.4 i	1,4	D, 1	55	06.98–08.00	KFX (TU3JP)	4	OPH 020
1.6 16V	1,6	R + D, 1	80	09.00–08.05	NFU (TU5JP4)	4	OPH 012
1.6 i	1,6	R, 1	65	01.98–09.00	NFZ (TU5JP), → Org. # 7707	4	OPH 010
1.6 i	1,6	R	65	10.97–12.97	NFZ (TU5JP)	4	OZH 074
1.8 i Aut.	1,8	R	74	10.97–09.00	LFZ (XU7JP)	4	OZH 079
2.0 16V	2,0	R	97	07.98–09.00	RFV (XU10J4R)	4	OZH 104
2.0 16V	2,0	R, 1	100	09.00–08.05	RFN (EW10J4)	4	OPH 012

XSARA Coupe

1.4 i	1,4	R, 1	55	06.98–08.00	KFX (TU3JP), (Euro 3)	4	OPH 010
1.4 i	1,4	D, 1	55	06.98–08.00	KFX (TU3JP)	4	OPH 020
1.6 16V	1,6	R + D, 1	80	09.00–03.05	NFU (TU5JP4)	4	OPH 012
2.0 16V	2,0	R, 1	100	09.00–03.05	RFN (EW10J4)	4	OPH 012
2.0 i 16V	2,0	R	120	02.98–03.05	RFS (XU10J4RS)	4	OZH 079

XSARA PICASSO

1.6	1,6	R, 1	65	12.99–	NFZ (TU5JP)	4	OPH 010
-----	-----	------	----	--------	-------------	---	----------------

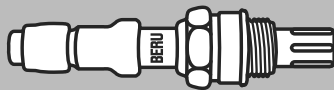
**BERU**

kW

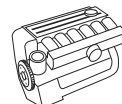
Zyl.
Cyl.
Cil.**CITROËN****XSARA PICASSO**

1.6	1,6	D, 1	67	06.02-02.07		4	OPH 010
1.6	1,6	R, 1	67	06.02-02.07		4	OPH 012
1.6	1,6	R, 1	70	12.99-	NFV (TU5JP)	4	OPH 012
1.6 16V	1,6	R, 1	80	09.05-	NFU (TU5JP4)	4	OPH 010
1.6 16V	1,6	D, 1	80	09.05-	NFU (TU5JP4)	4	OPH 012
2.0 16V	2,0	R, 1	100	01.03-	RFN (EW10J4)	4	OPH 012

ZX

1.1	1,1	R	44	10.91-03.94	HDZ (TU1M)	4	OZH 034
1.4 i	1,4	R	55	08.92-06.95	KDZ (TU3M/Z)/KFX (TU3JP)/ KDX (TU3M/Z), → Org. # 6808, → Org. # 5538	4	OZH 034
1.4 i	1,4	R	55	09.94-06.95	KDX → Org. # 6808, → Org. # 6506	4	OZH 038
1.4 i	1,4	R	55	07.95-06.97	KDZ (TU3M/Z)/KFX (TU3JP)/ KDX (TU3M/Z), → Org. # 6809	4	OZH 079
1.6 i	1,6	R	65	01.92-04.95	BDY → Org. # 5538	4	OZH 034
1.6 i	1,6	R	65	07.93-04.95	BFZ → Org. # 6748	4	OZH 034
1.6 i	1,6	R	65	05.95-06.97	BFZ → Org. # 6749	4	OZH 079
1.6 i	1,6	R	65	03.91-01.92	BDY	4	OZH 194
1.8	1,8	R	82	04.96-10.97	LFY (XU7JP4)	4	OZH 079
1.8 i	1,8	R	74	07.92-04.95	LFZ → Org. # 6748	4	OZH 034
1.8 i	1,8	R	74	05.95-06.97	LFZ → Org. # 6749	4	OZH 079
1.8 i 16V	1,8	R	81	01.96-06.97	LFY (XU7JP4)	4	OZH 079
1.9 i	1,9	R	88	03.91-04.95	DKZ (XU9JA), → Org. # 6748	4	OZH 034
1.9 i	1,9	R	88	05.95-06.97	DKZ (XU9JA), → Org. # 6749	4	OZH 079
2.0 i	2,0	R	89	07.92-04.95	RFX (XU10J2C), → Org. # 6748	4	OZH 034
2.0 i	2,0	R	89	05.95-06.97	RFX (XU10J2C), → Org. # 6749	4	OZH 079
2.0 i 16V	2,0	R	110	06.94-04.95	RFT (XU10J4/Z), → Org. # 6748	4	OZH 034
2.0 i 16V	2,0	R	110	05.95-06.97	RFT (XU10J4/Z), → Org. # 6749	4	OZH 079
2.0 i 16V	2,0	R	112	07.92-10.94	RFT (XU10J4/Z)/ RFY (XU10J4/Z), → Org. # 6748	4	OZH 034

ZX Break

1.4 i	1,4	R	55	10.93-10.97	KFX (TU3JP)/KDX (TU3M/Z)/ KDY (TU3M)	4	OZH 079
1.6 i	1,6	R	65	10.93-04.95	BFZ (XU5JP)/BDY (XU5M), → Org. # 6748	4	OZH 034
1.6 i	1,6	R	65	05.95-10.97	BFZ (XU5JP)/BDY (XU5M), → Org. # 6749	4	OZH 079
1.8 i	1,8	R	74	10.93-04.95	LFZ (XU7JP), → Org. # 6748	4	OZH 034
1.8 i	1,8	R	74	05.95-10.97	LFZ (XU7JP), → Org. # 6749	4	OZH 079
1.8 i 16V	1,8	R	81	01.96-02.98	LFY (XU7JP4)	4	OZH 079

C25 Bus

2.0	2,0	R	62	02.91-02.94	170C (XN1T)	4	OZH 005
2.0 E	2,0	R	58	09.81-02.94	170B (XN1T)/170A (XN1T)	4	OZH 005

JUMPER Bus

2.0	2,0	R	80	02.94-04.02	RFW (XU10J2U), → Chassis # 15267330	4	OZH 034
2.0	2,0	R	80	02.94-04.02	RFW (XU10J2U), Chassis # 15267331 →	4	OZH 159
2.0 4x4	2,0	R	80	08.96-04.02	RFW (XU10J2U)	4	OZH 034
2.0	2,0	R, 1	81	04.02-	XU10J2	4	OPH 012

JUMPER Kasten

2.0	2,0	R	80	03.94-04.02	RFW (XU10J2U)	4	OZH 034
2.0	2,0	R	80	03.94-04.02	RFW (XU10J2U)	4	OZH 159
2.0	2,0	R, 1	81	04.02-	XU10J2	4	OPH 012
2.0 bivalent	2,0	R, 1	81	02.03-	XU10J2	4	OPH 012

DAEWOO**ESPERO**

1.5 16V	1,5	R	66	02.95-06.99	A15MF	4	OZU 005
1.8	1,8	R	66	02.95-09.99	C18LE	4	OZU 005



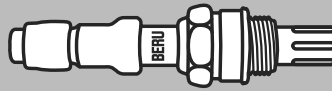

kW

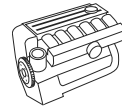
 Zyl.
Cyl.
Cil.

DAEWOO							
ESPERO							
1.8	1,8	R	70	02.95-06.99	C18LE	4	OZU 005
2.0	2,0	R	77	02.95-06.99	C20LE	4	OZU 005
NEXIA							
1.5	1,5	R	52	02.95-08.97	G15MF	4	OZU 005
1.5	1,5	R	55	02.95-08.97	G15MF	4	OZU 005
1.5 16V	1,5	R	66	02.95-08.97	A15MF	4	OZU 005
NEXIA Stufenheck							
1.5	1,5	R	52	02.95-08.97	G15MF	4	OZU 005
1.5	1,5	R	55	02.95-08.97	G15MF	4	OZU 005
1.5 16V	1,5	R	66	02.95-08.97	A15MF	4	OZU 005
NUBIRA							
1.8	1,8	R	70	04.97-05.99	C18LE	4	OZU 005
NUBIRA Stufenheck							
1.8	1,8	R	70	04.97-05.99	C18LE	4	OZU 005
NUBIRA Wagon							
1.8	1,8	R	70	04.97-05.99	C18LE	4	OZU 005
1.8	1,8	R	70	06.04-	C18LE	4	OZU 005
DAIHATSU							
APPLAUSE I							
1.6 16V	1,6	R	77	06.89-07.97	HD-E	4	OZU 001
1.6 16V 4WD	1,6	R	77	06.89-07.97	HD-E	4	OZU 001
CHARADE III							
1.0	1,0	R	40	11.90-12.92	CB 90	3	OZU 001
1.3 i	1,3	R	66	06.88-12.92	HCE	4	OZU 001
1.3 i 4WD	1,3	R	66	06.88-10.90	HCE	4	OZU 001
CUORE IV							
0.8	0,8	R	32	01.95-11.96	ED 20	3	OZU 001
CUORE V							
0.8	0,8	R	31	11.96-10.98	EF-EL	3	OZU 001
FEROZA Hard Top							
1.6 i 16V	1,6	R	70	09.90-08.93	HD-E	4	OZU 001
MOVE							
0.8	0,8	R	31	10.96-09.98	ED 20	3	OZU 001
DAIMLER							
XJ 40, 81							
Sovereign 3.6	3,6	R	136	10.86-09.89		6	OZH 037
DE LOREAN							
DMC-12							
2.9	2,8	R	97	01.81-10.82		6	OZU 001
DODGE							
NEON II							
2.0 16V	2,0	R, 1	98	09.00-08.02	ECB	4	OPH 030
2.0 16V	2,0	R, 1	112	09.00-08.02	ECH	4	OPH 030
FERRARI							
348 TB							
3.4	3,4	R	221	02.90-10.93	F 119 F 000	8	OZH 035
3.4	3,4	R	235	10.93-04.94	F 119 D 040	8	OZH 035
348 TS							
3.4	3,4	R	221	08.90-10.93	F 119 F 000	8	OZH 035
3.4	3,4	R	235	10.93-12.95	F 119 D 040	8	OZH 035
360 MODENA							
360 F1	3,6	D, 1	294	03.99-12.04	F 131 B40	8	OPH 020
360 MODENA Spider							
3.6	3,6	D, 1	294	06.00-	F 131 B40	8	OPH 020
512 TR							
5.0	4,9	R	315	01.92-10.94	F 113 D 00/40	12	OZH 035

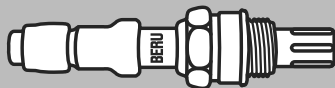
**BERU**

kW

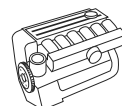
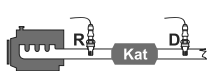
Zyl.
Cyl.
Cil.**FERRARI****MONDIAL**3.2 Quattrovalvole 3,2 R 199 10.85-12.88 F 105 C.. 8 **OZH 037****MONDIAL Cabriolet**3.2 Quattrovalvole 3,2 R 199 09.85-12.88 F 105 C.. 8 **OZH 037****TESTAROSSA**5.0 4,9 R 272 08.86-10.91 F 113 B.. 12 **OZH 037****FIAT****500**1.4 1,4 R, 1 74 10.07- 169 A3.000 4 **OPH 025**1.4 Abarth 1,4 R, 1 99 08.08- 312 A1.000 4 **OPH 025**1.4 Abarth 1,4 D, 1 99 08.08- 312 A1.000 4 **OPH 027****500 C**1.4 1,4 R, 1 74 09.09- 169 A3.000 4 **OPH 025****BARCETTA**1.8 16V 1,7 R 96 06.98- 183 A1.000 4 **OZH 064****BRAVA**1.2 16V 80 1,2 R, 1 59 10.00-10.01 188 A5.000 4 **OPH 025**1.2 16V 80 1,2 R, 1 60 12.98-10.00 182 B2.000 4 **OPH 025**1.4 1,4 R 55 10.95-10.98 182 A5.000, → Chassis # 4029959 4 **OZH 136**1.4 1,4 R 55 10.95-10.98 182 A5.000, Chassis # 4029960 → 4 **OZH 064**1.4 12 V 1,4 R 59 10.95-08.98 182 A3.000, → Chassis # 4029959 4 **OZH 136**1.4 12 V 1,4 R 59 10.95-08.98 182 A3.000, Chassis # 4029960 → 4 **OZH 064**1.6 16V 1,6 R 66 10.95-10.01 182 A6.000 4 **OZH 084**1.6 16V 1,6 R 76 02.96-10.98 182 A4.000 4 **OZH 084**1.6 16V 1,6 R 76 11.98-10.01 182 A4.000 4 **OZH 118**1.8 GT 16V 1,7 R 83 10.95-10.01 182 A2.000 4 **OZH 088****BRAVO I**1.2 16V 80 1,2 R, 1 59 10.00-10.01 188 A5.000 4 **OPH 025**1.2 16V 80 1,2 R, 1 60 12.98-10.00 182 B2.000 4 **OPH 025**1.4 1,4 R 55 10.95-10.98 182 A5.000, → Chassis # 4029959 4 **OZH 136**1.4 1,4 R 55 10.95-10.98 182 A5.000, Chassis # 4029960 → 4 **OZH 064**1.4 1,4 R 59 10.95-10.98 182 A3.000, → Chassis # 4029959 4 **OZH 136**1.4 1,4 R 59 10.95-10.98 182 A3.000, Chassis # 4029960 → 4 **OZH 064**1.6 16V 1,6 R 66 10.95-04.98 182 A6.000 4 **OZH 084**1.6 16V 1,6 R 76 03.96-10.98 182 A4.000 4 **OZH 084**1.6 16V 1,6 R 76 11.98-10.01 182 A4.000 4 **OZH 118**1.8 GT 1,7 R 83 10.95-10.01 182 A2.000 4 **OZH 088**2.0 HGT 20V 2,0 R 108 10.95-07.98 182 A1.000 5 **OZH 056****BRAVO II**1.4 1,4 R + D, 1 66 04.07- 192 B2.000 4 **OPH 025**1.4 T-Jet 1,4 R, 1 88 09.07- 198 A4.000 4 **OPH 025**1.4 T-Jet 1,4 D, 1 88 09.07- 198 A4.000 4 **OPH 027**1.4 T-Jet 1,4 R, 1 110 09.07- 198 A1.000 4 **OPH 025**1.4 T-Jet 1,4 D, 1 110 09.07- 198 A1.000 4 **OPH 027****CINQUECENTO**0.7 i 0,7 R 22 07.94-01.98 170 A.046 2 **OZU 006**0.9 i.e. 0,9 R 30 07.91-12.93 170 A1.046, → Mot. # 9147274 4 **OZH 035**0.9 i.e. 0,9 R 30 07.91-12.93 170 A1.046, Mot. # 9147275 → 4 **OZH 056**0.9 i.e. S 0,9 R 29 07.91-07.99 1170 A1.000/1170 A1.046, → Mot. # 9147274 4 **OZH 035**0.9 i.e. S 0,9 R 29 07.91-07.99 1170 A1.000/1170 A1.046, Mot. # 9147275 → 4 **OZH 056**1.1 Sporting 1,1 R 40 10.94-01.98 176 B2.000 4 **OZH 064****COUPE**1.8 16V 1,7 R 96 03.96-04.98 183 A1.000, → Mot. # 1070425 4 **OZH 088**1.8 16V 1,7 R 96 05.98-08.00 183 A1.000, Mot. # 1070426 → 4 **OZH 056**2.0 16V 2,0 R 102 11.93-04.95 836 A3.000 4 **OZH 046**2.0 16V 2,0 R 102 05.95-08.96 836 A3.000 4 **OZH 052**2.0 16V Turbo 2,0 R 140 11.93-08.96 175 A1.000 4 **OZH 037**2.0 20V 2,0 R 108 08.96-04.98 182 A1.000 5 **OZH 056**



kW

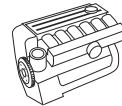

 Zyl.
Cyl.
Cil.

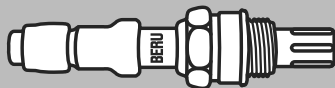
FIAT							
CROMA							
2000 16V	2,0	R	101	11.92–08.96	154 E1.000	4	OZH 035
2000 i.e.	2,0	R	83	03.86–09.90	834 B.048	4	OZH 037
2000 i.e.	2,0	R	85	10.87–08.96	154 C3.046/834 B.146	4	OZH 037
2000 i.e. Turbo	2,0	R	110	06.87–08.96	154 C4.046/834 C.146	4	OZH 037
2000 i.e. Turbo	2,0	R	111	11.86–11.88	834 C.146	4	OZH 037
2500 V6	2,5	R	119	06.93–08.96	834 G.000 → VET # 0014972	6	OZH 055
2500 V6	2,5	R	119	06.93–08.96	834 G.000, VET # 0014973 →	6	OZH 056
DOBLO							
1.2	1,2	R, 1	48	03.01–09.05	223 A5.000	4	OPH 025
1.2	1,2	D, 1	48	02.04–09.05	223 A5.000	4	OPH 025
1.2	1,2	D, 1	48	03.01–01.04	223 A5.000	4	OPH 028
1.4	1,4	R + D, 1	57	10.05–	350 A1.000	4	OPH 025
1.6	1,6	D, 1	68	09.02–01.04	182 B6.000	4	OPH 028
1.6 16V	1,6	R, 1	76	10.01–12.05	182 B6.000	4	OPH 026
1.6 16V	1,6	D, 1	76	01.05–12.05	182 B6.000	4	OPH 026
1.6 16V	1,6	D, 1	76	10.01–01.04	182 B6.000	4	OPH 028
1.6 Natural Power	1,6	D, 1	76	09.02–01.04	182 B6.000	4	OPH 028
1.4	1,4	R, 1	70	02.10–	843 A1.000	4	OPH 025
FIORINO							
1.5	1,5	R	55	01.88–08.93	149 C1.000	4	OZH 037
70 i.e. 1.4	1,4	R	49	05.94–05.01	146 C5.000/146 D5.000	4	OZH 037
75 i.e. 1.5	1,5	R	55	05.88–12.93	149 C1.000	4	OZH 037
75 i.e. 1.6	1,6	R	55	10.93–05.01	146 C 6000	4	OZH 037
75 i.e. 1.6	1,6	R	55	10.93–05.01	146 D 6000	4	OZH 056
1.4 Natural Power	1,4	R, 1	57	10.09–	350 A1.000	4	OPH 025
FIORINO Pick up							
1.4	1,4	R	49	05.94–05.01	146 D5.000	4	OZH 056
1.6	1,6	R	55	01.94–05.01	146 D6.000/146 C6.000	4	OZH 037
IDEA							
1.2 16V	1,2	R + D, 1	59	01.04–	188 A5.000	4	OPH 025
1.4	1,4	R + D, 1	57	10.05–	350 A1.000	4	OPH 025
1.4	1,4	R + D, 1	66	12.03–	192 B2.000	4	OPH 025
1.4 16V	1,4	R + D, 1	70	01.04–	843 A1.000	4	OPH 025
LINEA							
1.4	1,4	R, 1	57	06.07–	350 A1.000	4	OPH 025
1.4 T-Jet	1,4	R, 1	88	09.07–	198 A4.000	4	OPH 025
1.4 T-Jet	1,4	D, 1	88	09.07–	198 A4.000	4	OPH 027
MAREA							
1.2 16V	1,2	R, 1	60	03.99–09.02	182 B2.000	4	OPH 025
1.4 80 12V	1,4	R	59	09.96–	182 A3.000	4	OZH 064
1.6 100 16V	1,6	R	76	09.96–10.98	182 A4.000	4	OZH 084
1.6 100 16V	1,6	R	76	11.98–10.00	182 A4.000	4	OZH 118
1.6 100 16V	1,6	R	76	11.00–	182 A4.000	4	OZH 180
1.6 100 16V Bipower	1,6	R	76	04.99–10.99	186 A4.000/185 A3.000	4	OZH 084
1.8 115 16V	1,7	R	83	09.96–	182 A2.000	4	OZH 088
2.0 150 20V	2,0	R	108	09.96–04.99	182 A1.000	5	OZH 056
2.0 150 20V	2,0	R + D, 1	110	01.01–12.02	185 A8.000	5	OPH 025
MAREA Weekend							
1.2 16V	1,2	R, 1	60	03.99–09.02	182 B2.000	4	OPH 025
1.4 80 12V	1,4	R	59	09.96–	182 A3.000	4	OZH 064
1.6 100 16V	1,6	R	76	09.96–10.98	182 A4.000	4	OZH 084
1.6 100 16V	1,6	R	76	11.98–10.00	182 A4.000	4	OZH 118
1.6 100 16V	1,6	R	76	11.00–	182 A4.000	4	OZH 180
1.8 115 16V	1,7	R	83	09.96–	182 A2.000	4	OZH 088
2.0 150 20V	2,0	R	108	09.96–04.99	182 A1.000	5	OZH 056
2.0 150 20V	2,0	R + D, 1	110	01.01–09.02	185 A8.000	5	OPH 025
MULTIPLA							
1.6 100 16V	1,6	R	76	04.99–	182 A4.000	4	OZH 056
1.6 16V	1,6	R	70	04.02–	182 B6.000	4	OZH 180
1.6 16V Bipower	1,6	R	76	04.99–	186 A4.000	4	OZH 056
1.6 16V Bipower	1,6	R	76	10.01–	182 B6.000	4	OZH 180

**BERU**

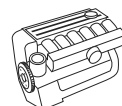
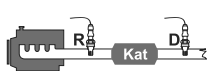
kW

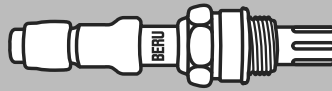
Zyl.
Cyl.
Cil.**FIAT****MULTIPLA**1.6 16V Blupower 1,6 R 70 04.99- 186 A3.000 4 **OZH 056****PALIO**1.2 1,2 R + D, 1 59 09.01- 188 A5.000 4 **OPH 025**1.6 16V 1,6 R 74 04.96- 178 B3.000 4 **OZH 056****PALIO Weekend**1.2 1,2 R + D, 1 44 02.01-09.01 178 C4.066/188 A4.000 4 **OPH 025**1.6 16V 1,6 R 74 04.96-09.99 178 B3.000 4 **OZH 056**1.6 16V 1,6 R 74 10.99-02.01 178 B3.000 4 **OZH 137****PANDA**1000 i.e. KAT 1,0 R 33 10.87-08.98 141 C2.000/156 A2.246 (Inj. Weber) 4 **OZH 035**1000 i.e. KAT 1,0 R 33 10.87-08.98 141 C2.000/156 A2.246 (Inj. Bosch) 4 **OZH 037**1000 4x4 1,0 R 33 05.86-12.94 156 A 2246 4 **OZH 037**1000 4x4 1,0 R 33 05.86-12.94 141 C2.000 4 **OZH 056**1100 1,1 R 37 05.91-12.99 156 C.046 (Inj. Weber) 4 **OZH 035**1100 1,1 R 37 05.91-12.99 156 C.046 (Inj. Bosch) 4 **OZH 037**1100 1,1 R 40 02.95-09.03 187 A1.000/176 B2.000 4 **OZH 056**1100 4x4 1,1 R 40 02.95-07.04 176 B2.000 4 **OZH 056**1100 Trekking 4x4 1,1 R 37 10.91-07.04 156 C.046 4 **OZH 037**900 0,9 R 29 04.92-12.96 1170 A1.046, → Mot. # 9117331 4 **OZH 035**900 0,9 R 29 04.92-12.96 1170 A1.046, Mot. # 9117332 → 4 **OZH 056**1.2 Bi-Power / Natural Power 1,2 R + D, 1 44 01.07- 188 A4.000 4 **OPH 025**1.4 1,4 R, 1 74 10.06- 169 A3.000 4 **OPH 025**1.4 1,4 D, 1 74 10.06- 169 A3.000 4 **OPH 026****PANDA Van**1000 i.e 1,0 R 33 08.92-02.04 156 A2.246 (Inj. Weber) 4 **OZH 035**1000 i.e 1,0 R 33 08.92-02.04 156 A2.246 4 **OZH 037****PUNTO (176)**55 1.1 1,1 R 40 09.93-09.99 176 A6.000/176 B2.000, → Mot. # 5795653 4 **OZH 035**55 1.1 1,1 R 40 09.93-09.99 176 A6.000/176 B2.000, Mot. # 5795654 → 4 **OZH 056**60 1.2 1,2 R 43 01.94-09.99 176 A7.000, → Mot. # 5795653 4 **OZH 035**60 1.2 1,2 R 43 01.94-09.99 176 A7.000, Mot. # 5795654 → 4 **OZH 056**60 1.2 1,2 R 44 03.94-09.99 176 B1.000/176 B4.000, → Mot. # 5795653 4 **OZH 035**60 1.2 1,2 R 44 03.94-09.99 176 B1.000/176 B4.000, Mot. # 5795654 → 4 **OZH 056**75 1.2 1,2 R 54 10.93-09.99 176 A8.000, → Mot. # 5795653 4 **OZH 035**75 1.2 1,2 R 54 10.93-09.99 176 A8.000, Mot. # 5795654 → 4 **OZH 056**85 16V 1.2 1,2 R 63 04.97-09.99 176 B9.000 4 **OZH 135**90 1.6 1,6 R 65 01.94-04.97 176 A9.000 4 **OZH 054**1.4 GT Turbo 1,4 R 96 09.96-09.99 176 B6.000 4 **OZH 056**1.4 GT Turbo 1,4 R 98 01.94-12.94 176 A4.000 4 **OZH 035**1.4 GT Turbo 1,4 R 98 01.95-09.96 176 A4.000 4 **OZH 056****PUNTO (188)**1.2 16V 80 1,2 R, 1 59 09.99-12.10 188 A5.000 4 **OPH 025**1.2 16V 80 1,2 D, 1 59 03.01-12.10 188 A5.000 4 **OPH 025**1.2 60 1,2 R + D, 1 44 10.00- 188 A4.000 4 **OPH 025**1.2 Natural Power 1,2 R + D, 1 44 09.03- 188 A4.000 4 **OPH 025**1.4 1,4 R + D, 1 70 09.03- 843 A1.000 4 **OPH 025**1.8 130 HGT 1,7 R 96 09.99- 183 A1.000/188 A6.000 4 **OZH 118****GRANDE PUNTO (199)**1.2 1,2 R + D, 1 48 10.05- 199 A4.000 4 **OPH 025**1.4 1,4 R + D, 1 57 10.05- 350 A1.000 4 **OPH 025**1.4 16V 1,4 R + D, 1 70 10.05- 199 A6.000 4 **OPH 025**1.4 T-Jet 1,4 R, 1 88 09.07- 198 A4.000 4 **OPH 025**1.4 T-Jet 1,4 D, 1 88 09.07- 198 A4.000 4 **OPH 027**1.4 Abarth 1,4 R, 1 114 12.07- 199 A8.000 4 **OPH 025**1.4 Abarth 1,4 D, 1 114 12.07- 199 A8.000 4 **OPH 027**

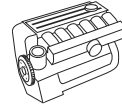

kW

 Zyl.
Cyl.
Cil.

FIAT							
PUNTO EVO							
1.2	1,2	R + D, 1	48	10.09–	199 A4.000	4	OPH 025
1.4	1,4	R + D, 1	57	10.09–	350 A1.000	4	OPH 025
PUNTO Van (176L)							
1.1	1,1	R	40	04.96–02.00	176 B2.000	4	OZH 056
PUNTO Van (188AX)							
1.2 60	1,2	R, 1	44	02.00–06.03	188 A4.000	4	OPH 025
1.2 60	1,2	D, 1	44	10.00–06.03	188 A4.000	4	OPH 025
QUBO							
1.4 Natural Power	1,4	R, 1	57	10.09–	350 A1.000	4	OPH 025
REGATA							
75 i.e. 1.5	1,5	R	55	07.85–07.89	149 C 1000	4	OZH 037
75 i.e. 1.5	1,5	R	55	07.85–07.89	138 C2.048	4	OZU 022
90 i.e. 1.6	1,6	R	66	01.87–07.89	149 C2.000	4	OZU 001
REGATA Weekend							
75 1.5 i.e. KAT	1,5	R	55	12.86–07.89	138 C2.048	4	OZU 022
90 i.e. 1.6	1,6	R	66	01.87–07.89	149 C2.000	4	OZU 001
RITMO I							
75 i.e. 1.5	1,5	R	55	10.85–05.87	138 C2.048	4	OZU 001
90 i.e. 1.6	1,6	R	66	05.87–12.87	149 C2.000	4	OZH 037
RITMO II							
75 1.5 KAT	1,5	R	55	09.85–12.88	149 C1.000	4	OZH 037
75 1.5 KAT	1,5	R	55	09.85–12.88	138 C2.048	4	OZU 022
SEICENTO							
0.9	0,9	R	29	01.98–	1170 A1.046	4	OZH 056
1.1	1,1	R	40	01.98–	187 A1.000/176 B2.000	4	OZH 064
SIENA							
1.2	1,2	R + D, 1	59	01.02–	188 A5.000	4	OPH 025
1.4	1,4	R + D, 1	57	01.07–	199 A1.000	4	OPH 025
STILO							
1.2 16V	1,2	R + D, 1	59	02.02–12.03	188 A5.000	4	OPH 025
1.4 16V	1,4	R + D, 1	66	03.05–12.07	192 B2.000	4	OPH 025
1.4 16V	1,4	R + D, 1	70	01.04–12.07	843 A1.000	4	OPH 025
1.6 16V	1,6	R, 1	76	10.01–	182 B6.000	4	OPH 026
1.8 16V	1,7	D	98	10.01–	192 A4.000	4	OZH 180
2.4 20V	2,4	R + D, 1	125	10.01–12.03	192 A2.000	5	OPH 025
STILO Multi Wagon							
1.4 16V	1,4	R + D, 1	66	03.05–12.07	192 B2.000	4	OPH 025
1.4 16V	1,4	R + D, 1	70	01.04–	843 A1.000	4	OPH 025
1.6 16V	1,6	R, 1	76	01.03–	182 B6.000	4	OPH 026
1.8 16V	1,7	D	98	01.03–	192 A4.000	4	OZH 180
STRADA							
1.2	1,2	R + D, 1	44	04.03–06.05	188 A4.000	4	OPH 025
TEMPRA							
1.4 i.e.	1,4	R	51	03.92–08.96	160 A1.046	4	OZH 037
1.4 i.e.	1,4	R	51	03.92–08.96	836 A4.000	4	OZH 056
1.6 i.e.	1,6	R	55	04.93–12.94	835 C 1000	4	OZH 035
1.6 i.e.	1,6	R, 2	55	06.92–08.96	159 A3.048/835 C1.000	4	OZH 037
1.6 i.e.	1,6	R	55	01.95–08.96	835 C 1000, VET # 7559353 →	4	OZH 056
1.6 i.e.	1,6	R	57	06.90–07.92	159 A3.046	4	OZH 037
1.8 i.e.	1,8	R	66	09.93–08.96	835 C4.000	4	OZH 035
1.8 i.e.	1,8	R	77	04.93–08.96	159 A4.046	4	OZH 035
2.0 i.e.	2,0	R	83	10.90–08.96	159 A6.046	4	OZH 037
TEMPRA S.W.							
1.4 i.e.	1,4	R	51	10.92–08.96	160 A1.046	4	OZH 037
1.4 i.e.	1,4	R	51	10.92–08.96	836 A4.000	4	OZH 056
1.6 i.e.	1,6	R, 2	55	10.92–08.96	159 A3.048/835 C1.000	4	OZH 037
1.6 i.e.	1,6	R	55	10.92–12.94	159 A3.048/835 C1.000	4	OZH 035
1.6 i.e.	1,6	R	55	01.95–08.96	159 A3.048/835 C1.000, VET # 7559353 →	4	OZH 056
1.6 i.e.	1,6	R	57	10.90–01.95	835 C 1000	4	OZH 035
1.6 i.e.	1,6	R	57	10.90–07.92	159 A 3046	4	OZH 037

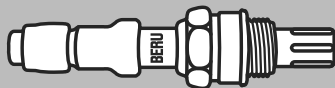
**BERU**

kW

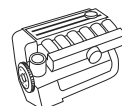
Zyl.
Cyl.
Cil.**FIAT****TEMPRA S.W.**

1.6 i.e.	1,6	R	57	02.95-08.96	835 C1.000	4	OZH 056
1.8 i.e.	1,8	R	66	09.93-08.96	835 C4.000	4	OZH 035
1.8 i.e.	1,8	R	76	09.93-08.96	835 C2.000	4	OZH 035
1.8 i.e.	1,8	R	77	04.93-12.93	159 A4.046	4	OZH 035
2.0 i.e.	2,0	R	83	01.91-03.95	159 A6.046	4	OZH 037
2.0 i.e. 4x4	2,0	R	83	03.92-03.95	159 A6.046	4	OZH 037

TIPO

1.4 i.e.	1,4	R	51	05.89-04.95	160 A 1046	4	OZH 037
1.4 i.e.	1,4	R	51	05.89-04.95	836 A4.000	4	OZH 056
1.6 i.e.	1,6	R	55	10.92-04.95	835 C 1000	4	OZH 035
1.6 i.e.	1,6	R	55	10.92-04.95	159 A 3048	4	OZH 037
1.6 i.e.	1,6	R	57	07.90-01.93	159 A3.046	4	OZH 037
1.8 i.e.	1,8	R	76	04.93-04.95	835 C2.000	4	OZH 037
1.8 i.e.	1,8	R	77	10.90-06.93	159 A4.046	4	OZH 037
2.0 i.e.	2,0	R	83	03.90-04.95	159 A6.046	4	OZH 037
2.0 i.e. 16V Sport	2,0	R	102	03.93-12.94	836 A3.000	4	OZH 046
2.0 i.e. 16V Sport	2,0	R	102	01.95-04.95	836 A3.000	4	OZH 052

ULYSSE (179AX)

2.0	2,0	R + D, 1	100	08.02-10.05	RFN(EW10J4)	4	OPH 010
3.0 V6	2,9	R, 1	150	01.03-10.05	XFW	6	OPH 010
3.0 V6	2,9	D, 1	150	01.03-10.05	XFW	6	OPH 010
3.0 V6	2,9	R, 1	150	01.03-10.05	XFW	6	OPH 012

ULYSSE (220)

1.8	1,8	R	73	05.97-08.02	LFW	4	OZH 159
2.0	2,0	R	89	06.94-08.02	RFU (XU10J2C)	4	OZH 159
2.0 16V	2,0	R, 1	97	05.98-05.00	RFV	4	OPH 020
2.0 16V	2,0	R + D, 1	100	09.00-08.02	RFN	4	OPH 010
2.0 Turbo	2,0	R	108	06.94-08.02	RGX (XU10J2CTE)	4	OZH 159

UNO

45 1.0	1,0	R	32	10.87-08.89	156 A2.048/156 A2.100	4	OZU 001
45 i.e. 1.0	1,0	R	33	09.89-10.95	156 A2.246	4	OZH 037
50 1.1	1,1	R	37	01.90-12.93	156 C.046	4	OZH 037
50 i.e. 1.1	1,1	R	36	06.92-12.93	146 C3.000	4	OZH 037
70 i.e. 1.4	1,4	R	51	09.89-12.93	160 A1.046	4	OZH 037
75 i.e. 1.5	1,5	R	55	10.85-12.93	149 C1.000	4	OZH 037
75 i.e. 1.5	1,5	R	55	10.85-12.93	138 C2.048	4	OZU 022
1.3 Turbo i.e.	1,3	R	73	01.87-12.87	146 A2.146	4	OZH 037
1.3 Turbo i.e.	1,3	R	74	09.89-03.91	146 A2.246	4	OZH 037
1.4 Turbo i.e.	1,4	R	82	09.89-09.93	146 A8.046	4	OZH 037

DUCATO

140 Natural Power	3,0	R, 1	100	04.09-	F1CE0441A	4	OPH 026
2.0	2,0	R	62	03.89-08.90	170 D	4	OZH 066
2.0	2,0	R	62	09.88-08.90	170 D	4	OZH 066
2.0	2,0	R	62	07.90-03.94	170 D	4	OZH 066
2.0	2,0	R	80	03.94-04.02	RFW	4	OZH 034
2.0	2,0	R	80	03.94-04.02	RFW	4	OZH 159
2.0	2,0	R, 1	81	04.02-08.06	RFL	4	OPH 012
2.0 4x4	2,0	R	80	11.94-11.01	RFW	4	OZH 034
2.0 4x4	2,0	R	80	11.94-11.01	RFW	4	OZH 159
2.0 Bipower	2,0	R, 1	81	11.02-08.06	RFL	4	OPH 012

SCUDO

1.6	1,6	R	58	02.96-	220 A 2.000	4	OZH 159
2.0 16V	2,0	R + D, 1	100	06.00-01.07	RFN	4	OPH 010

FORD**C-MAX**

1.8	1,8	R, 1	92	02.07-	QQDA/QQDB	4	OPH 002
1.8 Flexifuel	1,8	R, 1	92	02.07-	Q7DA	4	OPH 002
2.0	2,0	R, 1	107	02.07-	AODA/AODB/SYDA/AODE	4	OPH 002
2.0 CNG	2,0	R, 1	107	04.09-	SYDA	4	OPH 002
2.0 LPG	2,0	R, 1	107	06.08-	SYDA	4	OPH 002



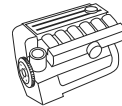

kW

 Zyl.
Cyl.
Cil.

FORD
COUGAR

2.0 16V	2,0	R	96	08.98-12.01	EDBB/EDBC/EDBD/EDBA	4	OZH 176
2.5 V6 24V	2,5	R	125	08.98-12.01	LCBA	6	OZH 176

COURIER

1.3	1,3	R	44	01.93-02.96	J6B	4	OZH 045
1.3	1,3	R	44	09.91-12.92	J6B	4	OZH 059
1.3	1,3	R	44	02.96-	J4C	4	OZH 045
1.4 i	1,4	R, 1	66	04.96-10.99	FHA	4	OPH 001

ESCORT IV

1.4	1,4	R	54	01.86-12.86	F6B, F6D	4	OZH 006
1.4	1,4	R	54	08.89-07.90	F6B, F6D	4	OZH 059
1.4	1,4	R	54	01.87-07.89	F6B, F6D	4	OZH 075
1.6 i	1,6	R	66	01.86-05.90	L4B	4	OZH 006
1.6 i	1,6	R	75	08.89-07.90	LJB	4	OZH 006
1.6 i	1,6	R	75	08.89-07.90	LJB	4	OZH 045
1.6 i	1,6	R	75	08.89-07.90	LJB	4	OZH 059

ESCORT IV Cabriolet

1.4	1,4	R	54	02.87-07.90	F6B, F6D	4	OZH 006
1.4	1,4	R	54	08.89-07.90	F6B, F6D	4	OZH 059
1.4	1,4	R	54	02.87-07.89	F6B, F6D	4	OZH 075
1.6 i	1,6	R	66	01.86-07.90	L4B	4	OZH 006
1.6 i	1,6	R	75	08.89-07.90	LJB	4	OZH 006
1.6 i	1,6	R	75	08.89-07.90	LJB	4	OZH 059

ESCORT IV Kombi

1.4	1,4	R	54	01.86-12.86	F6B, F6D	4	OZH 006
1.4	1,4	R	54	08.89-07.90	F6B, F6D	4	OZH 059
1.4	1,4	R	54	01.87-07.89	F6B, F6D	4	OZH 075
1.6 i	1,6	R	66	01.86-07.90	L4B	4	OZH 006

ESCORT V

1.3	1,3	R	44	05.91-09.92	J6A	4	OZH 059
1.4	1,4	R	52	07.90-09.92	F6F/F6G	4	OZH 059
1.6	1,6	R	77	07.90-12.92	LJF	4	OZH 059
1.8 16V XR3i	1,8	R	77	02.92-12.92	RDA	4	OZH 050
1.8 16V XR3i	1,8	R	96	02.92-12.92	RQB	4	OZH 050
RS 2000	2,0	R	110	05.91-12.92	N7A	4	OZH 014

ESCORT V Cabriolet

1.4	1,4	R	52	10.92-12.92	F6F/F6G	4	OZH 045
1.4	1,4	R	52	07.90-09.92	F6F/F6G	4	OZH 059
1.6	1,6	R	77	07.90-12.92	LJF	4	OZH 059
1.8 16V XR3i	1,8	R	77	02.92-12.92	RDA	4	OZH 050
1.8 16V XR3i	1,8	R	96	02.92-12.92	RQB	4	OZH 050

ESCORT V Kombi

1.3	1,3	R	44	09.91-09.92	J6A	4	OZH 059
1.4	1,4	R	52	07.90-09.92	F6F/F6G	4	OZH 059
1.6	1,6	R	77	07.90-09.92	LJF	4	OZH 059
1.8 16V	1,8	R	77	02.92-12.92	RDA	4	OZH 050

ESCORT VI

1.3	1,3	R	44	09.92-01.95	J6A/J4B	4	OZH 045
1.4	1,4	R	52	09.92-01.95	F6F/F6G	4	OZH 045
1.6 i 16V	1,6	R	66	09.92-01.95	L1E	4	OZH 050
1.8 i 16V	1,8	R	77	09.92-01.95	RDA	4	OZH 050
1.8 XR3i 16V 4x4	1,8	R	77	08.93-01.95	RDA	4	OZH 050
1.8 XR3i 16V 4x4	1,8	R	96	08.93-01.95	RQB	4	OZH 050
RS 2000 4x4	2,0	R	110	08.93-01.95	N7A	4	OZH 014

ESCORT VI Cabriolet

1.4 i	1,4	R	55	07.93-01.95	F4B	4	OZH 045
1.6 16V XR3i	1,6	R	66	12.92-01.95	L1E	4	OZH 050
1.8 16V XR3i	1,8	R	77	12.92-01.95	RDA	4	OZH 050
1.8 16V XR3i	1,8	R	96	12.92-01.95	RQB	4	OZH 050

ESCORT VI Kombi

1.3	1,3	R	44	09.92-01.95	J6A/J4B	4	OZH 045
1.4	1,4	R	52	09.92-01.94	F6F/F6G	4	OZH 045

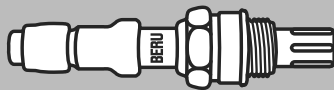
**BERU**

kW

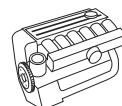
Zyl.
Cyl.
Cil.**FORD**

ESCORT VI Kombi								
1.4	1,4	R	55	01.94-01.95	F4B/FUH	4	OZH 045	
1.6 i 16V	1,6	R	66	09.92-01.95	L1E	4	OZH 050	
1.8 i 16V	1,8	R	96	02.93-01.95	RQB	4	OZH 050	
ESCORT VI Stufenheck								
1.3	1,3	R	44	08.93-01.95	J6A/J4B	4	OZH 045	
1.4	1,4	R	52	08.93-04.94	F6F/F6G	4	OZH 045	
1.4	1,4	R	55	08.93-01.95	F4B/FUH	4	OZH 045	
1.6 i 16V	1,6	R	66	08.93-01.95	L1E/L1K	4	OZH 050	
1.8 i 16V	1,8	R	77	08.93-01.95	RDA	4	OZH 050	
ESCORT VII								
1.3	1,3	R	44	01.95-10.98	J6A/J4B	4	OZH 045	
1.6 16V	1,6	R	66	01.95-10.98	L1E	4	OZH 050	
1.6 16V 4x4	1,6	R	66	01.95-10.98	L1E	4	OZH 050	
ESCORT VII Cabriolet								
1.4	1,4	R	55	02.95-08.98	F4B	4	OZH 045	
1.6 16V XR3i	1,6	R	66	02.95-09.99	L1E	4	OZH 050	
1.8 16V XR3i	1,8	R	96	02.95-08.00	RQB	4	OZH 050	
ESCORT VII Kombi								
1.6 16V	1,6	R	66	01.95-02.99	L1E	4	OZH 050	
FIESTA II								
1.4	1,4	R	52	10.86-02.89	F6C/F6A	4	OZH 006	
FIESTA III								
1.1	1,1	R	37	01.93-12.95	G6A	4	OZH 045	
1.1	1,1	R	37	03.89-12.92	G6A	4	OZH 059	
1.3 KAT	1,3	R	44	01.93-01.97	J6B	4	OZH 045	
1.3 KAT	1,3	R	44	05.91-12.92	J6B	4	OZH 059	
1.4	1,4	R	52	01.93-12.95	F6E	4	OZH 045	
1.4	1,4	R	52	03.89-12.92	F6E	4	OZH 059	
1.6 XR2i	1,6	R	76	01.93-03.93	LJD	4	OZH 045	
1.6 XR2i	1,6	R	76	03.89-12.92	LJD	4	OZH 059	
1.8 16V	1,8	R	77	01.94-12.95	RDB	4	OZH 059	
1.8 XR2i 16V	1,8	R	96	01.94-12.95	RQC	4	OZH 059	
FIESTA IV								
1.25 i 16V	1,2	R, 1, 3	55	11.95-09.98	DHG/DHB/DHC/DHE/DHF/DHA/DHD	4	OPH 001	
1.25 i 16V	1,2	R, 1, 2	55	10.98-01.02	DHG/DHB/DHC/DHE/DHF/DHA/DHD	4	OPH 001	
1.25 i 16V	1,2	R	55	08.95-10.95	DHG/DHB/DHC/DHE/DHF/DHA/DHD	4	OZH 176	
1.3 i	1,3	R	37	08.95-08.98	JJA/JJE/JJM/JJC/JJJ/JJK	4	OZH 045	
1.3 i	1,3	R	37	09.98-01.02	JJA/JJE/JJM/JJC/JJJ/JJK	4	OZH 176	
1.3 i	1,3	R	44	08.95-01.02	J4R/J4C/J4L/J4J/J4Q/J4T	4	OZH 045	
1.4 i 16V	1,4	R, 1	66	04.96-12.00	FHE/FHA	4	OPH 001	
FIESTA V								
ST150	2,0	R, 1	110	03.05-09.08	N4JB	4	OPH 002	
FOCUS								
1.4 16V	1,4	R	55	10.98-11.04	FXDA/FXDD/FXDC/FXDB	4	OZH 176	
1.6 16V	1,6	R	74	10.98-11.04	FYDH/FYDA/FYDB/FYDD/FYDC	4	OZH 176	
1.8 16V	1,8	R	85	10.98-11.04	EYDB, EYDC, EYDD, EYDE, EYDF	4	OZH 176	
2.0 16V	2,0	R	96	10.98-11.04	EDDC/EDDB/EDDD/EDDF	4	OZH 176	
FOCUS Kombi								
1.4 16V	1,4	R	55	02.99-11.04	FXDA/FXDD/FXDC/FXDB	4	OZH 176	
1.6 16V	1,6	R	74	02.99-11.04	FYDH/FYDA/FYDB/FYDD/FYDC	4	OZH 176	
1.8 16V	1,8	R	85	02.99-11.04	EYDC, EYDD, EYDB, EYDF, EYDE	4	OZH 176	
2.0 16V	2,0	R	96	02.99-11.04	EDDC/EDDB/EDDD/EDDF	4	OZH 176	
FOCUS Stufenheck								
1.4 16V	1,4	R	55	02.99-11.04	FXDA/FXDD/FXDC/FXDB	4	OZH 176	
1.6 16V	1,6	R	74	02.99-11.04	FYDH/FYDA/FYDB/FYDD/FYDC	4	OZH 176	
1.8 16V	1,8	R	85	02.99-11.04	EYDE, EYDF, EYDD, EYDC, EYDB	4	OZH 176	
2.0 16V	2,0	R	96	02.99-11.04	EDDC/EDDB/EDDD/EDDF	4	OZH 176	



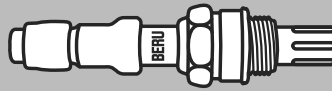

kW

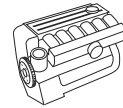

Zyl.
Cyl.
Cil.

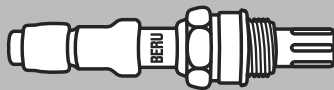

FORD							
FOCUS C-MAX							
1.8	1,8	R, 1	88	10.03-05.04	CSDB/CSDA	4	OPH 002
1.8	1,8	R, 1	92	04.04-03.07	QQDA, QQDB	4	OPH 002
1.8 Flexifuel	1,8	R, 1	92	01.06-03.07	Q7DA	4	OPH 002
2.0	2,0	R, 1	107	03.04-03.07	AODA/AODB/SYDA	4	OPH 002
FOCUS II							
1.8	1,8	R, 1	92	03.06-	QQDB	4	OPH 002
1.8 Flexifuel	1,8	R, 1	92	01.06-	Q7DA	4	OPH 002
2.0	2,0	R, 1	107	11.04-	AODA/AODB	4	OPH 002
2.0 CNG	2,0	R, 1	107	04.09-	SYDA	4	OPH 002
2.0 LPG	2,0	R, 1	107	06.08-	SYDA	4	OPH 002
FOCUS II Cabriolet							
2.0	2,0	R, 1	107	10.06-	AODA/AODB	4	OPH 002
FOCUS II Kombi							
1.8	1,8	R, 1	92	03.06-	QQDB/Q7DA	4	OPH 002
1.8 Flexifuel	1,8	R, 1	92	01.06-	Q7DA	4	OPH 002
2.0	2,0	R, 1	107	11.04-	AODA/AODB	4	OPH 002
2.0 LPG	2,0	R, 1	107	06.08-	SYDA	4	OPH 002
FOCUS II Stufenheck							
1.8 Flexifuel	1,8	R, 1	92	06.06-01.08	Q7DA	4	OPH 002
2.0	2,0	R, 1	107	04.05-	AODA/AODB	4	OPH 002
GALAXY							
2.0 i	2,0	R, 1	85	11.95-03.00	NSE	4	OPH 001
2.3 16V	2,3	R, 1	107	01.97-03.00	Y5B	4	OPH 001
2.8 i V6	2,8	R	128	01.96-10.97	AAA	6	OZH 151
2.8 i V6	2,8	R	128	11.95-12.95	AAA	6	OZH 181
2.8 i V6 4x4	2,8	R	128	04.96-10.97	AAA/AMY	6	OZH 151
KA							
1.3 i	1,3	R	37	09.96-10.02	JJB	4	OZH 045
1.3 i	1,3	R	44	09.96-12.98	J4S/J4K/J4M/J4P/J4N/J4D	4	OZH 020
MONDEO I							
1.6 i 16V	1,6	R	65	07.94-08.96	L1J	4	OZH 045
1.6 i 16V	1,6	R	66	02.93-08.96	L1F	4	OZH 045
1.6 i 16V	1,6	R	66	02.93-08.96	L1F	4	OZH 059
1.8 i 16V	1,8	R	82	07.94-08.96	RKB	4	OZH 045
1.8 i 16V	1,8	R	85	02.93-08.96	RKA	4	OZH 045
1.8 i 16V	1,8	R	85	02.93-08.96	RKA	4	OZH 059
1.8 i 16V 4x4	1,8	R	85	02.93-08.96	RKA	4	OZH 045
1.8 i 16V 4x4	1,8	R	85	02.93-08.96	RKA	4	OZH 059
2.0 i 16V	2,0	R	100	02.93-08.96	NGA	4	OZH 045
2.0 i 16V 4x4	2,0	R	97	12.94-08.96	NGA	4	OZH 045
MONDEO I Kombi							
1.6 i 16V	1,6	R	65	07.94-08.96	L1J	4	OZH 045
1.6 i 16V	1,6	R	66	04.93-08.96	L1F	4	OZH 045
1.6 i 16V	1,6	R	66	04.93-08.96	L1F	4	OZH 059
1.8 i 16V	1,8	R	82	07.94-08.96	RKB	4	OZH 045
1.8 i 16V	1,8	R	85	04.93-08.96	RKA	4	OZH 045
1.8 i 16V	1,8	R	85	04.93-08.96	RKA	4	OZH 059
1.8 i 16V 4x4	1,8	R	85	04.93-08.96	RKA	4	OZH 045
1.8 i 16V 4x4	1,8	R	85	04.93-08.96	RKA	4	OZH 059
2.0 i 16V	2,0	R	100	04.93-08.96	NGA	4	OZH 045
2.0 i 16V 4x4	2,0	R	97	12.94-08.96	NGA	4	OZH 045
2.0 i 16V 4x4	2,0	R	100	04.93-08.96	NGA	4	OZH 045
MONDEO I Stufenheck							
1.6 i 16V	1,6	R	65	07.94-08.96	L1J	4	OZH 045
1.6 i 16V	1,6	R	66	02.93-08.96	L1F	4	OZH 045
1.6 i 16V	1,6	R	66	02.93-08.96	L1F	4	OZH 059
1.8 i 16V	1,8	R	82	01.94-08.96	RKB	4	OZH 045
1.8 i 16V	1,8	R	85	02.93-08.96	RKA	4	OZH 045
1.8 i 16V	1,8	R	85	02.93-08.96	RKA	4	OZH 059
2.0 i 16V	2,0	R	100	04.93-08.96	NGA	4	OZH 045
2.0 i 16V	2,0	R	100	02.93-08.96	NGA	4	OZH 059

**BERU**

kW

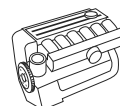
Zyl.
Cyl.
Cil.**FORD****MONDEO I Stufenheck**2.0 i 16V 4x4 2,0 R 97 01.95-08.96 NGA 4 **OZH 045****MONDEO II**1.6 i 1,6 R 66 09.96-11.00 L1J 4 **OZH 045**1.6 i 1,6 R 66 09.96-11.00 L1J 4 **OZH 176**1.8 i 1,8 R 85 09.96-07.98 RKB 4 **OZH 045**1.8 i 1,8 R 85 08.98-11.00 RKK/RKJ/RKB/RKF/RKH 4 **OZH 176**2.0 i 2,0 R 96 09.96-07.98 NGA/NGB/NGD/NGC 4 **OZH 014**2.0 i 2,0 R 96 08.98-11.00 NGA/NGB/NGD/NGC 4 **OZH 176**2.5 24V 2,5 R 125 09.96-11.00 SEA 6 **OZH 045****MONDEO II Kombi**1.6 i 1,6 R 66 09.96-07.98 L1J 4 **OZH 045**1.6 i 1,6 R 66 08.98-11.00 L1J 4 **OZH 176**1.8 i 1,8 R 85 09.96-07.98 RKK/RKJ/RKB/RKF/RKH 4 **OZH 045**1.8 i 1,8 R 85 08.98-11.00 RKK/RKJ/RKB/RKF/RKH 4 **OZH 176**2.0 i 2,0 R 96 09.96-07.98 NGA/NGB/NGD/NGC 4 **OZH 014**2.0 i 2,0 R 96 08.98-11.00 NGA/NGB/NGD/NGC 4 **OZH 176**2.5 24V 2,5 R 125 09.96-11.00 SEA 6 **OZH 045****MONDEO II Stufenheck**1.6 i 1,6 R 66 09.96-07.98 L1J 4 **OZH 045**1.6 i 1,6 R 66 08.98-11.00 L1J 4 **OZH 176**1.8 i 1,8 R 85 09.96-07.98 RKK/RKJ/RKB/RKF/RKH 4 **OZH 045**1.8 i 1,8 R 85 08.98-11.00 RKK/RKJ/RKB/RKF/RKH 4 **OZH 176**2.0 i 2,0 R 96 09.96-07.98 NGA/NGB/NGD/NGC 4 **OZH 014**2.0 i 2,0 R 96 08.98-11.00 NGA/NGB/NGD/NGC 4 **OZH 176**2.5 24V 2,5 R 125 09.96-11.00 SEA 6 **OZH 045****ORION II**1.4 1,4 R 52 10.87-07.90 FUAA 4 **OZH 006**1.4 KAT 1,4 R 54 10.87-07.90 F6D/F6B 4 **OZH 006**1.6 i 1,6 R 75 08.89-07.90 LJB 4 **OZH 059**1.6 i KAT 1,6 R 66 03.86-07.90 L4B 4 **OZH 006****ORION III**1.3 1,3 R 44 05.91-12.91 J6A 4 **OZH 045**1.3 1,3 R 44 01.92-12.93 J6A 4 **OZH 059**1.4 1,4 R 52 05.91-12.91 F6F/F6G 4 **OZH 045**1.4 1,4 R 52 07.90-01.92 F6F/F6G 4 **OZH 059**1.6 i 1,6 R 77 05.91-12.91 LJF 4 **OZH 045**1.6 i 1,6 R 77 01.92-09.92 LJF 4 **OZH 059**1.6 i 16V 1,6 R 66 07.92-08.93 L1E/L1K 4 **OZH 050**1.8 i 16V 1,8 R 77 02.92-08.93 RDA 4 **OZH 050**1.8 i 16V 1,8 R 96 01.92-08.92 RQB 4 **OZH 050****PUMA**1.4 16V 1,4 R + D, 1 66 01.98-10.00 FHD/FHF 4 **OPH 001**1.6 16V 1,6 R 76 08.00- L1W 4 **OZH 176**1.7 16V 1,7 R, 1 92 06.97-12.01 MHB/MHA 4 **OPH 001**1.7 16V 1,7 D, 1 92 06.97-09.00 MHB/MHA 4 **OPH 001****SCORPIO I**2.0 2,0 R 77 04.85-08.89 NEL 4 **OZH 006**2.0 i 2,0 R 74 10.85-05.89 NRC 4 **OZH 006**2.0 i 2,0 R 85 04.85-05.89 NRA 4 **OZH 006**2.0 i 2,0 R 85 02.92-01.93 NRI/NRA 4 **OZH 014**2.0 i 2,0 R 88 05.89-09.94 N9D 4 **OZH 059**2.4 i 2,4 R 92 10.88-07.89 ARD 6 **OZH 006**2.4 i KAT 2,4 R 92 10.88-07.89 ARD 6 **OZH 006****SCORPIO I Kombi**2.0 i 2,0 R 85 02.92-01.93 N9F 4 **OZH 014**2.0 i 2,0 R 88 09.91-02.92 N9D 4 **OZH 045**2.4 i 2,4 R 92 02.92-09.94 ARD 6 **OZH 045**2.9 24V 2,9 R 143 08.93-09.94 BOA 6 **OZH 020**2.9 24V 2,9 R 143 08.93-09.94 BOA 6 **OZH 045****SCORPIO I Stufenheck**2.0 i 2,0 R 85 02.92-01.93 N9F 4 **OZH 014**



kW

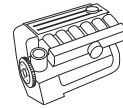

Zyl.
Cyl.
Cil.



FORD

SCORPIO I Stufenheck

2.0 i	2,0	R	88	08.89-02.92	N9D	4	OZH 045
2.0 i	2,0	R	88	08.89-01.90	N9D	4	OZH 075
2.4 i	2,4	R	92	10.88-07.89	ARD	6	OZH 006

SCORPIO II

2.0 i	2,0	R, 1	85	10.94-08.98	NSD	4	OPH 001
2.0 i 16V	2,0	R + D, 1	100	10.94-04.96	N3A	4	OPH 001
2.3 i 16V	2,3	R, 1	108	06.96-08.98	Y5A	4	OPH 001
2.9 i	2,9	R	110	02.95-08.98	BRG	6	OZH 021

SCORPIO II Kombi

2.0 i	2,0	R, 1	85	10.94-08.98	NSD	4	OPH 001
2.0 i 16V	2,0	R + D, 1	100	10.94-04.96	N3A	4	OPH 001
2.3 i 16V	2,3	R, 1	108	06.96-08.98	Y5A	4	OPH 001

SIERRA

1.6 i	1,6	R	59	10.89-02.93	L6B	4	OZH 014
2.0 4x4	2,0	R	88	01.90-02.93	N9C	4	OZH 014
2.0 i	2,0	R	85	01.87-11.91	N 4 A, N 4 I	4	OZH 006
2.0 i	2,0	R	88	02.90-02.93	N9C	4	OZH 014
2.0 i KAT	2,0	R	74	01.87-10.91	N4B	4	OZH 006
2.0 i KAT	2,0	R	74	11.91-02.93	N4B	4	OZH 045
2.0 i KAT	2,0	R	74	01.87-10.91	N4B	4	OZH 075
2.9 i	2,9	R	107	08.88-11.89	B4B/B4C	6	OZH 006

SIERRA Kombi

1.6 i	1,6	R	59	01.90-02.93	L6B	4	OZH 014
2.0	2,0	R	74	10.85-12.86	NRD	4	OZH 006
2.0	2,0	R	85	10.85-12.86	NR 2	4	OZH 006
2.0 4x4	2,0	R	88	02.90-02.93	N9C	4	OZH 014
2.0 4x4	2,0	R	88	02.90-02.93	N9C	4	OZH 075
2.0 i	2,0	R	74	01.87-11.91	NE5/NEJ	4	OZH 006
2.0 i	2,0	R	74	01.90-02.93	NE5/NEJ	4	OZH 014
2.0 i	2,0	R	74	11.91-02.93	NE5/NEJ	4	OZH 045
2.0 i	2,0	R	74	11.91-02.93	NE5/NEJ	4	OZH 059
2.0 i	2,0	R	74	05.89-01.90	NE5/NEJ	4	OZH 075
2.0 i	2,0	R	85	01.87-11.91	N 4 A, N 4 I	4	OZH 006
2.0 i	2,0	R	88	01.90-02.93	N9C	4	OZH 014
2.0 i	2,0	R	88	05.89-01.90	N9C	4	OZH 075
2.0 i KAT	2,0	R	74	01.87-11.91	N4B	4	OZH 006
2.0 i KAT	2,0	R	74	01.90-02.93	N4B	4	OZH 014
2.0 i KAT	2,0	R	74	11.91-02.93	N4B	4	OZH 045
2.0 i KAT	2,0	R	74	11.91-02.93	N4B	4	OZH 059
2.0 i KAT	2,0	R	74	05.89-01.90	N4B	4	OZH 075
2.9	2,9	R	107	08.88-11.89	B4B/B4C	6	OZH 006
2.9 4x4	2,9	R	107	08.88-11.89	B4B/B4C	6	OZH 006

SIERRA Schrägheck

1.6 i	1,6	R	59	01.90-02.93	L6B	4	OZH 014
2.0	2,0	R	74	10.85-12.86	NRD	4	OZH 006
2.0 i	2,0	R	85	03.85-12.86	NR2/NRB	4	OZH 006
2.0 i	2,0	R	85	01.87-11.91	N 4 A, N 4 I	4	OZH 006
2.0 i	2,0	R	88	01.90-02.93	N9C	4	OZH 014
2.0 i	2,0	R	88	06.89-01.90	N9C	4	OZH 075
2.0 i KAT	2,0	R	74	01.87-11.91	N4B	4	OZH 006
2.0 i KAT	2,0	R	74	01.90-02.93	N4B	4	OZH 014
2.0 i KAT	2,0	R	74	11.91-02.93	N4B	4	OZH 045
2.0 i KAT	2,0	R	74	11.91-02.93	N4B	4	OZH 059
2.0 i KAT	2,0	R	74	05.89-01.90	N4B	4	OZH 075
2.9 i	2,9	R	107	08.88-11.89	B4B/B4C	6	OZH 006
2.9 i XR 4x4	2,9	R	107	08.88-11.89	B4B/B4C	6	OZH 006
2.9 i XR 4x4	2,9	R	110	08.88-11.89	B4A	6	OZH 006

TRANSIT

2.0	2,0	R, 1	84	09.95-03.00	NSF/NSG	4	OPH 001
2.0 i	2,0	R	72	09.91-07.94	NCA	4	OZH 020
2.3 16V	2,3	R, 1	107	12.00-05.06	E5FC/E5FA	4	OPH 002

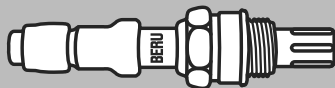
**BERU**

kW

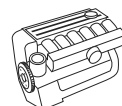
Zyl.
Cyl.
Cil.**FORD****TRANSIT TOURNEO**

2.0	2,0	R, 1	84	11.94-07.00	NSH	4	OPH 001
-----	-----	------	----	-------------	-----	---	----------------

FORD USA**EXPLORER**

4.0 V6 Allrad	4,0	R, 1	150	10.98-09.00		6	OPH 002
---------------	-----	------	-----	-------------	--	---	----------------

EXPLORER C4786

4.0 V6 Allrad	4,0	R, 1	152	10.98-09.00		6	OPH 002
---------------	-----	------	-----	-------------	--	---	----------------

HONDA**ACCORD III**

2.0 EX	2,0	R	75	10.87-12.89	A20A1	4	OZU 001
--------	-----	---	----	-------------	-------	---	----------------

2.0 EX	2,0	R	76	10.87-12.89	A20A1	4	OZU 001
--------	-----	---	----	-------------	-------	---	----------------

2.0 EX	2,0	R	78	10.87-05.89	A20A2	4	OZU 001
--------	-----	---	----	-------------	-------	---	----------------

ACCORD III Aerodeck

2.0 EX	2,0	R	75	10.87-12.89	A20A1	4	OZU 001
--------	-----	---	----	-------------	-------	---	----------------

2.0 EX	2,0	R	76	10.87-12.89	A20A1	4	OZU 001
--------	-----	---	----	-------------	-------	---	----------------

2.0 EX	2,0	R	78	11.85-05.89	A20A2	4	OZU 001
--------	-----	---	----	-------------	-------	---	----------------

ACCORD IV Aerodeck

2.2 i 16V	2,2	R	108	01.91-12.93	F22A8	4	OZH 009
-----------	-----	---	-----	-------------	-------	---	----------------

2.2 i 16V	2,2	R	110	01.91-12.93	F22A7	4	OZH 009
-----------	-----	---	-----	-------------	-------	---	----------------

ACCORD IV Coupe

2.0 i 16V	2,0	R	98	01.92-09.93	F20A7	4	OZH 009
-----------	-----	---	----	-------------	-------	---	----------------

ACCORD V

2.0 i	2,0	R	85	03.93-09.95	F20Z2	4	OZH 009
-------	-----	---	----	-------------	-------	---	----------------

2.0 i S	2,0	R	96	03.93-09.95	F20Z1	4	OZH 009
---------	-----	---	----	-------------	-------	---	----------------

ACCORD V Aerodeck

2.0 i LS 16V	2,0	R	100	09.93-02.98	F20B3	4	OZH 120
--------------	-----	---	-----	-------------	-------	---	----------------

ACCORD V Coupe

2.0	2,0	R	100	09.93-12.97	F20B3	4	OZH 120
-----	-----	---	-----	-------------	-------	---	----------------

ACCORD VI

1.9 i	1,9	R	85	02.96-10.98	F18A3	4	OZH 120
-------	-----	---	----	-------------	-------	---	----------------

ACCORD VII

1.8 i	1,9	R	100	10.98-12.02	F18B2	4	OZH 121
-------	-----	---	-----	-------------	-------	---	----------------

2.2 Type-R	2,2	D	156	02.99-12.02	H22A7	4	OZH 099
------------	-----	---	-----	-------------	-------	---	----------------

2.2 Type-R	2,2	R	156	02.99-12.02	H22A7	4	OZH 121
------------	-----	---	-----	-------------	-------	---	----------------

ACCORD VII Coupe

3.0 V6 24V	3,0	R	147	02.98-12.00	J30A1	6	OZH 028
------------	-----	---	-----	-------------	-------	---	----------------

ACCORD VII Hatchback

1.8 i	1,9	R	100	12.99-12.02	F18B2	4	OZH 121
-------	-----	---	-----	-------------	-------	---	----------------

CIVIC V Coupe

1.5 i LSi	1,5	R	74	01.94-11.95	D15B7	4	OZH 006
-----------	-----	---	----	-------------	-------	---	----------------

CIVIC VI Aerodeck

1.4 16V	1,4	D	55	02.99-02.01	D14A7	4	OZH 121
---------	-----	---	----	-------------	-------	---	----------------

1.4 16V	1,4	R	55	02.99-02.01	D14A7	4	OZH 123
---------	-----	---	----	-------------	-------	---	----------------

1.4 16V	1,4	D	66	02.99-02.01	D14A8	4	OZH 121
---------	-----	---	----	-------------	-------	---	----------------

1.4 16V	1,4	R	66	02.99-02.01	D14A8	4	OZH 123
---------	-----	---	----	-------------	-------	---	----------------

1.5 16V	1,5	R	84	02.99-02.01	D15Z8	4	OZH 122
---------	-----	---	----	-------------	-------	---	----------------

1.8 16V	1,8	R	124	04.98-02.01	B18C4	4	OZH 121
---------	-----	---	-----	-------------	-------	---	----------------

CIVIC VI Fastback

1.4 16V	1,4	D	55	02.99-02.01	D14A7	4	OZH 121
---------	-----	---	----	-------------	-------	---	----------------

1.4 16V	1,4	R	55	02.99-02.01	D14A7	4	OZH 123
---------	-----	---	----	-------------	-------	---	----------------

1.4 16V	1,4	D	66	02.99-02.01	D14A8	4	OZH 121
---------	-----	---	----	-------------	-------	---	----------------

1.4 16V	1,4	R	66	02.99-02.01	D14A8	4	OZH 123
---------	-----	---	----	-------------	-------	---	----------------

1.5 16V	1,5	R	84	02.99-02.01	D15Z8	4	OZH 122
---------	-----	---	----	-------------	-------	---	----------------

1.8 16V	1,8	R	124	01.97-02.01	B18C4	4	OZH 121
---------	-----	---	-----	-------------	-------	---	----------------

CIVIC VI Hatchback

1.4 i	1,4	R	55	11.95-02.01	D14Z1/D14A3	4	OZU 001
-------	-----	---	----	-------------	-------------	---	----------------

1.4 i S	1,4	D	66	02.99-02.01	D14A4/D14Z2	4	OZH 121
---------	-----	---	----	-------------	-------------	---	----------------

1.4 i S	1,4	R	66	02.99-02.01	D14A4/D14Z2	4	OZH 123
---------	-----	---	----	-------------	-------------	---	----------------

1.5 i	1,5	R	84	02.99-02.01	D15Z6	4	OZH 122
-------	-----	---	----	-------------	-------	---	----------------

1.6 i	1,6	R	84	11.95-02.01	D16Y5	4	OZH 123
-------	-----	---	----	-------------	-------	---	----------------



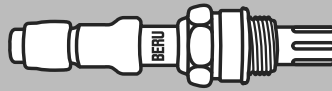

kW

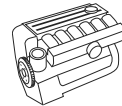
 Zyl.
Cyl.
Cil.

HONDA
CIVIC VI Stufenheck

1.4 i	1,4	D	66	02.99-02.01	D14A4/D14Z2	4	OZH 121
1.4 i	1,4	R	66	02.99-02.01	D14A4/D14Z2	4	OZH 123
1.5 i	1,5	R	84	02.99-02.01	D15Z6	4	OZH 122

CONCERTO

1.5 i 16V	1,5	R	66	08.89-03.95	D15B2	4	OZU 001
1.6 16V	1,6	R	78	08.89-03.95	D16Z2	4	OZU 001
1.6 i 16V	1,6	R	82	08.89-03.95	D16Z2	4	OZU 001
1.6 i 16V	1,6	R	90	08.89-03.95	D16A8	4	OZU 001

CONCERTO Stufenheck

1.5 i 16V	1,5	R	66	08.89-05.95	D15B2	4	OZU 001
1.6 16V	1,6	R	78	08.89-03.95	D16Z2	4	OZU 001
1.6 i 16V	1,6	R	82	08.89-03.95	D16Z2	4	OZU 001
1.6 i 16V	1,6	R	90	08.89-03.95	D16A8	4	OZU 001

CRX II

1.6 i 16V	1,6	R	91	10.88-02.92	D16Z5	4	OZU 001
1.6 i 16V	1,6	R	96	10.88-12.89	D16A8/D16A9	4	OZU 001

HR-V

1.6 16V	1,6	R	77	03.99-12.99	D16W1	4	OZH 006
1.6 16V 4WD	1,6	R	77	03.99-12.99	D16W1	4	OZH 006

JAZZ II

1.2	1,2	R, 1	57	03.02-	L12A1	4	OPH 031
1.2	1,2	D, 1	57	03.02-12.08	L12A1	4	OPH 032
1.4	1,3	R, 1	61	03.02-07.08	L13A1	4	OPH 031
1.4	1,3	D, 1	61	03.02-07.08	L13A1	4	OPH 032

LEGEND I

2.5 i	2,5	R	110	01.86-12.87	C25A1	6	OZU 001
2.7 i 24V	2,7	R	124	01.88-12.90	C27A1	6	OZU 001

LEGEND I Coupe

2.7 i 24V	2,7	R	124	10.87-12.90	C27A1	6	OZU 001
-----------	-----	---	-----	-------------	-------	---	----------------

PRELUDE II

1.8 EX	1,8	R	74	11.85-04.87	ET3/ET4	4	OZU 014
--------	-----	---	----	-------------	---------	---	----------------

PRELUDE III

2.0 i EX 16V	2,0	R	101	04.86-12.87	B20A1	4	OZU 001
2.0 i EX 16V	2,0	R	101	04.86-12.87	B20A1	4	OZU 001
2.0 i EX 16V	2,0	R	101	04.87-01.92	B20A5	4	OZU 001

PRELUDE IV

2.0 i 16V	2,0	R	98	02.92-09.96	F20A4	4	OZU 001
-----------	-----	---	----	-------------	-------	---	----------------

PRELUDE V

2.0 16V	2,0	R	98	10.96-10.00	F20A4	4	OZU 001
2.2 16V	2,2	R	136	10.96-10.98	H22A5	4	OZH 020
2.2 16V	2,2	R	147	10.96-10.98	H22A5	4	OZH 020

HYUNDAI
PONY

1.5	1,5	R	53	10.89-07.94	G15B/G4DJ	4	OZU 001
1.5 i	1,5	R	61	10.89-07.94	G15B/G4DJ	4	OZU 001
1.5 i	1,5	R	62	10.89-07.94	G15B/G4DJ	4	OZU 001

PONY/EXCEL Stufenheck

1.5	1,5	R	53	01.90-07.94	G15B/G4DJ	4	OZU 001
1.5 i	1,5	R	61	01.90-07.94	G15B/G4DJ	4	OZU 001
1.5 i	1,5	R	62	01.90-07.94	G15B/G4DJ	4	OZU 001

S COUPE

1.5 i	1,5	R	65	04.92-06.93	G4EK	4	OZH 037
1.5 i Turbo	1,5	R	85	04.91-06.93	G4EK-TC	4	OZH 037

H100 Bus

2.4	2,4	R	84	01.97-03.00	G4CS	4	OZU 001
2.4	2,4	R	90	07.93-03.00	G4CS	4	OZU 001

ISUZU
TROOPER

3.2	3,2	R	130	08.91-07.98	6VD1	6	OZH 196
-----	-----	---	-----	-------------	------	---	----------------

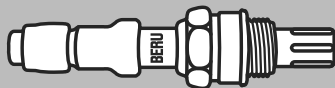
**BERU**

kW

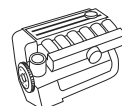
Zyl.
Cyl.
Cil.**KIA****CLARUS**

1.8 i 16V	1,8	R	85	07.96-05.98	T8	4	OZH 204
2.0 i 16V	2,0	R	98	07.96-05.98	FE (16 V)	4	OZH 204

PRIDE

1.3 16V	1,3	R	44	01.90-	B3	4	OZU 001
1.3 16V	1,3	R	47	10.96-	B3	4	OZU 001
1.3 16V	1,3	R	53	01.90-	B3	4	OZU 001

SPORTAGE

2.0 i 4WD	2,0	R	70	03.95-09.98	FE	4	OZH 207
-----------	-----	---	----	-------------	----	---	----------------

LANCIA**DEDRA**

1.6 i.e.	1,6	R	55	04.93-10.94	835 C1.000	4	OZH 035
1.6 i.e.	1,6	R	57	08.89-03.93	835 A1.046	4	OZH 037
1.6 16V	1,6	R	76	06.96-04.98	182 A4.000	4	OZH 084
1.6 16V	1,6	R	76	05.98-07.99	182 A4.000	4	OZH 118
1.8 i.e.	1,8	R	66	10.94-12.95	835 C5.000	4	OZH 056
1.8 i.e.	1,8	R	74	10.94-12.95	836 A5.000	4	OZH 056
1.8 i.e.	1,8	R	77	09.89-10.94	835 A2.046	4	OZH 037
1.8 16V LE	1,7	R	83	09.96-07.99	182 A2.000	4	OZH 088
1.8 GT 16V	1,7	R	96	03.96-07.99	183 A1.000	4	OZH 052
2.0 i.e.	2,0	R	83	09.89-07.99	835 A5.046	4	OZH 037
2.0 i.e. Turbo	2,0	R	119	04.91-10.94	835 A8.046	4	OZH 037
2.0 16V	2,0	R	102	07.94-07.99	836 A3.000	4	OZH 052
2.0 HF Integrale	2,0	R	124	04.91-07.94	835 A7.046	4	OZH 037

DEDRA SW

1.6 16V	1,6	R	76	06.96-04.98	182 A4.000	4	OZH 084
1.6 16V	1,6	R	76	05.98-07.99	182 A4.000	4	OZH 118
1.8 i.e.	1,8	R	74	10.94-12.95	836 A5.000	4	OZH 056
1.8 16V LE	1,7	R	83	06.96-07.99	182 A2.000	4	OZH 088
1.8 GT 16V	1,7	R	96	03.96-07.99	183 A1.000	4	OZH 052
2.0 Integrale	2,0	R	102	07.94-07.99	836 A3.000	4	OZH 052
2.0 16V	2,0	R	102	07.94-07.99	836 A3.000	4	OZH 052

DELTA I

1.6 HF Turbo	1,6	R	97	04.87-03.89	831 B7.046	4	OZH 037
1.6 HF Turbo	1,6	R	103	08.86-08.88	831 B3.000	4	OZH 037
2.0 HF Integrale	2,0	R	130	12.86-12.92	831 C5.046	4	OZH 037
2.0 16V HF Evo Integrale	2,0	R	155	06.93-01.94	831 E5.046/831 E5.000	4	OZH 037

DELTA II

1.4 i.e.	1,4	R	51	10.94-08.99	836 A4.000/160 A1.046	4	OZH 035
1.6 i.e.	1,6	R	55	06.93-12.95	835 C1.000	4	OZH 035
1.6 i.e. 16V	1,6	R	76	06.96-04.98	182 A4.000	4	OZH 084
1.6 i.e. 16V	1,6	R	76	05.98-08.99	182 A4.000	4	OZH 118
1.8 i.e.	1,7	R	83	06.96-08.99	182 A2.000	4	OZH 088
1.8 i.e.	1,8	R	66	07.94-12.94	835 C4.000/836 C4.000/ 836 A6.000	4	OZH 035
1.8 i.e.	1,8	R	66	01.95-08.99	835 C4.000/836 C4.000/ 836 A6.000	4	OZH 056
1.8 i.e.	1,8	R	76	06.93-12.94	835 C2.000	4	OZH 035
1.8 i.e. 16V GT	1,7	R	96	06.96-08.99	183 A1.000	4	OZH 088
2.0 16V	2,0	R	102	06.93-12.94	836 A3.000	4	OZH 037
2.0 16V	2,0	R	102	01.95-12.95	836 A3.000	4	OZH 052
2.0 16V Turbo	2,0	R	137	06.93-08.99	836 A2.000	4	OZH 037
2.0 16V Turbo	2,0	R	142	07.96-08.99	175 A4.000	4	OZH 037

DELTA III

1.4	1,4	D, 1	88	09.08-	198 A4.000	4	OPH 027
1.4	1,4	D, 1	110	09.08-	198 A1.000	4	OPH 027
1.8	1,7	R, 1	147	12.09-	939 B1.000	4	OPH 025

KAPPA

2.0 16V Turbo	2,0	R	151	02.95-10.01	838 A4.000	4	OZH 056
2.0 20V	2,0	R	107	11.94-06.96	838 A1.000 (Inj. Bosch)	5	OZH 056
2.0 20V	2,0	R	114	07.96-10.01	838 A6.000	5	OZH 056

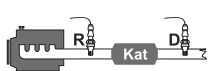

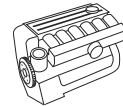

kW

 Zyl.
Cyl.
Cil.

LANCIA
KAPPA

2.0 20V Turbo	2,0	R	162	06.98-10.01	175 A3.000 → VET # 2084573	5	OZH 056
2.0 20V Turbo	2,0	R	162	06.98-12.00	175 A3.000, VET # 2084574 →	5	OZH 138
3.0 24V	3,0	R, 1	150	08.94-10.01	838 B.000, VET # 2092370 →	6	OPH 028
3.0 24V	3,0	R	150	08.94-06.98	838 B.000	6	OZH 056

KAPPA Coupe

2.0 16V Turbo	2,0	R	151	11.96-03.01	838 A4.000	4	OZH 056
2.0 20V	2,0	R	114	07.96-03.01	838 A6.000	5	OZH 056
2.4 20V	2,4	R	129	11.96-03.01	838 A2.000	5	OZH 056
3.0 24V	3,0	R, 1	150	11.96-03.01	838 B.000, VET # 7002899 →	6	OPH 028
3.0 24V	3,0	R	150	11.96-03.01	838 B.000	6	OZH 056

KAPPA SW

2.0 16V Turbo	2,0	R	151	07.96-10.01	838 A4.000	4	OZH 056
2.0 20V	2,0	R	114	07.96-10.01	838 A6.000	5	OZH 056
2.0 20V Turbo	2,0	R	162	06.98-10.01	175 A3.000 → VET # 2084573	5	OZH 056
2.0 20V Turbo	2,0	R	162	06.98-06.00	175 A3.000, VET # 2084574 →	5	OZH 138
2.4 20V	2,4	R	129	07.96-10.01	838 A2.000	5	OZH 056
3.0 24V	3,0	R, 1	150	07.96-10.01	838 B.000, VET # 2092370 →	6	OPH 028
3.0 24V	3,0	R	150	07.96-12.00	838 B.000	6	OZH 056

LYBRA

1.6 16V	1,6	R	76	07.99-	182 A4.000	4	OZH 118
1.8 16V	1,7	R	96	07.99-	839 A7.000/839 A9.000/ 839 A4.000	4	OZH 056
1.8 16V	1,7	R	96	11.00-	839 A7.000	4	OZH 180
2.0 20V	2,0	R, 1	110	09.00-09.05	185 A8.000	5	OPH 025

LYBRA SW

1.6 16V	1,6	R	76	07.99-	182 A4.000	4	OZH 118
1.8 16V	1,7	R	96	07.99-	839 A7.000/839 A4.000	4	OZH 056
1.8 16V	1,7	R	96	11.00-	839 A7.000	4	OZH 180
2.0 20V	2,0	R, 1	110	09.00-09.05	185 A8.000	5	OPH 025

MUSA

1.4	1,4	R, 1	70	10.04-	843 A 1.000	4	OPH 025
1.4	1,4	R, 1	57	09.05-	350 A1.000	4	OPH 025

PHEDRA

2.0	2,0	R + D, 1	100	09.02-09.05	RFN (EW10J4)	4	OPH 010
3.0 V6	2,9	D, 1	150	09.02-09.05	ES9 J4S	6	OPH 010
3.0 V6	2,9	R, 1	150	09.02-09.05	ES9 J4S	6	OPH 010
3.0 V6	2,9	R, 1	150	09.02-09.05	ES9 J4S	6	OPH 012

PRISMA

1.5	1,5	R	55	12.85-12.86	138 C2.048	4	OZU 022
1.6 i.e.	1,6	R	80	05.86-12.89	831 B7.000	4	OZU 001
1.6 i.e. Super	1,6	R	66	05.87-12.89	149 C2.000	4	OZU 001
2.0 i.e. 4WD	2,0	R	85	07.87-12.89	831 B4.000	4	OZH 046

THEMA

2000 i.e.	2,0	R	83	03.86-09.88	834 B.048	4	OZH 037
2000 i.e.	2,0	R	85	09.87-05.92	834 B.146	4	OZH 037
2000 i.e.	2,0	R	88	03.86-09.88	834 B.000	4	OZH 037
2000 i.e. 16V	2,0	R	108	05.88-08.92	834 B2.000	4	OZH 037
2000 i.e. 16V Turbo	2,0	R	130	04.89-05.92	834 C1.246	4	OZH 037
2000 i.e. Turbo	2,0	R	110	07.86-05.90	834 C.146	4	OZH 037
2000 16V	2,0	R	112	08.92-12.93	834 F1.000	4	OZH 035
2850 V6 i.e.	2,8	R	108	06.88-09.91	834 E.146	6	OZH 046
3000 V6	3,0	R	126	08.92-07.94	834 F.000	6	OZH 055
8.32	2,9	R	151	12.87-12.90	F 105 L.046	8	OZH 046
8.32	2,9	R	158	12.87-05.89	F 105 L	8	OZH 046

THEMA SW

2000 i.e. 16V Turbo	2,0	R	130	04.89-03.93	834 C1.246	4	OZH 037
2000 16V	2,0	R	112	05.92-07.94	834 F1.000	4	OZH 035
2000 Turbo	2,0	R	110	01.89-05.90	834 C.146	4	OZH 037
3000 V6	3,0	R	126	09.92-07.94	834 F.000	6	OZH 055

THEISIS

2.0 Turbo	2,0	R, 1	136	07.02-12.07	841 E.000	5	OPH 025
-----------	-----	------	-----	-------------	-----------	---	----------------

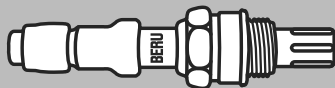
**BERU**

kW

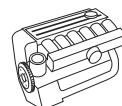
Zyl.
Cyl.
Cil.**LANCIA****THESIS**

2.4	2,4	D, 1	125	07.02-12.07	841 D.000	5	OPH 026
3.0 V6	3,0	R, 1	158	07.02-07.03	841 A.000	6	OPH 025
3.2 V6	3,2	R, 1	169	08.03-12.07	841 L.000	6	OPH 025

Y

1.1	1,1	R	40	11.95-06.00	176 B2.000	4	OZH 138
1.2	1,2	R, 1	44	10.96-06.03	840 A3.000/188 A4.000	4	OPH 025
1.2	1,2	R	44	03.96-10.96	840 A3.000/188 A4.000, → VET # 2084573	4	OZH 056
1.2 16V	1,2	R, 1	59	10.00-06.03	188 A5.000	4	OPH 025
1.2 16V	1,2	R	63	04.97-06.00	176 B9.000	4	OZH 135
1.4 12V	1,4	R	55	03.96-09.03	840 A4.000	4	OZH 056
1.4 12V	1,4	R	59	10.96-09.03	840 A2.000	4	OZH 056

Y10

1.0 Fire	1,0	R	32	06.85-06.91	156 A 2.100	4	OZH 037
1.0 Fire KAT	1,0	R	33	10.87-02.92	156 A2.246	4	OZH 037
1.1 Avenue	1,1	R	40	01.95-12.95	176 B2.000	4	OZH 056
1.1 Avenue 4WD	1,1	R	40	01.95-12.95	176 B2.000	4	OZH 056
1.1 i.e	1,1	R	42	08.89-06.92	156 C.000	4	OZH 065
1.1 i.e 4WD	1,1	R	42	08.89-06.92	156 C.000	4	OZH 065
1.1 i.e. Fire	1,1	R	37	07.89-09.92	156 C.046	4	OZH 037
1.1 i.e. Fire	1,1	R	37	09.92-09.95	156 C.046	4	OZH 035
1.1 i.e. Fire 4WD	1,1	R	37	09.92-12.95	156 C.046	4	OZH 035
1.3 i.e. Fire	1,3	R	53	02.89-12.95	156 B.000/146 A 5.046	4	OZH 037

YPSILON

1.2	1,2	R + D, 1	44	10.03-	188 A4.000	4	OPH 025
1.2	1,2	R + D, 1	59	10.03-09.06	188 A5.000	4	OPH 025
1.4	1,4	R, 1	57	10.06-	350 A1.000	4	OPH 025
1.4 16V	1,4	R + D, 1	70	10.03-	843 A 1.000	4	OPH 025

ZETA

2.0 16V	2,0	R, 1	97	05.98-07.00	RFV	4	OPH 010
2.0 16V	2,0	R, 1	97	10.99-07.00	RFV	4	OPH 020
2.0 16V	2,0	R, 1	100	07.00-09.02	RFN	4	OPH 010
2.0 Turbo	2,0	R	108	05.95-09.02	RGX (Inj. Bosch)	4	OZH 034
2.0 Turbo	2,0	R	108	05.95-09.02	RGX	4	OZH 159

LANDROVER**FREELANDER**

1.8 16V	1,8	R, 1	86	11.00-03.07	18 K4F, Chassis # 1A 000 001 →	4	OPH 085
1.8 i 16V	1,8	R, 1	88	02.98-11.00	Chassis # 1A 000 001 →	4	OPH 085
2.5 V6	2,5	R	130	11.00-	25 K4F	6	OZH 219

RANGE ROVER II

3.9	3,9	R	140	07.94-03.02	42 D	8	OZH 219
4.0	4,0	R	136	06.98-03.02		8	OZH 219
4.6	4,6	R	160	06.98-03.02		8	OZH 219
4.6	4,6	R	165	07.94-03.02	46 D	8	OZH 219

RANGE ROVER III

4.4	4,4	R	210	03.02-		8	OZH 173
-----	-----	---	-----	--------	--	---	----------------

LOTUS**ELISE**

1.8 16V	1,8	R, 1	88	01.96-11.00	18 K4F	4	OPH 085
---------	-----	------	----	-------------	--------	---	----------------

EXIGE

1.8 16V	1,8	R, 1	132	09.01-10.04	2ZZ-GE	4	OPH 085
---------	-----	------	-----	-------------	--------	---	----------------

MAZDA**121 II**

1.3 16V	1,3	R	39	11.90-03.96	B3 (16V)	4	OZH 095
1.3 i 16V	1,3	R	53	11.90-03.96	B3 (16V)	4	OZH 095

323 III

1.6 GT Turbo	1,6	R	103	06.87-05.89	B6T	4	OZU 001
--------------	-----	---	-----	-------------	-----	---	----------------



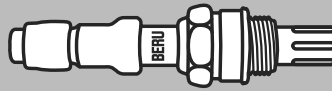

kW

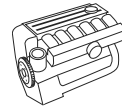
 Zyl.
Cyl.
Cil.

MAZDA
323 III Hatchback

1.6 GT Turbo	1,6	R	103	06.87-05.89	B6T	4	OZU 001
1.6 GT Turbo 4WD	1,6	R	103	10.87-05.89	B6T	4	OZU 001

323 III Station Wagon

1.6	1,6	R	63	07.87-10.95	B65M /B6/B6E	4	OZU 001
1.6 4x4	1,6	R	63	05.90-03.93	B65M /B6E	4	OZU 001

323 C IV

1.3	1,3	R	49	09.89-07.94	B3E	4	OZU 012
1.3 16V	1,3	R	54	08.91-07.94	B3	4	OZU 012
1.6	1,6	R	62	09.89-06.91	B6E	4	OZU 012
1.6 16V	1,6	R	65	03.91-10.94	B6	4	OZU 012
1.8 16V 4WD	1,8	R	76	11.91-12.93	BP	4	OZU 001
1.8 16V GT	1,8	R	94	09.89-03.93	B5	4	OZU 012

323 F IV

1.6	1,6	R	62	09.89-06.91	B6E	4	OZU 012
1.6 16V	1,6	R	65	03.91-10.94	B6	4	OZU 012
1.8 4WD	1,8	R	76	06.91-04.94		4	OZU 001
1.8 16V	1,8	R	76	03.91-05.94	BP	4	OZU 001
1.8 16V GT	1,8	R	94	03.91-07.94	BP (DOHC)	4	OZU 001

323 S IV

1.3	1,3	R	49	09.89-06.91	B3E/B383	4	OZU 012
1.3 16V	1,3	R	54	04.91-07.94	B3 (16V)	4	OZU 012
1.6	1,6	R	62	09.89-06.91	B6E	4	OZU 012
1.6 16V	1,6	R	65	08.89-10.94	B6	4	OZU 012
1.8 16V	1,8	R	76	04.91-07.94	BP52	4	OZU 001
1.8 16V 4WD	1,8	R	76	09.91-07.94	BP52	4	OZU 001

323 F V

1.5 16V	1,5	R	65	07.94-09.98	Z5, → Chassis # 194444	4	OZH 100
---------	-----	---	----	-------------	------------------------	---	----------------

323 S V

1.5 16V	1,5	R	65	08.94-09.98	Z5, → Chassis # 194444	4	OZH 100
---------	-----	---	----	-------------	------------------------	---	----------------

626 III

2.0	2,0	R	66	01.89-10.90	FE, Chassis # 500001 →	4	OZU 021
-----	-----	---	----	-------------	------------------------	---	----------------

626 III Hatchback

2.0	2,0	R	66	01.89-10.90	FE, Chassis # 500001 →	4	OZU 021
-----	-----	---	----	-------------	------------------------	---	----------------

626 III Station Wagon

2.0	2,0	R	66	01.89-09.97	FE, Chassis # 200001 →	4	OZU 021
-----	-----	---	----	-------------	------------------------	---	----------------

626 IV

1.8 i	1,8	R	66	08.94-04.97		4	OZH 163
1.8 i	1,8	R	77	01.92-05.94	FP	4	OZH 163
2.0 i	2,0	R	85	01.92-05.94	FS	4	OZH 076
2.0 i 4WD	2,0	R	85	04.92-05.94	FS	4	OZH 076

626 IV Hatchback

1.8	1,8	R	66	08.94-04.97		4	OZH 163
1.8	1,8	R	77	08.91-05.94	FP	4	OZH 163
2.0 i	2,0	R	85	08.91-05.94	FS	4	OZH 076
2.0 i 4WD	2,0	R	85	04.92-05.94	FS	4	OZH 076
2.5 24V	2,5	R	121	01.92-05.94	KL	6	OZH 163

929 III

3.0	3,0	R	125	01.88-05.89	JE3	6	OZH 022
3.0	3,0	R	125	01.88-12.89	JE3	6	OZH 139
3.0 i	3,0	R	123	01.90-06.91	JE3	6	OZH 139

MX-3

1.6 i	1,6	R	65	07.91-	B69	4	OZU 012
-------	-----	---	----	--------	-----	---	----------------

MX-5 I

1.6	1,6	R	85	05.90-08.93	B64F	4	OZU 001
-----	-----	---	----	-------------	------	---	----------------

MX-6

2.0	2,0	R	85	02.92-06.94	FS	4	OZH 076
2.5 24V	2,5	R	121	01.94-06.94	KL	6	OZH 163
2.5 i 24V	2,5	R	120	08.94-06.97	KL	6	OZH 163

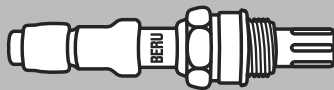
**BERU**

kW

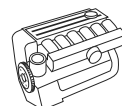
Zyl.
Cyl.
Cil.**MAZDA****XEDOS 6**

1.6 16V	1,6	R	79	06.94-04.96	B6 (DOHC), → Chassis # CA 122.129.84, Chassis # CA 122.107.58 →	4	OZH 043
2.0 V6	2,0	R	106	01.92-05.94	KF1	6	OZH 163
XEDOS 9							
2.3 24V	2,3	R	155	02.95-07.98	KJ -ZEM	6	OZH 200

MERCEDES-BENZ**A-KLASSE (W168)**

A 160	1,6	R, 1	75	10.97-08.04	M 166.960	4	OPH 034
A 190	1,9	R, 1	92	03.99-01.00	M 166.990, → Chassis # J 568589	4	OPH 034

A-KLASSE (W169)

A 150	1,5	R + D, 1	70	09.04-	M 266.920, Chassis # J 151 311 →	4	OPH 087
A 150	1,5	D	70	09.04-	M 266.920, → Chassis # J 151 311	4	OZH 235
A 160	1,5	R + D, 1	70	04.09-	M 266.920, Chassis # J 151 311 →	4	OPH 087
A 170	1,7	R + D, 1	85	09.04-	M 266.940, Chassis # J 151 311 →	4	OPH 087
A 170	1,7	D	85	09.04-	M 266.940, → Chassis # J 151 311	4	OZH 235
A 180	1,7	R + D, 1	85	04.09-	M 266.940, Chassis # J 151 311 →	4	OPH 087
A 200	2,0	R + D, 1	100	09.04-	M 266.960, Chassis # J 151 311 S4612 →	4	OPH 087
A 200	2,0	D	100	09.04-	M 266.960	4	OZH 235

C-KLASSE (W202)

C 180	1,8	R	89	11.94-05.00	M 111.921	4	OZH 098
C 180	1,8	R, 3, 5	90	03.93-05.00	M 111.920, → Mot. # M111.920xx117655	4	OZH 042
C 180	1,8	R, 3, 5	90	03.93-05.00	M 111.920, Mot. # M111.920xx117656 →	4	OZH 021
C 180	1,8	R, 3, 4	90	03.93-05.00	M 111.920, → Mot. # M111.920xx117655	4	OZH 021
C 180	1,8	R, 2, 5	90	03.93-05.00	M 111.920, → Mot. # M111.920xx050883	4	OZH 042
C 180	1,8	R, 2, 5	90	03.93-05.00	M 111.920, Mot. # M111.920xx050884 →	4	OZH 021
C 180	1,8	R, 2, 4	90	03.93-05.00	M 111.920, → Mot. # M111.920xx050883	4	OZH 021
C 180	1,8	R, 2	90	09.95-05.00	M 111.921 Mot. # 004127 →	4	OZH 098
C 200	2,0	R	100	01.94-05.00	M 111.941, → Mot. # xx014845	4	OZH 042
C 200	2,0	R	100	01.94-05.00	M 111.941 Mot. # xx014846 →	4	OZH 021
C 200	2,0	R	100	01.94-05.00	M 111.945	4	OZH 098
C 200 Kompressor	2,0	R, 3	132	10.95-05.00	M 111.944, → Mot. # 003872	4	OZH 025
C 200 Kompressor	2,0	R, 3	132	10.95-05.00	M 111.944, Mot. # 003873 →	4	OZH 098
C 200 Kompressor	2,0	R, 2	132	10.95-05.00	M 111.944, → Mot. # 000054	4	OZH 025
C 200 Kompressor	2,0	R, 2	132	10.95-05.00	M 111.944, Mot. # 000055 →	4	OZH 098
C 200 Kompressor	2,0	R, 3	141	11.96-05.00	M 111.944, → Mot. # 003872	4	OZH 025
C 200 Kompressor	2,0	R, 3	141	11.96-05.00	M 111.944, Mot. # 003873 →	4	OZH 098
C 200 Kompressor	2,0	R, 2	141	11.96-05.00	M 111.944, → Mot. # 000054	4	OZH 025
C 200 Kompressor	2,0	R, 2	141	11.96-05.00	M 111.944, Mot. # 000055 →	4	OZH 098
C 220	2,2	R, 3, 5	110	03.93-09.96	M 111.961, → Mot. # M111.961xx017341	4	OZH 042
C 220	2,2	R, 3, 5	110	03.93-09.96	M 111.961, Mot. # M111.961xx017342 →	4	OZH 021
C 220	2,2	R, 3, 4	110	03.93-09.96	M 111.961, → Mot. # M111.961xx017341	4	OZH 021
C 220	2,2	R, 2, 5	110	03.93-09.96	M 111.961, → Mot. # M111.961xx050895	4	OZH 042

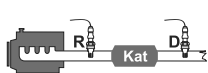



kW

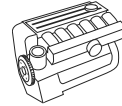

Zyl.
Cyl.
Cil.



MERCEDES-BENZ

C-KLASSE (W202)

C 220	2,2	R, 2, 5	110	03.93-09.96	M 111.961, Mot. # M111.961xx050896 →	4	OZH 021
C 220	2,2	R, 2, 4	110	03.93-09.96	M 111.961, → Mot. # M111.961xx050895	4	OZH 021
C 230	2,3	R, 3	110	06.96-06.97	M 111.974, → Mot. # 001871	4	OZH 025
C 230	2,3	R, 3	110	06.96-06.97	M 111.974, Mot. # 001872 →	4	OZH 098
C 230	2,3	R, 2	110	06.96-06.97	M 111.974, → Mot. # 004991	4	OZH 025
C 230	2,3	R, 2	110	06.96-06.97	M 111.974, Mot. # 004992 →	4	OZH 098
C 230 Kompressor	2,3	R, 3	142	10.95-05.00	M 111.975, → Mot. # 005799	4	OZH 025
C 230 Kompressor	2,3	R, 3	142	10.95-05.00	M 111.975, Mot. # 005800 →	4	OZH 098
C 230 Kompressor	2,3	R, 2	142	10.95-05.00	M 111.975, → Mot. # 000555	4	OZH 025
C 230 Kompressor	2,3	R, 2	142	10.95-05.00	M 111.975, Mot. # 000556 →	4	OZH 098
C 240	2,4	R	125	06.97-05.00	M 112.910	6	OZH 211
C 240	2,4	D	125	06.97-05.00	M 112.910	6	OZH 213
C 240	2,4	D	125	06.97-05.00	M 112.910	6	OZH 212
C 280	2,8	R	142	05.93-05.97	M 104.941	6	OZH 018
C 280	2,8	R	145	06.97-05.00	M 112.920	6	OZH 211
C 280	2,8	D	145	06.97-05.00	M 112.920	6	OZH 213
C 280	2,8	D	145	06.97-05.00	M 112.920	6	OZH 212
C 36 AMG	3,6	R	206	05.94-05.97	M 104.941 (AMG 3.6)	6	OZH 018
C 43 AMG	4,3	R	225	08.97-05.00	M 113.944	8	OZH 211
C 43 AMG	4,3	D	225	08.97-05.00	M 113.944	8	OZH 213
C 43 AMG	4,3	D	225	08.97-05.00	M 113.944	8	OZH 212

C-KLASSE Kombi (S202)

C 180 T	1,8	R, 3, 4	90	06.96-09.00	M 111.920, → Mot. # M111.920xx117655	4	OZH 021
C 180 T	1,8	R, 3	90	06.96-09.00	M 111.920, Mot. # M111.920xx117656 →	4	OZH 021
C 180 T	1,8	R, 2, 5	90	06.96-09.00	M 111.920, → Mot. # M111.920xx050883	4	OZH 042
C 180 T	1,8	R, 2	90	06.96-09.00	M 111.920, Mot. # M111.920xx050884 →	4	OZH 021
C 180 T	1,8	R, 2, 4	90	06.96-09.00	M 111.920, → Mot. # M111.920xx050883	4	OZH 021
C 180 T	1,8	R, 3	90	06.96-09.00	M 111.921, Mot. # M111.921xx007269 →	4	OZH 098
C 180 T	1,8	R, 2	90	06.96-09.00	M 111.921, Mot. # M111.921xx004127 →	4	OZH 098
C 200 T	2,0	R, 3, 5	100	06.96-03.01	M 111.941, → Mot. # M111.941xx014845	4	OZH 042
C 200 T	2,0	R, 3	100	06.96-03.01	M 111.941, Mot. # M111.941xx014846 →	4	OZH 021
C 200 T	2,0	R, 3, 4	100	06.96-03.01	M 111.941, → Mot. # M111.941xx014845	4	OZH 021
C 200 T	2,0	R, 2, 5	100	06.96-03.01	M 111.941, → Mot. # M111.941xx015981	4	OZH 042
C 200 T	2,0	R, 2	100	06.96-03.01	M 111.941, Mot. # M111.941xx015982 →	4	OZH 021
C 200 T	2,0	R, 2, 4	100	06.96-03.01	M 111.941, → Mot. # M111.941xx015981	4	OZH 021
C 200 T	2,0	R, 3	100	06.96-03.01	M 111.945, Mot. # M111.945xx001913 →	4	OZH 098
C 200 T	2,0	R, 2	100	06.96-03.01	M 111.945, Mot. # M111.945xx003753 →	4	OZH 098
C 200 T Kompressor	2,0	R, 3	141	11.96-03.01	M 111.944, → Mot. # 003872	4	OZH 025
C 200 T Kompressor	2,0	R, 3	141	11.96-03.01	M 111.944, Mot. # 003873 →	4	OZH 098
C 200 T Kompressor	2,0	R, 2	141	11.96-03.01	M 111.944, → Mot. # 000054	4	OZH 025
C 200 T Kompressor	2,0	R, 2	141	11.96-03.01	M 111.944, Mot. # 000055 →	4	OZH 098
C 230 T	2,3	R, 3	110	06.96-06.98	M 111.974, → Mot. # 001871	4	OZH 025
C 230 T	2,3	R, 3	110	06.96-06.98	M 111.974, Mot. # 001872 →	4	OZH 098
C 230 T	2,3	R, 2	110	06.96-06.98	M 111.974, → Mot. # 004991	4	OZH 025

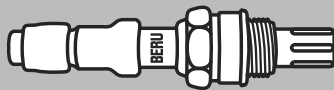
**BERU**

kW

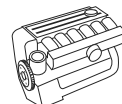
Zyl.
Cyl.
Cil.**MERCEDES-BENZ
C-KLASSE Kombi (S202)**

C 230 T	2,3	R, 2	110	06.96–06.98	M 111.974, Mot. # 004992 →	4	OZH 098
C 230 T Kompressor	2,3	R, 3	142	06.97–09.00	M 111.975, → Mot. # 005799	4	OZH 025
C 230 T Kompressor	2,3	R, 3	142	06.97–09.00	M 111.975, Mot. # 005800 →	4	OZH 098
C 230 T Kompressor	2,3	R, 2	142	06.97–09.00	M 111.975, → Mot. # 000555	4	OZH 025
C 230 T Kompressor	2,3	R, 2	142	06.97–09.00	M 111.975, Mot. # 000556 →	4	OZH 098
C 240 T	2,4	R + D, 1	125	06.97–09.00	M 112.910, Chassis # F 980 774 →	6	OPH 043
C 240 T	2,4	R	125	06.97–09.00	M 112.910, → Chassis # F 980 773	6	OZH 211
C 240 T	2,4	D	125	06.97–09.00	M 112.910, → Chassis # F 980 773	6	OZH 212
C 240 T	2,4	D	125	06.97–09.00	M 112.910, → Chassis # F 980 773	6	OZH 213
C 240 T	2,6	R, 1	125	09.00–03.01	M 112.915, Chassis # 980 774 →	6	OPH 041
C 240 T	2,6	R + D, 1	125	09.00–03.01	M 112.915, Chassis # F 980 774 →	6	OPH 043
C 240 T	2,6	R, 1	125	09.00–03.01	M 112.915, Chassis # F 980 774 →	6	OPH 047
C 240 T	2,6	R, 1	125	09.00–03.01	M 112.915, Chassis # F 980 774 →	6	OPH 048
C 280 T	2,8	R	145	06.97–03.01	M 112.920, → Chassis # F 980 773	6	OZH 211
C 280 T	2,8	D	145	06.97–03.01	M 112.920, → Chassis # F 980 773	6	OZH 212
C 280 T	2,8	D	145	06.97–03.01	M 112.920, → Chassis # F 980 773	6	OZH 213
C 280 T	2,8	R, 1	145	06.97–03.01	M 112.920, Chassis # 980 774 →	6	OPH 041
C 280 T	2,8	R + D, 1	145	06.97–03.01	M 112.920, Chassis # F 980 774 →	6	OPH 043
C 280 T	2,8	R, 1	145	06.97–03.01	M 112.920, Chassis # F 980 774 →	6	OPH 047
C 280 T	2,8	R, 1	145	06.97–03.01	M 112.920, Chassis # F 980 774 →	6	OPH 048
C 43 AMG	4,3	R	225	08.97–03.01	M 113.944, → Chassis # F 980 773	8	OZH 211
C 43 AMG	4,3	D	225	08.97–03.01	M 113.944, → Chassis # F 980 773	8	OZH 212
C 43 AMG	4,3	D	225	08.97–03.01	M 113.944, → Chassis # F 980 773	8	OZH 213
C 43 AMG	4,3	R, 1	225	08.97–03.01	M 113.944, Chassis # 980 774 →	8	OPH 041
C 43 AMG	4,3	R + D, 1	225	08.97–03.01	M 113.944, Chassis # F 980 774 →	8	OPH 043
C 43 AMG	4,3	R, 1	225	08.97–03.01	M 113.944, Chassis # F 980 774 →	8	OPH 047
C 43 AMG	4,3	R, 1	225	08.97–03.01	M 113.944, Chassis # F 980 774 →	8	OPH 048

C-KLASSE (W203)

C 180	2,0	D, 1	95	10.00–05.02	M 111.951, (Euro 4)	4	OPH 034
C 180	2,0	R, 1	95	10.00–05.02	M 111.951, (Euro 3)	4	OPH 037
C 180	2,0	D, 1	95	10.00–05.02	M 111.951	4	OPH 038
C 180 Kompressor	1,8	D, 1	105	05.02–	M 271.946	4	OPH 039
C 200 CGI Kompressor	1,8	D, 1	125	07.03–	M 271.942	4	OPH 039
C 200 Kompressor	1,8	D, 1	120	05.02–	M 271.940	4	OPH 039
C 200 Kompressor	2,0	R, 1	120	05.00–05.02	M 111.955	4	OPH 035
C 200 Kompressor	2,0	D, 1	120	05.00–05.02	M 111.955	4	OPH 038
C 230	2,5	D, 1	150	01.05–	M 272.920	6	OPH 087
C 230 Kompressor	1,8	D, 1	141	02.04–	M 271.948	4	OPH 039
C 240	2,6	R, 1	125	05.00–	M 112.912	6	OPH 040
C 240 4-matic	2,6	R, 1	125	07.02–	M 112.916	6	OPH 040
C 280	3,0	D, 1	170	01.05–	M 272.940	6	OPH 087
C 320	3,2	R, 1	160	05.00–	M 112.946	6	OPH 040



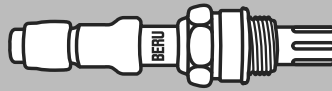

kW

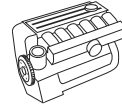
 Zyl.
Cyl.
Cil.

MERCEDES-BENZ
C-KLASSE (W203)

C 320 4-matic	3,2	R, 1	160	07.02–	M 112.953	6	OPH 040
C 350	3,5	D, 1	200	01.05–	M 272.960	6	OPH 087
C 32 AMG Kompressor	3,2	R, 1	260	02.01–	M 112.961	6	OPH 040
C 55 AMG	5,4	R, 1	270	02.04–	M 113.988	8	OPH 041
C 55 AMG	5,4	R, 1	270	02.04–	M 113.988	8	OPH 042

C-KLASSE Kombi (S203)

C 180	2,0	D, 1	95	03.01–05.02	M 111.951, (Euro 4)	4	OPH 034
C 180	2,0	R, 1	95	03.01–05.02	M 111.951, (Euro 3)	4	OPH 037
C 180	2,0	D, 1	95	03.01–05.02	M 111.951	4	OPH 038
C 180 Kompressor	1,8	D, 1	105	05.02–	M 271.946	4	OPH 039
C 200 CGI Kompressor	1,8	D, 1	125	07.03–	M 271.942	4	OPH 039
C 200 Kompressor	1,8	D, 1	120	05.02–	M 271.940	4	OPH 039
C 200 Kompressor	2,0	R, 1	120	03.01–05.02	M 111.955	4	OPH 035
C 200 Kompressor	2,0	D, 1	120	03.01–05.02	M 111.955	4	OPH 038
C 230	2,5	D, 1	150	01.05–	M 272.920	6	OPH 087
C 230 Kompressor	1,8	D, 1	141	02.04–	M 271.948	4	OPH 039
C 240	2,6	R, 1	125	03.01–	M 112.912	6	OPH 040
C 240 4-matic	2,6	R, 1	125	07.02–	M 112.916	6	OPH 040
C 280	3,0	D, 1	170	01.05–	M 272.940	6	OPH 087
C 320	3,2	R, 1	160	03.01–	M 112.946	6	OPH 040
C 320 4-matic	3,2	R, 1	160	07.02–	M 112.953	6	OPH 040
C 350	3,5	D, 1	200	01.05–	M 272.960	6	OPH 087
C 32 AMG Kompressor	3,2	R, 1	260	03.01–	M 112.961	6	OPH 040
C 55 AMG	5,4	R, 1	270	02.04–	M 113.988	8	OPH 041
C 55 AMG	5,4	R, 1	270	02.04–	M 113.988	8	OPH 042

C-KLASSE Sportcoupe (CL203)

C 160 Kompressor	1,8	D, 1	90	05.02–	M 271.921	4	OPH 039
C 180	2,0	D, 1	95	03.01–05.02	M 111.951, (Euro 4)	4	OPH 034
C 180	2,0	R, 1	95	03.01–05.02	M 111.951, (Euro 3)	4	OPH 037
C 180	2,0	D, 1	95	03.01–05.02	M 111.951	4	OPH 038
C 180 Kompressor	1,8	D, 1	105	05.02–	M 271.946	4	OPH 039
C 200 CGI Kompressor	1,8	D, 1	125	03.03–	M 271.942	4	OPH 039
C 200 Kompressor	1,8	D, 1	120	05.02–	M 271.940	4	OPH 039
C 200 Kompressor	2,0	R, 1	120	03.01–05.02	M 111.955	4	OPH 035
C 200 Kompressor	2,0	D, 1	120	03.01–05.02	M 111.955	4	OPH 038
C 230 Kompressor	1,8	D, 1	141	05.02–	M 271.948	4	OPH 039
C 230 Kompressor	2,3	R, 1	145	03.01–05.02	M 111.981	4	OPH 035
C 230 Kompressor	2,3	D, 1	145	03.01–05.02	M 111.981	4	OPH 038
C 320	3,2	R, 1	160	09.02–	M 112.946	6	OPH 040
C 350	3,5	D, 1	200	01.05–	M 272.960	6	OPH 087

CLC-KLASSE

CLC 160	1,6	D, 1	95	02.09–	M 271.911	4	OPH 039
CLC 180 Kompressor	1,8	D, 1	105	05.08–	M 271.946	4	OPH 039
CLC 200 Kompressor	1,8	D, 1	135	05.08–	M 271.955	4	OPH 039
CLC 230	2,5	D, 1	150	05.08–	M 272.920	6	OPH 087
CLC 350	3,5	D, 1	200	05.08–	M 272.960	6	OPH 087

C-KLASSE (W204)

C 180 Kompressor	1,6	D, 1	115	01.08–	M 271.910	4	OPH 039
C 180 Kompressor	1,8	D, 1	115	01.07–	M 271.952	4	OPH 039
C 200 Kompressor	1,8	D, 1	135	01.07–	M 271.950	4	OPH 039
C 230	2,5	D, 1	150	01.07–	M 272.921	6	OPH 087
C 280	3,0	D, 1	170	01.07–	M 272.947	6	OPH 087
C 300	3,0	D, 1	170	07.09–	M 272.947	6	OPH 087
C 350	3,5	D, 1	200	01.07–	M 272.961	6	OPH 087
C 63 AMG	6,2	D, 1	336	02.08–	M 156.985	8	OPH 087

C-KLASSE Kombi (S204)

C 180 Kompressor	1,6	D, 1	115	01.08–	M 271.910	4	OPH 039
C 180 Kompressor	1,8	D, 1	115	08.07–	M 271.952	4	OPH 039
C 200 Kompressor	1,8	D, 1	135	08.07–	M 271.950	4	OPH 039

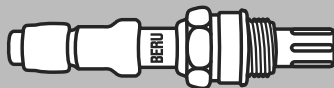
BERU

kW

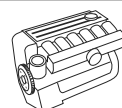

 Zyl.
Cyl.
Cil.

MERCEDES-BENZ
CLK (C208)

200	2,0	R, 3	100	06.97-06.02	M 111.945, → Mot. # 001912	4	OZH 025
200	2,0	R, 3	100	06.97-06.02	M 111.945, Mot. # 001913 →	4	OZH 098
200	2,0	R, 2	100	06.97-06.02	M 111.945 → Mot. # 003752	4	OZH 025
200	2,0	R, 2	100	06.97-06.02	M 111.945, Mot. # 003753 →	4	OZH 098
200 Kompressor	2,0	R, 2	141	06.97-06.00	M 111.944, → Mot. # 000054	4	OZH 025
200 Kompressor	2,0	R, 2	141	06.97-06.00	M 111.944, Mot. # 000055 →	4	OZH 098
200 Kompressor	2,0	R, 3	141	06.97-06.00	M 111.944, → Mot. # 003872	4	OZH 025
200 Kompressor	2,0	R, 3	141	06.97-06.00	M 111.944, Mot. # 003873 →	4	OZH 098
230 Kompressor	2,3	R, 3	142	06.97-06.00	M 111.975, → Mot. # 005799	4	OZH 025
230 Kompressor	2,3	R, 3	142	06.97-06.00	M 111.975/M 111.973, Mot. # 005800 →	4	OZH 098
230 Kompressor	2,3	R, 2	142	06.97-06.00	M 111.975, → Mot. # 000555	4	OZH 025
230 Kompressor	2,3	R, 2	142	06.97-06.00	M 111.975/M 111.973, Mot. # 000556 →	4	OZH 098
320	3,2	R	160	06.97-06.02	M 112.940, → Chassis # F 136 789, T 000 730	6	OZH 211
320	3,2	D	160	06.97-06.02	M 112.940, → Chassis # F 136 789, T 000 730	6	OZH 212
320	3,2	D	160	06.97-06.02	M 112.940, → Chassis # T 000 730, F 136 789	6	OZH 213
320	3,2	R, 1	160	06.97-06.02	M 112.940, Chassis # F 136 790, T 000 731 →	6	OPH 041
320	3,2	R, 1	160	06.97-06.02	M 112.940, Chassis # F 136 790, T 000 731 →	6	OPH 043
320	3,2	D, 1	160	06.97-06.02	M 112.940, Chassis # F 136 790, T 000 731 →	6	OPH 043
320	3,2	R, 1	160	06.97-06.02	M 112.940, Chassis # F 136 790, T 000 731 →	6	OPH 047
320	3,2	R, 1	160	06.97-06.02	M 112.940, Chassis # F 136 790, T 000 731 →	6	OPH 048
430	4,3	R, 1	205	07.98-06.02	M 113.943, Chassis # F 136 790, T 000 731 →	8	OPH 041
430	4,3	R + D, 1	205	07.98-06.02	M 113.943, Chassis # T 000 731, F 136 790 →	8	OPH 043
430	4,3	R, 1	205	07.98-06.02	M 113.943, Chassis # T 000 731, F 136 790 →	8	OPH 047
430	4,3	R, 1	205	07.98-06.02	M 113.943, Chassis # T 000 731, F 136 790 →	8	OPH 048
430	4,3	R	205	07.98-06.02	M 113.943, → Chassis # F 136 789, T 000 730	8	OZH 211
430	4,3	D	205	07.98-06.02	M 113.943, → Chassis # F 136 789, T 000 730	8	OZH 212
430	4,3	D	205	07.98-06.02	M 113.943, → Chassis # F 136 789, T 000 730	8	OZH 213
55 AMG	5,4	R, 1	255	08.99-06.02	M 113.981/M 113.984, Chassis # F 136 790, T 000 731 →	8	OPH 041
55 AMG	5,4	R + D, 1	255	08.99-06.02	M 113.981/M 113.984, Chassis # F 136 790, T 000 731 →	8	OPH 043
55 AMG	5,4	R, 1	255	08.99-06.02	M 113.981/M 113.984, Chassis # T 000 731, F 136 790 →	8	OPH 047
55 AMG	5,4	R, 1	255	08.99-06.02	M 113.981/M 113.984, Chassis # T 000 731, F 136 790 →	8	OPH 048
55 AMG	5,4	R	255	08.99-06.02	M 113.981/M 113.984, → Chassis # F 136 789, T 000 730	8	OZH 211
55 AMG	5,4	D	255	08.99-06.02	M 113.981/M 113.984, → Chassis # T 000 730, F 136 789	8	OZH 212
55 AMG	5,4	D	255	08.99-06.02	M 113.981/M 113.984, → Chassis # F 136 789, T 000 730	8	OZH 213

CLK Cabriolet (A208)

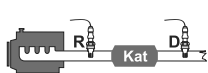
200	2,0	R, 3	100	03.98-03.02	M 111.945, → Mot. # 001912	4	OZH 025
200	2,0	R, 3	100	03.98-03.02	M 111.945, Mot. # 001913 →	4	OZH 098



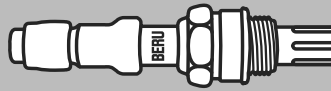

kW

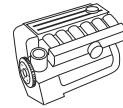

Zyl.
Cyl.
Cil.



MERCEDES-BENZ

CLK Cabriolet (A208)

200	2,0	R, 2	100	03.98-03.02	M 111.945 → Mot. # 003752	4	OZH 025
200	2,0	R, 2	100	03.98-03.02	M 111.945, Mot. # 003753 →	4	OZH 098
200 Kompressor	2,0	R, 2	141	03.98-06.00	M 111.944, → Mot. # 000054	4	OZH 025
200 Kompressor	2,0	R, 2	141	03.98-06.00	M 111.944, Mot. # 000055 →	4	OZH 098
200 Kompressor	2,0	R, 3	141	03.98-06.00	M 111.944 → Mot. # 003872	4	OZH 025
200 Kompressor	2,0	R, 3	141	03.98-06.00	M 111.944, Mot. # 003873 →	4	OZH 098
230 Kompressor	2,3	R, 3	142	03.98-06.00	M 111.975, → Mot. # 005799	4	OZH 025
230 Kompressor	2,3	R, 3	142	03.98-06.00	M 111.975/M 111.973, Mot. # 005800 →	4	OZH 098
230 Kompressor	2,3	R, 2	142	03.98-06.00	M 111.975, → Mot. # 000555	4	OZH 025
230 Kompressor	2,3	R, 2	142	03.98-06.00	M 111.975/M 111.973, Mot. # 000556 →	4	OZH 098
320	3,2	R	160	03.98-03.02	M 112.940, → Chassis # F 136 789, T 000 730	6	OZH 211
320	3,2	D	160	03.98-03.02	M 112.940, → Chassis # T 000 730, F 136 789	6	OZH 212
320	3,2	D	160	03.98-03.02	M 112.940, → Chassis # F 136 789, T 000 730	6	OZH 213
320	3,2	R, 1	160	03.98-03.02	M 112.940, Chassis # 054 272 →	6	OPH 041
320	3,2	R + D, 1	160	03.98-03.02	M 112.940, Chassis # F 136 790, T 000 731 →	6	OPH 043
320	3,2	R, 1	160	03.98-03.02	M 112.940, Chassis # T 000 731, F 136 790 →	6	OPH 047
320	3,2	R, 1	160	03.98-03.02	M 112.940, Chassis # T 000 731, F 136 790 →	6	OPH 048
430	4,3	R, 1	205	09.98-03.02	M 113.943, Chassis # 054 272 →	8	OPH 041
430	4,3	R + D, 1	205	09.98-03.02	M 113.943, Chassis # F 136 790, T 000 731 →	8	OPH 043
430	4,3	R, 1	205	09.98-03.02	M 113.943, Chassis # F 136 790, T 000 731 →	8	OPH 047
430	4,3	R, 1	205	09.98-03.02	M 113.943, Chassis # T 000 731, F 136 790 →	8	OPH 048
430	4,3	R	205	09.98-03.02	M 113.943, → Chassis # F 136 789, T 000 730	8	OZH 211
430	4,3	D	205	09.98-03.02	M 113.943, → Chassis # T 000 730, F 136 789	8	OZH 212
430	4,3	D	205	09.98-03.02	M 113.943, → Chassis # F 136 789, T 000 730	8	OZH 213
55 AMG	5,4	R, 1	255	03.01-03.02	M 113.981/M 113.984	8	OPH 041
55 AMG	5,4	R, 1	255	03.01-03.02	M 113.981/M 113.984	8	OPH 047

CLK (C209)

200 CGI	1,8	D, 1	125	07.03-	M 271.942	4	OPH 039
200 Kompressor	1,8	D, 1	120	09.02-	M 271.940	4	OPH 039
200 Kompressor	1,8	D, 1	135	10.06-	M 271.955	4	OPH 039
240	2,6	R, 1	125	06.02-08.02	M 112.912, → Chassis # F 024097	6	OPH 040
280	3,0	D, 1	170	01.05-	M 272.940	6	OPH 087
320	3,2	R, 1	160	06.02-08.02	M 112.955, → Chassis # F 024097	6	OPH 040
350	3,5	D, 1	200	01.05-	M 272.960	6	OPH 087
500	5,0	R, 1	225	06.02-08.02	M 113.968, → Chassis # F 024097	8	OPH 040
500	5,5	D, 1	285	06.06-	M 273.965	8	OPH 087
55 AMG	5,4	R, 1	270	09.02-	M 113.987, → Chassis # F 123 374	8	OPH 041
63 AMG	6,2	D, 1	354	04.06-	M 156.982	8	OPH 087
63 AMG	6,2	D, 1	373	05.07-	M 156.982	8	OPH 087

CLK Cabriolet (A209)

200 Kompressor	1,8	D, 1	135	10.06-	M 271.955	4	OPH 039
240	2,6	R, 1	125	02.03-	M 112.912, → Chassis # F 024097	6	OPH 040
280	3,0	D, 1	170	01.05-	M 272.940	6	OPH 087
320	3,2	R, 1	160	02.03-	M 112.955, → Chassis # F 024097	6	OPH 040
350	3,5	D, 1	200	01.05-	M 272.960	6	OPH 087
500	5,0	R, 1	225	02.03-	M 113.968, → Chassis # F 024097	8	OPH 040

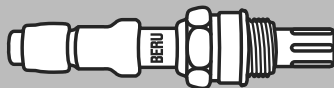
**BERU**

kW

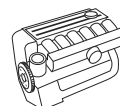
Zyl.
Cyl.
Cil.**MERCEDES-BENZ****CLK Cabriolet (A209)**

500	5,5	D, 1	285	06.06-	M 273.967	8	OPH 087
55 AMG	5,4	R, 1	270	02.03-	M 113.987, → Chassis # T 033 979, F 123 374	8	OPH 041
63 AMG	6,2	D, 1	354	04.06-	M 156.982	8	OPH 087
CLS (C219)							
280	3,0	D, 1	170	07.08-	M 272.943	6	OPH 087
300	3,0	D, 1	170	04.09-	M 272.943	6	OPH 087
350	3,5	D, 1	200	10.04-	M 272.964	6	OPH 087
350	3,5	D, 1	215	04.06-	M 272.985	6	OPH 087
350 CGI	3,5	D, 1	215	04.09-	M 272.985	6	OPH 087
500	5,0	R, 1	225	10.04-	M 113.967	8	OPH 035
500	5,0	D, 1	225	10.04-	M 113.967	8	OPH 045
500	5,5	D, 1	285	04.06-	M 273.960	8	OPH 087
CLS 55 AMG	5,4	R, 1	350	01.05-	M 113.990	8	OPH 035
CLS 55 AMG	5,4	D, 1	350	01.05-	M 113.990	8	OPH 045

E-KLASSE (W124)

E 200	2,0	R	100	06.93-06.95	M 111.940	4	OZH 041
E 220	2,2	R	110	06.93-06.95	M 111.960	4	OZH 041
E 280	2,8	R	145	06.93-06.95	M 104.942	6	OZH 016
E 300 Turbo-D 4-matic	3,0	R	108	06.93-06.95	OM 603.963	6	OZH 140
E 320	3,2	R	162	06.93-06.95	M 104.992	6	OZH 016

E-KLASSE Cabriolet (A124)

E 200	2,0	R	100	06.93-03.98	M 111.940	4	OZH 041
E 220	2,2	R	110	06.93-03.98	M 111.960	4	OZH 041
E 320	3,2	R	162	06.93-03.98	M 104.992/M 104.995	6	OZH 016
E 36 AMG	3,6	R	200	05.94-03.98	M 104.992 (AMG 3.6)	6	OZH 016

E-KLASSE Coupe (C124)

E 200	2,0	R	100	06.93-06.96	M 111.940	4	OZH 041
E 220	2,2	R	110	06.93-06.96	M 111.960	4	OZH 041
E 320	3,2	R	162	06.93-06.96	M 104.992	6	OZH 016
E 36 AMG	3,6	R	200	05.94-06.96	M 104.992 (AMG 3.6)	6	OZH 016

E-KLASSE Kombi (S124)

E 200 T	2,0	R	100	06.93-06.96	M 111.940	4	OZH 041
E 220 T	2,2	R	110	06.93-06.96	M 111.960	4	OZH 041
E 280 T	2,8	R	142	06.93-06.96	M 104.942	6	OZH 016
E 280 T	2,8	R	145	06.93-06.96	M 104.942	6	OZH 016
E 300 T 4-matic	3,0	R	132	06.93-06.96	M 103.985	6	OZH 140
E 300 TE-24 AMG	3,0	R	162	06.93-06.96	M 104.980	6	OZH 026
E 320 T	3,2	R	162	06.93-06.96	M 104.992	6	OZH 016
E 36 T AMG	3,6	R	200	05.94-06.96	M 104.992 (AMG 3.6)	6	OZH 016

E-KLASSE (W210)

E 200	2,0	R	100	06.95-08.00	M 111.942	4	OZH 145
E 200 Kompressor	2,0	R, 1	120	08.00-03.02	M 111.957	4	OPH 042
E 200 Kompressor	2,0	R	137	06.97-03.02	M 111.947	4	OZH 145
E 200 Kompressor	2,0	R	137	06.97-03.02	M 111.947	4	OZH 098
E 230	2,3	R	110	06.95-06.97	M 111.970	4	OZH 200
E 240	2,4	R	125	06.97-06.99	M 112.911	6	OZH 124
E 240	2,4	D	125	06.97-06.99	M 112.911	6	2 x OZH 143
E 280	2,8	R	142	01.96-06.97	M 104.945	6	OZH 023
E 280	2,8	R	150	06.99-03.02	M 112.921, → Chassis # B 173999	6	OZH 023
E 280	2,8	R	150	06.99-05.99	M 112.921, → Chassis # B 173999	6	OZH 124
E 280	2,8	D	150	06.99-03.02	M 112.921, → Chassis # B 173999	6	2 x OZH 143
E 280 4-matic	2,8	R	150	06.99-03.02	M 112.921, → Chassis # B 173999	6	OZH 023
E 280 4-matic	2,8	R	150	06.99-03.02	M 112.921, → Chassis # B 173999	6	OZH 124



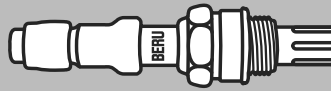

kW

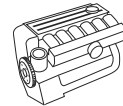

 Zyl.
Cyl.
Cil.

MERCEDES-BENZ
E-KLASSE (W210)

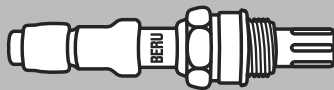
E 280 4-matic	2,8	D	150	06.99-03.02	M 112.921, → Chassis # B 173999	6	2 x OZH 143
E 320	3,2	R	162	06.95-08.96	M 104.995	6	OZH 023
E 320	3,2	R	162	09.96-06.97	M 104.995	6	OZH 124
E 320	3,2	R	165	06.97-03.02	M 112.941, → Chassis # B 173999	6	OZH 124
E 320	3,2	R	165	06.97-03.02	M 112.941, → Chassis # B 173999	6	OZH 023
E 320	3,2	D	165	06.97-03.02	M 112.941, → Chassis # B 173999	6	2 x OZH 143
E 320 4-matic	3,2	R	165	06.97-03.02	M 112.941, → Chassis # B 173999	6	OZH 124
E 320 4-matic	3,2	R	165	06.97-03.02	M 112.941, → Chassis # B 173999	6	OZH 023
E 320 4-matic	3,2	D	165	06.97-03.02	M 112.941, → Chassis # B 173999	6	2 x OZH 143
E 420	4,2	R	205	01.96-06.97	M 119.985, → Chassis # A 962231	8	OZH 021
E 420	4,2	R	205	01.96-06.97	M 119.985, Chassis # A 132402/J 020295 →	8	OZH 124
E 420	4,2	D	205	01.96-06.97	M 119.985	8	2 x OZH 143
E 420	4,2	D	205	01.96-06.97	M 119.985, → Chassis # B 17367	8	OZH 145
E 430	4,3	R	205	06.97-03.02	M 113.940	8	OZH 124
E 430	4,3	D	205	06.97-03.02	M 113.940	8	2 x OZH 143
E 430 4-matic	4,3	R	205	05.99-03.02	M 113.940, → Chassis # B 173367	8	OZH 124
E 430 4-matic	4,3	D	205	05.99-03.02	M 113.940	8	2 x OZH 143
E 50 AMG	5,0	R	255	02.96-08.97	M 119.985 (AMG 5.0), Chassis # A 132402/J 020295 →	8	OZH 124
E 55 AMG	5,4	R	260	08.97-03.02	M 113.980	8	OZH 124
E 55 AMG	5,4	D	260	07.99-03.02	M 113.980	8	2 x OZH 143
E-KLASSE Kombi (S210)							
E 200 T	2,0	R	100	06.96-08.00	M 111.942	4	OZH 145
E 200 T Kompressor	2,0	R, 1	120	08.00-03.03	M 111.957	4	OPH 042
E 200 T Kompressor	2,0	R	137	06.97-03.03	M 111.947	4	OZH 098
E 200 T Kompressor	2,0	R	137	06.97-03.03	M 111.947	4	OZH 145
E 230 T	2,3	R	110	06.96-06.97	M 111.970	4	OZH 200
E 240 T	2,4	R	125	06.97-03.03	M 112.911, → Chassis # A 962231	6	OZH 021
E 240 T	2,4	R	125	06.97-03.03	M 112.911	6	OZH 124
E 240 T	2,4	D	125	06.97-03.03	M 112.911	6	2 x OZH 143
E 240 T	2,4	D	125	06.97-03.03	M 112.911, → Chassis # B 17367	6	OZH 145
E 280 T	2,8	R	150	12.96-03.03	M 112.921	6	OZH 124
E 280 T	2,8	D	150	12.96-03.03	M 112.921	6	2 x OZH 143
E 280 T 4-matic	2,8	R	150	12.96-03.03	M 112.921	6	OZH 124
E 280 T 4-matic	2,8	D	150	12.96-03.03	M 112.921	6	2 x OZH 143
E 320 T	3,2	R	165	12.96-03.03	M 112.941, → Chassis # B 173999	6	OZH 124
E 320 T	3,2	R	165	12.96-03.03	M 112.941, → Chassis # B 173999	6	OZH 023
E 320 T	3,2	D	165	12.96-03.03	M 112.941, → Chassis # B 173999	6	2 x OZH 143
E 320 T 4-matic	3,2	R	165	12.96-03.03	M 112.941, → Chassis # B 173999	6	OZH 124

**BERU**

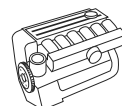
kW

Zyl.
Cyl.
Cil.**MERCEDES-BENZ****E-KLASSE Kombi (S210)**

E 320 T 4-matic	3,2	R	165	12.96-03.03	M 112.941, → Chassis # B 173999	6	OZH 023
E 320 T 4-matic	3,2	D	165	12.96-03.03	M 112.941, → Chassis # B 173999	6	2 x OZH 143
E 420 T	4,2	R	205	06.96-06.97	M 119.985, → Chassis # A 962231	8	OZH 021
E 420 T	4,2	D	205	06.96-06.97	M 119.985, → Chassis # B 17367	8	OZH 145
E 430 T	4,3	R	205	06.97-03.03	M 113.940, → Chassis # A 962231	8	OZH 021
E 430 T	4,3	R	205	06.97-03.03	M 113.940	8	OZH 124
E 430 T	4,3	D	205	06.97-03.03	M 113.940	8	2 x OZH 143
E 430 T	4,3	D	205	06.97-03.03	M 113.940, → Chassis # B 17367	8	OZH 145
E 430 T 4-matic	4,3	R	205	05.99-03.03	M 113.940	8	OZH 124
E 430 T 4-matic	4,3	D	205	05.99-03.03	M 113.940	8	2 x OZH 143
E 55 T AMG	5,4	R	260	08.97-03.03	M 113.980, → Chassis # A 962231	8	OZH 021
E 55 T AMG	5,4	R	260	03.98-03.03	M 113.980	8	OZH 124
E 55 T AMG	5,4	D	260	07.99-03.03	M 113.980	8	2 x OZH 143
E 55 T AMG	5,4	D	260	08.97-03.03	M 113.980, → Chassis # B 17367	8	OZH 145

E-KLASSE (W211)

E 200 Kompressor	1,8	D, 1	120	11.02-	M 271.941	4	OPH 039
E 200 Kompressor	1,8	D, 1	135	04.06-	M 271.956	4	OPH 039
E 240	2,6	R, 1	130	03.02-	M 112.917/M 112.913	6	OPH 035
E 240	2,6	D, 1	130	03.02-	M 112.917/M 112.913	6	OPH 045
E 240 4-matic	2,6	D, 1	130	03.03-	M 112.917	6	OPH 045
E 320	3,2	D, 1	165	03.02-	M 112.949	6	OPH 045
E 320 4-matic	3,2	D, 1	165	03.03-	M 112.954	6	OPH 045
E 500	5,0	R, 1	225	03.02-	M 113.967	8	OPH 035
E 500	5,0	D, 1	225	03.02-	M 113.967	8	OPH 045
E 500 4-matic	5,0	D, 1	225	10.03-	M 113.969	8	OPH 045
E 55 AMG Kompressor	5,4	R, 1	350	10.02-	M 113.990	8	OPH 035
E 55 AMG Kompressor	5,4	D, 1	350	10.02-	M 113.990	8	OPH 045

E-KLASSE Kombi (S211)

E 200 T Kompressor	1,8	D, 1	120	03.03-	M 271.941	4	OPH 039
E 200 Kompressor	1,8	D, 1	135	04.06-	M 271.956	4	OPH 039
E 240 T	2,6	R, 1	130	03.03-	M 112.913	6	OPH 035
E 240 T	2,6	D, 1	130	03.03-	M 112.913	6	OPH 045
E 240 T 4-matic	2,6	D, 1	130	07.03-	M 112.917	6	OPH 045
E 280 T	3,0	D, 1	170	03.05-	M 272.943, Chassis # A 786 704, X 175 299 →	6	OPH 087
E 320 T	3,2	R, 1	165	03.03-	M 112.949	6	OPH 035
E 320 T	3,2	D, 1	165	03.03-	M 112.949	6	OPH 045
E 320 T 4-matic	3,2	D, 1	165	07.03-	M 112.954	6	OPH 045
E 350 T	3,5	D, 1	200	03.05-	M 272.964/M 272.972, Chassis # A 786 704, X 175 299 →	6	OPH 087
E 500 T	5,0	R, 1	225	10.03-	M 113.967	8	OPH 035
E 500 T	5,0	D, 1	225	10.03-	M 113.967	8	OPH 045
E 500 T 4-matic	5,0	D, 1	225	10.03-	M 113.969	8	OPH 045
E 55 T AMG Kompressor	5,4	R, 1	350	07.03-	M 113.990	8	OPH 035
E 55 T AMG Kompressor	5,4	D, 1	350	07.03-	M 113.990	8	OPH 045

E-KLASSE (W212)

E 300	3,0	D, 1	170	01.09-	M 272.952	6	OPH 087
E 500	5,5	D, 1	285	01.09-	M 273.971	8	OPH 087

E-KLASSE Kombi (S212)

E 350 (212.256)	3,5	D, 1	200	08.09-	M 272.980	6	OPH 087
E 500 (212.272)	5,5	D, 1	285	11.09-	M 273.971	8	OPH 087

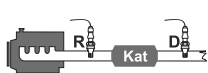



kW

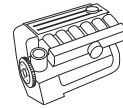

Zyl.
Cyl.
Cil.



MERCEDES-BENZ

E-KLASSE Cabriolet (A207)

E 500 (207.472)	5,5	D, 1	285	01.10-	M 273.966	8	OPH 087
-----------------	-----	------	-----	--------	-----------	---	----------------

E-KLASSE Coupe (C207)

E 350 CGI (207.357)	3,5	D, 1	215	01.09-	M 272.982/M 272.984	6	OPH 087
E 500 (207.372)	5,5	D, 1	285	01.09-	M 273.966	8	OPH 087

G-KLASSE (W463)

G 320	3,2	D, 1	158	07.97-11.97	M 112.945	6	OPH 034
G 320	3,2	R, 1	158	07.97-	M 112.945, → Chassis # 144225	6	OPH 040
G 320	3,2	D, 1	158	07.97-	M 112.945, Chassis # 144 226 →	6	OPH 041
G 500	5,0	R, 1	218	04.98-	M 113.962, → Chassis # 144225	8	OPH 040
G 500	5,0	D, 1	218	04.98-	M 113.962	8	OPH 041
G 55 AMG	5,4	R, 1	260	04.99-	M 113.982, → Chassis # 144225	8	OPH 040
G 55 AMG	5,4	D, 1	260	04.99-	M 113.982, Chassis # 144 226 →	8	OPH 041

GL-KLASSE (X164)

GL 450	4,7	D, 1	250	09.06-	M 273.923	8	OPH 087
GL 500	5,5	D, 1	285	09.06-	M 273.963	8	OPH 087

M-KLASSE (W163)

ML 320	3,2	D, 1	160	10.00-08.02	M 112.942	6	OPH 034
ML 320	3,2	R	160	02.98-08.02	M 112.942	6	2xOZH 143
ML 320	3,2	D	160	02.98-08.02	M 112.942, → Chassis # A 051463	6	2xOZH 143
ML 320	3,2	D	160	02.98-08.02	M 112.942	6	2xOZH 220
ML 350	3,7	D, 1	180	08.02-06.05	M 112.970	6	OPH 034
ML 430	4,3	D, 1	200	10.00-06.05	M 113.942	8	OPH 034
ML 500	5,0	D, 1	215	09.01-06.05	M 113.964/M 113.965	8	OPH 034
ML 55 AMG	5,4	R	255	02.00-06.05	M 113.981	8	2xOZH 143
ML 55 AMG	5,4	D	255	02.00-06.05	M 113.981	8	2xOZH 220

M-KLASSE (W164)

ML 350 4-matic	3,5	D, 1	200	07.05-	M 272.962/M 272.967	6	OPH 087
ML 500 4-matic	5,0	D, 1	225	07.05-	M 113.964	8	OPH 045
ML 500 4-matic	5,0	R, 1	225	07.05-	M 113.964	8	OPH 038
ML 500 4-matic	5,0	R, 1	225	07.05-	M 113.964	8	OPH 040
ML 500 4-matic	5,5	D, 1	285	12.07-	M 273.963	8	OPH 087

R-KLASSE (W251, V251)

R 280	3,0	D, 1	170	01.07-	M 272.945	6	OPH 087
R 300	3,0	D, 1	170	07.09-	M 272.945	6	OPH 087
R 350	3,5	D, 1	200	01.07-	M 272.967	6	OPH 087
R 350 4-matic	3,5	D, 1	200	01.06-	M 272.967	6	OPH 087
R 500 4-matic	5,0	R, 1	225	01.06-	M 113.971	8	OPH 040
R 500 4-matic	5,0	R, 1	225	01.06-	M 113.971	8	OPH 038
R 500 4-matic	5,0	D, 1	225	01.06-	M 113.971	8	OPH 045
R 500 4-matic	5,5	D, 1	285	01.07-	M 273.963	8	OPH 087

S-KLASSE (W126)

420 SE,SEL	4,2	R	150	10.85-06.91	M 116.965	8	OZH 142
420 SE,SEL	4,2	R	160	10.85-12.87	M 116.965	8	OZH 142
420 SE,SEL	4,2	R	165	10.85-06.91	M 116.965	8	OZH 142
420 SE,SEL	4,2	R	170	10.85-12.87	M 116.965	8	OZH 142
500 SE,SEL	5,0	R	164	09.85-06.91	M 117.965	8	OZH 142
500 SE,SEL	5,0	R	180	09.85-06.91	M 117.965	8	OZH 142
500 SE,SEL	5,0	R	185	09.87-06.91	M 117.965	8	OZH 142
500 SE,SEL	5,0	R	195	09.87-06.91	M 117.965	8	OZH 142
500 SE,SEL KAT	5,0	R	185	06.89-06.91	M 117.965	8	OZH 142
560 SE,SEL	5,5	R	178	10.85-06.91	M 117.968	8	OZH 142
560 SE,SEL	5,5	R	200	10.85-12.87	M 117.968	8	OZH 142
560 SE,SEL	5,5	R	205	08.87-06.91	M 117.968	8	OZH 142

S-KLASSE Coupe (C126)

420 SEC	4,2	R	150	10.85-06.91	M 116.965	8	OZH 142
420 SEC	4,2	R	160	10.85-12.87	M 116.965	8	OZH 142
420 SEC	4,2	R	165	10.85-06.91	M 116.965	8	OZH 142
500 SEC	5,0	R	164	10.85-06.91	M 117.965	8	OZH 142
500 SEC	5,0	R	180	09.85-06.91	M 117.965	8	OZH 142
500 SEC	5,0	R	185	08.87-06.91	M 117.965	8	OZH 142

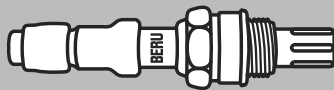
**BERU**

kW

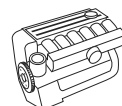
Zyl.
Cyl.
Cil.**MERCEDES-BENZ****S-KLASSE Coupe (C126)**

500 SEC	5,0	R	195	09.85-06.91	M 117.965	8	OZH 142
500 SEC KAT	5,0	R	185	06.89-06.91	M 117.965	8	OZH 142
560 SEC	5,5	R	178	10.85-06.91	M 117.968	8	OZH 142
560 SEC	5,5	R	205	10.85-06.91	M 117.968	8	OZH 142

S-KLASSE (W140)

S 280	2,8	R	142	02.93-10.98	M 104.944	6	OZH 018
S 280	2,8	R	142	02.93-10.98	M 104.944	6	OZH 144
300 SE 2.8	2,8	R	145	01.93-05.93	M 104.944	6	OZH 018
300 SE 2.8	2,8	R	145	01.93-10.98	M 104.944	6	OZH 144
300 SE,SEL/S320	3,2	R	170	03.91-06.93	M 104.990/M 104.994	6	OZH 018
300 SE,SEL/S320	3,2	R	170	03.91-10.98	M 104.990/M 104.994	6	OZH 144

S-KLASSE (W220)

S 280 (220.063, 220.163)	2,8	D	150	10.98-08.02	M 112.922, → Chassis # A 138350	6	2xOZH 143
S 320 (220.065, 220.165)	3,2	D	165	10.98-08.02	M 112.944, → Chassis # A 138350	6	2xOZH 143
S 430 (220.070, 220.170)	4,3	D	205	10.98-08.05	M 113.941, → Chassis # A 138350	8	2xOZH 143
S 500 (220.075, 220.175, 220.875)	5,0	D	225	10.98-08.05	M 113.960, → Chassis # A 138350	8	2xOZH 143

SL (R107)

300 SL	3,0	R	132	09.85-08.89	M 103.982	6	OZH 026
300 SL	3,0	R	132	09.85-08.89	M 103.982	6	OZH 140
300 SL	3,0	R	138	09.85-08.89	M 103.982	6	OZH 026
300 SL	3,0	R	138	09.85-08.89	M 103.982	6	OZH 140

SL (R129)

280	2,8	R	150	05.98-10.01	M 112.923/M 112.925, → Chassis # A 962231	6	OZH 021
280	2,8	R	150	05.98-10.01	M 112.923/M 112.925	6	OZH 124
280	2,8	D	150	05.98-10.01	M 112.923/M 112.925	6	2xOZH 143
280	2,8	D	150	05.98-10.01	M 112.923/M 112.925, → Chassis # B 17367	6	OZH 145
300 SL	3,0	R	140	03.89-08.93	M 103.984	6	OZH 033
320	3,2	D	165	05.98-10.01	M 112.943	6	OZH 198
500	5,0	R	225	05.98-10.01	M 113.961, → Chassis # A 962231	8	OZH 021
500	5,0	D	225	05.98-10.01	M 113.961, → Chassis # B 17367	8	OZH 145
500 SL	5,0	R	240	09.89-08.92	M 119.960/M 119.972	8	OZH 033
600	6,0	R	290	07.92-10.01	M 120.983/M 120.981	12	OZH 016

SL (R230)

350	3,7	D, 1	180	03.03-	M 112.973	6	OPH 046
500	5,0	D, 1	225	10.01-	M 113.963	8	OPH 045
55 AMG	5,4	D, 1	350	10.01-06.02	M 113.992	8	OPH 045
55 AMG Kompressor	5,4	D, 1	368	06.02-	M 113.992	8	OPH 045

SLK (R170)

200 Kompressor	2,0	R, 1	120	03.00-04.04	M 111.958, (Euro 4)	4	OPH 034
230 Kompressor	2,3	R, 1	145	03.00-04.04	M 111.983	4	OPH 037
320	3,2	D, 1	160	03.00-04.04	M 112.947	6	OPH 034
320	3,2	R, 1	160	03.00-04.04	M 112.947	6	OPH 037
32 AMG Kompressor	3,2	D, 1	260	03.01-04.04	M 112.960	6	OPH 034
32 AMG Kompressor	3,2	R, 1	260	03.01-04.04	M 112.960	6	OPH 037

SLK (R171)

200 Kompressor	1,8	D, 1	120	03.04-	M 271.944	4	OPH 039
200 Kompressor	1,8	D, 1	135	01.08-	M 271.954	4	OPH 039
280	3,0	D, 1	170	01.05-	M 272.942, Chassis # 017 564 →	6	OPH 087
280	3,0	D, 1	170	01.05-	M 272.942, Chassis # 017 564 →	6	OPH 087
300	3,0	D, 1	170	04.09-	M 272.942, Chassis # 017 564 →	6	OPH 087
300	3,0	D, 1	170	04.09-	M 272.942, Chassis # 017 564 →	6	OPH 087
350	3,5	D, 1	200	06.04-	M 272.963, Chassis # 017 564 →	6	OPH 087
350	3,5	D, 1	200	06.04-	M 272.963, Chassis # 017 564 →	6	OPH 087
350	3,5	D, 1	224	01.08-	M 272.969, Chassis # 017 564 →	6	OPH 087



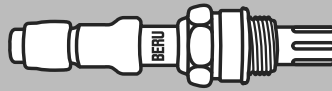

kW

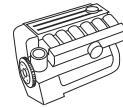

Zyl.
Cyl.
Cil.



MERCEDES-BENZ

SLK (R171)

350	3,5	D, 1	224	01.08-	M 272.969, Chassis # 017 564 →	6	OPH 087
55 AMG	5,4	R, 1	265	06.04-	M 113.989	8	OPH 038
55 AMG	5,4	R, 1	265	06.04-	M 113.989	8	OPH 041
55 AMG	5,4	D, 1	265	06.04-	M 113.989	8	OPH 046

Stufenheck (W124)

200	2,0	R	75	01.86-05.90	M 102.922, → Chassis # B 065 853	4	OZH 026
200	2,0	R	75	01.86-05.90	M 102.922, Chassis # B 065 854 →	4	OZH 141
200	2,0	R	77	01.86-08.89	M 102.922	4	OZH 026
200	2,0	R	80	12.85-08.89	M 102.922	4	OZH 026
200	2,0	R	80	09.89-05.90	M 102.922	4	OZH 141
200 E	2,0	R	87	09.88-08.89	M 102.963	4	OZH 026
200 E	2,0	R	87	09.89-08.92	M 102.963	4	OZH 032
200 E	2,0	R, 3	90	09.88-12.89	M 102.963, Mot. # 036322 →	4	OZH 032
200 E	2,0	R, 2	90	09.88-12.89	M 102.963, Mot. # 096990 →	4	OZH 032
220 E	2,2	R	110	10.92-06.93	M 111.960	4	OZH 041
230 E	2,3	R	97	05.85-08.88	M 102.982	4	OZH 026
230 E	2,3	R, 3	97	09.89-03.92	M 102.982, Mot. # 146597 →	4	OZH 032
230 E	2,3	R, 2	97	09.89-03.92	M 102.982, Mot. # 147102 →	4	OZH 032
230 E	2,3	R	100	05.85-08.88	M 102.982	4	OZH 026
230 E	2,3	R, 3	100	09.89-08.92	M 102.982, Mot. # 146597 →	4	OZH 032
230 E	2,3	R, 2	100	09.89-08.92	M 102.982, Mot. # 147102 →	4	OZH 032
230 E KAT	2,3	R	97	06.89-06.93	M 102.982	4	OZH 032
260 E	2,6	R	118	09.85-08.92	M 103.940	6	OZH 026
260 E	2,6	R	122	09.85-12.89	M 103.940	6	OZH 026
260 E 4-matic	2,6	R	118	09.86-08.92	M 103.943	6	OZH 140
260 E 4-matic	2,6	R	122	12.86-12.89	M 103.940	6	OZH 026
260 E 4-matic	2,6	R	122	12.86-12.89	M 103.940	6	OZH 140
280 E	2,8	R	145	10.92-06.93	M 104.942	6	OZH 016
300 E	3,0	R	132	08.85-08.92	M 103.983	6	OZH 026
300 E	3,0	R	138	06.85-08.92	M 103.983	6	OZH 026
300 E 4-matic	3,0	R	132	09.86-06.93	M 103.985	6	OZH 026
300 E 4-matic	3,0	R	132	09.86-06.93	M 103.985	6	OZH 140
300 E 4-matic	3,0	R	138	09.86-02.92	M 103.983	6	OZH 026
300 E 4-matic	3,0	R	138	09.86-02.92	M 103.983	6	OZH 140
300 E-24	3,0	R	162	09.88-08.89	M 104.980	6	OZH 016
300 E-24	3,0	R	162	09.89-08.92	M 104.980	6	OZH 026
320 E	3,2	R	162	10.92-06.93	M 104.992	6	OZH 016

COUPE (C124)

220 CE	2,2	R	110	10.92-05.93	M 111.960	4	OZH 041
230 CE	2,3	R, 3	97	03.87-12.92	M 102.982, Mot. # 146597 →	4	OZH 032
230 CE	2,3	R, 2	97	03.87-12.92	M 102.982, Mot. # 147102 →	4	OZH 032
230 CE	2,3	R	100	03.87-08.88	M 102.982	4	OZH 026
230 CE	2,3	R, 3	100	09.88-12.92	M 102.982, Mot. # 146597 →	4	OZH 032
230 CE	2,3	R, 2	100	09.88-12.92	M 102.982, Mot. # 147102 →	4	OZH 032
230 CE KAT	2,3	R, 3	97	06.89-12.92	M 102.982, Mot. # 146597 →	4	OZH 032
230 CE KAT	2,3	R, 2	97	06.89-12.92	M 102.982, Mot. # 147102 →	4	OZH 032
300 CE	3,0	R	132	03.87-08.92	M 103.983	6	OZH 026
300 CE	3,0	R	138	03.87-12.89	M 103.983	6	OZH 026
300 CE-24	3,0	R	162	09.89-12.92	M 104.980	6	OZH 026
300 CE-24	3,0	R	170	09.89-12.92	M 104.980	6	OZH 026
320 CE	3,2	R	162	10.92-05.93	M 104.992	6	OZH 016

KOMBI Kombi (S124)

200 T	2,0	R	77	01.86-08.89	M 102.922	4	OZH 026
200 T	2,0	R	77	09.89-05.90	M 102.922	4	OZH 141
200 T	2,0	R	80	09.85-08.89	M 102.922, → Chassis # B 065 853	4	OZH 026
200 T	2,0	R	80	09.85-08.89	M 102.922, Chassis # B 065 854 →	4	OZH 141
200 TE	2,0	R	87	09.88-08.92	M 102.963	4	OZH 032

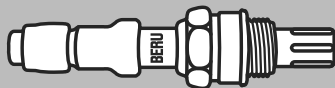
**BERU**

kW

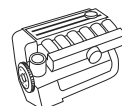
Zyl.
Cyl.
Cil.**MERCEDES-BENZ****KOMBI Kombi (S124)**

220 TE	2,2	R	110	10.92-05.93	M 111.960	4	OZH 041
230 TE	2,3	R	100	09.85-08.88	M 102.982	4	OZH 026
230 TE	2,3	R	100	09.88-08.92	M 102.982	4	OZH 032
230 TE KAT	2,3	R	97	06.89-08.92	M 102.982	4	OZH 032
260 TE	2,6	R	118	09.89-08.92	M 103.940	6	OZH 026
260 TE	2,6	R	122	09.85-12.89	M 103.940	6	OZH 026
280 TE	2,8	R	145	10.92-06.93	M 104.942	6	OZH 016
300 TE	3,0	R	132	01.86-08.92	M 103.983	6	OZH 026
300 TE	3,0	R	138	01.86-12.89	M 103.983	6	OZH 026
300 TE 4-matic	3,0	R	132	09.86-06.93	M 103.985	6	OZH 026
300 TE 4-matic	3,0	R	132	09.86-06.93	M 103.985	6	OZH 140
300 TE 4-matic	3,0	R	138	09.86-12.89	M 103.983	6	OZH 026
300 TE 4-matic	3,0	R	138	09.86-12.89	M 103.983	6	OZH 140
300 TE-24	3,0	R	162	09.89-08.92	M 104.980	6	OZH 026
320 TE	3,2	R	162	10.92-06.93	M 104.992	6	OZH 016

190 (W201)

2.0	2,0	R	75	09.88-08.89	M 102.924	4	OZH 007
2.0	2,0	R, 6	75	01.86-05.90	M 102.924	4	OZH 051
2.0	2,0	R	77	09.88-08.89	M 102.924	4	OZH 007
2.0	2,0	R, 6	77	09.84-05.90	M 102.924	4	OZH 051
E 1.8	1,8	R	80	04.90-08.93	M 102.910	4	OZH 032
E 2.0	2,0	R	83	09.85-12.86	M 102.961/M 102.962, → Chassis # A 528957	4	OZH 007
E 2.0	2,0	R	85	09.85-12.86	M 102.962, → Chassis # A 528957	4	OZH 007
E 2.0	2,0	R	87	09.88-08.89	M 102.962, → Chassis # A 528957	4	OZH 007
E 2.0	2,0	R, 3	87	09.89-08.93	M 102.962, Mot. # 236839 →	4	OZH 032
E 2.0	2,0	R, 2	87	09.89-08.93	M 102.962, Mot. # 122336 →	4	OZH 032
E 2.0	2,0	R	90	09.85-08.89	M 102.961/M 102.962, → Chassis # A 528957	4	OZH 007
E 2.0	2,0	R, 3	90	09.89-06.93	M 102.961/M 102.962, Mot. # 236839 →	4	OZH 032
E 2.0	2,0	R, 2	90	09.89-06.93	M 102.961/M 102.962, Mot. # 122336 →	4	OZH 032
E 2.3	2,3	R	97	09.86-09.89	M 102.985, → Chassis # A 528957	4	OZH 007
E 2.3	2,3	R	97	09.86-09.89	M 102.985	4	OZH 026
E 2.3	2,3	R, 3	97	09.89-08.91	M 102.985, Mot. # 033730 →	4	OZH 032
E 2.3	2,3	R, 2	97	09.89-08.91	M 102.985, Mot. # 080065 →	4	OZH 032
E 2.3	2,3	R	100	10.86-09.89	M 102.985, → Chassis # A 528957	4	OZH 007
E 2.3	2,3	R	100	10.86-09.89	M 102.985	4	OZH 026
E 2.3	2,3	R, 3	100	09.89-08.93	M 102.985, Mot. # 033730 →	4	OZH 032
E 2.3	2,3	R, 2	100	09.89-08.93	M 102.985, Mot. # 080065 →	4	OZH 032
E 2.3-16	2,3	R	125	09.85-12.87	M 102.983	4	OZH 007
E 2.3-16	2,3	R	125	09.85-12.87	M 102.983	4	OZH 026
E 2.3-16	2,3	R	130	09.85-08.88	M 102.983	4	OZH 007
E 2.3-16	2,3	R	130	09.85-08.88	M 102.983	4	OZH 026
E 2.3-16	2,3	R	136	09.85-01.87	M 102.983	4	OZH 007
E 2.3-16	2,3	R	136	09.85-01.87	M 102.983	4	OZH 026
E 2.5-16	2,5	R	143	03.89-04.90	M 102.991	4	OZH 007
E 2.5-16	2,5	R	150	09.88-08.93	M 102.990	4	OZH 007
E 2.6	2,6	R	118	09.86-08.93	M 103.942	6	OZH 007
E 2.6	2,6	R	122	09.86-12.89	M 103.942	6	OZH 007
E Evolution II 2.5	2,5	R	173	05.90-08.93	M 102.992	4	OZH 007

SPRINTER 2-t Bus (901, 902)

214	2,3	R	105	02.95-03.00	M 111.979/M 111.984	4	OZH 146
-----	-----	---	-----	-------------	---------------------	---	----------------

SPRINTER 2-t Kasten (901, 902)

214	2,3	R	105	02.95-03.00	M 111.979/M 111.984	4	OZH 146
-----	-----	---	-----	-------------	---------------------	---	----------------

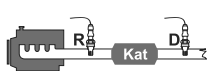

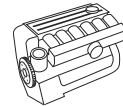

kW

 Zyl.
Cyl.
Cil.

MERCEDES-BENZ
**SPRINTER 2-t Pritsche/
Fahrgestell (901, 902)**

214	2,3	R	105	02.95-03.00	M 111.979/M 111.984	4	OZH 146
-----	-----	---	-----	-------------	---------------------	---	----------------

SPRINTER 3-t Bus (903)

314	2,3	R	105	02.95-08.02	M 111.979/M 111.984	4	OZH 146
-----	-----	---	-----	-------------	---------------------	---	----------------

SPRINTER 3-t Kasten (903)

314	2,3	R	105	02.95-08.02	M 111.979/M 111.984	4	OZH 146
-----	-----	---	-----	-------------	---------------------	---	----------------

**SPRINTER 3-t Pritsche/
Fahrgestell (903)**

314	2,3	R	105	02.95-08.02	M 111.979/M 111.984	4	OZH 146
-----	-----	---	-----	-------------	---------------------	---	----------------

SPRINTER 4-t Bus (904)

414	2,3	R	105	02.96-03.00	M 111.979/M 111.984	4	OZH 146
-----	-----	---	-----	-------------	---------------------	---	----------------

SPRINTER 4-t Kasten (904)

414	2,3	R	105	02.96-03.00	M 111.979/M 111.984	4	OZH 146
-----	-----	---	-----	-------------	---------------------	---	----------------

414 4x4	2,3	R	105	05.97-03.00	M 111.979/M 111.984	4	OZH 146
---------	-----	---	-----	-------------	---------------------	---	----------------

**SPRINTER 4-t Pritsche/
Fahrgestell (904)**

414	2,3	R	105	02.96-03.00	M 111.979/M 111.984	4	OZH 146
-----	-----	---	-----	-------------	---------------------	---	----------------

414 4x4	2,3	R	105	05.97-03.00	M 111.979/M 111.984	4	OZH 146
---------	-----	---	-----	-------------	---------------------	---	----------------

VANEO (414)

1.6	1,6	R, 1	60	02.02-	M 166.961	4	OPH 034
-----	-----	------	----	--------	-----------	---	----------------

1.6	1,6	R, 1	75	02.02-	M 166.961	4	OPH 034
-----	-----	------	----	--------	-----------	---	----------------

1.9	1,9	R, 1	92	02.02-	M 166.991	4	OPH 034
-----	-----	------	----	--------	-----------	---	----------------

MG
MG TF

120	1,8	R	88	03.02-	18 K4F, → Chassis # YD 522 572	4	OZH 053
-----	-----	---	----	--------	--------------------------------	---	----------------

120	1,8	R + D, 1	88	03.02-05.05	18 K4F, Chassis # YD 522 573 →	4	OPH 085
-----	-----	----------	----	-------------	--------------------------------	---	----------------

135	1,8	R	100	03.02-	18 K4F, → Chassis # YD 522 572	4	OZH 053
-----	-----	---	-----	--------	--------------------------------	---	----------------

135	1,8	R + D, 1	100	03.02-	18 K4F, Chassis # YD 522 573 →	4	OPH 085
-----	-----	----------	-----	--------	--------------------------------	---	----------------

160	1,8	R	118	03.02-	18 K4K, → Chassis # YD 522 572	4	OZH 053
-----	-----	---	-----	--------	--------------------------------	---	----------------

160	1,8	R + D, 1	118	03.02-05.05	18 K4K, Chassis # YD 522 573 →	4	OPH 085
-----	-----	----------	-----	-------------	--------------------------------	---	----------------

MG ZR

105	1,4	R	76	10.01-	14 K4F, → Chassis # YD 471 564	4	OZH 053
-----	-----	---	----	--------	--------------------------------	---	----------------

120	1,8	R, 1	86	10.01-05.05	18 K4F, Chassis # YD 522 573 →	4	OPH 085
-----	-----	------	----	-------------	--------------------------------	---	----------------

120	1,8	R	86	10.01-	18 K4F, → Chassis # YD 471 564	4	OZH 053
-----	-----	---	----	--------	--------------------------------	---	----------------

MG ZS

120	1,8	R + D, 1	86	10.01-05.05	18 K4F	4	OPH 085
-----	-----	----------	----	-------------	--------	---	----------------

MG ZS Hatchback

1.6	1,6	R, 1	82	03.05-05.05	16 K4F, Chassis # YD 471 064 →	4	OPH 085
-----	-----	------	----	-------------	--------------------------------	---	----------------

120	1,8	R + D, 1	86	10.01-05.05	18 K4F	4	OPH 085
-----	-----	----------	----	-------------	--------	---	----------------

MGF

1.6	1,6	R, 1	82	10.01-03.02	16 K4F, Chassis # YD 522 573 →	4	OPH 085
-----	-----	------	----	-------------	--------------------------------	---	----------------

1.8 i 16V	1,8	R	88	03.95-09.95	18 K4F, → Chassis # YD 522 572	4	OZH 053
-----------	-----	---	----	-------------	--------------------------------	---	----------------

1.8 i 16V	1,8	R, 1	88	10.95-03.02	18 K4F, Chassis # YD 522 573 →	4	OPH 085
-----------	-----	------	----	-------------	--------------------------------	---	----------------

1.8 i VVC	1,8	R	107	03.95-09.95	18 K4K, → Chassis # YD 522 572	4	OZH 053
-----------	-----	---	-----	-------------	--------------------------------	---	----------------

1.8 i VVC	1,8	R, 1	107	10.95-03.02	18 K4K, Chassis # YD 522 573 →	4	OPH 085
-----------	-----	------	-----	-------------	--------------------------------	---	----------------

1.8 i VVC	1,8	R, 1	118	10.01-03.02	18 K4K, Chassis # YD 522 573 →	4	OPH 085
-----------	-----	------	-----	-------------	--------------------------------	---	----------------

MITSUBISHI
COLT III

1.3	1,3	R	51	04.88-05.90	4 G 13	4	OZU 001
-----	-----	---	----	-------------	--------	---	----------------

1.3 GL	1,3	R	44	04.88-05.90	4 G 13	4	OZU 001
--------	-----	---	----	-------------	--------	---	----------------

NISSAN
100 NX

1.6	1,6	R	66	10.90-10.92	GA16DS	4	OZU 001
-----	-----	---	----	-------------	--------	---	----------------

1.6 SR	1,6	R	75	09.93-10.94	GA16DE	4	OZH 011
--------	-----	---	----	-------------	--------	---	----------------

ALMERA II

1.5	1,5	R, 1	72	10.02-	QG15DE	4	OPH 090
-----	-----	------	----	--------	--------	---	----------------

1.8	1,8	R	84	03.01-07.02	QG18DE	4	OZH 225
-----	-----	---	----	-------------	--------	---	----------------

1.8	1,8	D	84	03.01-07.02	QG18DE	4	OZH 226
-----	-----	---	----	-------------	--------	---	----------------

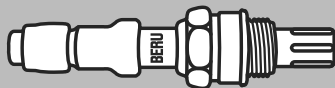
**BERU**

kW

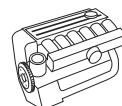
Zyl.
Cyl.
Cil.

NISSAN							
ALMERA II							
1.8	1,8	R, 1	85	10.02-	QG18DE	4	OPH 090
ALMERA II Hatchback							
1.5	1,5	R	66	11.00-07.02	QG15DE	4	OZH 225
1.5	1,5	D	66	11.00-07.02	QG15DE	4	OZH 226
1.5	1,5	R, 1	72	10.02-	QG15DE	4	OPH 090
1.8	1,8	R	84	11.00-07.02	QG18DE	4	OZH 225
1.8	1,8	D	84	11.00-07.02	QG18DE	4	OZH 226
1.8	1,8	R, 1	85	10.02-	QG18DE	4	OPH 090
ALMERA TINO							
1.8	1,8	R, 1	84	03.03-	QG18DE	4	OPH 090
1.8	1,8	R	84	08.00-02.03	QG18DE	4	OZH 225
1.8	1,8	R, 1	85	03.03-	QG18DE	4	OPH 090
1.8	1,8	R	85	12.02-02.03	QG18DE	4	OZH 225
ALTIMA							
2.5	2,5	D, 1	121	08.01-08.03	QR25DE	4	OPH 089
BLUEBIRD							
1.8 i 16V	1,8	R	95	02.89-12.90	CA18D	4	OZU 024
2.0 i	2,0	R	77	03.86-12.90	CA20E	4	OZU 010
2.0 i	2,0	R	77	01.86-01.88	CA20E	4	OZU 001
BLUEBIRD Hatchback							
1.8 i 16V	1,8	R	95	02.89-12.90	CA18D	4	OZU 024
2.0 i	2,0	R	77	03.86-12.90	CA20E	4	OZU 010
BLUEBIRD Station Wagon							
2.0 i	2,0	R	77	03.86-12.90	CA20E	4	OZU 010
MAXIMA QX							
2.0	2,0	R	103	02.95-01.00	VQ20DE	6	OZH 012
3.0	3,0	R	142	01.95-08.00	VQ30DE	6	OZH 012
MAXIMA Station Wagon							
2.0 QX	2,0	R	103	10.97-01.00	VQ20DE	6	OZH 012
3.0 QX	3,0	R	142	10.97-	VQ30DE	6	OZH 012
MICRA C+C							
1.4 16V	1,4	D, 1	65	08.05-	CR14DE	4	OPH 089
1.4 16V	1,4	D, 1	65	08.05-	CR14DE	4	OPH 090
MICRA I							
1.0	1,0	R	37	12.82-12.89	MA10S	4	OZU 010
1.0	1,0	R	40	12.82-05.89	MA10S	4	OZU 010
1.2	1,2	R	40	07.86-07.92	MA12S	4	OZU 010
1.2	1,2	R	44	07.86-07.92	MA12S	4	OZU 001
MICRA II							
1.0 i 16V	1,0	R	40	08.92-09.00	CG10DE	4	OZH 011
1.0 i 16V	1,0	R	44	09.00-11.00	CG10DE	4	OZH 011
1.0 i 16V	1,0	R	44	12.00-10.02	CG10DE	4	OZH 228
1.0 i 16V	1,0	D	44	12.00-10.02	CG10DE	4	OZH 229
1.3 i 16V	1,3	R	55	08.92-09.00	CG13DE	4	OZH 011
1.4 i 16V	1,3	R	60	12.00-10.02	CGA3DE	4	OZH 228
1.4 i 16V	1,3	D	60	12.00-10.02	CGA3DE	4	OZH 229
MICRA III							
1.0 16V	1,0	R, 1	48	01.03-05.05	CG10DE	4	OPH 090
1.2 16V	1,2	D, 1	48	06.05-	CR12DE/CG12DE	4	OPH 089
1.2 16V	1,2	D, 1	48	06.05-	CR12DE/CG12DE	4	OPH 090
1.2 16V	1,2	D, 1	59	06.05-	CR12DE/CG12DE	4	OPH 089
1.2 16V	1,2	D, 1	59	06.05-	CR12DE/CG12DE	4	OPH 090
1.4 16V	1,4	D, 1	65	06.05-	CR14DE	4	OPH 089
1.4 16V	1,4	D, 1	65	06.05-	CR14DE	4	OPH 090
NOTE							
1.4	1,4	D, 1	65	03.06-	CR14DE	4	OPH 089
1.4	1,4	D, 1	65	03.06-	CR14DE	4	OPH 090
PATHFINDER							
4.0 4WD	4,0	D, 1	198	09.05-08.07	VQ40DE	6	OPH 089
4.0 4WD	4,0	D, 1	198	09.05-12.07	VQ40DE	6	OPH 090



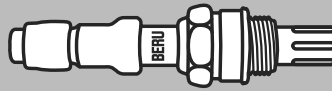

kW

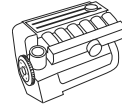
 Zyl.
Cyl.
Cil.

NISSAN
PICK UP

2.4 i 12V	2,4	R	91	04.92-02.98	KA24E	4	OZU 010
2.4 i 12V 4WD	2,4	R	93	04.92-05.94	KA24E	4	OZU 010
2.4 i 4WD	2,4	R	74	03.86-04.92	Z24i	4	OZU 024

PRAIRIE PRO

2.0 i	2,0	R	72	10.88-04.92	CA20E	4	OZU 010
2.0 i 4x4	2,0	R	72	10.88-12.92	CA20E	4	OZU 010

PRIMERA (P10)

1.6	1,6	R	66	06.90-04.93	GA16DS	4	OZU 024
2.0 i	2,0	R	92	01.95-06.96	SR20DE	4	OZH 203
2.0 GT	2,0	R	110	05.95-01.96	SR20DE	4	OZH 203

PRIMERA Hatchback (P10)

1.6	1,6	R	66	06.90-04.93	GA16DS	4	OZU 024
2.0 i	2,0	R	92	01.95-06.96	SR20DE	4	OZH 203
2.0	2,0	R	110	05.95-01.96	SR20DE	4	OZH 203

PRIMERA Traveller (W10)

1.6 i	1,6	R	66	07.90-04.93	GA16DS	4	OZU 024
-------	-----	---	----	-------------	--------	---	----------------

PRIMERA (P11)

1.6 16V	1,6	R	78	06.96-12.01	QG16DE	4	OZH 225
1.6 16V	1,6	D	78	06.96-12.01	QG16DE	4	OZH 226
1.8 16V	1,8	R	84	10.00-12.01	QG18DE	4	OZH 225
1.8 16V	1,8	D	84	10.00-12.01	QG18DE	4	OZH 226
2.0 16V	2,0	R, 2	85	09.96-10.97	SR 20 DE	4	OZH 201
2.0 16V	2,0	R, 2	96	09.96-10.97	SR 20 DE	4	OZH 201
2.0 16V	2,0	R	103	10.00-12.01	SR20DE	4	OZH 225
2.0 16V	2,0	D	103	10.01-12.01	SR20DE	4	OZH 226
2.0 16V	2,0	D	103	10.00-09.01	SR20DE	4	OZH 227

PRIMERA Hatchback (P11)

1.6 16V	1,6	R	78	09.00-12.01	QG16DE	4	OZH 225
1.6 16V	1,6	D	78	09.00-12.01	QG16DE	4	OZH 226
1.8 16V	1,8	R	84	10.00-12.01	QG18DE	4	OZH 225
1.8 16V	1,8	D	84	10.00-12.01	QG18DE	4	OZH 226
2.0 16V	2,0	R, 2	96	09.96-10.97	SR20DE	4	OZH 201
2.0 16V	2,0	R	103	10.00-12.01	SR20DE	4	OZH 225
2.0 16V	2,0	D	103	10.01-12.01	SR20DE	4	OZH 226
2.0 16V	2,0	D	103	10.00-09.01	SR20DE	4	OZH 227

PRIMERA Traveller (WP11)

1.8 16V	1,8	R	84	10.00-12.01	QG18DE	4	OZH 225
1.8 16V	1,8	D	84	10.00-12.01	QG18DE	4	OZH 226
2.0 16V	2,0	R	85	04.98-06.99	SR20De	4	OZH 201
2.0 16V	2,0	R	96	04.98-06.99	SR20DE	4	OZH 201
2.0 16V	2,0	R	103	10.00-12.01	SR20DE	4	OZH 225
2.0 16V	2,0	D	103	10.01-12.01	SR20DE	4	OZH 226
2.0 16V	2,0	D	103	10.00-09.01	SR20DE	4	OZH 227

PRIMERA (P12)

1.6	1,6	R, 1	78	03.02-	QG16DE	4	OPH 090
1.6	1,6	R, 1	80	01.02-	QG16DE	4	OPH 090
1.8	1,8	R, 1	85	03.02-	QG18DE	4	OPH 090

PRIMERA Hatchback (P12)

1.6	1,6	R, 1	78	07.02-	QG16DE	4	OPH 090
1.6	1,6	R, 1	80	07.02-	QG16DE	4	OPH 090
1.8	1,8	R, 1	85	07.02-	QG18DE	4	OPH 090

PRIMERA Traveller (WP12)

1.6 Visia	1,6	R, 1	80	01.02-	QG16DE	4	OPH 090
1.8	1,8	R, 1	85	03.02-	QG18DE	4	OPH 090

SUNNY II

1.6 i	1,6	R	54	06.86-10.90	E16i	4	OZU 024
1.6 i 4x4	1,6	R	54	06.86-10.90	E16i	4	OZU 024
1.6 i 12V	1,6	R	66	10.88-08.90	GA16i	4	OZU 001

SUNNY II Coupe

1.6 i	1,6	R	54	06.86-05.89	E16i	4	OZU 024
1.6 i 12V	1,6	R	66	10.88-09.90	GA16i	4	OZU 001

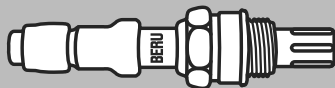
**BERU**

kW

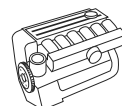
Zyl.
Cyl.
Cil.**NISSAN****SUNNY II Coupe**

1.6 GTI 16V	1,6	R	81	05.87-05.89	CA16D	4	OZU 024
1.8 GTI 16V	1,8	R	92	01.89-06.91	CA18D	4	OZU 024

SUNNY II Hatchback

1.6 i	1,6	R	54	06.86-10.90	E16i	4	OZU 024
1.8 GTI 16V	1,8	R	92	01.89-08.90	CA18D	4	OZU 001

SUNNY II Traveller

1.6 i	1,6	R	54	08.86-05.89	E16i	4	OZU 024
1.6 i 12V	1,6	R	66	10.88-09.90	GA16i	4	OZU 001
1.6 i 12V 4x4	1,6	R	66	10.88-08.90	GA16i	4	OZU 001

SUNNY III

1.4 i	1,4	R	55	10.90-05.95	GA14DE /GA14DS	4	OZU 001
1.6 i	1,6	R	66	10.90-05.95	GA16DS	4	OZU 024

SUNNY III Hatchback

1.4 i	1,4	R	55	10.90-05.95	GA14DE /GA14DS	4	OZU 001
1.6 i	1,6	R	66	10.90-05.95	GA16DS	4	OZU 024

SUNNY III Liftback

1.4 i	1,4	R	55	10.90-05.95	GA14DE /GA14DS	4	OZU 001
1.6 i	1,6	R	66	10.90-05.95	GA16DS	4	OZU 024

SUNNY III Traveller

1.6 16V 4x4	1,6	R	66	11.90-10.92	GA16DS	4	OZU 001
1.6 i	1,6	R	66	06.91-03.00	GA16DS	4	OZU 024

TERRANO I

2.4 i 4WD	2,4	R	76	10.87-07.92	Z24i	4	OZU 024
-----------	-----	---	----	-------------	------	---	----------------

VANETTE Bus

2.4 i	2,4	R	74	10.86-09.87	Z24i	4	OZU 010
2.4 i	2,4	R	74	09.87-12.95	Z24i	4	OZU 024
2.4 i	2,4	R	77	10.86-09.87	Z24i	4	OZU 010
2.4 i	2,4	R	77	09.87-12.95	Z24i	4	OZU 024

X-TRAIL

2.5 4x4	2,5	D, 1	121	09.04-08.05	QR25DE	4	OPH 089
---------	-----	------	-----	-------------	--------	---	----------------

OPEL**AGILA**

1.0 12V	1,0	R + D, 1	43	09.00-	Z 10 XE, → Chassis # 4G999999, 4G999999	3	OPH 078
1.2 16V	1,2	R + D, 1	55	09.00-	Z 12 XE, → Chassis # 4G999999, 4G999999	4	OPH 078

ASCONA C

1.6 i	1,6	R	55	09.87-08.88	E 16 NZ	4	OZU 005
1.6 i KAT	1,6	R	55	09.86-08.88	C 16 NZ/C 16 LZ	4	OZU 005
1.8 E	1,8	R	74	01.85-08.86	S 18 NV/C 18 NE	4	OZH 040
2.0 i	2,0	R	85	09.86-08.88	20 NE	4	OZH 040
2.0 i KAT	2,0	R	85	09.86-08.88	C 20 NE	4	OZH 040

ASCONA C CC

1.6 i	1,6	R	55	09.87-08.88	E 16 NZ	4	OZU 005
1.6 i KAT	1,6	R	55	09.86-08.88	C 16 NZ/C 16 LZ	4	OZU 005
1.8 E	1,8	R	74	01.85-08.86	S 18 NV/C 18 NE	4	OZH 040
2.0 i	2,0	R	85	09.86-08.88	20 NE	4	OZH 040
2.0 i KAT	2,0	R	85	09.86-08.88	C 20 NE	4	OZH 040

ASTRA F

1.4 i	1,4	R	44	09.91-09.98	C 14 NZ/X 14 NZ	4	OZU 005
1.4 i 16V	1,4	R	66	02.96-09.98	X 14 XE	4	OZU 005
1.4 Si	1,4	R	60	03.92-09.98	C 14 SE	4	OZU 005
1.6 i	1,6	R	52	05.93-07.96	X 16 SZ	4	OZU 005
1.6 i	1,6	R	55	03.92-09.98	C 16 NZ/X 16 SZR	4	OZU 005
1.6 i	1,6	R	55	08.96-09.98	X 16 SZR	4	OZU 005
1.6 i 16V	1,6	R	74	08.94-09.98	X 16 XEL, → Chassis # S 2531218/S 5223656	4	OZU 023
1.6 i 16V	1,6	R	74	08.94-09.98	X 16 XEL, Chassis # S 2531219/S 5223657 →	4	OZU 005
1.6 Si	1,6	R	74	05.92-12.94	C 16 SE	4	OZU 001

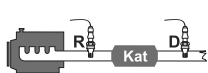

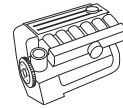

kW

 Zyl.
Cyl.
Cil.

OPEL
ASTRA F

1.8 i	1,8	R	66	03.92-09.98	C 18 NZ	4	OZU 005
2.0 i	2,0	R	85	03.92-09.98	C 20 NE	4	OZH 040

ASTRA F Cabriolet

1.4 i 16V	1,4	R	66	01.96-03.01	X 14 XE	4	OZU 005
1.4 Si	1,4	R	60	05.93-03.01	C 14 SE	4	OZU 005
1.6 i	1,6	R	52	03.93-08.96	X 16 SZ	4	OZU 005
1.6 i	1,6	R	55	01.96-03.01	X 16 SZR	4	OZU 005
2.0 i	2,0	R	85	03.93-10.94	C 20 NE	4	OZH 040

ASTRA F Caravan

1.4 i	1,4	R	44	09.91-01.98	C 14 NZ	4	OZU 005
1.4 i 16V	1,4	R	66	02.96-01.98	X 14 XE	4	OZU 005
1.4 Si	1,4	R	60	03.92-01.98	C 14 SE	4	OZU 005
1.6 i	1,6	R	52	05.93-07.96	X 16 SZ	4	OZU 005
1.6 i	1,6	R	55	09.91-01.98	C 16 NZ/X 16 SZR	4	OZU 005
1.6 i 16V	1,6	R	74	08.94-01.98	X 16 XEL, → Chassis # S 2531218/ S 5223656	4	OZU 023
1.6 i 16V	1,6	R	74	08.94-01.98	X 16 XEL, Chassis # S 2531219/ S 5223657 →	4	OZU 005
1.6 Si	1,6	R	74	03.92-12.94	C 16 SE	4	OZU 001
1.8 i	1,8	R	66	09.91-01.98	C 18 NZ	4	OZU 005
2.0 i	2,0	R	85	09.91-07.94	C 20 NE	4	OZH 040
2.0 i 16V	2,0	R	110	03.93-01.98	C 20 XE	4	OZH 040

ASTRA F CC

1.4 i	1,4	R	44	03.92-01.98	C 14 NZ	4	OZU 005
1.4 i 16V	1,4	R	66	01.96-01.98	X 14 XE	4	OZU 005
1.4 Si	1,4	R	60	03.92-01.98	C 14 SE	4	OZU 005
1.6 i	1,6	R	52	05.93-07.96	X 16 SZ	4	OZU 005
1.6 i	1,6	R	55	09.91-01.98	C 16 NZ/X 16 SZR	4	OZU 005
1.6 i 16V	1,6	R	74	08.94-01.98	X 16 XEL, → Chassis # S 2531218/ S 5223656	4	OZU 023
1.6 i 16V	1,6	R	74	08.94-01.98	X 16 XEL, Chassis # S 2531219/ S 5223657 →	4	OZU 005
1.6 Si	1,6	R	74	03.92-12.94	C 16 SE	4	OZU 001
1.8 i	1,8	R	66	09.91-01.98	C 18 NZ	4	OZU 005
2.0 GSI 16V	2,0	R	110	09.91-01.98	C 20 XE	4	OZH 040
2.0 i	2,0	R	85	09.91-01.98	C 20 NE	4	OZH 040

ASTRA F CLASSIC Caravan

1.6 i	1,6	R	55	01.98-01.05	X 16 SZR	4	OZU 005
1.6 i 16V	1,6	R	74	01.98-01.05	X 16 XEL	4	OZU 005

ASTRA F CLASSIC CC

1.4 i	1,4	R	66	03.98-08.00	X 14 XE	4	OZU 005
1.6 i	1,6	R	55	01.98-08.02	X 16 SZR	4	OZU 005
1.6 i 16V	1,6	R	74	01.98-08.02	X 16 XEL	4	OZU 005

**ASTRA F CLASSIC Stufen-
heck**

1.6 i	1,6	R	55	01.98-08.02	X 16 SZR	4	OZU 005
1.6 i 16V	1,6	R	74	01.98-08.02	X 16 XEL	4	OZU 005

ASTRA F Van

1.4 i	1,4	R	44	10.91-01.99	C 14 NZ	4	OZU 005
1.6 i	1,6	R	52	02.93-07.96	X 16 SZ	4	OZU 005
1.6 i	1,6	R	55	10.91-04.93	C 16 NZ	4	OZU 005

ASTRA G Cabriolet

1.6 16V	1,6	R	74	03.01-10.05	Z 16 XE	4	OZH 132
1.8 16V	1,8	R, 3	92	03.01-10.05	Z 18 XE	4	OZH 113
1.8 16V	1,8	R, 2	92	03.01-10.05	Z 18 XE	4	OZH 114
1.8 16V	1,8	D	92	03.01-10.05	Z 18 XE	4	OZH 115
2.0 OPC	2,0	R, 1	141	03.02-10.05	Z 20 LET	4	OPH 081
2.0 OPC	2,0	D, 1	141	03.02-10.05	Z 20 LET	4	OPH 084

ASTRA G Caravan

1.2 16V	1,2	D, 1	55	09.00-07.04	Z 12 XE	4	OPH 078
---------	-----	------	----	-------------	---------	---	----------------

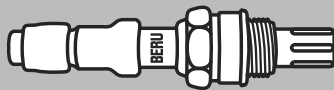
**BERU**

kW

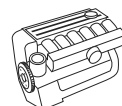
Zyl.
Cyl.
Cil.**OPEL****ASTRA G Caravan**

1.2 16V	1,2	R, 1	55	09.00-07.04	Z 12 XE	4	OPH 081
1.4 16V	1,4	R	66	09.00-07.04	X 14 XE, → Chassis # 18999999	4	OZH 132
1.4 16V	1,4	R	66	09.98-08.00	X 14 XE, Chassis # 22000001 →	4	OZH 110
1.4 16V	1,4	R	66	06.98-07.04	X 14 XE	4	OZH 148
1.6	1,6	R	55	02.98-09.00	X 16 SZR	4	OZU 005
1.6	1,6	R + D	62	09.00-07.04	Z 16 SE	4	OZH 110
1.6 16V	1,6	R	74	09.98-08.00	Z 16 XE, Chassis # 22000001 →	4	OZH 110
1.6 16V	1,6	R	74	02.98-07.04	X 16 XEL	4	OZH 148
1.6 CNG	1,6	R	71	03.03-07.04	Z 16 YNG	4	OZH 132
1.8 16V	1,8	R, 3	92	09.00-07.04	Z 18 XE	4	OZH 113
1.8 16V	1,8	R, 2	92	09.00-07.04	Z 18 XE	4	OZH 114
1.8 16V	1,8	D	92	09.00-07.04	Z 18 XE	4	OZH 115
2.0 OPC	2,0	R, 1	141	09.02-07.04	Z 20 LET	4	OPH 081
2.0 OPC	2,0	D, 1	141	09.02-07.04	Z 20 LET	4	OPH 084

ASTRA G CC

1.2 16V	1,2	D, 1	55	09.00-01.05	Z 12 XE	4	OPH 078
1.2 16V	1,2	R, 1	55	09.00-01.05	Z 12 XE	4	OPH 081
1.4 16V	1,4	R	66	09.00-01.05	Z 14 XE, → Chassis # 18999999	4	OZH 132
1.4 16V	1,4	R	66	09.98-08.00	X 14 XE, Chassis # 22000001 →	4	OZH 110
1.4 16V	1,4	R	66	02.98-01.05	X 14 XE	4	OZH 148
1.6	1,6	R	55	02.98-09.00	X 16 SZR	4	OZU 005
1.6	1,6	R + D	62	09.00-01.05	Z 16 SE	4	OZH 110
1.6 16V	1,6	R	74	02.98-08.00	Z 16 XE/X 16 XEL, → Chassis # 129/159/169/ 18999999	4	OZH 148
1.6 16V	1,6	R	74	09.98-08.00	Z 16 XE, Chassis # 22000001 →	4	OZH 110
1.8 16V	1,8	R, 3	92	09.00-01.05	Z 18 XE	4	OZH 113
1.8 16V	1,8	R, 2	92	09.00-01.05	Z 18 XE	4	OZH 114
1.8 16V	1,8	D	92	09.00-01.05	Z 18 XE	4	OZH 115
2.0 OPC	2,0	R, 1	141	09.02-01.05	Z 20 LET	4	OPH 081
2.0 OPC	2,0	D, 1	141	09.02-01.05	Z 20 LET	4	OPH 084
2.0 OPC	2,0	R, 1	147	11.02-01.05	Z 20 LET	4	OPH 081
2.0 OPC	2,0	D, 1	147	11.02-01.05	Z 20 LET	4	OPH 084

ASTRA G Coupe

1.8 16V	1,8	R, 3	92	09.00-05.05	Z 18 XE	4	OZH 113
1.8 16V	1,8	R, 2	92	09.00-05.05	Z 18 XE	4	OZH 114
1.8 16V	1,8	D	92	09.00-05.05	Z 18 XE	4	OZH 115
2.0 16V Turbo	2,0	R, 1	140	09.00-08.01	Z 20 LET	4	OPH 081
2.0 16V Turbo	2,0	D, 1	140	09.00-08.01	Z 20 LET	4	OPH 084
2.0 16V Turbo	2,0	R, 1	141	08.01-05.05	Z 20 LET	4	OPH 081
2.0 16V Turbo	2,0	D, 1	141	08.01-05.05	Z 20 LET	4	OPH 084

ASTRA G Kasten

1.6	1,6	R	55	01.99-09.00	X 16 SZR	4	OZU 005
1.6	1,6	R + D	62	09.00-04.05	Z 16 SE	4	OZH 110

ASTRA G Stufenheck

1.2 16V	1,2	D, 1	55	09.00-01.05	Z 12 XE	4	OPH 078
1.2 16V	1,2	R, 1	55	09.00-01.05	Z 12 XE	4	OPH 081
1.4 16V	1,4	R	66	09.00-01.05	X 14 XE/Z 14 XE, → Chassis # 18999999	4	OZH 132
1.4 16V	1,4	R	66	09.98-08.00	X 14 XE, Chassis # 22000001 →	4	OZH 110
1.4 16V	1,4	R	66	09.98-01.05	X 14 XE	4	OZH 148
1.6	1,6	R	55	09.98-09.00	X 16 SZR	4	OZU 005
1.6	1,6	R + D	62	09.00-01.05	Z 16 SE	4	OZH 110
1.6 16V	1,6	R	74	09.98-08.00	Z 16 XE, Chassis # 22000001 →	4	OZH 110
1.6 16V	1,6	R	74	09.98-01.05	X 16 XEL	4	OZH 148
1.8 16V	1,8	R, 3	92	09.00-01.05	Z 18 XE	4	OZH 113
1.8 16V	1,8	R, 2	92	09.00-01.05	Z 18 XE	4	OZH 114
1.8 16V	1,8	D	92	09.00-01.05	Z 18 XE	4	OZH 115

ASTRA H

2.0 Turbo	2,0	R, 1	125	03.04-	Z 20 LEL	4	OPH 081
2.0 Turbo	2,0	R, 1	147	09.04-	Z 20 LER	4	OPH 081



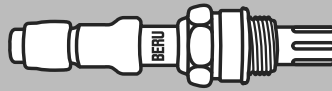

kW

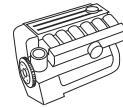
 Zyl.
Cyl.
Cil.

OPEL
ASTRA H

2.0 Turbo	2,0	D, 1	147	09.04-	Z 20 LER	4	OPH 084
2.0 Turbo	2,0	R, 1	177	03.05-	Z 20 LEH	4	OPH 081
2.0 Turbo	2,0	D, 1	177	03.05-	Z 20 LEH	4	OPH 084

ASTRA H Caravan

2.0 Turbo	2,0	R, 1	125	08.04-	Z 20 LEL	4	OPH 081
2.0 Turbo	2,0	D, 1	125	08.04-	Z 20 LEL	4	OPH 084
2.0 Turbo	2,0	R, 1	147	09.04-	Z 20 LER	4	OPH 081
2.0 Turbo	2,0	D, 1	147	09.04-	Z 20 LER	4	OPH 084

ASTRA H GTC

2.0 Turbo	2,0	R, 1	125	03.05-	Z 20 LEL	4	OPH 081
2.0 Turbo	2,0	D, 1	125	03.05-	Z 20 LEL	4	OPH 084
2.0 Turbo	2,0	R, 1	147	03.05-	Z 20 LER	4	OPH 081
2.0 Turbo	2,0	D, 1	147	03.05-	Z 20 LER	4	OPH 084
2.0 Turbo	2,0	R, 1	177	08.05-	Z 20 LEH	4	OPH 081
2.0 Turbo	2,0	D, 1	177	08.05-	Z 20 LEH	4	OPH 084

ASTRA H TwinTop

2.0 Turbo	2,0	R, 1	125	09.05-	Z 20 LEL	4	OPH 081
2.0 Turbo	2,0	D, 1	125	09.05-	Z 20 LEL	4	OPH 084
2.0 Turbo	2,0	R, 1	147	09.05-	Z 20 LER	4	OPH 081
2.0 Turbo	2,0	D, 1	147	09.05-	Z 20 LER	4	OPH 084

CALIBRA A

2.0 i	2,0	R	85	06.90-07.97	C 20 NE	4	OZH 040
2.0 i 4x4	2,0	R	85	06.90-03.97	C 20 NE	4	OZH 040
2.0 i 16V	2,0	R	110	06.90-02.94	C 20 XE, → Chassis # N9999999, P1000345, Chassis # P1000346, P9000001 →	4	OZH 040
2.0 i 16V 4x4	2,0	R	110	06.90-02.94	C 20 XE, → Chassis # N9999999, P1000345, Chassis # P1000346, P9000001 →	4	OZH 040
2.0 i Turbo 4x4	2,0	R	150	03.92-07.97	C 20 LET	4	OZH 028
2.5 i V6	2,5	R	125	04.93-07.97	C 25 XE	6	OZH 040
2.5 i V6	2,5	D	125	04.93-07.97	X 25 XE	6	OZH 147

COMBO

1.2	1,2	R	33	07.94-10.01	C 12 NZ/X 12 SZ	4	OZU 005
1.4	1,4	R	44	07.94-10.01	C 14 NZ/X 14 SZ	4	OZU 005
1.4	1,4	R	60	07.94-10.01	C 14 SE	4	OZU 005
1.4 16V	1,4	R	66	08.99-10.01	X 14 XE, → Chassis # S 4269627/ S 6011904	4	OZU 023
1.4 16V	1,4	R	66	08.99-10.01	X 14 XE, Chassis # S 4269628/ S 6011905 →	4	OZU 005

CORSA A CC

1.2 i	1,2	R	33	09.89-03.93	C 12 NZ	4	OZU 005
1.3 i	1,3	R	44	09.86-09.90	C 13 N	4	OZU 005
1.4 i	1,4	R	44	01.90-03.93	C 14 NZ	4	OZU 005
1.6 GSI	1,6	R	72	09.89-03.93	C 16 SEI	4	OZH 040

CORSA A CC

1.6 GSI	1,6	R	74	05.88-03.92	E 16 SE	4	OZH 040
1.6 GSI KAT	1,6	R	74	02.92-03.93	C 16 SE	4	OZH 040

CORSA B

1.2 i	1,2	R	33	03.93-09.00	C 12 NZ/X 12 SZ	4	OZU 005
1.4 i	1,4	R	44	03.93-09.00	C 14 NZ, X 14 SZ	4	OZU 005
1.4 i 16V	1,4	R	63	08.97-09.00	C 14 SEL, → Chassis # S 4269627/ S 6011904	4	OZU 023
1.4 i 16V	1,4	R	63	08.97-09.00	C 14 SEL, Chassis # S 4269628/ S 6011905 →	4	OZU 005
1.4 i 16V	1,4	R	66	09.94-09.00	X 14 XE, → Chassis # S 4269627/ S 6011904	4	OZU 023
1.4 i 16V	1,4	R	66	09.94-09.00	X 14 XE, Chassis # S 4269628/ S 6011905 →	4	OZU 005
1.4 Si	1,4	R	60	03.93-09.00	C 14 SE	4	OZU 005

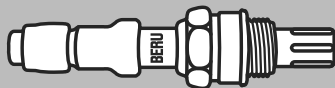
**BERU**

kW

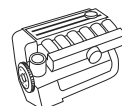
Zyl.
Cyl.
Cil.**OPEL****CORSA B**

1.6 i 16V	1,6	R	74	08.97-09.00	C 16 SEL, → Chassis # S 4269627/ S 6011904	4	OZU 023
1.6 i 16V	1,6	R	74	08.97-09.00	C 16 SEL, Chassis # S 4269628/ S 6011905 →	4	OZU 005
1.6 i 16V	1,6	R	78	09.94-09.00	X 16 XE, → Chassis # S 4269627/ S 6011904	4	OZU 023
1.6 i 16V	1,6	R	78	09.94-09.00	X 16 XE, Chassis # S 4269628/ S 6011905 →	4	OZU 005
1.6 GSI 16V	1,6	R	80	03.93-09.00	C 16 XE, → Chassis # S 4269627/ S 6011904	4	OZU 023
1.6 GSI 16V	1,6	R	80	03.93-09.00	C 16 XE, Chassis # S 4269628/ S 6011905 →	4	OZU 005

CORSA C

1.0	1,0	D, 1	43	09.00-	Z 10 XE	3	OPH 078
1.0	1,0	R, 1	43	09.00-	Z 10 XE	3	OPH 079
1.2	1,2	D, 1	55	09.00-	Z 12 XE, → Chassis # 14177496, 16079019, 13025250	4	OPH 078
1.2	1,2	R, 1	55	09.00-	Z 12 XE	4	OPH 081
1.4	1,4	R	66	09.00-	Z 14 XE	4	OZH 132

FRONTERA

2.2 i	2,2	R	100	03.95-10.98	X 22 XE	4	OZH 019
-------	-----	---	-----	-------------	---------	---	----------------

FRONTERA A Sport

2.0 i	2,0	R	85	02.95-10.98	X 20 SE	4	OZH 019
2.0 i	2,0	R	85	03.92-10.98	C 20 NE	4	OZH 028

KADETT E

1.3 i KAT	1,3	R	44	09.85-08.91	C 13 N	4	OZU 005
1.6 i	1,6	R	55	09.86-08.91	E 16 NZ	4	OZU 005
1.6 i KAT	1,6	R	55	09.86-08.91	C 16 LZ, C 16 NZ	4	OZU 005
1.8 i	1,8	R	66	09.90-08.91	C 18 NT	4	OZH 040
1.8 i	1,8	R	66	09.90-08.91	C 18 NZ	4	OZU 005
1.8 i	1,8	R	74	10.85-08.86	C 18 NE	4	OZH 040
2.0 i	2,0	R	85	03.87-08.91	20 NE	4	OZH 040
2.0 i KAT	2,0	R	85	03.87-08.91	C 20 NE	4	OZH 040

KADETT E Cabriolet

1.6 i	1,6	R	55	10.86-02.93	E 16 NZ	4	OZU 005
1.6 i KAT	1,6	R	55	10.87-02.93	C 16 LZ, C 16 NZ	4	OZU 005
2.0 i	2,0	R	85	10.86-02.93	20 NE	4	OZH 040
2.0 i KAT	2,0	R	85	10.86-02.93	C 20 NE	4	OZH 040

KADETT E Caravan

1.3 i KAT	1,3	R	44	09.85-08.91	C 13 N	4	OZU 005
1.6 i	1,6	R	55	09.86-08.91	E 16 NZ	4	OZU 005
1.6 i KAT	1,6	R	55	09.86-08.91	C 16 LZ, C 16 NZ	4	OZU 005
1.8 E	1,8	R	74	10.85-08.86	C 18 NE	4	OZH 040
1.8 i	1,8	R	66	06.85-08.91	C 18 NT	4	OZH 040
1.8 i	1,8	R	66	06.85-08.91	C 18 NZ	4	OZU 005
2.0 i	2,0	R	85	09.87-08.91	20 NE	4	OZH 040
2.0 i KAT	2,0	R	85	09.87-08.91	C 20 NE	4	OZH 040

KADETT E CC

1.3 i KAT	1,3	R	44	09.85-08.91	C 13 N	4	OZU 005
1.6 i	1,6	R	55	09.86-08.91	E 16 NZ	4	OZU 005
1.6 i KAT	1,6	R	55	09.86-08.91	C 16 NZ/C 16 LZ	4	OZU 005
1.8 E	1,8	R	74	10.85-08.86	C 18 NE	4	OZH 040
1.8 i	1,8	R	66	06.85-08.91	C 18 NT	4	OZH 040
1.8 i	1,8	R	66	06.85-08.91	C 18 NZ	4	OZU 005
2.0 GSI	2,0	R	85	09.86-08.91	20 NE	4	OZH 040
2.0 GSI KAT	2,0	R	85	09.86-08.91	C 20 NE	4	OZH 040
2.0 GSI 16V	2,0	R	110	03.88-08.91	20 XEJ	4	OZH 040
2.0 GSI 16V	2,0	R	115	12.87-08.91	20 XE	4	OZH 040
2.0 GSI 16V KAT	2,0	R	110	03.88-08.91	C 20 XE	4	OZH 040

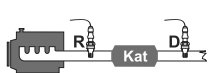

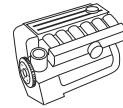

kW

 Zyl.
Cyl.
Cil.

OPEL
KADETT E Combo

1.3 N	1,3	R	44	01.86–12.89	13 N	4	OZU 005
1.6 i	1,6	R	55	08.91–07.94	C 16 NZ	4	OZU 005

KADETT E Kasten

1.3 N	1,3	R	44	09.84–07.89	13 N, 13 NB	4	OZU 005
1.6 i	1,6	R	55	08.89–09.93	C 16 NZ	4	OZU 005
1.8 i	1,8	R	66	08.84–09.85	C 18 NT	4	OZH 040
1.8 i	1,8	R	66	10.85–09.92	C 18 NT	4	OZU 005

MERIVA

1.6	1,6	R	64	05.03–05.10	Z 16 SE	4	OZH 110
1.6 16V	1,6	D	74	05.03–05.10	Z 16 XE	4	OZH 110
1.6 16V	1,6	R	74	05.03–05.10	Z 16 XE	4	OZH 132

MONTEREY A

3.2	3,2	R	130	06.92–07.98	6VD1	6	OZH 196
-----	-----	---	-----	-------------	------	---	----------------

OMEGA A

2.0	2,0	R	73	09.90–03.94	C 20 NEJ	4	OZH 028
2.0	2,0	R	74	09.90–03.94	C 20 NEF	4	OZH 028
2.0 i	2,0	R	85	09.86–03.94	C 20 NE	4	OZH 028
2.6 i	2,6	R	110	09.90–03.94	C 26 NE	6	OZH 040
3.0 (3000)	3,0	R	115	03.87–12.87	C 30 LE	6	OZH 040
3.0 (3000) KAT	3,0	R	130	03.88–03.94	C 30 NE	6	OZH 040
3.0 24V (3000)	3,0	R	147	09.89–03.94	C 30 SEJ	6	OZH 040
3.0 24V (3000)	3,0	R	150	09.89–03.94	C 30 SE	6	OZH 040

OMEGA A Caravan

2.0	2,0	R	74	09.90–03.94	C 20 NEF	4	OZH 028
2.0 i	2,0	R	73	09.90–03.94	C 20 NEJ	4	OZH 028
2.0 i	2,0	R	85	09.86–03.94	C 20 NE	4	OZH 028
2.6 i	2,6	R	110	09.90–03.94	C 26 NE	6	OZH 040
3.0	3,0	R	115	03.87–03.94	C 30 LE	6	OZH 040
3.0 KAT	3,0	R	130	03.87–03.94	C 30 NE	6	OZH 040
3.0 24V	3,0	R	147	09.89–03.94	C 30 SEJ	6	OZH 040

OMEGA B

2.0	2,0	R	85	03.94–09.99	X 20 SE	4	OZH 019
2.5 V6	2,5	R	125	03.94–09.00	X 25 XE	6	OZH 019
2.6 V6	2,6	D, 1, 2	132	09.00–07.03	Y 26 SE	6	OPH 080
2.6 V6	2,6	R, 1, 2	132	09.00–07.03	Y 26 SE	6	OPH 082
3.0 V6	3,0	R	155	04.94–02.01	X 30 XE	6	OZH 019
3.2 V6	3,2	D, 1, 2	160	02.01–07.03	Y 32 SE	6	OPH 080
3.2 V6	3,2	R, 1, 2	160	02.01–07.03	Y 32 SE	6	OPH 082

OMEGA B Caravan

2.0	2,0	R	85	03.94–09.99	X 20 SE	4	OZH 019
2.5 V6	2,5	R, 2	125	03.94–08.94	X 25 XE	6	OZH 019
2.6 V6	2,6	D, 1, 2	132	09.00–07.03	Y 26 SE	6	OPH 080
2.6 V6	2,6	R, 1, 2	132	09.00–07.03	Y 26 SE	6	OPH 082
3.0 V6	3,0	R	155	04.94–02.01	X 30 XE	6	OZH 019
3.2 V6	3,2	D, 1, 2	160	02.01–07.03	Y 32 SE	6	OPH 080
3.2 V6	3,2	R, 1, 2	160	02.01–07.03	Y 32 SE	6	OPH 082

REKORD E

1.8 E	1,8	R	74	05.85–08.86	C 18 NV	4	OZH 028
-------	-----	---	----	-------------	---------	---	----------------

SENATOR B

2.6 i	2,6	R	110	09.90–09.93	C 26 NE	6	OZH 040
3.0	3,0	R	115	09.87–09.93	C 30 LE, → Chassis # M1000000	6	OZH 040
3.0 i KAT	3,0	R	130	01.88–09.93	C 30 NE	6	OZH 040
3.0 24V	3,0	R	150	09.89–09.93	C 30 SE	6	OZH 040

SIGNUM

2.0 Turbo	2,0	R	129	05.03–	Z 20 NET	4	OZH 232
-----------	-----	---	-----	--------	----------	---	----------------

SINTRA

2.2 i 16V	2,2	R	104	11.96–04.99	X 22 XE	4	OZH 040
3.0 i 24V	3,0	R	148	11.96–04.99	X 30 XE	6	OZH 019

SPEEDSTER

2.0 Turbo	2,0	R, 1	147	04.03–	Z 20 LET	4	OPH 081
2.0 Turbo	2,0	D, 1	147	04.03–	Z 20 LET	4	OPH 084

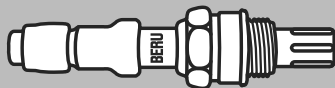
**BERU**

kW

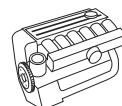
Zyl.
Cyl.
Cil.**OPEL****SPEEDSTER**

2.2	2,2	D	108	09.00-	Z 22 SE	4	OZH 236
-----	-----	---	-----	--------	---------	---	----------------

TIGRA

1.4 16V	1,4	R	63	08.97-12.00	X 14 XE, → Chassis # S 4269627/ S 6011904	4	OZU 023
---------	-----	---	----	-------------	--	---	----------------

1.4 16V	1,4	R	63	08.97-12.00	X 14 XE, Chassis # S 4269628/ S 6011905 →	4	OZU 005
---------	-----	---	----	-------------	--	---	----------------

1.4 16V	1,4	R	66	07.94-12.00	X 14 XE, → Chassis # S 4269627/ S 6011904	4	OZU 023
---------	-----	---	----	-------------	--	---	----------------

1.4 16V	1,4	R	66	07.94-12.00	X 14 XE, Chassis # S 4269628/ S 6011905 →	4	OZU 005
---------	-----	---	----	-------------	--	---	----------------

1.6 16V	1,6	R	74	08.97-08.98	C 16 SEL, → Chassis # S 4269627/ S 6011904	4	OZU 023
---------	-----	---	----	-------------	---	---	----------------

1.6 16V	1,6	R	74	08.97-08.98	C 16 SEL, Chassis # S 4269628/ S 6011905 →	4	OZU 005
---------	-----	---	----	-------------	---	---	----------------

1.6 16V	1,6	R	78	07.94-08.98	X 16 XE, → Chassis # S 4269627/ S 6011904	4	OZU 023
---------	-----	---	----	-------------	--	---	----------------

1.6 16V	1,6	R	78	07.94-08.98	X 16 XE, Chassis # S 4269628/ S 6011905 →	4	OZU 005
---------	-----	---	----	-------------	--	---	----------------

VECTRA A

1.6 i	1,6	R	52	09.93-11.95	X 16 SZ	4	OZU 005
-------	-----	---	----	-------------	---------	---	----------------

1.6 i	1,6	R	55	09.88-10.90	E 16 NZ	4	OZU 005
-------	-----	---	----	-------------	---------	---	----------------

1.6 i KAT	1,6	R	55	09.88-11.95	C 16 NZ2/C 16 NZ	4	OZU 005
-----------	-----	---	----	-------------	------------------	---	----------------

1.8 i KAT	1,8	R	66	03.90-11.95	C 18 NZ	4	OZU 005
-----------	-----	---	----	-------------	---------	---	----------------

2.0 i	2,0	R	85	09.88-10.90	20 NE	4	OZU 005
-------	-----	---	----	-------------	-------	---	----------------

2.0 i 4x4	2,0	R	85	01.89-10.90	20 NE	4	OZH 040
-----------	-----	---	----	-------------	-------	---	----------------

2.0 i 4x4 KAT	2,0	R	85	01.89-11.95	C 20 NE	4	OZH 040
---------------	-----	---	----	-------------	---------	---	----------------

2.0 i KAT	2,0	R	85	09.88-11.95	C 20 NE	4	OZH 040
-----------	-----	---	----	-------------	---------	---	----------------

2000 16V 4x4	2,0	R	110	01.89-10.90	20 XEJ	4	OZH 040
--------------	-----	---	-----	-------------	--------	---	----------------

2000/GT 16V	2,0	R	110	01.89-06.94	20 XEJ	4	OZH 040
-------------	-----	---	-----	-------------	--------	---	----------------

2000/GT 16V KAT	2,0	R	110	02.90-11.95	C 20 XE	4	OZH 040
-----------------	-----	---	-----	-------------	---------	---	----------------

2000/GT 16V 4x4 KAT	2,0	R	110	02.90-11.95	C 20 XE	4	OZH 040
---------------------	-----	---	-----	-------------	---------	---	----------------

VECTRA A CC

1.6 i	1,6	R	52	09.93-11.95	X 16 SZ	4	OZU 005
-------	-----	---	----	-------------	---------	---	----------------

1.6 i KAT	1,6	R	55	09.88-11.95	C 16 NZ2/C 16 NZ	4	OZU 005
-----------	-----	---	----	-------------	------------------	---	----------------

1.8 i KAT	1,8	R	66	03.90-11.95	C 18 NZ	4	OZU 005
-----------	-----	---	----	-------------	---------	---	----------------

2.0 i	2,0	R	85	09.88-10.90	20 NE	4	OZH 040
-------	-----	---	----	-------------	-------	---	----------------

2.0 i KAT	2,0	R	85	09.88-11.95	C 20 NE	4	OZH 040
-----------	-----	---	----	-------------	---------	---	----------------

2.0 i 16V	2,0	R	110	02.89-10.90	20 XEJ	4	OZH 040
-----------	-----	---	-----	-------------	--------	---	----------------

2.0 i 16V KAT	2,0	R	110	02.90-11.95	C 20 XE	4	OZH 040
---------------	-----	---	-----	-------------	---------	---	----------------

VECTRA B

1.6 i	1,6	R	55	10.95-04.02	X 16 SZR	4	OZU 005
-------	-----	---	----	-------------	----------	---	----------------

1.6 i 16V	1,6	R	74	04.99-04.02	Z 16 XE, Y 16 XE	4	OZH 112
-----------	-----	---	----	-------------	------------------	---	----------------

1.6 i 16V	1,6	R	74	10.95-08.00	X 16 XEL	4	OZH 148
-----------	-----	---	----	-------------	----------	---	----------------

1.6 i 16V	1,6	R	74	10.95-04.02	X 16 XEL	4	OZU 005
-----------	-----	---	----	-------------	----------	---	----------------

1.8 i 16V	1,8	R, 3	92	09.00-04.02	Z 18 XE	4	OZH 113
-----------	-----	------	----	-------------	---------	---	----------------

1.8 i 16V	1,8	R, 2	92	09.00-04.02	Z 18 XE	4	OZH 114
-----------	-----	------	----	-------------	---------	---	----------------

1.8 i 16V	1,8	D	92	09.00-04.02	Z 18 XE	4	OZH 115
-----------	-----	---	----	-------------	---------	---	----------------

2.5 i V6	2,5	R, 4	125	10.95-09.00	X 25 XE	6	OZH 019
----------	-----	------	-----	-------------	---------	---	----------------

2.5 i V6	2,5	R	125	10.95-10.96	X 25 XE	6	OZH 040
----------	-----	---	-----	-------------	---------	---	----------------

2.5 i V6	2,5	D	125	11.96-09.00	X 25 XE	6	OZH 147
----------	-----	---	-----	-------------	---------	---	----------------

2.6 i V6	2,6	D, 1	125	09.00-04.02	Y 26 SE	6	OPH 083
----------	-----	------	-----	-------------	---------	---	----------------

i 500 2.5	2,5	D	143	05.98-06.00	X 25 XE, → Chassis # 707 839 1, 514 189 2, V 114 943	6	OZH 147
-----------	-----	---	-----	-------------	---	---	----------------

VECTRA B Caravan

1.6 i	1,6	R	55	11.96-06.00	X 16 SZR	4	OZU 005
-------	-----	---	----	-------------	----------	---	----------------

1.6 i 16V	1,6	R	74	04.99-07.02	Z 16 XE, Y 16 XE	4	OZH 112
-----------	-----	---	----	-------------	------------------	---	----------------

1.6 i 16V	1,6	R	74	11.96-08.00	X 16 XEL	4	OZH 148
-----------	-----	---	----	-------------	----------	---	----------------

1.6 i 16V	1,6	R	74	11.96-07.02	X 16 XEL	4	OZU 005
-----------	-----	---	----	-------------	----------	---	----------------

1.8 i 16V	1,8	R, 3	92	09.00-07.03	Z 18 XE	4	OZH 113
-----------	-----	------	----	-------------	---------	---	----------------

1.8 i 16V	1,8	R, 2	92	09.00-07.03	Z 18 XE	4	OZH 114
-----------	-----	------	----	-------------	---------	---	----------------

1.8 i 16V	1,8	D	92	09.00-07.03	Z 18 XE	4	OZH 115
-----------	-----	---	----	-------------	---------	---	----------------



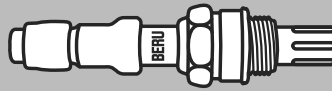

kW

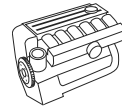
 Zyl.
Cyl.
Cil.

OPEL
VECTRA B Caravan

2.5 i V6	2,5	R, 4	125	11.96–09.00	X 25 XE	6	OZH 019
2.5 i V6	2,5	R	125	11.96–09.00	X 25 XE	6	OZH 040
2.5 i V6	2,5	D	125	11.96–06.00	X 25 XE, → Chassis # 707 839 1, 514 189 2, V 114 943	6	OZH 147
2.6 i V6	2,6	D, 1	125	09.00–07.03	Y 26 SE	6	OPH 083
i 500 2.5	2,5	D	143	05.98–06.00	X 25 XE, → Chassis # 707 839 1, 514 189 2, V 114 943	6	OZH 147

VECTRA B CC

1.6 i	1,6	R	55	10.95–07.03	X 16 SZR	4	OZU 005
1.6 i 16V	1,6	R	74	04.99–07.02	Y 16 XE, Z 16 XE	4	OZH 112
1.6 i 16V	1,6	R	74	10.95–08.00	X 16 XEL	4	OZH 148
1.6 i 16V	1,6	R	74	10.95–07.02	X 16 XEL	4	OZU 005
1.8 i 16V	1,8	R, 3	92	09.00–07.03	Z 18 XE	4	OZH 113
1.8 i 16V	1,8	R, 2	92	09.00–07.03	Z 18 XE	4	OZH 114
1.8 i 16V	1,8	D	92	09.00–07.03	Z 18 XE	4	OZH 115
2.5 i V6	2,5	R, 4	125	10.95–09.00	X 25 XE	6	OZH 019
2.5 i V6	2,5	R	125	10.95–09.00	X 25 XE	6	OZH 040
2.5 i V6	2,5	D	125	11.96–06.00	X 25 XE, → Chassis # 707 839 1, 514 189 2, V 114 943	6	OZH 147
2.6 i V6	2,6	D, 1	125	09.00–07.03	Y 26 SE	6	OPH 083

VECTRA C

1.6 16V	1,6	D	74	06.04–	Z 16 XE	4	OZH 110
1.6 16V	1,6	R	74	06.04–	Z 16 XE	4	OZH 132
2.0 16V Turbo	2,0	R	129	03.03–	Z 20 NET	4	OZH 232

VECTRA C Caravan

1.6 16V	1,6	D	74	06.04–	Z 16 XE	4	OZH 110
1.6 16V	1,6	R	74	06.04–	Z 16 XE	4	OZH 132
2.0 Turbo	2,0	R	129	10.03–	Z 20 NET	4	OZH 232

VECTRA C GTS

2.0 16V Turbo	2,0	R	129	03.03–	Z 20 NET	4	OZH 232
---------------	-----	---	-----	--------	----------	---	----------------

ZAFIRA (F75_)

1.6 16V	1,6	D	74	04.99–08.99	Z 16 XE, Chassis # 22000001 →	4	OZH 110
1.6 16V	1,6	R	74	09.00–06.05	Z 16 XE	4	OZH 132
1.6 16V	1,6	R	74	04.99–08.99	X 16 XEL	4	OZH 148
1.6 CNG	1,6	R	71	09.01–06.05	Z 16 YNG	4	OZH 132
1.8 16V	1,8	R, 3	92	09.00–06.05	Z 18 XE	4	OZH 113
1.8 16V	1,8	R, 2	92	09.00–06.05	Z 18 XE	4	OZH 114
1.8 16V	1,8	D	92	09.00–06.05	Z 18 XE	4	OZH 115
2.0 OPC	2,0	D, 1	141	09.01–06.05	Z 20 LET	4	OPH 084
2.0 OPC	2,0	D, 1	147	11.02–06.05	Z 20 LET	4	OPH 084
2.2 16V	2,2	D	108	09.00–06.05	Z 22 SE	4	OZH 236

ZAFIRA

2.0	2,0	R, 1	147	07.05–	Z 20 LER	4	OPH 081
2.0	2,0	D, 1	147	07.05–	Z 20 LER	4	OPH 084
2.0	2,0	R, 1	177	01.06–	Z 20 LEH	4	OPH 081
2.0	2,0	D, 1	177	01.06–	Z 20 LEH	4	OPH 084

PEUGEOT

1007							
1.6 16V	1,6	R, 1	80	04.05–01.09	NFU (TU5JP4)	4	OPH 010
1.6 16V	1,6	D, 1	80	04.05–01.09	NFU (TU5JP4)	4	OPH 012

106 I

1.0	1,0	R	33	07.92–06.95	TU9/CDY (TU9M)	4	OZH 072
1.0	1,0	R	33	07.95–04.96	TU9/CDY (TU9M)	4	OZH 074
1.0	1,0	R	37	07.92–06.95	CDZ (TU9M)	4	OZH 072
1.0	1,0	R	37	07.95–04.96	CDZ (TU9M)	4	OZH 074
1.1	1,1	R	44	09.91–06.95	HDZ (TU1M)	4	OZH 072
1.1	1,1	R	44	07.95–04.96	HDZ (TU1M)	4	OZH 074
1.3	1,3	R	72	10.93–06.95	TU2J2	4	OZH 072
1.3	1,3	R	72	07.95–04.96	TU2J2	4	OZH 074
1.4	1,4	R	55	10.92–06.95	KDX (TU3MC)/KDY (TU3M)	4	OZH 072

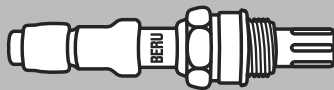

BERU



kW

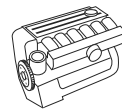

Zyl.
Cyl.
Cil.



PEUGEOT

106 I

1.4	1,4	R	55	07.95-04.96	KDX (TU3MC)/KDY (TU3M)	4	OZH 074
1.4	1,4	R	69	09.91-06.95	KFZ (TU3J2/Z)	4	OZH 072
1.4	1,4	R	69	07.95-04.96	KFZ (TU3J2/Z)	4	OZH 074
1.6	1,6	R	65	06.93-06.95	NFZ (TU5JP)	4	OZH 072
1.6	1,6	R	65	07.95-04.96	NFZ (TU5JP)	4	OZH 074
1.6	1,6	R	76	01.94-06.95	NFY (TU5J2)	4	OZH 072
1.6	1,6	R	76	07.95-04.96	NFY (TU5J2)	4	OZH 074

106 II

1.0 i	1,0	R	33	05.96-	CDY (TU9M)	4	OZH 074
1.0 i	1,0	R	37	01.97-	CDZ (TU9M)	4	OZH 074
1.1 i	1,1	R	40	01.97-	HDY (TU1M)	4	OZH 074
1.1 i	1,1	R + D, 1	44	03.00-05.05	HFX (TU1JP)	4	OPH 012
1.1 i	1,1	R	44	05.96-03.00	HDZ	4	OZH 074
1.4 i	1,4	R + D, 1	55	05.96-05.05	KFX (TU3JP), (Euro 3)	4	OPH 010
1.4 i	1,4	R	55	05.96-	KFX (TU3JP)/KFW (TU3JP)	4	OZH 074
1.6 i	1,6	R	65	05.96-	NFZ (TU5JP)	4	OZH 074
1.6 i	1,6	R	74	05.96-	NFW (TU5J2)/NFY (TU5J2)	4	OZH 074
1.6 S16	1,6	R	87	05.96-10.99	NFX (TU5J4)→ Org. # 8364	4	OZH 104
1.6 S16	1,6	R	87	05.96-05.05	NFX (TU5J4) (ECE-Norm)	4	OZH 205

205 I

1.4	1,4	R	44	02.83-10.87	150D (XY7)/150G (XY7)	4	OZH 066
1.6	1,6	R	53	03.87-10.87	B1E (XU51C)	4	OZH 066
1.6	1,6	R	55	08.86-10.87	BAZ (XU5CP)	4	OZH 066
1.9 GTI	1,9	R	75	03.87-10.87	DFZ (XU9J1)	4	OZH 066

205 I Cabriolet

1.1 CJ	1,1	R	44	10.89-12.94	HDZ (TU1M)	4	OZH 029
1.4 CJ	1,4	R	55	05.91-12.94	KDZ (TU3M)/KDY (TU3M)	4	OZH 029
1.4 CJ KAT	1,4	R	44	01.89-10.90	KAY (TU3CP)	4	OZH 066
1.6 CJ	1,6	R	65	08.92-12.94	BDY (XU5M3Z)	4	OZH 029
1.9 CTI	1,9	R	75	10.87-12.94	DFZ (XU9J1)	4	OZH 066

205 II

1.0	1,0	R	33	07.92-09.98	TU9	4	OZH 029
1.1	1,1	R	44	07.89-09.98	HDZ (TU1M)	4	OZH 029
1.4	1,4	R	55	07.88-10.90	KFX (TU3JP)/KDZ (TU3M)/ KDY (TU3M)	4	OZH 029
1.4	1,4	R	55	08.90-07.98	KDX (TU3MC)	4	OZH 034
1.4 KAT	1,4	R	44	08.87-10.90	KAY (TU3CP)	4	OZH 066
1.6 Aut.	1,6	R	65	05.90-09.98	BDY (XU5M2Z)/BDY (XU5M3Z)	4	OZH 029
1.9 GTI	1,9	R	75	10.87-05.89	D2A (XU92C)	4	OZH 066
1.9 GTI KAT	1,9	R	75	10.87-07.94	DFZ (XU9J1)	4	OZH 066
1.9 GTI	1,9	R	88	10.87-10.94	DKZ (XU9JAZ)	4	OZH 066

206 CC

1.6 16V	1,6	R, 1	80	09.00-03.07	NFU (TU5JP4), (Euro 4)	4	OPH 010
1.6 16V	1,6	R + D, 1	80	09.00-03.07	NFU (TU5JP4)	4	OPH 012
2.0 S16	2,0	R, 1	100	09.00-05.03	RFN (EW10J4),→ Org. # 9673	4	OPH 012
2.0 S16	2,0	R, 1	100	06.03-03.07	RFN (EW10J4),→ Org. # 9674	4	OPH 020

206 Schrägheck

1.1 i	1,1	R, 1	44	10.05-	HFX (TU1JP)→ Org. # 10556	4	OPH 010
1.1 i	1,1	R, 1	44	03.00-09.05	HFX (TU1JP)→ Org. # 10555	4	OPH 012
1.4 i	1,4	R, 1	55	09.98-02.09	KFX (TU3JP), (Euro 3)	4	OPH 010
1.6 16V	1,6	R, 1	80	12.00-08.07	NFU (TU5JP4), (Euro 4)	4	OPH 010
1.6 16V	1,6	R + D, 1	80	12.00-08.07	NFU (TU5JP4)	4	OPH 012
1.6 i	1,6	R, 1	65	09.98-12.00	NFZ (TU5JP)	4	OPH 010
2.0 S16	2,0	R, 1	99	04.99-10.00	RFR (DEW10J4)	4	OPH 012
2.0 S16	2,0	R, 1	100	10.00-05.03	RFN (EW10J4),→ Org. # 9673	4	OPH 012
2.0 S16	2,0	R, 1	100	06.03-11.04	RFN (EW10J4),→ Org. # 9674	4	OPH 020

206 Stufenheck

1.6 16V	1,6	R, 1	80	03.07-	NFU (TU5JP4), (Euro 4)	4	OPH 010
1.6 16V	1,6	R + D, 1	80	03.07-	NFU (TU5JP4)	4	OPH 012

206 Schrägheck

2.0 RC	2,0	R, 1	130	07.03-08.06	RFK (EW10J4S)	4	OPH 020
--------	-----	------	-----	-------------	---------------	---	----------------

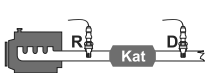

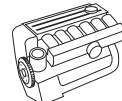

kW

Zyl.
Cyl.
Cil.**PEUGEOT****206 SW**

1.1	1,1	R, 1	44	10.05-	HFX (TU1JP), → Org. # 10556	4	OPH 010
1.1	1,1	R, 1	44	07.02-09.05	HFX (TU1JP), → Org. # 10555	4	OPH 012
1.6 16V	1,6	R, 1	80	07.02-12.06	NFU (TU5JP4), (Euro 4)	4	OPH 010
1.6 16V	1,6	R + D, 1	80	07.02-12.06	NFU (TU5JP4)	4	OPH 012
2.0 16V	2,0	R, 1	100	07.02-05.03	RFN (EW10J4), → Org. # 9673	4	OPH 012
2.0 16V	2,0	R, 1	100	06.03-10.05	RFN (EW10J4), → Org. # 9674	4	OPH 020

207

1.6 16V	1,6	R, 1	80	05.06-08.07	NFU (TU5JP4)	4	OPH 010
1.6 16V	1,6	D, 1	80	05.06-08.07	NFU (TU5JP4)	4	OPH 012

305 II

1.6	1,6	R	54	11.86-12.88	BAZ (XU5CP)	4	OZH 066
1.9	1,9	R	72	11.86-12.88	DFZ (XU9J1)	4	OZH 066

305 II Break

1.6	1,6	R	54	11.86-12.88	BAZ (XU5CP)	4	OZH 066
1.9	1,9	R	72	11.86-12.88	DFZ (XU9J1)	4	OZH 066

306

1.1	1,1	R	44	06.94-02.95	HDZ (TU1M)	4	OZH 038
1.1	1,1	R	44	03.95-04.97	HDZ (TU1M)	4	OZH 074
1.4 SL	1,4	R, 1	55	05.97-05.01	KFX (TU3JP), (Euro 3)	4	OPH 010
1.4 SL	1,4	D, 1	55	05.97-05.01	KFX (TU3JP), (Euro 3)	4	OPH 020
1.4 SL	1,4	R	55	06.94-02.95	KDX (TU3MC)/KFX (TU3JP)/ KFW (TU3JP)	4	OZH 038
1.4 SL	1,4	R	55	03.95-04.97	KDX (TU3MC)/KFX (TU3JP)/ KFW (TU3JP)	4	OZH 074
1.6	1,6	R + D, 1	72	10.00-05.01	NFT	4	OPH 012
1.6 SR	1,6	R, 1	65	07.98-10.00	NFZ (TU5JP) → Org. # 7875	4	OPH 010
1.6 SR	1,6	D, 1	65	05.97-10.00	NFZ (TU5JP), (Euro 3)	4	OPH 020
1.6 SR	1,6	R	65	06.94-02.95	NFZ (TU5JP)	4	OZH 038
1.6 SR	1,6	R	65	03.95-04.97	NFZ (TU5JP)	4	OZH 074
1.8 ST	1,8	R	74	06.94-02.95	LFZ (XU7JP)	4	OZH 034
1.8 ST	1,8	R	74	05.97-05.01	LFZ (XU7JP)	4	OZH 074
1.8 ST	1,8	R	74	03.95-04.97	LFZ (XU7JP)	4	OZH 104
1.8 16V	1,8	R, 1	81	03.97-05.01	LFY (XU7JP4), (Euro 3)	4	OPH 012
2.0 S16	2,0	R	110	06.94-02.95	RFT (XU10J4)	4	OZH 034
2.0 S16	2,0	R	110	03.95-04.97	RFT (XU10J4)	4	OZH 104
2.0 S16	2,0	R	112	06.94-02.95	RFY (XU10J4Z)	4	OZH 034
2.0 ST	2,0	R	89	07.94-02.95	RFX (XU10J2)	4	OZH 034
2.0 ST	2,0	R	89	03.95-04.97	RFX (XU10J2)	4	OZH 104

306 Break

1.4	1,4	R, 1	55	05.97-03.02	KFX (TU3JP), (Euro 3)	4	OPH 010
1.4	1,4	D, 1	55	03.97-03.02	KFX (TU3JP), (Euro 3)	4	OPH 020
1.4	1,4	R	55	03.97-04.97	KFX (TU3JP)/KFW (TU3JP), → Org. # 7874	4	OZH 074
1.6	1,6	R, 1	65	07.98-10.00	NFZ (TU5JP) → Org. # 7875	4	OPH 010
1.6	1,6	D, 1	65	03.97-10.00	NFZ (TU5JP), (Euro 3)	4	OPH 020
1.6	1,6	R	65	03.97-06.98	NFZ (TU5JP) → Org. # 7874	4	OZH 074
1.6	1,6	R + D, 1	72	10.00-04.02	NFT	4	OPH 012
1.8	1,8	R	74	05.97-04.02	LFZ (XU7JP)	4	OZH 074
1.8	1,8	R	74	03.97-04.97	LFZ (XU7JP)	4	OZH 104
1.8 16V	1,8	R, 1	81	03.97-04.02	LFY (XU7JP4), (Euro 3)	4	OPH 012
2.0	2,0	R	97	03.97-04.02	RFV (XU10J4R)	4	OZH 104

306 Cabriolet

1.6	1,6	R, 1	65	07.98-10.00	NFZ (TU5JP) → Org. # 7875	4	OPH 010
1.6	1,6	D, 1	65	05.97-10.00	NFZ (TU5JP), (Euro 3)	4	OPH 020
1.6	1,6	R	65	04.96-04.97	NFZ (TU5JP)	4	OZH 074
1.6	1,6	R + D, 1	72	10.00-04.02	NFT	4	OPH 012
1.8	1,8	R	74	05.97-04.02	LFZ (XU7JP)	4	OZH 074
1.8	1,8	R	74	03.94-04.97	LFZ (XU7JP)	4	OZH 104
1.8 16V	1,8	R, 1	81	07.00-04.02	LFY (XU7JP4), (Euro 3)	4	OPH 012
2.0	2,0	R	89	03.94-02.95	RFX (XU10J2)	4	OZH 034
2.0	2,0	R	89	03.95-04.97	RFX (XU10J2)	4	OZH 104

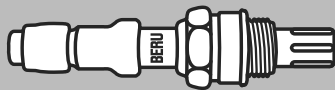
**BERU**

kW

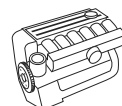
Zyl.
Cyl.
Cil.**PEUGEOT**

306 Cabriolet							
2.0 16V	2,0	R	97	03.97-04.02	RFV (XU10J4R)	4	OZH 104
306 Schrägheck							
1.1	1,1	R	44	05.93-02.95	HDZ (TU1M)	4	OZH 038
1.1	1,1	R	44	03.95-04.97	HDZ (TU1M)	4	OZH 074
1.4	1,4	R	55	05.93-02.95	KDX (TU3MC)/KFX (TU3JP)/ KFW (TU3JP)	4	OZH 038
1.4	1,4	R	55	03.95-04.97	KDX (TU3MC)/KFX (TU3JP)/ KFW (TU3JP)	4	OZH 074
1.6	1,6	R, 1	65	07.98-10.00	NFZ (TU5JP)→ Org. # 7875	4	OPH 010
1.6	1,6	D, 1	65	05.97-10.00	NFZ (TU5JP), (Euro 3)	4	OPH 020
1.6	1,6	R	65	05.93-02.95	NFZ (TU5JP)	4	OZH 038
1.6	1,6	R	65	03.95-04.97	NFZ (TU5JP)	4	OZH 074
1.6	1,6	R + D, 1	72	10.00-05.01	NFT	4	OPH 012
1.8	1,8	R	74	05.93-02.95	LFZ (XU7JP)	4	OZH 034
1.8	1,8	R	74	05.97-05.01	LFZ (XU7JP)	4	OZH 074
1.8	1,8	R	74	03.95-04.97	LFZ (XU7JP)	4	OZH 104
1.8 16V	1,8	R, 1	81	03.97-05.01	LFY (XU7JP4), (Euro 3)	4	OPH 012
2.0 16V	2,0	R	97	03.97-05.01	RFV (XU10J4R)	4	OZH 104
2.0 S16	2,0	R	110	06.94-02.95	RFT (XU10J4)	4	OZH 034
2.0 S16	2,0	R	110	03.95-04.97	RFT (XU10J4)	4	OZH 104
2.0 S16	2,0	R	112	05.93-02.95	RFY (XU10J4Z)	4	OZH 034
2.0 S16	2,0	R	112	03.95-04.97	RFY (XU10J4Z)	4	OZH 104
2.0 S16	2,0	R	120	07.96-04.97	RFS (XU10J4RS)	4	OZH 079
2.0 XSi	2,0	R	89	05.93-02.95	RFX (XU10J2)	4	OZH 034
2.0 XSi	2,0	R	89	03.95-04.97	RFX (XU10J2)	4	OZH 104
307							
1.6 16V	1,6	R, 1	80	12.04-08.07	NFU (TU5JP4),→ Org. # 10229	4	OPH 010
1.6 16V	1,6	R, 1	80	08.00-11.04	NFU (TU5JP4),→ Org. # 10228	4	OPH 012
1.6 16V	1,6	D, 1	80	08.00-08.07	NFU (TU5JP4)	4	OPH 012
2.0 16V	2,0	R, 1	100	08.00-05.05	RFN (EW10J4)	4	OPH 020
2.0 16V	2,0	R, 1	130	06.05-12.06	RFK (EW10J4S)	4	OPH 020
307 Break							
1.6 16V	1,6	R, 1	80	12.04-05.08	NFU (TU5JP4),→ Org. # 10229	4	OPH 010
1.6 16V	1,6	R, 1	80	03.02-11.04	NFU (TU5JP4),→ Org. # 10228	4	OPH 012
1.6 16V	1,6	D, 1	80	03.02-05.08	NFU (TU5JP4)	4	OPH 012
2.0	2,0	R, 1	100	03.02-05.05	RFN (EW10J4)	4	OPH 020
307 CC							
1.6 16V	1,6	R, 1	80	06.05-03.09	NFU (TU5JP4)	4	OPH 010
1.6 16V	1,6	D, 1	80	06.05-03.09	NFU (TU5JP4)	4	OPH 012
2.0 16V	2,0	R, 1	100	10.03-05.05	RFN (EW10J4)	4	OPH 020
2.0 16V	2,0	R, 1	130	10.03-03.09	RFK (EW10J4S)	4	OPH 020
307 SW							
1.6 16V	1,6	R, 1	80	12.04-05.08	NFU (TU5JP4),→ Org. # 10229	4	OPH 010
1.6 16V	1,6	R, 1	80	03.02-11.04	NFU (TU5JP4),→ Org. # 10228	4	OPH 012
1.6 16V	1,6	D, 1	80	03.02-05.08	NFU (TU5JP4)	4	OPH 012
2.0 16V	2,0	R, 1	100	03.02-05.05	RFN (EW10J4)	4	OPH 020
309 I							
1.4	1,4	R	55	03.89-07.89	KDZ (TU3M)/KDY (TU3M)	4	OZH 029
1.6	1,6	R	53	08.87-07.89	B1E (XU51C)	4	OZH 066
1.6 KAT	1,6	R	55	09.86-06.88	BAZ (XU5CP)	4	OZH 066
1.9	1,9	R	72	03.86-07.89	DFZ (XU9J1)	4	OZH 066
1.9	1,9	R	80	07.88-07.89	DDZ (XU9M)	4	OZH 029
1.9 GTI	1,9	R	88	07.88-07.89	DKZ (XU9JAZ)	4	OZH 029
309 II							
1.1	1,1	R	44	10.90-12.93	HDZ (TU1M)	4	OZH 029
1.4	1,4	R	55	07.89-10.90	KDZ (TU3M)/KDY (TU3M)	4	OZH 029
1.6	1,6	R	65	07.89-03.91	BDY (XU5M2Z)/BDZ (XU5M)/ BDY (XU5M3Z)	4	OZH 029
1.9	1,9	R	72	08.89-12.93	DFZ (XU9J1)	4	OZH 066
1.9	1,9	R	80	10.90-12.93	DDZ (XU9M)	4	OZH 029
1.9 GTI	1,9	R	88	07.89-12.93	DKZ (XU9JAZ)	4	OZH 029



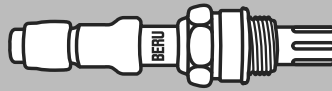

kW

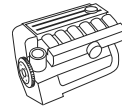

Zyl.
Cyl.
Cil.



PEUGEOT

309 II							
1.9 GTI 16V	1,9	R	108	10.90-12.93	DFW (XU9J4Z)	4	OZH 029
405 I							
1.6	1,6	R	65	07.89-09.90	BDY (XU5M2Z)/BDZ (XU5M)	4	OZH 005
1.6	1,6	R	66	10.89-09.90	BDZ (XU5M)	4	OZH 005
1.9	1,9	R	80	01.89-12.92	DDZ (XU9M)	4	OZH 005
1.9	1,9	R	80	07.88-01.89	DDZ (XU9M)	4	OZH 029
1.9	1,9	R	88	01.89-12.92	DKZ (XU9JAZ)	4	OZH 005
1.9	1,9	R	88	07.88-01.89	DKZ (XU9JAZ)	4	OZH 029
1.9 Injection	1,9	R	77	07.87-01.89	DFZ (XU9J1)	4	OZH 066
1.9 4x4	1,9	R	80	01.89-12.92	DDZ (XU9M)	4	OZH 005
1.9 4x4	1,9	R	80	07.88-01.89	DDZ (XU9M)	4	OZH 029
1.9 Sport MI-16	1,9	R	108	01.89-12.92	DFW (XU9J4Z)	4	OZH 005
1.9 Sport MI-16	1,9	R	108	04.88-01.89	DFW (XU9J4Z)	4	OZH 029
405 I Break							
1.6	1,6	R	65	07.89-09.90	BDY (XU5M2Z)/BDZ (XU5M)/ BDY (XU5M3Z)	4	OZH 005
1.9	1,9	R	72	05.88-01.89	DFZ (XU9J1)	4	OZH 066
1.9	1,9	R	77	10.88-01.89	DFZ (XU9J1)	4	OZH 066
1.9	1,9	R	80	01.89-08.92	DDZ (XU9M)	4	OZH 005
1.9	1,9	R	80	10.88-01.89	DDZ (XU9M)	4	OZH 029
1.9	1,9	R	88	01.89-08.92	DKZ (XU9JAZ)	4	OZH 005
1.9	1,9	R	88	10.88-01.89	DKZ (XU9JAZ)	4	OZH 029
1.9 4x4	1,9	R	80	01.89-08.92	DDZ (XU9M)	4	OZH 005
1.9 4x4	1,9	R	80	10.88-01.89	DDZ (XU9M)	4	OZH 029
405 II							
1.4	1,4	R	55	08.92-10.95	KDX (TU3MC)	4	OZH 034
1.6	1,6	R	65	08.92-06.95	BFZ (XU5JP)/BDZ (XU5M)	4	OZH 034
1.6	1,6	R	65	07.95-10.95	BFZ (XU5JP)/BDZ (XU5M)	4	OZH 079
1.8	1,8	R	74	08.92-06.95	LFZ (XU7JP)	4	OZH 034
1.8	1,8	R	74	07.95-10.95	LFZ (XU7JP)	4	OZH 079
2.0	2,0	R	89	08.92-06.95	RFX (XU10J2)	4	OZH 034
2.0	2,0	R	89	07.95-10.95	RFX (XU10J2)	4	OZH 079
2.0 X4	2,0	R	89	08.92-06.95	RFX (XU10J2)	4	OZH 034
2.0 X4	2,0	R	89	07.95-10.95	RFX (XU10J2)	4	OZH 079
2.0 16V	2,0	R	110	06.94-06.95	RFT (XU10J4)	4	OZH 034
2.0 16V	2,0	R	110	07.95-10.95	RFT (XU10J4)	4	OZH 079
2.0 MI-16	2,0	R	112	08.92-06.95	RFY (XU10J4Z)	4	OZH 034
2.0 MI-16	2,0	R	112	07.95-10.95	RFY (XU10J4Z)	4	OZH 079
2.0 T 16 X4	2,0	R	144	08.92-06.95	RGZ (XU10J4TE/Z)	4	OZH 034
2.0 T 16 X4	2,0	R	144	07.95-10.95	RGZ (XU10J4TE/Z)	4	OZH 079
405 II Break							
1.4	1,4	R	55	08.92-10.96	KDX (TU3MC)	4	OZH 034
1.6	1,6	R	65	08.92-06.95	BFZ (XU5JP)/BDY (XU5M2Z)/ BDZ (XU5M)/BDY (XU5M3Z)	4	OZH 034
1.6	1,6	R	65	07.95-10.96	BFZ (XU5JP)/BDY (XU5M2Z)/ BDZ (XU5M)/BDY (XU5M3Z)	4	OZH 079
1.8	1,8	R	74	08.92-06.95	LFZ (XU7JP)	4	OZH 034
1.8	1,8	R	74	07.95-10.96	LFZ (XU7JP)	4	OZH 079
2.0	2,0	R	89	08.92-06.95	RFX (XU10J2)	4	OZH 034
2.0	2,0	R	89	07.95-10.96	RFX (XU10J2)	4	OZH 079
2.0 4x4	2,0	R	89	08.92-06.95	RFX (XU10J2)	4	OZH 034
2.0 4x4	2,0	R	89	07.95-10.96	RFX (XU10J2)	4	OZH 079
2.0 4x4	2,0	R	144	08.92-06.95	RGZ (XU10J4TE/Z)	4	OZH 034
2.0 4x4	2,0	R	144	07.95-12.95	RGZ (XU10J4TE/Z)	4	OZH 079
406							
1.6	1,6	R	65	04.96-05.04	BFZ (XU5JP), → Org. # 7084	4	OZH 074
1.6	1,6	R	65	11.95-03.96	BFZ (XU5JP), → Org. # 7083	4	OZH 104
1.8 16V	1,8	R, 1	81	04.99-10.00	LFY (XU7JP4), (Euro 3)	4	OPH 010
1.8 16V	1,8	R	81	11.95-03.96	LFY (XU7JP4), → Org. # 7083	4	OZH 104
2.0 16V	2,0	R	97	11.95-03.99	RFV (XU10J4R)	4	OZH 079
2.0 16V	2,0	R	97	04.99-05.04	RFV (XU10J4R)	4	OZH 206

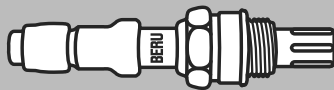
**BERU**

kW

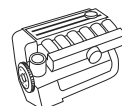
Zyl.
Cyl.
Cil.**PEUGEOT**

Model	Power (kW)	Cyl.	Valves	Power (kW)	Year Range	Part No.	Cyl.	Part No.
406								
2.0 16V	2,0	R, 1		99	04.99-08.00	RFR (DEW10J4)	4	OPH 012
2.0 16V	2,0	R, 1		100	08.00-05.04	RFN (EW10J4)	4	OPH 020
2.0 Turbo	2,0	R		108	04.96-05.04	RGX (XU10J2TE)	4	OZH 104
2.2	2,2	R, 1		116	07.00-05.04	3FZ (EW12J4)	4	OPH 020
3.0 V6	2,9	R + D, 1		152	03.00-05.04	XFX (ES9J4S)	6	OPH 012
406 Break								
1.8 16V	1,8	R, 1		81	04.99-10.00	LFY (XU7JP4), (Euro 3)	4	OPH 010
2.0 16V	2,0	R		97	10.96-03.99	RFV (XU10J4R)	4	OZH 079
2.0 16V	2,0	R, 1		99	04.99-10.00	RFR (DEW10J4)	4	OPH 012
2.0 16V	2,0	R, 1		100	10.00-06.04	RFN (EW10J4)	4	OPH 020
2.0 16V	2,0	R		97	04.99-06.04	RFV (XU10J4R)	4	OZH 206
2.0 Turbo	2,0	R		108	10.96-10.04	RGX (XU10J2TE)	4	OZH 104
2.2	2,2	R, 1		116	07.00-06.04	3FZ (EW12J4)	4	OPH 020
3.0 V6	2,9	R + D, 1		152	03.00-10.04	XFX (ES9J4S)	6	OPH 012
406 Coupe								
2.0 16V	2,0	R		97	03.97-12.04	RFV (XU10J4R)	4	OZH 079
2.0 16V	2,0	R		97	04.99-12.04	RFV (XU10J4R)	4	OZH 206
2.0 16V	2,0	R, 1		99	04.99-10.00	RFR (DEW10J4)	4	OPH 012
2.0 16V	2,0	R, 1		100	10.00-12.04	RFN (EW10J4)	4	OPH 020
2.2	2,2	R, 1		116	03.02-12.04	3FZ (EW12J4)	4	OPH 020
3.0 V6	2,9	R + D, 1		152	03.00-12.04	XFX (ES9J4S)	6	OPH 012
407								
2.0	2,0	R, 1		100	05.04-11.05	RFN (EW10J4)	4	OPH 020
2.2	2,2	R, 1		116	05.04-10.05	3FZ (EW12J4)	4	OPH 020
3.0	2,9	R + D, 1		155	05.04-12.06	XFV (ES9A)	6	OPH 012
407 Coupe								
3.0 V6	2,9	R + D, 1		155	10.05-06.09	XFV (ES9A)	6	OPH 012
407 SW								
2.0	2,0	R, 1		100	05.04-11.05	RFN (EW10J4)	4	OPH 020
2.2	2,2	R, 1		116	05.04-10.05	3FZ (EW12J4)	4	OPH 020
3.0	2,9	R + D, 1		155	05.04-12.06	XFV (ES9A)	6	OPH 012
505								
2.0	2,0	R		71	05.85-12.85	106 (XN1)	4	OZH 044
2.0	2,0	R		71	11.80-04.85	106 (XN1)	4	OZU 001
2.2	2,2	R		84	03.86-12.93	851X (ZDJL)	4	OZH 066
2.2 Turbo Injection	2,2	R		110	01.86-06.86	176X (N9TE)	4	OZH 044
2.2 Turbo Injection	2,2	R		110	07.86-12.87	176X (N9TE)	4	OZH 066
2.2 Turbo Injection	2,2	R		114	03.84-06.86	176B (N9TE)	4	OZH 044
2.2 Turbo Injection	2,2	R		114	07.86-10.88	176B (N9TE)	4	OZH 066
2.2 Turbo Injection	2,2	R		128	06.87-12.88	176W (N9TEA)	4	OZH 066
2.8 GTI V6	2,8	R		105	06.86-12.93	154X (ZN3J)	6	OZH 066
505 Break								
2.0	2,0	R		72	09.85-11.87	106E (XN1A)	4	OZH 044
2.2	2,2	R		84	03.86-12.93	851X (ZDJL)	4	OZH 066
605								
2.0	2,0	R		89	03.91-06.94	RFZ (XU10J2Z)	4	OZH 034
2.0	2,0	R		89	06.89-03.91	RFZ (XU10J2Z)	4	OZH 194
2.0 Turbo	2,0	R		104	07.92-06.94	RGY (XU10J2TE)	4	OZH 034
2.0 Turbo	2,0	R		108	07.91-09.99	RGX (XU10J2TE)	4	OZH 159
607								
2.0	2,0	R, 1		100	02.00-11.04	RFN (EW10J4)	4	OPH 020
2.2 16V	2,2	R, 1		116	02.00-11.04	3FZ (EW12J4)	4	OPH 020
2.2 16V	2,2	R, 1		120	09.05-	3FY (EW12J4)	4	OPH 020
3.0 V6 24V	2,9	R + D, 1		152	02.00-11.04	XFX (ES9J4S)	6	OPH 012
3.0 V6 24V	2,9	R, 1		155	12.04-	XFV (ES9A)	6	OPH 010
3.0 V6 24V	2,9	R + D, 1		155	12.04-	XFV (ES9A)	6	OPH 012
806								
1.8	1,8	R		73	07.95-08.02	LFW (XU7JP)	4	OZH 159
2.0	2,0	R		89	06.94-08.02	RFU (XU10J2)	4	OZH 159
2.0 16V	2,0	R, 1		97	05.98-09.00	RFV (XU10J4R)	4	OPH 020
2.0 16V	2,0	R		97	05.98-09.00	RFV (XU10J4R)	4	OZH 159

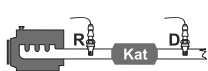



kW

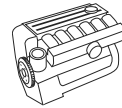

 Zyl.
Cyl.
Cil.

PEUGEOT

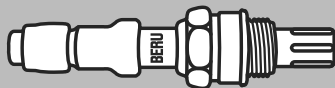
806							
2.0 16V	2,0	R, 1	100	09.00–08.02	RFN (EW10J4), (Euro 3)	4	OPH 010
2.0 Turbo	2,0	R	108	06.94–08.02	RGX (XU10J2TE)	4	OZH 159
807							
2.0	2,0	R + D, 1	100	06.02–	RFN (EW10J4)	4	OPH 010
2.2	2,2	R + D, 1	116	06.02–	3FZ (EW12J4)	4	OPH 010
3.0 V6	2,9	R + D, 1	150	06.02–05.06	AFX (ES9J4S)	6	OPH 012
BOXER							
2.0 i	2,0	R	80	03.94–12.95	RFW (XU10J2)	4	OZH 034
2.0 i	2,0	R	80	01.96–04.02	RFW (XU10J2)	4	OZH 159
2.0	2,0	R, 1	81	04.02–05.06	RFL (XU10J2U)	4	OPH 012
EXPERT							
1.6	1,6	R	58	02.96–	222A2 (1580 SPI)	4	OZH 159
2.0	2,0	R + D, 1	100	07.00–01.07	RFN (EW10J4)	4	OPH 010
J5							
2.0		R	62	10.90–12.93	170D (XN1TACP)	4	OZH 066
PARTNER Combispace							
1.1	1,1	R, 1	44	09.00–10.05	HFX (TU1JP)	4	OPH 012
1.1	1,1	D, 1	44	09.00–08.02	HFX (TU1JP)	4	OPH 012
1.1	1,1	R	44	06.96–08.00	HDZ (TU1M)/HFX (TU1JP)	4	OZH 074
1.4	1,4	R, 1	55	06.96–08.02	KFX (TU3JP), (Euro 3)	4	OPH 010
1.4	1,4	D, 1	55	06.96–08.02	KFX (TU3JP), (Euro 3)	4	OPH 020
1.4	1,4	R	55	06.96–	KFX (TU3JP)/TU32/KFW (TU3JP)	4	OZH 074
1.6 16V	1,6	R + D, 1	80	07.01–04.08	NFU (TU5JP4)	4	OPH 012
PARTNER Kasten (5)							
1.1	1,1	R	44	06.96–	HDZ (TU1M)	4	OZH 074
1.4	1,4	R, 1	55	06.96–08.02	KFX (TU3JP), (Euro 3)	4	OPH 010
1.4	1,4	D, 1	55	06.96–08.02	KFX (TU3JP), (Euro 3)	4	OPH 020
1.4	1,4	R	55	06.96–	KFX (TU3JP)/TU32	4	OZH 074
1.6	1,6	R + D, 1	80	09.00–10.02		4	OPH 012
PARTNER Kasten							
1.6	1,6	R, 1	66	04.08–	NFR (TU5JP4B)	4	OPH 010
1.6	1,6	D, 1	66	04.08–	NFR (TU5JP4B)	4	OPH 012
1.6	1,6	R, 1	80	04.08–		4	OPH 010
1.6	1,6	D, 1	80	04.08–		4	OPH 012
PARTNER Tepee							
1.6	1,6	R, 1	66	04.08–	NFR (TU5JP4B)	4	OPH 010
1.6	1,6	D, 1	66	04.08–	NFR (TU5JP4B)	4	OPH 012
1.6	1,6	R, 1	80	04.08–	NFU (TU5JP4)	4	OPH 010
1.6	1,6	D, 1	80	04.08–	NFU (TU5JP4)	4	OPH 012
PORSCHE							
911 (996)							
3.6 Carrera	3,6	R, 1	235	10.01–07.04	M 96.03	6	OPH 012
3.6 Carrera 4	3,6	R, 1	235	10.01–07.04	M 96.03	6	OPH 012
3.6 Carrera S	3,6	R, 1	254	02.03–07.04	M 96.03	6	OPH 012
3.6 Carrera 4S	3,6	R, 1	254	02.03–07.04	M 96.03	6	OPH 012
3.6 GT3	3,6	R, 1	280	10.03–08.05	M 96.79	6	OPH 012
911 (997)							
3.6 Carrera	3,6	R, 1	239	07.04–08.05	M 96.05	6	OPH 012
3.8 Carrera S	3,8	R, 1	261	08.04–08.05	M 97.01	6	OPH 012
3.6 GT 3	3,6	D, 1	305	03.06–12.08	M 97.76	6	OPH 077
3.8 GT3	3,8	D, 1	320	08.09–		6	OPH 077
BOXSTER (987)							
2.7	2,7	D, 1	176	11.04–08.06	M 96.25	6	OPH 077
2.7	2,7	D, 1	180	07.06–01.09	M 97.20	6	OPH 077
S 3.2	3,2	D, 1	206	11.04–08.06	M 96.26	6	OPH 077
S 3.4	3,4	D, 1	217	07.06–01.09	M 97.21	6	OPH 077
CARRERA GT							
5.7	5,7	D, 1	450	10.04–04.06	M 80.01	10	OPH 076
CAYMAN							
2.7	2,7	D, 1	180	07.06–01.09	M 97.20	6	OPH 077

**BERU**

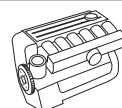
kW

Zyl.
Cyl.
Cil.**PORSCHE****CAYMAN**

S 3.4	3,4	D, 1	217	11.05-01.09	M 97.21	6	OPH 077
S 3,4 Sport	3,4	D, 1	223	08.08-01.09	M 97.22	6	OPH 077

RENAULT**11**

1.7	1,7	R	55	10.84-12.88	F3N 718	4	OZU 001
1.7	1,7	R	69	11.88-12.88	F3N 708	4	OZH 033
1.7	1,7	R	69	06.87-11.88	F3N 708	4	OZU 001

18

2.2 i	2,2	R	76	06.84-07.86		4	OZU 001
-------	-----	---	----	-------------	--	---	----------------

19 I

1.4 KAT	1,4	R	43	01.89-04.92	C3J 710	4	OZU 001
1.7	1,7	R	54	09.88-04.92	F3N 741/F3N 740	4	OZU 001
1.7	1,7	R	66	09.88-04.92	F3N 743/F3N 742	4	OZH 033
1.8 16V	1,8	R	99	06.89-04.92	F7P 704	4	OZH 033

19 I Cabriolet

1.7	1,7	R	70	07.91-04.92	F3N 743/F3N 742	4	OZH 033
1.8 16V	1,8	R	101	07.91-04.92	F7P 704	4	OZH 033

19 I Chamade

1.4	1,4	R	43	10.89-04.92	C3J 710/C2J 772	4	OZU 001
1.7	1,7	R	54	10.89-04.92	F3N 741/F3N 740	4	OZU 001
1.7	1,7	R	66	07.88-04.92	F3N 743/F3N 742	4	OZH 033
1.8 16V	1,8	R	99	10.89-04.92	F7P 704	4	OZH 033

19 II

1.4	1,4	R	43	08.93-12.95	C3J 710	4	OZH 033
1.4	1,4	R	43	04.92-07.93	C3J 710	4	OZU 001
1.4	1,4	R	55	01.92-12.95	E7J 742	4	OZH 033
1.7	1,7	R	54	04.92-12.95	F3N740/741	4	OZU 022
1.8	1,8	R	65	04.92-12.95	F3P 706/F3P 707/F3P 760/ F3P 708	4	OZH 033
1.8	1,8	R	66	04.92-12.95	F3P 706/F3P 760	4	OZH 033
1.8	1,8	R	79	05.94-12.95	F3P 765/F3P 682	4	OZH 033
1.8	1,8	R	81	04.92-05.94	F3P 700	4	OZH 033
1.8 16V	1,8	R	99	04.92-12.95	F7P 704	4	OZH 033

19 II Cabriolet

1.7	1,7	R	66	04.92-09.93	F3N 743/F3N 742	4	OZH 033
1.8	1,8	R	65	04.92-06.96	F3P 704/F3P 706/F3P 707/ F3P 760/F3P 708/F3P 705	4	OZH 033
1.8	1,8	R	66	09.93-06.96	F3P 706/F3P 760	4	OZH 033
1.8	1,8	R	79	07.94-06.96	F3P 765/F3P 682/F3P 764	4	OZH 033
1.8	1,8	R	99	04.92-06.96	F7P 704	4	OZH 033

19 II Chamade

1.4	1,4	R	43	08.93-12.95	C3J 710	4	OZH 033
1.4	1,4	R	43	04.92-07.93	C3J 710	4	OZU 001
1.4	1,4	R	55	11.93-12.95	E7J 742	4	OZH 033
1.7	1,7	R	54	04.92-12.95	F3N740/741	4	OZU 022
1.7	1,7	R	66	04.92-12.95	F3N 743/F3N 742	4	OZH 033
1.8	1,8	R	65	04.92-12.95	F3P 704/F3P 706/F3P 707/ F3P 760/F3P 708/F3P 705	4	OZH 033
1.8	1,8	R	66	04.92-12.95	F3P 706/F3P 760	4	OZH 033
1.8	1,8	R	79	05.94-12.95	F3P 682	4	OZH 033
1.8	1,8	R	81	04.92-05.94	F3P 700	4	OZH 033
1.8 16V	1,8	R	99	04.92-12.95	F7P 704	4	OZH 033

21

1.7	1,7	R	54	09.89-10.92	F3N 726	4	OZU 022
1.7	1,7	R	66	09.89-06.94	F3N 723/F3N 722, → Chassis # H 9000, S 1240	4	OZU 001
1.7	1,7	R	66	09.89-06.94	F3N 723/F3N 722, Chassis # H 9001, S 1241 →	4	OZH 033
2.0	2,0	R	88	09.89-12.93	J7R 747/J7R 746	4	OZH 033
2.0	2,0	R	99	02.90-10.92	J7R 740	4	OZH 033



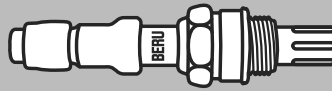

kW

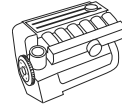
Zyl.
Cyl.
Cil.**RENAULT**

21							
2.0 4x4	2,0	R	99	09.90–10.92	J7R 740	4	OZH 033
2.2	2,2	R	79	09.89–06.94	J7T 754/J7T 755, → Chassis # S 00006709	4	OZH 033
2.2	2,2	R	79	09.89–06.94	J7T 754/J7T 755, Chassis # S 00006710 →	4	OZU 022
2.2 4x4	2,2	R	79	07.90–06.94	J7T 754/J7T 755, → Chassis # S00006709	4	OZH 033
2.2 4x4	2,2	R	79	07.90–06.94	J7T 754/J7T 755, Chassis # S00006710 →	4	OZU 022
21 Kombi							
1.7	1,7	R	66	10.89–12.93	F3N 723/F3N 722, Chassis # H00007401 →	4	OZH 033
1.7	1,7	R	66	10.89–12.93	F3N 723/F3N 722, → Chassis # H00007400	4	OZU 001
1.7	1,7	R	69	06.86–12.89	F3N 723/F3N 722, Chassis # H00007401 →	4	OZH 033
1.7	1,7	R	69	06.86–12.89	F3N 723/F3N 722, → Chassis # H00007400	4	OZU 001
1.7 KAT	1,7	R	54	05.88–06.93	F3N726/740/718, Chassis # H00004301 →	4	OZU 022
2.0	2,0	R	88	06.90–12.93	J7R 747/J7R 746	4	OZH 033
2.0 4x4	2,0	R	88	03.89–12.93	J7R 747/J7R 746	4	OZH 033
2.2	2,2	R	79	06.86–01.90	J7T 754/J7T 755, → Chassis # S00009741	4	OZH 033
2.2	2,2	R	79	02.90–11.93	J7T 754/J7T 755, Chassis # S00009742 →	4	OZU 022
2.2 4x4	2,2	R	79	06.86–01.90	J7T 754/J7T 755, → Chassis # S00009741	4	OZH 033
2.2 4x4	2,2	R	79	02.90–12.93	J7T 754/J7T 755, Chassis # S00009742 →	4	OZU 022
21 Stufenheck							
1.7	1,7	R	54	07.89–02.94	F 3 N 726, Chassis # H 7251, S 1723 →	4	OZU 022
1.7	1,7	R	66	09.89–02.94	F3N 723/F3N 722	4	OZH 033
1.7	1,7	R	69	09.89–02.94	F3N 723/F3N 722	4	OZH 033
2.0	2,0	R	88	06.90–12.93	J7R 747/J7R 746	4	OZH 033
2.0	2,0	R	99	02.90–06.94	J7R 740	4	OZH 033
2.0 4x4	2,0	R	99	12.89–02.94	J7R 740	4	OZH 033
2.0 Turbo	2,0	R	119	02.90–10.92	J7R 756	4	OZH 033
2.0 Turbo 4x4	2,0	R	119	02.90–10.92	J7R 756	4	OZH 033
2.2	2,2	R	79	07.86–02.90	J7T 754/J7T 755, → Chassis # S00005772	4	OZH 033
2.2	2,2	R	79	02.90–02.94	J7T 754/J7T 755, Chassis # S00005773 →	4	OZU 022
2.2 4x4	2,2	R	79	07.90–02.94	J7T 754/J7T 755, Chassis # S00005773 →	4	OZU 022
25							
2.0 12V	2,0	R	99	06.89–12.92	J7R 726	4	OZH 033
2.2	2,2	R	76	11.85–03.89		4	OZU 022
2.2	2,2	R	79	09.86–12.92	J7T732/733	4	OZU 022
2.5 V6 Turbo	2,5	R	151	01.90–12.92	Z7U 700	6	OZH 033
2.8 V6	2,8	R	115	05.89–02.90	Z7W 700	6	OZH 033
2.8 V6 Injection	2,8	R	100	06.86–06.87	Z7W 702	6	OZU 001
2.8 V6 Injection	2,8	R	110	06.87–12.92	Z7W 706/Z7W 707/Z7W 709	6	OZH 044
9							
1.7	1,7	R	54	10.86–12.88	F3N 718	4	OZU 001
1.7	1,7	R	69	11.88–12.88	F3N 708	4	OZH 033
1.7	1,7	R	69	06.87–11.88	F3N 708	4	OZU 001
AVANTIME							
3.0 V6	2,9	R + D, 1	152	09.01–05.03	L7X 720/L7X 721	6	OPH 012

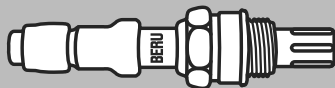
BERU

kW

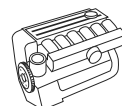
 Zyl.
Cyl.
Cil.

RENAULT
CLIO Grandtour

1.6 16V	1,6	R + D, 1	82	02.08-	K4M 800/K4M 801	4	OPH 033
1.6 16V	1,6	R + D, 1	94	11.08-01.10	K4M 862	4	OPH 033

CLIO I

1.2	1,1	R	40	04.96-02.98	D7F 730	4	OZH 160
1.2	1,2	R	40	01.96-03.96	C3G 720	4	OZU 001
1.2	1,2	R	40	01.91-01.96	E7F 706	4	OZH 033
1.2	1,1	R	43	04.96-02.98	D7F 730	4	OZH 160
1.2	1,2	R	43	05.90-09.98	E7F 750/E7F 700/E7F 708	4	OZH 033
1.4	1,4	R	58	01.91-03.96	E7J 719 /E7J 601 /E7J 718/ E7J 754	4	OZH 033
1.4	1,4	R	58	04.96-09.98	E7J 719 /E7J 601 /E7J 718/ E7J 754	4	OZH 108
1.8	1,8	R	65	01.91-09.98	F3P 710 /F3P 714	4	OZH 033
1.8	1,8	R	66	08.90-04.96	F3P 755	4	OZH 033
1.8	1,8	R	66	08.94-03.96	F3P 755 /F3P 754	4	OZH 033
1.8 Rsi	1,8	R	79	08.95-09.98	F3P 758	4	OZH 033
1.8 Rsi	1,8	R	80	01.93-08.95	F3P 712	4	OZH 033
1.8 16V	1,8	R	99	01.91-03.96	F7P 722	4	OZH 033
Williams	2,0	R	108	01.94-03.96	F7R 700	4	OZH 033

CLIO II

1.2	1,1	D, 1	43	10.99-10.07	D7F 726	4	OPH 033
1.2	1,1	R	43	09.98-	D7F 710/D7F 766/D7F 720/ D7F 726	4	OZH 107
1.2	1,1	R	43	09.98-	D7F 710/D7F 766/D7F 720/ D7F 726	4	OZH 160
1.2	1,1	R	43	09.98-	D7F 726	4	OZH 184
1.2	1,1	R	44	03.99-05.01	D7F 722	4	OZH 160
1.2 16V	1,1	R	55	06.01-	D4F 714/D4F 712/D4F 722	4	OZH 184
1.4	1,4	R	55	09.98-05.05	E7J 780	4	OZH 125
1.4 16V	1,4	R, 1	70	10.99-08.00	K4J 712/K4J 713	4	OPH 033
1.4 16V	1,4	R, 1	72	08.00-10.07	K4J 712/K4J 711/K4J 710/ K4J 713/K4J 700	4	OPH 033
1.6	1,6	R	66	09.98-05.05	K7M 744/K7M 745	4	OZH 125
1.6 16V	1,6	R, 1	79	09.98-10.07	K4M 748/K4M 744/K4M 708/ K4M 745	4	OPH 033
2.0 16V Sport	2,0	R, 1	124	02.00-10.07	F4R 730	4	OPH 033
2.0 16V Sport	2,0	R + D, 1	132	01.04-10.07	F4R 738	4	OPH 033
3.0 V6 Sport	2,9	R + D, 1	166	11.00-12.02	L7X 760	6	OPH 012
3.0 V6 Sport	2,9	R + D, 1	187	12.02-06.05	L7X 762	6	OPH 012

CLIO III

1.4 16V	1,4	R, 1	72	05.08-	K4J 780	4	OPH 033
1.6 16V	1,6	R + D, 1	65	06.05-	K4M 804	4	OPH 033
1.6 16V	1,6	R + D, 1	82	06.05-	K4M 800/K4M 801	4	OPH 033
2.0 16V Sport	2,0	R, 1	145	02.06-	F4R 830	4	OPH 033
2.0 16V Sport	2,0	R, 1	148	09.08-	F4R 830	4	OPH 033

ESPACE I

2.2	2,2	R	79	07.86-12.90	J7T 770	4	OZU 022
2.2 Quadra	2,2	R	79	01.88-12.90	J7T 770	4	OZU 022

ESPACE II

2.0	2,0	R	76	03.93-10.96	J7R 768	4	OZH 033
2.0	2,0	R	76	01.91-02.93	J7R 768	4	OZH 044
2.2	2,2	R	79	05.91-10.96	J7T 772/J7T 776/J7T 773	4	OZH 033
2.2	2,2	R	79	01.91-04.91	J7T 772/J7T 776/J7T 773	4	OZU 001
2.2 4x4	2,2	R	79	05.91-12.96	J7T 772/J7T 773	4	OZH 033
2.2 4x4	2,2	R	79	03.91-04.91	J7T 772/J7T 773	4	OZU 001
2.8 V6	2,8	R	110	01.91-07.94	Z7W 717/Z7W 712/Z7W 713, → Chassis # T18370	6	OZH 044
2.8 V6	2,8	R	110	08.94-10.96	Z7W 717/Z7W 712/Z7W 713, Chassis # T18371 →	6	OZH 033

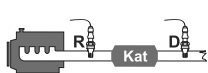

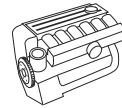

kW

 Zyl.
Cyl.
Cil.

RENAULT
ESPACE III

2.0	2,0	R	84	11.96-10.00	F3R 769/F3R 728/F3R 742/ F3R 729/F3R 768	4	OZH 161
2.0	2,0	R, 1	102	09.01-10.02	F4R 701/F4R 700	4	OPH 033
2.0 16V	2,0	R, 1	103	10.98-10.02	F4R 701/F4R 700	4	OPH 033
3.0 V6 24V	2,9	R	140	10.98-10.02	L7X 727	6	OZH 208

ESPACE IV

2.0	2,0	R, 1	98	11.02-02.05	F4R 790	4	OPH 033
2.0	2,0	R, 1	100	11.02-01.10	F4R 790/F4R 792/F4R 791	4	OPH 033

GRAND SCÉNIC II

1.6	1,6	R + D, 1	77	06.06-04.09	K4M 788	4	OPH 033
1.6	1,6	R + D, 1	83	04.04-04.09	K4M 761/K4M 782	4	OPH 033
2.0	2,0	R + D, 1	99	04.04-04.09	F4R 771/F4R 770	4	OPH 033

KANGOO

1.2	1,1	D, 1	43	09.98-12.07	D7F 726, D7F 746	4	OPH 033
1.2	1,1	R	43	08.97-	D7F 710/D7F 744/D7F 722/ D7F 720/D7F 726/D7F 746	4	OZH 160
1.2	1,1	R	43	08.97-	D7F 726	4	OZH 184
1.2 16V	1,1	R	55	06.01-	D4F 712, D4F 714	4	OZH 184
1.4	1,4	R	55	08.97-	E7J 634/K7J 701/E7J 635/ E7J 780/K7J 700	4	OZH 109
1.4	1,4	R	55	08.97-	E7J 634/K7J 701/E7J 635/ E7J 780/K7J 700	4	OZH 125
1.6 16V	1,6	R + D, 1	70	06.01-12.07	K4M 750/K4M 753/K4M 752	4	OPH 033
1.6 16V 4x4	1,6	R + D, 1	70	10.01-12.07	K4M 750/K4M 753/K4M 752	4	OPH 033

KANGOO Rapid

1.2	1,1	R + D, 1	43	09.98-12.07	D7F 746, D7F 726	4	OPH 033
1.2	1,1	R	43	08.97-	D7F 710/D7F 744/D7F 722/ D7F 720/D7F 726/D7F 746	4	OZH 160
1.4	1,4	R	55	08.97-	E7J 634/K7J 701/E7J 635/ E7J 780	4	OZH 109
1.4	1,4	R	55	08.97-	E7J 634/K7J 701/E7J 635/ E7J 780	4	OZH 125
1.2 16V	1,1	R	55	10.01-	D4F 714/D4F 712	4	OZH 184
1.6 16V	1,6	R + D, 1	70	10.01-12.07	K4M 752	4	OPH 033
1.6 16V 4x4	1,6	R + D, 1	70	10.01-12.07	K4M 750/K4M 753/K4M 752	4	OPH 033

LAGUNA

1.6 16V	1,6	R, 1	79	05.98-03.01	K4M 720/K4M 724	4	OPH 033
1.6 16V	1,6	D	79	11.97-03.01	K4M 720/K4M 724	4	OZH 216
1.8	1,8	R	66	11.93-03.01	F3P 720/F3P 724	4	OZH 019
1.8	1,8	R	66	08.95-03.01	F3P 678/F3P 670	4	OZH 101
1.8	1,8	R	69	08.95-03.01	F3P 720/F3P 724	4	OZH 019
1.8 16V	1,8	R, 1	88	11.98-03.01	F4P 760	4	OPH 033
1.8 16V	1,8	D	88	04.98-03.01	F4P 760	4	OZH 216
2.0	2,0	R	83	11.93-03.01	F3R 722/F3R 723	4	OZH 101
2.0 16V	1,9	R	102	06.95-03.01	N7Q 700/N7Q 704	4	OZH 087
2.0 16V	2,0	R, 1	103	09.99-03.01	F4R 780	4	OPH 033
2.0 16V	2,0	D	103	09.99-03.01	F4R 780	4	OZH 216
3.0	3,0	R	123	10.96-03.01	Z7X767	6	OZH 096
3.0 24V	2,9	R	140	03.97-03.01	L7X 700/L7X 701	6	OZH 208

LAGUNA Grandtour

1.6 16V	1,6	R, 1	79	05.98-03.01	K4M 720	4	OPH 033
1.6 16V	1,6	D	79	11.97-03.01	K4M 720/K4M 724	4	OZH 216
1.8	1,8	R	66	09.95-03.01	F3P 678/F3P 670	4	OZH 101
1.8	1,8	R	69	09.95-03.01	F3P 720/F3P 724	4	OZH 019
1.8 16V	1,8	R, 1	88	11.98-03.01	F4P 760	4	OPH 033
1.8 16V	1,8	D	88	04.98-03.01	F4P 760	4	OZH 216
2.0	2,0	R	83	09.95-03.01	F3R 722/F3R 723	4	OZH 101
2.0 16V	1,9	R	102	09.95-03.01	N7Q 700/N7Q 704	4	OZH 087
2.0 16V	2,0	R, 1	103	09.99-03.01	F4R 780	4	OPH 033
2.0 16V	2,0	D	103	09.99-03.01	F4R 780	4	OZH 216
3.0	3,0	R	123	10.96-03.01	Z7X767	6	OZH 096

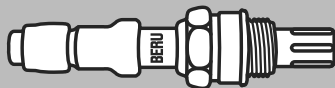
**BERU**

kW

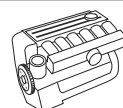
Zyl.
Cyl.
Cil.**RENAULT**

Model	Power (kW)	Cyl.	Valves	Power (kW)	Year Range	Part No.	Qty	Code
LAGUNA Grandtour								
3.0 24V	2,9	R		140	03.97-03.01	L7X 700/L7X 701	6	OZH 208
LAGUNA II								
1.6 16V	1,6	R, 1		79	03.01-09.07	K4M 711/K4M 714/K4M 710	4	OPH 033
1.6 16V	1,6	R, 1		82	02.05-09.07	K4M 716	4	OPH 033
1.8 16V	1,8	R, 1		85	03.01-09.07	F4P 771, F4P 775, F4P 770, F4P 774	4	OPH 033
1.8 16V	1,8	R, 1		86	03.01-	F4P 770	4	OPH 033
1.8 16V	1,8	R, 1		88	03.01-09.07	F4P 770/F4P 773	4	OPH 033
1.8 16V	1,8	R, 1		89	03.01-09.07	F4P 774/F4P 770	4	OPH 033
2.0 16V	2,0	R, 1		99	08.02-09.07	F4R 713/F4R 715/F4R 712/F4R 714	4	OPH 033
3.0 V6 24V	2,9	R + D, 1		152	03.01-09.07	L7X 731	6	OPH 012
LAGUNA II Grandtour								
1.6 16V	1,6	R, 1		79	03.01-09.07	K4M 711/K4M 714/K4M 710	4	OPH 033
1.6 16V	1,6	R, 1		82	02.05-09.07	K4M 716	4	OPH 033
1.8 16V	1,8	R, 1		85	03.01-09.07	F4P 771, F4P 774	4	OPH 033
1.8 16V	1,8	R, 1		86	03.01-	F4P 770	4	OPH 033
1.8 16V	1,8	R, 1		88	03.01-09.07	F4P 770	4	OPH 033
1.8 16V	1,8	R, 1		89	03.01-09.07	F4P 770	4	OPH 033
2.0	2,0	R, 1		95	09.02-05.05	F4R 713	4	OPH 033
2.0 16V	2,0	R, 1		99	08.02-09.07	F4R 713/F4R 715/F4R 712/F4R 714	4	OPH 033
3.0 V6 24V	2,9	R + D, 1		152	03.01-09.07	L7X 731	6	OPH 012
MEGANE I								
1.4 Eco	1,4	R		52	01.96-03.99	E7J 624	4	OZH 058
1.4 e	1,4	R		55	01.96-	E7J 626/E7J 764	4	OZH 058
1.4 16V	1,4	R, 1		70	03.99-10.02	K4J 714/K4J 750	4	OPH 033
1.6 i	1,6	R		55	01.96-03.99	K7M 720	4	OZH 058
1.6 e	1,6	R		66	01.96-03.99	K7M 702/K7M 703/K7M 790	4	OZH 058
1.6 16V	1,6	R, 1		79	03.99-10.02	K4M 704/K4M 700/K4M 708/K4M 701	4	OPH 033
1.8 16V	1,8	R, 1		85	01.01-10.02	F4P 722/F4P 720	4	OPH 033
2.0 16V	2,0	R		108	07.96-	F7R 710/F7R 714	4	OZH 101
2.0 i	2,0	R		80	03.99-	F3R 751/F3R 750	4	OZH 092
2.0 i	2,0	R		84	01.96-	F3R 751/F3R 750	4	OZH 161
MEGANE I Cabriolet								
1.4 16V	1,4	R, 1		70	03.99-09.03	K4J 714/K4J 750	4	OPH 033
1.6 e	1,6	R		66	10.96-03.99	K7M 702/K7M 703	4	OZH 058
1.6 16V	1,6	R, 1		79	03.99-	K4M 700/K4M 708/K4M 701	4	OPH 033
2.0	2,0	R		84	04.97-	F3R 750	4	OZH 101
2.0 16V	2,0	R, 1		102	01.02-09.03	F4R 746	4	OPH 033
2.0 16V	2,0	R		108	10.96-11.99	F7R 710/F7R 714	4	OZH 161
2.0 i	2,0	R		80	03.99-	F3R 791/F3R 796	4	OZH 092
MEGANE I Classic								
1.4	1,4	R		55	09.96-	E7J 626/E7J 764	4	OZH 058
1.4 16V	1,4	R, 1		70	03.99-09.03	K4J 714/K4J 750	4	OPH 033
1.6 i	1,6	R		55	09.96-03.99	K7M 720	4	OZH 058
1.6 e	1,6	R		66	09.96-03.99	K7M 702/K7M 703/K7M 790	4	OZH 058
1.6 16V	1,6	R, 1		79	03.99-09.03	K4M 700/K4M 708/K4M 701	4	OPH 033
1.8 16V	1,8	R, 1		85	01.01-09.03	F4P 722/F4P 720	4	OPH 033
2.0 i	2,0	R		84	09.96-	F3R 751/F3R 750	4	OZH 161
MEGANE I Coach								
1.4 16V	1,4	R, 1		70	03.99-10.02	K4J 714/K4J 750	4	OPH 033
1.6 e	1,6	R		66	03.96-03.99	K7M 702/K7M 703	4	OZH 058
1.6 16V	1,6	R, 1		79	03.99-10.02	K4M 700/K4M 708/K4M 701	4	OPH 033
2.0 i	2,0	R		84	03.96-03.97	F3R 751/F3R 750	4	OZH 092
2.0 16V	2,0	R, 1		102	01.02-10.02	F4R 746	4	OPH 033
2.0 16V	2,0	R		108	03.96-11.99	F7R 710/F7R 714	4	OZH 161
MEGANE I Grandtour								
1.4 16V	1,4	R, 1		70	03.99-09.03	K4J 714/K4J 750	4	OPH 033
1.6 e	1,6	R		66	03.99-	K7M 702/K7M 703	4	OZH 033

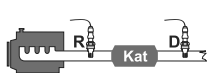

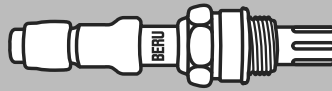

kW

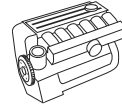
 Zyl.
Cyl.
Cil.

RENAULT
MEGANE I Grandtour

1.6 16V	1,6	R, 1	79	03.99-09.03	K4M 704/K4M 700/K4M 708/ K4M 701	4	OPH 033
---------	-----	------	----	-------------	-------------------------------------	---	----------------

1.8 16V	1,8	R, 1	85	01.01-09.03	F4P 722/F4P 720	4	OPH 033
---------	-----	------	----	-------------	-----------------	---	----------------

MEGANE II

1.4 16V	1,4	R + D, 1	60	10.03-10.08	K4J 732	4	OPH 033
---------	-----	----------	----	-------------	---------	---	----------------

1.4 16V	1,4	R + D, 1	72	11.02-10.08	K4J 740/K4J 730	4	OPH 033
---------	-----	----------	----	-------------	-----------------	---	----------------

1.6	1,6	R + D, 1	77	06.05-10.05	K4M 788	4	OPH 033
-----	-----	----------	----	-------------	---------	---	----------------

1.6 16V	1,6	R + D, 1	83	11.02-10.08	K4M 760	4	OPH 033
---------	-----	----------	----	-------------	---------	---	----------------

2.0 16	2,0	R + D, 1	99	11.02-10.08	F4R 770	4	OPH 033
--------	-----	----------	----	-------------	---------	---	----------------

MEGANE II Coupé-Cabriolet

1.6	1,6	R + D, 1	83	09.03-	K4M 760/K4M 761	4	OPH 033
-----	-----	----------	----	--------	-----------------	---	----------------

1.6 16V	1,6	R + D, 1	82	01.07-03.10	K4M C 813, K4M D 812, K4M C 813, K4M D 812	4	OPH 033
---------	-----	----------	----	-------------	---	---	----------------

2.0	2,0	R + D, 1	99	09.03-	F4R 771/F4R 770	4	OPH 033
-----	-----	----------	----	--------	-----------------	---	----------------

MEGANE II Grandtour

1.4	1,4	R + D, 1	72	08.03-05.09	K4J 740/K4J 730	4	OPH 033
-----	-----	----------	----	-------------	-----------------	---	----------------

1.6	1,6	R + D, 1	83	08.03-05.09	K4M 760/K4M 761	4	OPH 033
-----	-----	----------	----	-------------	-----------------	---	----------------

1.6 16V	1,6	R + D, 1	82	01.07-05.09	K4M D 812, K4M D 812	4	OPH 033
---------	-----	----------	----	-------------	----------------------	---	----------------

2.0	2,0	R + D, 1	99	08.03-05.09	F4R 771/F4R 770	4	OPH 033
-----	-----	----------	----	-------------	-----------------	---	----------------

MEGANE II Stufenheck

1.4	1,4	R + D, 1	72	09.03-	K4J 740/K4J 730	4	OPH 033
-----	-----	----------	----	--------	-----------------	---	----------------

1.6	1,6	R + D, 1	83	09.03-	K4M 760/K4M 761	4	OPH 033
-----	-----	----------	----	--------	-----------------	---	----------------

1.6 16V	1,6	R + D, 1	82	01.07-	K4M 812/K4M D 812	4	OPH 033
---------	-----	----------	----	--------	-------------------	---	----------------

2.0	2,0	R + D, 1	99	09.03-	F4R 771/F4R 770	4	OPH 033
-----	-----	----------	----	--------	-----------------	---	----------------

MEGANE Scenic

1.4 i	1,4	R	55	01.97-09.99	E7J 764	4	OZH 058
-------	-----	---	----	-------------	---------	---	----------------

1.6 i	1,6	R	55	01.97-09.99	K7M 720	4	OZH 058
-------	-----	---	----	-------------	---------	---	----------------

1.6 e	1,6	R	66	01.97-09.99	K7M 702/K7M 703	4	OZH 058
-------	-----	---	----	-------------	-----------------	---	----------------

2.0 i	2,0	R	80	01.99-09.99	F3R 796	4	OZH 092
-------	-----	---	----	-------------	---------	---	----------------

2.0 i	2,0	R	84	01.97-09.99	F3R 751/F3R 750	4	OZH 161
-------	-----	---	----	-------------	-----------------	---	----------------

MODUS

1.6	1,6	R + D, 1	65	12.04-12.06	K4M 792/K4M 794	4	OPH 033
-----	-----	----------	----	-------------	-----------------	---	----------------

1.6	1,6	R + D, 1	82	12.04-	K4M 790/K4M 791	4	OPH 033
-----	-----	----------	----	--------	-----------------	---	----------------

RAPID Kasten

1.2	1,2	R	40	09.91-10.97	C3G 712/C3G 710	4	OZU 001
-----	-----	---	----	-------------	-----------------	---	----------------

1.4 KAT	1,4	R	43	08.88-05.95	C3J 762/C3J 700/C3J 702/ C3J 760, → Chassis # U034749	4	OZU 022
---------	-----	---	----	-------------	--	---	----------------

1.4 KAT	1,4	R	43	06.95-03.98	C3J 762 Chassis # U034750 →	4	OZH 033
---------	-----	---	----	-------------	-----------------------------	---	----------------

1.4	1,4	R	55	09.91-03.98	E7J 720/E7J 773/E7J 724/ E7J 726	4	OZH 033
-----	-----	---	----	-------------	-------------------------------------	---	----------------

1.4	1,4	R	58	01.94-03.98	E7J 728	4	OZH 033
-----	-----	---	----	-------------	---------	---	----------------

SAFRANE I

2.0	2,0	R	77	11.92-07.96	J7R 732/J7R 733	4	OZH 058
-----	-----	---	----	-------------	-----------------	---	----------------

2.0 12V	2,0	R	97	04.92-07.96	J7R 735/J7R 734	4	OZH 058
---------	-----	---	----	-------------	-----------------	---	----------------

2.2	2,2	R	79	04.92-07.96	J7T 762	4	OZH 058
-----	-----	---	----	-------------	---------	---	----------------

2.2	2,2	R	101	04.92-07.96	J7T 760/J7T 761	4	OZH 058
-----	-----	---	-----	-------------	-----------------	---	----------------

3.0 V6	3,0	R	123	12.92-07.96	Z7X 721/Z7X 723/Z7X 722	6	OZH 058
--------	-----	---	-----	-------------	-------------------------	---	----------------

3.0 V6 4x4	3,0	R	123	12.92-07.96	Z7X 721/Z7X 723/Z7X 722	6	OZH 058
------------	-----	---	-----	-------------	-------------------------	---	----------------

SAFRANE II

2.0 16V	1,9	R	100	10.96-12.00	N7Q 710/N7Q 711	4	OZH 092
---------	-----	---	-----	-------------	-----------------	---	----------------

2.9 24V	2,9	R	140	03.99-12.00	L7X 713	6	OZH 208
---------	-----	---	-----	-------------	---------	---	----------------

3.0 V6	3,0	R	123	07.96-12.00	Z7X755	6	OZH 101
--------	-----	---	-----	-------------	--------	---	----------------

SCÉNIC I

1.4 16V	1,4	R, 1	70	09.99-04.03	K4J 714/K4J 750	4	OPH 033
---------	-----	------	----	-------------	-----------------	---	----------------

1.4 16V	1,4	R	70	09.99-08.03	K4J 714/K4J 750	4	OZH 184
---------	-----	---	----	-------------	-----------------	---	----------------

1.6	1,6	R, 1	75	03.01-04.03	K4M 708/K4M 709	4	OPH 033
-----	-----	------	----	-------------	-----------------	---	----------------

1.6 16V	1,6	R, 1	79	09.99-04.03	K4M 704/K4M 700/K4M 708/ K4M 701	4	OPH 033
---------	-----	------	----	-------------	-------------------------------------	---	----------------

1.6 16V	1,6	R	79	09.99-08.03	K4M 704/K4M 700/K4M 708/ K4M 701	4	OZH 184
---------	-----	---	----	-------------	-------------------------------------	---	----------------

1.8 16V	1,8	R, 1	85	01.01-04.03	F4P 720	4	OPH 033
---------	-----	------	----	-------------	---------	---	----------------

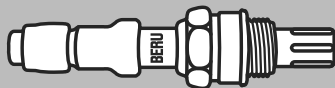
**BERU**

kW

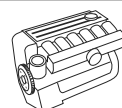
Zyl.
Cyl.
Cil.**RENAULT****SCÉNIC I**

2.0 16V	2,0	R, 1	102	07.00-04.03	F4R 741/F4R 740/F4R 746	4	OPH 033
2.0 16V	2,0	D	102	07.00-08.03	F4R 741/F4R 740/F4R 746	4	OZH 216
2.0 16V	2,0	R, 1	103	11.00-04.03	F4R 744	4	OPH 033
2.0 16V RX4	2,0	R, 1	102	06.00-04.03	F4R 746/F4R 744	4	OPH 033
2.0 16V RX4	2,0	D	102	06.00-08.03	F4R 746/F4R 744	4	OZH 216

SCÉNIC II

1.6	1,6	R + D, 1	83	06.03-04.09	K4M 761/K4M 782	4	OPH 033
1.6 16V	1,6	R + D, 1	82	01.07-04.09	K4M C 813/K4M 812/K4M 9 766	4	OPH 033
2.0	2,0	R + D, 1	99	06.03-04.09	F4R 771/F4R 770	4	OPH 033

SPORT SPIDER

2.0 16V	2,0	R	110	03.95-10.99	F7R 710	4	OZH 101
---------	-----	---	-----	-------------	---------	---	----------------

SUPER 5

1.4 KAT	1,4	R	43	10.85-12.96	C3J 700/C3J 702/C3J 760	4	OZU 022
1.7	1,7	R	54	10.86-03.95	F3N 716 /F3N 717	4	OZU 001
1.7 i	1,7	R	69	10.86-08.91	F3N 722/F3N 702, → Chassis # F00004690	4	OZU 001

1.7 i	1,7	R	69	10.86-08.91	F3N 722/F3N 702, → Chassis # F00004822, Chassis # F00004691 →	4	OZH 033
1.7 i	1,7	R	69	10.86-08.91	F3N 722/F3N 702, Chassis # F00004823 →	4	OZH 044

THALIA

1.4 16V	1,4	R, 1	72	06.01-10.07	K4J 712	4	OPH 033
---------	-----	------	----	-------------	---------	---	----------------

TRAFIC Bus

2.2	2,2	R	70	05.89-06.94	J7T 780	4	OZU 001
2.2	2,2	R	74	06.94-10.97	J7T 600	4	OZH 058
2.2 4x4	2,2	R	70	05.89-06.94	J7T 780	4	OZU 001
2.2 4x4	2,2	R	74	06.94-10.97	J7T 600	4	OZH 058

TRAFIC II Bus

2.0	2,0	R + D, 1	88	06.01-12.06	F4R 720, F4R 720	4	OPH 033
2.0 16V	2,0	R + D, 1	86	08.06-	F4R 820	4	OPH 033

TWINGO

1.2	1,1	R	40	05.96-11.99	D7F 700/D7F 701	4	OZH 107
1.2	1,1	R	40	12.99-	D7F 700/D7F 701	4	OZH 184
1.2	1,1	D, 1	43	05.96-05.07	D7F 703, D7F 702	4	OPH 033
1.2	1,1	R	43	05.96-11.99	D7F 700, D7F 701	4	OZH 160
1.2	1,1	R	43	12.99-	D7F 702, D7F 703	4	OZH 184
1.2	1,1	D, 1	43	03.07-	D7F 800	4	OPH 033
1.2	1,1	R + D, 1	44	09.98-08.00	D7F 702/D7F 704/D7F 703	4	OPH 033
1.2	1,2	R	40	05.94-10.96	C3G702	4	OZH 083
1.2	1,2	R	40	03.93-06.95	C3G700	4	OZU 025
1.2 16V	1,1	R	55	01.01-	D4F 704/D4F 702	4	OZH 184

ROVER**100 (METRO)**

111 C/L/S	1,1	R	44	03.90-12.98	11 K2D/11 K2A	4	OZH 057
114 GSi	1,4	R	76	10.94-10.95	14 K4F	4	OZH 057
114 GTI 16V	1,4	R	69	03.90-08.91	14 K4C/14 K4D	4	OZH 057
114 GTI 16V	1,4	R	76	08.91-12.98	14 K4F	4	OZH 057
114 GTI/GT 16V KAT	1,4	R	66	03.90-12.98	14 K4C/14 K4D	4	OZH 057
114 S/L/GTA	1,4	R	55	03.90-12.98	14 K2D/14 K2A	4	OZH 057

100 Cabriolet

111	1,1	R	44	04.94-	11 K2D	4	OZH 057
114	1,4	R	55	04.94-	14 K2D/14 K2A	4	OZH 057
114	1,4	R	75	03.97-10.98	14 K4F	4	OZH 057

200

211	1,1	R	44	01.98-03.00	11 K2D, → Chassis # YD 471564	4	OZH 053
211	1,1	R, 1	44	01.98-03.00	11 K2D, Chassis # YD 471 565 →	4	OPH 085
214 i	1,4	R	55	11.95-03.00	14 K2F, → Chassis # YD 471564	4	OZH 053
214 i	1,4	R, 1	55	11.95-03.00	14 K2F, Chassis # YD 471 565 →	4	OPH 085
214 Si	1,4	R	76	11.95-03.00	14 K4F, → Chassis # YD 471564	4	OZH 053

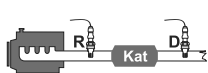



kW

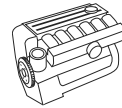

Zyl.
Cyl.
Cil.



ROVER

200							
214 Si	1,4	R, 1	76	11.95–03.00	14 K4F, Chassis # YD 471 565 →	4	OPH 085
218 K Vi	1,8	R	107	11.95–03.00	18 K4K, → Chassis # YD 471564	4	OZH 053
216 Si	1,6	R, 1	82	11.95–03.00	16 K4F, Chassis # YD 471 565 →	4	OPH 085
200 Coupe							
220 GSi	2,0	R	100	05.94–06.99	DOHC	4	OZH 094
220 Turbo	2,0	R	147	10.92–06.99	20 T4G	4	OZH 057
200 Hatchback							
214	1,4	R	55	09.93–10.95	14 K2D/14 K2A	4	OZH 057
214 GSi/Si	1,4	R	70	01.90–10.95	14 K4C	4	OZH 057
214 GSi/Si	1,4	R	76	12.92–10.95	14 K4F	4	OZH 057
214 Si/Gsi	1,4	R	66	10.89–10.95	14 K4C/14 K4D	4	OZH 057
220 GTi	2,0	R	100	01.93–10.95	DOHC	4	OZH 094
220 GTi	2,0	R	103	09.91–10.95	20 M4F	4	OZH 053
220 GTi	2,0	R	103	10.92–10.95	20 M4F	4	OZH 094
220 Turbo	2,0	R	147	01.93–10.95	20 T4G	4	OZH 057
25							
1.1 16V	1,1	R, 1	55	01.04–05.05	11 K4F, Chassis # YD 471 565 →	4	OPH 085
1.4 16V	1,4	R	62	10.99–	14 K4M, → Chassis # YD 471564	4	OZH 053
1.4 16V	1,4	R, 1	62	10.99–05.05	14 K4M, Chassis # YD 471 565 →	4	OPH 085
1.4 16V	1,4	R	76	10.99–	14 K4F, → Chassis # YD 471564	4	OZH 053
1.4 16V	1,4	R, 1	76	10.99–05.05	14 K4F, Chassis # YD 471 565 →	4	OPH 085
1.6 16V	1,6	R	80	10.99–	16 K4F, → Chassis # YD 471564	4	OZH 053
1.6 16V	1,6	R, 1	80	10.99–05.05	16 K4F, Chassis # YD 471 565 →	4	OPH 085
1.8 16V	1,8	R	85	10.99–	18 K4F, → Chassis # YD 471564	4	OZH 053
1.8 16V	1,8	R, 1	85	10.99–10.04	18 K4F, Chassis # YD 471 565 →	4	OPH 085
1.8 16V	1,8	R	107	02.00–	18 K4K, → Chassis # YD 471564	4	OZH 053
1.8 16V	1,8	R, 1	107	02.00–10.04	18 K4K, Chassis # YD 471 565 →	4	OPH 085
400 (RT)							
414 Si	1,4	R, 1	76	05.95–03.00	14 K4F, Chassis # YD 471 064 →	4	OPH 085
414 Si	1,4	R	76	05.95–03.00	14 K4F	4	OZH 057
416 Si	1,6	R	82	05.95–03.00	16 K4F, → Chassis # YD 471 063	4	OZH 053
416 Si	1,6	R, 1	82	05.95–03.00	16 K4F, Chassis # YD 471 064 →	4	OPH 085
400 (XW)							
414 GSi/Si	1,4	R	66	04.90–04.95	14 K4C/14 K4D	4	OZH 057
414 GSi/Si KAT	1,4	R	76	01.93–04.95	14 K4F	4	OZH 057
416 GSi	1,6	R	82	04.90–04.95	D 16 Z2	4	OZU 004
416 GTi	1,6	R	90	04.90–04.95	D 16 A8	4	OZU 004
420 GSi/SLI/GTi/Vite	2,0	R	100	01.93–04.95	20 T4H	4	OZH 053
420 GSi/SLI/GTi/Vite	2,0	R	100	01.93–04.95	20 T4H	4	OZH 094
420 GTi/GSi/Vitesse	2,0	R	103	02.92–04.95	20 M4F	4	OZH 053
420 GTi/GSi/Vitesse	2,0	R	103	02.92–08.92	DOHC	4	OZH 094
420 Turbo	2,0	R	147	01.93–04.95	20 T4G	4	OZH 057
45							
1.4	1,4	R	76	02.00–	14 K4F, → Chassis # YD 471063	4	OZH 053
1.4	1,4	R, 1	76	02.00–05.05	14 K4F, Chassis # YD 471 064 →	4	OPH 085
1.4	1,4	R	76	02.00–	14 K4F, Chassis # YD 471 064 →	4	OZH 067
1.6	1,6	R	80	02.00–	16 K4F, → Chassis # YD 471063	4	OZH 053
1.6	1,6	R, 1	80	02.00–05.05	16 K4F, Chassis # YD 471 064 →	4	OPH 085
1.6	1,6	R	80	02.00–	16 K4F, Chassis # YD 471 064 →	4	OZH 067
1.8	1,8	R, 1	86	02.00–05.05	18 K4F, Chassis # YD 471 064 →	4	OPH 085
2.0 V6	2,0	R	110	02.00–	20 K4F	6	OZH 067
45 Stufenheck							
1.4	1,4	R	76	02.00–	14 K4F, → Chassis # YD 471063	4	OZH 053
1.4	1,4	R, 1	76	02.00–05.05	14 K4F, Chassis # YD 471 064 →	4	OPH 085
1.6	1,6	R	80	02.00–	16 K4F, → Chassis # YD 471063	4	OZH 053
1.6	1,6	R, 1	80	02.00–05.05	16 K4F, Chassis # YD 471 064 →	4	OPH 085
1.8	1,8	R, 1	86	02.00–05.05	18 K4F, Chassis # YD 471 064 →	4	OPH 085
600							
618 i/Si	1,9	R	85	03.96–02.99	F 18 A3	4	OZH 120
620 i	2,0	R	85	01.96–06.96	F 20 Z2	4	OZH 120
620 Si	2,0	R	96	01.96–02.99	F 20 Z1	4	OZH 120

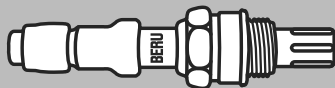
**BERU**

kW

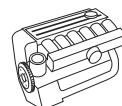
Zyl.
Cyl.
Cil.**ROVER****800**

820 I/SI	2,0	R	100	01.92-01.96	20 T4H, → Chassis # AM 152056	4	OZH 053
820 I/SI	2,0	R	100	01.92-01.96	20 T4H, Chassis # AM 152057 →	4	OZH 094
820 16V Turbo	2,0	R	132	01.92-01.96	T 16, → Chassis # 230966, Chassis # RS 100318 →	4	OZH 057
820 Sport	2,0	R	145	04.94-01.96	20 T4G, → Chassis # 230966, Chassis # RS 100318 →	4	OZH 057

800 Hatchback

820 I/SI	2,0	R	100	01.93-01.96	20 T4H, → Chassis # AM 152056	4	OZH 053
820 I/SI	2,0	R	100	01.93-01.96	20 T4H, Chassis # AM 152057 →	4	OZH 094
820 16V Turbo	2,0	R	132	01.92-01.96	T 16, → Chassis # 230966, Chassis # RS 100318 →	4	OZH 057
820 Sport	2,0	R	145	04.94-01.96	20 T4G, → Chassis # 230966, Chassis # RS 100318 →	4	OZH 057

CABRIOLET

214 1.4	1,4	R	66	01.92-11.99	14 K4C/14 K4D	4	OZH 057
214 1.4i 16V	1,4	R	76	01.93-11.99	14 K4F	4	OZH 057

COUPE

1.8 16 V	1,8	R	107	03.96-11.99	18 K4K	4	OZH 053
----------	-----	---	-----	-------------	--------	---	----------------

MINI MK I

1300	1,3	R	37	10.92-09.00	12 A2B	4	OZH 057
1300	1,3	R	39	01.92-04.95	12 A2D	4	OZH 057
1300	1,3	R	46	01.92-	12 A 2 E	4	OZH 057

SAAB**900 I**

2.0 i	2,0	R	81	09.87-08.90	B201	4	OZH 046
2.0 i	2,0	R	81	09.85-08.87	B201	4	OZU 001
2.0 -16	2,0	R	93	01.89-12.93	B202I	4	OZH 046
2.0 Turbo	2,0	R	103	09.87-12.91	B201XL	4	OZH 046
2.0 Turbo	2,0	R	103	10.86-08.87	B201XL	4	OZU 001
2.0 Turbo-16	2,0	R	118	11.85-08.89	B202XL	4	OZH 046
2.1 -16	2,1	R	100	08.90-12.93	B212I	4	OZH 046

900 I Cabriolet

2.0 -16	2,0	R	93	01.90-08.93	B202I	4	OZH 046
2.0 Turbo-16	2,0	R	118	11.86-08.89	B202XL	4	OZH 046
2.1 -16	2,1	R	100	08.90-08.93	B212I	4	OZH 046

900 I Combi Coupe

2.0 i	2,0	R	81	09.87-08.90	B201	4	OZH 046
2.0 i	2,0	R	81	09.85-08.87	B201	4	OZU 001
2.0 -16	2,0	R	93	01.89-08.92	B202I	4	OZH 046
2.0 Turbo	2,0	R	103	09.88-12.91	B201XL	4	OZH 046
2.0 Turbo	2,0	R	103	10.86-08.88	B201XL	4	OZU 001
2.0 Turbo-16	2,0	R	118	11.85-08.89	B202XL	4	OZH 046
2.1 -16	2,1	R	100	09.90-07.93	B212I	4	OZH 046

900 II

2.0 i	2,0	R	96	08.94-02.98	B204I	4	OZH 157
2.0 -16 Turbo	2,0	R	136	07.93-09.95	B204L	4	OZH 156
2.0 -16 Turbo	2,0	R	136	07.93-02.98	B204L	4	OZH 157
2.3 -16	2,3	R	110	07.93-02.98	B234I	4	OZH 157
2.5 -24 V6	2,5	R	125	07.93-02.98	B258I	6	OZH 154

900 II Cabriolet

2.0 i	2,0	R	96	12.93-02.98	B204I	4	OZH 157
2.0 -16 Turbo	2,0	R	136	12.93-09.95	B204L	4	OZH 156
2.0 -16 Turbo	2,0	R	136	12.93-02.98	B204L	4	OZH 157
2.3 -16	2,3	R	110	12.93-02.98	B234I	4	OZH 157

900 II Coupe

2.0 i	2,0	R	96	08.94-02.98	B204I	4	OZH 157
2.0 i	2,0	R	98	12.93-07.94	B206I	4	OZH 157
2.0 -16 Turbo	2,0	R	136	12.93-09.95	B204L	4	OZH 156
2.0 -16 Turbo	2,0	R	136	12.93-02.98	B204L	4	OZH 157
2.3 -16	2,3	R	110	12.93-02.98	B234I	4	OZH 157



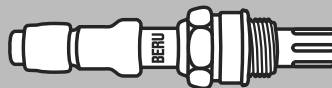

kW

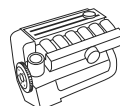

 Zyl.
Cyl.
Cil.

SAAB

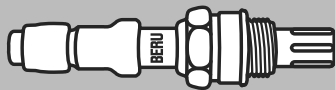
9000							
2.0 -16	2,0	R	94	01.89-01.93	B202I	4	OZH 046
2.0 -16 CD	2,0	R	96	09.93-12.98	B204I	4	OZH 157
2.0 -16 CD	2,0	R	96	09.93-12.98	B204I	4	OZH 158
2.0 -16 CD	2,0	R	110	09.93-12.98	B204S/B204E	4	OZH 157
2.0 -16 Turbo	2,0	R	118	05.88-08.93	B202XL	4	OZH 046
2.0 -16 Turbo	2,0	R	118	05.88-08.93	B202XL	4	OZH 157
2.0 -16 Turbo CD	2,0	R	108	09.92-12.98	B204E/B202S	4	OZH 157
2.0 -16 Turbo CD	2,0	R	120	09.88-08.91	B202XL	4	OZH 046
2.0 -16 Turbo CD	2,0	R	120	09.88-08.93	B202XL	4	OZH 157
2.3 -16 CD	2,3	R	107	08.89-08.91	B234I	4	OZH 046
2.3 -16 CD	2,3	R	107	09.91-12.98	B234I	4	OZH 157
2.3 -16 CD	2,3	R	107	09.91-12.98	B234I	4	OZH 158
2.3 -16 CDE	2,3	R	108	09.93-12.98	B234I	4	OZH 157
2.3 -16 CDE	2,3	R	108	09.93-12.98	B234I	4	OZH 158
2.3 -16 CDE Eco-Power	2,3	R	125	09.93-12.98	B234E	4	OZH 157
2.3 -16 CD Turbo	2,3	R	147	07.90-12.98	B234L	4	OZH 157
2.3 -16 Turbo	2,3	R	143	09.90-08.91	B234L	4	OZH 046
2.3 -16 Turbo	2,3	R	143	09.90-08.93	B234L	4	OZH 157
3.0 -24 V6 CD/CDE	3,0	R	155	07.94-12.98	B308I	6	OZH 154
9-3							
1,8t	2,0	R, 1	110	09.03-	B207E	4	OPH 011
1,8t	2,0	D, 1	110	09.03-	B207E	4	OPH 015
2.0 i	2,0	R	96	02.98-09.02	B204I	4	OZH 157
2.0 t	2,0	R, 1	129	09.03-08.06	B207L	4	OPH 011
2.0 t	2,0	D, 1	129	09.03-08.06	B207L	4	OPH 015
2.0 T	2,0	R, 1	154	09.03-	B207R	4	OPH 011
2.0 T	2,0	D, 1	154	09.03-	B207R	4	OPH 015
2.0 Turbo	2,0	R, 1	110	01.01-09.02	B205E	4	OPH 013
2.0 Turbo	2,0	D, 1	110	01.01-09.02	B205E	4	OPH 016
2.0 Turbo	2,0	R, 1	151	10.99-09.02	B205R	4	OPH 013
2.0 Turbo	2,0	D, 1	151	10.99-09.02	B205R	4	OPH 016
2.0 Turbo XWD	2,0	R, 1	154	09.03-	B207R	4	OPH 011
2.0 Turbo XWD	2,0	D, 1	154	09.03-	B207R	4	OPH 015
2.3 i	2,3	R	110	02.98-09.02	B234I	4	OZH 157
9-3 Cabriolet							
1,8t	2,0	R, 1	110	09.03-	B207E	4	OPH 011
1,8t	2,0	D, 1	110	09.03-	B207E	4	OPH 015
1,8t BioPower	2,0	R, 1	129	01.07-	B207L	4	OPH 011
2.0 i	2,0	R	96	02.98-08.03	B204I	4	OZH 021
2.0 t	2,0	R, 1	129	09.03-	B207L	4	OPH 011
2.0 t	2,0	D, 1	129	09.03-	B207L	4	OPH 015
2.0 T	2,0	R, 1	154	09.03-	B207R	4	OPH 011
2.0 T	2,0	D, 1	154	09.03-	B207R	4	OPH 015
2.0 Turbo	2,0	R, 1	110	01.01-08.03	B205E, Chassis # Y3040001 →	4	OPH 013
2.0 Turbo	2,0	D, 1	110	01.01-08.03	B205E	4	OPH 016
2.0 Turbo	2,0	R, 1	136	09.99-08.03	B205L	4	OPH 013
2.0 Turbo	2,0	D, 1	136	09.99-08.03	B205L	4	OPH 016
2.0 Turbo	2,0	R, 1	151	10.99-08.03	B205R	4	OPH 013
2.0 Turbo	2,0	D, 1	151	10.99-08.03	B205R	4	OPH 016
2.3 i	2,3	R	110	02.98-08.03	B234I	4	OZH 157
2.3 Turbo	2,3	R, 1	165	10.99-09.01	B235R	4	OPH 013
2.3 Turbo	2,3	D, 1	165	10.99-09.01	B235R	4	OPH 016
9-3 Kombi							
1.8 t	2,0	R, 1	110	03.05-		4	OPH 011
2.0 t	2,0	R, 1	110	03.05-	B207E	4	OPH 011
2.0 t	2,0	R, 1	129	03.05-	B207L	4	OPH 011
2.0 t BioPower	2,0	R, 1	129	01.07-	B207L	4	OPH 011
2.0 T	2,0	R, 1	154	03.05-	B207R	4	OPH 011
2.0 T XWD	2,0	R, 1	154	06.08-	B207R	4	OPH 011
9-5							
2.3 t	2,3	R, 1	125	09.99-08.00	B235E	4	OPH 013

**BERU**

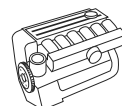
kW

Zyl.
Cyl.
Cil.**SAAB****9-5**

2.3 t	2,3	D, 1	125	09.99-08.00	B235E	4	OPH 016
2.3 t	2,3	R, 1	136	01.01-02.10	B235E	4	OPH 013
2.3 t	2,3	D, 1	136	01.01-02.10	B235E	4	OPH 016
2.3 t BioPower	2,3	R, 1	136	01.07-02.10	B235E	4	OPH 013
2.3 t BioPower	2,3	D, 1	136	01.07-02.10	B235E	4	OPH 016
2.3 Turbo	2,3	R, 1	162	07.03-02.10	B235L	4	OPH 013
2.3 Turbo	2,3	D, 1	162	07.03-02.10	B235L	4	OPH 016
2.3 Turbo	2,3	R, 1	169	10.99-09.01	B235R	4	OPH 013
2.3 Turbo	2,3	R, 1	184	09.01-02.10	B235R	4	OPH 013
2.3 Turbo	2,3	D, 1	184	09.01-02.10	B235R	4	OPH 016
3.0 V6t	3,0	R, 1	147	01.98-08.03	B308E, Chassis # Y3040001 →	6	OPH 013
3.0 V6t	3,0	D, 1	147	01.98-08.03	B308E, Chassis # Y3040001 →	6	OPH 021

9-5 Kombi

2.3 t	2,3	R, 1	125	09.99-08.00	B235E	4	OPH 013
2.3 t	2,3	D, 1	125	09.99-08.00	B235E	4	OPH 016
2.3 t	2,3	R, 1	136	01.01-02.10	B235E	4	OPH 013
2.3 t	2,3	D, 1	136	01.01-02.10	B235E	4	OPH 016
2.3 t BioPower	2,3	R, 1	136	01.07-02.10	B235E	4	OPH 013
2.3 t BioPower	2,3	D, 1	136	01.07-02.10	B235E	4	OPH 016
2.3 Turbo	2,3	R, 1	162	07.03-02.10	B235L	4	OPH 013
2.3 Turbo	2,3	D, 1	162	07.03-02.10	B235L	4	OPH 016
2.3 Turbo	2,3	R, 1	169	10.99-09.01	B235R	4	OPH 013
2.3 Turbo	2,3	R, 1	184	09.01-02.10	B235R	4	OPH 013
2.3 Turbo	2,3	D, 1	184	09.01-02.10	B235R	4	OPH 016
3.0 V6t	3,0	R, 1	147	10.98-08.03	B308E, Chassis # Y3040001 →	6	OPH 013
3.0 V6t	3,0	D, 1	147	10.98-08.03	B308E, Chassis # Y3040001 →	6	OPH 021

SEAT**ALTEA**

2.0 TFSI	2,0	D, 1	147	05.08-05.09	BWA, → Chassis # 5P-8-070 000	4	OPH 085
----------	-----	------	-----	-------------	-------------------------------	---	----------------

AROSA

1.0	1,0	D, 1	37	07.99-07.00	ANV	4	OPH 073
1.0	1,0	D, 1	37	07.00-05.03	AUC, → Chassis # 6H-3-009 600	4	OPH 073
1.0	1,0	R	37	05.97-06.04	AER	4	OZH 169
1.0	1,0	R	37	05.97-06.04	ALL	4	OZH 177
1.4	1,4	D, 1	44	07.99-10.00	ANW	4	OPH 073
1.4	1,4	D, 1	44	09.00-05.03	AUD, → Chassis # 6H-3-002 400	4	OPH 073
1.4	1,4	R	44	05.97-06.04	AEX/AKV/ANW/AKK/APQ/AUD	4	OZH 177
1.4 16V	1,4	R	74	01.00-06.04	AFK/AUB/AQQ	4	OZH 177

CORDOBA

1.0	1,0	R, 1	37	08.99-09.02	ALD	4	OPH 050
1.0	1,0	D, 1	37	08.99-07.00	ANV	4	OPH 071
1.0	1,0	D, 1	37	08.00-09.02	AUC	4	OPH 071
1.0 i	1,0	R	37	09.96-05.97	AER, → Chassis # 6K-V-165 000	4	OZH 071
1.0 i	1,0	R	37	05.97-10.98	AER, → Chassis # 6K..X..127 000, Chassis # 6K..V..165 000 →	4	OZH 151
1.4 i	1,4	R, 6	44	06.94-12.94	ABD, → Chassis # 6K-ZR700000	4	OZH 024
1.4 i	1,4	R	44	06.94-12.94	ABD, → Chassis # 6K-ZR 700 000	4	OZH 043
1.4 i	1,4	R	44	12.94-05.97	AEX, → Chassis # 6K-V-165 000	4	OZH 071
1.4 i	1,4	R	44	12.97-09.98	AKV, APQ, ANX	4	OZH 151
1.4 i	1,4	R	44	05.97-12.97	AEX	4	OZH 151
1.6	1,6	R, 1	74	04.03-11.09	BAH	4	OPH 061
1.6 i	1,6	R	55	02.93-06.99	ABU	4	OZH 043
1.6 i	1,6	R	55	02.93-06.99	AEE, ALM	4	OZH 070
1.8 i	1,8	R, 2, 6	66	02.93-06.99	ABS ADZ	4	OZH 012
1.8 i	1,8	R	66	02.93-06.99	ADZ	4	OZH 071
1.8 i	1,8	R, 2	66	09.93-07.94	ABS	4	OZH 164
1.8 i	1,8	R, 3	66	02.93-07.94	ABS	4	OZU 001
1.8 i	1,8	R, 3, 6	66	02.93-06.99	ABS	4	OZU 003
1.8 i 16V	1,8	R	95	10.93-08.96	ADL	4	OZH 043
2.0 i 16V	2,0	R	110	08.96-06.99	ABF	4	OZH 150

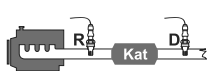



kW

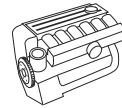

 Zyl.
Cyl.
Cil.

SEAT

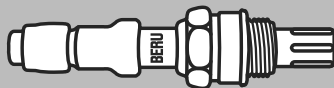
CORDOBA Schrägheck							
1.0	1,0	R, 1	37	08.99-08.02	ALD	4	OPH 050
1.0	1,0	D, 1	37	06.99-07.00	ANV	4	OPH 071
1.0	1,0	D, 1	37	07.00-08.02	AUC	4	OPH 071
1.4	1,4	R, 1	44	08.99-08.02	AKK	4	OPH 050
1.4	1,4	D, 1	44	06.00-08.02	AUD, → Chassis # 6K-2-205 000, Chassis # 6K-1-148 501 →	4	OPH 050
1.4	1,4	D, 1	44	06.99-08.00	ANW	4	OPH 071
1.4	1,4	D, 1	44	06.00-08.02	AUD, → Chassis # 6K-1-148 500	4	OPH 071
1.4	1,4	R	44	06.99-10.02	ANW/AKK/AUD	4	OZH 177
1.6	1,6	R, 1	74	11.99-08.02	AEH	4	OPH 050
1.6	1,6	D, 1	74	03.00-10.00	APF	4	OPH 071
1.6	1,6	D, 1	74	07.00-08.02	AUR	4	OPH 071
1.6 i	1,6	R	74	07.96-06.99	AFT	4	OZH 022
1.8 T 20V Cupra	1,8	D, 1	115	07.00-10.00	AQX, → Chassis # 6K-Y-045 784	4	OPH 070
2.0	2,0	R	110	07.96-04.99	ABF	4	OZH 150
IBIZA I							
1.5	1,5	R	63	10.86-05.93	021 A 2000	4	OZH 037
1.5 i KAT	1,5	R	66	10.86-05.93	021 C.2000	4	OZH 046
IBIZA II							
1.0	1,0	R, 6	33	03.93-09.96	AAU, → Chassis # 6K-ZR700000	4	OZH 024
1.0	1,0	R	33	03.93-09.96	AAU	4	OZH 043
1.0 i	1,0	R	37	05.97-10.98	AER, → Chassis # 6K..X..127 000, Chassis # 6K..V..165 000 →	4	OZH 151
1.0 i	1,0	R	37	10.98-08.99	AER	4	OZH 177
1.3 i	1,3	R	40	03.93-07.94	2G/AAV	4	OZH 043
1.4 i	1,4	R, 6	44	09.93-12.95	AEX/AKV/ABD/APQ, → Chassis # 6K-ZR155000	4	OZH 024
1.4 i	1,4	R	44	09.93-12.95	AEX/AKV/ABD/APQ, → Chassis # 6K-ZR155000	4	OZH 043
1.4 i	1,4	R	44	12.97-09.98	AKV APQ	4	OZH 151
1.4 i	1,4	R	44	05.97-12.97	AEX	4	OZH 151
1.6 i	1,6	R	55	03.93-07.94	ABU	4	OZH 043
1.8 i	1,8	R, 2	66	03.93-08.99	ABS	4	OZH 009
1.8 i	1,8	R, 2, 6	66	03.93-08.99	ABS, ADZ	4	OZH 012
1.8 i	1,8	R, 2	66	03.93-07.94	ABS	4	OZH 164
1.8 i	1,8	R, 3	66	03.93-07.94	ABS	4	OZU 001
1.8 i	1,8	R, 3, 6	66	03.93-08.99	ABS	4	OZU 003
2.0 i 16V	2,0	R	110	08.96-08.99	ABF	4	OZH 150
IBIZA III							
1.0	1,0	R, 1	37	08.99-02.02	ALD	4	OPH 050
1.0	1,0	D, 1	37	08.99-07.00	AUC, ANV	4	OPH 071
1.4	1,4	D, 1	44	06.00-08.00	ANW, AUD, → Chassis # 6K-1-148 500	4	OPH 071
1.4	1,4	R + D, 1	44	06.00-02.02	AKK, AUD, Chassis # 6K-1-148 501 →	4	OPH 050
1.6	1,6	R, 1	74	01.00-02.02	AEH	4	OPH 050
1.6	1,6	D, 1	74	03.00-10.00	APF	4	OPH 071
1.6	1,6	D, 1	74	07.00-02.02	AUR	4	OPH 071
IBIZA IV							
1.6	1,6	R, 1	74	04.03-11.09	BAH	4	OPH 061
INCA							
1.4 i	1,4	D, 1	44	09.00-06.03	AUD, → Chassis # 9K-3-001 200, Chassis # 9K-1-010 201 →	4	OPH 050
1.4 i	1,4	D, 1	44	09.00-06.03	AUD, → Chassis # 9K-1-010 200	4	OPH 071
1.6 i	1,6	R	55	11.95-05.97	1F	4	OZH 071
LEON							
1.6	1,6	R, 1	74	11.99-07.04	AKL/APF/AEH	4	OPH 070
1.8 20V	1,8	R	92	11.99-06.06	AGN	4	OZH 128
1.8 20V T 4	1,8	D, 1	132	11.99-04.04	ARY	4	OPH 066
1.8 20V T 4	1,8	R, 1	132	03.00-01.01	AJQ	4	OPH 068
1.8 T Cupra R	1,8	D, 1	154	02.02-05.03	AMK	4	OPH 066

**BERU**

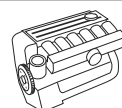
kW

Zyl.
Cyl.
Cil.**SEAT****LEON**

1.8 T Cupra R	1,8	D, 1	165	07.03-06.06	BAM	4	OPH 066
2.0 TFSI	2,0	D, 1	136	09.05-05.06	BWA1, → Chassis # 1P-8-108 000	4	OPH 085
2.0 TFSI	2,0	D, 1	147	05.06-03.09	BWA, → Chassis # 1P-8-108 000	4	OPH 085
2.0 TFSI	2,0	D, 1	177	11.06-05.11	BWJ/CDLD	4	OPH 085
2.8	2,8	D, 1	150	05.02-06.04	BDE	6	OPH 059

MALAGA

1.2 i	1,2	R	52	12.89-12.93	021 C.1000	4	OZH 037
1.5 i KAT	1,5	R	66	10.86-12.93	021 A 2000/021 C.2000/021 D.2000	4	OZH 037

TOLEDO I

1.6 i	1,6	R	55	01.93-11.93	1F, → Chassis # 1L-ZD308450	4	OZU 022
1.6 i	1,6	R	55	11.93-03.99	1F, Chassis # 1L-ZD308451 →	4	OZU 003
1.8 i	1,8	R, 6	65	05.91-11.93	RP, → Chassis # 1L-ZD308450	4	OZH 008
1.8 i	1,8	R	65	05.91-11.93	RP, → Chassis # 1L-ZD308450	4	OZU 022
1.8 i	1,8	R, 2	66	11.93-12.96	ABS	4	OZH 009
1.8 i	1,8	R, 2, 6	66	11.93-12.96	ABS, ADZ	4	OZH 012
1.8 i	1,8	R, 3	66	11.93-07.94	ABS	4	OZU 001
1.8 i	1,8	R, 3, 6	66	11.93-12.96	ABS	4	OZU 003
1.8 16V	1,8	R	92	05.91-03.99	PL	4	OZH 037
2.0 i	2,0	R	85	05.91-03.94	2 E, → Chassis # 1L-ZD 320 000	4	OZH 009
2.0 i	2,0	R, 6	85	03.94-06.96	2E/AGG	4	OZH 024

TOLEDO II

1.6 16V	1,6	D	77	09.00-05.06	AUS/BCB/AZD	4	OZH 182
1.8 20V	1,8	R	92	04.99-05.06	AGN/APG	4	OZH 177
2.3 V5	2,3	R	110	04.99-05.01	AGZ	5	OZH 177

TOLEDO III

2.0 TFSI	2,0	D, 1	147	11.05-05.09	BWA, → Chassis # 5P-8-070 000	4	OPH 085
----------	-----	------	-----	-------------	-------------------------------	---	----------------

SKODA**FABIA**

1.0	1,0	R, 1	37	10.00-08.02	ARV	4	OPH 061
1.4	1,4	R, 1	44	08.00-08.02	AZE	4	OPH 061
1.4	1,4	R, 1	50	08.99-05.03	AME	4	OPH 061

FABIA Combi

1.4	1,4	R, 1	44	04.00-03.03	AZE	4	OPH 061
1.4	1,4	R, 1	50	04.00-05.03	AME	4	OPH 061

FABIA Praktik

1.4	1,4	R, 1	50	07.01-05.03	AME	4	OPH 061
-----	-----	------	----	-------------	-----	---	----------------

FAVORIT

1.3	1,3	R	40	01.90-09.94	781.135E	4	OZH 037
1.3	1,3	R	50	01.94-09.94	136B	4	OZH 043

FELICIA I

1.3	1,3	R	40	08.96-03.98	135B/AMG	4	OZH 099
1.3	1,3	R	50	08.96-03.98	136B/AMH	4	OZH 099
1.6 LX	1,6	R	55	09.95-03.98	EA111/AEE	4	OZH 099

FELICIA I Fun

1.6	1,6	R	55	06.97-	AEE	4	OZH 099
-----	-----	---	----	--------	-----	---	----------------

FELICIA I Kombi

1.6 GLX	1,6	R	55	08.95-03.98	AEE	4	OZH 099
---------	-----	---	----	-------------	-----	---	----------------

OCTAVIA

1.6	1,6	R	55	09.96-09.00	AEE	4	OZH 177
1.6	1,6	R	74	02.97-	AKL/AEH	4	OZH 169
1.8	1,8	R	92	09.96-	AGN	4	OZH 177
1.8 T	1,8	R	110	08.97-	AGU	4	OZH 177
1.8 T 4x4	1,8	D, 1	110	05.01-04.06	ARX	4	OPH 066
1.8 T 4x4	1,8	R	110	05.01-	AGU	4	OZH 177
2.0	2,0	D, 1	85	04.99-03.02	AQY, APK	4	OPH 049
2.0 RS	2,0	D, 1	147	10.05-03.08	BWA	4	OPH 085

OCTAVIA Combi

1.6	1,6	R	74	07.98-	AKL/AEH	4	OZH 169
1.8 20V	1,8	R	92	07.98-	AGN	4	OZH 177

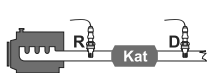

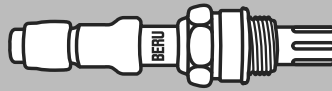

kW

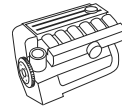
 Zyl.
Cyl.
Cil.

SKODA
OCTAVIA Combi

1.8 T	1,8	R	110	07.98–	AGU	4	OZH 177
1.8 T 4x4	1,8	D, 1	110	05.01–04.06	ARX	4	OPH 066
1.8 T 4x4	1,8	R	110	05.01–	AGU	4	OZH 177
1.8 TSI 4x4	1,8	D, 1	118	11.08–05.09	CDAA	4	OPH 085
2.0	2,0	D, 1	85	03.02–09.09	AZJ	4	OPH 075
2.0 4x4	2,0	D, 1	85	05.01–09.04	AZH	4	OPH 066
2.0 RS	2,0	D, 1	147	10.05–05.09	BWA/CCZA	4	OPH 085

SUPERB

1.8 T	1,8	D, 1	110	02.02–03.08	AWT	4	OPH 052
2.8 V6	2,8	D, 1	142	02.02–03.08	AMX	6	OPH 023
2.8 V6	2,8	D, 1	142	02.02–03.08	AMX	6	OPH 008

SMART
FORTWO Coupe

1.0	1,0	D, 1	45	01.07–	M 132.910	3	OPH 087
1.0	1,0	D, 1	52	01.07–	M 132.910	3	OPH 087

SUZUKI
BALENO

1.8 GTX	1,8	R	89	03.96–05.02	J18A	4	OZH 196
---------	-----	---	----	-------------	------	---	----------------

SWIFT II Schrägheck

1.3 GTi	1,3	R	74	03.89–05.01	G13B	4	OZU 015
---------	-----	---	----	-------------	------	---	----------------

VITARA

1.6	1,6	R	60	07.88–12.91	G16A	4	OZU 014
-----	-----	---	----	-------------	------	---	----------------

VAUXHALL
AGILA Mk I

1.0 12V	1,0	R + D, 1	43	09.00–08.05	Z 10 XE, → Chassis # 4G999999, 4G999999	3	OPH 078
1.0 12V	1,0	R, 1	43	09.00–08.05	Z 10 XE	3	OPH 081
1.2 16V	1,2	R + D, 1	55	09.00–	Z 12 XE, → Chassis # 4G999999, 4G999999	4	OPH 078

ASTRA Mk II Convertible

1.6 i	1,6	R	55	01.91–08.93	E 16 NZ	4	OZU 005
1.6 i KAT	1,6	R	55	10.87–02.93	C 16 LZ, C 16 NZ	4	OZU 005
2.0 i	2,0	R	85	01.87–12.91	20 NE	4	OZH 040
2.0 i KAT	2,0	R	85	01.91–08.93	C 20 NE	4	OZH 040

ASTRA Mk IV

1.2 16V	1,2	D, 1	55	09.00–	Z 12 XE	4	OPH 078
1.2 16V	1,2	R, 1	55	09.00–	Z 12 XE	4	OPH 081
1.4 16V	1,4	R	66	09.00–	X 14 XE/Z 14 XE, → Chassis # 18999999	4	OZH 132
1.4 16V	1,4	R	66	09.98–08.00	X 14 XE/Z 14 XE, → Chassis # 18999999	4	OZH 148
1.6	1,6	R	62	09.00–	Z 16 SE	4	OZH 110
1.6 16V	1,6	R	74	09.98–08.00	Z 16 XE/X 16 XEL/Z 16 XEP/ C 16 SEL, → Chassis # 18999999	4	OZH 148

ASTRA Mk IV CC

1.2 16V	1,2	D, 1	55	09.00–	Z 12 XE	4	OPH 078
1.2 16V	1,2	R, 1	55	09.00–	Z 12 XE	4	OPH 081
1.4 16V	1,4	R	66	09.00–	X 14 XE/Z 14 XE, → Chassis # 18999999	4	OZH 132
1.4 16V	1,4	R	66	02.98–08.00	X 14 XE/Z 14 XE, → Chassis # 18999999	4	OZH 148
1.6	1,6	R + D	62	09.00–	Z 16 SE	4	OZH 110
2.0 SRI Turbo	2,0	R, 1	141	07.02–	Z 20 LET	4	OPH 081
2.0 SRI Turbo	2,0	D, 1	141	07.02–	Z 20 LET	4	OPH 084

ASTRA Mk IV Convertible

1.6 16V	1,6	R	74	03.01–	Z 16 XE	4	OZH 132
2.0	2,0	R, 1	147	09.02–07.06	Z 20 LET	4	OPH 081
2.0	2,0	D, 1	147	09.02–07.06	Z 20 LET	4	OPH 084

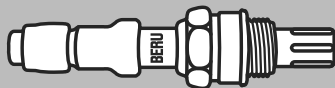
**BERU**

kW

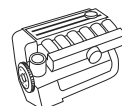
Zyl.
Cyl.
Cil.**VAUXHALL****ASTRA Mk IV Convertible**

2.0 Turbo	2,0	R, 1	141	03.02-	Z 20 LET	4	OPH 081
2.0 Turbo	2,0	D, 1	141	03.02-	Z 20 LET	4	OPH 084

ASTRA Mk IV Coupe

2.0	2,0	R, 1	147	08.02-05.05	Z 20 LET	4	OPH 081
2.0	2,0	D, 1	147	08.02-05.05	Z 20 LET	4	OPH 084
2.0 16V Turbo	2,0	R, 1	140	09.00-	Z 20 LET	4	OPH 081
2.0 16V Turbo	2,0	D, 1	140	09.00-	Z 20 LET	4	OPH 084

ASTRA Mk IV Estate

1.4 16V	1,4	R	66	09.00-	X 14 XE/Z 14 XE, → Chassis # 18999999	4	OZH 132
1.4 16V	1,4	R	66	02.98-08.00	X 14 XE/Z 14 XE, → Chassis # 18999999	4	OZH 148
1.6	1,6	R + D	62	03.98-04.04	Z 16 SE	4	OZH 110
1.6 Dualfuel	1,6	R	63	03.98-04.04	Z 16 XE	4	OZH 132
1.6 16V	1,6	R	74	03.98-08.00	Z 16 XE/X 16 XEL, → Chassis # 18999999	4	OZH 148

ASTRA Mk V CC

2.0 Turbo	2,0	R, 1	125	01.04-05.09	Z 20 LEL	4	OPH 081
2.0 Turbo	2,0	D, 1	125	01.04-05.09	Z 20 LEL	4	OPH 084
2.0 Turbo	2,0	D, 1	147	01.04-05.09	Z 20 LER	4	OPH 084
2.0 Turbo	2,0	R, 1	177	01.04-05.09	Z 20 LEH	4	OPH 081
2.0 Turbo	2,0	D, 1	177	01.04-05.09	Z 20 LEH	4	OPH 084

ASTRA Mk V Estate

2.0 Turbo	2,0	R, 1	125	08.04-	Z 20 LEL	4	OPH 081
2.0 Turbo	2,0	D, 1	125	08.04-	Z 20 LEL	4	OPH 084
2.0 Turbo	2,0	D, 1	147	08.04-	Z 20 LER	4	OPH 084

CORSA Convertible

1.4 i 16V	1,4	R	66	01.98-	X 14 XE, → Chassis # S 4269627/ S 6011904	4	OZU 023
1.4 i 16V	1,4	R	66	01.98-	X 14 XE, Chassis # S 4269628/ S 6011905 →	4	OZU 005

CORSA Mk II

1.4 i 16V	1,4	R	66	09.94-09.00	X 14 XE, → Chassis # S 4269627/ S 6011904	4	OZU 023
1.4 i 16V	1,4	R	66	09.94-09.00	X 14 XE, Chassis # S 4269628/ S 6011905 →	4	OZU 005
1.6 GSI 16V	1,6	R	80	03.93-09.00	C 16 XE, → Chassis # S 4269627/ S 6011904	4	OZU 023
1.6 GSI 16V	1,6	R	80	03.93-09.00	C 16 XE, Chassis # S 4269628/ S 6011905 →	4	OZU 005

CORSA Mk III

1.0 12V	1,0	D, 1	43	09.00-10.03	Z 10 XE	3	OPH 078
1.0 12V	1,0	R, 1	43	09.00-10.03	Z 10 XE	3	OPH 079
1.2 16V	1,2	D, 1	55	09.00-	Z 12 XE, → Chassis # 14177496, 13025250, 16079019	4	OPH 078
1.2 16V	1,2	R, 1	55	09.00-	Z 12 XE	4	OPH 081
1.2 16V Dualfuel	1,2	D, 1	55	08.01-	Z 12 XE, → Chassis # 16079019, 13025250, 14177496	4	OPH 078
1.2 16V Dualfuel	1,2	R, 1	55	08.01-	Z 12 XE	4	OPH 081
1.4 16V	1,4	R	66	09.00-	Z 14 XE	4	OZH 132

FRONTERA Mk I Sport

2.0 i	2,0	R	85	02.95-10.98	C 20 NE/X 20 SE	4	OZH 019
2.0 i	2,0	R	85	03.92-01.95	C 20 NE/X 20 SE	4	OZH 028

MERIVA Mk I

1.6 i 16V	1,6	R	74	01.03-10.09	Z 16 XE	4	OZH 132
-----------	-----	---	----	-------------	---------	---	----------------

MONTEREY

3.2	3,2	R	130	06.92-07.98	6 VD1	6	OZH 196
-----	-----	---	-----	-------------	-------	---	----------------

OMEGA

2.0	2,0	R	85	03.94-09.99	X 20 SE	4	OZH 019
2.5 V6	2,5	R, 2	125	03.94-08.94	X 25 XE	6	OZH 019
2.6 V6	2,6	D, 1, 2	132	08.00-03.04	Y 26 SE	6	OPH 080



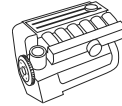

kW

 Zyl.
Cyl.
Cil.

VAUXHALL
OMEGA

2.6 V6	2,6	R, 1, 2	132	08.00-03.04	Y 26 SE	6	OPH 082
3.2 V6	3,2	D, 1, 2	160	02.01-03.04	Y 32 SE	6	OPH 080
3.2 V6	3,2	R, 1, 2	160	02.01-03.04	Y 32 SE	6	OPH 082

OMEGA Estate

2.0	2,0	R	85	03.94-09.99	X 20 SE	4	OZH 019
2.5 V6	2,5	R, 2	125	03.94-08.94	X 25 XE	6	OZH 019
2.6 V6	2,6	D, 1, 2	132	08.00-03.04	Y 26 SE	6	OPH 080
2.6 V6	2,6	R, 1, 2	132	08.00-03.04	Y 26 SE	6	OPH 082
3.2 V6	3,2	D, 1, 2	160	02.01-03.04	Y 32 SE	6	OPH 080
3.2 V6	3,2	R, 1, 2	160	02.01-03.04	Y 32 SE	6	OPH 082

SINTRA

2.2 i 16 V	2,2	R	104	11.96-04.99	X 22 XE	4	OZH 040
------------	-----	---	-----	-------------	---------	---	----------------

TIGRA Mk I

1.4 16V	1,4	R	66	07.94-12.00	X 14 XE, → Chassis # S 4269627/ S 6011904	4	OZU 023
1.4 16V	1,4	R	66	07.94-12.00	X 14 XE, Chassis # S 4269628/ S 6011905 →	4	OZU 005
1.6 16V	1,6	R	78	07.94-12.00	X 16 XE, → Chassis # S 4269627/ S 6011904	4	OZU 023
1.6 16V	1,6	R	78	07.94-12.00	X 16 XE, Chassis # S 4269628/ S 6011905 →	4	OZU 005

VECTRA

1.6 i 16V	1,6	R	74	08.95-08.00	X 16 XEL	4	OZH 148
1.8 i 16V	1,8	R, 3	92	09.00-	Z 18 XE	4	OZH 113
1.8 i 16V	1,8	R, 2	92	09.00-	Z 18 XE	4	OZH 114
1.8 i 16V	1,8	D	92	09.00-	Z 18 XE	4	OZH 115
2.6 i V6	2,6	D, 1	125	09.00-03.02	Y 26 SE	6	OPH 083

VECTRA CC

1.6 i 16V	1,6	R	74	08.95-08.00	X 16 XEL	4	OZH 148
2.6 i V6	2,6	D, 1	125	09.00-	Y 26 SE	6	OPH 083

VECTRA Estate

1.6 i 16V	1,6	R	74	11.96-08.00	X 16 XEL	4	OZH 148
1.8 i 16V	1,8	R, 3	92	09.00-	Z 18 XE	4	OZH 113
1.8 i 16V	1,8	R, 2	92	09.00-	Z 18 XE	4	OZH 114
1.8 i 16V	1,8	D	92	09.00-	Z 18 XE	4	OZH 115
2.6 i V6	2,6	D, 1	125	09.00-03.02	Y 26 SE	6	OPH 083

ZAFIRA Mk I

1.6 16V	1,6	R	74	04.99-08.99	Z 16 XE/X 16 XEL, → Chassis # 18999999	4	OZH 148
1.8 16V	1,8	R, 3	92	09.00-08.05	Z 18 XE	4	OZH 113
1.8 16V	1,8	R, 2	92	09.00-08.05	Z 18 XE	4	OZH 114
1.8 16V	1,8	D	92	09.00-08.05	Z 18 XE	4	OZH 115
2.0 GSI Turbo	2,0	D, 1	141	09.01-06.05	Z 20 LET	4	OPH 084

ZAFIRA Mk II

2.0	2,0	R, 1	147	07.05-	Z 20 LER	4	OPH 081
2.0	2,0	D, 1	147	07.05-	Z 20 LER	4	OPH 084
2.0	2,0	R, 1	176	01.06-	Z 20 LEH	4	OPH 081
2.0	2,0	D, 1	176	01.06-	Z 20 LEH	4	OPH 084

VOLVO

240							
2.3 i KAT	2,3	R	85	08.86-07.93	B 230 F	4	OZH 003
240 Kombi							
2.3	2,3	R	83	08.86-07.87	B 230 F	4	OZH 003
2.3 i KAT	2,3	R	85	08.86-07.93	B 230 F	4	OZH 003
340-360							
2.0	2,0	R	80	08.88-07.89	B 200 F	4	OZH 037
340-360 Stufenheck							
2.0	2,0	R	80	08.88-07.89	B 200 F	4	OZH 037
440 K							
1.6	1,6	R	61	09.93-12.96	B 16 F, → Chassis # 358975	4	OZH 003

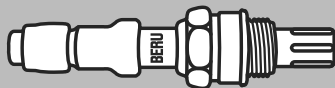
**BERU**

kW

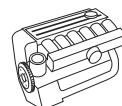
Zyl.
Cyl.
Cil.**VOLVO****440 K**

1.7	1,7	R	70	08.88-07.89	B 18 F	4	OZH 003
1.7 Turbo	1,7	R	88	08.88-07.96	B 18 FT	4	OZH 003
1.7 Turbo	1,7	R	90	01.91-07.96	B 18 FT	4	OZH 003
1.8	1,8	R	66	08.91-07.96	B 18 U	4	OZH 003

460 L

1.6	1,6	R	61	09.93-07.96	B 16 F, → Chassis # 358975	4	OZH 003
1.7	1,7	R	75	09.91-07.92	B 18 EP	4	OZH 003
1.7	1,7	R	75	08.89-08.91	B 18 EP	4	OZH 037
1.7 Turbo	1,7	R	88	09.91-07.96	B 18 FT	4	OZH 003
1.7 Turbo	1,7	R	88	08.89-08.91	B 18 FT	4	OZH 037
1.8	1,8	R	66	08.91-07.96	B 18 U	4	OZH 003
2.0	2,0	R	80	08.93-07.96	B 20 F	4	OZH 003
2.0	2,0	R	81	08.92-07.95	B 20 F	4	OZH 003

480 E

1.7	1,7	R	70	08.87-07.89	B 18 F	4	OZH 003
1.7 Turbo	1,7	R	88	08.88-08.95	B 18 FT	4	OZH 003
1.7 Turbo	1,7	R	90	01.91-08.95	B 18 FT	4	OZH 003
2.0	2,0	R	81	08.92-09.95	B 20 F	4	OZH 003

740

2.3	2,3	R	85	08.87-07.92	B 230 F	4	OZH 003
2.3	2,3	R	111	08.88-08.92	B 234 F	4	OZH 003
2.3	2,3	R	114	08.88-07.91	B 234 F	4	OZH 003
2.3	2,3	R	117	08.87-07.89	B 234 F	4	OZH 003
2.3 Turbo	2,3	R	121	08.89-07.90	B 230 FT	4	OZH 037

740 Kombi

2.0	2,0	R	82	08.89-07.91	B 200 F	4	OZH 003
2.3	2,3	R	83	08.88-12.89	B 230 F	4	OZH 037
2.3	2,3	R	85	08.87-07.92	B 230 F	4	OZH 003
2.3	2,3	R	111	07.89-08.92	B 234 F	4	OZH 003
2.3	2,3	R	114	08.88-07.90	B 234 F	4	OZH 003
2.3	2,3	R	117	08.87-07.89	B 234 F	4	OZH 003
2.3 Turbo	2,3	R	121	08.89-07.90	B 230 GT/B 230 FT	4	OZH 037

760

2.8	2,8	R	105	05.86-10.86	B 280 F	6	OZH 003
2.8	2,8	R	108	08.86-07.90	B 280 F	6	OZH 003

780

2.9	2,8	R	108	08.87-07.90	B 280 F	6	OZH 003
-----	-----	---	-----	-------------	---------	---	----------------

850

2.0	2,0	R	105	06.91-12.96	B 5204 F	5	OZH 035
2.0 Turbo	2,0	R	155	01.95-12.96	B 5204 T/B 5204 FT	5	OZH 073
2.3 T5	2,3	R	166	09.94-07.96	B 5234 FT	5	OZH 073
2.5	2,4	D	125	08.91-12.96	B 5254 S	5	OZH 209

850 Kombi

2.0 Turbo	2,0	R	155	01.95-12.96	B 5204 T/B 5204 FT	5	OZH 073
2.5	2,4	D	125	09.92-12.96	B 5254 S	5	OZH 209
2.5 AWD	2,4	D	142	09.96-12.96	B 5254 T	5	OZH 210

940

2.0	2,0	R	82	01.92-07.94	B 200 F	4	OZH 003
2.3	2,3	R	96	08.90-12.94	B 230 G/B 230 FB	4	OZH 003
2.3	2,3	R	114	08.90-07.91	B 234 F /B 234 G	4	OZH 003
2.3 Turbo	2,3	R	121	08.90-08.93	B 230 FT	4	OZH 046
2.3 Turbo	2,3	R	121	09.93-07.94	B 230 FT	4	OZH 155

940 II

2.3 ti	2,3	R	99	01.95-08.96	B 230 FK	4	OZH 155
2.3 Turbo	2,3	R	121	08.94-08.97	B 230 FT	4	OZH 155

940 II Kombi

2.3 ti	2,3	R	99	01.95-08.96	B 230 FK	4	OZH 155
2.3 Turbo	2,3	R	121	08.94-08.97	B 230 FT	4	OZH 155

940 Kombi

2.0	2,0	R	82	01.92-07.94	B 200 F	4	OZH 003
2.3	2,3	R	96	08.90-12.94	B 230 FB	4	OZH 003



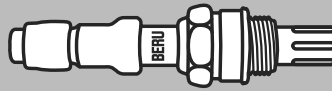

kW

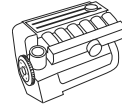

Zyl.
Cyl.
Cil.



VOLVO

940 Kombi

2.3	2,3	R	114	08.90-07.91	B 234 F	4	OZH 003
2.3 Turbo	2,3	R	121	08.90-07.94	B 230 FT	4	OZH 037
2.3 Turbo	2,3	R	121	09.93-07.94	B 230 FT	4	OZH 155

C30

1.8	1,8	R, 1	92	10.06-	B 4184 S11	4	OPH 002
1.8 FlexFuel	1,8	R, 1	92	01.07-	B 4184 S8	4	OPH 002
2.0	2,0	R, 1	107	10.06-	B 4204 S3	4	OPH 002
T5	2,5	D, 1	162	10.06-07.07	B 5254 T3	5	OPH 014
T5	2,5	D, 1	169	08.07-	B 5254 T7	5	OPH 014

C70 I Cabriolet

2.0	2,0	D	132	03.98-07.98	B 5204 T2	5	OZH 210
2.0 T	2,0	D, 1	120	03.00-07.02	B 5204 T4	5	OPH 013
2.0 T	2,0	D, 1	166	08.98-07.00	B 5204 T3	5	OPH 013
2.3 T-5	2,3	D, 1	176	08.98-07.02	B 5234 T3	5	OPH 013
2.5 T	2,4	D, 1	142	08.98-07.02	B 5254 T/B 5244 T	5	OPH 013

C70 I Coupe

2.0	2,0	D	132	03.97-07.98	B 5204 T2	5	OZH 210
2.0 T	2,0	D, 1	120	03.00-07.02	B 5204 T4	5	OPH 013
2.0 T	2,0	D, 1	166	08.98-07.00	B 5204 T3	5	OPH 013
2.0 T	2,0	D	166	03.97-07.98	B 5204 T3	5	OZH 210
2.3 T-5	2,3	D, 1	176	08.98-07.02	B 5234 T3	5	OPH 013
2.3 T-5	2,3	D	176	07.97-07.98	B 5234 T3	5	OZH 210
2.5 T	2,4	D, 1	142	08.98-07.02	B 5254 T/B 5244 T	5	OPH 013
2.5 T	2,4	D	142	01.98-07.98	B 5254 T	5	OZH 210

C70 II Cabriolet

T5	2,5	D, 1	162	03.06-07.07	B 5254 T3	5	OPH 014
T5	2,5	D, 1	169	08.07-	B 5254 T7	5	OPH 014

S40 I

1.6	1,6	R	77	09.95-08.99	B 4164 S	4	OZH 130
1.8	1,7	R	85	07.95-08.99	B 4184 S3/B 4184 S	4	OZH 130
2.0	1,9	R	100	07.95-12.03	B 4204 S2/B 4204 S	4	OZH 130

S40 II

1.8	1,8	R, 1	92	04.04-	B 4184 S11	4	OPH 002
1.8 FlexFuel	1,8	R, 1	92	04.06-	B 4184 S8	4	OPH 002
2.0	2,0	R, 1	107	10.06-	B 4204 S3	4	OPH 002
T5	2,5	D, 1	162	01.04-07.07	B 5254 T3	5	OPH 014
T5	2,5	D, 1	169	08.07-	B 5254 T7	5	OPH 014
T5 AWD	2,5	D, 1	162	04.04-07.07	B 5254 T3	5	OPH 014
T5 AWD	2,5	D, 1	169	08.07-	B 5254 T7	5	OPH 014

S60

2.0 T	2,0	D, 1	132	09.01-07.09	B 5204 T5	5	OPH 014
2.4 T	2,4	D, 1	147	11.00-07.03	B 5244 T3	5	OPH 014
2.4 T AWD	2,4	D, 1	147	11.01-07.03	B 5244 T3	5	OPH 014
2.4 AWD	2,4	D, 1	191	02.04-07.09	B 5244 T5	5	OPH 014
2.4 T5	2,4	D, 1	191	04.04-07.09	B 5244 T5	5	OPH 014
2.5 T	2,5	D, 1	154	08.04-07.09	B 5254 T2	5	OPH 014
2.5 T	2,5	D, 1	154	02.04-07.04	B 5254 T2	5	OPH 019
2.5 T AWD	2,5	D, 1	154	08.04-07.09	B 5254 T2	5	OPH 014
2.5 T AWD	2,5	D, 1	154	04.04-07.04	B 5254 T2	5	OPH 019
R 2,5 T AWD	2,5	D, 1	221	08.04-07.07	B 5254 T4	5	OPH 014
R 2,5 T AWD	2,5	D, 1	221	03.03-07.04	B 5254 T4	5	OPH 019
T5	2,3	D, 1	184	11.00-03.04	B 5234 T3	5	OPH 014

S70

2.0	2,0	D	105	01.97-07.98	B 5204 F	5	OZH 209
2.0	2,0	D, 1	120	08.98-07.00	B 5204 T4	5	OPH 013
2.0	2,0	D	132	01.97-07.98	B 5204 T2	5	OZH 210
2.0 Turbo	2,0	R	155	01.97-11.00	B 5204 T	5	OZH 073
2.0 Turbo	2,0	D	155	01.97-07.98	B 5204 T	5	OZH 210
2.0 Turbo	2,0	D, 1	166	08.98-07.00	B 5204 T3	5	OPH 013
2.0 Turbo	2,0	R	166	01.97-11.00	B 5204 T3	5	OZH 073
2.3	2,3	D, 1	195	04.99-09.00	B 5234 T7	5	OPH 013

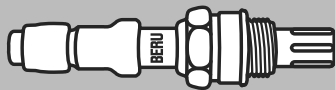
**BERU**

kW

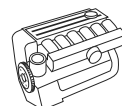
Zyl.
Cyl.
Cil.**VOLVO****S70**

2.3 T-5	2,3	D, 1	176	08.98-07.00	B 5234 T3	5	OPH 013
2.3 T-5	2,3	R	176	01.97-11.00	B 5234 T3	5	OZH 073
2.3 T-5	2,3	D	176	01.97-07.98	B 5234 T3	5	OZH 210
2.3 Turbo	2,3	D	184	01.97-07.98	B 5234 FT+	5	OZH 210
2.4	2,4	R	125	01.97-11.00	B 5244 S/B 5254 S	5	OZH 073
2.4 T5 AWD	2,4	D, 1	142	08.98-04.99	B 5254 T	5	OPH 013
2.4 Turbo	2,4	D, 1	142	08.98-07.00	B 5254 T/B 5244 T	5	OPH 013
2.4 Turbo	2,4	D	142	01.97-07.98	B 5254 T	5	OZH 210
2.5	2,4	D	121	06.98-07.98	B 5254 S	5	OZH 209

S80

2.0	2,0	D, 1	120	08.98-07.00	B 5204 T4	5	OPH 014
2.0 T	2,0	D, 1	132	12.99-07.06	B 5204 T5	5	OPH 014
2.0 T	2,0	D, 1	166	08.98-07.00	B 5204 T3	5	OPH 014
2.3 R	2,3	D, 1	195	04.00-08.05	B 5234 T7	5	OPH 014
2.4 T	2,4	D, 1	147	06.00-07.03	B 5244 T3	5	OPH 014
2.4 T5 AWD	2,4	D, 1	147	08.00-09.03	B 5244 T3	5	OPH 014
2.5 T	2,5	D, 1	154	08.03-07.06	B 5254 T2	5	OPH 014
2.5 T AWD	2,5	D, 1	154	07.03-07.06	B 5254 T2	5	OPH 014
2.8 T6	2,8	D, 1	200	05.98-07.01	B 6284 T	6	OPH 022
2.9	2,9	D, 1	147	08.99-07.01	B 6294 S	6	OPH 017
2.9	2,9	D, 1	150	05.98-07.99	B 6304 S3	6	OPH 022

V40 Kombi

1.6	1,6	R	77	12.95-08.99	B 4164 S	4	OZH 130
1.8	1,7	R	85	07.95-08.99	B 4184 S3/B 4184 S	4	OZH 130
2.0	1,9	R	100	07.95-06.04	B 4204 S	4	OZH 130

V50

1.8	1,8	R, 1	92	04.04-	B 4184 S11	4	OPH 002
1.8 FlexFuel	1,8	R, 1	92	04.06-	B 4184 S8	4	OPH 002
2.0	2,0	R, 1	107	10.06-	B 4204 S3	4	OPH 002
T5	2,5	D, 1	162	04.04-07.07	B 5254 T3	5	OPH 014
T5 AWD	2,5	D, 1	162	04.04-07.07	B 5254 T3	5	OPH 014
T5	2,5	D, 1	169	08.07-	B 5254 T7	5	OPH 014
T5 AWD	2,5	D, 1	169	08.07-	B 5254 T7	5	OPH 014

V70 I Kombi

2.0	2,0	D	105	01.97-07.98		5	OZH 209
2.0	2,0	D, 1	120	08.98-03.00	B 5204 T4	5	OPH 013
2.0	2,0	D	132	01.97-07.98	B 5204 T2	5	OZH 210
2.0 Turbo	2,0	D, 1	155	08.98-03.00	B 5204 T	5	OPH 013
2.0 Turbo	2,0	R	155	01.97-03.00	B 5204 T	5	OZH 073
2.0 Turbo	2,0	D	155	01.97-07.98	B 5204 T	5	OZH 210
2.0 Turbo	2,0	D, 1	166	08.98-07.99	B 5204 T3	5	OPH 013
2.0 Turbo	2,0	R	166	01.97-03.00	B 5204 T3	5	OZH 073
2.0 Turbo	2,0	D	166	01.97-07.98	B 5204 T3	5	OZH 210
2.0 Turbo AWD	2,0	D, 1	166	08.98-07.99	B 5204 T3	5	OPH 013
2.0 Turbo AWD	2,0	R	166	01.97-03.00	B 5204 T3	5	OZH 073
2.0 Turbo AWD	2,0	D	166	01.97-07.98	B 5204 T3	5	OZH 210
2.3 AWD	2,3	D, 1	177	08.98-09.98	B 5234 T3	5	OPH 013
2.3 AWD	2,3	D, 1	195	12.98-02.00	B 5234 T7/B 5234 T8	5	OPH 013
2.3 T AWD	2,3	R	184	04.97-03.00	B 5234 FT+	5	OZH 073
2.3 T AWD	2,3	D	184	08.97-07.98	B 5234 FT+	5	OZH 210
2.3 T-5	2,3	D, 1	176	08.98-03.00	B 5234 T3	5	OPH 013
2.3 T-5	2,3	R	176	01.97-03.00	B 5234 T3	5	OZH 073
2.3 T-5	2,3	D	176	01.97-07.98	B 5234 T3	5	OZH 210
2.3 T-5 AWD	2,3	D, 1	176	08.98-03.00	B 5234 T3	5	OPH 013
2.3 T-5 AWD	2,3	R	176	01.97-03.00	B 5234 T3	5	OZH 073
2.3 T-5 AWD	2,3	D	176	01.97-07.98	B 5234 T3	5	OZH 210
2.3 Turbo	2,3	R	184	01.97-03.00	B 5234 FT+	5	OZH 073
2.3 Turbo	2,3	D	184	01.97-07.98	B 5234 FT+	5	OZH 210
2.4	2,4	R	125	01.97-05.00	B 5254 S	5	OZH 073
2.4 AWD	2,4	D, 1	195	05.99-02.00	B 5244 T2	5	OPH 013
2.4 Turbo	2,4	D, 1	142	08.98-03.00	B 5254 T	5	OPH 013



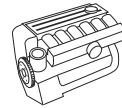

kW

 Zyl.
Cyl.
Cil.

VOLVO
V70 I Kombi

2.4 Turbo	2,4	R	142	01.97-03.00	B 5254 T/B 5244 T	5	OZH 073
2.4 Turbo	2,4	D	142	01.97-07.98	B 5254 T	5	OZH 210
2.5	2,4	D	121	06.98-07.98	B 5254 S	5	OZH 209
2.5 AWD	2,4	R, 1	195	03.99-03.00		5	OPH 013
2.5 Turbo AWD	2,4	D, 1	142	08.98-03.00	B 5254 T/B 5244 T	5	OPH 013
2.5 Turbo AWD	2,4	R	142	01.97-05.00	B 5254 T/B 5244 T	5	OZH 073
2.5 Turbo AWD	2,4	D	142	01.97-07.98	B 5254 T	5	OZH 210

V70 II Kombi

2.0 T	2,0	D, 1	132	07.01-07.07	B 5204 T5	5	OPH 014
2.3	2,3	D, 1	195	10.00-07.04	B 5234 T7	5	OPH 014
2.3 T5	2,3	D, 1	184	03.00-07.04	B 5234 T3	5	OPH 014
2.4 T	2,4	D, 1	147	03.00-07.03	B 5244 T3	5	OPH 014
2.4 T AWD	2,4	D, 1	147	09.01-07.03	B 5244 T3	5	OPH 014
2.4 T5	2,4	D, 1	191	04.04-07.07	B 5244 T5	5	OPH 014
2.5 T	2,5	D, 1	154	08.04-07.07	B 5254 T2	5	OPH 014
2.5 T	2,5	D, 1	154	04.04-07.04	B 5254 T2	5	OPH 019
2.5 T AWD	2,5	D, 1	154	08.04-07.07	B 5254 T2	5	OPH 014
2.5 T AWD	2,5	D, 1	154	09.02-07.04	B 5254 T2	5	OPH 019
2.5 R Sport	2,5	D, 1	221	08.04-07.07	B 5254 T4	5	OPH 014
2.5 R Sport	2,5	D, 1	221	12.02-07.04	B 5254 T4	5	OPH 019
R 2,5 T AWD	2,5	D, 1	221	08.04-07.07	B 5254 T4	5	OPH 014
R 2,5 T AWD	2,5	D, 1	221	03.03-07.04	B 5254 T4	5	OPH 019

XC 90

2.5 T	2,5	D, 1	154	08.04-	B 5254 T2	5	OPH 014
2.5 T	2,5	D, 1	154	10.02-07.04	B 5254 T2	5	OPH 019
T6	2,9	D, 1	200	01.03-07.06	B 6294 T	6	OPH 014

XC70 CROSS COUNTRY

2.4 T XC AWD	2,4	D, 1	142	08.98-03.00		5	OPH 013
2.4 T XC AWD	2,4	D, 1	147	09.00-07.02	B 5244 T3	5	OPH 014
2.5 T XC AWD	2,5	D, 1	154	08.04-07.07	B 5254 T2	5	OPH 014
2.5 T XC AWD	2,5	D, 1	154	09.02-07.04	B 5254 T2	5	OPH 019

VW
BORA

1.6	1,6	R	74	10.98-05.05	AEH, AKL, → Chassis # 1J-X-260 000	4	OZH 127
1.6	1,6	R, 1	74	10.98-05.05	AEH, AKL, Chassis # 1J-X-260 001 →	4	OPH 070
1.6	1,6	D, 1	74	05.99-04.01	APF	4	OPH 094
1.6 16V	1,6	D	77	05.00-05.05	ATN, AZD, AUS	4	OZH 182
1.8	1,8	R	92	10.98-05.05	AGN	4	OZH 128
1.8 4motion	1,8	R	92	02.99-05.05	AGN	4	OZH 177
1.8 T	1,8	R	110	05.00-05.05	AGU	4	OZH 128
2.0	2,0	D, 1	85	05.01-05.03	AZJ, AZG	4	OPH 075
2.0 4motion	2,0	D, 1	85	04.00-04.01	AZH	4	OPH 066
2.3 V5	2,3	R	110	10.98-10.00	AGZ	5	OZH 177
2.3 V5 4motion	2,3	D, 1	125	10.00-05.05	AQN	5	OPH 059
2.3 V5 4motion	2,3	R	110	12.98-10.00	AGZ	5	OZH 177
2.8 V6 4motion	2,8	D, 1	150	03.99-05.00	AQP	6	OPH 059
2.8 V6 4motion	2,8	D, 1	150	06.00-04.01	AUE	6	OPH 059
2.8 V6 4motion	2,8	D, 1	150	05.01-05.03	BDE	6	OPH 059

BORA Kombi

1.6	1,6	R	74	05.99-05.05	AEH, AKL, → Chassis # 1J-X-260 000	4	OZH 127
1.6	1,6	R, 1	74	05.99-05.05	AEH, AKL, Chassis # 1J-X-260 001 →	4	OPH 070
1.6	1,6	D, 1	74	05.99-04.01	APF	4	OPH 094
1.6 16V	1,6	D	77	02.00-05.05	AUS, ATN, AZD	4	OZH 182
1.8 4motion	1,8	R	92	05.99-05.05	AGN	4	OZH 177
1.8 T	1,8	R	110	05.00-05.05	AGU	4	OZH 128
2.0	2,0	D, 1	85	05.99-04.01	APK	4	OPH 049

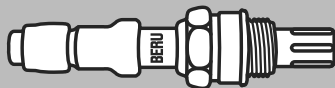
**BERU**

kW

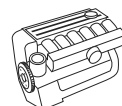
Zyl.
Cyl.
Cil.

VW							
BORA Kombi							
2.0	2,0	D, 1	85	05.01-05.05	AQY	4	OPH 049
2.0	2,0	D, 1	85	05.01-05.03	AZG	4	OPH 075
2.0	2,0	D, 1	85	05.01-05.05	AZJ	4	OPH 075
2.0 4motion	2,0	D, 1	85	04.00-04.01	AZH	4	OPH 066
2.3 V5	2,3	R	110	05.99-10.00	AGZ	5	OZH 177
2.3 V5 4motion	2,3	D, 1	125	10.00-05.05	AQN	5	OPH 059
2.8 V6 4motion	2,8	D, 1	150	05.99-05.00	AQP	6	OPH 059
2.8 V6 4motion	2,8	D, 1	150	06.00-04.01	AUE	6	OPH 059
2.8 V6 4motion	2,8	D, 1	150	05.01-05.03	BDE	6	OPH 059
CADDY I							
1.8	1,8	R	70	08.85-07.92	JH	4	OZU 022
CADDY II Kasten							
60 1.4	1,4	D, 1	44	09.00-06.03	AUD, → Chassis # 9K-3-501 800, Chassis # 9K-1-518 701 →	4	OPH 050
60 1.4	1,4	D, 1	44	09.00-06.03	AUD, → Chassis # 9K-1-518 700	4	OPH 071
60 1.4	1,4	R	44	11.95-05.97	AEX, → Chassis # 9K-W-502 300	4	OZH 071
60 1.4	1,4	R	44	11.97-10.98	APQ, → Chassis # 9K..X..521 000	4	OZH 151
60 1.4	1,4	R	44	06.97-12.97	AEX, Chassis # 9K..W..502 301 →	4	OZH 151
75 1.6	1,6	R	55	06.96-09.00	AEE	4	OZH 099
CADDY II Kombi							
1.4	1,4	D, 1	44	09.00-06.03	AUD, → Chassis # 9K-1-518 700	4	OPH 071
1.4	1,4	D, 1	44	09.00-06.03	AUD, → Chassis # 9K-3-501 800, Chassis # 9K-1-518 701 →	4	OPH 050
1.4	1,4	R	44	11.95-05.97	AEX	4	OZH 071
1.4	1,4	R	44	11.97-10.98	AKV, APQ	4	OZH 151
1.4	1,4	R	44	06.97-12.97	AEX	4	OZH 151
1.6	1,6	R	55	06.97-09.00	AEE	4	OZH 099
CORRADO							
1.8 G60	1,8	R	118	09.88-06.89	PG, → Chassis # 50K-011579	4	OZH 047
1.8 G60	1,8	R	118	07.89-09.93	PG, Chassis # 50 K- 011580 →	4	OZH 131
2.0 i 16V	2,0	R	100	08.91-12.95	9A	4	OZH 131
2.9 VR6	2,9	R	140	08.91-12.95	ABV	6	OZH 024
EOS							
2.0 TFSI	2,0	D, 1	147	03.06-05.08	BWA, BPY	4	OPH 085
FOX							
1.2	1,2	R	40	04.05-	BMD/CHFB	3	OZH 128
GOLF I Cabriolet							
1.3	1,3	R	40	08.83-07.86	HK	4	OZH 047
1.8	1,8	R	70	08.83-04.93	JH	4	OZU 022
1.8	1,8	R	72	08.89-03.93	2H	4	OZH 009
GOLF II							
1.3	1,3	R	40	08.83-06.87	MH, HK	4	OZH 047
1.3 KAT	1,3	R	40	08.90-07.92	NZ, Chassis # 1G-M-000001 →	4	OZH 031
1.3 KAT	1,3	R	40	02.87-07.87	NZ, → Chassis # 19-H-990000, Chassis # 19-H-000001 →	4	OZH 047
1.3 KAT	1,3	R	40	08.87-07.90	NZ, → Chassis # 19-G-L-990000, Chassis # 19-J-000001 →	4	OZH 048
1.6	1,6	R	51	10.86-07.92	PN	4	OZU 022
1.6	1,6	R	51	08.86-07.91	PN/EZA	4	OZU 022
1.8 i KAT	1,8	R	66	08.87-10.91	GX/RP	4	OZH 027
1.8	1,8	R	66	08.84-05.88	GX	4	OZU 022
1.8 Syncro	1,8	R	66	02.86-07.91	GX	4	OZH 037
1.8 Syncro	1,8	R	72	08.88-07.91	1P	4	OZH 047
1.8 GTI	1,8	R	79	08.85-10.87	RD	4	OZH 037
1.8 GTI	1,8	R	82	01.87-10.91	EV/GZ/PB/DX	4	OZU 022
1.8 GTI 16V	1,8	R	95	02.86-10.91	PL	4	OZH 037
1.8 GTI 16V	1,8	R	102	02.86-06.90	KR	4	OZU 022
1.8 GTI G60	1,8	R, 6	118	04.90-07.91	PG	4	OZH 008
1.8 GTI G60	1,8	R	118	04.90-07.91	PG	4	OZH 009
1.8 GTI G60	1,8	R	118	04.90-07.91	PG	4	OZH 131
1.8 GTI G60 Syncro	1,8	R	118	04.89-12.89	PG/1H	4	OZH 047

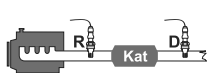

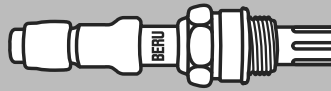

kW

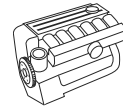

Zyl.
Cyl.
Cil.

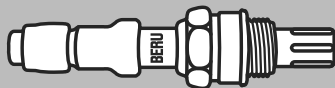

VW							
GOLF III							
1.4	1,4	R, 6	40	11.91-09.94	AEX/ABD, → Chassis # 1H-S-120000	4	OZH 024
1.4	1,4	R	40	11.91-09.94	AEX/ABD, → Chassis # 1H-S-120000	4	OZH 043
1.4	1,4	R	40	09.94-07.95	AEX/ABD, Chassis # 1H-S-120001 →	4	OZH 070
1.4	1,4	R, 6	44	10.91-09.94	ABD, → Chassis # 1H-S-120000	4	OZH 024
1.4	1,4	R	44	10.91-09.94	ABD, → Chassis # 1H-S-120000	4	OZH 043
1.4	1,4	R	44	09.94-07.95	ABD, Chassis # 1H-S-120001 →	4	OZH 070
1.4	1,4	R, 6	44	01.95-07.95	ABD, Chassis # 1H-S-120001 →	4	OZH 151
1.4	1,4	R	44	07.95-08.97	AEX	4	OZH 181
1.6	1,6	R	55	09.92-09.94	ABU, → Chassis # 1H-S-120000	4	OZH 043
1.6	1,6	R	55	07.95-08.97	AEE, → Chassis # 1H-S-120001	4	OZH 070
1.6	1,6	R	74	12.95-08.97	AFT	4	OZH 022
1.8	1,8	R, 2	55	11.91-09.94	AAM, → Chassis # 1H-S-120000	4	OZH 009
1.8	1,8	R, 6	55	11.91-09.94	AAM, → Chassis # 1H-S-120000	4	OZH 012
1.8	1,8	R	55	09.94-08.97	AAM, Chassis # 1H-S-120001 →	4	OZH 071
1.8	1,8	R	55	11.91-09.94	AAM, → Chassis # 1H-S-120000	4	OZU 003
1.8	1,8	R, 2	66	11.91-09.94	ABS, → Chassis # 1H-S-120000	4	OZH 009
1.8	1,8	R, 6	66	11.91-09.94	ABS, → Chassis # 1H-S-120000	4	OZH 012
1.8	1,8	R	66	09.94-08.97	ABS, Chassis # 1H-S-120001 →	4	OZH 071
1.8	1,8	R, 3	66	11.91-09.94	ABS, → Chassis # 1H-S-120000	4	OZU 003
1.8 Syncro	1,8	R, 2	66	01.93-09.94	ABS, → Chassis # 1 H-S-120 000	4	OZH 009
1.8 Syncro	1,8	R, 6	66	01.93-09.94	ADZ/ABS, → Chassis # 1H-S-120000	4	OZH 012
1.8 Syncro	1,8	R	66	10.94-08.97	ADZ, Chassis # 1H-S-120001 →	4	OZH 071
1.8 Syncro	1,8	R	66	01.93-09.94	ADZ/ABS, → Chassis # 1H-S-120000	4	OZU 003
2.0	2,0	R	85	10.94-08.97	ADY, AGG, AKR	4	OZH 022
2.0	2,0	R, 6	85	11.91-09.94	2E, → Chassis # 1H-S-120000	4	OZH 024
2.0 Syncro	2,0	R	85	08.95-08.97	AGG	4	OZH 022
2.0 GTI 16V	2,0	R, 6	110	08.92-09.94	ABF	4	OZH 024
2.0 GTI 16V	2,0	R	110	08.92-09.94	ABF	4	OZH 043
2.0 GTI 16V	2,0	R	110	01.95-08.97	ABF, Chassis # 1H..S..120 001 →	4	OZH 150
2.0 GTI 16V	2,0	R	110	08.92-12.94	ABF, → Chassis # 1H..S.. 120 000	4	OZH 165
2.8 VR6	2,8	R	128	09.94-06.95	AAA	6	OZH 022
2.8 VR6	2,8	R, 6	128	01.92-09.94	AAA	6	OZH 024
2.8 VR6	2,8	R	128	01.92-08.94	AAA	6	OZH 043
2.8 VR6	2,8	R	128	07.95-08.97	AAA	6	OZH 151
2.9 VR6 Syncro	2,9	R	140	07.95-08.97	ABV	6	OZH 181
GOLF III Cabriolet							
1.6	1,6	R	74	12.95-05.98	AFT	4	OZH 022
1.8	1,8	R, 2	55	07.93-05.98	AAM	4	OZH 009
1.8	1,8	R	55	07.93-05.98	AAM, → Chassis # 1E-S-024273, Chassis # 1E-S-012001 →	4	OZH 071
1.8	1,8	R	55	07.93-05.98	AAM, → Chassis # 1E-S-050000, Chassis # 1E-S-024274 →	4	OZH 086
1.8	1,8	R, 2	66	09.93-07.95	ABS	4	OZH 009
1.8	1,8	R, 6	66	07.93-05.98	ABS	4	OZH 012
1.8	1,8	R	66	07.93-05.98	ADZ/ABS, → Chassis # 1E-S-024273, Chassis # 1E-S-012001 →	4	OZH 071
1.8	1,8	R	66	07.93-05.98	ADZ/ABS, Chassis # 1E-S-024274 →	4	OZH 086
2.0	2,0	R	85	10.94-07.95	ADY	4	OZH 022
2.0	2,0	R	85	07.95-05.98	AGG	4	OZH 022
GOLF III Variant							
1.4	1,4	R, 6	40	07.93-09.94	ABD, → Chassis # 1H-S-120000	4	OZH 024
1.4	1,4	R	40	07.93-09.94	ABD, → Chassis # 1H-S-120000	4	OZH 043
1.4	1,4	R	40	10.94-07.95	ABD, Chassis # 1H-S-120001 →	4	OZH 070
1.4	1,4	R, 6	40	10.94-07.95	ABD, Chassis # S-120 001 →	4	OZH 151

**BERU**

kW

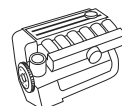
Zyl.
Cyl.
Cil.**VW****GOLF III Variant**

1.4	1,4	R, 6	44	07.93-09.94	ABD, → Chassis # 1H-S-120000	4	OZH 024
1.4	1,4	R	44	07.93-09.94	ABD, → Chassis # 1H-S-120000	4	OZH 043
1.4	1,4	R	44	09.94-07.95	ABD, Chassis # 1H-S-120001 →	4	OZH 070
1.4	1,4	R	44	12.97-05.98	APQ	4	OZH 070
1.4	1,4	R, 6	44	10.94-05.98	ABD, Chassis # S-120 001 →	4	OZH 151
1.4	1,4	R, 6	44	12.97-05.98	APQ	4	OZH 151
1.4	1,4	R	44	07.95-02.99	AEX	4	OZH 181
1.6	1,6	R	55	07.93-09.94	ABU, → Chassis # 1H-S-120000	4	OZH 043
1.6	1,6	R	55	07.95-12.97	AEE, → Chassis # 1H-S-120001	4	OZH 070
1.6	1,6	R	74	12.95-04.99	AFT	4	OZH 022
1.8	1,8	R, 2	55	07.93-09.94	ANN/AAM, → Chassis # 1H-S-120000	4	OZH 009
1.8	1,8	R, 6	55	07.93-09.94	ANN/AAM, → Chassis # 1H-S-120000	4	OZH 012
1.8	1,8	R	55	07.93-09.94	ANN/AAM, → Chassis # 1H-S-120000	4	OZU 003
1.8	1,8	R	55	09.94-04.99	ANN/AAM, Chassis # 1H-S-120001 →	4	OZH 071
1.8	1,8	R, 2	66	07.93-09.94	ABS, → Chassis # 1H-S-120000	4	OZH 009
1.8	1,8	R, 6	66	07.93-09.94	ADZ/ABS/ANP, → Chassis # 1H-S-120000	4	OZH 012
1.8	1,8	R	66	07.93-09.94	ADZ/ABS/ANP, → Chassis # 1H-S-120000	4	OZU 003
1.8	1,8	R	66	10.94-02.99	ADZ, Chassis # 1H-S-120001 →	4	OZH 071
1.8 Syncro	1,8	R	66	10.94-04.99	ADZ, Chassis # 1H-S-120001 →	4	OZH 071
2.0	2,0	R	85	10.94-04.99	ADY, AGG, AKR	4	OZH 022
2.0	2,0	R, 6	85	07.93-09.94	2E, → Chassis # 1H-S-120000	4	OZH 024
2.0 Syncro	2,0	R	85	08.95-04.99	AGG	4	OZH 022
2.9 VR6 Syncro	2,9	R	140	10.94-04.99	ABV	6	OZH 181

GOLF IV

1.6	1,6	R, 1, 2	74	08.97-02.00	AKL, → Chassis # 1J-X-132 000	4	OPH 069
1.6	1,6	D, 1	74	05.99-02.00	APF	4	OPH 094
1.6	1,6	R, 3	74	08.97-02.00	AEH, AKL, → Chassis # 1J-X-132 000	4	OZH 169
1.6	1,6	R, 3	74	08.97-02.00	AEH, Chassis # 1J-X-132 001 →	4	OZH 177
1.6 16V	1,6	D	77	02.00-06.05	AUS, AZD, ATN	4	OZH 182
1.8	1,8	R	92	08.97-06.05	AGN/BAF	4	OZH 177
1.8 4motion	1,8	R	92	05.98-06.05	AGN	4	OZH 128
1.8 T	1,8	R, 1	110	05.98-04.00	AQA	4	OPH 065
1.8 T	1,8	R, 1	110	05.99-04.01	ARZ	4	OPH 065
1.8 T	1,8	R	110	08.97-06.05	AGU	4	OZH 128
1.8 T	1,8	R	110	08.97-06.05	ARZ/AQA/AGU/AUM/AWD	4	OZH 177
1.8 T GTI	1,8	D, 1	132	08.01-04.02	AUQ	4	OPH 066
2.0	2,0	D, 1	85	05.01-04.02	AZJ, AZG	4	OPH 075
2.0 4motion	2,0	D, 1	85	10.00-06.01	AZH	4	OPH 066
2.3 V5	2,3	R	110	08.97-10.00	AGZ	5	OZH 177
2.3 V5 4motion	2,3	D, 1	125	10.00-06.05	AQN	5	OPH 059
2.8 V6 4motion	2,8	D, 1	150	03.99-05.00	AQP	6	OPH 059
2.8 V6 4motion	2,8	D, 1	150	06.00-04.01	AUE	6	OPH 059
2.8 V6 4motion	2,8	D, 1	150	05.01-05.03	BDE	6	OPH 059
3.2 R32 4motion	3,2	D, 1	177	09.02-06.05	BFH/BML	6	OPH 059

GOLF IV Cabriolet

2.0	2,0	D, 1	85	06.99-06.00	ATU	4	OPH 057
2.0	2,0	D, 1	85	06.00-12.01	AWF, AWG	4	OPH 057
2.0	2,0	R, 1	85	06.99-06.00	ATU	4	OPH 070
2.0	2,0	R, 1	85	06.00-12.01	AWG, AWF	4	OPH 070

GOLF IV Variant

1.6	1,6	R	74	05.99-02.00	AEH, AKL	4	OZH 127
1.6 16V	1,6	D	77	02.00-06.06	AZD, ATN, AUS	4	OZH 182
1.8 4motion	1,8	R	92	05.99-06.06	AGN	4	OZH 128
1.8 T	1,8	R	110	05.00-06.06	AGU	4	OZH 128

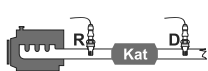

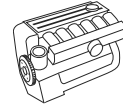

kW

 Zyl.
Cyl.
Cil.

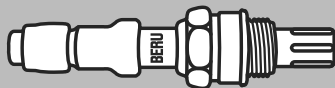

VW							
GOLF IV Variant							
2.0	2,0	D, 1	85	05.99-04.02	APK	4	OPH 049
2.0	2,0	D, 1	85	05.99-04.01	AQY	4	OPH 049
2.0	2,0	D, 1	85	05.02-06.06	AZJ	4	OPH 075
2.0 4motion	2,0	D, 1	85	10.00-06.01	AZH	4	OPH 066
2.0 Bi-Fuel	2,0	D, 1	85	05.02-06.06	BEH	4	OPH 075
2.3 V5 4motion	2,3	D, 1	125	10.00-06.06	AQN	5	OPH 059
2.8 V6 4motion	2,8	D, 1	150	05.99-05.00	AQP	6	OPH 059
2.8 V6 4motion	2,8	D, 1	150	06.00-04.01	AUE	6	OPH 059
2.8 V6 4motion	2,8	D, 1	150	05.01-05.03	BDE	6	OPH 059
GOLF V							
2.0 GTI	2,0	D, 1	147	10.04-07.05	AXX	4	OPH 085
2.0 GTI	2,0	D, 1	169	09.06-07.07	BYD	4	OPH 085
GOLF V Variant							
2.0	2,0	D, 1	147	06.07-02.09	BWA	4	OPH 085
JETTA II							
1.3	1,3	R	40	01.84-06.87	MH/HK	4	OZH 047
1.3 KAT	1,3	R	40	08.90-12.91	NZ	4	OZH 031
1.3 KAT	1,3	R	40	06.87-07.87	NZ	4	OZH 047
1.3 KAT	1,3	R	40	08.87-07.90	NZ	4	OZH 048
1.6	1,6	R	51	10.86-10.91	PN	4	OZU 022
1.8	1,8	R	66	08.84-10.87	GX	4	OZU 022
1.8 KAT	1,8	R	66	11.87-10.91	GX/RP	4	OZU 022
1.8 Syncro	1,8	R	66	08.87-12.88	RP/GU	4	OZH 037
1.8	1,8	R	79	08.85-10.87	RD	4	OZH 037
1.8 KAT	1,8	R	79	01.87-10.91	PF	4	OZH 047
1.8 Syncro	1,8	R	72	08.88-07.91	1P	4	OZH 047
1.8	1,8	R	82	02.87-10.91	PB	4	OZU 022
1.8 16V	1,8	R	95	08.86-10.91	PL	4	OZH 037
1.8 16V	1,8	R	102	06.87-12.89	KR	4	OZU 022
JETTA III							
2.0 TFSI	2,0	D, 1	147	01.06-03.08	BPY	4	OPH 085
2.0 TFSI	2,0	D, 1	147	10.05-06.08	BWA	4	OPH 085
KAEFER							
1600 i (Mexico)	1,6	R	34	10.92-09.95	ACD, → Chassis # S-999000	4	OZH 047
1600 i (Mexico)	1,6	R	34	08.96-07.03	ACD, Chassis # V-000001 →	4	OZH 043
LUPU							
1.0	1,0	D, 1	37	05.99-05.03	ALD	4	OPH 073
1.0	1,0	D, 1	37	05.99-05.00	ANV	4	OPH 073
1.0	1,0	D, 1	37	06.03-07.05	AUC, → Chassis # 6X-4-060 000	4	OPH 073
1.0	1,0	R	37	09.98-07.05	AER	4	OZH 169
1.0	1,0	R	37	09.98-07.05	ALL	4	OZH 177
1.4	1,4	D, 1	44	10.00-05.03	AUD, → Chassis # 6E-2-010 000	4	OPH 073
1.4 16V	1,4	R	55	09.98-07.05	AHW	4	OZH 177
1.4 16V	1,4	D	55	09.98-07.05	BBY	4	OZH 179
1.4 16V	1,4	R	74	08.99-07.05	AFK/AUB/AQQ	4	OZH 177
1.4 16V	1,4	R, 2	74	08.99-07.05	AFK/AUB/AQQ	4	OZH 179
1.6 GTI	1,6	D, 1	92	04.01-07.05	AVY	4	OPH 062
NEW BEETLE							
1.6	1,6	D, 1	74	06.00-09.00	AWH	4	OPH 094
1.8 T	1,8	D, 1	110	10.00-05.01	AWU	4	OPH 067
2.0	2,0	D, 1	85	01.98-	AEG, Chassis # 9C-X-645 561, 1C-X-460 001 →	4	OPH 049
2.0	2,0	D, 1	85	01.98-05.01	APK	4	OPH 049
2.0	2,0	D, 1	85	06.01-	AQY	4	OPH 049
2.0	2,0	R, 1	85	01.03-06.05	BER, → Chassis # 1C-3-433 833	4	OPH 070
2.0	2,0	D, 1	85	06.00-09.10	AZJ	4	OPH 075
2.0	2,0	D, 1	85	07.05-07.07	BER	4	OPH 075
2.0	2,0	D, 1	85	01.98-09.10	CBPA	4	OPH 075
2.3 V5	2,3	D, 1	125	10.00-05.01	AQN	5	OPH 067
RSI 3.2 (1C9)	3,2	D, 1	165	10.00-05.01	AXJ	6	OPH 059

**BERU**

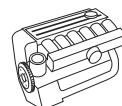
kW

Zyl.
Cyl.
Cil.

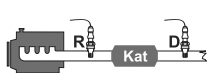
VW							
PASSAT (32B)							
1.6	1,6	R	51	08.87-03.88	PP	4	OZU 001
1.8	1,8	R	66	08.84-03.88	JN	4	OZU 022
2.2	2,2	R	85	08.85-03.88	KX	5	OZU 022
PASSAT (3A2, 35I)							
1.6	1,6	R	53	08.88-04.90	1F, → Chassis # 31-L-30000	4	OZU 022
1.8	1,8	R, 2	55	08.90-08.96	AAM	4	OZH 009
1.8	1,8	R	55	08.90-07.91	AAM, → Chassis # 3A-S-075000	4	OZU 001
1.8	1,8	R	55	09.94-07.95	AAM, → Chassis # 3A-S-300000, Chassis # 3A-S-075001 →	4	OZH 071
1.8	1,8	R	55	07.95-08.96	AAM, Chassis # 3A-T-000001 →	4	OZH 086
1.8	1,8	R, 2, 6	66	08.91-09.94	ABS	4	OZH 009
1.8	1,8	R, 6	66	08.91-09.94	ABS, → Chassis # 3A-S-07500	4	OZU 003
1.8	1,8	R	66	04.88-04.90	RP, → Chassis # 31-L-300000	4	OZU 022
1.8	1,8	R	79	04.88-07.90	PF	4	OZH 047
1.8	1,8	R	82	04.88-07.92	PB	4	OZH 047
1.8 16V	1,8	R	100	04.88-12.89	KR	4	OZH 037
1.8 G60 Syncro	1,8	R	118	09.89-07.93	PG	4	OZH 008
2.0	2,0	R, 6	85	08.90-09.94	2E	4	OZH 008
2.0	2,0	R	85	08.90-07.94	2E, → Chassis # 3 A-R-300 000	4	OZH 009
2.0	2,0	R	85	10.94-08.96	AGG, ADY	4	OZH 022
2.0	2,0	R	85	08.94-09.94	2E	4	OZH 043
2.0	2,0	R	85	07.94-09.94	2E, Chassis # 3A-R-300 001 →	4	OZH 165
2.0 Syncro	2,0	R, 6	85	10.90-09.94	2E	4	OZH 008
2.0 Syncro	2,0	R	85	10.90-07.94	2E, → Chassis # 3A-R-149 999	4	OZH 009
2.0 Syncro	2,0	R	85	10.94-08.96	AGG, ADY	4	OZH 022
2.0 Syncro	2,0	R	85	08.94-09.94	2E	4	OZH 043
2.0 Syncro	2,0	R	85	07.94-09.94	2E, , Chassis # 3A-R-150 000 →	4	OZH 165
2.0 16V	2,0	R	100	08.90-09.93	9A	4	OZH 009
2.0 16V	2,0	R	100	08.88-07.90	9A	4	OZH 037
2.0 16V	2,0	R	110	01.94-09.94	ABF, → Chassis # 3A-S-075000	4	OZH 043
2.0 16V	2,0	R	110	09.94-08.96	ABF, Chassis # 3A-S-075 001 →	4	OZH 150
2.8 VR6	2,8	R	128	07.94-07.95	AAA, → Chassis # 3A-T-000209, Chassis # 3A-S-000001 →	6	OZH 022
2.8 VR6	2,8	R, 6	128	06.91-07.94	AAA	6	OZH 024
2.8 VR6	2,8	R	128	07.95-08.96	AAA, Chassis # 3A-T-000 210 →	6	OZH 150
2.8 VR6	2,8	R	128	07.95-08.96	AAA, Chassis # 3A-T-000 210 →	6	OZH 151
PASSAT (3B2)							
1.6	1,6	R	74	10.96-11.00	AHL, ARM, ADP, → Chassis # 3 BX 360 000	4	OZH 068
1.6	1,6	R	74	06.99-11.00	ANA	4	OZH 190
1.8	1,8	R	92	10.96-11.00	ADR, → Chassis # 3B-X-310 000	4	OZH 068
1.8 Syncro/4motion	1,8	R	92	10.96-11.00	ADR, → Chassis # 3B-X-310 000	4	OZH 068
1.8 T	1,8	D, 1	110	10.96-11.00	ANB	4	OPH 052
1.8 T	1,8	R	110	10.96-11.00	AEB	4	OZH 152
2.0	2,0	R	88	04.00-11.00	AUZ	4	OZH 178
2.0	2,0	R	88	04.00-11.00	ASU	4	OZH 190
2.0 4motion	2,0	R	88	04.00-11.00	ASU	4	OZH 178
2.0 4motion	2,0	D	88	04.00-11.00	ASU	4	OZH 190
2.8 V6	2,8	R, 1	142	01.99-11.00	APR	6	OPH 004
2.8 V6	2,8	R	142	05.97-12.98	ACK, AQD	6	OZH 071
2.8 V6 Syncro/4motion	2,8	R	142	01.97-04.97	APR/ACK/ALG/AQD, → Chassis # 3B-V-120000	6	OZH 086
PASSAT (3B3)							
1.6	1,6	R	75	11.00-05.05	ALZ	4	OZH 178
2.0	2,0	D, 1	96	11.01-05.05	ALT	4	OPH 052
2.3 V5	2,3	D, 1	125	01.01-04.02	AZX	5	OPH 057
2.3 V5 4motion	2,3	D, 1	125	01.01-04.02	AZX	5	OPH 057
2.8 4motion	2,8	R, 1	142	06.03-05.05	ATQ/AMX	6	OPH 004
2.8 4motion	2,8	D, 1	142	05.02-05.05	AMX	6	OPH 008
2.8 4motion	2,8	D, 1	142	06.03-05.05	ATQ	6	OPH 008
2.8 4motion	2,8	D, 1	142	11.00-04.02	AMX	6	OPH 023



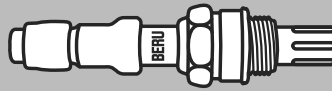

kW

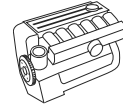

Zyl.
Cyl.
Cil.

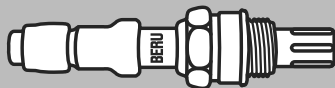

VW							
PASSAT (3B3)							
2.8 4motion	2,8	D, 1	142	11.00-04.02	ATQ	6	OPH 023
PASSAT Stufenheck (32B)							
1.6	1,6	R	51	08.87-03.88	PP	4	OZU 001
1.8	1,8	R	66	01.85-03.88	JN	4	OZU 022
2.2	2,2	R	85	08.85-03.88	KX	5	OZU 022
PASSAT Variant (32B)							
1.6	1,6	R	51	08.87-03.88	PP	4	OZU 001
1.8	1,8	R	66	01.83-03.88	JN	4	OZU 022
2.2	2,2	R	85	08.85-03.88	KX	5	OZU 022
2.2 Syncro	2,2	R	88	08.85-03.88	JT	5	OZH 037
PASSAT Variant (3A5, 35I)							
1.6	1,6	R	53	08.88-04.90	1F, → Chassis # 31-L-30000	4	OZU 022
1.8	1,8	R, 2	55	08.90-03.97	AAM	4	OZH 009
1.8	1,8	R	55	09.94-07.95	AAM, → Chassis # 3A-S-300000, Chassis # 3A-S-075001 →	4	OZH 071
1.8	1,8	R	55	07.95-03.97	AAM, Chassis # 3A-T-000001 →	4	OZH 086
1.8	1,8	R, 2	66	08.91-09.94	ABS	4	OZH 009
1.8	1,8	R, 6	66	08.91-09.94	ABS, → Chassis # 3A-S-07500	4	OZU 003
1.8	1,8	R	66	04.88-04.90	RP, → Chassis # 31-L-300000	4	OZU 022
1.8	1,8	R	79	04.88-07.90	PF	4	OZH 047
1.8	1,8	R	82	04.88-07.92	PB	4	OZH 047
1.8 16V	1,8	R	100	04.88-12.89	KR	4	OZH 037
1.8 G60 Syncro	1,8	R	118	09.89-07.93	PG	4	OZH 008
2.0	2,0	R, 6	85	08.90-09.94	2E	4	OZH 008
2.0	2,0	R	85	08.90-07.94	2E, → Chassis # 3A-R-300 000	4	OZH 009
2.0	2,0	R	85	10.94-05.97	AGG, ADY	4	OZH 022
2.0	2,0	R	85	08.94-09.94	2E	4	OZH 043
2.0	2,0	R	85	07.94-09.94	2EChassis # 3A-R-300 001 →	4	OZH 165
2.0 Syncro	2,0	R, 6	85	10.90-09.94	2E	4	OZH 008
2.0 Syncro	2,0	R	85	10.90-07.94	2E, → Chassis # 3A-R-149 999	4	OZH 009
2.0 Syncro	2,0	R	85	10.94-05.97	ADY, AGG	4	OZH 022
2.0 Syncro	2,0	R	85	08.94-09.94	2E	4	OZH 043
2.0 Syncro	2,0	R	85	07.94-09.94	2EChassis # 3A-R-150 000 →	4	OZH 165
2.0 16V	2,0	R	100	08.90-09.93	9A	4	OZH 009
2.0 16V	2,0	R	100	08.88-07.90	9A	4	OZH 037
2.0 16V	2,0	R	110	01.94-09.94	ABF, → Chassis # 3A-S-075000	4	OZH 043
2.0 16V	2,0	R	110	09.94-05.97	ABF, Chassis # 3A-S-075 001 →	4	OZH 150
2.8 VR6	2,8	R	128	07.94-07.95	AAA, → Chassis # 3A-T-000209, Chassis # 3A-S-000001 →	6	OZH 022
2.8 VR6	2,8	R, 6	128	06.91-07.94	AAA	6	OZH 024
2.8 VR6	2,8	R	128	07.95-05.97	AAA, Chassis # 3A-T-000 210 →	6	OZH 150
2.8 VR6	2,8	R	128	07.95-05.97	AAA, Chassis # 3A-T-000 210 →	6	OZH 151
2.9 VR6 Syncro	2,9	R	135	10.94-07.95	ABV, → Chassis # 3A-S-300000, Chassis # 3A-S-103000 →	6	OZH 022
2.9 VR6 Syncro	2,9	R	135	01.94-05.97	ABV	6	OZH 181
PASSAT Variant (3B5)							
1.6	1,6	R	74	06.97-12.98	ADP, AHL, ARM, → Chassis # 3 BX 360 000	4	OZH 068
1.6	1,6	R	74	06.99-11.00	ANA	4	OZH 190
1.8	1,8	R	92	06.97-11.00	ADR, → Chassis # 3B-X-310 000	4	OZH 068
1.8 Syncro/4motion	1,8	R	92	06.97-11.00	ADR, → Chassis # 3B-X-310 000	4	OZH 068
1.8 T	1,8	R	110	06.97-11.00	AEB	4	OZH 152
2.0	2,0	R	88	04.00-11.00	AUZ	4	OZH 178
2.0	2,0	R	88	04.00-11.00	ASU	4	OZH 190
2.0 4motion	2,0	R	88	04.00-11.00	AUZ	4	OZH 178
2.0 4motion	2,0	R	88	04.00-11.00	ASU	4	OZH 190
2.8 V6	2,8	R	142	06.97-11.00	AQD, ACK	6	OZH 071
2.8 V6 Syncro/4motion	2,8	R, 1	142	01.99-11.00	APR, AQD	6	OPH 004
2.8 V6 Syncro/4motion	2,8	R	142	06.97-11.00	ALG, ACK	6	OZH 071
PASSAT Variant (3B6)							
1.6	1,6	R	75	11.00-05.05	ALZ	4	OZH 178

**BERU**

kW

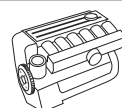
Zyl.
Cyl.
Cil.**VW****PASSAT Variant (3B6)**

2.3 VR5	2,3	D, 1	125	01.01-04.02	AZX	5	OPH 057
2.3 VR5 4motion	2,3	D, 1	125	01.01-04.02	AZX	5	OPH 057
2.8 4motion	2,8	R, 1	142	11.00-04.02	ATQ/AMX	6	OPH 004
2.8 4motion	2,8	D, 1	142	11.00-04.02	ATQ/AMX	6	OPH 008
2.8 4motion	2,8	D, 1	142	11.00-04.02	ATQ/AMX	6	OPH 023

PHAETON

4.2 V8 4motion	4,2	D, 1	246	08.03-05.09	BGH	8	OPH 055
4.2 V8 4motion	4,2	D, 1	246	05.03-07.03	BGJ	8	OPH 055
6.0 W12 4motion	6,0	D, 1	309	04.02-05.05	BAN	12	OPH 091
6.0 W12 4motion	6,0	D, 1	331	05.05-	BTT/BRN	12	OPH 091

POLO (6N1)

100 1.4 16V	1,4	R	74	04.96-04.98	AFH, → Chassis # 6N-V-350 000	4	OZH 068
100 1.4 16V	1,4	R	74	05.98-10.99	AFH	4	OZH 177
100 1.4 16V	1,4	R, 3	74	05.97-04.98	AFH, → Chassis # 6 N.X.. 068 038, Chassis # 6 N.V.. 350 001 →	4	OZH 215
120 1.6 16V GTI	1,6	R	88	09.98-10.99	AJV	4	OZH 177
45 1.0	1,0	R	33	10.94-09.96	AEV	4	OZH 068
50 1.0	1,0	R	37	09.96-10.99	AER	4	OZH 169
50 1.0	1,0	R	37	09.96-10.99	ALL	4	OZH 177
55 1.3	1,3	R	40	10.94-07.95	ADX	4	OZH 068
55 1.3	1,3	R, 6	40	10.94-07.95	ADX	4	OZH 181
60 1.4	1,4	R	44	07.95-05.96	AEX, → Chassis # 6N-T-250 000	4	OZH 068
60 1.4	1,4	R, 3	44	05.96-04.98	AEX	4	OZH 151
60 1.4	1,4	R	44	05.98-10.99	AEX/AKV/APQ	4	OZH 177
60 1.4	1,4	R	44	07.95-10.99	AEX/AKV/APQ	4	OZH 181
75 1.6	1,6	R	55	10.94-07.95	AEA	4	OZH 068
75 1.6	1,6	R	55	10.94-04.97	AEE, AHS	4	OZH 068
75 1.6	1,6	R	55	10.94-10.99	AEA/AEE/AHS, Chassis # 6N.T.. 140 001 →	4	OZH 215

POLO (6N2)

1.0	1,0	D, 1	37	10.99-09.01	AUC	4	OPH 073
1.4	1,4	D, 1	40	10.99-09.01	AKP	4	OPH 073
1.4	1,4	D, 1	44	10.99-09.01	AUD	4	OPH 073
1.4 16V	1,4	R, 2	55	10.99-09.01	AHW/APE/AUA	4	OZH 179
1.4 16V	1,4	R, 2	74	10.99-09.01	AFK/AUB/AQQ	4	OZH 179
1.6 16V GTI	1,6	D, 1	92	05.00-09.01	AVY/ARC	4	OPH 073

POLO (86C, 80)

1.0 KAT	1,0	R	33	10.90-09.94	AAU	4	OZH 031
1.3	1,3	R	40	08.83-07.88	MH/HK	4	OZH 047
1.3 KAT	1,3	R	40	01.91-07.91	AAV	4	OZH 031
1.3 KAT	1,3	R	40	10.90-12.92	NZ	4	OZH 031
1.3 KAT	1,3	R	40	07.87-09.87	NZ, → Chassis # 80-J-060000	4	OZH 047
1.3 KAT	1,3	R	40	10.87-08.90	NZ, Chassis # 80-J-060001 →	4	OZH 048
1.3 KAT	1,3	R	55	10.90-03.91	3F	4	OZH 031

POLO (9N)

1.2	1,2	R	40	01.02-05.07	BMD	3	OZH 128
-----	-----	---	----	-------------	-----	---	----------------

POLO CLASSIC (6KV2)

100 1.6	1,6	R, 1	74	10.99-09.01	AKL, AEH	4	OPH 050
100 1.6	1,6	D, 1	74	03.00-10.00	APF	4	OPH 071
100 1.6	1,6	D, 1	74	07.00-10.00	AUR	4	OPH 071
100 1.6	1,6	R	74	05.98-09.99	AKL/APF/AEH/AUR/AFT	4	OZH 022
60 1.4	1,4	R + D, 1	44	10.99-09.01	AKK	4	OPH 050
60 1.4	1,4	D, 1	44	06.00-09.01	AUD, → Chassis # 6K-1-526 500	4	OPH 071
60 1.4	1,4	R + D, 1	44	06.00-09.01	AUD, Chassis # 6K-1-526 501 →	4	OPH 050
60 1.4	1,4	D, 1	44	05.99-05.00	ANW	4	OPH 073
60 1.4	1,4	R	44	12.95-05.97	AEX	4	OZH 071
60 1.4	1,4	R	44	06.97-10.98	AEX, AKV, ANX, APQ	4	OZH 151
60 1.4	1,4	R	44	11.98-09.01	AEX, AKV, ANX, APQ	4	OZH 177
75 1.6	1,6	R	55	11.95-09.01	AEE, ALM	4	OZH 070
75 1.6	1,6	R	55	11.95-09.97	1F	4	OZH 071



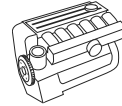

kW

 Zyl.
Cyl.
Cil.

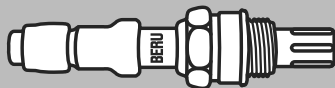

VW							
POLO Coupe (86C, 80)							
1.0 KAT	1,0	R	33	10.90-09.94	AAU	4	OZH 031
1.3	1,3	R	40	08.83-06.87	MH/HK	4	OZH 047
1.3 KAT	1,3	R	40	01.91-07.91	AAV	4	OZH 031
1.3 KAT	1,3	R	40	10.90-12.92	NZ	4	OZH 031
1.3 KAT	1,3	R	40	07.87-09.87	NZ, → Chassis # 80-J-060000	4	OZH 047
1.3 KAT	1,3	R	40	10.87-08.90	NZ, Chassis # 80-J-060001 →	4	OZH 048
1.3 KAT	1,3	R	55	10.90-09.94	3F	4	OZH 031
1.3 G40	1,3	R, 6	83	10.90-09.94	PY	4	OZH 008
1.3 G40	1,3	R	83	08.90-09.94	PY	4	OZH 031
POLO Variant (6KV5)							
1.4	1,4	D, 1	40	10.99-09.01	AKP	4	OPH 073
1.4	1,4	R, 1	44	10.99-09.01	AKK	4	OPH 050
1.4	1,4	D, 1	44	05.99-05.00	ANW	4	OPH 073
1.4	1,4	R	44	04.97-05.97	AEX	4	OZH 086
1.4	1,4	R	44	06.97-10.98	AEX, ANX	4	OZH 151
1.4	1,4	R	44	05.97-12.97	APQ, AKV	4	OZH 177
1.4 16V	1,4	R, 2	55	10.99-09.01	APE/AUA	4	OZH 179
1.6	1,6	R, 1	74	10.99-09.01	AEH, AKL	4	OPH 050
1.6	1,6	D, 1	74	03.00-10.00	APF	4	OPH 071
1.6	1,6	D, 1	74	07.00-	AUR	4	OPH 071
1.6	1,6	R	74	05.98-09.99	AKL/APF/AEH/AUR/AFT	4	OZH 022
SCIROCCO (53B)							
1.8	1,8	R	70	11.85-07.92	JH	4	OZU 022
1.8 16V	1,8	R	95	03.86-07.92	PL	4	OZH 037
SHARAN							
2.8 VR6	2,8	R	128	01.96-02.98	AAA	6	OZH 151
2.8 VR6	2,8	R	128	09.95-12.95	AAA	6	OZH 181
2.8 VR6 Syncro	2,8	R	128	11.96-02.98	AAA/AMY, → Chassis # 7M-W 050 000	6	OZH 151
TOUAREG							
3.2 V6	3,2	D, 1	162	10.02-05.04	AZZ	6	OPH 053
3.2 V6	3,2	D, 1	162	10.02-05.04	AZZ	6	OPH 063
3.2 V6	3,2	D, 1	162	05.03-05.04	BKJ	6	OPH 053
3.2 V6	3,2	D, 1	162	05.03-05.04	BKJ	6	OPH 063
3.2 V6	3,2	D, 1	177	11.04-11.06		6	OPH 063
4.2 V8	4,2	D, 1	228	12.02-11.06	AXQ	8	OPH 058
VENTO							
1.4	1,4	R, 6	40	11.91-09.94	AEX/ABD	4	OZH 024
1.4	1,4	R	40	11.91-09.94	AEX/ABD, → Chassis # 1H-S-120000	4	OZH 043
1.4	1,4	R, 6	44	11.91-09.94	ABD, → Chassis # 1H-S-120000	4	OZH 024
1.4	1,4	R	44	11.91-09.94	ABD, → Chassis # 1H-S-120000	4	OZH 043
1.4	1,4	R	44	09.94-07.95	ABD, Chassis # 1H-S-120001 →	4	OZH 070
1.4	1,4	R, 6	44	10.94-07.95	ABD, Chassis # 1H..S..120 001 →	4	OZH 151
1.4	1,4	R	44	07.95-12.97	AEX/ABD	4	OZH 181
1.6	1,6	R	55	09.92-09.94	ABU, → Chassis # 1H-S-120000	4	OZH 043
1.6	1,6	R	74	12.95-09.98	AFT	4	OZH 022
1.8	1,8	R, 2	55	11.91-09.94	AAM, → Chassis # 1 H-S-120 000	4	OZH 009
1.8	1,8	R	55	09.94-09.98	AAM, Chassis # 1H-S-120001 →	4	OZH 071
1.8	1,8	R	55	11.91-09.94	AAM	4	OZU 003
1.8	1,8	R, 2	66	11.91-09.94	ABS, → Chassis # 1H-S-120 000	4	OZH 009
1.8	1,8	R, 6	66	11.91-09.94	ADZ/ABS, → Chassis # 1H-S-120000	4	OZH 012
1.8	1,8	R	66	11.91-09.98	ADZ	4	OZH 071
1.8	1,8	R	66	11.91-09.94	ADZ/ABS, → Chassis # 1H-S-120000	4	OZU 003
2.0	2,0	R	85	10.94-12.97	ADY, AGG, AKR	4	OZH 022
2.0	2,0	R, 6	85	11.91-09.94	2E, → Chassis # 1H-S-120000	4	OZH 024
2.8 VR6	2,8	R	128	09.94-07.95	AAA	6	OZH 022
2.8 VR6	2,8	R, 6	128	01.92-09.94	AAA, → Chassis # 1H-S-120000	6	OZH 024
2.8 VR6	2,8	R	128	01.92-09.94	AAA	6	OZH 043

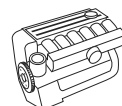

BERU

kW

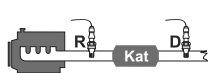

 Zyl.
Cyl.
Cil.

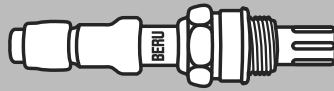



VW							
VENTO							
2.8 VR6	2,8	R	128	05.96-12.97	AAA	6	OZH 151
LT 28-35 I							
2.4 i	2,4	R	69	08.89-06.96	1E	6	OZH 047
LT 28-35 II							
2.3	2,3	R	105	05.96-11.01	AGL	4	OZH 146
LT 40-55 I							
2.4 i	2,4	R	69	01.93-06.96	1E	6	OZH 047
TRANSPORTER T3							
1.9	1,9	R	61	01.83-07.85	DH	4	OZU 001
2.1	2,1	R	64	10.86-07.92	SR	4	OZH 037
2.1	2,1	R	70	08.85-07.92	MV	4	OZH 037
2.1 i	2,1	R	68	07.89-07.92	SS	4	OZH 037
2.1 KAT	2,1	R	70	06.89-07.92	MV	4	OZH 037
2.1 Syncro	2,1	R	64	10.86-07.92	SR	4	OZH 037
2.1 Syncro	2,1	R	70	08.85-07.92	MV	4	OZH 037
TRANSPORTER T4							
2.0	2,0	R	62	09.90-12.95	AAC	4	OZH 010
2.0	2,0	R	62	01.96-04.03	AAC	4	OZH 028
2.5	2,5	R	81	11.90-12.95	AAF, ACU, → Chassis # T 200000	5	OZH 010
2.5	2,5	R	81	01.96-10.96	ACU	5	OZH 028
2.5	2,5	R, 6	81	01.94-12.95	ACU	5	OZH 134
2.5	2,5	R, 6	81	11.90-12.93	AAF	5	OZH 134
2.5 Syncro	2,5	R	81	11.92-12.95	AAF, ACU, → Chassis # T 200000	5	OZH 010
2.5 Syncro	2,5	R	81	01.96-10.96	ACU	5	OZH 028
2.5 Syncro	2,5	R, 6	81	11.92-10.96	AEN/AAF/ACU/AEU	5	OZH 134
2.8 VR 6	2,8	R	103	11.95-04.00	AES	6	OZH 151
2.8 VR 6	2,8	D	103	11.95-04.00	AES	6	OZH 153
ZASTAVA							
YUGO							
1.3 65 EFI	1,3	R	48	08.91-06.95	13 E 1.064	4	OZH 044
YUGO FLORIDA							
1.3	1,3	R	50	03.91-	13 E.3.064	4	OZH 044

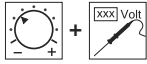

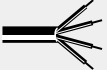
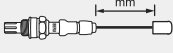

OPH 001
0 824 010 286



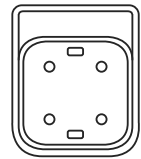
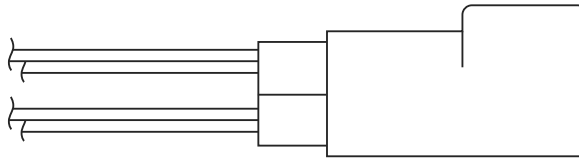

 4	 300
 M 18 x 1,5	 22 Nm 45



OPH 002
0 824 010 287

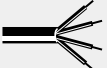
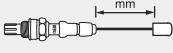

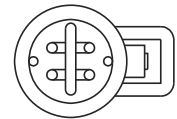
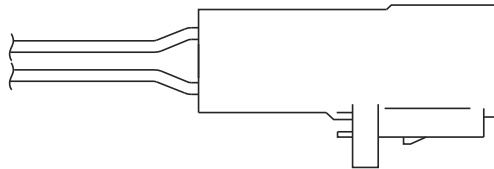
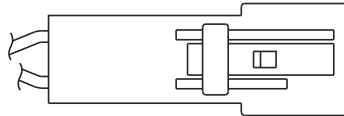

 4	 350
 M 18 x 1,5	 22 Nm 45



OPH 003
0 824 010 288

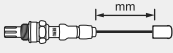

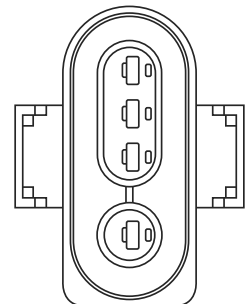
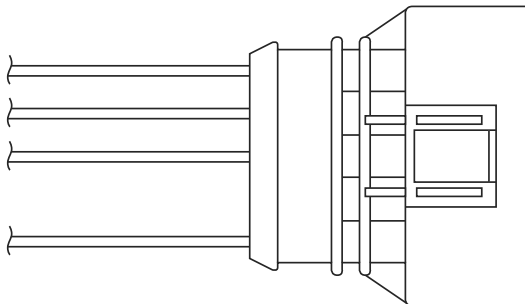

 4	 320
 M 18 x 1,5	 22 Nm 45



OPH 004
0 824 010 289

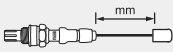

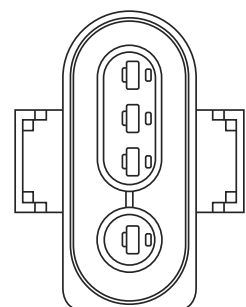
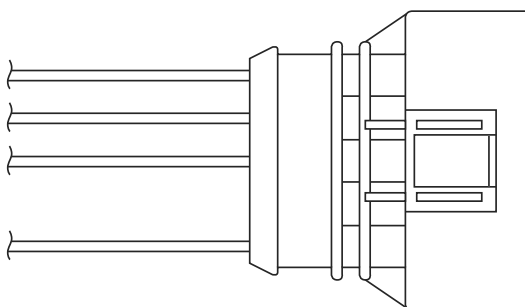

 4	 530
 M 18 x 1,5	 22 Nm 45



OPH 005
0 824 010 290

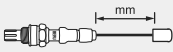

 4	 780
 M 18 x 1,5	 22 Nm 45

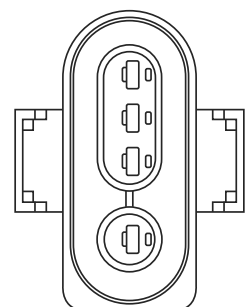
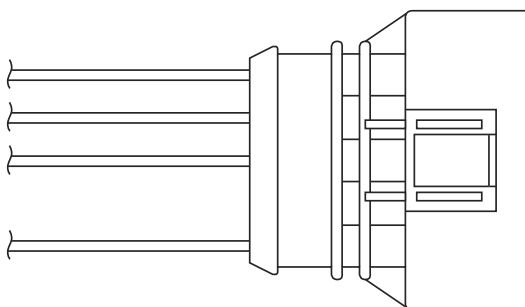

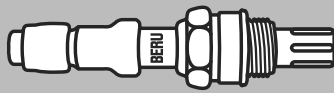



OPH 006

0 824 010 291

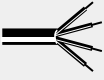
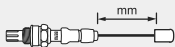

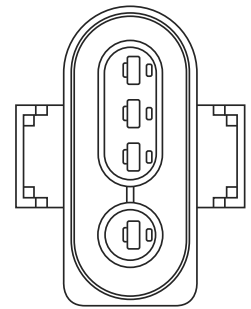
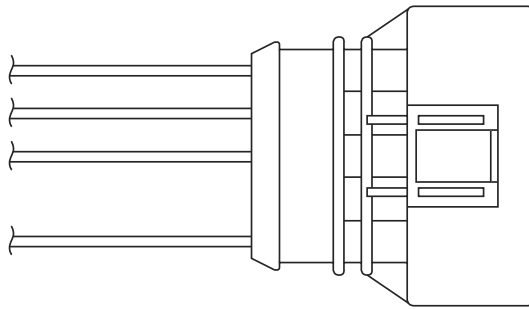

 4	 mm 1100
 M 18 x 1,5	 22 Nm 45



OPH 007

0 824 010 292

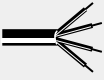
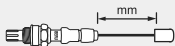

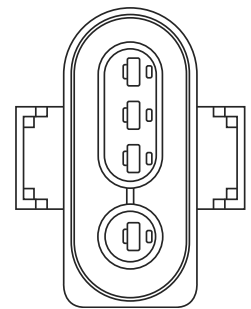
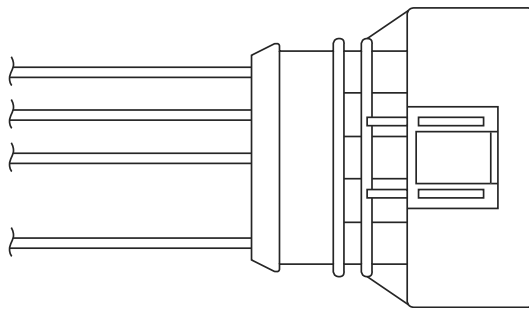

 4	 mm 1250
 M 18 x 1,5	 22 Nm 45



OPH 008

0 824 010 293

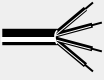
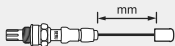

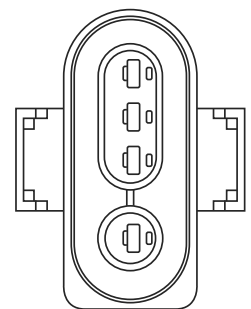
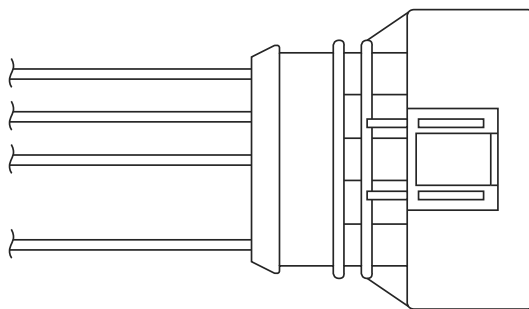

 4	 mm 1400
 M 18 x 1,5	 22 Nm 45



OPH 009

0 824 010 294

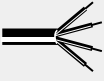
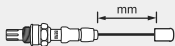

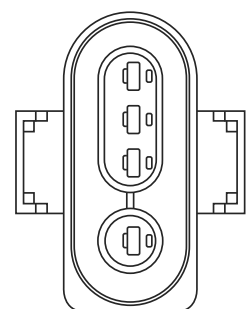
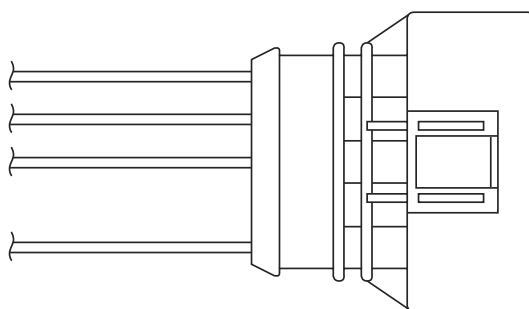

 4	 mm 1580
 M 18 x 1,5	 22 Nm 45



OPH 010

0 824 010 295

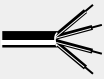
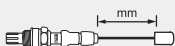

 4	 mm 310
 M 18 x 1,5	 22 Nm 45

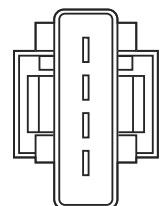
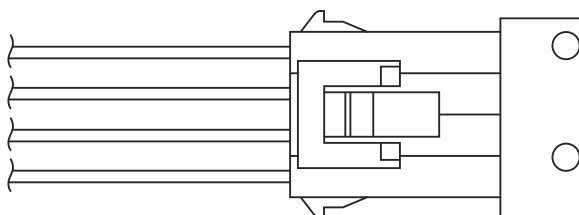



OPH 011

0 824 010 296

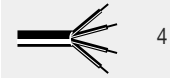

4

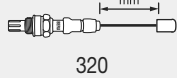

320



M 18 x 1,5



22

Nm

45

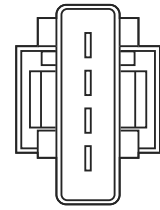
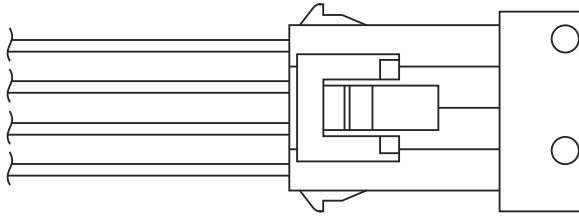

OPH 012

0 824 010 297

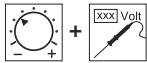

4

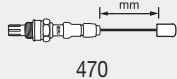

470



M 18 x 1,5



22

Nm

45

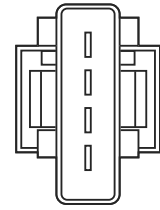
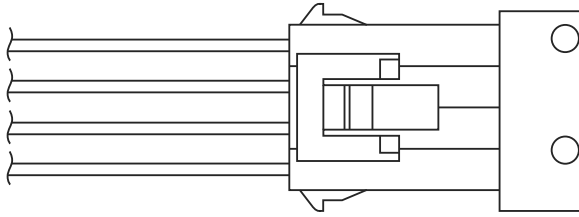

OPH 013

0 824 010 298

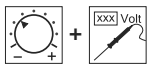

4

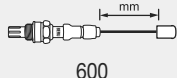

600



M 18 x 1,5



22

Nm

45

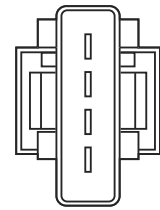
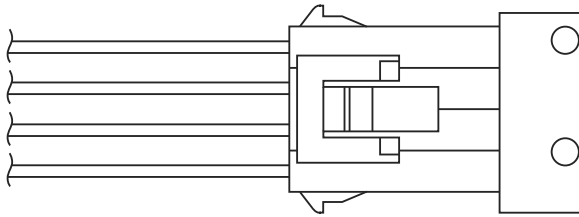

OPH 014

0 824 010 299



4

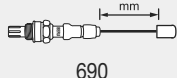

690



M 18 x 1,5



22

Nm

45

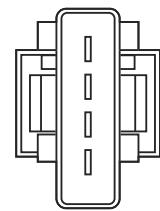
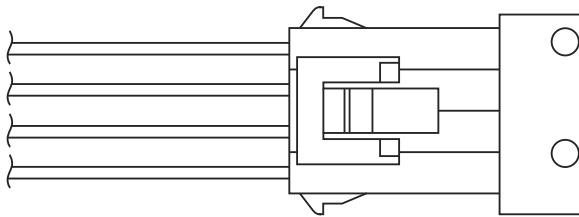

OPH 015

0 824 010 300



4

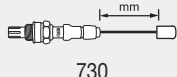

730



M 18 x 1,5



22

Nm

45

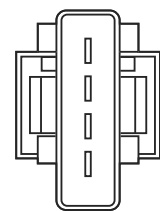
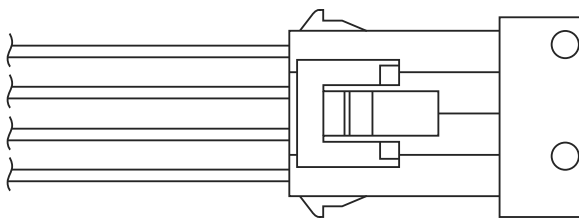

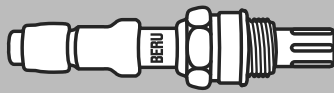

OPH 016

0 824 010 301



4	mm 750
M 18 x 1,5	22 Nm 45

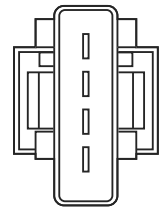
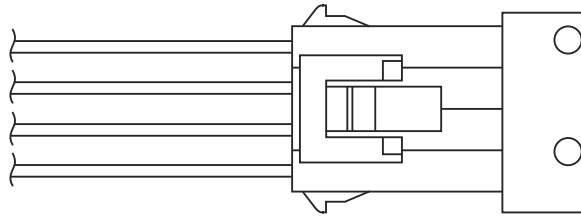

OPH 017

0 824 010 302



4	mm 900
M 18 x 1,5	22 Nm 45

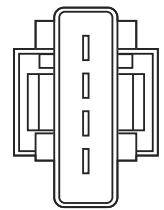
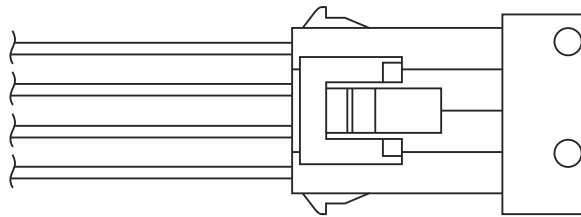

OPH 018

0 824 010 303



4	mm 960
M 18 x 1,5	22 Nm 45

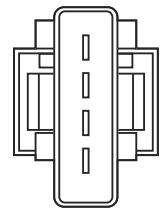
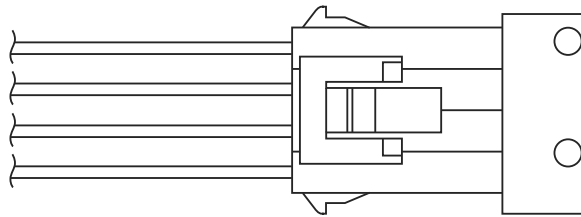

OPH 019

0 824 010 304



4	mm 960
M 18 x 1,5	22 Nm 45

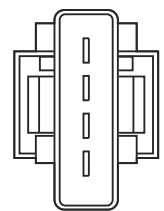
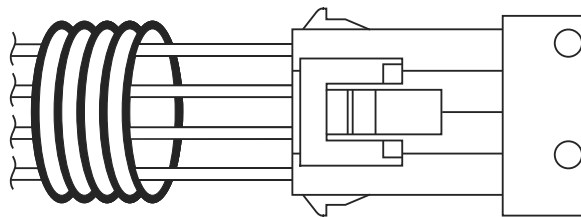

OPH 020

0 824 010 305



4	mm 1150
M 18 x 1,5	22 Nm 45

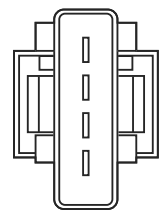
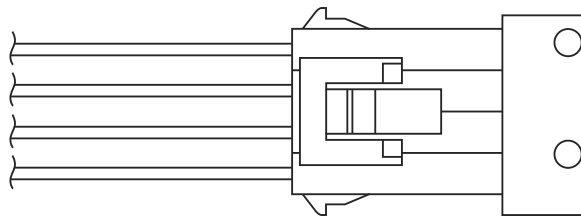



OPH 021

0 824 010 306

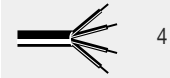

4

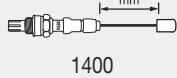

1400



M 18 x 1,5



22

Nm

45

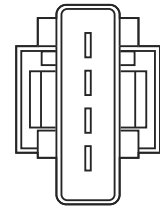
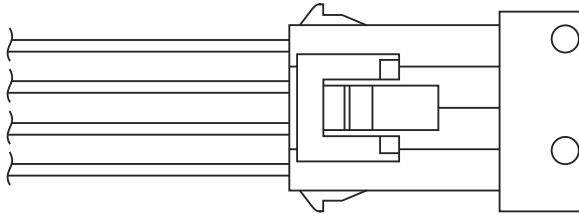

OPH 022

0 824 010 307



4

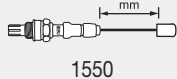

1550



M 18 x 1,5



22

Nm

45

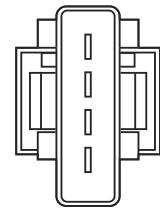
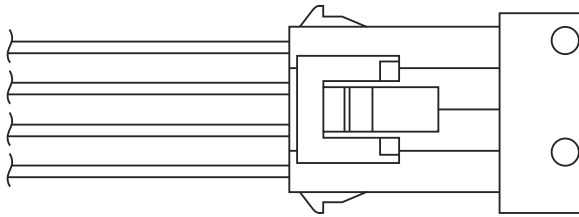

OPH 023

0 824 010 308



4

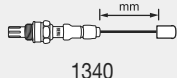

1340



M 18 x 1,5



22

Nm

45

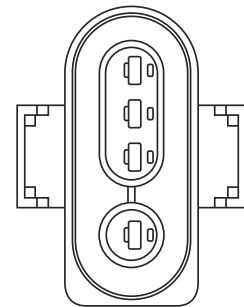
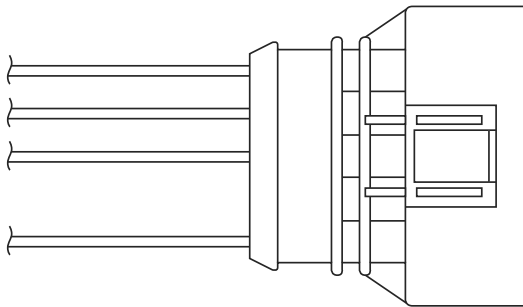

OPH 024

0 824 010 309



4

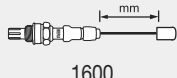

1600



M 18 x 1,5



22

Nm

45

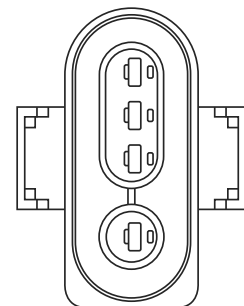
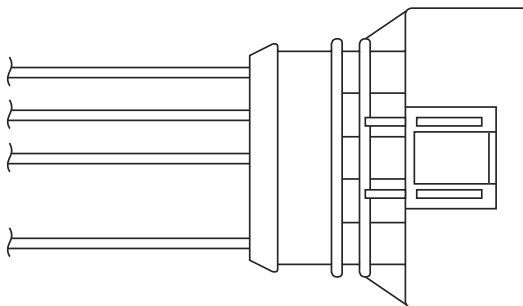

OPH 025

0 824 010 310



4

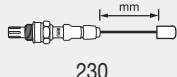

230

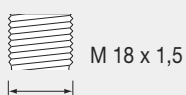

M 18 x 1,5



22

Nm

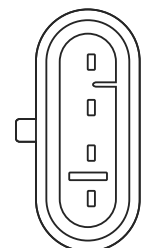
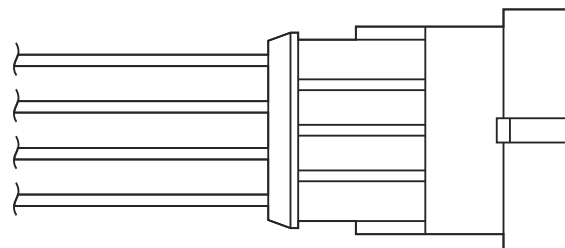

45

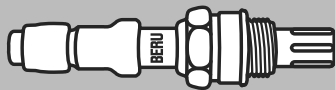



OPH 026
0 824 010 311

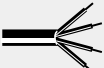
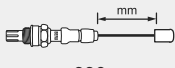

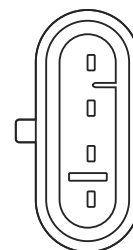
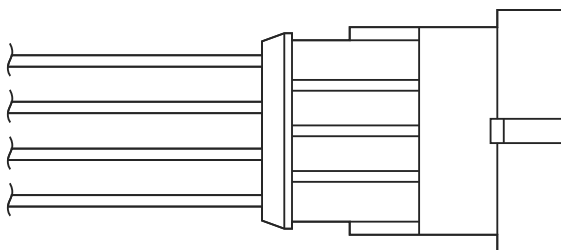

 4	 330
 M 18 x 1,5	 22 Nm 45



OPH 027
0 824 010 312

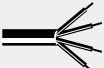
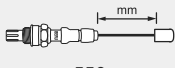

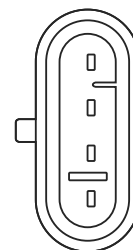
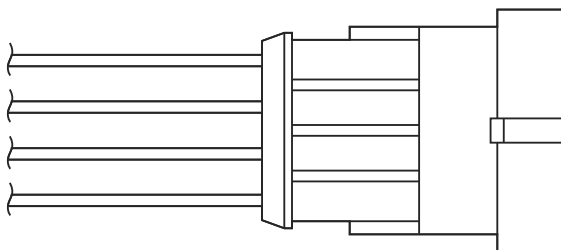

 4	 550
 M 18 x 1,5	 22 Nm 45



OPH 028
0 824 010 313

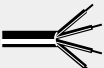
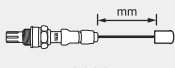

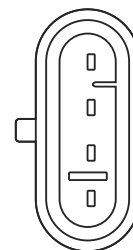
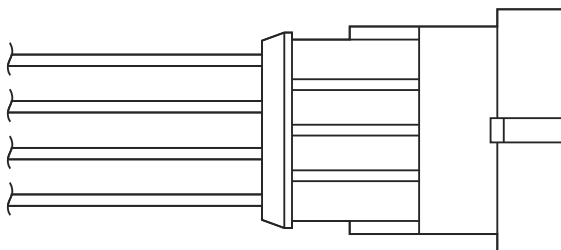

 4	 1100
 M 18 x 1,5	 22 Nm 45



OPH 029
0 824 010 314

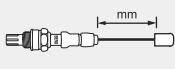

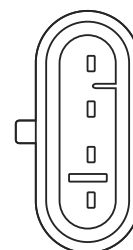
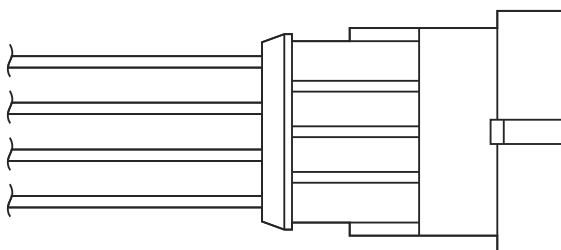

 4	 1680
 M 18 x 1,5	 22 Nm 45



OPH 030
0 824 010 315

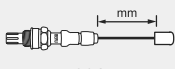

 4	 290
 M 18 x 1,5	 22 Nm 45

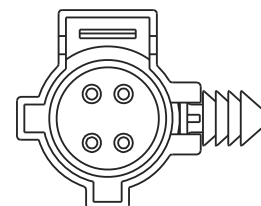
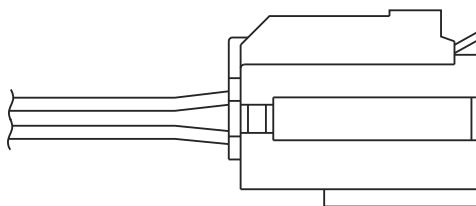



OPH 031
0 824 010 316



4	mm 600
M 18 x 1,5	22 Nm 45

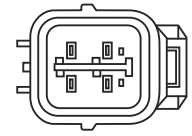
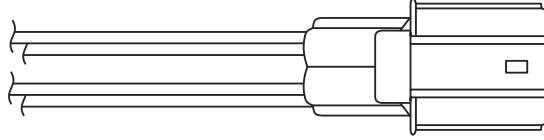

OPH 032
0 824 010 317



4	mm 320
M 18 x 1,5	22 Nm 45

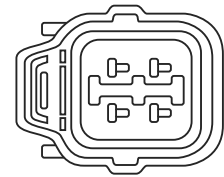
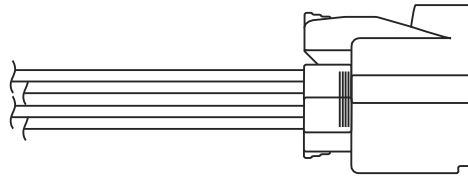

OPH 033
0 824 010 318

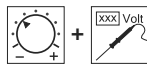

4	mm 350
M 18 x 1,5	22 Nm 45

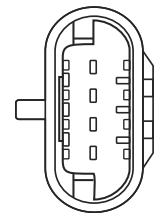
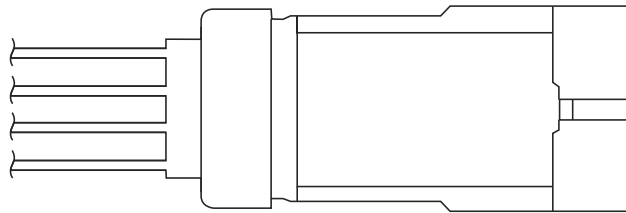

OPH 034
0 824 010 319



4	mm 220
M 18 x 1,5	22 Nm 45

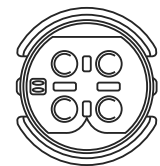
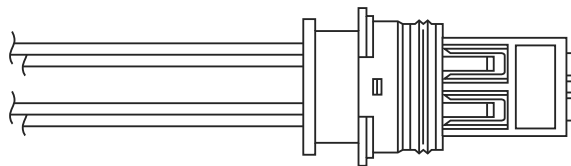

OPH 035
0 824 010 320



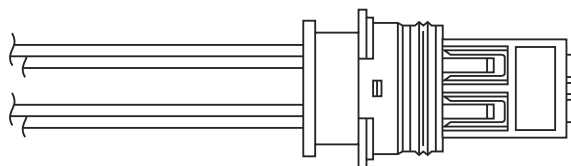

4	mm 300
M 18 x 1,5	22 Nm 45

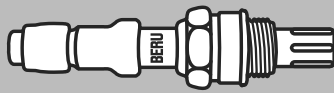

**OPH 036**

0 824 010 321

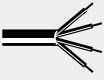
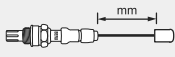

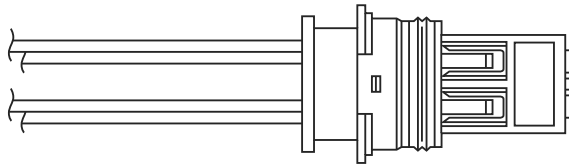

 4	 mm 350
 M 18 x 1,5	 22 Nm 45

**OPH 037**

0 824 010 322

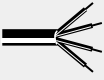
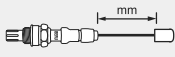

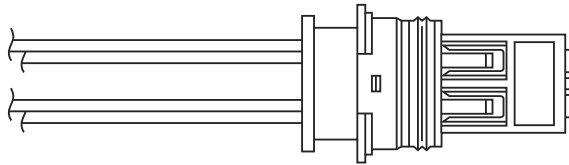

 4	 mm 400
 M 18 x 1,5	 22 Nm 45

**OPH 038**

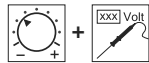
0 824 010 323

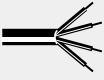
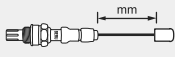

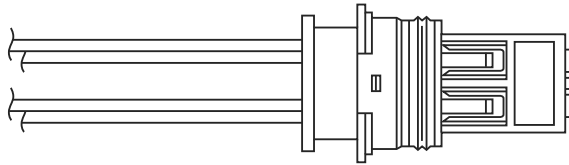

 4	 mm 490
 M 18 x 1,5	 22 Nm 45

**OPH 039**

0 824 010 324

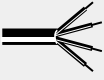
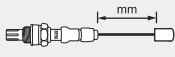

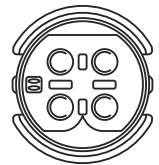
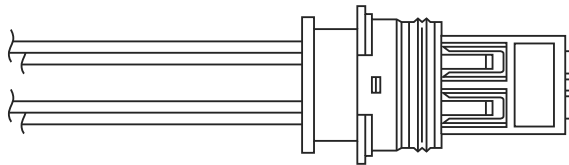

 4	 mm 560
 M 18 x 1,5	 22 Nm 45

**OPH 040**

0 824 010 325

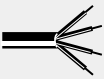
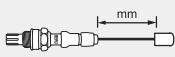

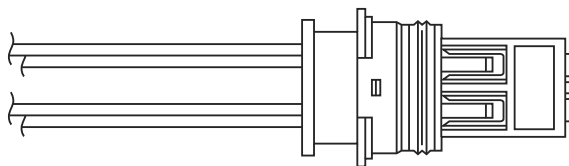

 4	 mm 620
 M 18 x 1,5	 22 Nm 45

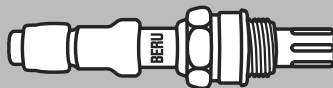



OPH 041
0 824 010 326

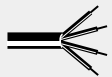
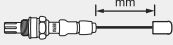

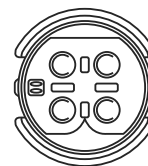
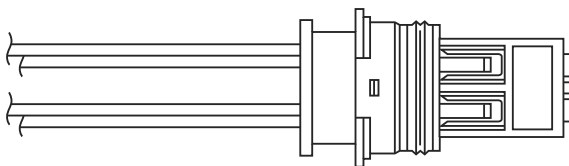

 4	 mm 720
 M 18 x 1,5	 22 Nm 45



OPH 042
0 824 010 327

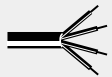
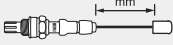

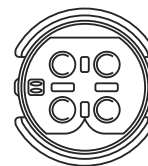
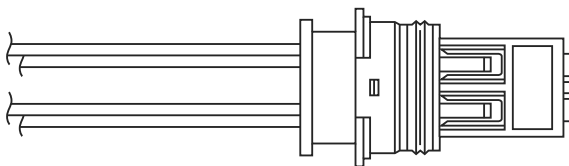

 4	 mm 800
 M 18 x 1,5	 22 Nm 45



OPH 043
0 824 010 328

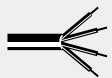
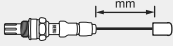

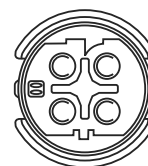
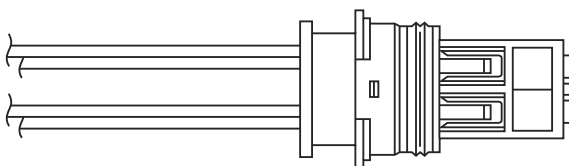

 4	 mm 230
 M 18 x 1,5	 22 Nm 45



OPH 044
0 824 010 329

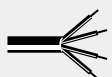
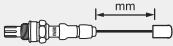

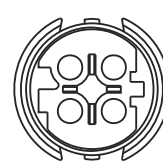
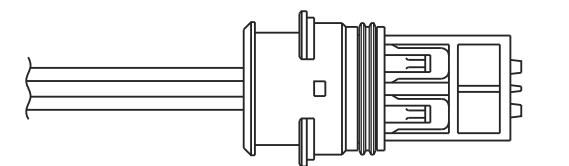

 4	 mm 250
 M 18 x 1,5	 22 Nm 45



OPH 045
0 824 010 330

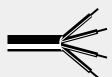
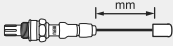

 4	 mm 360
 M 18 x 1,5	 22 Nm 45

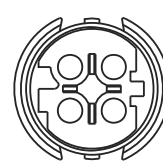
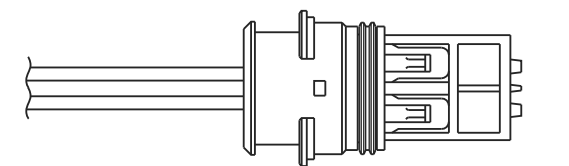

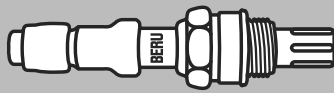



OPH 046

0 824 010 331

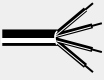
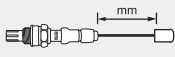

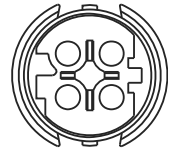
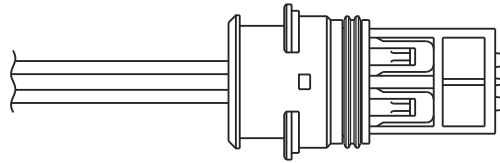

 4	 mm 420
 M 18 x 1,5	 22 Nm 45



OPH 047

0 824 010 332

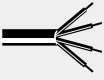
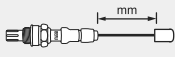

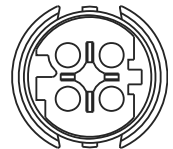
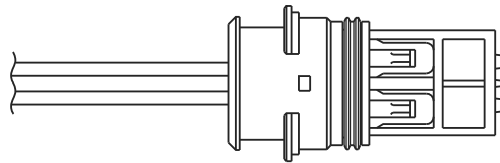

 4	 mm 550
 M 18 x 1,5	 22 Nm 45



OPH 048

0 824 010 333

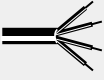
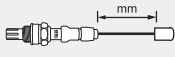

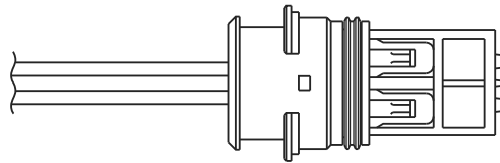

 4	 mm 1100
 M 18 x 1,5	 22 Nm 45



OPH 049

0 824 010 334

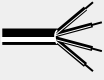
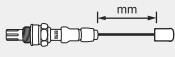

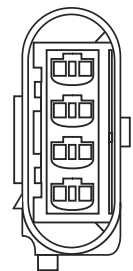
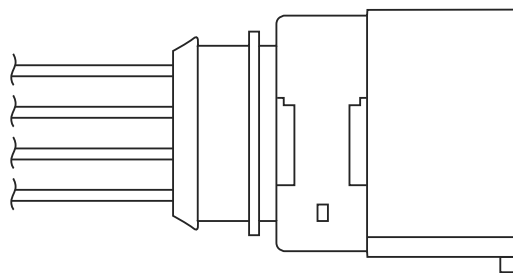

 4	 mm 400
 M 18 x 1,5	 22 Nm 45



OPH 050

0 824 010 335

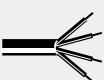
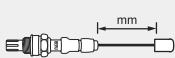

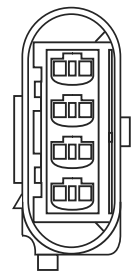
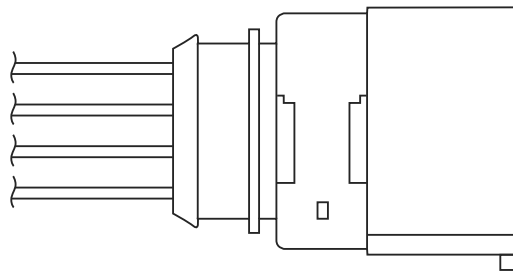

 4	 mm 410
 M 18 x 1,5	 22 Nm 45



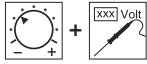

OPH 051
0 824 010 336

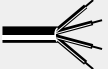
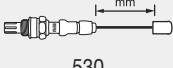

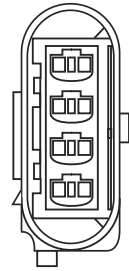
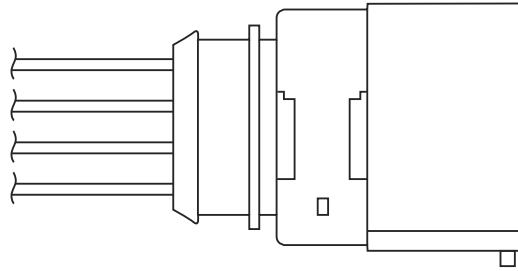

 4	 530
 M 18 x 1,5	 22 Nm 45



OPH 052
0 824 010 337

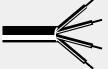
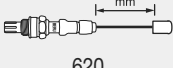

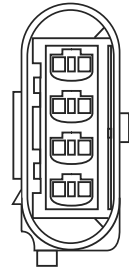
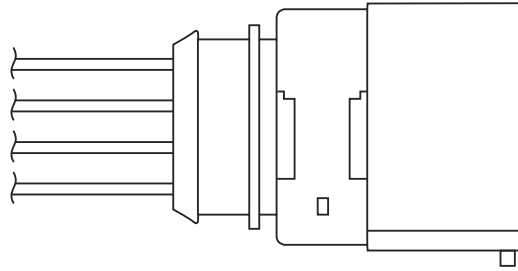

 4	 620
 M 18 x 1,5	 22 Nm 45



OPH 053
0 824 010 338

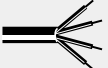
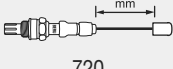

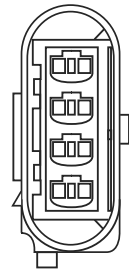
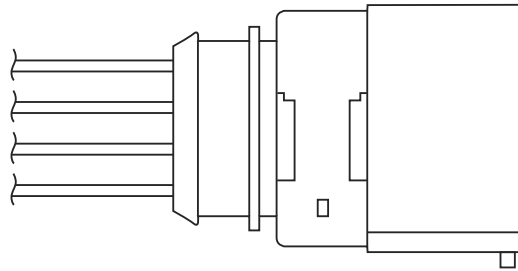

 4	 720
 M 18 x 1,5	 22 Nm 45



OPH 054
0 824 010 339

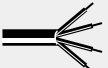
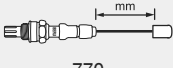

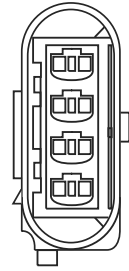
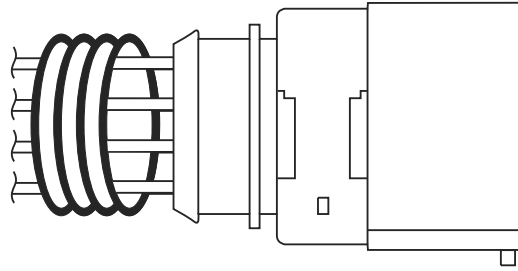

 4	 770
 M 18 x 1,5	 22 Nm 45



OPH 055
0 824 010 340

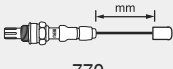

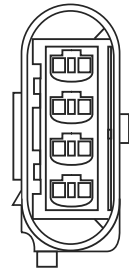
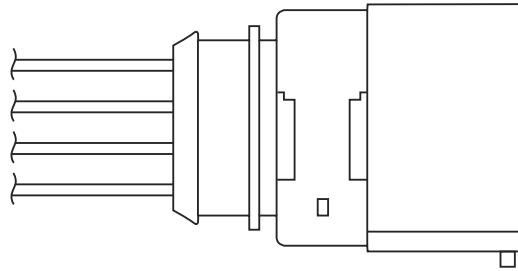

 4	 770
 M 18 x 1,5	 22 Nm 45

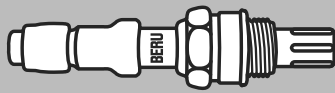

**OPH 056**

0 824 010 341

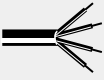
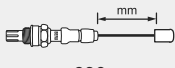

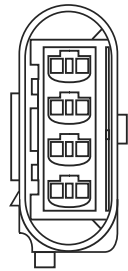
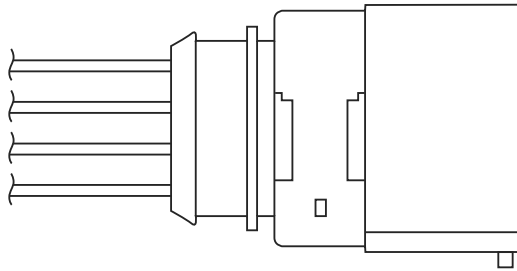

 4	 830
 M 18 x 1,5	 22 Nm 45

**OPH 057**

0 824 010 342

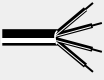
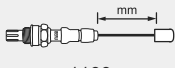

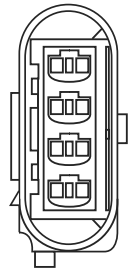
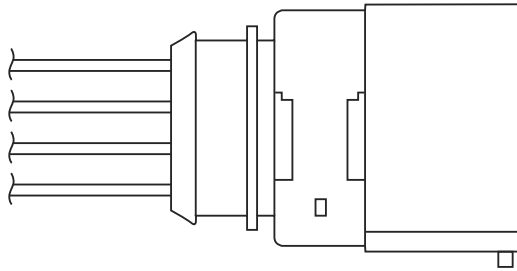

 4	 1100
 M 18 x 1,5	 22 Nm 45

**OPH 058**

0 824 010 343

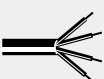
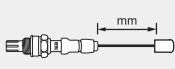

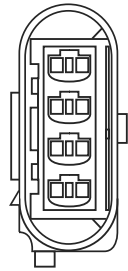
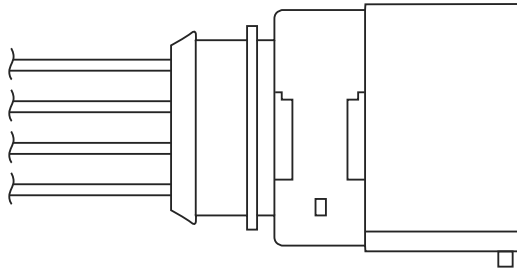

 4	 1170
 M 18 x 1,5	 22 Nm 45

**OPH 059**

0 824 010 344

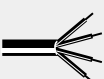
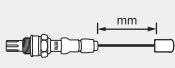

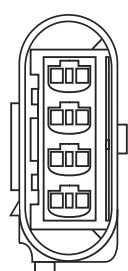
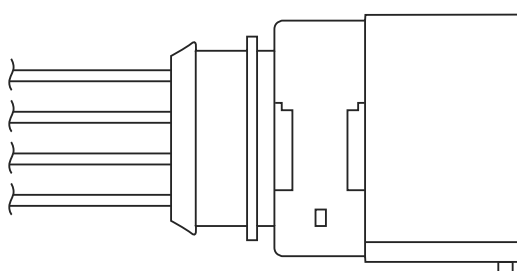

 4	 1380
 M 18 x 1,5	 22 Nm 45

**OPH 060**

0 824 010 345

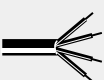
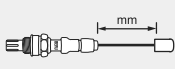

 4	 1540
 M 18 x 1,5	 22 Nm 45

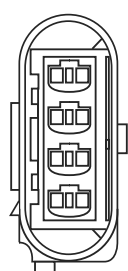
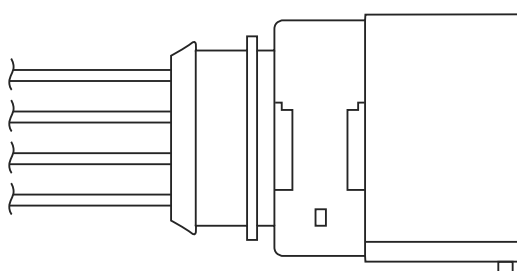



OPH 061

0 824 010 346

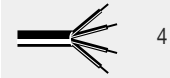

4

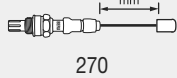

270



M 18 x 1,5



22

Nm

45

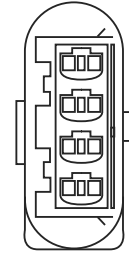
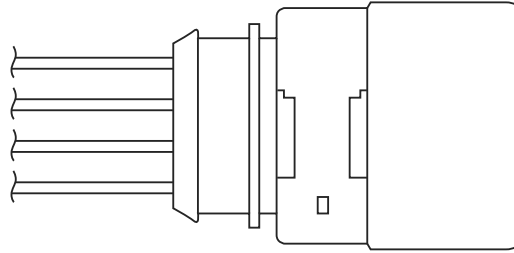

OPH 062

0 824 010 347



4

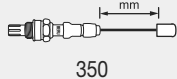

350



M 18 x 1,5



22

Nm

45

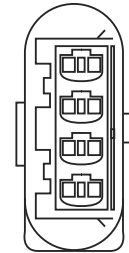
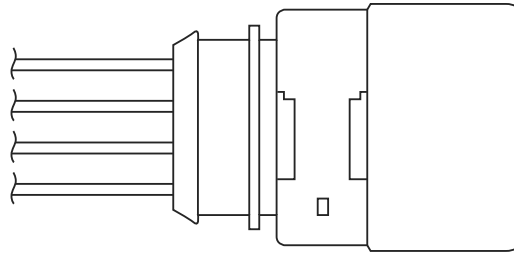

OPH 063

0 824 010 348



4

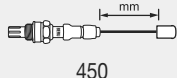

450



M 18 x 1,5



22

Nm

45

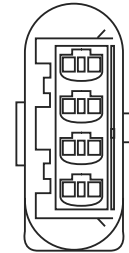
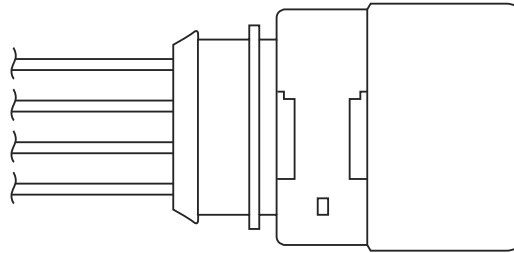

OPH 064

0 824 010 349



4

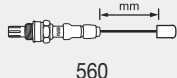

560



M 18 x 1,5



22

Nm

45

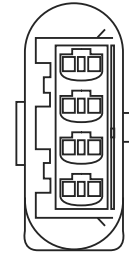
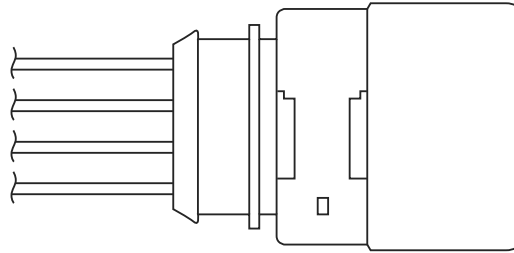

OPH 065

0 824 010 350



4

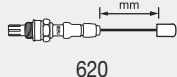

620



M 18 x 1,5



22

Nm

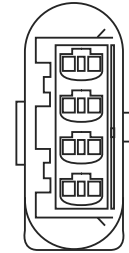
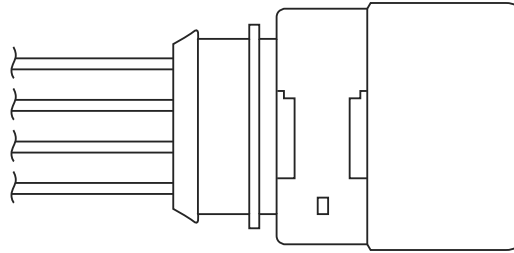

45

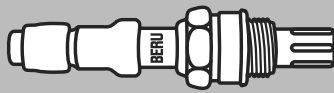

**OPH 066**

0 824 010 351

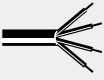
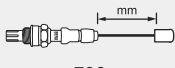

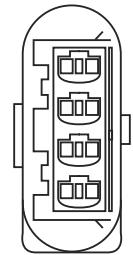
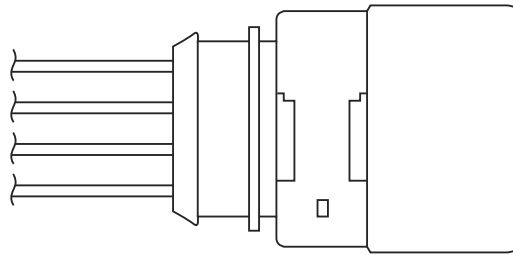

 4	 720
 M 18 x 1,5	 22 Nm 45

**OPH 067**

0 824 010 352

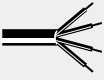
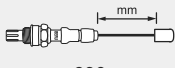

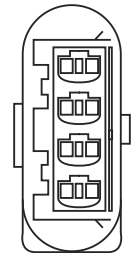
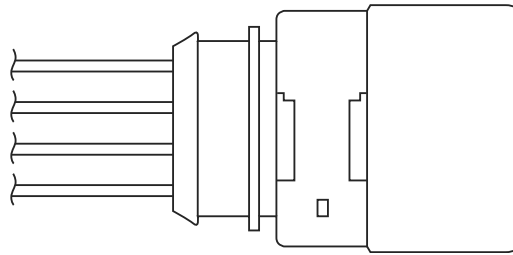

 4	 820
 M 18 x 1,5	 22 Nm 45

**OPH 068**

0 824 010 353

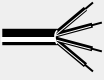
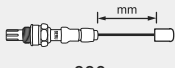

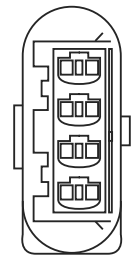
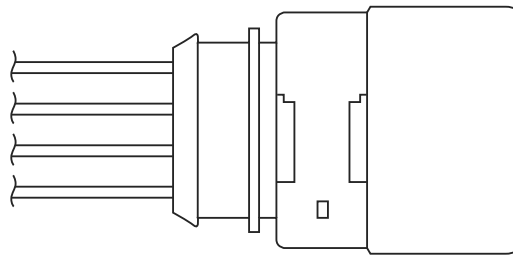

 4	 880
 M 18 x 1,5	 22 Nm 45

**OPH 069**

0 824 010 354

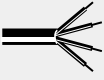
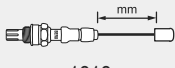

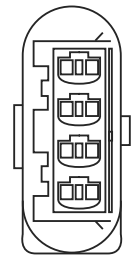
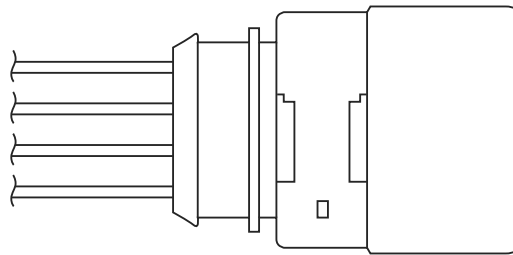

 4	 1010
 M 18 x 1,5	 22 Nm 45

**OPH 070**

0 824 010 355

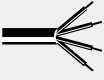
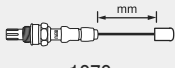

 4	 1070
 M 18 x 1,5	 22 Nm 45

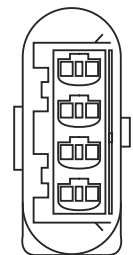
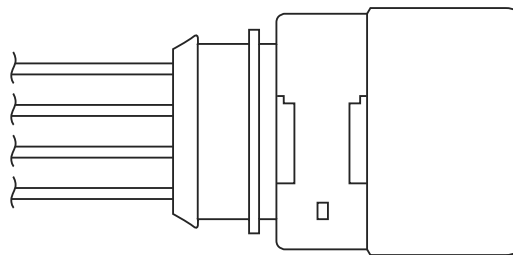

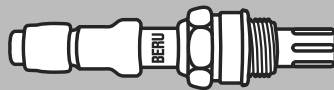

OPH 071

0 824 010 356



4	mm 1300
M 18 x 1,5	22 Nm 45

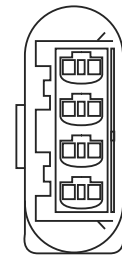
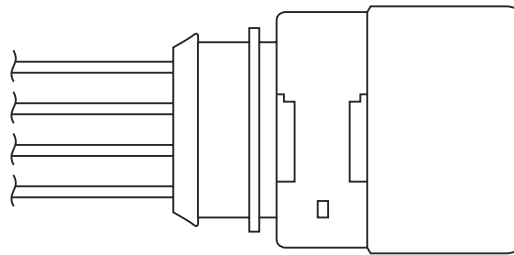

OPH 072

0 824 010 357



4	mm 1450
M 18 x 1,5	22 Nm 45

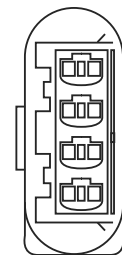
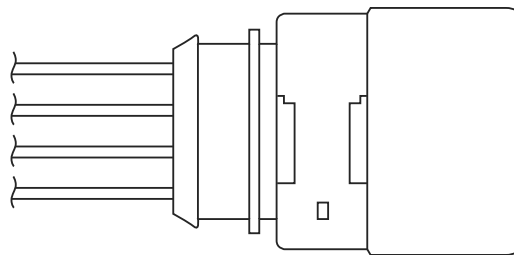

OPH 073

0 824 010 358



4	mm 1600
M 18 x 1,5	22 Nm 45

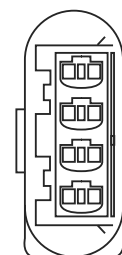
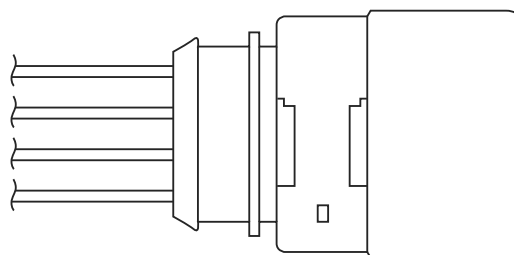

OPH 074

0 824 010 359



4	mm 340
M 18 x 1,5	22 Nm 45

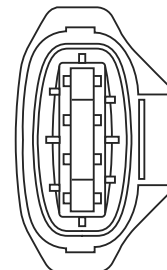
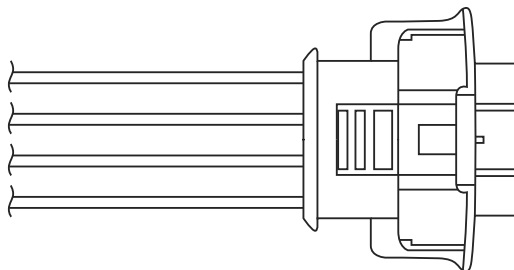

OPH 075

0 824 010 360



4	mm 410
M 18 x 1,5	22 Nm 45

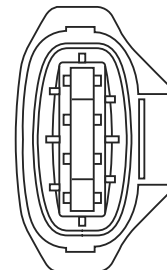
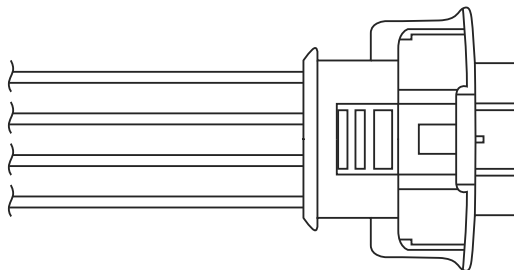

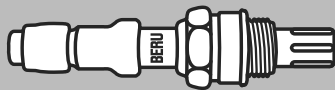

OPH 076

0 824 010 361



4	mm 480
M 18 x 1,5	22 Nm 45

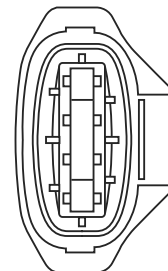
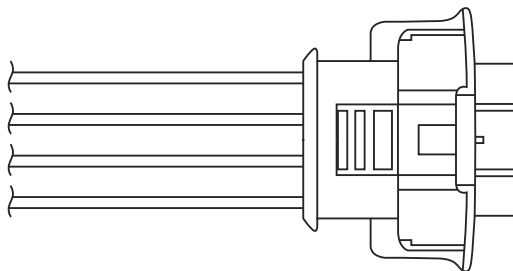

OPH 077

0 824 010 362



4	mm 650
M 18 x 1,5	22 Nm 45

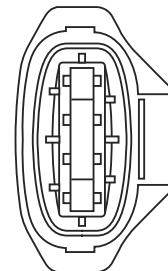
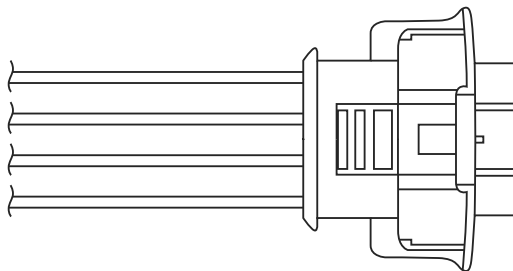

OPH 078

0 824 010 363



4	mm 200
M 18 x 1,5	22 Nm 45

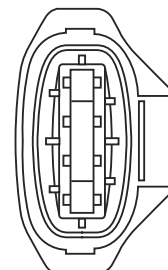
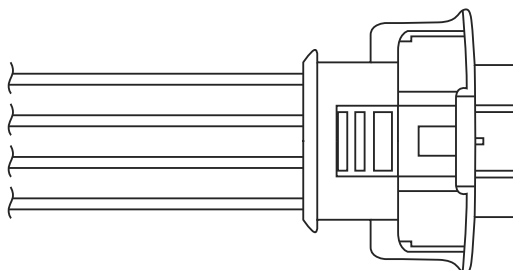

OPH 079

0 824 010 364



4	mm 350
M 18 x 1,5	22 Nm 45

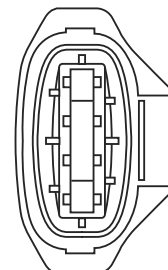
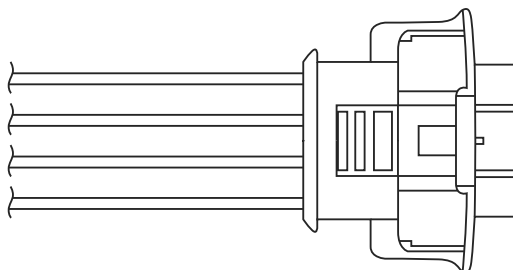

OPH 080

0 824 010 365



4	mm 400
M 18 x 1,5	22 Nm 45

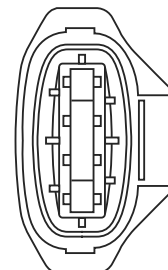
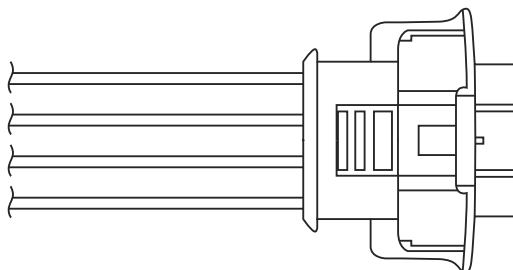

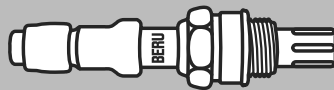

OPH 081

0 824 010 366

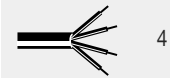

4

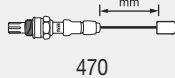

470



M 18 x 1,5



22

Nm

45

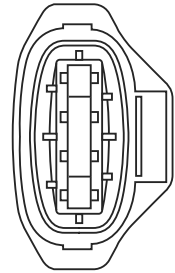
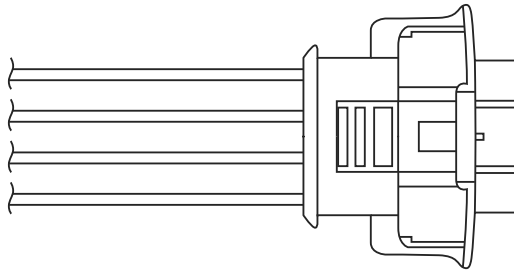

OPH 082

0 824 010 367



4

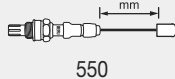

550



M 18 x 1,5



22

Nm

45

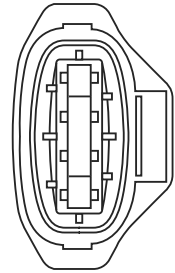
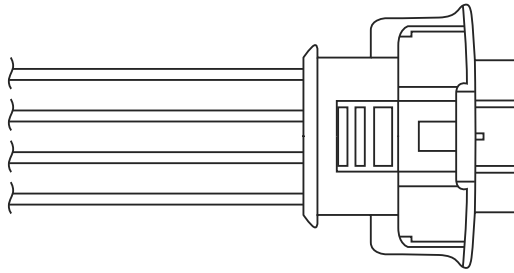

OPH 083

0 824 010 368



4

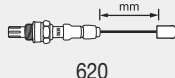

620



M 18 x 1,5



22

Nm

45

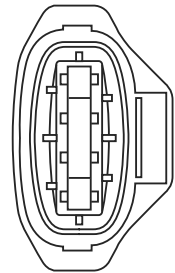
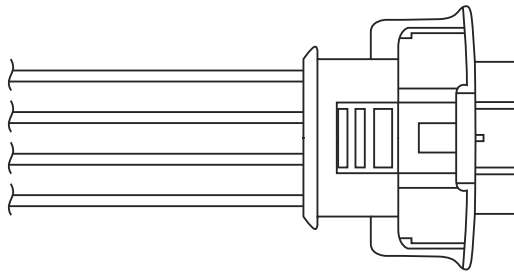

OPH 084

0 824 010 369



4

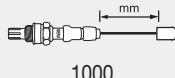

1000



M 18 x 1,5



22

Nm

45

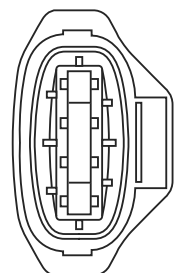
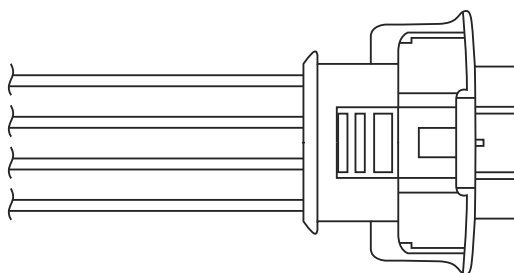

OPH 085

0 824 010 370



4

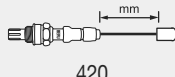

420



M 18 x 1,5



22

Nm

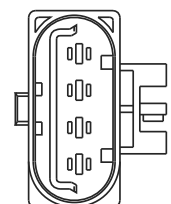
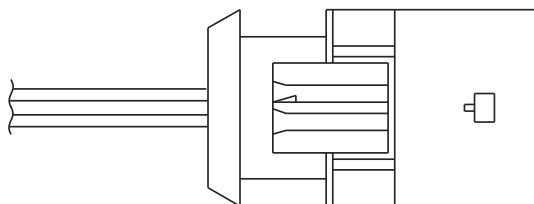

45

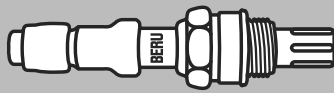

**OPH 086**

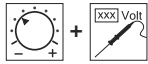
0 824 010 371

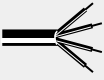
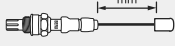

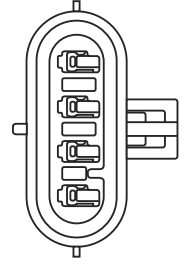
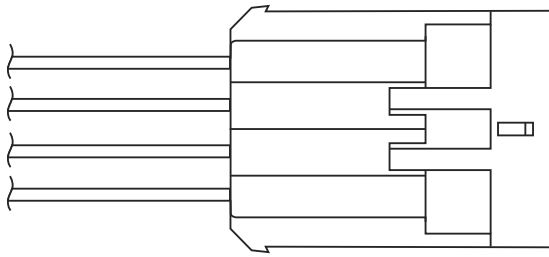

 4	 mm 330
 M 18 x 1,5	 22 Nm 45

**OPH 087**

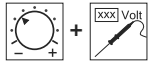
0 824 010 372

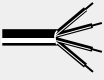
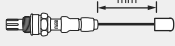

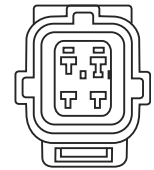
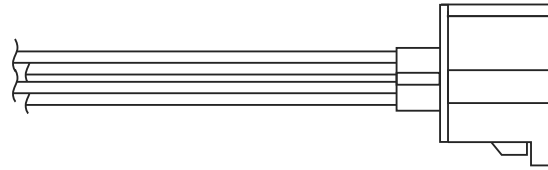

 4	 mm 400
 M 18 x 1,5	 22 Nm 45

**OPH 088**

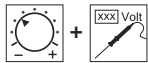
0 824 010 373

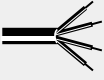
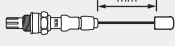

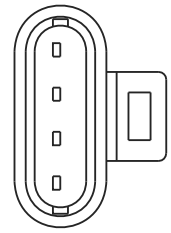
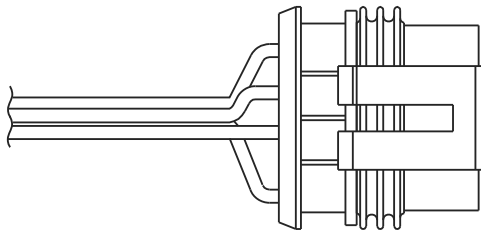

 4	 mm 250
 M 18 x 1,5	 22 Nm 45

**OPH 089**

0 824 010 374

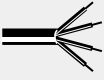
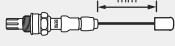

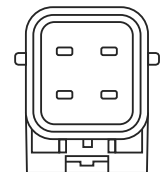
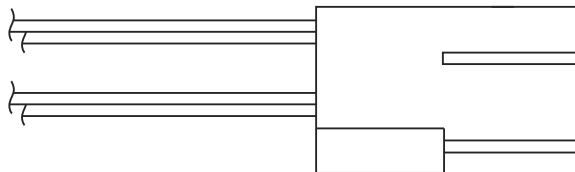

 4	 mm 190
 M 18 x 1,5	 22 Nm 45

**OPH 090**

0 824 010 375

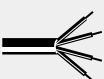
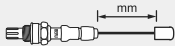

 4	 mm 370
 M 18 x 1,5	 22 Nm 45

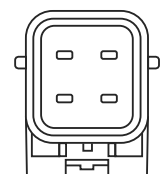
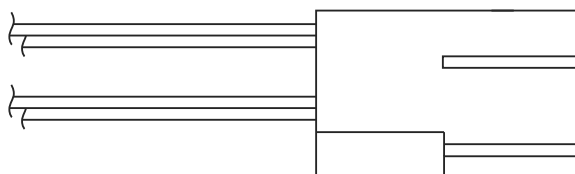

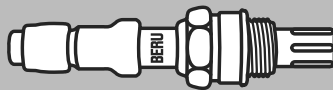

OPH 091
0 824 010 376



44	700
M 18 x 1,5	22 Nm 45

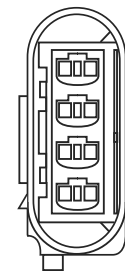
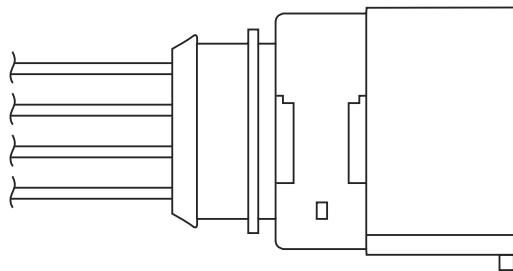

OPH 092
0 824 010 377



4	1350
M 18 x 1,5	22 Nm 45

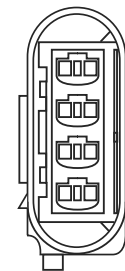
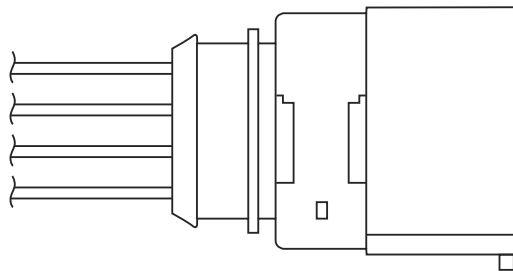

OPH 093
0 824 010 378



4	820
M 18 x 1,5	22 Nm 45

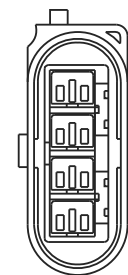
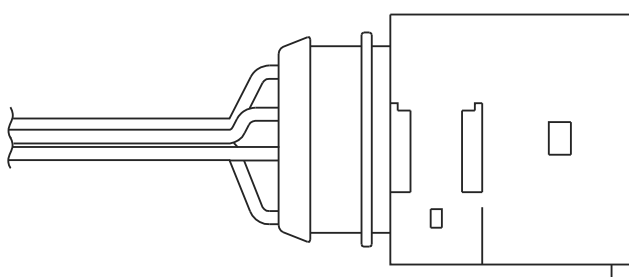

OPH 094
0 824 010 379



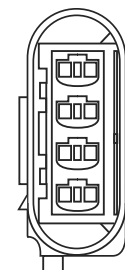
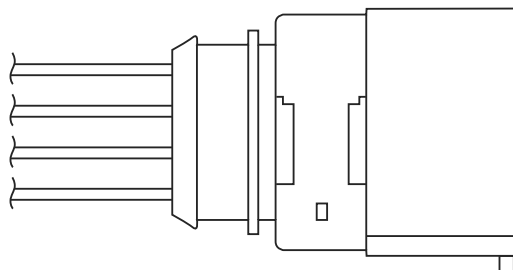

4	905
M 18 x 1,5	22 Nm 45

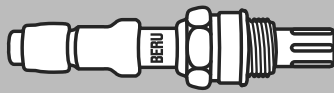

**OZH 001**

0 824 010 002

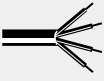
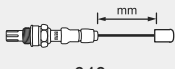

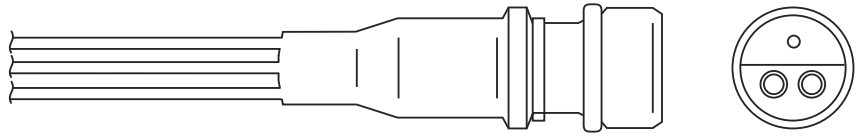

 3	 mm 640
 M 18 x 1,5	 22 Nm 45

**OZH 002**

0 824 010 003

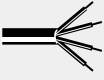
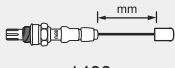

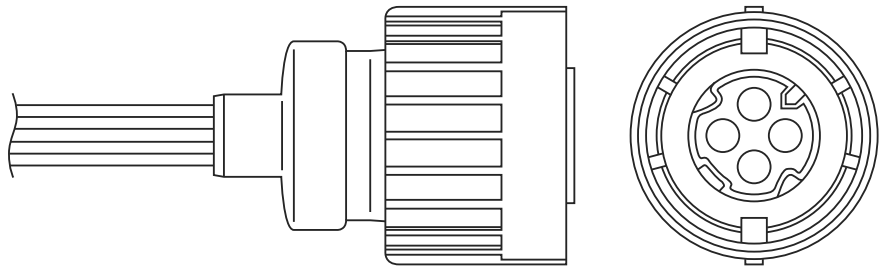

 4	 mm 1400
 M 18 x 1,5	 22 Nm 45

**OZH 003**

0 824 010 004

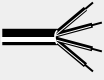
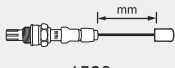

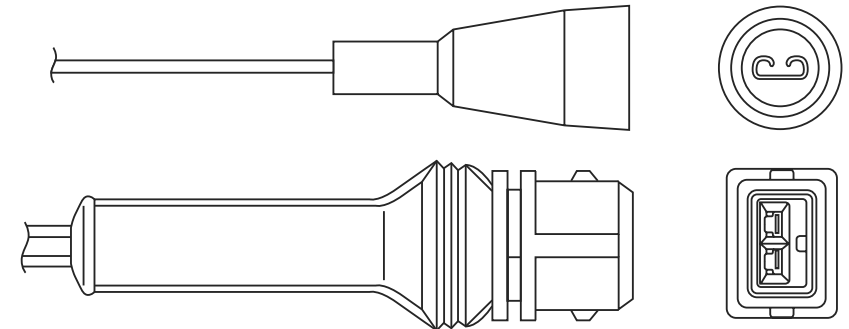

 3	 mm 1580
 M 18 x 1,5	 22 Nm 45

**OZH 004**

0 824 010 005

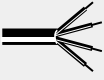
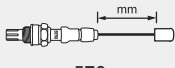

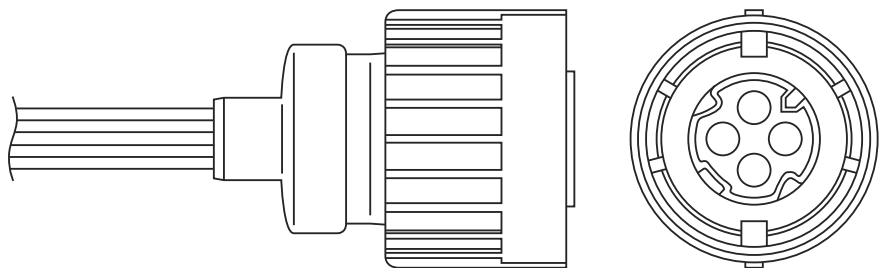

 4	 mm 570
 M 18 x 1,5	 22 Nm 45

**OZH 005**

0 824 010 006

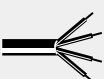
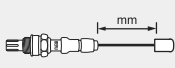

 4	 mm 1120
 M 18 x 1,5	 22 Nm 45

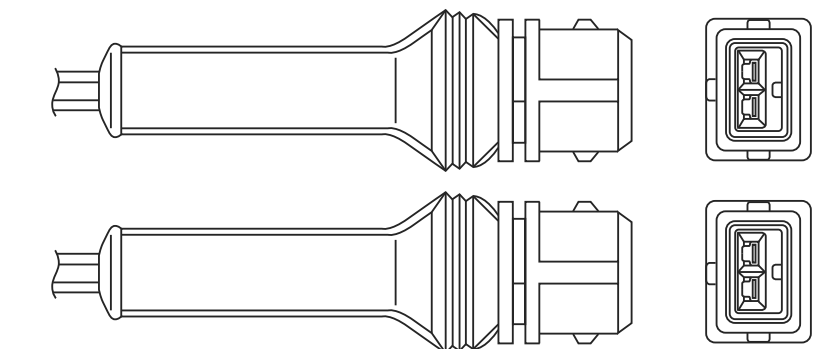



OZH 006
0 824 010 007



3

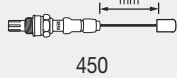

450



M 18 x 1,5



22

Nm

45

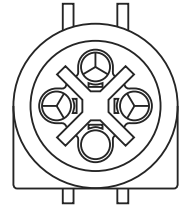
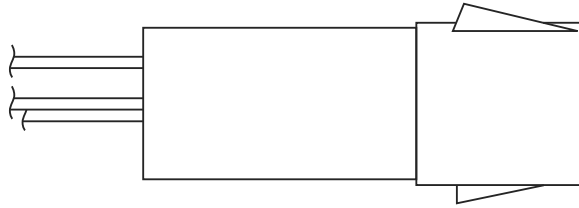

OZH 007
0 824 010 008



3

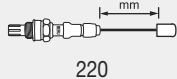

220



M 18 x 1,5



22

Nm

45

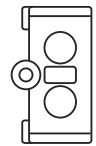
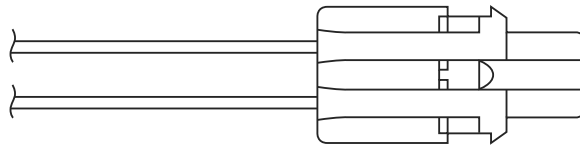
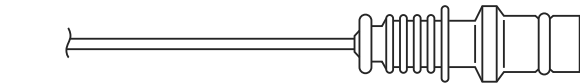

OZH 008
0 824 010 009



3

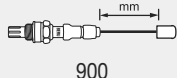

900



M 18 x 1,5



22

Nm

45

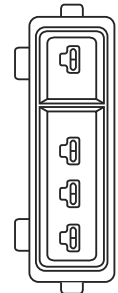
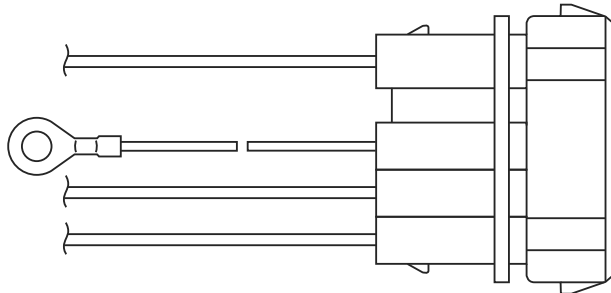

OZH 009
0 824 010 010



3

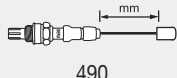

490



M 18 x 1,5



22

Nm

45

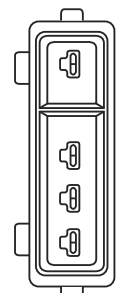
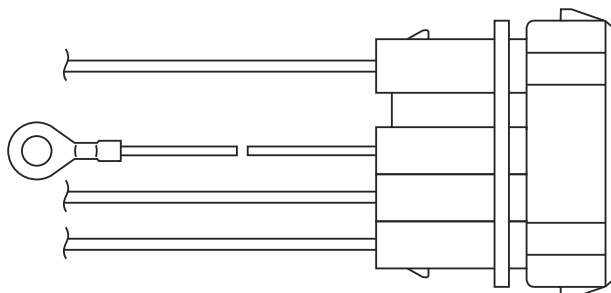

OZH 010
0 824 010 011



3

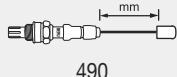

490



M 18 x 1,5



22

Nm

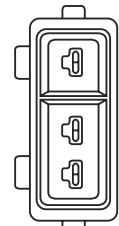
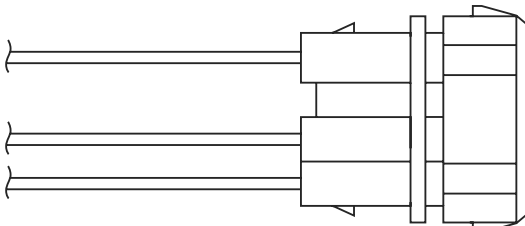

45

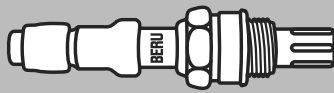

**OZH 011**

0 824 010 012

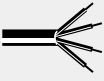
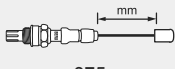

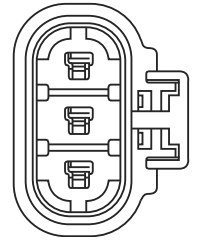
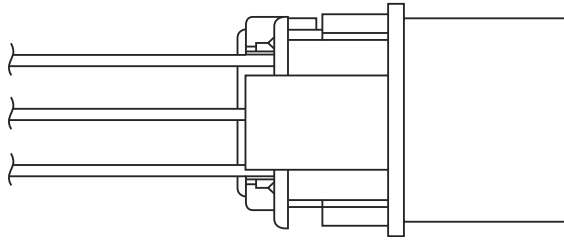

 3	 mm 275
 M 18 x 1,5	 22 Nm 45

**OZH 012**

0 824 010 013

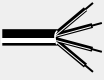
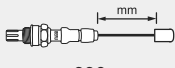

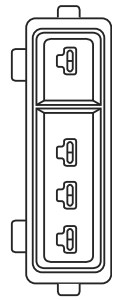
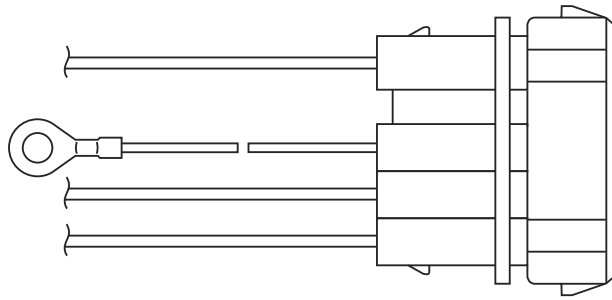

 3	 mm 390
 M 18 x 1,5	 22 Nm 45

**OZH 014**

0 824 010 015

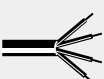
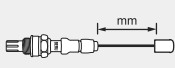

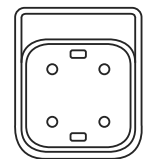
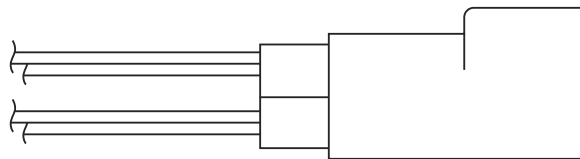

 4	 mm 620
 M 18 x 1,5	 22 Nm 45

**OZH 015**

0 824 010 016

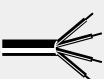
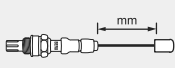

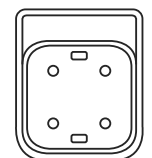
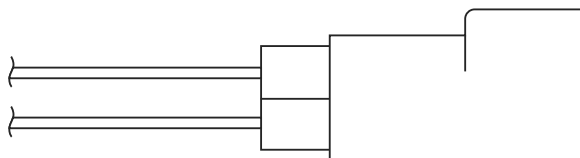

 4	 mm 170
 M 18 x 1,5	 22 Nm 45

**OZH 016**

0 824 010 017

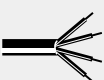
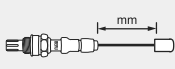

 4	 mm 670
 M 18 x 1,5	 22 Nm 45

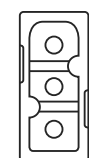
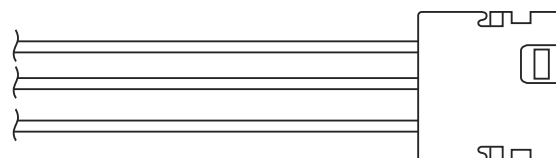
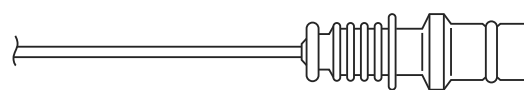

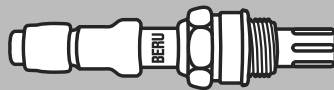

OZH 017
0 824 010 018

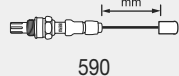

590



M 18 x 1,5



22

Nm

45

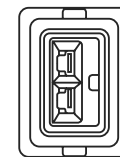
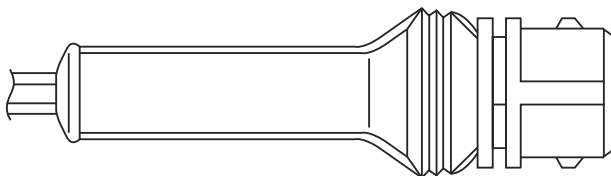
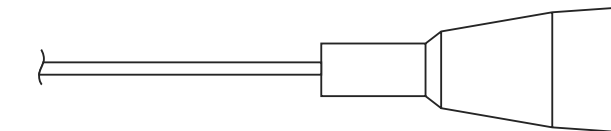

OZH 018
0 824 010 019

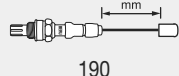

190



M 18 x 1,5



22

Nm

45

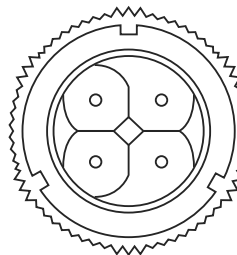
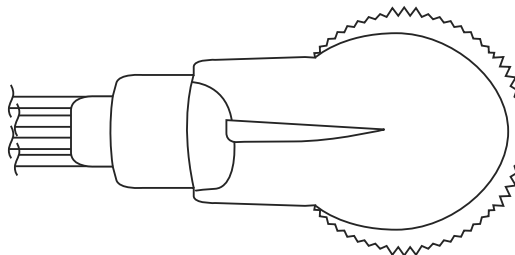

OZH 019
0 824 010 020

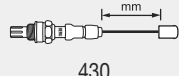

430



M 18 x 1,5



22

Nm

45

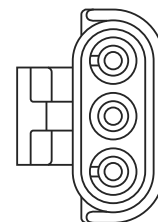
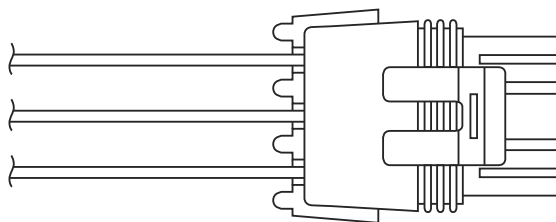

OZH 020
0 824 010 021

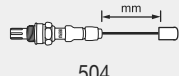

504



M 18 x 1,5



22

Nm

45

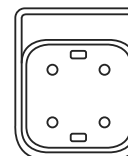
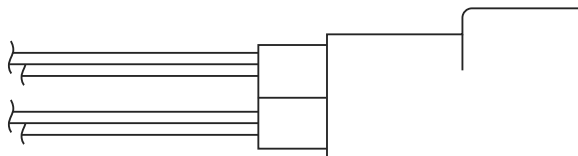

OZH 021
0 824 010 022

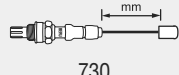

730



M 18 x 1,5



22

Nm

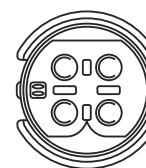
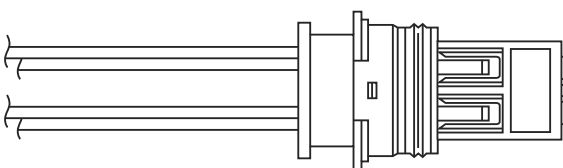

45

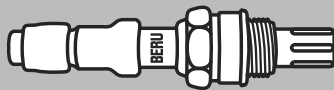



OZH 022
0 824 010 023

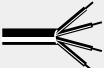
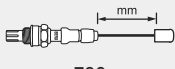

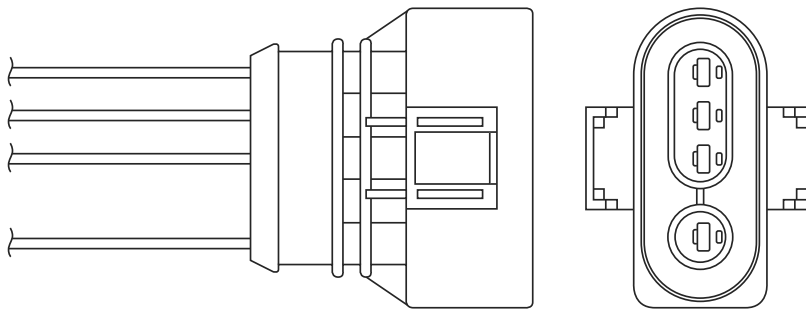

 4	 mm 780
 M 18 x 1,5	 22 Nm 45



OZH 023
0 824 010 024

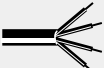
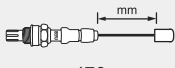

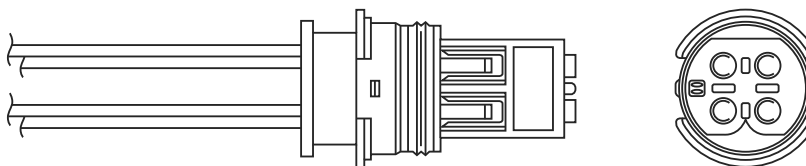

 4	 mm 470
 M 18 x 1,5	 22 Nm 45



OZH 024
0 824 010 025

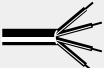
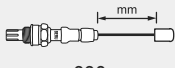

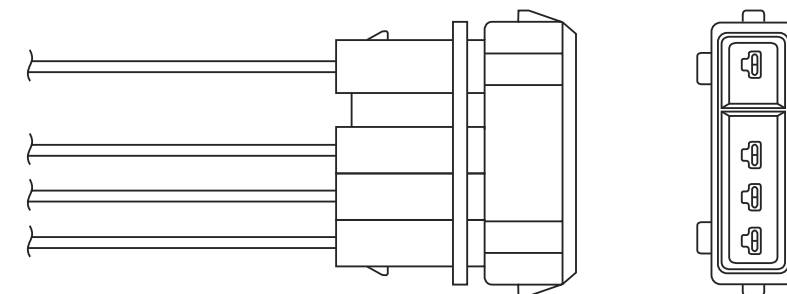

 4	 mm 990
 M 18 x 1,5	 22 Nm 45



OZH 025
0 824 010 026

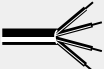
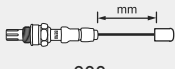

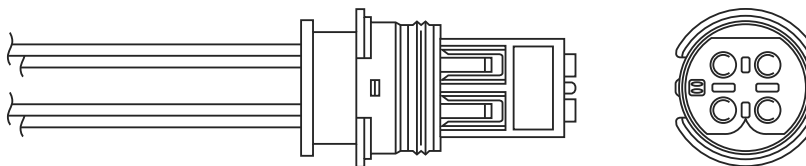

 4	 mm 900
 M 18 x 1,5	 22 Nm 45



OZH 026
0 824 010 027

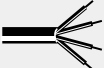
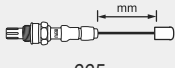

 3	 mm 665
 M 18 x 1,5	 22 Nm 45

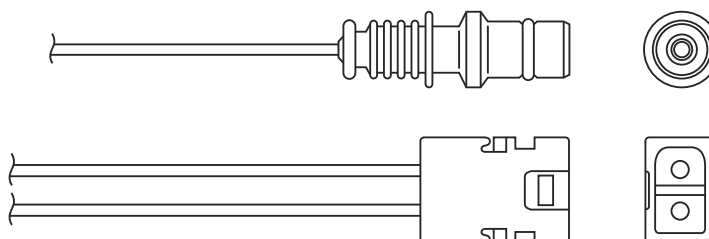

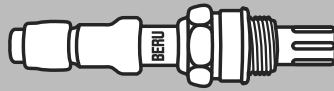

OZH 027

0 824 010 028

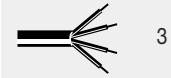

3

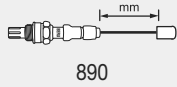

890



M 18 x 1,5



22

Nm

45

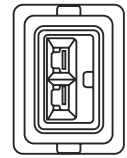
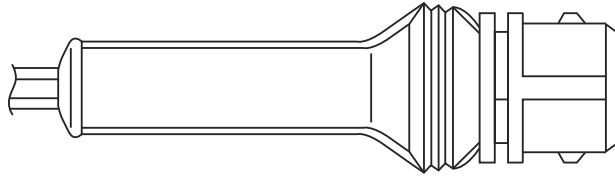
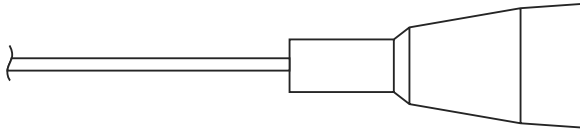

OZH 028

0 824 010 030



3

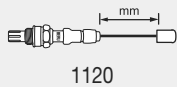

1120



M 18 x 1,5



22

Nm

45

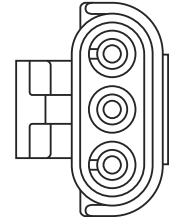
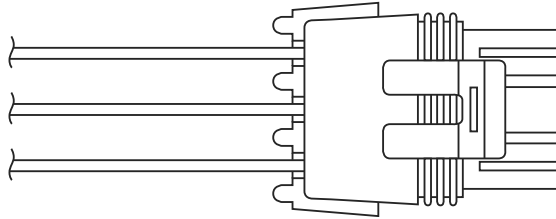

OZH 029

0 824 010 031



4

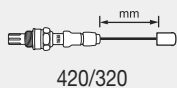

420/320



M 18 x 1,5



22

Nm

45

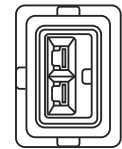
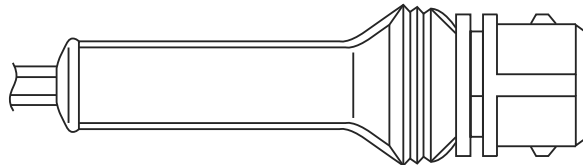
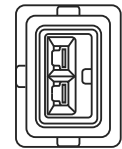
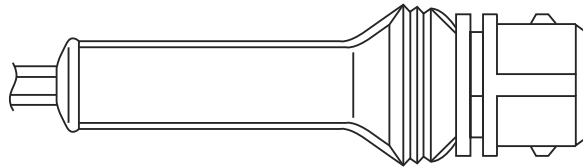

OZH 030

0 824 010 032



4

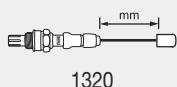

1320



M 18 x 1,5



22

Nm

45

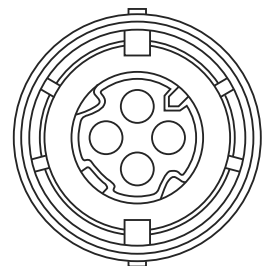
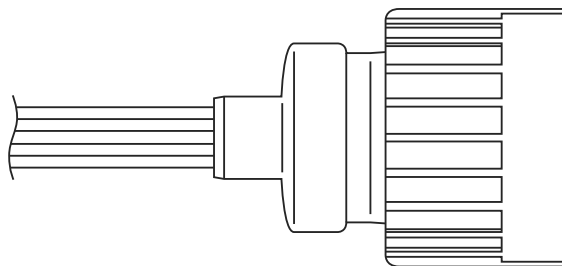

OZH 031

0 824 010 033



3

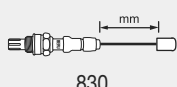

830



M 18 x 1,5



22

Nm

45

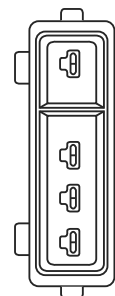
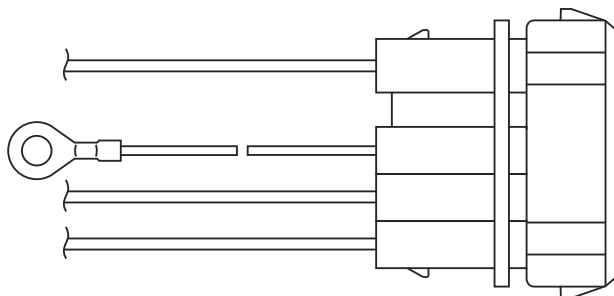

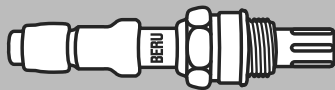



OZH 032

0 824 010 034

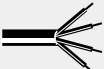
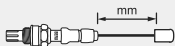

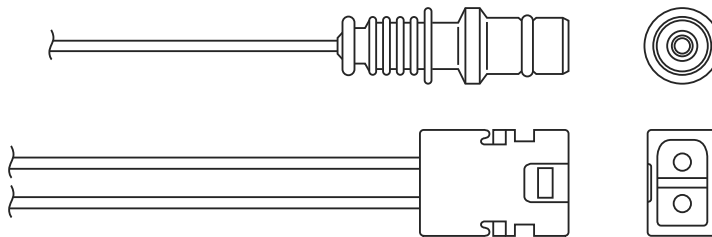

 3	 mm 430
 M 18 x 1,5	 22 Nm 45



OZH 033

0 824 010 035

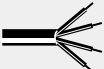
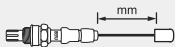

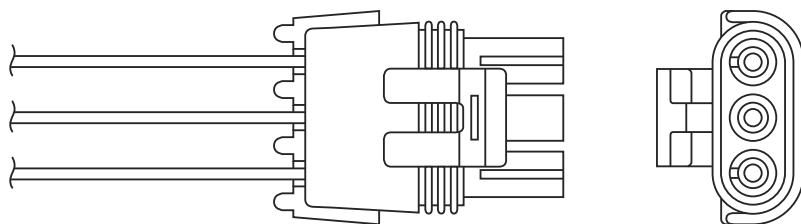

 3	 mm 270
 M 18 x 1,5	 22 Nm 45



OZH 034

0 824 010 036

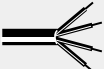
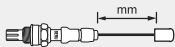

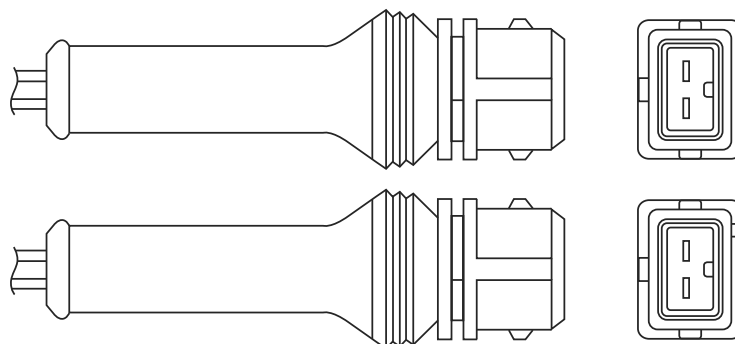

 4	 mm 1390
 M 18 x 1,5	 22 Nm 45



OZH 035

0 824 010 037

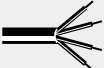
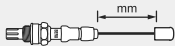

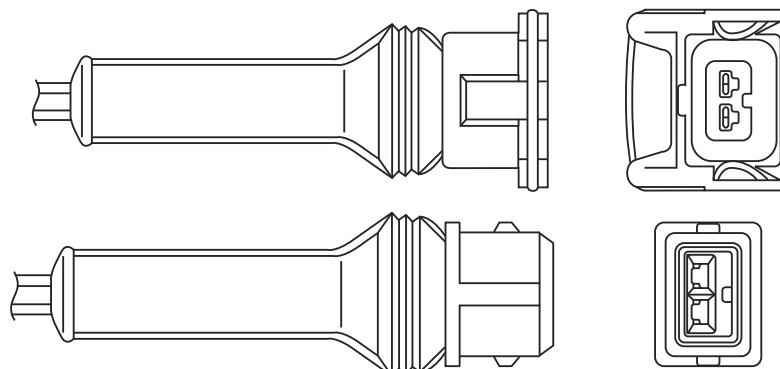

 4	 mm 800
 M 18 x 1,5	 22 Nm 45



OZH 036

0 824 010 038

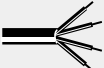
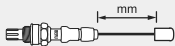

 4	 mm 450
 M 18 x 1,5	 22 Nm 45

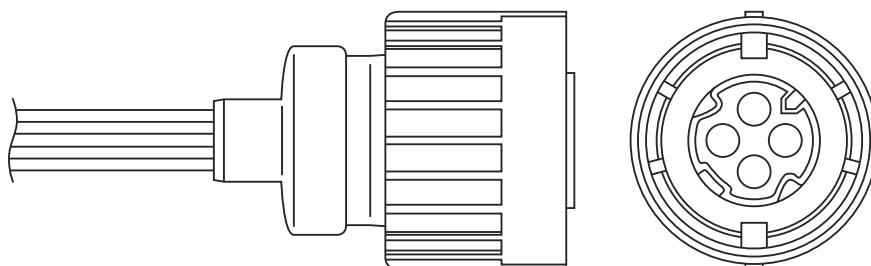



OZH 037
0 824 010 039

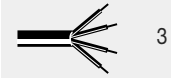

3

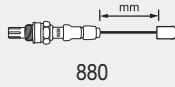

880



M 18 x 1,5



22

Nm

45

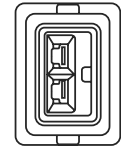
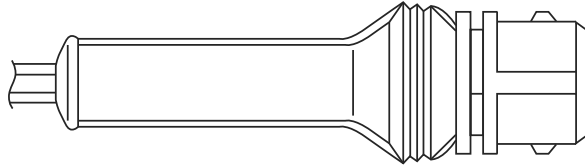
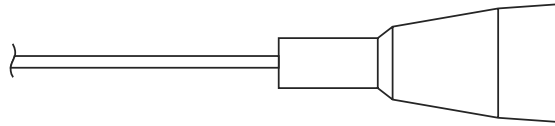

OZH 038
0 824 010 040



4

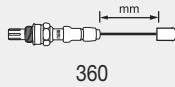

360



M 18 x 1,5



22

Nm

45

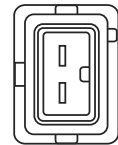
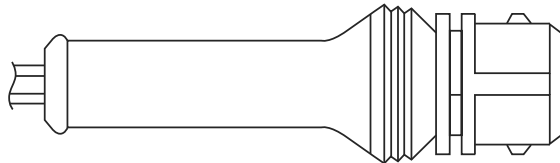
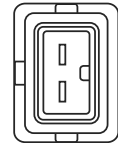
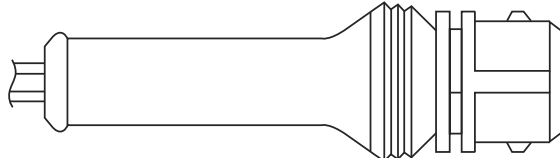

OZH 039
0 824 010 041



4

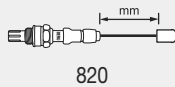

820



M 18 x 1,5



22

Nm

45

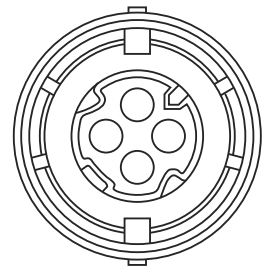
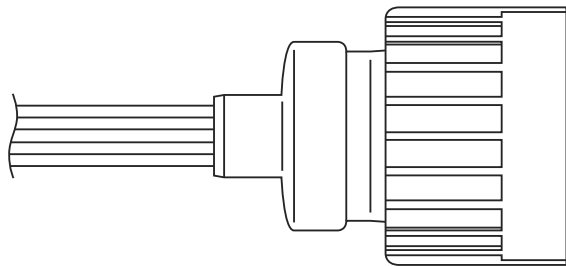

OZH 040
0 824 010 042



3

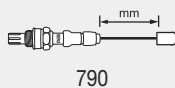

790



M 18 x 1,5



22

Nm

45

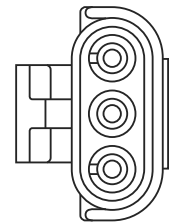
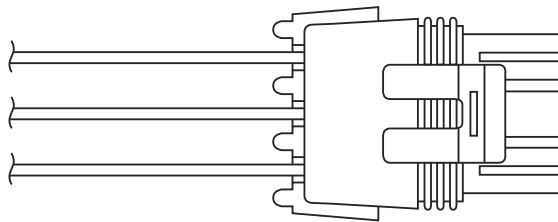

OZH 041
0 824 010 043



4

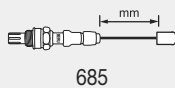

685



M 18 x 1,5



22

Nm

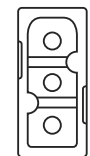
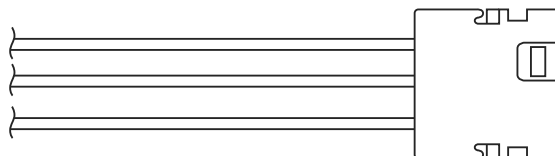
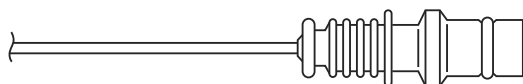

45

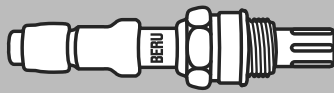

**OZH 042**

0 824 010 044

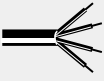
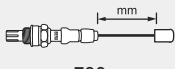

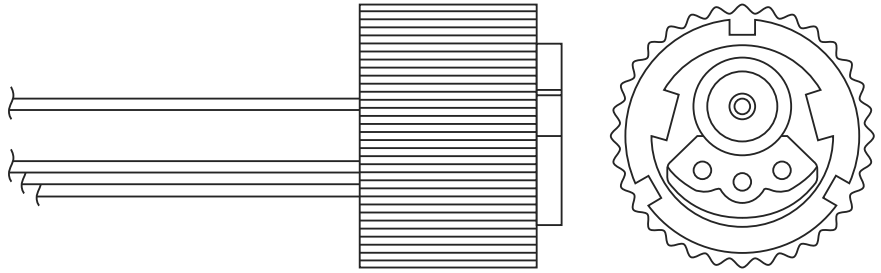

 4	 780
 M 18 x 1,5	 22 Nm 45

**OZH 043**

0 824 010 045

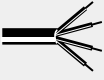
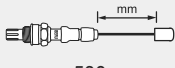

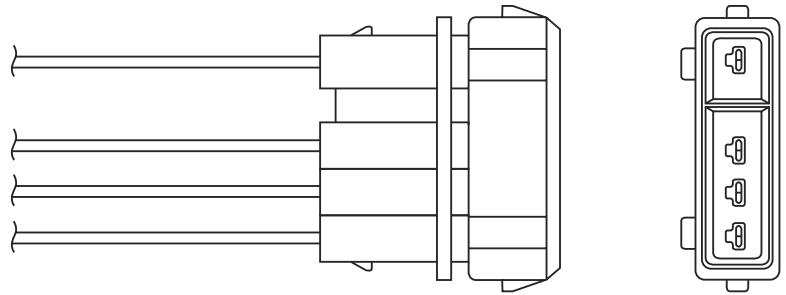

 4	 530
 M 18 x 1,5	 22 Nm 45

**OZH 044**

0 824 010 046

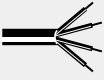
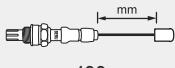

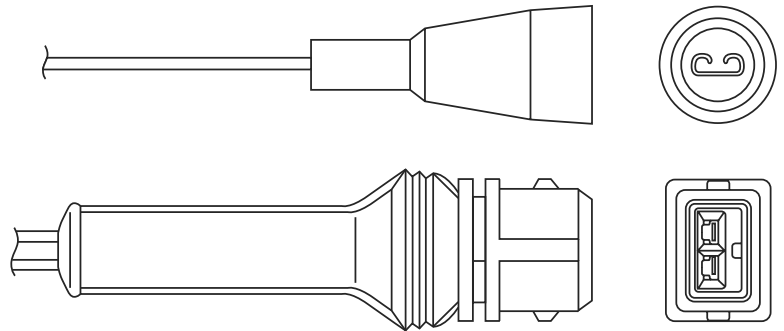

 3	 400
 M 18 x 1,5	 22 Nm 45

**OZH 045**

0 824 010 047

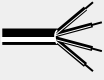
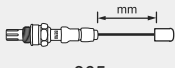

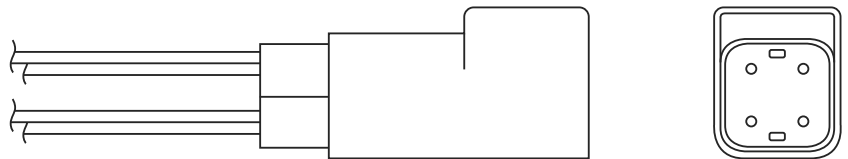

 4	 265
 M 18 x 1,5	 22 Nm 45

**OZH 046**

0 824 010 048

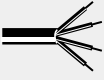
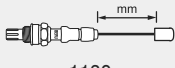

 3	 1130
 M 18 x 1,5	 22 Nm 45

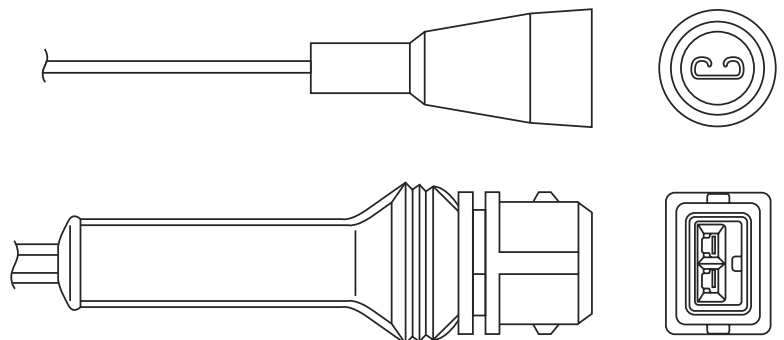

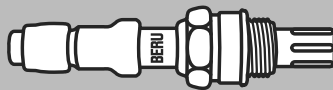

OZH 047

0 824 010 049



3

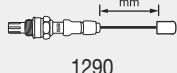

1290



M 18 x 1,5



22

Nm

45

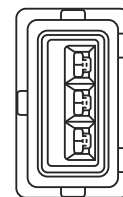
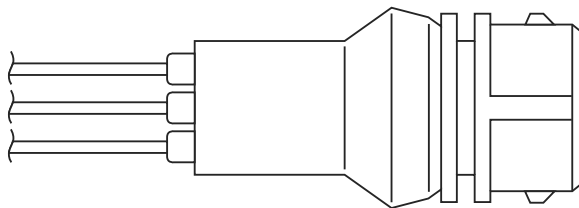

OZH 048

0 824 010 050



3

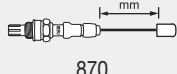

870



M 18 x 1,5



22

Nm

45

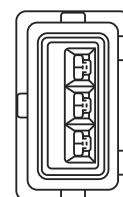
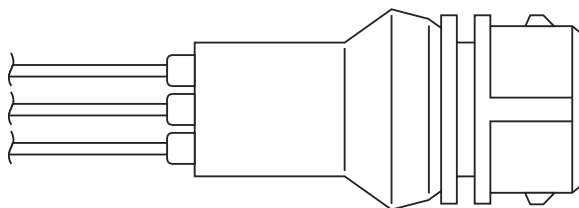

OZH 049

0 824 010 051



4

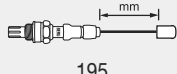

195



M 18 x 1,5



22

Nm

45

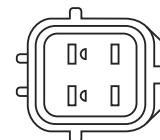
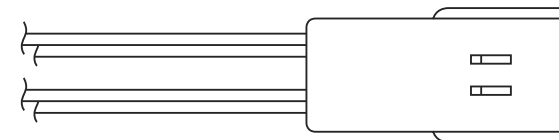

OZH 050

0 824 010 052



4

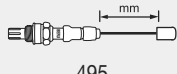

495



M 18 x 1,5



22

Nm

45

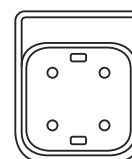
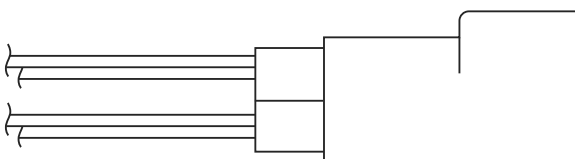

OZH 051

0 824 010 056



3

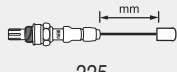

225



M 18 x 1,5



22

Nm

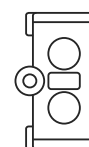
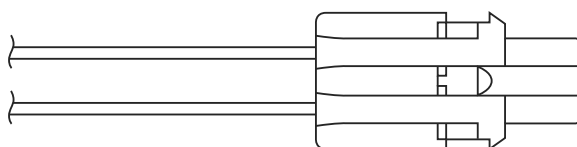
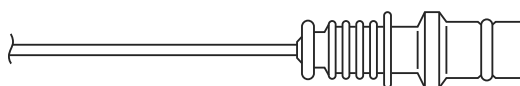

45

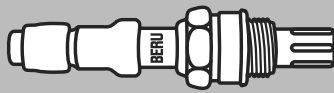

**OZH 052**

0 824 010 057

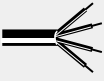
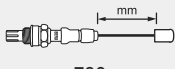

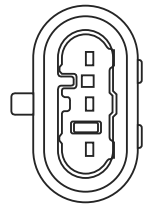
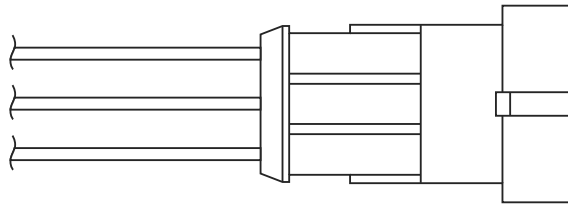

 3	 780
 M 18 x 1,5	 22 Nm 45

**OZH 053**

0 824 010 058

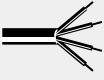
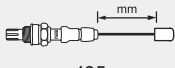

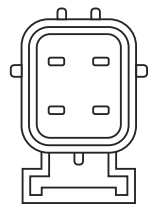
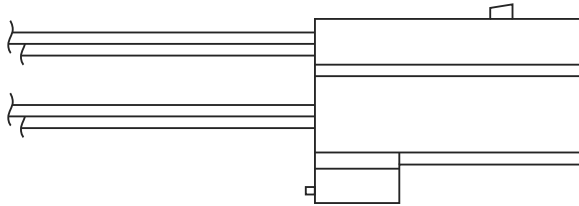

 4	 495
 M 18 x 1,5	 22 Nm 45

**OZH 054**

0 824 010 059

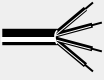
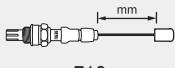

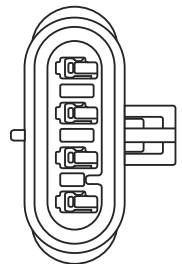
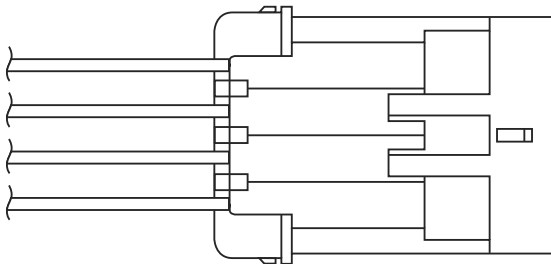

 4	 710
 M 18 x 1,5	 22 Nm 45

**OZH 055**

0 824 010 060

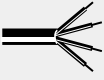
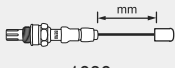

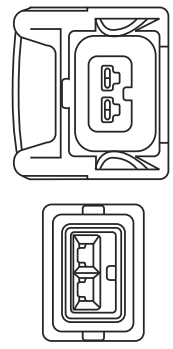
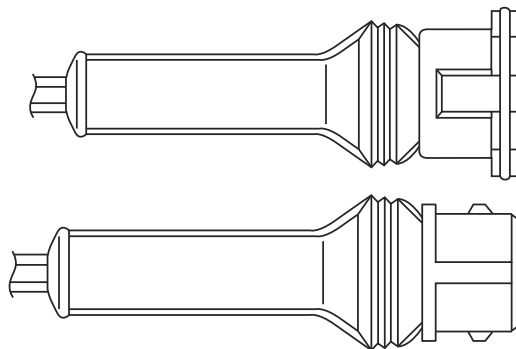

 4	 1030
 M 18 x 1,5	 22 Nm 45

**OZH 056**

0 824 010 061

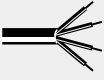
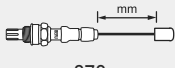

 4	 870
 M 18 x 1,5	 22 Nm 45

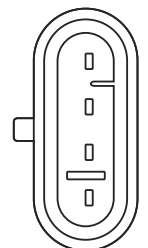
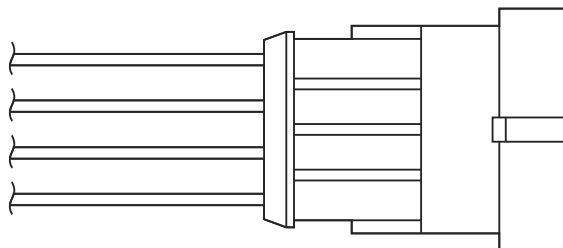



OZH 057

0 824 010 062



4	295
M 18 x 1,5	22 Nm 45

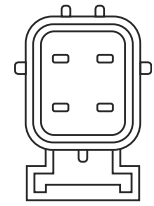
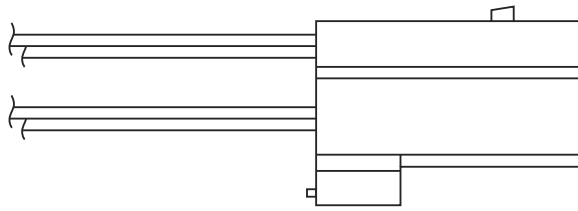

OZH 058

0 824 010 063



3	190
M 18 x 1,5	22 Nm 45

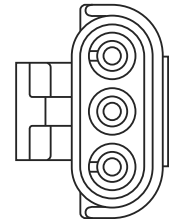
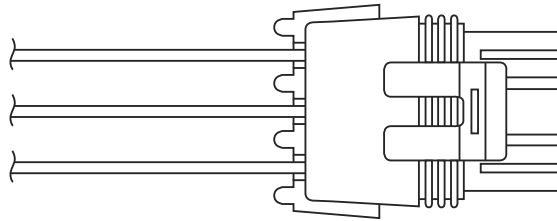

OZH 059

0 824 010 065



4	200
M 18 x 1,5	22 Nm 45

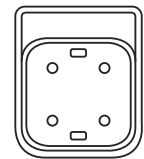
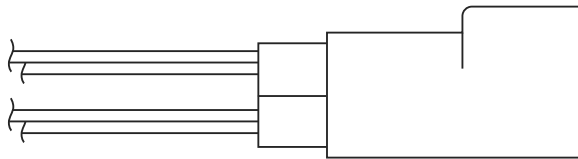

OZH 060

0 824 010 066



3	240
M 18 x 1,5	22 Nm 45

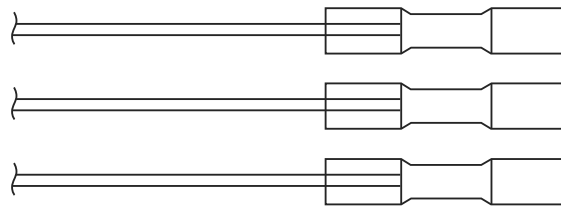

OZH 061

0 824 010 067



4	240
M 18 x 1,5	22 Nm 45

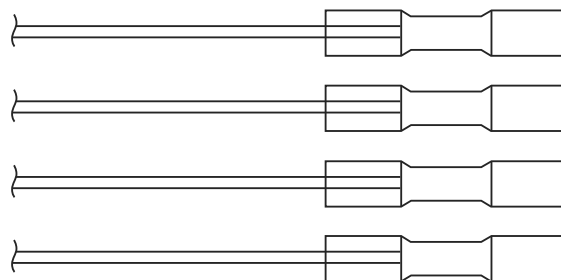

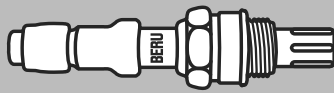



OZH 062

0 824 010 068

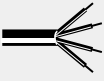
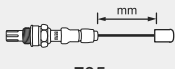

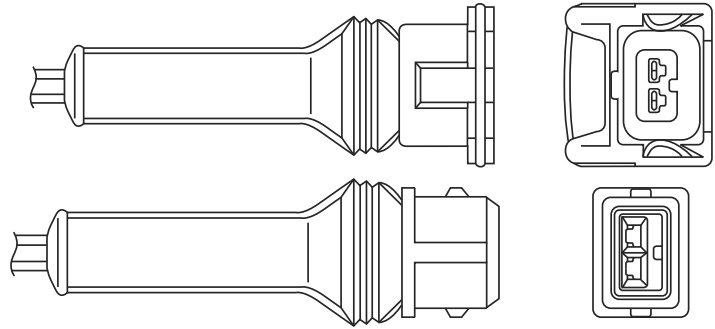

 4	 mm 795
 M 18 x 1,5	 22 Nm 45



OZH 064

0 824 010 070

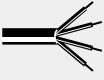
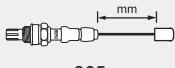

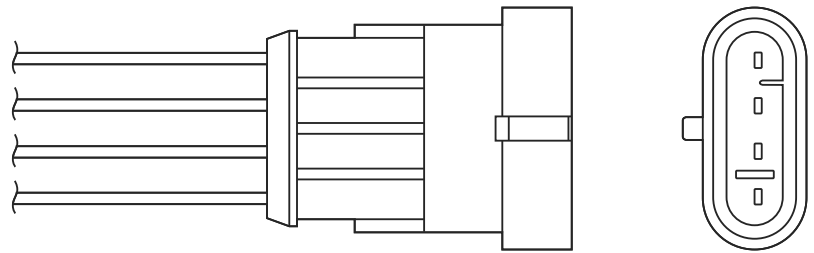

 4	 mm 265
 M 18 x 1,5	 22 Nm 45



OZH 065

0 824 010 071

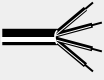
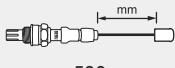

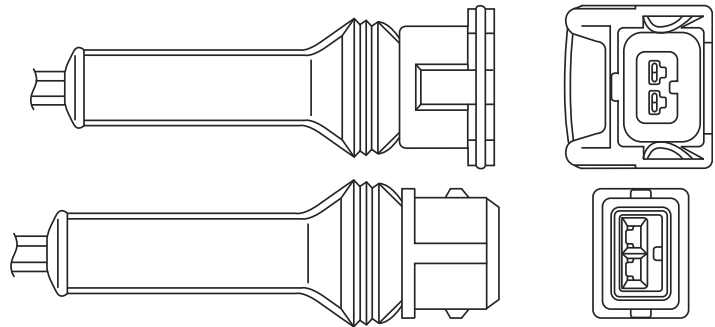

 4	 mm 530
 M 18 x 1,5	 22 Nm 45



OZH 066

0 824 010 072

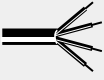
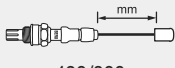

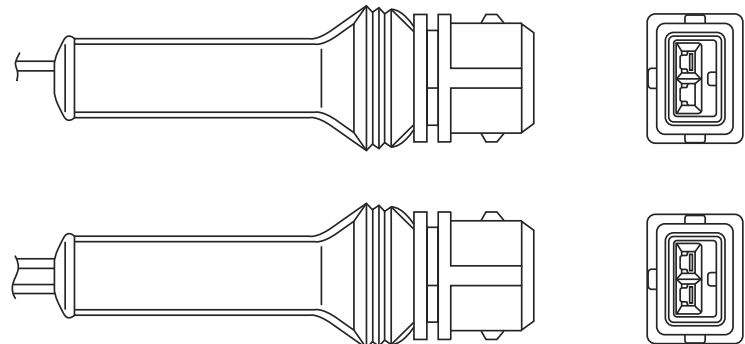

 3	 mm 420/300
 M 18 x 1,5	 22 Nm 45



OZH 067

0 824 010 073

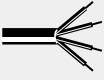
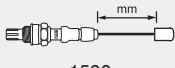

 4	 mm 1590
 M 18 x 1,5	 22 Nm 45

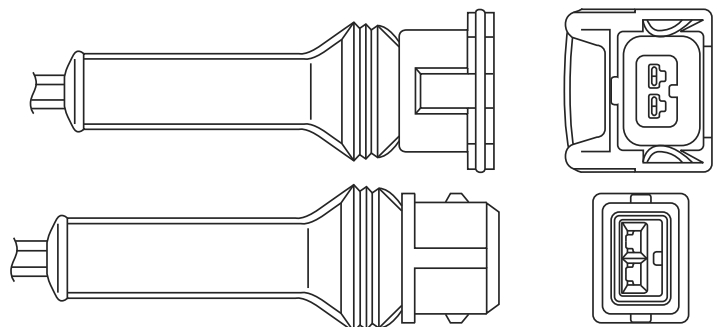

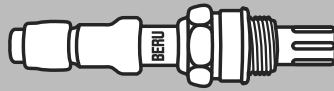

OZH 068

0 824 010 074

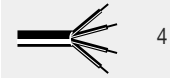

4

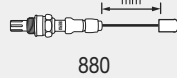

880



M 18 x 1,5



22

Nm

45

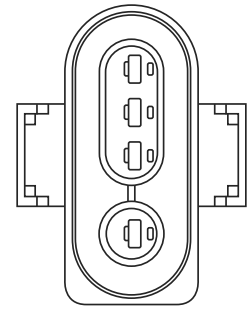
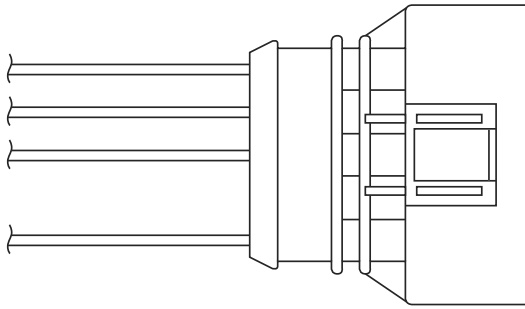

OZH 069

0 824 010 075



4

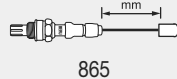

865



M 18 x 1,5



22

Nm

45

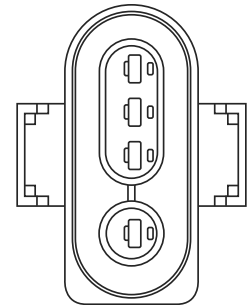
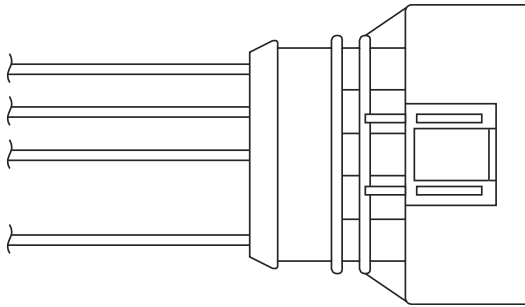

OZH 070

0 824 010 076



4

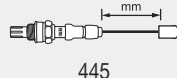

445



M 18 x 1,5



22

Nm

45

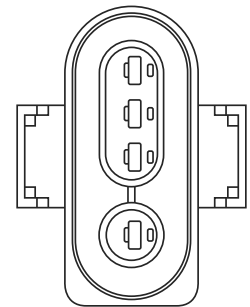
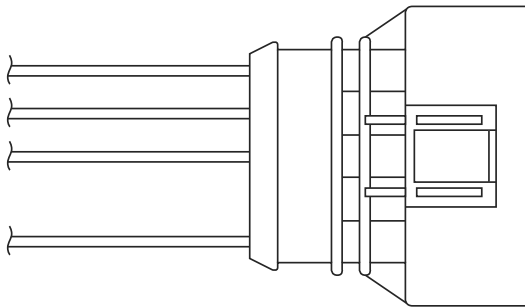

OZH 071

0 824 010 077



4

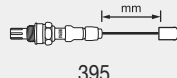

395



M 18 x 1,5



22

Nm

45

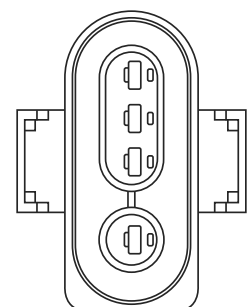
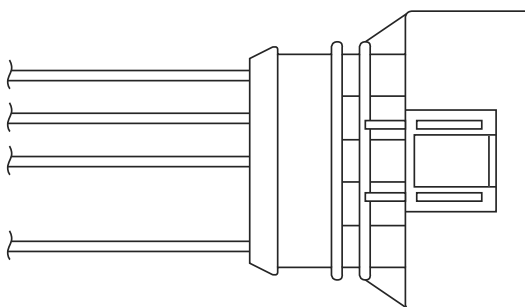

OZH 072

0 824 010 078



4

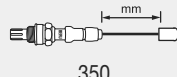

350



M 18 x 1,5



22

Nm

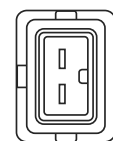
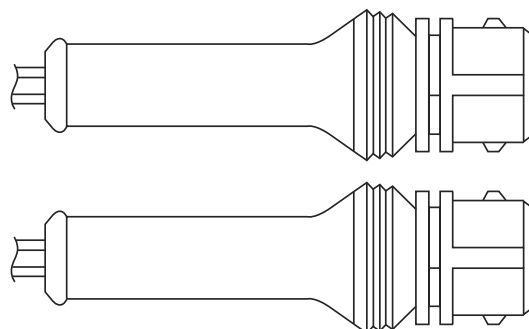

45

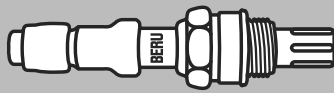

**OZH 073**

0 824 010 079

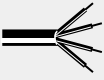
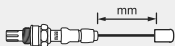

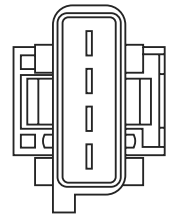
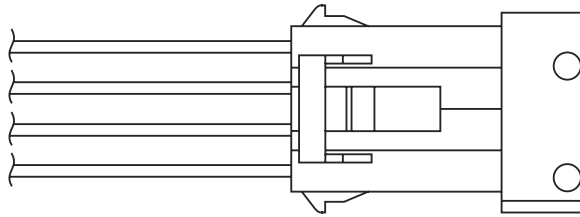

 4	 mm 395
 M 18 x 1,5	 22 Nm 45

**OZH 074**

0 824 010 080

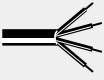
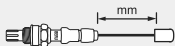

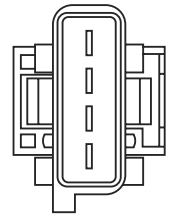
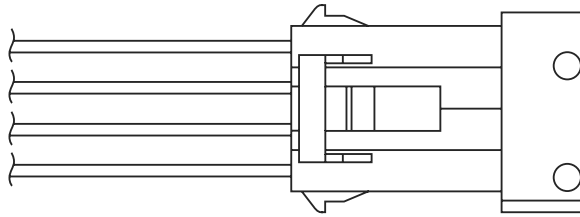

 4	 mm 265
 M 18 x 1,5	 22 Nm 45

**OZH 075**

0 824 010 081

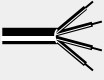
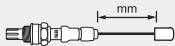

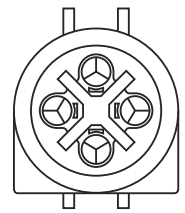
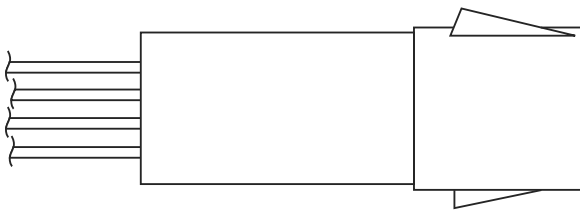

 4	 mm 600
 M 18 x 1,5	 22 Nm 45

**OZH 076**

0 824 010 084

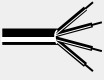
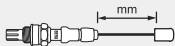

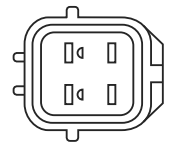
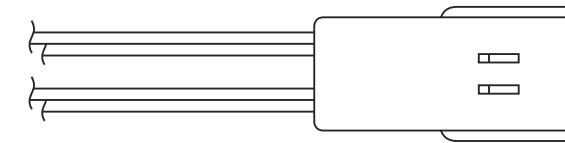

 4	 mm 160
 M 18 x 1,5	 22 Nm 45

**OZH 079**

0 824 010 089

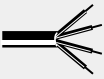
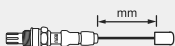

 4	 mm 1120
 M 18 x 1,5	 22 Nm 45

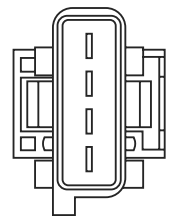
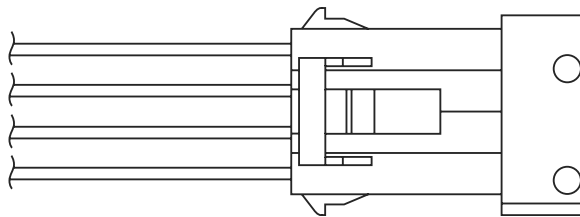



OZH 083

0 824 010 098

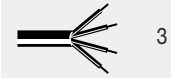

3

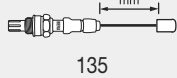

135



M 18 x 1,5



22

Nm

45

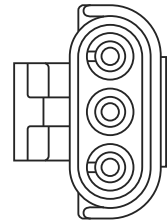
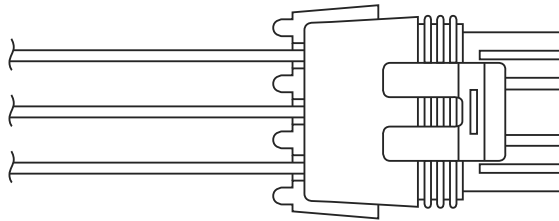

OZH 084

0 824 010 099



4

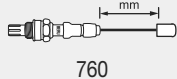

760



M 18 x 1,5



22

Nm

45

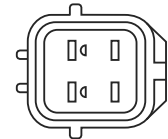
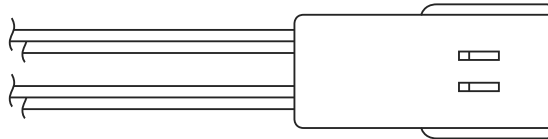

OZH 086

0 824 010 102



4

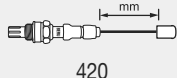

420



M 18 x 1,5



22

Nm

45

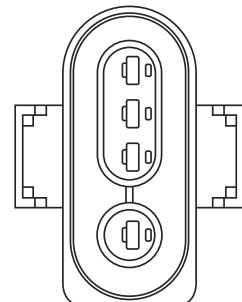
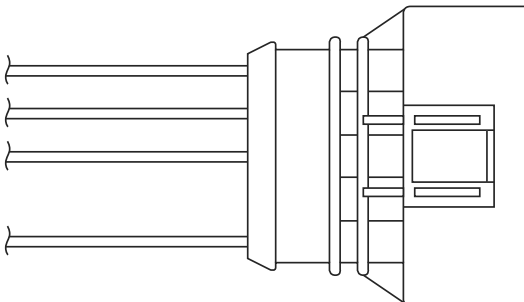

OZH 087

0 824 010 105



4

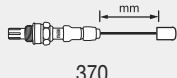

370



M 18 x 1,5



22

Nm

45

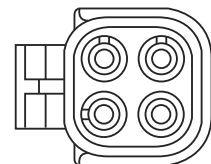
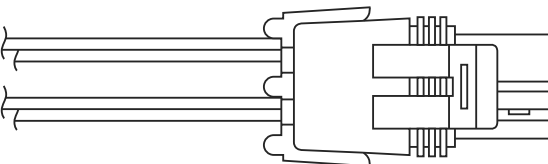

OZH 088

0 824 010 106

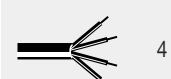

4

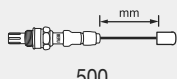

500



M 18 x 1,5



22

Nm

45

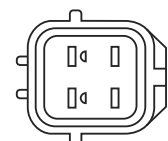
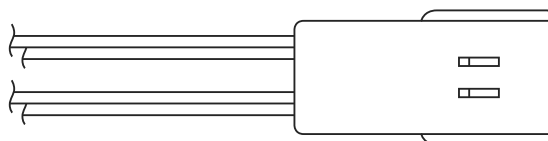

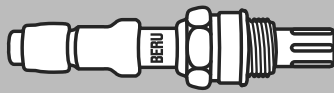



OZH 092

0 824 010 112

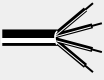
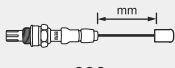

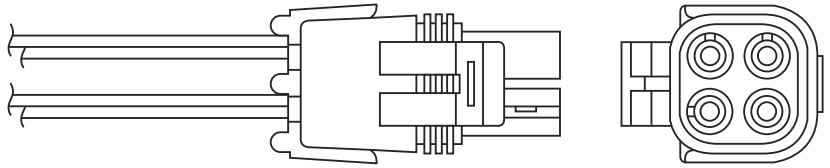

 4	 mm 220
 M 18 x 1,5	 22 Nm 45



OZH 094

0 824 010 114

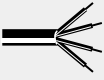
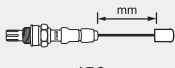

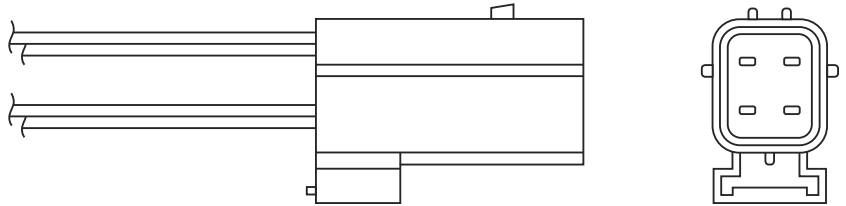

 4	 mm 450
 M 18 x 1,5	 22 Nm 45



OZH 095

0 824 010 117

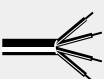
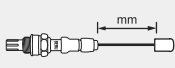

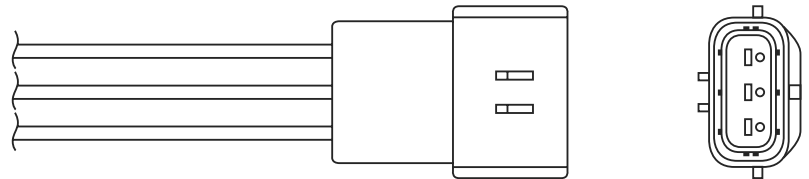

 3	 mm 260
 M 18 x 1,5	 22 Nm 45



OZH 096

0 824 010 118

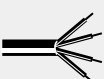
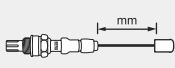

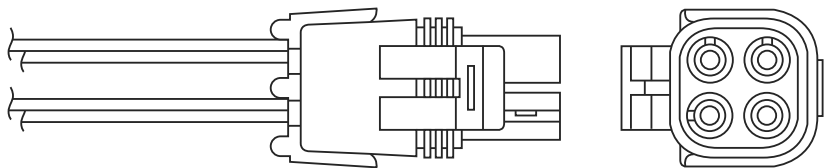

 4	 mm 265
 M 18 x 1,5	 22 Nm 45



OZH 098

0 824 010 120

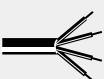
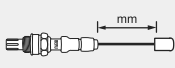



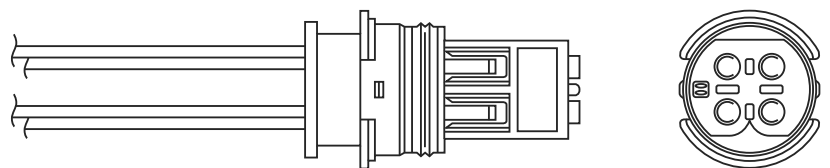

 4	 mm 1040
 M 18 x 1,5	 22 Nm 45



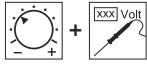

OZH 099
0 824 010 121

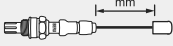

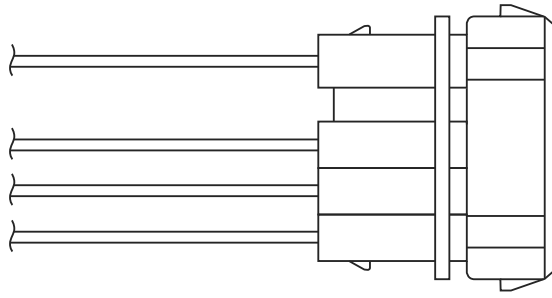

 4	 mm 420
 M 18 x 1,5	 22 Nm 45



OZH 100
0 824 010 124

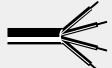
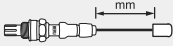

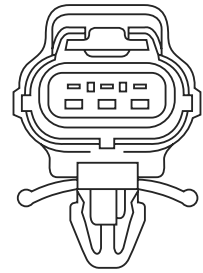
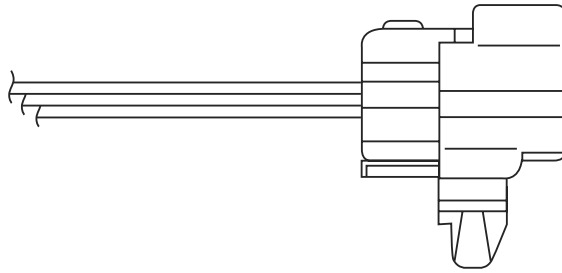

 3	 mm 290
 M 18 x 1,5	 22 Nm 45



OZH 101
0 824 010 125

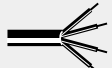
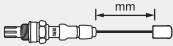

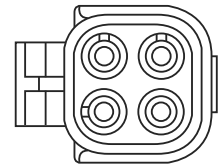
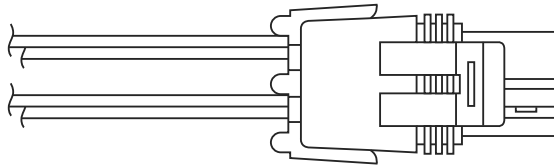

 4	 mm 150
 M 18 x 1,5	 22 Nm 45



OZH 103
0 824 010 128

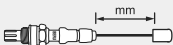

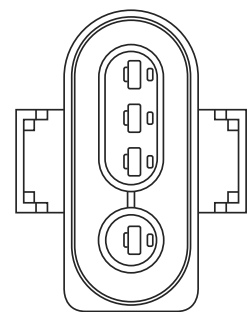
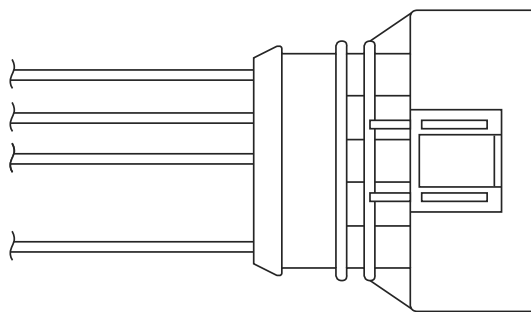

 4	 mm 310
 M 18 x 1,5	 22 Nm 45



OZH 104
0 824 010 129

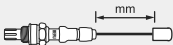

 4	 mm 530
 M 18 x 1,5	 22 Nm 45

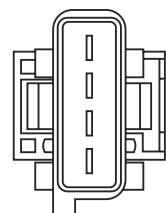
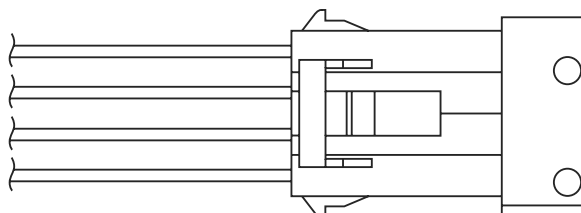

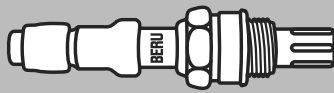
**OZH 107**

0 824 010 139

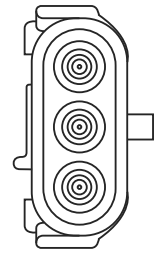
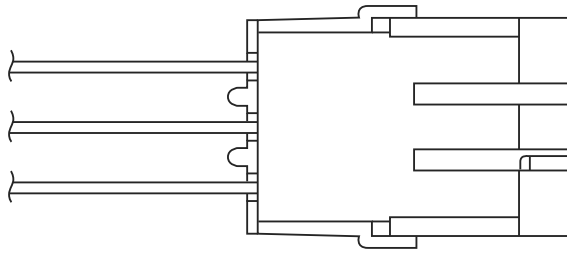

3	mm 275
M 18 x 1,5	22 Nm 45

**OZH 108**

0 824 010 107

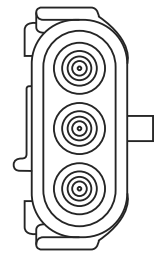
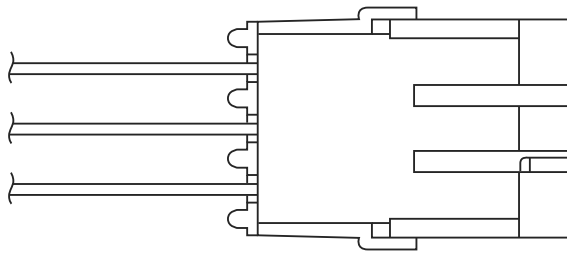

3	mm 80
M 18 x 1,5	22 Nm 45

**OZH 109**

0 824 010 127

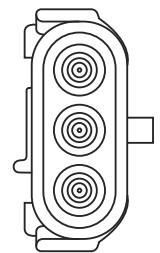
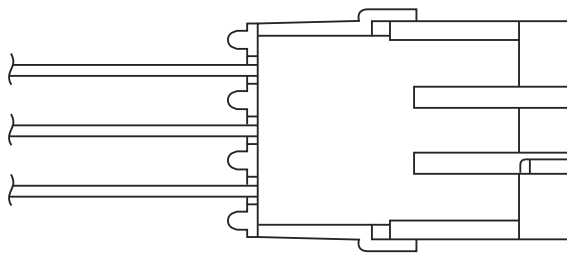

3	mm 150
M 18 x 1,5	22 Nm 45

**OZH 110**

0 824 010 144

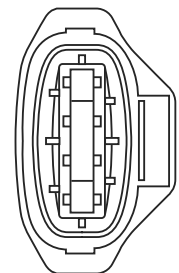
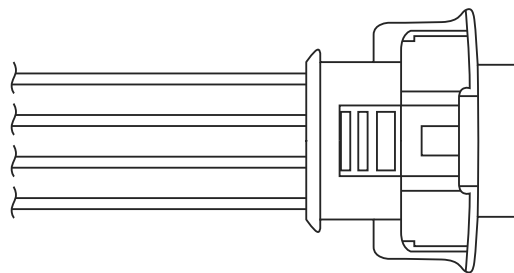

4	mm 200
M 18 x 1,5	22 Nm 45

**OZH 112**

0 824 010 146



4	mm 660
M 18 x 1,5	22 Nm 45

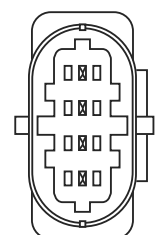
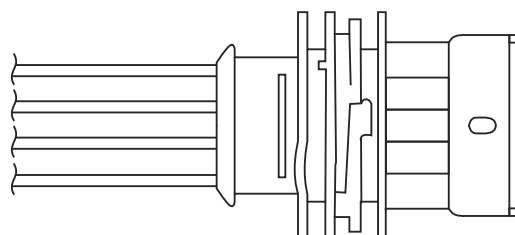



OZH 113

0 824 010 147

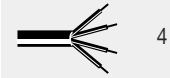

4

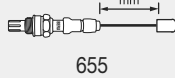

655



M 18 x 1,5



22

Nm

45

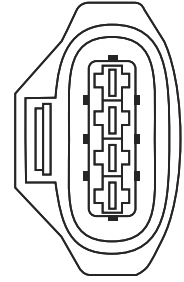
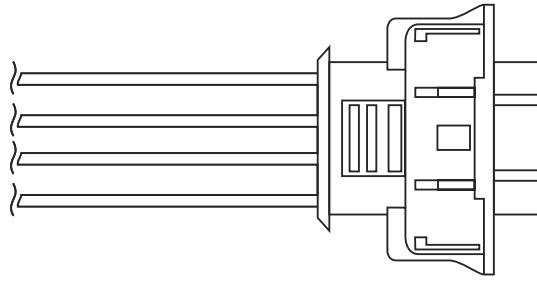

OZH 114

0 824 010 148



4

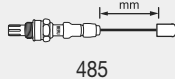

485



M 18 x 1,5



22

Nm

45

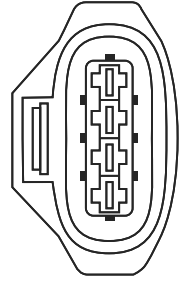
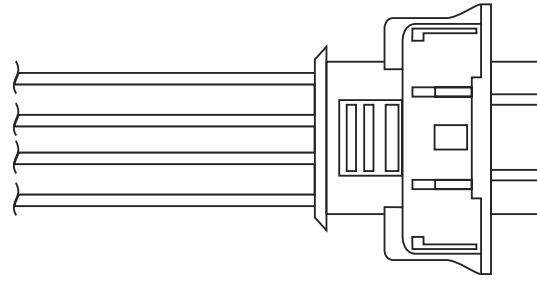

OZH 115

0 824 010 149



4

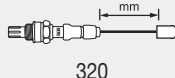

320



M 18 x 1,5



22

Nm

45

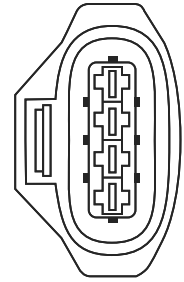
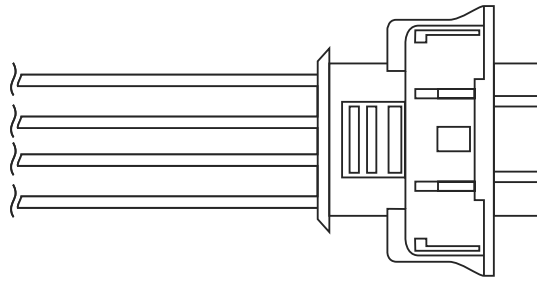

OZH 118

0 824 010 152



4

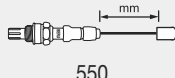

550



M 18 x 1,5



22

Nm

45

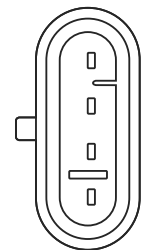
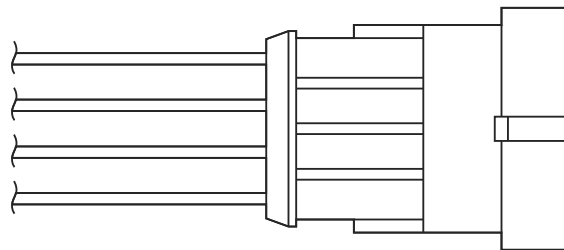

OZH 120

0 824 010 154



4

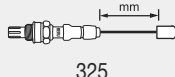

325



M 18 x 1,5



22

Nm

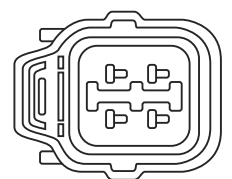
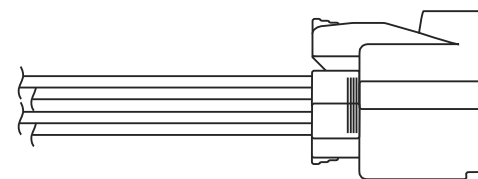

45

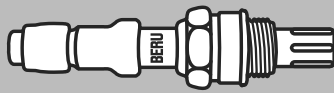

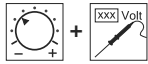

OZH 121
0 824 010 155

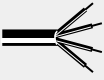
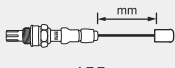

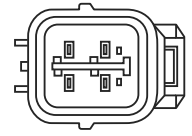
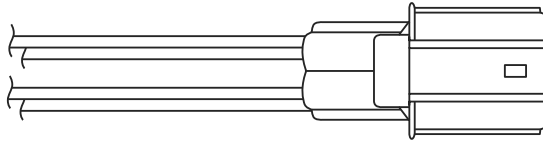

 4	 mm 155
 M 18 x 1,5	 22 Nm 45



OZH 122
0 824 010 156

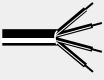
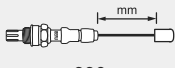

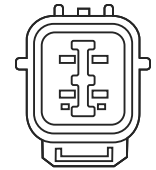
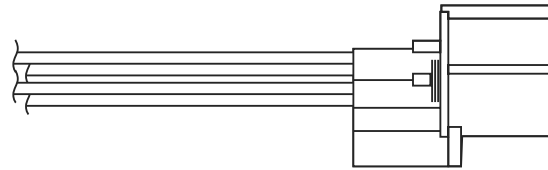

 4	 mm 320
 M 18 x 1,5	 22 Nm 45



OZH 123
0 824 010 157

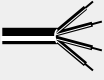
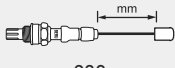

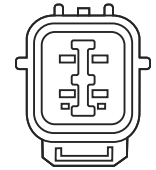
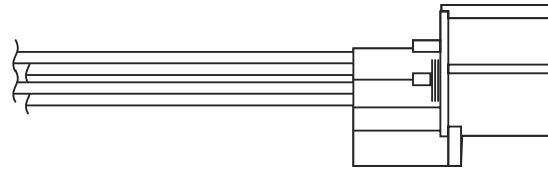

 4	 mm 230
 M 18 x 1,5	 22 Nm 45



OZH 124
0 824 010 158

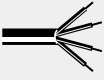
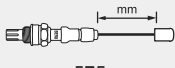

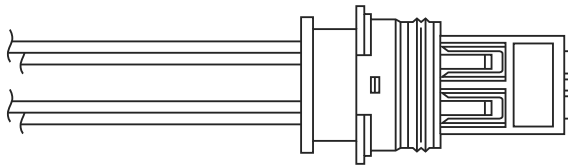

 4	 mm 575
 M 18 x 1,5	 22 Nm 45



OZH 125
0 824 010 159

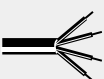
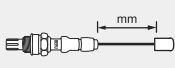

 3	 mm 150
 M 18 x 1,5	 22 Nm 45

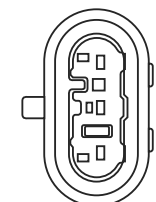
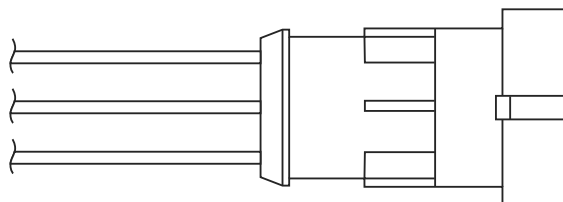



OZH 127

0 824 010 161

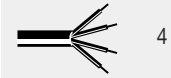

4

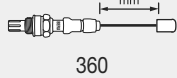

360



M 18 x 1,5



22

Nm

45

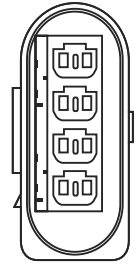
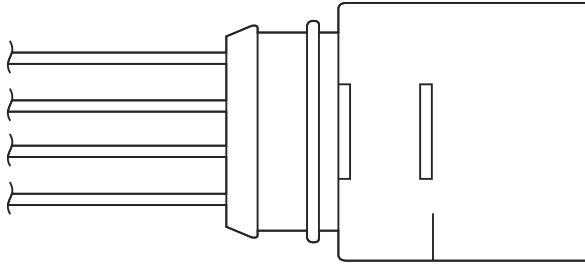

OZH 128

0 824 010 162



4

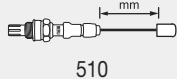

510



M 18 x 1,5



22

Nm

45

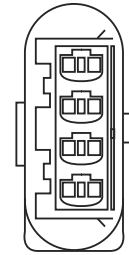
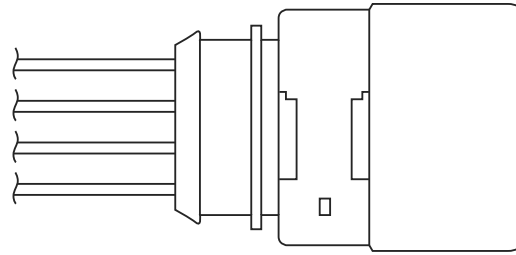

OZH 130

0 824 010 164



4

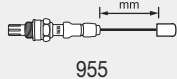

955



M 18 x 1,5



22

Nm

45

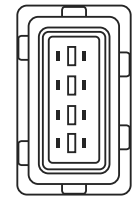
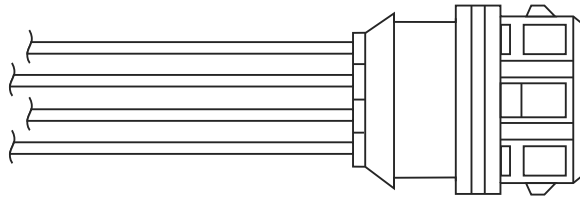

OZH 131

0 824 010 165



3

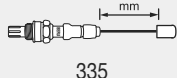

335



M 18 x 1,5



22

Nm

45

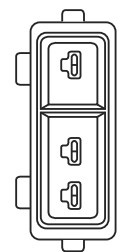
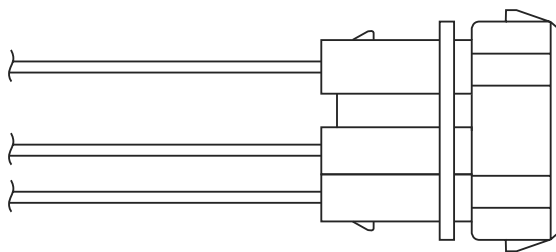

OZH 132

0 824 010 166



4

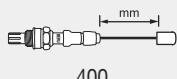

400



M 18 x 1,5



22

Nm

45

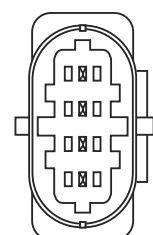
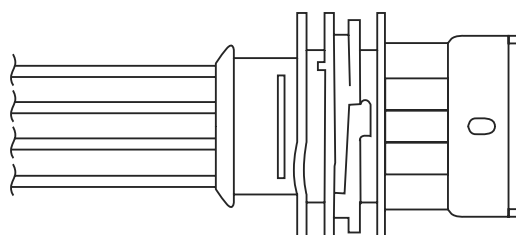

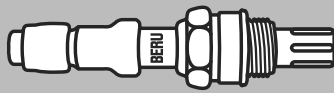



OZH 134

0 824 010 168

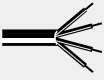
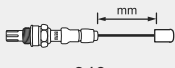

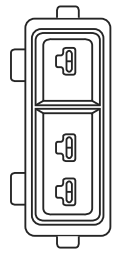
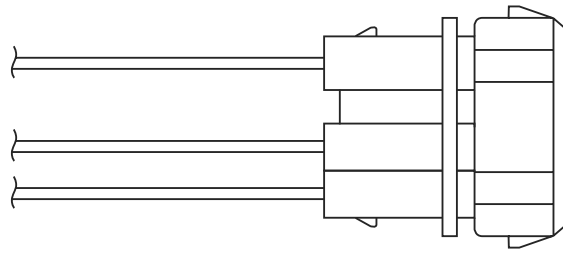

 3	 mm 240
 M 18 x 1,5	 22 Nm 45



OZH 135

0 824 010 169

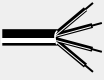
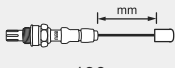

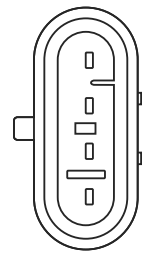
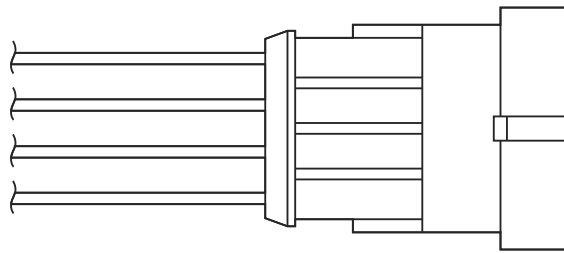

 4	 mm 190
 M 18 x 1,5	 22 Nm 45



OZH 136

0 824 010 170

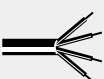
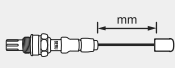

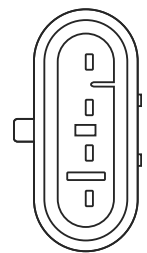
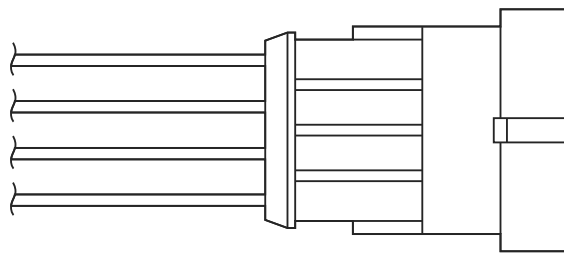

 4	 mm 470
 M 18 x 1,5	 22 Nm 45



OZH 137

0 824 010 171

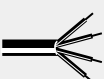
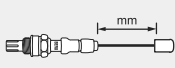

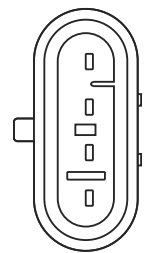
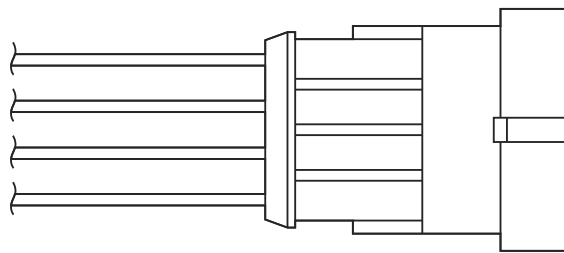

 4	 mm 710
 M 18 x 1,5	 22 Nm 45



OZH 138

0 824 010 172

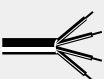
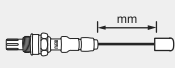

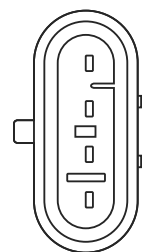
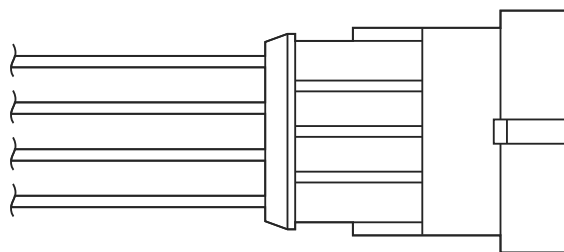

 4	 mm 780
 M 18 x 1,5	 22 Nm 45





OZH 139
0 824 010 173

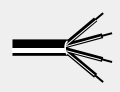
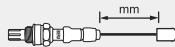

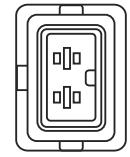
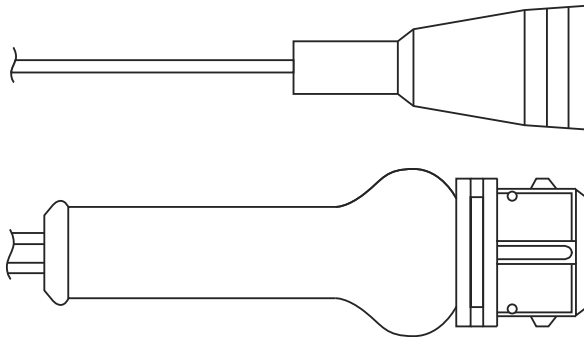

 3	 mm 1100/1120
 M 18 x 1,5	 22 Nm 45



OZH 140
0 824 010 174

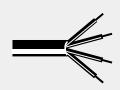
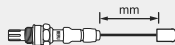

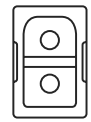
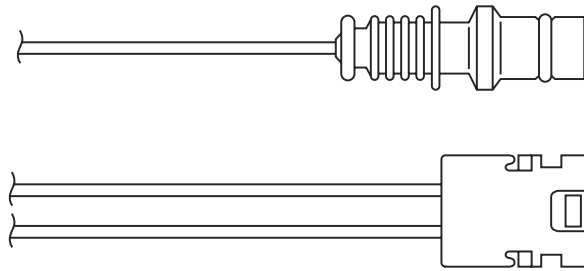

 3	 mm 270/280
 M 18 x 1,5	 22 Nm 45



OZH 141
0 824 010 175

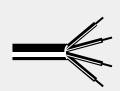
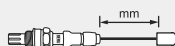



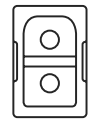
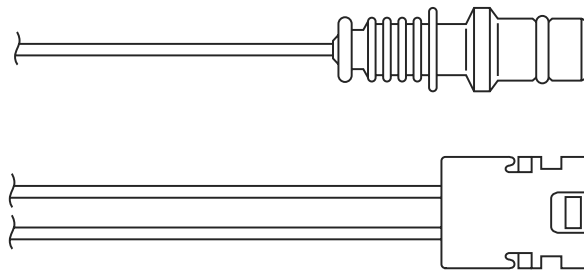

 3	 mm 540/550
 M 18 x 1,5	 22 Nm 45

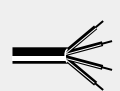

OZH 142
0 824 010 176



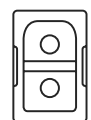
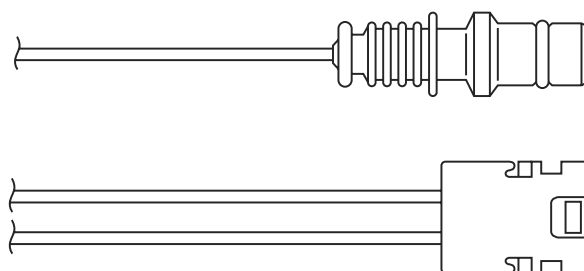

 3	 mm 870/880
 M 18 x 1,5	 22 Nm 45



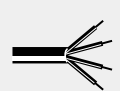
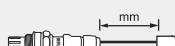

OZH 143
0 824 010 177



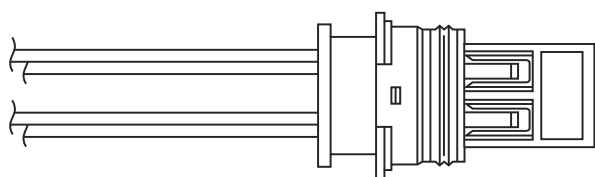

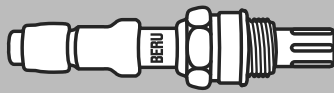
 4	 mm 220
 M 18 x 1,5	 22 Nm 45

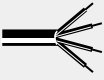
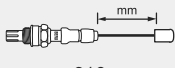

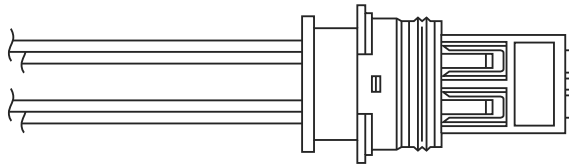
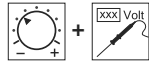

**OZH 144**
0 824 010 178

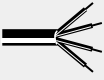
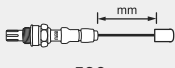
 4	 mm 310
 M 18 x 1,5	 22 Nm 45

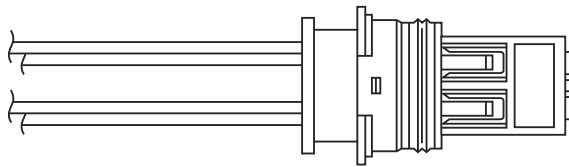

**OZH 145**
0 824 010 179

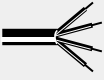
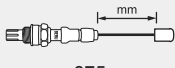
 4	 mm 530
 M 18 x 1,5	 22 Nm 45

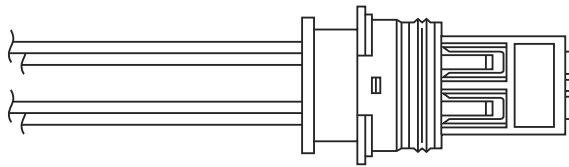

**OZH 146**
0 824 010 180

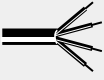
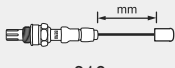
 4	 mm 875
 M 18 x 1,5	 22 Nm 45

**OZH 147**
0 824 010 181

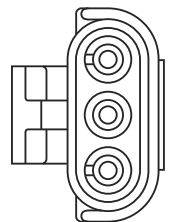
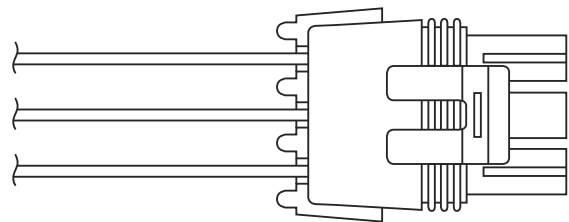
 3	 mm 310
 M 18 x 1,5	 22 Nm 45

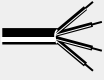
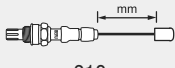
**OZH 148**
0 824 010 182

 4	 mm 210
 M 18 x 1,5	 22 Nm 45

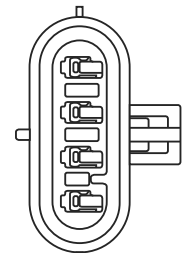
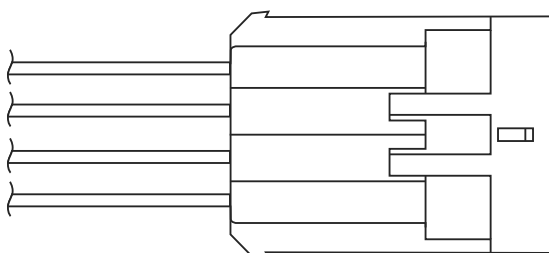

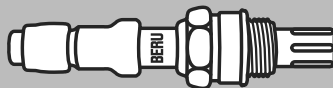

OZH 150

0 824 010 184



4

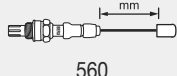

560



M 18 x 1,5



22

Nm

45

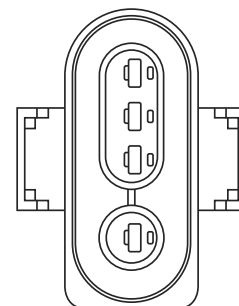
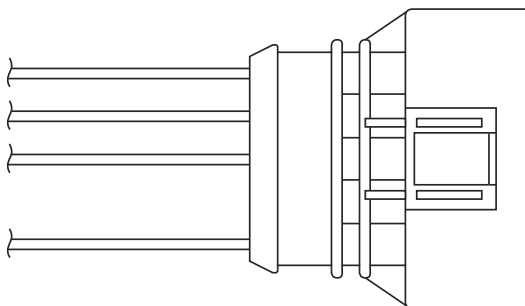

OZH 151

0 824 010 185



4

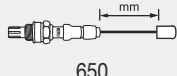

650



M 18 x 1,5



22

Nm

45

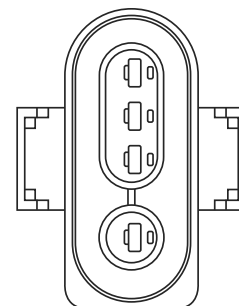
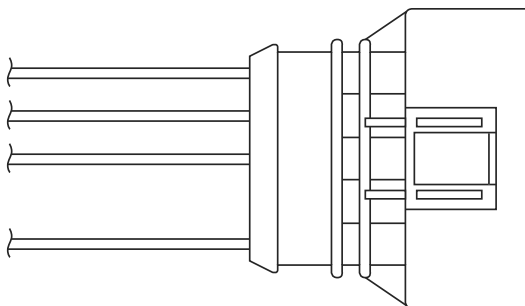

OZH 152

0 824 010 186



4

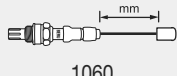

1060



M 18 x 1,5



22

Nm

45

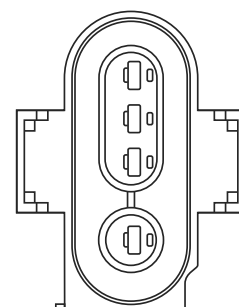
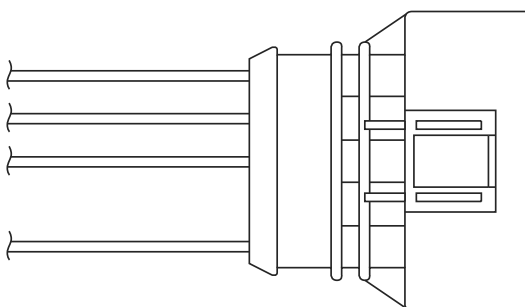

OZH 153

0 824 010 187



4

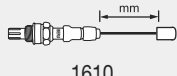

1610



M 18 x 1,5



22

Nm

45

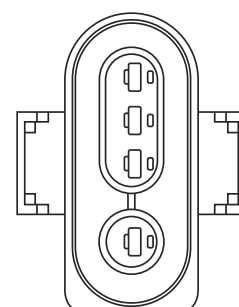
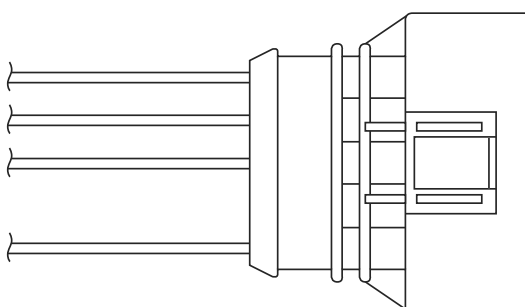

OZH 154

0 824 010 188



3

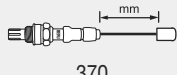

370



M 18 x 1,5



22

Nm

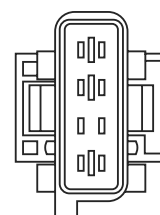
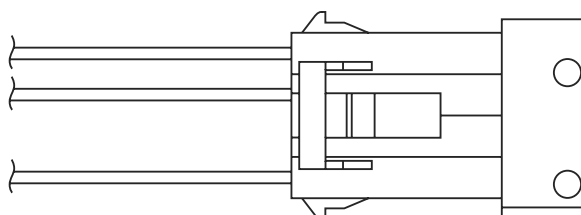

45

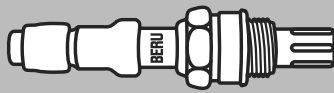

**OZH 155**

0 824 010 189

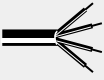
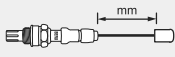

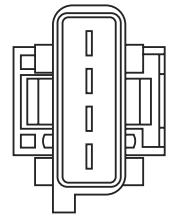
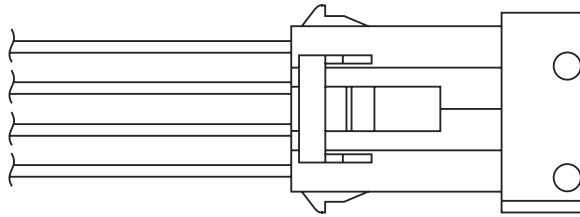

 3	 mm 790
 M 18 x 1,5	 22 Nm 45

**OZH 156**

0 824 010 190

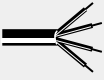
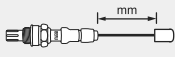

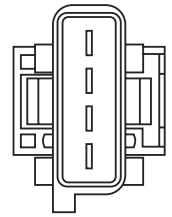
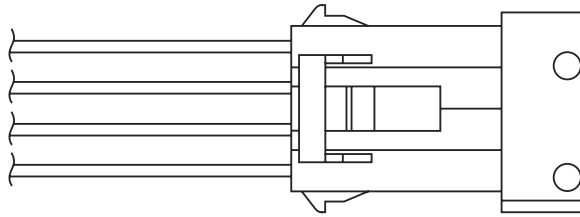

 4	 mm 990
 M 18 x 1,5	 22 Nm 45

**OZH 157**

0 824 010 191

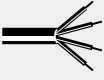
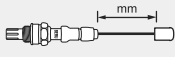

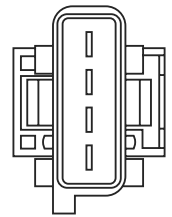
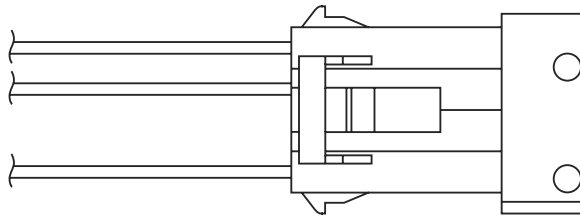

 3	 mm 1000
 M 18 x 1,5	 22 Nm 45

**OZH 158**

0 824 010 192

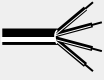
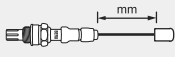

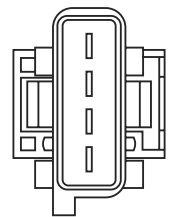
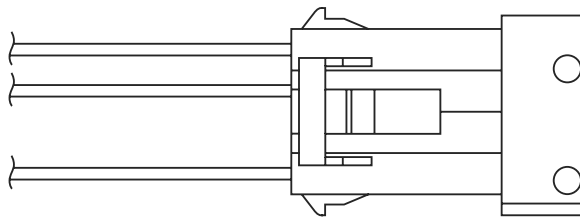

 3	 mm 1340
 M 18 x 1,5	 22 Nm 45

**OZH 159**

0 824 010 193

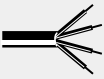
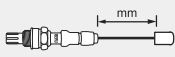

 4	 mm 1380
 M 18 x 1,5	 22 Nm 45

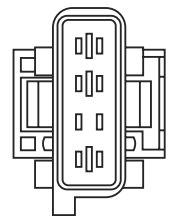
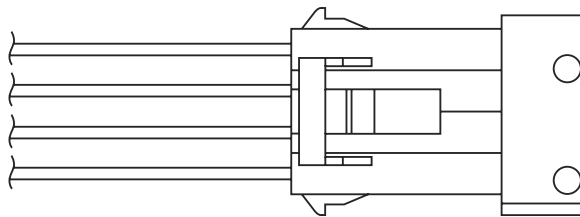



OZH 160

0 824 010 194

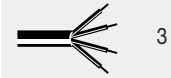

3

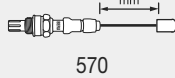

570



M 18 x 1,5



22

Nm

45

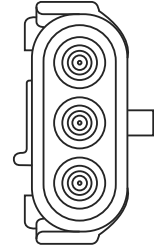
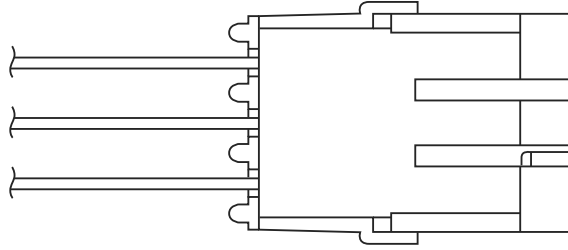

OZH 161

0 824 010 195



4

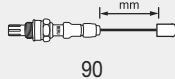

90



M 18 x 1,5



22

Nm

45

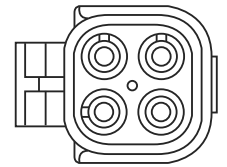
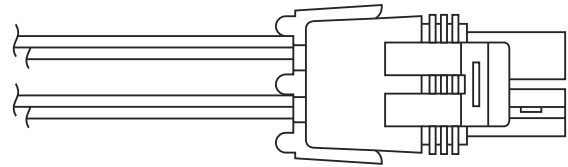

OZH 163

0 824 010 197



4

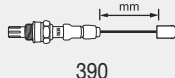

390



M 18 x 1,5



22

Nm

45

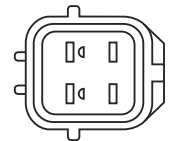
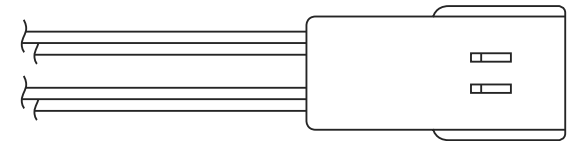

OZH 164

0 824 010 198



4

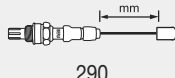

290



M 18 x 1,5



22

Nm

45

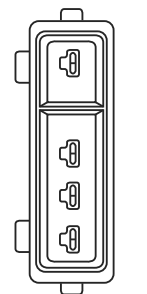
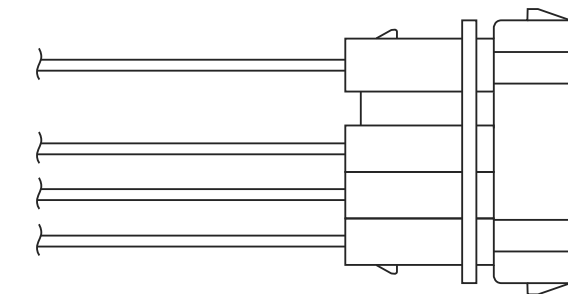

OZH 165

0 824 010 199



4

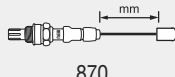

870



M 18 x 1,5



22

Nm

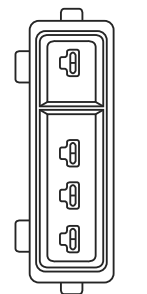
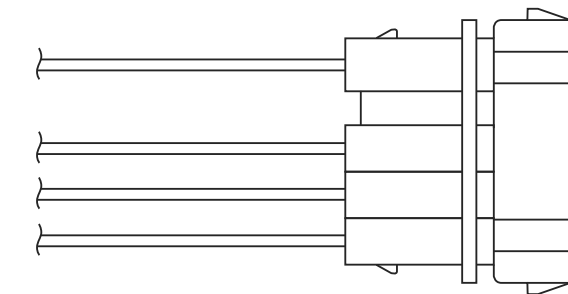

45

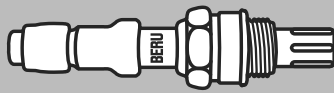

**OZH 166**

0 824 010 200

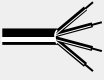
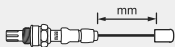

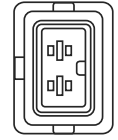
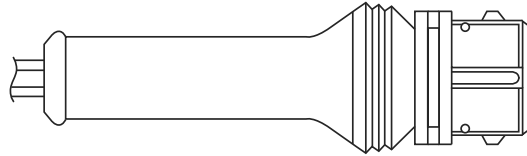
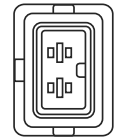
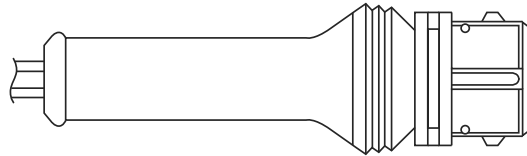

 4	 mm 1330/1430
 M 18 x 1,5	 22 Nm 45

**OZH 167**

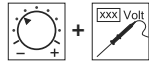
0 824 010 201

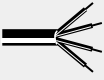
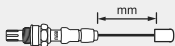

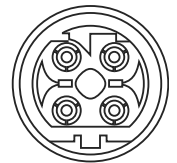
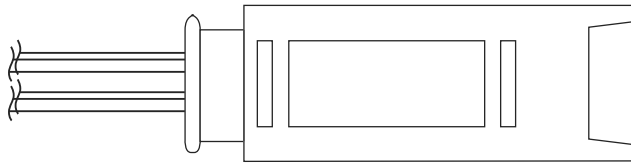

 4	 mm 440
 M 18 x 1,5	 22 Nm 45

**OZH 168**

0 824 010 202

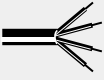
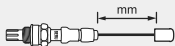

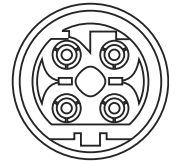
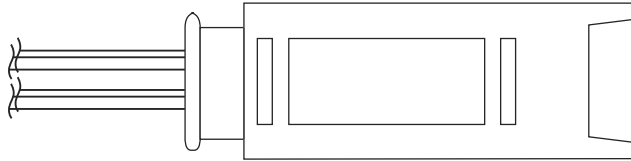

 4	 mm 870
 M 18 x 1,5	 22 Nm 45

**OZH 169**

0 824 010 203

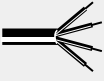
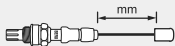

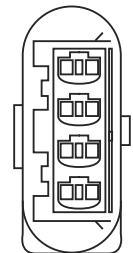
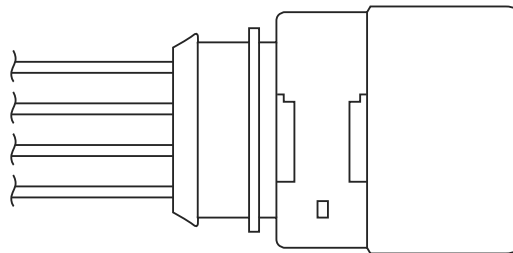

 4	 mm 365
 M 18 x 1,5	 22 Nm 45

**OZH 173**

0 824 010 207

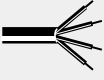
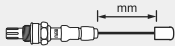

 4	 mm 240
 M 18 x 1,5	 22 Nm 45

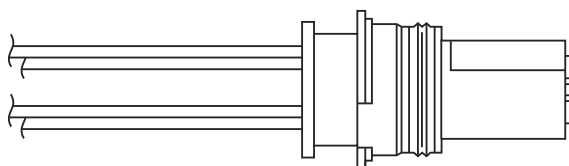

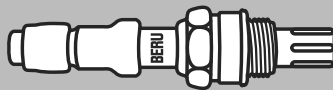



OZH 176

0 824 010 210

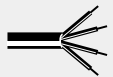
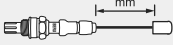

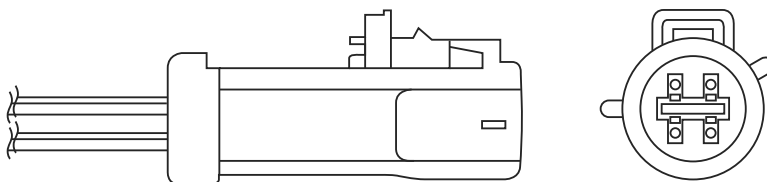

 4	 mm 270
 M 18 x 1,5	 22 Nm 45



OZH 177

0 824 010 211

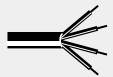
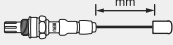

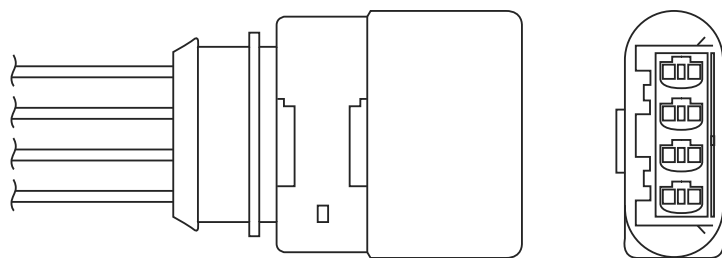

 4	 mm 590
 M 18 x 1,5	 22 Nm 45



OZH 178

0 824 010 212

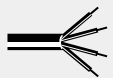
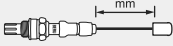

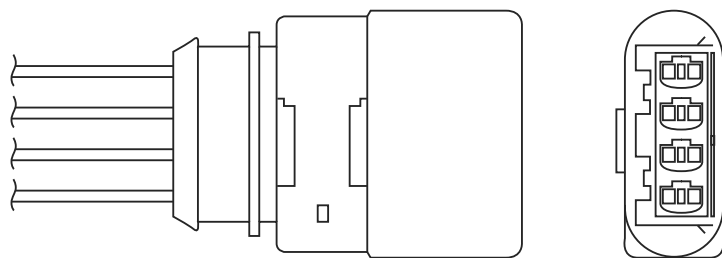

 4	 mm 950
 M 18 x 1,5	 22 Nm 45



OZH 179

0 824 010 213

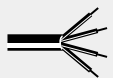
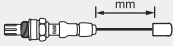

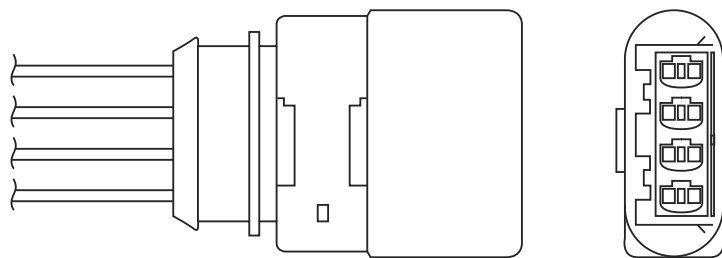

 4	 mm 1500
 M 18 x 1,5	 22 Nm 45



OZH 180

0 824 010 214

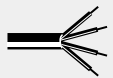
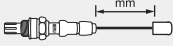

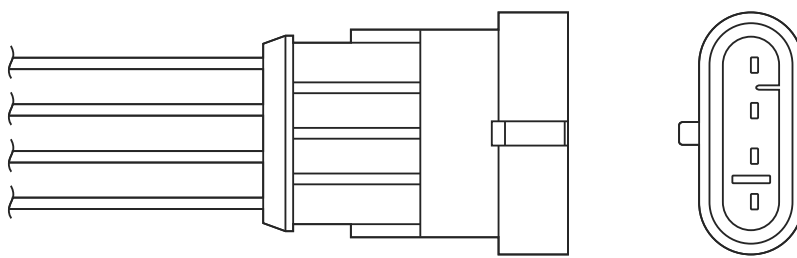

 4	 mm 520
 M 18 x 1,5	 22 Nm 45

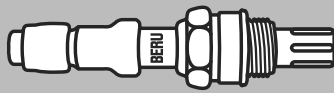

**OZH 181**

0 824 010 215

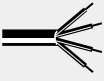
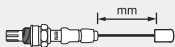

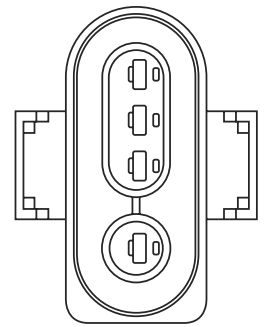
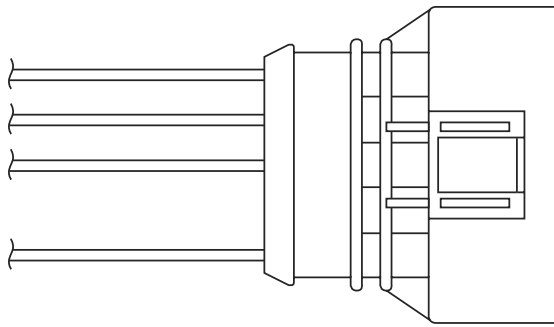

 4	 mm 1350
 M 18 x 1,5	 22 Nm 45

**OZH 182**

0 824 010 216

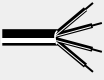
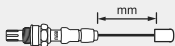

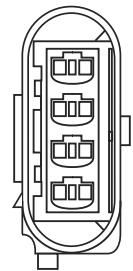
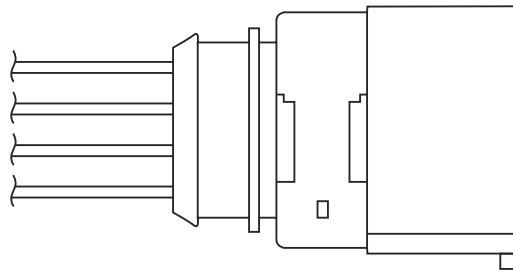

 4	 mm 440
 M 18 x 1,5	 22 Nm 45

**OZH 184**

0 824 010 218

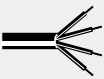
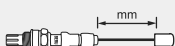



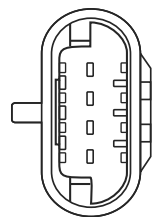
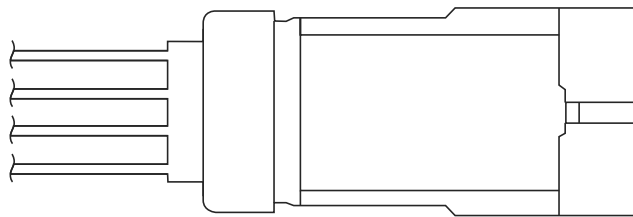

 4	 mm 340
 M 18 x 1,5	 22 Nm 45

**OZH 190**

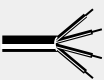
0 824 010 224





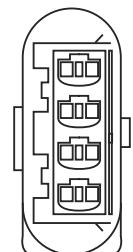
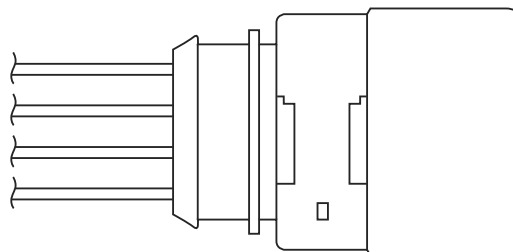

 4	 mm 600
 M 18 x 1,5	 22 Nm 45

**OZH 192**

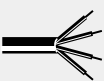
0 824 010 226



 3	 mm 740/770
 M 18 x 1,5	 22 Nm 45

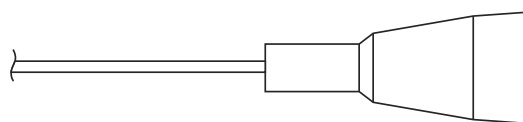
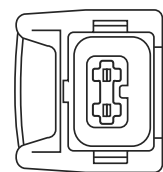
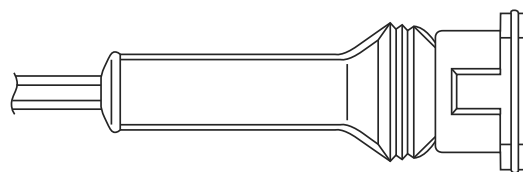

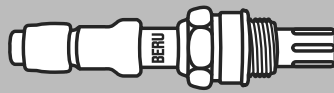

OZH 193

0 824 010 227

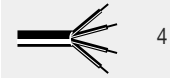

4

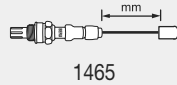

1465

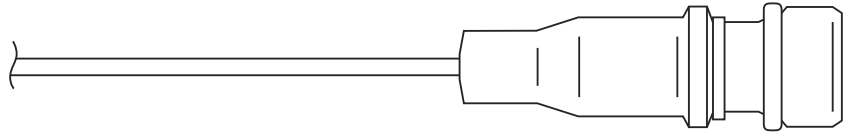

M 18 x 1,5



22

Nm

45

OZH 194

0 824 010 228



4

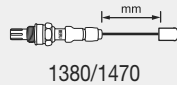

1380/1470

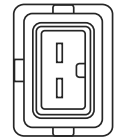
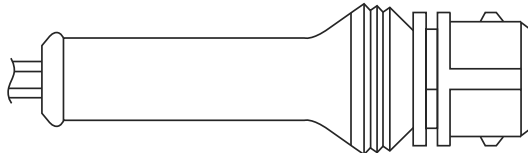

M 18 x 1,5



22

Nm

45

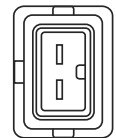
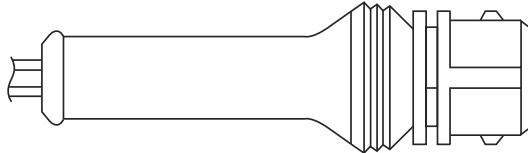

OZH 196

0 824 010 230



3

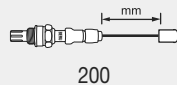

200

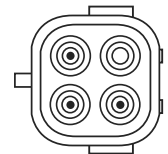
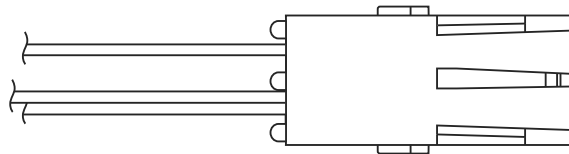

M 18 x 1,5



22

Nm

45

OZH 198

0 824 010 232



4

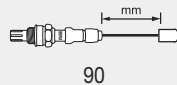

90

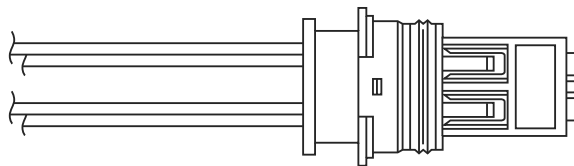

M 18 x 1,5



22

Nm

45

OZH 199

0 824 010 233



4

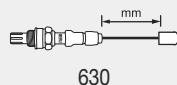

630

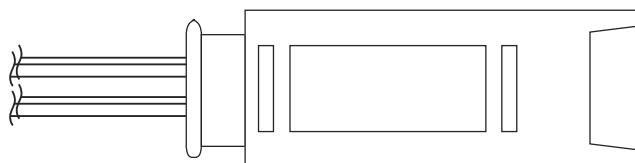

M 18 x 1,5



22

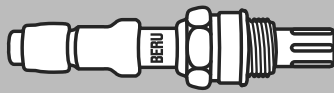

Nm

45

**OZH 200**

0 824 010 234

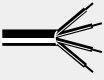
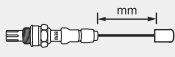

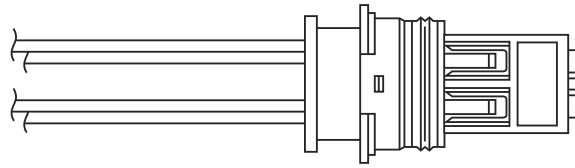

 4	 mm 385
 M 18 x 1,5	 22 Nm 45

**OZH 201**

0 824 010 235

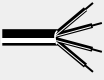
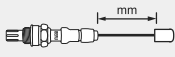

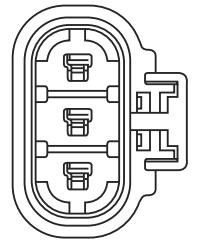
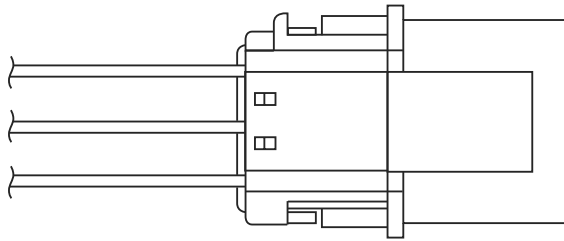

 3	 mm 150
 M 18 x 1,5	 22 Nm 45

**OZH 203**

0 824 010 237

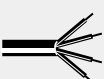
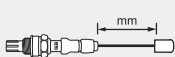

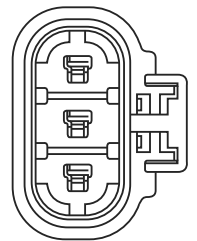
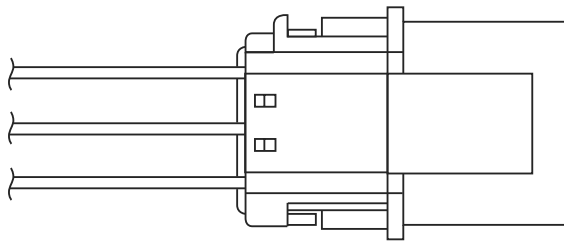

 3	 mm 420
 M 18 x 1,5	 22 Nm 45

**OZH 204**

0 824 010 238

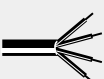
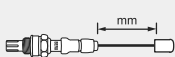

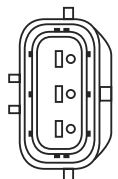
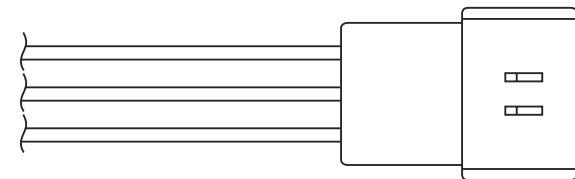

 3	 mm 420
 M 18 x 1,5	 22 Nm 45

**OZH 205**

0 824 010 239

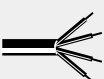
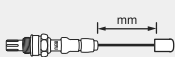

 4	 mm 430
 M 18 x 1,5	 22 Nm 45

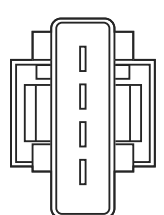
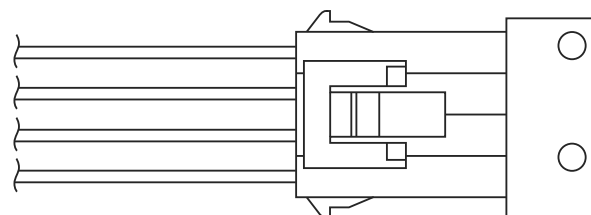

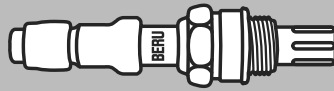

OZH 206

0 824 010 240

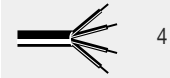

4

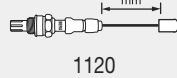

1120



M 18 x 1,5



22

Nm

45

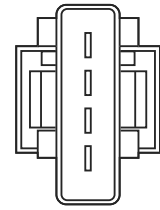
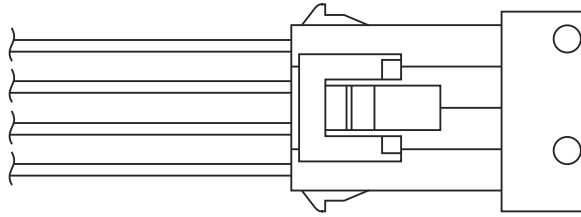

OZH 207

0 824 010 241



3

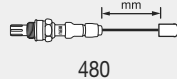

480



M 18 x 1,5



22

Nm

45

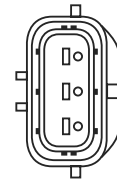
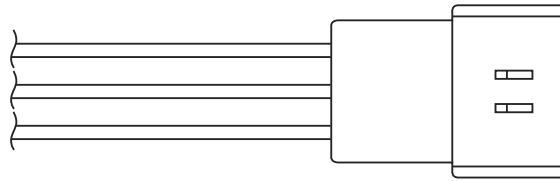

OZH 208

0 824 010 242



4

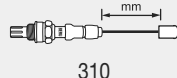

310



M 18 x 1,5



22

Nm

45

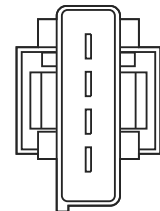
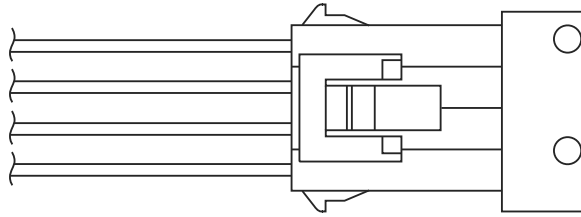

OZH 209

0 824 010 243



4

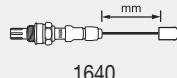

1640



M 18 x 1,5



22

Nm

45

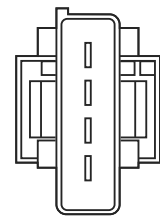
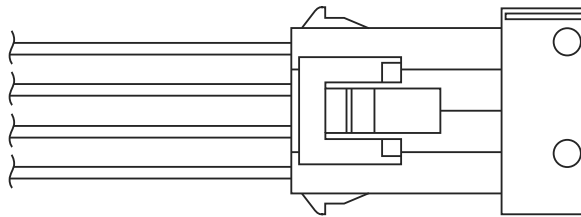

OZH 210

0 824 010 244



4

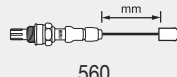

560



M 18 x 1,5



22

Nm

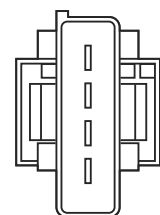
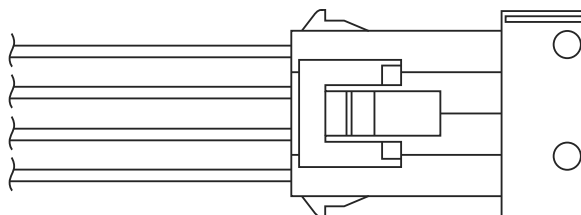

45

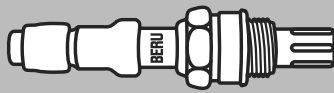

**OZH 211**

0 824 010 245

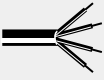
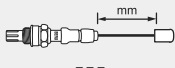

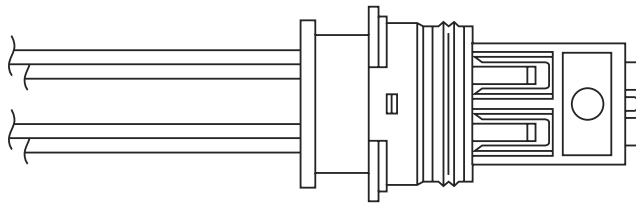

 4	 mm 555
 M 18 x 1,5	 22 Nm 45

**OZH 212**

0 824 010 246

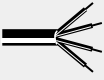
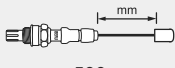

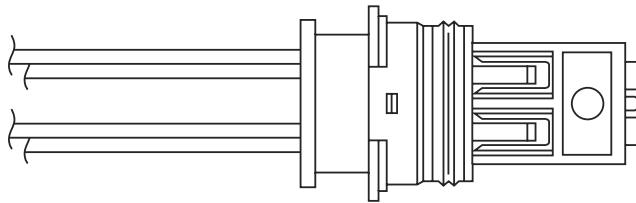

 4	 mm 500
 M 18 x 1,5	 22 Nm 45

**OZH 213**

0 824 010 247

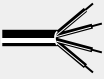
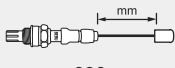

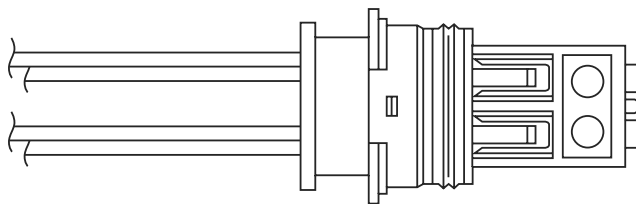

 4	 mm 220
 M 18 x 1,5	 22 Nm 45

**OZH 215**

0 824 010 249

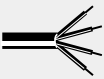
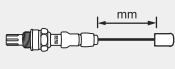

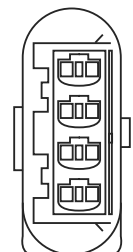
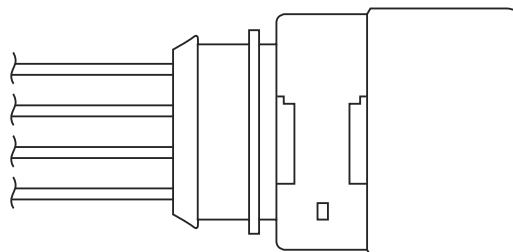

 4	 mm 875
 M 18 x 1,5	 22 Nm 45

**OZH 216**

0 824 010 250

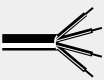
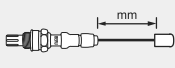

 4	 mm 230
 M 18 x 1,5	 22 Nm 45

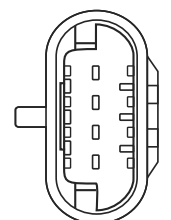
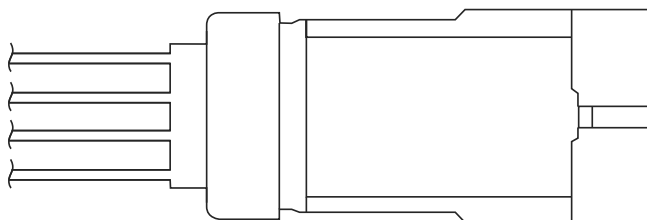



OZH 217

0 824 010 251

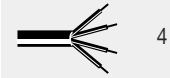

4

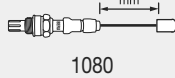

1080



M 18 x 1,5



22

Nm

45

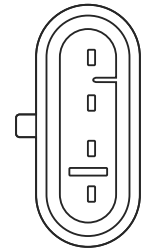
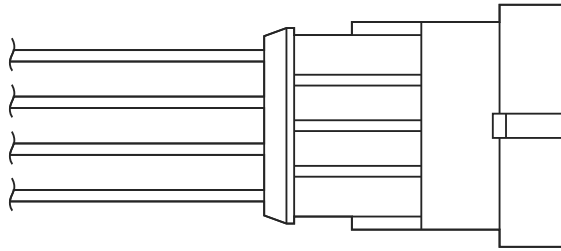

OZH 218

0 824 010 252



4

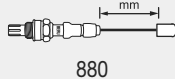

880



M 18 x 1,5



22

Nm

45

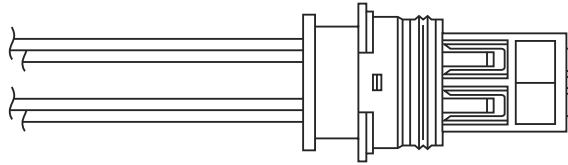

OZH 219

0 824 010 253



4

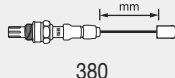

380



M 18 x 1,5



22

Nm

45

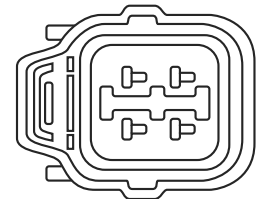
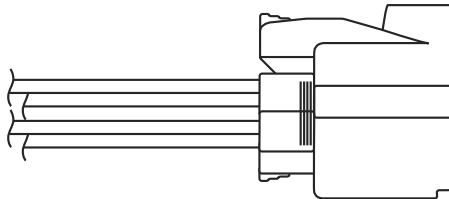

OHZ 220

0 824 010 254



4

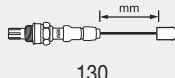

130



M 18 x 1,5



22

Nm

45

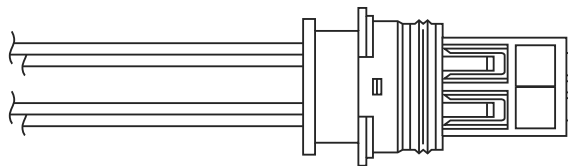

OZH 222

0 824 010 256



4

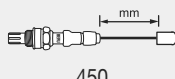

450



M 18 x 1,5



22

Nm

45

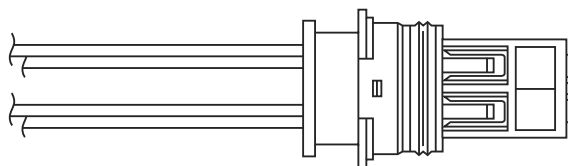

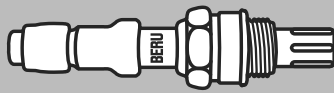



OZH 223

0 824 010 257

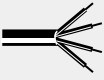
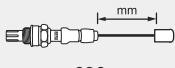

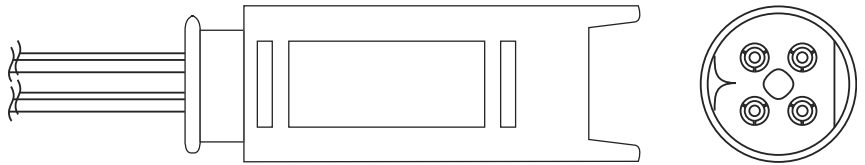

 4	 mm 630
 M 18 x 1,5	 22 Nm 45



OZH 224

0 824 010 258

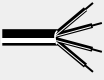
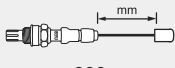

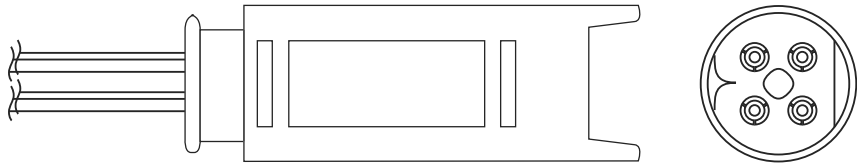

 4	 mm 300
 M 18 x 1,5	 22 Nm 45



OZH 225

0 824 010 259

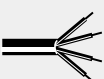
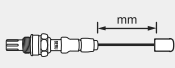

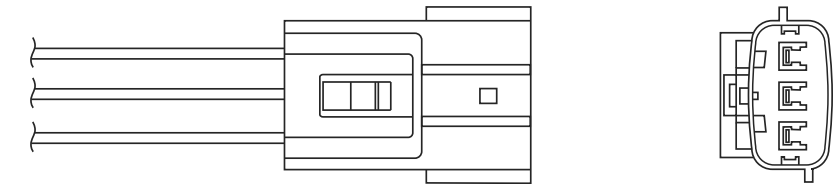

 3	 mm 225
 M 18 x 1,5	 22 Nm 45



OZH 226

0 824 010 260

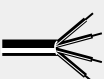
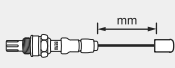

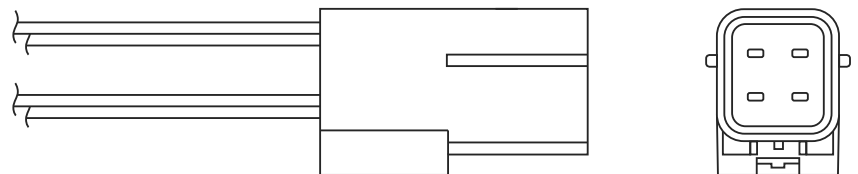

 4	 mm 315
 M 18 x 1,5	 22 Nm 45



OZH 227

0 824 010 261

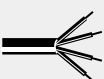
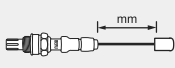

 4	 mm 245
 M 18 x 1,5	 22 Nm 45

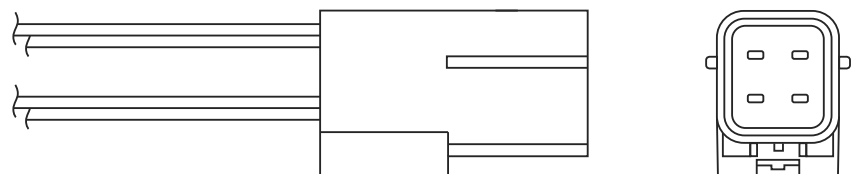

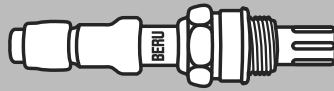

OZH 228

0 824 010 262

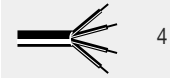

4

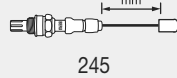

mm

245



M 18 x 1,5



22

Nm

45

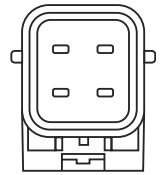
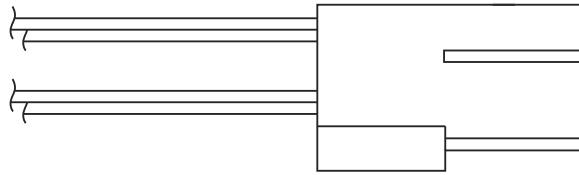

OZH 229

0 824 010 263



4

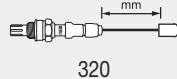

mm

320



M 18 x 1,5



22

Nm

45

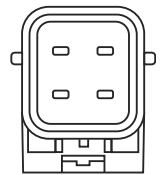
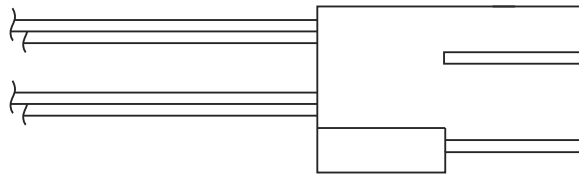

OZH 231

0 824 010 265



4

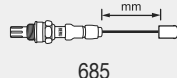

mm

685



M 18 x 1,5



22

Nm

45

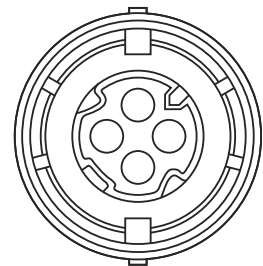
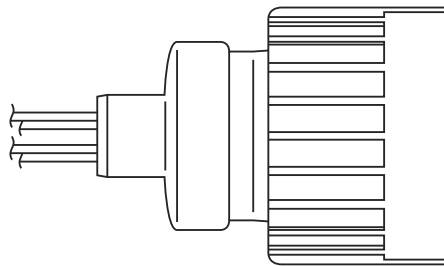

OZH 232

0 824 010 266



4

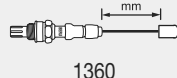

mm

1360



M 18 x 1,5



22

Nm

45

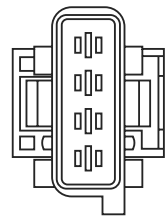
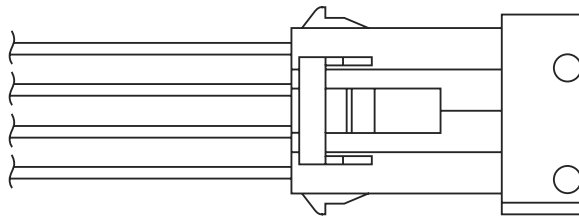

OZH 233

0 824 010 267



4

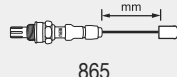

mm

865



M 18 x 1,5



22

Nm

45

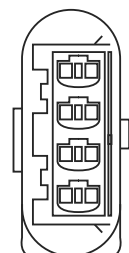
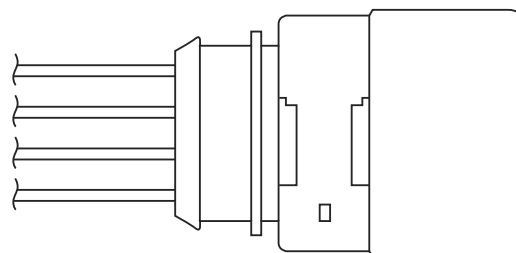

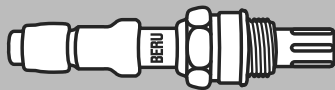



OZH 234

0 824 010 268

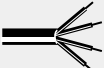
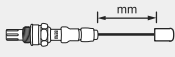

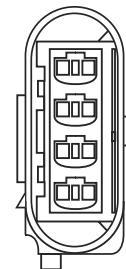
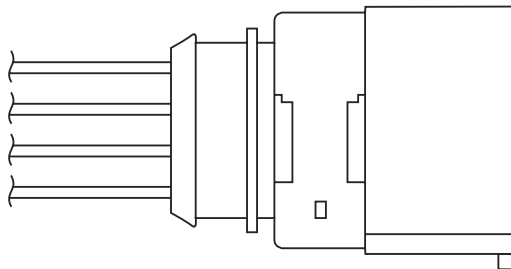

 4	 mm 865
 M 18 x 1,5	 22 Nm 45



OZH 235

0 824 010 269

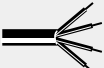
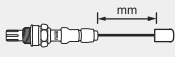

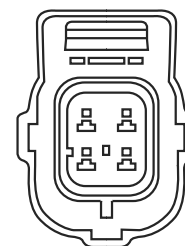
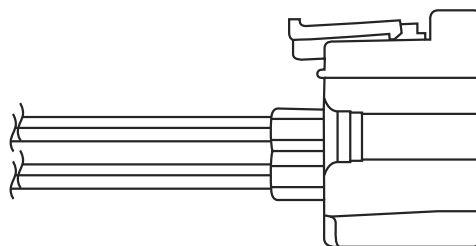

 4	 mm 250
 M 18 x 1,5	 22 Nm 45



OZH 236

0 824 010 270

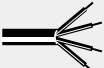
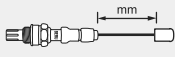

 4	 mm 550
 M 18 x 1,5	 22 Nm 45

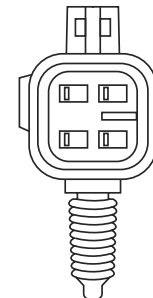
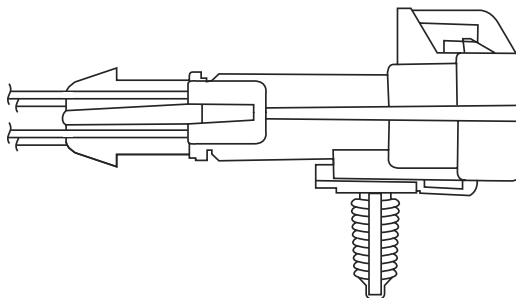



OZU 001

0 824 010 001

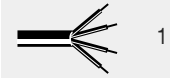

1

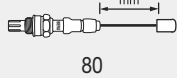

80



M 18 x 1,5



22

Nm

45

OZU 003

0 824 010 053



1

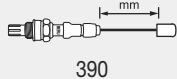

390

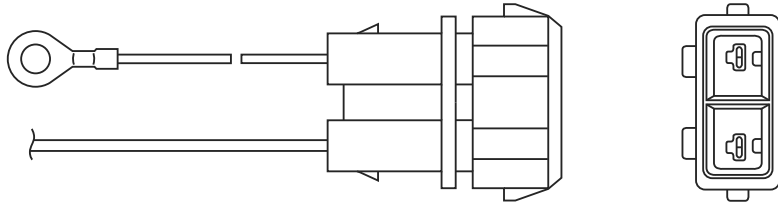

M 18 x 1,5



22

Nm

45

OZU 004

0 824 010 054



1

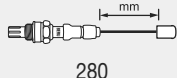

280

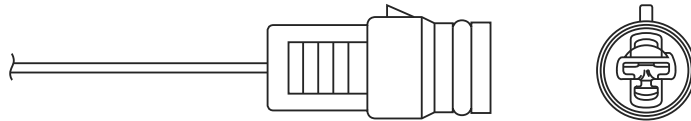

M 18 x 1,5



22

Nm

45

OZU 005

0 824 010 055



1

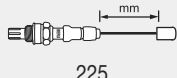

225

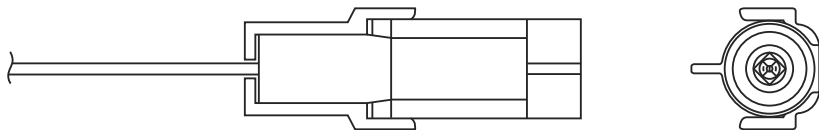

M 18 x 1,5



22

Nm

45

OZU 006

0 824 010 064



1

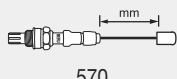

570

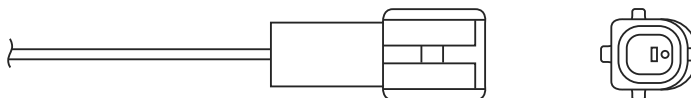

M 18 x 1,5



22

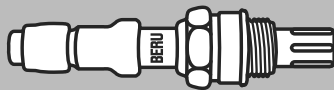

Nm

45

**OZU 007**

0 824 010 141

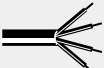
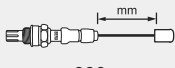

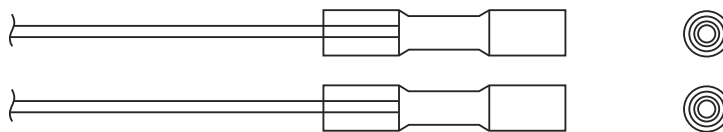

 2	 mm 280
 M 18 x 1,5	 22 Nm 45

**OZU 010**

0 824 010 090

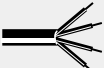
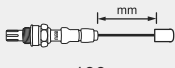

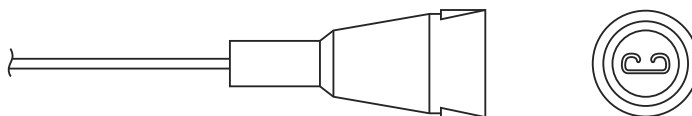

 1	 mm 100
 M 18 x 1,5	 22 Nm 45

**OZU 012**

0 824 010 096

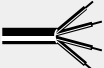
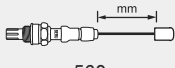

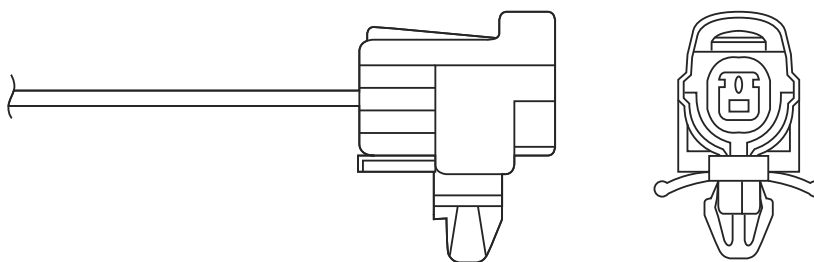

 1	 mm 560
 M 18 x 1,5	 22 Nm 45

**OZU 014**

0 824 010 104

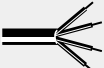
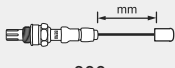

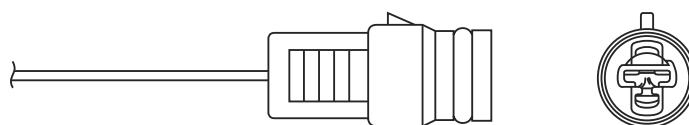

 1	 mm 300
 M 18 x 1,5	 22 Nm 45

**OZU 015**

0 824 010 111

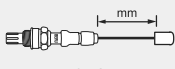

 1	 mm 350
 M 18 x 1,5	 22 Nm 45

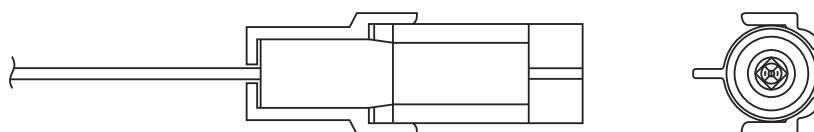

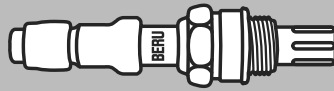

OZU 021

0 824 010 131

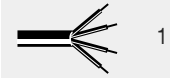

1

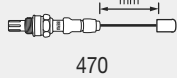

470

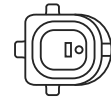
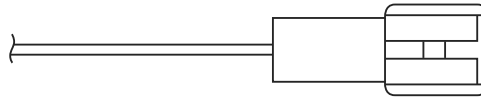

M 18 x 1,5



22

Nm

45

OZU 022

0 824 010 094



1

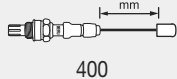

400

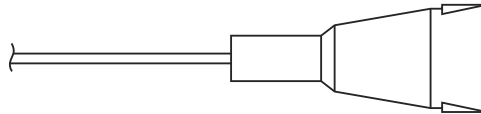

M 18 x 1,5



22

Nm

45

OZU 023

0 824 010 136



1

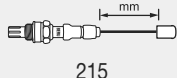

215

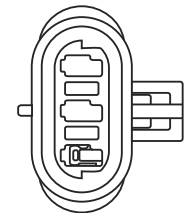
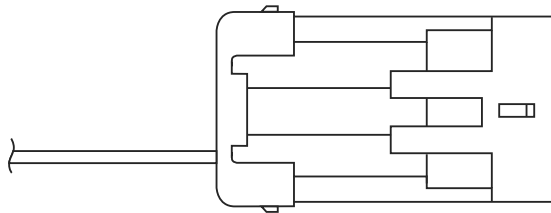

M 18 x 1,5



22

Nm

45

OZU 024

0 824 010 133



1

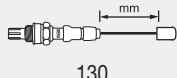

130

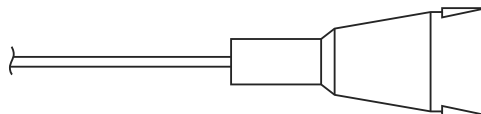

M 18 x 1,5



22

Nm

45

OZU 025

0 824 010 143



2

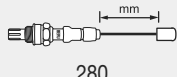

280

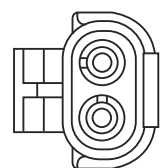
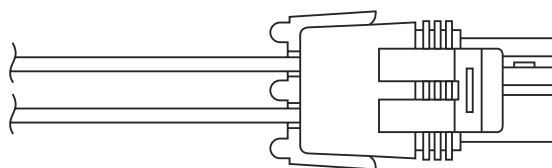

M 18 x 1,5



22

Nm

45

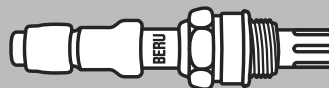

ALFA ROMEO	OPH 025, OPH 026, OPH 027, OPH 028, OPH 029, OZH 003, OZH 035, OZH 037, OZH 046, OZH 052, OZH 054, OZH 055, OZH 056, OZH 067, OZH 192, OZH 217,
ALPINA	OZH 173
ALPINE	OZH 033, OZH 044
AUDI	OPH 003, OPH 004, OPH 005, OPH 006, OPH 007, OPH 008, OPH 009, OPH 023, OPH 024, OPH 052, OPH 053, OPH 054, OPH 055, OPH 056, OPH 060, OPH 061, OPH 064, OPH 065, OPH 066, OPH 068, OPH 070, OPH 072, OPH 085, OPH 094, OZH 003, OZH 017, OZH 027, OZH 035, OZH 037, OZH 044, OZH 046, OZH 068, OZH 069, OZH 070, OZH 071, OZH 086, OZH 103, OZH 128, OZH 139, OZH 151, OZH 152, OZH 153, OZH 169, OZH 177, OZH 178, OZH 181, OZH 190, OZH 233, OZH 234, OZU 001, OZU 022
BERTONE	OZH 036
BMW	OPH 036, OPH 044, OZH 001, OZH 002, OZH 004, OZH 023, OZH 030, OZH 036, OZH 039, OZH 167, OZH 168, OZH 173, OZH 193, OZH 199, OZH 218, OZH 222, OZH 223, OZH 224, OZH 231, OZU 001
CADILLAC	OPH 074
CHEVROLET	OZH 033
CHRYSLER	OPH 030, OPH 034, OZH 024, OZH 044
CITROËN	OPH 010, OPH 012, OPH 020, OZH 005, OZH 034, OZH 038, OZH 074, OZH 079, OZH 104, OZH 107, OZH 159, OZH 166, OZH 194
DAEWOO	OZU 005
DAIHATSU	OZU 001
DAIMLER	OZH 037
DE LOREAN	OZU 001
DODGE	OPH 030
FERRARI	OPH 020, OZH 035, OZH 037
FIAT	OPH 010, OPH 012, OPH 020, OPH 025, OPH 026, OPH 027, OPH 028, OZH 034, OZH 035, OZH 037, OZH 046, OZH 052, OZH 054, OZH 055, OZH 056, OZH 064, OZH 066, OZH 084, OZH 088, OZH 118, OZH 135, OZH 136, OZH 137, OZH 159, OZH 180, OZU 001, OZU 006, OZU 022
FORD	OPH 001, OPH 002, OZH 006, OZH 014, OZH 020, OZH 021, OZH 045, OZH 050, OZH 059, OZH 075, OZH 151, OZH 176, OZH 181
FORD USA	OPH 002
HONDA	OPH 031, OPH 032, OZH 006, OZH 009, OZH 020, OZH 028, OZH 099, OZH 120, OZH 121, OZH 122, OZH 123, OZU 001, OZU 014
HYUNDAI	OZH 037, OZU 001
ISUZU	OZH 196
KIA	OZH 204, OZH 207, OZU 001
LANCIA	OPH 010, OPH 012, OPH 020, OPH 025, OPH 026, OPH 027, OPH 028, OZH 034, OZH 035, OZH 037, OZH 046, OZH 052, OZH 055, OZH 056, OZH 065, OZH 084, OZH 088, OZH 118, OZH 135, OZH 138, OZH 159, OZH 180, OZU 001, OZU 022
LANDROVER	OPH 085, OZH 173, OZH 219
LOTUS	OPH 085
MAZDA	OZH 022, OZH 043, OZH 076, OZH 095, OZH 100, OZH 139, OZH 163, OZH 200, OZU 001, OZU 012, OZU 021
MERCEDES-BENZ	OZH 143, OZH 220, OPH 034, OPH 035, OPH 037, OPH 038, OPH 039, OPH 040, OPH 041, OPH 042, OPH 043, OPH 045, OPH 046, OPH 047, OPH 048, OPH 087, OZH 007, OZH 016, OZH 018, OZH 021, OZH 023, OZH 025, OZH 026, OZH 032, OZH 041, OZH 042, OZH 033, OZH 051, OZH 098, OZH 124, OZH 140, OZH 141, OZH 142, OZH 144, OZH 145, OZH 146, OZH 198, OZH 200, OZH 211, OZH 212, OZH 213, OZH 235
MG	OPH 085, OZH 053
MITSUBISHI	OZU 001
NISSAN	OPH 089, OPH 090, OZH 011, OZH 012, OZH 201, OZH 203, OZH 225, OZH 226, OZH 227, OZH 228, OZH 229, OZU 001, OZU 010, OZU 024
OPEL	OPH 078, OPH 079, OPH 080, OPH 081, OPH 082, OPH 083, OPH 084, OZH 019, OZH 028, OZH 040, OZH 110, OZH 112, OZH 113, OZH 114, OZH 115, OZH 132, OZH 147, OZH 148, OZH 196, OZH 232, OZH 236, OZU 001, OZU 005, OZU 023

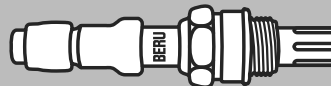

PEUGEOT	OPH 010, OPH 012, OPH 020, OZH 005, OZH 029, OZH 034, OZH 038, OZH 044, OZH 066, OZH 072, OZH 074, OZH 079, OZH 104, OZH 159, OZH 194, OZH 205, OZH 206, OZU 001
PORSCHE	OPH 012, OPH 076, OPH 077
RENAULT	OPH 012, OPH 033, OZH 019, OZH 033, OZH 044, OZH 058, OZH 083, OZH 087, OZH 092, OZH 096, OZH 101, OZH 107, OZH 108, OZH 109, OZH 125, OZH 160, OZH 161, OZH 184, OZH 208, OZH 216, OZU 001, OZU 022, OZU 025
ROVER	OPH 085, OZH 053, OZH 057, OZH 067, OZH 094, OZH 120, OZU 004
SAAB	OPH 011, OPH 013, OPH 015, OPH 016, OPH 021, OZH 046, OZH 154, OZH 156, OZH 157, OZH 158, OZU 001, OZU 021
SEAT	OPH 050, OPH 059, OPH 061, OPH 066, OPH 068, OPH 070, OPH 071, OPH 073, OPH 085, OZH 008, OZH 009, OZH 012, OZH 022, OZH 024, OZH 037, OZH 043, OZH 046, OZH 070, OZH 071, OZH 128, OZH 150, OZH 151, OZH 164, OZH 169, OZH 177, OZH 182, OZU 001, OZU 003, OZU 022
SKODA	OPH 008, OPH 023, OPH 049, OPH 052, OPH 061, OPH 066, OPH 075, OPH 085, OZH 037, OZH 043, OZH 099, OZH 169, OZH 177
SMART	OPH 087
SUZUKI	OZH 196, OZU 014, OZU 015
VAUXHALL	OPH 078, OPH 079, OPH 080, OPH 081, OPH 082, OPH 083, OPH 084, OZH 019, OZH 028, OZH 040, OZH 110, OZH 113, OZH 114, OZH 115, OZH 132, OZH 148, OZH 196, OZU 005, OZU 023
VOLVO	OPH 002, OPH 013, OPH 014, OPH 017, OPH 019, OPH 022, OZH 003, OZH 035, OZH 037, OZH 046, OZH 073, OZH 130, OZH 155, OZH 209, OZH 210
VW	OPH 004, OPH 008, OPH 023, OPH 049, OPH 050, OPH 052, OPH 053, OPH 055, OPH 057, OPH 058, OPH 059, OPH 062, OPH 063, OPH 065, OPH 066, OPH 067, OPH 069, OPH 070, OPH 071, OPH 073, OPH 075, OPH 085, OPH 091, OPH 094, OZH 008, OZH 009, OZH 010, OZH 012, OZH 022, OZH 024, OZH 027, OZH 028, OZH 031, OZH 037, OZH 043, OZH 047, OZH 048, OZH 068, OZH 070, OZH 071, OZH 086, OZH 099, OZH 127, OZH 128, OZH 131, OZH 134, OZH 146, OZH 150, OZH 151, OZH 152, OZH 153, OZH 165, OZH 169, OZH 177, OZH 178, OZH 179, OZH 181, OZH 182, OZH 190, OZH 215, OZU 001, OZU 003, OZU 022
ZASTAVA	OZH 044

D Wichtiger Hinweis

Diese Vergleichsliste ist nur eine Orientierungshilfe. Benützen Sie die aktuellen BERU Verwendungslisten um das verbindliche Produkt festzustellen. Eine Rückumschlüsselung von BERU zu Fremdtypen ist nicht erlaubt. Aus einer falschen Umschlüsselung können keine Gewährleistungsansprüche abgeleitet werden.

GB USA Important note

This comparison list is only an aid. Refer to the current BERU application lists to find the binding product. Reverse conversion from BERU to types from other manufacturers is not permitted. No liability claims can be derived from an incorrect conversion.

F Important

Cette liste comparative vous est donnée à titre indicatif. Pour déterminer le produit adéquat, veuillez vous référer aux listes d'affectations BERU en vigueur. L'utilisation de la liste d'équivalences dans l'autre sens (de BERU vers les autres marques) n'est pas possible. Une conversion erronée rend tout droit à la garantie caduque.

NL Waarschuwing

Deze vergelijkingslijst is slechts bedoeld als oriënteringhulp. Gebruik de actuele BERU-toepassingslijsten om het goedgekeurde product vast te stellen. Terugomzetten van BERU naar types van andere fabrikanten is niet toegestaan. Er kunnen geen garantieaanspraken afgeleid worden van een verkeerde omzetting.

E Nota importante

Esta lista comparativa sirve únicamente como referencia. Utilice las listas de aplicación actuales de BERU para determinar el producto adecuado. No se permite el uso inverso de la lista de equivalencias (de BERU a otras marcas). De una conversión errónea no se puede derivar ningún tipo de derechos de garantía.

I Indicazione importante

Questa lista di confronto serve solo a scopo di riferimento. Per definire in maniera vincolante il prodotto giusto utilizzate le liste di applicazione BERU più attuali. La riconversione dei codici BERU in codici di altri produttori non è ammessa. In caso di errori nella conversione dei codici decade qualsiasi diritto di garanzia.

RUS Важное указание!

Настоящий перечень сравнительных данных представляет собой лишь вспомогательное средство для ориентации. Следует использовать актуальный перечень фирмы BERU с описанием применений с тем, чтобы определить продукт, связанный гарантийными обязательствами. Не разрешается перекодирование BERU в другой тип. Неправильное перекодирование исключает право на гарантийные обязательства.

PL Ważne zalecenie:

Niniejsza lista porównawcza stanowi jedynie pomoc orientacyjną. W celu ustalenia obowiązującego produktu należy stosować aktualne listy zastosowań wyrobów firmy BERU. Niedozwolone jest wtórne zastępowanie wyrobów firmy BERU wyrobami innych firm. Nieprawidłowe zastąpienie powoduje przypadek rozszczeń gwarancyjnych.

GR Σημαντική υπόδειξη

Αυτός ο κατάλογος σύγκρισης αποτελεί μόνο βοήθεια προσανατολισμού. Για να εξακριβώσετε το αυθεντικό προϊόν χρησιμοποιήστε τους επίκαιρους καταλόγους χρήσης της BERU. Δεν επιτρέπεται η διακωδικοποίηση από προϊόντα της BERU σε προϊόντα ξένων κατασκευαστών. Από εσφαλμένη διακωδικοποίηση δεν μπορούν να συναχθούν εγγυητικές αξιώσεις.

H Fontos figyelmeztetés

Ez az összehasonlító lista kizárólag a tájékozódást segíti. A megfelelő termék kiválasztásához használja a BERU aktuális alkalmazási listáit. A BERU típusait nem szabad más gyártók típusaival helyettesíteni. Téves behelyettesítésből nem vezethet le jóállási igényt.

P Aviso importante

Esta lista de comparação é apenas uma ajuda de orientação. Utilize as listas de aplicação atuais para determinar o produto a usar. Não é permitida uma reconversão de Beru para outros modelos de terceiros. As conversões erradas não podem dar origem a pedidos de garantia.

TR Önemli bilgi

Bu karşılaştırma listesi sadece bir oryantasyon yardımıdır. Bağlayıcı ürünü belirlemek için güncel Beru kullanım listelerini kullanınız. Beru'dan harici tiplere geriye dönük kod dönüştürme işlemine izin verilmez. Yanlış bir kod dönüştürme işlemi nedeniyle hiçbir garanti talebinde bulunulamaz.



OZH 013	0 824 010 014	OZH 059	0 824 010 065
OZH 015	0 824 010 016	OZH 059	0 824 010 065
OZH 062	0 824 010 068	OZH 035	0 824 010 037
OZH 063	0 824 010 069	OZH 056	0 824 010 061

ALFA ROMEO	BERU	
112016	OZU 022	0824010094
116 85 11 016	OZU 001	0824010001
161 24 11 016 01	OZH 037	0824010039
162 28 11 016 00	OZH 037	0824010039
464 17 969	OZH 056	0824010061
46452598	OZH 138	0824010172
46750241	OPH 028	0824010313
548 193	OZH 003	0824010004
59 63 5160	OZU 022	0824010094
60 56 77 59	OZH 046	0824010048
605 87 697	OZH 067	0824010073
605076900	OZH 037	0824010039
60537650	OZH 003	0824010004
608 08 350	OZH 055	0824010060
60809012	OZH 037	0824010039
60812162	OZH 052	0824010057
619 30 40	OZH 065	0824010071
755 512 3	OZH 037	0824010039
75551290	OZH 037	0824010039
76193030	OZH 037	0824010039
76193040	OZH 065	0824010071
76303320	OZH 046	0824010048
76400820	OZH 037	0824010039
77 859 73	OZH 052	0824010057
7707638	OZH 037	0824010039
961 386 08	OZH 034	0824010036

AUDI	BERU	
025 906 265	OZU 001	0824010001
035 906 265 B	OZU 022	0824010094
048 906 265 B	OZH 017	0824010018

BMW	BERU	
1 277 565	OZU 001	0824010001
11 76 1 277 565	OZU 001	0824010001
11 78 1 247 406	OZH 173	0824010207
11 78 1 247 475	OZH 023	0824010024
11 78 1 433 159	OZH 023	0824010024
11 78 1 433 940	OZH 168	0824010202
11 78 1 437 586	OZH 218	0824010252
11 78 1 714 873	OZH 193	0824010227
11 78 1 720 536	OZH 036	0824010038
11 78 1 720 845	OZH 036	0824010038
11 78 1 725 676	OZH 036	0824010038
11 78 1 727 451	OZH 231	0824010265
11 78 1 730 005	OZH 036	0824010038
11 78 1 733 628	OZH 036	0824010038
11 78 1 734 345	OZH 036	0824010038

BMW	BERU	
11 78 1 734 390	OZH 036	0824010038
11 78 1 734 393	OZH 036	0824010038
11 78 1 735 345	OZH 036	0824010038
11 78 1 735 499	OZH 036	0824010038
11 78 1 735 500	OZH 036	0824010038
11 78 1 739 005	OZH 036	0824010038
11 78 1 739 642	OZH 036	0824010038
11 78 1 739 845	OZH 199	0824010233
11 78 1 741 317	OZH 023	0824010024
11 78 1 742 023	OZH 023	0824010024
11 78 1 742 050	OZH 173	0824010207
11 78 1 742 051	OZH 167	0824010201
11 78 1 747 005	OZH 036	0824010038
11 78 1 747 579	OZH 036	0824010038
11 78 1704 259	OZH 023	0824010024
11 78 1720 537	OZH 002	0824010003
11 78 1720 672	OZH 004	0824010005
11 78 1720 860	OZH 039	0824010041
11 78 1721 125	OZH 039	0824010041
11 78 1726 321	OZH 030	0824010032
11 78 1730 007	OZH 004	0824010005
11 78 1734 796	OZH 039	0824010041
11 78 1735 680	OZH 030	0824010032
11 78 1735 710	OZH 030	0824010032
11 78 7 503 441	OZH 222	0824010256
11 78 7 506 531	OZH 223	0824010257
11 78 7 506 539	OZH 224	0824010258
11 78 7 539 137	OPH 036	0824010321
11 78 7 544 655	OPH 044	0824010329

BOSCH	BERU	
0 258 001 025	OZU 001	0824010001
0 258 001 026	OZU 022	0824010094
0 258 001 027	OZU 001	0824010001
0 258 001 028	OZU 001	0824010001
0 258 001 030	OZU 001	0824010001
0 258 001 031	OZU 001	0824010001
0 258 001 032	OZU 001	0824010001
0 258 001 035	OZU 010	0824010090
0 258 001 037	OZU 001	0824010001
0 258 001 038	OZU 001	0824010001
0 258 001 039	OZU 001	0824010001
0 258 001 040	OZU 001	0824010001
0 258 001 041	OZU 001	0824010001
0 258 001 042	OZU 001	0824010001
0 258 001 043	OZU 022	0824010094

BOSCH	BERU	
0 258 001 047	OZU 001	0824010001
0 258 001 051	OZU 022	0824010094
0 258 001 052	OZU 022	0824010094
0 258 001 929	OZU 001	0824010001
0 258 001 960	OZU 001	0824010001
0 258 001 961	OZU 001	0824010001
0 258 001 962	OZU 001	0824010001
0 258 001 963	OZU 001	0824010001
0 258 001 964	OZU 001	0824010001
0 258 002 012	OZU 001	0824010001
0 258 002 014	OZU 005	0824010055
0 258 002 015	OZU 001	0824010001
0 258 002 017	OZU 001	0824010001
0 258 002 018	OZU 001	0824010001
0 258 002 020	OZU 001	0824010001
0 258 002 021	OZU 001	0824010001
0 258 002 022	OZU 001	0824010001
0 258 002 023	OZU 001	0824010001
0 258 002 024	OZU 001	0824010001
0 258 002 025	OZU 001	0824010001
0 258 002 026	OZU 001	0824010001
0 258 002 027	OZU 001	0824010001
0 258 002 028	OZU 001	0824010001
0 258 002 029	OZU 001	0824010001
0 258 002 031	OZU 001	0824010001
0 258 002 032	OZU 001	0824010001
0 258 002 033	OZU 001	0824010001
0 258 002 035	OZU 022	0824010094
0 258 002 036	OZU 001	0824010001
0 258 002 038	OZU 001	0824010001
0 258 002 039	OZU 001	0824010001
0 258 002 040	OZU 003	0824010053
0 258 002 041	OZU 003	0824010053
0 258 002 042	OZU 001	0824010001
0 258 002 044	OZU 001	0824010001
0 258 002 045	OZU 001	0824010001
0 258 002 046	OZU 001	0824010001
0 258 002 049	OZU 001	0824010001
0 258 002 908	OZU 001	0824010001
0 258 002 909	OZU 001	0824010001
0 258 002 919	OZU 001	0824010001
0 258 003 004	OZH 044	0824010046
0 258 003 005	OZH 192	0824010226
0 258 003 006	OZH 037	0824010039
0 258 003 009	OZH 037	0824010039
0 258 003 013	OZH 006	0824010007
0 258 003 014	OZH 037	0824010039
0 258 003 016	OZH 007	0824010008
0 258 003 017	OZH 040	0824010042
0 258 003 019	OZH 037	0824010039



BOSCH	BERU	
0 258 003 020	OZH 003	0824010004
0 258 003 021	OZH 028	0824010030
0 258 003 027	OZH 003	0824010004
0 258 003 028	OZH 046	0824010048
0 258 003 032	OZH 037	0824010039
0 258 003 034	OZH 003	0824010004
0 258 003 035	OZH 006	0824010007
0 258 003 037	OZH 193	0824010227
0 258 003 040	OZH 037	0824010039
0 258 003 044	OZH 005	0824010006
0 258 003 046	OZH 066	0824010072
0 258 003 047	OZH 001	0824010002
0 258 003 052	OZH 002	0824010003
0 258 003 057	OZH 046	0824010048
0 258 003 060	OZH 003	0824010004
0 258 003 061	OZH 037	0824010039
0 258 003 063	OZH 044	0824010046
0 258 003 064	OZH 036	0824010038
0 258 003 067	OZH 039	0824010041
0 258 003 068	OZH 004	0824010005
0 258 003 069	OZH 039	0824010041
0 258 003 074	OZH 029	0824010031
0 258 003 075	OZH 037	0824010039
0 258 003 077	OZH 033	0824010035
0 258 003 078	OZH 005	0824010006
0 258 003 081	OZH 033	0824010035
0 258 003 082	OZH 040	0824010042
0 258 003 083	OZH 027	0824010028
0 258 003 085	OZH 027	0824010028
0 258 003 086	OZH 033	0824010035
0 258 003 087	OZH 194	0824010228
0 258 003 088	OZH 166	0824010200
0 258 003 090	OZH 037	0824010039
0 258 003 095	OZH 027	0824010028
0 258 003 096	OZH 006	0824010007
0 258 003 097	OZH 006	0824010007
0 258 003 101	OZH 046	0824010048
0 258 003 103	OZH 035	0824010037
0 258 003 108	OZH 030	0824010032
0 258 003 110	OZH 009	0824010010
0 258 003 112	OZH 008	0824010009
0 258 003 114	OZH 031	0824010033
0 258 003 115	OZH 030	0824010032
0 258 003 116	OZH 008	0824010009
0 258 003 118	OZH 075	0824010081
0 258 003 119	OZH 003	0824010004
0 258 003 120	OZH 035	0824010037
0 258 003 130	OZH 026	0824010027
0 258 003 132	OZH 026	0824010027
0 258 003 134	OZH 007	0824010008
0 258 003 136	OZH 140	0824010174
0 258 003 139	OZH 040	0824010042
0 258 003 141	OZH 028	0824010030
0 258 003 144	OZH 051	0824010056
0 258 003 146	OZH 026	0824010027
0 258 003 154	OZH 141	0824010175
0 258 003 156	OZH 032	0824010034
0 258 003 157	OZH 032	0824010034
0 258 003 160	OZH 033	0824010035
0 258 003 164	OZH 044	0824010046
0 258 003 165	OZH 009	0824010010
0 258 003 167	OZH 009	0824010010
0 258 003 169	OZH 009	0824010010
0 258 003 171	OZH 008	0824010009
0 258 003 172	OZH 008	0824010009

BOSCH	BERU	
0 258 003 175	OZH 037	0824010039
0 258 003 179	OZH 009	0824010010
0 258 003 181	OZH 009	0824010010
0 258 003 189	OZH 033	0824010035
0 258 003 191	OZH 008	0824010009
0 258 003 193	OZH 057	0824010062
0 258 003 194	OZH 044	0824010046
0 258 003 199	OZH 018	0824010019
0 258 003 201	OZH 033	0824010035
0 258 003 203	OZH 034	0824010036
0 258 003 206	OZH 037	0824010039
0 258 003 207	OZH 010	0824010011
0 258 003 211	OZH 010	0824010011
0 258 003 213	OZH 010	0824010011
0 258 003 215	OZH 036	0824010038
0 258 003 216	OZH 043	0824010045
0 258 003 219	OZH 036	0824010038
0 258 003 220	OZH 036	0824010038
0 258 003 222	OZH 035	0824010037
0 258 003 229	OZH 053	0824010058
0 258 003 231	OZH 036	0824010038
0 258 003 232	OZH 010	0824010011
0 258 003 234	OZH 037	0824010039
0 258 003 235	OZH 037	0824010039
0 258 003 239	OZH 038	0824010040
0 258 003 240	OZH 035	0824010037
0 258 003 241	OZH 027	0824010028
0 258 003 243	OZH 028	0824010030
0 258 003 244	OZH 036	0824010038
0 258 003 246	OZH 003	0824010004
0 258 003 247	OZH 012	0824010013
0 258 003 248	OZH 012	0824010013
0 258 003 254	OZH 027	0824010028
0 258 003 256	OZH 011	0824010012
0 258 003 260	OZH 044	0824010046
0 258 003 261	OZH 039	0824010041
0 258 003 262	OZH 035	0824010037
0 258 003 263	OZH 009	0824010010
0 258 003 265	OZH 043	0824010045
0 258 003 266	OZH 043	0824010045
0 258 003 267	OZH 043	0824010045
0 258 003 269	OZH 024	0824010025
0 258 003 271	OZH 024	0824010025
0 258 003 273	OZH 012	0824010013
0 258 003 277	OZH 196	0824010230
0 258 003 279	OZH 044	0824010046
0 258 003 280	OZH 044	0824010046
0 258 003 281	OZH 017	0824010018
0 258 003 288	OZH 043	0824010045
0 258 003 290	OZH 067	0824010073
0 258 003 292	OZH 014	0824010015
0 258 003 295	OZH 017	0824010018
0 258 003 298	OZH 037	0824010039
0 258 003 300	OZH 040	0824010042
0 258 003 301	OZH 055	0824010060
0 258 003 303	OZH 165	0824010199
0 258 003 305	OZH 134	0824010168
0 258 003 307	OZH 059	0824010065
0 258 003 307	OZH 059	0824010065
0 258 003 310	OZH 036	0824010038
0 258 003 313	OZH 037	0824010039
0 258 003 314	OZH 016	0824010017
0 258 003 320	OZH 041	0824010043
0 258 003 321	OZH 041	0824010043
0 258 003 322	OZH 041	0824010043

BOSCH	BERU	
0 258 003 324	OZH 042	0824010044
0 258 003 325	OZH 042	0824010044
0 258 003 331	OZH 009	0824010010
0 258 003 333	OZH 094	0824010114
0 258 003 334	OZH 043	0824010045
0 258 003 337	OZH 157	0824010191
0 258 003 338	OZH 036	0824010038
0 258 003 339	OZH 045	0824010047
0 258 003 340	OZH 020	0824010021
0 258 003 342	OZH 045	0824010047
0 258 003 343	OZH 020	0824010021
0 258 003 344	OZH 017	0824010018
0 258 003 357	OZH 036	0824010038
0 258 003 363	OZH 139	0824010173
0 258 003 371	OZH 043	0824010045
0 258 003 374	OZH 156	0824010190
0 258 003 381	OZH 155	0824010189
0 258 003 392	OZH 045	0824010047
0 258 003 393	OZH 158	0824010192
0 258 003 396	OZH 017	0824010018
0 258 003 412	OZH 036	0824010038
0 258 003 420	OZH 011	0824010012
0 258 003 426	OZH 036	0824010038
0 258 003 427	OZH 018	0824010019
0 258 003 433	OZH 198	0824010232
0 258 003 437	OZH 043	0824010045
0 258 003 439	OZH 043	0824010045
0 258 003 443	OZH 018	0824010019
0 258 003 446	OZH 019	0824010020
0 258 003 447	OZH 019	0824010020
0 258 003 448	OZH 019	0824010020
0 258 003 456	OZH 045	0824010047
0 258 003 457	OZH 045	0824010047
0 258 003 460	OZH 036	0824010038
0 258 003 466	OZH 056	0824010061
0 258 003 475	OZH 167	0824010201
0 258 003 476	OZH 167	0824010201
0 258 003 477	OZH 173	0824010207
0 258 003 478	OZH 068	0824010074
0 258 003 484	OZH 045	0824010047
0 258 003 485	OZH 020	0824010021
0 258 003 486	OZH 045	0824010047
0 258 003 505	OZH 154	0824010188
0 258 003 508	OZH 044	0824010046
0 258 003 510	OZH 044	0824010046
0 258 003 511	OZH 044	0824010046
0 258 003 512	OZH 036	0824010038
0 258 003 513	OZH 021	0824010022
0 258 003 515	OZH 146	0824010180
0 258 003 518	OZH 069	0824010075
0 258 003 519	OZH 069	0824010075
0 258 003 524	OZH 103	0824010128
0 258 003 542	OZH 070	0824010076
0 258 003 544	OZH 071	0824010077
0 258 003 546	OZH 022	0824010023
0 258 003 548	OZH 022	0824010023
0 258 003 554	OZH 139	0824010173
0 258 003 560	OZH 056	0824010061
0 258 003 561	OZH 199	0824010233
0 258 003 567	OZH 072	0824010078
0 258 003 569	OZH 052	0824010057
0 258 003 571	OZH 200	0824010234
0 258 003 573	OZH 026	0824010027
0 258 003 578	OZH 035	0824010037
0 258 003 579	OZH 056	0824010061

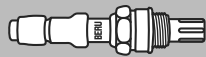

BOSCH			BERU			BOSCH			BERU		
0 258 003 584	OZH 150	0824010184	0 258 003 965	OZH 027	0824010028	0 258 006 064	OPH 018	0824010303			
0 258 003 586	OZH 022	0824010023	0 258 003 973	OZH 047	0824010049	0 258 006 121	OPH 068	0824010353			
0 258 003 597	OZH 023	0824010024	0 258 003 979	OZH 048	0824010050	0 258 006 123	OPH 034	0824010319			
0 258 003 599	OZH 145	0824010179	0 258 003 995	OZH 027	0824010028	0 258 006 159	OPH 003	0824010288			
0 258 003 605	OZH 022	0824010023	0 258 004 001	OZH 065	0824010071	0 258 006 163	OPH 069	0824010354			
0 258 003 624	OZH 201	0824010235	0 258 005 001	OZH 098	0824010120	0 258 006 165	OPH 002	0824010287			
0 258 003 626	OZH 073	0824010079	0 258 005 003	OZH 145	0824010179	0 258 006 170	OPH 079	0824010364			
0 258 003 627	OZH 064	0824010070	0 258 005 030	OZH 208	0824010242	0 258 006 171	OPH 081	0824010366			
0 258 003 630	OZH 181	0824010215	0 258 005 054	OZH 167	0824010201	0 258 006 172	OPH 078	0824010363			
0 258 003 634	OZH 203	0824010237	0 258 005 055	OZH 148	0824010182	0 258 006 173	OPH 021	0824010306			
0 258 003 638	OZH 016	0824010017	0 258 005 062	OZH 209	0824010243	0 258 006 175	OPH 016	0824010301			
0 258 003 644	OZH 101	0824010125	0 258 005 063	OZH 210	0824010244	0 258 006 176	OPH 082	0824010367			
0 258 003 644	OZH 161	0824010195	0 258 005 066	OZH 151	0824010185	0 258 006 179	OPH 040	0824010325			
0 258 003 646	OZH 151	0824010185	0 258 005 068	OZH 151	0824010185	0 258 006 181	OPH 037	0824010322			
0 258 003 648	OZH 164	0824010198	0 258 005 079	OZH 169	0824010203	0 258 006 190	OPH 028	0824010313			
0 258 003 653	OZH 204	0824010238	0 258 005 081	OZH 177	0824010211	0 258 006 190	OZH 056	0824010061			
0 258 003 666	OZH 099	0824010121	0 258 005 083	OZH 098	0824010120	0 258 006 197	OPH 013	0824010298			
0 258 003 667	OZH 074	0824010080	0 258 005 087	OZH 135	0824010169	0 258 006 200	OPH 017	0824010302			
0 258 003 668	OZH 104	0824010129	0 258 005 088	OZH 021	0824010022	0 258 006 205	OPH 076	0824010361			
0 258 003 669	OZH 079	0824010089	0 258 005 090	OZH 211	0824010245	0 258 006 206	OPH 025	0824010310			
0 258 003 672	OZH 205	0824010239	0 258 005 092	OZH 212	0824010246	0 258 006 217	OPH 065	0824010350			
0 258 003 673	OZH 206	0824010240	0 258 005 094	OZH 213	0824010247	0 258 006 219	OPH 073	0824010358			
0 258 003 694	OZH 151	0824010185	0 258 005 097	OZH 073	0824010079	0 258 006 229	OPH 050	0824010335			
0 258 003 696	OZH 151	0824010185	0 258 005 101	OZH 046	0824010048	0 258 006 233	OPH 061	0824010346			
0 258 003 704	OZH 207	0824010241	0 258 005 109	OZH 168	0824010202	0 258 006 237	OPH 049	0824010334			
0 258 003 713	OZH 045	0824010047	0 258 005 115	OZH 169	0824010203	0 258 006 239	OPH 071	0824010356			
0 258 003 714	OZH 045	0824010047	0 258 005 123	OZH 215	0824010249	0 258 006 245	OPH 068	0824010353			
0 258 003 715	OZH 107	0824010139	0 258 005 134	OZH 216	0824010250	0 258 006 251	OPH 062	0824010347			
0 258 003 716	OZH 074	0824010080	0 258 005 135	OZH 184	0824010218	0 258 006 255	OPH 051	0824010336			
0 258 003 717	OZH 104	0824010129	0 258 005 156	OZH 217	0824010251	0 258 006 259	OPH 057	0824010342			
0 258 003 718	OZH 079	0824010089	0 258 005 158	OZH 151	0824010185	0 258 006 261	OPH 070	0824010355			
0 258 003 719	OZH 159	0824010193	0 258 005 177	OZH 218	0824010252	0 258 006 263	OPH 094	0824010379			
0 258 003 734	OZH 151	0824010185	0 258 005 184	OZH 219	0824010253	0 258 006 268	OPH 038	0824010323			
0 258 003 738	OZH 151	0824010185	0 258 005 191	OZH 056	0824010061	0 258 006 272	OPH 035	0824010320			
0 258 003 740	OZH 152	0824010186	0 258 005 192	OZH 056	0824010061	0 258 006 280	OPH 084	0824010369			
0 258 003 744	OZH 033	0824010035	0 258 005 202	OZH 220	0824010254	0 258 006 283	OPH 024	0824010309			
0 258 003 745	OZH 099	0824010121	0 258 005 234	OZH 112	0824010146	0 258 006 287	OPH 004	0824010289			
0 258 003 759	OZH 071	0824010077	0 258 005 249	OZH 084	0824010099	0 258 006 296	OPH 056	0824010341			
0 258 003 763	OZH 040	0824010042	0 258 005 253	OZH 076	0824010084	0 258 006 305	OPH 052	0824010337			
0 258 003 766	OZH 019	0824010020	0 258 005 256	OZH 132	0824010166	0 258 006 312	OPH 008	0824010293			
0 258 003 769	OZH 136	0824010170	0 258 005 258	OZH 056	0824010061	0 258 006 314	OPH 023	0824010308			
0 258 003 770	OZH 138	0824010172	0 258 005 259	OZH 222	0824010256	0 258 006 318	OPH 041	0824010326			
0 258 003 772	OZH 056	0824010061	0 258 005 270	OZH 223	0824010257	0 258 006 320	OPH 043	0824010328			
0 258 003 779	OZH 050	0824010052	0 258 005 271	OZH 224	0824010258	0 258 006 322	OPH 047	0824010332			
0 258 003 780	OZH 045	0824010047	0 258 005 274	OZH 225	0824010259	0 258 006 326	OPH 048	0824010333			
0 258 003 781	OZH 045	0824010047	0 258 005 278	OZH 226	0824010260	0 258 006 328	OPH 045	0824010330			
0 258 003 782	OZH 143	0824010177	0 258 005 286	OZH 227	0824010261	0 258 006 334	OPH 066	0824010351			
0 258 003 784	OZH 144	0824010178	0 258 005 291	OZH 110	0824010144	0 258 006 346	OPH 083	0824010368			
0 258 003 798	OZH 023	0824010024	0 258 005 293	OZH 228	0824010262	0 258 006 348	OPH 042	0824010327			
0 258 003 800	OZH 050	0824010052	0 258 005 295	OZH 229	0824010263	0 258 006 363	OPH 091	0824010376			
0 258 003 801	OZH 059	0824010065	0 258 005 323	OZH 231	0824010265	0 258 006 371	OPH 007	0824010292			
0 258 003 805	OZH 064	0824010070	0 258 005 324	OZH 036	0824010038	0 258 006 373	OPH 075	0824010360			
0 258 003 829	OZH 024	0824010025	0 258 005 334	OZH 157	0824010191	0 258 006 375	OPH 027	0824010312			
0 258 003 842	OZH 150	0824010184	0 258 005 651	OZH 137	0824010171	0 258 006 376	OPH 026	0824010311			
0 258 003 862	OZH 124	0824010158	0 258 005 701	OZH 196	0824010230	0 258 006 377	OPH 029	0824010314			
0 258 003 870	OZH 025	0824010026	0 258 005 708	OZH 163	0824010197	0 258 006 378	OPH 074	0824010359			
0 258 003 892	OZH 160	0824010194	0 258 006 014	OPH 006	0824010291	0 258 006 387	OPH 080	0824010365			
0 258 003 913	OZH 006	0824010007	0 258 006 021	OPH 028	0824010313	0 258 006 406	OPH 009	0824010294			
0 258 003 915	OZH 051	0824010056	0 258 006 022	OPH 001	0824010286	0 258 006 420	OPH 046	0824010331			
0 258 003 925	OZH 026	0824010027	0 258 006 026	OPH 020	0824010305	0 258 006 427	OPH 022	0824010307			
0 258 003 926	OZH 142	0824010176	0 258 006 028	OPH 010	0824010295	0 258 006 433	OPH 012	0824010297			
0 258 003 930	OZH 026	0824010027	0 258 006 035	OPH 030	0824010315	0 258 006 442	OPH 092	0824010377			
0 258 003 931	OZH 037	0824010039	0 258 006 046	OPH 033	0824010318	0 258 006 444	OPH 059	0824010344			
0 258 003 936	OZH 047	0824010049	0 258 006 050	OPH 013	0824010298	0 258 006 452	OPH 067	0824010352			
0 258 003 957	OZH 046	0824010048	0 258 006 063	OPH 088	0824010373	0 258 006 475	OPH 039	0824010324			

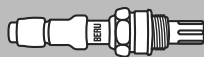

BOSCH		BERU	
0 258 006 488	OPH 019	0824010304	
0 258 006 511	OPH 090	0824010375	
0 258 006 513	OPH 089	0824010374	
0 258 006 517	OPH 093	0824010378	
0 258 006 525	OPH 054	0824010339	
0 258 006 538	OPH 032	0824010317	
0 258 006 539	OPH 031	0824010316	
0 258 006 541	OPH 014	0824010299	
0 258 006 544	OPH 005	0824010290	
0 258 006 557	OPH 063	0824010348	
0 258 006 559	OPH 053	0824010338	
0 258 006 582	OPH 058	0824010343	
0 258 006 589	OPH 055	0824010340	
0 258 006 591	OPH 064	0824010349	
0 258 006 623	OPH 011	0824010296	
0 258 006 624	OPH 015	0824010300	
0 258 006 663	OPH 072	0824010357	
0 258 006 665	OPH 060	0824010345	
0 258 006 697	OPH 077	0824010362	
0 258 006 741	OPH 085	0824010370	
0 258 006 749	OPH 087	0824010372	
0 258 006 792	OPH 036	0824010321	
0 258 006 809	OPH 044	0824010329	
0 258 006 827	OPH 086	0824010371	
0 258 010 032	OPH 049	0824010334	
0 258 010 810	OZH 023	0824010024	
0 986 258 024	OZU 023	0824010136	
0258010134	OZH 184	0824010218	

CADILLAC		BERU	
24 402 859	OPH 074	0824010359	

CHEVROLET		BERU	
90 448 458	OZH 040	0824010042	
93 232 414	OZU 001	0824010001	
93 385 924	OPH 086	0824010371	

CHRYSLER		BERU	
05269868 AB	OPH 030	0824010315	

CITROËN		BERU	
162 83W	OZH 072	0824010078	
1628 34	OZH 029	0824010031	
1628 6R	OZH 074	0824010080	
1628 6W	OZH 079	0824010089	
1628 9T	OZH 159	0824010193	
1628 9V	OZH 104	0824010129	
1628 A4	OZH 066	0824010072	
1628 HT	OZH 104	0824010129	
1628 J4	OZH 029	0824010031	
1628 L4	OZH 005	0824010006	
1628 L6	OZH 166	0824010200	
1628 V4	OZH 038	0824010040	
1628T2	OZH 034	0824010036	
91 540 672	OZH 066	0824010072	
95 494 924	OZU 001	0824010001	
95 635 047	OZH 046	0824010048	
96 027 244	OZH 029	0824010031	
96 036 827	OZH 005	0824010006	
96 039 269	OZH 166	0824010200	
96 127 817	OZH 038	0824010040	

CITROËN		BERU	
96 229 970	OZH 104	0824010129	
96 229 971	OZH 079	0824010089	
96 229 971 80	OZH 079	0824010089	
96 229 974	OZH 046	0824010048	
96 284 480	OZH 104	0824010129	
96 284 480 80	OZH 104	0824010129	
96 356 573	OZH 104	0824010129	
96051883	OZH 194	0824010228	
96211179	OZH 072	0824010078	
96211180	OZH 072	0824010078	
9621118080	OZH 072	0824010078	
96229969	OZH 074	0824010080	
9622996980	OZH 074	0824010080	

DAEWOO		BERU	
25 106 073	OZU 005	0824010055	
25162753	OZU 001	0824010001	
96335925	OZU 001	0824010001	

DAF		BERU	
1292638	OZH 037	0824010039	

DAIHATSU		BERU	
89465 87101 000	OZU 001	0824010001	
89465 87105 000	OZU 001	0824010001	
89465 87202 000	OZU 001	0824010001	
89465 87601 000	OZU 001	0824010001	
89465 87704 000	OZU 001	0824010001	
89465-87211-000	OZU 001	0824010001	

EBERSPÄCHER		BERU	
L07 188 971	OZH 028	0824010030	
L07 288 971	OZH 040	0824010042	
L08 488 971	OZH 040	0824010042	
L21 189 971	OZH 030	0824010032	
L21 190 971	OZH 036	0824010038	
L21 286 971	OZH 039	0824010041	
L21 288 971	OZH 004	0824010005	
L21 386 972	OZH 036	0824010038	
L21 490 971	OZH 036	0824010038	
L23 192 971	OZH 018	0824010019	
L23 279 971	OZH 007	0824010008	
L23 288 971	OZH 032	0824010034	
L23 692 971	OZH 016	0824010017	

FACET		BERU	
10.7020	OZH 138	0824010172	
10.7023	OZH 056	0824010061	
10.7027	OZH 047	0824010049	
10.7029	OZH 044	0824010046	
10.7034	OZH 165	0824010199	
10.7035	OZH 024	0824010025	
10.7038	OZH 067	0824010073	
10.7039	OZH 033	0824010035	
10.7040	OZH 065	0824010071	
10.7046	OZU 006	0824010064	
10.7050	OZH 023	0824010024	
10.7051	OZH 139	0824010173	
10.7058	OZH 160	0824010194	
10.7060	OZH 031	0824010033	
10.7087	OZH 181	0824010215	

FACET		BERU	
10.7090	OZH 182	0824010216	
10.7097	OZH 184	0824010218	
10.7102	OZH 036	0824010038	
10.7103	OZH 154	0824010188	
10.7104	OZH 156	0824010190	
10.7106	OZH 157	0824010191	
10.7110	OZH 100	0824010124	
10.7118	OZH 037	0824010039	
10.7119	OZU 005	0824010055	
10.7137	OZU 001	0824010001	
10.7147	OZH 028	0824010030	
10.7163	OZH 169	0824010203	
10.7214	OZH 180	0824010214	
10.7219	OZH 157	0824010191	
10.7221	OZH 158	0824010192	
10.7222	OZH 155	0824010189	
10.7255	OZH 168	0824010202	
10.7282	OZH 184	0824010218	
10.7298	OZH 173	0824010207	
10.7304	OZH 152	0824010186	
10.7356	OZH 178	0824010212	
10.7357	OZH 179	0824010213	
10.7362	OZH 190	0824010224	
10.7406	OZH 143	0824010177	
10.7411	OZH 146	0824010180	
10.7422	OZH 145	0824010179	
10.7428	OZH 153	0824010187	
10.7430	OZU 001	0824010001	
10.7594	OZH 184	0824010218	
10.7926	OZH 144	0824010178	

FERRARI		BERU	
121515	OZH 037	0824010039	
142514	OZH 035	0824010037	

FIAT		BERU	
112016	OZU 022	0824010094	
44 302 91	OZU 022	0824010094	
46 418 813	OZH 088	0824010106	
46 42 2649	OZH 054	0824010059	
46 42 4723	OZH 056	0824010061	
46 521 170	OZH 118	0824010152	
464 17 969	OZH 056	0824010061	
464 19 222	OZH 049	0824010051	
464 52 813	OZH 136	0824010170	
46408449	OZH 056	0824010061	
46418568	OZH 064	0824010070	
46420612	OZH 035	0824010037	
46423798	OZH 035	0824010037	
46444284	OZH 056	0824010061	
46449401	OZH 064	0824010070	
46452598	OZH 138	0824010172	
46455802	OZH 064	0824010070	
46460055	OZH 135	0824010169	
46462006	OZH 056	0824010061	
46523129	OZH 056	0824010061	
46523497	OZH 217	0824010251	
46555846	OZH 137	0824010171	
46750248	OPH 029	0824010314	
46750249	OZH 180	0824010214	
46762182	OPH 026	0824010311	



FIAT	BERU	
46762653	OPH 027	0824010312
504083015	OPH 025	0824010310
59 63 516	OZU 022	0824010094
60 50 7630	OZH 037	0824010039
60 50 7690	OZH 037	0824010039
60 56 7759	OZH 037	0824010039
60 73 3358	OZU 001	0824010001
60 80 5428	OZH 037	0824010039
60 80 8457	OZH 046	0824010048
60 80 9012	OZH 037	0824010039
605 78 768	OZH 055	0824010060
605 87 697	OZH 067	0824010073
60537650	OZH 003	0824010004
60562536	OZH 035	0824010037
60574613	OZH 066	0824010072
60583122	OZH 035	0824010037
608 08 350	OZH 055	0824010060
60810814	OZH 056	0824010061
60812162	OZH 052	0824010057
60812717	OZH 056	0824010061
7 751 308	OZH 084	0824010099
75 55 129	OZH 037	0824010039
76 19 303	OZH 037	0824010039
76 30 332	OZH 046	0824010048
76 40 082	OZH 037	0824010039
76 54 221	OZH 046	0824010048
7619304	OZH 065	0824010071
7668286	OZH 035	0824010037
7674048	OZH 027	0824010028
77 067 54	OZU 006	0824010064
77 07 638	OZH 037	0824010039
77 55 123	OZH 037	0824010039
77 859 73	OZH 052	0824010057
7789741	OZH 056	0824010061
9154067280	OZH 066	0824010072
96138608	OZH 034	0824010036
9628448280	OZH 159	0824010193

FORD	BERU	
01053108	OZH 176	0824010210
07 325 143	OZH 181	0824010215
1 001 702	OZH 045	0824010047
1 010 006	OPH 001	0824010286
1 025 958	OZH 014	0824010015
1 640 552	OZH 006	0824010007
6 164 926	OZH 006	0824010007
6 847 910	OZH 059	0824010065
7 089 574	OZH 045	0824010047
87 GB 9F472 AA	OZH 006	0824010007
89 BB 9F472 AA	OZH 075	0824010081
89 FB 9F472 AC	OZH 059	0824010065
89 FB 9F472 BA	OZH 059	0824010065
89 FB 9F472 CA	OZH 059	0824010065
89 GB 9F472 AA	OZH 006	0824010007
90 BB 9F472 AB	OZH 014	0824010015
92 AB 9F492 AA	OZH 050	0824010052
93 AB 9F472 AA	OZH 050	0824010052
93 AB 9F492 AA	OZH 050	0824010052
93 BB 9F472 AA	OZH 054	0824010059
93 BB 9F472 AA	OZH 059	0824010065
93 FB 9F472 AA	OZH 059	0824010065
93 GB 9F472 AA	OZH 045	0824010047
93 GB 9F472 BA	OZH 020	0824010021
93 VB 9F472 AA	OZH 020	0824010021

FORD	BERU	
95 FB 9F472 BA	OZH 045	0824010047
95 FB 9F472 CB	OZH 020	0824010021
95 FB 9F472 DB	OZH 045	0824010047
95 FB 9F472 EA	OZH 045	0824010047
95 VW 9F472 EA	OZH 022	0824010023
95VW 9F472 FA	OZH 151	0824010185
96 BB 9F472 BA	OZH 031	0824010033
96 FB 9F472 CA	OZH 045	0824010047
96 FB 9F472 DA	OZH 045	0824010047
96 GB 9F472 AA	OZH 050	0824010052
97VW 9F472 AA	OZH 150	0824010184
98AB 9F472 BB	OZH 176	0824010210
E4ZF 9F472 AA	OZH 006	0824010007
E59F 9F472 A1A	OZH 006	0824010007
E67F 9F472 AA	OZH 006	0824010007
E6ZF 9F472 AB	OZU 001	0824010001
E6ZZ 9F472 A	OZU 001	0824010001
F5M29F472B	OPH 002	0824010287

GMC	BERU	
241333391	OZU 001	0824010001

HELLA	BERU	
6PA 009 165 201	OZH 040	0824010042
6PA 009 165-001	OZU 005	0824010055
6PA 009 165-011	OZH 045	0824010047
6PA 009 165-021	OZH 037	0824010039
6PA 009 165-031	OZH 067	0824010073
6PA 009 165-041	OZH 074	0824010080
6PA 009 165-051	OZH 056	0824010061
6PA 009 165-061	OZH 033	0824010035
6PA 009 165-071	OZU 022	0824010094
6PA 009 165-081	OZH 035	0824010037
6PA 009 165-091	OZH 050	0824010052
6PA 009 165-101	OZH 036	0824010038
6PA 009 165-111	OZH 058	0824010063
6PA 009 165-131	OZH 031	0824010033
6PA 009 165-141	OZH 057	0824010062
6PA 009 165-151	OZH 043	0824010045
6PA 009 165-161	OZH 068	0824010074
6PA 009 165-171	OZH 029	0824010031
6PA 009 165-181	OZH 011	0824010012
6PA 009 165-191	OZH 009	0824010010
6PA 009 165-211	OZH 038	0824010040
6PA 009 165-221	OZH 069	0824010075
6PA 009 165-231	OZH 034	0824010036
6PA 009 165-241	OZH 047	0824010049
6PA 009 165-251	OZH 107	0824010139
6PA 009 165-261	OZH 021	0824010022
6PA 009 165-271	OZH 003	0824010004
6PA 009 165-281	OZH 024	0824010025
6PA 009 165-291	OZH 006	0824010007
6PA 009 165-301	OZU 010	0824010090
6PA 009 165-311	OZH 032	0824010034
6PA 009 165-331	OZU 003	0824010053
6PA 009 165-341	OZH 079	0824010089
6PA 009 165-351	OZH 019	0824010020
6PA 009 165-361	OZH 048	0824010050
6PA 009 165-371	OZH 070	0824010076
6PA 009 165-381	OZH 027	0824010028
6PA 009 165-391	OZU 012	0824010096
6PA 009 165-401	OZH 026	0824010027
6PA 009 165-411	OZH 104	0824010129

HELLA	BERU	
6PA 009 165-431	OZH 028	0824010030
6PA 009 165-441	OZH 064	0824010070
6PA 009 165-461	OZH 084	0824010099
6PA 009 165-471	OZH 083	0824010098
6PA 009 165-481	OZU 025	0824010143
6PA 009 165-491	OZH 039	0824010041
6PA 009 165-501	OZU 023	0824010136
6PA 009 165-511	OZH 044	0824010046
6PA 009 165-521	OZH 101	0824010125
6PA 009 165-531	OZH 012	0824010013
6PA 009 165-541	OZH 005	0824010006
6PA 009 165-551	OZH 022	0824010023
6PA 009 165-561	OZH 059	0824010065
6PA 009 165-571	OZH 014	0824010015
6PA 009 165-581	OZH 007	0824010008
6PA 009 165-591	OZH 030	0824010032
6PA 009 165-601	OZU 024	0824010133
6PA 009 165-611	OZH 072	0824010078
6PA 009 165-621	OZH 017	0824010018
6PA 009 165-631	OZU 004	0824010054
6PA 009 165-641	OZH 099	0824010121
6PA 009 165-651	OZH 053	0824010058
6PA 009 165-661	OZH 008	0824010009
6PA 009 165-671	OZH 108	0824010107
6PA 009 166-001	OZH 100	0824010124
6PA 009 166-011	OZH 041	0824010043
6PA 009 166-021	OZH 035	0824010037
6PA 009 166-031	OZH 086	0824010102
6PA 009 166-041	OZH 059	0824010065
6PA 009 166-051	OZH 004	0824010005
6PA 009 166-061	OZH 002	0824010003
6PA 009 166-071	OZU 021	0824010131
6PA 009 166-081	OZH 066	0824010072
6PA 009 166-091	OZH 075	0824010081
6PA 009 166-101	OZU 006	0824010064
6PA 009 166-111	OZH 055	0824010060
6PA 009 166-121	OZH 010	0824010011
6PA 009 166-131	OZH 001	0824010002
6PA 009 166-141	OZH 098	0824010120
6PA 009 166-151	OZH 088	0824010106
6PA 009 166-161	OZU 014	0824010104
6PA 009 166-171	OZH 052	0824010057
6PA 009 166-181	OZH 073	0824010079
6PA 009 166-191	OZH 076	0824010084
6PA 009 166-201	OZH 095	0824010117
6PA 009 166-211	OZH 094	0824010114
6PA 009 166-221	OZH 025	0824010026
6PA 009 166-231	OZH 016	0824010017
6PA 009 166-241	OZH 109	0824010127
6PA 009 166-251	OZH 054	0824010059
6PA 009 166-261	OZH 087	0824010105
6PA 009 166-271	OZH 103	0824010128
6PA 009 166-281	OZU 015	0824010111
6PA 009 166-291	OZH 065	0824010071
6PA 009 166-301	OZH 051	0824010056
6PA 009 166-311	OZH 020	0824010021
6PA 009 166-321	OZH 092	0824010112
6PA 009 166-331	OZH 096	0824010118
6PA 009 166-381	OZU 001	0824010001
6PA 009 166-391	OZU 007	0824010141
6PA 009 166-401	OZH 060	0824010066
6PA 009 166-411	OZH 006	0824010007
6PA 009165-321	OZH 071	0824010077
6PA 009165-421	OZH 046	0824010048
6PA 009165-451	OZH 023	0824010024

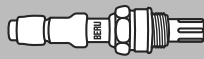

HELLA	BERU	
6PA 009166-361	OZH 049	0824010051

HONDA	BERU	
36531 P01 G01	OZU 001	0824010001
36531 P01 G02	OZU 001	0824010001
36531 P06 A01	OZU 001	0824010001
36531 P06 A02	OZU 001	0824010001
36531 P3Y G01	OZU 001	0824010001
36531 P3Y G02	OZU 001	0824010001
36531 PC7 664	OZU 001	0824010001
36531 PE7 662	OZU 001	0824010001
36531 PH2 024	OZU 001	0824010001
36531 PH4 661	OZU 001	0824010001
36531 PH4 662	OZU 001	0824010001
36531 PH7 003	OZU 001	0824010001
36531 PK 014	OZU 001	0824010001
36531 PL2 003	OZU 001	0824010001
36531 PL2 013	OZU 001	0824010001
36531 PM5 A01	OZU 001	0824010001
36531 PM8 305	OZU 001	0824010001
36531 PM8 A03	OZU 001	0824010001
36531 PWE01	OPH 031	0824010316
36531-P06-A11	OZH 017	0824010018
36531-P06-A12	OZH 006	0824010007
36531-P12-A02	OZH 010	0824010011
36531-P1K-E030-M2	OZH 123	0824010157
36531-P45-G012	OZH 120	0824010154
36531-P45-G02	OZH 120	0824010154
36531-P5S-G012	OZH 121	0824010155
36531-P8C-A01	OZH 028	0824010030
36531-P9K-E01	OZH 121	0824010155
36531-P9K-E011	OZH 121	0824010155
36531-P9L-E011	OZH 122	0824010156
36531-P9L-E02	OZH 122	0824010156
36531-P9L-E020-M2	OZH 122	0824010156
36531-PDA-E020-M2	OZH 121	0824010155
36531-PDE-E010-M2	OZH 121	0824010155
36531-PM8-A03	OZU 004	0824010054
36531-PT2-J04	OZH 009	0824010010
36531-PT2-J05	OZH 009	0824010010
36532 PWE01	OPH 032	0824010317
36532-P8C-A01	OZH 035	0824010037
36532-PDE-E010-M2	OZH 120	0824010154
36561-P2R-A01	OZH 006	0824010007
89706-22920	OZH 196	0824010230

HYUNDAI	BERU	
39210 22100	OZH 037	0824010039
39210 24550	OZU 001	0824010001
39210 32630	OZU 001	0824010001
39350 32510	OZU 001	0824010001

INTERMOTOR	BERU	
16300	OZU 001	0824010001
16301	OZU 001	0824010001
163011	OZH 040	0824010042
16302	OZH 040	0824010042
16303	OZH 037	0824010039
16304	OZH 037	0824010039
16305	OZH 037	0824010039
16306	OZH 037	0824010039
16308	OZH 039	0824010041
16309	OZH 029	0824010031

INTERMOTOR	BERU	
16310	OZH 005	0824010006
16312	OZH 034	0824010036
16313	OZH 037	0824010039
16314	OZH 003	0824010004
16315	OZH 020	0824010021
16316	OZH 046	0824010048
16317	OZH 033	0824010035
16318	OZH 035	0824010037
16319	OZH 057	0824010062
16320	OZH 038	0824010040
16322	OZH 045	0824010047
16324	OZH 045	0824010047
16329	OZU 005	0824010055
16340	OZH 040	0824010042
16341	OZH 059	0824010065
16342	OZH 023	0824010024
16343	OZH 022	0824010023
16344	OZH 036	0824010038
16345	OZH 031	0824010033
16346	OZH 045	0824010047

ISUZU	BERU	
8089907930	OZH 196	0824010230

IVECO	BERU	
59 63 516	OZU 022	0824010094
7555129	OZH 037	0824010039
7619303	OZH 037	0824010039
7619304	OZH 065	0824010071
7630332	OZH 046	0824010048
7640082	OZH 037	0824010039
76400820	OZH 037	0824010039
7654221	OZH 046	0824010048
7668286	OZH 035	0824010037
7674048	OZH 027	0824010028

JAGUAR	BERU	
AGU 1870	OZH 037	0824010039
DBC 10744	OZH 037	0824010039
DBC 4138	OZH 037	0824010039
DBC 6907	OZH 037	0824010039

KIA	BERU	
KK13518861	OZU 001	0824010001
OK 01118861	OZH 207	0824010241
OK9A 518861	OZH 204	0824010238

LANCIA	BERU	
44 302 91	OZU 022	0824010094
46 417 969	OZH 056	0824010061
46 418 813	OZH 088	0824010106
46 424 723	OZH 056	0824010061
46418 568	OZH 064	0824010070
46420612	OZH 035	0824010037
46423798	OZH 035	0824010037
46449401	OZH 064	0824010070
46452598	OZH 138	0824010172
46455802	OZH 064	0824010070

LANCIA	BERU	
60 812 162	OZH 052	0824010057
60537650	OZH 003	0824010004
60567759	OZH 046	0824010048
60583122	OZH 035	0824010037
60808457	OZH 046	0824010048
7 751 308	OZH 084	0824010099
7555123	OZH 037	0824010039
7555129	OZH 037	0824010039
7619304	OZH 065	0824010071
7640082	OZH 037	0824010039
7654221	OZH 046	0824010048
7674048	OZH 027	0824010028
77 859 73	OZH 052	0824010057
77 897 41	OZH 056	0824010061
7707638	OZH 037	0824010039
96138608	OZH 034	0824010036

LUCAS	BERU	
SEB 102	OZU 010	0824010090
SEB 128	OZH 044	0824010046
SEB 130	OZH 006	0824010007
SEB 132	OZH 040	0824010042
SEB 135	OZH 036	0824010038
SEB 136	OZH 039	0824010041
SEB 137	OZH 039	0824010041
SEB 138	OZH 047	0824010049

MAGNETI MARELLI	BERU	
460000124010	OZH 130	0824010164
460000146010	OZH 084	0824010099

MAZDA	BERU	
B3C7-18-861 A	OZH 095	0824010117
B601 18 861	OZU 001	0824010001
B61R 18 861 A	OZU 001	0824010001
B61Z 18 861 A	OZU 001	0824010001
B64N 18 861	OZU 001	0824010001
B64N-18-861	OZU 021	0824010131
B6B1 18 861	OZU 001	0824010001
B6B3 18 861 A	OZU 001	0824010001
B6DC-18-861 A	OZH 100	0824010124
BP03 18 861 B	OZU 001	0824010001
BP-03-18-861 B	OZU 012	0824010096
F201 18 861 A	OZU 001	0824010001
FEH1 18 861	OZU 001	0824010001
JE-08-18-861 B	OZH 022	0824010023
JE-46-18-86 Z	OZU 022	0824010094
JE49 18 861 A	OZH 163	0824010197
JE50-18-861 A	OZH 076	0824010084
K802 18 861 C	OZH 163	0824010197
N350 18 861	OZU 001	0824010001

MERCEDES-BENZ	BERU	
000 540 27 17	OZH 018	0824010019
000 540 29 17	OZH 044	0824010046
000 540 38 17	OZH 016	0824010017
000 540 39 17	OZH 041	0824010043
000 540 40 17	OZH 042	0824010044



MERCEDES-BENZ	BERU	
000 540 42 17	OZH 041	0824010043
000 540 49 17	OZH 198	0824010232
000 540 55 17	OZH 018	0824010019
000 540 56 17	OZH 018	0824010019
000 540 57 17	OZH 200	0824010234
000 540 59 17	OZH 023	0824010024
000 540 62 17	OZH 145	0824010179
000 540 64 17	OZH 021	0824010022
000 540 65 17	OZH 146	0824010180
000 540 81 17	OZH 143	0824010177
000 540 82 17	OZH 144	0824010178
000 540 85 17	OZH 023	0824010024
000 540 90 17	OZH 124	0824010158
000 540 92 17	OZH 025	0824010026
000 540 95 17	OZH 098	0824010120
001 540 04 17	OZH 098	0824010120
001 540 05 17	OPH 035	0824010320
001 540 06 17	OPH 037	0824010322
001 540 07 17	OPH 040	0824010325
001 540 10 17	OZH 211	0824010245
001 540 11 17	OZH 212	0824010246
001 540 12 17	OZH 213	0824010247
001 540 13 17	OZH 018	0824010019
001 540 28 17	OZH 220	0824010254
001 540 37 17	OPH 034	0824010319
001 540 47 17	OPH 038	0824010323
001 540 71 17	OPH 043	0824010328
001 540 72 17	OPH 048	0824010333
001 540 74 17	OPH 041	0824010326
001 540 75 17	OPH 047	0824010332
001 540 76 17	OPH 045	0824010330
001 540 80 17	OPH 042	0824010327
001 540 92 17	OPH 046	0824010331
002 540 06 17	OPH 039	0824010324
003 542 81 18	OZH 235	0824010269
004 542 07 18	OPH 087	0824010372
005 542 31 17	OZH 026	0824010027
007 542 32 17	OZH 142	0824010176
007 542 68 17	OZU 001	0824010001
008 542 91 17	OZH 026	0824010027
009 542 06 17	OZH 033	0824010035
009 542 41 17	OZH 007	0824010008
009 542 42 17	OZH 140	0824010174
009 542 86 17	OZH 141	0824010175
009 542 87 17	OZH 032	0824010034
009 542 90 17	OZH 026	0824010027
A 000 540 49 17	OZH 198	0824010232
A 000 540 57 17	OZH 200	0824010234
A 000 540 62 17	OZH 145	0824010179
A 000 540 65 17	OZH 146	0824010180
A 000 540 81 17	OZH 143	0824010177
A 000 540 82 17	OZH 144	0824010178
A 000 540 85 17	OZH 023	0824010024
A 001 540 05 17	OPH 035	0824010320
A 001 540 06 17	OPH 037	0824010322
A 001 540 07 17	OPH 040	0824010325
A 001 540 10 17	OZH 211	0824010245
A 001 540 11 17	OZH 212	0824010246
A 001 540 12 17	OZH 213	0824010247
A 001 540 28 17	OZH 220	0824010254
A 001 540 37 17	OPH 034	0824010319
A 001 540 47 17	OPH 038	0824010323
A 001 540 71 17	OPH 043	0824010328
A 001 540 72 17	OPH 048	0824010333
A 001 540 74 17	OPH 041	0824010326

MERCEDES-BENZ	BERU	
A 001 540 75 17	OPH 047	0824010332
A 001 540 76 17	OPH 045	0824010330
A 001 540 80 17	OPH 042	0824010327
A 001 540 92 17	OPH 046	0824010331
A 002 540 06 17	OPH 039	0824010324
A 003 542 81 18	OZH 235	0824010269
A 004 542 07 18	OPH 087	0824010372
A 007 542 32 17	OZH 142	0824010176
A 009 542 42 17	OZH 140	0824010174
A 009 542 86 17	OZH 141	0824010175

mitsubishi	BERU	
MD 073546	OZU 001	0824010001
MD 076706	OZU 001	0824010001
MD 078791	OZU 001	0824010001
MD 088616	OZU 001	0824010001
MD 089922	OZU 001	0824010001
MD 107793	OZU 001	0824010001
MD 108934	OZU 001	0824010001
MD 109613	OZU 001	0824010001
MD 110492	OZU 001	0824010001
MD 117240	OZU 001	0824010001
MD 119210	OZU 001	0824010001
MD 119609	OZU 001	0824010001
MD 127062	OZU 001	0824010001
MD 128262	OZU 001	0824010001
MD 149 888	OZU 003	0824010053
MD 149813	OZU 001	0824010001

NISSAN	BERU	
22690-06F00	OZU 010	0824010090
22690-06F00	OZU 022	0824010094
22690-07G00	OZU 022	0824010094
22690-07G00	OZU 024	0824010133
22690-0J000	OZH 203	0824010237
22690-17B00	OZU 010	0824010090
22690-19B10	OZU 010	0824010090
22690-1F701	OZH 228	0824010262
22690-3J410	OZH 201	0824010235
22690-40F00	OZU 010	0824010090
22690-4OU10	OZH 012	0824010013
22690-61A00	OZH 028	0824010030
22690-64Y12	OZU 001	0824010001
22690-69A01	OZH 028	0824010030
22690-73C00	OZU 001	0824010001
22690-73C00	OZH 011	0824010012
22690-76J00	OZH 011	0824010012
22690-81N00	OZU 024	0824010133
22690-8U300	OPH 090	0824010375
22690-95E00	OZU 001	0824010001
22690-99B00	OZH 011	0824010012
22690-9F601	OZH 225	0824010259
22690-F5300	OZU 010	0824010090
22690-J8000	OZU 001	0824010001
22690-J9200	OZU 001	0824010001
226A01-F701	OZH 229	0824010263
226A07-J503	OZH 227	0824010261
226A07-J601	OZH 226	0824010260
226A08-U300	OPH 089	0824010374

NTK	BERU	
0122	OZH 076	0824010084
0123	OZH 033	0824010035
0124	OZH 130	0824010164
0125	OZH 014	0824010015
0126	OZH 125	0824010159
0127	OZH 023	0824010024
0128	OZH 019	0824010020
0129	OZH 069	0824010075
0130	OZH 079	0824010089
0131	OZU 010	0824010090
0135	OZH 045	0824010047
0136	OZH 094	0824010114
0137/0299	OZH 123	0824010157
0138	OZH 004	0824010005
0139	OZH 006	0824010007
0141	OZH 064	0824010070
0142	OZU 024	0824010133
0143	OZU 012	0824010096
0145	OZH 083	0824010098
0146	OZH 084	0824010099
0147	OZH 058	0824010063
0148	OZH 122	0824010156
0149	OZH 036	0824010038
0150	OZH 009	0824010010
0151	OZH 086	0824010102
0153	OZU 004	0824010054
0154	OZU 014	0824010104
0155	OZH 011	0824010012
0156	OZH 087	0824010105
0157	OZH 088	0824010106
0158	OZH 108	0824010107
0159	OZH 121	0824010155
0160	OZH 016	0824010017
0161	OZH 043	0824010045
0162	OZH 037	0824010039
0166	OZU 015	0824010111
0167	OZH 092	0824010112
0169	OZH 120	0824010154
0171	OZH 021	0824010022
0172	OZH 022	0824010023
0173	OZH 094	0824010114
0177	OZH 095	0824010117
0178	OZH 096	0824010118
0180	OZH 121	0824010155
0182	OZH 098	0824010120
0183	OZH 099	0824010121
0184	OZH 074	0824010080
0188	OZH 100	0824010124
0189	OZH 101	0824010125
0190	OZH 045	0824010047
0191	OZH 109	0824010127
0193	OZH 019	0824010020
0194	OZH 103	0824010128
0195	OZH 104	0824010129
0198	OZU 021	0824010131
0199	OZH 059	0824010065
0201	OZH 034	0824010036
0204	OZH 017	0824010018
0205	OZH 022	0824010023
0206	OZH 025	0824010026
0209	OZH 036	0824010038
0212	OZH 122	0824010156
0213	OZH 056	0824010061
0215	OZH 010	0824010011
0216	OZH 023	0824010024



NTK			BERU			NTK			BERU			NTK			BERU		
0217	OZH 056	0824010061	0493	OZH 153	0824010187	OZA 448-E51	OZH 169	0824010203									
0218	OZH 035	0824010037	0494	OZH 152	0824010186	OZA 510-AU2	OZH 234	0824010268									
0220	OZH 038	0824010040	0498	OZH 053	0824010058	OZA 510-AU3	OZH 233	0824010267									
0226	OZH 131	0824010165	1777	OZH 023	0824010024	OZA 516-AU1	OZH 178	0824010212									
0227	OZH 124	0824010158	1778	OZH 128	0824010162	OZA 519-D1	OZH 176	0824010210									
0227	OZH 145	0824010179	1783	OZH 234	0824010268	OZA 531-GM1	OZH 236	0824010270									
0234	OZH 056	0824010061	1784	OZH 233	0824010267	OZA 534-V1	OZH 128	0824010162									
0237	OZH 010	0824010011	1801	OZH 038	0824010040	OZA 571-C10	OZH 235	0824010269									
0238	OZH 039	0824010041	1802	OZU 022	0824010094	OZA112-A1	OZH 084	0824010099									
0239	OZH 020	0824010021	1803	OZH 034	0824010036	OZA112-A3	OZH 088	0824010106									
0242	OZH 036	0824010038	1805	OZH 044	0824010046	OZA114-A1	OZH 049	0824010051									
0244	OZH 176	0824010210	1806	OZH 029	0824010031	OZA16-D2	OZH 059	0824010065									
0245	OZH 064	0824010070	1807	OZU 025	0824010143	OZA186-F5	OZH 100	0824010124									
0248	OZH 043	0824010045	1810	OZH 012	0824010013	OZA216-D2	OZH 045	0824010047									
0249	OZH 005	0824010006	1812	OZH 036	0824010038	OZA216-D3	OZH 014	0824010015									
0251	OZH 022	0824010023	1821	OZH 043	0824010045	OZA222-RV1	OZH 094	0824010114									
0252	OZH 036	0824010038	1822	OZU 003	0824010053	OZA236-R1	OZH 058	0824010063									
0253	OZH 055	0824010060	1823	OZH 035	0824010037	OZA236-R2	OZH 108	0824010107									
0254	OZH 043	0824010045	1826	OZH 051	0824010056	OZA245-H1	OZH 120	0824010154									
0255	OZH 121	0824010155	1827	OZH 033	0824010035	OZA245-H2	OZH 121	0824010155									
0258	OZH 027	0824010028	1828	OZU 004	0824010054	OZA253-F6	OZH 076	0824010084									
0259	OZH 070	0824010076	1830	OZH 059	0824010065	OZA25-F12	OZU 021	0824010131									
0260	OZH 020	0824010021	1832	OZH 055	0824010060	OZA277-R2	OZH 184	0824010218									
0263	OZH 041	0824010043	1833	OZH 037	0824010039	OZA311-R1	OZH 109	0824010127									
0264	OZH 039	0824010041	1834	OZH 053	0824010058	OZA333-H27	OZH 122	0824010156									
0265	OZH 029	0824010031	1836	OZH 235	0824010269	OZA333-H5	OZH 122	0824010156									
0269	OZH 027	0824010028	1837	OZH 026	0824010027	OZA334-A2	OZH 056	0824010061									
0270	OZH 127	0824010161	1838	OZH 046	0824010048	OZA334-A3	OZH 064	0824010070									
0271	OZH 020	0824010021	1839	OZH 039	0824010041	OZA334-D5	OZH 059	0824010065									
0273	OZH 039	0824010041	1843	OZH 041	0824010043	OZA33-D8	OZH 050	0824010052									
0274	OZH 005	0824010006	1848	OZH 047	0824010049	OZA401-E2	OZU 022	0824010094									
0277	OZH 120	0824010154	1849	OZH 030	0824010032	OZA401-E4	OZU 003	0824010053									
0280	OZH 066	0824010072	1850	OZH 031	0824010033	OZA401-E5	OZU 004	0824010054									
0281	OZH 128	0824010162	1854	OZH 042	0824010044	OZA401-E50	OZU 010	0824010090									
0282	OZH 092	0824010112	1855	OZH 037	0824010039	OZA401-E51	OZU 024	0824010133									
0283	OZH 043	0824010045	1856	OZH 049	0824010051	OZA401-E55	OZU 012	0824010096									
0284	OZH 057	0824010062	1859	OZH 046	0824010048	OZA401-E56	OZU 014	0824010104									
0285	OZH 021	0824010022	1860	OZH 048	0824010050	OZA401-E57	OZU 004	0824010054									
0287	OZH 056	0824010061	1861	OZH 040	0824010042	OZA401-E58	OZU 015	0824010111									
0288	OZH 121	0824010155	1862	OZH 236	0824010270	OZA401-E6	OZU 005	0824010055									
0291	OZH 003	0824010004	1865	OZH 045	0824010047	OZA428-E1	OZU 025	0824010143									
0293	OZH 045	0824010047	1866	OZH 028	0824010030	OZA445-E2	OZH 012	0824010013									
0295	OZH 030	0824010032	1867	OZH 050	0824010052	OZA445-E3	OZH 048	0824010050									
0296	OZH 064	0824010070	1872	OZH 032	0824010034	OZA445-E4	OZH 031	0824010033									
0298	OZH 074	0824010080	1876	OZH 056	0824010061	OZA445-E6	OZH 027	0824010028									
0402	OZH 179	0824010213	1877	OZH 037	0824010039	OZA445-E7	OZH 027	0824010028									
0404	OZH 148	0824010182	1878	OZH 058	0824010063	OZA446-E1	OZH 037	0824010039									
0415	OZH 184	0824010218	1882	OZU 005	0824010055	OZA446-E11	OZH 044	0824010046									
0416	OZH 173	0824010207	1883	OZH 179	0824010213	OZA446-E12	OZH 044	0824010046									
0423	OZH 022	0824010023	1887	OZH 052	0824010057	OZA446-E13	OZH 051	0824010056									
0424	OZH 182	0824010216	1888	OZH 036	0824010038	OZA446-E14	OZH 026	0824010027									
0426	OZH 169	0824010203	1889	OZU 006	0824010064	OZA446-E15	OZH 047	0824010049									
0427	OZH 173	0824010207	1890	OZH 059	0824010065	OZA446-E16	OZH 046	0824010048									
0430	OZH 094	0824010114	1891	OZH 232	0824010266	OZA446-E18	OZH 052	0824010057									
0434	OZH 104	0824010129	1893	OZH 054	0824010059	OZA446-E2	OZH 037	0824010039									
0438	OZH 168	0824010202	1894	OZH 057	0824010062	OZA446-E3	OZH 028	0824010030									
0445	OZH 079	0824010089	1898	OZH 044	0824010046	OZA446-E4	OZH 037	0824010039									
0452	OZH 178	0824010212	1899	OZH 039	0824010041	OZA446-E40	OZH 019	0824010020									
0455	OZH 043	0824010045	1909	OZH 228	0824010262	OZA446-E41	OZH 019	0824010020									
0459	OZH 144	0824010178	1950	OZH 181	0824010215	OZA446-E42	OZH 009	0824010010									
0463	OZH 042	0824010044	OZA 447-E 18	OZH 128	0824010162	OZA446-E43	OZH 103	0824010128									
0468	OZH 184	0824010218	OZA 447-E27	OZH 173	0824010207	OZA446-E44	OZH 037	0824010039									
0471	OZH 177	0824010211	OZA 447-E28	OZH 173	0824010207	OZA446-E45	OZH 011	0824010012									
0480	OZH 184	0824010218	OZA 447-E29	OZH 168	0824010202	OZA446-E46	OZH 006	0824010007									
0489	OZH 180	0824010214	OZA 447-E32	OZH 177	0824010211	OZA446-E48	OZH 066	0824010072									

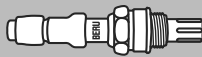

NTK	BERU	
OZA446-E49	OZH 003	0824010004
OZA446-E5	OZH 046	0824010048
OZA446-E50	OZH 017	0824010018
OZA446-E51	OZH 010	0824010011
OZA446-E53	OZH 010	0824010011
OZA446-E6	OZH 040	0824010042
OZA446-E7	OZH 032	0824010034
OZA446-E8	OZH 033	0824010035
OZA447-E1	OZH 036	0824010038
OZA447-E10	OZH 004	0824010005
OZA447-E11	OZH 036	0824010038
OZA447-E12	OZH 022	0824010023
OZA447-E13	OZH 099	0824010121
OZA447-E14	OZH 069	0824010075
OZA447-E16	OZH 070	0824010076
OZA447-E2	OZH 039	0824010041
OZA447-E20	OZH 022	0824010023
OZA447-E21	OZH 023	0824010024
OZA447-E23	OZH 039	0824010041
OZA447-E3	OZH 030	0824010032
OZA447-E35	OZH 153	0824010187
OZA447-E36	OZH 181	0824010215
OZA447-E4	OZH 036	0824010038
OZA447-E5	OZH 043	0824010045
OZA447-E7	OZH 043	0824010045
OZA447-E9	OZH 023	0824010024
OZA448-E1	OZH 029	0824010031
OZA448-E10	OZH 053	0824010058
OZA448-E11	OZH 041	0824010043
OZA448-E12	OZH 045	0824010047
OZA448-E13	OZH 054	0824010059
OZA448-E14	OZH 038	0824010040
OZA448-E16	OZH 039	0824010041
OZA448-E28	OZH 021	0824010022
OZA448-E29	OZH 098	0824010120
OZA448-E3	OZH 034	0824010036
OZA448-E30	OZH 043	0824010045
OZA448-E31	OZH 086	0824010102
OZA448-E32	OZH 074	0824010080
OZA448-E33	OZH 104	0824010129
OZA448-E34	OZH 079	0824010089
OZA448-E35	OZH 094	0824010114
OZA448-E36	OZH 064	0824010070
OZA448-E38	OZH 016	0824010017
OZA448-E4	OZH 035	0824010037
OZA448-E40	OZH 005	0824010006
OZA448-E41	OZH 020	0824010021
OZA448-E42	OZH 020	0824010021
OZA448-E43	OZH 092	0824010112
OZA448-E44	OZH 045	0824010047
OZA448-E45	OZH 025	0824010026
OZA448-E46	OZH 056	0824010061
OZA448-E48	OZH 020	0824010021
OZA448-E5	OZH 055	0824010060
OZA448-E50	OZH 184	0824010218
OZA448-E56	OZH 159	0824010193
OZA448-E58	OZH 228	0824010262
OZA448-E6	OZH 042	0824010044
OZA448-E7	OZH 056	0824010061
OZA448-E9	OZH 057	0824010062
OZA507-R2	OZH 184	0824010218
OZA510-V10	OZH 179	0824010213
OZA510-V2	OZH 179	0824010213
OZA510-V4	OZH 182	0824010216
OZA527-E10	OZH 041	0824010043

NTK	BERU	
OZA527-E12	OZH 038	0824010040
OZA527-E13	OZH 021	0824010022
OZA527-E14	OZH 043	0824010045
OZA527-E15	OZH 074	0824010080
OZA527-E16	OZH 104	0824010129
OZA527-E17	OZH 079	0824010089
OZA527-E18	OZH 094	0824010114
OZA527-E19	OZH 064	0824010070
OZA527-E2	OZH 029	0824010031
OZA527-E22	OZH 005	0824010006
OZA527-E24	OZH 056	0824010061
OZA527-E3	OZH 034	0824010036
OZA527-E4	OZH 035	0824010037
OZA527-E5	OZH 055	0824010060
OZA527-E6	OZH 042	0824010044
OZA527-E7	OZH 056	0824010061
OZA527-E8	OZH 057	0824010062
OZA527-E9	OZH 053	0824010058
OZA531-GM16	OZH 232	0824010266
OZA532-A2	OZH 180	0824010214
OZA55-R1	OZH 058	0824010063
OZA55-R2	OZH 033	0824010035
OZA55-R4	OZH 083	0824010098
OZA572-E1	OZH 043	0824010045
OZA572-E11	OZH 022	0824010023
OZA572-E12	OZH 039	0824010041
OZA572-E13	OZH 043	0824010045
OZA572-E2	OZH 036	0824010038
OZA572-E3	OZH 039	0824010041
OZA572-E4	OZH 030	0824010032
OZA572-E5	OZH 036	0824010038
OZA572-E6	OZH 023	0824010024
OZA572-E8	OZH 036	0824010038
OZA572-E9	OZH 022	0824010023
OZA65-A2	OZU 006	0824010064
OZA73-F1	OZH 095	0824010117
OZA83-R1	OZH 087	0824010105
OZA83-R2	OZH 092	0824010112
OZA83-R3	OZH 096	0824010118
OZA83-R4	OZH 101	0824010125
OZA89-D1	OZH 059	0824010065
OZA89-D2	OZH 045	0824010047

OPEL	BERU	
08 554 00	OZH 232	0824010266
0855360	OZH 112	0824010146
0855366	OZH 110	0824010144
0855375	OZH 132	0824010166
0855390	OZH 110	0824010144
10 096 129	OZH 033	0824010035
12 56 542 8	OZH 236	0824010270
23 36 121	OZH 028	0824010030
24 13 339 1	OZU 001	0824010001
24 411 440	OPH 083	0824010368
25 10 607 3	OZU 001	0824010001
25 106 073	OZU 005	0824010055
25 164 596	OZU 005	0824010055
25133607	OZU 023	0824010136
25163613	OZU 023	0824010136
8 55 300	OZH 040	0824010042
8 55 306	OZH 040	0824010042
8 55 321	OZU 023	0824010136
8 55 332	OZU 023	0824010136
8 55 358	OZH 115	0824010149

OPEL	BERU	
855 305	OZU 005	0824010055
855 315	OZU 005	0824010055
855 322	OZH 019	0824010020
855 323	OZH 019	0824010020
855 333	OZU 005	0824010055
855002	OZH 028	0824010030
855302	OZH 028	0824010030
855345	OZH 148	0824010182
855356	OZH 113	0824010147
855357	OZH 114	0824010148
90 009 053	OZH 040	0824010042
90 010 999	OZH 028	0824010030
90 019 999	OZH 028	0824010030
90 231 073	OZH 040	0824010042
90 234 326	OZH 028	0824010030
90 397 523	OZH 040	0824010042
90 397 524	OZH 028	0824010030
90 409 385	OZH 040	0824010042
90 409 521	OZH 028	0824010030
90 448 458	OZH 040	0824010042
90 499 265	OZH 019	0824010020
90 499 266	OZH 019	0824010020
90 499 267	OZH 019	0824010020
90 509 169	OZH 019	0824010020
90 509 274	OZH 019	0824010020
90 509 275	OZH 019	0824010020
90 510 147	OZH 040	0824010042
90 541 303	OZH 147	0824010181
90 541 304	OZH 147	0824010181
90 570 417	OZH 147	0824010181
91 142 813	OZH 028	0824010030
91 18 698	OZH 148	0824010182
91 20 293	OPH 088	0824010373
91 82 000	OPH 018	0824010303
91 92 922	OPH 078	0824010363
91 93 148	OPH 081	0824010366
91 93 654	OPH 079	0824010364
91 95 606	OPH 082	0824010367
91 99 469	OPH 080	0824010365
92 01 421	OPH 084	0824010369
97 062 292	OZH 196	0824010230

PEUGEOT	BERU	
1628 34	OZH 029	0824010031
1628 3W	OZH 072	0824010078
1628 58	OZU 001	0824010001
1628 6W	OZH 079	0824010089
1628 83	OZH 044	0824010046
1628 9T	OZH 159	0824010193
1628 9V	OZH 104	0824010129
1628 A4	OZH 066	0824010072
1628 CW	OPH 010	0824010295
1628 HQ	OPH 020	0824010305
1628 HT	OZH 104	0824010129
1628 J4	OZH 029	0824010031
1628 L4	OZH 005	0824010006
1628 L6	OZH 166	0824010200
1628 SW	OZH 184	0824010218
1628 V4	OZH 038	0824010040
16288 C	OZH 206	0824010240
16289 A	OZH 205	0824010239
91 540 672	OZH 066	0824010072
9151 797 880	OZU 001	0824010001



PEUGEOT	BERU	
9151 819 380	OZH 044	0824010046
9153 571 880	OZH 044	0824010046
95 494 924	OZU 001	0824010001
95 635 047	OZH 046	0824010048
96 027 244	OZH 029	0824010031
96 036 827	OZH 005	0824010006
96 039 269	OZH 166	0824010200
96 127 346	OZH 038	0824010040
96 127 817	OZH 038	0824010040
96 229 970	OZH 104	0824010129
96 229 971	OZH 079	0824010089
96 229 971 80	OZH 079	0824010089
96 229 974	OZH 046	0824010048
96 284 480	OZH 104	0824010129
96 284 480 80	OZH 104	0824010129
96 356 573	OZH 104	0824010129
961 38 599	OZH 034	0824010036
961 386 08	OZH 034	0824010036
96127346	OZH 072	0824010078
96211180	OZH 072	0824010078
9621118080	OZH 072	0824010078
96229969	OZH 074	0824010080

PONTIAC	BERU	
100 421 86	OZU 005	0824010055

PORSCHE	BERU	
911 606 123 00	OZU 001	0824010001
944 606 133 00	OZU 001	0824010001
987 606 124 00	OPH 077	0824010362
996 606 138 01	OPH 076	0824010361
996 606 168 01	OPH 012	0824010297

RENAULT	BERU	
60 01 009 534	OZH 044	0824010046
77 00 101 345	OZH 160	0824010194
77 00 105 557	OZH 208	0824010242
77 00 107 433	OPH 033	0824010318
77 00 107 434	OZH 184	0824010218
77 00 107 438	OZH 216	0824010250
77 00 108 027	OZH 184	0824010218
77 00 260 909	OZH 044	0824010046
77 00 266 922	OZH 044	0824010046
77 00 273 273	OZH 108	0824010107
77 00 273 715	OZH 125	0824010159
77 00 708 605	OZU 022	0824010094
77 00 708 955	OZU 010	0824010090
77 00 729 063	OZU 001	0824010001
77 00 729 963	OZU 001	0824010001
77 00 729 963	OZU 022	0824010094
77 00 746 375	OZH 033	0824010035
77 00 851 303	OZH 033	0824010035
77 00 854 136	OZU 022	0824010094
77 00 854 148	OZH 033	0824010035
77 00 854 506	OZH 058	0824010063
77 00 860 246	OZU 025	0824010143
77 00 862 426	OZH 033	0824010035
77 00 864 987	OZH 033	0824010035
77 00 869 034	OZU 001	0824010001

RENAULT	BERU	
77 00 870 318	OZH 058	0824010063
77 00 871 544	OZH 161	0824010195
77 00 872 820	OZH 109	0824010127
77 00 872 878	OZH 107	0824010139
7700 100 713	OZH 101	0824010125
7700 867 295	OZH 083	0824010098
7700 867 408	OZH 087	0824010105
7700 874 327	OZH 092	0824010112
7700 874 600	OZH 096	0824010118
89 33 002 455	OZU 001	0824010001

ROLLS-ROYCE	BERU	
UR 26474	OZU 001	0824010001
UT 10094	OZH 156	0824010190

ROVER	BERU	
MHK 000 940	OZH 219	0824010253
MHK 100 940	OZH 219	0824010253
MHK 10004	OZH 057	0824010062
MHK 10006	OZH 053	0824010058
MHK 10021	OZH 094	0824010114
MHK 10023	OZU 004	0824010054
MHK 10030	OZH 094	0824010114
MZY 10021	OZH 094	0824010114

SAAB	BERU	
41 64 323	OZH 157	0824010191
42 39 588	OZH 157	0824010191
42 39 596	OZH 154	0824010188
42 39 661	OZH 158	0824010192
43 01 305	OZH 158	0824010192
45 70 917	OPH 016	0824010301
45 71 477	OPH 021	0824010306
553 531 48	OPH 011	0824010296
553 531 49	OPH 015	0824010300
72 25 603	OZH 037	0824010039
72 25 751	OZH 037	0824010039
75 25 603	OZH 037	0824010039
75 25 751	OZH 037	0824010039
75 30 140	OZU 022	0824010094
75 34 795	OZU 001	0824010001
91 29 743	OZH 027	0824010028
91 32 564	OZH 157	0824010191
91 46 937	OZH 157	0824010191
91 46 945	OZH 158	0824010192
91 46 952	OZH 156	0824010190
93 17 751	OZU 022	0824010094
93 37 726	OZU 022	0824010094
93 92 762	OZH 046	0824010048

SCANIA	BERU	
30548563	OZH 156	0824010190

SEAT	BERU	
030 906 265 E	OZU 003	0824010053
030 906 265 J	OZH 031	0824010033
030 906 265 Q	OZH 012	0824010013
051 906 265 E	OZU 001	0824010001
051 906 265 E	OZU 003	0824010053

SKODA	BERU	
004 165 009	OZH 037	0824010039
030 906 265 E	OZU 003	0824010053
051 906 265 E	OZU 003	0824010053
441 04165-0196	OZH 043	0824010045
6UO 906 265 C	OZH 099	0824010121

SUBARU	BERU	
18213-60B00	OZU 005	0824010055
22690 AA 120	OZU 001	0824010001
22690 KA 020	OZU 001	0824010001
22690 KA 060	OZU 001	0824010001
22690 KA 081	OZU 001	0824010001
22690-KA-000	OZU 022	0824010094

SUZUKI	BERU	
18213 57B10	OZU 001	0824010001
18213 61A10	OZU 001	0824010001
18213 82010	OZU 001	0824010001
18213-58B20	OZH 047	0824010049
18213-60B00	OZU 005	0824010055
18213-61 A10	OZU 014	0824010104
18213-64B00	OZU 005	0824010055
19213-64 B00	OZU 015	0824010111

TALBOT	BERU	
96 027 244	OZH 029	0824010031
96 138 608	OZH 034	0824010036

TOYOTA	BERU	
894 65 19 366	OZH 103	0824010128
89465 87707	OZU 001	0824010001
89465-19295	OZH 069	0824010075
89465-39355	OZH 010	0824010011
89465-69115	OZH 033	0824010035
89465-69125	OZH 033	0824010035

VOLVO	BERU	
1271998	OZH 073	0824010079
1274367	OZU 001	0824010001
1274746	OZU 001	0824010001
1275610	OZH 210	0824010244
1276951	OZU 001	0824010001
1326578	OZH 044	0824010046
1346738	OZH 037	0824010039
1346962	OZH 037	0824010039
1378123	OZH 003	0824010004
30637837	OPH 014	0824010299
30814907	OZH 130	0824010164
3342945	OZH 037	0824010039
3462685	OZH 003	0824010004
3474457	OZH 003	0824010004
3501753	OZH 003	0824010004
3517778	OZH 027	0824010028
3531075	OZH 035	0824010037
3531400	OZH 037	0824010039
462 685	OZH 003	0824010004
8 677 894	OPH 019	0824010304



VOLVO	BERU	
9125371	OZH 209	0824010243
9135794	OZH 155	0824010189
9458187	OPH 022	0824010307
9470011	OPH 017	0824010302
9497345	OPH 013	0824010298

VW AG	BERU	
021 906 265 AA	OZH 153	0824010187
021 906 265 AC	OZH 181	0824010215
021 906 265 AD	OZH 151	0824010185
021 906 265 AE	OZH 153	0824010187
021 906 265 AG	OZH 152	0824010186
021 906 265 AK	OZH 150	0824010184
021 906 265 AQ	OZH 153	0824010187
021 906 265 AR	OZH 151	0824010185
021 906 265 B	OZH 043	0824010045
021 906 265 M	OZH 165	0824010199
021 906 265 R	OZH 022	0824010023
021 906 265 S	OZH 165	0824010199
021 906 265 T	OZH 151	0824010185
021 906 265C	OZH 165	0824010199
022 906 262 BG	OPH 063	0824010348
022 906 262 BH	OPH 053	0824010338
022 906 262 F	OPH 062	0824010347
022 906 262 S	OPH 067	0824010352
022 906 265 B	OPH 055	0824010340
022 906 265 C	OPH 064	0824010349
023 906 205 H	OZH 010	0824010011
023 906 265 A	OZH 134	0824010168
025 906 265	OZU 001	0824010001
025 906 265 B	OZH 037	0824010039
025 906 265 M	OZH 043	0824010045
030 906 262	OPH 073	0824010358
030 906 262 D	OPH 065	0824010350
030 906 262 F	OZH 179	0824010213
030 906 265	OZH 047	0824010049
030 906 265 AA	OZH 009	0824010010
030 906 265 AB	OZH 012	0824010013
030 906 265 AC	OZH 024	0824010025
030 906 265 AD	OZH 070	0824010076
030 906 265 AE	OZH 071	0824010077
030 906 265 AN	OZH 028	0824010030
030 906 265 AP	OZH 022	0824010023
030 906 265 B	OZH 047	0824010049
030 906 265 BD	OZH 022	0824010023
030 906 265 BG	OZH 151	0824010185
030 906 265 BH	OZH 086	0824010102
030 906 265 BM	OZH 151	0824010185
030 906 265 BR	OZH 151	0824010185
030 906 265 BT	OZH 177	0824010211
030 906 265 C	OZH 048	0824010050
030 906 265 CB	OZH 169	0824010203
030 906 265 G	OZH 010	0824010011
030 906 265 J	OZH 031	0824010033
030 906 265 K	OZH 009	0824010010
030 906 265 M	OZH 008	0824010009
030 906 265 N	OZH 008	0824010009
030 906 265 N	OZH 043	0824010045
030 906 265 P	OZH 009	0824010010
030 906 265 Q	OZH 012	0824010013
030 906 265 T	OZH 043	0824010045
032 906 265	OZH 068	0824010074

VW AG	BERU	
032 906 265 C	OZH 215	0824010249
032 906 265 D	OZH 215	0824010249
034 906 265	OZH 037	0824010039
034 906 265 A	OZH 037	0824010039
034 906 265 C	OZH 037	0824010039
034 906 265 D	OZH 003	0824010004
034 906 265 E	OZH 044	0824010046
034 906 265 F	OZH 046	0824010048
035 133 533 A	OZU 022	0824010094
035 906 265	OZU 022	0824010094
035 906 265 B	OZU 022	0824010094
035 906 265 C	OZU 001	0824010001
035 906 265 D	OZH 037	0824010039
036 906 262 F	OZH 182	0824010216
037 906 265	OZH 009	0824010010
037 906 265 AA	OZH 164	0824010198
037 906 265 AB	OZH 151	0824010185
037 906 265 C	OZH 009	0824010010
037 906 265 E	OZH 131	0824010165
037 906 265 F	OZH 010	0824010011
037 906 265 G	OZH 010	0824010011
037 906 265 J	OZH 024	0824010025
03D 906 265 B	OZH 128	0824010162
048 906 265	OZH 044	0824010046
048 906 265 A	OZH 044	0824010046
048 906 265 B	OZH 017	0824010018
050 906 265	OZU 001	0824010001
051 906 265 C	OZU 001	0824010001
051 906 265 D	OZH 027	0824010028
051 906 265 E	OZU 001	0824010001
051 906 265 E	OZU 003	0824010053
053 906 265	OZH 027	0824010028
058 906 265	OPH 006	0824010291
058 906 265 A	OZH 069	0824010075
058 906 265 C	OPH 052	0824010337
06A 906 262 AC	OPH 069	0824010354
06A 906 262 AH	OPH 051	0824010336
06A 906 262 AK	OPH 070	0824010355
06A 906 262 AL	OPH 057	0824010342
06A 906 262 AM	OPH 094	0824010379
06A 906 262 AQ	OPH 071	0824010356
06A 906 262 AR	OPH 050	0824010335
06A 906 262 BA	OPH 056	0824010341
06A 906 262 BB	OPH 066	0824010351
06A 906 262 BG	OPH 075	0824010360
06A 906 262 C	OPH 061	0824010346
06A 906 262 F	OPH 049	0824010334
06A 906 265 E	OZH 127	0824010161
06A 906 265 E	OZH 169	0824010203
06A 906 265 F	OZH 177	0824010211
06A 906 265 H	OZH 128	0824010162
06A 906 265 M	OPH 068	0824010353
06B 906 265 A	OZH 190	0824010224
06C 906 265 A	OPH 091	0824010376
06F 906 262 P	OPH 085	0824010370
077 906 262 B	OPH 058	0824010343
077 906 265	OZH 037	0824010039
077 906 265 A	OZH 037	0824010039
077 906 265 AA	OPH 009	0824010294
077 906 265 AD	OPH 054	0824010339
077 906 265 AF	OPH 005	0824010290
077 906 265 B	OZH 027	0824010028
077 906 265 D	OZH 019	0824010020
077 906 265 D	OZH 151	0824010185
077 906 265 F	OZH 139	0824010173

VW AG	BERU	
077 906 265 J	OPH 003	0824010288
077 906 265 K	OPH 024	0824010309
077 906 265 R	OPH 007	0824010292
078 906 265	OZH 017	0824010018
078 906 265 A	OZH 017	0824010018
078 906 265 AA	OPH 092	0824010377
078 906 265 B	OZH 017	0824010018
078 906 265 D	OZH 103	0824010128
078 906 265 L	OZH 151	0824010185
078 906 265 M	OPH 004	0824010289
078 906 265 N	OPH 008	0824010293
078 906 265 P	OPH 023	0824010308
078 906 265 T	OPH 059	0824010344
07C 906 262 AE	OPH 072	0824010357
07C 906 262 AF	OPH 060	0824010345
07C 906 262 P	OPH 093	0824010378
2DO 906 265	OZH 146	0824010180
6KO 906 265 A	OZH 151	0824010185
6UO 906 265 C	OZH 099	0824010121
O6E 906 265 D	OZH 234	0824010268
O6E 906 265 E	OZH 233	0824010267
X03 961 005	OZH 037	0824010039

WALKER	BERU	
250-2101	OZU 001	0824010001
250-2102	OZU 001	0824010001
250-2103	OZU 001	0824010001
250-2104	OZU 001	0824010001
250-2107	OZU 001	0824010001
250-2111	OZU 001	0824010001
250-2113	OZU 001	0824010001
250-2115	OZU 001	0824010001
250-2117	OZU 001	0824010001
250-2118	OZU 001	0824010001
250-2121	OZU 001	0824010001
250-2122	OZU 001	0824010001
250-2123	OZU 001	0824010001
250-2124	OZU 001	0824010001
250-2127	OZU 001	0824010001
250-2201	OZU 001	0824010001
250-2202	OZU 001	0824010001
250-2205	OZU 001	0824010001
250-2208	OZU 001	0824010001
250-2255	OZU 001	0824010001
250-2301	OZH 037	0824010039
250-2305	OZH 033	0824010035
250-2312	OZH 010	0824010011
250-2313	OZH 010	0824010011
250-2314	OZH 009	0824010010
250-2315	OZH 001	0824010002
250-2319	OZH 046	0824010048
250-2321	OZH 046	0824010048
250-2323	OZH 009	0824010010
250-2328	OZH 037	0824010039
250-2332	OZH 043	0824010045
250-2333	OZH 037	0824010039
250-2336	OZH 051	0824010056
250-2337	OZH 026	0824010027
250-2348	OZH 003	0824010004
250-2366	OZH 032	0824010034
250-2415	OZH 045	0824010047
250-2421	OZH 002	0824010003
250-2424	OZH 039	0824010041
250-2430	OZH 005	0824010006



WALKER	BERU	
250-2434	OZH 016	0824010017
250-2435	OZH 036	0824010038
250-2439	OZH 018	0824010019
250-2441	OZH 035	0824010037
250-2466	OZH 043	0824010045
250-2502	OZH 028	0824010030
250-2605	OZH 036	0824010038
250-2607	OZH 036	0824010038
250-2609	OZH 023	0824010024
250-2610	OZH 023	0824010024
250-2611	OZH 023	0824010024
250-8005	OZH 057	0824010062

BorgWarner BERU Systems Produktgewährleistung

Die in diesem Katalog aufgeführten Produkte können in allen Fahrzeugen/Motoren entsprechend unserer Empfehlung verwendet werden. Erkennbarer Irrtum oder offensichtliche Druckfehler unterliegen der Sorgfaltspflicht des Verwenders. Für die Fehlerfreiheit leistet BERU Gewähr entsprechend dem jeweiligen Stand der Technik. Werden BERU Produkte gemäß unseren Empfehlungen verwendet und entstehen hierdurch trotzdem nachweisbare Schäden am Motor, übernehmen wir ganz oder teilweise die entstandenen Kosten für die Behebung des Schadens. Nach Vorlage beanstandeter BERU Produkte, beschädigter Motorenteile und Reparaturbelege trifft BERU die Entscheidung über eine Kostenübernahme. Grundvoraussetzung dafür ist generell die sachgemäße Handhabung der BERU Produkte.

Die Gewährleistungsfrist für mangelhafte Produkte beträgt 24 Monate auf Grundlage unserer allgemeinen Geschäftsbedingungen. Ausgenommen davon ist normaler Verschleiß.

BorgWarner BERU Systems Product Guarantee

The products listed in this catalog can be used in all vehicles/engines in accordance with our recommendation. Recognisable mistakes or obvious printing errors are subject to the diligence of the user. BERU guarantees the faultless performance and specified properties according to the current standards of technology. If BERU products which are used in accordance with our recommendations are proven to have caused damage to an engine, we will cover, in full or in part, the resulting costs of rectifying the damage. Following submission of BERU products claimed to be defective as well as damaged engine parts and repair bills, we reserve the right to examine the claims and to decide based on the outcome of our analysis whether or not reimbursements will be made. Generally prerequisite is the correct use of the BERU products.

The warranty period for material flaws or faulty workmanship is 24 months based on our General Terms and Conditions. Normal wear is excluded.

Garantie produit BorgWarner BERU Systems

Les produits figurant dans ce catalogue peuvent être utilisés dans tous les véhicules/moteurs selon nos recommandations. Les erreurs reconnaissables ou les erreurs d'impression évidentes tombent sous l'obligation d'attention de l'utilisateur. BERU garantit l'absence d'erreurs et les propriétés annoncées sur la base de l'état actuel de la technique. Lorsque les produits BERU sont utilisés conformément à nos recommandations et que, suite à cela, le moteur subit malgré tout des dommages pouvant être prouvés, nous supportons en totalité ou en partie les coûts engendrés pour éliminer ces dommages. Après présentation des produits BERU faisant l'objet d'une réclamation, des pièces de moteur endommagées et des factures de réparation, BERU prend la décision concernant la prise en charge des coûts. La condition préalable fondamentale pour cela est en général l'utilisation conforme des produits BERU.

La période de garantie de nos produits est de 24 mois sur la base de nos conditions générales de vente. L'usure normale en est exclue.

BorgWarner BERU Systems productgarantie

De in deze catalogus vermelde producten kunnen in alle voertuigen/motoren volgens onze aanbeveling worden gebruikt. Duidelijk zichtbare vergissingen of duidelijke drukfouten vallen onder de verantwoordelijkheid van de gebruiker. Voor het correct functioneren staat BERU garant in overeenstemming met de stand van de techniek op dat moment. Als BERU-producten volgens onze aanbevelingen gebruikt worden en er ontstaat desondanks schade aan de motor, dan nemen wij geheel of gedeeltelijk de ontstane kosten voor het verhelpen van de schade op ons. Na het voorleggen van de bekrusteerde BERU producten, de beschadigde motoronderdelen en reparatiebonnen neemt BERU het besluit over overname van de kosten. Een eerste vereiste daarvoor is in het algemeen het deskundige gebruik van de BERU producten.

De garantietermijn voor defecte producten bedraagt 24 maanden op basis van onze algemene voorwaarden. Uitgezonderd daarvan is normale slijtage.

Garantía de producto BorgWarner BERU Systems

Los productos incluidos en este catálogo pueden utilizarse en todos los vehículos/motores conforme a nuestras recomendaciones. Los errores reconocibles o las faltas de imprenta evidentes están sometidas a la obligación de examen esmerado del usuario. Respecto a la ausencia de fallos ofrece BERU garantía en correspondencia con el respectivo estado de la técnica. Si se emplean los productos BERU conforme a nuestras recomendaciones y surgen sin embargo daños demostrables en el motor, nuestra empresa asume total o parcialmente los costes producidos para la eliminación del daño. Tras la presentación de productos BERU reclamados, piezas del motor dañadas y comprobantes de reparación, BERU toma la decisión sobre una adopción de los costes. Condición básica para ello es por norma general el tratamiento técnicamente correcto de los productos BERU. El plazo de garantía sobre productos defectuosos asciende a 24 meses en base a nuestras condiciones comerciales generales. Se exceptúa de ello el desgaste normal.

Garanzia di prodotto BorgWarner BERU Systems

I prodotti contenuti nel presente catalogo possono essere utilizzati in tutti i veicoli/motori secondo le nostre raccomandazioni. La BERU non risponde per errori di contenuto o di stampa palesi, il cui riconoscimento cade sotto l'obbligo di diligenza dell'utilizzatore. La BERU risponde per l'integrità assicurata nell'ambito dello stato odierno della tecnica. Se è possibile comprovare che il motore ha subito danni nonostante che i prodotti BERU siano stati usati rispettando le nostre raccomandazioni, ci prendiamo carico parzialmente o totalmente delle spese causate per la riparazione del danno. La BERU decide sul risarcimento dei danni

dietro presentazione dei prodotti BERU reclamati, dei componenti del motore danneggiati e delle relative fatture, a condizione che i prodotti BERU siano stati manipolati correttamente. Come dalle nostre condizioni generali di contratto, la garanzia per prodotti difettosi è di 24 mesi, a eccezione dei difetti causati da normale usura.

Гарантия на продукцию BorgWarner BERU Systems

Указанные в данном каталоге изделия могут использоваться во всех транспортных средствах/двигателях согласно нашим рекомендациям. Однако сюда не входит обычный износ, неправильное применение, неправильное обслуживание или установка и т. п. BERU гарантирует, что свечи зажигания, свечи накаливания и принадлежности, указанные в данном каталоге, могут применяться в двигателях в соответствии с нашими рекомендациями. Мы не несем ответственности за явные недоразумения и опечатки, их обнаружение входит в обязанности пользователя. Если изделия BERU применяются в соответствии с нашими рекомендациями и несмотря на это происходит повреждение двигателя, которое может быть подтверждено, после представления изделий BERU, по которым заявляется рекламация, а также поврежденных частей двигателя и документов, подтверждающих выполнение ремонта, компания BERU примет решение о том, должна ли она и в каком объеме отвечать за возникшее повреждение, и полностью или частично возьмет на себя расходы по устранению повреждения. Однако и здесь принципиальным условием является правильное применение изделий BERU.

Gwarancja na produkty BorgWarner BERU Systems

Wymienione w niniejszym katalogu produkty mogą być stosowane we wszystkich pojazdach/silnikach zgodnie z naszymi zaleceniami. W ramach obowiązku staranności użytkownika leży wykluczenie zdarzeń/pomyłek lub widocznych błędów w druku. Firma BERU udziela gwarancji na bezusterkowość oraz deklarowane właściwości produktów, zgodnie z aktualnym stanem techniki. Jeżeli produkty BERU będą stosowane zgodnie z naszymi zaleceniami i pomimo tego dojdzie do dających się udowodnić uszkodzeń silnika, wówczas przejmujemy w całości lub częściowo koszty związane z usunięciem tych szkód. Firma BERU podejmie decyzję o pokryciu kosztów po przedłożeniu reklamowanych produktów BERU, uszkodzonych części silnika oraz rachunków za przeprowadzone naprawy. Podstawowym tego warunkiem jest prawidłowe posługiwanie się produktami BERU.

Okres gwarancji na wadliwe wyroby wynosi 24 miesiące zgodnie z naszymi ogólnymi warunkami handlowymi. Gwarancja nie obejmuje normalnego zużycia się części na skutek eksploatacji.

Εγγύηση προϊόντων BorgWarner BERU Systems

Τα προϊόντα, τα οποία αναφέρονται στον κατάλογο αυτό, μπορούν να χρησιμοποιηθούν σε όλα τα οχήματα/κινητήρες σύμφωνα με τη σύστασή μας. Η ευδιάκριτη πλάνη ή τα προφανή τυπογραφικά λάθη υπόκεινται στην υποχρέωση καταβολής επιμέλειας του χρήστη. Για τη λειτουργία χωρίς βλάβες η εταιρία BERU παρέχει εγγύηση σύμφωνα με την εκάστοτε εξέλιξη της τεχνολογίας. Σε περίπτωση που προκληθούν αποδεδειγμένες βλάβες στον κινητήρα, παρά το γεγονός ότι η χρήση των προϊόντων BERU έγινε σύμφωνα με τις συστάσεις μας, αναλαμβάνουμε εξ ολοκλήρου ή εν μέρει τα έξοδα για την αποκατάσταση της βλάβης. Κατόπιν επιδείξεως των ελαττωματικών προϊόντων BERU, των εξαρτημάτων κινητήρα με εμφανή βλάβη και των αποδεικτικών επισκευής, η εταιρία BERU αποφασίζει για την ανάληψη των εξόδων. Βασική προϋπόθεση για την ανάληψη των εξόδων είναι ο κανονικός χειρισμός των προϊόντων BERU.

Η προθεσμία παροχής εγγύησης για ελαττωματικά προϊόντα ανέρχεται σε 24 μήνες σύμφωνα με τους γενικούς όρους συναλλαγών μας. Από την περίπτωση αυτή αποκλείονται οι φυσιολογικές φθορές.

BorgWarner BERU Systems termékjótállás

Az ebben a katalógusban felsorolt termékek minden általunk javasolt járműben/motorban használhatóak. Felismerető tévedések vagy nyilvánvaló nyomdahibák esetén a felhasználók gondossági kötelezettsége érvényesül. A hibamentességért és a biztosított tulajdonságokért a BERU a technika mindenkor állásának megfelelően jótáll. Ha a BERU termékeit az ajánlásunknak megfelelően alkalmazzák és ezáltal a motoron ennek ellenére bizonyítható meghibásodások lépnek fel, akkor teljes mértékben vagy részben átvesszük a hibák elhárításának a költségeit. Kifogásolt BERU termékek, vagy meghibásodott motorrészek és javítás nyugták felmutatása után a BERU dönt a költségkét átvállalásáról. Ennek alapvető feltétele mindig a BERU termékek szakszerű használata.

A hibás termékek miatti jótállási idő 24 hónap cégünk általános üzleti feltételei alapján. Kivételt képez ez alól a természetes elhasználódás.

BorgWarner BERU Systems Ürün Garantisi

Bu katalogda belirtilen ürünler, yaptığımız öneriye göre tüm araçlar/motorlarda kullanılabilir. Belirlenebilen hatalar veya açık baskı hataları, kullanıcının özenli davranma yükümlülüğüne tâbidir. BERU, hatasızlık konusunda mevcut teknolojik düzeyi uygun olarak garanti vermektedir. BERU ürünleri önerilerimize göre kullanılırsa ve buna rağmen motorda ispatlanabilen hasarlar oluşursa, hasarın giderilmesi için oluşan masrafları tamamen veya kısmen üstlenmekteyiz. Şikâyet konusu BERU ürünlerinin, hasarlı motor parçalarının ve onarım belgelerinin belgenmesinden sonra, BERU, masrafları üstlenme konusunda kararını verir. Bunun önkoşulu, genel olarak BERU ürünlerinin usulüne uygun şekilde kullanılmasıdır. Kusurlu ürünler için garanti süresi, genel çalışma koşullarımız temelinde 24 aydır. Normal aşınma bunun dışındadır.

Printed in Germany · 4.03.12 · Bestell-Nr. 5 824 001 004
BERU® is a Registered Trademark of BorgWarner BERU Systems GmbH
CATBU1201



Global Aftermarket EMEA bvba
Prins Boudewijnlaan 5
2550 Kontich • Belgium

www.federalmogul.com
www.beru.com

 www.fmecat.eu

Perfection
built in

