



Zündkerzen/Glühkerzen

Spark plugs/Glow plugs

Bougies d'allumage

Bougies de préchauffage

Bougies/Gloeibougies

Bujías de encendido

Bujías de calentamiento

Candele d'accensione

Candele di preriscaldamento

Свечи зажигания

Свечи накаливания

Świece zapłonowe

Świece żarowe

Μπουζι

Προθερμαντήρες

Gyújtógyertya

Izzítógyertya

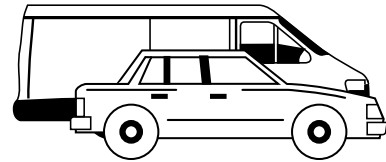

25

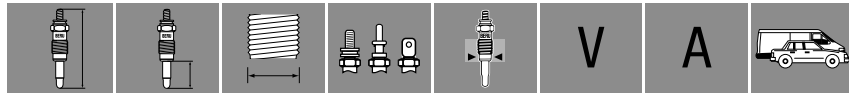

280

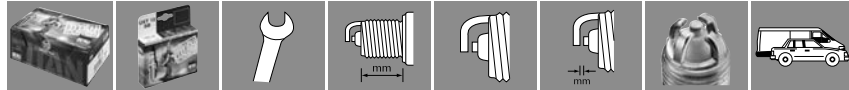

369

Ersatztypen

Cross reference list  
Tipos de recambio  
Typy zastępcze

Types de remplacement  
Tipi di sostituzione  
Τύποι ανταλλακτικών

Lijst reserveonderdelen  
Запасные типы  
Cseréltípusok

447

?



454

D



GB

USA

F

NL

E

I

RUS

PL

GR

H

510

Verkaufssysteme

Sales systems  
Sistemas de venta  
systemy sprzedaży

Systèmes de vente  
Sistemi di vendita  
Συστήματα πωλήσεων

Verkoopsystemen  
ситемсы продажы  
eladási rendszerek

520

**Ausgabe 06/13**

Mit Erscheinen dieser Ausgabe werden alle seitherigen Ausgaben ungültig.

With the publication of this issue, all previous issues become invalid.

Cette nouvelle édition rend caduques les éditions précédentes

Met het verschijnen van deze uitgave worden alle voorgaande uitgaven ongeldig

Con la publicación de esta edición pierden su validez todas las ediciones publicadas hasta ahora

Con la comparsa della presente edizione tutte le edizioni precedenti non sono più valide.

С опубликованием данного издания все предыдущие издания теряют силу.

Wraz z ukazaniem się niniejszego wydania wszystkie poprzednie tracą ważność.

Με την κυκλοφορία της παρούσας έκδοσης ακυρώνονται όλες οι προηγούμενες εκδόσεις.

Ennek a kiadásnak a megjelenésé val az összes korábban közölt adat elveszíti érvényességét.

				Nm	Nm	Nm max.	Nm max.		
<b>CGP 001</b> 0 106 671 105	134	29	M 10 × 1	10	15	4 mm	–	BMW	308
<b>GE 109</b> 0 100 266 059	136,5	28	M 10 × 1,25	12	15	M 4	2	Chevrolet, GMC	310
<b>GE 116</b> 0 100 266 042	130	28	M 10 × 1,0	10	15	M 4	2	Mercedes (USA)	311
<b>GE 118</b> 0 100 266 037	134	29	M 10 × 1,0	10	20	4 mm	–	Mini	311
<b>GE 119</b> 0 100 266 065	94	26	M 10 × 1,0	10	15	4 mm	–	AUDI/VW	311
<b>GE 120</b> 0 100 266 066	156	26	M 10 × 1,25	10	15	4 mm	–	Ssangyong	311
<b>GH 306</b> 0 102 174 306	71,5	39,5	M 18 × 1,5	22	20	4 mm	–	ARDIC	313
<b>GN 067</b> 0 100 226 569	81	20	M 10 × 1,25	12	15	M 4	2	Mitsubishi	321
<b>GN 068</b> 0 100 226 570	170	36,6	M 10 × 1,25	12	15	M 4	2	Toyota	321
<b>GN 069</b> 0 100 276 031	156,5	35	M 9 × 1,0	9	12	4 mm	–	Alfa Romeo	321
<b>GN 070</b> 0 100 800 033	170	35	M 10 × 1,25	12	15	M 4	2	Mitsubishi	321
<b>GN 071</b> 0 100 800 034	118,5	23	3/8"–24 UNF	3/8"	18	SAE	–	Caterpillar	321
<b>GN 072</b> 0 100 800 035	213	23	M 10 × 1,25	12	15	M 4	2	Nissan	321
<b>GN 073</b> 0 100 800 036	161	31	M 10 × 1,25	12	15	4 mm	–	Honda	321
<b>GN 074</b> 0 100 800 037	135,5	24	M 12 × 1,25	12	22	M 4	2	Isuzu	321
<b>GN 075</b> 0 100 800 038	87	21,5	M 10 × 1,25	12	18	M 4	2	Nissan	322
<b>GN 076</b> 0 100 800 039	77	20	M 12 × 1,25	12	22	M 4	2	Mitsubishi	322
<b>GN 077</b> 0 100 800 040	88,4	25	M 10 × 1,25	12	18	M 4	2	Isuzu	322
<b>GN 078</b> 0 100 800 041	134	30	M 10 × 1,25	12	18	M 4	2	Mitsubishi	322
<b>GN 080</b> 0 100 800 043	70,4	16	M 10 × 1,25	12	18	M 4	2	Kubota	322
<b>GN 081</b> 0 100 800 044	72,9	24	M 10 × 1,25	12	18	M 4	2	Kubota	322
<b>GN 082</b> 0 100 800 045	68	19	M 8 × 1,0	10	10	M 4	2	Kubota	322
<b>GN 095</b> 0 100 226 577	151,5	36	M 10 × 1,25	12	15	M 4	2	Isuzu	322





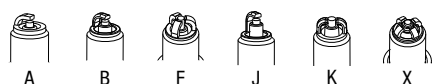

<sup>22</sup> Monoblock/SAE-Mutter nicht  
abschraubbar

					Nm		Nm max.		
<b>GN 096</b> 0 100 226 638	160	28	M 10 × 1,25	10	15	M 4	2	Toyota	322
<b>GN 097</b> 0 100 226 639	108	30	M 10 × 1,0	10	12	4 mm	–	Fiat, Opel	322
<b>PSG 001</b> 0 103 010 903	196,5	35	M 9 × 1,0	12	12	–	–	Opel	338
<b>PSG 002</b> 0 103 111 104	165	28	M 10 × 1,0	12	15	–	–	Audi, VW AG	338
<b>PSG 003</b> 0 103 110 904	149	28	M 9 × 1,0	12	12	–	–	Opel	338
<b>PSG 004</b> 0 103 010 104	168	24	M 10 × 1,25	12	15	–	–	Opel	338

<b>10 FR-7 KDUS<sup>22</sup></b>	<b>Z 341</b> 0 002 135 700	16	19	K	0,7	Alfa Romeo	411
<b>12 F-6 HPURW<sup>22</sup></b>	<b>Z 306</b> 0 001 240 901	16	19	J	0,9	VW AG	428
<b>12 FR-5 SDU<sup>22</sup></b>	<b>Z 286</b> 0 002 245 703	16	26,5	K	0,6	Smart	411
<b>12 VR-7 SPUX</b>	<b>Z 325</b> 0 002 235 905	14	26,5	B	1,1	Nissan	428
<b>12 ZR-6 SP2<sup>22</sup></b>	<b>Z 336</b> 0 002 240 907	14/BIHEX	26,5	B	1,0	Mini/PSA	429
<b>12 ZR-6 SPP2<sup>22</sup></b>	<b>Z 318</b> 0 002 240 909	14/BIHEX	26,5	B	0,7	Mini/PSA	412
<b>12 ZR-8 STP<sup>22</sup></b>	<b>Z 320</b> 0 002 230 901	14/BIHEX	26,5	B	1,0	Citroen/Peugeot	412
<b>14 F-4 NBPR<sup>22</sup></b>	<b>Z 339</b> 0 001 350 910	16	26,5	B	0,7	VW AG	429
<b>14 F-4 NBPR2LS<sup>22</sup></b>	<b>Z 345</b> 0 001 350 911	16	26,5	B	0,7	VW AG	429
<b>14 F-5 DPUR0<sup>22</sup></b>	<b>Z 347</b> 0 001 345 914	16	19	B	0,7	VW AG	429
<b>14 F-5 DPUR2T<sup>22</sup></b>	<b>Z 317</b> 0 001 345 912	16	19	B	0,85	VW AG	429
<b>14 F-5 MPUR2L<sup>22</sup></b>	<b>Z 348</b> 0 001 345 915	16	26,5	B	0,8	AUDI, VW AG	429
<b>14 F-6 DTPR0<sup>22</sup></b>	<b>Z 295</b> 0 001 340 915	16	19	B	0,8	AUDI, VW AG	430
<b>14 F-6 KPUR02W<sup>22</sup></b>	<b>Z 322</b> 0 001 340 916	16	19	J	0,9	Mercedes	430
<b>14 F-7 HTUR<sup>22</sup></b>	<b>Z 344</b> 0 001 335 788	16	19	J	1,0	VW AG	412





							
14 F-7 KPPRU2	Z 321 0 001 335 917	16	19	J	1,0	AUDI, VW AG	431
14 FGHR-7 DTUT	Z 304 0 002 335 137	16	19	F	0,9	Alfa Romeo	414
14 FGR-6 HQU <sup>22</sup>	Z 300 0 002 340 123	16	19	J	1,35	VW AG	414
14 FR-4 DIU02 <sup>22</sup>	Z 328 0 004 350 930	16	19	F	0,3	Mercedes Gas-Busse	431
14 FR-5 DPPUX	Z 323 0 002 345 904	16	19	B	1,1	Honda	431
14 FR-6 DPU02S <sup>22</sup>	Z 340 0 002 340 915	16	19	B	0,7	Mercedes	432
14 FR-6 DPUW2	Z 314 0 002 340 910	16	19	B	0,9	Nissan	432
14 FR-6 DPUX2 <sup>22</sup>	Z 313 0 002 340 909	16	19	B	1,0	Nissan	432
14 FR-6 DUW2 <sup>22</sup>	Z 335 0 002 340 771	16	19	B	0,9	Peugeot	416
14 FR-7 DPUV02 <sup>22</sup>	Z 307 0 002 335 937	16	19	B	1,3	Mazda	433
14 FR-7 KPPU	Z 312 0 002 335 938	16	19	J	1,1	Ford, Mazda, Mercedes	433
14 FR-7 LPUX02 <sup>22</sup>	Z 301 0 002 335 935	16	19	K	1,1	Honda	434
14 FR-7 MPUS <sup>22</sup>	Z 326 0 002 335 939	16	26,5	B	0,7	Volvo	434
14 FR-7 MUX2 <sup>22</sup>	Z 303 0 002 336 734	16	26,5	B	1,1	Nissan	418
14 FR-8 DEW <sup>22</sup>	Z 334 0 002 330 217	16	19	B	1,0	Kia	418
14 FR-8 MPUX2 <sup>22</sup>	Z 302 0 002 330 926	16	26,5	B	1,1	Nissan	435
14 KR-6 MPV <sup>22</sup>	Z 315 0 002 640 910	16	25,4	B	1,3	Ford	436
14 KR-6 MUU <sup>22</sup>	Z 305 0 002 640 712	16	25	B	1,0	Ford	427
14 KR-7 MPUV2 <sup>22</sup>	Z 342 0 002 635 904	16	25	B	1,3	Ford	436
14 KR-8 LQPU07 <sup>22</sup>	Z 309 0 002 630 904	16	19	X	1,6	Ford	436
14 KR-8 MPUV2 <sup>22</sup>	Z 310 0 002 630 905	16	25	B	1,3	Ford	436
14 R-8 DPUU	Z 311 0 002 330 925	21	19	B	1,0	Hyundai	435
14 R-9 KPUV2 <sup>22</sup>	Z 285 0 002 325 900	21	19	J	1,3	Chrysler	435











<sup>22</sup> Monoblock/SAE-Mutter nicht  
 abschraubbar

**RUS**

<b>Ассортименты изготовителя</b>	
Свечи накаливания	235
Свечи зажигания	439
Реле времени накаливания	354
<b>Запасные типы</b>	447
<b>Информация о продукции</b>	
Дизельная техника	
12-гранный ключ для свечей зажигания	442
Магнитные клапаны	355
Оснастка и запасные части	367
Пламенные свечи накаливания	363
Пусковые переключатели накаливания	368
Реле времени накаливания	348
Свечи накаливания	308
Свечи накаливания - инструменты	343
Сопротивления предварительных цепей свечей накаливания	367
Устройство контроля накаливания	368
Свечи зажигания	
Вспомогательное приспособление для монтажа свечей зажигания	442
Гайка свечи SAE	442
Набор для ремонта резьбы свечей зажигания	443
Платиновые свечи зажигания	428
Свечи зажигания	411
Смазка для штекера провода к свече зажигания	442
Специальные свечи зажигания	437
Ultra X Titan	406
<b>Использование</b>	
Свечи зажигания	
для легковых / транспортных автомобилей	25
Свечи накаливания	
для легковых/транспортных автомобилей	25
<b>Переводы</b>	510
<b>Перекодирование</b>	
OE → AM	454
Перекодирование деталей других изготовителей → BERU	456
<b>Перечень по типам и № для заказа</b>	12
<b>Техническая информация</b>	
Дизельная техника	
Правильная замена свеч накаливания	286
Показатели рабочего времени - замена свечи накаливания	292
Свечи накаливания	294
Система Instant Start System (ISS) фирмы Beru	304
Свечи зажигания	
Правильная замены свеч зажигания	380
Свечи зажигания Ultra	407
Типовое обозначение	386
Ultra X Titan	396
<b>Торговые системы</b>	520

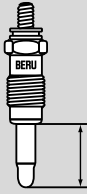
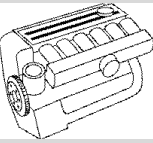
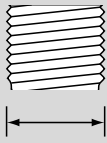
**PL**

<b>Informacja o produkcie</b>	
Świece zapłonowe	
Nakrętka przyłącza SAE	442
Narzędzie do montażu świec zapłonowych	442
Smar do świec zapłonowych	442
Świece zapłonowe	411
Świece specjalne	437
Świece z elektrodami platynowymi	428
Ultra X Titan	406
Zestaw do reperacji gwintu świec zapłonowych	443
Technika silników wysokoprężnych	
Czujnik żarowy	368
Klucz nasadowy do świec zapłonowych Bi-Hex	442
Narzędzia do świec żarowych	343
Oporniki stabilizacyjne do świec żarowych	367
Przełącznik czasowy żarzenia	348
Świece żarowe	308
Świece żarowe płomieniowe	363
Włącznik zapłonu żarowego	368
Wyposażenie do świec żarowych i części zamienne	367
Zawory elektromagnetyczne	355
<b>Informacja techniczna</b>	
Świece zapłonowe	
Opis typu	386
Świece zapłonowe Ultra	407
Ultra X Titan	396
Właściwa wymiana świec zapłonowych	380
Technika silników wysokoprężnych	
Prawidłowa wymiana świec żarowych	286
Czasy wymiany świec żarowych	292
Świece żarowe	294
System szybkiego rozruchu BERU ISS	304
<b>Systemy sprzedaży</b>	520
<b>Tłumaczenia</b>	510
<b>Typy zastępcze</b>	447
<b>Zamienniki</b>	
Część zamienna innego producenta → BERU	454
Numer katalogowy wyposażenia oryginalnego → numer katalogowy Beru	456
<b>Zastosowanie</b>	
Świece zapłonowe	
do samochodów osobowych/użytkowych	25
Świece żarowe	
do samochodów osobowych/dostawczych	25
<b>Zestawienie wg typu i numeru katalogowego</b>	12
<b>Zestawy elementów dostarczanych przez producenta</b>	
Świece żarowe	235
Świece zapłonowe	439
Przełącznik czasowy żarzenia	354

	<b>Zündkerzen</b> Spark plugs Bougie d'allumage Bougie Bujía de encendido Candela di accensione Свеча зажигания Świeca zapłonowa Σπινθηριστής gyújtógyertya		<b>Glühzeitsteuergeräte</b> Glow Relay Relais de temporisation Gloeitijdrelais Relé de precalentamiento Relé di preriscaldamento Релета за подгревно време Przełącznik czasowy żarzenia Ηλεκτρονόμοι (ρελαί) χρονικής ρύθμισης της πυράκτωσης Izzítórelék
	<b>Glühkerzen</b> Glow plugs Bougies de préchauffage Gloeibougies Bujías de calentamiento Candele di preriscaldamento Свечи накаливания Świece żarowe Προθερμανδηρες Izzítógyertya		<b>SR-Sets – Umwelt-Nachrüstätze für Diesel-Pkw</b> Environmental Replacement Kit for Diesel Passenger Cars Kit Écologique pour Voitures Particulieres Diesel Sets voor dieselpersonenwagens om in orde te zijn met de milieuwetgeving Juego ecológico para automóviles Diesel Set di riequipaggiamento ecologico Комплект устройство за бързо стартиране на дизелови автомобили / дооркомплектация Ekologiczna koncepcja podgrzewania świec żarowych dla silników Diesla Περιβαλλοντολογικό σετ συμπληρωματικών εφοδίων Diesel személygépkocsi gyorsindító szett/környezetbarát, utolagos beépítésre
	<b>Flammglühkerzen</b> Element flame glow plug Flamme à crayon Vlambougies Bujías de incandescencia a la llama Termoavviatore Пламенные свечи накаливания Świece żarowe płomieniowe Φλογοναφλεκτήρες (μπούζι) πυράκτωσης Lángszugaras izzógyertyák		<b>Doppelzündung</b> Twin-plug ignition Double allumage Dubbele ontsteking Encendido doble Doppia accensione двойное зажигание Podwójny zapłon διπλή ανάφλεξη Kettes gyújtás
	<b>Hubraum</b> Capacity Cylindrée Motorinhoud Cilindrada Cilindrata Рабочий объем rojemność skokowa Κυβισμός Lökettérfogat		<b>Glühkerzen Gesamtlänge</b> Glow plug total length Longueur totale des bougies de préchauffage Totale lengte bougies Largo total de las bujías Lunghezza totale candele di accensione Общая длина свечей накаливания Całkowita długość świecy żarowej Αναφλεκτήρες ολικό μήκος Gyújtógyertyák teljes hossza
	<b>Baujahr</b> Year Année de fabrication Bouwjaar Año de modelo Anno di costr. Год изготовления rok produkcji Έτος κατασκευής Gyártási év		<b>Glühstift Länge</b> Glow element length Longueur du crayon de préchauffage Lengte gloeisitift Largo total de la espiga Lunghezza perno di incandescenza Длина штифта свечи накаливания Długość ruręgrzejnej Ακίδα πυράκτωσης μήκος Csőves izzógyertya hossza
	<b>Motorbezeichnung</b> Engine type Désignation du moteur Motoraand. Designación del motor Denom. Motore Обозн. двигателя ozn. silnika Όνομ. κινητήρα Motormegi.		<b>Gewindedurchmesser</b> Thread diameter Diamètre du filetage Schroefdraaddiameter Diámetro de la rosca Diámetro filetto Диаметр резьбы Średnica gwintu Σταθεροί κινητήρες Menetátméno
	<b>Zylinder</b> Cylinder Cylindre Cilinder Cilindro Cilindro цилиндр Cylinder κύλινδρος Henger		<b>Schlüsselweite</b> Across flats Ouverture de clé Sleutelbreedte Boca de llave Grandezza chiave Раствор ключа Rozmiar klucza Ανοίγμα κλειδιού kulcsnyílás
	<b>Elektrodenabstand</b> Electrode gap Ecartement des électrodes Elektrodenafstand Distancia entre electrodos Distanza degli elettrodi Межэлектродное расстояние odstęp elektrod Απόσταση ηλεκτροδίων Szikraköz		<b>Glühkerzen Anschlusswerte</b> Glow plug connection values Bougies de préchauffage valeurs électriques Aansluitwaarden gloeibougies Bujías de incandescencia - valores de conexión Valori di collegamento per candele ad incandescenza Свеча накаливания, установл. мощность потребителей Świece żarowe, parametry przyłączeniowe Συντελεστές σύνδεσης μπούζι Izzítógyertyák teljesítményigénye

Symbole Symboles Symbolen	Symbols Symboles Symbolen	Símbolos Simboli Символы	Symbole Σύμβολα jelképek	
	<b>Glühkerzen Einbauwerte</b> Glow plug installation values Bougies de préchauffage valeurs de montage Inbouwwaarden gloeibougies Bujías de incandescencia - valores de instalación Valori di montaggio per candele ad incandescenza Свеча накаливания, установочные значения Świece żarowe, parametry montażowe Συντελεστές εγκατάστασης μπουζί Izzítógyertyák beszerelési értékei		<b>Konusdichtsitz</b> Conical seat Joint d'étanchéité conique Conus afdichting Asiento cónico Sede conica коническая уплотнительная посадка Płaskie gniazdo uszczelniające Κωνική στεγανωτική έδραση Kúpos tömítőváll	
	<b>Abdichtart</b> Seal type Type d'étanchéité Afdichtsoort Tipo de hermetización Tipo di guarnizione Тип уплотнения Rodzaj uszczelnienia Τρόπος μόνωσης Tömítés fajtája		<b>Magnetventile</b> Solenoid valve Electrovalves Magneteekleppen Válvulas electromagnéticas Valvole magnetiche Магнитные клапаны Zawory elektromagnetyczne Μαγνητικές βαλβίδες Mágnesszelepek	
	<b>Glühkerzenanschluss M 4, M 5</b> Glowplug connection M 4, M 5 Raccordement bougies de préchauffage M 4, M 5 Aansluiting bougies M 4, M 5 Conexión de bujías de incandescencia M 4, M 5 Attacco per candela ad incandescenza M 4, M 5 Подключение свечей накаливания M 4, M 5 Przyłącze świecy żarowej M 4, M 5 Σύνδεση μπουζί M 4, M 5 Izzítógyertya-csatlakozás M 4, M 5		<b>Vorglühzeit</b> Pre-glow time Préchauffage Voorgloeitijd Tiempo de precalentamiento Tempo di pre-incandescenza Время предпускового разогрева Czas nagrzewania wstępnego Χρόνος προθέρμανσης Előizzitás tartama	
	<b>Glühkerzenanschluss Rundstecker</b> Glowplug connection – Pin terminal Raccordement bougies de préchauffage – Fiche ronde Aansluiting bougies – Ronde stekker Conexión de bujías de incandescencia – Clavija coaxial Attacco per candela ad incandescenza – Connettore tondo Подключение свечей накаливания – Круглый штекер Przyłącze świecy żarowej – Wtyczka okrągła Σύνδεση μπουζί – Στρογγυλό φικ Izzítógyertya-csatlakozás – kerek dugasz		<b>Nachglühzeit</b> Post-heating time Post-préchauffage Nagloeitijd Tiempo de postcalentamiento Tempo di post-incandescenza Время сопровождения Czas nagrzewania wtórnego Χρόνος μεταγενέστερης θέρμανσης Utánizzitás tartama	
	<b>Glühkerzenanschluss Flachstecker</b> Glowplug connection – Flat-type connector Raccordement bougies de préchauffage – Fiche plate Aansluiting bougies – Platte stekker Conexión de bujías de incandescencia – Conector plano Attacco per candela ad incandescenza – Connettore piatto Подключение свечей накаливания – Плоский штекер Przyłącze świecy żarowej – Wtyczka płaska Σύνδεση μπουζί – Πεπλατυσμένο φικ Izzítógyertya-csatlakozás – laposdugasz		<b>Gewindelänge</b> Thread length Longueur du filetage Draadlengte Largo de la rosca Lunghezza filetto Длина резьбы Długość gwintu Μήκος σπειρώματος Menethosszáság	
	<b>Glühkerzenanschluss SAE</b> Glowplug connection SAE Raccordement bougies de préchauffage SAE Aansluiting bougies SAE Conexión de bujías de incandescencia SAE Attacco per candela ad incandescenza SAE Подключение свечей накаливания SAE Przyłącze świecy żarowej SAE Σύνδεση μπουζί SAE Izzítógyertya-csatlakozás SAE		<b>Elektroden-Ausführung</b> Electrode type Type d'électrode Elektrodenuitvoering Ejecución de los electrodos Esecuzione elettrodi Конструкция электрода Material elektrod Τύπος ηλεκτροδίων Elektródakivitel	
	<b>Glühkerzenanschluss Ringöse</b> Glowplug connection – Ear ring Raccordement bougies de préchauffage – Œillet Aansluiting bougies – Ringoog Conexión de bujías de incandescencia – Argolla anular Attacco per candela ad incandescenza – Occhiello anulare Подключение свечей накаливания – Кольцевая проушина Przyłącze świecy żarowej – Przyłącze oczkowe Σύνδεση μπουζί – Μεταλλικός δακτύλιος Izzítógyertya-csatlakozás – Karika-fogófül		<b>Volt / Ampere</b> Volt / Amps Volt / Ampères Volt / Ampère Voltio / Amperios Volt / Ampere вольт / Ампер Volt / Ampere Volt / Амтёр Volt / Ampere	
	<b>Flachdichtsitz</b> Flat Seat Siège d'étanchéité plat Platte afdichting Asiento de junta plana Sede a tenuta piatta Цилиндрическая уплотнительная посадка Uszczelnienie płaskie Επίπεδη επιφάνεια στεγάνωσης lapos tömítőváll		<b>Standheizung</b> Auxiliary heating Chauffage additionnel Standverwarming Calefacción independiente Riscaldamento statico Отопление при неработающем двигателе ogrzewanie postojowe Βοηθητικό σύστημα θέρμανσης Beépített fűtés	



			Nm	
<b>UXT 1 (UXF 79)</b>		0 002 335 606	25	406
<b>UXT 2 (UX 79)</b>		0 002 335 607	25	406
<b>UXT 3 (UXF 79 P)</b>		0 002 335 928	25	406
<b>UXT 4 (UXK 79)</b>		0 002 635 601	15	406
<b>UXT 5 (UXF 56)</b>		0 002 345 606	25	406
<b>UXT 6 (UX 79 P)</b>		0 002 335 929	25	406
<b>UXT 7</b>		0 002 635 900	15	406
<b>UXT 8</b>		0 002 635 901	15	406
<b>UXT 9</b>		0 002 335 930	25	406
<b>UXT 10</b>		0 002 335 931	25	406
<b>UXT 11</b>		0 002 335 932	25	406
<b>UXT 12</b>		0 002 345 902	25	406
<b>UXT 13</b>		0 002 335 934	25	406
<b>UXT 14</b>		0 002 345 903	25	406
<b>UXT 15</b>		0 002 640 909	15	406



			Nm	
<b>UXT 1 SB (UXF 79)</b>		0 900 004 153	25	406
<b>UXT 2 SB (UX 79)</b>		0 900 004 154	25	406
<b>UXT 3 SB (UXF 79 P)</b>		0 900 004 155	25	406
<b>UXT 4 SB (UXK 79)</b>		0 900 004 156	15	406
<b>UXT 5 SB (UXF 56)</b>		0 900 004 157	25	406
<b>UXT 6 SB (UX 79 P)</b>		0 900 004 158	25	406
<b>UXT 7 SB</b>		0 900 004 159	15	406
<b>UXT 8 SB</b>		0 900 004 160	15	406
<b>UXT 9 SB</b>		0 900 004 161	25	406
<b>UXT 10 SB</b>		0 900 004 162	25	406
<b>UXT 11 SB</b>		0 900 004 163	25	406
<b>UXT 12 SB</b>		0 900 004 164	25	406
<b>UXT 13 SB</b>		0 900 004 165	25	406
<b>UXT 14 SB</b>		0 900 004 166	25	406
<b>UXT 15 SB</b>		0 900 004 167	15	406



			Nm	
<b>UX 56</b>		0 002 345 600	25	424
<b>UXK 56</b>		0 002 645 600	15	427



			Nm	
<b>UX 56 SB</b>		0 900 004 114	25	424
<b>UXK 56 SB</b>		0 900 004 118	15	427



			Nm	
<b>Z 1</b>	14-8 DU	0 001 330 702	25	423
<b>Z 2</b>	14-8 DTU	0 001 330 709	25	423
<b>Z 3</b>	14-8 LUR	0 001 330 718	25	424
<b>Z 4</b>	14 F-8 LUR	0 001 330 717	25	413
<b>Z 5</b>	14 F-8 DUO	0 001 330 725	25	413
<b>Z 6</b>	14 K-8 DU	0 001 630 700	15	425



			Nm	
<b>Z 7</b>	14 K-8 DUO	0 001 630 704	15	425
<b>Z 8</b>	14 R-8 DU	0 002 330 701	25	421
<b>Z 9</b>	14 R-8 DUX	0 002 330 702	25	421
<b>Z 10</b>	14-7 BU	0 001 435 700	25	423
<b>Z 11</b>	14-7 DU	0 001 335 702	25	423
<b>Z 12</b>	14-7 DTU	0 001 335 709	25	423
<b>Z 13</b>	14 F-7 DUOR	0 001 335 729	25	412
<b>Z 14</b>	14 F-7 LDUR	0 001 335 732	25	413
<b>Z 15</b>	14 FR-7 DU	0 002 335 707	25	417
<b>Z 16</b>	14 FR-7 DUX	0 002 335 708	25	417
<b>Z 17</b>	14 K-7 DU	0 001 635 700	15	425
<b>Z 18</b>	14 K-7 DUO	0 001 635 709	15	425
<b>Z 19</b>	14 R-7 BU	0 002 435 701	25	421
<b>Z 20</b>	14 R-7 DU	0 002 335 701	25	421
<b>Z 21</b>	14 R-7 DUX	0 002 335 706	25	421
<b>Z 22</b>	14-6 DU	0 001 340 702	25	422
<b>Z 24</b>	14 FR-6 DU	0 002 340 702	25	416
<b>Z 25</b>	14 K-6 DU	0 001 640 700	15	425
<b>Z 26</b>	14 KR-6 DU	0 002 640 700	15	426
<b>Z 27</b>	14 R-6 DU	0 002 340 701	25	421
<b>Z 28</b>	14 R-6 DUX	0 002 340 703	25	421
<b>Z 29</b>	14 F-5 DU	0 001 345 720	25	412
<b>Z 30</b>	14 FR-5 DU	0 002 345 702	25	415
<b>Z 31</b>	14 K-5 DU	0 001 645 700	15	425
<b>Z 32</b>	18 K-7 BU	0 001 735 700	20	427
<b>Z 33</b>	18 K-6 BU	0 001 740 700	20	427
<b>Z 37</b>	14 Z-3 AU	0 001 455 702	25	422
<b>Z 38</b>	14 Z-3 CU	0 001 355 700	25	422
<b>Z 39</b>	14 Z-4 AU	0 001 450 702	25	422
<b>Z 40</b>	14-5 AU	0 001 445 702	25	422
<b>Z 41</b>	14-5 BU	0 001 445 700	25	422
<b>Z 42</b>	14-5 DU	0 001 345 702	25	422
<b>Z 44</b>	14-5 DTU	0 001 345 704	25	422
<b>Z 45</b>	14 FR-5 DTU	0 002 345 704	25	415
<b>Z 46</b>	14 K-5 DUO	0 001 645 703	15	425
<b>Z 47</b>	14 R-5 DU	0 002 345 701	25	420
<b>Z 48</b>	14-6 BU	0 001 440 700	25	422
<b>Z 49</b>	14 KR-6 BU	0 002 640 701	15	426
<b>Z 51</b>	14-6 DTU	0 001 340 704	25	422
<b>Z 52</b>	14 F-6 DTU	0 001 340 706	25	412
<b>Z 53</b>	14 F-6 DTU	0 001 340 717	25	412
<b>Z 55</b>	14 K-6 DUO	0 001 640 704	15	425
<b>Z 56</b>	14 K-6 DUO	0 001 640 705	15	425
<b>Z 57</b>	14-7 AU	0 001 435 705	25	423
<b>Z 58</b>	14-7 CU	0 001 335 707	25	423
<b>Z 59</b>	14 R-7 CU	0 002 335 704	25	421
<b>Z 60</b>	14 FGR-7 CTU	0 002 335 100	25	415
<b>Z 61</b>	14-7 DUO	0 001 335 714	25	423
<b>Z 62</b>	14-7 DUO	0 001 335 737	25	423
<b>Z 63</b>	14 F-7 DU	0 001 335 725	25	412
<b>Z 67</b>	14 KR-7 DUX	0 002 635 701	15	426
<b>Z 68</b>	14-8 AU	0 001 430 701	25	423
<b>Z 69</b>	14-8 DUO	0 001 330 713	25	424
<b>Z 70</b>	14-8 DUO	0 001 330 726	25	424
<b>Z 72</b>	14 FR-8 DU	0 002 330 703	25	418
<b>Z 73</b>	14 FR-8 DUX	0 002 330 704	25	419
<b>Z 74</b>	14 FR-8 LDUOX4	0 002 330 710	25	419
<b>Z 75</b>	14 G-8 DTU	0 001 330 104	25	420
<b>Z 76</b>	14-9 DU	0 001 325 701	25	424
<b>Z 78</b>	14-9 DTU	0 001 325 710	25	424
<b>Z 79</b>	14 F-9 DUO	0 001 325 705	25	413
<b>Z 80</b>	14 K-9 DU	0 001 625 700	15	426
<b>Z 81</b>	14 K-9 DUO	0 001 625 702	15	426
<b>Z 82</b>	14 R-9 DU	0 002 325 700	25	421



**ultra**

Nm



Z 85	14-X AU	0 001 400 701	25	424
Z 89	14 FGH-6 DTUR	0 001 340 103	25	413
Z 90	14 FGH-7 DTURX	0 001 335 107	25	413
Z 91	14 GH-7 DTUR	0 001 335 108	25	420
Z 92	14 GH-8 DTUR	0 001 330 113	25	420
Z 93	14 GH-8 DTURX	0 001 330 112	25	420
Z 94	14 GR-8 DTU	0 002 330 706	25	420
Z 95	14 KR-7 DU	0 002 635 700	15	426
Z 97	14 KR-8 MPX	0 002 640 900	15	436
Z 98	14 FR-7 LDU	0 002 335 500	25	418
Z 99	14 FR-6 DUX	0 002 340 704	25	416
Z 100	14 F-8 DU4	0 001 330 731	25	413
Z 101	14 F-8 LDUSR	0 001 330 501	25	413
Z 104	14-6 DPO	0 001 340 903	25	435
Z 105	14 F-6 DSR	0 001 340 806	25	437
Z 108	G 3/18	0 001 700 901	25	438
Z 109	KP105 DU	0 004 021 601	-	438
Z 110	EBE 514	0 004 500 400	-	438
Z 111	14 C-7 D	0 003 335 401	25	437
Z 112	14-8 E	0 001 529 302	25	424
Z 116	14 FR-6 LDU	0 002 340 500	25	416
Z 117	14 KR-9 DUX	0 002 625 700	15	427
Z 118	14-8 BU	0 001 430 700	25	423
Z 119	14 R-8 DU4	0 002 330 709	25	421
Z 120	14 FGH-7 DTURX0	0 001 335 110	25	414
Z 121	14 FGH-8 DTURX0	0 001 330 116	25	414
Z 122	14 FGH-8 DPURX2	0 001 330 904	25	431
Z 123	14 FR-7 KDU	0 002 335 709	25	417
Z 126	14 FGH-8 DTUR	0 001 330 117	25	414
Z 127	14 KGR-7 KQU	0 002 635 100	15	426
Z 128	14 FG-8 DTU	0 001 330 105	25	413
Z 129	14 FGR-6 KQU	0 002 340 101	25	415
Z 130	14 FR-5 DPUX	0 002 335 901	25	431
Z 132	14 S-7 F	0 004 535 402	25	437
Z 144	14 KGR-6 KQU	0 002 640 100	15	426
Z 145	14 FGR-6 DDU	0 002 340 102	25	414
Z 148	14 KR-8 DPUOV	0 002 630 900	15	436
Z 149	14 FR-7 KPUX	0 002 335 902	25	433
Z 150	14 FR-7 KPUV	0 002 335 903	25	433
Z 151	14 FR-7 KPU	0 002 335 904	25	433
Z 152	14 FR-8 HU	0 002 330 712	25	419
Z 153	14 FR-8 KU	0 002 330 713	25	419
Z 154	14 FR-8 KUO	0 002 330 714	25	419
Z 155	14 FR-7 KU	0 002 335 712	25	417
Z 156	14 FR-7 KUO	0 002 335 713	25	417
Z 157	14 FR-7 KUOX	0 002 335 714	25	418
Z 158	14 FR-7 LUX	0 002 335 715	25	418
Z 159	14 FR-6 DPUX	0 002 340 903	25	432
Z 170	14 F-7 DPURU2	0 001 335 919	25	430
Z 171	14 F-7 DPURX2	0 001 335 910	25	430
Z 172	14 FGR-7 KQU	0 002 335 104	25	415
Z 173	14 FGR-8 KQU	0 002 330 102	25	415
Z 174	14 K-9 BU	0 001 625 705	15	425
Z 175	18 K-9 BU	0 001 725 700	20	427
Z 176	14 F-7 HPURX2	0 001 335 911	25	430
Z 177	14 KR-8 MUV	0 002 630 701	15	427
Z 183	14 FR-8 MU2	0 002 330 718	25	420
Z 184	14 FR-7 MU2	0 002 335 719	25	418
Z 185	14 F-6 DPUR021	0 001 340 908	25	430
Z 188	14 F-7 DPUR02	0 001 335 914	25	430
Z 190	14 FGR-8 DQU7	0 002 330 104	25	415
Z 192	14 FR-5 LDU	0 002 345 501	25	416
Z 193	14 FR-7DU2	0 002 335 717	25	417
Z 194	14 FR-6 LDU3	0 002 340 501	25	416

**ultra**

Nm



Z 198	14 FR-5 LDU3	0 002 345 504	25	416
Z 199	10 FR-4 AU	0 002 150 700	12	411
Z 200	14 F-7 HUR2	0 001 335 742	25	412
Z 203	14 FR-8 LU2	0 002 330 794	25	419
Z 204	14 FGR-8 CTU	0 002 340 117	25	415
Z 206	14 FR-7 DPPUS2	0 002 335 940	25	432
Z 207	14 KG-8 DTU	0 001 630 101	15	426
Z 208	14 FR-8 LDU3	0 002 330 795	25	419
Z 209	14 KR-6 DPUV02	0 002 640 904	15	436
Z 210	10 FR-6 CPU03	0 002 140 900	12	428
Z 211	14 FGR-8 MQPU	0 002 330 902	25	431
Z 213	14 FGR-7 KDU6	0 002 335 128	25	415
Z 216	14 KR-10 SUV2	0 002 620 708	15	426
Z 219	14 FR-8 MPUX02	0 002 330 904	25	434
Z 220	14 FR-9 KUX2	0 002 325 723	25	420
Z 221	14 FR-6 DPUX02	0 002 340 905	25	432
Z 222	14 KR-8 STUX	0 002 630 715	15	427
Z 223	14 FR-8 NQU23	0 002 330 796	25	420
Z 224	14 FR-7 DPU3	0 002 335 912	25	433
Z 225	14 FR-7 HUX	0 002 336 715	25	417
Z 226	14 FR-6 MPU2	0 002 340 906	25	432
Z 227	14 F-8 DUR	0 001 330 780	25	413
Z 228	14 FR-7 DPUX02	0 002 335 914	25	433
Z 229	14 FR-8 LPO	0 002 330 903	25	434
Z 230	14 KR-6 KPUV02	0 002 640 907	15	436
Z 231	14 FR-4 DPU	0 002 350 901	25	431
Z 232	14 F-7 DPUR2	0 001 335 907	25	430
Z 233	12 ZR-6 SPO3	0 002 240 902	20	428
Z 234	12 FR-7 DU	0 002 235 700	20	411
Z 235	14 FR-7 SPUX03	0 002 335 915	25	434
Z 236	14 F-6 HTPRX02	0 001 340 910	25	430
Z 237	14 FR-7 DQUP7	0 002 335 911	25	433
Z 238	14 FR-8 DPU2	0 002 330 905	25	434
Z 239	14 FGR-7 KQE	0 002 335 131	25	415
Z 240	14 F-8 DPURX02	0 001 330 905	25	431
Z 242	12 ZR-8 TP	0 002 230 900	20	429
Z 243	12 VR-8 SE	0 002 230 300	20	411
Z 245	14 FR-6 LDUW	0 002 340 504	25	416
Z 246	14 FGH-8 DTURW	0 001 330 119	25	414
Z 247	14 FR-7 DUW	0 002 336 724	25	417
Z 248	14 FR-8 HUT	0 002 330 203	25	419
Z 249	14 FR-8 KUOU	0 002 330 204	25	419
Z 250	14 FR-7 DU2S	0 002 336 725	25	417
Z 251	14 FR-7 DU2T	0 002 336 726	25	417
Z 252	14 FR-6 DUW	0 002 340 768	25	416
Z 253	14 FR-5 DUU	0 002 345 731	25	416
Z 254	14 FR-8 DUS	0 002 330 205	25	418
Z 255	14 FR-8 DUW	0 002 330 206	25	419
Z 257	14 FR-7 LDUW	0 002 335 503	25	418
Z 260	14 SR-5 F	0 004 545 400	25	438
Z 261	14 SR-10 E0	0 004 520 300	25	438
Z 262	14 S-9 E0	0 004 525 302	25	437
Z 263	14 SR-7 F	0 004 535 403	25	438
Z 265	14 S-5 F	0 004 545 401	25	437
Z 266	14 S-7 E	0 004 535 300	25	437
Z 267	14 S-7 EU0	0 004 535 700	25	437
Z 269	14 SR-9 E0	0 004 525 304	25	438
Z 270	14 S-10 E0	0 004 520 301	25	437
Z 271	14 SR-7 E	0 004 535 301	25	437
Z 272	14 F-7 HURU02	0 001 335 789	25	412
Z 273	14 FR-7 NUX2	0 002 336 738	25	418
Z 274	12 VR-6 MPPUS	0 002 240 910	20	428
Z 275	14 FR-6 LPUOX	0 002 340 918	25	432
Z 277	14 F-5 MPUR03	0 001 345 906	25	429

**ultra**

Nm



Z 278	14 FR-8 LPU02	0 002 330 918	25	434
Z 279	14 FR-7 LPU02	0 002 335 925	25	433
Z 280	14 FR-7 KPUX02	0 002 335 926	25	433
Z 282	14 FGH-7 DPURX2	0 001 335 905	25	431
Z 284	14 FR-6 DPOX	0 002 340 908	25	432
Z 285	14 R-9 KPUV2	0 002 325 900	25	435
Z 286	12 FR-5 SDU	0 002 245 703	25	411
Z 287	14 FR-8 LU2T	0 002 330 215	25	420
Z 288	12 ZR-7 SP03	0 002 235 901	20	429
Z 291	12 FR-5 DU	0 002 245 704	20	411
Z 292	12 FR-6 DU	0 002 240 702	20	411
Z 293	12 FR-6 LUX	0 002 240 701	20	411
Z 294	14 FGR-5 NTE	0 002 345 118	25	414
Z 295	14 F-6 DTPR02	0 001 340 915	25	430
Z 296	14 KR-7 DPUV	0 002 635 902	15	436
Z 297	14 FR-7 LPUX0	0 002 335 936	25	434
Z 298	14 KR-8 DPUV	0 002 630 903	15	436
Z 299	14 FR-7 LUX0	0 002 335 802	25	418
Z 300	14 FGR-6 HQU	0 002 340 123	25	414
Z 301	14 FR-7LPUX02	0 002 335 935	25	434
Z 302	14 FR-8 MPUX2	0 002 330 926	25	435
Z 303	14 FR-7 MUX2	0 002 336 734	25	418
Z 304	14 FGH-7 DTUT	0 002 335 137	25	414
Z 305	14 KR-6 MUJ	0 002 640 712	15	427
Z 306	12 F-6 HPURW	0 002 240 901	20	428
Z 307	14 FR-7 DPUV02	0 002 335 937	25	433
Z 309	14 KR-8 LQPU07	0 002 630 904	15	436
Z 310	14 KR-8 MPUV2	0 002 630 905	15	436
Z 311	14 R-8 DPUU	0 002 330 925	25	435
Z 312	14 FR-7 KPPU	0 002 335 938	25	433
Z 313	14 FR-6 DPUX2	0 002 340 909	25	432
Z 314	14 FR-6 DPUW2	0 002 340 910	25	432
Z 315	14 KR-6 MPV	0 002 640 910	15	436
Z 317	14 F-5 DPUR2T	0 001 345 912	25	429
Z 318	12 ZR-6 SPP2	0 002 240 909	20	412
Z 320	12 ZR-8 STP	0 002 230 901	20	412
Z 321	14 F-7 KPPRU2	0 001 335 917	25	431
Z 322	14 F-6 KPUR2W	0 001 340 916	25	430
Z 323	14 FR-5 DPPUX	0 002 345 904	25	431
Z 324	14 FGH-7 LDUW	0 002 335 138	25	414
Z 325	12 VR-7 SPUX	0 002 235 905	20	428
Z 326	14 FR-7 MPUS	0 002 335 939	25	434
Z 332	12 ZR-6 SPP2-1	0 002 240 911	20	429
Z 333	12 FR-6 DPUX	0 002 240 913	20	428
Z 334	14 FR-8 DEW	0 002 330 217	25	418
Z 335	14 FR-6 DUW2	0 002 340 771	25	416
Z 336	12 ZR-6 SP2	0 002 240 907	20	429
Z 337	14 FR-7 DPPUW2	0 002 335 946	25	432
Z 338	12 FR-4 DPUT	0 002 250 900	20	428
Z 339	14 F-4 NBPR	0 001 350 910	25	429
Z 340	14 FR-6 DPU02S	0 002 340 915	25	432
Z 341	10 FR-7 KDUS	0 002 135 700	12	411
Z 342	14 KR-7 MPUV2	0 002 635 904	15	436
Z 343	14 FR-8 DPPUX	0 002 330 930	25	434
Z 344	14 F-7 HTUR	0 001 335 788	25	412
Z 345	14 F-4 NBPR2LS	0 001 350 911	25	429
Z 346	14 FR-7 LPUT02	0 002 335 947	25	434
Z 347	14 F-5 DPUR02	0 001 345 914	25	429
Z 348	14 F-5 MPUR2L	0 001 345 915	25	429
Z 349	14 F-6 LPURW03	0 001 340 917	25	430
Z 354	14 FR-5 LPU0X	0 002 345 906	25	431
Z 355	12 VR-5 SPPU	0 002 245 900	20	428
Z 356	14 KR-7 MPUX2	0 002 635 903	15	436
Z 357	12 FR-4 MPPUS	0 002 250 901	20	428

**ultra**

Nm



Z 358	12 FR-6 DUT	0 002 240 707	20	411
Z 359	12 F-5 NPUR2T	0 001 245 901	20	428
Z 360	14 FGH-7 DTUU	0 002 335 139	25	414



Nm



Z 1 SB	14-8 DU	0 900 004 024	25	423
Z 2 SB	14-8 DTU	0 900 004 067	25	423
Z 3 SB	14-8 LUR	0 900 004 091	25	424
Z 4 SB	14 F-8 LUR	0 900 004 072	25	413
Z 5 SB	14 F-8 DU0	0 900 004 080	25	413
Z 6 SB	14 K-8 DU	0 900 004 092	15	425
Z 7 SB	14 K-8 DU0	0 900 004 081	15	425
Z 8 SB	14 R-8 DU	0 900 004 052	25	421
Z 9 SB	14 R-8 DUX	0 900 004 082	25	421
Z 10 SB	14-7 BU	0 900 004 021	25	423
Z 11 SB	14-7 DU	0 900 004 023	25	423
Z 12 SB	14-7 DTU	0 900 004 066	25	423
Z 13 SB	14 F-7 DUOR	0 900 004 083	25	412
Z 14 SB	14 F-7 LDUR	0 900 004 084	25	413
Z 15 SB	14 FR-7 DU	0 900 004 085	25	417
Z 16 SB	14 FR-7 DUX	0 900 004 086	25	417
Z 17 SB	14 K-7 DU	0 900 004 030	15	425
Z 18 SB	14 K-7 DU0	0 900 004 087	15	425
Z 19 SB	14 R-7 BU	0 900 004 048	25	421
Z 20 SB	14 R-7 DU	0 900 004 049	25	421
Z 21 SB	14 R-7 DUX	0 900 004 088	25	421
Z 22 SB	14-6 DU	0 900 004 019	25	422
Z 24 SB	14 FR-6 DU	0 900 004 053	25	416
Z 25 SB	14 K-6 DU	0 900 004 051	15	425
Z 26 SB	14 KR-6 DU	0 900 004 054	15	426
Z 27 SB	14 R-6 DU	0 900 004 047	25	421
Z 28 SB	14 R-6 DUX	0 900 004 090	25	421
Z 29 SB	14 F-5 DU	0 900 004 029	25	412
Z 30 SB	14 FR-5 DU	0 900 004 076	25	415
Z 31 SB	14 K-5 DU	0 900 004 061	15	425
Z 33 SB	18 K-6 BU	0 900 004 055	20	427
Z 41 SB	14-5 BU	0 900 004 186	25	422
Z 42 SB	14-5 DU	0 900 004 187	25	422
Z 47 SB	14 R-5 DU	0 900 004 188	25	420
Z 49 SB	14 KR-6 BU	0 900 004 189	15	426
Z 59 SB	14 R-7 CU	0 900 004 190	25	421
Z 67 SB	14 KR-7 DUX	0 900 004 108	15	426
Z 72 SB	14 FR-8 DU	0 900 004 191	25	418
Z 73 SB	14 FR-8 DUX	0 900 004 169	25	419
Z 74 SB	14 FR-8 LDU0X4	0 900 004 113	25	419
Z 76 SB	14-9 DU	0 900 004 120	25	424
Z 89 SB	14 FGH-6 DTUR	0 900 004 106	25	413
Z 90 SB	14 FGH-7 DTURX	0 900 004 101	25	413
Z 91 SB	14 GH-7 DTUR	0 900 004 102	25	420
Z 92 SB	14 GH-8 DTUR	0 900 004 103	25	420
Z 93 SB	14 GH-8 DTURX	0 900 004 104	25	420
Z 94 SB	14 GR-8 DTU	0 900 004 105	25	420
Z 95 SB	14 KR-7 DU	0 900 004 121	15	426
Z 97 SB	14 KR-8 MPX	0 900 004 109	15	436
Z 98 SB	14 FR-7 LDU	0 900 004 192	25	418
Z 99 SB	14 FR-6 DUX	0 900 004 193	25	416
Z 100 SB	14 F-8 DU4	0 900 004 134	25	413
Z 116 SB	14 FR-6 LDU	0 900 004 200	25	416
Z 118 SB	14-8 BU	0 900 004 194	25	423
Z 119 SB	14 R-8 DU4	0 900 004 135	25	421
Z 120 SB	14 FGH-7 DTURX0	0 900 004 136	25	414



Nm

Z 121 SB	14 FGH-8 DTURX0	0 900 004 137	25	414
Z 122 SB	14 FGH-8 DPURX2	0 900 004 170	25	431
Z 126 SB	14 FGH-8 DTUR	0 900 004 201	25	414
Z 145 SB	14 FGR-6 DDU	0 900 004 205	25	416
Z 148 SB	14 KR-8 DPUOV	0 900 004 195	15	436
Z 153 SB	14 FR-8 KU	0 900 004 150	25	419
Z 154 SB	14 FR-8 KUO	0 900 004 151	25	419
Z 155 SB	14 FR-7 KU	0 900 004 152	25	417
Z 157 SB	14 FR-7 KUOX	0 900 004 203	25	418
Z 158 SB	14 FR-7 LUX	0 900 004 144	25	418
Z 170 SB	14 F-7 DPURU2	0 900 004 171	25	430
Z 173 SB	14 FGR-8 KQU	0 900 004 204	25	415
Z 176 SB	14 F-7 HPURX2	0 900 004 142	25	430
Z 177 SB	14 KR-8 MUV	0 900 004 141	15	427
Z 183 SB	14 FR-8 MU2	0 900 004 149	25	420
Z 184 SB	14 FR-7 MU2	0 900 004 148	25	418
Z 188 SB	14 F-7 DPUR02	0 900 004 145	25	430
Z 190 SB	14 FGR-8 DQU7	0 900 004 143	25	415
Z 193 SB	14 FR-7DU2	0 900 004 146	25	417
Z 194 SB	14 FR-6 LDU3	0 900 004 205	25	416
Z 200 SB	14 F-7 HUR2	0 900 004 147	25	412
Z 203 SB	14 FR-8 LU2	0 900 004 172	25	419
Z 204 SB	14 FGR-8 CTU	0 900 004 206	25	415
Z 206 SB	14 FR-7 DPPUS2	0 900 004 173	25	432
Z 209 SB	14 KR-6 DPUV02	0 900 004 174	25	436
Z 221 SB	14 FR-6 DPUX02	0 900 004 207	25	432
Z 222 SB	14 KR-8 STUX	0 900 004 175	15	427
Z 223 SB	14 FR-8 NQU23	0 900 004 208	25	420
Z 224 SB	14 FR-7 DPU3	0 900 004 176	25	433
Z 226 SB	14 FR-6 MPU2	0 900 004 177	25	432
Z 227 SB	14 F-8 DUR	0 900 004 178	25	413
Z 228 SB	14 FR-7 DPUX02	0 900 004 179	25	433
Z 230 SB	14 KR-6 MPUV02	0 900 004 238	15	436
Z 233 SB	14 ZR-6 SPO3	0 900 004 239	20	428
Z 234 SB	12 FR-7 DU	0 900 004 196	20	411
Z 235 SB	14 FR-7 SPUX03	0 900 004 180	25	434
Z 236 SB	14 F-6 HTPRX02	0 900 004 181	25	430
Z 237 SB	14 FR-7 DQUP7	0 900 004 182	25	433
Z 238 SB	14 FR-8 DPU2	0 900 004 183	25	434
Z 239 SB	14 FGR-7 KQE	0 900 004 240	25	415
Z 240 SB	14 F-8 DPURX02	0 900 004 184	25	431
Z 243 SB	12 VR-8 SE	0 900 004 185	25	411
Z 245 SB	14 FR-6 LDUW	0 900 004 197	25	416
Z 246 SB	14 FGH-8 DTURW	0 900 004 198	25	414
Z 247 SB	14 FR-7 DUW	0 900 004 199	25	417
Z 255 SB	14 FR-8 DUW	0 900 004 210	25	419
Z 257 SB	14 FR-7 LDUW	0 900 004 211	25	418
Z 293 SB	14 FR-6 LUX	0 900 004 241	20	411
Z 300 SB	14 FGR-6 HQU	0 900 004 237	25	414
Z 301 SB	14 FR-7 LPUX02	0 900 004 242	25	434
Z 310 SB	14 KR-8 MPUV2	0 900 004 243	15	436
Z 326 SB	14 FR-7 MPUS	0 900 004 244	25	434
Z 340 SB	14 FR-6 DPU02S	0 900 004 245	25	432



Nm

UX 56		0 002 345 600	25	424
UX 56 SB		0 900 004 114	25	424
UXK 56		0 002 645 600	15	427
UXK 56 SB		0 900 004 118	15	427
UXT 1 (UXF 79)		0 002 335 606	25	406
UXT 1 SB (UXF 79)		0 900 004 153	25	406
UXT 2 (UX 79)		0 002 335 607	25	406
UXT 2 SB (UX 79)		0 900 004 154	25	406
UXT 3 (UXF 79 P)		0 002 335 928	25	406
UXT 3 SB (UXF 79 P)		0 900 004 155	25	406
UXT 4 (UXK 79)		0 002 635 601	15	406
UXT 4 SB (UXK 79)		0 900 004 156	15	406
UXT 5 (UXF 56)		0 002 345 606	25	406
UXT 5 SB (UXF 56)		0 900 004 157	25	406
UXT 6 (UX 79 P)		0 002 335 929	25	406
UXT 6 SB (UX 79 P)		0 900 004 158	25	406
UXT 7		0 002 635 900	15	406
UXT 7 SB		0 900 004 159	15	406
UXT 8		0 002 635 901	15	406
UXT 8 SB		0 900 004 160	15	406
UXT 9		0 002 335 930	25	406
UXT 9 SB		0 900 004 161	25	406
UXT 10		0 002 335 931	25	406
UXT 10 SB		0 900 004 162	25	406
UXT 11		0 002 335 932	25	406
UXT 11 SB		0 900 004 163	25	406
UXT 12		0 002 345 902	25	406
UXT 12 SB		0 900 004 164	25	406
UXT 13		0 002 335 934	25	406
UXT 13 SB		0 900 004 165	25	406
UXT 14		0 002 345 903	25	406
UXT 14 SB		0 900 004 166	25	406
UXT 15		0 002 640 909	15	406
UXT 15 SB		0 900 004 167	15	406
10 FR-4 AU	<b>Z 199</b>	0 002 150 700	12	411
10 FR-6 CPU03	<b>Z 210</b>	0 002 140 900	12	428
10 FR-7 KDUS	<b>Z 341</b>	0 002 135 700	12	411
12 F-5 NPUR2T	<b>Z 359</b>	0 001 245 901	20	428
12 F-6 HPURW	<b>Z 306</b>	0 002 240 901	20	428
12 FR-4 DPUT	<b>Z 338</b>	0 002 250 900	20	428
12 FR-4 MPPUS	<b>Z 357</b>	0 002 250 901	20	428
12 FR-5 DU	<b>Z 291</b>	0 002 245 704	20	411
12 FR-5 DU	<b>Z 286</b>	0 002 245 703	25	411
12 FR-6 DPUX	<b>Z 333</b>	0 002 240 913	20	428
12 FR-6 DU	<b>Z 292</b>	0 002 240 702	20	411
12 FR-6 DUT	<b>Z 358</b>	0 002 240 707	20	411
12 FR-6 LUX	<b>Z 293</b>	0 002 240 701	20	411
12 FR-6 LUX	<b>Z 293 SB</b>	0 900 004 241	20	411
12 FR-7 DU	<b>Z 234</b>	0 002 235 700	20	411
12 FR-7 DU	<b>Z 234 SB</b>	0 900 004 196	20	411
12 VR-5 SPPU	<b>Z 355</b>	0 002 245 900	20	428
12 VR-6 MPPUS	<b>Z 274</b>	0 002 240 910	20	428
12 VR-7 SPUX	<b>Z 325</b>	0 002 235 905	20	428
12 VR-8 SE	<b>Z 243</b>	0 002 230 300	20	411
12 VR-8 SE	<b>Z 243 SB</b>	0 900 004 185	25	411
12 ZR-6 SPO3	<b>Z 233</b>	0 002 240 902	20	428
12 ZR-6 SPO3	<b>Z 233 SB</b>	0 900 004 239	20	428
12 ZR-6 SP2	<b>Z 336</b>	0 002 240 907	20	429
12 ZR-6 SPP2	<b>Z 318</b>	0 002 240 909	20	412
12 ZR-6 SPP2-1	<b>Z 332</b>	0 002 240 911	20	429
12 ZR-7 SPO3	<b>Z 288</b>	0 002 235 901	20	429
12 ZR-8 STP	<b>Z 320</b>	0 002 230 901	20	412
12 ZR-8 TP	<b>Z 242</b>	0 002 230 900	20	429
14 C-7 D	<b>Z 111</b>	0 003 335 401	25	437

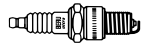

Nm



14 F-4 NBPR	<b>Z 339</b>	0 001 350 910	25	429
14 F-4 NBPR2LS	<b>Z 345</b>	0 001 350 911	25	429
14 F-5 DPUR02	<b>Z 347</b>	0 001 345 914	25	429
14 F-5 DPUR2T	<b>Z 317</b>	0 001 345 912	25	429
14 F-5 DU	<b>Z 29</b>	0 001 345 720	25	412
14 F-5 DU	<b>Z 29 SB</b>	0 900 004 029	25	412
14 F-5 MPUR03	<b>Z 277</b>	0 001 345 906	25	429
14 F-5 MPUR2L	<b>Z 348</b>	0 001 345 915	25	429
14 F-6 DPUR021	<b>Z 185</b>	0 001 340 908	25	430
14 F-6 DSR	<b>Z 105</b>	0 001 340 806	25	437
14 F-6 DTPR02	<b>Z 295</b>	0 001 340 915	25	430
14 F-6 DTU	<b>Z 52</b>	0 001 340 706	25	412
14 F-6 DTU	<b>Z 53</b>	0 001 340 717	25	412
14 F-6 HTPRX02	<b>Z 236</b>	0 001 340 910	25	430
14 F-6 HTPRX02	<b>Z 236 SB</b>	0 900 004 181	25	430
14 F-6 KPUR2W	<b>Z 322</b>	0 001 340 916	25	430
14 F-6 LPURW03	<b>Z 349</b>	0 001 340 917	25	430
14 F-7 DPUR02	<b>Z 188</b>	0 001 335 914	25	430
14 F-7 DPUR02	<b>Z 188 SB</b>	0 900 004 145	25	430
14 F-7 DPUR2	<b>Z 232</b>	0 001 335 907	25	430
14 F-7 DPURU2	<b>Z 170</b>	0 001 335 919	25	430
14 F-7 DPURU2	<b>Z 170 SB</b>	0 900 004 171	25	430
14 F-7 DPURX2	<b>Z 171</b>	0 001 335 910	25	430
14 F-7 DU	<b>Z 63</b>	0 001 335 725	25	412
14 F-7 DUOR	<b>Z 13</b>	0 001 335 729	25	412
14 F-7 DUOR	<b>Z 13 SB</b>	0 900 004 083	25	412
14 F-7 HPURX2	<b>Z 176</b>	0 001 335 911	25	430
14 F-7 HPURX2	<b>Z 176 SB</b>	0 900 004 142	25	430
14 F-7 HTUR	<b>Z 344</b>	0 001 335 788	25	412
14 F-7 HUR2	<b>Z 200</b>	0 001 335 742	25	412
14 F-7 HUR2	<b>Z 200 SB</b>	0 900 004 147	25	412
14 F-7 HURU02	<b>Z 272</b>	0 001 335 789	25	412
14 F-7 KPURU2	<b>Z 321</b>	0 001 335 917	25	431
14 F-7 LDUR	<b>Z 14</b>	0 001 335 732	25	413
14 F-7 LDUR	<b>Z 14 SB</b>	0 900 004 084	25	413
14 F-8 DPURX02	<b>Z 240</b>	0 001 330 905	25	431
14 F-8 DPURX02	<b>Z 240 SB</b>	0 900 004 184	25	431
14 F-8 DU0	<b>Z 5</b>	0 001 330 725	25	413
14 F-8 DU0	<b>Z 5 SB</b>	0 900 004 080	25	413
14 F-8 DU4	<b>Z 100</b>	0 001 330 731	25	413
14 F-8 DU4	<b>Z 100 SB</b>	0 900 004 134	25	413
14 F-8 DUR	<b>Z 227</b>	0 001 330 780	25	413
14 F-8 DUR	<b>Z 227 SB</b>	0 900 004 178	25	413
14 F-8 LDUSR	<b>Z 101</b>	0 001 330 501	25	413
14 F-8 LUR	<b>Z 4</b>	0 001 330 717	25	413
14 F-8 LUR	<b>Z 4 SB</b>	0 900 004 072	25	413
14 F-9 DU0	<b>Z 79</b>	0 001 325 705	25	413
14 FG-8 DTU	<b>Z 128</b>	0 001 330 105	25	413
14 FGH-6 DTUR	<b>Z 89</b>	0 001 340 103	25	413
14 FGH-6 DTUR	<b>Z 89 SB</b>	0 900 004 106	25	413
14 FGH-7 DPURX2	<b>Z 282</b>	0 001 335 905	25	431
14 FGH-7 DTURX	<b>Z 90</b>	0 001 335 107	25	413
14 FGH-7 DTURX	<b>Z 90 SB</b>	0 900 004 101	25	413
14 FGH-7 DTURX0	<b>Z 120</b>	0 001 335 110	25	414
14 FGH-7 DTURX0	<b>Z 120 SB</b>	0 900 004 136	25	414
14 FGH-8 DPURX2	<b>Z 122</b>	0 001 330 904	25	431
14 FGH-8 DPURX2	<b>Z 122 SB</b>	0 900 004 170	25	431
14 FGH-8 DTUR	<b>Z 126</b>	0 001 330 117	25	414
14 FGH-8 DTUR	<b>Z 126 SB</b>	0 900 004 201	25	414
14 FGH-8 DTURW	<b>Z 246</b>	0 001 330 119	25	414
14 FGH-8 DTURW	<b>Z 246 SB</b>	0 900 004 198	25	414
14 FGH-8 DTURX0	<b>Z 121</b>	0 001 330 116	25	414
14 FGH-8 DTURX0	<b>Z 121 SB</b>	0 900 004 137	25	414
14 FGHR-7 DTUT	<b>Z 304</b>	0 002 335 137	25	414



Nm



14 FGHR-7 DTUU	<b>Z 360</b>	0 002 335 139	25	414
14 FGHR-7 LDUW	<b>Z 324</b>	0 002 335 138	25	414
14 FGR-5 NTE	<b>Z 294</b>	0 002 345 118	25	414
14 FGR-6 DDU	<b>Z 145</b>	0 002 340 102	25	414
14 FGR-6 DDU	<b>Z 145 SB</b>	0 900 004 205	25	416
14 FGR-6 HQU	<b>Z 300</b>	0 002 340 123	25	414
14 FGR-6 HQU	<b>Z 300 SB</b>	0 900 004 237	25	414
14 FGR-6 KQU	<b>Z 129</b>	0 002 340 101	25	415
14 FGR-7 CTU	<b>Z 60</b>	0 002 335 100	25	415
14 FGR-7 KDU6	<b>Z 213</b>	0 002 335 128	25	415
14 FGR-7 KQE	<b>Z 239</b>	0 002 335 131	25	415
14 FGR-7 KQE	<b>Z 239 SB</b>	0 900 004 240	25	415
14 FGR-7 KQU	<b>Z 172</b>	0 002 335 104	25	415
14 FGR-8 CTU	<b>Z 204</b>	0 002 340 117	25	415
14 FGR-8 CTU	<b>Z 204 SB</b>	0 900 004 206	25	415
14 FGR-8 DQU7	<b>Z 190</b>	0 002 330 104	25	415
14 FGR-8 DQU7	<b>Z 190 SB</b>	0 900 004 143	25	415
14 FGR-8 KQU	<b>Z 173</b>	0 002 330 102	25	415
14 FGR-8 KQU	<b>Z 173 SB</b>	0 900 004 204	25	415
14 FGR-8 MQPU	<b>Z 211</b>	0 002 330 902	25	431
14 FR-4 DPU	<b>Z 231</b>	0 002 350 901	25	431
14 FR-5 DPPUX	<b>Z 323</b>	0 002 345 904	25	431
14 FR-5 DPUX	<b>Z 130</b>	0 002 335 901	25	431
14 FR-5 DTU	<b>Z 45</b>	0 002 345 704	25	415
14 FR-5 DU	<b>Z 30</b>	0 002 345 702	25	415
14 FR-5 DU	<b>Z 30 SB</b>	0 900 004 076	25	415
14 FR-5 DUU	<b>Z 253</b>	0 002 345 731	25	416
14 FR-5 LDU	<b>Z 192</b>	0 002 345 501	25	416
14 FR-5 LDU3	<b>Z 198</b>	0 002 345 504	25	416
14 FR-5 LPUOX	<b>Z 354</b>	0 002 345 906	25	431
14 FR-6 DPOX	<b>Z 284</b>	0 002 340 908	25	432
14 FR-6 DPU02S	<b>Z 340</b>	0 002 340 915	25	432
14 FR-6 DPU02S	<b>Z 340 SB</b>	0 900 004 245	25	432
14 FR-6 DPUW2	<b>Z 314</b>	0 002 340 910	25	432
14 FR-6 DPUX	<b>Z 159</b>	0 002 340 903	25	432
14 FR-6 DPUX02	<b>Z 221</b>	0 002 340 905	25	432
14 FR-6 DPUX02	<b>Z 221 SB</b>	0 900 004 207	25	432
14 FR-6 DPUX2	<b>Z 313</b>	0 002 340 909	25	432
14 FR-6 DU	<b>Z 24</b>	0 002 340 702	25	416
14 FR-6 DU	<b>Z 24 SB</b>	0 900 004 053	25	416
14 FR-6 DUW	<b>Z 252</b>	0 002 340 768	25	416
14 FR-6 DUW2	<b>Z 335</b>	0 002 340 771	25	416
14 FR-6 DUX	<b>Z 99</b>	0 002 340 704	25	416
14 FR-6 DUX	<b>Z 99 SB</b>	0 900 004 193	25	416
14 FR-6 LDU	<b>Z 116</b>	0 002 340 500	25	416
14 FR-6 LDU	<b>Z 116 SB</b>	0 900 004 200	25	416
14 FR-6 LDU3	<b>Z 194</b>	0 002 340 501	25	416
14 FR-6 LDU3	<b>Z 194 SB</b>	0 900 004 205	25	416
14 FR-6 LDUW	<b>Z 245</b>	0 002 340 504	25	416
14 FR-6 LDUW	<b>Z 245 SB</b>	0 900 004 197	25	416
14 FR-6 LPUOX	<b>Z 275</b>	0 002 340 918	25	432
14 FR-6 MPU2	<b>Z 226</b>	0 002 340 906	25	432
14 FR-6 MPU2	<b>Z 226 SB</b>	0 900 004 177	25	432
14 FR-7 DPPUS2	<b>Z 206</b>	0 002 335 940	25	432
14 FR-7 DPPUS2	<b>Z 206 SB</b>	0 900 004 173	25	432
14 FR-7 DPPUW2	<b>Z 337</b>	0 002 335 946	25	432
14 FR-7 DPU3	<b>Z 224</b>	0 002 335 912	25	433
14 FR-7 DPU3	<b>Z 224 SB</b>	0 900 004 176	25	433
14 FR-7 DPUV02	<b>Z 307</b>	0 002 335 937	25	433
14 FR-7 DPUX02	<b>Z 228</b>	0 002 335 914	25	433
14 FR-7 DPUX02	<b>Z 228 SB</b>	0 900 004 179	25	433
14 FR-7 DQUP7	<b>Z 237</b>	0 002 335 911	25	433
14 FR-7 DQUP7	<b>Z 237 SB</b>	0 900 004 182	25	433
14 FR-7 DU	<b>Z 15</b>	0 002 335 707	25	417



Nm



14 FR-7 DU	<b>Z 15 SB</b>	0 900 004 085	25	417
14 FR-7 DU2	<b>Z 193</b>	0 002 335 717	25	417
14 FR-7 DU2	<b>Z 193 SB</b>	0 900 004 146	25	417
14 FR-7 DU2S	<b>Z 250</b>	0 002 336 725	25	417
14 FR-7 DU2T	<b>Z 251</b>	0 002 336 726	25	417
14 FR-7 DUW	<b>Z 247</b>	0 002 336 724	25	417
14 FR-7 DUW	<b>Z 247 SB</b>	0 900 004 199	25	417
14 FR-7 DUX	<b>Z 16</b>	0 002 335 708	25	417
14 FR-7 DUX	<b>Z 16 SB</b>	0 900 004 086	25	417
14 FR-7 HUX	<b>Z 225</b>	0 002 336 715	25	417
14 FR-7 KDU	<b>Z 123</b>	0 002 335 709	25	417
14 FR-7 KPPU	<b>Z 312</b>	0 002 335 938	25	433
14 FR-7 KPU	<b>Z 151</b>	0 002 335 904	25	433
14 FR-7 KPUV	<b>Z 150</b>	0 002 335 903	25	433
14 FR-7 KPUX	<b>Z 149</b>	0 002 335 902	25	433
14 FR-7 KPUX02	<b>Z 280</b>	0 002 335 926	25	433
14 FR-7 KU	<b>Z 155</b>	0 002 335 712	25	417
14 FR-7 KU	<b>Z 155 SB</b>	0 900 004 152	25	417
14 FR-7 KU0	<b>Z 156</b>	0 002 335 713	25	417
14 FR-7 KU0X	<b>Z 157</b>	0 002 335 714	25	418
14 FR-7 KU0X	<b>Z 157 SB</b>	0 900 004 203	25	418
14 FR-7 LDU	<b>Z 98</b>	0 002 335 500	25	418
14 FR-7 LDU	<b>Z 98 SB</b>	0 900 004 192	25	418
14 FR-7 LDUW	<b>Z 257</b>	0 002 335 503	25	418
14 FR-7 LDUW	<b>Z 257 SB</b>	0 900 004 211	25	418
14 FR-7 LPU02	<b>Z 279</b>	0 002 335 925	25	433
14 FR-7 LPUT02	<b>Z 346</b>	0 002 335 947	25	434
14 FR-7 LPUX0	<b>Z 297</b>	0 002 335 936	25	434
14 FR-7 LPUX02	<b>Z 301</b>	0 002 335 935	25	434
14 FR-7 LPUX02	<b>Z 301 SB</b>	0 900 004 242	25	434
14 FR-7 LUX	<b>Z 158</b>	0 002 335 715	25	418
14 FR-7 LUX	<b>Z 158 SB</b>	0 900 004 144	25	418
14 FR-7 LUX0	<b>Z 299</b>	0 002 335 802	25	418
14 FR-7 MPUS	<b>Z 326</b>	0 002 335 939	25	434
14 FR-7 MPUS	<b>Z 326 SB</b>	0 900 004 244	25	434
14 FR-7 MU2	<b>Z 184</b>	0 002 335 719	25	418
14 FR-7 MU2	<b>Z 184 SB</b>	0 900 004 148	25	418
14 FR-7 MUX2	<b>Z 303</b>	0 002 336 734	25	418
14 FR-7 NUX2	<b>Z 273</b>	0 002 336 738	25	418
14 FR-7 SPUX03	<b>Z 235</b>	0 002 335 915	25	434
14 FR-7 SPUX03	<b>Z 235 SB</b>	0 900 004 180	25	434
14 FR-8 DEW	<b>Z 334</b>	0 002 330 217	25	418
14 FR-8 DPPUX	<b>Z 343</b>	0 002 330 930	25	434
14 FR-8 DPU2	<b>Z 238</b>	0 002 330 905	25	434
14 FR-8 DPU2	<b>Z 238 SB</b>	0 900 004 183	25	434
14 FR-8 DU	<b>Z 72</b>	0 002 330 703	25	418
14 FR-8 DU	<b>Z 72 SB</b>	0 900 004 191	25	418
14 FR-8 DUS	<b>Z 254</b>	0 002 330 205	25	418
14 FR-8 DUW	<b>Z 255</b>	0 002 330 206	25	419
14 FR-8 DUW	<b>Z 255 SB</b>	0 900 004 210	25	419
14 FR-8 DUX	<b>Z 73</b>	0 002 330 704	25	419
14 FR-8 DUX	<b>Z 73 SB</b>	0 900 004 169	25	419
14 FR-8 HU	<b>Z 152</b>	0 002 330 712	25	419
14 FR-8 HUT	<b>Z 248</b>	0 002 330 203	25	419
14 FR-8 KU	<b>Z 153</b>	0 002 330 713	25	419
14 FR-8 KU	<b>Z 153 SB</b>	0 900 004 150	25	419
14 FR-8 KU0	<b>Z 154</b>	0 002 330 714	25	419
14 FR-8 KU0	<b>Z 154 SB</b>	0 900 004 151	25	419
14 FR-8 KU0U	<b>Z 249</b>	0 002 330 204	25	419
14 FR-8 LDU0X4	<b>Z 74</b>	0 002 330 710	25	419
14 FR-8 LDU0X4	<b>Z 74 SB</b>	0 900 004 113	25	419
14 FR-8 LDU3	<b>Z 208</b>	0 002 330 795	25	419
14 FR-8 LPO	<b>Z 229</b>	0 002 330 903	25	434
14 FR-8 LPU02	<b>Z 278</b>	0 002 330 918	25	434



Nm



14 FR-8 LU2	<b>Z 203</b>	0 002 330 794	25	419
14 FR-8 LU2	<b>Z 203 SB</b>	0 900 004 172	25	419
14 FR-8 LU2T	<b>Z 287</b>	0 002 330 215	25	420
14 FR-8 MPUX02	<b>Z 219</b>	0 002 330 904	25	434
14 FR-8 MPUX2	<b>Z 302</b>	0 002 330 926	25	435
14 FR-8 MU2	<b>Z 183</b>	0 002 330 718	25	420
14 FR-8 MU2	<b>Z 183 SB</b>	0 900 004 149	25	420
14 FR-8 NQU23	<b>Z 223</b>	0 002 330 796	25	420
14 FR-8 NQU23	<b>Z 223 SB</b>	0 900 004 208	25	420
14 FR-9 KUX2	<b>Z 220</b>	0 002 325 723	25	420
14 G-8 DTU	<b>Z 75</b>	0 001 330 104	25	420
14 GH-7 DTUR	<b>Z 91</b>	0 001 335 108	25	420
14 GH-7 DTUR	<b>Z 91 SB</b>	0 900 004 102	25	420
14 GH-8 DTUR	<b>Z 92</b>	0 001 330 113	25	420
14 GH-8 DTUR	<b>Z 92 SB</b>	0 900 004 103	25	420
14 GH-8 DTURX	<b>Z 93</b>	0 001 330 112	25	420
14 GH-8 DTURX	<b>Z 93 SB</b>	0 900 004 104	25	420
14 GR-8 DTU	<b>Z 94</b>	0 002 330 706	25	420
14 GR-8 DTU	<b>Z 94 SB</b>	0 900 004 105	25	420
14 K-5 DU	<b>Z 31</b>	0 001 645 700	15	425
14 K-5 DU	<b>Z 31 SB</b>	0 900 004 061	15	425
14 K-5 DU0	<b>Z 46</b>	0 001 645 703	15	425
14 K-6 DU	<b>Z 25</b>	0 001 640 700	15	425
14 K-6 DU	<b>Z 25 SB</b>	0 900 004 051	15	425
14 K-6 DU0	<b>Z 55</b>	0 001 640 704	15	425
14 K-6 DU0	<b>Z 56</b>	0 001 640 705	15	425
14 K-7 DU	<b>Z 17</b>	0 001 635 700	15	425
14 K-7 DU	<b>Z 17 SB</b>	0 900 004 030	15	425
14 K-7 DU0	<b>Z 18</b>	0 001 635 709	15	425
14 K-7 DU0	<b>Z 18 SB</b>	0 900 004 087	15	425
14 K-8 DU	<b>Z 6</b>	0 001 630 700	15	425
14 K-8 DU	<b>Z 6 SB</b>	0 900 004 092	15	425
14 K-8 DU0	<b>Z 7</b>	0 001 630 704	15	425
14 K-8 DU0	<b>Z 7 SB</b>	0 900 004 081	15	425
14 K-9 BU	<b>Z 174</b>	0 001 625 705	15	425
14 K-9 DU	<b>Z 80</b>	0 001 625 700	15	426
14 K-9 DU0	<b>Z 81</b>	0 001 625 702	15	426
14 KG-8 DTU	<b>Z 207</b>	0 001 630 101	15	426
14 KGR-6 KQU	<b>Z 144</b>	0 002 640 100	15	426
14 KGR-7 KQU	<b>Z 127</b>	0 002 635 100	15	426
14 KR-10 SUV2	<b>Z 216</b>	0 002 620 708	15	426
14 KR-6 BU	<b>Z 49</b>	0 002 640 701	15	426
14 KR-6 BU	<b>Z 49 SB</b>	0 900 004 189	15	426
14 KR-6 DPUV02	<b>Z 209</b>	0 002 640 904	15	436
14 KR-6 DPUV02	<b>Z 209 SB</b>	0 900 004 174	25	436
14 KR-6 DU	<b>Z 26</b>	0 002 640 700	15	426
14 KR-6 DU	<b>Z 26 SB</b>	0 900 004 054	15	426
14 KR-6 KPUV02	<b>Z 230</b>	0 002 640 907	15	436
14 KR-6 KPUV02	<b>Z 230 SB</b>	0 900 004 238	15	436
14 KR-6 MPV	<b>Z 315</b>	0 002 640 910	15	436
14 KR-6 MUU	<b>Z 305</b>	0 002 640 712	15	427
14 KR-7 DPUV	<b>Z 296</b>	0 002 635 902	15	436
14 KR-7 DU	<b>Z 95</b>	0 002 635 700	15	426
14 KR-7 DU	<b>Z 95 SB</b>	0 900 004 121	15	426
14 KR-7 DUX	<b>Z 67</b>	0 002 635 701	15	426
14 KR-7 DUX	<b>Z 67 SB</b>	0 900 004 108	15	426
14 KR-7 MPUV2	<b>Z 342</b>	0 002 635 904	15	436
14 KR-7 MPUX2	<b>Z 356</b>	0 002 635 903	15	436
14 KR-8 DPU0V	<b>Z 148</b>	0 002 630 900	15	436
14 KR-8 DPU0V	<b>Z 148 SB</b>	0 900 004 195	15	433
14 KR-8 DPUV	<b>Z 298</b>	0 002 630 903	15	436
14 KR-8 LQPU07	<b>Z 309</b>	0 002 630 904	15	436
14 KR-8 MPUV2	<b>Z 310</b>	0 002 630 905	15	436
14 KR-8 MPUV2	<b>Z 310 SB</b>	0 900 004 243	15	436





Nm





14 KR-8 MPX	<b>Z 97</b>	0 002 640 900	15	436
14 KR-8 MPX	<b>Z 97 SB</b>	0 900 004 109	15	436
14 KR-8 MUV	<b>Z 177</b>	0 002 630 701	15	427
14 KR-8 MUV	<b>Z 177 SB</b>	0 900 004 141	15	427
14 KR-8 STUX	<b>Z 222</b>	0 002 630 715	15	427
14 KR-8 STUX	<b>Z 222 SB</b>	0 900 004 175	15	427
14 KR-9 DUX	<b>Z 117</b>	0 002 625 700	15	427
14 R-5 DU	<b>Z 47</b>	0 002 345 701	25	420
14 R-5 DU	<b>Z 47 SB</b>	0 900 004 188	25	420
14 R-6 DU	<b>Z 27</b>	0 002 340 701	25	421
14 R-6 DU	<b>Z 27 SB</b>	0 900 004 047	25	421
14 R-6 DUX	<b>Z 28</b>	0 002 340 703	25	421
14 R-6 DUX	<b>Z 28 SB</b>	0 900 004 090	25	421
14 R-7 BU	<b>Z 19</b>	0 002 435 701	25	421
14 R-7 BU	<b>Z 19 SB</b>	0 900 004 048	25	421
14 R-7 CU	<b>Z 59</b>	0 002 335 704	25	421
14 R-7 CU	<b>Z 59 SB</b>	0 900 004 190	25	421
14 R-7 DU	<b>Z 20</b>	0 002 335 701	25	421
14 R-7 DU	<b>Z 20 SB</b>	0 900 004 049	25	421
14 R-7 DUX	<b>Z 21</b>	0 002 335 706	25	421
14 R-7 DUX	<b>Z 21 SB</b>	0 900 004 088	25	421
14 R-8 DPUU	<b>Z 311</b>	0 002 330 925	25	435
14 R-8 DU	<b>Z 8</b>	0 002 330 701	25	421
14 R-8 DU	<b>Z 8 SB</b>	0 900 004 052	25	421
14 R-8 DU4	<b>Z 119</b>	0 002 330 709	25	421
14 R-8 DU4	<b>Z 119 SB</b>	0 900 004 135	25	421
14 R-8 DUX	<b>Z 9</b>	0 002 330 702	25	421
14 R-8 DUX	<b>Z 9 SB</b>	0 900 004 082	25	421
14 R-9 DU	<b>Z 82</b>	0 002 325 700	25	421
14 R-9 KPUV2	<b>Z 285</b>	0 002 325 900	25	435
14 S-10 E0	<b>Z 270</b>	0 004 520 301	25	437
14 S-5 F	<b>Z 265</b>	0 004 545 401	25	437
14 S-7 E	<b>Z 266</b>	0 004 535 300	25	437
14 S-7 EU0	<b>Z 267</b>	0 004 535 700	25	437
14 S-7 F	<b>Z 132</b>	0 004 535 402	25	437
14 S-9 E0	<b>Z 262</b>	0 004 525 302	25	437
14 SR-10 E0	<b>Z 261</b>	0 004 520 300	25	438
14 SR-5 F	<b>Z 260</b>	0 004 545 400	25	438
14 SR-7 E	<b>Z 271</b>	0 004 535 301	25	437
14 SR-7 F	<b>Z 263</b>	0 004 535 403	25	438
14 SR-9 E0	<b>Z 269</b>	0 004 525 304	25	438
14 Z-3 AU	<b>Z 37</b>	0 001 455 702	25	422
14 Z-3 CU	<b>Z 38</b>	0 001 355 700	25	422
14 Z-4 AU	<b>Z 39</b>	0 001 450 702	25	422
14-5 AU	<b>Z 40</b>	0 001 445 702	25	422
14-5 BU	<b>Z 41</b>	0 001 445 700	25	422
14-5 BU	<b>Z 41 SB</b>	0 900 004 186	25	422
14-5 DTU	<b>Z 44</b>	0 001 345 704	25	422
14-5 DU	<b>Z 42</b>	0 001 345 702	25	422
14-5 DU	<b>Z 42 SB</b>	0 900 004 187	25	422
14-6 BU	<b>Z 48</b>	0 001 440 700	25	422
14-6 DPO	<b>Z 104</b>	0 001 340 903	25	435
14-6 DTU	<b>Z 51</b>	0 001 340 704	25	422
14-6 DU	<b>Z 22</b>	0 001 340 702	25	422
14-6 DU	<b>Z 22 SB</b>	0 900 004 019	25	422
14-7 AU	<b>Z 57</b>	0 001 435 705	25	423
14-7 BU	<b>Z 10</b>	0 001 435 700	25	423
14-7 BU	<b>Z 10 SB</b>	0 900 004 021	25	423
14-7 CU	<b>Z 58</b>	0 001 335 707	25	423
14-7 DTU	<b>Z 12</b>	0 001 335 709	25	423
14-7 DTU	<b>Z 12 SB</b>	0 900 004 066	25	423
14-7 DU	<b>Z 11</b>	0 001 335 702	25	423
14-7 DU	<b>Z 11 SB</b>	0 900 004 023	25	423
14-7 DU0	<b>Z 61</b>	0 001 335 714	25	423





Nm



14-7 DU0	<b>Z 62</b>	0 001 335 737	25	423
14-8 AU	<b>Z 68</b>	0 001 430 701	25	423
14-8 BU	<b>Z 118</b>	0 001 430 700	25	423
14-8 BU	<b>Z 118 SB</b>	0 900 004 194	25	423
14-8 DTU	<b>Z 2</b>	0 001 330 709	25	423
14-8 DTU	<b>Z 2 SB</b>	0 900 004 067	25	423
14-8 DU	<b>Z 1</b>	0 001 330 702	25	423
14-8 DU	<b>Z 1 SB</b>	0 900 004 024	25	423
14-8 DU0	<b>Z 69</b>	0 001 330 713	25	424
14-8 DU0	<b>Z 70</b>	0 001 330 726	25	424
14-8 E	<b>Z 112</b>	0 001 529 302	25	424
14-8 LUR	<b>Z 3</b>	0 001 330 718	25	424
14-8 LUR	<b>Z 3 SB</b>	0 900 004 091	25	424
14-9 DTU	<b>Z 78</b>	0 001 325 710	25	424
14-9 DU	<b>Z 76</b>	0 001 325 701	25	424
14-9 DU	<b>Z 76 SB</b>	0 900 004 120	25	424
14-X AU	<b>Z 85</b>	0 001 400 701	25	424
18 K-6 BU	<b>Z 33</b>	0 001 740 700	20	427
18 K-6 BU	<b>Z 33 SB</b>	0 900 004 055	20	427
18 K-7 BU	<b>Z 32</b>	0 001 735 700	20	427
18 K-9 BU	<b>Z 175</b>	0 001 725 700	20	427
EBE 514	<b>Z 110</b>	0 004 500 400	-	438
G 3/18	<b>Z 108</b>	0 001 700 901	25	438
KP105 DU	<b>Z 109</b>	0 004 021 601	-	438

CGP 001		0 106 671 105	15		308
GD 01	HA 01	0 102 013 404	38	3	308
GD 12	MB 12	0 100 102 307	38	3	308
GD 71	MB 71	0 100 101 011	38	3	308
GD 203	203 G	0 102 124 601	38	3	308
GD 214	214 GK	0 100 101 302	38	3	308
GD 220	220 G	0 100 100 203	38	3	308
GD 255	255	0 100 101 001	38	3	308
GD 294	294 GK	0 100 102 302	38	3	308
GD 318	318 GK	0 100 101 304	38	3	308
GD 341	341 GL	0 100 101 204	38	3	309
GD 348	348 GK	0 100 101 305	38	3	309
GD 382	382 GK	0 100 101 308	38	3	309
GE 100		0 100 266 008	15		310
GE 101		0 100 266 009	10		310
GE 102		0 100 266 002	15		310
GE 103		0 100 266 003	15		310
GE 104		0 100 266 010	15		310
GE 105		0 100 266 011	10		310
GE 106		0 100 266 018	15	2	310
GE 109		0 100 266 059	15	2	310
GE 110		0 100 266 032	15		310
GE 111		0 100 266 033	15		310
GE 112		0 100 266 031	10		311
GE 113		0 100 266 019	10		311
GE 114		0 100 266 034	10		311
GE 115		0 100 266 040	15		311
GE 116		0 100 266 042	15	2	311
GE 118		0 100 266 037	20		311
GE 119		0 100 266 065	15		311
GE 120		0 100 266 066	15		311
GF 002		0 101 233 499	20	3	364
GF 006		0 101 223 461	20	3	363
GF 007		0 101 233 493	20	3	364
GF 111	111 G	0 101 233 403	20	3	364
GF 154	154 GSF	0 101 072 603	20		366
GF 163	163 GS	0 101 022 404	20		366
GF 167	167 G	0 101 233 401	20	3	364
GF 186	186 GS	0 101 022 405	20		366
GF 529		0 101 234 529	25	5	365
GF 630	630 G	0 101 233 413	20	3	364
GF 667	667 G	0 101 234 504	20	3	365
GF 683	683 G	0 101 223 454	20	3	363
GF 777	777 G	0 101 233 450	20	3	364
GF 817	817 G	0 101 234 513	20	3	365
GF 830		0 101 233 601	20	3	364
GF 831		0 101 223 603	20	3	363
GF 859		0 101 072 405	20		366
GF 972	972 G	0 101 223 457	20	3	363
GF 973	973 G	0 101 223 456	20	3	363
GF 974	974 G	0 101 223 459	20	3	363
GF 975	975 G	0 101 233 480	20	3	364
GF 976	976 G	0 101 233 481	20	3	364
GF 977	977 G	0 101 233 483	20	3	365
GF 978	978 G	0 101 233 486	20	3	365
GF 979	979 G	0 101 233 487	20	3	365
GF 980	980 G	0 101 233 488	20	3	365
GF 981	981 G	0 101 233 489	20	3	365
GF 982		0 101 072 408	20		366
GF 983		0 101 072 409	20		366
GF 984		0 101 223 449	20	5	363
GH 001		0 100 226 340	15	2	312
GH 008		0 100 331 103	15	2	312
GH 009		0 100 331 104	15	2	312

GH 010		0 102 124 416	20	3	312
GH 011		0 102 224 205	40	4	312
GH 13	GZE 13	0 105 100 002	20		312
GH 18	GZE 18	0 105 100 008	20		312
GH 30	GZE 30	0 105 100 021	20		312
GH 116	116 S	0 102 022 202	15	3	312
GH 191	191 GS	0 102 062 202	15		313
GH 195	195 GLS	0 102 012 205	15	3	313
GH 201	GZE 201	0 105 110 001	20		313
GH 202	GZE 202	0 105 110 002	20		313
GH 203	GZE 203	0 105 110 003	20		313
GH 306		0 102 174 306	20		313
GH 345	345 GK	0 102 113 302	20	3	313
GH 359	359 G	0 102 113 303	20	3	313
GH 401		0 102 124 418	60	3	313
GH 407	407 GS	0 101 172 403	20		314
GH 408	408 GS	0 102 123 203	15	2	314
GH 409	409 GS	0 102 174 303	20		314
GH 410	410 GS	0 102 184 303	20		314
GH 648	648 MJ	0 102 271 301	20		314
GH 649	649 GS	0 102 022 301	20	3	314
GH 760		0 102 024 405	20	3	314
GH 846	846 G	0 102 133 204	15		314
GH 847	847 G	0 102 173 212	15		314
GH 931	931 GS	0 102 133 403	20	2	315
GHA 408	408 GSA	0 102 123 403	20	2	315
GN 001		0 100 226 333	25		316
GN 002		0 100 231 119	25		316
GN 003		0 100 226 379	18		316
GN 005		0 100 226 336	15	2	316
GN 007		0 100 226 343	15		316
GN 008		0 100 226 338	15		316
GN 010		0 100 226 365	15	2	316
GN 012		0 100 226 354	15	2	316
GN 013		0 100 226 366	22	3	316
GN 015		0 100 226 392	15		316
GN 016		0 100 226 371	15	2	317
GN 017		0 100 226 372	15	2	317
GN 018		0 100 226 373	15		317
GN 019		0 100 226 375	15		317
GN 020		0 100 226 376	22		317
GN 022		0 100 226 381	25	3	317
GN 023		0 100 226 481	15	2	317
GN 024		0 100 226 362	15		317
GN 025		0 100 226 370	15		317
GN 026		0 100 226 351	15		317
GN 027		0 100 226 344	15	2	318
GN 030		0 100 226 391	15		318
GN 032		0 100 226 505	15	2	318
GN 033		0 100 226 417	15		318
GN 035		0 100 226 422	15	2	318
GN 036		0 100 271 204	18		318
GN 037		0 100 276 003	15		318
GN 039		0 100 226 352	15	2	318
GN 040		0 100 226 434	15	2	318
GN 041		0 100 226 436	12		318
GN 042		0 100 226 480	15	2	319
GN 043		0 100 226 475	20	1,5	319
GN 044		0 100 230 107	15	1,5	319
GN 045		0 100 276 005	10		319
GN 046		0 100 226 482	15		319
GN 047		0 100 276 004	15	1,5	319
GN 049		0 100 271 205	18		319
GN 050		0 100 226 435	15		319



GN 053		0 100 276 008	10		319
GN 054		0 100 226 492	15	1	319
GN 055		0 100 226 494	15		320
GN 056		0 100 276 012	10		320
GN 057		0 100 222 106	15	2	320
GN 058		0 100 276 014	10	2	320
GN 059		0 100 276 015	10		320
GN 060		0 100 226 517	15		320
GN 061		0 100 226 520	15	2	320
GN 062		0 100 226 522	15	2	320
GN 063		0 100 276 024	10		320
GN 064		0 100 226 526	15	2	320
GN 065		0 100 226 527	15	2	321
GN 066		0 100 231 133	25		321
GN 067		0 100 226 569	15	2	321
GN 068		0 100 226 570	15	2	321
GN 069		0 100 276 031	12		321
GN 070		0 100 800 033	15	2	321
GN 071		0 100 800 034	18		321
GN 072		0 100 800 035	15	2	321
GN 073		0 100 800 036	15		321
GN 074		0 100 800 037	22	2	321
GN 075		0 100 800 038	18	2	322
GN 076		0 100 800 039	22	2	322
GN 077		0 100 800 040	18	2	322
GN 078		0 100 800 041	18	2	322
GN 080		0 100 800 043	18	2	322
GN 081		0 100 800 044	18	2	322
GN 082		0 100 800 045	10	2	322
GN 095		0 100 226 577	15	2	322
GN 096		0 100 226 638	15	2	322
GN 097		0 100 226 639	12		322
GN 101		0 100 226 514	15	2	323
GN 102		0 100 226 513	15	2	323
GN 103		0 100 226 495	15	2	323
GN 104		0 100 226 497	15		323
GN 106		0 100 226 525	15	2	323
GN 107		0 100 226 511	15	2	323
GN 108		0 100 226 538	15	2	323
GN 109		0 100 800 031	15	2	323
GN 110		0 100 226 568	15	2	323
GN 853	853 MJ	0 100 226 170	15	2	323
GN 854	854 MJ	0 100 226 171	15	2	324
GN 855	855 MJ	0 100 226 227	15		324
GN 857	857 MJ	0 100 226 173	22	3	324
GN 858	858 MJ	0 100 226 234	22	3	324
GN 860	860 MJ	0 100 226 258	22		324
GN 905	905 MJ	0 100 226 184	15	2	324
GN 908	908 MJ	0 100 226 185	22	3	324
GN 909	909 MJ	0 100 226 186	22	3	324
GN 912	912 MJ	0 100 226 188	15	2	324
GN 917	917 MJ	0 100 226 189	22	3	324
GN 918	918 MJ	0 100 226 190	22	3	325
GN 925		0 100 226 432	22	2	325
GN 926		0 100 231 110	15	2	325
GN 927	927 MJ	0 100 226 198	22	2	325
GN 928	928 MJ	0 100 226 199	22		325
GN 939		0 100 226 385	15	2	325
GN 944	944 MJ	0 100 226 206	15	2	325
GN 948	948 MJ	0 100 226 235	22		325
GN 954	954 MJ	0 100 226 229	22	3	325
GN 955	955 MJ	0 100 226 233	15	2	325
GN 959	959 MJ	0 100 226 237	22	3	326
GN 960		0 100 226 239	25		326



GN 961	961 MJ	0 100 226 250	22		326
GN 963	963 MJ	0 100 226 245	15	2	326
GN 964	964 MJ	0 100 226 246	15	2	326
GN 970	970 MJ	0 100 226 249	22	2	326
GN 984		0 100 226 253	22	3	326
GN 985		0 100 226 255	15		326
GN 989		0 100 226 284	15		326
GN 991	991 MJ	0 100 226 299	22	2	326
GN 992		0 100 226 300	15		327
GN 993		0 100 226 384	15	2	327
GN 994		0 100 226 302	15	2	327
GN 997		0 100 226 312	15	2	327
GN 999	999 MJ	0 100 226 238	15	2	327
GV 001		0 100 222 105	15	2	328
GV 003		0 100 800 002	15		328
GV 004		0 100 271 106	15		328
GV 007		0 100 226 506	15	2	328
GV 106	106 MJ	0 100 221 209	25	3	328
GV 107	107 MJ	0 100 222 301	40	3	328
GV 108	108 MJ	0 100 222 302	40	3	328
GV 110	110 MJ	0 100 222 303	40	3	328
GV 112	112 M	0 100 221 101	15	3	328
GV 117	117 MJ	0 100 232 301	40	3	328
GV 119	119 M	0 100 221 201	25	3	329
GV 123	123 MJ	0 100 221 202	25	3	329
GV 127	127 MJ	0 100 332 301	40	3	329
GV 128	128 M	0 100 281 301	40		329
GV 129	129 MJ	0 100 221 203	25	3	329
GV 130	130 MJ	0 100 221 210	25	3	329
GV 133	133 MJ	0 100 231 202	25	3	329
GV 134	134 M	0 100 271 601	15		329
GV 136	136 MJ	0 100 221 204	25	3	329
GV 137	137 MJ	0 100 220 206	25	3	329
GV 142	142 MJ	0 100 222 201	25	3	330
GV 144	144 MNK	0 100 220 204	25	3	330
GV 145	145 M	0 100 271 301	40		330
GV 149	149 MJ	0 100 222 305	40	3	330
GV 153	153 MJ	0 100 231 101	22	3	330
GV 155	155 MJ	0 100 221 206	27	3	330
GV 165	165 MJ	0 100 231 302	40	3	330
GV 170	170 MJ	0 100 221 301	40	3	330
GV 175	175 M	0 100 222 202	25	3	330
GV 176	176 M	0 100 220 201	25	3	330
GV 179	179 MN	0 100 221 305	40	3	331
GV 181	181 MN	0 100 231 305	40	3	331
GV 182	182 MJ	0 100 221 302	40	3	331
GV 191	191 MJ	0 100 231 303	40	3	331
GV 196	196 MJ	0 100 221 303	40	3	331
GV 197	197 MJ	0 100 221 304	40	3	331
GV 198	198 M	0 100 222 203	25	3	331
GV 199	199 M	0 100 220 203	25	3	331
GV 361	361 MK	0 100 302 301	40	3	331
GV 380	380 MJ	0 100 331 301	40	3	331
GV 390	390 MJ	0 100 331 303	40	3	332
GV 602	602 MJ	0 100 221 106	22	3	332
GV 603	603 MJ	0 100 221 107	22	3	332
GV 604	604 MJ	0 100 221 108	22	3	332
GV 626	626 MJ	0 100 221 311	38	3	332
GV 631	631 MJ	0 100 221 132	22	3	332
GV 636	636 MJ	0 100 221 133	22	3	332
GV 642	642 MJ	0 100 221 135	22	3	332
GV 657	657 MJ	0 100 221 141	22	3	332
GV 661	661 MJ	0 100 221 144	22	2	332
GV 663	663 MJ	0 100 221 145	22	3	333

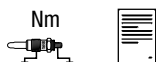

GV 664	664 MJ	0 100 232 204	25	3	333
GV 666	666 MJ	0 100 221 146	22	2	333
GV 673	673 MJ	0 100 221 147	15	2	333
GV 678	678 MJ	0 100 221 148	15	2	333
GV 685	685 MJ	0 100 221 149	15	2	333
GV 688	688 MJ	0 100 221 151	15	2	333
GV 689	689 MJ	0 100 221 152	22	3	333
GV 691	691 MJ	0 100 221 153	22	3	333
GV 705	705 MJ	0 100 221 154	15	2	333
GV 719	719 MJ	0 100 221 163	22	3	334
GV 724	724 MJ	0 100 221 164	22	3	334
GV 727	727 MJ	0 100 221 167	22	3	334
GV 728	728 MJ	0 100 221 168	15	2	334
GV 730	730 MJ	0 100 221 170	15	2	334
GV 736	736 MJ	0 100 231 120	22	3	334
GV 749	749 MJ	0 100 221 186	15	2	334
GV 776	776 MJ	0 100 231 103	22	3	334
GV 783	783 MJ	0 100 226 129	15	2	334
GV 798	798 MJ	0 100 226 128	22	2	334
GV 819	819 MJ	0 100 226 138	15		335
GV 823	823 MJ	0 100 271 101	15		335
GV 844	844 MJ	0 100 226 164	22	3	335
GV 852	852 MJ	0 100 226 163	22	3	335
GV 880	880 MJ	0 100 231 104	15	2	335
GV 886	886 MJ	0 100 226 180	15	2	335
GV 887	887 MJ	0 100 230 101	15	2	335
GV 888	888 MJ	0 100 220 113	22	3	335
GV 889	889 MJ	0 100 220 114	15	2	335
GV 890	890 MJ	0 100 230 102	15	2	336
GV 892	892 MJ	0 100 220 115	15	2	336
GV 894	894 MJ	0 100 222 101	15	2	336
GV 895	895 MJ	0 100 231 107	15	2	336
GV 896	896 MJ	0 100 222 102	15	2	336
GV 897	897 MJ	0 100 226 182	15	2	336
GV 910	910 MJ	0 100 221 314	40	3	336
GV 920	920 MJ	0 100 220 118	15	2	336
GV 921	921 MJ	0 100 226 194	15	2	336
GV 945	945 MJ	0 100 226 209	15	2	336
GV 946	946 MJ	0 100 226 207	15	2	337
GV 947	947 MJ	0 100 226 208	15	2	337
GV 967	967 MJ	0 100 226 242	15	2	337
GV 968	968 MJ	0 100 226 243	15	2	337
PSG 001		0 103 010 903	12		338
PSG 002		0 103 111 104	15		338
PSG 003		0 103 110 904	12		338
PSG 004		0 103 010 104	15		338

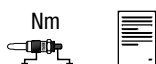

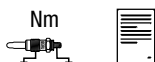

G 1 SB	GN 857	0 900 102 029	22	3	
G 5 SB	GN 858	0 900 102 045	22	3	
G 6 SB	GV 719	0 900 102 028	22	3	
G 7 SB	GN 954	0 900 102 038	22	3	
G 10 SB	GV 666	0 900 102 054	22	3	





0 100 100 203	<b>GD 220</b>	220 G	38	3	308
0 100 101 001	<b>GD 255</b>	255	38	3	308
0 100 101 011	<b>GD 71</b>	MB 71	38	3	308
0 100 101 204	<b>GD 341</b>	341 GL	38	3	309
0 100 101 302	<b>GD 214</b>	214 GK	38	3	308
0 100 101 304	<b>GD 318</b>	318 GK	38	3	308
0 100 101 305	<b>GD 348</b>	348 GK	38	3	309
0 100 101 308	<b>GD 382</b>	382 GK	38	3	309
0 100 102 302	<b>GD 294</b>	294 GK	38	3	308
0 100 102 307	<b>GD 12</b>	MB 12	38	3	308
0 100 220 113	<b>GV 888</b>	888 MJ	22	3	335
0 100 220 114	<b>GV 889</b>	889 MJ	15	2	335
0 100 220 115	<b>GV 892</b>	892 MJ	15	2	336
0 100 220 118	<b>GV 920</b>	920 MJ	15	2	336
0 100 220 201	<b>GV 176</b>	176 M	25	3	330
0 100 220 203	<b>GV 199</b>	199 M	25	3	331
0 100 220 204	<b>GV 144</b>	144 MNK	25	3	330
0 100 220 206	<b>GV 137</b>	137 MJ	25	3	329
0 100 221 101	<b>GV 112</b>	112 M	15	3	328
0 100 221 106	<b>GV 602</b>	602 MJ	22	3	332
0 100 221 107	<b>GV 603</b>	603 MJ	22	3	332
0 100 221 108	<b>GV 604</b>	604 MJ	22	3	332
0 100 221 132	<b>GV 631</b>	631 MJ	22	3	332
0 100 221 133	<b>GV 636</b>	636 MJ	22	3	332
0 100 221 135	<b>GV 642</b>	642 MJ	22	3	332
0 100 221 141	<b>GV 657</b>	657 MJ	22	3	332
0 100 221 144	<b>GV 661</b>	661 MJ	22	2	332
0 100 221 145	<b>GV 663</b>	663 MJ	22	3	333
0 100 221 146	<b>GV 666</b>	666 MJ	22	2	333
0 100 221 147	<b>GV 673</b>	673 MJ	15	2	333
0 100 221 148	<b>GV 678</b>	678 MJ	15	2	333
0 100 221 149	<b>GV 685</b>	685 MJ	15	2	333
0 100 221 151	<b>GV 688</b>	688 MJ	15	2	333
0 100 221 152	<b>GV 689</b>	689 MJ	22	3	333
0 100 221 153	<b>GV 691</b>	691 MJ	22	3	333
0 100 221 154	<b>GV 705</b>	705 MJ	15	2	333
0 100 221 163	<b>GV 719</b>	719 MJ	22	3	334
0 100 221 164	<b>GV 724</b>	724 MJ	22	3	334
0 100 221 167	<b>GV 727</b>	727 MJ	22	3	334
0 100 221 168	<b>GV 728</b>	728 MJ	15	2	334
0 100 221 170	<b>GV 730</b>	730 MJ	15	2	334
0 100 221 186	<b>GV 749</b>	749 MJ	15	2	334
0 100 221 201	<b>GV 119</b>	119 M	25	3	329
0 100 221 202	<b>GV 123</b>	123 MJ	25	3	329
0 100 221 203	<b>GV 129</b>	129 MJ	25	3	329
0 100 221 204	<b>GV 136</b>	136 MJ	25	3	329
0 100 221 206	<b>GV 155</b>	155 MJ	27	3	330
0 100 221 209	<b>GV 106</b>	106 MJ	25	3	328
0 100 221 210	<b>GV 130</b>	130 MJ	25	3	329
0 100 221 301	<b>GV 170</b>	170 MJ	40	3	330
0 100 221 302	<b>GV 182</b>	182 MJ	40	3	331
0 100 221 303	<b>GV 196</b>	196 MJ	40	3	331
0 100 221 304	<b>GV 197</b>	197 MJ	40	3	331
0 100 221 305	<b>GV 179</b>	179 MN	40	3	331
0 100 221 311	<b>GV 626</b>	626 MJ	38	3	332
0 100 221 314	<b>GV 910</b>	910 MJ	40	3	336
0 100 222 101	<b>GV 894</b>	894 MJ	15	2	336
0 100 222 102	<b>GV 896</b>	896 MJ	15	2	336
0 100 222 105	<b>GV 001</b>		15	2	328
0 100 222 106	<b>GN 057</b>		15	2	320
0 100 222 201	<b>GV 142</b>	142 MJ	25	3	330
0 100 222 202	<b>GV 175</b>	175 M	25	3	330
0 100 222 203	<b>GV 198</b>	198 M	25	3	331
0 100 222 301	<b>GV 107</b>	107 MJ	40	3	328

0 100 222 302	<b>GV 108</b>	108 MJ	40	3	328
0 100 222 303	<b>GV 110</b>	110 MJ	40	3	328
0 100 222 305	<b>GV 149</b>	149 MJ	40	3	330
0 100 226 128	<b>GV 798</b>	798 MJ	22	2	334
0 100 226 129	<b>GV 783</b>	783 MJ	15	2	334
0 100 226 138	<b>GV 819</b>	819 MJ	15		335
0 100 226 163	<b>GV 852</b>	852 MJ	22	3	335
0 100 226 164	<b>GV 844</b>	844 MJ	22	3	335
0 100 226 170	<b>GN 853</b>	853 MJ	15	2	323
0 100 226 171	<b>GN 854</b>	854 MJ	15	2	324
0 100 226 173	<b>GN 857</b>	857 MJ	22	3	324
0 100 226 180	<b>GV 886</b>	886 MJ	15	2	335
0 100 226 182	<b>GV 897</b>	897 MJ	15	2	336
0 100 226 184	<b>GN 905</b>	905 MJ	15	2	324
0 100 226 185	<b>GN 908</b>	908 MJ	22	3	324
0 100 226 186	<b>GN 909</b>	909 MJ	22	3	324
0 100 226 188	<b>GN 912</b>	912 MJ	15	2	324
0 100 226 189	<b>GN 917</b>	917 MJ	22	3	324
0 100 226 190	<b>GN 918</b>	918 MJ	22	3	325
0 100 226 194	<b>GV 921</b>	921 MJ	15	2	336
0 100 226 198	<b>GN 927</b>	927 MJ	22	2	325
0 100 226 199	<b>GN 928</b>	928 MJ	22		325
0 100 226 206	<b>GN 944</b>	944 MJ	15	2	325
0 100 226 207	<b>GV 946</b>	946 MJ	15	2	337
0 100 226 208	<b>GV 947</b>	947 MJ	15	2	337
0 100 226 209	<b>GV 945</b>	945 MJ	15	2	336
0 100 226 227	<b>GN 855</b>	855 MJ	15		324
0 100 226 229	<b>GN 954</b>	954 MJ	22	3	325
0 100 226 233	<b>GN 955</b>	955 MJ	15	2	325
0 100 226 234	<b>GN 858</b>	858 MJ	22	3	324
0 100 226 235	<b>GN 948</b>	948 MJ	22		325
0 100 226 237	<b>GN 959</b>	959 MJ	22	3	326
0 100 226 238	<b>GN 999</b>	999 MJ	15	2	327
0 100 226 239	<b>GN 960</b>		25		326
0 100 226 242	<b>GV 967</b>	967 MJ	15	2	337
0 100 226 243	<b>GV 968</b>	968 MJ	15	2	337
0 100 226 245	<b>GN 963</b>	963 MJ	15	2	326
0 100 226 246	<b>GN 964</b>	964 MJ	15	2	326
0 100 226 249	<b>GN 970</b>	970 MJ	22	2	326
0 100 226 250	<b>GN 961</b>	961 MJ	22		326
0 100 226 253	<b>GN 984</b>		22	3	326
0 100 226 255	<b>GN 985</b>		15		326
0 100 226 258	<b>GN 860</b>	860 MJ	22		324
0 100 226 284	<b>GN 989</b>		15		326
0 100 226 299	<b>GN 991</b>	991 MJ	22	2	326
0 100 226 300	<b>GN 992</b>		15		327
0 100 226 302	<b>GN 994</b>		15	2	327
0 100 226 312	<b>GN 997</b>		15	2	327
0 100 226 333	<b>GN 001</b>		25		316
0 100 226 336	<b>GN 005</b>		15	2	316
0 100 226 338	<b>GN 008</b>		15		316
0 100 226 340	<b>GH 001</b>		15	2	312
0 100 226 343	<b>GN 007</b>		15		316
0 100 226 344	<b>GN 027</b>		15	2	318
0 100 226 351	<b>GN 026</b>		15		317
0 100 226 352	<b>GN 039</b>		15	2	318
0 100 226 354	<b>GN 012</b>		15	2	316
0 100 226 362	<b>GN 024</b>		15		317
0 100 226 365	<b>GN 010</b>		15	2	316
0 100 226 366	<b>GN 013</b>		22	3	316
0 100 226 370	<b>GN 025</b>		15		317
0 100 226 371	<b>GN 016</b>		15	2	317
0 100 226 372	<b>GN 017</b>		15	2	317
0 100 226 373	<b>GN 018</b>		15		317



		Nm			
					
0 100 226 375	<b>GN 019</b>	15		317	
0 100 226 376	<b>GN 020</b>	22		317	
0 100 226 379	<b>GN 003</b>	18		316	
0 100 226 381	<b>GN 022</b>	25	3	317	
0 100 226 384	<b>GN 993</b>	15	2	327	
0 100 226 385	<b>GN 939</b>	15	2	325	
0 100 226 391	<b>GN 030</b>	15		318	
0 100 226 392	<b>GN 015</b>	15		316	
0 100 226 417	<b>GN 033</b>	15		318	
0 100 226 422	<b>GN 035</b>	15	2	318	
0 100 226 432	<b>GN 925</b>	22	2	325	
0 100 226 434	<b>GN 040</b>	15	2	318	
0 100 226 435	<b>GN 050</b>	15		319	
0 100 226 436	<b>GN 041</b>	12		318	
0 100 226 475	<b>GN 043</b>	20	1,5	319	
0 100 226 480	<b>GN 042</b>	15	2	319	
0 100 226 481	<b>GN 023</b>	15	2	317	
0 100 226 482	<b>GN 046</b>	15		319	
0 100 226 492	<b>GN 054</b>	15	1	319	
0 100 226 494	<b>GN 055</b>	15		320	
0 100 226 495	<b>GN 103</b>	15	2	323	
0 100 226 497	<b>GN 104</b>	15		323	
0 100 226 505	<b>GN 032</b>	15	2	318	
0 100 226 506	<b>GV 007</b>	15	2	328	
0 100 226 511	<b>GN 107</b>	15	2	323	
0 100 226 513	<b>GN 102</b>	15	2	323	
0 100 226 514	<b>GN 101</b>	15	2	323	
0 100 226 517	<b>GN 060</b>	15		320	
0 100 226 520	<b>GN 061</b>	15	2	320	
0 100 226 522	<b>GN 062</b>	15	2	320	
0 100 226 525	<b>GN 106</b>	15	2	323	
0 100 226 526	<b>GN 064</b>	15	2	320	
0 100 226 527	<b>GN 065</b>	15	2	321	
0 100 226 538	<b>GN 108</b>	15	2	323	
0 100 226 568	<b>GN 110</b>	15	2	323	
0 100 226 569	<b>GN 067</b>	15	2	321	
0 100 226 570	<b>GN 068</b>	15	2	321	
0 100 226 577	<b>GN 095</b>	15	2	322	
0 100 226 638	<b>GN 096</b>	15	2	322	
0 100 226 639	<b>GN 097</b>	12		322	
0 100 230 101	<b>GV 887</b>	887 MJ	15	2	335
0 100 230 102	<b>GV 890</b>	890 MJ	15	2	336
0 100 230 107	<b>GN 044</b>	15	1,5	319	
0 100 231 101	<b>GV 153</b>	153 MJ	22	3	330
0 100 231 103	<b>GV 776</b>	776 MJ	22	3	334
0 100 231 104	<b>GV 880</b>	880 MJ	15	2	335
0 100 231 107	<b>GV 895</b>	895 MJ	15	2	336
0 100 231 110	<b>GN 926</b>	15	2	325	
0 100 231 119	<b>GN 002</b>	25		316	
0 100 231 120	<b>GV 736</b>	736 MJ	22	3	334
0 100 231 133	<b>GN 066</b>	25		321	
0 100 231 202	<b>GV 133</b>	133 MJ	25	3	329
0 100 231 302	<b>GV 165</b>	165 MJ	40	3	330
0 100 231 303	<b>GV 191</b>	191 MJ	40	3	331
0 100 231 305	<b>GV 181</b>	181 MN	40	3	331
0 100 232 204	<b>GV 664</b>	664 MJ	25	3	333
0 100 232 301	<b>GV 117</b>	117 MJ	40	3	328
0 100 266 002	<b>GE 102</b>	15		310	
0 100 266 003	<b>GE 103</b>	15		310	
0 100 266 008	<b>GE 100</b>	15		310	
0 100 266 009	<b>GE 101</b>	10		310	
0 100 266 010	<b>GE 104</b>	15		310	
0 100 266 011	<b>GE 105</b>	10		310	
0 100 266 018	<b>GE 106</b>	15	2	310	

		Nm			
					
0 100 266 019	<b>GE 113</b>	10		311	
0 100 266 031	<b>GE 112</b>	10		311	
0 100 266 032	<b>GE 110</b>	15		310	
0 100 266 033	<b>GE 111</b>	15		310	
0 100 266 034	<b>GE 114</b>	10		311	
0 100 266 037	<b>GE 118</b>	20		311	
0 100 266 040	<b>GE 115</b>	15		311	
0 100 266 042	<b>GE 116</b>	15	2	311	
0 100 266 059	<b>GE 109</b>	15	2	310	
0 100 266 065	<b>GE 119</b>	15		311	
0 100 266 066	<b>GE 120</b>	15		311	
0 100 271 101	<b>GV 823</b>	823 MJ	15	335	
0 100 271 106	<b>GV 004</b>	15		328	
0 100 271 204	<b>GN 036</b>	18		318	
0 100 271 205	<b>GN 049</b>	18		319	
0 100 271 301	<b>GV 145</b>	145 M	40	330	
0 100 271 601	<b>GV 134</b>	134 M	15	329	
0 100 276 003	<b>GN 037</b>	15		318	
0 100 276 004	<b>GN 047</b>	15	1,5	319	
0 100 276 005	<b>GN 045</b>	10		319	
0 100 276 008	<b>GN 053</b>	10		319	
0 100 276 012	<b>GN 056</b>	10		320	
0 100 276 014	<b>GN 058</b>	10	2	320	
0 100 276 015	<b>GN 059</b>	10		320	
0 100 276 024	<b>GN 063</b>	10		320	
0 100 276 031	<b>GN 069</b>	12		321	
0 100 281 301	<b>GV 128</b>	128 M	40	329	
0 100 302 301	<b>GV 361</b>	361 MK	40	3	331
0 100 331 103	<b>GH 008</b>	15	2	312	
0 100 331 104	<b>GH 009</b>	15	2	312	
0 100 331 301	<b>GV 380</b>	380 MJ	40	3	331
0 100 331 303	<b>GV 390</b>	390 MJ	40	3	332
0 100 332 301	<b>GV 127</b>	127 MJ	40	3	329
0 100 800 002	<b>GV 003</b>	15		328	
0 100 800 031	<b>GN 109</b>	15	2	323	
0 100 800 033	<b>GN 070</b>	15	2	321	
0 100 800 034	<b>GN 071</b>	18		321	
0 100 800 035	<b>GN 072</b>	15	2	321	
0 100 800 036	<b>GN 073</b>	15		321	
0 100 800 037	<b>GN 074</b>	22	2	321	
0 100 800 038	<b>GN 075</b>	18	2	322	
0 100 800 039	<b>GN 076</b>	22	2	322	
0 100 800 040	<b>GN 077</b>	18	2	322	
0 100 800 041	<b>GN 078</b>	18	2	322	
0 100 800 043	<b>GN 080</b>	18	2	322	
0 100 800 044	<b>GN 081</b>	18	2	322	
0 100 800 045	<b>GN 082</b>	10	2	322	
0 101 022 404	<b>GF 163</b>	163 GS	20	366	
0 101 022 405	<b>GF 186</b>	186 GS	20	366	
0 101 072 405	<b>GF 859</b>	20		366	
0 101 072 408	<b>GF 982</b>	20		366	
0 101 072 409	<b>GF 983</b>	20		366	
0 101 072 603	<b>GF 154</b>	154 GSF	20	366	
0 101 172 403	<b>GH 407</b>	407 GS	20	314	
0 101 223 449	<b>GF 984</b>	20	5	363	
0 101 223 454	<b>GF 683</b>	683 G	20	3	363
0 101 223 456	<b>GF 973</b>	973 G	20	3	363
0 101 223 457	<b>GF 972</b>	972 G	20	3	363
0 101 223 459	<b>GF 974</b>	974 G	20	3	363
0 101 223 461	<b>GF 006</b>	20	3	363	
0 101 223 603	<b>GF 831</b>	20	3	363	
0 101 233 401	<b>GF 167</b>	167 G	20	3	364
0 101 233 403	<b>GF 111</b>	111 G	20	3	364
0 101 233 413	<b>GF 630</b>	630 G	20	3	364

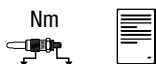

0 101 233 450	<b>GF 777</b>	777 G	20	3	364
0 101 233 480	<b>GF 975</b>	975 G	20	3	364
0 101 233 481	<b>GF 976</b>	976 G	20	3	364
0 101 233 483	<b>GF 977</b>	977 G	20	3	365
0 101 233 486	<b>GF 978</b>	978 G	20	3	365
0 101 233 487	<b>GF 979</b>	979 G	20	3	365
0 101 233 488	<b>GF 980</b>	980 G	20	3	365
0 101 233 489	<b>GF 981</b>	981 G	20	3	365
0 101 233 493	<b>GF 007</b>		20	3	364
0 101 233 499	<b>GF 002</b>		20	3	364
0 101 233 601	<b>GF 830</b>		20	3	364
0 101 234 504	<b>GF 667</b>	667 G	20	3	365
0 101 234 513	<b>GF 817</b>	817 G	20	3	365
0 101 234 529	<b>GF 529</b>		25	5	365
0 102 012 205	<b>GH 195</b>	195 GLS	15	3	313
0 102 013 404	<b>GD 01</b>	HA 01	38	3	308
0 102 022 202	<b>GH 116</b>	116 S	15	3	312
0 102 022 301	<b>GH 649</b>	649 GS	20	3	314
0 102 024 405	<b>GH 760</b>		20	3	314
0 102 062 202	<b>GH 191</b>	191 GS	15		313
0 102 113 302	<b>GH 345</b>	345 GK	20	3	313
0 102 113 303	<b>GH 359</b>	359 G	20	3	313
0 102 123 203	<b>GH 408</b>	408 GS	15	2	314
0 102 123 403	<b>GHA 408</b>	408 GSA	20	2	315
0 102 124 416	<b>GH 010</b>		20	3	312
0 102 124 418	<b>GH 401</b>		60	3	313
0 102 124 601	<b>GD 203</b>	203 G	38	3	308
0 102 133 204	<b>GH 846</b>	846 G	15		314
0 102 133 403	<b>GH 931</b>	931 GS	20	2	315
0 102 173 212	<b>GH 847</b>	847 G	15		314
0 102 174 303	<b>GH 409</b>	409 GS	20		314
0 102 174 306	<b>GH 306</b>		20		313
0 102 184 303	<b>GH 410</b>	410 GS	20		314
0 102 224 205	<b>GH 011</b>		40	4	312
0 102 271 301	<b>GH 648</b>	648 MJ	20		314
0 103 010 104	<b>PSG 004</b>		15		338
0 103 010 903	<b>PSG 001</b>		12		338
0 103 110 904	<b>PSG 003</b>		12		338
0 103 111 104	<b>PSG 002</b>		15		338
0 105 100 002	<b>GH 13</b>	GZE 13	20		312
0 105 100 008	<b>GH 18</b>	GZE 18	20		312
0 105 100 021	<b>GH 30</b>	GZE 30	20		312
0 105 110 001	<b>GH 201</b>	GZE 201	20		313
0 105 110 002	<b>GH 202</b>	GZE 202	20		313
0 105 110 003	<b>GH 203</b>	GZE 203	20		313
0 106 671 105	<b>CGP 001</b>		15		308

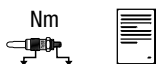

0 900 102 028	<b>G 6 SB</b>	GV 719	22	3	
0 900 102 029	<b>G 1 SB</b>	GN 857	22	3	
0 900 102 038	<b>G 7 SB</b>	GN 954	22	3	
0 900 102 045	<b>G 5 SB</b>	GN 858	22	3	
0 900 102 054	<b>G 10 SB</b>	GV 666	22	3	

## D Verwendung

Fahrzeuge vor Baujahr 1989 sind in den folgenden Verwendungen nur noch teilweise berücksichtigt. Alle Fahrzeuge finden Sie im online Produktfinder unter [www.fmecat.eu](http://www.fmecat.eu) oder auf der TecDoc-CD, die Sie unter [www.tecdoc.net](http://www.tecdoc.net) bestellen können.

## I L'uso

Soltanto autoveicoli costruiti prima dell'anno 1989 vengono ancora in parte considerati per le seguenti applicazioni. Tutte le autovetture si trovano nel finder prodotti al sito [www.fmecat.eu](http://www.fmecat.eu) oppure sul TecDoc-CD, che può essere ordinato al sito [www.tecdoc.net](http://www.tecdoc.net).

## GB USA Application

Only some of the vehicles manufactured prior to 1989 are taken into consideration in the following applications. All the vehicles are available online in the Product Finder at [www.fmecat.eu](http://www.fmecat.eu) or on the TecDoc CD, which you can order at [www.tecdoc.net](http://www.tecdoc.net).

## RUS Использование

Автомобили выпуска до 1989 г. учтены в последующих применениях лишь частично. Все транспортные средства можно найти в онлайн-перечне продукции на сайте [www.fmecat.eu](http://www.fmecat.eu) или на компакт-диске с технической документацией, который можно заказать на сайте [www.tecdoc.net](http://www.tecdoc.net).

## F Utilisation

Les utilisations décrites ci-après ne s'appliquent qu'en partie aux véhicules construits avant l'année 1989. Vous trouverez tous les véhicules dans le moteur de recherche de produits en ligne sur [www.fmecat.eu](http://www.fmecat.eu) ou sur le CD TecDoc que vous pouvez commander sur [www.tecdoc.net](http://www.tecdoc.net).

## PL Zastosowanie

Pojazdy z przed roku 1989 są na poniższej liście uwzględnione jedynie częściowo. Wszystkie pojazdy znajdziesz online w wyszukiwarce produktów pod adresem [www.fmecat.eu](http://www.fmecat.eu) lub na CD TecDoc, którą możesz zamówić pod adresem [www.tecdoc.net](http://www.tecdoc.net).

## NL Toepassing

Voor voertuigen van voor bouwjaar 1989 gelden de volgende toepassingen slechts gedeeltelijk. U vindt alle voertuigen in de online productfinder onder [www.fmecat.eu](http://www.fmecat.eu) of op de TecDoc-CD, die u kunt bestellen op [www.tecdoc.net](http://www.tecdoc.net).

## GR Χρήση

Οχήματα κατασκευασμένα πριν από το 1989 λαμβάνονται υπόψη μόνο εν μέρει στις ακόλουθες χρήσεις. Θα βρείτε όλα τα οχήματα στον κατάλογο αναζήτησης προϊόντων στην ιστοσελίδα [www.fmecat.eu](http://www.fmecat.eu) ή στο CD TecDoc, που μπορείτε να παραγγείλετε στην ιστοσελίδα [www.tecdoc.net](http://www.tecdoc.net).

## E Usos

Los vehículos anteriores al año de construcción 1989 solo se tienen en cuenta parcialmente en los usos que se indican a continuación. Encontrará todos los vehículos en el buscador de productos online, en [www.fmecat.eu](http://www.fmecat.eu) o en el CD TecDoc que puede pedir bajo en [www.tecdoc.net](http://www.tecdoc.net).

## H Használati útmutatókról

A következő felhasználói szövegekben az 1989 előtt előállított járműveket csak részben vettük figyelembe. Minden járművet megtalálhat az online termékkeresőben a [www.fmecat.eu](http://www.fmecat.eu) vagy a TecDoc CD-n, amit a [www.tecdoc.net](http://www.tecdoc.net) címen rendelhet meg.

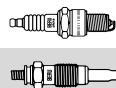
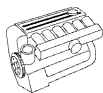

## AGURA

### LEGEND II

3.2	3.2	151	08.91-08.96	C32A	6	<b>Z 16</b>	14 FR-7 DUX	1,1	<b>UXT 1<sup>3</sup></b>
-----	-----	-----	-------------	------	---	-------------	-------------	-----	--------------------------

### LEGEND II Coupe

3.2	3.2	151	08.91-08.96	C32A2	6	<b>Z 16</b>	14 FR-7 DUX	1,1	<b>UXT 1<sup>3</sup></b>
-----	-----	-----	-------------	-------	---	-------------	-------------	-----	--------------------------

### LEGEND III

3.5	3.5	151	08.96-	C35A2	6	<b>Z 228</b>	14 FR-7 DPUX02	1,0	<b>UXT 11</b>
-----	-----	-----	--------	-------	---	--------------	----------------	-----	---------------

### SLX

3.2 Allrad	3.2	140	11.95-09.99	6VD1	6	<b>Z 343</b>	14 FR-8 DPPUX	1,1	○
------------	-----	-----	-------------	------	---	--------------	---------------	-----	---

## ALFA ROMEO

### 33

1.4 i.e.	1.4	65	06.91-09.94	AR 30755/AR 30753	4	<b>Z 42</b>	14-5 DU	0,8	<b>UX 56</b>
1.4 i.e.	1.4	66	06.91-09.94	AR 30755/AR 30753	4	<b>Z 12</b>	14-7 DTU	0,8	<b>UXT 2<sup>4</sup></b>
1.4 4x4	1.4	66	07.90-12.92	AR 30755	4	<b>Z 12</b>	14-7 DTU	0,8	<b>UXT 2<sup>4</sup></b>
1.5	1.5	70	05.83-12.93	AR 30182	4	<b>Z 42</b>	14-5 DU	0,8	<b>UX 56</b>
1.5 i.e.	1.5	71	01.90-09.94	AR 30751	4	<b>Z 42</b>	14-5 DU	0,8	<b>UX 56</b>
1.5 i.e.	1.5	74	07.90-08.91	AR 30750	4	<b>Z 51</b>	14-6 DTU	0,8	<b>UX 56</b>
1.5	1.5	77	01.90-04.93	AR 30734	4	<b>Z 51</b>	14-6 DTU	0,8	<b>UX 56</b>
1.7 i.e.	1.7	77	04.92-09.94	AR 30737 A	4	<b>Z 22</b>	14-6 DU	0,7	<b>UX 56</b>
1.7 i.e.	1.7	79	01.90-03.92	AR 30736/AR 30737	4	<b>Z 42</b>	14-5 DU	0,8	<b>UX 56</b>
1.7 i.e. 4x4	1.7	79	01.90-03.92	AR 30736/AR 30737	4	<b>Z 51</b>	14-6 DTU	0,8	<b>UX 56</b>
1.7 16V	1.7	95	01.90-09.94	AR 30747	4	<b>Z 130</b>	14 FR-5 DPUX	1,0	○
1.7 16V 4x4	1.7	95	01.90-09.94	AR 30747	4	<b>Z 130</b>	14 FR-5 DPUX	1,0	○
1.7 16V	1.7	97	01.90-03.92	AR 30747	4	<b>Z 130</b>	14 FR-5 DPUX	1,0	○
1.7 16V 4x4	1.7	97	01.90-09.94	AR 30747	4	<b>Z 130</b>	14 FR-5 DPUX	1,0	○
1.7 16V	1.7	101	01.90-03.92	AR 30746	4	<b>Z 188</b>	14 F-7 DPUR02	0,7	<b>UXT 10</b>
1.7 16V 4x4	1.7	101	01.90-09.94	AR 30746	4	<b>Z 188</b>	14 F-7 DPUR02	0,7	<b>UXT 10</b>
1.8 TD	1.8	54	02.90-06.90	VM 82 A	3	<b>GV 657 (11V)</b>	○		
1.8 TD	1.8	62	07.90-03.94	VM 96 A	3	<b>GV 657 (11V)</b>	○		

### 33 Sportwagon

1.4 i.e.	1.4	65	06.91-12.91	AR 30755	4	<b>Z 42</b>	14-5 DU	0,8	<b>UX 56</b>
1.4 i.e.	1.4	65	01.92-09.94	AR 30755	4	<b>Z 12</b>	14-7 DTU	0,8	<b>UXT 2<sup>4</sup></b>
1.4 i.e. 4x4	1.4	66	06.91-09.94	AR 30587/AR 30755	4	<b>Z 12</b>	14-7 DTU	0,8	<b>UXT 2<sup>4</sup></b>
1.5 i.e.	1.5	71	01.90-03.92	AR 30751	4	<b>Z 42</b>	14-5 DU	0,8	<b>UX 56</b>
1.5 i.e.	1.5	71	04.92-09.94	AR 30751	4	<b>Z 22</b>	14-6 DU	0,7	<b>UX 56</b>
1.7 i.e.	1.7	77	04.92-09.94	AR 30737	4	<b>Z 22</b>	14-6 DU	0,7	<b>UX 56</b>
1.7 i.e.	1.7	79	01.90-03.92	AR 30736/AR 30737	4	<b>Z 42</b>	14-5 DU	0,8	<b>UX 56</b>
1.7 i.e. 4x4	1.7	79	01.90-03.92	AR 30736/AR 30737	4	<b>Z 51</b>	14-6 DTU	0,8	<b>UX 56</b>
1.7 16V	1.7	95	01.90-09.94	AR 30747	4	<b>Z 130</b>	14 FR-5 DPUX	1,0	○
1.7 16V 4x4	1.7	95	01.90-09.94	AR 30747	4	<b>Z 130</b>	14 FR-5 DPUX	1,0	○
1.7 16V	1.7	97	01.90-09.94	AR 30747	4	<b>Z 130</b>	14 FR-5 DPUX	1,0	○
1.7 16V 4x4	1.7	97	01.90-03.92	AR 30747	4	<b>Z 130</b>	14 FR-5 DPUX	1,0	○
1.7 16V	1.7	101	01.90-03.92	AR 30746	4	<b>Z 188</b>	14 F-7 DPUR02	0,7	<b>UXT 10</b>

### 75

1.6 KAT	1.6	81	05.89-02.92	AR 61101	4	<b>Z 42</b>	14-5 DU	0,8	<b>UX 56</b>
1.8	1.8	88	09.88-02.92	AR 06168/AR 61102	4	<b>Z 42</b>	14-5 DU	0,8	<b>UX 56</b>
1.8	1.8	90	08.89-02.92	AR 61201	4	<b>Z 42</b>	14-5 DU	0,8	<b>UX 56</b>
1.8	1.8	95	08.89-02.92	AR 67101	4	<b>Z 42</b>	14-5 DU	0,8	<b>UX 56</b>
1.8 Turbo	1.8	110	09.86-02.92	AR 06134	4	<b>Z 22</b>	14-6 DU	0,7	<b>UX 56</b>
1.8 Turbo i.e.	1.8	114	02.86-01.90	AR 06158	4	<b>Z 22</b>	14-6 DU	0,7	<b>UX 56</b>
2.0 TD	2.0	70	05.85-09.92	VM 80 A	4	<b>GV 657 (11V)</b>	○		
2.0 T.S.	2.0	107	01.87-02.92	AR 06166/AR 06224	4	<b>Z 29</b>	14 F-5 DU=8x	0,8	<b>UXT 5</b>
2.0 T.S. KAT	2.0	109	05.85-02.92	AR 06224	4	<b>Z 29</b>	14 F-5 DU=8x	0,8	<b>UXT 5</b>
2.4 TD	2.4	82	01.89-02.92	VM 81 A	4	<b>GV 657 (11V)</b>	○		
3.0 V6	3.0	136	01.87-12.90	AR 06120	6	<b>Z 11</b>	14-7 DU	0,8	<b>UXT 2<sup>4</sup></b>
3.0 V6 KAT	3.0	136	01.87-02.92	AR 06124	6	<b>Z 11</b>	14-7 DU	0,8	<b>UXT 2<sup>4</sup></b>
3.0 V6	3.0	141	02.90-02.92	AR 61503	6	<b>Z 42</b>	14-5 DU	0,8	<b>UX 56</b>

### 145

1.4 i.e.	1.4	66	07.94-12.96	AR 33501	4	<b>Z 51</b>	14-6 DTU	0,8	<b>UX 56</b>
1.4 i.e. 16V T.S.	1.4	76	12.96-01.01	AR 33503/AR 38501	4	<b>Z 210</b>	10 FR-6 CPU03 <sup>10</sup>	0,6	○
						<b>Z 237</b>	14 FR-7 DQUP7 <sup>11</sup>	1,6	○
1.6 i.e.	1.6	76	10.94-12.96	AR 33201	4	<b>Z 51</b>	14-6 DTU	0,8	<b>UX 56</b>

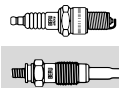
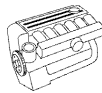

### ALFA ROMEO

#### 145

1.6 i.e. 16V T.S.	1.6	88	12.96-01.01	AR 67601/AR 38201	4	<b>Z 210</b>	10 FR-6 CPU03 <sup>10</sup>	0,6	○
						<b>Z 237</b>	14 FR-7 DQUP7 <sup>11</sup>	1,6	○
1.7 i.e. 16V	1.7	95	10.94-12.96	AR 33401	4	<b>Z 188</b>	14 F-7 DPUR02	0,7	<b>UXT 10</b>
1.8 i.e. 16V T.S.	1.7	103	12.96-12.98	AR 38401/AR 67106	4	<b>Z 210</b>	10 FR-6 CPU03 <sup>10</sup>	0,6	○
						<b>Z 237</b>	14 FR-7 DQUP7 <sup>11</sup>	1,6	○
1.8 i.e. 16V	1.7	106	03.98-01.01	AR 32201	4	<b>Z 210</b>	10 FR-6 CPU03 <sup>10</sup>	0,6	○
						<b>Z 237</b>	14 FR-7 DQUP7 <sup>11</sup>	1,6	○
1.9 TD	1.9	66	10.94-02.99	AR 33601/AR 67501	4	<b>GN 908</b> (11V)	○		
1.9 D	1.9	68	07.94-02.99	AR 67501	4	<b>GN 908</b> (11V)	○		
1.9 JTD	1.9	77	02.99-01.01	AR 32302 → Mot.Nr. 1716459	4	<b>GN 017</b> (11V)	○		
1.9 JTD	1.9	77	02.99-01.01	AR 32302 → Mot.Nr. 1716460 →	4	<b>GN 041</b> (11V)	○		
				Kühlwasservorwärmung <sup>15</sup> ⇄ Ø 4 mm		<b>GN 020</b> (12V)			
2.0 16V T.S.	2.0	110	10.95-01.01	AR 67204	4	<b>Z 210</b>	10 FR-6 CPU03 <sup>10</sup>	0,6	○
						<b>Z 237</b>	14 FR-7 DQUP7 <sup>11</sup>	1,6	○
2.0 16V Quadrifoglio	2.0	114	03.98-01.01	AR 32301	4	<b>Z 210</b>	10 FR-6 CPU03 <sup>10</sup>	0,6	○
						<b>Z 237</b>	14 FR-7 DQUP7 <sup>11</sup>	1,6	○

#### 146

1.4 i.e.	1.4	66	12.94-12.96	AR 33501	4	<b>Z 51</b>	14-6 DTU	0,8	<b>UX 56</b>
1.4 i.e. 16V T.S.	1.4	76	11.96-01.01	AR 33503/AR 38501	4	<b>Z 210</b>	10 FR-6 CPU03 <sup>10</sup>	0,6	○
						<b>Z 237</b>	14 FR-7 DQUP7 <sup>11</sup>	1,6	○
1.6 i.e.	1.6	76	12.94-12.96	AR 33201	4	<b>Z 51</b>	14-6 DTU	0,8	<b>UX 56</b>
1.6 i.e. 16V T.S.	1.6	88	11.96-01.01	AR 67601/AR 38201	4	<b>Z 210</b>	10 FR-6 CPU03 <sup>10</sup>	0,6	○
						<b>Z 237</b>	14 FR-7 DQUP7 <sup>11</sup>	1,6	○
1.7 i.e. 16V	1.7	95	12.94-12.96	AR 33401	4	<b>Z 188</b>	14 F-7 DPUR02	0,7	<b>UXT 10</b>
1.8 i.e. 16V T.S.	1.7	103	11.96-01.01	AR 38401/AR 67106	4	<b>Z 210</b>	10 FR-6 CPU03 <sup>10</sup>	0,6	○
						<b>Z 237</b>	14 FR-7 DQUP7 <sup>11</sup>	1,6	○
1.8 i.e. 16V T.S.	1.7	106	03.98-01.01	AR 32201	4	<b>Z 210</b>	10 FR-6 CPU03 <sup>10</sup>	0,6	○
						<b>Z 237</b>	14 FR-7 DQUP7 <sup>11</sup>	1,6	○
1.9 TD	1.9	66	12.94-02.99	AR 33601/AR 67501	4	<b>GN 908</b> (11V)	○		
1.9 D	1.9	68	05.95-09.96	AR 67501	4	<b>GN 908</b> (11V)	○		
1.9 JTD	1.9	77	02.99-01.01	AR 32302 → Mot.Nr. 1716459	4	<b>GN 017</b> (11V)	○		
1.9 JTD	1.9	77	02.99-01.01	AR 32302 Mot.Nr. 1716460 →	4	<b>GN 041</b> (11V)	○		
				Kühlwasservorwärmung <sup>15</sup> ⇄ Ø 4 mm		<b>GN 020</b> (12V)			
2.0 16V Quadrifoglio	2.0	114	03.98-01.01	AR 32301	4	<b>Z 210</b>	10 FR-6 CPU03 <sup>10</sup>	0,6	○
						<b>Z 237</b>	14 FR-7 DQUP7 <sup>11</sup>	1,6	○
2.0 16V T.S.	2.0	110	10.95-01.01	AR 67204	4	<b>Z 210</b>	10 FR-6 CPU03 <sup>10</sup>	0,6	○
						<b>Z 237</b>	14 FR-7 DQUP7 <sup>11</sup>	1,6	○

#### 147

1.6 16V T.SPARK ECO	1.6	77	01.01-	AR 37203	4	<b>Z 210</b>	10 FR-6 CPU03 <sup>10</sup>	0,6	○
						<b>Z 237</b>	14 FR-7 DQUP7 <sup>11</sup>	1,6	○
1.6 16V T.SPARK	1.6	88	01.01-	AR 32104	4	<b>Z 210</b>	10 FR-6 CPU03 <sup>10</sup>	0,6	○
						<b>Z 237</b>	14 FR-7 DQUP7 <sup>11</sup>	1,6	○
1.9 JTD	1.9	74	06.03-	182 B9.000	4	<b>GN 041</b> (11V)	○		
				Kühlwasservorwärmung <sup>15</sup> ⇄ Ø 4 mm		<b>GN 020</b> (12V)			
1.9 JTD	1.9	85	04.01-	937 A2.000	4	<b>GN 041</b> (11V)	○		
				Kühlwasservorwärmung <sup>15</sup> ⇄ Ø 4 mm		<b>GN 020</b> (12V)			
1.9 JTDM	1.9	85	10.04-03.10	939 A7.000	4	<b>GN 097</b> (11V)	○		
1.9 JTDM 8V	1.9	88	07.05-	937 A3.000	4	<b>GN 097</b> (11V)	○		
1.9 JTD 16V	1.9	93	09.03-09.04	937 A4.000	4	<b>GN 059</b> (11V)	○		
1.9 JTD 16V	1.9	100	10.04-	192 B1.000	4	<b>GN 059</b> (11V)	○		
1.9 JTD 16V	1.9	103	11.02-	192 A5.000	4	<b>GN 059</b> (11V)	○		
1.9 JTDM 16V	1.9	110	07.05-	937 A5.000	4	<b>GN 059</b> (11V)	○		
1.9 JTDM 16V	1.9	125	06.08-	937 A6.000	4	<b>GN 069</b> (11V)	○		
2.0 16V T.SPARK	2.0	110	01.01-	AR 32310	4	<b>Z 210</b>	10 FR-6 CPU03 <sup>10</sup>	0,6	○
						<b>Z 237</b>	14 FR-7 DQUP7 <sup>11</sup>	1,6	○



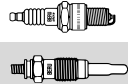

## ALFA ROMEO

### 155

1.6 16V T.S.	1.6	88	05.96-12.97	AR 67601	4	<b>Z 210</b>	10 FR-6 CPU03 <sup>10</sup>	0,6	○
						<b>Z 237</b>	14 FR-7 DQUP7 <sup>11</sup>	1,6	○
1.7 T.S.	1.7	83	04.93-04.96	AR 67103	4	<b>Z 29</b>	14 F-5 DU	0,8	<b>UXT 5</b>
1.7 T.S.	1.7	85	04.93-04.96	AR 67105	4	<b>Z 29</b>	14 F-5 DU	0,8	<b>UXT 5</b>
1.7 T.S. 16V	1.7	103	05.96-12.97	AR 67106	4	<b>Z 210</b>	10 FR-6 CPU03 <sup>10</sup>	0,6	○
						<b>Z 237</b>	14 FR-7 DQUP7 <sup>11</sup>	1,6	○
1.8 T.S.	1.8	95	02.92-06.93	AR 67101	4	<b>Z 29</b>	14 F-5 DU	0,8	<b>UXT 5</b>
1.8 T.S. Sport	1.8	93	01.92-12.96	AR 67101/AR 67102	4	<b>Z 29</b>	14 F-5 DU	0,8	<b>UXT 5</b>
1.9 TD	1.9	66	04.93-12.97	AR 67501	4	<b>GN 908</b> (11V)	○		
2.0 T.S.	2.0	104	02.92-02.95	AR 67202	4	<b>Z 29</b>	14 F-5 DU	0,8	<b>UXT 5</b>
2.0 T.S.	2.0	106	02.92-04.93	AR 67201	4	<b>Z 29</b>	14 F-5 DU	0,8	<b>UXT 5</b>
2.0 T.S. 16V	2.0	110	03.95-12.97	AR 67204	4	<b>Z 210</b>	10 FR-6 CPU03 <sup>10</sup>	0,6	○
						<b>Z 237</b>	14 FR-7 DQUP7 <sup>11</sup>	1,6	○
2.0 16V Turbo Q4	2.0	137	01.92-12.97	AR 67203	4	<b>Z 51</b>	14-6 DTU	0,8	<b>UX 56</b>
2.5 TD	2.5	92	04.93-04.95	VM 07 B/VM 31 B	4	<b>GN 908</b> (11V)	○		
2.5 TD	2.5	92	05.95-12.97	VM 07 B/VM 31 B	4	<b>GN 007</b> (11V)	○		
2.5 V6	2.5	120	10.92-12.97	AR 67302/AR 67303	6	<b>Z 42</b>	14-5 DU	0,8	<b>UX 56</b>
2.5 V6	2.5	121	02.92-09.96	AR 67301	6	<b>Z 42</b>	14-5 DU	0,8	<b>UX 56</b>

### 156

1.6 16V T.SPARK	1.6	88	09.97-09.05	AR 32102/AR 32103/ AR 32104/AR 67601	4	<b>Z 210</b>	10 FR-6 CPU03 <sup>10</sup>	0,6	○
						<b>Z 237</b>	14 FR-7 DQUP7 <sup>11</sup>	1,6	○
1.8 16V T.SPARK	1.7	103	10.00-09.05	AR 32205	4	<b>Z 210</b>	10 FR-6 CPU03 <sup>10</sup>	0,6	○
						<b>Z 237</b>	14 FR-7 DQUP7 <sup>11</sup>	1,6	○
1.8 16V T.SPARK	1.7	106	09.97-10.00	AR 32201	4	<b>Z 210</b>	10 FR-6 CPU03 <sup>10</sup>	0,6	○
						<b>Z 237</b>	14 FR-7 DQUP7 <sup>11</sup>	1,6	○
1.9 JTD	1.9	77	09.97-10.00	AR 32302 → Mot.Nr. 1713819	4	<b>GN 017</b> (11V)	○		
				Kühlwasservorwärmung <sup>15</sup> ⇄ Ø 4 mm		<b>GN 020</b> (12V)			
1.9 JTD	1.9	77	09.97-10.00	AR 32302 Mot.Nr. 1713820 →	4	<b>GN 041</b> (11V)	○		
				Kühlwasservorwärmung <sup>15</sup> ⇄ Ø 4 mm		<b>GN 020</b> (12V)			
1.9 JTD	1.9	81	10.00-05.01	AR 37101	4	<b>GN 041</b> (11V)	○		
				Kühlwasservorwärmung <sup>15</sup> ⇄ Ø 4 mm		<b>GN 020</b> (12V)			
1.9 JTD	1.9	85	05.01-09.05	937 A2.000	4	<b>GN 041</b> (11V)	○		
				Kühlwasservorwärmung <sup>15</sup> ⇄ Ø 4 mm		<b>GN 020</b> (12V)			
1.9 JTD	1.9	93	11.03-09.05	937 A4.000	4	<b>GN 059</b> (11V)	○		
1.9 JTD	1.9	100	11.02-11.04	192 B1.000	4	<b>GN 059</b> (11V)	○		
1.9 JTD 16V	1.9	103	11.02-09.05	192 A5.000	4	<b>GN 059</b> (11V)	○		
1.9 JTD	1.9	110	07.04-09.05	937 A5.000	4	<b>GN 059</b> (11V)	○		
2.0 16V T.SPARK	2.0	110	10.00-03.02	AR 32310	4	<b>Z 210</b>	10 FR-6 CPU03 <sup>10</sup>	0,6	○
						<b>Z 237</b>	14 FR-7 DQUP7 <sup>11</sup>	1,6	○
2.0 16V T.SPARK	2.0	114	09.97-10.00	AR 32301	4	<b>Z 210</b>	10 FR-6 CPU03 <sup>10</sup>	0,6	○
						<b>Z 237</b>	14 FR-7 DQUP7 <sup>11</sup>	1,6	○
2.0 JTS (932AXA)	2.0	122	03.02-09.05	937 A1.000	4	<b>Z 237</b>	14 FR-7 DQUP7	1,6	○
2.4 JTD	2.4	100	09.97-10.00	AR 32501	5	<b>GN 017</b> (11V)	○		
				Kühlwasservorwärmung <sup>15</sup> ⇄ Ø 4 mm		<b>GN 020</b> (12V)			
2.4 JTD	2.4	103	10.00-09.05	839 A6.000	5	<b>GN 041</b> (11V)	○		
2.4 JTD	2.4	110	03.02-09.05	841 C000	5	<b>GN 041</b> (11V)	○		
2.4 JTD	2.4	120	06.03-09.05	841 M.000	5	<b>GN 059</b> (11V)	○		
2.4 JTD	2.4	129	10.03-09.05	841 G.000	5	<b>GN 059</b> (11V)	○		
2.5 V6 24V (932A1)	2.5	140	09.97-12.01	AR 32401/AR 32402	6	<b>Z 188</b>	14 F-7 DPUR02	0,7	<b>UXT 10</b>

### 156 Sportwagon

1.6 16V T.SPARK.	1.6	88	05.00-05.06	AR 32102/AR 32103/ AR 32104/AR 67601	4	<b>Z 210</b>	10 FR-6 CPU03 <sup>10</sup>	0,6	○
						<b>Z 237</b>	14 FR-7 DQUP7 <sup>11</sup>	1,6	○
1.8 16V T.SPARK	1.7	103	10.00-05.06	AR 32205	4	<b>Z 210</b>	10 FR-6 CPU03 <sup>10</sup>	0,6	○
						<b>Z 237</b>	14 FR-7 DQUP7 <sup>11</sup>	1,6	○
1.8 16V T.SPARK	1.7	106	05.00-10.00	AR 32201	4	<b>Z 210</b>	10 FR-6 CPU03 <sup>10</sup>	0,6	○
						<b>Z 237</b>	14 FR-7 DQUP7 <sup>11</sup>	1,6	○
1.9 JTD	1.9	77	05.00-10.00	AR 32302 → Mot.Nr. 1713818	4	<b>GN 017</b> (11V)	○		



kW

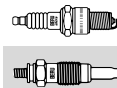
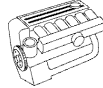

**ALFA ROMEO**

**156 Sportwagon**

1.9 JTD	1.9	77	Kühlwasservorwärmung <sup>15</sup> ⇄ Ø 4 mm	GN 020 (12V)			
			05.00-10.00 AR 32302	4	GN 041 (11V)	○	
			Mot-Nr. 1713820 →				
1.9 JTD	1.9	81	Kühlwasservorwärmung <sup>15</sup> ⇄ Ø 4 mm	GN 020 (12V)			
			10.00-05.01 AR 37101	4	GN 041 (11V)	○	
1.9 JTD	1.9	85	Kühlwasservorwärmung <sup>15</sup> ⇄ Ø 4 mm	GN 020 (12V)			
			05.01-05.06 937 A2.000	4	GN 041 (11V)	○	
			Kühlwasservorwärmung <sup>15</sup> ⇄ Ø 4 mm	GN 020 (12V)			
1.9 JTD	1.9	93	11.03-05.06 937 A4.000	4	GN 059 (11V)	○	
1.9 JTD	1.9	100	11.02-11.04 192 B1.000	4	GN 059 (11V)	○	
1.9 JTD 16V	1.9	103	11.02-05.06 192 A5.000	4	GN 059 (11V)	○	
1.9 JTD	1.9	110	03.05-05.06 937 A5.000	4	GN 059 (11V)	○	
1.9 JTD 16V Q4	1.9	110	07.04-05.06 937 A5.000	4	GN 059 (11V)	○	
2.0 16V T.SPARK	2.0	110	10.00-03.02 AR 32310	4	Z 210	10 FR-6 CPU03 <sup>10</sup>	0,6
					Z 237	14 FR-7 DQUP7 <sup>11</sup>	1,6
2.0 16V T.SPARK	2.0	114	05.00-10.00 AR 32301	4	Z 210	10 FR-6 CPU03 <sup>10</sup>	0,6
					Z 237	14 FR-7 DQUP7 <sup>11</sup>	1,6
2.0	2.0	119	03.02-05.06 932 A2.000	4	Z 193	14 FR-7 DU2=8x	0,9
							UXT 1 <sup>3</sup>
2.0 JTS	2.0	122	03.02-05.06 937 A1.000	4	Z 237	14 FR-7 DQUP7	1,6
2.4 JTD	2.4	100	05.00-10.00 AR 32501	5	GN 017 (11V)	○	
			Kühlwasservorwärmung <sup>15</sup> ⇄ Ø 4 mm	GN 020 (12V)			
2.4 JTD	2.4	103	10.00-05.06 839 A6.000	5	GN 041 (11V)	○	
2.4 JTD	2.4	110	03.02-05.06 841 C000	5	GN 041 (11V)	○	
2.4 JTD	2.4	120	06.03-05.06 841 M.000	5	GN 059 (11V)	○	
2.4 JTD	2.4	129	10.03-05.06 841 G.000	5	GN 059 (11V)	○	
			Kühlwasservorwärmung <sup>15</sup> ⇄ Ø 4 mm	GN 020 (12V)			
<b>159</b>							
1.8 MPI	1.8	103	03.07-11.11 939 A4.000	4	Z 203	14 FR-8 LU2	0,9
1.9 JTDM 8V	1.9	85	09.05-09.06 937 A7.000/939 A7.000	4	GN 041 (11V)	○	
1.9 JTDM 8V	1.9	85	10.06-12.08 937 A7.000/939 A7.000	4	GN 097 (11V)	○	
1.9 JTDM 8V	1.9	88	09.05-11.11 939 A1.000	4	GN 097 (11V)	○	
1.9 JTDM 16V	1.9	100	09.05-11.11 939 A8.000/937 A8.000	4	GN 059 (11V)	○	
1.9 JTDM 16V	1.9	110	09.05-11.11 939 A2.000	4	GN 059 (11V)	○	
2.2 JTS	2.2	136	09.05-11.11 939 A5.000	4	Z 240	14 F-8 DPURX02	1,0
2.4 JTDM	2.4	147	09.05-11.11 939 A3.000	5	GN 059 (11V)	○	
2.4 JTDM	2.4	154	05.07-11.11 939 A9.000	5	GN 059 (11V)	○	
2.4 JTDM Q4	2.4	154	05.07-11.11 939 A9.000	5	GN 069 (11V)	○	
3.2 JTS	3.2	191	02.08-11.11 939 A.000	6	Z 356	14 KR-7 MPUX2	1,1
3.2 JTS Q4	3.2	191	12.05-11.11 939 A.000	6	Z 356	14 KR-7 MPUX2	1,1
<b>159 Sportwagon</b>							
1.8 MPI	1.8	103	03.07-11.11 939 A4.000	4	Z 203	14 FR-8 LU2	0,9
1.9 JTDM 8V	1.9	85	03.06-09.06 937 A7.000	4	GN 041 (11V)	○	
1.9 JTDM 8V	1.9	85	10.06-12.08 937 A7.000	4	GN 097 (11V)	○	
1.9 JTDM 8V	1.9	88	03.06-11.11 939 A1.000	4	GN 097 (11V)	○	
1.9 JTDM 16V	1.9	100	03.06-11.11 937 A8.000	4	GN 059 (11V)	○	
1.9 JTDM 16V	1.9	110	03.06-11.11 939 A2.000	4	GN 059 (11V)	○	
2.2 JTS	2.2	136	03.06-11.11 939 A5.000	4	Z 240	14 F-8 DPURX02	1,0
2.4 JTDM	2.4	147	03.06-11.11 939 A3.000	5	GN 059 (11V)	○	
2.4 JTDM	2.4	154	05.07-11.11 939 A9.000	5	GN 059 (11V)	○	
2.4 JTDM Q4	2.4	154	05.07-11.11 939 A9.000	5	GN 069 (11V)	○	
3.2 JTS	3.2	191	02.08-11.11 939 A.000	6	Z 356	14 KR-7 MPUX2	1,1
3.2 JTS Q4	3.2	191	03.06-11.11 939 A.000	6	Z 356	14 KR-7 MPUX2	1,1
<b>164</b>							
2.0	2.0	102	06.87-09.98	4	Z 29	14 F-5 DU	0,8
2.0 T.S.	2.0	105	06.87-09.92 AR 06416	4	Z 29	14 F-5 DU	0,8
2.0 T.S.	2.0	106	09.92-09.98 AR 64103	4	Z 29	14 F-5 DU	0,8
2.0 T.S.	2.0	109	06.87-12.90 AR 06420	4	Z 29	14 F-5 DU	0,8
2.0 Turbo	2.0	128	10.87-09.98 AR 06476	4	Z 27	14 R-6 DU	0,8
2.0 V6 Turbo	2.0	148	09.92-09.98 AR 64102	6	Z 42	14-5 DU	0,8
2.0 V6 Turbo	2.0	150	03.91-09.92 AR 64101	6	Z 42	14-5 DU	0,8

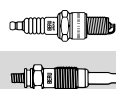

## ALFA ROMEO

### 164

2.5 TD	2.5	84	06.87-09.92	VM 84 A	4	<b>GV 657</b> (11V)	○		
2.5 TD	2.5	92	09.92-04.95	VM 32 B/VM 08 B	4	<b>GN 908</b> (11V)	○		
2.5 TD	2.5	92	05.95-09.98	VM 32 B/VM 08 B	4	<b>GN 007</b> (11V)	○		
2.5 V6	2.5	120	09.92-09.98	AR 66201	6	<b>Z 20</b>	14 R-7 DU	0,8	<b>UXT 2<sup>4</sup></b>
3.0 V6	3.0	132	09.92-09.98	AR 66303/AR 64305	6	<b>Z 27</b>	14 R-6 DU	0,8	<b>UX 56</b>
3.0 V6	3.0	135	06.87-09.92	AR 06412	6	<b>Z 42</b>	14-5 DU	0,8	<b>UX 56</b>
3.0	3.0	138	11.87-09.91	AR 06410	6	<b>Z 42</b>	14-5 DU	0,8	<b>UX 56</b>
3.0 V6	3.0	141	06.87-09.92	AR 06410	6	<b>Z 42</b>	14-5 DU	0,8	<b>UX 56</b>
3.0 i.e. QV	3.0	147	09.90-09.92	AR 64301/AR 06430	6	<b>Z 27</b>	14 R-6 DU	0,8	<b>UX 56</b>
3.0 24V	3.0	155	09.92-09.98	130	6	<b>Z 188</b>	14 F-7 DPUR02	0,7	<b>UXT 10</b>
3.0	3.0	168	04.93-02.95	AR 64304	6	<b>Z 188</b>	14 F-7 DPUR02	0,7	<b>UXT 10</b>
3.0 24V Q4	3.0	170	02.94-09.98	AR 64308/AR 64307	6	<b>Z 188</b>	14 F-7 DPUR02	0,7	<b>UXT 10</b>
3.0 24V QV	3.0	171	09.92-09.98	AR 64304	6	<b>Z 188</b>	14 F-7 DPUR02	0,7	<b>UXT 10</b>

### 166

2.0 T.Spark	2.0	110	10.00-06.07	AR 36301	4	<b>Z 210</b>	10 FR-6 CPU03 <sup>10</sup>	0,6	○
						<b>Z 237</b>	14 FR-7 DQUP7 <sup>11</sup>	1,6	○
2.0 T.Spark	2.0	114	09.98-10.00	AR 34103	4	<b>Z 210</b>	10 FR-6 CPU03 <sup>10</sup>	0,6	○
						<b>Z 237</b>	14 FR-7 DQUP7 <sup>11</sup>	1,6	○
2.0 V6	2.0	151	09.98-10.00	AR 34102	6	<b>Z 47</b>	14 R-5 DU	0,8	<b>UX 56</b>
2.4 JTD	2.4	100	09.98-10.00	AR 34202	5	<b>GN 017</b> (11V)	○		
				Kühlwasservorwärmung <sup>15</sup> ⇄ Ø 4 mm		<b>GN 020</b> (12V)			
2.4 JTD	2.4	103	10.00-06.07	839 A6.000	5	<b>GN 041</b> (11V)	○		
2.4 JTD	2.4	110	04.02-06.07	841 C000	5	<b>GN 041</b> (11V)	○		
2.4 JTD	2.4	129	10.03-06.07	841 G.000/841 H.000	5	<b>GN 059</b> (11V)	○		
2.4 JTD	2.4	132	07.06-06.07	841 M.000	5	<b>GN 059</b> (11V)	○		
2.4 JTD	2.4	136	07.05-06.07	841 M.000	5	<b>GN 059</b> (11V)	○		
2.5 V6 24V	2.5	138	10.00-06.07	AR 36201	6	<b>Z 188</b>	14 F-7 DPUR02	0,7	<b>UXT 10</b>
2.5 V6 24V	2.5	140	09.98-10.00	AR 34201	6	<b>Z 188</b>	14 F-7 DPUR02	0,7	<b>UXT 10</b>
3.0 V6 24V	3.0	162	10.00-06.07	AR 36101	6	<b>Z 188</b>	14 F-7 DPUR02	0,7	<b>UXT 10</b>
3.0 V6 24V	3.0	166	09.98-10.00	AR 34301	6	<b>Z 188</b>	14 F-7 DPUR02	0,7	<b>UXT 10</b>

### BRERA

2.2 JTS	2.2	136	01.06-	939 A5.000	4	<b>Z 240</b>	14 F-8 DPURX02	1,0	<b>UXT 9</b>
2.4 JTDM 20V	2.4	147	01.06-	939 A3.000	5	<b>GN 059</b> (11V)	○		
2.4 JTDM 20V	2.4	154	05.07-	939 A9.000	5	<b>GN 069</b> (11V)	○		
3.2 JTS	3.2	191	03.08-	939 A.000	6	<b>Z 356</b>	14 KR-7 MPUX2	1,1	○
3.2 JTS Q4	3.2	191	01.06-	939 A.000	6	<b>Z 356</b>	14 KR-7 MPUX2	1,1	○

### GIULIETTA

1.4 TB	1.4	88	04.10-	198 A4.000	4	<b>Z 338</b>	12 FR-4 DPUT	0,8	○
1.4 TB	1.4	125	04.10-	940 A2.000	4	<b>Z 338</b>	12 FR-4 DPUT	0,8	○

### GT

1.8 TS	1.7	103	11.03-09.10	AR 32205	4	<b>Z 210</b>	10 FR-6 CPU03 <sup>10</sup>	0,6	○
						<b>Z 237</b>	14 FR-7 DQUP7 <sup>11</sup>	1,6	○
1.9 JTD	1.9	110	11.03-09.10	937 A5.000	4	<b>GN 059</b> (11V)	○		
1.9 JTD	1.9	125	05.08-09.10	937 A6.000	4	<b>GN 069</b> (11V)	○		
2.0 JTS	2.0	119	12.06-09.10	932 A2.000	4	<b>Z 237</b>	14 FR-7 DQUP7	1,6	○
2.0 JTS	2.0	121	11.03-09.10	932 A2.000	4	<b>Z 193</b>	14 FR-7 DU2	0,9	<b>UXT 1<sup>3</sup></b>
2.0 JTS	2.0	121	11.03-09.10	937 A1.000	4	<b>Z 237</b>	14 FR-7 DQUP7	1,6	○

### GTV

1.8 16V	1.7	106	05.98-10.05	AR 32201	4	<b>Z 210</b>	10 FR-6 CPU03 <sup>10</sup>	0,6	○
						<b>Z 237</b>	14 FR-7 DQUP7 <sup>11</sup>	1,6	○
2.0 T.SPARK 16V	2.0	110	06.95-10.05	AR 16201/AR 32310	4	<b>Z 210</b>	10 FR-6 CPU03 <sup>10</sup>	0,6	○
						<b>Z 237</b>	14 FR-7 DQUP7 <sup>11</sup>	1,6	○
2.0 T.SPARK 16V	2.0	114	05.98-08.00	AR 32301	4	<b>Z 210</b>	10 FR-6 CPU03 <sup>10</sup>	0,6	○
						<b>Z 237</b>	14 FR-7 DQUP7 <sup>11</sup>	1,6	○
2.0 JTS	2.0	121	04.03-10.05	937 A1.000	4	<b>Z 237</b>	14 FR-7 DQUP7	1,6	○
2.0 V6 Turbo	2.0	148	06.95-09.98	AR 16202	6	<b>Z 42</b>	14-5 DU	0,8	<b>UX 56</b>
3.0 V6 24V	3.0	160	10.00-10.05	AR 16105	6	<b>Z 188</b>	14 F-7 DPUR02	0,7	<b>UXT 10</b>
3.0 V6 24V	3.0	162	10.96-10.00	AR 16102	6	<b>Z 188</b>	14 F-7 DPUR02	0,7	<b>UXT 10</b>

### MITO

1.3 JTDM	1.3	66	09.08-	199 A3.000	4	<b>GN 053</b> (11V)	○		
1.4	1.4	58	09.08-	955 A1.000	4	<b>Z 293</b>	12 FR-6 LUX	1,05	○

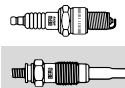
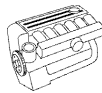

### ALFA ROMEO

#### MITO

1.4	1.4	70	09.08-	199 A6.000	4	<b>Z 293</b>	12 FR-6 LUX	1,05	○
1.4	1.4	77	08.10-	955 A6.000	4	<b>Z 234</b>	12 FR-7 DU	0,9	○
1.4	1.4	88	09.08-	198 A4.000	4	<b>Z 338</b>	12 FR-4 DPUT	0,8	○
1.4 TB	1.4	99	10.09-	955 A2.000	4	<b>Z 338</b>	12 FR-4 DPUT	0,8	○
1.4 TB	1.4	114	09.08-	199 A8.000	4	<b>Z 338</b>	12 FR-4 DPUT	0,8	○
1.4 TB	1.4	120	10.09-	955 A8.000	4	<b>Z 338</b>	12 FR-4 DPUT	0,8	○
1.4 TB	1.4	125	10.09-	940 A2.000	4	<b>Z 338</b>	12 FR-4 DPUT	0,8	○

#### RZ

3.0 V6 Zagato	3.0	152	01.92-12.94	AR 61501	6	<b>Z 42</b>	14-5 DU	0,8	<b>UX 56</b>
---------------	-----	-----	-------------	----------	---	-------------	---------	-----	--------------

#### SPIDER

1600	1.6	79	01.90-12.93	AR 01563	4	<b>Z 42</b>	14-5 DU	0,8	<b>UX 56</b>
2000	2.0	85	08.86-12.90	AR 01544	4	<b>Z 11</b>	14-7 DU	0,8	<b>UXT 2<sup>4</sup></b>
2000	2.0	88	01.90-12.93	AR 01588	4	<b>Z 11</b>	14-7 DU	0,8	<b>UXT 2<sup>4</sup></b>
2000	2.0	92	08.86-12.90	AR 00515	4	<b>Z 11</b>	14-7 DU	0,8	<b>UXT 2<sup>4</sup></b>
2000 Veloce	2.0	93	01.77-12.93	AR 00515/AR 01590	4	<b>Z 11</b>	14-7 DU	0,8	<b>UXT 2<sup>4</sup></b>
1.8 16V	1.7	106	05.98-04.05	AR 32201	4	<b>Z 210</b>	10 FR-6 CPU03 <sup>10</sup>	0,6	○
						<b>Z 237</b>	14 FR-7 DQUP7 <sup>11</sup>	1,6	○
2.0 T.SPARK 16V	2.0	110	06.95-04.05	AR 16201/AR 32310	4	<b>Z 210</b>	10 FR-6 CPU03 <sup>10</sup>	0,6	○
						<b>Z 237</b>	14 FR-7 DQUP7 <sup>11</sup>	1,6	○
2.0 T.SPARK 16V	2.0	114	05.98-08.00	AR 32301	4	<b>Z 210</b>	10 FR-6 CPU03 <sup>10</sup>	0,6	○
						<b>Z 237</b>	14 FR-7 DQUP7 <sup>11</sup>	1,6	○
2.0 JTS	2.0	121	04.03-04.05	937 A1.000	4	<b>Z 237</b>	14 FR-7 DQUP7	1,6	○
2.0 V6 Turbo	2.0	148	05.98-12.00	AR 16202	6	<b>Z 47</b>	14 R-5 DU	0,8	<b>UX 56</b>
2.2 JTS	2.2	136	09.06-	939 A5.000	4	<b>Z 240</b>	14 F-8 DPURX02	1,0	<b>UXT 9</b>
2.4 JTDM	2.4	147	04.07-	939 A3.000	5	<b>GN 059 (11V)</b>	○		
2.4 JTDM	2.4	154	03.08-	939 A3.000	5	<b>GN 059 (11V)</b>	○		
3.0 V6 24V	3.0	162	01.99-10.00	AR 16102	6	<b>Z 188</b>	14 F-7 DPUR02	0,7	<b>UXT 10</b>
3.2 JTS	3.2	191	03.08-	939 A.000	6	<b>Z 356</b>	14 KR-7 MPUX2	1,1	○
3.2 JTS Q4	3.2	191	09.06-	939 A.000	6	<b>Z 356</b>	14 KR-7 MPUX2	1,1	○

### ALPIN

#### A610

3.0 TURBO	3.0	184	01.91-04.95		6	<b>Z 89</b>	14 FGH-6 DTUR	0,8	<b>UXT 5</b>
-----------	-----	-----	-------------	--	---	-------------	---------------	-----	--------------

#### V6

2.9 GT	2.9	116	01.85-12.90	Z6W	6	<b>Z 31</b>	14 K-5 DU	0,8	<b>UXK 56</b>
--------	-----	-----	-------------	-----	---	-------------	-----------	-----	---------------

### ALPINA

#### B3 (E30)

2.7	2.7	150	09.87-06.92		6	<b>Z 20</b>	14 R-7 DU	0,8	<b>UXT 2<sup>4</sup></b>
2.7 Allrad	2.7	150	09.87-06.92		6	<b>Z 20</b>	14 R-7 DU	0,8	<b>UXT 2<sup>4</sup></b>

#### B3 (E36)

3.2	3.2	195	04.96-04.99		6	<b>Z 14</b>	14 F-7 LDUR4	0,9	<b>UXT 1<sup>3</sup></b>
-----	-----	-----	-------------	--	---	-------------	--------------	-----	--------------------------

#### B3 (E46)

3.3	3.3	206	05.99-07.02		6	<b>Z 237</b>	14 FR-7 DQUP7	1,6	○
3.3 Allrad	3.3	206	11.01-01.05		6	<b>Z 237</b>	14 FR-7 DQUP7	1,6	○
3.4 S	3.3	224	08.02-01.06		6	<b>Z 237</b>	14 FR-7 DQUP7	1,6	○

#### B3 Cabriolet (E36)

3.2	3.2	195	04.96-03.99		6	<b>Z 14</b>	14 F-7 LDUR4	0,9	<b>UXT 1<sup>3</sup></b>
-----	-----	-----	-------------	--	---	-------------	--------------	-----	--------------------------

#### B3 Cabriolet (E46)

3.3	3.3	206	10.00-07.02		6	<b>Z 237</b>	14 FR-7 DQUP7	1,6	○
3.4 S	3.3	224	11.02-		6	<b>Z 237</b>	14 FR-7 DQUP7	1,6	○

#### B3 Coupe (E36)

3.2	3.2	195	04.96-03.99		6	<b>Z 14</b>	14 F-7 LDUR4	0,9	<b>UXT 1<sup>3</sup></b>
-----	-----	-----	-------------	--	---	-------------	--------------	-----	--------------------------

#### B3 Coupe (E46)

3.3	3.3	206	09.99-07.02		6	<b>Z 237</b>	14 FR-7 DQUP7	1,6	○
3.4 S	3.3	224	11.02-01.06		6	<b>Z 237</b>	14 FR-7 DQUP7	1,6	○

#### B3 Kombi (E36)

3.2	3.2	195	04.96-03.99		6	<b>Z 14</b>	14 F-7 LDUR4	0,9	<b>UXT 1<sup>3</sup></b>
-----	-----	-----	-------------	--	---	-------------	--------------	-----	--------------------------

#### B3 Kombi (E46)

3.3	3.3	206	02.00-07.02		6	<b>Z 237</b>	14 FR-7 DQUP7	1,6	○
3.3 Allrad	3.3	206	11.01-01.05		6	<b>Z 237</b>	14 FR-7 DQUP7	1,6	○

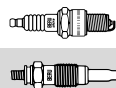
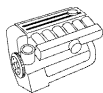

## ALPINA

### B3 Kombi (E46)

3.4 S	3.3	224	08.02-01.06	6	<b>Z 237</b>	14 FR-7 DQUP7	1,6	○
-------	-----	-----	-------------	---	--------------	---------------	-----	---

### B8 (E36)

4.6	4.6	245	01.95-03.98	M 62 B 46	8	<b>Z 14</b>	14 F-7 LDUR4	0,9	<b>UXT 1<sup>3</sup></b>
-----	-----	-----	-------------	-----------	---	-------------	--------------	-----	--------------------------

### B8 Cabriolet (E36)

4.6	4.6	245	01.95-03.98	M 62 B 46	8	<b>Z 14</b>	14 F-7 LDUR4	0,9	<b>UXT 1<sup>3</sup></b>
-----	-----	-----	-------------	-----------	---	-------------	--------------	-----	--------------------------

### B8 Coupe (E36)

4.6	4.6	245	01.95-03.98	M 62 B 46	8	<b>Z 14</b>	14 F-7 LDUR4	0,9	<b>UXT 1<sup>3</sup></b>
-----	-----	-----	-------------	-----------	---	-------------	--------------	-----	--------------------------

### B8 Kombi (E36)

4.6	4.6	245	01.95-03.98	M 62 B 46	8	<b>Z 14</b>	14 F-7 LDUR4	0,9	<b>UXT 1<sup>3</sup></b>
-----	-----	-----	-------------	-----------	---	-------------	--------------	-----	--------------------------

### B10 (E34)

3.5	3.4	187	04.88-12.92		6	<b>Z 11</b>	14-7 DU	0,8	<b>UXT 2<sup>4</sup></b>
-----	-----	-----	-------------	--	---	-------------	---------	-----	--------------------------

3.5 Biturbo	3.4	265	01.89-06.93		6	<b>Z 104</b>	14-6 DPO	0,6	○
-------------	-----	-----	-------------	--	---	--------------	----------	-----	---

### B10 (E39)

3.3	3.3	206	01.99-02.03		6	<b>Z 237</b>	14 FR-7 DQUP7	1,6	○
-----	-----	-----	-------------	--	---	--------------	---------------	-----	---

4.6 V8	4.6	250	12.96-10.98		8	<b>Z 14</b>	14 F-7 LDUR4	0,9	<b>UXT 1<sup>3</sup></b>
--------	-----	-----	-------------	--	---	-------------	--------------	-----	--------------------------

4.6 V8	4.6	255	10.98-09.02		8	<b>Z 237</b>	14 FR-7 DQUP7	1,6	○
--------	-----	-----	-------------	--	---	--------------	---------------	-----	---

### B10 Kombi (E39)

3.2	3.2	191	08.97-12.98		8	<b>Z 14</b>	14 F-7 LDUR4	0,9	<b>UXT 1<sup>3</sup></b>
-----	-----	-----	-------------	--	---	-------------	--------------	-----	--------------------------

3.3	3.3	206	02.99-10.03		6	<b>Z 237</b>	14 FR-7 DQUP7	1,6	○
-----	-----	-----	-------------	--	---	--------------	---------------	-----	---

4.6 V8	4.6	250	01.97-10.98		8	<b>Z 14</b>	14 F-7 LDUR4	0,9	<b>UXT 1<sup>3</sup></b>
--------	-----	-----	-------------	--	---	-------------	--------------	-----	--------------------------

4.6 V8	4.6	255	10.98-09.02		8	<b>Z 237</b>	14 FR-7 DQUP7	1,6	○
--------	-----	-----	-------------	--	---	--------------	---------------	-----	---

### B11 (E32)

3.5	3.4	187	10.87-12.93		6	<b>Z 11</b>	14-7 DU	0,8	<b>UXT 2<sup>4</sup></b>
-----	-----	-----	-------------	--	---	-------------	---------	-----	--------------------------

### B12 (E38)

5.7	5.6	285	12.95-09.98		12	<b>Z 14</b>	14 F-7 LDUR4	0,9	<b>UXT 1<sup>3</sup></b>
-----	-----	-----	-------------	--	----	-------------	--------------	-----	--------------------------

6.0	6.0	316	07.99-07.01		12	<b>Z 237</b>	14 FR-7 DQUP7	1,6	○
-----	-----	-----	-------------	--	----	--------------	---------------	-----	---

### D10 (E39)

3.0 D Biturbo	2.9	180	04.00-10.03		6	<b>GN 025</b> (11V)	○		
---------------	-----	-----	-------------	--	---	---------------------	---	--	--

### D10 Kombi (E39)

3.0 D Biturbo	2.9	180	04.00-10.03		6	<b>GN 025</b> (11V)	○		
---------------	-----	-----	-------------	--	---	---------------------	---	--	--

### ROADSTER (Z8)

4.8 V8	4.8	280	06.02-10.03		8	<b>Z 237</b>	14 FR-7 DQUP7	1,6	○
--------	-----	-----	-------------	--	---	--------------	---------------	-----	---

### ROADSTER S (Z4)

3.3	3.3	221	07.03-12.05	S54327S7	6	<b>Z 237</b>	14 FR-7 DQUP7	1,6	○
-----	-----	-----	-------------	----------	---	--------------	---------------	-----	---

## ARO

### 10

1.4	1.4	46	09.88-10.99	IAP 810-R-99	4	<b>Z 10</b>	14-7 BU	0,8	○
-----	-----	----	-------------	--------------	---	-------------	---------	-----	---

1.6	1.6	55	06.88-10.99	HN	4	<b>Z 69</b>	14-8 DUO	0,7	<b>UXT 2<sup>4</sup></b>
-----	-----	----	-------------	----	---	-------------	----------	-----	--------------------------

### 240-244

2.5 D	2.5	52	01.83-12.98	XD3P	4	<b>GV 636</b> (11V)	○		
-------	-----	----	-------------	------	---	---------------------	---	--	--

2.5	2.5	59	04.78-12.98	Aro L25	4	<b>Z 19</b>	14 R-7 BU	0,8	○
-----	-----	----	-------------	---------	---	-------------	-----------	-----	---

2.5	2.5	60	01.80-12.98	Aro L25	4	<b>Z 68</b>	14-8 AU	0,6	○
-----	-----	----	-------------	---------	---	-------------	---------	-----	---

2.5 TD	2.5	70	01.92-12.06	XD3TP	4	<b>GV 636</b> (11V)	○		
--------	-----	----	-------------	-------	---	---------------------	---	--	--

2.5 TD	2.5	74	01.92-12.06	VM-425HLT	4	<b>GV 636</b> (11V)	○		
--------	-----	----	-------------	-----------	---	---------------------	---	--	--

2.7 D	2.7	50	09.89-12.98		4	<b>GV 636</b> (11V)	○		
-------	-----	----	-------------	--	---	---------------------	---	--	--

2.7 D	2.7	52	04.85-12.98	Aro L-27D	4	<b>GV 636</b> (11V)	○		
-------	-----	----	-------------	-----------	---	---------------------	---	--	--

2.7 D	2.7	60	01.83-12.98	Aro L-27D	4	<b>GV 636</b> (11V)	○		
-------	-----	----	-------------	-----------	---	---------------------	---	--	--

3.0	3.0	70	01.92-12.06	Aro L30	4	<b>Z 57</b>	14-7 AU	0,6	○
-----	-----	----	-------------	---------	---	-------------	---------	-----	---

## ASIA MOTORS

### ROCSTA

1.8 i 4x4	1.8	57	06.93-12.99	F804	4	<b>Z 8</b>	14 R-8 DU	0,8	<b>UXT 2<sup>4</sup></b>
-----------	-----	----	-------------	------	---	------------	-----------	-----	--------------------------

## ASTON MARTIN

### DB7 Vantage

3.2	3.2	250	01.94-10.03		8	<b>Z 24</b>	14 FR-6 DU	0,8	<b>UXT 5</b>
-----	-----	-----	-------------	--	---	-------------	------------	-----	--------------

### DB7 Volante

3.2	3.2	250	01.96-10.03	AJ6HT	8	<b>Z 30</b>	14 FR-5 DU	0,8	<b>UXT 5</b>
-----	-----	-----	-------------	-------	---	-------------	------------	-----	--------------

### LAGONDA I Shooting Brake

5.3	5.3	228	01.86-12.97	40HES/40HCA	8	<b>Z 20</b>	14 R-7 DU	0,8	<b>UXT 2<sup>4</sup></b>
-----	-----	-----	-------------	-------------	---	-------------	-----------	-----	--------------------------

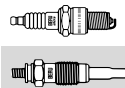

### ASTON MARTIN

#### VIRAGE Saloon

5.3	5.3	246	01.94-12.95	40HTE	8	<b>Z 250</b>	14 FR-7 DU2S	0,7	<b>UXT 1<sup>3</sup></b>
-----	-----	-----	-------------	-------	---	--------------	--------------	-----	--------------------------

#### VIRAGE Shooting Brake

5.3	5.3	246	01.93-12.95	40HTE	8	<b>Z 250</b>	14 FR-7 DU2S	0,7	<b>UXT 1<sup>3</sup></b>
-----	-----	-----	-------------	-------	---	--------------	--------------	-----	--------------------------

#### VIRAGE Vantage

5.3	5.3	246	10.88-12.92	40HTE	8	<b>Z 15</b>	14 FR-7 DU	0,8	<b>UXT 1<sup>3</sup></b>
-----	-----	-----	-------------	-------	---	-------------	------------	-----	--------------------------

5.3	5.3	410	10.92-10.00		8	<b>Z 250</b>	14 FR-7 DU2S	0,7	<b>UXT 1<sup>3</sup></b>
-----	-----	-----	-------------	--	---	--------------	--------------	-----	--------------------------

#### VIRAGE Volante

5.3	5.3	246	09.90-12.95	40HTE	8	<b>Z 15</b>	14 FR-7 DU	0,8	<b>UXT 1<sup>3</sup></b>
-----	-----	-----	-------------	-------	---	-------------	------------	-----	--------------------------

### AUDI

#### A1 (8X1)

1.4 TFSI	1.4	90	05.10-	CAXA/CNVA	4	<b>Z 349</b>	14 F-6 LPURW03	0,9	○
----------	-----	----	--------	-----------	---	--------------	----------------	-----	---

1.6 TDI	1.6	66	03.11-	CAYB	4	<b>GE 115</b> (4,4V)	○		
---------	-----	----	--------	------	---	----------------------	---	--	--

1.6 TDI	1.6	77	05.10-	CAYC	4	<b>GE 115</b> (4,4V)	○		
---------	-----	----	--------	------	---	----------------------	---	--	--

2.0 TDI	2.0	105	09.11-	CFHD	4	<b>GE 115</b> (4,4V)	○		
---------	-----	-----	--------	------	---	----------------------	---	--	--

#### A1 Sportback (8XA)

1.4 TFSI	1.4	90	11.11-	CAXA/CNVA	4	<b>Z 349</b>	14 F-6 LPURW03	0,9	○
----------	-----	----	--------	-----------	---	--------------	----------------	-----	---

1.6 TDI	1.6	66	11.11-	CAYB	4	<b>GE 115</b> (4,4V)	○		
---------	-----	----	--------	------	---	----------------------	---	--	--

1.6 TDI	1.6	77	11.11-	CAYC	4	<b>GE 115</b> (4,4V)	○		
---------	-----	----	--------	------	---	----------------------	---	--	--

#### A2 (8Z0)

1.2 TDI	1.2	45	03.01-08.05	ANY	3	<b>GN 046</b> (12V)	○		
---------	-----	----	-------------	-----	---	---------------------	---	--	--

1.4	1.4	55	02.00-08.05	AUA/BBY	4	<b>Z 90</b>	14 FGH-7 DTURX	1,0	<b>UXT 1<sup>3</sup></b>
-----	-----	----	-------------	---------	---	-------------	----------------	-----	--------------------------

1.4 TDI	1.4	55	02.00-08.05	AMF/BHC	3	<b>GN 046</b> (12V)	○		
---------	-----	----	-------------	---------	---	---------------------	---	--	--

1.4 TDI	1.4	66	11.03-08.05	ATL	3	<b>GE 100</b> (5V)	<b>GSE 100</b>		
---------	-----	----	-------------	-----	---	--------------------	----------------	--	--

1.6 FSI	1.6	81	05.02-08.05	BAD	4	<b>Z 300</b>	14 FGR-6 HQU	1,35	○
---------	-----	----	-------------	-----	---	--------------	--------------	------	---

#### A3 (8L1)

1.6	1.6	74	09.96-08.00	AEH/AKL/APF	4	<b>Z 90</b>	14 FGH-7 DTURX	1,0	<b>UXT 1<sup>3</sup></b>
-----	-----	----	-------------	-------------	---	-------------	----------------	-----	--------------------------

1.6	1.6	75	08.00-	AVU/BFQ	4	<b>Z 90</b>	14 FGH-7 DTURX	1,0	<b>UXT 1<sup>3</sup></b>
-----	-----	----	--------	---------	---	-------------	----------------	-----	--------------------------

1.8	1.8	92	09.96-	AGN/APG	4	<b>Z 90</b>	14 FGH-7 DTURX	1,0	<b>UXT 1<sup>3</sup></b>
-----	-----	----	--------	---------	---	-------------	----------------	-----	--------------------------

1.8 T	1.8	110	12.96-	AQA/ARZ/AGU/AUM	4	<b>Z 188</b>	14 F-7 DPUR02	0,7	<b>UXT 10</b>
-------	-----	-----	--------	-----------------	---	--------------	---------------	-----	---------------

1.8 T quattro	1.8	110	12.96-	AGU/AQA/ARX	4	<b>Z 188</b>	14 F-7 DPUR02	0,7	<b>UXT 10</b>
---------------	-----	-----	--------	-------------	---	--------------	---------------	-----	---------------

1.8 T	1.8	132	12.98-	ARY/AJQ/APP/AUQ	4	<b>Z 188</b>	14 F-7 DPUR02	0,7	<b>UXT 10</b>
-------	-----	-----	--------	-----------------	---	--------------	---------------	-----	---------------

1.8 T quattro	1.8	132	10.98-	ARY/AJQ	4	<b>Z 188</b>	14 F-7 DPUR02	0,7	<b>UXT 10</b>
---------------	-----	-----	--------	---------	---	--------------	---------------	-----	---------------

1.8 S3 quattro	1.8	154	03.99-	AMK/AUL/APY	4	<b>Z 188</b>	14 F-7 DPUR02	0,7	<b>UXT 10</b>
----------------	-----	-----	--------	-------------	---	--------------	---------------	-----	---------------

1.8 S3 quattro	1.8	165	10.01-	BAM	4	<b>Z 188</b>	14 F-7 DPUR02	0,7	<b>UXT 10</b>
----------------	-----	-----	--------	-----	---	--------------	---------------	-----	---------------

1.9 TDI	1.9	66	09.96-07.01	AGR/ALH	4	<b>GN 855</b> (12V)	○		
---------	-----	----	-------------	---------	---	---------------------	---	--	--

				Kühlwasservorwärmung <sup>15</sup>		<b>GN 857</b> (11V)=3x			
--	--	--	--	------------------------------------	--	------------------------	--	--	--

						<b>GN 928</b> (12V)=3x			
--	--	--	--	--	--	------------------------	--	--	--

1.9 TDI	1.9	74	10.00-	AXR/ATD	4	<b>GN 855</b> (12V)	○		
---------	-----	----	--------	---------	---	---------------------	---	--	--

				Kühlwasservorwärmung <sup>15</sup>		<b>GN 857</b> (11V)=3x			
--	--	--	--	------------------------------------	--	------------------------	--	--	--

						<b>GN 928</b> (12V)=3x			
--	--	--	--	--	--	------------------------	--	--	--

1.9 TDI	1.9	81	08.97-07.01	AHF/ASV	4	<b>GN 855</b> (12V)	○		
---------	-----	----	-------------	---------	---	---------------------	---	--	--

				Kühlwasservorwärmung <sup>15</sup>		<b>GN 857</b> (11V)=3x			
--	--	--	--	------------------------------------	--	------------------------	--	--	--

						<b>GN 928</b> (12V)=3x			
--	--	--	--	--	--	------------------------	--	--	--

1.9 TDI	1.9	96	08.00-05.03	ASZ	4	<b>GN 855</b> (12V)	○		
---------	-----	----	-------------	-----	---	---------------------	---	--	--

				Kühlwasservorwärmung <sup>15</sup>		<b>GN 857</b> (11V)=3x			
--	--	--	--	------------------------------------	--	------------------------	--	--	--

						<b>GN 928</b> (12V)=3x			
--	--	--	--	--	--	------------------------	--	--	--

1.9 TDI	1.9	96	06.03-	ASZ	4	<b>GN 046</b> (12V)	○		
---------	-----	----	--------	-----	---	---------------------	---	--	--

1.9 TDI quattro	1.9	96	08.00-05.03	ASZ	4	<b>GN 855</b> (12V)	○		
-----------------	-----	----	-------------	-----	---	---------------------	---	--	--

				Kühlwasservorwärmung <sup>15</sup>		<b>GN 857</b> (11V)=3x			
--	--	--	--	------------------------------------	--	------------------------	--	--	--

						<b>GN 928</b> (12V)=3x			
--	--	--	--	--	--	------------------------	--	--	--

1.9 TDI quattro	1.9	96	06.03-	ASZ	4	<b>GN 046</b> (12V)	○		
-----------------	-----	----	--------	-----	---	---------------------	---	--	--

#### A3 (8P1)

1.4 TFSI	1.4	92	09.07-	CAXC/CMSA	4	<b>Z 349</b>	14 F-6 LPURW03	0,9	○
----------	-----	----	--------	-----------	---	--------------	----------------	-----	---

1.6 TDI	1.6	66	05.09-	CAYB	4	<b>GE 115</b> (4,4V)	○		
---------	-----	----	--------	------	---	----------------------	---	--	--

1.6	1.6	75	05.03-	BGU/CCSA/BSF/CMXA/BSE	4	<b>Z 90</b>	14 FGH-7 DTURX	1,0	<b>UXT 1<sup>3</sup></b>
-----	-----	----	--------	-----------------------	---	-------------	----------------	-----	--------------------------

1.6 E-Power	1.6	75	01.11-	CMXA	4	<b>Z 90</b>	14 FGH-7 DTURX	1,0	<b>UXT 1<sup>3</sup></b>
-------------	-----	----	--------	------	---	-------------	----------------	-----	--------------------------

1.6 TDI	1.6	77	05.09-	CAYC	4	<b>GE 115</b> (4,4V)	○		
---------	-----	----	--------	------	---	----------------------	---	--	--

1.6 FSI	1.6	85	08.03-	BLF/BLP/BAG	4	<b>Z 300</b>	14 FGR-6 HQU	1,35	○
---------	-----	----	--------	-------------	---	--------------	--------------	------	---

1.8 TFSI	1.8	118	11.06-	BYT/BZB/CDAA	4	<b>Z 347</b>	14 F-5 DPUR02	0,7	○
----------	-----	-----	--------	--------------	---	--------------	---------------	-----	---

1.8 TFSI quattro	1.8	118	07.08-	CDAA	4	<b>Z 347</b>	14 F-5 DPUR02	0,7	○
------------------	-----	-----	--------	------	---	--------------	---------------	-----	---

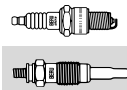
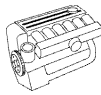

<b>AUDI</b>									
<b>A3 (8P1)</b>									
1.9 TDI	1.9	77	05.03-	BXE/BKC/BLS Fgst.Nr. 70251→	4	<b>GE 100</b> (5V)	<b>GSE 100</b>		
2.0 TDI	2.0	100	05.03-	AZV	4	<b>GE 101</b> (4,4V)	<b>GSE 100</b>		
2.0 TDI quattro	2.0	100	05.03-	AZV	4	<b>GE 101</b> (4,4V)	<b>GSE 100</b>		
2.0 TDI	2.0	100	05.03-	CFFA, CBAA	4	<b>GE 115</b> (4,4V)	○		
2.0 TDI 16V	2.0	103	05.03-	BKD	4	<b>GE 101</b> (4,4V) + <b>VW Nr. 03G 103 483</b>	<b>GSE 100</b>		
2.0 TDI 16V quattro	2.0	103	08.04-	BKD	4	<b>GE 101</b> (4,4V) + <b>VW Nr. 03G 103 483</b>	<b>GSE 100</b>		
2.0 TDI	2.0	103	06.05-	BMM Fgst.Nr. 8P-6B019 001, 4 8P-6A138 001 →	4	<b>GE 100</b> (5V)	○		
2.0 TDI quattro	2.0	103	01.06-	BMM Fgst.Nr. 8P-6B019 001, 4 8P-6A138 001 →	4	<b>GE 100</b> (5V)	○		
2.0 TDI 16V	2.0	103	05.03-	CFFB, CBAB, CLJA	4	<b>GE 115</b> (4,4V)	○		
2.0 TDI 16V quattro	2.0	103	08.04-	CBAB, CFFB	4	<b>GE 115</b> (4,4V)	○		
2.0 FSI	2.0	110	05.03-	AXW/BLR/BLX/BVY	4	<b>Z 236</b>	14 F-6 HTPRX02	1,0	○
2.0 FSI	2.0	110	05.03-	BMB/BVZ/BLY	4	<b>Z 228</b>	14 FR-7 DPUX02	1,0	<b>UXT 11</b>
2.0 TDI	2.0	125	03.06-	CBBB, CFGB	4	<b>GE 115</b> (4,4V)	○		
2.0 TDI quattro	2.0	125	03.06-	CBBB, CFGB	4	<b>GE 115</b> (4,4V)	○		
2.0 TFSI	2.0	147	09.04-	CAWB/AXX/BWA/CCZA	4	<b>Z 347</b>	14 F-5 DPUR02	0,7	○
2.0 TFSI quattro	2.0	147	09.04-	AXX/BWA/CCZA	4	<b>Z 347</b>	14 F-5 DPUR02	0,7	○
2.0 S3 quattro	2.0	188	02.07-	BZC/CDLC	4	<b>Z 347</b>	14 F-5 DPUR02	0,7	○
2.0 S3 quattro	2.0	195	11.06-	BHZ/CDLA	4	<b>Z 347</b>	14 F-5 DPUR02	0,7	○
<b>A3 Cabriolet (8P7)</b>									
1.6	1.6	75	09.08-	BSE	4	<b>Z 90</b>	14 FGH-7 DTURX	1,0	<b>UXT 13</b>
1.6 TDI	1.6	77	05.09-	CAYC	4	<b>GE 115</b> (4,4V)	○		
1.8 TFSI	1.8	118	04.08-	BZB/CDA	4	<b>Z 347</b>	14 F-5 DPUR02	0,7	○
1.9 TDI	1.9	77	04.08-	BLS	4	<b>GE 100</b> (5V)	<b>GSE 100</b>		
2.0 TDI	2.0	100	04.08-	CBAA/CFFA	4	<b>GE 115</b> (4,4V)	○		
2.0 TDI	2.0	103	04.08-	CBAB, CFFB	4	<b>GE 115</b> (4,4V)	○		
2.0 TFSI	2.0	147	04.08-	CAWB/CCZA	4	<b>Z 347</b>	14 F-5 DPUR02	0,7	○
<b>A3 Sportback (8PA)</b>									
1.4 TFSI	1.4	92	09.07-	CAXC/CMSA	4	<b>Z 349</b>	14 F-6 LPURW03	0,9	○
1.6 TDI	1.6	66	05.09-	CAYB	4	<b>GE 115</b> (4,4V)	○		
1.6	1.6	75	09.04-	BGU/CCSA/BSF/CMXA/BSE	4	<b>Z 90</b>	14 FGH-7 DTURX	1,0	<b>UXT 13</b>
1.6 E-Power	1.6	75	01.11-	CMXA	4	<b>Z 90</b>	14 FGH-7 DTURX	1,0	<b>UXT 13</b>
1.6 TDI	1.6	77	05.09-	CAYC	4	<b>GE 115</b> (4,4V)	○		
1.6 FSI	1.6	85	09.04-	BLF/BLP	4	<b>Z 300</b>	14 FGR-6 HQU	1,35	○
1.8 TFSI	1.8	118	11.06-	BYT/BZB/CDA	4	<b>Z 347</b>	14 F-5 DPUR02	0,7	○
1.8 TFSI quattro	1.8	118	07.08-	CDA	4	<b>Z 347</b>	14 F-5 DPUR02	0,7	○
1.9 TDI	1.9	77	09.04-	BXE/BKC/BLS Fgst.Nr. 70251→	4	<b>GE 100</b> (5V)	<b>GSE 100</b>		
2.0 TDI	2.0	100	09.04-	AZV	4	<b>GE 101</b> (4,4V)	<b>GSE 100</b>		
2.0 TDI	2.0	100	09.04-	CBAA, CFFA	4	<b>GE 115</b> (4,4V)	○		
2.0 TDI	2.0	103	06.05-	BMM Fgst.Nr. 8P-6B019 001, 4 8P-6A138 001 →	4	<b>GE 100</b> (5V)	○		
2.0 TDI quattro	2.0	103	01.06-	BMM Fgst.Nr. 8P-6B019 001, 4 8P-6A138 001 →	4	<b>GE 100</b> (5V)	○		
2.0 TDI 16V	2.0	103	09.04-	BKD	4	<b>GE 101</b> (4,4V) + <b>VW Nr. 03G 103 483</b>	<b>GSE 100</b>		
2.0 TDI 16V quattro	2.0	103	11.05-	BKD	4	<b>GE 101</b> (4,4V) + <b>VW Nr. 03G 103 483</b>	<b>GSE 100</b>		
2.0 TDI 16V	2.0	103	09.04-	CBAB/CFFB/CLJA	4	<b>GE 115</b> (4,4V)	○		
2.0 TDI 16V quattro	2.0	103	11.05-	CBAB/CFFB/CLJA	4	<b>GE 115</b> (4,4V)	○		
2.0 FSI	2.0	110	09.04-	BLR/BLX/BVY	4	<b>Z 236</b>	14 F-6 HTPRX02	1,0	○
2.0 FSI	2.0	110	09.04-	BVZ/BMB/BLY	4	<b>Z 228</b>	14 FR-7 DPUX02	1,0	<b>UXT 11</b>
2.0 TDI	2.0	125	03.06-	CBBB, CFGB	4	<b>GE 115</b> (4,4V)	○		



kW

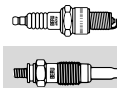

**AUDI**

**A3 Sportback (8PA)**

2.0 TDI quattro	2.0	125	03.06-	CBBB, CFGB	4	<b>GE 115</b> (4,4V)	○		
2.0 TFSI	2.0	147	09.04-	AXX/BWA/CAWB/BPY/CCZA,	4	<b>Z 347</b>	14 F-5 DPUR02	0,7	○
2.0 TFSI quattro	2.0	147	09.04-	AXX/BWA/CCZA	4	<b>Z 347</b>	14 F-5 DPUR02	0,7	○
2.0 S3 quattro	2.0	188	07.08-	CDLC	4	<b>Z 347</b>	14 F-5 DPUR02	0,7	○
2.0 S3 quattro	2.0	195	06.08-	BHZ, CDLA	4	<b>Z 347</b>	14 F-5 DPUR02	0,7	○
2.5 RS3 quattro	2.5	250	04.11-	CEPA	5	<b>Z 339</b>	14 F-4 NBPR	0,7	○

**A4 (8D2, B5)**

1.6	1.6	74	11.94-10.00	ADP/AHL/ANA/ARM	4	<b>Z 90</b>	14 FGH-7 DTURX	1,0	<b>UXT 1<sup>3</sup></b>
1.6	1.6	75	07.00-11.00	ALZ	4	<b>Z 90</b>	14 FGH-7 DTURX	1,0	<b>UXT 1<sup>3</sup></b>
1.8	1.8	85	04.95-11.00	AFY	4	<b>Z 90</b>	14 FGH-7 DTURX	1,0	<b>UXT 1<sup>3</sup></b>
1.8 quattro	1.8	85	07.95-11.00	AFY	4	<b>Z 90</b>	14 FGH-7 DTURX	1,0	<b>UXT 1<sup>3</sup></b>
1.8	1.8	92	01.95-11.00	ADR/APT/ARG/AVV	4	<b>Z 90</b>	14 FGH-7 DTURX	1,0	<b>UXT 1<sup>3</sup></b>
1.8 quattro	1.8	92	01.95-11.00	ADR/APT/ARG	4	<b>Z 90</b>	14 FGH-7 DTURX	1,0	<b>UXT 1<sup>3</sup></b>
1.8 T	1.8	110	01.95-11.00	AEB/ANB/APU/ARK/AWT	4	<b>Z 188</b>	14 F-7 DPUR02	0,7	<b>UXT 10</b>
1.8 T quattro	1.8	110	01.95-11.00	AEB/ANB/APU/ARK/AWT	4	<b>Z 188</b>	14 F-7 DPUR02	0,7	<b>UXT 10</b>
1.8	1.8	125	05.00-09.00	AMB	4	<b>Z 188</b>	14 F-7 DPUR02	0,7	<b>UXT 10</b>
1.8 T	1.8	132	12.97-11.00	AJL	4	<b>Z 188</b>	14 F-7 DPUR02	0,7	<b>UXT 10</b>
1.8 T quattro	1.8	132	12.97-11.00	AJL	4	<b>Z 188</b>	14 F-7 DPUR02	0,7	<b>UXT 10</b>
1.9 TDI	1.9	55	12.95-11.00	AFF	4	<b>GN 855</b> (12V)	○		
				Kühlwasservorwärmung <sup>15</sup>		<b>GN 857</b> (11V)=3x			
						<b>GN 928</b> (12V)=3x			
1.9 TDI	1.9	66	01.95-11.00	1Z/AHU/AHH	4	<b>GN 855</b> (12V)	○		
				Kühlwasservorwärmung <sup>15</sup>		<b>GN 857</b> (11V)=3x			
						<b>GN 928</b> (12V)=3x			
1.9 TDI	1.9	81	10.95-11.00	AVG/AFN	4	<b>GN 855</b> (12V)	○		
				Kühlwasservorwärmung <sup>15</sup>		<b>GN 857</b> (11V)=3x			
						<b>GN 928</b> (12V)=3x			
1.9 TDI quattro	1.9	81	09.96-11.00	AVG/AFN	4	<b>GN 855</b> (12V)	○		
				Kühlwasservorwärmung <sup>15</sup>		<b>GN 857</b> (11V)=3x			
						<b>GN 928</b> (12V)=3x			
1.9 TDI	1.9	85	03.00-11.00	AJM	4	<b>GN 855</b> (12V)	○		
				Kühlwasservorwärmung <sup>15</sup>		<b>GN 857</b> (11V)=3x			
						<b>GN 928</b> (12V)=3x			
1.9 TDI quattro	1.9	85	03.00-11.00	ATJ/AJM	4	<b>GN 855</b> (12V)	○		
				Kühlwasservorwärmung <sup>15</sup>		<b>GN 857</b> (11V)=3x			
						<b>GN 928</b> (12V)=3x			

2.4	2.4	120	08.97-11.00	AMM/APZ/AJG	6	<b>Z 145</b>	14 FGR-6 DDU	1,6	○
2.4 quattro	2.4	120	08.97-11.00	APZ	6	<b>Z 145</b>	14 FGR-6 DDU	1,6	○
2.4	2.4	121	03.97-11.00	AML/ARJ/ALF/AGA/APS	6	<b>Z 145</b>	14 FGR-6 DDU	1,6	○
2.4 quattro	2.4	121	03.97-11.00	AML/ARJ/ALF/AGA/APS	6	<b>Z 145</b>	14 FGR-6 DDU	1,6	○
2.5 TDI	2.5	110	09.97-11.00	AFB/AKN	6	<b>GN 008</b> (12V)	○		
2.5 TDI quattro	2.5	110	09.97-11.00	AFB/AKN	6	<b>GN 008</b> (12V)	○		
2.6	2.6	102	01.96-07.97	ACZ	6	<b>Z 90</b>	14 FGH-7 DTURX	1,0	<b>UXT 1<sup>3</sup></b>
2.6	2.6	110	01.95-11.00	ABC	6	<b>Z 90</b>	14 FGH-7 DTURX	1,0	<b>UXT 1<sup>3</sup></b>
2.6 quattro	2.6	110	01.95-11.00	ABC	6	<b>Z 90</b>	14 FGH-7 DTURX	1,0	<b>UXT 1<sup>3</sup></b>
2.8	2.8	128	09.95-07.97	AAH	6	<b>Z 90</b>	14 FGH-7 DTURX	1,0	<b>UXT 1<sup>3</sup></b>
2.8 quattro	2.8	128	01.95-07.97	AAH	6	<b>Z 90</b>	14 FGH-7 DTURX	1,0	<b>UXT 1<sup>3</sup></b>
2.8	2.8	142	10.96-11.00	APR/ACK/ALG/AQD/AMX	6	<b>Z 145</b>	14 FGR-6 DDU	1,6	○
2.8 quattro	2.8	142	10.96-11.00	APR/ACK/ALG/AQD/AMX	6	<b>Z 145</b>	14 FGR-6 DDU	1,6	○
S4 quattro	2.8	195	09.97-11.00	AGB/AZB	6	<b>Z 188</b>	14 F-7 DPUR02	0,7	<b>UXT 10</b>

**A4 (8E2, B6)**

1.6	1.6	75	11.00-12.04	ALZ	4	<b>Z 90</b>	14 FGH-7 DTURX	1,0	<b>UXT 1<sup>3</sup></b>
				Standheizung <sup>16</sup>		<b>GH 306</b> (12V)			
1.8 T	1.8	110	11.00-07.02	AVJ	4	<b>Z 188</b>	14 F-7 DPUR02	0,7	<b>UXT 10</b>
				Standheizung <sup>16</sup>		<b>GH 306</b> (12V)			
1.8 T quattro	1.8	110	11.00-07.02	AVJ	4	<b>Z 188</b>	14 F-7 DPUR02	0,7	<b>UXT 10</b>
				Standheizung <sup>16</sup>		<b>GH 306</b> (12V)			
1.8 T	1.8	120	07.02-12.04	BFB	4	<b>Z 188</b>	14 F-7 DPUR02	0,7	<b>UXT 10</b>
				Standheizung <sup>16</sup>		<b>GH 306</b> (12V)			



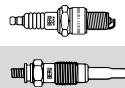

<b>AUDI</b>									
<b>A4 (8E2, B6)</b>									
1.8 T quattro	1.8	120	07.02–12.04	BFB	4	<b>Z 188</b>	14 F-7 DPUR02	0,7	<b>UXT 10</b>
				Standheizung <sup>16</sup>		<b>GH 306</b>	(12V)		
1.8 T	1.8	125	07.01–12.04	AMB	4	<b>Z 188</b>	14 F-7 DPUR02	0,7	<b>UXT 10</b>
				Standheizung <sup>16</sup>		<b>GH 306</b>	(12V)		
1.8 T quattro	1.8	125	07.01–12.04	AMB	4	<b>Z 188</b>	14 F-7 DPUR02	0,7	<b>UXT 10</b>
				Standheizung <sup>16</sup>		<b>GH 306</b>	(12V)		
1.8 T	1.8	140	11.02–12.04	BEX	4	<b>Z 188</b>	14 F-7 DPUR02	0,7	<b>UXT 10</b>
				Standheizung <sup>16</sup>		<b>GH 306</b>	(12V)		
1.8 T quattro	1.8	140	11.02–12.04	BEX	4	<b>Z 188</b>	14 F-7 DPUR02	0,7	<b>UXT 10</b>
				Standheizung <sup>16</sup>		<b>GH 306</b>	(12V)		
1.9 TDI	1.9	74	05.01–12.04	AVB	4	<b>GN 855</b>	(12V) ○		
				Standheizung <sup>16</sup>		<b>GH 306</b>	(12V)		
1.9 TDI	1.9	85	06.04–12.04	BKE Fgst.Nr. 8E-5-070 251 →	4	<b>GE 100</b>	(5V) <b>GSE 100</b>		
				Standheizung <sup>16</sup>		<b>GH 306</b>	(12V)		
1.9 TDI	1.9	96	11.00–12.04	AWX/AVF → Fgst.Nr. 8E-2-148 697	4	<b>GN 855</b>	(12V) ○		
				Kühlwasservorwärmung <sup>15</sup> M 5/3Nm Ø 4 mm		<b>GN 857</b>	(11V)=3x		
						<b>GN 928</b>	(12V)=3x		
1.9 TDI	1.9	96	11.00–12.04	AWX/AVF Fgst.Nr. 8E-2-148 698 →	4	<b>GN 046</b>	(12V) ○		
				Standheizung <sup>16</sup>		<b>GH 306</b>	(12V)		
1.9 TDI quattro	1.9	96	11.01–12.04	AVF → Fgst.Nr. 8E-2-148 697	4	<b>GN 855</b>	(12V) ○		
				Kühlwasservorwärmung <sup>15</sup> M 5/3Nm Ø 4 mm		<b>GN 857</b>	(11V)=3x		
						<b>GN 928</b>	(12V)=3x		
1.9 TDI quattro	1.9	96	11.01–12.04	AVF Fgst.Nr. 8E-2-148 698 →	4	<b>GN 046</b>	(12V) ○		
				Standheizung <sup>16</sup>		<b>GH 306</b>	(12V)		
2.0	2.0	96	11.00–12.04	ALT	4	<b>Z 121</b>	14 FGH-8 DTURXO	1,0	<b>UXT 9</b>
				Standheizung <sup>16</sup>		<b>GH 306</b>	(12V)		
2.0 FSI	2.0	110	07.02–12.04	AWA Fgst.Nr. 8E-1-000 001-8E-5-400 000	4	<b>Z 236</b>	14 F-6 HTPRX02	1,0	○
				Standheizung <sup>16</sup>		<b>GH 306</b>	(12V)		
2.4	2.4	120	09.01–12.04	AMM	6	<b>Z 145</b>	14 FGR-6 DDU	1,6	○
				Standheizung <sup>16</sup>		<b>GH 306</b>	(12V)		
2.4	2.4	125	09.01–12.04	BDV	6	<b>Z 145</b>	14 FGR-6 DDU	1,6	○
				Standheizung <sup>16</sup>		<b>GH 306</b>	(12V)		
2.5 TDI	2.5	114	08.01–07.02	AYM	6	<b>GN 008</b>	(12V) ○		
				Standheizung <sup>16</sup>		<b>GH 306</b>	(12V)		
2.5 TDI	2.5	120	07.02–12.04	BCZ/BDG/BFC	6	<b>GN 008</b>	(12V) ○		
				Standheizung <sup>16</sup>		<b>GH 306</b>	(12V)		
2.5 D	2.5	132	10.00–05.03	AKE	6	<b>GN 008</b>	(12V) ○		
				Standheizung <sup>16</sup>		<b>GH 306</b>	(12V)		
2.5 TDI quattro	2.5	132	11.00–12.04	BAU/AKE/BDH	6	<b>GN 008</b>	(12V) ○		
				Standheizung <sup>16</sup>		<b>GH 306</b>	(12V)		
3.0	3.0	160	04.01–12.04	BBJ	6	<b>Z 145</b>	14 FGR-6 DDU	1,6	○
				Standheizung <sup>16</sup>		<b>GH 306</b>	(12V)		
3.0 quattro	3.0	160	04.01–12.04	BBJ	6	<b>Z 145</b>	14 FGR-6 DDU	1,6	○
				Standheizung <sup>16</sup>		<b>GH 306</b>	(12V)		
3.0	3.0	162	11.00–12.04	ASN	6	<b>Z 145</b>	14 FGR-6 DDU	1,6	○
				Standheizung <sup>16</sup>		<b>GH 306</b>	(12V)		
3.0 quattro	3.0	162	11.00–12.04	ASN	6	<b>Z 145</b>	14 FGR-6 DDU	1,6	○
				Standheizung <sup>16</sup>		<b>GH 306</b>	(12V)		
4.2 S4 quattro	4.2	253	03.03–12.04	BBK	8	<b>Z 239</b>	14 FGR-7 KQE	1,6	○
				Standheizung <sup>16</sup>		<b>GH 306</b>	(12V)		
<b>A4 (8EC, B7)</b>									
1.6	1.6	75	11.04–06.08	ALZ	4	<b>Z 90</b>	14 FGH-7 DTURX	1,0	<b>UXT 1<sup>3</sup></b>
				Standheizung <sup>16</sup>		<b>GH 306</b>	(12V)		

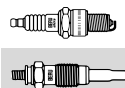
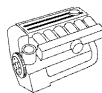

## AUDI

### A4 (8EC, B7)

1.8 T	1.8	120	11.04-06.08	BFB	4	<b>Z 188</b>	14 F-7 DPUR02	0,7	<b>UXT 10</b>
				Standheizung <sup>16</sup>		<b>GH 306</b> (12V)			
1.8 T quattro	1.8	120	11.04-06.08	BFB	4	<b>Z 188</b>	14 F-7 DPUR02	0,7	<b>UXT 10</b>
				Standheizung <sup>16</sup>		<b>GH 306</b> (12V)			
1.9 TDI	1.9	85	11.04-06.08	BKE Fgst.Nr. 8e-5-070 251 →	4	<b>GE 100</b> (5V)	<b>GSE 100</b>		
				Standheizung <sup>16</sup>		<b>GH 306</b> (12V)			
2.0	2.0	96	11.04-06.08	ALT	4	<b>Z 121</b>	14 FGH-8 DTURXO	1,0	<b>UXT 9</b>
				Standheizung <sup>16</sup>		<b>GH 306</b> (12V)			
2.0 TDI	2.0	100	11.04-06.08	BNA Fgst.Nr. 8E-5-400 001 →	4	<b>GE 101</b> (4,4V)	<b>GSE 100</b>		
				Standheizung <sup>16</sup>		<b>GH 306</b> (12V)			
2.0 TDI 16V	2.0	103	11.04-06.08	BLB Fgst.Nr. 8E-5-400 001 →	4	<b>GE 101</b> (4,4V)	<b>GSE 100</b>		
				Standheizung <sup>16</sup>		<b>GH 306</b> (12V)			
2.0 FSI	2.0	110	01.05-07.05	AWA	4	<b>Z 236</b>	14 F-6 HTPRX02	1,0	○
				Standheizung <sup>16</sup>		<b>GH 306</b> (12V)			
2.0 TFSI	2.0	125	10.06-06.08	BPJ	4	<b>Z 347</b>	14 F-5 DPUR02	0,7	○
				Standheizung <sup>16</sup>		<b>GH 306</b> (12V)			
2.0 TFSI	2.0	147	11.04-06.08	BGB/BWE	4	<b>Z 347</b>	14 F-5 DPUR02	0,7	○
				Standheizung <sup>16</sup>		<b>GH 306</b> (12V)			
2.0 TFSI quattro	2.0	147	11.04-06.08	BGB/BWE	4	<b>Z 347</b>	14 F-5 DPUR02	0,7	○
				Standheizung <sup>16</sup>		<b>GH 306</b> (12V)			
2.0 TFSI	2.0	162	06.05-06.08	BUL	4	<b>Z 347</b>	14 F-5 DPUR02	0,7	○
				Standheizung <sup>16</sup>		<b>GH 306</b> (12V)			
2.0 TFSI quattro	2.0	162	06.05-06.08	BUL	4	<b>Z 347</b>	14 F-5 DPUR02	0,7	○
				Standheizung <sup>16</sup>		<b>GH 306</b> (12V)			
2.5 TDI	2.5	120	11.04-05.06	BDG	6	<b>GN 008</b> (12V)	○		
				Standheizung <sup>16</sup>		<b>GH 306</b> (12V)			
2.7 TDI	2.7	120	11.05-06.08	BSG Fgst.Nr. 8E-7-065 820 →	6	<b>GE 115</b> (4,4V)	○		
				Standheizung <sup>16</sup>		<b>GH 306</b> (12V)			
2.7 TDI	2.7	132	01.06-06.08	BPP Fgst.Nr. 8E-7-065 820 →	6	<b>GE 115</b> (4,4V)	○		
				Standheizung <sup>16</sup>		<b>GH 306</b> (12V)			
3.0 TDI quattro	3.0	150	11.04-06.08	BKN	6	<b>GE 115</b> (4,4V)	○		
				Standheizung <sup>16</sup>		<b>GH 306</b> (12V)			
3.0	3.0	160	11.04-05.06	BBJ	6	<b>Z 145</b>	14 FGR-6 DDU	1,6	○
				Standheizung <sup>16</sup>		<b>GH 306</b> (12V)			
3.0 quattro	3.0	160	11.04-07.06	BBJ	6	<b>Z 145</b>	14 FGR-6 DDU	1,6	○
				Standheizung <sup>16</sup>		<b>GH 306</b> (12V)			
3.0 TDI quattro	3.0	171	01.06-06.08	ASB Fgst.Nr. 8E-7-065 820 →	6	<b>GE 115</b> (4,4V)	○		
				Standheizung <sup>16</sup>		<b>GH 306</b> (12V)			
4.2 S4 quattro	4.2	253	11.04-06.08	BHF/BBK	8	<b>Z 239</b>	14 FGR-7 KQE	1,6	○
				Standheizung <sup>16</sup>		<b>GH 306</b> (12V)			

### A4 (8K2, B8)

1.8 TFSI	1.8	88	01.08-	CABA/CDHA	4	<b>Z 347</b>	14 F-5 DPUR02	0,7	○
1.8 TFSI	1.8	118	11.07-	CABB/CDHB	4	<b>Z 347</b>	14 F-5 DPUR02	0,7	○
1.8 TFSI quattro	1.8	118	09.08-	CDHB	4	<b>Z 347</b>	14 F-5 DPUR02	0,7	○
1.8 TFSI	1.8	125	11.11-	CJEB	4	<b>Z 348</b>	14 F-5 MPUR2L	0,8	○
1.8 TFSI quattro	1.8	125	11.11-	CJEB	4	<b>Z 348</b>	14 F-5 MPUR2L	0,8	○
2.0 TDI	2.0	88	06.08-	CJCC/CAGC	4	<b>GE 115</b> (4,4V)	○		
2.0 TDI	2.0	100	11.07-	CAGB, CJCB	4	<b>GE 115</b> (4,4V)	○		
2.0 TDI	2.0	105	11.07-	CMEA/CJCA/CAGA/CMFA	4	<b>GE 115</b> (4,4V)	○		
2.0 TDI quattro	2.0	105	11.08-	CJCA/CAGA	4	<b>GE 115</b> (4,4V)	○		
2.0 TDI	2.0	120	08.08-	CGLD/CAHB	4	<b>GE 115</b> (4,4V)	○		
2.0 TDI	2.0	125	01.08-	CAHA	4	<b>GE 115</b> (4,4V)	○		
2.0 TDi quattro	2.0	125	01.08-	CAHA	4	<b>GE 115</b> (4,4V)	○		
2.0 TDI	2.0	130	11.11-	CGLC/CMGB	4	<b>GE 115</b> (4,4V)	○		

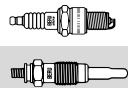
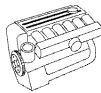

AUDI									
A4 (8K2, B8)									
2.0 TDI quattro	2.0	130	11.11-	CGLC	4	GE 115 (4,4V)	○		
2.0 TFSI	2.0	132	06.08-	CAEA/CDNB	4	Z 347	14 F-5 DPUR02	0,7	○
2.0 TFSI flexible fuel	2.0	132	11.09-	CFKA	4	Z 347	14 F-5 DPUR02	0,7	○
2.0 TFSI flexible fuel quattro	2.0	132	11.09-	CFKA	4	Z 347	14 F-5 DPUR02	0,7	○
2.0 TFSI	2.0	155	06.08-	CDNC	4	Z 347	14 F-5 DPUR02	0,7	○
2.0 TFSI quattro	2.0	155	06.08-	CAEB/CDNC	4	Z 347	14 F-5 DPUR02	0,7	○
2.7 TDI	2.7	120	11.07-	CAMB	6	GE 115 (4,4V)	○		
2.7 TDI	2.7	140	11.07-	CAMA	6	GE 115 (4,4V)	○		
3.0 TDI	3.0	150	11.11-	CLAB	6	GE 115 (4,4V)	○		
3.0 TDI quattro	3.0	155	06.08-	CCWB	6	GE 115 (4,4V)	○		
3.0 TDI quattro	3.0	176	11.07-	CAPA, CCWA	6	GE 115 (4,4V)=6x	○		
3.0 TDI quattro	3.0	176	11.07-	CCLA	6	PSG 002 (4,4V)=2x	○		
						GE 115 (4,4V)=4x	○		
3.0 TDI quattro	3.0	180	11.11-	CDUC	6	GE 115 (4,4V)=6x	○		
3.0 TDI quattro	3.0	180	11.11-	CKVB	6	PSG 002 (4,4V)=1x	○		
						GE 115 (4,4V)=5x	○		
3.2 FSI	3.2	195	09.08-	CALA	6	Z 321	14 F-7 KPPRU2	1,0	○
3.2 FSI quattro	3.2	195	11.07-	CALA	6	Z 321	14 F-7 KPPRU2	1,0	○
A4 Allroad (8KH, B8)									
2.0 TDI quattro	2.0	100	09.09-	CAGB/CJCB	4	GE 115 (4,4V)	○		
2.0 TDI quattro	2.0	105	09.09-	CJCA/CAGA	4	GE 115 (4,4V)	○		
2.0 TDI quattro	2.0	120	04.09-	CGLD/CAHB	4	GE 115 (4,4V)	○		
2.0 TDI quattro	2.0	125	04.09-	CAHA	4	GE 115 (4,4V)	○		
2.0 TDI quattro	2.0	130	11.11-	CGLC	4	GE 115 (4,4V)	○		
2.0 TFSI quattro	2.0	155	04.09-	CDNC	4	Z 347	14 F-5 DPUR02	0,7	○
3.0 TDI quattro	3.0	176	04.09-	CCWA	6	GE 115 (4,4V)	○		
3.0 TDI quattro	3.0	180	01.12-	CKVB/CDUC	6	PSG 002 (4,4V)=1x	○		
						GE 115 (4,4V)=5x	○		
A4 Avant (8D5, B5)									
1.6	1.6	74	11.94-09.01	ADP/AHL/ANA/ARM	4	Z 90	14 FGH-7 DTURX	1,0	UXT 1 <sup>3</sup>
1.6	1.6	75	07.00-09.01	ALZ	4	Z 90	14 FGH-7 DTURX	1,0	UXT 1 <sup>3</sup>
1.8	1.8	85	07.95-09.01	AFY	4	Z 90	14 FGH-7 DTURX	1,0	UXT 1 <sup>3</sup>
1.8 quattro	1.8	85	07.95-09.01	AFY	4	Z 90	14 FGH-7 DTURX	1,0	UXT 1 <sup>3</sup>
1.8	1.8	92	02.96-09.01	ADR/APT/ARG/AVV	4	Z 90	14 FGH-7 DTURX	1,0	UXT 1 <sup>3</sup>
1.8 quattro	1.8	92	01.96-09.01	ADR/APT/ARG	4	Z 90	14 FGH-7 DTURX	1,0	UXT 1 <sup>3</sup>
1.8 T	1.8	110	03.96-09.01	AEB/ANB/APU/ARK/AWT	4	Z 188	14 F-7 DPUR02	0,7	UXT 10
1.8 T quattro	1.8	110	01.96-09.01	AEB/ANB/APU/ARK/AWT	4	Z 188	14 F-7 DPUR02	0,7	UXT 10
1.8 T	1.8	132	12.97-09.01	AJL	4	Z 188	14 F-7 DPUR02	0,7	UXT 10
1.8 T quattro	1.8	132	12.97-09.01	AJL	4	Z 188	14 F-7 DPUR02	0,7	UXT 10
1.9 TDI	1.9	55	03.96-09.01	AFF	4	GN 855 (12V)	○		
				Kühlwasservorwärmung <sup>15</sup>		GN 857 (11V)=3x			
				↳ M 5/3Nm		GN 928 (12V)=3x			
				↳ Ø 4 mm					
1.9 DUO	1.9	66	03.98-09.01	AHU	4	GN 855 (12V)	○		
				Kühlwasservorwärmung <sup>15</sup>		GN 857 (11V)=3x			
				↳ M 5/3Nm		GN 928 (12V)=3x			
				↳ Ø 4 mm					
1.9 TDI	1.9	66	02.96-09.01	1Z/AHU/AHH	4	GN 855 (12V)	○		
				Kühlwasservorwärmung <sup>15</sup>		GN 857 (11V)=3x			
				↳ M 5/3Nm		GN 928 (12V)=3x			
				↳ Ø 4 mm					
1.9 TDI	1.9	81	02.96-09.01	AVG/AFN	4	GN 855 (12V)	○		
				Kühlwasservorwärmung <sup>15</sup>		GN 857 (11V)=3x			
				↳ M 5/3Nm		GN 928 (12V)=3x			
				↳ Ø 4 mm					
1.9 TDI quattro	1.9	81	09.96-09.01	AVG/AFN	4	GN 855 (12V)	○		
				Kühlwasservorwärmung <sup>15</sup>		GN 857 (11V)=3x			
				↳ M 5/3Nm		GN 928 (12V)=3x			
				↳ Ø 4 mm					
1.9 TDI	1.9	85	03.00-09.01	AJM	4	GN 855 (12V)	○		
				Kühlwasservorwärmung <sup>15</sup>		GN 857 (11V)=3x			
				↳ M 5/3Nm		GN 928 (12V)=3x			
				↳ Ø 4 mm					



kW

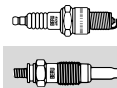
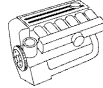

**AUDI**

**A4 Avant (8D5, B5)**

1.9 TDI quattro	1.9	85	03.00-09.01	ATJ/AJM	4	<b>GN 855</b> (12V) ○			
				Kühlwasservorwärmung <sup>15</sup>		<b>GN 857</b> (11V)=3x			
						<b>GN 928</b> (12V)=3x			
2.4	2.4	120	08.97-09.01	AMM/APZ/AJG	6	<b>Z 145</b>	14 FGR-6 DDU	1,6	○
2.4 quattro	2.4	120	08.97-09.01	APZ	6	<b>Z 145</b>	14 FGR-6 DDU	1,6	○
2.4	2.4	121	03.97-09.01	AML/ARJ/ALF/AGA/APS	6	<b>Z 145</b>	14 FGR-6 DDU	1,6	○
2.4 quattro	2.4	121	03.97-09.01	AML/ARJ/ALF/AGA/APS	6	<b>Z 145</b>	14 FGR-6 DDU	1,6	○
2.5 TDI	2.5	110	09.97-09.01	AFB/AKN	6	<b>GN 008</b> (12V) ○			
2.5 TDI quattro	2.5	110	09.97-09.01	AFB/AKN	6	<b>GN 008</b> (12V) ○			
2.6	2.6	102	01.96-07.97	ACZ	6	<b>Z 90</b>	14 FGH-7 DTURX	1,0	<b>UXT 1<sup>3</sup></b>
2.6	2.6	110	02.96-09.01	ABC	6	<b>Z 90</b>	14 FGH-7 DTURX	1,0	<b>UXT 1<sup>3</sup></b>
2.6 quattro	2.6	110	01.96-09.01	ABC	6	<b>Z 90</b>	14 FGH-7 DTURX	1,0	<b>UXT 1<sup>3</sup></b>
2.7 S4 quattro	2.7	195	09.97-09.01	AGB/AZB	6	<b>Z 188</b>	14 F-7 DPUR02	0,7	<b>UXT 10</b>
2.7 RS4 quattro	2.7	280	05.00-09.01	AZR/ASJ	6	<b>Z 317</b>	14 F-5 DPUR2T	0,8	○
2.8	2.8	128	03.96-09.96	AAH	6	<b>Z 90</b>	14 FGH-7 DTURX	1,0	<b>UXT 1<sup>3</sup></b>
2.8 quattro	2.8	128	01.96-09.96	AAH	6	<b>Z 90</b>	14 FGH-7 DTURX	1,0	<b>UXT 1<sup>3</sup></b>
2.8	2.8	140	03.99-09.00	ATX	6	<b>Z 145</b>	14 FGR-6 DDU	1,6	○
2.8 quattro	2.8	140	03.99-09.00	ATX	6	<b>Z 145</b>	14 FGR-6 DDU	1,6	○
2.8	2.8	142	10.96-09.01	APR/ACK/ALG/AQD/AMX	6	<b>Z 145</b>	14 FGR-6 DDU	1,6	○
2.8 quattro	2.8	142	10.96-09.01	APR/ACK/ALG/AQD/AMX	6	<b>Z 145</b>	14 FGR-6 DDU	1,6	○

**A4 Avant (8E5, B6)**

1.6	1.6	75	09.01-12.04	ALZ	4	<b>Z 90</b>	14 FGH-7 DTURX	1,0	<b>UXT 1<sup>3</sup></b>
				Standheizung <sup>16</sup>		<b>GH 306</b> (12V)			
1.8 T	1.8	110	09.01-07.02	AVJ	4	<b>Z 188</b>	14 F-7 DPUR02	0,7	<b>UXT 10</b>
				Standheizung <sup>16</sup>		<b>GH 306</b> (12V)			
1.8 T quattro	1.8	110	09.01-07.02	AVJ	4	<b>Z 188</b>	14 F-7 DPUR02	0,7	<b>UXT 10</b>
				Standheizung <sup>16</sup>		<b>GH 306</b> (12V)			
1.8 T	1.8	120	07.02-12.04	BFB	4	<b>Z 188</b>	14 F-7 DPUR02	0,7	<b>UXT 10</b>
				Standheizung <sup>16</sup>		<b>GH 306</b> (12V)			
1.8 T quattro	1.8	120	07.02-12.04	BFB	4	<b>Z 188</b>	14 F-7 DPUR02	0,7	<b>UXT 10</b>
				Standheizung <sup>16</sup>		<b>GH 306</b> (12V)			
1.8 T quattro	1.8	125	09.01-12.04	AMB	4	<b>Z 188</b>	14 F-7 DPUR02	0,7	<b>UXT 10</b>
				Standheizung <sup>16</sup>		<b>GH 306</b> (12V)			
1.8 T	1.8	140	11.02-12.04	BEX	4	<b>Z 188</b>	14 F-7 DPUR02	0,7	<b>UXT 10</b>
				Standheizung <sup>16</sup>		<b>GH 306</b> (12V)			
1.8 T quattro	1.8	140	11.02-12.04	BEX	4	<b>Z 188</b>	14 F-7 DPUR02	0,7	<b>UXT 10</b>
				Standheizung <sup>16</sup>		<b>GH 306</b> (12V)			
1.9 TDI	1.9	74	11.01-12.04	AVB	4	<b>GN 855</b> (12V) ○			
				Standheizung <sup>16</sup>		<b>GH 306</b> (12V)			
1.9 TDI	1.9	85	06.04-12.04	BKE Fgst.Nr. 8e-5-070 251 →	4	<b>GE 100</b> (5V)	<b>GSE 100</b>		
				Standheizung <sup>16</sup>		<b>GH 306</b> (12V)			
1.9 TDI	1.9	96	09.01-12.04	AWX/AVF → Fgst.Nr. 8E-2- 148 697	4	<b>GN 855</b> (12V) ○			
				Kühlwasservorwärmung <sup>15</sup>		<b>GN 857</b> (11V)=3x			
						<b>GN 928</b> (12V)=3x			
1.9 TDI	1.9	96	09.01-12.04	AWX/AVF Fgst.Nr. 8E-2-148 698 →	4	<b>GN 046</b> (12V) ○			
				Standheizung <sup>16</sup>		<b>GH 306</b> (12V)			
1.9 TDI quattro	1.9	96	11.01-12.04	AVF → Fgst.Nr. 8E-2-148 697	4	<b>GN 855</b> (12V) ○			
				Kühlwasservorwärmung <sup>15</sup>		<b>GN 857</b> (11V)=3x			
						<b>GN 928</b> (12V)=3x			
1.9 TDI quattro	1.9	96	11.01-12.04	AVF Fgst.Nr. 8E-2-148 698 →	4	<b>GN 046</b> (12V) ○			
				Standheizung <sup>16</sup>		<b>GH 306</b> (12V)			
2.0	2.0	96	09.01-12.04	ALT	4	<b>Z 121</b>	14 FGH-8 DTURXO	1,0	<b>UXT 9</b>
				Standheizung <sup>16</sup>		<b>GH 306</b> (12V)			

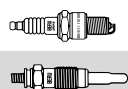

<b>AUDI</b>										
<b>A4 Avant (8E5, B6)</b>										
2.0 FSI	2.0	110	07.02-12.04	AWA Fgst.Nr. 8E-1-000 001-8E-5-400 000	4	<b>Z 236</b>	14 F-6 HTPRX02	1,0		○
			Standheizung <sup>16</sup>			<b>GH 306</b> (12V)				
2.4	2.4	120	09.01-12.04	AMM	6	<b>Z 145</b>	14 FGR-6 DDU	1,6		○
			Standheizung <sup>16</sup>			<b>GH 306</b> (12V)				
2.4	2.4	125	09.01-12.04	BDV	6	<b>Z 145</b>	14 FGR-6 DDU	1,6		○
			Standheizung <sup>16</sup>			<b>GH 306</b> (12V)				
2.5 TDI	2.5	114	09.01-07.02	AYM	6	<b>GN 008</b> (12V)	○			
			Standheizung <sup>16</sup>			<b>GH 306</b> (12V)				
2.5 TDI	2.5	120	07.02-12.04	BCZ/BDG/BFC	6	<b>GN 008</b> (12V)	○			
			Standheizung <sup>16</sup>			<b>GH 306</b> (12V)				
2.5 TDi	2.5	132	10.00-05.03	AKE	6	<b>GN 008</b> (12V)	○			
			Standheizung <sup>16</sup>			<b>GH 306</b> (12V)				
2.5 TDI quattro	2.5	132	09.01-12.04	BAU/AKE/BDH	6	<b>GN 008</b> (12V)	○			
			Standheizung <sup>16</sup>			<b>GH 306</b> (12V)				
3.0	3.0	160	04.01-12.04	BBJ	6	<b>Z 145</b>	14 FGR-6 DDU	1,6		○
			Standheizung <sup>16</sup>			<b>GH 306</b> (12V)				
3.0 quattro	3.0	160	04.01-12.04	BBJ	6	<b>Z 145</b>	14 FGR-6 DDU	1,6		○
			Standheizung <sup>16</sup>			<b>GH 306</b> (12V)				
3.0	3.0	162	09.01-12.04	ASN	6	<b>Z 145</b>	14 FGR-6 DDU	1,6		○
			Standheizung <sup>16</sup>			<b>GH 306</b> (12V)				
3.0 quattro	3.0	162	09.01-12.04	ASN	6	<b>Z 145</b>	14 FGR-6 DDU	1,6		○
			Standheizung <sup>16</sup>			<b>GH 306</b> (12V)				
4.2 S4 quattro	4.2	253	03.03-12.04	BBK	8	<b>Z 239</b>	14 FGR-7 KQE	1,6		○
			Standheizung <sup>16</sup>			<b>GH 306</b> (12V)				
<b>A4 Avant (8ED, B7)</b>										
1.6	1.6	75	11.04-06.08	ALZ	4	<b>Z 90</b>	14 FGH-7 DTURX	1,0		<b>UXT 1<sup>3</sup></b>
			Standheizung <sup>16</sup>			<b>GH 306</b> (12V)				
1.8 T	1.8	120	11.04-06.08	BFB	4	<b>Z 188</b>	14 F-7 DPUR02	0,7		<b>UXT 10</b>
			Standheizung <sup>16</sup>			<b>GH 306</b> (12V)				
1.8 T quattro	1.8	120	11.04-06.08	BFB	4	<b>Z 188</b>	14 F-7 DPUR02	0,7		<b>UXT 10</b>
			Standheizung <sup>16</sup>			<b>GH 306</b> (12V)				
1.9 TDI	1.9	85	11.04-06.08	BKE Fgst.Nr. 8e-5-070 251 →	4	<b>GE 100</b> (5V)	<b>GSE 100</b>			
			Standheizung <sup>16</sup>			<b>GH 306</b> (12V)				
2.0	2.0	96	11.04-06.08	ALT	4	<b>Z 121</b>	14 FGH-8 DTURX0	1,0		<b>UXT 9</b>
			Standheizung <sup>16</sup>			<b>GH 306</b> (12V)				
2.0 TDI	2.0	100	11.04-06.08	BNA Fgst.Nr. 8E-5-400 001 →	4	<b>GE 101</b> (4,4V)	<b>GSE 100</b>			
			Standheizung <sup>16</sup>			<b>GH 306</b> (12V)				
2.0 TDI 16V	2.0	103	11.04-06.08	BLB Fgst.Nr. 8E-5-400 001 →	4	<b>GE 101</b> (4,4V)	<b>GSE 100</b>			
			Standheizung <sup>16</sup>			<b>GH 306</b> (12V)				
2.0 FSi	2.0	110	01.05-07.05	AWA	4	<b>Z 236</b>	14 F-6 HTPRX02	1,0		○
			Standheizung <sup>16</sup>			<b>GH 306</b> (12V)				
2.0 TFSI	2.0	125	10.06-06.08	BPJ	4	<b>Z 347</b>	14 F-5 DPUR02	0,7		○
			Standheizung <sup>16</sup>			<b>GH 306</b> (12V)				
2.0 TFSI	2.0	147	11.04-06.08	BGB/BWE	4	<b>Z 347</b>	14 F-5 DPUR02	0,7		○
			Standheizung <sup>16</sup>			<b>GH 306</b> (12V)				
2.0 TFSI quattro	2.0	147	11.04-06.08	BGB/BWE	4	<b>Z 347</b>	14 F-5 DPUR02	0,7		○
			Standheizung <sup>16</sup>			<b>GH 306</b> (12V)				
2.0 TFSI	2.0	162	06.05-06.08	BUL	4	<b>Z 347</b>	14 F-5 DPUR02	0,7		○
			Standheizung <sup>16</sup>			<b>GH 306</b> (12V)				
2.0 TFSI quattro	2.0	162	06.05-06.08	BUL	4	<b>Z 347</b>	14 F-5 DPUR02	0,7		○
			Standheizung <sup>16</sup>			<b>GH 306</b> (12V)				
2.5 TDI	2.5	120	11.04-05.06	BDG	6	<b>GN 008</b> (12V)	○			
			Standheizung <sup>16</sup>			<b>GH 306</b> (12V)				
2.7 TDi	2.7	120	11.05-03.08	BSG Fgst.Nr. 8E-7-065 820 →	6	<b>GE 115</b> (4,4V)	○			
			Standheizung <sup>16</sup>			<b>GH 306</b> (12V)				



kW

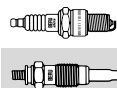
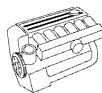

**AUDI**

**A4 Avant (8ED, B7)**

2.7 TDI	2.7	132	01.06-06.08	BPP Fgst.Nr. 8E-7-065 820 →	6	<b>GE 115</b> (4,4V)	○		
				Standheizung <sup>16</sup>		<b>GH 306</b> (12V)			
3.0 TDI quattro	3.0	150	11.04-06.08	BKN	6	<b>GE 115</b> (4,4V)	○		
				Standheizung <sup>16</sup>		<b>GH 306</b> (12V)			
3.0	3.0	160	11.04-05.06	BBJ	6	<b>Z 145</b>	14 FGR-6 DDU	1,6	○
				Standheizung <sup>16</sup>		<b>GH 306</b> (12V)			
3.0 quattro	3.0	160	11.04-07.06	BBJ	6	<b>Z 145</b>	14 FGR-6 DDU	1,6	○
				Standheizung <sup>16</sup>		<b>GH 306</b> (12V)			
3.0 TDI quattro	3.0	171	01.06-06.08	ASB Fgst.Nr. 8E-7-065 820 →	6	<b>GE 115</b> (4,4V)	○		
				Standheizung <sup>16</sup>		<b>GH 306</b> (12V)			
4.2 S4 quattro	4.2	253	11.04-06.08	BBK	8	<b>Z 239</b>	14 FGR-7 KQE	1,6	○
				Standheizung <sup>16</sup>		<b>GH 306</b> (12V)			

**A4 Avant (8K5, B8)**

1.8 TFSI	1.8	88	04.08-	CDHA	4	<b>Z 347</b>	14 F-5 DPUR02	0,7	○
1.8 TFSI	1.8	118	04.08-	CABB/CDHB	4	<b>Z 347</b>	14 F-5 DPUR02	0,7	○
1.8 TFSI quattro	1.8	118	09.08-	CDHB	4	<b>Z 347</b>	14 F-5 DPUR02	0,7	○
1.8 TFSI	1.8	125	11.11-	CJEB	4	<b>Z 348</b>	14 F-5 MPUR2L	0,8	○
1.8 TFSI quattro	1.8	125	11.11-	CJEB	4	<b>Z 348</b>	14 F-5 MPUR2L	0,8	○
2.0 TDI	2.0	88	06.08-	CJCC/CAGC	4	<b>GE 115</b> (4,4V)	○		
2.0 TDI	2.0	100	04.08-	CAGB, CJC	4	<b>GE 115</b> (4,4V)	○		
2.0 TDI	2.0	105	04.08-	CMEA/CJCA/CAGA/CMFA	4	<b>GE 115</b> (4,4V)	○		
2.0 TDI quattro	2.0	105	04.08-	CJCA/CAGA	4	<b>GE 115</b> (4,4V)	○		
2.0 TDI	2.0	120	08.08-	CGLD/CAHB	4	<b>GE 115</b> (4,4V)	○		
2.0 TDI	2.0	125	04.08-	CAHA	4	<b>GE 115</b> (4,4V)	○		
2.0 TDI quattro	2.0	125	08.08-	CAHA	4	<b>GE 115</b> (4,4V)	○		
2.0 TDI	2.0	130	11.11-	CGLC	4	<b>GE 115</b> (4,4V)	○		
2.0 TDI quattro	2.0	130	11.11-	CGLC	4	<b>GE 115</b> (4,4V)	○		
2.0 TFSI	2.0	132	06.08-	CDNB	4	<b>Z 347</b>	14 F-5 DPUR02	0,7	○
2.0 TFSI flexible fuel	2.0	132	11.09-	CFKA	4	<b>Z 347</b>	14 F-5 DPUR02	0,7	○
2.0 TFSI flexible fuel quattro	2.0	132	11.09-	CFKA	4	<b>Z 347</b>	14 F-5 DPUR02	0,7	○
2.0 TFSI	2.0	155	06.08-	CDNC	4	<b>Z 347</b>	14 F-5 DPUR02	0,7	○
2.0 TFSI quattro	2.0	155	06.08-	CDNC	4	<b>Z 347</b>	14 F-5 DPUR02	0,7	○
2.7 TDI	2.7	120	06.08-	CAMB	6	<b>GE 115</b> (4,4V)	○		
2.7 TDI	2.7	140	04.08-	CAMA	6	<b>GE 115</b> (4,4V)	○		
3.0 TDI	3.0	150	11.11-	CLAB	6	<b>GE 115</b> (4,4V)	○		
3.0 TDI quattro	3.0	155	06.08-	CCWB	6	<b>GE 115</b> (4,4V)	○		
3.0 TDI quattro	3.0	176	04.08-	CAPA, CCWA	6	<b>GE 115</b> (4,4V)=6x	○		
3.0 TDI quattro	3.0	176	04.08-	CCLA	6	<b>PSG 002</b> (4,4V)=2x <b>GE 115</b> (4,4V)=4x	○		
3.0 TDI quattro	3.0	180	11.11-	CDUC	6	<b>GE 115</b> (4,4V)=6x	○		
3.0 TDI quattro	3.0	180	11.11-	CKVB	6	<b>PSG 002</b> (4,4V)=1x <b>GE 115</b> (4,4V)=5x	○		
3.2 FSI	3.2	195	09.08-	CALA	6	<b>Z 321</b>	14 F-7 KPPRU2	1,0	○
3.2 FSI quattro	3.2	195	04.08-	CALA	6	<b>Z 321</b>	14 F-7 KPPRU2	1,0	○

**A4 Cabriolet (8H7, B6, 8HE, B7)**

1.8 T	1.8	120	07.02-03.09	BFB	4	<b>Z 188</b>	14 F-7 DPUR02	0,7	<b>UXT 10</b>
1.8 T quattro	1.8	120	05.03-03.09	BFB	4	<b>Z 188</b>	14 F-7 DPUR02	0,7	<b>UXT 10</b>
1.8	1.8	125	10.02-10.05	AMB	4	<b>Z 188</b>	14 F-7 DPUR02	0,7	<b>UXT 10</b>
2.0	2.0	96	09.04-12.05	ALT	4	<b>Z 121</b>	14 FGH-8 DTURXO	1,0	<b>UXT 9</b>
2.0 TFSI 16V	2.0	147	01.06-03.09	BWE	4	<b>Z 347</b>	14 F-5 DPUR02	0,7	○
2.4	2.4	120	04.02-12.05	AMM	6	<b>Z 145</b>	14 FGR-6 DDU	1,6	○
2.4	2.4	125	04.02-12.05	BDV	6	<b>Z 145</b>	14 FGR-6 DDU	1,6	○
2.5 TDI	2.5	120	08.02-12.05	BCZ/BDG/BFC	6	<b>GN 008</b> (12V)	○		
2.7 TDI	2.7	132	06.06-03.09	BPP Fgst.Nr. 8E-7-065 820 →	6	<b>GE 115</b> (4,4V)	○		
3.0 TDI quattro	3.0	150	01.06-03.09	BKN	6	<b>GE 115</b> (4,4V)	○		
3.0	3.0	162	04.02-12.05	ASN	6	<b>Z 145</b>	14 FGR-6 DDU	1,6	○
3.0 quattro	3.0	162	05.03-12.05	ASN	6	<b>Z 145</b>	14 FGR-6 DDU	1,6	○

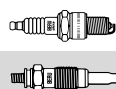

<b>AUDI</b>										
<b>A4 Cabriolet (8H7, B6, 8HE, B7)</b>										
3.0 TDI quattro	3.0	171	01.06-03.09	ASB Fgst.Nr. 8E-7-065 820 →	6	<b>GE 115</b> (4,4V)	○			
4.2 S4 quattro	4.2	253	03.04-03.09	BBK	8	<b>Z 239</b>	14 FGR-7 KQE	1,6		○
<b>A5 (8T3)</b>										
1.8 TFSI	1.8	118	05.09-	CDHB	4	<b>Z 347</b>	14 F-5 DPUR02	0,7		○
1.8 TFSI	1.8	125	10.07-	CABD	4	<b>Z 347</b>	14 F-5 DPUR02	0,7		○
2.0 TDI	2.0	120	08.08-	CAHB	4	<b>GE 115</b> (4,4V)	○			
2.0 TDI	2.0	125	08.08-	CAHA	4	<b>GE 115</b> (4,4V)	○			
2.0 TDI quattro	2.0	125	08.08-	CAHA	4	<b>GE 115</b> (4,4V)	○			
2.0 TDI	2.0	130	10.11-	CGLC	4	<b>GE 115</b> (4,4V)	○			
2.0 TDI quattro	2.0	130	12.11-	CGLC	4	<b>GE 115</b> (4,4V)	○			
2.0 TFSI	2.0	132	11.08-	CDNB	4	<b>Z 347</b>	14 F-5 DPUR02	0,7		○
2.0 TFSI	2.0	155	06.08-	CDNC	4	<b>Z 347</b>	14 F-5 DPUR02	0,7		○
2.0 TFSI quattro	2.0	155	06.08-	CAEB/CDNC	4	<b>Z 347</b>	14 F-5 DPUR02	0,7		○
2.7 TDI	2.7	120	09.07-	CAMB	6	<b>GE 115</b> (4,4V)	○			
2.7 TDI	2.7	140	06.07-	CAMA	6	<b>GE 115</b> (4,4V)	○			
3.0 TDI	3.0	150	10.11-	CLAB	6	<b>GE 115</b> (4,4V)	○			
3.0 TDI quattro	3.0	155	03.08-	CCWB	6	<b>GE 115</b> (4,4V)	○			
3.0 TDI quattro	3.0	176	06.07-	CAPA/CCWA	6	<b>GE 115</b> (4,4V)	○			
3.0 TDI quattro	3.0	180	10.11-	CDUC	6	<b>GE 115</b> (4,4V)	○			
3.2 FSI	3.2	195	06.07-	CALA	6	<b>Z 321</b>	14 F-7 KPPRU2	1,0		○
3.2 FSI quattro	3.2	195	06.07-	CALA	6	<b>Z 321</b>	14 F-7 KPPRU2	1,0		○
4.2 S5 quattro	4.2	260	06.07-	CAUA	8	<b>Z 295</b>	14 F-6 DTPRO2	0,8		○
<b>A5 Cabriolet (8F7)</b>										
1.8 TFSI	1.8	118	09.09-	CDHB	4	<b>Z 347</b>	14 F-5 DPUR02	0,7		○
1.8 TFSI	1.8	125	10.11-	CJEB	4	<b>Z 348</b>	14 F-5 MPUR2L	0,8		○
2.0 TDI	2.0	120	05.09-	CAHB	4	<b>GE 115</b> (4,4V)	○			
2.0 TDI	2.0	125	05.09-	CAHA	4	<b>GE 115</b> (4,4V)	○			
2.0 TDI	2.0	130	10.11-	CGLC	4	<b>GE 115</b> (4,4V)	○			
2.0 TDI quattro	2.0	130	01.12-	CGLC	4	<b>GE 115</b> (4,4V)	○			
2.0 TFSI	2.0	132	03.09-	CAEA/CDNB	4	<b>Z 347</b>	14 F-5 DPUR02	0,7		○
2.0 TFSI	2.0	155	03.09-	CAEB/CDNC	4	<b>Z 347</b>	14 F-5 DPUR02	0,7		○
2.0 TFSI quattro	2.0	155	03.09-	CAEB/CDNC	4	<b>Z 347</b>	14 F-5 DPUR02	0,7		○
2.7 TDI	2.7	120	05.09-	CGKB	6	<b>GE 115</b> (4,4V)	○			
2.7 TDI	2.7	140	03.09-	CGKA	6	<b>GE 115</b> (4,4V)	○			
3.0 TDI	3.0	150	10.11-	CLAB	6	<b>GE 115</b> (4,4V)	○			
3.0 TDI quattro	3.0	176	03.09-	CCWA	6	<b>GE 115</b> (4,4V)	○			
3.0 TDI quattro	3.0	180	10.11-	CDUC	6	<b>GE 115</b> (4,4V)	○			
3.2 FSI	3.2	195	03.09-	CALA	6	<b>Z 321</b>	14 F-7 KPPRU2	1,0		○
3.2 FSI quattro	3.2	195	03.09-	CALA	6	<b>Z 321</b>	14 F-7 KPPRU2	1,0		○
<b>A5 Sportback (8TA)</b>										
1.8 TFSI	1.8	118	11.09-	CDHB	4	<b>Z 347</b>	14 F-5 DPUR02	0,7		○
1.8 TFSI	1.8	125	08.11-	CJEB	4	<b>Z 348</b>	14 F-5 MPUR2L	0,8		○
2.0 TDI	2.0	100	09.09-	CAGB	4	<b>GE 115</b> (4,4V)	○			
2.0 TDI	2.0	105	09.09-	CAGA	4	<b>GE 115</b> (4,4V)	○			
2.0 TDI	2.0	120	09.09-	CAHB	4	<b>GE 115</b> (4,4V)	○			
2.0 TDI	2.0	125	09.09-	CAHA	4	<b>GE 115</b> (4,4V)	○			
2.0 TDI quattro	2.0	125	09.09-	CAHA	4	<b>GE 115</b> (4,4V)	○			
2.0 TDI	2.0	130	10.11-	CGLC	4	<b>GE 115</b> (4,4V)	○			
2.0 TDI quattro	2.0	130	12.11-	CGLC	4	<b>GE 115</b> (4,4V)	○			
2.0 TFSI	2.0	132	09.09-	CDNB	4	<b>Z 347</b>	14 F-5 DPUR02	0,7		○
2.0 TFSI	2.0	155	09.09-	CDNC	4	<b>Z 347</b>	14 F-5 DPUR02	0,7		○
2.0 TFSI quattro	2.0	155	09.09-	CDNC	4	<b>Z 347</b>	14 F-5 DPUR02	0,7		○
2.7 TDI	2.7	120	09.09-	CGKB	6	<b>GE 115</b> (4,4V)	○			
2.7 TDI	2.7	140	09.09-	CGKA	6	<b>GE 115</b> (4,4V)	○			
3.0 TDI	3.0	150	10.11-	CLAB	6	<b>GE 115</b> (4,4V)	○			
3.0 TDI quattro	3.0	176	09.09-	CCWA	6	<b>GE 115</b> (4,4V)	○			
3.0 TDI quattro	3.0	180	10.11-	CKVB	6	<b>PSG 002</b> (4,4V)=1x <b>GE 115</b> (4,4V)=5x	○			
3.2 FSI quattro	3.2	195	09.09-	CALA	6	<b>Z 321</b>	14 F-7 KPPRU2	1,0		○



kW

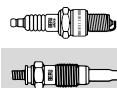
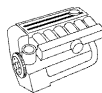

**AUDI**

**A6 (4A, C4)**

1.8	1.8	92	12.95-10.97	ADR	4	<b>Z 90</b>	14 FGH-7 DTURX	1,0	<b>UXT 1<sup>3</sup></b>
1.8 quattro	1.8	92	12.95-10.97	ADR	4	<b>Z 90</b>	14 FGH-7 DTURX	1,0	<b>UXT 1<sup>3</sup></b>
1.9 TDI	1.9	66	06.94-10.97	1Z/AHU Kühlwasservorwärmung <sup>15</sup> M 5/3Nm Ø 4 mm	4	<b>GN 855</b> (12V)	○		
						<b>GN 857</b> (11V)=3x			
						<b>GN 928</b> (12V)=3x			
2.0	2.0	74	06.94-10.97	AAE	4	<b>Z 91</b>	14 GH-7 DTUR	0,8	<b>UXT 2<sup>4</sup></b>
2.0	2.0	79	08.95-07.96	ADW	4	<b>Z 91</b>	14 GH-7 DTUR	0,8	<b>UXT 2<sup>4</sup></b>
2.0	2.0	85	06.94-10.97	ABK	4	<b>Z 91</b>	14 GH-7 DTUR	0,8	<b>UXT 2<sup>4</sup></b>
2.0 16V	2.0	103	06.94-10.97	ACE	4	<b>Z 89</b>	14 FGH-6 DTUR	0,8	<b>UXT 5</b>
2.0 16V quattro	2.0	103	06.94-10.97	ACE	4	<b>Z 89</b>	14 FGH-6 DTUR	0,8	<b>UXT 5</b>
2.3	2.3	98	06.94-12.95	AAR	5	<b>Z 94</b>	14 GR-8 DTU	0,8	<b>UXT 2<sup>4</sup></b>
2.3 quattro	2.3	98	06.94-12.95	AAR	5	<b>Z 94</b>	14 GR-8 DTU	0,8	<b>UXT 2<sup>4</sup></b>
2.5 TDI	2.5	84	01.95-10.97	AAT	5	<b>GN 855</b> (12V)	○		
2.5 TDI	2.5	85	06.94-10.97	AAT	5	<b>GN 855</b> (12V)	○		
2.5 TDI	2.5	103	08.94-10.97	AEL	5	<b>GN 855</b> (12V)	○		
2.5 TDI quattro	2.5	103	10.95-10.97	AEL	5	<b>GN 855</b> (12V)	○		
2.6	2.6	102	06.94-10.97	ACZ	6	<b>Z 90</b>	14 FGH-7 DTURX	1,0	<b>UXT 1<sup>3</sup></b>
2.6	2.6	110	06.94-10.97	ABC	6	<b>Z 90</b>	14 FGH-7 DTURX	1,0	<b>UXT 1<sup>3</sup></b>
2.6 quattro	2.6	110	06.94-10.97	ABC	6	<b>Z 90</b>	14 FGH-7 DTURX	1,0	<b>UXT 1<sup>3</sup></b>
2.8	2.8	128	06.94-10.97	AEJ	6	<b>Z 79</b>	14 F-9 DUO	0,8	<b>UXT 1<sup>3</sup></b>
2.8 quattro	2.8	128	06.94-10.97	AEJ	6	<b>Z 79</b>	14 F-9 DUO	0,8	<b>UXT 1<sup>3</sup></b>
2.8	2.8	128	06.94-10.97	AAH	6	<b>Z 90</b>	14 FGH-7 DTURX	1,0	<b>UXT 1<sup>3</sup></b>
2.8 quattro	2.8	128	06.94-10.97	AAH	6	<b>Z 90</b>	14 FGH-7 DTURX	1,0	<b>UXT 1<sup>3</sup></b>
2.8	2.8	142	12.95-10.97	ACK	6	<b>Z 145</b>	14 FGR-6 DDU	1,6	○
2.8 quattro	2.8	142	12.95-10.97	ACK	6	<b>Z 145</b>	14 FGR-6 DDU	1,6	○
4.2 S6 quattro	4.2	213	06.94-10.97	AEC	8	<b>Z 127</b>	14 KGR-7 KQU	1,6	○
4.2 S6 Plus quattro	4.2	240	04.96-10.97	AHK	8	<b>Z 144</b>	14 KGR-6 KQU	1,6	○

**A6 (4B, C5)**

1.8	1.8	85	05.97-01.05	AFY	4	<b>Z 90</b>	14 FGH-7 DTURX	1,0	<b>UXT 1<sup>3</sup></b>
1.8	1.8	92	07.97-01.05	AJP/AQE/ARH	4	<b>Z 90</b>	14 FGH-7 DTURX	1,0	<b>UXT 1<sup>3</sup></b>
1.8 T	1.8	110	01.97-01.05	AEB/ANB/APU/ARK/AWT	4	<b>Z 188</b>	14 F-7 DPUR02	0,7	<b>UXT 10</b>
1.8 T quattro	1.8	110	02.97-01.05	AEB/ANB/APU/ARK/AWT	4	<b>Z 188</b>	14 F-7 DPUR02	0,7	<b>UXT 10</b>
1.8 T	1.8	132	12.97-01.05	AJL	4	<b>Z 188</b>	14 F-7 DPUR02	0,7	<b>UXT 10</b>
1.8 T quattro	1.8	132	12.97-01.05	AJL	4	<b>Z 188</b>	14 F-7 DPUR02	0,7	<b>UXT 10</b>
1.9 TDI	1.9	81	04.97-10.00	AVG/AFN Kühlwasservorwärmung <sup>15</sup> M 5/3Nm Ø 4 mm	4	<b>GN 855</b> (12V)	○		
						<b>GN 857</b> (11V)=3x			
						<b>GN 928</b> (12V)=3x			
1.9 TDI	1.9	85	07.00-01.05	AJM Kühlwasservorwärmung <sup>15</sup> M 5/3Nm Ø 4 mm	4	<b>GN 855</b> (12V)	○		
						<b>GN 857</b> (11V)=3x			
						<b>GN 928</b> (12V)=3x			
1.9 TDI	1.9	96	08.01-01.05	AWX/AVF Kühlwasservorwärmung <sup>15</sup> M 5/3Nm Ø 4 mm	4	<b>GN 046</b> (12V)	○		
						<b>GN 857</b> (11V)=3x			
						<b>GN 928</b> (12V)=3x			
2.0	2.0	96	08.01-01.05	ALT	4	<b>Z 121</b>	14 FGH-8 DTURXO	1,0	<b>UXT 9</b>
2.4	2.4	100	07.98-01.05	ARN/ASM/ALW	6	<b>Z 145</b>	14 FGR-6 DDU	1,6	○
2.4	2.4	115	02.97-01.05	APC	6	<b>Z 145</b>	14 FGR-6 DDU	1,6	○
2.4 quattro	2.4	115	08.98-07.99	APC	6	<b>Z 145</b>	14 FGR-6 DDU	1,6	○
2.4	2.4	120	02.97-01.05	AMM/APZ/AJG	6	<b>Z 145</b>	14 FGR-6 DDU	1,6	○
2.4 quattro	2.4	120	02.97-01.05	APZ/AJG	6	<b>Z 145</b>	14 FGR-6 DDU	1,6	○
2.4	2.4	121	02.97-01.05	AML/ARJ/ALF/AGA/APS	6	<b>Z 145</b>	14 FGR-6 DDU	1,6	○
2.4 quattro	2.4	121	02.97-01.05	AML/ARJ/ALF/AGA/APS	6	<b>Z 145</b>	14 FGR-6 DDU	1,6	○
2.4	2.4	125	08.01-05.04	BDV	6	<b>Z 145</b>	14 FGR-6 DDU	1,6	○
2.4 quattro	2.4	125	08.01-05.04	BDV	6	<b>Z 145</b>	14 FGR-6 DDU	1,6	○
2.5 TDI	2.5	110	07.97-01.05	AFB/AKN	6	<b>GN 008</b> (12V)	○		
2.5 TDI quattro	2.5	110	07.97-01.05	AFB/AKN	6	<b>GN 008</b> (12V)	○		
2.5 TDI	2.5	114	08.01-01.05	AYM	6	<b>GN 008</b> (12V)	○		
2.5 TDI	2.5	120	07.02-01.05	BCZ/BDG/BFC	6	<b>GN 008</b> (12V)	○		
2.5 TDI	2.5	132	02.00-01.05	AKE, BAU, BDH	6	<b>GN 008</b> (12V)	○		
2.5 TDI quattro	2.5	132	02.00-01.05	BAU/AKE/BDH	6	<b>GN 008</b> (12V)	○		
2.7 T	2.7	169	02.99-01.05	AJK	6	<b>Z 188</b>	14 F-7 DPUR02	0,7	<b>UXT 10</b>



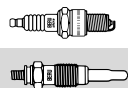
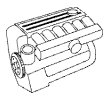

AUDI									
A6 (4B, C5)									
2.7 T quattro	2.7	169	12.97-01.05	AJK	6	Z 188	14 F-7 DPUR02	0,7	UXT 10
2.7 T quattro	2.7	184	08.01-01.05	ARE/BES	6	Z 188	14 F-7 DPUR02	0,7	UXT 10
2.8	2.8	132	10.97-05.00	AGE	6	Z 145	14 FGR-6 DDU	1,6	○
2.8 quattro	2.8	132	01.98-04.00	AGE	6	Z 145	14 FGR-6 DDU	1,6	○
2.8	2.8	140	07.99-01.05	ATX	6	Z 145	14 FGR-6 DDU	1,6	○
2.8 quattro	2.8	140	07.99-05.01	ATX	6	Z 145	14 FGR-6 DDU	1,6	○
2.8	2.8	142	02.97-01.05	APR/ACK/ALG/AQD/AMX	6	Z 145	14 FGR-6 DDU	1,6	○
2.8 quattro	2.8	142	02.97-01.05	APR/ACK/ALG/AQD/AMX	6	Z 145	14 FGR-6 DDU	1,6	○
3.0 quattro	3.0	160	06.01-07.04	BBJ	6	Z 145	14 FGR-6 DDU	1,6	○
3.0	3.0	162	08.01-01.05	ASN → Fgst.Nr. 4B-5-050 000	6	Z 145	14 FGR-6 DDU	1,6	○
3.0 quattro	3.0	162	08.01-01.05	ASN → Fgst.Nr. 4B-5-050 000	6	Z 145	14 FGR-6 DDU	1,6	○
3.7	3.7	191	03.99-01.05	AQG	8	Z 237	14 FR-7 DQUP7	1,6	○
3.7 quattro	3.7	191	03.99-01.05	AQG	8	Z 237	14 FR-7 DQUP7	1,6	○
4.2 quattro	4.2	220	11.98-01.05	AWN/ARS/ASG	8	Z 239	14 FGR-7 KQE	1,6	○
4.2 RS6 quattro	4.2	331	07.02-01.05	BCY	8	Z 317	14 F-5 DPUR2T	0,8	○
4.2 S6 quattro	4.2	250	09.99-01.05	AQJ/ANK	8	Z 129	14 FGR-6 KQU	1,6	○
A6 (4F2, C6)									
2.0 TDI	2.0	100	07.04-03.11	BNA Fgst.Nr. 8E-5-400 001 →	4	GE 101 (4,4V)	GSE 100		
2.0 TDI	2.0	100	07.04-03.11	CAGB	4	GE 115 (4,4V)	○		
2.0 TDI	2.0	103	07.04-10.08	BLB → Fgst.Nr. 4B-5-050-000	4	GN 046 (12V)	○		
2.0 TDI	2.0	103	07.04-10.08	BLB Fgst.Nr. 4F-5-000-001 →	4	GE 101 (4,4V)	GSE 100		
2.0 TDI	2.0	120	04.09-03.11	CAHB	4	GE 115 (4,4V)	○		
2.0 TDI	2.0	125	11.08-03.11	CAHA	4	GE 115 (4,4V)	○		
2.0 TFSI	2.0	125	06.05-03.11	BPJ	4	Z 347	14 F-5 DPUR02	0,7	○
2.7 TDI	2.7	120	11.04-03.11	BSG, CANB Fgst.Nr. 4F-7-039 579 →	6	GE 115 (4,4V)	○		
2.7 TDI quattro	2.7	120	06.05-03.11	BSG, CAND Fgst.Nr. 4F-7-039 579 →	6	GE 115 (4,4V)	○		
2.7 TDI	2.7	132	11.04-10.08	BPP Fgst.Nr. 4F-7-039 579 →	6	GE 115 (4,4V)	○		
2.7 TDI quattro	2.7	132	11.04-10.08	BPP Fgst.Nr. 4F-7-039 579 →	6	GE 115 (4,4V)	○		
2.7 TDI	2.7	140	10.08-03.11	CANA	6	GE 115 (4,4V)	○		
2.7 TDI quattro	2.7	140	10.08-03.11	CANC	6	GE 115 (4,4V)	○		
3.0 TDI quattro	3.0	155	05.04-03.11	BNG, CDYB Fgst.Nr. 4F-7-039 579 →	6	GE 115 (4,4V)	○		
3.0	3.0	160	08.04-05.06	BBJ	6	Z 145	14 FGR-6 DDU	1,6	○
3.0 quattro	3.0	160	05.04-05.06	BBJ	6	Z 145	14 FGR-6 DDU	1,6	○
3.0 TDI quattro	3.0	165	05.04-05.06	BMK Fgst.Nr. 4F-7-039 579 →	6	GE 115 (4,4V)	○		
3.0 TDI	3.0	171	06.06-03.11	ASB Fgst.Nr. F4F-5-028 001 →	6	GE 115 (4,4V)	○		
3.0 TDI quattro	3.0	171	06.06-10.08	ASB Fgst.Nr. 4E-5-003 301 →	6	GE 115 (4,4V)	○		
3.0 TDI quattro	3.0	176	10.08-03.11	CDYA/CDYC	6	GE 115 (4,4V)	○		
3.0 TFSI quattro	3.0	213	10.08-03.11	CAJA	6	Z 347	14 F-5 DPUR02	0,7	○
3.2 FSI	3.2	195	05.09-03.11	CALA	6	Z 321	14 F-7 KPPRU2	1,0	○
4.2 FSI quattro	4.2	257	06.06-03.11	BVJ Fgst.Nr. F4F-7-000 001 →	8	Z 295	14 F-6 DTPRO2	0,8	○
4.2 quattro	4.2	246	05.04-05.06	BAT	8	Z 239	14 FGR-7 KQE	1,6	○
5.2 S6 quattro	5.2	320	03.06-03.11	BXA	10	Z 295	14 F-6 DTPRO2	0,8	○
A6 (4G2, C7)									
2.0 TDI	2.0	120	03.11-	CGLD	4	GE 115 (4,4V)	○		
2.0 TDI	2.0	130	03.11-	CGLC, CMGB	4	GE 115 (4,4V)	○		
2.0 TFSI	2.0	132	05.11-	CDNB	4	Z 347	14 F-5 DPUR02	0,7	○
2.0 TFSI	2.0	155	03.11-	CAEB	4	Z 347	14 F-5 DPUR02	0,7	○



kW

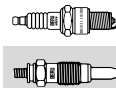
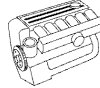

**AUDI**

**A6 (4G2, C7)**

3.0 TDI	3.0	150	11.10-	CLAB	6	<b>GE 115</b> (4,4V)	○		
3.0 TDI quattro	3.0	150	03.11-	CLAA	6	<b>GE 115</b> (4,4V)	○		
3.0 TDI quattro	3.0	180	03.11-	CDUD/CDUC	6	<b>GE 115</b> (4,4V)=6x	○		
3.0 TDI quattro	3.0	180	03.11-	CKVK/CKVB	6	<b>PSG 002</b> (4,4V)=1x <b>GE 115</b> (4,4V)=5x	○		
3.0 TDI quattro	3.0	230	11.11-	CGQB	6	<b>GE 115</b> (4,4V)	○		
4.0 S6 quattro	4.0	309	02.12-	CEUC Fgst.Nr. 4H-A-000 001 →	8	<b>Z 345</b>	14 F-4 NBPR2LS	0,7	○

**A6 Allroad (4FH, C6)**

2.7 TDI quattro	2.7	120	05.06-	BSG, CAND	6	<b>GE 115</b> (4,4V)	○		
2.7 TDI quattro	2.7	132	05.06-	BPP Fgst.Nr. 4F-7-039 579 →	6	<b>GE 115</b> (4,4V)	○		
2.7 TDI quattro	2.7	140	10.08-	CANC	6	<b>GE 115</b> (4,4V)	○		
3.0 TDI quattro	3.0	155	05.06-	CDYB, BNG	6	<b>GE 115</b> (4,4V)	○		
3.0 TDI quattro	3.0	171	05.06-	ASB Fgst.Nr. 4E-5-003 301 →	6	<b>GE 115</b> (4,4V)	○		
3.0 TDI quattro	3.0	176	10.08-	CDYA	6	<b>GE 115</b> (4,4V)	○		
3.0 TFSI quattro	3.0	213	10.08-	CAJA	6	<b>Z 347</b>	14 F-5 DPUR02	0,7	○
4.2 FSI quattro	4.2	257	05.06-	BJV Fgst.Nr. F4F-7-000 001 →	8	<b>Z 295</b>	14 F-6 DTPR02	0,8	○

**A6 Avant (4A, C4)**

1.8	1.8	92	12.95-12.97	ADR	4	<b>Z 90</b>	14 FGH-7 DTURX	1,0	<b>UXT 1<sup>3</sup></b>
1.8 quattro	1.8	92	12.95-12.97	ADR	4	<b>Z 90</b>	14 FGH-7 DTURX	1,0	<b>UXT 1<sup>3</sup></b>
1.9 TDI	1.9	66	06.94-12.97	1Z/AHU	4	<b>GN 855</b> (12V)	○		
				Kühlwasservorwärmung <sup>15</sup>		<b>GN 857</b> (11V)=3x <b>GN 928</b> (12V)=3x			
				↳ M 5/3Nm ↳ Ø 4 mm					
2.0	2.0	74	06.94-12.97	AAE	4	<b>Z 91</b>	14 GH-7 DTUR	0,8	<b>UXT 2<sup>4</sup></b>
2.0	2.0	79	08.95-07.96	ADW	4	<b>Z 91</b>	14 GH-7 DTUR	0,8	<b>UXT 2<sup>4</sup></b>
2.0	2.0	85	06.94-12.97	ABK	4	<b>Z 91</b>	14 GH-7 DTUR	0,8	<b>UXT 2<sup>4</sup></b>
2.0 16V	2.0	103	06.94-12.97	ACE	4	<b>Z 89</b>	14 FGH-6 DTUR	0,8	<b>UXT 5</b>
2.0 16V quattro	2.0	103	06.94-12.97	ACE	4	<b>Z 89</b>	14 FGH-6 DTUR	0,8	<b>UXT 5</b>
2.3	2.3	98	06.94-12.95	AAR	5	<b>Z 94</b>	14 GR-8 DTU	0,8	<b>UXT 2<sup>4</sup></b>
2.3 quattro	2.3	98	06.94-12.95	AAR	5	<b>Z 94</b>	14 GR-8 DTU	0,8	<b>UXT 2<sup>4</sup></b>
2.5 TDI	2.5	84	01.95-12.97	AAT	5	<b>GN 855</b> (12V)	○		
2.5 TDI	2.5	85	06.94-12.97	AAT	5	<b>GN 855</b> (12V)	○		
2.5 TDI	2.5	103	08.94-12.97	AEL	5	<b>GN 855</b> (12V)	○		
2.5 TDI quattro	2.5	103	07.95-12.97	AEL	5	<b>GN 855</b> (12V)	○		
2.6	2.6	102	06.94-02.97	ACZ	6	<b>Z 90</b>	14 FGH-7 DTURX	1,0	<b>UXT 1<sup>3</sup></b>
2.6	2.6	110	06.94-12.97	ABC	6	<b>Z 90</b>	14 FGH-7 DTURX	1,0	<b>UXT 1<sup>3</sup></b>
2.6 quattro	2.6	110	06.94-12.97	ABC	6	<b>Z 90</b>	14 FGH-7 DTURX	1,0	<b>UXT 1<sup>3</sup></b>
2.8	2.8	128	06.94-12.97	AEJ	6	<b>Z 79</b>	14 F-9 DUO	0,8	<b>UXT 1<sup>3</sup></b>
2.8 quattro	2.8	128	06.94-12.97	AEJ	6	<b>Z 79</b>	14 F-9 DUO	0,8	<b>UXT 1<sup>3</sup></b>
2.8	2.8	128	06.94-12.97	AAH	6	<b>Z 90</b>	14 FGH-7 DTURX	1,0	<b>UXT 1<sup>3</sup></b>
2.8 quattro	2.8	128	06.94-12.97	AAH	6	<b>Z 90</b>	14 FGH-7 DTURX	1,0	<b>UXT 1<sup>3</sup></b>
2.8	2.8	142	12.95-12.97	ACK	6	<b>Z 145</b>	14 FGR-6 DDU	1,6	○
2.8 quattro	2.8	142	12.95-12.97	ACK	6	<b>Z 145</b>	14 FGR-6 DDU	1,6	○
4.2 S6 4.2 quattro	4.2	213	06.94-12.97	AEC	8	<b>Z 127</b>	14 KGR-7 KQU	1,6	○
4.2 S6 Plus quattro	4.2	240	04.96-12.97	AHK	8	<b>Z 144</b>	14 KGR-6 KQU	1,6	○

**A6 Avant (4B, C5)**

1.8	1.8	85	02.98-01.05	AFY	4	<b>Z 90</b>	14 FGH-7 DTURX	1,0	<b>UXT 1<sup>3</sup></b>
1.8	1.8	92	12.97-01.05	AJP/AQE/ARH	4	<b>Z 90</b>	14 FGH-7 DTURX	1,0	<b>UXT 1<sup>3</sup></b>
1.8 T	1.8	110	12.97-01.05	AEB/ANB/APU/ARK/AWT	4	<b>Z 188</b>	14 F-7 DPUR02	0,7	<b>UXT 10</b>
1.8 T quattro	1.8	110	12.97-01.05	AEB/ANB/APU/ARK/AWT	4	<b>Z 188</b>	14 F-7 DPUR02	0,7	<b>UXT 10</b>
1.8 T	1.8	132	04.99-01.05	AJL	4	<b>Z 188</b>	14 F-7 DPUR02	0,7	<b>UXT 10</b>
1.8 T quattro	1.8	132	12.97-01.05	AJL	4	<b>Z 188</b>	14 F-7 DPUR02	0,7	<b>UXT 10</b>
1.9 TDI	1.9	81	02.98-04.01	AFN	4	<b>GN 855</b> (12V)	○		
				Kühlwasservorwärmung <sup>15</sup>		<b>GN 857</b> (11V)=3x <b>GN 928</b> (12V)=3x			
				↳ M 5/3Nm ↳ Ø 4 mm					
1.9 TDI	1.9	85	07.00-01.05	AJM	4	<b>GN 855</b> (12V)	○		
				Kühlwasservorwärmung <sup>15</sup>		<b>GN 857</b> (11V)=3x <b>GN 928</b> (12V)=3x			
				↳ M 5/3Nm ↳ Ø 4 mm					

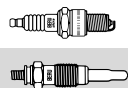
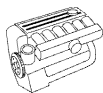

## AUDI

### A6 Avant (4B, C5)

1.9 TDI	1.9	96	08.01-01.05	AWX/AVF	4	<b>GN 046</b> (12V)	○		
2.0	2.0	96	08.01-01.05	ALT	4	<b>Z 121</b>	14 FGH-8 DTURXO	1,0	<b>UXT 9</b>
2.4	2.4	100	07.98-01.05	ARN/ASM/ALW	6	<b>Z 145</b>	14 FGR-6 DDU	1,6	○
2.4	2.4	115	12.97-01.05	APC	6	<b>Z 145</b>	14 FGR-6 DDU	1,6	○
2.4 quattro	2.4	115	08.98-05.01	APC	6	<b>Z 145</b>	14 FGR-6 DDU	1,6	○
2.4	2.4	120	12.97-01.05	AMM/APZ/AJG	6	<b>Z 145</b>	14 FGR-6 DDU	1,6	○
2.4 quattro	2.4	120	12.97-01.05	APZ/AJG	6	<b>Z 145</b>	14 FGR-6 DDU	1,6	○
2.4	2.4	121	12.97-01.05	AML/ARJ/ALF/AGA/APS	6	<b>Z 145</b>	14 FGR-6 DDU	1,6	○
2.4 quattro	2.4	121	12.97-01.05	AML/ARJ/ALF/AGA/APS	6	<b>Z 145</b>	14 FGR-6 DDU	1,6	○
2.4	2.4	125	08.01-01.05	BDV	6	<b>Z 145</b>	14 FGR-6 DDU	1,6	○
2.4 quattro	2.4	125	08.01-01.05	BDV	6	<b>Z 145</b>	14 FGR-6 DDU	1,6	○
2.5 TDI	2.5	110	12.97-01.05	AFB/AKN	6	<b>GN 008</b> (12V)	○		
2.5 TDI quattro	2.5	110	12.97-01.05	AFB/AKN	6	<b>GN 008</b> (12V)	○		
2.5 TDI	2.5	114	08.01-01.05	AYM	6	<b>GN 008</b> (12V)	○		
2.5 TDI	2.5	120	07.02-01.05	BCZ/BDG/BFC	6	<b>GN 008</b> (12V)	○		
2.5 TDI	2.5	132	02.00-01.05	BAU/AKE/BDH	6	<b>GN 008</b> (12V)	○		
2.5 TDI quattro	2.5	132	02.00-01.05	BAU/AKE/BDH	6	<b>GN 008</b> (12V)	○		
2.7 T	2.7	169	02.99-01.05	AJK	6	<b>Z 188</b>	14 F-7 DPUR02	0,7	<b>UXT 10</b>
2.7 T quattro	2.7	169	12.97-01.05	AJK, AZA	6	<b>Z 188</b>	14 F-7 DPUR02	0,7	<b>UXT 10</b>
2.7 T quattro	2.7	184	08.01-01.05	ARE, BES	6	<b>Z 188</b>	14 F-7 DPUR02	0,7	<b>UXT 10</b>
2.8	2.8	132	12.97-05.00	AGE	6	<b>Z 145</b>	14 FGR-6 DDU	1,6	○
2.8	2.8	140	07.99-01.05	ATX	6	<b>Z 145</b>	14 FGR-6 DDU	1,6	○
2.8	2.8	142	12.97-01.05	APR/ACK/ALG/AQD/AMX	6	<b>Z 145</b>	14 FGR-6 DDU	1,6	○
2.8 quattro	2.8	142	12.97-01.05	APR/ACK/ALG/AQD/AMX	6	<b>Z 145</b>	14 FGR-6 DDU	1,6	○
3.0	3.0	162	08.01-01.05	ASN → Fgst.Nr. 4B-5-050 000	6	<b>Z 145</b>	14 FGR-6 DDU	1,6	○
3.0 quattro	3.0	162	08.01-01.05	ASN → Fgst.Nr. 4B-5-050 000	6	<b>Z 145</b>	14 FGR-6 DDU	1,6	○
3.7	3.7	191	03.99-01.05	AQG	8	<b>Z 237</b>	14 FR-7 DQUP7	1,6	○
3.7 quattro	3.7	191	03.99-01.05	AQG	8	<b>Z 237</b>	14 FR-7 DQUP7	1,6	○
4.2 quattro	4.2	220	11.98-01.05	AWN/ARS/ASG	8	<b>Z 239</b>	14 FGR-7 KQE	1,6	○
4.2 S6 quattro	4.2	250	09.99-01.05	AQJ/ANK	8	<b>Z 129</b>	14 FGR-6 KQU	1,6	○
4.2 RS6 quattro	4.2	331	07.02-01.05	BCY	8	<b>Z 317</b>	14 F-5 DPUR2T	0,8	○
4.2 RS6 plus quattro	4.2	353	04.04-01.05	BRV	8	<b>Z 317</b>	14 F-5 DPUR2T	0,8	○

### A6 Avant (4F5, C6)

2.0 TDI	2.0	100	06.05-08.11	BNA Fgst.Nr. 8E-5-400 001 →	4	<b>GE 101</b> (4,4V)	<b>GSE 100</b>		
2.0 TDI	2.0	100	06.05-08.11	CAGB	4	<b>GE 115</b> (4,4V)	○		
2.0 TDI	2.0	103	06.05-10.08	BLB → Fgst.Nr. 4B-5-050-000	4	<b>GN 046</b> (12V)	○		
2.0 TDI	2.0	103	06.05-10.08	BLB Fgst.Nr. 4F-5-000-001 →	4	<b>GE 101</b> (4,4V)	<b>GSE 100</b>		
2.0 TDI	2.0	120	04.09-08.11	CAHB	4	<b>GE 115</b> (4,4V)	○		
2.0 TDI	2.0	125	10.08-08.11	CAHA	4	<b>GE 115</b> (4,4V)	○		
2.0 TFSI	2.0	125	06.05-08.11	BPJ	4	<b>Z 347</b>	14 F-5 DPUR02	0,7	○
2.7 TDI	2.7	120	03.05-08.11	BSG, CANB Fgst.Nr. 4F-7-039 579 →	6	<b>GE 115</b> (4,4V)	○		
2.7 TDI quattro	2.7	120	06.05-08.11	BSG, CAND Fgst.Nr. 4F-7-039 579 →	6	<b>GE 115</b> (4,4V)	○		
2.7 TDI	2.7	132	03.05-10.08	BPP Fgst.Nr. 4F-7-039 579 →	6	<b>GE 115</b> (4,4V)	○		
2.7 TDI quattro	2.7	132	03.05-10.08	BPP Fgst.Nr. 4F-7-039 579 →	6	<b>GE 115</b> (4,4V)	○		
2.7 TDI	2.7	140	10.08-08.11	CANA	6	<b>GE 115</b> (4,4V)	○		
2.7 TDI quattro	2.7	140	10.08-08.11	CANC	6	<b>GE 115</b> (4,4V)	○		
3.0 TDI quattro	3.0	155	03.05-08.11	BNG, CDYB Fgst.Nr. 4F-7-039 579 →	6	<b>GE 115</b> (4,4V)	○		
3.0	3.0	160	03.05-05.06	BBJ → Fgst.Nr. 4B-5-050 000	6	<b>Z 145</b>	14 FGR-6 DDU	1,6	○
3.0 quattro	3.0	160	03.05-05.06	BBJ	6	<b>Z 145</b>	14 FGR-6 DDU	1,6	○
3.0 TDI quattro	3.0	165	03.05-05.06	BMK	6	<b>GE 115</b> (4,4V)	○		



kW

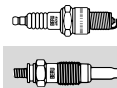
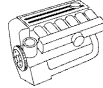

**AUDI**

**A6 Avant (4F5, C6)**

3.0 TDi	3.0	171	06.06-08.11	ASB Fgst.Nr. F4F-5-028 001 →	6	<b>GE 115</b> (4,4V)	○		
3.0 TDi quattro	3.0	171	06.06-10.08	ASB Fgst.Nr. 4E-5-003 301 →	6	<b>GE 115</b> (4,4V)	○		
3.0 TDi quattro	3.0	176	10.08-08.11	CDYA/CDYC	6	<b>GE 115</b> (4,4V)	○		
3.0 TFSI quattro	3.0	213	10.08-08.11	CAJA	6	<b>Z 347</b>	14 F-5 DPUR02	0,7	○
4.2 quattro	4.2	246	03.05-05.06	BAT	8	<b>Z 239</b>	14 FGR-7 KQE	1,6	○
4.2 FSI quattro	4.2	257	06.06-08.11	BJJ Fgst.Nr. F4F-7-000 001 →	8	<b>Z 295</b>	14 F-6 DTPR02	0,8	○
5.2 S6 quattro	5.2	320	03.06-08.11	BXA	10	<b>Z 295</b>	14 F-6 DTPR02	0,8	○

**A6 Avant (4G5, C7)**

2.0 TDi	2.0	120	05.11-	CGLD	4	<b>GE 115</b> (4,4V)	○		
2.0 TDi	2.0	130	05.11-	CGLC, CMGB	4	<b>GE 115</b> (4,4V)	○		
2.0 TFSI	2.0	132	06.11-	CDNB	4	<b>Z 347</b>	14 F-5 DPUR02	0,7	○
3.0 TDi	3.0	150	05.11-	CLAB	6	<b>GE 115</b> (4,4V)	○		
3.0 TDi quattro	3.0	150	05.11-	CLAA	6	<b>GE 115</b> (4,4V)	○		
3.0 TDi quattro	3.0	180	05.11-	CDUD/CDUC	6	<b>GE 115</b> (4,4V)=6x	○		
3.0 TDi quattro	3.0	180	05.11-	CKVC/CKVB	6	<b>PSG 002</b> (4,4V)=1x <b>GE 115</b> (4,4V)=5x	○		
3.0 TDi quattro	3.0	230	11.11-	CGQB	6	<b>GE 115</b> (4,4V)	○		
4.0 S6 quattro	4.0	309	02.12-	CEUC Fgst.Nr. 4H-A-000 001 →	8	<b>Z 345</b>	14 F-4 NBPR2LS	0,7	○

**A7 Sportback (4GA)**

3.0 TDi	3.0	150	11.10-	CLAB	6	<b>GE 115</b> (4,4V)	○		
3.0 TDi quattro	3.0	150	12.10-	CLAA	6	<b>GE 115</b> (4,4V)	○		
3.0 TDi quattro	3.0	180	10.10-	CDUD/CDUC	6	<b>GE 115</b> (4,4V)=6x	○		
3.0 TDi quattro	3.0	180	10.10-	CKVC/CKVB	6	<b>PSG 002</b> (4,4V)=1x <b>GE 115</b> (4,4V)=5x	○		
3.0 TDi quattro	3.0	230	11.11-	CGQB	6	<b>GE 115</b> (4,4V)	○		
4.0 S7 quattro	4.0	309	02.12-	CEUC	8	<b>Z 345</b>	14 F-4 NBPR2LS	0,7	○

**A8 (4D2, 4D8)**

2.5 TDi	2.5	110	01.97-04.00	AFB/AKN	6	<b>GN 008</b> (12V)	○		
2.5 TDi quattro	2.5	110	07.97-04.00	AFB/AKN	6	<b>GN 008</b> (12V)	○		
2.5 TDi	2.5	132	09.00-09.02	AKE	6	<b>GN 008</b> (12V)	○		
2.5 TDi quattro	2.5	132	09.00-09.02	AKE	6	<b>GN 008</b> (12V)	○		
2.8	2.8	120	07.95-03.96	AEJ	6	<b>Z 79</b>	14 F-9 DUO	0,8	<b>UXT 1<sup>3</sup></b>
2.8 quattro	2.8	120	07.95-03.96	AEJ	6	<b>Z 79</b>	14 F-9 DUO	0,8	<b>UXT 1<sup>3</sup></b>
2.8	2.8	128	03.94-03.96	AAH	6	<b>Z 90</b>	14 FGH-7 DTURX	1,0	<b>UXT 1<sup>3</sup></b>
2.8 quattro	2.8	128	03.94-03.96	AAH	6	<b>Z 90</b>	14 FGH-7 DTURX	1,0	<b>UXT 1<sup>3</sup></b>
2.8	2.8	142	04.96-09.02	APR/ACK/ALG/AQD/AMX	6	<b>Z 145</b>	14 FGR-6 DDU	1,6	○
2.8 quattro	2.8	142	04.96-09.02	APR/ACK/AQD/AMX	6	<b>Z 145</b>	14 FGR-6 DDU	1,6	○
3.3 TDi quattro	3.3	165	06.00-09.02	AKF	8	<b>GN 008</b> (12V)	○		
3.7	3.7	169	07.95-12.98	AEW	8	<b>Z 127</b>	14 KGR-7 KQU	1,6	○
3.7 quattro	3.7	169	07.95-11.98	AKJ/AEW	8	<b>Z 127</b>	14 KGR-7 KQU	1,6	○
3.7	3.7	191	11.98-09.02	AKC/AQG	8	<b>Z 237</b>	14 FR-7 DQUP7	1,6	○
3.7 quattro	3.7	191	11.98-09.02	AKC/AQG	8	<b>Z 237</b>	14 FR-7 DQUP7	1,6	○
4.2 quattro	4.2	175	02.99-04.00	ARU	8	<b>Z 172</b>	14 FGR-7 KQU	1,6	○
4.2 quattro	4.2	180	03.94-07.96	AEM	8	<b>Z 127</b>	14 KGR-7 KQU	1,6	○
4.2 quattro	4.2	220	03.94-11.98	AKG/ABZ	8	<b>Z 127</b>	14 KGR-7 KQU	1,6	○
4.2 quattro	4.2	228	11.98-09.02	AUW/AQF/AUX	8	<b>Z 239</b>	14 FGR-7 KQE	1,6	○
4.2 S 8 quattro	4.2	250	07.96-06.99	AHC/AKH	8	<b>Z 144</b>	14 KGR-6 KQU	1,6	○
4.2 S 8 quattro	4.2	265	06.99-09.02	AQH/AVP	8	<b>Z 129</b>	14 FGR-6 KQU	1,6	○
6.0 W12 quattro	6.0	309	01.01-09.02	AZC	12	<b>Z 176</b>	14 F-7 HPURX2	1,0	○

**A8 (4E )**

3.0 TDi quattro	3.0	155	11.03-07.10	BNG Fgst.Nr. 4F-7-039 579 →	6	<b>GE 115</b> (4,4V)	○		
3.0	3.0	160	07.03-05.06	BBJ	6	<b>Z 145</b>	14 FGR-6 DDU	1,6	○
3.0 quattro	3.0	160	11.03-05.04	BBJ	6	<b>Z 145</b>	14 FGR-6 DDU	1,6	○
3.0	3.0	162	07.03-05.05	ASN	6	<b>Z 145</b>	14 FGR-6 DDU	1,6	○
3.0 TDi quattro	3.0	171	08.03-07.10	ASB Fgst.Nr. 4E-5-003 301 →	6	<b>GE 115</b> (4,4V)	○		

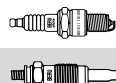

AUDI									
A8 (4E )									
3.7 quattro	3.7	206	10.02-05.06	BFL	8	Z 239	14 FGR-7 KQE	1,6	○
4.0 TDI quattro	3.9	202	05.03-07.05	ASE	8	GN 008 (12V)	○		
4.2 TDI quattro	4.2	235	01.05-06.05	BMC	8	GE 115 (4,4V)	○		
4.2 TDI quattro	4.2	240	07.05-07.10	BVN	8	GE 115 (4,4V)	○		
4.2 quattro	4.2	246	10.02-07.10	BFM	8	Z 239	14 FGR-7 KQE	1,6	○
4.2 FSI quattro	4.2	257	06.06-07.10	BVJ Fgst.Nr. F4F-7-000 001 →	8	Z 295	14 F-6 DTPRO2	0,8	○
5.2 S8 quattro	5.2	331	06.06-07.10	BSM	10	Z 295	14 F-6 DTPRO2	0,8	○
6.0 W12 quattro	6.0	331	12.03-07.10	BHT/BTE	12	Z 176	14 F-7 HPURX2	1,0	○
A8 (4H )									
3.0 TDI	3.0	150	09.11-	CLAB	6	GE 115 (4,4V)	○		
3.0 TDI quattro	3.0	155	08.10-	CDTB	6	GE 115 (4,4V)	○		
3.0 TDI quattro	3.0	184	07.10-	CDTA	6	GE 115 (4,4V)=6x	○		
3.0 TDI quattro	3.0	184	07.10-	CMHA	6	PSG 002 (4,4V)=1x GE 115 (4,4V)=5x	○		
4.0 S8 quattro	4.0	382	04.12-	CGTA Fgst.Nr. 4H-A-000 001 →	8	Z 345	14 F-4 NBPR2LS	0,7	○
4.2 TDI quattro	4.2	258	11.09-	CDSB	8	GE 115 (4,4V)	○		
4.2 FSI quattro	4.2	273	11.09-	CDRA	8	Z 295	14 F-6 DTPRO2	0,8	○
ALLROAD (4BH, C5)									
2.5 TDI quattro	2.5	120	05.03-08.05	BCZ	6	GN 008 (12V)	○		
2.5 TDI quattro	2.5	132	05.00-08.05	BAU/AKE	6	GN 008 (12V)	○		
2.7 T quattro	2.7	184	05.00-08.05	ARE/BES	6	Z 188	14 F-7 DPUR02	0,7	UXT 10
4.2 V8 quattro	4.2	220	07.02-08.05	BAS	8	Z 239	14 FGR-7 KQE	1,6	○
CABRIOLET (8G7, B4)									
1.8	1.8	92	01.97-08.00	ADR	4	Z 90	14 FGH-7 DTURX	1,0	UXT 13
1.9 TDI	1.9	66	06.95-08.00	1Z/AHU Kühlwasservorwärmung <sup>15</sup> M 5/3Nm Ø 4 mm	4	GN 855 (12V) GN 857 (11V)=3x GN 928 (12V)=3x	○		
2.0 E	2.0	85	01.93-07.98	ABK	4	Z 91	14 GH-7 DTUR	0,8	UXT 2 <sup>4</sup>
2.0 16V	2.0	103	06.95-07.96	ACE	4	Z 89	14 FGH-6 DTUR	0,8	UXT 5
2.3 E	2.3	98	05.91-07.93	NG	5	Z 75	14 G-8 DTU	1,2	UXT 2 <sup>4</sup>
2.3 E	2.3	98	08.93-07.94	NG	5	Z 94	14 GR-8 DTU	0,8	UXT 2 <sup>4</sup>
2.6	2.6	102	05.95-08.00	ACZ	6	Z 90	14 FGH-7 DTURX	1,0	UXT 13
2.6	2.6	110	06.93-08.00	ABC	6	Z 90	14 FGH-7 DTURX	1,0	UXT 13
2.8	2.8	128	11.92-08.00	AAH	6	Z 90	14 FGH-7 DTURX	1,0	UXT 13
COUPE (89, 8B)									
1.8	1.8	82	08.89-07.91	DZ	4	Z 12	14-7 DTU	0,8	UXT 2 <sup>4</sup>
2.0	2.0	82	03.90-07.90	3A	4	Z 91	14 GH-7 DTUR	0,8	UXT 2 <sup>4</sup>
2.0	2.0	83	05.89-03.90	3A	4	Z 91	14 GH-7 DTUR	0,8	UXT 2 <sup>4</sup>
2.0	2.0	85	05.89-12.96	AAD/ABK	4	Z 91	14 GH-7 DTUR	0,8	UXT 2 <sup>4</sup>
2.0 16 V	2.0	101	01.92-07.92	6A	4	Z 105	14 F-6 DSR	0,7	UXT 5
2.0 16 V	2.0	103	08.92-12.96	ACE	4	Z 89	14 FGH-6 DTUR	0,8	UXT 5
2.0 20 V	2.0	118	08.89-07.91	NM	5	Z 24	14 FR-6 DU	0,8	UXT 5
2.0 20 V quattro	2.0	118	08.89-07.91	NM	5	Z 52	14 F-6 DTU	0,8	UXT 5
2.2 quattro	2.2	100	11.88-07.91	KV	5	Z 51	14-6 DTU	0,8	UX 56
2.3	2.3	98	03.90-12.96	NG	5	Z 94	14 GR-8 DTU	0,8	UXT 2 <sup>4</sup>
2.3 quattro	2.3	98	05.90-07.93	NG	5	Z 75	14 G-8 DTU	1,2	UXT 2 <sup>4</sup>
2.3 quattro	2.3	98	08.93-12.96	NG	5	Z 94	14 GR-8 DTU	0,8	UXT 2 <sup>4</sup>
2.3	2.3	100	10.88-07.93	NG	5	Z 75	14 G-8 DTU	1,2	UXT 2 <sup>4</sup>
2.3	2.3	100	08.93-07.94	NG	5	Z 94	14 GR-8 DTU	0,8	UXT 2 <sup>4</sup>
2.3 quattro	2.3	100	11.88-12.92	NG	5	Z 75	14 G-8 DTU	1,2	UXT 2 <sup>4</sup>
2.3 20V	2.3	123	08.90-07.91	7A	5	Z 89	14 FGH-6 DTUR	0,8	UXT 5
2.3 20V quattro	2.3	123	05.90-12.96	7A	5	Z 89	14 FGH-6 DTUR	0,8	UXT 5
2.3 20V	2.3	125	08.89-07.91	7A	5	Z 89	14 FGH-6 DTUR	0,8	UXT 5
2.3 20V quattro	2.3	125	11.88-07.91	7A	5	Z 89	14 FGH-6 DTUR	0,8	UXT 5
2.6	2.6	110	08.92-12.96	ABC	6	Z 90	14 FGH-7 DTURX	1,0	UXT 13
2.6 quattro	2.6	110	08.92-12.96	ABC	6	Z 90	14 FGH-7 DTURX	1,0	UXT 13
2.8	2.8	128	09.91-12.96	AAH	6	Z 90	14 FGH-7 DTURX	1,0	UXT 13
2.8 quattro	2.8	128	08.91-12.96	AAH	6	Z 90	14 FGH-7 DTURX	1,0	UXT 13



kW

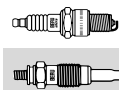
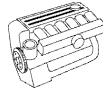

**AUDI**

**Q3**

2.0 TDI	2.0	100	09.11-	CFFA	4	<b>GE 115</b> (4,4V)	○		
2.0 TDI	2.0	103	09.11-	CFFB	4	<b>GE 115</b> (4,4V)	○		
2.0 TDI quattro	2.0	103	01.12-	CFFB	4	<b>GE 115</b> (4,4V)	○		

**Q5 (8R)**

2.0 TDI	2.0	100	11.10-	CJCB	4	<b>GE 115</b> (4,4V)	○		
2.0 TDI quattro	2.0	100	08.09-	CAGB, CJCB	4	<b>GE 115</b> (4,4V)	○		
2.0 TDI	2.0	105	11.10-	CJCA	4	<b>GE 115</b> (4,4V)	○		
2.0 TDI quattro	2.0	105	08.09-	CJCA, CAGA	4	<b>GE 115</b> (4,4V)	○		
2.0 TDI quattro	2.0	120	11.08-	CGLA/CGLD/CAHB	4	<b>GE 115</b> (4,4V)	○		
2.0 TDI quattro	2.0	125	11.08-	CAHA, CGLB, CMGA	4	<b>GE 115</b> (4,4V)	○		
2.0 TFSI quattro	2.0	132	08.09-	CDNB/CNCB	4	<b>Z 347</b>	14 F-5 DPUR02	0,7	○
2.0 TFSI quattro	2.0	155	11.08-	CDNC	4	<b>Z 347</b>	14 F-5 DPUR02	0,7	○
3.0 TDI quattro	3.0	155	11.08-	CCWB	6	<b>GE 115</b> (4,4V)	○		
3.0 TDI quattro	3.0	176	11.08-	CCWA	6	<b>GE 115</b> (4,4V)	○		
3.2 FSI quattro	3.2	199	11.08-	CALB	6	<b>Z 321</b>	14 F-7 KPURU2	1,0	○

**Q7 (4L)**

3.0 TDI	3.0	150	05.10-	CJMA/CJGC	6	<b>GE 115</b> (4,4V)	○		
3.0 TDI	3.0	155	03.06-05.10	CASB/BUN	6	<b>GE 115</b> (4,4V)	○		
3.0 TDI	3.0	165	06.09-05.12	CATA	6	<b>PSG 002</b> (4,4V)=2x <b>GE 115</b> (4,4V)=4x	○		
3.0 TDI	3.0	171	03.06-05.08	BUG	6	<b>GE 115</b> (4,4V)	○		
3.0 TDI	3.0	176	11.07-	CASA, CJGA Fgst.Nr. 4L-7-036 115 →	6	<b>GE 115</b> (4,4V)=6x	○		
3.0 TDI	3.0	176	11.07-	CNRB, CCMA	6	<b>PSG 002</b> (4,4V)=2x <b>GE 115</b> (4,4V)=4x	○		
3.0 TDI	3.0	180	05.11-	CJGD, CRCA	6	<b>GE 115</b> (4,4V)=6x	○		
3.0 TDI	3.0	180	05.11-	CLZB	6	<b>PSG 002</b> (4,4V)=2x <b>GE 115</b> (4,4V)=4x	○		
4.2 TDI	4.2	240	03.07-06.09	BTR	8	<b>GE 115</b> (4,4V)	○		
4.2 TDI	4.2	250	05.09-	CCFA, CCFC	8	<b>GE 115</b> (4,4V)	○		
4.2 FSI	4.2	257	03.06-05.10	BAR	8	<b>Z 295</b>	14 F-6 DTPR02	0,8	○
6.0 TDI	6.0	368	09.08-	CCGA	12	<b>GE 115</b> (4,4V)	○		

**R8**

4.2 FSI quattro	4.2	309	04.07-09.10	BYH	8	<b>Z 295</b>	14 F-6 DTPR02	0,8	○
4.2 FSI quattro	4.2	316	07.10-	CNDA	8	<b>Z 295</b>	14 F-6 DTPR02	0,8	○

**R8 Spyder**

4.2 FSI quattro	4.2	316	09.10-	CNDA	8	<b>Z 295</b>	14 F-6 DTPR02	0,8	○
-----------------	-----	-----	--------	------	---	--------------	---------------	-----	---

**TT (8J3)**

1.8 TFSI	1.8	118	06.08-	CDAА	4	<b>Z 347</b>	14 F-5 DPUR02	0,7	○
2.0 TDI quattro	2.0	125	06.08-	CBBB, CFGB	4	<b>GE 115</b> (4,4V)	○		
2.0 TFSI	2.0	147	08.06-06.10	BPY/BWA/CCTA	4	<b>Z 347</b>	14 F-5 DPUR02	0,7	○
2.0 TFSI quattro	2.0	147	06.08-06.10	CCZA	4	<b>Z 347</b>	14 F-5 DPUR02	0,7	○
2.0 TFSI	2.0	155	05.10-	CESA	4	<b>Z 347</b>	14 F-5 DPUR02	0,7	○
2.0 TFSI quattro	2.0	155	05.10-	CESA/CETA	4	<b>Z 347</b>	14 F-5 DPUR02	0,7	○
2.0 quattro	2.0	195	05.08-	CDLA/CDMA	4	<b>Z 347</b>	14 F-5 DPUR02	0,7	○
2.0 TFSI quattro	2.0	200	05.08-	CDLB	4	<b>Z 347</b>	14 F-5 DPUR02	0,7	○
2.5 TFSI quattro	2.5	250	07.09-	CEPA	5	<b>Z 339</b>	14 F-4 NBPR	0,7	○
2.5 TFSI quattro	2.5	265	05.11-	CEPB	5	<b>Z 339</b>	14 F-4 NBPR	0,7	○

**TT (8N3)**

1.8 T	1.8	110	09.02-06.06	AUM	4	<b>Z 188</b>	14 F-7 DPUR02	0,7	<b>UXT 10</b>
1.8 T	1.8	120	09.05-06.06	BVP	4	<b>Z 188</b>	14 F-7 DPUR02	0,7	<b>UXT 10</b>
1.8 T	1.8	132	10.98-06.06	APP/ARY/ATC/AJQ/AUQ/AWP	4	<b>Z 188</b>	14 F-7 DPUR02	0,7	<b>UXT 10</b>
1.8 T quattro	1.8	132	10.98-06.06	AJQ/ARY/ATC/AWP	4	<b>Z 188</b>	14 F-7 DPUR02	0,7	<b>UXT 10</b>
1.8 T	1.8	140	09.05-06.06	BVR	4	<b>Z 188</b>	14 F-7 DPUR02	0,7	<b>UXT 10</b>
1.8 T quattro	1.8	140	09.05-06.06	BVR	4	<b>Z 188</b>	14 F-7 DPUR02	0,7	<b>UXT 10</b>
1.8 T quattro	1.8	165	10.98-06.06	AMU, APX, BAM	4	<b>Z 188</b>	14 F-7 DPUR02	0,7	<b>UXT 10</b>
1.8 T quattro	1.8	176	03.05-06.06	BFV	4	<b>Z 188</b>	14 F-7 DPUR02	0,7	<b>UXT 10</b>

**TT Roadster (8J9)**

1.8 TFSI	1.8	118	06.08-	CDAА	4	<b>Z 347</b>	14 F-5 DPUR02	0,7	○
2.0 TDI quattro	2.0	125	06.08-	CFGB, CBBB	4	<b>GE 115</b> (4,4V)	○		
2.0 TFSI	2.0	147	03.07-06.10	BPY/BWA/CCTA	4	<b>Z 347</b>	14 F-5 DPUR02	0,7	○

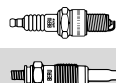

## AUDI

### TT Roadster (8J9)

2.0 TFSI quattro	2.0	147	06.08–06.10	CCZA	4	<b>Z 347</b>	14 F-5 DPUR02	0,7	○
2.0 TFSI	2.0	155	05.10–	CESA	4	<b>Z 347</b>	14 F-5 DPUR02	0,7	○
2.0 TFSI quattro	2.0	155	05.10–	CESA/CETA	4	<b>Z 347</b>	14 F-5 DPUR02	0,7	○
2.0 quattro	2.0	195	05.08–	CDLA, CDMA	4	<b>Z 347</b>	14 F-5 DPUR02	0,7	○
2.0 TFSI quattro	2.0	200	05.08–	CDLB	4	<b>Z 347</b>	14 F-5 DPUR02	0,7	○
2.5 TFSI quattro	2.5	250	07.09–	CEPA	5	<b>Z 339</b>	14 F-4 NBPR	0,7	○
2.5 TFSI quattro	2.5	265	03.12–	CEPB	5	<b>Z 339</b>	14 F-4 NBPR	0,7	○

### TT Roadster (8N9)

1.8 T	1.8	110	01.01–06.06	AUM	4	<b>Z 188</b>	14 F-7 DPUR02	0,7	<b>UXT 10</b>
1.8 T	1.8	120	09.05–06.06	BVP	4	<b>Z 188</b>	14 F-7 DPUR02	0,7	<b>UXT 10</b>
1.8 T	1.8	132	10.99–06.06	AJQ/APP/ATC/AUQ/AWP	4	<b>Z 188</b>	14 F-7 DPUR02	0,7	<b>UXT 10</b>
1.8 T quattro	1.8	132	02.00–06.06	AJQ/ARY/ATC/AWP	4	<b>Z 188</b>	14 F-7 DPUR02	0,7	<b>UXT 10</b>
1.8 T	1.8	140	09.05–06.06	BVR	4	<b>Z 188</b>	14 F-7 DPUR02	0,7	<b>UXT 10</b>
1.8 T quattro	1.8	140	09.05–06.06	BVR	4	<b>Z 188</b>	14 F-7 DPUR02	0,7	<b>UXT 10</b>
1.8 T quattro	1.8	165	10.99–06.06	AMU/APX/BAM	4	<b>Z 188</b>	14 F-7 DPUR02	0,7	<b>UXT 10</b>
3.2 VR6 quattro	3.2	184	07.03–06.06	BPF/BHE	6	<b>Z 306</b>	12 F-6 HPURW	0,9	○

### V8 (44, 4C)

3.6 quattro	3.6	180	04.93–02.94	PT	8	<b>Z 127</b>	14 KGR-7 KQU	1,6	○
3.6 quattro	3.6	184	10.88–02.94	PT	8	<b>Z 127</b>	14 KGR-7 KQU	1,6	○
4.2 quattro	4.2	206	10.91–02.94	ABH	8	<b>Z 127</b>	14 KGR-7 KQU	1,6	○

### 80 (89, 89Q, 8A, B3)

1.6 D	1.6	40	09.86–08.91	JK	4	<b>GN 857</b> (11V)	<b>GR 001</b>	<b>SR 028</b>	
1.6	1.6	51	08.87–09.91	PP	4	<b>Z 93</b>	14 GH-8 DTURX	1,0	<b>UXT 2<sup>4</sup></b>
1.6	1.6	55	09.86–08.91	RN	4	<b>Z 2</b>	14-8 DTU	1,0	<b>UXT 2<sup>4</sup></b>
1.6 TD	1.6	59	09.86–08.91	RA/SB	4	<b>GN 857</b> (11V)	<b>GR 001</b>	<b>SR 028</b>	
1.6	1.6	75	08.90–10.91	ABB	4	<b>Z 20</b>	14 R-7 DU	0,8	<b>UXT 2<sup>4</sup></b>
1.8	1.8	55	10.86–01.90	RU	4	<b>Z 93</b>	14 GH-8 DTURX	1,0	<b>UXT 2<sup>4</sup></b>
1.8 S	1.8	65	09.86–12.90	SF	4	<b>Z 91</b>	14 GH-7 DTUR	0,8	<b>UXT 2<sup>4</sup></b>
1.8 S quattro	1.8	65	09.86–07.90	SF	4	<b>Z 91</b>	14 GH-7 DTUR	0,8	<b>UXT 2<sup>4</sup></b>
1.8 S	1.8	66	09.86–10.91	PM/JN	4	<b>Z 91</b>	14 GH-7 DTUR	0,8	<b>UXT 2<sup>4</sup></b>
1.8 S quattro	1.8	66	09.86–09.91	PM/JN	4	<b>Z 91</b>	14 GH-7 DTUR	0,8	<b>UXT 2<sup>4</sup></b>
1.8 S	1.8	66	09.86–10.91	NE	4	<b>Z 12</b>	14-7 DTU	0,8	<b>UXT 2<sup>4</sup></b>
1.8 S quattro	1.8	66	09.86–09.91	NE	4	<b>Z 12</b>	14-7 DTU	0,8	<b>UXT 2<sup>4</sup></b>
1.8 E	1.8	82	06.86–08.91	DZ	4	<b>Z 12</b>	14-7 DTU	0,8	<b>UXT 2<sup>4</sup></b>
1.8 E quattro	1.8	82	09.86–08.91	DZ	4	<b>Z 12</b>	14-7 DTU	0,8	<b>UXT 2<sup>4</sup></b>
1.8 quattro	1.8	83	09.86–08.90	SD	4	<b>Z 91</b>	14 GH-7 DTUR	0,8	<b>UXT 2<sup>4</sup></b>
1.9 D	1.9	50	08.89–08.91	1Y	4	<b>GN 857</b> (11V)	<b>GR 001</b>	<b>SR 028</b>	
2.0	2.0	82	10.90–08.91	AAD	4	<b>Z 91</b>	14 GH-7 DTUR	0,8	<b>UXT 2<sup>4</sup></b>
2.0 quattro	2.0	82	10.90–08.91	3A	4	<b>Z 91</b>	14 GH-7 DTUR	0,8	<b>UXT 2<sup>4</sup></b>
2.0 E	2.0	83	08.88–10.90	3A	4	<b>Z 91</b>	14 GH-7 DTUR	0,8	<b>UXT 2<sup>4</sup></b>
2.0 E quattro	2.0	83	08.88–09.90	3A	4	<b>Z 91</b>	14 GH-7 DTUR	0,8	<b>UXT 2<sup>4</sup></b>
2.0 quattro	2.0	85	10.90–08.91	AAD	4	<b>Z 91</b>	14 GH-7 DTUR	0,8	<b>UXT 2<sup>4</sup></b>
2.0 E 16V	2.0	101	03.90–09.91	6A	4	<b>Z 105</b>	14 F-6 DSR	0,7	<b>UXT 5</b>
2.0 E 16V quattro	2.0	101	03.90–08.91	6A	4	<b>Z 105</b>	14 F-6 DSR	0,7	<b>UXT 5</b>

### 80 (8C, B4)

1.6	1.6	52	09.91–12.94	ABM	4	<b>Z 92</b>	14 GH-8 DTUR	0,8	<b>UXT 2<sup>4</sup></b>
1.6 E	1.6	74	06.93–12.94	ADA	4	<b>Z 91</b>	14 GH-7 DTUR	0,8	<b>UXT 2<sup>4</sup></b>
1.9 TD	1.9	55	09.91–12.94	AAZ	4	<b>GN 857</b> (11V)	○		
1.9 TDI	1.9	66	09.91–12.94	1Z	4	<b>GN 855</b> (12V)	○		
						Kühlwasservorwärmung <sup>15</sup> M 5/3Nm  Ø 4 mm			
						<b>GN 857</b> (11V)=3x			
						<b>GN 928</b> (12V)=3x			
2.0	2.0	66	09.91–12.94	ABT	4	<b>Z 91</b>	14 GH-7 DTUR	0,8	<b>UXT 2<sup>4</sup></b>
2.0 quattro	2.0	79	11.93–07.94	ADW	4	<b>Z 91</b>	14 GH-7 DTUR	0,8	<b>UXT 2<sup>4</sup></b>
2.0 E	2.0	85	09.91–12.94	ABK	4	<b>Z 91</b>	14 GH-7 DTUR	0,8	<b>UXT 2<sup>4</sup></b>
2.0 E quattro	2.0	85	09.91–12.94	ABK	4	<b>Z 91</b>	14 GH-7 DTUR	0,8	<b>UXT 2<sup>4</sup></b>
2.0 E 16V	2.0	103	08.92–12.94	ACE	4	<b>Z 89</b>	14 FGH-6 DTUR	0,8	<b>UXT 5</b>
2.0 E 16V quattro	2.0	103	04.92–12.94	ACE	4	<b>Z 89</b>	14 FGH-6 DTUR	0,8	<b>UXT 5</b>
2.3 E	2.3	98	09.91–07.93	NG	5	<b>Z 75</b>	14 G-8 DTU	1,2	<b>UXT 2<sup>4</sup></b>
2.3 E quattro	2.3	98	09.91–07.93	NG	5	<b>Z 75</b>	14 G-8 DTU	1,2	<b>UXT 2<sup>4</sup></b>
2.3 E	2.3	98	08.93–12.94	NG	5	<b>Z 94</b>	14 GR-8 DTU	0,8	<b>UXT 2<sup>4</sup></b>
2.3 E quattro	2.3	98	08.93–12.94	NG	5	<b>Z 94</b>	14 GR-8 DTU	0,8	<b>UXT 2<sup>4</sup></b>







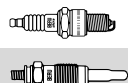

## AUDI

### 100 (4A, C4)

2.0 E 16V quattro	2.0	103	07.92-06.94	ACE	4	<b>Z 89</b>	14 FGH-6 DTUR	0,8	<b>UXT 5</b>
2.3 E	2.3	98	12.90-06.94	AAR	5	<b>Z 94</b>	14 GR-8 DTU	0,8	<b>UXT 2<sup>4</sup></b>
2.3 E quattro	2.3	98	12.90-06.94	AAR	5	<b>Z 94</b>	14 GR-8 DTU	0,8	<b>UXT 2<sup>4</sup></b>
2.4 D	2.4	60	12.90-06.94	AAS	5	<b>GN 857</b> (11V)	○		
2.5 TDI	2.5	85	12.90-06.94	AAT/ABP	5	<b>GN 855</b> (12V)	○		
2.6	2.6	102	07.93-06.94	ACZ	6	<b>Z 90</b>	14 FGH-7 DTURX	1,0	<b>UXT 1<sup>3</sup></b>
2.6 E quattro	2.6	102	08.93-07.94	ACZ	6	<b>Z 90</b>	14 FGH-7 DTURX	1,0	<b>UXT 1<sup>3</sup></b>
2.6	2.6	110	03.92-06.94	ABC	6	<b>Z 90</b>	14 FGH-7 DTURX	1,0	<b>UXT 1<sup>3</sup></b>
2.6 quattro	2.6	110	04.92-06.94	ABC	6	<b>Z 90</b>	14 FGH-7 DTURX	1,0	<b>UXT 1<sup>3</sup></b>
2.8 E	2.8	128	12.90-06.94	AAH	6	<b>Z 90</b>	14 FGH-7 DTURX	1,0	<b>UXT 1<sup>3</sup></b>
2.8 E quattro	2.8	128	12.90-06.94	AAH	6	<b>Z 90</b>	14 FGH-7 DTURX	1,0	<b>UXT 1<sup>3</sup></b>
S4 V8 quattro	4.2	206	10.92-06.94	ABH	8	<b>Z 127</b>	14 KGR-7 KQU	1,6	○
S4 V8 quattro	4.2	213	03.94-06.94	AEC	8	<b>Z 127</b>	14 KGR-7 KQU	1,6	○

### 100 Avant (4A, 44Q, C3)

1.8	1.8	65	02.86-07.90	SH	4	<b>Z 91</b>	14 GH-7 DTUR	0,8	<b>UXT 2<sup>4</sup></b>
1.8 quattro	1.8	65	08.86-07.90	SH	4	<b>Z 91</b>	14 GH-7 DTUR	0,8	<b>UXT 2<sup>4</sup></b>
1.8 KAT	1.8	66	03.85-11.90	4B/PH	4	<b>Z 91</b>	14 GH-7 DTUR	0,8	<b>UXT 2<sup>4</sup></b>
1.8 quattro KAT	1.8	66	08.85-10.90	4B/PH	4	<b>Z 91</b>	14 GH-7 DTUR	0,8	<b>UXT 2<sup>4</sup></b>
2.0 D	2.0	51	03.83-11.90	CN	5	<b>GN 857</b> (11V)	○		
2.0 TD	2.0	74	03.88-11.90	NC	5	<b>GN 857</b> (11V)	○		
2.0 E KAT	2.0	85	01.88-11.90	RT	5	<b>Z 91</b>	14 GH-7 DTUR	0,8	<b>UXT 2<sup>4</sup></b>
2.2 KAT	2.2	101	06.89-11.90	KU/HX	5	<b>Z 51</b>	14-6 DTU	0,8	<b>UX 56</b>
2.2 quattro KAT	2.2	101	06.89-11.90	KU/HX	5	<b>Z 51</b>	14-6 DTU	0,8	<b>UX 56</b>
2.2 Turbo	2.2	121	08.86-11.90	MC	5	<b>Z 12</b>	14-7 DTU	0,8	<b>UXT 2<sup>4</sup></b>
2.2 Turbo quattro	2.2	121	08.86-11.90	MC	5	<b>Z 12</b>	14-7 DTU	0,8	<b>UXT 2<sup>4</sup></b>
2.3	2.3	98	03.90-11.90	AAR	5	<b>Z 94</b>	14 GR-8 DTU	0,8	<b>UXT 2<sup>4</sup></b>
2.3 quattro	2.3	98	01.90-11.90	AAR	5	<b>Z 94</b>	14 GR-8 DTU	0,8	<b>UXT 2<sup>4</sup></b>
2.3	2.3	100	08.86-11.90	NF	5	<b>Z 12</b>	14-7 DTU	0,8	<b>UXT 2<sup>4</sup></b>
2.3 E quattro	2.3	100	08.86-11.90	NF	5	<b>Z 12</b>	14-7 DTU	0,8	<b>UXT 2<sup>4</sup></b>
2.4 D	2.4	60	08.89-11.90	3D	5	<b>GN 857</b> (11V)	○		
2.5 TDI	2.5	88	01.90-11.90	1T	5	<b>GN 855</b> (12V)	○		

### 100 Avant (4A, C4)

2.0 E	2.0	74	09.91-06.94	AAE	4	<b>Z 91</b>	14 GH-7 DTUR	0,8	<b>UXT 2<sup>4</sup></b>
2.0 E	2.0	85	09.91-06.94	AAD/ABK	4	<b>Z 91</b>	14 GH-7 DTUR	0,8	<b>UXT 2<sup>4</sup></b>
2.0 E quattro	2.0	85	12.90-07.92	AAD	4	<b>Z 91</b>	14 GH-7 DTUR	0,8	<b>UXT 2<sup>4</sup></b>
2.0 E 16V	2.0	103	07.92-06.94	ACE	4	<b>Z 89</b>	14 FGH-6 DTUR	0,8	<b>UXT 5</b>
2.0 E 16V quattro	2.0	103	07.92-06.94	ACE	4	<b>Z 89</b>	14 FGH-6 DTUR	0,8	<b>UXT 5</b>
2.3 E	2.3	98	09.91-06.94	AAR	5	<b>Z 94</b>	14 GR-8 DTU	0,8	<b>UXT 2<sup>4</sup></b>
2.3 E quattro	2.3	98	09.91-06.94	AAR	5	<b>Z 94</b>	14 GR-8 DTU	0,8	<b>UXT 2<sup>4</sup></b>
2.4 D	2.4	60	12.90-06.94	AAS	5	<b>GN 857</b> (11V)	○		
2.5 TDI	2.5	85	12.90-06.94	AAT/ABP	5	<b>GN 855</b> (12V)	○		
2.6	2.6	102	07.93-06.94	ACZ	6	<b>Z 90</b>	14 FGH-7 DTURX	1,0	<b>UXT 1<sup>3</sup></b>
2.6 E quattro	2.6	102	08.93-07.94	ACZ	6	<b>Z 90</b>	14 FGH-7 DTURX	1,0	<b>UXT 1<sup>3</sup></b>
2.6	2.6	110	03.92-06.94	ABC	6	<b>Z 90</b>	14 FGH-7 DTURX	1,0	<b>UXT 1<sup>3</sup></b>
2.6 quattro	2.6	110	07.92-06.94	ABC	6	<b>Z 90</b>	14 FGH-7 DTURX	1,0	<b>UXT 1<sup>3</sup></b>
2.8 E	2.8	128	09.91-06.94	AAH	6	<b>Z 90</b>	14 FGH-7 DTURX	1,0	<b>UXT 1<sup>3</sup></b>
2.8 E quattro	2.8	128	09.91-06.94	AAH	6	<b>Z 90</b>	14 FGH-7 DTURX	1,0	<b>UXT 1<sup>3</sup></b>
4.2 S4 V8 quattro	4.2	206	10.92-06.94	ABH	8	<b>Z 127</b>	14 KGR-7 KQU	1,6	○
4.2 S4 V8 quattro	4.2	213	03.94-06.94	AEC	8	<b>Z 127</b>	14 KGR-7 KQU	1,6	○

### 200 (44, 44Q)

2.2 Turbo	2.2	121	08.85-09.91	MC	5	<b>Z 12</b>	14-7 DTU	0,8	<b>UXT 2<sup>4</sup></b>
2.2 Turbo quattro	2.2	121	01.85-12.91	MC	5	<b>Z 12</b>	14-7 DTU	0,8	<b>UXT 2<sup>4</sup></b>
2.2 Turbo	2.2	140	02.88-12.90	2B	5	<b>Z 12</b>	14-7 DTU	0,8	<b>UXT 2<sup>4</sup></b>
2.2 Turbo	2.2	147	02.88-12.90	1B	5	<b>Z 12</b>	14-7 DTU	0,8	<b>UXT 2<sup>4</sup></b>
2.2 Turbo quattro	2.2	147	02.88-11.90	1B	5	<b>Z 12</b>	14-7 DTU	0,8	<b>UXT 2<sup>4</sup></b>
2.3	2.3	100	11.86-09.91	NF	5	<b>Z 12</b>	14-7 DTU	0,8	<b>UXT 2<sup>4</sup></b>

### 200 Avant (44, 44Q)

2.2 Turbo	2.2	121	08.85-09.91	MC	5	<b>Z 12</b>	14-7 DTU	0,8	<b>UXT 2<sup>4</sup></b>
2.2 Turbo quattro	2.2	121	09.83-12.90	MC	5	<b>Z 12</b>	14-7 DTU	0,8	<b>UXT 2<sup>4</sup></b>
2.2 Turbo quattro	2.2	147	02.88-12.91	1B	5	<b>Z 12</b>	14-7 DTU	0,8	<b>UXT 2<sup>4</sup></b>
2.3	2.3	100	11.86-09.91	NF	5	<b>Z 12</b>	14-7 DTU	0,8	<b>UXT 2<sup>4</sup></b>

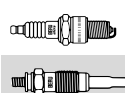
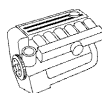

### AUSTIN

#### ALLEGRO

1.3	1.3	43	08.75-	12 L	4	<b>Z 20</b>	14 R-7 DU	0,8	<b>UXT 2<sup>4</sup></b>
-----	-----	----	--------	------	---	-------------	-----------	-----	--------------------------

#### AMBASSADOR

2.0	2.0	75	03.82-		4	<b>Z 25</b>	14 K-6 DU	0,8	<b>UXK 56</b>
-----	-----	----	--------	--	---	-------------	-----------	-----	---------------

#### MAESTRO

1.3 LS	1.3	49	03.83-08.90	12 H	4	<b>Z 11</b>	14-7 DU	0,8	<b>UXT 2<sup>4</sup></b>
1.6 Mayfair HLS	1.6	61	03.83-08.90	16 HC37	4	<b>Z 63</b>	14 F-7 DU	0,8	<b>UXT 1<sup>3</sup></b>
1.6 MG	1.6	73	03.83-08.90	16 HA35AL	4	<b>Z 22</b>	14-6 DU	0,7	<b>UX 56</b>
2.0 Efi	2.0	83	10.84-08.90	20 HA50AA/20 HC51AA/ 20 HC81	4	<b>Z 27</b>	14 R-6 DU	0,8	<b>UX 56</b>

#### METRO

1.0	1.0	30	10.80-04.90	99 H	4	<b>Z 20</b>	14 R-7 DU	0,8	<b>UXT 2<sup>4</sup></b>
1.0	1.0	33	10.80-04.90	99 H	4	<b>Z 20</b>	14 R-7 DU	0,8	<b>UXT 2<sup>4</sup></b>
1.0 Surf HLE	1.0	35	10.80-04.90	99 HA65P	4	<b>Z 20</b>	14 R-7 DU	0,8	<b>UXT 2<sup>4</sup></b>
1.3 L,HLE,S	1.3	44	10.80-04.90	12 H	4	<b>Z 20</b>	14 R-7 DU	0,8	<b>UXT 2<sup>4</sup></b>
1.3 Surf (XF)	1.3	44	11.85-04.90	12 HC21AA	4	<b>Z 11</b>	14-7 DU	0,8	<b>UXT 2<sup>4</sup></b>
1.3	1.3	51	10.80-04.90	12 HA83AA	4	<b>Z 20</b>	14 R-7 DU	0,8	<b>UXT 2<sup>4</sup></b>
1.3 Turbo	1.3	66	10.83-04.90	12 HA85AA	4	<b>Z 27</b>	14 R-6 DU	0,8	<b>UX 56</b>

#### MINI MK I

1000 Mayfair	1.0	31	08.82-06.93	99 HC20P/99 HA53P/ 99 H997P	4	<b>Z 20</b>	14 R-7 DU	0,8	<b>UXT 2<sup>4</sup></b>
1000 Mayfair Sport	1.0	30	09.88-06.93	99 HD81	4	<b>Z 11</b>	14-7 DU	0,8	<b>UXT 2<sup>4</sup></b>

### AUTOBIANCHI

#### Y10

1.0	1.0	33	03.85-	156A2.000	4	<b>Z 15</b>	14 FR-7 DU	0,8	<b>UXT 1<sup>3</sup></b>
1.0 KAT	1.0	33	10.87-	156A2.246	4	<b>Z 15</b>	14 FR-7 DU	0,8	<b>UXT 1<sup>3</sup></b>
1.0 4WD	1.0	37	12.86-	156A3.000	4	<b>Z 15</b>	14 FR-7 DU	0,8	<b>UXT 1<sup>3</sup></b>
1.0	1.0	41	03.85-	156A.000	4	<b>Z 20</b>	14 R-7 DU	0,8	<b>UXT 2<sup>4</sup></b>
1.1	1.1	42	06.89-	156C.000	4	<b>Z 15</b>	14 FR-7 DU	0,8	<b>UXT 1<sup>3</sup></b>
1.1 4WD	1.1	42	06.89-	156C.000	4	<b>Z 15</b>	14 FR-7 DU	0,8	<b>UXT 1<sup>3</sup></b>
1.1 i.e. KAT	1.1	42	09.90-	156C.046	4	<b>Z 247</b>	14 FR-7 DUW	0,9	<b>UXT 1<sup>3</sup></b>
1.3 i.e. GT	1.3	54	06.89-	146A5.046	4	<b>Z 20</b>	14 R-7 DU	0,8	<b>UXT 2<sup>4</sup></b>
1.3 i.e. GT	1.3	57	06.89-	156B.000	4	<b>Z 20</b>	14 R-7 DU	0,8	<b>UXT 2<sup>4</sup></b>

### BARKAS

#### B 1000

1.0	1.0	31	04.67-12.91	H362-21	3	<b>Z 57</b>	14-7 AU	0,6	○
1.0	1.0	34	01.76-12.91	353-1/B1000	3	<b>Z 57</b>	14-7 AU	0,6	○
1.3	1.3	43	01.76-12.91	4 V07.2/7.5 GRF	4	<b>Z 57</b>	14-7 AU	0,6	○

### BEDFORD

#### MIDI

2.2 D	2.2	45	06.88-08.92	22DIE	4	<b>GV 947</b> (11V)	○		
2.2 D	2.2	45	06.88-08.92	22DIE	4	<b>GV 945</b> (5V)	○		
2.2 D 4WD	2.2	45	06.88-08.92	22DIE	4	<b>GV 947</b> (11V)	○		
2.2 D 4WD	2.2	45	06.88-08.92	22DIE	4	<b>GV 945</b> (5V)	○		

#### RASCAL

1.0	1.0	34	07.86-06.90	FA10A	4	<b>Z 20</b>	14 R-7 DU	0,8	<b>UXT 2<sup>4</sup></b>
-----	-----	----	-------------	-------	---	-------------	-----------	-----	--------------------------

### BENTLEY

#### ARNAGE II

6.8 V8 T	6.8	336	02.02-10.09		8	<b>Z 228</b>	14 FR-7 DPX02	1,0	<b>UXT 11</b>
----------	-----	-----	-------------	--	---	--------------	---------------	-----	---------------

### BERTONE

#### FREELIMBER

2.0	2.0	95	12.90-12.93	BMW M20 B20	6	<b>Z 3</b>	14-8 LUR	0,7	<b>UXT 2<sup>4</sup></b>
2.0 KAT	2.0	95	12.90-12.93	BMW M20 B20 Kat	6	<b>Z 3</b>	14-8 LUR	0,7	<b>UXT 2<sup>4</sup></b>
2.4 TD	2.4	85	06.89-12.93	M21 D24	6	<b>GV 719</b> (11V)	○		
2.7	2.7	95	12.90-12.93	BMW M20 B27	6	<b>Z 3</b>	14-8 LUR	0,7	<b>UXT 2<sup>4</sup></b>

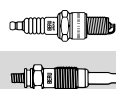

BMW										
<b>1 (E81, E87)</b>										
116 i	1.6	85	09.04–	N45 B16/N45 B16 TU2/ N45 B16 A/N43 B16 A	4	<b>Z 239</b>	14 FGR-7 KQE	1,6		○
118 d	2.0	90	09.04–	M47N 204 D4	4	<b>GE 102 (5V)</b>	<b>GSE 101</b>			
118 i	2.0	95	09.04–	N46 B20	4	<b>Z 301</b>	14 FR-7 LPUX02	1,1		○
120 i	2.0	110	09.04–	N46 B20	4	<b>Z 301</b>	14 FR-7 LPUX02	1,1		○
120 d	2.0	120	09.04–	M47N 204 D4	4	<b>GE 102 (5V)</b>	<b>GSE 101</b>			
130 i	3.0	190	03.05–	N52 B30 A	6	<b>Z 235</b>	14 FR-7 SPUX03	1,0		○
130 i	3.0	195	09.05–09.09	N52 B30 A/N52 B30	6	<b>Z 235</b>	14 FR-7 SPUX03	1,0		○
<b>1 (F20)</b>										
116 i	1.6	100	12.10–	N13 B16 A	4	<b>Z 332</b>	12 ZR-6 SPP2-1	0,7		○
118 i	1.6	125	11.10–	N13 B16 A	4	<b>Z 332</b>	12 ZR-6 SPP2-1	0,7		○
<b>1 Cabriolet (E88)</b>										
125 i	3.0	160	03.08–09.09	N52 B30 A	6	<b>Z 235</b>	14 FR-7 SPUX03	1,0		○
<b>1 Coupe (E82)</b>										
125 i	3.0	160	10.07–09.09	N53 B30 A	6	<b>Z 235</b>	14 FR-7 SPUX03	1,0		○
<b>3 (E30)</b>										
315	1.6	55	09.82–12.91	M10 B16	4	<b>Z 1</b>	14-8 DU	0,8		<b>UXT 2<sup>4</sup></b>
316 (Ecotronic)	1.8	66	09.83–12.90	M10 B18	4	<b>Z 1</b>	14-8 DU	0,8		<b>UXT 2<sup>4</sup></b>
316 i	1.6	73	09.88–06.91	M40 B16 (Kat.)	4	<b>Z 4</b>	14 F-8 LUR	0,7		<b>UXT 1<sup>3</sup></b>
316 i	1.6	75	07.88–06.91	M40 B16	4	<b>Z 4</b>	14 F-8 LUR	0,7		<b>UXT 1<sup>3</sup></b>
318 i	1.8	83	09.87–06.91	M40 B18	4	<b>Z 4</b>	14 F-8 LUR	0,7		<b>UXT 1<sup>3</sup></b>
318 i	1.8	85	09.87–06.91	M40 B18	4	<b>Z 4</b>	14 F-8 LUR	0,7		<b>UXT 1<sup>3</sup></b>
318 is	1.8	100	09.89–08.91	M42 B18	4	<b>Z 14</b>	14 F-7 LDUR4	0,9		<b>UXT 1<sup>3</sup></b>
320 i	2.0	95	12.85–06.91	M20 B20	6	<b>Z 3</b>	14-8 LUR	0,7		<b>UXT 2<sup>4</sup></b>
320 i	2.0	110	12.85–06.90	M20 B20	6	<b>Z 14</b>	14 F-7 LDUR4	0,9		<b>UXT 1<sup>3</sup></b>
324 d	2.4	63	09.85–08.91	M21 D24 W	6	<b>GV 636 (11V)</b>	○			
324 td	2.4	85	09.87–08.91	M21 D24/M21 D24 WA	6	<b>GV 719 (11V)</b>	○			
325 i	2.5	125	12.86–06.91	M20 B25	6	<b>Z 3</b>	14-8 LUR	0,7		<b>UXT 2<sup>4</sup></b>
325 i X	2.5	125	12.86–08.91	M20 B25	6	<b>Z 3</b>	14-8 LUR	0,7		<b>UXT 2<sup>4</sup></b>
<b>3 (E36)</b>										
316 i	1.6	73	09.90–09.93	M40 B16 (Kat.)	4	<b>Z 14</b>	14 F-7 LDUR4	0,9		<b>UXT 1<sup>3</sup></b>
316 i	1.6	75	09.90–09.93	M43 B16/M40 B16	4	<b>Z 14</b>	14 F-7 LDUR4	0,9		<b>UXT 1<sup>3</sup></b>
316 i	1.6	75	07.93–02.98	M43 B16	4	<b>Z 14</b>	14 F-7 LDUR4	0,9		<b>UXT 1<sup>3</sup></b>
318 tds	1.8	66	01.95–02.98	M41 D18 (Inter.)	4	<b>GV 719 (11V)</b>	○			
318 i	1.8	83	12.90–10.93	M40 B18	4	<b>Z 14</b>	14 F-7 LDUR4	0,9		<b>UXT 1<sup>3</sup></b>
318 i	1.8	85	10.93–02.98	M43 B18	4	<b>Z 14</b>	14 F-7 LDUR4	0,9		<b>UXT 1<sup>3</sup></b>
318 is	1.8	103	03.93–02.98	M42 B18	4	<b>Z 14</b>	14 F-7 LDUR4	0,9		<b>UXT 1<sup>3</sup></b>
318 is	1.9	103	09.95–02.98	M44 B19	4	<b>Z 14</b>	14 F-7 LDUR4	0,9		<b>UXT 1<sup>3</sup></b>
320 i	2.0	110	09.90–02.98	M52 B(20 6 S3) Vanos/ M50 B(20 6 S2) Vanos/ M50 B20/M50 B(20 6 S1)/ M52 B20/M50 B20 TU	6	<b>Z 14</b>	14 F-7 LDUR4	0,9		<b>UXT 1<sup>3</sup></b>
323 i 2.5	2.5	125	03.95–02.98	M52 B25 (Vanos)	6	<b>Z 14</b>	14 F-7 LDUR4	0,9		<b>UXT 1<sup>3</sup></b>
325 td	2.5	85	09.91–02.98	M51 D25	6	<b>GV 719 (11V)</b>	○			
325 tds	2.5	105	05.93–02.98	M51 D25 (Inter.)	6	<b>GV 719 (11V)</b>	○			
325 i	2.5	141	09.90–09.95	M50 B25/M50 B25 TU/ M50 B25 (Vanos)	6	<b>Z 14</b>	14 F-7 LDUR4	0,9		<b>UXT 1<sup>3</sup></b>
328 i	2.8	142	01.95–02.98	M52 B28/M52 B28 TU	6	<b>Z 14</b>	14 F-7 LDUR4	0,9		<b>UXT 1<sup>3</sup></b>
<b>3 (E46)</b>										
316 i	1.6	77	04.00–02.05	M43 B16/M43 B16 (16 4 E3)	4	<b>Z 237</b>	14 FR-7 DQUP7	1,6		○
316 i	1.8	85	02.02–03.04	N42 B18	4	<b>Z 237</b>	14 FR-7 DQUP7	1,6		○
316 i	1.6	85	06.02–02.05	N45 B16/N45 B16 A	4	<b>Z 301</b>	14 FR-7 LPUX02	1,1		○
316 i	1.8	85	02.02–02.05	N46 B18/N46 B18 A	4	<b>Z 301</b>	14 FR-7 LPUX02	1,1		○
316 i	1.9	77	09.98–02.05	M43 B19 TU/M43 164 E3	4	<b>Z 237</b>	14 FR-7 DQUP7	1,6		○
318 d	2.0	85	09.01–03.03	M47 ECE L N	4	<b>GN 024 (11V)</b>	○			
318 d	2.0	85	09.01–03.03	M47N ECE L N	4	<b>GE 102 (5V)</b>	<b>GSE 101</b>			
318 d	2.0	85	03.03–02.05	M47N 204 D4	4	<b>GE 102 (5V)</b>	<b>GSE 101</b>			
318 i	1.9	87	02.98–09.01	M43 B19/M43 B19 TU	4	<b>Z 237</b>	14 FR-7 DQUP7	1,6		○
318 i	2.0	105	09.01–03.04	N42B20	4	<b>Z 237</b>	14 FR-7 DQUP7	1,6		○
318 i	2.0	105	09.01–02.05	N46 B20/N46 B20 A	4	<b>Z 301</b>	14 FR-7 LPUX02	1,1		○
320 d	2.0	100	04.98–09.01	M47 D20/M47 204 D1	4	<b>GN 024 (11V)</b>	○			

● nicht erforderlich  
○ nicht im Programm

<sup>3</sup> wahlweise UXT 3 Platin

<sup>4</sup> wahlweise UXT 6 Platin

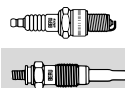
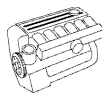

### BMW

#### 3 (E46)

320 d	2.0	110	09.01-02.05	M47N 204 D4	4	<b>GE 102 (5V)</b>	<b>GSE 101</b>		
320 i	2.0	110	03.98-09.00	M52 B(20 6 S3) Vanos/ M52 B20	6	<b>Z 237</b>	14 FR-7 DQUP7	1,6	○
320 i	2.2	125	09.00-02.05	M54 226 S1/M54 B22	6	<b>Z 237</b>	14 FR-7 DQUP7	1,6	○
323 i	2.5	125	03.98-09.00	M52 B25 TU/M52 B25 (Vanos)	6	<b>Z 237</b>	14 FR-7 DQUP7	1,6	○
325 i	2.5	141	09.00-02.05	M54 256 S5/M54 B25	6	<b>Z 237</b>	14 FR-7 DQUP7	1,6	○
325 xi	2.5	141	09.00-02.05	M54 256 S5	6	<b>Z 237</b>	14 FR-7 DQUP7	1,6	○
328 i	2.8	142	02.98-06.00	M52 B28	6	<b>Z 237</b>	14 FR-7 DQUP7	1,6	○
330 d	2.9	135	10.99-02.05	M57 D30/M57 306 D1	6	<b>GN 024 (11V)</b>	○		
330 xd	2.9	135	06.00-02.05	M57 D30	6	<b>GN 024 (11V)</b>	○		
330 d	3.0	150	03.03-02.05	M57N 306 D2	6	<b>GE 102 (5V)</b>	<b>GSE 102</b>		
330 xd	3.0	150	03.03-02.05	M57N 306 D2	6	<b>GE 102 (5V)</b>	<b>GSE 102</b>		
330 i	3.0	170	06.00-02.05	M54 B30 /M54 306 S3	6	<b>Z 237</b>	14 FR-7 DQUP7	1,6	○
330 xi	3.0	170	06.00-02.05	M54 306 S3	6	<b>Z 237</b>	14 FR-7 DQUP7	1,6	○

#### 3 (E90)

316 d	2.0	85	07.09-	N 47 N	4	<b>CGP 001 (5,4V)</b>	○		
316 i	1.6	85	02.06-	N45 B16/N45 B16 TU2/ N45 B16 A	4	<b>Z 239</b>	14 FGR-7 KQE	1,6	○
318 d	2.0	90	09.05-	M47N 204 D4	4	<b>GE 102 (5V)</b>	<b>GSE 101</b>		
318 i	2.0	95	09.05-03.07	N46 B20 B/N46 B20	4	<b>Z 301</b>	14 FR-7 LPUX02	1,1	○
318 d	2.0	100	07.07-02.11	N 47 N	4	<b>CGP 001 (5,4V)</b>	○		
320 d	2.0	110	09.05-	M47N 204 D4	4	<b>GE 102 (5V)</b>	<b>GSE 101</b>		
320 i	2.0	110	01.05-03.07	N46 B20 A/N46 B20/ N46 B20 C	4	<b>Z 301</b>	14 FR-7 LPUX02	1,1	○
323 i	2.5	130	04.06-06.07	N52 B25 A/N52N B25 A	6	<b>Z 235</b>	14 FR-7 SPUX03	1,0	○
325 i	2.5	160	01.05-	N52 B25/N52 B25 A	6	<b>Z 235</b>	14 FR-7 SPUX03	1,0	○
325 xi	2.5	160	09.05-	N52 B25 A	6	<b>Z 235</b>	14 FR-7 SPUX03	1,0	○
325 d	3.0	145	09.06-	M57 306 D3	6	<b>GE 102 (5V)</b>	<b>GSE 102</b>		
328 i	3.0	187	07.05-11.07	N52N B30 A	6	<b>Z 235</b>	14 FR-7 SPUX03	1,0	○
330 d	3.0	170	09.05-	M57 306 D3	6	<b>GE 102 (5V)</b>	<b>GSE 102</b>		
330 xd	3.0	170	09.05-	M57 306 D3	6	<b>GE 102 (5V)</b>	<b>GSE 102</b>		
330 i	3.0	190	01.05-	N52 B30 A/N52 B30	6	<b>Z 235</b>	14 FR-7 SPUX03	1,0	○
330 xi	3.0	190	01.05-	N52 B30 A	6	<b>Z 235</b>	14 FR-7 SPUX03	1,0	○
335 d	3.0	210	09.06-	M57N 306 D5	6	<b>GE 102 (5V)</b>	<b>GSE 102</b>		

#### 3 Cabriolet (E30)

318 i	1.8	83	09.90-10.93	M40 B18	4	<b>Z 4</b>	14 F-8 LUR	0,7	<b>UXT 1<sup>3</sup></b>
318 i	1.8	103	06.88-02.92	M40 B18 C	4	<b>Z 14</b>	14 F-7 LDUR4	0,9	<b>UXT 1<sup>3</sup></b>
320 i	2.0	95	04.86-10.93	M20 B20	6	<b>Z 3</b>	14-8 LUR	0,7	<b>UXT 2<sup>4</sup></b>
325 i	2.5	125	09.87-10.93	M20 B25	6	<b>Z 3</b>	14-8 LUR	0,7	<b>UXT 2<sup>4</sup></b>

#### 3 Cabriolet (E36)

318 i	1.8	85	01.94-04.99	M43 B18	4	<b>Z 14</b>	14 F-7 LDUR4	0,9	<b>UXT 1<sup>3</sup></b>
320 i	2.0	110	12.93-04.99	M52 B(20 6 S3) Vanos/ M50 B(20 6 S2) Vanos/ M50 B20/M52 B20/ M50 B20 TU	6	<b>Z 14</b>	14 F-7 LDUR4	0,9	<b>UXT 1<sup>3</sup></b>
323 i	2.5	125	06.95-04.99	M52 B25 (Vanos)	6	<b>Z 14</b>	14 F-7 LDUR4	0,9	<b>UXT 1<sup>3</sup></b>
325 i	2.5	141	03.93-03.95	M50 B25/M50 B25 TU	6	<b>Z 14</b>	14 F-7 LDUR4	0,9	<b>UXT 1<sup>3</sup></b>
328 i	2.8	142	03.95-04.99	M52 B28/M52 B28 TU	6	<b>Z 14</b>	14 F-7 LDUR4	0,9	<b>UXT 1<sup>3</sup></b>

#### 3 Cabriolet (E46)

318 Ci	2.0	105	09.01-	N42 B20	4	<b>Z 237</b>	14 FR-7 DQUP7	1,6	○
318 Ci	2.0	105	09.01-	N46 B20	4	<b>Z 301</b>	14 FR-7 LPUX02	1,1	○
318 Ci	2.0	110	02.05-	N46 B20 B	4	<b>Z 301</b>	14 FR-7 LPUX02	1,1	○
320 Cd	2.0	110	02.05-	M47N 204 D4	4	<b>GE 102 (5V)</b>	<b>GSE 101</b>		
320 Ci	2.2	125	09.00-	M54 226 S1/M54 B22	6	<b>Z 237</b>	14 FR-7 DQUP7	1,6	○
323 Ci	2.5	125	04.00-09.00	M52 B25 (Vanos)	6	<b>Z 237</b>	14 FR-7 DQUP7	1,6	○
325 Ci	2.5	141	09.00-	M54 256 S5	6	<b>Z 237</b>	14 FR-7 DQUP7	1,6	○
330 Cd	3.0	150	08.05-	M57N 306 D2	6	<b>GE 102 (5V)</b>	<b>GSE 102</b>		
330 Ci	3.0	170	06.00-	M54 306 S3	6	<b>Z 237</b>	14 FR-7 DQUP7	1,6	○

#### 3 Cabriolet (E93)

320 i	2.0	110	03.07-08.07	N46N B20 B/N46 B20	4	<b>Z 301</b>	14 FR-7 LPUX02	1,1	○
-------	-----	-----	-------------	--------------------	---	--------------	----------------	-----	---

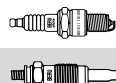

## BMW

### 3 Cabriolet (E93)

325 i	2.5	160	03.07-	N52 B25/N52 B25 A	6	<b>Z 235</b>	14 FR-7 SPUX03	1,0	○
-------	-----	-----	--------	-------------------	---	--------------	----------------	-----	---

### 3 Compact (E36)

316 g	1.6	75	12.95-08.00	M43 B16	4	<b>Z 14</b>	14 F-7 LDUR4	0,9	<b>UXT 1<sup>3</sup></b>
316 i	1.6	75	03.94-08.00	M43 B16	4	<b>Z 14</b>	14 F-7 LDUR4	0,9	<b>UXT 1<sup>3</sup></b>
316 i	1.9	77	12.98-08.00	M43 B19 TU/M43 164 E3	4	<b>Z 14</b>	14 F-7 LDUR4	0,9	<b>UXT 1<sup>3</sup></b>
318 tds	1.8	66	01.95-08.00	M41 D18 (Inter.)	4	<b>GV 719</b> (11V)	○		
318 ti	1.8	103	11.94-08.95	M42 B18	4	<b>Z 14</b>	14 F-7 LDUR4	0,9	<b>UXT 1<sup>3</sup></b>
318 ti	1.9	103	07.95-08.00	M44 B19	4	<b>Z 14</b>	14 F-7 LDUR4	0,9	<b>UXT 1<sup>3</sup></b>
323 ti	2.5	125	08.97-08.00	M52 B25 (Vanos)	6	<b>Z 14</b>	14 F-7 LDUR4	0,9	<b>UXT 1<sup>3</sup></b>

### 3 Compact (E46)

316 ti	1.6	85	06.02-02.05	N45 B16 A	4	<b>Z 301</b>	14 FR-7 LPUX02	1,1	○
316 ti	1.8	85	06.01-03.04	N42 B18	4	<b>Z 237</b>	14 FR-7 DQUP7	1,6	○
316 ti	1.8	85	06.01-02.05	N46 B18 A	4	<b>Z 301</b>	14 FR-7 LPUX02	1,1	○
318 td	2.0	85	03.03-02.05	M47N 204 D4	4	<b>GE 102</b> (5V)	<b>GSE 101</b>		
318 ti	2.0	105	09.01-02.05	N42 B20	4	<b>Z 237</b>	14 FR-7 DQUP7	1,6	○
318 ti	2.0	105	09.01-02.05	N46 B20 A	4	<b>Z 301</b>	14 FR-7 LPUX02	1,1	○
320 td	2.0	110	09.01-02.05	M47N 204 D4	4	<b>GE 102</b> (5V)	○		
325 ti	2.5	141	06.01-02.05	M54 256 S5/M54 B25	6	<b>Z 237</b>	14 FR-7 DQUP7	1,6	○

### 3 Coupe (E36)

316 i	1.6	75	09.93-04.99	M43 B16	4	<b>Z 14</b>	14 F-7 LDUR4	0,9	<b>UXT 1<sup>3</sup></b>
318 is	1.8	103	03.92-10.95	M42 B18	4	<b>Z 14</b>	14 F-7 LDUR4	0,9	<b>UXT 1<sup>3</sup></b>
318 is	1.9	103	09.95-04.99	M44 B19	4	<b>Z 14</b>	14 F-7 LDUR4	0,9	<b>UXT 1<sup>3</sup></b>
320 i	2.0	110	03.92-04.99	M52 B(20 6 S3) Vanos/ M50 B(20 6 S2) Vanos/ M50 B20/M50 B(20 6 S1)/ M52 B20/M50 B20 TU	6	<b>Z 14</b>	14 F-7 LDUR4	0,9	<b>UXT 1<sup>3</sup></b>
323 i	2.5	125	03.95-04.99	M52 B25 (Vanos)	6	<b>Z 14</b>	14 F-7 LDUR4	0,9	<b>UXT 1<sup>3</sup></b>
325 i	2.5	141	03.92-04.99	M50 B25/M50 B25 TU/ M50 B25 (Vanos)	6	<b>Z 14</b>	14 F-7 LDUR4	0,9	<b>UXT 1<sup>3</sup></b>
328 i	2.8	142	01.95-04.99	M52 B28/M52 B28 TU	6	<b>Z 14</b>	14 F-7 LDUR4	0,9	<b>UXT 1<sup>3</sup></b>

### 3 Coupe (E46)

316 Ci	1.6	77	04.00-	M43 B16 (16 4 E3)	4	<b>Z 237</b>	14 FR-7 DQUP7	1,6	○
316 Ci	1.6	85	06.02-	N45 B16 A	4	<b>Z 239</b>	14 FGR-7 KQE	1,6	○
318 Ci	1.9	87	11.99-09.01	M43 B19	4	<b>Z 237</b>	14 FR-7 DQUP7	1,6	○
318 Ci	2.0	105	09.01-	N42B20	4	<b>Z 237</b>	14 FR-7 DQUP7	1,6	○
318 Ci	2.0	105	09.01-	N46 B20	4	<b>Z 301</b>	14 FR-7 LPUX02	1,1	○
318 Ci	2.0	110	03.05-	N46 B20 A	4	<b>Z 301</b>	14 FR-7 LPUX02	1,1	○
320 Cd	2.0	110	11.03-	M47N 204 D4	4	<b>GE 102</b> (5V)	<b>GSE 101</b>		
320 Ci	2.0	110	08.99-09.00	M52 B(20 6 S4)/M52 B20	6	<b>Z 237</b>	14 FR-7 DQUP7	1,6	○
320 Ci	2.2	125	09.00-	M54 226 S1/M54 B22	6	<b>Z 237</b>	14 FR-7 DQUP7	1,6	○
323 Ci	2.5	125	04.99-09.00	M52 B25 (Vanos)	6	<b>Z 237</b>	14 FR-7 DQUP7	1,6	○
325 Ci	2.5	141	09.00-	M54 256 S5	6	<b>Z 237</b>	14 FR-7 DQUP7	1,6	○
328 Ci	2.8	142	04.99-06.00	M52 B28	6	<b>Z 237</b>	14 FR-7 DQUP7	1,6	○
330 Cd	3.0	150	03.03-	M57N 306 D2	6	<b>GE 102</b> (5V)	<b>GSE 102</b>		
330 Ci	3.0	170	06.00-05.06	M54 306 S3	6	<b>Z 237</b>	14 FR-7 DQUP7	1,6	○
330 xi	3.0	170	06.00-	M54 306 S3	6	<b>Z 237</b>	14 FR-7 DQUP7	1,6	○

### 3 Coupe (E92)

320 i	2.0	110	11.06-06.07	N46 B20 A/N46N B20 B	4	<b>Z 301</b>	14 FR-7 LPUX02	1,1	○
325 i	2.5	160	09.06-	N52 B25/N52 B25 C/ N52 B25 A	6	<b>Z 235</b>	14 FR-7 SPUX03	1,0	○
325 xi	2.5	160	09.06-	N52 B25 C/N52 B25 A	6	<b>Z 235</b>	14 FR-7 SPUX03	1,0	○
325 d	3.0	145	03.07-	M57 D 30 TU2	6	<b>GE 102</b> (5V)	<b>GSE 102</b>		
330 d	3.0	170	09.06-	M57 D30 TU2/M57 306 D3	6	<b>GE 102</b> (5V)	<b>GSE 102</b>		
330 xd	3.0	170	09.06-	M57 D30 TU2/M57 306 D3	6	<b>GE 102</b> (5V)	<b>GSE 102</b>		
330 i	3.0	190	09.06-	N52 B30 A	6	<b>Z 235</b>	14 FR-7 SPUX03	1,0	○
330 xi	3.0	190	09.06-	N52 B30 A	6	<b>Z 235</b>	14 FR-7 SPUX03	1,0	○
330 xi	3.0	200	09.06-	N52 B30 A	6	<b>Z 235</b>	14 FR-7 SPUX03	1,0	○
335 d	3.0	210	09.06-	M57N 306 D5	6	<b>GE 102</b> (5V)	<b>GSE 102</b>		

### 3 Touring (E30)

316 i	1.6	73	09.91-06.94	M40 B16 (Kat.)	4	<b>Z 4</b>	14 F-8 LUR	0,7	<b>UXT 1<sup>3</sup></b>
316 i	1.6	75	09.91-06.94	M40 B16	4	<b>Z 4</b>	14 F-8 LUR	0,7	<b>UXT 1<sup>3</sup></b>

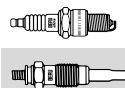
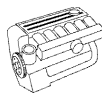
**BMW**
**3 Touring (E30)**

318 i	1.8	83	04.89-12.93	M40 B18	4	<b>Z 4</b>	14 F-8 LUR	0,7	<b>UXT 1<sup>3</sup></b>
320 i	2.0	95	01.88-12.91	M20 B20	6	<b>Z 3</b>	14-8 LUR	0,7	<b>UXT 2<sup>4</sup></b>
324 td	2.4	85	01.88-06.93	M21 D24/M21 D24 WA	6	<b>GV 719 (11V)</b>	○		
325 i	2.5	125	07.87-03.93	M20 B25	6	<b>Z 3</b>	14-8 LUR	0,7	<b>UXT 2<sup>4</sup></b>
325 i X	2.5	125	06.88-10.93	M20 B25	6	<b>Z 3</b>	14-8 LUR	0,7	<b>UXT 2<sup>4</sup></b>

**3 Touring (E36)**

316 i	1.6	75	01.96-10.99	M43 B16	4	<b>Z 14</b>	14 F-7 LDUR4	0,9	<b>UXT 1<sup>3</sup></b>
318 tds	1.8	66	01.95-10.99	M41 D18 (Inter.)	4	<b>GV 719 (11V)</b>	○		
318 i	1.8	85	07.95-10.99	M43 B18	4	<b>Z 14</b>	14 F-7 LDUR4	0,9	<b>UXT 1<sup>3</sup></b>
320 i	2.0	110	01.95-10.99	M52 B(20 6 S3) Vanos/ M50 B20/M52 B20/ M50 B20 TU	6	<b>Z 14</b>	14 F-7 LDUR4	0,9	<b>UXT 1<sup>3</sup></b>
323 i	2.5	125	09.95-10.99	M52 B25 (Vanos)	6	<b>Z 14</b>	14 F-7 LDUR4	0,9	<b>UXT 1<sup>3</sup></b>
325 tds	2.5	105	01.95-10.99	M51 D25 (Inter.)	6	<b>GV 719 (11V)</b>	○		
328 i	2.8	142	01.95-10.99	M52 B28/M52 B28 TU	6	<b>Z 14</b>	14 F-7 LDUR4	0,9	<b>UXT 1<sup>3</sup></b>

**3 Touring (E46)**

316 i	1.6	85	06.02-02.05	N45 B16/N45 B16 A	4	<b>Z 239</b>	14 FGR-7 KQE	1,6	○
316 i	1.8	85	03.02-02.05	N42 B18	4	<b>Z 237</b>	14 FR-7 DQUP7	1,6	○
316 i	1.8	85	03.02-02.05	N46 B18/N46 B18 A	4	<b>Z 301</b>	14 FR-7 LPUX02	1,1	○
318 i	1.9	87	10.99-09.01	M43 B19/M43 B19 TU	4	<b>Z 237</b>	14 FR-7 DQUP7	1,6	○
318 d	2.0	85	03.02-02.05	M47 ECE L N	4	<b>GN 024 (11V)</b>	○		
318 d	2.0	85	03.02-02.05	M47N ECE L N	4	<b>GE 102 (5V)</b>	<b>GSE 101</b>		
318 d	2.0	85	03.03-02.05	M47N 204 D4	4	<b>GE 102 (5V)</b>	<b>GSE 101</b>		
318 i	2.0	105	09.01-02.05	N42 B20	4	<b>Z 237</b>	14 FR-7 DQUP7	1,6	○
318 i	2.0	105	09.01-02.05	N46 B20/N46 B20 A	4	<b>Z 301</b>	14 FR-7 LPUX02	1,1	○
320 d	2.0	100	03.00-09.01	M47 D20/M47 204 D1	4	<b>GN 024 (11V)</b>	○		
320 d	2.0	110	09.01-02.05	M47N 204 D4	4	<b>GE 102 (5V)</b>	<b>GSE 101</b>		
320 i	2.0	110	10.99-09.00	M52 B(20 6 S3) Vanos/ M52 B20	6	<b>Z 237</b>	14 FR-7 DQUP7	1,6	○
320 i	2.2	125	09.00-02.05	M54 226 S1/M54 B22	6	<b>Z 237</b>	14 FR-7 DQUP7	1,6	○
325 i	2.5	141	09.00-02.05	M54 256 S5/M54 B25	6	<b>Z 237</b>	14 FR-7 DQUP7	1,6	○
325 xi	2.5	141	09.00-02.05	M54 256 S5	6	<b>Z 237</b>	14 FR-7 DQUP7	1,6	○
328 i	2.8	142	10.99-06.00	M52 B28	6	<b>Z 237</b>	14 FR-7 DQUP7	1,6	○
330 d	2.9	135	10.99-02.05	M57 D30/M57 306 D1	6	<b>GN 024 (11V)</b>	○		
330 xd	2.9	135	06.00-02.05	M57 D30	6	<b>GN 024 (11V)</b>	○		
330 d	3.0	150	03.03-02.05	M57N 306 D2	6	<b>GE 102 (5V)</b>	<b>GSE 102</b>		
330 xd	3.0	150	03.03-02.05	M57N 306 D2	6	<b>GE 102 (5V)</b>	<b>GSE 102</b>		
330 i	3.0	170	06.00-02.05	M54 B30 /M54 306 S3	6	<b>Z 237</b>	14 FR-7 DQUP7	1,6	○
330 xi	3.0	170	06.00-02.05	M54 306 S3	6	<b>Z 237</b>	14 FR-7 DQUP7	1,6	○

**3 Touring (E91)**

316 d	2.0	85	09.09-02.11	N 47 N	4	<b>CGP 001 (5,4V)</b>	○		
318 d	2.0	90	09.05-	M47N 204 D4	4	<b>GE 102 (5V)</b>	<b>GSE 101</b>		
318 i	2.0	95	01.06-	N46 B20 B/N46 B20	4	<b>Z 301</b>	14 FR-7 LPUX02	1,1	○
318 d	2.0	105	09.07-02.11	N 47 N	4	<b>CGP 001 (5,4V)</b>	○		
320 d	2.0	110	09.05-	M47N 204 D4	4	<b>GE 102 (5V)</b>	<b>GSE 101</b>		
320 i	2.0	110	09.05-	N46 B20 A/N46 B20/ N46 B20 C	4	<b>Z 301</b>	14 FR-7 LPUX02	1,1	○
320 d	2.0	120	09.05-	M47N 204 D5	4	<b>GE 102 (5V)</b>	○		
323 i	2.5	130	04.06-06.07	N52N B25 A	6	<b>Z 235</b>	14 FR-7 SPUX03	1,0	○
325 d	3.0	145	09.06-	M57 306 D3	6	<b>GE 102 (5V)</b>	<b>GSE 102</b>		
325 i	2.5	160	09.05-09.09	N52 B25/N52 B25 C/ N52 B25 A	6	<b>Z 235</b>	14 FR-7 SPUX03	1,0	○
325 xi	2.5	160	09.05-	N52 B25 C	6	<b>Z 235</b>	14 FR-7 SPUX03	1,0	○
330 d	3.0	170	09.05-	M57 306 D3	6	<b>GE 102 (5V)</b>	<b>GSE 102</b>		
330 xd	3.0	170	09.05-08.08	M57 D30 TU2/M57 306 D3	6	<b>GE 102 (5V)</b>	<b>GSE 102</b>		
330 i	3.0	190	09.05-09.09	N52 B30 A/N52 B30	6	<b>Z 235</b>	14 FR-7 SPUX03	1,0	○
330 xi	3.0	190	09.05-	N52 B30 A	6	<b>Z 235</b>	14 FR-7 SPUX03	1,0	○
335 d	3.0	210	09.06-	M57N 306 D5	6	<b>GE 102 (5V)</b>	<b>GSE 102</b>		

**5 (E28)**

520 i	2.0	110	12.86-06.90		6	<b>Z 14</b>	14 F-7 LDUR4	0,9	<b>UXT 1<sup>3</sup></b>
-------	-----	-----	-------------	--	---	-------------	--------------	-----	--------------------------

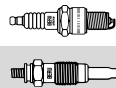
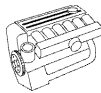

BMW										
5 (E34)										
518 i	1.8	83	08.89-09.95	M40 B18	4	Z 14	14 F-7 LDUR4	0,9		UXT 1 <sup>3</sup>
518 i	1.8	85	08.89-09.95	M43 B18	4	Z 14	14 F-7 LDUR4	0,9		UXT 1 <sup>3</sup>
520 i	2.0	95	01.88-08.91	M20 B20	6	Z 3	14-8 LUR	0,7		UXT 2 <sup>4</sup>
520 i 24V	2.0	110	09.89-09.95	M50 B(20 6 S2) Vanos/ M50 B20/M50 B(20 6 S1)/ M50 B20 TU	6	Z 14	14 F-7 LDUR4	0,9		UXT 1 <sup>3</sup>
524 td	2.4	85	03.88-09.95	M21 D24/M21 D24 WA	6	GV 719 (11V)	○			
525 td	2.5	85	04.93-09.95	M51 D25	6	GV 719 (11V)	○			
525 tds	2.5	105	09.91-09.95	M51 D25 (Inter.)	6	GV 719 (11V)	○			
525 i	2.5	125	01.88-08.91	M20 B25	6	Z 3	14-8 LUR	0,7		UXT 2 <sup>4</sup>
525 i 24V	2.5	141	09.89-09.95	M50 B25/M52 B25 (Vanos)/ M50 B25 TU	6	Z 14	14 F-7 LDUR4	0,9		UXT 1 <sup>3</sup>
525 iX 24V	2.5	141	10.91-09.95	M52 B25 (Vanos)	6	Z 14	14 F-7 LDUR4	0,9		UXT 1 <sup>3</sup>
530 i	3.0	138	01.88-08.91	M30 B30	6	Z 3	14-8 LUR	0,7		UXT 2 <sup>4</sup>
530 i V8	3.0	160	09.92-09.95	M60 B30	8	Z 14	14 F-7 LDUR4	0,9		UXT 1 <sup>3</sup>
535 i	3.4	155	01.88-04.93	M30 B35	6	Z 3	14-8 LUR	0,7		UXT 2 <sup>4</sup>
540 i V8	4.0	210	09.92-09.95	M60 B40	8	Z 14	14 F-7 LDUR4	0,9		UXT 1 <sup>3</sup>
5 (E39)										
520 d	2.0	100	02.00-06.03	M47 D20/M47 204 D1	4	GN 024 (11V)	○			
520 i	2.0	100	04.99-06.03	M52 B(20 6 S3) Vanos	6	Z 237	14 FR-7 DQUP7	1,6		○
520 i	2.0	110	01.96-09.98	M52 B(20 6 S3) Vanos/ M52 B(20 6 S4)/M52 B20	6	Z 14	14 F-7 LDUR4	0,9		UXT 1 <sup>3</sup>
520 i	2.0	110	10.98-09.00	M52 B(20 6 S3) Vanos/ M52 B(20 6 S4)/M52 B20	6	Z 237	14 FR-7 DQUP7	1,6		○
520 i	2.2	125	09.00-06.03	M54 B22	6	Z 237	14 FR-7 DQUP7	1,6		○
523 i	2.5	125	11.95-08.98	M52 B25 TU/M52 B25 (Vanos)	6	Z 14	14 F-7 LDUR4	0,9		UXT 1 <sup>3</sup>
523 i	2.5	125	09.98-09.00	M52 B25 TU/M52 B25 (Vanos)	6	Z 237	14 FR-7 DQUP7	1,6		○
525 td	2.5	85	01.97-06.03	M51 D25	6	GV 719 (11V)	○			
525 tds	2.5	105	01.96-06.03	M51 D25 (Inter.)	6	GV 719 (11V)	○			
525 d	2.5	120	02.00-06.03	M57 D25/M57 256 D1	6	GN 024 (11V)	○			
525 i	2.5	141	09.00-06.03	M54 256 S5/M54 B25	6	Z 237	14 FR-7 DQUP7	1,6		○
528 i	2.8	142	11.95-09.00	M52 B28/M52 B28 TU	6	Z 14	14 F-7 LDUR4	0,9		UXT 1 <sup>3</sup>
530 d	2.9	135	08.98-09.00	M57 D30	6	GN 024 (11V)	○			
530 d	2.9	142	09.00-06.03	M57 D30	6	GN 024 (11V)	○			
530 i	3.0	170	09.00-06.03	M54 B30 /M54 306 S3	6	Z 237	14 FR-7 DQUP7	1,6		○
535 i	3.5	173	04.96-08.98	M62 B(35 8 S1)/M62 B35	8	Z 14	14 F-7 LDUR4	0,9		UXT 1 <sup>3</sup>
535 i	3.5	173	09.98-03.99	M62 B(35 8 S1)/M62 B35	8	Z 237	14 FR-7 DQUP7	1,6		○
535 i	3.5	180	04.99-06.03	M62 B(35 8 S2)/M62 B35 TU	8	Z 237	14 FR-7 DQUP7	1,6		○
540 i	4.4	210	04.96-09.98	M62 B44/M62 B44 TU/ M62 448 S2	8	Z 14	14 F-7 LDUR4	0,9		UXT 1 <sup>3</sup>
540 i	4.4	210	10.98-06.03	M62 B44/M62 B44 TU/ M62 448 S2	8	Z 237	14 FR-7 DQUP7	1,6		○
M 4.9	4.9	294	10.98-06.03	S38 B49	8	Z 237	14 FR-7 DQUP7	1,6		○
5 (E60)										
520 d	2.0	110	09.05-03.10	M47N 204 D4	4	GE 102 (5V)	GSE 101			
520 d	2.0	120	07.05-03.10	M47N 204 D5	4	GE 102 (5V)	○			
520 d	2.0	130	09.07-03.10	M47N 204 D4	4	GE 102 (5V)	GSE 101			
520 i	2.2	125	07.03-03.10	M54 226 S1/M54 B22	6	Z 237	14 FR-7 DQUP7	1,6		○
523 i	2.5	130	07.05-09.09	N52 B25/N52 B25 A	6	Z 235	14 FR-7 SPUX03	1,0		○
523 i	2.5	140	01.07-03.10	N52 B25 A	6	Z 235	14 FR-7 SPUX03	1,0		○
525 d	2.5	120	12.04-03.10	M57 256 D1	6	GE 102 (5V)	GSE 102			
525 d	2.5	130	06.04-03.10	M57 D25 TU/M57N 256 D4	6	GE 102 (5V)	GSE 102			
525 i	2.5	141	09.03-03.05	M54 256 S5/M54 B25	6	Z 237	14 FR-7 DQUP7	1,6		○
525 i	2.5	160	07.05-09.09	N52 B25/N52 B25 A	6	Z 235	14 FR-7 SPUX03	1,0		○
525 xi	2.5	160	07.05-03.07	N52 B25 A	6	Z 235	14 FR-7 SPUX03	1,0		○
525 d	3.0	145	01.07-03.10	M57 306 D3	6	GE 102 (5V)	GSE 102			
525 d xDrive	3.0	145	09.08-03.10	N57 306 D3	6	GE 102 (5V)	○			
525 xd	3.0	145	01.07-03.10	M57 306 D3	6	GE 102 (5V)	GSE 102			
530 d	3.0	160	07.03-03.10	N57 306 D2	6	GE 102 (5V)	GSE 102			

● nicht erforderlich  
○ nicht im Programm

<sup>3</sup> wahlweise UXT 3 Platin

<sup>4</sup> wahlweise UXT 6 Platin

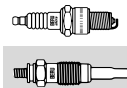

## BMW

### 5 (E60)

530 d	3.0	170	07.03-03.10	M57 306 D3	6	<b>GE 102 (5V)</b>	<b>GSE 102</b>		
530 xd	3.0	170	07.05-03.10	M57 306 D3	6	<b>GE 102 (5V)</b>	<b>GSE 102</b>		
530 i	3.0	170	07.03-03.05	M54 306 S3/M54 B30	6	<b>Z 237</b>	14 FR-7 DQUP7	1,6	○
530 d	3.0	173	01.07-03.10	M57 306 D3	6	<b>GE 102 (5V)</b>	<b>GSE 102</b>		
530 xd	3.0	173	01.07-03.10	M57 306 D3	6	<b>GE 102 (5V)</b>	<b>GSE 102</b>		
530 i	3.0	187	03.05-03.10	N52 B30 A	6	<b>Z 235</b>	14 FR-7 SPUX03	1,0	○
530 i	3.0	190	07.05-03.10	N52 B30 A/N52 B30	6	<b>Z 235</b>	14 FR-7 SPUX03	1,0	○
530 xi	3.0	190	07.05-03.10	N52 B30 A	6	<b>Z 235</b>	14 FR-7 SPUX03	1,0	○
535 d	3.0	200	09.04-03.10	M57 306 D4	6	<b>GE 102 (5V)</b>	<b>GSE 102</b>		
535 d	3.0	210	01.07-03.10	M57N 306 D5	6	<b>GE 102 (5V)</b>	<b>GSE 102</b>		
540 i	4.0	225	07.05-03.10	N62 B40 A	8	<b>Z 301</b>	14 FR-7 LPUX02	1,1	○
545 i	4.4	245	09.03-03.10	N62 B44	8	<b>Z 237</b>	14 FR-7 DQUP7	1,6	○
550 i	4.8	270	07.05-03.10	N62 B48 B	8	<b>Z 301</b>	14 FR-7 LPUX02	1,1	○

### 5 (F10)

530 d	3.0	180	03.10-01.12	N 57 N	6	<b>CGP 001 (5,4V)</b>	○		
530 d xDrive	3.0	190	09.11-01.12	N57 D30 A	6	<b>CGP 001 (5,4V)</b>	○		
535 d	3.0	230	09.11-	N 57 Z	6	<b>CGP 001 (5,4V)</b>	○		
535 d xDrive	3.0	230	09.11-	N57 D30 B	6	<b>CGP 001 (5,4V)</b>	○		

### 5 Touring (E34)

518 i	1.8	83	03.93-09.94	M40 B18	4	<b>Z 14</b>	14 F-7 LDUR4	0,9	<b>UXT 1<sup>3</sup></b>
518 g	1.8	85	11.95-06.96	M43 B18	4	<b>Z 14</b>	14 F-7 LDUR4	0,9	<b>UXT 1<sup>3</sup></b>
518 i	1.8	85	09.94-01.97	M43 B18	4	<b>Z 14</b>	14 F-7 LDUR4	0,9	<b>UXT 1<sup>3</sup></b>
520 i	2.0	110	11.91-01.97	M50 B(20 6 S2) Vanos/ M50 B20/M50 B(20 6 S1)/ M50 B20 TU	6	<b>Z 14</b>	14 F-7 LDUR4	0,9	<b>UXT 1<sup>3</sup></b>
525 td	2.5	85	03.93-01.97	M51 D25	6	<b>GV 719 (11V)</b>	○		
325 tds	2.5	105	12.91-01.97	M51 D25 (Inter.)	6	<b>GV 719 (11V)</b>	○		
525 i	2.5	141	11.91-01.97	M50 B25/M50 B25 TU	6	<b>Z 14</b>	14 F-7 LDUR4	0,9	<b>UXT 1<sup>3</sup></b>
525 ix	2.5	141	02.92-01.97	M50 B25/M52 B25 (Vanos)	6	<b>Z 14</b>	14 F-7 LDUR4	0,9	<b>UXT 1<sup>3</sup></b>
530 i V8	3.0	160	09.92-01.97	M60 B30	8	<b>Z 14</b>	14 F-7 LDUR4	0,9	<b>UXT 1<sup>3</sup></b>
540 i	4.0	210	09.93-01.97	M60 B40	8	<b>Z 14</b>	14 F-7 LDUR4	0,9	<b>UXT 1<sup>3</sup></b>

### 5 Touring (E39)

520 d	2.0	100	02.00-09.03	M47 D20/M47 204 D1	4	<b>GN 024 (11V)</b>	○		
520 i	2.0	100	04.99-05.04	M52 B(20 6 S3) Vanos	6	<b>Z 237</b>	14 FR-7 DQUP7	1,6	○
520 i	2.0	110	01.97-08.98	M52 B(20 6 S3) Vanos/ M52 B(20 6 S4)/M52 B20	6	<b>Z 14</b>	14 F-7 LDUR4	0,9	<b>UXT 1<sup>3</sup></b>
520 i	2.0	110	09.98-09.00	M52 B(20 6 S3) Vanos/ M52 B(20 6 S4)/M52 B20	6	<b>Z 237</b>	14 FR-7 DQUP7	1,6	○
520 i	2.2	125	09.00-05.04	M54 B22	6	<b>Z 237</b>	14 FR-7 DQUP7	1,6	○
523 i	2.5	125	01.97-08.98	M52 B25 TU/M52 B25 (Vanos)	6	<b>Z 14</b>	14 F-7 LDUR4	0,9	<b>UXT 1<sup>3</sup></b>
523 i	2.5	125	09.98-09.00	M52 B25 TU/M52 B25 (Vanos)	6	<b>Z 237</b>	14 FR-7 DQUP7	1,6	○
525 tds	2.5	105	03.97-05.04	M51 D25 (Inter.)	6	<b>GV 719 (11V)</b>	○		
525 d	2.5	120	02.00-05.04	M57 D25/M57 256 D1	6	<b>GN 024 (11V)</b>	○		
525 i	2.5	141	09.00-05.04	M54 256 S5/M54 B25	6	<b>Z 237</b>	14 FR-7 DQUP7	1,6	○
528 i	2.8	142	01.97-09.00	M52 B28/M52 B28 TU	6	<b>Z 237</b>	14 FR-7 DQUP7	1,6	○
530 d	2.9	135	08.98-09.00	M57 D30	6	<b>GN 024 (11V)</b>	○		
530 d	2.9	142	09.00-05.04	M57 D30	6	<b>GN 024 (11V)</b>	○		
530 i	3.0	170	09.00-05.04	M54 B30 /M54 306 S3	6	<b>Z 237</b>	14 FR-7 DQUP7	1,6	○
540 i	4.4	210	01.97-08.98	M62 B44/M62 B44 TU/ M62 448 S2	8	<b>Z 14</b>	14 F-7 LDUR4	0,9	<b>UXT 1<sup>3</sup></b>
540 i	4.4	210	09.98-05.04	M62 B44/M62 B44 TU/ M62 448 S2	8	<b>Z 237</b>	14 FR-7 DQUP7	1,6	○

### 5 Touring (E61)

520 d	2.0	110	09.05-	M47N 204 D4	4	<b>GE 102 (5V)</b>	<b>GSE 101</b>		
520 d	2.0	120	07.05-	M47N 204 D5	4	<b>GE 102 (5V)</b>	○		
520 i	2.2	125	06.04-	M54 226 S1	6	<b>Z 237</b>	14 FR-7 DQUP7	1,6	○
523 i	2.5	130	07.05-09.09	N52 B25/M52 B25 A	6	<b>Z 235</b>	14 FR-7 SPUX03	1,0	○
523 i	2.5	140	01.07-	N52 B25 A	6	<b>Z 235</b>	14 FR-7 SPUX03	1,0	○
525 d	2.5	120	12.04-	M57N 256 D4	6	<b>GE 102 (5V)</b>	<b>GSE 102</b>		



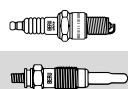

## BMW

### 5 Touring (E61)

525 d	2.5	130	06.04-08.05	M57 D25 TU/M57N 256 D4	6	<b>GE 102 (5V)</b>	<b>GSE 102</b>		
525 i	2.5	141	06.04-	M54 256 S5/M54 B25	6	<b>Z 237</b>	14 FR-7 DQUP7	1,6	○
525 i	2.5	160	07.05-	N52 B25/N52 B25 A	6	<b>Z 235</b>	14 FR-7 SPUX03	1,0	○
525 xi	2.5	160	07.05-03.07	N52 B25 A	6	<b>Z 235</b>	14 FR-7 SPUX03	1,0	○
525 d	3.0	145	01.07-	M57 306 D3	6	<b>GE 102 (5V)</b>	○		
525 d xDrive	3.0	145	09.08-	N57 306 D3	6	<b>GE 102 (5V)</b>	○		
525 xd	3.0	145	01.07-	M57 306 D3	6	<b>GE 102 (5V)</b>	○		
530 d	3.0	160	06.04-	N57 306 D2	6	<b>GE 102 (5V)</b>	<b>GSE 102</b>		
530 d	3.0	170	07.05-	M57 306 D3	6	<b>GE 102 (5V)</b>	<b>GSE 102</b>		
530 xd	3.0	170	07.05-	M57 306 D3	6	<b>GE 102 (5V)</b>	<b>GSE 102</b>		
530 i	3.0	170	06.04-12.09	M54 B30 /M54 306 S3	6	<b>Z 235</b>	14 FR-7 SPUX03	1,0	○
530 d	3.0	173	01.07-	M57 306 D3	6	<b>GE 102 (5V)</b>	<b>GSE 102</b>		
530 xd	3.0	173	01.07-	M57 306 D3	6	<b>GE 102 (5V)</b>	<b>GSE 102</b>		
530 i	3.0	190	07.05-09.09	N52 B30 A/N52 B30	6	<b>Z 235</b>	14 FR-7 SPUX03	1,0	○
530 xi	3.0	190	07.05-	N52 B30 A	6	<b>Z 235</b>	14 FR-7 SPUX03	1,0	○
535 d	3.0	200	09.04-	M57 306 D4	6	<b>GE 102 (5V)</b>	<b>GSE 102</b>		
535 d	3.0	210	01.07-	M57N 306 D5	6	<b>GE 102 (5V)</b>	<b>GSE 102</b>		
545 i	4.4	245	06.04-	N62 B44	8	<b>Z 237</b>	14 FR-7 DQUP7	1,6	○
550 i	4.8	270	07.05-	N62 B48 A/N62 B48 B	8	<b>Z 301</b>	14 FR-7 LPUX02	1,1	○

### 5 Touring (F11)

530 d	3.0	180	09.10-01.12	N 57 N	6	<b>CGP 001 (5,4V)</b>	○		
530 d	3.0	190	09.11-01.12	N 57 N	6	<b>CGP 001 (5,4V)</b>	○		
530 d xDrive	3.0	190	09.11-01.12	N57 D30 A	6	<b>CGP 001 (5,4V)</b>	○		
535 d	3.0	230	09.11-	N 57 Z	6	<b>CGP 001 (5,4V)</b>	○		
535 d xDrive	3.0	230	09.11-	N57 D30 B	6	<b>CGP 001 (5,4V)</b>	○		

### 6 (E24)

635 CSI	3.4	141	04.85-09.90	M30 B35	6	<b>Z 3</b>	14-8 LUR	0,7	<b>UXT 2<sup>4</sup></b>
---------	-----	-----	-------------	---------	---	------------	----------	-----	--------------------------

### 6 (E63)

630 i	3.0	190	09.04-09.09	N52 B30 A/N52 B30	6	<b>Z 235</b>	14 FR-7 SPUX03	1,0	○
645 Ci	4.4	245	01.04-09.05	N62 B44/N62 B44 A	8	<b>Z 237</b>	14 FR-7 DQUP7	1,6	○
650 i	4.8	270	07.05-	N62 B48 B	8	<b>Z 301</b>	14 FR-7 LPUX02	1,1	○

### 6 Cabriolet (E64)

630 i	3.0	190	09.04-09.09	N52 B30 A/N52 B30	6	<b>Z 235</b>	14 FR-7 SPUX03	1,0	○
635 d	3.0	210	07.07-	M57N 306 D5	6	<b>GE 102 (5V)</b>	<b>GSE 102</b>		
645 Ci	4.4	245	04.04-09.05	N62 B44/N62 B44 A	8	<b>Z 237</b>	14 FR-7 DQUP7	1,6	○
650 i	4.8	270	07.05-	N62 B48 B	8	<b>Z 301</b>	14 FR-7 LPUX02	1,1	○

### 6 Cabriolet (F12)

640 d	3.0	230	09.11-	N57 D30 B	6	<b>CGP 001 (5,4V)</b>	○		
-------	-----	-----	--------	-----------	---	-----------------------	---	--	--

### 7 (E32)

730 i,iL	3.0	138	12.86-09.94	M30 B30	6	<b>Z 3</b>	14-8 LUR	0,7	<b>UXT 2<sup>4</sup></b>
730 i,iL	3.0	145	12.86-09.94	M30 B30	6	<b>Z 3</b>	14-8 LUR	0,7	<b>UXT 2<sup>4</sup></b>
730 i,iL V8	3.0	160	04.92-09.94	M60 B30	8	<b>Z 14</b>	14 F-7 LDUR4	0,9	<b>UXT 1<sup>3</sup></b>
735 i,iL	3.4	155	09.86-09.92	M30 B35	6	<b>Z 3</b>	14-8 LUR	0,7	<b>UXT 2<sup>4</sup></b>
740 i,iL V8	4.0	210	04.92-09.94	M60 B40	8	<b>Z 14</b>	14 F-7 LDUR4	0,9	<b>UXT 1<sup>3</sup></b>
750 i,iL V12	5.0	220	09.87-09.94	M70 B50	12	<b>Z 4</b>	14 F-8 LUR	0,7	<b>UXT 1<sup>3</sup></b>

### 7 (E38)

725 tds	2.5	105	04.96-11.01	M51 D25 (Inter.)	6	<b>GV 719 (11V)</b>	○		
728 i,iL	2.8	142	08.95-11.01	M52 B28/M52 B28 TU	6	<b>Z 14</b>	14 F-7 LDUR4	0,9	<b>UXT 1<sup>3</sup></b>
730 d	2.9	135	08.98-04.00	M57 D30	6	<b>GN 024 (11V)</b>	○		
730 d	2.9	142	04.00-11.01	M57 306 D1	6	<b>GN 024 (11V)</b>	○		
730 i,iL	3.0	155	10.94-08.98	M60 B30	8	<b>Z 14</b>	14 F-7 LDUR4	0,9	<b>UXT 1<sup>3</sup></b>
730 i,iL	3.0	155	09.98-11.01	M60 B30	8	<b>Z 237</b>	14 FR-7 DQUP7	1,6	○
730 i,iL	3.0	160	10.94-08.98	M60 B30	8	<b>Z 14</b>	14 F-7 LDUR4	0,9	<b>UXT 1<sup>3</sup></b>
730 i,iL	3.0	160	09.98-11.01	M60 B30	8	<b>Z 237</b>	14 FR-7 DQUP7	1,6	○
735 i,iL	3.5	173	01.96-08.98	M62 B(35 8 S1)/M62 B35	8	<b>Z 14</b>	14 F-7 LDUR4	0,9	<b>UXT 1<sup>3</sup></b>
735 i,iL	3.5	173	09.98-11.01	M62 B(35 8 S1)/M62 B35	8	<b>Z 237</b>	14 FR-7 DQUP7	1,6	○
740 d	3.9	180	05.99-11.01	M67 D39	8	<b>GN 025 (11V)</b>	○		
740 i,iL	4.0	210	10.94-08.98	M60 B40	8	<b>Z 14</b>	14 F-7 LDUR4	0,9	<b>UXT 1<sup>3</sup></b>
740 i,iL	4.0	210	09.98-11.01	M60 B40	8	<b>Z 237</b>	14 FR-7 DQUP7	1,6	○
740 i,iL	4.4	210	01.96-08.98	M62 B44/M62 B44 TU/ M62 448 S2	8	<b>Z 14</b>	14 F-7 LDUR4	0,9	<b>UXT 1<sup>3</sup></b>



kW

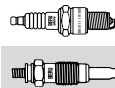
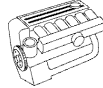

**BMW**

**7 (E38)**

740 i,iL	4.4	210	09.98-11.01	M62 B44/M62 B44 TU/ M62 448 S2	8	<b>Z 237</b>	14 FR-7 DQUP7	1,6	○
750 i,iL	5.4	240	12.94-11.01	M73 B54	12	<b>Z 237</b>	14 FR-7 DQUP7	1,6	○

**7 (E65, E66)**

730 d	3.0	160	10.02-	M57N2 306 D2	6	<b>GE 102 (5V)</b>	<b>GSE 102</b>		
730 i,Li	3.0	170	03.03-03.05	M54 B30 /M54 306 S3	6	<b>Z 237</b>	14 FR-7 DQUP7	1,6	○
730 Ld	3.0	170	07.05-	M57 306 D3	6	<b>GE 102 (5V)</b>	<b>GSE 102</b>		
730 i,Li	3.0	190	03.05-	N52 B30 A/N52 B30	6	<b>Z 235</b>	14 FR-7 SPUX03	1,0	○
735 i,Li	3.6	200	11.01-	N62 B36	8	<b>Z 237</b>	14 FR-7 DQUP7	1,6	○
740 d	3.9	190	10.02-	N67 398 D1	8	<b>GE 103 (5V)</b>	<b>GSE 103</b>		
740 i,Li	4.0	225	07.05-	N62 B40 A	8	<b>Z 301</b>	14 FR-7 LPUX02	1,1	○
745 d	4.4	220	03.05-08.05	N67N 448 D1	8	<b>GE 103 (5V)</b>	<b>GSE 103</b>		
745 d	4.4	242	07.05-	N67N 448 D2	8	<b>GE 103 (5V)</b>	<b>GSE 103</b>		
745 i,Li	4.4	245	11.01-	N62 B44/N62 B44 A	8	<b>Z 237</b>	14 FR-7 DQUP7	1,6	○
750 i,Li	4.8	270	07.05-	N62 B48 B	8	<b>Z 301</b>	14 FR-7 LPUX02	1,1	○
760 i,Li	6.0	327	01.03-	N73 B60	12	<b>Z 237</b>	14 FR-7 DQUP7	1,6	○

**7 (F01, F02, F03, F04)**

730 i	3.0	190	06.08-	N52 B30 A/N52 B30 BF	6	<b>Z 235</b>	14 FR-7 SPUX03	1,0	○
-------	-----	-----	--------	----------------------	---	--------------	----------------	-----	---

**8 (E31)**

840 i	4.0	210	02.93-02.96	M60 B40	8	<b>Z 14</b>	14 F-7 LDUR4	0,9	<b>UXT 1<sup>3</sup></b>
840 Ci	4.4	210	01.96-12.99	M62 B44/M62 B44 TU	8	<b>Z 14</b>	14 F-7 LDUR4	0,9	<b>UXT 1<sup>3</sup></b>
850 i,Ci	5.0	220	04.90-10.94	M70 B50	12	<b>Z 4</b>	14 F-8 LUR	0,7	<b>UXT 1<sup>3</sup></b>
850 Ci	5.4	240	09.94-12.99	M73 B54	12	<b>Z 237</b>	14 FR-7 DQUP7	1,6	○
850 CSI	5.6	280	04.93-12.96	M70 B56	12	<b>Z 4</b>	14 F-8 LUR	0,7	<b>UXT 1<sup>3</sup></b>

**X1 (E84)**

sDrive 18 i	2.0	110	01.10-	N46 B20 B	4	<b>Z 301</b>	14 FR-7 LPUX02	1,1	○
xDrive 25 i	3.0	160	01.10-	N52 B30 A	6	<b>Z 235</b>	14 FR-7 SPUX03	1,0	○
xDrive 28 i	3.0	190	10.09-	N52 B30 A	6	<b>Z 235</b>	14 FR-7 SPUX03	1,0	○

**X3 (E83)**

2.0 d	2.0	110	10.04-	M47N 204 D4	4	<b>GE 102 (5V)</b>	<b>GSE 101</b>		
2.0 i	2.0	110	07.05-	N46 B20 A/N46 B20	4	<b>Z 301</b>	14 FR-7 LPUX02	1,1	○
2.5 i	2.5	141	01.04-	M54 256 S5/M54 B25	6	<b>Z 237</b>	14 FR-7 DQUP7	1,6	○
2.5 si	2.5	160	09.06-	N52 B25 A	6	<b>Z 235</b>	14 FR-7 SPUX03	1,0	○
3.0 d	3.0	150	01.04-	M57N2 306 D2	6	<b>GE 102 (5V)</b>	<b>GSE 102</b>		
3.0 d	3.0	160	01.04-	M57N2 306 D2	6	<b>GE 102 (5V)</b>	<b>GSE 102</b>		
3.0 i	3.0	170	01.04-	M54 B30 /M54 306 S3	6	<b>Z 237</b>	14 FR-7 DQUP7	1,6	○
3.0 si	3.0	200	09.06-	N52 B30 A	6	<b>Z 235</b>	14 FR-7 SPUX03	1,0	○
3.0 sd	3.0	210	09.06-	M57 306 D5	6	<b>GE 102 (5V)</b>	○		
xDrive 30 i	3.0	200	09.08-	N52 B30 A	6	<b>Z 235</b>	14 FR-7 SPUX03	1,0	○

**X3 (F25)**

xDrive 28 i	3.0	190	04.11-	N52 B30 A	6	<b>Z 235</b>	14 FR-7 SPUX03	1,0	○
xDrive 30 d	3.0	190	05.11-01.12	N57 D30 A	6	<b>CGP 001 (5,4V)</b>	○		
xDrive 35 d	3.0	230	09.11-	N57 D30 B	6	<b>CGP 001 (5,4V)</b>	○		

**X5 (E53)**

3.0 d	2.9	135	05.01-	M57 306 D1	6	<b>GN 024 (11V)</b>	○		
3.0 d	3.0	160	12.03-	M57N 306 D4	6	<b>GE 102 (5V)</b>	<b>GSE 102</b>		
3.0 i	3.0	163	05.00-	M54 306 S3	6	<b>Z 237</b>	14 FR-7 DQUP7	1,6	○
3.0 i	3.0	170	05.00-	M54 B30 /M54 306 S3	6	<b>Z 237</b>	14 FR-7 DQUP7	1,6	○
4.4 i	4.4	210	05.00-	M62 B44/M62 B44 TU	8	<b>Z 237</b>	14 FR-7 DQUP7	1,6	○
4.4 i	4.4	235	12.03-	N62 B44/N62 B44 A	8	<b>Z 237</b>	14 FR-7 DQUP7	1,6	○
4.6 is	4.6	255	02.02-	M67 468 S1/M62 B46	8	<b>Z 237</b>	14 FR-7 DQUP7	1,6	○
4.8 is	4.8	265	04.04-	N62 B48 A	8	<b>Z 301</b>	14 FR-7 LPUX02	1,1	○

**X5 (E70)**

3.0 d	3.0	173	02.07-09.08	M57 306 D3	6	<b>GE 102 (5V)</b>	<b>GSE 102</b>		
3.0 si	3.0	200	02.07-09.08	N52 B30 A/N52 B30	6	<b>Z 235</b>	14 FR-7 SPUX03	1,0	○
3.0 sd	3.0	210	09.07-09.08	M57N 306 D5	6	<b>GE 102 (5V)</b>	<b>GSE 102</b>		
xDrive 30 i	3.0	200	09.08-03.10	N52 B30 A	6	<b>Z 235</b>	14 FR-7 SPUX03	1,0	○
4.8 i	4.8	261	02.07-09.08	N62 B48 B	8	<b>Z 301</b>	14 FR-7 LPUX02	1,1	○

**X6 (E71, E72)**

3.0 d	3.0	173	05.08-	M57N2 306 D3	6	<b>GE 102 (5V)</b>	○		
-------	-----	-----	--------	--------------	---	--------------------	---	--	--

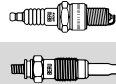
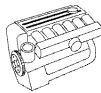

<b>BMW</b>									
<b>X6 (E71, E72)</b>									
35 d	3.0	210	05.08–	N57N 306 D5	6	<b>GE 102</b> (5V)	<b>GSE 102</b>		
xDrive 35 d	3.0	210	09.08–	N57N 306 D5	6	<b>GE 102</b> (5V)	○		
<b>Z1</b>									
2.5	2.5	125	06.88–06.91	M20 B25	6	<b>Z 3</b>	14-8 LUR	0,7	<b>UXT 2<sup>4</sup></b>
<b>Z3 (E36)</b>									
1.8	1.8	85	10.95–10.98	M43 B18	4	<b>Z 14</b>	14 F-7 LDUR4	0,9	<b>UXT 1<sup>3</sup></b>
1.9	1.9	85	01.99–01.03	M43 194 E1	4	<b>Z 237</b>	14 FR-7 DQUP7	1,6	○
1.9	1.9	87	07.98–01.03	M43 B19/M43 B19 TU/ M43 194 E1	4	<b>Z 237</b>	14 FR-7 DQUP7	1,6	○
1.9	1.9	103	10.95–03.99	M44 B19	4	<b>Z 14</b>	14 F-7 LDUR4	0,9	<b>UXT 1<sup>3</sup></b>
2.0	2.0	110	04.99–01.03	M52 B(20 6 S4)/M52 B20	6	<b>Z 237</b>	14 FR-7 DQUP7	1,6	○
2.2	2.2	125	08.00–01.03	M54 226 S1/M54 B22	6	<b>Z 237</b>	14 FR-7 DQUP7	1,6	○
2.8	2.8	141	04.97–08.98	M52 B28/M52 B28 TU	6	<b>Z 14</b>	14 F-7 LDUR4	0,9	<b>UXT 1<sup>3</sup></b>
2.8	2.8	141	09.98–06.00	M52 B28/M52 B28 TU	6	<b>Z 237</b>	14 FR-7 DQUP7	1,6	○
3.0	3.0	170	06.00–01.03	M54 B30 /M54 306 S3	6	<b>Z 237</b>	14 FR-7 DQUP7	1,6	○
<b>Z3 Coupe (E36)</b>									
2.8	2.8	141	07.97–06.00	M52 B28	6	<b>Z 237</b>	14 FR-7 DQUP7	1,6	○
3.0	3.0	170	06.00–06.03	M54 306 S3	6	<b>Z 237</b>	14 FR-7 DQUP7	1,6	○
<b>Z4 (E85)</b>									
2.0 i	2.0	110	04.05–	N46 B20 A/N46 B20	4	<b>Z 301</b>	14 FR-7 LPUX02	1,1	○
2.2 i	2.2	125	10.03–10.05	M54 226 S1/M54 B22	6	<b>Z 237</b>	14 FR-7 DQUP7	1,6	○
2.5 i	2.5	130	01.06–	N52 B25 A	6	<b>Z 235</b>	14 FR-7 SPUX03	1,0	○
2.5 i	2.5	141	02.03–	M54 256 S5/M54 B25	6	<b>Z 237</b>	14 FR-7 DQUP7	1,6	○
2.5 si	2.5	160	01.06–	N52 B25 A	6	<b>Z 235</b>	14 FR-7 SPUX03	1,0	○
3.0 i	3.0	170	02.03–	M54 B30 /M54 306 S3	6	<b>Z 237</b>	14 FR-7 DQUP7	1,6	○
3.0 si	3.0	195	01.06–	N52 B30 A/N52 B30	6	<b>Z 235</b>	14 FR-7 SPUX03	1,0	○
<b>Z4 (E89)</b>									
sDrive30i	3.0	190	05.09–	N52 B30 A	6	<b>Z 235</b>	14 FR-7 SPUX03	1,0	○
<b>Z4 Coupe (E86)</b>									
3.0 si	3.0	195	03.06–	N52 B30 A/N52 B30	6	<b>Z 235</b>	14 FR-7 SPUX03	1,0	○
<b>Z8 (E52)</b>									
4.9	4.9	294	06.00–06.03	S62 B50	8	<b>Z 237</b>	14 FR-7 DQUP7	1,6	○
<b>CADILLAC</b>									
<b>BLS</b>									
1.9 D	1.9	110	04.06–	Z19DTH	4	<b>GN 059</b> (11V)	○		
<b>CTS</b>									
3.6	3.6	189	03.05–09.07	LY7	6	<b>Z 356</b>	14 KR-7 MPUX2	1,1	○
<b>SEVILLE II</b>									
4.5 V8	4.5	134	09.87–09.90	LW2	8	<b>Z 117</b>	14 KR-9 DUX	1,0	<b>UXT 4</b>
<b>CHEVROLET</b>									
<b>AVEO</b>									
1.2	1.2	53	03.06–	F12S3	4	<b>Z 9</b>	14 R-8 DUX	1,1	<b>UXT 2<sup>4</sup></b>
1.2	1.2	62	04.08–	B12D1	4	<b>Z 358</b>	12 FR-6 DUT	0,8	○
1.2 LPG	1.2	62	04.08–	B12D1	4	<b>Z 291</b>	12 FR-5 DU	0,9	○
1.4	1.4	69	03.06–	F14D3	4	<b>Z 16</b>	14 FR-7 DUX	1,1	<b>UXT 1<sup>3</sup></b>
<b>BERETTA Coupe</b>									
2.3 16V	2.3	130	09.90–	L60	4	<b>Z 73</b>	14 FR-8 DUX	1,1	<b>UXT 1<sup>3</sup></b>
<b>CAPTIVA</b>									
2.4	2.4	100	06.06–	Z 24 SED	4	<b>Z 74</b>	14 FR-8 LDUOX4	1,0	<b>UXT 1<sup>3</sup></b>
2.4 4WD	2.4	100	06.06–	Z 24 SED	4	<b>Z 74</b>	14 FR-8 LDUOX4	1,0	<b>UXT 1<sup>3</sup></b>
3.2 4WD	3.2	169	06.06–	10 HM	6	<b>Z 356</b>	14 KR-7 MPUX2	1,1	○
<b>EPICA</b>									
2.0	2.0	105	06.06–	X 20 D1	6	<b>Z 313</b>	14 FR-6 DPUX2	1,0	○
2.5	2.5	115	06.06–	LF4	6	<b>Z 313</b>	14 FR-6 DPUX2	1,0	○
<b>KALOS</b>									
1.2	1.2	53	03.05–	B12S1	4	<b>Z 9</b>	14 R-8 DUX	1,1	<b>UXT 2<sup>4</sup></b>
1.2	1.2	53	03.05–	F12S3	4	<b>Z 9</b>	14 R-8 DUX	1,1	<b>UXT 2<sup>4</sup></b>
1.4	1.4	61	03.05–	F14S3	4	<b>Z 20</b>	14 R-7 DU	0,8	<b>UXT 2<sup>4</sup></b>
1.4 16V	1.4	69	03.05–	F14D3	4	<b>Z 16</b>	14 FR-7 DUX	1,1	<b>UXT 1<sup>3</sup></b>

● nicht erforderlich  
○ nicht im Programm

<sup>3</sup> wahlweise UXT 3 Platin

<sup>4</sup> wahlweise UXT 6 Platin

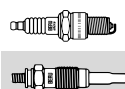
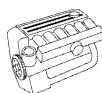

### CHEVROLET

#### LACETTI

1.4 16V	1.4	70	03.05-	F14D3	4	<b>Z 16</b>	14 FR-7 DUX	1,1	<b>UXT 1<sup>3</sup></b>
1.6	1.6	80	03.05-	F16D3	4	<b>Z 16</b>	14 FR-7 DUX	1,1	<b>UXT 1<sup>3</sup></b>
1.8	1.8	89	01.06-	F18D3	4	<b>Z 304</b>	14 FGHR-7 DTUT	0,9	○
1.8	1.8	90	01.06-	T18SED	4	<b>Z 304</b>	14 FGHR-7 DTUT	0,9	○

#### LOVA

1.4	1.4	69	08.05-	F14D3	4	<b>Z 16</b>	14 FR-7 DUX	1,1	<b>UXT 1<sup>3</sup></b>
-----	-----	----	--------	-------	---	-------------	-------------	-----	--------------------------

#### LUMINA APV

2.3	2.3	108	12.92-07.96	LD2	4	<b>Z 247</b>	14 FR-7 DUW	0,9	<b>UXT 1<sup>3</sup></b>
3.8	3.8	129	12.92-07.96	L27	6	<b>Z 117</b>	14 KR-9 DUX	1,0	<b>UXT 4</b>

#### LUV

3.5 AWD	3.5	169	10.02-09.05	6 VE1	6	<b>Z 343</b>	14 FR-8 DPPLUX	1,1	○
---------	-----	-----	-------------	-------	---	--------------	----------------	-----	---

#### MATIZ

0.8 LPG	0.8	38	03.05-12.10	F8CV	3	<b>Z 9</b>	14 R-8 DUX	1,1	<b>UXT 2<sup>4</sup></b>
1.0 LPG	1.0	49	03.05-12.10	B10S1	4	<b>Z 9</b>	14 R-8 DUX	1,1	<b>UXT 2<sup>4</sup></b>

#### NUBIRA

1.4	1.4	69	01.05-	F14D3	4	<b>Z 16</b>	14 FR-7 DUX	1,1	<b>UXT 1<sup>3</sup></b>
1.6	1.6	80	03.05-	F16D3	4	<b>Z 16</b>	14 FR-7 DUX	1,1	<b>UXT 1<sup>3</sup></b>
1.8	1.8	89	01.06-	F18D3	4	<b>Z 304</b>	14 FGHR-7 DTUT	0,9	○
1.8	1.8	90	01.06-	T18SED	4	<b>Z 304</b>	14 FGHR-7 DTUT	0,9	○

#### NUBIRA Kombi

1.6	1.6	80	03.05-	F16D3	4	<b>Z 16</b>	14 FR-7 DUX	1,1	<b>UXT 1<sup>3</sup></b>
1.8	1.8	89	01.06-	F18D3	4	<b>Z 304</b>	14 FGHR-7 DTUT	0,9	○
1.8	1.8	90	01.06-	T18SED	4	<b>Z 304</b>	14 FGHR-7 DTUT	0,9	○

#### REZZO

1.6	1.6	79	08.05-	A16DMS	4	<b>Z 16</b>	14 FR-7 DUX	1,1	<b>UXT 1<sup>3</sup></b>
-----	-----	----	--------	--------	---	-------------	-------------	-----	--------------------------



#### SILVERADO

2500 BASE TRUCK	6,6	-	01.01-	V8-400-(VIN: 1) Duramax	8	<b>GN 032</b> (11V)	○		
2500 LS TRUCK	6,6	-	01.01-12.02	V8-400-(VIN: 1) Duramax	8	<b>GN 032</b> (11V)	○		
2500 LT TRUCK	6,6	-	01.01-	V8-400-(VIN: 1) Duramax	8	<b>GN 032</b> (11V)	○		
2500 HD BASE TRUCK	6,6	-	01.01-12.04	V8-400-(VIN: 1) Duramax	8	<b>GN 032</b> (11V)	○		
2500 HD BASE TRUCK	6,6	-	01.05-	V8-400-(VIN: 2) Duramax	8	<b>GE 106</b> (4,7V)	○		
2500 HD LS TRUCK	6,6	-	01.01-12.04	V8-400-(VIN: 1) Duramax	8	<b>GN 032</b> (11V)	○		
2500 HD LS TRUCK	6,6	-	01.05-	V8-400-(VIN: 2) Duramax	8	<b>GE 106</b> (4,7V)	○		
2500 HD LT TRUCK	6,6	-	01.01-12.04	V8-400-(VIN: 1) Duramax	8	<b>GN 032</b> (11V)	○		
2500 HD LT TRUCK	6,6	-	01.05-	V8-400-(VIN: 2) Duramax	8	<b>GE 106</b> (4,7V)	○		
2500 HD WT TRUCK	6,6	-	01.01-12.04	V8-400-(VIN: 1) Duramax	8	<b>GN 032</b> (11V)	○		
3500 BASE TRUCK	6,6	-	01.01-12.04	V8-400-(VIN: 1) Duramax	8	<b>GN 032</b> (11V)	○		
3500 BASE TRUCK	6,6	-	01.05-	V8-400-(VIN: 2) Duramax	8	<b>GE 106</b> (4,7V)	○		
3500 LS TRUCK	6,6	-	01.01-12.04	V8-400-(VIN: 1) Duramax	8	<b>GN 032</b> (11V)	○		
3500 LS TRUCK	6,6	-	01.05-	V8-400-(VIN: 2) Duramax	8	<b>GE 106</b> (4,7V)	○		
3500 LT TRUCK	6,6	-	01.01-12.04	V8-400-(VIN: 1) Duramax	8	<b>GN 032</b> (11V)	○		
3500 LT TRUCK	6,6	-	01.05-	V8-400-(VIN: 2) Duramax	8	<b>GE 106</b> (4,7V)	○		
3500 WT TRUCK	6,6	-	01.01-12.04	V8-400-(VIN: 1) Duramax	8	<b>GN 032</b> (11V)	○		

#### SILVERADO Pick-up

6.6 TDi 2500	6,6	224	01.09-	LMM	8	<b>GE 109</b> (5V)	○		
6.6 TDi 2500 Allrad	6,6	224	01.09-	LMM	8	<b>GE 109</b> (5V)	○		
6.6 TDi	6,6	230	01.09-	LMM	8	<b>GE 109</b> (5V)	○		
6.6 TDi 4WD	6,6	230	01.09-	LMM	8	<b>GE 109</b> (5V)	○		

#### SIERRA

2500 HD BASE TRUCK	6,6	-	01.02-12.04	V8-400-(VIN: 1) Duramax	8	<b>GN 032</b> (11V)	○		
2500 HD BASE TRUCK	6,6	-	01.05-	V8-400-(VIN: 2) Duramax	8	<b>GE 106</b> (4,7V)	○		
2500 HD SL TRUCK	6,6	-	01.01-12.02	V8-400-(VIN: 1) Duramax	8	<b>GN 032</b> (11V)	○		
2500 HD SLE TRUCK	6,6	-	01.01-12.04	V8-400-(VIN: 1) Duramax	8	<b>GN 032</b> (11V)	○		
2500 HD SLE TRUCK	6,6	-	01.05-	V8-400-(VIN: 2) Duramax	8	<b>GE 106</b> (4,7V)	○		
2500 HD SLT TRUCK	6,6	-	01.01-12.04	V8-400-(VIN: 1) Duramax	8	<b>GN 032</b> (11V)	○		
2500 HD SLT TRUCK	6,6	-	01.05-	V8-400-(VIN: 2) Duramax	8	<b>GE 106</b> (4,7V)	○		
2500 HD WT TRUCK	6,6	-	01.03-12.04	V8-400-(VIN: 1) Duramax	8	<b>GN 032</b> (11V)	○		
2500 HD WT TRUCK	6,6	-	01.05-	V8-400-(VIN: 2) Duramax	8	<b>GE 106</b> (4,7V)	○		
3500 BASE TRUCK	6,6	-	01.02-12.04	V8-400-(VIN: 1) Duramax	8	<b>GN 032</b> (11V)	○		

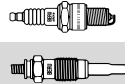
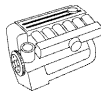

## CHEVROLET



### SIERRA

3500 SL TRUCK	6,6	-	01.01-12.02	V8-400-(VIN: 1) Duramax	8	<b>GN 032</b> (11V)	○	
3500 SLE TRUCK	6,6	-	01.01-12.04	V8-400-(VIN: 1) Duramax	8	<b>GN 032</b> (11V)	○	
3500 SLT TRUCK	6,6	-	01.01-12.04	V8-400-(VIN: 1) Duramax	8	<b>GN 032</b> (11V)	○	
3500 WT TRUCK	6,6	-	01.03-12.04	V8-400-(VIN: 1) Duramax	8	<b>GN 032</b> (11V)	○	

## CHRYSLER

### 300 C

3.0 CRD	3.0	160	09.05-	M664	6	<b>GE 105</b> (4,4V)	○	
5.7 SRT8	5.7	250	09.04-	EZH/EZD/EZB	8	<b>Z 216</b>	14 KR-10 SUV2=16x	1,3

### 300 C Touring

3.0 CRD	3.0	160	09.05-12.10	M664	6	<b>GE 105</b> (4,4V)	○	
5.7	5.7	250	09.04-12.10	EZH/EZD/EZB	8	<b>Z 216</b>	14 KR-10 SUV2=16x	1,3
5.7 AWD	5.7	250	04.05-12.10	EZH/EZB	8	<b>Z 216</b>	14 KR-10 SUV2=16x	1,3

### CIRRUS

2.0 LX	2.0	96	05.94-09.97	ECB	4	<b>Z 15</b>	14 FR-7 DU	0,8
2.0 LX	2.0	98	10.97-09.00	ECB	4	<b>Z 15</b>	14 FR-7 DU	0,8
2.5 LX	2.5	120	10.94-09.00	EEB	6	<b>Z 312</b>	14 FR-7 KPPU	1,1

### CROSSFIRE

3.2	3.2	160	07.03-12.07	EGX	6	<b>Z 170</b>	14 F-7 DPURU2	1,0
-----	-----	-----	-------------	-----	---	--------------	---------------	-----

### CROSSFIRE Roadster

3.2	3.2	160	05.04-12.07	EGX	6	<b>Z 170</b>	14 F-7 DPURU2	1,0
-----	-----	-----	-------------	-----	---	--------------	---------------	-----

### GS DAYTONA SHELBY Coupe

2.2 i Turbo	2.2	130	10.87-10.92	EDR	4	<b>Z 82</b>	14 R-9 DU	0,7
-------------	-----	-----	-------------	-----	---	-------------	-----------	-----

### LE BARON

2.2 i	2.2	69	09.86-12.94		4	<b>Z 82</b>	14 R-9 DU	0,7
2.2 i Turbo	2.2	130	09.86-01.91	EDR	4	<b>Z 82</b>	14 R-9 DU	0,7
3.0 i V6	3.0	105	01.90-12.94	EFA	6	<b>Z 82</b>	14 R-9 DU	0,7

### LE BARON Cabriolet

2.2 i Turbo	2.2	109	09.86-12.90		4	<b>Z 82</b>	14 R-9 DU	0,7
2.2 i Turbo	2.2	130	09.86-12.90	EDR	4	<b>Z 82</b>	14 R-9 DU	0,7
2.5 i Turbo	2.5	112	01.89-12.93	EDT	4	<b>Z 82</b>	14 R-9 DU	0,7
3.0 i V6	3.0	105	01.90-12.96	6G72	6	<b>Z 82</b>	14 R-9 DU	0,7

### LE BARON Coupe

3.0 i V6	3.0	105	01.90-12.93	EFA	6	<b>Z 82</b>	14 R-9 DU	0,7
----------	-----	-----	-------------	-----	---	-------------	-----------	-----

### NEON

1.8 16V	1.8	85	09.97-08.99	EBD	4	<b>Z 15</b>	14 FR-7 DU	0,8
2.0 16V	2.0	98	05.94-08.99	420H	4	<b>Z 15</b>	14 FR-7 DU	0,8
2.0 16V	2.0	107	06.94-08.99	ECC	4	<b>Z 72</b>	14 FR-8 DU	0,8
2.0 16V	2.0	109	04.96-08.99	420T	4	<b>Z 72</b>	14 FR-8 DU	0,8

### NEON II

2.0 16V	2.0	98	08.99-12.06	420H	4	<b>Z 15</b>	14 FR-7 DU	0,8
---------	-----	----	-------------	------	---	-------------	------------	-----

### NEW YORKER

3.5 i 24V	3.5	155	04.93-09.98	F01	6	<b>Z 152</b>	14 FR-8 HU	0,7
-----------	-----	-----	-------------	-----	---	--------------	------------	-----

### PT CRUISER

2.0	2.0	100	10.04-12.10	ECC	4	<b>Z 216</b>	14 KR-10 SUV2	1,3
2.0	2.0	104	06.00-12.10	ECC	4	<b>Z 216</b>	14 KR-10 SUV2	1,3
2.2 CRD	2.1	89	03.02-12.10	EDJ	4	<b>GN 003</b> (11,5V)	○	
2.2 CRD	2.1	110	08.05-12.10	EDJ	4	<b>GN 003</b> (11,5V)	○	
2.4	2.4	105	08.05-12.10	EDZ	4	<b>Z 216</b>	14 KR-10 SUV2	1,3
2.4	2.4	110	06.00-12.10	EDZ	4	<b>Z 216</b>	14 KR-10 SUV2	1,3
GT 2.4	2.4	164	08.03-12.10	EDV	4	<b>Z 216</b>	14 KR-10 SUV2	1,3

### PT CRUISER Cabriolet

2.4	2.4	105	03.04-03.08	EDZ	4	<b>Z 216</b>	14 KR-10 SUV2	1,3
2.4 GT	2.4	164	03.04-03.08	EDV	4	<b>Z 216</b>	14 KR-10 SUV2	1,3

### SARATOGA

3.0	3.0	105	09.89-12.95	6G72	6	<b>Z 9</b>	14 R-8 DUX	1,1
-----	-----	-----	-------------	------	---	------------	------------	-----

### SEBRING

2.0	2.0	104	04.01-06.07	ECC	4	<b>Z 216</b>	14 KR-10 SUV2	1,3
-----	-----	-----	-------------	-----	---	--------------	---------------	-----

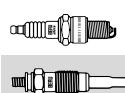
**CHRYSLER****SEBRING Cabriolet**

2.0	2.0	104	04.01-	ECC	4	<b>Z 216</b>	14 KR-10 SUV2	1,3	○
-----	-----	-----	--------	-----	---	--------------	---------------	-----	---

**SEBRING Coupe**

2.5 LE	2.5	120	05.95-08.00	EEB	6	<b>Z 312</b>	14 FR-7 KPPU	1,1	○
--------	-----	-----	-------------	-----	---	--------------	--------------	-----	---

**STRATUS**

2.0 LE	2.0	96	12.95-04.01	C00	4	<b>Z 15</b>	14 FR-7 DU	0,8	<b>UXT 1<sup>3</sup></b>
--------	-----	----	-------------	-----	---	-------------	------------	-----	--------------------------

2.0 16V	2.0	98	12.95-04.01	ECB	4	<b>Z 15</b>	14 FR-7 DU	0,8	<b>UXT 1<sup>3</sup></b>
---------	-----	----	-------------	-----	---	-------------	------------	-----	--------------------------

2.4 16 V	2.4	103	12.95-04.01	EDZ	4	<b>Z 73</b>	14 FR-8 DUX	1,1	<b>UXT 1<sup>3</sup></b>
----------	-----	-----	-------------	-----	---	-------------	-------------	-----	--------------------------

2.4 16V	2.4	112	12.95-04.01	EDZ	4	<b>Z 73</b>	14 FR-8 DUX	1,1	<b>UXT 1<sup>3</sup></b>
---------	-----	-----	-------------	-----	---	-------------	-------------	-----	--------------------------

2.5 LX V6	2.5	120	12.95-04.01	H00	6	<b>Z 73</b>	14 FR-8 DUX	1,1	<b>UXT 1<sup>3</sup></b>
-----------	-----	-----	-------------	-----	---	-------------	-------------	-----	--------------------------

2.5 V6	2.5	125	12.95-04.01		6	<b>Z 73</b>	14 FR-8 DUX	1,1	<b>UXT 1<sup>3</sup></b>
--------	-----	-----	-------------	--	---	-------------	-------------	-----	--------------------------

**STRATUS Cabriolet**

2.0 LE	2.0	96	06.96-04.01	420X	4	<b>Z 15</b>	14 FR-7 DU	0,8	<b>UXT 1<sup>3</sup></b>
--------	-----	----	-------------	------	---	-------------	------------	-----	--------------------------

2.5 LX	2.5	120	04.96-04.01	625H	6	<b>Z 228</b>	14 FR-7 DPUX02	1,0	<b>UXT 11</b>
--------	-----	-----	-------------	------	---	--------------	----------------	-----	---------------

**VIPER**

8.0	8.0	282	07.98-12.98	EPD	10	<b>Z 248</b>	14 FR-8 HUT	0,8	○
-----	-----	-----	-------------	-----	----	--------------	-------------	-----	---

8.0	8.0	290	08.92-12.96	EPA	10	<b>Z 152</b>	14 FR-8 HU	0,7	○
-----	-----	-----	-------------	-----	----	--------------	------------	-----	---

**VIPER Convertible**

8.0	8.0	282	07.98-12.98	EPD	10	<b>Z 248</b>	14 FR-8 HUT	0,8	○
-----	-----	-----	-------------	-----	----	--------------	-------------	-----	---

8.0	8.0	290	08.92-12.96	EPA	10	<b>Z 152</b>	14 FR-8 HU	0,7	○
-----	-----	-----	-------------	-----	----	--------------	------------	-----	---

**VOYAGER II**

2.5 i	2.5	72	01.91-09.95	K00	4	<b>Z 82</b>	14 R-9 DU	0,7	<b>UXT 2<sup>4</sup></b>
-------	-----	----	-------------	-----	---	-------------	-----------	-----	--------------------------

2.5 i	2.5	74	08.90-09.95	K	4	<b>Z 82</b>	14 R-9 DU	0,7	<b>UXT 2<sup>4</sup></b>
-------	-----	----	-------------	---	---	-------------	-----------	-----	--------------------------

2.5 TD	2.5	87	01.92-04.95	M00/09B	4	<b>GN 954</b> (11V)	○		
--------	-----	----	-------------	---------	---	---------------------	---	--	--

2.5 TD	2.5	87	05.95-09.95	M00/09B	4	<b>GN 007</b> (11V)	○		
--------	-----	----	-------------	---------	---	---------------------	---	--	--

3.0 i	3.0	108	01.91-09.95	300/6G72	6	<b>Z 8</b>	14 R-8 DU	0,8	<b>UXT 2<sup>4</sup></b>
-------	-----	-----	-------------	----------	---	------------	-----------	-----	--------------------------

3.3 i	3.3	110	08.90-09.95	EGA	6	<b>Z 285</b>	14 R-9 KPUV2	1,3	○
-------	-----	-----	-------------	-----	---	--------------	--------------	-----	---

**VOYAGER III**

2.0 i	2.0	98	08.96-12.00	C00	4	<b>Z 15</b>	14 FR-7 DU	0,8	<b>UXT 1<sup>3</sup></b>
-------	-----	----	-------------	-----	---	-------------	------------	-----	--------------------------

2.4 i	2.4	111	01.96-03.01	B00	4	<b>Z 73</b>	14 FR-8 DUX	1,1	<b>UXT 1<sup>3</sup></b>
-------	-----	-----	-------------	-----	---	-------------	-------------	-----	--------------------------

2.5 TD	2.5	85	01.95-04.95	425 CLIRS/X	4	<b>GN 954</b> (11V)	○		
--------	-----	----	-------------	-------------	---	---------------------	---	--	--

2.5 TD	2.5	85	05.95-03.01	425 CLIRS/X	4	<b>GN 007</b> (11V)	○		
--------	-----	----	-------------	-------------	---	---------------------	---	--	--

3.3 i	3.3	116	01.95-03.01	R00	6	<b>Z 285</b>	14 R-9 KPUV2	1,3	○
-------	-----	-----	-------------	-----	---	--------------	--------------	-----	---

3.8 i AWD	3.8	122	01.95-03.01	L00	6	<b>Z 285</b>	14 R-9 KPUV2	1,3	○
-----------	-----	-----	-------------	-----	---	--------------	--------------	-----	---

3.8 i AWD	3.8	131	01.95-03.01	EGH	6	<b>Z 285</b>	14 R-9 KPUV2	1,3	○
-----------	-----	-----	-------------	-----	---	--------------	--------------	-----	---

**VOYAGER IV**

2.4	2.4	108	02.00-12.08	EDZ	4	<b>Z 216</b>	14 KR-10 SUV2	1,3	○
-----	-----	-----	-------------	-----	---	--------------	---------------	-----	---

2.5 CRD	2.5	105	02.00-12.08	ENC	4	<b>GN 055</b> (11V)	○		
---------	-----	-----	-------------	-----	---	---------------------	---	--	--

2.8 CRD	2.8	110	06.04-12.08	ENR	4	<b>GN 055</b> (11V)	○		
---------	-----	-----	-------------	-----	---	---------------------	---	--	--

**CITROËN****2 CV**

6	0.6	20	08.79-07.90	A06/664	2	<b>Z 40</b>	14-5 AU	0,6	○
---	-----	----	-------------	---------	---	-------------	---------	-----	---

**AX**

10	1.0	32	09.86-06.92	C1A	4	<b>Z 193</b>	14 FR-7 DU2	0,9	<b>UXT 1<sup>3</sup></b>
----	-----	----	-------------	-----	---	--------------	-------------	-----	--------------------------

10	1.0	33	07.86-12.98	CDY (TU9M)	4	<b>Z 193</b>	14 FR-7 DU2	0,9	<b>UXT 1<sup>3</sup></b>
----	-----	----	-------------	------------	---	--------------	-------------	-----	--------------------------

10	1.0	37	02.87-12.98	CDZ (TU9M)	4	<b>Z 193</b>	14 FR-7 DU2	0,9	<b>UXT 1<sup>3</sup></b>
----	-----	----	-------------	------------	---	--------------	-------------	-----	--------------------------

11	1.1	40	12.86-04.94	H1A/H1B	4	<b>Z 193</b>	14 FR-7 DU2	0,9	<b>UXT 1<sup>3</sup></b>
----	-----	----	-------------	---------	---	--------------	-------------	-----	--------------------------

11 4x4	1.1	40	06.91-07.92	H1A	4	<b>Z 193</b>	14 FR-7 DU2	0,9	<b>UXT 1<sup>3</sup></b>
--------	-----	----	-------------	-----	---	--------------	-------------	-----	--------------------------

11	1.1	44	09.86-12.97	HDZ (TU1M)/H1B	4	<b>Z 193</b>	14 FR-7 DU2	0,9	<b>UXT 1<sup>3</sup></b>
----	-----	----	-------------	----------------	---	--------------	-------------	-----	--------------------------

14 D	1.4	37	08.91-12.97	K9Y (TUD3Y)	4	<b>GV 661</b> (11V)	○		
------	-----	----	-------------	-------------	---	---------------------	---	--	--

14 D	1.4	38	09.88-06.92	K9A (TUD3)	4	<b>GV 661</b> (11V)	<b>GR 065</b>		
------	-----	----	-------------	------------	---	---------------------	---------------	--	--

14	1.4	55	04.87-04.97	KDY (TU3FM)/KDZ (TU3M/Z)/ KDX (TU3M/Z)/KDY (TU3M)	4	<b>Z 193</b>	14 FR-7 DU2	0,9	<b>UXT 1<sup>3</sup></b>
----	-----	----	-------------	--	---	--------------	-------------	-----	--------------------------

14 4x4	1.4	55	08.91-06.95	KDY (TU3FM)/KDZ (TU3M/Z)/ KDX (TU3M/Z)/KDY (TU3M)	4	<b>Z 193</b>	14 FR-7 DU2	0,9	<b>UXT 1<sup>3</sup></b>
--------	-----	----	-------------	--	---	--------------	-------------	-----	--------------------------

14 4x4	1.4	55	07.95-12.96	KDY (TU3FM)/KDZ (TU3M/Z)/ KDX (TU3M/Z)/KDY (TU3M)	4	<b>Z 123</b>	14 FR-7 KDU	1,0	<b>UXT 9</b>
--------	-----	----	-------------	--	---	--------------	-------------	-----	--------------

14	1.4	62	01.88-12.92	K2B/K2A	4	<b>Z 24</b>	14 FR-6 DU	0,8	<b>UXT 5</b>
----	-----	----	-------------	---------	---	-------------	------------	-----	--------------

1.4 GTi	1.4	66	08.91-12.96	KFY (TU3FJ2)	4	<b>Z 60</b>	14 FGR-7 CTU	1,2	○
---------	-----	----	-------------	--------------	---	-------------	--------------	-----	---

1.4 GTi	1.4	69	06.91-12.96	KFZ (TU3FJ2)	4	<b>Z 60</b>	14 FGR-7 CTU	1,2	○
---------	-----	----	-------------	--------------	---	-------------	--------------	-----	---

1.4 GTi	1.4	74	06.91-12.92	KFZ (TU3FJ2)	4	<b>Z 193</b>	14 FR-7 DU2	0,9	<b>UXT 1<sup>3</sup></b>
---------	-----	----	-------------	--------------	---	--------------	-------------	-----	--------------------------

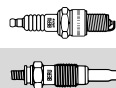
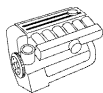

## CITROËN

<b>AX</b>									
15 D	1.5	40	08.94–12.97	VJY (TUD5)	4	<b>GN 912</b> (11V)	<b>GR 054</b>		
15 D	1.5	43	08.94–12.97	VJZ (TUD5)	4	<b>GN 912</b> (11V)	<b>GR 054</b>		

<b>AXEL</b>									
11	1.1	42	01.84–03.91	G11/631	4	<b>Z 25</b>	14 K-6 DU	0,8	<b>UXK 56</b>
11	1.3	45	01.84–03.91		4	<b>Z 25</b>	14 K-6 DU	0,8	<b>UXK 56</b>

<b>BERLINGO</b>									
1.1 i	1.1	44	07.96–	HDZ (TU1M)/HFX (TU1JP)	4	<b>Z 123</b>	14 FR-7 KDU	1,0	<b>UXT 9</b>
1.4 i	1.4	55	07.96–	KFX (TU3JP)/KFW (TU3JP)	4	<b>Z 123</b>	14 FR-7 KDU	1,0	<b>UXT 9</b>
1.4 i bivalent	1.4	55	04.03–	KFW (TU3JP)	4	<b>Z 206</b>	14 FR-7 DPPUS2	0,7	<b>UXT 10</b>
1.6 HDi 75	1.6	55	04.08–	9HT (DV6BTED4)/9HN (DV6ETED)/9HW (DV6ETED)	4	<b>GN 056</b> (11V)	○		
1.6 HDI 75	1.6	55	07.05–05.06	9HW (DV6ETED)/DV6B	4	<b>GN 047</b> (11V)	○		
1.6 HDI 75	1.6	55	06.06–	9HW (DV6ETED)/DV6B	4	<b>GN 056</b> (11V)	○		
1.6	1.6	66	04.08–	NFR (TU5JP4B)	4	<b>Z 184</b>	14 FR-7 MU2	0,9	<b>UXT 13</b>
1.6 HDi 90	1.6	66	04.08–	9HX (DV6ATED4)	4	<b>GN 056</b> (11V)	○		
1.6 HDI 90	1.6	66	07.05–02.06	9HX (DV6ATED4)/DV6ATED4 → Organisationnr. 10688	4	<b>GN 047</b> (11V)	○		
1.6 HDI 90	1.6	66	03.06–	9HX (DV6ATED4)/DV6ATED4 Organisationnr. 10689 →	4	<b>GN 056</b> (11V)	○		
1.6 VTi 95	1.6	72	07.10–	5FK (EP6 CB)	4	<b>Z 332</b>	12 ZR-6 SPP2-1	0,7	○
1.6 16V	1.6	80	10.00–11.02	NFU (TU5JP4)	4	<b>Z 184</b>	14 FR-7 MU2	0,9	<b>UXT 13</b>
1.6	1.6	80	04.08–	NFU (TU5JP4)	4	<b>Z 184</b>	14 FR-7 MU2	0,9	<b>UXT 13</b>
1.6 HDI 110	1.6	80	08.05–	DV6TED4	4	<b>GN 047</b> (11V)	○		
1.6 HDi 110	1.6	80	04.08–	9HZ (DV6TED4)	4	<b>GN 056</b> (11V)	○		
1.6 VTi 120	1.6	88	11.09–	5FS (EP6C)	4	<b>Z 332</b>	12 ZR-6 SPP2-1	0,7	○
1.8 D	1.8	43	07.98–	A9A (XUD7)	4	<b>GN 013</b> (11V)	○		
1.8 D	1.8	44	11.96–10.99	A9A (XUD7)	4	<b>GN 013</b> (11V)	○		
1.8 i	1.8	66	05.97–	LFX (XU7JB)	4	<b>Z 193</b>	14 FR-7 DU2	0,9	<b>UXT 13</b>
1.8 i 4WD	1.8	66	04.97–	LFX (XU7JB)	4	<b>Z 193</b>	14 FR-7 DU2	0,9	<b>UXT 13</b>
1.9 D	1.9	50	07.96–08.98	D9B (XUD9A/L)/DJY (XUD9A)	4	<b>GN 909</b> (11V)	<b>GR 054</b>		
1.9 D	1.9	50	09.98–	D9B (XUD9A/L)/DJY (XUD9A)	4	<b>GN 013</b> (11V)	○		
1.9 D	1.9	51	07.98–	WJY (DW8B)/WJZ (DW8)	4	<b>GN 016</b> (11V)	○		
1.9 D 4WD	1.9	51	07.98–	WJZ (DW8)	4	<b>GN 016</b> (11V)	○		
2.0 HDI 90	2.0	66	12.99–	RHY (DW10TD)	4	<b>GN 027</b> (11V)	○		
2.0 HDi 4x4	2.0	66	11.02–10.05	RHY (DW10TD)/DW10TD	4	<b>GN 027</b> (11V)	○		

<b>BX</b>									
11	1.1	40	10.88–06.92	HDZ (TU1M)	4	<b>Z 247</b>	14 FR-7 DUW	0,9	<b>UXT 13</b>
11	1.1	42	10.86–06.92		4	<b>Z 31</b>	14 K-5 DU	0,8	<b>UXK 56</b>
14 E	1.4	49	09.85–02.93	150F	4	<b>Z 95</b>	14 KR-7 DU	0,7	<b>UXT 4</b>
14 E	1.4	53	04.83–02.93	150C	4	<b>Z 95</b>	14 KR-7 DU	0,7	<b>UXT 4</b>
14	1.4	55	01.89–02.93	KDZ (TU3M/Z)/KDY (TU3M)	4	<b>Z 193</b>	14 FR-7 DU2	0,9	<b>UXT 13</b>
15	1.6	59	10.87–05.92	B1E (XU51C)	4	<b>Z 247</b>	14 FR-7 DUW	0,9	<b>UXT 13</b>
16	1.6	53	01.87–02.93	B1E (XU51C)	4	<b>Z 247</b>	14 FR-7 DUW	0,9	<b>UXT 13</b>
16	1.6	55	09.88–02.93	BAZ (XU5CP)/BAY (XU5CP)	4	<b>Z 247</b>	14 FR-7 DUW	0,9	<b>UXT 13</b>
16	1.6	58	09.87–02.93	B1A (XU51C/K)	4	<b>Z 31</b>	14 K-5 DU	0,8	<b>UXK 56</b>
16	1.6	64	07.87–02.93	171D	4	<b>Z 24</b>	14 FR-6 DU	0,8	<b>UXT 5</b>
16 E	1.6	65	05.89–02.93	BDY (XU5M)/BDZ (XU5M)	4	<b>Z 247</b>	14 FR-7 DUW	0,9	<b>UXT 13</b>
16	1.6	76	07.87–02.93	180Z	4	<b>Z 247</b>	14 FR-7 DUW	0,9	<b>UXT 13</b>
1.8 D	1.8	44	10.85–09.93	161 (XUD7)	4	<b>GV 636</b> (11V)	<b>GR 065</b>		
18 TRD Turbo	1.8	66	03.88–02.93	AJZ (XUD7TE)/A8A (XUD7TE)	4	<b>GV 636</b> (11V)	<b>GR 065</b>		
19 D	1.9	47	09.83–09.93	DJZ (XUD9Y)/D9A (XUD9)/162 (XUD9)	4	<b>GV 636</b> (11V)	<b>GR 065</b>		
19 D	1.9	51	03.87–02.93	D9B (XUD9A/U)	4	<b>GV 636</b> (11V)	<b>GR 065</b>		
19 E	1.9	80	06.88–02.93	DDZ (XU9M)	4	<b>Z 193</b>	14 FR-7 DU2	0,9	<b>UXT 13</b>
19 E 4x4	1.9	80	04.89–02.93	DZF	4	<b>Z 247</b>	14 FR-7 DUW	0,9	<b>UXT 13</b>
19 GTi	1.9	88	06.88–02.93	DKZ (XU9JA)	4	<b>Z 247</b>	14 FR-7 DUW	0,9	<b>UXT 13</b>
19 GTi 4x4	1.9	88	06.88–02.93	DKZ (XU9JA)	4	<b>Z 247</b>	14 FR-7 DUW	0,9	<b>UXT 13</b>
19 GTi	1.9	90	07.86–02.93	D6A (XU9J2)	4	<b>Z 24</b>	14 FR-6 DU	0,8	<b>UXT 5</b>
19 GTi 16V	1.9	108	03.88–02.93	DFW (XU9J4)	4	<b>Z 60</b>	14 FGR-7 CTU	1,2	○

<b>BX Break</b>									
14	1.4	52	01.87–01.92	150C	4	<b>Z 95</b>	14 KR-7 DU	0,7	<b>UXT 4</b>

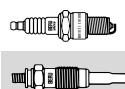
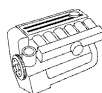

## CITROËN

### BX Break

14	1.4	53	01.86-02.93	150C	4	<b>Z 17</b>	14 K-7 DU	0,8	<b>UXT 4</b>
14	1.4	55	01.89-02.93	KDY (TU3M)	4	<b>Z 247</b>	14 FR-7 DUW	0,9	<b>UXT 1<sup>3</sup></b>
15	1.6	59	10.87-05.92	B1E (XU51C)	4	<b>Z 247</b>	14 FR-7 DUW	0,9	<b>UXT 1<sup>3</sup></b>
16	1.6	53	09.88-12.94	B1E (XU51C)	4	<b>Z 247</b>	14 FR-7 DUW	0,9	<b>UXT 1<sup>3</sup></b>
16	1.6	55	09.88-12.94	BAZ (XU5CP)/BAY (XU5CP)	4	<b>Z 247</b>	14 FR-7 DUW	0,9	<b>UXT 1<sup>3</sup></b>
16	1.6	64	04.88-12.94	171D	4	<b>Z 24</b>	14 FR-6 DU	0,8	<b>UXT 5</b>
16	1.6	65	05.89-12.94	BDY (XU5M)/BDZ (XU5M)	4	<b>Z 247</b>	14 FR-7 DUW	0,9	<b>UXT 1<sup>3</sup></b>
16	1.6	76	07.87-12.94	180Z	4	<b>Z 247</b>	14 FR-7 DUW	0,9	<b>UXT 1<sup>3</sup></b>
18 D	1.8	44	10.85-09.93	161A (XUD7)	4	<b>GV 636 (11V)</b>	<b>GR 065</b>		
18 TRD Turbo	1.8	66	03.88-12.94	AJZ (XUD7TE)/A8A (XUD7TE)	4	<b>GV 636 (11V)</b>	<b>GR 065</b>		
19 D	1.9	47	09.83-11.94	DJZ (XUD9Y)/D9A (XUD9)/162 (XUD9)	4	<b>GV 636 (11V)</b>	<b>GR 065</b>		
19 D	1.9	51	03.87-12.94	D9B (XUD9A/U)	4	<b>GV 636 (11V)</b>	<b>GR 065</b>		
19 KAT	1.9	75	07.87-12.94	DFZ (XU9J1)	4	<b>Z 193</b>	14 FR-7 DU2	0,9	<b>UXT 1<sup>3</sup></b>
19	1.9	75	07.86-12.94	D2A (XU92C)	4	<b>Z 25</b>	14 K-6 DU	0,8	<b>UXK 56</b>
19	1.9	80	06.88-12.94	DDZ (XU9M)	4	<b>Z 193</b>	14 FR-7 DU2	0,9	<b>UXT 1<sup>3</sup></b>
19 4x4	1.9	80	10.90-05.91	DDZ (XU9M)	4	<b>Z 247</b>	14 FR-7 DUW	0,9	<b>UXT 1<sup>3</sup></b>
19	1.9	88	06.88-12.94	DKZ (XU9JA)	4	<b>Z 247</b>	14 FR-7 DUW	0,9	<b>UXT 1<sup>3</sup></b>

### C1

1.0	1.0	50	06.05-	1KR-FE	3	<b>Z 273</b>	14 FR-7 NUX2	1,1	○
1.4 HDi	1.4	40	06.05-	DV4D	4	<b>GN 056 (11V)</b>	○		

### C2

1.4 HDi	1.4	50	09.03-	8HX (DV4TD)	4	<b>GN 047 (11V)</b>	○		
1.4	1.4	54	09.03-08.05	KFV (TU3JP)	4	<b>Z 193</b>	14 FR-7 DU2	0,9	<b>UXT 1<sup>3</sup></b>
1.4 16V	1.4	65	06.06-	KFU (ET3J4)	4	<b>Z 243</b>	12 VR-8 SE	0,9	○
1.6	1.6	80	09.03-	NFU (TU5JP4)	4	<b>Z 184</b>	14 FR-7 MU2	0,9	<b>UXT 13</b>
1.6 HDi	1.6	80	09.05-06.07	9HZ (DV6TED4)	4	<b>GN 047 (11V)</b>	○		
1.6 HDi	1.6	80	07.07-	9HZ (DV6TED4)	4	<b>GN 056 (11V)</b>	○		

### C2 ENTERPRISE

1.4 HDi	1.4	50	04.09-	8HX (DV4TD)	4	<b>GN 047 (11V)</b>	○		
---------	-----	----	--------	-------------	---	---------------------	---	--	--

### C3

1.1 i	1.1	44	02.02-	HFX (TU1JP)	4	<b>Z 193</b>	14 FR-7 DU2	0,9	<b>UXT 1<sup>3</sup></b>
1.4 HDi	1.4	50	02.02-	8HX (DV4TD)	4	<b>GN 047 (11V)</b>	○		
1.4 HDi	1.4	50	02.02-	8HX (DV4TD) → Organisationsnr. 10443	4	<b>GN 056 (11V)</b>	○		
1.4 HDi	1.4	50	02.02-	8HX (DV4TD) Organisationsnr. 10444 →	4	<b>GN 056 (11V)</b>	○		
1.4 i	1.4	54	02.02-08.05	KFV (TU3JP)	4	<b>Z 193</b>	14 FR-7 DU2	0,9	<b>UXT 1<sup>3</sup></b>
1.4 i Bivalent	1.4	54	02.02-08.05	KFV (TU3JP)	4	<b>Z 193</b>	14 FR-7 DU2	0,9	<b>UXT 1<sup>3</sup></b>
1.4 16V	1.4	65	12.03-	KFU (ET3J4)	4	<b>Z 243</b>	12 VR-8 SE	0,9	○
1.4 16V HDi	1.4	66	02.02-	8HY (DV4TED4) → Organisationsnr. 10226	4	<b>GN 047 (11V)</b>	○		
1.4 16V HDi	1.4	66	02.02-	8HY (DV4TED4) Organisationsnr. 10227 →	4	<b>GN 056 (11V)</b>	○		
1.6 16V HDi	1.6	66	10.05-	9HX (DV6ATED4) → Organisationsnr.10783	4	<b>GN 047 (11V)</b>	○		
1.6 16V HDi	1.6	66	10.05-	9HX (DV6ATED4) Organisationsnr.10784 →	4	<b>GN 056 (11V)</b>	○		
1.6 16V	1.6	80	02.02-08.05	NFU (TU5JP4)	4	<b>Z 184</b>	14 FR-7 MU2	0,9	<b>UXT 13</b>
1.6 16V HDi	1.6	80	09.05-	DV6TED4 → Organisationsnr.10783	4	<b>GN 047 (11V)</b>	○		
1.6 16V HDi	1.6	80	09.05-	DV6TED4 Organisationsnr.10784 →	4	<b>GN 056 (11V)</b>	○		

### C3 II

1.4 HDi 70	1.4	50	11.09-	8HR (DV4C)/8HZ (DV4TD)	4	<b>GN 056 (11V)</b>	○		
1.4	1.4	54	11.09-	KFT (TU3A)	4	<b>Z 193</b>	14 FR-7 DU2	0,9	<b>UXT 1<sup>3</sup></b>
1.4 VTi 95	1.4	70	11.09-		4	<b>Z 320</b>	12 ZR-8 STP	1,0	○
1.6 HDi 90	1.6	66	11.09-	9HX (DV6ATED4)/DV6ATED4	4	<b>GN 056 (11V)</b>	○		
1.6 VTi 120	1.6	88	11.09-	5FS (EP6C)	4	<b>Z 332</b>	12 ZR-6 SPP2-1	0,7	○

### C3 Picasso

1.4 VTi 95	1.4	70	02.09-	8FS (EP3)	4	<b>Z 320</b>	12 ZR-8 STP	1,0	○
1.6 HDi	1.6	66	02.09-	9HX (DV6ATED4)	4	<b>GN 056 (11V)</b>	○		



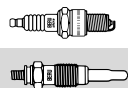
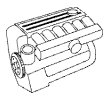

## CITROËN

### C3 Picasso

1.6 HDi	1.6	80	02.09–	9HZ (DV6TED4)	4	<b>GN 056</b> (11V)	○		
1.6 VTi 120	1.6	88	02.09–	5FW (EP6)	4	<b>Z 332</b>	12 ZR-6 SPP2-1	0,7	○

### C3 Pluriel

1.4 HDi	1.4	50	04.04–	8HX (DV4TD) → Organisationsnr. 10220	4	<b>GN 047</b> (11V)	○		
1.4 HDi	1.4	50	04.04–	8HX (DV4TD) Organisationsnr. 10221 →	4	<b>GN 056</b> (11V)	○		
1.4	1.4	54	05.03–08.05	KFV (TU3JP)	4	<b>Z 193</b>	14 FR-7 DU2	0,9	<b>UXT 13</b>
1.6	1.6	80	05.03–08.05	NFU (TU5JP4)	4	<b>Z 184</b>	14 FR-7 MU2	0,9	<b>UXT 13</b>

### C4

1.4 16V	1.4	65	11.04–	KFU (ET3J4)	4	<b>Z 243</b>	12 VR-8 SE	0,9	○
1.4 VTi 95	1.4	70	11.09–	8FP (EP3)	4	<b>Z 332</b>	12 ZR-6 SPP2-1	0,7	○
1.6 HDi	1.6	66	11.04–	9HX (DV6ATED4)	4	<b>GN 027</b> (11V)	○		
1.6 16V	1.6	80	11.04–	NFU (TU5JP4)	4	<b>Z 184</b>	14 FR-7 MU2	0,9	<b>UXT 13</b>
1.6 16V Bio-Flex	1.6	80	09.07–	NFU (TU5JP4)	4	<b>Z 184</b>	14 FR-7 MU2	0,9	<b>UXT 13</b>
1.6 HDi	1.6	80	11.04–02.06	9HY (DV6TED4)/9HZ (DV6TED4)/DV6TED4	4	<b>GN 047</b> (11V)	○		
1.6 HDi	1.6	80	03.06–	9HY (DV6TED4)/9HZ (DV6TED4)/DV6TED4	4	<b>GN 056</b> (11V)	○		
1.6 HDi	1.6	80	07.06–	DV6TED4	4	<b>GN 056</b> (11V)	○		
1.6 VTi 120	1.6	88	11.09–	5FS (EP6C)	4	<b>Z 332</b>	12 ZR-6 SPP2-1	0,7	○
1.6 VTi 120	1.6	88	07.08–	5FW (EP6)	4	<b>Z 332</b>	12 ZR-6 SPP2-1	0,7	○
1.6 THP 140	1.6	103	07.08–	5FT (EP6DT)	4	<b>Z 332</b>	12 ZR-6 SPP2-1	0,7	○
1.6 THP 150	1.6	110	07.08–	5FX (EP6DT)	4	<b>Z 332</b>	12 ZR-6 SPP2-1	0,7	○
1.6 THP 155	1.6	115	11.09–	5FV (EP6CDT)	4	<b>Z 332</b>	12 ZR-6 SPP2-1	0,7	○
2.0 16V	2.0	100	11.04–	RFN (EW10J4)	4	<b>Z 183</b>	14 FR-8 MU2	0,9	<b>UXT 13</b>
2.0 HDi	2.0	100	11.04–	RHR (DW10BTED4)/ DW10BTED4	4	<b>GN 054</b> (11V)	○		
2.0 16V	2.0	103	11.04–	RFJ (EW10A)/EW10A	4	<b>Z 223</b>	14 FR-8 NQU23	0,9	○
2.0 16V	2.0	103	07.06–	EW10A	4	<b>Z 223</b>	14 FR-8 NQU23	0,9	○
2.0 16V	2.0	130	11.04–	EW10J4S/RFK (EW10J4S)	4	<b>Z 184</b>	14 FR-7 MU2	0,9	<b>UXT 13</b>

### C4 Coupe

1.4 16V	1.4	65	11.04–	KFU (ET3J4)	4	<b>Z 243</b>	12 VR-8 SE	0,9	○
1.6 HDi	1.6	66	11.04–	9HX (DV6ATED4)	4	<b>GN 027</b> (11V)	○		
1.6 16V	1.6	80	11.04–	NFU (TU5JP4)	4	<b>Z 184</b>	14 FR-7 MU2	0,9	<b>UXT 13</b>
1.6 HDi	1.6	80	11.04–02.06	9HY (DV6TED4)/9HZ (DV6TED4)/DV6TED4	4	<b>GN 047</b> (11V)	○		
1.6 HDi	1.6	80	03.06–	9HY (DV6TED4)/9HZ (DV6TED4)/DV6TED4	4	<b>GN 056</b> (11V)	○		
1.6 VTi 120	1.6	88	07.08–	5FW (EP6)	4	<b>Z 332</b>	12 ZR-6 SPP2-1	0,7	○
1.6 THP 150	1.6	110	07.08–	5FX (EP6DT)	4	<b>Z 332</b>	12 ZR-6 SPP2-1	0,7	○
2.0 16V	2.0	100	11.04–	RFN (EW10J4)	4	<b>Z 183</b>	14 FR-8 MU2	0,9	<b>UXT 13</b>
2.0 HDi	2.0	100	11.04–	RHR (DW10BTED4)/DW10BTED4	4	<b>GN 054</b> (11V)	○		
2.0 16V	2.0	130	11.04–	EW10J4S/RFK (EW10J4S)	4	<b>Z 184</b>	14 FR-7 MU2	0,9	<b>UXT 13</b>

### C4 Grand Picasso

1.6 HDi	1.6	80	10.06–	9HY (DV6TED4)	4	<b>GN 056</b> (11V)	○		
1.6 16V	1.6	110	10.08–	5FX (EP6DT)	4	<b>Z 332</b>	12 ZR-6 SPP2-1	0,7	○
1.6 THP 155	1.6	115	09.10–	5FV (EP6CDT)	4	<b>Z 332</b>	12 ZR-6 SPP2-1	0,7	○
2.0 HDi 138	2.0	100	10.06–	RHR (DW10BTED4)	4	<b>GN 027</b> (11V)	○		
2.0 i 16V	2.0	103	10.06–	RFJ (EW10A)	4	<b>Z 223</b>	14 FR-8 NQU23	0,9	○

### C4 Picasso

1.6 HDi	1.6	80	02.07–	9HY (DV6TED4)	4	<b>GN 056</b> (11V)	○		
1.6 VTi 120	1.6	88	07.08–	5FW (EP6)	4	<b>Z 332</b>	12 ZR-6 SPP2-1	0,7	○
1.6 16V	1.6	110	07.08–	5FX (EP6DT)	4	<b>Z 332</b>	12 ZR-6 SPP2-1	0,7	○
1.6 THP 155	1.6	115	09.10–	5FV (EP6CDT)	4	<b>Z 332</b>	12 ZR-6 SPP2-1	0,7	○
2.0 HDi 138	2.0	100	02.07–	RHR (DW10BTED4)	4	<b>GN 027</b> (11V)	○		
2.0 i 16V	2.0	103	02.07–	RFJ (EW10A)	4	<b>Z 223</b>	14 FR-8 NQU23	0,9	○

### C5

1.6 HDi	1.6	80	02.08–	DV6TED4	4	<b>GN 056</b> (11V)	○		
1.6 HDi	1.6	80	09.04–	9HY (DV6TED4) → Organisationsnr.10783	4	<b>GN 047</b> (11V)	○		



kW

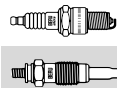
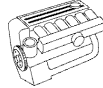

**CITROËN**

**C5**

1.6 HDi	1.6	80	09.04-	9HY (DV6TED4) Organisationsnr.10784 →	4	<b>GN 056</b> (11V)	○		
1.6 VTi 120	1.6	88	07.10-	5FS (EP6C)	4	<b>Z 332</b>	12 ZR-6 SPP2-1	0,7	○
1.6 THP 155	1.6	115	04.09-	5FV (EP6DT)	4	<b>Z 332</b>	12 ZR-6 SPP2-1	0,7	○
1.8 16V	1.7	85	03.01-08.04	6FZ (EW7J4)	4	<b>Z 223</b>	14 FR-8 NQU23	0,9	○
2.0 HDi	2.0	66	03.01-08.04	RHY (DW10TD)	4	<b>GN 027</b> (11V)	○		
2.0 HDi	2.0	79	03.01-08.04	RHZ (DW10ATED)/ RHS (DW10ATED)	4	<b>GN 027</b> (11V)	○		
2.0 HDi	2.0	80	03.01-08.04	RHZ (DW10ATED)	4	<b>GN 027</b> (11V)	○		
2.0 16V	2.0	100	03.01-08.04	RFN (EW10J4)	4	<b>Z 183</b>	14 FR-8 MU2	0,9	<b>UXT 13</b>
2.0 HDi	2.0	100	09.04-	DW10BTED4	4	<b>GN 054</b> (11V)	○		
2.0 HDi	2.0	100	02.08-	DW10BTED4	4	<b>GN 054</b> (11V)	○		
2.0 16V HPI	2.0	103	03.01-08.04	RLZ (EW10D)	4	<b>Z 242</b>	12 ZR-8 TP	1,0	○
2.0 16V	2.0	103	09.04-	RFJ (EW10A)/EW10A	4	<b>Z 223</b>	14 FR-8 NQU23	0,9	○
2.0 16V	2.0	103	02.08-	RFJ (EW10A)/EW10A	4	<b>Z 223</b>	14 FR-8 NQU23	0,9	○
2.2 HDi	2.2	98	03.01-08.04	4HX (DW12TED4/FAP)	4	<b>GN 027</b> (11V)	○		
2.2 HDi	2.2	98	03.01-08.04	4HX (DW12TED4/FAP) mit Diagnose	4	<b>GN 054</b> (11V)	○		
2.2 HDi	2.2	98	09.04-	4HX (DW12TED4/FAP)	4	<b>GN 027</b> (11V)	○		
2.2 HDi	2.2	125	04.06-	4HT (DW12BTED4)	4	<b>GN 063</b> (11V)	○		
2.2 HDi	2.2	125	02.08-	4HT (DW12BTED4)	4	<b>GN 063</b> (11V)	○		
2.7 HDi	2.7	150	02.08-	DT17ED4	6	<b>GN 045</b> (11V)	○		
3.0 V6	2.9	152	03.01-08.04	XFX (ES9J4S)	6	<b>Z 211</b>	14 FGR-8 MQPU	1,4	○
3.0 V6	2.9	152	09.04-	XFV (ES9A)/XFV (ES9J4S)	6	<b>Z 211</b>	14 FGR-8 MQPU	1,4	○

**C5 Break**

1.6 HdI	1.6	80	09.04-	9HY (DV6TED4) → Organisationsnr.10783	4	<b>GN 047</b> (11V)	○		
1.6 HDi	1.6	80	09.04-	9HY (DV6TED4) Organisationsnr.10784 →	4	<b>GN 056</b> (11V)	○		
1.6 HDi	1.6	80	02.08-	9HZ (DV6TED4)/DV6TED4	4	<b>GN 056</b> (11V)	○		
1.6 VTi 120	1.6	88	07.10-	5FS (EP6C)	4	<b>Z 332</b>	12 ZR-6 SPP2-1	0,7	○
1.6 THP 155	1.6	115	04.09-	5FV (EP6DT)	4	<b>Z 332</b>	12 ZR-6 SPP2-1	0,7	○
1.8 16V	1.7	85	06.01-08.04	6FZ (EW7J4)	4	<b>Z 223</b>	14 FR-8 NQU23	0,9	○
1.8 16V	1.7	85	09.04-	6FZ (EW7J4)	4	<b>Z 223</b>	14 FR-8 NQU23	0,9	○
2.0 HDi	2.0	66	06.01-08.04	RHY (DW10TD)	4	<b>GN 027</b> (11V)	○		
2.0 HDi	2.0	79	06.01-08.04	RHZ (DW10ATED)/ RHS (DW10ATED)	4	<b>GN 027</b> (11V)	○		
2.0 HDi	2.0	80	06.01-08.04	RHZ (DW10ATED)	4	<b>GN 027</b> (11V)	○		
2.0 16V	2.0	100	06.01-08.04	RFN (EW10J4)	4	<b>Z 183</b>	14 FR-8 MU2	0,9	<b>UXT 13</b>
2.0 HdI	2.0	100	09.04-	RHR (DW10BTED4)	4	<b>GN 054</b> (11V)	○		
2.0 HDi	2.0	100	02.08-	RHR (DW10BTED4)/DW10BTED4	4	<b>GN 054</b> (11V)	○		
2.0 16V HPI	2.0	103	06.01-08.04	RLZ (EW10D)	4	<b>Z 242</b>	12 ZR-8 TP	1,0	○
2.0 16V	2.0	103	09.04-	RFJ (EW10A)	4	<b>Z 223</b>	14 FR-8 NQU23	0,9	○
2.0 16V	2.0	103	02.08-	RFJ (EW10A)/EW10A	4	<b>Z 223</b>	14 FR-8 NQU23	0,9	○
2.2 HDi	2.2	98	06.01-08.04	4HX (DW12TED4/FAP)	4	<b>GN 027</b> (11V)	○		
2.2 HDi	2.2	98	06.01-08.04	4HX (DW12TED4/FAP) mit Diagnose	4	<b>GN 054</b> (11V)	○		
2.2 HDi	2.2	98	09.04-	4HX (DW12TED4/FAP)	4	<b>GN 027</b> (11V)	○		
2.2 HDi	2.2	125	04.06-	4HT (DW12BTED4)	4	<b>GN 063</b> (11V)	○		
2.2 HDi	2.2	125	02.08-	4HT (DW12BTED4)	4	<b>GN 063</b> (11V)	○		
2.7 HDi	2.7	150	02.08-	DT17ED4	6	<b>GN 045</b> (11V)	○		
3.0 V6	2.9	152	06.01-08.04	XFX (ES9J4S)	6	<b>Z 211</b>	14 FGR-8 MQPU	1,4	○
3.0 V6	2.9	152	09.04-	XFV (ES9A)	6	<b>Z 211</b>	14 FGR-8 MQPU	1,4	○

**C6**

2.2 HDi	2.2	125	06.06-	4HT (DW12BTED4)	4	<b>GN 063</b> (11V)	○		
2.7 HDi	2.7	150	09.05-	UHZ (DT17BTED4)/DT17ED4	6	<b>GN 045</b> (11V)	○		
3.0 V6	2.9	155	09.05-	XFV (ES9A)	6	<b>Z 211</b>	14 FGR-8 MQPU	1,4	○

**C8**

2.0 HDi	2.0	79	07.02-	RHT (DW10ATED4)/ RHM (DW10ATED4)/ RHW (DW10ATED4)	4	<b>GN 027</b> (11V)	○		
---------	-----	----	--------	---	---	---------------------	---	--	--

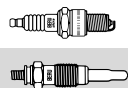
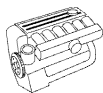

## CITROËN

<b>C8</b>									
2.0 HDi	2.0	88	02.07-	RHK (DW10UTED4)	4	<b>GN 027</b> (11V)	○		
2.0	2.0	100	07.02-	RFN (EW10J4)	4	<b>Z 183</b>	14 FR-8 MU2	0,9	<b>UXT 13</b>
2.0 HDi 135	2.0	100	03.06-	RHR (DW10BTED4)	4	<b>GN 054</b> (11V)	○		
2.0 16V	2.0	103	09.05-	RFJ (EW10A)	4	<b>Z 223</b>	14 FR-8 NQU23	0,9	○
2.2 HDi	2.2	94	07.02-04.03	4HW (DW12TED4)	4	<b>GN 027</b> (11V)	○		
2.2 HDi	2.2	94	05.03-	4HW (DW12TED4)	4	<b>GN 054</b> (11V)	○		
2.2	2.2	116	07.02-	3FZ (EW12J4)	4	<b>Z 223</b>	14 FR-8 NQU23	0,9	○
2.2 HDi	2.2	125	06.06-	4HT (DW12BTED4)	4	<b>GN 063</b> (11V)	○		
3.0 V6	2.9	150	07.02-	XFX (ES9J4S)	6	<b>Z 211</b>	14 FGR-8 MQPU	1,4	○

## C-CROSSER

2.2 HDi	2.2	115	02.07-	4HN (DW12MTED4)	4	<b>GN 063</b> (11V)	○		
---------	-----	-----	--------	-----------------	---	---------------------	---	--	--

## C-CROSSER ENTERPRISE

2.2 HDi	2.2	115	01.09-	4HN (DW12MTED4)	4	<b>GN 063</b> (11V)	○		
---------	-----	-----	--------	-----------------	---	---------------------	---	--	--

## CX II

20 RE	2.0	78	08.85-12.92	829 A5	4	<b>Z 17</b>	14 K-7 DU	0,8	<b>UXT 4</b>
22 TRS	2.2	83	07.85-12.92	J6T A500	4	<b>Z 25</b>	14 K-6 DU	0,8	<b>UXK 56</b>
25 D	2.5	54	08.85-12.92	M25-660	4	<b>GV 602</b> (11V)	<b>GR 059</b>		
25 D Turbo	2.5	88	01.87-12.92	M25-669	4	<b>GV 602</b> (11V)	<b>GR 059</b>		
25 GTi	2.5	89	05.86-12.92	M25-668	4	<b>Z 41</b>	14-5 BU	0,8	○
25 TRI	2.5	100	08.85-12.92	M25-659	4	<b>Z 41</b>	14-5 BU	0,8	○
25 GTi Turbo 2	2.5	115	09.86-12.92	M25-667	4	<b>Z 41</b>	14-5 BU	0,8	○
25 GTi Turbo 2	2.5	122	08.85-12.92	M25-662	4	<b>Z 41</b>	14-5 BU	0,8	○

## CX II Break

22 TRS	2.2	83	07.85-12.92	J6T A500	4	<b>Z 25</b>	14 K-6 DU	0,8	<b>UXK 56</b>
25 D	2.5	54	05.86-12.92	M25-660	4	<b>GV 602</b> (11V)	○		
25 D Turbo 2	2.5	88	01.87-12.92	M25-669	4	<b>GV 602</b> (11V)	<b>GR 059</b>		
25 i	2.5	89	05.86-12.92	M25-668	4	<b>Z 41</b>	14-5 BU	0,8	○
25 TRI	2.5	100	08.85-12.92	M25-659	4	<b>Z 41</b>	14-5 BU	0,8	○

## DS3

1.4 VTi 95	1.4	70	04.10-	8FP (EP3)	4	<b>Z 320</b>	12 ZR-8 STP	1,0	○
1.6 VTi 120	1.6	88	04.10-	5FS (EP6C)	4	<b>Z 332</b>	12 ZR-6 SPP2-1	0,7	○
1.6 THP 150	1.6	115	04.10-	5FR (EP6DT)	4	<b>Z 332</b>	12 ZR-6 SPP2-1	0,7	○

## DS4

1.6 VTi 120	1.6	88	04.11-	5FS (EP6C)	4	<b>Z 332</b>	12 ZR-6 SPP2-1	0,7	○
1.6 THP 155	1.6	115	04.11-	5FV (EP6CDT)	4	<b>Z 332</b>	12 ZR-6 SPP2-1	0,7	○

## DS5

1.6 THP 155	1.6	115	11.11-	5FV (EP6CDT)	4	<b>Z 332</b>	12 ZR-6 SPP2-1	0,7	○
-------------	-----	-----	--------	--------------	---	--------------	----------------	-----	---

## EVASION

1.8	1.8	73	05.97-07.02	LFZ (XU7JP)	4	<b>Z 247</b>	14 FR-7 DUW	0,9	<b>UXT 13</b>
1.9 TD	1.9	66	11.94-08.98	DHX (XUD9TF/BTF)/ D8B (XUD9TF)	4	<b>GN 909</b> (11V)	○		
1.9 TD	1.9	66	09.98-07.02	DHX (XUD9TF/BTF)/ D8B (XUD9TF)	4	<b>GN 013</b> (11V)	○		
1.9 TD	1.9	68	10.95-12.98	D8B (XUD9TF)	4	<b>GN 909</b> (11V)	○		
2.0 HDI	2.0	80	08.99-07.02	RHZ (DW10ATED)	4	<b>GN 027</b> (11V)	○		
2.0 HDI 16V	2.0	80	09.99-07.02	RHW (DW10ATED4)	4	<b>GN 027</b> (11V)	○		
2.0	2.0	89	06.94-07.02	RFU (XU10J2/C)	4	<b>Z 193</b>	14 FR-7 DU2	0,9	<b>UXT 13</b>
2.0 16V	2.0	97	05.98-04.00	RFV (XU10J4R)	4	<b>Z 193</b>	14 FR-7 DU2	0,9	<b>UXT 13</b>
2.0 16V	2.0	100	05.00-07.02	RFN (EW10J4)	4	<b>Z 183</b>	14 FR-8 MU2	0,9	<b>UXT 13</b>
2.0 Turbo C.T.	2.0	108	06.94-07.02	RGX (XU10J2TE)	4	<b>Z 193</b>	14 FR-7 DU2	0,9	<b>UXT 13</b>
2.1 TD	2.1	80	05.96-08.98	P8C (XUD11BTE)	4	<b>GN 909</b> (11V)	○		
2.1 TD	2.1	80	09.98-07.02	P8C (XUD11BTE)	4	<b>GN 013</b> (11V)	○		

## JUMPY

1.6	1.6	58	10.95-	220 A2.000/1580 SPI	4	<b>Z 24</b>	14 FR-6 DU	0,8	<b>UXT 5</b>
1.6 HDi 90	1.6	66	01.07-	9HU (DV6UTED4)	4	<b>GN 056</b> (11V)	○		
1.9 D	1.9	51	10.95-04.98	D9B (XUD9A/U)	4	<b>GN 013</b> (11V)	○		
1.9 D 70	1.9	51	04.98-	WJZ (DW8)	4	<b>GN 016</b> (11V)	○		
1.9 TD	1.9	66	10.95-08.98	DHX (XUD9TF/BTF)	4	<b>GN 909</b> (11V)	○		
1.9 TD	1.9	66	09.98-	DHX (XUD9TF/BTF)	4	<b>GN 013</b> (11V)	○		
1.9 TD	1.9	68	04.96-08.98	D8B (XUD9TF)	4	<b>GN 909</b> (11V)	○		
1.9 TD	1.9	68	09.98-	D8B (XUD9TF)	4	<b>GN 013</b> (11V)	○		



kW

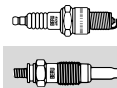
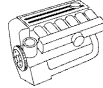

### CITROËN

#### JUMPY

2.0 HDi 95	2.0	69	10.99-	RHX	4	<b>GN 027</b> (11V)	○		
2.0 HDi 110	2.0	80	03.00-	RHW (DW10ATED4)	4	<b>GN 027</b> (11V)	○		
2.0 HDi 110	2.0	80	03.00-	RHZ (DW10ATED)	4	<b>GN 027</b> (11V)	○		
2.0 HDi 120	2.0	88	01.07-	RHK (DW10UTED4)	4	<b>GN 027</b> (11V)	○		
2.0 HDi 140	2.0	100	01.07-	RHR (DW10BTED4)	4	<b>GN 027</b> (11V)	○		
2.0	2.0	100	04.00-12.06	RFN (EW10J4)	4	<b>Z 183</b>	14 FR-8 MU2	0,9	<b>UXT 13</b>
2.0 i 16V	2.0	102	03.00-		4	<b>Z 183</b>	14 FR-8 MU2	0,9	<b>UXT 13</b>

#### NEMO

1.4 HDi	1.4	50	04.09-	8HS (DV4TD)	4	<b>GN 056</b> (11V)	○		
1.4	1.4	54	04.09-	KFV (TU3A)	4	<b>Z 193</b>	14 FR-7 DU2	0,9	<b>UXT 13</b>

#### SAXO

1.0 X	1.0	33	05.96-11.98	CDZ (TU9M)	4	<b>Z 193</b>	14 FR-7 DU2	0,9	<b>UXT 13</b>
1.0 X	1.0	37	05.98-06.03	CDZ (TU9M)	4	<b>Z 193</b>	14 FR-7 DU2	0,9	<b>UXT 13</b>
1.1 X,SX	1.1	40	05.96-09.03	HDZ (TU1M)	4	<b>Z 193</b>	14 FR-7 DU2	0,9	<b>UXT 13</b>
1.1 X,SX	1.1	44	05.96-09.03	HDZ (TU1M)/HFX (TU1JP)	4	<b>Z 193</b>	14 FR-7 DU2	0,9	<b>UXT 13</b>
1.4 VTS	1.4	55	05.96-06.03	KFX (TU3JP)/KFW (TU3JP)	4	<b>Z 123</b>	14 FR-7 KDU	1,0	<b>UXT 9</b>
1.5 D	1.5	40	09.96-09.03	VJY (TUD5)	4	<b>GN 912</b> (11V)	<b>GR 054</b>		
1.5 D	1.5	42	09.96-06.01	VJZ (TUD5)	4	<b>GN 912</b> (11V)	<b>GR 054</b>		
1.5 D	1.5	43	07.01-04.04		4	<b>GN 016</b> (11V)	○		
1.6 VTL,VTR	1.6	65	05.96-06.03	NFZ (TU5JP)	4	<b>Z 247</b>	14 FR-7 DUW	0,9	<b>UXT 13</b>
1.6	1.6	66	02.96-06.03	NFZ (TU5JP)	4	<b>Z 247</b>	14 FR-7 DUW	0,9	<b>UXT 13</b>
1.6 VTS	1.6	72	09.00-09.03	NFT	4	<b>Z 193</b>	14 FR-7 DU2	0,9	<b>UXT 13</b>
1.6	1.6	74	02.01-04.04	NFT	4	<b>Z 193</b>	14 FR-7 DU2	0,9	<b>UXT 13</b>
1.6 VTS	1.6	87	06.96-09.03	NFX (TU5JP4)	4	<b>Z 123</b>	14 FR-7 KDU	1,0	<b>UXT 9</b>
1.6	1.6	88	02.96-04.04	NFX (TU5JP4)	4	<b>Z 123</b>	14 FR-7 KDU	1,0	<b>UXT 9</b>

#### VISA

0.6	0.7	24	07.82-03.91	V06/665	2	<b>Z 17</b>	14 K-7 DU	0,8	<b>UXT 4</b>
11 E	1.1	37	07.82-03.91	109/5F	4	<b>Z 25</b>	14 K-6 DU	0,8	<b>UXK 56</b>
11 E	1.1	42	09.78-03.91	109/5	4	<b>Z 25</b>	14 K-6 DU	0,8	<b>UXK 56</b>
14	1.4	44	07.84-03.91	150D (XY7)	4	<b>Z 17</b>	14 K-7 DU	0,8	<b>UXT 4</b>
14 GT	1.4	58	03.82-03.91	150B (XY8)	4	<b>Z 17</b>	14 K-7 DU	0,8	<b>UXT 4</b>
16 GTI	1.6	83	06.86-03.91	B6D	4	<b>Z 25</b>	14 K-6 DU	0,8	<b>UXK 56</b>
17 D	1.8	44	04.84-03.91	161A (XUD7)	4	<b>GV 636</b> (11V)	○		

#### XANTIA I

1.6 i	1.6	65	03.93-01.98	BFZ (XU5JP)	4	<b>Z 193</b>	14 FR-7 DU2	0,9	<b>UXT 13</b>
1.8 i	1.8	66	04.97-01.98	LFX (XU7JB)	4	<b>Z 247</b>	14 FR-7 DUW	0,9	<b>UXT 13</b>
1.8 i	1.8	74	03.93-01.98	LFZ (XU7JP)	4	<b>Z 193</b>	14 FR-7 DU2	0,9	<b>UXT 13</b>
1.8 i 16V	1.8	81	06.95-01.98	LFY (XU7JP4)	4	<b>Z 193</b>	14 FR-7 DU2	0,9	<b>UXT 13</b>
1.9 D	1.9	50	06.94-01.98	DJZ (XUD9Y)	4	<b>GV 636</b> (11V)	<b>GR 054</b>		
1.9 D	1.9	51	06.94-05.95	D9B (XUD9A/L)	4	<b>GV 636</b> (11V)	○		
1.9 D	1.9	51	06.95-01.98	D9B (XUD9A/L)	4	<b>GN 909</b> (11V)	<b>GR 054</b>		
1.9 SD	1.9	55	02.96-01.98	DHW (XUD9SD)	4	<b>GN 909</b> (11V)	○		
1.9 Turbo D	1.9	66	10.94-01.98	DHX (XUD9TF/BTF)/ DHY (XUD9TE/Y)	4	<b>GN 909</b> (11V)	<b>GR 054</b>		
2.0 i	2.0	89	03.93-01.98	RFX (XU10J2C)	4	<b>Z 193</b>	14 FR-7 DU2	0,9	<b>UXT 13</b>
2.0 i 16V	2.0	97	06.95-01.98	RFV (XU10J4R)	4	<b>Z 193</b>	14 FR-7 DU2	0,9	<b>UXT 13</b>
2.0 Turbo	2.0	108	06.95-01.98	RGX (XU10J2TE)	4	<b>Z 193</b>	14 FR-7 DU2	0,9	<b>UXT 13</b>
2.0 i 16V	2.0	110	06.94-01.98	RFT (XU10J4/Z)	4	<b>Z 24</b>	14 FR-6 DU	0,8	<b>UXT 5</b>
2.0 i 16V	2.0	112	03.93-01.98	RFY (XU10J4/Z)	4	<b>Z 247</b>	14 FR-7 DUW	0,9	<b>UXT 13</b>
2.1 Turbo D 12V	2.1	80	06.95-01.98	P8C (XUD11BTE)	4	<b>GN 909</b> (11V)	○		
3.0 i 24V	2.9	140	01.97-01.98	XFZ (ES9J4)	6	<b>Z 123</b>	14 FR-7 KDU	1,0	<b>UXT 9</b>

#### XANTIA Break I

1.8 i	1.8	66	04.97-01.98	LFX (XU7JB)	4	<b>Z 247</b>	14 FR-7 DUW	0,9	<b>UXT 13</b>
1.8 i	1.8	74	06.95-01.98	LFZ (XU7JP)	4	<b>Z 193</b>	14 FR-7 DU2	0,9	<b>UXT 13</b>
1.8 i 16V	1.8	81	06.95-01.98	LFY (XU7JP4)	4	<b>Z 193</b>	14 FR-7 DU2	0,9	<b>UXT 13</b>
1.9 SD	1.9	55	04.97-01.98	DHW (XUD9SD)	4	<b>GN 909</b> (11V)	○		
1.9 Turbo D	1.9	66	06.95-01.98	DHX (XUD9TF/BTF)/ DHY (XUD9TE/Y)/D8B (XUD9TF)	4	<b>GN 909</b> (11V)	<b>GR 054</b>		
2.0 i	2.0	89	06.95-01.98	RFX (XU10J2C)	4	<b>Z 193</b>	14 FR-7 DU2	0,9	<b>UXT 13</b>
2.0 i 16V	2.0	97	06.95-01.98	RFV (XU10J4R)	4	<b>Z 74</b>	14 FR-8 LDU0X4	1,0	<b>UXT 13</b>

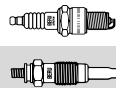
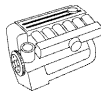

## CITROËN

### XANTIA Break I

2.0 Turbo	2.0	108	06.95-01.98	RGX (XU10J2TE)	4	<b>Z 193</b>	14 FR-7 DU2	0,9	<b>UXT 1<sup>3</sup></b>
2.1 Turbo D 12V	2.1	80	06.96-01.98	P8C (XUD11BTE)	4	<b>GN 909</b> (11V)	○		

### XANTIA II

1.8 i	1.8	66	01.98-04.03	LFX (XU7JB)	4	<b>Z 247</b>	14 FR-7 DUW	0,9	<b>UXT 1<sup>3</sup></b>
1.8 i 16V	1.8	81	01.98-04.03	LFY (XU7JP4)	4	<b>Z 193</b>	14 FR-7 DU2	0,9	<b>UXT 1<sup>3</sup></b>
1.9 SD	1.9	55	01.98-08.98	DHW (XUD9SD)	4	<b>GN 909</b> (11V)	○		
1.9 SD	1.9	55	09.98-04.03	DHW (XUD9SD)	4	<b>GN 013</b> (11V)	○		
1.9 Turbo D	1.9	66	01.98-08.98	DHX (XUD9TF/BTF)/ DHY (XUD9TE/Y)	4	<b>GN 909</b> (11V)	<b>GR 054</b>		
1.9 Turbo D	1.9	66	09.98-04.03	DHX (XUD9TF/BTF)/ DHY (XUD9TE/Y)	4	<b>GN 013</b> (11V)	<b>GR 054</b>		
2.0 HDI 90	2.0	66	03.99-04.03	RHY (DW10TD)	4	<b>GN 027</b> (11V)	○		
2.0 HDI 109	2.0	80	02.99-04.03	RHZ (DW10ATED)	4	<b>GN 027</b> (11V)	○		
2.0 i	2.0	89	01.98-04.03	RFX (XU10J2C)	4	<b>Z 193</b>	14 FR-7 DU2	0,9	<b>UXT 1<sup>3</sup></b>
2.0 i 16V	2.0	97	01.98-04.03	RFV (XU10J4R)	4	<b>Z 247</b>	14 FR-7 DUW	0,9	<b>UXT 1<sup>3</sup></b>
2.0 Turbo	2.0	108	01.98-04.03	RGX (XU10J2TE)	4	<b>Z 193</b>	14 FR-7 DU2	0,9	<b>UXT 1<sup>3</sup></b>
2.1 Turbo D 12V	2.1	80	01.98-08.98	P8C (XUD11BTE)	4	<b>GN 909</b> (11V)	○		
2.1 Turbo D 12V	2.1	80	09.98-02.99	P8C (XUD11BTE)	4	<b>GN 013</b> (11V)	○		

### XANTIA Break II

1.8 i	1.8	66	01.98-04.03	LFX (XU7JB)	4	<b>Z 247</b>	14 FR-7 DUW	0,9	<b>UXT 1<sup>3</sup></b>
1.8 i 16V	1.8	81	01.98-04.03	LFY (XU7JP4)	4	<b>Z 193</b>	14 FR-7 DU2	0,9	<b>UXT 1<sup>3</sup></b>
1.9 SD	1.9	55	01.98-08.98	DHW (XUD9SD)	4	<b>GN 909</b> (11V)	○		
1.9 SD	1.9	55	09.98-04.03	DHW (XUD9SD)	4	<b>GN 013</b> (11V)	○		
1.9 Turbo D	1.9	66	01.98-08.98	DHX (XUD9TF/BTF)/ D8B (XUD9TF)	4	<b>GN 909</b> (11V)	○		
1.9 Turbo D	1.9	66	09.98-04.03	DHX (XUD9TF/BTF)/ D8B (XUD9TF)	4	<b>GN 013</b> (11V)	○		
2.0 HDI 90	2.0	66	03.99-04.03	RHY (DW10TD)	4	<b>GN 027</b> (11V)	○		
2.0 HDI 109	2.0	80	02.99-04.03	RHZ (DW10ATED)	4	<b>GN 027</b> (11V)	○		
2.0 i	2.0	89	01.98-04.03	RFX (XU10J2C)	4	<b>Z 193</b>	14 FR-7 DU2	0,9	<b>UXT 1<sup>3</sup></b>
2.0 i 16V	2.0	97	01.98-04.03	RFV (XU10J4R)	4	<b>Z 247</b>	14 FR-7 DUW	0,9	<b>UXT 1<sup>3</sup></b>
2.0 Turbo	2.0	108	01.98-04.03	RGX (XU10J2TE)	4	<b>Z 193</b>	14 FR-7 DU2	0,9	<b>UXT 1<sup>3</sup></b>
2.1 Turbo D 12V	2.1	80	01.98-02.99	P8C (XUD11BTE)	4	<b>GN 013</b> (11V)	○		
3.0 V6	2.9	140	01.98-04.03	XFZ (ES9J4)	6	<b>Z 123</b>	14 FR-7 KDU	1,0	<b>UXT 9</b>

### XM

2.0 i	2.0	89	05.89-06.94	RFZ (XU10J2)	4	<b>Z 193</b>	14 FR-7 DU2	0,9	<b>UXT 1<sup>3</sup></b>
2.0 i 16V	2.0	97	05.94-10.00	RFV (XU10J4R)	4	<b>Z 247</b>	14 FR-7 DUW	0,9	<b>UXT 1<sup>3</sup></b>
2.0 i Turbo	2.0	104	09.92-06.94	RGY (XU10J2TE/Z)	4	<b>Z 193</b>	14 FR-7 DU2	0,9	<b>UXT 1<sup>3</sup></b>
2.0 Turbo	2.0	108	05.94-10.00	RGX (XU10J2TE)	4	<b>Z 193</b>	14 FR-7 DU2	0,9	<b>UXT 1<sup>3</sup></b>
2.1 D 12V	2.1	60	05.89-06.94	P9A (XUD11A)	4	<b>GV 636</b> (11V)	○		
2.1 TD 12V	2.1	80	05.89-06.94	PJZ (XUD11ATE)/ P8A (XUD11ATE)/ PHZ (XUD11ATE)	4	<b>GN 909</b> (11V)	○		
2.1 TD 12V	2.1	80	05.94-08.98	PJZ (XUD11ATE)/ P8A (XUD11ATE)/ P8C (XUD11BTE)/ PHZ (XUD11ATE)	4	<b>GN 909</b> (11V)	○		
2.1 TD 12V	2.1	80	09.98-10.00	PJZ (XUD11ATE)/ P8A (XUD11ATE)/ P8C (XUD11BTE)/ PHZ (XUD11ATE)	4	<b>GN 013</b> (11V)	○		
2.5 TD	2.4	95	05.94-10.00	THY (DK5ATE)	4	<b>GN 909</b> (11V)	○		
3.0 V6	3.0	123	05.89-06.94	UFZ (ZPJZ)/SFZ (ZPJZ)	6	<b>Z 60</b>	14 FGR-7 CTU	1,2	○
3.0 V6	3.0	123	05.94-10.00	UFZ (ZPJZ)/SFZ (ZPJZ)	6	<b>Z 60</b>	14 FGR-7 CTU	1,2	○
3.0 V6 24V	3.0	147	07.90-06.94	UKZ (ZPJ4Z)/SKZ (ZPJ4Z)	6	<b>Z 60</b>	14 FGR-7 CTU	1,2	○
3.0 V6 24V	3.0	147	05.94-10.00	UKZ (ZPJ4Z)/SKZ (ZPJ4Z)	6	<b>Z 60</b>	14 FGR-7 CTU	1,2	○

### XM Break

2.0 i	2.0	79	11.91-04.94	RDZ (XU10MZ)/XU102C	4	<b>Z 247</b>	14 FR-7 DUW	0,9	<b>UXT 1<sup>3</sup></b>
2.0 i	2.0	89	11.91-04.94	RFZ (XU10J2)	4	<b>Z 193</b>	14 FR-7 DU2	0,9	<b>UXT 1<sup>3</sup></b>
2.0 i 16V	2.0	97	05.94-10.00	RFV (XU10J4R)	4	<b>Z 247</b>	14 FR-7 DUW	0,9	<b>UXT 1<sup>3</sup></b>
2.0 Turbo	2.0	104	09.92-04.94	RGY (XU10J2TE/Z)	4	<b>Z 193</b>	14 FR-7 DU2	0,9	<b>UXT 1<sup>3</sup></b>

● nicht erforderlich  
○ nicht im Programm

<sup>3</sup> wahlweise UXT 3 Platin

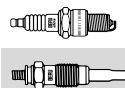
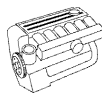

### CITROËN

#### XM Break

2.0 Turbo	2.0	108	05.94-10.00	RGX (XU10J2TE)/RGY (XU10J2TE/Z)	4	<b>Z 193</b>	14 FR-7 DU2	0,9		<b>UXT 1<sup>3</sup></b>
2.1 D 12V	2.1	60	11.91-04.94	P9A (XUD11A)	4	<b>GV 636</b> (11V)	○			
2.1 D12	2.1	60	07.94-06.96	P9A (XUD11A)	4	<b>GV 636</b> (11V)	○			
2.1 TD 12V	2.1	80	11.91-04.94	PJZ (XUD11ATE)/P8A (XUD11ATE)/P8C (XUD11BTE)/PHZ (XUD11ATE)	4	<b>GN 909</b> (11V)	○			
2.1 TD 12V	2.1	80	05.94-08.98	PJZ (XUD11ATE)/P8C (XUD11BTE)/PHZ (XUD11ATE)	4	<b>GN 909</b> (11V)	○			
2.1 TD 12V	2.1	80	09.98-10.00	PJZ (XUD11ATE)/P8C (XUD11BTE)/PHZ (XUD11ATE)	4	<b>GN 013</b> (11V)	○			
2.5 TD	2.4	95	05.94-10.00	THY (DK5ATE)	4	<b>GN 909</b> (11V)	○			
3.0 V6	3.0	123	11.91-04.94	UFZ (ZPJZ)/SFZ (ZPJZ)	6	<b>Z 60</b>	14 FGR-7 CTU	1,2		○
3.0 V6	3.0	123	05.94-10.00	UFZ (ZPJZ)/SFZ (ZPJZ)	6	<b>Z 60</b>	14 FGR-7 CTU	1,2		○

#### XSARA

1.4 HDi	1.4	50	01.03-03.05	8HX (DV4TD)	4	<b>GN 047</b> (11V)	○			
1.4 i	1.4	55	04.97-03.05	KFX (TU3JP)/KFW (TU3JP)	4	<b>Z 98</b>	14 FR-7 LDU	0,8		<b>UXT 1<sup>3</sup></b>
1.5 D	1.5	42	04.97-09.00	VJZ (TUD5)	4	<b>GN 013</b> (11V)	<b>GR 054</b>			
1.6 i	1.6	65	04.97-09.00	NFZ (TU5JP)	4	<b>Z 247</b>	14 FR-7 DUW	0,9		<b>UXT 1<sup>3</sup></b>
1.6 16V	1.6	80	09.00-03.05	NFU (TU5JP4)	4	<b>Z 184</b>	14 FR-7 MU2	0,9		<b>UXT 13</b>
1.8 D	1.8	43	04.97-09.00	A9A (XUD7)/161A (XUD7)	4	<b>GN 013</b> (11V)	<b>GR 054</b>			
1.8 i	1.8	66	04.97-09.00	LFX (XU7JB)	4	<b>Z 123</b>	14 FR-7 KDU	1,0		<b>UXT 9</b>
1.8 TD	1.8	66	10.97-09.00		4	<b>GN 013</b> (11V)	<b>GR 054</b>			
1.8 i Aut.	1.8	74	04.97-09.00	LFZ (XU7JP)	4	<b>Z 193</b>	14 FR-7 DU2	0,9		<b>UXT 1<sup>3</sup></b>
1.8 i 16V	1.8	81	04.97-09.00	LFY (XU7JP4)	4	<b>Z 193</b>	14 FR-7 DU2	0,9		<b>UXT 1<sup>3</sup></b>
1.9 D	1.9	50	04.97-09.00	DJY (XUD9A)	4	<b>GN 013</b> (11V)	<b>GR 054</b>			
1.9 D	1.9	51	07.98-03.05	WJY (DW8B)/WJZ (DW8)	4	<b>GN 016</b> (11V)	○			
1.9 SD	1.9	55	01.98-09.00	DHV (XUD9BSD)	4	<b>GN 013</b> (11V)	○			
1.9 TD	1.9	66	04.97-09.00	DHY (XUD9TE/Y)	4	<b>GN 013</b> (11V)	<b>GR 054</b>			
2.0 HDi 90	2.0	66	02.99-03.05	RHY (DW10TD)	4	<b>GN 027</b> (11V)	○			
2.0 HDi 109	2.0	80	05.01-03.05	RHZ (DW10ATED)	4	<b>GN 027</b> (11V)	○			
2.0 16V	2.0	97	07.98-09.00	RFV (XU10J4R)	4	<b>Z 193</b>	14 FR-7 DU2	0,9		<b>UXT 1<sup>3</sup></b>
2.0 16V	2.0	100	09.00-03.05	RFN (EW10J4)	4	<b>Z 183</b>	14 FR-8 MU2	0,9		<b>UXT 13</b>
2.0 16V	2.0	120	04.97-09.00	RFS (XU10J4RS)	4	<b>Z 98</b>	14 FR-7 LDU	0,8		<b>UXT 1<sup>3</sup></b>

#### XSARA Break

1.4 HDi	1.4	50	01.03-08.05	8HX (DV4TD)	4	<b>GN 047</b> (11V)	○			
1.4 i	1.4	55	10.97-08.05	KFX (TU3JP)/KFW (TU3JP)	4	<b>Z 98</b>	14 FR-7 LDU	0,8		<b>UXT 1<sup>3</sup></b>
1.5 D	1.5	42	10.97-09.00	VJZ (TUD5)	4	<b>GN 013</b> (11V)	<b>GR 054</b>			
1.6 i	1.6	65	10.97-09.00	NFZ (TU5JP)	4	<b>Z 247</b>	14 FR-7 DUW	0,9		<b>UXT 1<sup>3</sup></b>
1.6 16V	1.6	80	09.00-08.05	NFU (TU5JP4)	4	<b>Z 184</b>	14 FR-7 MU2	0,9		<b>UXT 13</b>
1.8 D	1.8	43	10.97-09.00	A9A (XUD7)	4	<b>GN 013</b> (11V)	<b>GR 054</b>			
1.8 i	1.8	66	10.97-09.00	LFX (XU7JB)	4	<b>Z 123</b>	14 FR-7 KDU	1,0		<b>UXT 9</b>
1.8 i Aut.	1.8	74	10.97-09.00	LFZ (XU7JP)	4	<b>Z 193</b>	14 FR-7 DU2	0,9		<b>UXT 1<sup>3</sup></b>
1.8 i 16V	1.8	81	10.97-09.00	LFY (XU7JP4)	4	<b>Z 193</b>	14 FR-7 DU2	0,9		<b>UXT 1<sup>3</sup></b>
1.9 D	1.9	50	10.97-09.00	DJY (XUD9A)	4	<b>GN 013</b> (11V)	<b>GR 054</b>			
1.9 D	1.9	51	07.98-08.05	WJY (DW8B)/WJZ (DW8)	4	<b>GN 016</b> (11V)	○			
1.9 D	1.9	55	01.98-09.00	DHV (XUD9BSD)	4	<b>GN 013</b> (11V)	○			
1.9 TD	1.9	66	10.97-09.00	DHY (XUD9TE/Y)	4	<b>GN 013</b> (11V)	<b>GR 054</b>			
2.0 HDi 90	2.0	66	02.99-08.05	RHY (DW10TD)	4	<b>GN 027</b> (11V)	○			
2.0 HDi 109	2.0	80	05.01-08.05	RHZ (DW10ATED)	4	<b>GN 027</b> (11V)	○			
2.0 16V	2.0	97	07.98-09.00	RFV (XU10J4R)	4	<b>Z 193</b>	14 FR-7 DU2	0,9		<b>UXT 1<sup>3</sup></b>
2.0 16V	2.0	100	09.00-08.05	RFN (EW10J4)	4	<b>Z 183</b>	14 FR-8 MU2	0,9		<b>UXT 13</b>

#### XSARA Coupe

1.4 HDi	1.4	50	01.03-03.05	8HX (DV4TD)	4	<b>GN 047</b> (11V)	○			
1.4 i	1.4	55	03.98-03.05	KFX (TU3JP)/KFW (TU3JP)	4	<b>Z 193</b>	14 FR-7 DU2	0,9		<b>UXT 1<sup>3</sup></b>
1.6 16V	1.6	80	09.00-03.05	NFU (TU5JP4)	4	<b>Z 184</b>	14 FR-7 MU2	0,9		<b>UXT 13</b>
1.8 i	1.8	66	02.98-09.00	LFX (XU7JB)	4	<b>Z 247</b>	14 FR-7 DUW	0,9		<b>UXT 1<sup>3</sup></b>
1.8 i 16V	1.8	81	02.98-09.00	LFY (XU7JP4)	4	<b>Z 247</b>	14 FR-7 DUW	0,9		<b>UXT 1<sup>3</sup></b>

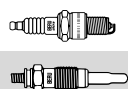

## CITROËN

### XSARA Coupe

1.9 D	1.9	50	02.98-09.00	DJY (XUD9A)	4	<b>GN 013</b> (11V)	○		
1.9 D	1.9	51	02.99-03.05	WJY (DW8B)/WJZ (DW8)	4	<b>GN 016</b> (11V)	○		
1.9 TD	1.9	66	02.98-09.00	DHY (XUD9TE/Y)	4	<b>GN 013</b> (11V)	○		
2.0 HDi 90	2.0	66	02.99-03.05	RHY (DW10TD)	4	<b>GN 027</b> (11V)	○		
2.0 HDi 109	2.0	80	05.01-03.05	RHZ (DW10ATED)	4	<b>GN 027</b> (11V)	○		
2.0 16V	2.0	100	09.00-03.05	RFN (EW10J4)	4	<b>Z 183</b>	14 FR-8 MU2	0,9	<b>UXT 13</b>
2.0 i 16V	2.0	120	02.98-03.05	RFS (XU10J4RS)	4	<b>Z 98</b>	14 FR-7 LDU	0,8	<b>UXT 13</b>

### XSARA PICASSO

1.6	1.6	65	12.99-	NFZ (TU5JP)	4	<b>Z 247</b>	14 FR-7 DUW	0,9	<b>UXT 13</b>
1.6 HDi	1.6	66	09.05-02.06		4	<b>GN 047</b> (11V)	○		
1.6 HDi	1.6	66	03.06-		4	<b>GN 056</b> (11V)	○		
1.6	1.6	70	12.99-	NFV (TU5JP)	4	<b>Z 247</b>	14 FR-7 DUW	0,9	<b>UXT 13</b>
1.6 16V	1.6	80	09.05-	NFU (TU5JP4)	4	<b>Z 184</b>	14 FR-7 MU2	0,9	<b>UXT 13</b>
1.6 HDi	1.6	80	05.04-02.06	DV6TED4	4	<b>GN 047</b> (11V)	○		
1.6 HDi	1.6	80	03.06-	DV6TED4	4	<b>GN 056</b> (11V)	○		
1.8 16V	1.7	85	02.00-	6FZ (EW7J4)	4	<b>Z 223</b>	14 FR-8 NQU23	0,9	○
2.0 HDi	2.0	66	12.99-	RHY (DW10TD)	4	<b>GN 027</b> (11V)	○		
2.0 16V	2.0	100	01.03-	RFN (EW10J4)	4	<b>Z 183</b>	14 FR-8 MU2	0,9	<b>UXT 13</b>

### ZX

1.1	1.1	44	03.91-06.97	HDZ (TU1M)	4	<b>Z 193</b>	14 FR-7 DU2	0,9	<b>UXT 13</b>
1.4 D	1.4	37	07.94-10.97	K9Y (TUD3Y)	4	<b>GV 661</b> (11V)	○		
1.4	1.4	55	03.91-06.95	KDZ (TU3M/Z)	4	<b>Z 247</b>	14 FR-7 DUW	0,9	<b>UXT 13</b>
1.4	1.4	55	07.95-06.97	KDZ (TU3M/Z)	4	<b>Z 123</b>	14 FR-7 KDU	1,0	<b>UXT 9</b>
1.4 i	1.4	55	03.91-06.95	KDZ (TU3M/Z)/KFX (TU3JP)/ KDX (TU3M/Z)	4	<b>Z 247</b>	14 FR-7 DUW	0,9	<b>UXT 13</b>
1.4 i	1.4	55	07.95-06.97	KDZ (TU3M/Z)/KFX (TU3JP)/ KDX (TU3M/Z)	4	<b>Z 123</b>	14 FR-7 KDU	1,0	<b>UXT 9</b>
1.6 i	1.6	65	03.91-06.97	BDY (XU5M)/BFZ (XU5JP)	4	<b>Z 193</b>	14 FR-7 DU2	0,9	<b>UXT 13</b>
1.8 D	1.8	44	06.93-06.97	161A (XUD7)	4	<b>GV 636</b> (11V)	○		
1.8 i	1.8	74	07.92-06.97	LFZ (XU7JP)	4	<b>Z 193</b>	14 FR-7 DU2	0,9	<b>UXT 13</b>
1.8 i 16V	1.8	81	01.96-06.97	LFY (XU7JP4)	4	<b>Z 247</b>	14 FR-7 DUW	0,9	<b>UXT 13</b>
1.8	1.8	82	04.96-10.97	LFY (XU7JP4)	4	<b>Z 247</b>	14 FR-7 DUW	0,9	<b>UXT 13</b>
1.9 D	1.9	47	03.91-04.94	DJZ (XUD9Y)	4	<b>GV 636</b> (11V)	○		
1.9 D	1.9	47	05.94-06.97	DJZ (XUD9Y)	4	<b>GN 909</b> (11V)	○		
1.9 D	1.9	50	07.93-05.95	D9B (XUD9A/U)/DJY (XUD9A)	4	<b>GV 636</b> (11V)	○		
1.9 D	1.9	50	06.95-06.97	D9B (XUD9A/U)/DJY (XUD9A)	4	<b>GN 909</b> (11V)	○		
1.9 DT	1.9	65	07.94-10.97		4	<b>GN 013</b> (11V)	○		
1.9 TD	1.9	66	07.92-06.97	DHY (XUD9TE/Y)	4	<b>GN 909</b> (11V)	<b>GR 034</b>		
1.9 DT	1.9	68	06.92-06.94		4	<b>GN 013</b> (11V)	○		
1.9 i	1.9	88	03.91-06.97	DKZ (XU9JA)	4	<b>Z 193</b>	14 FR-7 DU2	0,9	<b>UXT 13</b>
2.0 i	2.0	89	07.92-06.97	RFX (XU10J2C)	4	<b>Z 193</b>	14 FR-7 DU2	0,9	<b>UXT 13</b>
2.0 i 16V	2.0	110	06.94-06.97	RFT (XU10J4/Z)	4	<b>Z 24</b>	14 FR-6 DU	0,8	<b>UXT 5</b>
2.0 i 16V	2.0	112	07.92-10.94	RFT (XU10J4/Z)/ RFY (XU10J4/Z)	4	<b>Z 24</b>	14 FR-6 DU	0,8	<b>UXT 5</b>
2.0 i 16V	2.0	120	05.96-06.97	RFS (XU10J4RS)	4	<b>Z 193</b>	14 FR-7 DU2	0,9	<b>UXT 13</b>

### ZX Break

1.4 i	1.4	55	10.93-10.97	KDY (TU3M)/KFX (TU3JP)	4	<b>Z 193</b>	14 FR-7 DU2	0,9	<b>UXT 13</b>
1.6 i	1.6	65	10.93-10.97	BFZ (XU5JP)/BDY (XU5M)	4	<b>Z 193</b>	14 FR-7 DU2	0,9	<b>UXT 13</b>
1.8 D	1.8	44	10.93-10.97	161A (XUD7)	4	<b>GV 636</b> (11V)	○		
1.8 i	1.8	74	10.93-10.97	LFZ (XU7JP)	4	<b>Z 193</b>	14 FR-7 DU2	0,9	<b>UXT 13</b>
1.8 i 16V	1.8	81	01.96-02.98	LFY (XU7JP4)	4	<b>Z 247</b>	14 FR-7 DUW	0,9	<b>UXT 13</b>
1.9 D	1.9	47	10.93-04.94	DJZ (XUD9Y)	4	<b>GV 636</b> (11V)	○		
1.9 D	1.9	47	05.94-10.97	DJZ (XUD9Y)	4	<b>GN 909</b> (11V)	○		
1.9 D	1.9	50	06.94-05.95	D9B (XUD9A/U)	4	<b>GV 636</b> (11V)	○		
1.9 D	1.9	50	06.95-10.97	D9B (XUD9A/U)	4	<b>GN 909</b> (11V)	○		
1.9 TD	1.9	66	10.93-10.97	DHY (XUD9TE/Y)	4	<b>GN 909</b> (11V)	<b>GR 034</b>		



### C15

1.1 i	1.1	44	07.88-06.95	HDZ (TU1M)	4	<b>Z 247</b>	14 FR-7 DUW	0,9	<b>UXT 13</b>
1.1 i	1.1	44	07.95-12.96	HDZ (TU1M)	4	<b>Z 123</b>	14 FR-7 KDU	1,0	<b>UXT 9</b>

● nicht erforderlich  
○ nicht im Programm

<sup>3</sup> wahlweise UXT 3 Platin

<sup>4</sup> wahlweise UXT 6 Platin

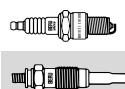
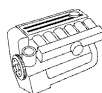

## CITROËN



### C15

1.4 E	1.4	44	05.87-12.96	150D (XY7)	4	<b>Z 25</b>	14 K-6 DU	0,8	<b>UXK 56</b>
1.4	1.4	49	07.87-12.96	K1H (TU3A)	4	<b>Z 247</b>	14 FR-7 DUW	0,9	<b>UXT 1<sup>3</sup></b>
1.4 i	1.4	55	05.91-06.95	KDY (TU3FM)/KDY (TU3M)	4	<b>Z 247</b>	14 FR-7 DUW	0,9	<b>UXT 1<sup>3</sup></b>
1.4 i	1.4	55	07.95-12.96	KDY (TU3FM)/KDY (TU3M)	4	<b>Z 123</b>	14 FR-7 KDU	1,0	<b>UXT 9</b>
1.8 D	1.8	44	07.86-12.00	161A (XUD7)	4	<b>GV 636</b> (11V)	<b>GR 065</b>		
1.9 D	1.9	44	12.00-12.05	DW 8	4	<b>GN 016</b> (11V)	○		

### C25

1.8 E	1.8	51	07.87-02.94	169 (XM7T)	4	<b>Z 11</b>	14-7 DU	0,8	<b>UXT 2<sup>4</sup></b>
1.9 D	1.9	51	07.87-02.94	D9B (XUD9A/U)	4	<b>GV 636</b> (11V)	<b>GR 065</b>		
1.9 TD	1.9	60	04.92-02.94	M705	4	<b>GN 909</b> (11V)	○		
2.0 E	2.0	58	09.81-02.94	170B (XN1T)/170A (XN1T)	4	<b>Z 11</b>	14-7 DU	0,8	<b>UXT 2<sup>4</sup></b>
2.0	2.0	62	02.91-02.94	170C (XN1T)	4	<b>Z 20</b>	14 R-7 DU	0,8	<b>UXT 2<sup>4</sup></b>
2.5 D	2.5	54	10.85-02.94	CRD93L (U25-661)	4	<b>GV 602</b> (11V)	○		
2.5 D 4x4	2.5	54	01.87-02.94	CRD93L (U25-661)	4	<b>GV 602</b> (11V)	<b>GR 059</b>		
2.5 D Turbo	2.5	70	08.87-02.94	CRD93LS (U25-673)	4	<b>GV 602</b> (11V)	<b>GR 059</b>		
2.5 D Turbo 4x4	2.5	70	08.87-02.94	CRD93LS (U25-673)	4	<b>GV 602</b> (11V)	<b>GR 059</b>		

### C35

2.5 D	2.5	51	02.80-01.94	B25637	4	<b>GV 602</b> (11V)	○		
-------	-----	----	-------------	--------	---	---------------------	---	--	--

### JUMPER

1.9 D	1.9	51	01.99-04.02	D9B (XUD9A/U)	4	<b>GN 013</b> (11V)	○		
1.9 TD	1.9	66	08.94-08.98	D8C (XUD9UTF)	4	<b>GN 909</b> (11V)	○		
1.9 TD	1.9	66	09.98-04.02	D8C (XUD9UTF)	4	<b>GN 013</b> (11V)	○		
1.9 TD	1.9	68	02.94-08.98	D8C (XUD9UTF)	4	<b>GN 909</b> (11V)	○		
1.9 TD	1.9	68	09.98-04.02	D8C (XUD9UTF)	4	<b>GN 013</b> (11V)	○		
1.9 TD 4x4	1.9	68	08.96-08.98	D8C (XUD9UTF)	4	<b>GN 909</b> (11V)	○		
1.9 TD 4x4	1.9	68	09.98-04.02	D8C (XUD9UTF)	4	<b>GN 013</b> (11V)	○		
2.0 HDi	2.0	62	04.02-	RHV (DW10UTD)	4	<b>GN 027</b> (11V)	○		
2.0	2.0	80	02.94-04.02	RFW (XU10J2U)	4	<b>Z 193</b>	14 FR-7 DU2	0,9	<b>UXT 1<sup>3</sup></b>
2.0 4x4	2.0	80	08.96-04.02	RFW (XU10J2U)	4	<b>Z 193</b>	14 FR-7 DU2	0,9	<b>UXT 1<sup>3</sup></b>
2.0	2.0	81	04.02-	XU10J2	4	<b>Z 193</b>	14 FR-7 DU2	0,9	<b>UXT 1<sup>3</sup></b>
2.0 bivalent	2.0	81	02.03-	XU10J2	4	<b>Z 193</b>	14 FR-7 DU2	0,9	<b>UXT 1<sup>3</sup></b>
2.2 HDi	2.2	74	04.02-	DW12TED	4	<b>GN 027</b> (11V)	○		
2.2 HDi 100	2.2	74	04.06-	4HV (P22DTE)	4	<b>GN 939</b> (11,5V)	○		
2.2 HDi 120	2.2	88	04.06-	4HU (P22DTE)	4	<b>GN 939</b> (11,5V)	○		
2.5 D	2.4	63	08.94-04.02	T9A (DJ5)	4	<b>GN 909</b> (11V)	<b>GR 054</b>		
2.5 D 4x4	2.4	63	08.96-04.02	T9A (DJ5)	4	<b>GN 909</b> (11V)	<b>GR 054</b>		
2.5 TD	2.4	76	08.94-04.02	T8A (DJ5T)	4	<b>GN 909</b> (11V)	<b>GR 054</b>		
2.5 TD 4x4	2.4	76	08.96-04.02	T8A (DJ5T)	4	<b>GN 909</b> (11V)	<b>GR 054</b>		
2.5 TDi	2.4	79	12.96-11.00	THX (DJ5TED)	4	<b>GN 964</b> (11V)	<b>GR 054</b>		
2.5 TDi 4x4	2.4	79	12.96-11.00	THX (DJ5TED)	4	<b>GN 964</b> (11V)	<b>GR 054</b>		
2.8 D	2.8	64	01.99-02.02	8140.63 (F28D)	4	<b>GN 012</b> (11V)	○		
2.8 HDi	2.8	94	09.00-04.02	8140.43S	4	<b>GF 006</b> (12V)	○		
2.8 HDi 4x4	2.8	94	09.00-04.02	8140.43S	4	<b>GF 006</b> (12V)	○		
2.8 HDi	2.8	94	04.02-	8140.43S	4	<b>GF 006</b> (12V)	○		
3.0 HDi 155	3.0	115	07.10-	F1CE0481D (F30DT)	4	<b>GN 037</b> (11V)	○		
3.0 HDi 160	3.0	116	09.06-	F1CE0481D (F30DT)	4	<b>GN 037</b> (11V)	○		

## DACIA

### 1310

1.3	1.3	40	05.83-07.04	810-02/-99	4	<b>Z 10</b>	14-7 BU	0,8	○
-----	-----	----	-------------	------------	---	-------------	---------	-----	---

### 1310 Kombi

1.3	1.3	40	05.83-07.04		4	<b>Z 10</b>	14-7 BU	0,8	○
-----	-----	----	-------------	--	---	-------------	---------	-----	---

### DUSTER

1.5 dCi	1.5	63	04.10-	K9K 796	4	<b>GN 018</b> (11V)	○		
1.6 16V	1.6	77	04.10-	K4M 696/K4M 690	4	<b>Z 15</b>	14 FR-7 DU	0,8	<b>UXT 1<sup>3</sup></b>
1.6 16V 4x4	1.6	77	06.10-	K4M 606	4	<b>Z 15</b>	14 FR-7 DU	0,8	<b>UXT 1<sup>3</sup></b>
1.6 16V LPG	1.6	77	04.11-	K4M 696	4	<b>Z 15</b>	14 FR-7 DU	0,8	<b>UXT 1<sup>3</sup></b>

### LOGAN

1.2 16V	1.1	55	02.06-	D4F 732	4	<b>Z 243</b>	12 VR-8 SE	0,9	○
---------	-----	----	--------	---------	---	--------------	------------	-----	---



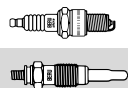
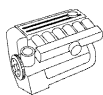

## DACIA

LOGAN									
1.4	1.4	55	09.04-	K7J 710	4	<b>Z 15</b>	14 FR-7 DU	0,8	<b>UXT 1<sup>3</sup></b>
1.4 MPI LPG	1.4	55	02.06-	K7J 714/K7J 710	4	<b>Z 340</b>	14 FR-6 DPU02S	0,7	○
1.5 dCi	1.5	48	09.05-	K9K 790	4	<b>GN 018</b> (11V)	○		
1.5 dCi	1.5	50	01.06-	K9K 792	4	<b>GN 018</b> (11V)	○		
1.5 dCi	1.5	63	09.07-	K9K 796	4	<b>GN 018</b> (11V)	○		
1.6	1.6	64	09.04-	K7M 710	4	<b>Z 15</b>	14 FR-7 DU	0,8	<b>UXT 1<sup>3</sup></b>
1.6 16V	1.6	77	02.06-	K4M 696/K4M 690	4	<b>Z 15</b>	14 FR-7 DU	0,8	<b>UXT 1<sup>3</sup></b>

## LOGAN EXPRESS

1.4	1.4	55	03.09-	K7J 710	4	<b>Z 15</b>	14 FR-7 DU	0,8	<b>UXT 1<sup>3</sup></b>
1.5 dCi	1.5	50	03.09-	K9K 792	4	<b>GN 018</b> (11V)	○		
1.5 dCi	1.5	63	03.09-	K9K 796	4	<b>GN 018</b> (11V)	○		
1.6	1.6	64	03.09-	K7M 710	4	<b>Z 15</b>	14 FR-7 DU	0,8	<b>UXT 1<sup>3</sup></b>

## LOGAN MCV

1.4	1.4	55	02.07-	K7J 710	4	<b>Z 15</b>	14 FR-7 DU	0,8	<b>UXT 1<sup>3</sup></b>
1.5 dCi	1.5	50	02.07-	K9K 792	4	<b>GN 018</b> (11V)	○		
1.5 dCi	1.5	63	09.07-	K9K 796	4	<b>GN 018</b> (11V)	○		
1.6	1.6	64	02.07-	K7M 710	4	<b>Z 15</b>	14 FR-7 DU	0,8	<b>UXT 1<sup>3</sup></b>
1.6 Bifuel	1.6	64	11.08-	K7M 710	4	<b>Z 98</b>	14 FR-7 LDU	0,8	<b>UXT 1<sup>3</sup></b>
1.6 16V	1.6	77	02.07-	K4M 696/K4M 690	4	<b>Z 15</b>	14 FR-7 DU	0,8	<b>UXT 1<sup>3</sup></b>
1.6 16V Flexifuel	1.6	77	11.09-	K4M 694/K4M 690	4	<b>Z 340</b>	14 FR-6 DPU02S	0,7	○

## LOGAN Pick-up

1.4	1.4	55	01.09-	K7J 710	4	<b>Z 98</b>	14 FR-7 LDU	0,8	<b>UXT 1<sup>3</sup></b>
1.5 dCi	1.5	50	03.08-	K9K 792	4	<b>GN 018</b> (11V)	○		
1.5 dCi	1.5	63	03.08-	K9K 796	4	<b>GN 018</b> (11V)	○		
1.6	1.6	64	03.08-	K7M 710	4	<b>Z 15</b>	14 FR-7 DU	0,8	<b>UXT 1<sup>3</sup></b>

## SANDERO

1.2 16V	1.1	55	11.08-	D4F 732	4	<b>Z 243</b>	12 VR-8 SE	0,9	○
1.4 MPI LPG	1.4	53	01.09-	K7J 714	4	<b>Z 340</b>	14 FR-6 DPU02S	0,7	○
1.4	1.4	55	06.08-	K7J 710	4	<b>Z 98</b>	14 FR-7 LDU	0,8	<b>UXT 1<sup>3</sup></b>
1.5 dCi	1.5	50	11.08-	K9K 792	4	<b>GN 018</b> (11V)	○		
1.5 dCi	1.5	55	05.10-	K9K 892	4	<b>GE 110</b> (4,4V)	○		
1.5 dCi	1.5	63	11.08-	K9K 796	4	<b>GN 018</b> (11V)	○		
1.6	1.6	64	06.08-	K7M 710	4	<b>Z 98</b>	14 FR-7 LDU	0,8	<b>UXT 1<sup>3</sup></b>
1.6 16V Bifuel	1.6	77	01.11-	K4M 696	4	<b>Z 15</b>	14 FR-7 DU	0,8	<b>UXT 1<sup>3</sup></b>

## SOLENZA

1.4	1.4	55	02.03-03.05		4	<b>Z 98</b>	14 FR-7 LDU	0,8	<b>UXT 1<sup>3</sup></b>
1.9 D	1.9	46	02.03-	F8Q 630	4	<b>GN 019</b> (11V)	○		

## DAEWOO

<b>1.5i</b>									
1.5	1.5	57	07.94-10.95	G15MF	4	<b>Z 20</b>	14 R-7 DU	0,8	<b>UXT 2<sup>4</sup></b>

## CIELO

1.5	1.5	59	01.95-11.00	G15MF	4	<b>Z 20</b>	14 R-7 DU	0,8	<b>UXT 2<sup>4</sup></b>
-----	-----	----	-------------	-------	---	-------------	-----------	-----	--------------------------

## ESPERO

1.5 16V	1.5	65	10.93-09.94	A15SMS/A15MF	4	<b>Z 16</b>	14 FR-7 DUX	1,1	<b>UXT 1<sup>3</sup></b>
1.5 16V	1.5	66	02.95-06.99	A15MF	4	<b>Z 16</b>	14 FR-7 DUX	1,1	<b>UXT 1<sup>3</sup></b>
1.8	1.8	66	02.95-09.99	C18LE	4	<b>Z 8</b>	14 R-8 DU	0,8	<b>UXT 2<sup>4</sup></b>
1.8	1.8	70	02.95-06.99	C18LE	4	<b>Z 8</b>	14 R-8 DU	0,8	<b>UXT 2<sup>4</sup></b>
2.0	2.0	74	10.91-09.93	C20LZ	4	<b>Z 82</b>	14 R-9 DU	0,7	<b>UXT 2<sup>4</sup></b>
2.0	2.0	77	02.95-06.99	C20LE	4	<b>Z 82</b>	14 R-9 DU	0,7	<b>UXT 2<sup>4</sup></b>

## KALOS

1.2	1.2	53	04.03-01.05	B12S1	4	<b>Z 9</b>	14 R-8 DUX	1,1	<b>UXT 2<sup>4</sup></b>
1.4	1.4	61	09.02-	F14S3	4	<b>Z 20</b>	14 R-7 DU	0,8	<b>UXT 2<sup>4</sup></b>
1.4	1.4	69	05.03-12.04	F14D3	4	<b>Z 16</b>	14 FR-7 DUX	1,1	<b>UXT 1<sup>3</sup></b>
1.4 16V	1.4	69	04.03-01.05	F14D3	4	<b>Z 16</b>	14 FR-7 DUX	1,1	<b>UXT 1<sup>3</sup></b>

## KORANDO

2.3	2.3	105	01.99-	M 161.970	4	<b>Z 100</b>	14 F-8 DU4	0,8	<b>UXT 1<sup>3</sup></b>
2.9 D	2.9	72	01.99-	MB-OM 662	5	<b>GN 858</b> (11,5V)	○		
2.9 TD	2.9	88	01.99-	MB-OM 601 29TD	5	<b>GN 858</b> (11,5V)	○		
3.2 4x4	3.2	156	01.99-	M 104.995	6	<b>Z 100</b>	14 F-8 DU4	0,8	<b>UXT 1<sup>3</sup></b>



kW

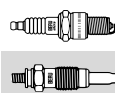
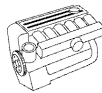

### DAEWOO

#### KORANDO Cabrio

2.0 16V	2.0	94	02.99-		4	<b>Z 100</b>	14 F-8 DU4	0,8	<b>UXT 1<sup>3</sup></b>
2.3	2.3	105	02.99-	M 161.970	4	<b>Z 100</b>	14 F-8 DU4	0,8	<b>UXT 1<sup>3</sup></b>
2.9 D	2.9	72	02.99-	MB-OM 662	5	<b>GN 858</b> (11,5V)	○		
2.9 TD	2.9	88	02.99-	MB-OM 601 29TD	5	<b>GN 858</b> (11,5V)	○		

#### LACETTI

1.4	1.4	70	02.04-	F14D3	4	<b>Z 16</b>	14 FR-7 DUX	1,1	<b>UXT 1<sup>3</sup></b>
1.6	1.6	80	02.04-	F16D3	4	<b>Z 16</b>	14 FR-7 DUX	1,1	<b>UXT 1<sup>3</sup></b>

#### LANOS

1.4	1.3	55	05.97-	A14SMS	4	<b>Z 8</b>	14 R-8 DU	0,8	<b>UXT 2<sup>4</sup></b>
1.5	1.5	63	05.97-	A15SMS	4	<b>Z 8</b>	14 R-8 DU	0,8	<b>UXT 2<sup>4</sup></b>
1.6 16V	1.6	78	05.97-	A16DMS	4	<b>Z 16</b>	14 FR-7 DUX	1,1	<b>UXT 1<sup>3</sup></b>

#### LEGANZA

2.0 16V	2.0	93	07.00-01.05	T20SED	4	<b>Z 74</b>	14 FR-8 LDUOX4	1,0	<b>UXT 1<sup>3</sup></b>
2.0 16V	2.0	98	06.97-12.02	X 20 SED	4	<b>Z 193</b>	14 FR-7 DU2	0,9	<b>UXT 1<sup>3</sup></b>
2.2 16V	2.2	100	04.99-12.02	T22SED	4	<b>Z 74</b>	14 FR-8 LDUOX4	1,0	<b>UXT 1<sup>3</sup></b>

#### MATIZ

0.8	0.8	38	09.98-	F8CV	3	<b>Z 9</b>	14 R-8 DUX	1,1	<b>UXT 2<sup>4</sup></b>
1.0	1.0	47	01.03-	B10S	4	<b>Z 9</b>	14 R-8 DUX	1,1	<b>UXT 2<sup>4</sup></b>

#### MUSSO

2.2 TD	2.3	74	09.99-	MB OM 601	4	<b>GN 858</b> (11,5V)	○		
2.3	2.3	103	01.99-	M 111.970	4	<b>Z 100</b>	14 F-8 DU4	0,8	<b>UXT 1<sup>3</sup></b>
2.9 D 4x4	2.9	73	01.99-09.99	MB-OM 662	5	<b>GN 858</b> (11,5V)	○		
2.9 TD 4x4	2.9	88	01.99-	MB-OM 601 29TD	5	<b>GN 858</b> (11,5V)	○		
3.2 4x4	3.2	162	01.99-	M 104.992	6	<b>Z 100</b>	14 F-8 DU4	0,8	<b>UXT 1<sup>3</sup></b>

#### NEXIA

1.5	1.5	44	08.96-08.97	G15MF	4	<b>Z 20</b>	14 R-7 DU	0,8	<b>UXT 2<sup>4</sup></b>
1.5	1.5	52	02.95-08.97	G15MF	4	<b>Z 16</b>	14 FR-7 DUX	1,1	<b>UXT 1<sup>3</sup></b>
1.5	1.5	55	02.95-08.97	G15MF	4	<b>Z 8</b>	14 R-8 DU	0,8	<b>UXT 2<sup>4</sup></b>
1.5 16V	1.5	66	02.95-08.97	A15MF	4	<b>Z 16</b>	14 FR-7 DUX	1,1	<b>UXT 1<sup>3</sup></b>

#### NUBIRA

1.4	1.4	69	10.03-12.04	F14D3	4	<b>Z 16</b>	14 FR-7 DUX	1,1	<b>UXT 1<sup>3</sup></b>
1.6 16V	1.6	78	05.97-	A16DMS	4	<b>Z 16</b>	14 FR-7 DUX	1,1	<b>UXT 1<sup>3</sup></b>
1.6	1.6	80	07.03-	F16D3	4	<b>Z 16</b>	14 FR-7 DUX	1,1	<b>UXT 1<sup>3</sup></b>
1.8	1.8	70	04.97-05.99	C18LE	4	<b>Z 8</b>	14 R-8 DU	0,8	<b>UXT 2<sup>4</sup></b>
2.0 CDX	2.0	93	08.02-07.03	T20SED	4	<b>Z 74</b>	14 FR-8 LDUOX4	1,0	<b>UXT 1<sup>3</sup></b>
2.0 16V	2.0	98	05.97-	X 20 SED	4	<b>Z 74</b>	14 FR-8 LDUOX4	1,0	<b>UXT 1<sup>3</sup></b>

#### NUBIRA Wagon

1.6 16V	1.6	78	05.97-	A16DMS	4	<b>Z 16</b>	14 FR-7 DUX	1,1	<b>UXT 1<sup>3</sup></b>
1.6	1.6	80	07.03-	F16D3	4	<b>Z 16</b>	14 FR-7 DUX	1,1	<b>UXT 1<sup>3</sup></b>
1.8	1.8	70	04.97-05.99	C18LE	4	<b>Z 8</b>	14 R-8 DU	0,8	<b>UXT 2<sup>4</sup></b>
1.8	1.8	70	06.04-	C18LE	4	<b>Z 8</b>	14 R-8 DU	0,8	<b>UXT 2<sup>4</sup></b>
2.0 16V	2.0	93	12.00-01.05	T20SED	4	<b>Z 74</b>	14 FR-8 LDUOX4	1,0	<b>UXT 1<sup>3</sup></b>
2.0 16V	2.0	98	05.97-	X 20 SED	4	<b>Z 193</b>	14 FR-7 DU2	0,9	<b>UXT 1<sup>3</sup></b>

#### REXTON

2.9 TD	2.9	88	04.02-	OM 662.983	5	<b>GN 858</b> (11,5V)	○		
3.2 V6	3.2	162	04.02-	M 162.992	6	<b>Z 100</b>	14 F-8 DU4	0,8	<b>UXT 1<sup>3</sup></b>

#### REZZO

1.6	1.6	77	09.00-	A16DMS	4	<b>Z 73</b>	14 FR-8 DUX	1,1	<b>UXT 1<sup>3</sup></b>
1.8	1.8	74	09.00-01.05	F18S2	4	<b>Z 8</b>	14 R-8 DU	0,8	<b>UXT 2<sup>4</sup></b>
2.0	2.0	94	09.00-01.05	T20SED	4	<b>Z 74</b>	14 FR-8 LDUOX4	1,0	<b>UXT 1<sup>3</sup></b>

#### TICO

0.8	0.8	35	02.95-12.00	F8C	3	<b>Z 9</b>	14 R-8 DUX	1,1	<b>UXT 2<sup>4</sup></b>
-----	-----	----	-------------	-----	---	------------	------------	-----	--------------------------

#### WINSTORM

2.4	2.4	104	12.06-	Z 24 XED	4	<b>Z 74<sup>5</sup></b>	14 FR-8 LDUOX4	1,0	<b>UXT 1<sup>3</sup></b>
2.4 4x4	2.4	104	12.06-	Z 24 XED	4	<b>Z 74<sup>5</sup></b>	14 FR-8 LDUOX4	1,0	<b>UXT 1<sup>3</sup></b>

### DAF

#### 400-Serie

428-435 2.5 D	2.5	53	04.89-08.93	BN 52/EN 55	4	<b>GN 908</b> (11V)	○		
428-435 2.5 TD	2.5	71	04.89-08.93	ET 70	4	<b>GN 908</b> (11V)	○		

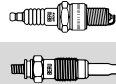
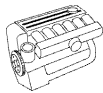

## DAIHATSU

### APPLAUSE I

1.6 16V	1.6	66	06.89-07.97	HD	4	Z 16	14 FR-7 DUX	1,1	UXT 1 <sup>3</sup>
1.6 16V	1.6	77	06.89-07.97	HD-E	4	Z 16	14 FR-7 DUX	1,1	UXT 1 <sup>3</sup>
1.6 16V 4WD	1.6	77	06.89-07.97	HD-E	4	Z 16	14 FR-7 DUX	1,1	UXT 1 <sup>3</sup>

### APPLAUSE II

1.6 16V	1.6	73	07.97-05.00	HD-E	4	Z 16	14 FR-7 DUX	1,1	UXT 1 <sup>3</sup>
---------	-----	----	-------------	------	---	------	-------------	-----	--------------------

### CERIA

1.0 DWT	1.0	43	06.05-	EJ-VE	3	Z 324	14 FGHR-7 LDUW	0,9	○
---------	-----	----	--------	-------	---	-------	----------------	-----	---

### CHARADE

1.0	1.0	43	03.03-	EJ-VE	3	Z 324	14 FGHR-7 LDUW	0,9	○
-----	-----	----	--------	-------	---	-------	----------------	-----	---

### CHARADE III

1.0 D	1.0	27	03.87-12.92	CL 11	3	GV 967 (11V)	○		
1.0 TD	1.0	35	03.87-12.92	CL/CL 61	3	GV 967 (11V)	○		
1.0	1.0	38	03.87-12.92	CB 23	3	Z 9	14 R-8 DUX	1,1	UXT 2 <sup>4</sup>
1.0	1.0	40	11.90-12.92	CB 90	3	Z 9	14 R-8 DUX	1,1	UXT 2 <sup>4</sup>
1.0	1.0	41	04.89-12.92	CB 90	3	Z 9	14 R-8 DUX	1,1	UXT 2 <sup>4</sup>
1.0 Turbo	1.0	50	03.87-10.90	CB 61	3	Z 20	14 R-7 DU	0,8	UXT 2 <sup>4</sup>
1.0 GTi	1.0	74	03.87-12.92	CB 80 T	3	Z 99	14 FR-6 DUX	1,0	UXT 5
1.3 i	1.3	66	06.88-12.92	HCE	4	Z 16	14 FR-7 DUX	1,1	UXT 1 <sup>3</sup>
1.3 i 4WD	1.3	66	06.88-01.93	HCE	4	Z 16	14 FR-7 DUX	1,1	UXT 1 <sup>3</sup>
1.3	1.3	66	11.90-12.92	HCE	4	Z 16	14 FR-7 DUX	1,1	UXT 1 <sup>3</sup>

### CHARADE IV

1.0	1.0	38	09.94-10.95	CB 22	3	Z 9	14 R-8 DUX	1,1	UXT 2 <sup>4</sup>
1.3	1.3	44	09.96-11.99	HC	4	Z 16	14 FR-7 DUX	1,1	UXT 1 <sup>3</sup>
1.3 16V	1.3	55	05.96-11.99	HCE	4	Z 16	14 FR-7 DUX	1,1	UXT 1 <sup>3</sup>
1.3 i 16V	1.3	62	01.93-11.99	HC	4	Z 16	14 FR-7 DUX	1,1	UXT 1 <sup>3</sup>
1.5 16V	1.5	55	10.94-	HEE	4	Z 16	14 FR-7 DUX	1,1	UXT 1 <sup>3</sup>
1.5 i 16V	1.5	66	08.94-	HEE	4	Z 16	14 FR-7 DUX	1,1	UXT 1 <sup>3</sup>
1.5 i 16V	1.5	66	01.97-11.99	HEE/HEEG	4	Z 16	14 FR-7 DUX	1,1	UXT 1 <sup>3</sup>
1.6 GTi	1.6	77	03.93-11.99	HD-E	4	Z 16	14 FR-7 DUX	1,1	UXT 1 <sup>3</sup>

### COO

1.0	1.0	43	10.06-	EJ-VE	3	Z 324	14 FGHR-7 LDUW	0,9	○
-----	-----	----	--------	-------	---	-------	----------------	-----	---

### COPEN

1.3	1.3	64	03.06-	K3-VE	4	Z 157	14 FR-7 KUOX	1,1	UXT 11
-----	-----	----	--------	-------	---	-------	--------------	-----	--------

### CUORE II

0.8	0.8	29	11.89-12.90	ED 10	3	Z 20	14 R-7 DU	0,8	UXT 2 <sup>4</sup>
0.8	0.8	32	09.85-06.90	ED 10	3	Z 20	14 R-7 DU	0,8	UXT 2 <sup>4</sup>

### CUORE III

0.8	0.8	30	10.90-12.94	ED 10 K	3	Z 20	14 R-7 DU	0,8	UXT 2 <sup>4</sup>
-----	-----	----	-------------	---------	---	------	-----------	-----	--------------------

### CUORE IV

0.8	0.8	32	01.95-11.96	ED 20	3	Z 20	14 R-7 DU	0,8	UXT 2 <sup>4</sup>
-----	-----	----	-------------	-------	---	------	-----------	-----	--------------------

### CUORE V

0.8	0.8	31	11.96-10.98	ED 20	3	Z 20	14 R-7 DU	0,8	UXT 2 <sup>4</sup>
-----	-----	----	-------------	-------	---	------	-----------	-----	--------------------

### CUORE VI

1.0 i	1.0	41	10.98-05.03	EJ-DE	3	Z 73	14 FR-8 DUX	1,1	UXT 1 <sup>3</sup>
1.0 DWT	1.0	43	10.00-02.03	EJ-VE	3	Z 324	14 FGHR-7 LDUW	0,9	○

### CUORE VII

1.0	1.0	43	05.03-	EJ-VE	3	Z 324	14 FGHR-7 LDUW	0,9	○
-----	-----	----	--------	-------	---	-------	----------------	-----	---

### CUORE VIII

1.0	1.0	51	04.07-	1KR-FE	3	Z 235	14 FR-7 SPUX03	1,0	○
-----	-----	----	--------	--------	---	-------	----------------	-----	---

### FEROZA Hard Top

1.6 16V	1.6	63	10.88-	HDC	4	Z 16	14 FR-7 DUX	1,1	UXT 1 <sup>3</sup>
1.6 i 16V	1.6	70	10.88-	HD-E	4	Z 16	14 FR-7 DUX	1,1	UXT 1 <sup>3</sup>

### FEROZA Soft Top

1.6 16V	1.6	63	10.88-	HDC	4	Z 16	14 FR-7 DUX	1,1	UXT 1 <sup>3</sup>
1.6 i 16V	1.6	70	10.88-	HD-E	4	Z 16	14 FR-7 DUX	1,1	UXT 1 <sup>3</sup>

### GRAN MOVE

1.5 16V	1.5	66	10.96-07.98	HEEG	4	Z 16	14 FR-7 DUX	1,1	UXT 1 <sup>3</sup>
1.6 16V	1.6	67	05.98-	HDEP	4	Z 16	14 FR-7 DUX	1,1	UXT 1 <sup>3</sup>

### MATERIA

1.0 DWT	1.0	43	10.06-	EJ-VE	3	Z 324	14 FGHR-7 LDUW	0,9	○
1.5	1.5	76	10.06-	3SZ-VE	4	Z 234	12 FR-7 DU	0,9	○

● nicht erforderlich  
○ nicht im Programm

<sup>3</sup> wahlweise UXT 3 Platin

<sup>4</sup> wahlweise UXT 6 Platin

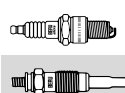
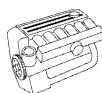

### DAIHATSU

#### MATERIA

1.5 ECO 4WD	1.5	76	10.06-	3SZ-VE	4	<b>Z 234</b>	12 FR-7 DU	0,9	○
-------------	-----	----	--------	--------	---	--------------	------------	-----	---

#### MOVE

0.8	0.8	31	10.96-	ED 20	3	<b>Z 21</b>	14 R-7 DUX	1,1	<b>UXT 2<sup>4</sup></b>
1.0 i	1.0	41	10.98-09.00	EJ-DE	3	<b>Z 16</b>	14 FR-7 DUX	1,1	<b>UXT 1<sup>3</sup></b>

#### ROCKY Hard Top

2.0	2.0	65	02.85-04.93	3Y	4	<b>Z 8</b>	14 R-8 DU	0,8	<b>UXT 2<sup>4</sup></b>
2.8 D	2.8	54	02.85-12.98	DL	4	<b>GV 886 (7V)</b>	○		
2.8 TD	2.8	67	12.87-04.93	DL 51	4	<b>GV 886 (7V)</b>	○		
2.8 TD	2.8	72	05.93-12.98	DL 52/DLT-C	4	<b>GV 886 (7V)</b>	○		
2.8 TD	2.8	75	09.91-04.93	DL 52	4	<b>GV 886 (7V)</b>	○		

#### ROCKY Soft Top

2.0	2.0	65	02.85-04.93	3Y	4	<b>Z 8</b>	14 R-8 DU	0,8	<b>UXT 2<sup>4</sup></b>
2.8 D	2.8	54	02.85-12.98	DL	4	<b>GV 886 (7V)</b>	○		
2.8 TD	2.8	67	12.87-04.93	DL 51	4	<b>GV 886 (7V)</b>	○		
2.8 TD	2.8	75	09.91-04.93	DL 52	4	<b>GV 886 (7V)</b>	○		

#### SIRION

1.0 i	1.0	41	04.98-09.00	EJ-DE	3	<b>Z 16</b>	14 FR-7 DUX	1,1	<b>UXT 1<sup>3</sup></b>
1.0 i 4WD	1.0	41	04.99-09.00	EJ-DE	3	<b>Z 16</b>	14 FR-7 DUX	1,1	<b>UXT 1<sup>3</sup></b>
1.0 i	1.0	43	09.00-01.05	EJ-VE	3	<b>Z 324</b>	14 FGHR-7 LDUW	0,9	○
1.0 i 4WD	1.0	43	09.00-01.05	EJ-VE	3	<b>Z 324</b>	14 FGHR-7 LDUW	0,9	○
1.0	1.0	51	01.05-	1KR-FE	3	<b>Z 273</b>	14 FR-7 NUX2	1,1	○
1.0 DWT 4WD	1.0	51	04.05-	1KR-FE	3	<b>Z 273</b>	14 FR-7 NUX2	1,1	○
1.3	1.3	64	01.05-	K3-VE	4	<b>Z 157</b>	14 FR-7 KUOX	1,1	<b>UXT 11</b>
1.3 4WD	1.3	64	04.05-06.07	K3-VE	4	<b>Z 157</b>	14 FR-7 KUOX	1,1	<b>UXT 11</b>
1.3 Sport	1.3	75	08.00-01.05	K3-VE2	4	<b>Z 360</b>	14 FGHR-7 DTUU	1,0	○
1.3 Sport 4WD	1.3	75	08.00-01.05	K3-VE2	4	<b>Z 360</b>	14 FGHR-7 DTUU	1,0	○
1.5	1.5	76	03.08-	3SZ-VE	4	<b>Z 234</b>	12 FR-7 DU	0,9	○

#### SKYWING

1.0	1.0	38	02.87-02.93	CB 23/CB 22	3	<b>Z 9</b>	14 R-8 DUX	1,1	<b>UXT 2<sup>4</sup></b>
-----	-----	----	-------------	-------------	---	------------	------------	-----	--------------------------

#### TERIOS

1.3 4WD	1.3	61	10.97-10.00	HE-EJ	4	<b>Z 98</b>	14 FR-7 LDU	0,8	<b>UXT 1<sup>3</sup></b>
1.3	1.3	63	09.01-10.05	K3-VE	4	<b>Z 257</b>	14 FR-7 LDUW	0,9	<b>UXT 1<sup>3</sup></b>
1.3 4WD	1.3	63	10.00-10.05	K3-VE	4	<b>Z 360</b>	14 FGHR-7 DTUU	1,0	○
1.3 DWT 4x4	1.3	63	11.05-	K3-VE	4	<b>Z 157</b>	14 FR-7 KUOX	1,1	<b>UXT 11</b>
1.5	1.5	77	11.05-	3SZ-VE	4	<b>Z 234</b>	12 FR-7 DU	0,9	○
1.5 4WD	1.5	77	05.06-	3SZ-VE	4	<b>Z 234</b>	12 FR-7 DU	0,9	○

#### TREVIS

1.0	1.0	43	06.06-	EJ-VE	3	<b>Z 324</b>	14 FGHR-7 LDUW	0,9	○
-----	-----	----	--------	-------	---	--------------	----------------	-----	---

#### YRV

1.0	1.0	43	02.01-	EJ-VE	3	<b>Z 324</b>	14 FGHR-7 LDUW	0,9	○
1.3	1.3	64	02.01-	K3-VE	4	<b>Z 360</b>	14 FGHR-7 DTUU	1,0	○
1.3 4WD	1.3	64	02.01-	K3-VE	4	<b>Z 360</b>	14 FGHR-7 DTUU	1,0	○



#### EXTOL

1.3	1.3	63	07.00-	K3-VE	4	<b>Z 360</b>	14 FGHR-7 DTUU	1,0	○
-----	-----	----	--------	-------	---	--------------	----------------	-----	---

#### HIJET

1.0	1.0	33	12.92-05.98	CB41	3	<b>Z 20</b>	14 R-7 DU	0,8	<b>UXT 2<sup>4</sup></b>
1.0 i	1.0	35	07.94-05.98	CB42	3	<b>Z 9</b>	14 R-8 DUX	1,1	<b>UXT 2<sup>4</sup></b>
1.3 i 16V	1.3	48	05.98-	HCE	4	<b>Z 16</b>	14 FR-7 DUX	1,1	<b>UXT 1<sup>3</sup></b>

### DAIMLER

Six 4.0	4.0	177	09.94-10.98	9JPFBR	6	<b>Z 15</b>	14 FR-7 DU	0,8	<b>UXT 1<sup>3</sup></b>
Six 4.0	4.0	209	07.97-12.02	BC	8	<b>Z 15</b>	14 FR-7 DU	0,8	<b>UXT 1<sup>3</sup></b>

#### XJ 40, 81

Sovereign 4.0	4.0	163	09.89-09.94	9EPCNA	6	<b>Z 15</b>	14 FR-7 DU	0,8	<b>UXT 1<sup>3</sup></b>
---------------	-----	-----	-------------	--------	---	-------------	------------	-----	--------------------------

### DODGE

#### NEON

2.0 16V	2.0	98	05.94-08.99	ECB	4	<b>Z 15</b>	14 FR-7 DU	0,8	<b>UXT 1<sup>3</sup></b>
2.0 16V	2.0	107	06.94-08.99	ECC	4	<b>Z 72</b>	14 FR-8 DU	0,8	<b>UXT 1<sup>3</sup></b>

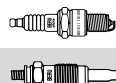

## DODGE

NEON									
2.0 16V	2.0	109	04.96-08.99	ECC	4	<b>Z 72</b>	14 FR-8 DU	0,8	<b>UXT 1<sup>3</sup></b>
2.0 16V	2.0	112	04.96-08.99	ECC	4	<b>Z 72</b>	14 FR-8 DU	0,8	<b>UXT 1<sup>3</sup></b>
NEON II									
2.0 16V	2.0	98	08.99-12.05	ECB	4	<b>Z 15</b>	14 FR-7 DU	0,8	<b>UXT 1<sup>3</sup></b>
STRATUS									
2.0 16V	2.0	98	12.95-12.00	ECB	4	<b>Z 15</b>	14 FR-7 DU	0,8	<b>UXT 1<sup>3</sup></b>
2.5 V6	2.5	125	12.95-	EEB	6	<b>Z 228</b>	14 FR-7 DPUX02	1,0	<b>UXT 11</b>

FIAT									
126									
700	0.7	19	09.87-06.96	126 A2.000/126 A2.048	2	<b>Z 20</b>	14 R-7 DU	0,8	<b>UXT 2<sup>4</sup></b>
147									
1.3 D	1.3	36	10.80-10.95		4	<b>GV 642</b> (11V)	○		
500									
0.9	0.9	63	07.10-	312 A2.000	2	<b>Z 357</b>	12 FR-4 MPPUS	0,7	○
1.2	1.2	51	10.07-	169 A4.000	4	<b>Z 293</b>	12 FR-6 LUX	1,05	○
1.2 LPG	1.2	51	12.10-	169 A4.000	4	<b>Z 293</b>	12 FR-6 LUX	1,05	○
1.4	1.4	74	10.07-	169 A3.000	4	<b>Z 292</b>	12 FR-6 DU	1,05	○
1.4 Abarth	1.4	99	08.08-	312 A1.000	4	<b>Z 338</b>	12 FR-4 DPUT	0,8	○
1.4 Abarth	1.4	132	08.08-	312 A3.000	4	<b>Z 338</b>	12 FR-4 DPUT	0,8	○
1.4 Abarth	1.4	140	08.08-	198 A.1000	4	<b>Z 338</b>	12 FR-4 DPUT	0,8	○
1.3 D Multijet	1.3	55	10.07-	169 A1.000	4	<b>GN 053</b> (11V)	○		
500 C									
0.9	0.9	63	09.09-	312 A2.000	2	<b>Z 357</b>	12 FR-4 MPPUS	0,7	○
1.2	1.2	51	09.09-	169 A4.000	4	<b>Z 293</b>	12 FR-6 LUX	1,05	○
1.3 D Multijet	1.3	55	09.09-	169 A1.000	4	<b>GN 053</b> (11V)	○		
1.4	1.4	74	09.09-	169 A3.000	4	<b>Z 292</b>	12 FR-6 DU	1,05	○
1.4 Abarth	1.4	103	09.09-	312 A3.000	4	<b>Z 338</b>	12 FR-4 DPUT	0,8	○
BARCETTA									
1.8 16V	1.7	96	04.95-05.05	183 A1000/188 A6.000 → Mot.Nr. 1945438	4	<b>Z 98</b>	14 FR-7 LDU	0,8	<b>UXT 1<sup>3</sup></b>
1.8 16V	1.7	96	04.95-05.05	188 A6.000 Mot.Nr. 1945439 →	4	<b>Z 255</b>	14 FR-8 DUW	0,9	<b>UXT 1<sup>3</sup></b>
BRAVA									
1.2 16V 80	1.2	59	10.00-10.01	188 A5.000	4	<b>Z 234</b>	12 FR-7 DU	0,9	○
1.2 16V 80	1.2	60	12.98-10.00	182 B2.000 → Mot.Nr. 1945437	4	<b>Z 234</b>	12 FR-7 DU	0,9	○
1.2 16V 80	1.2	60	12.98-10.00	182 B2.000 Mot.Nr. 1945438 →	4	<b>Z 291</b>	12 FR-5 DU	0,9	○
1.4	1.4	55	10.95-10.98	182 A5.000	4	<b>Z 98</b>	14 FR-7 LDU	0,8	<b>UXT 1<sup>3</sup></b>
1.4 12 V	1.4	59	10.95-08.98	182 A3.000	4	<b>Z 98</b>	14 FR-7 LDU	0,8	<b>UXT 1<sup>3</sup></b>
1.6 16V	1.6	66	10.95-10.98	182 A6.000	4	<b>Z 98</b>	14 FR-7 LDU	0,8	<b>UXT 1<sup>3</sup></b>
1.6 16V	1.6	76	02.96-10.98	182 A4.000	4	<b>Z 98</b>	14 FR-7 LDU	0,8	<b>UXT 1<sup>3</sup></b>
1.6 16V	1.6	76	11.98-10.01	182 A4.000	4	<b>Z 255</b>	14 FR-8 DUW	0,9	<b>UXT 1<sup>3</sup></b>
1.6 16V	1.6	76	01.99-12.02	182 B6.000	4	<b>Z 255</b>	14 FR-8 DUW	0,9	<b>UXT 1<sup>3</sup></b>
1.8 GT 16V	1.7	83	10.95-07.99	182 A2.000 → Mot.Nr.1945438	4	<b>Z 98</b>	14 FR-7 LDU	0,8	<b>UXT 1<sup>3</sup></b>
1.8 GT 16V	1.7	83	08.99-10.01	182 A2.000 Mot.Nr.1945439 →	4	<b>Z 255</b>	14 FR-8 DUW	0,9	<b>UXT 1<sup>3</sup></b>
1.9 D	1.9	48	10.95-10.96	160 A7.000	4	<b>GV 663</b> (11V)	○		
1.9 TD 75 S	1.9	55	03.96-10.01	182 A8.000	4	<b>GN 970</b> (11V)	○		
1.9 JTD	1.9	74	09.00-10.01	182 B9.000	4	<b>GN 041</b> (11V)	○		
1.9 TD 100 S	1.9	74	03.96-10.01	182 A7.000	4	<b>GN 970</b> (11V)	○		
1.9 JTD 105	1.9	77	12.98-10.99	182 B4.000 → Mot.Nr. 1716458	4	<b>GN 017</b> (11V)	○		
1.9 JTD 105	1.9	77	11.99-10.01	182 B4.000 Mot.Nr. 1716459 →	4	<b>GN 041</b> (11V)	○		
1.9 JTD 105	1.9	77	11.99-10.01	182 B4.000 Kühlwasservorwärmung <sup>15</sup> ⇄ Ø 4 mm	4	<b>GN 020</b> (12V)			
1.9 JTD 105	1.9	77	11.99-10.01	182 B4.000 Kühlwasservorwärmung <sup>15</sup> ⇄ Ø 4 mm	4	<b>GN 020</b> (12V)			
2.0	2.0	113	09.98-08.00	182 B7.000	5	<b>Z 98</b>	14 FR-7 LDU	0,8	<b>UXT 1<sup>3</sup></b>

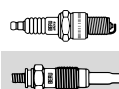

## FIAT

### BRAVO I

1.2 16V 80	1.2	59	10.00-10.01	188 A5.000	4	<b>Z 234</b>	12 FR-7 DU	0,9	○
1.2 16V 80	1.2	60	12.98-10.00	182 B2.000 → Mot.Nr. 1945437	4	<b>Z 234</b>	12 FR-7 DU	0,9	○
1.2 16V 80	1.2	60	12.98-10.00	182 B2.000 Mot.Nr. 1945438 →	4	<b>Z 291</b>	12 FR-5 DU	0,9	○
1.4	1.4	55	10.95-10.98	182 A5.000	4	<b>Z 98</b>	14 FR-7 LDU	0,8	<b>UXT 1<sup>3</sup></b>
1.4	1.4	59	10.95-10.98	182 A3.000	4	<b>Z 98</b>	14 FR-7 LDU	0,8	<b>UXT 1<sup>3</sup></b>
1.6 16V	1.6	66	10.95-10.98	182 A6.000	4	<b>Z 98</b>	14 FR-7 LDU	0,8	<b>UXT 1<sup>3</sup></b>
1.6	1.6	76	09.00-02.02	182 B6.000	4	<b>Z 255</b>	14 FR-8 DUW	0,9	<b>UXT 1<sup>3</sup></b>
1.6 16V	1.6	76	03.96-10.98	182 A4.000	4	<b>Z 98</b>	14 FR-7 LDU	0,8	<b>UXT 1<sup>3</sup></b>
1.6 16V	1.6	76	11.98-10.01	182 A4.000	4	<b>Z 255</b>	14 FR-8 DUW	0,9	<b>UXT 1<sup>3</sup></b>
1.8 GT	1.7	83	10.95-07.99	182 A2.000 → Mot.Nr.1945438	4	<b>Z 98</b>	14 FR-7 LDU	0,8	<b>UXT 1<sup>3</sup></b>
1.8 GT	1.7	83	08.99-10.01	182 A2.000 Mot.Nr.1945439 →	4	<b>Z 255</b>	14 FR-8 DUW	0,9	<b>UXT 1<sup>3</sup></b>
1.9 D	1.9	48	10.95-10.96	160 A7.000	4	<b>GV 663</b> (11V)	○		
1.9 TD 75 S	1.9	55	03.96-10.01	182 A8.000	4	<b>GN 970</b> (11V)	○		
1.9 JTD	1.9	74	09.00-10.01	182 B9.000	4	<b>GN 041</b> (11V)	○		
1.9 TD 100 S	1.9	74	03.96-10.01	182 A7.000	4	<b>GN 970</b> (11V)	○		
1.9 JTD 105	1.9	77	12.98-10.99	182 B4.000 → Mot.Nr. 1716458	4	<b>GN 017</b> (11V)	○		
1.9 JTD 105	1.9	77	11.99-10.01	182 B4.000 Mot.Nr. 1716459 →	4	<b>GN 041</b> (11V)	○		
				Kühlwasservorwärmung <sup>15</sup> Ø 4 mm		<b>GN 020</b> (12V)			
				Kühlwasservorwärmung <sup>15</sup> Ø 4 mm		<b>GN 020</b> (12V)			
2.0 HGT 20V	2.0	108	10.95-07.98	182 A1.000	5	<b>Z 98</b>	14 FR-7 LDU	0,8	<b>UXT 1<sup>3</sup></b>
2.0 HGT 20V	2.0	113	07.98-10.01	182 B7.000	5	<b>Z 98</b>	14 FR-7 LDU	0,8	<b>UXT 1<sup>3</sup></b>

### BRAVO II

1.4	1.4	66	04.07-	192 B2.000	4	<b>Z 292</b>	12 FR-6 DU	1,05	○
1.4 LPG	1.4	66	11.09-	192 B2.000	4	<b>Z 292</b>	12 FR-6 DU	1,05	○
1.4 T-Jet	1.4	88	09.07-	198 A4.000	4	<b>Z 338</b>	12 FR-4 DPUT	0,8	○
1.4 16V	1.4	103	03.08-	198 A7.000	4	<b>Z 338</b>	12 FR-4 DPUT	0,8	○
1.4 T-Jet	1.4	110	09.07-	198 A1.000	4	<b>Z 338</b>	12 FR-4 DPUT	0,8	○
1.9 D Multijet	1.9	66	04.07-12.08	192 B5.000	4	<b>GN 097</b> (11V)	○		
1.9 D Multijet	1.9	85	11.06-12.09	192 B4.000	4	<b>GN 097</b> (11V)	○		
1.9 D Multijet	1.9	88	04.07-	192 A8.000	4	<b>GN 097</b> (11V)	○		
1.9 D Multijet	1.9	110	04.07-	937 A5.000	4	<b>GN 059</b> (11V)	○		

### CINQUECENTO

0.7 i	0.7	22	07.94-01.98	170 A.046	2	<b>Z 20</b>	14 R-7 DU	0,8	<b>UXT 2<sup>4</sup></b>
0.7	0.7	23	12.91-01.96	170 A.000	2	<b>Z 20</b>	14 R-7 DU	0,8	<b>UXT 2<sup>4</sup></b>
0.9	0.9	30	07.91-12.93	170 A1.000	4	<b>Z 20</b>	14 R-7 DU	0,8	<b>UXT 2<sup>4</sup></b>
0.9 i.e.	0.9	30	07.91-12.93	170 A1.046	4	<b>Z 20</b>	14 R-7 DU	0,8	<b>UXT 2<sup>4</sup></b>
0.9 i.e. S	0.9	29	07.91-07.99	1170 A1.000/1170 A1.046	4	<b>Z 20</b>	14 R-7 DU	0,8	<b>UXT 2<sup>4</sup></b>
1.1 Sporting	1.1	40	10.94-01.98	176 B2.000	4	<b>Z 193</b>	14 FR-7 DU2	0,9	<b>UXT 1<sup>3</sup></b>

### COUPE

1.8 16V	1.7	96	03.96-08.00	183 A1.000	4	<b>Z 98</b>	14 FR-7 LDU	0,8	<b>UXT 1<sup>3</sup></b>
2.0 16V	2.0	102	11.93-08.96	836 A3.000	4	<b>Z 27</b>	14 R-6 DU	0,8	<b>UX 56</b>
2.0 20V	2.0	108	08.96-04.98	182 A1.000	5	<b>Z 98</b>	14 FR-7 LDU	0,8	<b>UXT 1<sup>3</sup></b>
2.0 20V	2.0	113	04.98-08.00	182 B3.000	5	<b>Z 98</b>	14 FR-7 LDU	0,8	<b>UXT 1<sup>3</sup></b>
2.0 16V Turbo	2.0	140	11.93-08.96	175 A1.000	4	<b>Z 27</b>	14 R-6 DU	0,8	<b>UX 56</b>

### CROMA

1600	1.6	61	12.85-12.90	154 A.048	4	<b>Z 27</b>	14 R-6 DU	0,8	<b>UX 56</b>
1900 Turbo D i.d.	1.9	66	05.89-10.92	154 C6.000	4	<b>GV 730</b> (11V)	○		
1900 Turbo D i.d.	1.9	69	11.92-12.96	154 D1.000	4	<b>GV 730</b> (11V)	○		
2000 CHT	2.0	74	01.91-09.92		4	<b>Z 27</b>	14 R-6 DU	0,8	<b>UX 56</b>
2000 i.e.	2.0	83	03.86-09.90	834 B.048	4	<b>Z 27</b>	14 R-6 DU	0,8	<b>UX 56</b>
2000 i.e.	2.0	85	10.87-08.96	154 C4.046/834 C.146	4	<b>Z 27</b>	14 R-6 DU	0,8	<b>UX 56</b>
2000 i.e.	2.0	88	03.87-09.92	834 B.000/154 C3.000	4	<b>Z 27</b>	14 R-6 DU	0,8	<b>UX 56</b>
2000 16V	2.0	101	08.92-08.96	154 E1.000	4	<b>Z 27</b>	14 R-6 DU	0,8	<b>UX 56</b>
2000 i.e. Turbo	2.0	110	06.87-08.96	154 C4.046/834 C.146	4	<b>Z 27</b>	14 R-6 DU	0,8	<b>UX 56</b>

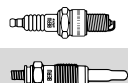

<b>FIAT</b>										
<b>CROMA</b>										
2000 i.e. Turbo	2.0	114	12.85-06.90	154 A2.000	4	<b>Z 27</b>	14 R-6 DU	0,8		<b>UX 56</b>
2500 TDE	2.5	77	12.91-08.96	8144.97 S	4	<b>GV 642</b> (11V)	○			
2500 TD	2.5	85	05.89-12.92	8144.97/8144.97 Y/ 8144.97.2400	4	<b>GV 727</b> (11V)	○			
2500 TD	2.5	85	01.93-12.93	8144.97/8144.97 Y/ 8144.97.2400	4	<b>GN 917</b> (11V)	○			
2500 V6	2.5	119	06.93-08.96	834 G.000	6	<b>Z 27</b>	14 R-6 DU	0,8		<b>UX 56</b>
1.8 16V	1.8	103	12.05-	939 A4.000	4	<b>Z 203</b>	14 FR-8 LU2	0,9		○
1.9 D Multijet	1.9	85	06.05-08.06	939 A7.000 → Mot.Nr. 5115898	4	<b>GN 041</b> (11V)	○			
1.9 D Multijet	1.9	85	09.06-	939 A7.000	4	<b>GN 097</b> (11V)	○			
1.9 D Multijet	1.9	88	06.05-	939 A1.000	4	<b>GN 097</b> (11V)	○			
1.9 D Multijet	1.9	100	12.05-	939 A8.000	4	<b>GN 059</b> (11V)	○			
1.9 D Multijet	1.9	110	06.05-	939 A2.000	4	<b>GN 059</b> (11V)	○			
2.2 16V	2.2	108	06.05-	194 A1.000	4	<b>Z 222</b>	14 KR-8 STUX	1,1		○
2.4 D Multijet	2.4	147	06.05-	939 A3.000	5	<b>GN 059</b> (11V)	○			
<b>DOBLO</b>										
1.2	1.2	48	03.01-	223 A5.000	4	<b>Z 255</b>	14 FR-8 DUW	0,9		<b>UXT 1<sup>3</sup></b>
1.3 JTD	1.3	55	05.05-	199 A2.000	4	<b>GN 053</b> (11V)	○			
1.3 D Multijet	1.3	62	10.05-	223 A9.000	4	<b>GN 053</b> (11V)	○			
1.3 D Multijet	1.3	66	02.10-	263 A2.000/199 A3.000	4	<b>GN 053</b> (11V)	○			
1.4	1.4	57	10.05-	350 A1.000	4	<b>Z 293</b>	12 FR-6 LUX	1,05		○
1.4	1.4	70	02.10-	843 A1.000	4	<b>Z 292</b>	12 FR-6 DU	1,05		○
1.4 Natural Power	1.4	88	02.10-	198 A4.000	4	<b>Z 338</b>	12 FR-4 DPUT	0,8		○
1.6 16V	1.6	76	10.01-	182 B6.000	4	<b>Z 255</b>	14 FR-8 DUW	0,9		<b>UXT 1<sup>3</sup></b>
1.6 Natural Power	1.6	76	09.02-	182 B6.000	4	<b>Z 98</b>	14 FR-7 LDU	0,8		<b>UXT 1<sup>3</sup></b>
1.9 D	1.9	46	03.01-	223 A6.000	4	<b>GN 030</b> (11V)	○			
1.9 JTD	1.9	74	10.01-	182 B9.000/223 B2.000	4	<b>GN 041</b> (11V)	○			
1.9 JTD	1.9	77	07.03-	223 B1.000/223 A7.000	4	<b>GN 041</b> (11V)	○			
1.9 D Multijet	1.9	88	10.05-	186 A9.000	4	<b>GN 097</b> (11V)	○			
<b>DOBLO Cargo</b>										
1.2	1.2	48	03.01-	223 A5.000	4	<b>Z 255</b>	14 FR-8 DUW	0,9		<b>UXT 1<sup>3</sup></b>
1.3 JTD 16V	1.3	51	05.04-	188 A9.000	4	<b>GN 053</b> (11V)	○			
1.3 D Multijet	1.3	55	10.05-	199 A2.000	4	<b>GN 053</b> (11V)	○			
1.3 JTD 16V Multijet	1.3	62	08.06-	223 A9.000	4	<b>GN 053</b> (11V)	○			
1.3 D Multijet	1.3	66	02.10-	263 A2.000/199 A3.000	4	<b>GN 053</b> (11V)	○			
1.4	1.4	57	10.05-	350 A1.000	4	<b>Z 293</b>	12 FR-6 LUX	1,05		○
1.4	1.4	70	02.10-	843 A1.000	4	<b>Z 292</b>	12 FR-6 DU	1,05		○
1.4 Natural Power	1.4	88	06.10-	198 A4.000	4	<b>Z 338</b>	12 FR-4 DPUT	0,8		○
1.6 16V	1.6	76	10.01-	182 B6.000	4	<b>Z 255</b>	14 FR-8 DUW	0,9		<b>UXT 1<sup>3</sup></b>
1.6 Natural Power	1.6	76	09.02-	182 B6.000	4	<b>Z 98</b>	14 FR-7 LDU	0,8		<b>UXT 1<sup>3</sup></b>
1.9 D	1.9	46	03.01-	223 A6.000	4	<b>GN 030</b> (11V)	○			
1.9 JTD	1.9	74	10.01-	182 B9.000	4	<b>GN 041</b> (11V)	○			
1.9 JTD	1.9	77	07.03-	223 B1.000/223 A7.000	4	<b>GN 041</b> (11V)	○			
1.9 JTD Multijet	1.9	88	12.06-12.10	186 A9.000	4	<b>GN 097</b> (11V)	○			
<b>DUNA</b>										
60 1.1	1.1	43	01.87-12.91	146 A6.000	4	<b>Z 20</b>	14 R-7 DU	0,8		<b>UXT 2<sup>4</sup></b>
70 1.3	1.3	49	01.87-12.91	146 A5.000	4	<b>Z 20</b>	14 R-7 DU	0,8		<b>UXT 2<sup>4</sup></b>
DS 1.7	1.7	44	01.87-12.91	149 B3.000	4	<b>GV 663</b> (11V)	○			
<b>DUNA Weekend</b>										
60 1.1	1.1	43	01.87-12.91	146 A6.000	4	<b>Z 20</b>	14 R-7 DU	0,8		<b>UXT 2<sup>4</sup></b>
70 1.3	1.3	49	01.87-12.91	146 A5.000	4	<b>Z 20</b>	14 R-7 DU	0,8		<b>UXT 2<sup>4</sup></b>
DS 1.7	1.7	44	01.87-12.91	149 B3.000	4	<b>GV 663</b> (11V)	○			
<b>ELBA</b>										
1.3 D	1.3	33	04.86-10.92	127 A5.000	4	<b>GV 636</b> (11V)	○			
1.5	1.5	55	01.92-12.96	149 C1.000	4	<b>Z 27</b>	14 R-6 DU	0,8		<b>UX 56</b>
1.7 D	1.7	43	04.89-12.96	146 B2.000	4	<b>GV 663</b> (11V)	○			
<b>GRANDE PUNTO Van</b>										
1.3 D Multijet	1.3	55	04.08-	199 A2.000	4	<b>GN 053</b> (11V)	○			
1.4	1.4	57	04.08-	350 A1.000	4	<b>Z 293</b>	12 FR-6 LUX	1,05		○

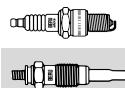
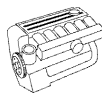

### FIAT

#### IDEA

1.2 16V	1.2	59	01.04-	188 A5.000	4	<b>Z 292</b>	12 FR-6 DU	1,05	○
1.3 JTD	1.3	51	01.04-	188 A9.000	4	<b>GN 053</b> (11V)	○		
1.3 D Multijet	1.3	66	10.05-	199 A3.000	4	<b>GN 053</b> (11V)	○		
1.4	1.4	57	10.05-	350 A1.000	4	<b>Z 293</b>	12 FR-6 LUX	1,05	○
1.4 LPG	1.4	57	03.09-	350 A1.000	4	<b>Z 293</b>	12 FR-6 LUX	1,05	○
1.4	1.4	66	12.03-	192 B2.000	4	<b>Z 292</b>	12 FR-6 DU	1,05	○
1.4 16V	1.4	70	01.04-	843 A1.000	4	<b>Z 292</b>	12 FR-6 DU	1,05	○
1.9 JTD	1.9	74	01.04-	188 B2.000	4	<b>GN 041</b> (11V)	○		

#### LINEA

1.3 D Multijet	1.3	66	06.07-	199 A3.000	4	<b>GN 053</b> (11V)	○		
1.4	1.4	57	06.07-	350 A1.000	4	<b>Z 293</b>	12 FR-6 LUX	1,05	○
1.4 T-Jet	1.4	88	09.07-	198 A4.000	4	<b>Z 338</b>	12 FR-4 DPUT	0,8	○

#### MAREA

1.2 16V	1.2	60	10.98-05.02	182 B2.000	4	<b>Z 291</b>	12 FR-5 DU	0,9	○
1.4 80 12V	1.4	59	09.96-03.99	182 A3.000	4	<b>Z 98</b>	14 FR-7 LDU	0,8	<b>UXT 1<sup>3</sup></b>
1.6	1.6	76	09.00-08.02	182 B6.000	4	<b>Z 255</b>	14 FR-8 DUW	0,9	<b>UXT 1<sup>3</sup></b>
1.6 100 16V	1.6	76	09.96-03.99	182 A4.000	4	<b>Z 98</b>	14 FR-7 LDU	0,8	<b>UXT 1<sup>3</sup></b>
1.6 100 16V	1.6	76	04.99-05.02	182 A4.000	4	<b>Z 255</b>	14 FR-8 DUW	0,9	<b>UXT 1<sup>3</sup></b>
1.6 100 16V Bipower	1.6	76	04.99-05.02	186 A4.000/185 A3.000	4	<b>Z 206</b>	14 FR-7 DPPUS2	0,7	<b>UXT 10</b>
1.8 115 16V	1.7	83	09.96-07.99	182 A2.000	4	<b>Z 98</b>	14 FR-7 LDU	0,8	<b>UXT 1<sup>3</sup></b>
1.8 115 16V	1.7	83	08.99-05.02	182 A2.000 → Mot.Nr.1945438	4	<b>Z 255</b>	14 FR-8 DUW	0,9	<b>UXT 1<sup>3</sup></b>
1.9 TD 75	1.9	55	09.96-05.02	182 A8.000	4	<b>GN 970</b> (11V)	○		
1.9 TD 100	1.9	74	09.96-05.02	182 A7.000	4	<b>GN 970</b> (11V)	○		
1.9 JTD 105	1.9	77	04.99-10.99	182 B4.000	4	<b>GN 017</b> (11V)	○		
1.9 JTD 105	1.9	77	11.99-01.01	182 B4.000 → Mot.Nr. 1713818	4	<b>GN 020</b> (12V)			
1.9 JTD 105	1.9	77	11.99-01.01	182 B4.000 → Mot.Nr. 1713819	4	<b>GN 041</b> (11V)	○		
1.9 JTD 110	1.9	81	01.01-05.02	186 A6.000	4	<b>GN 041</b> (11V)	○		
2.0 150 20V	2.0	108	09.96-04.99	182 A1.000	5	<b>Z 98</b>	14 FR-7 LDU	0,8	<b>UXT 1<sup>3</sup></b>
2.0 150 20V	2.0	110	01.01-05.02	185 A8.000	5	<b>Z 98</b>	14 FR-7 LDU	0,8	<b>UXT 1<sup>3</sup></b>
2.0 155 20V	2.0	113	04.99-01.01	182 B7.000	5	<b>Z 98</b>	14 FR-7 LDU	0,8	<b>UXT 1<sup>3</sup></b>
2.4 TD 125	2.4	91	09.96-04.99	185 A2.000	5	<b>GN 970</b> (11V)	○		
2.4 JTD 130	2.4	96	04.99-10.99	839 A5.000/185 A6.000	5	<b>GN 017</b> (11V)	○		
2.4 JTD 130	2.4	96	11.99-05.02	839 A5.000/185 A6.000 → Mot.Nr.1713818	5	<b>GN 020</b> (12V)			
2.4 JTD 130	2.4	96	11.99-05.02	839 A5.000/185 A6.000 → Mot.Nr.1713819	5	<b>GN 041</b> (11V)	○		
2.4 JTD 130	2.4	96	11.99-05.02	839 A5.000/185 A6.000 → Mot.Nr.1713819	5	<b>GN 020</b> (12V)			

#### MAREA Weekend

1.2 16V	1.2	60	10.98-05.02	182 B2.000	4	<b>Z 291</b>	12 FR-5 DU	0,9	○
1.4 80 12V	1.4	59	09.96-03.99	182 A3.000	4	<b>Z 98</b>	14 FR-7 LDU	0,8	<b>UXT 1<sup>3</sup></b>
1.6	1.6	76	09.00-08.02	182 B6.000	4	<b>Z 255</b>	14 FR-8 DUW	0,9	<b>UXT 1<sup>3</sup></b>
1.6 100 16V	1.6	76	09.96-03.99	182 A4.000	4	<b>Z 98</b>	14 FR-7 LDU	0,8	<b>UXT 1<sup>3</sup></b>
1.6 100 16V	1.6	76	04.99-05.02	182 A4.000	4	<b>Z 255</b>	14 FR-8 DUW	0,9	<b>UXT 1<sup>3</sup></b>
1.6 100 16V Bipower	1.6	76	04.99-05.02	186 A4.000/185 A3.000	4	<b>Z 206</b>	14 FR-7 DPPUS2	0,7	<b>UXT 10</b>
1.8 115 16V	1.7	83	09.96-07.99	182 A2.000	4	<b>Z 98</b>	14 FR-7 LDU	0,8	<b>UXT 1<sup>3</sup></b>
1.8 115 16V	1.7	83	08.99-05.02	182 A2.000 → Mot.Nr.1945438	4	<b>Z 255</b>	14 FR-8 DUW	0,9	<b>UXT 1<sup>3</sup></b>
1.9 TD 75	1.9	55	09.96-05.02	182 A8.000	4	<b>GN 970</b> (11V)	○		
1.9 TD 100	1.9	74	09.96-05.02	182 A7.000	4	<b>GN 970</b> (11V)	○		
1.9 JTD 105	1.9	77	04.99-10.99	182 B4.000	4	<b>GN 017</b> (11V)	○		
1.9 JTD 105	1.9	77	11.99-01.01	182 B4.000 → Mot.Nr. 1713818	4	<b>GN 020</b> (12V)			
1.9 JTD 105	1.9	77	11.99-01.01	182 B4.000 → Mot.Nr. 1713819	4	<b>GN 041</b> (11V)	○		



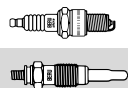
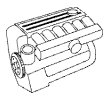

## FIAT

### MAREA Weekend

			Kühlwasservorwärmung <sup>15</sup> ⇄ Ø 4 mm		<b>GN 020</b> (12V)			
1.9 JTD 110	1.9	81	01.01-05.02 186 A6.000	4	<b>GN 041</b> (11V)	○		
2.0 150 20V	2.0	108	09.96-04.99 182 A1.000	5	<b>Z 98</b>	14 FR-7 LDU	0,8	<b>UXT 1<sup>3</sup></b>
2.0 150 20V	2.0	110	01.01-05.02 185 A8.000	5	<b>Z 98</b>	14 FR-7 LDU	0,8	<b>UXT 1<sup>3</sup></b>
2.0 155 20V	2.0	113	04.99-01.01 182 B7.000	5	<b>Z 98</b>	14 FR-7 LDU	0,8	<b>UXT 1<sup>3</sup></b>
2.4 TD 125	2.4	91	09.96-04.99 185 A2.000	5	<b>GN 970</b> (11V)	○		
2.4 JTD 130	2.4	96	04.99-10.99 839 A5.000/185 A6.000 → Mot.Nr.1713818	5	<b>GN 017</b> (11V)	○		
			Kühlwasservorwärmung <sup>15</sup> ⇄ Ø 4 mm		<b>GN 020</b> (12V)			
2.4 JTD 130	2.4	96	11.99-05.02 839 A5.000/185 A6.000 Mot.Nr.1713819 →	5	<b>GN 041</b> (11V)	○		
			Kühlwasservorwärmung <sup>15</sup> ⇄ Ø 4 mm		<b>GN 020</b> (12V)			

### MULTIPLA

1.6 16V	1.6	70	04.02-12.10 182 B6.000	4	<b>Z 255</b>	14 FR-8 DUW	0,9	<b>UXT 1<sup>3</sup></b>
1.6 16V Blupower	1.6	70	04.99- 186 A3.000	4	<b>Z 255</b>	14 FR-8 DUW	0,9	<b>UXT 1<sup>3</sup></b>
1.6	1.6	76	09.00- 182 B6.000	4	<b>Z 255</b>	14 FR-8 DUW	0,9	<b>UXT 1<sup>3</sup></b>
1.6 100 16V	1.6	76	04.99- 182 A4.000	4	<b>Z 255</b>	14 FR-8 DUW	0,9	<b>UXT 1<sup>3</sup></b>
1.6 16V Bipower	1.6	76	04.99- 186 A4.000	4	<b>Z 255</b>	14 FR-8 DUW	0,9	<b>UXT 1<sup>3</sup></b>
1.6 16V Bipower	1.6	76	10.01- 182 B6.000	4	<b>Z 255</b>	14 FR-8 DUW	0,9	<b>UXT 1<sup>3</sup></b>
1.9 JTD 105	1.9	77	04.99-10.99 182 B4.000 → Mot.Nr. 1692990	4	<b>GN 017</b> (11V)	○		
			Kühlwasservorwärmung <sup>15</sup> ⇄ Ø 4 mm		<b>GN 020</b> (12V)			
1.9 JTD 105	1.9	77	11.99- 182 B4.000 Mot.Nr. 1692991 →	4	<b>GN 041</b> (11V)	○		
			Kühlwasservorwärmung <sup>15</sup> ⇄ Ø 4 mm		<b>GN 020</b> (12V)			
1.9 JTD 110	1.9	81	03.01-07.02 186 A6.000	4	<b>GN 041</b> (11V)	○		
			Kühlwasservorwärmung <sup>15</sup> ⇄ Ø 4 mm		<b>GN 020</b> (12V)			
1.9 JTD 115	1.9	85	07.02-12.10 186 A8.000 <M7/EU3>	4	<b>GN 041</b> (11V)	○		
1.9 JTD 115	1.9	85	10.03-12.10 186 A8.000 <M87/EU4>	4	<b>GN 097</b> (11V)	○		
1.9 JTD	1.9	88	04.02-09.05 186 A9.000	4	<b>GN 041</b> (11V)	○		
1.9 JTD	1.9	88	10.05- 186 A9.000	4	<b>GN 097</b> (11V)	○		

### PALIO

1.0	1.0	45	04.96- 182 B6.000	4	<b>Z 15</b>	14 FR-7 DU	0,8	<b>UXT 1<sup>3</sup></b>
1.0	1.0	56	04.96- 182 B6.000	4	<b>Z 252</b>	14 FR-6 DUW	0,9	<b>UXT 5</b>
1.2	1.2	44	07.97-08.02 188 A4.000	4	<b>Z 292</b>	12 FR-6 DU	1,05	○
1.2	1.2	54	06.98- 178 B5.000/178 E2.000/176 A8.000	4	<b>Z 98</b>	14 FR-7 LDU	0,8	<b>UXT 1<sup>3</sup></b>
1.2	1.2	59	09.01- 188 A5.000	4	<b>Z 291</b>	12 FR-5 DU	0,9	○
1.3 JTD Multijet	1.3	51	06.03- 188 A9.000	4	<b>GN 053</b> (11V)	○		
1.3 D Multijet	1.3	55	03.08- 188 A9.000	4	<b>GN 053</b> (11V)	○		
1.4	1.4	51	04.96- 178 B2.000	4	<b>Z 74</b>	14 FR-8 LDUOX4	1,0	<b>UXT 1<sup>3</sup></b>
1.4 KAT	1.4	51	04.96- 178 B2.016	4	<b>Z 74</b>	14 FR-8 LDUOX4	1,0	<b>UXT 1<sup>3</sup></b>
1.5	1.5	57	04.96-09.02 182 B6.000	4	<b>Z 252</b>	14 FR-6 DUW	0,9	<b>UXT 5</b>
1.6 16V	1.6	74	04.96- 178 B3.000	4	<b>Z 255</b>	14 FR-8 DUW	0,9	<b>UXT 1<sup>3</sup></b>
1.9 D	1.9	46	09.00- 223 A6.000	4	<b>GN 030</b> (11V)	○		

### PALIO Weekend

1.2	1.2	44	02.01- 178 C4.066/188 A4.000	4	<b>Z 255</b>	14 FR-8 DUW	0,9	<b>UXT 1<sup>3</sup></b>
1.2	1.2	54	04.96-02.01 178 B5.000	4	<b>Z 98</b>	14 FR-7 LDU	0,8	<b>UXT 1<sup>3</sup></b>
1.2	1.2	59	09.01- 188 A5.000	4	<b>Z 291</b>	12 FR-5 DU	0,9	○
1.6 16V	1.6	74	04.96-02.01 178 B3.000	4	<b>Z 255</b>	14 FR-8 DUW	0,9	<b>UXT 1<sup>3</sup></b>
1.6 16V	1.6	76	02.01- 182 B6.000	4	<b>Z 255</b>	14 FR-8 DUW	0,9	<b>UXT 1<sup>3</sup></b>
1.7 TD	1.7	51	04.96-03.01 176 A3.000	4	<b>GN 908</b> (11V)	○		
1.9 D	1.9	46	03.01- 223 A6.000	4	<b>GN 030</b> (11V)	○		

### PANDA

750	0.8	25	01.86-01.95 156 A4.000	4	<b>Z 15</b>	14 FR-7 DU	0,8	<b>UXT 1<sup>3</sup></b>
750 KAT	0.8	25	01.95-12.97 156 A4.048	4	<b>Z 15</b>	14 FR-7 DU	0,8	<b>UXT 1<sup>3</sup></b>
900	0.9	29	04.92-10.95 1170 A1.046	4	<b>Z 20</b>	14 R-7 DU	0,8	<b>UXT 2<sup>4</sup></b>
900	0.9	29	11.95-12.96 1170 A1.046	4	<b>Z 255</b>	14 FR-8 DUW	0,9	<b>UXT 1<sup>3</sup></b>
900	0.9	33	10.80-06.94 146 A.000/100 GL3.000	4	<b>Z 20</b>	14 R-7 DU	0,8	<b>UXT 2<sup>4</sup></b>
1000	1.0	32	08.90-04.92 156 A2.100	4	<b>Z 15</b>	14 FR-7 DU	0,8	<b>UXT 1<sup>3</sup></b>



kW

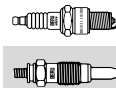
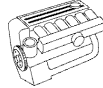

**FIAT**

**PANDA**

1000 4x4	1.0	33	05.86-12.94	141 C2.000/156 A2.246	4	<b>Z 193</b>	14 FR-7 DU2	0,9	<b>UXT 1<sup>3</sup></b>
1000 i.e. KAT	1.0	33	10.87-08.98	141 C2.000/156 A2.246	4	<b>Z 193</b>	14 FR-7 DU2	0,9	<b>UXT 1<sup>3</sup></b>
1000	1.0	37	01.85-12.92	156 A3.000	4	<b>Z 20</b>	14 R-7 DU	0,8	<b>UXT 2<sup>4</sup></b>
1000 4x4	1.0	37	01.86-12.92	156 A3.000	4	<b>Z 15</b>	14 FR-7 DU	0,8	<b>UXT 1<sup>3</sup></b>
1100	1.1	37	05.91-12.99	156 C.046	4	<b>Z 193</b>	14 FR-7 DU2	0,9	<b>UXT 1<sup>3</sup></b>
1100 Trekking 4x4	1.1	37	10.91-07.04	156 C.046	4	<b>Z 193</b>	14 FR-7 DU2	0,9	<b>UXT 1<sup>3</sup></b>
1100	1.1	40	02.95-09.03	187 A1.000/176 B2.000	4	<b>Z 193</b>	14 FR-7 DU2	0,9	<b>UXT 1<sup>3</sup></b>
1100 4x4	1.1	40	02.95-07.04	176 B2.000	4	<b>Z 193</b>	14 FR-7 DU2	0,9	<b>UXT 1<sup>3</sup></b>
1300 D	1.3	27	04.86-12.92	156 A5.000	4	<b>GN 909</b> (11V)	○		
0.9	0.9	57	02.12-	312 A2.000	2	<b>Z 357</b>	12 FR-4 MPPUS	0,7	○
0.9	0.9	63	02.12-	312 A2.000	2	<b>Z 357</b>	12 FR-4 MPPUS	0,7	○
1.1	1.1	40	09.03-	187 A1.000 → Mot.Nr. 2533528	4	<b>Z 255</b>	14 FR-8 DUW	0,9	<b>UXT 1<sup>3</sup></b>
1.1	1.1	40	09.03-	187 A1.000 Mot.Nr. 2533529 →	4	<b>Z 234</b>	12 FR-7 DU	0,9	○
1.2	1.2	44	09.03-	188 A4.000 → Mot.Nr. 2533528	4	<b>Z 255</b>	14 FR-8 DUW	0,9	<b>UXT 1<sup>3</sup></b>
1.2	1.2	44	09.03-	188 A4.000 Mot.Nr. 2533529 →	4	<b>Z 234</b>	12 FR-7 DU	0,9	○
1.2 4x4	1.2	44	10.04-	188 A4.000 → Mot.Nr. 2533528	4	<b>Z 255</b>	14 FR-8 DUW	0,9	<b>UXT 1<sup>3</sup></b>
1.2 4x4	1.2	44	10.04-	188 A4.000 Mot.Nr. 2533529 →	4	<b>Z 234</b>	12 FR-7 DU	0,9	○
1.2 Bi-Power / Natural Power	1.2	44	01.07-	188 A4.000 → Mot.Nr. 2533528	4	<b>Z 255</b>	14 FR-8 DUW	0,9	<b>UXT 1<sup>3</sup></b>
1.2 Bi-Power / Natural Power	1.2	44	01.07-	188 A4.000 Mot.Nr. 2533529 →	4	<b>Z 234</b>	12 FR-7 DU	0,9	○
1.2 LPG	1.2	44	04.09-	188 A4.000 → Mot.Nr. 2533528	4	<b>Z 255</b>	14 FR-8 DUW	0,9	<b>UXT 1<sup>3</sup></b>
1.2 LPG	1.2	44	04.09-	188 A4.000 Mot.Nr. 2533529 →	4	<b>Z 234</b>	12 FR-7 DU	0,9	○
1.2	1.2	51	03.10-	169 A4.000	4	<b>Z 293</b>	12 FR-6 LUX	1,05	○
1.2 4x4	1.2	51	11.09-	169 A4.000	4	<b>Z 293</b>	12 FR-6 LUX	1,05	○
1.2 LPG	1.2	51	11.10-	169 A4.000	4	<b>Z 292</b>	12 FR-6 DU	1,05	○
1.3 D Multijet	1.3	51	09.03-	188 A9.000	4	<b>GN 053</b> (11V)	○		
1.3 D Multijet 4x4	1.3	51	10.04-	188 A9.000	4	<b>GN 053</b> (11V)	○		
1.3 D Multijet	1.3	55	06.06-	169 A1.000	4	<b>GN 053</b> (11V)	○		
1.3 D Multijet 4x4	1.3	55	09.10-	169 A5.000/169 A1.000	4	<b>GN 053</b> (11V)	○		
1.4	1.4	74	10.06-	169 A3.000	4	<b>Z 292</b>	12 FR-6 DU	1,05	○

**PANDA Van**

750	0.8	25	01.86-07.92	141 B.000	4	<b>Z 20</b>	14 R-7 DU	0,8	<b>UXT 2<sup>4</sup></b>
1000	1.0	32	01.86-02.92	156 A3.100/156 A2.100	4	<b>Z 15</b>	14 FR-7 DU	0,8	<b>UXT 1<sup>3</sup></b>
1000 i.e	1.0	33	08.92-02.04	156 A2.246	4	<b>Z 193</b>	14 FR-7 DU2	0,9	<b>UXT 1<sup>3</sup></b>
1.2	1.2	44	09.04-	188 A4.000 → Mot.Nr. 2533528	4	<b>Z 255</b>	14 FR-8 DUW	0,9	<b>UXT 1<sup>3</sup></b>
1.2	1.2	44	09.04-	188 A4.000 Mot.Nr. 2533529 →	4	<b>Z 292</b>	12 FR-6 DU	1,05	○
1.2 4x4	1.2	44	09.04-	188 A4.000 → Mot.Nr. 2533528	4	<b>Z 255</b>	14 FR-8 DUW	0,9	<b>UXT 1<sup>3</sup></b>
1.2 4x4	1.2	44	09.04-	188 A4.000 Mot.Nr. 2533529 →	4	<b>Z 292</b>	12 FR-6 DU	1,05	○
1.3 JTD	1.3	51	03.04-	188 A9.000	4	<b>GN 053</b> (11V)	○		
1.3 JTD	1.3	55	01.06-	169 A1.000	4	<b>GN 053</b> (11V)	○		
1.4 Natural Power	1.4	57	10.09-	350 A1.000	4	<b>Z 292</b>	12 FR-6 DU	1,05	○

**PUNTO**

55 1.1	1.1	40	09.93-09.99	176 A6.000/176 B2.000	4	<b>Z 193</b>	14 FR-7 DU2	0,9	<b>UXT 1<sup>3</sup></b>
60 1.2	1.2	43	01.94-09.99	176 A7.000	4	<b>Z 193</b>	14 FR-7 DU2	0,9	<b>UXT 1<sup>3</sup></b>
60 1.2	1.2	44	03.94-09.99	176 B1.000/176 B4.000	4	<b>Z 193</b>	14 FR-7 DU2	0,9	<b>UXT 1<sup>3</sup></b>
60 1.2	1.2	44	09.99-	188 A4.000 → Mot.Nr. 2533528	4	<b>Z 255</b>	14 FR-8 DUW	0,9	<b>UXT 1<sup>3</sup></b>

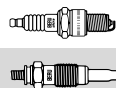
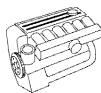

FIAT									
PUNTO									
60 1.2	1.2	44	09.99-	188 A4.000	4	Z 234	12 FR-7 DU	0,9	○
				Mot.Nr. 2533529 →					
60 TD 1.7	1.7	46	09.96-09.99	176 B7.000	4	GN 908 (11V)	○		
75 1.2	1.2	54	10.93-09.99	176 A8.000	4	Z 193	14 FR-7 DU2	0,9	UXT 1 <sup>3</sup>
80 1.2 16V	1.2	59	09.99-	188 A5.000	4	Z 291	12 FR-5 DU	0,9	○
80 1.9 JTD	1.9	59	09.99-	188 A2.000	4	GN 041 (11V)	○		
				Kühlwasservorwärmung <sup>15</sup> ⇐⇒ Ø 4 mm		GN 020 (12V)			
85 16V 1.2	1.2	63	04.97-09.99	176 B9.000	4	Z 234	12 FR-7 DU	0,9	○
90 1.6	1.6	65	01.94-04.97	176 A9.000	4	Z 252	14 FR-6 DUW	0,9	UXT 5
1.2 Natural Power	1.2	44	09.03-	188 A4.000	4	Z 255	14 FR-8 DUW	0,9	UXT 1 <sup>3</sup>
				→ Mot.Nr. 2533528					
1.2 Natural Power	1.2	44	09.03-	188 A4.000	4	Z 234	12 FR-7 DU	0,9	○
				Mot.Nr. 2533529 →					
1.3 JTD 16V	1.3	51	06.03-	188 A9.000	4	GN 053 (11V)	○		
1.4	1.4	70	09.03-	843 A1.000	4	Z 292	12 FR-6 DU	1,05	○
1.7 D	1.7	42	04.94-09.97	176 B3.000	4	GN 908 (11V)	○		
1.7 TD	1.7	51	01.94-09.99	176 A3.000	4	GN 908 (11V)	○		
1.7 TD	1.7	52	01.94-09.99	176 A5.000	4	GN 908 (11V)	○		
1.8 130 HGT	1.7	96	09.99-	183 A1.000/188 A6.000	4	Z 255	14 FR-8 DUW	0,9	UXT 1 <sup>3</sup>
1.9 DS 60	1.9	44	09.99-	188 A3.000	4	GN 030 (11V)	○		
1.9 JTD	1.9	63	10.01-09.05	188 A7.000	4	GN 041 (11V)	○		
				Kühlwasservorwärmung <sup>15</sup> ⇐⇒ Ø 4 mm		GN 020 (12V)			
1.9 JTD	1.9	63	10.05-	188 A7.000	4	GN 097 (11V)	○		
1.9 JTD	1.9	74	06.03-09.05	188 B2.000	4	GN 041 (11V)	○		
1.9 JTD	1.9	74	10.05-	188 B2.000	4	GN 097 (11V)	○		
PUNTO / GRANDE PUNTO									
1.2	1.2	48	10.05-	199 A4.000	4	Z 293	12 FR-6 LUX	1,05	○
1.2	1.2	51	09.10-	169 A4.000	4	Z 293	12 FR-6 LUX	1,05	○
1.3 D Multijet	1.3	55	10.05-	199 A2.000	4	GN 053 (11V)	○		
1.3 D Multijet	1.3	62	04.10-	223 A9.000	4	GN 053 (11V)	○		
1.3 D Multijet	1.3	66	10.05-	199 A3.000	4	GN 053 (11V)	○		
1.4	1.4	55	06.06-	199 A7.000	4	Z 234	12 FR-7 DU	0,9	○
1.4	1.4	57	10.05-	350 A1.000	4	Z 293	12 FR-6 LUX	1,05	○
1.4 Natural Power	1.4	57	07.08-	350 A1.000	4	Z 234	12 FR-7 DU	0,9	○
1.4 16V	1.4	70	10.05-	199 A6.000	4	Z 293	12 FR-6 LUX	1,05	○
1.4 T-Jet	1.4	88	09.07-	198 A4.000	4	Z 338	12 FR-4 DPUT	0,8	○
1.4 Abarth	1.4	114	12.07-	199 A8.000	4	Z 338	12 FR-4 DPUT	0,8	○
1.4 Abarth	1.4	132	12.07-	199 A8.000	4	Z 338	12 FR-4 DPUT	0,8	○
1.9 D Multijet	1.9	85	06.06-	939 A7.000	4	GN 097 (11V)	○		
1.9 D Multijet	1.9	88	10.05-	939 A1.000	4	GN 097 (11V)	○		
1.9 D Multijet	1.9	96	10.05-	199 A5.000	4	GN 097 (11V)	○		
PUNTO Cabriolet									
60 1.2	1.2	43	04.94-06.00	176 A7.000	4	Z 193	14 FR-7 DU2	0,9	UXT 1 <sup>3</sup>
60 1.2	1.2	44	05.95-06.00	176 B1.000/176 B4.000	4	Z 193	14 FR-7 DU2	0,9	UXT 1 <sup>3</sup>
85 16V 1.2	1.2	63	04.97-06.00	176 B9.000	4	Z 234	12 FR-7 DU	0,9	○
90 1.6	1.6	65	04.94-04.97	176 A9.000	4	Z 252	14 FR-6 DUW	0,9	UXT 5
PUNTO EVO									
1.2	1.2	48	10.09-02.12	199 A4.000	4	Z 293	12 FR-6 LUX	1,05	○
1.2	1.2	51	10.09-02.12	169 A4.000	4	Z 293	12 FR-6 LUX	1,05	○
1.3 D Multijet	1.3	55	10.09-02.12	199 A2.000	4	GN 053 (11V)	○		
1.3 D Multijet	1.3	66	10.09-02.12	199 A3.000	4	GN 053 (11V)	○		
1.4	1.4	55	07.09-02.12	199 A7.000	4	Z 234	12 FR-7 DU	0,9	○
1.4	1.4	57	10.09-02.12	350 A1.000	4	Z 293	12 FR-6 LUX	1,05	○
1.4 Natural Power	1.4	57	10.09-02.12	350 A1.000	4	Z 234	12 FR-7 DU	0,9	○
1.4 16V	1.4	99	10.09-02.12	955 A2.000	4	Z 338	12 FR-4 DPUT	0,8	○
1.4 Abarth	1.4	120	10.09-02.12	955 A8.000	4	Z 338	12 FR-4 DPUT	0,8	○
PUNTO EVO Van									
1.4	1.4	57	03.09-	350 A1.000	4	Z 293	12 FR-6 LUX	1,05	○
PUNTO Van									
1.1	1.1	40	04.96-02.00	176 B2.000	4	Z 193	14 FR-7 DU2	0,9	UXT 1 <sup>3</sup>

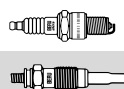
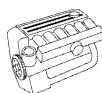
**FIAT**
**PUNTO Van**

1.2 60	1.2	44	02.00-10.09	188 A4.000 → Mot.Nr. 2533528	4	<b>Z 255</b>	14 FR-8 DUW	0,9	<b>UXT 1<sup>3</sup></b>
1.2 60	1.2	44	02.00-10.09	188 A4.000 Mot.Nr. 2533529 →	4	<b>Z 234</b>	12 FR-7 DU	0,9	○
1.3 JTD	1.3	51	06.03-10.05	188 A9.000	4	<b>GN 053</b> (11V)	○		
1.7 D	1.7	42	04.96-02.00	176 B3.000	4	<b>GN 908</b> (11V)	○		
1.7 TD	1.7	52	04.96-02.00	176 A5.000	4	<b>GN 908</b> (11V)	○		
1.9 D 60	1.9	44	02.00-10.09	188 A3.000	4	<b>GN 030</b> (11V)	○		
1.9 JTD	1.9	63	02.00-07.07	188 A7.000	4	<b>GN 041</b> (11V)	○		
1.9 JTD	1.9	63	08.07-10.09	188 A7.000	4	<b>GN 097</b> (11V)	○		

**QUBO**

1.3 D Multijet	1.3	55	09.08-	199 A2.000	4	<b>GN 053</b> (11V)	○		
1.4	1.4	54	09.08-	KFT/KFV	4	<b>Z 193</b>	14 FR-7 DU2	0,9	<b>UXT 1<sup>3</sup></b>
1.4 Natural Power	1.4	57	10.09-	350 A1.000	4	<b>Z 234</b>	12 FR-7 DU	0,9	○

**REGATA**

85 1.6	1.6	60	10.83-06.90	149 A.000	4	<b>Z 27</b>	14 R-6 DU	0,8	<b>UX 56</b>
<b>REGATA Weekend</b>									
100 i.e. 1.6	1.6	74	01.87-12.90	149 C3.000	4	<b>Z 27</b>	14 R-6 DU	0,8	<b>UX 56</b>

**SEDICI**

1.9 D Multijet 4x4	1.9	88	06.06-	D19AA	4	<b>GN 041</b> (11V)	○		
--------------------	-----	----	--------	-------	---	---------------------	---	--	--

**SEICENTO**

0.9	0.9	29	01.98-01.10	1170 A1.046	4	<b>Z 20</b>	14 R-7 DU	0,8	<b>UXT 2<sup>4</sup></b>
1.1	1.1	40	01.98-01.10	176 B2.000	4	<b>Z 193</b>	14 FR-7 DU2	0,9	<b>UXT 1<sup>3</sup></b>
1.1	1.1	40	01.98-01.10	187 A1000 → Mot.Nr. 2543170	4	<b>Z 255</b>	14 FR-8 DUW	0,9	<b>UXT 1<sup>3</sup></b>
1.1	1.1	40	01.98-01.10	187 A1.000 Mot.Nr. 2543171 →	4	<b>Z 234</b>	12 FR-7 DU	0,9	○

**SEICENTO Van**

0.9	0.9	29	01.98-01.10	1170 A1.046	4	<b>Z 20</b>	14 R-7 DU	0,8	<b>UXT 2<sup>4</sup></b>
1.1	1.1	40	01.98-01.10	176 B2.000	4	<b>Z 193</b>	14 FR-7 DU2	0,9	<b>UXT 1<sup>3</sup></b>

**SIENA**

1.2	1.2	44	09.01-	188 A4.000	4	<b>Z 292</b>	12 FR-6 DU	1,05	○
1.2	1.2	54	09.98-	178 B5.000	4	<b>Z 255</b>	14 FR-8 DUW	0,9	<b>UXT 1<sup>3</sup></b>
1.3 JTD	1.3	51	09.03-	188 A9.000	4	<b>GN 053</b> (11V)	○		
1.3 JTD	1.3	51	11.07-	188 A9.000	4	<b>GN 053</b> (11V)	○		
1.4	1.4	51	04.96-	178 B2.000	4	<b>Z 247</b>	14 FR-7 DUW	0,9	<b>UXT 1<sup>3</sup></b>
1.6	1.6	76	11.00-	182 B6.000	4	<b>Z 255</b>	14 FR-8 DUW	0,9	<b>UXT 1<sup>3</sup></b>
1.6 16V	1.6	78	09.98-	178 B3.000	4	<b>Z 255</b>	14 FR-8 DUW	0,9	<b>UXT 1<sup>3</sup></b>
1.7 TD	1.7	51	02.06-	176 A3.000	4	<b>GN 908</b> (11V)	○		
1.9 D	1.9	46	11.00-	223 A6.000	4	<b>GN 030</b> (11V)	○		

**STILO**

1.2 16V	1.2	59	02.02-12.03	188 A5.000	4	<b>Z 291</b>	12 FR-5 DU	0,9	○
1.4 16V	1.4	66	03.05-11.06	192 B2.000	4	<b>Z 292</b>	12 FR-6 DU	1,05	○
1.4 16V	1.4	70	01.04-11.06	843 A1.000	4	<b>Z 292</b>	12 FR-6 DU	1,05	○
1.6 16V	1.6	76	10.01-11.06	182 B6.000	4	<b>Z 255</b>	14 FR-8 DUW	0,9	<b>UXT 1<sup>3</sup></b>
1.8 16V	1.7	98	10.01-11.06	192 A4.000	4	<b>Z 255</b>	14 FR-8 DUW	0,9	<b>UXT 1<sup>3</sup></b>
1.9 JTD	1.9	59	02.02-11.06	192 A3.000	4	<b>GN 041</b> (11V)	○		
1.9 JTD	1.9	66	09.04-11.06	192 B5.000	4	<b>GN 097</b> (11V)	○		
1.9 D Multijet	1.9	74	09.05-11.06	192 A9.000	4	<b>GN 041</b> (11V)	○		
1.9 JTD	1.9	85	10.01-09.05	192 A1.000	4	<b>GN 041</b> (11V)	○		
1.9 JTD	1.9	85	10.05-11.06	192 A1.000/937 A7.000	4	<b>GN 097</b> (11V)	○		
1.9 D Multijet	1.9	88	09.05-11.06	192 A8.000	4	<b>GN 097</b> (11V)	○		
1.9 JTD	1.9	93	09.03-11.06	937 A4.000	4	<b>GN 059</b> (11V)	○		
1.9 JTD	1.9	103	01.04-11.06	192 A5.000	4	<b>GN 059</b> (11V)	○		
1.9 D Multijet	1.9	110	09.05-11.06	937 A5.000	4	<b>GN 059</b> (11V)	○		
2.4 20V	2.4	125	10.01-11.06	192 A2.000	5	<b>Z 98</b>	14 FR-7 LDU	0,8	<b>UXT 1<sup>3</sup></b>

**STILO Multi Wagon**

1.4 16V	1.4	66	03.05-08.08	192 B2.000	4	<b>Z 292</b>	12 FR-6 DU	1,05	○
1.4 16V	1.4	70	01.04-08.08	843 A1.000	4	<b>Z 292</b>	12 FR-6 DU	1,05	○
1.6 16V	1.6	76	01.03-08.08	182 B6.000	4	<b>Z 255</b>	14 FR-8 DUW	0,9	<b>UXT 1<sup>3</sup></b>
1.8 16V	1.7	98	01.03-08.08	192 A4.000	4	<b>Z 255</b>	14 FR-8 DUW	0,9	<b>UXT 1<sup>3</sup></b>

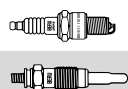

## FIAT

### STILO Multi Wagon

1.9 JTD	1.9	59	01.03-08.08	192 A3.000	4	<b>GN 041</b> (11V)	○		
1.9 D	1.9	66	09.04-09.05	192 B5.000	4	<b>GN 041</b> (11V)	○		
1.9 D	1.9	66	10.05-12.07	192 B5.000	4	<b>GN 097</b> (11V)	○		
1.9 D Multijet	1.9	74	09.05-08.08	192 A9.000	4	<b>GN 041</b> (11V)	○		
1.9 JTD	1.9	85	01.03-09.05	192 A1.000	4	<b>GN 041</b> (11V)	○		
1.9 JTD	1.9	85	07.05-12.07	937 A7.000	4	<b>GN 097</b> (11V)	○		
1.9 D Multijet	1.9	88	09.05-12.07	192 A8.000	4	<b>GN 097</b> (11V)	○		
1.9 JTD	1.9	93	09.03-08.08	937 A4.000	4	<b>GN 059</b> (11V)	○		
1.9 JTD	1.9	103	01.04-08.08	192 A5.000	4	<b>GN 059</b> (11V)	○		
1.9 D Multijet	1.9	110	09.05-08.08	937 A5.000	4	<b>GN 059</b> (11V)	○		

### STRADA

1.2	1.2	44	04.03-	188 A4.000	4	<b>Z 292</b>	12 FR-6 DU	1,05	○
1.3 D Multijet	1.3	62	05.06-	223 A9.000	4	<b>GN 053</b> (11V)	○		
1.7 TD	1.7	51	06.99-	176 A3.000	4	<b>GN 954</b> (11V)	○		
1.9 D	1.9	46	12.00-	223 A6.000	4	<b>GN 030</b> (11V)	○		
1.9 JTD	1.9	59	04.03-	188 A2.000	4	<b>GN 041</b> (11V)	○		

### TEMPRA

1.4 i.e.	1.4	51	03.92-03.95	836 A4.000/160 A1.046	4	<b>Z 20</b>	14 R-7 DU	0,8	<b>UXT 2<sup>4</sup></b>
1.4 i.e.	1.4	51	03.95-08.96	836 A4.000/160 A1.046	4	<b>Z 193</b>	14 FR-7 DU2	0,9	<b>UXT 1<sup>3</sup></b>
1.4 i.e.	1.4	57	03.91-08.96	159 A2.000	4	<b>Z 27</b>	14 R-6 DU	0,8	<b>UX 56</b>
1.6 i.e.	1.6	55	06.92-08.96	159 A3.048/835 C1.000	4	<b>Z 252</b>	14 FR-6 DUW	0,9	<b>UXT 5</b>
1.6 i.e.	1.6	57	06.90-07.92	159 A3.046	4	<b>Z 27</b>	14 R-6 DU	0,8	<b>UX 56</b>
1.6	1.6	63	03.90-04.93	159 A3.000	4	<b>Z 27</b>	14 R-6 DU	0,8	<b>UX 56</b>
1.6 i.e.	1.6	63	06.94-08.96	159 B9.000	4	<b>Z 252</b>	14 FR-6 DUW	0,9	<b>UXT 5</b>
1.6 i.e.	1.6	66	06.94-08.96	159 B9.000	4	<b>Z 252</b>	14 FR-6 DUW	0,9	<b>UXT 5</b>
1.8 i.e.	1.8	66	09.93-08.96	835 C4.000	4	<b>Z 27</b>	14 R-6 DU	0,8	<b>UX 56</b>
1.8 i.e.	1.8	74	10.94-08.96	836 A5.000	4	<b>Z 27</b>	14 R-6 DU	0,8	<b>UX 56</b>
1.8 i.e.	1.8	76	09.93-08.96	835 C2.000	4	<b>Z 27</b>	14 R-6 DU	0,8	<b>UX 56</b>
1.8 i.e.	1.8	77	03.92-08.96	159 A4.046	4	<b>Z 27</b>	14 R-6 DU	0,8	<b>UX 56</b>
1.8 i.e.	1.8	81	03.90-08.96	159 A4.000	4	<b>Z 27</b>	14 R-6 DU	0,8	<b>UX 56</b>
1.9 D	1.9	48	07.91-08.96	160 A7.000	4	<b>GN 908</b> (11V)	○		
1.9 TD	1.9	59	07.92-08.96	160 B6.046	4	<b>GN 908</b> (11V)	○		
1.9 TD	1.9	66	05.90-08.96	160 D1.000/160 A6.000	4	<b>GN 908</b> (11V)	○		
2.0 i.e.	2.0	83	10.90-08.96	159 A6.046	4	<b>Z 27</b>	14 R-6 DU	0,8	<b>UX 56</b>

### TEMPRA S.W.

1.4 i.e.	1.4	51	10.92-03.95	836 A4.000/160 A1.046	4	<b>Z 20</b>	14 R-7 DU	0,8	<b>UXT 2<sup>4</sup></b>
1.4 i.e.	1.4	51	03.95-08.96	836 A4.000/160 A1.046	4	<b>Z 193</b>	14 FR-7 DU2	0,9	<b>UXT 1<sup>3</sup></b>
1.4 i.e.	1.4	57	03.91-08.96	159 A2.000	4	<b>Z 27</b>	14 R-6 DU	0,8	<b>UX 56</b>
1.6 i.e.	1.6	55	10.92-08.96	159 A3.048/835 C1.000	4	<b>Z 252</b>	14 FR-6 DUW	0,9	<b>UXT 5</b>
1.6 i.e.	1.6	57	10.90-08.96	159 A3.046/835 C1.000	4	<b>Z 27</b>	14 R-6 DU	0,8	<b>UX 56</b>
1.6	1.6	63	12.90-04.93	159 A3.000	4	<b>Z 27</b>	14 R-6 DU	0,8	<b>UX 56</b>
1.6 i.e.	1.6	66	06.94-08.96	159 B9.000	4	<b>Z 252</b>	14 FR-6 DUW	0,9	<b>UXT 5</b>
1.8 i.e.	1.8	66	09.93-08.96	835 C4.000	4	<b>Z 27</b>	14 R-6 DU	0,8	<b>UX 56</b>
1.8 i.e.	1.8	74	10.94-08.96	836 A5.000	4	<b>Z 27</b>	14 R-6 DU	0,8	<b>UX 56</b>
1.8 i.e.	1.8	76	09.93-08.96	835 C2.000	4	<b>Z 27</b>	14 R-6 DU	0,8	<b>UX 56</b>
1.8 i.e.	1.8	77	03.92-12.93	159 A4.046	4	<b>Z 27</b>	14 R-6 DU	0,8	<b>UX 56</b>
1.8 i.e.	1.8	81	03.90-08.96	159 A4.000	4	<b>Z 27</b>	14 R-6 DU	0,8	<b>UX 56</b>
1.9 D	1.9	48	07.91-08.96	160 A7.000	4	<b>GN 908</b> (11V)	○		
1.9 TD	1.9	59	03.92-06.93	160 B6.046	4	<b>GN 908</b> (11V)	○		
1.9 TD	1.9	66	07.91-02.95	160 D1.000/160 A6.000	4	<b>GN 908</b> (11V)	○		
2.0 i.e.	2.0	83	01.91-03.95	159 A6.046	4	<b>Z 27</b>	14 R-6 DU	0,8	<b>UX 56</b>
2.0 i.e. 4x4	2.0	83	03.92-03.95	159 A6.046	4	<b>Z 27</b>	14 R-6 DU	0,8	<b>UX 56</b>

### TIPO

1.1	1.1	41	01.88-10.91	160 A3.000	4	<b>Z 15</b>	14 FR-7 DU	0,8	<b>UXT 1<sup>3</sup></b>
1.4 i.e.	1.4	51	05.89-04.95	836 A4.000/160 A1.046	4	<b>Z 20</b>	14 R-7 DU	0,8	<b>UXT 2<sup>4</sup></b>
1.4 i.e.	1.4	57	05.89-04.95	159 A2.000	4	<b>Z 27</b>	14 R-6 DU	0,8	<b>UX 56</b>
1.6 i.e.	1.6	55	10.92-04.95	159 A3.048/835 C1.000	4	<b>Z 252</b>	14 FR-6 DUW	0,9	<b>UXT 5</b>
1.6 i.e.	1.6	57	07.90-01.93	159 A3.046	4	<b>Z 27</b>	14 R-6 DU	0,8	<b>UX 56</b>
1.6	1.6	61	01.88-10.91	160 A2.000	4	<b>Z 20</b>	14 R-7 DU	0,8	<b>UXT 2<sup>4</sup></b>
1.6 i.e.	1.6	66	02.88-05.91	149 C2.046	4	<b>Z 20</b>	14 R-7 DU	0,8	<b>UXT 2<sup>4</sup></b>
1.7 D	1.7	43	01.88-10.94	149 B4.000	4	<b>GV 663</b> (11V)	○		

● nicht erforderlich  
○ nicht im Programm

<sup>3</sup> wahlweise UXT 3 Platin

<sup>4</sup> wahlweise UXT 6 Platin

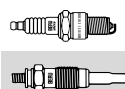

## FIAT

### TIPO

1.7 D	1.7	45	01.88-10.95		4	GV 663 (11V)	○		
1.8 i.e.	1.8	66	09.93-04.95	835 C4.000	4	Z 27	14 R-6 DU	0,8	UX 56
1.8 i.e.	1.8	74	10.94-04.95	159 A4.000	4	Z 27	14 R-6 DU	0,8	UX 56
1.8 i.e.	1.8	76	04.93-04.95	835 C2.000	4	Z 27	14 R-6 DU	0,8	UX 56
1.8 i.e.	1.8	77	10.90-06.93	159 A4.046	4	Z 27	14 R-6 DU	0,8	UX 56
1.8 i.e.	1.8	81	10.90-03.92	159 A4.000	4	Z 27	14 R-6 DU	0,8	UX 56
1.9 D	1.9	48	07.91-08.96	160 A7.000	4	GV 663 (11V)	○		
1.9 TD	1.9	59	03.92-06.93	160 B6.046	4	GV 663 (11V)	○		
1.9 TD	1.9	66	09.90-04.95	160 A6.000, 160 A6.046, 160 D1.000	4	GN 908 (11V)	○		
2.0 i.e.	2.0	80	06.90-03.92	159 A5.046	4	Z 27	14 R-6 DU	0,8	UX 56
2.0 i.e.	2.0	83	03.90-04.95	159 A6.046	4	Z 27	14 R-6 DU	0,8	UX 56
2.0 i.e. 16V Sport	2.0	102	03.93-04.95	836 A3.000	4	Z 27	14 R-6 DU	0,8	UX 56
2.0 16V	2.0	107	07.91-04.95	160 A8.046	4	Z 27	14 R-6 DU	0,8	UX 56

### ULYSSE

1.8	1.8	73	05.97-08.02	LFW	4	Z 193	14 FR-7 DU2	0,9	UXT 1 <sup>3</sup>
1.9 TD	1.9	66	02.95-08.02	DHX (XUD9TF/L)	4	GN 013 (11V)	○		
2.0 JTD	2.0	79	05.03-08.06	RHM (DW10ATED4)	4	GN 027 (11V)	○		
2.0 JTD 16V	2.0	80	05.99-08.02	RHW(DW10ATED4)	4	GN 027 (11V)	○		
2.0 JTD	2.0	80	08.02-08.06	RHW(DW10ATED4)	4	GN 027 (11V)	○		
2.0 JTD	2.0	80	10.99-08.02	RHZ	4	GN 027 (11V)	○		
2.0 D Multijet	2.0	88	05.06-06.11	RHK	4	GN 054 (11V)	○		
2.0	2.0	89	06.94-08.02	RFU (XU10J2C)	4	Z 193	14 FR-7 DU2	0,9	UXT 1 <sup>3</sup>
2.0 16V	2.0	97	05.98-09.00	RFV	4	Z 193	14 FR-7 DU2	0,9	UXT 1 <sup>3</sup>
2.0 16V	2.0	100	09.00-08.02	RFN	4	Z 183	14 FR-8 MU2	0,9	UXT 13
2.0	2.0	100	08.02-06.11	RFN(EW10J4)	4	Z 183	14 FR-8 MU2	0,9	UXT 13
2.0 D Multijet	2.0	100	05.06-06.11	RHR	4	GN 054 (11V)	○		
2.0 Turbo	2.0	108	06.94-06.95	RGX (XU10J2CTE)	4	Z 252	14 FR-6 DUW	0,9	UXT 5
2.0 Turbo	2.0	108	07.95-08.02	RGX (XU10J2CTE)	4	Z 193	14 FR-7 DU2	0,9	UXT 1 <sup>3</sup>
2.1 TD	2.1	80	03.96-10.99	P8C	4	GN 013 (11V)	○		
2.2 JTD	2.2	94	08.02-08.06	4HW(DW12ATED4)	4	GN 027 (11V)	○		
2.2 D Multijet	2.2	125	03.08-06.11	4HS, 4HT(DW12BTED4)	4	GN 063 (11V)	○		
3.0 V6	2.9	150	08.02-06.11	XFW	6	Z 219	14 FR-8 MPUX02	1,1	UXT 13

### UNO

45 0.9	0.9	33	03.83-09.92	146 A.000/146 A.1000	4	Z 20	14 R-7 DU	0,8	UXT 2 <sup>4</sup>
45 1.0	1.0	32	06.86-12.93	156 A2.048/156 A2.100	4	Z 15	14 FR-7 DU	0,8	UXT 1 <sup>3</sup>
45 i.e. 1.0	1.0	33	04.84-10.95	156 A2.246	4	Z 193	14 FR-7 DU2	0,9	UXT 1 <sup>3</sup>
45 1.0	1.0	37	06.86-12.93		4	Z 15	14 FR-7 DU	0,8	UXT 1 <sup>3</sup>
50 i.e. 1.1	1.1	36	06.92-12.93	146 C3.000	4	Z 247	14 FR-7 DUW	0,9	UXT 1 <sup>3</sup>
50 1.1	1.1	37	01.90-12.93	156 C.046	4	Z 247	14 FR-7 DUW	0,9	UXT 1 <sup>3</sup>
1.3 Super Diesel	1.3	33	06.83-03.92	146 B1.000/127 A5.000	4	GV 663 (11V)	○		
70 i.e. 1.4	1.4	51	09.89-12.93	160 A1.046	4	Z 20	14 R-7 DU	0,8	UXT 2 <sup>4</sup>
70 TD 1.4	1.4	52	10.86-10.90	146 B.000/146 B3.000	4	GV 663 (11V)	○		
75 i.e. 1.5	1.5	55	10.85-12.93	138 C2.046	4	Z 20	14 R-7 DU	0,8	UXT 2 <sup>4</sup>
75 i.e. 1.5	1.5	55	10.85-12.93	149 C1.000	4	Z 27	14 R-6 DU	0,8	UX 56
60 Diesel 1.7	1.7	42	09.89-12.93	146 B2.000	4	GV 663 (11V)	○		
1.9 D	1.9	44	09.89-03.94	149 B5.046	4	GV 663 (11V)	○		



### DUCATO

1.9 D	1.9	50	04.98-04.02	D9B/DJY/D9B (XUD9A)	4	GN 013 (11V)	○		
1.9 D	1.9	50	04.98-04.02	DJY	4	GN 013 (11V)	○		
1.9 D	1.9	51	03.94-04.02	230 A2.000	4	GN 917 (11V)	○		
1.9 D	1.9	52	02.87-03.94	149 B1.000	4	GV 663 (11V)	○		
1.9 TD Combinato	1.9	59	08.94-04.02	230 A4.000	4	GN 908 (11V)	○		
1.9 TD Panorama/Combinato	1.9	60	03.94-04.02	230 A3.000	4	GN 917 (11V)	○		
1.9 TD	1.9	60	03.89-03.94	280 A1.000	4	GV 663 (11V)	○		
1.9 TD	1.9	66	04.98-04.02	DHX (XUD9TF/L)	4	GN 908 (11V)	○		
2.0	2.0	55	07.85-08.90	170 B	4	Z 11	14-7 DU	0,8	UXT 2 <sup>4</sup>
2.0	2.0	58	01.82-08.90	XN 1T	4	Z 11	14-7 DU	0,8	UXT 2 <sup>4</sup>
2.0 JTD	2.0	62	10.01-04.02	RHV (DW10)	4	GN 027 (11V)	○		

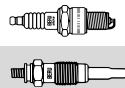
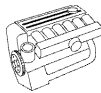

## FIAT



### DUCATO

2.0 JTD	2.0	62	04.02-	RHV (DW10)	4	<b>GN 027</b> (11V)	○		
2.0	2.0	62	09.88-03.94	170 D	4	<b>Z 11</b>	14-7 DU	0,8	<b>UXT 2<sup>4</sup></b>
2.0 Panorama/Combinato	2.0	80	03.94-04.02	RFW	4	<b>Z 247</b>	14 FR-7 DUW	0,9	<b>UXT 1<sup>3</sup></b>
2.0	2.0	81	04.02-	RFL	4	<b>Z 193</b>	14 FR-7 DU2	0,9	<b>UXT 1<sup>3</sup></b>
2.3 JTD	2.3	81	04.02-	F1AE0481C	4	<b>GN 037</b> (11V)	○		
120 Multijet 2,3 D	2.3	88	07.06-	F1AE0481D	4	<b>GN 037</b> (11V)	○		
2.3 JTD	2.3	93	12.09-	F1AE0481T	4	<b>GN 037</b> (11V)	○		
130 Multijet 2,3 D	2.3	96	01.07-	F1AE3481D	4	<b>GN 037</b> (11V)	○		
150 Multijet 2,3 D	2.3	109	06.11-	F1AE3481E	4	<b>GN 037</b> (11V)	○		
2.4 D	2.4	53	01.82-08.90	8144.61	4	<b>GN 909</b> (11V)	○		
2.4 D 4x4	2.4	55	09.86-05.90	8144.61	4	<b>GN 908</b> (11V)	○		
2.4 TD	2.4	68	01.86-08.90	8144.21	4	<b>GN 908</b> (11V)	<b>GR 065</b>		
2.5 D	2.5	55	01.82-08.90	CRD93L (U25-661)/8144.67	4	<b>GN 908</b> (11V)	<b>GR 065</b>		
2.5 D 4x4	2.5	55	03.89-03.94	8144.67	4	<b>GN 908</b> (11V)	<b>GR 065</b>		
2.5 D Combinato	2.5	62	08.94-04.02	8140.67	4	<b>GN 927</b> (11V)	<b>GR 065</b>		
2.5 TD	2.5	70	07.90-03.94	8140.27	4	<b>GN 908</b> (11V)	<b>GR 065</b>		
2.5 TD	2.5	80	06.94-08.98	8140.47	4	<b>GF 984</b> (11V)	○		
2.5 TDI Combinato	2.5	80	08.94-04.02	8140.47R	4	<b>GF 984</b> (11V)	○		
2.5 TD 4x4	2.5	85	11.94-04.02	8140.47	4	<b>GF 984</b> (11V)	○		
2.8 D	2.8	64	02.98-04.02	8140.63	4	<b>GN 012</b> (11V)	○		
2.8 TDS	2.8	76	04.05-	8140.23.2200	4	<b>GF 984</b> (11V)	○		
2.8 TDI	2.8	90	10.97-04.02	8140.43	4	<b>GF 006</b> (12V)	○		
2.8 JTD	2.8	93	03.01-11.01	8140.43S	4	<b>GF 006</b> (12V)	○		
2.8 JTD 4x4	2.8	94	11.00-04.02	8140.43S	4	<b>GF 006</b> (12V)	○		
2.8 JTD	2.8	94	04.02-	8140.43S	4	<b>GF 006</b> (12V)	○		
2.8 JTD Power	2.8	107	05.04-	8140.43N	4	<b>GN 012</b> (11V)	○		
150 Multijet 3,0 D	3.0	107	04.10-	F1CE3481N	4	<b>GN 037</b> (11V)	○		
160 Multijet 3,0 D	3.0	116	07.06-	F1CE0481D	4	<b>GN 037</b> (11V)	○		
3.0 D Multijet	3.0	130	06.11-	F1CE3481E	4	<b>GN 037</b> (11V)	○		

### FIORINO

60 1.1	1.1	40	05.88-12.93	146 A9.000	4	<b>Z 20</b>	14 R-7 DU	0,8	<b>UXT 2<sup>4</sup></b>
70 1.3	1.3	49	01.88-12.94	146 A5.000	4	<b>Z 20</b>	14 R-7 DU	0,8	<b>UXT 2<sup>4</sup></b>
1.3	1.3	49	12.87-08.93	146 A5.000	4	<b>Z 20</b>	14 R-7 DU	0,8	<b>UXT 2<sup>4</sup></b>
1.3 D Multijet	1.3	55	02.08-	199 A2.000	4	<b>GN 053</b> (11V)	○		
70 i.e. 1.4	1.4	49	05.94-05.01	146 C5.000/146 D5.000	4	<b>Z 20</b>	14 R-7 DU	0,8	<b>UXT 2<sup>4</sup></b>
1.4	1.4	54	02.08-	KFT/KFV	4	<b>Z 193</b>	14 FR-7 DU2	0,9	<b>UXT 1<sup>3</sup></b>
1.4 Natural Power	1.4	57	10.09-	350 A1.000	4	<b>Z 234</b>	12 FR-7 DU	0,9	○
1.5	1.5	55	01.88-08.93	149 C1.000	4	<b>Z 20</b>	14 R-7 DU	0,8	<b>UXT 2<sup>4</sup></b>
75 i.e. 1.5	1.5	55	05.88-12.93	149 C1.000	4	<b>Z 20</b>	14 R-7 DU	0,8	<b>UXT 2<sup>4</sup></b>
75 i.e. 1.6	1.6	55	10.93-05.01	146 D6.000/146 C6.000	4	<b>Z 252</b>	14 FR-6 DUW	0,9	<b>UXT 5</b>
1.7 Diesel	1.7	42	01.88-	149 B2.000	4	<b>GV 663</b> (11V)	○		
60 1.7 D	1.7	42	05.88-10.96	146 B2.000	4	<b>GV 663</b> (11V)	○		
60 1.7 D	1.7	44	05.88-05.00	149 B3.000	4	<b>GV 663</b> (11V)	○		
1.7 Diesel	1.7	44	12.87-12.90	149 B3.000	4	<b>GV 663</b> (11V)	○		
65 1.7 TD	1.7	46	01.97-05.01	146 D7.000	4	<b>GN 908</b> (11V)	○		

### FIORINO Pick up

1.4	1.4	49	05.94-05.01	146 D5.000	4	<b>Z 15</b>	14 FR-7 DU	0,8	<b>UXT 1<sup>3</sup></b>
1.6	1.6	55	01.94-05.01	146 D6.000/146 C6.000	4	<b>Z 27</b>	14 R-6 DU	0,8	<b>UX 56</b>
1.7 D	1.7	42	10.93-10.99	146 B2.000	4	<b>GV 663</b> (11V)	○		
1.7 D	1.7	44	05.88-10.99	149 B3.000	4	<b>GV 663</b> (11V)	○		
1.7 TD	1.7	46	01.97-05.01	146 D7.000	4	<b>GN 908</b> (11V)	○		

### SCUDO

1.6	1.6	58	02.96-12.06	220 A 2.000	4	<b>Z 24</b>	14 FR-6 DU	0,8	<b>UXT 5</b>
1.9 D	1.9	51	02.96-12.06	D9B	4	<b>GN 909</b> (11V)	○		
1.9 D	1.9	51	04.98-12.06	WJZ (DW8)	4	<b>GN 016</b> (11V)	○		
1.9 TD Eco	1.9	66	02.96-08.98	DHX (XUD9TF/L)	4	<b>GN 909</b> (11V)	○		
1.9 TD Eco	1.9	66	09.98-	DHX (XUD9TF/L)	4	<b>GN 013</b> (11V)	○		
1.9 TD	1.9	68	02.96-08.98	D8B	4	<b>GN 909</b> (11V)	○		
1.9 TD	1.9	68	09.98-	D8B	4	<b>GN 013</b> (11V)	○		



kW

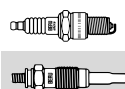
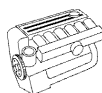

## FIAT



## SCUDO

2.0 JTD	2.0	69	12.99-12.06	RHX	4	GN 027 (11V)	○			
2.0 JTD	2.0	80	12.99-	RHZ	4	GN 027 (11V)	○			
2.0 JTD 16V	2.0	80	05.99-12.06	RHW(DW10ATED4)	4	GN 027 (11V)	○			
2.0 D Multijet	2.0	88	01.07-	RHK	4	GN 054 (11V)	○			
2.0 D Multijet	2.0	100	01.07-	RHR	4	GN 054 (11V)	○			
2.0	2.0	100	05.00-12.06	RFN	4	Z 183	14 FR-8 MU2	0,9		UXT 13
2.0 D Multijet	2.0	100	01.07-	DW10BTED4/RHR	4	GN 054 (11V)	○			
2.0 16V	2.0	103	03.07-	RFH (EW10A)	4	Z 223	14 FR-8 NQU23	0,9		○
2.0 D Multijet	2.0	120	07.10-	RHH	4	GN 054 (11V)	○			

## TALENTO

1.9 D	1.9	52	03.89-03.94	149 B1.000	4	GV 663 (11V)	○			
-------	-----	----	-------------	------------	---	--------------	---	--	--	--

## FORD

## C-MAX

1.6 TDCi	1.6	66	02.07-	HHDA/HHDB	4	GN 056 (11V)	○			
1.6	1.6	74	02.07-	SHDA/HWDB/SHDB/HWDA/SHDC	4	Z 177	14 KR-8 MUV	1,3		UXT 7
1.6 TDCi	1.6	80	02.07-	G8DA/G8DB/G8DD	4	GN 056 (11V)	○			
1.8 TDCi	1.8	85	02.07-	KKDA	4	GN 993 (10V)	○			
1.8	1.8	90	02.07-07.10	QQDC	4	Z 230	14 KR-6 KPUV02	1,3		○
1.8	1.8	92	02.07-	QQDA, QQDB	4	Z 209	14 KR-6 DPUOV	1,3		UXT 15
1.8 Flexifuel	1.8	92	02.07-	Q7DA	4	Z 209	14 KR-6 DPUOV	1,3		UXT 15
2.0 TDCi	2.0	98	02.07-	G6DC, G6DE, G6DF	4	GN 054 (11V)	○			
2.0 TDCi	2.0	100	02.07-	G6DD, G6DA, G6DB, G6DG	4	GN 054 (11V)	○			
2.0	2.0	107	02.07-	AODA, AODB, AODE, SYDA	4	Z 209	14 KR-6 DPUOV	1,3		UXT 15
2.0 CNG	2.0	107	04.09-	SYDA	4	Z 209	14 KR-6 DPUOV	1,3		UXT 15
2.0 LPG	2.0	107	06.08-	SYDA	4	Z 209	14 KR-6 DPUOV	1,3		UXT 15

## COUGAR

2.0 16V	2.0	96	08.98-12.01	EDBB/EDBC/EDBD/EDBA	4	Z 97	14 KR-8 MPX	1,0		UXT 8
2.5 V6 24V	2.5	125	08.98-12.01	LCBA	6	Z 148	14 KR-8 DPUOV	1,3		UXT 15
2.5 V6 24V	2.5	125	06.00-12.01	LCBC/LCBB/LCBE	6	Z 148	14 KR-8 DPUOV	1,3		UXT 15
2.5 ST 200	2.5	151	01.00-12.00	SGA	6	Z 148	14 KR-8 DPUOV	1,3		UXT 15

## ECOSPORT

1.4 TDCi	1.4	50	01.03-	F6JC	4	GN 047 (11V)	○			
----------	-----	----	--------	------	---	--------------	---	--	--	--

## ESCORT '86 Express

1.1	1.1	37	05.86-07.90	GSG	4	Z 95	14 KR-7 DU	0,7		UXT 4
1.3	1.3	44	02.86-07.90	JLA/JLB	4	Z 95	14 KR-7 DU	0,7		UXT 4
1.3	1.3	44	02.86-07.90	JBB	4	Z 67	14 KR-7 DUX	1,1		UXT 4
1.3	1.3	46	07.88-07.90	JBA	4	Z 67	14 KR-7 DUX	1,1		UXT 4
1.4 i	1.4	54	08.88-07.90	F6B/F6D	4	Z 16	14 FR-7 DUX	1,1		UXT 1 <sup>3</sup>
1.4 i	1.4	54	02.86-07.90	FUC	4	Z 253	14 FR-5 DUU	1,0		UXT 5
1.6 D	1.6	40	02.86-07.90	LTA	4	GV 631 (11,5V)	○			
1.8 D	1.8	44	07.88-07.90	RTA/RTB	4	GV 666 (11,5V)	○			

## ESCORT '91 Express

1.3	1.3	46	07.90-12.94	JBD	4	Z 67	14 KR-7 DUX	1,1		UXT 4
1.4	1.4	52	07.90-12.94	F6F/F6G	4	Z 16	14 FR-7 DUX	1,1		UXT 1 <sup>3</sup>
1.8 D	1.8	44	07.90-12.94	RTH	4	GV 666 (11,5V)	○			

## ESCORT '95 Express

1.4	1.4	54	01.95-	F4B	4	Z 16	14 FR-7 DUX	1,1		UXT 1 <sup>3</sup>
1.8 D	1.8	44	01.95-	RTH/RTF	4	GV 666 (11,5V)	○			
1.8 Turbo D	1.8	51	12.95-06.01	RVA	4	GN 022 (10V)	○			
1.8 TD	1.8	66	01.95-	RFD, RFK	4	GV 666 (11,5V)	○			
1.8 TD	1.8	66	01.95-	RFS	4	GN 022 (10V)	○			

## ESCORT CLASSIC

1.6 16V	1.6	66	10.98-07.00	L1E	4	Z 97	14 KR-8 MPX	1,0		UXT 8
1.8 TD	1.8	66	10.98-07.00	RFD, RFK	4	GV 666 (11,5V)	○			

## ESCORT CLASSIC Turnier

1.6 16V	1.6	66	02.99-07.00	L1E	4	Z 97	14 KR-8 MPX	1,0		UXT 8
1.8 TD	1.8	66	02.99-07.00	RFD/RFK	4	GV 666 (11,5V)	○			



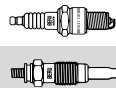

## FORD

### ESCORT IV

1.1	1.1	37	12.85-07.90	GSG	4	<b>Z 95</b>	14 KR-7 DU	0,7	<b>UXT 4</b>
1.3	1.3	44	01.86-07.90	JLA/JLB	4	<b>Z 95</b>	14 KR-7 DU	0,7	<b>UXT 4</b>
1.3	1.3	44	01.86-07.90	JBB	4	<b>Z 67</b>	14 KR-7 DUX	1,1	<b>UXT 4</b>
1.3	1.3	46	07.88-10.90	JBA	4	<b>Z 67</b>	14 KR-7 DUX	1,1	<b>UXT 4</b>
1.4	1.4	51	10.85-10.90	FUAA	4	<b>Z 24</b>	14 FR-6 DU	0,8	<b>UXT 5</b>
1.4	1.4	54	08.88-07.90	F6B/F6D	4	<b>Z 16</b>	14 FR-7 DUX	1,1	<b>UXT 1<sup>3</sup></b>
1.4	1.4	54	01.86-07.90	FUC	4	<b>Z 253</b>	14 FR-5 DUU	1,0	<b>UXT 5</b>
1.4	1.4	55	01.86-07.90	FUA	4	<b>Z 24</b>	14 FR-6 DU	0,8	<b>UXT 5</b>
1.6	1.6	65	04.89-07.90	LUG	4	<b>Z 24</b>	14 FR-6 DU	0,8	<b>UXT 5</b>
1.6 i	1.6	66	01.86-05.90	L4B	4	<b>Z 24</b>	14 FR-6 DU	0,8	<b>UXT 5</b>
1.6 i	1.6	75	08.89-07.90	LJB	4	<b>Z 99</b>	14 FR-6 DUX	1,0	<b>UXT 5</b>
1.8 D	1.8	44	01.89-07.90	RTA/RTB	4	<b>GV 666</b> (11,5V)	○		

### ESCORT IV Cabriolet

1.4	1.4	54	08.88-07.90	F6B/F6D	4	<b>Z 16</b>	14 FR-7 DUX	1,1	<b>UXT 1<sup>3</sup></b>
1.4	1.4	54	02.87-07.90	FUC	4	<b>Z 253</b>	14 FR-5 DUU	1,0	<b>UXT 5</b>
1.4	1.4	55	01.86-07.90	FUA	4	<b>Z 24</b>	14 FR-6 DU	0,8	<b>UXT 5</b>
1.6 i	1.6	66	01.86-07.90	L4B	4	<b>Z 24</b>	14 FR-6 DU	0,8	<b>UXT 5</b>
1.6 i	1.6	75	08.89-07.90	LJB	4	<b>Z 99</b>	14 FR-6 DUX	1,0	<b>UXT 5</b>
1.6 XR3i	1.6	77	01.86-07.90	LR2/LRB	4	<b>Z 30</b>	14 FR-5 DU	0,8	<b>UXT 5</b>

### ESCORT IV Kombi

1.1	1.1	37	10.85-09.90	GSG	4	<b>Z 95</b>	14 KR-7 DU	0,7	<b>UXT 4</b>
1.3	1.3	44	01.86-07.90	JLA/JLB	4	<b>Z 95</b>	14 KR-7 DU	0,7	<b>UXT 4</b>
1.3	1.3	44	01.86-07.90	JBB	4	<b>Z 67</b>	14 KR-7 DUX	1,1	<b>UXT 4</b>
1.4	1.4	51	10.85-10.90	FUAA	4	<b>Z 27</b>	14 R-6 DU	0,8	<b>UX 56</b>
1.4	1.4	54	08.88-07.90	F6B/F6D	4	<b>Z 16</b>	14 FR-7 DUX	1,1	<b>UXT 1<sup>3</sup></b>
1.4	1.4	54	01.86-07.90	FUC	4	<b>Z 253</b>	14 FR-5 DUU	1,0	<b>UXT 5</b>
1.4	1.4	55	01.86-07.90	FUA	4	<b>Z 24</b>	14 FR-6 DU	0,8	<b>UXT 5</b>
1.6	1.6	58	01.86-07.90	LP2	4	<b>Z 24</b>	14 FR-6 DU	0,8	<b>UXT 5</b>
1.6 i	1.6	66	01.86-07.90	L4B	4	<b>Z 24</b>	14 FR-6 DU	0,8	<b>UXT 5</b>
1.8 D	1.8	44	01.89-07.90	RTA/RTB	4	<b>GV 666</b> (11,5V)	○		

### ESCORT V

1.3	1.3	44	07.90-09.92	J4B/J6A	4	<b>Z 67</b>	14 KR-7 DUX	1,1	<b>UXT 4</b>
1.4	1.4	52	07.90-09.92	F6F/F6G	4	<b>Z 16</b>	14 FR-7 DUX	1,1	<b>UXT 1<sup>3</sup></b>
1.6	1.6	66	07.90-08.92	LUJ/LUK	4	<b>Z 30</b>	14 FR-5 DU	0,8	<b>UXT 5</b>
1.6	1.6	77	07.90-12.92	LJF	4	<b>Z 99</b>	14 FR-6 DUX	1,0	<b>UXT 5</b>
1.8 D	1.8	44	07.90-12.92	RTH/RTF/RTE	4	<b>GV 666</b> (11,5V)	○		
1.8 16V XR3i	1.8	77	02.92-12.92	RDA	4	<b>Z 97</b>	14 KR-8 MPX	1,0	<b>UXT 8</b>
1.8 16V XR3i	1.8	96	02.92-12.92	RQB	4	<b>Z 97</b>	14 KR-8 MPX	1,0	<b>UXT 8</b>
RS 2000	2.0	110	05.91-12.92	N7A	4	<b>Z 99</b>	14 FR-6 DUX	1,0	<b>UXT 5</b>

### ESCORT V Cabriolet

1.4	1.4	52	07.90-12.92	F6F/F6G	4	<b>Z 16</b>	14 FR-7 DUX	1,1	<b>UXT 1<sup>3</sup></b>
1.6	1.6	77	07.90-12.92	LJF	4	<b>Z 99</b>	14 FR-6 DUX	1,0	<b>UXT 5</b>
1.8 16V XR3i	1.8	77	02.92-12.92	RDA	4	<b>Z 97</b>	14 KR-8 MPX	1,0	<b>UXT 8</b>
1.8 16V XR3i	1.8	96	02.92-12.92	RQB	4	<b>Z 97</b>	14 KR-8 MPX	1,0	<b>UXT 8</b>

### ESCORT V Kombi

1.3	1.3	44	09.91-09.92	J4B/J6A	4	<b>Z 67</b>	14 KR-7 DUX	1,1	<b>UXT 4</b>
1.4	1.4	52	07.90-09.92	F6F/F6G	4	<b>Z 16</b>	14 FR-7 DUX	1,1	<b>UXT 1<sup>3</sup></b>
1.6	1.6	66	07.90-08.92	LUJ/LUK	4	<b>Z 30</b>	14 FR-5 DU	0,8	<b>UXT 5</b>
1.6	1.6	77	07.90-09.92	LJF	4	<b>Z 99</b>	14 FR-6 DUX	1,0	<b>UXT 5</b>
1.8 D	1.8	44	07.90-12.92	RTH/RTF/RTE	4	<b>GV 666</b> (11,5V)	○		
1.8 16V	1.8	77	02.92-12.92	RDA	4	<b>Z 97</b>	14 KR-8 MPX	1,0	<b>UXT 8</b>

### ESCORT VI

1.3	1.3	44	09.92-01.95	J4B/J6A	4	<b>Z 67</b>	14 KR-7 DUX	1,1	<b>UXT 4</b>
1.4	1.4	52	09.92-01.95	F6F/F6G	4	<b>Z 16</b>	14 FR-7 DUX	1,1	<b>UXT 1<sup>3</sup></b>
1.4	1.4	55	08.93-01.95	F4B	4	<b>Z 16</b>	14 FR-7 DUX	1,1	<b>UXT 1<sup>3</sup></b>
1.4	1.4	55	08.93-01.95	FUH	4	<b>Z 24</b>	14 FR-6 DU	0,8	<b>UXT 5</b>
1.6 i 16V	1.6	65	01.94-01.95	L1H	4	<b>Z 97</b>	14 KR-8 MPX	1,0	<b>UXT 8</b>
1.6 i 16V	1.6	66	08.93-01.95	L1E/L1K	4	<b>Z 97</b>	14 KR-8 MPX	1,0	<b>UXT 8</b>
1.8 D	1.8	44	09.92-01.95	RTH/RTF/RTE	4	<b>GV 666</b> (11,5V)	○		
1.8 TD	1.8	66	02.93-01.95	RFD/RFK	4	<b>GV 666</b> (11,5V)	○		
1.8 TD	1.8	66	02.93-01.95	RFS	4	<b>GN 022</b> (10V)	○		

● nicht erforderlich  
○ nicht im Programm

<sup>3</sup> wahlweise UXT 3 Platin



kW

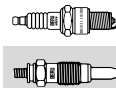
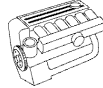

**FORD**

**ESCORT VI**

1.8 i 16V	1.8	77	09.92-01.95	RDA	4	<b>Z 97</b>	14 KR-8 MPX	1,0	<b>UXT 8</b>
1.8 16V XR3i	1.8	96	09.92-01.95	RQB	4	<b>Z 97</b>	14 KR-8 MPX	1,0	<b>UXT 8</b>
2.0 RS 2000	2.0	110	09.92-01.95	N7A	4	<b>Z 99</b>	14 FR-6 DUX	1,0	<b>UXT 5</b>
2.0 RS 2000 4x4	2.0	110	08.93-01.95	N7A	4	<b>Z 99</b>	14 FR-6 DUX	1,0	<b>UXT 5</b>

**ESCORT VI Cabriolet**

1.4	1.4	52	12.92-04.94	F6F/F6G	4	<b>Z 16</b>	14 FR-7 DUX	1,1	<b>UXT 1<sup>3</sup></b>
1.4 i	1.4	55	07.93-01.95	F4B	4	<b>Z 16</b>	14 FR-7 DUX	1,1	<b>UXT 1<sup>3</sup></b>
1.6 i 16V	1.6	65	02.94-01.95	L1H	4	<b>Z 97</b>	14 KR-8 MPX	1,0	<b>UXT 8</b>
1.6 16V XR3i	1.6	66	12.92-01.95	L1E	4	<b>Z 97</b>	14 KR-8 MPX	1,0	<b>UXT 8</b>
1.8 16V XR3i	1.8	77	12.92-01.95	RDA	4	<b>Z 97</b>	14 KR-8 MPX	1,0	<b>UXT 8</b>
1.8 16V XR3i	1.8	96	12.92-01.95	RQB	4	<b>Z 97</b>	14 KR-8 MPX	1,0	<b>UXT 8</b>

**ESCORT VI Kombi**

1.3	1.3	44	09.92-01.95	J4B/J6A	4	<b>Z 67</b>	14 KR-7 DUX	1,1	<b>UXT 4</b>
1.4	1.4	52	09.92-01.94	J4B/J6A	4	<b>Z 16</b>	14 FR-7 DUX	1,1	<b>UXT 1<sup>3</sup></b>
1.4	1.4	55	01.94-01.95	F4B	4	<b>Z 16</b>	14 FR-7 DUX	1,1	<b>UXT 1<sup>3</sup></b>
1.4	1.4	55	01.94-01.95	FUJH	4	<b>Z 24</b>	14 FR-6 DU	0,8	<b>UXT 5</b>
1.6 i 16V	1.6	65	01.94-01.95	L1H	4	<b>Z 97</b>	14 KR-8 MPX	1,0	<b>UXT 8</b>
1.6 i 16V	1.6	66	09.92-01.95	L1E	4	<b>Z 97</b>	14 KR-8 MPX	1,0	<b>UXT 8</b>
1.8 D	1.8	44	09.92-01.95	RTH	4	<b>GV 666</b> (11,5V)	○		
1.8 TD	1.8	66	02.93-01.95	RFD/RFK	4	<b>GV 666</b> (11,5V)	○		
1.8 i 16V	1.8	77	01.93-01.95	RDA	4	<b>Z 97</b>	14 KR-8 MPX	1,0	<b>UXT 8</b>
1.8 i 16V	1.8	96	02.93-01.95	RQB	4	<b>Z 97</b>	14 KR-8 MPX	1,0	<b>UXT 8</b>

**ESCORT VII**

1.3	1.3	44	01.95-10.98	J4B/J6A	4	<b>Z 67</b>	14 KR-7 DUX	1,1	<b>UXT 4</b>
1.4	1.4	55	01.95-10.98	F4B	4	<b>Z 16</b>	14 FR-7 DUX	1,1	<b>UXT 1<sup>3</sup></b>
1.4	1.4	55	01.95-02.99	FUJH	4	<b>Z 24</b>	14 FR-6 DU	0,8	<b>UXT 5</b>
1.6 i 16V	1.6	65	01.95-08.95	L1H	4	<b>Z 97</b>	14 KR-8 MPX	1,0	<b>UXT 8</b>
1.6 16V	1.6	66	01.95-10.98	L1E	4	<b>Z 97</b>	14 KR-8 MPX	1,0	<b>UXT 8</b>
1.6 16V 4x4	1.6	66	01.95-10.98	L1E	4	<b>Z 97</b>	14 KR-8 MPX	1,0	<b>UXT 8</b>
1.6 i 16V	1.6	66	01.95-02.99	L1E/L1K	4	<b>Z 97</b>	14 KR-8 MPX	1,0	<b>UXT 8</b>
1.6	1.6	70	01.01-08.02	L1K	4	<b>Z 97</b>	14 KR-8 MPX	1,0	<b>UXT 8</b>
1.8 D	1.8	44	01.95-12.96	RTH/RTF/RTE	4	<b>GV 666</b> (11,5V)	○		
1.8 TD	1.8	51	12.95-10.98	RVA	4	<b>GN 022</b> (10V)	○		
1.8 TD	1.8	66	01.95-10.98	RFD, RFK	4	<b>GV 666</b> (11,5V)	○		
1.8 16V	1.8	77	01.95-08.95	RDA	4	<b>Z 97</b>	14 KR-8 MPX	1,0	<b>UXT 8</b>
1.8 16V	1.8	85	01.95-10.98	RKC	4	<b>Z 97</b>	14 KR-8 MPX	1,0	<b>UXT 8</b>
2.0 RS 2000	2.0	110	02.95-02.98	N7A	4	<b>Z 99</b>	14 FR-6 DUX	1,0	<b>UXT 5</b>
2.0 RS 2000 4x4	2.0	110	02.95-10.98	N7A	4	<b>Z 99</b>	14 FR-6 DUX	1,0	<b>UXT 5</b>

**ESCORT VII Cabriolet**

1.4	1.4	55	02.95-08.98	F4B	4	<b>Z 16</b>	14 FR-7 DUX	1,1	<b>UXT 1<sup>3</sup></b>
1.6 16V XR3i	1.6	65	02.95-12.96	L1H	4	<b>Z 97</b>	14 KR-8 MPX	1,0	<b>UXT 8</b>
1.6 16V XR3i	1.6	66	02.95-09.99	L1E	4	<b>Z 97</b>	14 KR-8 MPX	1,0	<b>UXT 8</b>
1.8 Turbo D	1.8	51	10.96-08.99	RVA	4	<b>GN 022</b> (10V)	○		
1.8 TD	1.8	66	09.95-08.98	RFD/RFK	4	<b>GV 666</b> (11,5V)	○		
1.8 16V XR3i	1.8	77	02.95-08.98	RDA	4	<b>Z 97</b>	14 KR-8 MPX	1,0	<b>UXT 8</b>
1.8 16V XR3i	1.8	85	10.95-08.98	RKC	4	<b>Z 97</b>	14 KR-8 MPX	1,0	<b>UXT 8</b>
1.8 16V XR3i	1.8	96	02.95-08.00	RQB	4	<b>Z 97</b>	14 KR-8 MPX	1,0	<b>UXT 8</b>

**ESCORT VII Kombi**

1.3	1.3	44	01.95-10.98	J4B/J6A	4	<b>Z 67</b>	14 KR-7 DUX	1,1	<b>UXT 4</b>
1.4	1.4	55	01.95-02.99	F4B	4	<b>Z 16</b>	14 FR-7 DUX	1,1	<b>UXT 1<sup>3</sup></b>
1.4	1.4	55	01.95-02.99	FUJH	4	<b>Z 24</b>	14 FR-6 DU	0,8	<b>UXT 5</b>
1.6 i 16V	1.6	65	01.95-08.95	L1H	4	<b>Z 97</b>	14 KR-8 MPX	1,0	<b>UXT 8</b>
1.6 16V	1.6	66	01.95-02.99	L1E	4	<b>Z 97</b>	14 KR-8 MPX	1,0	<b>UXT 8</b>
1.8 D	1.8	44	01.95-02.99	RTH/RTF/RTE	4	<b>GV 666</b> (11,5V)	○		
1.8 Turbo D	1.8	51	12.95-02.99	RVA	4	<b>GN 022</b> (10V)	○		
1.8 TD	1.8	66	01.95-02.99	RFD/RFK	4	<b>GV 666</b> (11,5V)	○		
1.8 16V	1.8	77	01.95-08.95	RDA	4	<b>Z 97</b>	14 KR-8 MPX	1,0	<b>UXT 8</b>
1.8 16V	1.8	85	01.95-02.99	RKC	4	<b>Z 97</b>	14 KR-8 MPX	1,0	<b>UXT 8</b>

**FIESTA III**

1.0	1.0	33	03.89-12.95	TLB	4	<b>Z 67</b>	14 KR-7 DUX	1,1	<b>UXT 4</b>
1.1	1.1	37	03.89-12.95	G6A	4	<b>Z 67</b>	14 KR-7 DUX	1,1	<b>UXT 4</b>

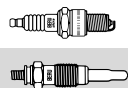
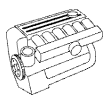

## FORD

### FIESTA III

1.1	1.1	40	03.89-12.95	GUD/GUE	4	<b>Z 67</b>	14 KR-7 DUX	1,1	<b>UXT 4</b>
1.3	1.3	44	03.89-12.92	JBC	4	<b>Z 67</b>	14 KR-7 DUX	1,1	<b>UXT 4</b>
1.3 KAT	1.3	44	05.91-01.97	J6B	4	<b>Z 67</b>	14 KR-7 DUX	1,1	<b>UXT 4</b>
1.4	1.4	52	03.89-12.95	F6E	4	<b>Z 16</b>	14 FR-7 DUX	1,1	<b>UXT 1<sup>3</sup></b>
1.4	1.4	54	03.89-12.95	FUJ	4	<b>Z 24</b>	14 FR-6 DU	0,8	<b>UXT 5</b>
1.4	1.4	54	03.89-12.95	FUG	4	<b>Z 99</b>	14 FR-6 DUX	1,0	<b>UXT 5</b>
1.4 KAT	1.4	54	03.89-12.95	F4A	4	<b>Z 16</b>	14 FR-7 DUX	1,1	<b>UXT 1<sup>3</sup></b>
1.6	1.6	65	01.89-01.94	LUH	4	<b>Z 24</b>	14 FR-6 DU	0,8	<b>UXT 5</b>
1.6 i 16V	1.6	65	01.94-12.95	L1G	4	<b>Z 177</b>	14 KR-8 MUV	1,3	<b>UXT 7</b>
1.6	1.6	66	03.89-12.92	LUH	4	<b>Z 24</b>	14 FR-6 DU	0,8	<b>UXT 5</b>
1.6 XR2i	1.6	76	03.89-03.93	LJD	4	<b>Z 99</b>	14 FR-6 DUX	1,0	<b>UXT 5</b>
1.6 XR2i	1.6	81	03.89-01.94	LJC	4	<b>Z 99</b>	14 FR-6 DUX	1,0	<b>UXT 5</b>
1.8 D	1.8	44	03.89-12.95	RTD/RTG/RTC	4	<b>GV 666</b> (11,5V)	○		
1.8 TD	1.8	57	03.93-12.95	RFL	4	<b>GV 666</b> (11,5V)	○		
1.8 16V	1.8	77	02.92-12.95	RDB	4	<b>Z 177</b>	14 KR-8 MUV	1,3	<b>UXT 7</b>
1.8 XR2i 16V	1.8	96	02.92-12.95	RQC	4	<b>Z 177</b>	14 KR-8 MUV	1,3	<b>UXT 7</b>

### FIESTA IV

1.25 i 16V	1.2	55	08.95-01.02	DHG/DHB/DHC/DHE/DHF/DHA/DHD	4	<b>Z 177</b>	14 KR-8 MUV	1,3	<b>UXT 7</b>
1.3 i	1.3	37	08.95-01.02	JJA/JJM	4	<b>Z 67</b>	14 KR-7 DUX	1,1	<b>UXT 4</b>
1.3 i	1.3	44	08.95-01.02	J4C/J4T	4	<b>Z 67</b>	14 KR-7 DUX	1,1	<b>UXT 4</b>
1.4 i 16V	1.4	66	04.96-01.02	FHA/FHE	4	<b>Z 177</b>	14 KR-8 MUV	1,3	<b>UXT 7</b>
1.6 16V Sport	1.6	76	02.00-01.02	L1V/L1T	4	<b>Z 177</b>	14 KR-8 MUV	1,3	<b>UXT 7</b>
1.8 D	1.8	44	08.95-04.00	RTK/RTJ	4	<b>GN 022</b> (10V)	○		
1.8 DI	1.8	55	04.00-01.02	RTN, RTP, RTQ	4	<b>GN 993</b> (10V)	○		

### FIESTA V

1.25 16V	1.2	51	03.03-	M7JA/M7JB	4	<b>Z 177</b>	14 KR-8 MUV	1,3	<b>UXT 7</b>
1.25 16V	1.2	55	05.02-	FUJA/FUJB	4	<b>Z 177</b>	14 KR-8 MUV	1,3	<b>UXT 7</b>
1.3	1.3	44	11.01-	BAJA	4	<b>Z 177</b>	14 KR-8 MUV	1,3	<b>UXT 7</b>
1.3	1.3	51	11.01-	A9JA/A9JB	4	<b>Z 177</b>	14 KR-8 MUV	1,3	<b>UXT 7</b>
1.4 TDCi	1.4	50	11.01-10.04	F6JA/F6JB	4	<b>GN 047</b> (11V)	○		
1.4 TDCi	1.4	50	11.04-	F6JA/F6JB	4	<b>GN 056</b> (11V)	○		
1.4 16V	1.4	59	11.01-	FXJB/FXJA	4	<b>Z 177</b>	14 KR-8 MUV	1,3	<b>UXT 7</b>
1.6 TDCi	1.6	66	11.04-05.06	HHJA/HHJB	4	<b>GN 047</b> (11V)	○		
1.6 TDCi	1.6	66	06.06-09.08	HHJA/HHJB	4	<b>GN 056</b> (11V)	○		
1.6 16V	1.6	74	11.01-	FYJA	4	<b>Z 177</b>	14 KR-8 MUV	1,3	<b>UXT 7</b>
2.0 ST150	2.0	110	03.05-	N4JB	4	<b>Z 209</b>	14 KR-6 DPUOV	1,3	<b>UXT 15</b>

### FIESTA VI

1.25	1.2	44	10.08-	STJA/STJB	4	<b>Z 177</b>	14 KR-8 MUV	1,3	<b>UXT 7</b>
1.25	1.2	60	10.08-	SNJA/SNJB	4	<b>Z 177</b>	14 KR-8 MUV	1,3	<b>UXT 7</b>
1.4 TDCi	1.4	50	01.09-	F6JB	4	<b>GN 056</b> (11V)	○		
1.4 TDCi	1.4	51	07.10-	F6JD	4	<b>GN 056</b> (11V)	○		
1.4	1.4	71	10.08-	SPJA/SPJC	4	<b>Z 177</b>	14 KR-8 MUV	1,3	<b>UXT 7</b>
1.4 LPG	1.4	71	01.09-	RTJA/RTJB	4	<b>Z 177</b>	14 KR-8 MUV	1,3	<b>UXT 7</b>
1.6 TDCi	1.6	66	10.08-	HHJC/HHJD/HHJE	4	<b>GN 056</b> (11V)	○		
1.6 Ti	1.6	88	10.08-	HXJB/HXJA	4	<b>Z 177</b>	14 KR-8 MUV	1,3	<b>UXT 7</b>

### FIESTA Van

1.3	1.3	51	10.03-	A9JA/A9JB	4	<b>Z 177</b>	14 KR-8 MUV	1,3	<b>UXT 7</b>
1.4 TDCi	1.4	50	10.03-10.04	F6JA/F6JB	4	<b>GN 047</b> (11V)	○		
1.4 TDCi	1.4	50	11.04-	F6JA/F6JB	4	<b>GN 056</b> (11V)	○		
1.4 TDCi	1.4	50	01.09-	F6JB	4	<b>GN 056</b> (11V)	○		
1.4 TDCi	1.4	51	07.10-	F6JD	4	<b>GN 056</b> (11V)	○		
1.6 TDCi	1.6	66	01.09-	HHJC/HHJD/HHJE	4	<b>GN 056</b> (11V)	○		

### FOCUS C-MAX

1.6 TDCi	1.6	66	02.05-05.06	HHDA/HHDB	4	<b>GN 047</b> (11V)	○		
1.6 TDCi	1.6	66	06.06-03.07	HHDA/HHDB	4	<b>GN 056</b> (11V)	○		
1.6	1.6	74	10.03-03.07	HWDB/HWDA	4	<b>Z 177</b>	14 KR-8 MUV	1,3	<b>UXT 7</b>
1.6 TDCi	1.6	80	10.03-05.06	G8DA/G8DB	4	<b>GN 047</b> (11V)	○		
1.6 TDCi	1.6	80	06.06-03.07	G8DA/G8DB	4	<b>GN 056</b> (11V)	○		
1.6 Ti	1.6	85	08.04-03.07	SIDA/HXDA	4	<b>Z 177</b>	14 KR-8 MUV	1,3	<b>UXT 7</b>
1.8	1.8	88	10.03-03.07	CSDA/CSDA	4	<b>Z 209</b>	14 KR-6 DPUOV	1,3	<b>UXT 15</b>



kW

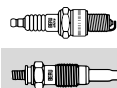
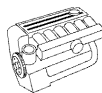

**FORD**

**FOCUS C-MAX**

1.8	1.8	92	04.04-03.07	Q7DA, QQDA, QQDB	4	<b>Z 209</b>	14 KR-6 DPUOV	1,3	<b>UXT 15</b>
1.8 Flexifuel	1.8	92	01.06-03.07	Q7DA	4	<b>Z 209</b>	14 KR-6 DPUOV	1,3	<b>UXT 15</b>
1.8 TDCi	1.8	85	01.05-03.07	KKDA	4	<b>GN 993</b> (10V)	○		
2.0 TDCi	2.0	98	10.03-03.07	G6DC, G6DE, G6DF	4	<b>GN 054</b> (11V)	○		
2.0 TDCi	2.0	100	10.03-03.07	G6DA, G6DB, G6DD, G6DG	4	<b>GN 054</b> (11V)	○		
2.0	2.0	107	03.04-03.07	AODA, AODB, SYDA	4	<b>Z 209</b>	14 KR-6 DPUOV	1,3	<b>UXT 15</b>

**FOCUS**

1.4 16V	1.4	55	10.98-11.04	FXDA/FXDD/FXDC/FXDB	4	<b>Z 177</b>	14 KR-8 MUV	1,3	<b>UXT 7</b>
1.6 16V	1.6	74	02.99-11.04	FYDA, FYDC, FYDB, FYDD	4	<b>Z 177</b>	14 KR-8 MUV	1,3	<b>UXT 7</b>
1.6 16V Flexifuel	1.6	75	01.02-11.04	FYDH	4	<b>Z 177</b>	14 KR-8 MUV	1,3	<b>UXT 7</b>
1.8 DI / TDDi	1.8	55	08.99-03.05	BHDB/BHDA	4	<b>GN 993</b> (10V)	○		
1.8 Turbo DI / TDDi	1.8	66	10.98-11.04	C9DA/C9DB/C9DC	4	<b>GN 993</b> (10V)	○		
1.8 TDCi	1.8	74	08.02-11.04	FFDA	4	<b>GN 993</b> (10V)	○		
1.8 16V	1.8	85	02.99-11.04	EYDB/EYDC/EYDD/EYDE/EYDF	4	<b>Z 97</b>	14 KR-8 MPX	1,0	<b>UXT 8</b>
1.8 TDCi	1.8	85	03.01-11.04	F9DA/F9DB	4	<b>GN 993</b> (10V)	○		
2.0 16V	2.0	96	10.98-11.04	EDDC/EDDB/EDDD/EDDF	4	<b>Z 97</b>	14 KR-8 MPX	1,0	<b>UXT 8</b>
2.0 ST170	2.0	127	03.02-11.04	ALDA	4	<b>Z 315</b>	14 KR-6 MPV	1,3	○
2.0 RS	2.0	158	10.02-11.04	HMDA	4	<b>Z 177</b>	14 KR-8 MUV	1,3	<b>UXT 7</b>

**FOCUS Kombi**

1.4 16V	1.4	55	02.99-11.04	FXDA, FXDC, FXDB, FXDD	4	<b>Z 177</b>	14 KR-8 MUV	1,3	<b>UXT 7</b>
1.6 16V	1.6	74	02.99-11.04	FYDA, FYDC, FYDB, FYDD	4	<b>Z 177</b>	14 KR-8 MUV	1,3	<b>UXT 7</b>
1.6 16V Flexifuel	1.6	75	01.02-11.04	FYDH	4	<b>Z 177</b>	14 KR-8 MUV	1,3	<b>UXT 7</b>
1.8 DI / TDDi	1.8	55	08.99-11.04	BHDB/BHDA	4	<b>GN 993</b> (10V)	○		
1.8 Turbo DI / TDDi	1.8	66	02.99-11.04	C9DA/C9DB/C9DC	4	<b>GN 993</b> (10V)	○		
1.8 TDCi	1.8	74	08.02-11.04	FFDA	4	<b>GN 993</b> (10V)	○		
1.8 16V	1.8	85	02.99-11.04	EYDB/EYDC/EYDD/EYDE/EYDF	4	<b>Z 97</b>	14 KR-8 MPX	1,0	<b>UXT 8</b>
1.8 TDCi	1.8	85	03.01-11.04	F9DA/F9DB	4	<b>GN 993</b> (10V)	○		
2.0 16V	2.0	96	02.99-11.04	EYDB/EYDC/EYDD/EYDE/EYDF	4	<b>Z 97</b>	14 KR-8 MPX	1,0	<b>UXT 8</b>
2.0 ST170	2.0	127	08.02-11.04	ALDA	4	<b>Z 315</b>	14 KR-6 MPV	1,3	○

**FOCUS II**

1.4	1.4	59	11.04-	ASDA, ASDB	4	<b>Z 177</b>	14 KR-8 MUV	1,3	<b>UXT 7</b>
1.6 TDCi	1.6	66	04.05-05.06	HHDA/HHDB	4	<b>GN 047</b> (11V)	○		
1.6 TDCi	1.6	66	06.06-	HHDA/HHDB	4	<b>GN 056</b> (11V)	○		
1.6	1.6	74	11.04-	SHDA/HWDB/HWDA	4	<b>Z 177</b>	14 KR-8 MUV	1,3	<b>UXT 7</b>
1.6	1.6	74	04.05-	SHDA/HWDB/HWDA	4	<b>Z 177</b>	14 KR-8 MUV	1,3	<b>UXT 7</b>
1.6 TDCi	1.6	80	11.04-05.06	G8DA/G8DB/G8DE/G8DD/G8DF	4	<b>GN 047</b> (11V)	○		
1.6 TDCi	1.6	80	06.06-	G8DA/G8DB/G8DE/G8DD/G8DF	4	<b>GN 056</b> (11V)	○		
1.6 Ti	1.6	85	11.04-	HXDB/HXDA	4	<b>Z 177</b>	14 KR-8 MUV	1,3	<b>UXT 7</b>
1.8 TDCi	1.8	85	04.05-	KKDA/KKDB	4	<b>GN 993</b> (10V)	○		
1.8	1.8	92	03.06-	QQDB	4	<b>Z 209</b>	14 KR-6 DPUOV	1,3	<b>UXT 15</b>
1.8 Flexifuel	1.8	92	01.06-01.08	Q7DA	4	<b>Z 209</b>	14 KR-6 DPUOV	1,3	<b>UXT 15</b>
1.8 Flexifuel	1.8	96	12.05-	QQDD	4	<b>Z 209</b>	14 KR-6 DPUOV	1,3	<b>UXT 15</b>
2.0 TDCi	2.0	98	11.04-	G6DE, G6DF	4	<b>GN 054</b> (11V)	○		
2.0 TDCi	2.0	100	11.04-	G6DD/G6DB/G6DA	4	<b>GN 054</b> (11V)	○		
2.0	2.0	107	11.04-	AODA, AODB	4	<b>Z 209</b>	14 KR-6 DPUOV	1,3	<b>UXT 15</b>
2.0 CNG	2.0	107	04.09-	SYDA	4	<b>Z 209</b>	14 KR-6 DPUOV	1,3	<b>UXT 15</b>
2.0 LPG	2.0	107	06.08-	SYDA	4	<b>Z 209</b>	14 KR-6 DPUOV	1,3	<b>UXT 15</b>
2.5 ST	2.5	166	10.05-01.08	HYDA	5	<b>Z 326</b>	14 FR-7 MPUS	0,7	○

**FOCUS II Cabriolet**

1.6	1.6	74	10.06-	HWDB/HWDA	4	<b>Z 177</b>	14 KR-8 MUV	1,3	<b>UXT 7</b>
2.0 TDCi	2.0	100	10.06-	G6DD/G6DB/G6DA	4	<b>GN 054</b> (11V)	○		
2.0	2.0	107	10.06-	AODA, AODB	4	<b>Z 209</b>	14 KR-6 DPUOV	1,3	<b>UXT 15</b>

**FOCUS II Kombi**

1.4	1.4	59	11.04-	ASDA, ASDB	4	<b>Z 177</b>	14 KR-8 MUV	1,3	<b>UXT 7</b>
1.6 TDCi	1.6	66	11.04-05.06	HHDA/HHDB	4	<b>GN 047</b> (11V)	○		
1.6 TDCi	1.6	66	06.06-	GPDC/HHDA/HHDB/GPDA	4	<b>GN 056</b> (11V)	○		
1.6	1.6	74	11.04-	SHDA/HWDB/HWDA	4	<b>Z 177</b>	14 KR-8 MUV	1,3	<b>UXT 7</b>
1.6 TDCi	1.6	80	11.04-05.06	G8DA/G8DB/G8DE/G8DD/G8DF	4	<b>GN 047</b> (11V)	○		
1.6 TDCi	1.6	80	06.06-	G8DA/G8DB/G8DE/G8DD/G8DF	4	<b>GN 056</b> (11V)	○		
1.6 Ti	1.6	85	11.04-	HXDB/HXDA	4	<b>Z 177</b>	14 KR-8 MUV	1,3	<b>UXT 7</b>
1.8 TDCi	1.8	85	11.04-	KKDA/KKDB	4	<b>GN 993</b> (10V)	○		

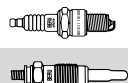

## FORD

### FOCUS II Kombi

1.8	1.8	92	03.06-	Q7DA, QQDB	4	<b>Z 209</b>	14 KR-6 DPUOV	1,3	<b>UXT 15</b>
1.8 Flexifuel	1.8	92	01.06-01.08	Q7DA	4	<b>Z 209</b>	14 KR-6 DPUOV	1,3	<b>UXT 15</b>
2.0 TDCi	2.0	98	11.04-	G6DE, G6DF	4	<b>GN 054</b> (11V)	○		
2.0 TDCi	2.0	100	11.04-	G6DD/G6DB/G6DA	4	<b>GN 054</b> (11V)	○		
2.0	2.0	107	11.04-	AODA, AODB	4	<b>Z 209</b>	14 KR-6 DPUOV	1,3	<b>UXT 15</b>
2.0 LPG	2.0	107	06.08-	SYDA	4	<b>Z 209</b>	14 KR-6 DPUOV	1,3	<b>UXT 15</b>

### FUSION

1.25	1.2	55	08.04-	FUJA/FUJB	4	<b>Z 177</b>	14 KR-8 MUV	1,3	<b>UXT 7</b>
1.4 TDCi	1.4	50	08.02-10.04	F6JA/F6JB	4	<b>GN 047</b> (11V)	○		
1.4 TDCi	1.4	50	11.04-	F6JA/F6JB	4	<b>GN 056</b> (11V)	○		
1.4	1.4	59	08.02-	FXJA/FXJB	4	<b>Z 177</b>	14 KR-8 MUV	1,3	<b>UXT 7</b>
1.6 TDCi	1.6	66	11.04-	HHJA/HHJB	4	<b>GN 047</b> (11V)	○		
1.6	1.6	74	08.02-	FYJA	4	<b>Z 177</b>	14 KR-8 MUV	1,3	<b>UXT 7</b>

### GALAXY

1.8 TDCi	1.8	74	05.06-	FFWA	4	<b>GN 993</b> (10V)	○		
1.8 TDCi	1.8	92	05.06-	QYWA	4	<b>GN 993</b> (10V)	○		
1.9 TDI	1.9	66	03.95-09.01	ANU/AHU/1Z	4	<b>GN 855</b> (12V)	○		
				Kühlwasservorwärmung <sup>15</sup> M 5/3Nm		<b>GN 857</b> (11V)=3x			
				Ø 4 mm		<b>GN 928</b> (12V)=3x			
1.9 TDI	1.9	66	10.01-05.06	ANU	4	<b>GN 046</b> (12V)	○		
1.9 TDI	1.9	81	08.97-04.00	AVG/AFN	4	<b>GN 855</b> (12V)	○		
				Kühlwasservorwärmung <sup>15</sup> M 5/3Nm		<b>GN 857</b> (11V)=3x			
				Ø 4 mm		<b>GN 928</b> (12V)=3x			
1.9 TDI	1.9	85	04.00-10.01	AUY	4	<b>GN 855</b> (12V)	○		
				Kühlwasservorwärmung <sup>15</sup> M 5/3Nm		<b>GN 857</b> (11V)=3x			
				Ø 4 mm		<b>GN 928</b> (12V)=3x			
1.9 TDI	1.9	85	11.01-05.06	AUY	4	<b>GN 046</b> (12V)	○		
1.9 TDI	1.9	96	02.03-05.06	ASZ	4	<b>GN 046</b> (12V)	○		
1.9 TDI	1.9	110	05.05-05.06	BTB	4	<b>GN 046</b> (12V)	○		
2.0 i	2.0	85	11.95-05.06	NSE/ZVSA	4	<b>Z 130</b>	14 FR-5 DPUX	1,0	○
2.0 TDCi	2.0	96	05.06-	AZWA	4	<b>GN 939</b> (11,5V)	○		
2.0 TDCi	2.0	103	05.06-	QXWA, QXWB, QXWC	4	<b>GN 939</b> (11,5V)	○		
2.0	2.0	107	05.06-	AOWB/AOWA	4	<b>Z 230</b>	14 KR-6 KPUV02	1,3	○
2.2 TDCi	2.2	129	03.08-	Q4BA/Q4WA	4	<b>GN 063</b> (11V)	○		
2.3 16V	2.3	103	09.01-05.06	E5SB	4	<b>Z 159</b>	14 FR-6 DPUX	1,1	<b>UXT 14</b>
2.3 16V	2.3	107	01.97-05.06	Y5B/E5SA	4	<b>Z 159</b>	14 FR-6 DPUX	1,1	<b>UXT 14</b>
2.3	2.3	118	07.07-	SEWA	4	<b>Z 342</b>	14 KR-7 MPUV2	1,3	○
2.8 i V6	2.8	128	11.95-04.00	AAA/AMY	6	<b>Z 173</b>	14 FGR-8 KQU	1,6	○
2.8 i V6 4x4	2.8	128	04.96-04.00	AAA/AMY	6	<b>Z 173</b>	14 FGR-8 KQU	1,6	○
2.8 V6	2.8	150	04.00-05.06	AYL	6	<b>Z 176</b>	14 F-7 HPURX2	1,0	○

### KA

1.0 i	1.0	38	07.97-09.99	ZH10JRB	4	<b>Z 67</b>	14 KR-7 DUX	1,1	<b>UXT 4</b>
1.0 i	1.0	48	09.99-11.08		4	<b>Z 67</b>	14 KR-7 DUX	1,1	<b>UXT 4</b>
1.2	1.2	51	10.08-	FP4	4	<b>Z 293</b>	12 FR-6 LUX	1,05	○
1.3 i	1.3	36	06.98-11.08	JJD/JJF/JJG/JJH/JJL	4	<b>Z 67</b>	14 KR-7 DUX	1,1	<b>UXT 4</b>
1.3 i	1.3	37	09.96-10.02	JJB	4	<b>Z 67</b>	14 KR-7 DUX	1,1	<b>UXT 4</b>
1.3 i	1.3	44	10.02-11.08	BAA	4	<b>Z 177</b>	14 KR-8 MUV	1,3	<b>UXT 7</b>
1.3 i	1.3	44	09.96-10.02	J4D/J4K/J4M/J4N/J4P/J4S	4	<b>Z 67</b>	14 KR-7 DUX	1,1	<b>UXT 4</b>
1.3 i	1.3	51	08.02-11.08	A9A/A9B	4	<b>Z 177</b>	14 KR-8 MUV	1,3	<b>UXT 7</b>
1.3 TDCi	1.3	55	10.08-	FD4	4	<b>GN 053</b> (11V)	○		
1.6 i	1.6	70	07.03-11.08	CDB/CDC	4	<b>Z 177</b>	14 KR-8 MUV	1,3	<b>UXT 7</b>

### KA Van

1.3 i	1.3	44	09.96-11.08	BAA	4	<b>Z 177</b>	14 KR-8 MUV	1,3	<b>UXT 7</b>
1.3 i	1.3	44	09.96-11.08	J4D/J4K/J4M/J4P/J4S	4	<b>Z 67</b>	14 KR-7 DUX	1,1	<b>UXT 4</b>

### MAVERICK

2.0 16V	2.0	91	07.01-12.03	YF	4	<b>Z 177</b>	14 KR-8 MUV	1,3	<b>UXT 7</b>
2.3 16V	2.3	110	03.04-	GZ	4	<b>Z 209</b>	14 KR-6 DPUOV	1,3	<b>UXT 15</b>
2.4 i	2.4	85	09.96-04.98	KA-24	4	<b>Z 225</b>	14 FR-7 HUX	1,1	○
2.4 i	2.4	87	09.96-04.98	KA-24	4	<b>Z 225</b>	14 FR-7 HUX	1,1	○
2.4 i	2.4	91	02.93-08.96	KA24-E	4	<b>Z 225</b>	14 FR-7 HUX	1,1	○
2.7 TD	2.7	74	02.93-08.96	TD27	4	<b>GN 854</b> (11V)	○		



kW

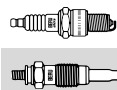
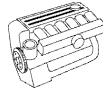

**FORD**

**MONDEO I**

1.6 i 16V	1.6	65	07.94-08.96	L1J	4	<b>Z 97</b>	14 KR-8 MPX	1,0	<b>UXT 8</b>
1.6 i 16V	1.6	66	02.93-08.96	L1F	4	<b>Z 97</b>	14 KR-8 MPX	1,0	<b>UXT 8</b>
1.8 TD	1.8	65	06.93-08.96	RFM/RFN	4	<b>GV 666</b> (11,5V)	○		
1.8 i 16V	1.8	82	07.94-08.96	RKB	4	<b>Z 97</b>	14 KR-8 MPX	1,0	<b>UXT 8</b>
1.8 i 16V	1.8	85	02.93-08.96	RKA	4	<b>Z 97</b>	14 KR-8 MPX	1,0	<b>UXT 8</b>
1.8 i 16V 4x4	1.8	85	02.93-08.96	RKA	4	<b>Z 97</b>	14 KR-8 MPX	1,0	<b>UXT 8</b>
2.0 i 16V	2.0	97	12.94-08.96	NGA	4	<b>Z 97</b>	14 KR-8 MPX	1,0	<b>UXT 8</b>
2.0 i 16V 4x4	2.0	97	12.94-08.96	NGA	4	<b>Z 97</b>	14 KR-8 MPX	1,0	<b>UXT 8</b>
2.0 i 16V	2.0	100	02.93-08.96	NGA	4	<b>Z 97</b>	14 KR-8 MPX	1,0	<b>UXT 8</b>
2.5 i 24V	2.5	125	07.94-08.96	SEA	6	<b>Z 148</b>	14 KR-8 DPUOV	1,3	<b>UXT 15</b>

**MONDEO I Kombi**

1.6 i 16V	1.6	65	07.94-08.96	L1J	4	<b>Z 97</b>	14 KR-8 MPX	1,0	<b>UXT 8</b>
1.6 i 16V	1.6	66	04.93-08.96	L1F	4	<b>Z 97</b>	14 KR-8 MPX	1,0	<b>UXT 8</b>
1.8 TD	1.8	65	06.93-08.96	RFM/RFN	4	<b>GV 666</b> (11,5V)	○		
1.8 i 16V	1.8	82	07.94-08.96	RKB	4	<b>Z 97</b>	14 KR-8 MPX	1,0	<b>UXT 8</b>
1.8 i 16V	1.8	85	04.93-08.96	RKA	4	<b>Z 97</b>	14 KR-8 MPX	1,0	<b>UXT 8</b>
1.8 i 16V 4x4	1.8	85	04.93-08.96	RKA	4	<b>Z 97</b>	14 KR-8 MPX	1,0	<b>UXT 8</b>
2.0 i 16V	2.0	97	01.93-08.96	NGA	4	<b>Z 97</b>	14 KR-8 MPX	1,0	<b>UXT 8</b>
2.0 i 16V 4x4	2.0	97	12.94-08.96	NGA	4	<b>Z 97</b>	14 KR-8 MPX	1,0	<b>UXT 8</b>
2.0 i 16V	2.0	100	04.93-08.96	NGA	4	<b>Z 97</b>	14 KR-8 MPX	1,0	<b>UXT 8</b>
2.0 i 16V 4x4	2.0	100	04.93-08.96	NGA	4	<b>Z 97</b>	14 KR-8 MPX	1,0	<b>UXT 8</b>
2.5 i 24V	2.5	125	07.94-08.96	SEA	6	<b>Z 148</b>	14 KR-8 DPUOV	1,3	<b>UXT 15</b>

**MONDEO II**

1.6 i	1.6	66	09.96-11.00	L1J	4	<b>Z 97</b>	14 KR-8 MPX	1,0	<b>UXT 8</b>
1.6 i 16V	1.6	70	05.98-11.00	L1N/L1L/L1Q	4	<b>Z 97</b>	14 KR-8 MPX	1,0	<b>UXT 8</b>
1.8 TD	1.8	66	09.96-11.00	RFN	4	<b>GN 022</b> (10V)	○		
1.8 i	1.8	85	09.96-11.00	RKK/RKJ/RKB/RKF/RKH	4	<b>Z 97</b>	14 KR-8 MPX	1,0	<b>UXT 8</b>
2.0 i	2.0	96	09.96-11.00	NGA/NGB/NGD/NGC	4	<b>Z 97</b>	14 KR-8 MPX	1,0	<b>UXT 8</b>
2.5 24V	2.5	125	06.00-11.00	SEB/SEC	6	<b>Z 148</b>	14 KR-8 DPUOV	1,3	<b>UXT 15</b>
2.5 24V	2.5	125	09.96-11.00	SEA	6	<b>Z 148</b>	14 KR-8 DPUOV	1,3	<b>UXT 15</b>
2.5 ST 200	2.5	151	05.99-11.00	SGA	6	<b>Z 209</b>	14 KR-6 DPUOV	1,3	<b>UXT 15</b>

**MONDEO II Kombi**

1.6 i	1.6	66	09.96-11.00	L1J	4	<b>Z 97</b>	14 KR-8 MPX	1,0	<b>UXT 8</b>
1.6 i 16V	1.6	70	05.98-11.00	L1N/L1L/L1Q	4	<b>Z 97</b>	14 KR-8 MPX	1,0	<b>UXT 8</b>
1.8 TD	1.8	66	09.96-11.00	RFN	4	<b>GN 022</b> (10V)	○		
1.8 i	1.8	85	09.96-11.00	RKK/RKJ/RKB/RKF/RKH	4	<b>Z 97</b>	14 KR-8 MPX	1,0	<b>UXT 8</b>
2.0 i	2.0	96	09.96-11.00	NGA/NGB/NGD/NGC	4	<b>Z 97</b>	14 KR-8 MPX	1,0	<b>UXT 8</b>
2.5 24V	2.5	125	10.99-11.00	SEB/SEC	6	<b>Z 148</b>	14 KR-8 DPUOV	1,3	<b>UXT 15</b>
2.5 24V	2.5	125	09.96-11.00	SEA	6	<b>Z 148</b>	14 KR-8 DPUOV	1,3	<b>UXT 15</b>
2.5 ST 200	2.5	151	05.99-11.00	SGA	6	<b>Z 209</b>	14 KR-6 DPUOV	1,3	<b>UXT 15</b>

**MONDEO III**

1.8 16V	1.8	81	11.00-08.07	CGBB/CGBA	4	<b>Z 209</b>	14 KR-6 DPUOV	1,3	<b>UXT 15</b>
1.8 16V	1.8	92	11.00-08.07	CHBA/CHBB	4	<b>Z 209</b>	14 KR-6 DPUOV	1,3	<b>UXT 15</b>
1.8 SCi	1.8	96	06.03-08.07	CFBA	4	<b>Z 309</b>	14 KR-8 LQPU07	1,6	○
2.0 16V DI / TDDi / TDCi	2.0	66	11.00-08.07	D5BA	4	<b>GN 939</b> (11,5V)	○		
2.0 16V TDDi / TDCi	2.0	85	11.00-08.07	HJBA/HJBB/D6BA/HJBC	4	<b>GN 939</b> (11,5V)	○		
2.0 TDCi	2.0	96	10.01-08.07	N7BA/FMBA	4	<b>GN 939</b> (11,5V)	○		
2.0 16V	2.0	107	11.00-08.07	CJBA/CJBB	4	<b>Z 209</b>	14 KR-6 DPUOV	1,3	<b>UXT 15</b>
2.2 TDCi	2.2	114	09.04-08.07	QJBA/QJBB	4	<b>GN 939</b> (11,5V)	○		
2.5 V6 24V	2.5	125	11.00-08.07	LCBD	6	<b>Z 148</b>	14 KR-8 DPUOV	1,3	<b>UXT 15</b>
3.0 V6 24V	3.0	150	09.04-08.07	REBA	6	<b>Z 209</b>	14 KR-6 DPUOV	1,3	<b>UXT 15</b>
3.0 ST220	3.0	166	04.02-08.07	MEBA	6	<b>Z 209</b>	14 KR-6 DPUOV	1,3	<b>UXT 15</b>

**MONDEO III Kombi**

1.8 16V	1.8	81	11.00-08.07	CGBB/CGBA	4	<b>Z 209</b>	14 KR-6 DPUOV	1,3	<b>UXT 15</b>
1.8 16V	1.8	92	11.00-08.07	CHBA/CHBB	4	<b>Z 209</b>	14 KR-6 DPUOV	1,3	<b>UXT 15</b>
1.8 SCi	1.8	96	06.03-08.07	CFBA	4	<b>Z 309</b>	14 KR-8 LQPU07	1,6	○
2.0 16V DI / TDDi / TDCi	2.0	66	11.00-08.07	D5BA	4	<b>GN 939</b> (11,5V)	○		
2.0 16V TDDi / TDCi	2.0	85	11.00-08.07	HJBA/HJBB/D6BA/HJBC	4	<b>GN 939</b> (11,5V)	○		
2.0 TDCi	2.0	96	10.01-08.07	N7BA/FMBA	4	<b>GN 939</b> (11,5V)	○		
2.0 16V	2.0	107	11.00-08.07	CJBA/CJBB	4	<b>Z 209</b>	14 KR-6 DPUOV	1,3	<b>UXT 15</b>
2.2 TDCi	2.2	110	09.04-08.07	QJBC/QJBD	4	<b>GN 939</b> (11,5V)	○		

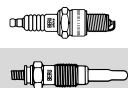
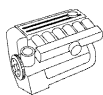

## FORD

### MONDEO III Kombi

2.2 TDCi	2.2	114	09.04-08.07	QJBA/QJBB	4	<b>GN 939</b> (11,5V)	○		
2.5 V6 24V	2.5	125	11.00-08.07	LCBD	6	<b>Z 148</b>	14 KR-8 DPUOV	1,3	<b>UXT 15</b>
3.0 V6 24V	3.0	150	09.04-08.07	REBA	6	<b>Z 209</b>	14 KR-6 DPUOV	1,3	<b>UXT 15</b>
3.0 ST220	3.0	166	04.02-08.07	MEBA	6	<b>Z 209</b>	14 KR-6 DPUOV	1,3	<b>UXT 15</b>

### MONDEO IV

1.6 Ti	1.6	81	03.07-	RHBA	4	<b>Z 177</b>	14 KR-8 MUV	1,3	<b>UXT 7</b>
1.6 Ti	1.6	92	03.07-	PNBA	4	<b>Z 177</b>	14 KR-8 MUV	1,3	<b>UXT 7</b>
1.8 TDCi	1.8	74	03.07-	FFBA	4	<b>GN 993</b> (10V)	○		
2.0 TDCi	2.0	85	11.07-	LPBA/KLBA/TYBA	4	<b>GN 054</b> (11V)	○		
2.0 TDCi	2.0	96	03.07-	AZBA	4	<b>GN 054</b> (11V)	○		
2.0 TDCi	2.0	103	03.07-	UFBA/QXBB	4	<b>GN 054</b> (11V)	○		
2.0	2.0	107	03.07-	AOBC/AOBA	4	<b>Z 230</b>	14 KR-6 KPUV02	1,3	○
2.0 Flexifuel	2.0	107	03.07-	TBBB/TBBA	4	<b>Z 230</b>	14 KR-6 KPUV02	1,3	○
2.2 TDCi	2.2	129	03.08-	Q4BA	4	<b>GN 063</b> (11V)	○		
2.3	2.3	118	07.07-	SEBA	4	<b>Z 342</b>	14 KR-7 MPUV2	1,3	○
2.5	2.5	162	03.07-	HUBA	5	<b>Z 326</b>	14 FR-7 MPUS	0,7	○

### MONDEO IV Turnier

1.6 Ti	1.6	81	03.07-	RHBA	4	<b>Z 177</b>	14 KR-8 MUV	1,3	<b>UXT 7</b>
1.6 Ti	1.6	92	03.07-	PNBA	4	<b>Z 177</b>	14 KR-8 MUV	1,3	<b>UXT 7</b>
1.8 TDCi	1.8	74	03.07-	FFBA	4	<b>GN 993</b> (10V)	○		
2.0 TDCi	2.0	85	11.07-	LPBA/KLBA/TYBA	4	<b>GN 054</b> (11V)	○		
2.0 TDCi	2.0	96	03.07-	AZBA	4	<b>GN 054</b> (11V)	○		
2.0 TDCi	2.0	103	03.07-	UFBA/QXBB	4	<b>GN 054</b> (11V)	○		
2.0 Flexifuel	2.0	107	03.07-	TBBB/TBBA	4	<b>Z 230</b>	14 KR-6 KPUV02	1,3	○
2.2 TDCi	2.2	129	03.08-	Q4BA	4	<b>GN 063</b> (11V)	○		
2.3	2.3	118	07.07-	SEBA	4	<b>Z 342</b>	14 KR-7 MPUV2	1,3	○
2.5	2.5	162	03.07-	HUBA	5	<b>Z 326</b>	14 FR-7 MPUS	0,7	○

## ORION II

1.3	1.3	44	12.85-07.90	JLA/JLB	4	<b>Z 95</b>	14 KR-7 DU	0,7	<b>UXT 4</b>
1.3	1.3	44	12.85-07.90	JBB	4	<b>Z 67</b>	14 KR-7 DUX	1,1	<b>UXT 4</b>
1.4	1.4	52	08.88-07.90	FUAA	4	<b>Z 16</b>	14 FR-7 DUX	1,1	<b>UXT 1<sup>3</sup></b>
1.4	1.4	54	01.86-07.90	FUC	4	<b>Z 99</b>	14 FR-6 DUX	1,0	<b>UXT 5</b>
1.4 KAT	1.4	54	08.88-07.90	F6B/F6D	4	<b>Z 16</b>	14 FR-7 DUX	1,1	<b>UXT 1<sup>3</sup></b>
1.4	1.4	55	12.85-07.90	FUA	4	<b>Z 24</b>	14 FR-6 DU	0,8	<b>UXT 5</b>
1.6	1.6	66	12.85-07.90	LUC	4	<b>Z 24</b>	14 FR-6 DU	0,8	<b>UXT 5</b>
1.6 i KAT	1.6	66	03.86-07.90	L4B	4	<b>Z 24</b>	14 FR-6 DU	0,8	<b>UXT 5</b>
1.6 i	1.6	75	08.89-07.90	LJB	4	<b>Z 99</b>	14 FR-6 DUX	1,0	<b>UXT 5</b>
1.6 i	1.6	77	03.86-07.90	LRB	4	<b>Z 30</b>	14 FR-5 DU	0,8	<b>UXT 5</b>
1.8 D	1.8	44	01.89-07.90	RTA/RTB	4	<b>GV 666</b> (11,5V)	○		

### ORION III

1.3	1.3	44	07.90-12.93	J4B/J6A	4	<b>Z 67</b>	14 KR-7 DUX	1,1	<b>UXT 4</b>
1.4	1.4	52	07.90-12.93	F6F/F6G	4	<b>Z 16</b>	14 FR-7 DUX	1,1	<b>UXT 1<sup>3</sup></b>
1.4	1.4	54	07.90-12.93	FUH	4	<b>Z 24</b>	14 FR-6 DU	0,8	<b>UXT 5</b>
1.6	1.6	66	07.90-12.93	LUJ/LUK	4	<b>Z 24</b>	14 FR-6 DU	0,8	<b>UXT 5</b>
1.6 i 16V	1.6	66	07.92-12.93	L1E/L1K	4	<b>Z 97</b>	14 KR-8 MPX	1,0	<b>UXT 8</b>
1.6 i	1.6	77	07.90-09.92	LJF	4	<b>Z 99</b>	14 FR-6 DUX	1,0	<b>UXT 5</b>
1.8 D	1.8	44	11.90-12.93	RTH/RTF/RTE	4	<b>GV 666</b> (11,5V)	○		
1.8 TD	1.8	66	03.92-12.93	RFD/RFK	4	<b>GV 666</b> (11,5V)	○		
1.8 i 16V	1.8	77	02.92-12.93	RDA	4	<b>Z 97</b>	14 KR-8 MPX	1,0	<b>UXT 8</b>
1.8 i 16V	1.8	96	01.92-12.93	RQB	4	<b>Z 97</b>	14 KR-8 MPX	1,0	<b>UXT 8</b>

### PUMA

1.4 16V	1.4	66	11.97-10.00	FHD/FHF	4	<b>Z 177</b>	14 KR-8 MUV	1,3	<b>UXT 7</b>
1.6 16V	1.6	76	08.00-	L1W	4	<b>Z 177</b>	14 KR-8 MUV	1,3	<b>UXT 7</b>
1.7 16V	1.7	92	03.97-	MHB/MHA	4	<b>Z 177</b>	14 KR-8 MUV	1,3	<b>UXT 7</b>

### RANGER

2.5 D	2.5	57	10.99-09.01	WL	4	<b>GN 005</b> (11V)	○		
2.5 D 4x4	2.5	57	10.99-09.01	WL	4	<b>GN 005</b> (11V)	○		
2.5 TD 4x4	2.5	80	10.99-09.01	WL-T	4	<b>GN 005</b> (11V)	○		

### SCORPIO I

1.8	1.8	66	04.85-02.92	REC	4	<b>Z 33</b>	18 K-6 BU	0,7	○
2.0 i	2.0	74	10.85-12.90	NRC	4	<b>Z 32</b>	18 K-7 BU	0,7	○



kW

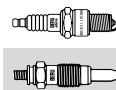

**FORD**

**SCORPIO I**

2.0 i	2.0	85	04.85-02.92	NRI/NRA	4	<b>Z 32</b>	18 K-7 BU	0,7	○
2.0 i	2.0	85	02.92-09.94	NRI/NRA	4	<b>Z 32</b>	18 K-7 BU	0,7	○
2.0 i	2.0	85	02.92-09.94	N9F	4	<b>Z 24</b>	14 FR-6 DU	0,8	<b>UXT 5</b>
2.0 i	2.0	88	05.89-09.94	N9D	4	<b>Z 24</b>	14 FR-6 DU	0,8	<b>UXT 5</b>
2.4 i	2.4	92	10.88-02.92	ARD	6	<b>Z 67</b>	14 KR-7 DUX	1,1	<b>UXT 4</b>
2.4 i KAT	2.4	92	10.88-09.94	ARD	6	<b>Z 67</b>	14 KR-7 DUX	1,1	<b>UXT 4</b>
2.5 D	2.5	51	12.85-02.92	STR	4	<b>GN 909</b> (11V)	<b>GR 064</b>		
2.5 TD	2.5	68	06.88-07.93	SFA/SFB	4	<b>GN 909</b> (11V)	○		
2.5 TD	2.5	85	08.93-09.94	SCB	4	<b>GN 909</b> (11V)	○		
2.9 i	2.9	107	09.86-09.94	BRD/BRE/BRF	6	<b>Z 117</b>	14 KR-9 DUX	1,0	<b>UXT 4</b>
2.9 i 4x4	2.9	107	05.88-02.93	BRD/BRE/BRF	6	<b>Z 117</b>	14 KR-9 DUX	1,0	<b>UXT 4</b>
2.9 i	2.9	110	09.86-09.94	BRC	6	<b>Z 15</b>	14 FR-7 DU	0,8	<b>UXT 1<sup>3</sup></b>
2.9 i 4x4	2.9	110	09.86-09.94	BRC	6	<b>Z 15</b>	14 FR-7 DU	0,8	<b>UXT 1<sup>3</sup></b>
2.9 i 24V	2.9	143	04.91-09.94	BOA	6	<b>Z 284</b>	14 FR-6 DPOX	1,1	<b>UXT 14</b>

**SCORPIO I Kombi**

2.0 i	2.0	85	09.91-09.94	N9F	4	<b>Z 24</b>	14 FR-6 DU	0,8	<b>UXT 5</b>
2.0 i	2.0	88	09.91-09.94	N9D	4	<b>Z 24</b>	14 FR-6 DU	0,8	<b>UXT 5</b>
2.4 i	2.4	92	09.91-09.94	ARD	6	<b>Z 67</b>	14 KR-7 DUX	1,1	<b>UXT 4</b>
2.5 D	2.5	51	10.90-08.92	STR	4	<b>GV 602</b> (11V)	○		
2.5 TD	2.5	68	09.91-07.93	SFA/SFB	4	<b>GN 909</b> (11V)	○		
2.5 TD	2.5	85	08.93-09.94	SCB	4	<b>GN 909</b> (11V)	○		
2.9 i	2.9	107	09.91-09.94	BRD/BRE/BRF	6	<b>Z 117</b>	14 KR-9 DUX	1,0	<b>UXT 4</b>
2.9 i 4x4	2.9	107	05.88-02.93	BRD/BRE/BRF	6	<b>Z 117</b>	14 KR-9 DUX	1,0	<b>UXT 4</b>
2.9 24V	2.9	143	08.93-09.94	BOA	6	<b>Z 284</b>	14 FR-6 DPOX	1,1	<b>UXT 14</b>

**SCORPIO II**

2.0 i	2.0	85	10.94-08.98	NSD	4	<b>Z 159</b>	14 FR-6 DPUX	1,1	<b>UXT 14</b>
2.0 i 16V	2.0	100	10.94-08.98	N3A	4	<b>Z 159</b>	14 FR-6 DPUX	1,1	<b>UXT 14</b>
2.3 i 16V	2.3	108	06.96-08.98	Y5A	4	<b>Z 159</b>	14 FR-6 DPUX	1,1	<b>UXT 14</b>
2.5 TD	2.5	85	10.94-08.98	SCC	4	<b>GN 007</b> (11V)	○		
2.5 TD	2.5	92	09.96-08.98	VM	4	<b>GN 007</b> (11V)	○		
2.9 i	2.9	110	02.95-08.98	BRG	6	<b>Z 16</b>	14 FR-7 DUX	1,1	<b>UXT 1<sup>3</sup></b>
2.9 i 24V	2.9	152	10.94-08.98	BOB	6	<b>Z 284</b>	14 FR-6 DPOX	1,1	<b>UXT 14</b>

**SCORPIO II Kombi**

2.0 i	2.0	85	10.94-08.98	NSD	4	<b>Z 159</b>	14 FR-6 DPUX	1,1	<b>UXT 14</b>
2.0 i 16V	2.0	100	10.94-08.98	N3A	4	<b>Z 159</b>	14 FR-6 DPUX	1,1	<b>UXT 14</b>
2.3 i 16V	2.3	108	06.96-08.98	Y5A	4	<b>Z 159</b>	14 FR-6 DPUX	1,1	<b>UXT 14</b>
2.5 TD	2.5	85	10.94-08.98	SCC	4	<b>GN 007</b> (11V)	○		
2.5 TD	2.5	92	09.96-08.98	VM	4	<b>GN 007</b> (11V)	○		
2.9 i	2.9	110	02.95-08.98	BRG	6	<b>Z 16</b>	14 FR-7 DUX	1,1	<b>UXT 1<sup>3</sup></b>
2.9 i 24V	2.9	152	10.94-08.98	BOB	6	<b>Z 284</b>	14 FR-6 DPOX	1,1	<b>UXT 14</b>

**SIERRA**

1.6	1.6	53	01.88-02.93	LSF	4	<b>Z 32</b>	18 K-7 BU	0,7	○
1.6	1.6	55	01.87-02.93	LSE	4	<b>Z 32</b>	18 K-7 BU	0,7	○
1.6 i	1.6	59	10.89-02.93	L6B	4	<b>Z 16</b>	14 FR-7 DUX	1,1	<b>UXT 1<sup>3</sup></b>
1.8 TD	1.8	55	08.88-02.93	RFA/RFB/RFL	4	<b>GV 666</b> (11,5V)	○		
1.8	1.8	64	05.88-02.93	R2C/R6A	4	<b>Z 16</b>	14 FR-7 DUX	1,1	<b>UXT 1<sup>3</sup></b>
2.0 i	2.0	74	01.87-02.93	NE5/NEJ	4	<b>Z 32</b>	18 K-7 BU	0,7	○
2.0 i KAT	2.0	74	01.87-02.93	N4B	4	<b>Z 32</b>	18 K-7 BU	0,7	○
2.0	2.0	77	01.87-02.93	N8C/NES	4	<b>Z 32</b>	18 K-7 BU	0,7	○
2.0 i	2.0	80	06.89-02.93	N8A	4	<b>Z 15</b>	14 FR-7 DU	0,8	<b>UXT 1<sup>3</sup></b>
2.0 i	2.0	85	01.87-02.93	N4I/N4A	4	<b>Z 32</b>	18 K-7 BU	0,7	○
2.0 i DOHC	2.0	85	12.91-02.93	N9E	4	<b>Z 24</b>	14 FR-6 DU	0,8	<b>UXT 5</b>
2.0 i	2.0	88	01.90-02.93	N9C	4	<b>Z 24</b>	14 FR-6 DU	0,8	<b>UXT 5</b>
2.0 4x4	2.0	88	01.90-02.93	N9C	4	<b>Z 24</b>	14 FR-6 DU	0,8	<b>UXT 5</b>
2.0 i	2.0	92	01.90-02.93	N9C	4	<b>Z 24</b>	14 FR-6 DU	0,8	<b>UXT 5</b>
2.0 4x4	2.0	92	01.90-02.93	N9C	4	<b>Z 24</b>	14 FR-6 DU	0,8	<b>UXT 5</b>
2.0 i	2.0	92	06.89-02.93	N9B	4	<b>Z 24</b>	14 FR-6 DU	0,8	<b>UXT 5</b>
2.0 16V Cosworth 4x4	2.0	162	01.90-02.93	N5C	4	<b>Z 313</b>	14 FR-6 DPUX2	1,0	○
2.0 16V Cosworth 4x4 KAT	2.0	162	01.90-02.93	N5C	4	<b>Z 284</b>	14 FR-6 DPOX	1,1	<b>UXT 14</b>
2.0 16V Cosworth 4x4	2.0	162	01.90-02.93	N5D	4	<b>Z 284</b>	14 FR-6 DPOX	1,1	<b>UXT 14</b>
2.8 i	2.8	105	08.87-02.93	PR8	6	<b>Z 20</b>	14 R-7 DU	0,8	<b>UXT 2<sup>4</sup></b>



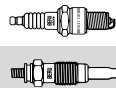

## FORD

### SIERRA

2.8 i XR 4x4	2.8	107	01.87-02.93	PR7	6	<b>Z 20</b>	14 R-7 DU	0,8	<b>UXT 2<sup>4</sup></b>
2.9 i	2.9	107	08.88-02.93	B4B/B4C	6	<b>Z 117</b>	14 KR-9 DUX	1,0	<b>UXT 4</b>
2.9 4x4	2.9	107	08.88-02.93	B4B/B4C ohne Kat.	6	<b>Z 117</b>	14 KR-9 DUX	1,0	<b>UXT 4</b>
2.9 i XR 4x4	2.9	107	08.88-02.93	B4B/B4C	6	<b>Z 117</b>	14 KR-9 DUX	1,0	<b>UXT 4</b>
2.9 i	2.9	110	08.88-02.93	B4B/B4C	6	<b>Z 117</b>	14 KR-9 DUX	1,0	<b>UXT 4</b>
2.9 4x4	2.9	110	08.88-02.93	B4B/B4C	6	<b>Z 117</b>	14 KR-9 DUX	1,0	<b>UXT 4</b>
2.9 i XR 4x4	2.9	110	08.88-02.93	B4A	6	<b>Z 15</b>	14 FR-7 DU	0,8	<b>UXT 1<sup>3</sup></b>

### SIERRA Kombi

1.6	1.6	53	01.88-02.93	LSF	4	<b>Z 32</b>	18 K-7 BU	0,7	○
1.6	1.6	55	01.87-02.93	LSE	4	<b>Z 32</b>	18 K-7 BU	0,7	○
1.6 i	1.6	59	10.89-02.93	L6B	4	<b>Z 16</b>	14 FR-7 DUX	1,1	<b>UXT 1<sup>3</sup></b>
1.8 TD	1.8	55	08.88-02.93	RFA/RFB/RFL	4	<b>GV 666</b> (11,5V)	○		
1.8	1.8	64	05.88-02.93	R2C/R6A	4	<b>Z 16</b>	14 FR-7 DUX	1,1	<b>UXT 1<sup>3</sup></b>
2.0 i	2.0	74	01.87-02.93	NE5/NEJ	4	<b>Z 32</b>	18 K-7 BU	0,7	○
2.0 i KAT	2.0	74	01.87-02.93	N4B	4	<b>Z 32</b>	18 K-7 BU	0,7	○
2.0	2.0	77	01.87-02.93	N8C/NES	4	<b>Z 32</b>	18 K-7 BU	0,7	○
2.0 i	2.0	85	01.87-02.93	N4A/N4I	4	<b>Z 33</b>	18 K-6 BU	0,7	○
2.0 i DOHC	2.0	85	12.91-02.93	N9E	4	<b>Z 24</b>	14 FR-6 DU	0,8	<b>UXT 5</b>
2.0 i	2.0	88	05.89-02.93	N9C	4	<b>Z 24</b>	14 FR-6 DU	0,8	<b>UXT 5</b>
2.0 4x4	2.0	88	02.90-02.93	N9C	4	<b>Z 24</b>	14 FR-6 DU	0,8	<b>UXT 5</b>
2.0 i	2.0	92	05.89-02.93	N9C	4	<b>Z 24</b>	14 FR-6 DU	0,8	<b>UXT 5</b>
2.0 4x4	2.0	92	05.89-02.93	N9C	4	<b>Z 24</b>	14 FR-6 DU	0,8	<b>UXT 5</b>
2.3 D	2.3	49	01.87-02.93	YTR	4	<b>GN 909</b> (11V)	○		
2.8 i	2.8	105	01.87-02.93	PR8	6	<b>Z 20</b>	14 R-7 DU	0,8	<b>UXT 2<sup>4</sup></b>
2.8 i	2.8	107	01.87-02.93	PR7	6	<b>Z 20</b>	14 R-7 DU	0,8	<b>UXT 2<sup>4</sup></b>
2.8 i 4x4	2.8	107	01.87-02.93	PR7	6	<b>Z 20</b>	14 R-7 DU	0,8	<b>UXT 2<sup>4</sup></b>
2.9	2.9	107	08.88-02.93	B4B/B4C	6	<b>Z 117</b>	14 KR-9 DUX	1,0	<b>UXT 4</b>
2.9 4x4	2.9	107	08.88-02.93	B4B/B4C	6	<b>Z 117</b>	14 KR-9 DUX	1,0	<b>UXT 4</b>
2.9 i	2.9	110	08.88-02.93	B4B/B4C	6	<b>Z 117</b>	14 KR-9 DUX	1,0	<b>UXT 4</b>
2.9 4x4	2.9	110	08.88-02.93	B4B/B4C ohne Kat.	6	<b>Z 117</b>	14 KR-9 DUX	1,0	<b>UXT 4</b>

### S-MAX

1.8 TDCi	1.8	74	01.07-	FFWA	4	<b>GN 993</b> (10V)	○		
1.8 TDCi	1.8	92	05.06-	QYWA	4	<b>GN 993</b> (10V)	○		
2.0 TDCi	2.0	96	05.06-	AZWA	4	<b>GN 939</b> (11,5V)	○		
2.0 TDCi	2.0	103	05.06-	QXWA, QXWB, QXWC ohne Partikelfilter	4	<b>GN 939</b> (11,5V)	○		
2.0	2.0	107	05.06-	AOWB/AOWA	4	<b>Z 230</b>	14 KR-6 KPUV02	1,3	○
2.0 Flexifuel	2.0	107	05.06-	TBWA/TBWB	4	<b>Z 230</b>	14 KR-6 KPUV02	1,3	○
2.2 TDCi	2.2	129	03.08-	Q4WA	4	<b>GN 063</b> (11V)	○		
2.3	2.3	118	07.07-	SEWA	4	<b>Z 342</b>	14 KR-7 MPUV2	1,3	○
2.5 ST	2.5	162	05.06-	HUWA	5	<b>Z 326</b>	14 FR-7 MPUS	0,7	○

### STREET KA

1.6	1.6	70	05.03-07.05	CDRA/CDRB	4	<b>Z 177</b>	14 KR-8 MUV	1,3	<b>UXT 7</b>
-----	-----	----	-------------	-----------	---	--------------	-------------	-----	--------------

### TOURNEO CONNECT

1.8 Di	1.8	55	06.02-	BHPA/P7PA/P7PB/R2PA	4	<b>GN 993</b> (10V)	○		
1.8 Turbo Di	1.8	66	06.02-	P9PB/P9PA/HCPB/RWPF/ P9PC/R3PA/RWPE/HCPA/ P9PD	4	<b>GN 993</b> (10V)	○		
1.8 TDCi	1.8	81	08.06-	RWPC/RWPA/RWPD	4	<b>GN 993</b> (10V)	○		
1.8 16V	1.8	85	06.02-	EYPC/EYPA/EYPD	4	<b>Z 97</b>	14 KR-8 MPX	1,0	<b>UXT 8</b>



### P 100 II

1.8 TD	1.8	55	10.87-12.92	RFA	4	<b>GV 666</b> (11,5V)	○		
--------	-----	----	-------------	-----	---	-----------------------	---	--	--

### COURIER

1.3	1.3	44	09.91-02.96	J6B	4	<b>Z 67</b>	14 KR-7 DUX	1,1	<b>UXT 4</b>
1.3	1.3	44	02.96-	J4C	4	<b>Z 67</b>	14 KR-7 DUX	1,1	<b>UXT 4</b>
1.4 i	1.4	66	04.96-10.99	FHA	4	<b>Z 177</b>	14 KR-8 MUV	1,3	<b>UXT 7</b>
1.8 D	1.8	44	09.91-02.96	RTD/RTG/RTC	4	<b>GV 666</b> (11,5V)	○		
1.8 D	1.8	44	02.96-	RTK	4	<b>GN 022</b> (10V)	○		
1.8 DI	1.8	55	09.00-12.02	RTP/RTN	4	<b>GN 993</b> (10V)	○		



kW

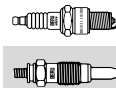
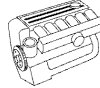

**FORD**



**ECONOVAN**

1.4	1.4	48	03.86-03.92	UC	4	<b>Z 8</b>	14 R-8 DU	0,8	<b>UXT 2<sup>4</sup></b>
2.0 D	2.0	41	03.86-03.92	RF	4	<b>GV 705 (7V)</b>	○		

**TRANSIT**

1.6	1.6	46	09.85-09.92	LAT	4	<b>Z 33</b>	18 K-6 BU	0,7	○
1.8 Di	1.8	55	06.02-	BHPA	4	<b>GN 993 (10V)</b>	○		
1.8 TDCi	1.8	66	06.02-	P9PB/P9PA/HCPB/RWPF/ P9PC/R3PA/RWPE/HCPA/ P9PD	4	<b>GN 993 (10V)</b>	○		
1.8 TDCi	1.8	81	08.06-	RWPC/RWPA/RWPD	4	<b>GN 993 (10V)</b>	○		
1.8 16V	1.8	85	06.02-	EYPC/EYPA/EYPD	4	<b>Z 97</b>	14 KR-8 MPX	1,0	<b>UXT 8</b>
1.8 16V LPG	1.8	85	06.02-	EYPC	4	<b>Z 97</b>	14 KR-8 MPX	1,0	<b>UXT 8</b>
2.0 DI	2.0	55	08.00-05.06	D3FA	4	<b>GN 939 (11,5V)</b>	○		
2.0 KAT	2.0	57	12.85-09.92	N6T	4	<b>Z 32</b>	18 K-7 BU	0,7	○
2.0	2.0	57	09.85-09.92	NAT/NAV	4	<b>Z 32</b>	18 K-7 BU	0,7	○
2.0 DI	2.0	63	08.00-05.06	F3FA	4	<b>GN 939 (11,5V)</b>	○		
2.0	2.0	66	09.91-09.94	NBA	4	<b>Z 32</b>	18 K-7 BU	0,7	○
2.0	2.0	72	09.91-08.94	NCA	4	<b>Z 32</b>	18 K-7 BU	0,7	○
2.0 DI	2.0	74	08.00-05.06	ABFA	4	<b>GN 939 (11,5V)</b>	○		
2.0	2.0	84	06.94-03.00	NSF/NSG	4	<b>Z 130</b>	14 FR-5 DPUX	1,0	○
2.0 CNG	2.0	84	06.94-03.00	NSH	4	<b>Z 159</b>	14 FR-6 DPUX	1,1	<b>UXT 14</b>
2.0 TDCi	2.0	92	08.02-05.06	FIFA	4	<b>GN 939 (11,5V)</b>	○		
2.2 TDCi	2.2	63	04.06-	P8FA/P8FB	4	<b>GN 939 (11,5V)</b>	○		
2.2 TDCi	2.2	81	04.06-	QVFA	4	<b>GN 939 (11,5V)</b>	○		
2.2 TDCi	2.2	85	10.08-	SRFC/SRFA/SRFB/SRFE/SRFD	4	<b>GN 939 (11,5V)</b>	○		
2.2 TDCi	2.2	96	04.06-	QWFA	4	<b>GN 939 (11,5V)</b>	○		
2.2 TDCi	2.2	103	10.07-	UHFA/UHFC/PGFB/PGFA/UHFB	4	<b>GN 939 (11,5V)</b>	○		
2.3 16V	2.3	107	08.00-05.06	E5FC/E5FA	4	<b>Z 24</b>	14 FR-6 DU	0,8	<b>UXT 5</b>
2.3 16V	2.3	107	04.06-	GZFA/GZFC	4	<b>Z 148</b>	14 KR-8 DPUOV	1,3	<b>UXT 15</b>
2.4 DI	2.4	55	01.00-05.06	F4FA	4	<b>GN 939 (11,5V)</b>	○		
2.4 DI	2.4	66	01.00-05.06	D2FA/D2FB/D2FE	4	<b>GN 939 (11,5V)</b>	○		
2.4 TDCi	2.4	74	04.06-	PHFA/PHFC	4	<b>GN 939 (11,5V)</b>	○		
2.4 TDCi	2.4	85	04.06-	JXFC/JXFA	4	<b>GN 939 (11,5V)</b>	○		
2.4 TDE	2.4	85	03.04-05.06	FXFA	4	<b>GN 939 (11,5V)</b>	○		
2.4 TDCi	2.4	85	04.06-	JXFA	4	<b>GN 939 (11,5V)</b>	○		
2.4 DI	2.4	88	01.00-05.06	D4FA	4	<b>GN 939 (11,5V)</b>	○		
2.4 TDE	2.4	92	07.01-05.06	DOFA	4	<b>GN 939 (11,5V)</b>	○		
2.4 TDCi	2.4	101	03.04-05.06	H9FA	4	<b>GN 939 (11,5V)</b>	○		
2.4 TDCi	2.4	103	04.06-	H9FD	4	<b>GN 939 (11,5V)</b>	○		
2.4 TDCi 4x4	2.4	103	11.06-	H9FB	4	<b>GN 939 (11,5V)</b>	○		
2.5 D	2.5	50	01.86-09.91	4AB	4	<b>GF 859 (8V)</b>	○		
2.5 DI	2.5	51	08.91-07.94	4FA /4BC/4CC	4	<b>GF 859 (8V)</b>	○		
2.5 DI	2.5	51	08.94-03.00	4FA /4FB/4FD/4FC	4	<b>GF 983 (8V)</b>	○		
2.5 D	2.5	52	09.88-09.92	4BA/4CA/4AB	4	<b>GF 859 (8V)</b>	○		
2.5 TD	2.5	55	08.94-06.00	4HD/4HA	4	<b>GF 982 (8V)</b>	○		
2.5 DI	2.5	56	08.94-03.00	4HC /4HB	4	<b>GF 982 (8V)</b>	○		
2.5 DI	2.5	59	09.91-07.94	4DA	4	<b>GF 859 (8V)</b>	○		
2.5 TD	2.5	63	10.92-07.94	4GB/4GC /4GA	4	<b>GF 859 (8V)</b>	○		
2.5 TD Automatic	2.5	63	06.94-03.00	4GF/4GB/4GC /4GA/4GE/4GD	4	<b>GF 983 (8V)</b>	○		
2.5 TD	2.5	63	06.94-03.00	4GF/4GB/4GC /4GA/4GE/4GD	4	<b>GF 982 (8V)</b>	○		
2.5 TD	2.5	74	09.91-07.94	4EA	4	<b>GF 859 (8V)</b>	○		
2.5 TD	2.5	74	07.94-03.00	4EB/4EC	4	<b>GF 982 (8V)</b>	○		
2.5 DI	2.5	85	05.99-03.00	4ED	4	<b>GF 982 (8V)</b>	○		
2.9 i	2.9	107	01.91-07.94	BRT	6	<b>Z 15</b>	14 FR-7 DU	0,8	<b>UXT 1<sup>3</sup></b>
3.2 TDCi	3.2	147	02.08-	SAFA/SAFB	5	<b>GN 939 (11,5V)</b>	○		

**TRANSIT TOURNEO**

2.0	2.0	84	11.94-12.00	NSH	4	<b>Z 130</b>	14 FR-5 DPUX	1,0	○
2.2 TDCi	2.2	81	07.06-	QVFA	4	<b>GN 993 (10V)</b>	○		
2.2 TDCi	2.2	85	10.08-	SRFC/SRFA/SRFB/SRFE/SRFD	4	<b>GN 939 (11,5V)</b>	○		
2.2 TDCi	2.2	96	07.06-	QWFA	4	<b>GN 993 (10V)</b>	○		

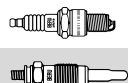

## FORD



### TRANSIT TOURNEO

2.2 TDCi	2.2	103	10.07-	PGFB/PGFA	4	<b>GN 939</b> (11,5V)	○	
2.5 DI	2.5	51	11.94-12.00	4FA /4FB/4FD/4FC	4	<b>GF 983</b> (8V)	○	
2.5 DI	2.5	56	11.94-12.00	4HC /4HB/4HA	4	<b>GF 982</b> (8V)	○	
2.5 TD Automatic	2.5	63	11.94-12.00	4GB/4GC /4GA	4	<b>GF 983</b> (8V)	○	
2.5 TD	2.5	63	11.94-12.00	4GB/4GC /4GA	4	<b>GF 982</b> (8V)	○	
2.5 TD	2.5	74	04.98-12.00	4EB/4EC	4	<b>GF 982</b> (8V)	○	

## FORD OTOSAN

### TAUNUS

1.6	1.6	52	01.89-		4	<b>Z 32</b>	18 K-7 BU	0,7	○
2.0	2.0	74	01.89-	NER	4	<b>Z 32</b>	18 K-7 BU	0,7	○

## FORD USA

### AEROSTAR

3.0 i V6	3.0	108	03.86-12.97		6	<b>Z 67</b>	14 KR-7 DUX	1,1	<b>UXT 4</b>
4.0 i V6 4WD	4.0	115	09.89-12.97		6	<b>Z 117</b>	14 KR-9 DUX	1,0	<b>UXT 4</b>

### ESCORT

1.6 i	1.6	70	01.01-08.02	L1K	4	<b>Z 97</b>	14 KR-8 MPX	1,0	<b>UXT 8</b>
-------	-----	----	-------------	-----	---	-------------	-------------	-----	--------------

### EXPLORER

4.0 V6 Allrad	4.0	121	01.93-		6	<b>Z 117</b>	14 KR-9 DUX	1,0	<b>UXT 4</b>
---------------	-----	-----	--------	--	---	--------------	-------------	-----	--------------

### PROBE I

2.2 GT	2.2	108	08.88-12.92		4	<b>Z 158</b>	14 FR-7 LUX	1,1	○
--------	-----	-----	-------------	--	---	--------------	-------------	-----	---

### PROBE II

2.0 16V	2.0	85	10.93-03.98	FS	4	<b>Z 99</b>	14 FR-6 DUX	1,0	<b>UXT 5</b>
2.5 V6 24V	2.5	119	10.93-03.98	KL	6	<b>Z 158</b>	14 FR-7 LUX	1,1	○
2.5 V6 24V	2.5	120	12.94-03.98	KL	6	<b>Z 158</b>	14 FR-7 LUX	1,1	○

### WINDSTAR

3.0 V6	3.0	109	03.95-02.99		6	<b>Z 148</b>	14 KR-8 DPUOV	1,3	<b>UXT 15</b>
--------	-----	-----	-------------	--	---	--------------	---------------	-----	---------------



### E-250 VAN

6.0 BASE VAN	6,0	-	12.05	V8 - 363 -(VIN:P) Powerstroke	8	<b>GN 049</b> (11V)	○	
--------------	-----	---	-------	----------------------------------	---	---------------------	---	--

### E-350 CLUB WAGON VAN

6.0 CHATEAU	6,0	-	01.04-12.05	V8 - 363 -(VIN:P) Powerstroke	8	<b>GN 049</b> (11V)	○	
-------------	-----	---	-------------	----------------------------------	---	---------------------	---	--

### E-350 ECONOLINE

7.3	7,3	444	01.88-12.94	-	8	<b>GV 823</b> (10,5V)	○	
7.3	7,3	444	01.95-12.96	-	8	<b>GV 819</b> (11V)	○	
7.3	7,3	445	01.97-12.02	-	8	<b>GV 819</b> (11V)	○	
7.3 HD CLUB WAGON	7,3	444	01.92-12.94	-	8	<b>GV 823</b> (10,5V)	○	
7.3 HD CLUB WAGON	7,3	444	01.95-12.96	-	8	<b>GV 819</b> (11V)	○	
7.3 HD CLUB WAGON	7,3	445	01.97-12.02	-	8	<b>GV 819</b> (11V)	○	
7.3 SUPER	7,3	444	01.88-12.94	-	8	<b>GV 823</b> (10,5V)	○	
7.3 SUPER	7,3	444	01.95-12.96	-	8	<b>GV 819</b> (11V)	○	
7.3 SUPER	7,3	445	01.97-12.02	-	8	<b>GV 819</b> (11V)	○	
7.3 SUPER WAGON	7,3	444	01.88-12.94	-	8	<b>GV 823</b> (10,5V)	○	
7.3 SUPER WAGON	7,3	444	01.95-12.96	-	8	<b>GV 819</b> (11V)	○	
7.3 SUPER WAGON	7,3	445	01.97-12.02	-	8	<b>GV 819</b> (11V)	○	

### E-350 SUPER DUTY VAN

6.0 BASE VAN	6,0	-	01.04-12.05	V8 - 363 -(VIN:P) Powerstroke	8	<b>GN 049</b> (11V)	○	
--------------	-----	---	-------------	----------------------------------	---	---------------------	---	--

### E-450 SUPER DUTY VAN

6.0 BASE VAN	6,0	-	01.04-12.05	V8 - 363 -(VIN:P) Powerstroke	8	<b>GN 049</b> (11V)	○	
--------------	-----	---	-------------	----------------------------------	---	---------------------	---	--

### EXCURSION

E. BAUER TRUCK	6,0	-	12.03	V8 - 363 -(VIN:-) Powerstroke	8	<b>GN 036</b> (11V)	○	
----------------	-----	---	-------	----------------------------------	---	---------------------	---	--

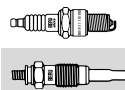

## FORD USA



### EXCURSION

E. BAUER TRUCK	6,0	-	01.04-12.05	V8 - 363 -(VIN:P) Powerstroke	8	<b>GN 049</b> (11V)	○		
LIMITED TRUCK	6,0	-	12.03	V8 - 363 -(VIN:-) Powerstroke	8	<b>GN 036</b> (11V)	○		
LIMITED TRUCK	6,0	-	01.04-	V8 - 363 -(VIN:P) Powerstroke	8	<b>GN 049</b> (11V)	○		
XLT TRUCK	6,0	-	12.03	V8 - 363 -(VIN:-) Powerstroke	8	<b>GN 036</b> (11V)	○		
XLS TRUCK	6,0	-	01.04-	V8 - 363 -(VIN:P) Powerstroke	8	<b>GN 049</b> (11V)	○		
XLT TRUCK	6,0	-	01.04-12.05	V8 - 363 -(VIN:P) Powerstroke	8	<b>GN 049</b> (11V)	○		
7.3	7,3	445	01.00-12.02	-	8	<b>GV 819</b> (11V)	○		

### F-150 PICKUP

4.9	4,9	300	01.94-	-	6	<b>GV 823</b> (10,5V)	○		
-----	-----	-----	--------	---	---	-----------------------	---	--	--

### F-250 PICKUP

4.9	4,9	300	01.94-	-	6	<b>GV 823</b> (10,5V)	○		
7.3	7,3	444	01.88-12.94	-	8	<b>GV 823</b> (10,5V)	○		
7.3	7,3	444	01.95-12.96	-	8	<b>GV 819</b> (11V)	○		
7.3	7,3	445	01.97-	-	8	<b>GV 819</b> (11V)	○		
7.3 SUPER CAB	7,3	444	01.88-12.94	-	8	<b>GV 823</b> (10,5V)	○		
7.3 SUPER CAB	7,3	444	01.95-12.96	-	8	<b>GV 819</b> (11V)	○		
7.3 SUPER CAB	7,3	445	01.97-	-	8	<b>GV 819</b> (11V)	○		
7.3 SUPER DUTY	7,3	445	01.99-01.02	-	8	<b>GV 819</b> (11V)	○		

### F-250 SUPER DUTY

6.0 BASE TRUCK	6,0	-	01.04-12.05		8	<b>GN 049</b> (11V)	○		
6.0 FX 4 TRUCK	6,0	-	01.04-12.05		8	<b>GN 049</b> (11V)	○		
6.0 HARLEY D.E. TRUCK	6,0	-	01.04-12.05		8	<b>GN 049</b> (11V)	○		
6.0 KING RANCH TRUCK	6,0	-	01.04-12.05		8	<b>GN 049</b> (11V)	○		
6.0 LARIAT TRUCK	6,0	-	12.03		8	<b>GN 036</b> (11V)	○		
6.0 LARIAT TRUCK	6,0	-	01.04-12.05		8	<b>GN 049</b> (11V)	○		
6.0 XL TRUCK	6,0	-	12.03		8	<b>GN 036</b> (11V)	○		
6.0 XL TRUCK	6,0	-	01.04-12.05		8	<b>GN 049</b> (11V)	○		
6.0 XLT TRUCK	6,0	-	12.03		8	<b>GN 036</b> (11V)	○		
6.0 XLT TRUCK	6,0	-	01.04-12.05		8	<b>GN 049</b> (11V)	○		

### F-350 PICKUP

7.3	7,3	444	01.88-12.94	-	8	<b>GV 823</b> (10,5V)	○		
7.3	7,3	444	01.95-12.97	-	8	<b>GV 819</b> (11V)	○		
7.3 SUPER CAB	7,3	444	01.88-12.94	-	8	<b>GV 823</b> (10,5V)	○		
7.3 SUPER CAB	7,3	444	01.95-12.97	-	8	<b>GV 819</b> (11V)	○		
7.3 SUPER DUTY	7,3	445	01.99-01.02	-	8	<b>GV 819</b> (11V)	○		

### F-350 SUPER DUTY

6.0 BASE TRUCK	6,0	-	01.04-12.05		8	<b>GN 049</b> (11V)	○		
6.0 HARLEY D.E. TRUCK	6,0	-	01.04-12.05		8	<b>GN 049</b> (11V)	○		
6.0 KING RANCH TRUCK	6,0	-	01.04-12.05		8	<b>GN 049</b> (11V)	○		
6.0 LARIAT TRUCK	6,0	-	12.03		8	<b>GN 036</b> (11V)	○		
6.0 LARIAT TRUCK	6,0	-	01.04-12.05		8	<b>GN 049</b> (11V)	○		
6.0 XL TRUCK	6,0	-	12.03		8	<b>GN 036</b> (11V)	○		
6.0 XL TRUCK	6,0	-	01.04-12.05		8	<b>GN 049</b> (11V)	○		
6.0 XLT TRUCK	6,0	-	12.03		8	<b>GN 036</b> (11V)	○		
6.0 XLT TRUCK	6,0	-	01.04-12.05		8	<b>GN 049</b> (11V)	○		

### F-450 PICKUP

7.3 SUPER DUTY	7,3	445	01.99-01.02	-	8	<b>GV 819</b> (11V)	○		
----------------	-----	-----	-------------	---	---	---------------------	---	--	--

### F-450 SUPER DUTY

6.0 LARIAT TRUCK	6,0	-	12.03		8	<b>GN 036</b> (11V)	○		
6.0 LARIAT TRUCK	6,0	-	01.04-12.05		8	<b>GN 049</b> (11V)	○		
6.0 XL TRUCK	6,0	-	12.03		8	<b>GN 036</b> (11V)	○		
6.0 XL TRUCK	6,0	-	01.04-12.05		8	<b>GN 049</b> (11V)	○		
6.0 XLT TRUCK	6,0	-	12.03		8	<b>GN 036</b> (11V)	○		

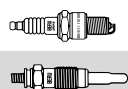

## FORD USA



### F-450 SUPER DUTY

6.0 XLT TRUCK	6,0	-	01.04-12.05	8	<b>GN 049</b> (11V)	○	
---------------	-----	---	-------------	---	---------------------	---	--

### F-550 PICKUP

7.3 SUPER DUTY	7,3	445	01.99-01.02	-	8	<b>GV 819</b> (11V)	○
----------------	-----	-----	-------------	---	---	---------------------	---

### F-550 SUPER DUTY

6.0 LARIAT TRUCK	6,0	-	12.03	8	<b>GN 036</b> (11V)	○	
6.0 LARIAT TRUCK	6,0	-	01.04-12.05	8	<b>GN 049</b> (11V)	○	
6.0 XL TRUCK	6,0	-	12.03	8	<b>GN 036</b> (11V)	○	
6.0 XL TRUCK	6,0	-	01.04-12.05	8	<b>GN 049</b> (11V)	○	
6.0 XLT TRUCK	6,0	-	12.03	8	<b>GN 036</b> (11V)	○	
6.0 XLT TRUCK	6,0	-	01.04-12.05	8	<b>GN 049</b> (11V)	○	

## FSO

<b>125P</b>									
1.3	1.3	47	10.67-08.92	116 C 076	4	<b>Z 11</b>	14-7 DU	0,8	<b>UXT 2<sup>4</sup></b>
1.5	1.5	55	10.67-08.92	115 C 076	4	<b>Z 11</b>	14-7 DU	0,8	<b>UXT 2<sup>4</sup></b>

<b>125P Kombi</b>									
1.3	1.3	47	10.67-08.92	116 C 076	4	<b>Z 11</b>	14-7 DU	0,8	<b>UXT 2<sup>4</sup></b>
1.5	1.5	55	10.67-08.92	115 C 076	4	<b>Z 11</b>	14-7 DU	0,8	<b>UXT 2<sup>4</sup></b>

<b>126P</b>									
0.6	0.7	22	07.77-12.91	126 A1.048	2	<b>Z 41</b>	14-5 BU	0,8	○

<b>POLONEZ II</b>									
1.5	1.5	55	08.88-08.92	AA	4	<b>Z 11</b>	14-7 DU	0,8	<b>UXT 2<sup>4</sup></b>
1.9 D	1.9	51	08.88-08.92	XUD 9A	4	<b>GV 642</b> (11V)	○		

<b>POLONEZ III</b>									
1.9 D	1.9	51	09.92-03.02	XUD 9A	4	<b>GV 636</b> (11V)	○		

## GEO

<b>METRO</b>									
1.0	1.0	41	08.94-12.98	3L <6>	3	<b>Z 9</b>	14 R-8 DUX	1,1	<b>UXT 2<sup>4</sup></b>

<b>METRO Cabriolet</b>									
1.0	1.0	41	08.94-12.98	3L <6>	3	<b>Z 9</b>	14 R-8 DUX	1,1	<b>UXT 2<sup>4</sup></b>

## HONDA

<b>ACCORD IV</b>									
2.0 16V	2.0	66	01.90-03.93	F20A6	4	<b>Z 158</b>	14 FR-7 LUX	1,1	○
2.0 16V	2.0	81	01.90-03.93	F20A3/F20A2	4	<b>Z 158</b>	14 FR-7 LUX	1,1	○
2.0 i 16V	2.0	98	01.90-03.93	F20A4/F20A8	4	<b>Z 158</b>	14 FR-7 LUX	1,1	○
2.2 i 16V Automatik	2.2	108	01.90-03.93	F22A3	4	<b>Z 158</b>	14 FR-7 LUX	1,1	○
2.2 i 16V	2.2	110	01.90-03.93	F22A3	4	<b>Z 158</b>	14 FR-7 LUX	1,1	○

<b>ACCORD IV Aerodeck</b>									
2.0 i 16V	2.0	98	03.93-12.93	F20Z3	4	<b>Z 158</b>	14 FR-7 LUX	1,1	○
2.2 i 16V	2.2	108	01.91-12.93	F22A8	4	<b>Z 158</b>	14 FR-7 LUX	1,1	○
2.2 i 16V	2.2	110	01.91-12.93	F22A7	4	<b>Z 158</b>	14 FR-7 LUX	1,1	○

<b>ACCORD IV Coupe</b>									
2.0 i 16V	2.0	98	01.92-09.93	F20A7	4	<b>Z 158</b>	14 FR-7 LUX	1,1	○

<b>ACCORD V</b>									
2.0 i	2.0	85	03.93-01.96	F20Z2	4	<b>Z 158</b>	14 FR-7 LUX	1,1	○
2.0 i S	2.0	96	03.93-01.96	F20Z1	4	<b>Z 158</b>	14 FR-7 LUX	1,1	○
2.3 i SR	2.3	116	03.93-01.96	H23A3	4	<b>Z 158</b>	14 FR-7 LUX	1,1	○

<b>ACCORD V Aerodeck</b>									
2.0 i LS 16V	2.0	100	09.93-02.98	F20B3	4	<b>Z 158</b>	14 FR-7 LUX	1,1	○
2.2 i ES	2.2	110	09.93-02.98	F22B5	4	<b>Z 158</b>	14 FR-7 LUX	1,1	○

<b>ACCORD V Coupe</b>									
2.0	2.0	100	09.93-12.97	F20B3	4	<b>Z 158</b>	14 FR-7 LUX	1,1	○
2.2 i ES	2.2	110	09.93-02.98	F22B5	4	<b>Z 158</b>	14 FR-7 LUX	1,1	○

<b>ACCORD VI</b>									
1.9 i	1.9	85	02.96-10.98	F18A3	4	<b>Z 158</b>	14 FR-7 LUX	1,1	○
2.0 TDi	2.0	77	04.96-10.98	20T2N	4	<b>GN 999</b> (11V)	○		
2.0 i LS	2.0	96	02.96-10.98	F20Z1	4	<b>Z 158</b>	14 FR-7 LUX	1,1	○

● nicht erforderlich  
○ nicht im Programm

<sup>3</sup> wahlweise UXT 3 Platin

<sup>4</sup> wahlweise UXT 6 Platin



kW

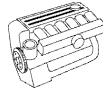

## HONDA

### ACCORD VI

2.2 i VTEC	2.2	110	02.96-10.98	F22Z2	4	<b>Z 158</b>	14 FR-7 LUX	1,1	○
------------	-----	-----	-------------	-------	---	--------------	-------------	-----	---

### ACCORD VII

1.6 i	1.6	85	10.98-12.02	D16B6	4	<b>Z 158</b>	14 FR-7 LUX	1,1	○
1.8 i	1.9	100	10.98-12.02	F18B2	4	<b>Z 158</b>	14 FR-7 LUX	1,1	○
2.0 Turbo Di	2.0	77	02.99-12.02	20T2N	4	<b>GN 905</b> (11V)	○		
2.0 i	2.0	108	10.98-01.01	F20B6	4	<b>Z 158</b>	14 FR-7 LUX	1,1	○
2.2 Type-R	2.2	156	02.99-12.02	H22A7	4	<b>Z 158</b>	14 FR-7 LUX	1,1	○
2.3	2.3	113	01.01-06.03	F23Z5/F23A1	4	<b>Z 158</b>	14 FR-7 LUX	1,1	○

### ACCORD VII Coupe

2.0 i 16V	2.0	108	02.98-06.03	F20B5	4	<b>Z 158</b>	14 FR-7 LUX	1,1	○
3.0 V6 24V	3.0	147	02.98-06.03	J30A1	6	<b>Z 158</b>	14 FR-7 LUX	1,1	○

### ACCORD VIII

2.0	2.0	114	02.03-	K20A6	4	<b>Z 299</b>	14 FR-7 LUX0	1,0	○
2.0 Allrad	2.0	114	02.03-	K20A6	4	<b>Z 299</b>	14 FR-7 LUX0	1,0	○
2.2 i-CTDi	2.2	103	01.04-	N22A1	4	<b>GN 073</b> (11V)	○		
2.4	2.4	140	02.03-	K24A/K24A3	4	<b>Z 354</b>	14 FR-5 LPUOX	1,1	○

### ACCORD VIII Tourer

2.0	2.0	114	04.03-	K20A6	4	<b>Z 299</b>	14 FR-7 LUX0	1,0	○
2.2 i-CTDi	2.2	103	01.04-	N22A1	4	<b>GN 073</b> (11V)	○		
2.4	2.4	140	04.03-	K24A	4	<b>Z 354</b>	14 FR-5 LPUOX	1,1	○

### CITY

1.3 4WD	1.3	63	09.01-10.04	L13A1	4	<b>Z 16</b>	14 FR-7 DUX	1,1	<b>UXT 1<sup>3</sup></b>
1.3 SES	1.3	63	05.03-09.05	L13A1	4	<b>Z 16</b>	14 FR-7 DUX	1,1	<b>UXT 1<sup>3</sup></b>

### CIVIC II Shuttle

1.5 i 16V	1.5	69	01.88-11.91	D15B2	4	<b>Z 99</b>	14 FR-6 DUX	1,0	<b>UXT 5</b>
1.6 i 16V 4WD	1.6	81	01.88-02.95	D16A6	4	<b>Z 16</b>	14 FR-7 DUX	1,1	<b>UXT 1<sup>3</sup></b>

### CIVIC IV

1.5 i 16V	1.5	66	10.87-09.91	D15B2	4	<b>Z 16</b>	14 FR-7 DUX	1,1	<b>UXT 1<sup>3</sup></b>
1.5 i 16V	1.5	69	10.87-09.91	D15B2	4	<b>Z 99</b>	14 FR-6 DUX	1,0	<b>UXT 5</b>
1.6 i 16V	1.6	80	11.87-09.91	D16A6	4	<b>Z 16</b>	14 FR-7 DUX	1,1	<b>UXT 1<sup>3</sup></b>
1.6 i 16V 4x4	1.6	80	10.89-09.91	D16A6	4	<b>Z 16</b>	14 FR-7 DUX	1,1	<b>UXT 1<sup>3</sup></b>
1.6 i 16V	1.6	81	10.87-09.91	D16Z2	4	<b>Z 99</b>	14 FR-6 DUX	1,0	<b>UXT 5</b>
1.6 i 16V	1.6	96	09.87-09.91	D16A7	4	<b>Z 16</b>	14 FR-7 DUX	1,1	<b>UXT 1<sup>3</sup></b>

### CIVIC IV Hatchback

1.3 16 V KAT	1.3	55	09.89-09.91	D13B2	4	<b>Z 16</b>	14 FR-7 DUX	1,1	<b>UXT 1<sup>3</sup></b>
1.3 16V	1.3	55	10.91-11.95	D13B2	4	<b>Z 16</b>	14 FR-7 DUX	1,1	<b>UXT 1<sup>3</sup></b>
1.5 i 16V	1.5	66	10.88-09.91	D15B2	4	<b>Z 16</b>	14 FR-7 DUX	1,1	<b>UXT 1<sup>3</sup></b>
1.5 i 16V	1.5	66	10.91-11.95	D15B2/D15Z2	4	<b>Z 16</b>	14 FR-7 DUX	1,1	<b>UXT 1<sup>3</sup></b>
1.5 i 16V	1.5	69	10.88-09.91	D15B2	4	<b>Z 99</b>	14 FR-6 DUX	1,0	<b>UXT 5</b>
1.5 i 16V	1.5	69	10.91-11.95	D15B2	4	<b>Z 16</b>	14 FR-7 DUX	1,1	<b>UXT 1<sup>3</sup></b>
1.5 i 16V	1.5	69	10.91-11.95	D15Z1	4	<b>Z 158</b>	14 FR-7 LUX	1,1	○
1.6 i 16V	1.6	80	10.87-09.91	D16A6	4	<b>Z 16</b>	14 FR-7 DUX	1,1	<b>UXT 1<sup>3</sup></b>
1.6 i 16V	1.6	81	10.87-09.91	D16Z2	4	<b>Z 99</b>	14 FR-6 DUX	1,0	<b>UXT 5</b>
1.6 16V Vtec	1.6	92	10.91-11.95	D16Z6	4	<b>Z 16</b>	14 FR-7 DUX	1,1	<b>UXT 1<sup>3</sup></b>
1.6 i 16V	1.6	96	09.87-09.91	D16A9/D16A7	4	<b>Z 16</b>	14 FR-7 DUX	1,1	<b>UXT 1<sup>3</sup></b>
1.6 i 16V Vtec	1.6	110	10.89-09.91	B16A1	4	<b>Z 16</b>	14 FR-7 DUX	1,1	<b>UXT 1<sup>3</sup></b>
1.6 VTi 16V	1.6	118	10.91-11.95	B16A2	4	<b>Z 16</b>	14 FR-7 DUX	1,1	<b>UXT 1<sup>3</sup></b>

### CIVIC V

1.5 i 16V	1.5	69	10.91-11.95	D15B2	4	<b>Z 16</b>	14 FR-7 DUX	1,1	<b>UXT 1<sup>3</sup></b>
1.5 i 16V	1.5	69	10.91-11.95	D15Z1	4	<b>Z 158</b>	14 FR-7 LUX	1,1	○
1.6 16V Vtec	1.6	92	10.91-11.95	D 16Z6	4	<b>Z 16</b>	14 FR-7 DUX	1,1	<b>UXT 1<sup>3</sup></b>
1.6 VTi	1.6	118	10.91-11.95	B16A2	4	<b>Z 16</b>	14 FR-7 DUX	1,1	<b>UXT 1<sup>3</sup></b>

### CIVIC V Coupe

1.5 i Lsi	1.5	74	01.94-11.95	D15B7	4	<b>Z 158</b>	14 FR-7 LUX	1,1	○
1.6 i	1.6	77	01.94-11.95	D16Y7	4	<b>Z 16</b>	14 FR-7 DUX	1,1	<b>UXT 1<sup>3</sup></b>
1.6 i Vtec	1.6	92	01.94-03.96	D 16Z9	4	<b>Z 16</b>	14 FR-7 DUX	1,1	<b>UXT 1<sup>3</sup></b>
1.6 i Vtec	1.6	118	01.94-11.95	B16A2	4	<b>Z 16</b>	14 FR-7 DUX	1,1	<b>UXT 1<sup>3</sup></b>

### CIVIC VI

1.4 i	1.4	66	11.95-02.01	D 14A4	4	<b>Z 16</b>	14 FR-7 DUX	1,1	<b>UXT 1<sup>3</sup></b>
1.5 i	1.5	84	11.95-02.01	D15Z6	4	<b>Z 158</b>	14 FR-7 LUX	1,1	○
1.6 i Vtec	1.6	92	11.95-02.01	D16Y6/D16Y8	4	<b>Z 16</b>	14 FR-7 DUX	1,1	<b>UXT 1<sup>3</sup></b>

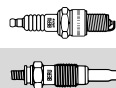
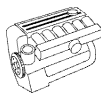

## HONDA

### CIVIC VI

1.6 Vti	1.6	118	11.95-02.01	B16A2	4	<b>Z 16</b>	14 FR-7 DUX	1,1	<b>UXT 1<sup>3</sup></b>
---------	-----	-----	-------------	-------	---	-------------	-------------	-----	--------------------------

### CIVIC VI Aerodeck

1.4 16V	1.4	55	04.98-02.01	D14A7	4	<b>Z 158</b>	14 FR-7 LUX	1,1	○
1.4 16V	1.4	66	04.98-02.01	D14A8	4	<b>Z 158</b>	14 FR-7 LUX	1,1	○
1.5 16V	1.5	84	04.98-02.01	D15Z8	4	<b>Z 158</b>	14 FR-7 LUX	1,1	○
1.6 16V	1.6	85	04.98-02.01	D16B2	4	<b>Z 158</b>	14 FR-7 LUX	1,1	○
1.8 16V	1.8	124	04.98-02.01	B18C4	4	<b>Z 16</b>	14 FR-7 DUX	1,1	<b>UXT 1<sup>3</sup></b>
2.0 i D	2.0	77	04.98-02.01	20T2N	4	<b>GN 073 (11V)</b>	○		

### CIVIC VI Coupe

1.6 i	1.6	77	03.96-12.98	D16V7	4	<b>Z 16</b>	14 FR-7 DUX	1,1	<b>UXT 1<sup>3</sup></b>
1.6 i	1.6	77	01.99-03.00	D16V7	4	<b>Z 158</b>	14 FR-7 LUX	1,1	○
1.6 i Vtec	1.6	92	03.96-12.98	D16Y8	4	<b>Z 16</b>	14 FR-7 DUX	1,1	<b>UXT 1<sup>3</sup></b>
1.6 i Vtec	1.6	92	01.99-03.00	D16Y8	4	<b>Z 158</b>	14 FR-7 LUX	1,1	○

### CIVIC VI Fastback

1.4 i	1.4	55	09.95-02.01	D14A5/D14A7	4	<b>Z 16</b>	14 FR-7 DUX	1,1	<b>UXT 1<sup>3</sup></b>
1.4 16V	1.4	55	01.97-02.01	D14A7	4	<b>Z 158</b>	14 FR-7 LUX	1,1	○
1.4 i	1.4	66	09.94-01.97	D14A8/D14A2	4	<b>Z 16</b>	14 FR-7 DUX	1,1	<b>UXT 1<sup>3</sup></b>
1.4 16V	1.4	66	01.97-02.01	D14A8	4	<b>Z 158</b>	14 FR-7 LUX	1,1	○
1.5 i Vtec-E	1.5	66	09.94-01.97	D15Z3	4	<b>Z 158</b>	14 FR-7 LUX	1,1	○
1.5 16V	1.5	84	01.97-02.01	D15Z8	4	<b>Z 158</b>	14 FR-7 LUX	1,1	○
1.6 i	1.6	83	09.94-01.97	D16Y3	4	<b>Z 16</b>	14 FR-7 DUX	1,1	<b>UXT 1<sup>3</sup></b>
1.6 16V	1.6	85	01.97-02.01	D16B2	4	<b>Z 158</b>	14 FR-7 LUX	1,1	○
1.6 i Vtec	1.6	93	09.94-01.97	D16Y2	4	<b>Z 16</b>	14 FR-7 DUX	1,1	<b>UXT 1<sup>3</sup></b>
1.6 Vti	1.6	118	01.97-02.01	B16A2	4	<b>Z 16</b>	14 FR-7 DUX	1,1	<b>UXT 1<sup>3</sup></b>
1.8 16V	1.8	124	01.97-02.01	B18C4	4	<b>Z 16</b>	14 FR-7 DUX	1,1	<b>UXT 1<sup>3</sup></b>
2.0 i TD	2.0	63	01.97-02.01	20T2R	4	<b>GN 073 (11V)</b>	○		

### CIVIC VI Hatchback

1.4 i	1.4	55	11.95-02.01	D 14A3	4	<b>Z 16</b>	14 FR-7 DUX	1,1	<b>UXT 1<sup>3</sup></b>
1.4 i	1.4	55	11.95-02.01	D 14Z1	4	<b>Z 158</b>	14 FR-7 LUX	1,1	○
1.4 i S	1.4	66	11.95-02.01	D 14A4	4	<b>Z 16</b>	14 FR-7 DUX	1,1	<b>UXT 1<sup>3</sup></b>
1.5 i	1.5	84	11.95-02.01	D15Z6	4	<b>Z 158</b>	14 FR-7 LUX	1,1	○
1.6 i	1.6	84	11.95-02.01	D16V5	4	<b>Z 98</b>	14 FR-7 LDU	0,8	<b>UXT 1<sup>3</sup></b>
1.6 Vti	1.6	118	11.95-02.01	B16A2	4	<b>Z 16</b>	14 FR-7 DUX	1,1	<b>UXT 1<sup>3</sup></b>

### CIVIC VII

1.4	1.4	66	02.01-09.05	D14Z5	4	<b>Z 158</b>	14 FR-7 LUX	1,1	○
1.6	1.6	81	02.01-09.05	D16V1	4	<b>Z 158</b>	14 FR-7 LUX	1,1	○
1.8	1.8	103	02.01-09.05	R18A1	4	<b>Z 275</b>	14 FR-6 LPUOX	1,1	○
2.0	2.0	118	10.03-09.05	K20A3	4	<b>Z 299</b>	14 FR-7 LUXO	1,0	○

### CIVIC VII Coupe

1.6 i	1.6	81	02.01-12.05	D16V1	4	<b>Z 158</b>	14 FR-7 LUX	1,1	○
1.7 i	1.7	88	05.01-12.05	D17A8	4	<b>Z 158</b>	14 FR-7 LUX	1,1	○
1.7 i VTEC	1.7	92	05.01-12.05	D 17A5	4	<b>Z 158</b>	14 FR-7 LUX	1,1	○

### CIVIC VII Hatchback

1.4 i	1.4	55	02.01-09.05	D14Z6	4	<b>Z 158</b>	14 FR-7 LUX	1,1	○
1.4 iS	1.4	66	02.01-09.05	D14Z5/D14Z6	4	<b>Z 158</b>	14 FR-7 LUX	1,1	○
1.6 i	1.6	81	02.01-09.05	D16V1	4	<b>Z 158</b>	14 FR-7 LUX	1,1	○
1.7 CTDi	1.7	74	01.02-09.05	4EE-2	4	<b>GN 104 (11V)</b>	○		
2.0 i Sport	2.0	118	01.04-09.05	K20A3	4	<b>Z 299</b>	14 FR-7 LUXO	1,0	○

### CIVIC VIII

2.0	2.0	114	02.06-	K20A3	4	<b>Z 299</b>	14 FR-7 LUXO	1,0	○
-----	-----	-----	--------	-------	---	--------------	--------------	-----	---

### CIVIC VIII Hatchback

1.4	1.3	61	01.06-10.08	L13A7	4	<b>Z 312</b>	14 FR-7 KPPU	1,1	○
1.8	1.8	103	01.06-	R18A2	4	<b>Z 275</b>	14 FR-6 LPUOX	1,1	○
2.2 CTDi	2.2	103	01.06-	N22A2	4	<b>GN 073 (11V)</b>	○		

### CONCERTO

1.5 i 16V	1.5	66	08.89-03.95	D15B2	4	<b>Z 99</b>	14 FR-6 DUX	1,0	<b>UXT 5</b>
1.6 i 16V	1.6	82	08.89-03.95	D16Z2	4	<b>Z 16</b>	14 FR-7 DUX	1,1	<b>UXT 1<sup>3</sup></b>
1.6 i 16V	1.6	90	08.89-03.95	D16A8	4	<b>Z 16</b>	14 FR-7 DUX	1,1	<b>UXT 1<sup>3</sup></b>

### CR-VI

2.0 16V	2.0	94	10.95-01.99	B20B	4	<b>Z 158</b>	14 FR-7 LUX	1,1	○
2.0 16V	2.0	108	01.99-02.02	B20Z1	4	<b>Z 158</b>	14 FR-7 LUX	1,1	○

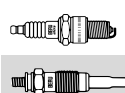
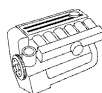

## HONDA

### CR-V II

2.0	2.0	110	07.02-09.06	K20A4	4	<b>Z 299</b>	14 FR-7 LUXO	1,0	○
2.2 CTDi	2.2	103	02.05-09.06	N22A2	4	<b>GN 073</b> (11V)	○		

### CR-V III

2.0 i	2.0	110	01.07-	R20A2	4	<b>Z 275</b>	14 FR-6 LPUOX	1,1	○
2.2 i-CTDi	2.2	103	01.07-	N22A2	4	<b>GN 073</b> (11V)	○		

### CRX II

1.6 i 16V	1.6	91	10.87-02.92	D16Z5	4	<b>Z 16</b>	14 FR-7 DUX	1,1	<b>UXT 1<sup>3</sup></b>
1.6 i 16V Vtec	1.6	110	10.89-02.92	B16A1	4	<b>Z 16</b>	14 FR-7 DUX	1,1	<b>UXT 1<sup>3</sup></b>

### CRX III

1.6 ESi	1.6	92	03.92-12.98	D 16Z6	4	<b>Z 16</b>	14 FR-7 DUX	1,1	<b>UXT 1<sup>3</sup></b>
1.6 i VTi	1.6	118	03.92-12.98	B16A2	4	<b>Z 16</b>	14 FR-7 DUX	1,1	<b>UXT 1<sup>3</sup></b>

### FR-V

1.7	1.7	92	08.04-	D17A2	4	<b>Z 158</b>	14 FR-7 LUX	1,1	○
1.8	1.8	103	01.07-	R18A1	4	<b>Z 275</b>	14 FR-6 LPUOX	1,1	○
2.0	2.0	110	02.05-09.06	K20A9	4	<b>Z 299</b>	14 FR-7 LUXO	1,0	○
2.0	2.0	114	08.04-09.06	K20A9	4	<b>Z 299</b>	14 FR-7 LUXO	1,0	○
2.0 4x4	2.0	114	08.04-09.06	K20A9	4	<b>Z 299</b>	14 FR-7 LUXO	1,0	○
2.2 i CTDi	2.2	103	07.05-	N22A1	4	<b>GN 073</b> (11V)	○		

### HR-V

1.6 16V 4WD	1.6	77	03.99-	D16W1	4	<b>Z 158</b>	14 FR-7 LUX	1,1	○
1.6 16V	1.6	77	03.99-	D16W1	4	<b>Z 158</b>	14 FR-7 LUX	1,1	○
1.6 16V 4WD	1.6	91	10.99-	D16W5	4	<b>Z 158</b>	14 FR-7 LUX	1,1	○

### INTEGRA

2.0	2.0	118	02.02-	K20A3	4	<b>Z 299</b>	14 FR-7 LUXO	1,0	○
-----	-----	-----	--------	-------	---	--------------	--------------	-----	---

### INTEGRA Coupe

1.8 Type-R	1.8	140	11.97-10.01	B18C6	4	<b>Z 284</b>	14 FR-6 DPOX	1,1	<b>UXT 14</b>
------------	-----	-----	-------------	-------	---	--------------	--------------	-----	---------------

### JAZZ II

1.2	1.2	57	03.02-	L12A1	4	<b>Z 16</b>	14 FR-7 DUX	1,1	<b>UXT 1<sup>3</sup></b>
1.3 iDSi	1.3	63	03.02-09.07	L13A1	4	<b>Z 16</b>	14 FR-7 DUX	1,1	<b>UXT 1<sup>3</sup></b>
1.4	1.3	61	03.02-07.08	L13A1	4	<b>Z 16</b>	14 FR-7 DUX	1,1	<b>UXT 1<sup>3</sup></b>

### LEGEND I

2.7 i 24V	2.7	124	01.88-12.90	C27A1	6	<b>Z 16</b>	14 FR-7 DUX	1,1	<b>UXT 1<sup>3</sup></b>
-----------	-----	-----	-------------	-------	---	-------------	-------------	-----	--------------------------

### LEGEND I Coupe

2.7 i 24V	2.7	124	10.87-12.90	C27A1	6	<b>Z 16</b>	14 FR-7 DUX	1,1	<b>UXT 1<sup>3</sup></b>
-----------	-----	-----	-------------	-------	---	-------------	-------------	-----	--------------------------

### LEGEND II

3.2 i 24V	3.2	151	01.91-02.96	C32A2	6	<b>Z 284</b>	14 FR-6 DPOX	1,1	<b>UXT 14</b>
-----------	-----	-----	-------------	-------	---	--------------	--------------	-----	---------------

### LEGEND II Coupe

3.2 i 24V	3.2	151	01.91-02.96	C32A2	6	<b>Z 284</b>	14 FR-6 DPOX	1,1	<b>UXT 14</b>
-----------	-----	-----	-------------	-------	---	--------------	--------------	-----	---------------

### LEGEND III

3.5 i 24V	3.5	151	02.96-	C35A2	6	<b>Z 284</b>	14 FR-6 DPOX	1,1	<b>UXT 14</b>
-----------	-----	-----	--------	-------	---	--------------	--------------	-----	---------------

### LEGEND IV

3.5 V6 4WD	3.5	217	05.06-	C35A8	6	<b>Z 354</b>	14 FR-5 LPUOX	1,1	○
------------	-----	-----	--------	-------	---	--------------	---------------	-----	---

### LOGO

1.3	1.3	48	03.99-03.02	D13B7	4	<b>Z 158</b>	14 FR-7 LUX	1,1	○
-----	-----	----	-------------	-------	---	--------------	-------------	-----	---

### NSX Cabriolet

3.0 24V Vtec Automatic	3.0	188	03.95-09.05	C30A4	6	<b>Z 284</b>	14 FR-6 DPOX	1,1	<b>UXT 14</b>
3.0 24V Vtec	3.0	201	03.95-09.05	C30A3	6	<b>Z 284</b>	14 FR-6 DPOX	1,1	<b>UXT 14</b>
3.2 24V Vtec	3.2	206	01.97-09.05	C32B2	6	<b>Z 284</b>	14 FR-6 DPOX	1,1	<b>UXT 14</b>

### NSX Coupe

3.0 24V Vtec Automatic	3.0	188	06.90-09.05	C30A4	6	<b>Z 284</b>	14 FR-6 DPOX	1,1	<b>UXT 14</b>
3.0 24V Vtec	3.0	201	06.90-09.05	C30A3	6	<b>Z 284</b>	14 FR-6 DPOX	1,1	<b>UXT 14</b>
3.2 24V Vtec	3.2	206	01.97-09.05	C32B2	6	<b>Z 284</b>	14 FR-6 DPOX	1,1	<b>UXT 14</b>

### PRELUDE III

2.0 EX	2.0	80	04.87-01.92	B20A3	4	<b>Z 16</b>	14 FR-7 DUX	1,1	<b>UXT 1<sup>3</sup></b>
2.0	2.0	84	08.87-01.92	B20A4	4	<b>Z 16</b>	14 FR-7 DUX	1,1	<b>UXT 1<sup>3</sup></b>
2.0 i EX 16V KAT	2.0	101	04.87-01.92	B20A5	4	<b>Z 16</b>	14 FR-7 DUX	1,1	<b>UXT 1<sup>3</sup></b>
2.0 i EX 16V	2.0	103	04.90-01.92	B20A9	4	<b>Z 16</b>	14 FR-7 DUX	1,1	<b>UXT 1<sup>3</sup></b>
2.0 i EX 16V	2.0	110	10.87-12.90	B20A7	4	<b>Z 16</b>	14 FR-7 DUX	1,1	<b>UXT 1<sup>3</sup></b>

### PRELUDE IV

2.0 i 16V	2.0	98	02.92-09.96	F20A4	4	<b>Z 158</b>	14 FR-7 LUX	1,1	○
2.2 i 16V Vtec	2.2	136	02.93-09.96	H22A2	4	<b>Z 158</b>	14 FR-7 LUX	1,1	○



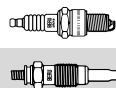
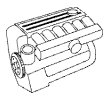

## HONDA

### PRELUDE IV

2.3 i 16V	2.3	118	02.92-09.96	H23A2	4	<b>Z 158</b>	14 FR-7 LUX	1,1	○
-----------	-----	-----	-------------	-------	---	--------------	-------------	-----	---

### PRELUDE V

2.0 16V	2.0	98	10.96-10.00	F20A4	4	<b>Z 158</b>	14 FR-7 LUX	1,1	○
2.2 16V	2.2	136	10.96-10.00	H22A5	4	<b>Z 228</b>	14 FR-7 DPUX02	1,0	<b>UXT 11</b>
2.2 16V	2.2	147	10.96-10.00	H22A5	4	<b>Z 228</b>	14 FR-7 DPUX02	1,0	<b>UXT 11</b>

### S2000

2.0	2.0	177	06.99-	F20C VTEC	4	<b>Z 323</b>	14 FR-5 DPPUX	1,1	○
-----	-----	-----	--------	-----------	---	--------------	---------------	-----	---

### SHUTTLE

2.2 16V	2.2	110	10.94-02.98	F22B8	4	<b>Z 158</b>	14 FR-7 LUX	1,1	○
2.3 16V	2.3	110	10.97-06.04	F23A7	4	<b>Z 158</b>	14 FR-7 LUX	1,1	○

### STEPWAGON

2.0	2.0	118	10.00-09.05	K20A9	4	<b>Z 299</b>	14 FR-7 LUX0	1,0	○
2.0 4WD	2.0	118	10.00-09.05	K20A9	4	<b>Z 299</b>	14 FR-7 LUX0	1,0	○

### STREAM

1.7 16V	1.7	92	05.01-	D17A2	4	<b>Z 158</b>	14 FR-7 LUX	1,1	○
2.0 16V	2.0	115	05.01-09.05	K20A1	4	<b>Z 299</b>	14 FR-7 LUX0	1,0	○

## HUMMER

### HUMMER H1

6.5 D	6.5	125	01.92-		8	<b>GV 004</b> (10,5V)	○		
6.5 Turbo D	6.5	143	01.92-		8	<b>GV 004</b> (10,5V)	○		

## HYUNDAI

### ACCENT

1.3	1.3	44	10.94-01.00	G4EH	4	<b>Z 73</b>	14 FR-8 DUX	1,1	<b>UXT 13</b>
1.3	1.3	55	10.94-01.00	G4EH	4	<b>Z 73</b>	14 FR-8 DUX	1,1	<b>UXT 13</b>
1.3 i 12V	1.3	62	10.94-01.00	G4EH	4	<b>Z 73</b>	14 FR-8 DUX	1,1	<b>UXT 13</b>
1.4 GL	1.4	71	11.05-	G4EE	4	<b>Z 16</b>	14 FR-7 DUX	1,1	<b>UXT 13</b>
1.5 CRDi	1.5	60	01.02-11.05	D3-EA	3	<b>GN 035</b> (11V)	○		
1.5 i 12V	1.5	65	10.94-01.00	G4EK	4	<b>Z 73</b>	14 FR-8 DUX	1,1	<b>UXT 13</b>
1.5	1.5	66	01.00-11.05	G4EB	4	<b>Z 73</b>	14 FR-8 DUX	1,1	<b>UXT 13</b>
1.5 i 16V	1.5	73	10.95-01.00	G4ER	4	<b>Z 73</b>	14 FR-8 DUX	1,1	<b>UXT 13</b>
1.5 CRDi GLS	1.5	81	11.05-	D4FA	4	<b>GN 062</b> (11V)	○		
1.6	1.6	77	12.02-11.05	G4ED-G	4	<b>Z 73</b>	14 FR-8 DUX	1,1	<b>UXT 13</b>

### ACCENT I

1.3	1.3	44	10.94-01.00	G4EH	4	<b>Z 73</b>	14 FR-8 DUX	1,1	<b>UXT 13</b>
1.3	1.3	55	10.94-01.00	G4EH	4	<b>Z 73</b>	14 FR-8 DUX	1,1	<b>UXT 13</b>
1.3 i 12V	1.3	62	10.94-01.00	G4EH	4	<b>Z 73</b>	14 FR-8 DUX	1,1	<b>UXT 13</b>
1.5 i 12V	1.5	65	10.94-01.00	G4EK	4	<b>Z 73</b>	14 FR-8 DUX	1,1	<b>UXT 13</b>
1.5 i 16V	1.5	73	12.95-01.00	G4ER	4	<b>Z 73</b>	14 FR-8 DUX	1,1	<b>UXT 13</b>

### ACCENT II

1.3	1.3	55	01.00-11.05	G4E-A	4	<b>Z 73</b>	14 FR-8 DUX	1,1	<b>UXT 13</b>
1.3	1.3	61	01.00-11.05	G4E-A	4	<b>Z 73</b>	14 FR-8 DUX	1,1	<b>UXT 13</b>
1.3	1.3	62	08.02-11.05		4	<b>Z 73</b>	14 FR-8 DUX	1,1	<b>UXT 13</b>
1.3	1.3	63	01.00-11.05	G4E-A	4	<b>Z 73</b>	14 FR-8 DUX	1,1	<b>UXT 13</b>
1.5	1.5	66	01.00-11.05	G4EB	4	<b>Z 73</b>	14 FR-8 DUX	1,1	<b>UXT 13</b>
1.5	1.5	75	09.00-11.05	G4EC-G	4	<b>Z 73</b>	14 FR-8 DUX	1,1	<b>UXT 13</b>
1.5 CRDi	1.5	60	04.02-11.05	D3-EA	3	<b>GN 035</b> (11V)	○		
1.6	1.6	77	12.02-11.05	G4ED-G	4	<b>Z 73</b>	14 FR-8 DUX	1,1	<b>UXT 13</b>

### ACCENT III

1.4 GL	1.4	71	11.05-	G4EE	4	<b>Z 16</b>	14 FR-7 DUX	1,1	<b>UXT 13</b>
1.5 CRDi GLS	1.5	81	11.05-	D4FA	4	<b>GN 062</b> (11V)	○		
1.6 GLS	1.6	82	11.05-	G4ED	4	<b>Z 16</b>	14 FR-7 DUX	1,1	<b>UXT 13</b>

### ACCENT IV

1.6 CRDi	1.6	94	10.11-	D4FB	4	<b>GN 062</b> (11V)	○		
----------	-----	----	--------	------	---	---------------------	---	--	--

### ATOS

1.0 i	1.0	40	02.98-03.02	G4HC	4	<b>Z 73</b>	14 FR-8 DUX	1,1	<b>UXT 13</b>
1.0 i	1.0	43	03.01-	G4HC-E	4	<b>Z 73</b>	14 FR-8 DUX	1,1	<b>UXT 13</b>
1.1	1.1	46	03.04-	G4HG	4	<b>Z 73</b>	14 FR-8 DUX	1,1	<b>UXT 13</b>

### ATOS PRIME

1.0 i	1.0	40	08.99-	G4HC	4	<b>Z 73</b>	14 FR-8 DUX	1,1	<b>UXT 13</b>
-------	-----	----	--------	------	---	-------------	-------------	-----	---------------

● nicht erforderlich  
○ nicht im Programm

<sup>3</sup> wahlweise UXT 3 Platin

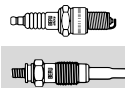
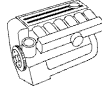

## HYUNDAI

### ATOS PRIME

1.0 i	1.0	43	03.01-	G4HC-E	4	Z 73	14 FR-8 DUX	1,1	UXT 1 <sup>3</sup>
1.1	1.1	43	06.03-	G4HD	4	Z 73	14 FR-8 DUX	1,1	UXT 1 <sup>3</sup>
1.1	1.1	46	09.05-03.08	G4HG	4	Z 73	14 FR-8 DUX	1,1	UXT 1 <sup>3</sup>

### COUPE

1.6 16V	1.6	77	03.02-08.09	G4ED-G	4	Z 16	14 FR-7 DUX	1,1	UXT 1 <sup>3</sup>
1.6 16V	1.6	79	03.02-08.09	G4ED-G	4	Z 16	14 FR-7 DUX	1,1	UXT 1 <sup>3</sup>
1.6 i 16V	1.6	84	12.96-04.02	4G61	4	Z 73	14 FR-8 DUX	1,1	UXT 1 <sup>3</sup>
1.6 16V	1.6	85	03.98-04.02	G4GR	4	Z 73	14 FR-8 DUX	1,1	UXT 1 <sup>3</sup>
2.0 16V	2.0	99	03.01-04.02	G4DF	4	Z 16	14 FR-7 DUX	1,1	UXT 1 <sup>3</sup>
2.0	2.0	102	03.02-08.09	G4GC-G	4	Z 73	14 FR-8 DUX	1,1	UXT 1 <sup>3</sup>
2.0 16V	2.0	102	08.96-04.02	G4GF Kat.	4	Z 73	14 FR-8 DUX	1,1	UXT 1 <sup>3</sup>
2.0 16V	2.0	102	08.96-04.02	G4GF ohne Kat.	4	Z 15	14 FR-7 DU	0,8	UXT 1 <sup>3</sup>
2.0 GLS	2.0	105	02.03-08.09	G4GC-G	4	Z 16	14 FR-7 DUX	1,1	UXT 1 <sup>3</sup>
2.7 V6	2.7	123	03.02-08.09	G6BA-G	6	Z 228	14 FR-7 DPUX02	1,0	UXT 11

### ELANTRA

1.6	1.6	77	05.03-07.06	G4ED-G	4	Z 73	14 FR-8 DUX	1,1	UXT 1 <sup>3</sup>
1.6	1.6	79	06.00-07.06	G4ED-G	4	Z 73	14 FR-8 DUX	1,1	UXT 1 <sup>3</sup>
1.6	1.6	82	04.04-07.06	G4GA	4	Z 312	14 FR-7 KPPU	1,1	○
1.6 CRDi	1.6	85	02.06-07.06	D4FB	4	GN 062 (11V)	○		
1.8	1.8	97	06.00-07.06	G4BB	4	Z 73	14 FR-8 DUX	1,1	UXT 1 <sup>3</sup>
1.8	1.8	98	05.04-07.06	G4GB	4	Z 312	14 FR-7 KPPU	1,1	○
2.0 CRDi	2.0	83	04.01-07.06	D4EA	4	GN 035 (11V)	○		
2.0	2.0	102	06.00-07.06	G4GC-G	4	Z 73	14 FR-8 DUX	1,1	UXT 1 <sup>3</sup>
2.0	2.0	104	06.00-07.06	G4GC	4	Z 73	14 FR-8 DUX	1,1	UXT 1 <sup>3</sup>
2.0	2.0	105	10.03-07.06	G4GC	4	Z 73	14 FR-8 DUX	1,1	UXT 1 <sup>3</sup>

### EQUUS / CENTENNIAL

3.5	3.5	155	08.00-03.05	G6CU	6	Z 312	14 FR-7 KPPU	1,1	○
4.5	4.5	195	08.00-09.03	8A80	8	Z 312	14 FR-7 KPPU	1,1	○

### GALLOPER I

2.5 TD	2.5	62	07.94-12.95	4D56T	4	GV 921 (11V)	○		
2.5 TD	2.5	62	01.96-07.98	4D56T	4	GN 107 (11V)	○		
2.5 TD intercooler	2.5	70	07.94-12.95	4D56T	4	GV 921 (11V)	○		
2.5 TD intercooler	2.5	70	01.96-07.98	4D56T	4	GN 107 (11V)	○		
3.0 V6	3.0	104	08.91-07.98	6G72	6	Z 73	14 FR-8 DUX	1,1	UXT 1 <sup>3</sup>

### GALLOPER II

2.5 TD intercooler	2.5	73	08.98-12.03	D4BH	4	GV 921 (11V)	○		
2.5 Tci D	2.5	77	08.98-12.03	D4BH	4	GN 955 (11V)	○		
3.0 V6	3.0	104	08.98-12.03	G6AT	6	Z 343	14 FR-8 DPPIX	1,1	○

### GETZ

1.1	1.1	46	09.02-09.05	G4HD	4	Z 73	14 FR-8 DUX	1,1	UXT 1 <sup>3</sup>
1.1	1.1	49	09.05-06.09	G4HD	4	Z 73	14 FR-8 DUX	1,1	UXT 1 <sup>3</sup>
1.3 i	1.3	60	09.02-03.04	G4E-A	4	Z 73	14 FR-8 DUX	1,1	UXT 1 <sup>3</sup>
1.3	1.3	63	09.03-09.05	G4E-A	4	Z 73	14 FR-8 DUX	1,1	UXT 1 <sup>3</sup>
1.4 i	1.4	71	08.05-06.09	G4EE	4	Z 73	14 FR-8 DUX	1,1	UXT 1 <sup>3</sup>
1.5 CRDi	1.5	60	03.03-09.05	D3-EA	3	GN 035 (11V)	○		
1.5 CRDi	1.5	65	08.05-06.09	D4FA	4	GN 062 (11V)	○		
1.5 CRDi GLS	1.5	81	08.05-06.09	D4FA	4	GN 062 (11V)	○		
1.6	1.6	77	09.02-09.05	G4ED-G	4	Z 73	14 FR-8 DUX	1,1	UXT 1 <sup>3</sup>
1.6	1.6	78	08.05-06.09	G4ED-G	4	Z 73	14 FR-8 DUX	1,1	UXT 1 <sup>3</sup>

### GRANDEUR

3.3	3.3	173	04.05-	G6DB	6	Z 240	14 F-8 DPURX02	1,0	UXT 9
-----	-----	-----	--------	------	---	-------	----------------	-----	-------

### HIGHWAY VAN

2.0 16V	2.0	100	03.00-		4	Z 343	14 FR-8 DPPIX	1,1	○
2.7 V6 24V	2.7	125	03.00-	G6BA	6	Z 343	14 FR-8 DPPIX	1,1	○

### i10

1.1	1.1	48	12.07-	G4HG	4	Z 73	14 FR-8 DUX	1,1	UXT 1 <sup>3</sup>
1.1	1.1	49	01.08-	G4HG	4	Z 73	14 FR-8 DUX	1,1	UXT 1 <sup>3</sup>

### i20

1.6 CRDi	1.6	85	09.08-	D4FB	4	GN 062 (11V)	○		
----------	-----	----	--------	------	---	--------------	---	--	--

### i30

1.6 CRDi	1.6	85	10.07-11.11	D4FB	4	GN 062 (11V)	○		
----------	-----	----	-------------	------	---	--------------	---	--	--

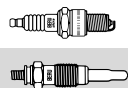
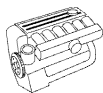

## HYUNDAI

i30									
1.6 CRDi	1.6	94	01.10–11.11	D4FB	4	<b>GN 062</b> (11V)	○		
2.0 CRDi	2.0	103	10.07–11.11	D4EA	4	<b>GN 035</b> (11V)	○		
2.0	2.0	105	10.07–11.11	G4GC-G/G4GC	4	<b>Z 73</b>	14 FR-8 DUX	1,1	<b>UXT 1<sup>3</sup></b>
ix20									
1.6 CRDi	1.6	85	06.11–	D4FB	4	<b>GN 062</b> (11V)	○		
ix35									
2.0	2.0	120	01.10–	G4KD	4	<b>Z 183</b>	14 FR-8 MU2	0,9	<b>UXT 13</b>
2.0 Allrad	2.0	120	01.10–	G4KD	4	<b>Z 183</b>	14 FR-8 MU2	0,9	<b>UXT 13</b>
2.0	2.0	122	01.10–	G4KD	4	<b>Z 183</b>	14 FR-8 MU2	0,9	<b>UXT 13</b>
ix55									
3.0 V6 CRDi	3.0	176	09.08–	D6EA	6	<b>GE 113</b> (4,4V)	○		
LANTRA I									
1.5 i.e.	1.5	63	10.90–11.95	G15B/G4DJ	4	<b>Z 21</b>	14 R-7 DUX	1,1	<b>UXT 2<sup>4</sup></b>
1.6 i.e. 16V	1.6	78	10.90–11.95	G4CR ohne Kat.	4	<b>Z 20</b>	14 R-7 DU	0,8	<b>UXT 2<sup>4</sup></b>
1.6 i.e. 16V	1.6	78	10.90–11.95	G4CR Kat.	4	<b>Z 21</b>	14 R-7 DUX	1,1	<b>UXT 2<sup>4</sup></b>
1.6 i.e. 16V	1.6	84	10.90–11.95	G4CR ohne Kat.	4	<b>Z 20</b>	14 R-7 DU	0,8	<b>UXT 2<sup>4</sup></b>
1.6 i.e. 16V	1.6	84	10.90–11.95	G4CR Kat.	4	<b>Z 21</b>	14 R-7 DUX	1,1	<b>UXT 2<sup>4</sup></b>
1.8 i.e. 16V	1.8	93	10.90–11.95	G4CN ohne Kat.	4	<b>Z 20</b>	14 R-7 DU	0,8	<b>UXT 2<sup>4</sup></b>
1.8 i.e. 16V	1.8	93	10.90–11.95	G4CN Kat.	4	<b>Z 21</b>	14 R-7 DUX	1,1	<b>UXT 2<sup>4</sup></b>
LANTRA II									
1.5 12V	1.5	65	12.96–09.00	G4EK	4	<b>Z 16</b>	14 FR-7 DUX	1,1	<b>UXT 1<sup>3</sup></b>
1.6 i	1.6	66	11.95–09.00	G4GR	4	<b>Z 73</b>	14 FR-8 DUX	1,1	<b>UXT 1<sup>3</sup></b>
1.6 16V	1.6	84	11.95–09.00	4G61	4	<b>Z 73</b>	14 FR-8 DUX	1,1	<b>UXT 1<sup>3</sup></b>
1.8 16V	1.8	94	11.95–09.00	G4GM	4	<b>Z 73</b>	14 FR-8 DUX	1,1	<b>UXT 1<sup>3</sup></b>
2.0 16V	2.0	102	08.96–09.00	G4GF	4	<b>Z 73</b>	14 FR-8 DUX	1,1	<b>UXT 1<sup>3</sup></b>
LANTRA II Wagon									
1.5 12V	1.5	65	04.97–10.00	G4EK	4	<b>Z 16</b>	14 FR-7 DUX	1,1	<b>UXT 1<sup>3</sup></b>
1.6 i	1.6	66	02.96–10.00	G4GR	4	<b>Z 73</b>	14 FR-8 DUX	1,1	<b>UXT 1<sup>3</sup></b>
1.6 16V	1.6	84	02.96–10.00	4G61	4	<b>Z 73</b>	14 FR-8 DUX	1,1	<b>UXT 1<sup>3</sup></b>
1.8 16V	1.8	94	02.96–10.00	G4GM	4	<b>Z 73</b>	14 FR-8 DUX	1,1	<b>UXT 1<sup>3</sup></b>
2.0 16V	2.0	102	12.96–10.00	G4GF	4	<b>Z 73</b>	14 FR-8 DUX	1,1	<b>UXT 1<sup>3</sup></b>
MATRIX									
1.5 CRDi	1.5	60	10.01–08.10	D3-EA	3	<b>GN 035</b> (11V)	○		
1.5 CRDi	1.5	75	12.04–08.10	D4FA	4	<b>GN 062</b> (11V)	○		
1.5 CRDi VGT	1.5	81	03.08–08.10	D4FA	4	<b>GN 062</b> (11V)	○		
1.6	1.6	76	06.01–08.10	G4ED-G	4	<b>Z 73</b>	14 FR-8 DUX	1,1	<b>UXT 1<sup>3</sup></b>
1.8	1.8	90	06.01–08.10	G4GB-G	4	<b>Z 73</b>	14 FR-8 DUX	1,1	<b>UXT 1<sup>3</sup></b>
PONY									
1.2	1.2	40	06.74–		4	<b>Z 8</b>	14 R-8 DU	0,8	<b>UXT 2<sup>4</sup></b>
1.3	1.3	43	10.89–01.95	G4DG	4	<b>Z 9</b>	14 R-8 DUX	1,1	<b>UXT 2<sup>4</sup></b>
1.3	1.3	49	10.89–01.95	G4DG	4	<b>Z 9</b>	14 R-8 DUX	1,1	<b>UXT 2<sup>4</sup></b>
1.4	1.4	50	08.77–		4	<b>Z 8</b>	14 R-8 DU	0,8	<b>UXT 2<sup>4</sup></b>
1.5	1.5	53	10.89–01.95	G15B/G4DJ	4	<b>Z 9</b>	14 R-8 DUX	1,1	<b>UXT 2<sup>4</sup></b>
1.5 i	1.5	61	10.89–01.95	G15B/G4DJ	4	<b>Z 21</b>	14 R-7 DUX	1,1	<b>UXT 2<sup>4</sup></b>
1.5 i	1.5	62	10.89–01.95	G15B/G4DJ	4	<b>Z 21</b>	14 R-7 DUX	1,1	<b>UXT 2<sup>4</sup></b>
PONY / EXCEL									
1.3	1.3	49	01.90–01.95	G4DG	4	<b>Z 9</b>	14 R-8 DUX	1,1	<b>UXT 2<sup>4</sup></b>
1.5	1.5	53	01.90–01.95	G15B/G4DJ	4	<b>Z 9</b>	14 R-8 DUX	1,1	<b>UXT 2<sup>4</sup></b>
1.5 i	1.5	61	01.90–01.95	G15B/G4DJ	4	<b>Z 9</b>	14 R-8 DUX	1,1	<b>UXT 2<sup>4</sup></b>
1.5 i	1.5	62	01.90–01.95	G15B/G4DJ	4	<b>Z 9</b>	14 R-8 DUX	1,1	<b>UXT 2<sup>4</sup></b>
PONY Wagon									
1.2	1.2	40	02.78–		4	<b>Z 8</b>	14 R-8 DU	0,8	<b>UXT 2<sup>4</sup></b>
1.4	1.4	50	02.78–		4	<b>Z 8</b>	14 R-8 DU	0,8	<b>UXT 2<sup>4</sup></b>
S COUPE									
1.5 i	1.5	62	02.90–06.92	G15B/G4DJ Kat.	4	<b>Z 21</b>	14 R-7 DUX	1,1	<b>UXT 2<sup>4</sup></b>
1.5 i	1.5	65	04.92–05.96	G4EK	4	<b>Z 73</b>	14 FR-8 DUX	1,1	<b>UXT 1<sup>3</sup></b>
1.5 i Turbo	1.5	85	04.91–05.96	G4EK-TC	4	<b>Z 73</b>	14 FR-8 DUX	1,1	<b>UXT 1<sup>3</sup></b>
SANTA FÉ I									
2.0 CRDi	2.0	83	08.01–03.06	D4EA	4	<b>GN 035</b> (11V)	○		
2.0 CRDi 4x4	2.0	83	04.01–03.06	D4EA	4	<b>GN 035</b> (11V)	○		
2.0 CRDi 4x4	2.0	92	08.03–03.06	D4EA	4	<b>GN 035</b> (11V)	○		

● nicht erforderlich  
○ nicht im Programm

<sup>3</sup> wahlweise UXT 3 Platin

<sup>4</sup> wahlweise UXT 6 Platin

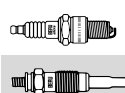
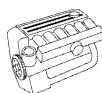
**HYUNDAI****SANTA FÉ I**

2.0	2.0	99	08.01-03.06	G4BP	4	<b>Z 343</b>	14 FR-8 DPPUX	1,1	○
2.2 CRDi	2.2	110	10.05-03.06	D4EB	4	<b>GN 035</b> (11V)	○		
2.2 CRDi 4x4	2.2	110	10.05-03.06	D4EB	4	<b>GN 035</b> (11V)	○		
2.4 16V	2.4	100	02.01-03.06	G4JS-G	4	<b>Z 311</b>	14 R-8 DPUU	1,0	<b>UXT 6</b>
2.4 16V 4x4	2.4	100	02.01-03.06	G4JS-G	4	<b>Z 311</b>	14 R-8 DPUU	1,0	<b>UXT 6</b>
2.4 16V	2.4	107	02.01-03.06	G4JS-G	4	<b>Z 311</b>	14 R-8 DPUU	1,0	<b>UXT 6</b>
2.4 16V 4x4	2.4	107	02.01-03.06	G4JS-G	4	<b>Z 311</b>	14 R-8 DPUU	1,0	<b>UXT 6</b>
2.7 V6 4x4	2.7	127	02.01-03.06	G6BA-G	6	<b>Z 228</b>	14 FR-7 DPUX02	1,0	<b>UXT 11</b>

**SANTA FÉ II**

2.2 CRDi	2.2	102	03.06-	D4EB	4	<b>GN 035</b> (11V)	○		
2.2 CRDi 4x4	2.2	102	03.06-	D4EB	4	<b>GN 035</b> (11V)	○		
2.2 CRDi GLS	2.2	110	03.06-	D4EB	4	<b>GN 035</b> (11V)	○		
2.2 CRDi GLS 4x4	2.2	110	03.06-	D4EB	4	<b>GN 035</b> (11V)	○		
2.2 CRDi	2.2	114	03.06-	D4EB	4	<b>GN 035</b> (11V)	○		
2.2 CRDi 4x4	2.2	114	03.06-	D4EB	4	<b>GN 035</b> (11V)	○		
2.4	2.4	128	11.10-	G4KE	4	<b>Z 183</b>	14 FR-8 MU2	0,9	<b>UXT 13</b>
2.7	2.7	125	03.06-	G6BA	6	<b>Z 343</b>	14 FR-8 DPPUX	1,1	○
2.7 4x4	2.7	125	03.06-	G6BA	6	<b>Z 343</b>	14 FR-8 DPPUX	1,1	○

**SONATA II**

1.8 i	1.8	70	09.88-10.93	G4G2	4	<b>Z 9</b>	14 R-8 DUX	1,1	<b>UXT 2<sup>4</sup></b>
2.0 i	2.0	74	09.88-08.91	G4CP	4	<b>Z 9</b>	14 R-8 DUX	1,1	<b>UXT 2<sup>4</sup></b>
2.0 i	2.0	80	01.91-10.93	G4CP-U	4	<b>Z 9</b>	14 R-8 DUX	1,1	<b>UXT 2<sup>4</sup></b>
2.0 i 16V	2.0	96	01.91-10.93	G4CP-D	4	<b>Z 9</b>	14 R-8 DUX	1,1	<b>UXT 2<sup>4</sup></b>
2.4 i	2.4	83	09.88-08.91	G4CS	4	<b>Z 9</b>	14 R-8 DUX	1,1	<b>UXT 2<sup>4</sup></b>
3.0 i V6	3.0	107	01.91-10.93	G6AT	6	<b>Z 82</b>	14 R-9 DU	0,7	<b>UXT 2<sup>4</sup></b>

**SONATA III**

1.8 i	1.8	72	05.93-06.98	G4CM	4	<b>Z 9</b>	14 R-8 DUX	1,1	<b>UXT 2<sup>4</sup></b>
2.0 i	2.0	70	08.96-06.98		4	<b>Z 21</b>	14 R-7 DUX	1,1	<b>UXT 2<sup>4</sup></b>
2.0 i	2.0	77	06.94-08.96	G4CP	4	<b>Z 1</b>	14-8 DU	0,8	<b>UXT 2<sup>4</sup></b>
2.0 i 16V	2.0	92	06.96-06.98	G4CP-DM	4	<b>Z 11</b>	14-7 DU	0,8	<b>UXT 2<sup>4</sup></b>
2.0 i 16V	2.0	102	05.93-04.96	G4CP-D	4	<b>Z 9</b>	14 R-8 DUX	1,1	<b>UXT 2<sup>4</sup></b>
2.0 i 16V	2.0	102	05.96-06.98	G4CP-D	4	<b>Z 11</b>	14-7 DU	0,8	<b>UXT 2<sup>4</sup></b>
3.0 i V6	3.0	107	05.93-06.98	G6AT	6	<b>Z 9</b>	14 R-8 DUX	1,1	<b>UXT 2<sup>4</sup></b>

**SONATA IV**

2.0 16V	2.0	96	10.01-11.04	G4JP-EG	4	<b>Z 9</b>	14 R-8 DUX	1,1	<b>UXT 2<sup>4</sup></b>
2.0 16V	2.0	100	06.98-10.01	G4JP-G	4	<b>Z 20</b>	14 R-7 DU	0,8	<b>UXT 2<sup>4</sup></b>
2.4 16V	2.4	105	03.98-10.01	G4BS	4	<b>Z 9</b>	14 R-8 DUX	1,1	<b>UXT 2<sup>4</sup></b>
2.5 V6 24V	2.5	118	06.98-10.01	G6BV-G	6	<b>Z 228</b>	14 FR-7 DPUX02	1,0	<b>UXT 11</b>
2.5 i V6	2.5	127	08.98-09.01	Kat.	6	<b>Z 312</b>	14 FR-7 KPPU	1,1	○
2.7 V6	2.7	127	10.01-11.04	G6BA-G	6	<b>Z 228</b>	14 FR-7 DPUX02	1,0	<b>UXT 11</b>
2.7 V6	2.7	129	11.02-11.04	G6BA Kat.	6	<b>Z 312</b>	14 FR-7 KPPU	1,1	○
2.7 i V6	2.7	132	10.01-05.05	G6BA-Y Kat.	6	<b>Z 312</b>	14 FR-7 KPPU	1,1	○

**SONATA V**

2.0 CRDi	2.0	100	02.06-	D4EA	4	<b>GN 035</b> (11V)	○		
2.0 CRDi	2.0	103	02.06-	D4EA	4	<b>GN 035</b> (11V)	○		
2.0 CRDi	2.0	110	03.09-	D4EA	4	<b>GN 035</b> (11V)	○		
2.0 VVTi GLS	2.0	121	01.08-	G4KD	4	<b>Z 183</b>	14 FR-8 MU2	0,9	<b>UXT 13</b>
2.4	2.4	119	01.05-	G4KC	4	<b>Z 9</b>	14 R-8 DUX	1,1	<b>UXT 2<sup>4</sup></b>
3.3	3.3	171	01.05-	G6DB	6	<b>Z 240</b>	14 F-8 DPURX02	1,0	<b>UXT 9</b>
3.3	3.3	173	06.05-	G6DB	6	<b>Z 240</b>	14 F-8 DPURX02	1,0	<b>UXT 9</b>
3.3	3.3	184	01.08-	G6DB	6	<b>Z 240</b>	14 F-8 DPURX02	1,0	<b>UXT 9</b>

**SONATA VI**

2.0 i	2.0	121	01.11-	G4KD	4	<b>Z 183</b>	14 FR-8 MU2	0,9	<b>UXT 13</b>
-------	-----	-----	--------	------	---	--------------	-------------	-----	---------------

**STELLAR**

1.6	1.6	56	10.83-12.91	G32B	4	<b>Z 8</b>	14 R-8 DU	0,8	<b>UXT 2<sup>4</sup></b>
-----	-----	----	-------------	------	---	------------	-----------	-----	--------------------------

**TERRACAN**

2.9 CRDi	2.9	110	11.01-07.03	J3	4	<b>GN 107</b> (11V)	○		
2.9 CRDi 4WD	2.9	110	12.01-12.06	J3	4	<b>GN 107</b> (11V)	○		
2.9 CRDi 4WD	2.9	120	11.03-12.06	J3	4	<b>GN 107</b> (11V)	○		
3.5 i V6 4WD	3.5	143	12.01-10.06	G6CU	6	<b>Z 228</b>	14 FR-7 DPUX02	1,0	<b>UXT 11</b>
3.5 i V6 4WD	3.5	147	12.01-12.06	G6CU	6	<b>Z 228</b>	14 FR-7 DPUX02	1,0	<b>UXT 11</b>

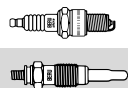
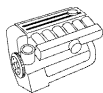

## HYUNDAI

### TRAJET

2.0 CRDi	2.0	83	04.01-07.08	D4EA	4	<b>GN 035</b> (11V)	○		
2.0 CRDi	2.0	92	08.05-07.08	D4EA	4	<b>GN 035</b> (11V)	○		
2.0	2.0	100	03.00-07.08	G4JP-G	4	<b>Z 21</b>	14 R-7 DUX	1,1	<b>UXT 2<sup>4</sup></b>
2.0	2.0	103	01.04-07.08	G4GC-G	4	<b>Z 73</b>	14 FR-8 DUX	1,1	<b>UXT 1<sup>3</sup></b>
2.7 V6	2.7	127	09.00-07.08	G6BA-G	6	<b>Z 228</b>	14 FR-7 DPUX02	1,0	<b>UXT 11</b>

### TUCSON

2.0 CRDi	2.0	83	08.04-03.10	D4EA	4	<b>GN 035</b> (11V)	○		
2.0 CRDi Allrad	2.0	83	08.04-03.10	D4EA	4	<b>GN 035</b> (11V)	○		
2.0 CRDi	2.0	88	01.07-03.10	D4EA	4	<b>GN 035</b> (11V)	○		
2.0 CRDi Allrad	2.0	88	01.07-03.10	D4EA	4	<b>GN 035</b> (11V)	○		
2.0 CRDi	2.0	100	01.06-03.10	D4EA	4	<b>GN 035</b> (11V)	○		
2.0 CRDi Allrad	2.0	100	01.06-03.10	D4EA	4	<b>GN 035</b> (11V)	○		
2.0 CRDi	2.0	103	01.06-03.10	D4EA-V	4	<b>GN 035</b> (11V)	○		
2.0 CRDi Allrad	2.0	103	01.06-03.10	D4EA-V/D4EA-F	4	<b>GN 035</b> (11V)	○		
2.0	2.0	104	08.04-03.10	G4GC	4	<b>Z 73</b>	14 FR-8 DUX	1,1	<b>UXT 1<sup>3</sup></b>
2.0 Allrad	2.0	104	08.04-03.10	G4GC	4	<b>Z 73</b>	14 FR-8 DUX	1,1	<b>UXT 1<sup>3</sup></b>
2.0 CRDi	2.0	110	01.09-03.10	D4EA	4	<b>GN 035</b> (11V)	○		
2.0 CRDi Allrad	2.0	110	01.09-03.10	D4EA	4	<b>GN 035</b> (11V)	○		
2.7 Allrad	2.7	129	08.04-03.10	G6BA-G	6	<b>Z 73</b>	14 FR-8 DUX	1,1	<b>UXT 1<sup>3</sup></b>

### XG

25	2.5	120	12.98-	G6AV	6	<b>Z 228</b>	14 FR-7 DPUX02	1,0	<b>UXT 11</b>
30/300	3.0	138	12.98-	G6CT-G	6	<b>Z 228</b>	14 FR-7 DPUX02	1,0	<b>UXT 11</b>
350	3.5	145	04.03-12.05	G6CU	6	<b>Z 228</b>	14 FR-7 DPUX02	1,0	<b>UXT 11</b>



### H-1

2.4	2.4	82	03.00-04.04	G4CS	4	<b>Z 9</b>	14 R-8 DUX	1,1	<b>UXT 2<sup>4</sup></b>
2.5 TD	2.5	59	03.00-09.00	D4BF	4	<b>GV 921</b> (11V)	○		
2.5 TD	2.5	73	03.00-08.02	D4BH	4	<b>GV 921</b> (11V)	○		
2.5 TD	2.5	74	10.01-07.03	D4BH	4	<b>GN 107</b> (11V)	○		
2.5 CRDi	2.5	103	08.03-04.04	D4CB	4	<b>GN 057</b> (11V)	○		

### H-1 / STAREX

2.4	2.4	82	06.97-04.04	G4CS	4	<b>Z 9</b>	14 R-8 DUX	1,1	<b>UXT 2<sup>4</sup></b>
2.4 4WD	2.4	82	02.98-04.04	G4CS	4	<b>Z 9</b>	14 R-8 DUX	1,1	<b>UXT 2<sup>4</sup></b>
2.5 D	2.5	57	10.97-04.04	D4BF	4	<b>GN 955</b> (11V)	○		
2.5 TD	2.5	59	06.97-04.04	D4BF	4	<b>GV 921</b> (11V)	○		
2.5 TD 4WD	2.5	59	02.98-04.04	D4BF	4	<b>GV 921</b> (11V)	○		
2.5 TD 4WD	2.5	73	03.01-04.04	D4BH	4	<b>GV 921</b> (11V)	○		
2.5 TD	2.5	74	11.01-07.03	D4BH	4	<b>GN 107</b> (11V)	○		
2.5 TD	2.5	74	08.03-04.04	D4BH	4	<b>GN 955</b> (11V)	○		
2.5 TD 4WD	2.5	74	11.01-04.04	D4BH	4	<b>GV 921</b> (11V)	○		

### H-1 Travel

2.5 CRDi	2.5	125	05.08-	D4CB	4	<b>GN 057</b> (11V)	○		
----------	-----	-----	--------	------	---	---------------------	---	--	--

### H100

2.4	2.4	84	01.97-03.00	G4CS	4	<b>Z 21</b>	14 R-7 DUX	1,1	<b>UXT 2<sup>4</sup></b>
2.4	2.4	90	07.93-03.00	G4CS	4	<b>Z 21</b>	14 R-7 DUX	1,1	<b>UXT 2<sup>4</sup></b>
2.5 D	2.5	55	07.93-12.94	D4BA/D4BX	4	<b>GN 955</b> (11V)	○		
2.5 D	2.5	57	12.94-03.00	D4BA	4	<b>GN 955</b> (11V)	○		
2.5 TD	2.5	59	07.94-03.00	D4BF	4	<b>GV 921</b> (11V)	○		

## INFINITI

### FX

35	3.5	206	01.03-	VQ35DE	6	<b>Z 219</b>	14 FR-8 MPUX02	1,1	<b>UXT 13</b>
45	4.5	232	01.03-	VK45DE	8	<b>Z 219</b>	14 FR-8 MPUX02	1,1	<b>UXT 13</b>

### I30

3.0	3.0	142	01.97-	VQ30DE	6	<b>Z 228</b>	14 FR-7 DPUX02	1,0	<b>UXT 11</b>
-----	-----	-----	--------	--------	---	--------------	----------------	-----	---------------

### J30

3.0	3.0	157	01.92-12.97	VG30DE	6	<b>Z 228</b>	14 FR-7 DPUX02	1,0	<b>UXT 11</b>
-----	-----	-----	-------------	--------	---	--------------	----------------	-----	---------------

### Q45

4.1	4.1	205	01.93-	VH41DE	8	<b>Z 228</b>	14 FR-7 DPUX02	1,0	<b>UXT 11</b>
4.5	4.5	205	01.89-12.93	VH45DE	8	<b>Z 343</b>	14 FR-8 DPPUX	1,1	○

● nicht erforderlich  
○ nicht im Programm

<sup>3</sup> wahlweise UXT 3 Platin

<sup>4</sup> wahlweise UXT 6 Platin

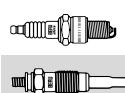

### INFINTI

#### QX4

3.3	3.3	125	01.97-	VG33E	6	<b>Z 73</b>	14 FR-8 DUX	1,1	<b>UXT 1<sup>3</sup></b>
-----	-----	-----	--------	-------	---	-------------	-------------	-----	--------------------------

### INNOCENTI

#### ELBA

1.7 D	1.7	42	08.91-12.96	146 B2.000	4	<b>GV 636</b> (11V)	○		
-------	-----	----	-------------	------------	---	---------------------	---	--	--

#### MINI

1.0	1.0	27	10.85-10.91	BLM C 99 H	4	<b>Z 20</b>	14 R-7 DU	0,8	<b>UXT 2<sup>4</sup></b>
-----	-----	----	-------------	------------	---	-------------	-----------	-----	--------------------------

### ISUZU

#### CAMPO

2.2 D	2.2	39	04.86-12.90	C223	4	<b>GV 749</b> (5V)	○		
2.2 D	2.2	39	04.86-12.90	C223	4	<b>GV 946</b> (11V)	○		
2.2 D 4WD	2.2	39	01.83-12.90	C223	4	<b>GV 946</b> (11V)	○		
2.2 D 4WD	2.2	39	01.83-12.90	C223	4	<b>GV 749</b> (5V)	○		

#### D-MAX

2.5 DiTD	2.5	100	10.06-	4JK1-TC	4	<b>GN 095</b> (11V)	○		
2.5 DiTD 4x4	2.5	100	01.07-	4JK1-TC	4	<b>GN 095</b> (11V)	○		
3.0 D	3.0	120	01.07-	4JJ1-TC	4	<b>GN 095</b> (11V)	○		
3.0 D 4x4	3.0	120	01.07-	4JJ1-TC	4	<b>GN 095</b> (11V)	○		

#### GEMINI

1.5 D	1.5	37	02.88-12.90	4EC1	4	<b>GV 946</b> (11V)	○		
1.5 TD	1.5	49	12.88-12.90	4EC1T	4	<b>GV 947</b> (11V)	○		
1.5	1.5	52	02.88-12.90	4XC1U Kat.	4	<b>Z 1</b>	14-8 DU	0,8	<b>UXT 2<sup>4</sup></b>
1.6 GTI 16V	1.6	84	08.88-12.90	4XE1	4	<b>Z 16</b>	14 FR-7 DUX	1,1	<b>UXT 1<sup>3</sup></b>

#### MIDI

2.0 TD	2.0	51	01.89-	4FC1T	4	<b>GV 945</b> (5V)	○		
2.0 TD	2.0	51	01.89-	4FC1T	4	<b>GV 947</b> (11V)	○		
2.0	2.0	61	01.89-	4ZC1	4	<b>Z 11</b>	14-7 DU	0,8	<b>UXT 2<sup>4</sup></b>
2.0 4WD	2.0	61	01.89-	4ZC1	4	<b>Z 11</b>	14-7 DU	0,8	<b>UXT 2<sup>4</sup></b>
2.2 D	2.2	45	01.89-	4FD1	4	<b>GV 947</b> (11V)	○		
2.2 D 4WD	2.2	45	01.89-	4FD1	4	<b>GV 947</b> (11V)	○		
2.2 D	2.2	45	01.89-	4FD1	4	<b>GV 945</b> (5V)	○		
2.2 D 4WD	2.2	45	01.89-	4FD1	4	<b>GV 945</b> (5V)	○		
2.4 D	2.4	56	01.94-	4FG1T	4	<b>GV 947</b> (11V)	○		
2.4 TD 4x4	2.4	56	01.94-07.96	4FG1T	4	<b>GV 947</b> (11V)	○		
2.4 D	2.4	56	01.94-	4FG1T	4	<b>GV 945</b> (5V)	○		
2.4 TD 4x4	2.4	56	01.94-07.96	4FG1T	4	<b>GV 945</b> (5V)	○		

#### MIDI Van

2.0 TD	2.0	51	01.89-	4FC1T	4	<b>GV 947</b> (11V)	○		
2.0 TD	2.0	51	01.89-	4FC1T	4	<b>GV 945</b> (5V)	○		
2.0	2.0	61	01.89-	4ZC1	4	<b>Z 11</b>	14-7 DU	0,8	<b>UXT 2<sup>4</sup></b>
2.0 4WD	2.0	61	01.89-	4ZC1	4	<b>Z 11</b>	14-7 DU	0,8	<b>UXT 2<sup>4</sup></b>
2.2 D	2.2	45	01.89-	4FD1	4	<b>GV 947</b> (11V)	○		
2.2 D 4WD	2.2	45	01.89-	4FD1	4	<b>GV 947</b> (11V)	○		
2.2 D	2.2	45	01.89-	4FD1	4	<b>GV 945</b> (5V)	○		
2.2 D 4WD	2.2	45	01.89-	4FD1	4	<b>GV 945</b> (5V)	○		
2.4 TD	2.4	56	01.94-	4FG1T	4	<b>GV 947</b> (11V)	○		
2.4 TD 4x4	2.4	56	01.94-07.96	4FG1T	4	<b>GV 947</b> (11V)	○		
2.4 TD	2.4	56	01.94-	4FG1T	4	<b>GV 945</b> (5V)	○		
2.4 TD 4x4	2.4	56	01.94-07.96	4FG1T	4	<b>GV 945</b> (5V)	○		

#### PIAZZA

2.0 Turbo	2.0	104	06.85-12.90	4ZC1-T	4	<b>Z 21</b>	14 R-7 DUX	1,1	<b>UXT 2<sup>4</sup></b>
-----------	-----	-----	-------------	--------	---	-------------	------------	-----	--------------------------

#### TROOPER

2.8 TD	2.8	71	10.87-12.91	4JB1T	4	<b>GN 061</b> (11V)	○		
2.8 TD	2.8	78	10.88-12.91	4JB1-TC	4	<b>GN 061</b> (11V)	○		
3.0 DTI	3.0	118	04.00-	4 JX1	4	<b>GN 997</b> (11V)	○		
3.2	3.2	130	08.91-07.98	6VD1	6	<b>Z 16</b>	14 FR-7 DUX	1,1	<b>UXT 1<sup>3</sup></b>
3.5 V6 24V	3.5	158	04.00-	6VE1	6	<b>Z 122</b>	14 FGH-8 DPURX2	1,0	<b>UXT 9</b>

#### TROOPER Soft Top

2.3	2.3	66	11.85-12.91	4ZD1	4	<b>Z 9</b>	14 R-8 DUX	1,1	<b>UXT 2<sup>4</sup></b>
2.6 i	2.6	85	10.87-12.91	4ZE1	4	<b>Z 9</b>	14 R-8 DUX	1,1	<b>UXT 2<sup>4</sup></b>

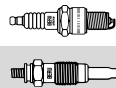
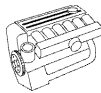

## ISUZU

### TROOPER Soft Top

3.0 DTI	3.0	118	04.00-	4JX1T	4	<b>GN 997</b> (11V)	○		
3.2	3.2	130	08.91-07.98	6VD1	6	<b>Z 16</b>	14 FR-7 DUX	1,1	<b>UXT 1<sup>3</sup></b>
3.5 V6 24V	3.5	158	04.00-	6VE1	6	<b>Z 343</b>	14 FR-8 DPPUX	1,1	○

## IVECO

### DAILY I

30-8	2.5	55	01.89-08.98	8140.07.2700, 8140.07.2712	4	<b>GF 974</b> (12V)	○		
30-8	2.5	60	01.89-08.98		4	<b>GN 927</b> (11V)	○		
30-8	2.8	62	09.98-05.99	8140.63.	4	<b>GN 012</b> (11V)	○		
30-8 V	2.8	62	09.98-	8140.63.	4	<b>GN 012</b> (11V)	○		
30-10	2.8	76	01.97-	8140.23.	4	<b>GF 984</b> (11V)	○		
30-10 C	2.8	76	01.97-	8140.23.	4	<b>GF 984</b> (11V)	○		
35-8	2.5	55	01.91-08.98	8140.07.2700, 8140.07.2712	4	<b>GF 974</b> (12V)	○		
35-8	2.5	60	01.91-08.98		4	<b>GN 927</b> (11V)	○		
35-8	2.5	60	01.89-08.98		4	<b>GN 927</b> (11V)	○		
35-8	2.8	62	09.98-05.99	8140.63.	4	<b>GN 012</b> (11V)	○		
35-8 K	2.8	62	09.98-	8140.63.	4	<b>GN 012</b> (11V)	○		
35-10	2.5	68	01.89-08.98	8140.97.2781	4	<b>GF 974</b> (12V)	○		
35-10	2.5	76	01.89-08.98	8140.47R.2790	4	<b>GF 974</b> (12V)	○		
35-10	2.8	76	01.96-05.99	8140.23.	4	<b>GF 984</b> (11V)	○		
35-10	2.5	80	01.89-08.98	8140.47R	4	<b>GF 974</b> (12V)	○		
35-12	2.5	85	01.90-04.96	8140.47.2700	4	<b>GF 984</b> (11V)	○		
35-12	2.8	90	05.96-05.99	8140.43.	4	<b>GF 974</b> (12V)	○		
35-12 K	2.8	90	09.96-08.98	8140.43.	4	<b>GF 974</b> (12V)	○		
40-10 4x4	2.8	76	01.97-	8140.23.	4	<b>GF 984</b> (11V)	○		
40-10 V	2.5	76	01.90-04.96	8140.27.2720	4	<b>GF 974</b> (12V)	○		
40-12	2.5	85	10.90-04.96	8140.47.2700	4	<b>GF 984</b> (11V)	○		
40-12 V	2.5	85	10.90-04.96	8140.47.2700	4	<b>GF 984</b> (11V)	○		
45-10	2.5	76	01.89-04.96	8140.27.2720	4	<b>GF 974</b> (12V)	○		
45-10 V	2.5	76	01.89-04.96	8140.27.2720	4	<b>GF 974</b> (12V)	○		
49-10	2.5	76	01.89-04.96	8140.47R.2790/ 8140.27.2700	4	<b>GF 974</b> (12V)	○		
49-10	2.8	76	05.96-05.99	8140.23.	4	<b>GF 984</b> (11V)	○		
49-10 K	2.5	76	01.89-04.96	8140.47R.2790/ 8140.27.2700	4	<b>GF 974</b> (12V)	○		
49-10 K	2.8	76	05.96-	8140.23.	4	<b>GF 984</b> (11V)	○		
49-10 V	2.5	76	01.89-04.96	8140.47R.2790/ 8140.27.2700	4	<b>GF 974</b> (12V)	○		
49-12	2.5	85	06.90-04.96	8140.47.2711/8140.47.2721	4	<b>GF 984</b> (11V)	○		
49-12	2.8	90	05.96-05.99	8140.43.	4	<b>GF 974</b> (12V)	○		
49-12 K	2.5	85	06.90-04.96	8140.47.2711/8140.47.2721	4	<b>GF 984</b> (11V)	○		
49-12 K	2.8	90	05.96-	8140.43.	4	<b>GF 974</b> (12V)	○		
49-12 V	2.5	85	06.90-04.96	8140.47.2711/8140.47.2721	4	<b>GF 984</b> (11V)	○		
49-12 V	2.8	90	05.96-	8140.43.	4	<b>GF 974</b> (12V)	○		
59-12	2.5	85	05.91-04.96	8140.47.2700/8140.47.2711	4	<b>GF 984</b> (11V)	○		
59-12	2.8	90	05.96-05.99	8140.43.	4	<b>GF 974</b> (12V)	○		
59-12 K	2.5	85	05.91-04.96	8140.47.2700/8140.47.2711	4	<b>GF 984</b> (11V)	○		
59-12 K	2.8	90	05.96-	8140.43.	4	<b>GF 974</b> (12V)	○		
59-12 V	2.5	85	05.91-04.96	8140.47.2700/8140.47.2711	4	<b>GF 984</b> (11V)	○		
59-12 V	2.8	90	05.96-	8140.43.	4	<b>GF 974</b> (12V)	○		
A 40-10	2.5	76	01.91-12.96	8140.27.2720	4	<b>GF 974</b> (12V)	○		
A 40-10	2.8	76	09.96-	8140.23.	4	<b>GF 984</b> (11V)	○		
A 40-12	2.8	90	05.96-	8140.43.	4	<b>GF 974</b> (12V)	○		
A 45-10	2.5	76	01.91-04.96	8140.27.2720	4	<b>GF 974</b> (12V)	○		
A 45-10	2.8	76	05.96-	8140.23.	4	<b>GF 984</b> (11V)	○		
A 45-12	2.5	85	06.90-04.96	8140.47.2711/8140.47.2721	4	<b>GF 984</b> (11V)	○		
A 45-12	2.8	90	05.96-	8140.43.	4	<b>GF 974</b> (12V)	○		

### DAILY II

29 L 9	2.8	62	05.99-	8140.63.	4	<b>GN 012</b> (11V)	○		
29 L 9 V	2.8	62	05.99-	8140.63.	4	<b>GN 012</b> (11V)	○		
29 L 10	2.3	70	09.02-	F1AE0481A	4	<b>GN 037</b> (11V)	○		

● nicht erforderlich  
○ nicht im Programm

<sup>3</sup> wahlweise UXT 3 Platin



kW

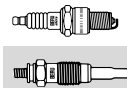

**IVECO**

**DAILY II**

29 L 10 V	2.3	70	09.02-	F1AE0481A	4	<b>GN 037</b> (11V)	○
29 L 11	2.8	78	05.99-	8140.43C	4	<b>GF 984</b> (11V)	○
29 L 11	2.8	78	05.99-	8140.43B	4	<b>GF 006</b> (12V)	○
29 L 11 V	2.8	78	05.99-	8140.43C	4	<b>GF 984</b> (11V)	○
29 L 12	2.3	85	09.02-	F1AE0481B	4	<b>GN 037</b> (11V)	○
29 L 12 V	2.3	85	09.02-	F1AE0481B	4	<b>GN 037</b> (11V)	○
29 L 13	2.8	92	05.01-	8140.43S	4	<b>GF 006</b> (12V)	○
29 L 14	2.3	100	01.05-04.06	F1AE0481M	4	<b>GN 037</b> (11V)	○
35 C 10 V , 35 S 10 V	2.3	70	09.02-	F1AE0481A	4	<b>GN 037</b> (11V)	○
35 C 12 , 35 S 12	2.3	85	09.02-	F1AE0481B	4	<b>GN 037</b> (11V)	○
35 C 12 V, 35 S 12 V	2.3	85	09.02-	F1AE0481B	4	<b>GN 037</b> (11V)	○
35 C 14	3.0	100	09.04-04.06	F1CE0481A	4	<b>GN 037</b> (11V)	○
35 C 14, 35 S 14	2.3	100	01.05-04.06	F1AE0481M	4	<b>GN 037</b> (11V)	○
35 C 15	2.8	107	11.01-	8140.43N	4	<b>GN 012</b> (11V)	○
35 C 17, 35 S 17	3.0	122	01.05-04.06	F1CE0481B	4	<b>GN 037</b> (11V)	○
35 S 9,35 C 9	2.8	62	05.99-	8140.63.	4	<b>GN 012</b> (11V)	○
35 S 9 V,35 C 9 V	2.8	62	05.99-	8140.63.	4	<b>GN 012</b> (11V)	○
35 S 10	2.3	70	09.02-	F1AE0481A	4	<b>GN 037</b> (11V)	○
35 S 11,35 C 11	2.8	78	05.99-	8140.43C	4	<b>GF 984</b> (11V)	○
35 S 11 V,35 C 11 V	2.8	78	05.99-	8140.43C	4	<b>GF 984</b> (11V)	○
35 S 13,35 C 13	2.8	92	05.99-	8140.43S	4	<b>GF 006</b> (12V)	○
35 S 13 V,35 C 13 V	2.8	92	05.99-	8140.43S	4	<b>GF 006</b> (12V)	○
35 S 15 V, 35 C 15 V	2.8	107	11.02-	8140.43N	4	<b>GN 012</b> (11V)	○
40 C 14	2.3	100	01.05-04.06	F1AE0481M	4	<b>GN 037</b> (11V)	○
40 C 14	3.0	100	09.04-04.06	F1CE0481A	4	<b>GN 037</b> (11V)	○
40 C 15	2.8	107	11.01-04.06	8140.43N	4	<b>GN 012</b> (11V)	○
40 C 17, 40 S 17	3.0	122	01.05-04.06	F1CE0481B	4	<b>GN 037</b> (11V)	○
50 C 11	2.8	78	05.99-	8140.43C	4	<b>GF 984</b> (11V)	○
50 C 13	2.8	92	05.99-	8140.43S	4	<b>GF 006</b> (12V)	○
50 C 14	3.0	100	09.04-04.06	F1CE0481A	4	<b>GN 037</b> (11V)	○
50 C 15	2.8	107	01.01-04.06	8140.43N	4	<b>GN 012</b> (11V)	○
50 C 17	3.0	122	09.04-04.06	F1CE0481B	4	<b>GN 037</b> (11V)	○
65 C 14	3.0	100	09.04-04.06	F1CE0481A	4	<b>GN 037</b> (11V)	○
65 C 15	2.8	107	11.01-04.06	8140.43N	4	<b>GN 012</b> (11V)	○
65 C 17	3.0	122	09.04-04.06	F1CE0481B	4	<b>GN 037</b> (11V)	○

**DAILY III**

29L10	2.3	70	05.06-	F1AE0481FA	4	<b>GN 037</b> (11V)	○
29L10 V	2.3	70	05.06-	F1AE0481FA	4	<b>GN 037</b> (11V)	○
29L12	2.3	85	05.06-	F1AE0481GA	4	<b>GN 037</b> (11V)	○
29L12 V, 29L12 V/P	2.3	85	05.06-	F1AE0481GA	4	<b>GN 037</b> (11V)	○
29L14	2.3	100	05.06-	F1AE0481HA	4	<b>GN 037</b> (11V)	○
29L14 C, 29L14 C/P, 29L14 V, 29L14 V/P	2.3	100	05.06-	F1AE0481HA	4	<b>GN 037</b> (11V)	○
35C10 K	2.3	70	05.06-	F1AE0481FA	4	<b>GN 037</b> (11V)	○
35C10, 35S10	2.3	70	05.06-	F1AE0481FA	4	<b>GN 037</b> (11V)	○
35C11 K, 35C11 DK, 35S11 K, 35S11 DK	2.3	78	07.07-	F1AE0481FA	4	<b>GN 037</b> (11V)	○
35C11 V, 35S11 V	2.3	78	07.07-	F1AE0481FA	4	<b>GN 037</b> (11V)	○
35C11, 35S11, 35S11 D, 35S11 /P	2.3	78	07.07-	F1AE0481FA	4	<b>GN 037</b> (11V)	○
35C12 V, 35C12 V/P, 35S12 V, 35S12 V/P	2.3	85	05.06-	F1AE0481GA	4	<b>GN 037</b> (11V)	○
35C12, 35S12	2.3	85	05.06-	F1AE0481GA	4	<b>GN 037</b> (11V)	○
35C13 K, 35C13 DK, 35S13 K, 35S13 DK	2.3	93	07.07-	F1AE0481GA	4	<b>GN 037</b> (11V)	○
35C13 V, 35C13 V/P, 35S13 V, 35S13 V/P	2.3	93	07.07-	F1AE0481GA	4	<b>GN 037</b> (11V)	○
35C13, 35C13 /P, 35S13 D, 35S13, 35S13 /P	2.3	93	07.07-	F1AE0481GA	4	<b>GN 037</b> (11V)	○
35S14 C, 35S14 C/P, 35S14 V, 35S14 V/P, 35C14 V, 35C14 V/P	2.3	100	05.06-	F1AE0481HA	4	<b>GN 037</b> (11V)	○



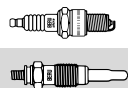
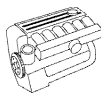

## IVECO

### DAILY III

35S14 K, 35S14 DK	2.3	100	07.07-	F1AE0481HA	4	<b>GN 037</b> (11V)	○
35C14, 35S14, 35S14 /P	2.3	100	05.06-	F1AE0481HA	4	<b>GN 037</b> (11V)	○
35C14 K, 35C14 DK, 35S14 K, 35S14 DK	3.0	103	07.07-	F1CE3481LC	4	<b>GN 037</b> (11V)	○
35C14 V, 35C14 V/P, 35S14 V, 35S14 V/P	3.0	103	07.07-	F1CE3481LC	4	<b>GN 037</b> (11V)	○
35C14, 35C14 /P, 35S14, 35S14 /P, 35S14 D, 35S14 D/P	3.0	103	07.07-	F1CE3481LC	4	<b>GN 037</b> (11V)	○
35C15	3.0	107	05.06-	F1CE0481FA	4	<b>GN 037</b> (11V)	○
35C15 V, 35C15 V/P	3.0	107	05.06-	F1CE0481FA	4	<b>GN 037</b> (11V)	○
35C17 K, 35C17 DK, 35S17 K, 35S17 DK	3.0	125	07.07-	F1CE0481HA	4	<b>GN 037</b> (11V)	○
35C17 V, 35C17 V/P, 35S17 V, 35S17 V/P	3.0	125	07.07-	F1CE0481HA	4	<b>GN 037</b> (11V)	○
35C17, 35C17 /P, 35S17, 35S17 /P, 35S17 D	3.0	125	07.07-	F1CE0481HA	4	<b>GN 037</b> (11V)	○
35C18 V, 35C18 V/P, 35S18 V, 35S18 V/P	3.0	130	05.06-	F1CE0481HA	4	<b>GN 037</b> (11V)	○
35C18, 35S18	3.0	130	05.06-	F1CE0481HA	4	<b>GN 037</b> (11V)	○
35S17 W, 35S17 WD	3.0	125	07.07-	F1CE0481HA	4	<b>GN 037</b> (11V)	○
40C10	2.3	70	05.06-	F1AE0481FA	4	<b>GN 037</b> (11V)	○
40C10 V	2.3	70	05.06-	F1AE0481FA	4	<b>GN 037</b> (11V)	○
40C11, 40C11 D	2.3	78	07.07-	F1AE0481FA	4	<b>GN 037</b> (11V)	○
40C12	2.3	85	05.06-	F1AE0481GA	4	<b>GN 037</b> (11V)	○
40C12 V, 40C14 V/P	2.3	85	05.06-	F1AE0481GA	4	<b>GN 037</b> (11V)	○
40C13 V, 40C13 V/P	2.3	93	07.07-	F1AE0481GA	4	<b>GN 037</b> (11V)	○
40C14 K, 40C14 DK	3.0	103	07.07-	F1CE3481LC	4	<b>GN 037</b> (11V)	○
40C14 V, 40C14 V/P	3.0	103	07.07-	F1CE3481LC	4	<b>GN 037</b> (11V)	○
40C14, 40C14 /P	3.0	103	07.07-	F1CE3481LC	4	<b>GN 037</b> (11V)	○
40C15	3.0	107	05.06-	F1CE0481FA	4	<b>GN 037</b> (11V)	○
40C15 V, 40C15 V/P	3.0	107	05.06-	F1CE0481FA	4	<b>GN 037</b> (11V)	○
40C17 K, 40C17 DK	3.0	125	07.07-	F1CE0481HA	4	<b>GN 037</b> (11V)	○
40C17 V, 40C17 V/P	3.0	125	07.07-	F1CE0481HA	4	<b>GN 037</b> (11V)	○
40C17, 40C17 /P	3.0	125	07.07-	F1CE0481HA	4	<b>GN 037</b> (11V)	○
40C18	3.0	130	05.06-	F1CE0481HA	4	<b>GN 037</b> (11V)	○
40C18 V, 40C18 V/P	3.0	130	05.06-	F1CE0481HA	4	<b>GN 037</b> (11V)	○
45C14, 45C14 /P	3.0	103	07.07-	F1CE3481LC	4	<b>GN 037</b> (11V)	○
45C15	3.0	107	05.06-	F1CE0481FA	4	<b>GN 037</b> (11V)	○
45C15 V	3.0	107	05.06-	F1CE0481FA	4	<b>GN 037</b> (11V)	○
45C17 V, 45C17 V/P	3.0	125	07.07-	F1CE0481HA	4	<b>GN 037</b> (11V)	○
45C17, 45C17 /P	3.0	125	07.07-	F1CE0481HA	4	<b>GN 037</b> (11V)	○
45C18, 45C18 /P, 45C18 D, 45C18 D/P	3.0	130	05.06-	F1CE0481HA	4	<b>GN 037</b> (11V)	○
50C14 K, 50C14 DK	3.0	103	07.07-	F1CE3481LC	4	<b>GN 037</b> (11V)	○
50C14 V, 50C14 V/P	3.0	103	07.07-	F1CE3481LC	4	<b>GN 037</b> (11V)	○
50C14, 50C14 /P	3.0	103	07.07-	F1CE3481LC	4	<b>GN 037</b> (11V)	○
50C15	3.0	107	05.06-	F1CE0481FA	4	<b>GN 037</b> (11V)	○
50C15 V, 50C15 V/P	3.0	107	05.06-	F1CE0481FA	4	<b>GN 037</b> (11V)	○
50C17 K, 50C17 DK	3.0	125	07.07-	F1CE0481HA	4	<b>GN 037</b> (11V)	○
50C17 V, 50C17 V/P	3.0	125	07.07-	F1CE0481HA	4	<b>GN 037</b> (11V)	○
50C17, 50C17 /P	3.0	125	07.07-	F1CE0481HA	4	<b>GN 037</b> (11V)	○
50C18	3.0	130	05.06-	F1CE0481HA	4	<b>GN 037</b> (11V)	○
50C18 V, 50C18 V/P	3.0	130	05.06-	F1CE0481HA	4	<b>GN 037</b> (11V)	○
55S17 W, 55S17 WD	3.0	125	07.07-	F1CE0481HA	4	<b>GN 037</b> (11V)	○
60C14 K, 60C14 DK	3.0	103	07.07-	F1CE3481LC	4	<b>GN 037</b> (11V)	○
60C14, 60C14 /P	3.0	103	07.07-	F1CE3481LC	4	<b>GN 037</b> (11V)	○
60C15 V	3.0	107	05.06-	F1CE0481FA	4	<b>GN 037</b> (11V)	○
60C15, 60C15 /P, 60C15 D, 60C15 D/P	3.0	107	05.06-	F1CE0481FA	4	<b>GN 037</b> (11V)	○
60C17 K, 60C17 DK	3.0	125	07.07-	F1CE0481HA	4	<b>GN 037</b> (11V)	○
60C17 V, 60C17 V/P	3.0	125	07.07-	F1CE0481HA	4	<b>GN 037</b> (11V)	○

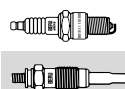
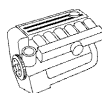

## IVECO

### DAILY III

60C17, 60C17 /P	3.0	125	07.07-	F1CE0481HA	4	<b>GN 037</b> (11V)	○		
60C18	3.0	130	05.06-	F1CE0481HC	4	<b>GN 037</b> (11V)	○		
65C14 K, 65C14 DK	3.0	103	07.07-	F1CE3481LC	4	<b>GN 037</b> (11V)	○		
65C14 V, 65C14 V/P	3.0	103	07.07-	F1CE3481LC	4	<b>GN 037</b> (11V)	○		
65C14, 65C14 /P	3.0	103	07.07-	F1CE3481LC	4	<b>GN 037</b> (11V)	○		
65C15, 65C15 /P, 65C15 D, 65C15 D/P	3.0	107	05.06-	F1CE0481FA	4	<b>GN 037</b> (11V)	○		
65C17 K, 65C17 DK, 65C17KK	3.0	125	07.07-	F1CE0481HA	4	<b>GN 037</b> (11V)	○		
65C17 V, 65C17 V/P	3.0	125	07.07-	F1CE0481HA	4	<b>GN 037</b> (11V)	○		
65C17, 65C17 /P	3.0	125	07.07-	F1CE0481HA	4	<b>GN 037</b> (11V)	○		
65C18	3.0	130	05.06-	F1CE0481HC	4	<b>GN 037</b> (11V)	○		
70C14 K, 70C14 DK, 70C14 KK	3.0	103	07.07-	F1CE3481LC	4	<b>GN 037</b> (11V)	○		
70C14 V, 70C14 V/P	3.0	103	07.07-	F1CE3481LC	4	<b>GN 037</b> (11V)	○		
70C14, 70C14 /P	3.0	103	07.07-	F1CE3481LC	4	<b>GN 037</b> (11V)	○		
70C17 K, 70C17 DK, 70C17 KK	3.0	125	07.07-	F1CE0481HA	4	<b>GN 037</b> (11V)	○		
70C17, 70C17 /P	3.0	125	07.07-	F1CE0481HA	4	<b>GN 037</b> (11V)	○		
70C17V, 70C17 V/P	3.0	125	07.07-	F1CE0481HA	4	<b>GN 037</b> (11V)	○		

### MASSIF Pick-up

3.0 HPI	3.0	107	10.08-	F1CE0481FA	4	<b>GN 037</b> (11V)	○		
3.0 HPT	3.0	130	10.08-	F1CE0481HA	4	<b>GN 037</b> (11V)	○		

### MASSIF Single Cab

3.0 HPI	3.0	107	10.08-	F1CE0481FA	4	<b>GN 037</b> (11V)	○		
3.0 HPT	3.0	130	10.08-	F1CE0481HA	4	<b>GN 037</b> (11V)	○		

### MASSIF Station Wagon

3.0 HPI	3.0	107	10.08-	F1CE0481FA	4	<b>GN 037</b> (11V)	○		
3.0 HPT	3.0	130	10.08-	F1CE0481HA	4	<b>GN 037</b> (11V)	○		

## JAGUAR

### S-TYPE

2.7 D	2.7	152	06.04-10.07	AJD	6	<b>GN 045</b> (11V)	○		
4.2 V8	4.2	219	04.02-10.07		8	<b>Z 312</b>	14 FR-7 KPPU	1,1	○
R 4,2 V8	4.2	291	04.02-10.07		8	<b>Z 312</b>	14 FR-7 KPPU	1,1	○

### X-TYPE

2.0 D	2.0	96	07.03-11.09	FMBA/FMBB/R4-X404	4	<b>GN 939</b> (11,5V)	○		
2.2 D	2.2	107	01.07-11.09	LJ46G	4	<b>GN 063</b> (11V)	○		
2.2 D	2.2	114	10.05-11.09	LJ46G	4	<b>GN 063</b> (11V)	○		

### X-TYPE Estate

2.2 D	2.2	107	01.07-12.09	LJ46G	4	<b>GN 063</b> (11V)	○		
2.2 D	2.2	114	10.05-12.09	LJ46G	4	<b>GN 063</b> (11V)	○		

### XF

2.7 D	2.7	152	03.08-02.09	AJD	6	<b>GN 045</b> (11V)	○		
4.2	4.2	219	03.08-10.09	SV82G	8	<b>Z 312</b>	14 FR-7 KPPU	1,1	○

### XJ

6 2,7 D	2.7	152	10.05-03.09		6	<b>GN 045</b> (11V)	○		
6 2.9	2.9	117	10.86-08.90	AJ 6 (2.9)	6	<b>Z 40</b>	14-5 AU	0,6	○
6 3.2	3.2	155	11.94-07.97	9JPGRB	6	<b>Z 193</b>	14 FR-7 DU2	0,9	<b>UXT 1<sup>3</sup></b>
6 3.2 24V	3.2	146	09.90-11.94	9BPMNA	6	<b>Z 193</b>	14 FR-7 DU2	0,9	<b>UXT 1<sup>3</sup></b>
6 4.0	4.0	163	09.89-11.94	9EPCNA	6	<b>Z 193</b>	14 FR-7 DU2	0,9	<b>UXT 1<sup>3</sup></b>
8 3.5	3.6	190	05.03-03.09		8	<b>Z 228</b>	14 FR-7 DPUX02	1,0	<b>UXT 11</b>
8 4.0	4.0	209	07.97-08.02	BC	8	<b>Z 15</b>	14 FR-7 DU	0,8	<b>UXT 1<sup>3</sup></b>
8 4.2	4.2	219	05.03-03.09		8	<b>Z 228</b>	14 FR-7 DPUX02	1,0	<b>UXT 11</b>
R 4.2	4.2	291	05.03-03.09		8	<b>Z 228</b>	14 FR-7 DPUX02	1,0	<b>UXT 11</b>

### XJS Coupe

3.6	3.6	136	01.88-05.92		6	<b>Z 193</b>	14 FR-7 DU2	0,9	<b>UXT 1<sup>3</sup></b>
3.6	3.6	146	01.88-05.91	9DPANA/9DPALA	6	<b>Z 193</b>	14 FR-7 DU2	0,9	<b>UXT 1<sup>3</sup></b>
4.0	4.0	163	05.91-09.94	9EPCNA	6	<b>Z 193</b>	14 FR-7 DU2	0,9	<b>UXT 1<sup>3</sup></b>
4.0	4.0	171	07.94-03.96	9LPFRB	6	<b>Z 193</b>	14 FR-7 DU2	0,9	<b>UXT 1<sup>3</sup></b>

### XJSC Convertible

3.6	3.6	136	08.87-05.91		6	<b>Z 193</b>	14 FR-7 DU2	0,9	<b>UXT 1<sup>3</sup></b>
3.6	3.6	156	08.87-05.91	AJ 6 (3.6, 156KW)	6	<b>Z 193</b>	14 FR-7 DU2	0,9	<b>UXT 1<sup>3</sup></b>
4.0	4.0	163	05.91-09.94	9EPCNA	6	<b>Z 193</b>	14 FR-7 DU2	0,9	<b>UXT 1<sup>3</sup></b>

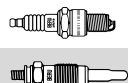

## JAGUAR

### XJSC Convertible

4.0	4.0	171	07.94-03.96	9LPFRB	6	<b>Z 193</b>	14 FR-7 DU2	0,9	<b>UXT 1<sup>3</sup></b>
-----	-----	-----	-------------	--------	---	--------------	-------------	-----	--------------------------

### XK 8 Convertible

4.2	4.2	219	08.02-07.05		8	<b>Z 228</b>	14 FR-7 DPUX02	1,0	<b>UXT 11</b>
R 4,2	4.2	291	08.02-07.05		8	<b>Z 228</b>	14 FR-7 DPUX02	1,0	<b>UXT 11</b>

### XK 8 Coupe (QEV)

4.2	4.2	219	08.02-07.05		8	<b>Z 228</b>	14 FR-7 DPUX02	1,0	<b>UXT 11</b>
R 4,2	4.2	291	08.02-07.05		8	<b>Z 228</b>	14 FR-7 DPUX02	1,0	<b>UXT 11</b>

### XK Cabriolet

3.6	3.6	190	03.08-02.09		8	<b>Z 312</b>	14 FR-7 KPPU	1,1	○
4.2 XKR	4.2	306	03.06-02.09		8	<b>Z 312</b>	14 FR-7 KPPU	1,1	○

### XK Coupe

3.5 XK	3.6	190	07.07-02.09		8	<b>Z 312</b>	14 FR-7 KPPU	1,1	○
4.2 XK8	4.2	219	03.06-02.09		8	<b>Z 312</b>	14 FR-7 KPPU	1,1	○
4.2 XKR	4.2	291	03.06-02.09		8	<b>Z 312</b>	14 FR-7 KPPU	1,1	○

## JEEP

### CHEROKEE

2.1 TD	2.1	59	06.89-03.92	J8S	4	<b>GV 852</b> (11V)	○		
2.1 TD	2.1	64	10.84-08.94	J8S	4	<b>GV 852</b> (11V)	○		
2.5 TD	2.5	85	01.88-04.95	VM HR 425 CLIRX	4	<b>GN 909</b> (11V)	○		
2.5 TD	2.5	85	05.95-09.01	VM HR 425 CLIRX	4	<b>GN 007</b> (11V)	○		
2.5	2.5	89	10.95-09.01	VM-HR 425	4	<b>GN 007</b> (11V)	○		
2.5 CRD	2.5	105	09.01-01.08	R 425 DOHC	4	<b>GN 055</b> (11V)	○		
2.8 CRD	2.8	110	11.02-01.08	ENR	4	<b>GN 055</b> (11V)	○		
2.8 CRD	2.8	120	11.04-01.08	ENR	4	<b>GN 055</b> (11V)	○		
3.7 V6	3.7	150	08.03-01.08	EKG	6	<b>Z 158</b>	14 FR-7 LUX	1,1	○
3.7 V6	3.7	155	09.01-01.08	EKG	6	<b>Z 158</b>	14 FR-7 LUX	1,1	○
3.7 V6	3.7	157	01.08-	EKG	6	<b>Z 158</b>	14 FR-7 LUX	1,1	○
3.7 V6 4WD	3.7	157	01.08-	EKG	6	<b>Z 158</b>	14 FR-7 LUX	1,1	○
4.0 i	4.0	127	07.98-04.01		6	<b>Z 248</b>	14 FR-8 HUT	0,8	○
4.0 i	4.0	131	01.95-09.01	ERH	6	<b>Z 248</b>	14 FR-8 HUT	0,8	○
4.0 i	4.0	135	12.91-09.01	MX	6	<b>Z 248</b>	14 FR-8 HUT	0,8	○
4.0 i	4.0	136	01.88-08.90	ERH	6	<b>Z 15</b>	14 FR-7 DU	0,8	<b>UXT 1<sup>3</sup></b>
4.0 i	4.0	136	09.90-09.01	ERH	6	<b>Z 248</b>	14 FR-8 HUT	0,8	○

### GRAND CHEROKEE I

2.5 TD	2.5	85	10.95-04.99	M52/M51	4	<b>GN 007</b> (11V)	○		
4.0 i	4.0	130	10.95-04.99	S01	6	<b>Z 248</b>	14 FR-8 HUT	0,8	○
4.0 i	4.0	132	09.91-04.99	ERH	6	<b>Z 248</b>	14 FR-8 HUT	0,8	○
4.0 i	4.0	135	09.91-04.99	MX	6	<b>Z 248</b>	14 FR-8 HUT	0,8	○
5.2 i	5.2	155	09.92-04.99	ELF	8	<b>Z 73</b>	14 FR-8 DUX	1,1	<b>UXT 1<sup>3</sup></b>
5.2	5.2	156	10.95-04.99	Y01	8	<b>Z 73</b>	14 FR-8 DUX	1,1	<b>UXT 1<sup>3</sup></b>
5.2 i	5.2	158	09.92-04.99	Y	8	<b>Z 255</b>	14 FR-8 DUW	0,9	<b>UXT 1<sup>3</sup></b>

### GRAND CHEROKEE II

2.7 CRD 4x4	2.7	120	10.01-09.05	ENF	5	<b>GN 003</b> (11,5V)	○		
3.1 TD	3.1	103	04.99-09.05	EXA	5	<b>GN 007</b> (11V)	○		
4.0 4x4	4.0	140	04.99-09.05		6	<b>Z 248</b>	14 FR-8 HUT	0,8	○
4.7 V8	4.7	162	04.99-08.00	EVA	8	<b>Z 220</b>	14 FR-9 KUX2	1,0	○
4.7 V8	4.7	164	08.00-09.05	EVA	8	<b>Z 220</b>	14 FR-9 KUX2	1,0	○

### GRAND CHEROKEE III

3.0 CRD	3.0	155	05.06-12.10	EXL	6	<b>GE 105</b> (4,4V)	○		
3.0 CRD	3.0	160	06.05-12.10	EXL	6	<b>GE 105</b> (4,4V)	○		

### WRANGLER I

2.5	2.5	76	01.88-12.91		4	<b>Z 248</b>	14 FR-8 HUT	0,8	○
2.5	2.5	89	12.91-08.96	EPE	4	<b>Z 248</b>	14 FR-8 HUT	0,8	○
4.0	4.0	131	12.91-08.96	ERH	6	<b>Z 248</b>	14 FR-8 HUT	0,8	○

### WRANGLER II

2.4	2.4	105	11.02-04.07	ED1	4	<b>Z 216</b>	14 KR-10 SUV2	1,3	○
2.5	2.5	87	08.96-04.07	P00	4	<b>Z 248</b>	14 FR-8 HUT	0,8	○
4.0	4.0	124	06.98-04.07		6	<b>Z 248</b>	14 FR-8 HUT	0,8	○
4.0	4.0	130	08.96-04.07	S01	6	<b>Z 248</b>	14 FR-8 HUT	0,8	○

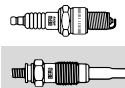
**KIA**
**BESTA**

2.2 D	2.2	48	02.96-07.99	R2	4	GN 005 (11V)	○		
-------	-----	----	-------------	----	---	--------------	---	--	--

**CARENS I**

1.8 i	1.8	81	11.00-07.02	T8	4	Z 15	14 FR-7 DU	0,8	UXT 1 <sup>3</sup>
-------	-----	----	-------------	----	---	------	------------	-----	--------------------

**CARENS II**

1.6	1.6	77	07.02-		4	Z 16	14 FR-7 DUX	1,1	UXT 1 <sup>3</sup>
-----	-----	----	--------	--	---	------	-------------	-----	--------------------

1.8	1.8	93	07.02-		4	Z 15	14 FR-7 DU	0,8	UXT 1 <sup>3</sup>
-----	-----	----	--------	--	---	------	------------	-----	--------------------

2.0 CRDi	2.0	83	07.02-	D4EA	4	GN 035 (11V)	○		
----------	-----	----	--------	------	---	--------------	---	--	--

2.0 CVT	2.0	102	08.04-	G4GC	4	Z 73	14 FR-8 DUX	1,1	UXT 1 <sup>3</sup>
---------	-----	-----	--------	------	---	------	-------------	-----	--------------------

2.0 CRDi	2.0	103	11.05-	D4EA	4	GN 035 (11V)	○		
----------	-----	-----	--------	------	---	--------------	---	--	--

**CARENS III**

1.6 CRDi 128	1.6	94	10.10-	D4FB	4	GN 062 (11V)	○		
--------------	-----	----	--------	------	---	--------------	---	--	--

2.0 CRDi 115	2.0	85	05.07-	D4EA	4	GN 035 (11V)	○		
--------------	-----	----	--------	------	---	--------------	---	--	--

2.0 CRDi 140	2.0	103	09.06-	D4EA	4	GN 035 (11V)	○		
--------------	-----	-----	--------	------	---	--------------	---	--	--

2.0 CVT	2.0	106	09.06-	G4KA	4	Z 73	14 FR-8 DUX	1,1	UXT 1 <sup>3</sup>
---------	-----	-----	--------	------	---	------	-------------	-----	--------------------

**CARNIVAL**

2.5 V6	2.5	121	08.99-10.01		6	Z 158	14 FR-7 LUX	1,1	○
--------	-----	-----	-------------	--	---	-------	-------------	-----	---

2.9 TD	2.9	93	08.99-10.01	J3	4	GN 035 (11V)	○		
--------	-----	----	-------------	----	---	--------------	---	--	--

**CARNIVAL II**

2.5 V6	2.5	110	10.01-	K5	6	Z 158	14 FR-7 LUX	1,1	○
--------	-----	-----	--------	----	---	-------	-------------	-----	---

2.9 TD	2.9	93	10.01-	J3	4	GN 035 (11V)	○		
--------	-----	----	--------	----	---	--------------	---	--	--

2.9 CRDi	2.9	106	10.01-	J3	4	GN 035 (11V)	○		
----------	-----	-----	--------	----	---	--------------	---	--	--

3.5	3.5	143	07.02-	G6CU	6	Z 228	14 FR-7 DPUX02	1,0	UXT 11
-----	-----	-----	--------	------	---	-------	----------------	-----	--------

**CEE'D**

1.6 CRDi 115	1.6	85	12.06-	D4FB	4	GN 062 (11V)	○		
--------------	-----	----	--------	------	---	--------------	---	--	--

1.6 CRDi 115	1.6	85	05.12-	D4FB	4	GN 062 (11V)	○		
--------------	-----	----	--------	------	---	--------------	---	--	--

1.6 CRDi 128	1.6	94	10.10-	D4FB	4	GN 062 (11V)	○		
--------------	-----	----	--------	------	---	--------------	---	--	--

2.0	2.0	105	12.06-	G4GC	4	Z 73	14 FR-8 DUX	1,1	UXT 1 <sup>3</sup>
-----	-----	-----	--------	------	---	------	-------------	-----	--------------------

**CEE'D Kombi**

1.6 CRDi 115	1.6	85	09.07-	D4FB	4	GN 062 (11V)	○		
--------------	-----	----	--------	------	---	--------------	---	--	--

1.6 CRDi 128	1.6	94	10.10-	D4FB	4	GN 062 (11V)	○		
--------------	-----	----	--------	------	---	--------------	---	--	--

2.0	2.0	105	09.07-	G4GC	4	Z 73	14 FR-8 DUX	1,1	UXT 1 <sup>3</sup>
-----	-----	-----	--------	------	---	------	-------------	-----	--------------------

**CERATO**

1.5 CRDi	1.5	75	07.05-	D4FA	4	GN 035 (11V)	○		
----------	-----	----	--------	------	---	--------------	---	--	--

1.6	1.6	77	04.04-	G4ED	4	Z 73	14 FR-8 DUX	1,1	UXT 1 <sup>3</sup>
-----	-----	----	--------	------	---	------	-------------	-----	--------------------

1.6 CRDi	1.6	85	06.05-	D4FB	4	GN 062 (11V)	○		
----------	-----	----	--------	------	---	--------------	---	--	--

1.8	1.8	93	08.05-	G4GB	4	Z 312	14 FR-7 KPPU	1,1	○
-----	-----	----	--------	------	---	-------	--------------	-----	---

2.0 CRDi	2.0	83	04.04-	D4EA	4	GN 035 (11V)	○		
----------	-----	----	--------	------	---	--------------	---	--	--

2.0	2.0	105	04.04-	G4GC	4	Z 73	14 FR-8 DUX	1,1	UXT 1 <sup>3</sup>
-----	-----	-----	--------	------	---	------	-------------	-----	--------------------

**CLARUS**

1.8 i 16V	1.8	85	07.96-	T8	4	Z 15	14 FR-7 DU	0,8	UXT 1 <sup>3</sup>
-----------	-----	----	--------	----	---	------	------------	-----	--------------------

2.0 i 16V	2.0	98	07.96-05.98	FE (16 V)	4	Z 73	14 FR-8 DUX	1,1	UXT 1 <sup>3</sup>
-----------	-----	----	-------------	-----------	---	------	-------------	-----	--------------------

**CLARUS Kombi**

1.8 i 16V	1.8	85	05.98-	T8	4	Z 15	14 FR-7 DU	0,8	UXT 1 <sup>3</sup>
-----------	-----	----	--------	----	---	------	------------	-----	--------------------

2.0 i 16V	2.0	98	05.98-	FE (16 V)	4	Z 73	14 FR-8 DUX	1,1	UXT 1 <sup>3</sup>
-----------	-----	----	--------	-----------	---	------	-------------	-----	--------------------

**JOICE**

2.0	2.0	88	09.01-		4	Z 21	14 R-7 DUX	1,1	UXT 2 <sup>4</sup>
-----	-----	----	--------	--	---	------	------------	-----	--------------------

2.0	2.0	102	02.00-09.01	G4CP	4	Z 21	14 R-7 DUX	1,1	UXT 2 <sup>4</sup>
-----	-----	-----	-------------	------	---	------	------------	-----	--------------------

**K2700**

2.7 D	2.7	59	10.99-	J2	4	GN 005 (11V)	○		
-------	-----	----	--------	----	---	--------------	---	--	--

**K2900**

2.9 D	2.9	92	01.08-	J3	4	GN 035 (11V)	○		
-------	-----	----	--------	----	---	--------------	---	--	--

**MAGENTIS**

2.0	2.0	100	05.01-	G4JP	4	Z 21	14 R-7 DUX	1,1	UXT 2 <sup>4</sup>
-----	-----	-----	--------	------	---	------	------------	-----	--------------------

2.0 CRDi	2.0	103	04.06-	D4EA	4	GN 035 (11V)	○		
----------	-----	-----	--------	------	---	--------------	---	--	--

2.0	2.0	106	11.05-	G4KA	4	Z 73	14 FR-8 DUX	1,1	UXT 1 <sup>3</sup>
-----	-----	-----	--------	------	---	------	-------------	-----	--------------------

2.0	2.0	121	07.09-	G4KD	4	Z 183	14 FR-8 MU2	0,9	UXT 13
-----	-----	-----	--------	------	---	-------	-------------	-----	--------

2.5 V6	2.5	124	05.01-	G6BV	6	Z 228	14 FR-7 DPUX02	1,0	UXT 11
--------	-----	-----	--------	------	---	-------	----------------	-----	--------

**OPIRUS**

3.5	3.5	149	09.03-	G6CU	6	Z 228	14 FR-7 DPUX02	1,0	UXT 11
-----	-----	-----	--------	------	---	-------	----------------	-----	--------

**PICANTO**

1.0	1.0	45	09.05-	G4HE	4	Z 16	14 FR-7 DUX	1,1	UXT 1 <sup>3</sup>
-----	-----	----	--------	------	---	------	-------------	-----	--------------------

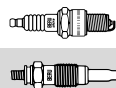
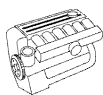

## KIA

### PICANTO

1.1	1.1	48	04.04-	G4HG	4	<b>Z 73</b>	14 FR-8 DUX	1,1	<b>UXT 13</b>
-----	-----	----	--------	------	---	-------------	-------------	-----	---------------

### PREGIO

2.7 D	2.7	60	10.97-	J2	4	<b>GN 005</b> (11V)	○		
-------	-----	----	--------	----	---	---------------------	---	--	--

### PRIDE

1.1 i	1.1	38	01.91-05.96	B1	4	<b>Z 11</b>	14-7 DU	0,8	<b>UXT 24</b>
1.3 16V	1.3	44	01.90-	B3	4	<b>Z 11</b>	14-7 DU	0,8	<b>UXT 24</b>
1.3 16V	1.3	47	10.96-	B3	4	<b>Z 21</b>	14 R-7 DUX	1,1	<b>UXT 24</b>
1.3 i	1.3	51	01.90-05.96		4	<b>Z 11</b>	14-7 DU	0,8	<b>UXT 24</b>
1.3 16V	1.3	53	10.93-	B3	4	<b>Z 11</b>	14-7 DU	0,8	<b>UXT 24</b>
1.4 LX	1.4	71	03.05-	G4EE	4	<b>Z 334</b>	14 FR-8 DEW	1,0	○
1.6 CVT LX	1.6	82	03.05-	G4ED	4	<b>Z 73</b>	14 FR-8 DUX	1,1	<b>UXT 13</b>

### PRIDE Kombi

1.3	1.3	47	08.99-		4	<b>Z 9</b>	14 R-8 DUX	1,1	<b>UXT 24</b>
-----	-----	----	--------	--	---	------------	------------	-----	---------------

### PRO CEE'D

1.6 CRDi 115	1.6	85	02.08-	D4FB	4	<b>GN 062</b> (11V)	○		
1.6 CRDi 128	1.6	94	10.10-	D4FB	4	<b>GN 062</b> (11V)	○		
2.0	2.0	105	02.08-	G4GC	4	<b>Z 73</b>	14 FR-8 DUX	1,1	<b>UXT 13</b>

### RETONA

2.0 TD	2.0	61	06.99-	RF	4	<b>GN 005</b> (11V)	○		
2.0 16V	2.0	94	05.00-	FE (16 V)	4	<b>Z 16</b>	14 FR-7 DUX	1,1	<b>UXT 13</b>

### RIO

1.3	1.3	55	09.00-02.05		4	<b>Z 9</b>	14 R-8 DUX	1,1	<b>UXT 24</b>
1.5 16V	1.5	72	09.00-02.05		4	<b>Z 15</b>	14 FR-7 DU	0,8	<b>UXT 13</b>

### RIO II

1.4 16V	1.4	71	03.05-	G4EE	4	<b>Z 73</b>	14 FR-8 DUX	1,1	<b>UXT 13</b>
1.5 CRDi	1.5	81	03.05-	D4FA	4	<b>GN 062</b> (11V)	○		
1.6 CVT	1.6	82	03.05-	G4ED	4	<b>Z 73</b>	14 FR-8 DUX	1,1	<b>UXT 13</b>
1.6 16V	1.6	82	03.05-	G4ED	4	<b>Z 73</b>	14 FR-8 DUX	1,1	<b>UXT 13</b>

### RIO Kombi

1.3	1.3	55	08.00-02.05		4	<b>Z 9</b>	14 R-8 DUX	1,1	<b>UXT 24</b>
1.3	1.3	60	08.00-02.05		4	<b>Z 9</b>	14 R-8 DUX	1,1	<b>UXT 24</b>
1.5 16V	1.5	71	09.02-02.05		4	<b>Z 16</b>	14 FR-7 DUX	1,1	<b>UXT 13</b>
1.5 16V	1.5	72	08.00-02.05		4	<b>Z 16</b>	14 FR-7 DUX	1,1	<b>UXT 13</b>

### SEPHIA

1.5 i	1.5	59	02.96-	B5	4	<b>Z 9</b>	14 R-8 DUX	1,1	<b>UXT 24</b>
1.6 i	1.6	59	01.95-	B6	4	<b>Z 9</b>	14 R-8 DUX	1,1	<b>UXT 24</b>
1.8 i 16V	1.8	82	01.95-	OK24N/OK26Y	4	<b>Z 15</b>	14 FR-7 DU	0,8	<b>UXT 13</b>

### SHUMA

1.5 i 16V	1.5	65	10.97-03.01		4	<b>Z 16</b>	14 FR-7 DUX	1,1	<b>UXT 13</b>
1.8 i 16V	1.8	81	10.97-03.01	T8	4	<b>Z 15</b>	14 FR-7 DU	0,8	<b>UXT 13</b>

### SHUMA II

1.6	1.6	75	05.01-08.04	GA6D	4	<b>Z 16</b>	14 FR-7 DUX	1,1	<b>UXT 13</b>
1.8	1.8	84	04.03-08.04	T8	4	<b>Z 15</b>	14 FR-7 DU	0,8	<b>UXT 13</b>

### SORENTO

2.4	2.4	102	08.02-	G4JS	4	<b>Z 311</b>	14 R-8 DPUU	1,0	<b>UXT 6</b>
2.4 CVT	2.4	128	11.09-	G4KE	4	<b>Z 183</b>	14 FR-8 MU2	0,9	<b>UXT 13</b>
2.4 CVT 4WD	2.4	128	11.09-	G4KE	4	<b>Z 183</b>	14 FR-8 MU2	0,9	<b>UXT 13</b>
2.5 CRDi	2.5	103	08.02-	D4CB	4	<b>GN 057</b> (11V)	○		
2.5 CRDi	2.5	125	12.06-	D4CB	4	<b>GN 057</b> (11V)	○		
3.5 V6	3.5	143	08.02-	G6CU	6	<b>Z 228</b>	14 FR-7 DPUX02	1,0	<b>UXT 11</b>

### SOUL

1.6 CRDi 115	1.6	85	02.09-	D4FB	4	<b>GN 062</b> (11V)	○		
1.6 CRDi 128	1.6	94	02.09-	D4FB	4	<b>GN 062</b> (11V)	○		

### SPORTAGE

2.0 TD 4WD	2.0	61	10.97-10.98	RF	4	<b>GN 005</b> (11V)	○		
2.0 i 4WD	2.0	70	04.94-05.95	FE	4	<b>Z 15</b>	14 FR-7 DU	0,8	<b>UXT 13</b>
2.0 i 4WD	2.0	70	06.95-08.99	FE	4	<b>Z 16</b>	14 FR-7 DUX	1,1	<b>UXT 13</b>
2.0 CRDi	2.0	83	02.05-	D4EA	4	<b>GN 035</b> (11V)	○		
2.0 CRDi 4WD	2.0	83	09.04-	D4EA	4	<b>GN 035</b> (11V)	○		
2.0	2.0	87	10.00-08.03		4	<b>Z 16</b>	14 FR-7 DUX	1,1	<b>UXT 13</b>
2.0 4WD	2.0	87	10.00-08.03		4	<b>Z 16</b>	14 FR-7 DUX	1,1	<b>UXT 13</b>

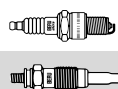

## KIA

### SPORTAGE

2.0 i 16V	2.0	94	10.99-08.03	FE (16 V)	4	Z 16	14 FR-7 DUX	1,1	UXT 1 <sup>3</sup>
2.0 i 16V 4WD	2.0	94	04.94-08.03	FE (16 V)	4	Z 16	14 FR-7 DUX	1,1	UXT 1 <sup>3</sup>
2.0 CRDi	2.0	103	01.06-	D4EA-V	4	GN 035 (11V)	○		
2.0 CRDi 4WD	2.0	103	01.06-	D4EA-V/D4EA-F	4	GN 035 (11V)	○		
2.0 i 16V	2.0	104	09.04-	G4GC	4	Z 73	14 FR-8 DUX	1,1	UXT 1 <sup>3</sup>
2.0 16V 4WD	2.0	104	09.04-	G4GC	4	Z 73	14 FR-8 DUX	1,1	UXT 1 <sup>3</sup>
2.0 CWiT	2.0	120	07.10-	G4KD	4	Z 183	14 FR-8 MU2	0,9	UXT 13
2.0 CWiT AWD	2.0	120	07.10-	G4KD	4	Z 183	14 FR-8 MU2	0,9	UXT 13
2.4 i AWD	2.4	130	08.10-	G4KE	4	Z 183	14 FR-8 MU2	0,9	UXT 13
2.7 V6 4WD	2.7	129	09.04-	G6BA	6	Z 73	14 FR-8 DUX	1,1	UXT 1 <sup>3</sup>

### VENGA

1.6 CRDi 115	1.6	85	02.10-	D4FB	4	GN 062 (11V)	○		
1.6 CRDi 128	1.6	94	02.10-	D4FB	4	GN 062 (11V)	○		

## LADA

### 110

1.5	1.5	54	01.95-		4	Z 20	14 R-7 DU	0,8	UXT 2 <sup>4</sup>
1.5	1.5	56	10.00-	VAZ-2111	4	Z 20	14 R-7 DU	0,8	UXT 2 <sup>4</sup>
1.5	1.5	57	01.95-	VAZ-2111	4	Z 20	14 R-7 DU	0,8	UXT 2 <sup>4</sup>
1.5 16V	1.5	67	10.00-		4	Z 16	14 FR-7 DUX	1,1	UXT 1 <sup>3</sup>
1.5 16V	1.5	70	01.95-09.00	VAZ-2112	4	Z 20	14 R-7 DU	0,8	UXT 2 <sup>4</sup>
1.5 16V	1.5	70	10.00-	VAZ-2112	4	Z 16	14 FR-7 DUX	1,1	UXT 1 <sup>3</sup>
1.6	1.6	60	01.00-	VAZ-21114	4	Z 20	14 R-7 DU	0,8	UXT 2 <sup>4</sup>
1.6	1.6	66	01.00-		4	Z 20	14 R-7 DU	0,8	UXT 2 <sup>4</sup>
2.0 i	2.0	110	08.96-	C 20 XE	4	Z 16	14 FR-7 DUX	1,1	UXT 1 <sup>3</sup>

### 111

1.5	1.5	56	10.00-	VAZ-2111	4	Z 20	14 R-7 DU	0,8	UXT 2 <sup>4</sup>
1.5	1.5	57	01.96-	VAZ-2111	4	Z 20	14 R-7 DU	0,8	UXT 2 <sup>4</sup>
1.5 16V	1.5	67	10.00-		4	Z 16	14 FR-7 DUX	1,1	UXT 1 <sup>3</sup>
1.5 16V	1.5	70	01.95-09.00	VAZ-2112	4	Z 20	14 R-7 DU	0,8	UXT 2 <sup>4</sup>
1.5 16V	1.5	70	10.00-	VAZ-2112	4	Z 16	14 FR-7 DUX	1,1	UXT 1 <sup>3</sup>
1.6	1.6	60	01.05-		4	Z 16	14 FR-7 DUX	1,1	UXT 1 <sup>3</sup>
1.6	1.6	66	03.06-		4	Z 16	14 FR-7 DUX	1,1	UXT 1 <sup>3</sup>

### 112

1.5	1.5	54	01.95-		4	Z 20	14 R-7 DU	0,8	UXT 2 <sup>4</sup>
1.5	1.5	56	10.00-	VAZ-2111	4	Z 20	14 R-7 DU	0,8	UXT 2 <sup>4</sup>
1.5	1.5	57	01.95-	VAZ-2111	4	Z 20	14 R-7 DU	0,8	UXT 2 <sup>4</sup>
1.5 16V	1.5	67	10.00-		4	Z 16	14 FR-7 DUX	1,1	UXT 1 <sup>3</sup>
1.5 16V	1.5	70	01.95-09.00	VAZ-2112	4	Z 20	14 R-7 DU	0,8	UXT 2 <sup>4</sup>
1.5 16V	1.5	70	10.00-	VAZ-2112	4	Z 16	14 FR-7 DUX	1,1	UXT 1 <sup>3</sup>
1.6	1.6	60	01.05-		4	Z 16	14 FR-7 DUX	1,1	UXT 1 <sup>3</sup>
1.6	1.6	66	03.06-		4	Z 16	14 FR-7 DUX	1,1	UXT 1 <sup>3</sup>

### KALINA

1.4 16V	1.4	66	11.08-	VAZ-11194	4	Z 16	14 FR-7 DUX	1,1	UXT 1 <sup>3</sup>
1.6	1.6	60	10.04-	VAZ-21114	4	Z 20	14 R-7 DU	0,8	UXT 2 <sup>4</sup>
1.6	1.6	60	10.04-	VAZ-21124	4	Z 16	14 FR-7 DUX	1,1	UXT 1 <sup>3</sup>

### KALINA Kombi

1.4 16V	1.4	66	11.08-	VAZ-11194	4	Z 16	14 FR-7 DUX	1,1	UXT 1 <sup>3</sup>
1.6	1.6	60	10.04-	VAZ-21114	4	Z 20	14 R-7 DU	0,8	UXT 2 <sup>4</sup>

### NIVA

1600	1.6	54	01.87-03.95	BA3 2121	4	Z 20	14 R-7 DU	0,8	UXT 2 <sup>4</sup>
1700 i	1.7	59	06.96-	BA3 21214	4	Z 20	14 R-7 DU	0,8	UXT 2 <sup>4</sup>
1700 i 4x4	1.7	60	10.00-		4	Z 20	14 R-7 DU	0,8	UXT 2 <sup>4</sup>
1900 Diesel	1.9	47	01.93-	XUD9A	4	GV 636 (11V)	○		
1900 Diesel	1.9	55	01.99-	XUD9SD	4	GN 013 (11V)	○		

### NOVA

1200 Junior/L	1.2	44	07.88-	BA3 2101	4	Z 20	14 R-7 DU	0,8	UXT 2 <sup>4</sup>
1300 Spezial/L	1.3	48	07.88-	BA3 2105	4	Z 20	14 R-7 DU	0,8	UXT 2 <sup>4</sup>
1500	1.5	49	05.93-04.04	BA3 2103 (KAT)	4	Z 11	14-7 DU	0,8	UXT 2 <sup>4</sup>
1500 S	1.5	52	06.89-	BA3 21083	4	Z 11	14-7 DU	0,8	UXT 2 <sup>4</sup>
1500 Special	1.5	55	07.88-	BA3 2103	4	Z 20	14 R-7 DU	0,8	UXT 2 <sup>4</sup>

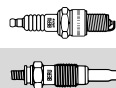
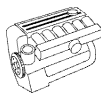

<b>LADA</b>										
<b>NOVA</b>										
1600	1.6	56	07.88–10.01	BA3 2106	4	<b>Z 20</b>	14 R-7 DU	0,8		<b>UXT 2<sup>4</sup></b>
1700 i Classic	1.7	62	06.96–		4	<b>Z 20</b>	14 R-7 DU	0,8		<b>UXT 2<sup>4</sup></b>
<b>NOVA Kombi</b>										
1300	1.3	48	07.88–12.90	BA3 2105	4	<b>Z 20</b>	14 R-7 DU	0,8		<b>UXT 2<sup>4</sup></b>
1500	1.5	49	08.94–	BA3 2103 (KAT)	4	<b>Z 11</b>	14-7 DU	0,8		<b>UXT 2<sup>4</sup></b>
1500	1.5	55	07.88–04.98	BA3 2103	4	<b>Z 20</b>	14 R-7 DU	0,8		<b>UXT 2<sup>4</sup></b>
1700	1.7	62	08.94–		4	<b>Z 11</b>	14-7 DU	0,8		<b>UXT 2<sup>4</sup></b>
<b>PRIORA</b>										
1.6	1.6	72	12.08–	VAZ-21126	4	<b>Z 16</b>	14 FR-7 DUX	1,1		<b>UXT 1<sup>3</sup></b>
<b>PRIORA Kombi</b>										
1.6	1.6	72	10.09–	VAZ-21126	4	<b>Z 16</b>	14 FR-7 DUX	1,1		<b>UXT 1<sup>3</sup></b>
<b>SAMARA</b>										
1100	1.1	39	02.88–12.94	BA3 21081	4	<b>Z 20</b>	14 R-7 DU	0,8		<b>UXT 2<sup>4</sup></b>
1100	1.1	43	02.96–	BA3 21081 (KAT)	4	<b>Z 11</b>	14-7 DU	0,8		<b>UXT 2<sup>4</sup></b>
1300	1.3	45	09.91–	BA3 2108 (KAT)	4	<b>Z 20</b>	14 R-7 DU	0,8		<b>UXT 2<sup>4</sup></b>
1300	1.3	46	07.88–	BA3 2108	4	<b>Z 20</b>	14 R-7 DU	0,8		<b>UXT 2<sup>4</sup></b>
1300	1.3	48	07.88–12.94	BA3 2108	4	<b>Z 20</b>	14 R-7 DU	0,8		<b>UXT 2<sup>4</sup></b>
1300	1.3	50	02.96–	BA3 21115	4	<b>Z 20</b>	14 R-7 DU	0,8		<b>UXT 2<sup>4</sup></b>
1500	1.5	50	09.91–	BA3 21083 (KAT)	4	<b>Z 20</b>	14 R-7 DU	0,8		<b>UXT 2<sup>4</sup></b>
1500	1.5	52	02.95–	BA3 2111	4	<b>Z 20</b>	14 R-7 DU	0,8		<b>UXT 2<sup>4</sup></b>
1500	1.5	53	01.88–	BA3 21083	4	<b>Z 20</b>	14 R-7 DU	0,8		<b>UXT 2<sup>4</sup></b>
1.5	1.5	57	04.96–	VAZ-2111	4	<b>Z 20</b>	14 R-7 DU	0,8		<b>UXT 2<sup>4</sup></b>
<b>SAMARA FORMA</b>										
1100	1.1	39	07.91–	BA3 21081 (KAT)	4	<b>Z 11</b>	14-7 DU	0,8		<b>UXT 2<sup>4</sup></b>
1300	1.3	45	07.91–	BA3 2108	4	<b>Z 11</b>	14-7 DU	0,8		<b>UXT 2<sup>4</sup></b>
1300	1.3	46	05.90–		4	<b>Z 11</b>	14-7 DU	0,8		<b>UXT 2<sup>4</sup></b>
1300	1.3	48	05.89–07.97	BA3 2108	4	<b>Z 20</b>	14 R-7 DU	0,8		<b>UXT 2<sup>4</sup></b>
1300	1.3	50	02.96–		4	<b>Z 11</b>	14-7 DU	0,8		<b>UXT 2<sup>4</sup></b>
1500	1.5	50	07.91–	BA3 21083 (KAT)	4	<b>Z 20</b>	14 R-7 DU	0,8		<b>UXT 2<sup>4</sup></b>
1500	1.5	52	11.94–	BA3 2111	4	<b>Z 20</b>	14 R-7 DU	0,8		<b>UXT 2<sup>4</sup></b>
1500	1.5	53	09.91–	BA3 21083	4	<b>Z 20</b>	14 R-7 DU	0,8		<b>UXT 2<sup>4</sup></b>
1.5	1.5	59	08.03–	VAZ-2111	4	<b>Z 20</b>	14 R-7 DU	0,8		<b>UXT 2<sup>4</sup></b>
<b>TOSCANA</b>										
1300	1.3	48	12.85–	BA3 2105	4	<b>Z 20</b>	14 R-7 DU	0,8		<b>UXT 2<sup>4</sup></b>
1500	1.5	55	09.83–02.93	BA3 2103	4	<b>Z 20</b>	14 R-7 DU	0,8		<b>UXT 2<sup>4</sup></b>
<b>LANCIA</b>										
<b>DEDRA</b>										
1.6 i.e.	1.6	55	04.93–07.99	835 C1.000	4	<b>Z 252</b>	14 FR-6 DUW	0,9		<b>UXT 5</b>
1.6 i.e.	1.6	57	08.89–03.93	835 A1.046	4	<b>Z 27</b>	14 R-6 DU	0,8		<b>UX 56</b>
1.6 LE KAT	1.6	66	07.94–07.99	159 B9.000	4	<b>Z 252</b>	14 FR-6 DUW	0,9		<b>UXT 5</b>
1.6 16V	1.6	76	01.96–07.99	182 A4.000	4	<b>Z 98</b>	14 FR-7 LDU	0,8		<b>UXT 1<sup>3</sup></b>
1.8 16V LE	1.7	83	03.96–07.99	182 A2.000	4	<b>Z 98</b>	14 FR-7 LDU	0,8		<b>UXT 1<sup>3</sup></b>
1.8 GT 16V	1.7	96	03.96–07.99	183 A1.000	4	<b>Z 98</b>	14 FR-7 LDU	0,8		<b>UXT 1<sup>3</sup></b>
1.8 i.e.	1.8	66	08.93–07.99	835 C5.000	4	<b>Z 30</b>	14 FR-5 DU	0,8		<b>UXT 5</b>
1.8 i.e.	1.8	74	07.94–07.99	836 A5.000	4	<b>Z 27</b>	14 R-6 DU	0,8		<b>UX 56</b>
1.8 i.e.	1.8	77	09.89–07.99	835 A2.046	4	<b>Z 27</b>	14 R-6 DU	0,8		<b>UX 56</b>
1.9 TDS	1.9	66	04.89–09.94	835 A4.000/835 A4.046/ 160 D1.000	4	<b>GV 663</b> (11V)	○			
1.9 TDS	1.9	66	10.94–07.99	835 A4.000/835 A4.046/ 160 D1.000	4	<b>GN 908</b> (11V)	○			
2.0 i.e.	2.0	83	09.89–07.99	835 A5.046	4	<b>Z 27</b>	14 R-6 DU	0,8		<b>UX 56</b>
2.0 16V	2.0	102	07.94–07.99	836 A3.000	4	<b>Z 27</b>	14 R-6 DU	0,8		<b>UX 56</b>
2.0 i.e. Turbo Integrale	2.0	121	05.90–07.92	835 A7.000	4	<b>Z 27</b>	14 R-6 DU	0,8		<b>UX 56</b>
2.0 Turbo	2.0	130	11.90–07.92	835 A8.000	4	<b>Z 27</b>	14 R-6 DU	0,8		<b>UX 56</b>
<b>DEDRA SW</b>										
1.6	1.6	66	10.94–07.99	159 B9.000	4	<b>Z 252</b>	14 FR-6 DUW	0,9		<b>UXT 5</b>
1.6 16V	1.6	76	01.96–07.99	182 A4.000	4	<b>Z 98</b>	14 FR-7 LDU	0,8		<b>UXT 1<sup>3</sup></b>
1.8 i.e.	1.8	74	07.94–07.99	836 A5.000	4	<b>Z 27</b>	14 R-6 DU	0,8		<b>UX 56</b>
1.8 16V LE	1.8	83	03.96–07.99	182 A2.000	4	<b>Z 98</b>	14 FR-7 LDU	0,8		<b>UXT 1<sup>3</sup></b>
1.8 GT 16V	1.8	96	03.96–07.99	183 A1.000	4	<b>Z 98</b>	14 FR-7 LDU	0,8		<b>UXT 1<sup>3</sup></b>

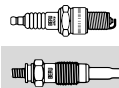

## LANCIA

### DEDRA SW

1.9 TDS	1.9	66	07.94-09.94	835 A4.000/160 D1.000	4	GV 663 (11V)	○		
1.9 TDS	1.9	66	10.94-07.99	835 A4.000/160 D1.000	4	GN 908 (11V)	○		
2.0 16V	2.0	102	07.94-07.99	836 A3.000	4	Z 27	14 R-6 DU	0,8	UX 56
2.0 Integrale	2.0	102	07.94-07.99	836 A3.000	4	Z 27	14 R-6 DU	0,8	UX 56

### DELTA I

1.3	1.3	55	09.79-08.92	831 A2.000/831 B.000	4	Z 27	14 R-6 DU	0,8	UX 56
1.3	1.3	58	09.83-08.92	831 A2.000	4	Z 27	14 R-6 DU	0,8	UX 56
1.5	1.5	63	09.79-12.92	831 A1.000/831 B1.000	4	Z 27	14 R-6 DU	0,8	UX 56
1.6 GT i.e.	1.6	66	05.87-08.92	149 C2.000	4	Z 27	14 R-6 DU	0,8	UX 56

### DELTA II

1.4 i.e.	1.4	51	10.94-08.99	836 A4.000/160 A1.046	4	Z 27	14 R-6 DU	0,8	UX 56
1.6 i.e.	1.6	55	06.93-08.99	835 C1.000	4	Z 252	14 FR-6 DUW	0,9	UXT 5
1.6 i.e.	1.6	66	03.96-08.99	182 A6.000	4	Z 98	14 FR-7 LDU	0,8	UXT 1 <sup>3</sup>
1.6 i.e. 16V	1.6	76	01.96-08.99	182 A4.000	4	Z 98	14 FR-7 LDU	0,8	UXT 1 <sup>3</sup>
1.8 i.e.	1.8	66	07.94-08.99	835 C4.000/836 C4.000/ 836 A6.000	4	Z 27	14 R-6 DU	0,8	UX 56
1.8 i.e.	1.8	76	06.93-08.99	835 C2.000	4	Z 27	14 R-6 DU	0,8	UX 56
1.8 i.e. 16V	1.8	83	03.96-08.99	182 A2.000	4	Z 98	14 FR-7 LDU	0,8	UXT 1 <sup>3</sup>
1.8 i.e. 16V GT	1.8	96	03.96-08.99	183 A1.000	4	Z 98	14 FR-7 LDU	0,8	UXT 1 <sup>3</sup>
1.9 TD	1.9	66	10.94-08.99	835 A4.000/160 D1.000	4	GN 908 (11V)	○		
2.0 16V	2.0	102	06.93-08.99	836 A3.000	4	Z 27	14 R-6 DU	0,8	UX 56
2.0 16V Turbo	2.0	137	06.93-09.96	836 A2.000	4	Z 12	14-7 DTU	0,8	UXT 2 <sup>4</sup>
2.0 16V Turbo	2.0	142	07.96-08.99	175 A4.000	4	Z 15	14 FR-7 DU	0,8	UXT 1 <sup>3</sup>

### DELTA III

1.4	1.4	88	09.08-	198 A4.000	4	Z 338	12 FR-4 DPUT	0,8	○
1.4 16V	1.4	103	07.10-	198 A7.000	4	Z 338	12 FR-4 DPUT	0,8	○
1.4	1.4	110	09.08-	198 A1.000	4	Z 338	12 FR-4 DPUT	0,8	○

### KAPPA

2.0 20V	2.0	107	10.94-10.01	838 A1.000	5	Z 245	14 FR-6 LDJW	0,9	UXT 5
2.0 20V	2.0	114	07.96-10.01	838 A6.000	5	Z 245	14 FR-6 LDJW	0,9	UXT 5
2.0 16V Turbo	2.0	151	02.95-10.01	838 A4.000	4	Z 245	14 FR-6 LDJW	0,9	UXT 5
2.4 T.DS	2.4	91	08.94-10.01	838 A7.000/838 A3.000	5	GN 970 (11V)	○		
2.4 JTD	2.4	100	06.98-10.01	838 A8.000	5	GN 041 (11V)	○		
				Kühlwasservorwärmung <sup>15</sup> ⇄ Ø 4 mm		GN 020 (12V)			
2.4 20V	2.4	129	08.94-10.01	838 A2.000/838 A2.027	5	Z 98	14 FR-7 LDU	0,8	UXT 1 <sup>3</sup>
3.0 24V	3.0	150	08.94-10.01	838 B.000	6	Z 188	14 F-7 DPUR02	0,7	UXT 10

### KAPPA Coupe

2.0 20V	2.0	114	07.96-03.01	838 A6.000	5	Z 245	14 FR-6 LDJW	0,9	UXT 5
2.0 16V Turbo	2.0	151	11.96-03.01	838 A4.000	4	Z 245	14 FR-6 LDJW	0,9	UXT 5
2.4 20V	2.4	129	11.96-03.01	838 A2.000	5	Z 98	14 FR-7 LDU	0,8	UXT 1 <sup>3</sup>
3.0 24V	3.0	150	11.96-03.01	838 B.000	6	Z 188	14 F-7 DPUR02	0,7	UXT 10

### KAPPA SW

2.0 20V	2.0	114	07.96-10.01	838 A6.000	5	Z 245	14 FR-6 LDJW	0,9	UXT 5
2.0 16V Turbo	2.0	151	07.96-10.01	838 A4.000	4	Z 245	14 FR-6 LDJW	0,9	UXT 5
2.4 T.DS	2.4	91	07.96-10.01	838 A7.000/838 A3.000	5	GN 970 (11V)	○		
2.4 JTD	2.4	100	06.98-10.01	838 A8.000	5	GN 041 (11V)	○		
				Kühlwasservorwärmung <sup>15</sup> ⇄ Ø 4 mm		GN 020 (12V)			
2.4 20V	2.4	129	07.96-10.01	838 A2.000	5	Z 98	14 FR-7 LDU	0,8	UXT 1 <sup>3</sup>
3.0 24V	3.0	150	07.96-10.01	838 B.000	6	Z 188	14 F-7 DPUR02	0,7	UXT 10

### LYBRA

1.6 16V	1.6	76	07.99-10.05	182 A4.000	4	Z 98	14 FR-7 LDU	0,8	UXT 1 <sup>3</sup>
1.8 16V	1.7	96	07.99-10.05	839 A7.000/839 A9.000/839 A4.000	4	Z 98	14 FR-7 LDU	0,8	UXT 1 <sup>3</sup>
1.9 JTD	1.9	77	07.99-09.00	AR 32302	4	GN 041 (11V)	○		
				Kühlwasservorwärmung <sup>15</sup> ⇄ Ø 4 mm		GN 020 (12V)			
1.9 JTD	1.9	81	09.00-05.01	AR 37101	4	GN 041 (11V)	○		
				Kühlwasservorwärmung <sup>15</sup> ⇄ Ø 4 mm		GN 020 (12V)			
1.9 JTD	1.9	85	05.01-10.05	937 A2.000	4	GN 041 (11V)	○		
				Kühlwasservorwärmung <sup>15</sup> ⇄ Ø 4 mm		GN 020 (12V)			
2.0 20V	2.0	110	09.00-10.05	185 A8.000	5	Z 98	14 FR-7 LDU	0,8	UXT 1 <sup>3</sup>
2.0 20V	2.0	113	07.99-09.00	182 B7.000	5	Z 98	14 FR-7 LDU	0,8	UXT 1 <sup>3</sup>



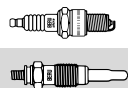
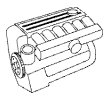

## LANCIA

LYBRA									
2.4 JTD	2.4	99	11.99-02.01	AR 32501/839 A5.000	5	<b>GN 041</b> (11V)	○		
				Kühlwasservorwärmung <sup>15</sup> ⇄ Ø 4 mm		<b>GN 020</b> (12V)			
2.4 JTD	2.4	103	09.00-05.02	839 A6.000	5	<b>GN 041</b> (11V)	○		
				Kühlwasservorwärmung <sup>15</sup> ⇄ Ø 4 mm		<b>GN 020</b> (12V)			
2.4 JTD	2.4	110	05.02-10.05	841 C.000	5	<b>GN 041</b> (11V)	○		
				Kühlwasservorwärmung <sup>15</sup> ⇄ Ø 4 mm		<b>GN 020</b> (12V)			

## LYBRA SW

1.6 16V	1.6	76	07.99-10.05	182 A4.000	4	<b>Z 98</b>	14 FR-7 LDU	0,8	<b>UXT 1<sup>3</sup></b>
1.8 16V	1.7	96	07.99-10.05	839 A7.000/839 A4.000	4	<b>Z 98</b>	14 FR-7 LDU	0,8	<b>UXT 1<sup>3</sup></b>
1.9 JTD	1.9	77	11.99-09.00	AR 32302	4	<b>GN 041</b> (11V)	○		
				Kühlwasservorwärmung <sup>15</sup> ⇄ Ø 4 mm		<b>GN 020</b> (12V)			
1.9 JTD	1.9	81	09.00-05.01	AR 37101	4	<b>GN 041</b> (11V)	○		
				Kühlwasservorwärmung <sup>15</sup> ⇄ Ø 4 mm		<b>GN 020</b> (12V)			
1.9 JTD	1.9	85	05.01-10.05	937 A2.000	4	<b>GN 041</b> (11V)	○		
				Kühlwasservorwärmung <sup>15</sup> ⇄ Ø 4 mm		<b>GN 020</b> (12V)			
2.0 20V	2.0	110	09.00-10.05	185 A8.000	5	<b>Z 98</b>	14 FR-7 LDU	0,8	<b>UXT 1<sup>3</sup></b>
2.0 20V	2.0	113	07.99-09.00	182 B7.000	5	<b>Z 98</b>	14 FR-7 LDU	0,8	<b>UXT 1<sup>3</sup></b>
2.4 JTD	2.4	99	10.99-09.00	AR 32501/839 A5.000	5	<b>GN 041</b> (11V)	○		
				Kühlwasservorwärmung <sup>15</sup> ⇄ Ø 4 mm		<b>GN 020</b> (12V)			
2.4 JTD	2.4	103	09.00-10.05	839 A6.000	5	<b>GN 041</b> (11V)	○		
				Kühlwasservorwärmung <sup>15</sup> ⇄ Ø 4 mm		<b>GN 020</b> (12V)			
2.4 JTD	2.4	110	05.02-10.05	841 C.000	5	<b>GN 041</b> (11V)	○		
				Kühlwasservorwärmung <sup>15</sup> ⇄ Ø 4 mm		<b>GN 020</b> (12V)			

## MUSA

1.3 D Multijet	1.3	51	10.04-	188 A9.000	4	<b>GN 053</b> (11V)	○		
1.3 D Multijet	1.3	66	09.06-	199 A3.000	4	<b>GN 053</b> (11V)	○		
1.4	1.4	57	09.05-	350 A1.000	4	<b>Z 293</b>	12 FR-6 LUX	1,05	○
1.4 LPG	1.4	57	11.10-	350 A1.000	4	<b>Z 293</b>	12 FR-6 LUX	1,05	○
1.4	1.4	66	10.07-	192 B2.000	4	<b>Z 292</b>	12 FR-6 DU	1,05	○
1.9 D Multijet	1.9	74	10.04-	188 B2.000	4	<b>GN 041</b> (11V)	○		

## PHEDRA

2.0 JTD	2.0	79	07.03-11.10	RHM	4	<b>GN 027</b> (11V)	○		
2.0 JTD	2.0	80	09.02-11.10	RHW(DW10ATED4)	4	<b>GN 027</b> (11V)	○		
2.0 JTD	2.0	88	06.06-11.10	RHK	4	<b>GN 054</b> (11V)	○		
2.0	2.0	100	09.02-11.10	RFN(EW10J4)	4	<b>Z 183</b>	14 FR-8 MU2	0,9	<b>UXT 13</b>
2.0 D Multijet	2.0	100	07.06-11.10	RHR	4	<b>GN 054</b> (11V)	○		
2.2 JTD	2.2	94	09.02-11.10	4HW(DW12ATED4)	4	<b>GN 027</b> (11V)	○		

## PRISMA

1.3	1.3	58	01.83-02.92	831 A2.000	4	<b>Z 27</b>	14 R-6 DU	0,8	<b>UX 56</b>
1.5	1.5	55	09.85-02.92	831 B1.048/138 C2.048	4	<b>Z 27</b>	14 R-6 DU	0,8	<b>UX 56</b>
1.5	1.5	59	08.86-02.92	831 B1.000	4	<b>Z 27</b>	14 R-6 DU	0,8	<b>UX 56</b>
1.6	1.6	73	08.86-02.92	831 B6.000	4	<b>Z 27</b>	14 R-6 DU	0,8	<b>UX 56</b>
1.9 Diesel	1.9	48	01.83-02.92	831 D.000	4	<b>GV 663</b> (11V)	○		

## THEMA

2000 i.e.	2.0	85	09.87-05.92	834 B.146	4	<b>Z 27</b>	14 R-6 DU	0,8	<b>UX 56</b>
2000 i.e. 16V	2.0	104	02.89-05.92	834 B2.246	4	<b>Z 27</b>	14 R-6 DU	0,8	<b>UX 56</b>
2000 i.e. Turbo	2.0	110	07.86-05.90	834 C.146	4	<b>Z 27</b>	14 R-6 DU	0,8	<b>UX 56</b>
2000 16V	2.0	112	08.92-12.93	834 F1.000	4	<b>Z 27</b>	14 R-6 DU	0,8	<b>UX 56</b>
2000 i.e. 16V Turbo	2.0	130	04.89-05.92	834 C1.246	4	<b>Z 12</b>	14-7 DTU	0,8	<b>UXT 2<sup>4</sup></b>
2000 16V Turbo	2.0	133	12.88-06.90	834 C1.000	4	<b>Z 12</b>	14-7 DTU	0,8	<b>UXT 2<sup>4</sup></b>
2500 Turbo DS	2.5	77	05.88-07.92	8144. 97S	4	<b>GN 909</b> (11V)	○		
2500 Turbo DS	2.5	85	06.88-05.92	8144.97	4	<b>GN 917</b> (11V)	○		
2500 Turbo DS	2.5	85	05.92-07.94	8144.97 Y	4	<b>GN 925</b> (11V)	○		
3000 V6	3.0	126	08.92-07.94	834 F.000	6	<b>Z 27</b>	14 R-6 DU	0,8	<b>UX 56</b>

## THEMA SW

2000 i.e. 16V	2.0	104	02.89-05.92	834 B2.246	4	<b>Z 27</b>	14 R-6 DU	0,8	<b>UX 56</b>
2000 Turbo	2.0	110	01.89-03.92	834 C.146	4	<b>Z 27</b>	14 R-6 DU	0,8	<b>UX 56</b>
2000 16V	2.0	112	05.92-07.94	834 F1.000	4	<b>Z 27</b>	14 R-6 DU	0,8	<b>UX 56</b>
2000 i.e. 16V Turbo	2.0	130	04.89-03.93	834 C1.246	4	<b>Z 11</b>	14-7 DU	0,8	<b>UXT 2<sup>4</sup></b>
2000 Turbo 16V	2.0	148	11.92-07.94	834 F2.000	4	<b>Z 12</b>	14-7 DTU	0,8	<b>UXT 2<sup>4</sup></b>

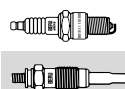
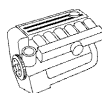

## LANCIA

### THEMA SW

2500 Turbo DS	2.4	74	03.87-09.90	8144.91	4	<b>GV 727</b> (11V)	○		
2500 Turbo DS	2.5	77	05.88-07.92	8144.97S	4	<b>GN 909</b> (11V)	○		
2500 Turbo DS	2.5	85	06.88-05.92	8144.97	4	<b>GN 909</b> (11V)	○		
2500 Turbo DS	2.5	85	09.92-07.94	8144.97 Y	4	<b>GN 925</b> (11V)	○		
3000 V6	3.0	126	09.92-07.94	834 F.000	6	<b>Z 27</b>	14 R-6 DU	0,8	<b>UX 56</b>

### THESIS

2.4 JTD	2.4	110	07.02-07.09	841 C.000	5	<b>GN 041</b> (11V)	○		
2.4	2.4	125	07.02-07.09	841 D.000	5	<b>Z 245</b>	14 FR-6 LDUW	0,9	<b>UXT 5</b>
2.4 JTD	2.4	129	05.03-07.09	841 G.000	5	<b>GN 059</b> (11V)	○		

### Y

1.1	1.1	40	11.95-09.03	176 B2.000	4	<b>Z 193</b>	14 FR-7 DU2	0,9	<b>UXT 1<sup>3</sup></b>
1.2	1.2	44	03.96-09.03	840 A3.000/188 A4.000	4	<b>Z 250</b>	14 FR-7 DU2S	0,7	<b>UXT 1<sup>3</sup></b>
1.2 16V	1.2	59	10.00-09.03	188 A5.000	4	<b>Z 234</b>	12 FR-7 DU	0,9	○
1.2 16V	1.2	63	04.97-09.03	176 B9.000	4	<b>Z 234</b>	12 FR-7 DU	0,9	○
1.4 12V	1.4	55	03.96-09.03	840 A4.000	4	<b>Z 245</b>	14 FR-6 LDUW	0,9	<b>UXT 5</b>
1.4 12V	1.4	59	10.96-09.03	840 A2.000	4	<b>Z 245</b>	14 FR-6 LDUW	0,9	<b>UXT 5</b>

### Y10

1.0 Fire	1.0	32	03.89-06.91	156 A 2.100	4	<b>Z 15</b>	14 FR-7 DU	0,8	<b>UXT 1<sup>3</sup></b>
1.0 Fire KAT	1.0	33	10.87-02.92	156 A2.246	4	<b>Z 247</b>	14 FR-7 DUW	0,9	<b>UXT 1<sup>3</sup></b>
1.0 Fire 4WD	1.0	33	12.87-02.92	156 A2.246	4	<b>Z 247</b>	14 FR-7 DUW	0,9	<b>UXT 1<sup>3</sup></b>
1.1 i.e. Fire	1.1	37	07.89-09.95	156 C.046	4	<b>Z 193</b>	14 FR-7 DU2	0,9	<b>UXT 1<sup>3</sup></b>
1.1 i.e. Fire 4WD	1.1	37	09.92-12.95	156 C.046	4	<b>Z 193</b>	14 FR-7 DU2	0,9	<b>UXT 1<sup>3</sup></b>
1.1 Avenue	1.1	40	01.95-12.95	176 B2.000	4	<b>Z 193</b>	14 FR-7 DU2	0,9	<b>UXT 1<sup>3</sup></b>
1.1 Avenue 4WD	1.1	40	01.95-12.95	176 B2.000	4	<b>Z 193</b>	14 FR-7 DU2	0,9	<b>UXT 1<sup>3</sup></b>
1.3 i.e. Fire	1.3	53	02.89-09.92	156 B.000/146 A 5.046	4	<b>Z 20</b>	14 R-7 DU	0,8	<b>UXT 2<sup>4</sup></b>

### YPSILON

1.2	1.2	44	10.03-12.11	188 A4.000 → Mot.Nr. 2533528	4	<b>Z 255</b>	14 FR-8 DUW	0,9	<b>UXT 1<sup>3</sup></b>
1.2	1.2	44	10.03-12.11	188 A4.000 Mot.Nr. 2533529 →	4	<b>Z 234</b>	12 FR-7 DU	0,9	○
1.2	1.2	51	05.11-	169 A4.000 Euro4(D4)	4	<b>Z 292</b>	12 FR-6 DU	1,05	○
1.2	1.2	51	05.11-	169 A4.000 Euro5	4	<b>Z 293</b>	12 FR-6 LUX	1,05	○
1.2	1.2	59	10.03-12.11	188 A5.000	4	<b>Z 234</b>	12 FR-7 DU	0,9	○
1.3 JTD	1.3	51	10.03-12.11	188 A9.000	4	<b>GN 053</b> (11V)	○		
1.3 D Multijet	1.3	55	09.06-12.11	169 A5.000/199 A2.000	4	<b>GN 053</b> (11V)	○		
1.3 D Multijet	1.3	66	09.06-12.11	199 A3.000	4	<b>GN 053</b> (11V)	○		
1.4	1.4	57	02.06-12.11	350 A1.000	4	<b>Z 293</b>	12 FR-6 LUX	1,05	○
1.4 LPG	1.4	57	11.10-12.11	350 A1.000	4	<b>Z 293</b>	12 FR-6 LUX	1,05	○

### ZETA

2.0 JTD	2.0	80	04.00-09.02	RHZ	4	<b>GN 027</b> (11V)	○		
2.0 JTD	2.0	80	09.99-09.02	RHW	4	<b>GN 027</b> (11V)	○		
2.0 16V	2.0	97	06.99-07.00	RFV	4	<b>Z 247</b>	14 FR-7 DUW	0,9	<b>UXT 1<sup>3</sup></b>
2.0 16V	2.0	100	07.00-09.02	RFN	4	<b>Z 183</b>	14 FR-8 MU2	0,9	<b>UXT 13</b>
2.0 Turbo	2.0	108	05.95-09.02	RGX	4	<b>Z 193</b>	14 FR-7 DU2	0,9	<b>UXT 1<sup>3</sup></b>
2.1 TD	2.1	80	05.96-09.99	P 8 C	4	<b>GN 909</b> (11V)	○		

## LANDROVER

### 90/110

2.5	2.5	62	09.85-07.90	17 H	4	<b>Z 62</b>	14-7 DUO	0,8	<b>UXT 2<sup>4</sup></b>
2.5 TD	2.5	63	09.86-07.90	19 J	4	<b>GV 602</b> (11V)	○		
3.5 V8	3.5	100	09.83-07.90		8	<b>Z 62</b>	14-7 DUO	0,8	<b>UXT 2<sup>4</sup></b>

### DEFENDER Cabrio

2.5 90 TDI	2.5	83	09.90-	23L	4	<b>GV 783</b> (11,5)	○		
2.5 Td5 4WD	2.5	90	06.98-12.98	14 P/10 P	5	<b>GV 783</b> (11,5)	○		
2.5 Td5 4WD	2.5	90	01.99-	14 P/10 P	5	<b>GN 985</b> (11V)	○		

### DEFENDER Pick-up

2.5 Td5 4WD	2.5	90	06.98-12.98	10 P	5	<b>GV 783</b> (11,5)	○		
2.5 Td5 4WD	2.5	90	01.99-	10 P	5	<b>GN 985</b> (11V)	○		

### DEFENDER Station Wagon

2.5 90,110 TDI	2.5	83	09.90-12.98	23L	4	<b>GV 783</b> (11,5)	○		
2.5 Td5 4WD	2.5	90	06.98-12.98	10 P	5	<b>GV 783</b> (11,5)	○		

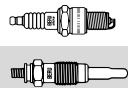
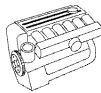

## LANDROVER

### DEFENDER Station Wagon

2.5 Td5 4WD	2.5	90	01.99-	10 P	5	<b>GN 985</b> (11V)	○		
3.9 V8	3.8	136	11.98-		8	<b>Z 82</b>	14 R-9 DU	0,7	<b>UXT 2<sup>4</sup></b>

### DISCOVERY I

2.0 16 V	2.0	99	09.93-10.98		4	<b>Z 15</b>	14 FR-7 DU	0,8	<b>UXT 1<sup>3</sup></b>
2.5 TDI	2.5	83	10.89-10.98	19 L/21 L/17 L/12 L	4	<b>GV 783</b> (11,5)	○		
3.5	3.5	113	10.89-06.94	22 D	8	<b>Z 20</b>	14 R-7 DU	0,8	<b>UXT 2<sup>4</sup></b>
3.9 V8	3.8	134	09.93-10.98	36 D/35 D	8	<b>Z 82</b>	14 R-9 DU	0,7	<b>UXT 2<sup>4</sup></b>

### DISCOVERY II

2.5 Td5	2.5	102	01.99-06.04	10 P	5	<b>GN 985</b> (11V)	○		
4.0 V8	4.0	136	11.98-06.04	56 D	8	<b>Z 82</b>	14 R-9 DU	0,7	<b>UXT 2<sup>4</sup></b>

### DISCOVERY III

2.7 TD	2.7	140	07.04-09.09	276DT	6	<b>GN 045</b> (11V)	○		
--------	-----	-----	-------------	-------	---	---------------------	---	--	--

### FREELANDER

1.8 16V	1.8	86	11.00-10.06	18 K4F	4	<b>Z 228</b>	14 FR-7 DPUX02	1,0	<b>UXT 11</b>
1.8 i 16V	1.8	88	02.98-11.00	18 K4F	4	<b>Z 228</b>	14 FR-7 DPUX02	1,0	<b>UXT 11</b>
2.0 DI	2.0	72	02.98-11.00	20 T2N	4	<b>GN 905</b> (11V)	○		
2.0 Td4	2.0	80	11.01-10.06	M 47	4	<b>GN 024</b> (11V)	○		
2.0 Td4	2.0	82	11.00-10.06	204D3	4	<b>GN 024</b> (11V)	○		
2.5 V6	2.5	130	11.00-10.06	25 K4F	6	<b>Z 228</b>	14 FR-7 DPUX02	1,0	<b>UXT 11</b>

### FREELANDER 2

2.2 TD4	2.2	110	08.10-	DW12BTED4	4	<b>GN 063</b> (11V)	○		
2.2 TD4 4x4	2.2	110	10.06-	DW12BTED4	4	<b>GN 063</b> (11V)	○		

### FREELANDER Soft Top

1.8 i 16V	1.8	88	02.98-10.06	18 K4F	4	<b>Z 228</b>	14 FR-7 DPUX02	1,0	<b>UXT 11</b>
2.0 DI	2.0	72	02.98-10.06	20 T2N	4	<b>GN 905</b> (11V)	○		

### RANGE ROVER I

2.4 Diesel	2.4	78	04.86-12.90	11 A	4	<b>GV 657</b> (11V)	○		
3.5 Vogue	3.5	93	08.81-09.90	11 D	8	<b>Z 11</b>	14-7 DU	0,8	<b>UXT 2<sup>4</sup></b>
3.5	3.5	107	01.87-09.90	31 D	8	<b>Z 11</b>	14-7 DU	0,8	<b>UXT 2<sup>4</sup></b>
3.5 Vogue	3.5	120	10.85-09.90	25 D/24 D	8	<b>Z 11</b>	14-7 DU	0,8	<b>UXT 2<sup>4</sup></b>
3.9 KAT	4.0	127	11.88-07.94	37 D/38 D	8	<b>Z 1</b>	14-8 DU	0,8	<b>UXT 2<sup>4</sup></b>
3.9 Vogue SEI	4.0	134	11.88-07.94	36 D/35 D	8	<b>Z 1</b>	14-8 DU	0,8	<b>UXT 2<sup>4</sup></b>
4.3 Vogue LSE	4.3	149	09.92-07.94	40 D	8	<b>Z 82</b>	14 R-9 DU	0,7	<b>UXT 2<sup>4</sup></b>

### RANGE ROVER II

2.5 D	2.5	83	08.94-03.02	14 L	4	<b>GV 719</b> (11V)	○		
2.5 TD	2.5	100	07.94-03.02	25 6T (BMW)	6	<b>GV 719</b> (11V)	○		
3.9	3.8	140	07.94-03.02	42 D	8	<b>Z 82</b>	14 R-9 DU	0,7	<b>UXT 2<sup>4</sup></b>
4.0	4.0	136	06.98-03.02		8	<b>Z 82</b>	14 R-9 DU	0,7	<b>UXT 2<sup>4</sup></b>
4.6	4.6	160	06.98-03.02	60 D	8	<b>Z 20</b>	14 R-7 DU	0,8	<b>UXT 2<sup>4</sup></b>
4.6	4.6	165	07.94-03.02	46 D	8	<b>Z 20</b>	14 R-7 DU	0,8	<b>UXT 2<sup>4</sup></b>

### RANGE ROVER III

3.0 TD 6	2.9	130	03.02-		6	<b>GN 024</b> (11V)	○		
3.6 TD 8	3.6	200	04.06-	368DT	8	<b>GN 045</b> (11V)	○		
4.4	4.4	210	03.02-		8	<b>Z 14</b>	14 F-7 LDUR4	0,9	<b>UXT 1<sup>3</sup></b>

### RANGE ROVER SPORT

2.7 TDVM	2.7	140	02.05-	276DT	6	<b>GN 045</b> (11V)	○		
----------	-----	-----	--------	-------	---	---------------------	---	--	--

## LANDWIND

2.8 D	2.8	68	09.05-	JX493ZQ	4	<b>GN 061</b> (11V)	○		
-------	-----	----	--------	---------	---	---------------------	---	--	--

## LDV

### 400

2.5 TD	2.5	71	11.95-	ET 70	4	<b>GV 603</b> (11,5V)	○		
--------	-----	----	--------	-------	---	-----------------------	---	--	--

## LEXUS

### ES

300	3.0	138	09.91-12.97	3VZ-FE	6	<b>Z 343</b>	14 FR-8 DPPUX	1,1	○
-----	-----	-----	-------------	--------	---	--------------	---------------	-----	---

### GS

300	3.0	156	03.93-08.97	2JZ-GE	6	<b>Z 312</b>	14 FR-7 KPPU	1,1	○
300	3.0	161	10.00-03.05	2JZ-GE	6	<b>Z 343</b>	14 FR-8 DPPUX	1,1	○
300 T3	3.0	163	08.97-10.00	2JZ-GE	6	<b>Z 343</b>	14 FR-8 DPPUX	1,1	○

● nicht erforderlich  
○ nicht im Programm

<sup>3</sup> wahlweise UXT 3 Platin

<sup>4</sup> wahlweise UXT 6 Platin

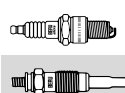
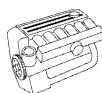

## LEXUS

### GS

300	3.0	183	04.05-11.11	3GR-FSE	6	<b>Z 280</b>	14 FR-7 KPUX02	1,0	○
400	4.0	216	12.97-11.00	1UZ-FE	8	<b>Z 313</b>	14 FR-6 DPUX2	1,0	○
430	4.3	208	11.00-03.05	3UZ-FE	8	<b>Z 221</b>	14 FR-6 DPUX02	1,0	<b>UXT 14</b>
430	4.3	208	04.05-11.11	3UZ-FE	8	<b>Z 280</b>	14 FR-7 KPUX02	1,0	○

### ISI

200	2.0	114	04.99-07.05	1G-FE	6	<b>Z 221</b>	14 FR-6 DPUX02	1,0	<b>UXT 14</b>
300	3.0	157	09.01-07.05	2JZ-GE	6	<b>Z 313</b>	14 FR-6 DPUX2	1,0	○

### IS SportCross

200	2.0	114	10.02-10.05	1G-FE	6	<b>Z 221</b>	14 FR-6 DPUX02	1,0	<b>UXT 14</b>
300	3.0	157	10.01-07.05	2JZ-GE	6	<b>Z 313</b>	14 FR-6 DPUX2	1,0	○

### LS

400	4.0	180	12.89-12.94	1UZ-FE	8	<b>Z 130</b>	14 FR-5 DPUX	1,0	○
400	4.0	194	12.94-08.97	1UZ-FE	8	<b>Z 151</b>	14 FR-7 KPU	0,8	<b>UXT 10</b>
430	4.3	207	10.00-08.06	3UZ-FE	8	<b>Z 221</b>	14 FR-6 DPUX02	1,0	<b>UXT 14</b>
460	4.6	280	04.06-	1UR-FSE	8	<b>Z 235</b>	14 FR-7 SPUX03	1,0	○

### RX

300 V6	3.0	148	10.00-05.03	1MZ-FE	6	<b>Z 221</b>	14 FR-6 DPUX02	1,0	<b>UXT 14</b>
300	3.0	150	05.03-12.08	1MZ-FE	6	<b>Z 221</b>	14 FR-6 DPUX02	1,0	<b>UXT 14</b>
400h 4WD	3.3	155	09.04-12.08	3MZ-FE	6	<b>Z 284</b>	14 FR-6 DPOX	1,1	<b>UXT 14</b>
400h FWD	3.3	155	09.05-12.08	3MZ-FE	6	<b>Z 284</b>	14 FR-6 DPOX	1,1	<b>UXT 14</b>

### SC

430	4.3	210	08.01-07.10	3UZ-FE	8	<b>Z 221</b>	14 FR-6 DPUX02	1,0	<b>UXT 14</b>
-----	-----	-----	-------------	--------	---	--------------	----------------	-----	---------------

## LOTUS

### ELAN

1.6 i 16V	1.6	97	09.89-06.92	4XE1	4	<b>Z 24</b>	14 FR-6 DU	0,8	<b>UXT 5</b>
1.6 i 16V Turbo	1.6	115	09.91-11.95	Isuzu-Lotus 1.6i 16V Turbo	4	<b>Z 24</b>	14 FR-6 DU	0,8	<b>UXT 5</b>
1.6 i 16V Turbo	1.6	123	09.89-06.92	4XE1-T	4	<b>Z 24</b>	14 FR-6 DU	0,8	<b>UXT 5</b>

### ELISE

1.8 16V	1.8	88	08.95-11.00	18 K4F	4	<b>Z 149</b>	14 FR-7 KPUX	1,1	<b>UXT 11</b>
1.8	1.8	90	11.00-08.05	18 K4F	4	<b>Z 312</b>	14 FR-7 KPUP	1,1	○

### ESPRIT S4

2.2 16V Turbo SE	2.2	197	05.89-09.96	910 S	4	<b>Z 47</b>	14 R-5 DU	0,8	<b>UX 56</b>
3.5 V8 32V Turbo	3.5	260	02.96-	618	8	<b>Z 98</b>	14 FR-7 LDU	0,8	<b>UXT 1<sup>3</sup></b>

### EXCEL

2.2 SE/SA	2.2	135	10.84-08.91	912 S	4	<b>Z 27</b>	14 R-6 DU	0,8	<b>UX 56</b>
-----------	-----	-----	-------------	-------	---	-------------	-----------	-----	--------------

## MAHINDRA

### CJ 3

2.1 D	2.1	46	10.88-09.92	XDP 290	4	<b>GV 636</b> (11V)	○		
2.3 D	2.3	28	10.88-09.92	Peugeot	4	<b>GV 636</b> (11V)	○		
2.5 D	2.5	29	10.88-09.92	Peugeot	4	<b>GV 636</b> (11V)	○		

### CJ 3 Wagon

2.1 D	2.1	46	10.88-09.92	XDP 290	4	<b>GV 636</b> (11V)	○		
2.3 D	2.3	28	10.88-09.92	Peugeot	4	<b>GV 636</b> (11V)	○		
2.5 D	2.5	29	10.88-09.92	Peugeot	4	<b>GV 636</b> (11V)	○		

## MARUTI

### 800

0.8	0.8	26	01.91-	F8B	3	<b>Z 1</b>	14-8 DU	0,8	<b>UXT 2<sup>4</sup></b>
-----	-----	----	--------	-----	---	------------	---------	-----	--------------------------

## MARUTSU

### A-STAR

1.0	1.0	49	10.08-	K10B	3	<b>Z 333</b>	12 FR-6 DPUX	1,1	○
-----	-----	----	--------	------	---	--------------	--------------	-----	---

## MASERATI

### 228

2.8	2.8	182	07.87-12.90	473	6	<b>Z 38</b>	14 Z-3 CU	0,4	○
2.8 i	2.8	184	12.86-12.90		6	<b>Z 42</b>	14-5 DU	0,8	<b>UX 56</b>

### 420/430

430 i	2.8	182	02.88-12.94	473	6	<b>Z 38</b>	14 Z-3 CU	0,4	○
-------	-----	-----	-------------	-----	---	-------------	-----------	-----	---

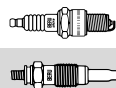
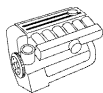

## MASERATI

KARIF									
2.8	2.8	165	04.88-	473 Kat.Weber Inj.	6	<b>Z 42</b>	14-5 DU	0,8	<b>UX 56</b>
2.8	2.8	182	04.88-	473 Weber Inj.	6	<b>Z 38</b>	14 Z-3 CU	0,4	○

## MAYBACH

MAYBACH									
5.5 V12 57/62	5.5	405	09.02-	M 285.950	12	<b>Z 312</b>	14 FR-7 KPPU	1,1	○
6.0 V12 57S	6.0	450	09.05-		12	<b>Z 312</b>	14 FR-7 KPPU	1,1	○

## MAZDA

121 I									
1.1	1.1	42	10.87-10.90	B1	4	<b>Z 8</b>	14 R-8 DU	0,8	<b>UXT 2<sup>4</sup></b>
1.1	1.1	42	10.87-10.90	B116	4	<b>Z 9</b>	14 R-8 DUX	1,1	<b>UXT 2<sup>4</sup></b>
1.3	1.3	40	04.89-10.90	B3	4	<b>Z 9</b>	14 R-8 DUX	1,1	<b>UXT 2<sup>4</sup></b>
1.3	1.3	44	10.87-11.90	B3	4	<b>Z 9</b>	14 R-8 DUX	1,1	<b>UXT 2<sup>4</sup></b>
121 II									
1.1	1.1	40	11.90-10.93	B1	4	<b>Z 8</b>	14 R-8 DU	0,8	<b>UXT 2<sup>4</sup></b>
1.3 16V	1.3	39	11.90-03.96	B3 (16V)	4	<b>Z 16</b>	14 FR-7 DUX	1,1	<b>UXT 1<sup>3</sup></b>
1.3 i 16V	1.3	53	11.90-03.96	B3 (16V)	4	<b>Z 16</b>	14 FR-7 DUX	1,1	<b>UXT 1<sup>3</sup></b>
121 III									
1.25	1.2	55	03.96-04.03	DHG/DHF	4	<b>Z 177</b>	14 KR-8 MUV	1,3	<b>UXT 7</b>
1.3	1.3	37	03.96-04.03	JJM/JJK	4	<b>Z 67</b>	14 KR-7 DUX	1,1	<b>UXT 4</b>
1.3	1.3	44	03.96-04.03	J4R/J4T	4	<b>Z 67</b>	14 KR-7 DUX	1,1	<b>UXT 4</b>
1.8 D	1.8	44	03.96-04.03	RTJ	4	<b>GN 022 (10V)</b>	○		
2									
1.25	1.2	55	04.03-	FUJA	4	<b>Z 177</b>	14 KR-8 MUV	1,3	<b>UXT 7</b>
1.3	1.3	55	10.07-	ZJ-VE	4	<b>Z 307</b>	14 FR-7 DPUV02	1,3	<b>UXT 3</b>
1.3	1.3	63	10.07-	ZJ-VE	4	<b>Z 307</b>	14 FR-7 DPUV02	1,3	<b>UXT 3</b>
1.4 MZR-CD	1.4	50	01.08-		4	<b>GN 047 (11V)</b>	○		
1.4 CD	1.4	50	04.03-	F6JA/F6JB	4	<b>GN 047 (11V)</b>	○		
1.4	1.4	59	04.03-	FXJA	4	<b>Z 177</b>	14 KR-8 MUV	1,3	<b>UXT 7</b>
1.5	1.5	76	10.07-	ZY-DE/ZY-VE	4	<b>Z 307</b>	14 FR-7 DPUV02	1,3	<b>UXT 3</b>
1.6 MZ-CD	1.6	66	10.08-		4	<b>GN 047 (11V)</b>	○		
1.6	1.6	74	04.03-	FYJA	4	<b>Z 177</b>	14 KR-8 MUV	1,3	<b>UXT 7</b>
3									
1.4	1.3	62	10.03-06.09	ZJ-VE	4	<b>Z 73</b>	14 FR-8 DUX	1,1	<b>UXT 1<sup>3</sup></b>
1.6	1.6	77	10.03-06.09	B6ZE	4	<b>Z 73</b>	14 FR-8 DUX	1,1	<b>UXT 1<sup>3</sup></b>
1.6 MZR	1.6	77	06.09-	Z6	4	<b>Z 73</b>	14 FR-8 DUX	1,1	<b>UXT 1<sup>3</sup></b>
2.0	2.0	110	10.03-06.09	LF17	4	<b>Z 298</b>	14 KR-8 DPUV	1,3	○
2.0	2.0	110	06.09-06.09	LF17	4	<b>Z 342</b>	14 KR-7 MPUV2	1,3	○
323 III Station Wagon									
1.3	1.3	44	07.86-04.90	E3	4	<b>Z 8</b>	14 R-8 DU	0,8	<b>UXT 2<sup>4</sup></b>
1.6	1.6	63	09.86-10.95	B65M /B6/B6E	4	<b>Z 9</b>	14 R-8 DUX	1,1	<b>UXT 2<sup>4</sup></b>
1.6 4x4	1.6	63	05.90-03.93	B65M /B6E	4	<b>Z 9</b>	14 R-8 DUX	1,1	<b>UXT 2<sup>4</sup></b>
1.7 D	1.7	41	10.89-03.93	PN26/PN54	4	<b>GN 005 (11V)</b>	○		
323 C IV									
1.3	1.3	49	09.89-07.94	B3E	4	<b>Z 9</b>	14 R-8 DUX	1,1	<b>UXT 2<sup>4</sup></b>
1.3 16V	1.3	54	09.89-07.94	B3 (16V)	4	<b>Z 16</b>	14 FR-7 DUX	1,1	<b>UXT 1<sup>3</sup></b>
1.6	1.6	62	09.89-06.91	B6E	4	<b>Z 9</b>	14 R-8 DUX	1,1	<b>UXT 2<sup>4</sup></b>
1.6 16V	1.6	65	03.91-10.94	B6	4	<b>Z 16</b>	14 FR-7 DUX	1,1	<b>UXT 1<sup>3</sup></b>
1.7 D	1.7	41	08.89-07.94	PN54	4	<b>GN 005 (11V)</b>	○		
1.8 16V 4WD	1.8	76	11.91-12.93	BP	4	<b>Z 16</b>	14 FR-7 DUX	1,1	<b>UXT 1<sup>3</sup></b>
1.8 16V GT	1.8	94	09.89-03.93	BP (DOHC)	4	<b>Z 16</b>	14 FR-7 DUX	1,1	<b>UXT 1<sup>3</sup></b>
1.8 16V Turbo 4WD	1.8	120	09.90-12.92	BP Turbo	4	<b>Z 16</b>	14 FR-7 DUX	1,1	<b>UXT 1<sup>3</sup></b>
1.8 16V Turbo 4WD	1.8	136	01.93-07.94	BP Turbo	4	<b>Z 16</b>	14 FR-7 DUX	1,1	<b>UXT 1<sup>3</sup></b>
323 C V									
1.3 16V	1.3	54	08.94-09.98	B3 (16V)	4	<b>Z 16</b>	14 FR-7 DUX	1,1	<b>UXT 1<sup>3</sup></b>
1.5 16V	1.5	65	08.94-09.98	Z5-DE	4	<b>Z 16</b>	14 FR-7 DUX	1,1	<b>UXT 1<sup>3</sup></b>
1.8 16V	1.8	84	08.94-09.98	BP-ZE	4	<b>Z 16</b>	14 FR-7 DUX	1,1	<b>UXT 1<sup>3</sup></b>
323 F IV									
1.6	1.6	62	09.89-06.91	B6E	4	<b>Z 9</b>	14 R-8 DUX	1,1	<b>UXT 2<sup>4</sup></b>
1.6 16V	1.6	65	03.91-10.94	B6	4	<b>Z 16</b>	14 FR-7 DUX	1,1	<b>UXT 1<sup>3</sup></b>

● nicht erforderlich  
○ nicht im Programm

<sup>3</sup> wahlweise UXT 3 Platin

<sup>4</sup> wahlweise UXT 6 Platin



kW

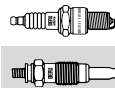

**MAZDA**

**323 F IV**

1.8 16V	1.8	76	08.89-07.94	BP	4	<b>Z 16</b>	14 FR-7 DUX	1,1	<b>UXT 1<sup>3</sup></b>
1.8 4WD	1.8	76	01.91-04.94	BPC	4	<b>Z 16</b>	14 FR-7 DUX	1,1	<b>UXT 1<sup>3</sup></b>
1.8 16V GT	1.8	94	08.89-07.94	BP (DOHC)	4	<b>Z 16</b>	14 FR-7 DUX	1,1	<b>UXT 1<sup>3</sup></b>

**323 F V**

1.5 16V	1.5	65	07.94-09.98	Z5-DE	4	<b>Z 16</b>	14 FR-7 DUX	1,1	<b>UXT 1<sup>3</sup></b>
1.8 16V	1.8	84	08.94-09.98	BP-ZE	4	<b>Z 16</b>	14 FR-7 DUX	1,1	<b>UXT 1<sup>3</sup></b>
2.0 24V	2.0	106	08.94-09.98	KF	6	<b>Z 16</b>	14 FR-7 DUX	1,1	<b>UXT 1<sup>3</sup></b>

**323 F VI**

1.4	1.3	53	01.01-05.04	B3 (16V)	4	<b>Z 73</b>	14 FR-8 DUX	1,1	<b>UXT 1<sup>3</sup></b>
1.4 16V	1.3	54	09.98-01.01	B3 ME	4	<b>Z 16</b>	14 FR-7 DUX	1,1	<b>UXT 1<sup>3</sup></b>
1.5 16V	1.5	65	09.98-01.01		4	<b>Z 16</b>	14 FR-7 DUX	1,1	<b>UXT 1<sup>3</sup></b>
1.6	1.6	70	01.01-05.04	ZM	4	<b>Z 158</b>	14 FR-7 LUX	1,1	○
1.6	1.6	72	01.01-05.04	ZM	4	<b>Z 158</b>	14 FR-7 LUX	1,1	○
1.9 16V	1.8	84	09.98-01.01	FP55	4	<b>Z 73</b>	14 FR-8 DUX	1,1	<b>UXT 1<sup>3</sup></b>
2.0 D	2.0	52	09.98-05.04	RF1G	4	<b>GN 064</b> (11V)	○		
2.0 TD	2.0	66	09.98-01.01		4	<b>GN 064</b> (11V)	○		
2.0 TD	2.0	74	01.01-05.04	RF4F	4	<b>GN 064</b> (11V)	○		
2.0	2.0	96	01.01-05.04	FS7G/FS7E	4	<b>Z 16</b>	14 FR-7 DUX	1,1	<b>UXT 1<sup>3</sup></b>

**323 P V**

1.3 16V	1.3	54	10.96-	B3 (16V)	4	<b>Z 16</b>	14 FR-7 DUX	1,1	<b>UXT 1<sup>3</sup></b>
1.5 16V	1.5	65	10.96-	Z5-DE	4	<b>Z 73</b>	14 FR-8 DUX	1,1	<b>UXT 1<sup>3</sup></b>
2.0 D	2.0	52	10.96-	RF1G	4	<b>GN 005</b> (11V)	○		

**323 S IV**

1.3	1.3	49	09.89-06.91	B3E/B383	4	<b>Z 9</b>	14 R-8 DUX	1,1	<b>UXT 2<sup>4</sup></b>
1.3 16V	1.3	54	04.91-07.94	B3 (16V) Fgst.Nr. 500001 →	4	<b>Z 16</b>	14 FR-7 DUX	1,1	<b>UXT 1<sup>3</sup></b>
1.6	1.6	62	09.89-06.91	B6E	4	<b>Z 9</b>	14 R-8 DUX	1,1	<b>UXT 2<sup>4</sup></b>
1.6 16V	1.6	65	08.89-10.94	B6	4	<b>Z 16</b>	14 FR-7 DUX	1,1	<b>UXT 1<sup>3</sup></b>
1.7 D	1.7	41	08.89-07.94	PN46/PN54/PN62	4	<b>GN 005</b> (11V)	○		
1.8 16V	1.8	76	08.89-07.94	BP52	4	<b>Z 16</b>	14 FR-7 DUX	1,1	<b>UXT 1<sup>3</sup></b>
1.8 16V 4WD	1.8	76	09.91-07.94	BP52	4	<b>Z 16</b>	14 FR-7 DUX	1,1	<b>UXT 1<sup>3</sup></b>
1.8 16V GT	1.8	94	06.89-07.94	BP (DOHC)	4	<b>Z 16</b>	14 FR-7 DUX	1,1	<b>UXT 1<sup>3</sup></b>
1.8 16V Turbo 4WD	1.8	120	01.91-07.94	BP Turbo	4	<b>Z 16</b>	14 FR-7 DUX	1,1	<b>UXT 1<sup>3</sup></b>

**323 S V**

1.3 16V	1.3	54	08.94-09.98	B3 (16V)	4	<b>Z 16</b>	14 FR-7 DUX	1,1	<b>UXT 1<sup>3</sup></b>
1.5 16V	1.5	65	08.94-09.98	Z5-DE	4	<b>Z 16</b>	14 FR-7 DUX	1,1	<b>UXT 1<sup>3</sup></b>
1.6 TD	1.7	60	05.94-09.98	4EE1-T	4	<b>GN 005</b> (11V)	○		
1.8 16V	1.8	84	08.94-09.98	BP-ZE	4	<b>Z 16</b>	14 FR-7 DUX	1,1	<b>UXT 1<sup>3</sup></b>
2.0 D	2.0	52	10.96-09.98	RF1G	4	<b>GN 005</b> (11V)	○		

**323 S VI**

1.4	1.3	53	01.01-05.04	B3 (16V)	4	<b>Z 73</b>	14 FR-8 DUX	1,1	<b>UXT 1<sup>3</sup></b>
1.4 16V	1.3	54	09.98-01.01	B3 ME	4	<b>Z 16</b>	14 FR-7 DUX	1,1	<b>UXT 1<sup>3</sup></b>
1.5 16V	1.5	65	09.98-01.01		4	<b>Z 73</b>	14 FR-8 DUX	1,1	<b>UXT 1<sup>3</sup></b>
1.6	1.6	70	01.01-09.03	ZM	4	<b>Z 158</b>	14 FR-7 LUX	1,1	○
1.6	1.6	72	01.01-09.03	ZM	4	<b>Z 158</b>	14 FR-7 LUX	1,1	○
1.9 16V	1.8	84	09.98-05.04	FP55	4	<b>Z 16</b>	14 FR-7 DUX	1,1	<b>UXT 1<sup>3</sup></b>
2.0 D	2.0	52	09.98-05.04		4	<b>GN 064</b> (11V)	○		
2.0 TD	2.0	66	09.98-05.04	RF3F	4	<b>GN 064</b> (11V)	○		
2.0	2.0	96	01.01-05.04	FS7G/FS7E	4	<b>Z 16</b>	14 FR-7 DUX	1,1	<b>UXT 1<sup>3</sup></b>

**5**

1.8	1.8	85	03.05-	L823	4	<b>Z 298</b>	14 KR-8 DPUV	1,3	○
2.0 CD	2.0	81	03.05-		4	<b>GN 064</b> (11V)	○		
2.0 CD	2.0	105	06.05-	RF7J	4	<b>GN 064</b> (11V)	○		

**6**

1.8	1.8	88	08.02-08.07	L813	4	<b>Z 298</b>	14 KR-8 DPUV	1,3	○
1.8 MZR	1.8	88	08.07-	L813	4	<b>Z 298</b>	14 KR-8 DPUV	1,3	○
2.0 DI	2.0	89	08.02-08.07	RF5C	4	<b>GN 064</b> (11V)	○		
2.0 DI	2.0	100	06.02-08.07	RF5C	4	<b>GN 064</b> (11V)	○		
2.0	2.0	104	06.02-08.07	LF18/LF17	4	<b>Z 230</b>	14 KR-6 KPUV02	1,3	○
2.0 DI	2.0	105	06.05-08.07	RF7J	4	<b>GN 064</b> (11V)	○		
2.0	2.0	108	03.05-08.07	LFF7	4	<b>Z 342</b>	14 KR-7 MPUV2	1,3	○
2.3	2.3	122	06.02-02.05	L3C1	4	<b>Z 230</b>	14 KR-6 KPUV02	1,3	○

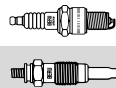

## MAZDA

6

2.3	2.3	122	03.05-08.07	L3C1	4	<b>Z 342</b>	14 KR-7 MPUV2	1,3	○
<b>6 Hatchback</b>									
1.8	1.8	88	08.02-08.07	L813	4	<b>Z 298</b>	14 KR-8 DPUV	1,3	○
2.0 DI	2.0	89	08.02-08.07	RF5C	4	<b>GN 064</b> (11V)	○		
2.0 DI	2.0	100	08.02-08.07	RF5C	4	<b>GN 064</b> (11V)	○		
2.0	2.0	104	08.02-08.07	LF18/LF17	4	<b>Z 230</b>	14 KR-6 KPUV02	1,3	○
2.0 DI	2.0	105	06.05-08.07	RF7J	4	<b>GN 064</b> (11V)	○		
2.0	2.0	108	03.05-08.07	LFF7	4	<b>Z 342</b>	14 KR-7 MPUV2	1,3	○
2.3	2.3	122	08.02-02.05	L3C1	4	<b>Z 230</b>	14 KR-6 KPUV02	1,3	○
2.3	2.3	122	03.05-08.07	L3C1	4	<b>Z 342</b>	14 KR-7 MPUV2	1,3	○
<b>6 Sport</b>									
1.8 MZR	1.8	88	08.07-	L813	4	<b>Z 298</b>	14 KR-8 DPUV	1,3	○
<b>6 Sport Kombi</b>									
1.8 MZR	1.8	88	02.08-	L813	4	<b>Z 298</b>	14 KR-8 DPUV	1,3	○
<b>6 Station Wagon</b>									
1.8	1.8	88	08.02-08.07	L813	4	<b>Z 298</b>	14 KR-8 DPUV	1,3	○
2.0 DI	2.0	89	08.02-08.07	RF5C	4	<b>GN 064</b> (11V)	○		
2.0 DI	2.0	100	08.02-08.07	RF5C	4	<b>GN 064</b> (11V)	○		
2.0	2.0	104	08.02-08.07	LF18/LF17	4	<b>Z 230</b>	14 KR-6 KPUV02	1,3	○
2.0 DI	2.0	105	06.05-08.07	RF7J	4	<b>GN 064</b> (11V)	○		
2.0	2.0	108	03.05-08.07	LFF7	4	<b>Z 342</b>	14 KR-7 MPUV2	1,3	○
2.3 AWD	2.3	119	11.02-02.05	L3C1	4	<b>Z 230</b>	14 KR-6 KPUV02	1,3	○
2.3 AWD	2.3	119	03.05-08.07	L3C1	4	<b>Z 342</b>	14 KR-7 MPUV2	1,3	○
2.3	2.3	122	08.02-02.05	L3C1	4	<b>Z 230</b>	14 KR-6 KPUV02	1,3	○
2.3	2.3	122	03.05-08.07	L3C1	4	<b>Z 342</b>	14 KR-7 MPUV2	1,3	○
<b>626 III</b>									
1.8	1.8	65	09.89-05.92	F8 (12V)	4	<b>Z 16</b>	14 FR-7 DUX	1,1	<b>UXT 1<sup>3</sup></b>
2.0 D	2.0	44	07.87-07.91	RF-N	4	<b>GN 005</b> (11V)	○		
2.0	2.0	66	09.87-10.90	FE	4	<b>Z 9</b>	14 R-8 DUX	1,1	<b>UXT 2<sup>4</sup></b>
2.0 16V	2.0	103	11.87-07.91	FE Kat. (16V)	4	<b>Z 16</b>	14 FR-7 DUX	1,1	<b>UXT 1<sup>3</sup></b>
2.2 12V	2.2	85	11.87-07.91	F2	4	<b>Z 158</b>	14 FR-7 LUX	1,1	○
2.2 12V 4WD	2.2	85	01.90-05.92	F2	4	<b>Z 158</b>	14 FR-7 LUX	1,1	○
<b>626 III Coupe</b>									
1.8	1.8	65	09.87-08.91	F8 (12V)	4	<b>Z 8</b>	14 R-8 DU	0,8	<b>UXT 2<sup>4</sup></b>
2.0	2.0	66	09.87-10.90	FE	4	<b>Z 9</b>	14 R-8 DUX	1,1	<b>UXT 2<sup>4</sup></b>
2.0 16V	2.0	103	12.87-10.90	FE Kat. (16V) Fgst.Nr. 500001 →	4	<b>Z 16</b>	14 FR-7 DUX	1,1	<b>UXT 1<sup>3</sup></b>
2.2 12V	2.2	85	04.88-12.91	F2	4	<b>Z 158</b>	14 FR-7 LUX	1,1	○
<b>626 III Hatchback</b>									
1.8	1.8	65	09.89-05.92	F8 (12V)	4	<b>Z 16</b>	14 FR-7 DUX	1,1	<b>UXT 1<sup>3</sup></b>
2.0 D	2.0	44	07.87-07.91	RF-N	4	<b>GN 005</b> (11V)	○		
2.0	2.0	66	09.87-10.90	FE	4	<b>Z 20</b>	14 R-7 DU	0,8	<b>UXT 2<sup>4</sup></b>
2.0 16V	2.0	103	11.87-10.90	FE Kat. (16V)	4	<b>Z 16</b>	14 FR-7 DUX	1,1	<b>UXT 1<sup>3</sup></b>
2.2 12V	2.2	85	06.88-04.92	F2	4	<b>Z 158</b>	14 FR-7 LUX	1,1	○
2.2 12V 4WD	2.2	85	11.87-07.90	F2	4	<b>Z 158</b>	14 FR-7 LUX	1,1	○
<b>626 III Station Wagon</b>									
1.8	1.8	65	10.89-07.91	F8 (12V)	4	<b>Z 15</b>	14 FR-7 DU	0,8	<b>UXT 1<sup>3</sup></b>
2.0 D	2.0	44	09.88-07.91	RF-N	4	<b>GN 005</b> (11V)	○		
2.0 D Complex	2.0	55	05.93-11.96	RF-CX	4	<b>GN 005</b> (11V)	○		
2.0 D	2.0	60	11.94-09.97	RFG5	4	<b>GN 005</b> (11V)	○		
2.0	2.0	66	10.88-09.97	FE	4	<b>Z 9</b>	14 R-8 DUX	1,1	<b>UXT 2<sup>4</sup></b>
2.0 12V	2.0	81	09.89-01.90	FE (12V)	4	<b>Z 15</b>	14 FR-7 DU	0,8	<b>UXT 1<sup>3</sup></b>
2.0 16V	2.0	103	01.88-03.92	FE Kat. (16V)	4	<b>Z 16</b>	14 FR-7 DUX	1,1	<b>UXT 1<sup>3</sup></b>
2.0 i 16V	2.0	110	11.94-09.97		4	<b>Z 16</b>	14 FR-7 DUX	1,1	<b>UXT 1<sup>3</sup></b>
2.2 12V	2.2	85	03.89-11.96	F2	4	<b>Z 158</b>	14 FR-7 LUX	1,1	○
2.2 12V 4WD	2.2	85	05.91-11.92	F2L1/F2	4	<b>Z 158</b>	14 FR-7 LUX	1,1	○
<b>626 IV</b>									
1.8 i	1.8	66	08.94-04.97		4	<b>Z 16</b>	14 FR-7 DUX	1,1	<b>UXT 1<sup>3</sup></b>
1.8 i	1.8	77	01.92-06.94	FP	4	<b>Z 16</b>	14 FR-7 DUX	1,1	<b>UXT 1<sup>3</sup></b>
2.0 D GLX Complex	2.0	55	10.92-04.97	RF OHC	4	<b>GN 005</b> (11V)	○		
2.0 i	2.0	85	01.92-06.94	FS	4	<b>Z 16</b>	14 FR-7 DUX	1,1	<b>UXT 1<sup>3</sup></b>

● nicht erforderlich  
○ nicht im Programm

<sup>3</sup> wahlweise UXT 3 Platin

<sup>4</sup> wahlweise UXT 6 Platin

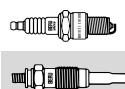
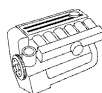

## MAZDA

### 626 IV

2.0 i 4WD	2.0	85	04.92-06.94	FS	4	<b>Z 16</b>	14 FR-7 DUX	1,1	<b>UXT 1<sup>3</sup></b>
-----------	-----	----	-------------	----	---	-------------	-------------	-----	--------------------------

### 626 IV Hatchback

1.8	1.8	66	08.94-04.97		4	<b>Z 16</b>	14 FR-7 DUX	1,1	<b>UXT 1<sup>3</sup></b>
1.8	1.8	77	08.91-04.97	FP	4	<b>Z 16</b>	14 FR-7 DUX	1,1	<b>UXT 1<sup>3</sup></b>
2.0 D GLX Comprex	2.0	55	01.93-12.95	RF OHC	4	<b>GN 005 (11V)</b>	○		
2.0 i	2.0	85	08.91-04.97	FS	4	<b>Z 16</b>	14 FR-7 DUX	1,1	<b>UXT 1<sup>3</sup></b>
2.0 i 4WD	2.0	85	04.92-06.94	FS	4	<b>Z 16</b>	14 FR-7 DUX	1,1	<b>UXT 1<sup>3</sup></b>
2.5 24V	2.5	120	08.94-04.97	KL	6	<b>Z 158</b>	14 FR-7 LUX	1,1	○
2.5 24V	2.5	121	01.92-04.97	KL	6	<b>Z 158</b>	14 FR-7 LUX	1,1	○

### 626 V

1.9	1.8	66	05.97-12.99	FPY3	4	<b>Z 229</b>	14 FR-8 LPUO	0,8	○
1.9	1.8	74	12.99-10.02	FP9A	4	<b>Z 229</b>	14 FR-8 LPUO	0,8	○
2.0 DITD	2.0	66	04.98-10.02	RF3F	4	<b>GN 064 (11V)</b>	○		
2.0 Turbo DI	2.0	74	04.98-10.02		4	<b>GN 064 (11V)</b>	○		
2.0 TD	2.0	81	10.00-10.02		4	<b>GN 064 (11V)</b>	○		
2.0	2.0	85	05.97-10.02	FS	4	<b>Z 229</b>	14 FR-8 LPUO	0,8	○
2.0	2.0	93	01.98-10.02	FS	4	<b>Z 229</b>	14 FR-8 LPUO	0,8	○
2.0	2.0	100	04.98-10.02	FS2C	4	<b>Z 229</b>	14 FR-8 LPUO	0,8	○

### 626 V Hatchback

1.8	1.8	66	05.97-12.99		4	<b>Z 229</b>	14 FR-8 LPUO	0,8	○
1.9	1.8	74	12.99-10.02	FP	4	<b>Z 229</b>	14 FR-8 LPUO	0,8	○
2.0 DITD	2.0	66	04.98-10.02	RF3F	4	<b>GN 064 (11V)</b>	○		
2.0 Turbo DI	2.0	74	04.98-10.02		4	<b>GN 064 (11V)</b>	○		
2.0 TD	2.0	81	10.00-10.02		4	<b>GN 064 (11V)</b>	○		
2.0	2.0	85	05.97-10.02	FS	4	<b>Z 229</b>	14 FR-8 LPUO	0,8	○
2.0	2.0	93	01.98-10.02	FS	4	<b>Z 229</b>	14 FR-8 LPUO	0,8	○
2.0 H.P.	2.0	100	02.98-10.02	FS2C	4	<b>Z 229</b>	14 FR-8 LPUO	0,8	○

### 626 V Station Wagon

1.9	1.8	66	02.98-01.00		4	<b>Z 229</b>	14 FR-8 LPUO	0,8	○
1.9	1.8	74	01.00-10.02	FP9A	4	<b>Z 229</b>	14 FR-8 LPUO	0,8	○
2.0 DITD	2.0	66	09.99-10.02	RF3F	4	<b>GN 064 (11V)</b>	○		
2.0 Turbo DI	2.0	74	04.98-10.02	RF4F	4	<b>GN 064 (11V)</b>	○		
2.0 TD	2.0	81	10.00-10.02		4	<b>GN 064 (11V)</b>	○		
2.0	2.0	85	02.98-10.02	FS	4	<b>Z 229</b>	14 FR-8 LPUO	0,8	○
2.0	2.0	93	01.98-10.02	FS	4	<b>Z 229</b>	14 FR-8 LPUO	0,8	○
2.0 H.P.	2.0	100	02.98-10.02	FS2C	4	<b>Z 229</b>	14 FR-8 LPUO	0,8	○

### 929 III

2.2 12V	2.2	94	04.89-06.91	F2-C	4	<b>Z 158</b>	14 FR-7 LUX	1,1	○
3.0 i	3.0	123	01.90-06.91	JE3	6	<b>Z 158</b>	14 FR-7 LUX	1,1	○

### B-SERIE

2.5 D	2.5	57	06.99-	MD25NA	4	<b>GN 005 (11V)</b>	○		
2.5 D 4WD	2.5	57	06.99-	MD25NA	4	<b>GN 005 (11V)</b>	○		
2.5 D 4WD	2.5	63	02.96-06.99		4	<b>GN 005 (11V)</b>	○		
2.5 TD 4WD	2.5	80	06.99-11.02	MD25TI	4	<b>GN 005 (11V)</b>	○		
2.6 12V 4WD	2.6	90	06.99-	JK26	4	<b>Z 158</b>	14 FR-7 LUX	1,1	○

### DEMIO

1.3 16V	1.3	46	08.98-10.02	B3 ME	4	<b>Z 16</b>	14 FR-7 DUX	1,1	<b>UXT 1<sup>3</sup></b>
1.3 i 16V	1.3	53	08.98-04.00	B3 (16V)	4	<b>Z 16</b>	14 FR-7 DUX	1,1	<b>UXT 1<sup>3</sup></b>
1.5 16V	1.5	55	04.00-	B5 E Fgst.Nr.300001 →	4	<b>Z 16</b>	14 FR-7 DUX	1,1	<b>UXT 1<sup>3</sup></b>

### MPV I

2.5 TD	2.5	85	05.96-09.99	WL-T	4	<b>GN 005 (11V)</b>	○		
3.0 i V6	3.0	109	05.96-09.99	JE94	6	<b>Z 16</b>	14 FR-7 DUX	1,1	<b>UXT 1<sup>3</sup></b>
3.0 i V6	3.0	113	03.95-09.99	JE94	6	<b>Z 158</b>	14 FR-7 LUX	1,1	○

### MPV II

2.0	2.0	90	09.99-08.00	FS-DS	4	<b>Z 158</b>	14 FR-7 LUX	1,1	○
2.0 DI	2.0	100	07.02-02.06	RF5C	4	<b>GN 064 (11V)</b>	○		
2.3	2.3	104	07.02-02.06	L3	4	<b>Z 298</b>	14 KR-8 DPUV	1,3	○

### MX-3

1.6 i	1.6	65	07.91-	B69	4	<b>Z 73</b>	14 FR-8 DUX	1,1	<b>UXT 1<sup>3</sup></b>
1.6 i	1.6	79	01.94-	B6D	4	<b>Z 16</b>	14 FR-7 DUX	1,1	<b>UXT 1<sup>3</sup></b>
1.8 i V6	1.8	95	01.94-	K838	6	<b>Z 16</b>	14 FR-7 DUX	1,1	<b>UXT 1<sup>3</sup></b>



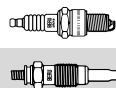
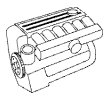

## MAZDA

MX-3									
1.8 i V6	1.8	98	01.92-01.94	K819	6	<b>Z 73</b>	14 FR-8 DUX	1,1	<b>UXT 1<sup>3</sup></b>
MX-5 I									
1.6	1.6	66	01.95-04.98		4	<b>Z 16</b>	14 FR-7 DUX	1,1	<b>UXT 1<sup>3</sup></b>
1.6	1.6	85	05.90-01.94	B64F	4	<b>Z 16</b>	14 FR-7 DUX	1,1	<b>UXT 1<sup>3</sup></b>
1.8	1.8	96	02.94-04.98	BPF1 /BP (DOHC)	4	<b>Z 16</b>	14 FR-7 DUX	1,1	<b>UXT 1<sup>3</sup></b>
MX-5 II									
1.6 16V	1.6	81	05.98-10.05	B6D	4	<b>Z 73</b>	14 FR-8 DUX	1,1	<b>UXT 1<sup>3</sup></b>
1.8 16V	1.8	102	11.00-10.05	BPD	4	<b>Z 73</b>	14 FR-8 DUX	1,1	<b>UXT 1<sup>3</sup></b>
1.8	1.8	103	01.98-07.02	BPD	4	<b>Z 73</b>	14 FR-8 DUX	1,1	<b>UXT 1<sup>3</sup></b>
1.8 16V	1.8	103	05.98-10.05	BP-ZE	4	<b>Z 73</b>	14 FR-8 DUX	1,1	<b>UXT 1<sup>3</sup></b>
1.8 16V	1.8	107	11.00-10.05	BPD	4	<b>Z 73</b>	14 FR-8 DUX	1,1	<b>UXT 1<sup>3</sup></b>
MX-5 III									
1.8	1.8	93	03.05-	L8-DE/L828	4	<b>Z 298</b>	14 KR-8 DPUV	1,3	○
2.0	2.0	118	03.05-	LF62/LF-DE	4	<b>Z 310</b>	14 KR-8 MPUV2	1,3	<b>UXT 7</b>
MX-6									
2.0	2.0	85	02.92-02.97	FS	4	<b>Z 16</b>	14 FR-7 DUX	1,1	<b>UXT 1<sup>3</sup></b>
2.5 i 24V	2.5	120	08.94-02.97	KL	6	<b>Z 158</b>	14 FR-7 LUX	1,1	○
2.5 24V	2.5	121	02.92-02.97	KL	6	<b>Z 158</b>	14 FR-7 LUX	1,1	○
PREMACY									
1.8	1.8	74	07.99-03.05	FP → Fgst.Nr.151 177	4	<b>Z 16</b>	14 FR-7 DUX	1,1	<b>UXT 1<sup>3</sup></b>
1.8	1.8	74	07.99-03.05	FP Fgst.Nr. 151 178 →	4	<b>Z 158</b>	14 FR-7 LUX	1,1	○
1.9	1.8	84	07.99-03.05	FP → Fgst.Nr.151 177	4	<b>Z 16</b>	14 FR-7 DUX	1,1	<b>UXT 1<sup>3</sup></b>
1.9	1.8	84	07.99-03.05	FP Fgst.Nr. 151 178 →	4	<b>Z 158</b>	14 FR-7 LUX	1,1	○
2.0 TD	2.0	66	10.99-07.00	RF3F	4	<b>GN 064</b> (11V)	○		
2.0 TD	2.0	74	07.00-03.05	RF4F	4	<b>GN 064</b> (11V)	○		
2.0	2.0	96	11.01-03.05	FS7G/FS7E Fgst.Nr. 151 178 →	4	<b>Z 158</b>	14 FR-7 LUX	1,1	○
2.0	2.0	96	11.01-03.05	FS7G/FS7E → Fgst.Nr.151 177	4	<b>Z 16</b>	14 FR-7 DUX	1,1	<b>UXT 1<sup>3</sup></b>
TRIBUTE									
2.0	2.0	91	03.00-05.08	YF	4	<b>Z 177</b>	14 KR-8 MUV	1,3	<b>UXT 7</b>
2.0 4WD	2.0	91	03.00-05.08	YF	4	<b>Z 177</b>	14 KR-8 MUV	1,3	<b>UXT 7</b>
2.3 AWD	2.3	110	04.04-05.08	L3-VE	4	<b>Z 298</b>	14 KR-8 DPUV	1,3	○
3.0 V6 24V 4WD	3.0	145	03.00-05.08	AJ	6	<b>Z 26</b>	14 KR-6 DU	0,7	<b>UXK 56</b>
XEDOS 6									
1.6 16V	1.6	79	06.94-10.99	B6 (DOHC)	4	<b>Z 73</b>	14 FR-8 DUX	1,1	<b>UXT 1<sup>3</sup></b>
1.6 16V	1.6	83	08.92-05.94	B69	4	<b>Z 73</b>	14 FR-8 DUX	1,1	<b>UXT 1<sup>3</sup></b>
2.0 V6	2.0	103	06.94-10.99	KF1	6	<b>Z 16</b>	14 FR-7 DUX	1,1	<b>UXT 1<sup>3</sup></b>
2.0 V6	2.0	106	01.92-05.94	KF1	6	<b>Z 16</b>	14 FR-7 DUX	1,1	<b>UXT 1<sup>3</sup></b>
XEDOS 9									
2.0 24V	2.0	105	08.93-01.00	KF	6	<b>Z 16</b>	14 FR-7 DUX	1,1	<b>UXT 1<sup>3</sup></b>
2.3 24V	2.3	155	02.95-01.00	KJ -ZEM	6	<b>Z 312</b>	14 FR-7 KPPU	1,1	○
2.5 V6	2.5	120	07.00-09.02	KL	6	<b>Z 73</b>	14 FR-8 DUX	1,1	<b>UXT 1<sup>3</sup></b>
2.5 24V	2.5	123	07.93-07.00	KL	6	<b>Z 158</b>	14 FR-7 LUX	1,1	○



## E-SERIE

E2000	2.0	60	03.91-05.94	FE60/FE61/FE	4	<b>Z 8</b>	14 R-8 DU	0,8	<b>UXT 2<sup>4</sup></b>
E2000	2.0	70	06.94-05.03	FE	4	<b>Z 16</b>	14 FR-7 DUX	1,1	<b>UXT 1<sup>3</sup></b>
E2200 D	2.2	47	03.91-04.97	R203/R207	4	<b>GV 705</b> (7V)	○		
E2200 D 4WD	2.2	47	03.91-04.97	R203/R207	4	<b>GV 705</b> (7V)	○		
E2200 D 4WD	2.2	52	02.97-05.03	R2	4	<b>GN 005</b> (11V)	○		

## MERCEDES

### A-KLASSE (W168)

A 140	1.4	60	07.97-08.04	M 166.940	4	<b>Z 121</b>	14 FGH-8 DTURXO	1,0	<b>UXT 9</b>
A 140	1.6	60	01.01-08.04	M 166.960	4	<b>Z 121</b>	14 FGH-8 DTURXO	1,0	<b>UXT 9</b>
A 160	1.6	75	07.97-08.04	M 166.960	4	<b>Z 121</b>	14 FGH-8 DTURXO	1,0	<b>UXT 9</b>
A 160 CDI	1.7	44	07.98-02.01	OM 668.941	4	<b>GN 010</b> (11,5V)	○		
A 160 CDI	1.7	55	02.01-08.04	OM 668.940	4	<b>GN 010</b> (11,5V)	○		
A 170 CDI	1.7	66	07.98-02.01	OM 668.940	4	<b>GN 010</b> (11,5V)	○		



kW

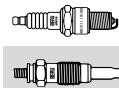
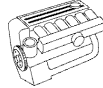

**MERCEDES**

**A-KLASSE (W168)**

A 170 CDI	1.7	70	02.01-08.04	OM 668.942	4	<b>GN 010</b> (11,5V)	○		
A 190	1.9	92	03.99-08.04	M 166.990	4	<b>Z 121</b>	14 FGH-8 DTURXO	1,0	<b>UXT 9</b>
A 210	2.1	103	03.02-08.04	M 166.995	4	<b>Z 121</b>	14 FGH-8 DTURXO	1,0	<b>UXT 9</b>

**A-KLASSE (W169)**

A 150	1.5	70	09.04-06.12	M 266.920	4	<b>Z 227</b>	14 F-8 DUR	0,8	<b>UXT 9</b>
A 160	1.5	70	04.09-06.12	M 266.920	4	<b>Z 227</b>	14 F-8 DUR	0,8	<b>UXT 9</b>
A 160 CDI	2.0	60	09.04-06.12	OM 640.942	4	<b>GE 105</b> (4,4V)	○		
A 170	1.7	85	09.04-06.12	M 266.940	4	<b>Z 227</b>	14 F-8 DUR	0,8	<b>UXT 9</b>
A 180	1.7	85	04.09-06.12	M 266.940	4	<b>Z 227</b>	14 F-8 DUR	0,8	<b>UXT 9</b>
A 180 CDI	2.0	80	09.04-06.12	OM 640.940	4	<b>GE 105</b> (4,4V)	○		
A 200 TURBO	2.0	100	09.04-06.12	M 266.960	4	<b>Z 227</b>	14 F-8 DUR	0,8	<b>UXT 9</b>
A 200 CDI	2.0	103	09.04-06.12	OM 640.941	4	<b>GE 105</b> (4,4V)	○		
A 200 TURBO	2.0	142	09.05-06.12	M 266.980	4	<b>Z 322</b>	14 F-6 KPUR02W	0,9	○

**B-KLASSE (W245)**

B 150	1.5	70	03.05-11.11	M 266.920	4	<b>Z 227</b>	14 F-8 DUR	0,8	<b>UXT 9</b>
B 160	1.5	70	04.09-11.11	M 266.920	4	<b>Z 227</b>	14 F-8 DUR	0,8	<b>UXT 9</b>
B 170	1.7	85	03.05-11.11	M 266.940	4	<b>Z 227</b>	14 F-8 DUR	0,8	<b>UXT 9</b>
B 170 NGT	2.0	85	04.08-11.11	M 266.960	4	<b>Z 227</b>	14 F-8 DUR	0,8	<b>UXT 9</b>
B 180	1.7	85	04.09-11.11	M 266.940	4	<b>Z 227</b>	14 F-8 DUR	0,8	<b>UXT 9</b>
B 180 CDI	2.0	80	03.05-11.11	OM 640.940	4	<b>GE 105</b> (4,4V)	○		
B 180 NGT	2.0	85	04.08-11.11	M 266.960	4	<b>Z 227</b>	14 F-8 DUR	0,8	<b>UXT 9</b>
B 200	2.0	100	03.05-11.11	M 266.960	4	<b>Z 227</b>	14 F-8 DUR	0,8	<b>UXT 9</b>
B 200 CDI	2.0	103	03.05-11.11	OM 640.941	4	<b>GE 105</b> (4,4V)	○		
B 200 TURBO	2.0	142	03.05-11.11	M 266.980	4	<b>Z 322</b>	14 F-6 KPUR02W	0,9	○

**C-KLASSE (W202)**

C 180	1.8	89	11.94-06.97	M 111.921	4	<b>Z 100</b>	14 F-8 DU4	0,8	<b>UXT 1<sup>3</sup></b>
C 180	1.8	89	07.97-05.00	M 111.921	4	<b>Z 121</b>	14 FGH-8 DTURXO	1,0	<b>UXT 9</b>
C 180	1.8	90	03.93-05.00	M 111.920	4	<b>Z 100</b>	14 F-8 DU4	0,8	<b>UXT 1<sup>3</sup></b>
C 180	1.8	90	03.93-05.00	M 111.921	4	<b>Z 121</b>	14 FGH-8 DTURXO	1,0	<b>UXT 9</b>
C 200 D	2.0	55	03.93-05.00	OM 601.913	4	<b>GN 858</b> (11,5V)	<b>GR 074</b>	<b>SR 040</b>	
C 200 D	2.0	65	10.96-05.00	OM 604.915	4	<b>GN 948</b> (11,5V)	<b>GR 079</b>		
C 200 CDI	2.2	75	03.98-05.00	OM 611.960	4	<b>GN 003</b> (11,5V)	○		
C 200	2.0	100	01.94-06.97	M 111.945/M 111.941	4	<b>Z 100</b>	14 F-8 DU4	0,8	<b>UXT 1<sup>3</sup></b>
C 200	2.0	100	07.97-05.00	M 111.945/M 111.941	4	<b>Z 121</b>	14 FGH-8 DTURXO	1,0	<b>UXT 9</b>
C 200 Kompressor	2.0	132	10.95-05.00	M 111.944	4	<b>Z 120</b>	14 FGH-7 DTURXO	1,0	<b>UXT 9</b>
C 200 Kompressor	2.0	141	11.96-05.00	M 111.944	4	<b>Z 120</b>	14 FGH-7 DTURXO	1,0	<b>UXT 9</b>
C 220 D	2.2	55	07.96-05.00	OM 604.910	4	<b>GN 948</b> (11,5V) <sup>111</sup>	○		
C 220 D	2.2	55	07.96-05.00	OM 604.910	4	<b>GN 860</b> (11,5V)	<b>GR 079</b>		
C 220 D	2.2	70	08.93-01.95	OM 604.910	4	<b>GN 860</b> (11,5V)	○		
C 220 D	2.2	70	02.95-05.00	OM 604.910	4	<b>GN 948</b> (11,5V)	<b>GR 079</b>		
C 220 CDI	2.2	92	09.97-05.00	OM 611.960	4	<b>GN 003</b> (11,5V)	○		
C 220	2.2	110	03.93-06.97	M 111.961	4	<b>Z 100</b>	14 F-8 DU4	0,8	<b>UXT 1<sup>3</sup></b>
C 220	2.2	110	07.97-05.00	M 111.961	4	<b>Z 121</b>	14 FGH-8 DTURXO	1,0	<b>UXT 9</b>
C 230	2.3	110	06.96-06.97	M 111.974	4	<b>Z 100</b>	14 F-8 DU4	0,8	<b>UXT 1<sup>3</sup></b>
C 230 Kompressor	2.3	142	10.95-05.00	M 111.975	4	<b>Z 120</b>	14 FGH-7 DTURXO	1,0	<b>UXT 9</b>
C 240	2.4	125	06.97-05.00	M 112.910	6	<b>Z 122</b>	14 FGH-8 DPURX2=12x	1,0	<b>UXT 9</b>
C 250 D	2.5	83	05.93-05.00	OM 605.910	5	<b>GN 948</b> (11,5V) <sup>111</sup>	<b>GR 080</b>		
C 250 D	2.5	83	05.93-05.00	OM 605.910	5	<b>GN 860</b> (11,5V)	○		
C 250 Turbo-D	2.5	110	10.95-05.00	OM 605.960	5	<b>GN 948</b> (11,5V)	<b>GR 080</b>		
C 280	2.8	142	05.93-06.97	M 104.941	6	<b>Z 100</b>	14 F-8 DU4	0,8	<b>UXT 1<sup>3</sup></b>
C 280	2.8	142	07.97-05.00	M 104.941	6	<b>Z 121</b>	14 FGH-8 DTURXO	1,0	<b>UXT 9</b>
C 280	2.8	145	06.97-05.00	M 112.920	6	<b>Z 122</b>	14 FGH-8 DPURX2=12x	1,0	<b>UXT 9</b>
C 36 AMG	3.6	206	05.94-06.97	M 104.941 (AMG 3.6)	6	<b>Z 100</b>	14 F-8 DU4	0,8	<b>UXT 1<sup>3</sup></b>
C 36 AMG	3.6	206	07.97-05.00	M 104.941 (AMG 3.6)	6	<b>Z 121</b>	14 FGH-8 DTURXO	1,0	<b>UXT 9</b>
C 43 AMG	4.3	225	08.97-05.00	M 113.944	8	<b>Z 122</b>	14 FGH-8 DPURX2=16x	1,0	<b>UXT 9</b>

**C-KLASSE Kombi (S202)**

C 180 T	1.8	90	06.96-09.00	M 111.921	4	<b>Z 121</b>	14 FGH-8 DTURXO	1,0	<b>UXT 9</b>
C 180 T	1.8	90	06.96-09.00	M 111.920	4	<b>Z 100</b>	14 F-8 DU4	0,8	<b>UXT 1<sup>3</sup></b>
C 180 T	2.0	95	09.00-03.01	M 111.952	4	<b>Z 282</b>	14 FGH-7 DPURX2	1,0	<b>UXT 9</b>
C 200 T D	2.0	65	10.96-03.01	OM 604.915	4	<b>GN 948</b> (11,5V)	<b>GR 079</b>		
C 200 T CDI	2.2	75	03.98-03.01	OM 611.960	4	<b>GN 003</b> (11,5V)	○		

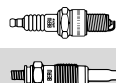
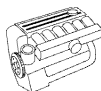

## MERCEDES

### C-KLASSE Kombi (S202)

C 200 T	2.0	100	06.96-06.97	M 111.945/M 111.941	4	<b>Z 100</b>	14 F-8 DU4	0,8	<b>UXT 13</b>
C 200 T	2.0	100	07.97-03.01	M 111.945/M 111.941	4	<b>Z 121</b>	14 FGH-8 DTURXO	1,0	<b>UXT 9</b>
C 200 T Kompressor	2.0	120	09.00-03.01	M 111.956	4	<b>Z 170</b>	14 F-7 DPURU2	1,0	<b>UXT 12</b>
C 200 T Kompressor	2.0	141	11.96-03.01	M 111.944	4	<b>Z 120</b>	14 FGH-7 DTURXO	1,0	<b>UXT 9</b>
C 220 T D	2.2	55	06.96-03.01	OM 604.910	4	<b>GN 948</b> (11,5V)	<b>GR 079</b>		
C 220 T D	2.2	70	06.96-09.98	OM 604.910	4	<b>GN 948</b> (11,5V)	<b>GR 079</b>		
C 220 T CDI	2.2	92	09.97-03.01	OM 611.960	4	<b>GN 003</b> (11,5V)	○		
C 230 T	2.3	110	06.96-06.98	M 111.974	4	<b>Z 100</b>	14 F-8 DU4	0,8	<b>UXT 13</b>
C 230 T Kompressor	2.3	142	06.97-09.00	M 111.975	4	<b>Z 120</b>	14 FGH-7 DTURXO	1,0	<b>UXT 9</b>
C 240 T	2.4	125	06.97-09.00	M 112.910	6	<b>Z 122</b>	14 FGH-8 DPURX2=12x	1,0	<b>UXT 9</b>
C 240 T	2.6	125	09.00-03.01	M 112.915	6	<b>Z 122</b>	14 FGH-8 DPURX2=12x	1,0	<b>UXT 9</b>
C 250 T Turbo-D	2.5	110	06.96-03.01	OM 605.960	5	<b>GN 948</b> (11,5V)	<b>GR 080</b>		
C 280 T	2.8	145	06.97-03.01	M 112.920	6	<b>Z 122</b>	14 FGH-8 DPURX2=12x	1,0	<b>UXT 9</b>
C 43 AMG	4.3	225	08.97-03.01	M 113.944	8	<b>Z 122</b>	14 FGH-8 DPURX2=16x	1,0	<b>UXT 9</b>

### C-KLASSE (W203)

C 180	2.0	95	10.00-05.02	M 111.951	4	<b>Z 282</b>	14 FGH-7 DPURX2	1,0	<b>UXT 9</b>
C 180 Kompressor	1.8	105	05.02-02.07	M 271.946 → Mot.Nr. 30853899	4	<b>Z 226</b>	14 FR-6 MPU2	0,8	○
C 180 Kompressor	1.8	105	05.02-02.07	M 271.946 Mot.Nr. 30853900 →	4	<b>Z 359</b>	12 F-5 NPUR2T	0,8	○
C 200 CDI	2.1	75	02.01-02.07	OM 646.962	4	<b>GN 003</b> (11,5V)	○		
C 200 CDI	2.1	85	09.00-02.07	OM 611.962	4	<b>GN 003</b> (11,5V)	○		
C 200 CDI	2.1	90	04.03-02.07	OM 646.962	4	<b>GN 003</b> (11,5V)	○		
C 200 Kompressor	1.8	120	05.02-02.07	M 271.940 → Mot.Nr. 30853899	4	<b>Z 226</b>	14 FR-6 MPU2	0,8	○
C 200 Kompressor	1.8	120	05.02-02.07	M 271.940 Mot.Nr. 30853900 →	4	<b>Z 359</b>	12 F-5 NPUR2T	0,8	○
C 200 Kompressor	2.0	120	05.00-05.02	M 111.955	4	<b>Z 170</b>	14 F-7 DPURU2	1,0	<b>UXT 12</b>
C 200 CGI Kompressor	1.8	125	07.03-02.07	M 271.942 → Mot.Nr. 30853899	4	<b>Z 226</b>	14 FR-6 MPU2	0,8	○
C 200 CGI Kompressor	1.8	125	07.03-02.07	M 271.942 Mot.Nr. 30853900 →	4	<b>Z 359</b>	12 F-5 NPUR2T	0,8	○
C 220 CDI	2.1	105	05.00-02.07	OM 611.962	4	<b>GN 003</b> (11,5V)	○		
C 220 CDI	2.1	110	02.04-02.07	OM 646.963	4	<b>GN 003</b> (11,5V)	○		
C 230 Kompressor	1.8	141	02.04-02.07	M 271.948 Mot.Nr. 30853900 →	4	<b>Z 359</b>	12 F-5 NPUR2T	0,8	○
C 230 Kompressor	1.8	141	02.04-02.07	M 271.948 → Mot.Nr. 30853899	4	<b>Z 226</b>	14 FR-6 MPU2	0,8	○
C 230	2.5	150	01.05-02.07	M 272.920	6	<b>Z 359</b>	12 F-5 NPUR2T	0,8	○
C 240	2.6	125	05.00-02.07	M 112.912	6	<b>Z 122</b>	14 FGH-8 DPURX2=12x	1,0	<b>UXT 9</b>
C 240	2.6	125	03.02-02.07	M 112.912	6	<b>Z 240</b>	14 F-8 DPURX02=12x	1,0	<b>UXT 9</b>
C 240 4-matic	2.6	125	07.02-02.07	M 112.916	6	<b>Z 240</b>	14 F-8 DPURX02=12x	1,0	<b>UXT 9</b>
C 270 CDI	2.7	125	12.00-02.07	OM 612.962	5	<b>GN 003</b> (11,5V)	○		
C 280	3.0	170	01.05-02.07	M 272.940	6	<b>Z 359</b>	12 F-5 NPUR2T	0,8	○
C 280 4-matic	3.0	170	01.05-02.07	M 272.941	6	<b>Z 359</b>	12 F-5 NPUR2T	0,8	○
C 320	3.2	160	05.00-02.07	M 112.946	6	<b>Z 122</b>	14 FGH-8 DPURX2=12x	1,0	<b>UXT 9</b>
C 320	3.2	160	03.02-02.07	M 112.946	6	<b>Z 240</b>	14 F-8 DPURX02=12x	1,0	<b>UXT 9</b>
C 320 4-matic	3.2	160	07.02-02.07	M 112.953	6	<b>Z 240</b>	14 F-8 DPURX02=12x	1,0	<b>UXT 9</b>
C 320 CDI	3.0	165	01.05-02.07	OM 642.910	6	<b>GE 105</b> (4,4V)	○		
C 350 4-matic	3.5	200	01.05-02.07	M 272.970	6	<b>Z 240</b>	14 F-8 DPURX02=12x	1,0	<b>UXT 9</b>
C 30 CDI AMG	3.0	170	01.03-02.07	OM 612.990	5	<b>GE 104</b> (5V)	○		
C 32 AMG Kompressor	3.2	260	02.01-02.07	M 112.961	6	<b>Z 170</b>	14 F-7 DPURU2=12x	1,0	<b>UXT 12</b>
C 55 AMG	5.4	270	02.04-02.07	M 113.988	8	<b>Z 170</b>	14 F-7 DPURU2	1,0	<b>UXT 12</b>

### C-KLASSE Kombi (S203)

C 180	2.0	95	03.01-05.02	M 111.951	4	<b>Z 282</b>	14 FGH-7 DPURX2	1,0	<b>UXT 9</b>
C 180 Kompressor	1.8	105	05.02-08.07	M 271.946	4	<b>Z 359</b>	12 F-5 NPUR2T	0,8	○
C 180 Kompressor	1.8	105	05.02-08.07	M 271.946 → Mot.Nr. 30853899	4	<b>Z 226</b>	14 FR-6 MPU2	0,8	○
C 200 CDI	2.1	75	03.01-08.07	OM 646.962	4	<b>GN 003</b> (11,5V)	○		
C 200 CDI	2.1	85	03.01-08.07	OM 611.962	4	<b>GN 003</b> (11,5V)	○		
C 200 CDI	2.1	90	04.03-08.07	OM 646.962	4	<b>GN 003</b> (11,5V)	○		



kW

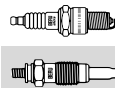
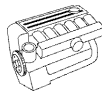

**MERCEDES**

**C-KLASSE Kombi (S203)**

C 200 Kompressor	1.8	120	05.02-08.07	M 271.940 → Mot.Nr. 30853899	4	<b>Z 226</b>	14 FR-6 MPU2	0,8	○
C 200 Kompressor	1.8	120	05.02-08.07	M 271.940 Mot.Nr. 30853900 →	4	<b>Z 359</b>	12 F-5 NPUR2T	0,8	○
C 200 Kompressor	2.0	120	03.01-05.02	M 111.955	4	<b>Z 170</b>	14 F-7 DPUUR2	1,0	<b>UXT 12</b>
C 200 CGI Kompressor	1.8	125	07.03-08.07	M 271.942 → Mot.Nr. 30853899	4	<b>Z 226</b>	14 FR-6 MPU2	0,8	○
C 200 CGI Kompressor	1.8	125	07.03-08.07	M 271.942 Mot.Nr. 30853900 →	4	<b>Z 359</b>	12 F-5 NPUR2T	0,8	○
C 220 CDI	2.1	105	03.01-08.07	OM 611.962	4	<b>GN 003</b> (11,5V)	○		
C 220 CDI	2.1	110	02.04-08.07	OM 646.963	4	<b>GN 003</b> (11,5V)	○		
C 230 Kompressor	1.8	141	02.04-08.07	M 271.948 → Mot.Nr. 30853899	4	<b>Z 226</b>	14 FR-6 MPU2	0,8	○
C 230 Kompressor	1.8	141	02.04-08.07	M 271.948 Mot.Nr. 30853900 →	4	<b>Z 359</b>	12 F-5 NPUR2T	0,8	○
C 230	2.5	150	01.05-08.07	M 272.920	6	<b>Z 359</b>	12 F-5 NPUR2T	0,8	○
C 240	2.6	125	03.01-02.02	M 112.912	6	<b>Z 122</b>	14 FGH-8 DPURX2=12x	1,0	<b>UXT 9</b>
C 240	2.6	125	03.02-08.07	M 112.912	6	<b>Z 240</b>	14 F-8 DPURX02=12x	1,0	<b>UXT 9</b>
C 240 4-matic	2.6	125	07.02-08.07	M 112.916	6	<b>Z 240</b>	14 F-8 DPURX02=12x	1,0	<b>UXT 9</b>
C 270 CDI	2.7	125	03.01-08.07	OM 612.962	5	<b>GN 003</b> (11,5V)	○		
C 280	3.0	170	01.05-08.07	M 272.940	6	<b>Z 359</b>	12 F-5 NPUR2T	0,8	○
C 280 4-matic	3.0	170	01.05-08.07	M 272.941	6	<b>Z 359</b>	12 F-5 NPUR2T	0,8	○
C 320	3.2	160	03.01-02.02	M 112.946	6	<b>Z 122</b>	14 FGH-8 DPURX2=12x	1,0	<b>UXT 9</b>
C 320	3.2	160	03.02-08.07	M 112.946	6	<b>Z 240</b>	14 F-8 DPURX02=12x	1,0	<b>UXT 9</b>
C 320 4-matic	3.2	160	07.02-08.07	M 112.953	6	<b>Z 240</b>	14 F-8 DPURX02=12x	1,0	<b>UXT 9</b>
C 320 CDI	3.0	165	06.05-08.07	OM 642.910	6	<b>GE 105</b> (4,4V)	○		
C 30 CDI AMG	3.0	170	01.03-08.07	OM 612.990	5	<b>GE 104</b> (5V)	○		
C 32 AMG Kompressor	3.2	260	03.01-08.07	M 112.961	6	<b>Z 170</b>	14 F-7 DPUUR2=12x	1,0	<b>UXT 12</b>
C 55 AMG	5.4	270	02.04-08.07	M 113.988	8	<b>Z 170</b>	14 F-7 DPUUR2	1,0	<b>UXT 12</b>

**C-KLASSE (W204)**

C 180 Kompressor	1.8	115	01.07-	M 271.952	4	<b>Z 359</b>	12 F-5 NPUR2T	0,8	○
C 200 Kompressor	1.8	135	01.07-	M 271.950	4	<b>Z 359</b>	12 F-5 NPUR2T	0,8	○
C 230	2.5	150	01.07-	M 272.921	6	<b>Z 359</b>	12 F-5 NPUR2T	0,8	○
C 230 4-matic	2.5	150	07.07-	M 272.911	6	<b>Z 359</b>	12 F-5 NPUR2T	0,8	○
C 280	3.0	170	01.07-	M 272.947	6	<b>Z 359</b>	12 F-5 NPUR2T	0,8	○
C 280 4-matic	3.0	170	07.07-	M 272.948	6	<b>Z 359</b>	12 F-5 NPUR2T	0,8	○
C 300	3.0	170	07.09-	M 272.947	6	<b>Z 359</b>	12 F-5 NPUR2T	0,8	○
C 300 4-matic	3.0	170	07.07-	M 272.948	6	<b>Z 359</b>	12 F-5 NPUR2T	0,8	○
C 320 CDI	3.0	165	01.07-	OM 642.960	6	<b>GE 105</b> (4,4V)	○		
C 320 CDI 4-matic	3.0	165	07.07-	OM 642.961	6	<b>GE 105</b> (4,4V)	○		
C 350 CDI	3.0	165	07.09-	OM 642.960	6	<b>GE 105</b> (4,4V)	○		
C 350 CDI 4-matic	3.0	165	07.09-	OM 642.961	6	<b>GE 105</b> (4,4V)	○		
C 63 AMG	6.2	336	02.08-	M 156.985	8	<b>Z 355</b>	12 VR-5 SPPU	1,0	○
C 63 AMG	6.2	358	02.08-	M 156.985	8	<b>Z 355</b>	12 VR-5 SPPU	1,0	○

**C-KLASSE Coupe (C204)**

C 63 AMG	6.2	336	06.11-	M 156.985	8	<b>Z 355</b>	12 VR-5 SPPU	1,0	○
C 63 AMG	6.2	358	01.12-	M 156.985	8	<b>Z 355</b>	12 VR-5 SPPU	1,0	○
C 63 AMG	6.2	380	01.12-	M 156.985	8	<b>Z 355</b>	12 VR-5 SPPU	1,0	○

**C-KLASSE Kombi (S204)**

C 180 Kompressor	1.8	115	08.07-	M 271.952	4	<b>Z 359</b>	12 F-5 NPUR2T	0,8	○
C 200 Kompressor	1.8	135	08.07-	M 271.950	4	<b>Z 359</b>	12 F-5 NPUR2T	0,8	○
C 230	2.5	150	08.07-	M 272.921	6	<b>Z 359</b>	12 F-5 NPUR2T	0,8	○
C 280	3.0	170	08.07-	M 272.947	6	<b>Z 359</b>	12 F-5 NPUR2T	0,8	○
C 300	3.0	170	08.07-	M 272.947	6	<b>Z 359</b>	12 F-5 NPUR2T	0,8	○
C 320 CDI	3.0	165	08.07-	OM 642.960	6	<b>GE 105</b> (4,4V)	○		
C 320 CDI 4-matic	3.0	165	08.07-	OM 642.961	6	<b>GE 105</b> (4,4V)	○		
C 63 AMG	6.2	336	02.08-	M 156.985	8	<b>Z 355</b>	12 VR-5 SPPU	1,0	○
C 63 AMG	6.2	358	01.12-	M 156.985	8	<b>Z 355</b>	12 VR-5 SPPU	1,0	○
C 63 AMG	6.2	386	02.08-	M 156.985	8	<b>Z 355</b>	12 VR-5 SPPU	1,0	○

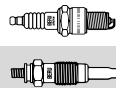
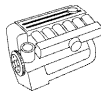

## MERCEDES

### C-KLASSE Sportcoupe (CL203)

C 160 Kompressor	1.8	90	05.02-06.11	M 271.921 → Mot.Nr. 30853899	4	<b>Z 226</b>	14 FR-6 MPU2	0,8	○
C 160 Kompressor	1.8	90	05.02-06.11	M 271.921 Mot.Nr. 30853900 →	4	<b>Z 359</b>	12 F-5 NPUR2T	0,8	○
C 180	2.0	95	03.01-05.02	M 111.951	4	<b>Z 282</b>	14 FGH-7 DPURX2	1,0	<b>UXT 9</b>
C 180 Kompressor	1.8	105	05.02-06.11	M 271.946 → Mot.Nr. 30853899	4	<b>Z 226</b>	14 FR-6 MPU2	0,8	○
C 180 Kompressor	1.8	105	05.02-06.11	M 271.946 Mot.Nr. 30853900 →	4	<b>Z 359</b>	12 F-5 NPUR2T	0,8	○
C 200 Kompressor	1.8	120	05.02-06.11	M 271.940 → Mot.Nr. 30853899	4	<b>Z 226</b>	14 FR-6 MPU2	0,8	○
C 200 Kompressor	1.8	120	05.02-06.11	M 271.940 Mot.Nr. 30853900 →	4	<b>Z 359</b>	12 F-5 NPUR2T	0,8	○
C 200 CGI Kompressor	1.8	125	03.03-06.11	M 271.942 → Mot.Nr. 30853899	4	<b>Z 226</b>	14 FR-6 MPU2	0,8	○
C 200 CGI Kompressor	1.8	125	03.03-06.11	M 271.942 Mot.Nr. 30853900 →	4	<b>Z 359</b>	12 F-5 NPUR2T	0,8	○
C 200 Kompressor	2.0	120	03.01-05.02	M 111.955	4	<b>Z 170</b>	14 F-7 DPURU2	1,0	<b>UXT 12</b>
C 200 CDI	2.1	90	03.03-06.11	OM 646.962	4	<b>GN 003</b> (11,5V)	○		
C 220 CDI	2.1	105	03.01-06.11	OM 611.962	4	<b>GN 003</b> (11,5V)	○		
C 220 CDI	2.1	110	02.04-06.11	OM 646.963	4	<b>GN 003</b> (11,5V)	○		
C 230 Kompressor	1.8	141	05.02-06.11	M 271.948 → Mot.Nr. 30853899	4	<b>Z 226</b>	14 FR-6 MPU2	0,8	○
C 230 Kompressor	1.8	141	05.02-06.11	M 271.948 Mot.Nr. 30853900 →	4	<b>Z 359</b>	12 F-5 NPUR2T	0,8	○
C 230 Kompressor	2.3	145	03.01-05.02	M 111.981	4	<b>Z 170</b>	14 F-7 DPURU2	1,0	<b>UXT 12</b>
C 230	2.5	150	01.05-06.11	M 272.920	6	<b>Z 359</b>	12 F-5 NPUR2T	0,8	○
C 30 CDI AMG	3.0	170	09.02-06.11	OM 612.990	5	<b>GE 104</b> (5V)	○		
C 320	3.2	160	09.02-06.11	M 112.946	6	<b>Z 122</b>	14 FGH-8 DPURX2=12x	1,0	<b>UXT 9</b>
C 32 AMG Kompressor	3.2	260	05.02-06.11	M 112.961	6	<b>Z 170</b>	14 F-7 DPURU2	1,0	<b>UXT 12</b>

### CLC-KLASSE (CL203)

CLC 180 Kompressor	1.8	105	05.08-	M 271.946	4	<b>Z 359</b>	12 F-5 NPUR2T	0,8	○
CLC 200 Kompressor	1.8	135	05.08-	M 271.955	4	<b>Z 359</b>	12 F-5 NPUR2T	0,8	○
CLC 200 CDI	2.1	90	05.08-	OM 646.962	4	<b>GN 003</b> (11,5V)	○		
CLC 220 CDI	2.1	110	05.08-	OM 646.963	4	<b>GN 003</b> (11,5V)	○		
CLC 230	2.5	150	05.08-	M 272.920	6	<b>Z 359</b>	12 F-5 NPUR2T	0,8	○

### CLK (C208)

200	2.0	100	06.97-06.02	M 111.945/M 111.941	4	<b>Z 121</b>	14 FGH-8 DTURX0	1,0	<b>UXT 9</b>
200 Kompressor	2.0	120	06.00-06.02	M 111.956	4	<b>Z 170</b>	14 F-7 DPURU2	1,0	<b>UXT 12</b>
200 Kompressor	2.0	141	06.97-06.00	M 111.944	4	<b>Z 120</b>	14 FGH-7 DTURX0	1,0	<b>UXT 9</b>
230 Kompressor	2.3	142	06.97-06.00	M 111.975/M 111.973	4	<b>Z 120</b>	14 FGH-7 DTURX0	1,0	<b>UXT 9</b>
230 Kompressor	2.3	145	06.00-06.02	M 111.982	4	<b>Z 170</b>	14 F-7 DPURU2	1,0	<b>UXT 12</b>
320	3.2	160	06.97-06.02	M 112.940	6	<b>Z 122</b>	14 FGH-8 DPURX2=12x	1,0	<b>UXT 9</b>
430	4.3	205	07.98-06.02	M 113.943	8	<b>Z 122</b>	14 FGH-8 DPURX2=16x	1,0	<b>UXT 9</b>
55 AMG	5.4	255	08.99-06.02	M 113.981/984	8	<b>Z 240</b>	14 F-8 DPURX02	1,0	<b>UXT 9</b>

### CLK Cabriolet (A208)

200	2.0	100	03.98-03.02	M 111.945/M 111.941	4	<b>Z 121</b>	14 FGH-8 DTURX0	1,0	<b>UXT 9</b>
200 Kompressor	2.0	120	06.00-03.02	M 111.956	4	<b>Z 170</b>	14 F-7 DPURU2	1,0	<b>UXT 12</b>
200 Kompressor	2.0	141	03.98-06.00	M 111.944	4	<b>Z 120</b>	14 FGH-7 DTURX0	1,0	<b>UXT 9</b>
230 Kompressor	2.3	142	03.98-06.00	M 111.975/M 111.973	4	<b>Z 120</b>	14 FGH-7 DTURX0	1,0	<b>UXT 9</b>
230 Kompressor	2.3	145	06.00-03.02	M 111.982	4	<b>Z 170</b>	14 F-7 DPURU2	1,0	<b>UXT 12</b>
320	3.2	160	03.98-03.02	M 112.940	6	<b>Z 122</b>	14 FGH-8 DPURX2=12x	1,0	<b>UXT 9</b>
430	4.3	205	09.98-03.02	M 113.943	8	<b>Z 122</b>	14 FGH-8 DPURX2=16x	1,0	<b>UXT 9</b>
55 AMG	5.4	255	01.00-03.02	M 113.981/984	8	<b>Z 240</b>	14 F-8 DPURX02	1,0	<b>UXT 9</b>

### CLK (C209)

200 CGI	1.8	125	07.03-05.09	M 271.942 → Mot.Nr. 30853899	4	<b>Z 226</b>	14 FR-6 MPU2	0,8	○
200 CGI	1.8	125	07.03-05.09	M 271.942 Mot.Nr. 30853900 →	4	<b>Z 359</b>	12 F-5 NPUR2T	0,8	○
200 Kompressor	1.8	120	09.02-05.09	M 271.940 → Mot.Nr. 30853899	4	<b>Z 226</b>	14 FR-6 MPU2	0,8	○



kW

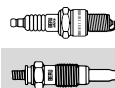
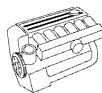

**MERCEDES**

**CLK (C209)**

200 Kompressor	1.8	120	09.02-05.09	M 271.940 Mot.Nr. 30853900 →	4	<b>Z 359</b>	12 F-5 NPUR2T	0,8	○
200 Kompressor	1.8	135	10.06-05.09	M 271.955 → Mot.Nr. 30853899	4	<b>Z 226</b>	14 FR-6 MPU2	0,8	○
200 Kompressor	1.8	135	10.06-05.09	M 271.955 Mot.Nr. 30853900 →	4	<b>Z 359</b>	12 F-5 NPUR2T	0,8	○
220 CDI	2.1	110	01.05-05.09	OM 646.966	4	<b>GN 003</b> (11,5V)	○		
240	2.6	125	06.02-05.09	M 112.912	6	<b>Z 240</b>	14 F-8 DPURX02	1,0	<b>UXT 9</b>
270 CDI	2.7	125	10.02-05.09	OM 612.967/OM 612.962	5	<b>GN 003</b> (11,5V)	○		
280	3.0	170	01.05-05.09	M 272.940	6	<b>Z 359</b>	12 F-5 NPUR2T	0,8	○
320	3.2	160	06.02-05.09	M 112.955	6	<b>Z 240</b>	14 F-8 DPURX02	1,0	<b>UXT 9</b>
320 CDI	3.0	165	01.05-05.09	OM 642.910	6	<b>GE 105</b> (4,4V)	○		
500	5.0	225	06.02-05.09	M 113.968	8	<b>Z 240</b>	14 F-8 DPURX02	1,0	<b>UXT 9</b>
500	5.5	285	06.06-05.09	M 273.965	8	<b>Z 359</b>	12 F-5 NPUR2T	0,8	○
55 AMG	5.4	270	09.02-05.09	M 113.987	8	<b>Z 170</b>	14 F-7 DPURU2	1,0	<b>UXT 12</b>
63 AMG	6.2	354	04.06-05.09	M 156.982	8	<b>Z 355</b>	12 VR-5 SPPU	1,0	○
63 AMG	6.2	373	05.07-05.09	M 156.982	8	<b>Z 355</b>	12 VR-5 SPPU	1,0	○

**CLK Cabriolet (A209)**

200 CGI	1.8	125	07.03-03.10	M 271.942 → Mot.Nr. 30853899	4	<b>Z 226</b>	14 FR-6 MPU2	0,8	○
200 CGI	1.8	125	07.03-03.10	M 271.942 Mot.Nr. 30853900 →	4	<b>Z 359</b>	12 F-5 NPUR2T	0,8	○
200 Kompressor	1.8	120	02.03-03.10	M 271.940 → Mot.Nr. 30853899	4	<b>Z 226</b>	14 FR-6 MPU2	0,8	○
200 Kompressor	1.8	120	02.03-03.10	M 271.940 Mot.Nr. 30853900 →	4	<b>Z 359</b>	12 F-5 NPUR2T	0,8	○
200 Kompressor	1.8	135	10.06-03.10	M 271.955 → Mot.Nr. 30853899	4	<b>Z 226</b>	14 FR-6 MPU2	0,8	○
240	2.6	125	02.03-03.10	M 112.912	6	<b>Z 240</b>	14 F-8 DPURX02	1,0	<b>UXT 9</b>
280	3.0	170	01.05-03.10	M 272.940	6	<b>Z 359</b>	12 F-5 NPUR2T	0,8	○
320	3.2	160	02.03-03.10	M 112.955	6	<b>Z 240</b>	14 F-8 DPURX02	1,0	<b>UXT 9</b>
320 CDI	3.2	165	03.05-03.10	OM 642.910	6	<b>GE 105</b> (4,4V)	○		
500	5.0	225	02.03-03.10	M 113.968	8	<b>Z 240</b>	14 F-8 DPURX02	1,0	<b>UXT 9</b>
500	5.5	285	06.06-03.10	M 273.967	8	<b>Z 359</b>	12 F-5 NPUR2T	0,8	○
55 AMG	5.4	270	02.03-03.10	M 113.987	8	<b>Z 170</b>	14 F-7 DPURU2	1,0	<b>UXT 12</b>
63 AMG	6.2	354	04.06-03.10	M 156.982	8	<b>Z 355</b>	12 VR-5 SPPU	1,0	○

**CLS (C219)**

280	3.0	170	07.08-12.10	M 272.943	6	<b>Z 359</b>	12 F-5 NPUR2T	0,8	○
300	3.0	170	04.09-12.10	M 272.943	6	<b>Z 359</b>	12 F-5 NPUR2T	0,8	○
320 CDI	3.2	165	01.05-12.10	OM 642.920	6	<b>GE 105</b> (4,4V)	○		
350 CDI	3.5	165	04.09-12.10	OM 642.920	6	<b>GE 105</b> (4,4V)	○		
500	5.0	225	10.04-12.10	M 113.967	8	<b>Z 240</b>	14 F-8 DPURX02	1,0	<b>UXT 9</b>
500	5.5	285	04.06-12.10	M 273.960	8	<b>Z 359</b>	12 F-5 NPUR2T	0,8	○
550	5.5	285	04.06-	M 273.960	8	<b>Z 359</b>	12 F-5 NPUR2T	0,8	○
CLS 63 AMG	6.2	378	04.06-12.10	M 156.983	8	<b>Z 355</b>	12 VR-5 SPPU	1,0	○

**E-KLASSE (W124)**

E 200 D	2.0	55	06.93-06.95	OM 601.912	4	<b>GN 858</b> (11,5V)	○		
E 200	2.0	100	06.93-06.95	M 111.940	4	<b>Z 100</b>	14 F-8 DU4	0,8	<b>UXT 1<sup>3</sup></b>
E 220	2.2	110	06.93-06.95	M 111.960	4	<b>Z 100</b>	14 F-8 DU4	0,8	<b>UXT 1<sup>3</sup></b>
E 250 D	2.5	83	07.93-06.95	OM 605.911	5	<b>GN 948</b> (11,5V) <sup>111</sup>	○		
E 250 D	2.5	83	07.93-06.95	OM 605.911	5	<b>GN 860</b> (11,5V)	○		
E 250 Turbo-D	2.5	93	06.93-06.95	OM 602.962	5	<b>GN 858</b> (11,5V)	○		
E 280 lang	2.8	142	06.93-06.95	M 104.942	6	<b>Z 100</b>	14 F-8 DU4	0,8	<b>UXT 1<sup>3</sup></b>
E 280	2.8	145	06.93-06.95	M 104.942	6	<b>Z 100</b>	14 F-8 DU4	0,8	<b>UXT 1<sup>3</sup></b>
E 300 D	3.0	100	07.93-06.95	OM 606.910	6	<b>GN 948</b> (11,5V) <sup>111</sup>	○		
E 300 D	3.0	100	07.93-06.95	OM 606.910	6	<b>GN 860</b> (11,5V)	○		
E 300 Turbo-D	3.0	108	06.93-06.95	OM 603.960	6	<b>GN 858</b> (11,5V)	○		
E 300 Turbo-D 4-matic	3.0	108	06.93-06.95	OM 603.963	6	<b>GN 858</b> (11,5V)	○		
E 300 4-matic	3.0	132	06.93-06.95	M 103.985	6	<b>Z 7</b>	14 K-8 DUO	0,8	<b>UXT 4</b>
E 320	3.2	162	06.93-06.95	M 104.992	6	<b>Z 100</b>	14 F-8 DU4	0,8	<b>UXT 1<sup>3</sup></b>
E 36 AMG	3.6	200	07.94-01.95	M 104.992 (AMG 3.6)	6	<b>Z 100</b>	14 F-8 DU4	0,8	<b>UXT 1<sup>3</sup></b>

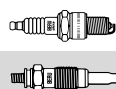

## MERCEDES

### E-KLASSE (W124)

E 420	4.2	205	06.93-06.95	M 119.975	8	<b>Z 100</b>	14 F-8 DU4	0,8	<b>UXT 13</b>
E 500	5.0	235	06.93-06.95	M 119.974	8	<b>Z 100</b>	14 F-8 DU4	0,8	<b>UXT 13</b>

### E-KLASSE Cabriolet (A124)

E 200	2.0	100	06.93-03.98	M 111.940	4	<b>Z 100</b>	14 F-8 DU4	0,8	<b>UXT 13</b>
E 220	2.2	110	06.93-03.98	M 111.960	4	<b>Z 100</b>	14 F-8 DU4	0,8	<b>UXT 13</b>
E 320	3.2	162	06.93-03.98	M 104.992/M 104.995	6	<b>Z 100</b>	14 F-8 DU4	0,8	<b>UXT 13</b>
E 36 AMG	3.6	200	05.94-03.98	M 104.992 (AMG 3.6)	6	<b>Z 100</b>	14 F-8 DU4	0,8	<b>UXT 13</b>

### E-KLASSE Coupe (C124)

E 200	2.0	100	06.93-06.97	M 111.940	4	<b>Z 100</b>	14 F-8 DU4	0,8	<b>UXT 13</b>
E 220	2.2	110	06.93-06.97	M 111.960	4	<b>Z 100</b>	14 F-8 DU4	0,8	<b>UXT 13</b>
E 320	3.2	162	06.93-06.97	M 104.992	6	<b>Z 100</b>	14 F-8 DU4	0,8	<b>UXT 13</b>
E 36 AMG	3.6	195	06.93-04.95	M 104.992 (AMG 3.6)	6	<b>Z 100</b>	14 F-8 DU4	0,8	<b>UXT 13</b>
E 36 AMG	3.6	200	05.94-06.97	M 104.992 (AMG 3.6)	6	<b>Z 100</b>	14 F-8 DU4	0,8	<b>UXT 13</b>

### E-KLASSE Kombi (S124)

E 200 T	2.0	100	06.93-06.96	M 111.940	4	<b>Z 100</b>	14 F-8 DU4	0,8	<b>UXT 13</b>
E 220 T	2.2	110	06.93-06.96	M 111.960	4	<b>Z 100</b>	14 F-8 DU4	0,8	<b>UXT 13</b>
E 250 T D	2.5	83	06.93-06.96	OM 605.911	5	<b>GN 948</b> (11,5V) <sup>111</sup>	○		
E 250 T D	2.5	83	06.93-06.96	OM 605.911	5	<b>GN 860</b> (11,5V)	○		
E 250 Turbo D	2.5	93	06.93-06.96	OM 602.962	5	<b>GN 858</b> (11,5V)	○		
E 280 T	2.8	142	06.93-06.96	M 104.942	6	<b>Z 100</b>	14 F-8 DU4	0,8	<b>UXT 13</b>
E 280 T	2.8	145	06.93-06.96	M 104.942	6	<b>Z 100</b>	14 F-8 DU4	0,8	<b>UXT 13</b>
E 300 TD T	3.0	100	06.92-05.93		6	<b>GN 858</b> (11,5V)	○		
E 300 T D	3.0	100	06.93-05.95	OM 606.910	6	<b>GN 860</b> (11,5V)	○		
E 300 T D	3.0	100	06.95-06.96	OM 606.910	6	<b>GN 948</b> (11,5V)	○		
E 300 T Turbo-D	3.0	108	06.93-06.96	OM 603.960	6	<b>GN 858</b> (11,5V)	○		
E 300 T Turbo-D 4-matic	3.0	108	06.93-06.96	OM 603.963	6	<b>GN 858</b> (11,5V)	○		
E 300 T 4-matic	3.0	132	06.93-06.96	M 103.985	6	<b>Z 7</b>	14 K-8 DU0	0,8	<b>UXT 4</b>
E 300 TE-24 AMG	3.0	162	06.93-06.96	M 104.980	6	<b>Z 100</b>	14 F-8 DU4	0,8	<b>UXT 13</b>
E 320 T	3.2	162	06.93-06.96	M 104.992	6	<b>Z 100</b>	14 F-8 DU4	0,8	<b>UXT 13</b>
E 36 T AMG	3.6	200	05.94-06.96	M 104.992 (AMG 3.6)	6	<b>Z 100</b>	14 F-8 DU4	0,8	<b>UXT 13</b>

### E-KLASSE Cabriolet (A207)

E 500	5.5	285	01.10-	M 273.966	8	<b>Z 359</b>	12 F-5 NPUR2T	0,8	○
-------	-----	-----	--------	-----------	---	--------------	---------------	-----	---

### E-KLASSE Coupe (C207)

E 500	5.5	285	01.09-	M 273.966	8	<b>Z 359</b>	12 F-5 NPUR2T	0,8	○
-------	-----	-----	--------	-----------	---	--------------	---------------	-----	---

### E-KLASSE (W210)

E 200 D	2.0	65	01.96-03.02	OM 604.917	4	<b>GN 948</b> (11,5V)	○		
E 200	2.0	100	06.95-06.97	M 111.942	4	<b>Z 100</b>	14 F-8 DU4	0,8	<b>UXT 13</b>
E 200	2.0	100	07.97-08.00	M 111.942	4	<b>Z 121</b>	14 FGH-8 DTURX0	1,0	<b>UXT 9</b>
E 200 CDI	2.1	85	07.99-03.02	OM 611.961	4	<b>GN 003</b> (11,5V)	○		
E 200 CDI	2.2	75	06.98-03.02	OM 611.961	4	<b>GN 003</b> (11,5V)	○		
E 200 Kompressor	2.0	120	08.00-03.02	M 111.957	4	<b>Z 170</b>	14 F-7 DPURU2	1,0	<b>UXT 12</b>
E 200 Kompressor	2.0	137	06.97-03.02	M 111.947	4	<b>Z 120</b>	14 FGH-7 DTURX0	1,0	<b>UXT 9</b>
E 220 D	2.2	55	05.96-03.02	OM 604.912	4	<b>GN 948</b> (11,5V)	○		
E 220 D	2.2	70	06.95-07.99	OM 604.912	4	<b>GN 948</b> (11,5V)	○		
E 220 CDI	2.2	92	06.98-07.99	OM 611.961	4	<b>GN 003</b> (11,5V)	○		
E 220 CDI	2.2	105	07.99-03.02	OM 611.961	4	<b>GN 003</b> (11,5V)	○		
E 230	2.3	110	06.95-06.97	M 111.970	4	<b>Z 100</b>	14 F-8 DU4	0,8	<b>UXT 13</b>
E 240	2.4	125	06.97-08.00	M 112.911	6	<b>Z 122</b>	14 FGH-8 DPURX2=12x	1,0	<b>UXT 9</b>
E 240	2.6	125	08.00-03.02	M 112.914	6	<b>Z 122</b>	14 FGH-8 DPURX2=12x	1,0	<b>UXT 9</b>
E 250 D	2.5	83	06.95-07.99	OM 605.912	5	<b>GN 948</b> (11,5V)	○		
E 250 Turbo-D	2.5	110	06.97-07.99	OM 605.962	5	<b>GN 948</b> (11,5V)	○		
E 270 CDI	2.7	125	07.99-03.02	OM 612.961	5	<b>GN 003</b> (11,5V)	○		
E 280	2.8	142	01.96-06.97	M 104.945	6	<b>Z 100</b>	14 F-8 DU4	0,8	<b>UXT 13</b>
E 280	2.8	150	12.96-03.02	M 112.921	6	<b>Z 122</b>	14 FGH-8 DPURX2=12x	1,0	<b>UXT 9</b>
E 280 4-matic	2.8	150	12.96-03.02	M 112.921	6	<b>Z 122</b>	14 FGH-8 DPURX2=12x	1,0	<b>UXT 9</b>
E 290 Turbo-D	2.9	95	03.96-07.99	OM 602.982	5	<b>GN 961</b> (11,5V)	○		
E 300 D	3.0	100	06.95-06.97	OM 606.912	6	<b>GN 948</b> (11,5V)	○		
E 300 Turbo-D	3.0	130	12.96-07.99	OM 606.962	6	<b>GN 948</b> (11,5V)	○		
E 320 CDI	3.2	145	07.99-03.02	OM 613.961	6	<b>GN 003</b> (11,5V)	○		
E 320	3.2	162	06.95-06.97	M 104.995	6	<b>Z 100</b>	14 F-8 DU4	0,8	<b>UXT 13</b>
E 320	3.2	165	06.97-03.02	M 112.941	6	<b>Z 122</b>	14 FGH-8 DPURX2=12x	1,0	<b>UXT 9</b>



kW

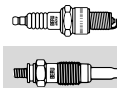

**MERCEDES**

**E-KLASSE (W210)**

E 320 4-matic	3.2	165	06.97-03.02	M 112.941	6	<b>Z 122</b>	14 FGH-8 DPURX2=12x	1,0	<b>UXT 9</b>
E 36 AMG	3.6	200	04.96-01.98	M 104.992	6	<b>Z 100</b>	14 F-8 DU4	0,8	<b>UXT 1<sup>3</sup></b>
E 420	4.2	205	01.96-06.97	M 119.985	8	<b>Z 100</b>	14 F-8 DU4	0,8	<b>UXT 1<sup>3</sup></b>
E 430	4.3	205	06.97-03.02	M 113.940	8	<b>Z 122</b>	14 FGH-8 DPURX2=16x	1,0	<b>UXT 9</b>
E 430 4-matic	4.3	205	05.99-03.02	M 113.940	8	<b>Z 122</b>	14 FGH-8 DPURX2=16x	1,0	<b>UXT 9</b>
E 50 AMG	5.0	255	02.96-08.97	M 119.985 (AMG 5.0)	8	<b>Z 100</b>	14 F-8 DU4	0,8	<b>UXT 1<sup>3</sup></b>
E 55 AMG	5.4	260	08.97-03.02	M 113.980	8	<b>Z 122</b>	14 FGH-8 DPURX2=16x	1,0	<b>UXT 9</b>
E 55 AMG 4-matic	5.4	260	03.01-03.02	M 113.980	8	<b>Z 122</b>	14 FGH-8 DPURX2=16x	1,0	<b>UXT 9</b>

**E-KLASSE Kombi (S210)**

E 200 T	2.0	100	06.96-06.97	M 111.942	4	<b>Z 100</b>	14 F-8 DU4	0,8	<b>UXT 1<sup>3</sup></b>
E 200 T	2.0	100	07.97-08.00	M 111.942	4	<b>Z 121</b>	14 FGH-8 DTURX0	1,0	<b>UXT 9</b>
E 200 T Kompressor	2.0	120	08.00-03.03	M 111.957	4	<b>Z 170</b>	14 F-7 DPURU2	1,0	<b>UXT 12</b>
E 200 T Kompressor	2.0	137	06.97-03.03	M 111.947	4	<b>Z 120</b>	14 FGH-7 DTURX0	1,0	<b>UXT 9</b>
E 220 T CDI	2.2	92	06.98-07.99	OM 611.961	4	<b>GN 003</b> (11,5V)	○		
E 220 T CDI	2.2	105	07.99-03.03	OM 611.961	4	<b>GN 003</b> (11,5V)	○		
E 230 T	2.3	110	06.96-06.97	M 111.970	4	<b>Z 100</b>	14 F-8 DU4	0,8	<b>UXT 1<sup>3</sup></b>
E 240 T	2.4	125	06.97-03.03	M 112.911	6	<b>Z 122</b>	14 FGH-8 DPURX2=12x	1,0	<b>UXT 9</b>
E 240 T	2.6	125	08.00-03.03	M 112.914	6	<b>Z 122</b>	14 FGH-8 DPURX2=12x	1,0	<b>UXT 9</b>
E 250 T D	2.5	83	06.96-07.99	OM 605.912	5	<b>GN 948</b> (11,5V)	○		
E 250 T Turbo-D	2.5	110	06.97-07.99	OM 605.962	5	<b>GN 948</b> (11,5V)	○		
E 270 T CDI	2.7	125	07.99-03.03	OM 612.961	5	<b>GN 003</b> (11,5V)	○		
E 280 T	2.8	150	12.96-03.03	M 112.921	6	<b>Z 122</b>	14 FGH-8 DPURX2=12x	1,0	<b>UXT 9</b>
E 280 T 4-matic	2.8	150	12.96-03.03	M 112.921	6	<b>Z 122</b>	14 FGH-8 DPURX2=12x	1,0	<b>UXT 9</b>
E 290 T Turbo-D	2.9	95	06.96-07.99	OM 602.982	5	<b>GN 961</b> (11,5V)	○		
E 300 T Turbo-D	3.0	130	12.96-07.99	OM 606.962	6	<b>GN 948</b> (11,5V)	○		
E 320 T CDI	3.2	145	07.99-03.03	OM 613.961	6	<b>GN 003</b> (11,5V)	○		
E 320 T	3.2	165	12.96-03.03	M 112.941	6	<b>Z 122</b>	14 FGH-8 DPURX2=12x	1,0	<b>UXT 9</b>
E 320 T 4-matic	3.2	165	12.96-03.03	M 112.941	6	<b>Z 122</b>	14 FGH-8 DPURX2=12x	1,0	<b>UXT 9</b>
E 420 T	4.2	205	06.96-06.97	M 119.985	8	<b>Z 122</b>	14 FGH-8 DPURX2	1,0	<b>UXT 9</b>
E 430 T	4.3	205	06.97-03.03	M 113.940	8	<b>Z 122</b>	14 FGH-8 DPURX2=16x	1,0	<b>UXT 9</b>
E 430 T 4-matic	4.3	205	05.99-03.03	M 113.940	8	<b>Z 122</b>	14 FGH-8 DPURX2=16x	1,0	<b>UXT 9</b>
E 55 T AMG	5.4	260	08.97-03.03	M 113.980	8	<b>Z 122</b>	14 FGH-8 DPURX2=16x	1,0	<b>UXT 9</b>
E 55 T AMG 4-matic	5.4	260	03.01-03.03	M 113.980	8	<b>Z 122</b>	14 FGH-8 DPURX2=16x	1,0	<b>UXT 9</b>

**E-KLASSE (W211)**

E 200 Kompressor	1.8	120	11.02-12.08	M 271.941 Mot.Nr. 30853900 →	4	<b>Z 359</b>	12 F-5 NPUR2T	0,8	○
E 200 Kompressor	1.8	120	11.02-12.08	M 271.941 → Mot.Nr. 30853899	4	<b>Z 226</b>	14 FR-6 MPU2	0,8	○
E 200 NGT	1.8	120	03.04-12.08	M 271.941 Mot.Nr. 30853900 →	4	<b>Z 359</b>	12 F-5 NPUR2T	0,8	○
E 200 NGT	1.8	120	03.04-12.08	M 271.941 → Mot.Nr. 30853899	4	<b>Z 226</b>	14 FR-6 MPU2	0,8	○
E 200 CGI	1.8	125	11.02-11.06	M 271.946 → Mot.Nr. 30853899	4	<b>Z 226</b>	14 FR-6 MPU2	0,8	○
E 200 Kompressor	1.8	135	04.06-11.06	M 271.956 → Mot.Nr. 30853899	4	<b>Z 226</b>	14 FR-6 MPU2	0,8	○
E 200 CDI	2.1	75	07.02-12.08	OM 646.951	4	<b>GN 003</b> (11,5V)	○		
E 200 CDI	2.1	90	07.02-12.08	OM 646.951	4	<b>GN 003</b> (11,5V)	○		
E 220 CDI	2.1	100	03.02-12.08	OM 646.961	4	<b>GN 003</b> (11,5V)	○		
E 220 CDI	2.1	110	03.02-12.08	OM 646.961	4	<b>GN 003</b> (11,5V)	○		
E 230	2.5	150	09.07-12.08	M 272.922	6	<b>Z 359</b>	12 F-5 NPUR2T	0,8	○
E 240	2.6	130	03.02-12.08	M 112.917/M 112.913	6	<b>Z 240</b>	14 F-8 DPURX02	1,0	<b>UXT 9</b>
E 240 4-matic	2.6	130	03.03-12.08	M 112.917	6	<b>Z 240</b>	14 F-8 DPURX02	1,0	<b>UXT 9</b>
E 270 CDI	2.7	130	03.02-12.08	OM 647.961	5	<b>GN 003</b> (11,5V)	○		
E 280 CDI	3.0	140	03.05-12.08	OM 642.920	6	<b>GE 105</b> (4,4V)	○		
E 280 CDI 4-matic	3.0	140	03.05-12.08	OM 642.921	6	<b>GE 105</b> (4,4V)	○		
E 280	3.0	170	03.05-12.08	M 272.943	6	<b>Z 359</b>	12 F-5 NPUR2T	0,8	○
E 280 4-matic	3.0	170	01.06-12.08	M 272.943	6	<b>Z 359</b>	12 F-5 NPUR2T	0,8	○
E 280 CDI	3.2	130	05.04-12.08	OM 648.961	6	<b>GE 116</b> (5V)	○		
E 320 CDI	3.2	150	11.02-12.08	OM 648.961	6	<b>GE 116</b> (5V)	○		
E 320	3.2	165	03.02-12.08	M 112.949	6	<b>Z 240</b>	14 F-8 DPURX02	1,0	<b>UXT 9</b>



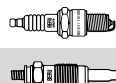
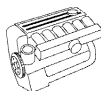

## MERCEDES

### E-KLASSE (W211)

E 320 4-matic	3.2	165	03.03–12.08	M 112.954	6	<b>Z 240</b>	14 F-8 DPURX02	1,0	<b>UXT 9</b>
E 320 CDI	3.0	165	03.05–12.08	OM 642.920	6	<b>GE 105</b> (4,4V)	○		
E 320 CDI 4-matic	3.0	165	03.05–12.08	OM 642.910	6	<b>GE 105</b> (4,4V)	○		
E 400 CDI	4.0	191	02.03–12.08	OM 628.961	8	<b>GN 003</b> (11,5V)	○		
E 420 CDI	4.0	231	01.06–12.08	OM 629.910	8	<b>GE 105</b> (4,4V)	○		
E 500	5.0	225	03.02–12.08	M 113.967	8	<b>Z 240</b>	14 F-8 DPURX02	1,0	<b>UXT 9</b>
E 500 4-matic	5.0	225	10.03–12.08	M 113.969	8	<b>Z 240</b>	14 F-8 DPURX02	1,0	<b>UXT 9</b>
E 500	5.5	285	04.06–12.08	M 273.960	8	<b>Z 359</b>	12 F-5 NPUR2T	0,8	○
E 500 4-matic	5.5	285	04.06–12.08	M 273.962	8	<b>Z 359</b>	12 F-5 NPUR2T	0,8	○
E 55 AMG Kompressor	5.4	350	10.02–12.08	M 113.990	8	<b>Z 226</b>	14 FR-6 MPU2	0,8	○
E 63 AMG	6.2	378	03.06–12.08	M 156.983	8	<b>Z 355</b>	12 VR-5 SPPU	1,0	○

### E-KLASSE Kombi (S211)

E 200 T Kompressor	1.8	120	03.03–07.09	M 271.941 → Mot.Nr. 30853899	4	<b>Z 226</b>	14 FR-6 MPU2	0,8	○
E 200 T Kompressor	1.8	120	03.03–07.09	M 271.941 Mot.Nr. 30853900 →	4	<b>Z 359</b>	12 F-5 NPUR2T	0,8	○
E 200 Kompressor	1.8	135	04.06–11.06	M 271.956 → Mot.Nr. 30853899	4	<b>Z 226</b>	14 FR-6 MPU2	0,8	○
E 220 CDI	2.1	100	03.03–07.09	OM 646.961	4	<b>GN 003</b> (11,5V)	○		
E 220 T CDI	2.1	110	03.03–07.09	OM 646.961	4	<b>GN 003</b> (11,5V)	○		
E 230 T	2.5	150	05.07–07.09	M 272.922	6	<b>Z 359</b>	12 F-5 NPUR2T	0,8	○
E 240 T	2.6	130	03.03–07.09	M 112.913	6	<b>Z 240</b>	14 F-8 DPURX02=12x	1,0	<b>UXT 9</b>
E 240 T 4-matic	2.6	130	07.03–07.09	M 112.917	6	<b>Z 240</b>	14 F-8 DPURX02	1,0	<b>UXT 9</b>
E 270 T CDI	2.7	130	03.03–07.09	OM 647.961	5	<b>GN 003</b> (11,5V)	○		
E 280 T CDI	3.0	140	03.05–07.09	OM 642.920	6	<b>GE 105</b> (4,4V)	○		
E 280 T CDI 4-matic	3.0	140	03.05–07.09	OM 642.921	6	<b>GE 105</b> (4,4V)	○		
E 280 T	3.0	170	03.05–07.09	M 272.943	6	<b>Z 359</b>	12 F-5 NPUR2T	0,8	○
E 280 T 4-matic	3.0	170	03.05–07.09	M 272.943	6	<b>Z 359</b>	12 F-5 NPUR2T	0,8	○
E 280 T CDI	3.2	130	05.04–07.09	OM 648.961	6	<b>GE 116</b> (5V)	○		
E 320 T CDI	3.2	150	03.03–07.09	OM 648.961	6	<b>GE 116</b> (5V)	○		
E 320 T	3.2	165	03.03–07.09	M 112.949	6	<b>Z 240</b>	14 F-8 DPURX02	1,0	<b>UXT 9</b>
E 320 T 4-matic	3.2	165	07.03–07.09	M 112.954	6	<b>Z 240</b>	14 F-8 DPURX02	1,0	<b>UXT 9</b>
E 320 T CDI	3.0	165	03.05–07.09	OM 642.920	6	<b>GE 105</b> (4,4V)	○		
E 320 T CDI 4-matic	3.0	165	03.05–07.09	OM 642.920	6	<b>GE 105</b> (4,4V)	○		
E 500 T	5.0	225	10.03–07.09	M 113.967	8	<b>Z 240</b>	14 F-8 DPURX02	1,0	<b>UXT 9</b>
E 500 T 4-matic	5.0	225	10.03–07.09	M 113.969	8	<b>Z 240</b>	14 F-8 DPURX02	1,0	<b>UXT 9</b>
E 500 T	5.5	285	04.06–07.09	M 273.960	8	<b>Z 359</b>	12 F-5 NPUR2T	0,8	○
E 500 T 4-matic	5.5	285	04.06–07.09	M 273.962	8	<b>Z 359</b>	12 F-5 NPUR2T	0,8	○
E 55 T AMG Kompressor	5.4	350	07.03–07.09	M 113.990	8	<b>Z 226</b>	14 FR-6 MPU2	0,8	○
E 63 AMG	6.2	378	03.06–07.09	M 156.983	8	<b>Z 355</b>	12 VR-5 SPPU	1,0	○

### E-KLASSE (W212)

E 300	3.0	170	01.09–	M 272.952	6	<b>Z 359</b>	12 F-5 NPUR2T	0,8	○
E 500	5.5	285	01.09–	M 273.971	8	<b>Z 359</b>	12 F-5 NPUR2T	0,8	○
E 500 4-matic	5.5	285	01.09–	M 273.970	8	<b>Z 359</b>	12 F-5 NPUR2T	0,8	○

### E-KLASSE Kombi (S212)

E 500	5.5	285	11.09–	M 273.971	8	<b>Z 359</b>	12 F-5 NPUR2T	0,8	○
-------	-----	-----	--------	-----------	---	--------------	---------------	-----	---

### G-KLASSE (W460)

230 G	2.3	66	03.79–07.93	M 115.973	4	<b>Z 22</b>	14-6 DU	0,7	<b>UX 56</b>
230 GE	2.3	90	05.87–08.92	M 102.979/M 102.987	4	<b>Z 18</b>	14 K-7 DUO	0,8	<b>UXT 4</b>
230 GE	2.3	92	04.82–08.92	M 102.987/M 102.981/M 102.989	4	<b>Z 18</b>	14 K-7 DUO	0,8	<b>UXT 4</b>
250 GD	2.5	62	02.89–12.92	OM 602.930	5	<b>GN 858</b> (11,5V)	<b>GR 071</b>	<b>SR 040</b>	
250 GD (24 Volt)	2.5	62	10.87–12.92	OM 602.930	5	<b>GV 736</b> (18V)	○		
250 GD	2.5	68	02.89–08.92	OM 602.930	5	<b>GN 858</b> (11,5V)	<b>GR 071</b>	<b>SR 040</b>	
250 GD (24 Volt)	2.5	68	12.88–08.92	OM 602.930	5	<b>GV 736</b> (18V)	○		
300 GD	3.0	65	08.80–12.91	OM 617.931	5	<b>GV 603</b> (11,5V)	<b>GR 071</b>	<b>SR 039</b>	
300 GD	3.0	83	09.89–07.93	OM 603.912	6	<b>GN 858</b> (11,5V)	○		

### G-KLASSE (W461)

230 GE	2.3	90	02.93–	M 102.979	4	<b>Z 7</b>	14 K-8 DUO	0,8	<b>UXT 4</b>
230 GE	2.3	92	06.93–	M 102.996/M 102.997	4	<b>Z 18</b>	14 K-7 DUO	0,8	<b>UXT 4</b>
250 GD	2.5	68	02.90–	OM 602.939	5	<b>GN 858</b> (11,5V)	○		

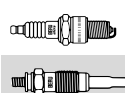
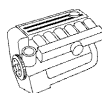

## MERCEDES

### G-KLASSE (W461)

290 GD/G 290 D	2.9	70	04.92-	OM 602.942	5	<b>GN 858</b> (11,5V)	<b>GR 049</b>	<b>SR 040</b>	
G 290 TD	2.9	88	07.97-	OM 602.983	5	<b>GN 961</b> (11,5V)	○		
G 290 TD (24 Volt)	2.9	88	07.97-	OM 602.983	5	<b>GN 066</b> (23V)	○		

### G-KLASSE (W463)

230 GE	2.3	93	06.90-02.93	M 102.989	4	<b>Z 18</b>	14 K-7 DUO	0,8	<b>UXT 4</b>
250 GD	2.5	69	06.90-	OM 602.931	5	<b>GN 858</b> (11,5V)	○		
300 GD	3.0	83	09.89-09.97	OM 603.931	6	<b>GN 858</b> (11,5V)	<b>GR 076</b>		
300 GE	3.0	125	09.89-09.97	M 103.987	6	<b>Z 7</b>	14 K-8 DUO	0,8	<b>UXT 4</b>
300 GE	3.0	128	06.90-	M 103.987	6	<b>Z 7</b>	14 K-8 DUO	0,8	<b>UXT 4</b>
320 GE	3.2	155	09.94-06.97	M 104.996	6	<b>Z 100</b>	14 F-8 DU4	0,8	<b>UXT 1<sup>3</sup></b>
320 GE	3.2	155	07.97-11.97	M 104.996	6	<b>Z 121</b>	14 FGH-8 DTURXO	1,0	<b>UXT 9</b>
350 G Turbo-D	3.4	100	09.91-09.97	OM 603.972	6	<b>GN 858</b> (11,5V)	○		
G 270 CDI	2.7	115	10.01-	OM 612.965	5	<b>GN 003</b> (11,5V)	○		
G 300 TD	3.0	130	08.96-	OM 606.964	6	<b>GN 948</b> (11,5V)	○		
G 320	3.2	155	09.94-06.97	M 104.996	6	<b>Z 100</b>	14 F-8 DU4	0,8	<b>UXT 1<sup>3</sup></b>
G 320	3.2	155	07.97-12.97	M 104.996	6	<b>Z 121</b>	14 FGH-8 DTURXO	1,0	<b>UXT 9</b>
G 320	3.2	158	11.97-	M 112.945	6	<b>Z 122</b>	14 FGH-8 DPURX2=12x	1,0	<b>UXT 9</b>
G 400 CDI	4.0	184	12.00-	OM 628.962	8	<b>GN 003</b> (11,5V)	○		
G 500 E	5.0	177	09.93-	M 117.965	8	<b>Z 62</b>	14-7 DUO	0,8	<b>UXT 2<sup>4</sup></b>
G 500	5.0	218	04.98-02.02	M 113.962	8	<b>Z 122</b>	14 FGH-8 DPURX2=16x	1,0	<b>UXT 9</b>
G 500	5.0	218	03.02-	M 113.962	8	<b>Z 240</b>	14 F-8 DPURX02=16x	1,0	<b>UXT 9</b>
G 500	5.5	285	12.09-	M 273.963	8	<b>Z 359</b>	12 F-5 NPUR2T	0,8	○
G 36 AMG	3.6	200	01.95-06.97		6	<b>Z 100</b>	14 F-8 DU4	0,8	<b>UXT 1<sup>3</sup></b>
G 55 AMG	5.4	260	04.99-	M 113.982	8	<b>Z 122</b>	14 FGH-8 DPURX2=16x	1,0	<b>UXT 9</b>

### GL-KLASSE (X164)

GL 320 CDI	3.0	165	09.06-05.09	OM 642.940	6	<b>GE 105</b> (4,4V)	○		
GL 350 CDI	3.0	165	05.09-	OM 642.940	6	<b>GE 105</b> (4,4V)	○		
GL 420 CDI	4.0	225	09.06-05.09	OM 629.912	8	<b>GE 105</b> (4,4V)	○		
GL 450 CDI	4.0	225	05.09-	OM 629.912	8	<b>GE 105</b> (4,4V)	○		
GL 450	4.7	250	09.06-	M 273.923	8	<b>Z 359</b>	12 F-5 NPUR2T	0,8	○
GL 500	5.5	285	09.06-	M 273.963	8	<b>Z 359</b>	12 F-5 NPUR2T	0,8	○

### GLK-KLASSE (X204)

280 4-matic	3.0	170	06.08-06.09	M 272.948	6	<b>Z 359</b>	12 F-5 NPUR2T	0,8	○
300 4-matic	3.0	170	07.09-04.11	M 272.948	6	<b>Z 359</b>	12 F-5 NPUR2T	0,8	○
320 CDI 4-matic	3.0	165	06.08-	OM 642.961	6	<b>GE 105</b> (4,4V)	○		

### M-KLASSE (W163)

ML 230	2.3	110	02.98-06.05	M 111.977	4	<b>Z 121</b>	14 FGH-8 DTURXO	1,0	<b>UXT 9</b>
ML 270 CDI	2.7	120	12.99-06.05	OM 612.963	5	<b>GN 003</b> (11,5V)	○		
ML 320	3.2	160	02.98-08.02	M 112.942	6	<b>Z 122</b>	14 FGH-8 DPURX2=12x	1,0	<b>UXT 9</b>
ML 350	3.7	173	02.03-06.05	M 112.970	6	<b>Z 240</b>	14 F-8 DPURX02	1,0	<b>UXT 9</b>
ML 350	3.7	180	08.02-06.05	M 112.970	6	<b>Z 240</b>	14 F-8 DPURX02	1,0	<b>UXT 9</b>
ML 400 CDI	4.0	184	09.01-06.05	OM 628.963	8	<b>GN 003</b> (11,5V)	○		
ML 430	4.3	200	02.98-06.05	M 113.942	8	<b>Z 240</b>	14 F-8 DPURX02=16x	1,0	<b>UXT 9</b>
ML 500	5.0	215	09.01-06.05	M 113.964/M 113.965	8	<b>Z 240</b>	14 F-8 DPURX02=16x	1,0	<b>UXT 9</b>
ML 55 AMG	5.4	255	02.00-02.02	M 113.981	8	<b>Z 122</b>	14 FGH-8 DPURX2=16x	1,0	<b>UXT 9</b>
ML 55 AMG	5.4	255	03.02-06.05	M 113.981	8	<b>Z 240</b>	14 F-8 DPURX02=16x	1,0	<b>UXT 9</b>

### M-KLASSE (W164)

ML 280 CDI 4-matic	3.0	140	07.05-07.09	OM 642.940	6	<b>GE 105</b> (4,4V)	○		
ML 300 CDI 4-matic	3.0	140	07.09-	OM 642.940	6	<b>GE 105</b> (4,4V)	○		
ML 320 CDI 4-matic	3.0	165	07.05-07.09	OM 642.940	6	<b>GE 105</b> (4,4V)	○		
ML 350 CDI 4-matic	3.0	165	07.09-	OM 642.940	6	<b>GE 105</b> (4,4V)	○		
ML 420 CDI 4-matic	4.0	225	02.06-09.09	OM 629.912	8	<b>GE 105</b> (4,4V)	○		
ML 450 CDI 4-matic	4.0	225	09.09-	OM 629.912	8	<b>GE 105</b> (4,4V)	○		
ML 500 4-matic	5.0	225	07.05-	M 113.964	8	<b>Z 240</b>	14 F-8 DPURX02=16x	1,0	<b>UXT 9</b>
ML 500 4-matic	5.5	285	12.07-	M 273.963	8	<b>Z 359</b>	12 F-5 NPUR2T	0,8	○
ML 63 AMG 4-matic	6.2	375	01.06-	M 156.980	8	<b>Z 355</b>	12 VR-5 SPPU	1,0	○

### R-KLASSE (W251, V251)

R 280 CDI	3.0	140	05.06-	OM 642.872/OM 642.950/ OM 642.870	6	<b>GE 105</b> (4,4V)	○		
R 280 CDI 4-matic	3.0	140	05.06-	OM 642.950	6	<b>GE 105</b> (4,4V)	○		
R 280	3.0	170	01.07-	M 272.945	6	<b>Z 359</b>	12 F-5 NPUR2T	0,8	○

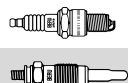

## MERCEDES

### R-KLASSE (W251, V251)

R 280 4-matic	3.0	170	05.07-	M 272.945	6	<b>Z 359</b>	12 F-5 NPUR2T	0,8	○
R 300 CDI 4-matic	3.0	140	07.09-	OM 642.950	6	<b>GE 105 (4,4V)</b>	○		
R 300	3.0	170	07.09-	M 272.945	6	<b>Z 359</b>	12 F-5 NPUR2T	0,8	○
R 320 CDI 4-matic	3.0	165	01.06-	OM 642.950	6	<b>GE 105 (4,4V)</b>	○		
R 350 CDI 4-matic	3.0	165	07.09-	OM 642.950	6	<b>GE 105 (4,4V)</b>	○		
R 500 4-matic	5.0	225	01.06-	M 113.971	8	<b>Z 240</b>	14 F-8 DPURX02	1,0	<b>UXT 9</b>
R 500 4-matic	5.5	285	01.07-	M 273.963	8	<b>Z 359</b>	12 F-5 NPUR2T	0,8	○
R 63 AMG	6.2	375	02.06-	M 156.980	8	<b>Z 355</b>	12 VR-5 SPPU	1,0	○

### S-KLASSE (W126)

260 SE	2.6	118	03.87-06.91	M 103.941	6	<b>Z 7</b>	14 K-8 DUO	0,8	<b>UXT 4</b>
260 SE	2.6	122	03.87-06.91	M 103.941	6	<b>Z 7</b>	14 K-8 DUO	0,8	<b>UXT 4</b>
300 SE,SEL	3.0	132	01.86-06.91	M 103.981	6	<b>Z 18</b>	14 K-7 DUO	0,8	<b>UXT 4</b>
420 SE,SEL	4.2	150	10.85-06.91	M 116.965	8	<b>Z 62</b>	14-7 DUO	0,8	<b>UXT 2<sup>4</sup></b>
420 SE,SEL	4.2	165	10.85-06.91	M 116.965	8	<b>Z 62</b>	14-7 DUO	0,8	<b>UXT 2<sup>4</sup></b>
500 SE,SEL	5.0	164	09.85-06.91	M 117.965	8	<b>Z 62</b>	14-7 DUO	0,8	<b>UXT 2<sup>4</sup></b>
500 SE,SEL	5.0	180	09.85-06.91	M 117.965	8	<b>Z 62</b>	14-7 DUO	0,8	<b>UXT 2<sup>4</sup></b>
500 SE,SEL KAT	5.0	185	06.89-06.91	M 117.965	8	<b>Z 62</b>	14-7 DUO	0,8	<b>UXT 2<sup>4</sup></b>
500 SE,SEL	5.0	185	09.87-06.91	M 117.965	8	<b>Z 62</b>	14-7 DUO	0,8	<b>UXT 2<sup>4</sup></b>
500 SE,SEL	5.0	195	09.87-06.91	M 117.965	8	<b>Z 62</b>	14-7 DUO	0,8	<b>UXT 2<sup>4</sup></b>
560 SE,SEL	5.5	178	10.85-06.91	M 117.968	8	<b>Z 62</b>	14-7 DUO	0,8	<b>UXT 2<sup>4</sup></b>
560 SE,SEL	5.5	205	08.87-06.91	M 117.968	8	<b>Z 62</b>	14-7 DUO	0,8	<b>UXT 2<sup>4</sup></b>
560 SE,SEL	5.5	220	10.85-06.91	M 117.968	8	<b>Z 62</b>	14-7 DUO	0,8	<b>UXT 2<sup>4</sup></b>

### S-KLASSE (W140)

300 SE 2.8	2.8	145	01.93-10.98	M 104.944	6	<b>Z 100</b>	14 F-8 DU4	0,8	<b>UXT 1<sup>3</sup></b>
3.2	3.2	162	10.95-08.98	M 104.990	6	<b>Z 100</b>	14 F-8 DU4	0,8	<b>UXT 1<sup>3</sup></b>
300 SE,SEL/S320	3.2	170	03.91-10.98	M 104.990/M 104.994	6	<b>Z 100</b>	14 F-8 DU4	0,8	<b>UXT 1<sup>3</sup></b>
400 SE,SEL/S420	4.2	210	02.91-08.95	M 119.971	8	<b>Z 100</b>	14 F-8 DU4	0,8	<b>UXT 1<sup>3</sup></b>
400 SE,SEL/S420	4.2	210	09.95-10.98	M 119.971	8	<b>Z 122</b>	14 FGH-8 DPURX2	1,0	<b>UXT 9</b>
500 SE,SEL	5.0	240	02.91-08.95	M 119.970	8	<b>Z 100</b>	14 F-8 DU4	0,8	<b>UXT 1<sup>3</sup></b>
500 SE,SEL	5.0	240	09.95-10.98	M 119.970	8	<b>Z 122</b>	14 FGH-8 DPURX2	1,0	<b>UXT 9</b>
600 SE,SEL	6.0	300	04.91-12.92	M 120.982/M 120.980	12	<b>Z 100</b>	14 F-8 DU4	0,8	<b>UXT 1<sup>3</sup></b>
S 280	2.8	142	02.93-10.98	M 104.944	6	<b>Z 100</b>	14 F-8 DU4	0,8	<b>UXT 1<sup>3</sup></b>
S 300 Turbo-D	3.0	130	05.96-10.98	OM 606.961	6	<b>GN 948 (11,5V)</b>	○		
S 350 Turbo-D	3.4	110	01.93-10.98	OM 603.971	6	<b>GN 858 (11,5V)</b>	○		
S 420	4.2	205	01.93-10.98	M 119.971	8	<b>Z 100</b>	14 F-8 DU4	0,8	<b>UXT 1<sup>3</sup></b>
S 500	5.0	235	01.93-08.95	M 119.970/M 119.980	8	<b>Z 100</b>	14 F-8 DU4	0,8	<b>UXT 1<sup>3</sup></b>
S 500	5.0	235	09.95-10.98	M 119.970/M 119.980	8	<b>Z 122</b>	14 FGH-8 DPURX2	1,0	<b>UXT 9</b>
S 600	6.0	290	01.93-08.95	M 120.982/M 120.980	12	<b>Z 100</b>	14 F-8 DU4	0,8	<b>UXT 1<sup>3</sup></b>
S 600	6.0	290	09.95-10.98	M 120.982/M 120.980	12	<b>Z 122</b>	14 FGH-8 DPURX2	1,0	<b>UXT 9</b>

### S-KLASSE (W220)

S 280	2.8	150	10.98-02.02	M 112.922	6	<b>Z 122</b>	14 FGH-8 DPURX2=12x	1,0	<b>UXT 9</b>
S 280	2.8	150	03.02-08.05	M 112.922	6	<b>Z 240</b>	14 F-8 DPURX02=12x	1,0	<b>UXT 9</b>
S 320 CDI	3.2	145	08.99-09.02	OM 613.960	6	<b>GN 003 (11,5V)</b>	○		
S 320 CDI	3.2	150	09.02-08.05	OM 648.960	6	<b>GN 003 (11,5V)</b>	○		
S 320	3.2	165	10.98-02.02	M 112.944	6	<b>Z 122</b>	14 FGH-8 DPURX2=12x	1,0	<b>UXT 9</b>
S 320	3.2	165	03.02-08.05	M 112.944	6	<b>Z 240</b>	14 F-8 DPURX02=12x	1,0	<b>UXT 9</b>
S 350	3.7	180	09.02-08.05	M 112.972	6	<b>Z 240</b>	14 F-8 DPURX02=12x	1,0	<b>UXT 9</b>
S 350 4-matic	3.7	180	06.03-08.05	M 112.975	6	<b>Z 240</b>	14 F-8 DPURX02=12x	1,0	<b>UXT 9</b>
S 400 CDI	4.0	184	06.00-08.05	OM 628.960	8	<b>GN 003 (11,5V)</b>	○		
S 400 CDI	4.0	191	06.03-08.05	OM 628.960	8	<b>GN 003 (11,5V)</b>	○		
S 430	4.3	205	10.98-02.02	M 113.941	8	<b>Z 122</b>	14 FGH-8 DPURX2=16x	1,0	<b>UXT 9</b>
S 430	4.3	205	03.02-08.05	M 113.941	8	<b>Z 240</b>	14 F-8 DPURX02=16x	1,0	<b>UXT 9</b>
S 430 4-matic	4.3	205	09.02-08.05	M 113.948	8	<b>Z 240</b>	14 F-8 DPURX02=16x	1,0	<b>UXT 9</b>
S 500	5.0	225	10.98-02.02	M 113.960	8	<b>Z 122</b>	14 FGH-8 DPURX2=16x	1,0	<b>UXT 9</b>
S 500	5.0	225	03.02-08.05	M 113.960	8	<b>Z 240</b>	14 F-8 DPURX02=16x	1,0	<b>UXT 9</b>
S 500 4-matic	5.0	225	09.02-08.05	M 113.966	8	<b>Z 240</b>	14 F-8 DPURX02=16x	1,0	<b>UXT 9</b>
S 600	5.5	368	09.02-08.05	M 275.950	12	<b>Z 312</b>	14 FR-7 KPPU	1,1	○
S 600	5.8	270	01.00-08.05	M 137.970	12	<b>Z 171</b>	14 F-7 DPURX2	1,0	<b>UXT 9</b>
S 55 AMG	5.4	265	04.99-02.02	M 113.986	8	<b>Z 122</b>	14 FGH-8 DPURX2=16x	1,0	<b>UXT 9</b>
S 55 AMG	5.4	265	03.02-08.05	M 113.986	8	<b>Z 240</b>	14 F-8 DPURX02=16x	1,0	<b>UXT 9</b>
S 55 AMG Kompressor	5.4	368	06.02-08.05	M 113.991	8	<b>Z 226</b>	14 FR-6 MPU2	0,8	○



kW

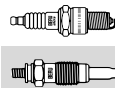

**MERCEDES**

**S-KLASSE (W220)**

S 65 AMG	6.0	450	03.04–08.05	M 275.980	12	<b>Z 312</b>	14 FR-7 KPPU	1,1	○
----------	-----	-----	-------------	-----------	----	--------------	--------------	-----	---

**S-KLASSE (W221)**

S 320 CDI / S 350 CDI	3.0	173	12.05–	OM 642.930	6	<b>GE 105</b> (4,4V)	○		
S 320 CDI 4-matic	3.0	173	10.06–	OM 642.932	6	<b>GE 105</b> (4,4V)	○		
S 420 CDI / S 450 CDI	4.0	235	10.06–	OM 629.911	8	<b>GE 105</b> (4,4V)	○		
S 450	4.7	250	12.05–	M 273.922	8	<b>Z 359</b>	12 F-5 NPUR2T	0,8	○
S 450 4-matic	4.7	250	12.05–	M 273.924	8	<b>Z 359</b>	12 F-5 NPUR2T	0,8	○
S 500	5.5	271	05.11–	M 273.961	8	<b>Z 359</b>	12 F-5 NPUR2T	0,8	○
S 500	5.5	285	10.05–	M 273.961	8	<b>Z 359</b>	12 F-5 NPUR2T	0,8	○
S 500 4-matic	5.5	285	10.05–	M 273.961/M 273.968	8	<b>Z 359</b>	12 F-5 NPUR2T	0,8	○
S 600	5.5	380	12.05–	M 275.953	12	<b>Z 312</b>	14 FR-7 KPPU	1,1	○
S 63 AMG	6.2	386	10.06–	M 156.984	8	<b>Z 355</b>	12 VR-5 SPPU	1,0	○
S 65 AMG	6.0	450	07.06–08.10	M 275.982	12	<b>Z 312</b>	14 FR-7 KPPU	1,1	○
S 65 AMG	6.0	463	04.11–	M 275.982	12	<b>Z 312</b>	14 FR-7 KPPU	1,1	○

**S-KLASSE Coupe (C126)**

420 SEC	4.2	150	10.85–06.91	M 116.965	8	<b>Z 62</b>	14-7 DUO	0,8	<b>UXT 2<sup>4</sup></b>
420 SEC	4.2	165	10.85–06.91	M 116.965	8	<b>Z 62</b>	14-7 DUO	0,8	<b>UXT 2<sup>4</sup></b>
500 SEC	5.0	164	10.85–06.91	M 117.965	8	<b>Z 62</b>	14-7 DUO	0,8	<b>UXT 2<sup>4</sup></b>
500 SEC	5.0	180	09.85–06.91	M 117.965	8	<b>Z 62</b>	14-7 DUO	0,8	<b>UXT 2<sup>4</sup></b>
500 SEC	5.0	185	08.87–06.91	M 117.965	8	<b>Z 62</b>	14-7 DUO	0,8	<b>UXT 2<sup>4</sup></b>
500 SEC KAT	5.0	185	06.89–06.91	M 117.965	8	<b>Z 62</b>	14-7 DUO	0,8	<b>UXT 2<sup>4</sup></b>
500 SEC	5.0	195	09.85–06.91	M 117.965	8	<b>Z 62</b>	14-7 DUO	0,8	<b>UXT 2<sup>4</sup></b>
560 SEC	5.5	178	10.85–06.91	M 117.968	8	<b>Z 62</b>	14-7 DUO	0,8	<b>UXT 2<sup>4</sup></b>
560 SEC	5.5	205	10.85–06.91	M 117.968	8	<b>Z 62</b>	14-7 DUO	0,8	<b>UXT 2<sup>4</sup></b>

**S-KLASSE Coupe (C140)**

SEC/CL 420	4.2	205	10.94–08.95	M 119.971/M 119.981	8	<b>Z 100</b>	14 F-8 DU4	0,8	<b>UXT 1<sup>3</sup></b>
SEC/CL 420	4.2	205	09.95–02.99	M 119.971/M 119.981	8	<b>Z 122</b>	14 FGH-8 DPURX2	1,0	<b>UXT 9</b>
SEC/CL 500	5.0	235	10.92–08.95	M 119.970	8	<b>Z 100</b>	14 F-8 DU4	0,8	<b>UXT 1<sup>3</sup></b>
SEC/CL 500	5.0	235	09.95–02.99	M 119.970	8	<b>Z 122</b>	14 FGH-8 DPURX2	1,0	<b>UXT 9</b>
SEC/CL 600	6.0	290	09.92–08.95	M 120.982/M 120.980	12	<b>Z 100</b>	14 F-8 DU4	0,8	<b>UXT 1<sup>3</sup></b>
SEC/CL 600	6.0	290	09.95–02.99	M 120.982/M 120.980	12	<b>Z 122</b>	14 FGH-8 DPURX2	1,0	<b>UXT 9</b>

**S-KLASSE Coupe (C215)**

CL 500	5.0	225	03.99–02.02	M 113.960	8	<b>Z 122</b>	14 FGH-8 DPURX2=16x	1,0	<b>UXT 9</b>
CL 500	5.0	225	03.02–03.06	M 113.960	8	<b>Z 240</b>	14 F-8 DPURX02=16x	1,0	<b>UXT 9</b>
CL 600	5.5	368	09.02–03.06	M 275.950	12	<b>Z 312</b>	14 FR-7 KPPU	1,1	○
CL 600	5.8	270	03.99–03.06	M 137.970	12	<b>Z 171</b>	14 F-7 DPURX2	1,0	<b>UXT 9</b>
CL 55 AMG	5.4	265	10.99–02.02	M 113.986	8	<b>Z 122</b>	14 FGH-8 DPURX2=16x	1,0	<b>UXT 9</b>
CL 55 AMG	5.4	265	03.02–03.06	M 113.986	8	<b>Z 240</b>	14 F-8 DPURX02=16x	1,0	<b>UXT 9</b>
CL 55 AMG Kompressor	5.4	368	06.02–03.06	M 113.991	8	<b>Z 226</b>	14 FR-6 MPU2	0,8	○
CL 65 AMG	6.0	450	09.03–03.06	M 275.980	12	<b>Z 312</b>	14 FR-7 KPPU	1,1	○

**S-KLASSE Coupe (C216)**

CL 500	5.5	285	06.06–	M 273.961	8	<b>Z 359</b>	12 F-5 NPUR2T	0,8	○
CL 500 4-matic	5.5	285	02.08–	M 273.968	8	<b>Z 359</b>	12 F-5 NPUR2T	0,8	○
CL 600	5.5	380	05.06–	M 275.953	12	<b>Z 312</b>	14 FR-7 KPPU	1,1	○
CL 63 AMG	6.2	386	10.06–	M 156.984	8	<b>Z 355</b>	12 VR-5 SPPU	1,0	○
CL 65 AMG	6.0	450	09.07–07.10	M 275.982	12	<b>Z 312</b>	14 FR-7 KPPU	1,1	○

**SL (R129)**

280	2.8	142	08.93–06.97	M 104.943	6	<b>Z 100</b>	14 F-8 DU4	0,8	<b>UXT 1<sup>3</sup></b>
280	2.8	142	07.97–10.01	M 104.943	6	<b>Z 121</b>	14 FGH-8 DTURX0	1,0	<b>UXT 9</b>
280	2.8	150	05.98–10.01	M 112.923/M 112.925	6	<b>Z 122</b>	14 FGH-8 DPURX2=12x	1,0	<b>UXT 9</b>
300 SL	3.0	140	03.89–08.93	M 103.984	6	<b>Z 7</b>	14 K-8 DUO	0,8	<b>UXT 4</b>
300 SL-24	3.0	170	03.89–07.93	M 104.981	6	<b>Z 100</b>	14 F-8 DU4	0,8	<b>UXT 1<sup>3</sup></b>
320	3.2	165	05.98–10.01	M 112.943	6	<b>Z 122</b>	14 FGH-8 DPURX2=12x	1,0	<b>UXT 9</b>
320	3.2	170	09.93–06.97	M 104.991	6	<b>Z 100</b>	14 F-8 DU4	0,8	<b>UXT 1<sup>3</sup></b>
320	3.2	170	07.97–10.01	M 104.991	6	<b>Z 121</b>	14 FGH-8 DTURX0	1,0	<b>UXT 9</b>
500	5.0	225	05.98–10.01	M 113.961	8	<b>Z 122</b>	14 FGH-8 DPURX2=16x	1,0	<b>UXT 9</b>
500	5.0	235	09.92–08.95	M 119.982/M 119.972	8	<b>Z 100</b>	14 F-8 DU4	0,8	<b>UXT 1<sup>3</sup></b>
500	5.0	235	09.95–10.01	M 119.982/M 119.972	8	<b>Z 122</b>	14 FGH-8 DPURX2	1,0	<b>UXT 9</b>
500 SL	5.0	240	09.89–08.92	M 119.960/M 119.972	8	<b>Z 100</b>	14 F-8 DU4	0,8	<b>UXT 1<sup>3</sup></b>
600	6.0	290	07.92–08.95	M 120.983/M 120.981	12	<b>Z 100</b>	14 F-8 DU4	0,8	<b>UXT 1<sup>3</sup></b>
600	6.0	290	09.95–10.01	M 120.983/M 120.981	12	<b>Z 122</b>	14 FGH-8 DPURX2	1,0	<b>UXT 9</b>

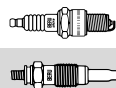
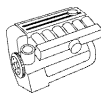

## MERCEDES

### SL (R129)

600 SL	6.0	300	02.92-05.93	M 120.980	12	<b>Z 100</b>	14 F-8 DU4	0,8	<b>UXT 13</b>
55 AMG	5.4	260	03.00-10.01	M 113.985	8	<b>Z 240</b>	14 F-8 DPURX02	1,0	<b>UXT 9</b>
60 AMG	6.0	280	05.97-10.01	M 122.981	8	<b>Z 100</b>	14 F-8 DU4	0,8	<b>UXT 13</b>

### SL (R230)

280	3.0	170	03.08-01.12	M 272.949	6	<b>Z 359</b>	12 F-5 NPUR2T	0,8	○
300	3.0	170	04.09-01.12	M 272.949	6	<b>Z 359</b>	12 F-5 NPUR2T	0,8	○
350	3.7	180	03.03-01.12	M 112.973	6	<b>Z 240</b>	14 F-8 DPURX02	1,0	<b>UXT 9</b>
500	5.0	225	10.01-01.12	M 113.963	8	<b>Z 240</b>	14 F-8 DPURX02	1,0	<b>UXT 9</b>
500	5.5	285	03.06-01.12	M 273.965	8	<b>Z 359</b>	12 F-5 NPUR2T	0,8	○
600	5.5	368	04.03-12.05	M 275.951	12	<b>Z 312</b>	14 FR-7 KPPU	1,1	○
600	5.5	380	03.06-01.12	M 275.954	12	<b>Z 312</b>	14 FR-7 KPPU	1,1	○
55 AMG	5.4	350	10.01-06.02	M 113.992	8	<b>Z 226</b>	14 FR-6 MPU2	0,8	○
55 AMG Kompressor	5.4	368	06.02-01.12	M 113.992	8	<b>Z 226</b>	14 FR-6 MPU2	0,8	○
55 AMG	5.4	380	03.06-01.12	M 113.995	8	<b>Z 226</b>	14 FR-6 MPU2=16x	0,8	○
63AMG	6.2	386	03.08-01.12	M 156.981	8	<b>Z 355</b>	12 VR-5 SPPU	1,0	○
65 AMG	6.0	450	03.04-01.12	M 275.981	12	<b>Z 312</b>	14 FR-7 KPPU	1,1	○

### SLK (R170)

200	2.0	100	09.96-06.97	M 111.946	4	<b>Z 100</b>	14 F-8 DU4	0,8	<b>UXT 13</b>
200	2.0	100	07.97-03.00	M 111.946	4	<b>Z 121</b>	14 FGH-8 DTURXO	1,0	<b>UXT 9</b>
200 Kompressor	2.0	120	03.00-04.04	M 111.958	4	<b>Z 170</b>	14 F-7 DPURU2	1,0	<b>UXT 12</b>
200 Kompressor	2.0	141	10.96-03.00	M 111.943	4	<b>Z 120</b>	14 FGH-7 DTURXO	1,0	<b>UXT 9</b>
230 Kompressor	2.3	142	09.96-03.00	M 111.973	4	<b>Z 120</b>	14 FGH-7 DTURXO	1,0	<b>UXT 9</b>
230 Kompressor	2.3	145	03.00-04.04	M 111.983	4	<b>Z 170</b>	14 F-7 DPURU2	1,0	<b>UXT 12</b>
320	3.2	160	03.00-02.02	M 112.947	6	<b>Z 122</b>	14 FGH-8 DPURX2=12x	1,0	<b>UXT 9</b>
320	3.2	160	03.02-04.04	M 112.947	6	<b>Z 240</b>	14 F-8 DPURX02=12x	1,0	<b>UXT 9</b>
32 AMG Kompressor	3.2	260	03.01-04.04	M 112.960	6	<b>Z 170</b>	14 F-7 DPURU2	1,0	<b>UXT 12</b>

### SLK (R171)

200 Kompressor	1.8	120	03.04-02.11	M 271.944 Mot.Nr. 30853900 →	4	<b>Z 359</b>	12 F-5 NPUR2T	0,8	○
200 Kompressor	1.8	120	03.04-02.11	M 271.944 → Mot.Nr. 30853899	4	<b>Z 226</b>	14 FR-6 MPU2	0,8	○
200 Kompressor	1.8	135	01.08-02.11	M 271.954	4	<b>Z 359</b>	12 F-5 NPUR2T	0,8	○
280	3.0	170	01.05-02.11	M 272.942	6	<b>Z 359</b>	12 F-5 NPUR2T	0,8	○
300	3.0	170	04.09-02.11	M 272.942	6	<b>Z 359</b>	12 F-5 NPUR2T	0,8	○
55 AMG	5.4	265	06.04-02.11	M 113.989	8	<b>Z 170</b>	14 F-7 DPURU2=16x	1,0	<b>UXT 12</b>

### SLR (R199)

5.4	5.4	460	04.04-	M 155.980	8	<b>Z 226</b>	14 FR-6 MPU2	0,8	○
5.4 722 Edition	5.4	478	10.06-	M 155.980	8	<b>Z 226</b>	14 FR-6 MPU2	0,8	○

### SLR ROADSTER (R199)

5.4	5.4	460	04.07-	M 155.980	8	<b>Z 226</b>	14 FR-6 MPU2	0,8	○
5.4	5.4	478	10.06-	M 155.980	8	<b>Z 226</b>	14 FR-6 MPU2	0,8	○

### V-KLASSE (638/2)

V 200	2.0	95	02.97-07.03	M 111.948/M 111.950	4	<b>Z 121</b>	14 FGH-8 DTURXO	1,0	<b>UXT 9</b>
V 200 CDI	2.2	75	03.99-07.03	OM 611.980	4	<b>GN 003</b> (11,5V)	○		
V 220 CDI	2.2	90	03.99-07.03	OM 611.980	4	<b>GN 003</b> (11,5V)	○		
V 230 TD	2.3	72	09.96-07.03	OM 601.970	4	<b>GN 858</b> (11,5V)	<b>GR 049</b>	<b>SR 040</b>	
V 230	2.3	105	10.96-07.03	M 111.978	4	<b>Z 121</b>	14 FGH-8 DTURXO	1,0	<b>UXT 9</b>
V 280	2.8	128	08.97-07.03	M 104.900	6	<b>Z 173</b>	14 FGR-8 KQU	1,6	○

### VANEO(414)

1.6	1.6	60	02.02-07.05	M 166.961	4	<b>Z 121</b>	14 FGH-8 DTURXO	1,0	<b>UXT 9</b>
1.6	1.6	75	02.02-07.05	M 166.961	4	<b>Z 121</b>	14 FGH-8 DTURXO	1,0	<b>UXT 9</b>
1.7 CDI	1.7	55	02.02-07.05	OM 668.914	4	<b>GN 010</b> (11,5V)	○		
1.7 CDI	1.7	67	02.02-07.05	OM 668.914	4	<b>GN 010</b> (11,5V)	○		
1.9	1.9	92	02.02-07.05	M 166.991	4	<b>Z 121</b>	14 FGH-8 DTURXO	1,0	<b>UXT 9</b>

### VIANO (W639)

2.0 CDI	2.1	80	09.03-	OM 646.982	4	<b>GN 003</b> (11,5V)	○		
2.0 CDI 4-matic	2.1	80	07.05-10.06	OM 646.982	4	<b>GN 003</b> (11,5V)	○		
2.0 CDI	2.1	85	08.05-	OM 646.982	4	<b>GN 003</b> (11,5V)	○		
2.2 CDI	2.1	110	09.03-	OM 646.982	4	<b>GN 003</b> (11,5V)	○		
2.2 CDI 4-matic	2.1	110	07.05-10.06	OM 646.982	4	<b>GN 003</b> (11,5V)	○		
3.0 CDI	3.0	150	03.06-	OM 642.990	6	<b>GE 105</b> (4,4V)	○		

● nicht erforderlich  
○ nicht im Programm

<sup>3</sup> wahlweise UXT 3 Platin



kW

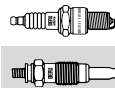

**MERCEDES**

**VIANO (W639)**

3.2	3.2	140	09.03-	M 112.951	6	<b>Z 240</b>	14 F-8 DPURX02	1,0	<b>UXT 9</b>
3.2	3.2	160	09.03-	M 112.951	6	<b>Z 240</b>	14 F-8 DPURX02	1,0	<b>UXT 9</b>
3.7	3.7	170	06.04-	M 112.976	6	<b>Z 240</b>	14 F-8 DPURX02	1,0	<b>UXT 9</b>

**190 (W201)**

1.8 E	1.8	80	04.90-08.93	M 102.910	4	<b>Z 18</b>	14 K-7 DUO	0,8	<b>UXT 4</b>
2.0 D	2.0	55	08.89-08.93	OM 601.911	4	<b>GN 858</b> (11,5V)	<b>GR 074</b>	<b>SR 040</b>	
2.0	2.0	75	01.86-05.90	M 102.924	4	<b>Z 18</b>	14 K-7 DUO	0,8	<b>UXT 4</b>
2.0	2.0	77	09.84-05.90	M 102.924	4	<b>Z 18</b>	14 K-7 DUO	0,8	<b>UXT 4</b>
2.0 E	2.0	87	01.85-08.93	M 102.962	4	<b>Z 18</b>	14 K-7 DUO	0,8	<b>UXT 4</b>
2.0 E	2.0	90	10.82-06.93	M 102.961/M 102.962	4	<b>Z 18</b>	14 K-7 DUO	0,8	<b>UXT 4</b>
2.0 E	2.0	93	10.82-06.93	M 102.961	4	<b>Z 18</b>	14 K-7 DUO	0,8	<b>UXT 4</b>
2.3 E	2.3	97	09.86-08.91	M 102.985	4	<b>Z 18</b>	14 K-7 DUO	0,8	<b>UXT 4</b>
2.3 E	2.3	100	10.86-08.93	M 102.985	4	<b>Z 18</b>	14 K-7 DUO	0,8	<b>UXT 4</b>
2.5 D	2.5	66	02.89-08.93	OM 602.911	5	<b>GN 858</b> (11,5V)	<b>GR 075</b>	<b>SR 040</b>	
2.5 D	2.5	69	08.89-08.93	OM 602.911	5	<b>GN 858</b> (11,5V)	<b>GR 075</b>	<b>SR 040</b>	
2.5 TD	2.5	90	02.89-08.93	OM 602.961	5	<b>GN 858</b> (11,5V)	<b>GR 049</b>	<b>SR 040</b>	
2.5 TD	2.5	93	02.89-08.93	OM 602.961	5	<b>GN 858</b> (11,5V)	○		
2.5-16 E	2.5	143	03.89-08.93	M 102.991	4	<b>Z 18</b>	14 K-7 DUO	0,8	<b>UXT 4</b>
2.5-16 E	2.5	150	09.88-08.93	M 102.990	4	<b>Z 18</b>	14 K-7 DUO	0,8	<b>UXT 4</b>
2.5 E Evolution II	2.5	173	05.90-08.93	M 102.992	4	<b>Z 18</b>	14 K-7 DUO	0,8	<b>UXT 4</b>
2.6 E	2.6	118	09.86-08.93	M 103.942	6	<b>Z 7</b>	14 K-8 DUO	0,8	<b>UXT 4</b>

**CABRIOLET (A124)**

300 CE-24	3.0	162	04.92-06.93	M 104.980	6	<b>Z 100</b>	14 F-8 DU4	0,8	<b>UXT 1<sup>3</sup></b>
-----------	-----	-----	-------------	-----------	---	--------------	------------	-----	--------------------------

**COUPE (C124)**

220 CE	2.2	110	10.92-05.93	M 111.960	4	<b>Z 100</b>	14 F-8 DU4	0,8	<b>UXT 1<sup>3</sup></b>
230 CE	2.3	97	03.87-12.92	M 102.982	4	<b>Z 18</b>	14 K-7 DUO	0,8	<b>UXT 4</b>
230 CE KAT	2.3	97	06.89-12.92	M 102.982	4	<b>Z 18</b>	14 K-7 DUO	0,8	<b>UXT 4</b>
230 CE	2.3	100	03.87-12.92	M 102.982	4	<b>Z 18</b>	14 K-7 DUO	0,8	<b>UXT 4</b>
300 CE	3.0	132	03.87-05.93	M 103.983	6	<b>Z 7</b>	14 K-8 DUO	0,8	<b>UXT 4</b>
300 CE-24	3.0	162	09.89-12.92	M 104.980	6	<b>Z 100</b>	14 F-8 DU4	0,8	<b>UXT 1<sup>3</sup></b>
300 CE-24	3.0	170	09.89-12.92	M 104.980	6	<b>Z 100</b>	14 F-8 DU4	0,8	<b>UXT 1<sup>3</sup></b>
320 CE	3.2	162	10.92-05.93	M 104.992	6	<b>Z 5</b>	14 F-8 DUO	0,8	<b>UXT 1<sup>3</sup></b>

**Stufenheck (W124)**

200 D	2.0	55	08.89-06.93	OM 601.912	4	<b>GN 858</b> (11,5V)	<b>GR 073</b>	<b>SR 040</b>	
200	2.0	75	01.86-05.90	M 102.922	4	<b>Z 18</b>	14 K-7 DUO	0,8	<b>UXT 4</b>
200	2.0	77	01.86-05.90	M 102.922	4	<b>Z 18</b>	14 K-7 DUO	0,8	<b>UXT 4</b>
200	2.0	80	12.85-05.90	M 102.922	4	<b>Z 18</b>	14 K-7 DUO	0,8	<b>UXT 4</b>
200 E	2.0	87	09.88-08.92	M 102.963	4	<b>Z 18</b>	14 K-7 DUO	0,8	<b>UXT 4</b>
200 E	2.0	100	10.92-06.93	M 111.940	4	<b>Z 100</b>	14 F-8 DU4	0,8	<b>UXT 1<sup>3</sup></b>
220 E	2.2	110	10.92-06.93	M 111.960	4	<b>Z 100</b>	14 F-8 DU4	0,8	<b>UXT 1<sup>3</sup></b>
230 E	2.3	97	12.84-03.92	M 102.982	4	<b>Z 18</b>	14 K-7 DUO	0,8	<b>UXT 4</b>
230 E KAT	2.3	97	06.89-06.93	M 102.982	4	<b>Z 18</b>	14 K-7 DUO	0,8	<b>UXT 4</b>
230 E	2.3	100	01.85-06.93	M 102.982	4	<b>Z 18</b>	14 K-7 DUO	0,8	<b>UXT 4</b>
250 D	2.5	66	02.89-06.93	OM 602.912	5	<b>GN 858</b> (11,5V)	<b>GR 075</b>	<b>SR 040</b>	
250 D	2.5	69	02.89-06.93	OM 602.912	5	<b>GN 858</b> (11,5V)	<b>GR 075</b>	<b>SR 040</b>	
250 Turbo-D	2.5	93	02.89-06.93	OM 602.962	5	<b>GN 858</b> (11,5V)	○		
260 E	2.6	118	09.85-08.92	M 103.940	6	<b>Z 7</b>	14 K-8 DUO	0,8	<b>UXT 4</b>
260 E 4-matic	2.6	118	09.86-08.92	M 103.943	6	<b>Z 7</b>	14 K-8 DUO	0,8	<b>UXT 4</b>
280 E	2.8	145	10.92-06.93	M 104.942	6	<b>Z 5</b>	14 F-8 DUO	0,8	<b>UXT 1<sup>3</sup></b>
300 D	3.0	81	06.90-06.93	OM 603.912	6	<b>GN 858</b> (11,5V)	<b>GR 076</b>		
300 D 4-matic	3.0	80	02.89-08.92	OM 603.913	6	<b>GN 858</b> (11,5V)	<b>GR 076</b>		
300 D	3.0	83	08.89-06.93	OM 603.912	6	<b>GN 858</b> (11,5V)	<b>GR 076</b>		
300 D 4-matic	3.0	83	08.89-06.93	OM 603.913	6	<b>GN 858</b> (11,5V)	<b>GR 076</b>		
300 Turbo-D	3.0	108	02.89-06.93	OM 603.960	6	<b>GN 858</b> (11,5V)	○		
300 Turbo-D 4-matic	3.0	108	02.89-06.93	OM 603.963	6	<b>GN 858</b> (11,5V)	○		
300 E	3.0	132	08.85-08.92	M 103.983	6	<b>Z 7</b>	14 K-8 DUO	0,8	<b>UXT 4</b>
300 E 4-matic	3.0	132	09.86-06.93	M 103.985	6	<b>Z 7</b>	14 K-8 DUO	0,8	<b>UXT 4</b>
300 E	3.0	138	06.85-08.92	M 103.983	6	<b>Z 7</b>	14 K-8 DUO	0,8	<b>UXT 4</b>
300 E 4-matic	3.0	138	09.86-02.92	M 103.983	6	<b>Z 7</b>	14 K-8 DUO	0,8	<b>UXT 4</b>
300 E-24	3.0	162	09.88-08.92	M 104.980	6	<b>Z 100</b>	14 F-8 DU4	0,8	<b>UXT 1<sup>3</sup></b>
320 E	3.2	162	10.92-06.93	M 104.992	6	<b>Z 100</b>	14 F-8 DU4	0,8	<b>UXT 1<sup>3</sup></b>

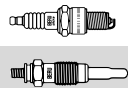
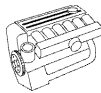

## MERCEDES

### Stufenheck (W124)

400 E 4.2	4.2	205	10.92-06.93	M 119.975	8	<b>Z 5</b>	14 F-8 DUO	0,8	<b>UXT 1<sup>3</sup></b>
500 E	5.0	240	01.91-06.93	M 119.974	8	<b>Z 5</b>	14 F-8 DUO	0,8	<b>UXT 1<sup>3</sup></b>

### KOMBI Kombi (S124)

200 T D	2.0	53	02.89-08.91	OM 601.912	4	<b>GN 858</b> (11,5V)	<b>GR 073</b>		
200 T D	2.0	55	02.89-08.91	OM 601.912	4	<b>GN 858</b> (11,5V)	<b>GR 073</b>		
200 T	2.0	77	01.86-05.90	M 102.922	4	<b>Z 18</b>	14 K-7 DUO	0,8	<b>UXT 4</b>
200 TE	2.0	87	09.88-08.92	M 102.963	4	<b>Z 18</b>	14 K-7 DUO	0,8	<b>UXT 4</b>
200 TE	2.0	100	10.92-06.93	M 111.940	4	<b>Z 100</b>	14 F-8 DU4	0,8	<b>UXT 1<sup>3</sup></b>
220 TE	2.2	110	10.92-05.93	M 111.960	4	<b>Z 100</b>	14 F-8 DU4	0,8	<b>UXT 1<sup>3</sup></b>
230 TE	2.3	97	09.85-08.92	M 102.982	4	<b>Z 18</b>	14 K-7 DUO	0,8	<b>UXT 4</b>
230 TE KAT	2.3	97	06.89-08.92	M 102.982	4	<b>Z 18</b>	14 K-7 DUO	0,8	<b>UXT 4</b>
230 TE	2.3	100	09.85-08.92	M 102.982	4	<b>Z 18</b>	14 K-7 DUO	0,8	<b>UXT 4</b>
250 T D	2.5	66	02.89-06.93	OM 602.912	5	<b>GN 858</b> (11,5V)	<b>GR 075</b>	<b>SR 040</b>	
250 T D	2.5	69	02.89-06.93	OM 602.912	5	<b>GN 858</b> (11,5V)	<b>GR 075</b>	<b>SR 040</b>	
250 TD Turbo	2.5	83	06.92-05.93	OM 605.911	5	<b>GN 858</b> (11,5V)	○		
250 TD Turbo	2.5	93	02.89-07.93	OM 602.962	5	<b>GN 858</b> (11,5V)	○		
260 TE FGST.	2.6	118	09.89-08.92	M 103.940	6	<b>Z 7</b>	14 K-8 DUO	0,8	<b>UXT 4</b>
280 TE	2.8	145	10.92-06.93	M 104.942	6	<b>Z 5</b>	14 F-8 DUO	0,8	<b>UXT 1<sup>3</sup></b>
300 T D	3.0	80	02.89-06.93	OM 603.912	6	<b>GN 858</b> (11,5V)	<b>GR 076</b>		
300 T D	3.0	81	02.89-06.93	OM 603.912	6	<b>GN 858</b> (11,5V)	<b>GR 076</b>		
300 T D	3.0	83	02.89-06.93	OM 603.912	6	<b>GN 858</b> (11,5V)	<b>GR 076</b>		
300 TD T	3.0	100	06.92-05.93	OM 603.960	6	<b>GN 858</b> (11,5V)	○		
300 T Turbo-D	3.0	108	02.89-06.93	OM 603.960	6	<b>GN 858</b> (11,5V)	○		
300 T Turbo-D 4-matic	3.0	108	02.89-06.93	OM 603.960	6	<b>GN 858</b> (11,5V)	○		
300 TE	3.0	132	01.86-08.92	M 103.983	6	<b>Z 7</b>	14 K-8 DUO	0,8	<b>UXT 4</b>
300 TE 4-matic	3.0	132	09.86-06.93	M 103.985	6	<b>Z 7</b>	14 K-8 DUO	0,8	<b>UXT 4</b>
300 TE-24	3.0	162	09.89-08.92	M 104.980	6	<b>Z 100</b>	14 F-8 DU4	0,8	<b>UXT 1<sup>3</sup></b>
320 TE	3.2	162	10.92-06.93	M 104.992	6	<b>Z 5</b>	14 F-8 DUO	0,8	<b>UXT 1<sup>3</sup></b>



### 100(631)

2.0 D	2.0	44	04.88-08.93	OM 615.970/OM 615.963	4	<b>GN 858</b> (11,5V)	○		
2.0 D	2.0	45	09.93-04.96	OM 615.970	4	<b>GN 858</b> (11,5V)	○		
2.4 D	2.4	41	12.90-12.94	OM 616	4	<b>GN 858</b> (11,5V)	○		
2.4 D	2.4	53	02.89-05.92	OM 616.963	4	<b>GN 858</b> (11,5V)	○		
2.4 D	2.4	55	12.90-02.96	OM 616/OM 616.963	4	<b>GN 858</b> (11,5V)	○		

### SPRINTER (901, 902)

208 CDI	2.1	60	04.00-05.06	OM 611.987	4	<b>GN 003</b> (11,5V)	○		
208 D	2.3	58	01.95-04.00	OM 601.943	4	<b>GN 858</b> (11,5V)	<b>GR 049</b>		
208 D	2.3	60	09.96-04.00	OM 601.943	4	<b>GN 858</b> (11,5V)	<b>GR 049</b>		
210 D	2.9	75	01.97-04.00	OM 602.980	5	<b>GN 961</b> (11,5V)	○		
211 CDI	2.1	80	04.00-05.06	OM 611.981	4	<b>GN 003</b> (11,5V)	○		
212 D	2.9	90	02.95-04.00	OM 602.980	5	<b>GN 909</b> (11V)	○		
				→ Mot. 009 849					
212 D	2.9	90	02.95-04.00	OM 602.980	5	<b>GN 961</b> (11,5V)	○		
				Mot.Nr. 009 850 →					
212 D Automatic	2.9	90	02.95-04.00	OM 602.980	5	<b>GN 909</b> (11V)	○		
				→ Mot. 000 136					
212 D Automatic	2.9	90	02.95-04.00	OM 602.980	5	<b>GN 961</b> (11,5V)	○		
				Mot.Nr. 000 137 →					
213 CDI	2.1	95	04.00-05.06	OM 611.981	4	<b>GN 003</b> (11,5V)	○		
214	2.3	105	02.95-05.06	M 111.979/984	4	<b>Z 101</b>	14 F-8 LDUSR	0,9	<b>UXT 1<sup>3</sup></b>
214 NGT	2.3	92	04.00-05.06	M 111.984	4	<b>Z 121</b>	14 FGH-8 DTURXO	1,0	<b>UXT 9</b>
216 CDI	2.7	115	04.00-05.06	OM 612.981	5	<b>GN 003</b> (11,5V)	○		

### SPRINTER (903)

308 CDI	2.1	60	04.00-05.06	OM 611.987	4	<b>GN 003</b> (11,5V)	○		
308 D	2.3	58	02.95-04.00	OM 601.943	4	<b>GN 858</b> (11,5V)	<b>GR 049</b>		
308 D 2.3	2.3	60	02.95-04.00	OM 601.943	4	<b>GN 858</b> (11,5V)	○		
310 D 2.9	2.9	75	01.97-04.00	OM 602.980	5	<b>GN 961</b> (11,5V)	○		
310 D 4x4	2.9	75	05.97-03.00	OM 602.980	5	<b>GN 961</b> (11,5V)	○		
311 CDI	2.1	80	04.00-05.06	OM 611.981	4	<b>GN 003</b> (11,5V)	○		

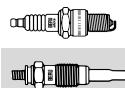
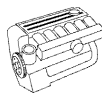

## MERCEDES



### SPRINTER (903)

311 CDI 4x4	2.1	80	08.02-05.06	OM 611.981	4	GN 003 (11,5V)	○		
312 D 2.9	2.9	90	02.95-04.00	OM 602.980	5	GN 909 (11,5V)	○		
				→ Mot.Nr. 009 849					
312 D 2.9	2.9	90	02.95-04.00	OM 602.980	5	GN 961 (11,5V)	○		
				Mot.Nr. 009 850 →					
312 D 2.9 4x4	2.9	90	05.97-08.02	OM 602.980	5	GN 909 (11,5V)	○		
				→ Mot.Nr. 009 849					
312 D 2.9 4x4	2.9	90	05.97-05.8.02	OM 602.980	5	GN 961 (11,5V)	○		
				Mot.Nr. 009 850 →					
312 D 2.9 Automatic	2.9	90	02.95-04.00	OM 602.980	5	GN 909 (11V)	○		
				→ Mot. 000 136					
312 D 2.9 Automatic	2.9	90	02.95-04.00	OM 602.980	5	GN 961 (11,5V)	○		
				Mot. 000 137 →					
312 D 2.9 4x4 Automatic	2.9	90	05.97-08.02	OM 602.980	5	GN 909 (11V)	○		
				→ Mot. 000 136					
312 D 2.9 4x4 Automatic	2.9	90	05.97-08.02	OM 602.980	5	GN 961 (11,5V)	○		
				Mot. 000 137 →					
313 CDI	2.1	95	04.00-05.06	OM 611.981	4	GN 003 (11,5V)	○		
313 CDI 4x4	2.1	95	08.02-05.06	OM 611.981	4	GN 003 (11,5V)	○		
314	2.3	105	02.95-05.06	M 111.984	4	Z 101 14 F-8 LDUSR	0,9		UXT 1 <sup>3</sup>
314 4x4	2.3	105	08.02-05.06	M 111.984	4	Z 121 14 FGH-8 DTURXO	1,0		UXT 9
314 NGT	2.3	92	04.00-05.06	M 111.984	4	Z 121 14 FGH-8 DTURXO	1,0		UXT 9
316 CDI	2.7	115	04.00-05.06	OM 612.981	5	GN 003 (11,5V)	○		
316 CDI 4x4	2.7	115	08.02-05.06	OM 612.981	5	GN 003 (11,5V)	○		

### SPRINTER (904)

408 CDI	2.1	60	04.00-05.06	OM 611.987	4	GN 003 (11,5V)	○		
408 D	2.3	58	02.96-05.06	OM 601.943	4	GN 858 (11,5V)	○		
410 D	2.9	75	02.96-05.06	OM 602.980	5	GN 909 (11,5V)	○		
				→ Mot.Nr. 009 849					
410 D	2.9	75	02.96-05.06	OM 602.980	5	GN 961 (11,5V)	○		
				Mot.Nr. 009 850 →					
410 D 4x4	2.9	75	05.97-03.00	OM 602.980	5	GN 909 (11,5V)	○		
				→ Mot.Nr. 009 849					
410 D 4x4	2.9	75	05.97-05.06	OM 602.980	5	GN 961 (11,5V)	○		
				Mot.Nr. 009 850 →					
410 D Automatic	2.9	75	02.96-03.00	OM 602.980	5	GN 909 (11V)	○		
				→ Mot. 000 136,					
410 D Automatic	2.9	75	02.96-03.00	OM 602.980	5	GN 961 (11,5V)	○		
				Mot. 000 137 →					
410 D 4x4 Automatic	2.9	75	05.97-03.00	OM 602.980	5	GN 909 (11V)	○		
				→ Mot. 000 136,					
410 D 4x4 Automatic	2.9	75	05.97-03.00	OM 602.980	5	GN 961 (11,5V)	○		
				Mot. 000 137 →					
411 CDI	2.1	80	04.00-05.06	OM 611.981	4	GN 003 (11,5V)	○		
411 CDI 4x4	2.1	80	04.00-05.06	OM 611.981	4	GN 003 (11,5V)	○		
412 D	2.9	85	02.96-03.00	OM 602.980	5	GN 909 (11,5V)	○		
				→ Mot.Nr. 009 849					
412 D	2.9	85	02.96-03.00	OM 602.980	5	GN 961 (11,5V)	○		
				Mot.Nr. 009 850 →					
412 D 4x4	2.9	90	05.97-03.00	OM 602.980	5	GN 909 (11,5V)	○		
				→ Mot.Nr. 009 849					
412 D 4x4	2.9	90	05.97-03.00	OM 602.980	5	GN 961 (11,5V)	○		
				Mot.Nr. 009 850 →					
412 D Automatic	2.9	85	02.96-03.00	OM 602.980	5	GN 909 (11V)	○		
				→ Mot. 000 136,					
412 D Automatic	2.9	85	02.96-03.00	OM 602.980	5	GN 961 (11,5V)	○		
				Mot. 000 137 →					
412 D 4x4 Automatic	2.9	90	02.96-03.00	OM 602.980	5	GN 909 (11V)	○		
				→ Mot. 000 136,					



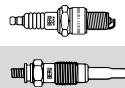

## MERCEDES



### SPRINTER (904)

412 D 4x4 Automatic	2.9	90	02.96-03.00	OM 602.980 Mot. 000 137 →	5	<b>GN 961</b> (11,5V)	○		
413 CDI	2.1	95	04.00-05.06	OM 611.981	4	<b>GN 003</b> (11,5V)	○		
413 CDI 4x4	2.1	95	04.00-05.06	OM 611.981	4	<b>GN 003</b> (11,5V)	○		
414	2.3	105	02.96-06.97	M 111.979	4	<b>Z 100</b>	14 F-8 DU4	0,8	<b>UXT 1<sup>3</sup></b>
414	2.3	105	07.97-05.06	M 111.979	4	<b>Z 121</b>	14 FGH-8 DTURXO	1,0	<b>UXT 9</b>
414 4x4	2.3	105	05.97-05.06	M 111.979	4	<b>Z 121</b>	14 FGH-8 DTURXO	1,0	<b>UXT 9</b>
415 CDI	2.1	110	06.06-	OM 646.990	4	<b>GN 003</b> (11,5V)	○		
416 CDI	2.7	115	04.00-05.06	OM 612.981	5	<b>GN 003</b> (11,5V)	○		
416 CDI 4x4	2.7	115	04.00-05.06	OM 612.981	5	<b>GN 003</b> (11,5V)	○		

### SPRINTER (906)

209 CDI	2.1	65	06.06-	OM 646.984	4	<b>GN 003</b> (11,5V)	○		
211 CDI	2.1	80	06.06-	OM 646.985	4	<b>GN 003</b> (11,5V)	○		
213 CDI	2.1	95	06.06-	OM 646.986	4	<b>GN 003</b> (11,5V)	○		
215 CDI	2.1	110	06.06-	OM 646.990	4	<b>GN 003</b> (11,5V)	○		
218 CDI	3.0	135	06.06-	OM 642.992	6	<b>GE 105</b> (4,4V)	○		
219 CDI	3.0	140	03.09-	OM 642.992	6	<b>GE 105</b> (4,4V)	○		
309 CDI	2.1	65	06.06-	OM 646.984	4	<b>GN 003</b> (11,5V)	○		
311 CDI	2.1	80	06.06-	OM 646.985	4	<b>GN 003</b> (11,5V)	○		
311 CDI 4x4	2.1	80	02.08-	OM 646.985	4	<b>GN 003</b> (11,5V)	○		
313 CDI	2.1	95	06.06-	OM 646.986	4	<b>GN 003</b> (11,5V)	○		
315 CDI	2.1	110	06.06-	OM 646.990	4	<b>GN 003</b> (11,5V)	○		
315 CDI 4x4	2.1	110	02.08-	OM 646.990	4	<b>GN 003</b> (11,5V)	○		
316	1.8	115	09.08-10.10	M 271.951 → Mot.Nr. 30856899	4	<b>Z 226</b>	14 FR-6 MPU2	0,8	○
316 NGT	1.8	115	09.08-10.10	M 271.951 → Mot.Nr. 30856899	4	<b>Z 226</b>	14 FR-6 MPU2	0,8	○
318 CDI	3.0	135	06.06-	OM 642.992	6	<b>GE 105</b> (4,4V)	○		
318 CDI 4x4	3.0	135	02.08-	OM 642.992	6	<b>GE 105</b> (4,4V)	○		
319 CDI	3.0	140	03.09-	OM 642.992	6	<b>GE 105</b> (4,4V)	○		
319 CDI 4x4	3.0	140	03.09-	OM 642.992	6	<b>GE 105</b> (4,4V)	○		
418 CDI	3.0	135	06.06-	OM 642.992	6	<b>GE 105</b> (4,4V)	○		
509 CDI	2.1	65	06.06-	OM 646.984	4	<b>GN 003</b> (11,5V)	○		
511 CDI	2.1	80	06.06-	OM 646.985	4	<b>GN 003</b> (11,5V)	○		
513 CDI	2.1	95	06.06-	OM 646.986	4	<b>GN 003</b> (11,5V)	○		
515 CDI	2.1	110	06.06-	OM 646.990	4	<b>GN 003</b> (11,5V)	○		
516	1.8	115	09.08-10.10	M 271.951 → Mot.Nr. 30856899	4	<b>Z 226</b>	14 FR-6 MPU2	0,8	○
518 CDI	3.0	135	06.06-	OM 642.992	6	<b>GE 105</b> (4,4V)	○		

### SPRINTER

616 CDI	2.7	115	04.01-	OM 612.981	5	<b>GN 003</b> (11,5V)	○		
<b>T1(601)</b>									
207 D 2.4	2.4	53	09.82-01.90	OM 616.937/OM 616.939	4	<b>GV 603</b> (11,5V)	○		
208 D 2.3	2.3	58	11.88-02.96	OM 601.940	4	<b>GN 858</b> (11,5V)	<b>GR 049</b>		
208 D 2.3	2.3	60	10.88-02.96	OM 601.940	4	<b>GN 858</b> (11,5V)	<b>GR 049</b>		
209 D 2.9	3.0	65	12.82-01.90	OM 617.913	5	<b>GV 603</b> (11,5V)	○		
210 2.3	2.3	70	07.82-01.90	M 102.942	4	<b>Z 7</b>	14 K-8 DU0	0,8	<b>UXT 4</b>
210 2.3	2.3	77	05.89-02.96	M 102.945	4	<b>Z 7</b>	14 K-8 DU0	0,8	<b>UXT 4</b>
210 D 2.9	2.9	70	11.88-02.96	OM 602.940	5	<b>GN 858</b> (11,5V)	<b>GR 049</b>		
210 D 2.8	2.9	72	10.88-02.96	OM 602.940	5	<b>GN 858</b> (11,5V)	<b>GR 049</b>		
<b>T1(602)</b>									
307 D 2.4	2.4	53	10.82-01.90	OM 616.937/OM 616.939	4	<b>GV 603</b> (11,5V)	○		
308 D 2.3	2.3	58	11.88-02.96	OM 601.940	4	<b>GN 858</b> (11,5V)	<b>GR 049</b>		
308 D 2.3	2.3	60	06.89-02.96	OM 601.940	4	<b>GN 858</b> (11,5V)	<b>GR 049</b>		
309 D 3.0	3.0	65	10.82-01.90	OM 617.913	5	<b>GV 603</b> (11,5V)	○		
310 D 2.9	2.9	70	06.89-02.96	OM 602.940	5	<b>GN 858</b> (11,5V)	<b>GR 049</b>		
310 D 2.9	2.9	72	06.89-02.96	OM 602.940	5	<b>GN 858</b> (11,5V)	○		
<b>T1/TN</b>									
408 D	2.3	58	11.88-06.95	OM 601.940	4	<b>GN 858</b> (11,5V)	○		

● nicht erforderlich  
○ nicht im Programm

<sup>3</sup> wahlweise UXT 3 Platin

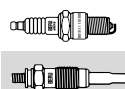
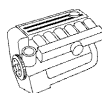

## MERCEDES



### T1/TN

408 D	2.3	60	11.88-06.95	OM 601.940	4	GN 858 (11,5V)	○		
410	2.3	70	08.82-06.95	M 102.942	4	Z 7	14 K-8 DUO	0,8	UXT 4
410 D	2.9	70	11.88-06.95	OM 602.940	5	GN 858 (11,5V)	○		
410 D	2.9	72	11.88-06.95	OM 602.940	5	GN 858 (11,5V)	○		
410	2.3	77	08.82-06.95	M 102.945	4	Z 7	14 K-8 DUO	0,8	UXT 4

### T2/LN1

508 D	2.3	58	03.89-12.94	OM 601.941	4	GN 858 (11,5V)	○		
510	2.3	70	04.86-12.94	M 102.946	4	Z 7	14 K-8 DUO	0,8	UXT 4
510	2.3	77	04.86-12.94	M 102.946	4	Z 7	14 K-8 DUO	0,8	UXT 4
814 D	4.0	100	11.87-12.94	OM 364.981/986	4	GH 011 (11,5V)	○		
814 DA 4x4	4.0	100	11.87-12.94	OM 364.987	4	GH 011 (11,5V)	○		
0 614 D	4.0	100	07.87-12.92	OM 364.980 /OM 364.981	4	GH 011 (11,5V)	○		

### VARIO

512 D	2.9	90	09.96-	OM 602.984	5	GN 961 (11,5V)	○		
612 D	2.9	90	09.96-	OM 602.985 /OM 602.984	5	GN 961 (11,5V)	○		
812 D	2.9	90	09.96-	OM 602.985 /OM 602.984	5	GN 961 (11,5V)	○		

### VITO(638)

108 CDI 2.2	2.2	60	03.99-07.03	OM 611A (60 KW CDI)	4	GN 003 (11,5V)	○		
108 D 2.3	2.3	58	02.96-07.03	OM 601.942	4	GN 858 (11,5V)	GR 049		
110 CDI 2.2	2.2	75	03.99-07.03	OM 611LA (75 KW CDI)	4	GN 003 (11,5V)	○		
110 D 2.3	2.3	72	03.97-07.03	OM 601.970	4	GN 858 (11,5V)	GR 049		
110 TD 2.3	2.3	72	02.96-07.03	OM 601.970	4	GN 858 (11,5V)	GR 049		
112 CDI 2.2	2.2	90	03.99-07.03	OM 611.980	4	GN 003 (11,5V)	○		
113 2.0	2.0	95	02.96-07.03	M 111.948/M 111.950	4	Z 121	14 FGH-8 DTURXO	1,0	UXT 9
114 2.3	2.3	105	12.96-07.03	M 111.978	4	Z 121	14 FGH-8 DTURXO	1,0	UXT 9

### VITO (W639)

109 CDI	2.1	65	09.03-	OM 646.983	4	GN 003 (11,5V)	○		
109 CDI 4x4	2.1	70	09.07-	OM 646.981	4	GN 003 (11,5V)	○		
111 CDI	2.1	80	09.03-	OM 646.982	4	GN 003 (11,5V)	○		
111 CDI	2.1	85	09.07-	OM 646.982	4	GN 003 (11,5V)	○		
111 CDI 4x4	2.1	80	09.07-	OM 646.982	4	GN 003 (11,5V)	○		
115 CDI	2.1	110	09.03-	OM 646.982	4	GN 003 (11,5V)	○		
115 CDI 4x4	2.1	110	09.07-	OM 646.982	4	GN 003 (11,5V)	○		
119	3.2	140	09.03-	M 112.951	6	Z 240	14 F-8 DPURX02	1,0	UXT 9
120 CDI	3.0	150	09.07-	OM 642.990	6	GE 105 (4,4V)	○		
122	3.2	160	09.03-	M 112.951	6	Z 240	14 F-8 DPURX02	1,0	UXT 9
123	3.7	170	06.04-	M 112.976	6	Z 240	14 F-8 DPURX02	1,0	UXT 9

### VITO / MIXTO (W639)

109 CDI	2.1	65	09.03-	OM 646.983	4	GN 003 (11,5V)	○		
109 CDI	2.1	70	08.06-	OM 646.981	4	GN 003 (11,5V)	○		
111 CDI	2.1	80	09.03-	OM 646.982	4	GN 003 (11,5V)	○		
111 CDI	2.1	85	09.07-	OM 646.982	4	GN 003 (11,5V)	○		
111 CDI 4x4	2.1	80	09.07-	OM 646.982	4	GN 003 (11,5V)	○		
115 CDI	2.1	110	09.03-	OM 646.982	4	GN 003 (11,5V)	○		
115 CDI 4x4	2.1	110	09.07-	OM 646.982	4	GN 003 (11,5V)	○		
119	3.2	140	09.03-	M 112.951	6	Z 240	14 F-8 DPURX02	1,0	UXT 9
120 CDI	3.0	150	09.07-	OM 642.990	6	GE 105 (4,4V)	○		
122	3.2	160	09.03-	M 112.951	6	Z 240	14 F-8 DPURX02	1,0	UXT 9

## MG

### MG TF

115	1.6	85	03.02-	16 K4F	4	Z 228	14 FR-7 DPURX02	1,0	UXT 11
120	1.8	88	03.02-	18 K4F	4	Z 228	14 FR-7 DPURX02	1,0	UXT 11
135	1.8	100	03.02-	18 K4F	4	Z 228	14 FR-7 DPURX02	1,0	UXT 11
160	1.8	118	03.02-	18 K4K	4	Z 228	14 FR-7 DPURX02	1,0	UXT 11

### MG ZR

105	1.4	76	06.01-04.05	14 K4F	4	Z 228	14 FR-7 DPURX02	1,0	UXT 11
120	1.8	86	06.01-04.05	18 K4F	4	Z 228	14 FR-7 DPURX02	1,0	UXT 11
160	1.8	118	06.01-04.05	18 K4K	4	Z 228	14 FR-7 DPURX02	1,0	UXT 11

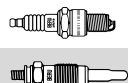

## MG

<b>MG ZR</b>									
2.0 Turbodiesel	2.0	74	06.01-04.05	20 T2N	4	<b>GN 999</b> (11V)	○		
<b>MG ZS</b>									
1.6	1.6	82	03.05-10.05	16 K4F	4	<b>Z 312</b>	14 FR-7 KPPU	1,1	○
2.0 TD	2.0	74	01.04-04.05	20 T2N	4	<b>GN 999</b> (11V)	○		
2.0 TD	2.0	83	01.04-04.05	20 T2N	4	<b>GN 999</b> (11V)	○		
120	1.8	86	07.01-04.05	18 K4F	4	<b>Z 228</b>	14 FR-7 DPUX02	1,0	<b>UXT 11</b>
180	2.5	130	07.01-04.05	25 K4F	6	<b>Z 228</b>	14 FR-7 DPUX02	1,0	<b>UXT 11</b>
<b>MG ZT</b>									
1.8 16V	1.8	88	01.03-07.05	18 K4F	4	<b>Z 228</b>	14 FR-7 DPUX02	1,0	<b>UXT 11</b>
1.8 T 16V	1.8	118	01.03-07.05	18 K4G	4	<b>Z 228</b>	14 FR-7 DPUX02	1,0	<b>UXT 11</b>
2.0 CDTi	2.0	85	06.02-09.03	204D2	4	<b>GN 024</b> (11V)	○		
2.0 CDTi	2.0	96	11.02-07.05	204D2	4	<b>GN 024</b> (11V)	○		
160	2.5	118	06.01-07.05	25 K4F	6	<b>Z 228</b>	14 FR-7 DPUX02	1,0	<b>UXT 11</b>
180	2.5	130	01.03-07.05	25 K4F	6	<b>Z 228</b>	14 FR-7 DPUX02	1,0	<b>UXT 11</b>
190	2.5	140	06.01-07.05	25 K4F	6	<b>Z 228</b>	14 FR-7 DPUX02	1,0	<b>UXT 11</b>
<b>MG ZT- T</b>									
1.8 16V	1.8	88	01.03-07.05	18 K4F	4	<b>Z 228</b>	14 FR-7 DPUX02	1,0	<b>UXT 11</b>
1.8 T 16V	1.8	118	01.03-07.05	18 K4G	4	<b>Z 228</b>	14 FR-7 DPUX02	1,0	<b>UXT 11</b>
2.0 CDTi	2.0	85	06.02-09.03	204D2	4	<b>GN 024</b> (11V)	○		
2.0 CDTi	2.0	96	11.02-07.05	204D2	4	<b>GN 024</b> (11V)	○		
160	2.5	118	10.01-07.05	25 K4F	6	<b>Z 228</b>	14 FR-7 DPUX02	1,0	<b>UXT 11</b>
190	2.5	140	10.01-07.05	25 K4F	6	<b>Z 228</b>	14 FR-7 DPUX02	1,0	<b>UXT 11</b>
<b>MGF</b>									
1.6	1.6	82	02.00-03.02	16 K4F	4	<b>Z 228</b>	14 FR-7 DPUX02	1,0	<b>UXT 11</b>
1.8 i 16V	1.8	88	03.95-03.02	18 K4F	4	<b>Z 228</b>	14 FR-7 DPUX02	1,0	<b>UXT 11</b>
1.8 i VVC	1.8	107	03.95-03.02	18 K4K	4	<b>Z 228</b>	14 FR-7 DPUX02	1,0	<b>UXT 11</b>
1.8 i VVC	1.8	118	10.01-03.02	18 K4K	4	<b>Z 228</b>	14 FR-7 DPUX02	1,0	<b>UXT 11</b>
<b>MGR V8</b>									
3.9	3.8	140	09.92-12.95		8	<b>Z 20</b>	14 R-7 DU	0,8	<b>UXT 2<sup>4</sup></b>

## MINI

<b>MINI</b>									
Cooper	1.6	85	06.01-09.06	N12B16A	4	<b>Z 237</b>	14 FR-7 DQUP7	1,6	○
Cooper	1.6	88	10.06-09.09	N12B16A	4	<b>Z 233</b>	12 ZR-6 SPO3	1,0	○
Cooper	1.6	88	10.09-	N12B16A	4	<b>Z 336</b>	12 ZR-6 SP2	1,0	○
Cooper	1.6	90	03.10-	N16 B16 A	4	<b>Z 336</b>	12 ZR-6 SP2	1,0	○
Cooper D	1.6	80	03.07-	9HZ (DV6TED4)	4	<b>GN 056</b> (11V)	○		
Cooper D LCI	1.6	82	06.10-	N47 C16 A	4	<b>GE 118</b> (4,4V)	○		
Cooper D LCI	2.0	82	02.11-	N47 C20 A	4	<b>GE 118</b> (4,4V)	○		
Cooper S	1.6	120	03.02-09.06	W11B16A	4	<b>Z 237</b>	14 FR-7 DQUP7	1,6	○
Cooper S	1.6	125	07.04-09.06	W11B16A	4	<b>Z 237</b>	14 FR-7 DQUP7	1,6	○
Cooper S	1.6	128	10.06-07.10	N14 B16 A nicht LCI	4	<b>Z 332</b>	12 ZR-6 SPP2-1	0,7	○
Cooper S	1.6	128	08.10-10.11	N14 B16 A LCI	4	<b>Z 318</b>	12 ZR-6 SPP2	0,7	○
Cooper S	1.6	135	03.10-10.11	N18 B16 A LCI	4	<b>Z 318</b>	12 ZR-6 SPP2	0,7	○
Cooper S	1.6	135	11.11-	N18 B16 A nicht LCI	4	<b>Z 332</b>	12 ZR-6 SPP2-1	0,7	○
Cooper SD LCI	2.0	105	02.11-	N47 C20 A	4	<b>GE 118</b> (4,4V)	○		
One	1.4	55	03.09-09.09	N12B14A	4	<b>Z 233</b>	12 ZR-6 SPO3	1,0	○
One	1.4	55	10.09-	N12B14A	4	<b>Z 336</b>	12 ZR-6 SP2	1,0	○
One	1.4	70	03.07-09.09	N12B14A	4	<b>Z 233</b>	12 ZR-6 SPO3	1,0	○
One	1.4	70	10.09-	N12B14A	4	<b>Z 336</b>	12 ZR-6 SP2	1,0	○
One	1.6	55	03.10-		4	<b>Z 336</b>	12 ZR-6 SP2	1,0	○
One	1.6	66	06.01-09.06	W10B16A	4	<b>Z 237</b>	14 FR-7 DQUP7	1,6	○
One	1.6	72	03.10-		4	<b>Z 336</b>	12 ZR-6 SP2	1,0	○
One D	1.4	55	06.03-09.06	1ND	4	<b>GN 042</b> (11V)	○		
One D	1.4	65	06.03-09.06	1ND-TV	4	<b>GN 042</b> (11V)	○		
One D LCI	1.6	66	07.10-	N47 C16 A	4	<b>GE 118</b> (4,4V)	○		
Works	1.6	155	11.03-09.06	W11B16A	4	<b>Z 237</b>	14 FR-7 DQUP7	1,6	○
<b>MINI Cabriolet</b>									
Cooper	1.6	85	07.04-11.07	W10B16A	4	<b>Z 237</b>	14 FR-7 DQUP7	1,6	○
Cooper	1.6	88	03.09-09.09	N12B16A	4	<b>Z 233</b>	12 ZR-6 SPO3	1,0	○
Cooper	1.6	88	10.09-	N12B16A	4	<b>Z 336</b>	12 ZR-6 SP2	1,0	○

● nicht erforderlich  
○ nicht im Programm

<sup>3</sup> wahlweise UXT 3 Platin

<sup>4</sup> wahlweise UXT 6 Platin



kW

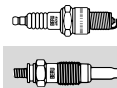
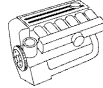

## MINI

### MINI Cabriolet

Cooper	1.6	90	03.10-	N16 B16 A	4	<b>Z 336</b>	12 ZR-6 SP2	1,0	○
Cooper D	2.0	82	02.11-	N47 C20 A	4	<b>GE 118</b> (4,4V)	○		
Cooper D LCI	1.6	82	06.10-	N47 C16 A	4	<b>GE 118</b> (4,4V)	○		
Cooper S	1.6	125	07.04-11.07	W11B16A	4	<b>Z 237</b>	14 FR-7 DQUP7	1,6	○
Cooper S	1.6	128	03.09-10.11	N14 B16 A LCI	4	<b>Z 318</b>	12 ZR-6 SPP2	0,7	○
Cooper S	1.6	128	11.11-	N14 B16 A nicht LCI	4	<b>Z 332</b>	12 ZR-6 SPP2-1	0,7	○
Cooper S	1.6	135	03.10-10.11	N18 B16 A LCI	4	<b>Z 318</b>	12 ZR-6 SPP2	0,7	○
Cooper S	1.6	135	11.11-	N18 B16 A nicht LCI	4	<b>Z 332</b>	12 ZR-6 SPP2-1	0,7	○
Cooper SD	2.0	105	02.11-	N47 C20 A	4	<b>GE 118</b> (4,4V)	○		
John Cooper Works	1.6	155	07.04-11.07	W11B16A	4	<b>Z 237</b>	14 FR-7 DQUP7	1,6	○
One	1.6	66	07.04-11.07	W10B16A	4	<b>Z 237</b>	14 FR-7 DQUP7	1,6	○
One	1.6	72	03.10-		4	<b>Z 336</b>	12 ZR-6 SP2	1,0	○

### MINI CLUBMAN

Cooper	1.6	88	10.07-09.09	N12B16A	4	<b>Z 233</b>	12 ZR-6 SP03	1,0	○
Cooper	1.6	88	10.09-	N12B16A	4	<b>Z 336</b>	12 ZR-6 SP2	1,0	○
Cooper	1.6	90	03.10-	N16 B16 A	4	<b>Z 336</b>	12 ZR-6 SP2	1,0	○
Cooper D	1.6	80	10.07-	9HZ (DV6TED4)	4	<b>GN 056</b> (11V)	○		
Cooper D LCI	1.6	82	03.10-	N47 C16 A	4	<b>GE 118</b> (4,4V)	○		
Cooper D LCI	2.0	82	02.11-	N47 C20 A	4	<b>GE 118</b> (4,4V)	○		
Cooper S	1.6	120	10.07-10.11	N14 B16 A LCI	4	<b>Z 318</b>	12 ZR-6 SPP2	0,7	○
Cooper S	1.6	120	11.11-	N14 B16 A nicht LCI	4	<b>Z 332</b>	12 ZR-6 SPP2-1	0,7	○
Cooper S	1.6	128	10.07-10.11	N14 B16 A LCI	4	<b>Z 318</b>	12 ZR-6 SPP2	0,7	○
Cooper S	1.6	128	11.11-	N14 B16 A nicht LCI	4	<b>Z 332</b>	12 ZR-6 SPP2-1	0,7	○
Cooper S	1.6	135	03.10-10.11	N18 B16 A LCI	4	<b>Z 318</b>	12 ZR-6 SPP2	0,7	○
Cooper S	1.6	135	11.11-	N18 B16 A nicht LCI	4	<b>Z 332</b>	12 ZR-6 SPP2-1	0,7	○
Cooper SD LCI	2.0	105	02.11-	N47 C20 A	4	<b>GE 118</b> (4,4V)	○		
One	1.4	70	03.09-02.10	N12B14A	4	<b>Z 336</b>	12 ZR-6 SP2	1,0	○
One	1.6	72	03.10-		4	<b>Z 336</b>	12 ZR-6 SP2	1,0	○
One D LCI	1.6	66	03.10-	N47 C16 A	4	<b>GE 118</b> (4,4V)	○		

### MINI COUNTRYMAN

Cooper	1.6	90	06.10-	N16 B16 A	4	<b>Z 336</b>	12 ZR-6 SP2	1,0	○
Cooper D	2.0	82	02.11-	N47 C20 A	4	<b>GE 118</b> (4,4V)	○		
Cooper D ALL4	2.0	82	02.11-	N47 C20 A	4	<b>GE 118</b> (4,4V)	○		
Cooper D ALL4 LCI	1.6	82	06.10-	N47 C16 A	4	<b>GE 118</b> (4,4V)	○		
Cooper D LCI	1.6	82	06.10-	N47 C16 A	4	<b>GE 118</b> (4,4V)	○		
Cooper S	1.6	135	06.10-10.11	N18 B16 A LCI	4	<b>Z 318</b>	12 ZR-6 SPP2	0,7	○
Cooper S	1.6	135	11.11-	N18 B16 A nicht LCI	4	<b>Z 332</b>	12 ZR-6 SPP2-1	0,7	○
Cooper S ALL4	1.6	135	06.10-10.11	N18 B16 A LCI	4	<b>Z 318</b>	12 ZR-6 SPP2	0,7	○
Cooper S ALL4	1.6	135	11.11-	N18 B16 A nicht LCI	4	<b>Z 332</b>	12 ZR-6 SPP2-1	0,7	○
Cooper SD	2.0	105	02.11-	N47 C20 A	4	<b>GE 118</b> (4,4V)	○		
Cooper SD ALL4	2.0	105	02.11-	N47 C20 A	4	<b>GE 118</b> (4,4V)	○		
One	1.6	72	06.10-		4	<b>Z 336</b>	12 ZR-6 SP2	1,0	○
One D LCI	1.6	66	06.10-	N47 C16 A	4	<b>GE 118</b> (4,4V)	○		

### MINI Coupe

Cooper	1.6	90	09.11-	N16 B16 A	4	<b>Z 336</b>	12 ZR-6 SP2	1,0	○
Cooper S	1.6	135	09.11-10.11	N18 B16 A LCI	4	<b>Z 318</b>	12 ZR-6 SPP2	0,7	○
Cooper S	1.6	135	11.11-	N18 B16 A nicht LCI	4	<b>Z 332</b>	12 ZR-6 SPP2-1	0,7	○
Cooper SD	2.0	105	09.11-	N47 C20 A	4	<b>GE 118</b> (4,4V)	○		

### MINI Roadster

Cooper SD	2.0	100	02.12-	N47 C20 A	4	<b>GE 118</b> (4,4V)	○		
Cooper SD	2.0	105	02.12-	N47 C20 A	4	<b>GE 118</b> (4,4V)	○		

## MITSUBISHI

### CARISMA

1.6	1.6	66	07.95-06.06	4 G 92	4	<b>Z 16</b>	14 FR-7 DUX	1,1	<b>UXT 1<sup>3</sup></b>
1.6	1.6	70	12.98-06.06	4 G 92	4	<b>Z 16</b>	14 FR-7 DUX	1,1	<b>UXT 1<sup>3</sup></b>
1.6	1.6	73	05.97-06.06	4 G 92	4	<b>Z 16</b>	14 FR-7 DUX	1,1	<b>UXT 1<sup>3</sup></b>
1.6	1.6	76	09.00-06.06	4 G 92	4	<b>Z 16</b>	14 FR-7 DUX	1,1	<b>UXT 1<sup>3</sup></b>
1.8	1.8	85	07.95-06.06	4G93	4	<b>Z 16</b>	14 FR-7 DUX	1,1	<b>UXT 1<sup>3</sup></b>
1.8 GDI	1.8	90	10.00-06.06	4G93 (GDI)	4	<b>Z 279</b>	14 FR-7 LPU02	0,6	○
1.8 16V GDI	1.8	92	09.97-06.06	4G93 (GDI)	4	<b>Z 279</b>	14 FR-7 LPU02	0,6	○

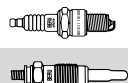

## MITSUBISHI

### CARISMA

1.8 16V	1.8	103	07.95-06.06	4G93	4	<b>Z 16</b>	14 FR-7 DUX	1,1	<b>UXT 1<sup>3</sup></b>
1.9 TD	1.9	66	10.96-09.00	F8QT	4	<b>GN 959</b> (11V)	○		
1.9 DI-D	1.9	75	09.00-06.06	F9Q1	4	<b>GN 018</b> (11V)	○		
1.9 DI-D	1.9	85	09.00-06.06	F9Q2	4	<b>GN 018</b> (11V)	○		

### COLT III

1.3 GL	1.3	44	04.88-12.90	4 G 13	4	<b>Z 20</b>	14 R-7 DU	0,8	<b>UXT 2<sup>4</sup></b>
1.3	1.3	51	04.88-05.92	4 G 13	4	<b>Z 20</b>	14 R-7 DU	0,8	<b>UXT 2<sup>4</sup></b>
1.3 12V	1.3	55	04.88-08.90	4 G 13 (12V)	4	<b>Z 20</b>	14 R-7 DU	0,8	<b>UXT 2<sup>4</sup></b>
1.3 12V	1.3	55	09.90-05.92	4 G 13 (12V)	4	<b>Z 9</b>	14 R-8 DUX	1,1	<b>UXT 2<sup>4</sup></b>
1.5 GLXi	1.5	62	04.88-08.90	4 G 15	4	<b>Z 20</b>	14 R-7 DU	0,8	<b>UXT 2<sup>4</sup></b>
1.5 GLXi	1.5	62	09.90-05.92	4 G 15	4	<b>Z 21</b>	14 R-7 DUX	1,1	<b>UXT 2<sup>4</sup></b>
1.5 KAT	1.5	66	07.90-05.92	4 G 15	4	<b>Z 9</b>	14 R-8 DUX	1,1	<b>UXT 2<sup>4</sup></b>
1.6 GTi 16V	1.6	91	04.88-05.90	4G61	4	<b>Z 20</b>	14 R-7 DU	0,8	<b>UXT 2<sup>4</sup></b>
1.8 Diesel GLX	1.8	44	04.88-05.92	4 D 65	4	<b>GV 673</b> (12V)	○		
1.8 GTi 16V KAT	1.8	100	06.90-05.92	4G67	4	<b>Z 27</b>	14 R-6 DU	0,8	<b>UX 56</b>

### COLT IV

1.3 GLi 12V	1.3	55	04.92-04.96	4 G 13 (BJ92-..., 12V)	4	<b>Z 9</b>	14 R-8 DUX	1,1	<b>UXT 2<sup>4</sup></b>
1.6	1.6	66	02.94-04.96	4 G 92	4	<b>Z 16</b>	14 FR-7 DUX	1,1	<b>UXT 1<sup>3</sup></b>
1.6 GLXi 16V	1.6	83	04.92-04.96	4 G 92	4	<b>Z 16</b>	14 FR-7 DUX	1,1	<b>UXT 1<sup>3</sup></b>
1.8 GTi 16V	1.8	103	04.92-04.96	4G93	4	<b>Z 16</b>	14 FR-7 DUX	1,1	<b>UXT 1<sup>3</sup></b>

### COLT V

1300 GL, GLX	1.3	55	05.96-09.00	4 G 13 (12V)	4	<b>Z 9</b>	14 R-8 DUX	1,1	<b>UXT 2<sup>4</sup></b>
1300	1.3	60	09.00-09.03	4 G 13 (16 V)	4	<b>Z 16</b>	14 FR-7 DUX	1,1	<b>UXT 1<sup>3</sup></b>
1500	1.5	69	11.95-09.03	4 G 15 (16V)	4	<b>Z 9</b>	14 R-8 DUX	1,1	<b>UXT 2<sup>4</sup></b>
1600 GLX	1.6	66	05.96-09.00	4 G 92	4	<b>Z 16</b>	14 FR-7 DUX	1,1	<b>UXT 1<sup>3</sup></b>
1600	1.6	76	09.00-09.03	4 G 92	4	<b>Z 16</b>	14 FR-7 DUX	1,1	<b>UXT 1<sup>3</sup></b>

### COLT VI

1.1	1.1	55	10.04-	3A91	3	<b>Z 273</b>	14 FR-7 NUX2	1,1	○
1.3	1.3	70	06.04-	4A90	4	<b>Z 273</b>	14 FR-7 NUX2	1,1	○
1.5 DI-D	1.5	50	08.04-	OM 639	3	<b>GN 058</b> (11V)	○		
1.5 DI-D	1.5	70	08.04-	OM639	3	<b>GN 058</b> (11V)	○		
1.5	1.5	80	06.04-	4A91	4	<b>Z 235</b>	14 FR-7 SPUX03	1,0	○

### ECLIPSE I

2.0 i 16V	2.0	110	04.91-11.95	4 G 63 (DOHC 16V)	4	<b>Z 27</b>	14 R-6 DU	0,8	<b>UX 56</b>
2.0 i 16V 4x4	2.0	110	04.91-11.95	4 G 63 (DOHC 16V)	4	<b>Z 27</b>	14 R-6 DU	0,8	<b>UX 56</b>

### ECLIPSE II

2000 GS 16V	2.0	107	12.95-04.99	4 G 63 (DOHC 16V)	4	<b>Z 21</b>	14 R-7 DUX	1,1	<b>UXT 2<sup>4</sup></b>
2000 GT 16V	2.0	157	12.95-04.99		4	<b>Z 8</b>	14 R-8 DU	0,8	<b>UXT 2<sup>4</sup></b>
2400 GS 16V	2.4	105	09.98-04.99		4	<b>Z 73</b>	14 FR-8 DUX	1,1	<b>UXT 1<sup>3</sup></b>

### GALANT IV

1.8	1.8	63	11.87-08.90	4G37	4	<b>Z 20</b>	14 R-7 DU	0,8	<b>UXT 2<sup>4</sup></b>
1.8	1.8	66	11.87-10.92	4G37	4	<b>Z 9</b>	14 R-8 DUX	1,1	<b>UXT 2<sup>4</sup></b>
2.0	2.0	80	11.87-10.92	4G63 (SOHC 8V)	4	<b>Z 9</b>	14 R-8 DUX	1,1	<b>UXT 2<sup>4</sup></b>
2.0 4x4	2.0	80	12.88-10.92	4G63 (SOHC 8V)	4	<b>Z 9</b>	14 R-8 DUX	1,1	<b>UXT 2<sup>4</sup></b>
2.0 GTi 16V	2.0	106	11.87-10.92	4 G 63 (DOHC 16V)	4	<b>Z 9</b>	14 R-8 DUX	1,1	<b>UXT 2<sup>4</sup></b>
2.0 GTi 16V 4x4	2.0	106	06.88-10.92	4 G 63 (DOHC 16V)	4	<b>Z 9</b>	14 R-8 DUX	1,1	<b>UXT 2<sup>4</sup></b>
2.0 GTi 16V	2.0	107	11.88-10.92	4 G 63 (DOHC 16V)	4	<b>Z 20</b>	14 R-7 DU	0,8	<b>UXT 2<sup>4</sup></b>
2.0 GTi 16V 4x4 KAT	2.0	110	09.91-10.92	4 G 63 (DOHC 16V)	4	<b>Z 20</b>	14 R-7 DU	0,8	<b>UXT 2<sup>4</sup></b>

### GALANT V

1.8	1.8	85	02.94-08.96	4G93	4	<b>Z 16</b>	14 FR-7 DUX	1,1	<b>UXT 1<sup>3</sup></b>
1.8 GLSi	1.8	93	11.92-08.96	4G93 (GDI)	4	<b>Z 16</b>	14 FR-7 DUX	1,1	<b>UXT 1<sup>3</sup></b>
2.0 GLSTD	2.0	66	12.93-08.96	4 D 68 T	4	<b>GN 107</b> (11V)	○		
2.0 GLSi	2.0	101	11.92-08.96	4G63 (SOHC 8V)	4	<b>Z 16</b>	14 FR-7 DUX	1,1	<b>UXT 1<sup>3</sup></b>
2.0 GLSi 4x4	2.0	101	11.92-08.96	4G63 (SOHC 8V)	4	<b>Z 16</b>	14 FR-7 DUX	1,1	<b>UXT 1<sup>3</sup></b>
2.5 V6-24 4x4	2.5	125	11.92-08.96	6G73	6	<b>Z 130</b>	14 FR-5 DPUX	1,0	○

### GALANT VI

2.0 TDI	2.0	66	09.96-02.00	4D68 SOHC	4	<b>GN 107</b> (11V)	○		
2.0	2.0	98	09.00-10.04	4G63 (SOHC 16V)	4	<b>Z 16</b>	14 FR-7 DUX	1,1	<b>UXT 1<sup>3</sup></b>
2.0	2.0	100	09.96-09.00	4G63 (SOHC 16V)	4	<b>Z 16</b>	14 FR-7 DUX	1,1	<b>UXT 1<sup>3</sup></b>
2.4 GDI	2.4	106	09.00-10.04	4G64 (GDI)	4	<b>Z 278</b>	14 FR-8 LPU02	0,6	○
2.4 GDI	2.4	110	02.99-09.00	4G64 (GDI)	4	<b>Z 278</b>	14 FR-8 LPU02	0,6	○



kW

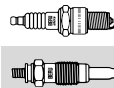
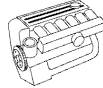

**MITSUBISHI**

**GALANT VI**

2.5 V6 24V	2.5	118	09.00-10.04	6A13	6	<b>Z 284</b>	14 FR-6 DPOX	1,1	<b>UXT 14</b>
2.5 V6 24V	2.5	120	09.96-09.00	6A13	6	<b>Z 284</b>	14 FR-6 DPOX	1,1	<b>UXT 14</b>
2.8 TD	2.8	92	10.96-07.01	4M40-T	4	<b>GN 067</b> (11V)	○		

**GALLOPER**

2.5 TD	2.5	65	02.99-12.06	D4BF	4	<b>GN 107</b> (11V)	○		
2.5 TD intercooler	2.5	73	02.99-12.01	D4BH	4	<b>GN 107</b> (11V)	○		
3.0 V6	3.0	104	02.99-12.06	G6AT	6	<b>Z 9</b>	14 R-8 DUX	1,1	<b>UXT 2<sup>4</sup></b>

**GRANDIS**

2.0 DI-D	2.0	100	09.05-	BSY	4	<b>GE 101</b> (4,4V)	○		
----------	-----	-----	--------	-----	---	----------------------	---	--	--

**LANCER**

1.3	1.3	60	09.03-	4 G 13 (16 V)	4	<b>Z 16</b>	14 FR-7 DUX	1,1	<b>UXT 1<sup>3</sup></b>
1.6	1.6	72	09.03-	4G18	4	<b>Z 16</b>	14 FR-7 DUX	1,1	<b>UXT 1<sup>3</sup></b>

**LANCER III**

1.8 4x4	1.8	69	08.90-06.92	4G37	4	<b>Z 9</b>	14 R-8 DUX	1,1	<b>UXT 2<sup>4</sup></b>
---------	-----	----	-------------	------	---	------------	------------	-----	--------------------------

**LANCER IV**

1.3	1.3	44	04.88-05.92	4 G 13	4	<b>Z 20</b>	14 R-7 DU	0,8	<b>UXT 2<sup>4</sup></b>
1.3	1.3	51	08.88-05.92	G13B	4	<b>Z 20</b>	14 R-7 DU	0,8	<b>UXT 2<sup>4</sup></b>
1.3 12V	1.3	55	07.90-06.92	4 G 13 (12V)	4	<b>Z 20</b>	14 R-7 DU	0,8	<b>UXT 2<sup>4</sup></b>
1.3 12V	1.3	55	06.92-05.94	4 G 13 (12V)	4	<b>Z 21</b>	14 R-7 DUX	1,1	<b>UXT 2<sup>4</sup></b>
1.5	1.5	62	04.88-08.90	4 G 15	4	<b>Z 20</b>	14 R-7 DU	0,8	<b>UXT 2<sup>4</sup></b>
1.5	1.5	62	09.90-05.92	4 G 15	4	<b>Z 9</b>	14 R-8 DUX	1,1	<b>UXT 2<sup>4</sup></b>
1.5 12V	1.5	66	05.89-08.90	4G15 (12V)	4	<b>Z 20</b>	14 R-7 DU	0,8	<b>UXT 2<sup>4</sup></b>
1.5 12V	1.5	66	09.90-05.92	4G15 (12V)	4	<b>Z 9</b>	14 R-8 DUX	1,1	<b>UXT 2<sup>4</sup></b>
1.6 16V	1.6	83	06.92-05.94	4 G 92 Fgst.Nr. 500001 →	4	<b>Z 16</b>	14 FR-7 DUX	1,1	<b>UXT 1<sup>3</sup></b>
1.8 4x4	1.8	71	09.89-06.92	4G37	4	<b>Z 9</b>	14 R-8 DUX	1,1	<b>UXT 2<sup>4</sup></b>
1.8 GTi 16V	1.8	100	11.89-05.92	4G67	4	<b>Z 20</b>	14 R-7 DU	0,8	<b>UXT 2<sup>4</sup></b>
1.8 GTi 16V	1.8	103	06.92-12.93	4G93	4	<b>Z 16</b>	14 FR-7 DUX	1,1	<b>UXT 1<sup>3</sup></b>

**LANCER V**

1.3	1.3	55	06.92-	4 G 13 (BJ92-..., 12V)	4	<b>Z 9</b>	14 R-8 DUX	1,1	<b>UXT 2<sup>4</sup></b>
1.6	1.6	66	02.94-	4 G 92	4	<b>Z 73</b>	14 FR-8 DUX	1,1	<b>UXT 1<sup>3</sup></b>
1.6 16V	1.6	83	06.92-10.03	4 G 92	4	<b>Z 16</b>	14 FR-7 DUX	1,1	<b>UXT 1<sup>3</sup></b>
1.6 16V 4WD	1.6	83	06.92-10.03	4 G 92	4	<b>Z 16</b>	14 FR-7 DUX	1,1	<b>UXT 1<sup>3</sup></b>
1.8 16V	1.8	103	06.92-12.93	4G93	4	<b>Z 16</b>	14 FR-7 DUX	1,1	<b>UXT 1<sup>3</sup></b>
2.0 D	2.0	50	12.93-04.96	4 D 68	4	<b>GN 107</b> (11V)	○		
2.0 D	2.0	50	12.93-05.96	4 D 68	4	<b>GN 107</b> (11V)	○		

**LANCER VI**

1.3 12V	1.3	55	12.95-08.03	4 G 13 (12V)	4	<b>Z 9</b>	14 R-8 DUX	1,1	<b>UXT 2<sup>4</sup></b>
1.5 16V	1.5	69	12.95-09.00	4 G 15 (16V)	4	<b>Z 9</b>	14 R-8 DUX	1,1	<b>UXT 2<sup>4</sup></b>
1.6 16V	1.6	66	12.95-08.03	4 G 92	4	<b>Z 73</b>	14 FR-8 DUX	1,1	<b>UXT 1<sup>3</sup></b>

**OUTLANDER II**

2.0 DI-D	2.0	103	02.07-	BSY	4	<b>GE 101</b> (4,4V)	○		
----------	-----	-----	--------	-----	---	----------------------	---	--	--

**PAJERO CLASSIC**

3.2 DI-D	3.2	118	05.05-	4M41	4	<b>GN 070</b> (11V)	○		
----------	-----	-----	--------	------	---	---------------------	---	--	--

**PAJERO I**

2.5 TD ohne Schnellstart	2.5	64	01.90-11.90	4 D 56 T	4	<b>GV 673</b> (12V)	○		
2.5 TD ohne Schnellstart	2.5	70	11.89-11.90	4 D 56 T	4	<b>GV 673</b> (12V)	○		
3.0 V6	3.0	104	11.88-11.90	6G72	6	<b>Z 9</b>	14 R-8 DUX	1,1	<b>UXT 2<sup>4</sup></b>

**PAJERO I Canvas Top**

2.5 TD ohne Schnellstart	2.5	70	11.89-11.90	4 D 56 T	4	<b>GV 673</b> (12V)	○		
2.6	2.6	76	09.84-11.90	4G54	4	<b>Z 8</b>	14 R-8 DU	0,8	<b>UXT 2<sup>4</sup></b>

**PAJERO II**

2.4	2.4	82	04.91-04.00	4G64 (12V)	4	<b>Z 9</b>	14 R-8 DUX	1,1	<b>UXT 2<sup>4</sup></b>
2.5 TD 4x4 ohne Schnellstart	2.5	73	12.90-10.93	4 D 56 TD	4	<b>GV 673</b> (12V)	○		
2.5 TD 4x4	2.5	73	11.93-01.98	4 D 56 TD	4	<b>GN 107</b> (11V)	○		
2.8 TD	2.8	92	06.97-04.00	4M40-T	4	<b>GN 067</b> (11V)	○		
3.0 V6 4x4	3.0	110	12.90-12.95	6G72 /6G72 (SOHC 12V)	6	<b>Z 9</b>	14 R-8 DUX	1,1	<b>UXT 2<sup>4</sup></b>
3.0 V6 24V	3.0	133	06.94-05.97	6G72 (SOHC 24V)	6	<b>Z 9</b>	14 R-8 DUX	1,1	<b>UXT 2<sup>4</sup></b>

**PAJERO II Canvas Top**

2.4	2.4	82	04.91-04.00	4G64 (12V)	4	<b>Z 9</b>	14 R-8 DUX	1,1	<b>UXT 2<sup>4</sup></b>
2.5 TD ohne Schnellstart	2.5	73	12.90-10.93	4 D 56 TD	4	<b>GV 673</b> (12V)	○		
2.5 TD	2.5	73	11.93-01.98	4 D 56 TD	4	<b>GN 107</b> (11V)	○		

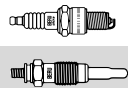
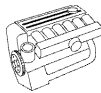

## MITSUBISHI

### PAJERO II Canvas Top

3.0 V6	3.0	110	12.90-12.95	6G72	6	<b>Z 9</b>	14 R-8 DUX	1,1	<b>UXT 2<sup>4</sup></b>
3.0 V6 24V	3.0	133	06.94-04.00	6G72 (SOHC 24V)	6	<b>Z 9</b>	14 R-8 DUX	1,1	<b>UXT 2<sup>4</sup></b>

### PAJERO III

2.5 TDi	2.5	73	04.00-	4 D 56 T	4	<b>GN 107</b> (11V)	○		
2.5 TDi	2.5	85	09.01-	4 D 56 T	4	<b>GN 107</b> (11V)	○		
3.2 DI-D	3.2	118	10.01-	4M41	4	<b>GN 070</b> (11V)	○		
3.2 DI-D	3.2	121	04.00-10.01	4M41	4	<b>GN 070</b> (11V)	○		

### PAJERO IV

3.2 DI-D	3.2	118	02.07-	4M41	4	<b>GN 070</b> (11V)	○		
3.2 DI-D	3.2	125	02.07-	4M41	4	<b>GN 070</b> (11V)	○		
3.2 TD 4x4	3.2	147	01.09-	4M41	4	<b>GN 070</b> (11V)	○		

### PAJERO PININ

1.8	1.8	84	11.01-06.07	4G93	4	<b>Z 279</b>	14 FR-7 LPU02	0,6	○
1.8 GDI	1.8	88	10.99-06.07	4G93 (GDI)	4	<b>Z 279</b>	14 FR-7 LPU02	0,6	○
2.0 GDI	2.0	95	10.00-06.07	4G94 (GDI)	4	<b>Z 278</b>	14 FR-8 LPU02	0,6	○

### PAJERO SPORT

2.8 TDi	2.8	92	11.98-10.03	4M40-T	4	<b>GN 067</b> (11V)	○		
3.0 V6	3.0	125	06.00-	6G72 (SOHC 24V)	6	<b>Z 228</b>	14 FR-7 DPUX02	1,0	<b>UXT 11</b>
3.0 V6	3.0	130	11.98-	6G72 (SOHC 24V)	6	<b>Z 228</b>	14 FR-7 DPUX02	1,0	<b>UXT 11</b>

### SAPPORO III

2.4 (E16A)	2.4	91	06.87-08.90	4G64 (8V)	4	<b>Z 28</b>	14 R-6 DUX	1,1	<b>UX 56</b>
------------	-----	----	-------------	-----------	---	-------------	------------	-----	--------------

### SIGMA

3.0 V6	3.0	125	01.93-07.96	6G72 SOHC	6	<b>Z 21</b>	14 R-7 DUX	1,1	<b>UXT 2<sup>4</sup></b>
3.0 V6	3.0	130	12.90-07.96	6G72	6	<b>Z 9</b>	14 R-8 DUX	1,1	<b>UXT 2<sup>4</sup></b>

### SPACE GEAR

2.0 16V	2.0	83	08.96-05.00	4 G 63 (DOHC 16V)	4	<b>Z 73</b>	14 FR-8 DUX	1,1	<b>UXT 1<sup>3</sup></b>
2.4 i	2.4	97	05.95-05.00	4G64 (SOHC 16V)	4	<b>Z 73</b>	14 FR-8 DUX	1,1	<b>UXT 1<sup>3</sup></b>
2.5 TD	2.5	64	05.95-05.00	4 D 56 T	4	<b>GN 107</b> (11V)	○		

### SPACE RUNNER

1.8	1.8	85	06.96-08.99	4G93	4	<b>Z 16</b>	14 FR-7 DUX	1,1	<b>UXT 1<sup>3</sup></b>
1.8 4x4	1.8	85	06.96-08.99	4G93	4	<b>Z 16</b>	14 FR-7 DUX	1,1	<b>UXT 1<sup>3</sup></b>
1.8	1.8	90	10.91-08.99	4G93	4	<b>Z 16</b>	14 FR-7 DUX	1,1	<b>UXT 1<sup>3</sup></b>
1.8 4x4	1.8	90	10.91-08.99	4G93	4	<b>Z 16</b>	14 FR-7 DUX	1,1	<b>UXT 1<sup>3</sup></b>
2.0 TD	2.0	60	06.93-08.99	4 D 68 T	4	<b>GN 107</b> (11V)	○		
2.0 16V	2.0	98	06.97-08.99	4 G 63 (DOHC 16V)	4	<b>Z 16</b>	14 FR-7 DUX	1,1	<b>UXT 1<sup>3</sup></b>
2.0	2.0	100	08.99-08.02	4 G 63 (DOHC 16V)	4	<b>Z 16</b>	14 FR-7 DUX	1,1	<b>UXT 1<sup>3</sup></b>
2.4 GDI	2.4	110	08.99-08.02	4G64 (GDI)	4	<b>Z 278</b>	14 FR-8 LPU02	0,6	○

### SPACE STAR

1.3 16V	1.3	60	09.00-12.04	4 G 13 (16 V)	4	<b>Z 73</b>	14 FR-8 DUX	1,1	<b>UXT 1<sup>3</sup></b>
1.3 16V	1.3	61	12.98-12.04	4 G 13 (16 V)	4	<b>Z 73</b>	14 FR-8 DUX	1,1	<b>UXT 1<sup>3</sup></b>
1.3 16V	1.3	63	06.98-12.04	4 G 13 (16 V)	4	<b>Z 73</b>	14 FR-8 DUX	1,1	<b>UXT 1<sup>3</sup></b>
1.6 16V	1.6	72	01.01-12.04	4G18	4	<b>Z 16</b>	14 FR-7 DUX	1,1	<b>UXT 1<sup>3</sup></b>
1.8 MPI	1.8	82	10.02-12.04	4G93	4	<b>Z 279</b>	14 FR-7 LPU02	0,6	○
1.8 GDI	1.8	87	06.98-12.04	4G93 (GDI)	4	<b>Z 279</b>	14 FR-7 LPU02	0,6	○
1.8 GDI	1.8	90	06.98-12.04	4G93 (GDI)	4	<b>Z 279</b>	14 FR-7 LPU02	0,6	○
1.9 DI-D	1.9	75	02.01-12.04	F9Q1	4	<b>GN 018</b> (11V)	○		
1.9 DI-D	1.9	85	10.02-12.04	F9Q2	4	<b>GN 018</b> (11V)	○		

### SPACE WAGON

1.8	1.8	90	10.91-10.98	4G93	4	<b>Z 16</b>	14 FR-7 DUX	1,1	<b>UXT 1<sup>3</sup></b>
1.8 4x4	1.8	90	10.91-10.98	4G93	4	<b>Z 16</b>	14 FR-7 DUX	1,1	<b>UXT 1<sup>3</sup></b>
2.0 TD	2.0	60	06.93-10.98	4D68 T	4	<b>GN 107</b> (11V)	○		
2.0 GLXi	2.0	74	06.88-04.91	4G63 (SOHC 8V)	4	<b>Z 28</b>	14 R-6 DUX	1,1	<b>UX 56</b>
2.0 GLXi 4x4	2.0	74	06.88-04.91	4G63 (SOHC 8V)	4	<b>Z 28</b>	14 R-6 DUX	1,1	<b>UX 56</b>
2.0 4x4	2.0	75	06.88-04.91	4G63 (SOHC 8V)	4	<b>Z 28</b>	14 R-6 DUX	1,1	<b>UX 56</b>
2.0	2.0	98	10.92-10.98	4 G 63 (DOHC 16V)	4	<b>Z 16</b>	14 FR-7 DUX	1,1	<b>UXT 1<sup>3</sup></b>
2.0 4x4	2.0	98	10.92-10.98	4 G 63 (DOHC 16V)	4	<b>Z 16</b>	14 FR-7 DUX	1,1	<b>UXT 1<sup>3</sup></b>
2.4 i	2.4	102	10.92-12.94	4G64 (SOHC 16V)	4	<b>Z 16</b>	14 FR-7 DUX	1,1	<b>UXT 1<sup>3</sup></b>
2.4 GDI	2.4	108	09.00-12.04	4G64 (GDI)	4	<b>Z 278</b>	14 FR-8 LPU02	0,6	○
2.4 GDI 4x4	2.4	108	09.00-12.04	4G64 (GDI)	4	<b>Z 278</b>	14 FR-8 LPU02	0,6	○
2.4 GDI	2.4	110	10.98-12.04	4G64 (GDI)	4	<b>Z 278</b>	14 FR-8 LPU02	0,6	○
2.4 GDI 4x4	2.4	110	10.98-12.04	4G64 (GDI)	4	<b>Z 278</b>	14 FR-8 LPU02	0,6	○

● nicht erforderlich  
○ nicht im Programm

<sup>3</sup> wahlweise UXT 3 Platin

<sup>4</sup> wahlweise UXT 6 Platin

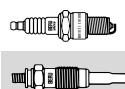
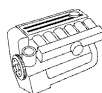

### MITSUBISHI

#### STARION

2.6 Turbo ECi	2.6	114	09.87-06.90	G 54 B T/C	4	<b>Z 9</b>	14 R-8 DUX	1,1	<b>UXT 2<sup>4</sup></b>
---------------	-----	-----	-------------	------------	---	------------	------------	-----	--------------------------



#### CANTER

2.8 TDiC	2.8	92	06.94-08.96	4M40-T	4	<b>GN 067</b> (11V)	○		
3.0 TDi	3.0	92	08.01-07.05	4M42-OAT	4	<b>GN 070</b> (11V)	○		

#### L 200

2.0	2.0	69	01.87-12.90	4G63 (SOHC 8V)	4	<b>Z 20</b>	14 R-7 DU	0,8	<b>UXT 2<sup>4</sup></b>
2.0	2.0	90	06.96-	4G63 (SOHC 8V)	4	<b>Z 20</b>	14 R-7 DU	0,8	<b>UXT 2<sup>4</sup></b>
2.4 4x4	2.4	97	06.96-	4G64 (SOHC 16V)	4	<b>Z 21</b>	14 R-7 DUX	1,1	<b>UXT 2<sup>4</sup></b>
2.5 D	2.5	51	11.86-10.93	4 D 56 (8V)	4	<b>GV 673</b> (12V)	○		
2.5 D	2.5	51	11.93-05.96	4 D 56 (8V)	4	<b>GN 107</b> (11V)	○		
2.5 D 4WD	2.5	51	12.87-05.93	4 D 56 (8V)	4	<b>GV 673</b> (12V)	○		
2.5 D	2.5	55	06.96-	4 D 56 (8V)	4	<b>GN 107</b> (11V)	○		
2.5 TD 4WD	2.5	64	11.92-10.93	4 D 56 T	4	<b>GV 673</b> (12V)	○		
2.5 TD 4WD	2.5	64	11.93-08.96	4 D 56 T	4	<b>GN 107</b> (11V)	○		
2.5 TD 4x4	2.5	73	06.96-	4 D 56 TD	4	<b>GN 107</b> (11V)	○		
2.5 TD 4x4	2.5	74	11.01-	4 D 56 T	4	<b>GN 107</b> (11V)	○		
2.5 TD 4WD	2.5	85	09.01-	4 D 56 T	4	<b>GN 107</b> (11V)	○		
2.6 4WD	2.6	76	11.89-05.95	G54B	4	<b>Z 21</b>	14 R-7 DUX	1,1	<b>UXT 2<sup>4</sup></b>
2.8 TD 4x4	2.8	92	04.03-06.06	4M40-T	4	<b>GN 067</b> (11V)	○		

#### L 300

1.6	1.6	51	04.83-04.94	4G32	4	<b>Z 8</b>	14 R-8 DU	0,8	<b>UXT 2<sup>4</sup></b>
2.0	2.0	64	11.86-	G63B	4	<b>Z 9</b>	14 R-8 DUX	1,1	<b>UXT 2<sup>4</sup></b>
2.0 4WD	2.0	65	12.86-	4G63 (SOHC 8V)	4	<b>Z 20</b>	14 R-7 DU	0,8	<b>UXT 2<sup>4</sup></b>
2.0	2.0	66	12.88-	4G63 (SOHC 8V)	4	<b>Z 20</b>	14 R-7 DU	0,8	<b>UXT 2<sup>4</sup></b>
2.0 4WD	2.0	66	11.86-	4G63 (SOHC 8V)	4	<b>Z 20</b>	14 R-7 DU	0,8	<b>UXT 2<sup>4</sup></b>
2.0 i	2.0	83	07.96-	4 G 63 (DOHC 16V)	4	<b>Z 73</b>	14 FR-8 DUX	1,1	<b>UXT 1<sup>3</sup></b>
2.0	2.0	85	07.94-04.00	4 G 63 (DOHC 16V)	4	<b>Z 16</b>	14 FR-7 DUX	1,1	<b>UXT 1<sup>3</sup></b>
2.4 4WD	2.4	80	11.86-12.90	G64B	4	<b>Z 9</b>	14 R-8 DUX	1,1	<b>UXT 2<sup>4</sup></b>
2.4	2.4	82	11.90-	4G64 (12V)	4	<b>Z 21</b>	14 R-7 DUX	1,1	<b>UXT 2<sup>4</sup></b>
2.4 4WD	2.4	82	11.90-	4G64 (12V)	4	<b>Z 9</b>	14 R-8 DUX	1,1	<b>UXT 2<sup>4</sup></b>
2.5 D	2.5	51	11.86-12.92	4 D 56 (8V) ohne Schnellstartanlage <sup>305</sup>	4	<b>GV 673</b> (12V)	○		
2.5 D	2.5	51	01.93-04.94	4 D 56 (8V) ohne Schnellstartanlage <sup>305</sup>	4	<b>GV 921</b> (11V)	○		
2.5 D	2.5	51	05.94-	4 D 56 (8V) ohne Schnellstartanlage <sup>305</sup>	4	<b>GN 107</b> (11V)	○		
2.5 D	2.5	51	06.93-12.00	4 D 56 (8V)	4	<b>GN 107</b> (11V)	○		
2.5 TD 4WD	2.5	64	11.88-12.92	4 D 56 T ohne Schnellstartanlage <sup>305</sup>	4	<b>GV 673</b> (12V)	○		
2.5 TD 4WD	2.5	64	01.93-04.94	4 D 56 T ohne Schnellstartanlage <sup>305</sup>	4	<b>GV 921</b> (11V)	○		
2.5 TD	2.5	64	11.94-04.00	4 D 56 T	4	<b>GN 107</b> (11V)	○		

#### L 400

2.0 16V	2.0	85	05.95-05.00	4 G 63 (DOHC 16V)	4	<b>Z 73</b>	14 FR-8 DUX	1,1	<b>UXT 1<sup>3</sup></b>
2.4 i 4x4	2.4	97	05.95-05.00	4G64 (SOHC 16V)	4	<b>Z 73</b>	14 FR-8 DUX	1,1	<b>UXT 1<sup>3</sup></b>
2500 TD	2.5	64	05.95-06.05	4 D 56 T	4	<b>GN 107</b> (11V)	○		
2500 TD 4x4	2.5	64	09.96-06.05	4 D 56 T	4	<b>GN 107</b> (11V)	○		
2.5 TD	2.5	73	05.95-05.00	4 D 56 TD	4	<b>GN 107</b> (11V)	○		
2.5 TD 4x4	2.5	73	05.95-05.00	4 D 56 TD	4	<b>GN 107</b> (11V)	○		

### MORGAN

#### AERO 8

4.4	4.4	210	10.00-	M62448S2	8	<b>Z 237</b>	14 FR-7 DQUP7	1,6	○
-----	-----	-----	--------	----------	---	--------------	---------------	-----	---

#### FOUR FOUR

1.8 i	1.8	92	01.93-08.03		4	<b>Z 177</b>	14 KR-8 MUV	1,3	<b>UXT 7</b>
-------	-----	----	-------------	--	---	--------------	-------------	-----	--------------

### MOSKVICH

#### 403

E 1.4	1.4	33	03.62-		4	<b>Z 57</b>	14-7 AU	0,6	○
-------	-----	----	--------	--	---	-------------	---------	-----	---





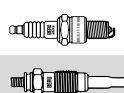
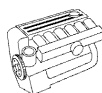

kW

**NISSAN****ALMERA TINO**

1.8	1.8	84	08.00–12.02	QG18DE	4	<b>Z 73</b>	14 FR-8 DUX	1,1	<b>UXT 1<sup>3</sup></b>
1.8	1.8	84	01.03–	QG18DE	4	<b>Z 303</b>	14 FR-7 MUX2	1,1	<b>UXT 13</b>
1.8	1.8	85	12.02–	QG18DE	4	<b>Z 303</b>	14 FR-7 MUX2	1,1	<b>UXT 13</b>
2.0	2.0	100	08.00–	SR20DE	4	<b>Z 221</b>	14 FR-6 DPUX02	1,0	<b>UXT 14</b>
2.2 dCi	2.2	82	09.03–	YD22DDT	4	<b>GN 109</b> (11V)	○		
2.2 Di	2.2	84	08.00–	YD22DDTi	4	<b>GN 109</b> (11V)	○		
2.2 dCi	2.2	100	09.03–	YD22DDTi	4	<b>GN 109</b> (11V)	○		

**AVENIR**

2.0 TD	2.0	66	11.92–10.97	CD20T	4	<b>GN 102</b> (11V)	○		
2.0 TD	2.0	66	11.97–09.99	CD20T	4	<b>GN 102</b> (11V)	○		

**BLUEBIRD**

1.6	1.6	61	03.86–06.90	CA16S	4	<b>Z 247</b>	14 FR-7 DUW	0,9	<b>UXT 1<sup>3</sup></b>
1.8 i 16V	1.8	95	02.89–12.90	CA18D	4	<b>Z 284</b>	14 FR-6 DPOX	1,1	<b>UXT 14</b>
2.0 D	2.0	49	03.86–04.90	LD20	4	<b>GN 101</b> (11V)	○		
2.0 D	2.0	49	03.86–12.90	LD20	4	<b>GV 888</b> (6,5V)	○		
2.0	2.0	75	04.86–09.90	CA20S	4	<b>Z 247</b>	14 FR-7 DUW	0,9	<b>UXT 1<sup>3</sup></b>
2.0 i	2.0	77	04.84–12.90	CA20E	4	<b>Z 73</b>	14 FR-8 DUX <sup>10</sup>	1,1	○
						<b>Z 16</b>	14 FR-7 DUX <sup>11</sup>	1,1	○
2.0 i	2.0	85	09.88–09.90	CA20E	4	<b>Z 16</b>	14 FR-7 DUX	1,1	<b>UXT 1<sup>3</sup></b>
2.0	2.0	98	09.05–	MR20DE	4	<b>Z 325</b>	12 VR-7 SPUX	1,1	○
2.0 i Turbo AWD	2.0	155	09.91–01.96	SR20DET	4	<b>Z 314</b>	14 FR-6 DPUX2	0,9	○

**CUBE**

1.4	1.4	72	01.03–09.05	CR14DE	4	<b>Z 302</b>	14 FR-8 MPUX2	1,1	<b>UXT 13</b>
1.4 4x4	1.4	72	01.03–09.05	CR14DE	4	<b>Z 302</b>	14 FR-8 MPUX2	1,1	<b>UXT 13</b>
1.6 16V	1.6	81	03.10–	HR 16 DE	4	<b>Z 325</b>	12 VR-7 SPUX	1,1	○

**ELGRAND**

3.0 D	3.0	113	04.03–12.10	ZD30	4	<b>GN 072</b> (11V)	○		
3.0 AWD	3.0	113	08.99–08.00	ZD30DDTi	4	<b>GN 072</b> (11V)	○		

**JUKE**

1.6	1.6	86	06.10–	HR 16 DE	4	<b>Z 325</b>	12 VR-7 SPUX	1,1	○
-----	-----	----	--------	----------	---	--------------	--------------	-----	---

**LATIO**

1.6	1.6	81	03.07–	HR 16 DE	4	<b>Z 325</b>	12 VR-7 SPUX	1,1	○
-----	-----	----	--------	----------	---	--------------	--------------	-----	---

**LIVINA /GRAND LIVINA**

1.6	1.6	80	02.07–	HR 16 DE	4	<b>Z 325</b>	12 VR-7 SPUX	1,1	○
-----	-----	----	--------	----------	---	--------------	--------------	-----	---

**LUCINO**

2.0	2.0	162	10.91–10.95	SR20DET	4	<b>Z 314</b>	14 FR-6 DPUX2	0,9	○
-----	-----	-----	-------------	---------	---	--------------	---------------	-----	---

**MAXIMA II**

3.0 i	3.0	125	10.88–06.94	VG30E	6	<b>Z 16</b>	14 FR-7 DUX	1,1	<b>UXT 1<sup>3</sup></b>
-------	-----	-----	-------------	-------	---	-------------	-------------	-----	--------------------------

**MAXIMA QX II**

2.0 V6 24V	2.0	103	03.00–	VQ20DE	6	<b>Z 284</b>	14 FR-6 DPOX	1,1	<b>UXT 14</b>
2.5 V6 24V	2.5	154	03.00–	VQ25DE	6	<b>Z 284</b>	14 FR-6 DPOX	1,1	<b>UXT 14</b>
3.0 V6 24V	3.0	147	03.00–	VQ30DE	6	<b>Z 284</b>	14 FR-6 DPOX	1,1	<b>UXT 14</b>

**MAXIMA QX III**

2.0	2.0	103	02.95–08.00	VQ20DE	6	<b>Z 284</b>	14 FR-6 DPOX	1,1	<b>UXT 14</b>
2.5 V6 24V	2.5	140	02.95–08.00	VQ25DE	6	<b>Z 284</b>	14 FR-6 DPOX	1,1	<b>UXT 14</b>
3.0	3.0	142	01.95–08.00	VQ30DE	6	<b>Z 284</b>	14 FR-6 DPOX	1,1	<b>UXT 14</b>

**MAXIMA Station Wagon**

2.0 QX	2.0	103	10.97–	VQ20DE	6	<b>Z 284</b>	14 FR-6 DPOX	1,1	<b>UXT 14</b>
2.5 V6 24V	2.5	140	10.97–	VQ25DE	6	<b>Z 284</b>	14 FR-6 DPOX	1,1	<b>UXT 14</b>
3.0 QX	3.0	142	10.97–	VQ30DE	6	<b>Z 284</b>	14 FR-6 DPOX	1,1	<b>UXT 14</b>

**MICRA C+C**

1.4 16V	1.4	65	08.05–	CR14DE	4	<b>Z 302</b>	14 FR-8 MPUX2	1,1	<b>UXT 13</b>
1.6 160 SR	1.6	81	08.05–	HR 16 DE	4	<b>Z 325</b>	12 VR-7 SPUX	1,1	○

**MICRA I**

1.2	1.2	40	07.86–07.92	MA12S	4	<b>Z 9</b>	14 R-8 DUX	1,1	<b>UXT 2<sup>4</sup></b>
1.2	1.2	44	12.88–07.92	MA12S	4	<b>Z 8</b>	14 R-8 DU	0,8	<b>UXT 2<sup>4</sup></b>

**MICRA II**

1.0 i 16V	1.0	40	08.92–09.00	CG10DE	4	<b>Z 73</b>	14 FR-8 DUX	1,1	<b>UXT 1<sup>3</sup></b>
1.0 i 16V	1.0	44	09.00–02.03	CG10DE	4	<b>Z 73</b>	14 FR-8 DUX	1,1	<b>UXT 1<sup>3</sup></b>
1.3 i 16V	1.3	55	08.92–09.00	CG13DE	4	<b>Z 73</b>	14 FR-8 DUX	1,1	<b>UXT 1<sup>3</sup></b>
1.4 i 16V	1.3	60	09.00–02.03	CGA3DE	4	<b>Z 73</b>	14 FR-8 DUX	1,1	<b>UXT 1<sup>3</sup></b>

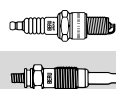

## NISSAN

### MICRA II

1.5 D	1.5	42	02.98-02.03	TD15	4	<b>GN 912</b> (11V)	○		
-------	-----	----	-------------	------	---	---------------------	---	--	--

### MICRA III

1.0 16V	1.0	48	01.03-	CG10DE	4	<b>Z 302</b>	14 FR-8 MPUX2	1,1	<b>UXT 13</b>
1.2 16V	1.2	48	01.03-	CR12DE/CG12DE	4	<b>Z 302</b>	14 FR-8 MPUX2	1,1	<b>UXT 13</b>
1.2 16V	1.2	59	01.03-	CR12DE/CG12DE	4	<b>Z 302</b>	14 FR-8 MPUX2	1,1	<b>UXT 13</b>
1.4 16V	1.4	65	01.03-	CR14DE	4	<b>Z 302</b>	14 FR-8 MPUX2	1,1	<b>UXT 13</b>
1.5 dCi	1.5	48	01.03-	K9K 704	4	<b>GN 018</b> (11V)	○		
1.5 dCi	1.5	50	06.05-	K9K 708	4	<b>GN 018</b> (11V)	○		
1.5 dCi	1.5	60	09.03-	K9K 722	4	<b>GN 018</b> (11V)	○		
160 SR	1.6	81	05.05-	HR 16 DE	4	<b>Z 325</b>	12 VR-7 SPUX	1,1	○

### MURANO

3.5 4x4	3.5	172	03.05-	VQ35DE	6	<b>Z 219</b>	14 FR-8 MPUX02	1,1	<b>UXT 13</b>
3.5 4x4	3.5	188	10.08-	VQ35DE	6	<b>Z 219</b>	14 FR-8 MPUX02	1,1	<b>UXT 13</b>

### NOTE

1.4	1.4	65	03.06-	CR14DE	4	<b>Z 302</b>	14 FR-8 MPUX2	1,1	<b>UXT 13</b>
1.5 dCi	1.5	50	03.06-	K9K 700	4	<b>GN 018</b> (11V)	○		
1.5 dCi	1.5	63	03.06-	K9K 276	4	<b>GN 018</b> (11V)	○		
1.6	1.6	81	03.06-	HR 16 DE	4	<b>Z 325</b>	12 VR-7 SPUX	1,1	○

### NP300

2.5 dCi 4x4	2.5	98	04.08-	YD25DDTi	4	<b>GN 109</b> (11V)	○		
-------------	-----	----	--------	----------	---	---------------------	---	--	--

### NV200 EVALIA

1.6 16V	1.6	81	07.10-	HR 16 DE	4	<b>Z 325</b>	12 VR-7 SPUX	1,1	○
---------	-----	----	--------	----------	---	--------------	--------------	-----	---

### PATHFINDER

2.5 dCi 4WD	2.5	126	10.06-	YD25DDTi	4	<b>GN 109</b> (11V)	○		
2.5 dCi 4WD	2.5	128	03.05-	YD25DDTi	4	<b>GN 109</b> (11V)	○		
3.3 V6 4WD	3.3	110	03.98-10.00	VG33E	6	<b>Z 73</b>	14 FR-8 DUX	1,1	<b>UXT 13</b>
3.3 V6 4WD	3.3	125	09.97-12.04	VG33E	6	<b>Z 73</b>	14 FR-8 DUX	1,1	<b>UXT 13</b>
3.5 V6 4WD	3.5	162	11.00-12.04	VQ35	6	<b>Z 219</b>	14 FR-8 MPUX02	1,1	<b>UXT 13</b>

### PATROL GR I

4.2 KAT	4.2	121	11.88-06.97	TB42E	6	<b>Z 8</b>	14 R-8 DU	0,8	<b>UXT 2<sup>4</sup></b>
---------	-----	-----	-------------	-------	---	------------	-----------	-----	--------------------------

### PATROL GR II

2.8 TD	2.8	95	06.97-05.00	RD28Ti	6	<b>GN 075</b> (11V)	○		
3.0 DTi	3.0	116	05.00-	ZD30DDTi	4	<b>GN 072</b> (11V)	○		
3.0 DTi	3.0	118	05.00-	ZD30DDTi	4	<b>GN 072</b> (11V)	○		

### PATROL Hardtop

2.8	2.8	88	05.86-06.90	L28	6	<b>Z 20</b>	14 R-7 DU	0,8	<b>UXT 2<sup>4</sup></b>
3.2 D	3.2	81	08.88-06.90	SD33T	6	<b>GN 044</b> (24V)	○		

### PATROL Station Wagon

3.2 D	3.2	81	08.88-06.90		6	<b>GN 044</b> (24V)	○		
-------	-----	----	-------------	--	---	---------------------	---	--	--

### PIXO

1.0	1.0	50	06.09-	K10 B	3	<b>Z 333</b>	12 FR-6 DPUX	1,1	○
-----	-----	----	--------	-------	---	--------------	--------------	-----	---

### PRAIRIE PRO

2.0 i	2.0	72	10.88-04.92	CA20E	4	<b>Z 73</b>	14 FR-8 DUX <sup>10</sup>	1,1	○
						<b>Z 16</b>	14 FR-7 DUX <sup>11</sup>	1,1	○
2.0 i 4x4	2.0	72	10.88-12.92	CA20E	4	<b>Z 73</b>	14 FR-8 DUX <sup>10</sup>	1,1	○
						<b>Z 16</b>	14 FR-7 DUX <sup>11</sup>	1,1	○
2.4 i	2.4	98	04.92-07.94	KA24E	4	<b>Z 225</b>	14 FR-7 HUX	1,1	○
2.4 i 4x4	2.4	98	04.92-07.94	KA24E	4	<b>Z 225</b>	14 FR-7 HUX	1,1	○

### PRIMERA

1.6	1.6	66	06.90-05.93	GA16DS	4	<b>Z 193</b>	14 FR-7 DU2	0,9	<b>UXT 13</b>
1.6	1.6	66	06.93-01.96	GA16DS	4	<b>Z 153</b>	14 FR-8 KUJ	0,8	<b>UXT 10</b>
1.6 16V	1.6	66	09.96-05.99	GA16DE	4	<b>Z 193</b>	14 FR-7 DU2	0,9	<b>UXT 13</b>
1.6	1.6	71	06.90-01.96	GA16DS	4	<b>Z 193</b>	14 FR-7 DU2	0,9	<b>UXT 13</b>
1.6 16V	1.6	73	09.96-10.00	GA16DE	4	<b>Z 193</b>	14 FR-7 DU2	0,9	<b>UXT 13</b>
1.6	1.6	75	06.93-01.96	GA16DE	4	<b>Z 193</b>	14 FR-7 DU2	0,9	<b>UXT 13</b>
1.6	1.6	78	03.02-10.10	QG16DE	4	<b>Z 183</b>	14 FR-8 MU2	0,9	<b>UXT 13</b>
1.6 16V	1.6	78	06.96-12.01	QG16DE	4	<b>Z 73</b>	14 FR-8 DUX	1,1	<b>UXT 13</b>
1.8 16V	1.8	84	08.99-12.01	QG18DE	4	<b>Z 73</b>	14 FR-8 DUX	1,1	<b>UXT 13</b>
1.8	1.8	85	03.02-	QG18DE	4	<b>Z 303</b>	14 FR-7 MUX2	1,1	<b>UXT 13</b>
1.9 dCi	1.9	88	04.03-		4	<b>GN 018</b> (11V)	○		
2.0 D	2.0	55	01.91-01.96	CD20	4	<b>GN 102</b> (11V)	○		



kw

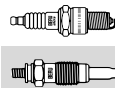
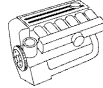

**NISSAN**

**PRIMERA**

2.0 TD	2.0	66	09.96-12.01	CD20T	4	<b>GN 102</b> (11V)	○		
2.0 16V	2.0	85	06.90-01.96	SR20DI	4	<b>Z 153</b>	14 FR-8 KU	0,8	<b>UXT 10</b>
2.0 16V 4x4	2.0	85	04.91-06.96	SR20DI	4	<b>Z 153</b>	14 FR-8 KU	0,8	<b>UXT 10</b>
2.0 16V	2.0	85	09.96-12.01	SR20De	4	<b>Z 155</b>	14 FR-7 KU	0,8	<b>UXT 10</b>
2.0 i	2.0	92	01.95-06.96	SR20DE	4	<b>Z 155</b>	14 FR-7 KU	0,8	<b>UXT 10</b>
2.0 16V	2.0	96	09.96-12.01	SR20DE	4	<b>Z 155</b>	14 FR-7 KU	0,8	<b>UXT 10</b>
2.0	2.0	103	03.02-	QR20DE	4	<b>Z 303</b>	14 FR-7 MUX2	1,1	<b>UXT 13</b>
2.0 16V	2.0	103	08.99-12.01	SR20DE	4	<b>Z 221</b>	14 FR-6 DPUX02	1,0	<b>UXT 14</b>
2.0 GT	2.0	110	06.90-01.96	SR20DE	4	<b>Z 155</b>	14 FR-7 KU	0,8	<b>UXT 10</b>
2.0 16V	2.0	110	09.96-12.01	SR20DE	4	<b>Z 155</b>	14 FR-7 KU	0,8	<b>UXT 10</b>
2.2 Di	2.2	93	03.02-	YD22DDT	4	<b>GN 109</b> (11V)	○		
2.2 dCi	2.2	102	04.03-	YD22DDT	4	<b>GN 109</b> (11V)	○		

**PRIMERA Hatchback**

1.6	1.6	66	06.90-05.93	GA16DS	4	<b>Z 193</b>	14 FR-7 DU2	0,9	<b>UXT 1<sup>3</sup></b>
1.6	1.6	66	06.93-01.96	GA16DS	4	<b>Z 153</b>	14 FR-8 KU	0,8	<b>UXT 10</b>
1.6 16V	1.6	66	09.96-07.02	GA16DE	4	<b>Z 193</b>	14 FR-7 DU2	0,9	<b>UXT 1<sup>3</sup></b>
1.6	1.6	71	06.90-06.93	GA16DS	4	<b>Z 193</b>	14 FR-7 DU2	0,9	<b>UXT 1<sup>3</sup></b>
1.6 16V	1.6	73	09.96-07.02	GA16DE	4	<b>Z 247</b>	14 FR-7 DUW	0,9	<b>UXT 1<sup>3</sup></b>
1.6	1.6	75	06.93-01.96	GA16DE	4	<b>Z 193</b>	14 FR-7 DU2	0,9	<b>UXT 1<sup>3</sup></b>
1.6	1.6	78	07.02-10.10	QG16DE	4	<b>Z 183</b>	14 FR-8 MU2	0,9	<b>UXT 13</b>
1.6 16V	1.6	78	09.00-07.02	QG16DE	4	<b>Z 73</b>	14 FR-8 DUX	1,1	<b>UXT 1<sup>3</sup></b>
1.8 16V	1.8	84	08.99-07.02	QG18DE	4	<b>Z 16</b>	14 FR-7 DUX	1,1	<b>UXT 1<sup>3</sup></b>
1.8	1.8	85	07.02-	QG18DE	4	<b>Z 303</b>	14 FR-7 MUX2	1,1	<b>UXT 13</b>
1.9 dCi	1.9	88	04.03-		4	<b>GN 018</b> (11V)	○		
2.0 D	2.0	55	01.91-01.96	CD20	4	<b>GN 102</b> (11V)	○		
2.0 TD	2.0	66	09.96-07.02	CD20T	4	<b>GN 102</b> (11V)	○		
2.0 16V	2.0	85	06.90-01.96	SR20DI	4	<b>Z 153</b>	14 FR-8 KU	0,8	<b>UXT 10</b>
2.0 16V 4x4	2.0	85	04.91-06.96	SR20DI	4	<b>Z 153</b>	14 FR-8 KU	0,8	<b>UXT 10</b>
2.0 16V	2.0	85	09.96-07.02	SR20De	4	<b>Z 155</b>	14 FR-7 KU	0,8	<b>UXT 10</b>
2.0 i	2.0	92	01.95-06.96	SR20DE	4	<b>Z 155</b>	14 FR-7 KU	0,8	<b>UXT 10</b>
2.0 16V	2.0	96	09.96-07.02	SR20DE	4	<b>Z 155</b>	14 FR-7 KU	0,8	<b>UXT 10</b>
2.0	2.0	103	07.02-	QR20DE	4	<b>Z 303</b>	14 FR-7 MUX2	1,1	<b>UXT 13</b>
2.0 16V	2.0	103	08.99-07.02	SR20DE	4	<b>Z 221</b>	14 FR-6 DPUX02	1,0	<b>UXT 14</b>
2.0 16V	2.0	110	09.96-07.02	SR20DE	4	<b>Z 155</b>	14 FR-7 KU	0,8	<b>UXT 10</b>
2.2 Di	2.2	93	07.02-	YD22DDT	4	<b>GN 109</b> (11V)	○		
2.2 dCi	2.2	102	04.03-	YD22DDT	4	<b>GN 109</b> (11V)	○		

**PRIMERA Traveller**

1.6 i	1.6	66	07.90-05.93	GA16DS	4	<b>Z 193</b>	14 FR-7 DU2	0,9	<b>UXT 1<sup>3</sup></b>
1.6 i	1.6	66	06.93-03.98	GA16DS	4	<b>Z 153</b>	14 FR-8 KU	0,8	<b>UXT 10</b>
1.6 16V	1.6	66	04.98-12.01	GA16DE	4	<b>Z 247</b>	14 FR-7 DUW	0,9	<b>UXT 1<sup>3</sup></b>
1.6 16V	1.6	73	04.98-12.01	GA16DE	4	<b>Z 247</b>	14 FR-7 DUW	0,9	<b>UXT 1<sup>3</sup></b>
1.6 i	1.6	75	03.94-03.98	GA16DE	4	<b>Z 247</b>	14 FR-7 DUW	0,9	<b>UXT 1<sup>3</sup></b>
1.8 16V	1.8	84	08.99-12.01	QG18DE	4	<b>Z 16</b>	14 FR-7 DUX	1,1	<b>UXT 1<sup>3</sup></b>
1.8	1.8	85	03.02-	QG18DE	4	<b>Z 303</b>	14 FR-7 MUX2	1,1	<b>UXT 13</b>
1.9 dCi	1.9	88	04.03-		4	<b>GN 018</b> (11V)	○		
2.0 D	2.0	55	07.90-12.95	CD20	4	<b>GN 102</b> (11V)	○		
2.0 TD	2.0	66	04.98-12.01	CD20T	4	<b>GN 102</b> (11V)	○		
2.0 i	2.0	85	07.90-03.98	SR20DI	4	<b>Z 153</b>	14 FR-8 KU	0,8	<b>UXT 10</b>
2.0 16V	2.0	85	04.98-12.01	SR20De	4	<b>Z 155</b>	14 FR-7 KU	0,8	<b>UXT 10</b>
2.0 16V	2.0	96	04.98-12.01	SR20DE	4	<b>Z 155</b>	14 FR-7 KU	0,8	<b>UXT 10</b>
2.0	2.0	103	03.02-	QR20DE	4	<b>Z 303</b>	14 FR-7 MUX2	1,1	<b>UXT 13</b>
2.0 16V	2.0	103	08.99-12.01	SR20DE	4	<b>Z 221</b>	14 FR-6 DPUX02	1,0	<b>UXT 14</b>
2.2 Di	2.2	93	03.02-	YD22DDT	4	<b>GN 109</b> (11V)	○		
2.2 dCi	2.2	102	04.03-	YD22DDT	4	<b>GN 109</b> (11V)	○		

**QASHQAI / QASHQAI +2**

1.6	1.6	84	02.07-	HR 16 DE	4	<b>Z 325</b>	12 VR-7 SPUX	1,1	○
1.6	1.6	86	11.10-	HR 16 DE	4	<b>Z 325</b>	12 VR-7 SPUX	1,1	○
2.0	2.0	103	02.07-	MR20DE	4	<b>Z 325</b>	12 VR-7 SPUX	1,1	○
2.0 Allrad	2.0	103	02.07-	MR20DE	4	<b>Z 325</b>	12 VR-7 SPUX	1,1	○
2.0	2.0	104	11.10-	MR20DE	4	<b>Z 325</b>	12 VR-7 SPUX	1,1	○
2.0 Allrad	2.0	104	11.10-	MR20DE	4	<b>Z 325</b>	12 VR-7 SPUX	1,1	○

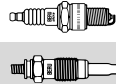
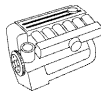

## NISSAN

### SENTRA

2.0 Flex	2.0	105	08.09-	MR20DE	4	<b>Z 325</b>	12 VR-7 SPUX	1,1	○
----------	-----	-----	--------	--------	---	--------------	--------------	-----	---

### SERENA

1.6 16V	1.6	71	02.93-09.01	GA16DE	4	<b>Z 193</b>	14 FR-7 DU2	0,9	<b>UXT 1<sup>3</sup></b>
2.0 D	2.0	49	11.92-09.94	LD20	4	<b>GN 101</b> (11V)	○		
2.3 D	2.3	55	01.95-02.98	LD23	4	<b>GN 853</b> (11V)	○		
2.3 D	2.3	55	03.98-09.01	LD23	4	<b>GN 039</b> (11V)	○		
2.0 16V	2.0	93	11.92-09.01	SR20DE	4	<b>Z 157</b>	14 FR-7 KUOX	1,1	<b>UXT 11</b>
2.0	2.0	108	04.05-	MR20DE	4	<b>Z 325</b>	12 VR-7 SPUX	1,1	○
2.0 4x4	2.0	108	04.05-	MR20DE	4	<b>Z 325</b>	12 VR-7 SPUX	1,1	○

### SILVIA Coupe

2.0 Turbo	2.0	162	04.94-09.99	SR20DET	4	<b>Z 314</b>	14 FR-6 DPUW2	0,9	○
-----------	-----	-----	-------------	---------	---	--------------	---------------	-----	---

### STAGEA

2.5	2.5	140	09.96-10.01	RB25DE	6	<b>Z 312</b>	14 FR-7 KPPU	1,1	○
2.5 AWD	2.5	140	09.96-10.01	RB25DE	6	<b>Z 312</b>	14 FR-7 KPPU	1,1	○
2.5 Turbo AWD	2.5	173	09.96-08.98	RB25DET	6	<b>Z 312</b>	14 FR-7 KPPU	1,1	○

### SUNNY II

1.3	1.3	44	07.86-10.91	E13S	4	<b>Z 8</b>	14 R-8 DU	0,8	<b>UXT 2<sup>4</sup></b>
1.4 LX	1.4	55	10.88-08.91	GA14S	4	<b>Z 247</b>	14 FR-7 DUW	0,9	<b>UXT 1<sup>3</sup></b>
1.6 i	1.6	54	06.86-10.90	E16i	4	<b>Z 9</b>	14 R-8 DUX	1,1	<b>UXT 2<sup>4</sup></b>
1.6 i 4x4	1.6	54	06.86-10.90	E16i	4	<b>Z 9</b>	14 R-8 DUX	1,1	<b>UXT 2<sup>4</sup></b>
1.6 i 12V	1.6	66	10.88-06.91	GA16i	4	<b>Z 16</b>	14 FR-7 DUX	1,1	<b>UXT 1<sup>3</sup></b>

### SUNNY II Coupe

1.6 i 12V	1.6	66	10.88-06.91	GA16i	4	<b>Z 16</b>	14 FR-7 DUX	1,1	<b>UXT 1<sup>3</sup></b>
1.8 GTI 16V	1.8	92	01.89-08.90	CA18D	4	<b>Z 228</b>	14 FR-7 DPUX02	1,0	<b>UXT 11</b>

### SUNNY II Hatchback

1.4 LX	1.4	55	01.89-08.91	GA14S	4	<b>Z 247</b>	14 FR-7 DUW	0,9	<b>UXT 1<sup>3</sup></b>
1.6 i	1.6	54	06.86-10.90	E16i	4	<b>Z 9</b>	14 R-8 DUX	1,1	<b>UXT 2<sup>4</sup></b>
1.6 i 12V	1.6	66	10.88-10.90	GA16i	4	<b>Z 16</b>	14 FR-7 DUX	1,1	<b>UXT 1<sup>3</sup></b>
1.7 D	1.7	40	06.86-08.90	CD17	4	<b>GN 101</b> (11V)	○		
1.7 D	1.7	40	06.86-01.91	CD17	4	<b>GV 685</b> (6,5V)	○		
1.8 GTI 16V	1.8	92	01.89-06.91	CA18D	4	<b>Z 313</b>	14 FR-6 DPUX2	1,0	○

### SUNNY II Traveller

1.6 i 12V	1.6	66	10.88-06.91	GA16i	4	<b>Z 16</b>	14 FR-7 DUX	1,1	<b>UXT 1<sup>3</sup></b>
1.7 D	1.7	40	01.86-09.90	CD17	4	<b>GN 101</b> (11V)	○		

### SUNNY III

1.4 i	1.4	55	10.90-05.95	GA14DE /GA14DS	4	<b>Z 15</b>	14 FR-7 DU	0,8	<b>UXT 1<sup>3</sup></b>
1.6 i	1.6	66	10.90-05.95	GA 16 DE/GA 16 DS	4	<b>Z 15</b>	14 FR-7 DU	0,8	<b>UXT 1<sup>3</sup></b>
1.6 i 16V 4WD	1.6	66	10.90-05.95	GA16DS	4	<b>Z 15</b>	14 FR-7 DU	0,8	<b>UXT 1<sup>3</sup></b>
1.6 i 16V	1.6	75	10.92-05.95	GA16DE	4	<b>Z 15</b>	14 FR-7 DU	0,8	<b>UXT 1<sup>3</sup></b>
2.0 D	2.0	55	10.90-05.95	CD20	4	<b>GN 102</b> (11V)	○		

### SUNNY III Hatchback

1.4 i	1.4	55	10.90-05.95	GA14DE /GA14DS	4	<b>Z 15</b>	14 FR-7 DU	0,8	<b>UXT 1<sup>3</sup></b>
1.6 i	1.6	66	10.90-05.95	GA 16 DE/GA 16 DS	4	<b>Z 15</b>	14 FR-7 DU	0,8	<b>UXT 1<sup>3</sup></b>
2.0 D	2.0	55	10.90-05.95	CD20	4	<b>GN 102</b> (11V)	○		
2.0 GTI 16V	2.0	105	10.90-05.95	SR20DE	4	<b>Z 155</b>	14 FR-7 KU	0,8	<b>UXT 10</b>
2.0 GTI-R 4x4	2.0	162	10.90-05.95	SR20DET	4	<b>Z 314</b>	14 FR-6 DPUW2	0,9	○

### SUNNY III Liftback

1.4 i	1.4	55	10.90-05.95	GA14DE /GA14DS	4	<b>Z 15</b>	14 FR-7 DU	0,8	<b>UXT 1<sup>3</sup></b>
1.6 i	1.6	66	10.92-05.95	GA16DE	4	<b>Z 15</b>	14 FR-7 DU	0,8	<b>UXT 1<sup>3</sup></b>
1.6 i	1.6	66	10.90-05.95	GA 16 DS	4	<b>Z 24</b>	14 FR-6 DU	0,8	<b>UXT 5</b>
2.0 D	2.0	55	10.90-05.95	CD20	4	<b>GN 102</b> (11V)	○		
2.0 i 16V	2.0	105	10.90-05.95	SR20DE	4	<b>Z 155</b>	14 FR-7 KU	0,8	<b>UXT 10</b>

### SUNNY III Traveller

1.6 i	1.6	66	06.91-03.00	GA16DE/GA16DS	4	<b>Z 24</b>	14 FR-6 DU	0,8	<b>UXT 5</b>
1.6 16V 4x4	1.6	66	11.90-05.95	GA16DS	4	<b>Z 24</b>	14 FR-6 DU	0,8	<b>UXT 5</b>
1.6 i 16V 4x4	1.6	75	10.92-03.00	GA16DE	4	<b>Z 15</b>	14 FR-7 DU	0,8	<b>UXT 1<sup>3</sup></b>
2.0 D	2.0	55	06.91-03.00	CD20	4	<b>GN 102</b> (11V)	○		

### TERRANO I

2.4 i 4WD	2.4	76	10.87-02.93	Z24i	4	<b>Z 8</b>	14 R-8 DU	0,8	<b>UXT 2<sup>4</sup></b>
2.7 TD 4WD	2.5	73	02.89-02.96	TD27T	4	<b>GN 854</b> (11V)	○		
3.0 i 4WD	3.0	109	01.90-12.95	VG30E	6	<b>Z 155</b>	14 FR-7 KU	0,8	<b>UXT 10</b>

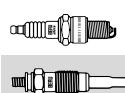

## NISSAN

### TERRANO II

2.4 4WD	2.4	85	05.96-01.02	KA24E	4	<b>Z 225</b>	14 FR-7 HUX	1,1	○
2.4 4WD	2.4	87	05.96-	KA24E	4	<b>Z 225</b>	14 FR-7 HUX	1,1	○
2.4 i 12V 4WD	2.4	91	02.93-06.96	KA24E	4	<b>Z 225</b>	14 FR-7 HUX	1,1	○
2.7 TD 4WD	2.5	74	02.93-01.02	TD27T	4	<b>GN 039</b> (11V)	○		
2.7 TDi 4WD	2.5	92	05.96-09.97	TD27Ti	4	<b>GN 101</b> (11V)	○		
2.7 TDi 4WD	2.5	92	10.97-	TD27Ti	4	<b>GN 994</b> (11V)	○		
3.0 Di 4WD	3.0	113	05.02-	ZD30	4	<b>GN 072</b> (11V)	○		

### TIIDA

1.6	1.6	81	05.04-	HR 16 DE	4	<b>Z 325</b>	12 VR-7 SPUX	1,1	○
1.6 4x4	1.6	81	05.04-	HR 16 DE	4	<b>Z 325</b>	12 VR-7 SPUX	1,1	○

### URVAN

2.0	2.0	64	05.87-05.97	Z20	4	<b>Z 20</b>	14 R-7 DU	0,8	<b>UXT 2<sup>4</sup></b>
2.3 D	2.3	51	01.88-05.97	TD23	4	<b>GV 921</b> (11V)	○		
2.4 i	2.4	74	05.89-09.93	Z24i	4	<b>Z 8</b>	14 R-8 DU	0,8	<b>UXT 2<sup>4</sup></b>
2.5 D	2.5	59	12.88-05.97	TD25	4	<b>GV 921</b> (11V)	○		
3.0 D	3.0	77	10.00-	ZD30DD	4	<b>GN 072</b> (11V)	○		
3.0 Di	3.0	77	10.00-	ZD30DD	4	<b>GN 072</b> (11V)	○		

### X-TRAIL

2.0	2.0	103	06.08-	MR20DE	4	<b>Z 325</b>	12 VR-7 SPUX	1,1	○
2.0 4x4	2.0	103	07.01-	QR20DE	4	<b>Z 303</b>	14 FR-7 MUX2	1,1	<b>UXT 13</b>
2.0 FWD	2.0	103	06.08-	MR20DE	4	<b>Z 325</b>	12 VR-7 SPUX	1,1	○
2.0	2.0	104	06.07-	MR20DE	4	<b>Z 325</b>	12 VR-7 SPUX	1,1	○
2.0 FWD	2.0	104	03.07-	MR20DE	4	<b>Z 325</b>	12 VR-7 SPUX	1,1	○
2.2 Di 4x4	2.2	84	07.01-	YD22ETi	4	<b>GN 109</b> (11V)	○		
2.2 dCi	2.2	100	12.03-	YD22DDTi	4	<b>GN 109</b> (11V)	○		
2.2 dCi 4x4	2.2	100	12.03-	YD22DDTi	4	<b>GN 109</b> (11V)	○		
2.5 4x4	2.5	121	01.03-	QR25DE	4	<b>Z 303</b>	14 FR-7 MUX2	1,1	<b>UXT 13</b>



### CARAVAN

3.0 Di	3.0	77	10.00-	ZD30DD	4	<b>GN 072</b> (11V)	○		
--------	-----	----	--------	--------	---	---------------------	---	--	--

### INTERSTAR

1.9 dCi 80	1.9	60	07.02-	F9Q 772	4	<b>GN 018</b> (11V)	○		
2.2 dCi 90	2.2	66	07.02-	G9T 722	4	<b>GN 026</b> (11V)	○		
2.5 dCi 120	2.5	84	08.03-	G9U 720	4	<b>GN 026</b> (11V)	○		
3.0 dCi 140	3.0	100	11.03-	ZD30	4	<b>GN 072</b> (11V)	○		

### KUBISTAR

1.2 16V	1.1	55	04.06-	D4F 712	4	<b>Z 243</b>	12 VR-8 SE	0,9	○
1.5 dCi	1.5	42	08.03-	K9K 710/K9K 714	4	<b>GN 018</b> (11V)	○		
1.5 dCi	1.5	45	08.05-	K9K 710/K9K 714	4	<b>GN 018</b> (11V)	○		
1.5 dCi	1.5	48	08.03-	K9K 704	4	<b>GN 018</b> (11V)	○		
1.5 dCi	1.5	60	08.03-	K9K 722	4	<b>GN 018</b> (11V)	○		
1.6 16V	1.6	70	08.03-	K4M 752	4	<b>Z 193</b>	14 FR-7 DU2	0,9	<b>UXT 1<sup>3</sup></b>

### NAVARA

2.5 dCi	2.5	106	07.05-12.09	YD25DDTi	4	<b>GN 109</b> (11V)	○		
2.5 dCi 4WD	2.5	126	10.06-	YD25DDTi	4	<b>GN 109</b> (11V)	○		
2.5 dCi 4WD	2.5	128	07.05-12.09	YD25DDTi	4	<b>GN 109</b> (11V)	○		
3.0 TD 4WD	3.0	110	12.01-01.08	ZD30	4	<b>GN 072</b> (11V)	○		

### PICK UP

2.4 i 4WD	2.4	74	03.86-04.92	Z24i	4	<b>Z 20</b>	14 R-7 DU	0,8	<b>UXT 2<sup>4</sup></b>
2.4 i	2.4	88	02.98-	KA24E	4	<b>Z 225</b>	14 FR-7 HUX	1,1	○
2.4 i 4WD	2.4	88	02.98-	KA24E	4	<b>Z 225</b>	14 FR-7 HUX	1,1	○
2.4 i 12V	2.4	91	04.92-02.98	KA24E	4	<b>Z 225</b>	14 FR-7 HUX	1,1	○
2.4 i 12V 4WD	2.4	93	04.92-02.98	KA24E	4	<b>Z 225</b>	14 FR-7 HUX	1,1	○
2.4 i 4WD	2.4	98	03.02-	KA24DE	4	<b>Z 225</b>	14 FR-7 HUX	1,1	○
2.5 D	2.5	55	09.87-02.98	TD25	4	<b>GV 921</b> (11V)	○		
2.5 D	2.5	59	09.94-08.96	TD25	4	<b>GV 921</b> (11V)	○		
2.5 D 4WD	2.5	59	08.87-02.98	TD25	4	<b>GV 921</b> (11V)	○		
2.5 D	2.5	61	03.96-02.98	TD25	4	<b>GV 921</b> (11V)	○		
2.5 D 4WD	2.5	61	02.98-	TD25	4	<b>GV 921</b> (11V)	○		
2.5 Di	2.5	98	03.02-	YD25DDTi	4	<b>GN 109</b> (11V)	○		

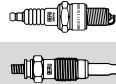
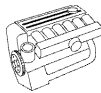

## NISSAN



### PICK UP

2.5 Di 4WD	2.5	98	03.02–	YD25DDTI	4	<b>GN 109</b> (11V)	○			
2.7 D 4WD	2.7	73	08.87–02.98	TD27	4	<b>GV 921</b> (11V)	○			
3.0 i V6 4WD	3.0	109	09.90–02.98	VG30E	6	<b>Z 155</b>		14 FR-7 KU	0,8	<b>UXT 10</b>

### PRIMASTAR

1.9 dCi 80	1.9	60	03.01–	F9Q 762	4	<b>GN 018</b> (11V)	○			
1.9 dCi 100	1.9	74	03.01–	F9Q 760	4	<b>GN 018</b> (11V)	○			
2.0	2.0	88	03.01–	F4R 722	4	<b>Z 206</b>		14 FR-7 DPPUS2	0,7	<b>UXT 10</b>
2.0	2.0	88	02.03–	F4R 720	4	<b>Z 206</b>		14 FR-7 DPPUS2	0,7	<b>UXT 10</b>
2.5 dCi 140	2.5	99	07.03–	G9U 730	4	<b>GN 026</b> (11V)	○			

### VANETTE

2.0 D	2.0	47	10.86–12.95	LD20	4	<b>GN 101</b> (11V)	○			
2.0 D	2.0	49	10.86–12.95	LD20	4	<b>GN 101</b> (11V)	○			
2.0 D	2.0	49	07.91–01.95	LD20II	4	<b>GN 101</b> (11V)	○			
2.4 i	2.4	74	10.86–12.95	Z24i	4	<b>Z 8</b>		14 R-8 DU	0,8	<b>UXT 2<sup>4</sup></b>
2.4 i	2.4	77	10.86–12.95	Z24i	4	<b>Z 8</b>		14 R-8 DU	0,8	<b>UXT 2<sup>4</sup></b>

### VANETTE CARGO

1.6 i	1.6	71	01.95–	GA16DE	4	<b>Z 247</b>		14 FR-7 DUW	0,9	<b>UXT 1<sup>3</sup></b>
1.6 i	1.6	72	01.96–	GA16DE	4	<b>Z 247</b>		14 FR-7 DUW	0,9	<b>UXT 1<sup>3</sup></b>
2.3 D	2.3	55	01.95–02.98	LD23	4	<b>GN 853</b> (11V)	○			
2.3 D	2.3	55	03.98–	LD23	4	<b>GN 039</b> (11V)	○			

## OPEL

### AGILA (A)

1.0 12V	1.0	43	09.00–	Z 10 XE	3	<b>Z 74<sup>5</sup></b>		14 FR-8 LDUOX4	1,0	<b>UXT 1<sup>3</sup></b>
1.0	1.0	44	08.03–	Z 10 XEP	3	<b>Z 203</b>		14 FR-8 LU2	0,9	○
1.2 16V	1.2	55	09.00–	Z 12 XE	4	<b>Z 74<sup>5</sup></b>		14 FR-8 LDUOX4	1,0	<b>UXT 1<sup>3</sup></b>
1.2 16V Twinport	1.2	59	07.04–	Z 12 XEP	4	<b>Z 203</b>		14 FR-8 LU2	0,9	○
1.3 CDTI	1.3	51	08.03–	Z 13 DT	4	<b>GN 053</b> (11V)	○			

### AGILA (B)

1.0	1.0	48	04.08–	K10B	3	<b>Z 333</b>		12 FR-6 DPUX	1,1	○
1.0 LPG	1.0	48	01.10–	K10B	3	<b>Z 333</b>		12 FR-6 DPUX	1,1	○
1.0	1.0	50	07.11–	K10B	3	<b>Z 333</b>		12 FR-6 DPUX	1,1	○
1.2	1.2	63	04.08–	K12B	4	<b>Z 333</b>		12 FR-6 DPUX	1,1	○
1.2 LPG	1.2	63	04.08–	K12B	4	<b>Z 333</b>		12 FR-6 DPUX	1,1	○
1.3 CDTI	1.3	55	04.08–	D13A/Z 13 DTJ	4	<b>GN 053</b> (11V)	○			

### ANTARA

2.4	2.4	103	09.08–	Z 24 XE	4	<b>Z 74<sup>5</sup></b>		14 FR-8 LDUOX4	1,0	<b>UXT 1<sup>3</sup></b>
2.4	2.4	104	05.06–	Z 24 XED	4	<b>Z 74<sup>5</sup></b>		14 FR-8 LDUOX4	1,0	<b>UXT 1<sup>3</sup></b>
3.2 V6	3.2	167	03.07–	Z 32 SEE/10 HM	6	<b>Z 356</b>		14 KR-7 MPUX2	1,1	○

### ARENA

1.9 D	1.9	44	03.98–08.01	F8Q 606/F8Q 600	4	<b>GN 963</b> (11V)	○		
2.5 D	2.5	55	03.98–08.01	S8U 780/S8U 782/S8U 758	4	<b>GN 927</b> (11V)	○		

### ASTRA F

1.4 i	1.4	44	09.91–09.98	C 14 NZ/X 14 NZ	4	<b>Z 119</b>		14 R-8 DU4	0,8	<b>UXT 2<sup>4</sup></b>
1.4 i	1.4	44	09.91–09.98	C 14 NZ/X 14 NZ <sup>18</sup>	4	<b>Z 74<sup>5</sup></b>		14 FR-8 LDUOX4	1,0	<b>UXT 1<sup>3</sup></b>
1.4	1.4	55	09.91–09.93	14 NV	4	<b>Z 119</b>		14 R-8 DU4	0,8	<b>UXT 2<sup>4</sup></b>
1.4	1.4	60	09.92–09.98	14 SE	4	<b>Z 74<sup>5</sup></b>		14 FR-8 LDUOX4	1,0	<b>UXT 1<sup>3</sup></b>
1.4 Si	1.4	60	03.92–09.98	C 14 SE	4	<b>Z 119</b>		14 R-8 DU4	0,8	<b>UXT 2<sup>4</sup></b>
1.4 Si	1.4	60	03.92–09.98	C 14 SE <sup>18</sup>	4	<b>Z 74<sup>5</sup></b>		14 FR-8 LDUOX4	1,0	<b>UXT 1<sup>3</sup></b>
1.4 i 16V	1.4	66	02.96–09.98	X 14 XE	4	<b>Z 74<sup>5</sup></b>		14 FR-8 LDUOX4	1,0	<b>UXT 1<sup>3</sup></b>
1.6 i	1.6	52	05.93–07.96	X 16 SZ	4	<b>Z 119</b>		14 R-8 DU4	0,8	<b>UXT 2<sup>4</sup></b>
1.6 i	1.6	52	05.93–07.96	X 16 SZ <sup>18</sup>	4	<b>Z 74<sup>5</sup></b>		14 FR-8 LDUOX4	1,0	<b>UXT 1<sup>3</sup></b>
1.6 i	1.6	55	08.96–09.98	X 16 SZR	4	<b>Z 74<sup>5</sup></b>		14 FR-8 LDUOX4	1,0	<b>UXT 1<sup>3</sup></b>
1.6	1.6	55	09.95–01.98	16 NZR/16 LZ2	4	<b>Z 74<sup>5</sup></b>		14 FR-8 LDUOX4	1,0	<b>UXT 1<sup>3</sup></b>
1.6 i	1.6	55	09.91–01.98	C 16 NZ/X 16 SZR	4	<b>Z 119</b>		14 R-8 DU4	0,8	<b>UXT 2<sup>4</sup></b>
1.6 i	1.6	55	09.91–01.98	C 16 NZ/X 16 SZR <sup>18</sup>	4	<b>Z 74<sup>5</sup></b>		14 FR-8 LDUOX4	1,0	<b>UXT 1<sup>3</sup></b>
1.6 i 16V	1.6	74	08.94–09.98	X 16 XEL	4	<b>Z 74<sup>5</sup></b>		14 FR-8 LDUOX4	1,0	<b>UXT 1<sup>3</sup></b>
1.6 Si	1.6	74	05.92–12.94	C 16 SE	4	<b>Z 119</b>		14 R-8 DU4	0,8	<b>UXT 2<sup>4</sup></b>
1.6 Si	1.6	74	05.92–12.94	C 16 SE <sup>18</sup>	4	<b>Z 74<sup>5</sup></b>		14 FR-8 LDUOX4	1,0	<b>UXT 1<sup>3</sup></b>

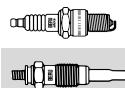
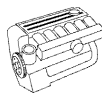
**OPEL**
**ASTRA F**

1.7 D	1.7	42	03.92-09.92	17 D	4	<b>GN 954</b> (11V)	<b>GR 064</b>		
1.7 D	1.7	44	07.92-09.98	17 DR	4	<b>GN 954</b> (11V)	○		
1.7 TD	1.7	50	11.94-09.98	X 17 DTL	4	<b>GN 954</b> (11V)	○		
1.7 TDS	1.7	60	12.91-01.98	17 DT (TC4EE1)/X 17 DT (TC4EE1) → Mot.Nr. 956632	4	<b>GV 947</b> (11V)	○		
1.7 TDS	1.7	60	12.91-01.98	17 DT (TC4EE1)/X 17 DT (TC4EE1) Mot.Nr. 956633 →	4	<b>GN 103</b> (11V)	○		
1.8 i	1.8	66	03.92-09.98	C 18 NZ	4	<b>Z 119</b>	14 R-8 DU4	0,8	<b>UXT 2<sup>4</sup></b>
1.8 i	1.8	66	03.92-09.98	C 18 NZ <sup>18</sup>	4	<b>Z 74<sup>5</sup></b>	14 FR-8 LDUOX4	1,0	<b>UXT 1<sup>3</sup></b>
1.8 i 16V	1.8	85	09.94-01.98	C 18 XEL/X 18 XE	4	<b>Z 74<sup>5</sup></b>	14 FR-8 LDUOX4	1,0	<b>UXT 1<sup>3</sup></b>
1.8 i 16V	1.8	92	06.93-10.94	C 18 XE	4	<b>Z 74<sup>5</sup></b>	14 FR-8 LDUOX4	1,0	<b>UXT 1<sup>3</sup></b>
2.0 i	2.0	85	09.91-01.98	C 20 NE	4	<b>Z 119</b>	14 R-8 DU4	0,8	<b>UXT 2<sup>4</sup></b>
2.0 i	2.0	85	09.91-01.98	C 20 NE <sup>18</sup>	4	<b>Z 74<sup>5</sup></b>	14 FR-8 LDUOX4	1,0	<b>UXT 1<sup>3</sup></b>
2.0 i 16V	2.0	100	02.95-09.98	X 20 XEV	4	<b>Z 74<sup>5</sup></b>	14 FR-8 LDUOX4	1,0	<b>UXT 1<sup>3</sup></b>
2.0 GSI 16V	2.0	110	09.91-08.92	C 20 XE	4	<b>Z 98</b>	14 FR-7 LDU	0,8	<b>UXT 1<sup>3</sup></b>
2.0 GSI 16V	2.0	110	09.92-01.98	C 20 XE	4	<b>Z 250</b>	14 FR-7 DU2S	0,7	<b>UXT 1<sup>3</sup></b>

**ASTRA F Cabriolet**

1.4 Si	1.4	60	05.93-03.01	C 14 SE	4	<b>Z 119</b>	14 R-8 DU4	0,8	<b>UXT 2<sup>4</sup></b>
1.4 Si	1.4	60	05.93-03.01	C 14 SE <sup>18</sup>	4	<b>Z 74<sup>5</sup></b>	14 FR-8 LDUOX4	1,0	<b>UXT 1<sup>3</sup></b>
1.4 i 16V	1.4	66	01.96-03.01	X 14 XE	4	<b>Z 74<sup>5</sup></b>	14 FR-8 LDUOX4	1,0	<b>UXT 1<sup>3</sup></b>
1.6 i	1.6	52	03.93-12.94	X 16 SZ	4	<b>Z 119</b>	14 R-8 DU4	0,8	<b>UXT 2<sup>4</sup></b>
1.6 i	1.6	52	01.95-08.96	X 16 SZ <sup>18</sup>	4	<b>Z 74<sup>5</sup></b>	14 FR-8 LDUOX4	1,0	<b>UXT 1<sup>3</sup></b>
1.6 i	1.6	55	01.96-03.01	X 16 SZR	4	<b>Z 74<sup>5</sup></b>	14 FR-8 LDUOX4	1,0	<b>UXT 1<sup>3</sup></b>
1.8 i 16V	1.8	85	11.94-03.01	C 18 XEL/X 18 XE	4	<b>Z 74<sup>5</sup></b>	14 FR-8 LDUOX4	1,0	<b>UXT 1<sup>3</sup></b>
2.0 i	2.0	85	03.93-10.94	C 20 NE	4	<b>Z 119</b>	14 R-8 DU4	0,8	<b>UXT 2<sup>4</sup></b>
2.0 i	2.0	85	03.93-10.94	C 20 NE <sup>18</sup>	4	<b>Z 74<sup>5</sup></b>	14 FR-8 LDUOX4	1,0	<b>UXT 1<sup>3</sup></b>

**ASTRA F Caravan**

1.4 i	1.4	44	09.91-01.98	C 14 NZ	4	<b>Z 119</b>	14 R-8 DU4	0,8	<b>UXT 2<sup>4</sup></b>
1.4 i	1.4	44	09.91-01.98	C 14 NZ <sup>18</sup>	4	<b>Z 74<sup>5</sup></b>	14 FR-8 LDUOX4	1,0	<b>UXT 1<sup>3</sup></b>
1.4	1.4	55	09.91-09.93	14 NV	4	<b>Z 119</b>	14 R-8 DU4	0,8	<b>UXT 2<sup>4</sup></b>
1.4	1.4	60	09.92-01.98	14 SE	4	<b>Z 74<sup>5</sup></b>	14 FR-8 LDUOX4	1,0	<b>UXT 1<sup>3</sup></b>
1.4 Si	1.4	60	03.92-01.98	C 14 SE	4	<b>Z 119</b>	14 R-8 DU4	0,8	<b>UXT 2<sup>4</sup></b>
1.4 Si	1.4	60	03.92-01.98	C 14 SE <sup>18</sup>	4	<b>Z 74<sup>5</sup></b>	14 FR-8 LDUOX4	1,0	<b>UXT 1<sup>3</sup></b>
1.4 i 16V	1.4	66	02.96-01.98	X 14 XE	4	<b>Z 74<sup>5</sup></b>	14 FR-8 LDUOX4	1,0	<b>UXT 1<sup>3</sup></b>
1.6 i	1.6	52	05.93-07.96	X 16 SZ	4	<b>Z 119</b>	14 R-8 DU4	0,8	<b>UXT 2<sup>4</sup></b>
1.6 i	1.6	52	05.93-07.96	X 16 SZ <sup>18</sup>	4	<b>Z 74<sup>5</sup></b>	14 FR-8 LDUOX4	1,0	<b>UXT 1<sup>3</sup></b>
1.6	1.6	55	09.95-01.98	16 NZR/16 LZ2	4	<b>Z 74<sup>5</sup></b>	14 FR-8 LDUOX4	1,0	<b>UXT 1<sup>3</sup></b>
1.6 i	1.6	55	09.91-01.98	C 16 NZ/X 16 SZR	4	<b>Z 119</b>	14 R-8 DU4	0,8	<b>UXT 2<sup>4</sup></b>
1.6 i	1.6	55	09.91-01.98	C 16 NZ/X 16 SZR <sup>18</sup>	4	<b>Z 74<sup>5</sup></b>	14 FR-8 LDUOX4	1,0	<b>UXT 1<sup>3</sup></b>
1.6 i 16V	1.6	74	08.94-01.98	X 16 XEL	4	<b>Z 74<sup>5</sup></b>	14 FR-8 LDUOX4	1,0	<b>UXT 1<sup>3</sup></b>
1.6 Si	1.6	74	03.92-12.94	C 16 SE	4	<b>Z 119</b>	14 R-8 DU4	0,8	<b>UXT 2<sup>4</sup></b>
1.6 Si	1.6	74	03.92-12.94	C 16 SE <sup>18</sup>	4	<b>Z 74<sup>5</sup></b>	14 FR-8 LDUOX4	1,0	<b>UXT 1<sup>3</sup></b>
1.7 D	1.7	42	12.91-09.92	17 D	4	<b>GN 954</b> (11V)	<b>GR 064</b>		
1.7 D	1.7	44	07.92-01.98	17 DR	4	<b>GN 954</b> (11V)	○		
1.7 TD	1.7	50	11.94-01.98	X 17 DTL	4	<b>GN 954</b> (11V)	○		
1.7 TDS	1.7	60	12.91-01.98	17 DT (TC4EE1)/X 17 DT (TC4EE1) → Mot.Nr. 956632	4	<b>GV 947</b> (11V)	○		
1.7 TDS	1.7	60	12.91-01.98	17 DT (TC4EE1)/X 17 DT (TC4EE1) Mot.Nr. 956633 →	4	<b>GN 103</b> (11V)	○		
1.8 i	1.8	66	09.91-01.98	C 18 NZ	4	<b>Z 119</b>	14 R-8 DU4	0,8	<b>UXT 2<sup>4</sup></b>
1.8 i	1.8	66	09.91-01.98	C 18 NZ <sup>18</sup>	4	<b>Z 74<sup>5</sup></b>	14 FR-8 LDUOX4	1,0	<b>UXT 1<sup>3</sup></b>
1.8 i 16V	1.8	85	07.94-01.98	C 18 XEL/X 18 XE	4	<b>Z 74<sup>5</sup></b>	14 FR-8 LDUOX4	1,0	<b>UXT 1<sup>3</sup></b>
1.8 i 16V	1.8	92	06.93-01.98	C 18 XE	4	<b>Z 74<sup>5</sup></b>	14 FR-8 LDUOX4	1,0	<b>UXT 1<sup>3</sup></b>
2.0 i	2.0	85	09.91-07.94	C 20 NE	4	<b>Z 119</b>	14 R-8 DU4	0,8	<b>UXT 2<sup>4</sup></b>
2.0 i	2.0	85	09.91-07.94	C 20 NE <sup>18</sup>	4	<b>Z 74<sup>5</sup></b>	14 FR-8 LDUOX4	1,0	<b>UXT 1<sup>3</sup></b>
2.0 i 16V	2.0	100	02.95-01.98	X 20 XEV	4	<b>Z 74<sup>5</sup></b>	14 FR-8 LDUOX4	1,0	<b>UXT 1<sup>3</sup></b>
2.0 i 16V	2.0	110	03.93-01.98	C 20 XE	4	<b>Z 74<sup>5</sup></b>	14 FR-8 LDUOX4	1,0	<b>UXT 1<sup>3</sup></b>

**ASTRA F CLASSIC**

1.4 i	1.4	44	01.98-08.02	X 14 NZ	4	<b>Z 74<sup>5</sup></b>	14 FR-8 LDUOX4	1,0	<b>UXT 1<sup>3</sup></b>
1.4 i	1.4	66	03.98-08.00	X 14 XE	4	<b>Z 74<sup>5</sup></b>	14 FR-8 LDUOX4	1,0	<b>UXT 1<sup>3</sup></b>
1.6 i	1.6	55	01.98-08.02	X 16 SZR	4	<b>Z 74<sup>5</sup></b>	14 FR-8 LDUOX4	1,0	<b>UXT 1<sup>3</sup></b>



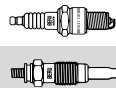

<b>OPEL</b>									
<b>ASTRA F CLASSIC</b>									
1.6 i 16V	1.6	74	01.98-08.02	X 16 XEL	4	<b>Z 74<sup>5</sup></b>	14 FR-8 LDUOX4	1,0	<b>UXT 1<sup>3</sup></b>
1.7 TD	1.7	50	03.98-08.00	X 17 DTL	4	<b>GN 954 (11V)</b>	○		
<b>ASTRA F CLASSIC Caravan</b>									
1.4 i	1.4	44	01.98-01.05	X 14 NZ	4	<b>Z 74<sup>5</sup></b>	14 FR-8 LDUOX4	1,0	<b>UXT 1<sup>3</sup></b>
1.4 Comfort	1.4	66	09.03-01.05	Z 14 XEP	4	<b>Z 203</b>	14 FR-8 LU2	0,9	○
1.6 i	1.6	55	01.98-01.05	X 16 SZR	4	<b>Z 74<sup>5</sup></b>	14 FR-8 LDUOX4	1,0	<b>UXT 1<sup>3</sup></b>
1.6 i 16V	1.6	74	01.98-01.05	X 16 XEL	4	<b>Z 74<sup>5</sup></b>	14 FR-8 LDUOX4	1,0	<b>UXT 1<sup>3</sup></b>
1.8	1.8	81	02.03-07.04	Z 18 XEL	4	<b>Z 203</b>	14 FR-8 LU2	0,9	○
<b>ASTRA F Van</b>									
1.4 i	1.4	44	10.91-01.99	C 14 NZ	4	<b>Z 119</b>	14 R-8 DU4	0,8	<b>UXT 2<sup>4</sup></b>
1.4 i	1.4	44	10.91-01.99	C 14 NZ <sup>18</sup>	4	<b>Z 74<sup>5</sup></b>	14 FR-8 LDUOX4	1,0	<b>UXT 1<sup>3</sup></b>
1.6 i	1.6	52	02.93-12.94	X 16 SZ	4	<b>Z 119</b>	14 R-8 DU4	0,8	<b>UXT 2<sup>4</sup></b>
1.6 i	1.6	52	01.95-07.96	X 16 SZ <sup>18</sup>	4	<b>Z 74<sup>5</sup></b>	14 FR-8 LDUOX4	1,0	<b>UXT 1<sup>3</sup></b>
1.6 i	1.6	55	10.91-04.93	C 16 NZ	4	<b>Z 119</b>	14 R-8 DU4	0,8	<b>UXT 2<sup>4</sup></b>
1.6 i	1.6	55	10.91-04.93	C 16 NZ <sup>18</sup>	4	<b>Z 74<sup>5</sup></b>	14 FR-8 LDUOX4	1,0	<b>UXT 1<sup>3</sup></b>
1.7 D	1.7	42	12.91-09.92	17 D	4	<b>GN 954 (11V)</b>	<b>GR 064</b>		
1.7 D	1.7	44	07.92-01.99	17 DR	4	<b>GN 954 (11V)</b>	○		
1.7 TD	1.7	50	08.94-01.99	X 17 DTL	4	<b>GN 954 (11V)</b>	○		
<b>ASTRA G</b>									
1.0	1.0	44	08.03-05.04	Z 10 XEP	3	<b>Z 203</b>	14 FR-8 LU2	0,9	○
1.2 16V	1.2	48	02.98-09.00	X 12 XE	4	<b>Z 74<sup>5</sup></b>	14 FR-8 LDUOX4	1,0	<b>UXT 1<sup>3</sup></b>
1.2 16V	1.2	55	09.00-01.05	Z 12 XE	4	<b>Z 190</b>	14 FGR-8 DQU7	1,2	<b>UXT 1<sup>3</sup></b>
1.4	1.4	66	09.07-12.09	Z 14 XEP	4	<b>Z 203</b>	14 FR-8 LU2	0,9	○
1.4 16V	1.4	66	02.98-01.05	X 14 XE/Z 14 XE	4	<b>Z 74<sup>5</sup></b>	14 FR-8 LDUOX4	1,0	<b>UXT 1<sup>3</sup></b>
1.6	1.6	55	02.98-09.00	X 16 SZR	4	<b>Z 74<sup>5</sup></b>	14 FR-8 LDUOX4	1,0	<b>UXT 1<sup>3</sup></b>
1.6	1.6	62	09.00-01.05	Z 16 SE	4	<b>Z 74<sup>5</sup></b>	14 FR-8 LDUOX4	1,0	<b>UXT 1<sup>3</sup></b>
1.6	1.6	70	06.02-03.04	Z 16 YNG	4	<b>Z 206</b>	14 FR-7 DPPUS2	0,7	<b>UXT 10</b>
1.6 16V	1.6	74	09.98-01.05	Z 16 XE/X 16 XEL → Mot.Nr. 420 00000	4	<b>Z 74<sup>5</sup></b>	14 FR-8 LDUOX4	1,0	<b>UXT 1<sup>3</sup></b>
1.6 16V	1.6	74	09.98-01.05	Z 16 XE/X 16 XEL Mot.Nr. 420 00001 →	4	<b>Z 203</b>	14 FR-8 LU2	0,9	○
1.6	1.6	76	12.02-08.03	Z 16 XEP	4	<b>Z 173</b>	14 FGR-8 KQU	1,6	○
1.6	1.6	76	09.03-12.09	Z 16 XEP	4	<b>Z 203</b>	14 FR-8 LU2	0,9	○
1.7 TD	1.7	50	02.98-08.00	X 17 DTL	4	<b>GN 954 (11V)</b>	○		
1.7 DTI 16V	1.7	55	02.00-01.05	Y 17 DT	4	<b>GN 104 (11V)</b>	○		
1.7 CDTI	1.7	59	04.03-01.05	Z 17 DTL	4	<b>GN 104 (11V)</b>	○		
1.8	1.8	81	02.03-01.05	Z 18 XEL	4	<b>Z 74<sup>5</sup></b>	14 FR-8 LDUOX4	1,0	<b>UXT 1<sup>3</sup></b>
1.8 16V	1.8	85	02.98-09.00	X 18 XE1	4	<b>Z 74<sup>5</sup></b>	14 FR-8 LDUOX4	1,0	<b>UXT 1<sup>3</sup></b>
1.8 16V	1.8	92	09.00-01.05	Z 18 XE	4	<b>Z 74<sup>5</sup></b>	14 FR-8 LDUOX4	1,0	<b>UXT 1<sup>3</sup></b>
2.0 DI	2.0	60	02.98-01.05	X 20 DTL/Y 20 DTL	4	<b>GN 992 (11V)</b>	○		
2.0 DTI 16V	2.0	74	08.99-08.02	Y 20 DTH	4	<b>GN 992 (11V)</b>	○		
2.0 DTI 16V	2.0	74	09.02-01.05	Y 20 DTH	4	<b>GN 033 (11V)</b>	○		
2.0 16V	2.0	100	02.98-01.05	X 20 XEV	4	<b>Z 74<sup>5</sup></b>	14 FR-8 LDUOX4	1,0	<b>UXT 1<sup>3</sup></b>
2.0 16V OPC	2.0	118	11.99-09.02	X 20 XER	4	<b>Z 74<sup>5</sup></b>	14 FR-8 LDUOX4	1,0	<b>UXT 1<sup>3</sup></b>
2.0 OPC	2.0	141	01.04-01.05	Z 20 LET	4	<b>Z 74<sup>5</sup></b>	14 FR-8 LDUOX4	1,0	<b>UXT 1<sup>3</sup></b>
2.0 OPC	2.0	147	01.04-01.05	Z 20 LET	4	<b>Z 74<sup>5</sup></b>	14 FR-8 LDUOX4	1,0	<b>UXT 1<sup>3</sup></b>
2.2 DTI	2.2	86	09.02-01.05	Y 22 DTR	4	<b>GN 033 (11V)</b>	○		
2.2 DTI	2.2	92	09.02-01.05	Y 22 DTR	4	<b>GN 033 (11V)</b>	○		
2.2 16V	2.2	108	03.01-01.05	Z 22 SE	4	<b>Z 222</b>	14 KR-8 STUX	1,1	○
<b>ASTRA G Cabriolet</b>									
1.6 16V	1.6	74	03.01-10.05	Z 16 XE → Mot.Nr. 420 00000	4	<b>Z 74<sup>5</sup></b>	14 FR-8 LDUOX4	1,0	<b>UXT 1<sup>3</sup></b>
1.6 16V	1.6	74	03.01-10.05	Z 16 XE Mot.Nr. 420 00001 →	4	<b>Z 203</b>	14 FR-8 LU2	0,9	○
1.6	1.6	76	01.03-08.03	Z 16 XEP	4	<b>Z 173</b>	14 FGR-8 KQU	1,6	○
1.6	1.6	76	09.03-10.05	Z 16 XEP	4	<b>Z 203</b>	14 FR-8 LU2	0,9	○
1.8 16V	1.8	92	03.01-10.05	Z 18 XE	4	<b>Z 74<sup>5</sup></b>	14 FR-8 LDUOX4	1,0	<b>UXT 1<sup>3</sup></b>
2.0 OPC	2.0	141	03.02-10.05	Z 20 LET	4	<b>Z 74<sup>5</sup></b>	14 FR-8 LDUOX4	1,0	<b>UXT 1<sup>3</sup></b>
2.0 16V Turbo	2.0	147	11.02-01.04	Z 20 LET	4	<b>Z 74<sup>5</sup></b>	14 FR-8 LDUOX4	1,0	<b>UXT 1<sup>3</sup></b>
2.0 16V Turbo	2.0	147	02.04-10.05	Z 20 LET	4	<b>Z 287</b>	14 FR-8 LU2T	0,8	○
2.2 DTI	2.2	92	09.02-10.05	Y 22 DTR	4	<b>GN 033 (11V)</b>	○		



kW

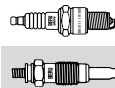

**OPEL**

**ASTRA G Cabriolet**

2.2 16V	2.2	108	03.01-10.05	Z 22 SE	4	<b>Z 222</b>	14 KR-8 STUX	1,1	○
---------	-----	-----	-------------	---------	---	--------------	--------------	-----	---

**ASTRA G Caravan**

1.2 16V	1.2	48	02.98-09.00	X 12 XE	4	<b>Z 74<sup>5</sup></b>	14 FR-8 LDUOX4	1,0	<b>UXT 1<sup>3</sup></b>
1.4	1.4	66	09.07-12.09	Z 14 XEP	4	<b>Z 203</b>	14 FR-8 LU2	0,9	○
1.4 16V	1.4	66	06.98-07.04	X 14 XE/Z 14 XE	4	<b>Z 74<sup>5</sup></b>	14 FR-8 LDUOX4	1,0	<b>UXT 1<sup>3</sup></b>
1.6	1.6	55	02.98-09.00	X 16 SZR	4	<b>Z 74<sup>5</sup></b>	14 FR-8 LDUOX4	1,0	<b>UXT 1<sup>3</sup></b>
1.6	1.6	62	09.00-07.04	Z 16 SE	4	<b>Z 74<sup>5</sup></b>	14 FR-8 LDUOX4	1,0	<b>UXT 1<sup>3</sup></b>
1.6 CNG	1.6	71	03.03-07.04	Z 16 YNG	4	<b>Z 206</b>	14 FR-7 DPPUS2	0,7	<b>UXT 10</b>
1.6 16V	1.6	74	02.98-07.04	Z 16 XE/X 16 XEL → Mot.Nr. 420 00000	4	<b>Z 74<sup>5</sup></b>	14 FR-8 LDUOX4	1,0	<b>UXT 1<sup>3</sup></b>
1.6 16V	1.6	74	02.98-07.04	Z 16 XE/X 16 XEL Mot.Nr. 420 00001 →	4	<b>Z 203</b>	14 FR-8 LU2	0,9	○
1.6	1.6	76	12.02-08.03	Z 16 XEP	4	<b>Z 173</b>	14 FGR-8 KQU	1,6	○
1.6	1.6	76	09.03-07.09	Z 16 XEP	4	<b>Z 203</b>	14 FR-8 LU2	0,9	○
1.7 TD	1.7	50	02.98-08.00	X 17 DTL	4	<b>GN 954</b> (11V)	○		
1.7 DTI 16V	1.7	55	02.00-07.04	Y 17 DT	4	<b>GN 104</b> (11V)	○		
1.7 CDTI	1.7	59	04.03-07.09	Z 17 DTL	4	<b>GN 104</b> (11V)	○		
1.8	1.8	81	02.03-07.04	Z 18 XEL	4	<b>Z 74<sup>5</sup></b>	14 FR-8 LDUOX4	1,0	<b>UXT 1<sup>3</sup></b>
1.8 16V	1.8	85	02.98-09.00	X 18 XE1	4	<b>Z 74<sup>5</sup></b>	14 FR-8 LDUOX4	1,0	<b>UXT 1<sup>3</sup></b>
1.8 16V	1.8	92	09.00-07.04	Z 18 XE	4	<b>Z 74<sup>5</sup></b>	14 FR-8 LDUOX4	1,0	<b>UXT 1<sup>3</sup></b>
2.0 DI	2.0	60	02.98-07.04	X 20 DTL/Y 20 DTL	4	<b>GN 992</b> (11V)	○		
2.0 DTI 16V	2.0	74	08.99-08.02	Y 20 DTH	4	<b>GN 992</b> (11V)	○		
2.0 DTI 16V	2.0	74	09.02-07.04	Y 20 DTH	4	<b>GN 033</b> (11V)	○		
2.0 16V	2.0	100	02.98-07.04	X 20 XEV	4	<b>Z 74<sup>5</sup></b>	14 FR-8 LDUOX4	1,0	<b>UXT 1<sup>3</sup></b>
2.0 OPC	2.0	141	09.02-07.04	Z 20 LET	4	<b>Z 74<sup>5</sup></b>	14 FR-8 LDUOX4	1,0	<b>UXT 1<sup>3</sup></b>
2.0 OPC	2.0	147	11.02-07.04	Z 20 LET	4	<b>Z 74<sup>5</sup></b>	14 FR-8 LDUOX4	1,0	<b>UXT 1<sup>3</sup></b>
2.2 DTI	2.2	86	09.02-07.04	Y 22 DTR	4	<b>GN 033</b> (11V)	○		
2.2 DTI	2.2	92	09.02-07.04	Y 22 DTR	4	<b>GN 033</b> (11V)	○		
2.2 16V	2.2	108	03.01-07.04	Z 22 SE	4	<b>Z 222</b>	14 KR-8 STUX	1,1	○

**ASTRA G Coupe**

1.6 16V	1.6	74	03.00-05.05	Z 16 XE → Mot.Nr. 420 00000	4	<b>Z 74<sup>5</sup></b>	14 FR-8 LDUOX4	1,0	<b>UXT 1<sup>3</sup></b>
1.6 16V	1.6	74	03.00-05.05	Z 16 XE Mot.Nr. 420 00001 →	4	<b>Z 203</b>	14 FR-8 LU2	0,9	○
1.6 16V	1.6	76	03.00-08.03	Z 16 XEP	4	<b>Z 173</b>	14 FGR-8 KQU	1,6	○
1.6 16V	1.6	76	09.03-05.05	Z 16 XEP	4	<b>Z 203</b>	14 FR-8 LU2	0,9	○
1.8 16V	1.8	85	03.00-10.00	X 18 XE1	4	<b>Z 190</b>	14 FGR-8 DQU7	1,2	<b>UXT 1<sup>3</sup></b>
1.8 16V	1.8	92	09.00-05.05	Z 18 XE	4	<b>Z 74<sup>5</sup></b>	14 FR-8 LDUOX4	1,0	<b>UXT 1<sup>3</sup></b>
2.0 16V Turbo	2.0	140	09.00-08.01	Z 20 LET	4	<b>Z 74<sup>5</sup></b>	14 FR-8 LDUOX4	1,0	<b>UXT 1<sup>3</sup></b>
2.0 16V Turbo	2.0	141	08.01-05.05	Z 20 LET	4	<b>Z 74<sup>5</sup></b>	14 FR-8 LDUOX4	1,0	<b>UXT 1<sup>3</sup></b>
2.0 16V Turbo	2.0	147	11.02-01.04	Z 20 LET	4	<b>Z 74<sup>5</sup></b>	14 FR-8 LDUOX4	1,0	<b>UXT 1<sup>3</sup></b>
2.0 16V Turbo	2.0	147	02.04-05.05	Z 20 LET	4	<b>Z 287</b>	14 FR-8 LU2T	0,8	○
2.2 DTI	2.2	92	09.02-05.05	Y 22 DTR	4	<b>GN 033</b> (11V)	○		
2.2 16V	2.2	108	09.00-05.05	Z 22 SE	4	<b>Z 222</b>	14 KR-8 STUX	1,1	○

**ASTRA H**

1.2	1.2	59	08.05-	Z 12 XEP	4	<b>Z 203</b>	14 FR-8 LU2	0,9	○
1.3 CDTI	1.3	66	08.05-	Z 13 DTH	4	<b>GN 053</b> (11V)	○		
1.4	1.4	66	03.04-	Z 14 XEP	4	<b>Z 203</b>	14 FR-8 LU2	0,9	○
1.4 LPG	1.4	66	08.09-	Z 14 XEP	4	<b>Z 203</b>	14 FR-8 LU2	0,9	○
1.6 CNG	1.6	69	11.05-	Z 16 YNG	4	<b>Z 206</b>	14 FR-7 DPPUS2	0,7	<b>UXT 10</b>
1.6	1.6	77	03.04-	Z 16 XEP	4	<b>Z 203</b>	14 FR-8 LU2	0,9	○
1.6	1.6	85	12.06-	A 16 XER	4	<b>Z 203</b>	14 FR-8 LU2	0,9	○
1.6	1.6	85	02.07-	Z 16 XER	4	<b>Z 203</b>	14 FR-8 LU2	0,9	○
1.6 Turbo	1.6	132	02.07-	Z 16 LET	4	<b>Z 346</b>	14 FR-7 LPUT02	0,8	○
1.7 CDTI	1.7	59	03.04-	Z 17 DTL	4	<b>GN 104</b> (11V)	○		
1.7 CDTI	1.7	74	03.04-	Z 17 DTH	4	<b>GN 104</b> (11V)	○		
1.7 CDTI	1.7	81	02.07-	A 17 DTJ/Z 17 DTJ	4	<b>GN 104</b> (11V)	○		
1.7 CDTI	1.7	92	02.07-	A 17 DTR/Z 17 DTR	4	<b>GN 104</b> (11V)	○		
1.8	1.8	92	03.04-	Z 18 XE	4	<b>Z 203</b>	14 FR-8 LU2	0,9	○
1.8	1.8	103	01.06-	Z 18 XER/A 18 XER	4	<b>Z 203</b>	14 FR-8 LU2	0,9	○

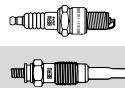
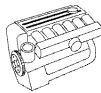

OPEL									
ASTRA H									
1.9 CDTI	1.9	74	09.05-	Z 19 DTL → Fgst.Nr. 78007391, 72045139, 75030986	4	<b>GN 041</b> (11V)	○		
1.9 CDTI	1.9	74	09.05-	Z 19 DTL Fgst.Nr. 72045140, 78007392, 75030987 →	4	<b>GN 097</b> (11V)	○		
1.9 CDTI	1.9	88	06.04-	Z 19 DT → Fgst.Nr. 78007391, 72045139, 75030986	4	<b>GN 041</b> (11V)	○		
1.9 CDTI	1.9	88	06.04-	Z 19 DT Fgst.Nr. 72045140, 78007392, 75030987 →	4	<b>GN 097</b> (11V)	○		
1.9 CDTI 16V	1.9	88	04.04-	Z 19 DTJ	4	<b>GN 059</b> (11V)	○		
1.9 CDTI	1.9	110	09.04-	Z 19 DTH	4	<b>GN 059</b> (11V)	○		
2.0 Turbo	2.0	125	03.04-	Z 20 LEL	4	<b>Z 287</b>	14 FR-8 LU2T	0,8	○
2.0 Turbo	2.0	147	09.04-	Z 20 LER	4	<b>Z 287</b>	14 FR-8 LU2T	0,8	○
2.0 Turbo	2.0	177	03.05-	Z 20 LEH	4	<b>Z 284</b>	14 FR-6 DPOX	1,1	<b>UXT 14</b>
ASTRA H Caravan									
1.3 CDTI	1.3	66	08.05-	Z 13 DTH	4	<b>GN 053</b> (11V)	○		
1.4	1.4	66	08.04-	Z 14 XEP	4	<b>Z 203</b>	14 FR-8 LU2	0,9	○
1.6 CNG	1.6	69	11.05-	Z 16 YNG	4	<b>Z 206</b>	14 FR-7 DPPUS2	0,7	<b>UXT 10</b>
1.6	1.6	77	08.04-	Z 16 XEP	4	<b>Z 203</b>	14 FR-8 LU2	0,9	○
1.6	1.6	85	12.06-	A 16 XER	4	<b>Z 203</b>	14 FR-8 LU2	0,9	○
1.6 LPG	1.6	85	08.09-	Z 16 XER	4	<b>Z 203</b>	14 FR-8 LU2	0,9	○
1.6 Turbo	1.6	132	02.07-	Z 16 LET	4	<b>Z 346</b>	14 FR-7 LPUT02	0,8	○
1.7 CDTI	1.7	59	08.04-	Z 17 DTL	4	<b>GN 104</b> (11V)	○		
1.7 CDTI	1.7	74	08.04-	Z 17 DTH	4	<b>GN 104</b> (11V)	○		
1.7 CDTI	1.7	81	02.07-	A 17 DTJ/Z 17 DTJ	4	<b>GN 104</b> (11V)	○		
1.7 CDTI	1.7	92	02.07-	A 17 DTR/Z 17 DTR	4	<b>GN 104</b> (11V)	○		
1.8	1.8	92	08.04-	Z 18 XE	4	<b>Z 203</b>	14 FR-8 LU2	0,9	○
1.8	1.8	103	08.05-	Z 18 XER/A 18 XER	4	<b>Z 203</b>	14 FR-8 LU2	0,9	○
1.9 CDTI	1.9	74	09.05-	Z 19 DTL → Fgst.Nr. 72045139, 78007391, 75030986	4	<b>GN 041</b> (11V)	○		
1.9 CDTI	1.9	74	09.05-	Z 19 DTL Fgst.Nr. 72045140, 78007392, 75030987 →	4	<b>GN 097</b> (11V)	○		
1.9 CDTI	1.9	88	09.05-	Z 19 DT → Fgst.Nr. 78007391, 72045139, 75030986	4	<b>GN 041</b> (11V)	○		
1.9 CDTI	1.9	88	09.05-	Z 19 DT Fgst.Nr. 72045140, 78007392, 75030987 →	4	<b>GN 097</b> (11V)	○		
1.9 CDTI 16V	1.9	88	08.04-	Z 19 DTJ	4	<b>GN 059</b> (11V)	○		
1.9 CDTI	1.9	110	09.04-	Z 19 DTH	4	<b>GN 059</b> (11V)	○		
2.0 Turbo	2.0	125	08.04-	Z 20 LEL	4	<b>Z 287</b>	14 FR-8 LU2T	0,8	○
2.0 Turbo	2.0	147	09.04-	Z 20 LER	4	<b>Z 287</b>	14 FR-8 LU2T	0,8	○
ASTRA H GTC									
1.2	1.2	59	08.05-	Z 12 XEP	4	<b>Z 203</b>	14 FR-8 LU2	0,9	○
1.3 CDTI	1.3	66	04.05-	Z 13 DTH	4	<b>GN 053</b> (11V)	○		
1.4	1.4	66	03.05-	Z 14 XEP	4	<b>Z 203</b>	14 FR-8 LU2	0,9	○
1.6 CNG	1.6	69	11.05-	Z 16 YNG	4	<b>Z 206</b>	14 FR-7 DPPUS2	0,7	<b>UXT 10</b>
1.6	1.6	77	03.05-	Z 16 XEP	4	<b>Z 203</b>	14 FR-8 LU2	0,9	○
1.6	1.6	85	12.06-	Z 16 XER	4	<b>Z 203</b>	14 FR-8 LU2	0,9	○
1.6 Turbo	1.6	132	02.07-	Z 16 LET	4	<b>Z 346</b>	14 FR-7 LPUT02	0,8	○
1.7 CDTI	1.7	59	03.05-	Z 17 DTL	4	<b>GN 104</b> (11V)	○		
1.7 CDTI	1.7	74	03.05-	Z 17 DTH	4	<b>GN 104</b> (11V)	○		
1.7 CDTI	1.7	81	02.07-	A 17 DTJ	4	<b>GN 104</b> (11V)	○		
1.7 CDTI	1.7	92	02.07-	A 17 DTR	4	<b>GN 104</b> (11V)	○		
1.8	1.8	92	03.05-	Z 18 XE	4	<b>Z 203</b>	14 FR-8 LU2	0,9	○
1.8	1.8	103	01.06-	Z 18 XER	4	<b>Z 203</b>	14 FR-8 LU2	0,9	○
1.9 CDTI	1.9	74	01.06-	Z 19 DTL → Fgst.Nr. 78007391	4	<b>GN 041</b> (11V)	○		
1.9 CDTI	1.9	74	01.06-	Z 19 DTL Fgst.Nr. 78007392 →	4	<b>GN 097</b> (11V)	○		

● nicht erforderlich  
○ nicht im Programm

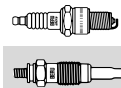
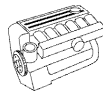

## OPEL

### ASTRA H GTC

1.9 CDTi	1.9	88	09.05-	Z 19 DT → Fgst.Nr. 78007391, 72045139, 75030986	4	<b>GN 041</b> (11V)	○		
1.9 CDTi	1.9	88	09.05-	Z 19 DT Fgst.Nr. 72045140, 78007392, 75030987 →	4	<b>GN 097</b> (11V)	○		
1.9 CDTi 16V	1.9	88	03.05-	Z 19 DTJ	4	<b>GN 059</b> (11V)	○		
1.9 CDTi	1.9	110	03.05-	Z 19 DTH	4	<b>GN 059</b> (11V)	○		
2.0 Turbo	2.0	125	03.05-	Z 20 LEL	4	<b>Z 287</b>	14 FR-8 LU2T	0,8	○
2.0 Turbo	2.0	147	03.05-	Z 20 LER	4	<b>Z 287</b>	14 FR-8 LU2T	0,8	○
2.0 Turbo	2.0	177	08.05-	Z 20 LEH	4	<b>Z 284</b>	14 FR-6 DPOX	1,1	<b>UXT 14</b>

### ASTRA H TwinTop

1.6	1.6	77	09.05-	Z 16 XE1/Z 16 XEP	4	<b>Z 203</b>	14 FR-8 LU2	0,9	○
1.6	1.6	85	12.06-	Z 16 XER	4	<b>Z 203</b>	14 FR-8 LU2	0,9	○
1.6 Turbo	1.6	132	02.07-	Z 16 LET	4	<b>Z 346</b>	14 FR-7 LPUT02	0,8	○
1.8	1.8	92	09.05-	Z 18 XE	4	<b>Z 203</b>	14 FR-8 LU2	0,9	○
1.8	1.8	103	09.05-	Z 18 XER/A 18 XER	4	<b>Z 203</b>	14 FR-8 LU2	0,9	○
1.9 CDTi	1.9	110	09.05-	Z 19 DTH	4	<b>GN 059</b> (11V)	○		
2.0 Turbo	2.0	125	09.05-	Z 20 LEL	4	<b>Z 287</b>	14 FR-8 LU2T	0,8	○
2.0 Turbo	2.0	147	09.05-	Z 20 LER	4	<b>Z 287</b>	14 FR-8 LU2T	0,8	○

### ASTRA H Van

1.3 CDTi	1.3	66	08.05-	Z 13 DTH	4	<b>GN 053</b> (11V)	○		
1.7 CDTi	1.7	74	03.04-	Z 17 DTH	4	<b>GN 104</b> (11V)	○		
1.7 CDTi	1.7	81	02.07-	A 17 DTJ/Z 17 DTJ	4	<b>GN 104</b> (11V)	○		
1.7 CDTi	1.7	92	02.07-	A 17 DTR/Z 17 DTR	4	<b>GN 104</b> (11V)	○		
1.9 CDTi	1.9	88	09.05-	Z 19 DT → Fgst.Nr. 78007391, 72045139, 75030986	4	<b>GN 041</b> (11V)	○		
1.9 CDTi	1.9	88	09.05-	Z 19 DT Fgst.Nr. 72045140, 78007392, 75030987 →	4	<b>GN 097</b> (11V)	○		
1.9 CDTi 16V	1.9	88	08.04-	Z 19 DTJ	4	<b>GN 059</b> (11V)	○		
1.9 CDTi	1.9	110	09.04-	Z 19 DTH	4	<b>GN 059</b> (11V)	○		

### ASTRA J

1.3 CDTi	1.3	70	12.09-	A 13 DTE	4	<b>GE 112</b> (4,4V)=2x <b>PSG 003</b> (4,4V)=2x	○		
1.4	1.4	64	12.09-	A 14 XEL	4	<b>Z 203</b>	14 FR-8 LU2	0,9	○
1.6 Turbo	1.6	132	12.09-	A 16 LET	4	<b>Z 346</b>	14 FR-7 LPUT02	0,8	○
1.7 CDTi	1.7	81	12.09-	A 17 DTJ	4	<b>GN 104</b> (11V)	○		
1.7 CDTi	1.7	81	12.09-	A 17 DTE	4	<b>PSG 004</b> (4,4V)	○		
1.7 CDTi	1.7	92	12.09-	A 17 DTR	4	<b>GN 104</b> (11V)	○		
1.7 CDTi	1.7	96	12.09-	A 17 DTF	4	<b>PSG 004</b> (4,4V)	○		
2.0 CDTi	2.0	118	12.09-	A 20 DTHv → Fgst.Nr. B3999999, B8999999, BG999999	4	<b>GE 114</b> (4,4V)	○		
2.0 CDTi	2.0	118	12.09-	A 20 DTH Fgst.Nr.CG000001, C1000001, C3000001, C8000001 →	4	<b>PSG 001</b> (4,4V)	○		
2.0 CDTi	2.0	121	06.11-	A 20 DTH → Fgst.Nr. B3999999, B8999999, BG999999	4	<b>GE 114</b> (4,4V)	○		
2.0 CDTi	2.0	121	06.11-	A 20 DTH Fgst.Nr.C8000001, CG000001, C3000001, C1000001 →	4	<b>PSG 001</b> (4,4V)	○		

### ASTRA GTC J

1.6	1.6	132	10.11-	A 16 LET	4	<b>Z 346</b>	14 FR-7 LPUT02	0,8	○
1.7 CDTi	1.7	81	10.11-	A 17 DTJ	4	<b>GN 104</b> (11V)	○		
1.7 CDTi	1.7	81	10.11-	A 17 DTE	4	<b>PSG 004</b> (4,4V)	○		
1.7 CDTi	1.7	96	10.11-	A 17 DTF	4	<b>PSG 004</b> (4,4V)	○		
2.0 CDTi	2.0	121	10.11-	A 20 DTH → Fgst.Nr. B3999999, B8999999, BG999999	4	<b>GE 114</b> (4,4V)	○		

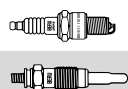

## OPEL

### ASTRA GTC J

2.0 CDTI	2.0	121	10.11-	A 20 DTH Fgst.Nr.C1000001, 4 C3000001, CG000001, C8000001 →	4	<b>PSG 001</b> (4,4V)	○		
----------	-----	-----	--------	---	---	-----------------------	---	--	--

### ASTRA Sports Tourer (J)

1.3 CDTI	1.3	70	10.10-	A 13 DTE → Fgst.Nr. B3999999, B8999999, BG999999	4	<b>GE 112</b> (4,4V)=2x <b>PSG 003</b> (4,4V)=2x	○		
1.3 CDTI	1.3	70	10.10-	A 13 DTE Fgst.Nr. C3000001, 4 C8000001, CG000000 →	4	<b>GE 112</b> (4,4V)=4x	○		
1.6 Turbo	1.6	132	10.10-	A 16 LET	4	<b>Z 346</b> 14 FR-7 LPUT02		0,8	○
1.7 CDTI	1.7	81	10.10-	A 17 DTJ	4	<b>GN 104</b> (11V)	○		
1.7 CDTI	1.7	81	10.10-	A 17 DTE	4	<b>PSG 004</b> (4,4V)	○		
1.7 CDTI	1.7	92	10.10-	A 17 DTR	4	<b>GN 104</b> (11V)	○		
1.7 CDTI	1.7	96	10.10-	A 17 DTF	4	<b>PSG 004</b> (4,4V)	○		
2.0 CDTI	2.0	118	10.10-	A 20 DTH Fgst.Nr.CG000001, 4 C8000001, C1000001, C3000001 →	4	<b>PSG 001</b> (4,4V)	○		
2.0 CDTI	2.0	121	08.11-	A 20 DTH → Fgst.Nr. B3999999, B8999999, BG999999	4	<b>GE 114</b> (4,4V)	○		
2.0 CDTI	2.0	121	08.11-	A 20 DTH Fgst.Nr. C3000001, C1000001, C8000001, CG000001 →	4	<b>PSG 001</b> (4,4V)	○		

### CALIBRA A

2.0 i	2.0	85	06.90-07.97	C 20 NE	4	<b>Z 119</b> 14 R-8 DU4		0,8	<b>UXT 2<sup>4</sup></b>
2.0 i	2.0	85	06.90-07.97	C 20 NE <sup>18</sup>	4	<b>Z 74<sup>5</sup></b> 14 FR-8 LDUOX4		1,0	<b>UXT 1<sup>3</sup></b>
2.0 i 4x4	2.0	85	06.90-07.97	C 20 NE	4	<b>Z 119</b> 14 R-8 DU4		0,8	<b>UXT 2<sup>4</sup></b>
2.0 i 4x4	2.0	85	06.90-07.97	C 20 NE <sup>18</sup>	4	<b>Z 74<sup>5</sup></b> 14 FR-8 LDUOX4		1,0	<b>UXT 1<sup>3</sup></b>
2.0 i 16V	2.0	100	02.94-07.97	X 20 XEV	4	<b>Z 250</b> 14 FR-7 DU2S		0,7	<b>UXT 1<sup>3</sup></b>
2.0 i 16V 4x4	2.0	100	02.94-07.97	X 20 XEV	4	<b>Z 250</b> 14 FR-7 DU2S		0,7	<b>UXT 1<sup>3</sup></b>
2.0 i 16V	2.0	110	06.90-08.92	C 20 XE	4	<b>Z 250</b> 14 FR-7 DU2S		0,7	<b>UXT 1<sup>3</sup></b>
2.0 i 16V	2.0	110	09.92-02.94	C 20 XE	4	<b>Z 74<sup>5</sup></b> 14 FR-8 LDUOX4		1,0	<b>UXT 1<sup>3</sup></b>
2.0 i 16V 4x4	2.0	110	06.90-08.92	C 20 XE	4	<b>Z 250</b> 14 FR-7 DU2S		0,7	<b>UXT 1<sup>3</sup></b>
2.0 i 16V 4x4	2.0	110	09.92-02.94	C 20 XE	4	<b>Z 74<sup>5</sup></b> 14 FR-8 LDUOX4		1,0	<b>UXT 1<sup>3</sup></b>
2.0 i Turbo 4x4	2.0	150	03.92-07.97	C 20 LET	4	<b>Z 158</b> 14 FR-7 LUX		1,1	○
2.5 i V6	2.5	125	04.93-07.97	X 25 XE/C 25 XE	6	<b>Z 74<sup>5</sup></b> 14 FR-8 LDUOX4		1,0	<b>UXT 1<sup>3</sup></b>

### CAMPO

2.2 D	2.2	39	08.91-09.96	C223	4	<b>GV 946</b> (11V)	○		
2.2 D	2.2	45	08.87-08.90	C223	4	<b>GV 946</b> (11V)	○		
2.3	2.3	69	08.91-08.94	4 ZD1	4	<b>Z 20</b> 14 R-7 DU		0,8	<b>UXT 2<sup>4</sup></b>
2.3	2.3	72	08.94-09.96	4 ZD1/23 P	4	<b>Z 20</b> 14 R-7 DU		0,8	<b>UXT 2<sup>4</sup></b>
2.5 D	2.5	56	08.91-06.94	4 JA1	4	<b>GN 061</b> (11V)	○		
2.5 TD	2.5	56	07.94-	4 JA1T	4	<b>GN 061</b> (11V)	○		
2.5 DTI	2.5	74	12.01-	4 JA1	4	<b>GN 061</b> (11V)	○		
3.1 TD	3.1	80	03.95-12.96	4 JG2T	4	<b>GV 947</b> (11V)	○		

### COMBO

1.2	1.2	33	07.94-10.01	C 12 NZ/X 12 SZ	4	<b>Z 119</b> 14 R-8 DU4		0,8	<b>UXT 2<sup>4</sup></b>
1.2	1.2	33	07.94-10.01	C 12 NZ/X 12 SZ <sup>18</sup>	4	<b>Z 74<sup>5</sup></b> 14 FR-8 LDUOX4		1,0	<b>UXT 1<sup>3</sup></b>
1.3 CDTI 16V	1.3	51	08.05-	Z 13 DT	4	<b>GN 053</b> (11V)	○		
1.3 CDTI 16V	1.3	55	10.05-	Z 13 DTJ	4	<b>GN 053</b> (11V)	○		
1.4	1.4	44	07.94-10.01	C 14 NZ/X 14 SZ	4	<b>Z 119</b> 14 R-8 DU4		0,8	<b>UXT 2<sup>4</sup></b>
1.4	1.4	44	07.94-10.01	C 14 NZ/X 14 SZ <sup>18</sup>	4	<b>Z 74<sup>5</sup></b> 14 FR-8 LDUOX4		1,0	<b>UXT 1<sup>3</sup></b>
1.4	1.4	60	07.94-10.01	C 14 SE	4	<b>Z 119</b> 14 R-8 DU4		0,8	<b>UXT 2<sup>4</sup></b>
1.4	1.4	60	07.94-10.01	C 14 SE <sup>18</sup>	4	<b>Z 74<sup>5</sup></b> 14 FR-8 LDUOX4		1,0	<b>UXT 1<sup>3</sup></b>
1.4 16V	1.4	66	08.99-10.01	X 14 XE	4	<b>Z 74<sup>5</sup></b> 14 FR-8 LDUOX4		1,0	<b>UXT 1<sup>3</sup></b>
1.4 16V	1.4	66	08.05-	Z 14 XEP	4	<b>Z 203</b> 14 FR-8 LU2		0,9	○
1.6	1.6	64	10.01-08.04	Z 16 SE	4	<b>Z 74<sup>5</sup></b> 14 FR-8 LDUOX4		1,0	<b>UXT 1<sup>3</sup></b>
1.6 CNG 16V	1.6	69	06.06-	Z 16 YNG	4	<b>Z 206</b> 14 FR-7 DPPUS2		0,7	<b>UXT 10</b>
1.6 CNG 16V	1.6	71	04.05-	Z 16 YNG	4	<b>Z 206</b> 14 FR-7 DPPUS2		0,7	<b>UXT 10</b>
1.7 D	1.7	44	07.94-10.01	17 D (4EE1)/X 17 D (4EE1)	4	<b>GN 103</b> (11V)	○		
1.7 DI 16V	1.7	48	10.01-	Y 17 DTL	4	<b>GN 104</b> (11V)	○		



kW

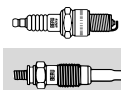
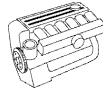

**OPEL**

**COMBO**

1.7 DTI 16V	1.7	55	10.01-	Y 17 DT	4	<b>GN 104</b> (11V)	○		
1.7 CDTI 16V	1.7	74	12.04-	Z 17 DTH	4	<b>GN 104</b> (11V)	○		

**COMBO Tour**

1.3 CDTI 16V	1.3	51	10.04-	Y 13 DT/Z 13 DT	4	<b>GN 053</b> (11V)	○		
1.3 CDTI 16V	1.3	55	10.05-	Z 13 DTJ	4	<b>GN 053</b> (11V)	○		
1.4	1.4	66	10.04-	Z 14 XEP	4	<b>Z 203</b>	14 FR-8 LU2	0,9	○
1.6	1.6	62	08.01-08.04	Z 16 SE	4	<b>Z 74<sup>5</sup></b>	14 FR-8 LDUOX4	1,0	<b>UXT 1<sup>3</sup></b>
1.6	1.6	64	10.01-08.04	Z 16 SE	4	<b>Z 74<sup>5</sup></b>	14 FR-8 LDUOX4	1,0	<b>UXT 1<sup>3</sup></b>
1.6 CNG	1.6	69	06.06-	Z 16 YNG	4	<b>Z 206</b>	14 FR-7 DPPUS2	0,7	<b>UXT 10</b>
1.6 CNG	1.6	71	04.05-	Z 16 YNG	4	<b>Z 206</b>	14 FR-7 DPPUS2	0,7	<b>UXT 10</b>
1.7 DI 16V	1.7	48	10.01-	Y 17 DTL	4	<b>GN 104</b> (11V)	○		
1.7 DTI 16V	1.7	55	10.01-	Y 17 DT	4	<b>GN 104</b> (11V)	○		
1.7 CDTI 16V	1.7	74	12.04-	Z 17 DTH	4	<b>GN 104</b> (11V)	○		

**CORSA A**

1.0	1.0	33	09.82-03.93	10 S	4	<b>Z 19</b>	14 R-7 BU	0,8	○
1.2	1.2	33	09.82-08.90	E 12 GV/12 NC	4	<b>Z 19</b>	14 R-7 BU	0,8	○
1.2 i	1.2	33	09.89-03.93	C 12 NZ	4	<b>Z 119</b>	14 R-8 DU4	0,8	<b>UXT 2<sup>4</sup></b>
1.2 N	1.2	38	01.90-03.93	12 NV	4	<b>Z 20</b>	14 R-7 DU	0,8	<b>UXT 2<sup>4</sup></b>
1.2 S	1.2	40	09.82-03.93	12 ST	4	<b>Z 20</b>	14 R-7 DU	0,8	<b>UXT 2<sup>4</sup></b>
1.2	1.2	44	09.82-08.90	12 S	4	<b>Z 20</b>	14 R-7 DU	0,8	<b>UXT 2<sup>4</sup></b>
1.3 i	1.3	44	09.86-09.90	C 13 N	4	<b>Z 20</b>	14 R-7 DU	0,8	<b>UXT 2<sup>4</sup></b>
1.4 i	1.4	44	01.90-03.93	C 14 NZ	4	<b>Z 20</b>	14 R-7 DU	0,8	<b>UXT 2<sup>4</sup></b>
1.4 i	1.4	44	01.90-03.93	C 14 NZ <sup>18</sup>	4	<b>Z 74<sup>5</sup></b>	14 FR-8 LDUOX4	1,0	<b>UXT 1<sup>3</sup></b>
1.4 S	1.4	53	01.90-03.93	14 NV	4	<b>Z 119</b>	14 R-8 DU4	0,8	<b>UXT 2<sup>4</sup></b>
1.4 S	1.4	53	01.90-03.93	14 NV <sup>18</sup>	4	<b>Z 74<sup>5</sup></b>	14 FR-8 LDUOX4	1,0	<b>UXT 1<sup>3</sup></b>
1.4 Si	1.4	60	09.91-03.93	C 14 SE	4	<b>Z 119</b>	14 R-8 DU4	0,8	<b>UXT 2<sup>4</sup></b>
1.4 Si	1.4	60	09.91-03.93	C 14 SE <sup>18</sup>	4	<b>Z 74<sup>5</sup></b>	14 FR-8 LDUOX4	1,0	<b>UXT 1<sup>3</sup></b>
1.5 D	1.5	37	09.87-03.93	15 D (4EC1) → Mot.Nr. 804794	4	<b>GV 749</b> (5V)	○		
1.5 D	1.5	37	09.87-03.93	15 D (4EC1) Mot.Nr. 804795 →	4	<b>GV 946</b> (11V)	○		
1.5 TD	1.5	49	03.88-03.93	15 DT (T4EC1) → Mot.Nr. 804794	4	<b>GV 945</b> (5V)	○		
1.5 TD	1.5	49	03.88-03.93	15 DT (T4EC1) Mot.Nr. 804795 →	4	<b>GV 947</b> (11V)	○		
1.6 GSI	1.6	55	01.90-09.92	C 16 NZ	4	<b>Z 74<sup>5</sup></b>	14 FR-8 LDUOX4	1,0	<b>UXT 1<sup>3</sup></b>
1.6 GSI	1.6	72	09.89-03.93	C 16 SEI	4	<b>Z 20</b>	14 R-7 DU	0,8	<b>UXT 2<sup>4</sup></b>
1.6 GSI	1.6	72	09.89-03.93	C 16 SEI <sup>18</sup>	4	<b>Z 74<sup>5</sup></b>	14 FR-8 LDUOX4	1,0	<b>UXT 1<sup>3</sup></b>
1.6 GSI	1.6	74	05.88-03.92	E 16 SE	4	<b>Z 20</b>	14 R-7 DU	0,8	<b>UXT 2<sup>4</sup></b>
1.6 GSI	1.6	74	05.88-03.92	E 16 SE <sup>18</sup>	4	<b>Z 74<sup>5</sup></b>	14 FR-8 LDUOX4	1,0	<b>UXT 1<sup>3</sup></b>
1.6 GSI KAT	1.6	74	02.92-03.93	C 16 SE	4	<b>Z 20</b>	14 R-7 DU	0,8	<b>UXT 2<sup>4</sup></b>
1.6 GSI KAT	1.6	74	02.92-03.93	C 16 SE <sup>18</sup>	4	<b>Z 74<sup>5</sup></b>	14 FR-8 LDUOX4	1,0	<b>UXT 1<sup>3</sup></b>

**CORSA B**

1.0 i 12V	1.0	40	11.96-09.00	X 10 XE	3	<b>Z 74<sup>5</sup></b>	14 FR-8 LDUOX4	1,0	<b>UXT 1<sup>3</sup></b>
1.2 i	1.2	33	03.93-09.00	12 NZ	4	<b>Z 119</b>	14 R-8 DU4	0,8	<b>UXT 2<sup>4</sup></b>
1.2 i	1.2	33	03.93-09.00	12 NZ <sup>18</sup>	4	<b>Z 74<sup>5</sup></b>	14 FR-8 LDUOX4	1,0	<b>UXT 1<sup>3</sup></b>
1.2 i	1.2	33	03.93-09.00	C 12 NZ/X 12 SZ	4	<b>Z 119</b>	14 R-8 DU4	0,8	<b>UXT 2<sup>4</sup></b>
1.2 i	1.2	33	03.93-09.00	C 12 NZ/X 12 SZ <sup>18</sup>	4	<b>Z 74<sup>5</sup></b>	14 FR-8 LDUOX4	1,0	<b>UXT 1<sup>3</sup></b>
1.2 i 16V	1.2	48	03.98-09.00	X 12 XE	4	<b>Z 74<sup>5</sup></b>	14 FR-8 LDUOX4	1,0	<b>UXT 1<sup>3</sup></b>
1.4 i	1.4	44	03.93-09.00	C 14 NZ/X 14 SZ	4	<b>Z 119</b>	14 R-8 DU4	0,8	<b>UXT 2<sup>4</sup></b>
1.4 i	1.4	44	03.93-09.00	C 14 NZ/X 14 SZ <sup>18</sup>	4	<b>Z 74<sup>5</sup></b>	14 FR-8 LDUOX4	1,0	<b>UXT 1<sup>3</sup></b>
1.4 i	1.4	44	08.99-09.00	X 14 SZ	4	<b>Z 74<sup>5</sup></b>	14 FR-8 LDUOX4	1,0	<b>UXT 1<sup>3</sup></b>
1.4 Si	1.4	60	03.93-09.00	C 14 SE	4	<b>Z 119</b>	14 R-8 DU4	0,8	<b>UXT 2<sup>4</sup></b>
1.4 Si	1.4	60	03.93-09.00	C 14 SE <sup>18</sup>	4	<b>Z 74<sup>5</sup></b>	14 FR-8 LDUOX4	1,0	<b>UXT 1<sup>3</sup></b>
1.4 i 16V	1.4	63	08.97-09.00	C 14 SEL	4	<b>Z 74<sup>5</sup></b>	14 FR-8 LDUOX4	1,0	<b>UXT 1<sup>3</sup></b>
1.4 i 16V	1.4	66	09.94-09.00	X 14 XE	4	<b>Z 74<sup>5</sup></b>	14 FR-8 LDUOX4	1,0	<b>UXT 1<sup>3</sup></b>
1.5 D	1.5	37	03.93-09.00	15 D (4EC1)	4	<b>GN 103</b> (11V)	○		
1.5 TD	1.5	49	03.93-09.00	X 15 DT (T4EC1)/15 DT (T4EC1)	4	<b>GN 103</b> (11V)	○		
1.6 i 16V	1.6	74	08.97-09.00	C 16 SEL	4	<b>Z 74<sup>5</sup></b>	14 FR-8 LDUOX4	1,0	<b>UXT 1<sup>3</sup></b>
1.6 i 16V	1.6	78	09.94-09.00	X 16 XE	4	<b>Z 74<sup>5</sup></b>	14 FR-8 LDUOX4	1,0	<b>UXT 1<sup>3</sup></b>
1.6 GSI 16V	1.6	80	03.93-09.00	C 16 XE	4	<b>Z 74<sup>5</sup></b>	14 FR-8 LDUOX4	1,0	<b>UXT 1<sup>3</sup></b>

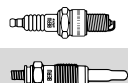

OPEL									
CORSA B									
1.7 D	1.7	44	02.96-09.00	17 D (4EE1)/X 17 D (4EE1)	4	GN 103 (11V)	○		
1.7 D	1.7	44	01.99-	X 17 D (4EE1)	4	GN 103 (11V)	○		
CORSA C									
1.0	1.0	43	09.00-	Z 10 XE	3	Z 74 <sup>5</sup>	14 FR-8 LDUOX4	1,0	UXT 1 <sup>3</sup>
1.0	1.0	44	06.03-	Z 10 XEP	3	Z 203	14 FR-8 LU2	0,9	○
1.2	1.2	55	09.00-	Z 12 XE	4	Z 74 <sup>5</sup>	14 FR-8 LDUOX4	1,0	UXT 1 <sup>3</sup>
1.2 Twinport	1.2	59	07.04-	Z 12 XEP	4	Z 203	14 FR-8 LU2	0,9	○
1.3 CDTI	1.3	51	06.03-	Z 13 DT	4	GN 053 (11V)	○		
1.4	1.4	44	08.94-07.02	C 14 NZ	4	Z 119	14 R-8 DU4	0,8	UXT 2 <sup>4</sup>
1.4	1.4	44	08.94-07.02	C 14 NZ <sup>18</sup>	4	Z 74 <sup>5</sup>	14 FR-8 LDUOX4	1,0	UXT 1 <sup>3</sup>
1.4	1.4	66	09.00-	Z 14 XE	4	Z 74 <sup>5</sup>	14 FR-8 LDUOX4	1,0	UXT 1 <sup>3</sup>
1.4	1.4	66	08.03-	Z 14 XEP	4	Z 203	14 FR-8 LU2	0,9	○
1.6	1.6	71	08.05-	Z 16 YNG	4	Z 206	14 FR-7 DPPUS2	0,7	UXT 10
1.7 DI	1.7	48	09.00-	Y 17 DTL	4	GN 104 (11V)	○		
1.7 DTI 16V	1.7	55	09.00-	Y 17 DT	4	GN 104 (11V)	○		
1.7 CDTI	1.7	74	06.03-09.06	Z 17 DTH	4	GN 104 (11V)	○		
1.8	1.8	92	09.00-	Z 18 XE	4	Z 74 <sup>5</sup>	14 FR-8 LDUOX4	1,0	UXT 1 <sup>3</sup>
CORSA D									
1.0	1.0	44	07.06-	Z 10 XEP	3	Z 203	14 FR-8 LU2	0,9	○
1.2	1.2	51	06.10-	A 12 XEL	4	Z 203	14 FR-8 LU2	0,9	○
1.2	1.2	59	07.06-	Z 12 XEP	4	Z 203	14 FR-8 LU2	0,9	○
1.2	1.2	63	06.10-	A 12 XER	4	Z 203	14 FR-8 LU2	0,9	○
1.3 CDTI	1.3	55	07.06-	A 13 DTC	4	GE 112 (4,4V)=2x	○		
						PSG 003 (4,4V)=2x			
1.3 CDTI	1.3	55	07.06-	Z 13 DTJ	4	GN 053 (11V)=4x	○		
1.3 CDTI	1.3	66	07.06-	Z 13 DTH	4	GN 053 (11V)	○		
1.3 CDTI	1.3	70	06.10-	A 13 DTR, Z 13 DTR, Z 13 DTE	4	GE 112 (4,4V)	○		
1.4	1.4	64	09.09-	A 14 XEL	4	Z 203	14 FR-8 LU2	0,9	○
1.6 Turbo	1.6	110	02.07-	Z 16 LEL/A 16 LEL	4	Z 346	14 FR-7 LPUT02	0,8	○
1.6 Turbo	1.6	141	02.07-	A 16 LER/Z 16 LER	4	Z 346	14 FR-7 LPUT02	0,8	○
1.6 Turbo	1.6	155	06.11-	A 16 LER/Z 16 LER	4	Z 346	14 FR-7 LPUT02	0,8	○
1.7 CDTI	1.7	92	07.06-	Z 17 DTR	4	GN 104 (11V)	○		
CORSA D Van									
1.2	1.2	51	06.10-	A 12 XEL	4	Z 203	14 FR-8 LU2	0,9	○
1.2	1.2	59	07.09-	Z 12 XEP	4	Z 203	14 FR-8 LU2	0,9	○
1.2	1.2	63	06.10-	A 12 XER	4	Z 203	14 FR-8 LU2	0,9	○
1.3 CDTI	1.3	55	07.06-	A 13 DTC	4	GE 112 (4,4V)=2x	○		
						PSG 003 (4,4V)=2x			
1.3 CDTI	1.3	55	07.06-	Z 13 DTJ	4	GN 053 (11V)=4x	○		
1.3 CDTI	1.3	66	07.06-	Z 13 DTH	4	GN 053 (11V)	○		
1.3 CDTI	1.3	70	06.10-	A 13 DTR/Z 13 DTE	4	GE 112 (4,4V)	○		
FRONTERA A									
2.2 i	2.2	100	03.95-10.98	X 22 XE	4	Z 74 <sup>5</sup>	14 FR-8 LDUOX4	1,0	UXT 1 <sup>3</sup>
2.3 TD	2.3	74	03.92-02.95	23 DTR	4	GN 954 (11V)	○		
2.4 i	2.4	92	03.92-08.95	C 24 NE	4	Z 19	14 R-7 BU	0,8	○
2.5 TDS	2.5	85	09.96-10.98	25TDS (VM41B)	4	GN 007 (11V)	○		
2.8 TD	2.8	83	03.95-10.98	28 TDI (4JB1T)	4	GN 061 (11V)	○		
FRONTERA A Sport									
2.0 i	2.0	85	03.92-08.95	C 20 NE	4	Z 119	14 R-8 DU4	0,8	UXT 2 <sup>4</sup>
2.0 i	2.0	85	03.92-08.95	C 20 NE/X 20 SE <sup>18</sup>	4	Z 74 <sup>5</sup>	14 FR-8 LDUOX4	1,0	UXT 1 <sup>3</sup>
2.5 TDS	2.5	85	09.96-10.98	25TDS (VM41B)	4	GN 007 (11V)	○		
2.8 TD	2.8	83	03.95-08.96	28 TDI (4JB1T)	4	GN 061 (11V)	○		
FRONTERA B									
2.2 DTI	2.2	85	10.98-08.00	X 22 DTH/Y 22 DTH → Fgst.Nr. YV699999	4	GN 992 (11V)	○		
2.2 DTI	2.2	85	09.00-09.02	X 22 DTH/Y 22 DTH	4	GN 033 (11V)	○		
2.2 DTI	2.2	88	09.02-	Y 22 DTH	4	GN 033 (11V)	○		
2.2 i	2.2	100	10.98-	X 22 SE	4	Z 74 <sup>5</sup>	14 FR-8 LDUOX4	1,0	UXT 1 <sup>3</sup>
2.2 i	2.2	100	10.98-	Y 22 SE	4	Z 343	14 FR-8 DPPUX	1,1	○
3.2 i	3.2	151	10.98-	Y 32 NE/6 VD1	6	Z 343	14 FR-8 DPPUX	1,1	○

● nicht erforderlich  
○ nicht im Programm

<sup>3</sup> wahlweise UXT 3 Platin

<sup>4</sup> wahlweise UXT 6 Platin

<sup>5</sup> wahlweise Z 190

<sup>18</sup> Hitzeschutzrohr

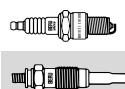
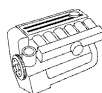

## OPEL

### INSIGNIA

1.6	1.6	85	07.08-	A 16 XER	4	<b>Z 203</b>	14 FR-8 LU2	0,9	○
1.6 Turbo	1.6	132	01.09-	A 16 LET	4	<b>Z 346</b>	14 FR-7 LPUT02	0,8	○
1.8	1.8	103	07.08-	A 18 XER	4	<b>Z 203</b>	14 FR-8 LU2	0,9	○
2.0 CDTI	2.0	81	07.08-	A 20 DTC	4	<b>GE 114 (4,4V)</b>	○		
2.0 CDTI	2.0	81	07.08-	A 20 DTL	4	<b>PSG 001 (4,4V)</b>	○		
2.0 CDTI	2.0	96	07.08-	A 20 DTJ	4	<b>GE 114 (4,4V)</b>	○		
2.0 CDTI	2.0	96	07.08-	A 20 DT	4	<b>PSG 001 (4,4V)</b>	○		
2.0 CDTI	2.0	118	07.08-	A 20 DTH	4	<b>GE 114 (4,4V)</b>	○		
2.0 Biturbo CDTI	2.0	140	07.08-	A 20 DTR	4	<b>PSG 001 (4,4V)</b>	○		
2.0 Biturbo CDTI	2.0	143	01.12-	A 20 DTR	4	<b>PSG 001 (4,4V)</b>	○		

### INSIGNIA Sports Tourer

1.6	1.6	85	07.08-	A 16 XER	4	<b>Z 203</b>	14 FR-8 LU2	0,9	○
1.6 Turbo	1.6	132	01.09-	A 16 LET	4	<b>Z 346</b>	14 FR-7 LPUT02	0,8	○
1.8	1.8	103	07.08-	A 18 XER	4	<b>Z 203</b>	14 FR-8 LU2	0,9	○
2.0 CDTI	2.0	81	07.08-	A 20 DTC	4	<b>GE 114 (4,4V)</b>	○		
2.0 CDTI	2.0	81	07.08-	A 20 DTL	4	<b>PSG 001 (4,4V)</b>	○		
2.0 CDTI	2.0	96	07.08-	A 20 DTJ	4	<b>GE 114 (4,4V)</b>	○		
2.0 CDTI	2.0	96	07.08-	A 20 DT	4	<b>PSG 001 (4,4V)</b>	○		
2.0 CDTI	2.0	118	07.08-	A 20 DTH	4	<b>PSG 001 (4,4V)</b>	○		
2.0 CDTI 4x4	2.0	118	06.10-	A 20 DTH	4	<b>PSG 001 (4,4V)</b>	○		
2.0 Biturbo CDTI	2.0	140	07.08-	A 20 DTR	4	<b>PSG 001 (4,4V)</b>	○		
2.0 Biturbo CDTI 4x4	2.0	140	07.08-	A 20 DTR	4	<b>PSG 001 (4,4V)</b>	○		
2.0 Biturbo CDTI	2.0	143	01.12-	A 20 DTR	4	<b>PSG 001 (4,4V)</b>	○		
2.0 Biturbo CDTI 4x4	2.0	143	01.12-	A 20 DTR	4	<b>PSG 001 (4,4V)</b>	○		

### KADETT E

1.3 i KAT	1.3	44	09.85-08.91	C 13 N	4	<b>Z 20</b>	14 R-7 DU	0,8	<b>UXT 2<sup>4</sup></b>
1.3 N	1.3	44	09.84-08.91	13 NB/13 N	4	<b>Z 20</b>	14 R-7 DU	0,8	<b>UXT 2<sup>4</sup></b>
1.4 i	1.4	44	08.91-07.94	C 14 NZ	4	<b>Z 119</b>	14 R-8 DU4	0,8	<b>UXT 2<sup>4</sup></b>
1.4 i	1.4	44	08.91-07.94	C 14 NZ <sup>18</sup>	4	<b>Z 74<sup>5</sup></b>	14 FR-8 LDUOX4	1,0	<b>UXT 1<sup>3</sup></b>
1.4 S	1.4	55	01.90-08.91	14 NV	4	<b>Z 119</b>	14 R-8 DU4	0,8	<b>UXT 2<sup>4</sup></b>
1.4 S	1.4	55	01.90-08.91	14 NV <sup>18</sup>	4	<b>Z 74<sup>5</sup></b>	14 FR-8 LDUOX4	1,0	<b>UXT 1<sup>3</sup></b>
1.4 S	1.4	60	09.89-08.91	C 14 SE	4	<b>Z 119</b>	14 R-8 DU4	0,8	<b>UXT 2<sup>4</sup></b>
1.4 S	1.4	60	09.89-08.91	C 14 SE <sup>18</sup>	4	<b>Z 74<sup>5</sup></b>	14 FR-8 LDUOX4	1,0	<b>UXT 1<sup>3</sup></b>
1.5 TD	1.5	53	07.88-08.91	15 DT (T4EC1) → Mot.Nr. 817252	4	<b>GV 945 (5V)</b>	○		
1.5 TD	1.5	53	07.88-08.91	15 DT (T4EC1) Mot.Nr. 817253 →	4	<b>GV 947 (11V)</b>	○		
1.6 i	1.6	55	09.86-08.91	E 16 NZ	4	<b>Z 119</b>	14 R-8 DU4	0,8	<b>UXT 2<sup>4</sup></b>
1.6 i	1.6	55	09.86-08.91	E 16 NZ <sup>18</sup>	4	<b>Z 74<sup>5</sup></b>	14 FR-8 LDUOX4	1,0	<b>UXT 1<sup>3</sup></b>
1.6 i KAT	1.6	55	09.86-08.91	C 16 NZ/C 16 LZ	4	<b>Z 21</b>	14 R-7 DUX	1,1	<b>UXT 2<sup>4</sup></b>
1.6 i	1.6	55	08.91-07.94	C 16 NZ	4	<b>Z 119</b>	14 R-8 DU4	0,8	<b>UXT 2<sup>4</sup></b>
1.6 i	1.6	55	08.91-07.94	C 16 NZ <sup>18</sup>	4	<b>Z 74<sup>5</sup></b>	14 FR-8 LDUOX4	1,0	<b>UXT 1<sup>3</sup></b>
1.6	1.6	60	09.86-12.91	16 SV	4	<b>Z 20</b>	14 R-7 DU	0,8	<b>UXT 2<sup>4</sup></b>
1.7 D	1.7	42	02.89-08.91	17 D	4	<b>GN 954 (11V)</b>	<b>GR 064</b>		
1.7 D	1.7	44	07.92-07.94	17 DR	4	<b>GN 954 (11V)</b>	○		
1.8 S	1.8	62	09.87-08.91	E 18 NV/S 18 NV	4	<b>Z 20</b>	14 R-7 DU	0,8	<b>UXT 2<sup>4</sup></b>
1.8 i	1.8	66	09.90-08.91	C 18 NZ/C 18 NT	4	<b>Z 119</b>	14 R-8 DU4	0,8	<b>UXT 2<sup>4</sup></b>
1.8 i	1.8	66	09.90-08.91	C 18 NZ/C 18 NT <sup>18</sup>	4	<b>Z 74<sup>5</sup></b>	14 FR-8 LDUOX4	1,0	<b>UXT 1<sup>3</sup></b>
1.8	1.8	84	09.87-08.90	18 E	4	<b>Z 20</b>	14 R-7 DU	0,8	<b>UXT 2<sup>4</sup></b>
2.0 GSI	2.0	85	09.86-08.91	20 NE	4	<b>Z 119</b>	14 R-8 DU4	0,8	<b>UXT 2<sup>4</sup></b>
2.0 GSI	2.0	85	09.86-08.91	20 NE <sup>18</sup>	4	<b>Z 74<sup>5</sup></b>	14 FR-8 LDUOX4	1,0	<b>UXT 1<sup>3</sup></b>
2.0 GSI KAT	2.0	85	09.86-08.91	C 20 NE	4	<b>Z 119</b>	14 R-8 DU4	0,8	<b>UXT 2<sup>4</sup></b>
2.0 GSI KAT	2.0	85	09.86-08.91	C 20 NE <sup>18</sup>	4	<b>Z 74<sup>5</sup></b>	14 FR-8 LDUOX4	1,0	<b>UXT 1<sup>3</sup></b>
2.0 GSI	2.0	95	09.86-08.91	20 SEH	4	<b>Z 20</b>	14 R-7 DU	0,8	<b>UXT 2<sup>4</sup></b>
2.0 GSI 16V	2.0	110	03.88-08.91	20 XEJ	4	<b>Z 250</b>	14 FR-7 DU2S	0,7	<b>UXT 1<sup>3</sup></b>
2.0 GSI 16V KAT	2.0	110	03.88-08.91	C 20 XE	4	<b>Z 250</b>	14 FR-7 DU2S	0,7	<b>UXT 1<sup>3</sup></b>
2.0 GSI 16V	2.0	115	12.87-08.91	20 XE	4	<b>Z 250</b>	14 FR-7 DU2S	0,7	<b>UXT 1<sup>3</sup></b>

### KADETT E Cabriolet

1.3 S	1.3	55	03.87-02.93	13 S	4	<b>Z 20</b>	14 R-7 DU	0,8	<b>UXT 2<sup>4</sup></b>
1.4 i	1.4	44	01.90-08.91	C 14 NZ	4	<b>Z 119</b>	14 R-8 DU4	0,8	<b>UXT 2<sup>4</sup></b>
1.4 i	1.4	44	01.90-08.91	C 14 NZ <sup>18</sup>	4	<b>Z 74<sup>5</sup></b>	14 FR-8 LDUOX4	1,0	<b>UXT 1<sup>3</sup></b>



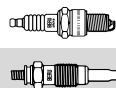
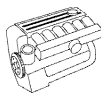

## OPEL

### KADETT E Cabriolet

1.4 S	1.4	55	08.90-02.93	14 NV	4	<b>Z 119</b>	14 R-8 DU4	0,8	<b>UXT 2<sup>4</sup></b>
1.4 S	1.4	55	08.90-02.93	14 NV <sup>18</sup>	4	<b>Z 74<sup>5</sup></b>	14 FR-8 LDUOX4	1,0	<b>UXT 1<sup>3</sup></b>
1.6 i	1.6	55	10.86-02.93	E 16 NZ	4	<b>Z 21</b>	14 R-7 DUX	1,1	<b>UXT 2<sup>4</sup></b>
1.6 i KAT	1.6	55	10.87-02.93	C 16 NZ	4	<b>Z 8</b>	14 R-8 DU	0,8	<b>UXT 2<sup>4</sup></b>
1.6 i KAT	1.6	55	10.87-02.93	C 16 LZ	4	<b>Z 21</b>	14 R-7 DUX	1,1	<b>UXT 2<sup>4</sup></b>
1.6 i	1.6	60	07.89-02.93	16 SV	4	<b>Z 20</b>	14 R-7 DU	0,8	<b>UXT 2<sup>4</sup></b>
2.0 i	2.0	85	10.86-02.93	20 NE	4	<b>Z 119</b>	14 R-8 DU4	0,8	<b>UXT 2<sup>4</sup></b>
2.0 i	2.0	85	10.86-02.93	20 NE <sup>18</sup>	4	<b>Z 74<sup>5</sup></b>	14 FR-8 LDUOX4	1,0	<b>UXT 1<sup>3</sup></b>
2.0 i KAT	2.0	85	10.86-02.93	C 20 NE	4	<b>Z 119</b>	14 R-8 DU4	0,8	<b>UXT 2<sup>4</sup></b>
2.0 i KAT	2.0	85	10.86-02.93	C 20 NE <sup>18</sup>	4	<b>Z 74<sup>5</sup></b>	14 FR-8 LDUOX4	1,0	<b>UXT 1<sup>3</sup></b>

### KADETT E Caravan

1.3 i KAT	1.3	44	09.85-08.91	C 13 N	4	<b>Z 20</b>	14 R-7 DU	0,8	<b>UXT 2<sup>4</sup></b>
1.3 N	1.3	44	09.84-08.91	13 N	4	<b>Z 20</b>	14 R-7 DU	0,8	<b>UXT 2<sup>4</sup></b>
1.4 i	1.4	44	01.90-08.91	C 14 NZ	4	<b>Z 119</b>	14 R-8 DU4	0,8	<b>UXT 2<sup>4</sup></b>
1.4 i	1.4	44	01.90-08.91	C 14 NZ <sup>18</sup>	4	<b>Z 74<sup>5</sup></b>	14 FR-8 LDUOX4	1,0	<b>UXT 1<sup>3</sup></b>
1.4 S	1.4	55	01.90-08.91	14 NV	4	<b>Z 20</b>	14 R-7 DU	0,8	<b>UXT 2<sup>4</sup></b>
1.5 TD	1.5	53	07.88-08.91	15 DT (T4EC1) → Mot.Nr. 817252	4	<b>GV 945 (5V)</b>	○		
1.5 TD	1.5	53	07.88-08.91	15 DT (T4EC1) Mot.Nr. 817253 →	4	<b>GV 947 (11V)</b>	○		
1.6 i	1.6	55	09.86-08.91	E 16 NZ	4	<b>Z 21</b>	14 R-7 DUX	1,1	<b>UXT 2<sup>4</sup></b>
1.6 i KAT	1.6	55	09.86-08.91	C 16 NZ/C 16 LZ	4	<b>Z 21</b>	14 R-7 DUX	1,1	<b>UXT 2<sup>4</sup></b>
1.6	1.6	60	09.86-08.91	16 SV	4	<b>Z 20</b>	14 R-7 DU	0,8	<b>UXT 2<sup>4</sup></b>
1.7 D	1.7	42	02.89-08.91	17 D	4	<b>GN 954 (11V)</b>	<b>GR 064</b>		
1.8 S	1.8	62	09.87-08.91	E 18 NV	4	<b>Z 20</b>	14 R-7 DU	0,8	<b>UXT 2<sup>4</sup></b>
1.8 i	1.8	66	10.85-08.91	C 18 NZ/C 18 NT	4	<b>Z 119</b>	14 R-8 DU4	0,8	<b>UXT 2<sup>4</sup></b>
1.8 i	1.8	66	10.85-08.91	C 18 NZ/C 18 NT <sup>18</sup>	4	<b>Z 74<sup>5</sup></b>	14 FR-8 LDUOX4	1,0	<b>UXT 1<sup>3</sup></b>
2.0 i	2.0	85	09.87-08.91	20 NE	4	<b>Z 119</b>	14 R-8 DU4	0,8	<b>UXT 2<sup>4</sup></b>
2.0 i	2.0	85	09.87-08.91	20 NE <sup>18</sup>	4	<b>Z 74<sup>5</sup></b>	14 FR-8 LDUOX4	1,0	<b>UXT 1<sup>3</sup></b>
2.0 i KAT	2.0	85	09.87-08.91	C 20 NE	4	<b>Z 119</b>	14 R-8 DU4	0,8	<b>UXT 2<sup>4</sup></b>
2.0 i KAT	2.0	85	09.87-08.91	C 20 NE <sup>18</sup>	4	<b>Z 74<sup>5</sup></b>	14 FR-8 LDUOX4	1,0	<b>UXT 1<sup>3</sup></b>

### MERIVA

1.3 CDTI	1.3	51	04.05-05.10	Y 13 DT/Z 13 DT	4	<b>GN 053 (11V)</b>	○		
1.3 CDTI	1.3	55	09.03-05.10	Z 13 DTJ	4	<b>GN 053 (11V)</b>	○		
1.4 16V Twinport	1.4	66	07.04-05.10	Z 14 XEP	4	<b>Z 203</b>	14 FR-8 LU2	0,9	○
1.4 16V Twinport LPG	1.4	66	07.04-05.10	Z 14 XEP	4	<b>Z 203</b>	14 FR-8 LU2	0,9	○
1.6	1.6	64	05.03-05.10	Z 16 SE	4	<b>Z 190</b>	14 FGR-8 DQU7	1,2	<b>UXT 1<sup>3</sup></b>
1.6 16V	1.6	74	05.03-05.10	Z 16 XE	4	<b>Z 203</b>	14 FR-8 LU2	0,9	○
1.6	1.6	77	01.06-05.10	Z 16 XEP	4	<b>Z 203</b>	14 FR-8 LU2	0,9	○
1.6 Turbo	1.6	132	09.05-05.10	Z 16 LET	4	<b>Z 346</b>	14 FR-7 LPUT02	0,8	○
1.7 DTI	1.7	48	09.03-05.10	Y 17 DTL	4	<b>GN 104 (11V)</b>	○		
1.7 DTI	1.7	55	09.03-05.10	Y 17 DT	4	<b>GN 104 (11V)</b>	○		
1.7 CDTI	1.7	74	09.03-05.10	Z 17 DT, Z 17 DTH	4	<b>GN 104 (11V)</b>	○		
1.7 CDTI	1.7	92	09.06-05.10	A 17 DTR/Z 17 DTR	4	<b>GN 104 (11V)</b>	○		
1.8	1.8	92	05.03-05.10	Z 18 XE	4	<b>Z 190</b>	14 FGR-8 DQU7	1,2	<b>UXT 1<sup>3</sup></b>

### MERIVA B

1.3 CDTI	1.3	55	06.10-	A 13 DTC	4	<b>GE 112 (4,4V)=2x</b>	○		
						<b>PSG 003 (4,4V)=2x</b>			
1.3 CDTI	1.3	70	06.10-	A 13 DTE	4	<b>GE 112 (4,4V)=2x</b>	○		
						<b>PSG 003 (4,4V)=2x</b>			
1.7 CDTI	1.7	74	06.10-	A 17 DT	4	<b>GN 104 (11V)</b>	○		

### MONTEREY A

3.1 TD	3.1	84	09.91-12.97	4 JG2TC	4	<b>GV 947 (11V)</b>	○		
3.2	3.2	130	06.92-07.98	6 VD1	6	<b>Z 343</b>	14 FR-8 DPPUX	1,1	○

### MONTEREY B

3.0 DTI	3.0	117	07.98-08.99	4 JX1	4	<b>GN 997 (11V)</b>	○		
3.5 V6 24V	3.5	158	07.98-08.99	6 VE1	6	<b>Z 343</b>	14 FR-8 DPPUX	1,1	○

### MOVANO

1.9 DTI	1.9	59	09.00-10.01	F9Q 770	4	<b>GN 018 (11V)</b>	○		
1.9 DTI	1.9	60	10.01-	F9Q 772	4	<b>GN 018 (11V)</b>	○		
2.2 DTI	2.2	66	09.00-	G9T 722/G9T 720/G9T 750	4	<b>GN 026 (11V)</b>	○		

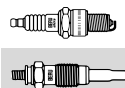
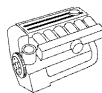

## OPEL

### MOVANO

2.5 D	2.5	59	07.98-09.00	S8U 772/S8U 770	4	<b>GN 927</b> (11V)	○		
2.5 DTi	2.5	73	10.03-	G9U 754	4	<b>GN 026</b> (11V)	○		
2.5 CDTi	2.5	74	10.03-	G9U 650	4	<b>GN 026</b> (11V)	○		
2.5 DTi	2.5	84	10.01-	G9U 754/G9U 750/G9U 724/ G9U 720	4	<b>GN 026</b> (11V)	○		
2.5 CDTi	2.5	88	10.03-	G9U 632, G9U 650	4	<b>GN 026</b> (11V)	○		
2.5 CDTi	2.5	107	10.03-	G9U 632, G9U 650	4	<b>GN 026</b> (11V)	○		
2.8 DTi	2.8	84	07.98-10.01	S9W 702/S9W 700	4	<b>GF 984</b> (11V)	○		

### OMEGA A

1.8	1.8	65	09.87-03.94	E 18 NVR	4	<b>Z 20</b>	14 R-7 DU	0,8	<b>UXT 2<sup>4</sup></b>
1.8 S	1.8	66	09.86-03.94	18 SV	4	<b>Z 20</b>	14 R-7 DU	0,8	<b>UXT 2<sup>4</sup></b>
1.8	1.8	85	09.86-03.94	18 SEH	4	<b>Z 20</b>	14 R-7 DU	0,8	<b>UXT 2<sup>4</sup></b>
2.0	2.0	73	09.90-03.94	C 20 NEJ	4	<b>Z 119</b>	14 R-8 DU4	0,8	<b>UXT 2<sup>4</sup></b>
2.0	2.0	74	09.90-03.94	C 20 NEF	4	<b>Z 119</b>	14 R-8 DU4	0,8	<b>UXT 2<sup>4</sup></b>
2.0 i	2.0	85	09.86-03.94	C 20 NE	4	<b>Z 119</b>	14 R-8 DU4	0,8	<b>UXT 2<sup>4</sup></b>
2.0	2.0	90	09.86-03.94	20 SE	4	<b>Z 20</b>	14 R-7 DU	0,8	<b>UXT 2<sup>4</sup></b>
2.3 D	2.3	54	10.86-03.94	23 YD	4	<b>GN 954</b> (11V)	<b>GR 064</b>		
2.3 TD Interc.	2.3	74	08.88-03.94	23 DTR	4	<b>GN 954</b> (11V)	<b>GR 064</b>		
2.4 i	2.4	92	09.88-03.94	C 24 NE	4	<b>Z 19</b>	14 R-7 BU	0,8	○
2.6 i	2.6	110	09.90-03.94	C 26 NE	6	<b>Z 19</b>	14 R-7 BU	0,8	○
3.0	3.0	130	03.87-09.90	30 NE	6	<b>Z 19</b>	14 R-7 BU	0,8	○
3.0 KAT	3.0	130	03.88-03.94	C 30 NE	6	<b>Z 19</b>	14 R-7 BU	0,8	○
3.0 24V	3.0	147	09.89-03.94	C 30 SEJ	6	<b>Z 98</b>	14 FR-7 LDU	0,8	<b>UXT 1<sup>3</sup></b>
3.0 24V	3.0	150	09.89-03.94	C 30 SE	6	<b>Z 98</b>	14 FR-7 LDU	0,8	<b>UXT 1<sup>3</sup></b>
3.0 24V Evolution500	3.0	169	03.91-07.92	C 30 XEI	6	<b>Z 98</b>	14 FR-7 LDU	0,8	<b>UXT 1<sup>3</sup></b>
3.6 24V Lotus	3.6	277	08.90-09.92	C 36 GET	6	<b>Z 15</b>	14 FR-7 DU	0,8	<b>UXT 1<sup>3</sup></b>

### OMEGA A Caravan

1.8	1.8	65	09.87-03.94	E 18 NVR	4	<b>Z 20</b>	14 R-7 DU	0,8	<b>UXT 2<sup>4</sup></b>
1.8 S	1.8	66	09.86-03.94	18 SV	4	<b>Z 20</b>	14 R-7 DU	0,8	<b>UXT 2<sup>4</sup></b>
1.8	1.8	85	09.86-03.94	18 SEH	4	<b>Z 20</b>	14 R-7 DU	0,8	<b>UXT 2<sup>4</sup></b>
2.0 i	2.0	73	09.90-03.94	C 20 NEJ	4	<b>Z 119</b>	14 R-8 DU4	0,8	<b>UXT 2<sup>4</sup></b>
2.0	2.0	74	09.90-03.94	C 20 NEF	4	<b>Z 119</b>	14 R-8 DU4	0,8	<b>UXT 2<sup>4</sup></b>
2.0 i	2.0	85	09.86-03.94	C 20 NE	4	<b>Z 119</b>	14 R-8 DU4	0,8	<b>UXT 2<sup>4</sup></b>
2.0	2.0	90	09.86-03.94	20 SE	4	<b>Z 20</b>	14 R-7 DU	0,8	<b>UXT 2<sup>4</sup></b>
2.3 D	2.3	54	09.86-03.94	23 YD	4	<b>GN 954</b> (11V)	<b>GR 064</b>		
2.3 TD Interc.	2.3	74	09.88-03.94	23 DTR	4	<b>GN 954</b> (11V)	<b>GR 064</b>		
2.4 i	2.4	92	09.88-03.94	C 24 NE	4	<b>Z 19</b>	14 R-7 BU	0,8	○
2.6 i	2.6	110	09.90-03.94	C 26 NE	6	<b>Z 19</b>	14 R-7 BU	0,8	○
3.0	3.0	115	03.87-03.94	C 30 LE	6	<b>Z 19</b>	14 R-7 BU	0,8	○
3.0	3.0	130	03.87-09.90	30 NE	6	<b>Z 19</b>	14 R-7 BU	0,8	○
3.0 KAT	3.0	130	03.87-03.94	C 30 NE	6	<b>Z 19</b>	14 R-7 BU	0,8	○
3.0 24V	3.0	147	09.89-03.94	C 30 SEJ	6	<b>Z 98</b>	14 FR-7 LDU	0,8	<b>UXT 1<sup>3</sup></b>
3.0 24V Omega 3000	3.0	150	09.88-04.94	C 30 SE	6	<b>Z 98</b>	14 FR-7 LDU	0,8	<b>UXT 1<sup>3</sup></b>

### OMEGA B

2.0 DTi 16V	2.0	74	09.97-09.00	X 20 DTH	4	<b>GN 992</b> (11V)	○		
2.0	2.0	85	03.94-12.00	20 SE	4	<b>Z 74<sup>5</sup></b>	14 FR-8 LDUOX4	1,0	<b>UXT 1<sup>3</sup></b>
2.0	2.0	85	03.94-09.99	X 20 SE	4	<b>Z 74<sup>5</sup></b>	14 FR-8 LDUOX4	1,0	<b>UXT 1<sup>3</sup></b>
2.0 16V	2.0	100	03.94-09.99	X 20 XEV	4	<b>Z 74<sup>5</sup></b>	14 FR-8 LDUOX4	1,0	<b>UXT 1<sup>3</sup></b>
2.2 DTi 16V	2.2	81	09.00-07.03	Y 22 DTH	4	<b>GN 033</b> (11V)	○		
2.2 DTi 16V	2.2	88	09.00-07.03	Y 22 DTH	4	<b>GN 033</b> (11V)	○		
2.2 16V	2.2	106	09.99-07.03	Y 22 XE/Z 22 XE	4	<b>Z 74<sup>5</sup></b>	14 FR-8 LDUOX4	1,0	<b>UXT 1<sup>3</sup></b>
2.5 TD	2.5	96	04.94-07.03	25 DT/X 25 TD/X 25 DT	6	<b>GV 719</b> (11V)	○		
2.5 DTi	2.5	110	09.01-07.03	Y 25 DT	6	<b>GN 024</b> (11V)	○		
2.5 V6	2.5	125	03.94-09.00	X 25 XE	6	<b>Z 74<sup>5</sup></b>	14 FR-8 LDUOX4	1,0	<b>UXT 1<sup>3</sup></b>
2.6 V6	2.6	132	09.00-07.03	Y 26 SE	6	<b>Z 173</b>	14 FGR-8 KQU	1,6	○
3.0 V6	3.0	155	04.94-02.01	X 30 XE	6	<b>Z 74<sup>5</sup></b>	14 FR-8 LDUOX4	1,0	<b>UXT 1<sup>3</sup></b>
3.2 V6	3.2	160	02.01-07.03	Y 32 SE	6	<b>Z 173</b>	14 FGR-8 KQU	1,6	○

### OMEGA B Caravan

2.0 DTi 16V	2.0	74	09.97-09.00	X 20 DTH	4	<b>GN 992</b> (11V)	○		
2.0	2.0	85	03.94-09.99	X 20 SE	4	<b>Z 74<sup>5</sup></b>	14 FR-8 LDUOX4	1,0	<b>UXT 1<sup>3</sup></b>
2.0 16V	2.0	100	03.94-09.99	X 20 XEV	4	<b>Z 74<sup>5</sup></b>	14 FR-8 LDUOX4	1,0	<b>UXT 1<sup>3</sup></b>

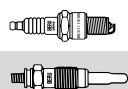

## OPEL

### OMEGA B Caravan

2.2 DTI 16V	2.2	81	09.00-07.03	Y 22 DTH	4	<b>GN 033</b> (11V)	○		
2.2 DTI 16V	2.2	88	09.00-07.03	Y 22 DTH	4	<b>GN 033</b> (11V)	○		
2.2 16V	2.2	106	09.99-07.03	Y 22 XE/Z 22 XE	4	<b>Z 74<sup>5</sup></b>	14 FR-8 LDUOX4	1,0	<b>UXT 1<sup>3</sup></b>
2.5 DTI	2.5	110	09.01-07.03	Y 25 DT	6	<b>GN 024</b> (11V)	○		
2.5 V6	2.5	125	03.94-09.00	X 25 XE	6	<b>Z 74<sup>5</sup></b>	14 FR-8 LDUOX4	1,0	<b>UXT 1<sup>3</sup></b>
2.6 V6	2.6	132	09.00-07.03	Y 26 SE	6	<b>Z 173</b>	14 FGR-8 KQU	1,6	○
3.0 V6	3.0	155	04.94-02.01	X 30 XE	6	<b>Z 74<sup>5</sup></b>	14 FR-8 LDUOX4	1,0	<b>UXT 1<sup>3</sup></b>
3.2 V6	3.2	160	02.01-07.03	Y 32 SE	6	<b>Z 173</b>	14 FGR-8 KQU	1,6	○

### SENATOR B

2.5 i	2.5	103	09.90-09.93	25 NE	6	<b>Z 19</b>	14 R-7 BU	0,8	○
2.6 i	2.6	110	09.90-09.93	C 26 NE	6	<b>Z 19</b>	14 R-7 BU	0,8	○
3.0	3.0	115	09.87-09.93	C 30 LE	6	<b>Z 19</b>	14 R-7 BU	0,8	○
3.0	3.0	130	01.88-09.90	30 NE	6	<b>Z 19</b>	14 R-7 BU	0,8	○
3.0 i KAT	3.0	130	01.88-09.93	C 30 NE	6	<b>Z 19</b>	14 R-7 BU	0,8	○
3.0 24V	3.0	150	09.89-09.93	C 30 SE	6	<b>Z 98</b>	14 FR-7 LDU	0,8	<b>UXT 1<sup>3</sup></b>

### SIGNUM

1.8	1.8	90	05.03-	Z 18 XE	4	<b>Z 190</b>	14 FGR-8 DQU7	1,2	<b>UXT 1<sup>3</sup></b>
1.8	1.8	103	09.05-	Z 18 XER	4	<b>Z 203</b>	14 FR-8 LU2	0,9	○
1.9 CDTI	1.9	74	08.05-09.08	Z 19 DT → Fgst.Nr. 71021891	4	<b>GN 041</b> (11V)	○		
1.9 CDTI	1.9	74	08.05-09.08	Z 19 DT Fgst.Nr. 71021892 →	4	<b>GN 097</b> (11V)	○		
1.9 CDTI	1.9	88	04.04-09.08	Z 19 DT → Fgst.Nr. 71021891	4	<b>GN 041</b> (11V)	○		
1.9 CDTI	1.9	88	04.04-09.08	Z 19 DT Fgst.Nr. 71021892 →	4	<b>GN 097</b> (11V)	○		
1.9 CDTI	1.9	110	04.04-	Z 19 DTH	4	<b>GN 059</b> (11V)	○		
2.0 DTI	2.0	74	05.03-	Y 20 DTH	4	<b>GN 033</b> (11V)	○		
2.0 Turbo	2.0	129	05.03-	Z 20 NET	4	<b>Z 284</b>	14 FR-6 DPOX	1,1	<b>UXT 14</b>
2.2 DTI	2.2	92	05.03-	Y 22 DTR	4	<b>GN 033</b> (11V)	○		
2.2 direct	2.2	114	05.03-	Z 22 YH	4	<b>Z 190</b>	14 FGR-8 DQU7	1,2	<b>UXT 1<sup>3</sup></b>
2.8 V6 Turbo	2.8	169	09.05-	Z 28 NEL	6	<b>Z 235</b>	14 FR-7 SPUX03	1,0	○
2.8 V6 Turbo	2.8	184	01.06-10.08	Z 28 NET	6	<b>Z 235</b>	14 FR-7 SPUX03	1,0	○
3.0 V6 CDTI	3.0	130	05.03-	Y 30 DT	6	<b>GN 106</b> (11V)	○		
3.0 V6 CDTI	3.0	135	09.05-	Z 30 DT	6	<b>GN 106</b> (11V)	○		
3.2 V6	3.2	155	05.03-	Z 32 SE	6	<b>Z 173</b>	14 FGR-8 KQU	1,6	○

### SINTRA

2.2 DTI	2.2	85	07.97-04.99	X 22 DTH	4	<b>GN 992</b> (11V)	○		
2.2 i 16V	2.2	104	11.96-04.99	X 22 XE	4	<b>Z 74<sup>5</sup></b>	14 FR-8 LDUOX4	1,0	<b>UXT 1<sup>3</sup></b>
3.0 i 24V	3.0	148	11.96-04.99	X 30 XE	6	<b>Z 74<sup>5</sup></b>	14 FR-8 LDUOX4	1,0	<b>UXT 1<sup>3</sup></b>

### SPEEDSTER

2.0 Turbo	2.0	147	04.03-	Z 20 LET	4	<b>Z 74<sup>5</sup></b>	14 FR-8 LDUOX4	1,0	<b>UXT 1<sup>3</sup></b>
2.0	2.0	162	10.03-08.06	Z 20 LET	4	<b>Z 74<sup>5</sup></b>	14 FR-8 LDUOX4	1,0	<b>UXT 1<sup>3</sup></b>
2.2	2.2	108	09.00-09.06	Z 22 SE	4	<b>Z 222</b>	14 KR-8 STUX	1,1	○

### TIGRA

1.4 16V	1.4	63	08.97-12.00	X 14 XE	4	<b>Z 74<sup>5</sup></b>	14 FR-8 LDUOX4	1,0	<b>UXT 1<sup>3</sup></b>
1.4 16V	1.4	66	07.94-12.00	X 14 XE	4	<b>Z 74<sup>5</sup></b>	14 FR-8 LDUOX4	1,0	<b>UXT 1<sup>3</sup></b>
1.6 16V	1.6	74	08.97-08.98	C 16 SEL	4	<b>Z 74<sup>5</sup></b>	14 FR-8 LDUOX4	1,0	<b>UXT 1<sup>3</sup></b>
1.6 16V	1.6	78	07.94-08.98	X 16 XE	4	<b>Z 74<sup>5</sup></b>	14 FR-8 LDUOX4	1,0	<b>UXT 1<sup>3</sup></b>

### TIGRA TwinTop

1.3 CDTI	1.3	51	06.04-	Z 13 DT	4	<b>GN 053</b> (11V)	○		
1.4	1.4	66	06.04-	Z 14 XEP	4	<b>Z 203</b>	14 FR-8 LU2	0,9	○
1.8	1.8	92	06.04-12.09	Z 18 XE	4	<b>Z 74<sup>5</sup></b>	14 FR-8 LDUOX4	1,0	<b>UXT 1<sup>3</sup></b>

### VECTRA A

1.4 S	1.4	55	09.88-06.92	14 NV	4	<b>Z 119</b>	14 R-8 DU4	0,8	<b>UXT 2<sup>4</sup></b>
1.6 i	1.6	52	09.93-11.95	X 16 SZ	4	<b>Z 119</b>	14 R-8 DU4	0,8	<b>UXT 2<sup>4</sup></b>
1.6 i	1.6	52	09.93-11.95	X 16 SZ <sup>18</sup>	4	<b>Z 74<sup>5</sup></b>	14 FR-8 LDUOX4	1,0	<b>UXT 1<sup>3</sup></b>
1.6 i	1.6	55	09.88-11.95	C 16 NZ2/C 16 NZ/E 16 NZ	4	<b>Z 119</b>	14 R-8 DU4	0,8	<b>UXT 2<sup>4</sup></b>
1.6 i	1.6	55	09.88-11.95	C 16 NZ2/C 16 NZ/E 16 NZ <sup>18</sup>	4	<b>Z 74<sup>5</sup></b>	14 FR-8 LDUOX4	1,0	<b>UXT 1<sup>3</sup></b>
1.6 i	1.6	55	09.93-11.95	16 L22	4	<b>Z 74<sup>5</sup></b>	14 FR-8 LDUOX4	1,0	<b>UXT 1<sup>3</sup></b>
1.6	1.6	60	09.88-05.93	16 SV	4	<b>Z 20</b>	14 R-7 DU	0,8	<b>UXT 2<sup>4</sup></b>



kW

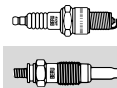
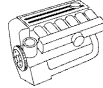

**OPEL**

**VECTRA A**

1.7 D	1.7	42	10.88-09.92	17 D	4	<b>GN 954</b> (11V)	<b>GR 064</b>		
1.7 D	1.7	44	07.92-11.95	17 DR	4	<b>GN 954</b> (11V)	○		
1.7 TD	1.7	60	03.90-11.95	17 DT (TC4EE1)/X 17 DT (TC4EE1) → Mot.Nr. 731416	4	<b>GV 749</b> (5V)	○		
1.7 TD	1.7	60	03.90-11.95	17 DT (TC4EE1)/X 17 DT (TC4EE1) → Mot.Nr. 731416	4	<b>GV 946</b> (11V)	○		
1.7 TD	1.7	60	03.90-11.95	17 DT (TC4EE1)/X 17 DT (TC4EE1) Mot.Nr. 731417 →	4	<b>GN 103</b> (11V)	○		
1.8 i	1.8	66	09.88-10.90	18 SV	4	<b>Z 20</b>	14 R-7 DU	0,8	<b>UXT 2<sup>4</sup></b>
1.8 i KAT	1.8	66	03.90-11.95	C 18 NZ	4	<b>Z 119</b>	14 R-8 DU4	0,8	<b>UXT 2<sup>4</sup></b>
1.8 i KAT	1.8	66	03.90-11.95	C 18 NZ <sup>18</sup>	4	<b>Z 74<sup>5</sup></b>	14 FR-8 LDUOX4	1,0	<b>UXT 1<sup>3</sup></b>
2.0 i	2.0	85	09.88-10.90	20 NE	4	<b>Z 119</b>	14 R-8 DU4	0,8	<b>UXT 2<sup>4</sup></b>
2.0 i	2.0	85	09.88-10.90	20 NE <sup>18</sup>	4	<b>Z 74<sup>5</sup></b>	14 FR-8 LDUOX4	1,0	<b>UXT 1<sup>3</sup></b>
2.0 i 4x4 KAT	2.0	85	01.89-11.95	C 20 NE	4	<b>Z 119</b>	14 R-8 DU4	0,8	<b>UXT 2<sup>4</sup></b>
2.0 i 4x4 KAT	2.0	85	01.89-11.95	C 20 NE <sup>18</sup>	4	<b>Z 74<sup>5</sup></b>	14 FR-8 LDUOX4	1,0	<b>UXT 1<sup>3</sup></b>
2.0 i GT	2.0	95	09.88-11.95	20 SEH	4	<b>Z 20</b>	14 R-7 DU	0,8	<b>UXT 2<sup>4</sup></b>
2.0 i 16V	2.0	100	06.94-11.95	X 20 XEV	4	<b>Z 74<sup>5</sup></b>	14 FR-8 LDUOX4	1,0	<b>UXT 1<sup>3</sup></b>
2000/GT 16V	2.0	110	01.89-06.94	20 XEJ	4	<b>Z 74<sup>5</sup></b>	14 FR-8 LDUOX4	1,0	<b>UXT 1<sup>3</sup></b>
2.0 i 16V KAT	2.0	110	02.90-11.95	C 20 XE	4	<b>Z 74<sup>5</sup></b>	14 FR-8 LDUOX4	1,0	<b>UXT 1<sup>3</sup></b>
2.0 i Turbo 4x4	2.0	150	06.94-11.95	C 20 LET	4	<b>Z 158</b>	14 FR-7 LUX	1,1	○
2.5 V6	2.5	125	02.93-11.95	C 25 XE	6	<b>Z 74<sup>5</sup></b>	14 FR-8 LDUOX4	1,0	<b>UXT 1<sup>3</sup></b>

**VECTRA B**

1.6 i	1.6	55	10.95-04.02	16 LZ2	4	<b>Z 74<sup>5</sup></b>	14 FR-8 LDUOX4	1,0	<b>UXT 1<sup>3</sup></b>
1.6 i	1.6	55	10.95-04.02	X 16 SZR	4	<b>Z 74<sup>5</sup></b>	14 FR-8 LDUOX4	1,0	<b>UXT 1<sup>3</sup></b>
1.6 i 16V	1.6	74	10.95-04.02	Z 16 XE/X 16 XEL/Y 16 XE	4	<b>Z 74<sup>5</sup></b>	14 FR-8 LDUOX4	1,0	<b>UXT 1<sup>3</sup></b>
1.7 TD	1.7	60	10.95-12.98	X 17 DT (TC4EE1)	4	<b>GN 103</b> (11V)	○		
1.8 i 16V	1.8	85	10.95-09.00	X 18 XE1	4	<b>Z 74<sup>5</sup></b>	14 FR-8 LDUOX4	1,0	<b>UXT 1<sup>3</sup></b>
1.8 i 16V	1.8	85	10.95-09.00	X 18 XE	4	<b>Z 74<sup>5</sup></b>	14 FR-8 LDUOX4	1,0	<b>UXT 1<sup>3</sup></b>
1.8 i 16V	1.8	92	09.00-07.03	Z 18 XE	4	<b>Z 74<sup>5</sup></b>	14 FR-8 LDUOX4	1,0	<b>UXT 1<sup>3</sup></b>
2.0 DI 16V	2.0	60	11.96-07.99	X 20 DTL	4	<b>GN 944</b> (11V)	○		
2.0 DI 16V	2.0	60	08.99-04.02	X 20 DTL	4	<b>GN 992</b> (11V)	○		
2.0 DTI 16V	2.0	74	06.97-04.02	X 20 DTH	4	<b>GN 992</b> (11V)	○		
2.0 DTI 16V	2.0	74	06.97-04.02	Y 20 DTH	4	<b>GN 033</b> (11V)	○		
2.0 i	2.0	82	10.95-04.02	20 NEJ	4	<b>Z 119</b>	14 R-8 DU4	0,8	<b>UXT 2<sup>4</sup></b>
2.0 i	2.0	82	10.95-04.02	20 NEJ <sup>18</sup>	4	<b>Z 74<sup>5</sup></b>	14 FR-8 LDUOX4	1,0	<b>UXT 1<sup>3</sup></b>
2.0 i 16V	2.0	100	10.95-09.00	X 20 XEV/C 20 SEL	4	<b>Z 74<sup>5</sup></b>	14 FR-8 LDUOX4	1,0	<b>UXT 1<sup>3</sup></b>
2.2 DTI 16V	2.2	88	09.00-04.02	Y 22 DTR	4	<b>GN 033</b> (11V)	○		
2.2 DTI 16V	2.2	92	09.00-07.03	Y 22 DTR	4	<b>GN 033</b> (11V)	○		
2.2 i 16V	2.2	108	09.00-07.03	Z 22 SE	4	<b>Z 222</b>	14 KR-8 STUX	1,1	○
2.5 i V6	2.5	125	10.95-09.00	X 25 XE	6	<b>Z 74<sup>5</sup></b>	14 FR-8 LDUOX4	1,0	<b>UXT 1<sup>3</sup></b>
i 500 2.5	2.5	143	05.98-09.00	X 25 XE	6	<b>Z 74<sup>5</sup></b>	14 FR-8 LDUOX4	1,0	<b>UXT 1<sup>3</sup></b>
2.5	2.5	144	10.99-06.00	X 25 XE	6	<b>Z 74<sup>5</sup></b>	14 FR-8 LDUOX4	1,0	<b>UXT 1<sup>3</sup></b>
2.6 i V6	2.6	125	09.00-07.03	Y 26 SE	6	<b>Z 173</b>	14 FGR-8 KQU	1,6	○

**VECTRA B Caravan**

1.6 i	1.6	55	11.96-06.00	16 LZ2	4	<b>Z 74<sup>5</sup></b>	14 FR-8 LDUOX4	1,0	<b>UXT 1<sup>3</sup></b>
1.6 i	1.6	55	11.96-06.00	X 16 SZR	4	<b>Z 74<sup>5</sup></b>	14 FR-8 LDUOX4	1,0	<b>UXT 1<sup>3</sup></b>
1.6 i 16V	1.6	74	11.96-07.02	Z 16 XE/X 16 XEL/Y 16 XE	4	<b>Z 74<sup>5</sup></b>	14 FR-8 LDUOX4	1,0	<b>UXT 1<sup>3</sup></b>
1.7 TD	1.7	60	11.96-12.97	X 17 DT (TC4EE1)	4	<b>GN 103</b> (11V)	○		
1.8 i 16V	1.8	85	11.96-09.00	X 18 XE1	4	<b>Z 74<sup>5</sup></b>	14 FR-8 LDUOX4	1,0	<b>UXT 1<sup>3</sup></b>
1.8 i 16V	1.8	85	11.96-09.00	X 18 XE	4	<b>Z 74<sup>5</sup></b>	14 FR-8 LDUOX4	1,0	<b>UXT 1<sup>3</sup></b>
1.8 i 16V	1.8	92	09.00-07.03	Z 18 XE	4	<b>Z 74<sup>5</sup></b>	14 FR-8 LDUOX4	1,0	<b>UXT 1<sup>3</sup></b>
2.0 DI 16V	2.0	60	11.96-07.99	X 20 DTL	4	<b>GN 944</b> (11V)	○		
2.0 DI 16V	2.0	60	08.99-06.00	X 20 DTL	4	<b>GN 992</b> (11V)	○		
2.0 DTI 16V	2.0	74	06.97-07.03	X 20 DTH	4	<b>GN 992</b> (11V)	○		
2.0 DTI 16V	2.0	74	06.97-07.03	Y 20 DTH	4	<b>GN 033</b> (11V)	○		
2.0 i	2.0	82	11.96-02.02	20 NEJ	4	<b>Z 119</b>	14 R-8 DU4	0,8	<b>UXT 2<sup>4</sup></b>
2.0 i	2.0	82	11.96-02.02	20 NEJ <sup>18</sup>	4	<b>Z 74<sup>5</sup></b>	14 FR-8 LDUOX4	1,0	<b>UXT 1<sup>3</sup></b>
2.0 i 16V	2.0	100	11.96-09.00	X 20 XEV/C 20 SEL	4	<b>Z 74<sup>5</sup></b>	14 FR-8 LDUOX4	1,0	<b>UXT 1<sup>3</sup></b>
2.2 DTI 16V	2.2	88	09.00-04.02	Y 22 DTR	4	<b>GN 033</b> (11V)	○		
2.2 DTI 16V	2.2	92	09.00-07.03	Y 22 DTR	4	<b>GN 033</b> (11V)	○		
2.2 i 16V	2.2	108	09.00-07.03	Z 22 SE	4	<b>Z 222</b>	14 KR-8 STUX	1,1	○

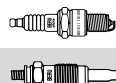

## OPEL

### VECTRA B Caravan

2.5 i V6	2.5	125	11.96-09.00	X 25 XE	6	<b>Z 74<sup>5</sup></b>	14 FR-8 LDUOX4	1,0	<b>UXT 1<sup>3</sup></b>
i 500 2.5	2.5	143	05.98-09.00	X 25 XE	6	<b>Z 74<sup>5</sup></b>	14 FR-8 LDUOX4	1,0	<b>UXT 1<sup>3</sup></b>
2.6 i V6	2.6	125	09.00-07.03	Y 26 SE	6	<b>Z 173</b>	14 FGR-8 KQU	1,6	○

### VECTRA C

1.6 16V	1.6	74	06.04-	Z 16 XE	4	<b>Z 203</b>	14 FR-8 LU2	0,9	○
1.6	1.6	77	01.06-	Z 16 XEP	4	<b>Z 203</b>	14 FR-8 LU2	0,9	○
1.8	1.8	81	04.02-08.03	Z 18 XEL	4	<b>Z 173</b>	14 FGR-8 KQU	1,6	○
1.8	1.8	81	09.03-	Z 18 XEL	4	<b>Z 203</b>	14 FR-8 LU2	0,9	○
1.8 16V	1.8	90	04.02-08.03	Z 18 XE	4	<b>Z 173</b>	14 FGR-8 KQU	1,6	○
1.8 16V	1.8	90	09.03-	Z 18 XE	4	<b>Z 203</b>	14 FR-8 LU2	0,9	○
1.8	1.8	103	01.06-	Z 18 XER	4	<b>Z 203</b>	14 FR-8 LU2	0,9	○
1.9 CDTI	1.9	74	10.05-07.07	Z 19 DT	4	<b>GN 041</b> (11V)	○		
1.9 CDTI	1.9	74	08.07-	Z 19 DT	4	<b>GN 097</b> (11V)	○		
1.9 CDTI	1.9	88	04.04-	Z 19 DT	4	<b>GN 041</b> (11V)	○		
				→ Fgst.Nr. 71021891					
1.9 CDTI	1.9	88	04.04-	Z 19 DT	4	<b>GN 097</b> (11V)	○		
				Fgst.Nr. 71021892 →					
1.9 CDTI	1.9	110	04.04-03.07	Z 19 DTH	4	<b>GN 059</b> (11V)	○		
2.0 DTI 16V	2.0	74	04.02-	Y 20 DTH	4	<b>GN 033</b> (11V)	○		
2.0 16V Turbo	2.0	129	03.03-	Z 20 NET	4	<b>Z 284</b>	14 FR-6 DPOX	1,1	<b>UXT 14</b>
2.2 DTI 16V	2.2	92	04.02-	Y 22 DTR	4	<b>GN 033</b> (11V)	○		
2.2 16V	2.2	108	04.02-09.05	Z 22 SE	4	<b>Z 222</b>	14 KR-8 STUX	1,1	
2.2 direct	2.2	114	10.03-	Z 22 YH	4	<b>Z 190</b>	14 FGR-8 DQU7	1,2	<b>UXT 1<sup>3</sup></b>
2.8 V6 Turbo	2.8	169	08.05-	Z 28 NEL	6	<b>Z 235</b>	14 FR-7 SPUX03	1,0	○
2.8 V6 Turbo	2.8	184	08.06-10.08	Z 28 NET	6	<b>Z 235</b>	14 FR-7 SPUX03	1,0	○
2.8 V6 Turbo	2.8	188	08.05-10.08	Z 28 NET	6	<b>Z 235</b>	14 FR-7 SPUX03	1,0	○
3.0 CDTI	3.0	130	06.03-	Y 30 DT	6	<b>GN 106</b> (11V)	○		
3.0 CDTi	3.0	135	08.05-	Z 30 DT	6	<b>GN 106</b> (11V)	○		
3.2 V6	3.2	155	08.02-	Z 32 SE	6	<b>Z 173</b>	14 FGR-8 KQU	1,6	○

### VECTRA C Caravan

1.6 16V	1.6	74	06.04-	Z 16 XE	4	<b>Z 203</b>	14 FR-8 LU2	0,9	○
1.6	1.6	77	01.06-	Z 16 XEP	4	<b>Z 203</b>	14 FR-8 LU2	0,9	○
1.8	1.8	90	10.03-	Z 18 XE	4	<b>Z 203</b>	14 FR-8 LU2	0,9	○
1.8	1.8	103	01.06-	Z 18 XER	4	<b>Z 203</b>	14 FR-8 LU2	0,9	○
1.9 CDTI	1.9	74	10.05-07.07	Z 19 DTL	4	<b>GN 041</b> (11V)	○		
1.9 CDTI	1.9	74	08.07-	Z 19 DTL	4	<b>GN 097</b> (11V)	○		
1.9 CDTI	1.9	88	04.04-	Z 19 DT	4	<b>GN 041</b> (11V)	○		
				→ Fgst.Nr. 71021891					
1.9 CDTI	1.9	88	04.04-	Z 19 DT	4	<b>GN 097</b> (11V)	○		
				Fgst.Nr. 71021892 →					
1.9 CDTI	1.9	110	04.04-03.07	Z 19 DTH	4	<b>GN 059</b> (11V)	○		
2.0 DTI	2.0	74	10.03-	Y 20 DTH	4	<b>GN 033</b> (11V)	○		
2.0 Turbo	2.0	129	10.03-	Z 20 NET	4	<b>Z 284</b>	14 FR-6 DPOX	1,1	<b>UXT 14</b>
2.2 DTI	2.2	92	10.03-	Y 22 DTR	4	<b>GN 033</b> (11V)	○		
2.2 direct	2.2	114	10.03-	Z 22 YH	4	<b>Z 190</b>	14 FGR-8 DQU7	1,2	<b>UXT 1<sup>3</sup></b>
2.8 V6 Turbo	2.8	169	08.05-	Z 28 NEL	6	<b>Z 235</b>	14 FR-7 SPUX03	1,0	○
2.8 V6 Turbo	2.8	184	01.07-10.08	Z 28 NET	6	<b>Z 235</b>	14 FR-7 SPUX03	1,0	○
2.8 V6 Turbo	2.8	188	08.05-10.08	Z 28 NET	6	<b>Z 235</b>	14 FR-7 SPUX03	1,0	○
2.8 V6 Turbo	2.8	206	01.07-10.08	Z 28 NET	6	<b>Z 235</b>	14 FR-7 SPUX03	1,0	○
3.0 V6 CDTI	3.0	130	10.03-	Y 30 DT	6	<b>GN 106</b> (11V)	○		
3.0 V6 CDTI	3.0	135	08.05-	Z 30 DT	6	<b>GN 106</b> (11V)	○		
3.2 V6	3.2	155	10.03-	Z 32 SE	6	<b>Z 173</b>	14 FGR-8 KQU	1,6	○

### VECTRA C GTS

1.6	1.6	74	08.05-	Z 16 XE	4	<b>Z 203</b>	14 FR-8 LU2	0,9	○
1.6	1.6	77	01.06-	Z 16 XEP	4	<b>Z 203</b>	14 FR-8 LU2	0,9	○
1.8 16V	1.8	90	08.02-08.03	Z 18 XE	4	<b>Z 173</b>	14 FGR-8 KQU	1,6	○
1.8 16V	1.8	90	09.03-	Z 18 XE	4	<b>Z 203</b>	14 FR-8 LU2	0,9	○
1.8	1.8	103	01.06-	Z 18 XER	4	<b>Z 203</b>	14 FR-8 LU2	0,9	○
1.9 CDTI	1.9	74	10.05-07.07	Z 19 DT	4	<b>GN 041</b> (11V)	○		
1.9 CDTI	1.9	74	08.07-	Z 19 DT	4	<b>GN 097</b> (11V)	○		

● nicht erforderlich  
○ nicht im Programm

<sup>3</sup> wahlweise UXT 3 Platin

<sup>5</sup> wahlweise Z 190

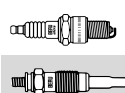
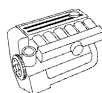

kW

**OPEL****VECTRA C GTS**

1.9 CDTI	1.9	88	04.04-07.07	Z 19 DT → Fgst.Nr. 71021891	4	<b>GN 041</b> (11V)	○		
1.9 CDTI	1.9	88	04.04-10.08	Z 19 DT Fgst.Nr. 71021892 →	4	<b>GN 097</b> (11V)	○		
1.9 CDTI	1.9	110	04.04-03.07	Z 19 DTH	4	<b>GN 059</b> (11V)	○		
2.0 DTI 16V	2.0	74	08.02-	Y 20 DTH	4	<b>GN 033</b> (11V)	○		
2.0 16V Turbo	2.0	129	03.03-	Z 20 NET	4	<b>Z 284</b>	14 FR-6 DPOX	1,1	<b>UXT 14</b>
2.2 DTI 16V	2.2	92	08.02-	Y 22 DTR	4	<b>GN 033</b> (11V)	○		
2.2 16V	2.2	108	08.02-09.05	Z 22 SE	4	<b>Z 222</b>	14 KR-8 STUX	1,1	○
2.2 direct	2.2	114	10.03-	Z 22 YH	4	<b>Z 190</b>	14 FGR-8 DQU7	1,2	<b>UXT 1<sup>3</sup></b>
2.8 V6 Turbo	2.8	169	08.05-	Z 28 NEL	6	<b>Z 235</b>	14 FR-7 SPUX03	1,0	○
2.8 V6 Turbo	2.8	184	08.06-10.08	Z 28 NET	6	<b>Z 235</b>	14 FR-7 SPUX03	1,0	○
2.8 V6 Turbo	2.8	188	08.05-10.08	Z 28 NET	6	<b>Z 235</b>	14 FR-7 SPUX03	1,0	○
2.8 V6 Turbo	2.8	206	08.06-10.08	Z 28 NET	6	<b>Z 235</b>	14 FR-7 SPUX03	1,0	○
3.0 CDTI	3.0	130	06.03-	Y 30 DT	6	<b>GN 106</b> (11V)	○		
3.0 CDTi	3.0	135	08.05-	Z 30 DT	6	<b>GN 106</b> (11V)	○		
3.2 V6	3.2	155	08.02-	Z 32 SE	6	<b>Z 173</b>	14 FGR-8 KQU	1,6	○

**VIVARO**

1.9 DI	1.9	60	08.01-	F9Q 762	4	<b>GN 018</b> (11V)	○		
1.9 DTI	1.9	74	08.01-	F9Q 760	4	<b>GN 018</b> (11V)	○		
2.0 ECOTEC	2.0	86	08.06-	F4R 820 Fgst.Nr. 7V600001, 7Y000001 →	4	<b>Z 337</b>	14 FR-7 DPPUW2	0,9	○
2.0 16V	2.0	88	08.01-	F4R 720 → Fgst.Nr. 6V699999, 6Y999999	4	<b>Z 337</b>	14 FR-7 DPPUW2	0,9	○
2.5 CDTI	2.5	84	08.06-	G9U 630	4	<b>GN 026</b> (11V)	○		
2.5 DTI	2.5	99	05.03-	G9U 630	4	<b>GN 026</b> (11V)	○		
2.5 DTi	2.5	99	08.06-	G9U 730	4	<b>GN 026</b> (11V)	○		
2.5 CDTI	2.5	107	08.06-	G9U 630	4	<b>GN 026</b> (11V)	○		

**ZAFIRA**

1.6 CNG	1.6	69	07.05-	Z 16 YNG	4	<b>Z 206</b>	14 FR-7 DPPUS2	0,7	<b>UXT 10</b>
1.6	1.6	70	09.02-06.05	Z 16 YNG	4	<b>Z 206</b>	14 FR-7 DPPUS2	0,7	<b>UXT 10</b>
1.6 CNG	1.6	71	09.01-06.05	Z 16 YNG	4	<b>Z 206</b>	14 FR-7 DPPUS2	0,7	<b>UXT 10</b>
1.6 16V	1.6	74	04.99-06.05	Z 16 XE/X 16 XEL → Mot.Nr. 420 00000	4	<b>Z 74<sup>5</sup></b>	14 FR-8 LDUOX4	1,0	<b>UXT 1<sup>3</sup></b>
1.6 16V	1.6	74	04.99-06.05	Z 16 XE/X 16 XEL Mot.Nr. 420 00001 →	4	<b>Z 203</b>	14 FR-8 LU2	0,9	○
1.6	1.6	77	07.05-	Z 16 XE1/Z 16 XEP	4	<b>Z 203</b>	14 FR-8 LU2	0,9	○
1.6	1.6	85	01.08-	Z 16 XER	4	<b>Z 203</b>	14 FR-8 LU2	0,9	○
1.7 CDTI	1.7	81	01.08-	A 17 DTJ/Z 17 DTJ	4	<b>GN 104</b> (11V)	○		
1.7 CDTI	1.7	92	01.08-	A 17 DTR	4	<b>GN 104</b> (11V)	○		
1.8	1.8	81	02.03-06.05	Z 18 XEL	4	<b>Z 74<sup>5</sup></b>	14 FR-8 LDUOX4	1,0	<b>UXT 1<sup>3</sup></b>
1.8 16V	1.8	85	04.99-09.00	X 18 XE1	4	<b>Z 74<sup>5</sup></b>	14 FR-8 LDUOX4	1,0	<b>UXT 1<sup>3</sup></b>
1.8 16V	1.8	92	09.00-06.05	Z 18 XE	4	<b>Z 74<sup>5</sup></b>	14 FR-8 LDUOX4	1,0	<b>UXT 1<sup>3</sup></b>
1.8	1.8	103	07.05-	A 18 XER/Z 18 XER	4	<b>Z 203</b>	14 FR-8 LU2	0,9	○
1.9 CDTI	1.9	74	07.05-03.08	Z 19 DTL → Fgst.Nr. 6G999999, 6Z999999	4	<b>GN 041</b> (11V)	○		
1.9 CDTI	1.9	74	07.05-03.08	Z 19 DTL Fgst.Nr 7G000001, 7Z000001 →	4	<b>GN 097</b> (11V)	○		
1.9 CDTI	1.9	88	07.05-03.08	Z 19 DT → Fgst.Nr. 6G999999, 6Z999999	4	<b>GN 041</b> (11V)	○		
1.9 CDTI	1.9	88	07.05-	Z 19 DT Fgst.Nr. 7Z000001, 7G000001 →	4	<b>GN 097</b> (11V)	○		
1.9 CDTI	1.9	110	07.05-	Z 19 DTH	4	<b>GN 059</b> (11V)	○		
2.0 DI 16V	2.0	60	10.99-06.05	X 20 DTL	4	<b>GN 992</b> (11V)	○		
2.0 DTI 16V	2.0	74	09.00-08.02	Y 20 DTH	4	<b>GN 992</b> (11V)	○		
2.0 DTI 16V	2.0	74	09.02-06.05	Y 20 DTH	4	<b>GN 033</b> (11V)	○		
2.0 CDTi	2.0	81	10.11-	A 20 DTL	4	<b>PSG 001</b> (4,4V)	○		
2.0 CDTi	2.0	96	10.11-	A 20 DT/Z 20 DTJ	4	<b>GE 114</b> (4,4V)	○		
2.0 CDTi	2.0	118	10.11-	A 20 DTH	4	<b>GE 114</b> (4,4V)	○		
2.0 CDTi	2.0	121	10.11-	A 20 DTH	4	<b>GE 114</b> (4,4V)	○		
2.0 OPC	2.0	147	11.02-01.04	Z 20 LET/Z 20 LER	4	<b>Z 74<sup>5</sup></b>	14 FR-8 LDUOX4	1,0	<b>UXT 1<sup>3</sup></b>

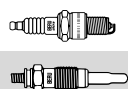

## OPEL

ZAFIRA									
2.0 OPC	2.0	147	02.04-06.05	Z 20 LET/Z 20 LER	4	<b>Z 287</b>	14 FR-8 LU2T	0,8	○
2.0	2.0	147	07.05-	Z 20 LER	4	<b>Z 287</b>	14 FR-8 LU2T	0,8	○
2.0	2.0	177	01.06-	Z 20 LEH	4	<b>Z 284</b>	14 FR-6 DPOX	1,1	<b>UXT 14</b>
2.2 DTI 16V	2.2	86	01.02-06.05	Y 22 DTR	4	<b>GN 033</b> (11V)	○		
2.2 DTI 16V	2.2	92	01.02-06.05	Y 22 DTR	4	<b>GN 033</b> (11V)	○		
2.2 16V	2.2	108	09.00-06.05	Z 22 SE	4	<b>Z 222</b>	14 KR-8 STUX	1,1	○
2.2	2.2	110	07.05-	Z 22 YH	4	<b>Z 190</b>	14 FGR-8 DQU7	1,2	<b>UXT 13</b>
ZAFIRA Van									
1.7 CDTI	1.7	81	01.08-	A 17 DTJ/Z 17 DTJ	4	<b>GN 104</b> (11V)	○		
1.7 CDTI	1.7	92	01.08-	A 17 DTR	4	<b>GN 104</b> (11V)	○		
1.8	1.8	103	07.05-	A 18 XER/Z 18 XER	4	<b>Z 203</b>	14 FR-8 LU2	0,9	○

## PEUGEOT

106 I									
1.0	1.0	33	09.91-04.96	TU9/CDY (TU9M)	4	<b>Z 193</b>	14 FR-7 DU2	0,9	<b>UXT 13</b>
1.0	1.0	37	09.91-04.96	CDZ (TU9M)	4	<b>Z 193</b>	14 FR-7 DU2	0,9	<b>UXT 13</b>
1.1	1.1	44	09.91-04.96	HDZ (TU1M)	4	<b>Z 193</b>	14 FR-7 DU2	0,9	<b>UXT 13</b>
1.3	1.3	72	10.93-04.96	TU2J2	4	<b>Z 193</b>	14 FR-7 DU2	0,9	<b>UXT 13</b>
1.4 D	1.4	37	09.92-04.96	K9Y (TUD3Y)	4	<b>GV 661</b> (11V)	○		
1.4	1.4	55	09.91-04.96	KDX (TU3MC)/KDY (TU3M)	4	<b>Z 193</b>	14 FR-7 DU2	0,9	<b>UXT 13</b>
1.4	1.4	69	09.91-04.96	KFZ (TU3J2/Z)	4	<b>Z 193</b>	14 FR-7 DU2	0,9	<b>UXT 13</b>
1.5 D	1.5	40	06.94-04.96	VJY (TUD5)	4	<b>GN 912</b> (11V)	<b>GR 054</b>		
1.5 D	1.5	43	06.94-04.96	VJY (TUD5)	4	<b>GN 912</b> (11V)	<b>GR 054</b>		
1.6	1.6	65	06.93-04.96	NFZ (TU5JP)	4	<b>Z 193</b>	14 FR-7 DU2	0,9	<b>UXT 13</b>
1.6	1.6	76	01.94-04.96	NFY (TU5J2)	4	<b>Z 193</b>	14 FR-7 DU2	0,9	<b>UXT 13</b>
106 II									
1.0 i	1.0	33	05.96-	CDY (TU9M)	4	<b>Z 193</b>	14 FR-7 DU2	0,9	<b>UXT 13</b>
1.0 i	1.0	37	01.97-	CDZ (TU9M)	4	<b>Z 193</b>	14 FR-7 DU2	0,9	<b>UXT 13</b>
1.1 i	1.1	40	01.97-	HDY (TU1M)	4	<b>Z 193</b>	14 FR-7 DU2	0,9	<b>UXT 13</b>
1.1 i	1.1	44	05.96-	HDZ (TU1M)/HFX (TU1JP)	4	<b>Z 193</b>	14 FR-7 DU2	0,9	<b>UXT 13</b>
1.4 i	1.4	55	05.96-	KFX (TU3JP)/KFW (TU3JP)	4	<b>Z 193</b>	14 FR-7 DU2	0,9	<b>UXT 13</b>
1.5 D	1.5	40	05.96-	VJY (TUD5)	4	<b>GN 912</b> (11V)	<b>GR 054</b>		
1.5 D	1.5	42	10.00-	VJX (TUD5)	4	<b>GN 912</b> (11V)	○		
1.6 i	1.6	65	05.96-	NFZ (TU5JP)	4	<b>Z 193</b>	14 FR-7 DU2	0,9	<b>UXT 13</b>
1.6 i	1.6	74	05.96-	NFW (TU5J2)/NFY (TU5J2)	4	<b>Z 193</b>	14 FR-7 DU2	0,9	<b>UXT 13</b>
1.6 S16	1.6	87	05.96-	NFX (TU5J4)	4	<b>Z 193</b>	14 FR-7 DU2	0,9	<b>UXT 13</b>
106 Van									
1.0	1.0	33	09.91-03.01	TU9/CDY (TU9M)	4	<b>Z 193</b>	14 FR-7 DU2	0,9	<b>UXT 13</b>
1.5 D	1.5	40	05.96-	VJY (TUD5)	4	<b>GN 016</b> (11V)	○		
1.5 D	1.5	42	10.00-	VJX (TUD5)	4	<b>GN 016</b> (11V)	○		
107									
1.0	1.0	50	06.05-	1KR (384 F)	3	<b>Z 273</b>	14 FR-7 NUX2	1,1	○
1.4 HDi	1.4	40	06.05-	8HT (DV4TD)	4	<b>GN 056</b> (11V)	○		
1007									
1.4 HDi	1.4	50	04.05-	8HZ (DV4TD)/8HX (DV4TD)	4	<b>GN 056</b> (11V)	○		
1.4	1.4	54	04.05-	KFV (TU3JP)	4	<b>Z 193</b>	14 FR-7 DU2	0,9	<b>UXT 13</b>
1.4 16V	1.4	65	10.05-	KFU (ET3J4)	4	<b>Z 243</b>	12 VR-8 SE	0,9	○
1.6 16V	1.6	80	04.05-	NFU (TU5JP4)	4	<b>Z 184</b>	14 FR-7 MU2	0,9	<b>UXT 13</b>
1.6 HDi	1.6	80	06.07-	9HZ (DV6TED4)	4	<b>GN 056</b> (11V)	○		
205 I Cabriolet									
1.1 CJ	1.1	44	10.89-12.94	HDZ (TU1M)	4	<b>Z 247</b>	14 FR-7 DUW	0,9	<b>UXT 13</b>
1.4 CJ KAT	1.4	44	01.89-09.93	KAY (TU3CP)	4	<b>Z 247</b>	14 FR-7 DUW	0,9	<b>UXT 13</b>
1.4 CJ	1.4	49	03.89-12.94	K1D (TU3A)	4	<b>Z 247</b>	14 FR-7 DUW	0,9	<b>UXT 13</b>
1.4 CJ	1.4	55	05.91-12.94	KDZ (TU3M)/KDY (TU3M)	4	<b>Z 247</b>	14 FR-7 DUW	0,9	<b>UXT 13</b>
1.6 CJ	1.6	65	08.92-12.94	BDY (XU5M3Z)	4	<b>Z 247</b>	14 FR-7 DUW	0,9	<b>UXT 13</b>
1.6 CTI	1.6	76	04.86-10.90	180A (XU5J)/180Z (XU5J)	4	<b>Z 25</b>	14 K-6 DU	0,8	<b>UXK 56</b>
1.9 CTI	1.9	75	10.87-12.94	DFZ (XU9J1)	4	<b>Z 247</b>	14 FR-7 DUW	0,9	<b>UXT 13</b>
205 II									
1.0	1.0	33	10.87-06.95	TU9	4	<b>Z 255</b>	14 FR-8 DUW	0,9	<b>UXT 13</b>
1.0	1.0	33	07.95-09.98	TU9	4	<b>Z 74</b>	14 FR-8 LDUOX4	1,0	<b>UXT 13</b>
1.1	1.1	36	10.87-10.90	109N (XW7)	4	<b>Z 17</b>	14 K-7 DU	0,8	<b>UXT 4</b>

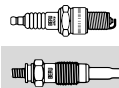

## PEUGEOT

### 205 II

1.1	1.1	40	10.87-10.90	H1B (TU1)	4	<b>Z 193</b>	14 FR-7 DU2	0,9	<b>UXT 1<sup>3</sup></b>
1.1	1.1	44	07.89-09.98	HDZ (TU1M)	4	<b>Z 193</b>	14 FR-7 DU2	0,9	<b>UXT 1<sup>3</sup></b>
1.4 KAT	1.4	44	08.87-10.90	KAY (TU3CP)	4	<b>Z 247</b>	14 FR-7 DUW	0,9	<b>UXT 1<sup>3</sup></b>
1.4	1.4	49	10.87-10.90	K1D (TU3A)	4	<b>Z 247</b>	14 FR-7 DUW	0,9	<b>UXT 1<sup>3</sup></b>
1.4	1.4	55	08.90-07.98	KDX (TU3MC)	4	<b>Z 193</b>	14 FR-7 DU2	0,9	<b>UXT 1<sup>3</sup></b>
1.4	1.4	55	07.88-09.98	KDY (TU3M)/KDZ (TU3M)/KFX (TU3JP)	4	<b>Z 193</b>	14 FR-7 DU2	0,9	<b>UXT 1<sup>3</sup></b>
1.6	1.6	53	10.87-09.98	B1E (XU51C)	4	<b>Z 247</b>	14 FR-7 DUW	0,9	<b>UXT 1<sup>3</sup></b>
1.6	1.6	55	10.87-09.98	BAZ (XU5CP)/B1A (XU51C)	4	<b>Z 247</b>	14 FR-7 DUW	0,9	<b>UXT 1<sup>3</sup></b>
1.6 Aut.	1.6	65	05.90-09.98	BDY (XU5M2Z)/BDY (XU5M3Z)	4	<b>Z 193</b>	14 FR-7 DU2	0,9	<b>UXT 1<sup>3</sup></b>
1.7 Diesel	1.8	44	07.87-09.98	161A (XUD7)	4	<b>GV 636 (11V)</b>	<b>GR 065</b>		
1.7 TD	1.8	57	01.90-09.98	A8B (XUD7TE)	4	<b>GV 636 (11V)</b>	<b>GR 065</b>		
1.9 Diesel	1.9	47	10.87-09.98	DJZ (XUD9Y)	4	<b>GV 636 (11V)</b>	<b>GR 065</b>		
1.9 Diesel	1.9	51	08.87-06.94	XUD9	4	<b>GN 013 (11V)</b>	○		
1.9 GTI KAT	1.9	75	10.87-07.94	DFZ (XU9J1)	4	<b>Z 247</b>	14 FR-7 DUW	0,9	<b>UXT 1<sup>3</sup></b>
1.9 GTI	1.9	88	10.87-10.94	DKZ (XU9JAZ)	4	<b>Z 193</b>	14 FR-7 DU2	0,9	<b>UXT 1<sup>3</sup></b>
1.9 GTI	1.9	94	10.87-09.98	D6B (XU9JA (G-KAT))	4	<b>Z 15</b>	14 FR-7 DU	0,8	<b>UXT 1<sup>3</sup></b>

### 206

1.1 i	1.1	44	09.98-	HFZ (TU1JP)/HFX (TU1JP)	4	<b>Z 193</b>	14 FR-7 DU2	0,9	<b>UXT 1<sup>3</sup></b>
1.4 HDi eco 70	1.4	50	09.01-	8HZ (DV4TD)/8HX (DV4TD) → Organisationsnr. 10443	4	<b>GN 047 (11V)</b>	○		
1.4 HDi eco 70	1.4	50	09.01-	8HZ (DV4TD)/8HX (DV4TD) Organisationsnr. 10444 →	4	<b>GN 056 (11V)</b>	○		
1.4 i	1.4	55	09.98-	TU 3 JP/KFX (TU3JP)/KFW (TU3JP)	4	<b>Z 193</b>	14 FR-7 DU2	0,9	<b>UXT 1<sup>3</sup></b>
1.4 16V	1.4	65	10.03-	KFU (ET3J4)	4	<b>Z 243</b>	12 VR-8 SE	0,9	○
1.6 i	1.6	65	09.98-12.00	NFZ (TU5JP)	4	<b>Z 193</b>	14 FR-7 DU2	0,9	<b>UXT 1<sup>3</sup></b>
1.6 16V	1.6	80	12.00-	NFU (TU5JP4)	4	<b>Z 184</b>	14 FR-7 MU2	0,9	<b>UXT 13</b>
1.6 16V	1.6	80	03.07-	NFU (TU5JP4)	4	<b>Z 184</b>	14 FR-7 MU2	0,9	<b>UXT 13</b>
1.6 HDi 110	1.6	80	05.04-	9HY (DV6TED4)/ 9HZ (DV6TED4) → Organisationsnr.10783	4	<b>GN 047 (11V)</b>	○		
1.6 HDi 110	1.6	80	05.04-	9HY (DV6TED4)/ 9HZ (DV6TED4) Organisationsnr.10784 →	4	<b>GN 056 (11V)</b>	○		
1.9 D	1.9	51	09.98-11.01	WJZ (DW8)	4	<b>GN 016 (11V)</b>	<b>GR 054</b>		
2.0 HDi 90	2.0	66	12.99-	RHY (DW10TD)	4	<b>GN 027 (11V)</b>	○		
2.0 S16	2.0	99	04.99-10.00	RFR (DEW10J4)	4	<b>Z 183</b>	14 FR-8 MU2	0,9	<b>UXT 13</b>
2.0 S16	2.0	100	10.00-	RFN (EW10J4)	4	<b>Z 183</b>	14 FR-8 MU2	0,9	<b>UXT 13</b>
2.0 RC	2.0	130	07.03-	RFK (EW10J4S)	4	<b>Z 184</b>	14 FR-7 MU2	0,9	<b>UXT 13</b>

### 206 CC

1.6 16V	1.6	80	09.00-	NFU (TU5JP4)	4	<b>Z 184</b>	14 FR-7 MU2	0,9	<b>UXT 13</b>
1.6 HDi 110	1.6	80	04.05-	9HZ (DV6TED4) → Organisationsnr.10783	4	<b>GN 047 (11V)</b>	○		
1.6 HDi 110	1.6	80	04.05-	9HZ (DV6TED4) Organisationsnr.10784 →	4	<b>GN 056 (11V)</b>	○		
2.0 S16	2.0	100	09.00-	RFN (EW10J4)	4	<b>Z 183</b>	14 FR-8 MU2	0,9	<b>UXT 13</b>

### 206 SW

1.1	1.1	44	07.02-	HFX (TU1JP)	4	<b>Z 193</b>	14 FR-7 DU2	0,9	<b>UXT 1<sup>3</sup></b>
1.4 HDi	1.4	50	07.02-	8HX (DV4TD) → Organisationsnr. 10443	4	<b>GN 047 (11V)</b>	○		
1.4 HDi	1.4	50	07.02-	8HX (DV4TD) Organisationsnr. 10444 →	4	<b>GN 056 (11V)</b>	○		
1.4	1.4	55	07.02-	KFV (TU3A)/KFW (TU3JP)	4	<b>Z 193</b>	14 FR-7 DU2	0,9	<b>UXT 1<sup>3</sup></b>
1.4 16V	1.4	65	10.03-	KFU (ET3J4)	4	<b>Z 243</b>	12 VR-8 SE	0,9	○
1.6 16V	1.6	80	07.02-	NFU (TU5JP4)	4	<b>Z 184</b>	14 FR-7 MU2	0,9	<b>UXT 13</b>
1.6 HDi 110	1.6	80	05.04-	9HZ (DV6TED4) → Organisationsnr.10783	4	<b>GN 047 (11V)</b>	○		
1.6 HDi 110	1.6	80	05.04-	9HZ (DV6TED4) Organisationsnr.10784 →	4	<b>GN 056 (11V)</b>	○		
2.0 HDi	2.0	66	07.02-	RHY (DW10TD)	4	<b>GN 027 (11V)</b>	○		



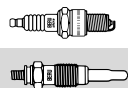
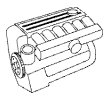

## PEUGEOT

### 206 SW

2.0 16V	2.0	100	07.02-	RFN (EW10J4)	4	<b>Z 193</b>	14 FR-8 MU2	0,9	<b>UXT 13</b>
---------	-----	-----	--------	--------------	---	--------------	-------------	-----	---------------

### 206 Van

1.4 HDi	1.4	50	09.01-03.09	8HZ (DV4TD)/8HX (DV4TD)	4	<b>GN 056</b> (11V)	○		
1.9 D	1.9	51	04.99-05.07	WJZ (DW8)	4	<b>GN 016</b> (11V)	○		

### 206+

1.4 HDi eco 70	1.4	50	01.09-	8HZ (DV4TD)/8HX (DV4TD)	4	<b>GN 056</b> (11V)	○		
1.4 i	1.4	54	09.10-	KFT (TU3A)	4	<b>Z 193</b>	14 FR-7 DU2	0,9	<b>UXT 13</b>
1.4 i	1.4	55	01.09-	KFV (TU3A)/KFW (TU3A)	4	<b>Z 193</b>	14 FR-7 DU2	0,9	<b>UXT 13</b>

### 207

1.4 HDi	1.4	50	02.06-	8HZ (DV4TD)/8HR (DV4TD)	4	<b>GN 056</b> (11V)	○		
1.4	1.4	53	02.06-	KFV (TU3A)	4	<b>Z 193</b>	14 FR-7 DU2	0,9	<b>UXT 13</b>
1.4	1.4	55	08.08-	KFV (TU3A)/KFW (TU3A)	4	<b>Z 193</b>	14 FR-7 DU2	0,9	<b>UXT 13</b>
1.4 16V	1.4	65	02.06-	KFU (ET3J4)	4	<b>Z 243</b>	12 VR-8 SE	0,9	○
1.4 16V	1.4	70	06.07-	EP3	4	<b>Z 320</b>	12 ZR-8 STP	1,0	○
1.6 HDi	1.6	66	02.06-	9HX (DV6ATED4)	4	<b>GN 056</b> (11V)	○		
1.6	1.6	78	11.08-	TU5JP4	4	<b>Z 193</b>	14 FR-7 DU2	0,9	<b>UXT 13</b>
1.6 16V	1.6	80	02.06-	NFU (TU5JP4)	4	<b>Z 184</b>	14 FR-7 MU2	0,9	<b>UXT 13</b>
1.6 HDi	1.6	80	02.06-	9HY (DV6TED4)/ 9HZ (DV6TED4)	4	<b>GN 056</b> (11V)	○		
1.6 16V Turbo	1.6	110	02.06-	EP6DT	4	<b>Z 332</b>	12 ZR-6 SPP2-1	0,7	○
1.6 16V Turbo	1.6	115	10.09-	5FR (EP6DT)	4	<b>Z 332</b>	12 ZR-6 SPP2-1	0,7	○
1.6 16V RC	1.6	128	02.07-	5FY (EP6DTS)	4	<b>Z 332</b>	12 ZR-6 SPP2-1	0,7	○

### 207 CC

1.6 HDi	1.6	80	02.07-	9HZ (DV6TED4)	4	<b>GN 056</b> (11V)	○		
1.6 16V	1.6	88	02.07-	EP6	4	<b>Z 288</b>	12 ZR-7 SPO3	1,0	○
1.6 16V Turbo	1.6	110	02.07-	EP6DT	4	<b>Z 332</b>	12 ZR-6 SPP2-1	0,7	○
1.6 16V Turbo	1.6	115	10.09-	5FR (EP6DT)	4	<b>Z 332</b>	12 ZR-6 SPP2-1	0,7	○

### 207 SW

1.4	1.4	54	06.07-	KFV (TU3A)	4	<b>Z 193</b>	14 FR-7 DU2	0,9	<b>UXT 13</b>
1.4 16V	1.4	70	06.07-	EP3	4	<b>Z 320</b>	12 ZR-8 STP	1,0	○
1.6 HDi	1.6	66	06.07-	9HX (DV6ATED4)	4	<b>GN 056</b> (11V)	○		
1.6 HDi	1.6	80	06.07-	9HZ (DV6TED4)	4	<b>GN 056</b> (11V)	○		
1.6 16V	1.6	88	06.07-	EP6	4	<b>Z 288</b>	12 ZR-7 SPO3	1,0	○
1.6 16V RC	1.6	128	02.07-	5FY (EP6DTS)	4	<b>Z 332</b>	12 ZR-6 SPP2-1	0,7	○

### 207 Van

1.4 HDi	1.4	50	04.07-	8HZ (DV4TD)	4	<b>GN 056</b> (11V)	○		
1.6 HDi	1.6	66	04.07-	9HX (DV6ATED4)	4	<b>GN 056</b> (11V)	○		

### 306

1.1	1.1	44	05.93-05.01	HDZ (TU1M)	4	<b>Z 193</b>	14 FR-7 DU2	0,9	<b>UXT 13</b>
1.4	1.4	55	05.93-05.01	KDX (TU3MC)/KFX (TU3JP)/ KFW (TU3JP)	4	<b>Z 193</b>	14 FR-7 DU2	0,9	<b>UXT 13</b>
1.6 SR	1.6	65	05.93-06.95	NFZ (TU5JP)	4	<b>Z 60</b>	14 FGR-7 CTU	1,2	○
1.6 SR	1.6	65	07.95-10.00	NFZ (TU5JP)	4	<b>Z 193</b>	14 FR-7 DU2	0,9	<b>UXT 13</b>
1.6	1.6	72	10.00-05.01	NFT	4	<b>Z 123</b>	14 FR-7 KDU	1,0	<b>UXT 9</b>
1.8 D	1.8	43	05.93-05.01	A9A (XUD7)	4	<b>GN 013</b> (11V)	○		
1.8 ST	1.8	74	06.94-05.01	LFZ (XU7JP)	4	<b>Z 193</b>	14 FR-7 DU2	0,9	<b>UXT 13</b>
1.8 16V	1.8	81	03.97-05.01	LFY (XU7JP4)	4	<b>Z 193</b>	14 FR-7 DU2	0,9	<b>UXT 13</b>
1.9 D	1.9	47	05.93-08.98	DJZ (XUD9Y)	4	<b>GV 636</b> (11V)	<b>GR 054</b>		
1.9 D	1.9	47	09.98-05.01	DJZ (XUD9Y)	4	<b>GN 013</b> (11V)	○		
1.9 SLD	1.9	47	06.94-08.98	DJZ (XUD9Y)	4	<b>GV 636</b> (11V)	<b>GR 054</b>		
1.9 SLD	1.9	47	09.98-05.01	DJZ (XUD9Y)	4	<b>GN 013</b> (11V)	○		
1.9 D	1.9	50	06.94-08.98	DJY (XUD9A)	4	<b>GV 636</b> (11V)	<b>GR 054</b>		
1.9 D	1.9	50	09.98-05.01	DJY (XUD9A)	4	<b>GN 013</b> (11V)	○		
1.9 SLD	1.9	50	06.94-08.98	DJY (XUD9A)	4	<b>GV 636</b> (11V)	<b>GR 054</b>		
1.9 SLD	1.9	50	09.98-05.01	DJY (XUD9A)	4	<b>GN 013</b> (11V)	○		
1.9 D	1.9	51	04.93-05.99	XUD9	4	<b>GN 013</b> (11V)	○		
1.9 D	1.9	51	09.98-05.01	WJY (DW8B)/WJZ (DW8)	4	<b>GN 016</b> (11V)	○		
1.9 STD	1.9	51	02.94-10.95	XUD9	4	<b>GN 013</b> (11V)	○		
1.9 D	1.9	55	03.98-05.01	DHV (XUD9BSD)	4	<b>GN 013</b> (11V)	○		
1.9 DT	1.9	66	05.93-08.98	DHY (XUD9TE)	4	<b>GN 909</b> (11V)	○		
1.9 DT	1.9	66	09.98-05.01	DHY (XUD9TE)	4	<b>GN 013</b> (11V)	○		

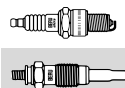
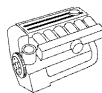

## PEUGEOT

## 306

1.9 SRDT	1.9	66	06.94-08.98	DHY (XUD9TE)	4	GN 909 (11V)	○		
1.9 SRDT	1.9	66	09.98-05.01	DHY (XUD9TE)	4	GN 013 (11V)	○		
1.9 D	1.9	69	04.93-04.97	XUD9TE	4	GN 013 (11V)	○		
2.0 HDI 90	2.0	66	06.99-05.01	RHY (DW10TD)	4	GN 027 (11V)	○		
2.0 XSi	2.0	89	05.93-05.01	RFX (XU10J2)	4	Z 193	14 FR-7 DU2	0,9	UXT 1 <sup>3</sup>
2.0	2.0	97	03.97-05.01	RFV (XU10J4R)	4	Z 193	14 FR-7 DU2	0,9	UXT 1 <sup>3</sup>
2.0 S16	2.0	110	06.94-05.01	RFT (XU10J4)	4	Z 193	14 FR-7 DU2	0,9	UXT 1 <sup>3</sup>
2.0 S16	2.0	112	05.93-05.01	RFY (XU10J4Z)	4	Z 193	14 FR-7 DU2	0,9	UXT 1 <sup>3</sup>
2.0 S16	2.0	120	03.96-05.01	RFS (XU10J4RS)	4	Z 193	14 FR-7 DU2	0,9	UXT 1 <sup>3</sup>

## 306 Break

1.4	1.4	55	03.97-04.02	KFX (TU3JP)/KFW (TU3JP)	4	Z 193	14 FR-7 DU2	0,9	UXT 1 <sup>3</sup>
1.6	1.6	65	03.97-10.00	NFZ (TU5JP)	4	Z 193	14 FR-7 DU2	0,9	UXT 1 <sup>3</sup>
1.6	1.6	72	10.00-04.02	NFT	4	Z 123	14 FR-7 KDU	1,0	UXT 9
1.8	1.8	74	03.97-04.02	LFZ (XU7JP)	4	Z 193	14 FR-7 DU2	0,9	UXT 1 <sup>3</sup>
1.8 16V	1.8	81	03.97-04.02	LFY (XU7JP4)	4	Z 193	14 FR-7 DU2	0,9	UXT 1 <sup>3</sup>
1.9 D	1.9	50	03.97-08.98	DJY (XUD9A)	4	GV 636 (11V)	○		
1.9 D	1.9	50	09.98-04.02	DJY (XUD9A)	4	GN 013 (11V)	GR 054		
1.9 D	1.9	51	09.98-04.02	WJY (DW8B)/WJZ (DW8)	4	GN 016 (11V)	○		
1.9 D	1.9	55	03.98-04.02	DHV (XUD9BSD)	4	GN 013 (11V)	○		
1.9 TD	1.9	66	02.97-08.98	DHY (XUD9TE)	4	GN 909 (11V)	○		
1.9 TD	1.9	66	09.98-04.02	DHY (XUD9TE)	4	GN 013 (11V)	○		
2.0 HDI 90	2.0	66	06.99-04.02	RHY (DW10TD)	4	GN 027 (11V)	○		
2.0	2.0	97	03.97-04.02	RFV (XU10J4R)	4	Z 193	14 FR-7 DU2	0,9	UXT 1 <sup>3</sup>

## 306 Cabriolet

1.6	1.6	65	04.96-10.00	NFZ (TU5JP)	4	Z 193	14 FR-7 DU2	0,9	UXT 1 <sup>3</sup>
1.6	1.6	72	10.00-04.02	NFT	4	Z 123	14 FR-7 KDU	1,0	UXT 9
1.8	1.8	74	03.94-04.02	LFZ (XU7JP)	4	Z 193	14 FR-7 DU2	0,9	UXT 1 <sup>3</sup>
1.8 16V	1.8	81	07.00-04.02	LFY (XU7JP4)	4	Z 193	14 FR-7 DU2	0,9	UXT 1 <sup>3</sup>
2.0	2.0	89	03.94-04.02	RFX (XU10J2)	4	Z 193	14 FR-7 DU2	0,9	UXT 1 <sup>3</sup>
2.0 16V	2.0	97	03.97-04.02	RFV (XU10J4R)	4	Z 193	14 FR-7 DU2	0,9	UXT 1 <sup>3</sup>

## 306 Van

1.9 STD	1.9	51	02.94-10.95	XUD9	4	GN 013 (11V)	○		
1.9 D	1.9	69	02.94-04.99	XUD9TE	4	GN 013 (11V)	○		

## 307

1.4 HDi	1.4	50	10.01-	8HZ (DV4TD)/8HX (DV4TD) → Organisationsnr. 10220	4	GN 047 (11V)	○		
1.4 HDi	1.4	50	10.01-	8HZ (DV4TD)/8HX (DV4TD) Organisationsnr. 10221 →	4	GN 056 (11V)	○		
1.4	1.4	55	08.00-	KFW (TU3JP)	4	Z 193	14 FR-7 DU2	0,9	UXT 1 <sup>3</sup>
1.4 16V	1.4	65	11.03-	KFU (ET3J4)	4	Z 243	12 VR-8 SE	0,9	○
1.6 HDi	1.6	66	04.05-	9HV (DV6ATED4)	4	GN 056 (11V)	○		
1.6 16V	1.6	80	08.00-05.05	NFU (TU5JP4)	4	Z 184	14 FR-7 MU2	0,9	UXT 13
1.6 HDi 110	1.6	80	02.04-	9HY (DV6TED4)/ 9HZ (DV6TED4) → Organisationsnr.10783	4	GN 047 (11V)	○		
1.6 HDi 110	1.6	80	02.04-	9HY (DV6TED4)/ 9HZ (DV6TED4) Organisationsnr.10784 →	4	GN 056 (11V)	○		
2.0 HDi 90	2.0	66	08.00-	RHY (DW10TD)	4	GN 027 (11V)	○		
2.0	2.0	99	08.04-05.06	EW10J4	4	Z 223	14 FR-8 NQU23	0,9	○
2.0 HDi 110	2.0	79	08.00-	RHS (DW10ATED)	4	GN 027 (11V)	○		
2.0 16V	2.0	100	08.00-	RFN (EW10J4)	4	Z 223	14 FR-8 NQU23	0,9	○
2.0 HDi 135	2.0	100	10.03-	RHR (DW10BTED4)	4	GN 054 (11V)	○		
2.0 16V	2.0	103	03.05-	RFJ (EW10A)	4	Z 223	14 FR-8 NQU23	0,9	○
2.0	2.0	108	05.06-	EW10A	4	Z 223	14 FR-8 NQU23	0,9	○
2.0 16V	2.0	130	06.05-	RFK (EW10J4S)	4	Z 223	14 FR-8 NQU23	0,9	○

## 307 Break

1.4 HDi	1.4	50	03.02-	8HZ (DV4TD) → Organisationsnr. 10220	4	GN 047 (11V)	○		
1.4 HDi	1.4	50	03.02-	8HZ (DV4TD) Organisationsnr. 10221 →	4	GN 056 (11V)	○		

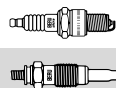
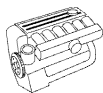

## PEUGEOT

### 307 Break

1.4 16V	1.4	65	11.03-	KFU (ET3J4)	4	<b>Z 243</b>	12 VR-8 SE	0,9	○
1.6 HDi	1.6	66	04.05-	9HV (DV6ATED4)	4	<b>GN 056</b> (11V)	○		
1.6 16V	1.6	80	03.02-05.05	NFU (TU5JP4)	4	<b>Z 184</b>	14 FR-7 MU2	0,9	<b>UXT 13</b>
1.6 HDi 110	1.6	80	02.04-	9HY (DV6TED4)/ 9HZ (DV6TED4) → Organisationsnr.10783	4	<b>GN 047</b> (11V)	○		
1.6 HDi 110	1.6	80	02.04-	9HY (DV6TED4)/ 9HZ (DV6TED4) Organisationsnr.10784 →	4	<b>GN 056</b> (11V)	○		
2.0 HDI 90	2.0	66	03.02-	RHY (DW10TD)	4	<b>GN 027</b> (11V)	○		
2.0 HDI 110	2.0	79	03.02-	RHS (DW10ATED)	4	<b>GN 027</b> (11V)	○		
2.0	2.0	100	03.02-	RFN (EW10J4)	4	<b>Z 223</b>	14 FR-8 NQU23	0,9	○
2.0 HDi 135	2.0	100	02.04-	RHR (DW10BTED4)	4	<b>GN 054</b> (11V)	○		
2.0 16V	2.0	103	03.05-	RFJ (EW10A)	4	<b>Z 223</b>	14 FR-8 NQU23	0,9	○
2.0 16V	2.0	130	06.05-	RFK (EW10J4S)	4	<b>Z 223</b>	14 FR-8 NQU23	0,9	○

### 307 CC

1.6 16V	1.6	80	03.05-	NFU (TU5JP4)	4	<b>Z 184</b>	14 FR-7 MU2	0,9	<b>UXT 13</b>
2.0 16V	2.0	100	10.03-	RFN (EW10J4)	4	<b>Z 223</b>	14 FR-8 NQU23	0,9	○
2.0 HDi 135	2.0	100	06.05-	RHR (DW10BTED4)	4	<b>GN 054</b> (11V)	○		
2.0 16V	2.0	103	03.05-	RFJ (EW10A)	4	<b>Z 223</b>	14 FR-8 NQU23	0,9	○
2.0 16V	2.0	130	10.03-	RFK (EW10J4S)	4	<b>Z 184</b>	14 FR-7 MU2	0,9	<b>UXT 13</b>

### 307 SW

1.4 16V	1.4	65	11.03-	KFU (ET3J4)	4	<b>Z 243</b>	12 VR-8 SE	0,9	○
1.6 D	1.6	66	12.06-	9HV (DV6ATED4) → Organisationsnr.10783	4	<b>GN 047</b> (11V)	○		
1.6 D	1.6	66	12.06-	9HV (DV6ATED4) Organisationsnr.10784 →	4	<b>GN 056</b> (11V)	○		
1.6 16V	1.6	80	03.02-05.05	NFU (TU5JP4)	4	<b>Z 184</b>	14 FR-7 MU2	0,9	<b>UXT 13</b>
1.6 HDi 110	1.6	80	02.04-	9HY (DV6TED4)/ 9HZ (DV6TED4) → Organisationsnr.10783	4	<b>GN 047</b> (11V)	○		
1.6 HDi 110	1.6	80	02.04-	9HY (DV6TED4)/ 9HZ (DV6TED4) Organisationsnr.10784 →	4	<b>GN 056</b> (11V)	○		
2.0 HDI 90	2.0	66	03.02-	RHY (DW10TD)	4	<b>GN 027</b> (11V)	○		
2.0 HDI 110	2.0	79	03.02-	RHS (DW10ATED)	4	<b>GN 027</b> (11V)	○		
2.0 16V	2.0	100	03.02-	RFN (EW10J4)	4	<b>Z 223</b>	14 FR-8 NQU23	0,9	○
2.0 HDi 135	2.0	100	02.04-	RHR (DW10BTED4)	4	<b>GN 054</b> (11V)	○		
2.0 16V	2.0	103	03.05-	RFJ (EW10A)	4	<b>Z 223</b>	14 FR-8 NQU23	0,9	○

### 308

1.4 16V	1.4	70	09.07-	EP3	4	<b>Z 320</b>	12 ZR-8 STP	1,0	○
1.4 16V	1.4	72	12.09-		4	<b>Z 320</b>	12 ZR-8 STP	1,0	○
1.6 HDi	1.6	66	09.07-		4	<b>GN 056</b> (11V)	○		
1.6 HDi	1.6	80	09.07-	9HZ (DV6TED4)	4	<b>GN 056</b> (11V)	○		
1.6 16V	1.6	88	09.07-	EP6	4	<b>Z 288</b>	12 ZR-7 SPO3	1,0	○
1.6 16V	1.6	103	09.07-	5FT (EP6DT)	4	<b>Z 332</b>	12 ZR-6 SPP2-1	0,7	○
1.6 16V	1.6	110	09.07-	EP6DT	4	<b>Z 332</b>	12 ZR-6 SPP2-1	0,7	○
1.6 16V	1.6	115	10.09-	EP6CDT	4	<b>Z 332</b>	12 ZR-6 SPP2-1	0,7	○
1.6 16V	1.6	128	03.08-	EP6DTS	4	<b>Z 332</b>	12 ZR-6 SPP2-1	0,7	○
2.0 HDi	2.0	100	09.07-	RHR (DW10BTED4)	4	<b>GN 054</b> (11V)	○		

### 308 CC

1.6 16V	1.6	88	06.09-	EP6 → Organisationsnr. 12005	4	<b>Z 288</b>	12 ZR-7 SPO3	1,0	○
1.6 16V	1.6	103	06.09-	5FT (EP6DT)	4	<b>Z 332</b>	12 ZR-6 SPP2-1	0,7	○
1.6 16V	1.6	110	06.09-	EP6DT	4	<b>Z 332</b>	12 ZR-6 SPP2-1	0,7	○
1.6 16V	1.6	115	06.09-	EP6CDT	4	<b>Z 332</b>	12 ZR-6 SPP2-1	0,7	○
2.0 HDi	2.0	100	04.09-	RHR (DW10BTED4)	4	<b>GN 054</b> (11V)	○		
2.0 HDi	2.0	103	04.09-	RHR (DW10BTED4)	4	<b>GN 054</b> (11V)	○		

### 308 SW

1.4 16V	1.4	70	09.07-	8FS (EP3)	4	<b>Z 320</b>	12 ZR-8 STP	1,0	○
1.4 16V	1.4	72	12.09-		4	<b>Z 320</b>	12 ZR-8 STP	1,0	○

● nicht erforderlich  
○ nicht im Programm

<sup>3</sup> wahlweise UXT 3 Platin



kW

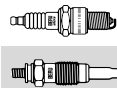

## PEUGEOT

## 308 SW

1.6 HDi	1.6	66	09.07-	9HX (DV6ATED4)/ 9HV (DV6ATED4)	4	<b>GN 056</b> (11V)	○		
1.6 HDi	1.6	80	09.07-	9HZ (DV6TED4)	4	<b>GN 056</b> (11V)	○		
1.6 16V	1.6	88	09.07-	EP6	4	<b>Z 288</b>	12 ZR-7 SP03	1,0	○
1.6 16V	1.6	103	09.07-	5FT (EP6DT)	4	<b>Z 332</b>	12 ZR-6 SPP2-1	0,7	○
1.6 16V	1.6	110	09.07-	EP6DT	4	<b>Z 332</b>	12 ZR-6 SPP2-1	0,7	○
1.6 16V	1.6	115	10.09-	EP6CDT	4	<b>Z 332</b>	12 ZR-6 SPP2-1	0,7	○
1.6 16V	1.6	128	03.08-	5FY (EP6DTS)	4	<b>Z 332</b>	12 ZR-6 SPP2-1	0,7	○
2.0 HDi	2.0	100	09.07-	RHR (DW10BTED4)	4	<b>GN 054</b> (11V)	○		
2.0 HDi	2.0	103	09.07-	RHR (DW10BTED4)	4	<b>GN 054</b> (11V)	○		

## 3008

1.6 HDi	1.6	80	06.09-	9HZ (DV6TED4)	4	<b>GN 056</b> (11V)	○		
1.6 THP	1.6	110	06.09-	5FX (EP6DT)	4	<b>Z 332</b>	12 ZR-6 SPP2-1	0,7	○
1.6 THP	1.6	115	06.09-	5FV (EP6DT)	4	<b>Z 332</b>	12 ZR-6 SPP2-1	0,7	○

## 309 II

1.1	1.1	44	08.90-12.93	HDZ (TU1M)	4	<b>Z 193</b>	14 FR-7 DU2	0,9	<b>UXT 1<sup>3</sup></b>
1.4	1.4	49	07.90-12.93	K1D (TU3A)	4	<b>Z 193</b>	14 FR-7 DU2	0,9	<b>UXT 1<sup>3</sup></b>
1.4	1.4	55	07.89-12.93	KDZ (TU3M)/KDY (TU3M)	4	<b>Z 193</b>	14 FR-7 DU2	0,9	<b>UXT 1<sup>3</sup></b>
1.6	1.6	65	07.89-12.93	BDY (XU5M2Z)/BDZ (XU5M)/ BDY (XU5M3Z)	4	<b>Z 193</b>	14 FR-7 DU2	0,9	<b>UXT 1<sup>3</sup></b>
1.6	1.6	68	07.89-12.93	B2A (XU52C/K)	4	<b>Z 247</b>	14 FR-7 DUW	0,9	<b>UXT 1<sup>3</sup></b>
1.6	1.6	69	07.89-12.93	B2A (XU52C/K)	4	<b>Z 247</b>	14 FR-7 DUW	0,9	<b>UXT 1<sup>3</sup></b>
1.8 Diesel	1.8	44	07.89-12.93	161A (XUD7)	4	<b>GV 636</b> (11V)	<b>GR 065</b>		
1.8 TD	1.8	57	08.89-12.93	A8B (XUD7TE)	4	<b>GV 636</b> (11V)	<b>GR 065</b>		
1.9 Diesel	1.9	47	07.89-12.93	D9A (XUD9)/DJZ (XUD9Y)/ 162 (XUD9)	4	<b>GV 636</b> (11V)	<b>GR 065</b>		
1.9	1.9	72	08.89-12.93	DFZ (XU9J1)	4	<b>Z 247</b>	14 FR-7 DUW	0,9	<b>UXT 1<sup>3</sup></b>
1.9	1.9	80	10.90-12.93	DDZ (XU9M)	4	<b>Z 247</b>	14 FR-7 DUW	0,9	<b>UXT 1<sup>3</sup></b>
1.9 GTI	1.9	88	07.89-12.93	DKZ (XU9JAZ)	4	<b>Z 193</b>	14 FR-7 DU2	0,9	<b>UXT 1<sup>3</sup></b>
1.9 GTI 16V	1.9	108	10.90-12.93	DFW (XU9JAZ)	4	<b>Z 60</b>	14 FGR-7 CTU	1,2	○
1.9 GTI 16V	1.9	116	08.89-07.90	D6C (XU9J4)	4	<b>Z 60</b>	14 FGR-7 CTU	1,2	○

## 405 I

1.4	1.4	47	01.87-07.92	TU 3	4	<b>Z 193</b>	14 FR-7 DU2	0,9	<b>UXT 1<sup>3</sup></b>
1.6	1.6	53	07.87-12.92	B1E (XU51C)	4	<b>Z 247</b>	14 FR-7 DUW	0,9	<b>UXT 1<sup>3</sup></b>
1.6	1.6	65	07.87-12.92	BDY (XU5M2Z)/BDZ (XU5M)	4	<b>Z 193</b>	14 FR-7 DU2	0,9	<b>UXT 1<sup>3</sup></b>
1.6	1.6	66	10.89-12.92	BDZ (XU5M)	4	<b>Z 193</b>	14 FR-7 DU2	0,9	<b>UXT 1<sup>3</sup></b>
1.6	1.6	69	01.87-12.92	B2A (XU52C/K)	4	<b>Z 193</b>	14 FR-7 DU2	0,9	<b>UXT 1<sup>3</sup></b>
1.8 Turbo Diesel	1.8	66	03.88-12.92	A8A (XUD7TE)/AJZ (XUD7TEY)	4	<b>GV 636</b> (11V)	<b>GR 065</b>		
1.9 Diesel	1.9	47	07.88-09.92	DJZ (XUD9Y)	4	<b>GV 636</b> (11V)	○		
1.9 Diesel	1.9	51	03.88-12.92	D9B (XUD9A)	4	<b>GV 636</b> (11V)	<b>GR 065</b>		
1.9	1.9	70	07.87-12.92	D2C (XU92C (U-KAT))	4	<b>Z 193</b>	14 FR-7 DU2	0,9	<b>UXT 1<sup>3</sup></b>
1.9 Injection	1.9	77	07.87-12.92	DFZ (XU9J1)	4	<b>Z 193</b>	14 FR-7 DU2	0,9	<b>UXT 1<sup>3</sup></b>
1.9	1.9	80	07.88-12.92	DDZ (XU9M)	4	<b>Z 193</b>	14 FR-7 DU2	0,9	<b>UXT 1<sup>3</sup></b>
1.9 4x4	1.9	80	07.88-12.92	DDZ (XU9M)	4	<b>Z 193</b>	14 FR-7 DU2	0,9	<b>UXT 1<sup>3</sup></b>
1.9	1.9	88	07.88-12.92	DKZ (XU9JAZ)	4	<b>Z 193</b>	14 FR-7 DU2	0,9	<b>UXT 1<sup>3</sup></b>
1.9	1.9	93	07.87-12.93		4	<b>Z 193</b>	14 FR-7 DU2	0,9	<b>UXT 1<sup>3</sup></b>
1.9 Sport MI-16	1.9	108	04.88-12.92	DFW (XU9JAZ)	4	<b>Z 60</b>	14 FGR-7 CTU	1,2	○
1.9 Sport MI-16 4x4	1.9	108	04.88-12.92	DFW (XU9JAZ)	4	<b>Z 60</b>	14 FGR-7 CTU	1,2	○
1.9 Sport MI-16	1.9	116	07.87-11.91	D6C (XU9J4)	4	<b>Z 60</b>	14 FGR-7 CTU	1,2	○

## 405 I Break

1.6	1.6	53	10.88-08.92	B1E (XU51C)	4	<b>Z 247</b>	14 FR-7 DUW	0,9	<b>UXT 1<sup>3</sup></b>
1.6	1.6	55	10.88-08.92	BAZ (XU50P)	4	<b>Z 247</b>	14 FR-7 DUW	0,9	<b>UXT 1<sup>3</sup></b>
1.6	1.6	65	10.88-08.92	BDY (XU5M2Z)/BDZ (XU5M)/ BDY (XU5M3Z)	4	<b>Z 193</b>	14 FR-7 DU2	0,9	<b>UXT 1<sup>3</sup></b>
1.6	1.6	66	10.88-08.92	BDZ (XU5M)	4	<b>Z 247</b>	14 FR-7 DUW	0,9	<b>UXT 1<sup>3</sup></b>
1.6	1.6	69	10.88-08.92		4	<b>Z 193</b>	14 FR-7 DU2	0,9	<b>UXT 1<sup>3</sup></b>
1.8 TD	1.8	66	10.88-08.92	A8A (XUD7TE)/AJZ (XUD7TEY)	4	<b>GV 636</b> (11V)	<b>GR 065</b>		
1.9 D	1.9	47	10.88-08.92	DJZ (XUD9Y)	4	<b>GV 636</b> (11V)	○		
1.9 D	1.9	51	10.88-08.92	DJY (XUD9A)/D9B (XUD9A)	4	<b>GV 636</b> (11V)	<b>GR 065</b>		
1.9	1.9	70	10.88-08.92	D2C (XU92C (U-KAT))	4	<b>Z 247</b>	14 FR-7 DUW	0,9	<b>UXT 1<sup>3</sup></b>
1.9	1.9	72	05.88-07.92	DFZ (XU9J1)	4	<b>Z 247</b>	14 FR-7 DUW	0,9	<b>UXT 1<sup>3</sup></b>

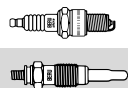
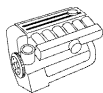

## PEUGEOT

### 405 I Break

1.9	1.9	77	10.88-08.92	DFZ (XU9J1)	4	<b>Z 247</b>	14 FR-7 DUW	0,9	<b>UXT 13</b>
1.9	1.9	80	10.88-08.92	DDZ (XU9M)	4	<b>Z 247</b>	14 FR-7 DUW	0,9	<b>UXT 13</b>
1.9	1.9	88	10.88-08.92	DKZ (XU9JAZ)	4	<b>Z 247</b>	14 FR-7 DUW	0,9	<b>UXT 13</b>
1.9 4x4	1.9	80	10.88-08.92	DDZ (XU9M)	4	<b>Z 247</b>	14 FR-7 DUW	0,9	<b>UXT 13</b>
1.9 Allrad	1.9	77	09.88-07.92	DFZ (XU9J1)	4	<b>Z 247</b>	14 FR-7 DUW	0,9	<b>UXT 13</b>

### 405 II

1.4	1.4	55	08.92-10.95	KDX (TU3MC)	4	<b>Z 193</b>	14 FR-7 DU2	0,9	<b>UXT 13</b>
1.6	1.6	65	08.92-10.95	BFZ (XU5JP)/BDY (XU5M2Z)/ BDZ (XU5M)/BDY (XU5M3Z)	4	<b>Z 193</b>	14 FR-7 DU2	0,9	<b>UXT 13</b>
1.8	1.8	74	08.92-10.95	LFZ (XU7JP)	4	<b>Z 193</b>	14 FR-7 DU2	0,9	<b>UXT 13</b>
1.9 D	1.9	47	08.92-10.95	DJZ (XUD9Y)	4	<b>GN 909</b> (11V)	<b>GR 054</b>		
1.9 D	1.9	50	06.94-10.95	DJY (XUD9A)	4	<b>GV 636</b> (11V)	<b>GR 065</b>		
1.9 TD	1.9	66	08.92-10.95	DHY (XUD9TE)	4	<b>GN 909</b> (11V)	○		
2.0	2.0	89	08.92-10.95	RFX (XU10J2)	4	<b>Z 193</b>	14 FR-7 DU2	0,9	<b>UXT 13</b>
2.0 X4	2.0	89	08.92-10.95	RFX (XU10J2)	4	<b>Z 193</b>	14 FR-7 DU2	0,9	<b>UXT 13</b>
2.0 16V	2.0	110	06.94-10.95	RFT (XU10J4)	4	<b>Z 193</b>	14 FR-7 DU2	0,9	<b>UXT 13</b>
2.0 MI-16	2.0	112	08.92-10.95	RFY (XU10J4Z)	4	<b>Z 193</b>	14 FR-7 DU2	0,9	<b>UXT 13</b>
2.0 T 16 X4	2.0	144	08.92-10.95	RGZ (XU10J4TE/Z)	4	<b>Z 60</b>	14 FGR-7 CTU	1,2	○

### 405 II Break

1.4	1.4	55	08.92-10.96	KDX (TU3MC)	4	<b>Z 193</b>	14 FR-7 DU2	0,9	<b>UXT 13</b>
1.6	1.6	65	08.92-10.96	BFZ (XU5JP)/BDY (XU5M2Z)/ BDZ (XU5M)/BDY (XU5M3Z)	4	<b>Z 193</b>	14 FR-7 DU2	0,9	<b>UXT 13</b>
1.8	1.8	74	08.92-10.96	LFZ (XU7JP)	4	<b>Z 193</b>	14 FR-7 DU2	0,9	<b>UXT 13</b>
1.9 D	1.9	47	08.92-10.96	DJZ (XUD9Y)	4	<b>GN 909</b> (11V)	<b>GR 054</b>		
1.9 D	1.9	50	06.94-10.96	DJY (XUD9A)	4	<b>GV 636</b> (11V)	<b>GR 065</b>		
1.9 D	1.9	51	09.93-12.95	XUD9	4	<b>GN 013</b> (11V)	○		
1.9 TD	1.9	66	08.92-10.96	DHY (XUD9TE)	4	<b>GN 909</b> (11V)	○		
2.0	2.0	89	08.92-10.96	RFX (XU10J2)	4	<b>Z 193</b>	14 FR-7 DU2	0,9	<b>UXT 13</b>
2.0 4x4	2.0	89	08.92-10.96	RFX (XU10J2)	4	<b>Z 193</b>	14 FR-7 DU2	0,9	<b>UXT 13</b>
2.0 4x4	2.0	144	08.92-12.95	RGZ (XU10J4TE/Z)	4	<b>Z 60</b>	14 FGR-7 CTU	1,2	○

### 406

1.6	1.6	65	11.95-05.04	BFZ (XU5JP)	4	<b>Z 193</b>	14 FR-7 DU2	0,9	<b>UXT 13</b>
1.8	1.8	66	05.97-05.04		4	<b>Z 193</b>	14 FR-7 DU2	0,9	<b>UXT 13</b>
1.8 16V	1.8	81	11.95-10.00	LFY (XU7JP4)	4	<b>Z 193</b>	14 FR-7 DU2	0,9	<b>UXT 13</b>
1.8 16V	1.8	85	10.00-05.04	6FZ (EW7J4)	4	<b>Z 183</b>	14 FR-8 MU2	0,9	<b>UXT 13</b>
1.9 D	1.9	55	10.96-05.04	DHW (XUD9SD)	4	<b>GN 013</b> (11V)	○		
1.9 TD	1.9	66	01.96-08.98	DHX (XUD9TE)	4	<b>GN 909</b> (11V)	○		
1.9 TD	1.9	66	09.98-05.04	DHX (XUD9TE)	4	<b>GN 013</b> (11V)	○		
1.9 TD	1.9	68	01.96-08.98	DHY (XUD9TE)	4	<b>GN 909</b> (11V)	○		
1.9 TD	1.9	68	09.98-05.04	DHY (XUD9TE)	4	<b>GN 013</b> (11V)	○		
2.0 HDI 90	2.0	66	02.99-05.04	RHY (DW10TD)	4	<b>GN 027</b> (11V)	○		
2.0 HDi 110	2.0	79	08.01-05.04	RHZ (DW10ATED)/ RHS (DW10ATED)	4	<b>GN 027</b> (11V)	○		
2.0 HDi 110	2.0	80	06.98-08.01	RHZ (DW10ATED)	4	<b>GN 027</b> (11V)	○		
2.0 16V	2.0	97	11.95-05.04	RFV (XU10J4R)	4	<b>Z 247</b>	14 FR-7 DUW	0,9	<b>UXT 13</b>
2.0 16V	2.0	99	01.99-08.00	RFR (DEW10J4)	4	<b>Z 183</b>	14 FR-8 MU2	0,9	<b>UXT 13</b>
2.0 16V	2.0	100	08.00-05.04	RFN (EW10J4)	4	<b>Z 183</b>	14 FR-8 MU2	0,9	<b>UXT 13</b>
2.0 16V HPi	2.0	103	05.01-05.04	RLZ (EW10D)	4	<b>Z 242</b>	12 ZR-8 TP	1,0	○
2.0 Turbo	2.0	108	04.96-05.04	RGX (XU10J2TE)	4	<b>Z 193</b>	14 FR-7 DU2	0,9	<b>UXT 13</b>
2.1 TD 12V	2.1	80	01.96-08.98	P8C (XUD11BTE)	4	<b>GN 909</b> (11V)	○		
2.1 TD 12V	2.1	80	09.98-05.04	P8C (XUD11BTE)	4	<b>GN 013</b> (11V)	○		
2.2 HDi	2.2	98	03.00-05.04	4HX (DW12TED4/FAP)	4	<b>GN 027</b> (11V)	○		
2.2	2.2	116	07.00-05.04	3FZ (EW12J4)	4	<b>Z 183</b>	14 FR-8 MU2	0,9	<b>UXT 13</b>
3.0 24V	2.9	140	10.96-05.04	XFZ (ES9J4)	6	<b>Z 123</b>	14 FR-7 KDU	1,0	<b>UXT 9</b>
3.0 V6	2.9	152	03.00-05.04	XFX (ES9J4S)	6	<b>Z 235</b>	14 FR-7 SPUX03	1,0	○

### 406 Break

1.8	1.8	66	05.97-10.04	LFX (XU7JB)	4	<b>Z 193</b>	14 FR-7 DU2	0,9	<b>UXT 13</b>
1.8 16V	1.8	81	10.96-10.00	LFY (XU7JP4)	4	<b>Z 193</b>	14 FR-7 DU2	0,9	<b>UXT 13</b>
1.8 16V	1.8	85	10.00-10.04	6FZ (EW7J4)	4	<b>Z 183</b>	14 FR-8 MU2	0,9	<b>UXT 13</b>
1.9 D	1.9	55	10.96-08.98	DHW (XUD9SD)	4	<b>GN 909</b> (11V)	○		
1.9 D	1.9	55	09.98-10.04	DHW (XUD9SD)	4	<b>GN 013</b> (11V)	○		

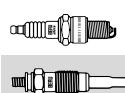
**PEUGEOT****406 Break**

1.9 TD	1.9	66	10.96-08.98	DHX (XUD9TE)	4	<b>GN 909</b> (11V)	○		
1.9 TD	1.9	66	09.98-10.04	DHX (XUD9TE)	4	<b>GN 013</b> (11V)	○		
2.0 HDi 90	2.0	66	02.99-10.04	RHY (DW10TD)	4	<b>GN 027</b> (11V)	○		
2.0 HDi 110	2.0	79	08.01-10.04	RHZ (DW10ATED)/ RHS (DW10ATED)	4	<b>GN 027</b> (11V)	○		
2.0 HDi 110	2.0	80	02.99-04.04	RHZ (DW10ATED)	4	<b>GN 027</b> (11V)	○		
2.0 16V	2.0	97	10.96-10.04	RFV (XU10J4R)	4	<b>Z 74</b>	14 FR-8 LDUOX4	1,0	<b>UXT 1<sup>3</sup></b>
2.0 16V	2.0	99	01.99-10.00	RFR (DEW10J4)	4	<b>Z 183</b>	14 FR-8 MU2	0,9	<b>UXT 13</b>
2.0 16V	2.0	100	10.00-10.04	RFN (EW10J4)	4	<b>Z 183</b>	14 FR-8 MU2	0,9	<b>UXT 13</b>
2.0 16V HPI	2.0	103	05.01-10.04	RLZ (EW10D)	4	<b>Z 242</b>	12 ZR-8 TP	1,0	○
2.0 Turbo	2.0	108	10.96-10.04	RGX (XU10J2TE)	4	<b>Z 193</b>	14 FR-7 DU2	0,9	<b>UXT 1<sup>3</sup></b>
2.1 TD 12V	2.1	80	10.96-08.98	P8C (XUD11BTE)	4	<b>GN 909</b> (11V)	○		
2.1 TD 12V	2.1	80	09.98-10.04	P8C (XUD11BTE)	4	<b>GN 013</b> (11V)	○		
2.2 HDi	2.2	98	03.00-10.04	4HX (DW12TED4/FAP)	4	<b>GN 027</b> (11V)	○		
2.2	2.2	116	07.00-10.04	3FZ (EW12J4)	4	<b>Z 183</b>	14 FR-8 MU2	0,9	<b>UXT 13</b>
3.0 24V	2.9	140	10.96-10.04	XFZ (ES9J4)	6	<b>Z 123</b>	14 FR-7 KDU	1,0	<b>UXT 9</b>
3.0 V6	2.9	152	03.00-10.04	XFZ (ES9J4S)	6	<b>Z 235</b>	14 FR-7 SPUX03	1,0	○

**406 Coupe**

2.0 16V	2.0	97	03.97-12.04	RFV (XU10J4R)	4	<b>Z 74</b>	14 FR-8 LDUOX4	1,0	<b>UXT 1<sup>3</sup></b>
2.0 16V	2.0	99	01.99-10.00	RFR (DEW10J4)	4	<b>Z 183</b>	14 FR-8 MU2	0,9	<b>UXT 13</b>
2.0 16V	2.0	100	10.00-12.04	RFN (EW10J4)	4	<b>Z 183</b>	14 FR-8 MU2	0,9	<b>UXT 13</b>
2.2 HDi	2.2	98	03.00-12.04	4HX (DW12TED4/FAP)	4	<b>GN 027</b> (11V)	○		
2.2	2.2	116	03.02-12.04	3FZ (EW12J4)	4	<b>Z 183</b>	14 FR-8 MU2	0,9	<b>UXT 13</b>
3.0 V6 24V	2.9	140	03.97-12.04	XFZ (ES9J4)	6	<b>Z 123</b>	14 FR-7 KDU	1,0	<b>UXT 9</b>
3.0 V6	2.9	152	03.00-12.04	XFZ (ES9J4S)	6	<b>Z 235</b>	14 FR-7 SPUX03	1,0	○

**407**

1.6 HDi 110	1.6	80	05.04-	9HY (DV6TED4) → Organisationsnr.10783	4	<b>GN 047</b> (11V)	○		
1.6 HDi 110	1.6	80	05.04-	9HY (DV6TED4) Organisationsnr.10784 →	4	<b>GN 056</b> (11V)	○		
1.8	1.7	85	05.04-	6FZ (EW7J4)	4	<b>Z 223</b>	14 FR-8 NQU23	0,9	○
2.0	2.0	100	05.04-	RFN (EW10J4)	4	<b>Z 223</b>	14 FR-8 NQU23	0,9	○
2.0 HDi 135	2.0	100	05.04-	RHR (DW10BTED4)	4	<b>GN 054</b> (11V)	○		
2.0 16V	2.0	103	09.05-	RFJ (EW10A)	4	<b>Z 223</b>	14 FR-8 NQU23	0,9	○
2.2	2.2	116	05.04-	3FZ (EW12J4)	4	<b>Z 223</b>	14 FR-8 NQU23	0,9	○
2.2 16V	2.2	120	09.05-	3FY (EW12J4)	4	<b>Z 183</b>	14 FR-8 MU2	0,9	<b>UXT 13</b>
2.2 HDi	2.2	120	06.08-	4HP (DW12BTED4)	4	<b>GN 063</b> (11V)	○		
2.2 HDi 170	2.2	125	05.06-	4HT (DW12BTED4)	4	<b>GN 063</b> (11V)	○		
2.7 HDi	2.7	150	10.05-	UHZ (DT17)	6	<b>GN 045</b> (11V)	○		
3.0	2.9	155	05.04-	XFV (ES9A)	6	<b>Z 211</b>	14 FGR-8 MQPU	1,4	○

**407 Coupe**

2.0 HDi	2.0	100	10.05-	RHR (DW10BTED4)	4	<b>GN 054</b> (11V)	○		
2.2 16V	2.2	120	10.05-	3FY (EW12J4)	4	<b>Z 183</b>	14 FR-8 MU2	0,9	<b>UXT 13</b>
2.7 HDi	2.7	150	10.05-	UHZ (DT17)	6	<b>GN 045</b> (11V)	○		
3.0 V6	2.9	155	10.05-	XFV (ES9A)	6	<b>Z 211</b>	14 FGR-8 MQPU	1,4	○

**407 SW**

1.6 HDi 110	1.6	80	05.04-	9HY (DV6TED4) → Organisationsnr.10783	4	<b>GN 047</b> (11V)	○		
1.6 HDi 110	1.6	80	05.04-	9HY (DV6TED4) Organisationsnr.10784 →	4	<b>GN 056</b> (11V)	○		
1.8	1.7	85	05.04-	6FZ (EW7J4)	4	<b>Z 223</b>	14 FR-8 NQU23	0,9	○
2.0	2.0	100	05.04-	RFN (EW10J4)	4	<b>Z 223</b>	14 FR-8 NQU23	0,9	○
2.0 HDi 135	2.0	100	05.04-	RHR (DW10BTED4)	4	<b>GN 054</b> (11V)	○		
2.0 16V	2.0	103	09.05-	RFJ (EW10A)	4	<b>Z 223</b>	14 FR-8 NQU23	0,9	○
2.2	2.2	116	05.04-	3FZ (EW12J4)	4	<b>Z 223</b>	14 FR-8 NQU23	0,9	○
2.2 16V	2.2	120	09.05-	3FY (EW12J4)	4	<b>Z 183</b>	14 FR-8 MU2	0,9	<b>UXT 13</b>
2.2 HDi	2.2	120	06.08-	4HP (DW12BTED4)	4	<b>GN 063</b> (11V)	○		
2.2 HDi 170	2.2	125	05.06-	4HT (DW12BTED4)	4	<b>GN 063</b> (11V)	○		
2.7 HDi	2.7	150	10.05-	UHZ (DT17)	6	<b>GN 045</b> (11V)	○		
3.0	2.9	155	05.04-	XFV (ES9A)	6	<b>Z 211</b>	14 FGR-8 MQPU	1,4	○

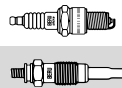
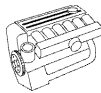

## PEUGEOT

<b>4007</b>										
2.2 HDi	2.2	115	02.07-	4HN (DW12MTED4)	4	<b>GN 063</b> (11V)	○			
<b>408</b>										
1.6	1.6	78	01.10-	TU5JP4	4	<b>Z 193</b>	14 FR-7 DU2	0,9		<b>UXT 1<sup>3</sup></b>
2.0	2.0	108	01.10-	EW10A	4	<b>Z 223</b>	14 FR-8 NQU23	0,9		○
<b>505</b>										
2.0	2.0	72	09.85-09.91	106E (XN1A)	4	<b>Z 11</b>	14-7 DU	0,8		<b>UXT 2<sup>4</sup></b>
2.2	2.2	84	03.86-12.93	851X (ZDJL)	4	<b>Z 25</b>	14 K-6 DU	0,8		<b>UXK 56</b>
2.2 GTI	2.2	90	08.83-12.93	851B (ZDJL)	4	<b>Z 25</b>	14 K-6 DU	0,8		<b>UXK 56</b>
2.5 Diesel	2.5	51	10.81-11.90	155 (XD3)	4	<b>GV 636</b> (11V)	<b>GR 065</b>			
2.5 Diesel	2.5	55	06.81-12.93	155 (XD3)	4	<b>GV 636</b> (11V)	<b>GR 065</b>			
2.5 Turbo Diesel	2.5	66	10.83-12.93	152A (XD3T)	4	<b>GV 636</b> (11V)	<b>GR 065</b>			
2.5 Turbo Diesel	2.5	70	10.83-12.90	XD3T	4	<b>GV 636</b> (11V)	<b>GR 065</b>			
2.5 Turbo Diesel	2.5	77	10.86-12.93	152B (XD3TE)	4	<b>GV 636</b> (11V)	○			
<b>505 Break</b>										
2.2	2.2	84	01.86-12.93	851X (ZDJL)	4	<b>Z 25</b>	14 K-6 DU	0,8		<b>UXK 56</b>
2.5 Diesel	2.5	51	01.86-12.93	155 (XD3)	4	<b>GV 636</b> (11V)	<b>GR 065</b>			
2.5 Diesel	2.5	55	08.83-12.93	155 (XD3)	4	<b>GV 636</b> (11V)	<b>GR 065</b>			
2.5 Turbo Diesel	2.5	77	10.86-12.93	152B (XD3TE)	4	<b>GV 636</b> (11V)	○			
<b>508</b>										
1.6 VTi	1.6	88	11.10-	5FS (EP6C)	4	<b>Z 332</b>	12 ZR-6 SPP2-1	0,7		○
<b>508 SW</b>										
1.6 VTi	1.6	88	11.10-	5FS (EP6C)	4	<b>Z 332</b>	12 ZR-6 SPP2-1	0,7		○
<b>5008</b>										
1.6 16V	1.6	115	09.09-	EP6CDT	4	<b>Z 332</b>	12 ZR-6 SPP2-1	0,7		○
<b>605</b>										
2.0	2.0	79	02.90-09.99		4	<b>Z 193</b>	14 FR-7 DU2	0,9		<b>UXT 1<sup>3</sup></b>
2.0	2.0	84	06.89-09.99	R5A (XU102C)	4	<b>Z 24</b>	14 FR-6 DU	0,8		<b>UXT 5</b>
2.0	2.0	89	06.89-09.99	RFZ (XU10J2Z)	4	<b>Z 193</b>	14 FR-7 DU2	0,9		<b>UXT 1<sup>3</sup></b>
2.0 16V	2.0	97	07.94-09.99	RFV (XU10J4R)	4	<b>Z 193</b>	14 FR-7 DU2	0,9		<b>UXT 1<sup>3</sup></b>
2.0 Turbo	2.0	104	07.92-09.99	RGY (XU10J2TE)	4	<b>Z 193</b>	14 FR-7 DU2	0,9		<b>UXT 1<sup>3</sup></b>
2.0 Turbo	2.0	108	07.91-09.99	RGX (XU10J2TE)	4	<b>Z 193</b>	14 FR-7 DU2	0,9		<b>UXT 1<sup>3</sup></b>
2.1 D	2.1	60	06.89-07.95	P9A (XUD11A)	4	<b>GV 636</b> (11V)	<b>GR 065</b>			
2.1 Turbo Diesel	2.1	80	06.89-09.99	PHZ (XUD11ATE)	4	<b>GN 909</b> (11V)	<b>GR 065</b>			
2.1 TD 12V	2.1	80	08.94-08.98	P8C (XUD11BTE)	4	<b>GN 909</b> (11V)	<b>GR 065</b>			
2.1 TD 12V	2.1	80	09.98-09.99	P8C (XUD11BTE)	4	<b>GN 013</b> (11V)	<b>GR 065</b>			
2.5 Turbo Diesel	2.4	95	07.94-09.99	THY (DK5ATE)	4	<b>GN 909</b> (11V)	○			
3.0	3.0	123	10.89-09.99	UFZ (ZPJ)	6	<b>Z 60</b>	14 FGR-7 CTU	1,2		○
3.0 V6	2.9	140	04.97-09.99	ES 9 J4	6	<b>Z 193</b>	14 FR-7 DU2	0,9		<b>UXT 1<sup>3</sup></b>
3.0 SV 24	3.0	147	08.89-09.99	UKZ (ZPJ4/Z)	6	<b>Z 60</b>	14 FGR-7 CTU	1,2		○
<b>607</b>										
2.0 HDi	2.0	79	03.01-07.04	RHS (DW10ATED)	4	<b>GN 027</b> (11V)	○			
2.0 HDi	2.0	80	05.00-	RHZ (DW10ATED)	4	<b>GN 027</b> (11V)	○			
2.0	2.0	100	02.00-	RFN (EW10J4)	4	<b>Z 223</b>	14 FR-8 NQU23	0,9		○
2.0 HDi	2.0	100	09.05-	RHR (DW10BTED4)	4	<b>GN 054</b> (11V)	○			
2.2 HDi	2.2	98	02.00-	4HX (DW12TED4/FAP)	4	<b>GN 027</b> (11V)	○			
2.2 16V	2.2	116	02.00-	3FZ (EW12J4)	4	<b>Z 223</b>	14 FR-8 NQU23	0,9		○
2.2 16V	2.2	120	09.05-	3FY (EW12J4)	4	<b>Z 223</b>	14 FR-8 NQU23	0,9		○
2.2 HDi	2.2	125	05.06-	4HT (DW12BTED4)	4	<b>GN 063</b> (11V)	○			
2.7 HDi 24V	2.7	150	12.04-	DT17TED4	6	<b>GN 045</b> (11V)	○			
3.0 V6 24V	2.9	152	02.00-	XFX (ES9J4S)	6	<b>Z 211</b>	14 FGR-8 MQPU	1,4		○
3.0 V6 24V	2.9	155	03.04-	XFV (ES9A)	6	<b>Z 211</b>	14 FGR-8 MQPU	1,4		○
<b>806</b>										
1.8	1.8	73	07.95-08.02	LFW (XU7JP)	4	<b>Z 193</b>	14 FR-7 DU2	0,9		<b>UXT 1<sup>3</sup></b>
1.9 TD	1.9	66	07.95-08.98	DHX (XUD9TE)	4	<b>GN 909</b> (11V)	○			
1.9 TD	1.9	66	09.98-08.02	DHX (XUD9TE)	4	<b>GN 013</b> (11V)	○			
1.9 TD	1.9	68	05.97-08.98	DHY (XUD9TE)	4	<b>GN 909</b> (11V)	○			
1.9 TD	1.9	68	09.98-08.02	DHY (XUD9TE)	4	<b>GN 013</b> (11V)	○			
2.0 HDi	2.0	80	08.99-08.02	RHZ (DW10ATED)	4	<b>GN 027</b> (11V)	○			
2.0 HDi 16V	2.0	80	08.99-08.02	RHW (DW10ATED4)	4	<b>GN 027</b> (11V)	○			
2.0	2.0	89	06.94-08.02	RFU (XU10J2)	4	<b>Z 193</b>	14 FR-7 DU2	0,9		<b>UXT 1<sup>3</sup></b>
2.0 16V	2.0	97	05.98-09.00	RFV (XU10J4R)	4	<b>Z 193</b>	14 FR-7 DU2	0,9		<b>UXT 1<sup>3</sup></b>

● nicht erforderlich  
○ nicht im Programm

<sup>3</sup> wahlweise UXT 3 Platin

<sup>4</sup> wahlweise UXT 6 Platin

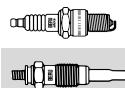
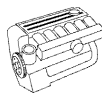

## PEUGEOT

### 806

2.0 16V	2.0	100	09.00-08.02	RFN (EW10J4)	4	<b>Z 183</b>	14 FR-8 MU2	0,9	<b>UXT 13</b>
2.0 Turbo	2.0	108	06.94-08.02	RGX (XU10J2TE)	4	<b>Z 193</b>	14 FR-7 DU2	0,9	<b>UXT 13</b>
2.1 td 12V	2.1	80	06.96-08.98	P8C (XUD11BTE)	4	<b>GN 909</b> (11V)	○		
2.1 td 12V	2.1	80	09.98-08.99	P8C (XUD11BTE)	4	<b>GN 013</b> (11V)	○		

### 807

2.0 HDi	2.0	79	06.02-	RHT (DW10ATED4)/ RHM (DW10ATED4)/ RHW (DW10ATED4)	4	<b>GN 027</b> (11V)	○		
2.0 HDi	2.0	88	11.06-	RHK (DW10UTED4)	4	<b>GN 054</b> (11V)	○		
2.0	2.0	100	06.02-	RFN (EW10J4)	4	<b>Z 223</b>	14 FR-8 NQU23	0,9	○
2.0 HDi	2.0	100	06.06-	RHR (DW10BTED4)	4	<b>GN 054</b> (11V)	○		
2.0 16V	2.0	103	09.05-	RFJ (EW10A)	4	<b>Z 223</b>	14 FR-8 NQU23	0,9	○
2.2 HDi	2.2	94	06.02-	4HX (DW12TED4/FAP)	4	<b>GN 027</b> (11V)	○		
2.2	2.2	116	06.02-	3FZ (EW12J4)	4	<b>Z 223</b>	14 FR-8 NQU23	0,9	○
2.2 HDi	2.2	125	06.06-	4HT (DW12BTED4)	4	<b>GN 063</b> (11V)	○		
3.0 V6	2.9	150	06.02-	XFX (ES9J4S)	6	<b>Z 211</b>	14 FGR-8 MQPU	1,4	○

### BIPPER

1.4 HDi	1.4	50	02.08-	8HS (DV4TD)	4	<b>GN 056</b> (11V)	○		
1.4	1.4	54	02.08-	KFV (TU3A)	4	<b>Z 193</b>	14 FR-7 DU2	0,9	<b>UXT 13</b>

### BIPPER Tepee

1.4 HDi	1.4	50	04.08-	8HS (DV4TD)	4	<b>GN 056</b> (11V)	○		
1.4	1.4	54	04.08-	KFV (TU3A)	4	<b>Z 193</b>	14 FR-7 DU2	0,9	<b>UXT 13</b>

### RCZ

1.6 16V	1.6	115	03.10-	EP6CDT	4	<b>Z 332</b>	12 ZR-6 SPP2-1	0,7	○
---------	-----	-----	--------	--------	---	--------------	----------------	-----	---



### BOXER

1.9 D	1.9	50	07.99-04.02	DJY (XUD9A)	4	<b>GN 013</b> (11V)	○		
1.9 D	1.9	51	03.94-08.98	D9B (XUD9AU)	4	<b>GN 909</b> (11V)	○		
1.9 D	1.9	51	09.98-04.02	D9B (XUD9AU)	4	<b>GN 013</b> (11V)	○		
1.9 TD	1.9	66	07.99-04.02	XUD9TE	4	<b>GN 013</b> (11V)	○		
1.9 DT 4x4	1.9	66	03.96-09.98	XUD9TE	4	<b>GN 013</b> (11V)	○		
1.9 TD	1.9	66	08.94-08.98	DHY (XUD9TE)	4	<b>GN 909</b> (11V)	○		
1.9 TD	1.9	66	09.98-04.02	DHY (XUD9TE)	4	<b>GN 013</b> (11V)	○		
1.9 TD	1.9	68	07.96-08.98	D8C (XUD9UTF)	4	<b>GN 909</b> (11V)	○		
1.9 TD	1.9	68	09.98-04.02	D8C (XUD9UTF)	4	<b>GN 013</b> (11V)	○		
1.9 TD 4x4	1.9	68	07.96-08.98	D8C (XUD9UTF)	4	<b>GN 909</b> (11V)	○		
1.9 TD 4x4	1.9	68	09.98-04.02	D8C (XUD9UTF)	4	<b>GN 013</b> (11V)	○		
2.0 HDi	2.0	62	08.01-04.02	RHV (DW10UTD)	4	<b>GN 027</b> (11V)	○		
2.0 HDi	2.0	62	04.02-	RHV (DW10TD)/RHW (DW10UTD)	4	<b>GN 027</b> (11V)	○		
2.0 i	2.0	80	06.94-04.02	RFW (XU10J2)	4	<b>Z 193</b>	14 FR-7 DU2	0,9	<b>UXT 13</b>
2.0 i 4x4	2.0	80	08.96-04.02	RFW (XU10J2)	4	<b>Z 193</b>	14 FR-7 DU2	0,9	<b>UXT 13</b>
2.0	2.0	81	04.02-	RFL (XU10J2U)	4	<b>Z 193</b>	14 FR-7 DU2	0,9	<b>UXT 13</b>
2.2 HDi	2.2	74	04.02-04.03	4HY (DW12UTED)	4	<b>GN 027</b> (11V)	○		
2.2 HDi	2.2	74	05.03-	4HY (DW12UTED)	4	<b>GN 054</b> (11V)	○		
2.2 HDi 100	2.2	74	04.06-	4HV (P22DTE)	4	<b>GN 939</b> (11,5V)	○		
2.2 HDi 120	2.2	88	04.06-	4HU (P22DTE)	4	<b>GN 939</b> (11,5V)	○		
2.5 D	2.4	63	03.94-04.02	T9A (DJ5)	4	<b>GN 909</b> (11V)	<b>GR 054</b>		
2.5 D 4x4	2.4	63	07.96-04.02	T9A (DJ5)	4	<b>GN 909</b> (11V)	<b>GR 054</b>		
2.5 TD	2.4	76	03.94-04.02	T8A (DJ5T)	4	<b>GN 909</b> (11V)	<b>GR 054</b>		
2.5 TD 4x4	2.4	76	07.96-04.02	T8A (DJ5T)	4	<b>GN 909</b> (11V)	<b>GR 054</b>		
2.5 TDI	2.4	79	01.97-04.02	THX (DJ5TED)	4	<b>GN 964</b> (11V)	○		
2.5 TDI 4x4	2.4	79	01.97-04.02	THX (DJ5TED)	4	<b>GN 964</b> (11V)	○		
2.8 D	2.8	64	01.99-02.02	8140.63 (F28D)	4	<b>GN 012</b> (11V)	○		
2.8 HDi	2.8	93	10.00-11.01	8140.43S (F28DTCR)	4	<b>GF 006</b> (12V)	○		
2.8 HDi Allrad	2.8	93	10.00-11.01	8140.43S (F28DTCR)	4	<b>GF 006</b> (12V)	○		
2.8 HDi	2.8	94	11.00-04.02	8140.43S (F28DTCR)	4	<b>GF 006</b> (12V)	○		
2.8 HDi	2.8	94	04.02-	8140.43S (F28DTCR)	4	<b>GF 006</b> (12V)	○		
2.8 HDi 4x4	2.8	94	10.00-04.02	8140.43S (F28DTCR)	4	<b>GF 006</b> (12V)	○		
2.8 HDi 4x4	2.8	94	04.02-	8140.43S (F28DTCR)	4	<b>GF 006</b> (12V)	○		
2.8 HDi	2.8	107	04.04-	8140.43N	4	<b>GN 012</b> (11V)	○		



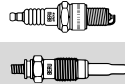

## PEUGEOT



### BOXER

3.0 HDi 160	3.0	116	04.06-	F1CE0481D (FG30DT)	4	<b>GN 037</b> (11V)	○		
-------------	-----	-----	--------	--------------------	---	---------------------	---	--	--

### EXPERT

1.6	1.6	58	02.96-	222A2 (1580 SPI)	4	<b>Z 252</b>	14 FR-6 DUW	0,9	<b>UXT 5</b>
1.6 HDi 90	1.6	66	01.07-	9HU (DV6UTED4)	4	<b>GN 056</b> (11V)	○		
1.8	1.8	74	10.96-09.00	LFZ (XU7JP)	4	<b>Z 193</b>	14 FR-7 DU2	0,9	<b>UXT 1<sup>3</sup></b>
1.9 D	1.9	51	02.96-08.98	D9B (XUD9AU)	4	<b>GN 909</b> (11V)	○		
1.9 D	1.9	51	09.98-	D9B (XUD9AU)	4	<b>GN 013</b> (11V)	○		
1.9 D	1.9	51	12.03-	WJZ (DW8)	4	<b>GN 016</b> (11V)	○		
1.9 D 70	1.9	51	12.98-	WJY (DW8B)/WJZ (DW8)	4	<b>GN 016</b> (11V)	○		
1.9 TD	1.9	66	02.96-08.98	DHX (XUD9TE)	4	<b>GN 909</b> (11V)	○		
1.9 TD	1.9	66	09.98-	DHX (XUD9TE)	4	<b>GN 013</b> (11V)	○		
1.9 TD	1.9	68	02.96-08.98	D8B (XUD9TE)	4	<b>GN 909</b> (11V)	○		
1.9 TD	1.9	68	09.98-	D8B (XUD9TE)	4	<b>GN 013</b> (11V)	○		
1.9 D	1.9	69	10.95-05.98	XUD9TE	4	<b>GN 013</b> (11V)	○		
2.0 HDi	2.0	69	07.00-	RHX (DW10BTED)	4	<b>GN 027</b> (11V)	○		
2.0 HDi	2.0	80	07.00-	RHZ (DW10ATED)	4	<b>GN 027</b> (11V)	○		
2.0 HDi	2.0	80	07.00-	RHW (DW10ATED4)	4	<b>GN 027</b> (11V)	○		
2.0 HDi 120	2.0	88	01.07-	RHK (DW10UTED4)	4	<b>GN 054</b> (11V)	○		
2.0 HDi 140	2.0	100	01.07-	RHR (DW10BTED4)	4	<b>GN 054</b> (11V)	○		
2.0	2.0	100	07.00-	RFN (EW10J4)	4	<b>Z 183</b>	14 FR-8 MU2	0,9	<b>UXT 13</b>
2.0 16V	2.0	103	01.07-	RFJ (EW10A)/RFH (EW10A)	4	<b>Z 223</b>	14 FR-8 NQU23	0,9	○

### EXPERT Tepee

1.6 HDi 90	1.6	66	01.07-	9HU (DV6UTED4)	4	<b>GN 056</b> (11V)	○		
2.0 HDi 120	2.0	88	01.07-	RHK (DW10UTED4)	4	<b>GN 054</b> (11V)	○		
2.0 HDi 140	2.0	100	01.07-	RHR (DW10BTED4)	4	<b>GN 054</b> (11V)	○		
2.0 16V	2.0	103	01.07-	RFJ (EW10A)/RFH (EW10A)	4	<b>Z 223</b>	14 FR-8 NQU23	0,9	○

### J5

1.9 D	1.9	51	09.87-08.90	XUD9	4	<b>GN 013</b> (11V)	○		
1.9 D	1.9	51	10.90-01.94	D9B (XUD9A)	4	<b>GV 636</b> (11V)	<b>GR 065</b>		
2.0	2.0	55	09.81-09.90	170B (XN1T)	4	<b>Z 11</b>	14-7 DU	0,8	<b>UXT 2<sup>4</sup></b>
2.0	2.0	58	01.83-09.90	170 (XN1T)	4	<b>Z 11</b>	14-7 DU	0,8	<b>UXT 2<sup>4</sup></b>
2.0	2.0	62	10.90-	170D (XN1TACP)	4	<b>Z 11</b>	14-7 DU	0,8	<b>UXT 2<sup>4</sup></b>
2.5 D	2.5	54	09.81-09.90	CRD93 (U25/661)	4	<b>GV 602</b> (11V)	<b>GR 059</b>		
2.5 D	2.5	54	10.90-06.91	CRD93 (U25/661)	4	<b>GV 602</b> (11V)	<b>GR 059</b>		
2.5 D	2.5	54	07.91-	CRD93 (U25/661)	4	<b>GV 636</b> (11V)	<b>GR 065</b>		
2.5 TD	2.5	70	10.90-06.91	CRD93LS (U25/673)	4	<b>GV 602</b> (11V)	<b>GR 059</b>		
2.5 TD	2.5	70	07.91-	CRD93LS (U25/673)	4	<b>GV 636</b> (11V)	<b>GR 065</b>		

### PARTNER

1.1	1.1	44	06.96-	HDZ (TU1M)	4	<b>Z 193</b>	14 FR-7 DU2	0,9	<b>UXT 1<sup>3</sup></b>
1.4	1.4	55	06.96-	KFX (TU3JP)	4	<b>Z 193</b>	14 FR-7 DU2	0,9	<b>UXT 1<sup>3</sup></b>
1.4 BiFuel	1.4	55	04.03-	KFW (TU3JP)	4	<b>Z 206</b>	14 FR-7 DPPUS2	0,7	<b>UXT 10</b>
1.6 HDi 75	1.6	55	02.06-	9HW (DV6BTED4)	4	<b>GN 056</b> (11V)	○		
1.6 HDi	1.6	55	01.09-	9HT (DV6BTED4)	4	<b>GN 047</b> (11V)	○		
1.6 HDi	1.6	55	01.09-	9HT (DV6BTED4)	4	<b>GN 056</b> (11V)	○		
1.6 HDi 90	1.6	66	02.06-	9HX (DV6ATED4)	4	<b>GN 047</b> (11V)	○		
1.6 HDi 90	1.6	66	02.06-	9HX (DV6ATED4)	4	<b>GN 056</b> (11V)	○		
1.6 HDi	1.6	66	04.08-	9HX (DV6ATED4)	4	<b>GN 047</b> (11V)	○		
1.6 HDi	1.6	66	04.08-	9HX (DV6ATED4)	4	<b>GN 056</b> (11V)	○		
1.8 D	1.8	43	06.96-08.98	A9A (XUD7)	4	<b>GN 909</b> (11V)	○		
1.8 D	1.8	43	09.98-	A9A (XUD7)	4	<b>GN 013</b> (11V)	○		
1.9 D	1.9	51	06.96-08.98	DJY (XUD9A)	4	<b>GN 909</b> (11V)	○		
1.9 D	1.9	51	09.98-	DJY (XUD9A)	4	<b>GN 013</b> (11V)	<b>GR 054</b>		
1.9 D	1.9	51	06.96-	WJY (DW8B)/WJZ (DW8)	4	<b>GN 016</b> (11V)	○		

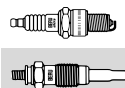
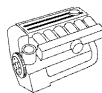

## PEUGEOT



### PARTNER

1.9 D 4x4	1.9	51	04.04-	WJY (DW8B)	4	<b>GN 016</b> (11V)	○		
2.0 HDi	2.0	66	04.00-	RHY (DW10TD)	4	<b>GN 027</b> (11V)	○		
2.0 HDi 4x4	2.0	66	04.04-	RHY (DW10TD)	4	<b>GN 027</b> (11V)	○		

### PARTNER Combispace

1.1	1.1	44	06.96-	HDZ (TU1M)/HFX (TU1JP)	4	<b>Z 193</b>	14 FR-7 DU2	0,9	<b>UXT 1<sup>3</sup></b>
1.4	1.4	55	06.96-	KFX (TU3JP)/KFW (TU3JP)	4	<b>Z 193</b>	14 FR-7 DU2	0,9	<b>UXT 1<sup>3</sup></b>
1.6 HDi 75	1.6	55	02.06-	9HW (DV6BTED4)	4	<b>GN 056</b> (11V)	○		
1.6 HDi 90	1.6	66	02.06-	9HX (DV6ATED4)	4	<b>GN 047</b> (11V)	○		
				→ Organisationsnr.10783					
1.6 HDi 90	1.6	66	02.06-	9HX (DV6ATED4)	4	<b>GN 056</b> (11V)	○		
				Organisationsnr.10784 →					
1.6 16V	1.6	80	07.01-08.02	NFU (TU5JP4)	4	<b>Z 184</b>	14 FR-7 MU2	0,9	<b>UXT 13</b>
1.8	1.8	66	05.97-	LFX (XU7JB)	4	<b>Z 193</b>	14 FR-7 DU2	0,9	<b>UXT 1<sup>3</sup></b>
1.9 D	1.9	50	06.96-08.98	DJY (XUD9A)	4	<b>GN 909</b> (11V)	○		
1.9 D	1.9	50	09.98-	DJY (XUD9A)	4	<b>GN 013</b> (11V)	<b>GR 054</b>		
1.9 D	1.9	51	05.96-12.98	XUD9	4	<b>GN 909</b> (11V)	○		
1.9 D	1.9	51	12.98-	WJY (DW8B)/WJZ (DW8)	4	<b>GN 016</b> (11V)	○		
1.9 D 4x4	1.9	51	04.04-08.05	WJY (DW8B)	4	<b>GN 016</b> (11V)	○		
2.0 HDi	2.0	66	02.00-	RHY (DW10TD)	4	<b>GN 027</b> (11V)	○		
2.0 HDi 4x4	2.0	66	04.04-08.05	RHY (DW10TD)	4	<b>GN 027</b> (11V)	○		

### PARTNER Tepee

1.6 HDi	1.6	55	04.08-	9HT (DV6BTED4)	4	<b>GN 056</b> (11V)	○		
1.6 HDi	1.6	66	04.08-	9HX (DV6ATED4)	4	<b>GN 056</b> (11V)	○		
1.6 HDi	1.6	80	04.08-	9HZ (DV6TED4)	4	<b>GN 047</b> (11V)	○		

## PONTIAC

### TRANS SPORT '89

2.3	2.3	101	01.93-03.97		4	<b>Z 73</b>	14 FR-8 DUX	1,1	<b>UXT 1<sup>3</sup></b>
2.3	2.3	108	01.93-03.97		4	<b>Z 73</b>	14 FR-8 DUX	1,1	<b>UXT 1<sup>3</sup></b>

## PORSCHE

### 911(964)

3.6 Carrera	3.6	184	07.89-09.93	M 64.01/M 64.02	6	<b>Z 45</b>	14 FR-5 DTU	0,7	<b>UXT 5</b>
3.6 Carrera 4	3.6	184	12.88-09.93	M 64.01	6	<b>Z 45</b>	14 FR-5 DTU	0,7	<b>UXT 5</b>
3.6 Carrera RS	3.6	191	06.91-09.93	64.03	6	<b>Z 45</b>	14 FR-5 DTU	0,7	<b>UXT 5</b>
3.6 Turbo	3.6	265	01.93-09.93	M 64.50	6	<b>Z 116</b>	14 FR-6 LDU	0,8	<b>UXT 5</b>

### 911 Cabriolet(964)

3.6 Carrera	3.6	184	07.89-05.94	M 64.01/M 64.02	6	<b>Z 45</b>	14 FR-5 DTU	0,7	<b>UXT 5</b>
3.6 Carrera 4	3.6	184	05.89-05.94	M 64.01	6	<b>Z 45</b>	14 FR-5 DTU	0,7	<b>UXT 5</b>

### 911(993)

3.6 Carrera	3.6	200	10.93-08.95	M 64.05/M 64.07/M 64.08/ M 64.06	6	<b>Z 45</b>	14 FR-5 DTU	0,7	<b>UXT 5</b>
3.6 Carrera 4	3.6	200	07.94-08.95	M 64.05/M 64.07	6	<b>Z 45</b>	14 FR-5 DTU	0,7	<b>UXT 5</b>
3.6 Carrera 4	3.6	210	08.95-09.97	M 64.21/M 64.23	6	<b>Z 45</b>	14 FR-5 DTU	0,7	<b>UXT 5</b>
3.6 Turbo 4	3.6	300	03.95-09.97	M 64.60	6	<b>Z 116</b>	14 FR-6 LDU	0,8	<b>UXT 5</b>
3.6 Turbo GT2	3.6	316	03.95-09.97	M 64.60R	6	<b>Z 116</b>	14 FR-6 LDU	0,8	<b>UXT 5</b>
3.6 Turbo GT2 4	3.6	316	08.95-09.97	M 64.60R	6	<b>Z 116</b>	14 FR-6 LDU	0,8	<b>UXT 5</b>
3.8 Carrera RS	3.8	221	06.95-09.97	M 64.20	6	<b>Z 45</b>	14 FR-5 DTU	0,7	<b>UXT 5</b>
3.8 Carrera RS 4	3.8	221	08.95-09.97	M 64.20	6	<b>Z 45</b>	14 FR-5 DTU	0,7	<b>UXT 5</b>

### 911 Cabriolet(993)

3.6 Carrera	3.6	200	07.94-08.95	M 64.05/M 64.07/M 64.08/ M 64.06	6	<b>Z 45</b>	14 FR-5 DTU	0,7	<b>UXT 5</b>
3.6 Carrera 4	3.6	200	07.94-08.95	M 64.05/M 64.07	6	<b>Z 45</b>	14 FR-5 DTU	0,7	<b>UXT 5</b>
3.6 Carrera	3.6	210	08.95-09.97	M 64.24/M 64.22/M 64.21/ M 64.23	6	<b>Z 45</b>	14 FR-5 DTU	0,7	<b>UXT 5</b>
3.6 Carrera 4	3.6	210	08.95-09.97	M 64.21/M 64.23	6	<b>Z 45</b>	14 FR-5 DTU	0,7	<b>UXT 5</b>
3.8 Carrera	3.7	210	06.95-09.97	M 64.05S/M 64.06S	6	<b>Z 45</b>	14 FR-5 DTU	0,7	<b>UXT 5</b>
3.8 Carrera 4	3.7	210	06.95-09.97	M 64.05S/M 64.06S	6	<b>Z 45</b>	14 FR-5 DTU	0,7	<b>UXT 5</b>
3.8 Carrera RS	3.8	221	08.95-09.97	M 64.21S	6	<b>Z 45</b>	14 FR-5 DTU	0,7	<b>UXT 5</b>

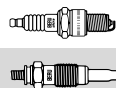
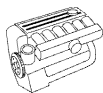

## PORSCHE

### 911 Cabriolet(993)

3.8 Carrera RS 4	3.8	221	08.95-09.97	M 64.21S	6	<b>Z 45</b>	14 FR-5 DTU	0,7	<b>UXT 5</b>
------------------	-----	-----	-------------	----------	---	-------------	-------------	-----	--------------

### 911(996)

3.4 Carrera	3.4	221	09.97-09.01	M 96.01/M 96.04	6	<b>Z 129</b>	14 FGR-6 KQU	1,6	○
3.4 Carrera 4	3.4	221	09.97-09.01	M 96.01/M 96.04	6	<b>Z 129</b>	14 FGR-6 KQU	1,6	○
3.4 Carrera	3.4	235	05.01-08.05		6	<b>Z 129</b>	14 FGR-6 KQU	1,6	○
3.4 Carrera 4	3.4	235	05.01-08.05		6	<b>Z 129</b>	14 FGR-6 KQU	1,6	○
3.6 GT3	3.6	265	03.99-08.05	M 96.76	6	<b>Z 116</b>	14 FR-6 LDU	0,8	<b>UXT 5</b>
3.6 GT3	3.6	280	03.03-08.05	M 96.79	6	<b>Z 116</b>	14 FR-6 LDU	0,8	<b>UXT 5</b>
3.6 Turbo 4	3.6	309	06.00-08.05	M 96.70	6	<b>Z 116</b>	14 FR-6 LDU	0,8	<b>UXT 5</b>
3.6 S	3.6	331	08.04-08.05	M 96.70	6	<b>Z 116</b>	14 FR-6 LDU	0,8	<b>UXT 5</b>
3.6 Turbo 4S	3.6	331	02.03-08.05	M 96.70	6	<b>Z 116</b>	14 FR-6 LDU	0,8	<b>UXT 5</b>
3.6 GT2	3.6	340	04.01-08.05	M 96.70	6	<b>Z 116</b>	14 FR-6 LDU	0,8	<b>UXT 5</b>
3.6 GT2	3.6	355	10.03-08.05	M 96.70	6	<b>Z 116</b>	14 FR-6 LDU	0,8	<b>UXT 5</b>

### 911 Cabriolet(996)

3.4 Carrera	3.4	221	02.98-09.01	M 96.01/M 96.04	6	<b>Z 129</b>	14 FGR-6 KQU	1,6	○
3.4 Carrera 4	3.4	221	02.98-09.01	M 96.02/M 96.04	6	<b>Z 129</b>	14 FGR-6 KQU	1,6	○
3.4 Carrera	3.4	235	05.01-08.05		6	<b>Z 129</b>	14 FGR-6 KQU	1,6	○
3.4 Carrera 4	3.4	235	05.01-08.05		6	<b>Z 129</b>	14 FGR-6 KQU	1,6	○
3.6 Turbo 4	3.6	309	10.03-08.05	M 96.70	6	<b>Z 116</b>	14 FR-6 LDU	0,8	<b>UXT 5</b>
3.6 S	3.6	331	08.04-08.05	M 96.70	6	<b>Z 116</b>	14 FR-6 LDU	0,8	<b>UXT 5</b>
3.6 Turbo 4S	3.6	331	10.03-08.05	M 96.70	6	<b>Z 116</b>	14 FR-6 LDU	0,8	<b>UXT 5</b>

### 911(997)

3.6 Turbo	3.6	353	03.06-	M 97.70	6	<b>Z 185</b>	14 F-6 DPUR021	0,8	○
3.6 GT2 RS	3.6	456	05.10-	M 97.70	6	<b>Z 185</b>	14 F-6 DPUR021	0,8	○

### 911 Cabriolet(997)

3.6 Turbo	3.6	353	09.07-	M 97.70	6	<b>Z 185</b>	14 F-6 DPUR021	0,8	○
-----------	-----	-----	--------	---------	---	--------------	----------------	-----	---

### 911 Targa(993)

3.6 Carrera	3.6	210	08.95-09.97	M 64.24/M 64.22/M 64.21/ M 64.23	6	<b>Z 45</b>	14 FR-5 DTU	0,7	<b>UXT 5</b>
3.7 Carrera	3.8	221	05.96-09.97	M 64.20	6	<b>Z 45</b>	14 FR-5 DTU	0,7	<b>UXT 5</b>

### 928

4.9 S	5.0	212	09.85-05.94	M 28.46/M 28.45	8	<b>Z 20</b>	14 R-7 DU	0,8	<b>UXT 2<sup>4</sup></b>
5.0 S4 KAT	5.0	235	08.86-07.91	M 28.41/M 28.42	8	<b>Z 20</b>	14 R-7 DU	0,8	<b>UXT 2<sup>4</sup></b>
4.9 S,S4	5.0	235	08.86-07.91	M 28.41/M 28.42	8	<b>Z 20</b>	14 R-7 DU	0,8	<b>UXT 2<sup>4</sup></b>
5.0 GT	5.0	243	01.89-07.91	M 28.47	8	<b>Z 20</b>	14 R-7 DU	0,8	<b>UXT 2<sup>4</sup></b>
5.4 GTS	5.4	257	08.91-11.95	M 28.49/M 28.50	8	<b>Z 20</b>	14 R-7 DU	0,8	<b>UXT 2<sup>4</sup></b>

### 944

2.5	2.5	118	08.87-12.90	M 44.05/M 44.09/M 44.10	4	<b>Z 20</b>	14 R-7 DU	0,8	<b>UXT 2<sup>4</sup></b>
2.5 Turbo	2.5	184	09.87-07.91	M 44.52	4	<b>Z 20</b>	14 R-7 DU	0,8	<b>UXT 2<sup>4</sup></b>
3.0 S2	3.0	155	12.88-07.91	M 44.41	4	<b>Z 47</b>	14 R-5 DU	0,8	<b>UX 56</b>

### 944 Cabriolet

2.5 Turbo	2.5	184	11.90-07.91	M 44.52	4	<b>Z 20</b>	14 R-7 DU	0,8	<b>UXT 2<sup>4</sup></b>
3.0 S2	3.0	155	12.88-07.91	M 44.41	4	<b>Z 47</b>	14 R-5 DU	0,8	<b>UX 56</b>

### 968

3.0 Turbo S	3.0	224	03.93-11.95		4	<b>Z 250</b>	14 FR-7 DU2S	0,7	<b>UXT 1<sup>3</sup></b>
-------------	-----	-----	-------------	--	---	--------------	--------------	-----	--------------------------

### BOXSTER(986)

2.5	2.5	150	09.96-08.99	M 96.20	6	<b>Z 98</b>	14 FR-7 LDU	0,8	<b>UXT 1<sup>3</sup></b>
2.7	2.7	162	08.99-07.02	M 96.22	6	<b>Z 129</b>	14 FGR-6 KQU	1,6	○
2.7	2.7	168	07.02-12.04	M 96.23	6	<b>Z 129</b>	14 FGR-6 KQU	1,6	○
S 3.2	3.2	185	08.99-07.02	M 96.21	6	<b>Z 129</b>	14 FGR-6 KQU	1,6	○
S 3.2	3.2	191	07.02-12.04	M 96.24	6	<b>Z 129</b>	14 FGR-6 KQU	1,6	○
S 3.2	3.2	196	01.04-12.04	M 96.24	6	<b>Z 129</b>	14 FGR-6 KQU	1,6	○

### BOXSTER(987)

S 3.2	3.2	206	11.04-	M 96.26	6	<b>Z 129</b>	14 FGR-6 KQU	1,6	○
-------	-----	-----	--------	---------	---	--------------	--------------	-----	---

### CAYENNE

3.0 D	3.0	155	06.10-	MCR.CB	6	<b>GE 115 (4,4V)</b>	○		
3.0 D	3.0	176	06.10-	M 05.9E	6	<b>GE 115 (4,4V)</b>	○		
3.0 TDI	3.0	176	02.09-		6	<b>GE 115 (4,4V)</b>	○		
3.0 D	3.0	180	06.11-	MCR.CA	6	<b>GE 115 (4,4V)</b>	○		
S 4.5	4.5	250	09.02-	M 48.00	8	<b>Z 129</b>	14 FGR-6 KQU	1,6	○
Turbo 4.5	4.5	331	09.02-	M 48.50	8	<b>Z 185</b>	14 F-6 DPUR021	0,8	○

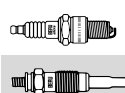
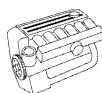

## PORSCHE

### CAYENNE

Turbo S 4.8	4.8	368	02.07-12.08	M 48.51	8	<b>Z 277</b>	14 F-5 MPUR03	0,8	○
-------------	-----	-----	-------------	---------	---	--------------	---------------	-----	---

## PROTON

### GEN 2

1.6	1.6	82	06.04-	S4PH	4	<b>Z 67</b>	14 KR-7 DUX	1,1	<b>UXT 4</b>
-----	-----	----	--------	------	---	-------------	-------------	-----	--------------

### IMPIAN

1.6	1.6	76	09.01-	4 G 18 P	4	<b>Z 16</b>	14 FR-7 DUX	1,1	<b>UXT 1<sup>3</sup></b>
-----	-----	----	--------	----------	---	-------------	-------------	-----	--------------------------

### PERSONA 300

313i	1.3	55	03.96-	G 13 B	4	<b>Z 20</b>	14 R-7 DU	0,8	<b>UXT 2<sup>4</sup></b>
------	-----	----	--------	--------	---	-------------	-----------	-----	--------------------------

315 GLSi	1.5	64	09.96-	G 15 B	4	<b>Z 20</b>	14 R-7 DU	0,8	<b>UXT 2<sup>4</sup></b>
----------	-----	----	--------	--------	---	-------------	-----------	-----	--------------------------

315 GLi/GLSi	1.5	66	03.96-	4 G 15 M	4	<b>Z 20</b>	14 R-7 DU	0,8	<b>UXT 2<sup>4</sup></b>
--------------	-----	----	--------	----------	---	-------------	-----------	-----	--------------------------

316	1.6	70	03.96-	4 G 92	4	<b>Z 16</b>	14 FR-7 DUX	1,1	<b>UXT 1<sup>3</sup></b>
-----	-----	----	--------	--------	---	-------------	-------------	-----	--------------------------

316 GLXi	1.6	83	03.96-	4 G 92	4	<b>Z 16</b>	14 FR-7 DUX	1,1	<b>UXT 1<sup>3</sup></b>
----------	-----	----	--------	--------	---	-------------	-------------	-----	--------------------------

318 16V GTI	1.8	99	03.96-	4 G 93 (DOHC)	4	<b>Z 16</b>	14 FR-7 DUX	1,1	<b>UXT 1<sup>3</sup></b>
-------------	-----	----	--------	---------------	---	-------------	-------------	-----	--------------------------

### PERSONA 400

413	1.3	55	01.94-		4	<b>Z 9</b>	14 R-8 DUX	1,1	<b>UXT 2<sup>4</sup></b>
-----	-----	----	--------	--	---	------------	------------	-----	--------------------------

415 GLi/GLSi	1.5	66	01.94-	4 G 15	4	<b>Z 9</b>	14 R-8 DUX	1,1	<b>UXT 2<sup>4</sup></b>
--------------	-----	----	--------	--------	---	------------	------------	-----	--------------------------

416 GLXi	1.6	83	01.94-	4 G 92	4	<b>Z 16</b>	14 FR-7 DUX	1,1	<b>UXT 1<sup>3</sup></b>
----------	-----	----	--------	--------	---	-------------	-------------	-----	--------------------------

418	1.8	85	05.96-	4 G 93 (DOHC)	4	<b>Z 16</b>	14 FR-7 DUX	1,1	<b>UXT 1<sup>3</sup></b>
-----	-----	----	--------	---------------	---	-------------	-------------	-----	--------------------------

420 GLS D	2.0	48	05.96-	4 D 68	4	<b>GN 107</b> (11V)	○		
-----------	-----	----	--------	--------	---	---------------------	---	--	--

420 TD	2.0	60	02.97-	4 D 68 T	4	<b>GN 107</b> (11V)	○		
--------	-----	----	--------	----------	---	---------------------	---	--	--

### PERSONA 400 Hatchback

413 GLSi	1.3	55	01.94-	4 G 13	4	<b>Z 9</b>	14 R-8 DUX	1,1	<b>UXT 2<sup>4</sup></b>
----------	-----	----	--------	--------	---	------------	------------	-----	--------------------------

415 GLi/GLSi	1.5	66	01.94-	4 G 15	4	<b>Z 9</b>	14 R-8 DUX	1,1	<b>UXT 2<sup>4</sup></b>
--------------	-----	----	--------	--------	---	------------	------------	-----	--------------------------

416 i	1.6	70	12.95-	4 G 92	4	<b>Z 16</b>	14 FR-7 DUX	1,1	<b>UXT 1<sup>3</sup></b>
-------	-----	----	--------	--------	---	-------------	-------------	-----	--------------------------

416 GLXi	1.6	83	01.94-	4 G 92	4	<b>Z 16</b>	14 FR-7 DUX	1,1	<b>UXT 1<sup>3</sup></b>
----------	-----	----	--------	--------	---	-------------	-------------	-----	--------------------------

418 GLXi	1.8	85	05.96-	4 G 93 (DOHC)	4	<b>Z 16</b>	14 FR-7 DUX	1,1	<b>UXT 1<sup>3</sup></b>
----------	-----	----	--------	---------------	---	-------------	-------------	-----	--------------------------

### SATRIA

1.5	1.5	64	07.00-	4 G 15	4	<b>Z 8</b>	14 R-8 DU	0,8	<b>UXT 2<sup>4</sup></b>
-----	-----	----	--------	--------	---	------------	-----------	-----	--------------------------

### WIRA

1.3	1.3	55	08.00-	4 G 13	4	<b>Z 8</b>	14 R-8 DU	0,8	<b>UXT 2<sup>4</sup></b>
-----	-----	----	--------	--------	---	------------	-----------	-----	--------------------------

1.5	1.5	64	08.00-	4 G 15	4	<b>Z 8</b>	14 R-8 DU	0,8	<b>UXT 2<sup>4</sup></b>
-----	-----	----	--------	--------	---	------------	-----------	-----	--------------------------

### WIRA Hatchback

1.3	1.3	55	08.00-	4 G 13	4	<b>Z 8</b>	14 R-8 DU	0,8	<b>UXT 2<sup>4</sup></b>
-----	-----	----	--------	--------	---	------------	-----------	-----	--------------------------

1.5	1.5	64	08.00-	4 G 15 M	4	<b>Z 8</b>	14 R-8 DU	0,8	<b>UXT 2<sup>4</sup></b>
-----	-----	----	--------	----------	---	------------	-----------	-----	--------------------------

## PUCH

### G-MODELL (W 460)

230 GE	2.3	92	04.82-08.92	M 102.987/M 102.981	4	<b>Z 18</b>	14 K-7 DUO	0,8	<b>UXT 4</b>
--------	-----	----	-------------	---------------------	---	-------------	------------	-----	--------------

250 GD	2.5	62	02.89-12.92	OM 602.930	5	<b>GN 858</b> (11,5V)	<b>GR 049</b>	<b>SR 040</b>	
--------	-----	----	-------------	------------	---	-----------------------	---------------	---------------	--

250 GD (24 Volt)	2.5	62	10.87-12.92	OM 602.930	5	<b>GV 736</b> (18V)	<b>GR 049</b>		
------------------	-----	----	-------------	------------	---	---------------------	---------------	--	--

300 GD	3.0	65	08.80-12.91	OM 617.931	5	<b>GV 603</b> (11,5V)	○		
--------	-----	----	-------------	------------	---	-----------------------	---	--	--

### G-MODELL (W 461)

230 GE	2.3	92	06.93-	M 102.996	4	<b>Z 18</b>	14 K-7 DUO	0,8	<b>UXT 4</b>
--------	-----	----	--------	-----------	---	-------------	------------	-----	--------------

290 GD/G 290 D	2.9	70	04.92-	OM 602.942	5	<b>GN 858</b> (11,5V)	<b>GR 049</b>	<b>SR 040</b>	
----------------	-----	----	--------	------------	---	-----------------------	---------------	---------------	--

G 290 TD	2.9	88	07.97-	OM 602.983	5	<b>GN 858</b> (11,5V)	○		
----------	-----	----	--------	------------	---	-----------------------	---	--	--

### G-MODELL (W 463)

230 GE	2.3	93	06.90-06.93	M 102.989	4	<b>Z 18</b>	14 K-7 DUO	0,8	<b>UXT 4</b>
--------	-----	----	-------------	-----------	---	-------------	------------	-----	--------------

300 GD	3.0	83	09.89-	OM 603.931	6	<b>GN 858</b> (11,5V)	<b>GR 076</b>		
--------	-----	----	--------	------------	---	-----------------------	---------------	--	--

300 GE	3.0	125	06.90-	M 103.987	6	<b>Z 7</b>	14 K-8 DUO	0,8	<b>UXT 4</b>
--------	-----	-----	--------	-----------	---	------------	------------	-----	--------------

350 G Turbo D	3.4	100	09.91-	OM 603.972	6	<b>GN 858</b> (11,5V)	○		
---------------	-----	-----	--------	------------	---	-----------------------	---	--	--

G 300 TD	3.0	130	08.96-	OM 606.964	6	<b>GN 948</b> (11,5V)	○		
----------	-----	-----	--------	------------	---	-----------------------	---	--	--

G 320	3.2	155	09.94-06.97	M 104.996	6	<b>Z 100</b>	14 F-8 DU4	0,8	<b>UXT 1<sup>3</sup></b>
-------	-----	-----	-------------	-----------	---	--------------	------------	-----	--------------------------

G 320	3.2	155	07.97-12.97	M 104.996	6	<b>Z 121</b>	14 FGH-8 DTURX0	1,0	<b>UXT 9</b>
-------	-----	-----	-------------	-----------	---	--------------	-----------------	-----	--------------

G 500	5.0	218	04.98-	M 113.962	8	<b>Z 122</b>	14 FGH-8 DPURX2=16x	1,0	<b>UXT 9</b>
-------	-----	-----	--------	-----------	---	--------------	---------------------	-----	--------------

G 55 AMG	5.4	260	04.99-	M 113.982	8	<b>Z 122</b>	14 FGH-8 DPURX2=16x	1,0	<b>UXT 9</b>
----------	-----	-----	--------	-----------	---	--------------	---------------------	-----	--------------

## RENAULT

### AVANTIME

2.0 16V Turbo	2.0	120	11.01-05.03	F4R 760/761	4	<b>Z 337</b>	14 FR-7 DPPUW2	0,9	○
---------------	-----	-----	-------------	-------------	---	--------------	----------------	-----	---

2.2 dCi	2.2	110	05.02-05.03	G9T 712	4	<b>GN 026</b> (11V)	○		
---------	-----	-----	-------------	---------	---	---------------------	---	--	--

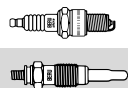
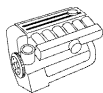

## RENAULT

### CLIO Grandtour

1.2 16V	1.1	55	02.08-	D4F 740	4	<b>Z 243</b>	12 VR-8 SE	0,9	○
1.2 16V	1.1	58	02.08-	D4F 764	4	<b>Z 243</b>	12 VR-8 SE	0,9	○
1.2 16V	1.1	74	02.08-	D4F 784	4	<b>Z 274</b>	12 VR-6 MPPUS	0,7	○
1.4 16V	1.4	72	02.10-	K4J 780	4	<b>Z 193</b>	14 FR-7 DU2	0,9	<b>UXT 1<sup>3</sup></b>
1.5 dCi	1.5	48	02.10-	K9K 752	4	<b>GN 018</b> (11V)	○		
1.5 dCi	1.5	50	02.08-	K9K 768	4	<b>GN 018</b> (11V)	○		
1.5 dCi	1.5	55	08.10-	K9K 770	4	<b>GN 018</b> (11V)	○		
1.5 dCi	1.5	63	02.08-	K9K 766	4	<b>GN 018</b> (11V)	○		
1.5 dCi	1.5	65	08.10-	K9K 770, K9K 772	4	<b>GN 018</b> (11V)	○		
1.5 dCi	1.5	76	02.08-	K9K 772	4	<b>GN 018</b> (11V)	○		
1.5 dCi	1.5	78	02.08-	K9K 764	4	<b>GN 018</b> (11V)	○		
1.6 16V	1.6	82	02.08-	K4M 800/K4M 801	4	<b>Z 193</b>	14 FR-7 DU2	0,9	<b>UXT 1<sup>3</sup></b>

### CLIO I

1.1	1.1	34	01.91-09.98	C1E 700	4	<b>Z 76</b>	14-9 DU	0,8	<b>UXT 2<sup>4</sup></b>
1.2	1.1	40	01.96-09.98	D7F 730	4	<b>Z 247</b>	14 FR-7 DUW	0,9	<b>UXT 1<sup>3</sup></b>
1.2	1.1	43	01.96-09.98	D7F 730	4	<b>Z 247</b>	14 FR-7 DUW	0,9	<b>UXT 1<sup>3</sup></b>
1.2	1.2	40	01.91-01.96	E7F 706	4	<b>Z 100</b>	14 F-8 DU4	0,8	<b>UXT 1<sup>3</sup></b>
1.2	1.2	40	01.96-12.96	C3G 720	4	<b>Z 76</b>	14-9 DU	0,8	<b>UXT 2<sup>4</sup></b>
1.2	1.2	43	05.90-09.98	E7F 750/E7F 700/E7F 708	4	<b>Z 5</b>	14 F-8 DUO	0,8	<b>UXT 1<sup>3</sup></b>
1.2	1.2	44	05.90-03.96	E5F 710	4	<b>Z 72</b>	14 FR-8 DU	0,8	<b>UXT 1<sup>3</sup></b>
1.4	1.4	55	01.91-09.98	E7J 756/E7J 757	4	<b>Z 247</b>	14 FR-7 DUW	0,9	<b>UXT 1<sup>3</sup></b>
1.4	1.4	58	01.91-09.98	E7J 719 /E7J 601 /E7J 718/ E7J 754	4	<b>Z 247</b>	14 FR-7 DUW	0,9	<b>UXT 1<sup>3</sup></b>
1.7	1.7	68	01.91-12.93	F2N 770	4	<b>Z 42</b>	14-5 DU	0,8	<b>UX 56</b>
1.8	1.8	65	09.96-09.98	F3P 710 /F3P 714	4	<b>Z 119</b>	14 R-8 DU4	0,8	<b>UXT 2<sup>4</sup></b>
1.8	1.8	66	08.90-04.96	F3P 755	4	<b>Z 20</b>	14 R-7 DU	0,8	<b>UXT 2<sup>4</sup></b>
1.8	1.8	66	09.96-09.98	F3P 755 /F3P 754	4	<b>Z 119</b>	14 R-8 DU4	0,8	<b>UXT 2<sup>4</sup></b>
1.8	1.8	70	09.96-09.98	F3P 710	4	<b>Z 119</b>	14 R-8 DU4	0,8	<b>UXT 2<sup>4</sup></b>
1.8 Rsi	1.8	79	09.96-09.98	F3P 758	4	<b>Z 119</b>	14 R-8 DU4	0,8	<b>UXT 2<sup>4</sup></b>
1.8 Rsi	1.8	80	01.93-08.95	F3P 712	4	<b>Z 20</b>	14 R-7 DU	0,8	<b>UXT 2<sup>4</sup></b>
1.8 16V	1.8	99	01.91-03.96	F7P 722	4	<b>Z 24</b>	14 FR-6 DU	0,8	<b>UXT 5</b>
1.9 D	1.9	40	01.97-09.98	F8Q 678	4	<b>GV 852</b> (11V)	○		
1.9 D	1.9	47	01.91-09.98	F8Q 730/F8Q 732	4	<b>GV 852</b> (11V)	<b>GR 067</b>		
2.0 Williams	2.0	108	01.94-09.98	F7R 700	4	<b>Z 60</b>	14 FGR-7 CTU	1,2	○

### CLIO II

1.1	1.1	43	09.98-	D7F 720/D7F 726	4	<b>Z 247</b>	14 FR-7 DUW	0,9	<b>UXT 1<sup>3</sup></b>
1.2	1.1	43	09.98-	D7F 766/D7F 764/D7F 746	4	<b>Z 224</b>	14 FR-7 DPU3	0,9	<b>UXT 9</b>
1.2	1.1	44	03.99-05.01	D7F 722	4	<b>Z 224</b>	14 FR-7 DPU3	0,9	<b>UXT 9</b>
1.2 16V	1.1	55	06.01-	D4F 712/714	4	<b>Z 243</b>	12 VR-8 SE	0,9	○
1.4	1.4	55	09.98-05.05	K7J 710/E7J 780	4	<b>Z 247</b>	14 FR-7 DUW	0,9	<b>UXT 1<sup>3</sup></b>
1.4 16V	1.4	70	10.99-08.00	K4J 712/713	4	<b>Z 193</b>	14 FR-7 DU2	0,9	<b>UXT 1<sup>3</sup></b>
1.4 16V	1.4	72	08.00-	K4J 712/713	4	<b>Z 193</b>	14 FR-7 DU2	0,9	<b>UXT 1<sup>3</sup></b>
1.5 dCi	1.5	47	06.05-	K9K 740	4	<b>GN 018</b> (11V)	○		
1.5 dCi	1.5	48	06.01-	K9K 704/K9K 700	4	<b>GN 018</b> (11V)	○		
1.5 dCi	1.5	50	08.04-	K9K 714	4	<b>GN 018</b> (11V)	○		
1.5 dCi	1.5	59	06.01-10.04	K9K 702	4	<b>GN 018</b> (11V)	○		
1.5 dCi	1.5	60	06.01-	K9K 702	4	<b>GN 018</b> (11V)	○		
1.5 dCi	1.5	60	11.03-	K9K 710	4	<b>GN 018</b> (11V)	○		
1.5 dCi	1.5	62	02.07-	K9K 718	4	<b>GN 018</b> (11V)	○		
1.5 dCi	1.5	74	01.04-	K9K 712	4	<b>GN 018</b> (11V)	○		
1.6	1.6	66	09.98-05.05	K7M 744/K7M 745	4	<b>Z 74</b>	14 FR-8 LDUOX4	1,0	<b>UXT 1<sup>3</sup></b>
1.6 16V	1.6	79	09.98-	K4M 708/748	4	<b>Z 193</b>	14 FR-7 DU2	0,9	<b>UXT 1<sup>3</sup></b>
1.9 D	1.9	47	09.98-02.99	F8Q 630	4	<b>GN 963</b> (11V)	○		
1.9 D	1.9	47	03.99-05.05	F8Q 630	4	<b>GN 019</b> (11V)	○		
1.9 D	1.9	48	02.00-05.01	F8Q 632	4	<b>GN 019</b> (11V)	○		
1.9 dTi	1.9	59	12.99-05.05	F9Q 780	4	<b>GN 018</b> (11V)	○		
1.9 DTi	1.9	59	02.00-05.01	F9Q 780	4	<b>GN 018</b> (11V)	○		
2.0 16V Sport	2.0	124	02.00-	F4R 730	4	<b>Z 193</b>	14 FR-7 DU2	0,9	<b>UXT 1<sup>3</sup></b>
2.0 16V Sport	2.0	132	01.04-	F4R 738	4	<b>Z 284</b>	14 FR-6 DPOX	1,1	<b>UXT 14</b>

### CLIO III

1.2 16V	1.1	48	06.05-	D4F 740	4	<b>Z 243</b>	12 VR-8 SE	0,9	○
---------	-----	----	--------	---------	---	--------------	------------	-----	---

● nicht erforderlich  
○ nicht im Programm

<sup>3</sup> wahlweise UXT 3 Platin

<sup>4</sup> wahlweise UXT 6 Platin

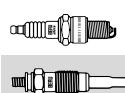
**RENAULT****CLIO III**

1.2 16V Hi-Flex	1.1	55	07.08-	D4F 742	4	<b>Z 243</b>	12 VR-8 SE	0,9	○
1.2 16V	1.1	55	06.05-	D4F 740	4	<b>Z 243</b>	12 VR-8 SE	0,9	○
1.2 16V	1.1	58	06.05-	D4F 764	4	<b>Z 243</b>	12 VR-8 SE	0,9	○
1.2 16V	1.1	74	05.07-	D4F 784	4	<b>Z 274</b>	12 VR-6 MPPUS	0,7	○
1.4 16V	1.4	72	06.05-	K4J 780	4	<b>Z 193</b>	14 FR-7 DU2	0,9	<b>UXT 1<sup>3</sup></b>
1.5 dCi	1.5	47	06.05-	K9K 752	4	<b>GN 018</b> (11V)	○		
1.5 dCi	1.5	50	06.05-	K9K 768	4	<b>GN 018</b> (11V)	○		
1.5 dCi	1.5	55	08.10-	K9K 770	4	<b>GN 018</b> (11V)	○		
1.5 dCi	1.5	60	11.07-	K9K 750	4	<b>GN 018</b> (11V)	○		
1.5 dCi	1.5	63	06.05-	K9K 766	4	<b>GN 018</b> (11V)	○		
1.5 dCi	1.5	65	08.10-	K9K 770	4	<b>GN 018</b> (11V)	○		
1.5 dCi	1.5	76	06.05-	K9K 772	4	<b>GN 018</b> (11V)	○		
1.5 dCi	1.5	78	06.05-	K9K 764	4	<b>GN 018</b> (11V)	○		
1.6 16V	1.6	65	06.05-	K4M 804	4	<b>Z 193</b>	14 FR-7 DU2	0,9	<b>UXT 1<sup>3</sup></b>
1.6 16V	1.6	82	06.05-	K4M 800/K4M 801	4	<b>Z 193</b>	14 FR-7 DU2	0,9	<b>UXT 1<sup>3</sup></b>

**ESPACE I**

2.0	2.0	74	01.88-12.90	J6R 734	4	<b>Z 25</b>	14 K-6 DU	0,8	<b>UXK 56</b>
2.0	2.0	80	07.84-12.90	J6R 234/J6R 236	4	<b>Z 25</b>	14 K-6 DU	0,8	<b>UXK 56</b>
2.0 i	2.0	87	01.89-12.90	J7R 760	4	<b>Z 31</b>	14 K-5 DU	0,8	<b>UXK 56</b>
2.0 i Quadra	2.0	87	03.88-12.92	J7R 760	4	<b>Z 31</b>	14 K-5 DU	0,8	<b>UXK 56</b>
2.1 TD	2.1	65	10.84-12.90	J8S 774/J8S 240	4	<b>GV 642</b> (11V)	<b>GR 066</b>		
2.2	2.2	79	07.86-12.90	J7T 770	4	<b>Z 25</b>	14 K-6 DU	0,8	<b>UXK 56</b>
2.2 Quadra	2.2	79	01.88-12.90	J7T 770	4	<b>Z 25</b>	14 K-6 DU	0,8	<b>UXK 56</b>

**ESPACE II**

2.0	2.0	76	01.91-10.96	J7R 768	4	<b>Z 25</b>	14 K-6 DU	0,8	<b>UXK 56</b>
2.1 TD	2.1	65	01.91-10.96	J8S 776/J8S 772/J8S 778/ J8S 610	4	<b>GV 642</b> (11V)	<b>GR 066</b>		
2.1 TD	2.1	66	11.94-10.96	J8S 612	4	<b>GV 642</b> (11V)	<b>GR 066</b>		
2.2	2.2	79	01.91-10.96	J7T 772/J7T 776/J7T 773	4	<b>Z 25</b>	14 K-6 DU	0,8	<b>UXK 56</b>
2.2 4x4	2.2	79	03.91-12.96	J7T 772/J7T 773	4	<b>Z 25</b>	14 K-6 DU	0,8	<b>UXK 56</b>
2.8 V6	2.8	110	01.91-10.96	Z7W 717/Z7W 712/Z7W 713	6	<b>Z 25</b>	14 K-6 DU	0,8	<b>UXK 56</b>

**ESPACE III**

1.9 dTi	1.9	72	02.99-10.02	F9Q 722	4	<b>GN 018</b> (11V)	○		
2.0	2.0	84	11.96-10.00	F3R 769/F3R 728/F3R 742/ F3R 729/F3R 768	4	<b>Z 119</b>	14 R-8 DU4	0,8	<b>UXT 2<sup>4</sup></b>
2.0	2.0	102	09.01-10.02	F4R 701/F4R 700	4	<b>Z 193</b>	14 FR-7 DU2	0,9	<b>UXT 1<sup>3</sup></b>
2.0 16V	2.0	103	10.98-10.02	F4R 701/F4R 700	4	<b>Z 193</b>	14 FR-7 DU2	0,9	<b>UXT 1<sup>3</sup></b>
2.2 12V TD	2.2	83	11.96-10.00	G8T 714, 716, 760	4	<b>GN 999</b> (11V)	○		
2.2 D	2.2	84	11.97-01.00	G8T 716	4	<b>GN 999</b> (11V)	○		
2.2 dCi	2.2	85	07.00-10.02	G9T 710	4	<b>GN 026</b> (11V)	○		
2.2 dCi	2.2	95	10.00-10.02	G9T 710/G9T 642	4	<b>GN 026</b> (11V)	○		
3.0	3.0	123	11.96-10.98	Z7X 775	6	<b>Z 16</b>	14 FR-7 DUX	1,1	<b>UXT 1<sup>3</sup></b>
3.0 V6 24V	2.9	140	10.98-10.02	L7X 727	6	<b>Z 313</b>	14 FR-6 DPXU2	1,0	○

**ESPACE IV**

1.9 dCi	1.9	88	11.02-	F9Q 680/F9Q 820/F9Q 826	4	<b>GN 018</b> (11V)	○		
2.0 Turbo	2.0	120	11.02-	F4R 796/F4R 795/F4R 794/ F4R 797	4	<b>Z 337</b>	14 FR-7 DPPUW2	0,9	○
2.0	2.0	125	04.05-	F4R 897/F4R 796/F4R 896/ F4R 797	4	<b>Z 337</b>	14 FR-7 DPPUW2	0,9	○
2.2 dCi	2.2	102	02.06-	G9T 645	4	<b>GN 026</b> (11V)	○		
2.2 dCi	2.2	110	11.02-	G9T 742/G9T 743	4	<b>GN 026</b> (11V)	○		
3.0 dCi	3.0	130	11.02-	P9X 701	6	<b>GN 106</b> (11V)	○		
3.5 V6	3.5	177	11.02-	V4Y 715/V4Y 711	6	<b>Z 183</b>	14 FR-8 MU2	0,9	<b>UXT 13</b>

**FLUENCE**

1.5 dCi	1.5	63	02.10-	K9K 830	4	<b>GE 110</b> (4,4V)	○		
1.5 dCi	1.5	81	02.10-	K9K 836/K9K 837	4	<b>GE 110</b> (4,4V)	○		

**GRAND SCÉNIC II**

1.5 dCi	1.5	74	04.04-	K9K 728	4	<b>GN 018</b> (11V)	○		
1.6	1.6	77	06.06-	K4M 788	4	<b>Z 247</b>	14 FR-7 DUW	0,9	<b>UXT 1<sup>3</sup></b>
1.6	1.6	83	04.04-	K4M 761/K4M 782	4	<b>Z 193</b>	14 FR-7 DU2	0,9	<b>UXT 1<sup>3</sup></b>
1.9 dCi	1.9	81	05.05-	F9Q E 804	4	<b>GN 018</b> (11V)	○		

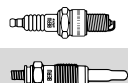

## RENAULT

### GRAND SCÉNIC II

1.9 dCi	1.9	88	04.04-	F9Q 812	4	<b>GN 018</b> (11V)	○		
1.9 dCi	1.9	96	05.05-	F9Q j803, F9QQ 816, 818	4	<b>GN 018</b> (11V)	○		
2.0	2.0	99	04.04-	F4R 771/F4R 770	4	<b>Z 193</b>	14 FR-7 DU2	0,9	<b>UXT 1<sup>3</sup></b>
2.0	2.0	120	04.04-	F4R 776	4	<b>Z 337</b>	14 FR-7 DPPUW2	0,9	○

### GRAND SCÉNIC III

1.4 16V	1.4	96	02.09-	H4J 700	4	<b>Z 274</b>	12 VR-6 MPPUS	0,7	○
1.5 dCi	1.5	63	04.09-	K9K 830	4	<b>GE 110</b> (4,4V)	○		
1.5 dCi	1.5	81	04.09-	K9K 836	4	<b>GE 110</b> (4,4V)	○		
1.9 dCi	1.9	96	02.09-	F9Q 870	4	<b>GE 111</b> (4,4V)	○		

### KANGOO

1.2	1.1	43	08.97-	D7F 710/D7F 744/D7F 722/ D7F 720/D7F 726/D7F 746	4	<b>Z 224</b>	14 FR-7 DPU3	0,9	<b>UXT 9</b>
1.2 16V	1.1	55	06.01-	D4F 714/D4F 716/D4F 712	4	<b>Z 243</b>	12 VR-8 SE	0,9	○
1.4	1.4	55	08.97-	K7J 700/701	4	<b>Z 14</b>	14 F-7 LDUR4	0,9	<b>UXT 1<sup>3</sup></b>
1.4	1.4	55	08.97-	E7J 634/635/780	4	<b>Z 247</b>	14 FR-7 DUW	0,9	<b>UXT 1<sup>3</sup></b>
1.5 dCi	1.5	42	07.03-	K9K 704	4	<b>GN 018</b> (11V)	○		
1.5 dCi	1.5	48	12.01-	K9K 704/K9K 700	4	<b>GN 018</b> (11V)	○		
1.5 dCi	1.5	50	06.05-	K9K 714	4	<b>GN 018</b> (11V)	○		
1.5 dCi	1.5	50	02.08-	K9K 800	4	<b>GN 018</b> (11V)	○		
1.5 dCi	1.5	60	07.02-	K9K 702/K9K 710	4	<b>GN 018</b> (11V)	○		
1.5 dCi	1.5	62	06.05-	K9K 718	4	<b>GN 018</b> (11V)	○		
1.5 dCi	1.5	63	02.08-	K9K 802	4	<b>GN 018</b> (11V)	○		
1.5 dCi	1.5	76	02.08-	K9K 804	4	<b>GN 018</b> (11V)	○		
1.6 16V	1.6	70	06.01-	K4M 750/K4M 753/K4M 752	4	<b>Z 193</b>	14 FR-7 DU2	0,9	<b>UXT 1<sup>3</sup></b>
1.6 16V 4x4	1.6	70	10.01-	K4M 750/K4M 753/K4M 752	4	<b>Z 193</b>	14 FR-7 DU2	0,9	<b>UXT 1<sup>3</sup></b>
1.9 D 55	1.9	40	08.97-02.99	F8Q 662	4	<b>GN 963</b> (11V)	○		
1.9 D 55	1.9	40	03.99-	F8Q 662	4	<b>GN 019</b> (11V)	○		
1.9 D 65	1.9	47	08.97-	F8Q 630	4	<b>GN 963</b> (11V)	○		
1.9 D 65	1.9	47	08.97-	F8Q 632	4	<b>GN 019</b> (11V)	○		
1.9 dCi 4x4	1.9	59	10.01-	F9Q 790/F9Q 782	4	<b>GN 018</b> (11V)	○		
1.9 dTi	1.9	59	02.00-	F9Q 780	4	<b>GN 018</b> (11V)	○		
1.9 dCi 4x4	1.9	62	10.03-	F9Q 790	4	<b>GN 018</b> (11V)	○		

### KANGOO Express

1.5 dCi 85	1.5	63	02.08-	K9K 802/K9K 800	4	<b>GN 018</b> (11V)	○		
------------	-----	----	--------	-----------------	---	---------------------	---	--	--

### KANGOO Rapid

1.2	1.1	43	08.97-	D7F 710/D7F 744/D7F 722/ D7F 720/D7F 726/D7F 746	4	<b>Z 224</b>	14 FR-7 DPU3	0,9	<b>UXT 9</b>
1.2 16V	1.1	55	10.01-	D4F 714/D4F 712/D4F 730	4	<b>Z 243</b>	12 VR-8 SE	0,9	○
1.4	1.4	55	08.97-	K7J 701	4	<b>Z 14</b>	14 F-7 LDUR4	0,9	<b>UXT 1<sup>3</sup></b>
1.4	1.4	55	08.97-	E7J 634/635/780	4	<b>Z 247</b>	14 FR-7 DUW	0,9	<b>UXT 1<sup>3</sup></b>
1.5 dCi	1.5	42	12.02-	K9K 704	4	<b>GN 018</b> (11V)	○		
1.5 dCi	1.5	48	12.01-	K9K 702/K9K 704/K9K 700	4	<b>GN 018</b> (11V)	○		
1.5 dCi	1.5	50	06.05-	K9K 714	4	<b>GN 018</b> (11V)	○		
1.5 dCi	1.5	60	04.03-	K9K 702/K9K 710	4	<b>GN 018</b> (11V)	○		
1.5 dCi	1.5	62	06.05-	K9K 718	4	<b>GN 018</b> (11V)	○		
1.6 16V	1.6	70	10.01-	K4M 752	4	<b>Z 193</b>	14 FR-7 DU2	0,9	<b>UXT 1<sup>3</sup></b>
1.6 16V 4x4	1.6	70	10.01-	K4M 750/K4M 753/K4M 752	4	<b>Z 193</b>	14 FR-7 DU2	0,9	<b>UXT 1<sup>3</sup></b>
1.9 D 55	1.9	40	08.97-02.99	F8Q 662	4	<b>GN 963</b> (11V)	○		
1.9 D 55	1.9	40	03.99-	F8Q 662	4	<b>GN 019</b> (11V)	○		
1.9 D 65	1.9	47	08.97-	F8Q 630	4	<b>GN 963</b> (11V)	○		
1.9 D 65	1.9	47	08.97-	F8Q 632	4	<b>GN 019</b> (11V)	○		
1.9 dTi	1.9	59	02.00-	F9Q 780	4	<b>GN 018</b> (11V)	○		
1.9 dCi 4x4	1.9	59	10.01-	F9Q 790/F9Q 782	4	<b>GN 018</b> (11V)	○		
1.9 dCi	1.9	62	07.03-	F9Q 790	4	<b>GN 018</b> (11V)	○		
1.9 dCi 4x4	1.9	62	07.03-	F9Q 790	4	<b>GN 018</b> (11V)	○		

### LAGUNA Coupe

2.0 16V Turbo	2.0	125	09.08-	F4Rt 811/F4R 811	4	<b>Z 337</b>	14 FR-7 DPPUW2	0,9	○
---------------	-----	-----	--------	------------------	---	--------------	----------------	-----	---

### LAGUNA Grandtour

1.6 16V	1.6	79	11.97-03.01	K4M 720	4	<b>Z 193</b>	14 FR-7 DU2	0,9	<b>UXT 1<sup>3</sup></b>
1.8	1.8	66	09.95-03.01	F3P 678/F3P 670	4	<b>Z 119</b>	14 R-8 DU4	0,8	<b>UXT 2<sup>4</sup></b>
1.8	1.8	69	09.95-03.01	F3P 720/F3P 724	4	<b>Z 119</b>	14 R-8 DU4	0,8	<b>UXT 2<sup>4</sup></b>

● nicht erforderlich  
○ nicht im Programm

<sup>3</sup> wahlweise UXT 3 Platin

<sup>4</sup> wahlweise UXT 6 Platin

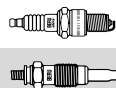
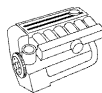

kW

**RENAULT****LAGUNA Grandtour**

1.8 16V	1.8	88	04.98-03.01	F4P 760	4	<b>Z 193</b>	14 FR-7 DU2	0,9	<b>UXT 1<sup>3</sup></b>
1.9 dTi	1.9	72	10.97-03.01	F9Q 716	4	<b>GN 999</b> (11V)	○		
1.9 dTi	1.9	72	10.97-03.01	F9Q 710	4	<b>GN 018</b> (11V)	○		
1.9 dCi	1.9	79	09.99-03.01	F9Q 718	4	<b>GN 018</b> (11V)	○		
2.0	2.0	83	09.95-03.01	F3R 722/F3R 723	4	<b>Z 119</b>	14 R-8 DU4	0,8	<b>UXT 2<sup>4</sup></b>
2.0	2.0	84	10.98-01.01	F3R 768	4	<b>Z 119</b>	14 R-8 DU4	0,8	<b>UXT 2<sup>4</sup></b>
2.0 16V	2.0	102	09.95-03.01	N7Q 700/704	4	<b>Z 204</b>	14 FGR-8 CTU	1,2	○
2.2 D	2.2	61	09.95-03.01	G8T 706/G8T 752/G8T 794/ G8T 790	4	<b>GN 999</b> (11V)	○		
2.2 dT	2.2	83	03.96-03.01	G8T 760	4	<b>GN 999</b> (11V)	○		
3.0	3.0	123	02.96-03.01	Z7X 765	6	<b>Z 60</b>	14 FGR-7 CTU	1,2	○
3.0 24V	3.0	140	03.97-03.01	L7X 700/L7X 701	6	<b>Z 123</b>	14 FR-7 KDU	1,0	<b>UXT 9</b>

**LAGUNA I**

1.6 16V	1.6	79	05.98-03.01	K4M 720	4	<b>Z 193</b>	14 FR-7 DU2	0,9	<b>UXT 1<sup>3</sup></b>
1.8	1.8	66	11.93-03.01	F3P 720/F3P 724	4	<b>Z 119</b>	14 R-8 DU4	0,8	<b>UXT 2<sup>4</sup></b>
1.8	1.8	66	08.95-03.01	F3P 678/F3P 670	4	<b>Z 119</b>	14 R-8 DU4	0,8	<b>UXT 2<sup>4</sup></b>
1.8	1.8	69	08.95-03.01	F3P 720/F3P 724	4	<b>Z 119</b>	14 R-8 DU4	0,8	<b>UXT 2<sup>4</sup></b>
1.8 16V	1.8	88	04.98-03.01	F4P 760	4	<b>Z 15</b>	14 FR-7 DU	0,8	<b>UXT 1<sup>3</sup></b>
1.9 dTi	1.9	72	10.97-03.01	F9Q 716	4	<b>GN 999</b> (11V)	○		
1.9 dTi	1.9	72	10.97-03.01	F9Q 710	4	<b>GN 018</b> (11V)	○		
1.9 dCi	1.9	79	09.99-03.01	F9Q 718	4	<b>GN 018</b> (11V)	○		
2.0	2.0	70	11.93-03.01		4	<b>Z 193</b>	14 FR-7 DU2	0,9	<b>UXT 1<sup>3</sup></b>
2.0	2.0	80	03.99-03.01	F3R 611	4	<b>Z 193</b>	14 FR-7 DU2	0,9	<b>UXT 1<sup>3</sup></b>
2.0	2.0	83	11.93-03.01	F3R 722/F3R 723	4	<b>Z 119</b>	14 R-8 DU4	0,8	<b>UXT 2<sup>4</sup></b>
2.0	2.0	84	06.95-02.01	F3R 768	4	<b>Z 119</b>	14 R-8 DU4	0,8	<b>UXT 2<sup>4</sup></b>
2.0 16V	2.0	102	06.95-03.01	N7Q 700/704	4	<b>Z 204</b>	14 FGR-8 CTU	1,2	○
2.0 16V	2.0	103	09.99-03.01	F4R 780	4	<b>Z 193</b>	14 FR-7 DU2	0,9	<b>UXT 1<sup>3</sup></b>
2.2 D	2.2	61	11.93-03.01	G8T 706/G8T 752/G8T 794/ G8T 790	4	<b>GN 999</b> (11V)	○		
2.2 dT	2.2	83	03.96-03.01	G8T 760	4	<b>GN 999</b> (11V)	○		
3.0	3.0	123	11.93-03.01	Z7X 765/Z7X 760	6	<b>Z 60</b>	14 FGR-7 CTU	1,2	○
3.0 24V	3.0	140	03.97-03.01	L7X 700/L7X 701	6	<b>Z 123</b>	14 FR-7 KDU	1,0	<b>UXT 9</b>

**LAGUNA II**

1.6 16V	1.6	79	03.01-	K4M 710	4	<b>Z 193</b>	14 FR-7 DU2	0,9	<b>UXT 1<sup>3</sup></b>
1.6 16V	1.6	82	02.05-	K4M 716	4	<b>Z 193</b>	14 FR-7 DU2	0,9	<b>UXT 1<sup>3</sup></b>
1.8 16V	1.8	85	03.01-	F4P 774/F4P 770/F4P 773/ F4P 771/F4P 775	4	<b>Z 193</b>	14 FR-7 DU2	0,9	<b>UXT 1<sup>3</sup></b>
1.8 16V	1.8	86	03.01-	F4P 774/F4P 770	4	<b>Z 193</b>	14 FR-7 DU2	0,9	<b>UXT 1<sup>3</sup></b>
1.8 16V	1.8	88	03.01-	F4P 770/773	4	<b>Z 193</b>	14 FR-7 DU2	0,9	<b>UXT 1<sup>3</sup></b>
1.8 16V	1.8	89	03.01-	F4P 774/F4P 772/F4P 770	4	<b>Z 193</b>	14 FR-7 DU2	0,9	<b>UXT 1<sup>3</sup></b>
1.9 dCi	1.9	68	03.04-	F9Q 664	4	<b>GN 018</b> (11V)	○		
1.9 dCi	1.9	74	10.01-	F9Q 754/F9Q 752	4	<b>GN 018</b> (11V)	○		
1.9 dCi	1.9	77	06.01-	F9Q 752	4	<b>GN 018</b> (11V)	○		
1.9 dCi	1.9	79	03.01-	F9Q 718/F9Q 754	4	<b>GN 018</b> (11V)	○		
1.9 dCi	1.9	81	01.05-	F9Q 674/F9Q 758	4	<b>GN 018</b> (11V)	○		
1.9 dCi	1.9	88	03.01-	F9Q 670/F9Q 674/F9Q 750	4	<b>GN 018</b> (11V)	○		
1.9 dCi	1.9	96	05.05-	F9Q 758/F9Q 759	4	<b>GN 018</b> (11V)	○		
2.0 16V	2.0	99	08.02-	F4R 713/F4R 715/F4R 712/ F4R 714	4	<b>Z 193</b>	14 FR-7 DU2	0,9	<b>UXT 1<sup>3</sup></b>
2.0 16V Turbo	2.0	120	01.03-	F4R 764/F4R 787/F4R 786/ F4R 765	4	<b>Z 337</b>	14 FR-7 DPPUW2	0,9	○
2.0 16V	2.0	125	01.05-	F4R 787/F4R 786/F4R 784	4	<b>Z 337</b>	14 FR-7 DPPUW2	0,9	○
2.0 16V	2.0	150	01.05-	F4R 887/F4R 886	4	<b>Z 337</b>	14 FR-7 DPPUW2	0,9	○
2.2 dCi	2.2	102	05.05-	G9T 707/G9T 600/G9T 706/ G9T 605	4	<b>GN 026</b> (11V)	○		
2.2 dCi	2.2	110	10.01-	G9T 700/G9T 702	4	<b>GN 026</b> (11V)	○		

**LAGUNA II Grandtour**

1.6 16V	1.6	79	03.01-	K4M 710	4	<b>Z 193</b>	14 FR-7 DU2	0,9	<b>UXT 1<sup>3</sup></b>
1.6 16V	1.6	82	02.05-	K4M 716	4	<b>Z 193</b>	14 FR-7 DU2	0,9	<b>UXT 1<sup>3</sup></b>
1.8 16V	1.8	85	03.01-	F4P 774/F4P 770/F4P 771/ F4P 775	4	<b>Z 193</b>	14 FR-7 DU2	0,9	<b>UXT 1<sup>3</sup></b>



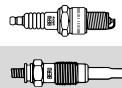

## RENAULT

### LAGUNA II Grandtour

1.8 16V	1.8	86	03.01-	F4P 770	4	<b>Z 193</b>	14 FR-7 DU2	0,9	<b>UXT 1<sup>3</sup></b>
1.8 16V	1.8	88	03.01-	F4P 770/773	4	<b>Z 193</b>	14 FR-7 DU2	0,9	<b>UXT 1<sup>3</sup></b>
1.8 16V	1.8	89	03.01-	F4P 774/F4P 770	4	<b>Z 193</b>	14 FR-7 DU2	0,9	<b>UXT 1<sup>3</sup></b>
1.9 dCi	1.9	68	03.04-	F9Q 664	4	<b>GN 018</b> (11V)	○		
1.9 dCi	1.9	74	10.01-	F9Q 754	4	<b>GN 018</b> (11V)	○		
1.9 dCi	1.9	77	06.01-	F9Q 752	4	<b>GN 018</b> (11V)	○		
1.9 dCi	1.9	79	03.01-	F9Q 718/F9Q 754	4	<b>GN 018</b> (11V)	○		
1.9 dCi	1.9	81	01.05-	F9Q 674/F9Q 758	4	<b>GN 018</b> (11V)	○		
1.9 dCi	1.9	88	03.01-	F9Q 670/F9Q 674/F9Q 750	4	<b>GN 018</b> (11V)	○		
1.9 dCi	1.9	96	05.05-	F9Q 758/F9Q 759	4	<b>GN 018</b> (11V)	○		
2.0 16V	2.0	99	08.02-	F4R 713/F4R 715/F4R 712/ F4R 714	4	<b>Z 193</b>	14 FR-7 DU2	0,9	<b>UXT 1<sup>3</sup></b>
2.0 16V Turbo	2.0	120	01.03-	F4R 764/F4R 787/F4R 786/ F4R 765	4	<b>Z 337</b>	14 FR-7 DPPUW2	0,9	○
2.0 16V	2.0	125	01.05-	F4R 787/F4R 786/F4R 784	4	<b>Z 337</b>	14 FR-7 DPPUW2	0,9	○
2.0 16V	2.0	150	01.05-	F4R 887/F4R 886	4	<b>Z 337</b>	14 FR-7 DPPUW2	0,9	○
2.2 dCi	2.2	102	05.05-	G9T 707/G9T 600/G9T 706	4	<b>GN 026</b> (11V)	○		
2.2 dCi	2.2	110	10.01-	G9T 702	4	<b>GN 026</b> (11V)	○		

### LAGUNA III

1.5 dCi	1.5	81	10.07-	K9K 780	4	<b>GN 018</b> (11V)	○		
2.0 16V	2.0	103	10.07-	M4R 704	4	<b>Z 325</b>	12 VR-7 SPUX	1,1	○
2.0 16V Hi-Flex	2.0	103	10.07-	M4R 726	4	<b>Z 325</b>	12 VR-7 SPUX	1,1	○
2.0 16V Turbo	2.0	125	10.07-	F4R 811	4	<b>Z 337</b>	14 FR-7 DPPUW2	0,9	○

### LAGUNA III Grandtour

1.5 dCi	1.5	81	10.07-	K9K 780	4	<b>GN 018</b> (11V)	○		
1.6 16V	1.6	81	10.07-	K4M 824	4	<b>Z 193</b>	14 FR-7 DU2	0,9	<b>UXT 1<sup>3</sup></b>
2.0 16V	2.0	103	10.07-	M4R 704	4	<b>Z 325</b>	12 VR-7 SPUX	1,1	○
2.0 16V Hi-Flex	2.0	103	10.07-	M4R 704/M4R 726	4	<b>Z 325</b>	12 VR-7 SPUX	1,1	○
2.0 16V Turbo	2.0	125	10.07-	F4R 811	4	<b>Z 337</b>	14 FR-7 DPPUW2	0,9	○

### LOGAN

1.4	1.4	55	09.04-	K7J 710	4	<b>Z 193</b>	14 FR-7 DU2	0,9	<b>UXT 1<sup>3</sup></b>
1.5 dCi	1.5	50	04.07-	K9K 792	4	<b>GN 018</b> (11V)	○		
1.5 dCi	1.5	63	02.08-	K9K 796	4	<b>GN 018</b> (11V)	○		
1.6	1.6	64	09.04-	K7M 710	4	<b>Z 98</b>	14 FR-7 LDU	0,8	<b>UXT 1<sup>3</sup></b>
1.6	1.6	77	04.07-	K4M 690	4	<b>Z 193</b>	14 FR-7 DU2	0,9	<b>UXT 1<sup>3</sup></b>

### LOGAN Kombi

1.4	1.4	55	10.07-	K7J 710	4	<b>Z 193</b>	14 FR-7 DU2	0,9	<b>UXT 1<sup>3</sup></b>
1.5 dCi	1.5	50	04.07-	K9K 792	4	<b>GN 018</b> (11V)	○		
1.5 dCi	1.5	63	02.08-	K9K 796	4	<b>GN 018</b> (11V)	○		
1.6	1.6	64	04.07-	K7M 710	4	<b>Z 98</b>	14 FR-7 LDU	0,8	<b>UXT 1<sup>3</sup></b>
1.6	1.6	77	04.07-	K4M 697	4	<b>Z 193</b>	14 FR-7 DU2	0,9	<b>UXT 1<sup>3</sup></b>

### MEGANE CC

1.4 TCe	1.4	96	06.10-	H4J 700	4	<b>Z 274</b>	12 VR-6 MPPUS	0,7	○
1.5 dCi	1.5	81	06.10-	K9K 836	4	<b>GE 110</b> (4,4V)	○		
2.0 TCe	2.0	132	06.10-	F4R 870/F4R 872	4	<b>Z 337</b>	14 FR-7 DPPUW2	0,9	○

### MEGANE I

1.4 Eco	1.4	52	01.96-03.99	E7J 624	4	<b>Z 193</b>	14 FR-7 DU2	0,9	<b>UXT 1<sup>3</sup></b>
1.4 e	1.4	55	01.96-	E7J 626/E7J 764	4	<b>Z 193</b>	14 FR-7 DU2	0,9	<b>UXT 1<sup>3</sup></b>
1.4 16V	1.4	70	03.99-	K4J 714/K4J 750	4	<b>Z 193</b>	14 FR-7 DU2	0,9	<b>UXT 1<sup>3</sup></b>
1.6 i	1.6	55	01.96-03.99	K7M 720	4	<b>Z 193</b>	14 FR-7 DU2	0,9	<b>UXT 1<sup>3</sup></b>
1.6 e	1.6	66	01.96-03.99	K7M 702/703/790	4	<b>Z 193</b>	14 FR-7 DU2	0,9	<b>UXT 1<sup>3</sup></b>
1.6 16V	1.6	79	03.99-	K4M 704/K4M 700/K4M 708/ K4M 701	4	<b>Z 193</b>	14 FR-7 DU2	0,9	<b>UXT 1<sup>3</sup></b>
1.8 16V	1.8	85	01.01-	F4P 720/722	4	<b>Z 193</b>	14 FR-7 DU2	0,9	<b>UXT 1<sup>3</sup></b>
1.9 D Eco	1.9	47	01.96-	F8Q 620/F8Q 624	4	<b>GN 991</b> (11V)	○		
1.9 dTi	1.9	59	02.01-	F9Q 744	4	<b>GN 018</b> (11V)	○		
1.9 dT	1.9	66	01.96-	F8Q 786/F8Q 784	4	<b>GN 959</b> (11V)	○		
1.9 TDI	1.9	69	09.96-	F8Q 784	4	<b>GN 959</b> (11V)	○		
1.9 dTi	1.9	72	03.97-02.01	F9Q 730, F9Q 734	4	<b>GN 999</b> (11V)	○		
1.9 dTi	1.9	72	03.97-02.01	F9Q-731, F9Q-736	4	<b>GN 018</b> (11V)	○		



kW

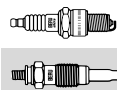

**RENAULT**

**MEGANE I**

1.9 dCi	1.9	75	02.01-	F9Q 733/F9Q 732	4	<b>GN 018</b> (11V)	○		
2.0 i	2.0	80	03.99-	F3R 751/F3R 750	4	<b>Z 193</b>	14 FR-7 DU2	0,9	<b>UXT 1<sup>3</sup></b>
2.0 i	2.0	84	01.96-	F3R 751/F3R 750	4	<b>Z 119</b>	14 R-8 DU4	0,8	<b>UXT 2<sup>4</sup></b>
2.0 16V	2.0	108	07.96-	F7R 710/F7R 714	4	<b>Z 60</b>	14 FGR-7 CTU	1,2	○

**MEGANE I Cabriolet**

1.4 16V	1.4	70	03.99-	K4J 714/K4J 750	4	<b>Z 193</b>	14 FR-7 DU2	0,9	<b>UXT 1<sup>3</sup></b>
1.6 e	1.6	66	10.96-03.99	K7M 702/703	4	<b>Z 193</b>	14 FR-7 DU2	0,9	<b>UXT 1<sup>3</sup></b>
1.6 16V	1.6	79	03.99-	K4M 700/K4M 708/K4M 701	4	<b>Z 193</b>	14 FR-7 DU2	0,9	<b>UXT 1<sup>3</sup></b>
2.0 i	2.0	80	03.99-	F3R 791/F3R 796	4	<b>Z 119</b>	14 R-8 DU4	0,8	<b>UXT 2<sup>4</sup></b>
2.0	2.0	84	04.97-	F3R 750	4	<b>Z 119</b>	14 R-8 DU4	0,8	<b>UXT 2<sup>4</sup></b>
2.0 16V	2.0	102	01.02-	F4R 746/F4R 770	4	<b>Z 193</b>	14 FR-7 DU2	0,9	<b>UXT 1<sup>3</sup></b>
2.0 16V	2.0	108	10.96-11.99	F7R 710/F7R 714	4	<b>Z 60</b>	14 FGR-7 CTU	1,2	○

**MEGANE I Classic**

1.4	1.4	55	09.96-	E7J 764	4	<b>Z 63</b>	14 F-7 DU	0,8	<b>UXT 1<sup>3</sup></b>
1.4	1.4	55	09.96-	E7J 626	4	<b>Z 193</b>	14 FR-7 DU2	0,9	<b>UXT 1<sup>3</sup></b>
1.4 16V	1.4	70	03.99-	K4J 714/K4J 750	4	<b>Z 193</b>	14 FR-7 DU2	0,9	<b>UXT 1<sup>3</sup></b>
1.6 i	1.6	55	09.96-03.99	K7M 720	4	<b>Z 193</b>	14 FR-7 DU2	0,9	<b>UXT 1<sup>3</sup></b>
1.6 e	1.6	66	09.96-03.99	K7M 702/703/790	4	<b>Z 193</b>	14 FR-7 DU2	0,9	<b>UXT 1<sup>3</sup></b>
1.6 16V	1.6	79	03.99-	K4M 700/K4M 708/K4M 701	4	<b>Z 193</b>	14 FR-7 DU2	0,9	<b>UXT 1<sup>3</sup></b>
1.8 16V	1.8	85	01.01-	F4P 720/722	4	<b>Z 193</b>	14 FR-7 DU2	0,9	<b>UXT 1<sup>3</sup></b>
1.9 D	1.9	47	09.96-	F8Q 620/F8Q 624	4	<b>GN 991</b> (11V)	○		
1.9 dCi	1.9	75	02.01-	F9Q 732, F9Q 733	4	<b>GN 018</b> (11V)	○		
1.9 dTi	1.9	59	02.01-	F9Q 744	4	<b>GN 018</b> (11V)	○		
1.9 dT	1.9	66	09.96-	F8Q 786/F8Q 784	4	<b>GN 959</b> (11V)	○		
1.9 TDI	1.9	69	09.96-	F8Q 784	4	<b>GN 959</b> (11V)	○		
				Kühlwasservorwärmung <sup>15</sup> M 4		<b>GN 984</b> (12V)=3x			
1.9 dTi	1.9	72	03.97-02.01	F9Q 730, F9Q 734	4	<b>GN 999</b> (11V)	○		
1.9 dTi	1.9	72	03.97-02.01	F9Q 731, F9Q 736	4	<b>GN 018</b> (11V)	○		
2.0 i	2.0	80	03.99-	F3R 750/751/752/791/796/797/798	4	<b>Z 193</b>	14 FR-7 DU2	0,9	<b>UXT 1<sup>3</sup></b>
2.0 i	2.0	84	09.96-04.97	F3R 750/751/752/791/796/797/798	4	<b>Z 119</b>	14 R-8 DU4	0,8	<b>UXT 2<sup>4</sup></b>

**MEGANE I Coach**

1.4 16V	1.4	70	03.99-08.03	K4J 714/K4J 750	4	<b>Z 193</b>	14 FR-7 DU2	0,9	<b>UXT 1<sup>3</sup></b>
1.6 e	1.6	66	03.96-03.99	K7M 702/703	4	<b>Z 193</b>	14 FR-7 DU2	0,9	<b>UXT 1<sup>3</sup></b>
1.6 16V	1.6	79	03.99-08.03	K4M 700/K4M 708/K4M 701	4	<b>Z 193</b>	14 FR-7 DU2	0,9	<b>UXT 1<sup>3</sup></b>
1.9 dTi	1.9	72	03.97-02.01	F9Q 734	4	<b>GN 999</b> (11V)	○		
1.9 dTi	1.9	72	03.97-02.01	F9Q 731, F9Q 736	4	<b>GN 018</b> (11V)	○		
1.9 dCi	1.9	75	02.01-08.03	F9Q 732, F9Q 733	4	<b>GN 018</b> (11V)	○		
2.0 i	2.0	80	03.99-08.03	F3R 791/F3R 796	4	<b>Z 193</b>	14 FR-7 DU2	0,9	<b>UXT 1<sup>3</sup></b>
2.0 i	2.0	84	03.96-08.03	F3R 751/F3R 750	4	<b>Z 119</b>	14 R-8 DU4	0,8	<b>UXT 2<sup>4</sup></b>
2.0 16V	2.0	108	03.96-11.99	F7R 710/F7R 714	4	<b>Z 60</b>	14 FGR-7 CTU	1,2	○

**MEGANE I Grandtour**

1.4 e	1.4	55	03.99-	E7J 626	4	<b>Z 193</b>	14 FR-7 DU2	0,9	<b>UXT 1<sup>3</sup></b>
1.4 16V	1.4	70	03.99-	K4J 714/K4J 750	4	<b>Z 193</b>	14 FR-7 DU2	0,9	<b>UXT 1<sup>3</sup></b>
1.6 e	1.6	66	03.99-	K7M 702/703	4	<b>Z 193</b>	14 FR-7 DU2	0,9	<b>UXT 1<sup>3</sup></b>
1.6 16V	1.6	79	03.99-	K4M 704/K4M 700/K4M 708/ K4M 701	4	<b>Z 193</b>	14 FR-7 DU2	0,9	<b>UXT 1<sup>3</sup></b>
1.8 16V	1.8	85	01.01-	F4P 722/F4P 720	4	<b>Z 193</b>	14 FR-7 DU2	0,9	<b>UXT 1<sup>3</sup></b>
1.9 D	1.9	47	04.99-	F8Q 622/F8Q 790	4	<b>GN 019</b> (11V)	○		
1.9 dTi	1.9	59	02.01-	F9Q 744	4	<b>GN 018</b> (11V)	○		
1.9 dTi	1.9	72	03.99-02.01	F9Q 731, F9Q 736	4	<b>GN 018</b> (11V)	○		
1.9 dCi	1.9	75	02.01-	F9Q 732, F9Q 733	4	<b>GN 018</b> (11V)	○		

**MEGANE II**

1.4	1.4	60	09.03-	K4J 732	4	<b>Z 193</b>	14 FR-7 DU2	0,9	<b>UXT 1<sup>3</sup></b>
1.4 16V	1.4	60	10.03-	K4J 732	4	<b>Z 193</b>	14 FR-7 DU2	0,9	<b>UXT 1<sup>3</sup></b>
1.4	1.4	72	09.03-	K4J 740/K4J 730	4	<b>Z 193</b>	14 FR-7 DU2	0,9	<b>UXT 1<sup>3</sup></b>
1.4 16V	1.4	72	11.02-	K4J 740/K4J 730	4	<b>Z 193</b>	14 FR-7 DU2	0,9	<b>UXT 1<sup>3</sup></b>
1.5 dCi	1.5	60	11.02-	K9K 722	4	<b>GN 018</b> (11V)	○		
1.5 dCi	1.5	63	05.05-	K9K 724	4	<b>GN 018</b> (11V)	○		
1.5 dCi	1.5	74	10.03-	K9K 729/K9K 728	4	<b>GN 018</b> (11V)	○		

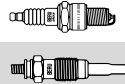
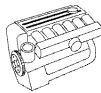

## RENAULT MEGANE II

1.5 dCi	1.5	76	01.07-	K9K 734	4	<b>GN 018</b> (11V)	○		
1.5 dCi	1.5	78	05.05-	K9K 734/K9K 732	4	<b>GN 018</b> (11V)	○		
1.6	1.6	77	06.05-	K4M 788	4	<b>Z 247</b>	14 FR-7 DUW	0,9	<b>UXT 1<sup>3</sup></b>
1.6 16V	1.6	82	01.06-	K4M 812/K4M 760/K4M 813	4	<b>Z 193</b>	14 FR-7 DU2	0,9	<b>UXT 1<sup>3</sup></b>
1.6 16V	1.6	82	01.06-	K4M D 812	4	<b>Z 193</b>	14 FR-7 DU2	0,9	<b>UXT 1<sup>3</sup></b>
1.6	1.6	83	11.02-	K4M 760/K4M 761	4	<b>Z 193</b>	14 FR-7 DU2	0,9	<b>UXT 1<sup>3</sup></b>
1.9 dCi	1.9	66	11.02-12.05	F9Q 808	4	<b>GN 018</b> (11V)	○		
1.9 dCi	1.9	68	03.04-	F9Q 808	4	<b>GN 018</b> (11V)	○		
1.9 dCi	1.9	81	05.05-	F9Q 818/F9Q 803/F9Q 816/ F9Q 804	4	<b>GN 018</b> (11V)	○		
1.9 dCi	1.9	85	11.02-	F9Q 818/F9Q 816/F9Q 804	4	<b>GN 018</b> (11V)	○		
1.9 dCi	1.9	88	11.02-	F9Q 800	4	<b>GN 018</b> (11V)	○		
1.9 dCi	1.9	96	05.05-	F9Q 803/F9Q 816	4	<b>GN 018</b> (11V)	○		
2.0	2.0	99	11.02-	F4R 771/F4R 770	4	<b>Z 193</b>	14 FR-7 DU2	0,9	<b>UXT 1<sup>3</sup></b>
2.0 16V Turbo	2.0	120	05.04-	F4R 776	4	<b>Z 337</b>	14 FR-7 DPPUW2	0,9	○
2.0 Renault Sport	2.0	165	05.04-	F4R 774/F4Rt 774	4	<b>Z 206</b>	14 FR-7 DPPUS2	0,7	<b>UXT 10</b>
2.0	2.0	169	08.06-	F4R 774	4	<b>Z 206</b>	14 FR-7 DPPUS2	0,7	<b>UXT 10</b>

## MEGANE II Coupé-Cabriolet

1.5 dCi	1.5	76	01.07-	K9K 734	4	<b>GN 018</b> (11V)	○		
1.5 dCi	1.5	78	03.06-	K9K 732	4	<b>GN 018</b> (11V)	○		
1.6	1.6	77	06.05-	K4M 788	4	<b>Z 247</b>	14 FR-7 DUW	0,9	<b>UXT 1<sup>3</sup></b>
1.6 16V	1.6	82	01.06-	K4M C 813/K4M 812/K4M 760/ K4M 761/K4M 813/K4M D 812	4	<b>Z 193</b>	14 FR-7 DU2	0,9	<b>UXT 1<sup>3</sup></b>
1.6	1.6	83	09.03-	K4M 760/K4M 761	4	<b>Z 193</b>	14 FR-7 DU2	0,9	<b>UXT 1<sup>3</sup></b>
1.9 dCi	1.9	81	05.05-	F9Q 818/F9Q 816/F9Q 804	4	<b>GN 018</b> (11V)	○		
1.9 dCi	1.9	85	09.03-	F9Q 818/F9Q 816/F9Q 804	4	<b>GN 018</b> (11V)	○		
1.9 dCi	1.9	88	09.03-	F9Q 800	4	<b>GN 018</b> (11V)	○		
1.9 dCi	1.9	96	05.05-	F9Q 803	4	<b>GN 018</b> (11V)	○		
2.0	2.0	99	09.03-	F4R 771/F4R 770	4	<b>Z 193</b>	14 FR-7 DU2	0,9	<b>UXT 1<sup>3</sup></b>
2.0 16V Turbo	2.0	120	05.04-	F4R 776	4	<b>Z 337</b>	14 FR-7 DPPUW2	0,9	○

## MEGANE II Grandtour

1.4	1.4	72	08.03-	K4J 740/K4J 730	4	<b>Z 193</b>	14 FR-7 DU2	0,9	<b>UXT 1<sup>3</sup></b>
1.5 dCi	1.5	60	08.03-	K9K 722	4	<b>GN 018</b> (11V)	○		
1.5 dCi	1.5	63	05.05-	K9K 724	4	<b>GN 018</b> (11V)	○		
1.5 dCi	1.5	74	02.04-	K9K 729/K9K 728	4	<b>GN 018</b> (11V)	○		
1.5 dCi	1.5	76	01.07-	K9K 728	4	<b>GN 018</b> (11V)	○		
1.5 dCi	1.5	78	05.05-	K9K 734/K9K 732	4	<b>GN 018</b> (11V)	○		
1.6 16V	1.6	82	01.06-	K4M 812/K4M 760/K4M 761/ K4M 813/K4M D 812	4	<b>Z 193</b>	14 FR-7 DU2	0,9	<b>UXT 1<sup>3</sup></b>
1.6	1.6	83	08.03-	K4M 760/K4M 761	4	<b>Z 193</b>	14 FR-7 DU2	0,9	<b>UXT 1<sup>3</sup></b>
1.9 dCi	1.9	66	04.04-12.05	F9Q 808	4	<b>GN 018</b> (11V)	○		
1.9 dCi	1.9	68	03.04-	F9Q 808	4	<b>GN 018</b> (11V)	○		
1.9 dCi	1.9	81	05.05-	F9Q 818/F9Q 804	4	<b>GN 018</b> (11V)	○		
1.9 dCi	1.9	85	05.05-	F9Q 818	4	<b>GN 018</b> (11V)	○		
1.9 dCi	1.9	88	08.03-	F9Q 800	4	<b>GN 018</b> (11V)	○		
1.9 dCi	1.9	96	05.05-	F9Q 803/F9Q 804	4	<b>GN 018</b> (11V)	○		
2.0	2.0	99	08.03-	F4R 771/F4R 770	4	<b>Z 193</b>	14 FR-7 DU2	0,9	<b>UXT 1<sup>3</sup></b>

## MEGANE III

1.4 Tce	1.4	96	04.09-	H4J 700	4	<b>Z 274</b>	12 VR-6 MPPUS	0,7	○
1.5 dCi	1.5	63	12.09-	K9K 830	4	<b>GE 110</b> (4,4V)	○		
1.5 dCi	1.5	66	11.08-	K9K H 834	4	<b>GE 110</b> (4,4V)	○		
1.5 dCi	1.5	81	02.09-	K9K 836	4	<b>GE 110</b> (4,4V)	○		
1.6 16V	1.6	74	11.08-	K4M 848	4	<b>Z 193</b>	14 FR-7 DU2	0,9	<b>UXT 1<sup>3</sup></b>
1.6 16V	1.6	81	11.08-	K4M 858	4	<b>Z 193</b>	14 FR-7 DU2	0,9	<b>UXT 1<sup>3</sup></b>
1.9 dCi	1.9	96	11.08-	F9Q 872/F9Q 870	4	<b>GE 111</b> (4,4V)	○		
2.0 Tce	2.0	132	11.08-	F4R 870	4	<b>Z 337</b>	14 FR-7 DPPUW2	0,9	○

## MEGANE III Coupe

1.4 Tce	1.4	96	04.09-	H4J 700	4	<b>Z 274</b>	12 VR-6 MPPUS	0,7	○
1.5 dCi	1.5	66	11.08-	K9K H 834	4	<b>GE 110</b> (4,4V)	○		
1.5 dCi	1.5	78	02.09-	K9K G 832	4	<b>GE 110</b> (4,4V)	○		
1.5 dCi	1.5	81	02.09-	K9K J 836	4	<b>GE 110</b> (4,4V)	○		



kW



## RENAULT

### MEGANE III Coupe

1.6 16V	1.6	74	11.08-	K4M P 848	4	<b>Z 193</b>	14 FR-7 DU2	0,9	<b>UXT 1<sup>3</sup></b>
1.6 16V	1.6	81	11.08-	K4M 858	4	<b>Z 193</b>	14 FR-7 DU2	0,9	<b>UXT 1<sup>3</sup></b>
1.9 dCi	1.9	96	11.08-	F9Q 872/F9Q 870	4	<b>GE 111</b> (4,4V)	○		
2.0 TCe	2.0	132	11.08-	F4R 870	4	<b>Z 337</b>	14 FR-7 DPPUW2	0,9	○

### MEGANE III Grandtour

1.4 TCe	1.4	96	05.09-	H4J 700	4	<b>Z 274</b>	12 VR-6 MPPUS	0,7	○
1.5 dCi	1.5	66	05.09-	K9K 834	4	<b>GE 110</b> (4,4V)	○		
1.5 dCi	1.5	78	02.09-	K9K 836/K9K 846	4	<b>GE 110</b> (4,4V)	○		
1.5 dCi	1.5	81	02.09-	K9K 836/K9K 837/K9K 846	4	<b>GE 110</b> (4,4V)	○		
1.6 16V	1.6	74	05.09-	K4M 848	4	<b>Z 193</b>	14 FR-7 DU2	0,9	<b>UXT 1<sup>3</sup></b>
1.6 16V	1.6	81	05.09-	K4M 858	4	<b>Z 193</b>	14 FR-7 DU2	0,9	<b>UXT 1<sup>3</sup></b>
1.9 dCi	1.9	96	05.09-	F9Q 872/F9Q 870	4	<b>GE 111</b> (4,4V)	○		
2.0 TCe	2.0	132	11.08-	F4R 870/F4R 872	4	<b>Z 337</b>	14 FR-7 DPPUW2	0,9	○

### MEGANE Scenic

1.4 i	1.4	55	01.97-09.99	E7J 764	4	<b>Z 193</b>	14 FR-7 DU2	0,9	<b>UXT 1<sup>3</sup></b>
1.6 i	1.6	55	01.97-09.99	K7M 720	4	<b>Z 193</b>	14 FR-7 DU2	0,9	<b>UXT 1<sup>3</sup></b>
1.6 e	1.6	66	01.97-09.99	K7M 702, 703 → Mot.Nr. 981015	4	<b>Z 247</b>	14 FR-7 DUW	0,9	<b>UXT 1<sup>3</sup></b>
1.6 e	1.6	66	01.97-09.99	K7M 702, 703 Mot.Nr. 981016 →	4	<b>Z 193</b>	14 FR-7 DU2	0,9	<b>UXT 1<sup>3</sup></b>
1.6 16V	1.6	79	04.98-10.99	K4M 704/K4M 700/K4M 708/ K4M 701	4	<b>Z 193</b>	14 FR-7 DU2	0,9	<b>UXT 1<sup>3</sup></b>
1.9 D	1.9	47	03.97-09.99	F8Q 790	4	<b>GN 019</b> (11V)	○		
1.9 dT	1.9	66	01.97-09.99	F8Q 786/F8Q 784	4	<b>GN 959</b> (11V)	○		
1.9 dTi	1.9	72	04.97-09.99	F9Q 730, F9Q 734	4	<b>GN 999</b> (11V)	○		
2.0 i	2.0	80	01.99-09.99	F3R 796	4	<b>Z 119</b>	14 R-8 DU4	0,8	<b>UXT 2<sup>4</sup></b>
2.0 i	2.0	84	01.97-09.99	F3R 751/F3R 750	4	<b>Z 119</b>	14 R-8 DU4	0,8	<b>UXT 2<sup>4</sup></b>

### MODUS

1.2	1.1	55	12.04-	D4F 740	4	<b>Z 243</b>	12 VR-8 SE	0,9	○
1.2 16V	1.1	74	05.07-	D4F 784	4	<b>Z 274</b>	12 VR-6 MPPUS	0,7	○
1.4	1.4	72	12.04-	K4J 770	4	<b>Z 193</b>	14 FR-7 DU2	0,9	<b>UXT 1<sup>3</sup></b>
1.5 dCi	1.5	50	12.04-	K9K 768/K9K 762	4	<b>GN 018</b> (11V)	○		
1.5 dCi 75	1.5	55	10.10-	K9K 770	4	<b>GN 018</b> (11V)	○		
1.5 dCi	1.5	60	09.04-	K9K 750	4	<b>GN 018</b> (11V)	○		
1.5 dCi	1.5	63	12.04-	K9K 766/K9K 760	4	<b>GN 018</b> (11V)	○		
1.5 dCi 90	1.5	65	10.10-	K9K 750	4	<b>GN 018</b> (11V)	○		
1.5 dCi	1.5	76	05.07-	K9K 772	4	<b>GN 018</b> (11V)	○		
1.5 dCi	1.5	78	05.05-	K9K 764	4	<b>GN 018</b> (11V)	○		
1.6	1.6	65	12.04-	K4M 794	4	<b>Z 193</b>	14 FR-7 DU2	0,9	<b>UXT 1<sup>3</sup></b>
1.6	1.6	82	12.04-	K4M 790/K4M 800/K4M 801/ K4M 791	4	<b>Z 193</b>	14 FR-7 DU2	0,9	<b>UXT 1<sup>3</sup></b>

### PULSE

1.5	1.5	47	01.12-	K9K 740	4	<b>GN 018</b> (11V)	○		
-----	-----	----	--------	---------	---	---------------------	---	--	--

### R 4

1.0	1.0	25	06.87-06.93	C1C 708	4	<b>Z 10</b>	14-7 BU	0,8	○
-----	-----	----	-------------	---------	---	-------------	---------	-----	---

### R 19 I

1.2	1.2	40	01.88-12.92	C1G 730	4	<b>Z 1</b>	14-8 DU	0,8	<b>UXT 2<sup>4</sup></b>
1.4 KAT	1.4	43	01.89-04.92	C3J 710	4	<b>Z 82</b>	14 R-9 DU	0,7	<b>UXT 2<sup>4</sup></b>
1.4	1.4	59	01.88-12.92	E6J 701/E6J 700	4	<b>Z 63</b>	14 F-7 DU	0,8	<b>UXT 1<sup>3</sup></b>
1.7	1.7	54	09.88-04.92	F3N 741/F3N 740	4	<b>Z 20</b>	14 R-7 DU	0,8	<b>UXT 2<sup>4</sup></b>
1.7	1.7	66	09.88-04.92	F3N 743/F3N 742	4	<b>Z 20</b>	14 R-7 DU	0,8	<b>UXT 2<sup>4</sup></b>
1.8 16V	1.8	99	06.89-04.92	F7P 704	4	<b>Z 24</b>	14 FR-6 DU	0,8	<b>UXT 5</b>
1.9 D	1.9	47	09.88-02.91	F8Q 706/F8Q 742	4	<b>GV 642</b> (11V)	○		
1.9 D	1.9	47	03.91-04.92	F8Q 706/F8Q 742	4	<b>GV 852</b> (11V)	<b>GR 067</b>		

### R 19 I Cabriolet

1.7	1.7	70	07.91-04.92	F3N 743/F3N 742	4	<b>Z 27</b>	14 R-6 DU	0,8	<b>UX 56</b>
1.8 16V	1.8	101	07.91-04.92	F7P 704	4	<b>Z 24</b>	14 FR-6 DU	0,8	<b>UXT 5</b>

### R 19 I Chamade

1.2	1.2	40	01.88-12.92	C1G 730	4	<b>Z 1</b>	14-8 DU	0,8	<b>UXT 2<sup>4</sup></b>
1.4	1.4	43	07.88-04.92	C3J 710/C2J 772	4	<b>Z 82</b>	14 R-9 DU	0,7	<b>UXT 2<sup>4</sup></b>
1.7	1.7	54	10.89-04.92	F3N 741/F3N 740	4	<b>Z 20</b>	14 R-7 DU	0,8	<b>UXT 2<sup>4</sup></b>

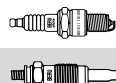

## RENAULT

### R 19 I Chamade

1.7	1.7	66	07.88-04.92	F3N 743/F3N 742	4	<b>Z 20</b>	14 R-7 DU	0,8	<b>UXT 2<sup>4</sup></b>
1.7	1.7	68	09.88-12.92	F2N 720/F2N 721	4	<b>Z 27</b>	14 R-6 DU	0,8	<b>UX 56</b>
1.7	1.7	79	08.88-12.92	F3N 746	4	<b>Z 20</b>	14 R-7 DU	0,8	<b>UXT 2<sup>4</sup></b>
1.8 16V	1.8	99	10.89-04.92	F7P 704	4	<b>Z 24</b>	14 FR-6 DU	0,8	<b>UXT 5</b>
1.9 D	1.9	47	10.89-02.91	F8Q 706/F8Q 742	4	<b>GV 642</b> (11V)	○		
1.9 D	1.9	47	03.91-04.92	F8Q 706/F8Q 742	4	<b>GV 852</b> (11V)	<b>GR 067</b>		
1.9 TD	1.9	68	09.90-04.92	F8Q 740	4	<b>GV 844</b> (11V)	○		

### R 19 II

1.2	1.2	40	04.92-12.95	C1G 730	4	<b>Z 1</b>	14-8 DU	0,8	<b>UXT 2<sup>4</sup></b>
1.4	1.4	43	04.92-12.95	C3J 710	4	<b>Z 82</b>	14 R-9 DU	0,7	<b>UXT 2<sup>4</sup></b>
1.4	1.4	55	01.92-12.95	E7J 742	4	<b>Z 247</b>	14 FR-7 DUW	0,9	<b>UXT 1<sup>3</sup></b>
1.4	1.4	59	01.92-12.95	E7J 706/E6J 700	4	<b>Z 63</b>	14 F-7 DU	0,8	<b>UXT 1<sup>3</sup></b>
1.7	1.7	54	04.92-12.95	F3N 741/F3N 740	4	<b>Z 20</b>	14 R-7 DU	0,8	<b>UXT 2<sup>4</sup></b>
1.7	1.7	66	04.92-12.95	F3N 743	4	<b>Z 20</b>	14 R-7 DU	0,8	<b>UXT 2<sup>4</sup></b>
1.8	1.8	65	04.92-12.95	F3P 706/F3P 707/F3P 760/ F3P 708	4	<b>Z 20</b>	14 R-7 DU	0,8	<b>UXT 2<sup>4</sup></b>
1.8	1.8	66	04.92-12.95	F3P 706/F3P 760	4	<b>Z 20</b>	14 R-7 DU	0,8	<b>UXT 2<sup>4</sup></b>
1.8	1.8	79	05.94-12.95	F3P 765/F3P 682	4	<b>Z 20</b>	14 R-7 DU	0,8	<b>UXT 2<sup>4</sup></b>
1.8	1.8	81	04.92-05.94	F3P 700	4	<b>Z 20</b>	14 R-7 DU	0,8	<b>UXT 2<sup>4</sup></b>
1.8 16V	1.8	99	04.92-12.95	F7P 704	4	<b>Z 24</b>	14 FR-6 DU	0,8	<b>UXT 5</b>
1.9 D	1.9	47	04.92-12.95	F8Q 742	4	<b>GV 852</b> (11V)	<b>GR 067</b>		
1.9 dT	1.9	66	04.92-12.95	F8Q 744	4	<b>GV 844</b> (11V)	○		

### R 19 II Cabriolet

1.7	1.7	66	04.92-09.93	F3N 743/F3N 742	4	<b>Z 20</b>	14 R-7 DU	0,8	<b>UXT 2<sup>4</sup></b>
1.8	1.8	66	09.93-06.96	F3P 706/F3P 760	4	<b>Z 20</b>	14 R-7 DU	0,8	<b>UXT 2<sup>4</sup></b>
1.8	1.8	65	04.92-06.96	F3P 704/705/706/707/708/ 760	4	<b>Z 20</b>	14 R-7 DU	0,8	<b>UXT 2<sup>4</sup></b>
1.8	1.8	79	07.94-06.96	F3P 765/F3P 682/F3P 764	4	<b>Z 20</b>	14 R-7 DU	0,8	<b>UXT 2<sup>4</sup></b>
1.8 16V	1.8	99	04.92-06.96	F7P 704	4	<b>Z 24</b>	14 FR-6 DU	0,8	<b>UXT 5</b>

### R 19 II Chamade

1.4	1.4	43	04.92-12.95	C3J 710	4	<b>Z 82</b>	14 R-9 DU	0,7	<b>UXT 2<sup>4</sup></b>
1.4	1.4	55	11.93-12.95	E7J 742	4	<b>Z 247</b>	14 FR-7 DUW	0,9	<b>UXT 1<sup>3</sup></b>
1.7	1.7	54	04.92-12.95	F3N 741/F3N 740	4	<b>Z 20</b>	14 R-7 DU	0,8	<b>UXT 2<sup>4</sup></b>
1.7	1.7	66	04.92-12.95	F3N 743/F3N 742	4	<b>Z 20</b>	14 R-7 DU	0,8	<b>UXT 2<sup>4</sup></b>
1.7	1.7	68	01.93-08.95	F2N 720/F2N 721	4	<b>Z 27</b>	14 R-6 DU	0,8	<b>UX 56</b>
1.8	1.8	65	04.92-12.95	F3P 704/706/708/760	4	<b>Z 1</b>	14-8 DU	0,8	<b>UXT 2<sup>4</sup></b>
1.8	1.8	66	04.92-12.95	F3P 706/F3P 760	4	<b>Z 20</b>	14 R-7 DU	0,8	<b>UXT 2<sup>4</sup></b>
1.8	1.8	79	05.94-12.95	F3P 682	4	<b>Z 20</b>	14 R-7 DU	0,8	<b>UXT 2<sup>4</sup></b>
1.8	1.8	81	04.92-05.94	F3P 700	4	<b>Z 20</b>	14 R-7 DU	0,8	<b>UXT 2<sup>4</sup></b>
1.8 16V	1.8	99	04.92-12.95	F7P 704	4	<b>Z 24</b>	14 FR-6 DU	0,8	<b>UXT 5</b>
1.9 D	1.9	47	04.92-12.95	F8Q 742	4	<b>GV 852</b> (11V)	<b>GR 067</b>		
1.9 dT	1.9	66	04.92-12.95	F8Q 744	4	<b>GV 844</b> (11V)	○		
1.9 D	1.9	68	05.92-11.95	F8Q 744	4	<b>GV 844</b> (11V)	○		

### R 21

1.4	1.4	51	06.88-10.93	C2J 770	4	<b>Z 1</b>	14-8 DU	0,8	<b>UXT 2<sup>4</sup></b>
1.7	1.7	54	07.86-02.94	F2N 750	4	<b>Z 22</b>	14-6 DU	0,7	<b>UX 56</b>
1.7	1.7	54	07.86-02.94	F3N 726	4	<b>Z 20</b>	14 R-7 DU	0,8	<b>UXT 2<sup>4</sup></b>
1.7	1.7	65	03.86-03.93	F2N 710	4	<b>Z 22</b>	14-6 DU	0,7	<b>UX 56</b>
1.7	1.7	66	09.89-06.94	F3N 723/F3N 722	4	<b>Z 22</b>	14-6 DU	0,7	<b>UX 56</b>
1.7	1.7	69	03.86-02.94	F3N 723/F3N 722	4	<b>Z 22</b>	14-6 DU	0,7	<b>UX 56</b>
1.9 D	1.9	47	09.89-10.93	F8Q 710	4	<b>GV 852</b> (11V)	<b>GR 066</b>		
2.0 4x4	2.0	99	12.89-02.94	J7R 740	4	<b>Z 52</b>	14 F-6 DTU	0,8	<b>UXT 5</b>
2.0 Turbo	2.0	119	02.90-10.92	J7R 756	4	<b>Z 46</b>	14 K-5 DUO	0,8	<b>UXK 56</b>
2.1 D	2.1	51	04.92-06.94	J8S 784	4	<b>GV 642</b> (11V)	<b>GR 066</b>		
2.1 D	2.1	53	05.89-06.94	J8S 740/J8S 600	4	<b>GV 642</b> (11V)	<b>GR 066</b>		
2.1 Turbo-D	2.1	65	03.86-06.94	J8S 788/J8S 786/J8S 714	4	<b>GV 642</b> (11V)	<b>GR 066</b>		
2.2	2.2	79	07.86-02.94	J7T 754/J7T 755	4	<b>Z 25</b>	14 K-6 DU	0,8	<b>UXK 56</b>
2.2 4x4	2.2	79	07.90-06.94	J7T 754/J7T 755	4	<b>Z 25</b>	14 K-6 DU	0,8	<b>UXK 56</b>

### R 21 Kombi

1.7 KAT	1.7	54	05.88-06.93	F3N 726	4	<b>Z 20</b>	14 R-7 DU	0,8	<b>UXT 2<sup>4</sup></b>
1.7	1.7	55	06.86-03.93	F2N 712	4	<b>Z 22</b>	14-6 DU	0,7	<b>UX 56</b>



kW

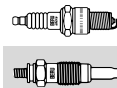
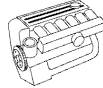

**RENAULT**

**R 21 Kombi**

1.7	1.7	66	10.89-12.93	F3N 723/F3N 722	4	<b>Z 20</b>	14 R-7 DU	0,8	<b>UXT 2<sup>4</sup></b>
1.9 D	1.9	47	03.86-08.94	F8Q 710	4	<b>GV 642 (11V)</b>	<b>GR 066</b>		
2.0	2.0	99	06.90-02.94	J7R 740	4	<b>Z 52</b>	14 F-6 DTU	0,8	<b>UXT 5</b>
2.1 D	2.1	48	10.86-09.90	J8S 704	4	<b>GV 642 (11V)</b>	<b>GR 066</b>		
2.1 D 4x4	2.1	48	10.88-05.92	J8S 704	4	<b>GV 642 (11V)</b>	<b>GR 066</b>		
2.1 D	2.1	51	02.92-09.95	J8S 784	4	<b>GV 642 (11V)</b>	○		
2.1 D	2.1	53	08.89-12.92	J8S 740/J8S 600	4	<b>GV 642 (11V)</b>	<b>GR 066</b>		
2.1 Turbo-D	2.1	65	10.86-11.93	J8S 788/J8S 786/J8S 714	4	<b>GV 642 (11V)</b>	<b>GR 066</b>		
2.2	2.2	79	06.86-11.93	J7T 754/J7T 755	4	<b>Z 25</b>	14 K-6 DU	0,8	<b>UXK 56</b>
2.2 4x4	2.2	79	06.86-12.93	J7T 754/J7T 755	4	<b>Z 25</b>	14 K-6 DU	0,8	<b>UXK 56</b>

**R 25**

2.0	2.0	74	04.84-12.92	J6R 763/J6R 707/J6R 760/ J6R 706/J6R 762	4	<b>Z 25</b>	14 K-6 DU	0,8	<b>UXK 56</b>
2.0 12V	2.0	99	06.89-12.92	J7R 726	4	<b>Z 60</b>	14 FGR-7 CTU	1,2	○
2.1 Diesel	2.1	51	06.89-12.92	J8S 736	4	<b>GV 642 (11V)</b>	<b>GR 065</b>		
2.1 Turbo-D	2.1	63	04.84-12.92	J8S 708/J8S 738	4	<b>GV 642 (11V)</b>	<b>GR 065</b>		
2.2	2.2	79	09.86-12.92	J7T 708/J7T 733 /J7T 732	4	<b>Z 31</b>	14 K-5 DU	0,8	<b>UXK 56</b>
2.8 V6 Injection	2.8	110	06.87-12.92	Z7W 706/Z7W 707/Z7W 709	6	<b>Z 25</b>	14 K-6 DU	0,8	<b>UXK 56</b>
2.8 V6	2.8	115	06.87-02.90	Z7W 700	6	<b>Z 25</b>	14 K-6 DU	0,8	<b>UXK 56</b>

**SAFRANE I**

2.0 12V	2.0	97	04.92-07.96	J7R 735/J7R 734	4	<b>Z 53</b>	14 F-6 DTU	1,0	<b>UXT 5</b>
2.1 dT	2.1	65	11.93-07.96	J8S 760	4	<b>GV 642 (11V)</b>	○		
2.2	2.2	79	04.92-07.96	J7T 762	4	<b>Z 17</b>	14 K-7 DU	0,8	<b>UXT 4</b>
2.2	2.2	101	04.92-07.96	J7T 760/J7T 761	4	<b>Z 52</b>	14 F-6 DTU	0,8	<b>UXT 5</b>
2.5 dT	2.5	83	12.92-07.96	S8U 763/S8U 762	4	<b>GN 917 (11V)</b>	○		
3.0 V6	3.0	123	12.92-07.96	Z7X 721/Z7X 723/Z7X 722	6	<b>Z 60</b>	14 FGR-7 CTU	1,2	○
3.0 Biturbo 4x4	3.0	193	02.93-07.96	Z7X 726	6	<b>Z 30</b>	14 FR-5 DU	0,8	<b>UXT 5</b>

**SAFRANE II**

2.0 16V	1.9	100	07.96-12.00	N7Q 710/N7Q 711	4	<b>Z 247</b>	14 FR-7 DUW	0,9	<b>UXT 1<sup>3</sup></b>
2.2 dT	2.2	83	07.96-12.00	G8T 740	4	<b>GN 999 (11V)</b>	○		
2.5 20V	2.4	121	07.96-12.00	N7U 700/N7U 701	5	<b>Z 247</b>	14 FR-7 DUW	0,9	<b>UXT 1<sup>3</sup></b>
2.9 24V	2.9	140	03.99-12.00	L7X 713	6	<b>Z 123</b>	14 FR-7 KDU	1,0	<b>UXT 9</b>
3.0 V6	3.0	123	07.96-12.00	Z7X 755	6	<b>Z 60</b>	14 FGR-7 CTU	1,2	○

**SANDERO/STEPWAY**

1.4	1.4	55	02.09-	K7J 710	4	<b>Z 98</b>	14 FR-7 LDU	0,8	<b>UXT 1<sup>3</sup></b>
-----	-----	----	--------	---------	---	-------------	-------------	-----	--------------------------

**SCÉNIC I**

1.4 16V	1.4	70	09.99-08.03	K4J 714/K4J 750	4	<b>Z 193</b>	14 FR-7 DU2	0,9	<b>UXT 1<sup>3</sup></b>
1.8 16V	1.8	85	01.01-08.03	F4P 722/F4P 720	4	<b>Z 193</b>	14 FR-7 DU2	0,9	<b>UXT 1<sup>3</sup></b>
1.9 D	1.9	47	09.99-03.01	F8Q 790	4	<b>GN 019 (11V)</b>	○		
1.9 dTi	1.9	59	02.01-08.03	F9Q 744	4	<b>GN 018 (11V)</b>	○		
1.9 dTi	1.9	72	09.99-08.03	F9Q 734	4	<b>GN 999 (11V)</b>	○		
1.9 dTi	1.9	72	09.99-08.03	F9Q 731, F9Q 736	4	<b>GN 018 (11V)</b>	○		
1.9 dCi	1.9	75	09.99-08.03	F9Q 733/F9Q 732	4	<b>GN 018 (11V)</b>	○		
1.9 dCi RX4	1.9	75	11.00-08.03	F9Q 740	4	<b>GN 018 (11V)</b>	○		
2.0 16V	2.0	102	07.00-08.03	F4R 740/741	4	<b>Z 193</b>	14 FR-7 DU2	0,9	<b>UXT 1<sup>3</sup></b>
2.0 16V RX4	2.0	102	06.00-08.03	F4R 746/F4R 744	4	<b>Z 193</b>	14 FR-7 DU2	0,9	<b>UXT 1<sup>3</sup></b>

**SCÉNIC II**

1.4	1.4	72	06.03-	K4J 740/K4J 730	4	<b>Z 193</b>	14 FR-7 DU2	0,9	<b>UXT 1<sup>3</sup></b>
1.5 dCi	1.5	60	06.03-	K9K 722	4	<b>GN 018 (11V)</b>	○		
1.5 dCi	1.5	63	05.05-	K9K 724	4	<b>GN 018 (11V)</b>	○		
1.5 dCi	1.5	74	11.03-	K9K 729/K9K 728	4	<b>GN 018 (11V)</b>	○		
1.5 dCi	1.5	76	01.07-	K9K 734	4	<b>GN 018 (11V)</b>	○		
1.5 dCi	1.5	78	05.05-	K9K 732	4	<b>GN 018 (11V)</b>	○		
1.6	1.6	77	06.06-	K4M 788	4	<b>Z 247</b>	14 FR-7 DUW	0,9	<b>UXT 1<sup>3</sup></b>
1.6	1.6	83	06.03-	K4M 761/K4M 782	4	<b>Z 193</b>	14 FR-7 DU2	0,9	<b>UXT 1<sup>3</sup></b>
1.9 dCi	1.9	81	05.05-	F9Q 804	4	<b>GN 018 (11V)</b>	○		
1.9 D	1.9	85	06.06-	F9Q J 803/F9Q 812	4	<b>GN 018 (11V)</b>	○		
1.9 dCi	1.9	88	06.03-	F9Q 812	4	<b>GN 018 (11V)</b>	○		
1.9 dCi	1.9	92	06.03-	F9Q 804	4	<b>GN 018 (11V)</b>	○		

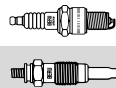
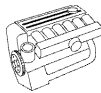

## RENAULT

### SCÉNIC II

1.9 dCi	1.9	96	05.05-	F9Q J 803/F9Q 818/ F9Q 816/F9Q 804	4	<b>GN 018</b> (11V)	○		
2.0	2.0	99	06.03-	F4R 771/F4R 770	4	<b>Z 193</b>	14 FR-7 DU2	0,9	<b>UXT 1<sup>3</sup></b>
2.0 16V Turbo	2.0	120	05.04-	F4R 776	4	<b>Z 337</b>	14 FR-7 DPPUW2	0,9	○

### SCÉNIC III

1.4 16V	1.4	96	02.09-	H4J 700	4	<b>Z 274</b>	12 VR-6 MPPUS	0,7	○
1.5 dCi	1.5	63	04.09-	K9K 830	4	<b>GE 110</b> (4,4V)	○		
1.5 dCi	1.5	81	04.09-	K9K 836	4	<b>GE 110</b> (4,4V)	○		
1.9 dCi	1.9	96	02.09-	F9Q 870	4	<b>GE 111</b> (4,4V)	○		

### SUPER 5

1.1	1.1	33	01.86-09.90	C1E 752/C1E 750/C1E 756/ C1E 760	4	<b>Z 1</b>	14-8 DU	0,8	<b>UXT 2<sup>4</sup></b>
1.1	1.1	33	10.90-03.95	C1E 752/C1E 750/C1E 756/ C1E 760	4	<b>Z 82</b>	14 R-9 DU	0,7	<b>UXT 2<sup>4</sup></b>
1.1	1.1	34	09.83-12.96	C1E 752/C1E 750/C1E 754	4	<b>Z 1</b>	14-8 DU	0,8	<b>UXT 2<sup>4</sup></b>
1.2	1.2	40	01.87-08.90	C1G 722/C1G 702/C1G 720	4	<b>Z 1</b>	14-8 DU	0,8	<b>UXT 2<sup>4</sup></b>
1.2	1.2	44	01.87-12.96	C1G 702	4	<b>Z 1</b>	14-8 DU	0,8	<b>UXT 2<sup>4</sup></b>
1.4 KAT	1.4	43	10.85-12.96	C3J 700/C3J 702/C3J 760	4	<b>Z 1</b>	14-8 DU	0,8	<b>UXT 2<sup>4</sup></b>
1.4	1.4	44	06.87-08.90	C2J 784	4	<b>Z 1</b>	14-8 DU	0,8	<b>UXT 2<sup>4</sup></b>
1.6 D	1.6	40	10.84-12.96	F8M 730/F8M 720	4	<b>GV 852</b> (11V)	○		
1.7	1.7	54	10.86-03.95	F3N 716 /F3N 717	4	<b>Z 20</b>	14 R-7 DU	0,8	<b>UXT 2<sup>4</sup></b>
1.7	1.7	64	06.87-03.95	F2N 742/F2N 740	4	<b>Z 22</b>	14-6 DU	0,7	<b>UX 56</b>
1.7 i	1.7	69	10.86-08.91	F3N 722/F3N 702	4	<b>Z 20</b>	14 R-7 DU	0,8	<b>UXT 2<sup>4</sup></b>

### THALIA

1.2 16V	1.1	55	04.02-	D4F 712	4	<b>Z 243</b>	12 VR-8 SE	0,9	○
1.4 16V	1.4	72	08.00-	K4J 712	4	<b>Z 193</b>	14 FR-7 DU2	0,9	<b>UXT 1<sup>3</sup></b>
1.5 dCi	1.5	47	06.05-	K9K 740	4	<b>GN 018</b> (11V)	○		
1.5 dCi	1.5	48	04.02-	K9K 700	4	<b>GN 018</b> (11V)	○		
1.5 dCi	1.5	50	02.03-	K9K 714/K9K 700	4	<b>GN 018</b> (11V)	○		
1.5 dCi	1.5	60	06.01-	K9K 702	4	<b>GN 018</b> (11V)	○		
2.0	2.0	124	09.01-	F4R 738	4	<b>Z 284</b>	14 FR-6 DPOX	1,1	<b>UXT 14</b>

### THALIA II

1.5 dCi	1.5	47	09.08-	K9K 740	4	<b>GN 018</b> (11V)	○		
1.5 dCi	1.5	48	01.09-	K9K 700	4	<b>GN 018</b> (11V)	○		
1.5 dCi	1.5	62	09.08-	K9K 718	4	<b>GN 018</b> (11V)	○		

### TWINGO

1.2	1.2	40	03.93-10.96	C3G 702/C3G 700	4	<b>Z 82</b>	14 R-9 DU	0,7	<b>UXT 2<sup>4</sup></b>
1.2	1.2	40	05.96-	D7F 700/D7F 701	4	<b>Z 257</b>	14 FR-7 LDUW	0,9	<b>UXT 1<sup>3</sup></b>
1.2	1.2	43	05.96-	D7F 700/701/702/703/704	4	<b>Z 257</b>	14 FR-7 LDUW	0,9	<b>UXT 1<sup>3</sup></b>
1.2	1.2	43	05.96-06.97	D7F 700/701	4	<b>Z 63</b>	14 F-7 DU	0,8	<b>UXT 1<sup>3</sup></b>
1.2 16V	1.2	44	08.04-	D4F 708	4	<b>Z 243</b>	12 VR-8 SE	0,9	○
1.2 16V	1.2	55	01.01-	D4F 702	4	<b>Z 243</b>	12 VR-8 SE	0,9	○

### TWINGO II

1.2	1.2	43	03.07-	D7F 800	4	<b>Z 193</b>	14 FR-7 DU2	0,9	<b>UXT 1<sup>3</sup></b>
1.2 16V	1.2	56	03.07-	D4F 772	4	<b>Z 243</b>	12 VR-8 SE	0,9	○
1.2 Turbo	1.2	74	03.07-	D4F 780/782	4	<b>Z 274</b>	12 VR-6 MPPUS	0,7	○
1.5 dCi	1.5	47	03.07-	K9K 740	4	<b>GN 018</b> (11V)	○		
1.5 dCi	1.5	62	04.08-	K9K 718	4	<b>GN 018</b> (11V)	○		

### VEL SATIS

2.0 16V Turbo	2.0	120	06.02-	F4R 762/F4R 763	4	<b>Z 337</b>	14 FR-7 DPPUW2	0,9	○
2.0 16 V Turbo	2.0	125	04.04-	F4R 766/F4R 767	4	<b>Z 337</b>	14 FR-7 DPPUW2	0,9	○
2.2 dCi	2.2	102	09.04-	G9T 607/G9T 600/G9T 606/ G9T 700/G9T 702	4	<b>GN 026</b> (11V)	○		
2.2 dCi	2.2	85	04.04-	G9T 600	4	<b>GN 026</b> (11V)	○		
2.2 dCi	2.2	110	06.02-	G9T 703/G9T 702	4	<b>GN 026</b> (11V)	○		
3.0 dCi	3.0	130	06.02-	P9X701, P9X715	6	<b>GN 106</b> (11V)	○		
3.5 V6	3.5	177	06.02-	V4Y 701/V4Y 711	6	<b>Z 193</b>	14 FR-8 MU2	0,9	<b>UXT 13</b>

### WIND

1.2	1.1	74	07.10-	D4F 782	4	<b>Z 274</b>	12 VR-6 MPPUS	0,7	○
-----	-----	----	--------	---------	---	--------------	---------------	-----	---



kW

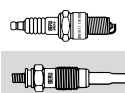
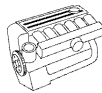

## RENAULT



### MASCOTT

90	2.8	78	01.00-06.04	8140.43B3586, 3588	4	GF 006 (12V)	○		
90	2.8	78	01.00-06.04	8140.43C2586	4	GF 984 (11V)	○		
110	2.8	78	01.99-06.04	8140.43B3586, 3588	4	GF 006 (12V)	○		
110	2.8	78	01.99-06.04	8140.43C2586	4	GF 984 (11V)	○		
110.35	2.8	78	01.99-06.04	8140.43C2586	4	GF 984 (11V)	○		
110.35	2.8	78	01.99-06.04	8140.43B3586, 3588	4	GF 006 (12V)	○		
110.50	2.8	78	01.99-06.04	8140.43C2586	4	GF 984 (11V)	○		
110.50	2.8	78	01.99-06.04	8140.43B3586, 3588	4	GF 006 (12V)	○		
110.55	2.8	78	01.99-06.04	8140.43C2586	4	GF 984 (11V)	○		
110.55	2.8	78	01.99-06.04	8140.43B3586, 3588	4	GF 006 (12V)	○		
130	2.8	92	01.99-06.04	8140.43.S.2585/ 8140.43.S.3585	4	GF 006 (12V)	○		
130.35	2.8	92	01.99-06.04	8140.43.S.2585/ 8140.43.S.3585	4	GF 006 (12V)	○		
130.55	2.8	92	01.99-06.04	8140.43.S.2585/ 8140.43.S.3585	4	GF 006 (12V)	○		
150.35	2.8	107	10.01-06.04	8140.43N.3585	4	GN 012 (11V)	○		
150.55	2.8	107	10.01-06.04	8140.43N.3585	4	GN 012 (11V)	○		
150.65	2.8	107	10.01-06.04	8140.43N.3585	4	GN 012 (11V)	○		

### MASTER I

28-35 2.1 D	2.1	44	01.86-07.98	J8S 330	4	GV 642 (11V)	GR 066		
28-35 2.5 D	2.4	52	09.80-07.98	8140.61.2300/S8U 731	4	GV 642 (11V)	GR 066		
28-35 2.5 D	2.5	55	08.89-07.98	8140.67.2510/S8U 742	4	GV 642 (11V)	GR 066		
28-35 2,5 TD	2.5	72	08.89-07.98	8140.27.2580/S9U 702	4	GN 909 (11V)	○		
30 2,2	2.2	67	08.80-07.98	J7T 782	4	Z 18	14 K-7 DUO	0,8	UXT 4
30 2,2	2.2	67	08.80-07.98	J7T 788	4	Z 207	14 KG-8 DTU	1,2	○
35 2,5 TD	2.5	69	08.89-07.98	8140.27.2500/S9U 714/ 8140.27.2510	4	GN 927 (11V)	○		

### MASTER II

1.9 dTi	1.9	59	09.00-	F9Q 770	4	GN 018 (11V)	○		
1.9 dCi 80	1.9	60	11.01-	F9Q 772/F9Q 774	4	GN 018 (11V)	○		
2.2 dCi 90	2.2	66	09.00-	G9T 722/G9T 720/G9T 750	4	GN 026 (11V)	○		
2.5 D	2.5	59	07.98-01.01	S8U 770	4	GN 927 (11V)	○		
2.5 dCi 100	2.5	73	10.03-	G9U 754	4	GN 026 (11V)	○		
2.5 dCi	2.5	74	08.06-	G9U 754	4	GN 026 (11V)	○		
2.5 dCi	2.5	84	01.04-10.06	G9U 750	4	GN 026 (11V)	○		
2.5 dCi 120	2.5	84	10.01-	G9U 754/G9U 720	4	GN 026 (11V)	○		
2.5 dCi	2.5	88	08.06-	G9U 650	4	GN 026 (11V)	○		
2.5 dCi	2.5	107	08.06-	G9U 632	4	GN 026 (11V)	○		
2.8 dTi	2.8	84	07.98-10.01	S9W 702	4	GN 012 (11V)	○		
3.0 dCi 140	3.0	100	10.03-	ZD3 202/ZD3 200	4	GN 072 (11V)	○		

### MESSENGER

B 120.35	2.5	85	10.91-07.96	8140.47.2590/ 8140.47.2530 IDR	4	GF 984 (11V)	○		
B 120.55	2.5	85	01.94-09.96	8140.47.2585	4	GF 984 (11V)	○		
B 120.55T	2.5	85	01.94-09.96	8140.47.2585	4	GF 984 (11V)	○		
B 120.65	2.5	85	01.94-09.96	8140.47.2585	4	GF 984 (11V)	○		

### RAPID

1.1	1.1	33	07.85-04.95	C1E 752/C1E 762/C1E 750/ C1E 754/C1E 760/C1E 792	4	Z 1	14-8 DU	0,8	UXT 2 <sup>4</sup>
1.1	1.1	33	06.87-09.91	C1E 756	4	Z 1	14-8 DU	0,8	UXT 2 <sup>4</sup>
1.4	1.4	43	07.85-08.91	C1J 780/C1J 768	4	Z 1	14-8 DU	0,8	UXT 2 <sup>4</sup>
1.4 KAT	1.4	43	08.88-03.98	C3J 762/C3J 700/C3J 702/ C3J 760	4	Z 1	14-8 DU	0,8	UXT 2 <sup>4</sup>
1.4	1.4	44	03.86-08.91	C2J 784	4	Z 1	14-8 DU	0,8	UXT 2 <sup>4</sup>
1.4	1.4	55	09.91-03.98	E7J 720/E7J 773/E7J 724/ E7J 726	4	Z 247	14 FR-7 DUW	0,9	UXT 1 <sup>3</sup>
1.4	1.4	58	01.94-03.98	E7J 728	4	Z 247	14 FR-7 DUW	0,9	UXT 1 <sup>3</sup>



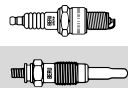

## RENAULT



RAPID							
1.6 D	1.6	40	03.86-08.98	F8M 730/F8M 760/F8M 736/ F8M 720	4	GV 852 (11V)	○
1.9 D	1.9	40	09.94-03.98	F8Q 682/F8Q 640	4	GN 991 (11V)	○
1.9 D	1.9	47	09.91-03.98	F8Q 774/F8Q 722/F8Q 776/ F8Q 724	4	GV 852 (11V)	○

TRAFIC									
1.7	1.7	50	08.92-08.94	F1N 724	4	Z 22	14-6 DU	0,7	UX 56
1.7	1.7	50	08.92-08.94	F1N 720	4	Z 22	14-6 DU	0,7	UX 56
1.9 D	1.9	44	06.97-03.01	F8Q 606	4	GN 963 (11V)	○		
2.0	2.0	59	05.89-08.90	J5R 726	4	Z 22	14-6 DU	0,7	UX 56
2.0	2.0	59	05.89-08.90	J5R 716	4	Z 22	14-6 DU	0,7	UX 56
2.1 D	2.1	43	05.89-06.94	852 750/852 720	4	GV 642 (11V)	GR 066		
2.1 D	2.1	47	06.94-10.97	J8S 758/J8S 620	4	GN 954 (11V)	○		
2.2	2.2	70	05.89-06.94	J7T 780	4	Z 17	14 K-7 DU	0,8	UXT 4
2.2 4x4	2.2	74	06.94-10.97	J7T 600	4	Z 207	14 KG-8 DTU	1,2	○
2.5 D	2.4	51	05.89-03.01	8140.61.240/S8U 722/ S8U 720	4	GV 642 (11V)	○		
2.5 D	2.5	55	05.89-03.01	8140.67.2500/2550/2580, S8U 750, 752	4	GN 927 (11V)	GR 066		
2.5 D 4x4	2.5	55	08.89-03.01	S8U 750, 752,8140.67.2500/ 2550/2580	4	GV 642 (11V)	○		
2.5 D 4x4	2.5	55	08.89-03.01	S8U 758	4	GN 927 (11V)	○		

TRAFIC II									
1.9 dCi 80	1.9	60	03.01-	F9Q 762	4	GN 018 (11V)	○		
1.9 dCi 100	1.9	74	03.01-	F9Q 760	4	GN 018 (11V)	○		
2.0 16V	2.0	86	08.06-	F4R 820	4	Z 337	14 FR-7 DPPUW2	0,9	○
2.0	2.0	88	03.01-	F4R 722/F4R 720	4	Z 337	14 FR-7 DPPUW2	0,9	○
2.5 dCi 135	2.5	99	03.01-	G9U 730	4	GN 026 (11V)	○		
2.5 dCi 145	2.5	107	08.06-	G9U 630	4	GN 026 (11V)	○		

## ROVER

25									
1.1 16V	1.1	55	01.04-	11 K4F	4	Z 15	14 FR-7 DU	0,8	UXT 1 <sup>3</sup>
1.4 16V	1.4	62	10.99-	14 K4M → Fgst.Nr. YD 471 564	4	Z 15	14 FR-7 DU	0,8	UXT 1 <sup>3</sup>
1.4 16V	1.4	76	02.00-	14 K4F → Fgst.Nr. YD 471 564	4	Z 15	14 FR-7 DU	0,8	UXT 1 <sup>3</sup>
1.6 16V	1.6	80	10.99-	16 K4F → Fgst.Nr. YD 471 564	4	Z 15	14 FR-7 DU	0,8	UXT 1 <sup>3</sup>
1.8 16V	1.8	85	10.99-	18 K4F	4	Z 228	14 FR-7 DPUX02	1,0	UXT 11
1.8 16V	1.8	107	02.00-	18 K4K	4	Z 228	14 FR-7 DPUX02	1,0	UXT 11
2.0 iDT	2.0	74	10.99-	20 T2N	4	GN 905 (11V)	○		
45									
1.4	1.4	76	02.00-05.05	14 K4F	4	Z 228	14 FR-7 DPUX02	1,0	UXT 11
1.6	1.6	80	02.00-05.05	16 K4F	4	Z 228	14 FR-7 DPUX02	1,0	UXT 11
1.8	1.8	86	02.00-05.05	18 K4F	4	Z 228	14 FR-7 DPUX02	1,0	UXT 11
2.0 iDT	2.0	74	02.00-05.05	20 T2N	4	GN 905 (11V)	○		
2.0 V6	2.0	110	02.00-05.05	20 K4F	6	Z 228	14 FR-7 DPUX02	1,0	UXT 11
75									
1.8	1.8	88	02.99-05.05	K 1.8	4	Z 228	14 FR-7 DPUX02	1,0	UXT 11
1.8 Turbo	1.8	110	05.03-05.05	18 K4G	4	Z 228	14 FR-7 DPUX02	1,0	UXT 11
2.0 CDT	2.0	85	02.99-05.05	M 47 R	4	GN 024 (11V)	○		
2.0 CDTi	2.0	96	02.03-05.05	204D2	4	GN 024 (11V)	○		
2.0 V6	2.0	110	02.99-05.05	20 K4F	6	Z 228	14 FR-7 DPUX02	1,0	UXT 11
2.5 V6	2.5	129	02.99-10.01	KV 6	6	Z 228	14 FR-7 DPUX02	1,0	UXT 11
2.5 V6	2.5	130	10.01-05.05	25 K4F	6	Z 228	14 FR-7 DPUX02	1,0	UXT 11
75 Tourer									
1.8	1.8	88	08.01-05.05	K 1.8	4	Z 228	14 FR-7 DPUX02	1,0	UXT 11
1.8 Turbo	1.8	110	05.03-05.05	18 K4G	4	Z 228	14 FR-7 DPUX02	1,0	UXT 11

● nicht erforderlich  
○ nicht im Programm

<sup>3</sup> wahlweise UXT 3 Platin

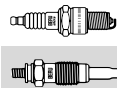
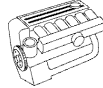

kW

**ROVER****75 Tourer**

2.0 CDT	2.0	85	08.01-05.05	M 47 R	4	<b>GN 024</b> (11V)	○		
2.0 CDTi	2.0	96	02.03-05.05	204D2	4	<b>GN 024</b> (11V)	○		
2.0 V6	2.0	110	08.01-05.05	20 K4F	6	<b>Z 228</b>	14 FR-7 DPUX02	1,0	<b>UXT 11</b>
2.5 V6	2.5	130	08.01-05.05	KV 6	6	<b>Z 228</b>	14 FR-7 DPUX02	1,0	<b>UXT 11</b>

**100**

111 C/L/S	1.1	44	03.90-12.98	11 K2D/11 K2A	4	<b>Z 15</b>	14 FR-7 DU	0,8	<b>UXT 1<sup>3</sup></b>
114 D	1.4	38	10.92-12.94	TUD 3	4	<b>GV 661</b> (11V)	○		
114 S/L/GTA	1.4	55	03.90-12.98	14 K2D/14 K2A	4	<b>Z 15</b>	14 FR-7 DU	0,8	<b>UXT 1<sup>3</sup></b>
114 GTI/GT 16V KAT	1.4	66	03.90-12.98	14 K4C/14 K4D	4	<b>Z 15</b>	14 FR-7 DU	0,8	<b>UXT 1<sup>3</sup></b>
114 GTI 16V	1.4	69	03.90-08.91	14 K4C/14 K4D	4	<b>Z 15</b>	14 FR-7 DU	0,8	<b>UXT 1<sup>3</sup></b>
114 GSi	1.4	76	10.94-10.95	14 K4F	4	<b>Z 15</b>	14 FR-7 DU	0,8	<b>UXT 1<sup>3</sup></b>
114 GTI 16V	1.4	76	08.91-12.98	14 K4F	4	<b>Z 15</b>	14 FR-7 DU	0,8	<b>UXT 1<sup>3</sup></b>
115 D	1.5	42	12.94-12.98	TUD 5	4	<b>GN 912</b> (11V)	○		

**100 Cabriolet**

111	1.1	44	04.94-	11 K2D	4	<b>Z 15</b>	14 FR-7 DU	0,8	<b>UXT 1<sup>3</sup></b>
114	1.4	55	04.94-	14 K2D/14 K2A	4	<b>Z 15</b>	14 FR-7 DU	0,8	<b>UXT 1<sup>3</sup></b>
114	1.4	75	03.97-10.98	14 K4F	4	<b>Z 15</b>	14 FR-7 DU	0,8	<b>UXT 1<sup>3</sup></b>

**200**

214 i	1.4	55	11.95-03.00	14 K2F	4	<b>Z 15</b>	14 FR-7 DU	0,8	<b>UXT 1<sup>3</sup></b>
214 Si	1.4	76	11.95-03.00	14 K4F	4	<b>Z 247</b>	14 FR-7 DUW	0,9	<b>UXT 1<sup>3</sup></b>
216 Si	1.6	82	11.95-03.00	16 K4F	4	<b>Z 16</b>	14 FR-7 DUX	1,1	<b>UXT 1<sup>3</sup></b>
218 K Vi	1.8	107	11.95-03.00	18 K4K	4	<b>Z 188</b>	14 F-7 DPUR02	0,7	<b>UXT 10</b>
220 D/SD	2.0	63	11.95-03.00	20 T2R	4	<b>GN 905</b> (11V)	○		
220 SDi	2.0	77	11.95-03.00	20 T2N	4	<b>GN 905</b> (11V)	○		

**200 CABRIOLET**

214 1.4	1.4	66	01.92-11.99	14 K4C/14 K4D	4	<b>Z 247</b>	14 FR-7 DUW	0,9	<b>UXT 1<sup>3</sup></b>
214 1.4i 16V	1.4	76	01.93-11.99	14 K4F	4	<b>Z 247</b>	14 FR-7 DUW	0,9	<b>UXT 1<sup>3</sup></b>
216 1.6i 16V	1.6	82	01.96-11.99	16 K4F	4	<b>Z 16</b>	14 FR-7 DUX	1,1	<b>UXT 1<sup>3</sup></b>
216 1.6i	1.6	90	01.92-11.99	D 16 A8	4	<b>Z 16</b>	14 FR-7 DUX	1,1	<b>UXT 1<sup>3</sup></b>

**200 Coupe**

216	1.6	90	10.92-06.99	D 16 A8	4	<b>Z 16</b>	14 FR-7 DUX	1,1	<b>UXT 1<sup>3</sup></b>
220 GSi	2.0	100	05.94-06.99	20 T4H	4	<b>Z 247</b>	14 FR-7 DUW	0,9	<b>UXT 1<sup>3</sup></b>
220 Turbo	2.0	147	10.92-06.99	20 T4G	4	<b>Z 15</b>	14 FR-7 DU	0,8	<b>UXT 1<sup>3</sup></b>

**200 Hatchback**

214	1.4	55	09.93-10.95	14 K2D/14 K2A	4	<b>Z 15</b>	14 FR-7 DU	0,8	<b>UXT 1<sup>3</sup></b>
214 GSi/Si	1.4	66	10.89-10.95	14 K4C/14 K4D	4	<b>Z 15</b>	14 FR-7 DU	0,8	<b>UXT 1<sup>3</sup></b>
214 GSi/Si	1.4	70	01.90-10.95	14 K4C	4	<b>Z 247</b>	14 FR-7 DUW	0,9	<b>UXT 1<sup>3</sup></b>
214 GSi/Si	1.4	76	12.92-10.95	14 K4F	4	<b>Z 15</b>	14 FR-7 DU	0,8	<b>UXT 1<sup>3</sup></b>
216 GSi	1.6	82	10.89-10.95	D 16 Z2	4	<b>Z 16</b>	14 FR-7 DUX	1,1	<b>UXT 1<sup>3</sup></b>
216 GTi	1.6	90	09.90-10.95	D 16 A8	4	<b>Z 16</b>	14 FR-7 DUX	1,1	<b>UXT 1<sup>3</sup></b>
218 TD	1.8	65	09.91-10.95	XUD 7TE	4	<b>GN 909</b> (11V)	○		
218 D	1.9	52	09.91-10.95		4	<b>GV 636</b> (11V)	○		
220 GTi	2.0	100	01.93-10.95	20 T4H	4	<b>Z 247</b>	14 FR-7 DUW	0,9	<b>UXT 1<sup>3</sup></b>
220 GTi	2.0	103	09.91-10.95	20 M4F	4	<b>Z 16</b>	14 FR-7 DUX	1,1	<b>UXT 1<sup>3</sup></b>
220 Turbo	2.0	147	01.93-10.95	20 T4G	4	<b>Z 24</b>	14 FR-6 DU	0,8	<b>UXT 5</b>

**400**

414 GSi/Si	1.4	66	04.90-04.95	14 K4C/14 K4D	4	<b>Z 247</b>	14 FR-7 DUW	0,9	<b>UXT 1<sup>3</sup></b>
414 Si	1.4	76	05.95-03.00	14 K4F	4	<b>Z 247</b>	14 FR-7 DUW	0,9	<b>UXT 1<sup>3</sup></b>
414 GSi/Si KAT	1.4	76	01.93-04.95	14 K4F	4	<b>Z 15</b>	14 FR-7 DU	0,8	<b>UXT 1<sup>3</sup></b>
416 Si	1.6	82	05.95-03.00	16 K4F	4	<b>Z 247</b>	14 FR-7 DUW	0,9	<b>UXT 1<sup>3</sup></b>
416 GSi	1.6	82	04.90-04.95	D 16 Z2	4	<b>Z 16</b>	14 FR-7 DUX	1,1	<b>UXT 1<sup>3</sup></b>
416 Si	1.6	83	05.95-03.00	D 16 Y2	4	<b>Z 16</b>	14 FR-7 DUX	1,1	<b>UXT 1<sup>3</sup></b>
416 GTi	1.6	90	04.90-04.95	D 16 A8	4	<b>Z 16</b>	14 FR-7 DUX	1,1	<b>UXT 1<sup>3</sup></b>
418 D	1.8	49	09.91-04.95		4	<b>GV 636</b> (11V)	○		
418 TD	1.8	65	09.91-04.95	XUD 7TE	4	<b>GN 909</b> (11V)	○		
420 D	2.0	63	11.95-03.00	20 T2R	4	<b>GN 905</b> (11V)	○		
420 Di	2.0	77	05.95-03.00	20 T2N	4	<b>GN 905</b> (11V)	○		
420 Si Lux	2.0	100	12.95-03.00	20 T4H	4	<b>Z 15</b>	14 FR-7 DU	0,8	<b>UXT 1<sup>3</sup></b>
420 GSi/SLI/GTi/Vite	2.0	100	01.93-04.95	20 T4H	4	<b>Z 15</b>	14 FR-7 DU	0,8	<b>UXT 1<sup>3</sup></b>
420 GTi/GSi/Vitesse	2.0	103	02.92-04.95	20 M4F	4	<b>Z 247</b>	14 FR-7 DUW	0,9	<b>UXT 1<sup>3</sup></b>
420 Turbo	2.0	147	01.93-04.95	20 T4G	4	<b>Z 24</b>	14 FR-6 DU	0,8	<b>UXT 5</b>

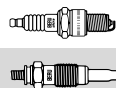
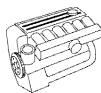

## ROVER

### 400 Hatchback

414 Si	1.4	76	05.95-03.00	14 K4F	4	Z 247	14 FR-7 DUW	0,9	UXT 1 <sup>3</sup>
416 Si	1.6	82	05.95-03.00	16 K4F	4	Z 15	14 FR-7 DU	0,8	UXT 1 <sup>3</sup>
416 Si	1.6	83	06.95-03.00	D 16 Y2	4	Z 15	14 FR-7 DU	0,8	UXT 1 <sup>3</sup>
420 D	2.0	63	11.95-03.00	20 T2R	4	GN 905 (11V)	○		
420 Di	2.0	77	05.95-03.00	20 T2N	4	GN 905 (11V)	○		
420 Si Lux	2.0	100	12.95-03.00	20 T4H	4	Z 15	14 FR-7 DU	0,8	UXT 1 <sup>3</sup>

### 400 Tourer

1.6 i	1.6	82	05.94-11.98	D 16 Z2	4	Z 16	14 FR-7 DUX	1,1	UXT 1 <sup>3</sup>
1.6 i	1.6	90	05.94-11.98	D 16 A8	4	Z 16	14 FR-7 DUX	1,1	UXT 1 <sup>3</sup>
1.8 TD	1.8	65	09.93-11.98	XUD 7TE	4	GV 636 (11V)	○		
1.8 i	1.8	107	06.96-11.98	18 K4K	4	Z 228	14 FR-7 DPUX02	1,0	UXT 11
2.0 i	2.0	100	05.94-11.98	20 T4H	4	Z 15	14 FR-7 DU	0,8	UXT 1 <sup>3</sup>

### 600

618 i/Si	1.9	85	03.96-02.99	F 18 A3	4	Z 158	14 FR-7 LUX	1,1	○
620 Sdi	2.0	77	12.94-02.99	20 T2N	4	GN 905 (11V)	○		
620 i	2.0	85	08.93-06.96	F 20 Z2	4	Z 158	14 FR-7 LUX	1,1	○
620 Si	2.0	96	08.93-02.99	F 20 Z1	4	Z 158	14 FR-7 LUX	1,1	○
620 Ti Vitesse	2.0	147	07.94-02.99	20 T4G	4	Z 247	14 FR-7 DUW	0,9	UXT 1 <sup>3</sup>
623 Si	2.3	116	08.93-02.99	H 23 A3	4	Z 158	14 FR-7 LUX	1,1	○

### 800

820	2.0	74	10.88-10.91		4	Z 22	14-6 DU	0,7	UX 56
820e	2.0	88	10.86-10.91	20 HS	4	Z 15	14 FR-7 DU	0,8	UXT 1 <sup>3</sup>
820 Si (XS)	2.0	98	10.88-12.91	20 HD M 16	4	Z 15	14 FR-7 DU	0,8	UXT 1 <sup>3</sup>
820 I/Si (RS)	2.0	100	01.92-02.99	20 T4H	4	Z 15	14 FR-7 DU	0,8	UXT 1 <sup>3</sup>
820 16V Turbo (RS)	2.0	132	01.92-02.99	T 16	4	Z 15	14 FR-7 DU	0,8	UXT 1 <sup>3</sup>
820 Sport	2.0	145	04.94-03.96	20 T4G	4	Z 15	14 FR-7 DU	0,8	UXT 1 <sup>3</sup>
825 D/SD	2.5	87	01.90-04.95	425 SL1RR/492 4 SHIRG	4	GN 909 (11V)	○		
825 D/SD	2.5	87	05.95-02.99	425 SL1RR/492 4 SHIRG	4	GN 007 (11V)	○		
825 Si/Sterling (XS) KAT	2.5	110	10.86-12.91	C 25 A1	6	Z 16	14 FR-7 DUX	1,1	UXT 1 <sup>3</sup>
825 Si/Sterling (XS)	2.5	127	01.87-12.91	C 25 A2	6	Z 16	14 FR-7 DUX	1,1	UXT 1 <sup>3</sup>
825 Si Lux (RS)	2.5	129	04.96-02.99	25 K4F	6	Z 15	14 FR-7 DU	0,8	UXT 1 <sup>3</sup>
827 Si/Sterling (XS) KAT	2.7	124	02.88-02.99	C 27 A1	6	Z 16	14 FR-7 DUX	1,1	UXT 1 <sup>3</sup>
827 Si/Sterling (XS)	2.7	130	02.88-12.91	C 27 A2	6	Z 16	14 FR-7 DUX	1,1	UXT 1 <sup>3</sup>

### 800 Coupe

825 SD	2.5	87	09.93-04.95	425 SL1RR/492 4 SHIRG	4	GN 909 (11V)	○		
825 SD	2.5	87	05.95-02.99	425 SL1RR/492 4 SHIRG	4	GN 007 (11V)	○		
825 Si (RS)	2.5	129	04.96-02.99	25 K4F	6	Z 15	14 FR-7 DU	0,8	UXT 1 <sup>3</sup>
827 24V (RS)	2.7	124	08.92-02.99	C 27 A1	6	Z 16	14 FR-7 DUX	1,1	UXT 1 <sup>3</sup>

### 800 Hatchback

820 Si (XS)	2.0	98	10.88-12.91	20 HD M 16	4	Z 15	14 FR-7 DU	0,8	UXT 1 <sup>3</sup>
820 I/Si (XS)	2.0	100	01.93-02.99	20 T4H	4	Z 15	14 FR-7 DU	0,8	UXT 1 <sup>3</sup>
820 i/Si (XS)	2.0	103	10.88-12.91	20 HD	4	Z 15	14 FR-7 DU	0,8	UXT 1 <sup>3</sup>
820 16V Turbo (RS)	2.0	132	01.92-02.99	T 16	4	Z 15	14 FR-7 DU	0,8	UXT 1 <sup>3</sup>
820 Sport	2.0	145	04.94-03.96	20 T4G	4	Z 15	14 FR-7 DU	0,8	UXT 1 <sup>3</sup>
825 D/SD	2.5	87	01.92-04.95	425 SL1RR/492 4 SHIRG	4	GN 909 (11V)	○		
825 D/SD	2.5	87	05.95-02.99	425 SL1RR/492 4 SHIRG	4	GN 007 (11V)	○		
2.5	2.5	129	02.96-10.98	25 K4F	6	Z 15	14 FR-7 DU	0,8	UXT 1 <sup>3</sup>
2.5 Si	2.5	129	02.96-10.98	25 K4F	6	Z 15	14 FR-7 DU	0,8	UXT 1 <sup>3</sup>
827 Vitesse (XS) KAT	2.7	124	10.88-12.91	C 27 A1	6	Z 16	14 FR-7 DUX	1,1	UXT 1 <sup>3</sup>
827 24V I/Si (RS) KAT	2.7	124	01.92-02.99	C 27 A1	6	Z 16	14 FR-7 DUX	1,1	UXT 1 <sup>3</sup>
827 Vitesse/SLI	2.7	130	10.88-12.91	C 27 A2	6	Z 16	14 FR-7 DUX	1,1	UXT 1 <sup>3</sup>

### COUPE

1.6 16 V	1.6	82	03.96-11.99	16 K4F	4	Z 15	14 FR-7 DU	0,8	UXT 1 <sup>3</sup>
1.8 16 V	1.8	107	03.96-11.99	18 K4K	4	Z 228	14 FR-7 DPUX02	1,0	UXT 11

### MAESTRO

2.0 D	2.0	44	09.90-10.92		4	GV 636 (11V)	○		
2.0 TD	2.0	60	09.90-01.95	BB	4	GV 636 (11V)	○		

### MINI MK I

1000	1.0	30	01.92-06.93	99 HD 81	4	Z 11	14-7 DU	0,8	UXT 2 <sup>4</sup>
1300	1.3	37	10.92-	12 A2B	4	Z 20	14 R-7 DU	0,8	UXT 2 <sup>4</sup>
1300	1.3	39	01.92-04.95	12 A2D	4	Z 20	14 R-7 DU	0,8	UXT 2 <sup>4</sup>

● nicht erforderlich  
○ nicht im Programm

<sup>3</sup> wahlweise UXT 3 Platin

<sup>4</sup> wahlweise UXT 6 Platin



kW

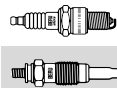

## ROVER

### MINI MK I

1300	1.3	45	01.91-12.91	12 A2A	4	<b>Z 20</b>	14 R-7 DU	0,8	<b>UXT 2<sup>4</sup></b>
1300	1.3	46	01.92-	12 A2E/12 A2L	4	<b>Z 20</b>	14 R-7 DU	0,8	<b>UXT 2<sup>4</sup></b>

### MINI MK I Cabriolet

1300	1.3	46	09.92-04.95	12 A2E	4	<b>Z 20</b>	14 R-7 DU	0,8	<b>UXT 2<sup>4</sup></b>
------	-----	----	-------------	--------	---	-------------	-----------	-----	--------------------------

### MONTEGO

2.0 D Turbo	2.0	60	10.88-10.95	BB	4	<b>GV 636</b> (11V)	○		
2.0 i KAT	2.0	75	12.90-10.94	20 H	4	<b>Z 21</b>	14 R-7 DUX	1,1	<b>UXT 2<sup>4</sup></b>

### MONTEGO Estate

2.0 Turbo-D	2.0	60	01.93-12.93	BB	4	<b>GN 909</b> (11V)	○		
2.0 GTI/LXI	2.0	75	12.90-12.93	20 H	4	<b>Z 11</b>	14-7 DU	0,8	<b>UXT 2<sup>4</sup></b>

## SAAB

### 9-3

1.8t	2.0	110	09.02-	B207E	4	<b>Z 221</b>	14 FR-6 DPUX02	1,0	<b>UXT 14</b>
1.9 TiD	1.9	88	09.04-12.10	Z 19 DT → Fgst.Nr. 76004481, 71019398	4	<b>GN 041</b> (11V)	○		
1.9 TiD	1.9	88	09.04-12.10	Z 19 DT Fgst.Nr. 71100001, 76100001 →	4	<b>GN 097</b> (11V)	○		
1.9 TiD	1.9	110	09.04-	Z 19 DTH	4	<b>GN 059</b> (11V)	○		
2.0 i	2.0	96	02.98-08.00	B204I	4	<b>Z 16</b>	14 FR-7 DUX	1,1	<b>UXT 1<sup>3</sup></b>
2.0 Turbo	2.0	110	01.01-09.02	B205E	4	<b>Z 221</b>	14 FR-6 DPUX02	1,0	<b>UXT 14</b>
2.0 Turbo	2.0	113	10.98-09.02	B204E	4	<b>Z 253</b>	14 FR-5 DUU	1,0	<b>UXT 5</b>
2.0 t	2.0	129	09.02-	B207L	4	<b>Z 221</b>	14 FR-6 DPUX02	1,0	<b>UXT 14</b>
2.0 Turbo	2.0	136	02.98-09.02	B205L/B204L	4	<b>Z 253</b>	14 FR-5 DUU	1,0	<b>UXT 5</b>
2.0 SE Turbo	2.0	147	02.98-09.02	B204R	4	<b>Z 253</b>	14 FR-5 DUU	1,0	<b>UXT 5</b>
2.0 Turbo	2.0	151	10.99-09.02	B205R	4	<b>Z 221</b>	14 FR-6 DPUX02	1,0	<b>UXT 14</b>
2.0 T	2.0	154	02.03-	B207R	4	<b>Z 221</b>	14 FR-6 DPUX02	1,0	<b>UXT 14</b>
2.0 Turbo XWD	2.0	154	09.02-08.09	B207R	4	<b>Z 313</b>	14 FR-6 DPUX2	1,0	○
2.2 TiD	2.2	85	02.98-11.00	X 22 DTH/D223L	4	<b>GN 992</b> (11V)	○		
2.2 TiD	2.2	92	11.00-09.02	D223L	4	<b>GN 033</b> (11V)	○		
2.2 TiD	2.2	92	09.02-	D223L	4	<b>GN 033</b> (11V)	○		
2.3 i	2.3	110	02.98-09.02	B234I	4	<b>Z 151</b>	14 FR-7 KPU	0,8	<b>UXT 10</b>
2.3 Turbo	2.3	165	10.98-09.01	B235R	4	<b>Z 221</b>	14 FR-6 DPUX02	1,0	<b>UXT 14</b>
2.8 Turbo V6	2.8	188	12.07-	B284L	6	<b>Z 235</b>	14 FR-7 SPUX03	1,0	○

### 9-3 Cabriolet

1.8t	2.0	110	08.03-	B207E	4	<b>Z 221</b>	14 FR-6 DPUX02	1,0	<b>UXT 14</b>
1.9 TiD	1.9	110	01.06-	Z 19 DTH	4	<b>GN 059</b> (11V)	○		
2.0 i	2.0	96	02.98-08.00	B204I	4	<b>Z 16</b>	14 FR-7 DUX	1,1	<b>UXT 1<sup>3</sup></b>
2.0 Turbo	2.0	110	01.01-08.03	B205E	4	<b>Z 221</b>	14 FR-6 DPUX02	1,0	<b>UXT 14</b>
2.0 Turbo	2.0	113	10.98-08.03	B204E	4	<b>Z 253</b>	14 FR-5 DUU	1,0	<b>UXT 5</b>
1.8t BioPower	2.0	129	01.07-	B207L	4	<b>Z 313</b>	14 FR-6 DPUX2	1,0	○
2.0 t	2.0	129	08.03-	B207L	4	<b>Z 221</b>	14 FR-6 DPUX02	1,0	<b>UXT 14</b>
2.0 Turbo	2.0	136	02.98-08.03	B205L/B204L	4	<b>Z 221</b>	14 FR-6 DPUX02	1,0	<b>UXT 14</b>
2.0 SE Turbo	2.0	147	02.98-08.03	B204R	4	<b>Z 253</b>	14 FR-5 DUU	1,0	<b>UXT 5</b>
2.0 Turbo	2.0	151	10.99-08.03	B205R	4	<b>Z 221</b>	14 FR-6 DPUX02	1,0	<b>UXT 14</b>
2.0 T	2.0	154	08.03-	B207R	4	<b>Z 221</b>	14 FR-6 DPUX02	1,0	<b>UXT 14</b>
2.3 i	2.3	110	02.98-08.00	B234I	4	<b>Z 221</b>	14 FR-6 DPUX02	1,0	<b>UXT 14</b>
2.3 Turbo	2.3	165	10.99-09.01	B235R	4	<b>Z 221</b>	14 FR-6 DPUX02	1,0	<b>UXT 14</b>
2.8 Turbo V6	2.8	188	12.07-	B284L	6	<b>Z 235</b>	14 FR-7 SPUX03	1,0	○

### 9-3 Kombi

1.8 t	2.0	110	03.05-	B207E	4	<b>Z 313</b>	14 FR-6 DPUX2	1,0	○
1.9 TiD	1.9	88	03.05-	Z 19 DTJ → Fgst.Nr. 71019398, 76004481	4	<b>GN 041</b> (11V)	○		
1.9 TiD	1.9	88	03.05-	Z 19 DTJ Fgst.Nr. 71100001, 76100001 →	4	<b>GN 097</b> (11V)	○		
1.9 TiD	1.9	110	03.05-	Z 19 DTH	4	<b>GN 059</b> (11V)	○		
2.0 t	2.0	110	03.05-	B207E	4	<b>Z 221</b>	14 FR-6 DPUX02	1,0	<b>UXT 14</b>
2.0 t	2.0	129	03.05-	B207L	4	<b>Z 221</b>	14 FR-6 DPUX02	1,0	<b>UXT 14</b>
2.0 T	2.0	154	03.05-	B207R	4	<b>Z 221</b>	14 FR-6 DPUX02	1,0	<b>UXT 14</b>
2.8 Turbo V6	2.8	188	12.07-	B284L	6	<b>Z 235</b>	14 FR-7 SPUX03	1,0	○

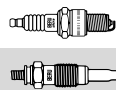
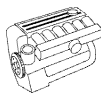

## SAAB

### 9-5

1.9 TiD	1.9	110	01.06-	Z 19 DTH	4	GN 059 (11V)	○	
2.0 t	2.0	110	09.97-09.00	B205E	4	Z 221	14 FR-6 DPUX02	1,0 UXT 14
2.0 Turbo SE	2.0	141	10.98-07.00	B205E	4	Z 221	14 FR-6 DPUX02	1,0 UXT 14
2.2 TiD	2.2	88	03.02-	D223L	4	GN 992 (11V)	○	
2.3 t	2.3	125	09.97-08.00	B235E	4	Z 221	14 FR-6 DPUX02	1,0 UXT 14
2.3 t	2.3	136	01.01-	B235E	4	Z 221	14 FR-6 DPUX02	1,0 UXT 14
2.3 Turbo	2.3	162	07.03-	B235L	4	Z 99	14 FR-6 DUX	1,0 UXT 5
2.3 Turbo	2.3	169	10.99-09.01	B235R	4	Z 221	14 FR-6 DPUX02	1,0 UXT 14
2.3 Turbo	2.3	184	09.01-	B235R	4	Z 221	14 FR-6 DPUX02	1,0 UXT 14
3.0 TiD	3.0	130	07.01-	D308L	6	GN 106 (11V)	○	
3.0 V6t	3.0	147	01.98-08.01	B308E	6	Z 221	14 FR-6 DPUX02	1,0 UXT 14

### 9-5 Kombi

1.9 TiD	1.9	110	01.06-	Z 19 DTH	4	GN 059 (11V)	○	
2.0 t	2.0	110	10.98-09.00	B205E	4	Z 221	14 FR-6 DPUX02	1,0 UXT 14
2.0	2.0	136	07.00-07.01	B205L	4	Z 221	14 FR-6 DPUX02	1,0 UXT 14
2.0 t	2.0	141	09.99-08.00	B204R	4	Z 221	14 FR-6 DPUX02	1,0 UXT 14
2.2 TiD	2.2	88	03.02-	D223L	4	GN 992 (11V)	○	
2.3 t	2.3	125	10.98-08.00	B235E	4	Z 221	14 FR-6 DPUX02	1,0 UXT 14
2.3 t	2.3	136	01.01-	B235E	4	Z 221	14 FR-6 DPUX02	1,0 UXT 14
2.3 Turbo	2.3	169	10.99-09.01	B235R	4	Z 221	14 FR-6 DPUX02	1,0 UXT 14
2.3 Turbo	2.3	184	09.01-	B235R	4	Z 221	14 FR-6 DPUX02	1,0 UXT 14
3.0 TiD	3.0	130	07.01-	D308L	6	GN 106 (11V)	○	
3.0 V6t	3.0	147	10.98-08.01	B308E	6	Z 221	14 FR-6 DPUX02	1,0 UXT 14

### 900 I

2.0 i	2.0	81	09.85-08.90	B201	4	Z 11	14-7 DU	0,8 UXT 2 <sup>4</sup>
2.0 i	2.0	85	09.83-08.90	BI 20/B201XI	4	Z 11	14-7 DU	0,8 UXT 2 <sup>4</sup>
2.0 -16	2.0	93	01.89-08.91	B202I	4	Z 73	14 FR-8 DUX	1,1 UXT 1 <sup>3</sup>
2.0 Turbo	2.0	103	10.86-09.90	B201XL	4	Z 22	14-6 DU	0,7 UX 56
2.0 S Turbo-16	2.0	104	07.91-12.93	B202S	4	Z 24	14 FR-6 DU	0,8 UXT 5
2.0 Turbo-16	2.0	118	11.85-12.93	B202XL	4	Z 24	14 FR-6 DU	0,8 UXT 5
2.0 Turbo-16 S KAT	2.0	129	01.89-12.93	B202XL	4	Z 24	14 FR-6 DU	0,8 UXT 5
2.1 -16	2.1	100	08.90-08.91	B212I	4	Z 73	14 FR-8 DUX	1,1 UXT 1 <sup>3</sup>

### 900 I Cabriolet

2.0 -16	2.0	93	01.90-08.91	B202I	4	Z 73	14 FR-8 DUX	1,1 UXT 1 <sup>3</sup>
2.0 S Turbo-16	2.0	104	09.91-08.93	B202S	4	Z 24	14 FR-6 DU	0,8 UXT 5
2.0 Turbo-16	2.0	118	11.86-08.93	B202XL	4	Z 24	14 FR-6 DU	0,8 UXT 5
2.0 Turbo-16 S	2.0	129	11.86-08.93	B202XL	4	Z 24	14 FR-6 DU	0,8 UXT 5
2.1 -16	2.1	100	08.90-08.91	B212I	4	Z 73	14 FR-8 DUX	1,1 UXT 1 <sup>3</sup>

### 900 I Combi Coupe

2.0 i	2.0	81	09.85-08.90	B201	4	Z 11	14-7 DU	0,8 UXT 2 <sup>4</sup>
2.0 -16	2.0	93	08.91-08.92	B202I	4	Z 73	14 FR-8 DUX	1,1 UXT 1 <sup>3</sup>
2.0 Turbo	2.0	103	10.86-09.90	B201XL	4	Z 22	14-6 DU	0,7 UX 56
2.0 S Turbo-16	2.0	104	09.91-07.93	B202S	4	Z 24	14 FR-6 DU	0,8 UXT 5
2.0 Turbo-16	2.0	118	11.85-08.93	B202XL	4	Z 24	14 FR-6 DU	0,8 UXT 5
2.0 Turbo-16 S KAT	2.0	125	01.89-12.93	B202XL	4	Z 24	14 FR-6 DU	0,8 UXT 5
2.0 Turbo-16	2.0	132	01.93-08.93	B202L	4	Z 24	14 FR-6 DU	0,8 UXT 5
2.1 -16	2.1	100	08.91-07.93	B212I	4	Z 73	14 FR-8 DUX	1,1 UXT 1 <sup>3</sup>

### 900 II

2.0 i	2.0	96	08.94-02.98	B204I	4	Z 16	14 FR-7 DUX	1,1 UXT 1 <sup>3</sup>
2.0 -16 Turbo	2.0	136	07.93-02.98	B204L	4	Z 253	14 FR-5 DUU	1,0 UXT 5
2.3 -16	2.3	110	07.93-02.98	B234I	4	Z 15	14 FR-7 DU	0,8 UXT 1 <sup>3</sup>
2.5 -24 V6	2.5	125	07.93-02.98	B258I	6	Z 237	14 FR-7 DQUP7	1,6 ○

### 900 II Cabriolet

2.0 i	2.0	96	12.93-02.98	B204I	4	Z 16	14 FR-7 DUX	1,1 UXT 1 <sup>3</sup>
2.0 -16 Turbo	2.0	136	12.93-02.98	B204L	4	Z 253	14 FR-5 DUU	1,0 UXT 5
2.3 -16	2.3	110	12.93-02.98	B234I	4	Z 15	14 FR-7 DU	0,8 UXT 1 <sup>3</sup>
2.5 -24 V6	2.5	125	12.93-02.98	B258I	6	Z 237	14 FR-7 DQUP7	1,6 ○

### 900 II Coupe

2.0 i	2.0	96	08.94-02.98	B204I	4	Z 16	14 FR-7 DUX	1,1 UXT 1 <sup>3</sup>
2.0 -16 Turbo	2.0	136	12.93-02.98	B204L	4	Z 253	14 FR-5 DUU	1,0 UXT 5
2.3 -16	2.3	110	12.93-02.98	B234I	4	Z 15	14 FR-7 DU	0,8 UXT 1 <sup>3</sup>

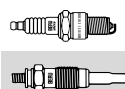

### SAAB

#### 900 II Coupe

2.5 -24 V6	2.5	125	12.93-02.98	B258I	6	<b>Z 237</b>	14 FR-7 DQUP7	1,6	○
------------	-----	-----	-------------	-------	---	--------------	---------------	-----	---

#### 9000

2.0 -16	2.0	94	09.89-01.93	B202I	4	<b>Z 73</b>	14 FR-8 DUX	1,1	<b>UXT 1<sup>3</sup></b>
2.0 -16 CD	2.0	96	09.93-12.98	B204I	4	<b>Z 16</b>	14 FR-7 DUX	1,1	<b>UXT 1<sup>3</sup></b>
2.0 -16 CS	2.0	96	09.93-12.98	B204I	4	<b>Z 16</b>	14 FR-7 DUX	1,1	<b>UXT 1<sup>3</sup></b>
2.0 -16 Turbo CD	2.0	108	09.92-12.98	B204E/B202S	4	<b>Z 16</b>	14 FR-7 DUX	1,1	<b>UXT 1<sup>3</sup></b>
2.0 -16 CD	2.0	110	09.93-12.98	B204S/B204E	4	<b>Z 253</b>	14 FR-5 DUU	1,0	<b>UXT 5</b>
2.0 -16 ND Turbo	2.0	110	09.93-12.98	B204S/B204E/B202S	4	<b>Z 253</b>	14 FR-5 DUU	1,0	<b>UXT 5</b>
2.0 -16 Turbo	2.0	118	09.84-08.93	B202XL	4	<b>Z 253</b>	14 FR-5 DUU	1,0	<b>UXT 5</b>
2.0 -16 Turbo	2.0	120	05.88-08.93	B202XL	4	<b>Z 253</b>	14 FR-5 DUU	1,0	<b>UXT 5</b>
2.0 -16 Turbo CD	2.0	120	09.88-08.93	B202XL	4	<b>Z 253</b>	14 FR-5 DUU	1,0	<b>UXT 5</b>
2.0 -16 Turbo	2.0	127	06.89-12.92	B202	4	<b>Z 253</b>	14 FR-5 DUU	1,0	<b>UXT 5</b>
2.0 -16 Turbo	2.0	129	09.84-12.91	B202XL	4	<b>Z 253</b>	14 FR-5 DUU	1,0	<b>UXT 5</b>
2.0 -16 Turbo CD	2.0	136	09.89-12.98	B202L	4	<b>Z 253</b>	14 FR-5 DUU	1,0	<b>UXT 5</b>
2.0 -16 Turbo CS	2.0	136	09.88-12.98	B202L	4	<b>Z 253</b>	14 FR-5 DUU	1,0	<b>UXT 5</b>
2.3 -16 CD	2.3	107	08.89-08.93	B234I	4	<b>Z 16</b>	14 FR-7 DUX	1,1	<b>UXT 1<sup>3</sup></b>
2.3 -16 CS	2.3	107	09.89-08.93	B234I	4	<b>Z 16</b>	14 FR-7 DUX	1,1	<b>UXT 1<sup>3</sup></b>
2.3 -16 CDE	2.3	108	09.93-12.98	B234I	4	<b>Z 16</b>	14 FR-7 DUX	1,1	<b>UXT 1<sup>3</sup></b>
2.3 -16 CSE	2.3	108	09.93-12.98	B234I	4	<b>Z 16</b>	14 FR-7 DUX	1,1	<b>UXT 1<sup>3</sup></b>
2.3 -16 CDE Eco-Power	2.3	125	09.93-12.98	B234E	4	<b>Z 253</b>	14 FR-5 DUU	1,0	<b>UXT 5</b>
2.3 -16 CSE Eco Power	2.3	125	09.93-12.98	B234E	4	<b>Z 253</b>	14 FR-5 DUU	1,0	<b>UXT 5</b>
2.3 -16 Turbo	2.3	143	09.90-12.98	B234L	4	<b>Z 253</b>	14 FR-5 DUU	1,0	<b>UXT 5</b>
2.3 -16 CD Turbo	2.3	147	07.90-12.98	B234L	4	<b>Z 253</b>	14 FR-5 DUU	1,0	<b>UXT 5</b>
2.3 -16 Turbo CSE	2.3	147	09.93-12.98	B234L	4	<b>Z 253</b>	14 FR-5 DUU	1,0	<b>UXT 5</b>
2.3 -16 Aero CS	2.3	162	02.93-12.98	B234R	4	<b>Z 253</b>	14 FR-5 DUU	1,0	<b>UXT 5</b>
2.3 -16 Aero CS	2.3	165	02.93-12.98	B234R	4	<b>Z 253</b>	14 FR-5 DUU	1,0	<b>UXT 5</b>
3.0 -24 V6 CD/CDE	3.0	155	07.94-12.98	B308I	6	<b>Z 74</b>	14 FR-8 LDUOX4	1,0	<b>UXT 1<sup>3</sup></b>
3.0 -24 V6 CS/CSE	3.0	155	07.94-12.98	B308I	6	<b>Z 74</b>	14 FR-8 LDUOX4	1,0	<b>UXT 1<sup>3</sup></b>

### SANTANA

#### 300/350

1.6 D	1.6	66	09.98-	DV6ATED4	4	<b>GN 056</b> (11V)	○		
-------	-----	----	--------	----------	---	---------------------	---	--	--

#### 300/350 Cabriolet

1.6 D	1.6	66	09.98-	DV6ATED4	4	<b>GN 056</b> (11V)	○		
-------	-----	----	--------	----------	---	---------------------	---	--	--

### SEAT

#### ALHAMBRA

1.4 TSI	1.4	110	06.10-	CAVA	4	<b>Z 349</b>	14 F-6 LPURW03	0,9	○
1.8 T 20V	1.8	110	10.97-03.10	AJH	4	<b>Z 90</b>	14 FGH-7 DTURX	1,0	<b>UXT 1<sup>3</sup></b>
1.8 T 20V	1.8	110	10.97-03.10	AWE	4	<b>Z 188</b>	14 F-7 DPUR02	0,7	<b>UXT 10</b>
1.9 TDI	1.9	66	04.96-03.10	ANU/1Z/AHU	4	<b>GN 855</b> (12V)	○		
				Kühlwasservorwärmung <sup>15</sup>		<b>GN 857</b> (11V)=3x			
				↳ M 5/3Nm		<b>GN 928</b> (12V)=3x			
				↳ Ø 4 mm					
1.9 TDI	1.9	81	08.96-06.00	AFN	4	<b>GN 855</b> (12V)	○		
				Kühlwasservorwärmung <sup>15</sup>		<b>GN 857</b> (11V)=3x			
				↳ M 5/3Nm		<b>GN 928</b> (12V)=3x			
				↳ Ø 4 mm					
1.9 TDI	1.9	85	06.00-03.10	AUY → Fgst.Nr. 7M-2-514 000	4	<b>GN 855</b> (12V)	○		
				Kühlwasservorwärmung <sup>15</sup>		<b>GN 857</b> (11V)=3x			
				↳ M 5/3Nm		<b>GN 928</b> (12V)=3x			
				↳ Ø 4 mm					
1.9 TDI	1.9	85	06.00-03.10	AUY Fgst.Nr. 7M-2-514-001	4	<b>GN 046</b> (12V)	○		
				→					
1.9 TDI 4motion	1.9	85	06.00-03.10	BVK/AUY	4	<b>GN 855</b> (12V)	○		
				Kühlwasservorwärmung <sup>15</sup>		<b>GN 857</b> (11V)=3x			
				↳ M 5/3Nm		<b>GN 928</b> (12V)=3x			
				↳ Ø 4 mm					
1.9 TDI	1.9	96	11.02-11.08	ASZ	4	<b>GN 046</b> (12V)	○		
1.9 Tdi 4x4	1.9	96	06.05-11.08	ASZ	4	<b>GN 046</b> (12V)	○		
1.9 TDI	1.9	110	05.05-05.07	BTB	4	<b>GN 046</b> (12V)	○		
2.0 i	2.0	85	04.96-03.10	ADY/ATM	4	<b>Z 90</b>	14 FGH-7 DTURX	1,0	<b>UXT 1<sup>3</sup></b>
2.0 TDI	2.0	85	05.11-	CFFE	4	<b>GE 115</b> (4,4V)	○		
2.0 TDI	2.0	100	06.10-05.11	CFFA	4	<b>GE 115</b> (4,4V)	○		

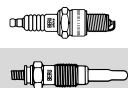
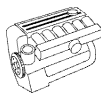

## SEAT

### ALHAMBRA

2.0 TDI	2.0	103	06.10-	CFFB	4	<b>GE 115</b> (4,4V)	○		
2.0 TDI Allrad	2.0	103	05.11-	CFFB	4	<b>GE 115</b> (4,4V)	○		
2.0 TDI	2.0	125	06.10-	CFGB	4	<b>GE 115</b> (4,4V)	○		
2.0 TSI	2.0	147	11.10-	CCZA	4	<b>Z 347</b>	14 F-5 DPUR02	0,7	○
2.8 V6	2.8	150	06.00-03.10	AYL/AUE	6	<b>Z 176</b>	14 F-7 HPURX2	1,0	○
2.8 V6 4motion	2.8	150	06.00-03.10	AYL/AUE	6	<b>Z 176</b>	14 F-7 HPURX2	1,0	○

### ALTEA

1.4 16V	1.4	63	05.06-	BXW/CGGB	4	<b>Z 272</b>	14 F-7 HURU02	1,0	○
1.4 TSI	1.4	92	11.07-	CAXC	4	<b>Z 349</b>	14 F-6 LPURW03	0,9	○
1.6	1.6	75	03.04-	BGU/CCSA/BSF/CMXA/BSE	4	<b>Z 90</b>	14 FGH-7 DTURX	1,0	<b>UXT 1<sup>3</sup></b>
1.6 LPG	1.6	75	09.09-	CHGA	4	<b>Z 90</b>	14 FGH-7 DTURX	1,0	<b>UXT 1<sup>3</sup></b>
1.6 TDI	1.6	77	10.09-	CAYC	4	<b>GE 115</b> (4,4V)	○		
1.8 TFSI	1.8	118	01.07-	BYT/BZB/CDA	4	<b>Z 347</b>	14 F-5 DPUR02	0,7	○
1.9 TDI	1.9	66	08.09-	BXF	4	<b>GE 100</b> (5V)	○		
1.9 TDI	1.9	77	04.04-	BXE/BKC/BJB	4	<b>GE 100</b> (5V)	<b>GSE 100</b>		
2.0 TDI	2.0	100	03.04-05.09	AZV	4	<b>GE 100</b> (5V)	<b>GSE 100</b>		
2.0 TDI 16V	2.0	103	03.04-	BKD	4	<b>GE 101</b> (4,4V) + VW Nr. 03G 103 483	<b>GSE 100</b>		
2.0 TDI 16V	2.0	103	03.04-	CFHC	4	<b>GE 115</b> (4,4V)	○		
2.0 FSI	2.0	110	05.04-03.09	BLR/BLY/BVY/BVZ	4	<b>Z 236</b>	14 F-6 HTPRX02	1,0	○
2.0 TDI	2.0	125	03.06-	CEGA	4	<b>GE 115</b> (4,4V)	○		
2.0 TFSI	2.0	147	04.06-05.09	BWA	4	<b>Z 347</b>	14 F-5 DPUR02	0,7	○

### ALTEA XL

1.4 16V	1.4	63	10.06-	BXW/CGGB	4	<b>Z 272</b>	14 F-7 HURU02	1,0	○
1.4 TSI	1.4	92	11.07-	CAXC	4	<b>Z 349</b>	14 F-6 LPURW03	0,9	○
1.6	1.6	75	10.06-	CCSA/BSF/CMXA/BSE	4	<b>Z 90</b>	14 FGH-7 DTURX	1,0	<b>UXT 1<sup>3</sup></b>
1.6 LPG	1.6	75	09.09-	CHGA	4	<b>Z 90</b>	14 FGH-7 DTURX	1,0	<b>UXT 1<sup>3</sup></b>
1.6 TDI	1.6	77	10.09-	CAYC	4	<b>GE 115</b> (4,4V)	○		
1.8 TFSI	1.8	118	01.07-	BYT	4	<b>Z 347</b>	14 F-5 DPUR02	0,7	○
1.9 TDI	1.9	66	08.09-	BXF	4	<b>GE 100</b> (5V)	○		
1.9 TDI	1.9	77	10.06-	BXE	4	<b>GE 100</b> (5V)	<b>GSE 100</b>		
2.0 TDI	2.0	100	11.06-03.09	AZV	4	<b>GE 101</b> (4,4V)	○		
2.0 TDI 16V	2.0	103	10.06-	BKD	4	<b>GE 101</b> (4,4V) + VW Nr. 03G 103 483	○		
2.0 TDI 16V	2.0	103	10.06-	CFHC	4	<b>GE 115</b> (4,4V)	○		
2.0 FSI	2.0	110	10.06-03.09	BVY/BVZ	4	<b>Z 236</b>	14 F-6 HTPRX02	1,0	○
2.0 TDI	2.0	125	06.07-	CEGA	4	<b>GE 115</b> (4,4V)	○		
2.0 TDI 4x4	2.0	125	06.07-	CEGA, CFJA	4	<b>GE 115</b> (4,4V)	○		
2.0 TFSI 4x4	2.0	147	06.07-05.09	BWA	4	<b>Z 347</b>	14 F-5 DPUR02	0,7	○

### AROSA

1.0	1.0	37	05.97-06.04	AER/ALL	4	<b>Z 91</b>	14 GH-7 DTUR	0,8	<b>UXT 2<sup>4</sup></b>
1.0	1.0	37	05.97-06.04	ALD/ANV/AUC	4	<b>Z 176</b>	14 F-7 HPURX2	1,0	○
1.0	1.0	37	10.98-02.00	AHT	4	<b>Z 188</b>	14 F-7 DPUR02	0,7	<b>UXT 10</b>
1.4	1.4	44	05.97-06.04	AEX/AKV/APQ	4	<b>Z 91</b>	14 GH-7 DTUR	0,8	<b>UXT 2<sup>4</sup></b>
1.4	1.4	44	05.97-06.04	AKK/ANW/AUD	4	<b>Z 176</b>	14 F-7 HPURX2	1,0	○
1.4 TDI	1.4	55	01.00-10.01	AMF	3	<b>GN 855</b> (12V)	○		
1.4 TDI	1.4	55	11.01-06.04	AMF	3	<b>GN 046</b> (12V)	○		
1.4 16V	1.4	74	01.00-06.04	AFK/AUB/AQQ	4	<b>Z 90</b>	14 FGH-7 DTURX	1,0	<b>UXT 1<sup>3</sup></b>
1.7 SDI	1.7	44	08.97-10.01	AKU	4	<b>GN 855</b> (12V)	○		
1.7 SDI	1.7	44	11.01-06.04	AKU	4	<b>GN 046</b> (12V)	○		

### CORDOBA

1.0	1.0	37	06.99-10.02	ANV/ALD/AUC	4	<b>Z 176</b>	14 F-7 HPURX2	1,0	○
1.0 i	1.0	37	09.96-06.99	AER	4	<b>Z 91</b>	14 GH-7 DTUR	0,8	<b>UXT 2<sup>4</sup></b>
1.2	1.2	47	10.02-06.06	AZQ/BME	3	<b>Z 200</b>	14 F-7 HUR2	0,9	○
1.2 12V	1.2	51	05.06-11.09	BXV	3	<b>Z 200</b>	14 F-7 HUR2	0,9	○
1.4 i	1.4	44	06.94-06.99	ABD	4	<b>Z 2</b>	14-8 DTU	1,0	<b>UXT 2<sup>4</sup></b>
1.4 i	1.4	44	06.94-06.99	AEX/AKV/APQ	4	<b>Z 91</b>	14 GH-7 DTUR	0,8	<b>UXT 2<sup>4</sup></b>
1.4	1.4	44	06.99-10.02	ANW/AKV/AUD	4	<b>Z 176</b>	14 F-7 HPURX2	1,0	○
1.4 TDI	1.4	51	05.05-11.09	BNM	3	<b>GN 046</b> (12V)	○		
1.4 16V Automatic	1.4	55	09.02-12.07	BBY, BKY	4	<b>Z 176</b>	14 F-7 HPURX2	1,0	○
1.4 16V	1.4	55	05.00-10.02	APE/AUA	4	<b>Z 90</b>	14 FGH-7 DTURX	1,0	<b>UXT 1<sup>3</sup></b>

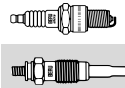
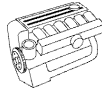

**SEAT**
**CORDOBA**

1.4 16V	1.4	55	09.02-12.07	BBY	4	<b>Z 90</b>	14 FGH-7 DTURX	1,0	<b>UXT 1<sup>3</sup></b>
1.4 16V	1.4	55	09.02-12.07	BKY	4	<b>Z 272</b>	14 F-7 HURU02	1,0	○
1.4 TDI	1.4	55	10.02-12.05	AMF	3	<b>GN 046</b> (12V)	○		
1.4 TDI	1.4	59	06.05-11.09	BNV	3	<b>GN 046</b> (12V)	○		
1.4 16V	1.4	63	05.06-11.09	BXW	4	<b>Z 272</b>	14 F-7 HURU02	1,0	○
1.4 i 16V	1.4	74	09.96-06.99	AFH	4	<b>Z 90</b>	14 FGH-7 DTURX	1,0	<b>UXT 1<sup>3</sup></b>
1.4 16V	1.4	74	02.00-10.02	AQQ/AUB	4	<b>Z 90</b>	14 FGH-7 DTURX	1,0	<b>UXT 1<sup>3</sup></b>
1.4 16V	1.4	74	10.02-11.09	AUB/BBZ	4	<b>Z 90</b>	14 FGH-7 DTURX	1,0	<b>UXT 1<sup>3</sup></b>
1.6 i	1.6	55	02.93-06.99	ABU/AEE/ALM	4	<b>Z 91</b>	14 GH-7 DTUR	0,8	<b>UXT 2<sup>4</sup></b>
1.6 i	1.6	55	05.94-06.99	1F	4	<b>Z 92</b>	14 GH-8 DTUR	0,8	<b>UXT 2<sup>4</sup></b>
1.6 SXE	1.6	55	07.96-04.99	1F	4	<b>Z 92</b>	14 GH-8 DTUR	0,8	<b>UXT 2<sup>4</sup></b>
1.6	1.6	55	06.99-10.02	ALM	4	<b>Z 91</b>	14 GH-7 DTUR	0,8	<b>UXT 2<sup>4</sup></b>
1.6 i	1.6	74	07.96-10.99	AFT/AKL	4	<b>Z 90</b>	14 FGH-7 DTURX	1,0	<b>UXT 1<sup>3</sup></b>
1.6 i	1.6	74	07.96-06.99	AFT	4	<b>Z 90</b>	14 FGH-7 DTURX	1,0	<b>UXT 1<sup>3</sup></b>
1.6	1.6	74	06.99-10.02	AEH/AKL/APF/AUR	4	<b>Z 90</b>	14 FGH-7 DTURX	1,0	<b>UXT 1<sup>3</sup></b>
1.6	1.6	74	04.03-11.09	BAH	4	<b>Z 344</b>	14 F-7 HTUR	1,0	○
1.6 16V	1.6	77	11.06-11.09	BTS	4	<b>Z 272</b>	14 F-7 HURU02	1,0	○
1.7 SDI	1.7	44	07.97-06.99		4	<b>GN 855</b> (12V)	○		
1.8 i	1.8	66	02.93-06.99	ABS/ACC/ADZ	4	<b>Z 91</b>	14 GH-7 DTUR	0,8	<b>UXT 2<sup>4</sup></b>
1.8 i 16V	1.8	95	10.93-08.96	ADL	4	<b>Z 89</b>	14 FGH-6 DTUR	0,8	<b>UXT 5</b>
1.8 T 20V Cupra	1.8	115	07.00-10.02	AYP/AQX	4	<b>Z 90</b>	14 FGH-7 DTURX	1,0	<b>UXT 1<sup>3</sup></b>
1.9 D	1.9	47	01.96-08.96	1Y	4	<b>GN 857</b> (11V)	○		
1.9 SDI	1.9	47	08.96-06.99	AEY	4	<b>GN 857</b> (11V)	○		
1.9 SDI	1.9	47	08.96-06.99	AEY	4	<b>GN 855</b> (12V)	○		
1.9 SDI	1.9	47	09.02-11.09	ASY	4	<b>GN 046</b> (12V)	○		
1.9 D	1.9	50	02.93-08.96	1Y	4	<b>GN 857</b> (11V)	○		
1.9 SDI	1.9	50	06.99-10.02	AQM/AGP	4	<b>GN 855</b> (12V)	○		
1.9 TD	1.9	55	02.93-08.96	AAZ	4	<b>GN 857</b> (11V)	○		
1.9 D	1.9	66	07.96-04.99	1Z/AHU	4	<b>GN 855</b> (12V)	○		
			Kühlwasservorwärmung <sup>15</sup>	⇄: M 5/3Nm ⇄: Ø 4 mm		<b>GN 857</b> (11V)=3x <b>GN 928</b> (12V)=3x			
1.9 TDI	1.9	66	08.96-06.99	1Z/AHU	4	<b>GN 855</b> (12V)	○		
			Kühlwasservorwärmung <sup>15</sup>	⇄: M 5/3Nm ⇄: Ø 4 mm		<b>GN 857</b> (11V)=3x <b>GN 928</b> (12V)=3x			
1.9 TDI	1.9	66	06.99-10.02	AGR/ALH	4	<b>GN 855</b> (12V)	○		
			Kühlwasservorwärmung <sup>15</sup>	⇄: M 5/3Nm ⇄: Ø 4 mm		<b>GN 857</b> (11V)=3x <b>GN 928</b> (12V)=3x			
1.9 TDI	1.9	74	09.02-11.09	AXR, ATD	4	<b>GN 046</b> (12V)	○		
1.9 TDI	1.9	81	06.99-10.02	ASV	4	<b>GN 855</b> (12V)	○		
			Kühlwasservorwärmung <sup>15</sup>	⇄: M 5/3Nm ⇄: Ø 4 mm		<b>GN 857</b> (11V)=3x <b>GN 928</b> (12V)=3x			
1.9 TDI	1.9	81	03.97-06.99	AFN	4	<b>GN 855</b> (12V)	○		
			Kühlwasservorwärmung <sup>15</sup>	⇄: M 5/3Nm ⇄: Ø 4 mm		<b>GN 857</b> (11V)=3x <b>GN 928</b> (12V)=3x			
1.9 TDI	1.9	96	10.02-11.09	BLT/ASZ	4	<b>GN 046</b> (12V)	○		
2.0 i	2.0	85	02.93-06.99	2E/AGG	4	<b>Z 91</b>	14 GH-7 DTUR	0,8	<b>UXT 2<sup>4</sup></b>
2.0	2.0	85	09.02-11.09	AZL/BBX	4	<b>Z 90</b>	14 FGH-7 DTURX	1,0	<b>UXT 1<sup>3</sup></b>
2.0	2.0	110	07.96-04.99	ABF	4	<b>Z 317</b>	14 F-5 DPUR2T	0,8	○
2.0 i 16V	2.0	110	08.96-06.99	ABF	4	<b>Z 317</b>	14 F-5 DPUR2T	0,8	○
<b>CORDOBA Vario</b>									
1.4	1.4	44	06.99-12.02	ANW/AKK/AUD	4	<b>Z 176</b>	14 F-7 HPURX2	1,0	○
1.4 i	1.4	44	09.96-06.99	AEX/AKW/APQ	4	<b>Z 91</b>	14 GH-7 DTUR	0,8	<b>UXT 2<sup>4</sup></b>
1.4 16V	1.4	55	06.99-12.02	APE/AUA	4	<b>Z 90</b>	14 FGH-7 DTURX	1,0	<b>UXT 1<sup>3</sup></b>
1.4	1.4	74	02.00-12.02	AQQ/AUB	4	<b>Z 90</b>	14 FGH-7 DTURX	1,0	<b>UXT 1<sup>3</sup></b>
1.6	1.6	55	06.99-12.02	ALM	4	<b>Z 91</b>	14 GH-7 DTUR	0,8	<b>UXT 2<sup>4</sup></b>
1.6 i	1.6	55	05.97-06.99	1F	4	<b>Z 92</b>	14 GH-8 DTUR	0,8	<b>UXT 2<sup>4</sup></b>
1.6 i	1.6	55	09.96-06.99	AEE/ALM	4	<b>Z 91</b>	14 GH-7 DTUR	0,8	<b>UXT 2<sup>4</sup></b>
1.6	1.6	74	06.99-12.02	AEH/AKL/APF/AUR	4	<b>Z 90</b>	14 FGH-7 DTURX	1,0	<b>UXT 1<sup>3</sup></b>
1.6 i	1.6	74	09.96-06.99	AFT	4	<b>Z 90</b>	14 FGH-7 DTURX	1,0	<b>UXT 1<sup>3</sup></b>
1.7 SDI	1.7	44	07.97-06.99		4	<b>GN 855</b> (12V)	○		
1.9 SDI	1.9	47	09.96-06.99	AEY	4	<b>GN 855</b> (12V)	○		

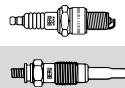

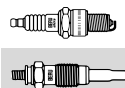
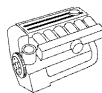

SEAT									
CORDOBA Vario									
1.9 SDI	1.9	50	06.99-12.02	AQM/AGP	4	<b>GN 855</b> (12V)	○		
1.9 TDI	1.9	66	08.96-06.99	1Z/AHU	4	<b>GN 855</b> (12V)	○		
				Kühlwasservorwärmung <sup>15</sup>		<b>GN 857</b> (11V)=3x			
						<b>GN 928</b> (12V)=3x			
1.9 TDI	1.9	66	06.99-12.02	AGR/ALH	4	<b>GN 855</b> (12V)	○		
				Kühlwasservorwärmung <sup>15</sup>		<b>GN 857</b> (11V)=3x			
						<b>GN 928</b> (12V)=3x			
1.9 TDI	1.9	81	07.97-06.99	AFN	4	<b>GN 855</b> (12V)	○		
				Kühlwasservorwärmung <sup>15</sup>		<b>GN 857</b> (11V)=3x			
						<b>GN 928</b> (12V)=3x			
1.9 TDI	1.9	81	06.99-12.02	ASV	4	<b>GN 855</b> (12V)	○		
				Kühlwasservorwärmung <sup>15</sup>		<b>GN 857</b> (11V)=3x			
						<b>GN 928</b> (12V)=3x			
EXEO									
1.6	1.6	75	03.09-	ALZ	4	<b>Z 90</b>	14 FGH-7 DTURX	1,0	<b>UXT 1<sup>3</sup></b>
1.8 T	1.8	110	12.08-	CFMA	4	<b>Z 90</b>	14 FGH-7 DTURX	1,0	<b>UXT 1<sup>3</sup></b>
1.8 TSI	1.8	118	05.10-	CDHB	4	<b>Z 347</b>	14 F-5 DPUR02	0,7	○
2.0 TDI	2.0	105	03.09-	CAGA	4	<b>GE 115</b> (4,4V)	○		
2.0 TDI	2.0	125	03.09-	CAHA	4	<b>GE 115</b> (4,4V)	○		
2.0 TFSI	2.0	147	03.09-	BWE	4	<b>Z 347</b>	14 F-5 DPUR02	0,7	○
2.0 TFSI	2.0	155	05.10-	CDND	4	<b>Z 347</b>	14 F-5 DPUR02	0,7	○
EXEO ST									
1.6	1.6	75	06.09-	ALZ	4	<b>Z 90</b>	14 FGH-7 DTURX	1,0	<b>UXT 1<sup>3</sup></b>
1.8 T	1.8	110	06.09-	CFMA	4	<b>Z 90</b>	14 FGH-7 DTURX	1,0	<b>UXT 1<sup>3</sup></b>
1.8 TSI	1.8	118	05.10-	CDHB	4	<b>Z 347</b>	14 F-5 DPUR02	0,7	○
2.0 TDI	2.0	105	06.09-	CAGA	4	<b>GE 115</b> (4,4V)	○		
2.0 TDI	2.0	125	06.09-	CAHA	4	<b>GE 115</b> (4,4V)	○		
2.0 TFSI	2.0	147	06.09-	BWE	4	<b>Z 347</b>	14 F-5 DPUR02	0,7	○
2.0 TFSI	2.0	155	05.10-	CDND	4	<b>Z 347</b>	14 F-5 DPUR02	0,7	○
IBIZA I									
0.9	0.9	29	08.90-05.93	146 A 000/09 NCA	4	<b>Z 20</b>	14 R-7 DU	0,8	<b>UXT 2<sup>4</sup></b>
0.9	0.9	32	08.86-05.93	146 A 000	4	<b>Z 20</b>	14 R-7 DU	0,8	<b>UXT 2<sup>4</sup></b>
1.2	1.2	44	11.84-12.93	021 A 1000	4	<b>Z 29</b>	14 F-5 DU	0,8	<b>UXT 5</b>
1.2	1.2	47	11.84-12.93	021 A 1000	4	<b>Z 30</b>	14 FR-5 DU	0,8	<b>UXT 5</b>
1.2 i	1.2	52	01.89-05.93	021 C.1000	4	<b>Z 29</b>	14 F-5 DU	0,8	<b>UXT 5</b>
1.5	1.5	63	11.84-05.93	021 A 2000	4	<b>Z 29</b>	14 F-5 DU	0,8	<b>UXT 5</b>
1.5 i	1.5	65	10.86-05.93	021 D.2000	4	<b>Z 29</b>	14 F-5 DU	0,8	<b>UXT 5</b>
1.5 i KAT	1.5	66	10.86-05.93	021 C.2000	4	<b>Z 29</b>	14 F-5 DU	0,8	<b>UXT 5</b>
1.5 i	1.5	74	10.86-05.93	021 B.2000	4	<b>Z 29</b>	14 F-5 DU	0,8	<b>UXT 5</b>
1.7 D	1.7	40	09.87-05.93	022 A.5000	4	<b>GV 663</b> (11V)	○		
1.7 D	1.7	42	08.90-05.93	022 A.5000	4	<b>GV 663</b> (11V)	○		
1.7	1.7	72	01.91-05.93	021 A.3000	4	<b>Z 29</b>	14 F-5 DU	0,8	<b>UXT 5</b>
1.7	1.7	76	01.91-05.93	021 B.3000	4	<b>Z 29</b>	14 F-5 DU	0,8	<b>UXT 5</b>
IBIZA II									
1.0	1.0	33	03.93-09.96	AAU	4	<b>Z 2</b>	14-8 DTU	1,0	<b>UXT 2<sup>4</sup></b>
1.0 i	1.0	37	09.96-08.99	AER	4	<b>Z 91</b>	14 GH-7 DTUR	0,8	<b>UXT 2<sup>4</sup></b>
1.3 i	1.3	40	03.93-07.94	AAV	4	<b>Z 2</b>	14-8 DTU	1,0	<b>UXT 2<sup>4</sup></b>
1.3 i	1.3	40	03.93-08.99	2G	4	<b>Z 12</b>	14-7 DTU	0,8	<b>UXT 2<sup>4</sup></b>
1.4 i	1.4	44	09.93-08.99	ABD	4	<b>Z 2</b>	14-8 DTU	1,0	<b>UXT 2<sup>4</sup></b>
1.4 i	1.4	44	09.93-08.99	AEX/AKV/APQ	4	<b>Z 91</b>	14 GH-7 DTUR	0,8	<b>UXT 2<sup>4</sup></b>
1.4 i 16V	1.4	74	06.97-08.99	AFH	4	<b>Z 90</b>	14 FGH-7 DTURX	1,0	<b>UXT 1<sup>3</sup></b>
1.6 i	1.6	55	09.94-06.99	1F	4	<b>Z 92</b>	14 GH-8 DTUR	0,8	<b>UXT 2<sup>4</sup></b>
1.6 i	1.6	55	03.93-08.99	AEE/ABU/ALM	4	<b>Z 91</b>	14 GH-7 DTUR	0,8	<b>UXT 2<sup>4</sup></b>
1.6 i	1.6	74	04.96-08.99	AFT	4	<b>Z 90</b>	14 FGH-7 DTURX	1,0	<b>UXT 1<sup>3</sup></b>
1.8 i	1.8	66	03.93-08.99	ABS/ADZ	4	<b>Z 91</b>	14 GH-7 DTUR	0,8	<b>UXT 2<sup>4</sup></b>
1.8 i 16V	1.8	95	11.93-08.96	ADL	4	<b>Z 89</b>	14 FGH-6 DTUR	0,8	<b>UXT 5</b>
1.9 D	1.9	47	04.93-08.96	1Y	4	<b>GN 857</b> (11V)	○		
1.9 SDI	1.9	47	08.96-08.99	AEY	4	<b>GN 857</b> (11V)	○		
1.9 SDI	1.9	47	08.96-08.99	AEY	4	<b>GN 855</b> (12V)	○		
1.9 D	1.9	50	10.94-08.96	1Y	4	<b>GN 857</b> (11V)	○		
1.9 TD	1.9	55	03.93-08.96	AAZ	4	<b>GN 857</b> (11V)	○		



## SEAT

### IBIZA II

1.9 TDI	1.9	66	08.96-08.99	1Z/AHU	4	<b>GN 855</b> (12V) ○		
				Kühlwasservorwärmung <sup>15</sup>		<b>GN 857</b> (11V)=3x		
						<b>GN 928</b> (12V)=3x		
1.9 TDI	1.9	81	02.97-08.99	AFN	4	<b>GN 855</b> (12V) ○		
				Kühlwasservorwärmung <sup>15</sup>		<b>GN 857</b> (11V)=3x		
						<b>GN 928</b> (12V)=3x		
2.0 i	2.0	85	03.93-08.99	2E/AGG	4	<b>Z 91</b>	14 GH-7 DTUR	0,8
2.0 i 16V	2.0	110	08.96-08.99	ABF	4	<b>Z 317</b>	14 F-5 DPUR2T	0,8

### IBIZA III

1.0	1.0	37	08.99-02.02	ANW/ALD/AUC	4	<b>Z 176</b>	14 F-7 HPURX2	1,0
1.4	1.4	44	08.99-02.02	ANW/AKK/AUD	4	<b>Z 176</b>	14 F-7 HPURX2	1,0
1.4 16V	1.4	55	05.00-02.02	APE/AUA	4	<b>Z 90</b>	14 FGH-7 DTURX	1,0
1.4 16V	1.4	74	08.99-02.02	AUB/AQQ	4	<b>Z 90</b>	14 FGH-7 DTURX	1,0
1.6	1.6	55	08.99-02.02	ALM	4	<b>Z 91</b>	14 GH-7 DTUR	0,8
1.6	1.6	74	08.99-02.02	AEH/AKL/APF/AUR	4	<b>Z 90</b>	14 FGH-7 DTURX	1,0
1.8 T 20V Cupra	1.8	115	07.00-02.02	AYP/AQX	4	<b>Z 90</b>	14 FGH-7 DTURX	1,0
1.9 SDI	1.9	50	08.99-02.02	AQM/AGP	4	<b>GN 855</b> (12V) ○		
1.9 TDI	1.9	66	08.99-02.02	AGR/ALH	4	<b>GN 855</b> (12V) ○		
				Kühlwasservorwärmung <sup>15</sup>		<b>GN 857</b> (11V)=3x		
						<b>GN 928</b> (12V)=3x		
1.9 TDI	1.9	81	08.99-02.02	ASV	4	<b>GN 855</b> (12V) ○		
				Kühlwasservorwärmung <sup>15</sup>		<b>GN 857</b> (11V)=3x		
						<b>GN 928</b> (12V)=3x		

### IBIZA IV

1.2	1.2	44	06.07-05.08	BBM	3	<b>Z 200</b>	14 F-7 HUR2	0,9
1.2	1.2	47	02.02-06.06	AZQ/BME	3	<b>Z 200</b>	14 F-7 HUR2	0,9
1.2 12V	1.2	51	05.06-11.09	BXV	3	<b>Z 200</b>	14 F-7 HUR2	0,9
1.4 TDI	1.4	51	05.05-11.09	BNM	3	<b>GN 046</b> (12V) ○		
1.4 16V Automatic	1.4	55	02.02-12.07	BBY, BKY	4	<b>Z 176</b>	14 F-7 HPURX2	1,0
1.4 16V	1.4	55	02.02-12.07	BBY	4	<b>Z 90</b>	14 FGH-7 DTURX	1,0
1.4 16V	1.4	55	02.02-12.07	BKY	4	<b>Z 272</b>	14 F-7 HURU02	1,0
1.4 TDI	1.4	55	05.02-12.05	AMF	3	<b>GN 046</b> (12V) ○		
1.4 TDI	1.4	59	06.05-11.09	BNV	3	<b>GN 046</b> (12V) ○		
1.4 16V	1.4	63	05.06-11.09	BXW	4	<b>Z 272</b>	14 F-7 HURU02	1,0
1.4 16V	1.4	74	02.02-11.09	BBZ/AUB	4	<b>Z 90</b>	14 FGH-7 DTURX	1,0
1.6	1.6	74	02.03-11.09	BAH	4	<b>Z 344</b>	14 F-7 HTUR	1,0
1.6 16V	1.6	77	11.06-11.09	BTS	4	<b>Z 272</b>	14 F-7 HURU02	1,0
1.8 T FR	1.8	110	12.03-05.08	BKV/BJX	4	<b>Z 188</b>	14 F-7 DPUR02	0,7
1.8 T Cupra R	1.8	132	01.04-02.08	BBU/BLZ	4	<b>Z 188</b>	14 F-7 DPUR02	0,7
1.9 SDI	1.9	47	02.02-12.05	ASY	4	<b>GN 046</b> (12V) ○		
1.9 TDI	1.9	74	02.02-11.09	ATD, AXR	4	<b>GN 046</b> (12V) ○		
1.9 TDI	1.9	96	02.02-11.09	BLT/ASZ	4	<b>GN 046</b> (12V) ○		
1.9 TDI Cupra R	1.9	118	03.04-02.08	BUK, BPX	4	<b>GN 046</b> (12V) ○		
				Fgst.Nr. 6L-2-001 501 →				
2.0	2.0	85	04.02-11.09	AZL/BBX	4	<b>Z 90</b>	14 FGH-7 DTURX	1,0

### IBIZA V

1.2	1.2	44	07.09-	CGPB	3	<b>Z 272</b>	14 F-7 HURU02	1,0
1.2	1.2	51	03.08-	BZG/CGPA	3	<b>Z 272</b>	14 F-7 HURU02	1,0
1.4	1.4	63	03.08-	BXW/CGGB	4	<b>Z 272</b>	14 F-7 HURU02	1,0
1.4 TSI	1.4	110	06.09-	CAVF	4	<b>Z 349</b>	14 F-6 LPURW03	0,9
1.6 LPG	1.6	60	05.11-	CNKA	4	<b>Z 272</b>	14 F-7 HURU02	1,0
1.6 TDI	1.6	66	05.09-	CAYB	4	<b>GE 115</b> (4,4V) ○		
1.6	1.6	77	05.08-	BTS	4	<b>Z 272</b>	14 F-7 HURU02	1,0
1.6 TDI	1.6	77	05.09-	CAYC, CLNA	4	<b>GE 115</b> (4,4V) ○		
2.0 TDI	2.0	105	01.10-	CFHD	4	<b>GE 115</b> (4,4V) ○		

### IBIZA V SPORTCOUPE

1.2	1.2	44	07.09-	CGPB	3	<b>Z 272</b>	14 F-7 HURU02	1,0
1.2	1.2	51	07.08-	BZG/CGPA	3	<b>Z 272</b>	14 F-7 HURU02	1,0
1.2 TDI	1.2	55	05.10-	CFWA	3	<b>GE 115</b> (4,4V) ○		
1.4	1.4	63	07.08-	CGGB/BXW	4	<b>Z 272</b>	14 F-7 HURU02	1,0

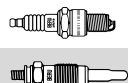

## SEAT

### IBIZA V SPORTCOUPE

1.4 TSI	1.4	110	06.09-	CAVF	4	<b>Z 349</b>	14 F-6 LPURW03	0,9	○
1.4 TSI	1.4	132	06.09-	CAVE	4	<b>Z 349</b>	14 F-6 LPURW03	0,9	○
1.6 LPG	1.6	60	05.11-	CNKA	4	<b>Z 272</b>	14 F-7 HURU02	1,0	○
1.6 TDI	1.6	66	05.09-	CAYB	4	<b>GE 115 (4,4V)</b>	○		
1.6	1.6	77	07.08-	BTS	4	<b>Z 272</b>	14 F-7 HURU02	1,0	○
1.6 TDI	1.6	77	05.09-	CAYC, CLNA	4	<b>GE 115 (4,4V)</b>	○		
2.0 TDI	2.0	105	01.10-	CFHD	4	<b>GE 115 (4,4V)</b>	○		

### IBIZA V ST

1.2	1.2	44	05.10-	CGPB	3	<b>Z 272</b>	14 F-7 HURU02	1,0	○
1.2	1.2	51	05.10-	CGPA	3	<b>Z 272</b>	14 F-7 HURU02	1,0	○
1.4	1.4	63	03.10-	CGGB	4	<b>Z 272</b>	14 F-7 HURU02	1,0	○
1.6 TDI	1.6	66	03.10-	CAYB	4	<b>GE 115 (4,4V)</b>	○		
1.6	1.6	77	02.12-	BTS	4	<b>Z 272</b>	14 F-7 HURU02	1,0	○

### INCA

1.4 i	1.4	44	11.95-06.03	AEX/AKV/APQ	4	<b>Z 91</b>	14 GH-7 DTUR	0,8	<b>UXT 2<sup>4</sup></b>
1.4 i	1.4	44	11.95-06.03	AUD	4	<b>Z 176</b>	14 F-7 HPURX2	1,0	○
1.4 16V	1.4	55	04.00-06.03	AUA	4	<b>Z 90</b>	14 FGH-7 DTURX	1,0	<b>UXT 1<sup>3</sup></b>
1.6 i	1.6	55	11.95-05.98	1F	4	<b>Z 93</b>	14 GH-8 DTURX	1,0	<b>UXT 2<sup>4</sup></b>
1.6 i	1.6	55	06.97-09.00	AEE	4	<b>Z 91</b>	14 GH-7 DTUR	0,8	<b>UXT 2<sup>4</sup></b>
1.7 D	1.7	42	09.96-06.03	AHB	4	<b>GN 857 (11V)</b>	○		
1.9 D	1.9	47	11.95-06.03	1Y	4	<b>GN 857 (11V)</b>	○		
1.9 SDI	1.9	47	11.95-06.03	AYQ/AEY	4	<b>GN 855 (12V)</b>	○		
1.9 TDI	1.9	66	09.96-06.03	ALH	4	<b>GN 855 (12V)</b>	○		
Kühlwasservorwärmung <sup>15</sup>						: M 5/3Nm	<b>GN 857 (11V)=3x</b>		
						: Ø 4 mm	<b>GN 928 (12V)=3x</b>		

### LEON

1.4 16V	1.4	55	11.99-06.06	AHW/APE/AXP	4	<b>Z 90</b>	14 FGH-7 DTURX	1,0	<b>UXT 1<sup>3</sup></b>
1.4 16V	1.4	55	11.99-06.06	BCA	4	<b>Z 200</b>	14 F-7 HUR2	0,9	○
1.4 16V	1.4	63	06.06-	BXW/CGGB	4	<b>Z 272</b>	14 F-7 HURU02	1,0	○
1.4 TSI	1.4	92	11.07-	CAXC	4	<b>Z 349</b>	14 F-6 LPURW03	0,9	○
1.6 TDI	1.6	66	11.10-	CAYB	4	<b>GE 115 (4,4V)</b>	○		
1.6	1.6	74	11.99-06.06	AEH/AKL	4	<b>Z 90</b>	14 FGH-7 DTURX	1,0	<b>UXT 1<sup>3</sup></b>
1.6	1.6	75	10.05-06.06	BFQ	4	<b>Z 90</b>	14 FGH-7 DTURX	1,0	<b>UXT 1<sup>3</sup></b>
1.6	1.6	75	07.05-	BSE/BSF/CCSA/CMXA	4	<b>Z 90</b>	14 FGH-7 DTURX	1,0	<b>UXT 1<sup>3</sup></b>
1.6 16 V	1.6	77	09.00-06.06	AUS	4	<b>Z 90</b>	14 FGH-7 DTURX	1,0	<b>UXT 1<sup>3</sup></b>
1.6 16 V	1.6	77	09.00-06.06	AZD/BCB	4	<b>Z 176</b>	14 F-7 HPURX2	1,0	○
1.6 TDI	1.6	77	02.10-	CAYC	4	<b>GE 115 (4,4V)</b>	○		
1.8 20V	1.8	92	11.99-06.06	AGN/APG	4	<b>Z 90</b>	14 FGH-7 DTURX	1,0	<b>UXT 1<sup>3</sup></b>
1.8 TSI	1.8	118	06.07-	BZB/CDA	4	<b>Z 347</b>	14 F-5 DPUR02	0,7	○
1.8 20V T	1.8	132	11.99-06.06	APP/AUQ	4	<b>Z 188</b>	14 F-7 DPUR02	0,7	<b>UXT 10</b>
1.8 20V T 4	1.8	132	11.99-06.06	AJU/ARY	4	<b>Z 188</b>	14 F-7 DPUR02	0,7	<b>UXT 10</b>
1.8 T Cupra R	1.8	154	02.02-06.06	AMK	4	<b>Z 90</b>	14 FGH-7 DTURX	1,0	<b>UXT 1<sup>3</sup></b>
1.8 Turbo 4x4	1.8	154	05.02-05.03	AMK	4	<b>Z 90</b>	14 FGH-7 DTURX	1,0	<b>UXT 1<sup>3</sup></b>
1.8 T Cupra R	1.8	165	07.03-06.06	BAM	4	<b>Z 188</b>	14 F-7 DPUR02	0,7	<b>UXT 10</b>
1.9 SDI	1.9	50	11.99-06.06	AQM	4	<b>GN 855 (12V)</b>	○		
1.9 TDI	1.9	66	11.99-06.06	AGR/ALH	4	<b>GN 855 (12V)</b>	○		
Kühlwasservorwärmung <sup>15</sup>						: M 5/3Nm	<b>GN 857 (11V)=3x</b>		
						: Ø 4 mm	<b>GN 928 (12V)=3x</b>		
1.9 TDI	1.9	66	06.07-	BXF	4	<b>GE 100 (5V)</b>	○		
1.9 TDI	1.9	74	10.05-06.06	AXR	4	<b>GE 100 (5V)</b>	<b>GSE 100</b>		
1.9 TDI	1.9	77	07.05-	BkC, BXE	4	<b>GE 100 (5V)</b>	<b>GSE 100</b>		
1.9 TDI	1.9	81	11.99-06.06	AHF, ASV	4	<b>GN 855 (12V)</b>	○		
Kühlwasservorwärmung <sup>15</sup>						: M 5/3Nm	<b>GN 857 (11V)=3x</b>		
						: Ø 4 mm	<b>GN 928 (12V)=3x</b>		
1.9 Tdi	1.9	81	10.05-	ASV	4	<b>GN 855 (12V)</b>	○		
Kühlwasservorwärmung <sup>15</sup>						: Ø 4 mm	<b>GN 928 (12V)=3x</b>		
1.9 TDI	1.9	96	05.03-06.06	ASZ	4	<b>GN 046 (12V)</b>	○		
1.9 TDI	1.9	110	02.01-05.02	ARL	4	<b>GN 855 (12V)</b>	○		
Kühlwasservorwärmung <sup>15</sup>						: M 5/3Nm	<b>GN 857 (11V)=3x</b>		
						: Ø 4 mm	<b>GN 928 (12V)=3x</b>		
1.9 TDI	1.9	110	06.02-06.06	ARL	4	<b>GN 046 (12V)</b>	○		



kW

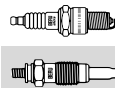

**SEAT**

**LEON**

1.9 TDI Syncro	1.9	110	05.02-06.06	ARL	4	<b>GN 046</b> (12V)	○		
2.0 TDI	2.0	100	07.05-05.10	AZV	4	<b>GE 101</b> (4,4V)	<b>GSE 100</b>		
2.0 TDI 16V	2.0	103	07.05-	BKD	4	<b>GE 101</b> (4,4V) + VW Nr. 03G 103 483	<b>GSE 100</b>		
2.0 TDI 16V	2.0	103	07.05-	CFHC, CLCB	4	<b>GE 115</b> (4,4V)	○		
2.0 FSI	2.0	110	07.05-05.10	BLR/BLV/BVY/BVZ	4	<b>Z 236</b>	14 F-6 HTPRX02	1,0	○
2.0 TDI	2.0	125	05.06-	CFJA, CEGA	4	<b>GE 115</b> (4,4V)	○		
2.0 TFSI	2.0	136	09.05-05.06	BWA1	4	<b>Z 347</b>	14 F-5 DPUR02	0,7	○
2.0 TFSI	2.0	147	05.05-03.09	BWA	4	<b>Z 347</b>	14 F-5 DPUR02	0,7	○
2.0 TFSI	2.0	177	11.06-	BWJ	4	<b>Z 347</b>	14 F-5 DPUR02	0,7	○
2.8	2.8	150	05.02-06.04	BDE	6	<b>Z 176</b>	14 F-7 HPURX2	1,0	○
2.8 Cupra 4	2.8	150	02.01-06.06	AUE	6	<b>Z 176</b>	14 F-7 HPURX2	1,0	○

**MALAGA**

1.2	1.2	44	05.85-12.93	021 A 1000	4	<b>Z 29</b>	14 F-5 DU	0,8	<b>UXT 5</b>
1.2 i	1.2	52	12.89-12.93	021 C.1000	4	<b>Z 29</b>	14 F-5 DU	0,8	<b>UXT 5</b>
1.5	1.5	63	05.85-12.93	021 A 2000	4	<b>Z 29</b>	14 F-5 DU	0,8	<b>UXT 5</b>
1.5 i KAT	1.5	66	10.86-12.93	021 A 2000/021 C.2000/ 021 D.2000	4	<b>Z 29</b>	14 F-5 DU	0,8	<b>UXT 5</b>
1.5 i	1.5	74	11.89-12.93	021 B.2000	4	<b>Z 29</b>	14 F-5 DU	0,8	<b>UXT 5</b>
1.7 D	1.7	40	09.87-12.93	022 A.5000	4	<b>GV 663</b> (11V)	○		
1.7 D	1.7	42	05.90-12.93	022 A.5000	4	<b>GV 663</b> (11V)	○		

**MARBELLA**

0.8	0.8	25	08.86-12.93	08 NCA	4	<b>Z 20</b>	14 R-7 DU	0,8	<b>UXT 2<sup>4</sup></b>
0.9	0.9	29	01.87-12.93	100 GL 7000/09 NCA	4	<b>Z 20</b>	14 R-7 DU	0,8	<b>UXT 2<sup>4</sup></b>
0.9 KAT	0.9	29	01.90-11.96	100 GL 7000/09 NCB	4	<b>Z 82</b>	14 R-9 DU	0,7	<b>UXT 2<sup>4</sup></b>
0.9 KAT	0.9	30	11.96-10.98	08 NCB	4	<b>Z 82</b>	14 R-9 DU	0,7	<b>UXT 2<sup>4</sup></b>
0.9	0.9	32	07.97-10.98	08 NCB	4	<b>Z 82</b>	14 R-9 DU	0,7	<b>UXT 2<sup>4</sup></b>

**TERRA**

0.9	0.9	29	02.87-12.96	09 NCA	4	<b>Z 20</b>	14 R-7 DU	0,8	<b>UXT 2<sup>4</sup></b>
0.9 KAT	0.9	29	02.92-12.94	09 NCB	4	<b>Z 20</b>	14 R-7 DU	0,8	<b>UXT 2<sup>4</sup></b>
1.3 D	1.3	33	03.90-12.94	MN	4	<b>GN 857</b> (11V)	○		
1.4 D	1.4	35	10.90-12.95	1 W	4	<b>GN 857</b> (11V)	○		

**TOLEDO I**

1.6 i	1.6	52	05.91-09.91	1F	4	<b>Z 2</b>	14-8 DTU	1,0	<b>UXT 2<sup>4</sup></b>
1.6 i	1.6	52	10.91-12.93	1F	4	<b>Z 92</b>	14 GH-8 DTUR	0,8	<b>UXT 2<sup>4</sup></b>
1.6 i	1.6	54	05.91-03.99	1F	4	<b>Z 92</b>	14 GH-8 DTUR	0,8	<b>UXT 2<sup>4</sup></b>
1.6 i	1.6	54	05.91-03.99	ABN/EZ	4	<b>Z 2</b>	14-8 DTU	1,0	<b>UXT 2<sup>4</sup></b>
1.6 i	1.6	55	01.93-07.94	1F	4	<b>Z 2</b>	14-8 DTU	1,0	<b>UXT 2<sup>4</sup></b>
1.6 i	1.6	55	08.94-03.99	1F	4	<b>Z 92</b>	14 GH-8 DTUR	0,8	<b>UXT 2<sup>4</sup></b>
1.6 i	1.6	74	11.96-03.99	AFT	4	<b>Z 90</b>	14 FGH-7 DTURX	1,0	<b>UXT 1<sup>3</sup></b>
1.8 i	1.8	65	05.91-11.93	RP	4	<b>Z 12</b>	14-7 DTU	0,8	<b>UXT 2<sup>4</sup></b>
1.8 i	1.8	65	12.93-12.96	RP	4	<b>Z 91</b>	14 GH-7 DTUR	0,8	<b>UXT 2<sup>4</sup></b>
1.8 i	1.8	66	11.93-12.96	ABS/ADZ	4	<b>Z 91</b>	14 GH-7 DTUR	0,8	<b>UXT 2<sup>4</sup></b>
1.8 16V	1.8	92	05.91-03.99	PL	4	<b>Z 89</b>	14 FGH-6 DTUR	0,8	<b>UXT 5</b>
1.8 16V	1.8	98	05.91-03.99	KR	4	<b>Z 52</b>	14 F-6 DTU	0,8	<b>UXT 5</b>
1.9 D	1.9	47	12.95-03.99	1Y	4	<b>GN 857</b> (11V)	○		
1.9 D	1.9	50	05.91-03.99	1Y	4	<b>GN 857</b> (11V)	○		
1.9 TD	1.9	55	05.91-03.99	AAZ	4	<b>GN 857</b> (11V)	○		
1.9 TDI	1.9	66	08.95-03.99	1Z/AHU	4	<b>GN 855</b> (12V)	○		
1.9 TDI	1.9	81	11.96-03.99	AFN	4	<b>GN 855</b> (12V)	○		
1.9 TDI	1.9	81	11.96-03.99	AFN	4	<b>GN 855</b> (12V)	○		
2.0 i	2.0	85	05.91-03.99	2E/AGG	4	<b>Z 91</b>	14 GH-7 DTUR	0,8	<b>UXT 2<sup>4</sup></b>
2.0 i 16V	2.0	110	11.93-03.99	ABF	4	<b>Z 317</b>	14 F-5 DPUR2T	0,8	○

**TOLEDO II**

1.4 16V	1.4	55	07.99-05.06	AHW/AXP	4	<b>Z 90</b>	14 FGH-7 DTURX	1,0	<b>UXT 1<sup>3</sup></b>
1.6	1.6	74	04.99-09.00	AEH/AKL	4	<b>Z 90</b>	14 FGH-7 DTURX	1,0	<b>UXT 1<sup>3</sup></b>
1.6	1.6	75	08.05-05.06	BFQ	4	<b>Z 90</b>	14 FGH-7 DTURX	1,0	<b>UXT 1<sup>3</sup></b>
1.6 16V	1.6	77	09.00-05.06	AUS	4	<b>Z 90</b>	14 FGH-7 DTURX	1,0	<b>UXT 1<sup>3</sup></b>

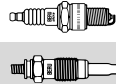
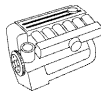

SEAT									
TOLEDO II									
1.6 16V	1.6	77	09.00-05.06	AZD/BCB	4	Z 176	14 F-7 HPURX2	1,0	○
1.8 20V	1.8	92	04.99-05.06	AGN/APG	4	Z 90	14 FGH-7 DTURX	1,0	UXT 1 <sup>3</sup>
1.8 20VT	1.8	132	05.01-05.02	AUQ	4	Z 188	14 F-7 DPUR02	0,7	UXT 10
1.8 Allrad	1.8	132	05.01-04.04	AJQ/ARY	4	Z 188	14 F-7 DPUR02	0,7	UXT 10
1.8 Allrad	1.8	154	05.02-05.03	AMK	4	Z 90	14 FGH-7 DTURX	1,0	UXT 1 <sup>3</sup>
1.8 Allrad	1.8	165	05.03-10.05	BAM	4	Z 188	14 F-7 DPUR02	0,7	UXT 10
1.9 SDI	1.9	50	11.99-06.04	AQM	4	GN 855 (12V)	○		
1.9 TDI	1.9	66	04.99-05.06	AGR/ALH	4	GN 855 (12V)	○		
						Kühlwasservorwärmung <sup>15</sup> M 5/3Nm Ø 4 mm	GN 857 (11V)=3x	GN 928 (12V)=3x	
1.9 TDi	1.9	74	08.05-05.06	AXR	4	GE 100 (5V)	GSE 100		
1.9 TDI	1.9	81	04.99-05.06	AHF, ASV	4	GN 855 (12V)	○		
						Kühlwasservorwärmung <sup>15</sup> M 5/3Nm Ø 4 mm	GN 857 (11V)=3x	GN 928 (12V)=3x	
1.9 TDI	1.9	96	05.03-05.06	ASZ	4	GN 046 (12V)	○		
1.9 TDI	1.9	110	10.00-05.06	ARL → Fgst.Nr. F1M-2-062 000	4	GN 855 (12V)	○		
						Kühlwasservorwärmung <sup>15</sup> Ø 4 mm	GN 928 (12V)=3x		
1.9 TDI	1.9	110	10.00-05.06	ARL Fgst.Nr. F1M-2-062 001 →	4	GN 046 (12V)	○		
2.3 V5	2.3	110	04.99-05.01	AGZ	5	Z 173	14 FGR-8 KQU	1,6	○
2.3 V5 20V	2.3	125	05.01-05.06	AGN	5	Z 176	14 F-7 HPURX2	1,0	○
2.8	2.8	150	10.00-07.01	AUE	6	Z 176	14 F-7 HPURX2	1,0	○
2.8 4x4	2.8	150	05.02-04.04	BDE	6	Z 176	14 F-7 HPURX2	1,0	○
TOLEDO III									
1.6	1.6	75	10.04-05.09	BGU/BSE/BSF	4	Z 90	14 FGH-7 DTURX	1,0	UXT 1 <sup>3</sup>
1.8 TFSI	1.8	118	01.07-05.09	BYT/BZB/CDA	4	Z 347	14 F-5 DPUR02	0,7	○
1.9 TDI	1.9	77	10.04-05.09	BKC, BJB, BXE	4	GE 100 (5V)	GSE 100		
2.0 TDI	2.0	100	09.04-05.09	AZV	4	GE 101 (4,4V)	○		
2.0 TDI 16V	2.0	103	04.04-05.09	BKD	4	GE 101 (4,4V) +	GSE 100		
						VW Nr. 03G 103 483			
2.0 FSI	2.0	110	10.04-05.09	BLR/BVY	4	Z 236	14 F-6 HTPRX02	1,0	○
2.0 FSI	2.0	110	10.04-05.09	BLY/BVZ	4	Z 228	14 FR-7 DPUR02	1,0	UXT 11
2.0 TDI	2.0	125	01.06-05.09	CEGA	4	GE 115 (4,4V)	○		
2.0 TFSI	2.0	147	11.05-05.09	BWA	4	Z 347	14 F-5 DPUR02	0,7	○
SKODA									
105,120									
1.0 105 S,L	1.0	32	02.88-12.90	742	4	Z 10	14-7 BU	0,8	○
1.0 105 S,L,LS	1.0	33	10.83-12.90	742	4	Z 10	14-7 BU	0,8	○
1.0 105 S,L	1.0	34	08.76-12.90	742	4	Z 10	14-7 BU	0,8	○
1.2 120 L	1.2	35	08.87-12.90	742	4	Z 10	14-7 BU	0,8	○
1.2 120 L	1.2	38	08.76-12.90	742	4	Z 10	14-7 BU	0,8	○
1.2 120 LS	1.2	43	08.76-12.90	742.12 X	4	Z 48	14-6 BU	0,8	○
130									
GL (S135)	1.3	43	05.88-10.91	135/8	4	Z 48	14-6 BU	0,8	○
L, GL	1.3	45	02.85-12.90	742	4	Z 48	14-6 BU	0,8	○
G, GL (S136)	1.3	46	05.88-10.91		4	Z 48	14-6 BU	0,8	○
FABIA									
1.0	1.0	37	12.99-08.02	AQV/ARV	4	Z 188	14 F-7 DPUR02	0,7	UXT 10
1.2	1.2	40	07.01-03.08	AWY/BMD	3	Z 200	14 F-7 HUR2	0,9	○
1.2	1.2	44	12.06-	BBM, CHFA → Fgst.Nr. 5J-8B501225	3	Z 200	14 F-7 HUR2	0,9	○
						Z 272	14 F-7 HURU02	1,0	○
1.2	1.2	44	12.06-	BBM, CHFA Fgst.Nr. 5J-8B501226 →	3	Z 272	14 F-7 HURU02	1,0	○
1.2 12V	1.2	44	11.11-	CGPB	3	Z 272	14 F-7 HURU02	1,0	○
1.2	1.2	47	01.03-03.08	AZQ	3	Z 200	14 F-7 HUR2	0,9	○
1.2	1.2	47	01.03-03.08	BME	3	Z 272	14 F-7 HURU02	1,0	○
1.2	1.2	51	01.07-	BZG, CEVA, CGPA, CHTA → Fgst.Nr. 5J-83074394, 5J-8B501225	3	Z 200	14 F-7 HUR2	0,9	○



kW

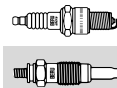
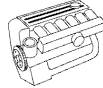

**SKODA**

**FABIA**

1.2	1.2	51	01.07-	BZG, CEVA, CGPA, CHTA Fgst.Nr. 5J-83074395, 5J-8B501226 →	3	<b>Z 272</b>	14 F-7 HURU02	1,0	○
1.4	1.4	44	08.00-08.02	AZE/AZF	4	<b>Z 238</b>	14 FR-8 DPU2	0,8	○
1.4	1.4	50	08.99-03.08	AME/ATZ/AQW	4	<b>Z 238</b>	14 FR-8 DPU2	0,8	○
1.4 TDI	1.4	51	10.05-	BNM	3	<b>GN 046</b> (12V)	○		
1.4 16V Automatic	1.4	55	12.99-03.08	AJA, BBY	4	<b>Z 176</b>	14 F-7 HPURX2	1,0	○
1.4 16V	1.4	55	12.99-03.08	AJA, BBY	4	<b>Z 90</b>	14 FGH-7 DTURX	1,0	<b>UXT 1<sup>3</sup></b>
1.4 16V	1.4	55	12.99-03.08	BKY	4	<b>Z 200</b>	14 F-7 HUR2	0,9	○
1.4 TDI	1.4	55	04.03-03.08	AMF	3	<b>GN 046</b> (12V)	○		
1.4 TDI	1.4	59	10.05-	BNV	3	<b>GN 046</b> (12V)	○		
1.4	1.4	59	02.06-10.06	BUD	4	<b>Z 272</b>	14 F-7 HURU02	1,0	○
1.4 16V	1.4	59	04.06-12.07	BUD	4	<b>Z 272</b>	14 F-7 HURU02	1,0	○
1.4	1.4	63	01.07-	CGGB/BXW	4	<b>Z 272</b>	14 F-7 HURU02	1,0	○
1.4 16V	1.4	74	12.99-03.08	BBZ/AUB	4	<b>Z 90</b>	14 FGH-7 DTURX	1,0	<b>UXT 1<sup>3</sup></b>
1.4 TSI	1.4	132	05.10-	CAVE	4	<b>Z 349</b>	14 F-6 LPURW03	0,9	○
1.6 TDI	1.6	55	04.10-	CAYA	4	<b>GE 115</b> (4,4V)	○		
1.6 TDI	1.6	66	03.10-	CAYB	4	<b>GE 115</b> (4,4V)	○		
1.6	1.6	77	04.07-	BTS/CFNA	4	<b>Z 272</b>	14 F-7 HURU02	1,0	○
1.6 TDI	1.6	77	03.10-	CAYC	4	<b>GE 115</b> (4,4V)	○		
1.9 SDI	1.9	47	12.99-03.08	ASY	4	<b>GN 855</b> (12V)	○		
1.9 TDI	1.9	74	01.00-12.07	ATD, AXR	4	<b>GN 046</b> (12V)	○		
1.9 TDI	1.9	77	04.07-	BSW Fgst.Nr. 5J-7-000 001 →	4	<b>GN 046</b> (12V)	○		
1.9 TDI RS	1.9	96	06.03-03.08	BLT/ASZ	4	<b>GN 046</b> (12V)	○		
2.0	2.0	85	12.99-03.08	AQY/AZL	4	<b>Z 90</b>	14 FGH-7 DTURX	1,0	<b>UXT 1<sup>3</sup></b>

**FABIA Combi**

1.2	1.2	40	07.01-12.07	AWY/BMD	3	<b>Z 200</b>	14 F-7 HUR2	0,9	○
1.2	1.2	44	10.07-	BBM, CHFA → Fgst.Nr. 5J-8B501225	3	<b>Z 200</b>	14 F-7 HUR2	0,9	○
1.2	1.2	44	10.07-	BBM, CHFA Fgst.Nr. 5J-8B501226 →	3	<b>Z 272</b>	14 F-7 HURU02	1,0	○
1.2 12V	1.2	44	11.11-	CGPB	3	<b>Z 272</b>	14 F-7 HURU02	1,0	○
1.2	1.2	47	01.03-12.07	AZQ	3	<b>Z 200</b>	14 F-7 HUR2	0,9	○
1.2	1.2	47	01.03-12.07	BME	3	<b>Z 272</b>	14 F-7 HURU02	1,0	○
1.2	1.2	51	10.07-	BZG, CEVA, CGPA, CHTA → Fgst.Nr. 5J-83074394, 5J-8B501225	3	<b>Z 200</b>	14 F-7 HUR2	0,9	○
1.2	1.2	51	10.07-	BZG, CEVA, CGPA, CHTA Fgst.Nr. 5J-83074395, 5J-8B501226 →	3	<b>Z 272</b>	14 F-7 HURU02	1,0	○
1.4	1.4	44	04.00-12.07	AZF/AZE	4	<b>Z 238</b>	14 FR-8 DPU2	0,8	○
1.4	1.4	50	04.00-12.07	AME/ATZ/AQW	4	<b>Z 238</b>	14 FR-8 DPU2	0,8	○
1.4 TDI	1.4	51	10.05-	BNM	3	<b>GN 046</b> (12V)	○		
1.4 16V Automatic	1.4	55	05.00-12.07	AJA, BBY	4	<b>Z 176</b>	14 F-7 HPURX2	1,0	○
1.4 16V	1.4	55	05.00-12.07	AJA, BBY	4	<b>Z 90</b>	14 FGH-7 DTURX	1,0	<b>UXT 1<sup>3</sup></b>
1.4 16V	1.4	55	05.00-12.07	BKY	4	<b>Z 200</b>	14 F-7 HUR2	0,9	○
1.4 TDI	1.4	55	04.03-12.07	AMF	3	<b>GN 046</b> (12V)	○		
1.4 TDI	1.4	59	10.05-	BNV	3	<b>GN 046</b> (12V)	○		
1.4 16V	1.4	59	04.06-12.07	BUD	4	<b>Z 272</b>	14 F-7 HURU02	1,0	○
1.4	1.4	63	10.07-	CGGB/BXW	4	<b>Z 272</b>	14 F-7 HURU02	1,0	○
1.4 16V	1.4	74	04.00-12.07	BBZ/AUB	4	<b>Z 90</b>	14 FGH-7 DTURX	1,0	<b>UXT 1<sup>3</sup></b>
1.4 TSI	1.4	132	05.10-	CAVE	4	<b>Z 349</b>	14 F-6 LPURW03	0,9	○
1.6 TDI	1.6	55	04.10-	CAYA	4	<b>GE 115</b> (4,4V)	○		
1.6 TDI	1.6	66	03.10-	CAYB	4	<b>GE 115</b> (4,4V)	○		
1.6 TDI	1.6	77	03.10-	CAYC	4	<b>GE 115</b> (4,4V)	○		
1.6	1.6	77	10.07-	BTS/CFNA	4	<b>Z 272</b>	14 F-7 HURU02	1,0	○
1.9 SDI	1.9	47	04.00-12.07	ASY	4	<b>GN 855</b> (12V)	○		

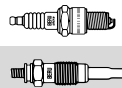
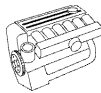

## SKODA

### FABIA Combi

1.9 TDI	1.9	74	04.00–12.07	AXR, ATD	4	<b>GN 046</b> (12V)	○		
				Kühlwasservorwärmung <sup>15</sup>		<b>GN 857</b> (11V)=3x			
						<b>GN 928</b> (12V)=3x			
1.9 TDI	1.9	77	10.07–	BSW	4	<b>GN 046</b> (12V)	○		
1.9 TDI	1.9	77	10.07–	BLS	4	<b>GE 100</b> (5V)	○		
2.0	2.0	85	04.00–12.07	AZL	4	<b>Z 90</b>		14 FGH-7 DTURX	1,0

### FABIA Praktik

1.2	1.2	40	07.01–12.07	AWY/BMD	3	<b>Z 200</b>		14 F-7 HUR2	0,9	○
1.2	1.2	47	01.03–12.07	AZQ	3	<b>Z 200</b>		14 F-7 HUR2	0,9	○
1.2	1.2	47	01.03–12.07	BME	3	<b>Z 272</b>		14 F-7 HURU02	1,0	○
1.4	1.4	50	07.01–12.07	AME/ATZ/AQW	4	<b>Z 238</b>		14 FR-8 DPU2	0,8	○
1.4 TDI	1.4	51	10.05–12.07	BNM	3	<b>GN 046</b> (12V)	○			
1.9 SDI	1.9	47	07.01–12.07	ASY	4	<b>GN 046</b> (12V)	○			

### FAVORIT

1.3 135	1.3	42	12.91–09.94	781.135	4	<b>Z 100</b>		14 F-8 DU4	0,8	<b>UXT 1<sup>3</sup></b>
1.3 135	1.3	43	12.91–09.94	781.135	4	<b>Z 100</b>		14 F-8 DU4	0,8	<b>UXT 1<sup>3</sup></b>
1.3 135	1.3	44	10.90–09.94	781.135	4	<b>Z 100</b>		14 F-8 DU4	0,8	<b>UXT 1<sup>3</sup></b>
1.3 135 X,LX,GLX	1.3	40	01.90–09.94	781.135E	4	<b>Z 254</b>		14 FR-8 DUS	0,7	<b>UXT 1<sup>3</sup></b>
1.3 135L	1.3	43	05.89–09.94	781.135	4	<b>Z 63</b>		14 F-7 DU	0,8	<b>UXT 1<sup>3</sup></b>
1.3 136	1.3	45	10.90–09.94	136 L	4	<b>Z 100</b>		14 F-8 DU4	0,8	<b>UXT 1<sup>3</sup></b>
1.3	1.3	50	01.94–09.94	136B	4	<b>Z 15</b>		14 FR-7 DU	0,8	<b>UXT 1<sup>3</sup></b>

### FAVORIT Forman

1.3	1.3	40	09.91–06.95	781.135E	4	<b>Z 254</b>		14 FR-8 DUS	0,7	<b>UXT 1<sup>3</sup></b>
1.3	1.3	44	12.91–06.95	781.135	4	<b>Z 100</b>		14 F-8 DU4	0,8	<b>UXT 1<sup>3</sup></b>
1.3	1.3	45	08.91–06.95	OHC	4	<b>Z 100</b>		14 F-8 DU4	0,8	<b>UXT 1<sup>3</sup></b>
1.3	1.3	50	01.94–06.95	136B	4	<b>Z 15</b>		14 FR-7 DU	0,8	<b>UXT 1<sup>3</sup></b>

### FAVORIT Pick-up

1.3	1.3	40	12.92–06.97	135B	4	<b>Z 254</b>		14 FR-8 DUS	0,7	<b>UXT 1<sup>3</sup></b>
1.3	1.3	42	12.92–06.97	781.135	4	<b>Z 254</b>		14 FR-8 DUS	0,7	<b>UXT 1<sup>3</sup></b>
1.3	1.3	50	12.92–06.97	136B	4	<b>Z 15</b>		14 FR-7 DU	0,8	<b>UXT 1<sup>3</sup></b>

### FELICIA I

1.3	1.3	40	10.94–03.98	135B	4	<b>Z 15</b>		14 FR-7 DU	0,8	<b>UXT 1<sup>3</sup></b>
1.3	1.3	40	10.94–03.98	AMG	4	<b>Z 90</b>		14 FGH-7 DTURX	1,0	<b>UXT 1<sup>3</sup></b>
1.3	1.3	43	10.94–03.98	135L	4	<b>Z 15</b>		14 FR-7 DU	0,8	<b>UXT 1<sup>3</sup></b>
1.3	1.3	43	10.94–03.98	AMJ	4	<b>Z 90</b>		14 FGH-7 DTURX	1,0	<b>UXT 1<sup>3</sup></b>
1.3	1.3	50	10.94–03.98	136B	4	<b>Z 15</b>		14 FR-7 DU	0,8	<b>UXT 1<sup>3</sup></b>
1.3	1.3	50	10.94–03.98	AMH	4	<b>Z 121</b>		14 FGH-8 DTURXO	1,0	<b>UXT 9</b>
1.6 LX	1.6	55	08.95–03.98	EA111/AEE	4	<b>Z 91</b>		14 GH-7 DTUR	0,8	<b>UXT 2<sup>4</sup></b>
1.9 D	1.9	47	10.95–03.98	AEF	4	<b>GN 857</b> (11V)	○			

### FELICIA I Fun

1.3	1.3	40	06.97–04.02	135B/135M	4	<b>Z 238</b>		14 FR-8 DPU2	0,8	○
1.3	1.3	43	10.95–04.02	AMJ	4	<b>Z 90</b>		14 FGH-7 DTURX	1,0	<b>UXT 1<sup>3</sup></b>
1.3	1.3	50	06.97–04.02	136B/136M	4	<b>Z 238</b>		14 FR-8 DPU2	0,8	○
1.6	1.6	55	06.97–04.02	AEE	4	<b>Z 91</b>		14 GH-7 DTUR	0,8	<b>UXT 2<sup>4</sup></b>
1.9 D	1.9	47	06.97–04.02	AEF	4	<b>GN 857</b> (11V)	○			

### FELICIA I Kombi

1.3 LX	1.3	40	08.95–03.98	135B	4	<b>Z 15</b>		14 FR-7 DU	0,8	<b>UXT 1<sup>3</sup></b>
1.3 LX	1.3	40	08.95–03.98	AMG	4	<b>Z 90</b>		14 FGH-7 DTURX	1,0	<b>UXT 1<sup>3</sup></b>
1.3	1.3	43	08.95–03.98	135L	4	<b>Z 15</b>		14 FR-7 DU	0,8	<b>UXT 1<sup>3</sup></b>
1.3	1.3	43	08.95–03.98	AMJ	4	<b>Z 90</b>		14 FGH-7 DTURX	1,0	<b>UXT 1<sup>3</sup></b>
1.3 LXI	1.3	50	08.95–07.96	136B	4	<b>Z 15</b>		14 FR-7 DU	0,8	<b>UXT 1<sup>3</sup></b>
1.3 LXI	1.3	50	08.95–03.98	AMH	4	<b>Z 121</b>		14 FGH-8 DTURXO	1,0	<b>UXT 9</b>
1.6 GLX	1.6	55	08.95–03.98	AEE	4	<b>Z 91</b>		14 GH-7 DTUR	0,8	<b>UXT 2<sup>4</sup></b>
1.9 D	1.9	47	10.95–03.98	AEF	4	<b>GN 857</b> (11V)	○			

### FELICIA II

1.3	1.3	40	01.98–06.01	AMG	4	<b>Z 238</b>		14 FR-8 DPU2	0,8	○
1.3	1.3	43	01.98–06.01	AMJ	4	<b>Z 90</b>		14 FGH-7 DTURX	1,0	<b>UXT 1<sup>3</sup></b>
1.3	1.3	50	01.98–06.01	AMH	4	<b>Z 238</b>		14 FR-8 DPU2	0,8	○
1.6	1.6	55	01.98–06.01	AEE	4	<b>Z 91</b>		14 GH-7 DTUR	0,8	<b>UXT 2<sup>4</sup></b>
1.9 D	1.9	47	01.98–06.01	AEF	4	<b>GN 857</b> (11V)	○			

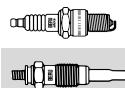
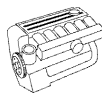

## SKODA

### FELICIA II Kombi

1.3	1.3	50	01.98-06.01	AMH	4	<b>Z 238</b>	14 FR-8 DPU2	0,8	○
1.6	1.6	55	01.98-06.01	AEE	4	<b>Z 91</b>	14 GH-7 DTUR	0,8	<b>UXT 2<sup>4</sup></b>
1.9 D	1.9	47	01.98-06.01	AEF	4	<b>GN 857</b> (11V)	○		

### OCTAVIA

1.2 TSI	1.2	77	02.10-	CBZB	4	<b>Z 347</b>	14 F-5 DPUR02	0,7	○
1.4	1.4	44	04.99-03.01	AMD	4	<b>Z 238</b>	14 FR-8 DPU2	0,8	○
1.4	1.4	55	05.04-05.06	BCA	4	<b>Z 200</b>	14 F-7 HUR2	0,9	○
1.4 16V	1.4	55	09.00-12.10	AXP/BCA	4	<b>Z 188</b>	14 F-7 DPUR02	0,7	<b>UXT 10</b>
1.4	1.4	59	06.04-	BUD, CGGA → Fgst.Nr.1Z-4-000 000	4	<b>Z 200</b>	14 F-7 HUR2	0,9	○
1.4	1.4	59	06.04-	BUD, CGGA Fgst.Nr. 1Z-4-000 001 →	4	<b>Z 272</b>	14 F-7 HURU02	1,0	○
1.4 TSI	1.4	90	11.08-	CAXA	4	<b>Z 349</b>	14 F-6 LPURW03	0,9	○
1.6	1.6	55	09.96-09.04	AEE	4	<b>Z 91</b>	14 GH-7 DTUR	0,8	<b>UXT 2<sup>4</sup></b>
1.6	1.6	74	02.97-12.07	AKL/AEH	4	<b>Z 90</b>	14 FGH-7 DTURX	1,0	<b>UXT 1<sup>3</sup></b>
1.6	1.6	75	11.00-12.10	AVU/BFQ	4	<b>Z 90</b>	14 FGH-7 DTURX	1,0	<b>UXT 1<sup>3</sup></b>
1.6	1.6	75	06.04-	BGU/BSE/BSF/CCSA/CMXA	4	<b>Z 90</b>	14 FGH-7 DTURX	1,0	<b>UXT 1<sup>3</sup></b>
1.6 MultiFuel	1.6	75	01.08-	CCSA	4	<b>Z 90</b>	14 FGH-7 DTURX	1,0	<b>UXT 1<sup>3</sup></b>
1.6 TDI	1.6	77	06.09-	CAVC	4	<b>GE 115</b> (4,4V)	○		
1.6 FSI	1.6	85	02.04-10.08	BLF	4	<b>Z 300</b>	14 FGR-6 HQU	1,35	○
1.8	1.8	92	09.96-07.00	AGN	4	<b>Z 90</b>	14 FGH-7 DTURX	1,0	<b>UXT 1<sup>3</sup></b>
1.8 T	1.8	110	08.97-12.10	AGU	4	<b>Z 90</b>	14 FGH-7 DTURX	1,0	<b>UXT 1<sup>3</sup></b>
1.8 T	1.8	110	08.97-12.10	ARX/ARZ/AUM	4	<b>Z 188</b>	14 F-7 DPUR02	0,7	<b>UXT 10</b>
1.8 T 4x4	1.8	110	05.01-05.06	ARX	4	<b>Z 188</b>	14 F-7 DPUR02	0,7	<b>UXT 10</b>
1.8 TSI	1.8	118	06.07-	BZB/CDA	4	<b>Z 347</b>	14 F-5 DPUR02	0,7	○
RS 1.8 T	1.8	132	05.01-01.06	AUQ	4	<b>Z 188</b>	14 F-7 DPUR02	0,7	<b>UXT 10</b>
1.9 SDI	1.9	50	06.97-12.03	AQM/AGP	4	<b>GN 855</b> (12V)	○		
1.9 TDI	1.9	66	09.96-03.10	AGR/ALH	4	<b>GN 855</b> (12V)	○		
				Kühlwasservorwärmung <sup>15</sup> M 5/3Nm Ø 4 mm		<b>GN 857</b> (11V)=3x <b>GN 928</b> (12V)=3x			
1.9 TDI	1.9	74	10.05-12.10	AXR → Fgst.Nr. 1U-28558 122, 1U-22598 796	4	<b>GN 855</b> (12V)	○		
1.9 TDI	1.9	74	10.05-12.10	AXR Fgst.Nr. 1U-22598 797, 1U-28558 123 →	4	<b>GN 046</b> (12V)	○		
1.9 TDI	1.9	77	06.04-12.10	BXE/BKC/BJB/BLS Fgst.Nr. 70251→	4	<b>GE 100</b> (5V)	<b>GSE 100</b>		
1.9 TDI	1.9	81	08.97-01.06	AHF/ASV	4	<b>GN 855</b> (12V)	○		
				Kühlwasservorwärmung <sup>15</sup> M 5/3Nm Ø 4 mm		<b>GN 857</b> (11V)=3x <b>GN 928</b> (12V)=3x			
1.9 TDI	1.9	96	09.02-09.04	ASZ	4	<b>GN 046</b> (12V)	○		
2.0 TDI	2.0	81	03.10-	CFHC, CLCA	4	<b>GE 115</b> (4,4V)	○		
2.0	2.0	85	04.99-05.07	AEG/APK/AQY/AZH	4	<b>Z 90</b>	14 FGH-7 DTURX	1,0	<b>UXT 1<sup>3</sup></b>
2.0 TDI	2.0	100	02.04-05.10	AZV	4	<b>GE 101</b> (4,4V)	○		
2.0 TDI	2.0	103	01.06-	BMM Fgst.Nr. 1Z-62195 293, 1Z-68075 880 →	4	<b>GE 100</b> (5V)	<b>GSE 100</b>		
2.0 TDI 16V	2.0	103	02.04-	BKD	4	<b>GE 101</b> (4,4V) + VW Nr. 03G 103 483	<b>GSE 100</b>		
2.0 TDI 16V	2.0	103	02.04-	CFHC, CLCB	4	<b>GE 115</b> (4,4V)	○		
2.0 FSI	2.0	110	11.04-	BLR/BVY	4	<b>Z 236</b>	14 F-6 HTPRX02	1,0	○
2.0 FSI	2.0	110	11.04-	BLY/BVZ	4	<b>Z 228</b>	14 FR-7 DPUR02	1,0	<b>UXT 11</b>
2.0 TDI RS	2.0	125	04.06-	CEGA	4	<b>GE 115</b> (4,4V)	○		
2.0 RS	2.0	147	10.05-	BWA/CCZA	4	<b>Z 347</b>	14 F-5 DPUR02	0,7	○

### OCTAVIA Combi

1.2 TSI	1.2	77	02.10-	CBZB	4	<b>Z 347</b>	14 F-5 DPUR02	0,7	○
1.4 16V	1.4	55	08.00-12.10	AXP/BCA	4	<b>Z 188</b>	14 F-7 DPUR02	0,7	<b>UXT 10</b>
1.4	1.4	59	05.06-	BUD, CGGA → Fgst.Nr.1Z-4-000 000	4	<b>Z 200</b>	14 F-7 HUR2	0,9	○
1.4	1.4	59	05.06-	BUD, CGGA Fgst.Nr. 1Z-4-000 001 →	4	<b>Z 272</b>	14 F-7 HURU02	1,0	○



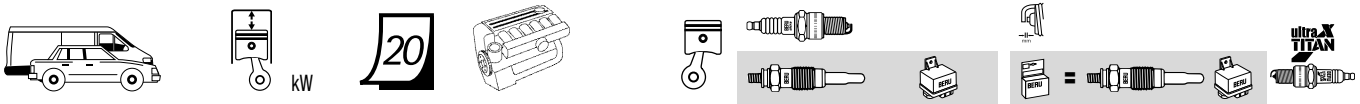

## SKODA

### OCTAVIA Combi

1.4 TSI	1.4	90	11.08–	CAXA	4	<b>Z 349</b>	14 F-6 LPURW03	0,9	○
1.6	1.6	55	07.98–09.04	AEE	4	<b>Z 91</b>	14 GH-7 DTUR	0,8	<b>UXT 2<sup>4</sup></b>
1.6	1.6	74	07.98–12.07	AKL/AEH	4	<b>Z 90</b>	14 FGH-7 DTURX	1,0	<b>UXT 1<sup>3</sup></b>
1.6	1.6	75	09.00–12.10	AVU/BFQ	4	<b>Z 90</b>	14 FGH-7 DTURX	1,0	<b>UXT 1<sup>3</sup></b>
1.6	1.6	75	09.04–	BGU/CCSA/BSF/CMXA/BSE	4	<b>Z 90</b>	14 FGH-7 DTURX	1,0	<b>UXT 1<sup>3</sup></b>
1.6 LPG	1.6	75	08.09–	CHGA	4	<b>Z 90</b>	14 FGH-7 DTURX	1,0	<b>UXT 1<sup>3</sup></b>
1.6 MultiFuel	1.6	75	01.08–	CCSA	4	<b>Z 90</b>	14 FGH-7 DTURX	1,0	<b>UXT 1<sup>3</sup></b>
1.6 TDI	1.6	77	06.09–	CAYC	4	<b>GE 115</b> (4,4V)	○		
1.6 TDI 4x4	1.6	77	06.09–	CAYC	4	<b>GE 115</b> (4,4V)	○		
1.6 FSI	1.6	85	02.04–10.08	BLF	4	<b>Z 300</b>	14 FGR-6 HQU	1,35	○
1.8 20V	1.8	92	07.98–07.00	AGN	4	<b>Z 90</b>	14 FGH-7 DTURX	1,0	<b>UXT 1<sup>3</sup></b>
1.8 T	1.8	110	07.98–12.10	AGU	4	<b>Z 90</b>	14 FGH-7 DTURX	1,0	<b>UXT 1<sup>3</sup></b>
1.8 T	1.8	110	07.98–12.10	ARX/ARZ/AUM	4	<b>Z 188</b>	14 F-7 DPUR02	0,7	<b>UXT 10</b>
1.8 T 4x4	1.8	110	05.01–05.06	ARX	4	<b>Z 188</b>	14 F-7 DPUR02	0,7	<b>UXT 10</b>
1.8 TSI	1.8	118	06.07–	BZB/CDA	4	<b>Z 347</b>	14 F-5 DPUR02	0,7	○
1.8 TSI 4x4	1.8	118	11.08–	CDA	4	<b>Z 347</b>	14 F-5 DPUR02	0,7	○
RS 1.8 T	1.8	132	01.03–01.06	AUQ	4	<b>Z 188</b>	14 F-7 DPUR02	0,7	<b>UXT 10</b>
1.9 SDI	1.9	50	07.98–12.03	AQM/AGP	4	<b>GN 855</b> (12V)	○		
1.9 TDI	1.9	66	07.98–03.10	AGR/ALH	4	<b>GN 855</b> (12V)	○		
				Kühlwasservorwärmung <sup>15</sup>		<b>GN 857</b> (11V)=3x			
						<b>GN 928</b> (12V)=3x			
1.9 TDI 4x4	1.9	66	11.99–02.06	AGR	4	<b>GN 855</b> (12V)	○		
				Kühlwasservorwärmung <sup>15</sup>		<b>GN 857</b> (11V)=3x			
						<b>GN 928</b> (12V)=3x			
1.9 TDI	1.9	74	08.00–12.10	ATD, AXR	4	<b>GN 046</b> (12V)	○		
				Kühlwasservorwärmung <sup>15</sup>		<b>GN 857</b> (11V)=3x			
						<b>GN 928</b> (12V)=3x			
1.9 TDI 4x4	1.9	74	09.00–01.06	ATD	4	<b>GN 046</b> (12V)	○		
				Kühlwasservorwärmung <sup>15</sup>		<b>GN 857</b> (11V)=3x			
						<b>GN 928</b> (12V)=3x			
1.9 TDI	1.9	77	09.04–12.10	BXE/BKC/BJB/BLS Fgst.Nr. 70251→	4	<b>GE 100</b> (5V)	<b>GSE 100</b>		
1.9 TDI 4x4	1.9	77	11.04–12.10	BXE/BKC/BLS Fgst.Nr. 70251→	4	<b>GE 100</b> (5V)	<b>GSE 100</b>		
1.9 TDI	1.9	81	07.98–01.06	AHF/ASV	4	<b>GN 855</b> (12V)	○		
				Kühlwasservorwärmung <sup>15</sup>		<b>GN 857</b> (11V)=3x			
						<b>GN 928</b> (12V)=3x			
1.9 TDI	1.9	96	09.02–09.04	ASZ	4	<b>GN 046</b> (12V)	○		
2.0 TDI	2.0	81	03.10–	CFHF, CLCA	4	<b>GE 115</b> (4,4V)	○		
2.0	2.0	85	04.99–05.07	AEG/APK/AQY/AZH	4	<b>Z 90</b>	14 FGH-7 DTURX	1,0	<b>UXT 1<sup>3</sup></b>
2.0 4x4	2.0	85	08.00–09.04	AZH	4	<b>Z 90</b>	14 FGH-7 DTURX	1,0	<b>UXT 1<sup>3</sup></b>
2.0	2.0	85	04.99–05.07	AZJ	4	<b>Z 176</b>	14 F-7 HPURX2	1,0	○
2.0 4x4	2.0	85	08.00–09.04	AZJ	4	<b>Z 176</b>	14 F-7 HPURX2	1,0	○
2.0 4x4	2.0	88	01.00–12.10	ATF	4	<b>Z 176</b>	14 F-7 HPURX2	1,0	○
2.0 TDI 16V	2.0	100	02.04–05.10	AZV	4	<b>GE 101</b> (4,4V)	○		
2.0 TDI	2.0	103	01.06–	BMM Fgst.Nr. 1Z-62195 293, 1Z-68075 880 →	4	<b>GE 100</b> (5V)	<b>GSE 100</b>		
2.0 TDI 4x4	2.0	103	07.06–	BMM Fgst.Nr. 1Z-62195 293, 1Z-68075 880 →	4	<b>GE 100</b> (5V)	<b>GSE 100</b>		
2.0 TDI 16V	2.0	103	02.04–	BKD	4	<b>GE 101</b> (4,4V) + VW Nr. 03G 103 483	<b>GSE 100</b>		
2.0 TDI 16V	2.0	103	02.04–	CFHC	4	<b>GE 115</b> (4,4V)	○		
2.0 TDI 16V 4x4	2.0	103	05.10–	CFHC	4	<b>GE 115</b> (4,4V)	○		
2.0 FSI	2.0	110	11.04–	BLR/BVY	4	<b>Z 236</b>	14 F-6 HTPRX02	1,0	○
2.0 FSI	2.0	110	11.04–	BLY/BVZ	4	<b>Z 228</b>	14 FR-7 DPUX02	1,0	<b>UXT 11</b>
2.0 FSI 4x4	2.0	110	11.04–	BLX/BVX	4	<b>Z 236</b>	14 F-6 HTPRX02	1,0	○
2.0 TDI RS	2.0	125	04.06–	CEGA	4	<b>GE 115</b> (4,4V)	○		
2.0 RS	2.0	147	10.05–	BWA/CCZA	4	<b>Z 347</b>	14 F-5 DPUR02	0,7	○
<b>RAPID</b>									
1.3 S	1.3	43	09.84–12.90	135/8	4	<b>Z 48</b>	14-6 BU	0,8	○
1.6	1.6	77	10.11–	CLSA	4	<b>Z 272</b>	14 F-7 HURU02	1,0	○

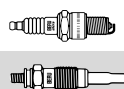
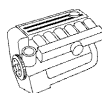

## SKODA

### ROOMSTER

1.2	1.2	47	05.06-01.07	BME	3	<b>Z 272</b>	14 F-7 HURU02	1,0	○
1.2	1.2	51	01.07-	BZG	3	<b>Z 200</b>	14 F-7 HUR2	0,9	○
1.2	1.2	51	01.07-	CGPA	3	<b>Z 272</b>	14 F-7 HURU02	1,0	○
1.2 TDI	1.2	55	03.10-	CFWA	3	<b>GE 115</b> (4,4V)	○		
1.2 TSI	1.2	77	03.10-	CBZB	4	<b>Z 347</b>	14 F-5 DPUR02	0,7	○
1.4 TDI	1.4	51	07.06-03.10	BNM	3	<b>GN 046</b> (12V)	○		
1.4 TDI	1.4	59	09.06-03.10	BNV	3	<b>GN 046</b> (12V)	○		
1.4	1.4	63	09.06-	BXW/CGGB	4	<b>Z 272</b>	14 F-7 HURU02	1,0	○
1.6 TDI	1.6	66	03.10-	CAYB	4	<b>GE 115</b> (4,4V)	○		
1.6	1.6	77	09.06-	BTS/CFNA	4	<b>Z 272</b>	14 F-7 HURU02	1,0	○
1.6 TDI	1.6	77	03.10-	CAVC	4	<b>GE 115</b> (4,4V)	○		
1.9 TDI	1.9	74	03.06-05.06	AXR	4	<b>GN 046</b> (12V)	○		
1.9 TDI	1.9	77	09.06-03.10	BSW	4	<b>GN 046</b> (12V)	○		

### ROOMSTER Praktik

1.2	1.2	51	03.07-	BZG	3	<b>Z 200</b>	14 F-7 HUR2	0,9	○
1.2	1.2	51	03.07-	CGPA	3	<b>Z 272</b>	14 F-7 HURU02	1,0	○
1.2 TDI	1.2	55	03.10-	CFWA	3	<b>GE 115</b> (4,4V)	○		
1.4 TDI	1.4	51	03.07-03.10	BNM	3	<b>GN 046</b> (12V)	○		
1.4 TDI	1.4	59	03.07-03.10	BNV	3	<b>GN 046</b> (12V)	○		
1.4	1.4	63	03.07-	BXW/CGGB	4	<b>Z 272</b>	14 F-7 HURU02	1,0	○
1.6 TDI	1.6	66	03.10-	CAYB	4	<b>GE 115</b> (4,4V)	○		

### SUPERB

1.4 TSI	1.4	92	07.08-	CAXC	4	<b>Z 349</b>	14 F-6 LPURW03	0,9	○
1.6 TDI	1.6	77	09.10-	CAVC	4	<b>GE 115</b> (4,4V)	○		
1.8 T	1.8	110	02.02-03.08	AWT	4	<b>Z 188</b>	14 F-7 DPUR02	0,7	<b>UXT 10</b>
1.8 TSI	1.8	112	03.09-04.10	CDAB	4	<b>Z 347</b>	14 F-5 DPUR02	0,7	○
1.8 TSI 4x4	1.8	112	03.09-04.10	CDAB	4	<b>Z 347</b>	14 F-5 DPUR02	0,7	○
1.8 TSI	1.8	118	03.08-	BZB/CDA	4	<b>Z 347</b>	14 F-5 DPUR02	0,7	○
1.8 TSI 4x4	1.8	118	11.08-	CDA	4	<b>Z 347</b>	14 F-5 DPUR02	0,7	○
1.9 TDI	1.9	74	08.02-10.05	AVB	4	<b>GN 046</b> (12V)	○		
1.9 TDI	1.9	77	03.08-	BXE/BLS	4	<b>GE 100</b> (5V)	<b>GSE 100</b>		
1.9 TDI	1.9	96	02.02-03.08	AWX/AVF	4	<b>GN 046</b> (12V)	○		
2.0	2.0	85	02.02-03.08	AZM	4	<b>Z 90</b>	14 FGH-7 DTURX	1,0	<b>UXT 1<sup>3</sup></b>
2.0 TDI 16V	2.0	103	01.09-	BKD	4	<b>GE 101</b> (4,4V)	<b>GSE 100</b>		
2.0 TDI 16V	2.0	103	01.09-	CFFB, CLJA	4	<b>GE 115</b> (4,4V)	○		
2.0 TDI 16V 4x4	2.0	103	11.10-	CFFB	4	<b>GE 115</b> (4,4V)	○		
2.0 TDI	2.0	125	07.08-	CBBB, CFGB	4	<b>GE 115</b> (4,4V)	○		
2.0 TDI 4x4	2.0	125	09.08-	CBBB, CFGB	4	<b>GE 115</b> (4,4V)	○		
2.0 TSI	2.0	147	05.10-	CCZA	4	<b>Z 347</b>	14 F-5 DPUR02	0,7	○
2.5 TDI	2.5	114	02.02-08.03	AYM	6	<b>GN 008</b> (12V)	○		
2.5 TDI	2.5	120	06.03-03.08	BDG	6	<b>GN 008</b> (12V)	○		
2.8 V6	2.8	142	02.02-03.08	AMX	6	<b>Z 237</b>	14 FR-7 DQUP7	1,6	○

### SUPERB Kombi

1.4 TSI	1.4	92	10.09-	CAXC	4	<b>Z 349</b>	14 F-6 LPURW03	0,9	○
1.6 TDI	1.6	77	09.10-	CAVC	4	<b>GE 115</b> (4,4V)	○		
1.8 TSI	1.8	112	10.09-04.10	CDAB	4	<b>Z 347</b>	14 F-5 DPUR02	0,7	○
1.8 TSI 4x4	1.8	112	10.09-04.10	CDAB	4	<b>Z 347</b>	14 F-5 DPUR02	0,7	○
1.8 TSI	1.8	118	10.09-	CDA	4	<b>Z 347</b>	14 F-5 DPUR02	0,7	○
1.8 TSI 4x4	1.8	118	10.09-	CDA	4	<b>Z 347</b>	14 F-5 DPUR02	0,7	○
1.9 TDI	1.9	77	10.09-11.10	BLS, BXE	4	<b>GE 100</b> (5V)	○		
2.0 TDI 16V	2.0	103	10.09-	BKD	4	<b>GE 101</b> (4,4V)	<b>GSE 100</b>		
2.0 TDI 16V	2.0	103	10.09-	CFFB, CLJA	4	<b>GE 115</b> (4,4V)	○		
2.0 TDI 16V 4x4	2.0	103	11.10-	CFFB	4	<b>GE 115</b> (4,4V)	○		
2.0 TDI	2.0	125	10.09-	CBBB	4	<b>GE 115</b> (4,4V)	○		
2.0 TDI 4x4	2.0	125	10.09-	CBBB	4	<b>GE 115</b> (4,4V)	○		
2.0 TSI	2.0	147	05.10-	CCZA	4	<b>Z 347</b>	14 F-5 DPUR02	0,7	○

### YETI

1.2 TSI	1.2	77	09.09-	CBZB	4	<b>Z 347</b>	14 F-5 DPUR02	0,7	○
1.6 TDI	1.6	77	11.10-	CAVC	4	<b>GE 115</b> (4,4V)	○		
1.8 TSI 4x4	1.8	112	11.09-	CDAB	4	<b>Z 347</b>	14 F-5 DPUR02	0,7	○
1.8 TSI 4x4	1.8	118	05.09-	CDA	4	<b>Z 347</b>	14 F-5 DPUR02	0,7	○

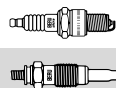
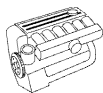

## SKODA

YETI									
2.0 TDI	2.0	81	11.09-	CFHA	4	<b>GE 115</b> (4,4V)	○		
2.0 TDI 4x4	2.0	81	11.09-	CFHF	4	<b>GE 115</b> (4,4V)	○		
2.0 TDI	2.0	103	11.11-	CFHC	4	<b>GE 115</b> (4,4V)	○		
2.0 TDI 4x4	2.0	103	05.09-	CBDB/CFHC/CLCB	4	<b>GE 115</b> (4,4V)	○		
2.0 TDI 4x4	2.0	125	11.09-	CEGA/CFJA	4	<b>GE 115</b> (4,4V)	○		

## SMART

CABRIO									
0.6	0.6	40	03.00-01.04	M 160 E6AL B03/M 160.920	3	<b>Z 194</b>	14 FR-6 LDU3=6x	0,6	<b>UXT 5</b>
0.6	0.6	45	01.01-01.04	M 160 E6AL B05/M 160.920	3	<b>Z 194</b>	14 FR-6 LDU3=6x	0,6	<b>UXT 5</b>
0.6	0.6	52	06.02-01.04	M 160.920	3	<b>Z 194</b>	14 FR-6 LDU3=6x	0,6	<b>UXT 5</b>
0.7	0.7	45	01.03-01.04	M 160.910	3	<b>Z 286</b>	12 FR-5 SDU=6x	0,6	○
0.7	0.7	55	01.03-01.04	M 160.910	3	<b>Z 286</b>	12 FR-5 SDU=6x	0,6	○
0.8 CDI	0.8	30	03.01-01.04	OM 660 DE 8LA/OM 660.940	3	<b>GN 015</b> (11,5V)	○		

CITY-COUPÉ									
0.6	0.6	33	07.98-01.04	M 160 E6AL B04/M 160.920	3	<b>Z 194</b>	14 FR-6 LDU3=6x	0,6	<b>UXT 5</b>
0.6	0.6	40	07.98-01.04	M 160 E6AL B03/M 160.920	3	<b>Z 194</b>	14 FR-6 LDU3=6x	0,6	<b>UXT 5</b>
0.6	0.6	45	01.01-01.04	M 160 E6AL B05/M 160.920	3	<b>Z 194</b>	14 FR-6 LDU3=6x	0,6	<b>UXT 5</b>
0.6	0.6	52	06.02-01.04	M 160.920	3	<b>Z 194</b>	14 FR-6 LDU3=6x	0,6	<b>UXT 5</b>
0.7	0.7	37	01.03-01.04	M 160.910	3	<b>Z 286</b>	12 FR-5 SDU=6x	0,6	○
0.7	0.7	45	01.03-01.04	M 160.910	3	<b>Z 286</b>	12 FR-5 SDU=6x	0,6	○
0.7	0.7	55	01.03-01.04	M 160.910	3	<b>Z 286</b>	12 FR-5 SDU=6x	0,6	○
0.8 CDI	0.8	30	11.99-01.04	OM 660 DE 8LA/OM 660.940	3	<b>GN 015</b> (11,5V)	○		

CROSSBLADE									
0.6	0.6	52	06.02-12.03	M 160.920	3	<b>Z 194</b>	14 FR-6 LDU3=6x	0,6	<b>UXT 5</b>

FORFOUR									
1.1	1.1	47	02.05-06.06	M 134.911	3	<b>Z 235</b>	14 FR-7 SPUX03	1,0	○
1.1	1.1	55	01.04-06.06	M 134.910	3	<b>Z 235</b>	14 FR-7 SPUX03	1,0	○
1.3	1.3	70	01.04-06.06	M 135.930	4	<b>Z 235</b>	14 FR-7 SPUX03	1,0	○
1.5 CDI	1.5	50	09.04-06.06	OM 639.939	3	<b>GN 058</b> (11V)	○		
1.5 CDI	1.5	70	09.04-06.06	OM 639.939	3	<b>GN 058</b> (11V)	○		
1.5	1.5	80	01.04-06.06	M 135.950	4	<b>Z 235</b>	14 FR-7 SPUX03	1,0	○
1.5	1.5	90	01.04-06.06	M 135.950	4	<b>Z 235</b>	14 FR-7 SPUX03	1,0	○

FORTWO Cabrio									
0.7	0.7	45	01.04-01.07	M 160.910	3	<b>Z 286</b>	12 FR-5 SDU=6x	0,6	○
0.7	0.7	55	01.04-01.07	M 160.910	3	<b>Z 286</b>	12 FR-5 SDU=6x	0,6	○
0.8 CDI	0.8	30	01.04-01.07	OM 660 DE 8LA/OM 660.940	3	<b>GN 015</b> (11,5V)	○		
1.0	1.0	52	01.07-	M 132.910	3	<b>Z 308</b>	12 FR-6 MUW	0,9	○
1.0 Turbo	1.0	62	01.07-	M 132.930	3	<b>Z 308</b>	12 FR-6 MUW	0,9	○
1.0 Brabus	1.0	72	01.08-	M 132.930	3	<b>Z 308</b>	12 FR-6 MUW	0,9	○
1.0 Turbo Brabus	1.0	75	07.10-	M 132.930	3	<b>Z 308</b>	12 FR-6 MUW	0,9	○

FORTWO Coupe									
0.7	0.7	37	01.04-01.07	M 160.910	3	<b>Z 286</b>	12 FR-5 SDU=6x	0,6	○
0.7	0.7	45	01.04-01.07	M 160.910	3	<b>Z 286</b>	12 FR-5 SDU=6x	0,6	○
0.7	0.7	55	01.04-01.07	M 160.910	3	<b>Z 286</b>	12 FR-5 SDU=6x	0,6	○
0.8 CDI	0.8	30	01.04-01.07	OM 660 DE 8LA/OM 660.940	3	<b>GN 015</b> (11,5V)	○		
1.0	1.0	45	01.07-	M 132.910	3	<b>Z 308</b>	12 FR-6 MUW	0,9	○
1.0	1.0	52	01.07-	M 132.910	3	<b>Z 308</b>	12 FR-6 MUW	0,9	○
1.0 Turbo	1.0	62	01.07-	M 132.930	3	<b>Z 308</b>	12 FR-6 MUW	0,9	○
1.0 Brabus	1.0	72	01.08-	M 132.930	3	<b>Z 308</b>	12 FR-6 MUW	0,9	○
1.0 Turbo Brabus	1.0	75	07.10-	M 132.930	3	<b>Z 308</b>	12 FR-6 MUW	0,9	○

ROADSTER									
0.7	0.7	45	04.03-11.05		3	<b>Z 286</b>	12 FR-5 SDU=6x	0,6	○
0.7	0.7	60	04.03-11.05		3	<b>Z 286</b>	12 FR-5 SDU=6x	0,6	○

ROADSTER Coupe									
0.7	0.7	60	04.03-11.05		3	<b>Z 286</b>	12 FR-5 SDU=6x	0,6	○

## SSANGYONG

ACTYON									
2.0 Xdi	2.0	100	07.07-	D20DT	4	<b>GN 060</b> (11V)	○		
200 Xdi 4WD	2.0	100	07.07-	D20DT	4	<b>GN 060</b> (11V)	○		

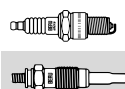
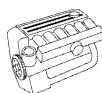

## SSANGYONG

### ACTYON

2.0 Xdi	2.0	104	11.05-	D20DT	4	<b>GN 060</b> (11V)	○		
---------	-----	-----	--------	-------	---	---------------------	---	--	--

### ACTYON SPORTS Pick-up

2.0 Xdi 4WD	2.0	104	04.07-	D20DT	4	<b>GN 060</b> (11V)	○		
2.0 Xdi 4WD	2.0	114	09.11-	D20DTR	4	<b>GE 120</b> (4,4V)	○		

### KORANDO

2.0 e-XDi	2.0	129	11.10-	D20DTF	4	<b>GE 120</b> (4,4V)	○		
2.0 e-XDi 4x4	2.0	129	11.10-	D20DTF	4	<b>GE 120</b> (4,4V)	○		
2.2 D	2.2	50	12.88-12.96	DC23	4	<b>GV 946</b> (11V)	○		
2.3 D	2.3	58	12.96-	OM 601.940	4	<b>GN 858</b> (11,5V)	○		
2.3	2.3	103	05.97-	M 111.970	4	<b>Z 100</b>	14 F-8 DU4	0,8	<b>UXT 1<sup>3</sup></b>
2.9 D	2.9	72	12.96-	MB-OM 662	5	<b>GN 858</b> (11,5V)	○		
2.9 TD	2.9	88	04.98-		5	<b>GN 858</b> (11,5V)	○		
3.2	3.2	154	12.96-	M 104.995	6	<b>Z 100</b>	14 F-8 DU4	0,8	<b>UXT 1<sup>3</sup></b>

### KORANDO Cabrio

2.3	2.3	103	11.97-		4	<b>Z 100</b>	14 F-8 DU4	0,8	<b>UXT 1<sup>3</sup></b>
2.9 D	2.9	72	11.97-	MB-OM 662	5	<b>GN 858</b> (11,5V)	○		
2.9 TD	2.9	88	04.98-		5	<b>GN 858</b> (11,5V)	○		

### KYRON

2.0 Xdi	2.0	100	01.10-	D20DT	4	<b>GN 060</b> (11V)	○		
2.0 Xdi 4x4	2.0	100	01.10-	D20DT	4	<b>GN 060</b> (11V)	○		
2.0 Xdi	2.0	104	05.05-	D20DT	4	<b>GN 060</b> (11V)	○		
2.0 Xdi 4x4	2.0	104	05.05-	D20DT	4	<b>GN 060</b> (11V)	○		
2.7 Xdi	2.7	121	05.05-	D27DT	5	<b>GN 060</b> (11V)	○		
3.2 M320 4WD	3.2	162	03.08-	G32D	6	<b>Z 100</b>	14 F-8 DU4	0,8	<b>UXT 1<sup>3</sup></b>

### MUSSO

2.0	2.0	93	10.96-	E20	4	<b>Z 100</b>	14 F-8 DU4	0,8	<b>UXT 1<sup>3</sup></b>
2.3 D	2.3	59	10.95-	OM 601.940/MB-OM 661	4	<b>GN 858</b> (11,5V)	<b>GR 049</b>		
2.3	2.3	103	10.96-	M 111.970	4	<b>Z 100</b>	14 F-8 DU4	0,8	<b>UXT 1<sup>3</sup></b>
2.9 D	2.9	73	03.96-	MB-OM 662	5	<b>GN 858</b> (11,5V)	○		
2.9 TD	2.9	88	04.98-		5	<b>GN 858</b> (11,5V)	○		
3.2	3.2	162	06.96-	M 104.992	6	<b>Z 100</b>	14 F-8 DU4	0,8	<b>UXT 1<sup>3</sup></b>

### REXTON

2.3 RX230 4x4	2.3	110	05.02-	G23D	4	<b>Z 100</b>	14 F-8 DU4	0,8	<b>UXT 1<sup>3</sup></b>
2.7 Xdi 4x4	2.7	118	03.11-	D27DT	5	<b>GN 060</b> (11V)	○		
2.7 Xdi	2.7	120	08.04-		5	<b>GN 060</b> (11V)	○		
2.9 TD	2.9	88	04.02-		5	<b>GN 858</b> (11,5V)	○		
3.2	3.2	162	04.02-	G32D	6	<b>Z 100</b>	14 F-8 DU4	0,8	<b>UXT 1<sup>3</sup></b>

### RODIUS

2.7 Xdi	2.7	120	05.05-	D27DT	5	<b>GN 060</b> (11V)	○		
2.7 Xdi 4WD	2.7	120	05.05-	D27DT	5	<b>GN 060</b> (11V)	○		
2.7 Xdi	2.7	121	05.05-	D27DT	5	<b>GN 060</b> (11V)	○		
2.7 Xdi 4WD	2.7	121	05.05-	D27DT	5	<b>GN 060</b> (11V)	○		
3.2	3.2	162	07.07-	G32D	6	<b>Z 100</b>	14 F-8 DU4	0,8	<b>UXT 1<sup>3</sup></b>
3.2 4WD	3.2	162	07.07-	G32D	6	<b>Z 100</b>	14 F-8 DU4	0,8	<b>UXT 1<sup>3</sup></b>

## SUBARU

### FORESTER

2.0	2.0	90	08.97-09.02	EJ20	4	<b>Z 73</b>	14 FR-8 DUX	1,1	<b>UXT 1<sup>3</sup></b>
2.0	2.0	92	06.98-09.02	EJ20	4	<b>Z 16</b>	14 FR-7 DUX	1,1	<b>UXT 1<sup>3</sup></b>
2.0	2.0	92	09.02-	EJ20	4	<b>Z 73</b>	14 FR-8 DUX	1,1	<b>UXT 1<sup>3</sup></b>
2.0 S Turbo	2.0	125	06.98-04.01	EJ20	4	<b>Z 221</b>	14 FR-6 DPUX02	1,0	<b>UXT 14</b>
2.0 S Turbo	2.0	130	04.01-09.02	EJ205	4	<b>Z 188</b>	14 F-7 DPUR02	0,7	<b>UXT 10</b>
2.0 S Turbo	2.0	130	09.02-	EJ20	4	<b>Z 221</b>	14 FR-6 DPUX02	1,0	<b>UXT 14</b>

### IMPREZA

1.6 i	1.6	66	08.92-12.00	EJ16	4	<b>Z 16</b>	14 FR-7 DUX	1,1	<b>UXT 1<sup>3</sup></b>
1.6 i 4WD	1.6	66	08.92-07.96	EJ16	4	<b>Z 16</b>	14 FR-7 DUX	1,1	<b>UXT 1<sup>3</sup></b>
1.6 i	1.6	70	06.98-12.00	EJ161	4	<b>Z 16</b>	14 FR-7 DUX	1,1	<b>UXT 1<sup>3</sup></b>
1.6 i 4WD	1.6	70	06.98-12.00	EJ161	4	<b>Z 16</b>	14 FR-7 DUX	1,1	<b>UXT 1<sup>3</sup></b>
1.6 AWD	1.6	70	12.00-	EJ16	4	<b>Z 16</b>	14 FR-7 DUX	1,1	<b>UXT 1<sup>3</sup></b>
1.8 i 4WD	1.8	76	08.92-06.96	EJ18	4	<b>Z 16</b>	14 FR-7 DUX	1,1	<b>UXT 1<sup>3</sup></b>
2.0 i 4WD	2.0	85	10.95-07.96	EJ20	4	<b>Z 16</b>	14 FR-7 DUX	1,1	<b>UXT 1<sup>3</sup></b>

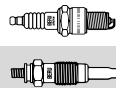

## SUBARU

### IMPREZA

2.0	2.0	92	09.98-09.00	EJ201	4	<b>Z 16</b>	14 FR-7 DUX	1,1	<b>UXT 13</b>
2.0 i 4WD	2.0	92	06.98-12.00	EJ20	4	<b>Z 16</b>	14 FR-7 DUX	1,1	<b>UXT 13</b>
2.0	2.0	92	12.00-	EJ20	4	<b>Z 16</b>	14 FR-7 DUX	1,1	<b>UXT 13</b>
2.0 Turbo GT 4WD	2.0	155	03.94-12.00	EJ20 (Turbo)	4	<b>Z 221</b>	14 FR-6 DPUX02	1,0	<b>UXT 14</b>
2.0 Turbo GT 4WD	2.0	160	06.98-12.00	EJ205	4	<b>Z 188</b>	14 F-7 DPUR02	0,7	<b>UXT 10</b>
2.0 WRX Turbo	2.0	160	12.00-	EJ205	4	<b>Z 188</b>	14 F-7 DPUR02	0,7	<b>UXT 10</b>
2.0 WRX Turbo	2.0	165	12.02-	EJ205	4	<b>Z 188</b>	14 F-7 DPUR02	0,7	<b>UXT 10</b>
2.0 WRX STi	2.0	195	11.01-	EJ207	4	<b>Z 284</b>	14 FR-6 DPOX	1,1	<b>UXT 14</b>

### IMPREZA Coupe

1.6	1.6	66	12.96-12.00	EJ16E	4	<b>Z 16</b>	14 FR-7 DUX	1,1	<b>UXT 13</b>
1.6 4WD	1.6	66	12.96-12.00	EJ161	4	<b>Z 16</b>	14 FR-7 DUX	1,1	<b>UXT 13</b>
2.0 4WD	2.0	85	12.95-07.96	EJ20	4	<b>Z 16</b>	14 FR-7 DUX	1,1	<b>UXT 13</b>

### IMPREZA Station Wagon

1.6 i 4WD	1.6	66	08.92-07.96	EJ16	4	<b>Z 16</b>	14 FR-7 DUX	1,1	<b>UXT 13</b>
1.6 i	1.6	70	06.98-12.00	EJ161	4	<b>Z 16</b>	14 FR-7 DUX	1,1	<b>UXT 13</b>
1.6 i 4WD	1.6	70	06.98-12.00	EJ161	4	<b>Z 16</b>	14 FR-7 DUX	1,1	<b>UXT 13</b>
1.6	1.6	70	12.00-	EJ16	4	<b>Z 16</b>	14 FR-7 DUX	1,1	<b>UXT 13</b>
1.8 i 4WD	1.8	76	08.92-06.96	EJ18	4	<b>Z 16</b>	14 FR-7 DUX	1,1	<b>UXT 13</b>
2.0 4WD	2.0	85	12.95-12.00	EJ20	4	<b>Z 16</b>	14 FR-7 DUX	1,1	<b>UXT 13</b>
2.0 16V AWD	2.0	92	06.98-12.00	EJ20	4	<b>Z 16</b>	14 FR-7 DUX	1,1	<b>UXT 13</b>
2.0	2.0	92	12.00-	EJ20	4	<b>Z 16</b>	14 FR-7 DUX	1,1	<b>UXT 13</b>
2.0 i Turbo 4WD	2.0	155	03.94-12.00	EJ20 (Turbo)	4	<b>Z 221</b>	14 FR-6 DPUX02	1,0	<b>UXT 14</b>
2.0 Turbo GT 4WD	2.0	160	06.98-12.00	EJ205	4	<b>Z 188</b>	14 F-7 DPUR02	0,7	<b>UXT 10</b>
2.0 Turbo	2.0	160	12.00-	EJ205	4	<b>Z 284</b>	14 FR-6 DPOX	1,1	<b>UXT 14</b>
2.0 WRX Turbo	2.0	165	12.02-	EJ205	4	<b>Z 188</b>	14 F-7 DPUR02	0,7	<b>UXT 10</b>

### JUSTY I

1000	1.0	37	05.87-10.95	EF10	3	<b>Z 9</b>	14 R-8 DUX	1,1	<b>UXT 24</b>
1000 4WD	1.0	37	05.87-11.94	EF10	3	<b>Z 9</b>	14 R-8 DUX	1,1	<b>UXT 24</b>
1000 4WD	1.0	40	11.84-12.90	EF10	3	<b>Z 9</b>	14 R-8 DUX	1,1	<b>UXT 24</b>
1200	1.2	49	05.87-10.95	EF12	3	<b>Z 9</b>	14 R-8 DUX	1,1	<b>UXT 24</b>
1200 4WD	1.2	49	05.87-05.91	EF12	3	<b>Z 9</b>	14 R-8 DUX	1,1	<b>UXT 24</b>
1200 4WD	1.2	50	10.86-12.90	EF12	3	<b>Z 9</b>	14 R-8 DUX	1,1	<b>UXT 24</b>
1200 4WD	1.2	55	10.90-12.94	EF12	3	<b>Z 9</b>	14 R-8 DUX	1,1	<b>UXT 24</b>

### JUSTY II

1.3 GX 4x4	1.3	50	10.95-09.96	EF13	4	<b>Z 20</b>	14 R-7 DU	0,8	<b>UXT 24</b>
1.3 4x4	1.3	63	04.01-11.03	G13BB	4	<b>Z 16</b>	14 FR-7 DUX	1,1	<b>UXT 13</b>

### JUSTY IV

1.0	1.0	51	01.07-	1KR-FE	3	<b>Z 235</b>	14 FR-7 SPUX03	1,0	○
-----	-----	----	--------	--------	---	--------------	----------------	-----	---

### LEGACY I

1800	1.8	76	01.89-12.93	EJ18 SPI	4	<b>Z 16</b>	14 FR-7 DUX	1,1	<b>UXT 13</b>
1800 4WD	1.8	76	01.89-09.91	EJ18 SPI	4	<b>Z 16</b>	14 FR-7 DUX	1,1	<b>UXT 13</b>
2000 4WD	2.0	85	08.91-07.94	EJ20 EMPI	4	<b>Z 16</b>	14 FR-7 DUX	1,1	<b>UXT 13</b>
2000 Turbo 4WD	2.0	147	05.92-07.94	EJ20-GN	4	<b>Z 149</b>	14 FR-7 KPIX	1,1	<b>UXT 11</b>
2200 4WD	2.2	100	01.89-07.94	EJ22 EMPI	4	<b>Z 16</b>	14 FR-7 DUX	1,1	<b>UXT 13</b>

### LEGACY I Station Wagon

1800	1.8	76	01.89-07.94	EJ18 SPI	4	<b>Z 16</b>	14 FR-7 DUX	1,1	<b>UXT 13</b>
1800 4WD	1.8	76	01.89-07.94	EJ18 SPI	4	<b>Z 16</b>	14 FR-7 DUX	1,1	<b>UXT 13</b>
2000	2.0	85	09.91-12.93	EJ20 EMPI	4	<b>Z 16</b>	14 FR-7 DUX	1,1	<b>UXT 13</b>
2000 4WD	2.0	85	09.91-07.94	EJ20 EMPI	4	<b>Z 16</b>	14 FR-7 DUX	1,1	<b>UXT 13</b>
2000 Turbo Super 4WD	2.0	147	05.92-07.94	EJ20-GN	4	<b>Z 149</b>	14 FR-7 KPIX	1,1	<b>UXT 11</b>
2200 Super 4WD	2.2	100	01.89-07.94	EJ22 EMPI	4	<b>Z 16</b>	14 FR-7 DUX	1,1	<b>UXT 13</b>

### LEGACY II

2.0 i	2.0	85	09.94-03.99	EJ20E	4	<b>Z 16</b>	14 FR-7 DUX	1,1	<b>UXT 13</b>
2.0 i 4WD	2.0	85	09.94-03.99	EJ20	4	<b>Z 16</b>	14 FR-7 DUX	1,1	<b>UXT 13</b>
2.2 i 4WD	2.2	94	09.94-03.99	EJ22 EMPI	4	<b>Z 16</b>	14 FR-7 DUX	1,1	<b>UXT 13</b>
2.2 i 4WD	2.2	96	06.96-03.99	EJ22 EMPI	4	<b>Z 16</b>	14 FR-7 DUX	1,1	<b>UXT 13</b>
2.5 i 4WD	2.5	110	06.96-03.99	EJ25D	4	<b>Z 343</b>	14 FR-8 DPPUX	1,1	○

### LEGACY II Station Wagon

2.0 i	2.0	85	09.94-11.98	EJ20 EMPI	4	<b>Z 16</b>	14 FR-7 DUX	1,1	<b>UXT 13</b>
2.0 i 4WD	2.0	85	09.94-11.98	EJ20	4	<b>Z 16</b>	14 FR-7 DUX	1,1	<b>UXT 13</b>
2.2 i 4WD	2.2	94	02.94-12.98	EJ22 EMPI	4	<b>Z 16</b>	14 FR-7 DUX	1,1	<b>UXT 13</b>

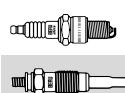

## SUBARU

### LEGACY II Station Wagon

2.2 i 4WD	2.2	96	06.96-11.98	EJ22 EMPI	4	Z 16	14 FR-7 DUX	1,1	UXT 1 <sup>3</sup>
-----------	-----	----	-------------	-----------	---	------	-------------	-----	--------------------

### LEGACY III

2.0	2.0	92	04.99-08.03	EJ20	4	Z 16	14 FR-7 DUX	1,1	UXT 1 <sup>3</sup>
-----	-----	----	-------------	------	---	------	-------------	-----	--------------------

2.5	2.5	115	10.98-08.03	EJ25	4	Z 16	14 FR-7 DUX	1,1	UXT 1 <sup>3</sup>
-----	-----	-----	-------------	------	---	------	-------------	-----	--------------------

### LEGACY III Station Wagon

2.0	2.0	92	12.98-08.03	EJ20	4	Z 16	14 FR-7 DUX	1,1	UXT 1 <sup>3</sup>
-----	-----	----	-------------	------	---	------	-------------	-----	--------------------

2.5	2.5	115	12.98-08.03	EJ25	4	Z 16	14 FR-7 DUX	1,1	UXT 1 <sup>3</sup>
-----	-----	-----	-------------	------	---	------	-------------	-----	--------------------

### LEGACY IV

2.0	2.0	101	09.03-	EJ20	4	Z 16	14 FR-7 DUX	1,1	UXT 1 <sup>3</sup>
-----	-----	-----	--------	------	---	------	-------------	-----	--------------------

2.5	2.5	121	09.03-06.06	EJ25	4	Z 312	14 FR-7 KPPU	1,1	○
-----	-----	-----	-------------	------	---	-------	--------------	-----	---

2.5 i	2.5	127	09.07-05.09	EJ25	4	Z 312	14 FR-7 KPPU	1,1	○
-------	-----	-----	-------------	------	---	-------	--------------	-----	---

### LEGACY IV Station Wagon

2.0	2.0	101	09.03-	EJ20	4	Z 16	14 FR-7 DUX	1,1	UXT 1 <sup>3</sup>
-----	-----	-----	--------	------	---	------	-------------	-----	--------------------

2.5	2.5	121	09.03-06.06	EJ25	4	Z 312	14 FR-7 KPPU	1,1	○
-----	-----	-----	-------------	------	---	-------	--------------	-----	---

2.5 i	2.5	127	01.08-05.09	EJ25	4	Z 312	14 FR-7 KPPU	1,1	○
-------	-----	-----	-------------	------	---	-------	--------------	-----	---

### LEONE II

1800 4WD	1.8	66	11.84-12.90	EA82	4	Z 20	14 R-7 DU	0,8	UXT 2 <sup>4</sup>
----------	-----	----	-------------	------	---	------	-----------	-----	--------------------

1800 4WD KAT	1.8	70	07.86-09.91	EA82	4	Z 20	14 R-7 DU	0,8	UXT 2 <sup>4</sup>
--------------	-----	----	-------------	------	---	------	-----------	-----	--------------------

1800 4WD	1.8	72	01.88-12.90	EA82	4	Z 20	14 R-7 DU	0,8	UXT 2 <sup>4</sup>
----------	-----	----	-------------	------	---	------	-----------	-----	--------------------

1800 Turbo 4WD	1.8	96	03.89-12.90	EA82	4	Z 21	14 R-7 DUX	1,1	UXT 2 <sup>4</sup>
----------------	-----	----	-------------	------	---	------	------------	-----	--------------------

1800 Turbo 4WD	1.8	100	11.84-12.90	EA82	4	Z 21	14 R-7 DUX	1,1	UXT 2 <sup>4</sup>
----------------	-----	-----	-------------	------	---	------	------------	-----	--------------------

### LEONE II Station Wagon

1800 4WD	1.8	66	11.84-12.90	EA82	4	Z 20	14 R-7 DU	0,8	UXT 2 <sup>4</sup>
----------	-----	----	-------------	------	---	------	-----------	-----	--------------------

1800 Super 4WD KAT	1.8	70	07.86-02.92	EA82	4	Z 20	14 R-7 DU	0,8	UXT 2 <sup>4</sup>
--------------------	-----	----	-------------	------	---	------	-----------	-----	--------------------

1800 4WD	1.8	72	12.86-07.91	EA82	4	Z 20	14 R-7 DU	0,8	UXT 2 <sup>4</sup>
----------	-----	----	-------------	------	---	------	-----------	-----	--------------------

1800 Super 4WD	1.8	96	03.89-12.90	EA82	4	Z 21	14 R-7 DUX	1,1	UXT 2 <sup>4</sup>
----------------	-----	----	-------------	------	---	------	------------	-----	--------------------

1800 Super Turbo 4WD	1.8	100	11.84-12.90	EA82	4	Z 21	14 R-7 DUX	1,1	UXT 2 <sup>4</sup>
----------------------	-----	-----	-------------	------	---	------	------------	-----	--------------------

### LIBERO

1.2 4WD	1.2	38	08.86-02.00	EF12	3	Z 9	14 R-8 DUX	1,1	UXT 2 <sup>4</sup>
---------	-----	----	-------------	------	---	-----	------------	-----	--------------------

1.2 i 4WD	1.2	40	08.91-02.00	EF12	3	Z 9	14 R-8 DUX	1,1	UXT 2 <sup>4</sup>
-----------	-----	----	-------------	------	---	-----	------------	-----	--------------------

### OUTBACK

2.5	2.5	115	10.00-08.03	EJ25	4	Z 16	14 FR-7 DUX	1,1	UXT 1 <sup>3</sup>
-----	-----	-----	-------------	------	---	------	-------------	-----	--------------------

2.5	2.5	127	09.08-09.09	EJ251	4	Z 312	14 FR-7 KPPU	1,1	○
-----	-----	-----	-------------	-------	---	-------	--------------	-----	---

### SVX

3.3 i 24V 4WD	3.3	162	09.94-12.97	EG33 DOHC	6	Z 284	14 FR-6 DPOX	1,1	UXT 14
---------------	-----	-----	-------------	-----------	---	-------	--------------	-----	--------

3.3 i 24V 4WD	3.3	169	09.92-09.94	EG33 DOHC	6	Z 284	14 FR-6 DPOX	1,1	UXT 14
---------------	-----	-----	-------------	-----------	---	-------	--------------	-----	--------

### VIVIO

660 4WD	0.7	32	03.92-10.95	EN07E	4	Z 16	14 FR-7 DUX	1,1	UXT 1 <sup>3</sup>
---------	-----	----	-------------	-------	---	------	-------------	-----	--------------------

### XT Coupe

Turbo 4WD	1.8	88	01.88-12.90	EA82	4	Z 27	14 R-6 DU	0,8	UX 56
-----------	-----	----	-------------	------	---	------	-----------	-----	-------

Turbo 4WD	1.8	96	01.87-12.90	EA82	4	Z 21	14 R-7 DUX	1,1	UXT 2 <sup>4</sup>
-----------	-----	----	-------------	------	---	------	------------	-----	--------------------

Turbo 4WD	1.8	100	11.84-12.90	EA82	4	Z 21	14 R-7 DUX	1,1	UXT 2 <sup>4</sup>
-----------	-----	-----	-------------	------	---	------	------------	-----	--------------------

## SUZUKI

### ALTO II

0.8	0.8	29	01.86-11.93	F8B	3	Z 8	14 R-8 DU	0,8	UXT 2 <sup>4</sup>
-----	-----	----	-------------	-----	---	-----	-----------	-----	--------------------

### ALTO III

1.0	1.0	39	09.94-06.02	G10B	4	Z 8	14 R-8 DU	0,8	UXT 2 <sup>4</sup>
-----	-----	----	-------------	------	---	-----	-----------	-----	--------------------

1.0	1.0	43	01.00-	G10BB/G10B	4	Z 8	14 R-8 DU	0,8	UXT 2 <sup>4</sup>
-----	-----	----	--------	------------	---	-----	-----------	-----	--------------------

### ALTO IV

1.1	1.1	46	06.02-12.08	F10DN/F10D	4	Z 234	12 FR-7 DU	0,9	○
-----	-----	----	-------------	------------	---	-------	------------	-----	---

### ALTO V

1.0	1.0	50	01.09-	K10B	3	Z 333	12 FR-6 DPUX	1,1	○
-----	-----	----	--------	------	---	-------	--------------	-----	---

### BALENO

1.3	1.3	52	09.96-05.02	G13BA	4	Z 15	14 FR-7 DU	0,8	UXT 1 <sup>3</sup>
-----	-----	----	-------------	-------	---	------	------------	-----	--------------------

1.3 i 16V	1.3	63	07.95-05.02	G13B/G13BB	4	Z 15	14 FR-7 DU	0,8	UXT 1 <sup>3</sup>
-----------	-----	----	-------------	------------	---	------	------------	-----	--------------------

1.6 i 16V	1.6	72	07.95-05.02	G16B	4	Z 15	14 FR-7 DU	0,8	UXT 1 <sup>3</sup>
-----------	-----	----	-------------	------	---	------	------------	-----	--------------------

1.6 i 16V 4x4	1.6	72	07.95-05.02	G16B	4	Z 15	14 FR-7 DU	0,8	UXT 1 <sup>3</sup>
---------------	-----	----	-------------	------	---	------	------------	-----	--------------------

1.8 GTX	1.8	89	03.96-05.02	J18A	4	Z 16	14 FR-7 DUX	1,1	UXT 1 <sup>3</sup>
---------	-----	----	-------------	------	---	------	-------------	-----	--------------------

1.9 TD	1.9	55	04.98-05.02		4	GN 909 (11V)	○		
--------	-----	----	-------------	--	---	--------------	---	--	--

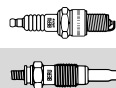
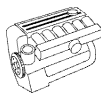

## SUZUKI

### BALENO Kombi

1.3 16V	1.3	63	03.97-05.02	G13BB	4	<b>Z 15</b>	14 FR-7 DU	0,8	<b>UXT 1<sup>3</sup></b>
1.6 i 16V	1.6	72	08.96-05.02	G16B	4	<b>Z 15</b>	14 FR-7 DU	0,8	<b>UXT 1<sup>3</sup></b>
1.6 i 16V 4x4	1.6	72	08.96-05.02	G16B	4	<b>Z 15</b>	14 FR-7 DU	0,8	<b>UXT 1<sup>3</sup></b>
1.8 i 16V	1.8	89	08.96-05.02	J18A	4	<b>Z 16</b>	14 FR-7 DUX	1,1	<b>UXT 1<sup>3</sup></b>
1.9 TD	1.9	55	04.98-05.02		4	<b>GN 909</b> (11V)	○		

### CARRY

1.3	1.3	58	03.99-	G13B	4	<b>Z 15</b>	14 FR-7 DU	0,8	<b>UXT 1<sup>3</sup></b>
-----	-----	----	--------	------	---	-------------	------------	-----	--------------------------

### GRAND VITARA I

1.6	1.6	69	03.98-	G16B	4	<b>Z 16</b>	14 FR-7 DUX	1,1	<b>UXT 1<sup>3</sup></b>
2.0 TD Intercooler	2.0	64	03.98-	RF	4	<b>GN 005</b> (11V)	○		
2.0 HDI 110	2.0	80	07.01-	RHZ	4	<b>GN 027</b> (11V)	○		
2.0 HDI 110 16V	2.0	80	07.01-	RHW	4	<b>GN 027</b> (11V)	○		
2.0	2.0	94	03.98-	J20A	4	<b>Z 16</b>	14 FR-7 DUX	1,1	<b>UXT 1<sup>3</sup></b>
2.5 V6 24V	2.5	106	04.98-	H 25 A	6	<b>Z 16</b>	14 FR-7 DUX	1,1	<b>UXT 1<sup>3</sup></b>

### GRAND VITARA II

1.6 Allrad	1.6	78	04.05-	M16A	4	<b>Z 221</b>	14 FR-6 DPUX02	1,0	<b>UXT 14</b>
1.9 DDiS	1.9	95	10.05-	F9QB	4	<b>GE 111</b> (4,4V)	○		
1.9 DDiS	1.9	95	10.05-	F9QB	4	<b>GN 018</b> (11V)	○		
3.2 Allrad	3.2	171	01.09-	N32A	6	<b>Z 342</b>	14 KR-7 MPUV2	1,3	○

### IGNIS

1.3	1.3	61	10.00-09.03	M13A	4	<b>Z 16</b>	14 FR-7 DUX	1,1	<b>UXT 1<sup>3</sup></b>
1.3 4WD	1.3	61	10.00-09.03	M13A	4	<b>Z 16</b>	14 FR-7 DUX	1,1	<b>UXT 1<sup>3</sup></b>

### IGNIS II

1.3	1.3	69	09.03-	M13A	4	<b>Z 284</b>	14 FR-6 DPOX	1,1	<b>UXT 14</b>
1.3 4x4	1.3	69	09.03-	M13A	4	<b>Z 221</b>	14 FR-6 DPUX02	1,0	<b>UXT 14</b>
1.3 DDiS	1.3	51	09.03-	Z13DT	4	<b>GN 053</b> (11V)	○		
1.5	1.5	73	09.03-	M15A	4	<b>Z 284</b>	14 FR-6 DPOX	1,1	<b>UXT 14</b>
1.5 4x4	1.5	73	09.03-	M15A	4	<b>Z 284</b>	14 FR-6 DPOX	1,1	<b>UXT 14</b>
1.5 Sport	1.5	80	12.03-	M15A	4	<b>Z 284</b>	14 FR-6 DPOX	1,1	<b>UXT 14</b>

### JIMNY

1.3 16V	1.3	59	09.98-	G13BB	4	<b>Z 15</b>	14 FR-7 DU	0,8	<b>UXT 1<sup>3</sup></b>
1.3 16V 4WD	1.3	59	09.98-	G13BB	4	<b>Z 15</b>	14 FR-7 DU	0,8	<b>UXT 1<sup>3</sup></b>
1.3 16V	1.3	60	02.01-	M13A	4	<b>Z 15</b>	14 FR-7 DU	0,8	<b>UXT 1<sup>3</sup></b>
1.3 16V 4WD	1.3	60	02.01-	M13A	4	<b>Z 15</b>	14 FR-7 DU	0,8	<b>UXT 1<sup>3</sup></b>
1.3 16V 4x4	1.3	63	08.05-	M13A	4	<b>Z 221</b>	14 FR-6 DPUX02	1,0	<b>UXT 14</b>
1.5 DDiS 4WD	1.5	48	12.03-	K9K 700	4	<b>GN 018</b> (11V)	○		
1.5 DDiS 4x4	1.5	63	08.05-	K9K 266	4	<b>GN 018</b> (11V)	○		

### LIANA

1.3	1.3	66	03.02-	M13A	4	<b>Z 284</b>	14 FR-6 DPOX	1,1	<b>UXT 14</b>
1.4 DDiS	1.4	66	04.04-	8HY	4	<b>GN 047</b> (11V)	○		
1.6	1.6	76	03.02-	M16A	4	<b>Z 284</b>	14 FR-6 DPOX	1,1	<b>UXT 14</b>
1.6 4WD	1.6	76	03.02-	M16A	4	<b>Z 284</b>	14 FR-6 DPOX	1,1	<b>UXT 14</b>
1.6 i	1.6	78	04.02-	M16A	4	<b>Z 284</b>	14 FR-6 DPOX	1,1	<b>UXT 14</b>
1.6 4WD	1.6	78	04.02-	M16A	4	<b>Z 284</b>	14 FR-6 DPOX	1,1	<b>UXT 14</b>

### LIANA Kombi

1.3	1.3	66	07.01-12.07		4	<b>Z 284</b>	14 FR-6 DPOX	1,1	<b>UXT 14</b>
1.4 DDiS	1.4	66	04.04-12.07	8HY	4	<b>GN 047</b> (11V)	○		
1.6	1.6	76	07.01-12.07	M16A	4	<b>Z 284</b>	14 FR-6 DPOX	1,1	<b>UXT 14</b>
1.6 4WD	1.6	76	07.01-12.07	M16A	4	<b>Z 284</b>	14 FR-6 DPOX	1,1	<b>UXT 14</b>
1.6 i	1.6	78	04.02-12.07	M16A	4	<b>Z 284</b>	14 FR-6 DPOX	1,1	<b>UXT 14</b>
1.6 4WD	1.6	78	04.02-12.07	M16A	4	<b>Z 284</b>	14 FR-6 DPOX	1,1	<b>UXT 14</b>
1.6 4WD	1.6	79	01.05-12.07	M16A	4	<b>Z 284</b>	14 FR-6 DPOX	1,1	<b>UXT 14</b>

### SAMURAI

1.0 Allrad	1.0	33	11.88-12.04	F10A	4	<b>Z 8</b>	14 R-8 DU	0,8	<b>UXT 2<sup>4</sup></b>
1.3	1.3	44	11.88-12.04	G13A	4	<b>Z 8</b>	14 R-8 DU	0,8	<b>UXT 2<sup>4</sup></b>
1.3	1.3	47	11.88-12.04	G13A	4	<b>Z 8</b>	14 R-8 DU	0,8	<b>UXT 2<sup>4</sup></b>
1.3 Allrad	1.3	51	11.88-12.04	G13BA	4	<b>Z 8</b>	14 R-8 DU	0,8	<b>UXT 2<sup>4</sup></b>
1.9 TD	1.9	46	11.98-12.04	XUD9	4	<b>GN 013</b> (11V)	○		

### SJ 413

1.3	1.3	44	08.86-08.90	G13A	4	<b>Z 8</b>	14 R-8 DU	0,8	<b>UXT 2<sup>4</sup></b>
-----	-----	----	-------------	------	---	------------	-----------	-----	--------------------------

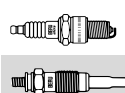
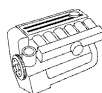
**SUZUKI****SPLASH**

1.0	1.0	48	01.08-	K10B	3	<b>Z 333</b>	12 FR-6 DPUX	1,1	○
1.0	1.0	50	06.11-	K10B	3	<b>Z 333</b>	12 FR-6 DPUX	1,1	○
1.2	1.2	63	01.08-	K12B	4	<b>Z 333</b>	12 FR-6 DPUX	1,1	○
1.2 WT	1.2	66	06.11-	K12B	4	<b>Z 333</b>	12 FR-6 DPUX	1,1	○
1.2 WT	1.2	69	09.10-	K12B	4	<b>Z 333</b>	12 FR-6 DPUX	1,1	○

**SUPER CARRY**

1.0	1.0	30	09.94-03.99	F10A	4	<b>Z 8</b>	14 R-8 DU	0,8	<b>UXT 2<sup>4</sup></b>
1.0	1.0	31	10.92-03.99	F10A	4	<b>Z 8</b>	14 R-8 DU	0,8	<b>UXT 2<sup>4</sup></b>
1.0	1.0	33	10.85-03.99	F10A	4	<b>Z 8</b>	14 R-8 DU	0,8	<b>UXT 2<sup>4</sup></b>

**SWIFT Cabriolet**

1.3 i	1.3	50	09.91-10.96	G13BA	4	<b>Z 20</b>	14 R-7 DU	0,8	<b>UXT 2<sup>4</sup></b>
-------	-----	----	-------------	-------	---	-------------	-----------	-----	--------------------------

**SWIFT II**

1.0	1.0	37	03.89-05.01	G10A	3	<b>Z 20</b>	14 R-7 DU	0,8	<b>UXT 2<sup>4</sup></b>
1.0 i	1.0	39	09.91-05.01	G10A	3	<b>Z 20</b>	14 R-7 DU	0,8	<b>UXT 2<sup>4</sup></b>
1.0 i	1.0	40	03.89-12.91	G10A	3	<b>Z 20</b>	14 R-7 DU	0,8	<b>UXT 2<sup>4</sup></b>
1.3	1.3	50	03.89-05.01	G13A	4	<b>Z 20</b>	14 R-7 DU	0,8	<b>UXT 2<sup>4</sup></b>
1.3 4WD	1.3	50	03.89-05.01	G13A	4	<b>Z 20</b>	14 R-7 DU	0,8	<b>UXT 2<sup>4</sup></b>
1.3	1.3	52	03.89-12.91	G13A	4	<b>Z 20</b>	14 R-7 DU	0,8	<b>UXT 2<sup>4</sup></b>
1.3 4WD	1.3	52	10.89-12.91	G13A	4	<b>Z 20</b>	14 R-7 DU	0,8	<b>UXT 2<sup>4</sup></b>
1.3 GTi	1.3	74	03.89-05.01	G13B	4	<b>Z 20</b>	14 R-7 DU	0,8	<b>UXT 2<sup>4</sup></b>
1.6 i	1.6	68	01.90-05.01	G16B	4	<b>Z 15</b>	14 FR-7 DU	0,8	<b>UXT 1<sup>3</sup></b>
1.6 i 4WD	1.6	68	01.90-05.01	G16B	4	<b>Z 15</b>	14 FR-7 DU	0,8	<b>UXT 1<sup>3</sup></b>
1.6	1.6	70	11.89-12.91	G16B	4	<b>Z 15</b>	14 FR-7 DU	0,8	<b>UXT 1<sup>3</sup></b>
1.6 4WD	1.6	70	11.89-12.91	G16B	4	<b>Z 15</b>	14 FR-7 DU	0,8	<b>UXT 1<sup>3</sup></b>

**SWIFT III**

1.3 DDiS	1.3	51	08.05-	Z13DT	4	<b>GN 053</b> (11V)	○		
1.3 DDiS	1.3	55	08.05-	Z 13 DTJ	4	<b>GN 053</b> (11V)	○		
1.3 4x4	1.3	66	01.06-	M13A	4	<b>Z 221</b>	14 FR-6 DPUX02	1,0	<b>UXT 14</b>
1.3	1.3	68	02.05-	M13A	4	<b>Z 284</b>	14 FR-6 DPOX	1,1	<b>UXT 14</b>
1.3 4x4	1.3	68	02.05-	M13A	4	<b>Z 284</b>	14 FR-6 DPOX	1,1	<b>UXT 14</b>
1.5 4x4	1.5	74	02.05-	M15A	4	<b>Z 221</b>	14 FR-6 DPUX02	1,0	<b>UXT 14</b>
1.5	1.5	75	02.05-	M15A	4	<b>Z 284</b>	14 FR-6 DPOX	1,1	<b>UXT 14</b>
1.6	1.6	92	05.06-	M16A	4	<b>Z 284</b>	14 FR-6 DPOX	1,1	<b>UXT 14</b>

**SWIFT IV**

1.2	1.2	66	10.10-	K12B	4	<b>Z 333</b>	12 FR-6 DPUX	1,1	○
1.2 4x4	1.2	66	10.10-	K12B	4	<b>Z 333</b>	12 FR-6 DPUX	1,1	○
1.2	1.2	69	10.10-	K12B	4	<b>Z 333</b>	12 FR-6 DPUX	1,1	○
1.2 4x4	1.2	69	10.10-	K12B	4	<b>Z 333</b>	12 FR-6 DPUX	1,1	○

**SX4**

1.5	1.5	73	06.06-	M15A	4	<b>Z 284</b>	14 FR-6 DPOX	1,1	<b>UXT 14</b>
1.9 DDiS	1.9	88	06.06-	D19AA	4	<b>GN 097</b> (11V)	○		
1.9 DDiS 4x4	1.9	88	06.06-	D19AA	4	<b>GN 097</b> (11V)	○		

**VITARA**

1.6	1.6	59	07.88-03.98	G16A (8V)	4	<b>Z 20</b>	14 R-7 DU	0,8	<b>UXT 2<sup>4</sup></b>
1.6	1.6	60	07.88-12.91	G16A (8V)	4	<b>Z 20</b>	14 R-7 DU	0,8	<b>UXT 2<sup>4</sup></b>
1.6 i 16V	1.6	71	07.90-03.98	G16B	4	<b>Z 15</b>	14 FR-7 DU	0,8	<b>UXT 1<sup>3</sup></b>
1.9 D	1.9	50	01.95-03.98	XUD9A	4	<b>GN 013</b> (11V)	○		
1.9 D	1.9	55	08.96-03.98	XUD9SD	4	<b>GN 909</b> (11V)	○		
2.0 TD	2.0	52	12.94-03.98	RF	4	<b>GN 005</b> (11V)	○		
2.0 TD Intercooler	2.0	64	12.95-03.98	RF	4	<b>GN 005</b> (11V)	○		
2.0 16V	2.0	97	12.96-03.98	J20A	4	<b>Z 15</b>	14 FR-7 DU	0,8	<b>UXT 1<sup>3</sup></b>
2.0 V6 24V	2.0	100	12.94-03.98	H 20 A	6	<b>Z 15</b>	14 FR-7 DU	0,8	<b>UXT 1<sup>3</sup></b>
2.5 V6 24V	2.5	118	12.95-03.98	H 25 A	6	<b>Z 15</b>	14 FR-7 DU	0,8	<b>UXT 1<sup>3</sup></b>

**VITARA Cabrio**

1.6	1.6	59	07.88-01.95	G16A (8V)	4	<b>Z 20</b>	14 R-7 DU	0,8	<b>UXT 2<sup>4</sup></b>
1.6 i 16V	1.6	71	07.90-03.99	G16B	4	<b>Z 15</b>	14 FR-7 DU	0,8	<b>UXT 1<sup>3</sup></b>
1.9 D	1.9	50	01.95-03.98	XUD9A	4	<b>GN 013</b> (11V)	○		
1.9 D	1.9	55	08.96-03.99	XUD9SD	4	<b>GN 909</b> (11V)	○		
2.0 16V	2.0	97	12.96-03.99	J20A	4	<b>Z 15</b>	14 FR-7 DU	0,8	<b>UXT 1<sup>3</sup></b>

**WAGON R+**

1.0	1.0	48	02.98-05.00	K10A	4	<b>Z 234</b>	12 FR-7 DU	0,9	○
-----	-----	----	-------------	------	---	--------------	------------	-----	---



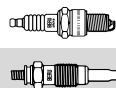
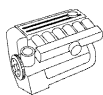

## SUZUKI

### WAGON R+

1.2	1.2	51	02.98-05.00	K12A	4	<b>Z 234</b>	12 FR-7 DU	0,9	○
1.2 4WD	1.2	51	02.98-05.00		4	<b>Z 234</b>	12 FR-7 DU	0,9	○
1.3 DDiS	1.3	51	09.03-	Z13DT	4	<b>GN 053</b> (11V)	○		
1.3	1.3	56	05.00-	G13BB	4	<b>Z 16</b>	14 FR-7 DUX	1,1	<b>UXT 1<sup>3</sup></b>
1.3 4WD	1.3	56	10.01-		4	<b>Z 16</b>	14 FR-7 DUX	1,1	<b>UXT 1<sup>3</sup></b>
1.3	1.3	65	08.01-	M13A	4	<b>Z 221</b>	14 FR-6 DPUX02	1,0	<b>UXT 14</b>
1.3	1.3	69	09.03-	M13A	4	<b>Z 284</b>	14 FR-6 DPOX	1,1	<b>UXT 14</b>
1.3 4WD	1.3	69	09.03-	M13A	4	<b>Z 284</b>	14 FR-6 DPOX	1,1	<b>UXT 14</b>

### X-90

1.6 i 16V	1.6	71	09.95-12.97	G16B	4	<b>Z 15</b>	14 FR-7 DU	0,8	<b>UXT 1<sup>3</sup></b>
1.6 i 16V 4x4	1.6	71	09.95-12.97	G16B	4	<b>Z 15</b>	14 FR-7 DU	0,8	<b>UXT 1<sup>3</sup></b>

## TOYOTA

### 1000

1.0	1.0	33	04.69-	2K	4	<b>Z 20</b>	14 R-7 DU	0,8	<b>UXT 2<sup>4</sup></b>
-----	-----	----	--------	----	---	-------------	-----------	-----	--------------------------

### 4 RUNNER

2.7	2.7	112	11.95-07.02	3RZ-FE	4	<b>Z 150</b>	14 FR-7 KPUV	1,3	○
2.7 i 4x4	2.7	112	11.95-03.96	3RZ-FE	4	<b>Z 150</b>	14 FR-7 KPUV	1,3	○
3.0 Turbo-D	3.0	92	10.93-11.02	1KZ-T	4	<b>GN 110</b> (11V)	○		
3.0 V6	3.0	105	07.90-11.95	3VZ-E	6	<b>Z 249</b>	14 FR-8 KUOU	1,0	○
3.4 i 4x4	3.4	136	11.95-03.96	5VZ-FE	6	<b>Z 208</b>	14 FR-8 LDU3	1,0	○

### ARISTO

3.0	3.0	169	10.91-07.97	2JZ-GE	6	<b>Z 312</b>	14 FR-7 KPPU	1,1	○
3.0	3.0	205	10.90-09.96	2JZ-GTE	6	<b>Z 284</b>	14 FR-6 DPOX	1,1	<b>UXT 14</b>

### AURIS

1.4 D-4D	1.4	66	03.07-	1ND-TV	4	<b>GN 042</b> (11V)	○		
2.2 D	2.2	130	03.07-	2AD-FHV	4	<b>GN 108</b> (11V)	○		

### AURIS VAN

1.4 D-4D	1.4	66	03.07-	1ND-TV	4	<b>GN 042</b> (11V)	○		
----------	-----	----	--------	--------	---	---------------------	---	--	--

### AVENSIS

1.6	1.6	74	09.97-10.00	4A-FE	4	<b>Z 150</b>	14 FR-7 KPUV	1,3	○
1.6	1.6	81	09.97-10.00	4A-FE	4	<b>Z 150</b>	14 FR-7 KPUV	1,3	○
1.6 WT-i	1.6	81	10.00-02.03	3ZZ-FE	4	<b>Z 150</b>	14 FR-7 KPUV	1,3	○
1.6 WT-i	1.6	81	04.03-11.08	3ZZ-FE	4	<b>Z 157</b>	14 FR-7 KUOX	1,1	<b>UXT 11</b>
1.8	1.8	81	09.97-10.00	7A-FE	4	<b>Z 284</b>	14 FR-6 DPOX	1,1	<b>UXT 14</b>
1.8 WT-i	1.8	95	10.00-02.03	1ZZ-FE	4	<b>Z 249</b>	14 FR-8 KUOU	1,0	○
1.8	1.8	95	04.03-11.08	1ZZ-FE	4	<b>Z 249</b>	14 FR-8 KUOU	1,0	○
1.8	1.8	95	04.03-11.08	1ZZ-FE	4	<b>Z 249</b>	14 FR-8 KUOU	1,0	○
2.0 TD	2.0	66	09.97-07.00	2C-TE	4	<b>GN 043</b> (11V)	○		
2.0 D-4D	2.0	81	10.99-02.03	1CD-FTV	4	<b>GN 065</b> (11V)	○		
2.0 D-4D	2.0	85	04.03-11.08	1CD-FTV	4	<b>GN 065</b> (11V)	○		
2.0 D-4D	2.0	85	04.03-11.08	1CD-FTV	4	<b>GN 065</b> (11V)	○		
2.0	2.0	94	09.97-10.00	3S-FE	4	<b>Z 157</b>	14 FR-7 KUOX	1,1	<b>UXT 11</b>
2.0	2.0	108	04.03-11.08	1AZ-FSE	4	<b>Z 280</b>	14 FR-7 KPUX02	1,0	○
2.0	2.0	108	04.03-11.08	1AZ-FSE	4	<b>Z 280</b>	14 FR-7 KPUX02	1,0	○
2.0 WT-i	2.0	110	10.00-02.03	1AZ-FSE	4	<b>Z 280</b>	14 FR-7 KPUX02	1,0	○
2.0 WTi	2.0	114	04.03-11.08	1AZ-FE	4	<b>Z 221</b>	14 FR-6 DPUX02	1,0	<b>UXT 14</b>
2.0 WTi	2.0	114	04.03-11.08	1AZ-FE	4	<b>Z 221</b>	14 FR-6 DPUX02	1,0	<b>UXT 14</b>
2.2 D-4D	2.2	110	02.09-	2AD-FHV	4	<b>GN 108</b> (11V)	○		
2.2 D-CAT	2.2	130	07.05-11.08	2AD-FHV	4	<b>GN 108</b> (11V)	○		
2.2 D-CAT	2.2	130	07.05-11.08	2AD-FHV	4	<b>GN 108</b> (11V)	○		
2.2 D-4D	2.2	130	02.09-	2AD-FHV	4	<b>GN 108</b> (11V)	○		
2.4	2.4	120	10.03-11.08	2AZ-FSE	4	<b>Z 312</b>	14 FR-7 KPPU	1,1	○
2.4	2.4	120	10.03-11.08	2AZ-FSE	4	<b>Z 312</b>	14 FR-7 KPPU	1,1	○
2.4	2.4	125	09.03-11.08	2AZ-FSE	4	<b>Z 312</b>	14 FR-7 KPPU	1,1	○
2.4	2.4	125	09.03-11.08	2AZ-FSE	4	<b>Z 312</b>	14 FR-7 KPPU	1,1	○

### AVENSIS Combi

1.6 WT-i	1.6	81	04.03-11.08	3ZZ-FE	4	<b>Z 157</b>	14 FR-7 KUOX	1,1	<b>UXT 11</b>
1.8	1.8	95	04.03-11.08	1ZZ-FE	4	<b>Z 249</b>	14 FR-8 KUOU	1,0	○
2.0	2.0	108	04.03-11.08	1AZ-FSE	4	<b>Z 280</b>	14 FR-7 KPUX02	1,0	○
2.0 WTi	2.0	114	04.03-11.08	1AZ-FE	4	<b>Z 221</b>	14 FR-6 DPUX02	1,0	<b>UXT 14</b>

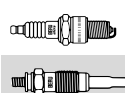
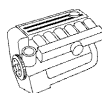

## TOYOTA

### AVENSIS Combi

2.0 D-4D	2.0	85	04.03-11.08	1CD-FTV	4	GN 065 (11V)	○		
2.2 D-CAT	2.2	130	07.05-11.08	2AD-FHV	4	GN 108 (11V)	○		
2.4	2.4	120	10.03-11.08	2AZ-FSE	4	Z 312	14 FR-7 KPPU	1,1	○
2.4	2.4	125	09.03-11.08	2AZ-FSE	4	Z 312	14 FR-7 KPPU	1,1	○

### AVENSIS Liftback

1.6	1.6	74	09.97-10.00	4A-FE	4	Z 150	14 FR-7 KPUV	1,3	○
1.6	1.6	81	09.97-10.00	4A-FE	4	Z 150	14 FR-7 KPUV	1,3	○
1.6 WT-i	1.6	81	10.00-02.03	3ZZ-FE	4	Z 150	14 FR-7 KPUV	1,3	○
1.8	1.8	81	09.97-10.00	7A-FE	4	Z 284	14 FR-6 DPOX	1,1	UXT 14
1.8 WT-i	1.8	95	10.00-02.03	1ZZ-FE	4	Z 150	14 FR-7 KPUV	1,3	○
2.0	2.0	94	09.97-10.00	3S-FE	4	Z 157	14 FR-7 KUOX	1,1	UXT 11
2.0 WT-i	2.0	110	10.00-02.03	1AZ-FSE	4	Z 280	14 FR-7 KPUX02	1,0	○
2.0 TD	2.0	66	09.97-07.00	2C-TE	4	GN 043 (11V)	○		
2.0 D-4D	2.0	81	10.99-02.03	1CD-FTV	4	GN 065 (11V)	○		

### AVENSIS Station Wagon

1.6	1.6	74	09.97-10.00	4A-FE	4	Z 150	14 FR-7 KPUV	1,3	○
1.6	1.6	81	09.97-10.00	4A-FE	4	Z 150	14 FR-7 KPUV	1,3	○
1.6 WT-i	1.6	81	10.00-02.03	3ZZ-FE	4	Z 150	14 FR-7 KPUV	1,3	○
1.8	1.8	81	09.97-10.00	7A-FE	4	Z 284	14 FR-6 DPOX	1,1	UXT 14
1.8 WT-i	1.8	95	10.00-02.03	1ZZ-FE	4	Z 249	14 FR-8 KUOU	1,0	○
2.0 TD	2.0	66	09.97-07.00	2C-TE	4	GN 043 (11V)	○		
2.0 D-4D	2.0	81	10.99-02.03	1CD-FTV	4	GN 065 (11V)	○		
2.0	2.0	94	09.97-10.00	3S-FE	4	Z 157	14 FR-7 KUOX	1,1	UXT 11
2.2 D-4D	2.2	110	02.09-	2AD-FHV	4	GN 108 (11V)	○		
2.2 D-4D	2.2	130	02.09-	2AD-FHV	4	GN 108 (11V)	○		

### AVENSIS VERSO

2.0 D-4D	2.0	85	08.01-08.05	1CD-FTV	4	GN 065 (11V)	○		
2.0 WT-i	2.0	110	08.01-11.09	1AZ-FE	4	Z 221	14 FR-6 DPUX02	1,0	UXT 14

### AYGO

1.0	1.0	50	07.05-	1KR-FE	3	Z 273	14 FR-7 NUX2	1,1	○
1.4 Hdi	1.4	40	07.05-	2WZ-TV	4	GN 047 (11V)	○		

### CAMRY

2.0 Turbo-D	2.0	62	08.88-05.91	2C-T	4	GN 043 (11V)	○		
2.0 Turbo-D	2.0	63	11.88-05.91	2C-T	4	GN 043 (11V)	○		
2.0	2.0	94	10.87-05.91	3S-FE	4	Z 73	14 FR-8 DUX	1,1	UXT 1 <sup>3</sup>
2.0 WT-i	2.0	108	01.06-	1AZ-FE	4	Z 221	14 FR-6 DPUX02	1,0	UXT 14
2.0 WTI	2.0	110	08.01-11.06	1AZ-FE	4	Z 221	14 FR-6 DPUX02	1,0	UXT 14
2.2	2.2	96	08.96-11.01	5S-FE	4	Z 157	14 FR-7 KUOX	1,1	UXT 11
2.2	2.2	100	06.91-08.96	5S-FE	4	Z 157	14 FR-7 KUOX	1,1	UXT 11
2.4 WT-i	2.4	112	11.01-11.06	2AZ-FE	4	Z 221	14 FR-6 DPUX02	1,0	UXT 14
2.5 V6 GXI	2.5	118	02.88-05.91	2VZ-FE	6	Z 149	14 FR-7 KPUX	1,1	UXT 11
3.0 V6	3.0	137	11.01-11.06	1MZ-FE	6	Z 284	14 FR-6 DPOX	1,1	UXT 14
3.0	3.0	138	06.91-08.96	3VZ-FE	6	Z 284	14 FR-6 DPOX	1,1	UXT 14
3.0 24V	3.0	140	08.96-11.01	1MZ-FE	6	Z 16	14 FR-7 DUX	1,1	UXT 1 <sup>3</sup>

### CAMRY Station Wagon

2.0 Turbo-D	2.0	62	08.88-05.91	2C-T	4	GN 043 (11V)	○		
2.0 Turbo-D	2.0	63	11.88-05.91	2C-T	4	GN 043 (11V)	○		
2.0 GLi 16V	2.0	89	10.87-05.91	3S-FE	4	Z 73	14 FR-8 DUX	1,1	UXT 1 <sup>3</sup>
2.0	2.0	94	10.87-05.91	3S-FE	4	Z 73	14 FR-8 DUX	1,1	UXT 1 <sup>3</sup>
2.2	2.2	100	03.92-07.96	5S-FE	4	Z 157	14 FR-7 KUOX	1,1	UXT 11
2.5	2.5	118	01.90-05.91	2VZ-FE	6	Z 149	14 FR-7 KPUX	1,1	UXT 11
3.0	3.0	138	03.92-07.96	3VZ-FE	6	Z 284	14 FR-6 DPOX	1,1	UXT 14

### CARIBE Station Wagon

1.3	1.3	55	09.94-08.96	4E-FE	4	Z 156	14 FR-7 KUO	0,7	UXT 10
-----	-----	----	-------------	-------	---	-------	-------------	-----	--------

### CARINA E

1.6	1.6	73	12.93-09.97	4A-FE	4	Z 151	14 FR-7 KPU	0,8	UXT 10
1.6	1.6	78	10.95-09.97	4A-FE	4	Z 150	14 FR-7 KPUV	1,3	○
1.6 16V	1.6	78	10.95-09.97	4A-FE	4	Z 150	14 FR-7 KPUV	1,3	○
1.6	1.6	79	01.93-09.97	4A-FE	4	Z 150	14 FR-7 KPUV	1,3	○
1.6 GLI	1.6	79	04.92-09.97	4A-FE	4	Z 150	14 FR-7 KPUV	1,3	○
1.6	1.6	85	12.93-09.97	4A-FE	4	Z 150	14 FR-7 KPUV	1,3	○

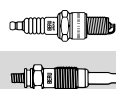

## TOYOTA

### CARINA E

1.6 16V	1.6	85	12.94-09.97	4A-FE	4	<b>Z 150</b>	14 FR-7 KPUV	1,3	○
1.8	1.8	79	01.95-09.97	7A-FE	4	<b>Z 284</b>	14 FR-6 DPOX	1,1	<b>UXT 14</b>
1.8 i 16V	1.8	79	01.95-09.97	7A-FE	4	<b>Z 284</b>	14 FR-6 DPOX	1,1	<b>UXT 14</b>
2.0 D	2.0	54	04.92-01.96	2C	4	<b>GN 043</b> (11V)	○		
2.0 TD	2.0	61	01.96-09.97	2C-T	4	<b>GN 043</b> (11V)	○		
2.0 i	2.0	93	12.92-09.97	3S-FE	4	<b>Z 157</b>	14 FR-7 KUOX	1,1	<b>UXT 11</b>
2.0	2.0	98	01.93-09.97	3S-FE	4	<b>Z 157</b>	14 FR-7 KUOX	1,1	<b>UXT 11</b>
2.0 GLJ	2.0	98	04.92-09.97	3S-FE	4	<b>Z 157</b>	14 FR-7 KUOX	1,1	<b>UXT 11</b>
2.0 GTi	2.0	116	04.92-02.94	3S-GE	4	<b>Z 151</b>	14 FR-7 KPU	0,8	<b>UXT 10</b>
2.0 GTi 16V	2.0	129	03.94-09.97	3S-GE	4	<b>Z 151</b>	14 FR-7 KPU	0,8	<b>UXT 10</b>

### CARINA E Sportswagon

1.6 i	1.6	73	02.95-09.97	4A-FE	4	<b>Z 151</b>	14 FR-7 KPU	0,8	<b>UXT 10</b>
1.6 GLJ	1.6	79	01.93-09.97	4A-FE	4	<b>Z 150</b>	14 FR-7 KPUV	1,3	○
1.8 i	1.8	79	02.95-09.97	7A-FE	4	<b>Z 284</b>	14 FR-6 DPOX	1,1	<b>UXT 14</b>
2.0 D	2.0	54	01.93-01.96	2C	4	<b>GN 043</b> (11V)	○		
2.0 TD	2.0	61	01.96-09.97	2C-T	4	<b>GN 043</b> (11V)	○		
2.0 i	2.0	93	05.95-09.97	3S-FE	4	<b>Z 157</b>	14 FR-7 KUOX	1,1	<b>UXT 11</b>
2.0 GLJ	2.0	98	01.93-09.97	3S-FE	4	<b>Z 157</b>	14 FR-7 KUOX	1,1	<b>UXT 11</b>

### CARINA II

1.6	1.6	66	12.87-08.90	4A-F	4	<b>Z 248</b>	14 FR-8 HUT	0,8	○
1.6	1.6	72	09.89-03.92	4A-FE	4	<b>Z 150</b>	14 FR-7 KPUV	1,3	○
1.6	1.6	75	12.87-03.92	4A-FE	4	<b>Z 150</b>	14 FR-7 KPUV	1,3	○
2.0 D	2.0	54	03.88-01.92	2C	4	<b>GN 043</b> (11V)	○		
2.0 D	2.0	54	03.88-01.92	2C-L	4	<b>GN 043</b> (11V)	○		
2.0 GLJ	2.0	89	12.87-03.92	3S-FE	4	<b>Z 157</b>	14 FR-7 KUOX	1,1	<b>UXT 11</b>

### CARINA II Station Wagon

1.6	1.6	72	09.89-03.92	4A-FE	4	<b>Z 150</b>	14 FR-7 KPUV	1,3	○
1.6	1.6	75	09.89-03.92	4A-FE	4	<b>Z 150</b>	14 FR-7 KPUV	1,3	○
2.0 D	2.0	54	12.87-01.92	2C-L	4	<b>GN 043</b> (11V)	○		
2.0	2.0	89	12.87-04.92	3S-FE	4	<b>Z 157</b>	14 FR-7 KUOX	1,1	<b>UXT 11</b>

### CELICA

1.6	1.6	63	04.86-02.90	4A-L	4	<b>Z 8</b>	14 R-8 DU	0,8	<b>UXT 2<sup>4</sup></b>
1.8 i 16V	1.8	85	11.93-11.99	7A-FE	4	<b>Z 156</b>	14 FR-7 KUO	0,7	<b>UXT 10</b>
1.8 16V VT-i	1.8	105	11.99-03.06	1ZZ-FE	4	<b>Z 249</b>	14 FR-8 KUOU	1,0	○
1.8 16V TS	1.8	141	11.99-03.06	2ZZ-GE	4	<b>Z 284</b>	14 FR-6 DPOX	1,1	<b>UXT 14</b>
2.0	2.0	110	01.87-08.90	3S-GEL	4	<b>Z 157</b>	14 FR-7 KUOX	1,1	<b>UXT 11</b>
2.0 i 16V	2.0	125	04.96-11.99	3S-GE	4	<b>Z 151</b>	14 FR-7 KPU	0,8	<b>UXT 10</b>
2.0 i 16V	2.0	129	11.93-11.99	3S-GE	4	<b>Z 151</b>	14 FR-7 KPU	0,8	<b>UXT 10</b>
2.0 i Turbo 4WD	2.0	178	02.94-11.99	3S-GTE	4	<b>Z 151</b>	14 FR-7 KPU	0,8	<b>UXT 10</b>

### CELICA Cabriolet

2.0 GT	2.0	103	10.86-08.90	3S-GELC	4	<b>Z 228</b>	14 FR-7 DPX02	1,0	<b>UXT 11</b>
2.0 GT	2.0	110	10.86-08.90	3S-GEL	4	<b>Z 157</b>	14 FR-7 KUOX	1,1	<b>UXT 11</b>
2.0 GTi	2.0	115	05.91-01.94	3S-GE	4	<b>Z 151</b>	14 FR-7 KPU	0,8	<b>UXT 10</b>
2.0 i 16V	2.0	125	04.96-11.99	3S-GE	4	<b>Z 151</b>	14 FR-7 KPU	0,8	<b>UXT 10</b>

### CELICA Coupe

1.6 STi	1.6	77	10.89-10.93	4A-FE	4	<b>Z 72</b>	14 FR-8 DU	0,8	<b>UXT 1<sup>3</sup></b>
2.0 GTi	2.0	115	10.89-01.94	3S-GE	4	<b>Z 151</b>	14 FR-7 KPU	0,8	<b>UXT 10</b>
2.0 Turbo 4x4	2.0	136	03.88-08.90	3S-GTE	4	<b>Z 228</b>	14 FR-7 DPX02	1,0	<b>UXT 11</b>
2.0 Turbo 4WD	2.0	150	10.89-01.94	3S-GTE	4	<b>Z 151</b>	14 FR-7 KPU	0,8	<b>UXT 10</b>
2.0 Turbo 4WD	2.0	153	10.89-01.94	3S-GTE	4	<b>Z 151</b>	14 FR-7 KPU	0,8	<b>UXT 10</b>

### CHASER

2.4 D	2.4	63	11.91-10.96	2L	4	<b>GV 968</b> (11V)	○		
-------	-----	----	-------------	----	---	---------------------	---	--	--

### COROLLA

1.3 12V	1.3	53	07.92-04.97	2E	4	<b>Z 9</b>	14 R-8 DUX	1,1	<b>UXT 2<sup>4</sup></b>
1.3 i	1.3	55	08.87-12.92	2E-E/2E	4	<b>Z 9</b>	14 R-8 DUX	1,1	<b>UXT 2<sup>4</sup></b>
1.3 XLI	1.3	55	09.95-04.97	4E-FE	4	<b>Z 156</b>	14 FR-7 KUO	0,7	<b>UXT 10</b>
1.3 XLI 16V	1.3	65	07.92-09.95	4E-FE	4	<b>Z 156</b>	14 FR-7 KUO	0,7	<b>UXT 10</b>
1.4	1.3	63	04.97-02.00	4E-FE	4	<b>Z 208</b>	14 FR-8 LDU3	1,0	○
1.4 D4d	1.4	66	06.04-	1ND-TV	4	<b>GN 042</b> (11V)	○		
1.4 D	1.4	66	07.04-02.07	1ND-TV	4	<b>GN 042</b> (11V)	○		
1.4 D-4D	1.4	66	01.07-	1ND-TV	4	<b>GN 042</b> (11V)	○		

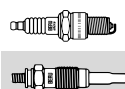
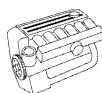

### TOYOTA COROLLA

1.4 16V	1.4	71	02.00-01.02	4ZZ-FE	4	<b>Z 154</b>	14 FR-8 KUO	0,9	<b>UXT 9</b>
1.4 WT-i	1.4	71	08.02-07.07	4ZZ-FE	4	<b>Z 154</b>	14 FR-8 KUO	0,9	<b>UXT 9</b>
1.6 i	1.6	77	11.89-04.92	4A-FE	4	<b>Z 254</b>	14 FR-8 DUS	0,7	<b>UXT 1<sup>3</sup></b>
1.6 i 4WD	1.6	77	10.87-08.90	4A-FE	4	<b>Z 155</b>	14 FR-7 KU	0,8	<b>UXT 10</b>
1.6 Aut.	1.6	79	04.97-02.00	4A-FE	4	<b>Z 155</b>	14 FR-7 KU	0,8	<b>UXT 10</b>
1.6	1.6	81	04.97-02.00	4A-FE	4	<b>Z 157</b>	14 FR-7 KUOX	1,1	<b>UXT 11</b>
1.6 16V	1.6	81	02.00-01.02	3ZZ-FE	4	<b>Z 157</b>	14 FR-7 KUOX	1,1	<b>UXT 11</b>
1.6 WT-i	1.6	81	01.02-12.06	3ZZ-FE	4	<b>Z 157</b>	14 FR-7 KUOX	1,1	<b>UXT 11</b>
1.6 Si	1.6	84	09.95-04.97	4A-FE	4	<b>Z 156</b>	14 FR-7 KUO	0,7	<b>UXT 10</b>
1.8 D	1.8	47	07.87-04.92	1C	4	<b>GN 043</b> (11V)	○		
1.8 D	1.8	49	11.89-04.92	1C	4	<b>GN 043</b> (11V)	○		
1.8	1.8	96	11.01-07.07	1ZZ-FE	4	<b>Z 249</b>	14 FR-8 KUOU	1,0	○
1.8	1.8	100	11.01-07.07	1ZZ-FE	4	<b>Z 249</b>	14 FR-8 KUOU	1,0	○
1.8 WTL-i TS	1.8	141	01.02-02.07	2ZZ-GE	4	<b>Z 221</b>	14 FR-6 DPUX02	1,0	<b>UXT 14</b>
1.8 WTL-i TS	1.8	160	10.05-12.06	2ZZ-GE	4	<b>Z 313</b>	14 FR-6 DPUX2	1,0	○
1.8 WTL-i TS	1.8	165	02.05-02.07	2ZZ-GE	4	<b>Z 221</b>	14 FR-6 DPUX02	1,0	<b>UXT 14</b>
2.0 D	2.0	53	07.92-04.97	2C	4	<b>GN 043</b> (11V)	○		
2.0 D	2.0	53	04.97-10.99	2C-E	4	<b>GN 043</b> (11V)	○		
2.0 D-4D	2.0	66	09.00-01.02	1CD-FTV	4	<b>GN 065</b> (11V)	○		
2.0 D-4D	2.0	66	01.02-07.07	1CD-FTV	4	<b>GN 065</b> (11V)	○		
2.0 D-4D	2.0	81	01.02-12.06	1CD-FTV	4	<b>GN 065</b> (11V)	○		
2.0 D-4D	2.0	85	05.03-02.07	1CD-FTV	4	<b>GN 065</b> (11V)	○		
2.2 D-4D	2.2	130	11.06-	2AD-FHV	4	<b>GN 108</b> (11V)	○		

### COROLLA Combi

1.4 D	1.4	66	07.04-02.07	1ND-TV	4	<b>GN 042</b> (11V)	○		
1.4 WT-i	1.4	71	01.02-02.07	4ZZ-FE	4	<b>Z 154</b>	14 FR-8 KUO	0,9	<b>UXT 9</b>
1.6 WT-i	1.6	81	01.02-02.07	3ZZ-FE	4	<b>Z 154</b>	14 FR-8 KUO	0,9	<b>UXT 9</b>
1.8	1.8	100	06.04-02.07	1ZZ-FE	4	<b>Z 249</b>	14 FR-8 KUOU	1,0	○
2.0 D-4D	2.0	66	01.02-02.07	1CD-FTV	4	<b>GN 065</b> (11V)	○		
2.0 D-4D	2.0	85	04.04-02.07	1CD-FTV	4	<b>GN 065</b> (11V)	○		

### COROLLA Compact

1.3 12V	1.3	53	07.92-05.95	2E	4	<b>Z 9</b>	14 R-8 DUX	1,1	<b>UXT 2<sup>4</sup></b>
1.3 i	1.3	55	06.89-04.92	2E-E	4	<b>Z 8</b>	14 R-8 DU	0,8	<b>UXT 2<sup>4</sup></b>
1.3 XLI	1.3	55	09.95-04.97	4E-FE	4	<b>Z 156</b>	14 FR-7 KUO	0,7	<b>UXT 10</b>
1.3 XLI 16V	1.3	65	07.92-09.95	4E-FE	4	<b>Z 156</b>	14 FR-7 KUO	0,7	<b>UXT 10</b>
1.4	1.3	63	04.97-02.00	4E-FE	4	<b>Z 156</b>	14 FR-7 KUO	0,7	<b>UXT 10</b>
1.4	1.4	71	02.00-01.02	4ZZ-FE	4	<b>Z 154</b>	14 FR-8 KUO	0,9	<b>UXT 9</b>
1.6	1.6	66	08.87-04.92	4A-F	4	<b>Z 248</b>	14 FR-8 HUT	0,8	○
1.6 i	1.6	77	08.89-04.92	4A-FE	4	<b>Z 254</b>	14 FR-8 DUS	0,7	<b>UXT 1<sup>3</sup></b>
1.6 Aut.	1.6	79	04.97-02.00	4A-FE	4	<b>Z 155</b>	14 FR-7 KU	0,8	<b>UXT 10</b>
1.6	1.6	81	04.97-02.00	4A-FE	4	<b>Z 155</b>	14 FR-7 KU	0,8	<b>UXT 10</b>
1.6	1.6	81	02.00-01.02	3ZZ-FE	4	<b>Z 157</b>	14 FR-7 KUOX	1,1	<b>UXT 11</b>
1.6 Si	1.6	84	07.92-04.97	4A-FE	4	<b>Z 156</b>	14 FR-7 KUO	0,7	<b>UXT 10</b>
1.6 GTi	1.6	85	09.89-04.92	4A-GE	4	<b>Z 151</b>	14 FR-7 KPU	0,8	<b>UXT 10</b>
1.8 D	1.8	47	08.87-04.92	1C	4	<b>GN 043</b> (11V)	○		
1.8 D	1.8	49	08.89-04.92	1C	4	<b>GN 043</b> (11V)	○		
2.0 D	2.0	53	07.92-04.97	2C	4	<b>GN 043</b> (11V)	○		
2.0 D	2.0	53	04.97-09.99	2C-E	4	<b>GN 043</b> (11V)	○		
2.0 D-4D	2.0	66	09.00-01.02	1CD-FTV	4	<b>GN 065</b> (11V)	○		

### COROLLA Liftback

1.3 12V	1.3	53	07.92-05.95	2E	4	<b>Z 9</b>	14 R-8 DUX	1,1	<b>UXT 2<sup>4</sup></b>
1.3 i	1.3	55	08.87-02.90	2E-E/2E	4	<b>Z 9</b>	14 R-8 DUX	1,1	<b>UXT 2<sup>4</sup></b>
1.3 i	1.3	55	03.90-04.92	2E-E/2E	4	<b>Z 8</b>	14 R-8 DU	0,8	<b>UXT 2<sup>4</sup></b>
1.3 XLI	1.3	65	07.92-04.97	4E-FE	4	<b>Z 156</b>	14 FR-7 KUO	0,7	<b>UXT 10</b>
1.4	1.4	63	04.97-02.00	4E-FE	4	<b>Z 208</b>	14 FR-8 LDU3	1,0	○
1.4	1.4	71	02.00-01.02	4ZZ-FE	4	<b>Z 154</b>	14 FR-8 KUO	0,9	<b>UXT 9</b>
1.6	1.6	66	08.87-04.92	4A-F	4	<b>Z 248</b>	14 FR-8 HUT	0,8	○
1.6	1.6	70	08.87-04.92	4A-F	4	<b>Z 248</b>	14 FR-8 HUT	0,8	○
1.6	1.6	77	08.89-04.92	4A-FE	4	<b>Z 254</b>	14 FR-8 DUS	0,7	<b>UXT 1<sup>3</sup></b>
1.6 Aut.	1.6	79	04.97-02.00	4A-FE	4	<b>Z 155</b>	14 FR-7 KU	0,8	<b>UXT 10</b>
1.6	1.6	81	04.97-02.00	4A-FE	4	<b>Z 155</b>	14 FR-7 KU	0,8	<b>UXT 10</b>

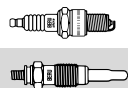
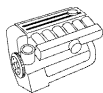

## TOYOTA

### COROLLA Liftback

1.6	1.6	81	02.00-01.02	3ZZ-FE	4	<b>Z 157</b>	14 FR-7 KUOX	1,1	<b>UXT 11</b>
1.6 GLI	1.6	84	07.92-04.97	4A-FE	4	<b>Z 156</b>	14 FR-7 KUO	0,7	<b>UXT 10</b>
1.6 GTI	1.6	92	08.89-06.93	4A-GE	4	<b>Z 151</b>	14 FR-7 KPU	0,8	<b>UXT 10</b>
1.8 D	1.8	47	08.87-04.92	1C	4	<b>GN 043</b> (11V)	○		
1.8 D	1.8	49	08.89-04.92	1C	4	<b>GN 043</b> (11V)	○		
2.0 D	2.0	53	07.92-04.97	2C	4	<b>GN 043</b> (11V)	○		
2.0 D	2.0	53	04.97-09.99	2C-E	4	<b>GN 043</b> (11V)	○		
2.0 D-4D	2.0	66	09.00-01.02	1CD-FTV	4	<b>GN 065</b> (11V)	○		

### COROLLA Station Wagon

1.3 i	1.3	55	06.89-06.92	2E-E	4	<b>Z 8</b>	14 R-8 DU	0,8	<b>UXT 2<sup>4</sup></b>
1.6	1.6	66	02.88-05.92	4A-F	4	<b>Z 248</b>	14 FR-8 HUT	0,8	○
1.6	1.6	70	12.87-04.92	4A-F	4	<b>Z 248</b>	14 FR-8 HUT	0,8	○
1.6 XLI	1.6	77	11.89-06.92	4A-FE	4	<b>Z 254</b>	14 FR-8 DUS	0,7	<b>UXT 1<sup>3</sup></b>
1.6 XLI 4x4	1.6	77	08.88-06.92	4A-FE	4	<b>Z 254</b>	14 FR-8 DUS	0,7	<b>UXT 1<sup>3</sup></b>
1.8 D	1.8	47	12.87-04.92	1C	4	<b>GN 043</b> (11V)	○		
1.8 D	1.8	49	08.89-04.92	1C	4	<b>GN 043</b> (11V)	○		

### COROLLA Verso

1.4 D-4D	1.4	66	03.04-03.09	1ND-TV	4	<b>GN 042</b> (11V)	○		
1.4 VWT-i	1.4	71	01.02-05.04	4ZZ-FE	4	<b>Z 249</b>	14 FR-8 KUOU	1,0	○
1.6 VWT-i	1.6	81	01.02-05.04	3ZZ-FE	4	<b>Z 157</b>	14 FR-7 KUOX	1,1	<b>UXT 11</b>
1.6	1.6	81	04.04-03.09	3ZZ-FE	4	<b>Z 157</b>	14 FR-7 KUOX	1,1	<b>UXT 11</b>
1.8	1.8	95	04.04-03.09	1ZZ-FE	4	<b>Z 249</b>	14 FR-8 KUOU	1,0	○
1.8 VWT-i	1.8	99	01.02-05.04	1ZZ-FE	4	<b>Z 249</b>	14 FR-8 KUOU	1,0	○
2.0 D-4D	2.0	66	01.02-05.04	1CD-FTV	4	<b>GN 065</b> (11V)	○		
2.0 D-4D	2.0	85	04.04-03.09	1CD-FTV	4	<b>GN 065</b> (11V)	○		
2.2 D-4D	2.2	130	10.05-03.09	2AD-FHV	4	<b>GN 108</b> (11V)	○		

### COROLLA Wagon

1.3 12V	1.3	53	07.92-05.95	2E	4	<b>Z 9</b>	14 R-8 DUX	1,1	<b>UXT 2<sup>4</sup></b>
1.3 XLI	1.3	55	09.95-04.97	4E-FE	4	<b>Z 156</b>	14 FR-7 KUO	0,7	<b>UXT 10</b>
1.3 XLI 16V	1.3	65	07.92-09.95	4E-FE	4	<b>Z 156</b>	14 FR-7 KUO	0,7	<b>UXT 10</b>
1.4	1.4	63	04.97-02.00	4E-FE	4	<b>Z 208</b>	14 FR-8 LDU3	1,0	○
1.4 D4d	1.4	66	06.04-	1ND-TV	4	<b>GN 042</b> (11V)	○		
1.4 16V	1.4	71	02.00-01.02	4ZZ-FE	4	<b>Z 154</b>	14 FR-8 KUO	0,9	<b>UXT 9</b>
1.6 Aut.	1.6	79	04.97-02.00	4A-FE	4	<b>Z 155</b>	14 FR-7 KU	0,8	<b>UXT 10</b>
1.6	1.6	81	04.97-02.00	4A-FE	4	<b>Z 155</b>	14 FR-7 KU	0,8	<b>UXT 10</b>
1.6 16V	1.6	81	02.00-01.02	3ZZ-FE	4	<b>Z 157</b>	14 FR-7 KUOX	1,1	<b>UXT 11</b>
1.6 Si	1.6	84	07.92-04.97	4A-FE	4	<b>Z 156</b>	14 FR-7 KUO	0,7	<b>UXT 10</b>
1.8 AWD	1.8	81	04.97-01.02	7A-FE	4	<b>Z 155</b>	14 FR-7 KU	0,8	<b>UXT 10</b>
1.8 16V 4WD	1.8	81	09.95-04.97	7A-FE	4	<b>Z 156</b>	14 FR-7 KUO	0,7	<b>UXT 10</b>
2.0 D	2.0	53	07.92-04.97	2C	4	<b>GN 043</b> (11V)	○		
2.0 D	2.0	53	04.97-10.99	2C-E	4	<b>GN 043</b> (11V)	○		
2.0 D-4D	2.0	66	09.00-01.02	1CD-FTV	4	<b>GN 065</b> (11V)	○		

### CRESTA

2.4 D	2.4	63	09.88-10.96	2L	4	<b>GV 968</b> (11V)	○		
-------	-----	----	-------------	----	---	---------------------	---	--	--

### CROWN

3.0	3.0	147	09.99-08.03	2JZ-FSE	6	<b>Z 312</b>	14 FR-7 KPPU	1,1	○
4.3 Royal Saloon	4.3	206	09.03-02.08	3UZ-FE	8	<b>Z 284</b>	14 FR-6 DPOX	1,1	<b>UXT 14</b>
4.3 Royal Saloon 4x4	4.3	206	09.03-02.08	3UZ-FE	8	<b>Z 284</b>	14 FR-6 DPOX	1,1	<b>UXT 14</b>

### ECHO Liftback

1.4 D4d	1.4	55	01.00-03.03	1ND-TV	4	<b>GN 042</b> (11V)	○		
---------	-----	----	-------------	--------	---	---------------------	---	--	--

### FORTUNER

2.5 D-4D 4WD	2.5	75	01.09-	2KD-FTV	4	<b>GN 065</b> (11V)	○		
2.5 D-4D 4x4	2.5	106	01.09-	2KD-FTV	4	<b>GN 065</b> (11V)	○		
3.0 D	3.0	120	08.09-	1KD-FTV	4	<b>GN 068</b> (11V)	○		
3.0 D	3.0	125	08.09-	1KD-FTV	4	<b>GN 068</b> (11V)	○		

### GRANVIA

2.7	2.7	112	07.91-08.98	3RZ-FE	4	<b>Z 150</b>	14 FR-7 KPUV	1,3	○
-----	-----	-----	-------------	--------	---	--------------	--------------	-----	---

### IQ

1.4 D-4D	1.4	66	01.09-	1ND-TV	4	<b>GN 042</b> (11V)	○		
----------	-----	----	--------	--------	---	---------------------	---	--	--

### LAND CRUISER

2.4 TD	2.4	63	01.90-05.90	2L-T	4	<b>GV 968</b> (11V)	○		
--------	-----	----	-------------	------	---	---------------------	---	--	--



kW

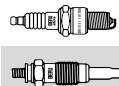
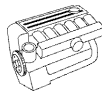

## TOYOTA

### LAND CRUISER

2.4 TD	2.4	66	01.90-05.93	2L-T	4	GV 968 (11V)	○		
2.4	2.4	77	11.84-05.93	22R	4	Z 8	14 R-8 DU	0,8	UXT 2 <sup>4</sup>
2.4	2.4	81	11.84-05.93	22R	4	Z 8	14 R-8 DU	0,8	UXT 2 <sup>4</sup>
2.4	2.4	84	12.88-12.96	22RE	4	Z 8	14 R-8 DU	0,8	UXT 2 <sup>4</sup>
2.7	2.7	112	09.02-08.04	3RZ-FE	4	Z 150	14 FR-7 KPUV	1,3	○
3.0 TD	3.0	92	05.93-05.96	1KZ-T	4	GN 110 (11V)	○		
3.0 D-4D	3.0	120	01.03-02.10	1KD-FTV	4	GN 068 (11V)	○		
3.0 D-4D	3.0	122	08.04-02.10	1KD-FTV	4	GN 068 (11V)	○		
3.0 D-4D	3.0	127	01.07-02.10	1KD-FTV	4	GN 068 (11V)	○		
3.4 D	3.4	70	09.88-12.96	3B	4	GN 043 (11V)	○		
4.7 V8	4.7	212	01.08-	2UZ-FE	8	Z 313	14 FR-6 DPUX2	1,0	○

### LAND CRUISER 80

4.0	4.0	115	01.90-08.92	3F-E	6	Z 9	14 R-8 DUX	1,1	UXT 2 <sup>4</sup>
4.2 D	4.2	99	01.90-12.97	1H-Z	6	GN 043 (11V)	○		
4.2 TD	4.2	118	10.92-12.97	1HD-T	6	GN 043 (11V)	○		
4.2 TD	4.2	123	01.90-12.97	1HD-T	6	GN 043 (11V)	○		
4.5 24V	4.5	151	08.92-12.97	1FZ-FE	6	Z 249	14 FR-8 KUOU	1,0	○

### LAND CRUISER 90

2.7	2.7	110	04.95-07.02	3RZ-FE	4	Z 150	14 FR-7 KPUV	1,3	○
3.0 TD	3.0	92	04.96-	1KZ-TE	4	GN 110 (11V)	○		
3.0 D-4D	3.0	120	10.00-	1KD-FTV	4	GN 068 (11V)	○		
3.4 i 24V	3.4	131	04.96-	5VZ-FE	6	Z 208	14 FR-8 LDU3	1,0	○

### LAND CRUISER 100

4.7	4.7	173	01.98-	2UZ-FE	8	Z 221	14 FR-6 DPUX02	1,0	UXT 14
4.7	4.7	175	02.02-	2UZ-FE	8	Z 221	14 FR-6 DPUX02	1,0	UXT 14

### LAND CRUISER 150

3.0 D-4D	3.0	127	03.10-	1KD-FTV	4	GN 068 (11V)	○		
3.0 D-4D	3.0	140	01.10-	1KD-FTV	4	GN 068 (11V)	○		
4.0 V6 VVT-i	4.0	207	01.10-	1GR-FE	6	Z 235	14 FR-7 SPUX03	1,0	○

### LAND CRUISER Hardtop

2.4 TD	2.4	66	07.90-05.93	2L-T	4	GV 968 (11V)	○		
--------	-----	----	-------------	------	---	--------------	---	--	--

### MARK II Station Wagon

2.4 D	2.4	54	04.88-09.96	2L	4	GV 968 (11V)	○		
-------	-----	----	-------------	----	---	--------------	---	--	--

### MODELL F

2.0	2.0	66	08.88-01.90	3Y	4	Z 8	14 R-8 DU	0,8	UXT 2 <sup>4</sup>
-----	-----	----	-------------	----	---	-----	-----------	-----	--------------------

### MR 2 I

1.6 16V	1.6	85	11.84-06.90	4A-GELC	4	Z 228	14 FR-7 DPUX02	1,0	UXT 11
1.6 16V	1.6	91	11.84-06.90	4A-GEL	4	Z 157	14 FR-7 KUOX	1,1	UXT 11

### MR 2 II

2.0 16V	2.0	115	12.89-05.00	3S-GE	4	Z 155	14 FR-7 KU	0,8	UXT 10
2.0 16V	2.0	125	12.89-05.96	3S-GE	4	Z 151	14 FR-7 KPU	0,8	UXT 10
2.0 16V	2.0	125	06.96-05.00	3S-GE	4	Z 155	14 FR-7 KPU	0,8	UXT 10
2.0 16V	2.0	129	12.89-05.96	3S-GE	4	Z 151	14 FR-7 KPU	0,8	UXT 10
2.0 16V	2.0	129	06.96-05.00	3S-GE	4	Z 155	14 FR-7 KU	0,8	UXT 10

### MR 2 III

1.8 16V VT-i	1.8	103	04.00-09.05	1ZZ-FE	4	Z 249	14 FR-8 KUOU	1,0	○
--------------	-----	-----	-------------	--------	---	-------	--------------	-----	---

### PICNIC

2.0 16V	2.0	94	05.96-12.01	3S-FE	4	Z 157	14 FR-7 KUOX	1,1	UXT 11
2.2 D	2.2	66	08.97-12.01	3C-TE	4	GN 110 (11V)	○		

### PREVIA

2.0 D-4D	2.0	85	03.01-	1CD-FTV	4	GN 065 (11V)	○		
2.4	2.4	97	05.90-08.00	2TZ-FE	4	Z 228	14 FR-7 DPUX02	1,0	UXT 11
2.4 4WD	2.4	97	05.90-08.00	2TZ-FE	4	Z 228	14 FR-7 DPUX02	1,0	UXT 11
2.4 16V	2.4	115	08.00-01.06	2AZ-FE	4	Z 221	14 FR-6 DPUX02	1,0	UXT 14

### PRIUS

1.5	1.5	53	05.00-01.04	1NZ-FXE	4	Z 240	14 F-8 DPURX02	1,0	UXT 9
1.5	1.5	57	08.03-03.09	1NZ-FXE	4	Z 240	14 F-8 DPURX02	1,0	UXT 9

### PROBOX/SUCCEED

1.4 D4d	1.4	55	07.02-	1ND-TV	4	GN 042 (11V)	○		
1.5 VVTi Hybrid	1.5	68	07.02-	1NZ-FXE	4	Z 240	14 F-8 DPURX02	1,0	UXT 9

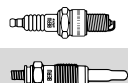

## TOYOTA

### RAV 4 I

2.0 16V	2.0	95	06.94-06.00	3S-FE	4	<b>Z 157</b>	14 FR-7 KUOX	1,1	<b>UXT 11</b>
---------	-----	----	-------------	-------	---	--------------	--------------	-----	---------------

### RAV 4 I Cabrio

2.0 16V	2.0	94	12.97-06.00	3S-FE	4	<b>Z 157</b>	14 FR-7 KUOX	1,1	<b>UXT 11</b>
---------	-----	----	-------------	-------	---	--------------	--------------	-----	---------------

### RAV 4 II

1.8 WTi	1.8	92	02.01-	1ZZ-FE	4	<b>Z 249</b>	14 FR-8 KUOU	1,0	○
---------	-----	----	--------	--------	---	--------------	--------------	-----	---

2.0 D-4D 4WD	2.0	85	09.01-	1CD-FTV	4	<b>GN 065</b> (11V)	○		
--------------	-----	----	--------	---------	---	---------------------	---	--	--

2.0 WTi 4WD	2.0	110	06.00-	1AZ-FE	4	<b>Z 221</b>	14 FR-6 DPUX02	1,0	<b>UXT 14</b>
-------------	-----	-----	--------	--------	---	--------------	----------------	-----	---------------

### RAV 4 III

2.0 WTi 4WD	2.0	112	03.06-	1AZ-FE	4	<b>Z 221</b>	14 FR-6 DPUX02	1,0	<b>UXT 14</b>
-------------	-----	-----	--------	--------	---	--------------	----------------	-----	---------------

2.2 D-4D	2.2	110	12.08-	2AD-FHV	4	<b>GN 108</b> (11V)	○		
----------	-----	-----	--------	---------	---	---------------------	---	--	--

2.2 D-CAT	2.2	130	03.06-	2AD-FHV	4	<b>GN 108</b> (11V)	○		
-----------	-----	-----	--------	---------	---	---------------------	---	--	--

2.4 WTi	2.4	125	11.05-	2AZ-FE	4	<b>Z 221</b>	14 FR-6 DPUX02	1,0	<b>UXT 14</b>
---------	-----	-----	--------	--------	---	--------------	----------------	-----	---------------

### STARLET

1.0	1.0	40	12.89-12.92	1E	4	<b>Z 20</b>	14 R-7 DU	0,8	<b>UXT 2<sup>4</sup></b>
-----	-----	----	-------------	----	---	-------------	-----------	-----	--------------------------

1.3	1.3	55	04.96-03.99	4E-FE	4	<b>Z 156</b>	14 FR-7 KUO	0,7	<b>UXT 10</b>
-----	-----	----	-------------	-------	---	--------------	-------------	-----	---------------

1.3 12V	1.3	55	12.89-12.92	2E-E/2E	4	<b>Z 8</b>	14 R-8 DU	0,8	<b>UXT 2<sup>4</sup></b>
---------	-----	----	-------------	---------	---	------------	-----------	-----	--------------------------

1.3 12V KAT	1.3	55	12.89-03.96	2E-E	4	<b>Z 9</b>	14 R-8 DUX	1,1	<b>UXT 2<sup>4</sup></b>
-------------	-----	----	-------------	------	---	------------	------------	-----	--------------------------

1.5 D	1.5	40	12.89-03.96	1N	4	<b>GV 968</b> (11V)	○		
-------	-----	----	-------------	----	---	---------------------	---	--	--

### SUPRA

3.0 Turbo	3.0	173	09.87-04.93	7M-GTE	6	<b>Z 151</b>	14 FR-7 KPU	0,8	<b>UXT 10</b>
-----------	-----	-----	-------------	--------	---	--------------	-------------	-----	---------------

3.0 Turbo	3.0	175	08.88-05.93	7M-GTE	6	<b>Z 151</b>	14 FR-7 KPU	0,8	<b>UXT 10</b>
-----------	-----	-----	-------------	--------	---	--------------	-------------	-----	---------------

3.0 i Bi-Turbo	3.0	210	05.93-08.98	2JZ-GTE	6	<b>Z 284</b>	14 FR-6 DPOX	1,1	<b>UXT 14</b>
----------------	-----	-----	-------------	---------	---	--------------	--------------	-----	---------------

3.0 i Bi-Turbo	3.0	243	05.93-08.98	2JZ-GTE	6	<b>Z 284</b>	14 FR-6 DPOX	1,1	<b>UXT 14</b>
----------------	-----	-----	-------------	---------	---	--------------	--------------	-----	---------------

### URBAN CRUISER

1.4 D-4D	1.4	66	04.09-	1ND-TV	4	<b>GN 042</b> (11V)	○		
----------	-----	----	--------	--------	---	---------------------	---	--	--

1.4 D-4D 4x4	1.4	66	04.09-	1ND-TV	4	<b>GN 042</b> (11V)	○		
--------------	-----	----	--------	--------	---	---------------------	---	--	--

### VERSO

2.2 D-4D	2.2	110	04.09-	2AD-FHV	4	<b>GN 108</b> (11V)	○		
----------	-----	-----	--------	---------	---	---------------------	---	--	--

2.2 D-CAT	2.2	130	04.09-	2AD-FHV	4	<b>GN 108</b> (11V)	○		
-----------	-----	-----	--------	---------	---	---------------------	---	--	--

### VERSO S

1.4 D4-D	1.4	66	11.10-	1ND-TV	4	<b>GN 042</b> (11V)	○		
----------	-----	----	--------	--------	---	---------------------	---	--	--

### VISTA

2.0 D4 N200	2.0	112	06.98-08.03	1AZ-FE	4	<b>Z 221</b>	14 FR-6 DPUX02	1,0	<b>UXT 14</b>
-------------	-----	-----	-------------	--------	---	--------------	----------------	-----	---------------

2.0 D4 N200 4WD	2.0	112	06.98-08.03	1AZ-FE	4	<b>Z 221</b>	14 FR-6 DPUX02	1,0	<b>UXT 14</b>
-----------------	-----	-----	-------------	--------	---	--------------	----------------	-----	---------------

### WISH

2.0 Zi	2.0	114	04.03-03.09	1AZ-FSE	4	<b>Z 284</b>	14 FR-6 DPOX	1,1	<b>UXT 14</b>
--------	-----	-----	-------------	---------	---	--------------	--------------	-----	---------------

### YARIS

1.0 16V	1.0	48	03.03-09.05	1SZ-FE	4	<b>Z 157</b>	14 FR-7 KUOX	1,1	<b>UXT 11</b>
---------	-----	----	-------------	--------	---	--------------	--------------	-----	---------------

1.0 16V	1.0	50	04.99-09.05	1SZ-FE	4	<b>Z 157</b>	14 FR-7 KUOX	1,1	<b>UXT 11</b>
---------	-----	----	-------------	--------	---	--------------	--------------	-----	---------------

1.0 WTi	1.0	51	01.06-	1KR-FE	3	<b>Z 273</b>	14 FR-7 NUX2	1,1	○
---------	-----	----	--------	--------	---	--------------	--------------	-----	---

1.3 16V	1.3	63	11.99-09.05	2NZ-FE	4	<b>Z 249</b>	14 FR-8 KUOU	1,0	○
---------	-----	----	-------------	--------	---	--------------	--------------	-----	---

1.3	1.3	64	04.02-09.05	2SZ-FE	4	<b>Z 156</b>	14 FR-7 KUO	0,7	<b>UXT 10</b>
-----	-----	----	-------------	--------	---	--------------	-------------	-----	---------------

1.4 D-4D	1.4	55	12.01-09.05	1ND-TV	4	<b>GN 042</b> (11V)	○		
----------	-----	----	-------------	--------	---	---------------------	---	--	--

1.4 D-4D	1.4	66	01.06-Aug11	1ND-TV	4	<b>GN 042</b> (11V)	○		
----------	-----	----	-------------	--------	---	---------------------	---	--	--

1.4 D-4D	1.4	66	09.11-	1ND-TV	4	<b>GN 096</b> (11V)	○		
----------	-----	----	--------	--------	---	---------------------	---	--	--

1.5 TS	1.5	77	01.03-09.05	1NZ-FE	4	<b>Z 156</b>	14 FR-7 KUO	0,7	<b>UXT 10</b>
--------	-----	----	-------------	--------	---	--------------	-------------	-----	---------------

1.5 WTi TS	1.5	78	04.01-09.05	1NZ-FE	4	<b>Z 156</b>	14 FR-7 KUO	0,7	<b>UXT 10</b>
------------	-----	----	-------------	--------	---	--------------	-------------	-----	---------------

### YARIS VERSO

1.3	1.3	62	11.99-09.05	2NZ-FE	4	<b>Z 249</b>	14 FR-8 KUOU	1,0	○
-----	-----	----	-------------	--------	---	--------------	--------------	-----	---

1.3	1.3	63	11.99-09.05	2NZ-FE	4	<b>Z 249</b>	14 FR-8 KUOU	1,0	○
-----	-----	----	-------------	--------	---	--------------	--------------	-----	---

1.4 D-4D	1.4	55	12.01-09.05	1ND-TV	4	<b>GN 042</b> (11V)	○		
----------	-----	----	-------------	--------	---	---------------------	---	--	--

1.5	1.5	77	05.03-09.05	1NZ-FE	4	<b>Z 156</b>	14 FR-7 KUO	0,7	<b>UXT 10</b>
-----	-----	----	-------------	--------	---	--------------	-------------	-----	---------------

1.5	1.5	78	03.00-09.05	1NZ-FE	4	<b>Z 156</b>	14 FR-7 KUO	0,7	<b>UXT 10</b>
-----	-----	----	-------------	--------	---	--------------	-------------	-----	---------------



### COASTER

2.7	2.7	112	08.99-10.03	3RZ-FE	4	<b>Z 150</b>	14 FR-7 KPUV	1,3	○
-----	-----	-----	-------------	--------	---	--------------	--------------	-----	---

### COMMUTER

2.4 D	2.4	57	09.89-08.95	2L	4	<b>GV 968</b> (11V)	○		
-------	-----	----	-------------	----	---	---------------------	---	--	--

2.4 D 4x4	2.4	57	09.89-08.95	2L	4	<b>GV 968</b> (11V)	○		
-----------	-----	----	-------------	----	---	---------------------	---	--	--

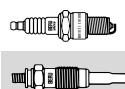
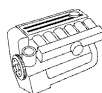

## TOYOTA



### DYNA

2.5 D4d	2.5	65	08.01-	2KD-FTV	4	<b>GN 065</b> (11V)	○		
2.5 D4d	2.5	75	08.01-	2KD-FTV	4	<b>GN 065</b> (11V)	○		
3.0 D4d	3.0	80	09.06-	1KD-FTV	4	<b>GN 068</b> (11V)	○		
3.0 D4d	3.0	100	10.09-	1KD-FTV	4	<b>GN 068</b> (11V)	○		
3.0 D4d	3.0	106	09.06-	1KD-FTV	4	<b>GN 068</b> (11V)	○		
3.0 D4d 4WD	3.0	106	09.06-	1KD-FTV	4	<b>GN 068</b> (11V)	○		

### HIACE III

2.0	2.0	74	08.89-08.95	1RZ	4	<b>Z 8</b>	14 R-8 DU	0,8	<b>UXT 2<sup>4</sup></b>
2.4 D	2.4	55	08.89-08.95	2L	4	<b>GV 968</b> (11V)	○		
2.4 D 4WD	2.4	55	08.89-08.95	2L	4	<b>GV 968</b> (11V)	○		
2.4 D	2.4	57	09.89-08.95	2L	4	<b>GV 968</b> (11V)	○		
2.4 D 4x4	2.4	57	09.89-08.95	2L	4	<b>GV 968</b> (11V)	○		
2.4	2.4	88	08.89-08.95	2RZ-E	4	<b>Z 9</b>	14 R-8 DUX	1,1	<b>UXT 2<sup>4</sup></b>
2.4 4WD	2.4	88	08.89-08.95	2RZ-E	4	<b>Z 9</b>	14 R-8 DUX	1,1	<b>UXT 2<sup>4</sup></b>

### HIACE IV

2.4 D	2.4	55	09.95-08.97	2L	4	<b>GV 968</b> (11V)	○		
2.4 D	2.4	58	08.95-08.97	2L	4	<b>GV 968</b> (11V)	○		
2.4 D	2.4	61	08.95-08.97	2L	4	<b>GV 968</b> (11V)	○		
2.4 TD	2.4	66	08.95-	2L-T	4	<b>GV 968</b> (11V)	○		
2.4 TD 4WD	2.4	66	08.95-	2L-T	4	<b>GV 968</b> (11V)	○		
2.5 D-4D	2.5	65	11.01-	2KD-FTV	4	<b>GN 065</b> (11V)	○		
2.5 D-4D 4x4	2.5	65	08.01-08.06	2KD-FTV	4	<b>GN 065</b> (11V)	○		
2.5 D-4D	2.5	75	11.01-	2KD-FTV	4	<b>GN 065</b> (11V)	○		
2.5 D-4D 4WD	2.5	75	11.01-	2KD-FTV	4	<b>GN 065</b> (11V)	○		
2.7	2.7	105	04.98-	3RZ-FE	4	<b>Z 150</b>	14 FR-7 KPUV	1,3	○
2.7 4WD	2.7	105	04.98-	3RZ-FE	4	<b>Z 150</b>	14 FR-7 KPUV	1,3	○
2.7	2.7	106	11.01-	3RZ-FE	4	<b>Z 150</b>	14 FR-7 KPUV	1,3	○

### HIACE V

2.5 D-4D	2.5	70	08.06-	2KD-FTV	4	<b>GN 065</b> (11V)	○		
2.5 D-4D	2.5	75	09.06-	2KD-FTV	4	<b>GN 065</b> (11V)	○		
2.5 D-4D	2.5	80	09.06-	2KD-FTV	4	<b>GN 065</b> (11V)	○		
2.5 D-4D	2.5	86	08.06-	2KD-FTV	4	<b>GN 065</b> (11V)	○		
2.5 D-4D 4WD	2.5	94	01.05-	2KD-FTV	4	<b>GN 065</b> (11V)	○		
3.0 D	3.0	80	11.06-	1KD-FTV	4	<b>GN 068</b> (11V)	○		
3.0 D	3.0	100	01.05-	1KD-FTV	4	<b>GN 068</b> (11V)	○		
3.0 D	3.0	106	11.08-	1KD-FTV	4	<b>GN 068</b> (11V)	○		

### HILUX

2.7	2.7	107	08.01-07.04	3RZ-FE	4	<b>Z 150</b>	14 FR-7 KPUV	1,3	○
-----	-----	-----	-------------	--------	---	--------------	--------------	-----	---

### HILUX II Pick-up

2.4 D	2.4	56	10.88-08.91	2L	4	<b>GV 968</b> (11V)	○		
2.4 D	2.4	58	03.95-08.97	2L	4	<b>GV 968</b> (11V)	○		
2.4 D 4WD	2.4	58	01.94-08.97	2L	4	<b>GV 968</b> (11V)	○		
2.4 D	2.4	59	01.92-08.97	2L	4	<b>GV 968</b> (11V)	○		
2.4 D	2.4	61	08.88-08.97	2L	4	<b>GV 968</b> (11V)	○		
2.4 D 4WD	2.4	61	08.88-08.97	2L	4	<b>GV 968</b> (11V)	○		
2.4 TD 4WD	2.4	66	08.98-01.02	2L-T	4	<b>GV 968</b> (11V)	○		
2.4 i 4WD	2.4	84	06.89-	22RE	4	<b>Z 8</b>	14 R-8 DU	0,8	<b>UXT 2<sup>4</sup></b>
2.4 i 4WD	2.4	84	06.89-	22R	4	<b>Z 8</b>	14 R-8 DU	0,8	<b>UXT 2<sup>4</sup></b>
2.4 i 4WD	2.4	103	08.97-	2RZ-FE	4	<b>Z 155</b>	14 FR-7 KU	0,8	<b>UXT 10</b>
2.5 D-4D	2.5	65	11.01-	2KD-FTV	4	<b>GN 065</b> (11V)	○		
2.5 D-4D 4WD	2.5	75	11.01-	2KD-FTV	4	<b>GN 065</b> (11V)	○		
2.7	2.7	107	08.01-07.04	3RZ-FE	4	<b>Z 150</b>	14 FR-7 KPUV	1,3	○
2.7 Allrad	2.7	108	11.97-04.05	3RZ-FE	4	<b>Z 150</b>	14 FR-7 KPUV	1,3	○
2.7	2.7	110	08.94-07.00	3RZ-FE	4	<b>Z 150</b>	14 FR-7 KPUV	1,3	○
2.7 4WD	2.7	110	08.94-07.00	3RZ-FE	4	<b>Z 150</b>	14 FR-7 KPUV	1,3	○

### HILUX III Pick-up

2.5 D-4D	2.5	75	06.06-	2KD-FTV	4	<b>GN 065</b> (11V)	○		
2.5 D 4x4	2.5	75	08.05-	2KD-FTV	4	<b>GN 065</b> (11V)	○		
2.5 D-4D	2.5	88	12.07-	2KD-FTV	4	<b>GN 065</b> (11V)	○		



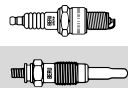

## TOYOTA



### HILUX III Pick-up

2.5 D-4D 4x4	2.5	88	12.07-	2KD-FTV	4	<b>GN 065</b> (11V)	○		
2.5 D-4D 4x4	2.5	106	12.07-	2KD-FTV	4	<b>GN 065</b> (11V)	○		
3.0	3.0	120	08.05-09.06	1KD-FTV	4	<b>GN 068</b> (11V)	○		
3.0 Allrad 4x4	3.0	120	08.05-	1KD-FTV	4	<b>GN 068</b> (11V)	○		
3.0 D	3.0	126	10.06-	1KD-FTV	4	<b>GN 068</b> (11V)	○		
3.0 D-4D 4x4	3.0	126	12.07-	1KD-FTV	4	<b>GN 068</b> (11V)	○		

### KIJANG

2.4 D	2.4	57	08.89-08.95	2L	4	<b>GV 968</b> (11V)	○		
-------	-----	----	-------------	----	---	---------------------	---	--	--

### KIJANG INNOVA

2.5 D4d	2.5	75	08.04-	2KD-FTV	4	<b>GN 065</b> (11V)	○		
---------	-----	----	--------	---------	---	---------------------	---	--	--

### LITEACE

1.5	1.5	52	07.89-01.92	5K	4	<b>Z 8</b>	14 R-8 DU	0,8	<b>UXT 2<sup>4</sup></b>
2.0 D	2.0	53	08.88-01.92	2C	4	<b>GN 043</b> (11V)	○		
2.0 D	2.0	53	01.92-05.94	2C	4	<b>GV 967</b> (11V)	○		

### REGIUSACE

2.5 D4d	2.5	80	08.03-	2KD-FTV	4	<b>GN 065</b> (11V)	○		
---------	-----	----	--------	---------	---	---------------------	---	--	--

### TARAGO

2.7	2.7	106	08.98-08.04	3RZ-FE	4	<b>Z 150</b>	14 FR-7 KPUV	1,3	○
-----	-----	-----	-------------	--------	---	--------------	--------------	-----	---

### TOWN ACE

2.4 D	2.4	57	09.88-12.91	2L	4	<b>GV 968</b> (11V)	○		
-------	-----	----	-------------	----	---	---------------------	---	--	--

## TRABANT

### 1.1

1.1	1.0	30	05.90-12.91	4V05,9 / 7,5GRF	4	<b>Z 11</b>	14-7 DU	0,8	<b>UXT 2<sup>4</sup></b>
-----	-----	----	-------------	-----------------	---	-------------	---------	-----	--------------------------

### 1.1 Tramp

1.1	1.0	30	05.90-12.91	4V05,9 / 7,5GRF	4	<b>Z 11</b>	14-7 DU	0,8	<b>UXT 2<sup>4</sup></b>
-----	-----	----	-------------	-----------------	---	-------------	---------	-----	--------------------------

### 1.1 Universal

1.1	1.0	30	12.90-12.91	4V05,9 / 7,5GRF	4	<b>Z 11</b>	14-7 DU	0,8	<b>UXT 2<sup>4</sup></b>
-----	-----	----	-------------	-----------------	---	-------------	---------	-----	--------------------------

### P 601 Tramp

0.6	0.6	19	10.66-04.90	P65/66/P63/64	2	<b>Z 48</b>	14-6 BU	0,8	○
-----	-----	----	-------------	---------------	---	-------------	---------	-----	---

### P 601 Universal

0.6	0.6	19	01.66-04.90	P65/66/P63/64	2	<b>Z 48</b>	14-6 BU	0,8	○
-----	-----	----	-------------	---------------	---	-------------	---------	-----	---

## VAUXHALL

### AGILA Mk I

1.0 12V	1.0	43	09.00-08.05	Z 10 XE	3	<b>Z 74<sup>5</sup></b>	14 FR-8 LDUOX4	1,0	<b>UXT 1<sup>3</sup></b>
1.0 12V	1.0	44	02.00-11.06	Z 10 XEP	3	<b>Z 203</b>	14 FR-8 LU2	0,9	○
1.2 16V	1.2	55	09.00-	Z 12 XE	4	<b>Z 74<sup>5</sup></b>	14 FR-8 LDUOX4	1,0	<b>UXT 1<sup>3</sup></b>
1.2 16V Twinport	1.2	59	07.04-11.06	Z 12 XEP	4	<b>Z 203</b>	14 FR-8 LU2	0,9	○
1.3 CDTI	1.3	51	08.03-03.08	Z 13 DT	4	<b>GN 053</b> (11V)	○		

### AGILA Mk II

1.0 LPG	1.0	48	01.08-	K10B	3	<b>Z 333</b>	12 FR-6 DPUX	1,1	○
1.2 LPG	1.2	63	04.08-	K12B	4	<b>Z 333</b>	12 FR-6 DPUX	1,1	○
1.3 CDTI	1.3	55	01.08-	D13A/Z 13 DTJ	4	<b>GN 053</b> (11V)	○		

### ANTARA

3.2 V6	3.2	167	11.06-	10 HM/Z 32 SED	6	<b>Z 356</b>	14 KR-7 MPUX2	1,1	○
--------	-----	-----	--------	----------------	---	--------------	---------------	-----	---

### ARENA Combi

1.9 D	1.9	44	03.98-08.01	F8Q 606/F8Q 600	4	<b>GN 963</b> (11V)	○		
2.5 D	2.5	55	03.98-08.01	S8U 780/S8U 782/S8U 758	4	<b>GV 642</b> (11V)	○		

### ARENA Van

1.9 D	1.9	44	03.98-08.01	F8Q 606/F8Q 600	4	<b>GN 963</b> (11V)	○		
2.5 D	2.5	55	03.98-08.01	S8U 780/S8U 782/S8U 758	4	<b>GV 642</b> (11V)	○		

### ASTRA Mk II

1.2	1.2	44	01.89-08.91	12 S	4	<b>Z 20</b>	14 R-7 DU	0,8	<b>UXT 2<sup>4</sup></b>
1.3	1.3	55	09.84-08.91	13 S	4	<b>Z 20</b>	14 R-7 DU	0,8	<b>UXT 2<sup>4</sup></b>
1.4 i	1.4	44	01.90-08.91	C 14 NZ	4	<b>Z 119</b>	14 R-8 DU4	0,8	<b>UXT 2<sup>4</sup></b>
1.4 i	1.4	44	01.90-08.91	C 14 NZ <sup>18</sup>	4	<b>Z 74<sup>5</sup></b>	14 FR-8 LDUOX4	1,0	<b>UXT 1<sup>3</sup></b>
1.4 S	1.4	55	01.90-08.91	14 NV	4	<b>Z 20</b>	14 R-7 DU	0,8	<b>UXT 2<sup>4</sup></b>
1.6	1.6	60	09.84-08.91	16 SV	4	<b>Z 20</b>	14 R-7 DU	0,8	<b>UXT 2<sup>4</sup></b>

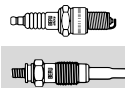
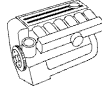

## VAUXHALL

### ASTRA Mk II

1.7 D	1.7	42	01.89-08.91	17 DR	4	GV 636 (11V)	GR 064		
1.8 GTE	1.8	82	09.84-08.91	18 SE	4	Z 119	14 R-8 DU4	0,8	UXT 2 <sup>4</sup>
1.8 GTE	1.8	82	09.84-08.91	18 SE <sup>18</sup>	4	Z 74 <sup>5</sup>	14 FR-8 LDUOX4	1,0	UXT 1 <sup>3</sup>
1.8 GTE	1.8	82	09.84-08.91	18 E	4	Z 20	14 R-7 DU	0,8	UXT 2 <sup>4</sup>
2.0 GTE	2.0	95	09.86-08.91	20 SEH	4	Z 20	14 R-7 DU	0,8	UXT 2 <sup>4</sup>
2.0 GTE 16V	2.0	115	05.88-08.91	20 XE	4	Z 250	14 FR-7 DU2S	0,7	UXT 1 <sup>3</sup>

### ASTRA Mk II Belmont

1.3	1.3	55	09.85-08.91	13 S	4	Z 20	14 R-7 DU	0,8	UXT 2 <sup>4</sup>
1.4 i	1.4	44	01.90-12.91	C 14 NZ	4	Z 119	14 R-8 DU4	0,8	UXT 2 <sup>4</sup>
1.4 i	1.4	44	01.90-12.91	C 14 NZ <sup>18</sup>	4	Z 74 <sup>5</sup>	14 FR-8 LDUOX4	1,0	UXT 1 <sup>3</sup>
1.5 DT	1.5	49	01.88-08.90	15 DT (T4EC1)	4	GV 947 (11V)	○		
1.6 D	1.6	40	09.85-08.91	16 DA	4	GV 636 (11V)	○		
1.6 S	1.6	60	01.89-12.91	16 SV	4	Z 20	14 R-7 DU	0,8	UXT 2 <sup>4</sup>
1.6	1.6	66	09.85-08.91	16 SH	4	Z 20	14 R-7 DU	0,8	UXT 2 <sup>4</sup>
1.7 D	1.7	42	01.89-12.91	17 D	4	GV 636 (11V)	GR 064		
1.8	1.8	82	01.86-12.90	18 SE	4	Z 119	14 R-8 DU4	0,8	UXT 2 <sup>4</sup>
1.8	1.8	82	01.86-12.90	18 SE <sup>18</sup>	4	Z 74 <sup>5</sup>	14 FR-8 LDUOX4	1,0	UXT 1 <sup>3</sup>
1.8 i	1.8	85	09.85-08.91	18 SE	4	Z 119	14 R-8 DU4	0,8	UXT 2 <sup>4</sup>
1.8 i	1.8	85	09.85-08.91	18 SE <sup>18</sup>	4	Z 74 <sup>5</sup>	14 FR-8 LDUOX4	1,0	UXT 1 <sup>3</sup>
1.8 i	1.8	85	09.85-08.91	18 E	4	Z 20	14 R-7 DU	0,8	UXT 2 <sup>4</sup>

### ASTRA Mk II Convertible

1.6 i	1.6	55	01.91-08.93	E 16 NZ	4	Z 21	14 R-7 DUX	1,1	UXT 2 <sup>4</sup>
1.6 i KAT	1.6	55	10.87-02.93	C 16 NZ/C 16 LZ	4	Z 21	14 R-7 DUX	1,1	UXT 2 <sup>4</sup>
1.6 i	1.6	60	01.87-12.91	16 SV	4	Z 20	14 R-7 DU	0,8	UXT 2 <sup>4</sup>
2.0 i	2.0	85	01.87-12.91	20 NE	4	Z 119	14 R-8 DU4	0,8	UXT 2 <sup>4</sup>
2.0 i	2.0	85	01.87-12.91	20 NE <sup>18</sup>	4	Z 74 <sup>5</sup>	14 FR-8 LDUOX4	1,0	UXT 1 <sup>3</sup>
2.0 i KAT	2.0	85	01.91-08.93	C 20 NE	4	Z 119	14 R-8 DU4	0,8	UXT 2 <sup>4</sup>
2.0 i KAT	2.0	85	01.91-08.93	C 20 NE <sup>18</sup>	4	Z 74 <sup>5</sup>	14 FR-8 LDUOX4	1,0	UXT 1 <sup>3</sup>

### ASTRA Mk II Estate

1.3	1.3	51	09.84-08.91	13 S	4	Z 20	14 R-7 DU	0,8	UXT 2 <sup>4</sup>
1.3	1.3	55	09.84-08.91	13 S	4	Z 20	14 R-7 DU	0,8	UXT 2 <sup>4</sup>
1.4 S	1.4	55	01.89-08.91	14 NV	4	Z 20	14 R-7 DU	0,8	UXT 2 <sup>4</sup>
1.5 DT	1.5	49	01.88-08.91	15 DT (T4EC1)	4	GV 947 (11V)	○		
1.6	1.6	60	09.84-08.91	16 SV	4	Z 20	14 R-7 DU	0,8	UXT 2 <sup>4</sup>
1.7 D	1.7	42	02.89-08.91	17 D	4	GV 636 (11V)	GR 064		
1.8 i	1.8	83	01.90-08.91	18 E	4	Z 20	14 R-7 DU	0,8	UXT 2 <sup>4</sup>

### ASTRA Mk III

1.4 i	1.4	44	09.91-02.98	C 14 NZ	4	Z 119	14 R-8 DU4	0,8	UXT 2 <sup>4</sup>
1.4 i	1.4	44	09.91-02.98	C 14 NZ <sup>18</sup>	4	Z 74 <sup>5</sup>	14 FR-8 LDUOX4	1,0	UXT 1 <sup>3</sup>
1.4 S	1.4	55	09.91-02.98	14 NV	4	Z 119	14 R-8 DU4	0,8	UXT 2 <sup>4</sup>
1.4 S	1.4	55	09.91-02.98	14 NV <sup>18</sup>	4	Z 74 <sup>5</sup>	14 FR-8 LDUOX4	1,0	UXT 1 <sup>3</sup>
1.4 i	1.4	60	04.92-09.98	C 14 SE	4	Z 119	14 R-8 DU4	0,8	UXT 2 <sup>4</sup>
1.4 i	1.4	60	04.92-09.98	C 14 SE <sup>18</sup>	4	Z 74 <sup>5</sup>	14 FR-8 LDUOX4	1,0	UXT 1 <sup>3</sup>
1.4 i 16V	1.4	66	02.96-09.98	X 14 XE	4	Z 74 <sup>5</sup>	14 FR-8 LDUOX4	1,0	UXT 1 <sup>3</sup>
1.6 i	1.6	52	08.94-07.96	X 16 SZ	4	Z 119	14 R-8 DU4	0,8	UXT 2 <sup>4</sup>
1.6 i	1.6	52	08.94-07.96	X 16 SZ <sup>18</sup>	4	Z 74 <sup>5</sup>	14 FR-8 LDUOX4	1,0	UXT 1 <sup>3</sup>
1.6 i	1.6	55	03.92-08.96	C 16 NZ/X 16 SZR	4	Z 119	14 R-8 DU4	0,8	UXT 2 <sup>4</sup>
1.6 i	1.6	55	03.92-09.98	C 16 NZ/X 16 SZR <sup>18</sup>	4	Z 74 <sup>5</sup>	14 FR-8 LDUOX4	1,0	UXT 1 <sup>3</sup>
1.6 i	1.6	55	09.91-02.98	C 16 NZ/E 16 NZ	4	Z 119	14 R-8 DU4	0,8	UXT 2 <sup>4</sup>
1.6 i	1.6	55	09.91-02.98	C 16 NZ/E 16 NZ <sup>18</sup>	4	Z 74 <sup>5</sup>	14 FR-8 LDUOX4	1,0	UXT 1 <sup>3</sup>
1.6 i	1.6	74	03.92-02.98	C 16 SE	4	Z 119	14 R-8 DU4	0,8	UXT 2 <sup>4</sup>
1.6 i	1.6	74	03.92-02.98	C 16 SE <sup>18</sup>	4	Z 74 <sup>5</sup>	14 FR-8 LDUOX4	1,0	UXT 1 <sup>3</sup>
1.6 i 16V	1.6	74	08.94-09.98	X 16 XEL	4	Z 74 <sup>5</sup>	14 FR-8 LDUOX4	1,0	UXT 1 <sup>3</sup>
1.7 D	1.7	42	12.91-02.98	17 D	4	GV 636 (11V)	GR 064		
1.7 D	1.7	44	09.91-09.98	17 DR	4	GV 636 (11V)	○		
1.7 TD	1.7	50	08.94-09.98	X 17 DTL	4	GN 954 (11V)	○		
1.7 TD	1.7	60	12.91-02.98	17 DT (TC4EE1)	4	GV 945 (5V)	○		
				→ Mot.Nr. 731416					
1.7 TD	1.7	60	12.91-02.98	17 DT (TC4EE1)	4	GV 947 (11V)	○		
				Mot.Nr. 731417 →					

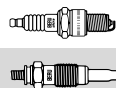
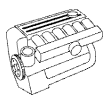

## VAUXHALL

### ASTRA Mk III

1.7 TD	1.7	60	12.91-02.98	17 DT (TC4EE1) Mot.Nr. 956633 →	4	<b>GN 103</b> (11V)	○		
1.8 i	1.8	66	09.91-02.98	C 18 NZ	4	<b>Z 119</b>	14 R-8 DU4	0,8	<b>UXT 2<sup>4</sup></b>
1.8 i	1.8	66	09.91-02.98	C 18 NZ <sup>18</sup>	4	<b>Z 74<sup>5</sup></b>	14 FR-8 LDUOX4	1,0	<b>UXT 1<sup>3</sup></b>
1.8 i 16V	1.8	85	01.94-12.96	C 18 XEL	4	<b>Z 74<sup>5</sup></b>	14 FR-8 LDUOX4	1,0	<b>UXT 1<sup>3</sup></b>
1.8 i 16V	1.8	92	06.93-10.94	C 18 XE	4	<b>Z 74<sup>5</sup></b>	14 FR-8 LDUOX4	1,0	<b>UXT 1<sup>3</sup></b>
2.0 i	2.0	85	09.91-02.98	C 20 NE	4	<b>Z 119</b>	14 R-8 DU4	0,8	<b>UXT 2<sup>4</sup></b>
2.0 i	2.0	85	09.91-02.98	C 20 NE <sup>18</sup>	4	<b>Z 74<sup>5</sup></b>	14 FR-8 LDUOX4	1,0	<b>UXT 1<sup>3</sup></b>
2.0 i 16V	2.0	100	01.94-02.98	X 20 XEV	4	<b>Z 74<sup>5</sup></b>	14 FR-8 LDUOX4	1,0	<b>UXT 1<sup>3</sup></b>
2.0 i 16V	2.0	110	09.91-08.92	C 20 XE	4	<b>Z 250</b>	14 FR-7 DU2S	0,7	<b>UXT 1<sup>3</sup></b>
2.0 i 16V	2.0	110	09.92-02.98	C 20 XE	4	<b>Z 74<sup>5</sup></b>	14 FR-8 LDUOX4	1,0	<b>UXT 1<sup>3</sup></b>

### ASTRA Mk III Convertible

1.4 i	1.4	44	09.91-02.98	C 14 NZ	4	<b>Z 119</b>	14 R-8 DU4	0,8	<b>UXT 2<sup>4</sup></b>
1.4 i	1.4	44	09.91-02.98	C 14 NZ <sup>18</sup>	4	<b>Z 74<sup>5</sup></b>	14 FR-8 LDUOX4	1,0	<b>UXT 1<sup>3</sup></b>
1.4 i	1.4	60	05.93-03.01	C 14 SE	4	<b>Z 119</b>	14 R-8 DU4	0,8	<b>UXT 2<sup>4</sup></b>
1.4 i	1.4	60	05.93-03.01	C 14 SE <sup>18</sup>	4	<b>Z 74<sup>5</sup></b>	14 FR-8 LDUOX4	1,0	<b>UXT 1<sup>3</sup></b>
1.4 i 16V	1.4	66	01.96-03.01	X 14 XE	4	<b>Z 74<sup>5</sup></b>	14 FR-8 LDUOX4	1,0	<b>UXT 1<sup>3</sup></b>
1.6 i	1.6	52	03.93-08.96	X 16 SZ	4	<b>Z 119</b>	14 R-8 DU4	0,8	<b>UXT 2<sup>4</sup></b>
1.6 i	1.6	52	03.93-08.96	X 16 SZ <sup>18</sup>	4	<b>Z 74<sup>5</sup></b>	14 FR-8 LDUOX4	1,0	<b>UXT 1<sup>3</sup></b>
1.6 i	1.6	55	01.96-03.01	X 16 SZR	4	<b>Z 119</b>	14 R-8 DU4	0,8	<b>UXT 2<sup>4</sup></b>
1.6 i	1.6	55	01.96-03.01	X 16 SZR <sup>18</sup>	4	<b>Z 74<sup>5</sup></b>	14 FR-8 LDUOX4	1,0	<b>UXT 1<sup>3</sup></b>
1.8 16V	1.8	85	11.94-03.01	X 18 XE/C 18 XEL	4	<b>Z 74<sup>5</sup></b>	14 FR-8 LDUOX4	1,0	<b>UXT 1<sup>3</sup></b>
2.0 i	2.0	85	03.93-10.94	C 20 NE	4	<b>Z 119</b>	14 R-8 DU4	0,8	<b>UXT 2<sup>4</sup></b>
2.0 i	2.0	85	03.93-10.94	C 20 NE <sup>18</sup>	4	<b>Z 74<sup>5</sup></b>	14 FR-8 LDUOX4	1,0	<b>UXT 1<sup>3</sup></b>

### ASTRA Mk III Estate

1.4 i	1.4	44	09.91-02.98	C 14 NZ	4	<b>Z 119</b>	14 R-8 DU4	0,8	<b>UXT 2<sup>4</sup></b>
1.4 i	1.4	44	09.91-02.98	C 14 NZ <sup>18</sup>	4	<b>Z 74<sup>5</sup></b>	14 FR-8 LDUOX4	1,0	<b>UXT 1<sup>3</sup></b>
1.4 S	1.4	55	09.91-02.98	14 NV	4	<b>Z 119</b>	14 R-8 DU4	0,8	<b>UXT 2<sup>4</sup></b>
1.4 S	1.4	55	09.91-02.98	14 NV <sup>18</sup>	4	<b>Z 74<sup>5</sup></b>	14 FR-8 LDUOX4	1,0	<b>UXT 1<sup>3</sup></b>
1.4 i	1.4	60	03.91-02.98	C 14 SE	4	<b>Z 119</b>	14 R-8 DU4	0,8	<b>UXT 2<sup>4</sup></b>
1.4 i	1.4	60	03.91-02.98	C 14 SE <sup>18</sup>	4	<b>Z 74<sup>5</sup></b>	14 FR-8 LDUOX4	1,0	<b>UXT 1<sup>3</sup></b>
1.4 i 16V	1.4	66	02.96-01.98	X 14 XE	4	<b>Z 74<sup>5</sup></b>	14 FR-8 LDUOX4	1,0	<b>UXT 1<sup>3</sup></b>
1.6 i	1.6	52	07.94-02.98	X 16 SZ	4	<b>Z 119</b>	14 R-8 DU4	0,8	<b>UXT 2<sup>4</sup></b>
1.6 i	1.6	52	07.94-02.98	X 16 SZ <sup>18</sup>	4	<b>Z 74<sup>5</sup></b>	14 FR-8 LDUOX4	1,0	<b>UXT 1<sup>3</sup></b>
1.6 i	1.6	55	09.91-02.98	C 16 NZ/E 16 NZ	4	<b>Z 119</b>	14 R-8 DU4	0,8	<b>UXT 2<sup>4</sup></b>
1.6 i	1.6	55	09.91-02.98	C 16 NZ/E 16 NZ <sup>18</sup>	4	<b>Z 74<sup>5</sup></b>	14 FR-8 LDUOX4	1,0	<b>UXT 1<sup>3</sup></b>
1.6 i 16V	1.6	74	01.94-02.98	X 16 XEL	4	<b>Z 74<sup>5</sup></b>	14 FR-8 LDUOX4	1,0	<b>UXT 1<sup>3</sup></b>
1.6 Si	1.6	74	03.91-12.94	C 16 SE	4	<b>Z 74<sup>5</sup></b>	14 FR-8 LDUOX4	1,0	<b>UXT 1<sup>3</sup></b>
1.7 D	1.7	42	12.91-02.98	17 D	4	<b>GV 636</b> (11V)	<b>GR 064</b>		
1.7 D	1.7	44	03.91-12.94	17 DR	4	<b>GN 954</b> (11V)	○		
1.7 TD	1.7	50	01.94-02.98	X 17 DTL	4	<b>GN 954</b> (11V)	○		
1.7 TD	1.7	60	12.91-02.98	17 DT (TC4EE1) → Mot.Nr. 731416	4	<b>GV 945</b> (5V)	○		
1.7 TD	1.7	60	12.91-02.98	17 DT (TC4EE1) Mot.Nr. 731417 →	4	<b>GV 947</b> (11V)	○		
1.7 TD	1.7	60	12.91-02.98	17 DT (TC4EE1) Mot.Nr. 956633 →	4	<b>GN 103</b> (11V)	○		
1.8 i	1.8	66	09.91-02.98	C 18 NZ	4	<b>Z 119</b>	14 R-8 DU4	0,8	<b>UXT 2<sup>4</sup></b>
1.8 i	1.8	66	09.91-02.98	C 18 NZ <sup>18</sup>	4	<b>Z 74<sup>5</sup></b>	14 FR-8 LDUOX4	1,0	<b>UXT 1<sup>3</sup></b>
1.8 i 16V	1.8	85	09.94-02.98	X 18 XE/C 18 XEL	4	<b>Z 74<sup>5</sup></b>	14 FR-8 LDUOX4	1,0	<b>UXT 1<sup>3</sup></b>
1.8 i 16V	1.8	92	09.94-02.98	C 18 XE	4	<b>Z 74<sup>5</sup></b>	14 FR-8 LDUOX4	1,0	<b>UXT 1<sup>3</sup></b>
2.0 i	2.0	85	09.91-02.98	C 20 NE	4	<b>Z 119</b>	14 R-8 DU4	0,8	<b>UXT 2<sup>4</sup></b>
2.0 i	2.0	85	09.91-02.98	C 20 NE <sup>18</sup>	4	<b>Z 74<sup>5</sup></b>	14 FR-8 LDUOX4	1,0	<b>UXT 1<sup>3</sup></b>
2.0 i 16V	2.0	100	01.94-02.98	X 20 XEV	4	<b>Z 190</b>	14 FGR-8 DQU7	1,2	<b>UXT 1<sup>3</sup></b>

### ASTRA Mk IV

1.2 16V	1.2	48	02.98-09.00	X 12 XE	4	<b>Z 74<sup>5</sup></b>	14 FR-8 LDUOX4	1,0	<b>UXT 1<sup>3</sup></b>
1.2 16V	1.2	55	09.00-	Z 12 XE	4	<b>Z 74<sup>5</sup></b>	14 FR-8 LDUOX4	1,0	<b>UXT 1<sup>3</sup></b>
1.4	1.4	44	05.98-	C 14 NZ/X 14 SZ	4	<b>Z 119</b>	14 R-8 DU4	0,8	<b>UXT 2<sup>4</sup></b>
1.4	1.4	44	05.98-	C 14 NZ/X 14 SZ <sup>18</sup>	4	<b>Z 74<sup>5</sup></b>	14 FR-8 LDUOX4	1,0	<b>UXT 1<sup>3</sup></b>
1.4 16V	1.4	66	09.98-	X 14 XE/Z 14 XE	4	<b>Z 74<sup>5</sup></b>	14 FR-8 LDUOX4	1,0	<b>UXT 1<sup>3</sup></b>
1.6	1.6	55	09.98-09.00	X 16 SZR	4	<b>Z 74<sup>5</sup></b>	14 FR-8 LDUOX4	1,0	<b>UXT 1<sup>3</sup></b>



kW

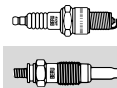
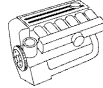

**VAUXHALL**

**ASTRA Mk IV**

1.6	1.6	62	09.00-	Z 16 SE	4	<b>Z 74<sup>5</sup></b>	14 FR-8 LDUOX4	1,0	<b>UXT 1<sup>3</sup></b>
1.6 Dualfuel	1.6	63	09.02-08.05	Z 16 XE	4	<b>Z 206</b>	14 FR-7 DPPUS2	0,7	<b>UXT 10</b>
1.6 16V	1.6	74	09.98-	X 16 XEL	4	<b>Z 74<sup>5</sup></b>	14 FR-8 LDUOX4	1,0	<b>UXT 1<sup>3</sup></b>
1.6 16V	1.6	74	02.98-	Z 16 XE	4	<b>Z 203</b>	14 FR-8 LU2	0,9	○
1.7 TD	1.7	50	09.98-08.00	X 17 DTL	4	<b>GN 954</b> (11V)	○		
1.7 DTI 16V	1.7	55	02.00-	Y 17 DT	4	<b>GN 104</b> (11V)	○		
1.7 CDTI 16V	1.7	59	04.03-	Z 17 DTL	4	<b>GN 104</b> (11V)	○		
1.8 16V	1.8	85	02.98-07.04	X 18 XE1	4	<b>Z 74<sup>5</sup></b>	14 FR-8 LDUOX4	1,0	<b>UXT 1<sup>3</sup></b>
1.8 16V Dualfuel	1.8	87	02.98-08.05	Z 18 XE	4	<b>Z 203</b>	14 FR-8 LU2	0,9	○
1.8 16V	1.8	92	02.98-07.04	Z 18 XE	4	<b>Z 74<sup>5</sup></b>	14 FR-8 LDUOX4	1,0	<b>UXT 1<sup>3</sup></b>
2.0 DI	2.0	60	02.98-	X 20 DTL/Y 20 DTL	4	<b>GN 992</b> (11V)	○		
2.0 DTI 16V	2.0	74	02.98-08.02	X 20 DTH	4	<b>GN 992</b> (11V)	○		
2.0 DTI 16V	2.0	74	09.02-07.04	Y 20 DTH	4	<b>GN 033</b> (11V)	○		
2.0 DTI 16V	2.0	74	08.99-08.02	X 20 DTH	4	<b>GN 992</b> (11V)	○		
2.0 DTI 16V	2.0	74	09.02-	Y 20 DTH	4	<b>GN 033</b> (11V)	○		
2.0 16V	2.0	100	09.98-	X 20 XEV	4	<b>Z 74<sup>5</sup></b>	14 FR-8 LDUOX4	1,0	<b>UXT 1<sup>3</sup></b>
2.0 SRI Turbo	2.0	141	07.02-	Z 20 LET	4	<b>Z 74<sup>5</sup></b>	14 FR-8 LDUOX4	1,0	<b>UXT 1<sup>3</sup></b>
2.2 16V	2.2	108	03.01-	Z 22 SE	4	<b>Z 222</b>	14 KR-8 STUX	1,1	○

**ASTRA Mk IV Convertible**

1.6 16V	1.6	74	03.01-	Z 16 XE	4	<b>Z 74<sup>5</sup></b>	14 FR-8 LDUOX4	1,0	<b>UXT 1<sup>3</sup></b>
1.8 16V	1.8	92	03.01-	Z 18 XE	4	<b>Z 74<sup>5</sup></b>	14 FR-8 LDUOX4	1,0	<b>UXT 1<sup>3</sup></b>
2.0 Turbo	2.0	141	03.02-	Z 20 LET	4	<b>Z 74<sup>5</sup></b>	14 FR-8 LDUOX4	1,0	<b>UXT 1<sup>3</sup></b>
2.2 16V	2.2	108	03.01-08.05	Z 22 SE	4	<b>Z 222</b>	14 KR-8 STUX	1,1	○

**ASTRA Mk IV Coupe**

1.8 16V	1.8	85	03.00-08.05	Z 18 XEL/X 18 XE1	4	<b>Z 74<sup>5</sup></b>	14 FR-8 LDUOX4	1,0	<b>UXT 1<sup>3</sup></b>
1.8 16V	1.8	92	09.00-	Z 18 XE	4	<b>Z 74<sup>5</sup></b>	14 FR-8 LDUOX4	1,0	<b>UXT 1<sup>3</sup></b>
2.0 16V Turbo	2.0	140	09.00-08.05	Z 20 LET	4	<b>Z 74<sup>5</sup></b>	14 FR-8 LDUOX4	1,0	<b>UXT 1<sup>3</sup></b>
2.2 16V	2.2	108	09.00-08.05	Z 22 SE	4	<b>Z 222</b>	14 KR-8 STUX	1,1	○

**ASTRA Mk IV Estate**

1.2 16V	1.2	48	02.98-09.00	X 12 XE	4	<b>Z 74<sup>5</sup></b>	14 FR-8 LDUOX4	1,0	<b>UXT 1<sup>3</sup></b>
1.2 16V	1.2	55	09.00-	Z 12 XE	4	<b>Z 74<sup>5</sup></b>	14 FR-8 LDUOX4	1,0	<b>UXT 1<sup>3</sup></b>
1.4 16V	1.4	66	02.98-	X 14 XE/Z 14 XE	4	<b>Z 74<sup>5</sup></b>	14 FR-8 LDUOX4	1,0	<b>UXT 1<sup>3</sup></b>
1.6	1.6	55	03.98-04.04	X 16 SZR	4	<b>Z 74<sup>5</sup></b>	14 FR-8 LDUOX4	1,0	<b>UXT 1<sup>3</sup></b>
1.6	1.6	62	03.98-04.04	Z 16 SE	4	<b>Z 74<sup>5</sup></b>	14 FR-8 LDUOX4	1,0	<b>UXT 1<sup>3</sup></b>
1.6 Dualfuel	1.6	63	03.98-04.04	Z 16 XE	4	<b>Z 206</b>	14 FR-7 DPPUS2	0,7	<b>UXT 10</b>
1.6 16V	1.6	74	03.98-04.04	Z 16 XE/X 16 XEL	4	<b>Z 74<sup>5</sup></b>	14 FR-8 LDUOX4	1,0	<b>UXT 1<sup>3</sup></b>
1.7 TD	1.7	50	02.98-08.00	X 17 DTL	4	<b>GN 954</b> (11V)	○		
1.7 DTI 16V	1.7	55	02.00-	Y 17 DT	4	<b>GN 104</b> (11V)	○		
1.7 CDTI 16V	1.7	59	04.03-	Z 17 DTL	4	<b>GN 104</b> (11V)	○		
1.8 16V	1.8	85	02.98-08.00	X 18 XE1	4	<b>Z 74<sup>5</sup></b>	14 FR-8 LDUOX4	1,0	<b>UXT 1<sup>3</sup></b>
1.8 16V Dualfuel	1.8	87	09.02-08.05	Z 18 XE	4	<b>Z 203</b>	14 FR-8 LU2	0,9	○
1.8 16V	1.8	92	09.00-	Z 18 XE	4	<b>Z 74<sup>5</sup></b>	14 FR-8 LDUOX4	1,0	<b>UXT 1<sup>3</sup></b>
2.0 DI	2.0	60	03.98-04.04	X 20 DTL/Y 20 DTL	4	<b>GN 992</b> (11V)	○		
2.0 DTI 16V	2.0	74	03.98-04.04	Y 20 DTH/X 20 DTH	4	<b>GN 992</b> (11V)	○		
2.0 16V	2.0	100	02.98-	X 20 XEV	4	<b>Z 74<sup>5</sup></b>	14 FR-8 LDUOX4	1,0	<b>UXT 1<sup>3</sup></b>
2.2 16V	2.2	108	03.01-	Z 22 SE	4	<b>Z 222</b>	14 KR-8 STUX	1,1	○

**ASTRA Mk V**

1.2	1.2	59	08.05-05.09	Z 12 XEP	4	<b>Z 203</b>	14 FR-8 LU2	0,9	○
1.3 CDTI	1.3	66	01.04-05.09	Z 13 DTH	4	<b>GN 053</b> (11V)	○		
1.4	1.4	66	01.04-05.09	Z 14 XEP	4	<b>Z 203</b>	14 FR-8 LU2	0,9	○
1.6	1.6	77	01.04-05.09	Z 16 XEP	4	<b>Z 203</b>	14 FR-8 LU2	0,9	○
1.6	1.6	85	01.04-05.09	Z 16 XER	4	<b>Z 203</b>	14 FR-8 LU2	0,9	○
1.7 CDTI	1.7	59	01.04-05.09	Z 17 DTL	4	<b>GN 104</b> (11V)	○		
1.7 CDTI	1.7	74	01.04-03.07	Z 17 DTH	4	<b>GN 104</b> (11V)	○		
1.7 CDTi	1.7	81	01.04-05.09	Z 17 DTJ/A 17 DTJ	4	<b>GN 104</b> (11V)	○		
1.7 CDTI	1.7	92	02.07-	A 17 DTR/Z 17 DTR	4	<b>GN 104</b> (11V)	○		
1.8	1.8	92	01.04-05.09	Z 18 XE	4	<b>Z 203</b>	14 FR-8 LU2	0,9	○
1.8	1.8	103	01.04-05.09	Z 18 XER/A 18 XER	4	<b>Z 203</b>	14 FR-8 LU2	0,9	○
1.9 CDTI	1.9	88	01.04-05.09	Z 19 DT → Fgst.Nr. 78007391, 72045139, 75030986	4	<b>GN 041</b> (11V)	○		

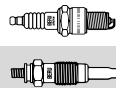
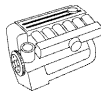

## VAUXHALL

### ASTRA Mk V

1.9 CDTi	1.9	88	01.04-05.09	Z 19 DT Fgst.Nr. 72045140, 78007392, 75030987 →	4	<b>GN 097</b> (11V)	○		
1.9 CDTi	1.9	88	01.04-05.09	Z 19 DTJ	4	<b>GN 059</b> (11V)	○		
1.9 CDTi	1.9	110	01.04-05.09	Z 19 DTH	4	<b>GN 059</b> (11V)	○		
2.0 Turbo	2.0	125	01.04-05.09	Z 20 LEL	4	<b>Z 287</b>	14 FR-8 LU2T	0,8	○
2.0 Turbo	2.0	147	01.04-05.09	Z 20 LER	4	<b>Z 287</b>	14 FR-8 LU2T	0,8	○
2.0 Turbo	2.0	177	01.04-05.09	Z 20 LEH	4	<b>Z 284</b>	14 FR-6 DPOX	1,1	<b>UXT 14</b>

### ASTRA Mk V Estate

1.2	1.2	59	08.05-	Z 12 XEP	4	<b>Z 203</b>	14 FR-8 LU2	0,9	○
1.3 CDTi	1.3	66	08.04-03.09	Z 13 DTH	4	<b>GN 053</b> (11V)	○		
1.4	1.4	66	08.04-03.09	Z 14 XEP	4	<b>Z 203</b>	14 FR-8 LU2	0,9	○
1.6	1.6	77	08.04-03.09	Z 16 XEP	4	<b>Z 203</b>	14 FR-8 LU2	0,9	○
1.6	1.6	85	08.04-03.09	A 16 XER/Z 16 XER	4	<b>Z 203</b>	14 FR-8 LU2	0,9	○
1.6	1.6	132	08.04-03.09	Z 16 LET	4	<b>Z 346</b>	14 FR-7 LPUT02	0,8	○
1.7 CDTi	1.7	74	08.04-03.07	Z 17 DTH	4	<b>GN 104</b> (11V)	○		
1.7 CDTi	1.7	81	08.04-03.09	Z 17 DTJ/A 17 DTJ	4	<b>GN 104</b> (11V)	○		
1.7 CDTi	1.7	92	02.07-	A 17 DTR/Z 17 DTR	4	<b>GN 104</b> (11V)	○		
1.8	1.8	92	01.04-03.09	Z 18 XE	4	<b>Z 203</b>	14 FR-8 LU2	0,9	○
1.8	1.8	103	01.04-03.09	Z 18 XER/A 18 XER	4	<b>Z 203</b>	14 FR-8 LU2	0,9	○
1.9 CDTi	1.9	74	08.04-03.09	Z 19 DTL → Fgst.Nr. 78007391, 72045139, 75030986	4	<b>GN 041</b> (11V)	○		
1.9 CDTi	1.9	74	08.04-03.09	Z 19 DTL Fgst.Nr. 72045140, 78007392, 75030987 →	4	<b>GN 097</b> (11V)	○		
1.9 CDTi	1.9	88	08.04-03.09	Z 19 DT → Fgst.Nr. 78007391, 72045139, 75030986	4	<b>GN 041</b> (11V)	○		
1.9 CDTi	1.9	88	08.04-03.09	Z 19 DT Fgst.Nr. 72045140, 78007392, 75030987 →	4	<b>GN 097</b> (11V)	○		
1.9 CDTi	1.9	110	08.04-03.09	Z 19 DTH	4	<b>GN 059</b> (11V)	○		
2.0 Turbo	2.0	125	08.04-	Z 20 LEL	4	<b>Z 287</b>	14 FR-8 LU2T	0,8	○
2.0 Turbo	2.0	147	08.04-	Z 20 LER	4	<b>Z 287</b>	14 FR-8 LU2T	0,8	○

### ASTRA Mk V Sport Hatch

1.4 i 16V	1.4	66	03.05-	Z 14 XEP	4	<b>Z 203</b>	14 FR-8 LU2	0,9	○
1.6 i 16V	1.6	85	12.06-	Z 16 XER	4	<b>Z 203</b>	14 FR-8 LU2	0,9	○
1.6	1.6	132	10.06-	Z 16 LET	4	<b>Z 346</b>	14 FR-7 LPUT02	0,8	○
1.7 CDTi	1.7	74	02.05-03.07	Z 17 DTH	4	<b>GN 104</b> (11V)	○		
1.7 CDTi	1.7	81	02.07-	A 17 DTJ	4	<b>GN 104</b> (11V)	○		
1.8	1.8	92	02.05-	Z 18 XE	4	<b>Z 203</b>	14 FR-8 LU2	0,9	○
1.8 i 16V	1.8	103	03.07-	A 18 XER/Z 18 XER	4	<b>Z 203</b>	14 FR-8 LU2	0,9	○
1.9 CDTi	1.9	74	08.05-03.10	Z 19 DTL Fgst.Nr. 72045140, 78007392, 75030987 →	4	<b>GN 097</b> (11V)	○		
1.9 CDTi	1.9	88	02.05-07.07	Z 19 DT	4	<b>GN 041</b> (11V)	○		
1.9 CDTi	1.9	110	02.05-	Z 19 DTH	4	<b>GN 059</b> (11V)	○		
2.0 Turbo	2.0	125	02.05-	Z 20 LEL	4	<b>Z 287</b>	14 FR-8 LU2T	0,8	○
2.0 VXR	2.0	176	02.09-	Z 20 LEH	4	<b>Z 284</b>	14 FR-6 DPOX	1,1	<b>UXT 14</b>

### ASTRA Mk V Twin Top

1.6	1.6	77	09.05-	Z 16 XEP	4	<b>Z 203</b>	14 FR-8 LU2	0,9	○
1.6	1.6	132	10.06-	Z 16 LET	4	<b>Z 346</b>	14 FR-7 LPUT02	0,8	○
1.8	1.8	103	05.08-	Z 18 XER	4	<b>Z 203</b>	14 FR-8 LU2	0,9	○
1.9 CDTi	1.9	110	01.06-	Z 19 DTH	4	<b>GN 059</b> (11V)	○		
2.0	2.0	125	02.06-09.06	Z 20 LEL	4	<b>Z 287</b>	14 FR-8 LU2T	0,8	○

### ASTRA Mk VI

1.3 CDTi	1.3	70	12.09-	A 13 DTE	4	<b>GE 112</b> (4,4V)=2x <b>PSG 003</b> (4,4V)=2x	○		
1.4	1.4	64	12.09-	A 14 XEL	4	<b>Z 203</b>	14 FR-8 LU2	0,9	○
1.6	1.6	85	12.09-	A 16 XER	4	<b>Z 203</b>	14 FR-8 LU2	0,9	○
1.6 Turbo	1.6	132	12.09-	A 16 LET	4	<b>Z 346</b>	14 FR-7 LPUT02	0,8	○
1.7 CDTi	1.7	81	12.09-	A 17 DTJ	4	<b>GN 104</b> (11V)	○		
1.7 CDTi	1.7	81	12.09-	A 17 DTE	4	<b>PSG 004</b> (4,4V)	○		
1.7 CDTi	1.7	92	12.09-	A 17 DTR	4	<b>GN 104</b> (11V)	○		

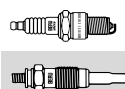

## VAUXHALL

### ASTRA Mk VI

1.7 CDTi	1.7	96	06.11-	A 17 DTF	4	PSG 004 (4,4V)	○		
2.0 CDTi	2.0	118	12.09-	A 20 DTH	4	GE 114 (4,4V)	○		

### ASTRA GTC Mk VI

1.6	1.6	132	10.11-	A 16 LET	4	Z 346	14 FR-7 LPUT02	0,8	○
1.7 CDTi	1.7	81	10.11-	A 17 DTJ	4	GN 104 (11V)	○		
1.7 CDTi	1.7	81	10.11-	A 17 DTE	4	PSG 004 (4,4V)	○		
1.7 CDTi	1.7	96	10.11-	A 17 DTF	4	PSG 004 (4,4V)	○		

### ASTRA Mk VI Sedan

1.3 CDTi	1.3	70	06.12-	A 13 DTE	4	GE 112 (4,4V)=2x	○		
						PSG 003 (4,4V)=2x	○		
1.6 Turbo	1.6	132	06.12-	A 16 LET	4	Z 346	14 FR-7 LPUT02	0,8	○

### ASTRA Mk VI Sports Tourer

1.3 CDTi	1.3	70	10.10-	A 13 DTE	4	GE 112 (4,4V)=2x	○		
						PSG 003 (4,4V)=2x	○		
1.6 Turbo	1.6	132	12.09-	A 16 LET	4	Z 346	14 FR-7 LPUT02	0,8	○
1.7 CDTi	1.7	81	10.10-	A 17 DTJ	4	GN 104 (11V)	○		
1.7 CDTi	1.7	81	10.10-	A 17 DTE	4	PSG 004 (4,4V)	○		
1.7 CDTi	1.7	92	10.10-	A 17 DTR	4	GN 104 (11V)	○		
1.7 CDTi	1.7	96	06.11-	A 17 DTF	4	PSG 004 (4,4V)	○		
2.0 CDTi	2.0	118	10.10-	A 20 DTH	4	PSG 001 (4,4V)	○		

### ASTRAMAX

1.4 i	1.4	44	08.91-07.94	C 14 NZ	4	Z 20	14 R-7 DU	0,8	UXT 2 <sup>4</sup>
1.4 S	1.4	55	07.89-08.91	14 NV	4	Z 119	14 R-8 DU4	0,8	UXT 2 <sup>4</sup>
1.4 S	1.4	55	07.89-08.91	14 NV <sup>18</sup>	4	Z 74 <sup>5</sup>	14 FR-8 LDUOX4	1,0	UXT 1 <sup>3</sup>
1.6 D	1.6	40	05.86-06.90	16 DA	4	GN 954 (11V)	○		
1.7 D	1.7	42	01.89-07.94	17 D	4	GN 954 (11V)	GR 064		

### ASTRAVAN Mk III

1.4 i	1.4	44	01.91-10.94	C 14 NZ	4	Z 119	14 R-8 DU4	0,8	UXT 2 <sup>4</sup>
1.4 i	1.4	44	01.91-10.94	C 14 NZ <sup>18</sup>	4	Z 74 <sup>5</sup>	14 FR-8 LDUOX4	1,0	UXT 1 <sup>3</sup>
1.6 i	1.6	52	02.94-10.96	X 16 SZ	4	Z 74 <sup>5</sup>	14 FR-8 LDUOX4	1,0	UXT 1 <sup>3</sup>
1.6 i	1.6	55	01.91-08.98	C 16 NZ	4	Z 119	14 R-8 DU4	0,8	UXT 2 <sup>4</sup>
1.6 i	1.6	55	01.91-08.98	C 16 NZ <sup>18</sup>	4	Z 74 <sup>5</sup>	14 FR-8 LDUOX4	1,0	UXT 1 <sup>3</sup>
1.7 D	1.7	44	01.91-08.94	17 DR	4	GN 954 (11V)	○		
1.7 TD	1.7	50	01.94-08.98	X 17 DTL	4	GN 954 (11V)	○		

### ASTRAVAN Mk IV

1.6 i	1.6	55	08.98-09.00	X 16 SZR	4	Z 74 <sup>5</sup>	14 FR-8 LDUOX4	1,0	UXT 1 <sup>3</sup>
1.6 i	1.6	62	09.00-10.09	Z 16 SE	4	Z 74 <sup>5</sup>	14 FR-8 LDUOX4	1,0	UXT 1 <sup>3</sup>
1.7 TD	1.7	50	08.98-10.09	X 17 DTL	4	GN 954 (11V)	○		
1.7 DTI	1.7	55	04.01-10.09	Y 17 DT	4	GN 104 (11V)	○		
1.7 CDTi	1.7	59	04.04-10.09	Z 17 DTL	4	GN 104 (11V)	○		
2.0 DI	2.0	60	08.98-10.09	X 20 DTL	4	GN 992 (11V)	○		
2.0 DTI	2.0	74	04.04-08.05	Y 20 DTH	4	GN 992 (11V)	○		

### ASTRAVAN Mk V

1.3 CDTi	1.3	66	08.05-	Z 13 DTH	4	GN 053 (11V)	○		
1.4 i	1.4	66	03.05-	Z 14 XEP	4	Z 203	14 FR-8 LU2	0,9	○
1.7 CDTi	1.7	74	03.05-03.07	Z 17 DTH	4	GN 104 (11V)	○		
1.7 CDTi	1.7	81	11.11-	Z 17 DTJ/A 17 DTJ	4	GN 104 (11V)	○		
1.7 CDTi	1.7	92	11.11-	A 17 DTR/Z 17 DTR	4	GN 104 (11V)	○		
1.9 CDTi	1.9	88	03.05-07.07	Z 19 DT	4	GN 041 (11V)	○		
1.9 CDTi	1.9	110	03.05-11.11	Z 19 DTH	4	GN 059 (11V)	○		

### BRAVA Pick-up

2.2 D	2.2	39	08.91-09.96	C223	4	GV 946 (11V)	○		
2.2 D 4x4	2.2	39	08.91-09.96	C223	4	GV 946 (11V)	○		
2.3	2.3	69	08.91-08.94	4 ZD1	4	Z 20	14 R-7 DU	0,8	UXT 2 <sup>4</sup>
2.3 4x4	2.3	69	06.90-08.94	4 ZD1	4	Z 20	14 R-7 DU	0,8	UXT 2 <sup>4</sup>
2.3	2.3	72	08.94-09.96	23 P	4	Z 20	14 R-7 DU	0,8	UXT 2 <sup>4</sup>
2.3 4x4	2.3	72	08.94-09.96	23 P	4	Z 20	14 R-7 DU	0,8	UXT 2 <sup>4</sup>
2.5 D	2.5	56	08.91-06.94	4 JA1	4	GV 636 (11V)	GR 064		
2.5 D 4x4	2.5	56	06.90-06.94	4 JA1T	4	GN 061 (11V)	○		
2.5 TD	2.5	56	07.94-12.02	4 JA1T	4	GN 061 (11V)	○		
2.5 TD 4x4	2.5	56	07.94-12.02	4 JA1T	4	GN 061 (11V)	○		

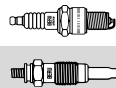

## VAUXHALL

### BRAVA Pick-up

2.5 DTI	2.5	74	08.01-12.02	4 JA1	4	<b>GN 061</b> (11V)	○	
2.5 DTI 4x4	2.5	74	08.01-12.02	4 JA1	4	<b>GN 061</b> (11V)	○	

### CALIBRA

2.0 i	2.0	85	06.90-07.97	C 20 NE	4	<b>Z 119</b>	14 R-8 DU4	0,8	<b>UXT 2<sup>4</sup></b>
2.0 i 4x4	2.0	85	06.90-07.97	C 20 NE	4	<b>Z 74<sup>5</sup></b>	14 FR-8 LDUOX4	1,0	<b>UXT 1<sup>3</sup></b>
2.0 i 16V	2.0	100	06.90-07.97	X 20 XEV	4	<b>Z 74<sup>5</sup></b>	14 FR-8 LDUOX4	1,0	<b>UXT 1<sup>3</sup></b>
2.0 i 16V 4x4	2.0	100	02.94-07.97	X 20 XEV	4	<b>Z 74<sup>5</sup></b>	14 FR-8 LDUOX4	1,0	<b>UXT 1<sup>3</sup></b>
2.0 i 16V	2.0	110	06.90-02.94	C 20 XE	4	<b>Z 250</b>	14 FR-7 DU2S	0,7	<b>UXT 1<sup>3</sup></b>
2.0 i 16V 4x4	2.0	110	06.90-02.94	C 20 XE	4	<b>Z 250</b>	14 FR-7 DU2S	0,7	<b>UXT 1<sup>3</sup></b>
2.0 i Turbo 4x4	2.0	150	03.92-07.97	C 20 LET	4	<b>Z 158</b>	14 FR-7 LUX	1,1	○
2.5 i V6	2.5	125	04.93-07.97	X 25 XE/C 25 XE	6	<b>Z 74<sup>5</sup></b>	14 FR-8 LDUOX4	1,0	<b>UXT 1<sup>3</sup></b>

### CARLTON Mk III

1.8	1.8	65	09.87-03.94	E 18 NVR	4	<b>Z 20</b>	14 R-7 DU	0,8	<b>UXT 2<sup>4</sup></b>
1.8 S	1.8	66	09.86-03.94	18 SV	4	<b>Z 20</b>	14 R-7 DU	0,8	<b>UXT 2<sup>4</sup></b>
1.8 i	1.8	85	09.86-03.94	18 SEH	4	<b>Z 119</b>	14 R-8 DU4	0,8	<b>UXT 2<sup>4</sup></b>
1.8 i	1.8	85	09.86-03.94	18 SEH <sup>18</sup>	4	<b>Z 74<sup>5</sup></b>	14 FR-8 LDUOX4	1,0	<b>UXT 1<sup>3</sup></b>
2.0	2.0	73	09.90-03.94	C 20 NEJ	4	<b>Z 119</b>	14 R-8 DU4	0,8	<b>UXT 2<sup>4</sup></b>
2.0	2.0	73	09.90-03.94	C 20 NEJ <sup>18</sup>	4	<b>Z 74<sup>5</sup></b>	14 FR-8 LDUOX4	1,0	<b>UXT 1<sup>3</sup></b>
2.0	2.0	74	09.90-03.94	C 20 NEF	4	<b>Z 119</b>	14 R-8 DU4	0,8	<b>UXT 2<sup>4</sup></b>
2.0	2.0	74	09.90-03.94	C 20 NEF <sup>18</sup>	4	<b>Z 74<sup>5</sup></b>	14 FR-8 LDUOX4	1,0	<b>UXT 1<sup>3</sup></b>
2.0	2.0	85	09.86-03.94	C 20 NE	4	<b>Z 119</b>	14 R-8 DU4	0,8	<b>UXT 2<sup>4</sup></b>
2.0	2.0	85	09.86-03.94	C 20 NE <sup>18</sup>	4	<b>Z 74<sup>5</sup></b>	14 FR-8 LDUOX4	1,0	<b>UXT 1<sup>3</sup></b>
2.0 i	2.0	90	09.86-03.94	20 SE	4	<b>Z 20</b>	14 R-7 DU	0,8	<b>UXT 2<sup>4</sup></b>
2.3 D	2.3	54	09.86-03.94	23 YD	4	<b>GN 954</b> (11V)	<b>GR 064</b>		
2.3 TD Interc.	2.3	74	08.88-03.94	23 DTR	4	<b>GV 636</b> (11V)	<b>GR 064</b>		
2.4 i	2.4	92	09.88-03.94	C 24 NE	4	<b>Z 19</b>	14 R-7 BU	0,8	○
2.6 i	2.6	110	09.90-03.94	C 26 NE	6	<b>Z 19</b>	14 R-7 BU	0,8	○
3.0 3000	3.0	130	03.87-09.90	30 NE	6	<b>Z 19</b>	14 R-7 BU	0,8	○
3000 KAT	3.0	130	03.88-03.94	C 30 NE	6	<b>Z 19</b>	14 R-7 BU	0,8	○
3000 24V	3.0	147	09.89-03.94	C 30 SEJ	6	<b>Z 98</b>	14 FR-7 LDU	0,8	<b>UXT 1<sup>3</sup></b>
3.0 3000 24V	3.0	150	09.89-03.94	C 30 SE	6	<b>Z 98</b>	14 FR-7 LDU	0,8	<b>UXT 1<sup>3</sup></b>
3.6 24V Lotus	3.6	277	08.90-09.92	C 36 GET	6	<b>Z 63</b>	14 F-7 DU	0,8	<b>UXT 1<sup>3</sup></b>

### CARLTON Mk III Estate

1.8	1.8	65	09.87-03.94	E 18 NVR	4	<b>Z 20</b>	14 R-7 DU	0,8	<b>UXT 2<sup>4</sup></b>
1.8 S	1.8	66	09.86-03.94	18 SV	4	<b>Z 20</b>	14 R-7 DU	0,8	<b>UXT 2<sup>4</sup></b>
1.8 i	1.8	85	09.86-03.94	18 SEH	4	<b>Z 119</b>	14 R-8 DU4	0,8	<b>UXT 2<sup>4</sup></b>
1.8 i	1.8	85	09.86-03.94	18 SEH <sup>18</sup>	4	<b>Z 74<sup>5</sup></b>	14 FR-8 LDUOX4	1,0	<b>UXT 1<sup>3</sup></b>
2.0 i	2.0	73	09.90-03.94	C 20 NEJ	4	<b>Z 119</b>	14 R-8 DU4	0,8	<b>UXT 2<sup>4</sup></b>
2.0 i	2.0	73	09.90-03.94	C 20 NEJ <sup>18</sup>	4	<b>Z 74<sup>5</sup></b>	14 FR-8 LDUOX4	1,0	<b>UXT 1<sup>3</sup></b>
2.0	2.0	74	09.90-03.94	C 20 NEF	4	<b>Z 119</b>	14 R-8 DU4	0,8	<b>UXT 2<sup>4</sup></b>
2.0	2.0	74	09.90-03.94	C 20 NEF <sup>18</sup>	4	<b>Z 74<sup>5</sup></b>	14 FR-8 LDUOX4	1,0	<b>UXT 1<sup>3</sup></b>
2.0	2.0	85	09.86-03.94	C 20 NE	4	<b>Z 119</b>	14 R-8 DU4	0,8	<b>UXT 2<sup>4</sup></b>
2.0	2.0	85	09.86-03.94	C 20 NE <sup>18</sup>	4	<b>Z 74<sup>5</sup></b>	14 FR-8 LDUOX4	1,0	<b>UXT 1<sup>3</sup></b>
2.0 i	2.0	90	09.86-03.94	20 SE	4	<b>Z 20</b>	14 R-7 DU	0,8	<b>UXT 2<sup>4</sup></b>
2.3 D	2.3	54	09.86-03.94	23 YD	4	<b>GN 954</b> (11V)	<b>GR 064</b>		
2.3 TD Interc.	2.3	74	09.88-03.94	23 DTR	4	<b>GV 636</b> (11V)	<b>GR 064</b>		
2.4 i	2.4	92	09.88-03.94	C 24 NE	4	<b>Z 19</b>	14 R-7 BU	0,8	○
2.6 i	2.6	110	09.90-03.94	C 26 NE	6	<b>Z 19</b>	14 R-7 BU	0,8	○
3.0	3.0	130	03.87-03.94	C 30 NE	6	<b>Z 19</b>	14 R-7 BU	0,8	○
3.0 24V	3.0	147	09.89-03.94	C 30 SEJ	6	<b>Z 98</b>	14 FR-7 LDU	0,8	<b>UXT 1<sup>3</sup></b>

### CAVALIER Mk III

1.4 S	1.4	55	09.88-11.95	14 NV	4	<b>Z 119</b>	14 R-8 DU4	0,8	<b>UXT 2<sup>4</sup></b>
1.4 S	1.4	55	09.88-11.95	14 NV <sup>18</sup>	4	<b>Z 74<sup>5</sup></b>	14 FR-8 LDUOX4	1,0	<b>UXT 1<sup>3</sup></b>
1.6 i	1.6	52	09.93-11.95	X 16 SZ	4	<b>Z 74<sup>5</sup></b>	14 FR-8 LDUOX4	1,0	<b>UXT 1<sup>3</sup></b>
1.6 i	1.6	55	09.88-11.95	E 16 NZ	4	<b>Z 119</b>	14 R-8 DU4	0,8	<b>UXT 2<sup>4</sup></b>
1.6 i	1.6	55	09.88-11.95	E 16 NZ <sup>18</sup>	4	<b>Z 74<sup>5</sup></b>	14 FR-8 LDUOX4	1,0	<b>UXT 1<sup>3</sup></b>
1.6	1.6	60	09.88-05.93	16 SV	4	<b>Z 20</b>	14 R-7 DU	0,8	<b>UXT 2<sup>4</sup></b>
1.7 D	1.7	42	09.88-09.92	17 D	4	<b>GV 636</b> (11V)	<b>GR 064</b>		
1.7 D	1.7	44	07.92-11.95	17 DR	4	<b>GN 954</b> (11V)	○		
1.7 TD	1.7	60	09.88-11.95	17 DT (TC4EE1)	4	<b>GV 946</b> (11V)	○		

→ Mot.Nr. 731416

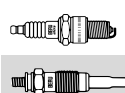
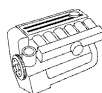

## VAUXHALL

### CAVALIER Mk III

1.7 TD	1.7	60	09.88-11.95	17 DT (TC4EE1) Mot.Nr. 731417 →	4	GN 103 (11V)	○		
1.8	1.8	66	09.88-10.90	C 18 NZ	4	Z 119	14 R-8 DU4	0,8	UXT 2 <sup>4</sup>
1.8	1.8	66	09.88-10.90	C 18 NZ <sup>18</sup>	4	Z 74 <sup>5</sup>	14 FR-8 LDUOX4	1,0	UXT 1 <sup>3</sup>
1.8	1.8	66	09.88-08.95	18 SV	4	Z 20	14 R-7 DU	0,8	UXT 2 <sup>4</sup>
1.8 i KAT	1.8	66	03.90-11.95	C 18 NZ	4	Z 119	14 R-8 DU4	0,8	UXT 2 <sup>4</sup>
1.8 i KAT	1.8	66	03.90-11.95	C 18 NZ <sup>18</sup>	4	Z 74 <sup>5</sup>	14 FR-8 LDUOX4	1,0	UXT 1 <sup>3</sup>
2.0 i 4x4	2.0	85	09.88-10.92	20 NE	4	Z 119	14 R-8 DU4	0,8	UXT 2 <sup>4</sup>
2.0 i 4x4	2.0	85	09.88-10.92	20 NE <sup>18</sup>	4	Z 74 <sup>5</sup>	14 FR-8 LDUOX4	1,0	UXT 1 <sup>3</sup>
2.0 i KAT	2.0	85	09.90-11.95	C 20 NE	4	Z 119	14 R-8 DU4	0,8	UXT 2 <sup>4</sup>
2.0 i KAT	2.0	85	09.90-11.95	C 20 NE <sup>18</sup>	4	Z 74 <sup>5</sup>	14 FR-8 LDUOX4	1,0	UXT 1 <sup>3</sup>
2.0 i 4x4	2.0	95	09.88-09.92	20 SEH	4	Z 20	14 R-7 DU	0,8	UXT 2 <sup>4</sup>
2.0 SRi 16V	2.0	100	09.93-11.95	X 20 XEV	4	Z 74 <sup>5</sup>	14 FR-8 LDUOX4	1,0	UXT 1 <sup>3</sup>
2.0 i 16V	2.0	110	09.88-08.92	C 20 XE	4	Z 250	14 FR-7 DU2S	0,7	UXT 1 <sup>3</sup>
2.0 i 16V	2.0	110	09.92-11.95	C 20 XE	4	Z 74 <sup>5</sup>	14 FR-8 LDUOX4	1,0	UXT 1 <sup>3</sup>
2.0 i Turbo 4x4	2.0	150	06.92-11.94	C 20 LET	4	Z 158	14 FR-7 LUX	1,1	○
2.5 V6	2.5	125	08.88-08.93	C 25 XE	6	Z 98	14 FR-7 LDU	0,8	UXT 1 <sup>3</sup>
2.5 V6	2.5	125	09.93-06.94	C 25 XE	6	Z 74 <sup>5</sup>	14 FR-8 LDUOX4	1,0	UXT 1 <sup>3</sup>

### COMBO Mk I

1.2	1.2	33	07.94-10.01	C 12 NZ/X 12 SZ	4	Z 119	14 R-8 DU4	0,8	UXT 2 <sup>4</sup>
1.2	1.2	33	07.94-10.01	C 12 NZ/X 12 SZ <sup>18</sup>	4	Z 74 <sup>5</sup>	14 FR-8 LDUOX4	1,0	UXT 1 <sup>3</sup>
1.4	1.4	44	07.94-10.01	C 14 NZ	4	Z 119	14 R-8 DU4	0,8	UXT 2 <sup>4</sup>
1.4	1.4	44	07.94-10.01	C 14 NZ <sup>18</sup>	4	Z 74 <sup>5</sup>	14 FR-8 LDUOX4	1,0	UXT 1 <sup>3</sup>
1.4	1.4	60	07.94-10.01	C 14 SE	4	Z 119	14 R-8 DU4	0,8	UXT 2 <sup>4</sup>
1.4	1.4	60	07.94-10.01	C 14 SE <sup>18</sup>	4	Z 74 <sup>5</sup>	14 FR-8 LDUOX4	1,0	UXT 1 <sup>3</sup>
1.7 D	1.7	44	04.96-10.01	17 D (4EE1)/X 17 D (4EE1)	4	GN 103 (11V)	○		

### COMBO Mk II

1.3 CDTi 16V	1.3	55	10.05-	Z 13 DTJ	4	GN 053 (11V)	○		
1.4 16V	1.4	66	10.01-05.07	Z 14 XE	4	Z 74 <sup>5</sup>	14 FR-8 LDUOX4	1,0	UXT 1 <sup>3</sup>
1.4 i 16V	1.4	66	01.04-	Z 14 XEP	4	Z 203	14 FR-8 LU2	0,9	○
1.6	1.6	62	08.01-10.04	Z 16 SE	4	Z 74 <sup>5</sup>	14 FR-8 LDUOX4	1,0	UXT 1 <sup>3</sup>
1.6 CNG 16V	1.6	69	06.06-02.12	Z 16 YNG	4	Z 206	14 FR-7 DPPUS2	0,7	UXT 10
1.6 CNG 16V	1.6	71	04.05-02.12	Z 16 YNG	4	Z 206	14 FR-7 DPPUS2	0,7	UXT 10
1.7 DI 16V	1.7	48	09.01-	Y 17 DTL	4	GN 104 (11V)	○		
1.7 DTi 16V	1.7	55	10.01-	Y 17 DT	4	GN 104 (11V)	○		
1.7 CDTi 16V	1.7	74	12.04-	Z 17 DTH	4	GN 104 (11V)	○		

### COMBO TOUR Mk II

1.6 CNG	1.6	69	06.06-09.10	Z 16 YNG	4	Z 206	14 FR-7 DPPUS2	0,7	UXT 10
1.6 CNG 16V	1.6	71	04.05-02.12	Z 16 YNG	4	Z 206	14 FR-7 DPPUS2	0,7	UXT 10
1.7 DTi 16V	1.7	55	10.01-02.12	Y 17 DT	4	GN 104 (11V)	○		

### CORSA Mk I

1.0 i 12V	1.0	40	11.96-09.00	X 10 XE	3	Z 74 <sup>5</sup>	14 FR-8 LDUOX4	1,0	UXT 1 <sup>3</sup>
1.2 i	1.2	33	03.93-09.00	C 12 NZ/X 12 SZ	4	Z 119	14 R-8 DU4	0,8	UXT 2 <sup>4</sup>
1.2 i	1.2	33	03.93-09.00	C 12 NZ/X 12 SZ <sup>18</sup>	4	Z 74 <sup>5</sup>	14 FR-8 LDUOX4	1,0	UXT 1 <sup>3</sup>
1.2 i 16V	1.2	48	03.98-09.00	X 12 XE	4	Z 74 <sup>5</sup>	14 FR-8 LDUOX4	1,0	UXT 1 <sup>3</sup>
1.4 i	1.4	44	03.93-09.00	C 14 NZ/X 14 SZ	4	Z 119	14 R-8 DU4	0,8	UXT 2 <sup>4</sup>
1.4 i	1.4	44	03.93-09.00	C 14 NZ/X 14 SZ <sup>18</sup>	4	Z 74 <sup>5</sup>	14 FR-8 LDUOX4	1,0	UXT 1 <sup>3</sup>
1.4 i S	1.4	60	03.93-09.00	C 14 SE	4	Z 119	14 R-8 DU4	0,8	UXT 2 <sup>4</sup>
1.4 i S	1.4	60	03.93-09.00	C 14 SE <sup>18</sup>	4	Z 74 <sup>5</sup>	14 FR-8 LDUOX4	1,0	UXT 1 <sup>3</sup>
1.4 i 16V	1.4	66	09.94-09.00	X 14 XE	4	Z 74 <sup>5</sup>	14 FR-8 LDUOX4	1,0	UXT 1 <sup>3</sup>
1.5 D	1.5	37	03.93-09.00	15 D	4	GN 103 (11V)	○		
1.5 TD	1.5	49	03.93-10.96	X 15 DT (T4EC1)/15 DT (T4EC1)	4	GN 103 (11V)	○		
1.6 i 16V	1.6	78	09.94-09.00	X 16 XE	4	Z 74 <sup>5</sup>	14 FR-8 LDUOX4	1,0	UXT 1 <sup>3</sup>
1.6 GSi 16V	1.6	80	03.93-09.00	C 16 XE	4	Z 74 <sup>5</sup>	14 FR-8 LDUOX4	1,0	UXT 1 <sup>3</sup>
1.7 D	1.7	44	02.96-09.00	17 D (4EE1)/X 17 D (4EE1)	4	GN 103 (11V)	○		

### CORSA Mk II

1.0 12V	1.0	43	09.00-10.03	Z 10 XE	3	Z 74 <sup>5</sup>	14 FR-8 LDUOX4	1,0	UXT 1 <sup>3</sup>
1.0 12V	1.0	44	11.03-10.06	Z 10 XEP	3	Z 203	14 FR-8 LU2	0,9	○
1.2 16V	1.2	55	09.00-10.06	Z 12 XE	4	Z 74 <sup>5</sup>	14 FR-8 LDUOX4	1,0	UXT 1 <sup>3</sup>
1.2 16V Dualfuel	1.2	55	08.01-10.06	Z 12 XE	4	Z 74 <sup>5</sup>	14 FR-8 LDUOX4	1,0	UXT 1 <sup>3</sup>
1.2 Twinport	1.2	59	07.04-10.06	Z 12 XEP	4	Z 203	14 FR-8 LU2	0,9	○



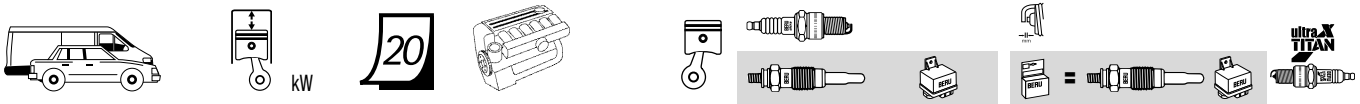

## VAUXHALL

### CORSA Mk II

1.3 CDTI 16V	1.3	52	08.00–09.06	Z 13 DT	4	<b>GN 053</b> (11V)	○		
1.4 16V	1.4	66	09.00–10.06	Z 14 XE	4	<b>Z 74<sup>5</sup></b>	14 FR-8 LDUOX4	1,0	<b>UXT 1<sup>3</sup></b>
1.6 CNG	1.6	69	05.03–10.06	Z 16 YNG	4	<b>Z 206</b>	14 FR-7 DPPUS2	0,7	<b>UXT 10</b>
1.7 DI 16V	1.7	48	08.00–09.06	Y 17 DTL	4	<b>GN 104</b> (11V)	○		
1.7 DTI 16V	1.7	55	08.00–09.06	Y 17 DT	4	<b>GN 104</b> (11V)	○		
1.7 CDTI 16V	1.7	74	08.00–09.05	Z 17 DTH	4	<b>GN 104</b> (11V)	○		
1.8 16V	1.8	92	08.00–09.06	Z 18 XE	4	<b>Z 74<sup>5</sup></b>	14 FR-8 LDUOX4	1,0	<b>UXT 1<sup>3</sup></b>

### CORSA Mk III

1.0	1.0	44	11.06–	Z 10 XEP	3	<b>Z 203</b>	14 FR-8 LU2	0,9	○
1.2	1.2	59	11.06–	Z 12 XEP	4	<b>Z 203</b>	14 FR-8 LU2	0,9	○
1.2 i 16V	1.2	63	11.06–	A 12 XER	4	<b>Z 203</b>	14 FR-8 LU2	0,9	○
1.3 CDTI	1.3	55	11.06–	Z 13 DTJ	4	<b>GN 053</b> (11V)	○		
1.3 CDTI	1.3	55	11.06–	A 13 DTC	4	<b>GE 112</b> (4,4V)=2x	○		
						<b>PSG 003</b> (4,4V)=2x			
1.3 CDTI	1.3	66	11.06–	Z 13 DTH	4	<b>GN 053</b> (11V)	○		
1.3 CDTI	1.3	70	11.06–	A 13 DTE	4	<b>GE 112</b> (4,4V)=2x	○		
						<b>PSG 003</b> (4,4V)=2x			
1.4	1.4	66	07.06–	Z 14 XEP	4	<b>Z 203</b>	14 FR-8 LU2	0,9	○
1.6 SRi	1.6	110	05.07–	Z 16 LEL/A 16 LEL	4	<b>Z 346</b>	14 FR-7 LPUTO2	0,8	○
1.6 VXR	1.6	141	02.07–	A 16 LER/Z 16 LER	4	<b>Z 346</b>	14 FR-7 LPUTO2	0,8	○
1.6 VXR	1.6	155	06.11–03.12	A 16 LES	4	<b>Z 346</b>	14 FR-7 LPUTO2	0,8	○
1.7 CDTI	1.7	92	11.06–	A 17 DTR	4	<b>GN 104</b> (11V)	○		

### CORSAVAN Mk I

1.4 i	1.4	44	01.94–09.00	C 14 NZ	4	<b>Z 119</b>	14 R-8 DU4	0,8	<b>UXT 2<sup>4</sup></b>
1.4 i	1.4	44	01.94–09.00	C 14 NZ <sup>18</sup>	4	<b>Z 74<sup>5</sup></b>	14 FR-8 LDUOX4	1,0	<b>UXT 1<sup>3</sup></b>
1.7 D	1.7	44	04.96–09.00	17 D (4EE1)/X 17 D (4EE1)	4	<b>GN 103</b> (11V)	○		

### CORSAVAN Mk II

1.2 16V	1.2	55	09.00–06.06	Z 12 XE	4	<b>Z 74<sup>5</sup></b>	14 FR-8 LDUOX4	1,0	<b>UXT 1<sup>3</sup></b>
1.3 CDTI 16V	1.3	52	04.04–06.06	Z 13 DT	4	<b>GN 053</b> (11V)	○		
1.7 DI 16V	1.7	48	09.00–06.06	Y 17 DTL	4	<b>GN 104</b> (11V)	○		
1.7 DTI 16V	1.7	55	09.00–06.06	Y 17 DT	4	<b>GN 104</b> (11V)	○		

### CORSAVAN Mk III

1.2	1.2	51	01.10–	A 12 XEL	4	<b>Z 203</b>	14 FR-8 LU2	0,9	○
1.2	1.2	59	07.09–	Z 12 XEP	4	<b>Z 203</b>	14 FR-8 LU2	0,9	○
1.3 CDTI	1.3	55	07.06–	Z 13 DTJ	4	<b>GN 053</b> (11V)	○		
1.3 CDTI	1.3	70	07.06–	Z 13 DTE	4	<b>GE 112</b> (4,4V)	○		

### FRONTERA Mk I

2.2 i	2.2	100	03.95–10.98	X 22 XE	4	<b>Z 74<sup>5</sup></b>	14 FR-8 LDUOX4	1,0	<b>UXT 1<sup>3</sup></b>
2.3 TD	2.3	74	03.92–10.98	23 DTR	4	<b>GV 636</b> (11V)	<b>GR 064</b>		
2.4 i	2.4	92	03.92–10.98	C 24 NE	4	<b>Z 19</b>	14 R-7 BU	0,8	○
2.5 TDS	2.5	85	09.96–10.98	25TDS (VM41B)	4	<b>GN 007</b> (11V)	○		
2.8 TD	2.8	83	03.95–10.98	28 TDI (4JB1T)	4	<b>GN 061</b> (11V)	○		

### FRONTERA Mk I Sport

2.0 i	2.0	85	03.92–10.98	C 20 NE/X 20 SE	4	<b>Z 119</b>	14 R-8 DU4	0,8	<b>UXT 2<sup>4</sup></b>
2.0 i	2.0	85	03.92–10.98	C 20 NE/X 20 SE <sup>18</sup>	4	<b>Z 74<sup>5</sup></b>	14 FR-8 LDUOX4	1,0	<b>UXT 1<sup>3</sup></b>
2.5 TDS	2.5	85	09.96–10.98	25TDS (VM41B)	4	<b>GN 007</b> (11V)	○		
2.8 TD	2.8	83	03.95–08.96	28 TDI (4JB1T)	4	<b>GN 061</b> (11V)	○		

### FRONTERA Mk II

2.2 DTI	2.2	85	10.98–08.00	X 22 DTH/Y 22 DTH	4	<b>GN 992</b> (11V)	○		
2.2 DTI	2.2	85	09.00–09.04	X 22 DTH/Y 22 DTH	4	<b>GN 033</b> (11V)	○		
2.2 i	2.2	100	10.98–	X 22 XE	4	<b>Z 74<sup>5</sup></b>	14 FR-8 LDUOX4	1,0	<b>UXT 1<sup>3</sup></b>
2.2 i	2.2	100	10.98–	Y 22 XE	4	<b>Z 343</b>	14 FR-8 DPPUX	1,1	○
3.2 i	3.2	151	10.98–10.04	Y 32 NE/6 VD1	6	<b>Z 343</b>	14 FR-8 DPPUX	1,1	○

### INSIGNIA

1.6	1.6	85	07.08–	A 16 XER	4	<b>Z 203</b>	14 FR-8 LU2	0,9	○
1.6 Turbo	1.6	132	01.09–	A 16 LET	4	<b>Z 346</b>	14 FR-7 LPUTO2	0,8	○
1.8	1.8	103	07.08–	A 18 XER	4	<b>Z 203</b>	14 FR-8 LU2	0,9	○
2.0 CDTI	2.0	81	07.08–	A 20 DTC	4	<b>GE 114</b> (4,4V)	○		
2.0 CDTI 4x4	2.0	118	07.08–	A 20 DTH	4	<b>GE 114</b> (4,4V)	○		
2.0 CDTI	2.0	140	10.08–	A 20 DTR	4	<b>PSG 001</b> (4,4V)	○		
2.0 CDTI 4x4	2.0	140	05.09–	A 20 DTR	4	<b>PSG 001</b> (4,4V)	○		

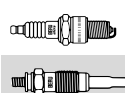
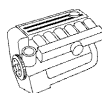

## VAUXHALL

### INSIGNIA Sedan

1.6	1.6	85	07.08-	A 16 XER	4	<b>Z 203</b>	14 FR-8 LU2	0,9	○
1.6 Turbo	1.6	132	01.09-	A 16 LET	4	<b>Z 346</b>	14 FR-7 LPUT02	0,8	○
1.8	1.8	103	07.08-	A 18 XER	4	<b>Z 203</b>	14 FR-8 LU2	0,9	○
2.0 CDTI	2.0	81	07.08-	A 20 DTC	4	<b>GE 114</b> (4,4V)	○		
2.0 CDTI 4x4	2.0	118	07.08-	A 20 DTH	4	<b>GE 114</b> (4,4V)	○		
2.0 CDTI	2.0	140	11.08-	A 20 DTR	4	<b>PSG 001</b> (4,4V)	○		
2.0 CDTI 4x4	2.0	140	05.09-	A 20 DTR	4	<b>PSG 001</b> (4,4V)	○		

### INSIGNIA SPORTS TOURER

1.6	1.6	85	07.08-	A 16 XER	4	<b>Z 203</b>	14 FR-8 LU2	0,9	○
1.6 Turbo	1.6	132	01.09-	A 16 LET	4	<b>Z 346</b>	14 FR-7 LPUT02	0,8	○
1.8	1.8	103	07.08-	A 18 XER	4	<b>Z 203</b>	14 FR-8 LU2	0,9	○
2.0 CDTI	2.0	81	07.08-	A 20 DTC	4	<b>GE 114</b> (4,4V)	○		
2.0 CDTI 4x4	2.0	118	07.08-	A 20 DTH	4	<b>PSG 001</b> (4,4V)	○		
2.0 CDTI	2.0	140	11.08-	A 20 DTR	4	<b>PSG 001</b> (4,4V)	○		
2.0 CDTI 4x4	2.0	140	05.09-	A 20 DTR	4	<b>PSG 001</b> (4,4V)	○		

### MERIVA Mk I

1.3 CDTI	1.3	51	04.05-06.10	Y 13 DT/Z 13 DT	4	<b>GN 053</b> (11V)	○		
1.3 CDTI	1.3	55	01.03-10.09	Z 13 DTJ	4	<b>GN 053</b> (11V)	○		
1.4 16V Twinport	1.4	66	01.03-10.09	Z 14 XEP	4	<b>Z 203</b>	14 FR-8 LU2	0,9	○
1.6 i 16V	1.6	74	01.03-02.06	Z 16 XE	4	<b>Z 74<sup>5</sup></b>	14 FR-8 LDUOX4	1,0	<b>UXT 1<sup>3</sup></b>
1.6 i 16V Twinport	1.6	77	01.03-10.09	Z 16 XEP	4	<b>Z 203</b>	14 FR-8 LU2	0,9	○
1.7 DTI 16V	1.7	55	06.03-06.10	Y 17 DT	4	<b>GN 104</b> (11V)	○		
1.7 CDTI 16V	1.7	74	09.03-08.05	Z 17 DTH	4	<b>GN 104</b> (11V)	○		
1.7 CDTi	1.7	92	08.06-06.10	Z 17 DTR	4	<b>GN 104</b> (11V)	○		
1.8 i 16V	1.8	92	05.03-08.05	Z 18 XE	4	<b>Z 203</b>	14 FR-8 LU2	0,9	○

### MERIVA Mk II

1.3 CDTI	1.3	55	06.10-	A 13 DTC	4	<b>GE 112</b> (4,4V)=2x	○		
						<b>PSG 003</b> (4,4V)=2x	○		
1.3 CDTi	1.3	70	06.10-	A 13 DTE	4	<b>GE 112</b> (4,4V)=2x	○		
						<b>PSG 003</b> (4,4V)=2x	○		
1.7 CDTI	1.7	74	06.10-	A 17 DT	4	<b>GN 104</b> (11V)	○		

### MIDI II

2.4 TD	2.4	56	09.94-08.97	4FG1T	4	<b>GV 947</b> (11V)	○		
2.4 TD	2.4	56	09.94-08.97	4FG1T	4	<b>GV 945</b> (5V)	○		
2.4 TD 4x4	2.4	56	01.94-07.96	4FG1T	4	<b>GV 947</b> (11V)	○		
2.4 TD 4x4	2.4	56	01.94-07.96	4FG1T	4	<b>GV 945</b> (5V)	○		

### MONTEREY

3.2	3.2	130	06.92-07.98	6 VD1	6	<b>Z 16</b>	14 FR-7 DUX	1,1	<b>UXT 1<sup>3</sup></b>
-----	-----	-----	-------------	-------	---	-------------	-------------	-----	--------------------------

### MONTEREY Mk II

3.0 DTI	3.0	117	07.98-08.99	4 JX1	4	<b>GN 997</b> (11V)	○		
3.5 V6 24V	3.5	158	07.98-08.99	6 VE1	6	<b>Z 343</b>	14 FR-8 DPPIX	1,1	○

### MOVANO Mk I

1.9 DTI	1.9	59	09.00-10.01	F9Q 770	4	<b>GN 018</b> (11V)	○		
1.9 DTI	1.9	60	10.01-05.10	F9Q 774	4	<b>GN 018</b> (11V)	○		
2.2 DTI	2.2	66	09.00-05.10	G9T 722/G9T 720/G9T 750	4	<b>GN 026</b> (11V)	○		
2.5 D	2.5	59	10.98-09.00	S8U 770	4	<b>GN 927</b> (11V)	○		
2.5 CDTI	2.5	74	10.01-05.10	G9U 650/G9U 754	4	<b>GN 026</b> (11V)	○		
2.5 DTI	2.5	84	10.01-05.10	G9U 754/G9U 724/G9U 720	4	<b>GN 026</b> (11V)	○		
2.5 CDTI	2.5	88	02.03-05.10	G9U 650/G9U 632	4	<b>GN 026</b> (11V)	○		
2.5 CDTI	2.5	107	08.06-05.10	G9U 632	4	<b>GN 026</b> (11V)	○		
2.8 DTI	2.8	84	10.98-10.01	S9W 702	4	<b>GF 984</b> (11V)	○		

### NOVA

1.0	1.0	33	05.83-03.93	10 S	4	<b>Z 19</b>	14 R-7 BU	0,8	○
1.2 i KAT	1.2	33	09.89-03.93	C 12 NZ	4	<b>Z 20</b>	14 R-7 DU	0,8	<b>UXT 2<sup>4</sup></b>
1.2 N	1.2	38	01.90-03.93	12 NV	4	<b>Z 20</b>	14 R-7 DU	0,8	<b>UXT 2<sup>4</sup></b>
1.2 S	1.2	40	05.83-02.90	12 ST	4	<b>Z 19</b>	14 R-7 BU	0,8	○
1.3 i KAT	1.3	44	09.89-03.93	C 13 N	4	<b>Z 20</b>	14 R-7 DU	0,8	<b>UXT 2<sup>4</sup></b>
1.4 i	1.4	44	01.90-03.93	C 14 NZ	4	<b>Z 119</b>	14 R-8 DU4	0,8	<b>UXT 2<sup>4</sup></b>
1.4 i	1.4	44	01.90-03.93	C 14 NZ <sup>18</sup>	4	<b>Z 74<sup>5</sup></b>	14 FR-8 LDUOX4	1,0	<b>UXT 1<sup>3</sup></b>
1.4 S	1.4	55	01.90-02.93	14 NV	4	<b>Z 119</b>	14 R-8 DU4	0,8	<b>UXT 2<sup>4</sup></b>
1.4 S	1.4	55	01.90-02.93	14 NV <sup>18</sup>	4	<b>Z 74<sup>5</sup></b>	14 FR-8 LDUOX4	1,0	<b>UXT 1<sup>3</sup></b>

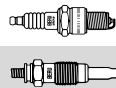
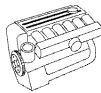

## VAUXHALL

NOVA									
1.4 i S	1.4	60	09.91-03.93	C 14 SE	4	Z 119	14 R-8 DU4	0,8	UXT 2 <sup>4</sup>
1.4 i S	1.4	60	09.91-03.93	C 14 SE <sup>18</sup>	4	Z 74 <sup>5</sup>	14 FR-8 LDUOX4	1,0	UXT 1 <sup>3</sup>
1.5 D	1.5	37	09.87-02.93	15 D Mot.Nr. 804795 →	4	GV 946 (11V)	○		
1.5 TD	1.5	49	01.90-02.93	15 DT (T4EC1) → Mot.Nr. 804794	4	GV 945 (5V)	○		
1.5 TD	1.5	49	01.90-02.93	15 DT (T4EC1) Mot.Nr. 804795 →	4	GV 947 (11V)	○		
1.6 GSI	1.6	72	09.89-03.93	C 16 SEI	4	Z 119	14 R-8 DU4	0,8	UXT 2 <sup>4</sup>
1.6 GSI	1.6	72	09.89-03.93	C 16 SEI <sup>18</sup>	4	Z 74 <sup>5</sup>	14 FR-8 LDUOX4	1,0	UXT 1 <sup>3</sup>
1.6 GSI KAT	1.6	74	02.92-03.93	C 16 SE	4	Z 119	14 R-8 DU4	0,8	UXT 2 <sup>4</sup>
1.6 GSI KAT	1.6	74	02.92-03.93	C 16 SE <sup>18</sup>	4	Z 74 <sup>5</sup>	14 FR-8 LDUOX4	1,0	UXT 1 <sup>3</sup>
1.6 GSI	1.6	74	05.88-03.92	E 16 SE	4	Z 20	14 R-7 DU	0,8	UXT 2 <sup>4</sup>

## NOVAVAN

1.2	1.2	38	01.90-10.94	12 NV	4	Z 20	14 R-7 DU	0,8	UXT 2 <sup>4</sup>
1.5 D	1.5	37	01.91-10.94	15 D Mot.Nr. 804795 →	4	GV 946 (11V)	○		

## OMEGA

2.0 DTI 16V	2.0	74	01.98-09.00	X 20 DTH	4	GN 992 (11V)	○		
2.0	2.0	85	09.95-09.96	20 SE	4	Z 74 <sup>5</sup>	14 FR-8 LDUOX4	1,0	UXT 1 <sup>3</sup>
2.0	2.0	85	03.94-09.99	X 20 SE	4	Z 74 <sup>5</sup>	14 FR-8 LDUOX4	1,0	UXT 1 <sup>3</sup>
2.0 16V	2.0	100	03.94-09.99	X 20 XEV	4	Z 74 <sup>5</sup>	14 FR-8 LDUOX4	1,0	UXT 1 <sup>3</sup>
2.2 DTI 16V	2.2	88	08.00-03.04	Y 22 DTH	4	GN 033 (11V)	○		
2.2 16V	2.2	106	01.94-06.03	Y 22 XE/Z 22 XE	4	Z 74 <sup>5</sup>	14 FR-8 LDUOX4	1,0	UXT 1 <sup>3</sup>
2.5 TD	2.5	96	04.94-02.01	25 DT/X 25 DT	6	GV 719 (11V)	○		
2.5 DTI 24V	2.5	110	09.01-	Y 25 DT	6	GN 024 (11V)	○		
2.5 V6	2.5	125	03.94-09.00	X 25 XE	6	Z 74 <sup>5</sup>	14 FR-8 LDUOX4	1,0	UXT 1 <sup>3</sup>
2.6 V6	2.6	132	08.00-03.04	Y 26 SE	6	Z 173	14 FGR-8 KQU	1,6	○
3.0 V6	3.0	155	04.94-07.00	X 30 XE	6	Z 74 <sup>5</sup>	14 FR-8 LDUOX4	1,0	UXT 1 <sup>3</sup>
3.2 V6	3.2	160	02.01-03.04	Y 32 SE	6	Z 173	14 FGR-8 KQU	1,6	○

## OMEGA Estate

2.0 DTI 16V	2.0	74	01.98-09.00	X 20 DTH	4	GN 992 (11V)	○		
2.0	2.0	85	03.94-09.99	X 20 SE	4	Z 74 <sup>5</sup>	14 FR-8 LDUOX4	1,0	UXT 1 <sup>3</sup>
2.0 16V	2.0	100	03.94-02.01	X 20 XEV	4	Z 74 <sup>5</sup>	14 FR-8 LDUOX4	1,0	UXT 1 <sup>3</sup>
2.2 DTI 16V	2.2	88	08.00-03.04	Y 22 DTH	4	GN 033 (11V)	○		
2.2 16V	2.2	106	02.94-06.03	Y 22 XE/Z 22 XE	4	Z 74 <sup>5</sup>	14 FR-8 LDUOX4	1,0	UXT 1 <sup>3</sup>
2.5 DTI 24V	2.5	110	09.01-	Y 25 DT	6	GN 024 (11V)	○		
2.5 V6	2.5	125	03.94-09.00	X 25 XE	6	Z 74 <sup>5</sup>	14 FR-8 LDUOX4	1,0	UXT 1 <sup>3</sup>
2.6 V6	2.6	132	08.00-03.04	Y 26 SE	6	Z 173	14 FGR-8 KQU	1,6	○
3.0 V6	3.0	155	07.94-07.00	X 30 XE	6	Z 74 <sup>5</sup>	14 FR-8 LDUOX4	1,0	UXT 1 <sup>3</sup>
3.2 V6	3.2	160	02.01-03.04	Y 32 SE	6	Z 173	14 FGR-8 KQU	1,6	○

## SENATOR Mk II

2.5 i	2.5	103	09.87-10.90	25 E	6	Z 19	14 R-7 BU	0,8	○
2.6 i	2.6	110	09.90-09.93	C 26 NE	6	Z 19	14 R-7 BU	0,8	○
3.0	3.0	115	09.87-09.93	C 30 LE	6	Z 19	14 R-7 BU	0,8	○
3.0	3.0	130	01.88-09.90	30 NE	6	Z 19	14 R-7 BU	0,8	○
3.0 i KAT	3.0	130	01.88-09.93	C 30 NE	6	Z 19	14 R-7 BU	0,8	○
3.0 24V	3.0	150	09.89-09.93	C 30 SE	6	Z 98	14 FR-7 LDU	0,8	UXT 1 <sup>3</sup>

## SIGNUM

1.8	1.8	90	06.03-07.05	Z 18 XE	4	Z 190	14 FGR-8 DQU7	1,2	UXT 1 <sup>3</sup>
1.8	1.8	103	08.05-	Z 18 XER	4	Z 203	14 FR-8 LU2	0,9	○
1.9 CDTI	1.9	88	04.04-03.08	Z 19 DT → Fgst.Nr. 71021891	4	GN 041 (11V)	○		
1.9 CDTI	1.9	88	04.04-03.08	Z 19 DT Fgst.Nr. 71021892 →	4	GN 097 (11V)	○		
1.9 CDTI 16V	1.9	110	04.04-03.08	Z 19 DTH	4	GN 059 (11V)	○		
2.0 Turbo	1.9	74	01.05-05.08	Z 19 DT → Fgst.Nr. 71021891	4	GN 041 (11V)	○		
2.0 Turbo	1.9	74	01.05-05.08	Z 19 DT Fgst.Nr. 71021892 →	4	GN 097 (11V)	○		
2.0 DTI	2.0	74	05.03-09.05	Y 20 DTH	4	GN 033 (11V)	○		
2.0 i Turbo	2.0	129	01.02-10.08	Z 20 NET	4	Z 284	14 FR-6 DPOX	1,1	UXT 14
2.2 DTI	2.2	92	05.03-	Y 22 DTR	4	GN 033 (11V)	○		

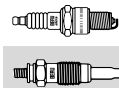
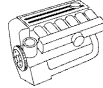

kW

**VAUXHALL****SIGNUM**

3.0 CDTi	3.0	130	05.03-	Y 30 DT	6	<b>GN 106</b> (11V)	○		
3.0 V6 CDTi	3.0	135	04.02-05.08	Z 30 DT	6	<b>GN 106</b> (11V)	○		
3.2 V6	3.2	155	05.03-09.05	Z 32 SE	6	<b>Z 190</b>	14 FGR-8 DQU7	1,2	<b>UXT 1<sup>3</sup></b>

**SINTRA**

2.2 DTi	2.2	85	07.97-04.99	X 22 DTH	4	<b>GN 992</b> (11V)	○		
2.2 i 16 V	2.2	104	11.96-04.99	X 22 XE	4	<b>Z 74<sup>5</sup></b>	14 FR-8 LDUOX4	1,0	<b>UXT 1<sup>3</sup></b>

**TIGRA Mk I**

1.4 16V	1.4	66	07.94-12.00	X 14 XE	4	<b>Z 74<sup>5</sup></b>	14 FR-8 LDUOX4	1,0	<b>UXT 1<sup>3</sup></b>
1.6 16V	1.6	78	07.94-12.00	X 16 XE	4	<b>Z 74<sup>5</sup></b>	14 FR-8 LDUOX4	1,0	<b>UXT 1<sup>3</sup></b>

**TIGRA TwinTop**

1.3 CDTi	1.3	51	06.04-	Z 13 DT	4	<b>GN 053</b> (11V)	○		
1.4	1.4	66	06.04-	Z 14 XEP	4	<b>Z 203</b>	14 FR-8 LU2	0,9	○
1.8	1.8	92	06.04-	Z 18 XE	4	<b>Z 203</b>	14 FR-8 LU2	0,9	○

**VECTRA**

1.6 i	1.6	55	08.95-10.01	X 16 SZR	4	<b>Z 74<sup>5</sup></b>	14 FR-8 LDUOX4	1,0	<b>UXT 1<sup>3</sup></b>
1.6 i 16V	1.6	74	08.95-10.01	Z 16 XE/X 16 XEL/Y 16 XE	4	<b>Z 74<sup>5</sup></b>	14 FR-8 LDUOX4	1,0	<b>UXT 1<sup>3</sup></b>
1.7 TD	1.7	60	10.95-11.96	X 17 DT (TC4EE1)	4	<b>GN 103</b> (11V)	○		
1.8 i 16V	1.8	85	10.95-09.00	X 18 XE/X 18 XE1	4	<b>Z 74<sup>5</sup></b>	14 FR-8 LDUOX4	1,0	<b>UXT 1<sup>3</sup></b>
1.8 i 16V	1.8	92	09.00-	Z 18 XE	4	<b>Z 74<sup>5</sup></b>	14 FR-8 LDUOX4	1,0	<b>UXT 1<sup>3</sup></b>
2.0 DI 16V	2.0	60	08.95-07.99	X 20 DTL	4	<b>GN 944</b> (11V)	○		
2.0 DI 16V	2.0	60	08.99-10.01	X 20 DTL	4	<b>GN 992</b> (11V)	○		
2.0 DTi 16V	2.0	74	08.95-08.00	Y 20 DTH/X 20 DTH	4	<b>GN 992</b> (11V)	○		
2.0 DTi 16V	2.0	74	09.00-10.01	Y 20 DTH/X 20 DTH	4	<b>GN 033</b> (11V)	○		
2.0 i 16V	2.0	100	10.95-01.01	X 20 XEV	4	<b>Z 74<sup>5</sup></b>	14 FR-8 LDUOX4	1,0	<b>UXT 1<sup>3</sup></b>
2.2 DTi 16V	2.2	92	08.95-10.01	Y 22 DTR	4	<b>GN 033</b> (11V)	○		
2.2 i 16V	2.2	108	08.95-08.01	Z 22 SE	4	<b>Z 222</b>	14 KR-8 STUX	1,1	○
2.5 i V6	2.5	125	09.95-08.00	X 25 XE	6	<b>Z 74<sup>5</sup></b>	14 FR-8 LDUOX4	1,0	<b>UXT 1<sup>3</sup></b>
2.6 i V6	2.6	125	09.00-03.02	Y 26 SE	6	<b>Z 173</b>	14 FGR-8 KQU	1,6	○

**VECTRA Estate**

1.6 i	1.6	55	11.96-	X 16 SZR	4	<b>Z 74<sup>5</sup></b>	14 FR-8 LDUOX4	1,0	<b>UXT 1<sup>3</sup></b>
1.6 i 16V	1.6	74	11.96-	Z 16 XE/X 16 XEL/Y 16 XE	4	<b>Z 74<sup>5</sup></b>	14 FR-8 LDUOX4	1,0	<b>UXT 1<sup>3</sup></b>
1.7 TD	1.7	60	11.96-12.97	X 17 DT (TC4EE1)	4	<b>GN 103</b> (11V)	○		
1.8 i 16V	1.8	85	11.96-09.00	X 18 XE/X 18 XE1	4	<b>Z 74<sup>5</sup></b>	14 FR-8 LDUOX4	1,0	<b>UXT 1<sup>3</sup></b>
1.8 i 16V	1.8	92	09.00-	Z 18 XE	4	<b>Z 74<sup>5</sup></b>	14 FR-8 LDUOX4	1,0	<b>UXT 1<sup>3</sup></b>
2.0 DI 16V	2.0	60	08.95-07.99	X 20 DTL	4	<b>GN 944</b> (11V)	○		
2.0 DI 16V	2.0	60	08.99-10.01	X 20 DTL	4	<b>GN 992</b> (11V)	○		
2.0 DTi 16V	2.0	74	08.95-10.01	X 20 DTH	4	<b>GN 992</b> (11V)	○		
2.0 DTi 16V	2.0	74	08.95-10.01	Y 20 DTH	4	<b>GN 033</b> (11V)	○		
2.0 i 16V	2.0	100	10.95-01.01	X 20 XEV	4	<b>Z 74<sup>5</sup></b>	14 FR-8 LDUOX4	1,0	<b>UXT 1<sup>3</sup></b>
2.2 DTi 16V	2.2	92	08.95-10.01	Y 22 DTR	4	<b>GN 033</b> (11V)	○		
2.5 i V6	2.5	125	11.96-08.00	X 25 XE	6	<b>Z 74<sup>5</sup></b>	14 FR-8 LDUOX4	1,0	<b>UXT 1<sup>3</sup></b>
2.6 i V6	2.6	125	09.00-03.02	Y 26 SE	6	<b>Z 173</b>	14 FGR-8 KQU	1,6	○

**VECTRA Mk II**

1.6 16V	1.6	74	06.04-07.05	Z 16 XE	4	<b>Z 74<sup>5</sup></b>	14 FR-8 LDUOX4	1,0	<b>UXT 1<sup>3</sup></b>
1.6	1.6	77	01.06-07.08	Z 16 XEP	4	<b>Z 203</b>	14 FR-8 LU2	0,9	○
1.8 16V	1.8	90	04.02-08.05	Z 18 XE	4	<b>Z 190</b>	14 FGR-8 DQU7	1,2	<b>UXT 1<sup>3</sup></b>
1.8 16V Dualfuel	1.8	90	04.02-08.05	Z 18 XE	4	<b>Z 190</b>	14 FGR-8 DQU7	1,2	<b>UXT 1<sup>3</sup></b>
1.8	1.8	103	01.06-07.08	Z 18 XER	4	<b>Z 203</b>	14 FR-8 LU2	0,9	○
1.9 CDTi	1.9	74	10.05-07.08	Z 19 DTL	4	<b>GN 041</b> (11V)	○		
1.9 CDTi	1.9	88	04.02-09.08	Z 19 DT	4	<b>GN 041</b> (11V)	○		
1.9 CDTi 16V	1.9	110	04.04-08.08	Z 19 DTH	4	<b>GN 059</b> (11V)	○		
2.0 DTi 16V	2.0	74	04.02-	Y 20 DTH	4	<b>GN 033</b> (11V)	○		
2.0 16V Turbo	2.0	129	01.00-10.08	Z 20 NET	4	<b>Z 284</b>	14 FR-6 DPOX	1,1	<b>UXT 14</b>
2.2 DTi 16V	2.2	92	04.02-	Y 22 DTR	4	<b>GN 033</b> (11V)	○		
2.2 16V	2.2	108	01.02-09.05	Z 22 SE	4	<b>Z 222</b>	14 KR-8 STUX	1,1	○
2.8 V6 Turbo	2.8	169	08.05-07.08	Z 28 NEL	6	<b>Z 235</b>	14 FR-7 SPUX03	1,0	○
2.8 V6 Turbo	2.8	184	08.06-07.08	Z 28 NET	6	<b>Z 235</b>	14 FR-7 SPUX03	1,0	○
2.8 V6 Turbo	2.8	188	08.05-07.08	Z 28 NET	6	<b>Z 235</b>	14 FR-7 SPUX03	1,0	○
2.8 V6 Turbo	2.8	206	10.06-08.08	Z 28 NET	6	<b>Z 235</b>	14 FR-7 SPUX03	1,0	○
3.0 V6 CDTi	3.0	130	06.03-08.05	Y 30 DT	6	<b>GN 106</b> (11V)	○		
3.0 CDTi	3.0	135	08.05-07.08	Z 30 DT	6	<b>GN 106</b> (11V)	○		

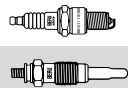
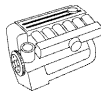

## VAUXHALL

### VECTRA Mk II Estate

1.6 16V	1.6	74	06.04-07.05	Z 16 XE	4	<b>Z 74<sup>5</sup></b>	14 FR-8 LDUOX4	1,0	<b>UXT 1<sup>3</sup></b>
1.8 16V	1.8	90	10.03-08.05	Z 18 XE	4	<b>Z 203</b>	14 FR-8 LU2	0,9	○
1.8	1.8	103	01.06-07.08	Z 18 XER	4	<b>Z 203</b>	14 FR-8 LU2	0,9	○
1.9 CDTi	1.9	74	10.05-07.08	Z 19 DTL	4	<b>GN 041</b> (11V)	○		
1.9 CDTi	1.9	88	04.04-07.08	Z 19 DT	4	<b>GN 041</b> (11V)	○		
1.9 CDTi 16V	1.9	110	04.04-07.08	Z 19 DTH	4	<b>GN 059</b> (11V)	○		
2.0 DTi 16V	2.0	74	10.03-09.05	Y 20 DTH	4	<b>GN 033</b> (11V)	○		
2.0 16V Turbo	2.0	129	10.03-07.08	Z 20 NET	4	<b>Z 284</b>	14 FR-6 DPOX	1,1	<b>UXT 14</b>
2.2 DTi 16V	2.2	92	10.03-07.08	Y 22 DTR	4	<b>GN 033</b> (11V)	○		
2.8 V6 Turbo	2.8	169	08.05-07.08	Z 28 NEL	6	<b>Z 235</b>	14 FR-7 SPUX03	1,0	○
2.8 V6 Turbo	2.8	188	08.06-07.08	Z 28 NET	6	<b>Z 235</b>	14 FR-7 SPUX03	1,0	○
2.8 V6 Turbo	2.8	206	10.06-07.08	Z 28 NET	6	<b>Z 235</b>	14 FR-7 SPUX03	1,0	○
3.0 V6 CDTi	3.0	130	10.03-08.05	Y 30 DT	6	<b>GN 106</b> (11V)	○		
3.0 CDTi	3.0	135	08.05-07.08	Z 30 DT	6	<b>GN 106</b> (11V)	○		
3.2 V6	3.2	155	10.03-08.05	Z 32 SE	6	<b>Z 190</b>	14 FGR-8 DQU7	1,2	<b>UXT 1<sup>3</sup></b>

### VECTRA Mk II GTS

1.6 16V	1.6	74	06.04-07.05	Z 16 XE	4	<b>Z 74<sup>5</sup></b>	14 FR-8 LDUOX4	1,0	<b>UXT 1<sup>3</sup></b>
1.6	1.6	77	01.06-07.08	Z 16 XEP	4	<b>Z 203</b>	14 FR-8 LU2	0,9	○
1.8 16V	1.8	90	08.02-08.05	Z 18 XE	4	<b>Z 203</b>	14 FR-8 LU2	0,9	○
1.8 16V Dualfuel	1.8	90	08.02-08.05	Z 18 XE	4	<b>Z 203</b>	14 FR-8 LU2	0,9	○
1.8	1.8	103	01.06-07.08	Z 18 XER	4	<b>Z 203</b>	14 FR-8 LU2	0,9	○
1.9 CDTi	1.9	74	10.05-07.08	Z 19 DTL	4	<b>GN 041</b> (11V)	○		
1.9 CDTi	1.9	88	08.02-07.08	Z 19 DT	4	<b>GN 041</b> (11V)	○		
1.9 CDTi 16V	1.9	110	04.04-07.08	Z 19 DTH	4	<b>GN 059</b> (11V)	○		
2.0 DTi 16V	2.0	74	08.02-09.05	Y 20 DTH	4	<b>GN 033</b> (11V)	○		
2.0 16V Turbo	2.0	129	03.03-07.08	Z 20 NET	4	<b>Z 284</b>	14 FR-6 DPOX	1,1	<b>UXT 14</b>
2.2 DTi 16V	2.2	92	08.02-07.08	Y 22 DTR	4	<b>GN 033</b> (11V)	○		
2.2 16V	2.2	108	08.02-09.05	Z 22 SE	4	<b>Z 222</b>	14 KR-8 STUX	1,1	○
2.8 V6 Turbo	2.8	169	08.05-07.08	Z 28 NEL	6	<b>Z 235</b>	14 FR-7 SPUX03	1,0	○
2.8 V6 Turbo	2.8	184	08.06-07.08	Z 28 NET	6	<b>Z 235</b>	14 FR-7 SPUX03	1,0	○
2.8 V6 Turbo	2.8	188	08.05-07.08	Z 28 NET	6	<b>Z 235</b>	14 FR-7 SPUX03	1,0	○
3.0 V6 CDTi	3.0	130	06.03-08.05	Y 30 DT	6	<b>GN 106</b> (11V)	○		
3.0 CDTi	3.0	135	08.05-07.08	Z 30 DT	6	<b>GN 106</b> (11V)	○		
3.2 V6	3.2	155	08.02-09.05	Z 32 SE	6	<b>Z 190</b>	14 FGR-8 DQU7	1,2	<b>UXT 1<sup>3</sup></b>

### VIVARO

1.9 DI	1.9	59	08.01-	F9Q 762	4	<b>GN 018</b> (11V)	○		
1.9 DTi	1.9	74	08.01-	F9Q 760	4	<b>GN 018</b> (11V)	○		
2.0 16V	2.0	88	08.01-	F4R 720 → Fgst.Nr. 6V699999, 6Y999999	4	<b>Z 337</b>	14 FR-7 DPPUW2	0,9	○
2.0 16V	2.0	88	04.03-	F4R 720	4	<b>Z 206</b>	14 FR-7 DPPUS2	0,7	<b>UXT 10</b>
2.5 DTi	2.5	99	04.04-	G9U 730	4	<b>GN 026</b> (11V)	○		
2.5 CDTi	2.5	107	08.06-	G9U 730	4	<b>GN 026</b> (11V)	○		

### VX220

2.2 i	2.2	108	09.00-07.05	Z 22 SE	4	<b>Z 222</b>	14 KR-8 STUX	1,1	○
-------	-----	-----	-------------	---------	---	--------------	--------------	-----	---

### ZAFIRA Mk I

1.6 CNG	1.6	71	09.01-06.05	Z 16 YNG	4	<b>Z 206</b>	14 FR-7 DPPUS2	0,7	<b>UXT 10</b>
1.6 16V	1.6	74	04.99-08.05	Z 16 XE/X 16 XEL	4	<b>Z 190</b>	14 FGR-8 DQU7	1,2	<b>UXT 1<sup>3</sup></b>
1.6 16V	1.6	74	04.99-08.05	Z 16 XE/X 16 XEL Mot.Nr. 410 00001 →	4	<b>Z 203</b>	14 FR-8 LU2	0,9	○
1.8 16V	1.8	85	05.99-08.00	X 18 XE1	4	<b>Z 74<sup>5</sup></b>	14 FR-8 LDUOX4	1,0	<b>UXT 1<sup>3</sup></b>
1.8 16V	1.8	92	09.00-08.05	Z 18 XE	4	<b>Z 74<sup>5</sup></b>	14 FR-8 LDUOX4	1,0	<b>UXT 1<sup>3</sup></b>
2.0 DI 16V	2.0	60	10.99-08.05	X 20 DTL	4	<b>GN 992</b> (11V)	○		
2.0 DTi 16V	2.0	74	04.99-08.05	Y 20 DTH	4	<b>GN 992</b> (11V)	○		
2.0	2.0	147	06.02-01.04	Z 20 LET	4	<b>Z 74<sup>5</sup></b>	14 FR-8 LDUOX4	1,0	<b>UXT 1<sup>3</sup></b>
2.0	2.0	147	02.04-06.05	Z 20 LET	4	<b>Z 287</b>	14 FR-8 LU2T	0,8	○
2.2 D	2.2	92	06.01-06.05	Y 22 DTR	4	<b>GN 033</b> (11V)	○		
2.2 16V	2.2	108	11.98-08.04	Z 22 SE	4	<b>Z 222</b>	14 KR-8 STUX	1,1	○

### ZAFIRA Mk II

1.6 CNG	1.6	69	07.05-	Z 16 YNG	4	<b>Z 206</b>	14 FR-7 DPPUS2	0,7	<b>UXT 10</b>
1.6	1.6	77	07.05-	Z 16 XEP	4	<b>Z 203</b>	14 FR-8 LU2	0,9	○
1.6	1.6	85	12.07-	A 16 XER/Z 16 XER	4	<b>Z 203</b>	14 FR-8 LU2	0,9	○

● nicht erforderlich  
○ nicht im Programm

<sup>3</sup> wahlweise UXT 3 Platin

<sup>4</sup> wahlweise UXT 6 Platin

<sup>5</sup> wahlweise Z 190



kW

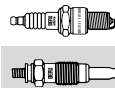
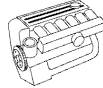

### VAUXHALL

#### ZAFIRA Mk II

1.7 CDTi	1.7	81	04.09-	Z 17 DTJ	4	<b>GN 104</b> (11V)	○		
1.7 CDTi	1.7	92	01.08-	A 17 DTR	4	<b>GN 104</b> (11V)	○		
1.8	1.8	103	04.05-	A 18 XER/Z 18 XER	4	<b>Z 203</b>	14 FR-8 LU2	0,9	○
1.9 CDTi	1.9	74	07.05-	Z 19 DTL	4	<b>GN 041</b> (11V)	○		
1.9 CDTi	1.9	74	07.05-	Z 19 DTL Fgst.Nr. 72000001, 7G000001 →	4	<b>GN 097</b> (11V)	○		
1.9 CDTi	1.9	88	07.05-	Z 19 DT Fgst.Nr. 72000001, 7G000001 →	4	<b>GN 097</b> (11V)	○		
1.9 CDTi	1.9	110	07.05-	Z 19 DTH	4	<b>GN 059</b> (11V)	○		
2.0	2.0	147	07.05-	Z 20 LER	4	<b>Z 287</b>	14 FR-8 LU2T	0,8	○
2.0	2.0	176	01.06-	Z 20 LEH	4	<b>Z 284</b>	14 FR-6 DPOX	1,1	<b>UXT 14</b>

#### ZAFIRA Mk III

1.8	1.8	103	10.11-	A 18 XER	4	<b>Z 203</b>	14 FR-8 LU2	0,9	○
2.0 CDTi	2.0	81	10.11-	A 20 DTL	4	<b>PSG 001</b> (4,4V)	○		
2.0 CDTi	2.0	96	10.11-	A 20 DT	4	<b>PSG 001</b> (4,4V)	○		

### VOLVO

#### 240

2.0	2.0	89	09.84-12.93	B 200 E	4	<b>Z 27</b>	14 R-6 DU	0,8	<b>UX 56</b>
2.3 i KAT	2.3	85	08.86-07.93	B 230 F	4	<b>Z 20</b>	14 R-7 DU	0,8	<b>UXT 2<sup>4</sup></b>
2.4 Diesel	2.4	58	08.87-08.93	D 24	6	<b>GN 857</b> (11V)	○		

#### 240 Kombi

2.0	2.0	86	08.83-07.93	B 200 E	4	<b>Z 27</b>	14 R-6 DU	0,8	<b>UX 56</b>
2.3 i KAT	2.3	85	08.86-07.93	B 230 F	4	<b>Z 20</b>	14 R-7 DU	0,8	<b>UXT 2<sup>4</sup></b>
2.4 Diesel	2.4	58	08.88-08.93	D 24	6	<b>GN 857</b> (11V)	○		
2.4 Diesel	2.4	60	04.79-08.93	D 24	6	<b>GN 857</b> (11V)	○		

#### 340-360

1.6 Diesel	1.6	40	08.84-07.91	D 16	4	<b>GV 852</b> (11V)	○		
1.7	1.7	59	09.86-07.91	B 17 2 K Fgst.Nr. 241000 →	4	<b>Z 82</b>	14 R-9 DU	0,7	<b>UXT 2<sup>4</sup></b>
2.0	2.0	75	08.84-07.90	B 200 K	4	<b>Z 20</b>	14 R-7 DU	0,8	<b>UXT 2<sup>4</sup></b>

#### 440 K

1.7	1.7	64	09.88-12.96	B 18 KP	4	<b>Z 20</b>	14 R-7 DU	0,8	<b>UXT 2<sup>4</sup></b>
1.7	1.7	75	08.89-12.96	B 18 FP	4	<b>Z 20</b>	14 R-7 DU	0,8	<b>UXT 2<sup>4</sup></b>
1.7 Turbo	1.7	88	08.88-07.96	B 18 FT	4	<b>Z 20</b>	14 R-7 DU	0,8	<b>UXT 2<sup>4</sup></b>
1.7 Turbo	1.7	90	01.91-12.96	B 18 FT	4	<b>Z 20</b>	14 R-7 DU	0,8	<b>UXT 2<sup>4</sup></b>
1.9 Turbo-Diesel	1.9	66	07.94-12.96	D 19 T	4	<b>GV 844</b> (11V)	○		
2.0	2.0	80	08.93-07.96	B 20 F	4	<b>Z 20</b>	14 R-7 DU	0,8	<b>UXT 2<sup>4</sup></b>
2.0	2.0	81	08.92-07.95	B 20 F	4	<b>Z 20</b>	14 R-7 DU	0,8	<b>UXT 2<sup>4</sup></b>

#### 460 L

1.7 Turbo	1.7	88	08.89-07.96	B 18 FT	4	<b>Z 20</b>	14 R-7 DU	0,8	<b>UXT 2<sup>4</sup></b>
1.7 Turbo	1.7	90	01.91-07.96	B 18 FT	4	<b>Z 20</b>	14 R-7 DU	0,8	<b>UXT 2<sup>4</sup></b>
1.9 Turbo-Diesel	1.9	66	07.94-07.96	D 19 T	4	<b>GV 844</b> (11V)	○		
2.0	2.0	80	08.93-07.96	B 20 F	4	<b>Z 20</b>	14 R-7 DU	0,8	<b>UXT 2<sup>4</sup></b>
2.0	2.0	81	08.92-07.95	B 20 F	4	<b>Z 20</b>	14 R-7 DU	0,8	<b>UXT 2<sup>4</sup></b>

#### 480 E

1.7 Turbo	1.7	88	08.87-07.96	B 18 FT	4	<b>Z 20</b>	14 R-7 DU	0,8	<b>UXT 2<sup>4</sup></b>
1.7 Turbo	1.7	90	01.91-07.96	B 18 FT	4	<b>Z 20</b>	14 R-7 DU	0,8	<b>UXT 2<sup>4</sup></b>
2.0	2.0	81	08.92-09.95	B 20 F	4	<b>Z 20</b>	14 R-7 DU	0,8	<b>UXT 2<sup>4</sup></b>

#### 740

2.0	2.0	89	08.85-07.92	B 200 G	4	<b>Z 20</b>	14 R-7 DU	0,8	<b>UXT 2<sup>4</sup></b>
2.3	2.3	84	08.87-07.90	B 23 A/B 230 F	4	<b>Z 27</b>	14 R-6 DU	0,8	<b>UX 56</b>
2.3	2.3	85	08.87-07.92	B 230 F	4	<b>Z 20</b>	14 R-7 DU	0,8	<b>UXT 2<sup>4</sup></b>
2.3	2.3	111	08.88-08.92	B 234 F	4	<b>Z 27</b>	14 R-6 DU	0,8	<b>UX 56</b>
2.3	2.3	114	08.88-07.91	B 234 F	4	<b>Z 27</b>	14 R-6 DU	0,8	<b>UX 56</b>
2.3 Turbo	2.3	121	08.89-07.90	B 230 FT	4	<b>Z 27</b>	14 R-6 DU	0,8	<b>UX 56</b>
2.3 Turbo	2.3	140	08.89-07.90	B 230 FT	4	<b>Z 27</b>	14 R-6 DU	0,8	<b>UX 56</b>
2.4 Diesel	2.4	60	08.84-07.92	D 24	6	<b>GN 857</b> (11V)	○		
2.4 TD	2.4	83	08.84-07.90	D 24 T	6	<b>GN 857</b> (11V)	○		

#### 740 Kombi

2.0	2.0	82	08.89-07.91	B 200 F	4	<b>Z 20</b>	14 R-7 DU	0,8	<b>UXT 2<sup>4</sup></b>
2.0	2.0	89	08.85-07.92	B 200 G	4	<b>Z 20</b>	14 R-7 DU	0,8	<b>UXT 2<sup>4</sup></b>

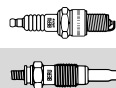
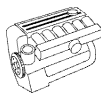

## VOLVO

### 740 Kombi

2.0	2.0	89	08.85-07.92	B 200 E	4	<b>Z 27</b>	14 R-6 DU	0,8	<b>UX 56</b>
2.3	2.3	84	09.86-07.90	B 230 K	4	<b>Z 27</b>	14 R-6 DU	0,8	<b>UX 56</b>
2.3	2.3	85	08.87-07.92	B 230 F	4	<b>Z 20</b>	14 R-7 DU	0,8	<b>UXT 2<sup>4</sup></b>
2.3	2.3	87	01.88-10.90	B 230 F	4	<b>Z 20</b>	14 R-7 DU	0,8	<b>UXT 2<sup>4</sup></b>
2.3	2.3	111	07.89-08.92	B 234 F	4	<b>Z 27</b>	14 R-6 DU	0,8	<b>UX 56</b>
2.3	2.3	114	08.88-07.90	B 234 F	4	<b>Z 27</b>	14 R-6 DU	0,8	<b>UX 56</b>
2.3 Turbo	2.3	121	08.89-07.90	B 230 GT/B 230 FT	4	<b>Z 27</b>	14 R-6 DU	0,8	<b>UX 56</b>
2.3 Turbo	2.3	140	08.89-07.90	B 230 FT	4	<b>Z 27</b>	14 R-6 DU	0,8	<b>UX 56</b>
2.4 Turbo-Diesel	2.4	80	09.85-07.92	D 24 T	6	<b>GN 857 (11V)</b>	○		

### 760

2.4 D	2.4	60	01.82-07.92	D 24	6	<b>GN 857 (11V)</b>	○		
2.4 Turbo Diesel	2.4	80	04.87-07.92	D 24 T	6	<b>GN 857 (11V)</b>	○		
2.4 TD Interc.	2.4	85	08.87-07.92	D 24 TIC	6	<b>GN 857 (11V)</b>	○		
2.8	2.8	105	05.86-08.91	B 280 F	6	<b>Z 26</b>	14 KR-6 DU	0,7	<b>UXK 56</b>
2.8	2.8	108	08.86-07.90	B 280 F	6	<b>Z 26</b>	14 KR-6 DU	0,7	<b>UXK 56</b>

### 760 Kombi

2.3 Turbo	2.3	134	08.84-08.90	B 230 ET	4	<b>Z 20</b>	14 R-7 DU	0,8	<b>UXT 2<sup>4</sup></b>
2.4 D	2.4	60	01.82-07.92	D 24	6	<b>GN 857 (11V)</b>	○		
2.4 TD Interc.	2.4	85	08.87-07.92	D 24 TIC	6	<b>GN 857 (11V)</b>	○		
2.8	2.8	105	05.86-08.91	B 280 F	6	<b>Z 26</b>	14 KR-6 DU	0,7	<b>UXK 56</b>
2.8	2.8	115	08.86-08.90	B 28 E, B 280 E Kat.	6	<b>Z 26</b>	14 KR-6 DU	0,7	<b>UXK 56</b>

### 780

2.4 D	2.4	90	04.86-07.90	D 24 TIC	6	<b>GN 857 (11V)</b>	○		
2.9	2.8	108	08.87-07.90	B 280 F	6	<b>Z 26</b>	14 KR-6 DU	0,7	<b>UXK 56</b>

### 850

2.0	2.0	93	08.94-12.96	B 5202 S	5	<b>Z 204</b>	14 FGR-8 CTU	1,2	○
2.0	2.0	105	06.91-12.96	B 5204 F	5	<b>Z 24</b>	14 FR-6 DU	0,8	<b>UXT 5</b>
2.0 Turbo	2.0	155	08.93-12.96	B 5204 T/B 5204 FT	5	<b>Z 206</b>	14 FR-7 DPPUS2	0,7	<b>UXT 10</b>
2.3 T5	2.3	166	08.93-07.96	B 5234 FT	5	<b>Z 206</b>	14 FR-7 DPPUS2	0,7	<b>UXT 10</b>
2.3 T5-R	2.3	184	08.95-12.96	B 5234 T4	5	<b>Z 206</b>	14 FR-7 DPPUS2	0,7	<b>UXT 10</b>
2.5 TDI	2.5	103	08.95-12.96	D 5252 T	5	<b>GN 855 (12V)</b>	○		
			Kühlwasservorwärmung <sup>15</sup> ⇄ Ø 4 mm			<b>GN 928 (12V)=3x</b>			
2.5	2.5	103	06.91-07.94	B 5252	5	<b>Z 204</b>	14 FGR-8 CTU	1,2	○
2.5	2.5	106	08.94-12.96	B 5252 S	5	<b>Z 204</b>	14 FGR-8 CTU	1,2	○
2.5	2.5	125	08.91-12.96	B 5254 S	5	<b>Z 204</b>	14 FGR-8 CTU	1,2	○

### 850 Kombi

2.0	2.0	93	08.94-12.96	B 5202 S	5	<b>Z 204</b>	14 FGR-8 CTU	1,2	○
2.0	2.0	105	02.93-12.96	B 5204 F	5	<b>Z 24</b>	14 FR-6 DU	0,8	<b>UXT 5</b>
2.0 Turbo	2.0	155	02.93-12.96	B 5204 T/B 5204 FT	5	<b>Z 206</b>	14 FR-7 DPPUS2	0,7	<b>UXT 10</b>
2.3 T5	2.3	166	02.93-12.96	B 5234 FT	5	<b>Z 206</b>	14 FR-7 DPPUS2	0,7	<b>UXT 10</b>
2.3 T5-R	2.3	184	08.95-12.96	B 5234 T4	5	<b>Z 206</b>	14 FR-7 DPPUS2	0,7	<b>UXT 10</b>
2.5 TDI	2.5	103	08.95-12.96	D 5252 T	5	<b>GN 855 (12V)</b>	○		
			Kühlwasservorwärmung <sup>15</sup> ⇄ Ø 4 mm			<b>GN 928 (12V)=3x</b>			
2.5	2.5	103	08.92-07.94	B 5252	5	<b>Z 204</b>	14 FGR-8 CTU	1,2	○
2.5	2.5	106	08.94-12.96	B 5252 S	5	<b>Z 204</b>	14 FGR-8 CTU	1,2	○
2.5	2.5	125	09.92-12.96	B 5254 S	5	<b>Z 204</b>	14 FGR-8 CTU	1,2	○
2.5 AWD	2.5	142	04.96-12.96	B 5254 T	5	<b>Z 206</b>	14 FR-7 DPPUS2	0,7	<b>UXT 10</b>

### 940

2.0	2.0	82	01.92-07.94	B 200 F	4	<b>Z 20</b>	14 R-7 DU	0,8	<b>UXT 2<sup>4</sup></b>
2.0	2.0	89	09.90-09.93	B 200 G	4	<b>Z 20</b>	14 R-7 DU	0,8	<b>UXT 2<sup>4</sup></b>
2.0	2.0	89	09.90-09.93	B 200 E	4	<b>Z 27</b>	14 R-6 DU	0,8	<b>UX 56</b>
2.3	2.3	85	08.92-07.94	B 230 FD	4	<b>Z 20</b>	14 R-7 DU	0,8	<b>UXT 2<sup>4</sup></b>
2.3	2.3	90	08.90-12.94	B 230 G	4	<b>Z 20</b>	14 R-7 DU	0,8	<b>UXT 2<sup>4</sup></b>
2.3	2.3	90	08.90-12.94	B 230 E	4	<b>Z 27</b>	14 R-6 DU	0,8	<b>UX 56</b>
2.3	2.3	96	08.90-12.94	B 230 G/B 230 FB	4	<b>Z 20</b>	14 R-7 DU	0,8	<b>UXT 2<sup>4</sup></b>
2.3	2.3	114	08.90-07.91	B 234 F / B 234 G	4	<b>Z 27</b>	14 R-6 DU	0,8	<b>UX 56</b>
2.3 Turbo	2.3	121	08.90-07.94	B 230 FT	4	<b>Z 20</b>	14 R-7 DU	0,8	<b>UXT 2<sup>4</sup></b>
2.3 Turbo	2.3	140	08.91-07.93	B 230 FT+	4	<b>Z 20</b>	14 R-7 DU	0,8	<b>UXT 2<sup>4</sup></b>
2.4 D	2.4	60	08.90-12.94	D 24	6	<b>GN 857 (11V)</b>	○		
2.4 Turbo Diesel	2.4	80	08.90-12.94	D 24 T	6	<b>GN 857 (11V)</b>	○		
2.4 TD Intercooler	2.4	90	08.90-12.94	D 24 TIC	6	<b>GN 857 (11V)</b>	○		

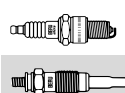
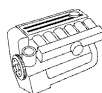

## VOLVO

### 940 Kombi

2.0	2.0	82	01.92-07.94	B 200 F	4	<b>Z 20</b>	14 R-7 DU	0,8	<b>UXT 2<sup>4</sup></b>
2.0	2.0	89	09.90-09.93	B 200 G	4	<b>Z 20</b>	14 R-7 DU	0,8	<b>UXT 2<sup>4</sup></b>
2.3	2.3	85	08.92-07.94	B 230 FD	4	<b>Z 20</b>	14 R-7 DU	0,8	<b>UXT 2<sup>4</sup></b>
2.3	2.3	96	08.90-12.94	B 230 FB	4	<b>Z 20</b>	14 R-7 DU	0,8	<b>UXT 2<sup>4</sup></b>
2.3	2.3	114	08.90-07.91	B 234 F	4	<b>Z 27</b>	14 R-6 DU	0,8	<b>UX 56</b>
2.3 Turbo	2.3	121	08.90-07.94	B 230 FT	4	<b>Z 20</b>	14 R-7 DU	0,8	<b>UXT 2<sup>4</sup></b>
2.3 Turbo	2.3	140	08.91-07.93	B 230 FT+	4	<b>Z 20</b>	14 R-7 DU	0,8	<b>UXT 2<sup>4</sup></b>
2.4 D	2.4	60	08.90-07.95	D 24	6	<b>GN 857</b> (11V)	○		
2.4 Turbo Diesel	2.4	80	08.90-07.94	D 24 T	6	<b>GN 857</b> (11V)	○		
2.4 TD Intercooler	2.4	90	08.90-08.94	D 24 TIC	6	<b>GN 857</b> (11V)	○		

### 940 II

2.0	2.0	89	11.94-12.95	B 200 G	4	<b>Z 20</b>	14 R-7 DU	0,8	<b>UXT 2<sup>4</sup></b>
2.3	2.3	85	08.94-07.95	B 230 FD	4	<b>Z 20</b>	14 R-7 DU	0,8	<b>UXT 2<sup>4</sup></b>
2.3	2.3	96	08.94-10.98	B 230 FB	4	<b>Z 20</b>	14 R-7 DU	0,8	<b>UXT 2<sup>4</sup></b>
2.3 ti	2.3	99	01.95-10.98	B 230 FK	4	<b>Z 20</b>	14 R-7 DU	0,8	<b>UXT 2<sup>4</sup></b>
2.3 Turbo	2.3	121	08.94-10.98	B 230 FT	4	<b>Z 20</b>	14 R-7 DU	0,8	<b>UXT 2<sup>4</sup></b>
2.4 TD Interc.	2.4	90	08.94-10.98	D 24 TIC	6	<b>GN 857</b> (11V)	○		

### 940 II Kombi

2.0	2.0	89	11.94-12.95	B 200 G	4	<b>Z 20</b>	14 R-7 DU	0,8	<b>UXT 2<sup>4</sup></b>
2.3	2.3	85	08.94-07.95	B 230 FD	4	<b>Z 20</b>	14 R-7 DU	0,8	<b>UXT 2<sup>4</sup></b>
2.3	2.3	96	08.94-10.98	B 230 FB	4	<b>Z 20</b>	14 R-7 DU	0,8	<b>UXT 2<sup>4</sup></b>
2.3 ti	2.3	99	01.95-10.98	B 230 FK	4	<b>Z 20</b>	14 R-7 DU	0,8	<b>UXT 2<sup>4</sup></b>
2.3 Turbo	2.3	121	08.94-10.98	B 230 FT	4	<b>Z 20</b>	14 R-7 DU	0,8	<b>UXT 2<sup>4</sup></b>
2.3 Turbo	2.3	126	08.95-10.98	B 230 FT	4	<b>Z 20</b>	14 R-7 DU	0,8	<b>UXT 2<sup>4</sup></b>
2.4 TD Interc.	2.4	90	08.94-10.98	D 24 TIC	6	<b>GN 857</b> (11V)	○		

### 960

2.4 TD Interc.	2.4	85	09.91-07.94	D 24 TIC	6	<b>GN 857</b> (11V)	○		
2.9	2.9	150	08.90-07.94	B 6304 F	6	<b>Z 15</b>	14 FR-7 DU	0,8	<b>UXT 1<sup>3</sup></b>

### 960 Kombi

2.4 TD Interc.	2.4	85	09.91-07.94	D 24 TIC	6	<b>GN 857</b> (11V)	○		
2.4 Tdi	2.4	90	09.90-08.93	D 24 TIC	6	<b>GN 857</b> (11V)	○		
2.9	2.9	150	08.90-07.94	B 6304 F/B 6304 S	6	<b>Z 15</b>	14 FR-7 DU	0,8	<b>UXT 1<sup>3</sup></b>

### 960 II

2.5	2.5	125	07.94-12.96	B 6254 S	6	<b>Z 251</b>	14 FR-7 DU2T	0,8	<b>UXT 1<sup>3</sup></b>
2.9	2.9	150	07.94-12.96	B 6304 S	6	<b>Z 15</b>	14 FR-7 DU	0,8	<b>UXT 1<sup>3</sup></b>

### 960 II Kombi

2.5	2.5	125	08.94-12.96	B 6254 S	6	<b>Z 250</b>	14 FR-7 DU2S	0,7	<b>UXT 1<sup>3</sup></b>
2.9	2.9	150	09.94-12.96	B 6304 S	6	<b>Z 15</b>	14 FR-7 DU	0,8	<b>UXT 1<sup>3</sup></b>

### C30

1.6	1.6	74	10.06-	B 4164 S3	4	<b>Z 177</b>	14 KR-8 MUV	1,3	<b>UXT 7</b>
2.0 D	2.0	100	10.06-	D 4204 T	4	<b>GN 054</b> (11V)	○		
2.0 FlexFuel	2.0	107	01.10-	B 4204 S4	4	<b>Z 230</b>	14 KR-6 KPUV02	1,3	○
2.4 i	2.4	125	10.06-	B 5244 S4	5	<b>Z 294</b>	14 FGR-5 NTE	0,6	○
2.5 T5	2.5	162	10.06-07.07	B 5254 T3	5	<b>Z 326</b>	14 FR-7 MPUS	0,7	○
2.5 T5	2.5	169	08.07-	B 5254 T7	5	<b>Z 326</b>	14 FR-7 MPUS	0,7	○

### C70 I Cabriolet

2.0 T	2.0	120	03.00-10.05	B 5204 T4	5	<b>Z 206</b>	14 FR-7 DPPUS2	0,7	<b>UXT 10</b>
2.0	2.0	132	03.98-10.05	B 5204 T2	5	<b>Z 206</b>	14 FR-7 DPPUS2	0,7	<b>UXT 10</b>
2.0 T	2.0	166	03.98-10.05	B 5204 T3	5	<b>Z 206</b>	14 FR-7 DPPUS2	0,7	<b>UXT 10</b>
2.3 T-5	2.3	176	03.98-10.05	B 5234 T3	5	<b>Z 206</b>	14 FR-7 DPPUS2	0,7	<b>UXT 10</b>
2.3 T5	2.3	180	07.02-10.05	B 5234 T9	5	<b>Z 206</b>	14 FR-7 DPPUS2	0,7	<b>UXT 10</b>
2.4 T	2.4	147	07.02-10.05	B 5244 T7	5	<b>Z 206</b>	14 FR-7 DPPUS2	0,7	<b>UXT 10</b>
2.5	2.5	125	06.98-10.05	B 5254 S	5	<b>Z 204</b>	14 FGR-8 CTU	1,2	○
2.5 T	2.5	142	03.98-10.05	B 5254 T/B 5244 T	5	<b>Z 206</b>	14 FR-7 DPPUS2	0,7	<b>UXT 10</b>

### C70 I Coupe

2.0 T	2.0	120	03.00-09.02	B 5204 T4	5	<b>Z 206</b>	14 FR-7 DPPUS2	0,7	<b>UXT 10</b>
2.0	2.0	132	03.97-09.02	B 5204 T2	5	<b>Z 206</b>	14 FR-7 DPPUS2	0,7	<b>UXT 10</b>
2.0 T	2.0	166	03.97-09.02	B 5204 T3	5	<b>Z 206</b>	14 FR-7 DPPUS2	0,7	<b>UXT 10</b>
2.3 T-5	2.3	176	03.97-09.02	B 5234 T3	5	<b>Z 206</b>	14 FR-7 DPPUS2	0,7	<b>UXT 10</b>
2.5	2.4	121	03.99-09.02	B 5254 S	5	<b>Z 15</b>	14 FR-7 DU	0,8	<b>UXT 1<sup>3</sup></b>
2.5	2.4	125	05.99-09.02	B 5244 S/B 5254 S	5	<b>Z 204</b>	14 FGR-8 CTU	1,2	○



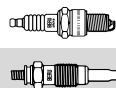
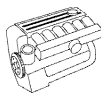

## VOLVO

### C70 I Coupe

2.5 T	2.4	142	03.97-09.02	B 5254 T/B 5244 T	5	<b>Z 206</b>	14 FR-7 DPPUS2	0,7	<b>UXT 10</b>
-------	-----	-----	-------------	-------------------	---	--------------	----------------	-----	---------------

### C70 II Cabriolet

2.0 D	2.0	100	01.08-	D 4204 T	4	<b>GN 054</b> (11V)	○		
2.4	2.4	103	03.06-	B 5244 S5	5	<b>Z 294</b>	14 FGR-5 NTE	0,6	○
2.5 T5	2.5	162	03.06-07.07	B 5254 T3	5	<b>Z 326</b>	14 FR-7 MPUS	0,7	○
2.5 T5	2.5	169	08.07-	B 5254 T7	5	<b>Z 326</b>	14 FR-7 MPUS	0,7	○

### S40 I

1.6	1.6	77	09.95-08.99	B 4164 S	4	<b>Z 204</b>	14 FGR-8 CTU	1,2	○
1.6	1.6	80	03.99-12.03	B 4164 S2	4	<b>Z 204</b>	14 FGR-8 CTU	1,2	○
1.8	1.7	85	07.95-08.99	B 4184 S3/B 4184 S	4	<b>Z 204</b>	14 FGR-8 CTU	1,2	○
1.8	1.8	85	06.01-08.03	B 4184 S2	4	<b>Z 204</b>	14 FGR-8 CTU	1,2	○
1.8	1.8	90	03.99-12.03	B 4184 S2/B 4184 S9	4	<b>Z 204</b>	14 FGR-8 CTU	1,2	○
1.8 i	1.8	90	06.01-12.03	B 4184 SJ	4	<b>Z 279</b>	14 FR-7 LPU02	0,6	○
1.8 i	1.8	92	03.98-12.03	B 4184 SM	4	<b>Z 279</b>	14 FR-7 LPU02	0,6	○
1.9 TD	1.9	66	07.95-08.99	D 4192 T	4	<b>GN 959</b> (11V)	○		
1.9 DI	1.9	70	03.99-07.00	D 4192 T2	4	<b>GN 999</b> (11V)	○		
1.9 DI	1.9	75	07.00-12.03	D 4192 T4	4	<b>GN 018</b> (11V)	○		
1.9 DI	1.9	85	07.00-12.03	D 4192 T3	4	<b>GN 018</b> (11V)	○		
2.0	1.9	100	07.95-12.03	B 4204 S2/B 4204 S	4	<b>Z 204</b>	14 FGR-8 CTU	1,2	○
2.0	1.9	103	07.95-08.99	B 4204 S	4	<b>Z 204</b>	14 FGR-8 CTU	1,2	○
2.0 T	1.9	118	10.97-07.00	B 4204 T	4	<b>Z 206</b>	14 FR-7 DPPUS2	0,7	<b>UXT 10</b>
2.0 T	1.9	120	06.01-12.03	B 4204 T3	4	<b>Z 206</b>	14 FR-7 DPPUS2	0,7	<b>UXT 10</b>
2.0 T	1.9	121	07.00-06.01	B 4204 T3	4	<b>Z 206</b>	14 FR-7 DPPUS2	0,7	<b>UXT 10</b>
1.9 T4	1.9	147	05.97-07.00	B 4194 T/B 4194 T2	4	<b>Z 206</b>	14 FR-7 DPPUS2	0,7	<b>UXT 10</b>
2.0 T4	1.9	147	07.00-12.03	B 4204 T5	4	<b>Z 206</b>	14 FR-7 DPPUS2	0,7	<b>UXT 10</b>

### S40 II

1.6	1.6	74	01.05-	B 4164 S3	4	<b>Z 177</b>	14 KR-8 MUV	1,3	<b>UXT 7</b>
1.6 D	1.6	81	01.05-	D 4164 T	4	<b>GN 047</b> (11V)	○		
2.0 D	2.0	100	01.04-	D 4204 T	4	<b>GN 054</b> (11V)	○		
2.0 F	2.0	107	10.06-	B 4204 S4	4	<b>Z 230</b>	14 KR-6 KPUV02	1,3	○
2.4	2.4	103	01.04-	B 5244 S5	5	<b>Z 294</b>	14 FGR-5 NTE	0,6	○
2.4	2.4	125	01.04-	B 5244 S	5	<b>Z 294</b>	14 FGR-5 NTE	0,6	○
2.5 T5	2.5	162	01.04-07.07	B 5254 T3	5	<b>Z 326</b>	14 FR-7 MPUS	0,7	○
2.5 T5 AWD	2.5	162	04.04-07.07	B 5254 T3	5	<b>Z 326</b>	14 FR-7 MPUS	0,7	○
2.5 T5	2.5	169	08.07-	B 5254 T7	5	<b>Z 326</b>	14 FR-7 MPUS	0,7	○
2.5 T5 AWD	2.5	169	08.07-	B 5254 T7	5	<b>Z 326</b>	14 FR-7 MPUS	0,7	○

### S60

2.0 T	2.0	132	09.01-07.04	B 5204 T5	5	<b>Z 206</b>	14 FR-7 DPPUS2	0,7	<b>UXT 10</b>
2.0 T	2.0	132	08.04-07.09	B 5204 T5	5	<b>Z 326</b>	14 FR-7 MPUS	0,7	○
2.3 T5	2.3	184	11.00-04.10	B 5234 T3	5	<b>Z 206</b>	14 FR-7 DPPUS2	0,7	<b>UXT 10</b>
2.4 D	2.4	96	12.01-04.10	D 5244 T2	5	<b>GN 045</b> (11V)	○		
2.4	2.4	103	11.00-04.10	B 5244 S2	5	<b>Z 204</b>	14 FGR-8 CTU	1,2	○
2.4 Bifuel	2.4	103	06.02-04.10	B 5244 SG2	5	<b>Z 204</b>	14 FGR-8 CTU	1,2	○
2.4 D5	2.4	120	07.01-04.10	D 5244 T	5	<b>GN 045</b> (11V)	○		
2.4	2.4	125	11.00-04.10	B 5244 S	5	<b>Z 204</b>	14 FGR-8 CTU	1,2	○
2.4 T	2.4	147	11.00-10.01	B 5244 T3	5	<b>Z 206</b>	14 FR-7 DPPUS2	0,7	<b>UXT 10</b>
2.4 T	2.4	147	11.01-04.10	B 5244 T3	5	<b>Z 326</b>	14 FR-7 MPUS	0,7	○
2.4 T5	2.4	191	04.04-07.09	B 5244 T5	5	<b>Z 326</b>	14 FR-7 MPUS	0,7	○
2.5 T	2.5	154	02.04-04.10	B 5254 T2	5	<b>Z 206</b>	14 FR-7 DPPUS2	0,7	<b>UXT 10</b>
2.5 T AWD	2.5	154	04.04-04.10	B 5254 T2	5	<b>Z 206</b>	14 FR-7 DPPUS2	0,7	<b>UXT 10</b>
R 2,5 T AWD	2.5	221	03.03-07.07	B 5254 T4	5	<b>Z 326</b>	14 FR-7 MPUS	0,7	○

### S70

2.0	2.0	93	01.97-11.00	B 5202 S	5	<b>Z 204</b>	14 FGR-8 CTU	1,2	○
2.0	2.0	105	01.97-11.00	B 5204 F	5	<b>Z 204</b>	14 FGR-8 CTU	1,2	○
2.0	2.0	120	01.97-11.00	B 5204 T4	5	<b>Z 204</b>	14 FGR-8 CTU	1,2	○
2.0	2.0	132	01.97-11.00	B 5204 T2	5	<b>Z 204</b>	14 FGR-8 CTU	1,2	○
2.0 Turbo	2.0	155	01.97-11.00	B 5204 T	5	<b>Z 206</b>	14 FR-7 DPPUS2	0,7	<b>UXT 10</b>
2.0 Turbo	2.0	166	01.97-11.00	B 5204 T3	5	<b>Z 206</b>	14 FR-7 DPPUS2	0,7	<b>UXT 10</b>
2.3 T-5	2.3	176	01.97-11.00	B 5234 T3	5	<b>Z 206</b>	14 FR-7 DPPUS2	0,7	<b>UXT 10</b>
2.3 Turbo	2.3	184	01.97-11.00	B 5234 FT+	5	<b>Z 206</b>	14 FR-7 DPPUS2	0,7	<b>UXT 10</b>
2.4	2.4	103	08.99-11.00	B 5244 SG/B 5244 S2	5	<b>Z 204</b>	14 FGR-8 CTU	1,2	○

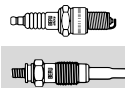
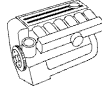

## VOLVO

### S70

2.5	2.4	106	01.97-11.00	B 5252 S	5	<b>Z 204</b>	14 FGR-8 CTU	1,2	○
2.5 Bifuel	2.4	106	10.98-11.00	GB 5252 S	5	<b>Z 204</b>	14 FGR-8 CTU	1,2	○
2.5	2.4	121	06.98-11.00	B 5254 S	5	<b>Z 204</b>	14 FGR-8 CTU	1,2	○
2.4	2.4	125	01.97-11.00	B 5254 S	5	<b>Z 204</b>	14 FGR-8 CTU	1,2	○
2.4 Turbo	2.4	142	01.97-11.00	B 5254 T/B 5244 T	5	<b>Z 206</b>	14 FR-7 DPPUS2	0,7	<b>UXT 10</b>
2.5 TDI	2.5	103	01.97-11.00	D 5252 T	5	<b>GN 855</b> (12V)	○		
				Kühlwasservorwärmung <sup>15</sup> ⇄ Ø 4 mm		<b>GN 928</b> (12V)=3x			

### S80

2.0	2.0	120	06.98-07.06	B 5204 T4	5	<b>Z 206</b>	14 FR-7 DPPUS2	0,7	<b>UXT 10</b>
2.0 T	2.0	132	12.99-07.04	B 5204 T5	5	<b>Z 206</b>	14 FR-7 DPPUS2	0,7	<b>UXT 10</b>
2.0 T	2.0	132	08.04-07.06	B 5204 T5	5	<b>Z 326</b>	14 FR-7 MPUS	0,7	○
2.0 T	2.0	166	06.98-07.06	B 5204 T3	5	<b>Z 206</b>	14 FR-7 DPPUS2	0,7	<b>UXT 10</b>
2.4 D	2.4	96	10.01-07.06	D 5244 T2	5	<b>GN 045</b> (11V)	○		
2.4	2.4	103	01.99-07.06	B 5244 S2	5	<b>Z 204</b>	14 FGR-8 CTU	1,2	○
2.4 Bifuel	2.4	103	09.01-07.06	B 5244 SG2	5	<b>Z 204</b>	14 FGR-8 CTU	1,2	○
2.4 D5	2.4	120	08.01-07.06	D 5244 T	5	<b>GN 045</b> (11V)	○		
2.4	2.4	125	01.99-07.06	B 5244 S	5	<b>Z 204</b>	14 FGR-8 CTU	1,2	○
2.4 T	2.4	147	06.00-10.01	B 5244 T3	5	<b>Z 206</b>	14 FR-7 DPPUS2	0,7	<b>UXT 10</b>
2.4 T	2.4	147	11.01-07.06	B 5244 T3	5	<b>Z 326</b>	14 FR-7 MPUS	0,7	○
2.4 T5 AWD	2.4	147	04.00-10.01	B 5244 T3	5	<b>Z 206</b>	14 FR-7 DPPUS2	0,7	<b>UXT 10</b>
2.4 T5 AWD	2.4	147	11.01-09.03	B 5244 T3	5	<b>Z 326</b>	14 FR-7 MPUS	0,7	○
2.5 TDI	2.5	103	01.99-07.06	D 5252 T	5	<b>GN 855</b> (12V)	○		
2.5 T	2.5	154	03.03-07.06	B 5254 T2	5	<b>Z 206</b>	14 FR-7 DPPUS2	0,7	<b>UXT 10</b>
2.5 T AWD	2.5	154	07.03-07.06	B 5254 T2	5	<b>Z 206</b>	14 FR-7 DPPUS2	0,7	<b>UXT 10</b>
2.8 T6	2.8	200	05.98-07.06	B 6284 T	6	<b>Z 206</b>	14 FR-7 DPPUS2	0,7	<b>UXT 10</b>
2.9	2.9	150	05.98-07.06	B 6304 S3	6	<b>Z 204</b>	14 FGR-8 CTU	1,2	○
3.0 T6	2.9	200	06.01-07.06	B 6294 T	6	<b>Z 206</b>	14 FR-7 DPPUS2	0,7	<b>UXT 10</b>

### S80 II

2.0 TDi	2.0	100	02.08-	D 4204 T	4	<b>GN 054</b> (11V)	○		
2.0 FlexFuel	2.0	107	01.08-	B 4204 S4	4	<b>Z 230</b>	14 KR-6 KPUV02	1,3	○
2.5 T	2.5	147	03.06-07.09	B 5254 T6	5	<b>Z 326</b>	14 FR-7 MPUS	0,7	○
	3.2	175	08.06-	B 6324 S	6	<b>Z 326</b>	14 FR-7 MPUS	0,7	○
4.4 V8 AWD	4.4	232	03.06-12.10	B 8444 S	8	<b>Z 312</b>	14 FR-7 KPPU	1,1	○

### S90

2.9	2.9	132	01.97-05.98	B 6304 S2	6	<b>Z 251</b>	14 FR-7 DU2T	0,8	<b>UXT 1<sup>3</sup></b>
2.9	2.9	150	01.97-05.98	B 6304 G	6	<b>Z 251</b>	14 FR-7 DU2T	0,8	<b>UXT 1<sup>3</sup></b>

### V40 Kombi

1.6	1.6	77	12.95-08.99	B 4164 S	4	<b>Z 204</b>	14 FGR-8 CTU	1,2	○
1.6	1.6	80	03.99-06.04	B 4164 S2	4	<b>Z 204</b>	14 FGR-8 CTU	1,2	○
1.8	1.7	85	07.95-08.99	B 4184 S3/B 4184 S	4	<b>Z 204</b>	14 FGR-8 CTU	1,2	○
1.8	1.8	90	03.99-06.04	B 4184 S2/B 4184 S9	4	<b>Z 204</b>	14 FGR-8 CTU	1,2	○
1.8 i	1.8	90	06.01-06.04	B 4184 SJ	4	<b>Z 279</b>	14 FR-7 LPU02	0,6	○
1.8 i	1.8	92	03.98-06.04	B 4184 SM	4	<b>Z 279</b>	14 FR-7 LPU02	0,6	○
1.9 TD	1.9	66	07.95-08.99	D 4192 T	4	<b>GN 959</b> (11V)	○		
1.9 DI	1.9	70	03.99-07.00	D 4192 T2	4	<b>GN 999</b> (11V)	○		
1.9 DI	1.9	75	07.00-06.04	D 4192 T4	4	<b>GN 018</b> (11V)	○		
1.9 DI	1.9	85	07.00-06.04	D 4192 T3	4	<b>GN 018</b> (11V)	○		
1.9 T4	1.9	147	05.97-07.00	B 4194 T	4	<b>Z 206</b>	14 FR-7 DPPUS2	0,7	<b>UXT 10</b>
2.0	1.9	100	07.95-06.04	B 4204 S2/B 4204 S	4	<b>Z 204</b>	14 FGR-8 CTU	1,2	○
2.0 D	2.0	100	12.02-06.04	D 4204 T	4	<b>GN 054</b> (11V)	○		
2.0	1.9	103	07.95-08.99	B 4204 S	4	<b>Z 204</b>	14 FGR-8 CTU	1,2	○
2.0 T	1.9	118	10.97-07.00	B 4204 T	4	<b>Z 206</b>	14 FR-7 DPPUS2	0,7	<b>UXT 10</b>
2.0 T	1.9	120	06.01-06.04	B 4204 T3	4	<b>Z 206</b>	14 FR-7 DPPUS2	0,7	<b>UXT 10</b>
2.0 T	1.9	121	07.99-06.01	B 4204 T2	4	<b>Z 206</b>	14 FR-7 DPPUS2	0,7	<b>UXT 10</b>
2.0 T4	1.9	147	07.00-06.04	B 4204 T5	4	<b>Z 206</b>	14 FR-7 DPPUS2	0,7	<b>UXT 10</b>

### V50

1.6	1.6	74	01.05-	B 4164 S3	4	<b>Z 177</b>	14 KR-8 MUV	1,3	<b>UXT 7</b>
1.6 D	1.6	81	01.05-	D 4164 T	4	<b>GN 047</b> (11V)	○		
2.0 D	2.0	100	04.04-	D 4204 T	4	<b>GN 054</b> (11V)	○		
2.0 FlexFuel	2.0	107	01.10-	B 4204 S4	4	<b>Z 230</b>	14 KR-6 KPUV02	1,3	○
2.4	2.4	103	04.04-	B 5244 S5	5	<b>Z 294</b>	14 FGR-5 NTE	0,6	○

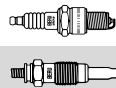

## VOLVO

V50										
2.4	2.4	125	04.04-	B 5244 S	5	Z 294	14 FGR-5 NTE	0,6		○
2.5 T5	2.5	162	04.04-07.07	B 5254 T3	5	Z 326	14 FR-7 MPUS	0,7		○
2.5 T5 AWD	2.5	162	04.04-07.07	B 5254 T3	5	Z 326	14 FR-7 MPUS	0,7		○
2.5 T5	2.5	169	08.07-	B 5254 T7	5	Z 326	14 FR-7 MPUS	0,7		○
2.5 T5 AWD	2.5	169	08.07-	B 5254 T7	5	Z 326	14 FR-7 MPUS	0,7		○
V70 I										
2.0	2.0	93	01.97-03.00	B 5202 S	5	Z 204	14 FGR-8 CTU	1,2		○
2.0	2.0	105	01.97-03.00		5	Z 204	14 FGR-8 CTU	1,2		○
2.0	2.0	120	01.97-03.00	B 5204 T4	5	Z 204	14 FGR-8 CTU	1,2		○
2.0	2.0	132	01.97-03.00	B 5204 T2	5	Z 206	14 FR-7 DPPUS2	0,7		UXT 10
2.0 Turbo	2.0	155	01.97-03.00	B 5204 T	5	Z 206	14 FR-7 DPPUS2	0,7		UXT 10
2.0 Turbo	2.0	166	01.97-03.00	B 5204 T3	5	Z 206	14 FR-7 DPPUS2	0,7		UXT 10
2.0 Turbo AWD	2.0	166	01.97-03.00	B 5204 T3	5	Z 206	14 FR-7 DPPUS2	0,7		UXT 10
2.3 T-5	2.3	176	01.97-03.00	B 5234 T3	5	Z 206	14 FR-7 DPPUS2	0,7		UXT 10
2.3 T-5 AWD	2.3	176	01.97-03.00	B 5234 T3	5	Z 206	14 FR-7 DPPUS2	0,7		UXT 10
2.3 Turbo	2.3	184	01.97-03.00	B 5234 FT+	5	Z 206	14 FR-7 DPPUS2	0,7		UXT 10
2.3 T AWD	2.3	184	04.97-03.00	B 5234 FT+	5	Z 206	14 FR-7 DPPUS2	0,7		UXT 10
2.4	2.4	103	08.99-05.00	B 5244 SG2/B 5244 S2	5	Z 204	14 FGR-8 CTU	1,2		○
2.4 Bifuel	2.4	103	08.99-03.00	B 5244 SG	5	Z 204	14 FGR-8 CTU	1,2		○
2.4	2.4	125	01.97-05.00	B 5254 S	5	Z 204	14 FGR-8 CTU	1,2		○
2.4 Turbo	2.4	142	01.97-03.00	B 5254 T/B 5244 T	5	Z 206	14 FR-7 DPPUS2	0,7		UXT 10
2.5	2.4	106	01.97-03.00	B 5252 S	5	Z 204	14 FGR-8 CTU	1,2		○
2.5 Bifuel	2.4	106	10.98-08.99	GB 5252 S	5	Z 204	14 FGR-8 CTU	1,2		○
2.5	2.4	121	06.98-03.00	B 5254 S	5	Z 204	14 FGR-8 CTU	1,2		○
2.5 Turbo AWD	2.4	142	01.97-05.00	B 5254 T/B 5244 T	5	Z 206	14 FR-7 DPPUS2	0,7		UXT 10
2.5 TDI	2.5	103	01.97-05.00	D 5252 T	5	GN 855 (12V)	○			
V70 II										
2.0 T	2.0	132	07.01-07.04	B 5204 T5	5	Z 206	14 FR-7 DPPUS2	0,7		UXT 10
2.0 T	2.0	132	08.04-08.07	B 5204 T5	5	Z 326	14 FR-7 MPUS	0,7		○
2.3 T5	2.3	184	03.00-08.07	B 5234 T3/B 5234 T4	5	Z 206	14 FR-7 DPPUS2	0,7		UXT 10
2.4 D	2.4	96	12.01-08.07	D 5244 T2	5	GN 045 (11V)	○			
2.4	2.4	103	03.00-08.07	B 5244 S2	5	Z 204	14 FGR-8 CTU	1,2		○
2.4 Bifuel	2.4	103	09.01-08.07	B 5244 SG	5	Z 204	14 FGR-8 CTU	1,2		○
2.4 D5	2.4	120	08.01-07.06	D 5244 T/D 5244 T5	5	GN 045 (11V)	○			
2.4 D5 AWD	2.4	120	03.03-08.07	D 5244 T5/D 5244 T2	5	GN 045 (11V)	○			
2.4	2.4	125	03.00-08.07	B 5244 S	5	Z 204	14 FGR-8 CTU	1,2		○
2.4 T	2.4	147	03.00-10.01	B 5244 T3	5	Z 206	14 FR-7 DPPUS2	0,7		UXT 10
2.4 T	2.4	147	11.01-08.07	B 5244 T3	5	Z 326	14 FR-7 MPUS	0,7		○
2.4 T AWD	2.4	147	09.01-10.01	B 5244 T3	5	Z 206	14 FR-7 DPPUS2	0,7		UXT 10
2.4 T AWD	2.4	147	11.01-08.07	B 5244 T3	5	Z 326	14 FR-7 MPUS	0,7		○
2.4 T5	2.4	191	04.04-07.07	B 5244 T5	5	Z 326	14 FR-7 MPUS	0,7		○
2.5 TDI	2.5	103	03.00-08.07	D 5252 T	5	GN 855 (12V)	○			
2.5 T	2.5	154	04.04-08.07	B 5254 T2	5	Z 206	14 FR-7 DPPUS2	0,7		UXT 10
2.5 T AWD	2.5	154	09.02-08.07	B 5254 T2	5	Z 206	14 FR-7 DPPUS2	0,7		UXT 10
2.5 R Sport	2.5	221	12.02-07.07	B 5254 T4	5	Z 326	14 FR-7 MPUS	0,7		○
R 2.5 T AWD	2.5	221	03.03-07.07	B 5254 T4	5	Z 326	14 FR-7 MPUS	0,7		○
V70 III										
2.0 D	2.0	100	10.07-	D 4204 T	4	GN 054 (11V)	○			
2.0 FlexiFuel	2.0	107	01.08-	B 4204 S4	4	Z 230	14 KR-6 KPUV02	1,3		○
V90 Kombi										
2.9	2.9	132	01.97-12.98	B 6304 S2	6	Z 251	14 FR-7 DU2T	0,8		UXT 13
2.9	2.9	150	01.97-12.98	B 6304 G	6	Z 251	14 FR-7 DU2T	0,8		UXT 13
XC60										
T6 AWD	3.0	210	03.09-07.10	B 6304 T2	6	Z 326	14 FR-7 MPUS	0,7		○
XC70 CROSS COUNTRY										
2.4 D5 XC AWD	2.4	120	09.02-08.07	D 5244 T	5	GN 045 (11V)	○			
2.4 T XC AWD	2.4	142	11.97-09.02	B 5254 T	5	Z 206	14 FR-7 DPPUS2	0,7		UXT 10
2.4 T XC AWD	2.4	147	03.00-10.01	B 5244 T3	5	Z 206	14 FR-7 DPPUS2	0,7		UXT 10
2.4 T XC AWD	2.4	147	11.01-09.02	B 5244 T3	5	Z 326	14 FR-7 MPUS	0,7		○
2.5 T XC AWD	2.5	154	09.02-08.07	B 5254 T2	5	Z 206	14 FR-7 DPPUS2	0,7		UXT 10



kW

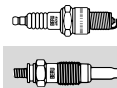
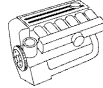

**VOLVO**

**XC70 II**

3.0 T6 AWD	3.0	210	08.08-	B 6304 T2	6	<b>Z 326</b>	14 FR-7 MPUS	0,7	○
------------	-----	-----	--------	-----------	---	--------------	--------------	-----	---

**XC90**

2.4 D5	2.4	120	10.02-	D 5244 T/D 5244 T5	5	<b>GN 045</b> (11V)	○		
2.5 T	2.5	154	10.02-	B 5254 T2	5	<b>Z 206</b>	14 FR-7 DPPUS2	0,7	<b>UXT 10</b>
2.9 T6	2.9	200	10.02-	B 6294 T	6	<b>Z 206</b>	14 FR-7 DPPUS2	0,7	<b>UXT 10</b>
3.2	3.2	175	05.06-	B 6324 S	6	<b>Z 326</b>	14 FR-7 MPUS	0,7	○
4.4 V8 AWD	4.4	232	01.05-12.10	B 8444 S	8	<b>Z 312</b>	14 FR-7 KPPU	1,1	○

**VW AG**

**AMAROK**

2.0 TDI	2.0	90	09.10-	CDBA	4	<b>GE 115</b> (4,4V)	○		
2.0 TDI 4motion	2.0	90	09.10-	CDBA	4	<b>GE 115</b> (4,4V)	○		
2.0 TSI	2.0	118	12.10-	CFPA	4	<b>Z 347</b>	14 F-5 DPUR02	0,7	○
2.0 BiTDI	2.0	120	09.10-	CDCA	4	<b>GE 115</b> (4,4V)	○		
2.0 BiTDI 4motion	2.0	120	09.10-	CDCA	4	<b>GE 115</b> (4,4V)	○		

**BEETLE (5C1)**

1.6 TDI	1.6	77	10.11-	CAYC	4	<b>GE 115</b> (4,4V)	○		
2.0 TDI	2.0	103	04.12-	CFFB	4	<b>GE 115</b> (4,4V)	○		
2.0 TDI	2.0	103	04.12-	CJAA	4	<b>PSG 002</b> (4,4V)	○		
2.0 TSI	2.0	147	10.11-	CBFA, CCTA, CCZA	4	<b>Z 347</b>	14 F-5 DPUR02	0,7	○

**BORA (1J2)**

1.4 16V	1.4	55	03.00-05.05	AKQ, AHW, APE, AXP	4	<b>Z 90</b>	14 FGH-7 DTURX	1,0	<b>UXT 1<sup>3</sup></b>
1.4 16V	1.4	55	03.00-05.05	BCA	4	<b>Z 176</b>	14 F-7 HPURX2	1,0	○
1.6	1.6	74	10.98-05.05	AKL/APF/AEH	4	<b>Z 90</b>	14 FGH-7 DTURX	1,0	<b>UXT 1<sup>3</sup></b>
1.6	1.6	75	08.00-05.05	AVU,BFQ	4	<b>Z 90</b>	14 FGH-7 DTURX	1,0	<b>UXT 1<sup>3</sup></b>
1.6 16V	1.6	77	05.00-05.05	ATN, AUS	4	<b>Z 90</b>	14 FGH-7 DTURX	1,0	<b>UXT 1<sup>3</sup></b>
1.6 16V	1.6	77	05.00-05.05	AZD, BCB	4	<b>Z 176</b>	14 F-7 HPURX2	1,0	○
1.6 FSI	1.6	81	01.02-05.05	BAD	4	<b>Z 300</b>	14 FGR-6 HQU	1,35	○
1.8	1.8	92	10.98-05.05	AGN	4	<b>Z 90</b>	14 FGH-7 DTURX	1,0	<b>UXT 1<sup>3</sup></b>
1.8 4motion	1.8	92	02.99-05.05	AGN	4	<b>Z 90</b>	14 FGH-7 DTURX	1,0	<b>UXT 1<sup>3</sup></b>
1.8 T	1.8	110	05.00-05.05	AGU, ARX, AUM	4	<b>Z 188</b>	14 F-7 DPUR02	0,7	<b>UXT 10</b>
1.8 T	1.8	132	03.02-05.05	AUQ	4	<b>Z 188</b>	14 F-7 DPUR02	0,7	<b>UXT 10</b>
1.9 SDI	1.9	50	10.98-05.05	AGP/AQM	4	<b>GN 855</b> (12V)	○		
1.9 TDI	1.9	66	10.98-06.01	AGR/ALH	4	<b>GN 855</b> (12V)	○		
				Kühlwasservorwärmung <sup>15</sup> M 5/3Nm Ø 4 mm		<b>GN 857</b> (11V)=3x <b>GN 928</b> (12V)=3x			
1.9 TDI 4motion	1.9	66	02.99-06.01	AGR	4	<b>GN 855</b> (12V)	○		
				Kühlwasservorwärmung <sup>15</sup> M 5/3Nm Ø 4 mm		<b>GN 857</b> (11V)=3x <b>GN 928</b> (12V)=3x			
1.9 TDI	1.9	74	09.00-05.05	AXR/ATD	4	<b>GN 855</b> (12V)	○		
				Kühlwasservorwärmung <sup>15</sup> M 5/3Nm Ø 4 mm		<b>GN 857</b> (11V)=3x <b>GN 928</b> (12V)=3x			
1.9 TDI 4motion	1.9	74	09.00-05.05	ATD	4	<b>GN 855</b> (12V)	○		
				Kühlwasservorwärmung <sup>15</sup> M 5/3Nm Ø 4 mm		<b>GN 857</b> (11V)=3x <b>GN 928</b> (12V)=3x			
1.9 TDI	1.9	81	10.98-06.01	AHF/ASV	4	<b>GN 855</b> (12V)	○		
				Kühlwasservorwärmung <sup>15</sup> M 5/3Nm Ø 4 mm		<b>GN 857</b> (11V)=3x <b>GN 928</b> (12V)=3x			
1.9 TDI	1.9	85	12.98-06.01	AJM	4	<b>GN 855</b> (12V)	○		
				Kühlwasservorwärmung <sup>15</sup> M 5/3Nm Ø 4 mm		<b>GN 857</b> (11V)=3x <b>GN 928</b> (12V)=3x			
1.9 TDI	1.9	85	12.98-06.01	AUY	4	<b>GN 046</b> (12V)	○		
1.9 TDI 4motion	1.9	85	02.99-06.01	AJM	4	<b>GN 855</b> (12V)	○		
				Kühlwasservorwärmung <sup>15</sup> M 5/3Nm Ø 4 mm		<b>GN 857</b> (11V)=3x <b>GN 928</b> (12V)=3x			
1.9 TDI 4motion	1.9	85	02.99-06.01	AUY	4	<b>GN 046</b> (12V)	○		
1.9 TDI	1.9	96	11.00-05.05	ASZ → Fgst.Nr. F1J-2-600 000	4	<b>GN 855</b> (12V)	○		
				Kühlwasservorwärmung <sup>15</sup> M 5/3Nm Ø 4 mm		<b>GN 857</b> (11V)=3x <b>GN 928</b> (12V)=3x			

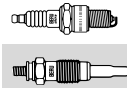
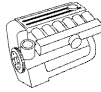

## VW AG

### BORA (1J2)

1.9 TDI	1.9	96	11.00-05.05	ASZ Fgs.Nr. F1J-2-600 001 →	4	<b>GN 046</b> (12V)	○		
1.9 TDI 4motion	1.9	96	11.00-05.05	ASZ → Fgst.Nr. F1J-2-600 000	4	<b>GN 855</b> (12V)	○		
				Kühlwasservorwärmung <sup>15</sup> M 5/3Nm Ø 4 mm		<b>GN 857</b> (11V)=3x <b>GN 928</b> (12V)=3x			
1.9 TDI 4motion	1.9	96	11.00-05.05	ASZ Fgs.Nr. F1J-2-600 001 →	4	<b>GN 046</b> (12V)	○		
1.9 TDI	1.9	110	05.00-09.01	ARL	4	<b>GN 855</b> (12V)	○		
				Kühlwasservorwärmung <sup>15</sup> M 5/3Nm Ø 4 mm		<b>GN 857</b> (11V)=3x <b>GN 928</b> (12V)=3x			
1.9 TDI	1.9	110	10.01-05.05	ARL	4	<b>GN 046</b> (12V)	○		
1.9 TDI 4motion	1.9	110	05.00-09.01		4	<b>GN 855</b> (12V)	○		
				Kühlwasservorwärmung <sup>15</sup> M 5/3Nm Ø 4 mm		<b>GN 857</b> (11V)=3x <b>GN 928</b> (12V)=3x			
1.9 TDI 4motion	1.9	110	10.01-05.05	ARL	4	<b>GN 046</b> (12V)	○		
2.0	2.0	85	10.98-05.05	APK, AQY, AZH	4	<b>Z 90</b>	14 FGH-7 DTURX	1,0	<b>UXT 13</b>
2.0	2.0	85	10.98-05.05	AZG, AZJ	4	<b>Z 176</b>	14 F-7 HPURX2	1,0	○
2.0 4motion	2.0	85	04.00-05.05	AZH	4	<b>Z 90</b>	14 FGH-7 DTURX	1,0	<b>UXT 13</b>
2.0 4motion	2.0	85	04.00-05.05	AZJ	4	<b>Z 176</b>	14 F-7 HPURX2	1,0	○
2.3 V5	2.3	110	10.98-10.00	AGZ	5	<b>Z 173</b>	14 FGR-8 KQU	1,6	○
2.3 V5 4motion	2.3	110	12.98-10.00	AGZ	5	<b>Z 173</b>	14 FGR-8 KQU	1,6	○
2.3 V5	2.3	125	10.00-05.05	AQN	5	<b>Z 176</b>	14 F-7 HPURX2	1,0	○
2.3 V5 4motion	2.3	125	10.00-05.05	AQN	5	<b>Z 176</b>	14 F-7 HPURX2	1,0	○
2.8 VR6	2.8	147	02.02-07.05	BDF	6	<b>Z 176</b>	14 F-7 HPURX2	1,0	○
2.8 V6 4motion	2.8	150	03.99-05.05	AQP/AUE/BDE	6	<b>Z 176</b>	14 F-7 HPURX2	1,0	○

### BORA Kombi (1J6)

1.4 16V	1.4	55	09.01-05.05	AHW, AXP	4	<b>Z 90</b>	14 FGH-7 DTURX	1,0	<b>UXT 13</b>
1.4 16V	1.4	55	09.01-05.05	BCA	4	<b>Z 176</b>	14 F-7 HPURX2	1,0	○
1.6	1.6	74	05.99-05.05	AKL/APF/AEH	4	<b>Z 90</b>	14 FGH-7 DTURX	1,0	<b>UXT 13</b>
1.6	1.6	75	08.00-05.05	AVU/BFQ	4	<b>Z 90</b>	14 FGH-7 DTURX	1,0	<b>UXT 13</b>
1.6 16V	1.6	77	02.00-05.05	ATN, AUS	4	<b>Z 90</b>	14 FGH-7 DTURX	1,0	<b>UXT 13</b>
1.6 16V	1.6	77	02.00-05.05	AZD, BCB	4	<b>Z 176</b>	14 F-7 HPURX2	1,0	○
1.6 FSI	1.6	81	01.02-05.05	BAD	4	<b>Z 300</b>	14 FGR-6 HQU	1,35	○
1.8 4motion	1.8	92	05.99-05.05	AGN	4	<b>Z 90</b>	14 FGH-7 DTURX	1,0	<b>UXT 13</b>
1.8 T	1.8	110	05.00-05.05	AGU, ARX, AUM	4	<b>Z 188</b>	14 F-7 DPUR02	0,7	<b>UXT 10</b>
1.8 T	1.8	132	05.02-05.05	AUQ	4	<b>Z 188</b>	14 F-7 DPUR02	0,7	<b>UXT 10</b>
1.9 TDI	1.9	66	07.04-05.05	AGR	4	<b>GN 855</b> (12V)	○		
				Kühlwasservorwärmung <sup>15</sup> M 5/3Nm Ø 4 mm		<b>GN 857</b> (11V)=3x <b>GN 928</b> (12V)=3x			
1.9 TDI	1.9	74	09.00-10.01	AXR/ATD	4	<b>GN 855</b> (12V)	○		
				Kühlwasservorwärmung <sup>15</sup> M 5/3Nm Ø 4 mm		<b>GN 857</b> (11V)=3x <b>GN 928</b> (12V)=3x			
1.9 TDI	1.9	74	11.01-05.05	ATD, AXR	4	<b>GN 046</b> (12V)	○		
1.9 TDI 4motion	1.9	74	09.00-04.01	ATD	4	<b>GN 855</b> (12V)	○		
				Kühlwasservorwärmung <sup>15</sup> M 5/3Nm Ø 4 mm		<b>GN 857</b> (11V)=3x <b>GN 928</b> (12V)=3x			
1.9 TDI 4motion	1.9	74	05.01-05.05	ATD	4	<b>GN 046</b> (12V)	○		
1.9 TDI	1.9	81	05.99-06.01	AHF/ASV	4	<b>GN 855</b> (12V)	○		
				Kühlwasservorwärmung <sup>15</sup> M 5/3Nm Ø 4 mm		<b>GN 857</b> (11V)=3x <b>GN 928</b> (12V)=3x			
1.9 TDI	1.9	85	05.99-06.01	AJM	4	<b>GN 855</b> (12V)	○		
				Kühlwasservorwärmung <sup>15</sup> M 5/3Nm Ø 4 mm		<b>GN 857</b> (11V)=3x <b>GN 928</b> (12V)=3x			
1.9 TDI	1.9	85	05.99-06.01	AUY	4	<b>GN 046</b> (12V)	○		
1.9 TDI 4motion	1.9	85	05.99-06.01	AJM	4	<b>GN 855</b> (12V)	○		
				Kühlwasservorwärmung <sup>15</sup> M 5/3Nm Ø 4 mm		<b>GN 857</b> (11V)=3x <b>GN 928</b> (12V)=3x			
1.9 TDI 4motion	1.9	85	05.99-06.01	AUY	4	<b>GN 046</b> (12V)	○		

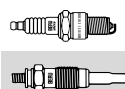
**VW AG**
**BORA Kombi (1J6)**

1.9 TDI	1.9	96	11.00-05.05	ASZ → Fgst.Nr. F1J-2-600 000	4	<b>GN 855</b> (12V)	○		
				Kühlwasservorwärmung <sup>15</sup> ↳ M 5/3Nm ↳ Ø 4 mm		<b>GN 857</b> (11V)=3x <b>GN 928</b> (12V)=3x			
1.9 TDI	1.9	96	11.00-05.05	ASZ Fgs.Nr. F1J-2-600 001 →	4	<b>GN 046</b> (12V)	○		
1.9 TDI 4motion	1.9	96	11.00-05.05	ASZ → Fgst.Nr. F1J-2-600 000	4	<b>GN 855</b> (12V)	○		
				Kühlwasservorwärmung <sup>15</sup> ↳ M 5/3Nm ↳ Ø 4 mm		<b>GN 857</b> (11V)=3x <b>GN 928</b> (12V)=3x			
1.9 TDI 4motion	1.9	96	11.00-05.05	ASZ Fgst.Nr. F1J-2-600 001 →	4	<b>GN 046</b> (12V)	○		
1.9 TDI	1.9	110	05.01-05.05	ARL	4	<b>GN 046</b> (12V)	○		
1.9 TDI 4motion	1.9	110	05.01-05.05	ARL	4	<b>GN 046</b> (12V)	○		
2.0	2.0	85	05.99-05.05	APK, AQY, AZH	4	<b>Z 90</b>	14 FGH-7 DTURX	1,0	<b>UXT 1<sup>3</sup></b>
2.0	2.0	85	05.99-05.05	AZG, AZJ	4	<b>Z 176</b>	14 F-7 HPURX2	1,0	○
2.0 4motion	2.0	85	04.00-05.05	AZG	4	<b>Z 90</b>	14 FGH-7 DTURX	1,0	<b>UXT 1<sup>3</sup></b>
2.0 4motion	2.0	85	04.00-05.05	AZJ	4	<b>Z 176</b>	14 F-7 HPURX2	1,0	○
2.3 V5	2.3	110	05.99-10.00	AGZ	5	<b>Z 173</b>	14 FGR-8 KQU	1,6	○
2.3 V5 4motion	2.3	110	05.99-10.00	AGZ	5	<b>Z 173</b>	14 FGR-8 KQU	1,6	○
2.3 V5	2.3	125	10.00-05.05	AQN	5	<b>Z 176</b>	14 F-7 HPURX2	1,0	○
2.3 V5 4motion	2.3	125	10.00-05.05	AQN	5	<b>Z 176</b>	14 F-7 HPURX2	1,0	○
2.8 VR6	2.8	150	03.00-05.00	AUE	6	<b>Z 176</b>	14 F-7 HPURX2	1,0	○
2.8 VR6 4motion	2.8	150	05.99-05.05	AQP/AUE/BDE	6	<b>Z 176</b>	14 F-7 HPURX2	1,0	○

**CC**

2.0 TDI	2.0	103	02.12-	CFFB	4	<b>GE 115</b> (4,4V)	○		
2.0 TDI	2.0	125	02.12-	CFGB, CLLA	4	<b>GE 115</b> (4,4V)	○		
2.0 TSI	2.0	155	02.12-	CCZB	4	<b>Z 347</b>	14 F-5 DPUR02	0,7	○

**CORRADO (53I)**

1.8 16V	1.8	100	04.89-07.92	KR	4	<b>Z 52</b>	14 F-6 DTU	0,8	<b>UXT 5</b>
1.8 G60	1.8	118	09.88-09.93	PG	4	<b>Z 104</b>	14-6 DPO	0,6	○
2.0 i	2.0	85	04.93-12.95	2E/ADY	4	<b>Z 91</b>	14 GH-7 DTUR	0,8	<b>UXT 2<sup>4</sup></b>
2.0 i 16V	2.0	100	08.91-12.95	9A	4	<b>Z 89</b>	14 FGH-6 DTUR	0,8	<b>UXT 5</b>
2.9 VR6	2.9	140	08.91-12.95	ABV	6	<b>Z 173</b>	14 FGR-8 KQU	1,6	○

**EOS (1F7, 1F8)**

1.4 TSI	1.4	90	11.07-	CAXA	4	<b>Z 349</b>	14 F-6 LPURW03	0,9	○
1.4 TSI	1.4	118	05.08-	CAVD	4	<b>Z 349</b>	14 F-6 LPURW03	0,9	○
1.6 FSI	1.6	85	06.06-05.08	BLF	4	<b>Z 300</b>	14 FGR-6 HQU	1,35	○
2.0 TDI	2.0	100	05.08-	CFFA	4	<b>GE 115</b> (4,4V)	○		
2.0 TDI	2.0	103	06.06-05.08	BMM	4	<b>GE 100</b> (5V)	<b>GSE 100</b>		
2.0 TDI 16V	2.0	103	05.08-	CFFB/CBAB	4	<b>GE 115</b> (4,4V)	○		
2.0 FSI	2.0	110	03.06-05.08	BVY	4	<b>Z 236</b>	14 F-6 HTPRX02	1,0	○
2.0 FSI	2.0	110	03.06-05.08	BVZ	4	<b>Z 228</b>	14 FR-7 DPUR02	1,0	<b>UXT 11</b>
2.0 TFSI	2.0	147	03.06-	BPY/BWA/CAWB/CBFA/CCTA/ CCZA	4	<b>Z 347</b>	14 F-5 DPUR02	0,7	○
2.0 TSI	2.0	155	11.09-	CCZB	4	<b>Z 347</b>	14 F-5 DPUR02	0,7	○

**FOX (5Z1, 5Z3)**

1.2	1.2	40	04.05-	BMD	3	<b>Z 200</b>	14 F-7 HUR2	0,9	○
1.2	1.2	40	04.05-	CHFB	3	<b>Z 272</b>	14 F-7 HURU02	1,0	○
1.2	1.2	44	09.10-	CHFA	3	<b>Z 272</b>	14 F-7 HURU02	1,0	○
1.4 TDI	1.4	51	04.05-	BNM	3	<b>GN 046</b> (12V)	○		
1.4	1.4	55	04.05-	BKR	4	<b>Z 344</b>	14 F-7 HTUR	1,0	○
1.6	1.6	74	10.03-	BAH/BLH/CFZA	4	<b>Z 344</b>	14 F-7 HTUR	1,0	○
1.9 D	1.9	47	12.07-	ASY	4	<b>GN 046</b> (12V)	○		

**GOLF I**

1.8	1.8	64	05.84-09.94	RM	4	<b>Z 22</b>	14-6 DU	0,7	<b>UX 56</b>
1.8	1.8	73	06.02-05.08	UDH	4	<b>Z 91</b>	14 GH-7 DTUR	0,8	<b>UXT 2<sup>4</sup></b>

**GOLF I Cabriolet(155)**

1.6	1.6	53	04.86-02.90	RE	4	<b>Z 93</b>	14 GH-8 DTURX	1,0	<b>UXT 2<sup>4</sup></b>
1.6	1.6	55	08.83-04.92	EW/HN	4	<b>Z 2</b>	14-8 DTU	1,0	<b>UXT 2<sup>4</sup></b>
1.8	1.8	66	09.84-09.92	EX	4	<b>Z 12</b>	14-7 DTU	0,8	<b>UXT 2<sup>4</sup></b>

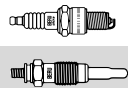
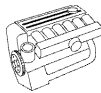

## VW AG

### GOLF I Cabriolet(155)

1.8	1.8	70	08.83-04.93	JH	4	<b>Z 91</b>	14 GH-7 DTUR	0,8	<b>UXT 2<sup>4</sup></b>
1.8	1.8	72	08.89-03.93	2H	4	<b>Z 12</b>	14-7 DTU	0,8	<b>UXT 2<sup>4</sup></b>
1.8	1.8	82	08.83-12.92	DX	4	<b>Z 12</b>	14-7 DTU	0,8	<b>UXT 2<sup>4</sup></b>

### GOLF II (19E, 1G1)

1.0	1.0	37	08.85-10.91	HZ	4	<b>Z 61</b>	14-7 DUO	0,7	<b>UXT 2<sup>4</sup></b>
1.3 KAT	1.3	40	06.86-12.92	2G/MH/NZ	4	<b>Z 61</b>	14-7 DUO	0,7	<b>UXT 2<sup>4</sup></b>
1.6 D	1.6	37	08.83-10.91		4	<b>GN 857</b> (11V)	○		
1.6 D	1.6	40	08.83-10.91	ME/JP	4	<b>GN 857</b> (11V)	<b>GR 001/031</b>	<b>SR 028</b>	
1.6 TD	1.6	44	08.89-10.91	1V	4	<b>GN 857</b> (11V)	<b>GR 031</b>	<b>SR 028</b>	
1.6 TD	1.6	51	08.83-10.91	JR/MF	4	<b>GN 857</b> (11V)	<b>GR 001/031</b>	<b>SR 028</b>	
1.6	1.6	51	10.86-12.92	PN	4	<b>Z 93</b>	14 GH-8 DTURX	1,0	<b>UXT 2<sup>4</sup></b>
1.6	1.6	51	08.86-07.91	EZA	4	<b>Z 93</b>	14 GH-8 DTURX	1,0	<b>UXT 2<sup>4</sup></b>
1.6	1.6	53	02.86-10.91	RF	4	<b>Z 93</b>	14 GH-8 DTURX	1,0	<b>UXT 2<sup>4</sup></b>
1.6	1.6	55	08.83-07.92	HM	4	<b>Z 2</b>	14-8 DTU	1,0	<b>UXT 2<sup>4</sup></b>
1.6	1.6	55	08.83-07.92	EZ	4	<b>Z 69</b>	14-8 DUO	0,7	<b>UXT 2<sup>4</sup></b>
1.6 TD	1.6	59	04.89-10.91	RA/SB	4	<b>GN 857</b> (11V)	<b>GR 001/031</b>	<b>SR 028</b>	
1.8	1.8	62	08.86-01.90	RH	4	<b>Z 61</b>	14-7 DUO	0,7	<b>UXT 2<sup>4</sup></b>
1.8	1.8	66	08.84-10.91	GX	4	<b>Z 91</b>	14 GH-7 DTUR	0,8	<b>UXT 2<sup>4</sup></b>
1.8 Syncro	1.8	66	02.86-07.91	GX	4	<b>Z 91</b>	14 GH-7 DTUR	0,8	<b>UXT 2<sup>4</sup></b>
1.8	1.8	66	08.84-10.91	GU/HV	4	<b>Z 12</b>	14-7 DTU	0,8	<b>UXT 2<sup>4</sup></b>
1.8 Syncro	1.8	66	02.86-07.91	GU	4	<b>Z 12</b>	14-7 DTU	0,8	<b>UXT 2<sup>4</sup></b>
1.8 i KAT	1.8	66	08.87-10.91	GX/RP	4	<b>Z 91</b>	14 GH-7 DTUR	0,8	<b>UXT 2<sup>4</sup></b>
1.8 i Syncro KAT	1.8	66	08.87-10.91	RP	4	<b>Z 91</b>	14 GH-7 DTUR	0,8	<b>UXT 2<sup>4</sup></b>
1.8 Syncro	1.8	72	08.88-07.91	1P	4	<b>Z 61</b>	14-7 DUO	0,7	<b>UXT 2<sup>4</sup></b>
1.8 GTI KAT	1.8	79	01.87-10.91	PF	4	<b>Z 61</b>	14-7 DUO	0,7	<b>UXT 2<sup>4</sup></b>
1.8 GTI	1.8	82	08.83-10.91	DX/EV/GZ	4	<b>Z 12</b>	14-7 DTU	0,8	<b>UXT 2<sup>4</sup></b>
1.8 GTI	1.8	82	08.83-10.91	PB	4	<b>Z 61</b>	14-7 DUO	0,7	<b>UXT 2<sup>4</sup></b>
1.8 GTI 16V	1.8	95	02.86-10.91	PL	4	<b>Z 89</b>	14 FGH-6 DTUR	0,8	<b>UXT 5</b>
1.8 GTI 16V	1.8	102	02.86-06.90	KR	4	<b>Z 52</b>	14 F-6 DTU	0,8	<b>UXT 5</b>
1.8 GTI G60	1.8	118	04.90-07.91	PG	4	<b>Z 104</b>	14-6 DPO	0,6	○
1.8 GTI G60 Syncro	1.8	118	08.88-07.91	PG/1H	4	<b>Z 104</b>	14-6 DPO	0,6	○

### GOLF III (1H1)

1.4	1.4	40	11.91-08.97	ABD	4	<b>Z 2</b>	14-8 DTU	1,0	<b>UXT 2<sup>4</sup></b>
1.4	1.4	44	10.91-08.97	AEX	4	<b>Z 91</b>	14 GH-7 DTUR	0,8	<b>UXT 2<sup>4</sup></b>
1.6	1.6	55	09.92-08.97	AEA/ABU/AEE	4	<b>Z 91</b>	14 GH-7 DTUR	0,8	<b>UXT 2<sup>4</sup></b>
1.6	1.6	74	07.95-08.97	AEK, AKS	4	<b>Z 246</b>	14 FGH-8 DTURW	0,9	<b>UXT 1<sup>3</sup></b>
1.6	1.6	74	07.95-08.97	AFT	4	<b>Z 90</b>	14 FGH-7 DTURX	1,0	<b>UXT 1<sup>3</sup></b>
1.8	1.8	55	11.91-08.97	AEK, AKS	4	<b>Z 92</b>	14 GH-8 DTUR	0,8	<b>UXT 2<sup>4</sup></b>
1.8	1.8	66	11.91-08.97	ABS/ACC/ADZ	4	<b>Z 91</b>	14 GH-7 DTUR	0,8	<b>UXT 2<sup>4</sup></b>
1.9 SDI	1.9	47	07.95-08.97	AEY	4	<b>GN 855</b> (12V)	○		
1.9 D	1.9	48	11.91-08.97	1Y	4	<b>GN 857</b> (11V)	○		
1.9 TD, GTD	1.9	55	11.91-08.97	AAZ	4	<b>GN 857</b> (11V)	○		
1.9 TDI	1.9	66	09.93-08.97	ALE/1Z/AHU	4	<b>GN 855</b> (12V)	○		
				Kühlwasservorwärmung <sup>15</sup>		<b>GN 857</b> (11V)=3x			
						<b>GN 928</b> (12V)=3x			
1.9 TDI Syncro	1.9	66	08.95-08.97	ALE/1Z/AHU	4	<b>GN 855</b> (12V)	○		
				Kühlwasservorwärmung <sup>15</sup>		<b>GN 857</b> (11V)=3x			
						<b>GN 928</b> (12V)=3x			
1.9 TDI	1.9	81	04.96-08.97	AFN	4	<b>GN 855</b> (12V)	○		
				Kühlwasservorwärmung <sup>15</sup>		<b>GN 857</b> (11V)=3x			
						<b>GN 928</b> (12V)=3x			
2.0 GL	2.0	79	08.95-09.97	AEK, AKS	4	<b>Z 91</b>	14 GH-7 DTUR	0,8	<b>UXT 2<sup>4</sup></b>
2.0	2.0	85	11.91-08.97	2E/2G/ADY/AGG	4	<b>Z 91</b>	14 GH-7 DTUR	0,8	<b>UXT 2<sup>4</sup></b>
2.0 Syncro	2.0	85	08.95-08.97	AEK, AKS	4	<b>Z 91</b>	14 GH-7 DTUR	0,8	<b>UXT 2<sup>4</sup></b>
2.0 GTI 16V	2.0	110	08.92-08.97	AEK, AKS	4	<b>Z 317</b>	14 F-5 DPUR2T	0,8	○
2.8 VR6	2.8	120	08.95-09.97	AEK, AKS	6	<b>Z 173</b>	14 FGR-8 KQU	1,6	○
2.8 VR6	2.8	128	01.92-08.97	AEK, AKS	6	<b>Z 173</b>	14 FGR-8 KQU	1,6	○
2.9 VR6 Syncro	2.9	140	10.94-08.97	AEK, AKS	6	<b>Z 173</b>	14 FGR-8 KQU	1,6	○

### GOLF III Cabriolet (1E7)

1.6	1.6	74	10.94-05.98	AEK, AKS	4	<b>Z 246</b>	14 FGH-8 DTURW	0,9	<b>UXT 1<sup>3</sup></b>
1.6	1.6	74	10.94-05.98	AFT	4	<b>Z 90</b>	14 FGH-7 DTURX	1,0	<b>UXT 1<sup>3</sup></b>



kW

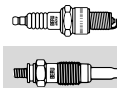

**VW AG**

**GOLF III Cabriolet (1E7)**

1.8	1.8	55	07.93-05.98	AEK, AKS	4	<b>Z 92</b>	14 GH-8 DTUR	0,8	<b>UXT 2<sup>4</sup></b>
1.8	1.8	66	07.93-05.98	ABS/ADZ	4	<b>Z 91</b>	14 GH-7 DTUR	0,8	<b>UXT 2<sup>4</sup></b>
1.9 TDI	1.9	66	08.95-05.98	ALE/1Z/AHU	4	<b>GN 855</b> (12V)	○		
				Kühlwasservorwärmung <sup>15</sup>		<b>GN 857</b> (11V)=3x			
						<b>GN 928</b> (12V)=3x			
1.9 TDI	1.9	81	07.96-05.98	AFN	4	<b>GN 855</b> (12V)	○		
				Kühlwasservorwärmung <sup>15</sup>		<b>GN 857</b> (11V)=3x			
						<b>GN 928</b> (12V)=3x			
2.0	2.0	85	07.93-05.98	2E/ADY/AGG/AKR	4	<b>Z 91</b>	14 GH-7 DTUR	0,8	<b>UXT 2<sup>4</sup></b>

**GOLF III Variant (1H5)**

1.4	1.4	40	07.93-06.95	AEK, AKS	4	<b>Z 2</b>	14-8 DTU	1,0	<b>UXT 2<sup>4</sup></b>
1.4	1.4	40	07.95-04.99	AEK, AKS	4	<b>Z 91</b>	14 GH-7 DTUR	0,8	<b>UXT 2<sup>4</sup></b>
1.4	1.4	44	07.93-04.99	ABD	4	<b>Z 2</b>	14-8 DTU	1,0	<b>UXT 2<sup>4</sup></b>
1.4	1.4	44	07.93-04.99	AEX/APQ	4	<b>Z 91</b>	14 GH-7 DTUR	0,8	<b>UXT 2<sup>4</sup></b>
1.6	1.6	55	07.93-12.97	AEA/AEE/ABU	4	<b>Z 91</b>	14 GH-7 DTUR	0,8	<b>UXT 2<sup>4</sup></b>
1.6	1.6	74	07.94-04.99	AEK, AKS	4	<b>Z 246</b>	14 FGH-8 DTURW	0,9	<b>UXT 1<sup>3</sup></b>
1.6	1.6	74	07.94-04.99	AFT	4	<b>Z 90</b>	14 FGH-7 DTURX	1,0	<b>UXT 1<sup>3</sup></b>
1.8	1.8	55	07.93-04.99	ANN/AAM	4	<b>Z 92</b>	14 GH-8 DTUR	0,8	<b>UXT 2<sup>4</sup></b>
1.8	1.8	66	07.93-04.99	ABS/ADZ/ANP	4	<b>Z 91</b>	14 GH-7 DTUR	0,8	<b>UXT 2<sup>4</sup></b>
1.8 Syncro	1.8	66	10.94-04.99	ADZ	4	<b>Z 91</b>	14 GH-7 DTUR	0,8	<b>UXT 2<sup>4</sup></b>
1.9 SDI	1.9	47	07.95-04.99	AEY	4	<b>GN 855</b> (12V)	○		
				Kühlwasservorwärmung <sup>15</sup>		<b>GN 857</b> (11V)=3x			
						<b>GN 928</b> (12V)=3x			
1.9 D	1.9	48	07.93-04.99	1Y	4	<b>GN 857</b> (11V)	○		
1.9 TD	1.9	55	07.93-04.99	AAZ	4	<b>GN 857</b> (11V)	○		
1.9 TDI	1.9	66	03.94-04.99	ALE/1Z/AHU	4	<b>GN 855</b> (12V)	○		
				Kühlwasservorwärmung <sup>15</sup>		<b>GN 857</b> (11V)=3x			
						<b>GN 928</b> (12V)=3x			
1.9 TDI Syncro	1.9	66	07.95-04.99	ALE/1Z/AHU	4	<b>GN 855</b> (12V)	○		
				Kühlwasservorwärmung <sup>15</sup>		<b>GN 857</b> (11V)=3x			
						<b>GN 928</b> (12V)=3x			
1.9 TDI	1.9	81	04.96-04.99	AFN	4	<b>GN 855</b> (12V)	○		
				Kühlwasservorwärmung <sup>15</sup>		<b>GN 857</b> (11V)=3x			
						<b>GN 928</b> (12V)=3x			
2.0	2.0	79	08.95-04.96	AEP	4	<b>Z 91</b>	14 GH-7 DTUR	0,8	<b>UXT 2<sup>4</sup></b>
2.0	2.0	85	07.93-04.99	2E/ADY/AGG/AKR	4	<b>Z 91</b>	14 GH-7 DTUR	0,8	<b>UXT 2<sup>4</sup></b>
2.0 Syncro	2.0	85	08.95-04.99	AGG	4	<b>Z 91</b>	14 GH-7 DTUR	0,8	<b>UXT 2<sup>4</sup></b>
2.9 VR6	2.9	140	10.94-04.99	ABV	6	<b>Z 173</b>	14 FGR-8 KQU	1,6	○
2.9 VR6 Syncro	2.9	140	10.94-04.99	ABV	6	<b>Z 173</b>	14 FGR-8 KQU	1,6	○

**GOLF IV (1J1)**

1.4 16V	1.4	55	08.97-06.05	AHW/AKQ/APE/AXP/BCA	4	<b>Z 90</b>	14 FGH-7 DTURX	1,0	<b>UXT 1<sup>3</sup></b>
1.6	1.6	74	08.97-02.00	AEH/AKL/APF	4	<b>Z 90</b>	14 FGH-7 DTURX	1,0	<b>UXT 1<sup>3</sup></b>
1.6	1.6	74	02.01-06.01	BAH	4	<b>Z 344</b>	14 F-7 HTUR	1,0	○
1.6	1.6	75	08.00-06.05	AVU/BFQ	4	<b>Z 90</b>	14 FGH-7 DTURX	1,0	<b>UXT 1<sup>3</sup></b>
1.6 16V	1.6	77	02.00-06.05	ATN, AUS	4	<b>Z 90</b>	14 FGH-7 DTURX	1,0	<b>UXT 1<sup>3</sup></b>
1.6 16V	1.6	77	02.00-06.05	AZD, BCB	4	<b>Z 176</b>	14 F-7 HPURX2	1,0	○
1.6 FSI	1.6	81	01.02-06.05	BAD	4	<b>Z 300</b>	14 FGR-6 HQU	1,35	○
1.8	1.8	66	10.97-09.99	ACC	4	<b>Z 91</b>	14 GH-7 DTUR	0,8	<b>UXT 2<sup>4</sup></b>
1.8	1.8	92	08.97-06.05	AGN	4	<b>Z 90</b>	14 FGH-7 DTURX	1,0	<b>UXT 1<sup>3</sup></b>
1.8 4motion	1.8	92	05.98-06.05	AGN	4	<b>Z 90</b>	14 FGH-7 DTURX	1,0	<b>UXT 1<sup>3</sup></b>
1.8 T	1.8	110	08.97-06.05	AGU, ARZ, AUM, AWD	4	<b>Z 188</b>	14 F-7 DPUR02	0,7	<b>UXT 10</b>
1.8 T GTI	1.8	132	08.01-06.05	AUQ	4	<b>Z 188</b>	14 F-7 DPUR02	0,7	<b>UXT 10</b>
1.9 SDI	1.9	50	08.97-06.05	AGP/AQM	4	<b>GN 855</b> (12V)	○		
1.9 TD	1.9	55	10.97-09.99	AAZ	4	<b>GN 857</b> (11V)	○		
1.9 TDI	1.9	66	10.97-05.04	AGR/ALH	4	<b>GN 855</b> (12V)	○		
				Kühlwasservorwärmung <sup>15</sup>		<b>GN 857</b> (11V)=3x			
						<b>GN 928</b> (12V)=3x			
1.9 TDI 4motion	1.9	66	07.98-04.02	AGR/ALH	4	<b>GN 855</b> (12V)	○		
				Kühlwasservorwärmung <sup>15</sup>		<b>GN 857</b> (11V)=3x			
						<b>GN 928</b> (12V)=3x			



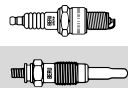
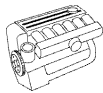

## VW AG

### GOLF IV (1J1)

1.9 TDI	1.9	74	09.00-10.01	AXR/ATD	4	<b>GN 855</b> (12V)	○		
				Kühlwasservorwärmung <sup>15</sup>		<b>GN 857</b> (11V)=3x			
						<b>GN 928</b> (12V)=3x			
1.9 TDI	1.9	74	11.01-06.05	AXR/ATD	4	<b>GN 046</b> (12V)	○		
1.9 TDI 4motion	1.9	74	09.00-10.01	ATD	4	<b>GN 855</b> (12V)	○		
				Kühlwasservorwärmung <sup>15</sup>		<b>GN 857</b> (11V)=3x			
						<b>GN 928</b> (12V)=3x			
1.9 TDI 4motion	1.9	74	11.01-06.05	ATD	4	<b>GN 046</b> (12V)	○		
1.9 TDI	1.9	81	08.97-05.04	AHF/ASV	4	<b>GN 855</b> (12V)	○		
				Kühlwasservorwärmung <sup>15</sup>		<b>GN 857</b> (11V)=3x			
						<b>GN 928</b> (12V)=3x			
1.9 TDI	1.9	85	12.98-06.01	AJM	4	<b>GN 855</b> (12V)	○		
				Kühlwasservorwärmung <sup>15</sup>		<b>GN 857</b> (11V)=3x			
						<b>GN 928</b> (12V)=3x			
1.9 TDI	1.9	85	12.98-06.01	AUY	4	<b>GN 046</b> (12V)	○		
1.9 TDI 4motion	1.9	85	09.99-06.01	AJM	4	<b>GN 855</b> (12V)	○		
				Kühlwasservorwärmung <sup>15</sup>		<b>GN 857</b> (11V)=3x			
						<b>GN 928</b> (12V)=3x			
1.9 TDI 4motion	1.9	85	09.99-06.01	AUY	4	<b>GN 046</b> (12V)	○		
1.9 TDI	1.9	96	11.00-06.05	ASZ → Fgst.Nr. F1J-2-600 000	4	<b>GN 855</b> (12V)	○		
				Kühlwasservorwärmung <sup>15</sup>		<b>GN 857</b> (11V)=3x			
						<b>GN 928</b> (12V)=3x			
1.9 TDI	1.9	96	11.00-06.05	ASZ Fgs.Nr. F1J-2-600 001 →	4	<b>GN 046</b> (12V)	○		
1.9 TDI 4motion	1.9	96	11.00-06.05	ASZ → Fgst.Nr. F1J-2-600 000	4	<b>GN 855</b> (12V)	○		
				Kühlwasservorwärmung <sup>15</sup>		<b>GN 857</b> (11V)=3x			
						<b>GN 928</b> (12V)=3x			
1.9 TDI 4motion	1.9	96	11.00-06.05	ASZ Fgs.Nr. F1J-2-600 001 →	4	<b>GN 046</b> (12V)	○		
1.9 TDI	1.9	110	05.00-10.01	ARL	4	<b>GN 855</b> (12V)	○		
				Kühlwasservorwärmung <sup>15</sup>		<b>GN 857</b> (11V)=3x			
						<b>GN 928</b> (12V)=3x			
1.9 TDI	1.9	110	11.01-06.05	ARL	4	<b>GN 046</b> (12V)	○		
1.9 TDI 4motion	1.9	110	02.00-10.01	ARL	4	<b>GN 855</b> (12V)	○		
				Kühlwasservorwärmung <sup>15</sup>		<b>GN 857</b> (11V)=3x			
						<b>GN 928</b> (12V)=3x			
1.9 TDI 4motion	1.9	110	11.01-06.05	ARL	4	<b>GN 046</b> (12V)	○		
2.0	2.0	85	07.98-05.04	APK, AQY	4	<b>Z 90</b>	14 FGH-7 DTURX	1,0	<b>UXT 1<sup>3</sup></b>
2.0	2.0	85	07.98-05.04	AZG, AZJ	4	<b>Z 176</b>	14 F-7 HPURX2	1,0	○
2.0 4motion	2.0	85	10.00-06.05	AZJ	4	<b>Z 176</b>	14 F-7 HPURX2	1,0	○
2.0 4motion	2.0	85	10.00-06.05	AZH	4	<b>Z 90</b>	14 FGH-7 DTURX	1,0	<b>UXT 1<sup>3</sup></b>
2.3 V5	2.3	110	08.97-10.00	AGZ	5	<b>Z 173</b>	14 FGR-8 KQU	1,6	○
2.3 V5 4motion	2.3	110	12.98-10.00	AGZ	5	<b>Z 173</b>	14 FGR-8 KQU	1,6	○
2.3 V5	2.3	125	10.00-06.05	AQN	5	<b>Z 176</b>	14 F-7 HPURX2	1,0	○
2.3 V5 4motion	2.3	125	10.00-06.05	AQN	5	<b>Z 176</b>	14 F-7 HPURX2	1,0	○
2.8	2.8	128	08.97-09.99	AAA	6	<b>Z 173</b>	14 FGR-8 KQU	1,6	○
2.8 VR6	2.8	147	03.02-10.05	BDF	6	<b>Z 176</b>	14 F-7 HPURX2	1,0	○
2.8 V6 4motion	2.8	150	03.99-06.05	AQP/AUE/BDE	6	<b>Z 176</b>	14 F-7 HPURX2	1,0	○
<b>GOLF IV Cabriolet (1E7)</b>									
1.6	1.6	74	06.98-06.02	AKS	4	<b>Z 246</b>	14 FGH-8 DTURW	0,9	<b>UXT 1<sup>3</sup></b>
1.6	1.6	74	06.98-06.02	AFT	4	<b>Z 90</b>	14 FGH-7 DTURX	1,0	<b>UXT 1<sup>3</sup></b>
1.8	1.8	55	06.98-06.02	AAM/ANN	4	<b>Z 92</b>	14 GH-8 DTUR	0,8	<b>UXT 2<sup>4</sup></b>
1.8	1.8	66	06.98-06.02	ADZ/ANP	4	<b>Z 91</b>	14 GH-7 DTUR	0,8	<b>UXT 2<sup>4</sup></b>
1.9 TDI	1.9	66	06.98-06.02	ALE/AHU	4	<b>GN 855</b> (12V)	○		
				Kühlwasservorwärmung <sup>15</sup>		<b>GN 857</b> (11V)=3x			
						<b>GN 928</b> (12V)=3x			



kW

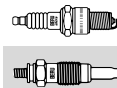
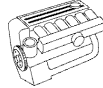

**VW AG**

**GOLF IV Cabriolet (1E7)**

1.9 TDI	1.9	81	06.98-06.02	AVG/AFN	4	<b>GN 855</b> (12V) ○		
				Kühlwasservorwärmung <sup>15</sup>		<b>GN 857</b> (11V)=3x		
						<b>GN 928</b> (12V)=3x		
2.0	2.0	85	06.98-06.02	AGG/AKR	4	<b>Z 91</b>	14 GH-7 DTUR	0,8
2.0	2.0	85	06.98-06.02	ATU/AWF/AWG	4	<b>Z 188</b>	14 F-7 DPUR02	0,7

**GOLF IV Variant (1J5)**

1.4 16V	1.4	55	05.99-06.06	AHW/AKO/APE/AXP/BCA	4	<b>Z 90</b>	14 FGH-7 DTURX	1,0	<b>UXT 1<sup>3</sup></b>
1.6	1.6	74	05.99-02.00	AEH/AKL/APF	4	<b>Z 90</b>	14 FGH-7 DTURX	1,0	<b>UXT 1<sup>3</sup></b>
1.6	1.6	75	08.00-06.06	AVU/BFQ	4	<b>Z 90</b>	14 FGH-7 DTURX	1,0	<b>UXT 1<sup>3</sup></b>
1.6 16V	1.6	77	02.00-06.06	ATN. AUS	4	<b>Z 90</b>	14 FGH-7 DTURX	1,0	<b>UXT 1<sup>3</sup></b>
1.6 16V	1.6	77	02.00-06.06	AZD, BCB	4	<b>Z 176</b>	14 F-7 HPURX2	1,0	○
1.6 FSI	1.6	81	01.02-06.06	BAD	4	<b>Z 300</b>	14 FGR-6 HQU	1,35	○
1.6 FSI	1.6	85	10.03-07.04	BAG	4	<b>Z 300</b>	14 FGR-6 HQU	1,35	○
1.8 4motion	1.8	92	05.99-06.06	AGN	4	<b>Z 90</b>	14 FGH-7 DTURX	1,0	<b>UXT 1<sup>3</sup></b>
1.8 T	1.8	110	05.00-06.06	AGU, ARZ, AUM, AWD	4	<b>Z 188</b>	14 F-7 DPUR02	0,7	<b>UXT 10</b>
1.9 SDI	1.9	50	05.99-06.06	AGP/AQM	4	<b>GN 855</b> (12V) ○			
1.9 TDI	1.9	66	05.99-05.06	AGR/ALH	4	<b>GN 855</b> (12V) ○			
				Kühlwasservorwärmung <sup>15</sup>		<b>GN 857</b> (11V)=3x			
						<b>GN 928</b> (12V)=3x			
1.9 TDI 4motion	1.9	66	05.99-04.02	AGR/ALH	4	<b>GN 855</b> (12V) ○			
				Kühlwasservorwärmung <sup>15</sup>		<b>GN 857</b> (11V)=3x			
						<b>GN 928</b> (12V)=3x			
1.9 TDI	1.9	74	09.00-06.06	ATD	4	<b>GN 855</b> (12V) ○			
				Kühlwasservorwärmung <sup>15</sup>		<b>GN 857</b> (11V)=3x			
						<b>GN 928</b> (12V)=3x			
1.9 TDI	1.9	74	09.00-06.06	AXR	4	<b>GN 046</b> (12V) ○			
1.9 TDI 4motion	1.9	74	09.00-10.01	ATD	4	<b>GN 855</b> (12V) ○			
				Kühlwasservorwärmung <sup>15</sup>		<b>GN 857</b> (11V)=3x			
						<b>GN 928</b> (12V)=3x			
1.9 TDI 4motion	1.9	74	11.01-06.06	ATD	4	<b>GN 046</b> (12V) ○			
1.9 TDI	1.9	81	05.99-06.01	AHF/ASV	4	<b>GN 855</b> (12V) ○			
				Kühlwasservorwärmung <sup>15</sup>		<b>GN 857</b> (11V)=3x			
						<b>GN 928</b> (12V)=3x			
1.9 TDI	1.9	85	08.99-06.01	AJM	4	<b>GN 855</b> (12V) ○			
				Kühlwasservorwärmung <sup>15</sup>		<b>GN 857</b> (11V)=3x			
						<b>GN 928</b> (12V)=3x			
1.9 TDI	1.9	85	08.99-06.01	AUY	4	<b>GN 046</b> (12V) ○			
1.9 TDI 4motion	1.9	85	05.99-06.01	AJM	4	<b>GN 855</b> (12V) ○			
				Kühlwasservorwärmung <sup>15</sup>		<b>GN 857</b> (11V)=3x			
						<b>GN 928</b> (12V)=3x			
1.9 TDI	1.9	96	11.00-06.06		4	<b>GN 855</b> (12V) ○			
				Kühlwasservorwärmung <sup>15</sup>		<b>GN 857</b> (11V)=3x			
						<b>GN 928</b> (12V)=3x			
1.9 TDI	1.9	96	11.00-06.06	ASZ Fgs.Nr. F1J-2-600 001 →	4	<b>GN 046</b> (12V) ○			
1.9 TDI 4motion	1.9	96	11.00-06.06	ASZ → Fgst.Nr. F1J-2-600 000	4	<b>GN 855</b> (12V) ○			
				Kühlwasservorwärmung <sup>15</sup>		<b>GN 857</b> (11V)=3x			
						<b>GN 928</b> (12V)=3x			
1.9 TDI 4motion	1.9	96	11.00-06.06	ASZ Fgs.Nr. F1J-2-600 001 →	4	<b>GN 046</b> (12V) ○			
1.9 TDi GTi	1.9	110	06.01-10.01	ARL	4	<b>GN 855</b> (12V) ○			
				Kühlwasservorwärmung <sup>15</sup>		<b>GN 857</b> (11V)			
						<b>GN 928</b> (12V)			
1.9 TDi GTi	1.9	110	11.01-06.06	ARL	4	<b>GN 046</b> (12V) ○			
2.0	2.0	85	05.99-06.06	APK, AQY	4	<b>Z 90</b>	14 FGH-7 DTURX	1,0	<b>UXT 1<sup>3</sup></b>
2.0	2.0	85	05.99-06.06	AZJ	4	<b>Z 176</b>	14 F-7 HPURX2	1,0	○
2.0 4motion	2.0	85	10.00-06.06	AZJ	4	<b>Z 176</b>	14 F-7 HPURX2	1,0	○
2.0 4motion	2.0	85	10.00-06.06	AZH	4	<b>Z 90</b>	14 FGH-7 DTURX	1,0	<b>UXT 1<sup>3</sup></b>
2.0 Bi-Fuel	2.0	85	02.02-06.06	BEH	4	<b>Z 176</b>	14 F-7 HPURX2	1,0	○

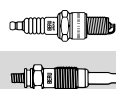

## VW AG

### GOLF IV Variant (1J5)

2.3 V5	2.3	110	05.99-06.06	AGZ	5	<b>Z 173</b>	14 FGR-8 KQU	1,6	○
2.3 V5 4motion	2.3	110	05.99-06.06	AGZ	5	<b>Z 173</b>	14 FGR-8 KQU	1,6	○
2.3 V5	2.3	125	10.00-06.06	AQN	5	<b>Z 176</b>	14 F-7 HPURX2	1,0	○
2.3 V5 4motion	2.3	125	10.00-06.06	AQN	5	<b>Z 176</b>	14 F-7 HPURX2	1,0	○
2.8 V6 4motion	2.8	150	05.99-06.06	AQP/AUE/BDE	6	<b>Z 176</b>	14 F-7 HPURX2	1,0	○

### GOLF V (1K1)

1.4 16V	1.4	55	10.03-05.06	BCA	4	<b>Z 90</b>	14 FGH-7 DTURX	1,0	<b>UXT 13</b>
1.4 16V	1.4	59	05.06-11.08	BUD	4	<b>Z 272</b>	14 F-7 HURU02	1,0	○
1.4 FSI	1.4	66	10.03-07.06	BKG/BLN	4	<b>Z 300</b>	14 FGR-6 HQU	1,35	○
1.4 TSI	1.4	90	05.07-11.08	CAXA	4	<b>Z 349</b>	14 F-6 LPURW03	0,9	○
1.4 TSI	1.4	103	05.06-11.08	BMY	4	<b>Z 349</b>	14 F-6 LPURW03	0,9	○
1.4 TSI	1.4	125	11.05-11.08	BLG	4	<b>Z 349</b>	14 F-6 LPURW03	0,9	○
1.6	1.6	75	01.04-11.08	BGU/BSF/BSE	4	<b>Z 90</b>	14 FGH-7 DTURX	1,0	<b>UXT 13</b>
1.6 MultiFuel	1.6	75	10.07-11.08	CCSA	4	<b>Z 90</b>	14 FGH-7 DTURX	1,0	<b>UXT 13</b>
1.6 FSI	1.6	85	10.03-07.08	BLF/BLP/BAG	4	<b>Z 300</b>	14 FGR-6 HQU	1,35	○
1.9 SDI	1.9	47	12.05-11.08	BGG	4	<b>GN 857</b> (11V)	○		
1.9 TDI	1.9	66	05.04-11.08	BXF/BXJ/BRU Fgst.Nr. 70251→	4	<b>GE 100</b> (5V)	<b>GSE 100</b>		
1.9 TDI	1.9	77	10.03-11.08	BXE/BKC/BLS Fgst.Nr. 70251→	4	<b>GE 100</b> (5V)	<b>GSE 100</b>		
1.9 TDI 4motion	1.9	77	08.04-11.08	BXE/BKC/BLS Fgst.Nr. 70251→	4	<b>GE 100</b> (5V)	<b>GSE 100</b>		
2.0 SDI	2.0	55	01.04-11.08	BDK	4	<b>GE 100</b> (5V)	<b>GSE 100</b>		
2.0 TDI	2.0	100	10.03-11.08	AZV	4	<b>GE 101</b> (4,4V)	<b>GSE 100</b>		
2.0 TDI	2.0	100	10.03-11.08	CBDA	4	<b>GE 115</b> (4,4V)	○		
2.0 TDI	2.0	103	12.04-11.08	BMM	4	<b>GE 100</b> (5V)	<b>GSE 100</b>		
2.0 TDI 4motion	2.0	103	08.04-11.08	BMM	4	<b>GE 100</b> (5V)	<b>GSE 100</b>		
2.0 TDI 16V	2.0	103	10.03-11.08	BKD	4	<b>GE 101</b> (4,4V) + VW Nr. 03G 103 483	<b>GSE 100</b>		
2.0 TDI 16V 4motion	2.0	103	08.04-11.08	BKD	4	<b>GE 101</b> (4,4V) + VW Nr. 03G 103 483	<b>GSE 100</b>		
2.0 FSI	2.0	110	01.04-11.08	AXW/BLR/BLX/BVX	4	<b>Z 236</b>	14 F-6 HTPRX02	1,0	○
2.0 FSI	2.0	110	01.04-11.08	BLY	4	<b>Z 228</b>	14 FR-7 DPUX02	1,0	<b>UXT 11</b>
2.0 FSI 4motion	2.0	110	08.04-11.08	BLX/BVX	4	<b>Z 236</b>	14 F-6 HTPRX02	1,0	○
2.0 GTI	2.0	147	10.04-02.09	AXX/BPY/BWA/CAWB/CBFA/ CCTA	4	<b>Z 347</b>	14 F-5 DPUR02	0,7	○
2.0 GTI	2.0	169	09.06-12.08	BYD	4	<b>Z 347</b>	14 F-5 DPUR02	0,7	○

### GOLF V Variant (1K5)

1.4	1.4	59	06.07-	BUD	4	<b>Z 272</b>	14 F-7 HURU02	1,0	○
1.4 TSI	1.4	90	06.07-	CAXA	4	<b>Z 349</b>	14 F-6 LPURW03	0,9	○
1.4 TSI	1.4	103	06.07-	BMY	4	<b>Z 349</b>	14 F-6 LPURW03	0,9	○
1.4 TSI	1.4	118	07.08-	CAVD	4	<b>Z 349</b>	14 F-6 LPURW03	0,9	○
1.4 TSI	1.4	125	06.07-	BLG	4	<b>Z 349</b>	14 F-6 LPURW03	0,9	○
1.6	1.6	75	06.07-	BSE/BSF/CCSA	4	<b>Z 90</b>	14 FGH-7 DTURX	1,0	<b>UXT 13</b>
1.6 MultiFuel	1.6	75	11.07-	CCSA	4	<b>Z 90</b>	14 FGH-7 DTURX	1,0	<b>UXT 13</b>
1.9 TDI	1.9	77	06.07-	BXE/BLS	4	<b>GE 100</b> (5V)	<b>GSE 100</b>		
1.9 TDI 4motion	1.9	77	01.08-	BLS	4	<b>GE 100</b> (5V)	<b>GSE 100</b>		
2.0 TDI	2.0	100	06.07-	AZV	4	<b>GE 101</b> (4,4V)	<b>GSE 100</b>		
2.0 TDI 4motion	2.0	100	06.07-	AZV	4	<b>GE 101</b> (4,4V)	<b>GSE 100</b>		
2.0 TDI	2.0	103	06.07-	BMM	4	<b>GE 100</b> (5V)	<b>GSE 100</b>		
2.0 TDI 16V	2.0	103	06.07-	BKD	4	<b>GE 101</b> (4,4V) + VW Nr. 03G 103 483	<b>GSE 100</b>		
2.0 TDI 16V	2.0	103	06.07-	CBDB	4	<b>GE 115</b> (4,4V)	○		
2.0	2.0	147	06.07-	BWA/CAWB/CCTA	4	<b>Z 347</b>	14 F-5 DPUR02	0,7	○

### GOLF VI (5K1)

1.4	1.4	59	10.08-	CGGA → Fgst.Nr. 1K-9-400 001	4	<b>Z 200</b>	14 F-7 HUR2	0,9	○
1.4	1.4	59	10.08-	CGGA Fgst.Nr. 1K-9-400 001→	4	<b>Z 272</b>	14 F-7 HURU02	1,0	○
1.4 TSI	1.4	90	10.08-	CAXA	4	<b>Z 349</b>	14 F-6 LPURW03	0,9	○
1.4 TSI	1.4	118	10.08-	CAVD	4	<b>Z 349</b>	14 F-6 LPURW03	0,9	○



kW

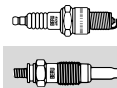
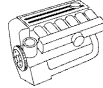

**VW AG**

**GOLF VI (5K1)**

1.6 TDI	1.6	66	02.09-	CAYB	4	<b>GE 115</b> (4,4V)	○		
1.6	1.6	75	10.08-	BSE/BSF/CCSA/CMXA	4	<b>Z 90</b>	14 FGH-7 DTURX	1,0	<b>UXT 1<sup>3</sup></b>
1.6 BiFuel	1.6	75	03.09-	CHGA	4	<b>Z 90</b>	14 FGH-7 DTURX	1,0	<b>UXT 1<sup>3</sup></b>
1.6 MultiFuel	1.6	75	10.08-	CCSA/CMXA	4	<b>Z 90</b>	14 FGH-7 DTURX	1,0	<b>UXT 1<sup>3</sup></b>
1.6 TDI	1.6	77	02.09-	CAYC	4	<b>GE 115</b> (4,4V)	○		
1.8 TSI	1.8	118	06.09-	CDAA	4	<b>Z 347</b>	14 F-5 DPUR02	0,7	○
2.0 TDI	2.0	81	10.08-	CBDC/CLCA	4	<b>GE 115</b> (4,4V)	○		
2.0 TDI	2.0	100	10.08-	CBAA, CFFA	4	<b>GE 115</b> (4,4V)	○		
2.0 TDI	2.0	103	10.08-	CBAB, CFFB	4	<b>GE 115</b> (4,4V)	○		
2.0 TDI	2.0	103	10.08-	CJAA	4	<b>PSG 002</b> (4,4V)	○		
2.0 TDI 4motion	2.0	103	05.09-	CFFB, CBAB	4	<b>GE 115</b> (4,4V)	○		
2.0 TDI	2.0	125	04.09-	CFGB, CBBB	4	<b>GE 115</b> (4,4V)	○		
2.0 GTi	2.0	147	06.09-	CBFA/CCCTA	4	<b>Z 347</b>	14 F-5 DPUR02	0,7	○
2.0 TSI	2.0	155	04.09-	CCZB	4	<b>Z 347</b>	14 F-5 DPUR02	0,7	○
2.0 TSI	2.0	173	05.11-	CDLG	4	<b>Z 347</b>	14 F-5 DPUR02	0,7	○
2.0 R 4motion	2.0	188	11.09-	CDLC	4	<b>Z 347</b>	14 F-5 DPUR02	0,7	○
2.0 R 4motion	2.0	195	11.09-	CDLA	4	<b>Z 347</b>	14 F-5 DPUR02	0,7	○
2.0 R 4motion	2.0	199	11.09-	CDLF	4	<b>Z 347</b>	14 F-5 DPUR02	0,7	○

**GOLF VI Cabriolet(517)**

1.4 TSI	1.4	90	11.11-	CAXA	4	<b>Z 349</b>	14 F-6 LPURW03	0,9	○
1.6 TDI	1.6	77	03.11-	CAYC	4	<b>GE 115</b> (4,4V)	○		
2.0 TDI	2.0	103	11.11-	CFHC	4	<b>GE 115</b> (4,4V)	○		
2.0 TSI	2.0	155	11.11-	CCZB	4	<b>Z 347</b>	14 F-5 DPUR02	0,7	○

**GOLF VI Variant (AJ5)**

1.4	1.4	59	07.09-	BUD	4	<b>Z 200</b>	14 F-7 HUR2	0,9	○
1.4	1.4	59	07.09-	CGGA Fgst.Nr. 1K-9-400 001→	4	<b>Z 272</b>	14 F-7 HURU02	1,0	○
1.4 TSI	1.4	90	07.09-	CAXA	4	<b>Z 349</b>	14 F-6 LPURW03	0,9	○
1.4 TSI	1.4	118	07.09-	CAVD	4	<b>Z 349</b>	14 F-6 LPURW03	0,9	○
1.6 TDI	1.6	66	12.09-	CAYB	4	<b>GE 115</b> (4,4V)	○		
1.6	1.6	75	07.09-	BSE/BSF/CCSA/CMXA	4	<b>Z 90</b>	14 FGH-7 DTURX	1,0	<b>UXT 1<sup>3</sup></b>
1.6 MultiFuel	1.6	75	07.09-	CMXA	4	<b>Z 90</b>	14 FGH-7 DTURX	1,0	<b>UXT 1<sup>3</sup></b>
1.6 TDI	1.6	77	07.09-	CAYC	4	<b>GE 115</b> (4,4V)	○		
1.6 TDI 4motion	1.6	77	07.09-	CAYC	4	<b>GE 115</b> (4,4V)	○		
2.0 TDI	2.0	100	07.09-	CBDA, CFHB	4	<b>GE 115</b> (4,4V)	○		
2.0 TDI	2.0	103	07.09-	BMM	4	<b>GE 100</b> (5V)	○		
2.0 TDI 16V	2.0	103	07.09-	CBDB, CFHC	4	<b>GE 115</b> (4,4V)	○		

**GOLF PLUS (5M1, 521)**

1.4 16V	1.4	55	01.05-	BCA	4	<b>Z 90</b>	14 FGH-7 DTURX	1,0	<b>UXT 1<sup>3</sup></b>
1.4 16V	1.4	59	05.06-	BUD	4	<b>Z 200</b>	14 F-7 HUR2	0,9	○
1.4 16V	1.4	59	05.06-	CGGA Fgst.Nr. 1K-9-400 001→	4	<b>Z 272</b>	14 F-7 HURU02	1,0	○
1.4 FSI	1.4	66	07.05-	BLN	4	<b>Z 300</b>	14 FGR-6 HQU	1,35	○
1.4 TSI	1.4	90	06.07-	CAXA	4	<b>Z 349</b>	14 F-6 LPURW03	0,9	○
1.4 TSI	1.4	103	05.06-06.08	BMY	4	<b>Z 349</b>	14 F-6 LPURW03	0,9	○
1.4 TSI	1.4	118	06.08-	CAVD	4	<b>Z 349</b>	14 F-6 LPURW03	0,9	○
1.4 TSI	1.4	125	05.06-06.08	BLG	4	<b>Z 349</b>	14 F-6 LPURW03	0,9	○
1.6 TDI	1.6	66	02.09-	CAYB	4	<b>GE 115</b> (4,4V)	○		
1.6	1.6	75	05.05-	BSE/BSF/CCSA/CMXA	4	<b>Z 90</b>	14 FGH-7 DTURX	1,0	<b>UXT 1<sup>3</sup></b>
1.6 BiFuel	1.6	75	05.09-	CHGA	4	<b>Z 90</b>	14 FGH-7 DTURX	1,0	<b>UXT 1<sup>3</sup></b>
1.6 MultiFuel	1.6	75	11.07-	CCSA/CMXA	4	<b>Z 90</b>	14 FGH-7 DTURX	1,0	<b>UXT 1<sup>3</sup></b>
1.6 TDI	1.6	77	03.09-	CAYC	4	<b>GE 115</b> (4,4V)	○		
1.6 FSI	1.6	85	01.05-05.08	BLF	4	<b>Z 300</b>	14 FGR-6 HQU	1,35	○
1.9 SDI	1.9	47	12.05-	BGG	4	<b>GN 857</b> (11V)	○		
1.9 TDI	1.9	66	05.05-12.08	BRU, BXF, BXJ	4	<b>GE 100</b> (5V)	<b>GSE 100</b>		
1.9 TDI	1.9	77	01.05-01.09	BLS, BKC, BXE	4	<b>GE 100</b> (5V)	<b>GSE 100</b>		
2.0 TDI	2.0	81	01.09-	CBDC, CLCA	4	<b>GE 115</b> (4,4V)	○		
2.0 TDI	2.0	96	05.05-05.07	BEE	4	<b>GE 101</b> (4,4V)	<b>GSE 100</b>		
2.0 TDI	2.0	100	05.05-	AVZ	4	<b>GE 101</b> (4,4V)	<b>GSE 100</b>		
2.0 TDI	2.0	100	05.05-	CFHB, CBDA	4	<b>GE 115</b> (4,4V)	○		
2.0 TDI	2.0	103	12.05-05.09	BMM	4	<b>GE 100</b> (5V)	<b>GSE 100</b>		

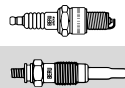
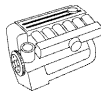

## VW AG

### GOLF PLUS (5M1, 521)

2.0 TDI 16V	2.0	103	01.05-	BKD	4	<b>GE 101</b> (4,4V) + VW Nr. 03G 103 483	<b>GSE 100</b>		
2.0 TDI 16V	2.0	103	01.05-	CFHC, CBDB	4	<b>GE 115</b> (4,4V)	○		
2.0 FSI	2.0	110	05.05-06.08	BLR/BVY	4	<b>Z 236</b>	14 F-6 HTPRX02	1,0	○
2.0 FSI	2.0	110	05.05-06.08	BLY/BVZ	4	<b>Z 228</b>	14 FR-7 DPUX02	1,0	<b>UXT 11</b>

### JETTA II (19E, 1G2)

1.3 KAT	1.3	40	06.87-12.91	2G/MH/NZ	4	<b>Z 61</b>	14-7 DUO	0,7	<b>UXT 2<sup>4</sup></b>
1.6 D	1.6	40	01.84-10.91	ME/JP	4	<b>GN 857</b> (11V)	<b>GR 001/031</b>		
1.6 TD	1.6	44	01.90-10.91	1V	4	<b>GN 857</b> (11V)	<b>GR 001/031</b>		
1.6 TD	1.6	51	01.84-10.91	JR/MF	4	<b>GN 857</b> (11V)	<b>GR 001/031</b>		
1.6	1.6	51	10.86-10.91	PN	4	<b>Z 93</b>	14 GH-8 DTURX	1,0	<b>UXT 2<sup>4</sup></b>
1.6	1.6	53	03.86-10.91	RF	4	<b>Z 93</b>	14 GH-8 DTURX	1,0	<b>UXT 2<sup>4</sup></b>
1.6	1.6	55	01.84-07.92	AB/VEZ	4	<b>Z 1</b>	14-8 DU	0,8	<b>UXT 2<sup>4</sup></b>
1.6	1.6	55	01.84-07.92	HM	4	<b>Z 2</b>	14-8 DTU	1,0	<b>UXT 2<sup>4</sup></b>
1.6 TD	1.6	59	04.89-10.91	RA/SB	4	<b>GN 857</b> (11V)	<b>GR 001/031</b>		
1.8	1.8	62	08.86-01.90	RH	4	<b>Z 61</b>	14-7 DUO	0,7	<b>UXT 2<sup>4</sup></b>
1.8	1.8	66	08.84-10.91	GX	4	<b>Z 91</b>	14 GH-7 DTUR	0,8	<b>UXT 2<sup>4</sup></b>
1.8 KAT	1.8	66	08.87-10.91	GX/RP	4	<b>Z 91</b>	14 GH-7 DTUR	0,8	<b>UXT 2<sup>4</sup></b>
1.8	1.8	66	08.84-10.91	GU/HV	4	<b>Z 12</b>	14-7 DTU	0,8	<b>UXT 2<sup>4</sup></b>
1.8 Syncro	1.8	72	08.88-07.91	1P	4	<b>Z 61</b>	14-7 DUO	0,7	<b>UXT 2<sup>4</sup></b>
1.8 KAT	1.8	79	01.87-10.91	PF	4	<b>Z 61</b>	14-7 DUO	0,7	<b>UXT 2<sup>4</sup></b>
1.8	1.8	82	01.84-10.91	EV/GZ	4	<b>Z 12</b>	14-7 DTU	0,8	<b>UXT 2<sup>4</sup></b>
1.8	1.8	82	01.84-10.91	PB	4	<b>Z 61</b>	14-7 DUO	0,7	<b>UXT 2<sup>4</sup></b>
1.8 16V	1.8	95	08.86-10.91	PL	4	<b>Z 89</b>	14 FGH-6 DTUR	0,8	<b>UXT 5</b>
2.0	2.0	100	08.89-07.92	9A	4	<b>Z 89</b>	14 FGH-6 DTUR	0,8	<b>UXT 5</b>

### JETTA III (1K2)

1.4 TSI	1.4	90	05.07-10.10	CAXA	4	<b>Z 349</b>	14 F-6 LPURW03	0,9	○
1.4 TSI	1.4	103	07.06-10.10	BMV	4	<b>Z 349</b>	14 F-6 LPURW03	0,9	○
1.4 TSI	1.4	118	07.08-10.10	CAVD	4	<b>Z 349</b>	14 F-6 LPURW03	0,9	○
1.4 TSI	1.4	125	07.06-10.10	BLG	4	<b>Z 349</b>	14 F-6 LPURW03	0,9	○
1.6 TDI	1.6	66	12.09-10.10	CAYB	4	<b>GE 115</b> (4,4V)	○		
1.6	1.6	75	10.05-10.10	BSE/BSF/CCSA	4	<b>Z 90</b>	14 FGH-7 DTURX	1,0	<b>UXT 1<sup>3</sup></b>
1.6 MultiFuel	1.6	75	01.08-10.10	CCSA	4	<b>Z 90</b>	14 FGH-7 DTURX	1,0	<b>UXT 1<sup>3</sup></b>
1.6 TDI	1.6	77	06.09-10.10	CAYC	4	<b>GE 115</b> (4,4V)	○		
1.6 FSI	1.6	85	09.05-10.10	BLF	4	<b>Z 300</b>	14 FGR-6 HQU	1,35	○
1.9 TDI	1.9	77	08.05-12.07	BKC, BLS, BXE	4	<b>GE 100</b> (5V)	<b>GSE 100</b>		
2.0 TDI	2.0	100	09.05-10.10	AZV	4	<b>GE 101</b> (4,4V)	<b>GSE 100</b>		
2.0 TDI	2.0	100	09.05-10.10	CBDA	4	<b>GE 115</b> (4,4V)	○		
2.0 TDI	2.0	103	10.05-10.10	BMM	4	<b>GE 100</b> (5V)	<b>GSE 100</b>		
2.0 TDI 16V	2.0	103	08.05-10.10	BKD	4	<b>GE 101</b> (4,4V)	○		
2.0 TDI 16V	2.0	103	08.05-10.10	CBDB	4	<b>GE 115</b> (4,4V)	○		
2.0 TDI 16V	2.0	103	08.05-10.10	CJAA	4	<b>PSG 002</b> (4,4V)	○		
2.0 FSI	2.0	110	08.05-10.10	BLR/BVY	4	<b>Z 236</b>	14 F-6 HTPRX02	1,0	○
2.0 FSI	2.0	110	08.05-10.10	BLY/BVZ	4	<b>Z 228</b>	14 FR-7 DPUX02	1,0	<b>UXT 11</b>
2.0 TDI	2.0	125	10.06-10.10	CEGA	4	<b>GE 115</b> (4,4V)	○		
2.0	2.0	136	08.05-06.08	BWA	4	<b>Z 347</b>	14 F-5 DPUR02	0,7	○
2.0 TFSI	2.0	147	10.05-10.10	BPY/BWA/CBFA/CCTA/CCZA	4	<b>Z 347</b>	14 F-5 DPUR02	0,7	○
2.5 FSI	2.5	110	01.06-10.10	BTK/BGP	5	<b>Z 176</b>	14 F-7 HPURX2	1,0	○
2.5 FSI	2.5	125	07.08-10.10	CCCA	5	<b>Z 272</b>	14 F-7 HURU02	1,0	○
2.5 FSI	2.5	125	07.08-10.10	CBTA	5	<b>Z 176</b>	14 F-7 HPURX2	1,0	○

### JETTA IV(162)

1.4 TSI	1.4	90	05.11-	CAXA/CMSB	4	<b>Z 349</b>	14 F-6 LPURW03	0,9	○
1.6 TDI	1.6	77	02.11-	CAYC	4	<b>GE 115</b> (4,4V)	○		
2.0 TDI	2.0	81	10.10-	CLCA	4	<b>GE 115</b> (4,4V)	○		
2.0	2.0	85	06.10-	CBPA Fgst.Nr. 16-B-000 001 →	4	<b>Z 272</b>	14 F-7 HURU02	1,0	○
2.0 TDI	2.0	103	02.11-	CFFB, CFHC, CLCB	4	<b>GE 115</b> (4,4V)	○		

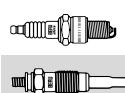
**VW AG**
**JETTA IV(162)**

2.0 TDI	2.0	103	02.11-	CJAA	4	<b>PSG 002</b> (4,4V)	○		
2.0 TSI	2.0	147	12.10-	CBFA/CCTA/CCZA	4	<b>Z 347</b>	14 F-5 DPURO2	0,7	○
2.5 FSI	2.5	125	04.10-	CCCA	5	<b>Z 272</b>	14 F-7 HURU02	1,0	○
2.5 FSI	2.5	125	04.10-	CBTA	5	<b>Z 176</b>	14 F-7 HPURX2	1,0	○

**KAEFER**

1600 (Mexico)	1.6	34	05.73-09.92	AF	4	<b>Z 57</b>	14-7 AU	0,6	○
1600 i (Mexico)	1.6	34	10.92-07.03	ACD	4	<b>Z 76</b>	14-9 DU	0,8	<b>UXT 2<sup>4</sup></b>

**LOGUS**

1.8	1.8	64	10.93-09.94	RM	4	<b>Z 22</b>	14-6 DU	0,7	<b>UX 56</b>
-----	-----	----	-------------	----	---	-------------	---------	-----	--------------

**LUPO (6X1, 6E1)**

1.0	1.0	37	09.98-07.05	AER/ALL	4	<b>Z 91</b>	14 GH-7 DTUR	0,8	<b>UXT 2<sup>4</sup></b>
1.0	1.0	37	09.98-07.05	ALD/ANW/AUC	4	<b>Z 176</b>	14 F-7 HPURX2	1,0	○
1.0	1.0	37	10.98-05.00	AHT	4	<b>Z 188</b>	14 F-7 DPURO2	0,7	<b>UXT 10</b>
1.2 TDI 3L	1.2	45	07.99-07.05	AYZ, ANY → Fgst.Nr. 6X-2-005 000	3	<b>GN 855</b> (12V)	○		
1.2 TDI 3L	1.2	45	07.99-07.05	AYZ Fgst.Nr. 6X-2-005-001 →	3	<b>GN 046</b> (12V)	○		
1.4	1.4	44	10.00-07.05	AUD	4	<b>Z 176</b>	14 F-7 HPURX2	1,0	○
1.4 16V	1.4	55	09.98-07.05	AHW/AKQ/APE/AUA/BBY	4	<b>Z 90</b>	14 FGH-7 DTURX	1,0	<b>UXT 1<sup>3</sup></b>
1.4 TDI	1.4	55	01.99-10.01	AMF	3	<b>GN 855</b> (12V)	○		
1.4 TDI	1.4	55	11.01-07.05	AMF	3	<b>GN 046</b> (12V)	○		
1.4 16V	1.4	74	08.99-07.05	AFK, AQQ, AUB	4	<b>Z 90</b>	14 FGH-7 DTURX	1,0	<b>UXT 1<sup>3</sup></b>
1.4 FSI	1.4	77	02.01-07.05	ARR	4	<b>Z 300</b>	14 FGR-6 HQU	1,35	○
1.6 GTI	1.6	92	09.00-07.05	AVY	4	<b>Z 90</b>	14 FGH-7 DTURX	1,0	<b>UXT 1<sup>3</sup></b>
1.7 SDI	1.7	44	09.98-09.01	AKU	4	<b>GN 855</b> (12V)	○		
1.7 SDI	1.7	44	10.01-07.05	AKU	4	<b>GN 046</b> (12V)	○		

**NEW BEETLE (9C1, 1C1)**

1.4	1.4	55	11.01-	BCA	4	<b>Z 176</b>	14 F-7 HPURX2	1,0	○
1.6	1.6	74	10.99-09.00	AWH	4	<b>Z 90</b>	14 FGH-7 DTURX	1,0	<b>UXT 1<sup>3</sup></b>
1.6	1.6	75	06.00-	BFS	4	<b>Z 90</b>	14 FGH-7 DTURX	1,0	<b>UXT 1<sup>3</sup></b>
1.6	1.6	75	06.00-	AYD	4	<b>Z 176</b>	14 F-7 HPURX2	1,0	○
1.8 T	1.8	110	10.99-	APH, AVC, AWW, AWU, BKF	4	<b>Z 188</b>	14 F-7 DPURO2	0,7	<b>UXT 10</b>
1.8 T	1.8	132	11.01-06.05	AWP/BNU	4	<b>Z 188</b>	14 F-7 DPURO2	0,7	<b>UXT 10</b>
1.9 TDI	1.9	66	01.98-06.04	ALH	4	<b>GN 855</b> (12V)	○		
				Kühlwasservorwärmung <sup>15</sup> M 5/3Nm Ø 4 mm		<b>GN 857</b> (11V)=3x <b>GN 928</b> (12V)=3x			
1.9 TDI	1.9	74	02.01-	ATD Fgst.Nr. 9E-2-623 845 →	4	<b>GN 046</b> (12V)	○		
1.9 TDI	1.9	77	07.05-	BSW	4	<b>GE 100</b> (5V)	<b>GSE 100</b>		
2.0	2.0	85	01.98-	AEG, APK, AQY, BER, CBPA	4	<b>Z 90</b>	14 FGH-7 DTURX	1,0	<b>UXT 1<sup>3</sup></b>
2.0	2.0	85	01.98-	AVH, AZG, AZJ, BEJ, BEV, BHP	4	<b>Z 176</b>	14 F-7 HPURX2	1,0	○
2.3 V5	2.3	125	10.00-	AQN	5	<b>Z 176</b>	14 F-7 HPURX2	1,0	○
2.5	2.5	110	07.05-	BPS/BPR Fgst.Nr. →1C-8-517 069	5	<b>Z 176</b>	14 F-7 HPURX2	1,0	○
2.5	2.5	110	07.05-	BPS/BPR Fgst.Nr. 1C-8-517 070 →	5	<b>Z 272</b>	14 F-7 HURU02	1,0	○
RSI 3.2 (1C9)	3.2	165	04.00-05.01	AXJ	6	<b>Z 176</b>	14 F-7 HPURX2	1,0	○

**NEW BEETLE Cabriolet (1Y7)**

1.4	1.4	55	01.03-09.10	BCA	4	<b>Z 176</b>	14 F-7 HPURX2	1,0	○
1.6	1.6	75	01.03-09.10	BFS	4	<b>Z 90</b>	14 FGH-7 DTURX	1,0	<b>UXT 1<sup>3</sup></b>
1.8 T	1.8	110	01.03-09.10	AWW/AWU/BKF	4	<b>Z 188</b>	14 F-7 DPURO2	0,7	<b>UXT 10</b>
1.9 TDI	1.9	74	06.03-09.10	AXR	4	<b>GN 046</b> (12V)	○		
1.9 TDI	1.9	77	07.05-09.10	BSW	4	<b>GE 100</b> (5V)	<b>GSE 100</b>		
2.0	2.0	85	09.02-10.10	AZJ, BDC, BEV, BGD	4	<b>Z 176</b>	14 F-7 HPURX2	1,0	○
2.5	2.5	110	07.05-09.10	BPS/BPR Fgst.Nr. →1C-8-517 069	5	<b>Z 176</b>	14 F-7 HPURX2	1,0	○
2.5	2.5	110	07.05-09.10	BPS/BPR Fgst.Nr. 1C-8-517 070 →	5	<b>Z 272</b>	14 F-7 HURU02	1,0	○

**PARATI**

1.8	1.8	64	08.91-07.94	RM	4	<b>Z 22</b>	14-6 DU	0,7	<b>UX 56</b>
1.8 Hybrid	1.8	70	08.87-07.94	JH	4	<b>Z 91</b>	14 GH-7 DTUR	0,8	<b>UXT 2<sup>4</sup></b>

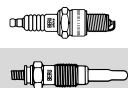
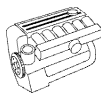

## VW AG

### PARATI

1.8	1.8	73	08.02-	UDH	4	<b>Z 91</b>	14 GH-7 DTUR	0,8	<b>UXT 2<sup>4</sup></b>
1.9 D	1.9	47	08.02-	1Y	4	<b>GN 857</b> (11V)	○		
1.9 SDI	1.9	47	08.02-	BGG	4	<b>GN 857</b> (11V)	○		

### PASSAT (3A2, 35I)

1.6	1.6	53	02.88-09.91	1F	4	<b>Z 92</b>	14 GH-8 DTUR	0,8	<b>UXT 2<sup>4</sup></b>
1.6	1.6	53	02.88-09.91	EZ	4	<b>Z 69</b>	14-8 DUO	0,7	<b>UXT 2<sup>4</sup></b>
1.6 TD	1.6	59	08.88-09.93	RA/SB	4	<b>GN 857</b> (11V)	<b>GR 001</b>		
1.6	1.6	74	10.94-08.96	AEK	4	<b>Z 246</b>	14 FGH-8 DTURW	0,9	<b>UXT 1<sup>3</sup></b>
1.6	1.6	74	10.94-08.96	AFT	4	<b>Z 90</b>	14 FGH-7 DTURX	1,0	<b>UXT 1<sup>3</sup></b>
1.8	1.8	55	08.90-08.96	AAM	4	<b>Z 92</b>	14 GH-8 DTUR	0,8	<b>UXT 2<sup>4</sup></b>
1.8	1.8	66	02.88-08.96	ABS/ADZ/RP	4	<b>Z 91</b>	14 GH-7 DTUR	0,8	<b>UXT 2<sup>4</sup></b>
1.8	1.8	79	04.88-07.93	PF	4	<b>Z 61</b>	14-7 DUO	0,7	<b>UXT 2<sup>4</sup></b>
1.8	1.8	82	04.88-07.92	PB	4	<b>Z 61</b>	14-7 DUO	0,7	<b>UXT 2<sup>4</sup></b>
1.8 GL	1.8	102	08.91-09.93	KR	4	<b>Z 52</b>	14 F-6 DTU	0,8	<b>UXT 5</b>
1.8 G60 Syncro	1.8	118	08.88-08.96	PG	4	<b>Z 104</b>	14-6 DPO	0,6	○
1.9 D	1.9	50	05.89-10.93	1Y	4	<b>GN 857</b> (11V)	<b>GR 001</b>		
1.9 TD	1.9	55	03.91-08.96	AAZ	4	<b>GN 857</b> (11V)	○		
1.9 TDI	1.9	66	10.93-08.96	1Z/AHU	4	<b>GN 855</b> (12V)	○		
			Kühlwasservorwärmung <sup>15</sup>	M 5/3Nm		<b>GN 857</b> (11V)=3x			
				Ø 4 mm		<b>GN 928</b> (12V)=3x			
1.9 TDI	1.9	81	03.96-08.96	AFN	4	<b>GN 855</b> (12V)	○		
			Kühlwasservorwärmung <sup>15</sup>	M 5/3Nm		<b>GN 857</b> (11V)=3x			
				Ø 4 mm		<b>GN 928</b> (12V)=3x			
2.0	2.0	79	03.95-08.96	AEP	4	<b>Z 91</b>	14 GH-7 DTUR	0,8	<b>UXT 2<sup>4</sup></b>
2.0 Syncro	2.0	85	10.90-08.96	2E/ADY/AGG	4	<b>Z 91</b>	14 GH-7 DTUR	0,8	<b>UXT 2<sup>4</sup></b>
2.0 16V	2.0	100	08.88-09.93	9A	4	<b>Z 89</b>	14 FGH-6 DTUR	0,8	<b>UXT 5</b>
2.0 16V	2.0	110	01.94-08.96	ABF	4	<b>Z 317</b>	14 F-5 DPUR2T	0,8	○
2.8 VR6	2.8	128	06.91-08.96	AAA	6	<b>Z 173</b>	14 FGR-8 KQU	1,6	○

### PASSAT (3B2)

1.6	1.6	74	10.96-11.00	ADP/AHL/ANA/ARM	4	<b>Z 90</b>	14 FGH-7 DTURX	1,0	<b>UXT 1<sup>3</sup></b>
1.8	1.8	85	01.97-11.00	AFY	4	<b>Z 90</b>	14 FGH-7 DTURX	1,0	<b>UXT 1<sup>3</sup></b>
1.8	1.8	92	10.96-11.00	ADR/APT/ARG	4	<b>Z 90</b>	14 FGH-7 DTURX	1,0	<b>UXT 1<sup>3</sup></b>
1.8 Syncro/4motion	1.8	92	10.96-11.00	ADR/APT/ARG	4	<b>Z 90</b>	14 FGH-7 DTURX	1,0	<b>UXT 1<sup>3</sup></b>
1.8 T	1.8	110	10.96-11.00	AEB/ANB/APU	4	<b>Z 188</b>	14 F-7 DPUR02	0,7	<b>UXT 10</b>
1.8 T Syncro	1.8	110	11.96-08.00	AEB	4	<b>Z 188</b>	14 F-7 DPUR02	0,7	<b>UXT 10</b>
1.9 TDI	1.9	66	10.96-11.00	AHU/AHH	4	<b>GN 855</b> (12V)	○		
			Kühlwasservorwärmung <sup>15</sup>	M 5/3Nm		<b>GN 857</b> (11V)=3x			
				Ø 4 mm		<b>GN 928</b> (12V)=3x			
1.9 TDI	1.9	74	02.00-11.00	AVB	4	<b>GN 855</b> (12V)	○		
			Kühlwasservorwärmung <sup>15</sup>	M 5/3Nm		<b>GN 857</b> (11V)=3x			
				Ø 4 mm		<b>GN 928</b> (12V)=3x			
1.9 TDI	1.9	81	10.96-11.00	AVG/AFN	4	<b>GN 855</b> (12V)	○		
			Kühlwasservorwärmung <sup>15</sup>	M 5/3Nm		<b>GN 857</b> (11V)=3x			
				Ø 4 mm		<b>GN 928</b> (12V)=3x			
1.9 TDI Syncro/4motion	1.9	81	10.96-11.00	AVG/AFN	4	<b>GN 855</b> (12V)	○		
			Kühlwasservorwärmung <sup>15</sup>	M 5/3Nm		<b>GN 857</b> (11V)=3x			
				Ø 4 mm		<b>GN 928</b> (12V)=3x			
1.9 TDI	1.9	85	08.98-11.00	ATJ/AJM	4	<b>GN 855</b> (12V)	○		
			Kühlwasservorwärmung <sup>15</sup>	M 5/3Nm		<b>GN 857</b> (11V)=3x			
				Ø 4 mm		<b>GN 928</b> (12V)=3x			
1.9 TDI 4motion	1.9	85	08.99-11.00	ATJ/AJM	4	<b>GN 855</b> (12V)	○		
			Kühlwasservorwärmung <sup>15</sup>	M 5/3Nm		<b>GN 857</b> (11V)=3x			
				Ø 4 mm		<b>GN 928</b> (12V)=3x			
2.3 VR5	2.3	110	10.96-11.00	AGZ	5	<b>Z 173</b>	14 FGR-8 KQU	1,6	○
2.3 VR5 Syncro/4motion	2.3	110	10.97-11.00	AGZ	5	<b>Z 173</b>	14 FGR-8 KQU	1,6	○
2.5 TDI	2.5	110	07.98-11.00	AKN/AFB	6	<b>GN 008</b> (12V)	○		
2.5 TDI Syncro/4motion	2.5	110	12.98-11.00	AKN/AFB	6	<b>GN 008</b> (12V)	○		
2.8 V6	2.8	132	05.97-09.99	AGE	6	<b>Z 145</b>	14 FGR-6 DDU	1,6	○
2.8 Syncro	2.8	132	05.97-09.99	AGE	6	<b>Z 145</b>	14 FGR-6 DDU	1,6	○
2.8 V6	2.8	140	09.99-11.00	ATX	6	<b>Z 145</b>	14 FGR-6 DDU	1,6	○



kW

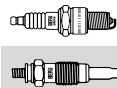

**VW AG**

**PASSAT (3B2)**

2.8 V6 4motion	2.8	140	09.99-11.00	ATX	6	<b>Z 145</b>	14 FGR-6 DDU	1,6	○
2.8 V6	2.8	142	08.96-11.00	APR/ACK/AQD	6	<b>Z 145</b>	14 FGR-6 DDU	1,6	○
2.8 V6 Syncro/4motion	2.8	142	10.96-11.00	APR/ACK/ALG/AQD	6	<b>Z 145</b>	14 FGR-6 DDU	1,6	○

**PASSAT (3B3)**

1.6	1.6	75	11.00-05.05	ALZ	4	<b>Z 90</b>	14 FGH-7 DTURX	1,0	<b>UXT 1<sup>3</sup></b>
1.8	1.8	92	03.03-03.05	APT	4	<b>Z 90</b>	14 FGH-7 DTURX	1,0	<b>UXT 1<sup>3</sup></b>
1.8 T 20V	1.8	110	11.00-05.05	AWT	4	<b>Z 188</b>	14 F-7 DPUR02	0,7	<b>UXT 10</b>
1.8 T	1.8	125	02.01-05.05	AWM	4	<b>Z 188</b>	14 F-7 DPUR02	0,7	<b>UXT 10</b>
1.8 4motion	1.8	125	03.01-05.05	AWM	4	<b>Z 188</b>	14 F-7 DPUR02	0,7	<b>UXT 10</b>
1.9 TDI	1.9	74	11.00-10.01	AVB	4	<b>GN 855</b> (12V)	○		
			Kühlwasservorwärmung <sup>15</sup>	↻ M 5/3Nm ↻ Ø 4 mm		<b>GN 857</b> (11V)=3x <b>GN 928</b> (12V)=3x			
1.9 TDI	1.9	74	11.01-05.05	AVB	4	<b>GN 046</b> (12V)	○		
1.9 TDI	1.9	96	11.00-10.01	AWX/AVF	4	<b>GN 855</b> (12V)	○		
			Kühlwasservorwärmung <sup>15</sup>	↻ M 5/3Nm ↻ Ø 4 mm		<b>GN 857</b> (11V)=3x <b>GN 928</b> (12V)=3x			
1.9 TDI	1.9	96	11.01-05.05	AWX/AVF	4	<b>GN 046</b> (12V)	○		
1.9 TDI 4motion	1.9	96	11.00-10.01	AVF	4	<b>GN 855</b> (12V)	○		
			Kühlwasservorwärmung <sup>15</sup>	↻ M 5/3Nm ↻ Ø 4 mm		<b>GN 857</b> (11V)=3x <b>GN 928</b> (12V)=3x			
1.9 TDI 4motion	1.9	96	11.01-05.05	AVF	4	<b>GN 046</b> (12V)	○		
2.0	2.0	85	11.00-05.05	AZM	4	<b>Z 90</b>	14 FGH-7 DTURX	1,0	<b>UXT 1<sup>3</sup></b>
2.0 4motion	2.0	85	11.00-05.05	AZM	4	<b>Z 90</b>	14 FGH-7 DTURX	1,0	<b>UXT 1<sup>3</sup></b>
2.0	2.0	96	11.01-05.05	ALT	4	<b>Z 121</b>	14 FGH-8 DTURXO	1,0	<b>UXT 9</b>
2.3 V5	2.3	125	11.00-05.05	AZX	5	<b>Z 176</b>	14 F-7 HPURX2	1,0	○
2.3 V5 4motion	2.3	125	11.00-05.05	AZX	5	<b>Z 176</b>	14 F-7 HPURX2	1,0	○
2.5 TDI	2.5	110	11.00-05.05	AKN/AFB	6	<b>GN 008</b> (12V)	○		
2.5 TDI 4motion	2.5	110	11.00-05.05	AKN/AFB	6	<b>GN 008</b> (12V)	○		
2.5 TDI	2.5	120	05.03-05.05	BDG	6	<b>GN 008</b> (12V)	○		
2.5 TDI 4motion	2.5	132	01.03-05.05	BAU/BDH	6	<b>GN 008</b> (12V)	○		
2.8	2.8	142	05.02-05.03	AMX/ATQ	6	<b>Z 145</b>	14 FGR-6 DDU	1,6	○
2.8 4motion	2.8	142	11.00-05.05	ATQ/AMX	6	<b>Z 145</b>	14 FGR-6 DDU	1,6	○
4.0 W8 4motion	4.0	202	09.01-05.05	BDV/BDP	8	<b>Z 213</b>	14 FGR-7 KDU6	1,7	○

**PASSAT (3C2)**

1.4 TSI	1.4	90	05.07-07.10	CAXA	4	<b>Z 349</b>	14 F-6 LPURW03	0,9	○
1.6	1.6	75	05.05-07.10	BSE/BSF	4	<b>Z 90</b>	14 FGH-7 DTURX	1,0	<b>UXT 1<sup>3</sup></b>
1.6 TDI	1.6	77	08.09-07.10	CAVC	4	<b>GE 115</b> (4,4V)	○		
1.6 FSI	1.6	85	03.05-06.08	BLF	4	<b>Z 300</b>	14 FGR-6 HQU	1,35	○
1.8 TSI	1.8	112	11.09-05.10	CDAB/CGYA	4	<b>Z 347</b>	14 F-5 DPUR02	0,7	○
1.8 TSI	1.8	118	05.07-07.10	BZB/CDAA	4	<b>Z 347</b>	14 F-5 DPUR02	0,7	○
1.9 TDI	1.9	77	03.05-11.08	BXE/BKC/BLS	4	<b>GE 100</b> (5V)	<b>GSE 100</b>		
2.0 TDI	2.0	81	11.08-07.10	CBDC	4	<b>GE 115</b> (4,4V)	○		
2.0 TDI	2.0	100	06.07-05.09	BMA	4	<b>GE 101</b> (4,4V)	<b>GSE 100</b>		
2.0 TDI	2.0	100	03.05-11.10	CBAA	4	<b>GE 115</b> (4,4V)	○		
2.0 TDI 16V	2.0	103	06.07-05.09	BKP ohne Partikelfilter	4	<b>GE 101</b> (4,4V)	<b>GSE 100</b>		
2.0 TDI 16V 4motion	2.0	103	06.07-05.09	BKP ohne Partikelfilter	4	<b>GE 101</b> (4,4V)	<b>GSE 100</b>		
2.0 TDI 16V	2.0	103	03.05-	CBAB	4	<b>GE 115</b> (4,4V)	○		
2.0 TDI 16V 4motion	2.0	103	03.05-	CBAB	4	<b>GE 115</b> (4,4V)	○		
2.0 BlueTDI	2.0	105	01.09-	CBAC	4	<b>GE 115</b> (4,4V)	○		
2.0 FSI	2.0	110	03.05-07.10	BLR/BVY	4	<b>Z 236</b>	14 F-6 HTPRX02	1,0	○
2.0 FSI	2.0	110	03.05-07.10	BLY/BVZ	4	<b>Z 228</b>	14 FR-7 DPUR02	1,0	<b>UXT 11</b>
2.0 FSI 4motion	2.0	110	09.05-07.10	BLX/BVX	4	<b>Z 236</b>	14 F-6 HTPRX02	1,0	○
2.0 FSI 4motion	2.0	110	09.05-07.10	BLY	4	<b>Z 228</b>	14 FR-7 DPUR02	1,0	<b>UXT 11</b>
2.0 TDI	2.0	125	08.05-	CBBB	4	<b>GE 115</b> (4,4V)	○		
2.0 TDI 4motion	2.0	125	05.09-	CBBB	4	<b>GE 115</b> (4,4V)	○		
2.0 FSI	2.0	147	07.05-07.10	AXX/BPY/BWA/CAWB/CBFA/ CCTA/CCZA	4	<b>Z 347</b>	14 F-5 DPUR02	0,7	○

**PASSAT CC**

1.8 TSI	1.8	112	11.08-05.10	CDAB/CGYA	4	<b>Z 347</b>	14 F-5 DPUR02	0,7	○
1.8 TSI	1.8	118	06.08-11.10	BZB/CDAA	4	<b>Z 347</b>	14 F-5 DPUR02	0,7	○
2.0 TDI	2.0	100	06.08-05.11	CBAA, CFFA	4	<b>GE 115</b> (4,4V)	○		



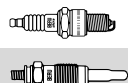

## VW AG

### PASSAT CC

2.0 TDI	2.0	103	06.08-	CBAB, CFFB	4	<b>GE 115</b> (4,4V)	○		
2.0 TDI 4motion	2.0	103	08.09-	CBAB, CFFB	4	<b>GE 115</b> (4,4V)	○		
2.0 BlueTDI	2.0	105	05.09-11.10	CBAC	4	<b>GE 115</b> (4,4V)	○		
2.0 TDI	2.0	120	05.08-11.08	CBBA	4	<b>GE 115</b> (4,4V)	○		
2.0 TDI	2.0	125	06.08-	CBBB, CFGB, CLLA	4	<b>GE 115</b> (4,4V)	○		
2.0 TDI 4motion	2.0	125	11.09-	CBBB, CFGB	4	<b>GE 115</b> (4,4V)	○		
2.0 TSI	2.0	147	06.08-	CAWB/CBFA/CCTA/CCZA	4	<b>Z 347</b>	14 F-5 DPUR02	0,7	○
2.0 TSI	2.0	155	11.10-	CCZB	4	<b>Z 347</b>	14 F-5 DPUR02	0,7	○

### PASSAT(362)

1.4 TSI	1.4	90	08.10-	CAXA	4	<b>Z 349</b>	14 F-6 LPURW03	0,9	○
1.6 TDI	1.6	77	08.10-	CAYC	4	<b>GE 115</b> (4,4V)	○		
1.8 TSI	1.8	112	02.11-	CDAB	4	<b>Z 347</b>	14 F-5 DPUR02	0,7	○
1.8 TSI	1.8	118	08.10-	CDAA	4	<b>Z 347</b>	14 F-5 DPUR02	0,7	○
2.0 TDI	2.0	100	08.10-	CFFA	4	<b>GE 115</b> (4,4V)	○		
2.0 TDI	2.0	103	08.10-	CFFB	4	<b>GE 115</b> (4,4V)	○		
2.0 TDI 4motion	2.0	103	08.10-	CFFB	4	<b>GE 115</b> (4,4V)	○		
2.0 TDI	2.0	125	08.10-	CFGB, CLLA	4	<b>GE 115</b> (4,4V)	○		
2.0 TDI 4motion	2.0	125	08.10-	CFGB, CLLA	4	<b>GE 115</b> (4,4V)	○		
2.0 TSI	2.0	155	11.10-	CCZB	4	<b>Z 347</b>	14 F-5 DPUR02	0,7	○

### PASSAT Variant (3A5, 35I)

1.6	1.6	53	04.88-09.91	1F	4	<b>Z 92</b>	14 GH-8 DTUR	0,8	<b>UXT 2<sup>4</sup></b>
1.6	1.6	53	04.88-09.91	EZ	4	<b>Z 69</b>	14-8 DUO	0,7	<b>UXT 2<sup>4</sup></b>
1.6 TD	1.6	59	08.88-09.93	RA/SB	4	<b>GN 857</b> (11V)	<b>GR 001</b>		
1.6	1.6	74	07.94-12.95	AEK	4	<b>Z 246</b>	14 FGH-8 DTURW	0,9	<b>UXT 1<sup>3</sup></b>
1.6	1.6	74	07.94-12.95	AFT	4	<b>Z 90</b>	14 FGH-7 DTURX	1,0	<b>UXT 1<sup>3</sup></b>
1.8	1.8	55	08.90-05.97	AAM	4	<b>Z 92</b>	14 GH-8 DTUR	0,8	<b>UXT 2<sup>4</sup></b>
1.8	1.8	66	02.88-05.97	ABS/ADZ/RP	4	<b>Z 91</b>	14 GH-7 DTUR	0,8	<b>UXT 2<sup>4</sup></b>
1.8	1.8	79	04.88-07.90	PF	4	<b>Z 61</b>	14-7 DUO	0,7	<b>UXT 2<sup>4</sup></b>
1.8	1.8	82	04.88-07.92	PB	4	<b>Z 61</b>	14-7 DUO	0,7	<b>UXT 2<sup>4</sup></b>
1.8	1.8	102	08.91-09.93	KR	4	<b>Z 52</b>	14 F-6 DTU	0,8	<b>UXT 5</b>
1.8 G60 Syncro	1.8	118	08.88-05.97	PG	4	<b>Z 104</b>	14-6 DPO	0,6	○
1.9 D	1.9	50	05.89-10.93	1Y	4	<b>GN 857</b> (11V)	<b>GR 001</b>		
1.9 TD	1.9	55	03.91-05.97	AAZ	4	<b>GN 857</b> (11V)	○		
1.9 TDI	1.9	66	10.93-05.97	1Z/AHU	4	<b>GN 855</b> (12V)	○		
				Kühlwasservorwärmung <sup>15</sup>		<b>GN 857</b> (11V)=3x			
						<b>GN 928</b> (12V)=3x			
1.9 TDI	1.9	81	03.96-05.97	AFN	4	<b>GN 855</b> (12V)	○		
				Kühlwasservorwärmung <sup>15</sup>		<b>GN 857</b> (11V)=3x			
						<b>GN 928</b> (12V)=3x			
2.0	2.0	79	03.95-08.96	AEP	4	<b>Z 91</b>	14 GH-7 DTUR	0,8	<b>UXT 2<sup>4</sup></b>
2.0	2.0	85	02.90-05.97	2E/ADY/AGG	4	<b>Z 91</b>	14 GH-7 DTUR	0,8	<b>UXT 2<sup>4</sup></b>
2.0 Syncro	2.0	85	10.90-05.97	2E/ADY/AGG	4	<b>Z 91</b>	14 GH-7 DTUR	0,8	<b>UXT 2<sup>4</sup></b>
2.0 16V	2.0	100	08.88-09.93	9A	4	<b>Z 89</b>	14 FGH-6 DTUR	0,8	<b>UXT 5</b>
2.0 16V	2.0	110	01.94-05.97	ABF	4	<b>Z 317</b>	14 F-5 DPUR2T	0,8	○
2.8 VR6	2.8	128	06.91-05.97	AAA	6	<b>Z 173</b>	14 FGR-8 KQU	1,6	○
2.9 VR6 Syncro	2.9	135	01.94-05.97	ABV	6	<b>Z 173</b>	14 FGR-8 KQU	1,6	○

### PASSAT Variant (3B5)

1.6	1.6	74	06.97-11.00	ADP/AHL/ANA/ARM	4	<b>Z 90</b>	14 FGH-7 DTURX	1,0	<b>UXT 1<sup>3</sup></b>
1.8	1.8	85	06.97-11.00	AFY	4	<b>Z 90</b>	14 FGH-7 DTURX	1,0	<b>UXT 1<sup>3</sup></b>
1.8	1.8	92	06.97-11.00	ADR/APT/ARG	4	<b>Z 90</b>	14 FGH-7 DTURX	1,0	<b>UXT 1<sup>3</sup></b>
1.8 Syncro/4motion	1.8	92	06.97-11.00	ADR/APT/ARG	4	<b>Z 90</b>	14 FGH-7 DTURX	1,0	<b>UXT 1<sup>3</sup></b>
1.8 T	1.8	110	06.97-11.00	AEB/ANB/APU	4	<b>Z 188</b>	14 F-7 DPUR02	0,7	<b>UXT 10</b>
1.9 TDI	1.9	66	06.97-11.00	AHU/AHH	4	<b>GN 855</b> (12V)	○		
				Kühlwasservorwärmung <sup>15</sup>		<b>GN 857</b> (11V)=3x			
						<b>GN 928</b> (12V)=3x			
1.9 TDI	1.9	74	02.00-11.00	AVB	4	<b>GN 855</b> (12V)	○		
				Kühlwasservorwärmung <sup>15</sup>		<b>GN 857</b> (11V)=3x			
						<b>GN 928</b> (12V)=3x			
1.9 TDI	1.9	81	06.97-11.00	AVG/AFN	4	<b>GN 855</b> (12V)	○		
				Kühlwasservorwärmung <sup>15</sup>		<b>GN 857</b> (11V)=3x			
						<b>GN 928</b> (12V)=3x			



kW

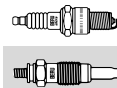
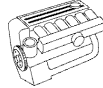

**VW AG**

**PASSAT Variant (3B5)**

1.9 TDI Syncro/4motion	1.9	81	06.97-11.00	AVG/AFN	4	<b>GN 855</b> (12V) ○			
				Kühlwasservorwärmung <sup>15</sup>		<b>GN 857</b> (11V)=3x <b>GN 928</b> (12V)=3x			
						⚙️ M 5/3Nm ⚙️ Ø 4 mm			
1.9 TDI	1.9	85	08.98-11.00	ATJ/AJM	4	<b>GN 855</b> (12V) ○			
				Kühlwasservorwärmung <sup>15</sup>		<b>GN 857</b> (11V)=3x <b>GN 928</b> (12V)=3x			
						⚙️ M 5/3Nm ⚙️ Ø 4 mm			
1.9 TDI 4motion	1.9	85	08.99-11.00	ATJ	4	<b>GN 855</b> (12V) ○			
				Kühlwasservorwärmung <sup>15</sup>		<b>GN 857</b> (11V)=3x <b>GN 928</b> (12V)=3x			
						⚙️ M 5/3Nm ⚙️ Ø 4 mm			
2.3 VR5	2.3	110	06.97-11.00	AGZ	5	<b>Z 173</b> 14 FGR-8 KQU	1,6		○
2.3 VR5 Syncro/4motion	2.3	110	10.97-11.00	AGZ	5	<b>Z 173</b> 14 FGR-8 KQU	1,6		○
2.5 TDI	2.5	110	07.98-11.00	AKN/AFB	6	<b>GN 008</b> (12V) ○			
2.5 TDI Syncro/4motion	2.5	110	12.98-11.00	AKN/AFB	6	<b>GN 008</b> (12V) ○			
2.8 V6	2.8	132	09.97-09.99	AGE	6	<b>Z 145</b> 14 FGR-6 DDU	1,6		○
2.8 Syncro	2.8	132	05.97-09.99	AGE	6	<b>Z 145</b> 14 FGR-6 DDU	1,6		○
2.8 V6	2.8	140	09.99-11.00	ATX	6	<b>Z 145</b> 14 FGR-6 DDU	1,6		○
2.8 V6 4motion	2.8	140	09.99-11.00	ATX	6	<b>Z 145</b> 14 FGR-6 DDU	1,6		○
2.8 V6	2.8	142	06.97-11.00	APR/ACK/AQD	6	<b>Z 145</b> 14 FGR-6 DDU	1,6		○
2.8 V6 Syncro/4motion	2.8	142	06.97-11.00	APR/ACK/ALG/AQD	6	<b>Z 145</b> 14 FGR-6 DDU	1,6		○

**PASSAT Variant (3B6)**

1.6	1.6	75	11.00-05.05	ALZ	4	<b>Z 90</b> 14 FGH-7 DTURX	1,0		<b>UXT 1<sup>3</sup></b>
1.8 T 20V	1.8	110	11.00-05.05	AWT	4	<b>Z 188</b> 14 F-7 DPUR02	0,7		<b>UXT 10</b>
1.8 T	1.8	125	05.02-08.05	AWM	4	<b>Z 188</b> 14 F-7 DPUR02	0,7		<b>UXT 10</b>
1.8 4motion	1.8	125	03.01-05.05	AWM	4	<b>Z 188</b> 14 F-7 DPUR02	0,7		<b>UXT 10</b>
1.9 TDI	1.9	74	11.00-10.01	AVB	4	<b>GN 855</b> (12V) ○			
				Kühlwasservorwärmung <sup>15</sup>		<b>GN 857</b> (11V)=3x <b>GN 928</b> (12V)=3x			
						⚙️ M 5/3Nm ⚙️ Ø 4 mm			
1.9 TDI	1.9	74	11.01-05.05	AVB	4	<b>GN 046</b> (12V) ○			
1.9 TDI	1.9	96	11.00-10.01	AWX/AVF	4	<b>GN 855</b> (12V) ○			
				Kühlwasservorwärmung <sup>15</sup>		<b>GN 857</b> (11V)=3x <b>GN 928</b> (12V)=3x			
						⚙️ M 5/3Nm ⚙️ Ø 4 mm			
1.9 TDI	1.9	96	11.01-05.05	AWX/AVF	4	<b>GN 046</b> (12V) ○			
1.9 TDI 4motion	1.9	96	11.00-10.01	AVF	4	<b>GN 855</b> (12V) ○			
				Kühlwasservorwärmung <sup>15</sup>		<b>GN 857</b> (11V)=3x <b>GN 928</b> (12V)=3x			
						⚙️ M 5/3Nm ⚙️ Ø 4 mm			
1.9 TDI 4motion	1.9	96	11.01-05.05	AVF	4	<b>GN 046</b> (12V) ○			
2.0	2.0	85	11.00-05.05	AZM	4	<b>Z 90</b> 14 FGH-7 DTURX	1,0		<b>UXT 1<sup>3</sup></b>
2.0 4motion	2.0	85	11.00-05.05	AZM	4	<b>Z 90</b> 14 FGH-7 DTURX	1,0		<b>UXT 1<sup>3</sup></b>
2.0	2.0	96	11.01-05.05	ALT	4	<b>Z 121</b> 14 FGH-8 DTURXO	1,0		<b>UXT 9</b>
2.3 VR5	2.3	125	11.00-05.05	AZX	5	<b>Z 176</b> 14 F-7 HPURX2	1,0		○
2.3 VR5 4motion	2.3	125	11.00-05.05	AZX	5	<b>Z 176</b> 14 F-7 HPURX2	1,0		○
2.5 TDI	2.5	110	11.00-05.05	AKN/AFB	6	<b>GN 008</b> (12V) ○			
2.5 TDI 4motion	2.5	110	11.00-05.05	AKN/AFB	6	<b>GN 008</b> (12V) ○			
2.5 TDI	2.5	120	05.03-05.05	BDG	6	<b>GN 008</b> (12V) ○			
2.5 TDI 4motion	2.5	132	01.03-05.05	BAU/BDH	6	<b>GN 008</b> (12V) ○			
2.8 4motion	2.8	142	11.00-05.05	ATQ/AMX	6	<b>Z 145</b> 14 FGR-6 DDU	1,6		○
4.0 W8 4motion	4.0	202	09.01-05.05	BDV/BDP	8	<b>Z 213</b> 14 FGR-7 KDU6	1,7		○

**PASSAT Variant (3C5)**

1.4 TSI	1.4	90	05.07-11.10	CAXA	4	<b>Z 349</b> 14 F-6 LPURW03	0,9		○
1.6	1.6	75	08.05-11.10	BSE/BSF	4	<b>Z 90</b> 14 FGH-7 DTURX	1,0		<b>UXT 1<sup>3</sup></b>
1.6 TDI	1.6	77	08.09-11.10	CAVC	4	<b>GE 115</b> (4,4V) ○			
1.6 FSI	1.6	85	08.05-06.08	BLF	4	<b>Z 300</b> 14 FGR-6 HQU	1,35		○
1.8 TSI	1.8	112	11.09-05.10	CDAB/CGYA	4	<b>Z 347</b> 14 F-5 DPUR02	0,7		○
1.8 TSI	1.8	118	05.07-10.11	BZB/CDA	4	<b>Z 347</b> 14 F-5 DPUR02	0,7		○
1.9 TDI	1.9	77	08.05-11.08	BKC, BLS, BXE	4	<b>GE 100</b> (5V) <b>GSE 100</b>			
2.0 TDI	2.0	81	11.08-11.10	CBDC	4	<b>GE 115</b> (4,4V) ○			
2.0 TDI	2.0	88	11.05-05.07	BWV	4	<b>GN 855</b> (12V) ○			
2.0 TDI	2.0	100	06.07-05.09	BMA	4	<b>GE 101</b> (4,4V) <b>GSE 100</b>			
2.0 TDI	2.0	100	08.05-11.10	CBAA	4	<b>GE 115</b> (4,4V) ○			
2.0 TDI 16V	2.0	103	06.07-05.09	BKP ohne Partikelfilter	4	<b>GE 101</b> (4,4V) <b>GSE 100</b>			

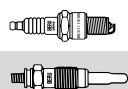

## VW AG

### PASSAT Variant (3C5)

2.0 TDI 16V	2.0	103	08.05-	CBAB	4	<b>GE 115</b> (4,4V)	○		
2.0 TDI 16V 4motion	2.0	103	06.07-05.09	BKP ohne Partikelfilter	4	<b>GE 101</b> (4,4V)	<b>GSE 100</b>		
2.0 TDI 16V 4motion	2.0	103	08.05-	CBAB	4	<b>GE 115</b> (4,4V)	○		
2.0 BlueTDI	2.0	105	01.09-	CBAC	4	<b>GE 115</b> (4,4V)	○		
2.0 FSI	2.0	110	08.05-11.10	BLR/BVY	4	<b>Z 236</b>	14 F-6 HTPRX02	1,0	○
2.0 FSI	2.0	110	08.05-11.10	BLY/BVZ	4	<b>Z 228</b>	14 FR-7 DPUX02	1,0	<b>UXT 11</b>
2.0 FSI 4motion	2.0	110	09.05-11.10	BLX/BVX	4	<b>Z 236</b>	14 F-6 HTPRX02	1,0	○
2.0 FSI 4motion	2.0	110	09.05-11.10	BLY	4	<b>Z 228</b>	14 FR-7 DPUX02	1,0	<b>UXT 11</b>
2.0 TDI	2.0	125	08.05-	CBBB	4	<b>GE 115</b> (4,4V)	○		
2.0 TDI 4motion	2.0	125	05.09-	CBBB	4	<b>GE 115</b> (4,4V)	○		
2.0 FSI	2.0	147	08.05-11.10	AXX/BPY/BWACAW/CBFA/CCTA/CCZA	4	<b>Z 347</b>	14 F-5 DPUR02	0,7	○

### PASSAT Variant(365)

1.4 TSI	1.4	90	08.10-	CAXA	4	<b>Z 349</b>	14 F-6 LPURW03	0,9	○
1.6 TDI	1.6	77	08.10-	CAYC	4	<b>GE 115</b> (4,4V)	○		
1.8 TSI	1.8	112	02.11-	CDAB	4	<b>Z 347</b>	14 F-5 DPUR02	0,7	○
1.8 TSI	1.8	118	08.10-	CDAA	4	<b>Z 347</b>	14 F-5 DPUR02	0,7	○
2.0 TDI	2.0	100	08.10-	CFFA	4	<b>GE 115</b> (4,4V)	○		
2.0 TDI	2.0	103	08.10-	CFFB	4	<b>GE 115</b> (4,4V)	○		
2.0 TDI 4motion	2.0	103	08.10-	CFFB	4	<b>GE 115</b> (4,4V)	○		
2.0 TDI	2.0	125	08.10-	CFGB, CLLA	4	<b>GE 115</b> (4,4V)	○		
2.0 TDI 4motion	2.0	125	08.10-	CFGB, CLLA	4	<b>GE 115</b> (4,4V)	○		
2.0 TSI	2.0	155	11.10-	CCZB	4	<b>Z 347</b>	14 F-5 DPUR02	0,7	○
2.0 TSI 4motion	2.0	155	01.12-	CCZB	4	<b>Z 347</b>	14 F-5 DPUR02	0,7	○

### PHAETON (3D\_)

3.0 V6 TDI 4motion	3.0	165	09.04-	BMK	6	<b>GE 115</b> (4,4V)	○		
3.0 V6 TDI 4motion	3.0	171	06.07-	CARA	6	<b>GE 115</b> (4,4V)	○		
3.0 V6 TDI 4motion	3.0	176	11.08-	CEXA	6	<b>GE 115</b> (4,4V)	○		
3.2 V6	3.2	177	04.02-	BKL	6	<b>GE 100</b> (5V)	○		
4.2 V8 4motion	4.2	246	05.03-	BGJ/BGH	8	<b>Z 239</b>	14 FGR-7 KQE	1,6	○
5.0 V10 TDI 4motion	5.0	230	11.02-	AJS	10	<b>GN 046</b> (12V)	○		
6.0 W12 4motion	6.0	309	04.02-	BAN	12	<b>Z 176</b>	14 F-7 HPURX2	1,0	○

### POINTER

1.8	1.8	64	10.93-09.94	RM	4	<b>Z 22</b>	14-6 DU	0,7	<b>UX 56</b>
1.8	1.8	73	06.02-07.05	UDH	4	<b>Z 91</b>	14 GH-7 DTUR	0,8	<b>UXT 2<sup>4</sup></b>
1.8	1.8	73	08.05-	UDH	4	<b>Z 91</b>	14 GH-7 DTUR	0,8	<b>UXT 2<sup>4</sup></b>
1.8 Hybrid	1.8	73	08.05-	UDH	4	<b>Z 91</b>	14 GH-7 DTUR	0,8	<b>UXT 2<sup>4</sup></b>
1.9 SDi	1.9	47	12.05-	BGG	4	<b>GN 857</b> (11V)	○		
1.9 TD	1.9	55	08.95-09.97		4	<b>GN 857</b> (11V)	○		

### POINTER Pick-up

1.8	1.8	73	06.02-07.05	UDH	4	<b>Z 91</b>	14 GH-7 DTUR	0,8	<b>UXT 2<sup>4</sup></b>
-----	-----	----	-------------	-----	---	-------------	--------------	-----	--------------------------

### POINTER Variant

1.8	1.8	73	06.02-07.05	UDH	4	<b>Z 91</b>	14 GH-7 DTUR	0,8	<b>UXT 2<sup>4</sup></b>
-----	-----	----	-------------	-----	---	-------------	--------------	-----	--------------------------

### POLO (6N1)

45 1.0	1.0	33	10.94-09.96	AEV	4	<b>Z 91</b>	14 GH-7 DTUR	0,8	<b>UXT 2<sup>4</sup></b>
50 1.0	1.0	37	09.96-10.99	AER/ALL	4	<b>Z 91</b>	14 GH-7 DTUR	0,8	<b>UXT 2<sup>4</sup></b>
55 1.3	1.3	40	10.94-07.95	ADX	4	<b>Z 91</b>	14 GH-7 DTUR	0,8	<b>UXT 2<sup>4</sup></b>
55 1.4	1.4	40	08.95-10.99	AEX	4	<b>Z 91</b>	14 GH-7 DTUR	0,8	<b>UXT 2<sup>4</sup></b>
60 1.4	1.4	44	07.95-10.99	AEX/AKV/APQ	4	<b>Z 91</b>	14 GH-7 DTUR	0,8	<b>UXT 2<sup>4</sup></b>
60 1.7 SDi	1.7	44	08.97-10.99	AKU	4	<b>GN 855</b> (12V)	○		
64 1.9 D	1.9	47	10.94-10.99	AEF	4	<b>GN 857</b> (11V)	○		
64 1.9 SDi	1.9	47	07.96-10.99	AGD	4	<b>GN 855</b> (12V)	○		
75 1.6	1.6	55	10.94-10.99	AEA/AEE	4	<b>Z 91</b>	14 GH-7 DTUR	0,8	<b>UXT 2<sup>4</sup></b>
75 1.6	1.6	55	10.94-10.99	AHS	4	<b>Z 94</b>	14 GR-8 DTU	0,8	<b>UXT 2<sup>4</sup></b>
100 1.4 16V	1.4	74	04.96-10.99	AFH	4	<b>Z 90</b>	14 FGH-7 DTURX	1,0	<b>UXT 1<sup>3</sup></b>
120 1.6 16V GTI	1.6	88	09.98-10.99	AJV	4	<b>Z 90</b>	14 FGH-7 DTURX	1,0	<b>UXT 1<sup>3</sup></b>
1.7 SDi	1.7	42	04.97-10.99	AHG	4	<b>GN 855</b> (12V)	○		

### POLO (6N2)

1.0	1.0	37	10.99-09.01	ALD/AUC	4	<b>Z 176</b>	14 F-7 HPURX2	1,0	○
1.4	1.4	40	10.99-09.01	ANX/AKP	4	<b>Z 176</b>	14 F-7 HPURX2	1,0	○
1.4	1.4	44	10.99-09.01	AKK/AUD	4	<b>Z 176</b>	14 F-7 HPURX2	1,0	○

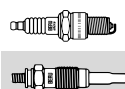
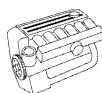
**VW AG**
**POLO (6N2)**

1.4 16V	1.4	55	10.99-09.01	AHW/APE/AUA	4	<b>Z 90</b>	14 FGH-7 DTURX	1,0	<b>UXT 1<sup>3</sup></b>
1.4 TDI	1.4	55	10.99-09.01	AMF	3	<b>GN 855</b> (12V)	○		
1.4 TDi	1.4	66	01.00-10.00	ATL	3	<b>GN 855</b> (12V)	○		
1.4 16V	1.4	74	10.99-09.01	AFK, AQQ, AUB	4	<b>Z 90</b>	14 FGH-7 DTURX	1,0	<b>UXT 1<sup>3</sup></b>
1.6 16V GTI	1.6	92	10.99-09.01	ARC/AVY	4	<b>Z 90</b>	14 FGH-7 DTURX	1,0	<b>UXT 1<sup>3</sup></b>
1.7 SDI	1.7	44	10.99-09.01	AKU	4	<b>GN 855</b> (12V)	○		
				Kühlwasservorwärmung <sup>15</sup>		<b>GN 857</b> (11V)=3x			
						<b>GN 928</b> (12V)=3x			
1.9 D	1.9	47	10.99-09.01	AEF	4	<b>GN 857</b> (11V)	○		
1.9 SDI	1.9	47	10.99-09.01	ASX/AGD	4	<b>GN 855</b> (12V)	○		

**POLO (6R\_)**

1.2	1.2	44	06.09-	CGPB	3	<b>Z 272</b>	14 F-7 HURU02	1,0	○
1.2	1.2	51	06.09-	CGPA	3	<b>Z 272</b>	14 F-7 HURU02	1,0	○
1.2 TDI	1.2	55	10.09-	CFWA	3	<b>GE 115</b> (4,4V)	○		
1.4 BiFuel	1.4	60	03.10-01.11	CMAA	4	<b>Z 200</b>	14 F-7 HUR2	0,9	○
1.4	1.4	63	06.09-	CGGB/CLPA	4	<b>Z 272</b>	14 F-7 HURU02	1,0	○
1.6 TDI	1.6	55	06.09-	CAYA	4	<b>GE 115</b> (4,4V)	○		
1.6 BiFuel	1.6	60	01.11-	CNKA	4	<b>Z 272</b>	14 F-7 HURU02	1,0	○
1.6 TDI	1.6	66	06.09-	CAYB	4	<b>GE 115</b> (4,4V)	○		
1.6	1.6	77	01.10-	CLSA	4	<b>Z 272</b>	14 F-7 HURU02	1,0	○
1.6 TDI	1.6	77	06.09-	CAYC, CLNA	4	<b>GE 115</b> (4,4V)	○		

**POLO (9N\_)**

1.2	1.2	40	01.02-05.07	AWY/BMD	3	<b>Z 200</b>	14 F-7 HUR2	0,9	○
1.2	1.2	44	05.07-11.09	BBM	3	<b>Z 272</b>	14 F-7 HURU02	1,0	○
1.2 12V	1.2	47	10.01-07.07	AZQ/BME	3	<b>Z 200</b>	14 F-7 HUR2	0,9	○
1.2 12V	1.2	51	05.07-11.09	BZG	3	<b>Z 272</b>	14 F-7 HURU02	1,0	○
1.4 TDI	1.4	51	04.05-11.09	BMN	3	<b>GN 046</b> (12V)	○		
1.4	1.4	55	07.03-	BBY	4	<b>Z 176</b>	14 F-7 HPUX2	1,0	○
1.4 16V Automatic	1.4	55	10.01-05.08	BBY	4	<b>Z 176</b>	14 F-7 HPUX2	1,0	○
1.4 16V Automatic	1.4	55	10.01-05.08	AUA, BBY	4	<b>Z 90</b>	14 FGH-7 DTURX	1,0	<b>UXT 1<sup>3</sup></b>
1.4 16V	1.4	55	10.01-05.08	BKY	4	<b>Z 200</b>	14 F-7 HUR2	0,9	○
1.4 TDI	1.4	55	10.01-06.05	AMF/BAY	3	<b>GN 046</b> (12V)	○		
1.4 TDI	1.4	59	04.05-11.09	BNV	3	<b>GN 046</b> (12V)	○		
1.4 16V	1.4	59	05.06-11.09	BUD	4	<b>Z 272</b>	14 F-7 HURU02	1,0	○
1.4 FSI	1.4	63	02.02-07.06	AXU	4	<b>Z 300</b>	14 FGR-6 HQU	1,35	○
1.4 16V	1.4	74	10.01-05.08	AUB, BBZ	4	<b>Z 90</b>	14 FGH-7 DTURX	1,0	<b>UXT 1<sup>3</sup></b>
1.6	1.6	74	08.02-05.05	BAH	4	<b>Z 344</b>	14 F-7 HTUR	1,0	○
1.6 16V	1.6	77	05.06-11.09	BTS	4	<b>Z 272</b>	14 F-7 HURU02	1,0	○
1.8 GTI	1.8	110	09.05-11.09	BJX	4	<b>Z 188</b>	14 F-7 DPUR02	0,7	<b>UXT 10</b>
1.8 GTI Cup Edition	1.8	132	05.06-11.09	BBU	4	<b>Z 188</b>	14 F-7 DPUR02	0,7	<b>UXT 10</b>
1.9 SDI	1.9	47	10.01-11.09	ASY	4	<b>GN 046</b> (12V)	○		
1.9 TDI	1.9	74	10.01-11.09	AXR/ATD	4	<b>GN 046</b> (12V)	○		
1.9 TDI	1.9	96	11.03-11.09	ASZ, BLT	4	<b>GN 046</b> (12V)	○		

**POLO (86C, 80)**

1.0	1.0	33	08.85-01.92	HZ	4	<b>Z 61</b>	14-7 DUO	0,7	<b>UXT 2<sup>4</sup></b>
1.0 KAT	1.0	33	08.89-09.94	AAU	4	<b>Z 2</b>	14-8 DTU	1,0	<b>UXT 2<sup>4</sup></b>
1.0 KAT	1.0	33	08.89-09.94	AAK/ACM	4	<b>Z 12</b>	14-7 DTU	0,8	<b>UXT 2<sup>4</sup></b>
1.3 D	1.3	33	08.86-07.90	MN	4	<b>GN 857</b> (11V)	○		
1.3 KAT	1.3	40	07.87-09.94	AAV	4	<b>Z 2</b>	14-8 DTU	1,0	<b>UXT 2<sup>4</sup></b>
1.3 KAT	1.3	40	07.87-09.94	2G/MH/NZ	4	<b>Z 61</b>	14-7 DUO	0,7	<b>UXT 2<sup>4</sup></b>
1.3 KAT	1.3	55	10.89-03.91	3F	4	<b>Z 51</b>	14-6 DTU	0,8	<b>UX 56</b>
1.4 D	1.4	35	10.90-09.94	1W	4	<b>GN 857</b> (11V)	○		

**POLO CLASSIC (6KV2)**

1.0	1.0	37	08.96-12.01	AER	4	<b>Z 91</b>	14 GH-7 DTUR	0,8	<b>UXT 2<sup>4</sup></b>
1.4	1.4	62	05.96-07.02	AGY	4	<b>Z 22</b>	14-6 DU	0,7	<b>UX 56</b>
1.9 SDI	1.9	48	06.96-09.01	AEY	4	<b>GN 857</b> (11V)	○		
54 1.4	1.4	40	01.98-08.99	ANX	4	<b>Z 91</b>	14 GH-7 DTUR	0,8	<b>UXT 2<sup>4</sup></b>
57 1.7 SDI	1.7	42	07.97-09.01	AKW	4	<b>GN 855</b> (12V)	○		
				Kühlwasservorwärmung <sup>15</sup>		<b>GN 857</b> (11V)=3x			
						<b>GN 928</b> (12V)=3x			
60 1.4	1.4	44	12.95-09.01	AEX/AKV/APQ	4	<b>Z 91</b>	14 GH-7 DTUR	0,8	<b>UXT 2<sup>4</sup></b>

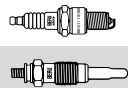
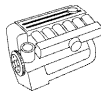

## VW AG

### POLO CLASSIC (6KV2)

60 1.4	1.4	44	12.95-09.01	AKK/ANW/AUD	4	<b>Z 176</b>	14 F-7 HPURX2	1,0	○
64 1.9 D	1.9	47	01.96-10.96	1Y	4	<b>GN 857</b> (11V)	○		
64 1.9 SDI	1.9	47	12.95-08.99	AEY	4	<b>GN 855</b> (12V)	○		
68 1.9 SDI	1.9	50	08.99-09.01	AGP/AQM	4	<b>GN 855</b> (12V)	○		
75 1.4 16V	1.4	55	10.99-09.01	APE/AUA	4	<b>Z 90</b>	14 FGH-7 DTURX	1,0	<b>UXT 1<sup>3</sup></b>
75 1.6	1.6	55	11.95-09.97	1F	4	<b>Z 92</b>	14 GH-8 DTUR	0,8	<b>UXT 2<sup>4</sup></b>
75 1.6	1.6	55	11.95-09.01	AEE/ALM	4	<b>Z 91</b>	14 GH-7 DTUR	0,8	<b>UXT 2<sup>4</sup></b>
90 1.8	1.8	66	01.97-09.01	ADD	4	<b>Z 91</b>	14 GH-7 DTUR	0,8	<b>UXT 2<sup>4</sup></b>
90 1.9 TDI	1.9	66	09.96-09.01	ALE/AHU/AGR/ALH	4	<b>GN 855</b> (12V)	○		
				Kühlwasservorwärmung <sup>15</sup>		<b>GN 857</b> (11V)=3x			
				⚙️: M 5/3Nm		<b>GN 928</b> (12V)=3x			
				⚙️: Ø 4 mm					
100 1.6	1.6	74	12.95-09.01	AEH/AFT/AKL/APF/AUR	4	<b>Z 90</b>	14 FGH-7 DTURX	1,0	<b>UXT 1<sup>3</sup></b>
110 1.9 TDI	1.9	81	06.98-09.01	AFN/ASV	4	<b>GN 855</b> (12V)	○		
				Kühlwasservorwärmung <sup>15</sup>		<b>GN 857</b> (11V)=3x			
				⚙️: M 5/3Nm		<b>GN 928</b> (12V)=3x			
				⚙️: Ø 4 mm					

### POLO CLASSIC (86C, 80)

1.0	1.0	33	01.85-09.94	AAK/AU/HZ	4	<b>Z 61</b>	14-7 DUO	0,7	<b>UXT 2<sup>4</sup></b>
1.3 KAT	1.3	40	07.87-09.94	MH/NZ	4	<b>Z 61</b>	14-7 DUO	0,7	<b>UXT 2<sup>4</sup></b>
1.4 D	1.4	35	10.90-09.94	1W	4	<b>GN 857</b> (11V)	○		

### POLO Coupe (86C, 80)

1.0	1.0	33	08.85-01.92	HZ	4	<b>Z 61</b>	14-7 DUO	0,7	<b>UXT 2<sup>4</sup></b>
1.0 KAT	1.0	33	08.89-09.94	AAU	4	<b>Z 2</b>	14-8 DTU	1,0	<b>UXT 2<sup>4</sup></b>
1.0 KAT	1.0	33	08.89-09.94	AAK/ACM	4	<b>Z 12</b>	14-7 DTU	0,8	<b>UXT 2<sup>4</sup></b>
1.3 D	1.3	33	08.86-08.90	MN	4	<b>GN 857</b> (11V)	○		
1.3 KAT	1.3	40	07.87-08.94	AAV	4	<b>Z 2</b>	14-8 DTU	1,0	<b>UXT 2<sup>4</sup></b>
1.3 KAT	1.3	40	07.87-08.94	2G/MH/NZ	4	<b>Z 61</b>	14-7 DUO	0,7	<b>UXT 2<sup>4</sup></b>
1.3 KAT	1.3	55	10.89-09.94	3F	4	<b>Z 51</b>	14-6 DTU	0,8	<b>UX 56</b>
1.3	1.3	57	03.91-09.94	3F	4	<b>Z 51</b>	14-6 DTU	0,8	<b>UX 56</b>
1.3 G40	1.3	85	01.87-08.90	PY	4	<b>Z 44</b>	14-5 DTU	0,8	<b>UX 56</b>
1.4 D	1.4	35	08.90-09.94	1W	4	<b>GN 857</b> (11V)	○		

### POLO PLAYA

1.4	1.4	62	05.96-07.02	AGY	4	<b>Z 22</b>	14-6 DU	0,7	<b>UX 56</b>
-----	-----	----	-------------	-----	---	-------------	---------	-----	--------------

### POLO Stufenheck

1.0	1.0	37	08.96-12.01	AER	4	<b>Z 91</b>	14 GH-7 DTUR	0,8	<b>UXT 2<sup>4</sup></b>
1.4	1.4	55	07.03-	BBY	4	<b>Z 90</b>	14 FGH-7 DTURX	1,0	<b>UXT 1<sup>3</sup></b>
1.4 TDI	1.4	55	07.03-	BAY	3	<b>GN 046</b> (12V)	○		
1.4	1.4	55	07.03-	BKY	4	<b>Z 200</b>	14 F-7 HUR2	0,9	○
1.4	1.4	63	12.03-05.05	BLM	4	<b>Z 344</b>	14 F-7 HTUR	1,0	○
1.4	1.4	63	12.10-	CLPA	4	<b>Z 272</b>	14 F-7 HURU02	1,0	○
1.4	1.4	74	11.03-	BBZ	4	<b>Z 90</b>	14 FGH-7 DTURX	1,0	<b>UXT 1<sup>3</sup></b>
1.6	1.6	63	11.10-	CFNB	4	<b>Z 272</b>	14 F-7 HURU02	1,0	○
1.6	1.6	74	09.02-	BAH	4	<b>Z 344</b>	14 F-7 HTUR	1,0	○
1.6	1.6	77	05.10-	CFNA/CLSA	4	<b>Z 272</b>	14 F-7 HURU02	1,0	○
1.6 TDI	1.6	77	07.10-	CLNA	4	<b>GE 115</b> (4,4V)	○		
1.9 SDI	1.9	47	09.02-	ASY	4	<b>GN 046</b> (12V)	○		
1.9 TDi	1.9	74	09.02-	ATD	4	<b>GN 046</b> (12V)	○		

### POLO Variant (6KV5)

1.4	1.4	40	12.98-09.01	AKP	4	<b>Z 176</b>	14 F-7 HPURX2	1,0	○
1.4	1.4	44	05.97-09.01	AEX/AKV/APQ	4	<b>Z 91</b>	14 GH-7 DTUR	0,8	<b>UXT 2<sup>4</sup></b>
1.4	1.4	44	05.97-09.01	AKK/ANW/AUD	4	<b>Z 176</b>	14 F-7 HPURX2	1,0	○
1.4 16V	1.4	55	10.99-09.01	APE/AUA	4	<b>Z 90</b>	14 FGH-7 DTURX	1,0	<b>UXT 1<sup>3</sup></b>
1.6	1.6	55	05.97-09.01	AEE/ALM	4	<b>Z 91</b>	14 GH-7 DTUR	0,8	<b>UXT 2<sup>4</sup></b>
1.6	1.6	74	05.97-09.01	AEH/AKL/APF/AUR	4	<b>Z 90</b>	14 FGH-7 DTURX	1,0	<b>UXT 1<sup>3</sup></b>
1.7 SDI	1.7	42	08.97-09.01	AKW	4	<b>GN 855</b> (12V)	○		
				Kühlwasservorwärmung <sup>15</sup>		<b>GN 857</b> (11V)=3x			
				⚙️: M 5/3Nm		<b>GN 928</b> (12V)=3x			
				⚙️: Ø 4 mm					
1.8	1.8	66	05.97-09.01	ADZ	4	<b>Z 91</b>	14 GH-7 DTUR	0,8	<b>UXT 2<sup>4</sup></b>
1.9 SDI	1.9	47	06.97-09.01	AEY	4	<b>GN 855</b> (12V)	○		
1.9 SDI	1.9	50	08.99-09.01	AGP/AQM	4	<b>GN 855</b> (12V)	○		



kW

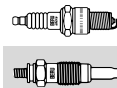
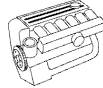

**VW AG**

**POLO Variant (6KV5)**

1.9 TDI	1.9	66	05.97-09.01	ALE/AHU/AGR/ALH	4	<b>GN 855</b> (12V)	○		
				Kühlwasservorwärmung <sup>15</sup>		<b>GN 857</b> (11V)=3x			
						<b>GN 928</b> (12V)=3x			
1.9 TDI	1.9	81	06.98-09.01	AFN/ASV	4	<b>GN 855</b> (12V)	○		
				Kühlwasservorwärmung <sup>15</sup>		<b>GN 857</b> (11V)=3x			
						<b>GN 928</b> (12V)=3x			

**QUANTUM**

1.9 TD	1.9	55	10.93-06.97		4	<b>GN 857</b> (11V)	○		
--------	-----	----	-------------	--	---	---------------------	---	--	--

**SANTANA**

1.8	1.8	63	01.95-		4	<b>Z 11</b>	14-7 DU	0,8	<b>UXT 2<sup>4</sup></b>
-----	-----	----	--------	--	---	-------------	---------	-----	--------------------------

**SCIROCCO (53B)**

1.6	1.6	53	04.86-07.90	RE	4	<b>Z 93</b>	14 GH-8 DTURX	1,0	<b>UXT 2<sup>4</sup></b>
1.8	1.8	66	09.84-07.92	EX	4	<b>Z 12</b>	14-7 DTU	0,8	<b>UXT 2<sup>4</sup></b>
1.8	1.8	70	11.85-07.92	JH	4	<b>Z 91</b>	14 GH-7 DTUR	0,8	<b>UXT 2<sup>4</sup></b>
1.8 16V	1.8	95	03.86-07.92	PL	4	<b>Z 89</b>	14 FGH-6 DTUR	0,8	<b>UXT 5</b>

**SCIROCCO(137)**

1.4 TSI	1.4	90	08.08-	CAXA/CMSB	4	<b>Z 349</b>	14 F-6 LPURW03	0,9	○
1.4 TSI	1.4	118	05.08-	CAVD	4	<b>Z 349</b>	14 F-6 LPURW03	0,9	○
2.0 TDI	2.0	100	11.10-	CFHB	4	<b>GE 115</b> (4,4V)	○		
2.0 TDI	2.0	103	08.08-	CFHC, CBDB	4	<b>GE 115</b> (4,4V)	○		
2.0 TDI	2.0	125	05.09-	CFGB, CBDB	4	<b>GE 115</b> (4,4V)	○		
2.0 TSI	2.0	147	05.08-11.09	CAWB	4	<b>Z 347</b>	14 F-5 DPUR02	0,7	○
2.0 TSI	2.0	155	11.09-05.11	CCZB	4	<b>Z 347</b>	14 F-5 DPUR02	0,7	○
2.0 R	2.0	188	11.09-	CDLC	4	<b>Z 347</b>	14 F-5 DPUR02	0,7	○
2.0 R	2.0	195	11.09-	CDLA	4	<b>Z 347</b>	14 F-5 DPUR02	0,7	○

**SHARAN (7M8, 7M9, 7M6)**

1.8 T 20V	1.8	110	09.97-03.10	AJH/AWC	4	<b>Z 188</b>	14 F-7 DPUR02	0,7	<b>UXT 10</b>
1.9 TDI	1.9	66	09.95-02.00	ANU/1Z/AHU	4	<b>GN 855</b> (12V)	○		
				Kühlwasservorwärmung <sup>15</sup>		<b>GN 857</b> (11V)=3x			
						<b>GN 928</b> (12V)=3x			
1.9 TDI	1.9	66	03.00-03.10	ANU	4	<b>GN 046</b> (12V)	○		
1.9 TDI	1.9	81	09.96-04.00	AVG/AFN	4	<b>GN 855</b> (12V)	○		
				Kühlwasservorwärmung <sup>15</sup>		<b>GN 857</b> (11V)=3x			
						<b>GN 928</b> (12V)=3x			
1.9 TDI	1.9	85	04.00-03.10	AUY Fgst.Nr → 7M-2-030 004	4	<b>GN 855</b> (12V)	○		
1.9 TDI	1.9	85	04.00-03.10	AUY Fgst.Nr 7M-2-030 005 →	4	<b>GN 046</b> (12V)	○		
1.9 TDI 4motion	1.9	85	04.00-03.10	AUY Fgst.Nr → 7M-2-030 004	4	<b>GN 855</b> (12V)	○		
				Kühlwasservorwärmung <sup>15</sup>		<b>GN 857</b> (11V)=3x			
						<b>GN 928</b> (12V)=3x			
1.9 TDI 4motion	1.9	85	04.00-03.10	AUY Fgst.Nr 7M-2-030 005 →	4	<b>GN 046</b> (12V)	○		
1.9 TDI	1.9	96	11.02-03.10	ASZ	4	<b>GN 046</b> (12V)	○		
1.9 TDI	1.9	110	06.05-03.10	BTB	4	<b>GN 046</b> (12V)	○		
2.0	2.0	85	09.95-03.10	ADY/ATM	4	<b>Z 90</b>	14 FGH-7 DTURX	1,0	<b>UXT 1<sup>3</sup></b>
2.0 LPG	2.0	85	04.06-03.10	ATM	4	<b>Z 90</b>	14 FGH-7 DTURX	1,0	<b>UXT 1<sup>3</sup></b>
2.0	2.0	110	09.95-02.00	ABF	4	<b>Z 317</b>	14 F-5 DPUR2T	0,8	○
2.8 VR6	2.8	128	09.95-04.00	AAA/AMY	6	<b>Z 173</b>	14 FGR-8 KQU	1,6	○
2.8 VR6 Syncro	2.8	128	11.96-04.00	AAA/AMY	6	<b>Z 173</b>	14 FGR-8 KQU	1,6	○
2.8 V6 24V	2.8	150	04.00-03.10	AYL	6	<b>Z 176</b>	14 F-7 HPURX2	1,0	○
2.8 V6 24V 4motion	2.8	150	04.00-03.10	AYL	6	<b>Z 176</b>	14 F-7 HPURX2	1,0	○

**SHARAN (7N)**

1.4 TSI	1.4	110	05.10-	CAVA	4	<b>Z 349</b>	14 F-6 LPURW03	0,9	○
2.0 TDI	2.0	85	11.11-	CFFE	4	<b>GE 115</b> (4,4V)	○		
2.0 TDI	2.0	100	05.10-	CFFA	4	<b>GE 115</b> (4,4V)	○		
2.0 TDI 4motion	2.0	100	05.11-	CFFA	4	<b>GE 115</b> (4,4V)	○		
2.0 TDI	2.0	103	05.10-	CFFB	4	<b>GE 115</b> (4,4V)	○		
2.0 TDI 4motion	2.0	103	05.11-	CFFB	4	<b>GE 115</b> (4,4V)	○		
2.0 TDI	2.0	125	08.10-	CFGB	4	<b>GE 115</b> (4,4V)	○		
2.0 TSI	2.0	147	12.10-	CCZA	4	<b>Z 347</b>	14 F-5 DPUR02	0,7	○

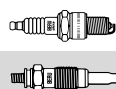

## VW AG

### SPACEFOX (5Z6, 5Z7)

1.6	1.6	74	03.06-	BAH	4	Z 344	14 F-7 HTUR	1,0	○
1.6	1.6	74	03.06-	CFZA	4	Z 344	14 F-7 HTUR	1,0	○
1.6 Total Flex	1.6	74	03.06-	CFZA	4	Z 344	14 F-7 HTUR	1,0	○
1.9 SDI	1.9	47	09.07-	ASY	4	GN 046 (12V)	○		

### TIGUAN (5N )

1.4 TSI	1.4	90	08.10-	CAXA	4	Z 349	14 F-6 LPURW03	0,9	○
1.4 TSI	1.4	110	05.08-	CAVA	4	Z 349	14 F-6 LPURW03	0,9	○
1.4 TSI 4motion	1.4	110	09.07-	CAVA	4	Z 349	14 F-6 LPURW03	0,9	○
2.0 TDI	2.0	81	05.10-	CFFD	4	GE 115 (4,4V)	○		
2.0 TDI 4motion	2.0	100	11.07-	CBAA/CFFA	4	GE 115 (4,4V)	○		
2.0 TDI	2.0	103	03.08-	CBAB, CFFB	4	GE 115 (4,4V)	○		
2.0 TDI 4motion	2.0	103	09.07-	CFFB/CLJA/CBAB	4	GE 115 (4,4V)	○		
2.0 TDI 4motion	2.0	120	02.08-08.09	CBBA	4	GE 115 (4,4V)	○		
2.0 TDI 4motion	2.0	125	09.07-	CFGB, CBBB	4	GE 115 (4,4V)	○		
2.0 TFSI 4motion	2.0	125	09.07-	CAWA/CCZC	4	Z 347	14 F-5 DPUR02	0,7	○
2.0 TFSI	2.0	147	11.07-	CCTA	4	Z 347	14 F-5 DPUR02	0,7	○
2.0 TFSI 4motion	2.0	147	09.07-	CAWB/CCTA/CCZA	4	Z 347	14 F-5 DPUR02	0,7	○
2.0 TSI 4motion	2.0	155	05.11-	CCZB	4	Z 347	14 F-5 DPUR02	0,7	○

### TOUAREG (7LA, 7L6, 7L7)

2.5 R5 TDI	2.5	120	08.03-11.06	BLK	5	GN 046 (12V)	○		
2.5 R5 TDI	2.5	128	01.03-05.10	BAC	5	GN 046 (12V)	○		
3.0 TDI	3.0	155	04.06-05.10	CASB	6	GE 115 (4,4V)	○		
3.0 V6 TDI	3.0	165	11.04-05.10	CATA	6	GE 115 (4,4V)	○		
3.0 V6 TDI	3.0	176	11.07-05.10	CASA/CASC	6	GE 115 (4,4V)	○		
3.2 V6	3.2	162	10.02-11.06	AZZ,BMX,BAA,BMV,BKJ	6	Z 306	12 F-6 HPURW	0,9	○
4.2 V8	4.2	228	12.02-11.06	AXQ	8	Z 239	14 FGR-7 KQE	1,6	○
4.2 V8 FSI	4.2	257	06.06-05.10	BAR	8	Z 295	14 F-6 DTPRO2	0,8	○
5.0 V10 TDI	5.0	230	10.02-05.10	AYH	10	GN 046 (12V)	○		
6.0 W12	6.0	331	08.04-05.10	CFRA/BJN	12	Z 176	14 F-7 HPURX2	1,0	○

### TOUAREG (7P5)

3.0 V6 TDI	3.0	150	01.10-	CASD, CJMA	6	GE 115 (4,4V)	○		
3.0 V6 TDI	3.0	176	01.10-	CASA	6	GE 115 (4,4V)	○		
4.2 V8 TDI	4.2	250	01.10-06.10	CKDA	8	GE 115 (4,4V)	○		

### TOURAN (1T1, 1T2)

1.4 TSI	1.4	103	02.06-05.10	BMV/CAVC	4	Z 349	14 F-6 LPURW03	0,9	○
1.4 FSI	1.4	125	11.06-05.10	BLG/CAVB	4	Z 349	14 F-6 LPURW03	0,9	○
1.6	1.6	75	07.03-05.10	BGU/BSF/BSE	4	Z 90	14 FGH-7 DTURX	1,0	UXT 1 <sup>3</sup>
1.6 FSI	1.6	85	02.03-01.07	BLF/BLP/BAG	4	Z 300	14 FGR-6 HQU	1,35	○
1.6 TDI	1.6	77	05.10-	CAYC	4	GE 115 (4,4V)	○		
1.9 TDI	1.9	66	11.04-05.10	BXF/BXJ/BRU	4	GE 100 (5V)	GSE 100		
1.9 TDI	1.9	74	02.03-05.04	AVQ	4	GE 100 (5V)	GSE 100		
1.9 TDI	1.9	77	08.03-05.10	BXE/BKC/BLS	4	GE 100 (5V)	GSE 100		
					Fgst.Nr. 70251 →				
2.0 EcoFuel	2.0	80	02.06-05.09	BSX	4	Z 250	14 FR-7 DU2S	0,7	UXT 1 <sup>3</sup>
2.0 TDI	2.0	100	02.03-05.10	AZV	4	GE 101 (4,4V)	GSE 100		
2.0 TDI	2.0	103	12.05-05.10	BMM	4	GE 100 (5V)	GSE 100		
2.0 TDI 16V	2.0	103	08.03-05.10	BKD	4	GE 101 (4,4V) +	GSE 100		
					VW Nr. 03G 103 483				
2.0 FSI	2.0	110	10.03-11.05	AXW/BLR/BLX/BVY	4	Z 236	14 F-6 HTPRX02	1,0	○
2.0 FSI	2.0	110	10.03-11.05	BVZ	4	Z 193	14 FR-7 DU2	0,9	UXT 1 <sup>3</sup>
2.0 FSI	2.0	110	10.03-11.05	BLY	4	Z 228	14 FR-7 DPUX02	1,0	UXT 11
2.0 TDI	2.0	125	12.05-05.10	CFJA	4	GE 115 (4,4V)	○		

### TOURAN (1T3)

1.6 TDI	1.6	66	05.10-	CAYB	4	GE 115 (4,4V)	○		
2.0 TDI	2.0	81	11.10-	CLCA	4	GE 115 (4,4V)	○		

### VENTO (1H2)

1.4	1.4	40	11.91-06.95	AEX/ABD	4	Z 2	14-8 DTU	1,0	UXT 2 <sup>4</sup>
1.4	1.4	40	07.95-09.98	AEX/ABD	4	Z 91	14 GH-7 DTUR	0,8	UXT 2 <sup>4</sup>
1.4	1.4	44	11.91-09.98	ABD	4	Z 2	14-8 DTU	1,0	UXT 2 <sup>4</sup>
1.4	1.4	44	11.91-09.98	AEX	4	Z 91	14 GH-7 DTUR	0,8	UXT 2 <sup>4</sup>
1.6	1.6	55	09.92-09.98	AEA/AEE/ABU	4	Z 91	14 GH-7 DTUR	0,8	UXT 2 <sup>4</sup>



kW

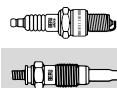
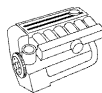

**VW AG**

**VENTO (1H2)**

1.6	1.6	74	10.94-09.98	AEK	4	<b>Z 126</b>	14 FGH-8 DTUR	0,8	<b>UXT 1<sup>3</sup></b>
1.6	1.6	74	10.94-09.98	AFT	4	<b>Z 90</b>	14 FGH-7 DTURX	1,0	<b>UXT 1<sup>3</sup></b>
1.8	1.8	55	11.91-09.98	AAM	4	<b>Z 92</b>	14 GH-8 DTUR	0,8	<b>UXT 2<sup>4</sup></b>
1.8	1.8	66	11.91-09.98	ABS/ADZ	4	<b>Z 91</b>	14 GH-7 DTUR	0,8	<b>UXT 2<sup>4</sup></b>
1.9 SDI	1.9	47	04.97-09.98	AEY	4	<b>GN 855</b> (12V)	○		
1.9 D	1.9	48	11.91-09.98	1Y	4	<b>GN 857</b> (11V)	○		
1.9 TD	1.9	55	11.91-09.98	AAZ	4	<b>GN 857</b> (11V)	○		
1.9 TDI	1.9	66	09.93-09.98	ALE/1Z/AHU	4	<b>GN 855</b> (12V)	○		
			Kühlwasservorwärmung <sup>15</sup>			<b>GN 857</b> (11V)=3x			
						<b>GN 928</b> (12V)=3x			
						⊗: M 5/3Nm			
						⊗: Ø 4 mm			
1.9 TDI	1.9	81	04.96-09.98	AFN	4	<b>GN 855</b> (12V)	○		
			Kühlwasservorwärmung <sup>15</sup>			<b>GN 857</b> (11V)=3x			
						<b>GN 928</b> (12V)=3x			
						⊗: M 5/3Nm			
						⊗: Ø 4 mm			
2.0 GL	2.0	62	11.91-07.95	AAC	4	<b>Z 78</b>	14-9 DTU	0,8	<b>UXT 2<sup>4</sup></b>
2.0 GL	2.0	62	08.95-07.98	AAC	4	<b>Z 92</b>	14 GH-8 DTUR	0,8	<b>UXT 2<sup>4</sup></b>
2.0 GL	2.0	79	05.96-12.97	AEP	4	<b>Z 91</b>	14 GH-7 DTUR	0,8	<b>UXT 2<sup>4</sup></b>
2.0	2.0	85	11.91-09.98	2E/ADY/AGG/AKR	4	<b>Z 91</b>	14 GH-7 DTUR	0,8	<b>UXT 2<sup>4</sup></b>
2.8 VR6	2.8	128	01.92-09.98	AAA	6	<b>Z 173</b>	14 FGR-8 KQU	1,6	○

**VOYAGE**

1.0	1.0	37	08.96-12.01	AER	4	<b>Z 91</b>	14 GH-7 DTUR	0,8	<b>UXT 2<sup>4</sup></b>
1.4	1.4	62	05.96-07.02	AGY	4	<b>Z 22</b>	14-6 DU	0,7	<b>UX 56</b>
1.6 TD	1.6	51	10.94-05.02	JXF	4	<b>GN 857</b> (11V)	○		
1.6 Flex	1.6	74	07.08-	CFZA	4	<b>Z 344</b>	14 F-7 HTUR	1,0	○
1.9 TDi	1.9	66	09.99-09.01	1Z	4	<b>GN 855</b> (12V)	○		
			Kühlwasservorwärmung <sup>15</sup>			<b>GN 857</b> (11V)=3x			
						<b>GN 928</b> (12V)=3x			
						⊗: M 5/3Nm			
						⊗: Ø 4 mm			



**BUS/TRANSPORTER T3**

1.6 TD	1.6	51	08.84-07.92	JX	4	<b>GN 857</b> (11V)	<b>GR 001</b>	<b>SR 028</b>	
1.6 TD Syncro	1.6	51	03.86-07.92	JX	4	<b>GN 857</b> (11V)	<b>GR 001</b>	<b>SR 028</b>	
1.7 D	1.7	42	10.86-07.92	KY	4	<b>GN 857</b> (11V)	<b>GR 001</b>	<b>SR 028</b>	
1.9	1.9	44	08.82-07.92	DF	4	<b>Z 61</b>	14-7 DUO	0,7	<b>UXT 2<sup>4</sup></b>
1.9	1.9	57	10.82-07.92	DG	4	<b>Z 62</b>	14-7 DUO	0,8	<b>UXT 2<sup>4</sup></b>
1.9 Syncro	1.9	57	11.84-07.92	DG	4	<b>Z 62</b>	14-7 DUO	0,8	<b>UXT 2<sup>4</sup></b>
2.1	2.1	64	10.86-07.92	SR	4	<b>Z 58</b>	14-7 CU	0,8	○
2.1 Syncro	2.1	64	10.86-07.92	SR	4	<b>Z 58</b>	14-7 CU	0,8	○
2.1 i	2.1	68	07.89-07.92	SS	4	<b>Z 58</b>	14-7 CU	0,8	○
2.1	2.1	70	08.85-07.92	MV	4	<b>Z 58</b>	14-7 CU	0,8	○
2.1 KAT	2.1	70	06.89-07.92	MV	4	<b>Z 58</b>	14-7 CU	0,8	○
2.1 Syncro	2.1	70	08.85-07.92	MV	4	<b>Z 58</b>	14-7 CU	0,8	○
2.1	2.1	82	08.85-07.92	DJ → Fgst.Nr K	4	<b>Z 42</b>	14-5 DU	0,8	<b>UX 56</b>
2.1	2.1	82	08.85-07.92	DJ Fgst.Nr L →	4	<b>Z 12</b>	14-7 DTU	0,8	<b>UXT 2<sup>4</sup></b>
2.1 Syncro	2.1	82	01.86-07.92	DJ → Fgst.Nr K	4	<b>Z 42</b>	14-5 DU	0,8	<b>UX 56</b>
2.1 Syncro	2.1	82	01.86-07.92	DJ Fgst.Nr L →	4	<b>Z 12</b>	14-7 DTU	0,8	<b>UXT 2<sup>4</sup></b>

**BUS/TRANSPORTER T4**

1.8	1.8	49	12.90-07.92	PD	4	<b>Z 12</b>	14-7 DTU	0,8	<b>UXT 2<sup>4</sup></b>
			Standheizung <sup>16</sup>			<b>GH 408</b> (12V)			
1.9 D	1.9	44	09.90-04.03	1X	4	<b>GN 857</b> (11V)	<b>GR 031</b>	<b>SR 028</b>	
1.9 D	1.9	45	07.90-04.03	1X	4	<b>GN 857</b> (11V)	<b>GR 031</b>	<b>SR 028</b>	
			Standheizung <sup>16</sup>			<b>GH 408</b> (12V)			
1.9 TD	1.9	50	10.92-04.03	ABL	4	<b>GN 857</b> (11V)	○		
			Standheizung <sup>16</sup>			<b>GH 408</b> (12V)			
2.0	2.0	62	09.90-07.95	AAC	4	<b>Z 78</b>	14-9 DTU	0,8	<b>UXT 2<sup>4</sup></b>
			Standheizung <sup>16</sup>			<b>GH 408</b> (12V)			
2.0	2.0	62	08.95-04.03	AAC	4	<b>Z 92</b>	14 GH-8 DTUR	0,8	<b>UXT 2<sup>4</sup></b>
			Standheizung <sup>16</sup>			<b>GH 408</b> (12V)			
2.0	2.0	62	07.90-07.95	APL/AVT	4	<b>Z 78</b>	14-9 DTU	0,8	<b>UXT 2<sup>4</sup></b>
2.0	2.0	62	08.95-04.03	APL/AVT	4	<b>Z 92</b>	14 GH-8 DTUR	0,8	<b>UXT 2<sup>4</sup></b>
2.4 D	2.4	55	08.97-04.03	AJA	5	<b>GN 857</b> (11V)	<b>GR 031</b>	<b>SR 028</b>	
			Standheizung <sup>16</sup>			<b>GH 408</b> (12V)			







kW

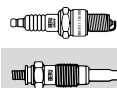
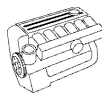

**VW AG**



**CADDY II**

1.4 60	1.4	44	11.95-01.04	AEX/APQ	4	<b>Z 91</b>	14 GH-7 DTUR	0,8	<b>UXT 2<sup>4</sup></b>
1.4 60	1.4	44	11.95-01.04	AUD	4	<b>Z 176</b>	14 F-7 HPURX2	1,0	○
1.4	1.4	55	08.00-01.04	AUA	4	<b>Z 90</b>	14 FGH-7 DTURX	1,0	<b>UXT 1<sup>3</sup></b>
1.4 16V	1.4	55	08.00-01.04	AUA	4	<b>Z 90</b>	14 FGH-7 DTURX	1,0	<b>UXT 1<sup>3</sup></b>
1.6	1.6	55	11.95-05.97	1F	4	<b>Z 92</b>	14 GH-8 DTUR	0,8	<b>UXT 2<sup>4</sup></b>
1.6	1.6	55	06.97-09.00	AEE	4	<b>Z 91</b>	14 GH-7 DTUR	0,8	<b>UXT 2<sup>4</sup></b>
1.6 75	1.6	55	11.95-05.97	1F	4	<b>Z 92</b>	14 GH-8 DTUR	0,8	<b>UXT 2<sup>4</sup></b>
1.6 75	1.6	55	11.95-09.00	AEE	4	<b>Z 91</b>	14 GH-7 DTUR	0,8	<b>UXT 2<sup>4</sup></b>
1.7 SDI	1.7	42	07.96-09.00	AHB	4	<b>GN 855</b> (12V)	○		
1.9 D	1.9	47	11.95-01.04	1Y	4	<b>GN 857</b> (11V)	○		
1.9 SDI	1.9	47	11.95-01.04	AYQ/AEY	4	<b>GN 855</b> (12V)	○		
1.9 TDI	1.9	66	09.96-01.04	1Z/AHU/ALH	4	<b>GN 855</b> (12V)	○		
				Kühlwasservorwärmung <sup>15</sup>		<b>GN 857</b> (11V)=3x			
						<b>GN 928</b> (12V)=3x			
1.9 TDI	1.9	66	10.96-01.04	ALE/AHU/ALH	4	<b>GN 855</b> (12V)	○		
				Kühlwasservorwärmung <sup>15</sup>		<b>GN 857</b> (11V)			
						<b>GN 928</b> (12V)=3x			

**CADDY II Pick-up**

1.6	1.6	55	06.96-12.00	AEE	4	<b>Z 91</b>	14 GH-7 DTUR	0,8	<b>UXT 2<sup>4</sup></b>
1.9 D	1.9	47	06.96-12.00	AEF	4	<b>GN 857</b> (11V)	○		

**CADDY III**

1.4	1.4	55	03.04-05.06	BCA	4	<b>Z 90</b>	14 FGH-7 DTURX	1,0	<b>UXT 1<sup>3</sup></b>
1.4 16V	1.4	59	05.06-08.10	BUD	4	<b>Z 272</b>	14 F-7 HURU02	1,0	○
1.6 TDI	1.6	55	08.10-	CAYE	4	<b>GE 115</b> (4,4V)	○		
1.6	1.6	75	04.04-	BGU/BSF/BSE	4	<b>Z 90</b>	14 FGH-7 DTURX	1,0	<b>UXT 1<sup>3</sup></b>
1.6 BiFuel	1.6	75	05.11-	CHGA	4	<b>Z 90</b>	14 FGH-7 DTURX	1,0	<b>UXT 1<sup>3</sup></b>
1.6 TDI	1.6	75	08.10-	CAYD	4	<b>GE 115</b> (4,4V)	○		
1.9 TDI	1.9	55	09.05-08.10	BSU	4	<b>GE 100</b> (5V)	<b>GSE 100</b>		
1.9 TDI	1.9	77	04.04-08.10	BJB/BLS Fgst.Nr. 70251→	4	<b>GE 100</b> (5V)	<b>GSE 100</b>		
1.9 TDI 4motion	1.9	77	11.08-08.10	BLS	4	<b>GE 100</b> (5V)	<b>GSE 100</b>		
2.0 SDI	2.0	51	03.04-08.10	BST/BDJ	4	<b>GN 046</b> (12V)	○		
2.0 TDI	2.0	62	11.10-	CFHE	4	<b>GE 115</b> (4,4V)	○		
2.0 TDI 4motion	2.0	62	12.10-	CFHE	4	<b>GE 115</b> (4,4V)	○		
2.0 EcoFuel	2.0	80	04.06-	BSX	4	<b>Z 193</b>	14 FR-7 DU2	0,9	<b>UXT 1<sup>3</sup></b>
2.0 TDI	2.0	81	08.10-	CLCA	4	<b>GE 115</b> (4,4V)	○		
2.0 TDI 4motion	2.0	81	08.10-	CFHF	4	<b>GE 115</b> (4,4V)	○		
2.0 TDI	2.0	103	09.07-08.10	BMM	4	<b>GE 100</b> (5V)	<b>GSE 100</b>		
2.0 TDI 16V	2.0	103	11.10-	CFHC	4	<b>GE 115</b> (4,4V)	○		
2.0 TDI 16V 4motion	2.0	103	11.10-	CFHC	4	<b>GE 115</b> (4,4V)	○		
2.0 TDI	2.0	125	05.12-	CFJA	4	<b>GE 115</b> (4,4V)	○		

**CRAFTER 30-35**

2.0 TDI	2.0	80	05.11-	CKTB	4	<b>GE 115</b> (4,4V)	○		
2.0 TDI	2.0	100	05.11-	CKTC	4	<b>GE 115</b> (4,4V)	○		
2.0 TDI	2.0	105	10.11-	CKUC	4	<b>GE 115</b> (4,4V)	○		
2.0 TDI	2.0	120	07.11-	CKUB	4	<b>GE 115</b> (4,4V)	○		
2.0 TDI 4motion	2.0	120	11.11-	CKUB	4	<b>GE 115</b> (4,4V)	○		

**CRAFTER 30-50**

2.0 TDI	2.0	80	05.11-	CKTB	4	<b>GE 115</b> (4,4V)	○		
2.0 TDI	2.0	100	05.11-	CKTC	4	<b>GE 115</b> (4,4V)	○		
2.0 TDI	2.0	105	10.11-	CKUC	4	<b>GE 115</b> (4,4V)	○		
2.0 TDI	2.0	120	07.11-	CKUB	4	<b>GE 115</b> (4,4V)	○		
2.0 TDI 4motion	2.0	120	11.11-	CKUB	4	<b>GE 115</b> (4,4V)	○		

**LT 28-35 I**

2.4 D	2.4	51	08.89-06.96	1S/ACT	6	<b>GN 857</b> (11V)	○		
2.4 D Syncro	2.4	51	08.91-07.92	1S	6	<b>GN 857</b> (11V)	○		
2.4 D	2.4	55	12.78-07.92	DW/CP	6	<b>GN 857</b> (11V)	<b>GR 001</b>	<b>SR 028</b>	
2.4 D Syncro	2.4	55	08.91-07.92	DW	6	<b>GN 857</b> (11V)	○		
2.4	2.4	66	12.82-07.92	DL	6	<b>Z 61</b>	14-7 DU0	0,7	<b>UXT 2<sup>4</sup></b>
2.4 Syncro	2.4	66	08.91-07.92	DL → Fgst.Nr. 28-H-025 000	6	<b>Z 11</b>	14-7 DU	0,8	<b>UXT 2<sup>4</sup></b>

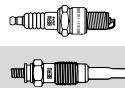
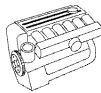

## VW AG



### LT 28-35 I

2.4 Syncro	2.4	66	08.91-07.92	DL Fgst.Nr. 28-J-000 001 → 6	6	<b>Z 61</b>	14-7 DUO	0,7	<b>UXT 2<sup>4</sup></b>
2.4 TD	2.4	68	08.88-08.92	1G	6	<b>GN 857</b> (11V)	<b>GR 001</b>	<b>SR 028</b>	
2.4 i	2.4	69	08.89-12.90	1E	6	<b>Z 61</b>	14-7 DUO	0,7	<b>UXT 2<sup>4</sup></b>
2.4 i	2.4	69	01.91-07.95	1E	6	<b>Z 2</b>	14-8 DTU	1,0	<b>UXT 2<sup>4</sup></b>
2.4 i	2.4	69	08.95-06.96	1E	6	<b>Z 92</b>	14 GH-8 DTUR	0,8	<b>UXT 2<sup>4</sup></b>
2.4 TD	2.4	70	08.92-06.96	ACL	6	<b>GN 857</b> (11V)	○		
2.4 Syncro	2.4	70	08.92-07.94	1E	6	<b>Z 8</b>	14 R-8 DU	0,8	<b>UXT 2<sup>4</sup></b>
2.4 TD	2.4	75	12.82-09.93	DV	6	<b>GN 857</b> (11V)	<b>GR 001</b>	<b>SR 028</b>	

### LT 28-35 II

2.3	2.3	105	05.96-07.06	AGL	4	<b>Z 101</b>	14 F-8 LDUSR	0,9	<b>UXT 1<sup>3</sup></b>
2.5 SDI	2.5	55	07.96-07.06	AGX	5	<b>GN 855</b> (12V)	○		
2.5 TDI	2.5	61	05.01-07.06	BBE	5	<b>GN 855</b> (12V)	○		
2.5 TDI	2.5	66	05.99-07.06	APA	5	<b>GN 855</b> (12V)	○		
2.5 TDI	2.5	70	05.01-07.06	BBF	5	<b>GN 855</b> (12V)	○		
2.5 TDI	2.5	75	05.96-08.99	AHD	5	<b>GN 855</b> (12V)	○		
2.5 TDI	2.5	80	05.99-07.06	AVR/ANJ	5	<b>GN 855</b> (12V)	○		
2.8 TDi	2.8	92	02.97-12.98	AGK	4	<b>GN 989</b> (11,5V)	○		
2.8 TDi	2.8	96	01.99-01.02	ATA	4	<b>GN 989</b> (11,5V)	○		
2.8 TDi	2.8	116	05.01-06.06	BCQ	4	<b>GN 050</b> (11,5V)	○		

### LT 28-46 II

2.3	2.3	105	05.96-07.06	AGL	4	<b>Z 101</b>	14 F-8 LDUSR	0,9	<b>UXT 1<sup>3</sup></b>
2.3	2.3	105	06.96-07.06	AGL	4	<b>Z 101</b>	14 F-8 LDUSR	0,9	<b>UXT 1<sup>3</sup></b>
2.5 SDI	2.5	55	09.96-07.06	AGX	5	<b>GN 855</b> (12V)	○		
2.5 TDI	2.5	61	05.01-07.06	BBE	5	<b>GN 855</b> (12V)	○		
2.5 TDI	2.5	66	05.99-07.06	APA	5	<b>GN 855</b> (12V)	○		
2.5 TDI	2.5	70	05.01-07.06	BBF	5	<b>GN 855</b> (12V)	○		
2.5 TDI	2.5	75	05.96-08.99	AHD	5	<b>GN 855</b> (12V)	○		
2.5 TDI	2.5	80	05.99-07.06	AVR/ANJ	5	<b>GN 855</b> (12V)	○		
2.8 TDI	2.8	92	06.97-12.98	AGK	4	<b>GN 989</b> (11,5V)	○		
2.8 TDI	2.8	96	01.99-07.06	ATA	4	<b>GN 989</b> (11,5V)	○		
2.8 TDI	2.8	116	04.02-07.06	AUH, BCQ	4	<b>GN 050</b> (11,5V)	○		

### LT 40-55 I

2.4 D	2.4	51	07.90-05.96	1S/ACT	6	<b>GN 857</b> (11V)	○		
2.4 D	2.4	55	12.78-07.92	DW/CP	6	<b>GN 857</b> (11V)	<b>GR 001</b>	<b>SR 028</b>	
2.4	2.4	66	12.82-07.92	DL	6	<b>Z 61</b>	14-7 DUO	0,7	<b>UXT 2<sup>4</sup></b>
2.4 4WD	2.4	66	12.82-07.92	DL	6	<b>Z 61</b>	14-7 DUO	0,7	<b>UXT 2<sup>4</sup></b>
2.4 TD	2.4	68	08.88-08.92	1G	6	<b>GN 857</b> (11V)	<b>GR 001</b>	<b>SR 028</b>	
2.4 i	2.4	69	01.93-07.95	1E	6	<b>Z 2</b>	14-8 DTU	1,0	<b>UXT 2<sup>4</sup></b>
2.4 i	2.4	69	08.95-06.96	1E	6	<b>Z 92</b>	14 GH-8 DTUR	0,8	<b>UXT 2<sup>4</sup></b>
2.4 TD	2.4	70	08.92-06.96	ACL	6	<b>GN 857</b> (11V)	○		
2.4 TD	2.4	75	12.82-09.93	DV	6	<b>GN 857</b> (11V)	<b>GR 001</b>	<b>SR 028</b>	
2.4 TD 4WD	2.4	75	08.78-07.92	DV	6	<b>GN 857</b> (11V)	<b>GR 001</b>	<b>SR 028</b>	

### MULTIVAN T5

1.9 TDI	1.9	62	01.06-11.09	BRR	4	<b>GE 100</b> (5V)	○		
1.9 TDI	1.9	75	06.06-11.09	BRS	4	<b>GE 100</b> (5V)	○		
1.9 TDI	1.9	77	04.03-11.09	AXB	4	<b>GN 046</b> (12V)	○		
2.0 TDI	2.0	62	09.09-	CAAA	4	<b>GE 115</b> (4,4V)	○		
2.0 TDI	2.0	75	09.09-	CAAB	4	<b>GE 115</b> (4,4V)	○		
2.0	2.0	85	11.03-	AXA	4	<b>Z 90</b>	14 FGH-7 DTURX	1,0	<b>UXT 1<sup>3</sup></b>
2.0 TDI	2.0	100	05.10-	CAAE/CCHB	4	<b>GE 115</b> (4,4V)	○		
2.0 TDI 4motion	2.0	100	05.10-	CAAE/CCHB	4	<b>GE 115</b> (4,4V)	○		
2.0 TDI	2.0	103	09.09-	CAAC/CCHA	4	<b>GE 115</b> (4,4V)	○		
2.0 TDI 4motion	2.0	103	09.09-	CAAC/CCHA	4	<b>GE 115</b> (4,4V)	○		
2.0 BitDI	2.0	132	09.09-	CFCA	4	<b>GE 115</b> (4,4V)	○		
2.0 BitDI 4motion	2.0	132	09.09-	CFCA	4	<b>GE 115</b> (4,4V)	○		
2.5 TDI	2.5	96	04.03-11.09	AXD	5	<b>GN 046</b> (12V)	○		
2.5 TDI 4motion	2.5	96	07.04-11.09	AXD	5	<b>GN 046</b> (12V)	○		
2.5 TDI	2.5	120	11.03-11.09	BLJ	5	<b>GN 046</b> (12V)	○		
2.5 TDI	2.5	128	04.03-11.09	AXE	5	<b>GN 046</b> (12V)	○		

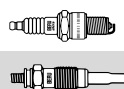
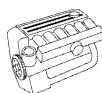
**VW AG****MULTIVAN T5**

2.5 TDI 4motion	2.5	128	07.04-11.09	AXE	5	<b>GN 046</b> (12V)	○		
3.2 V6	3.2	170	02.04-06.04	BDL	6	<b>Z 306</b>	12 F-6 HPURW	0,9	○
3.2 4motion	3.2	170	11.03-06.06	BDL	6	<b>Z 306</b>	12 F-6 HPURW	0,9	○

**SAVEIRO**

1.6	1.6	55	08.90-07.96	1F	4	<b>Z 92</b>	14 GH-8 DTUR	0,8	<b>UXT 2<sup>4</sup></b>
1.6	1.6	55	08.96-02.02	1F	4	<b>Z 92</b>	14 GH-8 DTUR	0,8	<b>UXT 2<sup>4</sup></b>
1.6	1.6	55	08.90-07.96	EW	4	<b>Z 1</b>	14-8 DU	0,8	<b>UXT 2<sup>4</sup></b>
1.6	1.6	55	08.96-02.02	EW	4	<b>Z 1</b>	14-8 DU	0,8	<b>UXT 2<sup>4</sup></b>
1.6 D	1.6	59	08.91-07.96	SB	4	<b>GN 857</b> (11V)	○		
1.8	1.8	73	08.96-02.02	UDH	4	<b>Z 91</b>	14 GH-7 DTUR	0,8	<b>UXT 2<sup>4</sup></b>
1.8	1.8	73	03.02-	UDH	4	<b>Z 91</b>	14 GH-7 DTUR	0,8	<b>UXT 2<sup>4</sup></b>

**TARO**

1.8	1.8	61	04.89-09.94	2Y	4	<b>Z 8</b>	14 R-8 DU	0,8	<b>UXT 2<sup>4</sup></b>
2.2	2.2	69	06.89-07.94	4Y	4	<b>Z 8</b>	14 R-8 DU	0,8	<b>UXT 2<sup>4</sup></b>
2.2 4x4	2.2	69	06.89-07.94	4Y	4	<b>Z 8</b>	14 R-8 DU	0,8	<b>UXT 2<sup>4</sup></b>
2.4 D	2.4	58	07.94-03.97	2L	4	<b>GV 968</b> (11V)	○		
2.4 D 4x4	2.4	58	07.94-03.97	2L	4	<b>GV 968</b> (11V)	○		
2.4 D	2.4	59	09.91-07.94	2L	4	<b>GV 968</b> (11V)	○		
2.4 D	2.4	61	06.89-03.97	2L	4	<b>GV 968</b> (11V)	○		
2.4 D 4x4	2.4	61	04.89-03.97	2L	4	<b>GV 968</b> (11V)	○		
2.4 i 4x4	2.4	84	06.89-03.97	22R	4	<b>Z 82</b>	14 R-9 DU	0,7	<b>UXT 2<sup>4</sup></b>

**WARTBURG****353**

1.3	1.3	43	09.88-05.91	4V07,2/7,5GRF	4	<b>Z 11</b>	14-7 DU	0,8	<b>UXT 2<sup>4</sup></b>
-----	-----	----	-------------	---------------	---	-------------	---------	-----	--------------------------

**353 Tourist**

1.3	1.3	43	02.89-05.91	4V07,2/7,5GRF	4	<b>Z 11</b>	14-7 DU	0,8	<b>UXT 2<sup>4</sup></b>
-----	-----	----	-------------	---------------	---	-------------	---------	-----	--------------------------

**WIESMANN****ROADSTER**

2.8	2.8	142	01.96-	M52286S1	6	<b>Z 237</b>	14 FR-7 DQUP7	1,6	○
-----	-----	-----	--------	----------	---	--------------	---------------	-----	---

**ZASTAVA****101**

1.1	1.1	40	06.73-01.90	128 A.000	4	<b>Z 11</b>	14-7 DU	0,8	<b>UXT 2<sup>4</sup></b>
1.1	1.1	41	05.75-12.93	128 A.064	4	<b>Z 11</b>	14-7 DU	0,8	<b>UXT 2<sup>4</sup></b>

**YUGO**

0.9	0.9	33	04.80-06.92	9A	4	<b>Z 20</b>	14 R-7 DU	0,8	<b>UXT 2<sup>4</sup></b>
1.1 60 EFI	1.1	44	08.91-06.95	11 E 1.064/100 GL. 0.64	4	<b>Z 8</b>	14 R-8 DU	0,8	<b>UXT 2<sup>4</sup></b>
1.3 65 EFI	1.3	48	08.91-06.95	13 E 1.064	4	<b>Z 8</b>	14 R-8 DU	0,8	<b>UXT 2<sup>4</sup></b>

**YUGO FLORIDA**

1.3	1.3	50	03.91-	13 E.3.064	4	<b>Z 8</b>	14 R-8 DU	0,8	<b>UXT 2<sup>4</sup></b>
-----	-----	----	--------	------------	---	------------	-----------	-----	--------------------------

**ZAZ****TAVRIJA**

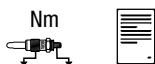

1.1	1.1	37	06.90-	MEMZ-245	4	<b>Z 11</b>	14-7 DU	0,8	<b>UXT 2<sup>4</sup></b>
1.3	1.3	44	06.90-	MEMZ-310	4	<b>Z 11</b>	14-7 DU	0,8	<b>UXT 2<sup>4</sup></b>





<b>CGP 001</b>		0 106 671 105	15		308
<b>GD 01</b>	HA 01	0 102 013 404	38	3	308
<b>GD 12</b>	MB 12	0 100 102 307	38	3	308
<b>GD 71</b>	MB 71	0 100 101 011	38	3	308
<b>GD 203</b>	203 G	0 102 124 601	38	3	308
<b>GD 214</b>	214 GK	0 100 101 302	38	3	308
<b>GD 220</b>	220 G	0 100 100 203	38	3	308
<b>GD 255</b>	255	0 100 101 001	38	3	308
<b>GD 294</b>	294 GK	0 100 102 302	38	3	308
<b>GD 318</b>	318 GK	0 100 101 304	38	3	308
<b>GD 341</b>	341 GL	0 100 101 204	38	3	309
<b>GD 348</b>	348 GK	0 100 101 305	38	3	309
<b>GD 382</b>	382 GK	0 100 101 308	38	3	309
<b>GE 100</b>		0 100 266 008	15		310
<b>GE 101</b>		0 100 266 009	10		310
<b>GE 102</b>		0 100 266 002	15		310
<b>GE 103</b>		0 100 266 003	15		310
<b>GE 104</b>		0 100 266 010	15		310
<b>GE 105</b>		0 100 266 011	10		310
<b>GE 106</b>		0 100 266 018	15	2	310
<b>GE 109</b>		0 100 266 059	15	2	310
<b>GE 110</b>		0 100 266 032	15		310
<b>GE 111</b>		0 100 266 033	15		310
<b>GE 112</b>		0 100 266 031	10		311
<b>GE 113</b>		0 100 266 019	10		311
<b>GE 114</b>		0 100 266 034	10		311
<b>GE 115</b>		0 100 266 040	15		311
<b>GE 116</b>		0 100 266 042	15	2	311
<b>GE 118</b>		0 100 266 037	20		311
<b>GE 119</b>		0 100 266 065	15		311
<b>GE 120</b>		0 100 266 066	15		311
<b>GF 002</b>		0 101 233 499	20	3	364
<b>GF 006</b>		0 101 223 461	20	3	363
<b>GF 007</b>		0 101 233 493	20	3	364
<b>GF 111</b>	111 G	0 101 233 403	20	3	364
<b>GF 154</b>	154 GSF	0 101 072 603	20		366
<b>GF 163</b>	163 GS	0 101 022 404	20		366
<b>GF 167</b>	167 G	0 101 233 401	20	3	364
<b>GF 186</b>	186 GS	0 101 022 405	20		366
<b>GF 529</b>		0 101 234 529	25	5	365
<b>GF 630</b>	630 G	0 101 233 413	20	3	364
<b>GF 667</b>	667 G	0 101 234 504	20	3	365
<b>GF 683</b>	683 G	0 101 223 454	20	3	363
<b>GF 777</b>	777 G	0 101 233 450	20	3	364
<b>GF 817</b>	817 G	0 101 234 513	20	3	365
<b>GF 830</b>		0 101 233 601	20	3	364
<b>GF 831</b>		0 101 223 603	20	3	363
<b>GF 859</b>		0 101 072 405	20		366
<b>GF 972</b>	972 G	0 101 223 457	20	3	363
<b>GF 973</b>	973 G	0 101 223 456	20	3	363
<b>GF 974</b>	974 G	0 101 223 459	20	3	363
<b>GF 975</b>	975 G	0 101 233 480	20	3	364
<b>GF 976</b>	976 G	0 101 233 481	20	3	364
<b>GF 977</b>	977 G	0 101 233 483	20	3	365
<b>GF 978</b>	978 G	0 101 233 486	20	3	365
<b>GF 979</b>	979 G	0 101 233 487	20	3	365
<b>GF 980</b>	980 G	0 101 233 488	20	3	365
<b>GF 981</b>	981 G	0 101 233 489	20	3	365
<b>GF 982</b>		0 101 072 408	20		366
<b>GF 983</b>		0 101 072 409	20		366
<b>GF 984</b>		0 101 223 449	20	5	363
<b>GH 001</b>		0 100 226 340	15	2	312
<b>GH 008</b>		0 100 331 103	15	2	312
<b>GH 009</b>		0 100 331 104	15	2	312



<b>GH 010</b>		0 102 124 416	20	3	312
<b>GH 011</b>		0 102 224 205	40	4	312
<b>GH 13</b>	GZE 13	0 105 100 002	20		312
<b>GH 18</b>	GZE 18	0 105 100 008	20		312
<b>GH 30</b>	GZE 30	0 105 100 021	20		312
<b>GH 116</b>	116 S	0 102 022 202	15	3	312
<b>GH 191</b>	191 GS	0 102 062 202	15		313
<b>GH 195</b>	195 GLS	0 102 012 205	15	3	313
<b>GH 201</b>	GZE 201	0 105 110 001	20		313
<b>GH 202</b>	GZE 202	0 105 110 002	20		313
<b>GH 203</b>	GZE 203	0 105 110 003	20		313
<b>GH 306</b>		0 102 174 306	20		313
<b>GH 345</b>	345 GK	0 102 113 302	20	3	313
<b>GH 359</b>	359 G	0 102 113 303	20	3	313
<b>GH 401</b>		0 102 124 418	60	3	313
<b>GH 407</b>	407 GS	0 101 172 403	20		314
<b>GH 408</b>	408 GS	0 102 123 203	15	2	314
<b>GH 409</b>	409 GS	0 102 174 303	20		314
<b>GH 410</b>	410 GS	0 102 184 303	20		314
<b>GH 648</b>	648 MJ	0 102 271 301	20		314
<b>GH 649</b>	649 GS	0 102 022 301	20	3	314
<b>GH 760</b>		0 102 024 405	20	3	314
<b>GH 846</b>	846 G	0 102 133 204	15		314
<b>GH 847</b>	847 G	0 102 173 212	15		314
<b>GH 931</b>	931 GS	0 102 133 403	20	2	315
<b>GHA 408</b>	408 GSA	0 102 123 403	20	2	315
<b>GN 001</b>		0 100 226 333	25		316
<b>GN 002</b>		0 100 231 119	25		316
<b>GN 003</b>		0 100 226 379	18		316
<b>GN 005</b>		0 100 226 336	15	2	316
<b>GN 007</b>		0 100 226 343	15		316
<b>GN 008</b>		0 100 226 338	15		316
<b>GN 010</b>		0 100 226 365	15	2	316
<b>GN 012</b>		0 100 226 354	15	2	316
<b>GN 013</b>		0 100 226 366	22	3	316
<b>GN 015</b>		0 100 226 392	15		316
<b>GN 016</b>		0 100 226 371	15	2	317
<b>GN 017</b>		0 100 226 372	15	2	317
<b>GN 018</b>		0 100 226 373	15		317
<b>GN 019</b>		0 100 226 375	15		317
<b>GN 020</b>		0 100 226 376	22		317
<b>GN 022</b>		0 100 226 381	25	3	317
<b>GN 023</b>		0 100 226 481	15	2	317
<b>GN 024</b>		0 100 226 362	15		317
<b>GN 025</b>		0 100 226 370	15		317
<b>GN 026</b>		0 100 226 351	15		317
<b>GN 027</b>		0 100 226 344	15	2	318
<b>GN 030</b>		0 100 226 391	15		318
<b>GN 032</b>		0 100 226 505	15	2	318
<b>GN 033</b>		0 100 226 417	15		318
<b>GN 035</b>		0 100 226 422	15	2	318
<b>GN 036</b>		0 100 271 204	18		318
<b>GN 037</b>		0 100 276 003	15		318
<b>GN 039</b>		0 100 226 352	15	2	318
<b>GN 040</b>		0 100 226 434	15	2	318
<b>GN 041</b>		0 100 226 436	12		318
<b>GN 042</b>		0 100 226 480	15	2	319
<b>GN 043</b>		0 100 226 475	20	1,5	319
<b>GN 044</b>		0 100 230 107	15	1,5	319
<b>GN 045</b>		0 100 276 005	10		319
<b>GN 046</b>		0 100 226 482	15		319
<b>GN 047</b>		0 100 276 004	15	1,5	319
<b>GN 049</b>		0 100 271 205	18		319
<b>GN 050</b>		0 100 226 435	15		319

				Nm	
					
GN 053		0 100 276 008	10		319
GN 054		0 100 226 492	15	1	319
GN 055		0 100 226 494	15		320
GN 056		0 100 276 012	10		320
GN 057		0 100 222 106	15	2	320
GN 058		0 100 276 014	10	2	320
GN 059		0 100 276 015	10		320
GN 060		0 100 226 517	15		320
GN 061		0 100 226 520	15	2	320
GN 062		0 100 226 522	15	2	320
GN 063		0 100 276 024	10		320
GN 064		0 100 226 526	15	2	320
GN 065		0 100 226 527	15	2	321
GN 066		0 100 231 133	25		321
GN 067		0 100 226 569	15	2	321
GN 068		0 100 226 570	15	2	321
GN 069		0 100 276 031	12		321
GN 070		0 100 800 033	15	2	321
GN 071		0 100 800 034	18		321
GN 072		0 100 800 035	15	2	321
GN 073		0 100 800 036	15		321
GN 074		0 100 800 037	22	2	321
GN 075		0 100 800 038	18	2	322
GN 076		0 100 800 039	22	2	322
GN 077		0 100 800 040	18	2	322
GN 078		0 100 800 041	18	2	322
GN 080		0 100 800 043	18	2	322
GN 081		0 100 800 044	18	2	322
GN 082		0 100 800 045	10	2	322
GN 095		0 100 226 577	15	2	322
GN 096		0 100 226 638	15	2	322
GN 097		0 100 226 639	12		322
GN 101		0 100 226 514	15	2	323
GN 102		0 100 226 513	15	2	323
GN 103		0 100 226 495	15	2	323
GN 104		0 100 226 497	15		323
GN 106		0 100 226 525	15	2	323
GN 107		0 100 226 511	15	2	323
GN 108		0 100 226 538	15	2	323
GN 109		0 100 800 031	15	2	323
GN 110		0 100 226 568	15	2	323
GN 853	853 MJ	0 100 226 170	15	2	323
GN 854	854 MJ	0 100 226 171	15	2	324
GN 855	855 MJ	0 100 226 227	15		324
GN 857	857 MJ	0 100 226 173	22	3	324
GN 858	858 MJ	0 100 226 234	22	3	324
GN 860	860 MJ	0 100 226 258	22		324
GN 905	905 MJ	0 100 226 184	15	2	324
GN 908	908 MJ	0 100 226 185	22	3	324
GN 909	909 MJ	0 100 226 186	22	3	324
GN 912	912 MJ	0 100 226 188	15	2	324
GN 917	917 MJ	0 100 226 189	22	3	324
GN 918	918 MJ	0 100 226 190	22	3	325
GN 925		0 100 226 432	22	2	325
GN 926		0 100 231 110	15	2	325
GN 927	927 MJ	0 100 226 198	22	2	325
GN 928	928 MJ	0 100 226 199	22		325
GN 939		0 100 226 385	15	2	325
GN 944	944 MJ	0 100 226 206	15	2	325
GN 948	948 MJ	0 100 226 235	22		325
GN 954	954 MJ	0 100 226 229	22	3	325
GN 955	955 MJ	0 100 226 233	15	2	325
GN 959	959 MJ	0 100 226 237	22	3	326
GN 960		0 100 226 239	25		326

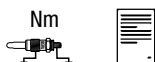

				Nm	
					
GN 961	961 MJ	0 100 226 250	22		326
GN 963	963 MJ	0 100 226 245	15	2	326
GN 964	964 MJ	0 100 226 246	15	2	326
GN 970	970 MJ	0 100 226 249	22	2	326
GN 984		0 100 226 253	22	3	326
GN 985		0 100 226 255	15		326
GN 989		0 100 226 284	15		326
GN 991	991 MJ	0 100 226 299	22	2	326
GN 992		0 100 226 300	15		327
GN 993		0 100 226 384	15	2	327
GN 994		0 100 226 302	15	2	327
GN 997		0 100 226 312	15	2	327
GN 999	999 MJ	0 100 226 238	15	2	327
GV 001		0 100 222 105	15	2	328
GV 003		0 100 800 002	15		328
GV 004		0 100 271 106	15		328
GV 007		0 100 226 506	15	2	328
GV 106	106 MJ	0 100 221 209	25	3	328
GV 107	107 MJ	0 100 222 301	40	3	328
GV 108	108 MJ	0 100 222 302	40	3	328
GV 110	110 MJ	0 100 222 303	40	3	328
GV 112	112 M	0 100 221 101	15	3	328
GV 117	117 MJ	0 100 232 301	40	3	328
GV 119	119 M	0 100 221 201	25	3	329
GV 123	123 MJ	0 100 221 202	25	3	329
GV 127	127 MJ	0 100 332 301	40	3	329
GV 128	128 M	0 100 281 301	40		329
GV 129	129 MJ	0 100 221 203	25	3	329
GV 130	130 MJ	0 100 221 210	25	3	329
GV 133	133 MJ	0 100 231 202	25	3	329
GV 134	134 M	0 100 271 601	15		329
GV 136	136 MJ	0 100 221 204	25	3	329
GV 137	137 MJ	0 100 220 206	25	3	329
GV 142	142 MJ	0 100 222 201	25	3	330
GV 144	144 MNK	0 100 220 204	25	3	330
GV 145	145 M	0 100 271 301	40		330
GV 149	149 MJ	0 100 222 305	40	3	330
GV 153	153 MJ	0 100 231 101	22	3	330
GV 155	155 MJ	0 100 221 206	27	3	330
GV 165	165 MJ	0 100 231 302	40	3	330
GV 170	170 MJ	0 100 221 301	40	3	330
GV 175	175 M	0 100 222 202	25	3	330
GV 176	176 M	0 100 220 201	25	3	330
GV 179	179 MN	0 100 221 305	40	3	331
GV 181	181 MN	0 100 231 305	40	3	331
GV 182	182 MJ	0 100 221 302	40	3	331
GV 191	191 MJ	0 100 231 303	40	3	331
GV 196	196 MJ	0 100 221 303	40	3	331
GV 197	197 MJ	0 100 221 304	40	3	331
GV 198	198 M	0 100 222 203	25	3	331
GV 199	199 M	0 100 220 203	25	3	331
GV 361	361 MK	0 100 302 301	40	3	331
GV 380	380 MJ	0 100 331 301	40	3	331
GV 390	390 MJ	0 100 331 303	40	3	332
GV 602	602 MJ	0 100 221 106	22	3	332
GV 603	603 MJ	0 100 221 107	22	3	332
GV 604	604 MJ	0 100 221 108	22	3	332
GV 626	626 MJ	0 100 221 311	38	3	332
GV 631	631 MJ	0 100 221 132	22	3	332
GV 636	636 MJ	0 100 221 133	22	3	332
GV 642	642 MJ	0 100 221 135	22	3	332
GV 657	657 MJ	0 100 221 141	22	3	332
GV 661	661 MJ	0 100 221 144	22	2	332
GV 663	663 MJ	0 100 221 145	22	3	333



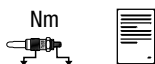

<b>GV 664</b>	664 MJ	0 100 232 204	25	3	333
<b>GV 666</b>	666 MJ	0 100 221 146	22	2	333
<b>GV 673</b>	673 MJ	0 100 221 147	15	2	333
<b>GV 678</b>	678 MJ	0 100 221 148	15	2	333
<b>GV 685</b>	685 MJ	0 100 221 149	15	2	333
<b>GV 688</b>	688 MJ	0 100 221 151	15	2	333
<b>GV 689</b>	689 MJ	0 100 221 152	22	3	333
<b>GV 691</b>	691 MJ	0 100 221 153	22	3	333
<b>GV 705</b>	705 MJ	0 100 221 154	15	2	333
<b>GV 719</b>	719 MJ	0 100 221 163	22	3	334
<b>GV 724</b>	724 MJ	0 100 221 164	22	3	334
<b>GV 727</b>	727 MJ	0 100 221 167	22	3	334
<b>GV 728</b>	728 MJ	0 100 221 168	15	2	334
<b>GV 730</b>	730 MJ	0 100 221 170	15	2	334
<b>GV 736</b>	736 MJ	0 100 231 120	22	3	334
<b>GV 749</b>	749 MJ	0 100 221 186	15	2	334
<b>GV 776</b>	776 MJ	0 100 231 103	22	3	334
<b>GV 783</b>	783 MJ	0 100 226 129	15	2	334
<b>GV 798</b>	798 MJ	0 100 226 128	22	2	334
<b>GV 819</b>	819 MJ	0 100 226 138	15		335
<b>GV 823</b>	823 MJ	0 100 271 101	15		335
<b>GV 844</b>	844 MJ	0 100 226 164	22	3	335
<b>GV 852</b>	852 MJ	0 100 226 163	22	3	335
<b>GV 880</b>	880 MJ	0 100 231 104	15	2	335
<b>GV 886</b>	886 MJ	0 100 226 180	15	2	335
<b>GV 887</b>	887 MJ	0 100 230 101	15	2	335
<b>GV 888</b>	888 MJ	0 100 220 113	22	3	335
<b>GV 889</b>	889 MJ	0 100 220 114	15	2	335
<b>GV 890</b>	890 MJ	0 100 230 102	15	2	336
<b>GV 892</b>	892 MJ	0 100 220 115	15	2	336
<b>GV 894</b>	894 MJ	0 100 222 101	15	2	336
<b>GV 895</b>	895 MJ	0 100 231 107	15	2	336
<b>GV 896</b>	896 MJ	0 100 222 102	15	2	336
<b>GV 897</b>	897 MJ	0 100 226 182	15	2	336
<b>GV 910</b>	910 MJ	0 100 221 314	40	3	336
<b>GV 920</b>	920 MJ	0 100 220 118	15	2	336
<b>GV 921</b>	921 MJ	0 100 226 194	15	2	336
<b>GV 945</b>	945 MJ	0 100 226 209	15	2	336
<b>GV 946</b>	946 MJ	0 100 226 207	15	2	337
<b>GV 947</b>	947 MJ	0 100 226 208	15	2	337
<b>GV 967</b>	967 MJ	0 100 226 242	15	2	337
<b>GV 968</b>	968 MJ	0 100 226 243	15	2	337
<b>PSG 001</b>		0 103 010 903	12		338
<b>PSG 002</b>		0 103 111 104	15		338
<b>PSG 003</b>		0 103 110 904	12		338
<b>PSG 004</b>		0 103 010 104	15		338



<b>G 1 SB</b>	GN 857	0 900 102 029	22	3	
<b>G 5 SB</b>	GN 858	0 900 102 045	22	3	
<b>G 6 SB</b>	GV 719	0 900 102 028	22	3	
<b>G 7 SB</b>	GN 954	0 900 102 038	22	3	
<b>G 10 SB</b>	GV 666	0 900 102 054	22	3	





0 100 100 203	<b>GD 220</b>	220 G	38	3	308
0 100 101 001	<b>GD 255</b>	255	38	3	308
0 100 101 011	<b>GD 71</b>	MB 71	38	3	308
0 100 101 204	<b>GD 341</b>	341 GL	38	3	309
0 100 101 302	<b>GD 214</b>	214 GK	38	3	308
0 100 101 304	<b>GD 318</b>	318 GK	38	3	308
0 100 101 305	<b>GD 348</b>	348 GK	38	3	309
0 100 101 308	<b>GD 382</b>	382 GK	38	3	309
0 100 102 302	<b>GD 294</b>	294 GK	38	3	308
0 100 102 307	<b>GD 12</b>	MB 12	38	3	308
0 100 220 113	<b>GV 888</b>	888 MJ	22	3	335
0 100 220 114	<b>GV 889</b>	889 MJ	15	2	335
0 100 220 115	<b>GV 892</b>	892 MJ	15	2	336
0 100 220 118	<b>GV 920</b>	920 MJ	15	2	336
0 100 220 201	<b>GV 176</b>	176 M	25	3	330
0 100 220 203	<b>GV 199</b>	199 M	25	3	331
0 100 220 204	<b>GV 144</b>	144 MNK	25	3	330
0 100 220 206	<b>GV 137</b>	137 MJ	25	3	329
0 100 221 101	<b>GV 112</b>	112 M	15	3	328
0 100 221 106	<b>GV 602</b>	602 MJ	22	3	332
0 100 221 107	<b>GV 603</b>	603 MJ	22	3	332
0 100 221 108	<b>GV 604</b>	604 MJ	22	3	332
0 100 221 132	<b>GV 631</b>	631 MJ	22	3	332
0 100 221 133	<b>GV 636</b>	636 MJ	22	3	332
0 100 221 135	<b>GV 642</b>	642 MJ	22	3	332
0 100 221 141	<b>GV 657</b>	657 MJ	22	3	332
0 100 221 144	<b>GV 661</b>	661 MJ	22	2	332
0 100 221 145	<b>GV 663</b>	663 MJ	22	3	333
0 100 221 146	<b>GV 666</b>	666 MJ	22	2	333
0 100 221 147	<b>GV 673</b>	673 MJ	15	2	333
0 100 221 148	<b>GV 678</b>	678 MJ	15	2	333
0 100 221 149	<b>GV 685</b>	685 MJ	15	2	333
0 100 221 151	<b>GV 688</b>	688 MJ	15	2	333
0 100 221 152	<b>GV 689</b>	689 MJ	22	3	333
0 100 221 153	<b>GV 691</b>	691 MJ	22	3	333
0 100 221 154	<b>GV 705</b>	705 MJ	15	2	333
0 100 221 163	<b>GV 719</b>	719 MJ	22	3	334
0 100 221 164	<b>GV 724</b>	724 MJ	22	3	334
0 100 221 167	<b>GV 727</b>	727 MJ	22	3	334
0 100 221 168	<b>GV 728</b>	728 MJ	15	2	334
0 100 221 170	<b>GV 730</b>	730 MJ	15	2	334
0 100 221 186	<b>GV 749</b>	749 MJ	15	2	334
0 100 221 201	<b>GV 119</b>	119 M	25	3	329
0 100 221 202	<b>GV 123</b>	123 MJ	25	3	329
0 100 221 203	<b>GV 129</b>	129 MJ	25	3	329
0 100 221 204	<b>GV 136</b>	136 MJ	25	3	329
0 100 221 206	<b>GV 155</b>	155 MJ	27	3	330
0 100 221 209	<b>GV 106</b>	106 MJ	25	3	328
0 100 221 210	<b>GV 130</b>	130 MJ	25	3	329
0 100 221 301	<b>GV 170</b>	170 MJ	40	3	330
0 100 221 302	<b>GV 182</b>	182 MJ	40	3	331
0 100 221 303	<b>GV 196</b>	196 MJ	40	3	331
0 100 221 304	<b>GV 197</b>	197 MJ	40	3	331
0 100 221 305	<b>GV 179</b>	179 MN	40	3	331
0 100 221 311	<b>GV 626</b>	626 MJ	38	3	332
0 100 221 314	<b>GV 910</b>	910 MJ	40	3	336
0 100 222 101	<b>GV 894</b>	894 MJ	15	2	336
0 100 222 102	<b>GV 896</b>	896 MJ	15	2	336
0 100 222 105	<b>GV 001</b>		15	2	328
0 100 222 106	<b>GN 057</b>		15	2	320
0 100 222 201	<b>GV 142</b>	142 MJ	25	3	330
0 100 222 202	<b>GV 175</b>	175 M	25	3	330
0 100 222 203	<b>GV 198</b>	198 M	25	3	331
0 100 222 301	<b>GV 107</b>	107 MJ	40	3	328

0 100 222 302	<b>GV 108</b>	108 MJ	40	3	328
0 100 222 303	<b>GV 110</b>	110 MJ	40	3	328
0 100 222 305	<b>GV 149</b>	149 MJ	40	3	330
0 100 226 128	<b>GV 798</b>	798 MJ	22	2	334
0 100 226 129	<b>GV 783</b>	783 MJ	15	2	334
0 100 226 138	<b>GV 819</b>	819 MJ	15		335
0 100 226 163	<b>GV 852</b>	852 MJ	22	3	335
0 100 226 164	<b>GV 844</b>	844 MJ	22	3	335
0 100 226 170	<b>GN 853</b>	853 MJ	15	2	323
0 100 226 171	<b>GN 854</b>	854 MJ	15	2	324
0 100 226 173	<b>GN 857</b>	857 MJ	22	3	324
0 100 226 180	<b>GV 886</b>	886 MJ	15	2	335
0 100 226 182	<b>GV 897</b>	897 MJ	15	2	336
0 100 226 184	<b>GN 905</b>	905 MJ	15	2	324
0 100 226 185	<b>GN 908</b>	908 MJ	22	3	324
0 100 226 186	<b>GN 909</b>	909 MJ	22	3	324
0 100 226 188	<b>GN 912</b>	912 MJ	15	2	324
0 100 226 189	<b>GN 917</b>	917 MJ	22	3	324
0 100 226 190	<b>GN 918</b>	918 MJ	22	3	325
0 100 226 194	<b>GV 921</b>	921 MJ	15	2	336
0 100 226 198	<b>GN 927</b>	927 MJ	22	2	325
0 100 226 199	<b>GN 928</b>	928 MJ	22		325
0 100 226 206	<b>GN 944</b>	944 MJ	15	2	325
0 100 226 207	<b>GV 946</b>	946 MJ	15	2	337
0 100 226 208	<b>GV 947</b>	947 MJ	15	2	337
0 100 226 209	<b>GV 945</b>	945 MJ	15	2	336
0 100 226 227	<b>GN 855</b>	855 MJ	15		324
0 100 226 229	<b>GN 954</b>	954 MJ	22	3	325
0 100 226 233	<b>GN 955</b>	955 MJ	15	2	325
0 100 226 234	<b>GN 858</b>	858 MJ	22	3	324
0 100 226 235	<b>GN 948</b>	948 MJ	22		325
0 100 226 237	<b>GN 959</b>	959 MJ	22	3	326
0 100 226 238	<b>GN 999</b>	999 MJ	15	2	327
0 100 226 239	<b>GN 960</b>		25		326
0 100 226 242	<b>GV 967</b>	967 MJ	15	2	337
0 100 226 243	<b>GV 968</b>	968 MJ	15	2	337
0 100 226 245	<b>GN 963</b>	963 MJ	15	2	326
0 100 226 246	<b>GN 964</b>	964 MJ	15	2	326
0 100 226 249	<b>GN 970</b>	970 MJ	22	2	326
0 100 226 250	<b>GN 961</b>	961 MJ	22		326
0 100 226 253	<b>GN 984</b>		22	3	326
0 100 226 255	<b>GN 985</b>		15		326
0 100 226 258	<b>GN 860</b>	860 MJ	22		324
0 100 226 284	<b>GN 989</b>		15		326
0 100 226 299	<b>GN 991</b>	991 MJ	22	2	326
0 100 226 300	<b>GN 992</b>		15		327
0 100 226 302	<b>GN 994</b>		15	2	327
0 100 226 312	<b>GN 997</b>		15	2	327
0 100 226 333	<b>GN 001</b>		25		316
0 100 226 336	<b>GN 005</b>		15	2	316
0 100 226 338	<b>GN 008</b>		15		316
0 100 226 340	<b>GH 001</b>		15	2	312
0 100 226 343	<b>GN 007</b>		15		316
0 100 226 344	<b>GN 027</b>		15	2	318
0 100 226 351	<b>GN 026</b>		15		317
0 100 226 352	<b>GN 039</b>		15	2	318
0 100 226 354	<b>GN 012</b>		15	2	316
0 100 226 362	<b>GN 024</b>		15		317
0 100 226 365	<b>GN 010</b>		15	2	316
0 100 226 366	<b>GN 013</b>		22	3	316
0 100 226 370	<b>GN 025</b>		15		317
0 100 226 371	<b>GN 016</b>		15	2	317
0 100 226 372	<b>GN 017</b>		15	2	317
0 100 226 373	<b>GN 018</b>		15		317



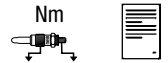
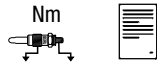
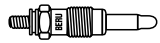

0 100 226 375	<b>GN 019</b>		15		317
0 100 226 376	<b>GN 020</b>		22		317
0 100 226 379	<b>GN 003</b>		18		316
0 100 226 381	<b>GN 022</b>		25	3	317
0 100 226 384	<b>GN 993</b>		15	2	327
0 100 226 385	<b>GN 939</b>		15	2	325
0 100 226 391	<b>GN 030</b>		15		318
0 100 226 392	<b>GN 015</b>		15		316
0 100 226 417	<b>GN 033</b>		15		318
0 100 226 422	<b>GN 035</b>		15	2	318
0 100 226 432	<b>GN 925</b>		22	2	325
0 100 226 434	<b>GN 040</b>		15	2	318
0 100 226 435	<b>GN 050</b>		15		319
0 100 226 436	<b>GN 041</b>		12		318
0 100 226 475	<b>GN 043</b>		20	1,5	319
0 100 226 480	<b>GN 042</b>		15	2	319
0 100 226 481	<b>GN 023</b>		15	2	317
0 100 226 482	<b>GN 046</b>		15		319
0 100 226 492	<b>GN 054</b>		15	1	319
0 100 226 494	<b>GN 055</b>		15		320
0 100 226 495	<b>GN 103</b>		15	2	323
0 100 226 497	<b>GN 104</b>		15		323
0 100 226 505	<b>GN 032</b>		15	2	318
0 100 226 506	<b>GV 007</b>		15	2	328
0 100 226 511	<b>GN 107</b>		15	2	323
0 100 226 513	<b>GN 102</b>		15	2	323
0 100 226 514	<b>GN 101</b>		15	2	323
0 100 226 517	<b>GN 060</b>		15		320
0 100 226 520	<b>GN 061</b>		15	2	320
0 100 226 522	<b>GN 062</b>		15	2	320
0 100 226 525	<b>GN 106</b>		15	2	323
0 100 226 526	<b>GN 064</b>		15	2	320
0 100 226 527	<b>GN 065</b>		15	2	321
0 100 226 538	<b>GN 108</b>		15	2	323
0 100 226 568	<b>GN 110</b>		15	2	323
0 100 226 569	<b>GN 067</b>		15	2	321
0 100 226 570	<b>GN 068</b>		15	2	321
0 100 226 577	<b>GN 095</b>		15	2	322
0 100 226 638	<b>GN 096</b>		15	2	322
0 100 226 639	<b>GN 097</b>		12		322
0 100 230 101	<b>GV 887</b>	887 MJ	15	2	335
0 100 230 102	<b>GV 890</b>	890 MJ	15	2	336
0 100 230 107	<b>GN 044</b>		15	1,5	319
0 100 231 101	<b>GV 153</b>	153 MJ	22	3	330
0 100 231 103	<b>GV 776</b>	776 MJ	22	3	334
0 100 231 104	<b>GV 880</b>	880 MJ	15	2	335
0 100 231 107	<b>GV 895</b>	895 MJ	15	2	336
0 100 231 110	<b>GN 926</b>		15	2	325
0 100 231 119	<b>GN 002</b>		25		316
0 100 231 120	<b>GV 736</b>	736 MJ	22	3	334
0 100 231 133	<b>GN 066</b>		25		321
0 100 231 202	<b>GV 133</b>	133 MJ	25	3	329
0 100 231 302	<b>GV 165</b>	165 MJ	40	3	330
0 100 231 303	<b>GV 191</b>	191 MJ	40	3	331
0 100 231 305	<b>GV 181</b>	181 MN	40	3	331
0 100 232 204	<b>GV 664</b>	664 MJ	25	3	333
0 100 232 301	<b>GV 117</b>	117 MJ	40	3	328
0 100 266 002	<b>GE 102</b>		15		310
0 100 266 003	<b>GE 103</b>		15		310
0 100 266 008	<b>GE 100</b>		15		310
0 100 266 009	<b>GE 101</b>		10		310
0 100 266 010	<b>GE 104</b>		15		310
0 100 266 011	<b>GE 105</b>		10		310
0 100 266 018	<b>GE 106</b>		15	2	310

0 100 266 019	<b>GE 113</b>		10		311
0 100 266 031	<b>GE 112</b>		10		311
0 100 266 032	<b>GE 110</b>		15		310
0 100 266 033	<b>GE 111</b>		15		310
0 100 266 034	<b>GE 114</b>		10		311
0 100 266 037	<b>GE 118</b>		20		311
0 100 266 040	<b>GE 115</b>		15		311
0 100 266 042	<b>GE 116</b>		15	2	311
0 100 266 059	<b>GE 109</b>		15	2	310
0 100 266 065	<b>GE 119</b>		15		311
0 100 266 066	<b>GE 120</b>		15		311
0 100 271 101	<b>GV 823</b>	823 MJ	15		335
0 100 271 106	<b>GV 004</b>		15		328
0 100 271 204	<b>GN 036</b>		18		318
0 100 271 205	<b>GN 049</b>		18		319
0 100 271 301	<b>GV 145</b>	145 M	40		330
0 100 271 601	<b>GV 134</b>	134 M	15		329
0 100 276 003	<b>GN 037</b>		15		318
0 100 276 004	<b>GN 047</b>		15	1,5	319
0 100 276 005	<b>GN 045</b>		10		319
0 100 276 008	<b>GN 053</b>		10		319
0 100 276 012	<b>GN 056</b>		10		320
0 100 276 014	<b>GN 058</b>		10	2	320
0 100 276 015	<b>GN 059</b>		10		320
0 100 276 024	<b>GN 063</b>		10		320
0 100 276 031	<b>GN 069</b>		12		321
0 100 281 301	<b>GV 128</b>	128 M	40		329
0 100 302 301	<b>GV 361</b>	361 MK	40	3	331
0 100 331 103	<b>GH 008</b>		15	2	312
0 100 331 104	<b>GH 009</b>		15	2	312
0 100 331 301	<b>GV 380</b>	380 MJ	40	3	331
0 100 331 303	<b>GV 390</b>	390 MJ	40	3	332
0 100 332 301	<b>GV 127</b>	127 MJ	40	3	329
0 100 800 002	<b>GV 003</b>		15		328
0 100 800 031	<b>GN 109</b>		15	2	323
0 100 800 033	<b>GN 070</b>		15	2	321
0 100 800 034	<b>GN 071</b>		18		321
0 100 800 035	<b>GN 072</b>		15	2	321
0 100 800 036	<b>GN 073</b>		15		321
0 100 800 037	<b>GN 074</b>		22	2	321
0 100 800 038	<b>GN 075</b>		18	2	322
0 100 800 039	<b>GN 076</b>		22	2	322
0 100 800 040	<b>GN 077</b>		18	2	322
0 100 800 041	<b>GN 078</b>		18	2	322
0 100 800 043	<b>GN 080</b>		18	2	322
0 100 800 044	<b>GN 081</b>		18	2	322
0 100 800 045	<b>GN 082</b>		10	2	322
0 101 022 404	<b>GF 163</b>	163 GS	20		366
0 101 022 405	<b>GF 186</b>	186 GS	20		366
0 101 072 405	<b>GF 859</b>		20		366
0 101 072 408	<b>GF 982</b>		20		366
0 101 072 409	<b>GF 983</b>		20		366
0 101 072 603	<b>GF 154</b>	154 GSF	20		366
0 101 172 403	<b>GH 407</b>	407 GS	20		314
0 101 223 449	<b>GF 984</b>		20	5	363
0 101 223 454	<b>GF 683</b>	683 G	20	3	363
0 101 223 456	<b>GF 973</b>	973 G	20	3	363
0 101 223 457	<b>GF 972</b>	972 G	20	3	363
0 101 223 459	<b>GF 974</b>	974 G	20	3	363
0 101 223 461	<b>GF 006</b>		20	3	363
0 101 223 603	<b>GF 831</b>		20	3	363
0 101 233 401	<b>GF 167</b>	167 G	20	3	364
0 101 233 403	<b>GF 111</b>	111 G	20	3	364
0 101 233 413	<b>GF 630</b>	630 G	20	3	364

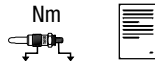

0 101 233 450	<b>GF 777</b>	777 G	20	3	364
0 101 233 480	<b>GF 975</b>	975 G	20	3	364
0 101 233 481	<b>GF 976</b>	976 G	20	3	364
0 101 233 483	<b>GF 977</b>	977 G	20	3	365
0 101 233 486	<b>GF 978</b>	978 G	20	3	365
0 101 233 487	<b>GF 979</b>	979 G	20	3	365
0 101 233 488	<b>GF 980</b>	980 G	20	3	365
0 101 233 489	<b>GF 981</b>	981 G	20	3	365
0 101 233 493	<b>GF 007</b>		20	3	364
0 101 233 499	<b>GF 002</b>		20	3	364
0 101 233 601	<b>GF 830</b>		20	3	364
0 101 234 504	<b>GF 667</b>	667 G	20	3	365
0 101 234 513	<b>GF 817</b>	817 G	20	3	365
0 101 234 529	<b>GF 529</b>		25	5	365
0 102 012 205	<b>GH 195</b>	195 GLS	15	3	313
0 102 013 404	<b>GD 01</b>	HA 01	38	3	308
0 102 022 202	<b>GH 116</b>	116 S	15	3	312
0 102 022 301	<b>GH 649</b>	649 GS	20	3	314
0 102 024 405	<b>GH 760</b>		20	3	314
0 102 024 602	<b>GH 185</b>	185 G	15	3	313
0 102 062 202	<b>GH 191</b>	191 GS	15		313
0 102 113 302	<b>GH 345</b>	345 GK	20	3	313
0 102 113 303	<b>GH 359</b>	359 G	20	3	313
0 102 123 203	<b>GH 408</b>	408 GS	15	2	314
0 102 123 403	<b>GHA 408</b>	408 GSA	20	2	315
0 102 124 416	<b>GH 010</b>		20	3	312
0 102 124 418	<b>GH 401</b>		60	3	313
0 102 124 601	<b>GD 203</b>	203 G	38	3	308
0 102 133 204	<b>GH 846</b>	846 G	15		314
0 102 133 403	<b>GH 931</b>	931 GS	20	2	315
0 102 173 212	<b>GH 847</b>	847 G	15		314
0 102 174 303	<b>GH 409</b>	409 GS	20		314
0 102 174 306	<b>GH 306</b>		20		313
0 102 184 303	<b>GH 410</b>	410 GS	20		314
0 102 184 304	<b>GH 750</b>	750 G	20	2	314
0 102 224 205	<b>GH 011</b>		40	4	312
0 102 271 301	<b>GH 648</b>	648 MJ	20		314
0 103 010 104	<b>PSG 004</b>		15		338
0 103 010 903	<b>PSG 001</b>		12		338
0 103 110 904	<b>PSG 003</b>		12		338
0 103 111 104	<b>PSG 002</b>		15		338
0 105 100 002	<b>GH 13</b>	GZE 13	20		312
0 105 100 008	<b>GH 18</b>	GZE 18	20		312
0 105 100 012	<b>GH 22</b>	GZE 22	20		312
0 105 100 021	<b>GH 30</b>	GZE 30	20		312
0 105 110 001	<b>GH 201</b>	GZE 201	20		313
0 105 110 002	<b>GH 202</b>	GZE 202	20		313
0 105 110 003	<b>GH 203</b>	GZE 203	20		313
0 106 671 105	<b>CGP 001</b>		15		308

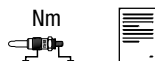

0 900 102 028	<b>G 6 SB</b>	GV 719	22	3	
0 900 102 029	<b>G 1 SB</b>	GN 857	22	3	
0 900 102 038	<b>G 7 SB</b>	GN 954	22	3	
0 900 102 045	<b>G 5 SB</b>	GN 858	22	3	
0 900 102 054	<b>G 10 SB</b>	GV 666	22	3	

## Wichtig beim Austausch: Die richtigen Anzugsdreh- momente von Glühkerze und Stromanschlußmutter!

Beim Austausch von Glühkerzen muß man auf drei Dinge besonders achten:

- 1.) Verschmutzungen rund ums Kerzenloch dürfen auf keinen Fall in den Brennraum fallen.
- 2.) Die Glühkerzen müssen mit dem richtigen Drehmoment angezogen werden.
- 3.) Die Stromanschlußmutter müssen mit dem richtigen Drehmoment angezogen werden.

Bei zu hohen Drehmomenten kann die Glühkerze beschädigt werden. Dies kann deren Zerstörung zur Folge haben (Anschlußbolzen-Abriß oder Überhitzung durch zugezogenen Ringspalt).

### 1. Einbau der Glühkerze mit Drehmomentschlüssel:

Die Vorschriften der Fahrzeughersteller dringend beachten.  
Achtung – maximales Anzugsdrehmoment beachten:  
Gewinde M 8: 10 Nm,  
Gewinde M 9: 12 Nm,  
Gewinde M 10: 12-18 Nm,  
Gewinde M 12: 25-30 Nm.

### 2. Anziehen der Stromanschlußmutter:

Das maximale Anzugsdrehmoment der Strom-Anschlußmutter darf folgende Werte nicht überschreiten:  
bei Gewinde M 4 max. 2 Nm,  
bei Gewinde M 5 max. 3 Nm.  
Bei Glühkerzen mit Steckanschluß diesen auf Korrosion prüfen.

## Important on replacement: the right tightening torque for glow plugs and power connection nuts!

*When replacing glow plugs, there are three aspects to which special attention must be paid:*

- 1.) *Dirt around the hole for the plug must not fall into the combustion chamber under any circumstances.*
- 2.) *The glow plugs must be tightened to the correct torque.*
- 3.) *The power connection nuts must be tightened to the correct tightening torque.*

*The glow plug may be damaged by excessive torque. This can result in irreparable damage to the plug (connecting stud shear or overheating due to closed annular gap).*

### 1. Fitting a glow plug with a torque wrench:

*Ensure to observe vehicle manufacturer's specifications.*

*Caution – observe maximum torque settings:*

- M 8 threads: 10 Nm,*
- M 9 threads: 12 Nm,*
- M 10 threads: 12-18 Nm,*
- M 12 threads: 25-30 Nm.*

### 2. Tightening the power connection nut:

*The maximum torque setting for the power connection nuts must not exceed the following values:*

- M 4 threads max. 2 Nm,*
- M 5 threads max. 3 Nm.*

*If glow plugs have plug connections, check these for corrosion.*

### Wichtig:

Bei jedem Glühkerzenwechsel den Glühkerzenschaft und das Gewinde fetten.

Glühkerzen-Montagefett - GKF 001

- verhindert Korrosion am Gewinde, dadurch kein Festsitzen der Glühkerze
- vermeidet das Eindringen von Feuchtigkeit
- erleichtert den Glühkerzenwechsel

BERU Glühkerzen-Montagefett,  
10 gr. Tube  
Bestell-Nr. 0 890 300 034

### Important:

*Always grease the glow plug shaft and thread when changing glow plugs.*

Glow plug mounting grease - GFK 001

- prevents thread corrosion and therefore stuck glow plugs
- prevents the penetration of water
- facilitates glow plug replacement

BERU glow plug mounting grease,  
10 g tube  
Order no. 0 890 300 034



## Important au moment du remplacement: le couple de serrage de la bougie de préchauffage et de l'écrou de raccordement électrique!

Lors du remplacement des bougies de préchauffage, toujours tenir compte des points suivants:

- 1.) Les impuretés entourant l'orifice de la bougie ne doivent en aucun cas tomber dans la chambre de combustion.
- 2.) Les bougies doivent être serrées avec le couple prescrit.
- 3.) Les écrous de raccordement électrique doivent être serrés avec le couple prescrit.

Un couple trop important peut endommager la bougie de préchauffage et la rendre inutilisable (arrachement des boulons de raccordement ou surchauffe due à l'obturation du passage annulaire).

### 1. Montage de la bougie de préchauffage avec clé dynamométrique:

Respecter absolument les instructions du fabricant.

Attention – respecter le couple de serrage maxi:

filetage M 8: 10 Nm,  
filetage M 9: 12 Nm,  
filetage M 10: 12 à 18 Nm,  
filetage M 12: 25 à 30 Nm.

### 2. Serrage de l'écrou de raccordement électrique:

Le couple de serrage maxi de la barre de raccordement ne doit pas dépasser les valeurs suivantes:  
2 Nm maxi pour un filetage M 4 et  
3 Nm maxi pour un filetage M 5.  
Pour les bougies de préchauffage avec raccordement, contrôler que celui-ci n'est pas rouillé.

## Belangrijk bij het vervangen: het juiste aanhaalmoment van de gloeibougie en de stroomaansluitbout!

*Bij het vervangen van bougies moet op drie dingen in het bijzonder gelet worden:*

- 1.) *Vuil rondom het bougiegat mag in geen geval in de verbrandingsruimte vallen.*
- 2.) *De gloeibougies moeten met het juiste draaimoment aangetrokken worden.*
- 3.) *De stroomaansluitmoeren moeten met het juiste draaimoment aangetrokken worden.*

*Bij te hoge aanhaalmoment kan de gloeibougie beschadigen. Het huis van de gloeibougie kan scheuren of door vervorming kan de ringspleet worden dicht geknepen waardoor oververhitting ontstaat.*

### 1. Inbouw van de gloeibougie met momentsleutel:

*Volg de voorschriften van de fabrikant van het voertuig absoluut op.*

*Let op – let op het maximale aantrekmoment:*

*schroefdraad M 8: 10 Nm,  
schroefdraad M 9: 12 Nm,  
schroefdraad M 10: 12-18 Nm,  
schroefdraad M 12: 25-30 Nm.*

### 2. Aantrekken van de stroomaansluitmoer:

*Het maximale aantrekmoment van de stroomaansluitrails mag de volgende waarden niet overschrijden:  
bij schroefdraad M 4 max. 2 Nm.  
bij schroefdraad M 5 max. 3 Nm.  
Bougies met steekaansluiting controleren op corrosie.*

### Important:

Lors de chaque changement des bougies de préchauffage, lubrifier le bout de la bougie ainsi que le filetage.

Graisse de montage de bougies de préchauffage - GKF 001

- prévient la corrosion du filetage et donc le grippage des bougies de préchauffage
- protège contre la pénétration de l'humidité
- facilite le remplacement des bougies de préchauffage

Graisse de montage de bougies de préchauffage BERU, tube de 10 g  
Référence No. 0 890 300 034

### Belangrijk:

*Bij iedere vervanging van de gloeibougies de schacht en het draad invetten.*

Gloeibougie-montagevet - GKF 001

- verhindert corrosie aan schroefdraad, daardoor komt de gloeibougie niet vast te zitten
- voorkomt het binnendringen van vochtigheid
- vergemakkelijkt het wisselen van gloeibougies

BERU gloeibougies-montagevet,  
10 gr. tube

Bestelnummer 0 890 300 034



## Importante para el cambio de calentadores: ¡Aplicar el par de apriete correcto de la bujía de incandescencia y de la tuerca de conexión de corriente!

Para cambiar las bujías de incandescencia es necesario observar especialmente los tres siguientes puntos:

- 1.) Evitar siempre que la suciedad depositada alrededor del orificio de la bujía caiga hacia el interior de la cámara de combustión.
- 2.) Las bujías de incandescencia deben ser apretadas al par de apriete correcto.
- 3.) Las tuercas de conexión de corriente deben ser apretadas al par de apriete correcto.

Si los pares de apriete son demasiado altos puede dañarse la bujía de incandescencia. Esto puede causar su destrucción (rotura del bulón de conexión o sobrecalentamiento debido al cierre del paso anular).

### 1. Montaje de la bujía de incandescencia con llave dinamométrica:

Es indispensable tener en cuenta las prescripciones del fabricante del automóvil.

Atención: tener en cuenta el par máximo de apriete:

rosca M 8: 10 Nm,  
rosca M 9: 12 Nm,  
rosca M 10: 12-18 Nm,  
rosca M 12: 25-30 Nm.

### 2. Apriete de la tuerca de conexión de corriente:

El par máximo de apriete de la tuerca de conexión de corriente no debe sobrepasar los valores siguientes: En rosca M 4, máx. 2 Nm, en rosca M 5 máx. 3 Nm. En bujías de incandescencia con conexión de enchufe, examinar dicha conexión para ver si está corroída.

## Importante durante la sustitución: le corrette coppie di serraggio della candela e del dado di collegamento per la corrente!

*Durante la sostituzione delle candele bisogna fare particolare attenzione a tre punti:*

- 1.) *I depositi di sporcizia che si trovano sulla cava della candela non devono assolutamente cadere nella camera di combustione.*
- 2.) *Le candele devono essere strette con la coppia di serraggio giusta.*
- 3.) *I dadi per il collegamento della corrente devono essere stretti con la coppia di serraggio corretta.*

*Se tale coppia di serraggio viene oltrepassata è possibile che la candela venga danneggiata, provocandone il completo danneggiamento (la rottura del perno di collegamento o il surriscaldamento a causa della fessura anulare chiusasi).*

### 1. Montaggio della candela con la chiave dinamometrica:

*Rispettare assolutamente le prescrizioni del costruttore del veicolo.*

*Attenzione – osservare la coppia massima di serraggio:*

*Filetto M 8: 10 Nm,  
Filetto M 9: 12 Nm,  
Filetto M 10: 12-18 Nm,  
Filetto M 12: 25-30 Nm.*

### 2. Stringere il dado di collegamento della corrente:

*La coppia di serraggio massima della barra di collegamento a corrente non deve oltrepassare i seguenti valori: con filetto M 4 max. 2 Nm, con filetto M 5 max. 3 Nm. Nel caso di candele ad incandescenza con spinotto controllare che esso non sia corroso.*

### Importante:

Engrasar en cada cambio de bujías incandescente el vástago de la bujía incandescente y la rosca.

Grasa de montaje de bujías incandescentes - GFK 001

- impide la corrosión en la rosca; por ello no se agarrota la bujía incandescente
- impide la penetración de humedad
- facilita el cambio de bujías incandescentes

Grasa de montaje para bujías incandescentes BERU, tubo de 10 g.  
N.º de pedido 0 890 300 034

### Importante:

*In ogni cambio delle candele di preriscaldamento, è necessario ingrassare il fuso della stessa e il filetto.*

Grasso di montaggio per candele di preriscaldamento - GKF 001

- evita corrosione del filetto ed il bloccaggio della candela di preriscaldamento
- evita la penetrazione di umidità
- facilita il cambio delle candele di preriscaldamento

Grasso di montaggio per candele di pre-riscaldamento BERU, tubetto da 10 gr.  
Numero di ordinazione no. 0 890 300 034



## При замене важно: надлежащие крутящие моменты затяжки свечи накаливания и контактной гайки свечи!

При замене свечей накаливания необходимо в необходимо учитывать три основных требования:

- 1.) Ни в коем случае не допускать попадания загрязнений, имеющих по периметру отверстия свечи, в камеру сгорания.
- 2.) Обеспечить надлежащий крутящий момент при затяжке свечей накаливания.
- 3.) Обеспечить надлежащий крутящий момент при затяжке контактных гаек свечей.

При чрезмерных крутящих моментах возможно повреждение свечи накаливания. Это может привести к ее выходу из строя (срыв болта крепления или перегрев вследствие закрытия кольцевого зазора при затяжке).

### 1. Монтаж свечи накаливания с использованием динамометрического ключа:

В обязательном порядке придерживаться предписаний изготовителя автомобиля. Внимание! Выдерживать максимальный крутящий момент затяжки:

для резьбы M 8: 10 Нм,  
для резьбы M 9: 12 Нм,  
для резьбы M 10: 12-18 Нм,  
для резьбы M 12: 25-30 Нм.

### 2. Затяжка контактной гайки свечи:

Максимальный крутящий момент затяжки контактной шины не должен превышать следующих величин: для резьбы M 4 – макс. 2 Нм, для резьбы M 5 – макс. 3 Нм. Для свечей накаливания со штекерным разъемом проверить его на наличие коррозии.

## Ważne przy wymianie świec: właściwy moment dokręcania świecy żarowej i nakrętki zaciskowej przewodu!

Podczas wymiany świecy żarowej należy zwrócić szczególną uwagę na trzy rzeczy:

- 1.) Zanieczyszczenia z okolic otworu pod świecę nie mogą pod żadnym pozorem wpaść do wnętrza komory spalania.
- 2.) Świece muszą być dokręcone właściwym momentem.
- 3.) Nakrętki zaciskowe przewodu muszą być dokręcone właściwym momentem.

Zbyt duży moment dokręcania może spowodować uszkodzenie świecy, w konsekwencji może dojść do jej zniszczenia (zerwanie kołka zaciskowego lub przegrzanie z powodu ściśnięcia szczeliny pierścieniowej).

### 1. Wkręcanie świecy przy pomocy klucza dynamometrycznego:

Ścisłe stosować się do wskazówek producenta pojazdu.

Uwaga – nie przekraczać maksymalnego momentu dokręcania:  
gwint M 8: 10 Nm,  
gwint M 9: 12 Nm,  
gwint M 10: 12-18 Nm,  
gwint M 12: 25-30 Nm.

### 2. Dokręcanie nakrętki zaciskowej przewodu:

Maksymalny moment dokręcania do przyłączonej szyny prądowej nie może przekraczać następujących wartości:  
przy gwincie  
M 4 maks. 2 Nm, przy gwincie  
M 5 maks. 3 Nm. Sprawdzić świece żarowe z przyłączem na wtyk czy nie występują na nich ślady korozji.

### Важно:

При каждой замене свечей накаливания смазать хвостовик свечи накаливания и резьбу.

- Мазь для монтажа свеч накаливания
- GKF 001
  - предотвращает коррозию на резьбе и тем самым заклинивание свеч зажигания
  - предотвращает проникновение влажности
  - облегчает смену свеч зажигания

Мазь фирмы BERU для монтажа свеч зажигания, 10 г в тубике.  
Номер заказа 0 890 300 034

### Uwaga:

Przy każdej wymianie świec żarowych nasmarować trzonek świecy żarowej oraz gwint.

Smar do montażu świec żarowych – GKF 001

- zapobiega korozji i zapiekaniu się gwintu
- zapobiega penetracji wody
- umożliwia późniejsze łatwe wykręcenie świecy

Smar do świec żarowych BERU GKF 001, tubka 10 g  
Nr katalogowy 0 890 300 034



Σημαντικό κατά την αντικατάσταση: Οι σωστές ροπές στρέψης μπουζιού και ακροδάκτη σύνδεσης ρεύματος!

Κατά την αντικατάσταση μπουζιών, πρέπει να προσέχονται ιδιαίτερα τρία πράγματα:

- 1.) Δεν επιτρέπεται σε καμία περίπτωση να εισέλθουν ακαθαρσίες στο θάλαμο καύσης του μπουζιού.
- 2.) Τα μπουζιά πρέπει να βιδωθούν με τη σωστή ροπή στρέψης.
- 3.) Οι ακροδέκτες σύνδεσης ρεύματος πρέπει να βιδωθούν με τη σωστή ροπή στρέψης.

Εάν η ροπή στρέψης είναι πολύ υψηλή, μπορεί να προκληθεί ζημιά στο μπουζί. Κάτι τέτοιο μπορεί να προκαλέσει την καταστροφή του μπουζιού (σπάσιμο μπουλονιού σύνδεσης ή υπερθέρμανση λόγω φραγής της σχισμής).

### 1. Εγκατάσταση μπουζιών με ροπόκλειδο:

Πρέπει να τηρούνται οπωσδήποτε οι προδιαγραφές των κατασκευαστών αυτοκινήτων.

Προσοχή – έχετε υπόψη σας τη μέγιστη ροπή στρέψης:

σπείρωμα M 8: 10 Nm,  
σπείρωμα M 9: 12 Nm,  
σπείρωμα M 10: 12-18 Nm,  
σπείρωμα M 12: 25-30 Nm.

### 2. Σφίξιμο ακροδέκτη σύνδεσης ρεύματος:

Η μέγιστη ροπή στρέψης του ακροδέκτη σύνδεσης ρεύματος δεν επιτρέπεται να υπερβαίνει τις ακόλουθες τιμές: Σπείρωμα M 4 μέγ. ροπή 2 Nm, σπείρωμα M 5 μέγ. ροπή 3 Nm. Σε μπουζιά με εμβυσματώσιμη σύνδεση πρέπει να ελέγχετε τη σύνδεση αν έχει υποστεί διάβρωση.

### Σημαντικό:

Σε κάθε αντικατάσταση αναφλεκτήρα πυράκτωσης λιπαίνετε την άτρακτο αναφλεκτήρα πυράκτωσης και το σπείρωμα.

Λιπαντικό συναρμολόγησης προθερμαντήρων - GKf 001  
- εμποδίζει τη διάβρωση στο σπείρωμα και την προσκόλληση των προθερμαντήρων  
- αποτρέπει τη διείδυση υγρασίας  
- διευκολύνει την αντικατάσταση των προθερμαντήρων

Λιπαντικό συναρμολόγησης των προθερμαντήρων της BERU, σωληνάριο 10 gr.

Κωδικός παραγγελίας προϊόντος  
0 890 300 034



## A gyertya cseréjénél fontos: az izzítógyertya és az áram-csatlakozóanya helyes meghúzási nyomatéka!

Az izzítógyertyák cseréjekor három dologra kell különös figyelmet fordítani:

- 1.) A gyertyafurat körül található szennyeződéseknek semmi esetre sem szabad beleesniük az égéstérbe.
- 2.) Az izzítógyertyákat a helyes meghúzási nyomatékkal kell meghúzni.
- 3.) Az áram csatlakozóanyákat helyes meghúzási nyomatékkal kell meghúzni.

Nagy nyomaték esetén az izzítógyertya károsodást szenvedhet. Ennek következtében tönkremehet az izzítógyertya (csatlakozószegecs leszakadása vagy túlhevülés a gyűrűs hézag összehúzódása folytán).

### 1. Az izzítógyertya beszerelése dinamométer-kulccsal:

Feltétlenül tartsa be a gépkocsigyártó előírásait.

Figyelem! A maximális meghúzási nyomatékra ügyelni kell:

- M 8-es menet: 10 Nm,
- M 9-es menet: 12 Nm,
- M 10-es menet: 12-18 Nm,
- M 12-es menet: 25-30 Nm.

### 2. Az áram-csatlakozóanya meghúzása:

Az áram-csatlakozósín maximális meghúzási nyomatékának az alábbi értékeket nem szabad meghaladnia:

- M 4-es menet: max. 2 Nm, M5-ös menet: max. 3 Nm.

A dugaszoló csatlakozóval rendelkező izzítógyertyáknál a csatlakozót korrózióra meg kell vizsgálni.

#### Fontos:

Minden izzítógyertya-cserénél zsírozza be az izzítógyertya-szárat és a mentet.

Szerelőzsír izzítógyertyához - GKF 001

- megakadályozza a korrózió képződését, ami a gyertya beszorulását eredményezheti
- megakadályozza a nedvesség beszívargását
- megkönnyíti az izzítógyertya cseréjét

BERU szerelőzsír izzítógyertyához,  
10 g/tubus

Rendelési szám: 0 890 300 034





## D Glühkerzen-Arbeitszeitwerte

Arbeitszeitwerte für den Glühkerzenwechsel der gängigsten Fahrzeugmodelle, übersichtlich nach Hersteller gegliedert. Alle hier angegebenen Zeiten gelten für den kompletten Arbeitsgang, also den Ausbau des alten Glühkerzensatzes und den Einbau des neuen. Gemessen wurde unter normalen Bedingungen, das heißt: Der Monteur hatte sowohl allgemeine Routine als auch Erfahrung mit dem Fahrzeugtyp, und die Werkstatt verfügte über die erforderlichen Werkzeuge und Diagnosegeräte – und die Glühkerzen sind nicht festgefressen.

## GB USA Glow plug job value

Job values for replacing glow plugs in the most standard vehicle models, clearly listed according to manufacturers. All time values specified here apply to the entire work cycle, i.e. the removal of the old glow plug set and installation of the new one. The time was measured under normal circumstances; this means: the mechanic had general routine and also experience with the vehicle type and the garage had the required tools and diagnosis values - and the glow plugs were not jammed.

## F Valeur du temps de travail pour les bougies de préchauffage

Valeur du temps de travail pour le remplacement des bougies de préchauffage sur les modèles de voitures courants, liste établie par les constructeurs. Les temps indiqués ici comprennent la procédure de travail complète, c'est-à-dire le démontage du jeu d'anciennes bougies et le montage du nouveau. La mesure a été réalisée dans des conditions normales; à savoir (que) le mécanicien maîtrise la pratique du travail et a une certaine expérience du modèle de voitures en question, le garage est équipé des outillages et des appareils de diagnostic nécessaires, les bougies ne sont pas grippées.

## NL Arbeidstijdwaarden gloeibougies

Arbeidstijdwaarden voor het wisselen van gloeibougies bij de meest gebruikelijke voertuigmodellen, overzichtelijk ingedeeld naar de fabrikant. Alle hier aangegeven tijden gelden voor het complete arbeidsp proces, dus voor het demonteren van de oude set gloeibougies tot aan het monteren van de nieuwe set. Gemeten onder normale omstandigheden, dat wil zeggen: de monteur had zowel algemene routine als ook ervaring met het type voertuig en de werkplaats beschikte over het noodzakelijke gereedschap en diagnoseapparatuur – en de gloeibougies zijn niet vastgevreten.

## E Valores de tiempo de trabajo de bujías incandescentes

Valores de tiempo de trabajo para el cambio de bujías incandescentes de los modelos más usuales de vehículos, divididos sinópticamente por fabricantes. Todos los tiempos indicados aquí son válidos para la operación completa, es decir el desmontaje del antiguo juego de calentadores y el montaje del nuevo. Fue medido en condiciones normales, es decir que el mecánico tenía tanto la rutina general como experiencia con el modelo de vehículo y el taller disponía de las herramientas y equipos de diagnóstico necesarios y las bujías incandescentes no estaban agarrotadas.

## I Tempistica di ricambio delle candele di preriscaldamento.

Tempistica per il ricambio delle candele di preriscaldamento nei tradizionali modelli di autoveicoli, suddivisi in modo sinottico secondo costruttori. Tutti i tempi qui indicati valgono per un completo ciclo operativo, cioè lo smontaggio del vecchio set di candele di preriscaldamento e il montaggio di quelle nuove. Le misurazioni sono state effettuate in condizioni normali, vale a dire: il meccanico era in possesso della routine generale come pure delle esperienze con il rispettivo tipo di autoveicolo, mentre l'officina disponeva di tutti gli utensili e unità di diagnosi a tal fine richiesti – e le candele di preriscaldamento non sono bloccate sulla testa del motore.

## RUS Параметры рабочего времени свечей накаливания

Параметры рабочего времени, необходимого для замены свечей накаливания для самых распространенных моделей транспортных средств наглядно распределены по изготовителям. Все приведенные здесь значения по времени включают в себя всю операцию, т.е. и время для демонтажа старого комплекта свечей накаливания и монтажа нового комплекта. Измерения проводились в нормальных условиях, то есть: монтер имел как общие навыки работы, так и опыт обращения с данным типом автомобиля, мастерская была оснащена всеми необходимыми инструментами и приборами диагностики, а свечи накаливания не заклинены.

## PL Czasy wymiany świec żarowych

Czasy wymiany świec żarowych są przejrzysto posortowane wg. Producentów i dotyczą podstawowych modeli. Odnoszą się do kompletnej wymiany w normalnych warunkach tzn. demontażu starych i montażu nowych świec żarowych, mechanik ma ogólną rutynę i doświadczenie z tym typem samochodu, warsztat posiada odpowiednie narzędzia i urządzenia diagnostyczne oraz świece żarowe nie są zapieczone.

## GR Χρόνος εργασίας (προθερμαντήρες)

Χρόνος εργασίας για την αντικατάσταση προθερμαντήρων των πιο διαδεδομένων μοντέλων αυτών συνοπτικά ταξινομημένων κατά κατασκευαστή. Όλοι οι αναφερόμενοι χρόνοι ισχύουν για ολοκληρωμένο κύκλο εργασιών, δηλαδή την αποσυναρμολόγηση του παλαιού σετ προθερμαντήρων και την τοποθέτηση του καινούριου. Η μέτρηση έγινε υπό κανονικές συνθήκες, δηλαδή: Ο μηχανικός ήταν εξοικωμένος και κατείχε εμπειρία σχετικά με τον τύπο του οχήματος και το συνεργείο διέθετε τα απαιτούμενα εργαλεία και τις απαιτούμενες διαγνωστικές συσκευές – και οι προθερμαντήρες δεν ήταν μαγκωμένοι.

## H Izzítógyertyák cseréjének normaideje

A legismertebb járműtípusok izzítógyertya-cseréjének normaidő adatai a gyártók által megadottak szerint. Az összes itt megadott normaidő a teljes munkafolyamatra vonatkozik, tehát a régi izzítógyertyák kiszerezésére és az újak beszerelésére. A normaidő mérése optimális feltételek mellett történt, azaz: a szerelő általános rutinnal rendelkezett, volt tapasztalata a járműtípussal is és a műhelyben rendelkezésre álltak a szükséges szerszámok és diagnosztikai készülékek – és a régi izzítógyertyák menetei nem voltak elszennyeződve.



<b>Alfa Romeo</b>	156		45
	166		45
<b>Audi</b>	A 3		25
	A 4		70
	A 6		70
	80/90/100		70
<b>BMW</b>	318 D		90
	318 TDS	E 36	45
	325 TDS	E 36	55
	525 TDS		60
	725 TDS		50
	730 TDS		55
	740 TDS		25
	X5		90
<b>Mercedes-Benz 210</b>	E 220 CDI	611961	50
	E 200 CDI	611961	50
	E 220 D	604912	80
	E 290 DT	602982	90
	E 250 D	605912	90
	E 250 DT	605962	90
	E 300 D	606912	150
	E 300 DT	606962	150
<b>460, 461, 463</b>	240 GD	616.93	25
	300 GD	617.93	30
	250 GD	602.93	45
	290 GD	602942	50
	300 GD	603.93	80
	G 300 D	603.93	80
	290 GD Turbo	602983	90
	350 GD Turbo	603972	100
	G 350 Turbo	603972	100
	G 300 Turbo	606964	100
<b>638</b>	108 CDI	611986	20
	110 CDI	611980	20
	112 CDI	611980	20
	V 200 CDI	611980	20
	V 220 CDI	611980	20
	108 D	601942	130
<b>202 + 203</b>	110 D	601970	130
	V 230 TD	601970	130
	C 220 CDI	611960	60
	C 200 CDI	611962	60
	C 250 D, TD	605910, 605960	65
<b>124</b>	C 220 D	604910	105
	C 200 D	601913	125
	200 D, E 200 D	601912	40
	250 D, TD	602912	50
	300 D	603912	80
	250 DT	602962	90
	300 D Turbo	603.960, 603.963	100
<b>201</b>	E 250 D Turbo	605911	130
	E 300 D, TD	606910	150
	190 D	601911	40
<b>Fiat</b>	190 D 2,5 ltr.	602911	45
	190 D 2,5 ltr. Turbo	602961	55
	Multipla		65
	Doblo		50
	Punto		30
	Scudo		30



	Ducato		50
	Ulysse		30
<b>Ford</b>	Fiesta		30
	Focus		30
	Escort		30
	Mondeo		30
	Scorpio		30
<b>Lancia</b>	Lybra		80
<b>Peugeot</b>	106		30
	206		60
	306	DW 8	40
	306	N 20	30
	306	DW 10 TD	20
	307	DW 10 TD	40
	406	DW 10 TD	20
	406	DW 10 ATED	40
	406	XUD 9 TF	140
	406	XUD 11	80
	607	Y 2 P	120
	608	XUD 9 TE	30
	608	DW 10 ATED	30
	608	XUDL	90
	Boxer	XUD 9	80
	Boxer	XUD 9 TE	60
	Boxer	DJ 5	70
	Boxer	DJ 5 TE	100
	Expert	XUD 9	30
	Expert	XUD 9 TE	30
	Expert	DW 8	45
	Partner	XUD 7	40
	Partner	XUD 9	60
	Partner	DW 8	40
	Partner	DW 10 TD	50
	Partner	L 20	20
<b>Renault</b>	Clio		60
	R 5		70
	Espace		70
	Kangoo		50
	Mégane		30
	Laguna		50
	Safrane		50
	Trafo		70
	19		70
	25		70
<b>VW</b>	Bora		45
	Caddy		70
	Golf/Jetta → 97		70
	Golf/Jetta → 98		45
	Lupo 3 Zyl.		55
	Lupo 4 Zyl.		70
	New Beetle		45
	Passat 96		70
	Passat 97		45
	Polo 94		95
	Polo 95		70
Sharan		80	
Taro		45	
Transporter → 90		70	
Transporter → 91		80	

**Glühkerzen werden speziell auf die verschiedenen Motoren- und Glühkonzepte abgestimmt. Deshalb ist beim Glühkerzenwechsel besonders wichtig: Jedes Glühsystem darf nur mit den exakt auf den Motor abgestimmten Glühkerzen bestückt werden!**



**GE**

Glühkerze elektronisch gesteuert, vorglühen – startglühen – nachglühen

Typ: Stabglühkerze in Zweiwendeltechnologie, elektronisch gesteuert

Einsatz: Motoren der neuesten Generation mit elektronischer Glühzeitsteuerung

Funktionsweise: Das BERU Diesel-Schnellstart-System ISS (Instant Start System) besteht aus leistungsoptimierten, elektronisch gesteuerten Glühkerzen und einem Steuergerät mit Mikrocontroller. Der Glühbedarf des Motors wird über ein gespeichertes Kennfeld angepasst. Es berücksichtigt Last, Drehzahl, Temperatur und Kraftstoffdurchfluss. Mit ISS ist ein spontaner „ottomotorischer“ Schlüsselstart bis minus 15 °C möglich. Bei minus 24 °C beträgt die Vorglühzeit nur 2 Sekunden. Der Schadstoffausstoß wird minimiert.

Betriebsspannung: bis 5 Volt



**GN**

Glühkerze, vorglühen – startglühen – nachglühen

Typ: Stabglühkerze in Zweiwendeltechnik

Einsatz: Fahrzeuge mit nachglühfähigem Glühsystem

Funktionsweise: 3-Phasen-Glühung für moderne Glühsysteme (Vorglühen – Startglühen – Nachglühen), neue Materialien für Glührohr, Heiz- und Regelwendel, modernste Fertigungstechnik

Betriebsspannung: bis 13,5 Volt

Nur GN-Glühkerzen sind auf diese erhöhte Betriebsspannung abgestimmt! Wird an einem für „GN“-Glühkerzen konzipierten Glühsystem beispielsweise eine „GV“-Glühkerze betrieben, kann diese innerhalb kurzer Zeit zerstört werden!



**GV**

Glühkerze (nur vorglühen)

Typ: Stabglühkerze in Zweiwendel-/Einwendeltechnik

Einsatz: Fahrzeuge älterer Generationen

Funktionsweise: 2-Phasen-Glühung (lediglich Vor- und Startglühen), nach dem Anspringen des Motors wird die Glühkerze abgeschaltet

Betriebsspannung: 11 Volt

Da diese Glühkerze nur für eine niedrige Betriebsspannung ausgelegt ist, sollte sie nur dann montiert werden, wenn sie vom Fahrzeughersteller vorgeschrieben ist!



**GF**

Glühkerze für Flammstartanlagen

Typ: Flammglühkerze

Einsatz: Großvolumige Direkteinspritzer-Dieselmotoren

Funktionsweise: Bei Erreichen der Glühtemperatur gelangt über ein Ventil zusätzlich Kraftstoff in die Verdampfungszone der Flammglühkerze – eine Flamme entsteht, die die Ansaugluft nachhaltig erwärmt



**GD**

Glühkerze, mit Drahtwendel

Typ: Drahtwendel-Glühkerze

Einsatz: Zumeist in älteren Diesel-Fahrzeugen sowie in Traktoren, Schleppern, Baumaschinen und Stationärmotoren

Funktionsweise: Als Heizelement dient die Drahtschleife an der Glühkerze



**GH**

Glühkerze für Zuheizgeräte

Typ: Glühstab- oder Wendelglühkerze

Einsatz: Zusatzheizgeräte (Benzin oder Diesel)

**Glow plugs are specifically matched to the various motor and glowing concepts. For this reason, the following is especially important when changing glow plugs:  
Each heating system may only be fitted with the glow plugs which exactly match the engine!**

**GE**

Heating plug electronically controlled, pre-heating – start heating – after-heating

Type: Sheathed type plug with two-filament technology, electronically controlled

Use: Engines of the latest generation with electronic heating time control

Mode of function: The BERU diesel Instant Start System ISS consists of optimum performance, electronically controlled heating plugs and a control unit with microcontroller. The heating requirement of the engine is adapted by a stored parameter profile. It takes into account load, speed, temperature and fuel flow. ISS enables a spontaneous “combustion engine” key start up to minus 15°. At minus 24° the pre-heating time is only 2 seconds. Emission of pollutants is minimised.

Operating voltage: up to 5 Volts

**GN**

Heating plug, pre-heating – start heating – after-heating

Type: Sheathed type glow plug in two-filament technique

Use: Vehicles with heating system capable of post-heating

Mode of function: 3-phase glowing for modern glow systems (pre-heating – start heating – post-heating), new materials for glow tube, heating and control coil, most modern production technique

Operating voltage: up to 13.5 Volts

Only GN glow plugs are designed for this increased operational voltage! If, for example, a “GV” glow plug is used on a glow system designed for “GN” glow plugs, it can be destroyed within a very short space of time!

**GV**

Glow plug (only pre-heating)

Type: Sheathed type glow plug in two-filament/single filament technique

Use: Vehicles of older generations

Mode of function: 2-phase heating (merely pre-heating and start heating); after the engine has started, the glow plug is switched off

Operating voltage: 11 Volts

As this glow plug is only designed for a low operating voltage, it only ought to be fitted when prescribed by the manufacturer of the vehicle!

**GF**

Glow plug for flame-start engines

Type: Flame glow plug

Use: Large-volume direct injection diesel engines

Mode of function: When the glow temperature is reached, additional fuel enters the evaporation zone of the flame glow plug via a valve – a flame is generated, which permanently warms the intake air

**GD**

Glow plug with wire filament

Type: Wire-filament glow plug

Use: Mainly in older diesel vehicles and in tractors, traction engines, construction machines and stationary motors

Mode of function: The wire loop on the glow plug acts as a heating element

**GH**

Glow plug for additional heaters

Type: Sheathed type or filament glow plug

Use: Additional heating devices (petrol or diesel)

Les bougies de préchauffage sont spécialement conçues en accord avec les différents concepts de moteur et de préchauffage. C'est pourquoi ce qui suit est particulièrement important lors du remplacement des bougies de préchauffage.

**Chaque système de préchauffage doit être muni des bougies de préchauffage correspondant exactement au moteur!**

**GE**

Bougie de préchauffage à commande électronique, préchauffage – préchauffage au démarrage – postchauffage

Type: bougie-crayon de préchauffage, technique à double filament, commande électronique

Utilisation: moteurs de la dernière génération avec commande électronique du temps de préchauffage

Fonctionnement: le système de démarrage immédiat ISS – Instant Start System – conçu par BERU pour les moteurs diesel se compose de bougies de préchauffage haute performance à commande électronique, ainsi que d'un boîtier électronique de commande équipé d'un microcontrôleur. Les courbes caractéristiques mises en mémoire permettent de réguler le préchauffage en tenant compte de la charge, du régime, de la température et du débit de carburant. Avec l'ISS, un démarrage au quart de tour, comme avec un moteur à essence, est possible jusqu'à -15°. A -24°, le temps de préchauffage n'est que de 2 secondes. Les émissions polluantes se voient par ailleurs réduites

Tension: jusqu'à 5 volts

**GN**

Bougie de préchauffage GN pour préchauffage – préchauffage au démarrage – postchauffage

Type: bougie-crayon – technologie double spirale

Utilisation: véhicules équipés d'un système convenant au postchauffage

Fonctionnement: préchauffage à trois phases pour systèmes de préchauffage modernes (préchauffage – préchauffage de démarrage – postchauffage), nouveaux matériaux pour le tube à incandescence, spirale chauffante, spirale de régulation, technique de fabrication

Tension: jusqu'à 13,5 Volt

Seules les bougies de préchauffage GN sont valables pour une tension de service plus élevée! Si, sur un système conçu pour des bougies de préchauffage «GN», on utilise, par exemple, une bougie de préchauffage «GV», elle pourra être détruite extrêmement rapidement!

**GV**

Bougie de préchauffage (préchauffage seulement)

Type: bougie-crayon – technologie une ou deux spirales

Utilisation: véhicules de l'ancienne génération

Fonctionnement: préchauffage à deux phases (seulement préchauffage et préchauffage de démarrage), une fois que le moteur a démarré, la bougie de préchauffage est mise hors circuit

Tension: 11 Volt

Etant donné que cette bougie de préchauffage n'est conçue que pour une basse tension elle ne devra être montée que lorsqu'elle est prescrite par le fabricant!

**GF**

Bougie de préchauffage pour installations de démarrage à flamme

Type: bougie de préchauffage à flamme

Utilisation: moteurs Diesel de grand volume à injection directe

Fonctionnement: à l'atteinte de la température de préchauffage, du carburant complémentaire arrive par une soupape dans la zone de vaporisation de la bougie de préchauffage à flamme – une flamme se produit qui réchauffe durablement l'air d'admission

**GD**

Bougie de préchauffage à spirale en fil métallique

Type: bougie de préchauffage à fil métallique

Utilisation: la plupart du temps sur des véhicules diesel plus anciens tels que tracteurs, remorques, engins de chantier et moteurs stationnaires

Fonctionnement: la boucle en fil sert d'élément de chauffe à la bougie de préchauffage

**GH**

Bougie de préchauffage pour appareils de chauffage d'appoint

Type: bougie-crayon ou bougie de préchauffage à spirale

Utilisation: appareils de chauffage d'appoint (essence ou diesel)

**Gloeibougies worden speciaal afgestemd op de verschillende motoren- en gloeiconcepten. Daarom is het volgende bij een vervanging van de gloeibougies bijzonder belangrijk: Alle gloeisystemen mogen slechts worden voorzien van de exact op de motor afgestemde gloeibougies!**

**GE**

Gloeibougies elektronisch aangestuurd, voorgloeien – startgloeien – nagloeien

Type: Staafgloeibougie in dubbel-schroefdraadtechnologie, elektronisch aangestuurd

Gebruik: Motoren van de nieuwste generatie met elektronische voor-gloeitijdbesturing

Werkwijze: Het BERU diesel-snelstart-systeem ISS – Instant Start System bestaat uit prestatiegeoptimaliseerde, elektronisch gestuurde bougies en een besturingsapparaat met microcontroller. De gloeibehefte van de motor wordt via een opgeslagen kenveld aangepast. Er wordt rekening gehouden met last, toerental, temperatuur en brandstof-doorstroom. Met ISS is een spontane „ottomotorische“ sleutelstart tot minus 15° mogelijk. Bij minus 24° bedraagt de voor-gloeitijd slechts 2 seconden. De uitstoot van schadelijke stoffen wordt geminimaliseerd.

Bedrijfsspanning: tot 5 Volt

**GN**

Gloeibougies, voor-gloeien – startgloeien – nagloeien

Type: Gloeibougie in technische uitvoering met twee spiralen

Gebruik: Voertuigen gloeisysteem geschikt om na te gloeien

Werkwijze: 3-fasen gloeiing voor moderne gloeisystemen (vóorgloeien – gloeien bij start – nagloeien), nieuwe materialen voor gloeibuis, verwarmings- en regelspiraal, zeer moderne productietechniek

Bedrijfsspanning: tot 13,5 Volt

Alleen GN-gloeibougies zijn afgestemd op deze verhoogde bedrijfsspanning. Als in een voor "GN"-gloeibougies opgezet gloeisysteem b.v. een "GV"-gloeibougie wordt gebruikt, dan kan deze binnen zeer korte tijd worden vernietigd.

**GV**

Gloeibougie (alleen voorgloeien)

Type: Gloeibougie in technische uitvoering met twee spiralen/een spiraal

Gebruik: Voertuigen van de oudere generaties

Werkwijze: 2-fasen gloeiing (alleen vóorgloeien en gloeien bij start), nadat de motor gestart is wordt de gloeibougie uitgeschakeld

Bedrijfsspanning: 11 Volt

Omdat deze gloeibougie voor een lage bedrijfsspanning is bedoeld, mag hij slechts gemonteerd worden als hij door de fabrikant van het voertuig is voorgeschreven!

**GF**

Gloeibougie voor start-installaties met vlam

Type: Vlambougie

Gebruik: Dieselmotoren met grote volumes met directe inspuiting

Werkwijze: Bij het bereiken van de gloeitemperatuur komt via een ventiel extra brandstof in de verdampingsruimte van de gloeibougie – er ontstaat een vlam, die de aangezogen lucht blijvend verwarmt

**GD**

Gloeibougie met draadsdraadspiraal

Type: Gloeibougie met draadsdraadspiraal

Gebruik: Meestal bij oudere dieselvoertuigen en in tractoren, sleepboten, machines in de bouw en stationaire motoren

Werkwijze: Als verwarmingselement dient de draadlus op de gloeibougie

**GH**

Gloeibougie voor apparaten voor bijverwarming

Typ: Gloeibougie en bougie met draadsdraadspiraal

Gebruik: Apparaten voor bijverwarming (benzine of diesel)

La bujías de incandescencia se han concebido especialmente para los diferentes conceptos de motor y de calentamiento. Por eso es muy importante lo siguiente al cambiar las bujías de incandescencia: **¡Cada sistema de calentamiento sólo puede equiparse con las bujías correspondientes al motor!**

**GE**

Bujía de incandescencia controlada electrónicamente, con precalentamiento – calentamiento de arranque y poscalentamiento

Tipo: Bujía de vástago de incandescencia en técnica de dos espirales, controlada electrónicamente

Aplicación: Motores de la última generación con control electrónico de tiempo de calentamiento

Modo de funcionar: El Sistema de Arranque Rápido-Diesel ISS de BERU se compone de bujías de incandescencia controladas electrónicamente optimizadas para el rendimiento y un mando de microcontrolador. La demanda de calentamiento del motor se adapta a un campo de conocimiento memorizado. Éste tiene en cuenta el peso, el número de revoluciones, la temperatura y el paso de circulación del combustible. Con el ISS es posible realizar un arranque por llave de "motor de gasolina" espontáneo de hasta menos de 15° Con menos de 24°, el tiempo de precalentamiento sólo es de 2 segundos Se minimiza la emisión de sustancias contaminantes

Tensión de servicio: hasta 5 voltios

**GN**

Bujía incandescente, precalentamiento – calentamiento de arranque – poscalentamiento

Tipo: Bujía de vástago incandescencia con técnica de dos espirales

Aplicación: Vehículos con sistema de incandescencia capacitado para poscalentamiento

Modo de funcionar: Incandescencia de 3 fases para sistemas modernos de incandescencia (previa, de arranque y posterior), nuevos materiales para tubo incandescente, espiral de calentamiento y regulación, técnica actual de fabricación

Tensión de servicio: hasta 13,5 voltios

¡Sólo las bujías de incandescencia GN se han fabricado para este voltaje de servicio tan alto! Si en un sistema de incandescencia para bujías «GN» se emplea por ejemplo una bujía «GV», puede estropearse muy rápidamente.

**GV**

Bujía de incandescencia (sólo incandescencia previa)

Tipo: Bujía de incandescencia con técnica de una o dos espirales

Aplicación: Vehículos de generaciones más viejas

Modo de funcionar: Incandescencia de dos fases (sólo incandescencia previa y de arranque); tras arrancar el motor, la bujía se desconecta

Tensión de servicio: 11 Volts

¡Como esta bujía de incandescencia sólo se ha concebido para un voltaje de servicio bajo, sólo se debería montar si el fabricante del vehículo así lo prescribe!

**GF**

Bujía de incandescencia para sistemas de arranque con llama

Tipo: Bujía incandescente de llama

Aplicación: Motores diesel de gran volumen e inyección directa

Modo de funcionar: Al alcanzarse la temperatura de incandescencia, por medio de una válvula llega adicionalmente carburante a la zona de evaporación de la bujía de llama: se produce una llama que calienta constantemente el aire de admisión

**GD**

Bujía de incandescencia con espiral de alambre

Tipo: Bujía de incandescencia de espiral de alambre

Aplicación: Fundamentalmente en vehículos diesel viejos, así como en tractores, máquinas de obras públicas y motores estacionarios

Modo de funcionar: Como elemento de calentamiento se emplea la espiral de alambre de la bujía de incandescencia

**GH**

Bujía de incandescencia para calefactores auxiliares

Tipo: Bujía incandescente de espiral o de tubo incandescente

Aplicación: Aparatos calefactores auxiliares (gasolina o diesel)

**Le candele vengono personalizzate per diversi concetti di motori e di preriscaldamento. Pertanto è importante osservare quanto segue ogni volta che si cambiano le candele:  
Ogni sistema di preriscaldamento deve essere equipaggiato con le candele appositamente previste per il tipo di motore!**

**GE**

Candela ad incandescenza controllata elettronicamente (preriscaldamento – incandescenza d'avviamento – postriscaldamento)

**Tipo:** Candela ad incandescenza in tecnica a doppia spirale, controllata elettronicamente

**Impiego:** Motori di ultima generazione con regolatore elettronico

**Funzionamento:** Il sistema d'avviamento immediato diesel (ISS – Instant Start System) BERU è composto da candele ad incandescenza controllate elettronicamente che offrono prestazioni ottimizzate e da un apparecchio di comando con microcontrollore. La regolazione del motore viene effettuata mediante un diagramma caratteristico memorizzato che tiene in considerazione carico, numero di giri, temperatura e portata di carburante. Con ISS l'avviamento a chiave del motore a ciclo Otto è istantaneo fino a meno 15 °C e a meno 24 °C il tempo di preriscaldamento è di soli 2 secondi, riducendo in tal modo l'emissione di sostanze inquinanti.

**Tensione d'esercizio:** sino a 5 Volt

**GN**

Candela ad incandescenza (preriscaldamento, incandescenza d'avviamento, postriscaldamento)

**Tipo:** Candele corazzata con due spirali

**Impiego:** Veicoli con sistema a postriscaldamento

**Funzionamento:** Incandescenza a 3 fasi per sistemi moderni ad incandescenza (preriscaldamento – riscaldamento in fase d'avviamento – postriscaldamento), nuovi materiali per il tubo ad incandescenza, la spirale di riscaldamento e regolazione, tecnica di produzione d'avanguardia

**Tensione d'esercizio:** fino a 13,5 volt

Questa tensione di esercizio maggiorata è prevista solo per le candele «GN»! Se, ad esempio, si usa una candele «GV» in un sistema ad incandescenza concepito per candele «GN», la si può distruggere in brevissimo tempo!

**GV**

Candele (solo preriscaldamento)

**Tipo:** Candele corazzata con due spirali/ una spirale

**Impiego:** Veicoli delle generazioni più vecchie

**Funzionamento:** Incandescenza a 2 fasi (solo preriscaldamento e riscaldamento in fase l'avviamento), dopo l'avviamento del motore la candele viene disinserita

**Tensione d'esercizio:** 11 Volt

Poiché questa candele è prevista solo per una tensione di esercizio bassa, la si dovrebbe montare solo se prescritta dal costruttore del veicolo!

**GF**

Candele per impianti di termoavviamento

**Tipo:** Termoavviatore

**Impiego:** Motori diesel di grande cilindrata a iniezione diretta

**Funzionamento:** Quando viene raggiunta la temperatura di incandescenza viene inviato, tramite una valvola, ulteriore carburante alla zona di evaporazione del termoavviatore – si crea una fiamma che riscalda ulteriormente l'aria aspirata

**GD**

Candele con spirale a filo

**Tipo:** Candele con spirale a filo

**Impiego:** Per lo più in veicoli diesel di vecchio tipo nonché in trattori, trattrici, macchine da costruzione e motori stazionari

**Funzionamento:** Come elemento di riscaldamento è prevista la spirale a filo della candele

**GH**

Candele per apparecchiature di riscaldamento supplementari

**Tipo:** Candele a bulbo o spirale

**Impiego:** Apparecchi di riscaldamento supplementari (benzina o diesel)



Свечи накалывания раррабатываются спејиалсно с учетом конструкии івигателя и конјепји накалывания. Позтопу при замене свечей накалывания особенно важно:

**Кажія система накалывания іолжна снащатся толско спејиалсно изготовленными іля іанного івигателя свечами накалывания!**

**GE**

Свеча накалывания с электронным управлением, предварительный разогрев – пусковой разогрев – олонительный разогрев

Тип: Стержневая свеча накалывания в двухспиральном исполнении, с электронным управлением временем накалывания

Назначение: двигатели последнего поколения с 1 электронным управлением накалывания

Принцип работы: Система облегчения пуска дизеля (ISS — Instant Start System) фирмы BERU состоит из свечей накалывания оптимизированной мощности с электронным управлением и устройства управления с микроконтроллером. Потребность двигателя в разогреве регулируется посредством сохраненного в памяти идентификационного массива данных. В нем учтены нагрузка, скорость вращения, температура и расход топлива. При температуре до минус 15° система ISS обеспечивает моментальный пуск двигателя поворотом ключа как у карбюраторного двигателя. При температуре минус 24° время предварительного разогрева составляет всего лишь 2 секунды. Выброс вредных веществ снижается до минимума.

Рабочее напряжение: до 5 Вольт

**GN**

Свеча накалывания, предварительный разогрев – пусковой разогрев – дополнительный разогрев

Тип: Штифтовая свеча с івойной спиралью накалывания

Назначение: автомобили с системой накалывания, обеспечивающей дополнительный разогрев

Принцип работы: трехфазовое накалывание іля современных систем накалывания (разогрев – пуск – сопровождение), новые материалы іля капиллярной трубки, спиралей наги управления, самая современная технология производства

Рабочее напряжение: іо 13,5 Вольт

Толско свечи накалывания GN рассчитаны на повышенное рабочее напряжение! Если, например, в системе накалывания, рассчитанной на свечи накалывания GN, эксплуатировать свечу накалывания GV, то она может быть разрушена в течение короткого времени!

**GV**

Свеча накалывания (толско разогрев)

Тип: Штифтовая свеча с івойной/іойнарной спиралью накалывания

Назначение: Автомобили более старых поколений

Принцип работы: івухфазовое накалывание (толско разогрев и пуск), после запуска івигателя свеча накалывания отключается

Рабочее напряжение: 11 Вольт

тас как зта свеча накалывания рассчитана толско на низкое рабочее напряжение, то ее слеіует устанавливать толско тогіа, когіа она преіписывается изготовителемавтомобіля!

**GF**

Свеча накалывания іля факельного устройства облегчения пуска

Тип: факельная свеча накалывания

Назначение: Іизельные івигатели большого объема с непосредственным впрыскиванием

Принцип работы: При іостижении температуры накалывания топливо іополнительно поіаіает через клапан в зону испарения факельной свечи накалывания – возникает плямя, которое постоянно нагревает всасываемый возіух

**GD**

Свеча накалывания с проволочной спиралью

Тип: Свеча накалывания с проволочной спиралью

Назначение: Чаще всего в старых іизельных автомобилях, а таюко тракторах, тягачах, строительных машинах и стаіонарных івигателях

Принцип работы: В качестве нагревательного элемента служит проволочная спираль на свече накалывания

**GH**

Свеча накалывания іля іополнительного отопителя

Тип: Штифтовая или спиральная свеча накалывания

Назначение: Іополнительные отопители (на бензине или іизельном топливе)

**Świece żarowe konstruowane są specjalnie do różnych typów silników oraz systemów ich podgrzewania. Dlatego przy wymianie świec żarowych na nowe, koniecznie należy stosować, tylko te przewidziane do danego silnika!**

**GE**

Świeca żarowa, sterowana elektronicznie – podgrzewanie wstępne, rozruchowe i dogrzewające

Typ: Trzpieniowa świeca żarowa, wykonana w technologii dwuspiralnej, sterowana elektronicznie

Zastosowanie: Silniki najnowszej generacji z elektronicznym układem sterowania świecami żarowymi

Zasada działania: Układ szybkiego rozruchu silników diesla BERU ISS (Instant Start System) składa się ze świec żarowych z optymalnie dobraną mocą i elektronicznego sterownika z mikroprocesorem. Stopień zapotrzebowania na dogrzewanie silnika porównywany jest z danymi zapisanymi w sterowniku. Uwzględniają one obciążenie, prędkość obrotową, temperaturę i ilość podawanego paliwa. System ISS umożliwia natychmiastowy "benzynowy" rozruch do -15 °C. Przy -24 °C czas podgrzewania wynosi tylko 2 sek. Wydzielanie szkodliwych substancji zredukowane jest do minimum.

Napięcie robocze: do 5V

**GN**

Świeca żarowa – podgrzewanie wstępne, rozruchowe i dogrzewające

Typ: Trzpieniowa świeca żarowa, wykonana w technologii dwuspiralnej

Zastosowanie: Samochody z układem żarowodogrzewającym

Zasada działania: Żarzenie trzyczasowe w nowoczesnych systemach żarowodogrzewających (podgrzewanie wstępne, rozruchowe i dogrzewające), nowe materiały na rurę grzejną oraz spiralę regulacyjną i grzejną. Innowacyjna technologia produkcji.

Napięcie robocze: do 13,5V

Tylko świece żarowe GN dostosowane są do zwiększonego napięcia! Jeżeli w systemie podgrzewania przewidzianym dla świec GN zostanie zamontowana np. świeca GV, może ona ulec w krótkim czasie uszkodzeniu.

**GV**

Świeca żarowa – wyłącznie podgrzewanie wstępne

Typ: Świeca żarowa w technologii jedno lub dwuspiralnej

Zastosowanie: Samochody starszych roczników

Zasada działania: Dwufazowe podgrzewanie (żarzenie wstępne i rozruchowe), po uruchomieniu silnika świeca żarowa zostaje odłączona

Napięcie robocze: 11 V

Ponieważ świece żarowe GV konstruowane są na niskie napięcie zasilania, można ją montować tylko tam, gdzie jest to przewidziane przez producenta samochodu.

**GF**

Świeca żarowa do systemów podgrzewania płomieniowego

Typ: Świeca żarowa płomieniowa

Zastosowanie: Silniki diesla o dużej pojemności skokowej z wtryskiem bezpośrednim

Zasada działania: Po osiągnięciu zadanej temperatury żarzenia przez zawór dostarczane jest dodatkowe paliwo w obszar pozwalający na jego odparowanie. Powstający płomień podgrzewa powietrze zasysane do silnika.

**GD**

Świeca żarowa z drucianą spiralą grzejną

Typ: Świeca żarowa z drucianą spiralą

Zastosowanie: Głównie w starszych pojazdach oraz w traktorach, maszynach budowlanych i silnikach stacjonarnych

Zasada działania: Elementem grzejnym jest zewnętrzna spiralą z drutu oporowego

**GH**

Świeca żarowa do ogrzewań stacjonarnych

Typ: Trzpieniowa lub z zewnętrzną spiralą grzejną

Zastosowanie: Ogrzewania stacjonarne (na benzynie lub oleju napędowym)

Τα μπουζιά σοντονίζονται ειδικά για τα διάφορα είδη κινητήρων και πυράκτωσης. Ως εκ τούτου κατά την αντικατάσταση μπουζιών είναι πολύ σημαντικό:

**Κάθε σύστημα πυράκτωσης επιτρέπεται να εξοπλίζεται μόνο με μπουζιά, τα οποία είναι ακριβώς συντονισμένα για τον συγκεκριμένο κινητήρα!**

**GE**

Μπουζί με ηλεκτρονική ρύθμιση, προπυράκτωση – πυράκτωση εκκίνησης – μεταπυράκτωση

Τύπος: Μπουζί με τεχνολογία διπλού πηνίου, και ηλεκτρονική ρύθμιση

Εφαρμογές: Κινητήρες της νέας γενιάς με ηλεκτρονική ρύθμιση χρόνου πυράκτωσης

Τρόπος λειτουργίας: Το σύστημα ταχείας εκκίνησης Diesel της BERU ISS (Instant Start System) αποτελείται από μπουζί ηλεκτρονικής ρύθμισης και βελτιστοποιημένης απόδοσης και από μονάδα ελέγχου με μικροελεγκτή. Οι ανάγκες πυράκτωσης του κινητήρα προσαρμόζονται μέσω αποθηκευμένου χαρακτηριστικού πεδίου. Το πεδίο αυτό λαμβάνει υπόψη το φορτίο, τον αριθμό στροφών, τη θερμοκρασία και τη ροή καυσίμων. Με το σύστημα ISS είναι εφικτή η ταχεία εκκίνηση “κινητήρα όττο” με το κλειδί σε θερμοκρασίες έως μείον 15°. Σε θερμοκρασίες μείον 24° ο χρόνος προπυράκτωσης ανέρχεται μόνο σε 2 δευτερόλεπτα. Η εκπομπή ρύπων ελαχιστοποιείται.

Τάση λειτουργίας: έως 5 Volt

**GN**

Μπουζί με προπυράκτωση – πυράκτωση εκκίνησης – μεταπυράκτωση

Τύπος: Μπουζί με τεχνολογία διπλού πηνίου

Εφαρμογές: Κινητήρες με σύστημα πυράκτωσης με δυνατότητα μεταπυράκτωσης

Τρόπος λειτουργίας: Πυράκτωση 3 φάσεων για μοντέρνα συστήματα πυράκτωσης (προπυράκτωση – πυράκτωση εκκίνησης – μεταπυράκτωση), νέα υλικά για ελίκωση σωλήνα πυράκτωσης, θέρμανσης και ρύθμισης, υπερσύγχρονη τεχνολογία κατασκευής

Τάση λειτουργίας: έως 13,5 Volt

Μόνο τα μπουζί GN έχουν προσαρμοστεί σε αυτή την υψηλή τάση λειτουργίας! Αν για παράδειγμα λειτουργήσει ένα μπουζί „GV“ σε σύστημα πυράκτωσης που προβλέπεται για μπουζί „GN“, τότε το μπουζί μπορεί να καταστραφεί μέσα σε μικρό χρονικό διάστημα!

**GV**

Μπουζί (μόνο προπυράκτωση)

Τύπος: Επενδυμένο μπουζί με τεχνολογία διπλού/μονού πηνίου

Εφαρμογές: Οχήματα παλαιότερων γενεών

Τρόπος λειτουργίας: Πυράκτωση 2 φάσεων (μόνο προπυράκτωση και πυράκτωση εκκίνησης), μετά την εκκίνηση του κινητήρα το μπουζί απενεργοποιείται

Τάση λειτουργίας: έως 11 Volt

Επειδή το μπουζί αυτό προορίζεται μόνο για χαμηλή τάση λειτουργίας, επιτρέπεται να χρησιμοποιείται μόνο εφόσον το προδιαγράφει ο κατασκευαστής του οχήματος!

**GF**

Μπουζί για κινητήρες ανάφλεξης

Τύπος: Μπουζί ανάφλεξης

Εφαρμογές: Μεγάλοι πετρελαιοκινητήρες με άμεσο ψεκασμό καυσίμου

Τρόπος λειτουργίας: Αφού επιτευχθεί η θερμοκρασία πυράκτωσης, εισέρχεται επιπλέον καύσιμο μέσω βαλβίδας στο χώρο εξάτμισης των μπουζιών ανάφλεξης, και δημιουργείται μία φλόγα, η οποία θερμαίνει σημαντικά τον αέρα αναρρόφησης

**GD**

Μπουζί με συρμάτινο πηνίο

Τύπος: Μπουζί με συρμάτινο πηνίο

Εφαρμογές: Ιδιαίτερα για πετρελαιοκινητήρες παλαιότερων οχημάτων, όπως επίσης για τρακτέρ, τράκτορες, δομικά μηχανήματα και κινητήρες σε σταθερή εγκατάσταση

Τρόπος λειτουργίας: Το συρμάτινο σπειρώμα στο μπουζί λειτουργεί ως στοιχείο θέρμανσης

**GH**

Μπουζί για πρόσθετους θερμαντήρες

Τύπος: Επενδυμένο μπουζί ή μπουζί με πηνίο

Εφαρμογές: Πρόσθετοι θερμαντήρες (πετρελαιοκινητήρες ή βενζινοκινητήρες)

Az izzítógyertyák a különböző motortípusok és izzítási eljárások követelményeinek megfelelően kerülnek kialakításra. Ezért az izzóspirál cseréjekor különös figyelmet kell szentelni az alábbi szempontoknak: **Minden izzítási rendszerhez kizárólag az adott motorhoz előírt izzítógyertyákat szabad felhasználni!**

**GE**

Elektronikusan vezérelt izzítógyertya, előizzítás – indításkori izzítás – utóizzítás

Típusa: Elektronikus vezérlésű, rúd alakú izzítógyertya kettős spirál-technológiával

Alkalmazása: Újgenerációs, elektronikusan vezérelt izzítási idejű motorokban

Működése: A BERU dízel indítórendszer, az ISS (Instant Start System) optimális teljesítményű, elektronikusan vezérelt izzítógyertyákból és mikrokontrolleres vezérlőkészülekből áll. A szükséges motorizzítás összehangolása tárolt jelzőszámok segítségével, a terhelés, a fordulatszám, a hőmérséklet és az átáramló üzemanyag figyelembevételével történik. Az ISS-szel spontán, az Ottó-motorhoz hasonló indítás érhető el, akár mínusz 15 fokban is. Mínusz 24 foknál az előizzítási idő csupán 2 másodperc. A kibocsátott káros anyag mennyisége minimális.

Üzemi feszültség: max. 5 Volt

**GN**

Izzítógyertya, előizzítás – indításkori izzítás – utóizzítás

Típusa: Kétizzóspirál technika elve szerint működő izzórudas izzítógyertya

Alkalmazása: Járművekben utóizzításra alkalmas izzítórendszerrel

Működése: 3-fázisú izzás korszerű izzófejes motorrendszerekhez (előizzítás - indító izzítás - utánizzás), izzócsőhöz, fűtő- és szabályozó spirálhoz felhasznált új anyagok, rendkívül korszerű gyártási technológia

Üzemi feszültség: max. 13,5 Volt

Csak a GN-izzítógyertyák elégítik ki a fokozott üzemi feszültség által támasztott követelményeket! Ha például „GV”-izzítógyertyát üzemeltet egy „GN”- izzítógyertya számára kialakított izzófejes rendszeren, akkor az igen rövid elő leforgása alatt tönkremehet!

**GV**

Izzítógyertya (csak előizzítás)

Típusa: Két-/egy-izzóspirál technika elve szerint működő izzórudas izzítógyertya

Alkalmazása: Korábbi generációhoz tartozó járművek

Működése: 2-fázisú izzás (csak elő- és indító izzítás), a motor megindulása után az izzítógyertya kikapcsol

Üzemi feszültség: 11 Volt

Mivel ez az izzítógyertya kialakítása alacsony üzemi feszültségnek felel meg, csak akkor szerelje be, ha a jármű gyártója ezt a típust írta elő!

**GF**

Izzítógyertya lángszikrás indító rendszerekhez

Típusa: Láng-izzítógyertya

Alkalmazása: Nagy lökettérfogatú közvetlen befecskendezésű dízel motorok számára

Működése: Az izzási hőmérséklet elérésekor egy szelepen keresztül többlet-üzemanyag jut a láng-izzítógyertya porlasztási térségébe – olyan láng keletkezik, amely tartósan felmelegíti a beszívott levegőt

**GD**

Huzalspirállal működő izzítógyertya

Típusa: Huzalspirálos izzítógyertya

Alkalmazása: Többnyire régebbi típusú dízeljárművekben valamint traktorokban, vontatókban, építőipari gépekben és helyhez kötött motorokban

Működése: Az izzítógyertyán található vezeték hurok szolgál fűtőelemként

**GH**

Izzítógyertya kiegészítő fűtőberendezésekhez

Típusa: Izzórudas- vagy izzóspirálos izzítógyertya

Alkalmazása: (Benzinnel vagy dízellel táplált) kiegészítő fűtőberendezések

BERU ist die Nr. 1 bei Glühkerzen: Keine Glühkerzenmarke wird öfter geordert und in die selbstzündenden Pkw- und Nfz-Motoren aller namhaften Automobilhersteller eingebaut. Und nicht nur in der Erstausrüstung ist Original BERU Markenqualität gefragt – auch im Wartungs- und Reparaturmarkt ist das umfangreiche BERU Glühkerzen-Sortiment erste Wahl: BERU Glühkerzen erreichen eine Marktbedeckung des verschleißrelevanten Bedarfs in Europa von 98%.

### **BERU – Technologieführer im Dieselmotorkaltstart**

Vieles, was heute Stand der Technik in der Dieselmotorkaltstarttechnologie ist, wurde durch BERU erst möglich. Bereits 1929 entwickelte BERU die erste Glühkerze für den Dieselmotor – und prägt den Markt bis heute mit zahlreichen patentierten Innovationen. Beispiele hierfür sind die selbstregelnde nachglühfähige Glühkerze, das Diesel-Kaltstart-System ISS oder die innovative BERU Drucksensor-Glühkerze PSG (Pressure Sensor Glow Plug).

### **BERU Glühkerzen**

Für nahezu jedes Fahrzeug die richtige Glühkerze in 1:1-OE-Qualität – das bietet Ihnen kein anderer Glühkerzenhersteller.

### **BERU Steuergeräte**

BERU bietet Handel und Werkstatt ein umfassendes Sortiment an Glühzeit-Steuergeräten – auch für das elektronisch gesteuerte Dieselmotorkaltstart-System ISS, das es nur von BERU gibt.

*BERU is the world's leading glow plug supplier: no other glow plug brand is ordered more often and fitted in auto-ignition car and commercial vehicle engines by all leading automobile manufacturers. The original BERU brand quality is not only in demand in the OE sector; BERU's extensive glow plug range is the first choice in the servicing and repair market too: BERU glow plugs have a market coverage of 98% in Europe for all models subject to wear and tear.*

### **BERU – technology leader in diesel cold start technology**

*Many developments that are now state-of-the-art in diesel cold start technology owe their origins to BERU. BERU developed the first diesel engine glow plug back in 1929 – and it continues to shape the market today with countless patented innovations. Examples include the self-regulating, post-heating glow plug, the diesel cold start system ISS and the innovative BERU pressure sensor glow plug PSG.*

### **BERU Glow Plugs**

*The right glow plug in 1:1 OEM quality for almost any vehicle - no other glow plug manufacturer can offer this.*

### **BERU Control Units**

*BERU supplies an extensive range of glow-time control units. For the electronic diesel cold start system ISS, which is unique to BERU, BERU offers dealers and workshops the full range of control units as separate components.*



BERU est N°1 pour les bougies de préchauffage: aucune marque de bougies de préchauffage n'est plus souvent commandée et montée dans les moteurs à allumage par compression des véhicules légers et utilitaires de tous les constructeurs automobiles renommés. La qualité d'origine de BERU n'est pas seulement requise en première monte – la large gamme de bougies de préchauffage BERU constitue également un premier choix sur le marché des réparations et de l'entretien: les bougies de préchauffage BERU couvrent 98% du marché des besoins en pièces de rechange en Europe.

### **BERU – Leader technologique dans le démarrage à froid des moteurs diesel**

L'état actuel de la technique de démarrage à froid des moteurs diesel doit beaucoup à BERU. En 1929 déjà, BERU a mis au point la première bougie de préchauffage pour les moteurs diesel – et occupe aujourd'hui encore une place de choix sur le marché avec de nombreuses innovations brevetées. Citons par exemple la bougie à auto-régulation ayant une fonction de post-allumage, le système de démarrage à froid des moteurs diesel ISS ou la bougie BERU de préchauffage avec capteur de pression PSG (Pressure Sensor Glow Plug).

### **Bougies de préchauffage BERU**

La bougie de préchauffage adaptée pour pratiquement chaque type de véhicule en qualité 100% première monte - un service proposé uniquement par BERU.

### **Appareils de commande BERU**

BERU livre un large assortiment d'appareils de commande du temps de préchauffage. Pour le système de démarrage à froid des moteurs diesel ISS à commande électronique, proposé uniquement par BERU, BERU propose, dans le commerce et les ateliers, la gamme intégrale des appareils de commande sous forme de composants séparés.

*BERU is de nummer 1 in gloei-bougies: Geen gloeibougiemerkt wordt vaker besteld en in de zelffontstekende personen- en bestelwagenmotoren van alle aansprekende autofabrikanten ingebouwd. En niet alleen voor de nieuwe voertuigen wordt de originele BERU merkkwaliteit gevraagd – ook op het gebied van onderhoud en reparatie is het uitgebreide assortiment gloeibougies van BERU de eerste keus: BERU-gloeibougies hebben in Europa een marktdekking van 98% wanneer het om vervanging van versleten bougies gaat.*

### **BERU – marktleider in de koudestarttechnologie voor dieselmotoren**

*Veel van hetgeen tegenwoordig mogelijk is bij de koudestarttechnologie voor dieselmotoren, is te danken aan BERU. Al in 1929 ontwikkelde BERU de eerste gloeibougie voor de dieselmotor – en drukt nog steeds haar stempel op de markt met talrijke gepatenteerde innovaties. Voorbeelden hiervan zijn de zelfregulerende nagloeierende gloeibougie, het koudestartsysteem voor dieselmotoren ISS of de innovatieve BERU druksensor gloeibougie PSG (Pressure Sensor Glow Plug).*

### **BERU-Gloeibougies**

*Voor vrijwel ieder voertuig de juiste gloeibougie in 1:1-OE-kwaliteit - dat biedt geen enkele andere fabrikant van gloeibougies.*

### **BERU-Regelaars**

*BERU biedt een uitgebreid assortiment gloeitijdregelaars aan. Voor het elektronische geregelde koudestartsysteem voor dieselmotoren ISS, dat alleen door BERU wordt geleverd, biedt BERU aan groothandel en werkplaats haar volledige assortiment regelaars als aparte componenten aan.*



BERU es el nº 1 en lo que se refiere a bujías incandescentes: no existe ninguna otra marca de bujías incandescentes más solicitada e instalada en los motores de encendido espontáneo de automóviles y vehículos utilitarios de todos los fabricantes de automóviles de renombre, que la de BERU. No solo en el primer equipo es necesaria la calidad original de la marca BERU; en el mercado del mantenimiento y las reparaciones, el amplio surtido de bujías incandescentes de BERU también es la primera opción: las bujías incandescentes de BERU alcanzan una cobertura de mercado de 98% en Europa en cuanto a la demanda de piezas de desgaste.

### BERU – Líder tecnológico en el arranque en frío para diesel

Muchos de los factores que hoy corresponden al último estado de la técnica, han sido posibles gracias a BERU. Ya en 1929, BERU desarrolló la primera bujía incandescente para el motor diesel y hasta hoy, se encarga de enriquecer el mercado con numerosas innovaciones patentadas. Algunos ejemplos de ello son las bujías autorreguladas de incandescencia posterior, el sistema de arranque en frío para diesel ISS o la innovadora bujía incandescente con sensor de presión PSG (Pressure Sensor Glow Plug).

### Bujías incandescentes BERU

Para cada vehículo la correspondiente bujía incandescente con calidad OE al 100%. Ningún otro fabricante de bujías le ofrece lo mismo.

### Dispositivos de control BERU

BERU suministra un surtido amplio de dispositivos de control del tiempo de incandescencia. Para el sistema de arranque en frío para diesel ISS con control electrónico, que tiene a BERU como único proveedor, se oferta una gama completa de dispositivos de control como componentes separados para la tienda y el taller.

*BERU è il N°1 delle candele di preriscaldamento: nessuna marca di candele di preriscaldamento è più ricercata per il montaggio nei motori ad autoaccensione per automobili e autocarri di tutte le più rinomate case automobilistiche. La qualità del marchio originale BERU è richiesta sia nel primo equipaggiamento che nel mercato della manutenzione e della riparazione. L'ampio assortimento di candele di preriscaldamento BERU raggiunge una copertura dell'After Market europeo del 98%.*

### BERU – Leader nella tecnologia di avviamento a freddo per motori Diesel

*Molto di ciò che oggi è considerato "standard" nella tecnica e nella tecnologia di avviamento a freddo per motori Diesel è stato reso possibile da BERU. Già nel 1929 BERU sviluppò la prima candela di preriscaldamento per il motore Diesel. Da allora l'impronta in questo settore è stata ed è contrassegnata da numerose innovazioni tecniche e tecnologiche BERU tutte brevettate. Diversi esempi possiamo citare tra cui la candela di preriscaldamento con post-riscaldamento autoregolante, il sistema di avviamento a freddo per motori diesel ISS o l'innovativa candela di preriscaldamento BERU con sensore di pressione PSG (Pressure Sensor Glow Plug).*

### Candele di preriscaldamento BERU

*Per ogni veicolo la relativa candela di preriscaldamento con qualità OE del 100%. Nessun altro fabbricante di candele è in grado di offrirle tanto.*

### Centraline BERU

*BERU propone un vasto assortimento di centraline per candele di preriscaldamento e per il sistema di avviamento a freddo per motori Diesel ISS a controllo elettronico. BERU offre a tutto l'After Market l'intera gamma di centraline come componenti separati.*

BERU является № 1 в производстве свечей накаливания: ни один тип свечей накаливания не заказывается и не встраивается столь часто в дизельные двигатели легковых и безрельсовых транспортных средств всех известных фирм-изготовителей автомобилей как свечи фирмы BERU. Оригинальное фирменное изделие BERU пользуется спросом не только в комплектации предприятий-изготовителей, но также и на рынке запасных частей и средств технического обслуживания обширный ассортимент свечей накаливания BERU является непревзойденным лидером: свечи накаливания BERU покрывают потребность рынка Европы в деталях, подвергающихся износу, на 98%.

### BERU – лидер в технологии дизельных двигателей холодного запуска

Многое, что на сегодняшний день определяет уровень развития технологий в дизельных двигателях холодного запуска, стало возможным лишь благодаря фирме BERU. Первые свечи накаливания для дизельного двигателя, разработанные фирмой BERU уже в 1929 году, до сих пор преобладают на рынке, благодаря своим многочисленным запатентованным инновациям. Примером этого является саморегулирующаяся свеча накаливания с вторичным накалом, дизельная система холодного запуска ISS или новаторская свеча накаливания BERU с датчиком давления PSG (Pressure Sensor Glow Plug).

### Свечи накаливания BERU

Почти для любого транспортного средства – это необходимая свеча накаливания, отвечающая на 100% качеству оригинального оборудования. Такой выбор не может предложить Вам ни один изготовитель свеч накаливания!

### УПРАВЛЯЮЩИЕ УСТРОЙСТВА BERU

Фирма BERU поставляет обширный ассортимент реле времени накаливания свечи. Для дизельной системы холодного запуска с электронным управлением типа ISS, которую производит только фирма BERU, торговая сеть и автомастерские этой фирмы предлагают полный спектр управляющих устройств в качестве отдельных компонентов.

Marka BERU – światowy lider w rosnącym rynku podgrzewania Diesla, jest najczęściej zamawiana i montowana w silnikach samochodowych i użytkowych wiodących producentów. Oryginalna jakość BERU jest wymagana przez fabryki, doceniana w warsztatach i na rynku części zamiennych. Świece żarowe Beru pokrywają 98% zapotrzebowania rynku wtórnego.

### BERU – lider technologii podgrzewania Diesla

To co dziś jest już standardem w technologii podgrzewania Diesla było możliwe dzięki BERU. Już w 1929 roku BERU skonstruowało pierwszą świecę żarową i poprzez wiele opatentowanych innowacji, kształtuje obecne kierunki rozwoju. Najnowszymi przykładami są: samoregulująca się świeca żarowo-dogrzewająca, system szybkiego rozruchu „ISS” oraz świeca żarowa z sensorem ciśnienia „PSG”.

### Świece żarowe BERU

Właściwa świeca żarowa do prawie każdego samochodu w jakości identycznej jak na pierwszym montażu – tego nie zapewnia Wam żaden inny producent świec.

### Sterowniki świec żarowych BERU

BERU produkuje szeroki asortyment sterowników świec żarowych. Do elektronicznego systemu podgrzewania Diesla ISS, (który produkowany jest tylko przez BERU) dostępne są wszystkie referencje sterowników jako osobne komponenty.

*BERU είναι το νούμερο 1 στους αναφλεκτήρες πυρακτώσεως: Καμία μάρκα αναφλεκτήρων πυρακτώσεως δεν παραγγέλλεται και δεν τοποθετείται συχνότερα στους κινητήρες επιβατικών και φορτηγών αυτοκινήτων με λειτουργία αυτανάφλεξης όλων των επώνυμων κατασκευαστών αυτοκινήτων. Τα υψηλής ποιότητας γνήσια BERU δεν είναι περιζήτητα μόνο στον πρώτο εξοπλισμό – επίσης και στην αγορά συντήρησης και επισκευής η ευρύτατη συλλογή αναφλεκτήρων πυρακτώσεως BERU είναι πρώτη επιλογή: Οι αναφλεκτήρες πυρακτώσεως BERU επιτυγχάνουν μια κάλυψη της αγοράς του αναλώσιμου υλικού στην Ευρώπη από 98%.*

### BERU – Πρωτοπόρος στην τεχνολογία της κρύας εκκίνησης πετρελαιοκινητήρων

*Πολλά, που σήμερα αποτελούν την κορυφή στην τεχνολογία κρύας εκκίνησης πετρελαιοκινητήρων, έγιναν δυνατά χάρη στην BERU. Ήδη το 1929 ανέπτυξε η BERU τους πρώτους αναφλεκτήρες πυρακτώσεως για πετρελαιοκινητήρες – και διαμορφώνει την αγορά μέχρι και σήμερα με πολυάριθμες πατενταρισμένες καινοτομίες. Παραδείγματα για αυτό είναι οι αυτορρυθμιζόμενοι αναφλεκτήρες πυρακτώσεως με ικανότητα συνέχισης της πυράκτωσης, το σύστημα κρύας εκκίνησης πετρελαιοκινητήρων ISS ή ο καινοτομικός αναφλεκτήρας πυρακτώσεως αισθητήρας πίεσης BERU PSG (Pressure Sensor Glow Plug).*

### Αναφλεκτήρες πυρακτώσεως BERU

*Σχεδόν για κάθε όχημα ο σωστός αναφλεκτήρας πυρακτώσεως σε ποιότητα ΓΑ 1:1 – αυτό δε σας το προσφέρει κανένας άλλος κατασκευαστής αναφλεκτήρων πυρακτώσεως.*

### BERU ΜΟΝΑΔΕΣ ΕΛΕΓΧΟΥ

*Η εταιρεία BERU προσφέρει μια ευρύτατη συλλογή μονάδων ελέγχου του χρόνου πυράκτωσης. Για το ηλεκτρονικά ελεγχόμενο σύστημα κρύας εκκίνησης πετρελαιοκινητήρων ISS, που υπάρχει μόνο από την εταιρεία BERU, προσφέρει η BERU στο εμπόριο και στα συνεργεία όλη την παλέτα των μονάδων ελέγχου ως ξεχωριστά εξαρτήματα.*

A BERU az első számú izzítógyertya gyártó: Nincs olyan izzítógyertya márka, amelyből többet rendeléne, és építené be az összes elismert autógyár öngyulladásos személy- és haszongépjármű motorjaiba. És nem csak gyártói beszállítóként keresett az eredeti BERU minőség – a karbantartási és javítási piacon is a széles BERU izzítógyertya-választék a legjobb választás: A BERU izzítógyertyák az elhasználódásból eredő igény piacát Európában 98%-ban fedik le.

### BERU – a vezető technológia a diesel-hidegindítás területén

Számos megoldás, ami a technika jelenlegi színvonalának felel meg, a BERU-nak köszönhetően vált lehetővé. Már 1929-ben kifejlesztette a BERU az első dieselmotorhoz való izzítógyertyát – és máig nagy befolyással rendelkezik a piacon, számos szabadalmaztatott innovációval. A legjobb példák: az önszabályzó, utánizzításra alkalmas izzítógyertya, az ISS diesel-hidegindítási rendszer, és az innovatív, nyomásérzékelős PSG (Pressure Sensor Glow Plug) BERU izzítógyertya.

### Beru gyújtógyertyák

Majdnem minden járműhöz megfelelő gyújtógyertya 1:1-OE minőségben – ezt nem kapja meg más gyújtógyertya-gyártónál

### BERU Vezérlőegységek

A BERU izzításiidő-vezérlőegységek széles választékát kínálja. Az elektronikusan vezérelt ISS diesel-hidegindítási rendszerhez, amely csak a BERU-nál kapható, a BERU kereskedések és szervizek a vezérlőegységek teljes skáláját kínálják egyedi komponensként.







**1**



**2**



**3**



**4**



**5**



**6**



**7**



**8**



**9**



**10**





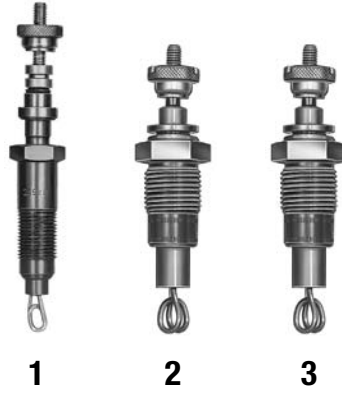



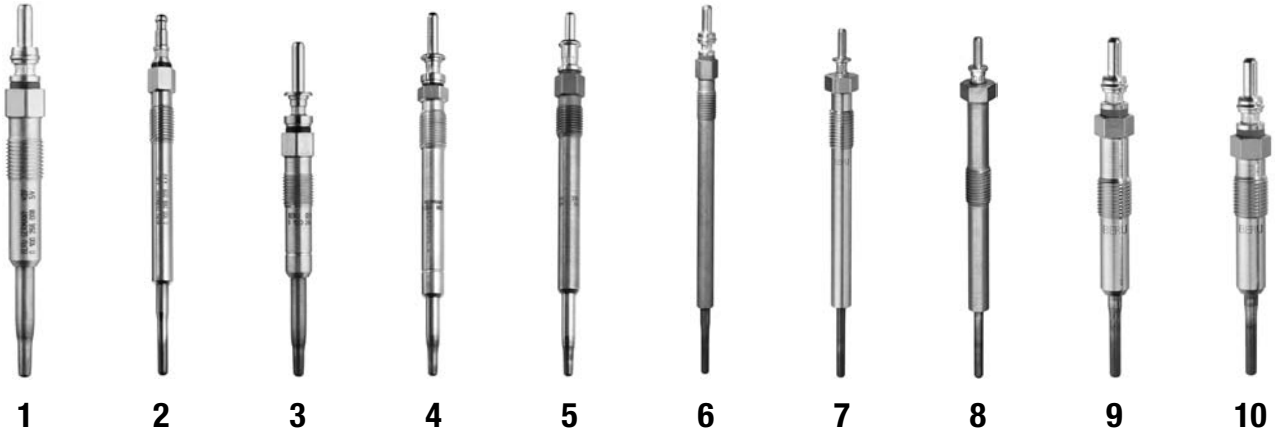



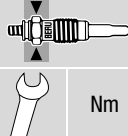
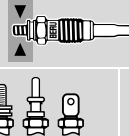

1			M 10 × 1					63°	V	A	
	134	29		10	Nm		Nm max.				
<b>CGP 001</b> 0 106 671 105							–		5,4	45	BMW

<b>2</b>	<b>GD 01</b> 0 102 013 404	76	47	M 24 × 1,5	27	Fzg.-spez.		M 5	3	Plan <sup>59</sup>	6	17	Scirocco Neubrandenburg
<b>3</b>	<b>GD 12</b> 0 100 102 307	83	39,5	M 18 × 1,5	19	Fzg.-spez.		M 5	3	Plan <sup>59</sup>	1,7	40	Robur-Werke Zittau <sup>21</sup>
<b>4</b>	<b>GD 71</b> 0 100 101 011	126	31,5	Überwurf- mutter <sup>19</sup>	–	Fzg.-spez.		M 5	3	60°	1,7	40	Elbe-Werk Roßlau <sup>21</sup>
<b>5</b>	<b>GD 203</b> 0 102 124 601	105	65	UNF 7/8-14	26	Fzg.-spez.		M 5	3	Plan <sup>59</sup>	12	58	Int. Harv. Comp. <sup>21</sup>
<b>6</b>	<b>GD 214</b> 0 100 101 302	90	27,3	M 18 × 1,5	21	38		M 5	3	60°	0,9	40	Hanomag <sup>21</sup>
<b>7</b>	<b>GD 220</b> 0 100 100 203	105	20	M 14 × 1,25	17	38		M 5	3	60°	1,7	38	Land-Rover
<b>8</b>	<b>GD 255</b> 0 100 101 001	132,5	28,5	Überwurf- mutter <sup>19</sup>	–	Fzg.-spez.		M 5	3	60°	1,7	37	Int. Harv. Comp. <sup>21</sup>
<b>9</b>	<b>GD 294</b> 0 100 102 302	82	39	M 18 × 1,5	26	Fzg.-spez.		M 5	3	Dichtring <sup>30</sup>	1,7	43	Hanomag <sup>21</sup>
<b>10</b>	<b>GD 318</b> 0 100 101 304	90	27,3	M 18 × 1,5	21	Fzg.-spez.		M 5	3	60°	1,7	40	Case, Kramer, Poclairn



										V	A	
					Nm	Nm max.						
<b>1</b>	<b>GD 341</b> 0 100 101 204	110,5	29	M 14 × 1,25	17	Fzg.-spez.	M 5	3	60°	1	42,5	Hanomag <sup>21</sup>
<b>2</b>	<b>GD 348</b> 0 100 101 305	88	28	M 18 × 1,5	21	Fzg.-spez.	M 5	3	60°	0,9	42	Mercedes (Unimog)
<b>3</b>	<b>GD 382</b> 0 100 101 308	88	28	M 18 × 1,5	21	38	M 5	3	60°	0,9	63	Mercedes



									V	A		
				Nm	Nm max.							
<b>1</b>	<b>GE 100</b> 0 100 266 008	97	30	M 10 × 1,0	10	15	 Ø 4 mm	–	63°	5	–	VW AG
<b>2</b>	<b>GE 101</b> 0 100 266 009	117	30	M 8 × 1,0	8	10	 Ø 4 mm	–	93°	4,4	–	VW AG
<b>3</b>	<b>GE 102</b> 0 100 266 002	106,5	33	M 10 × 1,0	10	15	 Ø 4 mm	–	63°	5	–	BMW
<b>4</b>	<b>GE 103</b> 0 100 266 003	133,5	29	M 10 × 1,0	10	15	 Ø 4 mm	–	63°	5	–	BMW
<b>5</b>	<b>GE 104</b> 0 100 266 010	133	31	M 10 × 1,0	10	15	 Ø 4 mm	–	63°	5	–	Mercedes
<b>6</b>	<b>GE 105</b> 0 100 266 011	148,5	27	M 8 × 1,0	8	10	 Ø 4 mm	–	93°	4,4	21	Mercedes
<b>7</b>	<b>GE 106</b> 0 100 266 018	136,5	28	M 10 × 1,25	12	15	 M 4	2	119°	4,7	10	Isuzu
<b>8</b>	<b>GE 109</b> 0 100 266 059	136,5	28	M 10 × 1,25	12	15	 M 4	2	119°	4,7	10	Chevrolet, GMC
<b>9</b>	<b>GE 110</b> 0 100 266 032	96,5	24,5	M 10 × 1,0	10	15	 Ø 4 mm	–	63°	4,4	9	Renault
<b>10</b>	<b>GE 111</b> 0 100 266 033	90,5	24,5	M 10 × 1,0	10	15	 Ø 4 mm	–	63°	4,4	9	Renault

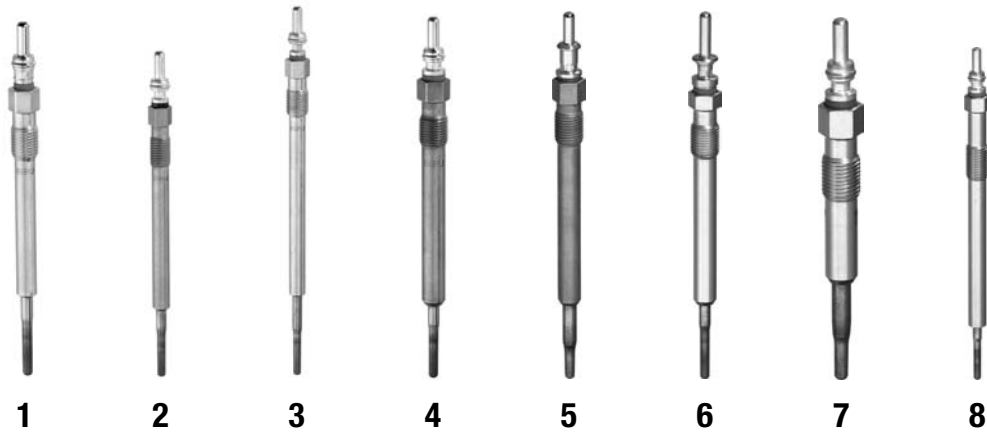

										V	A	
				Nm	Nm max.							
<b>1</b>	<b>GE 112</b> 0 100 266 031	119,5	28	M 9 × 1,0	9	10	Ø 4 mm	–	93°	4,4	7	Opel
<b>2</b>	<b>GE 113</b> 0 100 266 019	132	28	M 8 × 1,0	8	10	Ø 4 mm	–	93°	4,4	9	Hyundai
<b>3</b>	<b>GE 114</b> 0 100 266 034	156,5	35	M 9 × 1,0	9	10	Ø 4 mm	–	93°	4,4	7	Opel
<b>4</b>	<b>GE 115</b> 0 100 266 040	130	28	M 10 × 1,0	10	15	Ø 4 mm	–	63°	4,4	9	VW AG
<b>5</b>	<b>GE 116</b> 0 100 266 042	130	28	M 10 × 1,0	10	15	M 4	2	63°	5	–	Mercedes (USA)
<b>6</b>	<b>GE 118</b> 0 100 266 037	134	29	M 10 × 1,0	10	20	Ø 4 mm	–	63°	4,4	–	Mini
<b>7</b>	<b>GE 119</b> 0 100 266 065	94	26	M 10 × 1,0	10	15	Ø 4 mm	–	63°	5	–	AUDI/VW
<b>8</b>	<b>GE 120</b> 0 100 266 066	156	26	M 10 × 1,25	10	15	Ø 4 mm	–	119°	4,4	8,5	Ssangyong



1										V	A		
					Nm	Nm max.							
<b>1</b>	<b>GH 001</b> 0 100 226 340	55	19	M 10 × 1,0	13	15		M 4	2	63°	8	8,5	Eberspächer
<b>2</b>	<b>GH 008</b> 0 100 331 103	68	25	M 10 × 1,0	13	15		M 4	2	63°	18	4,5	Eberspächer
<b>3</b>	<b>GH 009</b> 0 100 331 104	68	25	M 10 × 1,0	13	15		M 4	2	63°	18	5,3	Eberspächer
<b>4</b>	<b>GH 010</b> 0 102 124 416	105	55	M 22 × 1,5	26	20		M 5	3	Plan <sup>59</sup>	12	58	DAF, MAN, Renault, Volvo
<b>5</b>	<b>GH 011</b> 0 102 224 205	87	64,5	M 14 × 1,25	19	max. 40		M 5	max. 4	Plan <sup>59</sup>	11,5	21	Mercedes
<b>6</b>	<b>GH 13</b> 0 105 100 002	72,2	36	M 18 × 1,5	22	20		6,3 mm		Dichtring <sup>30</sup>	12	6,6	Eberspächer
<b>7</b>	<b>GH 18</b> 0 105 100 008	68,5	36	M 18 × 1,5	22	20		6,3/8 mm		Dichtring <sup>30</sup> , Plan <sup>59</sup>	11	10	Webasto
<b>8</b>	<b>GH 30</b> 0 105 100 021	71,7	36	M 18 × 1,5	22	20		6,3/8 mm		Dichtring <sup>30</sup>	11	9	Eberspächer
<b>9</b>	<b>GH 116</b> 0 102 022 202	59	40	M 14 × 1,25	19	15		M 5	3	Dichtring <sup>30</sup>	12	18	Bahco <sup>21</sup>

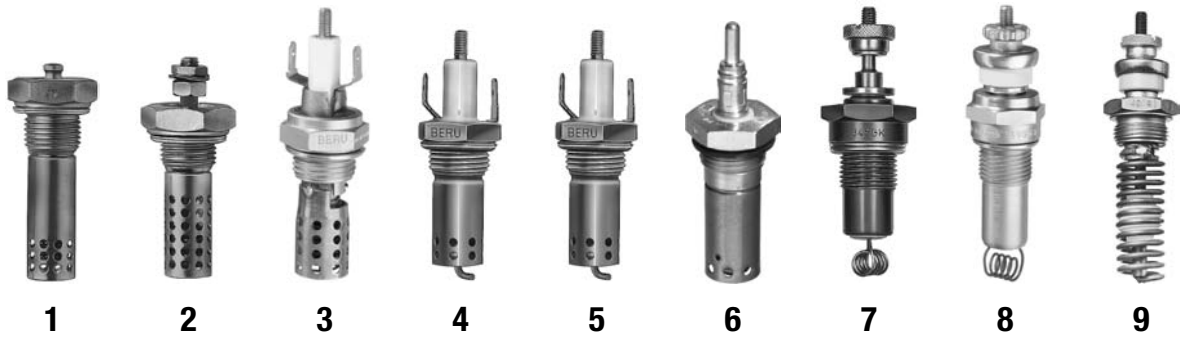

1										V	A	
					Nm	Nm max.						
1	<b>GH 191</b> 0 102 062 202	53	40	M 14 × 1,25	19	15		SAE	Dichtring <sup>30</sup>	3,2	8	Eberspächer
2	<b>GH 195</b> 0 102 012 205	54	35	M 14 × 1,25	21	15		M 5	Dichtring <sup>30</sup>	3,2	8	Eberspächer
3	<b>GH 201</b> 0 105 110 001	75	35,5	M 18 × 1,5	22	20		6,3 mm	Dichtring <sup>30</sup>	11	10	Eberspächer
4	<b>GH 202</b> 0 105 110 002	75	35,5	M 18 × 1,5	22	20		6,3 mm	Dichtring <sup>30</sup>	11	10	Eberspächer
5	<b>GH 203</b> 0 105 110 003	78	35,5	M 18 × 1,5	22	20		6,3 mm	Dichtring <sup>30</sup>	11	9	Eberspächer
6	<b>GH 306</b> 0 102 174 306	71,5	39,5	M 18 × 1,5	22	20		Ø 4 mm	Dichtring <sup>30</sup> Plan <sup>59</sup>	12	20	ARDIC
7	<b>GH 345</b> 0 102 113 302	85	42	M 18 × 1,5	26	20		M 5	Dichtring <sup>30</sup> , Plan <sup>59</sup>	3,2	10	Eberspächer
8	<b>GH 359</b> 0 102 113 303	92	49	M 18 × 1,5	24	20		M 5	Dichtring <sup>30</sup> Plan <sup>59</sup>	4	15,8	Webasto
9	<b>GH 401</b> 0 102 124 418	105,5	65	M 22 × 1,5	26	60		M 5	Plan <sup>59</sup>	12	58	DAF, Cummings



1										V	A	
					Nm	Nm max.	mm	mm				
<b>1</b>	<b>GH 407</b> 0 101 172 403	67,5	31,5	M 20 × 1,5	26	20		6,3 mm	Dichtring <sup>30</sup> , Plan <sup>59</sup>	12	19,5	Eberspächer
<b>2</b>	<b>GH 408</b> 0 102 123 203	62,5	42,5	M 14 × 1,25	19	15		M 4	Dichtring <sup>30</sup> , Plan <sup>59</sup>	12	20	Eberspächer, Webasto
<b>3</b>	<b>GH 409</b> 0 102 174 303	76	51	M 18 × 1,5	22	20		6,3 mm	Dichtring <sup>30</sup> , Plan <sup>59</sup>	12	11	Webasto
<b>4</b>	<b>GH 410</b> 0 102 184 303	76	51	M 18 × 1,5	22	20		6,3 mm	Dichtring <sup>30</sup> , Plan <sup>59</sup>	24	6	Webasto
<b>5</b>	<b>GH 648</b> 0 102 271 301	64	36	M 18 × 1,5	22	20		6,3/8 mm	Dichtring <sup>30</sup> , Plan <sup>59</sup>	11	10	Eberspächer
<b>6</b>	<b>GH 649</b> 0 102 022 301	55	36	M 18 × 1,5	22	20		M 5	Dichtring <sup>30</sup> , Plan <sup>59</sup>	12	11	Volvo
<b>7</b>	<b>GH 760</b> 0 102 024 405	89	65	M 22 × 1,5	26	20		M 5	Plan <sup>59</sup>	11	50	Ford
<b>8</b>	<b>GH 846</b> 0 102 133 204	64	43,5	M 14 × 1,25	19	15		Ø 4 mm	Dichtring <sup>30</sup> , Plan <sup>59</sup>	24	12	Webasto
<b>9</b>	<b>GH 847</b> 0 102 173 212	64	43,5	M 14 × 1,25	19	15		Ø 4 mm	Dichtring <sup>30</sup> , Plan <sup>59</sup>	12	20	Webasto



1

2

				M 24 × 1,5						V	A		
					Nm	Nm max.	M 4	Nm max.					
<b>8</b>	<b>GH 931</b> 0 102 133 403	69	42,5	M 24 × 1,5	19	20		M 4	2	Graphitring	20	10	Eberspächer
<b>9</b>	<b>GHA 408</b> 0 102 123 403	64,5	37,5	M 24 × 1,5	19	20		M 4	2	Dichtring <sup>30</sup> , Plan <sup>59</sup>	12	20	Eberspächer



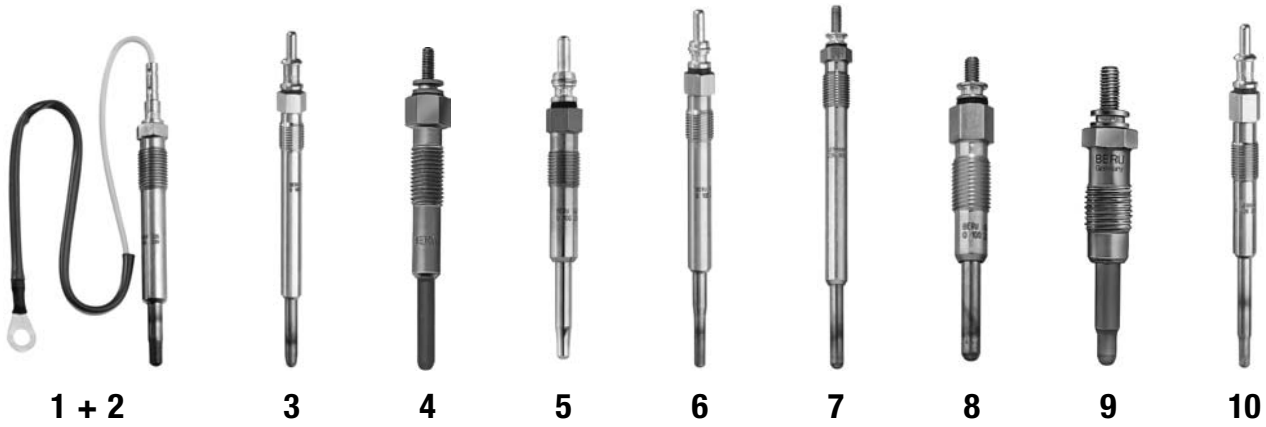



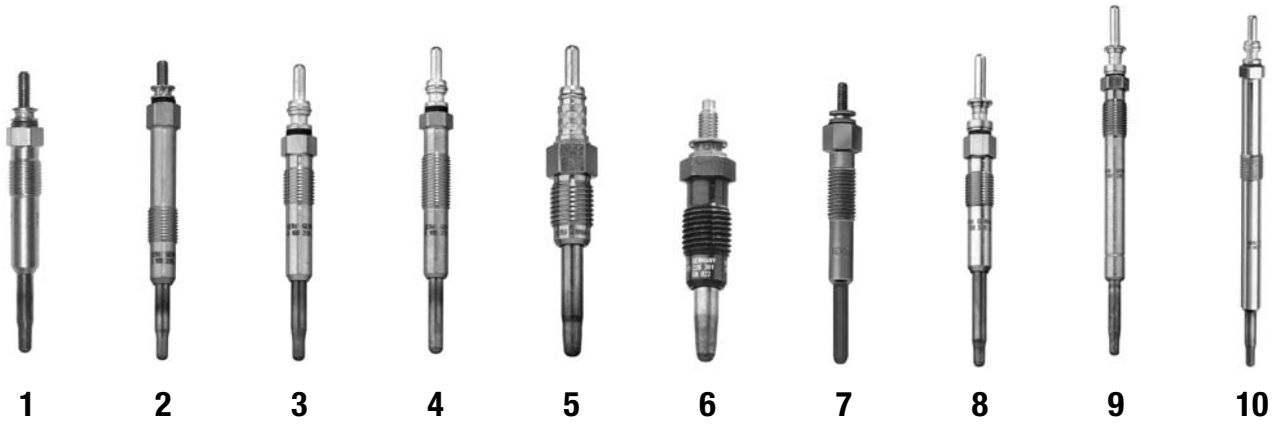



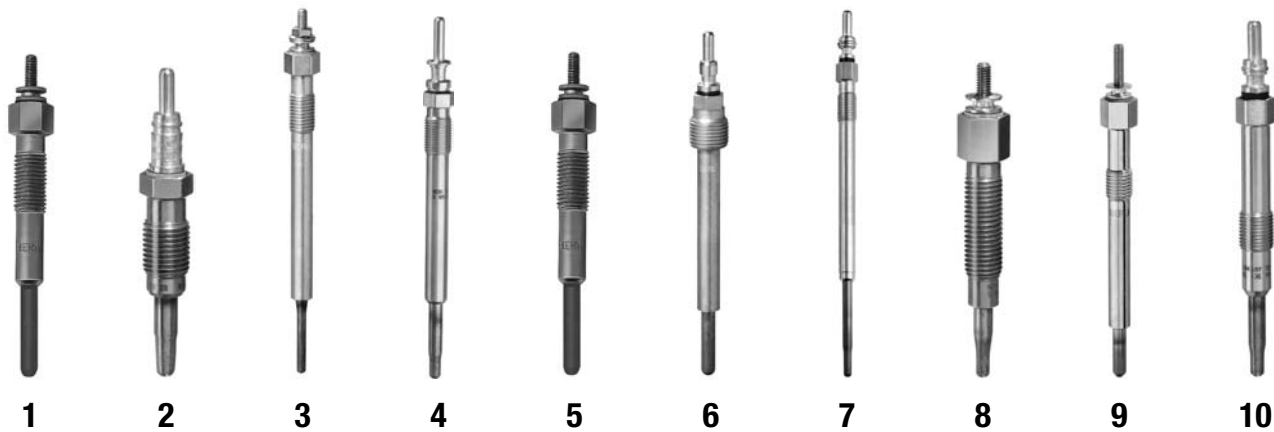





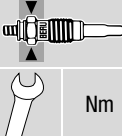
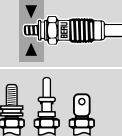



No.	Part No.	Total Length (mm)	Thread Length (mm)	Thread	Torque		Ring Groove	Gap	Angle	Voltage (V)	Current (A)	Vehicle
					Wrench	Nm						
1	GN 001 0 100 226 333	94,4	25	M 12 × 1,25	12	25	Ringöse 6 mm		63°	11	15	KHD
2	GN 002 0 100 231 119	94,4	25	M 12 × 1,25	12	25	Ringöse 6 mm		63°	23	9	KHD
3	GN 003 0 100 226 379	130	28	M 10 × 1,0	10	18	Ø 4 mm		63°	11,5	13	Mercedes
4	GN 005 0 100 226 336	87,5	22	M 10 × 1,25	12	15	M 4	2	120°	11	13	KIA
5	GN 007 0 100 226 343	97	30	M 10 × 1,0	10	15	Ø 4 mm		63°	11	16	Alfa Romeo, Chrysler, Ford
6	GN 008 0 100 226 338	126	35	M 10 × 1,0	10	15	Ø 4 mm		63°	12	18	VW AG TDI 6+8 Zyl.
7	GN 010 0 100 226 365	128	30,5	M 10 × 1,0	10	15	M 4	2	63°	11,5	14	Mercedes
8	GN 012 0 100 226 354	75	25	M 10 × 1,0	10	15	M 4	2	63°	11	15,5	Fiat, Renault
9	GN 013 0 100 226 366	71	25	M 12 × 1,25	12	22	M 5	3	63°	11	14	Citroën, Peugeot
10	GN 015 0 100 226 392	121	40	M 10 × 1,0	10	15	Ø 4 mm		63°	11,5	14	Mercedes Smart



									V	A		
				Nm	Nm max.							
<b>1</b>	<b>GN 016</b> 0 100 226 371	89	30	M 10 × 1,0	10	15	M 4	2	63°	11		Citroën, Fiat, Peugeot
<b>2</b>	<b>GN 017</b> 0 100 226 372	95	25	M 10 × 1,0	10	15	M 4	2	63°	11	16	Alfa Romeo, Fiat, Lancia
<b>3</b>	<b>GN 018</b> 0 100 226 373	89	25	M 10 × 1,0	10	15	Ø 4 mm		63°	11	–	Renault
<b>4</b>	<b>GN 019</b> 0 100 226 375	99	25	M 10 × 1,0	10	15	Ø 4 mm		63°	11	–	Renault
<b>5</b>	<b>GN 020</b> 0 100 226 376	81	30	M 12 × 1,25	12	22	Ø 4 mm		63°	12	14	Wasserkерze (Alfa Romeo)
<b>6</b>	<b>GN 022</b> 0 100 226 381	62	18	M 12 × 1,25	12	25	M 5	3	63°	10	18	Ford
<b>7</b>	<b>GN 023</b> 0 100 226 481	84	22	M 10 × 1,25	12	15	M 4	2	120°	11	9,5	Perkins
<b>8</b>	<b>GN 024</b> 0 100 226 362	106,5	33	M 10 × 1,0	10	15	Ø 4 mm		63°	11	15	BMW
<b>9</b>	<b>GN 025</b> 0 100 226 370	133,5	29	M 10 × 1,0	10	15	Ø 4 mm		63°	11	14	BMW
<b>10</b>	<b>GN 026</b> 0 100 226 351	151	25	M 10 × 1,0	10	15	Ø 4 mm		63°	11	–	BMW





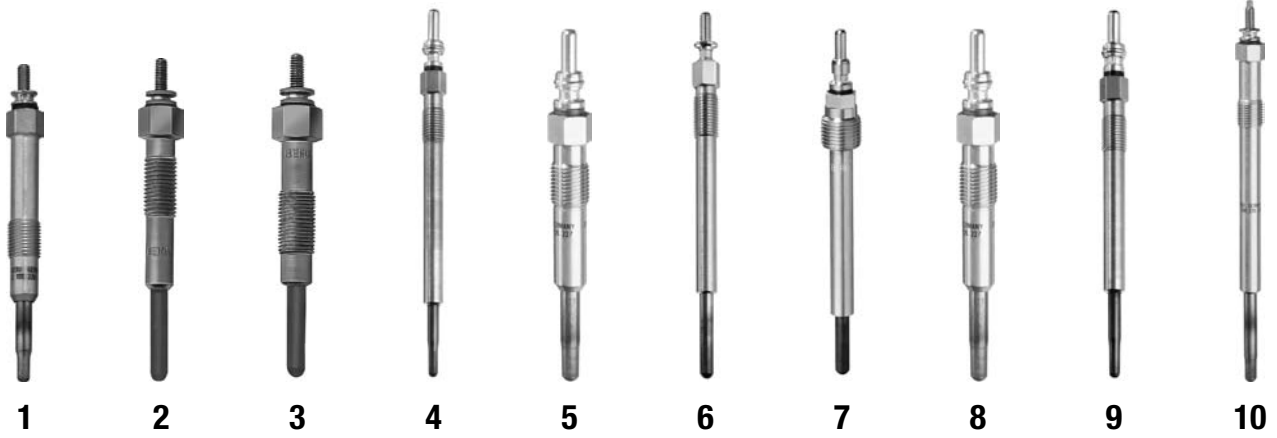



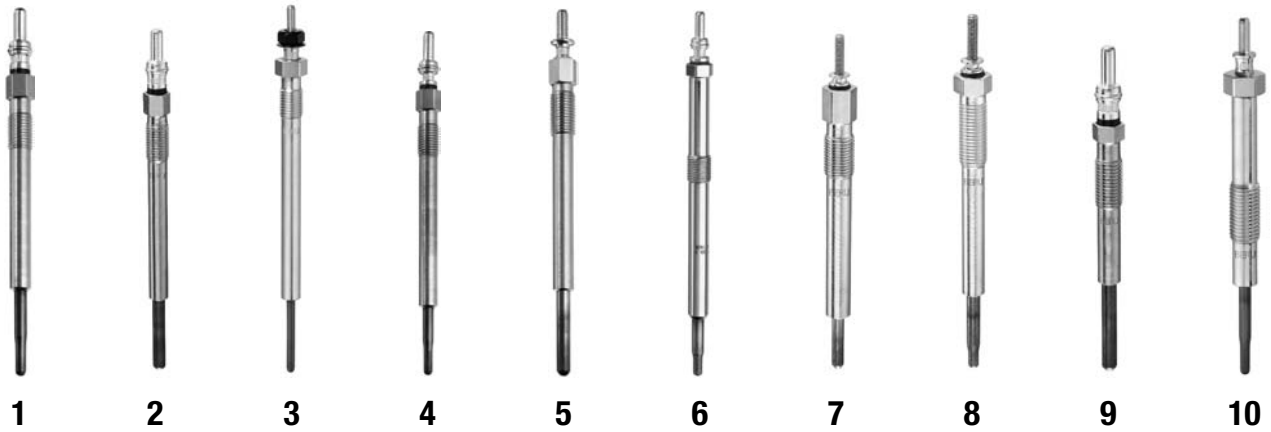









									V	A		
				Nm	Nm max.							
<b>1</b>	<b>GN 027</b> 0 100 226 344	107	28	M 10 × 1,0	10	15	 M 4	2	63°	11	18,5	Citroën, Peugeot
<b>2</b>	<b>GN 030</b> 0 100 226 391	76	21	M 12 × 1,25	12	15	 Ø 4 mm		63°	11	18	Fiat, Renault
<b>3</b>	<b>GN 032</b> 0 100 226 505	136,5	28	M 10 × 1,25	12	15	 M 4	2	119°	11	16	Isuzu
<b>4</b>	<b>GN 033</b> 0 100 226 417	135	31	M 10 × 1,0	10	15	 Ø 4 mm		63°	11	15,5	Opel
<b>5</b>	<b>GN 035</b> 0 100 226 422	111,5	29,6	M 10 × 1,0	10	15	 M 4	2	63°	11	16	Hyundai
<b>6</b>	<b>GN 036</b> 0 100 271 204	122	23,5	M 14 × 1,25	10	18	 Ø 4 mm	–	123°	11	16,5	Ford USA
<b>7</b>	<b>GN 037</b> 0 100 276 003	152	40	M 8 × 1,0	8	15	 Ø 4 mm	–	93°	11	11	Citroën, Peugeot, Ford
<b>8</b>	<b>GN 039</b> 0 100 226 352	81,9	19	M 10 × 1,25	12	15	 M 4	2	123°	11	–	Nissan
<b>9</b>	<b>GN 040</b> 0 100 226 434	125	19,5	M 10 × 1,25	12	15	 M 4	2	119°	12	10	Kubota
<b>10</b>	<b>GN 041</b> 0 100 226 436	102,5	25	M 10 × 1,0	10	12	 Ø 4 mm		63°	11	17,5	Fiat, Lancia









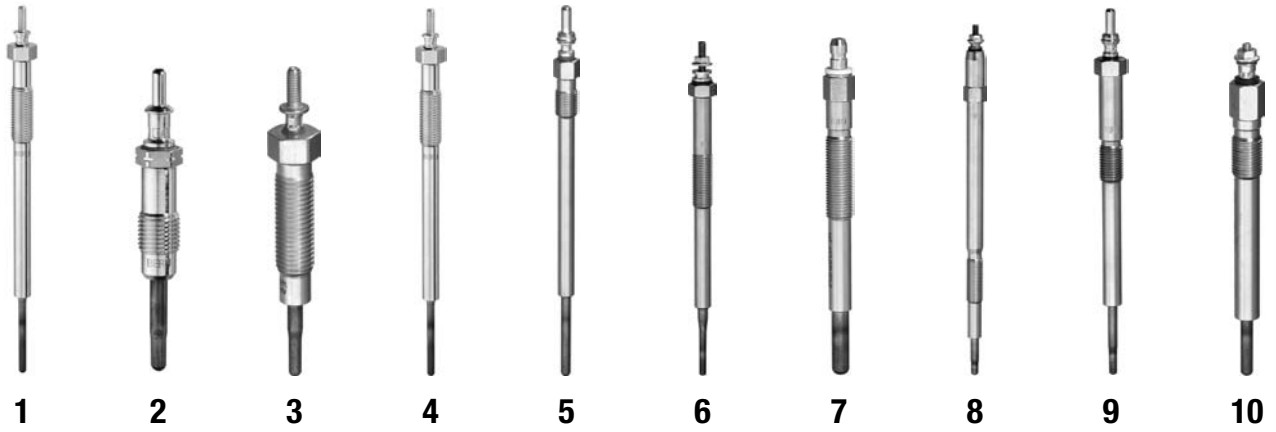



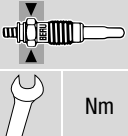
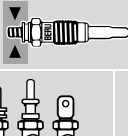



										V	A	
				Nm	Nm max.							
<b>1</b>	<b>GN 042</b> 0 100 226 480	160	36	M 10 × 1,25	10	15	M 4	2	93°	11	17,5	Toyota
<b>2</b>	<b>GN 043</b> 0 100 226 475	96	27	M 10 × 1,25	12	20	M 4	1,5	93°	11	9,5	Toyota
<b>3</b>	<b>GN 044</b> 0 100 230 107	68	17	M 10 × 1,25	12	15	M 4	1,5	120°	24	5,5	Nissan
<b>4</b>	<b>GN 045</b> 0 100 276 005	126,5	25	M 8 × 1,0	8	10	Ø 4 mm		93°	11	9	Volvo
<b>5</b>	<b>GN 046</b> 0 100 226 482	97	30	M 10 × 1,0	10	15	Ø 4 mm		63°	12	16	VW AG, Seat, Skoda
<b>6</b>	<b>GN 047</b> 0 100 276 004	118,5	28	M 8 × 1,0	8	15	M 4	1,5	123°	11	11	Citroën, Peugeot, Ford
<b>7</b>	<b>GN 049</b> 0 100 271 205	120	21,7	M 14 × 1,25	10	18	Ø 4 mm	–	123°	11	18	Ford USA
<b>8</b>	<b>GN 050</b> 0 100 226 435	130	26,5	M 10 × 1,0	10	15	Ø 4 mm		90°	11,5	16	VW AG
<b>9</b>	<b>GN 053</b> 0 100 276 008	119	28	M 8 × 1,0	8	10	Ø 4 mm		93°	11	20	Fiat, Opel
<b>10</b>	<b>GN 054</b> 0 100 226 492	118,4	27,75	M 10 × 1,0	10	15	M 4	1	63°	11	18,5	Ford, PSA



1									V	A	
				Nm	Nm max.						
<b>1</b>	<b>GN 055</b> 0 100 226 494	129,5	25,8	M 10 × 1,0	10	15	 Ø 4 mm	63°	11	14	Jeep
<b>2</b>	<b>GN 056</b> 0 100 276 012	124,5	28	M 8 × 1,0	8	10	 Ø 4 mm	123°	11	10	Citroën, Peugeot, Ford
<b>3</b>	<b>GN 057</b> 0 100 222 106	153,5	31	M 10 × 1,25	12	15	 M 4	120°	11	14,5	Hyundai, Kia
<b>4</b>	<b>GN 058</b> 0 100 276 014	148,5	27	M 8 × 1,0	8	10	 M 4	93°	11,5	13	Smart
<b>5</b>	<b>GN 059</b> 0 100 276 015	151,5	30	M 9 × 1,0	9	10	 Ø 4 mm	93°	11	20	Alfa, Fiat, Opel
<b>6</b>	<b>GN 060</b> 0 100 226 517	151	24,5	M 10 × 1,0	10	15	 Ø 4 mm	63°	11	11	Ssangyong
<b>7</b>	<b>GN 061</b> 0 100 226 520	140	24	M 12 × 1,25	12	15	 M 4	119°	11	7	Isuzu
<b>8</b>	<b>GN 062</b> 0 100 226 522	134,5	30	M 10 × 1,25	12	15	 M 4	120°	11	13	Hyundai
<b>9</b>	<b>GN 063</b> 0 100 276 024	97	28	M 8 × 1,0	8	10	 Ø 4 mm	123°	11	11,5	Citron, Peugeot
<b>10</b>	<b>GN 064</b> 0 100 226 526	119,5	31	M 10 × 1,25	12	15	 M 4	119°	11	14,5	Mazda



									V	A		
				Nm	Nm max.							
<b>1</b>	<b>GN 065</b> 0 100 226 527	171	36,7	M 10 × 1,25	12	15	 M 4	2	119°	11	14,5	Toyota
<b>2</b>	<b>GN 066</b> 0 100 231 133	86	28	M 12 × 1,25	12	25	 Ø 4 mm		63°	23	8	Mercedes
<b>3</b>	<b>GN 067</b> 0 100 226 569	81	20	M 10 × 1,25	12	15	 M 4	2	123°	11	10	Mitsubishi
<b>4</b>	<b>GN 068</b> 0 100 226 570	170	36,6	M 10 × 1,25	12	15	 M 4	2	93°	11	16	Toyota
<b>5</b>	<b>GN 069</b> 0 100 276 031	156,5	35	M 9 × 1,0	9	12	 Ø 4 mm		93°	11	20	Alfa Romeo
<b>6</b>	<b>GN 070</b> 0 100 800 033	170	35	M 10 × 1,25	12	15	 M 4	2	93°	11	10	Mitsubishi
<b>7</b>	<b>GN 071</b> 0 100 800 034	118,5	23	3/8"-24 UNF	3/8"	18	 SAE		120°	24	7	Caterpillar
<b>8</b>	<b>GN 072</b> 0 100 800 035	213	23	M 10 × 1,25	12	15	 M 4	2	123°	11	10	Nissan
<b>9</b>	<b>GN 073</b> 0 100 800 036	161	31	M 10 × 1,25	12	15	 Ø 4 mm		119°	11	10	Honda
<b>10</b>	<b>GN 074</b> 0 100 800 037	135,5	24	M 12 × 1,25	12	22	 M 4	2	120°	20,5	5	Isuzu



**1**



**2**



**3**



**4**



**5**



**6**



**7**



**8**



**9**



**10**

									V	A		
				Nm	Nm max.							
<b>1</b>	<b>GN 075</b> 0 100 800 038	87	21,5	M 10 × 1,25	12	18	M 4	2	120°	11	10	Nissan
<b>2</b>	<b>GN 076</b> 0 100 800 039	77	20	M 12 × 1,25	12	22	M 4	2	120°	22,5	5	Mitsubishi
<b>3</b>	<b>GN 077</b> 0 100 800 040	88,4	25	M 10 × 1,25	12	18	M 4	2	118°	20,5	5	Isuzu
<b>4</b>	<b>GN 078</b> 0 100 800 041	134	30	M 10 × 1,25	12	18	M 4	2	120°	22,5	5	Mitsubishi
<b>5</b>	<b>GN 080</b> 0 100 800 043	70,4	16	M 10 × 1,25	12	18	M 4	2	119°	10,5	10	Kubota
<b>6</b>	<b>GN 081</b> 0 100 800 044	72,9	24	M 10 × 1,25	12	18	M 4	2	120°	11	10	Kubota
<b>7</b>	<b>GN 082</b> 0 100 800 045	68	19	M 8 × 1,0	10	10	M 4	2	123°	11	10	Kubota
<b>8</b>	<b>GN 095</b> 0 100 226 577	151,5	36	M 10 × 1,25	12	15	M 4	2	119°	11	11	Isuzu
<b>9</b>	<b>GN 096</b> 0 100 226 638	160	28	M 10 × 1,25	10	15	M 4	2	93°	11	20	Toyota
<b>10</b>	<b>GN 097</b> 0 100 226 639	108	30	M 10 × 1,0	10	12	Ø 4 mm	-	63°	11	31	Fiat, Opel

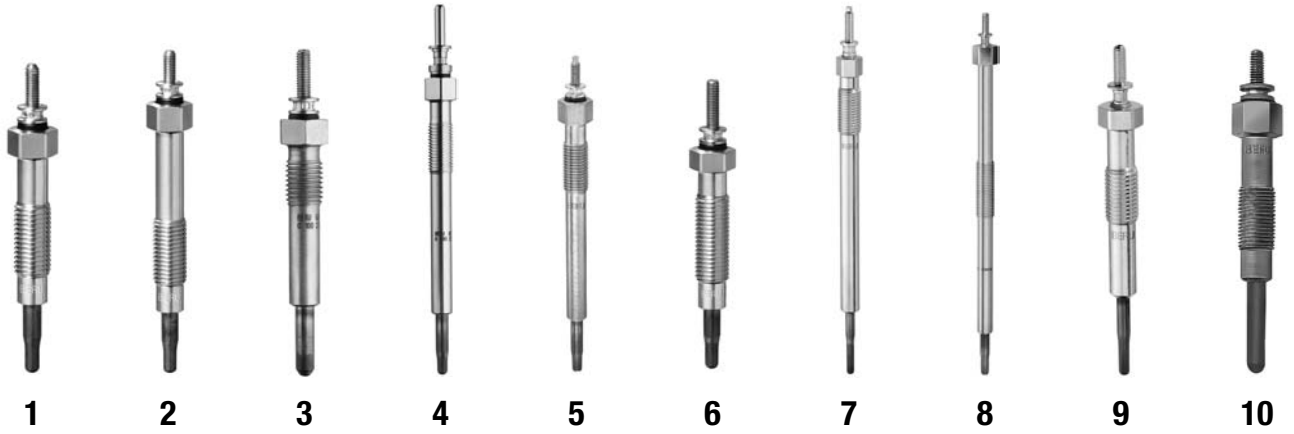

										V	A	
				Nm	Nm max.							
<b>1</b>	<b>GN 101</b> 0 100 226 514	82,5	19	M 10 × 1,25	12	15	M 4	2	123°	11	16	Nissan
<b>2</b>	<b>GN 102</b> 0 100 226 513	94,5	18,5	M 10 × 1,25	12	15	M 4	2	123°	11	17	Nissan
<b>3</b>	<b>GN 103</b> 0 100 226 495	85	19	M 10 × 1,25	12	15	M 4	2	119°	11	6	Opel
<b>4</b>	<b>GN 104</b> 0 100 226 497	143	24	M 10 × 1,25	12	15	Ø 4 mm	–	119°	11	15	Opel
<b>5</b>	<b>GN 106</b> 0 100 226 525	132	24	M 10 × 1,25	12	15	M 4	2	119°	11	14,5	Opel
<b>6</b>	<b>GN 107</b> 0 100 226 511	84,5	18	M 10 × 1,25	12	15	M 4	2	123°	11	17	Mitsubishi
<b>7</b>	<b>GN 108</b> 0 100 226 538	160	28,3	M 10 × 1	10	15	M 4	2	93°	11	8,5	Toyota
<b>8</b>	<b>GN 109</b> 0 100 800 031	179	20,8	M 10 × 1,0	12	15	M 4	2	119°	11	–	Nissan
<b>9</b>	<b>GN 110</b> 0 100 226 568	101	25,4	M 10 × 1,25	12	15	M 4	2	93°	11	–	Toyota
<b>10</b>	<b>GN 853</b> 0 100 226 170	82	19	M 10 × 1,25	12	15	M 4	2	123°	11	12,5	Nissan



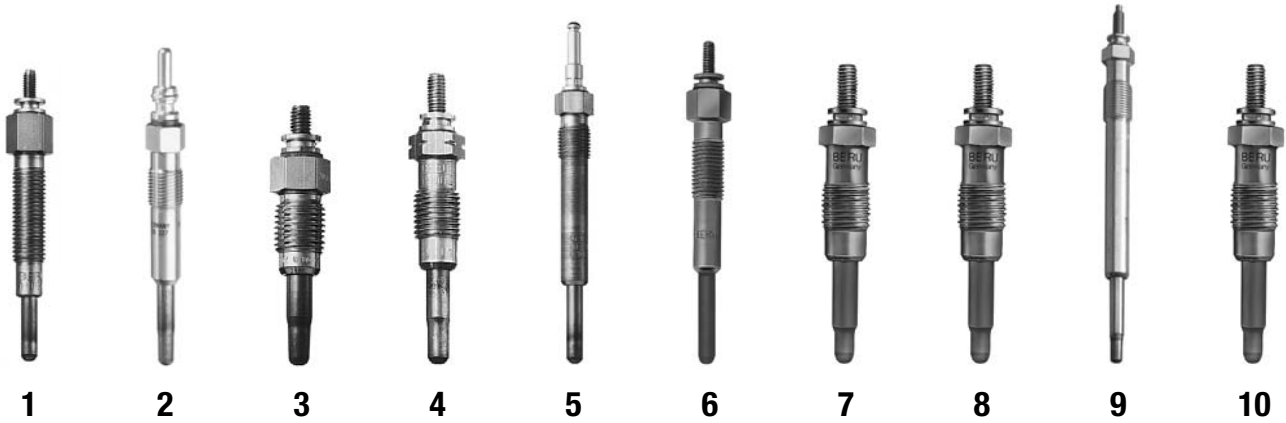



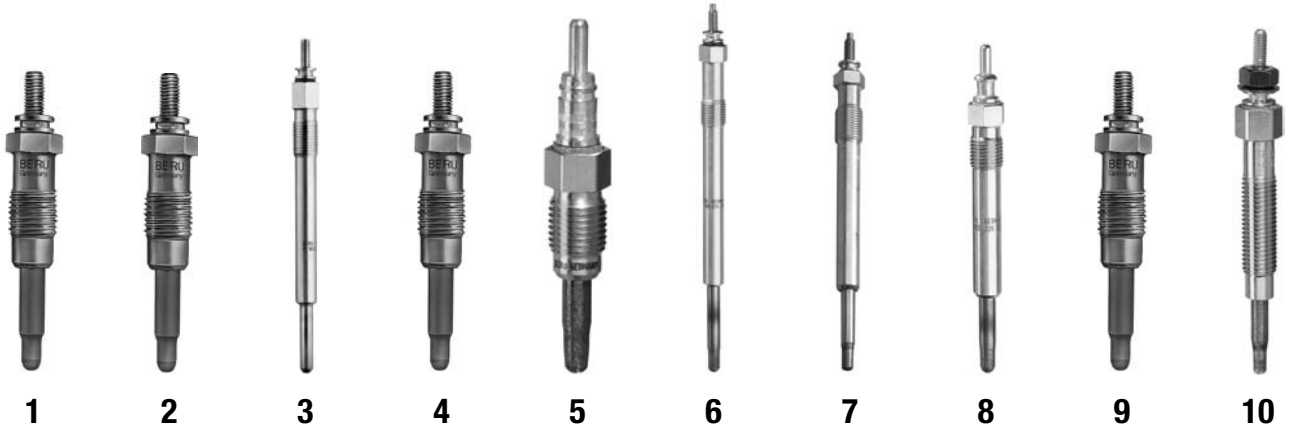



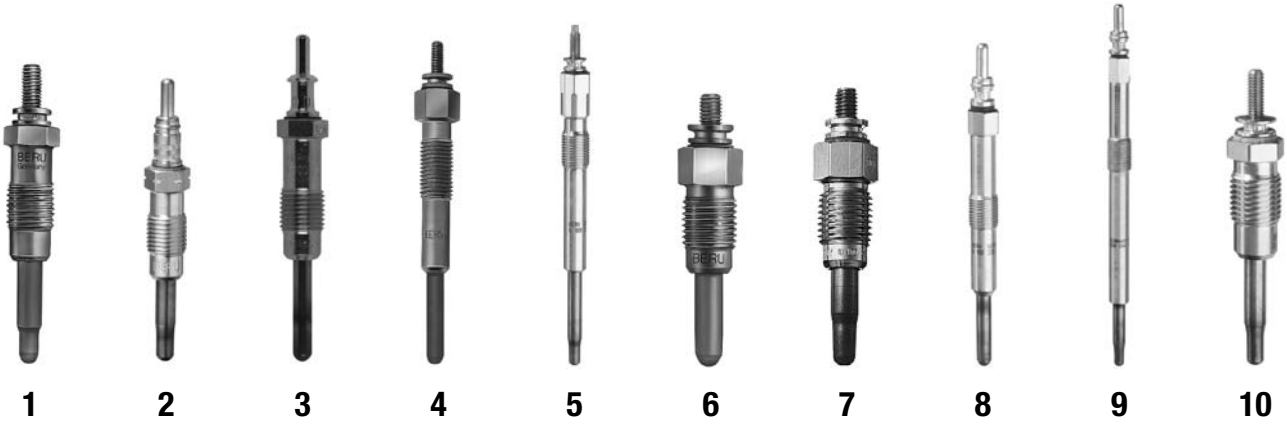





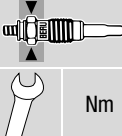
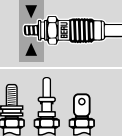



1										V	A		
						Nm		Nm max.					
<b>1</b>	<b>GN 854</b> 0 100 226 171	84	20	M 10 × 1,25	12	15		M 4	2	119°	11	12,7	Ford, Motor Iberica, Nissan
<b>2</b>	<b>GN 855</b> 0 100 226 227	92	25	M 10 × 1,0	10	15		∅ 4 mm		63°	12	16	VW AG TDI 4+5 Zyl.
<b>3</b>	<b>GN 857</b> 0 100 226 173	58	21	M 12 × 1,25	12	22		M 5	3	63°	11	14	VW AG
<b>4</b>	<b>GN 858</b> 0 100 226 234	69	23	M 12 × 1,25	12	22		M 5	3	63°	11,5	15,5	Mercedes
<b>5</b>	<b>GN 860</b> 0 100 226 258	119,5	28	M 12 × 1,25	12	22		∅ 5 mm		63°	11,5	12	Mercedes
<b>6</b>	<b>GN 905</b> 0 100 226 184	83	25	M 10 × 1,0	10	15		M 4	2	63°	11	14,5	Renault
<b>7</b>	<b>GN 908</b> 0 100 226 185	71	25	M 12 × 1,25	12	22		M 5	3	63°	11	17	Alfa Romeo, Fiat
<b>8</b>	<b>GN 909</b> 0 100 226 186	71	25	M 12 × 1,25	12	22		M 5	3	63°	11	14	Alfa Romeo, Citroën, Chrysler, Ford
<b>9</b>	<b>GN 912</b> 0 100 226 188	89	30	M 10 × 1,0	10	15		M 4	2	63°	11	16	Citroën, Peugeot
<b>10</b>	<b>GN 917</b> 0 100 226 189	71	25	M 12 × 1,25	12	22		M 5	3	63°	11	18	Fiat, Iveco, Lancia, Renault



									V	A		
				Nm	Nm max.							
<b>1</b>	<b>GN 918</b> 0 100 226 190	64	21	M 12 × 1,25	12	22	M 5	3	63°	11	14	Ford (SR-Set 030/034)
<b>2</b>	<b>GN 925</b> 0 100 226 432	67	16	M 12 × 1,25	12	22	M 4	2	63°	11	12	Lancia
<b>3</b>	<b>GN 926</b> 0 100 231 110	125	26	M 10 × 1,0	10	15	M 4	2	90°	23	5,5	Rover
<b>4</b>	<b>GN 927</b> 0 100 226 198	67	21	M 12 × 1,25	12	22	M 4	2	63°	11	14	Fiat
<b>5</b>	<b>GN 928</b> 0 100 226 199	72,5	21	M 12 × 1,25	12	22	Ø 4 mm		63°	12	14	Wasserkерze (VAG)
<b>6</b>	<b>GN 939</b> 0 100 226 385	147	35	M 10 × 1,0	10	15	M 4	2	93°	11,5	15,5	Ford
<b>7</b>	<b>GN 944</b> 0 100 226 206	126	29	M 10 × 1,0	10	15	M 4	2	63°	11	15,5	Opel DI
<b>8</b>	<b>GN 948</b> 0 100 226 235	115	28	M 12 × 1,25	12	22	Ø 4 mm		63°	11,5	15	Mercedes
<b>9</b>	<b>GN 954</b> 0 100 226 229	71	25	M 12 × 1,25	12	22	M 5	3	63°	11	14	Opel
<b>10</b>	<b>GN 955</b> 0 100 226 233	95	22	M 10 × 1,25	12	15	M 4	2	119°	11	–	Hyundai





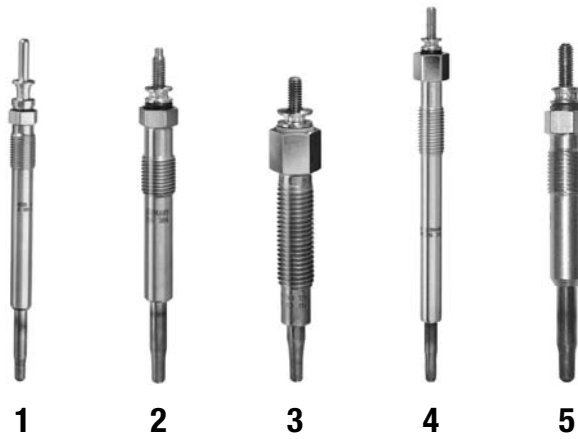



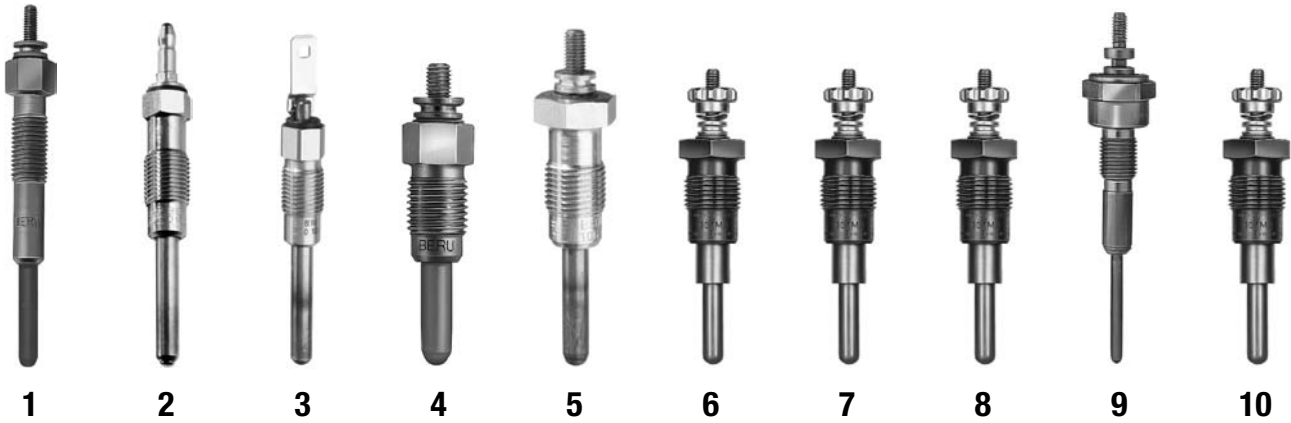









1									V	A		
				Nm	Nm max.							
<b>1</b>	<b>GN 959</b> 0 100 226 237	61	21	M 12 × 1,25	12	22	 M 5	3	63°	11	16	Renault
<b>2</b>	<b>GN 960</b> 0 100 226 239	82	25	M 12 × 1,25	12	25	 Ø 4 mm		63°	11	18	KHD
<b>3</b>	<b>GN 961</b> 0 100 226 250	86	28	M 12 × 1,25	12	22	 Ø 4 mm		63°	11,5	–	Mercedes DI-DELA Motoren 2,9 L
<b>4</b>	<b>GN 963</b> 0 100 226 245	93	25	M 10 × 1,0	10	15	 M 4	2	63°	11	–	Renault
<b>5</b>	<b>GN 964</b> 0 100 226 246	120	34	M 10 × 1,0	10	15	 M 4	2	93°	11	16,5	Citroën, Peugeot
<b>6</b>	<b>GN 970</b> 0 100 226 249	71	25	M 12 × 1,25	12	22	 M 4	2	63°	11	14	Fiat, Lancia
<b>7</b>	<b>GN 984</b> 0 100 226 253	67	30	M 12 × 1,25	12	22	 M 5	3	63°	12	14	Wasserkерze (Renault)
<b>8</b>	<b>GN 985</b> 0 100 226 255	106,5	25	M 10 × 1,0	10	15	 Ø 4 mm		63°	11	15,5	Rover
<b>9</b>	<b>GN 989</b> 0 100 226 284	149	26,5	M 10 × 1,0	8	15	 Ø 4 mm		90°	11,5	17	VW AG
<b>10</b>	<b>GN 991</b> 0 100 226 299	68	26	M 12 × 1,25	12	22	 M 4	2	63°	11	16	Renault



						Nm		Nm max.		V	A		
<b>1</b>	<b>GN 992</b> 0 100 226 300	133	29	M 10 × 1,0	10	15	Ø 4 mm		63°	11	15,5	Opel DI	
<b>2</b>	<b>GN 993</b> 0 100 226 384	96	24,5	M 10 × 1,0	10	15	M 4	2	93°	10	16,5	Ford	
<b>3</b>	<b>GN 994</b> 0 100 226 302	82	16	M 10 × 1,25	12	15	M 4	2	119°	11	18	Nissan	
<b>4</b>	<b>GN 997</b> 0 100 226 312	144,5	24	M 10 × 1,25	12	15	M 4	2	123°	11	18	Isuzu, Opel, Vauxhall	
<b>5</b>	<b>GN 999</b> 0 100 226 238	83	25	M 10 × 1,0	10	15	M 4	2	63°	11	–	Renault	



1									V	A		
				Nm	Nm max.							
<b>1</b>	<b>GV 001</b> 0 100 222 105	96	32	M 10 × 1,25	12	15	 M 4	2	93°	6	11,5	Toyota
<b>2</b>	<b>GV 003</b> 0 100 800 002	76	29	M 10 × 1,0	3/8"	15	 Ø 4 mm		93°	17,5	–	Navistar
<b>3</b>	<b>GV 004</b> 0 100 271 106	76	28,5	M 10 × 1,0	3/8"	15	 6,3 mm		93°	10,5	19	Navistar
<b>4</b>	<b>GV 007</b> 0 100 226 506	61,5	21	M 12 × 1,25	12	15	 M 5	2	63°	11	10	Hunter/USA (Army-Brenner)
<b>5</b>	<b>GV 106</b> 0 100 221 209	77	28	M 14 × 1,25	17	25	 M 5	3	60°	8	10	Opel
<b>6</b>	<b>GV 107</b> 0 100 222 301	93	38	M 18 × 1,5	21	40	 M 5	3	60°	10,5	10	Hanomag
<b>7</b>	<b>GV 108</b> 0 100 222 302	93	38	M 18 × 1,5	21	40	 M 5	3	60°/Plan <sup>59</sup>	9,5	10	Hanomag, Peugeot
<b>8</b>	<b>GV 110</b> 0 100 222 303	93	33,5	M 18 × 1,5	21	40	 M 5	3	60°	10,5	10	Hanomag <sup>21</sup>
<b>9</b>	<b>GV 112</b> 0 100 221 101	90	28	M 10 × 1,0	17	15	8/32" UNC	3	93°	12	6	Leyland <sup>21</sup>
<b>10</b>	<b>GV 117</b> 0 100 232 301	93	38	M 18 × 1,5	21	40	 M 5	3	60°/Plan <sup>59</sup>	22,5	5	KHD

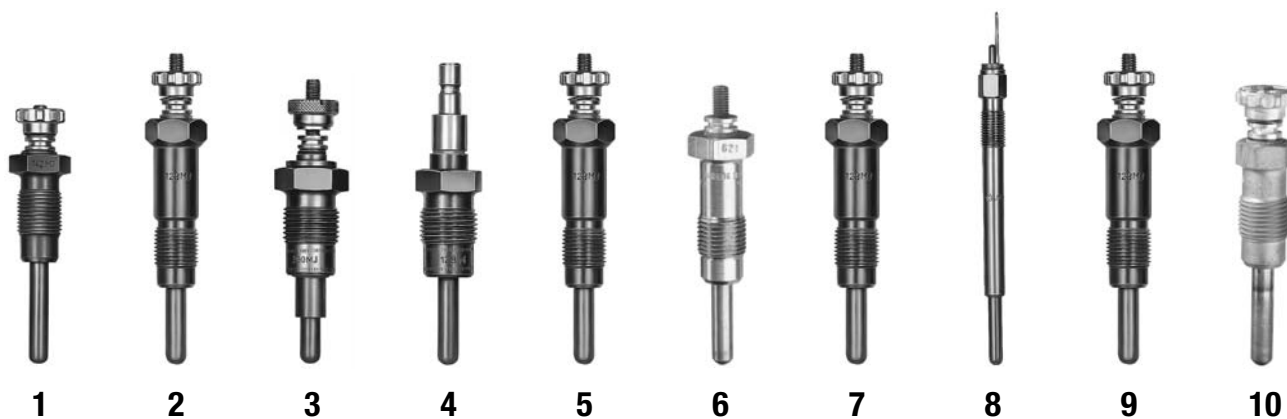

									V	A		
				Nm	Nm max.							
<b>1</b>	<b>GV 119</b> 0 100 221 201	78	28	M 14 × 1,25	17	25	M 5	3	60°/Plan <sup>59</sup>	9,5	10	KHD
<b>2</b>	<b>GV 123</b> 0 100 221 202	98	24	M 14 × 1,25	17	25	M 5	3	60°	10,5	10	Hanomag
<b>3</b>	<b>GV 127</b> 0 100 332 301	100	38	M 18 × 1,5	21	40	M 5	3	60°/Plan <sup>59</sup>	22,5	5	Saurer
<b>4</b>	<b>GV 128</b> 0 100 281 301	96	28	M 18 × 1,5	19	40	7 mm		60°/Plan <sup>59</sup>	24	5	Fiat <sup>21</sup>
<b>5</b>	<b>GV 129</b> 0 100 221 203	101	28	M 14 × 1,25	17	25	M 5	3	60°	9,5	10	KHD
<b>6</b>	<b>GV 130</b> 0 100 221 210	80	24	M 14 × 1,25	17	25	M 5	3	60°	9,5	10	Citroën
<b>7</b>	<b>GV 133</b> 0 100 231 202	98	24	M 14 × 1,25	17	25	M 5	3	60°	22,5	5	Hanomag <sup>21</sup>
<b>8</b>	<b>GV 134</b> 0 100 271 601	134	26	UNF 3/8-24	3/8"	15	6,3 mm		60°	11	8,25	Saurer
<b>9</b>	<b>GV 136</b> 0 100 221 204	120	24	M 14 × 1,25	17	25	M 5	3	60°	9,5	10	KHD
<b>10</b>	<b>GV 137</b> 0 100 220 206	77	28	M 14 × 1,25	14	25	M 5	3	63°	11	8,5	Opel

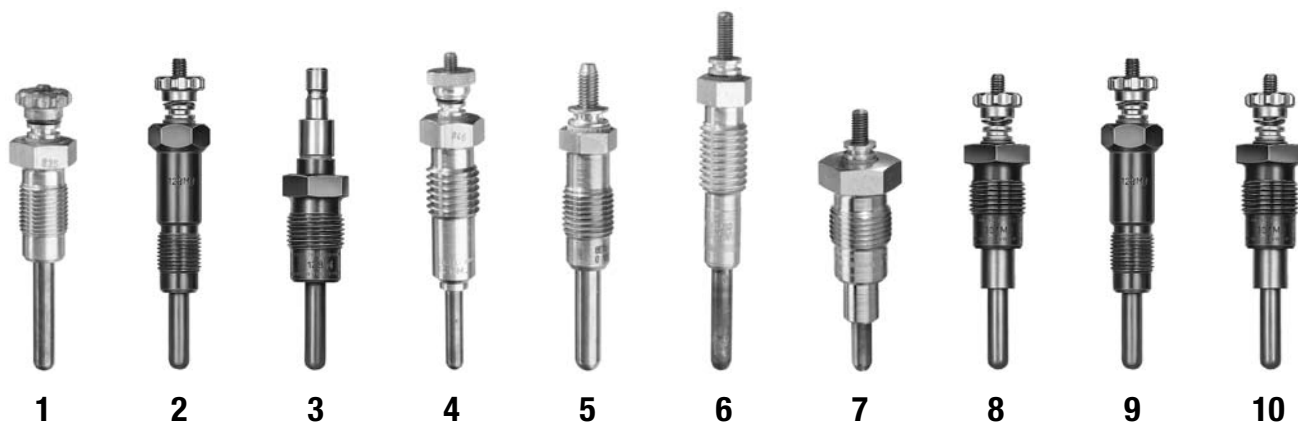

1									V	A		
				Nm	Nm max.	Nm	Nm max.					
<b>1</b>	<b>GV 142</b> 0 100 222 201	82	32	M 14 × 1,25	17	25	M 5	3	60°	9,5	10	Hanomag <sup>21</sup>
<b>2</b>	<b>GV 144</b> 0 100 220 204	115	16	M 14 × 1,25	17	25	M 5	3	60°	9,5	10	Farmex
<b>3</b>	<b>GV 145</b> 0 100 271 301	96	28	M 18 × 1,5	19	40	7 mm		60°/Plan <sup>59</sup>	12	10	Fiat <sup>21</sup>
<b>4</b>	<b>GV 149</b> 0 100 222 305	109	31	M 18 × 2,5	19	40	M 5	3	90°	10,5	10	Hatz <sup>21</sup>
<b>5</b>	<b>GV 153</b> 0 100 231 101	71	24	M 12 × 1,25	12	22	M 5	3	63°	18	5	Deutz
<b>6</b>	<b>GV 155</b> 0 100 221 206	102	30	M 14 × 2,0	14	27	M 5	3	60°	9,5	10	Peugeot
<b>7</b>	<b>GV 165</b> 0 100 231 302	77	28	M 18 × 1,5	21	40	M 5	3	60°/Plan <sup>59</sup>	18	5	Mercedes <sup>21</sup>
<b>8</b>	<b>GV 170</b> 0 100 221 301	93	28	M 18 × 1,5	21	40	M 5	3	60°/Plan <sup>59</sup>	10,5	10	Hanomag <sup>21</sup>
<b>9</b>	<b>GV 175</b> 0 100 222 202	120	35	M 14 × 1,25	14	25	M 5	3	60°	10,5	10	Lanz <sup>21</sup>
<b>10</b>	<b>GV 176</b> 0 100 220 201	93	15	M 14 × 2,0	14	25	M 5	3	60°	10,5	10	Lanz <sup>21</sup>

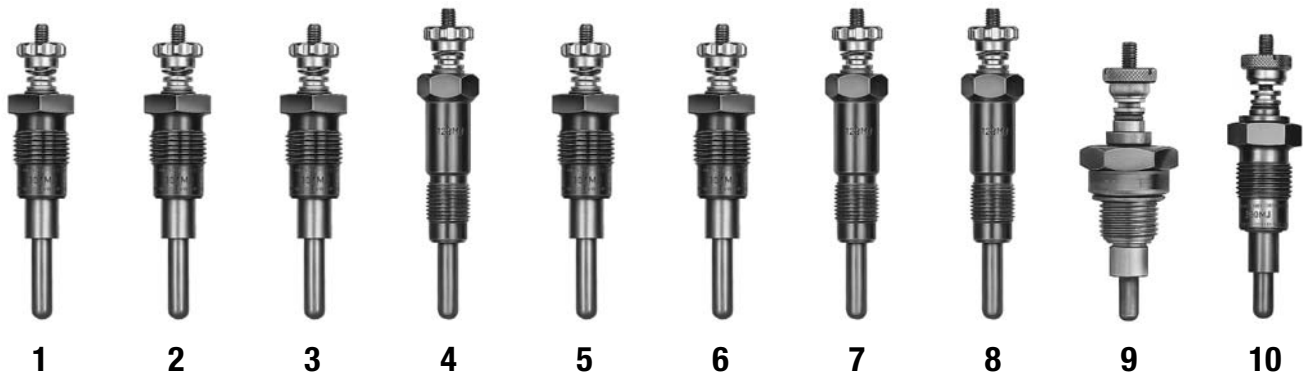

									V	A		
				Nm	Nm max.							
<b>1</b>	<b>GV 179</b> 0 100 221 305	77	21	M 18 × 1,5	21	40	M 5	3	63°/Plan <sup>59</sup>	9,5	10	KHD
<b>2</b>	<b>GV 181</b> 0 100 231 305	77	21	M 18 × 1,5	21	40	M 5	3	63°/Plan <sup>59</sup>	18	5	Eberspächer
<b>3</b>	<b>GV 182</b> 0 100 221 302	79	28	M 18 × 1,5	21	40	M 5	3	60°/Plan <sup>59</sup>	9,5	10	Mercedes <sup>21</sup>
<b>4</b>	<b>GV 191</b> 0 100 231 303	93	28	M 18 × 1,5	21	40	M 5	3	60°	18	5	KHD
<b>5</b>	<b>GV 196</b> 0 100 221 303	85	25,5	M 18 × 1,5	21	40	M 5	3	60°/Plan <sup>59</sup>	12	10	KHD
<b>6</b>	<b>GV 197</b> 0 100 221 304	93	28	M 18 × 1,5	21	40	M 5	3	60°/Plan <sup>59</sup>	9,5	10	ARO, KHD
<b>7</b>	<b>GV 198</b> 0 100 222 203	93	36	M 14 × 1,25	17	25	M 5	3	60°	10,5	10	Steyr
<b>8</b>	<b>GV 199</b> 0 100 220 203	93	20	M 14 × 1,25	17	25	M 5	3	60°	10,5	10	Hirth <sup>21</sup>
<b>9</b>	<b>GV 361</b> 0 100 302 301	83	39	M 18 × 1,5	26	40	M 5	3	Flachdichtring <sup>30</sup>	1,7	50	KHD, MWM
<b>10</b>	<b>GV 380</b> 0 100 331 301	90	28	M 18 × 1,5	21	40	M 5	3	60°/Plan <sup>59</sup>	22,5	5	KHD



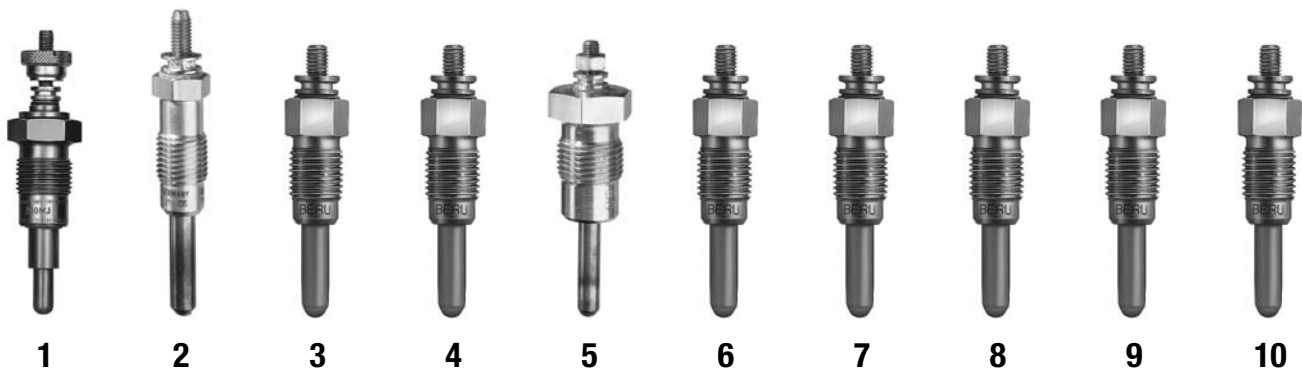



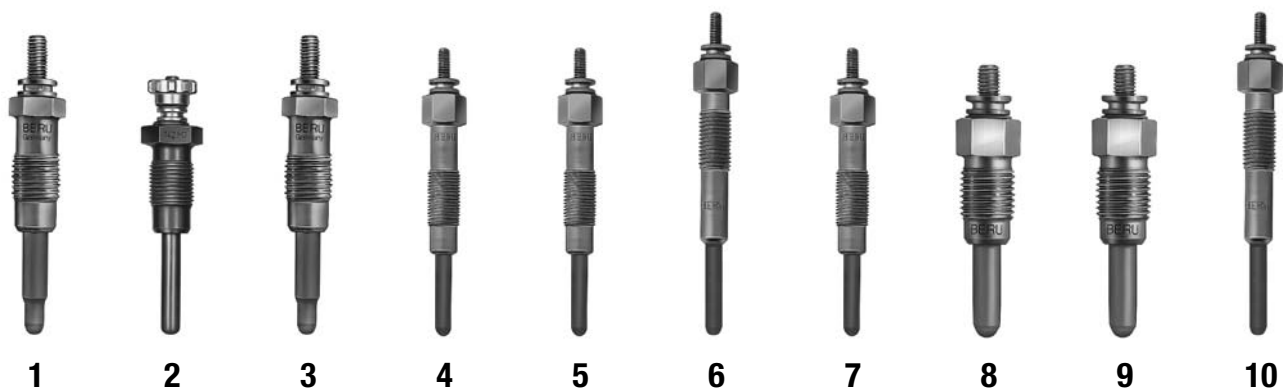



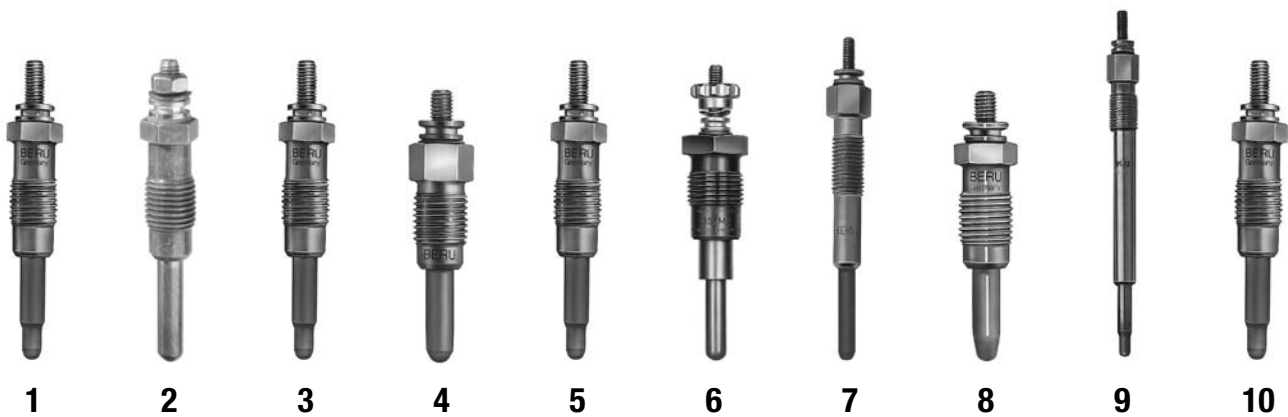





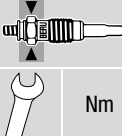
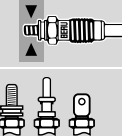



										V	A	
					Nm	Nm max.						
<b>1</b>	<b>GV 390</b> 0 100 331 303	90	28	M 18 × 1,5	21	40	M 5	3	60°/Plan <sup>59</sup>	18	5	KHD
<b>2</b>	<b>GV 602</b> 0 100 221 106	71	25	M 12 × 1,25	12	22	M 5	3	63°	11	10	Alfa Romeo, Citroën, Peugeot
<b>3</b>	<b>GV 603</b> 0 100 221 107	71	25	M 12 × 1,25	12	22	M 5	3	63°	11,5	14	Mercedes
<b>4</b>	<b>GV 604</b> 0 100 221 108	67	21	M 12 × 1,25	12	22	M 5	3	63°	11	8,5	Ford
<b>5</b>	<b>GV 626</b> 0 100 221 311	75	28	M 18 × 1,5	21	38	M 5	3	63°/Plan <sup>59</sup>	11	15	Mercedes (SR-Set 002)
<b>6</b>	<b>GV 631</b> 0 100 221 132	67	21	M 12 × 1,25	12	22	M 5	3	63°	11,5	14	Ford
<b>7</b>	<b>GV 636</b> 0 100 221 133	71	25	M 12 × 1,25	12	22	M 5	3	63°	11	13	Opel, Peugeot
<b>8</b>	<b>GV 642</b> 0 100 221 135	71	25	M 12 × 1,25	12	22	M 5	3	63°	11	15,5	Alfa Romeo, Iveco, Renault
<b>9</b>	<b>GV 657</b> 0 100 221 141	76	30	M 12 × 1,25	12	22	M 5	3	63°	11	13	Alfa Romeo
<b>10</b>	<b>GV 661</b> 0 100 221 144	66	21	M 12 × 1,25	12	22	M 4	2	63°	11	13	Citroën, Peugeot, Renault



										V	A	
					Nm	Nm max.						
<b>1</b>	<b>GV 663</b> 0 100 221 145	71	25	M 12 × 1,25	12	22	M 5	3	63°	11	13	Alfa Romeo, Fiat
<b>2</b>	<b>GV 664</b> 0 100 232 204	88	32	M 14 × 1,25	17	25	M 5	3	60°	24	5	Hanomag <sup>21</sup>
<b>3</b>	<b>GV 666</b> 0 100 221 146	69	21	M 12 × 1,25	12	22	M 4	2	63°	11,5	16	Ford
<b>4</b>	<b>GV 673</b> 0 100 221 147	91	22	M 10 × 1,25	12	15	M 4	2	119°	12	9	Mitsubishi
<b>5</b>	<b>GV 678</b> 0 100 221 148	98	28	M 10 × 1,25	12	15	M 4	2	119°	8,5	11	Daihatsu, Toyota
<b>6</b>	<b>GV 685</b> 0 100 221 149	88	25	M 10 × 1,0	12	15	M 4	2	119°	6,5	14	Nissan
<b>7</b>	<b>GV 688</b> 0 100 221 151	92	31,5	M 10 × 1,25	12	15	M 4	2	93°	11	9	Toyota
<b>8</b>	<b>GV 689</b> 0 100 221 152	62	21	M 12 × 1,25	12	22	M 5	3	63°	11	14	Nissan
<b>9</b>	<b>GV 691</b> 0 100 221 153	73	27	M 12 × 1,25	12	22	M 5	3	63°	11,5	15	Mercedes (USA) <sup>21</sup>
<b>10</b>	<b>GV 705</b> 0 100 221 154	84	22,5	M 10 × 1,25	12	15	M 4	2	119°	7	14	Mazda



									V	A		
				Nm	Nm max.							
<b>1</b>	GV 719 0 100 221 163	71	25	M 12 × 1,25	12	22	 M 5	3	63°	11	17	BMW
<b>2</b>	GV 724 0 100 221 164	70	25	M 12 × 1,25	12	22	 M 5	3	63°	11,5	15	Mercedes (USA) <sup>21</sup>
<b>3</b>	GV 727 0 100 221 167	71	25	M 12 × 1,25	12	22	 M 5	3	63°	11	17	Fiat
<b>4</b>	GV 728 0 100 221 168	82	19	M 10 × 1,25	12	15	 M 4	2	123°	11	12	Motor Iberica, Nissan
<b>5</b>	GV 730 0 100 221 170	79	25	M 10 × 1,0	10	15	 M 4	2	63°	11	13	Fiat
<b>6</b>	GV 736 0 100 231 120	69	23	M 12 × 1,25	12	22	 M 5	3	63°	18	5	Mercedes <sup>21</sup>
<b>7</b>	GV 749 0 100 221 186	90	24	M 10 × 1,25	12	15	 M 4	2	119°	5	14	Opel, Isuzu (blau <sup>27</sup> , lang <sup>30s</sup> )
<b>8</b>	GV 776 0 100 231 103	70	25	M 12 × 1,25	12	22	 M 5	3	63°	22,5	7	Motor Iberica, Nissan <sup>21</sup>
<b>9</b>	GV 783 0 100 226 129	125	26	M 10 × 1,0	10	15	 M 4	2	90°	11,5	16	BLMC, Rover <sup>21</sup>
<b>10</b>	GV 798 0 100 226 128	71	25	M 12 × 1,25	12	22	 M 4	2	63°	11,5	16	Perkins <sup>21</sup>

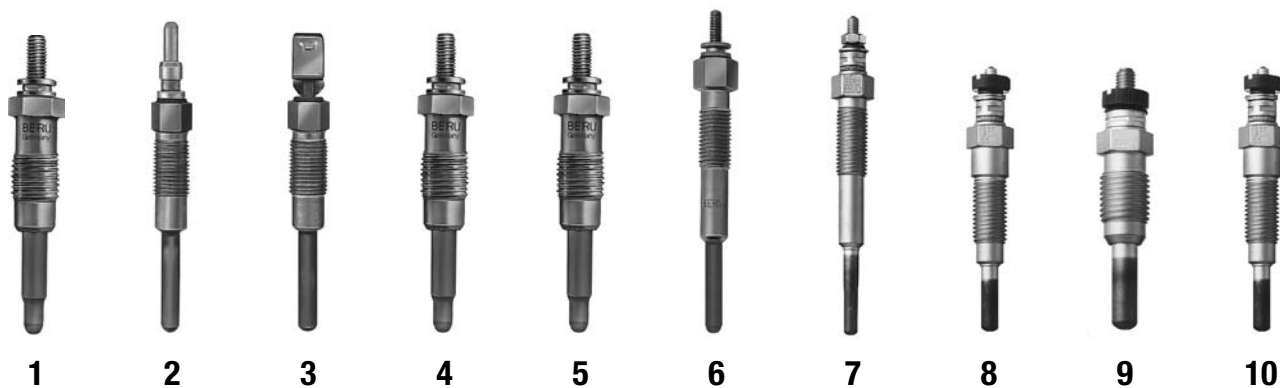



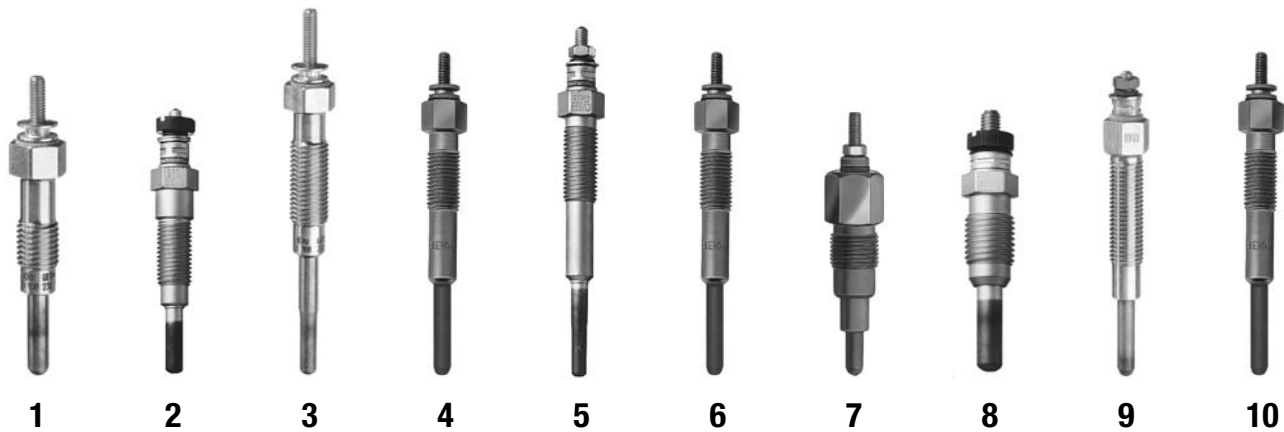



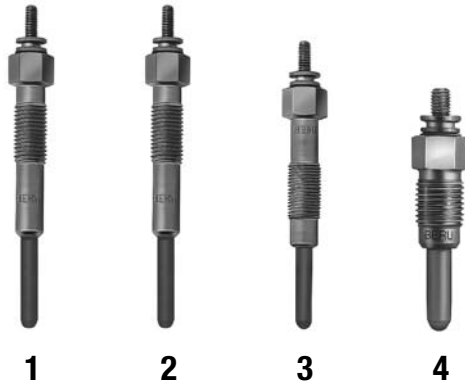

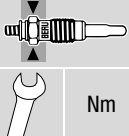
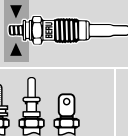

1											V	A		
														Nm
1	<b>GV 819</b> 0 100 226 138	129	31	M 10 × 1,0	10	15	10	15	Ø 4 mm	–	93°	11	16,5	Navistar <sup>21</sup>
2	<b>GV 823</b> 0 100 271 101	81	28	M 10 × 1,0	3/8"	15	3/8"	15	Ø 4 mm	–	93°	10,5	–	Navistar <sup>21</sup>
3	<b>GV 835</b> 0 100 271 102	79	27,5	M 10 × 1,0	3/8"	15	3/8"	15	8,5 mm	–	93°	10,5	–	Navistar <sup>21</sup>
4	<b>GV 844</b> 0 100 226 164	61	21	M 12 × 1,25	12	22	12	22	M 5	3	63°	11	13,5	Renault
5	<b>GV 852</b> 0 100 226 163	67	25	M 12 × 1,25	12	22	12	22	M 5	3	63°	11	13,5	Renault
6	<b>GV 880</b> 0 100 231 104	87	22	M 10 × 1,25	12	15	12	15	M 4	2	120°	23	–	Mazda
7	<b>GV 886</b> 0 100 226 180	100,5	28	M 10 × 1,25	12	15	12	15	M 4	2	93°	7	–	Daihatsu
8	<b>GV 887</b> 0 100 230 101	76	20	M 10 × 1,25	12	15	12	15	M 4	2	119°	23	–	Nissan
9	<b>GV 888</b> 0 100 220 113	61	21	M 12 × 1,25	12	22	12	22	M 5	3	63°	6,5	11	Nissan
10	<b>GV 889</b> 0 100 220 114	70	20	M 10 × 1,25	12	15	12	15	M 4	2	119°	11	–	Nissan



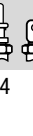



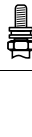

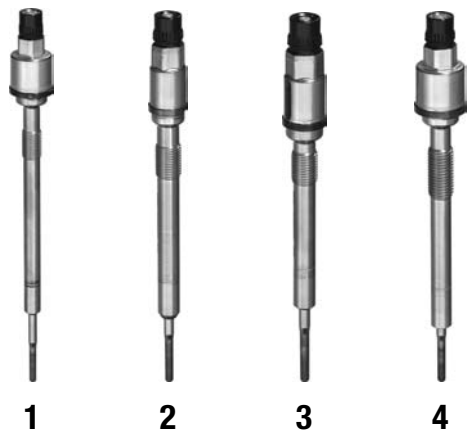

									V	A		
				Nm	Nm max.							
<b>1</b>	<b>GV 890</b> 0 100 230 102	69,5	20	M 10 × 1,25	12	15	M 4	2	119°	23	6,7	Nissan
<b>2</b>	<b>GV 892</b> 0 100 220 115	70	19	M 10 × 1,25	12	15	M 4	2	120°	10,5	16,5	Nissan
<b>3</b>	<b>GV 894</b> 0 100 222 101	96	32	M 10 × 1,25	12	15	M 4	2	93°	7	–	Toyota
<b>4</b>	<b>GV 895</b> 0 100 231 107	100,5	28	M 10 × 1,25	12	15	M 4	2	93°	14	–	Toyota
<b>5</b>	<b>GV 896</b> 0 100 222 102	96	32	M 10 × 1,25	12	15	M 4	2	93°	16	–	Toyota
<b>6</b>	<b>GV 897</b> 0 100 226 182	99	28	M 10 × 1,25	12	15	M 4	2	93°	10,5	–	Toyota
<b>7</b>	<b>GV 910</b> 0 100 221 314	93	28	M 18 × 1,5	19	40	M 5	3	60°	10,5	10	Multicar
<b>8</b>	<b>GV 920</b> 0 100 220 118	68	18	M 10 × 1,25	12	15	M 4	2	119°	11	–	Nissan
<b>9</b>	<b>GV 921</b> 0 100 226 194	88	23	M 10 × 1,25	12	15	M 4	2	119°	11	–	Nissan
<b>10</b>	<b>GV 945</b> 0 100 226 209	85	19	M 10 × 1,25	12	15	M 4	2	119°	5	8	Opel, Isuzu (blau <sup>27</sup> , kurz <sup>302</sup> )



									V	A		
				Nm	Nm max.							
<b>1</b>	<b>GV 946</b> 0 100 226 207	90	24	M 10 × 1,25	12	15	 M 4	2	119°	11	10	Opel, Isuzu (gelb <sup>43</sup> , lang <sup>303</sup> )
<b>2</b>	<b>GV 947</b> 0 100 226 208	85	19	M 10 × 1,25	12	15	 M 4	2	119°	11	6	Opel, Isuzu (gelb <sup>43</sup> , kurz <sup>302</sup> )
<b>3</b>	<b>GV 967</b> 0 100 226 242	100,5	28	M 10 × 1,25	12	15	 M 4	2	93°	11	9,5	Toyota
<b>4</b>	<b>GV 968</b> 0 100 226 243	95,5	32	M 10 × 1,25	12	15	 M 4	2	90°	11	9,5	Toyota



										V	A	
						Nm		Nm max.				
<b>1</b>	<b>PSG 001</b> 0 103 010 903	196,5	35	M 9 × 1,0	12	12	-	-	93°	4,4	-	Opel
<b>2</b>	<b>PSG 002</b> 0 103 111 104	165	28	M 10 × 1,0	12	15	-	-	63°	4,4	-	Audi, VW AG
<b>3</b>	<b>PSG 003</b> 0 103 110 904	149	28	M 9 × 1,0	12	12	-	-	93°	4,4	-	Opel
<b>4</b>	<b>PSG 004</b> 0 103 010 104	168	24	M 10 × 1,25	12	15	-	-	121°	4,4	-	Opel

## ALFA ROMEO

GN 007, GN 017, GN 020, GN 041, GN 053, GN 059, GN 069, GN 097, GN 908, GV 657

## ALPINA

GN 025

## ARO

GV 636

## AUDI

GE 100, GE 101, GE 115, GH 306, GN 008, GN 046, GN 855, GN 857, GN 928, PSG 002

## BEDFORD

GV 945, GV 947

## BMW

CGP 001, GE 102, GE 103, GN 024, GN 025, GV 636, GV 719

## CADILLAC

GN 059

## CHEVROLET

GE 106, GE 109, GN 032

## CHRYSLER

GE 105, GN 003, GN 007, GN 055, GN 954

## CITROËN

GF 006, GN 012, GN 013, GN 016, GN 027, GN 037, GN 045, GN 047, GN 054, GN 056, GN 063, GN 909, GN 912, GN 939, GN 964, GV 602, GV 636, GV 661

## DACIA

GE 110, GN 018, GN 019

## DAEWOO

GN 858

## DAF

GN 908

## DAIHATSU

GV 886, GV 967

## FIAT

GF 006, GF 984, GN 012, GN 013, GN 016, GN 017, GN 020, GN 027, GN 030, GN 037, GN 041, GN 053, GN 054, GN 059, GN 063, GN 097, GN 908, GN 909, GN 917, GN927, GN 954, GN 970, GV 636, GV 642, GV663, GV 727, GV 730

## FORD

GF 859, GF 982, GF 983, GN 005, GN 007, GN022, GN 046, GN 047, GN 053, GN 054, GN 056, GN 063, GN 854, GN 855, GN 857, GN 909, GN 928, GN939, GN 993, GV 602, GV 631, GV 666, GV 705

## FORD (USA)

GN 036, GN 049, GV 819, GV 823



**FSO**

GV 636, GV 642

**HONDA**

GN 073, GN 104, GN 905, GN 999

**HUMMER**

GV 004

**HYUNDAI**

GE 113, GN 035, GN 057, GN 062, GN 107, GN 955, GV 921

**INNOCENTI**

GV 636

**ISUZU**

GN 061, GN 095, GN 997, GV 749, GV 945, GV 946, GV 947

**IVECO**

GF 006, GF 974, GF 984, GN 012, GN 037, GN927

**JAGUAR**

GN 045, GN 063, GN 939

**JEEP**

GE 105, GN 003, GN 007, GN 055, GN 909, GV 852

**KIA**

GN 005, GN 035, GN 057, GN 062

**LADA**

GN 013, GV 636

**LANCIA**

GN 020, GN 027, GN 041, GN 053, GN 054, GN 059, GN 908, GN 909, GN 917, GN 925, GN 970, GV 663, GV 727

**LANDROVER**

GN 024, GN 045, GN 063, GN 905, GN 985, GV 602, GV 657, GV 783

**LANDWIND**

GN 061

**LDV**

GV 603

**MAHINDRA**

GV 636

**MAZDA**

GN 005, GN 022, GN 047, GN 064, GV 705

**MERCEDES**

GE 104, GE 105, GE 116, GH 011, GN 003, GN 010, GN 066, GN 858, GN860, GN 909, GN948, GN 961, GV 603, GV 736

## MG

GN 024, GN 999

## MINI

GE 118, GN 042, GN 056

## MITSUBISHI

GE 101, GN 018, GN 058, GN 067, GN 070, GN 107, GN 959, GV 673, GV 921

## NISSAN

GN 018, GN 026, GN 039, GN 044, GN 072, GN 075, GN 101, GN 102, GN 109, GN 853, GN 854, GN 912, GN 994, GV 685, GV 888, GV 921

## OPEL

GE 112, GE 114, GF 984, GN 007, GN 018, GN 024, GN 026, GN 033, GN 041, GN 053, GN 059, GN 061, GN 097, GN 103, GN 104, GN 106, GN 927, GN 944, GN 954, GN 963, GN 992, GN 997, GV 749, GV 945, GV 946, GV 947, PSG 001, PSG 003, PSG 004

## PEUGEOT

GF 006, GN 012, GN 013, GN 016, GN 027, GN 037, GN 045, GN 047, GN 054, GN 056, GN 063, GN 909, GN 912, GN 939, GN 964, GV 602, GV 636, GV 661

## PORSCHE

GE 115

## PROTON

GN 107

## PUCH

GN 858, GN 948, GV 603, GV 736

## RENAULT

GE 110, GE 111, GF 006, GF 984, GN 012, GN 018, GN 019, GN 026, GN 072, GN 106, GN 909, GN 917, GN 927, GN 954, GN 959, GN 963, GN 984, GN 991, GN 999, GV 642, GV 844, GV 852

## ROVER

GN 007, GN 024, GN 905, GN 909, GN 912, GV 636, GV 661

## SAAB

GN 033, GN 041, GN 059, GN 097, GN106, GN 992

## SANTANA

GN 056

## SEAT

GE 100, GE 101, GE 115, GN 046, GN 855, GN 857, GN 928, GV 663

## SKODA

GE 100, GE 101, GE 115, GN 008, GN 046, GN 855, GN 857, GN 928

## SMART

GN 015, GN 058

## SSANGYONG

GE 120, GN 060, GN 858, GV 946

**SUZUKI**

GE 111, GN 005, GN 013, GN 018, GN 027, GN 047, GN 053, GN 097, GN 909

**TOYOTA**

GN 042, GN 043, GN 047, GN 065, GN 068, GN 096, GN 108, GN 110, GV 967, GV 968

**VAUXHALL**

GE 112, GE 114, GF 984, GN 007, GN 018, GN 024, GN 026, GN 033, GN 041, GN 053, GN 059, GN 061, GN 097, GN 103, GN 104, GN 106, GN 927, GN 944, GN 954, GN 963, GN 992, GN 997, GV 642, GV 945, GV 946, GV 947, PSG 001, PSG 003, PSG 004

**VOLVO**

GN 018, GN 045, GN 047, GN 054, GN 855, GN 857, GN 928, GN 959, GN 999, GV844, GV 852

**VW AG**

GE 100, GE 101, GE 115, GH 408, GN 008, GN 046, GN 050, GN 855, GN 857, GN 928, GN 989, GV 968, PSG 002

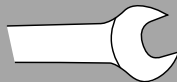
**D****GB****USA****BERU****1****2****3****4**

Typ	Bestell-Nr.	Bezeichnung		
1	RRS 8 x 12	0 890 100 002	<b>Ring-Ratschen-Schlüssel</b> Gekröpfter Ring-Ratschen-Schlüssel zur Montage von Glühkerzen	Passend für: Audi, Volkswagen, Renault Gekröpfter Ring-Ratschen-Schlüssel für Demontage/Montage von Glühkerzen und Stromschienenverschraubungen bei Audi-, Volkswagen- und Renault-Motoren. Insbesondere geeignet für schwer zugängliche Glühkerzen. für Glühkerzenanschlüsse – Ratsche mit Schlüsselweite (SW) 8 mm für Glühkerzen – Ratsche mit Schlüsselweite (SW) 12 mm
2		0 890 100 003	<b>Reibahle</b> Reibahle für Glühkerzenschacht	Zum Entfernen von Ablagerungen / Verkokungen im Glühkerzenschacht des Zylinderkopfes bei Daimler-Chrysler Dieselfahrzeugen mit Motor OM 611, OM 612 und OM 613 (CDI).
3		0 890 000 006	<b>PSG-Steckschlüsseleinsatz SW 12 mm</b>	Für den Ein-/Ausbau von PSG-Glühkerzen
4	GKF 01	0 890 300 034	<b>Glühkerzen-Montagefett</b> 10 gr. Tube	– verhindert Korrosion am Gewinde, dadurch kein Festsitzen der Glühkerze – vermeidet das Eindringen von Feuchtigkeit – erleichtert den Glühkerzenwechsel BERU empfiehlt: Bei jedem Glühkerzenwechsel den Glühkerzenschacht und das Gewinde fetten.

Type	Ref.-No.			
1	RRS 8 x 12	0 890 100 002	<b>Ring-ratchet spanner</b> Cranked ring-ratchet spanner for mounting of glow plugs	Suitable for: Audi, Volkswagen, Renault Cranked ring-ratchet spanner for dismantling / mounting glow plugs and conductor rail connections on Audi, Volkswagen and Renault engines. Particularly suited for difficult to access glow plugs. for glow plug connections - ratchet with width across flats (A/F) 8 mm for glow plug connections - ratchet with width across flats (A/F) 12 mm
2		0 890 100 003	<b>Reamer</b> Reamer for glow plug slot	For removal of deposits / coke in glow plug slot of cylinder head on Daimler-Chrysler diesel vehicles equipped with OM 611, OM 612 and OM 613 engines (CDI).
3		0 890 000 006	<b>PSG glow plug wrench</b> 12 mm	For the installation/removal of PSG glow plugs
4	GKF 01	0 890 300 034	<b>Glow plug mounting grease</b> 10 g tube	– prevents thread corrosion and therefore stuck glow plugs – prevents the penetration of water – facilitates glow plug replacement BERU recommends: Always grease the glow plug shaft and thread when changing glow plugs.



1



2



3





4

Type	No. de Réf.		
1 RRS 8 x 12	0 890 100 002	<b>Clé à cliquet</b> Clé coudée à cliquet pour le montage des bougies	Applications: Audi, Renault, Volkswagen Clé coudée à cliquet pour le démontage et le montage des bougies et des raccords de rails à vis sur les moteurs Audi, Renault et Volkswagen. Tout particulièrement adaptée aux bougies difficiles d'accès Avec ouverture de clé 8 mm pour les connexions de bougies Avec ouverture de clé 12 mm pour les bougies
2	0 890 100 003	<b>Alésoir</b> Alésoir pour compartiment bougies	Pour éliminer les dépôts de calamine dans le compartiment bougies de la culasse sur les véhicules Diesel Daimler-Chrysler équipés de moteurs OM 611, OM 612 et OM 613 (CDI)
3	0 890 000 006	<b>Clé de 12 mm pour bougie de préchauffage PSG</b>	Pour le montage/démontage des bougies de préchauffage PSG
4 GKF 01	0 890 300 034	<b>Graisse de montage de bougies de préchauffage</b> Tube de 10 g	<ul style="list-style-type: none"> <li>– prévient la corrosion du filetage et donc le grippage des bougies de préchauffage</li> <li>– protège contre la pénétration de l'humidité</li> <li>– facilite le remplacement des bougies de préchauffage</li> </ul> BERU recommande: Lors de chaque changement des bougies de préchauffage, lubrifier le bout de la bougie ainsi que le filetage.

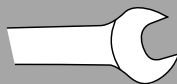
Typ	Bestelnummer		
1 RRS 8 x 12	0 890 100 002	<b>Ringratelsleutel</b> Krukvormige ringratelsleutel voor de montage van gloeibougies	Geschikt voor: Audi, Volkswagen, Renault Krukvormige ringratelsleutel voor demontage / montage van bougies en contactrailsschroefverbindingen bij Audi-, Volkswagen- en Renaultmotoren. In het bijzonder geschikt voor moeilijk toegankelijke bougies. voor bougie-aansluitingen - ratel met sleutelbreedte (SW) 8 mm voor bougies - ratel met sleutelbreedte (SW) 12 mm
2	0 890 100 003	<b>Ruimer</b> Ruimer voor gloeibougieschacht	Voor het verwijderen van afzettingen / carbonisatie in de bougieschacht van de cilinderkop bij Daimler-Chrysler dieselveertuigen met motor OM 611, OM 612 en OM 613 (CDI).
3	0 890 000 006	<b>PSG gloeibougie-sleutel</b> 12 mm	Voor het installeren/verwijderen van PSG gloeibougies
4 GKF 01	0 890 300 034	<b>Gloeibougies-montagevet</b> 10 gr. tube	<ul style="list-style-type: none"> <li>– voorkomt corrosie aan schroefdraad, daardoor komt de gloeibougie niet vast te zitten</li> <li>– voorkomt het binnendringen van vocht</li> <li>– vergemakkelijkt het wisselen van gloeibougies</li> </ul> BERU adviseert: Bij iedere vervanging van de gloeibougies de schacht en het draad invetten.

**E****I****BERU****1****2****3****4**

Tipo	Referencia			
<b>1</b>	RRS 8 x 12	0 890 100 002	<b>Llave anular de carraca</b> Llave anular de carraca acodada para el montaje de bujías	Válido para: Audi, Volkswagen, Renault Llave anular de carraca acodada para el desmontaje / montaje de bujías y racores de regletas de corriente de los motores de Audi, Volkswagen y Renault. Especialmente indicada para bujías de difícil acceso. Para conexiones de calentadores - llave de carraca con una boca (SW) de 8 mm Para bujías - llave de escape con una boca (SW) de 12 mm
<b>2</b>		0 890 100 003	<b>Escariador</b> Escariador para el hueco de las bujías	Para eliminar sedimentos / carbonizaciones en el hueco de las bujías de la culata de los vehículos Diesel de Daimler-Chrysler con motor OM 611, OM 612 y OM 613 (CDI).
<b>3</b>		0 890 000 006	<b>Llave para las bujías de calentamiento PSG</b> 12 mm	Para el montaje / desmontaje de las bujías de calentamiento PSG
<b>4</b>	GKF 01	0 890 300 034	<b>Grasa de montaje para bujías incandescentes</b> Tubo de 10 g.	– impide la corrosión en la rosca; por ello no se agarrota la bujía incandescente – impide la penetración de humedad – facilita el cambio de bujías incandescentes BERU recomienda: Engrasar en cada cambio de bujías incandescente el vástago de la bujía incandescente y la rosca.

Tipo	Contenido			
<b>1</b>	RRS 8 x 12	0 890 100 002	<b>Chiave ad anello a cricchetto</b> Chiave ad anello a cricchetto ricurva per il montaggio di candele ad incandescenza.	Adatta per: Audi, Volkswagen, Renault Chiave ad anello a cricchetto ricurva per il montaggio e lo smontaggio di candele ad incandescenza e barre di alimentazione in motori Audi, Volkswagen e Renault. Idonea soprattutto per candele ad incandescenza difficilmente accessibili. per chiave a cricchetto per candele ad incandescenza da 8 mm per chiave a cricchetto per candele ad incandescenza da 12 mm
<b>2</b>		0 890 100 003	<b>Alesatore</b> Alesatore per pozzetto candela ad incandescenza	Per rimuovere depositi / residui di bruciature nel pozzetto della candela ad incandescenza in testate motore di veicoli Daimler-Chrysler con motore OM 611, OM 612 e OM 613 (CDI)
<b>3</b>		0 890 000 006	<b>Chiave da 12 mm per candele di preriscaldamento PSG</b>	Per l'installazione/rimozione delle candele di preriscaldamento PSG
<b>4</b>	GKF 01	0 890 300 034	<b>Grasso di montaggio per candele di preriscaldamento</b> Tubetto da 10 gr.	– evita corrosione del filetto ed il bloccaggio della candela di preriscaldamento – evita la penetrazione di umidità – facilita il cambio delle candele di preriscaldamento BERU raccomanda: In ogni cambio delle candele di preriscaldamento, è necessario ingrassare il fuso della stessa e il filetto.



1



2



3



4

	Тип	Номер за поръчка		
1	RRS 8 x 12	0 890 100 002	<b>Кольцевой динамометрический ключ</b> Изогнутый кольц. динамометрич. ключ для монтажа свечей накаливания	Подходит для Audi, Volkswagen, Renault Изогнут. кольц. динамометрич. ключ для демонтажа/монтажа свечей накалив. и винт. соединений шинопроводов в двигателях Audi, Volkswagen и Renault. В особенности применим для свечей накалив. с трудным доступом д/подсоедин. свечей накалив. - динамометр. ключ с раствором (PK) – 8 мм д/свечей накалив. - динамометр. ключ с раствором (PK) – 12 мм
2		0 890 100 003	<b>Развертка</b> Развертка для шахты свечей накаливания	Для удаления отложений / нагарообразования в шахте свечей накаливания цилиндр. головки в дизельн. трансп. средствах Daimler-Crysler с двигателями OM 611, OM 612 и OM 613 (CDI)
3		0 890 000 006	<b>Ключ 12 мм для свечей накаливания PSG</b>	для установки/удаления свечей накаливания PSG
4	GKF 01	0 890 300 034	<b>Смазка для монтажа свечи накаливания</b> 10 г в тубике	– предотвращает коррозию на резьбе и тем самым заклинивание свечи накаливания – предотвращает проникновение влаги – облегчает замену свечи накаливания Фирма BERU рекомендует: При каждой замене свечей накаливания смазать хвостовик свечи накаливания и резьбу.

	Typ	Nr. czesci		
1	RRS 8 x 12	0 890 100 002	<b>Ключ заподково-пирсциениowy</b> Zagięty klucz zapadkowopierścieniowy do montowania świec żarowych	Pasujący do: Audi, Volkswagen, Renault Zagięty klucz zapadkowo-pierścieniowy do demontażu / montażu świec żarowych oraz połączeń śrubowych szyn zasilających w silnikach Audi, Volkswagen oraz Renault. Szczególnie nadaje się do demontowania / montowania świec żarowych zainstalowanych w miejscach trudnodostępnych. do przyłączy świec żarowych - klucz zapadkowy o rozwarości (SW) 8 mm do świec żarowych - klucz zapadkowy o rozwarości (SW) 12 mm
2		0 890 100 003	<b>Rozwiertak</b> Rozwiertak do szybika świecy żarowej	Do usuwania złożeń / nagaru w szybiku świecy żarowej w głowicy cylindrowej w pojazdach firmy Daimler-Chrysler z silnikiem dieslowskim OM 611, OM 612 oraz OM 613 (CDI).
3		0 890 000 006	<b>Ключ 12 мм до świeц żарowych typu PSG</b>	Do montażu i demontażu świec żарowych typu PSG
4	GKF 01	0 890 300 034	<b>Smar do montażu świec żарowych</b> Tubka 10 g	– zapobiega korozji i zapiekaniu się gwintu – zapobiega penetracji wody – umożliwia późniejsze łatwe wykręcenie świecy BERU zaleca: Przy każdej wymianie świec żарowych nasmarować trzonek świecy żарowej oraz gwint.

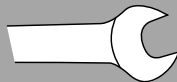

GR

H

BERU®



1



2



3



4

	Τύπος	Αρ. Παραγγελίας:		
1	RRS 8 x 12	0 890 100 002	<b>Κλειδί με κασάνια-δακτύλιο</b> Κλειδί με κασάνια-δακτύλιο σε σχήμα ορθής γωνίας για τη συναρμολόγηση των μπουζί	Κατάλληλο για: Audi, Volkswagen, Renault Κλειδί με κασάνια-δακτύλιο σε σχήμα ορθής γωνίας για την αποσυναρμολόγηση/ συναρμολόγηση των μπουζί και των κοχλιώσεων ράβδων αγωγού σε κινητήρες Audi, Volkswagen και Renault. Ειδικότερα, κατάλληλο για μπουζί με δύσκολη πρόσβαση. για συνδέσεις μπουζί -κασάνια με μέγεθος κλειδιού (SW) 8 mm για μπουζί- κασάνια με μέγεθος κλειδιού (SW) 12 mm
2		0 890 100 003	<b>Γλύφανο</b> Γλύφανο για περίβλημα μπουζί	Για την απομάκρυνση εναποθέσεων ή αποθέσεων άνθρακα στο περίβλημα μπουζί της κυλινδροκεφαλής σε οχήματα ντίζελ της Daimler-Chrysler με κινητήρες OM 611, OM 612 και OM 613 (CDI).
3		0 890 000 006	<b>Προθερμαντήρας PSG 12mm</b>	Για την εγκατάσταση / απεγκατάσταση του προθερμαντήρα PSG
4	GKF 01	0 890 300 034	<b>Λιπαντικό συναρμολόγησης προθερμαντήρων</b> σωληνάριο 10 gr.	<ul style="list-style-type: none"> <li>εμποδίζει τη διάβρωση στο σπείρωμα και την προσκόλληση των προθερμαντήρων</li> <li>αποτρέπει τη διείσδυση υγρασίας</li> <li>διευκολύνει την αντικατάσταση των προθερμαντήρων</li> </ul> Η BERU συνιστά: Σε κάθε αντικατάσταση αναφλεκτήρα πυράκτωσης λιπαίνετε την άτρακτο αναφλεκτήρα πυράκτωσης και το σπείρωμα.

	Típus	Rendelési szám		
1	RRS 8 x 12	0 890 100 002	<b>Racsnis csillagkulcs</b> Κοηγökös racsnis csillagkulcs izzítógertyák beszereléséhez	Audi, Volkswagen, Renault gépkocsik számára Κοηγökös racsnis csillagkulcs Audi-, Volkswagen- és Renault-motorok izzítógertyáinak és áramsin-csavarkötéseinek be- és kiszerezéséhez. Különösen alkalmas nehezen hozzáférhető izzítógertyákhoz. izzítógertya-csatlakozásokhoz 8 mm-es kulcsnyílású racsnis izzítógertyákhoz 12 mm-es kulcsnyílású racsnis
2		0 890 100 003	<b>Dörzsár</b> Dörzsár izzítógertya-akna tisztításához	Lerakódás / elkokszosodás eltávolításához a hengerfej izzítógertyaaknájából a Daimler-Chrysler OM 611, OM 612 és OM 613 (CDI) jelű motorokkal felszerelt dízeljárműveinél
3		0 890 000 006	<b>PSG izzítógertya 12 mm-es kulcsnyílással</b>	Ki és beszereléséhez a PSG izzítógertyának
4	GKF 01	0 890 300 034	<b>Szerelőzsír izzítógertyához</b> 10 g/tubus	<ul style="list-style-type: none"> <li>megakadályozza a korrózió képződését, ami a gertya beszorulását eredményezheti</li> <li>megakadályozza a nedvesség beszivárgását</li> <li>megkönnyíti az izzítógertya cseréjét</li> </ul> BERU ajánlás: Minden izzítógertya-cserénél zsírozza be az izzítógertya-aszárat és a mentet.





**GR 001**  
0 201 010 001

Volkswagen, Audi 08.80–08.91

	4-5
Volt	12
 Sec.	5,4
 Sec.	0

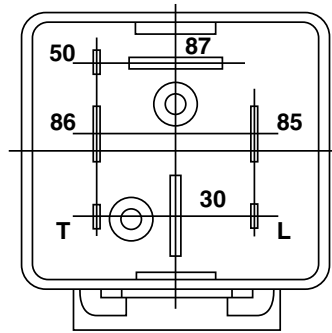
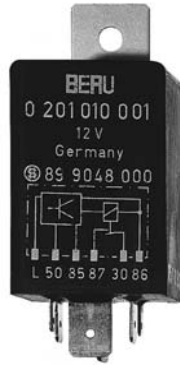

**GR 031**  
0 201 010 031

Volkswagen, Audi 09.91–  
SR-Set 028, 029

	4-6
Volt	12
 Sec.	5,7
 Sec.	180

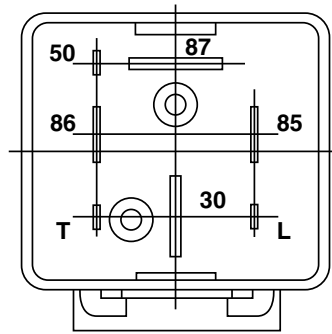
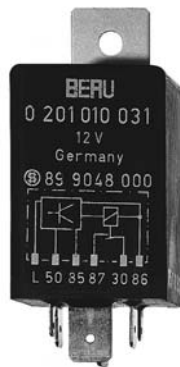

**GR 033**  
0 201 010 033

Ford, Opel, Vauxhall  
SR-Set 030, 031, 034, 035

	4
Volt	12
 Sec.	5,1
 Sec.	180

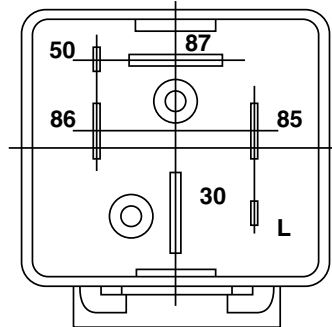
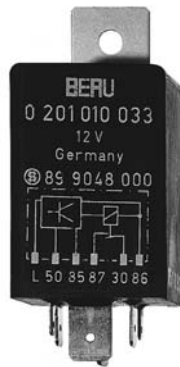

**GR 034**  
0 201 010 034

Citroën, Peugeot  
SR-Set 032, 037

	4
Volt	12
 Sec.	4,6
 Sec.	180



- |   |                         |
|---|-------------------------|
| 1 | 31                      |
| 2 | Schalter <sup>227</sup> |
| 3 | 15                      |
| 4 | 50                      |
| 5 | Lampe <sup>226</sup>    |
| 6 | 30                      |
| 7 | 87                      |

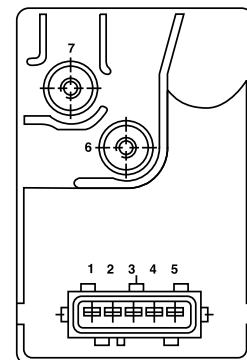

<sup>20</sup> solange Vorrat reicht



**GR 049**  
0 201 010 049

Mercedes SR-Set 039, 040

	4-5
Volt	12
 Sec.	3,8
 Sec.	180

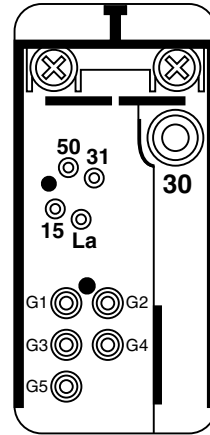

**GR 054**  
0 201 010 054

Citroën, Peugeot

	4
Volt	12
 Sec.	3,3
 Sec.	13



1	31
2	T
3	15
4	50
5	Lampe <sup>226</sup>
6	-
7	Schalter <sup>227</sup>
8	87
9	30

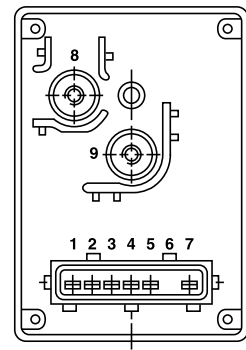

**GR 059**  
0 201 010 059

Citroën, Peugeot, Renault, Talbot

	4
Volt	12
 Sec.	12,6
 Sec.	0



1	30
2	31
3	15
4	50
5	87
6	Lampe <sup>226</sup>

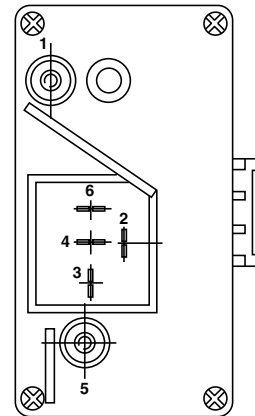

**GR 064**  
0 201 010 064

Ford, Opel, Vauxhall

	4
Volt	12
 Sec.	5
 Sec.	0

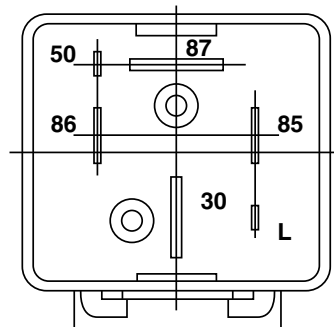



**GR 065**  
0 201 010 065

Citroën, Fiat, Peugeot, Renault, Seat, Talbot

	4
Volt	12
 Sec.	6,8
 Sec.	0

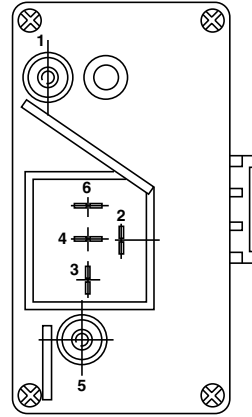

**GR 066**  
0 201 010 066

Alfa Romeo, Renault

	4
Volt	12
 Sec.	8,1
 Sec.	0



1	30
2	31
3	15
4	50
5	87
6	Lampe <sup>226</sup>

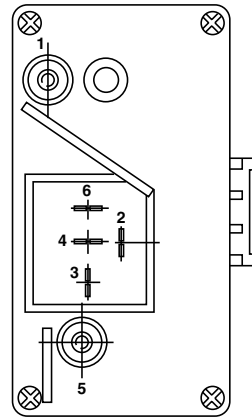

**GR 067**  
0 201 010 067

Renault (R 19, Express)

	4
Volt	12
 Sec.	8,5
 Sec.	180

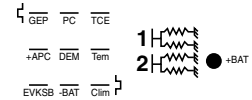
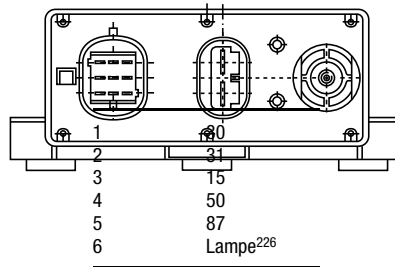

**GR 069**  
0 201 010 069

Mercedes

	4
Volt	12
 Sec.	5,3
 Sec.	0

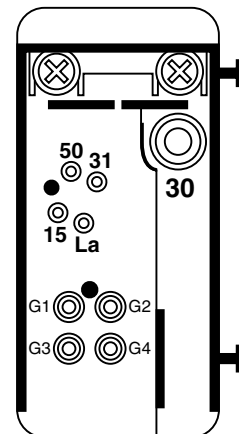



**GR 070**  
0 201 010 070

Mercedes

	4
Volt	12
 Sec.	5
 Sec.	0

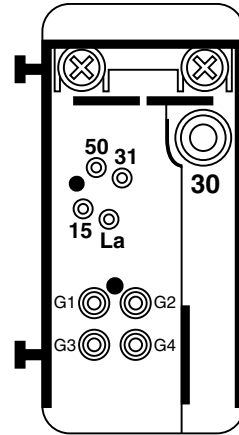

**GR 071**  
0 201 010 071

Mercedes

	5
Volt	12
 Sec.	5
 Sec.	0

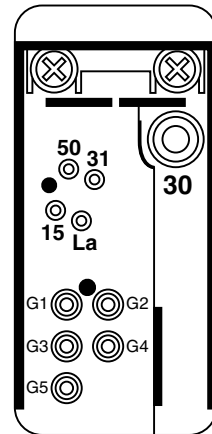

**GR 073**  
0 201 010 073

Mercedes

	4
Volt	12
 Sec.	12,9
 Sec.	18,1

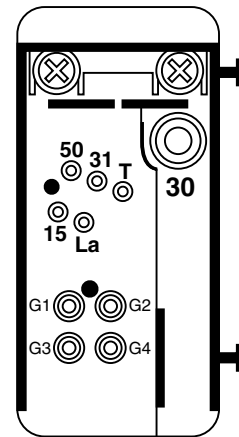

**GR 074**  
0 201 010 074

Mercedes

	4
Volt	12
 Sec.	12,9
 Sec.	18,1

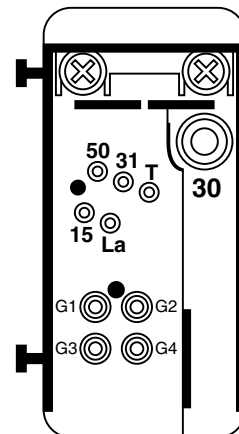



**GR 075**  
0 201 010 075

Mercedes

	5
Volt	12
	13
	18

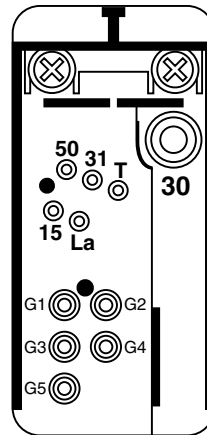

**GR 076**  
0 201 010 076

Mercedes

	6
Volt	12
	11,5
	16,5

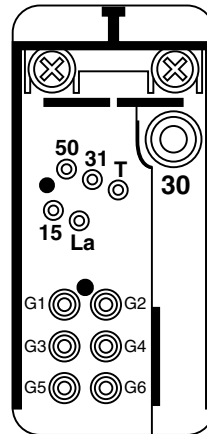

**GR 079**  
0 201 010 079

Mercedes

	4
Volt	12
	13
	18

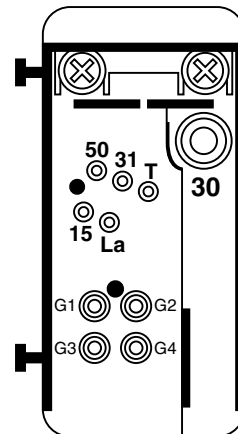

**GR 080**  
0 201 010 080

Mercedes

	5
Volt	12
	13
	18

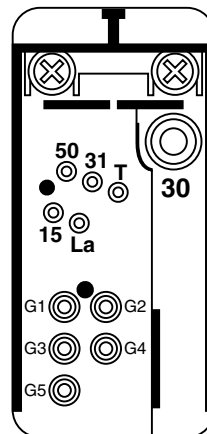



**GSE 100** VW AG  
0 522 120 702

	4
Volt	12



Softwarestand beachten<sup>152</sup>

**GSE 101** BMW  
0 522 120 701

	4
Volt	12



Softwarestand beachten<sup>152</sup>

**GSE 102** BMW  
0 522 140 701

	6
Volt	12



Softwarestand beachten<sup>152</sup>

**GSE 103** BMW  
0 522 150 701

	8
Volt	12



Softwarestand beachten<sup>152</sup>

**ALFA ROMEO**

GR 066

**AUDI**

GR 001, GSE 100\*\*

**BMW**

GSE 101\*\*, GSE 102\*\*, GSE 103\*\*

**CITROËN**

GR 034, GR 054, GR 059, GR 065

**FIAT**

GR 065

**FORD**

GR 064

**MERCEDES-BENZ**

GR 049, GR 069, GR 070, GR 071, GR 073, GR 074, GR 075, GR 076, GR 079, GR 080

**OPEL**

GR 064

**PEUGEOT**

GR 054, GR 059, GR 065

**PUCH**

GR 049, GR 076

**RENAULT**

GR 059, GR 065, GR 066, GR 067

**SEAT**

GR 065, GSE 100\*\*

**SKODA**

GSE 100\*\*

**SSANGYONG**

GR 049

**TALBOT**

GR 065

**VAUXHALL**

GR 064

**VW**

GR 001, GR 031, GSE 100\*\*



## 12 Volt

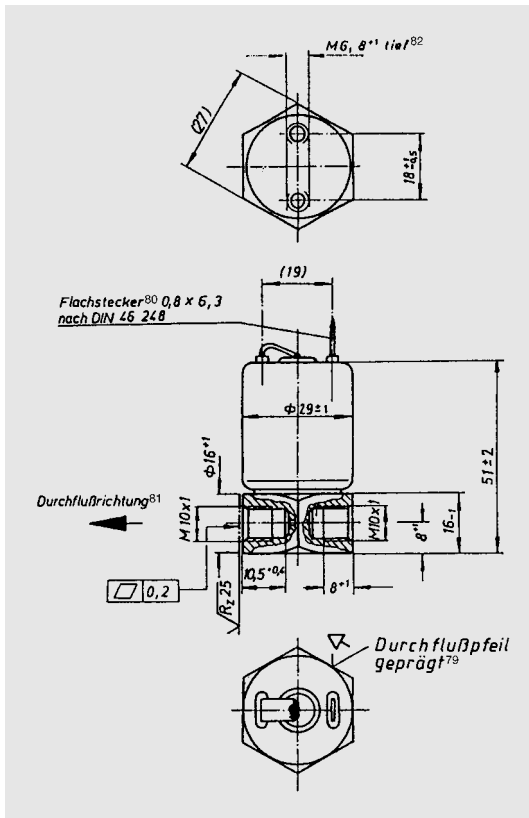

Best.-Nr./Ref.-No. 0 210 142 115

## Typ Nr. MV 115

### Technische Daten:

Nennspannung: 12 V  
 Nennleistung: 20 W  
 Spulenwiderstand:  $8,0 \pm 0,5 \Omega$  bei 20 °C  
 Einschaltdauer (ED): 100 %  
 Ventilfunktion: stromlos geschlossen

Elektrischer Anschluß: einpolig  
 Einbaulage: beliebig  
 Betriebsmedium: Diesel- und  
 Ottokraftstoffe  
 Durchflußmenge bei 20 °C  
 und 500 mm Gefälle: ca. 4 l/h

### Technical Data:

Rated voltage: 12 V  
 Rated capacity: 20 W  
 Coil resistance:  $8,0 \pm 0,5 \Omega$  at 20 °C  
 Duty cycle: 100 %  
 Valve function: currentless closed

Electr. connection: 1-pin  
 Installation: where required  
 Operating medium: diesel and  
 otto fuels  
 Flow quantity at 20 °C and 0,5 bar  
 overpressure of the medium: ca. 4 l/h

Stat. Zuflußdruck: max. 10 bar  
 Dyn. Druckstöße: max. 45 bar  
 Druckanstieg: max. 60 bar/ms  
 Zul. Temperaturbereich:  
 von -55 °C bis +140 °C  
 Zul. Schwingungsbeschleunigung:  
 400 m/s<sup>2</sup>  
 Schutzart nach DIN 40 050: IP 60  
 Durchgang am Ventilsitz: Ø 1,5  
 Anzugsspannung: ≤ 7,5 V  
 Selbsthaltespannung: ≤ 3 V

Stat. flow pressure: max. 10 bar  
 Dynamic impulsion: max. 45 bar  
 Pressure increase: max. 60 bar/ms  
 Permissible temperature range:  
 from -55 °C to +140 °C  
 Permissible acceleration of vibration:  
 400 m/s<sup>2</sup>  
 Protection acc. DIN 40 050: IP 60  
 Passage at valve seat: Ø 1,5  
 Attraction: ≤ 7,5 V  
 Holding voltage: ≤ 3 V

## 24 Volt

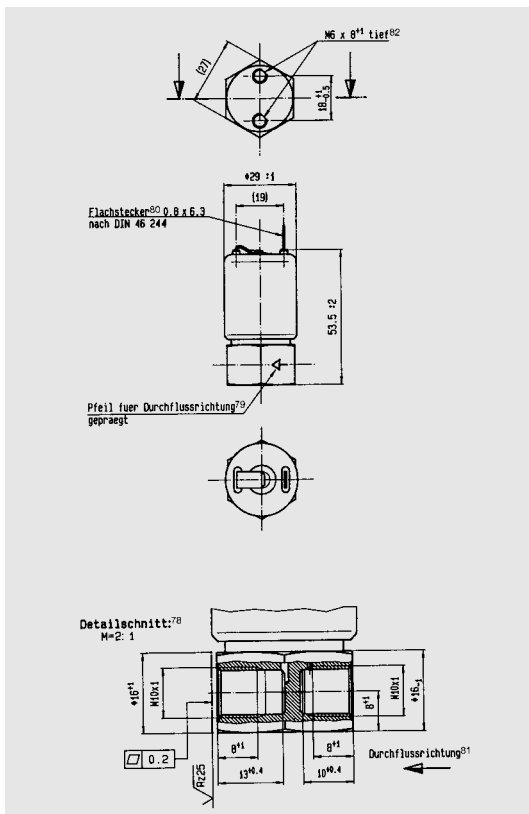

Best.-Nr./Ref.-No. 0 210 143 116

## Typ Nr. MV 116

### Technische Daten:

Nennspannung: 24 V  
 Nennleistung: 20 W  
 Spulenwiderstand:  $32 \Omega$  bei 20 °C  
 Einschaltdauer (ED): 100 %  
 Ventilfunktion: stromlos geschlossen

Elektrischer Anschluß: einpolig  
 Einbaulage: beliebig  
 Betriebsmedium: Diesel- und  
 Ottokraftstoffe  
 Durchflußmenge bei 20 °C  
 und 500 mm Gefälle: ca. 4 l/h

### Technical Data:

Rated voltage: 24 V  
 Rated capacity: 20 W  
 Coil resistance:  $32 \Omega$  at 20 °C  
 Duty cycle: 100 %  
 Valve function: currentless closed

Electr. connection: 1-pin  
 Installation: where required  
 Operating medium: diesel and  
 otto fuels  
 Flow quantity at 20 °C and 0,5 bar  
 overpressure of the medium: ca. 4 l/h

Stat. Zuflußdruck: max. 10 bar  
 Dyn. Druckstöße: max. 45 bar  
 Druckanstieg: max. 60 bar/ms  
 Zul. Temperaturbereich:  
 von -55 °C bis +140 °C  
 Zul. Schwingungsbeschleunigung:  
 400 m/s<sup>2</sup>  
 Schutzart nach DIN 40 050: IP 60  
 Durchgang am Ventilsitz: Ø 1,5  
 Anzugsspannung: ≤ 7,5 V  
 Selbsthaltespannung: ≤ 3 V

Stat. flow pressure: max. 10 bar  
 Dynamic impulsion: max. 45 bar  
 Pressure increase: max. 60 bar/ms  
 Permissible temperature range:  
 from -55 °C to +140 °C  
 Permissible acceleration of vibration:  
 400 m/s<sup>2</sup>  
 Protection acc. DIN 40 050: IP 60  
 Passage at valve seat: Ø 1,5  
 Attraction: ≤ 7,5 V  
 Holding voltage: ≤ 3 V



## 24 Volt

## Typ Nr. MV 111

## Technische Daten:

Nennspannung: 24 V  
 Nennleistung: 20 W  
 Spulenwiderstand:  $32 \pm 2 \Omega$  bei 20 °C  
 Einschaltdauer (ED): 100 %  
 Ventilfunktion: stromlos geschlossen

Elektrischer Anschluß: zweipolig  
 Einbaulage: beliebig  
 Betriebsmedium: Diesel- und  
 Ottokraftstoffe JP 4  
 Durchflußmenge bei 20 °C  
 und 500 mm Gefälle: ca. 4 l/h

## Technical Data:

Rated voltage: 24 V  
 Rated capacity: 20 W  
 Coil resistance:  $32 \pm 2 \Omega$  at 20 °C  
 Duty cycle: 100 %  
 Valve function: currentless closed

Electr. connection: 2-pin  
 Installation: where required  
 Operating medium: diesel and  
 otto fuels, JP 4  
 Flow quantity at 20 °C and 0,5 bar  
 overpressure of the medium: ca. 4 l/h

Stat. Zuflußdruck: max. 10 bar  
 Dyn. Druckstöße: max. 45 bar  
 Druckerhöhung: max. 60 bar/ms  
 Zul. Temperaturbereich:  
 von -55 °C bis +140 °C  
 Zul. Schwingungsbeschleunigung:  
 400 m/s<sup>2</sup>  
 Schutzart nach DIN 40 050: IP 60  
 Durchgang am Ventilsitz:  $\varnothing 1,5$   
 Drosselbohrung am Zulauf:  $\varnothing 0,8$   
 Anzugsspannung:  $\leq 7,5$  V  
 Selbsthaltungsspannung:  $\leq 7$  V

Stat. flow pressure: max. 10 bar  
 Dynamic impulsion: max. 45 bar  
 Pressure increase: max. 60 bar/ms  
 Permissible temperature range:  
 from -55 °C to +140 °C  
 Permissible acceleration of vibration:  
 400 m/s<sup>2</sup>  
 Protection acc. DIN 40 050: IP 60  
 Passage at valve seat:  $\varnothing 1,5$   
 Throttle-hole at input:  $\varnothing 0,8$   
 Attraction:  $\leq 7,5$  V  
 Holding voltage:  $\leq 7$  V

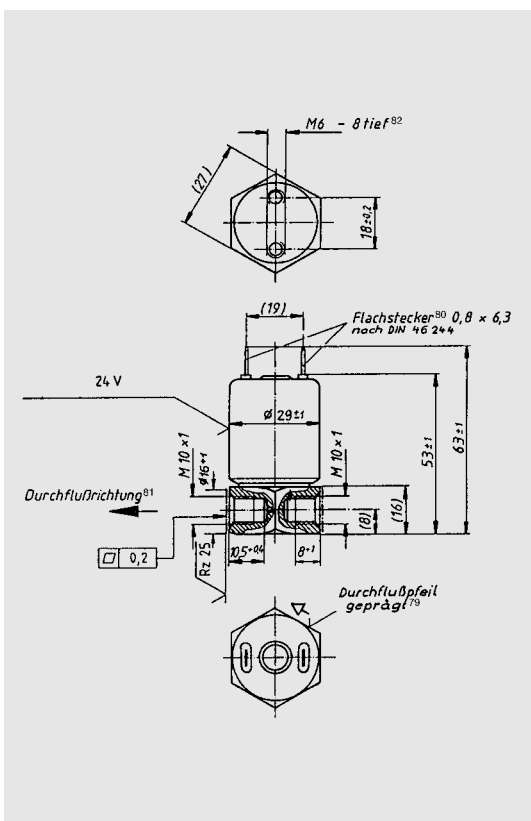

Best.-Nr./Ref.-No. 0 210 243 111

## 24 Volt

## Typ Nr. MV 129

## Technische Daten:

Nennspannung: 24 V  
 Nennleistung: 19 W  
 Spulenwiderstand:  $32 \pm 2 \Omega$  bei 20 °C  
 Einschaltdauer (ED): max. 15 min.  
 Ventilfunktion: stromlos geschlossen

Elektrischer Anschluß: zweipolig  
 Einbaulage: beliebig  
 Betriebsmedium: Diesel- und  
 Ottokraftstoffe JP 4  
 Durchflußmenge bei 20 °C  
 und 500 mm Gefälle: ca. 7 l/h

## Technical Data:

Rated voltage: 24 V  
 Rated capacity: 19 W  
 Coil resistance:  $32 \pm 2 \Omega$  at 20 °C  
 Duty cycle: max. 15 min.  
 Valve function: currentless closed

Electr. connection: 2-pin  
 Installation: where required  
 Operating medium: diesel and  
 otto fuels  
 Flow quantity at 20 °C and 0,5 bar  
 overpressure of the medium: ca. 4 l/h

Stat. Zuflußdruck: max. 10 bar  
 Dyn. Druckstöße: max. 45 bar  
 Druckerhöhung: max. 60 bar/ms  
 Zul. Temperaturbereich:  
 von -55 °C bis +140 °C  
 Zul. Schwingungsbeschleunigung:  
 400 m/s<sup>2</sup>  
 Schutzart nach DIN 40 050: IPGK 9K  
 Durchgang am Ventilsitz:  $\varnothing 1,5$   
 Drosselbohrung am Zulauf: 0,8  
 Anzugsspannung:  $\leq 14$  V  
 Selbsthaltungsspannung:  $\leq 6,5$  V

Stat. flow pressure: max. 10 bar  
 Dynamic impulsion: max. 45 bar  
 Pressure increase: max. 60 bar/ms  
 Permissible temperature range:  
 from -55 °C to +140 °C  
 Permissible acceleration of vibration:  
 400 m/s<sup>2</sup>  
 Protection acc. DIN 40 050: IPGK 9K  
 Passage at valve seat:  $\varnothing 1,5$   
 Throttle-hole at input:  $\varnothing 0,8$   
 Attraction:  $\leq 14$  V  
 Holding voltage:  $\leq 6,5$  V

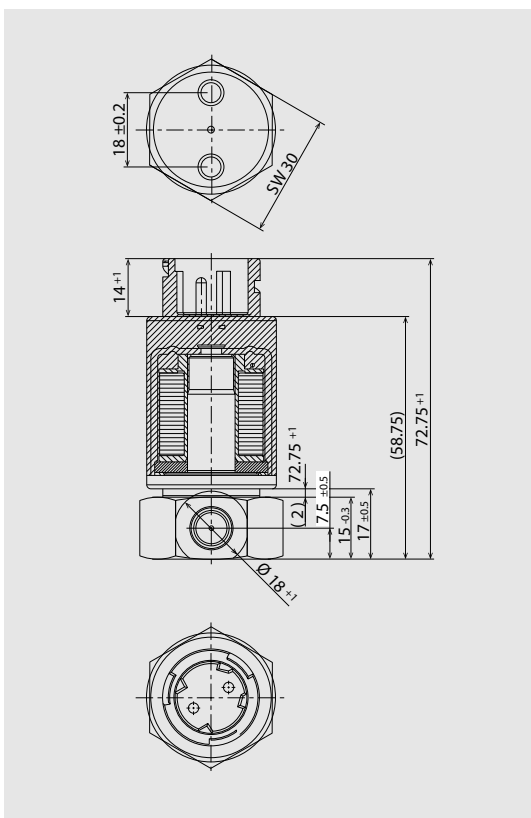

Best.-Nr./Ref.-No. 0 210 243 129

## 12 Volt

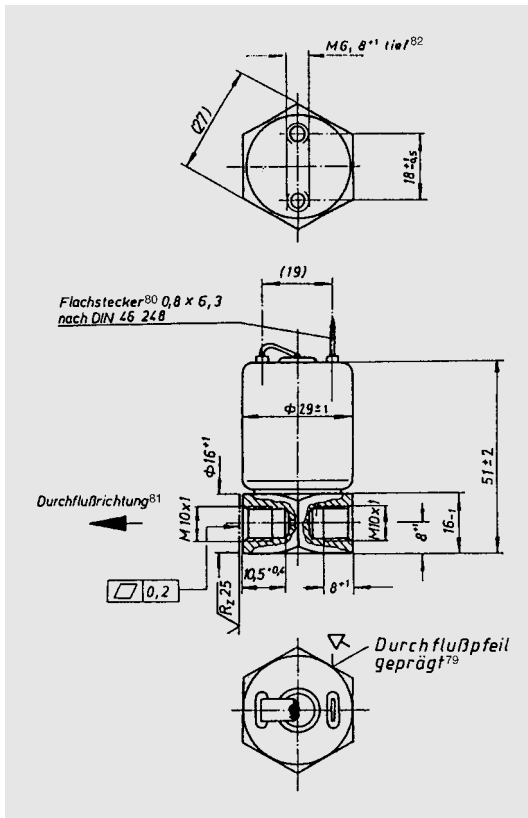

No. de Réf./Bestelnummer 0 210 142 115

## Typ Nr. MV 115

### Spécifications techniques:

Tension nominale: 12 V  
 Puissance nominale: 20 W  
 Résistance de bobine:  $8,0 \pm 0,5 \Omega$  à 20 °C  
 Temps de fonctionnement: 100 %  
 Fonction de l'électro-vanne:  
 sans courant fermée

Connexion électrique: unipolaire  
 Installation: suivant exigence  
 Fluides de fonctionnement:  
 gasoil et essence  
 Débit à 20 °C  
 et 500 mm chute: environ 4 l/h

### Technische gegevens:

Nominale spanning: 12 V  
 Nominaal vermogen: 20 W  
 Spoelweerstand:  $8,0 \pm 0,5 \Omega$  bij 20 °C  
 Inschakelduur: 100%  
 Klepfunctie: stroomloos gesloten

Elektrische aansluiting: 1-polig  
 Inbouwstand: willekeurig  
 Bedrijfsmedium: diesel- en otto-  
 brandstoffen  
 Doorstroomhoeveelheid bij 20 °C en  
 500 mm overdruk van het medium: ca. 4 l/u

Pression stat. d'écoulement: max. 10 bar  
 Impulsion dynamique: max. 45 bar  
 Augmentation de pression:  
 max. 60 bar/ms  
 Champ de température admissible:  
 de -55 °C à +140 °C  
 Accélération vibratoire admissible:  
 400 m/s<sup>2</sup>  
 Protection selon DIN 40 050: IP 60  
 Passage au siège de soupape:  $\varnothing 1,5$   
 Tension d'attaction:  $\leq 7,5$  V  
 Tension de maintien:  $\leq 3$  V

Stat. doorstroomdruk: max. 10 bar  
 Dynamische impuls: max. 45 bar  
 Drukstijging: max. 60 bar/ms  
 Toegest. temperatuurbereik:  
 van -55 °C tot +140 °C  
 Toegest. trillingsversnelling: 400 m/s<sup>2</sup>  
 Beschermsoort volgens DIN 40 050: IP 60  
 Doorgang op klepzitting:  $\varnothing 1,5$   
 Aantrekspanning:  $\leq 7,5$  V  
 Vasthoudspanning:  $\leq 3$  V

## 24 Volt

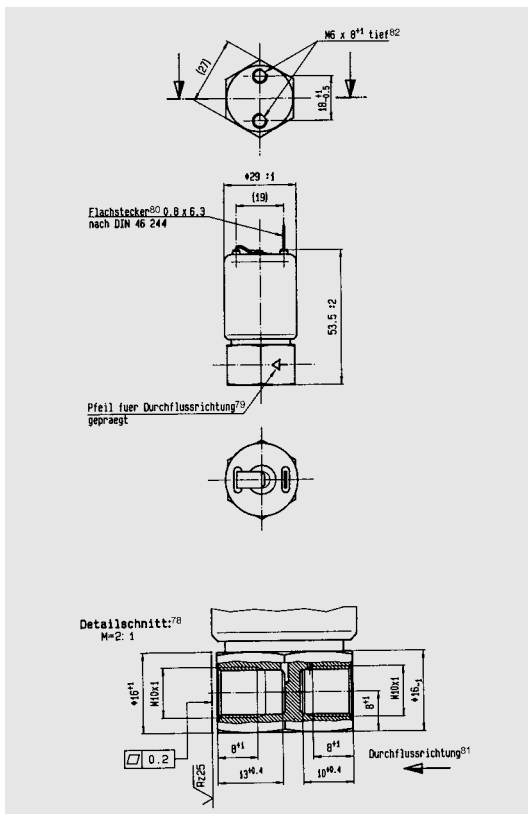

No. de Réf./Bestelnummer 0 210 143 116

## Typ Nr. MV 116

### Spécifications techniques:

Tension nominale: 24 V  
 Puissance nominale: 20 W  
 Résistance de bobine:  $32 \Omega$  à 20 °C  
 Temps de fonctionnement: 100 %  
 Fonction de l'électro-vanne:  
 sans courant fermée

Connexion électrique: unipolaire  
 Installation: suivant exigence  
 Fluides de fonctionnement:  
 gasoil et essence  
 Débit à 20 °C  
 et 500 mm chute: environ 4 l/h

### Technische gegevens:

Nominale spanning: 24 V  
 Nominaal vermogen: 20 W  
 Spoelweerstand:  $32 \Omega$  bij 20 °C  
 Inschakelduur: 100%  
 Klepfunctie: stroomloos gesloten

Elektrische aansluiting: 1-polig  
 Inbouwstand: willekeurig  
 Bedrijfsmedium: diesel- en otto-  
 brandstoffen  
 Doorstroomhoeveelheid bij 20 °C en  
 500 mm overdruk van het medium: ca. 4 l/u

Pression stat. d'écoulement: max. 10 bar  
 Impulsion dynamique: max. 45 bar  
 Augmentation de pression:  
 max. 60 bar/ms  
 Champ de température admissible:  
 de -55 °C à +140 °C  
 Accélération vibratoire admissible:  
 400 m/s<sup>2</sup>  
 Protection selon DIN 40 050: IP 60  
 Passage au siège de soupape:  $\varnothing 1,5$   
 Tension d'attaction:  $\leq 7,5$  V  
 Tension de maintien:  $\leq 3$  V

Stat. doorstroomdruk: max. 10 bar  
 Dynamische impuls: max. 45 bar  
 Drukstijging: max. 60 bar/ms  
 Toegest. temperatuurbereik:  
 van -55 °C tot +140 °C  
 Toegest. trillingsversnelling: 400 m/s<sup>2</sup>  
 Beschermsoort volgens DIN 40 050: IP 60  
 Doorgang op klepzitting:  $\varnothing 1,5$   
 Aantrekspanning:  $\leq 7,5$  V  
 Vasthoudspanning:  $\leq 3$  V

## 24 Volt

## Typ Nr. MV 111

## Spécifications techniques:

Tension nominale: 24 V  
 Puissance nominale: 20 W  
 Résistance de bobine:  $32 \pm 2 \Omega$  à 20°C  
 Temps de fonctionnement: 100%  
 Fonction de l'électro-vanne:  
 sans courant fermée

Connexion électrique: bipolaire  
 Installation: suivant exigence  
 Fluides de fonctionnement:  
 gasoil et essence, JP 4  
 Débit à 20°C  
 et 500 mm chute: environ 4 l/h

## Technische gegevens:

Nominale spanning: 24 V  
 Nominaal vermogen: 20 W  
 Spoelweerstand:  $32 \pm 2 \Omega$  bij 20°C  
 Inschakelduur: 100%  
 Klepfunctie: stroomloos gesloten

Elektrische aansluiting: 2-polig  
 Inbouwstand: willekeurig  
 Bedrijfsmedium: diesel- en otto-  
 brandstoffen  
 Doorstroomhoeveelheid bij 20°C en  
 500 mm overdruk van het medium: ca. 4 l/u

Pression stat. d'écoulement: max. 10 bar  
 Impulsion dynamique: max. 45 bar  
 Augmentation de pression:  
 max. 60 bar/ms  
 Champ de température admissible:  
 de -55°C à +140°C  
 Accélération vibratoire admissible:  
 400 m/s<sup>2</sup>  
 Protection selon DIN 40 050: IP 60  
 Passage au siège de soupape:  $\varnothing 1,5$   
 Orifice calibré sur le côté arrive:  $\varnothing 0,8$   
 Tension d'attacco:  $\leq 7,5$  V  
 Tension de maintien:  $\leq 3$  V

Stat. doorstroomdruk: max. 10 bar  
 Dynamische impuls: max. 45 bar  
 Drukstijging: max. 60 bar/ms  
 Toegest. temperatuurbereik:  
 van -55°C tot +140°C  
 Toegest. trillingsversnelling: 400 m/s<sup>2</sup>  
 Beschermsoort volgens DIN 40 050: IP 60  
 Doorgang op klepzitting:  $\varnothing 1,5$   
 Smoorboring op de toeloop:  $\varnothing 0,8$   
 Aantrekspanning:  $\leq 7,5$  V  
 Vasthoudspanning:  $\leq 3$  V

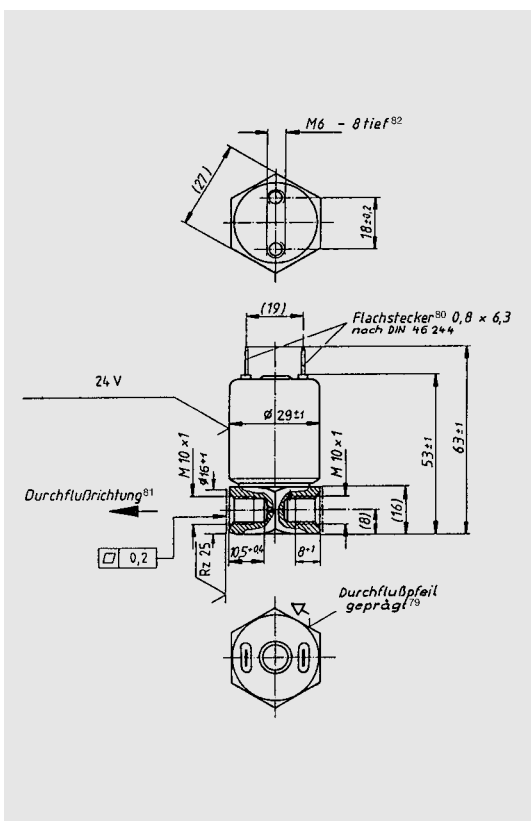

No. de Réf./Bestelnummer 0 210 243 111

## 24 Volt

## Typ Nr. MV 129

## Spécifications techniques:

Tension nominale: 24 V  
 Puissance nominale: 19 W  
 Résistance de bobine:  $32 \pm 2 \Omega$  à 20°C  
 Temps de fonctionnement: max. 15 min.  
 Fonction de l'électro-vanne:  
 sans courant fermée

Connexion électrique: bipolaire  
 Installation: suivant exigence  
 Fluides de fonctionnement:  
 gasoil et essence, JP 4  
 Débit à 20°C  
 et 500 mm chute: environ 7 l/h

## Technische gegevens:

Nominale spanning: 24 V  
 Nominaal vermogen: 19 W  
 Spoelweerstand:  $32 \pm 2 \Omega$  bij 20°C  
 Inschakelduur: max. 15 min.  
 Klepfunctie: stroomloos gesloten

Elektrische aansluiting: 2-polig  
 Inbouwstand: willekeurig  
 Bedrijfsmedium: diesel- en otto-  
 brandstoffen  
 Doorstroomhoeveelheid bij 20°C en  
 500 mm overdruk van het medium: ca. 7 l/u

Pression stat. d'écoulement: max. 10 bar  
 Impulsion dynamique: max. 45 bar  
 Augmentation de pression:  
 max. 60 bar/ms  
 Champ de température admissible:  
 de -55°C à +140°C  
 Accélération vibratoire admissible:  
 400 m/s<sup>2</sup>  
 Protection selon DIN 40 050: IPGK 9K  
 Passage au siège de soupape:  $\varnothing 1,5$   
 Orifice calibré sur le côté arrive:  $\varnothing 0,8$   
 Tension d'attacco:  $\leq 14$  V  
 Tension de maintien:  $\leq 6,5$  V

Stat. doorstroomdruk: max. 10 bar  
 Dynamische impuls: max. 45 bar  
 Drukstijging: max. 60 bar/ms  
 Toegest. temperatuurbereik:  
 van -55°C tot +140°C  
 Toegest. trillingsversnelling: 400 m/s<sup>2</sup>  
 Beschermsoort volgens DIN 40 050: IPGK 9K  
 Doorgang op klepzitting:  $\varnothing 1,5$   
 Smoorboring op de toeloop:  $\varnothing 0,8$   
 Aantrekspanning:  $\leq 14$  V  
 Vasthoudspanning:  $\leq 6,5$  V

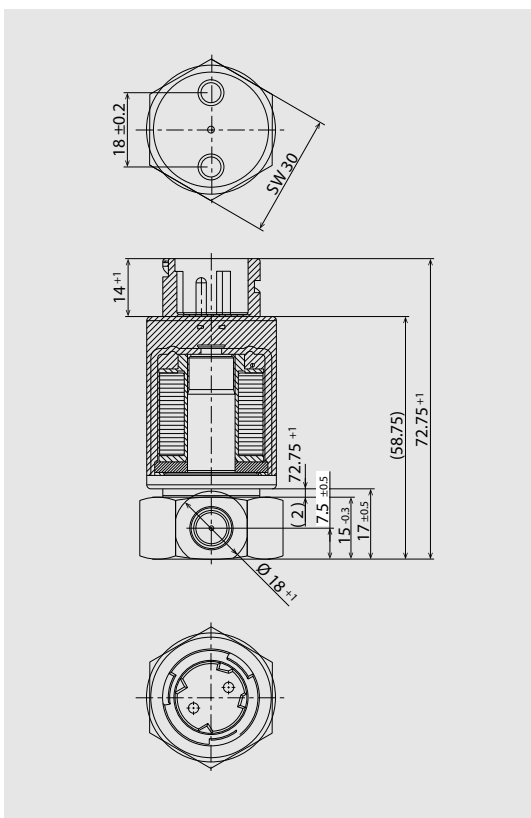

No. de Réf./Bestelnummer 0 210 243 129



## 12 Volt

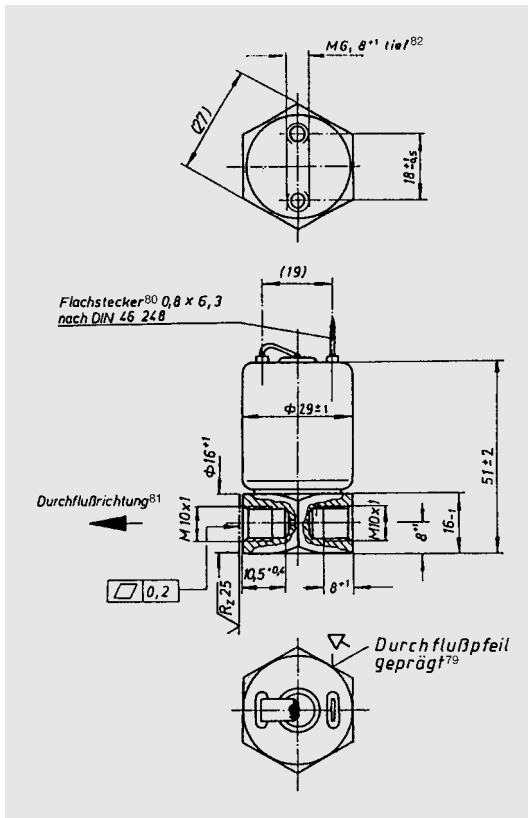

Referencia/Codice/Номер за поръчка 0 210 142 115

## Typ Nr. MV 115

### Características técnicas:

Tensión nominal: 12 V  
 Potencia nominal: 20 W  
 Resistencia de bobina:  $8,0 \pm 0,5 \Omega$  a 20 °C  
 Duración de la conmutación: 100 %  
 Funcionamiento de la válvula:  
 sin corriente, cerrada  
 Toma de corriente: monopolar  
 Posición de montaje: discrecional  
 Producto de servicio: gasoil y gasolina  
 Caudal a 20 °C y 500 mm de inclinación:  
 aprox. 4 l/h  
 Presión de alimentación estática: máx. 10 bares

### Dati tecnici:

Tensione nominale: 12 V  
 Potenza nominale: 20 W  
 Resistenza di bobina:  $8,0 \pm 0,5 \Omega$  a 20 °C  
 Durata di accensione (ED): 100 %  
 Funzione valvola: chiuso senza corrente  
 Collegamento elettrico: monopolare  
 Posizione di montaggio: a piacere  
 Mezzo di esercizio: carburanti diesel e a benzina  
 Portata a 20 °C e pendo di 500 mm: ca. 4 l/h  
 Pressione statica di alimentazione: max. 10 bar

### Технические данные:

Номинальное напряжение: 12 В  
 Номинальная мощность: 20 Вт  
 Сопротивление катушки:  
 $8,0 \pm 0,5 \Omega$  при 20 °C  
 Время включения: 100 %  
 Функция клапана: при отсутствии тока закрыт  
 Электрическое подключение: однополюсное  
 Монтажное положение: любое  
 Рабочая среда: дизельное топливо и топливо двигателей внутреннего сгорания  
 Расход при 20 °C и перепаде высот 500 мм:  
 прил. 4 л/ч

impulsos dinámicos de presión:  
 máx. 45 bares  
 Incremento de presión: máx. 60 bares/ms  
 Gama de temperaturas permisibles:  
 desde -55 °C hasta +140 °C  
 Aceleración vibratoria permisible: 400 m/s<sup>2</sup>  
 Tipo de protección conforme a DIN 40 050: IP 60  
 Paso en asiento de válvula:  $\varnothing 1,5$   
 Tensión de tiro:  $\leq 7,5$  V  
 Tensión de automantenimiento:  $\leq 3$  V

Colpi di pressione dinamica: max. 45 bar  
 Innalzamento di pressione: max. 60 bar/ms  
 Campo di temperatura ammesso:  
 da -55 °C a +140 °C  
 Accelerazione oscillazioni ammessa: 400 m/s<sup>2</sup>  
 Tipo di protezione secondo DIN 40 050: IP 60  
 Passaggio alla sede valvola:  $\varnothing 1,5$   
 Tensione di serraggio:  $\leq 7,5$  V  
 Tensione di autoblocco:  $\leq 3$  V

Статич. приточное давление: макс. 10 бар  
 Динам. ударное давление: макс. 45 бар  
 Повышение давления: макс. 60 бар/мс  
 Диапазон допуст. температур:  
 от -55 °C до +140 °C  
 Допуст. колебательное ускорение: 400 м/с<sup>2</sup>  
 Тип защиты по DIN 40 050: IP 60  
 Проходное отверстие седла клапана:  $\varnothing 1,5$   
 Пусковое напряжение:  $\leq 7,5$  В  
 Напряжение самоблокировки:  $\leq 3$  В

## 24 Volt

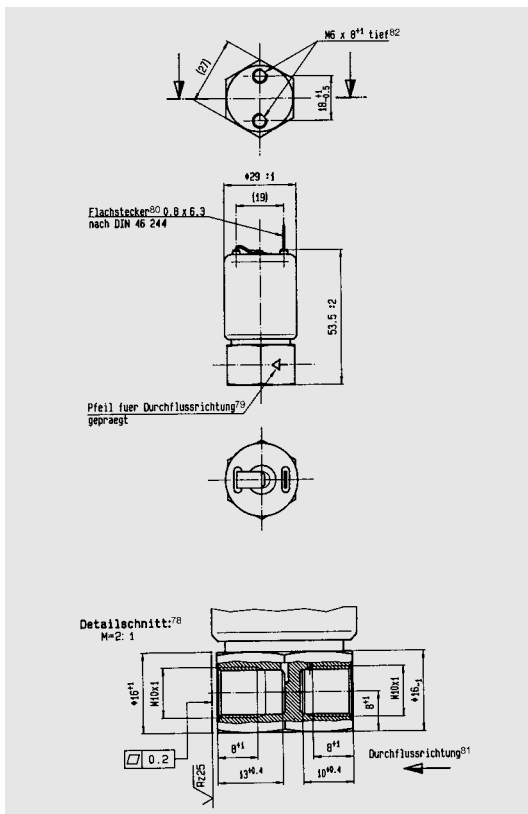

Referencia/Codice/Номер за поръчка 0 210 143 116

## Typ Nr. MV 116

### Características técnicas:

Tensión nominal: 24 V  
 Potencia nominal: 20 W  
 Resistencia de bobina:  $32 \Omega$  a 20 °C  
 Duración de la conmutación: 100 %  
 Funcionamiento de la válvula:  
 sin corriente, cerrada  
 Toma de corriente: monopolar  
 Posición de montaje: discrecional  
 Producto de servicio: gasoil y gasolina  
 Caudal a 20 °C y 500 mm de inclinación:  
 aprox. 4 l/h  
 Presión de alimentación estática: máx. 10 bares

### Dati tecnici:

Tensione nominale: 24 V  
 Potenza nominale: 20 W  
 Resistenza di bobina:  $32 \Omega$  a 20 °C  
 Durata di accensione (ED): 100 %  
 Funzione valvola: chiuso senza corrente  
 Collegamento elettrico: monopolare  
 Posizione di montaggio: a piacere  
 Mezzo di esercizio: carburanti diesel e a benzina  
 Portata a 20 °C e pendo di 500 mm: ca. 4 l/h  
 Pressione statica di alimentazione: max. 10 bar

### Технические данные:

Номинальное напряжение: 24 В  
 Номинальная мощность: 20 Вт  
 Сопротивление катушки: 32 Ом при 20 °C  
 Время включения: 100 %  
 Функция клапана: при отсутствии тока закрыт  
 Электрическое подключение: однополюсное  
 Монтажное положение: любое  
 Рабочая среда: дизельное топливо и топливо двигателей внутреннего сгорания  
 Расход при 20 °C и перепаде высот 500 мм:  
 прил. 4 л/ч

Impulsos dinámicos de presión:  
 máx. 45 bares  
 Incremento de presión: máx. 60 bares/ms  
 Gama de temperaturas permisibles:  
 desde -55 °C hasta +140 °C  
 Aceleración vibratoria permisible: 400 m/s<sup>2</sup>  
 Tipo de protección conforme a DIN 40 050:  
 IP 60  
 Paso en asiento de válvula:  $\varnothing 1,5$   
 Tensión de tiro:  $\leq 7,5$  V  
 Tensión de automantenimiento:  $\leq 3$  V

Colpi di pressione dinamica: max. 45 bar  
 Innalzamento di pressione: max. 60 bar/ms  
 Campo di temperatura ammesso:  
 da -55 °C a +140 °C  
 Accelerazione oscillazioni ammessa: 400 m/s<sup>2</sup>  
 Tipo di protezione secondo DIN 40 050: IP 60  
 Passaggio alla sede valvola:  $\varnothing 1,5$   
 Tensione di serraggio:  $\leq 7,5$  V  
 Tensione di autoblocco:  $\leq 3$  V

Статич. приточное давление: макс. 10 бар  
 Динам. ударное давление: макс. 45 бар  
 Повышение давления: макс. 60 бар/мс  
 Диапазон допуст. температур:  
 от -55 °C до +140 °C  
 Допуст. колебательное ускорение: 400 м/с<sup>2</sup>  
 Тип защиты по DIN 40 050: IP 60  
 Проходное отверстие седла клапана:  $\varnothing 1,5$   
 Пусковое напряжение:  $\leq 7,5$  В  
 Напряжение самоблокировки:  $\leq 3$  В

## 24 Volt

## Typ Nr. MV 111

## Características técnicas:

Tensión nominal: 24 V  
Potencia nominal: 20 W  
Resistencia de bobina:  $32 \pm 2 \Omega$  a 20 °C  
Duración de la conmutación: 100 %  
Funcionamiento de la válvula:  
sin corriente, cerrada  
Toma de corriente: bipolar  
Posición de montaje: discrecional  
Producto de servicio: gasoil y gasolina, JP 4  
Caudal a 20 °C y 500 mm de inclinación:  
aprox. 4 l/h  
Presión de alimentación estática:  
máx. 10 bares

## Dati tecnici:

Tensione nominale: 24 V  
Potenza nominale: 20 W  
Resistenza di bobina:  $32 \pm 2 \Omega$  a 20 °C  
Durata di accensione (ED): 100 %  
Funzione valvola: chiuso senza corrente  
Collegamento elettrico: bipolare  
Posizione di montaggio: a piacere  
Mezzo di esercizio: carburanti diesel e  
a benzina, JP 4  
Portata a 20 °C e pendo di 500 mm: ca. 4 l/h  
Pressione statica di alimentazione: max. 10 bar

## Технические данные:

Номинальное напряжение: 24 В  
Номинальная мощность: 20 Вт  
Сопротивление катушки:  $32 \pm 2 \Omega$  при 20 °C  
Время включения: 100 %  
Функция клапана: при отсутствии тока закрыт  
Электрическое подключение: двухполюсное  
Монтажное положение: любое  
Рабочая среда: дизельное топливо и топливо дв  
игателей внутреннего сгорания, JP 4  
Расход при 20 °C и перепаде высот 500 мм:  
прибл. 4 л/ч  
Статич. приточное давление: макс. 10 бар

Impulsos dinámicos de presión:  
máx. 45 bares  
Incremento de presión: máx. 60 bares/ms  
Gama de temperaturas permisibles:  
desde -55 °C hasta +140 °C  
Aceleración vibratoria permisible: 400 m/s<sup>2</sup>  
Tipo de protección conforme a DIN 40 050: IP  
60  
Paso en asiento de válvula:  $\varnothing 1,5$   
Perforación de la mariposa en la admisión:  
 $\varnothing 0,8$   
Tensión de tiro:  $\leq 7,5$  V  
Tensión de automantenimiento:  $\leq 7$  V

Colpi di pressione dinamici: max. 45 bar  
Innalzamento di pressione: max. 60 bar/ms  
Campo di temperatura ammesso:  
da -55 °C a +140 °C  
Accelerazione oscillazioni ammessa: 400 m/s<sup>2</sup>  
Tipo di protezione secondo DIN 40 050: IP 60  
Passaggio alla sede valvola:  $\varnothing 1,5$   
Foro di regolazione all'alimentazione:  $\varnothing 0,8$   
Tensione di serraggio:  $\leq 7,5$  V  
Tensione di autoblocco:  $\leq 7$  V

Динам. ударное давление: макс. 45 бар  
Повышение давления: макс. 60 бар/мс  
Диапазон допуст. температур:  
от -55 °C до +140 °C  
Допуст. колебательное ускорение: 400 м/с<sup>2</sup>  
Тип защиты по DIN 40 050: IP 60  
Проходное отверстие седла клапана:  $\varnothing 1,5$   
Дроссельное отверстие приточной линии:  
 $\varnothing 0,8$   
Пусковое напряжение:  $\leq 7,5$  В  
Напряжение самоблокировки:  $\leq 7$  В

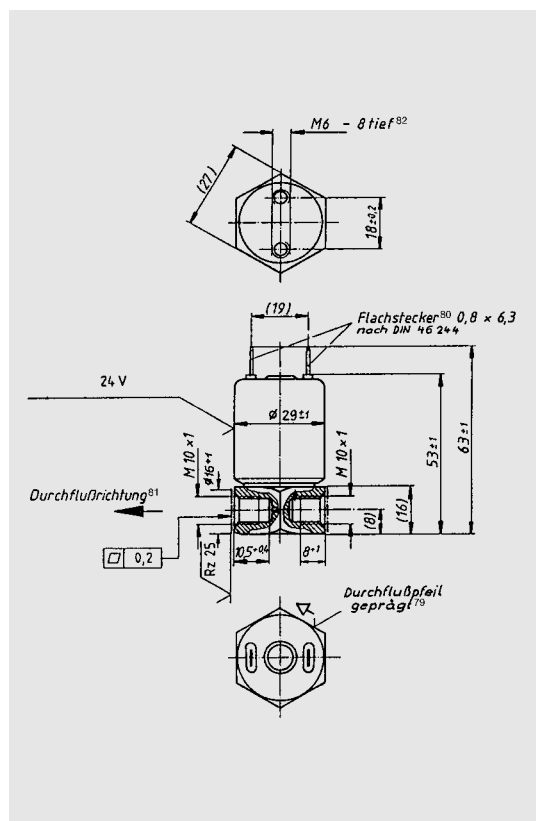

Referencia/Codice/Номер за поръчка 0 210 243 111

## 24 Volt

## Typ Nr. MV 129

## Características técnicas:

Tensión nominal: 24 V  
Potencia nominal: 19 W  
Resistencia de bobina:  $32 \pm 2 \Omega$  a 20 °C  
Duración de la conmutación: máx. 15 min.  
Funcionamiento de la válvula:  
sin corriente, cerrada  
Toma de corriente: bipolar  
Posición de montaje: discrecional  
Producto de servicio: gasoil y gasolina, JP 4  
Caudal a 20 °C y 500 mm de inclinación:  
aprox. 7 l/h  
Presión de alimentación estática:  
máx. 10 bares

## Dati tecnici:

Tensione nominale: 24 V  
Potenza nominale: 19 W  
Resistenza di bobina:  $32 \pm 2 \Omega$  a 20 °C  
Durata di accensione (ED): max. 15 min.  
Funzione valvola: chiuso senza corrente  
Collegamento elettrico: bipolare  
Posizione di montaggio: a piacere  
Mezzo di esercizio: carburanti diesel e  
a benzina, JP 4  
Portata a 20 °C e pendo di 500 mm: ca. 7 l/h  
Pressione statica di alimentazione: max. 10 bar

## Технические данные:

Номинальное напряжение: 24 В  
Номинальная мощность: 19 Вт  
Сопротивление катушки:  $32 \pm 2 \Omega$  при 20 °C  
Время включения: max. 15 мин.  
Функция клапана: при отсутствии тока закрыт  
Электрическое подключение: двухполюсное  
Монтажное положение: любое  
Рабочая среда: дизельное топливо и топливо дв  
игателей внутреннего сгорания, JP 4  
Расход при 20 °C и перепаде высот 500 мм:  
прибл. 7 л/ч  
Статич. приточное давление: макс. 10 бар

Impulsos dinámicos de presión:  
máx. 45 bares  
Incremento de presión: máx. 60 bares/ms  
Gama de temperaturas permisibles:  
desde -55 °C hasta +140 °C  
Aceleración vibratoria permisible: 400 m/s<sup>2</sup>  
Tipo de protección conforme a DIN 40 050:  
IPGK 9K  
Paso en asiento de válvula:  $\varnothing 1,5$   
Perforación de la mariposa en la admisión:  
 $\varnothing 0,8$   
Tensión de tiro:  $\leq 14$  V  
Tensión de automantenimiento:  $\leq 6,5$  V

Colpi di pressione dinamici: max. 45 bar  
Innalzamento di pressione: max. 60 bar/ms  
Campo di temperatura ammesso:  
da -55 °C a +140 °C  
Accelerazione oscillazioni ammessa: 400 m/s<sup>2</sup>  
Tipo di protezione secondo DIN 40 050: IPGK 9K  
Passaggio alla sede valvola:  $\varnothing 1,5$   
Foro di regolazione all'alimentazione:  $\varnothing 0,8$   
Tensione di serraggio:  $\leq 14$  V  
Tensione di autoblocco:  $\leq 6,5$  V

Динам. ударное давление: макс. 45 бар  
Повышение давления: макс. 60 бар/мс  
Диапазон допуст. температур:  
от -55 °C до +140 °C  
Допуст. колебательное ускорение: 400 м/с<sup>2</sup>  
Тип защиты по DIN 40 050: IPGK 9K  
Проходное отверстие седла клапана:  $\varnothing 1,5$   
Дроссельное отверстие приточной линии:  
 $\varnothing 0,8$   
Пусковое напряжение:  $\leq 14$  В  
Напряжение самоблокировки:  $\leq 6,5$  В

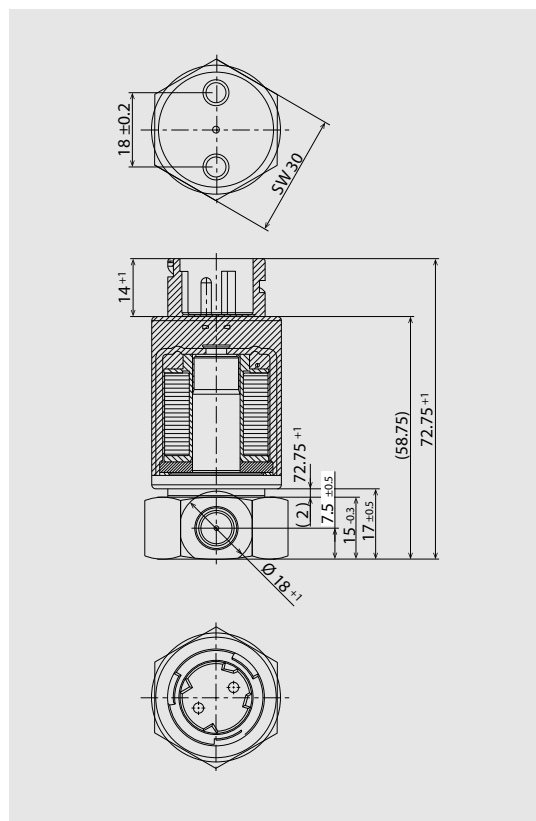

Referencia/Codice/Номер за поръчка 0 210 243 129



## 12 Volt

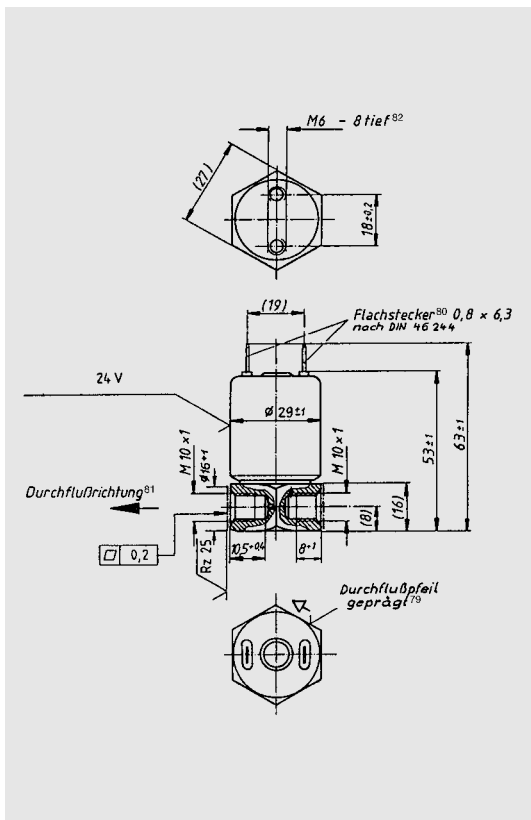

Nr katalogowy/Αρ. Παραγγελίας/Ρendelészám 0 210 142 115

## Typ Nr. MV 115

### Dane techniczne:

Napięcie nominalne: 12 V  
Moc nominalna: 20 W  
Opór cewek:  $8,0 \pm 0,5 \Omega$  przy  $20^\circ\text{C}$   
Czas pracy (ED): 100 %  
Funkcja zaworu: zamknięty przy braku dopływu prądu  
Podłączenie elektryczne: jednobiegunowe  
Polozenie zabudowania: dowolne  
Medium eksploatacyjne: olej napędowy i paliwo gaznikowe, JP 4  
Nateżenie przepływu przy  $20^\circ\text{C}$  oraz spadku 500 mm: ok. 4/h

### Τεχνικά στοιχεία:

Ονομαστική ηλεκτρική τάση: 12 V  
Ονομαστική ισχύς: 20 W  
Αντίσταση πηνίου:  $8,0 \pm 0,5 \Omega$  σε θερμοκρασία  $20^\circ\text{C}$   
Διάρκεια θέσης σε λειτουργία (ED): 100 %  
Λειτουργία βαλβίδας: Κλεισμένη κατά τον μηδενισμό του ηλεκτρικού ρεύματος  
Ηλεκτρική σύνδεση: Ένας πόλος  
Θέση συναρμολόγησης: Άνευ περιορισμών  
Λειτουργικό μέσο: Καύσιμα ντίζελ και ότο  
Ποσότητα διαρροής σε θερμοκρασία  $20^\circ\text{C}$  και σε κλίση 500 mm περίπου 4 l/h  
Στατική πίεση τροφοδότησης: Κατά ανώτατο όριο 10 bar

Statische ciśnienie dopływu: maks. 10 bar  
Dynamiczne uderzenia hydrauliczne: maks. 45 bar  
Wzrost ciśnienia: maks. 60 bar/ms  
Dopuszczalny zakres temperatury: od  $-55^\circ\text{C}$  do  $+140^\circ\text{C}$   
Dopuszczalne przyspieszenie obrotów:  $400 \text{ m/s}^2$   
Rodzaj zabezpieczenia według DIN 40 050, IP 60  
Przelot w gnieździe zaworu  $\varnothing 1,5$   
Napięcie przyciągania:  $\leq 7,5 \text{ V}$   
Napięcie utrzymania:  $\leq 3 \text{ V}$

### Műszaki adatok:

Névleges feszültség: 12 V  
Névleges teljesítmény: 20 W  
Tekercselenállás:  $8 \pm 0,5 \Omega$   $20^\circ\text{C}$ -on  
Viszonylagos bekapcsolási idő: 100 %  
Szelepműködés: árammentes állapotban zárva  
Villamos csatlakozás: egy pólusú  
Beépítési helyzet: tetszőleges  
Üzemi közeg: dízel- és Otto-tüzelőanyagok, JP 4  
Átfolyó mennyiség:  $20^\circ\text{C}$ -on és 0,5 bar túlnyomáson: kb. 4 l/h

Δυναμικές κρούσεις της πίεσης: Κατά ανώτατο όριο 45 bar  
Αύξηση της πίεσης: Κατά ανώτατο όριο 60 bar/ms  
Επιτρεπόμενος τομέας θερμοκρασίας: από  $-55^\circ\text{C}$  μέχρι  $+140^\circ\text{C}$   
Επιτρεπόμενη επιτάχυνση ταλαντώσεων:  $400 \text{ m/s}^2$   
Προστατευτικός τρόπος σύμφωνα με τον κανονισμό DIN 40050: IP 60  
Διάμετρος διαπέρασης στην έδρα της βαλβίδας:  $\varnothing 1,5$   
Τάση σύσφιξης:  $\leq 7,5 \text{ V}$   
Τάση αυτόνομης συγκράτησης:  $\leq 3 \text{ V}$

## 24 Volt

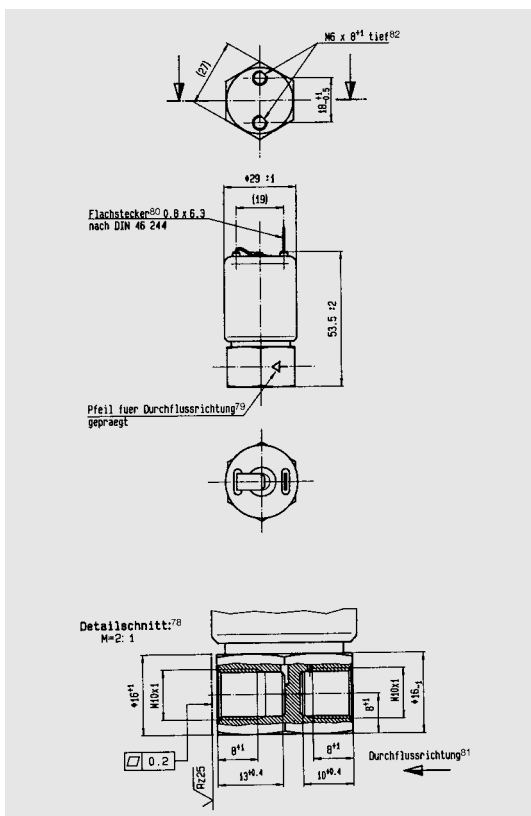

Nr katalogowy/Αρ. Παραγγελίας/Ρendelészám 0 210 143 116

## Typ Nr. MV 116

### Dane techniczne:

Napięcie nominalne: 24 V  
Moc nominalna: 20 W  
Opór cewek:  $32 \Omega$  przy  $20^\circ\text{C}$   
Czas pracy (ED): 100 %  
Funkcja zaworu: zamknięty przy braku dopływu prądu  
Podłączenie elektryczne: jednobiegunowe  
Polozenie zabudowania: dowolne  
Medium eksploatacyjne: olej napędowy i paliwo gaznikowe, JP 4  
Nateżenie przepływu przy  $20^\circ\text{C}$  oraz spadku 500 mm: ok. 4/h

### Τεχνικά στοιχεία:

Ονομαστική ηλεκτρική τάση: 24 V  
Ονομαστική ισχύς: 20 W  
Αντίσταση πηνίου:  $32 \Omega$  σε θερμοκρασία  $20^\circ\text{C}$   
Διάρκεια θέσης σε λειτουργία (ED): 100 %  
Λειτουργία βαλβίδας: Κλεισμένη κατά τον μηδενισμό του ηλεκτρικού ρεύματος  
Ηλεκτρική σύνδεση: Ένας πόλος  
Θέση συναρμολόγησης: Άνευ περιορισμών  
Λειτουργικό μέσο: Καύσιμα ντίζελ και ότο  
Ποσότητα διαρροής σε θερμοκρασία  $20^\circ\text{C}$  και σε κλίση 500 mm περίπου 4 l/h  
Στατική πίεση τροφοδότησης: Κατά ανώτατο όριο 10 bar

Statische ciśnienie dopływu: maks. 10 bar  
Dynamiczne uderzenia hydrauliczne: maks. 45 bar  
Wzrost ciśnienia: maks. 60 bar/ms  
Dopuszczalny zakres temperatury: od  $-55^\circ\text{C}$  do  $+140^\circ\text{C}$   
Dopuszczalne przyspieszenie obrotów:  $400 \text{ m/s}^2$   
Rodzaj zabezpieczenia według DIN 40 050, IP 60  
Przelot w gnieździe zaworu  $\varnothing 1,5$   
Napięcie przyciągania:  $\leq 7,5 \text{ V}$   
Napięcie utrzymania:  $\leq 3 \text{ V}$

### Műszaki adatok:

Névleges feszültség: 24 V  
Névleges teljesítmény: 20 W  
Tekercselenállás:  $32 \Omega$   $20^\circ\text{C}$ -on  
Viszonylagos bekapcsolási idő: 100 %  
Szelepműködés: árammentes állapotban zárva  
Villamos csatlakozás: egy pólusú  
Beépítési helyzet: tetszőleges  
Üzemi közeg: dízel- és Otto-tüzelőanyagok, JP 4  
Átfolyó mennyiség:  $20^\circ\text{C}$ -on és 0,5 bar túlnyomáson: kb. 4 l/h

Δυναμικές κρούσεις της πίεσης: Κατά ανώτατο όριο 45 bar  
Αύξηση της πίεσης: Κατά ανώτατο όριο 60 bar/ms  
Επιτρεπόμενος τομέας θερμοκρασίας: από  $-55^\circ\text{C}$  μέχρι  $+140^\circ\text{C}$   
Επιτρεπόμενη επιτάχυνση ταλαντώσεων:  $400 \text{ m/s}^2$   
Προστατευτικός τρόπος σύμφωνα με τον κανονισμό DIN 40050: IP 60  
Διάμετρος διαπέρασης στην έδρα της βαλβίδας:  $\varnothing 1,5$   
Τάση σύσφιξης:  $\leq 7,5 \text{ V}$   
Τάση αυτόνομης συγκράτησης:  $\leq 3 \text{ V}$

## 24 Volt

## Typ Nr. MV 111

## Dane techniczne:

Napięcie nominalne: 24 V  
 Moc nominalna: 20 W  
 Opór cewek:  $32 \pm 2 \Omega$  przy 20 °C  
 Czas pracy (ED): 100 %  
 Funkcja zaworu: zamknięty przy braku dopływu prądu  
 Podłączenie elektryczne: dwubiegunowe  
 Położenie zabudowania: dowolne  
 Medium eksploatacyjne: olej napędowy i paliwo gaznikowe, JP 4  
 Natężenie przepływu przy 20 °C oraz spadku 500 mm: ok. 4/h  
 Statyczne ciśnienie dopływu: maks. 4 bar

Dynamiczne uderzenia hydrauliczne: maks. 45 bar  
 Wzrost ciśnienia: maks. 60 bar/ms  
 Dopuszczalny zakres temperatury: od -55 °C do +140 °C  
 Dopuszczalne przyspieszenie obrotów: 400 m/s<sup>2</sup>  
 Rodzaj zabezpieczenia według DIN 40 050, IP 60  
 Przelot w gnieździe zaworu  $\varnothing 1,5$   
 Otwór dławicy na dopływie:  $\varnothing 0,8$   
 Napięcie przyciągania:  $\leq 7,5$  V  
 Napięcie utrzymania:  $\leq 7$  V

## Τεχνικά στοιχεία:

Ονομαστική ηλεκτρική τάση: 24 V  
 Ονομαστική ισχύς: 20 W  
 Αντίσταση πηνίου:  $32 \pm 2 \Omega$  σε θερμοκρασία 20 °C  
 Διάρκεια θέσης σε λειτουργία (ED): 100 %  
 Λειτουργία βαλβίδας: Κλεισμένη κατά τον μηδενισμό του ηλεκτρικού ρεύματος  
 Ηλεκτρική σύνδεση: Δύο πόλοι  
 Θέση συναρμολόγησης: Άνευ περιορισμών  
 Λειτουργικό μέσο: Καύσιμα ντίζελ και ότο, JP 4  
 Ποσότητα διαρροής σε θερμοκρασία 20 °C και σε κλίση 500 mm περίπου 4 l/h  
 Στατική πίεση τροφοδότησης: Κατά ανώτατο όριο 10 bar  
 Δυναμικές κρούσεις της πίεσης: Κατά ανώτατο όριο 45 bar

Αύξηση της πίεσης: Κατά ανώτατο όριο 60 bar/ms  
 Επιτρεπόμενος τομέας θερμοκρασίας: από -55 °C μέχρι +140 °C  
 Επιτρεπόμενη επιτάχυνση ταλαντώσεων: 400 m/s<sup>2</sup>  
 Προστατευτικός τρόπος σύμφωνα με τον κανονισμό DIN 40050: IP 60  
 Διάμετρος διαπέρασης στην έδρα της βαλβίδας:  $\varnothing 1,5$   
 Οπή στραγγαλισμού στο σημείο της τροφοδότησης:  $\varnothing 0,8$   
 Τάση σύσφιξης:  $\leq 7,5$  V  
 Τάση αυτόνομη συγκράτησης:  $\leq 7$  V

## Műszaki adatok:

Névleges feszültség: 24 V  
 Névleges teljesítmény: 20 W  
 Tekercsellállás:  $32 \pm 2 \Omega$  20 °C-on  
 Viszonylagos bekapcsolási idő: 100 %  
 Szелеpműködés: árammentes állapotban zárva  
 Villamos csatlakozás: kétpólusú  
 Beépítési helyzet: tetszőleges  
 Üzemi közeg: dízel- és Otto-tűzelőanyagok, JP 4  
 Átfolyó mennyiség: 20 °C-on és 0,5 bar túlnyomáson: kb. 4 l/h  
 Statikus bemenőoldali nyomás: max. 10 bar

Dinamikus terhelhetőség: max. 45 bar  
 Nyomásfelfutás: max. 60 bar/ms  
 Megengedett hőmérséklet: -55 °C és +140 °C között  
 Megengedett rezgőgyorsulás: 400 m/s<sup>2</sup>  
 Érintésvédelem: DIN 40 050, IP 60 szerint  
 Átmenőfurat a szeleplülésnél:  $\varnothing 1,5$   
 Bemeneti fojtófurat:  $\varnothing 0,8$   
 Megszólalási feszültség:  $\leq 7,5$  V  
 Őntartó feszültség:  $\leq 7$  V

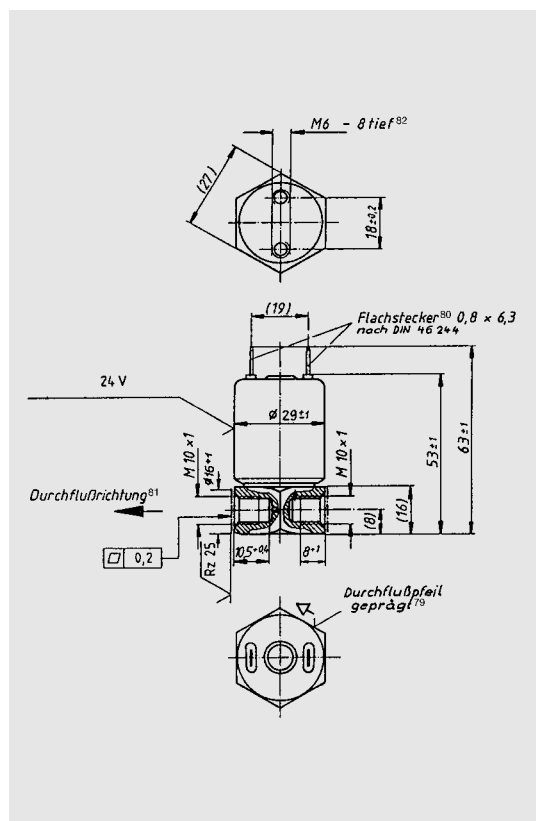

Nr katalogowy/Ap. Παράγγελία/Rendelészám 0 210 243 111

## 24 Volt

## Typ Nr. MV 129

## Dane techniczne:

Napięcie nominalne: 24 V  
 Moc nominalna: 19 W  
 Opór cewek:  $32 \pm 2 \Omega$  przy 20 °C  
 Czas pracy (ED): max. 15 min.  
 Funkcja zaworu: zamknięty przy braku dopływu prądu  
 Podłączenie elektryczne: dwubiegunowe  
 Położenie zabudowania: dowolne  
 Medium eksploatacyjne: olej napędowy i paliwo gaznikowe, JP 4  
 Natężenie przepływu przy 20 °C oraz spadku 500 mm: ok. 7/h  
 Statyczne ciśnienie dopływu: maks. 10 bar

Dynamiczne uderzenia hydrauliczne: maks. 45 bar  
 Wzrost ciśnienia: maks. 60 bar/ms  
 Dopuszczalny zakres temperatury: od -55 °C do +140 °C  
 Dopuszczalne przyspieszenie obrotów: 400 m/s<sup>2</sup>  
 Rodzaj zabezpieczenia według DIN 40 050, IPGK 9K  
 Przelot w gnieździe zaworu  $\varnothing 1,5$   
 Otwór dławicy na dopływie:  $\varnothing 0,8$   
 Napięcie przyciągania:  $\leq 14$  V  
 Napięcie utrzymania:  $\leq 6,5$  V

## Τεχνικά στοιχεία:

Ονομαστική ηλεκτρική τάση: 24 V  
 Ονομαστική ισχύς: 19 W  
 Αντίσταση πηνίου:  $32 \pm 2 \Omega$  σε θερμοκρασία 20 °C  
 Διάρκεια θέσης σε λειτουργία (ED): max. 15 min.  
 Λειτουργία βαλβίδας: Κλεισμένη κατά τον μηδενισμό του ηλεκτρικού ρεύματος  
 Ηλεκτρική σύνδεση: Δύο πόλοι  
 Θέση συναρμολόγησης: Άνευ περιορισμών  
 Λειτουργικό μέσο: Καύσιμα ντίζελ και ότο, JP 4  
 Ποσότητα διαρροής σε θερμοκρασία 20 °C και σε κλίση 500 mm περίπου 7 l/h  
 Στατική πίεση τροφοδότησης: Κατά ανώτατο όριο 10 bar  
 Δυναμικές κρούσεις της πίεσης: Κατά ανώτατο όριο 45 bar

Αύξηση της πίεσης: Κατά ανώτατο όριο 60 bar/ms  
 Επιτρεπόμενος τομέας θερμοκρασίας: από -55 °C μέχρι +140 °C  
 Επιτρεπόμενη επιτάχυνση ταλαντώσεων: 400 m/s<sup>2</sup>  
 Προστατευτικός τρόπος σύμφωνα με τον κανονισμό DIN 40050: IPGK 9K  
 Διάμετρος διαπέρασης στην έδρα της βαλβίδας:  $\varnothing 1,5$   
 Οπή στραγγαλισμού στο σημείο της τροφοδότησης:  $\varnothing 0,8$   
 Τάση σύσφιξης:  $\leq 14$  V  
 Τάση αυτόνομη συγκράτησης:  $\leq 6,5$  V

## Műszaki adatok:

Névleges feszültség: 24 V  
 Névleges teljesítmény: 19 W  
 Tekercsellállás:  $32 \pm 2 \Omega$  20 °C-on  
 Viszonylagos bekapcsolási idő: max. 15 min.  
 Szелеpműködés: árammentes állapotban zárva  
 Villamos csatlakozás: kétpólusú  
 Beépítési helyzet: tetszőleges  
 Üzemi közeg: dízel- és Otto-tűzelőanyagok, JP 4  
 Átfolyó mennyiség: 20 °C-on és 0,5 bar túlnyomáson: kb. 7 l/h  
 Statikus bemenőoldali nyomás: max. 10 bar

Dinamikus terhelhetőség: max. 45 bar  
 Nyomásfelfutás: max. 60 bar/ms  
 Megengedett hőmérséklet: -55 °C és +140 °C között  
 Megengedett rezgőgyorsulás: 400 m/s<sup>2</sup>  
 Érintésvédelem: DIN 40 050, IPGK 9K szerint  
 Átmenőfurat a szeleplülésnél:  $\varnothing 1,5$   
 Bemeneti fojtófurat:  $\varnothing 0,8$   
 Megszólalási feszültség:  $\leq 14$  V  
 Őntartó feszültség:  $\leq 6,5$  V

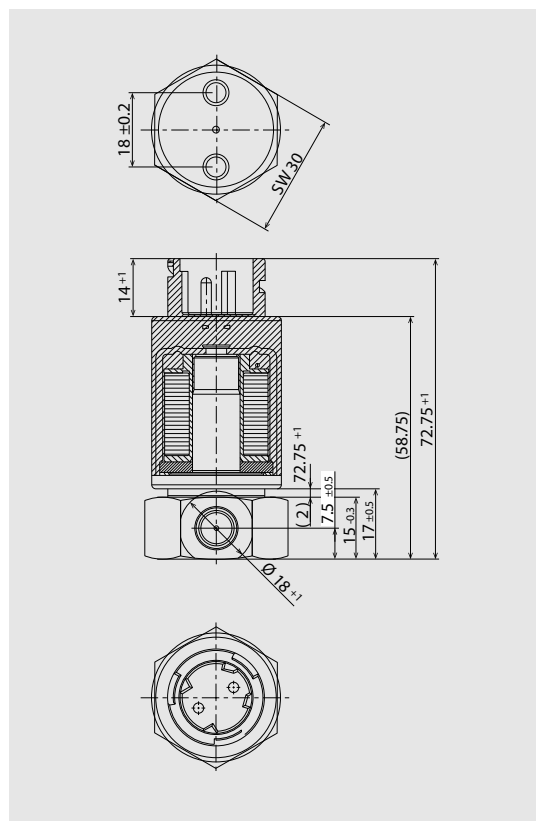

Nr katalogowy/Ap. Παράγγελία/Rendelészám 0 210 243 129

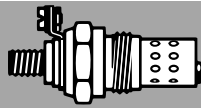

# 12 Volt-Anlage<sup>84</sup>

## Stab-Flamm-Glühkerzen für Magnetventilsteuerung<sup>65</sup>



1



2

										V	A	
					Nm	Nm max.	Nm max.					
2	<b>GF 006</b> 0 101 223 461	96	46	M 20 x 1,5	21/24	20	M 5	3	6	12	20	Iveco
1	<b>GF 683</b> 0 101 223 454	92	41	M 20 x 1,5	21/24	20	M 5	3	9	9,5	21	Iveco
2	<b>GF 831</b> 0 101 223 603	92	41	UNF 7/8-14	22/27	20	M 5	3	9,4	11	28	Universal
2	<b>GF 972</b> 0 101 223 457	96	46	M 20 x 1,5	21/24	20	M 5	3	8,0	12	29	Universal
2	<b>GF 973</b> 0 101 223 456	96	46	M 20 x 1,5	21/24	20	M 5	3	6,0	12	29	Cummins
2	<b>GF 974</b> 0 101 223 459	96	46	M 20 x 1,5	21/24	20	M 5	3	9,4	12	29	Iveco
2	<b>GF 984</b> 0 101 223 449	92	41	M 20 x 1,5	21/24	20	M 5	5	9,4	11	29	Opel

<sup>20</sup> solange Vorrat reicht



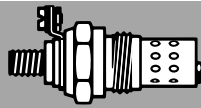

## 24 Volt-Anlage<sup>85</sup>

### Stab-Flamm- Glühkerzen für Magnetventil- steuerung<sup>65</sup>



1



2

									cm <sup>3</sup> /min. → 1,5 bar	V	A		
					Nm	Nm max.	Nm	Nm max.					
2	<b>GF 002</b> 0 101 233 499	100	46	M 20 x 1,5	21/24	20		M 5	3	7,0	23,5	14	Mercedes
2	<b>GF 007</b> 0 101 233 493	96	46	M 20 x 1,5	21/24	20		M 5	3	11,9	24	13	Universal
2	<b>GF 111</b> 0 101 233 403	92	41	M 20 x 1,5	22/24	20		M 5	3	7,6	19	11,5	Universal
1	<b>GF 167</b> 0 101 233 401	92	41	M 20 x 1,5	22/24	20		M 5	3	10,8	19	12	KHD
1	<b>GF 630</b> 0 101 233 413	93	41	M 20 x 1,5	22/24	20		M 5	3	11,8	19	12	KHD
1	<b>GF 777<sup>20</sup></b> 0 101 233 450	92	41	M 20 x 1,5	21/24	20		M 5	3	16	23	14	Universal
1	<b>GF 830</b> 0 101 233 601	92	41	UNF 7/8-14	22/27	20		M 5	3	9,4	23	14	Universal
2	<b>GF 975</b> 0 101 233 480	96	46	M 20 x 1,5	21/24	20		M 5	3	6	24	14	Universal
2	<b>GF 976</b> 0 101 233 481	96	46	M 20 x 1,5	21/24	20		M 5	3	P6	24	13	Cummins

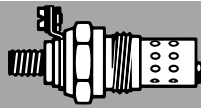

## 24 Volt-Anlage<sup>85</sup>

### Stab-Flamm-Glühkerzen für Magnetventilsteuerung<sup>65</sup>



1



2

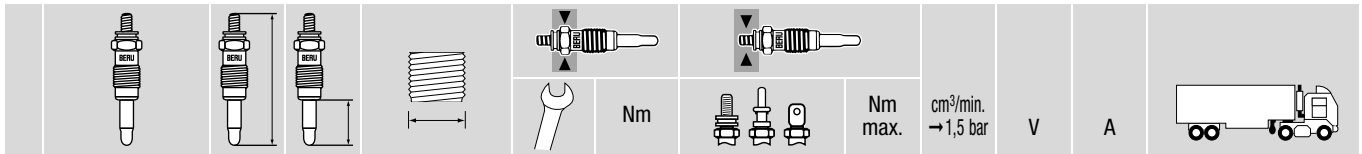

#### 2-Stab-Typen<sup>83</sup>

1	<b>GF 529</b> 0 101 234 529	104,5	33	M 32 x 1,5	27/36	25	M 5	5	13,2	24	28	Universal	
1	<b>GF 667</b> 0 101 234 504	102	54	M 32 x 1,5	27/36	20	M 5	3	23,7	19	23	Universal	
1	<b>GF 817</b> 0 101 234 513	115	54	M 32 x 1,5	27/36	20	M 5	3		23	22	Universal	

2	<b>GF 977</b> 0 101 233 483	96	46	M 20 x 1,5	21/24	20	M 5	3	11,9	24	14	Iveco
2	<b>GF 978</b> 0 101 233 486	96	46	M 20 x 1,5	21/24	20	M 5	3	9,4	24	14	Iveco
2	<b>GF 979</b> 0 101 233 487	96	46	M 20 x 1,5	21/24	20	M 5	3	14,3	24	14	Iveco
2	<b>GF 980</b> 0 101 233 488	96	46	M 20 x 1,5	21/24	20	M 5	3	20,8	24	14	Iveco
2	<b>GF 981</b> 0 101 233 489	96	46	M 20 x 1,5	21/24	20	M 5	3	16,0	24	14	Iveco

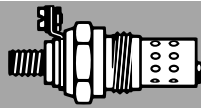

# Wendel-Flamm-Glühkerzen<sup>72</sup>

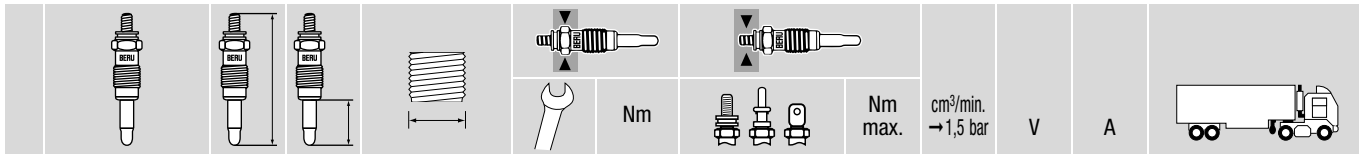
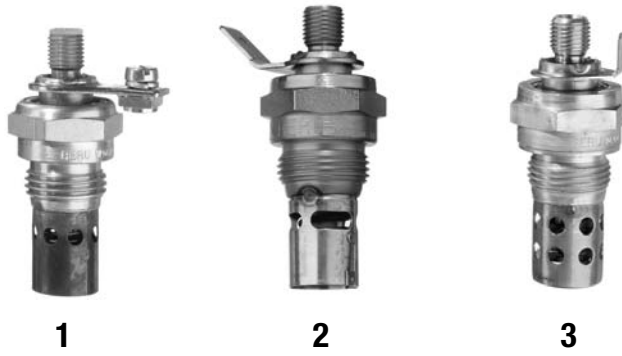

## Mit temperaturbedingter Kraftstoffsteuerung (Bimetallventil)<sup>58</sup>

<b>1</b>	<b>GF 154</b> 0 101 072 603	62	32	UNF 7/8-142A	24	20	9,5 mm		–	12	18	Universal
<b>2</b>	<b>GF 859</b> 0 101 072 405	64,5	33	M 22 x 1,5	26	20	9,5 mm		–	8	16	Universal
<b>2</b>	<b>GF 982</b> 0 101 072 408	64,5	33	M 22 x 1,5	26	20	9,5 mm		15,3	8	–	Ford
<b>2</b>	<b>GF 983</b> 0 101 072 409	64,5	33	M 22 x 1,5	26	20	9,5 mm		10,1	8	–	Ford

## Für Magnetventilsteuerung<sup>39</sup>

<b>3</b>	<b>GF 163</b> 0 101 022 404	63	31,5	M 20 x 1,5	26	20	6,3 mm		–	13	18	Eberspächer
<b>3</b>	<b>GF 186</b> 0 101 022 405	63	31,5	M 20 x 1,5	26	20	6,3 mm		–	13	18	Eberspächer

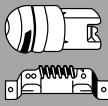

## Vorschalt-Widerstände für Glühkerzen<sup>70</sup>

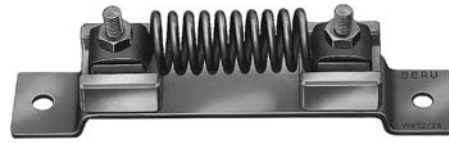
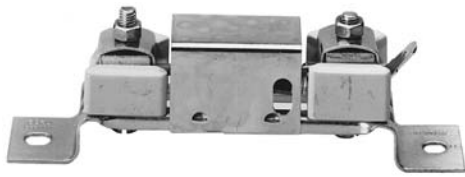

Typ	Bestell-Nr. <sup>26</sup>	V	A ca.	$\Omega$	L	H	B	l	d	KA
-----	---------------------------	---	----------	----------	---	---	---	---	---	----

### Gekapselt mit Bi-Metall-Kontakt<sup>42</sup>

BW 38/23/1	0 110 211 003	3,8	23	1,165	126	39	26	110	6,6	62
BW 45/12/1	0 110 210 001	4,5	12	–	126	39	26	110	6,6	62
BW 45/23/1 <sup>20</sup>	0 110 211 002	4,5	23	0,195	126	39	26	110	6,6	62

### Gekapselt, Anschl. berührungssicher<sup>41</sup>

WU 30/15	0 110 020 015	3	15	0,2	126	41	30	110	6,6	62
WU 45/15	0 110 020 016	4,5	15	0,3	126	41	30	110	6,6	62

### Ungekapselt<sup>69</sup>

WT 155/38	0 110 041 001	15,5	38	0,40	127	42	25	–	6,5	–
-----------	---------------	------	----	------	-----	----	----	---	-----	---

## Glühkerzenzubehör und Ersatzteile<sup>47</sup>



**GDS 3**  
1 102 000 003

**Druckhülse<sup>33</sup>**  
Metallkappe verstärkt<sup>57</sup>



**BEN 2013-A**  
1 103 000 001

**Rändelmutter<sup>60</sup>**  
→ Stabglühkerzen  
zweipolig<sup>75</sup>

**M 26 × 1**



1 112 600 001  
→ KOS, KOSK, KOB,  
KOBs, KOBs/1

**Deckel<sup>29</sup>**

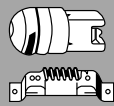

## Glühüberwacher<sup>48</sup>

**KOBS**



**KOS**



Typ	Bestell-Nr. <sup>26</sup>	V	A	Ω
<b>Gewindebefestigung M 26 × 1</b>				
KOBS	0 110 101 001	1,7	38	0,045
KOBS 065/52	0 110 102 001	0,65	52	0,0125
KOBS 1	0 110 101 002	1,7	38	0,045
KOS 08/50	0 110 102 009	0,8	55	0,014
KOS 11/20 <sup>20</sup>	0 110 100 004	1,1	20	0,055
KOS 17	0 110 101 008	1,7	38	0,045
KOS 25/22/1 <sup>20</sup>	0 110 101 015	2,2	22	0,114
KOSK 08/45	0 110 102 012	0,8	45	0,0178
KOSK 15/10	0 110 100 008	1,2	10	0,120
KOSK 15/20	0 110 100 009	1,1	20	0,055
KOSK 17	0 110 101 016	1,7	38	0,045

## Glühanlaßschalter<sup>46</sup>



**1**



**2**

		Typ/Bestell-Nr.	
<b>1</b>		<b>AK 167 A</b> 0 200 100 017	für Lastwagen, Omnibusse usw. <sup>38</sup>
		<b>AK 167 SK</b> 0 200 100 016	für Schlepper mit Gewindebefestigung <sup>40</sup>
		2 905 390 001	Ersatzknopf aus Bakelit <sup>35</sup>
<b>2</b>		<b>AK 167 j</b> 0 200 100 009	IHC



				Nm		
UXT 1 (UXF 79)		0 002 335 606	25	406		
UXT 2 (UX 79)		0 002 335 607	25	406		
UXT 3 (UXF 79 P)		0 002 335 928	25	406		
UXT 4 (UXK 79)		0 002 635 601	15	406		
UXT 5 (UXF 56)		0 002 345 606	25	406		
UXT 6 (UX 79 P)		0 002 335 929	25	406		
UXT 7		0 002 635 900	15	406		
UXT 8		0 002 635 901	15	406		
UXT 9		0 002 335 930	25	406		
UXT 10		0 002 335 931	25	406		
UXT 11		0 002 335 932	25	406		
UXT 12		0 002 345 902	25	406		
UXT 13		0 002 335 934	25	406		
UXT 14		0 002 345 903	25	406		
UXT 15		0 002 640 909	15	406		



				Nm		
UXT 1 SB (UXF 79)		0 900 004 153	25	406		
UXT 2 SB (UX 79)		0 900 004 154	25	406		
UXT 3 SB (UXF 79 P)		0 900 004 155	25	406		
UXT 4 SB (UXK 79)		0 900 004 156	15	406		
UXT 5 SB (UXF 56)		0 900 004 157	25	406		
UXT 6 SB (UX 79 P)		0 900 004 158	25	406		
UXT 7 SB		0 900 004 159	15	406		
UXT 8 SB		0 900 004 160	15	406		
UXT 9 SB		0 900 004 161	25	406		
UXT 10 SB		0 900 004 162	25	406		
UXT 11 SB		0 900 004 163	25	406		
UXT 12 SB		0 900 004 164	25	406		
UXT 13 SB		0 900 004 165	25	406		
UXT 14 SB		0 900 004 166	25	406		
UXT 15 SB		0 900 004 167	15	406		



				Nm		
UX 56		0 002 345 600	25	424		
UXK 56		0 002 645 600	15	427		



				Nm		
UX 56 SB		0 900 004 114	25	424		
UXK 56 SB		0 900 004 118	15	427		



				Nm		
Z 1	14-8 DU	0 001 330 702	25	423		
Z 2	14-8 DTU	0 001 330 709	25	423		
Z 3	14-8 LUR	0 001 330 718	25	424		
Z 4	14 F-8 LUR	0 001 330 717	25	413		
Z 5	14 F-8 DUO	0 001 330 725	25	413		
Z 6	14 K-8 DU	0 001 630 700	15	425		



				Nm		
Z 7	14 K-8 DUO	0 001 630 704	15	425		
Z 8	14 R-8 DU	0 002 330 701	25	421		
Z 9	14 R-8 DUX	0 002 330 702	25	421		
Z 10	14-7 BU	0 001 435 700	25	423		
Z 11	14-7 DU	0 001 335 702	25	423		
Z 12	14-7 DTU	0 001 335 709	25	423		
Z 13	14 F-7 DUOR	0 001 335 729	25	412		
Z 14	14 F-7 LDUR	0 001 335 732	25	413		
Z 15	14 FR-7 DU	0 002 335 707	25	417		
Z 16	14 FR-7 DUX	0 002 335 708	25	417		
Z 17	14 K-7 DU	0 001 635 700	15	425		
Z 18	14 K-7 DUO	0 001 635 709	15	425		
Z 19	14 R-7 BU	0 002 435 701	25	421		
Z 20	14 R-7 DU	0 002 335 701	25	421		
Z 21	14 R-7 DUX	0 002 335 706	25	421		
Z 22	14-6 DU	0 001 340 702	25	422		
Z 24	14 FR-6 DU	0 002 340 702	25	416		
Z 25	14 K-6 DU	0 001 640 700	15	425		
Z 26	14 KR-6 DU	0 002 640 700	15	426		
Z 27	14 R-6 DU	0 002 340 701	25	421		
Z 28	14 R-6 DUX	0 002 340 703	25	421		
Z 29	14 F-5 DU	0 001 345 720	25	412		
Z 30	14 FR-5 DU	0 002 345 702	25	415		
Z 31	14 K-5 DU	0 001 645 700	15	425		
Z 32	18 K-7 BU	0 001 735 700	20	427		
Z 33	18 K-6 BU	0 001 740 700	20	427		
Z 37	14 Z-3 AU	0 001 455 702	25	422		
Z 38	14 Z-3 CU	0 001 355 700	25	422		
Z 39	14 Z-4 AU	0 001 450 702	25	422		
Z 40	14-5 AU	0 001 445 702	25	422		
Z 41	14-5 BU	0 001 445 700	25	422		
Z 42	14-5 DU	0 001 345 702	25	422		
Z 44	14-5 DTU	0 001 345 704	25	422		
Z 45	14 FR-5 DTU	0 002 345 704	25	415		
Z 46	14 K-5 DUO	0 001 645 703	15	425		
Z 47	14 R-5 DU	0 002 345 701	25	420		
Z 48	14-6 BU	0 001 440 700	25	422		
Z 49	14 KR-6 BU	0 002 640 701	15	426		
Z 51	14-6 DTU	0 001 340 704	25	422		
Z 52	14 F-6 DTU	0 001 340 706	25	412		
Z 53	14 F-6 DTU	0 001 340 717	25	412		
Z 55	14 K-6 DUO	0 001 640 704	15	425		
Z 56	14 K-6 DUO	0 001 640 705	15	425		
Z 57	14-7 AU	0 001 435 705	25	423		
Z 58	14-7 CU	0 001 335 707	25	423		
Z 59	14 R-7 CU	0 002 335 704	25	421		
Z 60	14 FGR-7 CTU	0 002 335 100	25	415		
Z 61	14-7 DUO	0 001 335 714	25	423		
Z 62	14-7 DUO	0 001 335 737	25	423		
Z 63	14 F-7 DU	0 001 335 725	25	412		
Z 67	14 KR-7 DUX	0 002 635 701	15	426		
Z 68	14-8 AU	0 001 430 701	25	423		
Z 69	14-8 DUO	0 001 330 713	25	424		
Z 70	14-8 DUO	0 001 330 726	25	424		
Z 72	14 FR-8 DU	0 002 330 703	25	418		
Z 73	14 FR-8 DUX	0 002 330 704	25	419		
Z 74	14 FR-8 LDUOX4	0 002 330 710	25	419		
Z 75	14 G-8 DTU	0 001 330 104	25	420		
Z 76	14-9 DU	0 001 325 701	25	424		
Z 78	14-9 DTU	0 001 325 710	25	424		
Z 79	14 F-9 DUO	0 001 325 705	25	413		
Z 80	14 K-9 DU	0 001 625 700	15	426		
Z 81	14 K-9 DUO	0 001 625 702	15	426		
Z 82	14 R-9 DU	0 002 325 700	25	421		

**ultra**

Nm



Z 85	14-X AU	0 001 400 701	25	424
Z 89	14 FGH-6 DTUR	0 001 340 103	25	413
Z 90	14 FGH-7 DTURX	0 001 335 107	25	413
Z 91	14 GH-7 DTUR	0 001 335 108	25	420
Z 92	14 GH-8 DTUR	0 001 330 113	25	420
Z 93	14 GH-8 DTURX	0 001 330 112	25	420
Z 94	14 GR-8 DTU	0 002 330 706	25	420
Z 95	14 KR-7 DU	0 002 635 700	15	426
Z 97	14 KR-8 MPX	0 002 640 900	15	436
Z 98	14 FR-7 LDU	0 002 335 500	25	418
Z 99	14 FR-6 DUX	0 002 340 704	25	416
Z 100	14 F-8 DU4	0 001 330 731	25	413
Z 101	14 F-8 LDU SR	0 001 330 501	25	413
Z 104	14-6 DPO	0 001 340 903	25	435
Z 105	14 F-6 DSR	0 001 340 806	25	437
Z 108	G 3/18	0 001 700 901	25	438
Z 109	KP105 DU	0 004 021 601	-	438
Z 110	EBE 514	0 004 500 400	-	438
Z 111	14 C-7 D	0 003 335 401	25	437
Z 112	14-8 E	0 001 529 302	25	424
Z 116	14 FR-6 LDU	0 002 340 500	25	416
Z 117	14 KR-9 DUX	0 002 625 700	15	427
Z 118	14-8 BU	0 001 430 700	25	423
Z 119	14 R-8 DU4	0 002 330 709	25	421
Z 120	14 FGH-7 DTURXO	0 001 335 110	25	414
Z 121	14 FGH-8 DTURXO	0 001 330 116	25	414
Z 122	14 FGH-8 DPURX2	0 001 330 904	25	431
Z 123	14 FR-7 KDU	0 002 335 709	25	417
Z 126	14 FGH-8 DTUR	0 001 330 117	25	414
Z 127	14 KGR-7 KQU	0 002 635 100	15	426
Z 128	14 FG-8 DTU	0 001 330 105	25	413
Z 129	14 FGR-6 KQU	0 002 340 101	25	415
Z 130	14 FR-5 DPUX	0 002 335 901	25	431
Z 132	14 S-7 F	0 004 535 402	25	437
Z 144	14 KGR-6 KQU	0 002 640 100	15	426
Z 145	14 FGR-6 DDU	0 002 340 102	25	414
Z 148	14 KR-8 DPUOV	0 002 630 900	15	436
Z 149	14 FR-7 KPUX	0 002 335 902	25	433
Z 150	14 FR-7 KPUV	0 002 335 903	25	433
Z 151	14 FR-7 KPU	0 002 335 904	25	433
Z 152	14 FR-8 HU	0 002 330 712	25	419
Z 153	14 FR-8 KU	0 002 330 713	25	419
Z 154	14 FR-8 KUO	0 002 330 714	25	419
Z 155	14 FR-7 KU	0 002 335 712	25	417
Z 156	14 FR-7 KUO	0 002 335 713	25	417
Z 157	14 FR-7 KUOX	0 002 335 714	25	418
Z 158	14 FR-7 LUX	0 002 335 715	25	418
Z 159	14 FR-6 DPUX	0 002 340 903	25	432
Z 170	14 F-7 DPURU2	0 001 335 919	25	430
Z 171	14 F-7 DPURX2	0 001 335 910	25	430
Z 172	14 FGR-7 KQU	0 002 335 104	25	415
Z 173	14 FGR-8 KQU	0 002 330 102	25	415
Z 174	14 K-9 BU	0 001 625 705	15	425
Z 175	18 K-9 BU	0 001 725 700	20	427
Z 176	14 F-7 HPURX2	0 001 335 911	25	430
Z 177	14 KR-8 MUV	0 002 630 701	15	427
Z 183	14 FR-8 MU2	0 002 330 718	25	420
Z 184	14 FR-7 MU2	0 002 335 719	25	418
Z 185	14 F-6 DPUR021	0 001 340 908	25	430
Z 188	14 F-7 DPUR02	0 001 335 914	25	430
Z 190	14 FGR-8 DQU7	0 002 330 104	25	415
Z 192	14 FR-5 LDU	0 002 345 501	25	416
Z 193	14 FR-7DU2	0 002 335 717	25	417
Z 194	14 FR-6 LDU3	0 002 340 501	25	416

**ultra**

Nm



Z 198	14 FR-5 LDU3	0 002 345 504	25	416
Z 199	10 FR-4 AU	0 002 150 700	12	411
Z 200	14 F-7 HUR2	0 001 335 742	25	412
Z 203	14 FR-8 LU2	0 002 330 794	25	419
Z 204	14 FGR-8 CTU	0 002 340 117	25	415
Z 206	14 FR-7 DPPUS2	0 002 335 940	25	432
Z 207	14 KG-8 DTU	0 001 630 101	15	426
Z 208	14 FR-8 LDU3	0 002 330 795	25	419
Z 209	14 KR-6 DPUV02	0 002 640 904	15	436
Z 210	10 FR-6 CPU03	0 002 140 900	12	428
Z 211	14 FGR-8 MQPU	0 002 330 902	25	431
Z 213	14 FGR-7 KDU6	0 002 335 128	25	415
Z 216	14 KR-10 SUV2	0 002 620 708	15	426
Z 219	14 FR-8 MPUX02	0 002 330 904	25	434
Z 220	14 FR-9 KUX2	0 002 325 723	25	420
Z 221	14 FR-6 DPUX02	0 002 340 905	25	432
Z 222	14 KR-8 STUX	0 002 630 715	15	427
Z 223	14 FR-8 NQU23	0 002 330 796	25	420
Z 224	14 FR-7 DPU3	0 002 335 912	25	433
Z 225	14 FR-7 HUX	0 002 336 715	25	417
Z 226	14 FR-6 MPU2	0 002 340 906	25	432
Z 227	14 F-8 DUR	0 001 330 780	25	413
Z 228	14 FR-7 DPUX02	0 002 335 914	25	433
Z 229	14 FR-8 LPO	0 002 330 903	25	434
Z 230	14 KR-6 KPUV02	0 002 640 907	15	436
Z 231	14 FR-4 DPU	0 002 350 901	25	431
Z 232	14 F-7 DPUR2	0 001 335 907	25	430
Z 233	12 ZR-6 SP03	0 002 240 902	20	428
Z 234	12 FR-7 DU	0 002 235 700	20	411
Z 235	14 FR-7 SPUX03	0 002 335 915	25	434
Z 236	14 F-6 HTPRX02	0 001 340 910	25	430
Z 237	14 FR-7 DQUP7	0 002 335 911	25	433
Z 238	14 FR-8 DPU2	0 002 330 905	25	434
Z 239	14 FGR-7 KQE	0 002 335 131	25	415
Z 240	14 F-8 DPURX02	0 001 330 905	25	431
Z 242	12 ZR-8 TP	0 002 230 900	20	429
Z 243	12 VR-8 SE	0 002 230 300	20	411
Z 245	14 FR-6 LDUW	0 002 340 504	25	416
Z 246	14 FGH-8 DTURW	0 001 330 119	25	414
Z 247	14 FR-7 DUW	0 002 336 724	25	417
Z 248	14 FR-8 HUT	0 002 330 203	25	419
Z 249	14 FR-8 KUOU	0 002 330 204	25	419
Z 250	14 FR-7 DU2S	0 002 336 725	25	417
Z 251	14 FR-7 DU2T	0 002 336 726	25	417
Z 252	14 FR-6 DUW	0 002 340 768	25	416
Z 253	14 FR-5 DUU	0 002 345 731	25	416
Z 254	14 FR-8 DUS	0 002 330 205	25	418
Z 255	14 FR-8 DUW	0 002 330 206	25	419
Z 257	14 FR-7 LDUW	0 002 335 503	25	418
Z 260	14 SR-5 F	0 004 545 400	25	438
Z 261	14 SR-10 E0	0 004 520 300	25	438
Z 262	14 S-9 E0	0 004 525 302	25	437
Z 263	14 SR-7 F	0 004 535 403	25	438
Z 265	14 S-5 F	0 004 545 401	25	437
Z 266	14 S-7 E	0 004 535 300	25	437
Z 267	14 S-7 EU0	0 004 535 700	25	437
Z 269	14 SR-9 E0	0 004 525 304	25	438
Z 270	14 S-10 E0	0 004 520 301	25	437
Z 271	14 SR-7 E	0 004 535 301	25	437
Z 272	14 F-7 HURU02	0 001 335 789	25	412
Z 273	14 FR-7 NUX2	0 002 336 738	25	418
Z 274	12 VR-6 MPPUS	0 002 240 910	20	428
Z 275	14 FR-6 LPUOX	0 002 340 918	25	432
Z 277	14 F-5 MPUR03	0 001 345 906	25	429

**ultra**

Nm



Z 278	14 FR-8 LPU02	0 002 330 918	25	434
Z 279	14 FR-7 LPU02	0 002 335 925	25	433
Z 280	14 FR-7 KPUX02	0 002 335 926	25	433
Z 282	14 FGH-7 DPURX2	0 001 335 905	25	431
Z 284	14 FR-6 DPOX	0 002 340 908	25	432
Z 285	14 R-9 KPUV2	0 002 325 900	25	435
Z 286	12 FR-5 SDU	0 002 245 703	25	411
Z 287	14 FR-8 LU2T	0 002 330 215	25	420
Z 288	12 ZR-7 SPO3	0 002 235 901	20	429
Z 291	12 FR-5 DU	0 002 245 704	20	411
Z 292	12 FR-6 DU	0 002 240 702	20	411
Z 293	12 FR-6 LUX	0 002 240 701	20	411
Z 294	14 FGR-5 NTE	0 002 345 118	25	414
Z 295	14 F-6 DTPR02	0 001 340 915	25	430
Z 296	14 KR-7 DPUV	0 002 635 902	15	436
Z 297	14 FR-7 LPUX0	0 002 335 936	25	434
Z 298	14 KR-8 DPUV	0 002 630 903	15	436
Z 299	14 FR-7 LUX0	0 002 335 802	25	418
Z 300	14 FGR-6 HQU	0 002 340 123	25	414
Z 301	14 FR-7LPUX02	0 002 335 935	25	434
Z 302	14 FR-8 MPUX2	0 002 330 926	25	435
Z 303	14 FR-7 MUX2	0 002 336 734	25	418
Z 304	14 FGHR-7 DTUT	0 002 335 137	25	414
Z 305	14 KR-6 MUU	0 002 640 712	15	427
Z 306	12 F-6 HPURW	0 002 240 901	20	428
Z 307	14 FR-7 DPUV02	0 002 335 937	25	433
Z 309	14 KR-8 LQPU07	0 002 630 904	15	436
Z 310	14 KR-8 MPUV2	0 002 630 905	15	436
Z 311	14 R-8 DPUU	0 002 330 925	25	435
Z 312	14 FR-7 KPPU	0 002 335 938	25	433
Z 313	14 FR-6 DPUX2	0 002 340 909	25	432
Z 314	14 FR-6 DPUW2	0 002 340 910	25	432
Z 315	14 KR-6 MPV	0 002 640 910	15	436
Z 317	14 F-5 DPUR2T	0 001 345 912	25	429
Z 318	12 ZR-6 SPP2	0 002 240 909	20	412
Z 320	12 ZR-8 STP	0 002 230 901	20	412
Z 321	14 F-7 KPPRU2	0 001 335 917	25	431
Z 322	14 F-6 KPUR2W	0 001 340 916	25	430
Z 323	14 FR-5 DPPUX	0 002 345 904	25	431
Z 324	14 FGHR-7 LDUW	0 002 335 138	25	414
Z 325	12 VR-7 SPUX	0 002 235 905	20	428
Z 326	14 FR-7 MPUS	0 002 335 939	25	434
Z 332	12 ZR-6 SPP2-1	0 002 240 911	20	429
Z 333	12 FR-6 DPUX	0 002 240 913	20	428
Z 334	14 FR-8 DEW	0 002 330 217	25	418
Z 335	14 FR-6 DUW2	0 002 340 771	25	416
Z 336	12 ZR-6 SP2	0 002 240 907	20	429
Z 337	14 FR-7 DPPUW2	0 002 335 946	25	432
Z 338	12 FR-4 DPUT	0 002 250 900	20	428
Z 339	14 F-4 NBPR	0 001 350 910	25	429
Z 340	14 FR-6 DPU02S	0 002 340 915	25	432
Z 341	10 FR-7 KDUS	0 002 135 700	12	411
Z 342	14 KR-7 MPUV2	0 002 635 904	15	436
Z 343	14 FR-8 DPPUX	0 002 330 930	25	434
Z 344	14 F-7 HTUR	0 001 335 788	25	412
Z 345	14 F-4 NBPR2LS	0 001 350 911	25	429
Z 346	14 FR-7 LPUT02	0 002 335 947	25	434
Z 347	14 F-5 DPU02	0 001 345 914	25	429
Z 348	14 F-5 MPUR2L	0 001 345 915	25	429
Z 349	14 F-6 LPURW03	0 001 340 917	25	430
Z 354	14 FR-5 LPU0X	0 002 345 906	25	431
Z 355	12 VR-5 SPPU	0 002 245 900	20	428
Z 356	14 KR-7 MPUX2	0 002 635 903	15	436
Z 357	12 FR-4 MPPUS	0 002 250 901	20	428

**ultra**

Nm



Z 358	12 FR-6 DUT	0 002 240 707	20	411
Z 359	12 F-5 NPUR2T	0 001 245 901	20	428
Z 360	14 FGHR-7 DTUU	0 002 335 139	25	414



Nm



Z 1 SB	14-8 DU	0 900 004 024	25	423
Z 2 SB	14-8 DTU	0 900 004 067	25	423
Z 3 SB	14-8 LUR	0 900 004 091	25	424
Z 4 SB	14 F-8 LUR	0 900 004 072	25	413
Z 5 SB	14 F-8 DU0	0 900 004 080	25	413
Z 6 SB	14 K-8 DU	0 900 004 092	15	425
Z 7 SB	14 K-8 DU0	0 900 004 081	15	425
Z 8 SB	14 R-8 DU	0 900 004 052	25	421
Z 9 SB	14 R-8 DUX	0 900 004 082	25	421
Z 10 SB	14-7 BU	0 900 004 021	25	423
Z 11 SB	14-7 DU	0 900 004 023	25	423
Z 12 SB	14-7 DTU	0 900 004 066	25	423
Z 13 SB	14 F-7 DU0R	0 900 004 083	25	412
Z 14 SB	14 F-7 LDUR	0 900 004 084	25	413
Z 15 SB	14 FR-7 DU	0 900 004 085	25	417
Z 16 SB	14 FR-7 DUX	0 900 004 086	25	417
Z 17 SB	14 K-7 DU	0 900 004 030	15	425
Z 18 SB	14 K-7 DU0	0 900 004 087	15	425
Z 19 SB	14 R-7 BU	0 900 004 048	25	421
Z 20 SB	14 R-7 DU	0 900 004 049	25	421
Z 21 SB	14 R-7 DUX	0 900 004 088	25	421
Z 22 SB	14-6 DU	0 900 004 019	25	422
Z 24 SB	14 FR-6 DU	0 900 004 053	25	416
Z 25 SB	14 K-6 DU	0 900 004 051	15	425
Z 26 SB	14 KR-6 DU	0 900 004 054	15	426
Z 27 SB	14 R-6 DU	0 900 004 047	25	421
Z 28 SB	14 R-6 DUX	0 900 004 090	25	421
Z 29 SB	14 F-5 DU	0 900 004 029	25	412
Z 30 SB	14 FR-5 DU	0 900 004 076	25	415
Z 31 SB	14 K-5 DU	0 900 004 061	15	425
Z 33 SB	18 K-6 BU	0 900 004 055	20	427
Z 41 SB	14-5 BU	0 900 004 186	25	422
Z 42 SB	14-5 DU	0 900 004 187	25	422
Z 47 SB	14 R-5 DU	0 900 004 188	25	420
Z 49 SB	14 KR-6 BU	0 900 004 189	15	426
Z 59 SB	14 R-7 CU	0 900 004 190	25	421
Z 67 SB	14 KR-7 DUX	0 900 004 108	15	426
Z 72 SB	14 FR-8 DU	0 900 004 191	25	418
Z 73 SB	14 FR-8 DUX	0 900 004 169	25	419
Z 74 SB	14 FR-8 LDU0X4	0 900 004 113	25	419
Z 76 SB	14-9 DU	0 900 004 120	25	424
Z 89 SB	14 FGH-6 DTUR	0 900 004 106	25	413
Z 90 SB	14 FGH-7 DTURX	0 900 004 101	25	413
Z 91 SB	14 GH-7 DTUR	0 900 004 102	25	420
Z 92 SB	14 GH-8 DTUR	0 900 004 103	25	420
Z 93 SB	14 GH-8 DTURX	0 900 004 104	25	420
Z 94 SB	14 GR-8 DTU	0 900 004 105	25	420
Z 95 SB	14 KR-7 DU	0 900 004 121	15	426
Z 97 SB	14 KR-8 MPX	0 900 004 109	15	436
Z 98 SB	14 FR-7 LDU	0 900 004 192	25	418
Z 99 SB	14 FR-6 DUX	0 900 004 193	25	416
Z 100 SB	14 F-8 DU4	0 900 004 134	25	413
Z 116 SB	14 FR-6 LDU	0 900 004 200	25	416
Z 118 SB	14-8 BU	0 900 004 194	25	423
Z 119 SB	14 R-8 DU4	0 900 004 135	25	421
Z 120 SB	14 FGH-7 DTURX0	0 900 004 136	25	414



			Nm					Nm	
									
Z 121 SB	14 FGH-8 DTURX0	0 900 004 137	25	414	UX 56		0 002 345 600	25	424
Z 122 SB	14 FGH-8 DPURX2	0 900 004 170	25	431	UX 56 SB		0 900 004 114	25	424
Z 126 SB	14 FGH-8 DTUR	0 900 004 201	25	414	UXK 56		0 002 645 600	15	427
Z 145 SB	14 FGR-6 DDU	0 900 004 205	25	416	UXK 56 SB		0 900 004 118	15	427
Z 148 SB	14 KR-8 DPU0V	0 900 004 195	15	436	UXT 1 (UXF 79)		0 002 335 606	25	406
Z 153 SB	14 FR-8 KU	0 900 004 150	25	419	UXT 1 SB (UXF 79)		0 900 004 153	25	406
Z 154 SB	14 FR-8 KU0	0 900 004 151	25	419	UXT 2 (UX 79)		0 002 335 607	25	406
Z 155 SB	14 FR-7 KU	0 900 004 152	25	417	UXT 2 SB (UX 79)		0 900 004 154	25	406
Z 157 SB	14 FR-7 KU0X	0 900 004 203	25	418	UXT 3 (UXF 79 P)		0 002 335 928	25	406
Z 158 SB	14 FR-7 LUX	0 900 004 144	25	418	UXT 3 SB (UXF 79 P)		0 900 004 155	25	406
Z 170 SB	14 F-7 DPURU2	0 900 004 171	25	430	UXT 4 (UXK 79)		0 002 635 601	15	406
Z 173 SB	14 FGR-8 KQU	0 900 004 204	25	415	UXT 4 SB (UXK 79)		0 900 004 156	15	406
Z 176 SB	14 F-7 HPURX2	0 900 004 142	25	430	UXT 5 (UXF 56)		0 002 345 606	25	406
Z 177 SB	14 KR-8 MUV	0 900 004 141	15	427	UXT 5 SB (UXF 56)		0 900 004 157	25	406
Z 183 SB	14 FR-8 MU2	0 900 004 149	25	420	UXT 6 (UX 79 P)		0 002 335 929	25	406
Z 184 SB	14 FR-7 MU2	0 900 004 148	25	418	UXT 6 SB (UX 79 P)		0 900 004 158	25	406
Z 188 SB	14 F-7 DPUR02	0 900 004 145	25	430	UXT 7		0 002 635 900	15	406
Z 190 SB	14 FGR-8 DQU7	0 900 004 143	25	415	UXT 7 SB		0 900 004 159	15	406
Z 193 SB	14 FR-7DU2	0 900 004 146	25	417	UXT 8		0 002 635 901	15	406
Z 194 SB	14 FR-6 LDU3	0 900 004 205	25	416	UXT 8 SB		0 900 004 160	15	406
Z 200 SB	14 F-7 HUR2	0 900 004 147	25	412	UXT 9		0 002 335 930	25	406
Z 203 SB	14 FR-8 LU2	0 900 004 172	25	419	UXT 9 SB		0 900 004 161	25	406
Z 204 SB	14 FGR-8 CTU	0 900 004 206	25	415	UXT 10		0 002 335 931	25	406
Z 206 SB	14 FR-7 DPPUS2	0 900 004 173	25	432	UXT 10 SB		0 900 004 162	25	406
Z 209 SB	14 KR-6 DPUV02	0 900 004 174	25	436	UXT 11		0 002 335 932	25	406
Z 221 SB	14 FR-6 DPUX02	0 900 004 207	25	432	UXT 11 SB		0 900 004 163	25	406
Z 222 SB	14 KR-8 STUX	0 900 004 175	15	427	UXT 12		0 002 345 902	25	406
Z 223 SB	14 FR-8 NQU23	0 900 004 208	25	420	UXT 12 SB		0 900 004 164	25	406
Z 224 SB	14 FR-7 DPU3	0 900 004 176	25	433	UXT 13		0 002 335 934	25	406
Z 226 SB	14 FR-6 MPU2	0 900 004 177	25	432	UXT 13 SB		0 900 004 165	25	406
Z 227 SB	14 F-8 DUR	0 900 004 178	25	413	UXT 14		0 002 345 903	25	406
Z 228 SB	14 FR-7 DPUX02	0 900 004 179	25	433	UXT 14 SB		0 900 004 166	25	406
Z 230 SB	14 KR-6 KPUV02	0 900 004 238	15	436	UXT 15		0 002 640 909	15	406
Z 233 SB	14 ZR-6 SPO3	0 900 004 239	20	428	UXT 15 SB		0 900 004 167	15	406
Z 234 SB	12 FR-7 DU	0 900 004 196	20	411	10 FR-4 AU	<b>Z 199</b>	0 002 150 700	12	411
Z 235 SB	14 FR-7 SPUX03	0 900 004 180	25	434	10 FR-6 CPU03	<b>Z 210</b>	0 002 140 900	12	428
Z 236 SB	14 F-6 HTPRX02	0 900 004 181	25	430	10 FR-7 KDUS	<b>Z 341</b>	0 002 135 700	12	411
Z 237 SB	14 FR-7 DQUP7	0 900 004 182	25	433	12 F-5 NPUR2T	<b>Z 359</b>	0 001 245 901	20	428
Z 238 SB	14 FR-8 DPU2	0 900 004 183	25	434	12 F-6 HPURW	<b>Z 306</b>	0 002 240 901	20	428
Z 239 SB	14 FGR-7 KQE	0 900 004 240	25	415	12 FR-4 DPUT	<b>Z 338</b>	0 002 250 900	20	428
Z 240 SB	14 F-8 DPURX02	0 900 004 184	25	431	12 FR-4 MPPUS	<b>Z 357</b>	0 002 250 901	20	428
Z 243 SB	12 VR-8 SE	0 900 004 185	25	411	12 FR-5 DU	<b>Z 291</b>	0 002 245 704	20	411
Z 245 SB	14 FR-6 LDUW	0 900 004 197	25	416	12 FR-5 SDU	<b>Z 286</b>	0 002 245 703	25	411
Z 246 SB	14 FGH-8 DTURW	0 900 004 198	25	414	12 FR-6 DPUX	<b>Z 333</b>	0 002 240 913	20	428
Z 247 SB	14 FR-7 DUW	0 900 004 199	25	417	12 FR-6 DU	<b>Z 292</b>	0 002 240 702	20	411
Z 255 SB	14 FR-8 DUW	0 900 004 210	25	419	12 FR-6 DUT	<b>Z 358</b>	0 002 240 707	20	411
Z 257 SB	14 FR-7 LDUW	0 900 004 211	25	418	12 FR-6 LUX	<b>Z 293</b>	0 002 240 701	20	411
Z 293 SB	14 FR-6 LUX	0 900 004 241	20	411	12 FR-6 LUX	<b>Z 293 SB</b>	0 900 004 241	20	411
Z 300 SB	14 FGR-6 HQU	0 900 004 237	25	414	12 FR-7 DU	<b>Z 234</b>	0 002 235 700	20	411
Z 301 SB	14 FR-7 LPUX02	0 900 004 242	25	434	12 FR-7 DU	<b>Z 234 SB</b>	0 900 004 196	20	411
Z 310 SB	14 KR-8 MPUV2	0 900 004 243	15	436	12 VR-5 SPPU	<b>Z 355</b>	0 002 245 900	20	428
Z 326 SB	14 FR-7 MPUS	0 900 004 244	25	434	12 VR-6 MPPUS	<b>Z 274</b>	0 002 240 910	20	428
Z 340 SB	14 FR-6 DPU02S	0 900 004 245	25	432	12 VR-7 SPUX	<b>Z 325</b>	0 002 235 905	20	428
					12 VR-8 SE	<b>Z 243</b>	0 002 230 300	20	411
					12 VR-8 SE	<b>Z 243 SB</b>	0 900 004 185	25	411
					12 ZR-6 SPO3	<b>Z 233</b>	0 002 240 902	20	428
					12 ZR-6 SPO3	<b>Z 233 SB</b>	0 900 004 239	20	428
					12 ZR-6 SP2	<b>Z 336</b>	0 002 240 907	20	429
					12 ZR-6 SPP2	<b>Z 318</b>	0 002 240 909	20	412
					12 ZR-6 SPP2-1	<b>Z 332</b>	0 002 240 911	20	429
					12 ZR-7 SPO3	<b>Z 288</b>	0 002 235 901	20	429
					12 ZR-8 STP	<b>Z 320</b>	0 002 230 901	20	412
					12 ZR-8 TP	<b>Z 242</b>	0 002 230 900	20	429
					14 C-7 D	<b>Z 111</b>	0 003 335 401	25	437



Nm



14 F-4 NBPR	<b>Z 339</b>	0 001 350 910	25	429
14 F-4 NBPR2LS	<b>Z 345</b>	0 001 350 911	25	429
14 F-5 DPUR02	<b>Z 347</b>	0 001 345 914	25	429
14 F-5 DPUR2T	<b>Z 317</b>	0 001 345 912	25	429
14 F-5 DU	<b>Z 29</b>	0 001 345 720	25	412
14 F-5 DU	<b>Z 29 SB</b>	0 900 004 029	25	412
14 F-5 MPUR03	<b>Z 277</b>	0 001 345 906	25	429
14 F-5 MPUR2L	<b>Z 348</b>	0 001 345 915	25	429
14 F-6 DPUR021	<b>Z 185</b>	0 001 340 908	25	430
14 F-6 DSR	<b>Z 105</b>	0 001 340 806	25	437
14 F-6 DTPR02	<b>Z 295</b>	0 001 340 915	25	430
14 F-6 DTU	<b>Z 52</b>	0 001 340 706	25	412
14 F-6 DTU	<b>Z 53</b>	0 001 340 717	25	412
14 F-6 HTPRX02	<b>Z 236</b>	0 001 340 910	25	430
14 F-6 HTPRX02	<b>Z 236 SB</b>	0 900 004 181	25	430
14 F-6 KPUR2W	<b>Z 322</b>	0 001 340 916	25	430
14 F-6 LPURW03	<b>Z 349</b>	0 001 340 917	25	430
14 F-7 DPUR02	<b>Z 188</b>	0 001 335 914	25	430
14 F-7 DPUR02	<b>Z 188 SB</b>	0 900 004 145	25	430
14 F-7 DPUR2	<b>Z 232</b>	0 001 335 907	25	430
14 F-7 DPURU2	<b>Z 170</b>	0 001 335 919	25	430
14 F-7 DPURU2	<b>Z 170 SB</b>	0 900 004 171	25	430
14 F-7 DPURX2	<b>Z 171</b>	0 001 335 910	25	430
14 F-7 DU	<b>Z 63</b>	0 001 335 725	25	412
14 F-7 DU0R	<b>Z 13</b>	0 001 335 729	25	412
14 F-7 DU0R	<b>Z 13 SB</b>	0 900 004 083	25	412
14 F-7 HPURX2	<b>Z 176</b>	0 001 335 911	25	430
14 F-7 HPURX2	<b>Z 176 SB</b>	0 900 004 142	25	430
14 F-7 HTUR	<b>Z 344</b>	0 001 335 788	25	412
14 F-7 HUR2	<b>Z 200</b>	0 001 335 742	25	412
14 F-7 HUR2	<b>Z 200 SB</b>	0 900 004 147	25	412
14 F-7 HURU02	<b>Z 272</b>	0 001 335 789	25	412
14 F-7 KPPRU2	<b>Z 321</b>	0 001 335 917	25	431
14 F-7 LDUR	<b>Z 14</b>	0 001 335 732	25	413
14 F-7 LDUR	<b>Z 14 SB</b>	0 900 004 084	25	413
14 F-8 DPURX02	<b>Z 240</b>	0 001 330 905	25	431
14 F-8 DPURX02	<b>Z 240 SB</b>	0 900 004 184	25	431
14 F-8 DU0	<b>Z 5</b>	0 001 330 725	25	413
14 F-8 DU0	<b>Z 5 SB</b>	0 900 004 080	25	413
14 F-8 DU4	<b>Z 100</b>	0 001 330 731	25	413
14 F-8 DU4	<b>Z 100 SB</b>	0 900 004 134	25	413
14 F-8 DUR	<b>Z 227</b>	0 001 330 780	25	413
14 F-8 DUR	<b>Z 227 SB</b>	0 900 004 178	25	413
14 F-8 LDUSR	<b>Z 101</b>	0 001 330 501	25	413
14 F-8 LUR	<b>Z 4</b>	0 001 330 717	25	413
14 F-8 LUR	<b>Z 4 SB</b>	0 900 004 072	25	413
14 F-9 DU0	<b>Z 79</b>	0 001 325 705	25	413
14 FG-8 DTU	<b>Z 128</b>	0 001 330 105	25	413
14 FGH-6 DTUR	<b>Z 89</b>	0 001 340 103	25	413
14 FGH-6 DTUR	<b>Z 89 SB</b>	0 900 004 106	25	413
14 FGH-7 DPURX2	<b>Z 282</b>	0 001 335 905	25	431
14 FGH-7 DTURX	<b>Z 90</b>	0 001 335 107	25	413
14 FGH-7 DTURX	<b>Z 90 SB</b>	0 900 004 101	25	413
14 FGH-7 DTURX0	<b>Z 120</b>	0 001 335 110	25	414
14 FGH-7 DTURX0	<b>Z 120 SB</b>	0 900 004 136	25	414
14 FGH-8 DPURX2	<b>Z 122</b>	0 001 330 904	25	431
14 FGH-8 DPURX2	<b>Z 122 SB</b>	0 900 004 170	25	431
14 FGH-8 DTUR	<b>Z 126</b>	0 001 330 117	25	414
14 FGH-8 DTUR	<b>Z 126 SB</b>	0 900 004 201	25	414
14 FGH-8 DTURW	<b>Z 246</b>	0 001 330 119	25	414
14 FGH-8 DTURW	<b>Z 246 SB</b>	0 900 004 198	25	414
14 FGH-8 DTURX0	<b>Z 121</b>	0 001 330 116	25	414
14 FGH-8 DTURX0	<b>Z 121 SB</b>	0 900 004 137	25	414
14 FGH-7 DTUT	<b>Z 304</b>	0 002 335 137	25	414



Nm



14 FGHR-7 DTUU	<b>Z 360</b>	0 002 335 139	25	414
14 FGHR-7 LDUW	<b>Z 324</b>	0 002 335 138	25	414
14 FGR-5 NTE	<b>Z 294</b>	0 002 345 118	25	414
14 FGR-6 DDU	<b>Z 145</b>	0 002 340 102	25	414
14 FGR-6 DDU	<b>Z 145 SB</b>	0 900 004 205	25	416
14 FGR-6 HQU	<b>Z 300</b>	0 002 340 123	25	414
14 FGR-6 HQU	<b>Z 300 SB</b>	0 900 004 237	25	414
14 FGR-6 KQU	<b>Z 129</b>	0 002 340 101	25	415
14 FGR-7 CTU	<b>Z 60</b>	0 002 335 100	25	415
14 FGR-7 KDU6	<b>Z 213</b>	0 002 335 128	25	415
14 FGR-7 KQE	<b>Z 239</b>	0 002 335 131	25	415
14 FGR-7 KQE	<b>Z 239 SB</b>	0 900 004 240	25	415
14 FGR-7 KQU	<b>Z 172</b>	0 002 335 104	25	415
14 FGR-8 CTU	<b>Z 204</b>	0 002 340 117	25	415
14 FGR-8 CTU	<b>Z 204 SB</b>	0 900 004 206	25	415
14 FGR-8 DQU7	<b>Z 190</b>	0 002 330 104	25	415
14 FGR-8 DQU7	<b>Z 190 SB</b>	0 900 004 143	25	415
14 FGR-8 KQU	<b>Z 173</b>	0 002 330 102	25	415
14 FGR-8 KQU	<b>Z 173 SB</b>	0 900 004 204	25	415
14 FGR-8 MQPU	<b>Z 211</b>	0 002 330 902	25	431
14 FR-4 DPU	<b>Z 231</b>	0 002 350 901	25	431
14 FR-5 DPPUX	<b>Z 323</b>	0 002 345 904	25	431
14 FR-5 DPUX	<b>Z 130</b>	0 002 335 901	25	431
14 FR-5 DTU	<b>Z 45</b>	0 002 345 704	25	415
14 FR-5 DU	<b>Z 30</b>	0 002 345 702	25	415
14 FR-5 DU	<b>Z 30 SB</b>	0 900 004 076	25	415
14 FR-5 DUU	<b>Z 253</b>	0 002 345 731	25	416
14 FR-5 LDU	<b>Z 192</b>	0 002 345 501	25	416
14 FR-5 LDU3	<b>Z 198</b>	0 002 345 504	25	416
14 FR-5 LPUOX	<b>Z 354</b>	0 002 345 906	25	431
14 FR-6 DPOX	<b>Z 284</b>	0 002 340 908	25	432
14 FR-6 DPU02S	<b>Z 340</b>	0 002 340 915	25	432
14 FR-6 DPU02S	<b>Z 340 SB</b>	0 900 004 245	25	432
14 FR-6 DPUW2	<b>Z 314</b>	0 002 340 910	25	432
14 FR-6 DPUX	<b>Z 159</b>	0 002 340 903	25	432
14 FR-6 DPUX02	<b>Z 221</b>	0 002 340 905	25	432
14 FR-6 DPUX02	<b>Z 221 SB</b>	0 900 004 207	25	432
14 FR-6 DPUX2	<b>Z 313</b>	0 002 340 909	25	432
14 FR-6 DU	<b>Z 24</b>	0 002 340 702	25	416
14 FR-6 DU	<b>Z 24 SB</b>	0 900 004 053	25	416
14 FR-6 DUW	<b>Z 252</b>	0 002 340 768	25	416
14 FR-6 DUW2	<b>Z 335</b>	0 002 340 771	25	416
14 FR-6 DUX	<b>Z 99</b>	0 002 340 704	25	416
14 FR-6 DUX	<b>Z 99 SB</b>	0 900 004 193	25	416
14 FR-6 LDU	<b>Z 116</b>	0 002 340 500	25	416
14 FR-6 LDU	<b>Z 116 SB</b>	0 900 004 200	25	416
14 FR-6 LDU3	<b>Z 194</b>	0 002 340 501	25	416
14 FR-6 LDU3	<b>Z 194 SB</b>	0 900 004 205	25	416
14 FR-6 LDUW	<b>Z 245</b>	0 002 340 504	25	416
14 FR-6 LDUW	<b>Z 245 SB</b>	0 900 004 197	25	416
14 FR-6 LPUOX	<b>Z 275</b>	0 002 340 918	25	432
14 FR-6 MPU2	<b>Z 226</b>	0 002 340 906	25	432
14 FR-6 MPU2	<b>Z 226 SB</b>	0 900 004 177	25	432
14 FR-7 DPPUS2	<b>Z 206</b>	0 002 335 940	25	432
14 FR-7 DPPUS2	<b>Z 206 SB</b>	0 900 004 173	25	432
14 FR-7 DPPUW2	<b>Z 337</b>	0 002 335 946	25	432
14 FR-7 DPU3	<b>Z 224</b>	0 002 335 912	25	433
14 FR-7 DPU3	<b>Z 224 SB</b>	0 900 004 176	25	433
14 FR-7 DPUV02	<b>Z 307</b>	0 002 335 937	25	433
14 FR-7 DPUX02	<b>Z 228</b>	0 002 335 914	25	433
14 FR-7 DPUX02	<b>Z 228 SB</b>	0 900 004 179	25	433
14 FR-7 DQUP7	<b>Z 237</b>	0 002 335 911	25	433
14 FR-7 DQUP7	<b>Z 237 SB</b>	0 900 004 182	25	433
14 FR-7 DU	<b>Z 15</b>	0 002 335 707	25	417

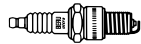

Nm



14 FR-7 DU	<b>Z 15 SB</b>	0 900 004 085	25	417
14 FR-7 DU2	<b>Z 193</b>	0 002 335 717	25	417
14 FR-7 DU2	<b>Z 193 SB</b>	0 900 004 146	25	417
14 FR-7 DU2S	<b>Z 250</b>	0 002 336 725	25	417
14 FR-7 DU2T	<b>Z 251</b>	0 002 336 726	25	417
14 FR-7 DUW	<b>Z 247</b>	0 002 336 724	25	417
14 FR-7 DUW	<b>Z 247 SB</b>	0 900 004 199	25	417
14 FR-7 DUX	<b>Z 16</b>	0 002 335 708	25	417
14 FR-7 DUX	<b>Z 16 SB</b>	0 900 004 086	25	417
14 FR-7 HUX	<b>Z 225</b>	0 002 336 715	25	417
14 FR-7 KDU	<b>Z 123</b>	0 002 335 709	25	417
14 FR-7 KPPU	<b>Z 312</b>	0 002 335 938	25	433
14 FR-7 KPU	<b>Z 151</b>	0 002 335 904	25	433
14 FR-7 KPUV	<b>Z 150</b>	0 002 335 903	25	433
14 FR-7 KPUX	<b>Z 149</b>	0 002 335 902	25	433
14 FR-7 KPUX02	<b>Z 280</b>	0 002 335 926	25	433
14 FR-7 KU	<b>Z 155</b>	0 002 335 712	25	417
14 FR-7 KU	<b>Z 155 SB</b>	0 900 004 152	25	417
14 FR-7 KU0	<b>Z 156</b>	0 002 335 713	25	417
14 FR-7 KU0X	<b>Z 157</b>	0 002 335 714	25	418
14 FR-7 KU0X	<b>Z 157 SB</b>	0 900 004 203	25	418
14 FR-7 LDU	<b>Z 98</b>	0 002 335 500	25	418
14 FR-7 LDU	<b>Z 98 SB</b>	0 900 004 192	25	418
14 FR-7 LDUW	<b>Z 257</b>	0 002 335 503	25	418
14 FR-7 LDUW	<b>Z 257 SB</b>	0 900 004 211	25	418
14 FR-7 LPU02	<b>Z 279</b>	0 002 335 925	25	433
14 FR-7 LPUT02	<b>Z 346</b>	0 002 335 947	25	434
14 FR-7 LPUX0	<b>Z 297</b>	0 002 335 936	25	434
14 FR-7 LPUX02	<b>Z 301</b>	0 002 335 935	25	434
14 FR-7 LPUX02	<b>Z 301 SB</b>	0 900 004 242	25	434
14 FR-7 LUX	<b>Z 158</b>	0 002 335 715	25	418
14 FR-7 LUX	<b>Z 158 SB</b>	0 900 004 144	25	418
14 FR-7 LUX0	<b>Z 299</b>	0 002 335 802	25	418
14 FR-7 MPUS	<b>Z 326</b>	0 002 335 939	25	434
14 FR-7 MPUS	<b>Z 326 SB</b>	0 900 004 244	25	434
14 FR-7 MU2	<b>Z 184</b>	0 002 335 719	25	418
14 FR-7 MU2	<b>Z 184 SB</b>	0 900 004 148	25	418
14 FR-7 MUX2	<b>Z 303</b>	0 002 336 734	25	418
14 FR-7 NUX2	<b>Z 273</b>	0 002 336 738	25	418
14 FR-7 SPUX03	<b>Z 235</b>	0 002 335 915	25	434
14 FR-7 SPUX03	<b>Z 235 SB</b>	0 900 004 180	25	434
14 FR-8 DEW	<b>Z 334</b>	0 002 330 217	25	418
14 FR-8 DPPUX	<b>Z 343</b>	0 002 330 930	25	434
14 FR-8 DPU2	<b>Z 238</b>	0 002 330 905	25	434
14 FR-8 DPU2	<b>Z 238 SB</b>	0 900 004 183	25	434
14 FR-8 DU	<b>Z 72</b>	0 002 330 703	25	418
14 FR-8 DU	<b>Z 72 SB</b>	0 900 004 191	25	418
14 FR-8 DUS	<b>Z 254</b>	0 002 330 205	25	418
14 FR-8 DUW	<b>Z 255</b>	0 002 330 206	25	419
14 FR-8 DUW	<b>Z 255 SB</b>	0 900 004 210	25	419
14 FR-8 DUX	<b>Z 73</b>	0 002 330 704	25	419
14 FR-8 DUX	<b>Z 73 SB</b>	0 900 004 169	25	419
14 FR-8 HU	<b>Z 152</b>	0 002 330 712	25	419
14 FR-8 HUT	<b>Z 248</b>	0 002 330 203	25	419
14 FR-8 KU	<b>Z 153</b>	0 002 330 713	25	419
14 FR-8 KU	<b>Z 153 SB</b>	0 900 004 150	25	419
14 FR-8 KU0	<b>Z 154</b>	0 002 330 714	25	419
14 FR-8 KU0	<b>Z 154 SB</b>	0 900 004 151	25	419
14 FR-8 KU0U	<b>Z 249</b>	0 002 330 204	25	419
14 FR-8 LDU0X4	<b>Z 74</b>	0 002 330 710	25	419
14 FR-8 LDU0X4	<b>Z 74 SB</b>	0 900 004 113	25	419
14 FR-8 LDU3	<b>Z 208</b>	0 002 330 795	25	419
14 FR-8 LPO	<b>Z 229</b>	0 002 330 903	25	434
14 FR-8 LPU02	<b>Z 278</b>	0 002 330 918	25	434



Nm



14 FR-8 LU2	<b>Z 203</b>	0 002 330 794	25	419
14 FR-8 LU2	<b>Z 203 SB</b>	0 900 004 172	25	419
14 FR-8 LU2T	<b>Z 287</b>	0 002 330 215	25	420
14 FR-8 MPUX02	<b>Z 219</b>	0 002 330 904	25	434
14 FR-8 MPUX2	<b>Z 302</b>	0 002 330 926	25	435
14 FR-8 MU2	<b>Z 183</b>	0 002 330 718	25	420
14 FR-8 MU2	<b>Z 183 SB</b>	0 900 004 149	25	420
14 FR-8 NQU23	<b>Z 223</b>	0 002 330 796	25	420
14 FR-8 NQU23	<b>Z 223 SB</b>	0 900 004 208	25	420
14 FR-9 KUX2	<b>Z 220</b>	0 002 325 723	25	420
14 G-8 DTU	<b>Z 75</b>	0 001 330 104	25	420
14 GH-7 DTUR	<b>Z 91</b>	0 001 335 108	25	420
14 GH-7 DTUR	<b>Z 91 SB</b>	0 900 004 102	25	420
14 GH-8 DTUR	<b>Z 92</b>	0 001 330 113	25	420
14 GH-8 DTUR	<b>Z 92 SB</b>	0 900 004 103	25	420
14 GH-8 DTURX	<b>Z 93</b>	0 001 330 112	25	420
14 GH-8 DTURX	<b>Z 93 SB</b>	0 900 004 104	25	420
14 GR-8 DTU	<b>Z 94</b>	0 002 330 706	25	420
14 GR-8 DTU	<b>Z 94 SB</b>	0 900 004 105	25	420
14 K-5 DU	<b>Z 31</b>	0 001 645 700	15	425
14 K-5 DU	<b>Z 31 SB</b>	0 900 004 061	15	425
14 K-5 DU0	<b>Z 46</b>	0 001 645 703	15	425
14 K-6 DU	<b>Z 25</b>	0 001 640 700	15	425
14 K-6 DU	<b>Z 25 SB</b>	0 900 004 051	15	425
14 K-6 DU0	<b>Z 55</b>	0 001 640 704	15	425
14 K-6 DU0	<b>Z 56</b>	0 001 640 705	15	425
14 K-7 DU	<b>Z 17</b>	0 001 635 700	15	425
14 K-7 DU	<b>Z 17 SB</b>	0 900 004 030	15	425
14 K-7 DU0	<b>Z 18</b>	0 001 635 709	15	425
14 K-7 DU0	<b>Z 18 SB</b>	0 900 004 087	15	425
14 K-8 DU	<b>Z 6</b>	0 001 630 700	15	425
14 K-8 DU	<b>Z 6 SB</b>	0 900 004 092	15	425
14 K-8 DU0	<b>Z 7</b>	0 001 630 704	15	425
14 K-8 DU0	<b>Z 7 SB</b>	0 900 004 081	15	425
14 K-9 BU	<b>Z 174</b>	0 001 625 705	15	425
14 K-9 DU	<b>Z 80</b>	0 001 625 700	15	426
14 K-9 DU0	<b>Z 81</b>	0 001 625 702	15	426
14 KG-8 DTU	<b>Z 207</b>	0 001 630 101	15	426
14 KGR-6 KQU	<b>Z 144</b>	0 002 640 100	15	426
14 KGR-7 KQU	<b>Z 127</b>	0 002 635 100	15	426
14 KR-10 SUV2	<b>Z 216</b>	0 002 620 708	15	426
14 KR-6 BU	<b>Z 49</b>	0 002 640 701	15	426
14 KR-6 BU	<b>Z 49 SB</b>	0 900 004 189	15	426
14 KR-6 DPUV02	<b>Z 209</b>	0 002 640 904	15	436
14 KR-6 DPUV02	<b>Z 209 SB</b>	0 900 004 174	25	436
14 KR-6 DU	<b>Z 26</b>	0 002 640 700	15	426
14 KR-6 DU	<b>Z 26 SB</b>	0 900 004 054	15	426
14 KR-6 KPUV02	<b>Z 230</b>	0 002 640 907	15	436
14 KR-6 KPUV02	<b>Z 230 SB</b>	0 900 004 238	15	436
14 KR-6 MPV	<b>Z 315</b>	0 002 640 910	15	436
14 KR-6 MUJ	<b>Z 305</b>	0 002 640 712	15	427
14 KR-7 DPUV	<b>Z 296</b>	0 002 635 902	15	436
14 KR-7 DU	<b>Z 95</b>	0 002 635 700	15	426
14 KR-7 DU	<b>Z 95 SB</b>	0 900 004 121	15	426
14 KR-7 DUX	<b>Z 67</b>	0 002 635 701	15	426
14 KR-7 DUX	<b>Z 67 SB</b>	0 900 004 108	15	426
14 KR-7 MPUV2	<b>Z 342</b>	0 002 635 904	15	436
14 KR-7 MPUX2	<b>Z 356</b>	0 002 635 903	15	436
14 KR-8 DPUOV	<b>Z 148</b>	0 002 630 900	15	436
14 KR-8 DPUOV	<b>Z 148 SB</b>	0 900 004 195	15	433
14 KR-8 DPUV	<b>Z 298</b>	0 002 630 903	15	436
14 KR-8 LQPU07	<b>Z 309</b>	0 002 630 904	15	436
14 KR-8 MPUV2	<b>Z 310</b>	0 002 630 905	15	436
14 KR-8 MPUV2	<b>Z 310 SB</b>	0 900 004 243	15	436



Nm



14 KR-8 MPX	<b>Z 97</b>	0 002 640 900	15	436
14 KR-8 MPX	<b>Z 97 SB</b>	0 900 004 109	15	436
14 KR-8 MUV	<b>Z 177</b>	0 002 630 701	15	427
14 KR-8 MUV	<b>Z 177 SB</b>	0 900 004 141	15	427
14 KR-8 STUX	<b>Z 222</b>	0 002 630 715	15	427
14 KR-8 STUX	<b>Z 222 SB</b>	0 900 004 175	15	427
14 KR-9 DUX	<b>Z 117</b>	0 002 625 700	15	427
14 R-5 DU	<b>Z 47</b>	0 002 345 701	25	420
14 R-5 DU	<b>Z 47 SB</b>	0 900 004 188	25	420
14 R-6 DU	<b>Z 27</b>	0 002 340 701	25	421
14 R-6 DU	<b>Z 27 SB</b>	0 900 004 047	25	421
14 R-6 DUX	<b>Z 28</b>	0 002 340 703	25	421
14 R-6 DUX	<b>Z 28 SB</b>	0 900 004 090	25	421
14 R-7 BU	<b>Z 19</b>	0 002 435 701	25	421
14 R-7 BU	<b>Z 19 SB</b>	0 900 004 048	25	421
14 R-7 CU	<b>Z 59</b>	0 002 335 704	25	421
14 R-7 CU	<b>Z 59 SB</b>	0 900 004 190	25	421
14 R-7 DU	<b>Z 20</b>	0 002 335 701	25	421
14 R-7 DU	<b>Z 20 SB</b>	0 900 004 049	25	421
14 R-7 DUX	<b>Z 21</b>	0 002 335 706	25	421
14 R-7 DUX	<b>Z 21 SB</b>	0 900 004 088	25	421
14 R-8 DPUU	<b>Z 311</b>	0 002 330 925	25	435
14 R-8 DU	<b>Z 8</b>	0 002 330 701	25	421
14 R-8 DU	<b>Z 8 SB</b>	0 900 004 052	25	421
14 R-8 DU4	<b>Z 119</b>	0 002 330 709	25	421
14 R-8 DU4	<b>Z 119 SB</b>	0 900 004 135	25	421
14 R-8 DUX	<b>Z 9</b>	0 002 330 702	25	421
14 R-8 DUX	<b>Z 9 SB</b>	0 900 004 082	25	421
14 R-9 DU	<b>Z 82</b>	0 002 325 700	25	421
14 R-9 KPUV2	<b>Z 285</b>	0 002 325 900	25	435
14 S-10 E0	<b>Z 270</b>	0 004 520 301	25	437
14 S-5 F	<b>Z 265</b>	0 004 545 401	25	437
14 S-7 E	<b>Z 266</b>	0 004 535 300	25	437
14 S-7 EU0	<b>Z 267</b>	0 004 535 700	25	437
14 S-7 F	<b>Z 132</b>	0 004 535 402	25	437
14 S-9 E0	<b>Z 262</b>	0 004 525 302	25	437
14 SR-10 E0	<b>Z 261</b>	0 004 520 300	25	438
14 SR-5 F	<b>Z 260</b>	0 004 545 400	25	438
14 SR-7 E	<b>Z 271</b>	0 004 535 301	25	437
14 SR-7 F	<b>Z 263</b>	0 004 535 403	25	438
14 SR-9 E0	<b>Z 269</b>	0 004 525 304	25	438
14 Z-3 AU	<b>Z 37</b>	0 001 455 702	25	422
14 Z-3 CU	<b>Z 38</b>	0 001 355 700	25	422
14 Z-4 AU	<b>Z 39</b>	0 001 450 702	25	422
14-5 AU	<b>Z 40</b>	0 001 445 702	25	422
14-5 BU	<b>Z 41</b>	0 001 445 700	25	422
14-5 BU	<b>Z 41 SB</b>	0 900 004 186	25	422
14-5 DTU	<b>Z 44</b>	0 001 345 704	25	422
14-5 DU	<b>Z 42</b>	0 001 345 702	25	422
14-5 DU	<b>Z 42 SB</b>	0 900 004 187	25	422
14-6 BU	<b>Z 48</b>	0 001 440 700	25	422
14-6 DPO	<b>Z 104</b>	0 001 340 903	25	435
14-6 DTU	<b>Z 51</b>	0 001 340 704	25	422
14-6 DU	<b>Z 22</b>	0 001 340 702	25	422
14-6 DU	<b>Z 22 SB</b>	0 900 004 019	25	422
14-7 AU	<b>Z 57</b>	0 001 435 705	25	423
14-7 BU	<b>Z 10</b>	0 001 435 700	25	423
14-7 BU	<b>Z 10 SB</b>	0 900 004 021	25	423
14-7 CU	<b>Z 58</b>	0 001 335 707	25	423
14-7 DTU	<b>Z 12</b>	0 001 335 709	25	423
14-7 DTU	<b>Z 12 SB</b>	0 900 004 066	25	423
14-7 DU	<b>Z 11</b>	0 001 335 702	25	423
14-7 DU	<b>Z 11 SB</b>	0 900 004 023	25	423
14-7 DU0	<b>Z 61</b>	0 001 335 714	25	423



Nm



14-7 DU0	<b>Z 62</b>	0 001 335 737	25	423
14-8 AU	<b>Z 68</b>	0 001 430 701	25	423
14-8 BU	<b>Z 118</b>	0 001 430 700	25	423
14-8 BU	<b>Z 118 SB</b>	0 900 004 194	25	423
14-8 DTU	<b>Z 2</b>	0 001 330 709	25	423
14-8 DTU	<b>Z 2 SB</b>	0 900 004 067	25	423
14-8 DU	<b>Z 1</b>	0 001 330 702	25	423
14-8 DU	<b>Z 1 SB</b>	0 900 004 024	25	423
14-8 DU0	<b>Z 69</b>	0 001 330 713	25	424
14-8 DU0	<b>Z 70</b>	0 001 330 726	25	424
14-8 E	<b>Z 112</b>	0 001 529 302	25	424
14-8 LUR	<b>Z 3</b>	0 001 330 718	25	424
14-8 LUR	<b>Z 3 SB</b>	0 900 004 091	25	424
14-9 DTU	<b>Z 78</b>	0 001 325 710	25	424
14-9 DU	<b>Z 76</b>	0 001 325 701	25	424
14-9 DU	<b>Z 76 SB</b>	0 900 004 120	25	424
14-X AU	<b>Z 85</b>	0 001 400 701	25	424
18 K-6 BU	<b>Z 33</b>	0 001 740 700	20	427
18 K-6 BU	<b>Z 33 SB</b>	0 900 004 055	20	427
18 K-7 BU	<b>Z 32</b>	0 001 735 700	20	427
18 K-9 BU	<b>Z 175</b>	0 001 725 700	20	427
EBE 514	<b>Z 110</b>	0 004 500 400	–	438
G 3/18	<b>Z 108</b>	0 001 700 901	25	438
KP105 DU	<b>Z 109</b>	0 004 021 601	–	438



Nm



0 001 245 901	<b>Z 359</b>	12 F-5 NPUR2T	20	428
0 001 325 701	<b>Z 76</b>	14-9 DU	25	424
0 001 325 705	<b>Z 79</b>	14 F-9 DU0	25	413
0 001 325 710	<b>Z 78</b>	14-9 DTU	25	424
0 001 330 104	<b>Z 75</b>	14 G-8 DTU	25	420
0 001 330 105	<b>Z 128</b>	14 FG-8 DTU	25	413
0 001 330 112	<b>Z 93</b>	14 GH-8 DTURX	25	420
0 001 330 113	<b>Z 92</b>	14 GH-8 DTUR	25	420
0 001 330 116	<b>Z 121</b>	14 FGH-8 DTURXO	25	414
0 001 330 117	<b>Z 126</b>	14 FGH-8 DTUR	25	414
0 001 330 119	<b>Z 246</b>	14 FGH-8 DTURW	25	414
0 001 330 501	<b>Z 101</b>	14 F-8 LDUSR	25	413
0 001 330 702	<b>Z 1</b>	14-8 DU	25	423
0 001 330 709	<b>Z 2</b>	14-8 DTU	25	423
0 001 330 713	<b>Z 69</b>	14-8 DU0	25	424
0 001 330 717	<b>Z 4</b>	14 F-8 LUR	25	413
0 001 330 718	<b>Z 3</b>	14-8 LUR	25	424
0 001 330 725	<b>Z 5</b>	14 F-8 DU0	25	413
0 001 330 726	<b>Z 70</b>	14-8 DU0	25	424
0 001 330 731	<b>Z 100</b>	14 F-8 DU4	25	413
0 001 330 780	<b>Z 227</b>	14 F-8 DUR	25	413
0 001 330 904	<b>Z 122</b>	14 FGH-8 DPURX2	25	431
0 001 330 905	<b>Z 240</b>	14 F-8 DPURX02	25	431
0 001 335 107	<b>Z 90</b>	14 FGH-7 DTURX	25	413
0 001 335 108	<b>Z 91</b>	14 GH-7 DTUR	25	420
0 001 335 110	<b>Z 120</b>	14 FGH-7 DTURXO	25	414
0 001 335 702	<b>Z 11</b>	14-7 DU	25	423
0 001 335 707	<b>Z 58</b>	14-7 CU	25	423
0 001 335 709	<b>Z 12</b>	14-7 DTU	25	423
0 001 335 714	<b>Z 61</b>	14-7 DU0	25	423
0 001 335 725	<b>Z 63</b>	14 F-7 DU	25	412
0 001 335 729	<b>Z 13</b>	14 F-7 DU0R	25	412
0 001 335 732	<b>Z 14</b>	14 F-7 LDUR	25	413
0 001 335 737	<b>Z 62</b>	14-7 DU0	25	423
0 001 335 742	<b>Z 200</b>	14 F-7 HUR2	25	412
0 001 335 788	<b>Z 344</b>	14 F-7 HTUR	25	412
0 001 335 789	<b>Z 272</b>	14 F-7 HURU02	25	412
0 001 335 905	<b>Z 282</b>	14 FGH-7 DPURX2	25	431
0 001 335 907	<b>Z 232</b>	14 F-7 DPUR2	25	430
0 001 335 910	<b>Z 171</b>	14 F-7 DPURX2	25	430
0 001 335 911	<b>Z 176</b>	14 F-7 HPURX2	25	430
0 001 335 914	<b>Z 188</b>	14 F-7 DPUR02	25	430
0 001 335 917	<b>Z 321</b>	14 F-7 KPPRU2	25	431
0 001 335 919	<b>Z 170</b>	14 F-7 DPURU2	25	430
0 001 340 103	<b>Z 89</b>	14 FGH-6 DTUR	25	413
0 001 340 702	<b>Z 22</b>	14-6 DU	25	422
0 001 340 704	<b>Z 51</b>	14-6 DTU	25	422
0 001 340 706	<b>Z 52</b>	14 F-6 DTU	25	412
0 001 340 717	<b>Z 53</b>	14 F-6 DTU	25	412
0 001 340 806	<b>Z 105</b>	14 F-6 DSR	25	437
0 001 340 903	<b>Z 104</b>	14-6 DPO	25	435
0 001 340 908	<b>Z 185</b>	14 F-6 DPUR021	25	430
0 001 340 910	<b>Z 236</b>	14 F-6 HTPRX02	25	430
0 001 340 915	<b>Z 295</b>	14 F-6 DTPRO2	25	430
0 001 340 916	<b>Z 322</b>	14 F-6 KPUR2W	25	430
0 001 340 917	<b>Z 349</b>	14 F-6 LPURW03	25	430
0 001 345 702	<b>Z 42</b>	14-5 DU	25	422
0 001 345 704	<b>Z 44</b>	14-5 DTU	25	422
0 001 345 720	<b>Z 29</b>	14 F-5 DU	25	412
0 001 345 906	<b>Z 277</b>	14 F-5 MPUR03	25	429
0 001 345 912	<b>Z 317</b>	14 F-5 DPUR2T	25	429
0 001 345 914	<b>Z 347</b>	14 F-5 DPUR02	25	429
0 001 345 915	<b>Z 348</b>	14 F-5 MPUR2L	25	429
0 001 350 910	<b>Z 339</b>	14 F-4 NBPR	25	429



Nm



0 001 350 911	<b>Z 345</b>	14 F-4 NBPR2LS	25	429
0 001 355 700	<b>Z 38</b>	14 Z-3 CU	25	422
0 001 400 701	<b>Z 85</b>	14-X AU	25	424
0 001 430 700	<b>Z 118</b>	14-8 BU	25	423
0 001 430 701	<b>Z 68</b>	14-8 AU	25	423
0 001 435 700	<b>Z 10</b>	14-7 BU	25	423
0 001 435 705	<b>Z 57</b>	14-7 AU	25	423
0 001 440 700	<b>Z 48</b>	14-6 BU	25	422
0 001 445 700	<b>Z 41</b>	14-5 BU	25	422
0 001 445 702	<b>Z 40</b>	14-5 AU	25	422
0 001 450 702	<b>Z 39</b>	14 Z-4 AU	25	422
0 001 455 702	<b>Z 37</b>	14 Z-3 AU	25	422
0 001 529 302	<b>Z 112</b>	14-8 E	25	424
0 001 625 700	<b>Z 80</b>	14 K-9 DU	15	426
0 001 625 702	<b>Z 81</b>	14 K-9 DU0	15	426
0 001 625 705	<b>Z 174</b>	14 K-9 BU	15	425
0 001 630 101	<b>Z 207</b>	14 KG-8 DTU	15	426
0 001 630 700	<b>Z 6</b>	14 K-8 DU	15	425
0 001 630 704	<b>Z 7</b>	14 K-8 DU0	15	425
0 001 635 700	<b>Z 17</b>	14 K-7 DU	15	425
0 001 635 709	<b>Z 18</b>	14 K-7 DU0	15	425
0 001 640 700	<b>Z 25</b>	14 K-6 DU	15	425
0 001 640 704	<b>Z 55</b>	14 K-6 DU0	15	425
0 001 640 705	<b>Z 56</b>	14 K-6 DU0	15	425
0 001 645 700	<b>Z 31</b>	14 K-5 DU	15	425
0 001 645 703	<b>Z 46</b>	14 K-5 DU0	15	425
0 001 700 901	<b>Z 108</b>	G 3/18	25	438
0 001 725 700	<b>Z 175</b>	18 K-9 BU	20	427
0 001 735 700	<b>Z 32</b>	18 K-7 BU	20	427
0 001 740 700	<b>Z 33</b>	18 K-6 BU	20	427
0 002 135 700	<b>Z 341</b>	10 FR-7 KDUS	12	411
0 002 140 900	<b>Z 210</b>	10 FR-6 CPU03	12	428
0 002 150 700	<b>Z 199</b>	10 FR-4 AU	12	411
0 002 230 300	<b>Z 243</b>	12 VR-8 SE	20	411
0 002 230 900	<b>Z 242</b>	12 ZR-8 TP	20	429
0 002 230 901	<b>Z 320</b>	12 ZR-8 STP	20	412
0 002 235 700	<b>Z 234</b>	12 FR-7 DU	20	411
0 002 235 901	<b>Z 288</b>	12 ZR-7 SPO3	20	429
0 002 235 905	<b>Z 325</b>	12 VR-7 SPUX	20	428
0 002 240 701	<b>Z 293</b>	12 FR-6 LUX	20	411
0 002 240 702	<b>Z 292</b>	12 FR-6 DU	20	411
0 002 240 707	<b>Z 358</b>	12 FR-6 DUT	20	411
0 002 240 901	<b>Z 306</b>	12 F-6 HPURW	20	428
0 002 240 902	<b>Z 233</b>	12 ZR-6 SPO3	20	428
0 002 240 907	<b>Z 336</b>	12 ZR-6 SP2	20	429
0 002 240 909	<b>Z 318</b>	12 ZR-6 SPP2	20	412
0 002 240 910	<b>Z 274</b>	12 VR-6 MPPUS	20	428
0 002 240 911	<b>Z 332</b>	12 ZR-6 SPP2-1	20	429
0 002 240 913	<b>Z 333</b>	12 FR-6 DPUX	20	428
0 002 245 703	<b>Z 286</b>	12 FR-5 SDU	25	411
0 002 245 704	<b>Z 291</b>	12 FR-5 DU	20	411
0 002 245 900	<b>Z 355</b>	12 VR-5 SPPU	20	428
0 002 250 900	<b>Z 338</b>	12 FR-4 DPUT	20	428
0 002 250 901	<b>Z 357</b>	12 FR-4 MPPUS	20	428
0 002 325 700	<b>Z 82</b>	14 R-9 DU	25	421
0 002 325 723	<b>Z 220</b>	14 FR-9 KUX2	25	420
0 002 325 900	<b>Z 285</b>	14 R-9 KPUV2	25	435
0 002 330 102	<b>Z 173</b>	14 FGR-8 KQU	25	415
0 002 330 104	<b>Z 190</b>	14 FGR-8 DQU7	25	415
0 002 330 203	<b>Z 248</b>	14 FR-8 HUT	25	419
0 002 330 204	<b>Z 249</b>	14 FR-8 KU0U	25	419
0 002 330 205	<b>Z 254</b>	14 FR-8 DUS	25	418
0 002 330 206	<b>Z 255</b>	14 FR-8 DUW	25	419
0 002 330 215	<b>Z 287</b>	14 FR-8 LU2T	25	420



Nm



0 002 330 217	<b>Z 334</b>	14 FR-8 DEW	25	418
0 002 330 701	<b>Z 8</b>	14 R-8 DU	25	421
0 002 330 702	<b>Z 9</b>	14 R-8 DUX	25	421
0 002 330 703	<b>Z 72</b>	14 FR-8 DU	25	418
0 002 330 704	<b>Z 73</b>	14 FR-8 DUX	25	419
0 002 330 706	<b>Z 94</b>	14 GR-8 DTU	25	420
0 002 330 709	<b>Z 119</b>	14 R-8 DU4	25	421
0 002 330 710	<b>Z 74</b>	14 FR-8 LDUOX4	25	419
0 002 330 712	<b>Z 152</b>	14 FR-8 HU	25	419
0 002 330 713	<b>Z 153</b>	14 FR-8 KU	25	419
0 002 330 714	<b>Z 154</b>	14 FR-8 KU0	25	419
0 002 330 718	<b>Z 183</b>	14 FR-8 MU2	25	420
0 002 330 794	<b>Z 203</b>	14 FR-8 LU2	25	419
0 002 330 795	<b>Z 208</b>	14 FR-8 LDU3	25	419
0 002 330 796	<b>Z 223</b>	14 FR-8 NQU23	25	420
0 002 330 902	<b>Z 211</b>	14 FGR-8 MQPU	25	431
0 002 330 903	<b>Z 229</b>	14 FR-8 LP0	25	434
0 002 330 904	<b>Z 219</b>	14 FR-8 MPUX02	25	434
0 002 330 905	<b>Z 238</b>	14 FR-8 DPU2	25	434
0 002 330 918	<b>Z 278</b>	14 FR-8 LPU02	25	434
0 002 330 925	<b>Z 311</b>	14 R-8 DPUU	25	435
0 002 330 926	<b>Z 302</b>	14 FR-8 MPUX2	25	435
0 002 330 930	<b>Z 343</b>	14 FR-8 DPPUX	25	434
0 002 335 100	<b>Z 60</b>	14 FGR-7 CTU	25	415
0 002 335 104	<b>Z 172</b>	14 FGR-7 KQU	25	415
0 002 335 128	<b>Z 213</b>	14 FGR-7 KDU6	25	415
0 002 335 131	<b>Z 239</b>	14 FGR-7 KQE	25	415
0 002 335 137	<b>Z 304</b>	14 FGHR-7 DTUT	25	414
0 002 335 138	<b>Z 324</b>	14 FGHR-7 LDUW	25	414
0 002 335 139	<b>Z 360</b>	14 FGHR-7 DTUU	25	414
0 002 335 500	<b>Z 98</b>	14 FR-7 LDU	25	418
0 002 335 503	<b>Z 257</b>	14 FR-7 LDUW	25	418
0 002 335 606	<b>UXT 1 (UXF 79)</b>		25	406
0 002 335 607	<b>UXT 2 (UX 79)</b>		25	406
0 002 335 701	<b>Z 20</b>	14 R-7 DU	25	421
0 002 335 704	<b>Z 59</b>	14 R-7 CU	25	421
0 002 335 706	<b>Z 21</b>	14 R-7 DUX	25	421
0 002 335 707	<b>Z 15</b>	14 FR-7 DU	25	417
0 002 335 708	<b>Z 16</b>	14 FR-7 DUX	25	417
0 002 335 709	<b>Z 123</b>	14 FR-7 KDU	25	417
0 002 335 712	<b>Z 155</b>	14 FR-7 KU	25	417
0 002 335 713	<b>Z 156</b>	14 FR-7 KU0	25	417
0 002 335 714	<b>Z 157</b>	14 FR-7 KUOX	25	418
0 002 335 715	<b>Z 158</b>	14 FR-7 LUX	25	418
0 002 335 717	<b>Z 193</b>	14 FR-7 DU2	25	417
0 002 335 719	<b>Z 184</b>	14 FR-7 MU2	25	418
0 002 335 802	<b>Z 299</b>	14 FR-7 LUX0	25	418
0 002 335 901	<b>Z 130</b>	14 FR-5 DPUX	25	431
0 002 335 902	<b>Z 149</b>	14 FR-7 KPUX	25	433
0 002 335 903	<b>Z 150</b>	14 FR-7 KPUV	25	433
0 002 335 904	<b>Z 151</b>	14 FR-7 KPU	25	433
0 002 335 911	<b>Z 237</b>	14 FR-7 DQUP7	25	433
0 002 335 912	<b>Z 224</b>	14 FR-7 DPU3	25	433
0 002 335 914	<b>Z 228</b>	14 FR-7 DPUX02	25	433
0 002 335 915	<b>Z 235</b>	14 FR-7 SPUX03	25	434
0 002 335 925	<b>Z 279</b>	14 FR-7 LPU02	25	433
0 002 335 926	<b>Z 280</b>	14 FR-7 KPUX02	25	433
0 002 335 928	<b>UXT 3 (UXF 79 P)</b>		25	406
0 002 335 929	<b>UXT 6 (UX 79 P)</b>		25	406
0 002 335 930	<b>UXT 9</b>		25	406
0 002 335 931	<b>UXT 10</b>		25	406
0 002 335 932	<b>UXT 11</b>		25	406
0 002 335 934	<b>UXT 13</b>		25	406
0 002 335 935	<b>Z 301</b>	14 FR-7 LPUX02	25	434



Nm



0 002 335 936	<b>Z 297</b>	14 FR-7 LPUX0	25	434
0 002 335 937	<b>Z 307</b>	14 FR-7 DPUV02	25	433
0 002 335 938	<b>Z 312</b>	14 FR-7 KPPU	25	433
0 002 335 939	<b>Z 326</b>	14 FR-7 MPUS	25	434
0 002 335 940	<b>Z 206</b>	14 FR-7 DPPUS2	25	432
0 002 335 946	<b>Z 337</b>	14 FR-7 DPPUW2	25	432
0 002 335 947	<b>Z 346</b>	14 FR-7 LPUT02	25	434
0 002 336 715	<b>Z 225</b>	14 FR-7 HUX	25	417
0 002 336 724	<b>Z 247</b>	14 FR-7 DUW	25	417
0 002 336 725	<b>Z 250</b>	14 FR-7 DU2S	25	417
0 002 336 726	<b>Z 251</b>	14 FR-7 DU2T	25	417
0 002 336 734	<b>Z 303</b>	14 FR-7 MUX2	25	418
0 002 336 738	<b>Z 273</b>	14 FR-7 NUX2	25	418
0 002 340 101	<b>Z 129</b>	14 FGR-6 KQU	25	415
0 002 340 102	<b>Z 145</b>	14 FGR-6 DDU	25	414
0 002 340 117	<b>Z 204</b>	14 FGR-8 CTU	25	415
0 002 340 123	<b>Z 300</b>	14 FGR-6 HQU	25	414
0 002 340 500	<b>Z 116</b>	14 FR-6 LDU	25	416
0 002 340 501	<b>Z 194</b>	14 FR-6 LDU3	25	416
0 002 340 504	<b>Z 245</b>	14 FR-6 LDUW	25	416
0 002 340 701	<b>Z 27</b>	14 R-6 DU	25	421
0 002 340 702	<b>Z 24</b>	14 FR-6 DU	25	416
0 002 340 703	<b>Z 28</b>	14 R-6 DUX	25	421
0 002 340 704	<b>Z 99</b>	14 FR-6 DUX	25	416
0 002 340 768	<b>Z 252</b>	14 FR-6 DUW	25	416
0 002 340 771	<b>Z 335</b>	14 FR-6 DUW2	25	416
0 002 340 903	<b>Z 159</b>	14 FR-6 DPUX	25	432
0 002 340 905	<b>Z 221</b>	14 FR-6 DPUX02	25	432
0 002 340 906	<b>Z 226</b>	14 FR-6 MPU2	25	432
0 002 340 908	<b>Z 284</b>	14 FR-6 DPOX	25	432
0 002 340 909	<b>Z 313</b>	14 FR-6 DPUX2	25	432
0 002 340 910	<b>Z 314</b>	14 FR-6 DPUW2	25	432
0 002 340 915	<b>Z 340</b>	14 FR-6 DPU02S	25	432
0 002 340 918	<b>Z 275</b>	14 FR-6 LPUOX	25	432
0 002 345 118	<b>Z 294</b>	14 FGR-5 NTE	25	414
0 002 345 501	<b>Z 192</b>	14 FR-5 LDU	25	416
0 002 345 504	<b>Z 198</b>	14 FR-5 LDU3	25	416
0 002 345 600	<b>UX 56</b>		25	424
0 002 345 606	<b>UXT 5 (UXF 56)</b>		25	406
0 002 345 701	<b>Z 47</b>	14 R-5 DU	25	420
0 002 345 702	<b>Z 30</b>	14 FR-5 DU	25	415
0 002 345 704	<b>Z 45</b>	14 FR-5 DTU	25	415
0 002 345 731	<b>Z 253</b>	14 FR-5 DUU	25	416
0 002 345 902	<b>UXT 12</b>		25	406
0 002 345 903	<b>UXT 14</b>		25	406
0 002 345 904	<b>Z 323</b>	14 FR-5 DPPUX	25	431
0 002 345 906	<b>Z 354</b>	14 FR-5 LPUOX	25	431
0 002 350 901	<b>Z 231</b>	14 FR-4 DPU	25	431
0 002 435 701	<b>Z 19</b>	14 R-7 BU	25	421
0 002 620 708	<b>Z 216</b>	14 KR-10 SUV2	15	426
0 002 625 700	<b>Z 117</b>	14 KR-9 DUX	15	427
0 002 630 701	<b>Z 177</b>	14 KR-8 MUV	15	427
0 002 630 715	<b>Z 222</b>	14 KR-8 STUX	15	427
0 002 630 900	<b>Z 148</b>	14 KR-8 DPUOV	15	436
0 002 630 903	<b>Z 298</b>	14 KR-8 DPUV	15	436
0 002 630 904	<b>Z 309</b>	14 KR-8 LQPU07	15	436
0 002 630 905	<b>Z 310</b>	14 KR-8 MPUV2	15	436
0 002 635 100	<b>Z 127</b>	14 KGR-7 KQU	15	426
0 002 635 601	<b>UXT 4 (UXK 79)</b>		15	406
0 002 635 700	<b>Z 95</b>	14 KR-7 DU	15	426
0 002 635 701	<b>Z 67</b>	14 KR-7 DUX	15	426
0 002 635 900	<b>UXT 7</b>		15	406
0 002 635 901	<b>UXT 8</b>		15	406
0 002 635 902	<b>Z 296</b>	14 KR-7 DPUV	15	436



Nm



0 002 635 903	<b>Z 356</b>	14 KR-7 MPUX2	15	436
0 002 635 904	<b>Z 342</b>	14 KR-7 MPUV2	15	436
0 002 640 100	<b>Z 144</b>	14 KGR-6 KQU	15	426
0 002 640 700	<b>Z 26</b>	14 KR-6 DU	15	426
0 002 640 701	<b>Z 49</b>	14 KR-6 BU	15	426
0 002 640 712	<b>Z 305</b>	14 KR-6 MUJ	15	427
0 002 640 900	<b>Z 97</b>	14 KR-8 MPX	15	436
0 002 640 904	<b>Z 209</b>	14 KR-6 DPUV02	15	436
0 002 640 907	<b>Z 230</b>	14 KR-6 KPUV02	15	436
0 002 640 909	<b>UXT 15</b>		15	406
0 002 640 910	<b>Z 315</b>	14 KR-6 MPV	15	436
0 002 645 600	<b>UXK 56</b>		15	427
0 003 335 401	<b>Z 111</b>	14 C-7 D	25	437
0 004 021 601	<b>Z 109</b>	KP105 DU	–	438
0 004 500 400	<b>Z 110</b>	EBE 514	–	438
0 004 520 300	<b>Z 261</b>	14 SR-10 E0	25	438
0 004 520 301	<b>Z 270</b>	14 S-10 E0	25	437
0 004 525 302	<b>Z 262</b>	14 S-9 E0	25	437
0 004 525 304	<b>Z 269</b>	14 SR-9 E0	25	438
0 004 535 300	<b>Z 266</b>	14 S-7 E	25	437
0 004 535 301	<b>Z 271</b>	14 SR-7 E	25	437
0 004 535 402	<b>Z 132</b>	14 S-7 F	25	437
0 004 535 403	<b>Z 263</b>	14 SR-7 F	25	438
0 004 535 700	<b>Z 267</b>	14 S-7 EU0	25	437
0 004 545 400	<b>Z 260</b>	14 SR-5 F	25	438
0 004 545 401	<b>Z 265</b>	14 S-5 F	25	437
0 900 004 019	<b>Z 22 SB</b>	14-6 DU	25	422
0 900 004 021	<b>Z 10 SB</b>	14-7 BU	25	423
0 900 004 023	<b>Z 11 SB</b>	14-7 DU	25	423
0 900 004 024	<b>Z 1 SB</b>	14-8 DU	25	423
0 900 004 029	<b>Z 29 SB</b>	14 F-5 DU	25	412
0 900 004 030	<b>Z 17 SB</b>	14 K-7 DU	15	425
0 900 004 047	<b>Z 27 SB</b>	14 R-6 DU	25	421
0 900 004 048	<b>Z 19 SB</b>	14 R-7 BU	25	421
0 900 004 049	<b>Z 20 SB</b>	14 R-7 DU	25	421
0 900 004 051	<b>Z 25 SB</b>	14 K-6 DU	15	425
0 900 004 052	<b>Z 8 SB</b>	14 R-8 DU	25	421
0 900 004 053	<b>Z 24 SB</b>	14 FR-6 DU	25	416
0 900 004 054	<b>Z 26 SB</b>	14 KR-6 DU	15	426
0 900 004 055	<b>Z 33 SB</b>	18 K-6 BU	20	427
0 900 004 061	<b>Z 31 SB</b>	14 K-5 DU	15	425
0 900 004 066	<b>Z 12 SB</b>	14-7 DTU	25	423
0 900 004 067	<b>Z 2 SB</b>	14-8 DTU	25	423
0 900 004 072	<b>Z 4 SB</b>	14 F-8 LUR	25	413
0 900 004 076	<b>Z 30 SB</b>	14 FR-5 DU	25	415
0 900 004 080	<b>Z 5 SB</b>	14 F-8 DU0	25	413
0 900 004 081	<b>Z 7 SB</b>	14 K-8 DU0	15	425
0 900 004 082	<b>Z 9 SB</b>	14 R-8 DUX	25	421
0 900 004 083	<b>Z 13 SB</b>	14 F-7 DUOR	25	412
0 900 004 084	<b>Z 14 SB</b>	14 F-7 LDUR	25	413
0 900 004 085	<b>Z 15 SB</b>	14 FR-7 DU	25	417
0 900 004 086	<b>Z 16 SB</b>	14 FR-7 DUX	25	417
0 900 004 087	<b>Z 18 SB</b>	14 K-7 DU0	15	425
0 900 004 088	<b>Z 21 SB</b>	14 R-7 DUX	25	421
0 900 004 090	<b>Z 28 SB</b>	14 R-6 DUX	25	421
0 900 004 091	<b>Z 3 SB</b>	14-8 LUR	25	424
0 900 004 092	<b>Z 6 SB</b>	14 K-8 DU	15	425
0 900 004 101	<b>Z 90 SB</b>	14 FGH-7 DTURX	25	413
0 900 004 102	<b>Z 91 SB</b>	14 GH-7 DTUR	25	420
0 900 004 103	<b>Z 92 SB</b>	14 GH-8 DTUR	25	420
0 900 004 104	<b>Z 93 SB</b>	14 GH-8 DTURX	25	420
0 900 004 105	<b>Z 94 SB</b>	14 GR-8 DTU	25	420
0 900 004 106	<b>Z 89 SB</b>	14 FGH-6 DTUR	25	413
0 900 004 108	<b>Z 67 SB</b>	14 KR-7 DUX	15	426



Nm



0 900 004 109	<b>Z 97 SB</b>	14 KR-8 MPX	15	436
0 900 004 113	<b>Z 74 SB</b>	14 FR-8 LDUOX4	25	419
0 900 004 114	<b>UX 56 SB</b>		25	424
0 900 004 118	<b>UXK 56 SB</b>		15	427
0 900 004 120	<b>Z 76 SB</b>	14-9 DU	25	424
0 900 004 121	<b>Z 95 SB</b>	14 KR-7 DU	15	426
0 900 004 134	<b>Z 100 SB</b>	14 F-8 DU4	25	413
0 900 004 135	<b>Z 119 SB</b>	14 R-8 DU4	25	421
0 900 004 136	<b>Z 120 SB</b>	14 FGH-7 DTURX0	25	414
0 900 004 137	<b>Z 121 SB</b>	14 FGH-8 DTURX0	25	414
0 900 004 141	<b>Z 177 SB</b>	14 KR-8 MUV	15	427
0 900 004 142	<b>Z 176 SB</b>	14 F-7 HPURX2	25	430
0 900 004 143	<b>Z 190 SB</b>	14 FGR-8 DQU7	25	415
0 900 004 144	<b>Z 158 SB</b>	14 FR-7 LUX	25	418
0 900 004 145	<b>Z 188 SB</b>	14 F-7 DPURO2	25	430
0 900 004 146	<b>Z 193 SB</b>	14 FR-7 DU2	25	417
0 900 004 147	<b>Z 200 SB</b>	14 F-7 HUR2	25	412
0 900 004 148	<b>Z 184 SB</b>	14 FR-7 MU2	25	418
0 900 004 149	<b>Z 183 SB</b>	14 FR-8 MU2	25	420
0 900 004 150	<b>Z 153 SB</b>	14 FR-8 KU	25	419
0 900 004 151	<b>Z 154 SB</b>	14 FR-8 KU0	25	419
0 900 004 152	<b>Z 155 SB</b>	14 FR-7 KU	25	417
0 900 004 153	<b>UXT 1 SB (UXF 79)</b>		25	406
0 900 004 154	<b>UXT 2 SB (UX 79)</b>		25	406
0 900 004 155	<b>UXT 3 SB (UXF 79 P)</b>		25	406
0 900 004 156	<b>UXT 4 SB (UXK 79)</b>		15	406
0 900 004 157	<b>UXT 5 SB (UXF 56)</b>		25	406
0 900 004 158	<b>UXT 6 SB (UX 79 P)</b>		25	406
0 900 004 159	<b>UXT 7 SB</b>		15	406
0 900 004 160	<b>UXT 8 SB</b>		15	406
0 900 004 161	<b>UXT 9 SB</b>		25	406
0 900 004 162	<b>UXT 10 SB</b>		25	406
0 900 004 163	<b>UXT 11 SB</b>		25	406
0 900 004 164	<b>UXT 12 SB</b>		25	406
0 900 004 165	<b>UXT 13 SB</b>		25	406
0 900 004 166	<b>UXT 14 SB</b>		25	406
0 900 004 167	<b>UXT 15 SB</b>		15	406
0 900 004 169	<b>Z 73 SB</b>	14 FR-8 DUX	25	419
0 900 004 170	<b>Z 122 SB</b>	14 FGH-8 DPURX2	25	431
0 900 004 171	<b>Z 170 SB</b>	14 F-7 DPURO2	25	430
0 900 004 172	<b>Z 203 SB</b>	14 FR-8 LU2	25	419
0 900 004 173	<b>Z 206 SB</b>	14 FR-7 DPPUS2	25	432
0 900 004 174	<b>Z 209 SB</b>	14 KR-6 DPUV02	25	436
0 900 004 175	<b>Z 222 SB</b>	14 KR-8 STUX	15	427
0 900 004 176	<b>Z 224 SB</b>	14 FR-7 DPU3	25	433
0 900 004 177	<b>Z 226 SB</b>	14 FR-6 MPU2	25	432
0 900 004 178	<b>Z 227 SB</b>	14 F-8 DUR	25	413
0 900 004 179	<b>Z 228 SB</b>	14 FR-7 DPURX0	25	433
0 900 004 180	<b>Z 235 SB</b>	14 FR-7 SPUX03	25	434
0 900 004 181	<b>Z 236 SB</b>	14 F-6 HTPRX02	25	430
0 900 004 182	<b>Z 237 SB</b>	14 FR-7 DQUP7	25	433
0 900 004 183	<b>Z 238 SB</b>	14 FR-8 DPU2	25	434
0 900 004 184	<b>Z 240 SB</b>	14 F-8 DPURX02	25	431
0 900 004 185	<b>Z 243 SB</b>	12 VR-8 SE	25	411
0 900 004 186	<b>Z 41 SB</b>	14-5 BU	25	422
0 900 004 187	<b>Z 42 SB</b>	14-5 DU	25	422
0 900 004 188	<b>Z 47 SB</b>	14 R-5 DU	25	420
0 900 004 189	<b>Z 49 SB</b>	14 KR-6 BU	15	426
0 900 004 190	<b>Z 59 SB</b>	14 R-7 CU	25	421
0 900 004 191	<b>Z 72 SB</b>	14 FR-8 DU	25	418
0 900 004 192	<b>Z 98 SB</b>	14 FR-7 LDU	25	418
0 900 004 193	<b>Z 99 SB</b>	14 FR-6 DUX	25	416
0 900 004 194	<b>Z 118 SB</b>	14-8 BU	25	423
0 900 004 195	<b>Z 148 SB</b>	14 KR-8 DPUOV	15	433



Nm



0 900 004 196	<b>Z 234 SB</b>	12 FR-7 DU	20	411
0 900 004 197	<b>Z 245 SB</b>	14 FR-6 LDUW	25	416
0 900 004 198	<b>Z 246 SB</b>	14 FGH-8 DTURW	25	414
0 900 004 199	<b>Z 247 SB</b>	14 FR-7 DUW	25	417
0 900 004 200	<b>Z 116 SB</b>	14 FR-6 LDU	25	416
0 900 004 201	<b>Z 126 SB</b>	14 FGH-8 DTUR	25	414
0 900 004 203	<b>Z 157 SB</b>	14 FR-7 KU0X	25	418
0 900 004 204	<b>Z 173 SB</b>	14 FGR-8 KQU	25	415
0 900 004 205	<b>Z 145 SB</b>	14 FGR-6 DDU	25	416
0 900 004 205	<b>Z 194 SB</b>	14 FR-6 LDU3	25	416
0 900 004 206	<b>Z 204 SB</b>	14 FGR-8 CTU	25	415
0 900 004 207	<b>Z 221 SB</b>	14 FR-6 DPUX02	25	432
0 900 004 208	<b>Z 223 SB</b>	14 FR-8 NQU23	25	420
0 900 004 210	<b>Z 255 SB</b>	14 FR-8 DUW	25	419
0 900 004 211	<b>Z 257 SB</b>	14 FR-7 LDUW	25	418
0 900 004 237	<b>Z 300 SB</b>	14 FGR-6 HQU	25	414
0 900 004 238	<b>Z 230 SB</b>	14 KR-6 KPUV02	15	436
0 900 004 239	<b>Z 233 SB</b>	12 ZR-6 SP03	20	428
0 900 004 240	<b>Z 239 SB</b>	14 FGR-7 KQE	25	415
0 900 004 241	<b>Z 293 SB</b>	12 FR-6 LUX	20	411
0 900 004 242	<b>Z 301 SB</b>	14 FR-7 LPUX02	25	434
0 900 004 243	<b>Z 310 SB</b>	14 KR-8 MPUV2	15	436
0 900 004 244	<b>Z 326 SB</b>	14 FR-7 MPUS	25	434
0 900 004 245	<b>Z 340 SB</b>	14 FR-6 DPU02S	25	432



**Wichtig beim Austausch:  
Das richtige Anzugsdrehmoment!**

Beim Austausch von abgenutzten Zündkerzen muß man auf zwei Dinge besonders achten:

- 1.) Verschmutzungen rund ums Kerzenloch dürfen auf keinen Fall in den Brennraum fallen.
- 2.) Die Kerzen müssen mit dem richtigen Drehmoment angezogen werden. Bei einem zu hohen Drehmoment kann die Kerze beschädigt werden, ein zu niedriges bewirkt eine schlechte Dichtung und Wärmeableitung.

**Wichtig:** Bei jedem Zündkerzenwechsel den Zündkerzenstecker (innen) fetten.

Zündkerzen-Steckerfett - ZKF 01

- verhindert Zündaussetzer und Hochspannungsüberschläge
- unterbindet das Verbacken von Zündkerzenstecker und Zündkerze - das erleichtert das Abziehen des Steckers und verringert die Gefahr von Beschädigungen des Kezensteckers
- für optimale Isolation

BERU Zündkerzen-Steckerfett, 10 gr. Tube  
Bestell-Nr. 0 890 300 029

**Important on replacement:  
the right tightening torque!**

When replacing worn out spark plugs, there are two aspects to which special attention must be paid:

- 1.) Dirt around the hole for the plug must not fall into the combustion chamber under any circumstances.
- 2.) The spark plugs must be tightened to the correct torque. The spark plug may be damaged by excessive torque, insufficient torque results in poor sealing and poor heat conduction.

**Important:** Always grease the spark-plug connector (inner) when changing spark plugs.

Spark plug - connector grease ZKF 001

- prevents misfiring and high voltage arc-over
- prevents the spark plug connector and spark plug from caking - this facilitates the removal of the spark plug connector and reduces the risk of damage to the connector
- for optimum electrical insulation

BERU spark plug connector grease, 10 g tube  
Order no.: 0 890 300 029

**Einbau mit Drehmomentschlüssel:****Fitting with a torque wrench:**

Anziehmomente in Nm, Gewinde darf nicht gefettet sein  
Tightening torque in Nm, thread must not be greased

**Flachdichtsitzkerzen:  
Flat seat spark plugs:**

Kerzengewinde      Zylinderkopf  
Spark plug thread    Cylinder head

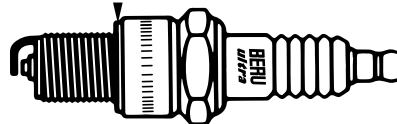

	Gußeisen Cast iron	Leichtmetall Alloy
M 10x1,0	10-15	10-15
M 12x1,25	15-25	12-20
M 14x1,25	20-35	15-30
M 18x1,5	30-45	20-35

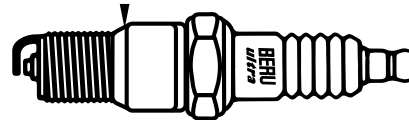
**Kegeldichtsitzkerzen:  
Conical seat spark plugs:**

M 14x1,25	15-25	12-20
M 18x1,5	15-30	15-25



Genauere Angaben zum Anzugsdrehmoment entnehmen Sie der Bedienungsanleitung des Fahrzeugherstellers.

Exact details on the tightening torque are available in the vehicle manufacturer's operating instructions.



## Important au moment du remplacement: le couple de serrage!

Lors du remplacement des bougies d'allumage usées, toujours tenir compte des points suivants:

- 1.) Les impuretés entourant l'orifice de la bougie ne doivent en aucun cas tomber dans la chambre de combustion.
- 2.) Les bougies doivent être serrées avec le couple prescrit. Un couple trop important peut endommager la bougie, un couple trop faible entraîne des problèmes d'étanchéité et une dissipation de chaleur.

**Important:** Lors de chaque changement des bougies d'allumage, lubrifier le connecteur (à l'intérieur).

Graisse pour embout de bougie d'allumage - ZKF 001

- prévient les ratés d'allumage et la décharge disruptive haute tension
- prévient le grippage des embouts (de bougie d'allumage) et de la bougie d'allumage, d'où une plus grande facilité de démontage de l'embout et une réduction des risques d'endommagements (du connecteur)
- pour une isolation électrique optimale

Graisse pour embouts de bougies d'allumage BERU, tube de 10 g, Référence No. 0 890 300 029

## Belangrijk bij het vervangen: het juiste aantrekmoment!

Bij het vervangen van versleten bougies moet op twee dingen in het bijzonder gelet worden:

- 1.) Vuil rondom het bougiegat mag in geen geval in de verbrandingsruimte vallen.
- 2.) De bougies moeten met het juiste draaimoment aangetrokken worden. Bij een te hoog draaimoment kan de bougie beschadigd worden, een te laag zorgt voor een slechte afdichting en warmteafvoer.

**Belangrijk:** Bij iedere vervanging van de bougie de stekker (binnen) invetten.

Bougie-stekker - ZKF 001

- voorkomt uitvallen van de ontsteking en hoogspanningsoverslag
- voorkomt het samenkoeken van bougiestekkers en bougie - dit vergemakkelijkt het lostrekken van de stekker en reduceert het gevaar van beschadiging van de bougiestekker.
- voor een optimale elektrische isolatie

BERU bougie-stekker, 10 gr. tube  
Bestelnummer 0 890 300 029

## Montage avec clé dynamométrique:

### Inbouw met draaimomentsleutel:

Couples de serrage en Nm, les filetages ne doivent pas être graissés  
Aantrekmomenten in Nm, schroefdraad mag niet ingevet zijn

### Bougies à logement plat de bague d'étanchéité:

#### Bougies met platte afdichting:

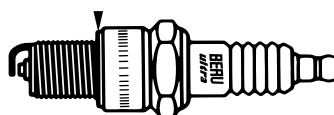

Filetage  
Bougiedraad

Tête cylindrique  
Cilinderkop

	Fonte Gietijzer	Métal léger Lichtmetaal
M 10x1,0	10-15	10-15
M 12x1,25	15-25	12-20
M 14x1,25	20-35	15-30
M 18x1,5	30-45	20-35

### Bougies à logement conique de bague d'étanchéité:

#### Bougies met conische afdichting:

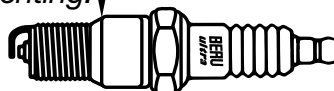

M 14x1,25	15-25	12-20
M 18x1,5	15-30	15-25



Vous trouverez les données exactes concernant le couple de serrage, dans le mode d'emploi du constructeur.  
De precieze gegevens over het aandraaikoppel vindt u in de gebruiksaanwijzing van de voertuigfabrikant.



## Importante para el cambio de bujías: ¡Aplicar el par de apriete correcto!

Para cambiar las bujías de encendido desgastadas es necesario observar especialmente los dos siguientes puntos:

- 1.) Evitar siempre que la suciedad depositada alrededor del orificio de la bujía caiga hacia el interior de la cámara de combustión.
- 2.) Las bujías de encendido deben ser apretadas al par de apriete correcto. Si el par de apriete fuera demasiado alto, puede dañarse la bujía y si el par de apriete fuera insuficiente, la junta no quedará estanca y la disipación de calor será insuficiente.

**Importante:** Engrasar en cada cambio de bujías de encendido el conector de la bujía (interior).

Grasa para conector de bujías de encendido - ZKF 001  
 - impide fallos de encendido y descargas de alta tensión  
 - impide la fusión del conector de bujías y de las bujías, lo que facilita extraer el conector y disminuye el riesgo de que el conector de bujías sufra daños  
 - para un aislamiento eléctrico óptimo

Grasa para conectores de bujías de encendido BERU, tubo de 10 g., N.º de pedido 0 890 300 029

## Importante per la sostituzione: la giusta coppia di serraggio!

Durante la sostituzione di candele usurate bisogna fare particolare attenzione a due cose:

- 1.) La sporcizia depositatasi intorno alla cava della candela non deve assolutamente cadere nella camera di combustione.
- 2.) Le candele devono essere strette con la giusta coppia di serraggio. Se tale coppia è troppo alta la candela può essere danneggiata; una coppia di serraggio insufficiente provoca una scarsa tenuta e un basso smaltimento di calore.

**Importante:** In ogni cambio delle candele d'accensione, è necessario ingrassare la spina della stessa (all'interno).

Grasso per connettore delle candele d'accensione - ZKF 001  
 - previene mancate accensioni e scariche ad alta tensione sull'isolatore ceramico  
 - previene bloccaggi dei connettori delle candele d'accensione e depositi sulla candela d'accensione  
 - ciò facilita il distacco dal connettore e riduce il pericolo di danneggiare il connettore stesso.  
 - per un isolamento elettrico ottimale

Grasso per connettori di candele d'accensione BERU, tubetto da 10 gr.  
 Numero di ordinazione no. 0 890 300 029

### Montaje con llave dinamo métrica:

#### Montaggio con chiave dinamometrica:

Pares de apriete en Nm, la rosca no debe estar engrasada  
 Coppie di serraggio in nm, la filettatura non deve essere ingrassata

Bujías de asiento de junta plana:

Candele a base piana:



Rosca de la bujía  
 Filetto candela

Culata  
 Testata del cilindro

Fundición de hierro  
 Ghisa

Metal ligero  
 Lega leggera

M 10x1,0	10-15	10-15
M 12x1,25	15-25	12-20
M 14x1,25	20-35	15-30
M 18x1,5	30-45	20-35

Bujías de asiento de junta cónica:

Candele a base conica:

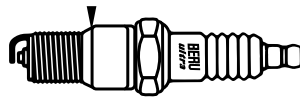

M 14x1,25	15-25	12-20
M 18x1,5	15-30	15-25



Consulte los datos exactos relativos al par de apriete de las instrucciones de manejo del fabricante del vehículo.

Le specifiche esatte sulla coppia di serraggio sono da apprendere nelle istruzioni per l'uso fornite dal costruttore dell'automobile.



## При замене важно: надлежащий крутящий момент затяжки!

При замене изношенных свечей зажигания необходимо учитывать два основных требования:

- 1.) Ни в коем случае не допускать попадания загрязнений, имеющихся по периметру отверстия свечи, в камеру сгорания.
- 2.) Обеспечить надлежащий крутящий момент при затяжке свечей зажигания. При чрезмерном крутящем моменте возможно повреждение свечи, недостаточный крутящий момент обуславливает некачественное уплотнение и плохой отвод тепла.

**Важно:** При каждой замене свечей зажигания смазать (изнутри) штекер свечи зажигания.

Мазь для наконечника провода к свече зажигания - ZKF 001

- предотвращает перебои искрообразования и пробой высокого напряжения
- предотвращает спекание наконечника провода к свече зажигания и свечи зажигания, это облегчает съем наконечника провода к свече зажигания и снижает опасность повреждения наконечника
- для оптимальной электрической изоляции

Мазь для наконечника провода к свече зажигания фирмы BERU, 10 г в тубике.  
Номер заказа 0 890 300 029

## Ważne przy wymianie świec: właściwy moment dokręcania!

Podczas wymiany zużytych świec zapłonowych należy zwrócić szczególną uwagę na dwie rzeczy:

- 1.) Zanieczyszczenia z okolic otworu pod świecę nie mogą pod żadnym pozorem wpaść do wnętrza komory spalania.
- 2.) Świece muszą być dokręcone właściwym momentem. Zbyt duży moment dokręcania może spowodować uszkodzenie świecy, zbyt mały moment powoduje pogorszenie szczelności i odprowadzania ciepła.

**Uwaga:** Przy każdej wymianie świec zapłonowych nasmarować wtyczkę świecy zapłonowej (wewnątrz).

Smar do świec zapłonowych ZKF 001

- zapobiega wypadaniu zapłonu i przebiegom wysokiego napięcia
- zapobiega zapiekaniu się wtyczek przewodów zapłonowych co ułatwia ich ściąganie i zażegnuje niebezpieczeństwu ich urwania.
- do optymalnej izolacji elektrycznej

Smar do świec zapłonowych BERU ZKF 001,  
tubka 10 g; Nr katalogowy 0 890 300 029

## Монтаж с использованием динамометрического ключа:

Wkręcanie świecy za pomocą klucza dynamometrycznego:

Моменты затяжки указаны в Нм, наносить смазку запрещается  
Momenty dokręcania w Nm, nie wolno smarować gwintu

Свечи с цилиндрической  
уплотнительной поверхностью:  
Świece z płaską powierzchnią  
pod uszczelkę:

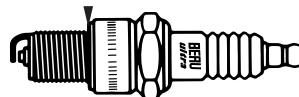

Резьба свечи      Головка цилиндра  
Gwint świecy      Głowica cylindrów

	чугунная Żeliwo	легкоплавная Stop lekkie
M 10x1,0	10-15	10-15
M 12x1,25	15-25	12-20
M 14x1,25	20-35	15-30
M 18x1,5	30-45	20-35

Свечи с конической  
уплотнительной поверхностью:  
Świece ze stożkową  
powierzchnią pod uszczelkę:

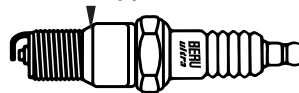

M 14x1,25	15-25	12-20
M 18x1,5	15-30	15-25



Точные данные по моменту затяжки приведены в инструкции по эксплуатации транспортного средства изготовителя.

Dokładne dane na temat momentu dokręcenia podane są w instrukcji obsługi wydanej przez producenta pojazdu.



## Σημαντικό κατά την αντικατάσταση: Η σωστή ροπή στρέψης!

Κατά την αντικατάσταση φθαρμένων μπουζιών, πρέπει να προσέχονται ιδιαίτερα δύο πράγματα:

- 1.) Δεν επιτρέπεται σε καμία περίπτωση να εισέλθουν ακαθαρσίες στο θάλαμο καύσης του μπουζιού.
- 2.) Τα μπουζιά πρέπει να βιδωθούν με τη σωστή ροπή στρέψης. Εάν η ροπή στρέψης είναι πολύ υψηλή, μπορεί να καταστραφεί το μπουζί, εάν είναι πολύ χαμηλή, δεν υπάρχει καλή στεγανότητα και διάχυση θερμότητας.

Σημαντικό: Σε κάθε αντικατάσταση μπουζί λιπαίνετε το συνδετήρα μπουζί (εσωτερικά).

Λιπαντικό για πίπες μπουζί - ZKF 001

- εμποδίζει αποτυχίες ανάφλεξης και σπινθηρισμούς εξαιτίας υψηλής τάσης
- αποτρέπει την συγκόλληση της πίπας μπουζί με το μπουζί- αυτό διευκολύνει την αφαίρεση της πίπας και μειώνει τον κίνδυνο φθοράς της πίπας του μπουζί
- για βέλτιστη ηλεκτρική μόνωση

Λιπαντικό για πίπα μπουζί BERU, σωληνάριο 10 gr.

Κωδικός παραγγελίας προϊόντος  
0 890 300 029

### Εγκατάσταση με ροπόκλειδο:

Ροπές στρέψης σε Nm, το σπείρωμα δεν επιτρέπεται να λιπαίνεται

#### Μπουζιά επίπεδης εφαρμογής:

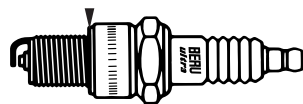

Σπείρωμα μπουζιού    Κεφαλή κυλίνδρου

Χυτοσίδηρος

Ελαφρύ μέταλλο

M 10x1,0	10-15	10-15
M 12x1,25	15-25	12-20
M 14x1,25	20-35	15-30
M 18x1,5	30-45	20-35

#### Μπουζιά κωνικής εφαρμογής:



M 14x1,25	15-25	12-20
M 18x1,5	15-30	15-25



Τα ακριβή στοιχεία σχετικά με τη ροπή σύσφιξης θα τα βρείτε στις οδηγίες χρήσης του κατασκευαστή του οχήματος.



## A gyertya cseréjénél fontos: a helyes meghúzási nyomaték!

Az elhasználódott gyújtógyertyák cseréjekor két dologra kell különös figyelmet fordítani:

- 1.) A gyertyafurat körül található szennyeződéseknek semmi esetre sem szabad beleesniük az égéstérbe.
- 2.) A gyertyákat a helyes meghúzási nyomatékkal kell meghúzni. Nagy nyomaték esetén a gyertya káro-sodást szenvedhet, túl alacsony nyomaték következménye pedig nem kielégítő tömítettség és rossz hőleadás lehet.

**Fontos:** Minden gyújtógyertyacserénél zsírozza be a gyertyakupakot (belül).

Szerelőzsír gyújtógyertyához - ZKF 001

- megakadályozza a gyújtáskimaradást és a szikraáthúzást
- megakadályozza a gyújtógyertya-csatlakozósapka és a gyújtógyertya összeégését - így megkönnyíti a gyertyapipa lehúzását és csökkenti megrongálódásának veszélyét.
- optimális elektromos szigeteléshez

BERU szerelőzsír gyújtógyertyához, 10 g/tubus  
Rendelési szám: 0 890 300 029

### Beszerelés dinamométer-kulccsal:

Meghúzási nyomatékok Nm-ben, a csavarmenetet nem szabad beszírozni

Lapos tömítésen ülő gyertyák:

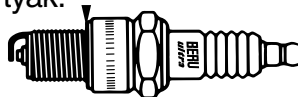

Gyertyamenet	Hengerfej	
	Öntöttvas	Könnyűfém
M 10x1,0	10-15	10-15
M 12x1,25	15-25	12-20
M 14x1,25	20-35	15-30
M 18x1,5	30-45	20-35

Kúpos tömítésen ülő gyertyák:

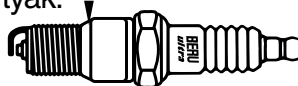



M 14x1,25	15-25	12-20
M 18x1,5	15-30	15-25





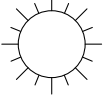

A meghúzónyomatéokra vonatkozó pontos adatokat a járműgyártó kezelési utasításában találhatja meg.

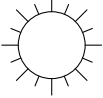

Gewinde Thread <b>14</b>		Sitzform und Ausführung Configuration <b>F</b>		Wärmewertkennzahl Thermal rating <b>7</b>			
<b>10</b>	M 10x1,0	<b>B</b>	Geschirmt, wasserdicht, Abbrandwiderstand, Zündleitung 7 mm <i>Screened, waterproof, burn-off resistor, ignition cable 7 mm</i>	neu <i>new</i>		alt <i>old</i>	
<b>12</b>	M 12x1,25			<b>13</b>		<b>25</b>	
<b>14</b>	M 14x1,25	<b>C</b>	wie B, jedoch Zündleitung 5 mm <i>same as B, however, ignition cable 5 mm</i>	<b>12</b>	<b>50</b>	<b>11</b>	<b>75</b>
				<b>10</b>	<b>100</b>	<b>9</b>	<b>125</b>
<b>18</b>	M 18x1,5	<b>F</b>	Flachdichtsitz <i>Flat seat</i>		<b>16 mm</b>	<b>8</b>	<b>150</b>
						<b>7</b>	<b>175</b>
		<b>G</b>	Gleitfunkenkerze <i>Surface-gap plug</i>	<b>6</b>	<b>200</b>	<b>5</b>	<b>225</b>
				<b>GH</b>	Gleitfunkenkerze mit Hilfsfunkenstrecke <i>Surface gap plug with auxiliary spark path</i>	<b>4</b>	<b>250</b>
		<b>K</b>	Konusdichtsitz <i>Conical seat</i>			<b>2</b>	<b>300</b>
				<b>R</b>	Entstörwiderstand 5 kΩ/10 kΩ <i>Interference-suppression resistor 5 kΩ/10 kΩ</i>	<b>08</b>	<b>350</b>
		<b>S</b>	Kerze für Kleinmotoren Flachdichtsitz <i>Spark plug for small engines</i> <i>Flat seat</i>			<b>06</b>	<b>400</b>
				<b>T</b>	wie S, jedoch mit Konusdichtsitz <i>same as S, however, with taper sealing seat</i>	Sonderkennzeichnung <i>Special indication</i>	
		<b>V</b>	Flachdichtsitz <i>Flat seat</i>				
				<b>Z</b>	Kerze für Zweitaktmotoren <i>Spark plug for two-stroke engine</i>	<b>01</b>	
		<b>ZR</b>	Doppelsechskant Bi-Hex <i>Double hexagon Bi-hex</i>				<b>14 mm</b>
						<b>04</b>	
						<b>05</b>	

Gewindelänge und Funkenlage <i>Spark position and thread length</i>	Elektrodenausführung <i>Type of electrode</i>	Elektrodenwerkstoff <i>Electrode material</i>	Ausführungsart <i>Other characteristics</i>
<b>D</b>	<b>T</b>	<b>U</b>	<b>O</b>
<b>A</b> 	<b>A</b> Dreieck-Masse-Elektrode <i>Triangular ground electrode</i>	<b>U</b> BERU ultra NiCu	<b>O</b> Abweichung von der Grundauführung (z.B. stärkere Mittelelektrode) <i>Deviation from the basic design (e.g. thicker middle electrode)</i>
<b>B</b> 	<b>T</b> mit mehrpoligen Körper- elektroden <i>with multi-polar ground electrode</i>	<b>S</b> Silber <i>Silver</i>	<b>R</b> mit Abbrandwiderstand <i>with consumption resistance</i>
<b>C</b> 	<b>D</b> 2 Masse- elektroden <i>2 ground electrodes</i>	<b>P</b> Platin <i>Platinum</i>	<b>S</b>  = 0,7 mm
<b>D</b> 	<b>Q</b> 4 Masse- elektroden <i>4 ground electrodes</i>	<b>I</b> Iridium <i>Iridium</i>	<b>T</b>  = 0,8 mm
<b>E</b> 	<b>K</b> Ring- elektrode <i>Annular electrode</i>	<b>E</b> Nickel-AL <i>Nickel-AL</i>	<b>U</b>  = 1,0 mm
<b>F</b> 	<b>L</b> 	<b>1</b> Abweichend vom Wärmewert <i>Differing from heat range</i>	<b>V</b>  = 1,3 mm
<b>H</b> 	<b>M</b> 	<b>2</b> Zweistoff Masseelektrode <i>Two component ground electrode</i>	<b>W</b>  = 0,9 mm
<b>K</b> 	<b>N</b> 	<b>3</b> Spezial <i>Special</i>	<b>X</b>  = 1,1 mm
<b>L</b> 	<b>S</b> 	<b>4</b> Verlängerter Isolatorfuß <i>Extended insulator</i>	<b>Y</b>  = 1,5 mm
<b>M</b> 	<b>T</b> 	<b>5</b> Vorgezogener Isolatorfuß <i>Advanced insulator base</i>	<b>Z</b>  = 2,0 mm
<b>N</b> 	<b>W</b> 	<b>6</b> Zurückgezogener Isolatorfuß <i>Retracted insulator base</i>	<b>7</b> Hörnerelektrode <i>Horn electrode</i>
<b>S</b> 	<b>A</b> 	<b>7</b> Hörnerelektrode <i>Horn electrode</i>	
<b>T</b> 			
<b>W</b> 			

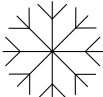

Filetage Draad <b>14</b>	Forme du siège et type Samenstelling van het type <b>F</b>	Valeur thermique-indice Thermisch kengetal <b>7</b>
<b>10</b> M 10x1,0	<b>B</b> Blindage, étanchéité à l'eau, résistance à l'érosion, fil d'allumage 7 mm <i>Afgeschermd, waterproof, afbrandweerstand, ontstekingskabel 7 mm</i>	nouvel <i>nieuw</i>  ancien <i>oud</i>
<b>12</b> M 12x1,25	<b>C</b> comme B, mais fil d'allumage 5 mm <i>als B, echter ontstekingskabel 5 mm</i>	<b>13</b> 25
<b>14</b> M 14x1,25	<b>F</b> Joint d'étanchéité <i>Vlakke zitting</i>  16 mm	<b>12</b> 50
<b>18</b> M 18x1,5	<b>G</b> Bougie à étincelle glissante <i>Oppervlakteontlaadbougie</i>	<b>11</b> 75
	<b>GH</b> Bougie à étincelle glissante avec chemin d'aide à l'étincelage <i>Oppervlakteontlaadbougie met hulpvonkpad</i>	<b>10</b> 100
	<b>K</b> Joint d'étanchéité conique <i>Conische zit</i>	<b>9</b> 125
	<b>R</b> Résistance antiparasite 5 kΩ/10 kΩ <i>Ontstoringsweerstand 5 kΩ/10 kΩ</i>	<b>8</b> 150
	<b>S</b> Bougies d'allumage pour petits moteurs Joint d'étanchéité plat <i>Bougie voor kleine motoren Vlakke zit</i>	<b>7</b> 175
	<b>T</b> comme S, mais avec portée de joint conique <i>als S, echter met conische afdichtzit</i>	<b>6</b> 200
	<b>V</b> Joint d'étanchéité <i>Vlakke zitting</i>  14 mm	<b>5</b> 225
	<b>Z</b> Bougies d'allumage pour moteurs deux temps <i>Bougie voor tweetaktmotoren</i>	<b>4</b> 250
	<b>ZR</b> Bihexagonal(e) Bi-Hex <i>Dubbele zeskant Bi-Hex</i>  14 mm	<b>3</b> 275
		<b>2</b> 300
		<b>09</b> 325
		<b>08</b> 350
		<b>07</b> 375
		<b>06</b> 400
		
		Indication spéciale <i>Speciale indicatie</i>
		<b>X</b>
		<b>01</b>
		<b>02</b>
		<b>03</b>
		<b>04</b>
		<b>05</b>

Longueur du filetage et position d'étincelle  
*Draadlengte en vonkpositie*

**D**

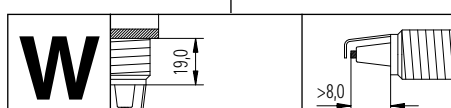
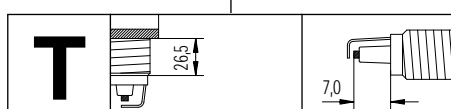
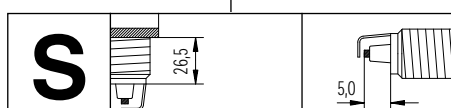
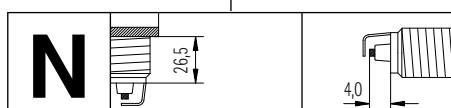
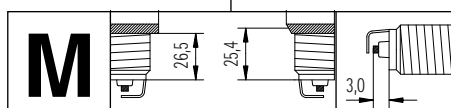
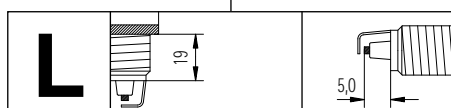
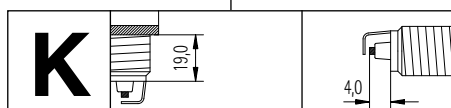
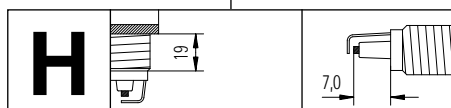
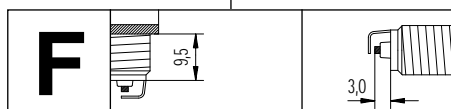
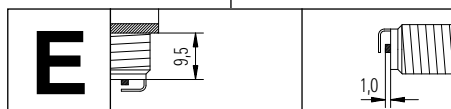
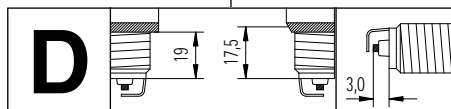
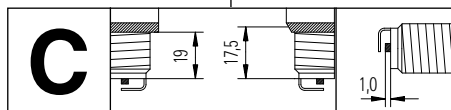
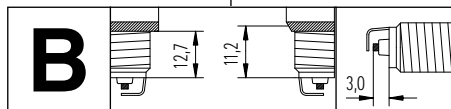
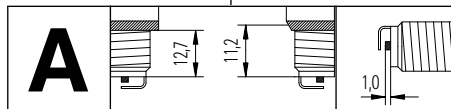

Type d'électrode  
*Type elektrode*

**T**

**A** Electrode de masse triangulaire  
*Driehoekige massa-elektrode*

**T** avec électrode de masse multipolaire  
*met meerpolige massa-elektrode*

**D** 2 électrodes de masse  
*2 massa-elektroden*

**Q** 4 électrodes de masse  
*4 massa-elektroden*

**K** Electrode annulaire  
*Ring-elektrode*

Matière d'électrode  
*Elektrodenmateriaal*

**U**

**U** BERU ultra NiCu

**S** Argent Zilver

**P** Platine Platina

**I** Iridium Iridium

**E** Nickel-AL Nikkel-AL

Sorte de construction  
*Andere kenmerken*

**O**

**O** Variantes de la version standard (par ex. électrode plus épaisse)  
*Afwijking van de basisuitvoering (bijv. dikkere midden-elektrode)*

**R** avec résistance d'usure  
*met afbrandweerstand*

**S** = 0,7 mm

**T** = 0,8 mm

**U** = 1,0 mm

**V** = 1,3 mm

**W** = 0,9 mm

**X** = 1,1 mm

**Y** = 1,5 mm

**Z** = 2,0 mm

**1** Différent de la valeur thermique  
*Afwijkend van de warmtewaarde*

**2** Electrode de masse avec 2 matériaux  
*Tweecomponenten massa-elektrode*

**3** Spécial Speciaal

**4** Bec d'isolant rallongé  
*Verlengde isolatievoet*

**5** Pied d'isolateur avancé  
*Naar voren geschoven isolatorvoet*

**6** Pied d'isolateur reculé  
*Teruggetrokken isolatorvoet*

**7** Electrode à cornes  
*Hörner-elektrode*

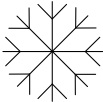
Rosca <i>Filettatura</i>		Forma de asiento y versión <i>Forma della sede ed esercizio</i>		Indice valor térmico <i>Coefficiente termico</i>	
<b>14</b>		<b>F</b>		<b>7</b>	
<b>10</b>	M 10x1,0	<b>B</b>	Cable de encendido de 7 mm, apantallada, hermética al agua, resistente al desgaste <i>Schermatura, a tenuta d'acqua, resistente alla bruciatura, conduttore di accensione 7 mm</i>	nuevo <i>nuovo</i>	anterior <i>vecchio</i>
<b>12</b>	M 12x1,25			13	25
<b>14</b>	M 14x1,25	<b>C</b>	Como B pero con cable de encendido de 5 mm <i>Come B, ma con conduttore di accensione di 5 mm</i>	12	50
<b>18</b>	M 18x1,5			11	75
		<b>F</b>	Asiento plano <i>Sede piana</i>	10	100
				9	125
		<b>G</b>	Bujía de chispa deslizante <i>Candela a scintilla superficiale</i>	8	150
				7	175
		<b>GH</b>	Bujía de chispa deslizante pero con tramo auxiliar para la chispa <i>Candela a scintilla superficiale con scintilla ausiliaria</i>	6	200
				5	225
		<b>K</b>	Asiento cónico <i>Sede conica</i>	4	250
				3	275
		<b>R</b>	Resistencia antiparasitaje 5 kΩ/10 kΩ <i>Resistenza di schermatura 5 kΩ/10 kΩ</i>	2	300
				09	325
		<b>S</b>	Bujía para motores pequeños Asiento plano <i>Candela per piccoli motori</i> <i>Sede piana</i>	08	350
				07	375
		<b>T</b>	Como S pero con asiento cónico <i>Come S, ma con sede conica</i>	06	400
					
		<b>V</b>	Asiento plano <i>Sede piana</i>		
				X	
		<b>Z</b>	Bujía para motores de 2 tiempos <i>Candela per motori a due tempi</i>	01	
				02	
		<b>ZR</b>	Hexágono doble Bi-Hex <i>Esagono doppio Bi-Hex</i>	03	
				04	
				05	

Longitud de rosca y posición de chispa  
*Lunghezza filetto e posizione scintilla*  
**D**

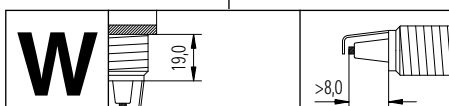
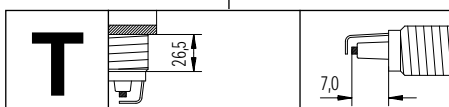
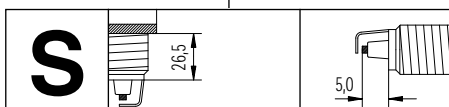
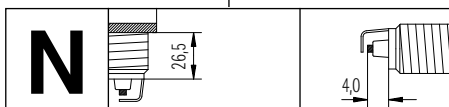
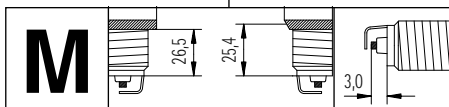
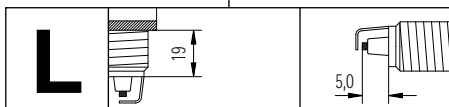
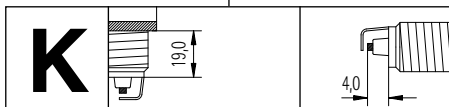
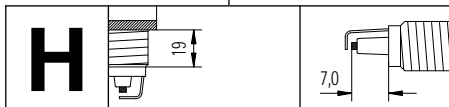
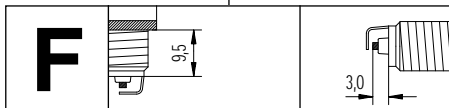
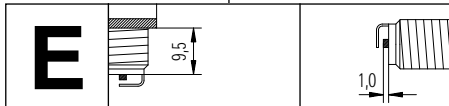
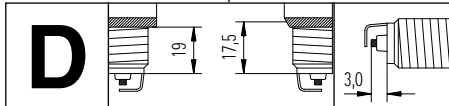
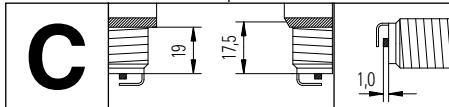
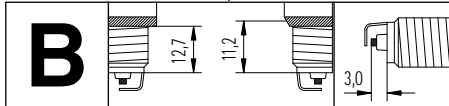
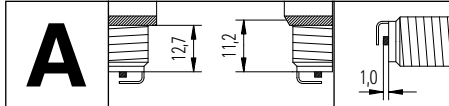

Tipo de electrodo  
*Esecuzione elettrodi*  
**T**

**A** Electrodo de masa triangular  
*Elettrodo di massa triangolare*

**T** con electrodo de masa multipolar  
*con elettrodi di massa multipolari*

**D** 2 electrodo de masa  
*2 elettrodi di massa*

**Q** 4 electrodo de masa  
*4 elettrodi di massa*

**K** Electrodo anular  
*Elettrodo ad anello*

Material de electrodo  
*Materiale elettrodi*  
**U**

**U** BERU ultra NiCu

**S** Plata  
*Argento*

**P** Platino  
*Platino*

**I** Iridio  
*Iridio*

**E** Níquel-AL  
*Nichle-AL*

Tipo constructivo  
*Esercuzione*  
**O**

**O** Divergencia con la versión básica (p.ej., electrodo central más grueso)  
*Differenze dalla versione base (p.es. elettrodo centrale più forte)*

**R** Con resistencia de desgaste  
*Con resistenza alla bruciatura*

**S** = 0,7 mm

**T** = 0,8 mm

**U** = 1,0 mm

**V** = 1,3 mm

**W** = 0,9 mm

**X** = 1,1 mm

**Y** = 1,5 mm

**Z** = 2,0 mm

**1** A diferencia del valor térmico  
*Diverso dal coefficiente termico*

**2** Electrodo de masa bicomponente  
*Elettrodo di massa a 2 componenti*





**3** Especial  
*Speciale*

**4** Pie aislante prolongado  
*Piede dell'isolatore prolungato*



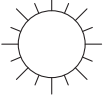

**5** Pie de aislador avanzado  
*Piede dell'isolatore avanzato*

**6** Pie de aislador retirado  
*Piede dell'isolatore represso*

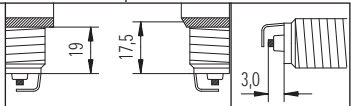
**7** Electrodo de cuernos  
*Elettrodo a corna*

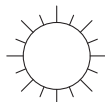
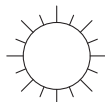
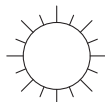
Резьба Gwint <b>14</b>	Форма посадки и исполнение <i>Kształt gniazda i wykonanie</i> <b>F</b>	Индекс калильного числа <i>Parametr wartości cieplnej</i> <b>7</b>
<b>10</b> M 10x1,0	<b>B</b> Экранированная, водонепроницаемая, стойкая против обгорания, провод зажигания 7 мм <i>Ekranowana, wodoszczelna, odporna na wypala nie się styków, przewód zapłonowy 7 mm</i>	новый <i>nowy</i>  старый <i>stary</i>
<b>12</b> M 12x1,25	<b>C</b> Как и B, но с проводом зажигания 5 мм <i>Tak jak w B, jednakże przewód zapłonowy 5 mm</i>	<b>13</b> 25
<b>14</b> M 14x1,25	<b>F</b> Цилиндрическая уплотнительная посадка <i>Płaskie gniazdo uszczelniające</i>  16 mm	<b>12</b> 50
<b>18</b> M 18x1,5	<b>G</b> Свеча со скользящей искрой <i>Świeca do zapłonu kondensatorowego</i>	<b>11</b> 75
	<b>GH</b> Свеча со скользящей искрой и вспомогательным искровым промежутком <i>Świece do zapłonu kondensatorowego z pomocniczym iskiernikiem</i>	<b>10</b> 100
	<b>K</b> Коническая уплотнительная посадка <i>Płaskie gniazdo uszczelniające</i>	<b>9</b> 125
	<b>R</b> Помехозащитное сопротивление 5 кОм/10 кОм <i>Opór eliminacji zakłóceń 5 kΩ/10 kΩ</i>	<b>8</b> 150
	<b>S</b> Свеча для малых двигателей Цилиндрическая уплотнительная посадка <i>Świece zapłonowe do małych silników</i> <i>Płaskie gniazdo uszczelniające</i>	<b>7</b> 175
	<b>T</b> Как и S, но с конической уплотнительной посадкой <i>Tak jak w S, jednakże ze stożkowym gniazdem uszczelniającym</i>	<b>6</b> 200
	<b>V</b> Цилиндрическая уплотнительная посадка <i>Płaskie gniazdo uszczelniające</i>  14 mm	<b>5</b> 225
	<b>Z</b> Свеча для двухтактных двигателей <i>Świece zapłonowe do silników dwusuwowych</i>	<b>4</b> 250
	<b>ZR</b> Двойной шестигранник Bi-Hex <i>Podwójny sześciokąt Bi-Hex</i>  14 mm	<b>3</b> 275
		<b>2</b> 300
		<b>09</b> 325
		<b>08</b> 350
		<b>07</b> 375
		<b>06</b> 400
		
		Специальное обозначение <i>Oznaczenie specjalne</i>
		<b>X</b>
		<b>01</b>
		<b>02</b>
		<b>03</b>
		<b>04</b>
		<b>05</b>

<p>Длина резьбы и положение искры/s4 <i>Długość gwintu i pozycja iskry</i></p> <p><b>D</b></p>	<p>Исполнение электродов <i>Typ elektrod</i></p> <p><b>T</b></p>	<p>Материал электрода <i>Tworzywo elektrod</i></p> <p><b>U</b></p>	<p>Тип исполнения <i>Rodzaj</i></p> <p><b>O</b></p>
<p><b>A</b></p> 	<p><b>A</b> электрод по схеме "треугольничка" <i>Elektroda z trójkątną masą</i></p>	<p><b>U</b> BERU ultra NiCu</p>	<p><b>O</b> отклонение от основного исполнения (например, усиленный средний электрода) <i>Różnica w stosunku do wersji podstawowej (np. grubsza elektroda środkowa)</i></p>
<p><b>B</b></p> 	<p><b>T</b> с многополюсными электродами корпуса <i>z wielobiegunowymi elektrodami pusowymi</i></p>	<p><b>S</b> серебро <i>srebro</i></p>	<p><b>R</b> стойкость против обгорания <i>o zwiększonej odpor ności na wypalanie</i></p>
<p><b>C</b></p> 	<p><b>D</b> 2 электрода массы <i>2 elektrody masy</i></p>	<p><b>P</b> платина <i>platyna</i></p>	<p><b>S</b> = 0,7 mm</p> <p><b>T</b> = 0,8 mm</p>
<p><b>D</b></p> 	<p><b>Q</b> 4 электрода массы <i>4 elektrody masy</i></p>	<p><b>I</b> Иридий <i>Iryd</i></p>	<p><b>U</b> = 1,0 mm</p> <p><b>V</b> = 1,3 mm</p> <p><b>W</b> = 0,9 mm</p>
<p><b>E</b></p> 	<p><b>K</b> Кольцевой электрод <i>Elektroda pierścieniowa</i></p>	<p><b>E</b> Никелевый AL <i>Nikiel-AL</i></p>	<p><b>X</b> = 1,1 mm</p> <p><b>Y</b> = 1,5 mm</p> <p><b>Z</b> = 2,0 mm</p>
<p><b>F</b></p> 	<p><b>1</b> в отличие от каильного числа <i>Odbiegający od wartości cieplnej</i></p>	<p><b>1</b></p>	<p><b>2</b> двухкомпонентный электрод массы <i>Dwuskładnikowa elektroda masy</i></p>
<p><b>H</b></p> 	<p><b>3</b> специальный <i>Specjalny</i></p>	<p><b>2</b></p>	<p><b>3</b> специальная опора изолятора <i>Przedłużona stopa izolatora</i></p>
<p><b>K</b></p> 	<p><b>5</b> Выдвинутая опора изолятора <i>Wyciągnięta do przodu podstawa izolatora</i></p>	<p><b>3</b></p>	<p><b>5</b> Выдвинутая опора изолятора <i>Wyciągnięta do przodu podstawa izolatora</i></p>
<p><b>L</b></p> 	<p><b>6</b> Выдвинутая опора изолятора <i>Wyciągnięta do przodu podstawa izolatora</i></p>	<p><b>4</b></p>	<p><b>6</b> Дуговой электрод <i>Elektroda sygnału dźwiękowego</i></p>
<p><b>M</b></p> 	<p><b>7</b></p>	<p><b>4</b></p>	<p><b>7</b></p>
<p><b>N</b></p> 	<p><b>5</b></p>	<p><b>5</b></p>	<p><b>5</b></p>
<p><b>S</b></p> 	<p><b>6</b></p>	<p><b>6</b></p>	<p><b>6</b></p>
<p><b>T</b></p> 	<p><b>7</b></p>	<p><b>7</b></p>	<p><b>7</b></p>
<p><b>W</b></p> 	<p><b>7</b></p>	<p><b>7</b></p>	<p><b>7</b></p>

Σπείρωμα Menet <b>14</b>	Σχήμα έδρασης και τρόπος κατασκευής Vállkiképzés és kivitel <b>F</b>	Χαρακτηριστικός αριθμός της θερμοαντικτικής τιμής Hőértékjelzőszám <b>7</b>																																																			
<b>10</b> M 10x1,0	<b>B</b> Προστατευμένο, στεγανωμένο κατά εισόδου νερού εξάρτημα, αντίσταση κατά δημιουργίας μεταλλικής οξειδωσης, αγωγός ανάφλεξης 7 mm Árnyékolt, vízzáró, ellenálló az égési kopással szemben, 7 mm-es csatlakozóval	<table border="1"> <tr> <td>Νέο újí</td> <td></td> <td>Παλιό régí</td> </tr> <tr> <td><b>13</b></td> <td></td> <td>25</td> </tr> <tr> <td><b>12</b></td> <td></td> <td>50</td> </tr> <tr> <td><b>11</b></td> <td></td> <td>75</td> </tr> <tr> <td><b>10</b></td> <td></td> <td>100</td> </tr> <tr> <td><b>9</b></td> <td></td> <td>125</td> </tr> <tr> <td><b>8</b></td> <td></td> <td>150</td> </tr> <tr> <td><b>7</b></td> <td></td> <td>175</td> </tr> <tr> <td><b>6</b></td> <td></td> <td>200</td> </tr> <tr> <td><b>5</b></td> <td></td> <td>225</td> </tr> <tr> <td><b>4</b></td> <td></td> <td>250</td> </tr> <tr> <td><b>3</b></td> <td></td> <td>275</td> </tr> <tr> <td><b>2</b></td> <td></td> <td>300</td> </tr> <tr> <td><b>09</b></td> <td></td> <td>325</td> </tr> <tr> <td><b>08</b></td> <td></td> <td>350</td> </tr> <tr> <td><b>07</b></td> <td></td> <td>375</td> </tr> <tr> <td><b>06</b></td> <td></td> <td>400</td> </tr> </table>	Νέο újí		Παλιό régí	<b>13</b>		25	<b>12</b>		50	<b>11</b>		75	<b>10</b>		100	<b>9</b>		125	<b>8</b>		150	<b>7</b>		175	<b>6</b>		200	<b>5</b>		225	<b>4</b>		250	<b>3</b>		275	<b>2</b>		300	<b>09</b>		325	<b>08</b>		350	<b>07</b>		375	<b>06</b>		400
Νέο újí				Παλιό régí																																																	
<b>13</b>		25																																																			
<b>12</b>		50																																																			
<b>11</b>		75																																																			
<b>10</b>		100																																																			
<b>9</b>		125																																																			
<b>8</b>		150																																																			
<b>7</b>		175																																																			
<b>6</b>		200																																																			
<b>5</b>		225																																																			
<b>4</b>		250																																																			
<b>3</b>		275																																																			
<b>2</b>		300																																																			
<b>09</b>		325																																																			
<b>08</b>		350																																																			
<b>07</b>		375																																																			
<b>06</b>		400																																																			
<b>12</b> M 12x1,25																																																					
<b>14</b> M 14x1,25	<b>C</b> Όπως ο κατασκευαστικός τύπος B, με διαφορά τώρα αγωγό ανάφλεξης 5 mm Ugyanaz, mint a B, de 5 mm-es csatlakozóval																																																				
<b>18</b> M 18x1,5	<b>F</b> Επίπεδη στεγανωτική έδραση Lapos tömítőváll  16 mm																																																				
	<b>G</b> Σπινθηστήρας (μπουζί ολίσθησης) Kúszószikrás gyertya																																																				
	<b>GH</b> Σπινθηστήρας (μπουζί) ολίσθησης με βοηθητική απόσταση σπινθηστήρα Kúszószikrás, segédszikrautas gyújtó gyertya																																																				
	<b>K</b> Κωνική στεγανωτική έδραση Kúpos tömítőváll																																																				
	<b>R</b> Αντίσταση εξουδετέρωσης παρασίτων 5 κΩ/10 κΩ Zavarszűrő ellenállás 5 kΩ/10 kΩ																																																				
	<b>S</b> Μπουζί για μικρούς κινητήρες Επίπεδη στεγανωτική έδραση Lapos tömítővállú gyertya kis motorokhoz																																																				
	<b>T</b> Όπως ο κατασκευαστικός τύπος S, με διαφορά τώρα μία κωνική στεγανωτική έδραση Ugyanaz, mint az S, de kúpos tömítővállal																																																				
	<b>V</b> Επίπεδη στεγανωτική έδραση Lapos tömítőváll  14 mm																																																				
	<b>Z</b> Μπουζί για δίχρονους κινητήρες Gyújtógyertya kétütemű motorokhoz																																																				
	<b>ZR</b> Διπλό εξάγωνο Bi-Hex Dupla hatlapú Bi-hex  14 mm																																																				
		<table border="1"> <tr> <td colspan="3">Ειδικός χαρακτηρισμός Különleges jelzések</td> </tr> <tr> <td></td> <td><b>X</b></td> <td></td> </tr> <tr> <td></td> <td><b>01</b></td> <td></td> </tr> <tr> <td></td> <td><b>02</b></td> <td></td> </tr> <tr> <td></td> <td><b>03</b></td> <td></td> </tr> <tr> <td></td> <td><b>04</b></td> <td></td> </tr> <tr> <td></td> <td><b>05</b></td> <td></td> </tr> </table>	Ειδικός χαρακτηρισμός Különleges jelzések				<b>X</b>			<b>01</b>			<b>02</b>			<b>03</b>			<b>04</b>			<b>05</b>																															
Ειδικός χαρακτηρισμός Különleges jelzések																																																					
	<b>X</b>																																																				
	<b>01</b>																																																				
	<b>02</b>																																																				
	<b>03</b>																																																				
	<b>04</b>																																																				
	<b>05</b>																																																				

Μήκος σπειρώματος και θέση  
οπισθηστήρα  
*Menethossz és szikraköz-benyúlás*

**D**

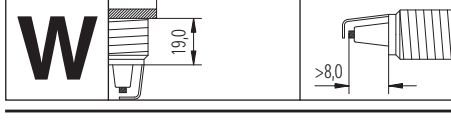
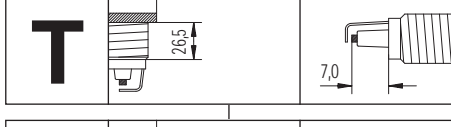
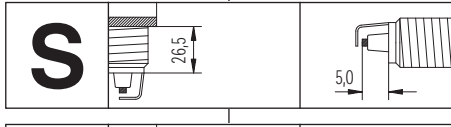
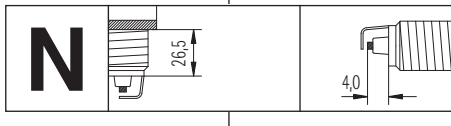
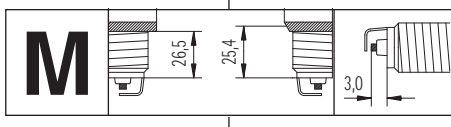
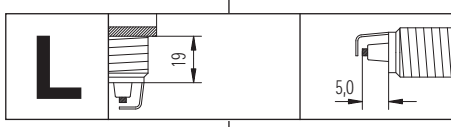
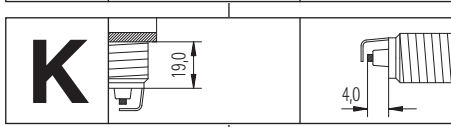
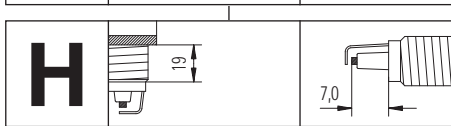
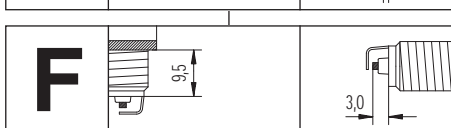
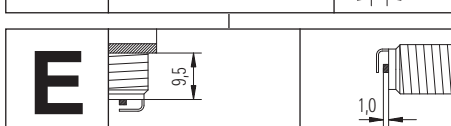
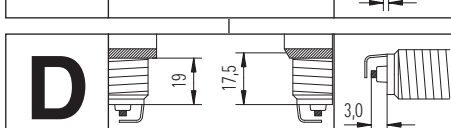
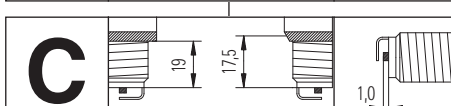
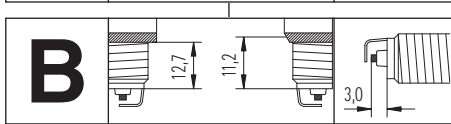
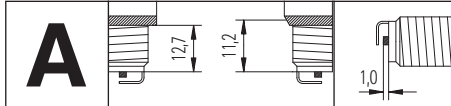

Κατασκευαστική  
μορφή ηλεκτροδίων  
*Elektródakiképzés*

**T**

**A** Τριγωνικό  
ηλεκτρόδιο  
γείωσης  
*Háromszögű  
testelektroda*

**T** με σώματα  
ηλεκτροδίων  
πολλαπλών  
πόλων  
*Többpólusú  
testelektroda*

**D** 2 ηλεκτρόδια  
γείωσης  
*2 test-  
elektroda*

**Q** 4 ηλεκτρόδια  
γείωσης  
*4 test-  
elektroda*

**K** Δακτυλιοειδές  
ηλεκτρόδιο  
*Gyűrűs  
elektroda*

Υλικό ηλεκτροδίων  
*Az elektróda  
szerkezeti anyaga*

**U**

**U** BERU  
ultra  
NiCu

**S** Άργυρος  
*ezüst*

**P** Πλατίνα  
*platina*

**I** Ιρίδιο  
*irídium*

**E** Νικέλιο - AL  
*nikkel-AL*

Κατασκευαστικός τρόπος  
*Kivitel*

**0**

**0** Απόκλιση από το βασικό  
κατασκευαστικό τρόπο  
(π.χ. ισχυρότερα μεσαία  
ηλεκτρόδια)  
*Eltérés az alapkivi teltől (pl.  
erősebb kö zépelektroda)*

**R** Με αντίσταση κατά  
δημιουργίας μεταλλικής  
οξειδωσης  
*Korósálló*

**S** = 0,7 mm

**T** = 0,8 mm

**U** = 1,0 mm

**V** = 1,3 mm

**W** = 0,9 mm

**X** = 1,1 mm

**Y** = 1,5 mm

**Z** = 2,0 mm

**1** Με απόκλιση από τη θερμαντική δύναμη  
*Hőértéktől eltérő*

**2** Ηλεκτρόδια γείωσης, κατασκευασμένα με δύο  
διαφορετικά υλικά  
*Kettős anyagú testelektroda*

**3** Ειδικ.  
*Speciális*

**4** Πόδι μονωτή με μεγαλύτερο μήκος  
*Meghosszabbított szigetelőnyak*

**5** Ρύγχος μονωτήρα τραβηγμένο προς τα μπροστά  
*Előrehúzott szigetelőláb*

**6** Ρύγχος μονωτήρα τραβηγμένο προς τα πίσω  
*Hátrahúzott szigetelőláb*

**7** Κερατοειδές ηλεκτρόδιο  
*Tölcsérelektroda*



Je höher der Brennraumdruck, desto stärker muss die Power des Funkens sein – als Voraussetzung für eine sichere Entflammung des Kraftstoff-Luft-Gemisches und eine effizient arbeitende Zündkerze. Hier setzt die Zündkerzen-Innovation BERU Ultra X Titan neue Maßstäbe: mit einer hoch effektiven Verbrennung – durch die Kombination mehrerer neuer Konstruktionsmerkmale. Eine langzeitkonstante Zündleistung bei optimierter Kraftstoffausnutzung und damit kraftstoffsparender Verbrennung mit entsprechend niedrigeren Emissionswerten ist somit sichergestellt – bei gleichzeitig deutlich höherer Verschleißresistenz und einer Laufleistung bis zu 60.000 km.

### BERU Ultra X Titan UXT 1–6

X-förmige Masseelektroden mit Nickel-Titan-Legierung für konstante Luft-/Gleitfunkenstechnologie mit mehreren Funkenwegen.

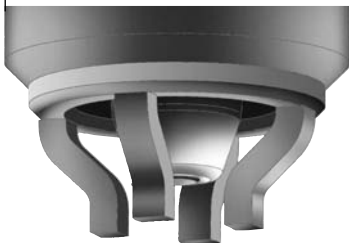

### BERU Ultra X Titan UXT 7–15

Einpolige Dachelektrode in innovativer Poly-V-Form mit hoch abbrandfester Nickel-Titan-Legierung.



**15 Zündkerzentypen.  
90% Marktabdeckung.  
100% werkstattgerecht.**

**Volles Programm für Ihren  
Umsatz – mit dem straffsten  
Zündkerzen-Sortiment der  
Branche!**

Das BERU Ultra X Titan Programm besteht nun aus 15 Typen: 6 Typen mit X-förmiger Masseelektrode, die nun mit einer Nickel-Titan-Legierung ausgerüstet sind – und 9 neue Ultra X Titan mit innovativer Poly-V-Elektrode. Mit diesem durchdachten Sortiment bietet sich Ihnen ein immenses Inspektionspotenzial von nahezu 90% Marktabdeckung!

Bei den 9 neuen Ultra X Titan Typen ist die Dachelektrode einpolig und in innovativer Poly-V-Form gearbeitet. Bei den 6 bewährten Ultra X Zündkerzen wurde die X-Form der Elektrode beibehalten und deren Abbrandfestigkeit durch eine Titan-Legierung verstärkt. Das Ultra X Titan Programm ist seit September 2008 unter der Kurzbezeichnung UXT 1 bis UXT 15 in neuer optimierter Verpackung erhältlich. Gut zu wissen: Die 6 bisherigen Ultra X Typen ohne Titan-Elektroden (Kurzbezeichnung: UX), die während der Umstellungsphase sicherlich parallel im Handel sein werden, sind zu den neuen Ultra X Titan kompatibel.



The higher the combustion chamber pressure, the greater the power of the spark must be – as a condition for a reliable ignition of the fuel-air mixture and an efficiently operating spark plug. This is where the spark plug innovation BERU Ultra X Titan is setting new standards: with a highly effective combustion – thanks to the combination of several new design features. Long-term constant ignition performance is ensured with optimized fuel utilization, together with fuel-saving combustion and correspondingly lower emission values – with significantly higher wear resistance and a service life up to 60,000 km.

**15 spark plug types. 90% market coverage. 100% suitable for workshops.**

**Full range of products for your sales – with the most streamlined range of spark plug products in the industry!**

The BERU Ultra X Titan range consists now of 15 models: 6 models with an X-shaped ground electrode, now with nickel-titanium alloy – and 9 new Ultra X Titan with the innovative Poly-V electrode. This elaborate range of products offers you an immense inspection potential of almost 90% market coverage!

In the case of the 9 new Ultra X Titan types, the ground electrode is single-pole and is worked in an innovative Poly-V design. In the case of the 6 established Ultra X spark plugs, the X shape of the electrode was retained and their erosion resistance reinforced by a titanium alloy. As from January 2009, the Ultra X Titan range is available in a new optimized packaging under the abbreviation UXT 1 to UXT 15. Good to know: The 6 previous Ultra X types without titanium electrodes (abbreviated designation: UX), which will certainly be on the market during the switch-over phase, are compatible with the new Ultra X Titan.



**BERU Ultra X Titan UXT 1-6**

X-shaped ground electrodes with nickel-titanium alloy for constant air/surface discharge technology with multiple spark distances.

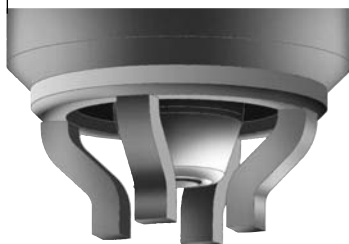

**BERU Ultra X Titan UXT 7-15**

Single-pole ground electrode in an innovative Poly-V design with high erosion-resistant nickel-titanium alloy.



Car, plus la pression dans la chambre à combustion est élevée, plus la puissance de l'étincelle doit être forte ; c'est la condition pour une inflammation sûre du mélange carburant-air et une bougie d'allumage fonctionnant de manière efficace. Ici, la bougie d'allumage innovante, l'Ultra X Titan de BERU, fait référence : avec une combustion extrêmement efficace : grâce à la combinaison de plusieurs caractéristiques nouvelles en matière de construction. Une puissance d'allumage constante de longue durée pour une utilisation optimisée du carburant et ainsi une combustion économe en carburant avec de plus faibles émissions polluantes à la clé. Le tout, avec une résistance à l'usure nettement supérieure et une distance parcourue pouvant atteindre 60 000 km.

### BERU Ultra X Titan UXT 1-6

Électrodes de toit en forme de X en alliage nickel-titane pour une technique de l'étincelle dans l'air/étincelle glissante constante à plusieurs trajectoires d'étincelle.

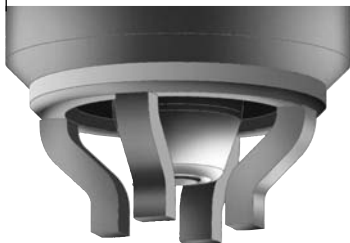

### BERU Ultra X Titan UXT 7-15

Électrode de toit à un pôle de forme « Poly-V » innovante avec alliage nickel-titane à haute résistance à l'érosion.



**15 modèles de bougies d'allumage. 90 % de couverture du marché 100% adaptées aux ateliers.**

**Tout un programme pour votre chiffre d'affaires avec la gamme de bougies d'allumage la plus étroite de la branche !**

Le programme BERU Ultra X Titan comprend maintenant 15 types : 6 types avec électrode de toit en forme de X qui sont maintenant dotés d'un alliage nickel-titane et 9 nouveaux types Ultra X Titan avec électrode « Poly-V » innovante. Cette gamme bien étudiée vous offre un immense potentiel et une couverture de près de 90 % du marché :

L'électrode de toit des 9 nouveaux modèles Ultra X Titan est à un pôle et est conçue avec un profil « Poly-V » innovant. Quant aux 6 bougies d'allumage Ultra X ayant fait leurs preuves, la forme en X de l'électrode a été conservée et leur résistance à l'érosion a été renforcée grâce à l'alliage titane. A partir de janvier 2009, la gamme Ultra X Titan sera disponible sous les références UXT 1 à UXT 15 avec un nouveau conditionnement optimisé. Bon à savoir : Les 6 modèles d'Ultra X commercialisés jusqu'à présent sans électrodes en titane (référence : UX) que l'on continuera certainement de trouver dans le commerce durant la phase de transition, sont compatibles avec la nouvelle Ultra X Titan.



Hoe hoger de druk in de verbrandingskamer, des te krachtiger moet de vonk zijn – als voorwaarde voor een veilige ontvlaming van het brandstof/luchtmengsel en een efficiënt werkende bougie. Op dit gebied stelt de innovatieve bougie BERU Ultra X Titan nieuwe normen: met een uiterst effectieve verbranding – door de combinatie van meerdere nieuwe constructiekenmerken. Een langdurige, constante ontstekingscapaciteit bij geoptimaliseerde benutting van de brandstof en hieruit resulterende brandstofsparende verbranding met lagere emissiewaarden is zodoende gewaarborgd – bij een gelijktijdig duidelijk hogere slijtresistentie en een loopvermogen tot maximaal 60.000 km.

**15 Bougietypes. 90% Marktpenetratie. 100% werkplaats gericht.**

**Compleet programma voor uw omzet – met het stabielste bougie-sortiment van de branche!**

Het BERU Ultra X Titan programma bestaat nu uit 15 types: 6 Types met X-vormige massa-elektrode, die nu zijn uitgerust met een nikkel/titaniumlegering – en 9 nieuwe Ultra X Titan met innovatieve poly-V-elektrode. Met dit doordachte sortiment biedt zich een immens inspectiepotentiaal van bijna 90% marktpenetratie!

Bij de 9 nieuwe Ultra X Titan-typen is de elektrode enkelpolig en in een innovatieve poly-V-vorm uitgevoerd. Bij de 6 beproefde Ultra X-bougies bleef de X-vorm van de elektrode behouden en de afbrandingsterkte nog versterkt door een titaniumlegering. Het Ultra X Titan-programma is sinds september 2008 onder de afkorting UXT 1 tot UXT 15 in een nieuwe, verbeterde verpakking verkrijgbaar. Goed om te weten: De 6 huidige Ultra X-typen zonder titaniumelektroden (afkorting: UX), die tijdens de omschakelfase zeker parallel in de handel zullen zijn, zijn compatibel met de nieuwe Ultra X Titan.



#### **BERU Ultra X Titan UXT 1-6**

X-vormige massa-elektroden met nikkel-titanium-legering voor constante lucht-/glijvonkentechnologie met meerdere vonkenwegen.

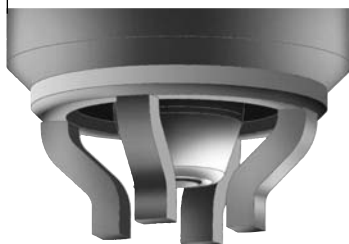

#### **BERU Ultra X Titan UXT 7-15**

Enkelpolige elektrode in innovatieve poly-V-vorm met uiterst slijtvaste nikkel/titaniumlegering.



Cuanto más alta sea la presión de la cámara de combustión, mayor tiene que ser la potencia de la chispa. Este es el requisito de una inflamación segura de la mezcla de combustible y aire, así como el de una bujía de encendido que funcione con eficiencia. Aquí la innovación de las bujías de encendido BERU Ultra X Titan fija nuevas bases: una combustión altamente efectiva mediante la combinación de varias características de construcción nuevas y un rendimiento de encendido constante de larga duración en un aprovechamiento de combustible óptimo, que puede garantizar una combustión económica de combustible con unos valores de emisión correspondientes menores, momento, a su vez, en el que las bujías de encendido alcanzan una resistencia al desgaste claramente superior y recorren una distancia de hasta 60.000 km.

### BERU Ultra X Titan UXT 1-6

Electrodos superior dispuestos en X con aleación de titanio y níquel para tecnología de chispa aérea / deslizante con varios recorridos de la chispa.

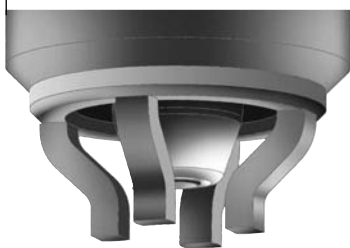

### BERU Ultra X Titan UXT 7-15

Electrodo superior con un polo de forma poly-V innovadora con aleación de titanio y níquel extremadamente resistente.

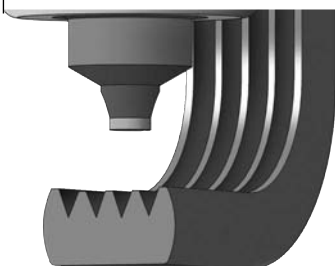

**15 tipos de bujías de encendido. 90% de cobertura de mercado. 100% adecuado para talleres.**

**Programa completo para su venta con el surtido de bujías más preciso del sector.**

¡Ahora el programa Ultra X Titan de BERU ofrece 15 tipos: 6 tipos con electrodos superior dispuestos en X, equipados ahora con una aleación de titanio y níquel, así como 9 Ultra X Titan nuevos con electrodos de forma poly-V innovadora. Con este surtido pensado minuciosamente le ofrecemos un nuevo potencial de inspección inmenso con una cobertura de mercado de prácticamente el 90%!

En los 9 tipos nuevos de Ultra X Titan, el electrodo superior es de un polo y tiene una forma poly-V innovadora. En las 6 bujías de encendido Ultra X acreditadas se ha mantenido la forma de X de los electrodos y se ha reforzado su resistencia a la quemadura mediante una aleación de titanio. El programa Ultra X Titan estará disponible enero de 2009 con la denominación abreviada de UXT 1 hasta UXT 15 en un nuevo embalaje optimizado. Vale la pena saber: los 6 tipos Ultra X hasta ahora sin electrodos de titanio (denominación abreviada: UX), que durante la fase de cambio seguramente estarán a la venta paralelamente, son compatibles con los nuevos Ultra X Titan.



Maggiore è la pressione della camera di combustione e più forte deve essere la potenza della scintilla: un presupposto fondamentale per garantire l'accensione sicura della miscela carburante-aria ed un funzionamento efficiente della candela di accensione. In questo senso, le innovative candele di accensione BERU Ultra X Titan pongono nuovi standard: con una combustione altamente efficace ottenuta dalla combinazione di varie caratteristiche costruttive nuove. Viene quindi garantita una potenza di accensione costante e duratura, con una combustione economica e valori di emissione ridotti di conseguenza, ottenendo allo stesso tempo una resistenza notevolmente superiore all'usura ed una percorrenza che può arrivare fino a 60.000 km.

**15 tipi di candele d'accensione. 90% di copertura del mercato. 100% idoneità all'impiego in officina.**

**Un programma completo per il vostro lavoro – con l'assortimento di candele d'accensione più mirato del settore!**

Il nuovo programma BERU Ultra X Titan è composto ora da 15 tipi: 6 tipi con elettrodo di massa a forma di X, ora equipaggiate con una lega al nichel e titanio – e 9 nuove Ultra X Titan con l'innovativo elettrodo poly-V. Con questo ponderato assortimento ora potete contare su un immenso potenziale di ispezione in grado di coprire il 90% del mercato!

Nel caso dei 9 nuovi tipi di candele Ultra X Titan l'elettrodo di massa è unipolare e realizzato con l'innovativa forma poly-V. Nel caso degli altri 6 tipi di candele di accensione Ultra X già collaudati, è stata mantenuta la forma a X dell'elettrodo, mentre la sua resistenza alla bruciatura è stata aumentata ricorrendo ad una lega al titanio. Il programma Ultra X Titan sarà disponibile a partire dal Gennaio 2009 con le sigle da UXT 1 a UXT 15 in una nuova confezione ottimizzata. Buono a sapersi: i 6 tipi Ultra X attuali senza elettrodi al titanio (abbreviati: UX), che nella fase di transizione si troveranno sicuramente ad essere contemporaneamente presenti sul mercato, sono compatibili con i nuovi articoli Ultra X Titan.



#### **BERU Ultra X Titan UXT 1-6**

Elettrodi di massa a forma di "X" in lega di nichel-titanio per una costante tecnologia a scarica superficiale con un maggior numero di percorsi delle scintille.

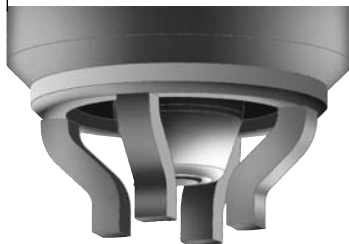

#### **BERU Ultra X Titan UXT 7-15**

Elettrodo di massa a un polo nella forma innovativa poly-V, con una lega di nichel e titanio altamente resistente alla bruciatura.





Чем выше давление в камере сгорания, тем больше должна быть мощность искры – как предпосылки для надежного воспламенения топливоздушную смеси и эффективно работающей свечи зажигания. Здесь свеча-новинка зажигания BERU Ultra X Titan является новым мерилom: с высокоэффективным сгоранием – благодаря комбинации нескольких новых конструктивных особенностей. Таким образом обеспечивается длительная постоянная мощность системы зажигания при оптимальном использовании топлива и связанным с ним топливосберегающим сгоранием с соответственно более низкими выбросами - при одновременно значительно более высокой износостойкости и длине пробега до 60.000 км.

### BERU Ultra X Titan UXT 1-6

X-образные боковые электроды с никель-титановым сплавом для обеспечения постоянного воздушного зажигания с поверхностным разрядом и с расширенными искровыми промежутками.

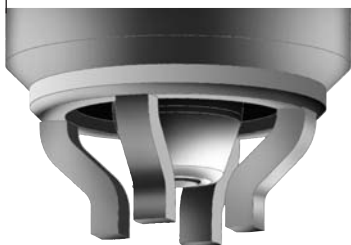

### BERU Ultra X Titan UXT 7-15

Однополюсный торцовый электрод новаторской формы Poly-V-Form с никель-титановым сплавом высокой жаропрочности.



**15 типов свечей зажигания.  
90%-й охват рынка. 100%-е  
удобство техобслуживания.**

**Полная программа для Вашего  
оборота – с самым плотным  
ассортиментом свечей зажигания  
в отрасли!**

Программа BERU Ultra X Titan состоит из 15 типов свечей зажигания: 6 типов X-образных боковых электродов, оснащенных теперь никель-титановым сплавом, и 9 новых свечей Ultra X Titan с новаторским электродом Poly-V. Этот хорошо продуманный ассортимент обеспечивает Вам огромный инспекционный потенциал и почти 90%-ый охват рынка!

9 новых типов Ultra X Titan имеют однополюсный торцовый электрод, изготовленный в новой форме Poly-V. 6 испытанных свечей зажигания Ultra X сохранили свою форму, а их жаростойкость усилена титановым сплавом. Программа Ultra X Titan поставляется начиная с сентября 2008 года под обозначением UXT 1 до UXT 15 в новой оптимизированной упаковке. Следует отметить: 6 прежних типов Ultra X без титанового электрода (сокращенное название: UX), которые будут наверняка также встречаться в торговле на стадии переналадки производства, совместимы с новыми типами Ultra X Titan.

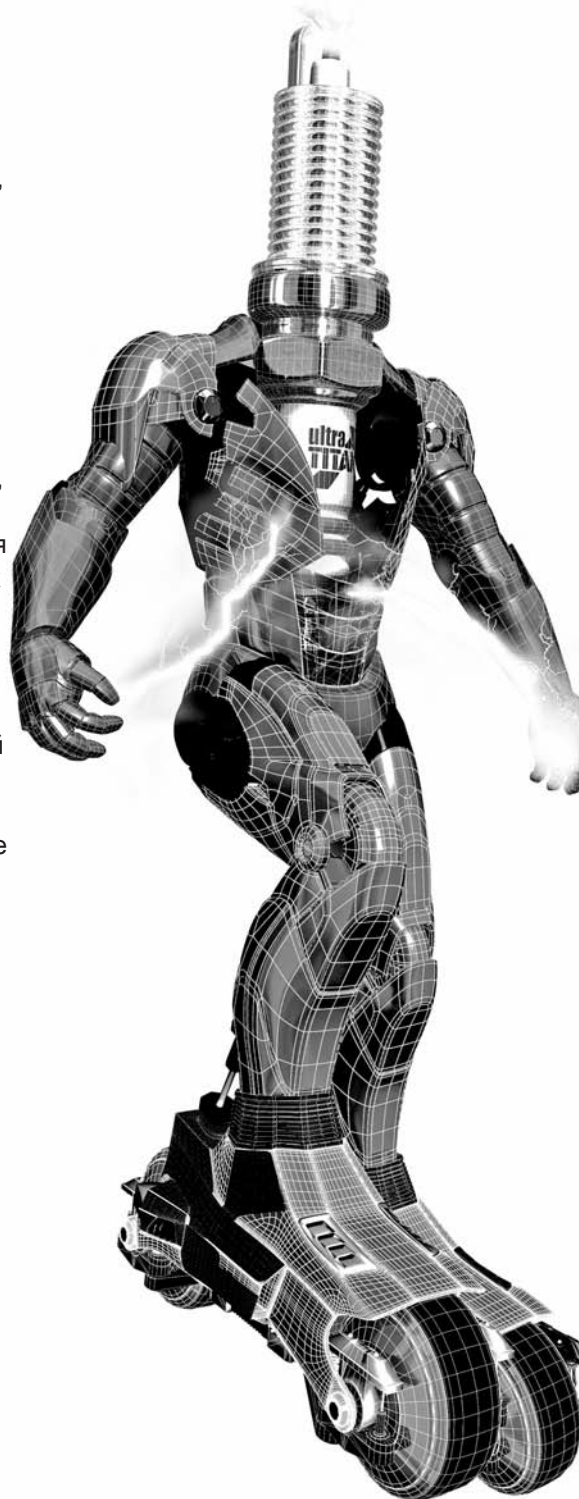

Im wyższe ciśnienie w komorze spalania, tym większą energię musi mieć iskra – jako warunek niezawodnego spalania mieszanki paliwowo-powietrznej i skutecznego działania świecy zapłonowej. Tutaj innowacyjne świece zapłonowe BERU Ultra X Titan stwarzają nowe standardy: jeszcze wyższa wydajność spalania dzięki kombinacji kilku nowych cech konstrukcyjnych. Trwała energia iskry przy optymalnym wykorzystaniu paliwa, a tym samym oszczędniejsze spalanie z odpowiednio niższymi emisjami – przy jednocześnie wyraźnie wyższej odporności na zużycie i przebiegu do 60.000 km.

**15 typów świec zapłonowych. 90% pokrycia zapotrzebowania rynku. 100% przydatności warsztatowej.**

**Kompletny program Twoich obrotów – najbogatszy asortyment świec zapłonowych w branży!**

Program BERU Ultra X Titan składa się obecnie z 15 typów: 6 typów z elektrodą masową w kształcie X, wykonanych ze stopu niklowo-tytanowego, oraz 9 nowych typów Ultra X Titan z innowacyjną elektrodą Poly-V. Te przemysłowy asortyment zapewnia ogromny potencjał przy przeglądach serwisowych, obejmujący prawie 90% rynku!

W przypadku 9 nowych typów Ultra X Titan elektroda boczna jest jednobiegunowa i posiada innowacyjny kształt Poly-V. 6 popularnych świec zapłonowych Ultra X posiada elektrodę o sprawdzonym kształcie X, przy czym jej odporność na nadpalenie została zwiększona przez zastosowanie stopu tytanowego. Program Ultra X Titan jest dostępny od września 2008 pod oznaczeniami skrótowymi od UXT 1 do UXT 15 w nowych, zoptymalizowanych opakowaniach. Warto wiedzieć: dotychczasowych 6 typów Ultra X bez elektrod tytanowych (oznaczenie skrótowe: UX) – z pewnością równolegle obecnych w handlu w okresie zmiany asortymentu – cechuje kompatybilność z nowymi świecami Ultra X Titan.



#### BERU Ultra X Titan UXT 1–6

Elektroda masowa o kształcie X ze stopem niklowo-tytanowym, zapewniająca stałą technikę isker ślizgowo-powietrznych.



#### BERU Ultra X Titan UXT 7–15

Jednobiegunowa elektroda boczna o innowacyjnym kształcie Poly-V ze stopu niklowo-tytanowego o wysokiej odporności na nadpalenie.

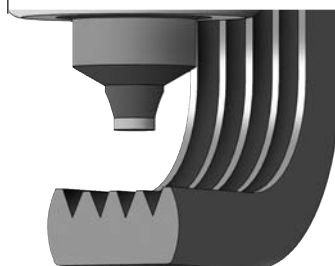



Όσο μεγαλύτερη είναι η πίεση του θαλάμου καύσης, τόσο μεγαλύτερη πρέπει να είναι αντίστοιχα και η δύναμη του σπινθήρα, προκειμένου να επιτυγχάνεται ασφαλής ανάφλεξη του μείγματος καυσίμου - αέρα και αποδοτική λειτουργία του μπουζί. Στο σημείο αυτό, τα πρωτοποριακά μπουζί σπινθήρα BERU Ultra X Titan δημιουργούν νέα δεδομένα: με υψηλής απόδοσης καύση, χάρη στη συνέργεια πολλών νέων κατασκευαστικών χαρακτηριστικών. Εξασφαλίζεται σταθερή για μεγάλο χρονικό διάστημα ισχύς ανάφλεξης με βέλτιστη εκμετάλλευση του καυσίμου, και συνεπώς καύση με χαμηλή κατανάλωση και αντίστοιχα χαμηλές τιμές εκπομπών, ενώ ταυτόχρονα παρατηρείται αισθητή αύξηση της αντοχής στη φθορά και διάρκεια ζωής έως και 60.000 km.

### BERU Ultra X Titan UXT 1-6

Ηλεκτρόδια γείωσης διάταξης X με κράμα νικελίου-πτανίου για σταθερή τεχνολογία σπινθήρα μέσω του αέρα / ολισθαίνοντα σπινθήρα με πολλαπλές πορείες σπινθήρα.

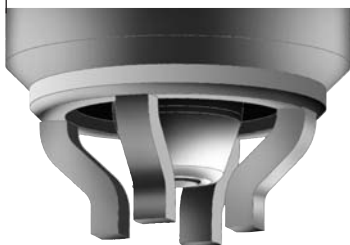

### Beru Ultra X Titan UXT 7-15

Μονοπολικό ηλεκτρόδιο οροφής με πρωτοποριακή πολυγωνική μορφή και κράμα νικελίου-πτανίου υψηλής αντοχής στην καύση.



**15 τύποι μπουζί σπινθήρα.  
90% κάλυψη αγοράς.  
100% ενδεδειγμένη χρήση  
για το συνεργείο.**

**Πλήρης γκάμα προϊόντων για τις  
πωλήσεις σας – με την αυστηρότερα  
επιλεγμένη σειρά μπουζί  
σπινθηρισμού του κλάδου!**

Η σειρά BERU Ultra X Titan αποτελείται τώρα από 15 τύπους: 6 τύπους με ηλεκτρόδια γείωσης διάταξης X, που τώρα διαθέτουν κράμα νικελίου-πτανίου – και 9 νέους τύπους Ultra X Titan με πρωτοποριακά πολυγωνικά ηλεκτρόδια. Με αυτήν την καλά μελετημένη γκάμα προϊόντων αποκτάτε αστείρευτες δυνατότητες συντήρησης με δυνατότητα κάλυψης σχεδόν του 90% της αγοράς!

Οι 9 νέοι τύποι Ultra X Titan διαθέτουν μονοπολικό ηλεκτρόδιο οροφής και έχουν κατασκευαστεί βάσει της πρωτοποριακής γεωμετρίας πολυγωνικού σχήματος. Στα 6 ήδη καταξιωμένα μπουζί Ultra X διατηρήθηκε η χιαστί διάταξη του ηλεκτροδίου και παράλληλα ενισχύθηκε η αντοχή τους στην καύση μέσω ενός κράματος τιτανίου. Από το Σεπτέμβριο του 2008, η σειρά Ultra X Titan διατίθεται με τις συντομογραφίες UXT 1 έως UXT 15 και σε νέα βελτιωμένη συσκευασία. Κάτι που πρέπει να γνωρίζετε: Οι 6 τύποι Ultra X που κυκλοφορούσαν μέχρι τώρα χωρίς ηλεκτρόδιο τιτανίου (συντομογραφία: UX), και θα συνεχίσουν ασφαλώς να κυκλοφορούν κατά τη διάρκεια της μεταβατικής φάσης παράλληλα με την καινούρια σειρά, είναι συμβατοί με τους νέους τύπους Ultra X Titan.

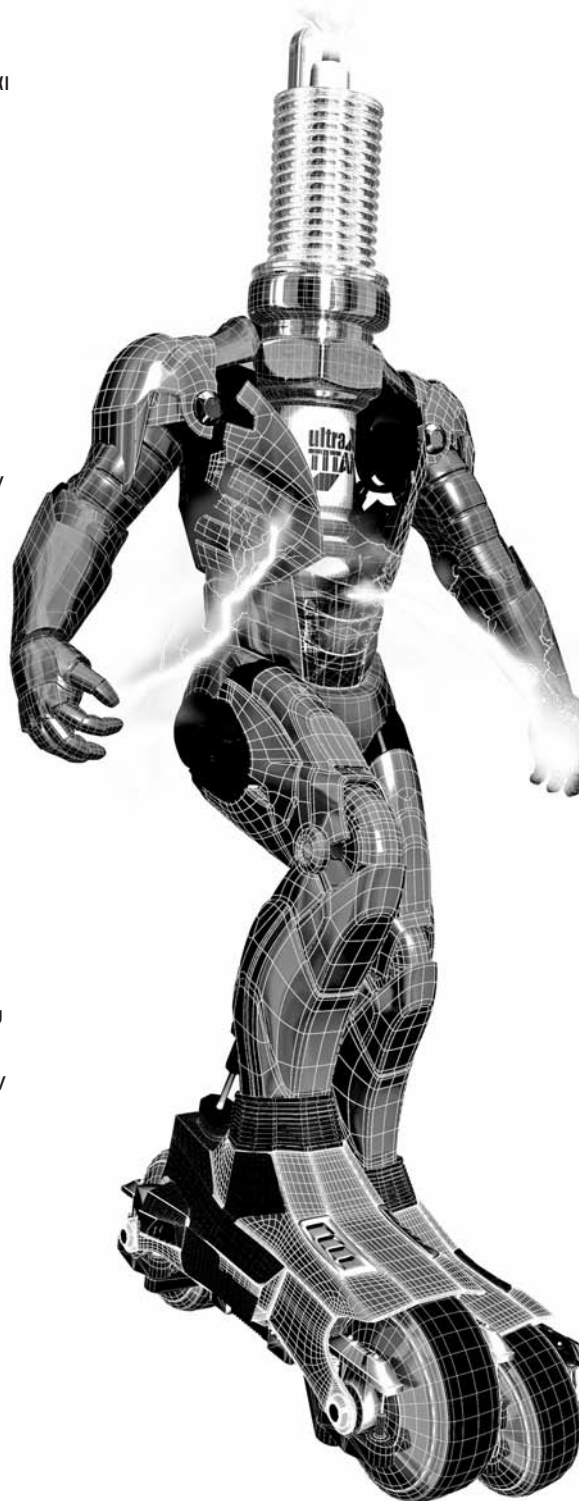

Minél nagyobb az égéstérnyomás, annál nagyobb teljesítményű szikrára is van szükség – az üzemanyag-levegő keverék biztos begyűjtéséhez és a gyújtógyertya hatékony működéséhez. Ezen a területen új mércét állít a BERU Ultra X Titan gyújtógyertya innovációja: rendkívül hatékony égéssel – több új konstrukciós jellemző kombinációja által. Hosszú időn keresztül állandó gyújtásteljesítményt biztosít, optimalizált üzemanyag-felhasználás mellett, ami üzemanyag-takarékos égést és egyúttal alacsonyabb emissziós értékeket eredményez – a jelentősen megnövekedett kopásállóságnak köszönhetően akár 60.000 km futásteljesítmény is elérhető.

**15 gyújtógyertya típus.**  
**90% piaci lefedettség.**  
**100% műhelybe való.**

**Teljes választék az Ön forgalma érdekében – az iparág legfeszesebb gyújtógyertya kínálatával!**

A BERU Ultra X Titan választék már 15 típusból áll: 6 típus X-alakú testelektródával, amelyek már nikkel-titán ötvözetrel rendelkeznek – és 9 új Ultra X Titan innovatív poli-V elektródával. Ezzel az alaposan átgondolt választékkal közel 90% piaci lefedettséget érhet el, ami óriási szervízpotenciált jelent!

A 9 új Ultra X Titan típusnál a külső elektróda egypólusú, és kimunkálása innovatív poli-V formájú. A 6 bevált Ultra X gyújtógyertyánál megmaradt az elektróda X formája, de a kiegészítő szembeni ellenállása titán ötvözetrel lett megerősítve. Az Ultra X Titan program az UXT 1 - UXT 15 rövidített jelölés alatt kapható 2008 szeptemberétől, új, optimalizált csomagolásban. Jó tudni: A 6 eddigi, titán elektróda nélküli Ultra X típus (UX rövidített jelölés), amelyek az átállási időszakban minden bizonnyal párhuzamosan lesznek jelen a kereskedelemben, mind kompatibilis az új Ultra X Titan gyújtógyertyákkal.



#### **BERU Ultra X Titan UXT 1–6**

X-alakú testelektródák nikkel-titán ötvözetrel az állandó levegő-felületi szikra technológiához, több szikraúttal.



#### **Beru Ultra X Titan UXT 7–15**

Egypólusú, innovatív poli-V formájú külső elektróda a kiegészítő szembeni ellenálló nikkel-titán ötvözetrel.

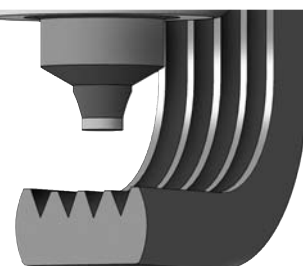

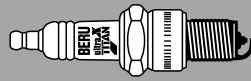

<b>1</b>	<b>UXT 1</b> 0 002 335 606	<b>UXT 1 SB</b> 0 900 004 153	16	19	X	—	9-7
<b>2</b>	<b>UXT 2</b> 0 002 335 607	<b>UXT 2 SB</b> 0 900 004 154	21	19	X	—	9-7
<b>3</b>	<b>UXT 3</b> 0 002 335 928	<b>UXT 3 SB</b> 0 900 004 155	16	19	X	—	9-7
<b>4</b>	<b>UXT 4</b> 0 002 635 601	<b>UXT 4 SB</b> 0 900 004 156	16	19	X	—	9-7
<b>1</b>	<b>UXT 5</b> 0 002 345 606	<b>UXT 5 SB</b> 0 900 004 157	16	19	X	—	6-5
<b>5</b>	<b>UXT 6</b> 0 002 335 929	<b>UXT 6 SB</b> 0 900 004 158	21	19	X	—	9-7
<b>6</b>	<b>UXT 7</b> 0 002 635 900	<b>UXT 7 SB</b> 0 900 004 159	16	25	B	1,3	8-7
<b>6</b>	<b>UXT 8</b> 0 002 635 901	<b>UXT 8 SB</b> 0 900 004 160	16	25	B	1,0	8-7
<b>7</b>	<b>UXT 9</b> 0 002 335 930	<b>UXT 9 SB</b> 0 900 004 161	16	19	B	1,0	9-7
<b>7</b>	<b>UXT 10</b> 0 002 335 931	<b>UXT 10 SB</b> 0 900 004 162	16	19	B	0,8	9-7
<b>7</b>	<b>UXT 11</b> 0 002 335 932	<b>UXT 11 SB</b> 0 900 004 163	16	19	B	1,1	9-7
<b>7</b>	<b>UXT 12</b> 0 002 345 902	<b>UXT 12 SB</b> 0 900 004 164	16	19	B	0,8	6-5
<b>8</b>	<b>UXT 13</b> 0 002 335 934	<b>UXT 13 SB</b> 0 900 004 165	16	26,5	B	1,0	9-7
<b>6</b>	<b>UXT 14</b> 0 002 345 903	<b>UXT 14 SB</b> 0 900 004 166	16	19	B	1,0	6-5
<b>9</b>	<b>UXT 15</b> 0 002 640 909	<b>UXT 15 SB</b> 0 900 004 167	16	17,5	B	1,3	8-6

## Die Markenzündkerze in kompromißloser Erstausrüster-Qualität

### Praktisches Kurz-Nummern- System!

Profitieren Sie vom hohen Bekanntheitsgrad der BERU Ultra: ein komplettes Programm in Erstausrüster-Qualität!

- Aktuelle Technologie:  
Luftfunkentechnik/Gleitfunken-  
technik
- Sichere Zündung
- Optimale, umweltfreundliche  
Verbrennung
- Bewährte Materialien:  
Zweistoff-Mittelelektrode  
(nickelummantelter Kupferkern)
- Lange Lebensdauer, hohe  
Standzeit
- Katalysatorschutz

*The branded spark plug in  
uncompromising OEM quality*

### Practical short numbering system!

*Profit from the high degree of  
familiarity of the BERU Ultra: a  
complete range in OEM quality!*

- Latest technology: air discharge/  
surface discharge technology
- Reliable sparking
- Optimal, environmentally friendly  
combustion
- Proven materials:  
Two material centre electrode  
(nickel encapsulated copper  
core)
- Long life, high durability
- Catalytic converter protection

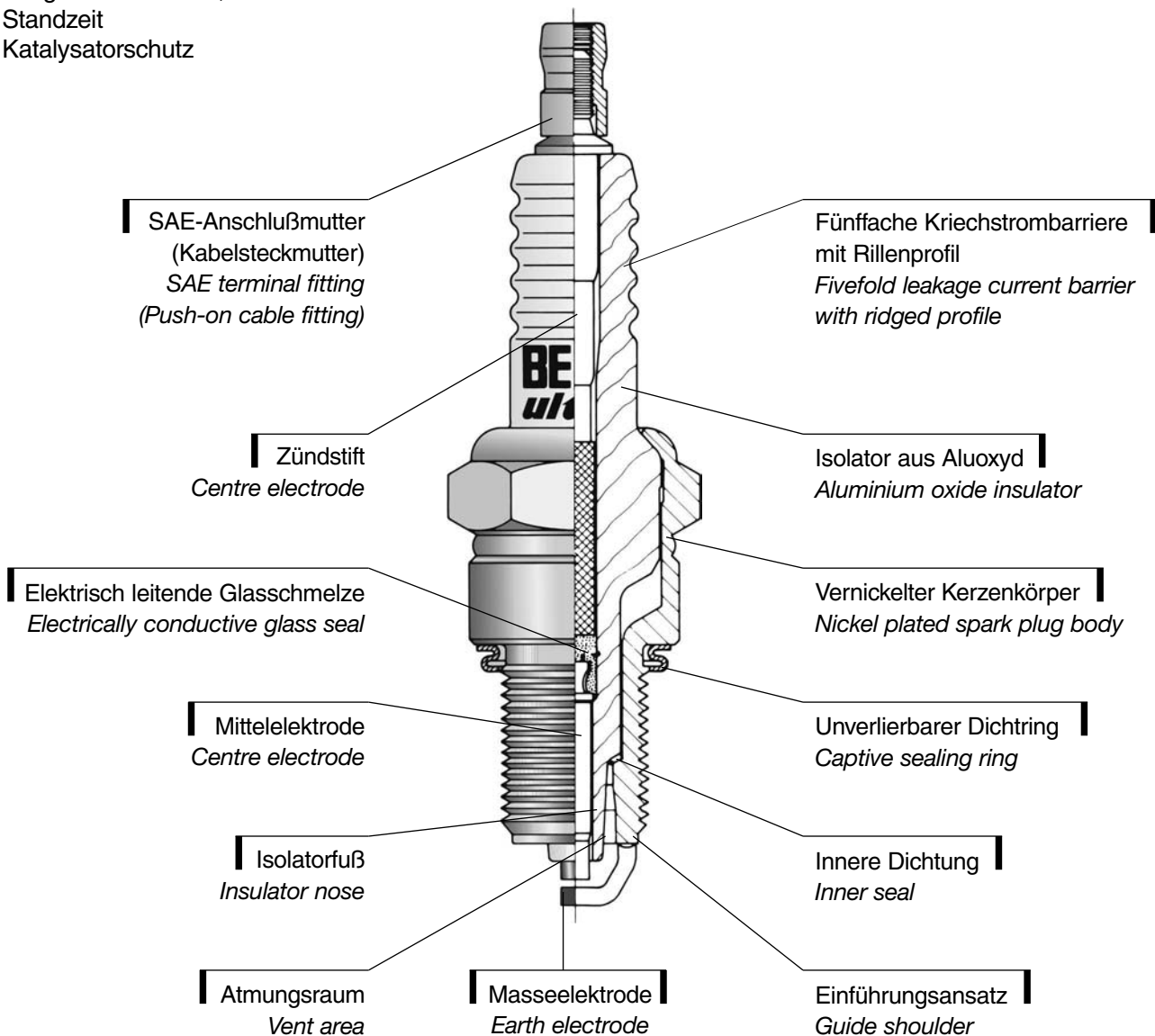

**La bougie de marque la qualité première monte sans compromis**

*De merkbougie in compromisloze, originele kwaliteit*

**Système pratique de références simplifiés!**

*Praktisch systeem met korte nummers!*

Profitez de la renommée de BERU Ultra: une gamme complète de qualité première monte!

- Techniques de pointe: étincelle aérigne/étincelle glissante
- Allumage sûr
- Combustion optimale et écologique
- Matériaux éprouvés: électrode centrale à 2 composants (noyau de cuivre avec enveloppe de nickel)
- Durée de vie élevée, grande longévité
- Protection du catalyseur

*Profiteer van de hoge mate van bekendheid van de BERU Ultra: een compleet programma in originele kwaliteit!*

- *Actuele technologie: luchtvonktechniek/glijvonktechniek*
- *Betrouwbare ontsteking*
- *Optimale, milieuvriendelijke verbranding*
- *Bewezen materialen: 2 componenten centrale elektrode (nikkelomantelde koperkern)*
- *Lange levensduur, hoge standtijd*
- *Katalysatorbescherming*

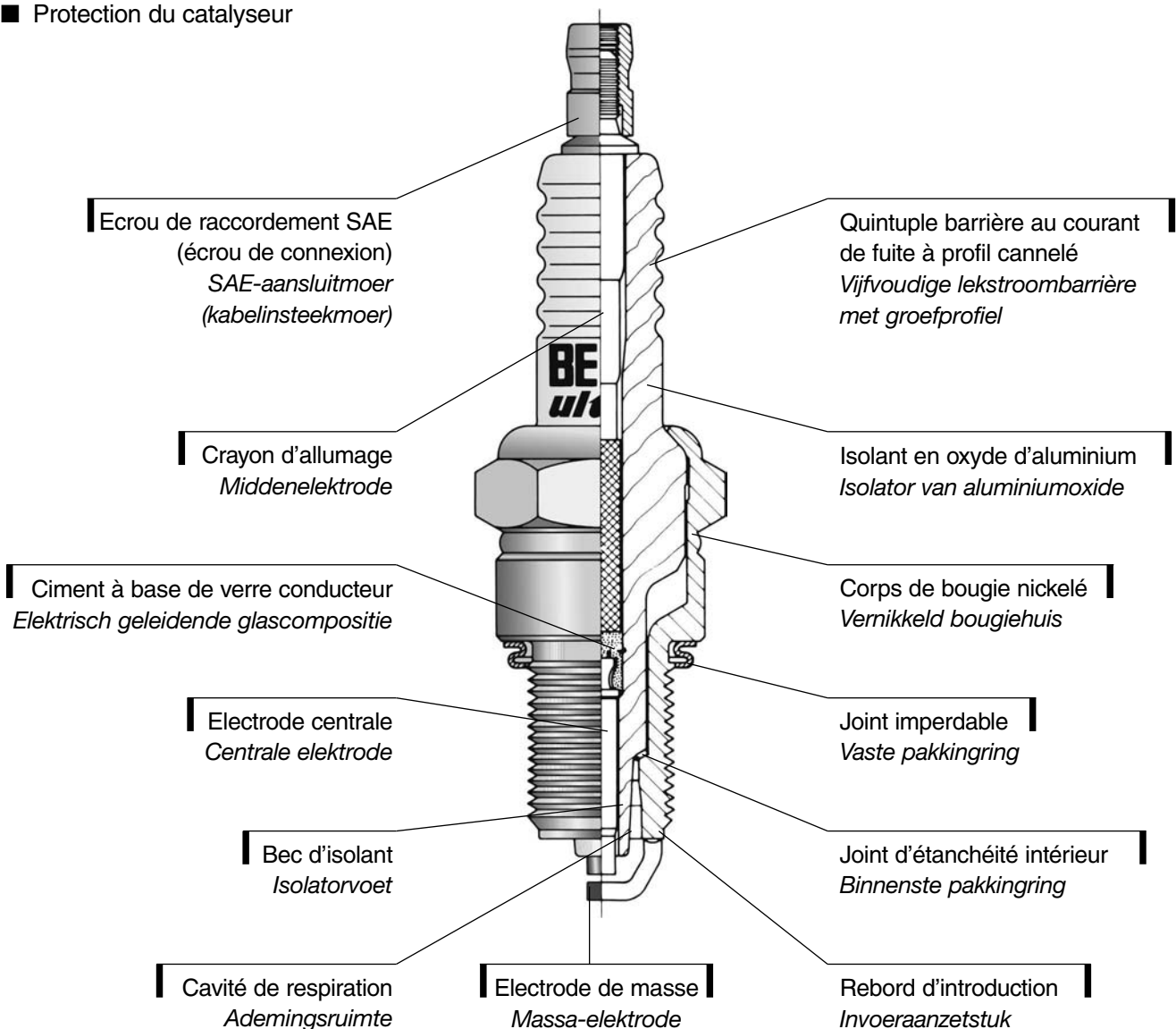



**La bujía de marca, en calidad de equipamiento original sin compromisos**

**¡Práctico sistema de numeración abreviada!**

Aproveche Vd. el alto grado de popularidad de la bujía BERU Ultra: ¡Un programa completo en calidad de equipamiento original!

- **Tecnología actual:**  
Tecnología de chispas al aire y tecnología de chispas deslizantes
- **Encendido seguro**
- **Combustión óptima y ecológica**
- **Materiales de comprobada eficacia:** Electrodo central de dos materiales (núcleo de cobre revestido de níquel)
- **Larga vida útil, alta durabilidad**
- **Protección catalítica**

*La candela di marca in qualità da primo equipaggiamento, senza compromessi*

*Pratico sistema di codificazione numerica!*

*Approfittate dell'alto grado di fama della BERU ultra: un programma completo in qualità di primo impianto!*

- *Tecnologia moderna: tecnica di scarico in aria/scarico superficiale*
- *Accensione sicura*
- *Combustione ottimale ed ecologica*
- *Materiali affermati: elettrodo centrale bicomponente (anima di rame rivestita di nichel)*
- *Lunga durata, grande longevità*
- *Protezione del catalizzatore*

**Фирменная свеча зажигания, полностью соответствующая качеству первой сборки**

**Практичная система краткой нумерации!**

Высокая степень известности свечей BERU Ultra принесет Вам прибыль: полный ассортимент, соответствующий качеству первой сборки!

- **Современная технология:** воздушный искровой разряд/поверхностный искровой разряд
- **Надежное зажигание**
- **Оптимальное, берегающее окружающую среду сгорание топлива**
- **Проверенные в эксплуатации материалы** двухкомпонентный средний электрод (медный сердечник с никелевой оболочкой)
- **Длительный срок службы, высокий ресурс**
- **Защита катализатора**

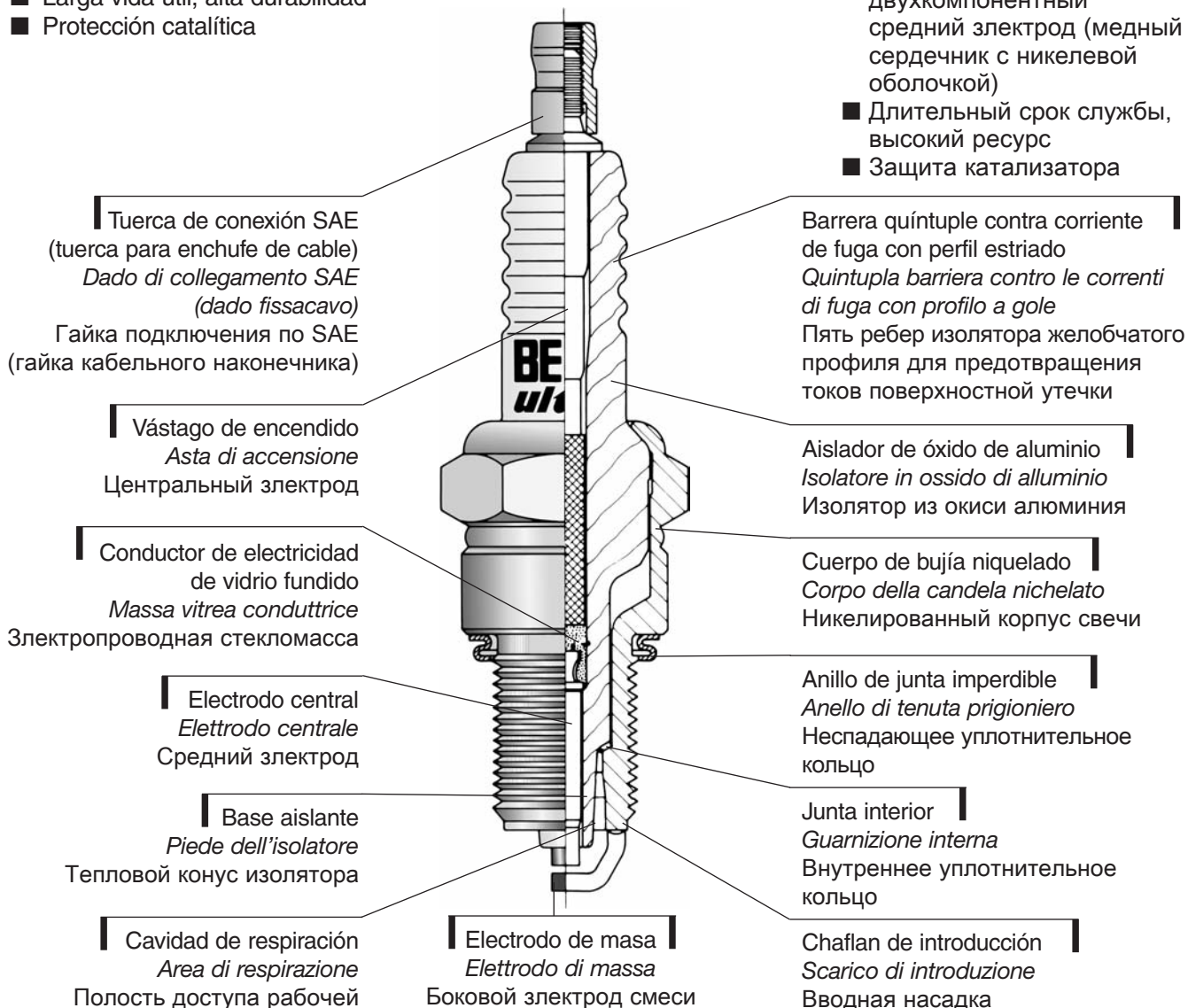

Tuerca de conexión SAE  
(tuerca para enchufe de cable)  
*Dado di collegamento SAE*  
(dado fissacavo)  
Гайка подключения по SAE  
(гайка кабельного наконечника)

Vástago de encendido  
*Asta di accensione*  
Центральный электрод

Conductor de electricidad de vidrio fundido  
*Massa vitrea conduttrice*  
Электропроводная стекломасса

Electrodo central  
*Elettrodo centrale*  
Средний электрод

Base aislante  
*Piede dell'isolatore*  
Тепловой конус изолятора

Cavidad de respiración  
*Area di respirazione*  
Полость доступа рабочей

Electrodo de masa  
*Elettrodo di massa*  
Боковой электрод смеси

Barrera quintuple contra corriente de fuga con perfil estriado  
*Quintupla barriera contro le correnti di fuga con profilo a gole*  
Пять ребер изолятора желобчатого профиля для предотвращения токов поверхностной утечки

Aislador de óxido de aluminio  
*Isolatore in ossido di alluminio*  
Изолятор из окиси алюминия

Cuerpo de bujía niquelado  
*Corpo della candela nichelato*  
Никелированный корпус свечи

Anillo de junta imperdible  
*Anello di tenuta prigioniero*  
Неспадающее уплотнительное кольцо

Junta interior  
*Guarnizione interna*  
Внутреннее уплотнительное кольцо

Chafan de introducción  
*Scarico di introduzione*  
Вводная насадка

Markowa świeca zapłonowa o niedoścignionej jakości oryginalnego wyposażenia samochodu

### Praktyczny system skróconych oznaczeń!

Skorzystaj z zalet dużej popularności świec BERU Ultra: kompletny program świec o jakości oryginalnego wyposażenia samochodu!

- Aktualna technika: zapłon iskrowy/kondensatorowy
- Pewny zapłon
- Optymalne i ekologiczne spalanie paliwa
- Nowoczesne materiały: bimetaliczna elektroda centralna (rdzeń miedziany pokryty niklem)
- Wysoka trwałość i niezawodność
- Ochrona katalizatora

Το μπουζί αξεπέραστης ποιότητας

### Πρακτικό σύστημα μικρών αριθμών!

Επωφεληθείτε από το πασίγνωστο μπουζί BERU Ultra: ένα πλήρες πρόγραμμα σε αξεπέραστη ποιότητα!

- Σύγχρονη τεχνολογία
- Ασφαλής ανάφλεξη
- Ιδανική καύση, φιλική προς το περιβάλλον
- Δοκιμασμένα υλικά: Κεντρικό ηλεκτρόδιο με διπλό υλικό (χάλκινος πυρήνας σε νικέλινο περίβλημα)
- Μακροζωία, υψηλή σταθερότητα
- Προστασία καταλύτη

A megalkuvást nem ismerő márkás gyújtógyertya eredeti készülék-gyártói minőségben

### Praktikus hivatkozási számrendszer:

Húzzon hasznát a BERU Ultra népszerűségéből: komplett szállítási program eredeti készülék-gyártói minőségben!

- Korszerű technológia: légréses technika/kúszó szikra kisüléssel
- Biztonságos gyújtás
- Optimális, környezetbarát égés
- Jól bevált anyagok: kétközeges közepső elektroda (nikkel-köpenyes rézmag)
- Hosszú élettartam és nagyfokú állékonyosság
- Katalizátorvédelem

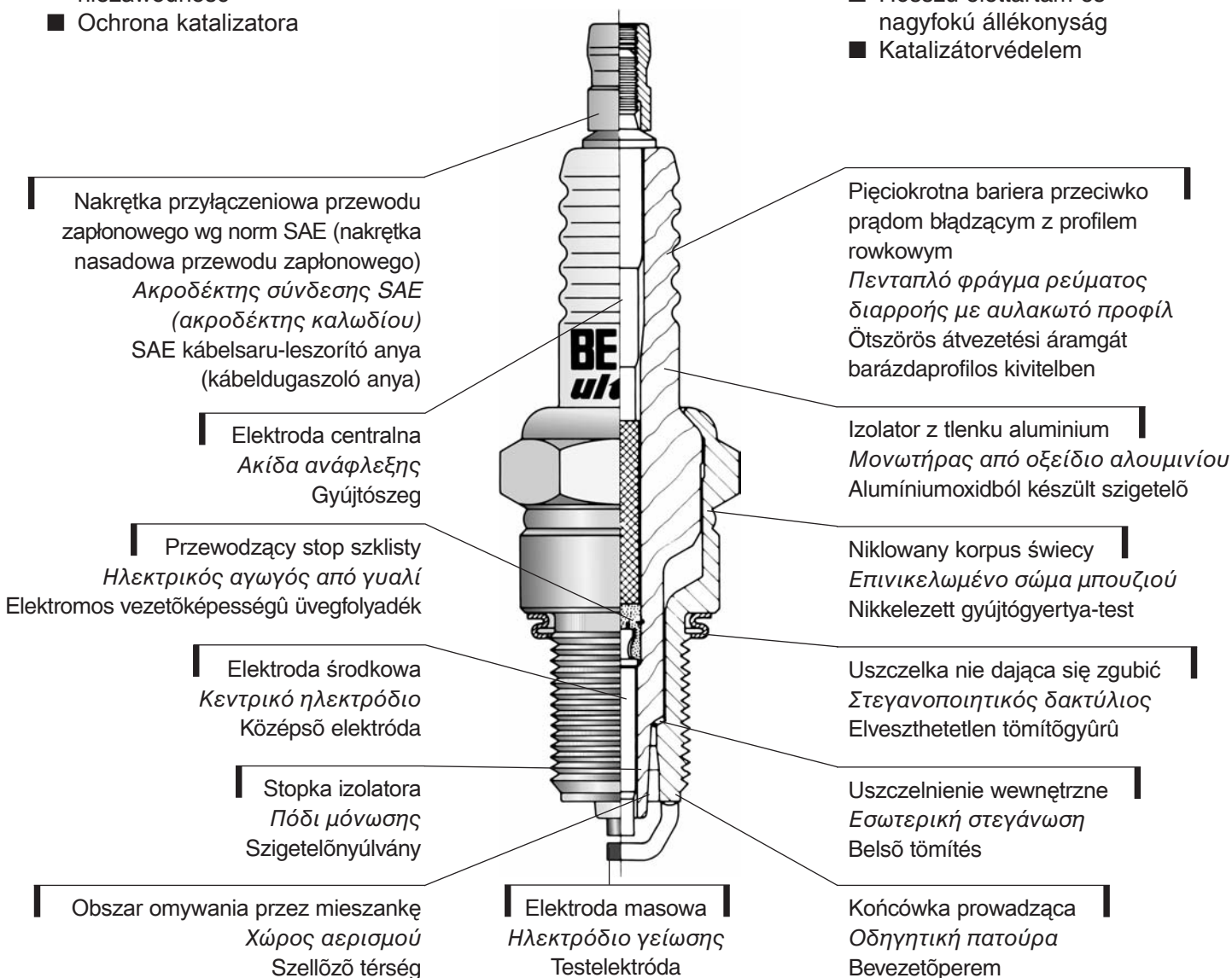

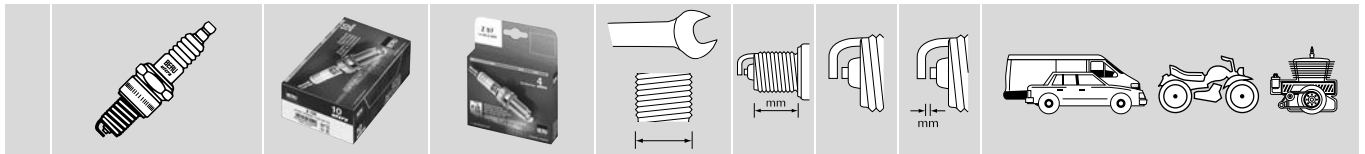
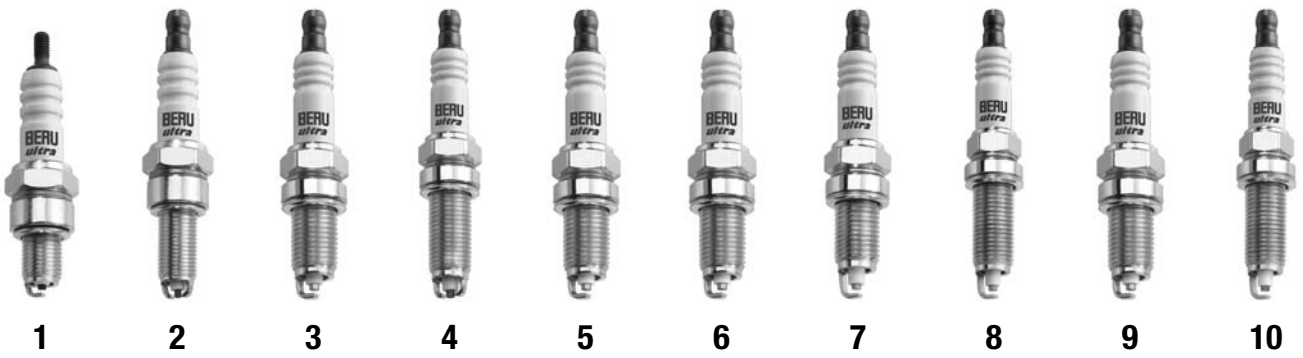
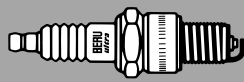

1	10 FR-4 AU	Z 199 0 002 150 700		16 M 10 × 1	12,7	A	0,6	Zweirad
2	10 FR-7 KDUS <sup>22</sup>	Z 341 0 002 135 700		16 M 10 × 1,0	19	K		
3	12 FR-5 DU <sup>22</sup>	Z 291 0 002 245 704		16 M 12 × 1,25	19	B	0,9	Fiat
4	12 FR-5 SDU <sup>22</sup>	Z 286 0 002 245 703		16 M 12 × 1,25	26,5	K		Smart
5	12 FR-6 DU <sup>22</sup>	Z 292 0 002 240 702		16 M 12 × 1,25	19	B	1,05	Fiat
6	12 FR-6 DUT <sup>22</sup>	Z 358 0 002 240 707		16 M 12 × 1,25	19	B	0,8	Chevrolet
7	12 FR-6 LUX <sup>22</sup>	Z 293 0 002 240 701	Z 293 SB 0 900 004 241	16 M 12 × 1,25	19	J	1,05	Fiat, Lancia
8	12 FR-6 MUW	Z 308 0 002 240 703					0,9	Smart
9	12 FR-7 DU <sup>22</sup>	Z 234 0 002 235 700	Z 234 SB 0 900 004 196	16 M 12 × 1,25	19	B	0,85	BMW, Fiat
10	12 VR-8 SE <sup>22</sup>	Z 243 0 002 230 300	Z 243 SB 0 900 004 185	14 M 12 × 1,25	26,5	B	0,9	Citroën, Peugeot, Renault

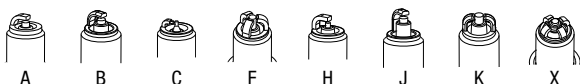

<sup>22</sup> Monoblock/SAE-Mutter nicht  
abschraubbar



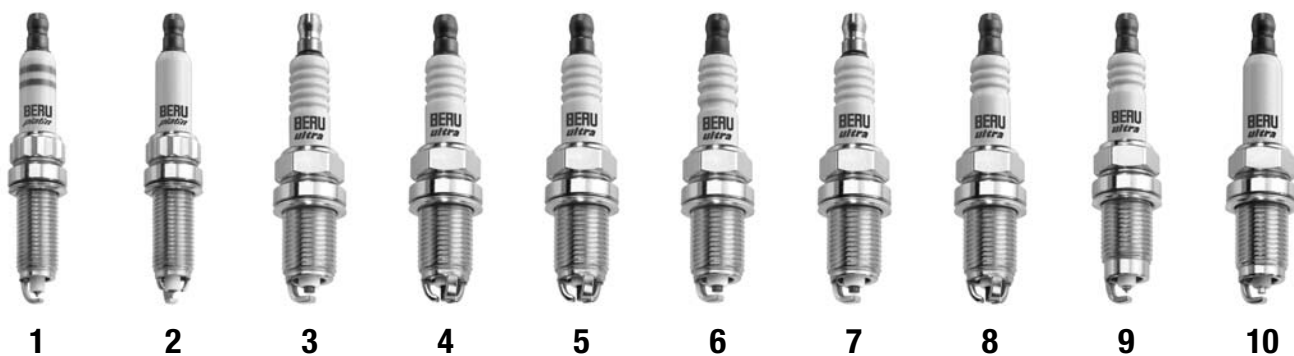
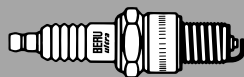

1 2 3 4 5 6 7 8 9 10

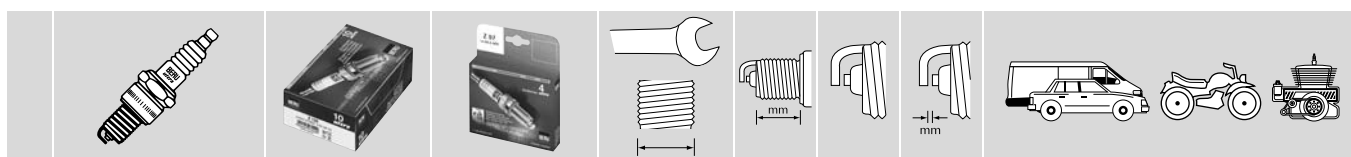

1	12 ZR-6 SPP2 <sup>22</sup>	Z 318 0 002 240 909		14/BIHEX M 12 × 1,25	26,5	B	0,7	Mini/PSA
2	12 ZR-8 STP <sup>22</sup>	Z 320 0 002 230 901		14/BIHEX M 12 × 1,25	26,5	B	1	Citroën/Peugeot
3	14 F-5 DU	Z 29 0 001 345 720	Z 29 SB 0 900 004 029	16 M 14 × 1,25	19	B	0,8	Alfa Romeo, Austin, Citroën, Ford, Seat
4	14 F-6 DTU <sup>22</sup>	Z 52 0 001 340 706		16 M 14 × 1,25	19	F	0,8	VW AG
5	14 F-6 DTU <sup>22</sup>	Z 53 0 001 340 717		16 M 14 × 1,25	19	F	1,0	VW AG
6	14 F-7 DU <sup>22</sup>	Z 63 0 001 335 725		16 M 14 × 1,25	19	B	0,8	Lancia, Mazda, Nissan, Opel, Peugeot, Renault, Saab, Skoda
7	14 F-7 DUOR	Z 13 0 001 335 729	Z 13 SB 0 900 004 083	16 M 14 × 1,25	19	B	0,8	Citroën, Peugeot, Renault
8	14 F-7 HTUR <sup>22</sup>	Z 344 0 001 335 788		16 M 14 × 1,25	19	F	1,0	VW AG
9	14 F-7 HUR2 <sup>22</sup>	Z 200 0 001 335 742	Z 200 SB 0 900 004 147	16 M 14 × 1,25	19	J	0,9	VW AG
10	14 F-7 HURU2 <sup>22</sup>	Z 272 0 001 335 789		16 M 14 × 1,25	19	J	1,0	VW AG

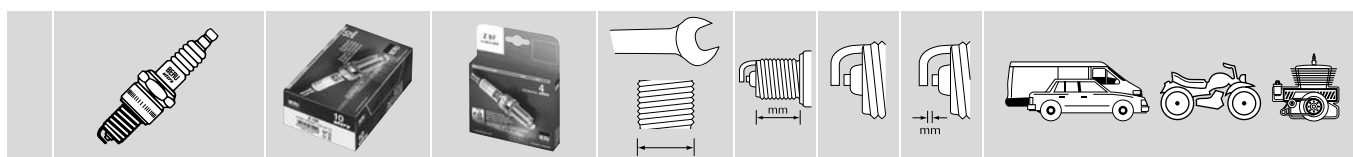
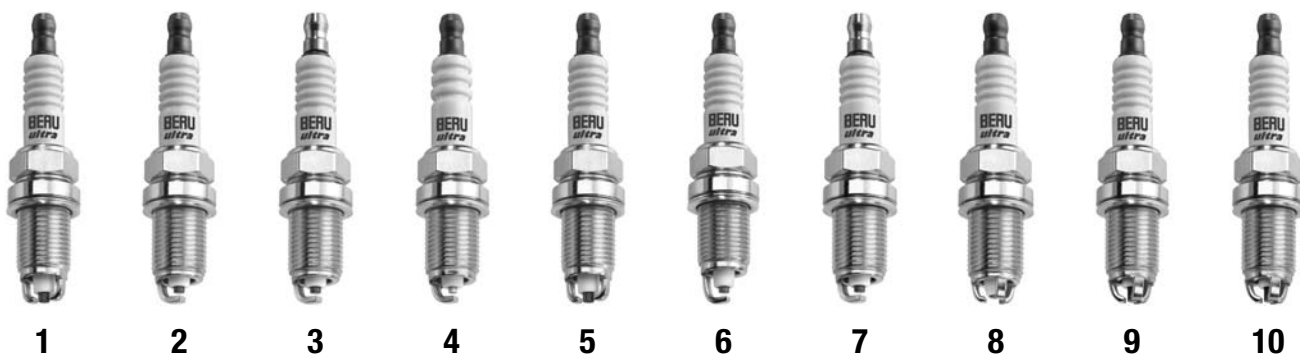
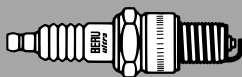

1	14 F-7 LDUR4 <sup>22</sup>	Z 14 0 001 335 732	Z 14 SB 0 900 004 084	16 M 14 × 1,25	19	K	0,9	BMW
2	14 F-8 DU4 <sup>22</sup>	Z 100 0 001 330 731	Z 100 SB 0 900 004 134	16 M 14 × 1,25	19	B	0,8	Mercedes
3	14 F-8 DUO <sup>22</sup>	Z 5 0 001 330 725	Z 5 SB 0 900 004 080	16 M 14 × 1,25	19	B	0,8	Mercedes
4	14 F-8 DUR <sup>22</sup>	Z 227 0 001 330 780	Z 227 SB 0 900 004 178	16 M 14 × 1,25	19	B	0,8	Mercedes
5	14 F-8 LDUSR <sup>22</sup>	Z 101 0 001 330 501		16 M 14 × 1,25	19	K	0,9	Mercedes
6	14 F-8 LUR <sup>22</sup>	Z 4 0 001 330 717	Z 4 SB 0 900 004 072	16 M 14 × 1,25	19	J	0,7	BMW
7	14 F-9 DUO	Z 79 0 001 325 705		16 M 14 × 1,25	19	B	0,8	Mercedes
8	14 FG-8 DTU <sup>22</sup>	Z 128 0 001 330 105		16 M 14 × 1,25	19	F	1,2	VW AG
9	14 FGH-6 DTUR <sup>22</sup>	Z 89 0 001 340 103	Z 89 SB 0 900 004 106	16 M 14 × 1,25	19	F	0,8	VW AG
10	14 FGH-7 DTURX <sup>22</sup>	Z 90 0 001 335 107	Z 90 SB 0 900 004 101	16 M 14 × 1,25	19	F	1,0	VW AG

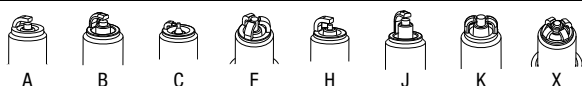

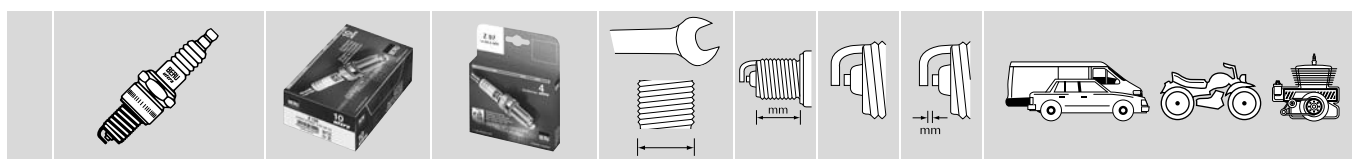
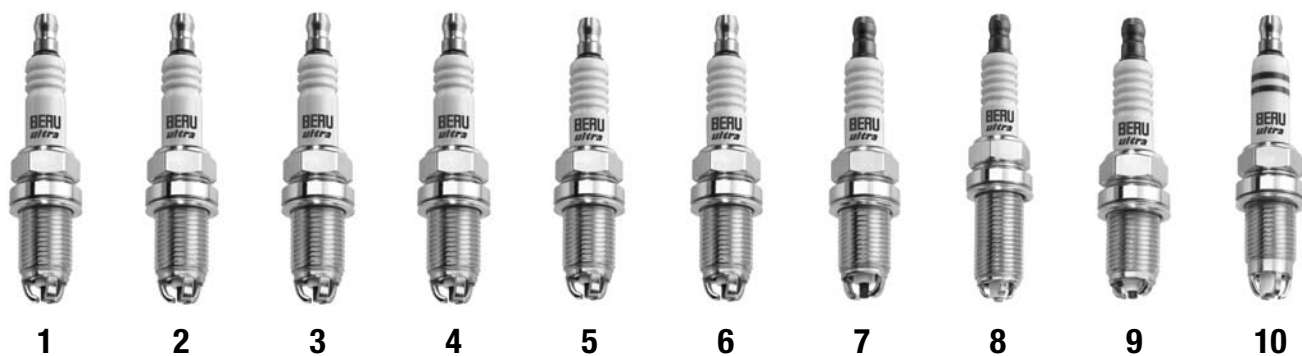
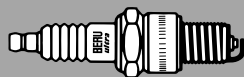

<b>1</b>	<b>14 FGH-7 DTURXO</b>	<b>Z 120</b> 0 001 335 110	<b>Z 120 SB</b> 0 900 004 136	16 M 14 × 1,25	19	F	1,0	Mercedes
<b>2</b>	<b>14 FGH-8 DTUR</b>	<b>Z 126</b> 0 001 330 117	<b>Z 126 SB</b> 0 900 004 201	16 M 14 × 1,25	19	F	0,8	VW AG
<b>3</b>	<b>14 FGH-8 DTURW<sup>22</sup></b>	<b>Z 246</b> 0 001 330 119	<b>Z 246</b> 0 900 004 198	16 M 14 × 1,25	19	F	0,9	VW AG
<b>4</b>	<b>14 FGH-8 DTURXO</b>	<b>Z 121</b> 0 001 330 116	<b>Z 121 SB</b> 0 900 004 137	16 M 14 × 1,25	19	F	1,0	Mercedes
<b>5</b>	<b>14 FGHR-7 DTUT</b>	<b>Z 304</b> 0 002 335 137		16 M 14 × 1,25	19	F	0,9	Alfa Romeo
<b>6</b>	<b>14 FGHR-7 DTUU</b>	<b>Z 360</b> 0 002 335 139		16 M 14 × 1,25	19	F	1,0	Daihatsu
<b>7</b>	<b>14 FGHR-7 LDUW</b>	<b>Z 324</b> 0 002 335 138		16 M 14 × 1,25	19	K	0,9	Daihatsu
<b>8</b>	<b>14 FGR-5 NTE<sup>22</sup></b>	<b>Z 294</b> 0 002 345 118		16 M 14 × 1,25	26,5	F	0,6	VOLVO
<b>9</b>	<b>14 FGR-6 DDU<sup>22</sup></b>	<b>Z 145</b> 0 002 340 102	<b>Z 145 SB</b> 0 900 004 205	16 M 14 × 1,25	19	K	1,6	VW AG
<b>10</b>	<b>14 FGR-6 HQU<sup>22</sup></b>	<b>Z 300</b> 0 002 340 123	<b>Z 300 SB</b> 0 900 004 237	16 M 14 × 1,25	19	X	1,35	VW AG

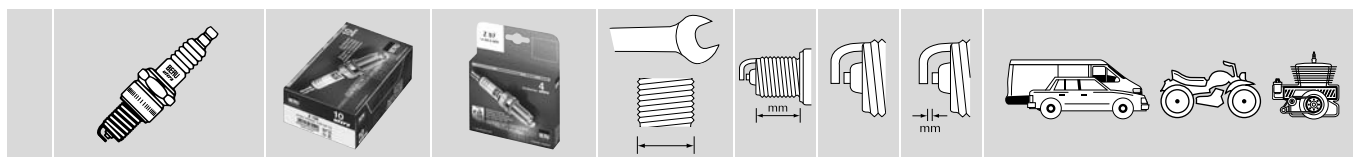
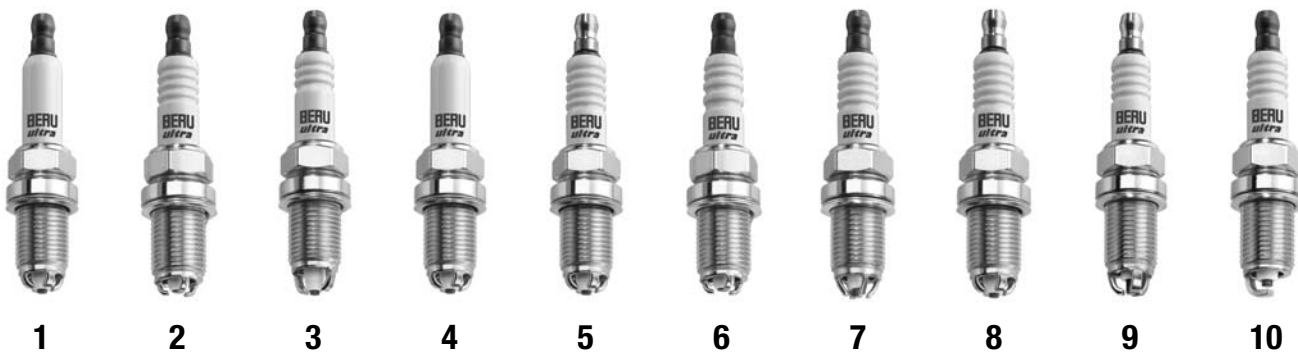

1	14 FGR-6 KQU <sup>22</sup>	Z 129 0 002 340 101		16 M 14 × 1,25	19	X	1,6	Porsche
2	14 FGR-7 CTU <sup>22</sup>	Z 160 0 002 335 100		16 M 14 × 1,25	19	F	1,2	Citroën, Peugeot, Renault
3	14 FGR-7 KDU <sup>622</sup>	Z 213 0 002 335 128		16 M 14 × 1,25	19	K	1,7	VW AG
4	14 FGR-7 KQE <sup>22</sup>	Z 239 0 002 335 131	Z 239 SB 0 900 004 240	16 M 14 × 1,25	19	X	1,6	BMW
5	14 FGR-7 KQU	Z 172 0 002 335 104		16 M 14 × 1,25	19	X	1,6	VW AG
6	14 FGR-8 CTU <sup>22</sup>	Z 204 0 002 340 117	Z 204 SB 0 900 004 206	16 M 14 × 1,25	19	F	1,2	Volvo, Renault
7	14 FGR-8 DQU <sup>722</sup>	Z 190 0 002 330 104	Z 190 SB 0 900 004 143	16 M 14 × 1,25	19	X	1,2	Opel
8	14 FGR-8 KQU	Z 173 0 002 330 102	Z 173 SB 0 900 004 204	16 M 14 × 1,25	19	X	1,6	Ford, Seat, VW AG
9	14 FR-5 DTU	Z 45 0 002 345 704		16 M 14 × 1,25	19	F	0,7	Porsche
10	14 FR-5 DU <sup>22</sup>	Z 30 0 002 345 702	Z 30 SB 0 900 004 076	16 M 14 × 1,25	19	B	0,8	Ford

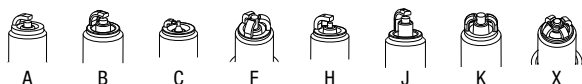

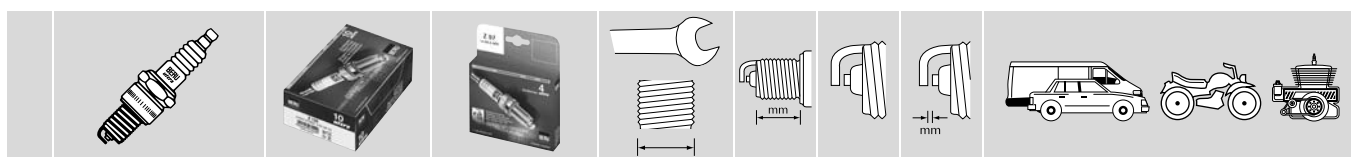
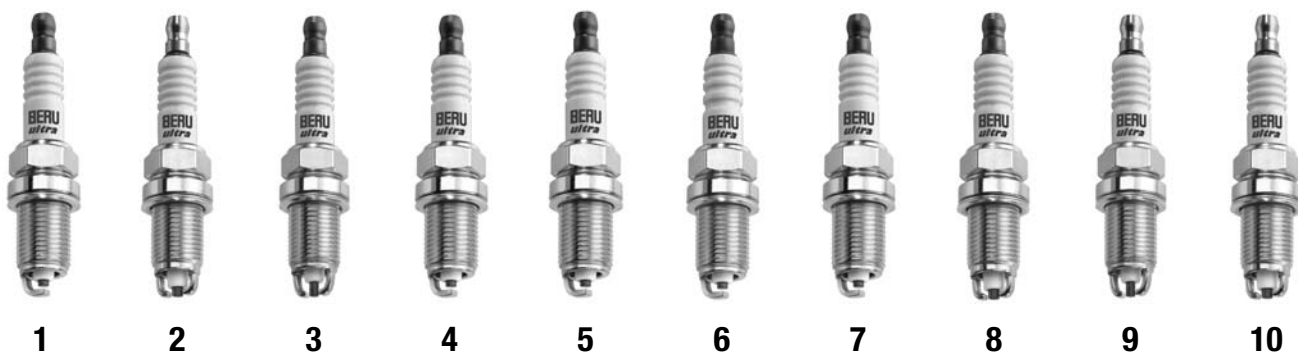
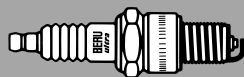

<b>1</b>	<b>14 FR-5 DUU<sup>22</sup></b>	<b>Z 253</b> 0 002 345 731		16 M 14 × 1,25	19	B	1,0	Ford, Saab
<b>2</b>	<b>14 FR-5 LDU</b>	<b>Z 192</b> 0 002 345 501		16 M 14 × 1,25	19	K	0,8	Porsche
<b>3</b>	<b>14 FR-5 LDU3<sup>22</sup></b>	<b>Z 198</b> 0 002 345 504		16 M 14 × 1,25	19	K	0,9	BMW
<b>4</b>	<b>14 FR-6 DU<sup>22</sup></b>	<b>Z 24</b> 0 002 340 702	<b>Z 24 SB</b> 0 900 004 053	16 M 14 × 1,25	19	B	0,8	Austin, Citroën, Fiat, Ford, Honda, Jaguar, Mazda, Nissan, Opel, Peugeot, Rover, Saab, Toyota
<b>5</b>	<b>14 FR-6 DUW<sup>22</sup></b>	<b>Z 252</b> 0 002 340 768		16 M 14 × 1,25	19	B	0,9	Citroën, Fiat, Lancia, Peugeot
<b>6</b>	<b>14 FR-6 DUW<sup>22</sup></b>	<b>Z 335</b> 0 002 340 771		16 M 14 × 1,25	19	B		Peugeot
<b>7</b>	<b>14 FR-6 DUX<sup>22</sup></b>	<b>Z 99</b> 0 002 340 704	<b>Z 99 SB</b> 0 900 004 193	16 M 14 × 1,25	19	B	1,0	Ford, Honda, Hyundai, Nissan, Rover
<b>8</b>	<b>14 FR-6 LDU</b>	<b>Z 116</b> 0 002 340 500	<b>Z 116 SB</b> 0 900 004 200	16 M 14 × 1,25	19	K	0,8	Citroën, Fiat, Lancia, Peugeot, Porsche
<b>9</b>	<b>14 FR-6 LDU3</b>	<b>Z 194</b> 0 002 340 501	<b>Z 194 SB</b> 0 900 004 205	16 M 14 × 1,25	19	K	0,6	Mercedes (Smart)
<b>10</b>	<b>14 FR-6 LDUW</b>	<b>Z 245</b> 0 002 340 504	<b>Z 245 SB</b> 0 900 004 197	16 M 14 × 1,25	19	K	0,9	Lancia

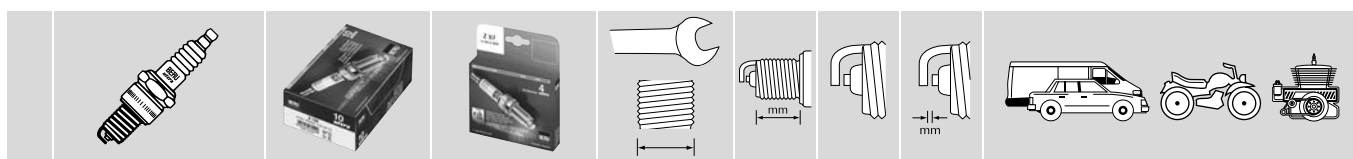
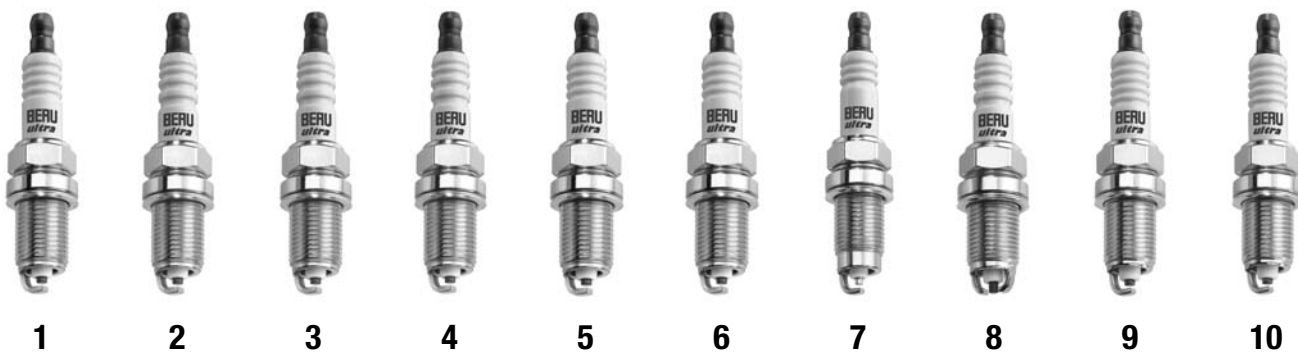

1	14 FR-7 DU <sup>22</sup>	Z 15 0 002 335 707	Z 15 SB 0 900 004 085	M 16 M 14 × 1,25	19	B	0,85	Fiat, Nissan, Peugeot, Rover, Saab, Suzuki, Volvo
2	14 FR-7 DU2	Z 193 0 002 335 717	Z 193 SB 0 900 004 146	M 16 M 14 × 1,25	19	B	0,9	Fiat, Lancia, Opel, Renault
3	14 FR-7 DU2S	Z 250 0 002 336 725		M 16 M 14 × 1,25	19	B	0,7	Opel, Porsche, Vauxhall, Volvo, Volkswagen
4	14 FR-7 DU2T	Z 251 0 002 336 726		M 16 M 14 × 1,25	19	B	0,8	Volvo
5	14 FR-7 DUW <sup>22</sup>	Z 247 0 002 336 724	Z 247 SB 0 900 004 199	M 16 M 14 × 1,25	19	B	0,9	Citoren, Lancia, Nissan, Peugeot
6	14 FR-7 DUX <sup>22</sup>	Z 16 0 002 335 708	Z 16 SB 0 900 004 086	M 16 M 14 × 1,25	19	B	1,1	Daihatsu, Mitsubishi
7	14 FR-7 HUX <sup>22</sup>	Z 225 0 002 336 715		M 16 M 14 × 1,25	19	J	1,1	Nissan
8	14 FR-7 KDU <sup>22</sup>	Z 123 0 002 335 709		M 16 M 14 × 1,25	19	K	1,0	Citroën, Peugeot
9	14 FR-7 KU	Z 155 0 002 335 712	Z 155 SB 0 900 004 152	M 16 M 14 × 1,25	19	J	0,8	Nissan
10	14 FR-7 KUO	Z 156 0 002 335 713		M 16 M 14 × 1,25	19	J	0,7	Toyota

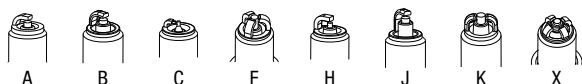

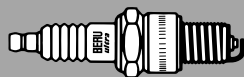

**1 2 3 4 5 6 7 8 9 10 11**

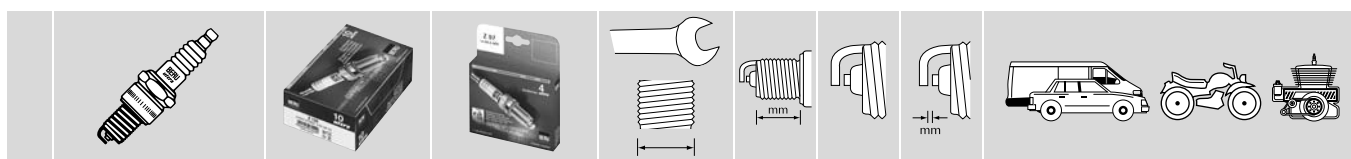

<b>1</b>	<b>14 FR-7 KUOX</b>	<b>Z 157</b> 0 002 335 714	<b>Z 157 SB</b> 0 900 004 203	16 M 14 × 1,25	19	J	1,1	Toyota
<b>2</b>	<b>14 FR-7 LDU<sup>22</sup></b>	<b>Z 98</b> 0 002 335 500	<b>Z 98 SB</b> 0 900 004 192	16 M 14 × 1,25	19	K	0,8	Citroën, Fiat, Lancia, Honda, Opel, Peugeot, Vauxhall
<b>3</b>	<b>14 FR-7 LDUW<sup>22</sup></b>	<b>Z 257</b> 0 002 335 503	<b>Z 257 SB</b> 0 900 004 211	16 M 14 × 1,25	19	K	0,9	Daihatsu, Renault
<b>4</b>	<b>14 FR-7 LUX<sup>22</sup></b>	<b>Z 158</b> 0 002 335 715	<b>Z 158 SB</b> 0 900 004 144	16 M 14 × 1,25	19	J	1,1	Ford, Honda, Mazda, Opel, Rover
<b>5</b>	<b>14 FR-7 LUX0<sup>22</sup></b>	<b>Z 299</b> 0 002 335 802		16 M 14 × 1,25	19	J	1,0	Honda
<b>6</b>	<b>14 FR-7 MU2<sup>22</sup></b>	<b>Z 184</b> 0 002 335 719	<b>Z 184 SB</b> 0 900 004 148	16 M 14 × 1,25	26,5	B	0,9	Citroën, Fiat, Lancia, Peugeot
<b>7</b>	<b>14 FR-7 MUX2<sup>22</sup></b>	<b>Z 303</b> 0 002 336 734		16 M 14 × 1,25	26,5	B	1,1	Nissan
<b>8</b>	<b>14 FR-7 NUX2<sup>22</sup></b>	<b>Z 273</b> 0 002 336 738		16 M 14 × 1,25	26,5	B	1,1	Citroën, Mitsubishi, Peugeot, Toyota
<b>9</b>	<b>14 FR-8 DEW<sup>22</sup></b>	<b>Z 334</b> 0 002 330 217		16 M 14 × 1,25	19	B	1,0	Kia
<b>10</b>	<b>14 FR-8 DU<sup>22</sup></b>	<b>Z 72</b> 0 002 330 703	<b>Z 72 SB</b> 0 900 004 191	16 M 14 × 1,25	19	B	0,8	Nissan
<b>11</b>	<b>14 FR-8 DUS<sup>22</sup></b>	<b>Z 254</b> 0 002 330 205		16 M 14 × 1,25	19	B	0,7	Skoda, Toyota

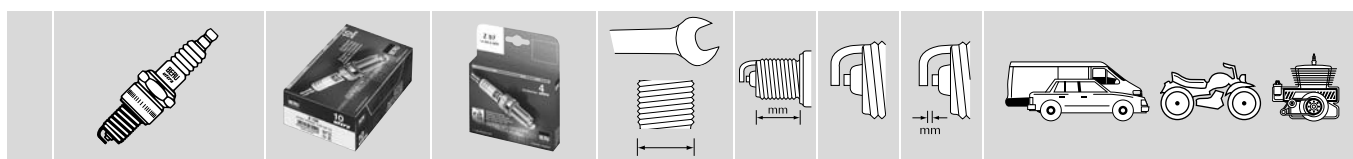
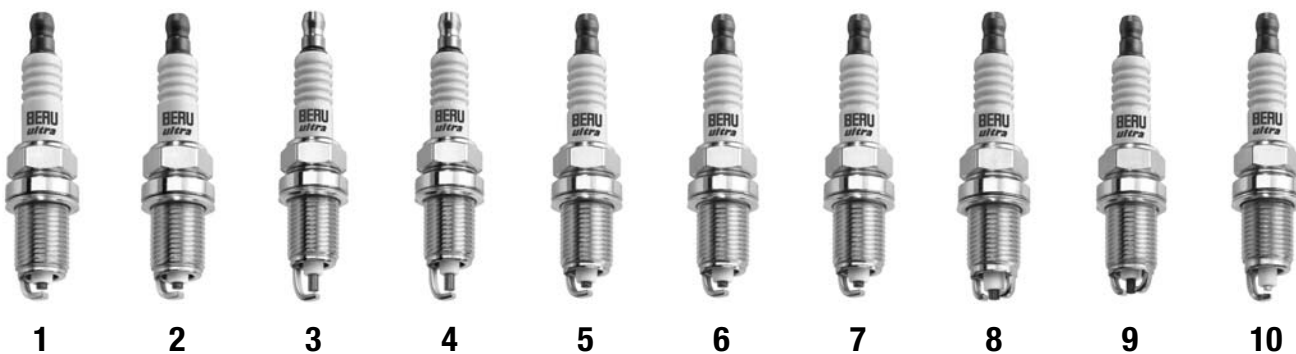

1	14 FR-8 DUW <sup>22</sup>	Z 255 0 002 330 206	Z 255 SB 0 900 004 210	16 M 14 × 1,25	19	B	0,9	Fiat, Jeep, Peugeot
2	14 FR-8 DUX <sup>22</sup>	Z 73 0 002 330 704	Z 73 SB 0 900 004 169	16 M 14 × 1,25	19	B	1,1	Nissan
3	14 FR-8 HU	Z 152 0 002 330 712		16 M 14 × 1,25	19	J	0,7	Toyota
4	14 FR-8 HUT	Z 248 0 002 330 203		16 M 14 × 1,25	19	J	0,8	Jeep, Toyota
5	14 FR-8 KU	Z 153 0 002 330 713	Z 153 SB 0 900 004 150	16 M 14 × 1,25	19	J	0,8	Nissan
6	14 FR-8 KUO	Z 154 0 002 330 714	Z 154 SB 0 900 004 151	16 M 14 × 1,25	19	J	0,9	Toyota
7	14 FR-8 KUOU	Z 249 0 002 330 204		16 M 14 × 1,25	19	J	1,0	Toyota
8	14 FR-8 LDUOX <sup>422</sup>	Z 74 0 002 330 710	Z 74 SB 0 900 004 113	16 M 14 × 1,25	19	K	1,0	Citroën, Opel, Peugeot
9	14 FR-8 LDU3 <sup>22</sup>	Z 208 0 002 330 795		16 M 14 × 1,25	19	K	1,0	Toyota
10	14 FR-8 LU2 <sup>22</sup>	Z 203 0 002 330 794	Z 203 SB 0 900 004 172	16 M 14 × 1,25	19	J	0,9	Opel

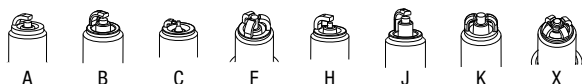



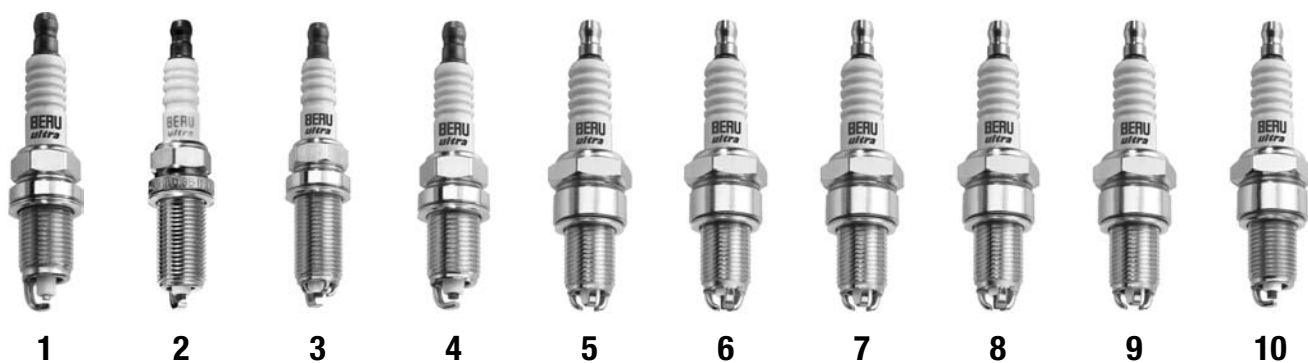
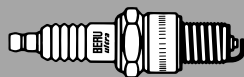

1

2

3

4

5

6

7

8

9

10

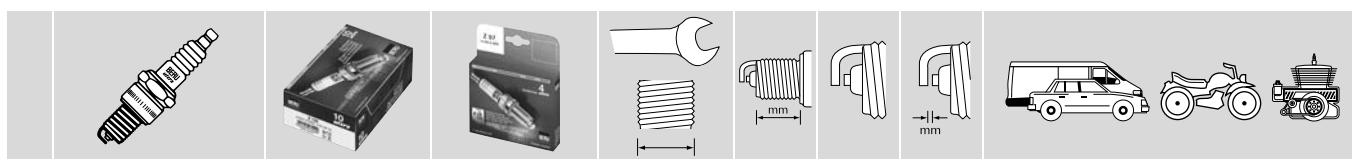

1	14 FR-8 LU2T <sup>22</sup>	Z 287 0 002 330 215		16 M 14 × 1,25	19	J	0,8	Opel
2	14 FR-8 MU2 <sup>22</sup>	Z 183 0 002 330 718	Z 183 SB 0 900 004 149	16 M 14 × 1,25	26,5	B	0,9	Citroën, Fiat, Peugeot
3	14 FR-8 NQU23 <sup>22</sup>	Z 223 0 002 330 796	Z 223 SB 0 900 004 208	16 M 14 × 1,25	26,5	X	0,9	Citroën, Peugeot
4	14 FR-9 KUX2 <sup>22</sup>	Z 220 0 002 325 723		16 M 14 × 1,25	19	B	1,0	Jeep
5	14 G-8 DTU	Z 75 0 001 330 104		21 M 14 × 1,25	19	F	1,2	VW AG
6	14 GH-7 DTUR	Z 91 0 001 335 108	Z 91 SB 0 900 004 102	21 M 14 × 1,25	19	F	0,8	Seat, Skoda, VW AG
7	14 GH-8 DTUR	Z 92 0 001 330 113	Z 92 SB 0 900 004 103	21 M 14 × 1,25	19	F	0,8	Seat, Skoda, VW AG
8	14 GH-8 DTURX	Z 93 0 001 330 112	Z 93 SB 0 900 004 104	21 M 14 × 1,25	19	F	1,0	Seat, Skoda, VW AG
9	14 GR-8 DTU	Z 94 0 002 330 706	Z 94 SB 0 900 004 105	21 M 14 × 1,25	19	F	0,8	VW AG
10	14 R-5 DU	Z 47 0 002 345 701	Z 47 SB 0 900 004 188	21 M 14 × 1,25	19	B	0,8	Austin, Fiat, Ford, Lancia, Mazda, Volvo

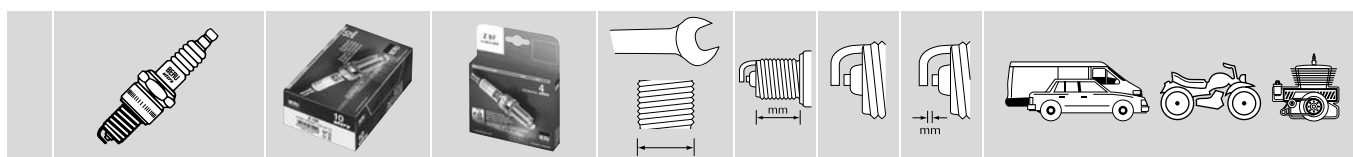
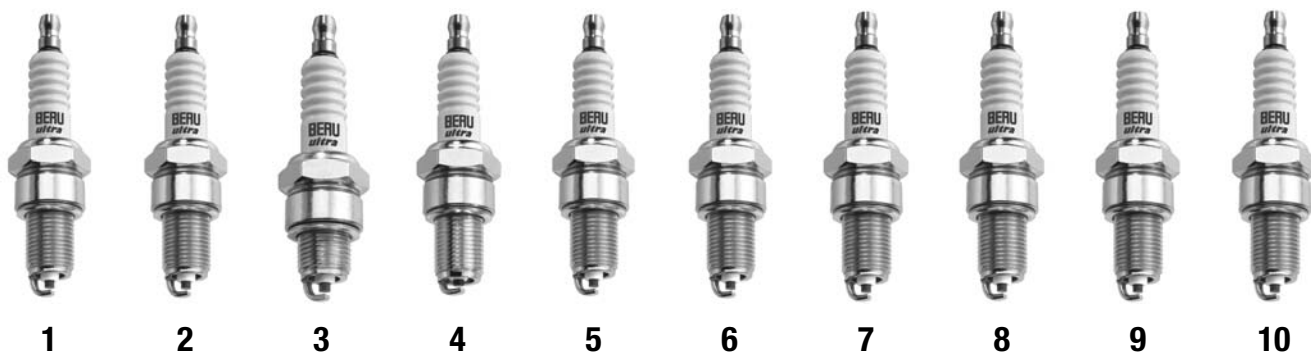
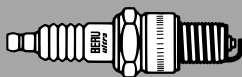

1	14 R-6 DU	Z 27 0 002 340 701	Z 27 SB 0 900 004 047	M 21 14 × 1,25	19	B	0,8	Alfa Romeo, Austin, Fiat, Ford, Lancia, Opel, Subaru, Vauxhall, Volvo
2	14 R-6 DUX	Z 28 0 002 340 703	Z 28 SB 0 900 004 090	M 21 14 × 1,25	19	B	1,1	Mitsubishi, Opel, Vauxhall
3	14 R-7 BU	Z 19 0 002 435 701	Z 19 SB 0 900 004 048	M 21 14 × 1,25	12,7	B	0,8	Fiat, Opel Vauxhall
4	14 R-7 CU	Z 59 0 002 335 704	Z 59 SB 0 900 004 190	M 21 14 × 1,25	19	A	0,8	MMC, Nissan
5	14 R-7 DU	Z 20 0 002 335 701	Z 20 SB 0 900 004 049	M 21 14 × 1,25	19	B	0,8	Alfa Romeo, Austin, Daihatsu, Fiat, Ford, Honda, Isuzu, Lada, Lancia, Mazda, Nissan, Opel, Porsche, Renault, Seat, Subaru, Suzuki, Talbot, Toyota, Vauxhall, Volvo, Zastava
6	14 R-7 DUX	Z 21 0 002 335 706	Z 21 SB 0 900 004 088	M 21 14 × 1,25	19	B	1,1	Honda, Mitsubishi
7	14 R-8 DU	Z 8 0 002 330 701	Z 8 SB 0 900 004 052	M 21 14 × 1,25	19	B	0,8	AMC, Bentley, Bristol, Daihatsu, Honda, Hyundai, Mazda, Nissan, Rover, Renault, Suzuki, Toyota, Zastava
8	14 R-8 DU4	Z 119 0 002 330 709	Z 119 SB 0 900 004 135	M 21 14 × 1,25	19	B	0,8	Opel, Renault
9	14 R-8 DUX	Z 9 0 002 330 702	Z 9 SB 0 900 004 082	M 21 14 × 1,25	19	B	1,1	Honda, Mitsubishi, Mazda, Nissan
10	14 R-9 DU	Z 82 0 002 325 700		M 21 14 × 1,25	19	B	0,7	Chrysler, Renault

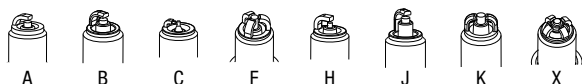

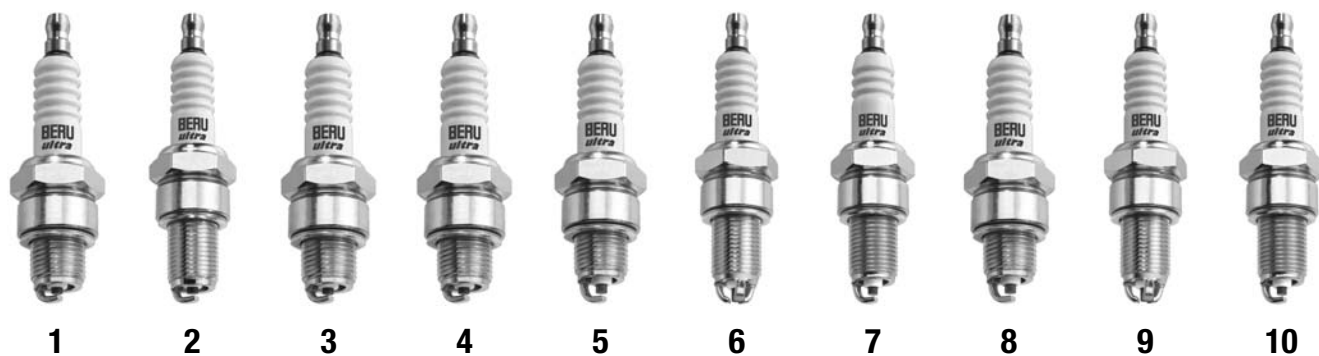
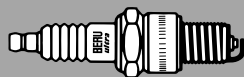

**1 2 3 4 5 6 7 8 9 10**

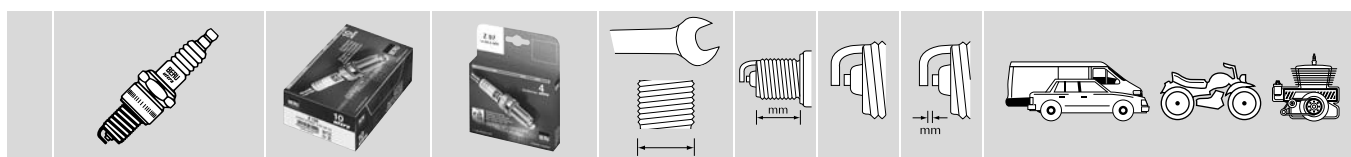

<b>1</b>	<b>14 Z-3 AU</b>	<b>Z 37</b> 0 001 455 702		21 M 14 × 1,25	12,7	A	0,4	Zweirad
<b>2</b>	<b>14 Z-3 CU</b>	<b>Z 38</b> 0 001 355 700		21 M 14 × 1,25	19	A	0,4	Zweirad
<b>3</b>	<b>14 Z-4 AU</b>	<b>Z 39</b> 0 001 450 702		21 M 14 × 1,25	12,7	A	0,4	Zweirad
<b>4</b>	<b>14-5 AU</b>	<b>Z 40</b> 0 001 445 702		21 M 14 × 1,25	12,7	A	0,6	Citroën, Fiat, Jaguar, Piaggio, Steyr, Trabant
<b>5</b>	<b>14-5 BU</b>	<b>Z 41</b> 0 001 445 700	<b>Z 41 SB</b> 0 900 004 186	21 M 14 × 1,25	12,7	B	0,8	Citroën, Fiat, Opel, Renault, Skoda, Volvo
<b>6</b>	<b>14-5 DTU</b>	<b>Z 44</b> 0 001 345 704		21 M 14 × 1,25	19	F	0,8	VW AG
<b>7</b>	<b>14-5 DU</b>	<b>Z 42</b> 0 001 345 702	<b>Z 42 SB</b> 0 900 004 187	21 M 14 × 1,25	19	B	0,8	Alfa Romeo, Ferrari, Fiat, Honda, Lancia, Mercedes, Porsche, Seat, VW AG
<b>8</b>	<b>14-6 BU</b>	<b>Z 48</b> 0 001 440 700		21 M 14 × 1,25	12,7	B	0,8	Opel
<b>9</b>	<b>14-6 DTU</b>	<b>Z 51</b> 0 001 340 704		21 M 14 × 1,25	19	F	0,8	VW AG
<b>10</b>	<b>14-6 DU</b>	<b>Z 22</b> 0 001 340 702	<b>Z 22 SB</b> 0 900 004 019	21 M 14 × 1,25	19	B	0,7	Alfa Romeo, BMW, Citroën, Fiat, Ford, Lancia, Mercedes, Renault, Saab, Seat, Talbot, Toyota, Volvo, VW AG

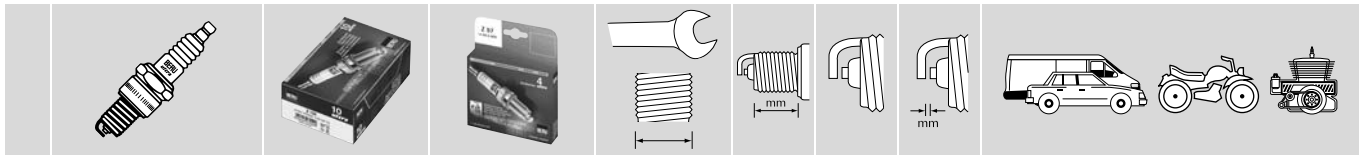
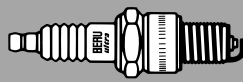

1	14-7 AU	Z 57 0 001 435 705		21 M 14 × 1,25	12,7	A	0,6	Citroën, Fiat, Moskvich, Seat, Skoda, Volkswagen, Volvo, Wartburg
2	14-7 BU	Z 10 0 001 435 700	Z 10 SB 0 900 004 021	21 M 14 × 1,25	12,7	B	0,8	Citroën, Fiat, Moskvich, Opel, Rover, Skoda, Suzuki, Volvo, Zastava
3	14-7 CU	Z 58 0 001 335 707		21 M 14 × 1,25	19	A	0,8	Austin, Daihatsu, Honda, Leyland, Nissan, Tasbot, Volkswagen, Volvo
4	14-7 DTU	Z 12 0 001 335 709	Z 12 SB 0 900 004 066	21 M 14 × 1,25	19	F	0,8	VW AG
5	14-7 DU	Z 11 0 001 335 702	Z 11 SB 0 900 004 023	21 M 14 × 1,25	19	B	0,8	BMW, Citroën, Fiat, Ford, Lada, Mercedes, VW AG
6	14-7 DUO	Z 61 0 001 335 714		21 M 14 × 1,25	19	B	0,7	VW AG
7	14-7 DUO	Z 62 0 001 335 737		21 M 14 × 1,25	19	B	0,8	Mercedes
8	14-8 AU	Z 68 0 001 430 701		21 M 14 × 1,25	12,7	A	0,6	Universal
9	14-8 BU	Z 118 0 001 430 700	Z 118 SB 0 900 004 194	21 M 14 × 1,25	12,7	B	0,9	Moskvich, Nysa, Tarpan, Zuk
10	14-8 DTU	Z 2 0 001 330 709	Z 2 SB 0 900 004 067	21 M 14 × 1,25	19	F	1,0	VW AG
11	14-8 DU	Z 1 0 001 330 702	Z 1 SB 0 900 004 024	21 M 14 × 1,25	19	B	0,8	BMW, Daihatsu, Honda, Jaguar, Mazda, Mercedes, Nissan, Porsche, Renault, Rover, Saab, Seat, Volvo, VW AG

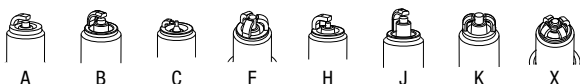

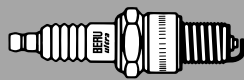

**1 2 3 4 5 6 7 8 9 10 11**

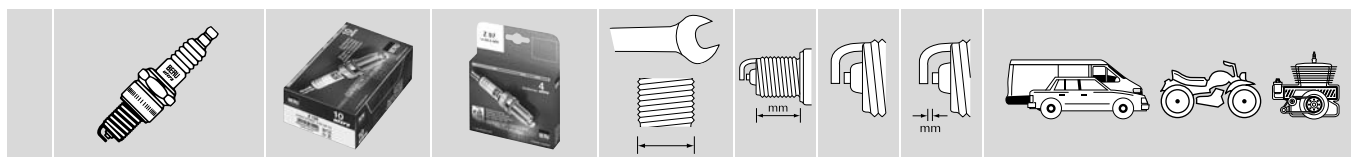

<b>1</b>	<b>14-8 DUO</b>	<b>Z 69</b> 0 001 330 713		21 M 14 × 1,25	19	B	0,7	VW AG
<b>2</b>	<b>14-8 DUO</b>	<b>Z 70</b> 0 001 330 726		21 M 14 × 1,25	19	B	0,8	Mercedes
<b>3</b>	<b>14-8 E</b>	<b>Z 112</b> 0 001 529 302		21 M 14 × 1,25	9,5	A	0,5	Kleinmotoren
<b>4</b>	<b>14-8 LUR</b>	<b>Z 3</b> 0 001 330 718	<b>Z 3 SB</b> 0 900 004 091	21 M 14 × 1,25	19	J	0,7	BMW
<b>5</b>	<b>14-9 DTU</b>	<b>Z 78</b> 0 001 325 710		21 M 14 × 1,25	19	F	0,8	VW AG
<b>6</b>	<b>14-9 DU</b>	<b>Z 76</b> 0 001 325 701	<b>Z 76 SB</b> 0 900 004 120	21 M 14 × 1,25	19	B	0,8	Mercedes
<b>7</b>	<b>14-X AU</b>	<b>Z 85</b> 0 001 400 701		21 M 14 × 1,25	12,7	A	0,4	Universal, Zweiräder
<b>8</b>	<b>UX 56</b>	<b>Z 85</b> 0 002 345 600	<b>UX 56 SB</b> 0 900 004 114	21 M 14 × 1,25	19	6-5		
<b>9</b>	<b>UX 79</b>	- 0 002 335 600	<b>UX 79 SB</b> 0 900 004 115	21 M 14 × 1,25	19	9-7		
<b>10</b>	<b>UXF 56</b>	- 0 002 345 601	<b>UXF 56 SB</b> 0 900 004 116	16 M 14 × 1,25	19	6-5		
<b>11</b>	<b>UXF 79</b>	- 0 002 335 601	<b>UXF 79 SB</b> 0 900 004 117	16 M 14 × 1,25	19	9-7		

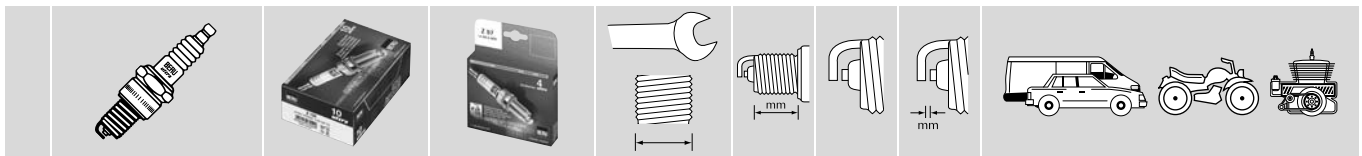
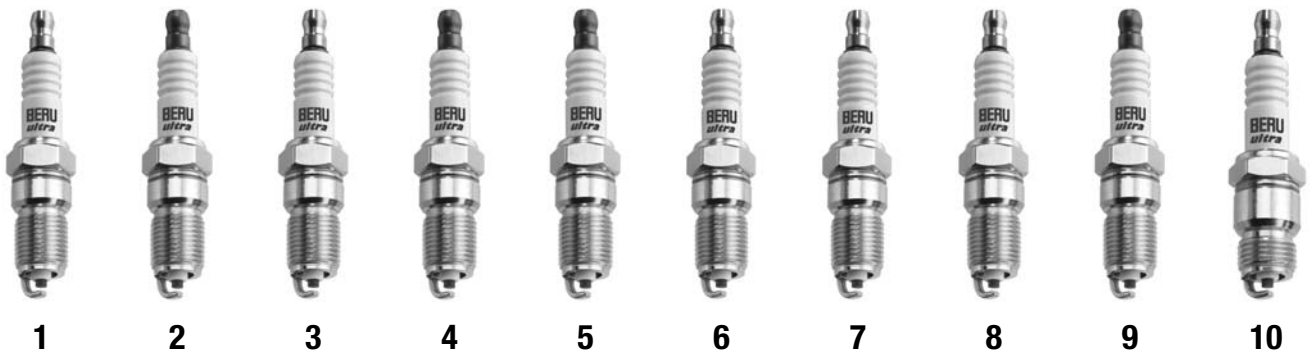
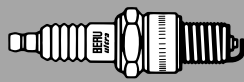

1	<b>14 K-5 DU</b>	<b>Z 31</b> 0 001 645 700	<b>Z 31 SB</b> 0 900 004 061	16 M 14 × 1,25	17,5	B	0,8	Citroen, Mercedes, Peugeot, Renault, Talbot
2	<b>14 K-5 DUO<sup>22</sup></b>	<b>Z 46</b> 0 001 645 703		16 M 14 × 1,25	17,5	B	0,8	Mercedes
3	<b>14 K-6 DU</b>	<b>Z 25</b> 0 001 640 700	<b>Z 25 SB</b> 0 900 004 051	16 M 14 × 1,25	17,5	B	0,8	Austin, Citroen, Lancia, Opel, Peugeot
4	<b>14 K-6 DUO</b>	<b>Z 55</b> 0 001 640 704		16 M 14 × 1,25	17,5	B	0,7	VW AG
5	<b>14 K-6 DUO</b>	<b>Z 56</b> 0 001 640 705		16 M 14 × 1,25	17,5	B	0,8	Mercedes
6	<b>14 K-7 DU</b>	<b>Z 17</b> 0 001 635 700	<b>Z 17 SB</b> 0 900 004 030	16 M 14 × 1,25	17,5	B	0,8	AMC, Citroen, Ford, Mercedes, Peugeot, Renault, Rover, Talbot
7	<b>14 K-7 DUO</b>	<b>Z 18</b> 0 001 635 709	<b>Z 18 SB</b> 0 900 004 087	16 M 14 × 1,25	17,5	B	0,8	Mercedes
8	<b>14 K-8 DU</b>	<b>Z 6</b> 0 001 630 700	<b>Z 6 SB</b> 0 900 004 092	16 M 14 × 1,25	17,5	B	0,8	Mercedes
9	<b>14 K-8 DUO<sup>22</sup></b>	<b>Z 7</b> 0 001 630 704	<b>Z 7 SB</b> 0 900 004 081	16 M 14 × 1,25	17,5	B	0,8	Mercedes
10	<b>14 K-9 BU<sup>22</sup></b>	<b>Z 174</b> 0 001 625 705		16 M 14 × 1,25	11,2	B	0,9	Export

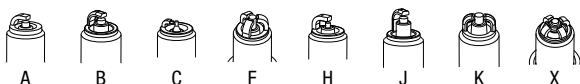

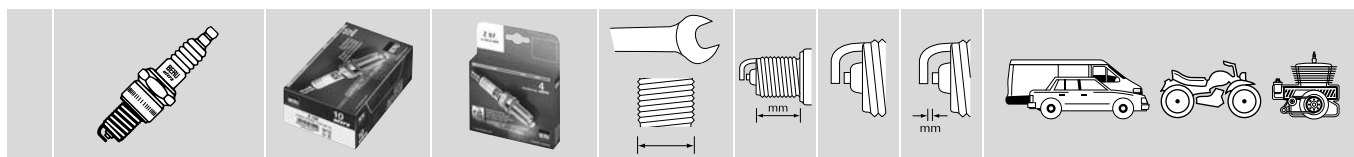
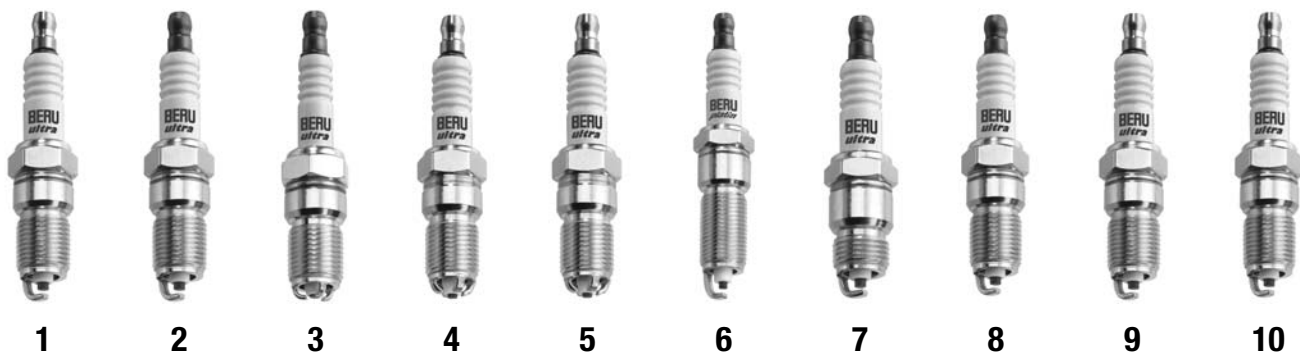
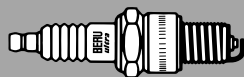

<b>1</b>	<b>14 K-9 DU</b>	<b>Z 80</b> 0 001 625 700		16 M 14 × 1,25	17,5	B	0,8	Mercedes
<b>2</b>	<b>14 K-9 DU0<sup>22</sup></b>	<b>Z 81</b> 0 001 625 702		16 M 14 × 1,25	17,5	B	0,8	Mercedes
<b>3</b>	<b>14 KG-8 DTU<sup>22</sup></b>	<b>Z 207</b> 0 001 630 101		16 M 14 × 1,25	17,5	F	1,2	Renault
<b>4</b>	<b>14 KGR-6 KQU</b>	<b>Z 144</b> 0 002 640 100		16 M 14 × 1,25	17,5	X	1,6	VW AG
<b>5</b>	<b>14 KGR-7 KQU</b>	<b>Z 127</b> 0 002 635 100		16 M 14 × 1,25	17,5	X	1,6	VW AG
<b>6</b>	<b>14 KR-10 SUV<sup>22</sup></b>	<b>Z 216</b> 0 002 620 708		16 M 14 × 1,25	25,4	B	1,3	Chrysler
<b>7</b>	<b>14 KR-6 BU<sup>22</sup></b>	<b>Z 49</b> 0 002 640 701	<b>Z 49 SB</b> 0 900 004 189	16 M 14 × 1,25	11,2	B	0,8	Opel, Vauxhall
<b>8</b>	<b>14 KR-6 DU<sup>22</sup></b>	<b>Z 26</b> 0 002 640 700	<b>Z 26 SB</b> 0 900 004 054	16 M 14 × 1,25	17,5	B	0,7	Ford, Peugeot, Renault, Volvo
<b>9</b>	<b>14 KR-7 DU<sup>22</sup></b>	<b>Z 95</b> 0 002 635 700	<b>Z 95 SB</b> 0 900 004 121	16 M 14 × 1,25	17,5	B	0,7	Ford
<b>10</b>	<b>14 KR-7 DUX<sup>22</sup></b>	<b>Z 67</b> 0 002 635 701	<b>Z 67 SB</b> 0 900 004 108	16 M 14 × 1,25	17,5	B	1,1	Ford

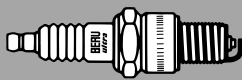

1

2

3

4

5

6

7

8

9

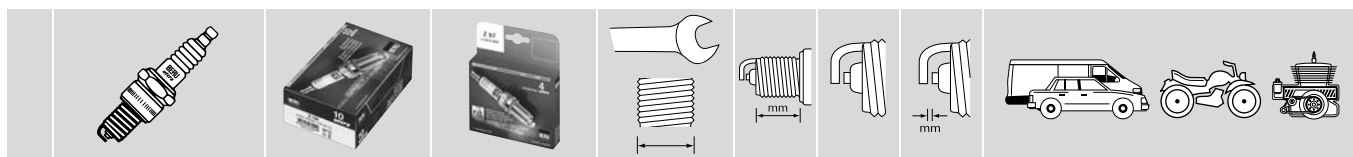

1	14 KR-6 MUU <sup>22</sup>	Z 305 0 002 640 712		M 14 × 1,25	25	B	1,1	Ford
2	14 KR-8 MUV <sup>22</sup>	Z 177 0 002 630 701	Z 177 SB 0 900 004 141	16 M 14 × 1,25	25,4	B	1,3	Ford
3	14 KR-8 STUX <sup>22</sup>	Z 222 0 002 630 715	Z 222 SB 0 900 004 175	16 M 14 × 1,25	25,4	B	1,1	Opel
4	14 KR-9 DUX	Z 117 0 002 625 700		16 M 14 × 1,25	17,5	B	1,0	Ford
5	18 K-6 BU	Z 33 0 001 740 700	Z 33 SB 0 900 004 055	21 M 18 × 1,5	11,2	B	0,7	Ford
6	18 K-7 BU	Z 32 0 001 735 700		21 M 18 × 1,5	11,2	B	0,7	Ford
7	18 K-9 BU	Z 175 0 001 725 700		21 M 18 × 1,5	11,2	B	0,9	Export
8	UXK 56	- 0 002 645 600	UXK 56 SB 0 900 004 118	16 M 14 × 1,25	17,5	6-5		Ford
9	UXK 79	- 0 002 635 600	UXK 79 SB 0 900 004 119	16 M 14 × 1,25	17,5	9-7		

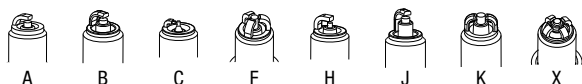



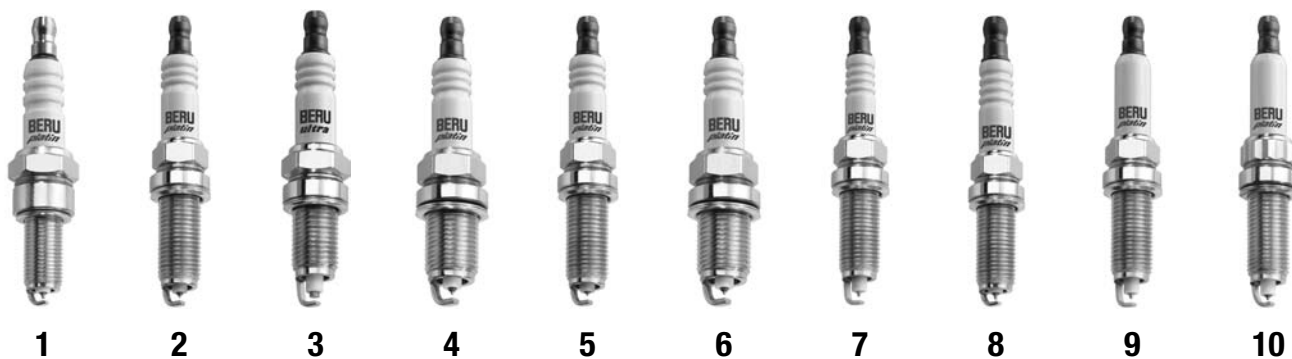
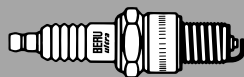

**1      2      3      4      5      6      7      8      9      10**

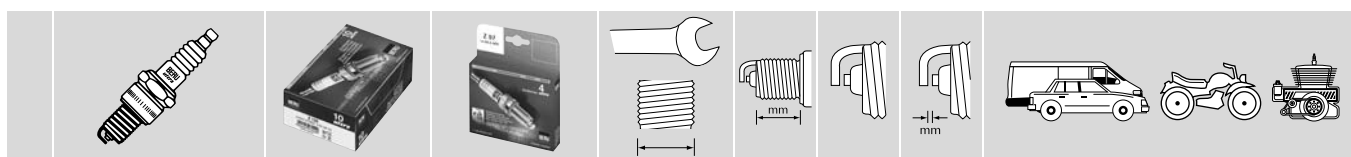

**Platin-Zündkerzen<sup>88</sup>**



<b>1</b>	<b>10 FR-6 CPU03</b>	<b>Z 210</b> 0 002 140 900		16 M 10 × 1	19	A	0,6	Alfa Romeo
<b>2</b>	<b>12 F-5 NPUR2T<sup>22</sup></b>	<b>Z 359</b> 0 001 245 901		16 M 12 × 1,25	26,5	B	0,8	Mercedes
<b>3</b>	<b>12 F-6 HPURW<sup>22</sup></b>	<b>Z 306</b> 0 002 240 901		16 M 12 × 1,25	19	J	0,9	VW AG
<b>4</b>	<b>12 FR-4 DPUT<sup>22</sup></b>	<b>Z 338</b> 0 002 250 900		16 M 12 × 1,25	19	B	0,8	Fiat
<b>5</b>	<b>12 FR-4 MPPUS<sup>22</sup></b>	<b>Z 357</b> 0 002 250 901		16 M 12 × 1,25	25,4	B	0,7	Fiat
<b>6</b>	<b>12 FR-6 DPUX<sup>22</sup></b>	<b>Z 333</b> 0 002 240 913		16 M 12 × 1,25	19	B	1,1	Suzuki
<b>7</b>	<b>12 VR-5 SPPU<sup>22</sup></b>	<b>Z 355</b> 0 002 245 900		16 M 12 × 1,25	25,4	B	1,0	Mercedes
<b>8</b>	<b>12 VR-6 MPPUS<sup>22</sup></b>	<b>Z 274</b> 0 002 240 910		16 M 12 × 1,25	25,4	B	0,7	Renault
<b>9</b>	<b>12 VR-7 SPUX</b>	<b>Z 325</b> 0 002 235 905		14 M 12 × 1,25	26,5	B	1,1	Nissan
<b>10</b>	<b>12 ZR-6 SP03<sup>22</sup></b>	<b>Z 233</b> 0 002 240 902	<b>Z 233 SB</b> 0 900 004 239	14/BIHEX M 12 × 1,25	26,5	B	1,0	BMW, Citroen

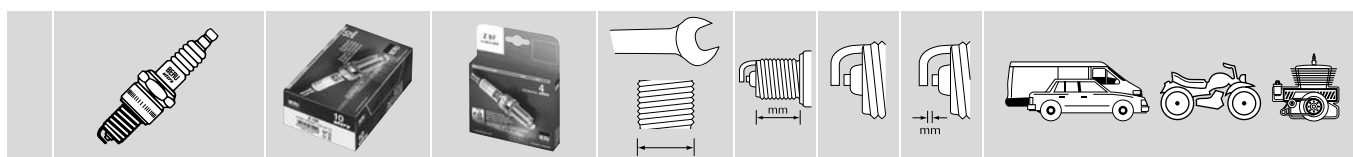
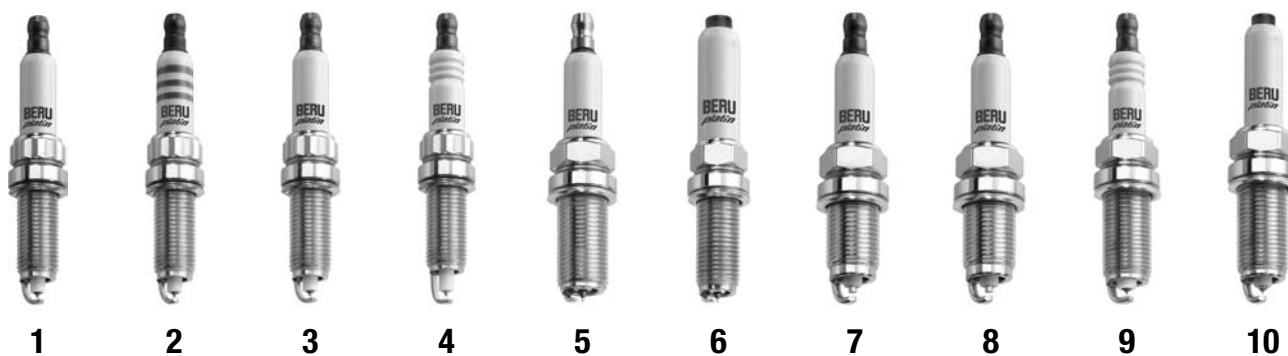
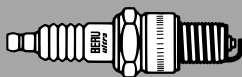

1	12 ZR-6 SP2	Z 336 0 002 240 907		14/BIHEX M 12 × 1,25	26,5	B	1,0	Mini
2	12 ZR-6 SPP2-1 <sup>22</sup>	Z 332 0 002 240 911		14/BIHEX M 12 × 1,25	26,5	B	0,7	Citroen/Peugeot
3	12 ZR-7 SP03 <sup>22</sup>	Z 288 0 002 235 901		14/BIHEX M 12 × 1,25	26,5	B	1,0	Peugeot
4	12 ZR-8 TP <sup>22</sup>	Z 242 0 002 230 900		14/BIHEX M 12 × 1,25	26,5	B	1,05	Citroen/Peugeot
5	14 F-4 NBPR <sup>22</sup>	Z 339 0 001 350 910		16 M 14 × 1,25	26,5	B	0,7	VW AG
6	14 F-4 NBPR2LS <sup>22</sup>	Z 345 0 001 350 911		16 M 14 × 1,25	26,5	B	0,7	VW AG
7	14 F-5 DPUR02 <sup>22</sup>	Z 347 0 001 345 914		16 M 14 × 1,25	19	B	0,7	VW AG
8	14 F-5 DPUR2T <sup>22</sup>	Z 317 0 001 345 912		16 M 14 × 1,25	19	B	0,8	VW AG
9	14 F-5 MPUR03 <sup>22</sup>	Z 277 0 001 345 906		16 M 14 × 1,25	26,5	B	0,8	Porsche
10	14 F-5 MPUR2L <sup>22</sup>	Z 348 0 001 345 915		16 M 14 × 1,25	26,5	B	0,8	VW AG

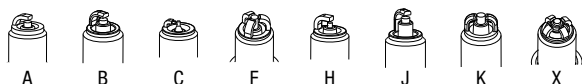

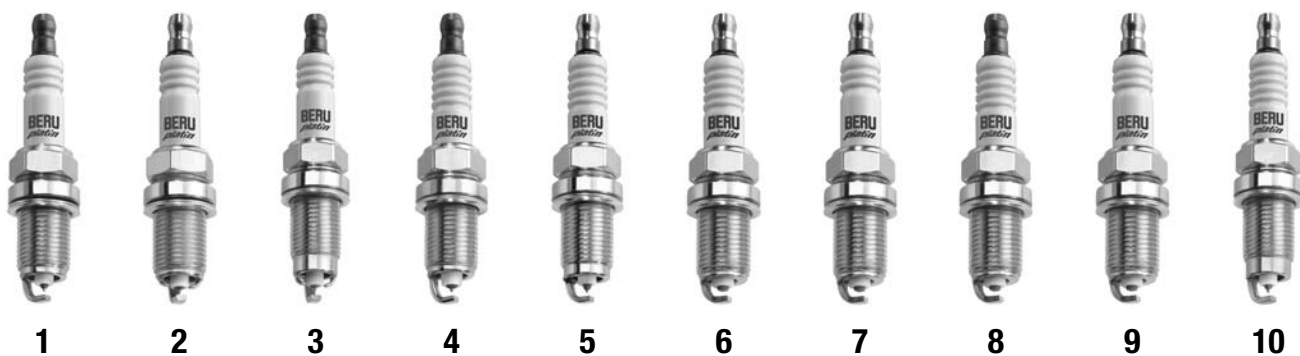
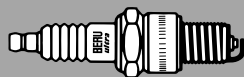

**1 2 3 4 5 6 7 8 9 10**

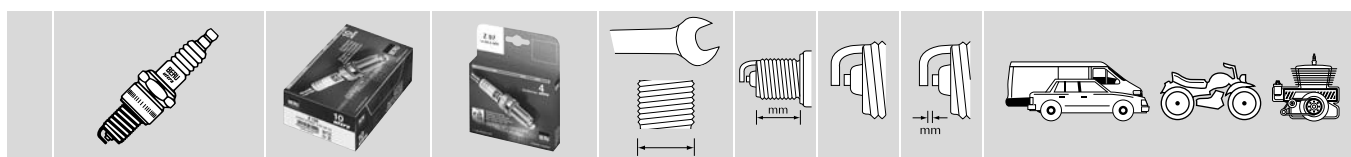

<b>1</b>	<b>14 F-6 DPUR021<sup>22</sup></b>	<b>Z 185</b> 0 001 340 908		16 M 14 × 1,25	19	B	0,8	Porsche
<b>2</b>	<b>14 F-6 DTPR02<sup>22</sup></b>	<b>Z 295</b> 0 001 340 915		16 M 14 × 1,25	19	B	0,8	AUDI, VW AG
<b>3</b>	<b>14 F-6 HTPRX02<sup>22</sup></b>	<b>Z 236</b> 0 001 340 910	<b>Z 236 SB</b> 0 900 004 181	16 M 14 × 1,25	19	J	1,0	AUDI, VW AG
<b>4</b>	<b>14 F-6 KPUR02W<sup>22</sup></b>	<b>Z 322</b> 0 001 340 916		16 M 14 × 1,25	19	J	0,9	Mercedes
<b>5</b>	<b>14 F-6 LPURW03</b>	<b>Z 349</b> 0 001 340 917		16 M 14 × 1,25	19	J	0,9	VW AG
<b>6</b>	<b>14 F-7 DPUR02</b>	<b>Z 188</b> 0 001 335 914	<b>Z 188 SB</b> 0 900 004 145	16 M 14 × 1,25	19	B	0,7	VW AG
<b>7</b>	<b>14 F-7 DPUR2<sup>22</sup></b>	<b>Z 232</b> 0 001 335 907		16 M 14 × 1,25	19	B	0,35	Mercedes
<b>8</b>	<b>14 F-7 DPURU2<sup>22</sup></b>	<b>Z 170</b> 0 001 335 919	<b>Z 170 SB</b> 0 900 004 171	16 M 14 × 1,25	19	B	1,0	Mercedes
<b>9</b>	<b>14 F-7 DPURX2</b>	<b>Z 171</b> 0 001 335 910		16 M 14 × 1,25	19	B	1,0	Mercedes
<b>10</b>	<b>14 F-7 HPURX2</b>	<b>Z 176</b> 0 001 335 911	<b>Z 176 SB</b> 0 900 004 142	16 M 14 × 1,25	19	J	1,0	VW AG

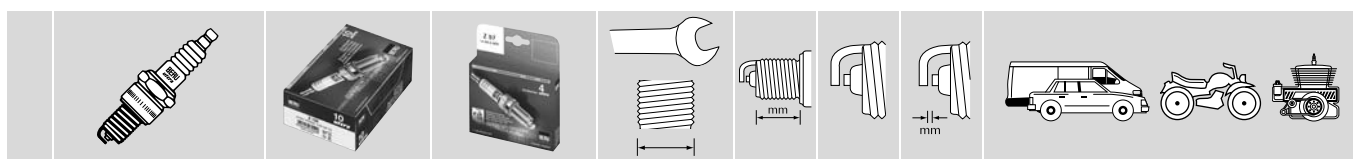
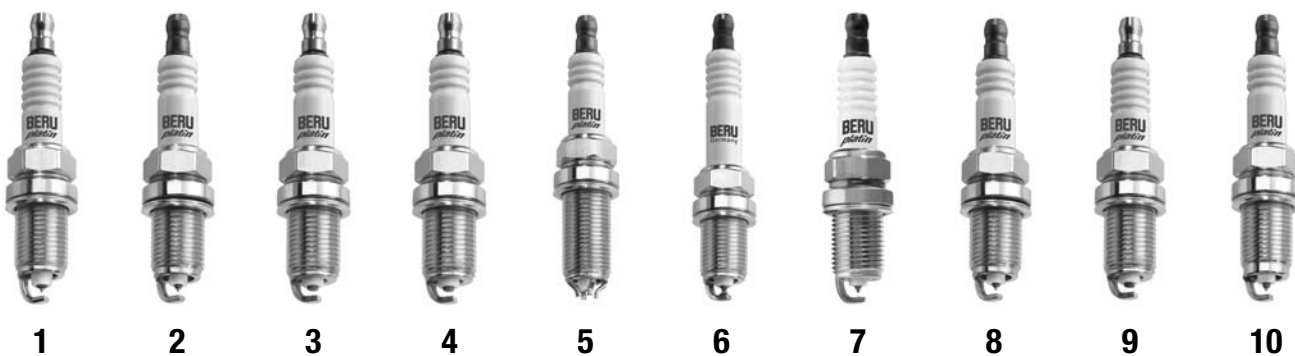

1	14 F-7 KPPRU2	Z 321 0 001 335 917		16 M 14 × 1,25	19	J	1,0	AUDI, VW AG
2	14 F-8 DPURX02 <sup>22</sup>	Z 240 0 001 330 905	Z 240 SB 0 900 004 184	16 M 14 × 1,25	19	B	1,0	Mercedes
3	14 FGH-7 DPURX2 <sup>22</sup>	Z 282 0 001 335 905		16 M 14 × 1,25	19	B	1,0	Mercedes
4	14 FGH-8 DPURX2 <sup>22</sup>	Z 122 0 001 330 904	Z 122 SB 0 900 004 170	16 M 14 × 1,25	19	B	1,0	Mercedes
5	14 FGR-8 MQPU <sup>22</sup>	Z 211 0 002 330 902		16 M 14 × 1,25	25,4	X	0,7	Citroen, Peugeot, Renault
6	14 FR-4 DIU02 <sup>22</sup>	Z 328 0 004 350 930		16 M 14 × 1,25	19	F	0,3	Mercedes Gas-Busse
7	14 FR-4 DPU <sup>22</sup>	Z 231 0 002 350 901		16 M 14 × 1,25	19	B	0,6	Iveco
8	14 FR-5 DPPUX	Z 323 0 002 345 904		16 M 14 × 1,25	19	B	1,1	Honda
9	14 FR-5 DPUX	Z 130 0 002 335 901		16 M 14 × 1,25	19	B	1,0	Ford
10	14 FR-5 LPUOX	Z 354 0 002 345 906		16 M 14 × 1,25	19	J	1,1	Honda

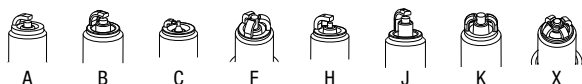

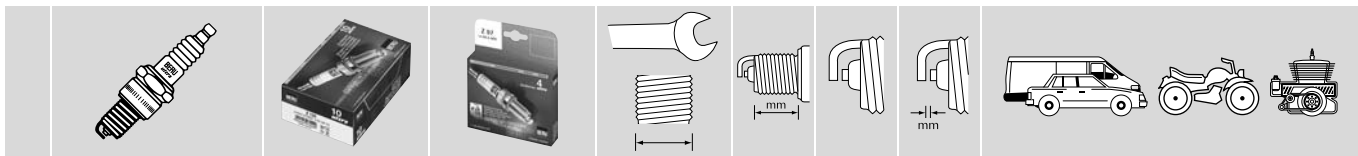
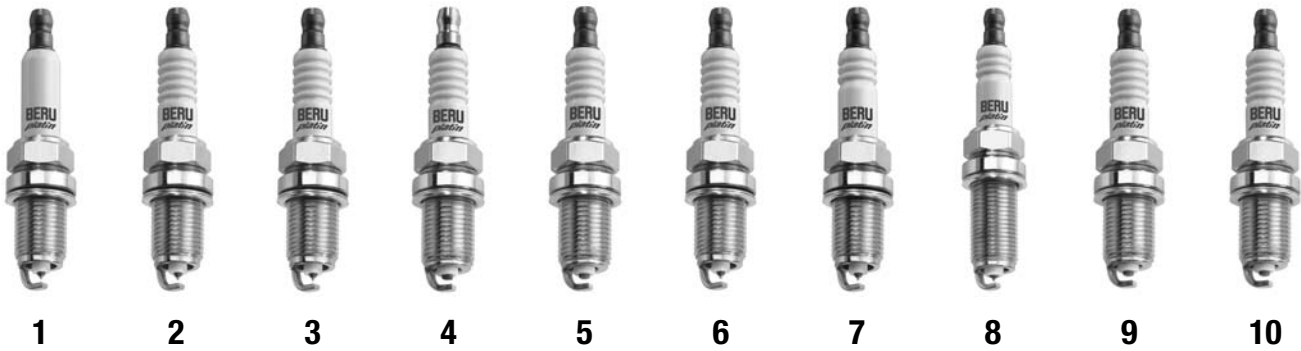
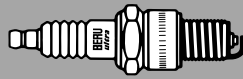

<b>1</b>	<b>14 FR-6 DPOX<sup>22</sup></b>	<b>Z 284</b> 0 002 340 908		16 M 14 × 1,25	19	B	1,1	Ford, Toyota
<b>2</b>	<b>14 FR-6 DPU02S<sup>22</sup></b>	<b>Z 340</b> 0 002 340 915	<b>Z 340 SB</b> 0 900 004 245	16 M 14 × 1,25	19	B	0,7	Mercedes
<b>3</b>	<b>14 FR-6 DPUW2</b>	<b>Z 314</b> 0 002 340 910		16 M 14 × 1,25	19	B	0,9	Nissan
<b>4</b>	<b>14 FR-6 DPUX</b>	<b>Z 159</b> 0 002 340 903		16 M 14 × 1,25	19	B	1,1	Ford
<b>5</b>	<b>14 FR-6 DPUX02<sup>22</sup></b>	<b>Z 221</b> 0 002 340 905	<b>Z 221 SB</b> 0 900 004 207	16 M 14 × 1,25	19	B	1,0	SAAB
<b>6</b>	<b>14 FR-6 DPUX2<sup>22</sup></b>	<b>Z 313</b> 0 002 340 909		16 M 14 × 1,25	19	B	1,0	Nissan
<b>7</b>	<b>14 FR-6 LPU08</b>	<b>Z 275</b> 0 002 340 918		16 M 14 × 1,25	19	J	1,1	Honda
<b>8</b>	<b>14 FR-6 MPU2<sup>22</sup></b>	<b>Z 226</b> 0 002 340 906	<b>Z 226 SB</b> 0 900 004 177	16 M 14 × 1,25	26,5	B	0,8	Citroen, Mercedes, Peugeot
<b>9</b>	<b>14 FR-7 DPPUS2<sup>22</sup></b>	<b>Z 206</b> 0 002 335 940	<b>Z 206 SB</b> 0 900 004 173	16 M 14 × 1,25	19	B	0,7	Renault, Volvo
<b>10</b>	<b>14 FR-7 DPPUW2<sup>22</sup></b>	<b>Z 337</b> 0 002 335 946		16 M 14 × 1,25	19	B	0,9	Opel, Renault

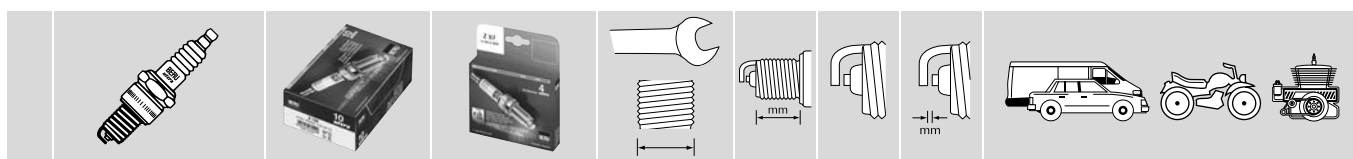
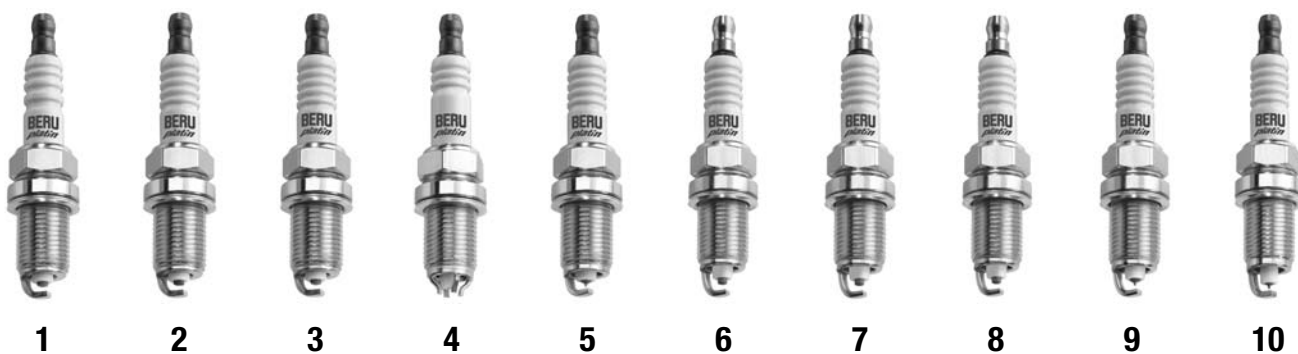

1	14 FR-7 DPU3 <sup>22</sup>	Z 224 0 002 335 912	Z 224 SB 0 900 004 176	16 M 14 × 1,25	19	B	0,9	Renault, Volvo
2	14 FR-7 DPUV02 <sup>22</sup>	Z 307 0 002 335 937		16 M 14 × 1,25	19	B	1,3	Mazda
3	14 FR-7 DPUX02 <sup>22</sup>	Z 228 0 002 335 914	Z 228 SB 0 900 004 179	16 M 14 × 1,25	19	B	1,0	Honda, Mitsubishi, Nissan, Subaru
4	14 FR-7 DQUP7 <sup>22</sup>	Z 237 0 002 335 911	Z 237 SB 0 900 004 182	16 M 14 × 1,25	19	B	1,6	BMW
5	14 FR-7 KPPU	Z 312 0 002 335 938		16 M 14 × 1,25	19	J	1,1	Ford, Mazda, Mercedes
6	14 FR-7 KPU	Z 151 0 002 335 904		16 M 14 × 1,25	19	J	0,8	Toyota
7	14 FR-7 KPUV	Z 150 0 002 335 903		16 M 14 × 1,25	19	J	1,3	Toyota
8	14 FR-7 KPUX	Z 149 0 002 335 902		16 M 14 × 1,25	19	J	1,1	Toyota
9	14 FR-7 KPUX02	Z 280 0 002 335 926		16 M 14 × 1,25	19	J	1,0	Lexus, Toyota
10	14 FR-7 LPU02 <sup>22</sup>	Z 279 0 002 335 925		16 M 14 × 1,25	19	K	0,6	Mitsubishi, Volvo

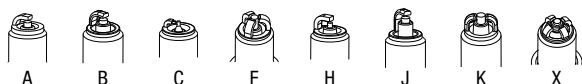

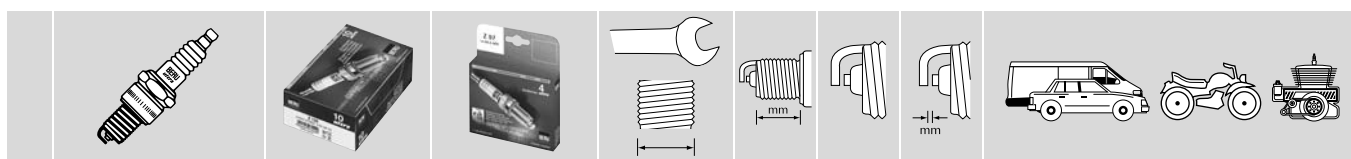
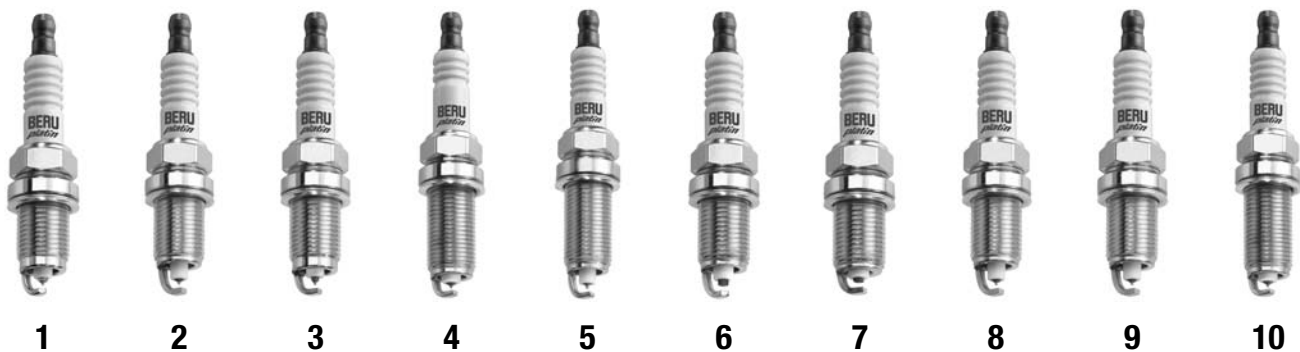
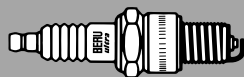

1	14 FR-7 LPUT02 <sup>22</sup>	Z 346 0 002 335 947		16 M 14 × 1,25	19	J	0,8	Opel/Vauxhall
2	14 FR-7 LPUX02 <sup>22</sup>	Z 301 0 002 335 935	Z 301 SB 0 900 004 242	16 M 14 × 1,25	19	K	1,1	Honda
3	14 FR-7 LPUX0 <sup>22</sup>	Z 297 0 002 335 936		16 M 14 × 1,25	19	K	1,1	Honda
4	14 FR-7 MPUS <sup>22</sup>	Z 326 0 002 335 939	Z 326 SB 0 900 004 244	16 M 14 × 1,25	26,5	B	0,7	Volvo
5	14 FR-7 SPUX03 <sup>22</sup>	Z 235 0 002 335 915	Z 235 SB 0 900 004 180	16 M 14 × 1,25	26,5	B	1,0	Mitsubishi, Smart
6	14 FR-8 DPPUX2	Z 343 0 002 330 930		16 M 14 × 1,25	19	B	1,1	Opel, Vauxhall
7	14 FR-8 DPU2	Z 238 0 002 330 905	Z 238 SB 0 900 004 183	16 M 14 × 1,25	19	B	0,8	Skoda
8	14 FR-8 LPU02 <sup>22</sup>	Z 278 0 002 330 918		16 M 14 × 1,25	19	K	0,6	Mitsubishi
9	14 FR-8 LPUO	Z 229 0 002 330 903		16 M 14 × 1,25	19	K	0,8	Mazda
10	14 FR-8 MPUX02 <sup>22</sup>	Z 219 0 002 330 904		16 M 14 × 1,25	26,5	B	1,1	Nissan

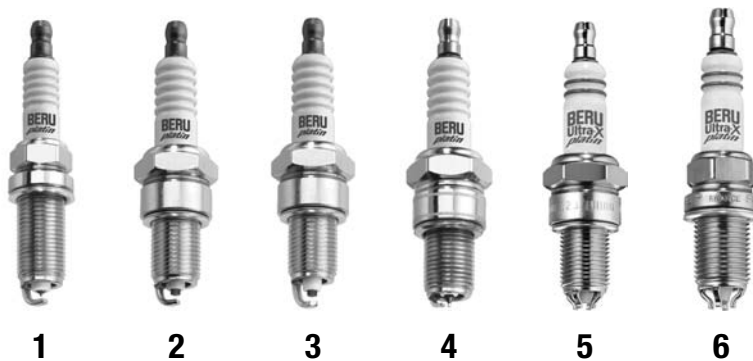

1 2 3 4 5 6

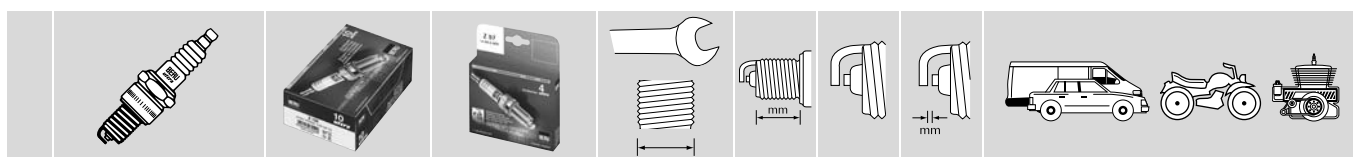

1	14 FR-8 MPUX2 <sup>22</sup>	Z 302 0 002 330 926		16 M 14 × 1,25	26,5	B	1,1	Nissan
2	14 R-8 DPUU	Z 311 0 002 330 925		21 M 14 × 1,25	19	B	1,0	Hyundai
3	14 R-9 KPUV2 <sup>22</sup>	Z 285 0 002 325 900		21 M 14 × 1,25	19	J	1,3	Chrysler
4	14-6 DPO	Z 104 0 001 340 903		21 M 14 × 1,25	19	C	0,6	VW AG
5	UX 79 P	0 002 335 905	UX 79 P SB 0 900 004 140	16 M 14 × 1,25	19	6-5		
6	UXF 79 P	0 002 335 906	UXF 79 P SB 0 900 004 139	16 M 14 × 1,25	19	9-7		

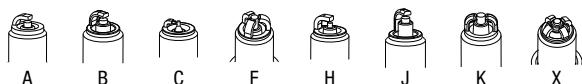



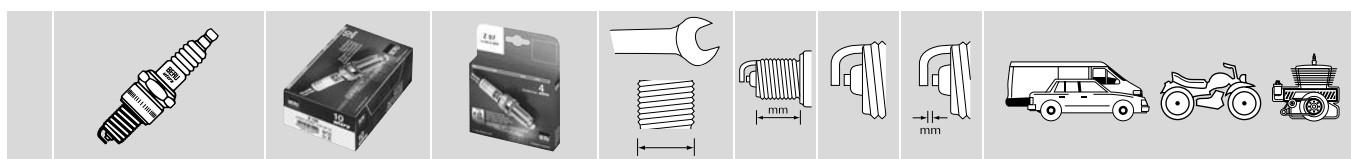
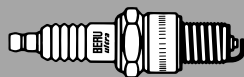

1	14 KR-6 DPUV <sup>22</sup>	Z 209 0 002 640 904	Z 209 SB 0 900 004 174	16 M 14 × 1,25	17,5	B	1,3	Ford
2	14 KR-6 KPUV02 <sup>22</sup>	Z 230 0 002 640 907	Z 230 SB 0 900 004 238	16 M 14 × 1,25	17,5	B	1,3	Ford, Mazda
3	14 KR-6 MPV <sup>22</sup>	Z 315 0 002 640 910		16 M 14 × 1,25	25,4	B	1,3	Ford
4	14 KR-7 DPUV <sup>22</sup>	Z 296 0 002 635 902		16 M 14 × 1,25	17,5	B	1,3	Ford
5	14 KR-7 MPUV <sup>22</sup>	Z 342 0 002 635 904		16 M 14 × 1,25	25	B	1,3	Ford
6	14 KR-7 MPUX <sup>22</sup>	Z 356 0 002 635 903		16 M 14 × 1,25	25,4	B		Alfa Romeo
7	14 KR-8 DPUV <sup>22</sup>	Z 148 0 002 630 900	Z 148 SB 0 900 004 195	16 M 14 × 1,25	17,5	B	1,3	Ford
8	14 KR-8 DPUV <sup>22</sup>	Z 298 0 002 630 903		16 M 14 × 1,25	17,5	B	1,3	Mazda
9	14 KR-8 LQPU07 <sup>22</sup>	Z 309 0 002 630 904		16 M 14 × 1,25	17,5	X	1,6	Ford
10	14 KR-8 MPUV <sup>22</sup>	Z 310 0 002 630 905	Z 310 SB 0 900 004 243	16 M 14 × 1,25	25	B	1,3	Ford
11	14 KR-8 MPX <sup>22</sup>	Z 097 0 002 640 900	Z 97 SB 0 900 004 109	16 M 14 × 1,25	25,4	B	1,0	Ford

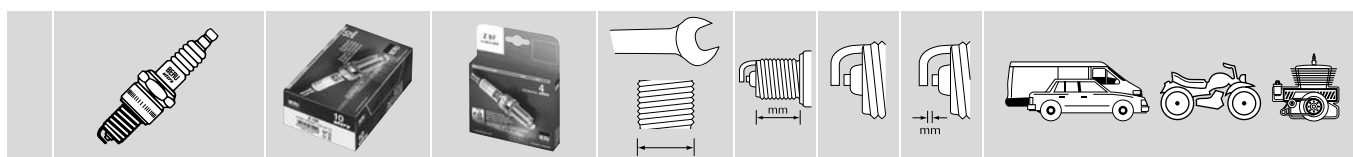
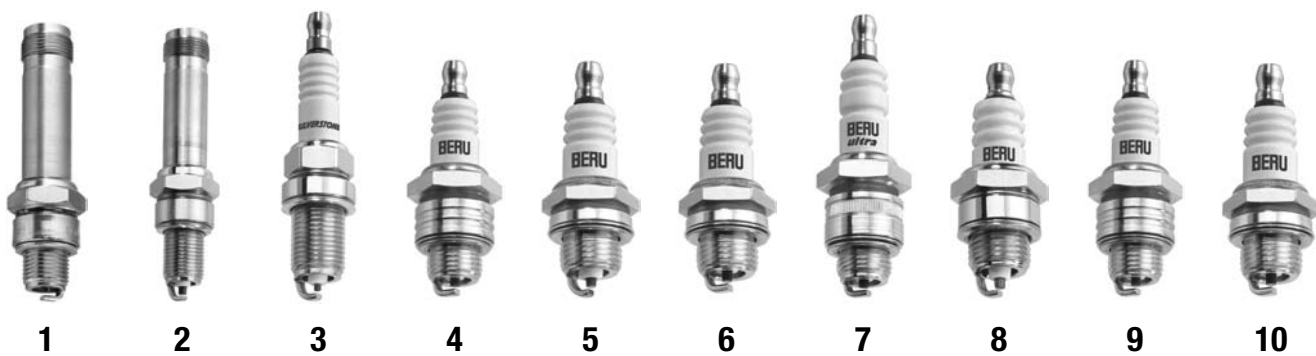
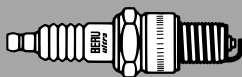

### Sonder-Zündkerzen<sup>89</sup>



1	14 C-7 A <sup>20</sup>	— 0 003 435 300		21 M 14 × 1,25	12,7	A	0,8	
2	14 C-7 D <sup>20</sup>	Z 111 0 003 335 401		21 M 14 × 1,25	19	B	0,5	
3	14 F-6 DSR	Z 105 0 001 340 806		16 M 14 × 1,25	19	G	0,7	VW AG
4	14 S-10 E0 <sup>22</sup>	Z 270 0 004 520 301		21 M 14 × 1,25	9,5	B	0,75	
5	14 S-5 F <sup>22</sup>	Z 265 0 004 545 401		19 M 14 × 1,25	9,5	B	0,6	
6	14 S-7 E <sup>22</sup>	Z 266 0 004 535 300		19 M 14 × 1,25	9,5	B	0,6	
7	14 S-7 EU0 <sup>22</sup>	Z 267 0 004 535 700		21 M 14 × 1,25	9,5	B	0,6	
8	14 S-7 F	Z 132 0 004 535 402		19 M 14 × 1,25	9,5	B	0,5	
9	14 S-9 E0 <sup>22</sup>	Z 262 0 004 525 302		21 M 14 × 1,25	9,5	B	0,75	
10	14 SR 7 E <sup>22</sup>	Z 271 0 004 535 301		19 M 14 × 1,25	9,5	B	0,6	

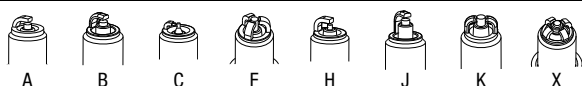

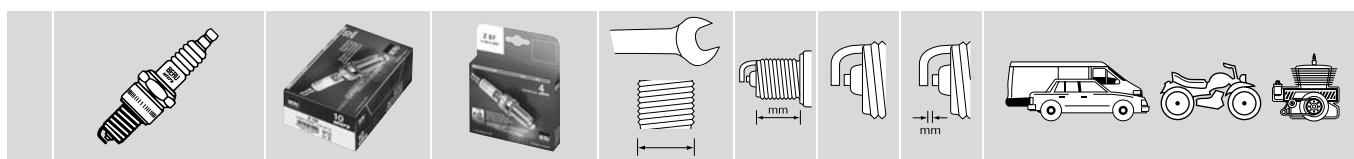
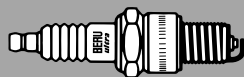

1	14 SR-10 E0 <sup>22</sup>	Z 261 0 004 520 300		21 M 14 × 1,25	9,5	B	0,75	
2	14 SR-5 F <sup>22</sup>	Z 260 0 004 545 400		19 M 14 × 1,25	9,5	B	0,6	
3	14 SR-7 F <sup>22</sup>	Z 263 0 004 535 403		19 M 14 × 1,25	9,5	B	0,6	
4	14 SR-9 E0 <sup>22</sup>	Z 269 0 004 525 304		21 M 14 × 1,25	9,5	B	0,75	
5	18 C-7 A <sup>20</sup>	– 0 003 835 300		26 M 18 × 1,5	12,7	A	0,5	
6	EBE 514	Z 110 0 004 500 400		21 M 14 × 1,25	10	–	2,5	Eberspächer
7	G 3/18	Z 108 0 001 700 901		21 M 18 × 1,5	23,5	E	0,7	NSU RO 80
8	KP105 DU	Z 109 0 004 021 601		– M 14 × 1,25	–	–	–	Delmag Ramme

## ACURA

Z 16, Z 228, 343, UXT 1, UXT 3, UXT 11

## ALFA ROMEO

Z 11, Z 12, Z 20, Z 22, Z 27, Z 29, Z 42, Z 47, Z 51, Z 130, Z 188, Z 193, Z 203, Z 210, Z 234, Z 237, Z 240, Z 293, Z 338, Z 356, UX 56, UXT 1, UXT 3, UXT 2, UXT 6, UXT 5, UXT 9, UXT 10

## ALPIN

Z 31, Z 89, UXK 56, UXT 5

## ALPINA

Z 11, Z 14, Z 20, Z 104, Z 237, UXT 1, UXT 2, UXT 3, UXT 6

## ARO

Z 10, Z 19, Z 57, Z 68, Z 69, UXT 2, UXT 6

## ASIAM

Z 8, UXT 2, UXT 6

## ASTON MARTIN

Z 15, Z 20, Z 24, Z 30, Z 250, UXT 1, UXT 2, UXT 3, UXT 5, UXT 6

## AUDI

Z 2, Z 12, Z 20, Z 24, Z 51, Z 52, Z 75, Z 79, Z 89, Z 90, Z 91, Z 92, Z 93, Z 94, Z 105, Z 121, Z 127, Z 129, Z 144, Z 145, Z 172, Z 176, Z 188, Z 228, Z 236, Z 237, Z 239, Z 295, Z 300, Z 306, Z 317, Z 321, Z 339, Z 345, Z 347, Z 348, Z 349, UX 56, UXT 1, UXT 2, UXT 3, UXT 5, UXT 6, UXT 9, UXT 10, UXT 11

## AUSTIN

Z 11, Z 20, Z 22, Z 25, Z 27, Z 63, UX56, UXK 56, UXT 1, UXT 2, UXT 3, UXT 6

## AUTOBIANCHI

Z 15, Z 20, Z 247, UXT 1, UXT 2, UXT 3, UXT 6

## BARKAS

Z 57

## BEDFORD

Z 20, UXT 2, UXT 6

## BENTLEY

Z 228, UXT 11

## BERTONE

Z 3, UXT 2, UXT 6

## BMW

Z 1, Z 3, Z 4, Z 14, Z 235, Z 237, Z 239, Z 301, Z 332, UXT 1, UXT 2, UXT 3, UXT 6

## CADILLAC

Z 117, Z 356, UXT 4

## CHEVROLET

Z 9, Z 16, Z 20, Z 73, Z 74, Z 117, Z 247, Z 291, Z 304, Z 313, Z 343, Z 356, Z 358, UXT 1, UXT 2, UXT 3, UXT 4, UXT 6

## CHRYSLER

Z 8, Z 9, Z 15, Z 72, Z 73, Z 82, Z 152, Z 170, Z 216, Z 228, Z 248, Z 285, Z 312, UXT 1, UXT 2, UXT 3, UXT 6, UXT 11, UXT 12

## CITROEN

Z 11, Z 17, Z 20, Z 24, Z 25, Z 31, Z 40, Z 41, Z 60, Z 74, Z 95, Z 98, Z 123, Z 183, Z 184, Z 193, Z 206, Z 211, Z 223, Z 242, Z 243, Z 247, Z 273, Z 320, Z 332, UXK 56, UXT 1, UXT 2, UXT 3, UXT 4, UXT 5, UXT 6, UXT 9, UXT 10, UXT 13

## DACIA

Z 10, Z 15, Z 98, Z 243, Z 340, UXT 1, UXT 3

## DAEWOO

Z 8, Z 9, Z 16, Z 20, Z 73, Z 74, Z 82, Z 100, Z 193, UXT 1, UXT 2, UXT 3, UXT 6

## DAIHATSU

Z 8, Z 9, Z 16, Z 20, Z 21, Z 73, Z 98, Z 99, Z 157, Z 234, Z 235, Z 257, Z 273, Z 324, Z 360, UXT 1, UXT 2, UXT 3, UXT 5, UXT 6, UXT 11

## DAIMLER

Z 15, UXT 1, UXT 3

## DODGE

Z 15, Z 72, Z 228, UXT 1, UXT 3, UXT 11

## FIAT

Z 11, Z 15, Z 20, Z 24, Z 27, Z 74, Z 98, Z 183, Z 193, Z 203, Z 206, Z 219, Z 222, Z 223, Z 234, Z 247, Z 252, Z 255, Z 291, Z 292, Z 293, Z 338, Z 357, UX 56, UXT 1, UXT 2, UXT 3, UXT 5, UXT 6, UXT 10, UXT 13

## FORD

Z 8, Z 15, Z 16, Z 20, Z 24, Z 27, Z 30, Z 32, Z 33, Z 67, Z 95, Z 97, Z 99, Z 117, Z 130, Z 148, Z 159, Z 173, Z 176, Z 177, Z 209, Z 225, Z 230, Z 253, Z 284, Z 293, Z 309, Z 313, Z 315, Z 326, Z 342, UX 56, UXT 1, UXT 2, UXT 3, UXT 4, UXT 5, UXT 6, UXT 7, UXT 8, UXT 14, UXT 15

## FORD OTOSAN

Z 32

## FORD (USA)

Z 67, Z 97, Z 99, Z 117, Z 148, Z 158, UXT 4, UXT 5, UXT 8, UXT 15

## FSO

Z 11, Z 41, UXT 2, UXT 6, Z 41

## GEO

Z 9, UXT 2, UXT 6

## HONDA

Z 16, Z 98, Z 99, Z 158, Z 228, Z 275, Z 284, Z 299, Z 301, Z 312, Z 323, Z 354, UXT 1, UXT 3, UXT 5, UXT 11, UXT 14

## HYUNDAI

Z 1, Z 8, Z 9, Z 11, Z 15, Z 16, Z 20, Z 21, Z 73, Z 82, Z 183, Z 228, Z 240, Z 311, Z 312, Z 343, UXT 1, UXT 2, UXT 3, UXT 6, UXT 9, UXT 11, UXT 13

**INFINITI**

Z 73, Z 219, Z 228, Z 343, UXT 1, UXT 3, UXT 11, UXT 13

**INNOCENTI**

Z 20, UXT 2, UXT 6

**ISUZU**

Z 1, Z 9, Z 11, Z 16, Z 21, Z 122, Z 343, UXT 1, UXT 2, UXT 3, UXT 6, UXT 9

**JAGUAR**

Z 15, Z 40, Z 193, Z 228, Z 312, UXT 1, UXT 3, UXT 11

**JEEP**

Z 15, Z 73, Z 158, Z 216, Z 220, Z 248, Z 255, UXT 1, UXT 3

**KIA**

Z 9, Z 11, Z 15, Z 16, Z 21, Z 73, Z 158, Z 183, Z 228, Z 311, Z 312, Z 334, UXT 1, UXT 2, UXT 3, UXT 6, UXT 11, UXT 13

**LADA**

Z 11, Z 16, Z 20, UXT 1, UXT 2, UXT 3, UXT 6

**LANCIA**

Z 11, Z 12, Z 15, Z 20, Z 27, Z 30, Z 98, Z 183, Z 188, Z 193, Z 234, Z 245, Z 247, Z 250, Z 252, Z 255, Z 292, Z 293, Z 338, UX 56, UXT 1, UXT 2, UXT 3, UXT 5, UXT 6, UXT 10, UXT 13

**LANDROVER**

Z 1, Z 11, Z 14, Z 15, Z 20, Z 62, Z 82, Z 228, UXT 1, UXT 2, UXT 3, UXT 6, UXT 11

**LEXUS**

Z 130, Z 151, Z 221, Z 235, Z 280, Z 284, Z 312, Z 313, Z 343, UXT 10, UXT 14

**LOTUS**

Z 24, Z 27, Z 47, Z 98, Z 149, Z 312, UX 56, UXT 1, UXT 3, UXT 5, UXT 11

**MARUTI**

Z 1, UXT 2, UXT 6

**MARUTSU**

Z 333

**MASERATI**

Z 38, Z 42, UX 56

**MAYBACH**

Z 312

**MAZDA**

Z 8, Z 9, Z 15, Z 16, Z 20, Z 26, Z 67, Z 73, Z 158, Z 177, Z 229, Z 230, Z 298, Z 307, Z 310, Z 312, 342, UXK 56, UXT 1, UXT 2, UXT 3, UXT 4, UXT 6, UXT 7

**MERCEDES**

Z 5, Z 7, Z 18, Z 22, Z 62, Z 100, Z 101, Z 120, Z 121, Z 122, Z 170, Z 171, Z 173, Z 226, Z 227, Z 240, Z 282, Z 312, Z 322, Z 355, Z 359, UX 56, UXT 1, UXT 2, UXT 3, UXT 4, UXT 6, UXT 9, UXT 12

**MG**

Z 20, Z 228, Z 312, UXT 2, UXT 6, UXT 11

**MINI**

Z 233, Z 237, Z 318, Z 332, Z 336

**MITSUBISHI**

Z 8, Z 9, Z 16, Z 20, Z 21, Z 27, Z 28, Z 73, Z 130, Z 228, Z 235, Z 273, Z 278, Z 279, Z 284, UX 56, UXT 1, UXT 2, UXT 3, UXT 6, UXT 11, UXT 14

**MORGAN**

Z 177, Z 237, UXT 7

**MOSKVICH**

Z 11, Z 22, Z 42, Z 57, UX 56, UXT 2, UXT 6

**NISSAN**

Z 8, Z 9, Z 15, Z 16, Z 20, Z 24, Z 73, Z 153, Z 155, Z 157, Z 183, Z 193, Z 206, Z 219, Z 221, Z 225, Z 228, Z 243, Z 247, Z 284, Z 302, Z 303, Z 312, Z 313, Z 314, Z 325, Z 333, UXT 1, UXT 2, UXT 3, UXT 5, UXT 6, UXT 10, UXT 11, UXT 13, UXT 14

**OPEL**

Z 8, Z 15, Z 19, Z 20, Z 21, Z 74, Z 98, Z 119, Z 158, Z 173, Z 190, Z 203, Z 206, Z 222, Z 235, Z 250, Z 284, Z 287, Z 333, Z 337, Z 343, Z 346, Z 356, UXT 1, UXT 2, UXT 3, UXT 6, UXT 10, UXT 14

**PEUGEOT**

Z 11, Z 15, Z 17, Z 24, Z 25, Z 60, Z 74, Z 123, Z 183, Z 184, Z 193, Z 206, Z 211, Z 223, Z 235, Z 242, Z 247, Z 252, Z 255, Z 273, Z 288, Z 320, Z 332, UXK 56, UXT 1, UXT 2, UXT 3, UXT 4, UXT 5, UXT 6, UXT 9, UXT 10, UXT 13

**PONTIAC**

Z 73, UXT 1, UXT 3

**PORSCHE**

Z 20, Z 45, Z 47, Z 98, Z 116, Z 129, Z 185, Z 250, Z 277, UXT 1, UXT 2, UXT 3, UXT 5, UXT 6

**PROTON**

Z 8, Z 9, Z 16, Z 20, Z 67, UXT 1, UXT 2, UXT 3, UXT 4, UXT 6

**PUCH**

Z 7, Z 18, Z 100, Z 121, Z 122, UXT 1, UXT 3, UXT 4, UXT 9

**RENAULT**

Z 1, Z 5, Z 10, Z 14, Z 15, Z 16, Z 17, Z 18, Z 20, Z 22, Z 24, Z 25, Z 27, Z 30, Z 31, Z 42, Z 46, Z 52, Z 53, Z 60, Z 63, Z 72, Z 74, Z 76, Z 82, Z 98, Z 100, Z 119, Z 123, Z 183, Z 193, Z 204, Z 206, Z 207, Z 224, Z 243, Z 247, Z 257, Z 274, Z 284, Z 313, Z 325, Z 337, UX 56, UXK 56, UXT 1, UXT 2, UXT 3, UXT 4, UXT 5, UXT 6, UXT 9, UXT 10, UXT 13, UXT 14

## ROVER

Z 11, Z 15, Z 16, Z 20, Z 21, Z 22, Z 24, Z 158, Z 188, Z 228, Z 247, UX 56, UXT 1, UXT 2, UXT 3, UXT 5, UXT 6, UXT 10, UXT 11

## SAAB

Z 11, Z 15, Z 16, Z 22, Z 24, Z 73, Z 74, Z 99, Z 151, Z 221, Z 235, Z 237, Z 253, Z 313, UX 56, UXT 1, UXT 2, UXT 3, UXT 5, UXT 10, UXT 14

## SEAT

Z 2, Z 12, Z 20, Z 29, Z 30, Z 52, Z 82, Z 89, Z 90, Z 91, Z 92, Z 93, Z 173, Z 176, Z 188, Z 200, Z 228, Z 236, Z 272, Z 317, Z 344, Z 347, Z 349, UXT 1, UXT 2, UXT 3, UXT 5, UXT 6, UXT 10, UXT 11

## SKODA

Z 10, Z 15, Z 48, Z 63, Z 90, Z 91, Z 100, Z 121, Z 176, Z 188, Z 200, Z 228, Z 236, Z 237, Z 238, Z 254, Z 272, Z 300, Z 347, Z 349, UXT 1, UXT 2, UXT 3, UXT 6, UXT 9, UXT 10, UXT 11

## SMART

Z 194, Z 235, Z 286, Z 308, UXT 5

## SSANGYONG

Z 100, UXT 1, UXT 3

## SUBARU

Z 9, Z 16, Z 20, Z 21, Z 27, Z 73, Z 149, Z 188, Z 221, Z 235, Z 284, Z 312, Z 343, UX 56, UXT 1, UXT 2, UXT 3, UXT 6, UXT 10, UXT 11, UXT 14

## SUZUKI

Z 8, Z 15, Z 16, Z 20, Z 221, Z 234, Z 284, Z 333, Z 342, UXT 1, UXT 2, UXT 3, UXT 6, UXT 14

## TOYOTA

Z 8, Z 9, Z 16, Z 20, Z 72, Z 73, Z 149, Z 150, Z 151, Z 154, Z 155, Z 156, Z 157, Z 208, Z 221, Z 228, Z 235, Z 240, Z 248, Z 249, Z 254, Z 273, Z 280, Z 284, Z 312, Z 313, UXT 1, UXT 2, UXT 3, UXT 6, UXT 9, UXT 10, UXT 11, UXT 14

## TRABANT

Z 11, Z 48, UXT 2, UXT 6

## VAUXHALL

Z 16, Z 19, Z 20, Z 21, Z 63, Z 74, Z 98, Z 119, Z 158, Z 173, Z 190, Z 203, Z 206, Z 222, Z 235, Z 250, Z 284, Z 287, Z 333, Z 337, Z 343, Z 346, Z 356, UXT 1, UXT 2, UXT 3, UXT 6, UXT 10, UXT 14

## VOLVO

Z 15, Z 20, Z 24, Z 26, Z 27, Z 82, Z 177, Z 204, Z 206, Z 230, Z 250, Z 251, Z 279, Z 294, Z 312, Z 326, UX 56, UXK 56, UXT 1, UXT 2, UXT 3, UXT 5, UXT 6, UXT 7, UXT 10

## VW AG

Z 1, Z 2, Z 8, Z 11, Z 12, Z 22, Z 42, Z 44, Z 51, Z 52, Z 57, Z 58, Z 61, Z 62, Z 69, Z 76, Z 78, Z 82, Z 89, Z 90, Z 91, Z 92, Z 93, Z 94, Z 101, Z 104, Z 121, Z 126, Z 145, Z 173, Z 176, Z 188, Z 193, Z 200, Z 213, Z 228, Z 236, Z 239, Z 246, Z 250, Z 272, Z 295, Z 300, Z 306, Z 317, Z 344, Z 347, Z 349, UX 56, UXT 1, UXT 2, UXT 3, UXT 5, UXT 6, UXT 9, UXT 10, UXT 11

## WARTBURG

Z 11, UXT 2, UXT 6

## WIESMANN

Z 237

## ZASTAVA

Z 8, Z 11, Z 20, UXT 2, UXT 6

## ZAZ

Z 11, UXT 2, UXT 6

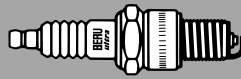

## Zündkerzen-Montagehilfe<sup>74</sup> ZMH 001



Die biegsame Montagehilfe ermöglicht ein schnelles und sicheres Ein- und Ausschrauben von Zündkerzen. Kerzen nur noch lockern bzw. festziehen (Anzugsdrehmomente der Fahrzeughersteller beachten!). Ideal geeignet für schwer zugängliche Einbaustellen. Gewindebeschädigungen an Zylinderkopf und Zündkerze durch schräges Ansetzen werden verhindert. Zündkerzen können nicht in den Motorraum fallen. Der Elektrodenabstand bleibt so erhalten.<sup>32</sup>

Bestell-Nr.<sup>26</sup> 0 890 000 001

## Zündkerzen-Montagehilfe<sup>74</sup> ZMH 002



Für den einfachen und sicheren Zündkerzenwechsel ohne Verkanten des Schlüssels und ohne Isolatorrisse.<sup>153</sup>

Bestell-Nr.<sup>26</sup> 0 890 000 002

## SAE-Kerzenmutter<sup>86</sup>



Bestell-Nr.<sup>26</sup> 2 004 652 001

## Zündkerzen-Steckerfett<sup>154</sup> ZKF 01, ZKF 02



- verhindert Zündaussetzer und Hochspannungsüberschläge<sup>155</sup>
- unterbindet das Verbacken von Zündkerzenstecker und Zündkerze – das erleichtert das Abziehen des Steckers und verringert die Gefahr von Beschädigungen des Kerzensteckers<sup>156</sup>
- für optimale elektrische Isolation<sup>157</sup>

BERU empfiehlt: Bei jedem Zündkerzenwechsel den Zündkerzenstecker innen fetten.<sup>158</sup>

10 gr. Tube<sup>159</sup>. Bestell-Nr.<sup>26</sup> 0 890 300 029  
50 gr. Tube<sup>159</sup>. Bestell-Nr.<sup>26</sup> 0 890 300 045

## BERU Bi-Hex-Schlüssel für 12-Kant-Zündkerzen<sup>171</sup>



- 3/8-Antriebsvierkant<sup>172</sup>
- Haltemagnet: für sicheren Halt auch bei evtl. veröltten Kerzen<sup>173</sup>
- 17-mm-Außen-Sechskant am Antriebsende<sup>174</sup>
- Abgerundete Ecken: zur Vermeidung von Zündkerzenschäden<sup>175</sup>
- Hochwertiger Chrom-Vanadium-Stahl, hochglanzverchromte Oberfläche<sup>176</sup>

Schlüsselweite<sup>90</sup>: 14 mm, Bestell-Nr.<sup>26</sup> 0 890 000 004  
Schlüsselweite<sup>90</sup>: 16 mm, Bestell-Nr.<sup>26</sup> 0 890 000 005



Im Zylinderkopf ist das Gewinde defekt.  
Was tun? Mit dem ZGR-Set 1 kein Problem!  
Einfach mit dem Spezialbohrer altes Gewinde  
herausschälen – neues Gewinde schneiden –  
Zündkerze mit Gewindeeinsatz hineindrehen –  
fertig! Vorteil: Der Zylinderkopf muß bei der  
Reparatur nicht ausgebaut werden!  
Nachträglich eingebaute Zündkerzen-  
gewindeeinsätze sitzen sicher und sind  
kompressionsdicht.





What can be done with a worn thread in the cylinder  
head? No problem with the ZGR Set 1. Simply  
bore out the old thread with the special bit  
supplied, tap a new thread and reinstall the  
sparkplug with a thread insert.  
The advantage of this is that the cylinder head  
need not be removed to carry out the repair.  
Retrospectively installed sparkplug thread  
inserts provide secure seating and are  
compression-tight.

## Sie sparen Zeit und Kosten! You save time and money!

Für Zündkerzen mit Gewinde M 14 × 1,25 For sparkplugs with M 14 × 1.25 thread	
Flachdichtsitz Gewindelängen: Flat seat Thread lengths: 3/8" = 9,5 mm 1/2" = 12,7 mm 3/8" = 19,0 mm	Konusdichtsitz Gewindelänge: Traped seat Thread lengths: 11/16" = 17,5 mm



Zündkerzengewinde-Reparaturset Sparkplug socket repair kit		Inhalt/Stück Contents/units				
Typ Type	Bestell-Nr. Ref. No.	Bohrer Drill-bit	Gewindeeinsätze für Gewindelänge Thread inserts/thread length			
			9,5 mm	12,7 mm	19,0 mm	17,5 mm
ZGR-Set 1	1 909 800 001	M 16 × 1,25	4	4	4	4

	Gewindeeinsätze und Bohrer für Ersatzbedarf Replacement thread inserts and drill-bits		
	Typ Type	Bestell-Nr. Ref. No.	Inhalt/Stück Contents/units
	ZGB 1	0 900 891 001	1
	ZGE 14–9,5 mm	2 903 427 001	10
	ZGE 14–12,7 mm	2 903 427 002	10
	ZGE 14–19,0 mm	2 903 427 003	10
	ZGE 14–17,5 K mm	2 903 421 001	10



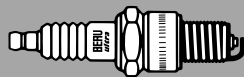

Le taraudage de bougie, dans la culasse, est défectueux. La bougie ne peut plus être revissée. Que faire? Avec le set de réparation ZGR 1, pas de problème! Réaliser l'ancien filet au moyen du taraud spécial, mettre en place un adaptateur sur le filetage de la bougie et revisser celle-ci sur la culasse. C'est tout! Et il n'y a même pas besoin de démonter la culasse pour cela!  
Les adaptateurs mis ultérieurement en place sont aussi bien assis que la bougie elle-même et assurent la même herméticité – donc pas de perte de compression.

In de cilinderkop is de schroefdraad defect. Wat nu? Met de ZGR-set 1 geen probleem! Eenvoudig met de speciale boor de oude schroefdraad er uitboren  
– nieuwe schroefdraad tappen – bougie met schroefdraadinzetstuk er indraaien – klaar!  
Voordeel: de cilinderkop behoeft bij de reparatie niet uitgebouwd te worden!  
Later ingebouwde bougieschroefdraadinzetstukken zitten veilig en zijn compressiedicht.

## **Vous économisez en temps et en argent! U spaart tijd en kosten!**

Pour bougies à pas de vis M 14 × 1,25 Voor bougies met schroefdraad M 14 × 1,25	
Siège cylindrique Longueur de filet: Platte zit Schroefdraad- lengtes: 3/8" = 9,5 mm 1/2" = 12,7 mm 3/8" = 19,0 mm	Siège conique Longueur de filet Conuszit Draadlengtes: 1 1/16" = 17,5 mm



Set de réparation pour taraudages Reparatieset bougieschroefdraad		Contenu/pièces Inhoud/stuks				
Type	Référence Bestelnummer	Taraud Boorbit	Adaptateur pour longueurs de filets Schroefdraadinzetstuk voor draadlengte			
			9,5 mm	12,7 mm	19,0 mm	17,5 mm
ZGR-Set 1	1 909 800 001	M 16 × 1,25	4	4	4	4

	Adaptateurs et tarauds de rechange Schroefdraadinzetstuk en boorbit		
	Type	Référence Bestelnummer	Contenu/pièces Inhoud/stuks
	ZGB 1	0 900 891 001	1
	ZGE 14–9,5 mm	2 903 427 001	10
	ZGE 14–12,7 mm	2 903 427 002	10
	ZGE 14–19,0 mm	2 903 427 003	10
	ZGE 14–17,5 K mm	2 903 421 001	10

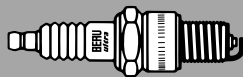

¿Que hacer cuando en la culata hay una rosca deteriorada? ¡Con el juego ZGR-Set 1 no es problema alguno! Descascarillar sencillamente con la broca especial la rosca antigua – terrajar una rosca nueva – enroscar la bujía con un adaptador – ¡listo!

Ventaja: ¡la culata no debe desmontarse para realizar la reparación! Los adaptadores de rosca de bujías asientan fiablemente y son herméticos a la compresión.

Nella testata dei cilindri la filettatura è difettosa. Cosa fare? Con il set ZGR 1 non è un problema! Pelare con il trapano speciale tutta la filettatura, eseguire una nuova filettatura, inserire la candela con il nuovo inserto filettato, pronti!

Il vantaggio: non è necessario smontare la testata dei cilindri per eseguire la riparazione! Gli inserti montati in tale maniera risiedono stabilmente al loro posto e non presentano perdite di compressione.

Что делать, если изношена резьба в головке цилиндра? При наличии ремонтного набора ZGR-Set 1 – нет проблем! Нужно лишь срезать специальным сверлом старую резьбу – нарезать новую резьбу – вернуть свечу зажигания с резьбовой насадкой – готово!

Преимущество: при ремонте нет необходимости демонтировать головку цилиндра! Дополнительно установленные резьбовые насадки свечей зажигания обеспечивают плотность посадки и компрессионную герметичность.

## ¡Vd. ahorra tiempo y dinero! Risparmierete tempo e denaro! Вы сэкономите время и деньги!

Para bujías con rosca M 14 x 1,25 Per candele con filettatura M14 x 1,25 Для свечей зажигания с резьбой M 14 x 1,25	
Asiento plano, longitudes de rosca: Sede piatta lunghezze filettature: Цилиндрическая уплотнительная посадка, длина резьбы: $3/8'' = 9,5 \text{ mm}$ $1/2'' = 12,7 \text{ mm}$ $3/8'' = 19,0 \text{ mm}$	Asiento cónico, longitudes de rosca: Sede conica lunghezze filettature: Коническая уплотн ительная посадка, длина резьбы: $11/16'' = 17,5 \text{ mm}$



Juego de reparación para roscas de bujías Set di riparazione per filettatura candele Набор для ремонта резьбы свечей зажигания		Contenido/Unidades Contenuto/pezzi Содержимое/кол-во штук				
Tipo Tipo Тип	Nº de referencia Nº di ord. № заказа	Broca Trapano Сверло	Adaptador para longitud de rosca Inserti filettati per lunghezza filettatura Резьбовые насадки для резьбы длиной			
ZGR-Set 1	1 909 800 001	M 16 × 1,25	4	4	4	4

Adaptador de rosca y brocas de recambio Inserti filettati e trapano di ricambio Резьбовые насадки и сверла для замены		Contenido/Unidades Contenuto/pezzi Содержимое/кол-во штук	
Tipo Tipo Тип	Nº de referencia Nº di ord. № заказа	Contenido/Unidades Contenuto/pezzi Содержимое/кол-во штук	
	ZGB 1	0 900 891 001	1
	ZGE 14–9,5 mm	2 903 427 001	10
	ZGE 14–12,7 mm	2 903 427 002	10
	ZGE 14–19,0 mm	2 903 427 003	10
	ZGE 14–17,5 K mm	2 903 421 001	10

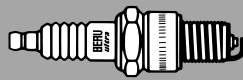

Co można zrobić gdy gwint w głowicy cylindra jest uszkodzony? Dzięki zestawowi ZGR Set 1 nie stanowi to problemu. Po prostu stary gwint należy wywiercić za pomocą specjalnego wiertła i naciąć nowy gwint – wkręcić świecę wraz ze specjalną gwintowaną wkładką – gotowe!  
Zaleta: do przeprowadzenia naprawy nie trzeba demontować głowicy cylindra!  
Później zainstalowane wkładki gwintowane świec zapłonowych siedzą mocno i są szczelne w trakcie sprężania mieszanki paliwowej.

Στην κεφαλή του κυλίνδρου είναι χαλασμένο το σπειρώμα. Τι πρέπει να κάνουμε τότε; Κανένα πρόβλημα κατά την εφαρμογή του σετ 1 τύπου ZGR! Με το ειδικό τρυπάνι πρέπει απλούστατα να διενεργηθεί ξεφλούδισμα του παλιού σπειρώματος και επακόλουθο κόψιμο νέου σπειρώματος -- ακολούθως πρέπει να βιδωθεί το μπουζί με το σπειρώμα του -- έτοιμο!  
Πλεονέκτημα: Η κεφαλή του κυλίνδρου δεν είναι απαραίτητο να αποσυαρμολογηθεί κατά τη διάρκεια της επιδιορθωσης!  
Ένα μπουζί με εφαρμοστικό σπειρώμα, το οποίο εφαρμόστηκε εκ των υστέρων στην μηχανή, έχει σταθερή έδραση και είναι στεγανό κατά της συμπίεστικής επενέργειας.

A hengerfejben tönkrement a menet. Vajon van-e segítség? – Igen, van! A ZGR-készlettel ez már nem okoz gondot. A speciális fúróval egyszerűen távolítsuk el a régi menetet, fúrjuk ki az újat, a gyertyát pedig a menetes persellyel együtt csavarozzuk be, és máris kész!  
A megoldás előnye, hogy így nem kell leszerelni a hengerfejet. Az utólag beépített menetes gyújtógyertya-persely biztosan tart és jól tömit.

## Oszczędność czasu i pieniędzy! Εξοικονομάτε χρόνο και χρήματα! Időt és költséget takarít meg!

Do świec zapłonowych z gwintem M 14 x 1,25 Για σπινθηστήρες (μπουζί) με σπειρώμα à 14 x 1,25 M 14 x 1,25 menetű gyújtógyertyákhoz	
Πlatiké gniazdo uszczelniające Długości gwintów: Επίπεδη στεγανωτική έδραση Μήκη σπειρωμάτων: Lapos tömitőváll menethossz: 3/8" = 9,5 mm 1/2" = 12,7 mm 3/8" = 19,0 mm	Stożkowe gniazdo uszczelniające Długość gwintu: Κωνική στεγανωτική έδραση Μήκος σπειρώματος: Kúpos tömitőváll menethossz: 11/16" = 17,5 mm



Zestaw do reperacji gwintu świec zapłonowych Σετ επιδιορθώσεων σπειρωμάτων σπινθηστήρων (μπουζί) Gyújtógyertyamenet-javitőkészlet		Zawartość / sztuk Περιεχόμενο/Τεμάχια Tartozékok/darab				
Typ Τύπος Típus	Nr katalogowy Αρ. παραγγελίας Rendelészám	Wiertło Τρυπάνι Fúró	Wkładki gwintowane dla gwintu o długości Εξαρτήματα σπειρωμάτων για μήκος σπειρώματος Darabszám a menetes perselyek menethossza szerint			
ZGR-Set 1	1 909 800 001	M 16 × 1,25	4	4	4	4

Wkładki gwintowane i wiertła do wykorzystania w razie potrzeby Εξαρτήματα σπειρωμάτων και τρυπάνια για αναπληρωματικές αναγκαιότητες Külön utánrendelhető menetes perselyek és fúrók			
Typ Τύπος Típus	Nr katalogowy Αρ. παραγγελίας Rendelészám	Zawartość / sztuk Περιεχόμενο/Τεμάχια Tartozékok/darab	
	ZGB 1	0 900 891 001	1
	ZGE 14–9,5 mm	2 903 427 001	10
	ZGE 14–12,7 mm	2 903 427 002	10
	ZGE 14–19,0 mm	2 903 427 003	10
	ZGE 14–17,5 K mm	2 903 421 001	10

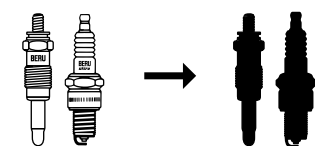

102 M	–
105 G	–
105 MN	GV 602
107 M	GV 107
110 M	GV 110
111 M	GV 119
113 S	–
114 G	–
116 G	GH 116
116 M	GV 119
117 S 3	–
120 M	–
121 M	–
123 MJ	GV 123
124 MJ	GV 107
125/14/3 A	14-9 DU
128 G	GH 113
129 G	–
129 M	GV 129
131 MJ	GV 191
132 MJ	–
133 M	–
137 G	–
138 G	–
139 S	–
14 F-5 DU	14 F-5 DU
14 F-6 DPUR2	14 F-7 DPURU2
14 F-6 DUO	14 FR-6 DU
14 F-6 DUOR	14 FR-6 DU
14 F-7 DUO	14 F-7 DU
14 FGH-7 DPURX2	14 F-7 DPURX 2
14 FGH-8 DTUR	14 FGH-8 DTURW
14 FLR-8 LDUX	14 FR-8 LDUOX4
14 FR-7 DPU2	14 FR-7 DPPUS2
14 FR-8 LDU4	14 FR-8 LDUOX4
14 GZ 3	14 GZ 6-77-2
14 K-6 D	14 K-6 DU
14 K-7 D	14 K-7 DU
14 KR-6 ZPPV	14 KR-8 MPX
14 L-7 C	14-7 CU
14 R-6 B	–
14 R-6 D	14 R-6 DU
14 R-7 A	–
14 R-7 B	14 R-7 BU
14 R-7 D	14 R-7 DU
14 R-9 E0	14 R-9 EU0
14 R-11 F	–
14 S-7 A	–
14 Z-2 A1	–
14 Z-2 C1	–
14 Z-3 A1	14 Z-3 AU
14 Z-3 C1	14 Z-3 CU
14 Z-6 A2	–
140 M	–
141 G	–
141 MJ	GN 857
144 MJ	–
144 MN	GV 136
144 MNK	GV 144
145/14	14-8 AU
145/14/3	14-7 CU
145/14/3 A	14-8 DU

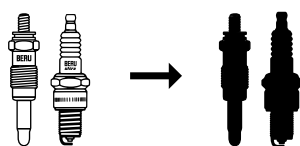

145/14/5	14-8 E
145/14/A	14-8 BU
145/18	18-7 AU
145/18 K	18 K-7 BU
146 G	–
148 E	–
149 G	GV 149/umbauen <sup>68</sup>
14-04 A	–
14-10 A	14 X AU
14-10 B	–
14-10 D	14-10 DU
14-10 E	–
14-3 A1	14 Z-3 AU
14-3 DP2	–
14-4 A1	14 Z-4 AU
14-4 A2	–
14-4 C1	14 Z-3 CU
14-4 CS1	14 Z-3 CU
14-4 DP0	–
14-5 A	14-5 AU
14-5 B	14-5 BU
14-5 C	–
14-5 D	14-5 DU
14-5 D1	14-5 DU
14-5 DU0	14-5 DU
14-5 E	–
14-6 A2	14-6 BU
14-6 B	14-6 BU
14-6 C	–
14-6 D	14-6 DU
14-6 D1	14-5 DU
14-6 DU0	14-6 DU
14-7 A	14-7 AU
14-7 B	14-7 BU
14-7 C	14-7 CU
14-7 D	14-7 DU
14-8 A	14-8 AU
14-8 B	14-8 BU
14-8 C	14-7 CU
14-8 C1	14-7 CU
14-8 DU0	14-8 DU
14-9 C	–
14-9 D	14-9 DU
14-9 DU0	14-9 DU
14-9 EU0	14 S-9 E0
14 R-9 EU0	14 SR-9 E0
14 SR-6 F	14 SR-5 F
18-5 AU	–
18-7 AU	–
150 M	GD 294/umbauen <sup>68</sup>
151 G	–
151 MJ	GV 602
156 S	–
159 G	–
159 MJ	–
161 GS	–
161 MJ	GV 602
162 MJ	GN 857
163 G	GF 163
164 MJ	–
166 GS	–
169 G	GF 974

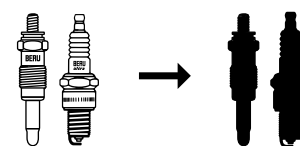

170 M	GV 170
171 MJ	GV 108
172 G	GF 630
173 G	–
175/14	14-7 AU
175/14 A	14-7 BU
175/14 LU3	14-7 BU
175/14 U2	14-7 AU
175/14 UK4	–
175/14/3	14-7 CU
175/14/3 A	14-7 DU
175/14/3 K	14 K-7 DU
175/14/3L	14-7 CU
175/14/5	14-8 E
175/18 K	18 K-7 BU
176 G	–
177 GS	–
178 M	–
179 G	–
180 M	–
18-10 AU	–
18-7 AU	–
18 C-7A	–
18 GZ 5-77	18 GZ 5-77-2
18 GZ 6-77	18 GZ 6-77-2
18 K-7 BU	18 K-7 BU
18 K-8 B	18 K-7 BU
18 K-9 BU	18 K-9 BU
183 G	–
184 G	GH 760
185 G	GH 185
185 MJ	GV 110
186 MJ	–
187 GS	GH 195
188 G	GV 123/umbauen <sup>68</sup>
188 GS	–
188 M	GV 123/umbauen <sup>68</sup>
18-4 A1	–
18-4 A2	–
18-8 A	18-7 AU
190/14 S	14-7 AU
190 G	–
193 M	–
194 GrmS	–
194 MJ	–
195 M	–
199 G	GV 199/umbauen <sup>68</sup>
199 M	GV 199
20 A4-18 S	–
200/14 A	14-6 BU
200/14/3	–
200/14/3 A	14-6 DU
202 Ge	GD 318
202 GK	GD 318
214 Ge	GD 214
219cG	GD 220
223 R	–
225/14	14-5 AU
225/14 A	14-5 BU
225/14 LU2	14-5 AU
225/14/3 A	14-5 DU
225/14 UK 4	–

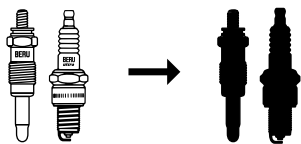

225/18	–
230 G	–
230/14/3 A	14-5 DU
234 GA	–
234 Gas	–
235/14/3P	–
240/14	14 Z-4 AU
240/14/3	–
240/18	–
244 Gn	GD 318
244 Gne	GD 318
247 G	GV 110/umbauen <sup>68</sup>
248 Gn	GD 255
250/14/3 P	14-4 DPO
254 Gn	GD 255
256 G	–
260/14	14 Z-3 AU
260/14/3	14 Z-3 CU
260/14/3 S	14 Z-3 CU
260/18	–
280/14/3 Z	14 Z-3 CU
283 G	–
290 GK	–
293 Ge	GD 294
293 GK	GD 294
294 G	GD 294
294 Ge	GD 294
294 Gr	GD 294
296 G	GD 294
296 Gu	GD 294
304 G	–
306 Gn	–
313 Ge	–
313 GK	–
315 Ge	GD 318
315 Gen	GD 318
318 Ge	GD 318
322 Ge	GD 214
332 Ge	GD 318
340 G	–
340/14/3K- HGF	–
341 GL	GD 341
347 G	–
357 M (	–
358 M	–
	GH 359
360 G	–
367 G	–
370 GK	GD 318
371 MK	GV 110/umbauen <sup>68</sup>
372 M	–
373 M	GV 357
374 G	–
378 GK	–
381 GK	GD 382
385 M	GV 179/umbauen <sup>68</sup>
387 GK	–
392 MJ	–
393 MJ	–
397 G	–
400 G	GH 010

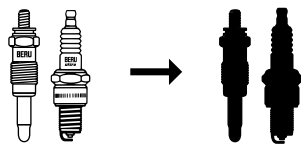

400 G	GH 010
401 GS	GH 407
402 GS	–
404 GS	GH 409
405 GS	GH 410
408 GS	GH 408
408 GSA	GHA 408
6 B	–
601 MJ	GN 857
605 MJ	GN 857
607 MJ	GV 636
609 MJ	GV 642
610 MJ	–
611 MJ	GV 626
612 MJ	GV 112
613 MJ	GV 636
616 MJ	GV 142
624 MJ	GV 852
632 MJ	–
633 MJ	GV 636
634 GS	GF 859
635 GS	GH 408
639 GS	GH 847
640 GS	GH 649
640 MJ	–
641 G	–
643 G	GH 400
646 MJ	–
647 G	–
651 MJ	GV 691
652 MJ	–
652 MJ	–
655 MJ	–
662 G	–
665 G	–
671 G	GF 111
672 G	–
674 G	GF 667
676 G	GF 667
677 G	–
680 G	–
681 G	–
682 G	–
683 G	GF 974
686 MJ	–
687 MJ	GN 857
690 G	–
694 G	GF 977
699 G	GF 111
700 G	GF 111
702 G	–
704 G	–
718 MJ	GN 858
725 MJ	GN 855
726 MJ	–
729 MJ	GV 636
736 MJ	GV 736
739 G	GF 977
742 G	–
746 G	–
747 G	–
748 G	GH 846

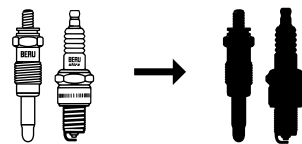

753 G	GF 978
754 G	–
755 G	–
764 MJ	–
765 G	–
771 MJ	–
777 G	–
784 MJ	GN 927
788 G	–
790 GS	–
791 G	777 G
794 G	–
795 G	GF 002
796 G	–
813 MJ	–
815 MJ	GN 857
818 G	–
819 MJ	–
829 G	–
835 MJ	–
836 MJ	–
839 G	–
840 G	–
841 MJ	–
851 GS	–
903 MJ	GN 002
913 G	–
940 MJ	GN 001
941 MJ	GN 002
943 MJ	GN 022
950 MJ	GN 855
951 MJ	–
952 MJ	GH 008
953 MJ	GH 001
95/14	14 X AU
95/14/3 A	14-10 DU
95/18	–
961 MJ	GN 961
966 MJ	GN 022
986 MJ	GN 008
982 MJ	–
AK 165	AK 167 SK
AK 167 j	AK 167 SK
AK 167 ML	–
AK 167 MN	–
AK 167 MP	–
AK 167 MS	–
BEN 2012	–
BW 07/60	–
BW 09/20	–
BW 09/30	–
BW 25/22/1	–
BW 25/44/1	–
DS 12	–
DS 24	–
E 175/14 m5	–
E 175/14/3 A m5	14 C-7 D
E 175/18 U2	–
E 175/18 m5	–
EBE 513/2	EBE 514
ED 175/14/3 m5	–
EMV 12 F	MV 115

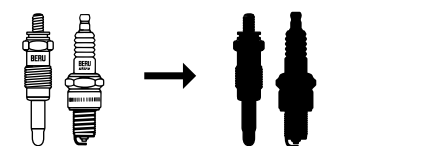

F 06552	KOBS 065/52
F 0680	–
F 0760	–
F 0845	KOSK 08/45
F 0850	KOS 08/50
F 0938	–
F 0940	–
F 1024	–
F 1030	–
F 1038	–
F 1050	–
F 1120	–
F 1210	KOS 12/10
F 1215	KOSK 15/10
F 1305	–
F 1442-1	–
F 1510	KOSK 15/10
F 1520	KOSK 15/20
F 1526	–
F 1530	–
F 1540	–
F 1735	–
F 1738	KOSK 17
F 224	–
F 2522/1	KOS 25/22/1
F 2555	–
F 3020	–
F 3542	–
F 3825	–
F 424	–
F 524	–
F 624	–
FA 10	–
FA 10/1	–
FA 20	–
GD 31	–
GD 313	–
GD 368	GD 214
GE 108	GE 115
GF 138	–
GF 169	GF 974
GF 176	–
GF 647	–
GF 674	–
GF 671	GF 111
GF 680	–
GF 681	–
GF 683	GF 974
GF 699	GF 111
GF 739	–
GF 747	–
GF 777	–
GF 788	–
GF 829	–
GF 833	–
GH 16	GH 13
GH 21	–
GH 22	GH 30
GH 28	GH 648
GH 113	–
GH 114	–
GH 117	–

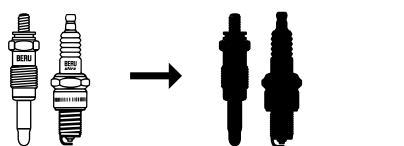

GH 146	–
GH 159	–
GH 194	–
GH 400	GH 010
GH 400	GH 010
GH 402	–
GH 408	GH 408
GH 952	GH 008
GH 953	GH 001
GN 028	–
GN 031	–
GN 870	GN 001
GN 940	GN 001
GN 966	GN 022
GN 966	GN 022
GR 063	–
GR 072	–
GV 02	–
GV 006	GN 857 ohne Verl.
GV 102	–
GV 164	–
GV 124	GV 107
GV 178	–
GV 185	GV 110
GV 186	–
GV 357	–
GV 358	–
GV 372	–
GV 612	GV 112
GV 624	GV 852
GV 736	GV 736
GV 819	–
GV 835	–
GV 898	–
GV 922	–
GV 969	–
GV 982	–
GZE 14	GH 18
GZE 15	GH 30
GZE 16	GH 13
GZE 18	GH 18
GZE 19	GH 30
GZE 20	GH 30
GZE 22	GH 30
GZE 24	GH 30
GZE 28	GH 648
GZE 30	GH 30
GZE 201	GH 201
GZE 205	GH 202
H 297/3	–
HA 01	GD 01
HB 01	–
HE 01	–
HFG 12/40 mW	–
HFH 11/48 m	–
HFH 83/36 i	–
KA 01	–
KA 02	–
KE 01	GF 667
KOBS 1N-0850	KOS 08/50
KOBS 1-0850	KOS 08/50
KOBS 1-0940	KOSK 08/45

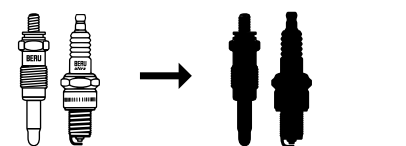

KOBS 14/42/1	–
KOS	KOS 17
KOS 06/80	–
KOS 09/40	KOSK 08/45
KOS 10/24	–
KOS 10/30	–
KOS 10/50	–
KOS 12/10	KOSK 15/10
KOS 12/15	–
KOS 13/05	–
KOS 17/40	KOS 17
KOS 2/24	KOSK 15/10
KOS 38/12	–
KOS 38/25	–
KOS 3/24	KOS 25/22/1
KOS 4/24	KOS 25/22/1
KOS 4/24	KOS 25/22/1
KOS 5/24	KOS 25/22/1
KOS 6/24	–
KOS 8/24	–
KOSK	KOSK 17
KOSK 15/30	–
KOSK 15/40	–
KOSK 20/50	–
KOSK 30/20	KOS 25/22/1
MB 10	–
MB 11	GD 318
MB 12	GD 12
MB 20	–
MB 21	–
MB 31	–
MC 01	–
MC 02	GV 02
MC 03	GV 910
MC 06	GN 857+2 902 823 006
RS 18	14-5 AU
RS 37	–
RS 39	–
S 7	–
S 9	–
SR-Set 001	SR-Set 028
W 36-12	WU 45/15
WN 37/42/60	–
WN 64-42/60	–
WT 103/38	–
WT 120/50	–
WT 120/50	–
WT 18/38	–
WT 18/50	–
WT 25/38	–
WT 25/50	–
WT 35/38	–
WT 43/38	–
WT 43/50	–
WT 52/38	–
WT 52/50	–
WT 69/38	–
WT 69/50	–
WT 69/50	–
WT 72/38	–
WT 86/38	–
WT 86/50	–

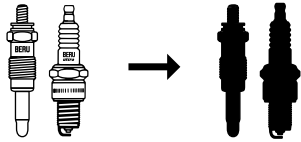

WT 92/38	–
WTP 35/50	–
WTP 68/085	–
WTP 69/50	–
WU 35/38	–
WU 58/42	–
WU 68/085	–

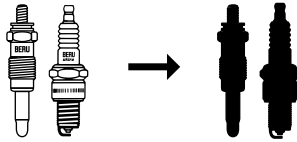

0 001 325 704	0 001 325 701
0 001 330 117	0 001 330 119
0 001 330 713	0 001 330 702
0 001 335 721	0 001 335 725
0 001 340 707	0 001 340 702
0 001 340 716	0 002 340 702
0 001 340 723	0 002 340 702
0 001 340 906	0 001 335 919
0 001 345 703	0 001 345 720
0 001 345 711	0 001 345 702
0 001 350 903	–
0 001 440 701	–
0 001 725 700	0 001 725 701
0 001 735 700	0 001 735 704
0 001 820 700	–
0 001 835 700	–
0 001 845 700	–
0 002 240 908	0 002 240 909
0 002 330 708	0 002 330 710
0 002 335 908	0 002 335 940
0 002 515 400	–
0 002 640 900	0 002 640 900
0 004 350 910	0 004 350 924
0 004 350 915	0 004 350 921
0 004 525 700	0 004 525 302
0 004 525 701	0 004 525 304
0 004 540 401	0 004 545 400
0 004 800 906	0 004 800 918
0 004 800 907	0 004 800 919
0 004 800 931	0 004 800 926
0 004 800 937	0 004 800 919
0 010 110 002	0 010 100 003
0 100 001 201	–
0 100 001 203	0 100 220 203
0 100 002 301	0 100 222 305
0 100 100 201	0 100 100 203
0 100 100 204	–
0 100 100 205	–
0 100 100 205	–
0 100 100 301	–
0 100 100 302	–
0 100 100 303	–
0 100 100 304	–
0 100 101 003	–
0 100 101 008	–
0 100 101 009	0 100 101 001
0 100 101 205	–
0 100 101 306	0 100 101 302
0 100 101 307	0 100 101 304
0 100 101 309	–
0 100 101 322	0 100 101 304
0 100 101 323	–
0 100 101 323	–
0 100 101 324	0 100 101 308
0 100 102 201	–
0 100 102 301	0 100 102 302
0 100 102 304	0 100 102 302
0 100 102 305	0 100 102 307
0 100 102 306	–
0 100 103 302	–
0 100 103 302	–
0 100 103 303	–

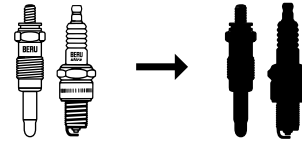

0 100 112 301	0 100 222 303
0 100 201 006	–
0 100 220 101	0 100 226 173
0 100 220 103	0 100 226 173
0 100 220 117	0 100 226 173
0 100 220 119	0 100 220 118
0 100 220 202	–
0 100 220 601	–
0 100 221 102	0 100 221 106
0 100 221 103	0 100 221 106
0 100 221 104	0 100 221 106
0 100 221 105	0 100 226 173
0 100 221 110	0 100 226 173
0 100 221 112	0 100 221 133
0 100 221 114	0 100 221 135
0 100 221 116	0 100 221 101
0 100 221 116	0 100 221 101
0 100 221 116	0 100 221 101
0 100 221 118	0 100 221 133
0 100 221 125	0 100 226 163
0 100 221 125	0 100 226 163
0 100 221 128	0 100 221 133
0 100 221 136	0 100 221 101
0 100 221 136	0 100 221 101
0 100 221 138	0 100 221 153
0 100 221 150	0 100 226 173
0 100 221 162	0 100 226 234
0 100 221 165	0 100 226 227
0 100 221 166	–
0 100 221 169	0 100 221 133
0 100 221 193	0 100 221 147
0 100 221 194	0 100 221 148
0 100 221 195	0 100 221 149
0 100 221 196	0 100 221 151
0 100 221 197	0 100 221 154
0 100 221 198	0 100 221 186
0 100 221 199	–
0 100 221 205	0 100 220 204
0 100 221 207	0 100 221 202
0 100 221 208	–
0 100 221 215	–
0 100 221 306	0 100 221 311
0 100 221 313	0 100 221 314
0 100 222 103	0 100 222 101
0 100 222 205	0 100 222 201
0 100 222 304	0 100 222 301
0 100 222 304	0 100 222 301
0 100 222 306	0 100 102 302
0 100 222 307	0 100 222 302
0 100 222 308	0 100 222 303
0 100 222 308	0 100 222 303
0 100 226 114	0 100 226 198
0 100 226 120	0 100 220 115
0 100 226 124	0 100 220 113
0 100 226 125	0 100 220 114
0 100 226 131	0 100 221 133
0 100 226 134	0 100 226 173
0 100 226 134	0 100 226 173
0 100 226 135	0 100 221 152
0 100 226 138	–
0 100 226 138	–
0 100 226 140	0 100 221 135

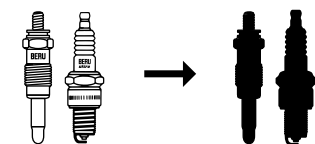

0 100 226 141	0 100 221 101
0 100 226 142	0 100 221 132
0 100 226 143	0 100 221 141
0 100 226 144	0 100 221 146
0 100 226 172	0 100 226 227
0 100 226 175	0 100 226 258
0 100 226 176	0 100 226 234
0 100 226 177	0 100 226 333
0 100 226 177	0 100 226 333
0 100 226 183	–
0 100 226 187	0 100 221 144
0 100 226 201	0 100 226 333
0 100 226 201	0 100 226 333
0 100 226 205	0 100 226 381
0 100 226 205	0 100 226 381
0 100 226 210	0 100 226 235
0 100 226 211	–
0 100 226 227	0 100 226 227
0 100 226 228	0 100 226 340
0 100 226 228	0 100 226 340
0 100 226 231	0 100 226 163
0 100 226 232	0 100 221 145
0 100 226 241	0 100 226 250
0 100 226 248	0 100 226 381
0 100 226 248	0 100 226 381
0 100 226 256	0 100 226 338
0 100 226 256	0 100 226 338
0 100 226 260	0 100 226 379
0 100 226 305	0 100 226 180
0 100 226 307	0 100 226 194
0 100 226 308	0 100 226 209
0 100 226 309	0 100 226 207
0 100 226 310	0 100 226 208
0 100 226 313	0 100 226 173
0 100 226 314	0 100 226 234
0 100 226 315	0 100 221 163
0 100 226 316	0 100 226 129
0 100 226 317	0 100 226 235
0 100 226 318	0 100 226 188
0 100 226 319	0 100 226 227
0 100 226 320	0 100 226 184
0 100 226 321	0 100 226 189
0 100 226 322	0 100 226 186
0 100 226 323	0 100 226 229
0 100 226 324	0 100 226 185
0 100 226 345	0 100 226 182
0 100 226 348	–
0 100 226 353	0 100 226 365
0 100 226 367	0 100 226 381
0 100 226 368	0 100 226 392
0 100 226 369	0 100 226 381
0 100 226 372	0 100 226 343
0 100 226 377	0 100 226 186
0 100 226 383	–
0 100 226 383	–
0 100 226 389	0 100 226 186
0 100 226 393	–
0 100 226 393	–
0 100 226 396	0 100 226 362
0 100 226 397	0 100 226 338
0 100 226 417	0 100 226 300
0 100 226 425	0 100 221 133

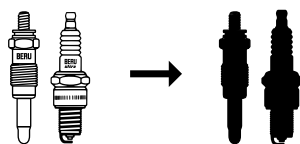

0 100 226 500	0 100 226 245
0 100 226 501	0 100 226 351
0 100 226 502	0 100 226 373
0 100 226 503	0 100 226 375
0 100 226 518	0 100 226 505
0 100 226 523	0 100 226 379
0 100 226 524	0 100 226 138
0 100 230 103	0 100 230 102
0 100 230 105	0 100 230 101
0 100 230 203	–
0 100 230 203	–
0 100 230 204	–
0 100 231 102	0 100 231 120
0 100 231 102	0 100 231 120
0 100 231 108	0 100 231 119
0 100 231 109	–
0 100 231 112	0 100 231 119
0 100 231 114	–
0 100 231 114	–
0 100 231 115	–
0 100 231 115	–
0 100 231 116	0 100 231 107
0 100 231 122	0 100 231 104
0 100 231 304	0 100 231 303
0 100 232 002	–
0 100 232 201	–
0 100 232 201	–
0 100 232 302	–
0 100 232 303	0 100 232 304
0 100 232 304	–
0 100 232 401	–
0 100 233 401	–
0 100 266 016	0 100 266 040
0 100 266 016	0 100 266 040
0 100 266 053	0 100 266 033
0 100 266 057	0 100 266 018
0 100 271 102	–
0 100 271 102	–
0 100 271 102	–
0 100 271 107	0 100 271 106
0 100 271 111	0 100 271 101
0 100 271 112	0 100 271 102
0 100 271 113	0 100 271 106
0 100 271 206	0 100 271 204
0 100 271 207	0 100 271 205
0 100 271 602	–
0 100 271 602	–
0 100 276 009	0 100 276 014
0 100 301 201	–
0 100 301 201	–
0 100 301 202	0 100 301 201
0 100 301 301	–
0 100 301 301	–
0 100 301 301	–
0 100 301 302	0 100 221 305
0 100 302 001	–
0 100 302 001	–
0 100 302 302	0 100 222 303
0 100 321 101	–
0 100 321 201	–
0 100 321 201	–
0 100 321 202	0 100 321 201
0 100 331 101	0 100 331 103

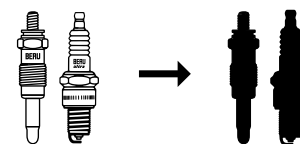

0 100 331 101	0 100 331 103
0 100 331 203	–
0 101 022 401	–
0 101 022 406	0 101 072 405
0 101 022 408	–
0 101 022 413	–
0 101 022 414	–
0 101 022 415	–
0 101 022 603	–
0 101 032 401	–
0 101 032 603	–
0 101 032 604	–
0 101 072 401	0 101 072 405
0 101 072 403	0 101 072 405
0 101 172 401	0 101 172 403
0 101 172 404	0 101 172 403
0 101 223 401	0 101 223 459
0 101 223 401	0 101 223 459
0 101 223 402	–
0 101 223 411	–
0 101 223 414	–
0 101 223 415	–
0 101 223 416	–
0 101 223 423	–
0 101 223 423	–
0 101 223 424	–
0 101 223 425	0 101 223 459
0 101 223 426	–
0 101 223 426	–
0 101 223 436	–
0 101 223 437	–
0 101 223 441	–
0 101 223 441	–
0 101 223 442	–
0 101 223 445	–
0 101 223 452	–
0 101 223 454	0 101 223 459
0 101 223 468	0 101 223 459
0 101 223 601	–
0 101 223 601	–
0 101 223 605	–
0 101 233 402	0 101 233 413
0 101 233 406	–
0 101 233 406	–
0 101 233 416	0 100 233 437
0 101 233 418	0 101 233 403
0 101 233 418	0 101 233 403
0 101 233 420	0 101 233 403
0 101 233 420	0 101 233 403
0 101 233 422	–
0 101 233 425	–
0 101 233 431	–
0 101 233 433	–
0 101 233 437	0 101 233 403
0 101 233 437	0 101 233 403
0 101 233 441	0 101 233 483
0 101 233 442	–
0 101 233 443	–
0 101 233 443	–
0 101 233 444	0 101 233 483
0 101 233 444	–
0 101 233 447	0 101 233 486



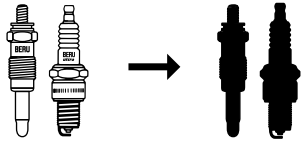

0 101 233 448	–
0 101 233 450	–
0 101 233 450	–
0 101 233 453	0 101 233 450
0 101 233 455	0 101 233 499
0 101 233 455	0 101 233 499
0 101 233 456	–
0 101 233 459	0 101 233 499
0 101 233 460	0 101 233 499
0 101 233 462	–
0 101 233 462	–
0 101 233 465	–
0 101 233 472	0 101 233 495
0 101 233 484	0 101 233 499
0 101 233 485	0 101 233 499
0 101 233 491	0 101 233 493
0 101 233 496	0 101 233 499
0 101 233 497	0 101 233 499
0 101 234 503	–
0 101 234 507	0 101 234 504
0 101 234 508	0 101 234 504
0 101 234 516	–
0 101 234 517	0 101 234 504
0 101 234 520	0 101 234 504
0 101 234 520	–
0 101 234 521	0 101 234 529
0 101 234 524	0 101 234 529
0 101 333 402	–
0 102 012 204	0 102 012 205
0 102 012 301	–
0 102 012 303	–
0 102 013 301	–
0 102 013 301	–
0 102 013 305	–
0 102 013 305	–
0 102 013 401	–
0 102 013 403	0 102 013 404
0 102 022 201	–
0 102 022 201	–
0 102 022 204	0 102 022 201
0 102 022 205	–
0 102 022 206	0 102 022 202
0 102 022 302	0 102 022 301
0 102 023 301	–
0 102 023 301	–
0 102 024 401	–
0 102 024 402	0 102 024 405
0 102 024 404	–
0 102 024 407	–
0 102 024 601	–
0 102 024 601	–
0 102 024 602	0 102 024 604
0 102 034 201	–
0 102 034 401	–
0 102 072 301	–
0 102 072 303	–
0 102 072 304	–
0 102 072 305	0 102 022 301
0 102 112 401	–
0 102 113 201	–
0 102 113 201	–
0 102 113 304	–

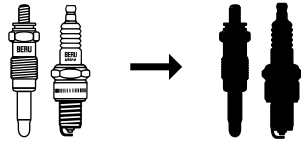

0 102 113 306	0 102 113 303
0 102 113 401	–
0 102 113 402	0 102 124 402
0 102 113 403	–
0 102 123 202	0 102 123 203
0 102 123 204	0 102 123 203
0 102 123 402	0 102 123 403
0 102 124 201	–
0 102 124 402	0 102 124 416
0 102 124 402	0 102 124 416
0 102 124 404	0 102 124 416
0 102 124 404	0 102 124 416
0 102 124 405	0 102 123 203
0 102 124 405	0 102 123 203
0 102 124 407	0 102 124 405
0 102 124 411	0 102 123 403
0 102 124 412	0 102 123 203
0 102 124 415	0 102 124 418
0 102 124 416	0 102 124 418
0 102 133 202	0 102 133 204
0 102 133 203	0 102 133 204
0 102 133 402	0 102 133 403
0 102 173 201	0 102 173 212
0 102 173 211	0 102 173 212
0 102 174 301	0 102 174 303
0 102 184 301	0 102 184 303
0 102 184 305	0 102 184 303
0 102 211 201	–
0 102 221 201	–
0 102 231 601	–
0 102 231 602	–
0 102 231 604	–
0 102 232 102	–
0 102 234 201	–
0 102 234 203	–
0 102 234 301	–
0 102 234 302	–
0 102 234 303	–
0 102 282 201	–
0 105 100 003	0 105 100 008
0 105 100 005	0 105 100 002
0 105 100 005	0 105 100 002
0 105 100 009	0 105 100 021
0 105 100 010	0 105 100 021
0 105 100 012	0 105 100 021
0 105 100 013	0 105 100 021
0 105 100 015	0 105 100 008
0 105 100 016	–
0 105 100 019	0 102 271 301
0 105 100 019	0 102 271 301
0 105 100 023	0 105 100 008
0 105 100 024	0 105 100 012
0 105 100 026	0 105 100 021
0 105 110 006	0 105 110 002
0 105 110 009	0 105 110 001
0 108 266 002	0 100 266 002
0 108 266 008	0 100 266 008
0 108 266 009	0 100 266 009
0 108 266 040	0 100 266 040
0 110 001 001	–
0 110 001 002	–
0 110 002 002	–

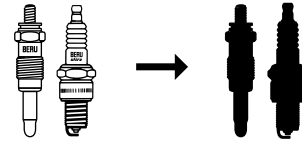

0 110 002 003	–
0 110 011 003	–
0 110 011 005	–
0 110 011 006	–
0 110 011 008	–
0 110 012 003	–
0 110 012 004	–
0 110 012 007	–
0 110 012 008	–
0 110 020 008	–
0 110 020 008	–
0 110 020 011	0 110 020 016
0 110 021 003	–
0 110 021 004	–
0 110 021 004	–
0 110 022 001	–
0 110 022 001	–
0 110 022 002	–
0 110 022 004	–
0 110 031 002	–
0 110 031 003	–
0 110 032 002	–
0 110 032 002	–
0 110 100 001	0 110 100 008
0 110 100 003	0 110 101 015
0 110 100 005	0 110 100 008
0 110 100 006	–
0 110 100 007	–
0 110 100 010	0 110 101 015
0 110 101 004	0 110 102 012
0 110 101 009	0 110 101 015
0 110 101 009	0 110 101 015
0 110 101 010	–
0 110 101 011	–
0 110 101 012	0 110 102 012
0 110 101 019	0 110 101 013
0 110 101 020	0 110 101 012
0 110 102 002	0 110 102 009
0 110 102 003	0 110 102 009
0 110 102 004	–
0 110 102 007	–
0 110 102 010	–
0 110 102 013	–
0 110 103 001	–
0 110 110 001	–
0 110 111 001	–
0 110 200 001	–
0 110 201 001	–
0 110 202 001	–
0 110 202 002	–
0 110 510 018	0 110 510 007
0 111 031 001	–
0 111 032 001	–
0 111 121 002	–
0 120 000 001	0 120 000 028
0 121 221 001	–
0 121 321 001	–
0 121 321 002	–
0 200 100 001	0 200 100 016
0 200 100 009	0 200 100 016
0 200 100 010	–
0 200 100 011	–

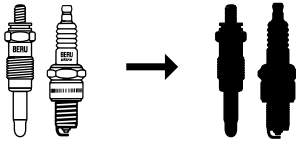

0 200 100 013	–
0 200 100 014	–
0 201 010 063	–
0 201 010 072	–
0 210 142 101	–
0 210 142 103	0 210 142 115
0 210 142 109	0 210 142 115
0 210 142 110	0 210 142 115
0 210 142 111	0 210 142 113
0 210 143 101	0 210 143 116
0 210 143 102	0 210 143 116
0 210 143 105	0 210 143 102
0 210 143 112	0 210 143 116
0 210 243 104	0 210 243 114
0 210 243 124	0 210 243 129
0 210 243 125	0 210 243 129
0 211 212 101	–
0 211 213 101	–
0 800 115 001	0 800 115 010
0 800 141 001	–
0 900 104 009	–
2 004 650 017	2 004 650 022
2 112 130 001	0 110 100 001
2 112 130 003	–
2 112 130 004	0 110 101 009
2 112 130 005	–
2 112 130 007	–
2 112 130 008	–
2 112 130 009	0 110 102 008
2 112 130 010	–
2 112 130 011	0 110 102 012
2 112 130 012	0 110 102 009
2 112 130 013	–
2 112 130 014	0 110 101 012
2 112 130 014	0 110 101 020
2 112 130 015	–
2 112 130 016	0 110 101 013
2 112 130 016	0 110 101 019
2 112 130 018	–
2 112 130 018	0 110 100 009
2 112 130 019	0 110 100 005
2 112 130 019	0 110 100 008
2 112 130 020	0 110 100 008
2 112 130 021	0 110 100 007
2 112 130 022	–
2 112 130 023	–
2 112 130 024	0 110 101 016
2 112 130 028	0 110 101 015
2 112 130 029	0 110 102 013
2 112 130 030	0 110 100 010
2 112 130 031	–
2 112 130 033	–
2 112 130 034	0 110 102 001
2 112 130 036	–
2 903 050 001	–
2 909 847 003	0 900 891 001

OE		AM
0 001 325 704	14-9 DU	0 001 325 701
0 001 330 109	14 GH-8 DTUR	0 001 330 113
0 001 330 110	14 FGH-8 DTUR	0 001 330 117
0 001 330 111	14 GH-8 DTURX	0 001 330 112
0 001 330 114	14 FGH-8 DTURO	0 001 330 116
0 001 330 117	14 FGH-8 DTURW	0 001 330 119
0 001 330 707	14 F-8 DU4	0 001 330 731
0 001 330 713	14-8 DU	0 001 330 702
0 001 330 729	14 F-8 DU4	0 001 330 731
0 001 330 732	14 F-8 DU4	0 001 330 731
0 001 330 903	14 FGH-8 DPURX2	0 001 330 904
0 001 335 104	14 FGH-7 DTURX	0 001 335 107
0 001 335 105	14 GH-7 DTUR	0 001 335 108
0 001 335 414	14-7 DU	0 001 335 702
0 001 335 721	14 F-7 DU	0 001 335 725
0 001 335 723	14-7 DU0	0 001 335 737
0 001 335 731	14-7 DU	0 001 335 702
0 001 335 904	14 FGH-7 DPURX2	0 001 335 905
0 001 335 908	14 F-7 DPURX2	0 001 335 910
0 001 340 102	14 FGH-6 DTUR	0 001 340 103
0 001 340 409	14-6 DU	0 001 340 702
0 001 340 707	14-6 DU	0 001 340 702
0 001 340 716	14 FR-6 DU	0 002 340 702
0 001 340 723	14 FR-6 DU	0 002 340 702
0 001 340 906	14 F-7 DPURU2	0 001 335 919
0 001 345 403	14-5 DU	0 001 345 702
0 001 345 711	14-5 DU	0 001 345 702
0 001 345 911	14 F-5 MPUR2L	0 001 345 915
0 001 345 913	14 F-5 DPURS2	0 001 345 914
0 001 350 907	14 F-4 NBPR	0 001 350 910
0 001 350 908	14 F-4 NBPR2LS	0 001 350 911
0 001 350 909	14 F-4 NBPR2LS	0 001 350 911
0 001 435 307	14-7 AU	0 001 435 705
0 001 435 706	14-7 AU	0 001 435 705
0 001 435 707	14-7 BU	0 001 435 700
0 001 635 704	14 K-7 DU0	0 001 635 709
0 001 635 706	14 K-7 DU	0 001 635 700
0 001 640 401	14 K-6 DU	0 001 640 700
0 001 645 705	14 K-5 DU	0 001 645 700
0 001 725 700	18 K-9 BU	0 001 725 701
0 002 230 301	12 VR-8 SE	0 002 230 300
0 002 240 908	12 ZR-6 SPP2	0 002 240 909
0 002 330 210	14 R-8 DUX	0 002 330 702
0 002 330 705	14 GR-8 DTU	0 002 330 706
0 002 335 103	14 FGR-7 KQU	0 002 335 104
0 002 335 908	14 FR-7 DPPUS2	0 002 335 940
0 004 350 910	14 R-4 CIU2	0 004 350 924
0 004 350 915	14 GZ 6-77-2	0 004 350 921
0 004 525 700	14 S-9 E0	0 004 525 302
0 004 525 701	14 SR-9 E0	0 004 525 304
0 004 540 401	14 SR-5 F	0 004 545 400
0 004 800 906	18 GZ 5-77-2	0 004 800 918
0 004 800 907	18 GZ 6-77-2	0 004 800 919
0 004 800 924	18 GZ 6-77-2	0 004 800 938
0 004 800 937	18 GZ 6-77-2	0 004 800 919
0 100 101 306	GD 214	0 100 101 302
0 100 102 305	GD 12	0 100 102 307
0 100 112 301	GV 110	0 100 222 303
0 100 220 119	GV 920	0 100 220 118
0 100 220 176	GN 858	0 100 226 234
0 100 220 210	GV 137	0 100 220 206
0 100 221 102	GV 602	0 100 221 106
0 100 221 103	GV 602	0 100 221 106
0 100 221 113	GV 642	0 100 221 135
0 100 221 116	GV 112	0 100 221 101
0 100 221 125	GV 852	0 100 226 163

OE		AM
0 100 221 155	GV 603	0 100 221 107
0 100 221 162	GN 858	0 100 226 234
0 100 222 103	GV 894	0 100 222 101
0 100 222 104	GV 001	0 100 222 105
0 100 226 118	GV 852	0 100 226 163
0 100 226 120	GV 892	0 100 220 115
0 100 226 124	GV 888	0 100 220 113
0 100 226 125	GV 889	0 100 220 114
0 100 226 159	GV 666	0 100 221 146
0 100 226 161	—	—
0 100 226 172	GN 855	0 100 226 227
0 100 226 175	GN 860	0 100 226 258
0 100 226 176	GN 858	0 100 226 234
0 100 226 177	GN 001	0 100 226 333
0 100 226 197	GN 925	0 100 226 432
0 100 226 201	GN 001	0 100 226 333
0 100 226 203	GN 939	0 100 226 385
0 100 226 205	GN 022	0 100 226 381
0 100 226 210	GN 948	0 100 226 235
0 100 226 226	GV 852	0 100 226 163
0 100 226 228	GH 001	0 100 226 340
0 100 226 231	GV 852	0 100 226 163
0 100 226 241	GN 961	0 100 226 250
0 100 226 248	GN 022	0 100 226 381
0 100 226 251	GN 858	0 100 226 234
0 100 226 254	GN 909	0 100 226 186
0 100 226 256	GN 008	0 100 226 338
0 100 226 260	GN 003	0 100 226 379
0 100 226 301	GN 993	0 100 226 384
0 100 226 305	GV 886	0 100 226 180
0 100 226 307	GV 921	0 100 226 194
0 100 226 311	GV 968	0 100 226 243
0 100 226 331	GV 886	0 100 226 180
0 100 226 345	GV 897	0 100 226 182
0 100 226 348	—	—
0 100 226 349	GN 043	0 100 226 475
0 100 226 353	GN 010	0 100 226 365
0 100 226 367	GN 022	0 100 226 381
0 100 226 368	GN 015	0 100 226 392
0 100 226 369	GN 022	0 100 226 381
0 100 226 382	GN 023	0 100 226 481
0 100 226 394	GN 032	0 100 226 505
0 100 226 395	GN 003	0 100 226 379
0 100 226 396	GN 024	0 100 226 362
0 100 226 397	GN 008	0 100 226 338
0 100 226 418	GN 858	0 100 226 234
0 100 226 419	GN 003	0 100 226 379
0 100 226 437	GN 042	0 100 226 480
0 100 226 438	GV 636	0 100 221 133
0 100 226 439	GV 852	0 100 226 163
0 100 226 440	GN 857	0 100 226 173
0 100 226 441	GV 642	0 100 221 135
0 100 226 442	GN 909	0 100 226 186
0 100 226 443	GV 666	0 100 221 146
0 100 226 444	GV 663	0 100 221 145
0 100 226 445	GV 602	0 100 221 106
0 100 226 446	GV 661	0 100 221 144
0 100 226 447	GV 719	0 100 221 163
0 100 226 448	GN 908	0 100 226 185
0 100 226 449	GN 858	0 100 226 234
0 100 226 450	GN 970	0 100 226 249
0 100 226 451	GV 603	0 100 221 107
0 100 226 452	GV 631	0 100 221 132
0 100 226 453	GN 954	0 100 226 229
0 100 226 454	GN 912	0 100 226 188
0 100 226 455	GN 855	0 100 226 227

OE		AM
0 100 226 456	GN 860	0 100 226 258
0 100 226 457	GN 948	0 100 226 235
0 100 226 458	GN 003	0 100 226 379
0 100 226 459	GN 007	0 100 226 343
0 100 226 460	GN 008	0 100 226 338
0 100 226 461	GN 010	0 100 226 365
0 100 226 462	GN 015	0 100 226 392
0 100 226 463	GN 022	0 100 226 381
0 100 226 464	GN 024	0 100 226 362
0 100 226 465	GV 749	0 100 221 186
0 100 226 466	GV 746	0 100 226 207
0 100 226 473	GN 003	0 100 226 379
0 100 226 474	GN 046	0 100 226 482
0 100 226 477	GN 007	0 100 226 343
0 100 226 489	GN 033	0 100 226 417
0 100 226 493	GN 060	0 100 226 517
0 100 226 496	GN 060	0 100 226 517
0 100 226 504	GN 018	0 100 226 373
0 100 226 508	GN 104	0 100 226 497
0 100 226 510	GN 026	0 100 226 351
0 100 226 515	GN 061	0 100 226 520
0 100 226 518	GN 032	0 100 226 505
0 100 226 519	GN 018	0 100 226 373
0 100 226 575	GN 096	0 100 226 638
0 100 230 005	GV 109	0 100 230 002
0 100 230 103	GV 890	0 100 230 102
0 100 230 105	GV 887	0 100 230 101
0 100 230 106	GN 044	0 100 230 107
0 100 231 102	GV 736	0 100 231 120
0 100 231 111	–	–
0 100 231 112	GN 002	0 100 231 119
0 100 231 115	GV 895	0 100 231 107
0 100 231 121	GV 153	0 100 231 101
0 100 231 122	GV 880	0 100 231 104
0 100 231 124	GN 066	0 100 231 133
0 100 266 001	GE 100	0 100 266 008
0 100 266 004	GE 101	0 100 266 009
0 100 266 005	GE 104	0 100 266 010
0 100 266 006	GE 106	0 100 266 018
0 100 266 007	GE 105	0 100 266 011
0 100 266 012	GE 116	0 100 266 042
0 100 266 014	GE 115	0 100 266 040
0 100 266 016	GE 115	0 100 266 040
0 100 266 017	GE 109	0 100 266 059
0 100 266 020	GE 115	0 100 266 040
0 100 266 023	GE 110	0 100 266 032
0 100 266 024	GE 114	0 100 266 034
0 100 266 025	GE 112	0 100 266 031
0 100 266 026	GE 111	0 100 266 033
0 100 266 044	GE 120	0 100 266 066
0 100 266 045	GE 105	0 100 266 011
0 100 266 053	GE 111	0 100 266 033
0 100 266 057	GE 106	0 100 266 018
0 100 266 058	GE 109	0 100 266 059
0 100 266 063	GE 109	0 100 266 059
0 100 271 103	GV 823	0 100 271 101
0 100 271 104	–	–
0 100 271 107	GV 004	0 100 271 106
0 100 271 201	GN 036	0 100 271 204
0 100 271 202	GN 049	0 100 271 205
0 100 271 203	GN 049	0 100 271 205
0 100 271 206	GN 036	0 100 271 204
0 100 271 207	GN 049	0 100 271 205
0 100 276 002	GN 045	0 100 276 005
0 100 276 006	GN 045	0 100 276 005
0 100 276 007	GN 053	0 100 276 008

OE		AM
0 100 276 009	GN 058	0 100 276 014
0 100 276 010	GN 059	0 100 276 015
0 100 276 012	GN 056	0 100 276 012
0 100 276 013	GN 045	0 100 276 005
0 100 276 016	–	–
0 100 276 017	GN 037	0 100 276 003
0 100 276 019	GN 069	0 100 276 031
0 100 276 035	GN 037	0 100 276 003
0 100 331 101	GH 008	0 100 331 103
0 100 331 102	GH 009	0 100 331 104
0 100 800 029	GN 019	0 100 226 375
0 100 800 030	GN 012	0 100 226 354
0 101 072 401	GF 859	0 101 072 405
0 101 072 403	GF 859	0 101 072 405
0 101 072 404	GF 983	0 101 072 409
0 101 072 406	GF 982	0 101 072 408
0 101 072 407	GF 983	0 101 072 409
0 101 223 401	GF 683	0 101 223 454
0 101 223 425	GF 974	0 101 223 459
0 101 233 418	GF 111	0 101 233 403
0 101 233 420	GF 111	0 101 233 403
0 101 233 441	GF 977	0 101 233 483
0 101 233 444	GF 977	0 101 233 483
0 101 233 459	GF 002	0 101 233 499
0 101 233 460	GF 002	0 101 233 499
0 101 233 484	GF 002	0 101 233 499
0 101 233 485	GF 002	0 101 233 499
0 101 233 490	GF 001	–
0 101 233 496	GF 002	0 101 233 499
0 101 233 497	GF 002	0 101 233 499
0 101 234 507	GF 667	0 101 234 504
0 101 234 521	GF 529	0 101 234 529
0 101 234 524	GF 529	0 101 234 529
0 102 022 206	GH 116	0 102 022 202
0 102 022 302	GH 649	0 102 022 301
0 102 024 402	GH 760	0 102 024 405
0 102 072 301	GH 117	0 102 072 304
0 102 123 202	GH 408	0 102 123 203
0 102 123 204	GH 408	0 102 123 203
0 102 123 402	GHA 408	0 102 123 403
0 102 124 402	GH 010	0 102 124 416
0 102 124 411	GHA 408	0 102 123 403
0 102 124 415	GH 400	0 102 124 402/404
0 102 133 402	GH 931	0 102 133 403
0 102 173 201	GH 847	0 102 173 212
0 102 173 211	GH 847	0 102 173 212
0 102 174 304	GH 306	0 102 174 306
0 102 224 204	GH 011	0 102 224 205
0 103 010 101	PSG 004	0 103 010 104
0 103 010 901	PSG 001	0 103 010 903
0 103 110 903	PSG 003	0 103 110 904
0 103 111 101	PSG 002	0 103 111 104
0 103 111 103	PSG 002	0 103 111 104
0 103 111 105	PSG 002	0 103 111 104
0 105 100 005	GH 13	0 105 100 002
0 106 671 101	CGP 001	0 106 671 105
0 210 243 124	MV 129	0 210 243 129
0 210 243 125	MV 129	0 210 243 129
0 300 353 001	–	–
0 522 120 101	GSE 101	0 522 120 701
0 522 120 502	GSE 100	0 522 120 702
0 522 140 101	GSE 102	0 522 140 701
9 133 242 000	GN 047	0 100 276 004
9 233 118 000	GN 964	0 100 226 246

**D Wichtiger Hinweis:**

Diese Vergleichsliste ist nur eine Orientierungshilfe. Benützen Sie die aktuellen Beru Verwendungslisten um das verbindliche Produkt festzustellen. Eine Rückumschlüsselung von Beru zu Fremdtypen ist nicht erlaubt. Aus einer falschen Umschlüsselung können keine Gewährleistungsansprüche abgeleitet werden.

**GB USA Important note:**

This comparison list is only an aid. Refer to the current Beru application lists to find the binding product. Reverse conversion from Beru to types from other manufacturers is not permitted. No liability claims can be derived from an incorrect conversion.

**F Important:**

Cette liste comparative vous est donnée à titre indicatif. Pour déterminer le produit adéquat, veuillez vous référer aux listes d'affectations Beru en vigueur. L'utilisation de la liste d'équivalences dans l'autre sens (de Beru vers les autres marques) n'est pas possible. Une conversion erronée rend tout droit à la garantie caduque.

**NL Waarschuwing:**

Deze vergelijkingslijst is slechts bedoeld als oriënteringshulp. Gebruik de actuele Beru-toepassingslijsten om het goedgekeurde product vast te stellen. Terugomzetten van Beru naar types van andere fabrikanten is niet toegestaan. Er kunnen geen garantieaanspraken afgeleid worden van een verkeerde omzetting.

**E Nota importante:**

Esta lista comparativa sirve únicamente como referencia. Utilice las listas de aplicación actuales de Beru para determinar el producto adecuado. No se permite el uso inverso de la lista de equivalencias (de Beru a otras marcas). De una conversión errónea no se puede derivar ningún tipo de derechos de garantía.

**I Indicazione importante:**

Questa lista di confronto serve solo a scopo di riferimento. Per definire in maniera vincolante il prodotto giusto utilizzate le liste di applicazione Beru più attuali. La riconversione dei codici Beru in codici di altri produttori non è ammessa. In caso di errori nella conversione dei codici decade qualsiasi diritto di garanzia.

**RUS Важное указание!**

Настоящий перечень сравнительных данных представляет собой лишь вспомогательное средство для ориентации. Следует использовать актуальный перечень фирмы Beru с описанием применений с тем, чтобы определить продукт, связанный гарантией иными обязательствами. Не разрешается перекодирование Beru в другой тип. Неправильное перекодирование исключает право на гарантийные обязательства.

**PL Ważne zalecenie:**

Niniejsza lista porównawcza stanowi jedynie pomoc orientacyjną. W celu ustalenia obowiązującego produktu należy stosować aktualne listy zastosowań wyrobów firmy Beru. Niedozwolone jest wtórne zastępowanie wyrobów firmy Beru wyrobami innych firm. Nieprawidłowe zastąpienie powoduje przepadek rozszczeń gwarancyjnych.

**GR Σημαντική υπόδειξη:**

Αυτός ο κατάλογος σύγκρισης αποτελεί μόνο βοήθεια προσανατολισμού. Για να εξακριβώσετε το αυθεντικό προϊόν χρησιμοποιήστε τους επίκαιρους καταλόγους χρήσης της Beru. Δεν επιτρέπεται η διακωδικοποίηση από προϊόντα της Beru σε προϊόντα ξένων κατασκευαστών. Από εσφαλμένη διακωδικοποίηση δεν μπορούν να συναχθούν εγγυητικές αξιώσεις.

**H Fontos figyelmeztetés:**

Ez az összehasonlító lista kizárólag a tájékozódást segíti. A megfelelő termék kiválasztásához használja a Beru aktuális alkalmazási listáit. A Beru típusait nem szabad más gyártók típusaival helyettesíteni. Téves behelyettesítésből nem vezethet le jótállási igényt.

AC DELCO	BERU		
41 F	Z 42	14-5 DU	UX 56
41-2 XLS	Z 42	14-5 DU	UX 56
41-8 XLS	Z 11	14-7 DU	UXT 2/UXT 6
42 F	Z 39	14 Z-4 AU	-
42 FF	Z 57	14-7 AU	-
42 FS	Z 48	14-6 BU	-
42 LTS	Z 25	14 K-6 DU	UXK 56
42 LZ	Z 57	14-7 AU	-
42 XLS	Z 11	14-7 DU	UXT 2/UXT 6
42-5 F	Z 57	14-7 AU	-
42-6 FS	Z 10	14-7 BU	-
43 F	Z 57	14-7 AU	-
43 FO	Z 57	14-7 AU	-
43 FS	Z 10	14-7 BU	-
43 N	Z 58	14-7 CU	-
43 XLS	Z 1	14-8 DU	UXT 2/UXT 6
43-5 XLS	Z 1	14-8 DU	UXT 2/UXT 6
44 F	Z 57	14-7 AU	-
44 XL	Z 58	14-7 CU	-
44 XLS	Z 76	14-9 DU	UXT 2/UXT 6
45 F	Z 57	14-7 AU	-
45 XL	Z 58	14-7 CU	-
45 XLS	Z 76	14-9 DU	UXT 2/UXT 6
46 TS	Z 32	18 K-7 BU	-
46 XL	Z 58	14-7 CU	-
46 XLS	Z 1	14-8 DU	UXT 2/UXT 6
47 XL	Z 58	14-7 CU	-
83 TS	Z 32	18 K-7 BU	-
84 TS	Z 32	18 K-7 BU	-
85 TS	Z 32	18 K-7 BU	-
425 Z	Z 57	14-7 AU	-
420 Z	Z 57	14-7 AU	-
422 Z	Z 57	14-7 AU	-
430 Z	Z 39	14 Z-4 AU	-
6500	Z 2	14-8 DTU	UXT 2/UXT 6
C 41 CLTS	Z 31	14 K-5 DU	UXK 56
C 41 CXLS	Z 22	14-6 DU	UX 56
C 42 CFS	Z 10	14-7 BU	-
C 42 CLTS	Z 56	14 K-6 DUO	UXK 56
C 42 CLTS 9	Z 56	14 K-6 DUO	UXK 56
C 42 CXLS	Z 22	14-6 DU	UX 56
C 42 LTS	Z 25	14 K-6 DU	UXK 56
C 43 CXLS	Z 11	14-7 DU	UXT 2/UXT 6
C 44 NS	Z 22	14-6 DU	UX 56
C 44 XL	Z 58	14-7 CU	-
CFR 1 CLS	Z 15	14 FR-7 DU	UXT 1/UXT 3
CFR 2 CLS	Z 15	14 FR-7 DU	UXT 1/UXT 3
CR 42 CFS	Z 19	14 R-7 BU	-
CR 42 CXLSX	Z 21	14 R-7 DUX	UXT 2/UXT 6
CR 42 XLSX	Z 21	14 R-7 DUX	UXT 2/UXT 6
CR 43 CXLS	Z 82	14 R-9 DU	UXT 2/UXT 6
FR 1 LS	Z 15	14 FR-7 DU	UXT 1/UXT 3
FR 2 LS	Z 16	14 FR-7 DUX	UXT 1/UXT 3
FR 3 CLS	Z 72	14 FR-8 DU	UXT 1/UXT 3
FR 3 LS	Z 72	14 FR-8 DU	UXT 1/UXT 3
FR 3 LS 6	Z 73	14 FR-8 DUX	UXT 1/UXT 3
R 41 CF	Z 39	14 Z-4 AU	-
R 41 CXL	Z 38	14 Z-3 CU	-
R 41 CXLS	Z 47	14 R-5 DU	UX 56
R 41-4 XLS	Z 27	14 R-6 DU	UX 56
R 42 CF	Z 39	14 Z-4 AU	-
R 42 CFS	Z 48	14-6 BU	-
R 42 CLTS	Z 95	14 KR-7 DU	UXT 4
R 42 CLTS 6	Z 95	14 KR-7 DU	UXT 4
R 42 CXLS	Z 20	14 R-7 DU	UXT 2/UXT 6
R 42 T	Z 49	14 KR-6 BU	-

AC DELCO	BERU		
R 42 TS	Z 49	14 KR-6 BU	-
R 42 XLS	Z 20	14 R-7 DU	UXT 2/UXT 6
R 42 XLS 6	Z 21	14 R-7 DUX	UXT 2/UXT 6
R 42 XLS-11	Z 21	14 R-7 DUX	UXT 2/UXT 6
R 42-6 FS	Z 19	14 R-7 BU	-
R 43 CFS	Z 19	14 R-7 BU	-
R 43 CXL	Z 59	14 R-7 CU	-
R 43 CXLS	Z 82	14 R-9 DU	UXT 2/UXT 6
R 43 N	Z 8	14 R-8 DU	UXT 2/UXT 6
R 43 XLS	Z 8	14 R-8 DU	UXT 2/UXT 6
R 44 CF	Z 57	14-7 AU	-
R 44 CXL	Z 58	14-7 CU	-
R 44 CXLS	Z 82	14 R-9 DU	UXT 2/UXT 6
R 44 XLS	Z 82	14 R-9 DU	UXT 2/UXT 6
R 44 XLS-11	Z 9	14 R-8 DUX	UXT 2/UXT 6
R 45 NS	Z 82	14 R-9 DU	UXT 2/UXT 6
R 45 XLS	Z 82	14 R-9 DU	UXT 2/UXT 6
R 46 XLS	Z 82	14 R-9 DU	UXT 2/UXT 6
R 83 CTS	Z 32	18 K-7 BU	-
R 83 CTS	Z 32	18 K-7 BU	-
R 84 TS	Z 32	18 K-7 BU	-
R 84 TS	Z 32	18 K-7 BU	-
R 2601	Z 30	14 FR-5 DU	UXT 5
R 5602	Z 257	14 FR-7 LDUW	UXT 1/UXT 3
R 5602	Z 98	14 FR-7 LDU	UXT 1/UXT 3
R 5607	Z 91	14 GH-7 DTUR	UXT 2/UXT 6
R 5608	Z 155	14 FR-7 KU	UXT 10
R 5608	Z 156	14 FR-7 KU0	UXT 10
R 5610	Z 158	14 FR-7 LUX	-
R 6602	Z 95	14 KR-7 DU	UXT 4
R 6606	Z 9	14 R-8 DUX	UXT 2/UXT 6
R 6612	Z 183	14 FR-8 MU2	UXT 13
S 41 F	Z 39	14 Z-4 AU	-
S 44 F	Z 57	14-7 AU	-
S 44 XL	Z 58	14-7 CU	-

AGRIA	BERU		
031 150	Z 57	14-7 AU	-
031 160	Z 57	14-7 AU	-
031 170	Z 39	14 Z-4 AU	-
113 751 680 1	Z 57	14-7 AU	-
283 340	Z 57	14-7 AU	-
426 43	Z 57	14-7 AU	-
509 12	Z 10	14-7 BU	-
516 80	Z 57	14-7 AU	-
599 99	Z 1	14-8 DU	UXT 2/UXT 6

ALFA ROMEO	BERU		
116 61 05 358 00	GV 657		
116 61 96 016 00	GR 066		
116 76 05 358 01	GV 657		
460 72 001	GN 909		
462 29 251	Z 11	14-7 DU	UXT 2/UXT 6
464 51 951	GN 017		
465 21 529	Z 237	14 FR-7 DQUP7	-
465 21 530	Z 210	10 FR-6 CPU03	-
472 95 95	GV 602		
552 08 177	GN 069		
589 45 85	Z 27	14 R-6 DU	UX 56
589 45 86	Z 24	14 FR-6 DU	UXT 5
589 45 87	Z 20	14 R-7 DU	UXT 2/UXT 6
589 45 88	Z 24	14 FR-6 DU	UXT 5
589 61 77	Z 98	14 FR-7 LDU	UXT 1/UXT 3
598 40 36	Z 20	14 R-7 DU	UXT 2/UXT 6

ALFA ROMEO	BERU		
605 04 563	Z 42	14-5 DU	UX 56
605 07 123	GV 657		
605 12 848	Z 29	14 F-5 DU	UXT 5
605 12 929	Z 42	14-5 DU	UX 56
605 96 245	GN 908		
605 97 490	Z 29	14 F-5 DU	UXT 5
605 99 495	Z 210	10 FR-6 CPU03	–
606 17 002	GN 007		
608 00 325	Z 27	14 R-6 DU	UX 56
608 10 689	Z 130	14 FR-5 DPUX	–
608 16 139	GN 017		
717 11 638	Z 15	14 FR-7 DU	UXT 1/UXT 3
717 11 639	Z 27	14 R-6 DU	UX 56
717 11 640	Z 20	14 R-7 DU	UXT 2/UXT 6
717 11 806	Z 15	14 FR-7 DU	UXT 1/UXT 3
754 65 19	Z 15	14 FR-7 DU	UXT 1/UXT 3
755 44 36	Z 27	14 R-6 DU	UX 56
755 44 44	Z 20	14 R-7 DU	UXT 2/UXT 6
755 44 45	Z 48	14-6 BU	–
756 54 76	Z 38	14 Z-3 CU	–
776 03 81	Z 27	14 R-6 DU	UX 56
776 03 82	Z 20	14 R-7 DU	UXT 2/UXT 6
776 03 83	Z 15	14 FR-7 DU	UXT 1/UXT 3
776 03 84	Z 24	14 FR-6 DU	UXT 5
777 24 53	Z 24	14 FR-6 DU	UXT 5
915 170 018 0	Z 70	14-8 DU0	UXT 2/UXT 6
961 473 868 0	Z 98	14 FR-7 LDU	UXT 1/UXT 3
961 962 458 0	Z 74	14 FR-8 LDUOX4	UXT 1/UXT 3
962 800 028 0	Z 14	14 F-7 LDUR4	UXT 1/UXT 3

AUTOLITE	BERU		
33	Z 33	18 K-6 BU	–
34	Z 32	18 K-7 BU	–
35	Z 32	18 K-7 BU	–
36	Z 32	18 K-7 BU	–
44	Z 32	18 K-7 BU	–
45	Z 32	18 K-7 BU	–
53	Z 22	14-6 DU	UX 56
64	Z 21	14 R-7 DUX	UXT 2/UXT 6
65	Z 8	14 R-8 DU	UXT 2/UXT 6
66	Z 8	14 R-8 DU	UXT 2/UXT 6
103	Z 26	14 KR-6 DU	UXK 56
156	Z 32	18 K-7 BU	–
156	Z 32	18 K-7 BU	–
273	Z 48	14-6 BU	–
274	Z 10	14-7 BU	–
275	Z 10	14-7 BU	–
284	Z 19	14 R-7 BU	–
393	Z 58	14-7 CU	–
394	Z 58	14-7 CU	–
397	Z 58	14-7 CU	–
404	Z 8	14 R-8 DU	UXT 2/UXT 6
413	Z 39	14 Z-4 AU	–
414	Z 57	14-7 AU	–
415	Z 57	14-7 AU	–
416	Z 57	14-7 AU	–
646	Z 8	14 R-8 DU	UXT 2/UXT 6
745	Z 32	18 K-7 BU	–
764	Z 95	14 KR-7 DU	UXT 4
765	Z 95	14 KR-7 DU	UXT 4

AUTOUNION	BERU		
001 270 051 700 9	Z 22	14-6 DU	UX 56
005 620 051 700 9	Z 38	14 Z-3 CU	–

AUTOUNION	BERU		
009 330 233 100 9	Z 58	14-7 CU	–
011 180 006 800 0	Z 57	14-7 AU	–
725 020 339 000 9	Z 38	14 Z-3 CU	–
782 170 010 100 0	Z 42	14-5 DU	UX 56
N 017 811 1	Z 58	14-7 CU	–
N 017 811 19	Z 58	14-7 CU	–
N 017 811 20	Z 22	14-6 DU	UX 56
N 017 811 23	Z 42	14-5 DU	UX 56
N 017 812 13	Z 22	14-6 DU	UX 56

BMW	BERU		
12 12 0 030 548	Z 237	14 FR-7 DQUP7	–
12 12 0 032 134	Z 301	14 FR-7 LPUX02	–
12 12 0 032 135	Z 301	14 FR-7 LPUX02	–
12 12 0 032 136	Z 239	14 FGR-7 KQE	–
12 12 0 032 137	Z 235	14 FR-7 SPUX03	–
12 12 0 032 138	Z 235	14 FR-7 SPUX03	–
12 12 0 034 677	Z 233	12 ZR-6 SP03	–
12 12 0 035 915	Z 235	14 FR-7 SPUX03	–
12 12 0 035 933	Z 233	12 ZR-6 SP03	–
12 12 0 037 607	Z 237	14 FR-7 DQUP7	–
12 12 0 037 608	Z 237	14 FR-7 DQUP7	–
12 12 0 141 871	Z 237	14 FR-7 DQUP7	–
12 12 1 257 081	Z 22	14-6 DU	UX 56
12 12 1 257 082	Z 22	14-6 DU	UX 56
12 12 1 257 513	Z 11	14-7 DU	UXT 2/UXT 6
12 12 1 258 158	Z 11	14-7 DU	UXT 2/UXT 6
12 12 1 258 159	Z 11	14-7 DU	UXT 2/UXT 6
12 12 1 258 973	Z 11	14-7 DU	UXT 2/UXT 6
12 12 1 262 360	Z 1	14-8 DU	UXT 2/UXT 6
12 12 1 262 361	Z 1	14-8 DU	UXT 2/UXT 6
12 12 1 263 070	Z 1	14-8 DU	UXT 2/UXT 6
12 12 1 265 595	Z 11	14-7 DU	UXT 2/UXT 6
12 12 1 267 485	Z 11	14-7 DU	UXT 2/UXT 6
12 12 1 269 333	Z 76	14-9 DU	UXT 2/UXT 6
12 12 1 276 283	Z 1	14-8 DU	UXT 2/UXT 6
12 12 1 279 526	Z 1	14-8 DU	UXT 2/UXT 6
12 12 1 286 059	GV 636		
12 12 1 286 682	Z 1	14-8 DU	UXT 2/UXT 6
12 12 1 288 161	GV 636		
12 12 1 288 234	Z 1	14-8 DU	UXT 2/UXT 6
12 12 1 288 245	GV 749		
12 12 1 334 315	Z 1	14-8 DU	UXT 2/UXT 6
12 12 1 338 145	Z 22	14-6 DU	UX 56
12 12 1 338 145	Z 22	14-6 DU	UX 56
12 12 1 338 146	Z 42	14-5 DU	UX 56
12 12 1 351 716	Z 58	14-7 CU	–
12 12 1 353 286	Z 22	14-6 DU	UX 56
12 12 1 353 673	Z 11	14-7 DU	UXT 2/UXT 6
12 12 1 435 955	Z 237	14 FR-7 DQUP7	–
12 12 1 435 956	Z 237	14 FR-7 DQUP7	–
12 12 1 714 751	Z 3	14-8 LUR	UXT 2/UXT 6
12 12 1 715 539	Z 4	14 F-8 LUR	UXT 1/UXT 3
12 12 1 882 34	Z 11	14-7 DU	UXT 2/UXT 6
12 12 2 158 165	Z 336	12 ZR-6 SP2	–
12 12 2 158 252	Z 301	14 FR-7 LPUX02	–
12 12 2 158 253	Z 235	14 FR-7 SPUX03	–
12 12 2 163 332	Z 318	12 ZR-6 SPP2	–
12 12 7 653 771	Z 198	14 FR-5 LDU3	UXT 5
12 12 8 353 286	Z 22	14-6 DU	UX 56
12 12 8 636 155	Z 42	14-5 DU	UX 56
12 12 8 636 166	Z 22	14-6 DU	UX 56
12 12 8 636 167	Z 42	14-5 DU	UX 56
12 12 8 636 168	Z 22	14-6 DU	UX 56
12 12 8 636 169	Z 42	14-5 DU	UX 56

BMW	BERU		
12 12 9 005 913	Z 1	14-8 DU	UXT 2/UXT 6
12 12 9 005 914	Z 76	14-9 DU	UXT 2/UXT 6
12 12 9 055 912	Z 11	14-7 DU	UXT 2/UXT 6
12 12 9 056 446	Z 1	14-8 DU	UXT 2/UXT 6
12 12 9 056 447	Z 1	14-8 DU	UXT 2/UXT 6
12 12 9 057 189	Z 1	14-8 DU	UXT 2/UXT 6
12 12 9 057 190	Z 1	14-8 DU	UXT 2/UXT 6
12 12 9 057 749	Z 1	14-8 DU	UXT 2/UXT 6
12 12 9 057 750	Z 1	14-8 DU	UXT 2/UXT 6
12 12 9 057 992	Z 1	14-8 DU	UXT 2/UXT 6
12 12 9 059 162	Z 14	14 F-7 LDUR4	UXT 1/UXT 3
12 12 9 059 794	Z 14	14 F-7 LDUR4	UXT 1/UXT 3
12 12 9 059 869	Z 3	14-8 LUR	UXT 2/UXT 6
12 12 9 059 870	Z 4	14 F-8 LUR	UXT 1/UXT 3
12 12 9 061 383	Z 3	14-8 LUR	UXT 2/UXT 6
12 12 9 061 811	Z 14	14 F-7 LDUR4	UXT 1/UXT 3
12 12 9 061 869	Z 3	14-8 LUR	UXT 2/UXT 6
12 12 9 061 870	Z 4	14 F-8 LUR	UXT 1/UXT 3
12 12 9 063 428	Z 14	14 F-7 LDUR4	UXT 1/UXT 3
12 12 9 064 619	Z 14	14 F-7 LDUR4	UXT 1/UXT 3
12 12 9 071 003	Z 237	14 FR-7 DQUP7	-
12 12 9 976 330	Z 39	14 Z-4 AU	-
12 21 7 786 821	GSE 101		
12 21 7 788 327	GSE 102		
12 21 7 788 956	GSE 103		
12 23 1 288 245	GV 636		
12 23 2 240 255	GV 636		
12 23 2 241 387	GV 719		
12 23 2 241 388	GV 719		
12 23 2 241 389	GV 719		
12 23 2 248 059	GN 024		
12 23 22 48 422	GN 025		
12 23 7 786 869	GE 102		
12 23 7 788 957	GE 103		
12 23 7 791 101	GN 042		
12 23 7 798 001	GE 118		
12 23 9 061 353	GV 636		
12 23 9 061 354	GV 719		
12 65 5 95	Z 11	14-7 DU	UXT 2/UXT 6
12 65 5 95	Z 61	14-7 DU0	UXT 2/UXT 6
12 79 5 264	Z 1	14-8 DU	UXT 2/UXT 6
21 58 1 65	Z 336	12 ZR-6 SP2	-
77 49 7 43	Z 145	14 FGR-6 DDU	-
77 86 8 21	GSE 101		
77 86 8 69	GE 102		
77 88 3 27	GSE 102		
77 88 9 56	GSE 103		
77 88 9 57	GE 103		

BOMAG	BERU		
057 199 03	GV 108		
057 199 05	GF 167		
057 439 95	Z 39	14 Z-4 AU	-

BOSCH	BERU		
+1 Super Plus	Z 20	14 R-7 DU	UXT 2/UXT 6
+2 Super Plus	Z 91	14 GH-7 DTUR	UXT 2/UXT 6
+3 Super Plus	Z 8	14 R-8 DU	UXT 2/UXT 6
+4 Super Plus	Z 92	14 GH-8 DTUR	UXT 2/UXT 6
+5 Super Plus	Z 95	14 KR-7 DU	UXT 4
+6 Super Plus	Z 72	14 FR-8 DU	UXT 1/UXT 3
+7 Super Plus	Z 98	14 FR-7 LDU	UXT 1/UXT 3
+8 Super Plus	Z 15	14 FR-7 DU	UXT 1/UXT 3

BOSCH	BERU		
+9 Super Plus	Z 74	14 FR-8 LDUOX4	UXT 1/UXT 3
+10 Super Plus	Z 19	14 R-7 BU	-
+11 Super Plus	Z 16	14 FR-7 DUX	UXT 1/UXT 3
+12 Super Plus	Z 27	14 R-6 DU	UX 56
+13 Super Plus	Z 24	14 FR-6 DU	UXT 5
+14 Super Plus	UXT 4	-	-
+15 Super Plus	Z 47	14 R-5 DU	UX 56
+16 Super Plus	Z 82	14 R-9 DU	UXT 2/UXT 6
+17 Super Plus	Z 97	14 KR-8 MPX	UXT 8
+18 Super Plus	Z 26	14 KR-6 DU	UXK 56
+19 Super Plus	Z 73	14 FR-8 DUX	UXT 1/UXT 3
+21 Super Plus	Z 21	14 R-7 DUX	UXT 2/UXT 6
+22 Super Plus	Z 9	14 R-8 DUX	UXT 2/UXT 6
+23 Super Plus	UXT 1	-	-
+24 Super Plus	Z 206	14 FR-7 DPPUS2	UXT 10
+27 Super Plus	Z 82	14 R-9 DU	UXT 2/UXT 6
+30 Super Plus	UXT 15	-	-
+31 Super Plus	Z 157	14 FR-7 KUOX	UXT 11
+32 Super Plus	Z 158	14 FR-7 LUX	-
+35 Super Plus	Z 67	14 KR-7 DUX	UXT 4
+36 Super Plus	Z 208	14 FR-8 LDU3	-
+37 Super Plus	UXT 15	-	-
+39 Super Plus	Z 177	14 KR-8 MUV	UXT 7
+40 Super Plus	Z 243	12 VR-8 SE	-
+41 Super Plus	Z 234	12 FR-7 DU	-
+43 Super Plus	Z 153	14 FR-8 KU	UXT 10
+44 Super Plus	Z 121	14 FGH-8 DTURX0	UXT 9
+45 Super Plus	Z 240	14 F-8 DPURX02	UXT 9
+46 Super Plus	Z 67	14 KR-7 DUX	UXT 4
+47 Super Plus	Z 155	14 FR-7 KU	UXT 10
+48 Super Plus	Z 237	14 FR-7 DQUP7	-
+49 Super Plus	UXT 15	-	-
+50 Super Plus	Z 188	14 F-7 DPUR02	UXT 10
+51 Super Plus	Z 225	14 FR-7 HUX	-
+52 Super Plus	Z 176	14 F-7 HPURX2	-
+54 Super Plus	Z 313	14 FR-6 DPURX2	-
0 241 219 543	Z 85	14 X-AU	-
0 241 219 891	Z 85	14 X-AU	-
0 241 225 012	Z 3	14-8 LUR	UXT 2/UXT 6
0 241 225 013	Z 76	14-9 DU	UXT 2/UXT 6
0 241 225 544	Z 85	14 X-AU	-
0 241 225 545	Z 76	14-9 DU	UXT 2/UXT 6
0 241 225 548	Z 262	14 S-9 E0	-
0 241 225 549	Z 85	14 X-AU	-
0 241 225 550	Z 76	14-9 DU	UXT 2/UXT 6
0 241 225 551	Z 262	14 S-9 E0	-
0 241 225 556	Z 76	14-9 DU	UXT 2/UXT 6
0 241 225 558	Z 81	14 K-9 DU0	UXT 4
0 241 225 573	Z 80	14 K-9 DU	UXT 4
0 241 225 573	Z 81	14 K-9 DU0	UXT 4
0 241 225 574	Z 79	14 F-9 DU0	UXT 1/UXT 3
0 241 225 576	Z 78	14-9 DTU	UXT 2/UXT 6
0 241 225 588	Z 80	14 K-9 DU	UXT 4
0 241 225 589	Z 266	14 S-7 E	-
0 241 225 825	Z 266	14 S-7 E	-
0 241 225 896	Z 262	14 S-9 E0	-
0 241 229 059	Z 3	14-8 LUR	UXT 2/UXT 6
0 241 229 060	Z 2	14-8 DTU	UXT 2/UXT 6
0 241 229 061	Z 69	14-8 DU0	UXT 2/UXT 6
0 241 229 062	Z 69	14-8 DU0	UXT 2/UXT 6
0 241 229 560	Z 266	14 S-7 E	-
0 241 229 561	Z 132	14 S-7 F	-
0 241 229 565	Z 68	14-8 AU	-
0 241 229 574	Z 1	14-8 DU	UXT 2/UXT 6
0 241 229 578	Z 118	14-8 BU	-
0 241 229 579	Z 58	14-7 CU	-



BOSCH	BERU		
0 241 229 580	Z 112	14-8 E	–
0 241 229 588	Z 1	14-8 DU	UXT 2/UXT 6
0 241 229 596	Z 1	14-8 DU	UXT 2/UXT 6
0 241 229 600	Z 58	14-7 CU	–
0 241 229 604	Z 68	14-8 AU	–
0 241 229 612	Z 68	14-8 AU	–
0 241 229 617	Z 6	14 K-8 DU	UXT 4
0 241 229 617	Z 7	14 K-8 DU0	UXT 4
0 241 229 619	Z 2	14-8 DTU	UXT 2/UXT 6
0 241 229 633	Z 2	14-8 DTU	UXT 2/UXT 6
0 241 229 634	Z 71	14 F-8 DU	UXT 1/UXT 3
0 241 229 638	Z 2	14-8 DTU	UXT 2/UXT 6
0 241 229 639	Z 4	14 F-8 LUR	UXT 1/UXT 3
0 241 229 641	Z 118	14-8 BU	–
0 241 229 649	Z 7	14 K-8 DU0	UXT 4
0 241 229 650	Z 5	14 F-8 DU0	UXT 1/UXT 3
0 241 229 656	Z 14	14 F-7 LDUR4	UXT 1/UXT 3
0 241 229 657	Z 4	14 F-8 LUR	UXT 1/UXT 3
0 241 229 658	Z 94	14 GR-8 DTU	UXT 2/UXT 6
0 241 229 663	Z 93	14 GH-8 DTURX	UXT 2/UXT 6
0 241 229 665	Z 92	14 GH-8 DTUR	UXT 2/UXT 6
0 241 229 676	Z 121	14 FGH-8 DTURX0	UXT 9
0 241 229 685	Z 100	14 F-8 DU4	UXT 1/UXT 3
0 241 229 689	Z 122	14 FGH-8 DPURX2	UXT 9
0 241 229 704	Z 122	14 FGH-8 DPURX2	UXT 9
0 241 229 715	Z 1	14-8 DU	UXT 2/UXT 6
0 241 229 715	Z 69	14-8 DU0	UXT 2/UXT 6
0 241 229 716	Z 2	14-8 DTU	UXT 2/UXT 6
0 241 229 855	Z 118	14-8 BU	–
0 241 229 857	Z 68	14-8 AU	–
0 241 229 887	Z 68	14-8 AU	–
0 241 229 918	Z 68	14-8 AU	–
0 241 229 919	Z 118	14-8 BU	–
0 241 229 923	Z 68	14-8 AU	–
0 241 229 961	Z 100	14 F-8 DU4	UXT 1/UXT 3
0 241 235 001	Z 57	14-7 AU	–
0 241 235 089	Z 58	14-7 CU	–
0 241 235 098	Z 58	14-7 CU	–
0 241 235 102	Z 61	14-7 DU0	UXT 2/UXT 6
0 241 235 102	Z 62	14-7 DU0	UXT 2/UXT 6
0 241 235 103	Z 61	14-7 DU0	UXT 2/UXT 6
0 241 235 103	Z 62	14-7 DU0	UXT 2/UXT 6
0 241 235 515	Z 57	14-7 AU	–
0 241 235 536	Z 10	14-7 BU	–
0 241 235 563	Z 11	14-7 DU	UXT 2/UXT 6
0 241 235 564	Z 10	14-7 BU	–
0 241 235 567	Z 132	14 S-7 F	–
0 241 235 574	Z 58	14-7 CU	–
0 241 235 585	Z 10	14-7 BU	–
0 241 235 594	Z 267	14 S-7 EU0	–
0 241 235 601	Z 57	14-7 AU	–
0 241 235 602	Z 11	14-7 DU	UXT 2/UXT 6
0 241 235 607	Z 57	14-7 AU	–
0 241 235 609	Z 58	14-7 CU	–
0 241 235 610	Z 11	14-7 DU	UXT 2/UXT 6
0 241 235 633	Z 12	14-7 DTU	UXT 2/UXT 6
0 241 235 635	Z 17	14 K-7 DU	UXT 4
0 241 235 636	Z 17	14 K-7 DU	UXT 4
0 241 235 643	Z 12	14-7 DTU	UXT 2/UXT 6
0 241 235 650	Z 63	14 F-7 DU	UXT 1/UXT 3
0 241 235 664	Z 64	14 F-7 DU0	UXT 1/UXT 3
0 241 235 666	Z 11	14-7 DU	UXT 2/UXT 6
0 241 235 668	Z 17	14 K-7 DU	UXT 4
0 241 235 669	Z 64	14 F-7 DU0	UXT 1/UXT 3
0 241 235 673	Z 63	14 F-7 DU	UXT 1/UXT 3
0 241 235 675	Z 18	14 K-7 DU0	UXT 4

BOSCH	BERU		
0 241 235 676	Z 64	14 F-7 DU0	UXT 1/UXT 3
0 241 235 681	Z 18	14 K-7 DU0	UXT 4
0 241 235 682	Z 13	14 F-7 DUOR	UXT 1/UXT 3
0 241 235 685	Z 63	14 F-7 DU	UXT 1/UXT 3
0 241 235 686	Z 14	14 F-7 LDUR4	UXT 1/UXT 3
0 241 235 690	Z 14	14 F-7 LDUR4	UXT 1/UXT 3
0 241 235 693	Z 62	14-7 DU0	UXT 2/UXT 6
0 241 235 697	Z 90	14 FGH-7 DTURX	UXT 1/UXT 3
0 241 235 698	Z 91	14 GH-7 DTUR	UXT 2/UXT 6
0 241 235 705	Z 61	14-7 DU0	UXT 2/UXT 6
0 241 235 706	Z 120	14 FGH-7 DTURX0	UXT 9
0 241 235 715	Z 176	14 F-7 HPURX2	–
0 241 235 718	Z 176	14 F-7 HPURX2	–
0 241 235 720	Z 188	14 F-7 DPUR02	UXT 10
0 241 235 735	Z 200	14 F-7 HUR2	–
0 241 235 750	Z 64	14 F-7 DU0	UXT 1/UXT 3
0 241 235 752	Z 90	14 FGH-7 DTURX	UXT 1/UXT 3
0 241 235 753	Z 17	14 K-7 DU	UXT 4
0 241 235 754	Z 10	14-7 BU	–
0 241 235 755	Z 11	14-7 DU	UXT 2/UXT 6
0 241 235 755	Z 61	14-7 DU0	UXT 2/UXT 6
0 241 235 756	Z 12	14-7 DTU	UXT 2/UXT 6
0 241 235 757	Z 91	14 GH-7 DTUR	UXT 2/UXT 6
0 241 235 804	Z 10	14-7 BU	–
0 241 235 911	Z 11 SB	14-7 DU SB	UXT 2/UXT 6
0 241 240 057	Z 22	14-6 DU	UX 56
0 241 240 058	Z 22	14-6 DU	UX 56
0 241 240 524	Z 25	14 K-6 DU	UXK 56
0 241 240 532	Z 48	14-6 BU	–
0 241 240 539	Z 22	14-6 DU	UX 56
0 241 240 542	Z 24	14 FR-6 DU	UXT 5
0 241 240 547	Z 25	14 K-6 DU	UXK 56
0 241 240 558	Z 51	14-6 DTU	UX 56
0 241 240 563	Z 25	14 K-6 DU	UXK 56
0 241 240 564	Z 52	14 F-6 DTU	UXT 5
0 241 240 578	Z 56	14 K-6 DU0	UXK 56
0 241 240 580	Z 24	14 FR-6 DU	UXT 5
0 241 240 581	Z 56	14 K-6 DU0	UXK 56
0 241 240 585	Z 105	14 F-6 DSR	UXT 5
0 241 240 587	Z 24	14 FR-6 DU	UXT 5
0 241 240 590	Z 53	14 F-6 DTU	UXT 5
0 241 240 592	Z 89	14 FGH-6 DTUR	UXT 5
0 241 240 609	Z 53	14 F-6 DTU	UXT 5
0 241 242 502	UXK 56	–	–
0 241 242 802	UXK 56	–	–
0 241 243 501	Z 104	14-6 DPO	–
0 241 245 070	Z 44	14-5 DTU	UX 56
0 241 245 071	Z 42	14-5 DU	UX 56
0 241 245 552	Z 42	14-5 DU	UX 56
0 241 245 553	Z 41	14-5 BU	–
0 241 245 555	Z 265	14 S-5 F	–
0 241 245 580	Z 40	14-5 AU	–
0 241 245 593	Z 29	14 F-5 DU	UXT 5
0 241 245 599	Z 42	14-5 DU	UX 56
0 241 245 601	Z 31	14 K-5 DU	UXK 56
0 241 245 602	Z 40	14-5 AU	–
0 241 245 615	Z 29	14 F-5 DU	UXT 5
0 241 245 619	Z 41	14-5 BU	–
0 241 245 636	Z 46	14 K-5 DU0	UXK 56
0 241 245 642	Z 29	14 F-5 DU	UXT 5
0 241 246 001	Z 42	14-5 DU	UX 56
0 241 248 531	Z 39	14 Z-4 AU	–
0 241 248 532	Z 38	14 Z-3 CU	–
0 241 248 534	Z 38	14 Z-3 CU	–
0 241 248 538	Z 38	14 Z-3 CU	–
0 241 248 540	Z 39	14 Z-4 AU	–

BOSCH	BERU		
0 241 256 512	Z 37	14 Z-3 AU	–
0 241 256 513	Z 38	14 Z-3 CU	–
0 241 256 519	Z 37	14 Z-3 AU	–
0 241 256 522	Z 38	14 Z-3 CU	–
0 241 319 512	Z 88	18-10 AU	–
0 241 319 513	Z 88	18-10 AU	–
0 241 329 520	Z 32	18 K-7 BU	–
0 241 335 516	Z 32	18 K-7 BU	–
0 241 340 501	Z 33	18 K-6 BU	–
0 241 368 003	Z 108	G 3/18	–
0 242 040 502	Z 210	10 FR-6 CPU03	–
0 242 050 501	Z 199	10 FR-4 AU	–
0 242 129 500	Z 242	12 ZR-8 TP	–
0 242 129 508	Z 243	12 VR-8 SE	–
0 242 129 508	Z 243 SB	12 VR-8 SE SB	–
0 242 129 510	Z 243	12 VR-8 SE	–
0 242 129 801	Z 243	12 VR-8 SE	–
0 242 135 501	Z 234	12 FR-7 DU	–
0 242 135 515	Z 234	12 FR-7 DU	–
0 242 135 802	Z 234	12 FR-7 DU	–
0 242 215 801	Z 261	14 SR-10 E0	–
0 242 222 503	UXT 1/UXT 3	–	–
0 242 222 505	UXT 1/UXT 3	–	–
0 242 225 522	Z 269	14 SR-9 E0	–
0 242 225 524	Z 82	14 R-9 DU	UXT 2/UXT 6
0 242 225 534	Z 117	14 KR-9 DUX	UXT 4
0 242 225 536	Z 269	14 SR-9 E0	–
0 242 225 548	Z 82	14 R-9 DU	UXT 2/UXT 6
0 242 225 550	Z 82	14 R-9 DU	UXT 2/UXT 6
0 242 225 599	Z 82	14 R-9 DU	UXT 2/UXT 6
0 242 225 612	Z 269	14 SR-9 E0	–
0 242 225 624	Z 82	14 R-9 DU	UXT 2/UXT 6
0 242 225 824	Z 262	14 S-9 E0	–
0 242 225 859	Z 82	14 R-9 DU	UXT 2/UXT 6
0 242 225 898	Z 269	14 SR-9 E0	–
0 242 229 518	Z 8	14 R-8 DU	UXT 2/UXT 6
0 242 229 530	Z 73	14 FR-8 DUX	UXT 1/UXT 3
0 242 229 531	Z 8	14 R-8 DU	UXT 2/UXT 6
0 242 229 555	Z 311	14 R-8 DPUU	UXT 2/UXT 6
0 242 229 566	Z 9	14 R-8 DUX	UXT 2/UXT 6
0 242 229 568	Z 72	14 FR-8 DU	UXT 1/UXT 3
0 242 229 570	Z 8	14 R-8 DU	UXT 2/UXT 6
0 242 229 579	Z 229	14 FR-8 LPU0	–
0 242 229 586	Z 19	14 R-7 BU	–
0 242 229 587	Z 72	14 FR-8 DU	UXT 1/UXT 3
0 242 229 590	Z 248	14 FR-8 HUT	–
0 242 229 591	Z 74	14 FR-8 LDUOX4	UXT 1/UXT 3
0 242 229 594	Z 72	14 FR-8 DU	UXT 1/UXT 3
0 242 229 605	Z 74	14 FR-8 LDUOX4	UXT 1/UXT 3
0 242 229 606	Z 74	14 FR-8 LDUOX4	UXT 1/UXT 3
0 242 229 607	Z 119	14 R-8 DU4	UXT 2/UXT 6
0 242 229 611	Z 8	14 R-8 DU	UXT 2/UXT 6
0 242 229 613	Z 173	14 FGR-8 KQU	–
0 242 229 615	Z 74	14 FR-8 LDUOX4	UXT 1/UXT 3
0 242 229 626	Z 74	14 FR-8 LDUOX4	UXT 1/UXT 3
0 242 229 630	Z 183	14 FR-8 MU2	UXT 13
0 242 229 634	Z 211	14 FGR-8 MQPU	–
0 242 229 635	Z 249	14 FR-8 KUOU	–
0 242 229 648	Z 173	14 FGR-8 KQU	–
0 242 229 650	Z 177	14 KR-8 MUV	UXT 7
0 242 229 652	UXT 15	–	–
0 242 229 652	Z 148	14 KR-8 DPU0V	UXT 15
0 242 229 654	Z 74	14 FR-8 LDUOX4	UXT 1/UXT 3
0 242 229 655	UXT 4	–	–
0 242 229 656	Z 8	14 R-8 DU	UXT 2/UXT 6
0 242 229 658	Z 92	14 GH-8 DTUR	UXT 2/UXT 6

BOSCH	BERU		
0 242 229 659	Z 255	14 FR-8 DUW	UXT 1/UXT 3
0 242 229 659	Z 72	14 FR-8 DU	UXT 1/UXT 3
0 242 229 660	Z 73	14 FR-8 DUX	UXT 1/UXT 3
0 242 229 661	Z 222	14 KR-8 STUX	–
0 242 229 666	UXT 9	–	–
0 242 229 671	Z 208	14 FR-8 LDU3	–
0 242 229 673	Z 72	14 FR-8 DU	UXT 1/UXT 3
0 242 229 687	Z 9	14 R-8 DUX	UXT 2/UXT 6
0 242 229 698	Z 203	14 FR-8 LU2	–
0 242 229 699	Z 203	14 FR-8 LU2	–
0 242 229 706	Z 121	14 FGH-8 DTURX0	UXT 9
0 242 229 712	Z 4	14 F-8 LUR	UXT 1/UXT 3
0 242 229 713	Z 240	14 F-8 DPURX02	UXT 9
0 242 229 715	Z 287	14 FR-8 LU2T	–
0 242 229 724	Z 227	14 F-8 DUR	UXT 9
0 242 229 775	Z 67	14 KR-7 DUX	UXT 4
0 242 229 782	Z 208	14 FR-8 LDU3	–
0 242 229 785	Z 177	14 KR-8 MUV	UXT 7
0 242 229 797	UXT 13	–	–
0 242 229 798	Z 153	14 FR-8 KU	UXT 10
0 242 229 799	Z 121	14 FGH-8 DTURX0	UXT 9
0 242 229 864	Z 119	14 R-8 DU4	UXT 2/UXT 6
0 242 229 865	Z 74	14 FR-8 LDUOX4	UXT 1/UXT 3
0 242 229 877	Z 177	14 KR-8 MUV	UXT 7
0 242 229 878	Z 74	14 FR-8 LDUOX4	UXT 1/UXT 3
0 242 229 879	UXT 4	–	–
0 242 229 880	Z 8	14 R-8 DU	UXT 2/UXT 6
0 242 229 882	Z 92	14 GH-8 DTUR	UXT 2/UXT 6
0 242 229 883	Z 72	14 FR-8 DU	UXT 1/UXT 3
0 242 229 884	Z 73	14 FR-8 DUX	UXT 1/UXT 3
0 242 229 885	Z 9	14 R-8 DUX	UXT 2/UXT 6
0 242 229 902	Z 177	14 KR-8 MUV	UXT 7
0 242 229 924	Z 121	14 FGH-8 DTURX0	UXT 9
0 242 229 925	Z 240	14 F-8 DPURX02	UXT 9
0 242 230 500	Z 240	14 F-8 DPURX02	UXT 9
0 242 232 501	UXT 1/UXT 3	–	–
0 242 232 502	UXT 1/UXT 3	–	–
0 242 232 504	UXT 2/UXT 6	–	–
0 242 232 505	UXT 2/UXT 6	–	–
0 242 232 507	UXT 4	–	–
0 242 235 511	Z 20	14 R-7 DU	UXT 2/UXT 6
0 242 235 522	Z 19	14 R-7 BU	–
0 242 235 529	Z 20	14 R-7 DU	UXT 2/UXT 6
0 242 235 530	Z 21	14 R-7 DUX	UXT 2/UXT 6
0 242 235 532	Z 59	14 R-7 CU	–
0 242 235 537	Z 20	14 R-7 DU	UXT 2/UXT 6
0 242 235 538	Z 95	14 KR-7 DU	UXT 4
0 242 235 542	Z 95	14 KR-7 DU	UXT 4
0 242 235 544	Z 16	14 FR-7 DUX	UXT 1/UXT 3
0 242 235 549	Z 15	14 FR-7 DU	UXT 1/UXT 3
0 242 235 551	Z 250	14 FR-7 DU2S	UXT 1/UXT 3
0 242 235 567	Z 158	14 FR-7 LUX	–
0 242 235 587	Z 193	14 FR-7 DU2	UXT 1/UXT 3
0 242 235 589	Z 98	14 FR-7 LDU	UXT 1/UXT 3
0 242 235 592	Z 67	14 KR-7 DUX	UXT 4
0 242 235 597	Z 15	14 FR-7 DU	UXT 1/UXT 3
0 242 235 599	Z 155	14 FR-7 KU	UXT 10
0 242 235 599	Z 156	14 FR-7 KUO	UXT 10
0 242 235 602	Z 157	14 FR-7 KUOX	UXT 11
0 242 235 607	Z 127	14 KGR-7 KQU	–
0 242 235 609	Z 123	14 FR-7 KDU	UXT 9
0 242 235 610	Z 150	14 FR-7 KPUV	–
0 242 235 615	Z 60	14 FGR-7 CTU	–
0 242 235 617	Z 237	14 FR-7 DQUP7	–
0 242 235 624	Z 193	14 FR-7 DU2	UXT 1/UXT 3
0 242 235 636	Z 184	14 FR-7 MU2	UXT 13

BOSCH	BERU		
0 242 235 640	Z 15	14 FR-7 DU	UXT 1/UXT 3
0 242 235 642	Z 145	14 FGR-6 DDU	–
0 242 235 643	Z 97	14 KR-8 MPX	UXT 8
0 242 235 644	Z 15	14 FR-7 DU	UXT 1/UXT 3
0 242 235 651	Z 260	14 SR-5 F	–
0 242 235 656	Z 172	14 FGR-7 KQU	–
0 242 235 658	Z 97	14 KR-8 MPX	UXT 8
0 242 235 660	Z 309	14 KR-8 LQU07	–
0 242 235 661	UXT 4	–	–
0 242 235 661	Z 95	14 KR-7 DU	UXT 4
0 242 235 663	Z 20	14 R-7 DU	UXT 2/UXT 6
0 242 235 664	Z 91	14 GH-7 DTUR	UXT 2/UXT 6
0 242 235 665	Z 19	14 R-7 BU	–
0 242 235 666	Z 15	14 FR-7 DU	UXT 1/UXT 3
0 242 235 666	Z 247	14 FR-7 DUW	UXT 1/UXT 3
0 242 235 667	Z 16	14 FR-7 DUX	UXT 1/UXT 3
0 242 235 668	Z 257	14 FR-7 LDUW	UXT 1/UXT 3
0 242 235 668	Z 98	14 FR-7 LDU	UXT 1/UXT 3
0 242 235 690	Z 228	14 FR-7 DPX02	UXT 11
0 242 235 692	Z 225	14 FR-7 HUX	–
0 242 235 699	Z 206	14 FR-7 DPPUS2	UXT 10
0 242 235 707	Z 21	14 R-7 DUX	UXT 2/UXT 6
0 242 235 733	Z 209	14 KR-6 DPUV02	UXT 15
0 242 235 740	Z 206	14 FR-7 DPPUS2	UXT 10
0 242 235 743	Z 326	14 FR-7 MPUS	UXT 13
0 242 235 746	Z 97	14 KR-8 MPX	UXT 8
0 242 235 748	UXT 1	–	–
0 242 235 749	Z 206	14 FR-7 DPPUS2	UXT 10
0 242 235 756	Z 235	14 FR-7 SPUX03	–
0 242 235 758	Z 235	14 FR-7 SPUX03	UXT 13
0 242 235 761	Z 200	14 F-7 HUR2	–
0 242 235 764	Z 176	14 F-7 HPURX2	–
0 242 235 776	Z 301	14 FR-7 LPUX02	–
0 242 235 791	Z 184	14 FR-7 MU2	UXT 13
0 242 235 797	Z 193	14 FR-7 DU2	UXT 1/UXT 3
0 242 235 894	Z 247	14 FR-7 DUW	UXT 1/UXT 3
0 242 235 908	Z 95	14 KR-7 DU	UXT 4
0 242 235 909	Z 20	14 R-7 DU	UXT 2/UXT 6
0 242 235 910	Z 91	14 GH-7 DTUR	UXT 2/UXT 6
0 242 235 911	Z 19	14 R-7 BU	–
0 242 235 912	Z 15	14 FR-7 DU	UXT 1/UXT 3
0 242 235 913	Z 16	14 FR-7 DUX	UXT 1/UXT 3
0 242 235 914	Z 98	14 FR-7 LDU	UXT 1/UXT 3
0 242 235 915	Z 21	14 R-7 DUX	UXT 2/UXT 6
0 242 235 916	Z 97	14 KR-8 MPX	UXT 8
0 242 235 917	UXT 1	–	–
0 242 235 918	Z 206	14 FR-7 DPPUS2	UXT 10
0 242 235 957	UXT 11	–	–
0 242 235 979	Z 67	14 KR-7 DUX	UXT 4
0 242 235 980	Z 155	14 FR-7 KU	UXT 10
0 242 235 981	Z 237	14 FR-7 DQUP7	–
0 242 235 982	Z 188	14 F-7 DPUR02	UXT 10
0 242 235 983	Z 225	14 FR-7 HUX	–
0 242 235 985	Z 157	14 FR-7 KUOX	UXT 11
0 242 235 986	Z 158	14 FR-7 LUX	–
0 242 236 510	Z 235	14 FR-7 SPUX03	–
0 242 236 511	Z 282	14 FGH-7 DPURX2	UXT 9
0 242 236 539	Z 176	14 F-7 HPURX2	–
0 242 236 541	Z 157	14 FR-7 KUOX	UXT 11
0 242 236 542	Z 158	14 FR-7 LUX	–
0 242 236 544	Z 171	14 F-7 DPURX2	UXT 9
0 242 236 560	Z 67	14 KR-7 DUX	UXT 4
0 242 236 561	UXT 10	–	–
0 242 236 561	Z 155	14 FR-7 KU	UXT 10
0 242 236 562	Z 237	14 FR-7 DQUP7	–
0 242 236 563	UXT 15	–	–

BOSCH	BERU		
0 242 236 564	Z 188	14 F-7 DPUR02	UXT 10
0 242 236 565	Z 225	14 FR-7 HUX	–
0 242 236 566	Z 176	14 F-7 HPURX2	–
0 242 236 583	Z 321	14 F-7 KPUR02	UXT 10
0 242 240 511	Z 27	14 R-6 DU	UX 56
0 242 240 514	Z 26	14 KR-6 DU	UXK 56
0 242 240 520	Z 49	14 KR-6 BU	–
0 242 240 522	Z 300	14 FGR-6 HQU	–
0 242 240 523	Z 26	14 KR-6 DU	UXK 56
0 242 240 526	Z 24	14 FR-6 DU	UXT 5
0 242 240 530	Z 151	14 FR-7 KPU	UXT 9
0 242 240 531	Z 28	14 R-6 DUX	UX 56
0 242 240 539	Z 99	14 FR-6 DUX	UXT 5
0 242 240 548	Z 151	14 FR-7 KPU	UXT 9
0 242 240 557	Z 116	14 FR-6 LDU	UXT 5
0 242 240 566	Z 245	14 FR-6 LDUW	UXT 5
0 242 240 569	Z 144	14 KGR-6 KQU	–
0 242 240 577	Z 252	14 FR-6 DUW	UXT 5
0 242 240 584	Z 194	14 FR-6 LDU3	UXT 5
0 242 240 587	Z 129	14 FGR-6 KQU	–
0 242 240 590	Z 300	14 FGR-6 HQU	–
0 242 240 591	Z 26	14 KR-6 DU	UXK 56
0 242 240 592	Z 27	14 R-6 DU	UX 56
0 242 240 593	UXT 5	–	–
0 242 240 593	Z 24	14 FR-6 DU	UXT 5
0 242 240 606	Z 151	14 FR-7 KPU	UXT 9
0 242 240 615	Z 284	14 FR-6 DPOX	–
0 242 240 619	Z 226	14 FR-6 MPU2	–
0 242 240 620	Z 230	14 KR-6 KPUV02	–
0 242 240 621	Z 221	14 FR-6 DPX02	UXT 14
0 242 240 625	Z 221	14 FR-6 DPX02	UXT 14
0 242 240 635	Z 294	14 FGR-5 NTE	–
0 242 240 649	Z 313	14 FR-6 DPX02	–
0 242 240 848	Z 26	14 KR-6 DU	UXK 56
0 242 240 849	Z 27	14 R-6 DU	UX 56
0 242 240 850	Z 24	14 FR-6 DU	UXT 5
0 242 242 501	UXT 5	–	–
0 242 242 505	UX 56	–	–
0 242 242 801	UXT 5	–	–
0 242 245 018	Z 192	14 FR-5 LDU	–
0 242 245 515	Z 30	14 FR-5 DU	UXT 5
0 242 245 516	Z 47	14 R-5 DU	UX 56
0 242 245 533	Z 260	14 SR-5 F	–
0 242 245 536	Z 30	14 FR-5 DU	UXT 5
0 242 245 537	Z 47	14 R-5 DU	UX 56
0 242 245 539	Z 45	14 FR-5 DTU	UXT 5
0 242 245 546	Z 130	14 FR-5 DPX	–
0 242 245 548	Z 130	14 FR-5 DPX	–
0 242 245 552	Z 47	14 R-5 DU	UX 56
0 242 245 576	Z 347	14 F-5 DPUR02	–
0 242 245 812	Z 47	14 R-5 DU	UX 56
0 242 250 506	Z 39	14 Z-4 AU	–
0 242 329 503	Z 32	18 K-7 BU	–
0 242 329 504	Z 32	18 K-7 BU	–
0 242 340 501	Z 33	18 K-6 BU	–
0 242 540 576	Z 260	14 SR-5 F	–
0 250 001 001	GD 214	–	–
0 250 001 005	GD 214	–	–
0 250 001 007	GD 341	–	–
0 250 001 008	GD 348	–	–
0 250 001 010	GD 214	–	–
0 250 001 012	GD 348	–	–
0 250 001 015	GD 382	–	–
0 250 001 016	GD 382	–	–
0 250 001 017	GD 382	–	–
0 250 001 416	GD 382	–	–

BOSCH	BERU		
0 250 001 782	GN 054	-	-
0 250 002 001	GD 294	-	-
0 250 002 004	GD 255	-	-
0 250 002 008	GD 318	-	-
0 250 002 009	GD 220	-	-
0 250 002 010	GD 255	-	-
0 250 004 003	GH 010	-	-
0 250 101 001	GV 199	-	-
0 250 101 002	GV 176	-	-
0 250 102 002	GH 760	-	-
0 250 102 003	GH 760	-	-
0 250 200 002	GV 123	-	-
0 250 200 004	GV 117	-	-
0 250 200 006	GV 128	-	-
0 250 200 008	GV 107	-	-
0 250 200 009	GV 110	-	-
0 250 200 010	GV 175	-	-
0 250 200 011	GV 191	-	-
0 250 200 012	GV 119	-	-
0 250 200 013	GV 170	-	-
0 250 200 014	GV 107	-	-
0 250 200 015	GV 198	-	-
0 250 200 017	GV 119	-	-
0 250 200 018	GV 186	-	-
0 250 200 019	GV 123	-	-
0 250 200 020	GV 108	-	-
0 250 200 021	GV 197	-	-
0 250 200 022	GV 390	-	-
0 250 200 023	GV 196	-	-
0 250 200 025	GV 119	-	-
0 250 200 028	GV 136	-	-
0 250 200 029	GV 110	-	-
0 250 200 030	GV 129	-	-
0 250 200 032	GV 137	-	-
0 250 200 034	GV 142	-	-
0 250 200 035	GV 112	-	-
0 250 200 037	GV 155	-	-
0 250 200 041	GV 165	-	-
0 250 200 046	GV 106	-	-
0 250 200 048	GV 130	-	-
0 250 200 051	GV 137	-	-
0 250 200 053	GV 657	-	-
0 250 200 054	GV 602	-	-
0 250 200 055	GV 107	-	-
0 250 200 056	GV 602	-	-
0 250 200 057	GV 636	-	-
0 250 200 058	GV 631	-	-
0 250 200 059	GV 602	-	-
0 250 200 059	GV 642	-	-
0 250 200 060	GV 602	-	-
0 250 200 061	GV 636	-	-
0 250 200 063	GN 857	-	-
0 250 200 064	GV 153	-	-
0 250 200 065	GV 602	-	-
0 250 200 066	GV 631	-	-
0 250 200 068	GV 602	-	-
0 250 200 069	GV 642	-	-
0 250 200 422	GV 390	-	-
0 250 200 451	GV 137	-	-
0 250 200 454	GV 602	-	-
0 250 200 456	GV 602	-	-
0 250 200 465	GV 602	-	-
0 250 200 468	GV 602	-	-
0 250 200 469	GV 642	-	-
0 250 201 001	GV 603	-	-
0 250 201 004	GN 857	-	-

BOSCH	BERU		
0 250 201 005	GV 636	-	-
0 250 201 006	GV 642	-	-
0 250 201 008	GV 636	-	-
0 250 201 009	GV 636	-	-
0 250 201 010	GV 626	-	-
0 250 201 011	GN 857	-	-
0 250 201 012	GV 657	-	-
0 250 201 017	GV 631	-	-
0 250 201 019	GV 636	-	-
0 250 201 026	GN 858	-	-
0 250 201 027	GV 719	-	-
0 250 201 029	GV 852	-	-
0 250 201 030	GV 636	-	-
0 250 201 031	GV 844	-	-
0 250 201 032	GN 857	-	-
0 250 201 033	GN 908	-	-
0 250 201 034	GV 657	-	-
0 250 201 035	GN 860	-	-
0 250 201 036	GN 928	-	-
0 250 201 037	GN 909	-	-
0 250 201 038	GN 948	-	-
0 250 201 039	GN 954	-	-
0 250 201 040	GN 857	-	-
0 250 201 041	GN 858	-	-
0 250 201 042	GN 013	-	-
0 250 201 043	GN 954	-	-
0 250 201 044	GV 626	-	-
0 250 201 045	GN 909	-	-
0 250 201 046	GN 857	-	-
0 250 201 047	GN 858	-	-
0 250 201 048	GN 948	-	-
0 250 201 049	GN 022	-	-
0 250 201 050	GN 959	-	-
0 250 201 053	GN 030	-	-
0 250 201 405	GV 663	-	-
0 250 201 901	SR 002	-	-
0 250 201 902	SR 028	-	-
0 250 201 927	GV 636	-	-
0 250 201 929	GV 642	-	-
0 250 201 930	GN 857	-	-
0 250 201 932	GV 603	-	-
0 250 201 933	SR 028	-	-
0 250 201 934	GV 631	-	-
0 250 201 935	GV 852	-	-
0 250 201 936	GN 908	-	-
0 250 201 937	GN 909	-	-
0 250 201 937	GV 719	-	-
0 250 201 938	GV 844	-	-
0 250 201 940	GN 858	-	-
0 250 201 953	SR 039	-	-
0 250 201 954	SR 040	-	-
0 250 202 001	GN 927	-	-
0 250 202 002	GN 012	-	-
0 250 202 003	GV 673	-	-
0 250 202 004	GV 678	-	-
0 250 202 005	GV 685	-	-
0 250 202 006	GV 688	-	-
0 250 202 007	GV 705	-	-
0 250 202 008	GV 749	-	-
0 250 202 009	GN 855	-	-
0 250 202 010	GV 689	-	-
0 250 202 013	GV 888	-	-
0 250 202 014	GV 889	-	-
0 250 202 017	GV 892	-	-
0 250 202 018	GV 666	-	-
0 250 202 020	GN 016	-	-

BOSCH	BERU		
0 250 202 021	GN 991	-	-
0 250 202 022	GN 855	-	-
0 250 202 023	GN 046	-	-
0 250 202 024	GN 991	-	-
0 250 202 025	GN 999	-	-
0 250 202 026	GN 961	-	-
0 250 202 027	GN 944	-	-
0 250 202 028	GN 017	-	-
0 250 202 029	GN 003	-	-
0 250 202 032	GN 027	-	-
0 250 202 033	GN 927	-	-
0 250 202 033	GV 661	-	-
0 250 202 034	GN 970	-	-
0 250 202 035	GN 963	-	-
0 250 202 036	GN 041	-	-
0 250 202 038	GN 055	-	-
0 250 202 039	GN 003	-	-
0 250 202 040	GV 783	-	-
0 250 202 041	GN 010	-	-
0 250 202 042	GN 992	-	-
0 250 202 043	GN 033	-	-
0 250 202 045	GN 003	-	-
0 250 202 046	GN 046	-	-
0 250 202 048	GN 054	-	-
0 250 202 051	GV 886	-	-
0 250 202 052	GV 967	-	-
0 250 202 053	GV 968	-	-
0 250 202 054	GV 894	-	-
0 250 202 058	GV 897	-	-
0 250 202 059	GV 685	-	-
0 250 202 060	GV 921	-	-
0 250 202 062	GV 888	-	-
0 250 202 064	GN 044	-	-
0 250 202 065	GN 061	-	-
0 250 202 069	GV 890	-	-
0 250 202 070	GV 896	-	-
0 250 202 071	GV 887	-	-
0 250 202 073	GV 001	-	-
0 250 202 076	GV 895	-	-
0 250 202 077	GV 920	-	-
0 250 202 079	GN 043	-	-
0 250 202 085	GV 946	-	-
0 250 202 086	GV 945	-	-
0 250 202 087	GV 947	-	-
0 250 202 088	GV 819	-	-
0 250 202 092	GN 107	-	-
0 250 202 093	GN 854	-	-
0 250 202 094	GV 921	-	-
0 250 202 095	GN 043	-	-
0 250 202 096	GV 968	-	-
0 250 202 102	GN 008	-	-
0 250 202 103	GN 024	-	-
0 250 202 105	GN 074	-	-
0 250 202 107	GV 880	-	-
0 250 202 120	GN 074	-	-
0 250 202 124	GN 070	-	-
0 250 202 125	GN 065	-	-
0 250 202 128	GN 026	-	-
0 250 202 129	GN 019	-	-
0 250 202 130	GN 939	-	-
0 250 202 131	GN 993	-	-
0 250 202 135	GN 054	-	-
0 250 202 137	GN 104	-	-
0 250 202 251	GV 835	-	-
0 250 202 254	GV 823	-	-
0 250 203 001	GN 059	-	-

BOSCH	BERU		
0 250 203 002	GN 053	-	-
0 250 203 003	GN 053	-	-
0 250 203 004	GN 045	-	-
0 250 203 010	GE 106	-	-
0 250 203 011	GE 109	-	-
0 250 204 001	GN 047	-	-
0 250 204 002	GN 056	-	-
0 250 251 471	GN 970	-	-
0 250 312 001	GN 101	-	-
0 250 312 002	GN 102	-	-
0 250 312 003	GN 103	-	-
0 250 312 007	GN 107	-	-
0 250 402 001	GE 100	-	-
0 250 402 002	GE 102	-	-
0 250 403 002	GE 101	-	-
0 250 403 006	GE 105	-	-
0 250 403 007	GE 115	-	-
0 250 503 003	GN 073	-	-
0 251 001 001	KOBS/1	-	-
0 251 002 002	KOBS	-	-
0 251 002 012	KOBS 1-0940	-	-
0 251 002 015	KOS 10/30	-	-
0 251 002 018	KOS 12/15	-	-
0 251 002 028	KOBS	-	-
0 251 002 032	KOBS 065/52	-	-
0 251 002 034	KOBS 065/52	-	-
0 251 002 038	KOBS 065/52	-	-
0 251 100 001	WT 35/38	-	-
0 251 100 011	WT 35/38	-	-
0 251 103 005	BW 09/40	-	-
0 251 103 007	BW 45/23/1	-	-
0 251 103 009	KOBS 1-0940	-	-
0 251 103 011	BW 45/12/1	-	-
0 251 103 013	BW 38/23/1	-	-
0 251 103 020	BW 09/40	-	-
0 257 002 038	KOBS 065/52	-	-
0 257 100 009	GF 154	-	-
0 257 100 010	GF 154	-	-
0 257 200 003	GF 111	-	-
0 257 201 001	GF 630	-	-
0 257 201 004	GF 111	-	-
0 257 201 006	GF 111	-	-
0 257 201 008	GF 111	-	-
0 257 201 401	GF 111	-	-
0 257 202 001	GF 167	-	-
0 257 202 002	GF 683	-	-
0 257 202 004	GF 683	-	-
0 257 203 001	GF 111	-	-
0 257 203 002	GF 111	-	-
0 257 204 001	GF 973	-	-
0 257 204 002	GF 683	-	-
0 257 204 003	GF 974	-	-
0 257 205 003	GF 007	-	-
0 257 210 001	GF 667	-	-
0 257 900 023	MV 116	-	-
0 281 003 005	GR 034	-	-
0 281 003 009	GR 054	-	-
0 281 003 096	GR 049	-	-
0 281 003 098	GR 033	-	-
0 281 003 099	GR 031	-	-
0 333 402 006	GR 066	-	-
0 333 402 501	GR 059	-	-
0 333 402 505	GR 069	-	-
0 333 402 506	GR 069	-	-
0 333 402 507	GR 071	-	-
0 333 402 508	GR 071	-	-

BOSCH	BERU		
0 333 402 509	GR 065	-	-
0 333 402 512	GR 001	-	-
0 333 402 513	GR 066	-	-
0 333 402 515	GR 070	-	-
0 333 402 516	GR 070	-	-
0 333 402 517	GR 065	-	-
0 333 402 524	GR 065	-	-
0 986 257 001	GH 410	-	-
0 986 257 002	GH 191	-	-
0 986 257 003	GH 16	-	-
0 986 257 004	GF 186	-	-
0 986 257 005	GH 21	-	-
0 986 257 006	GF 163	-	-
0 986 257 007	GH 847	-	-
0 986 257 008	GH 408	-	-
0 986 257 009	GH 201	-	-
0 986 257 010	GH 30	-	-
0 986 257 011	GH 22	-	-
0 986 257 012	GH 407	-	-
0 986 257 013	GH 359	-	-
0 986 257 014	GH 18	-	-
0 986 257 015	GH 846	-	-
D 6 BC	Z 33	18 K-6 BU	-
D 7 BC	Z 32	18 K-7 BU	-
D 8 BC	Z 32	18 K-7 BU	-
DR 6 BC	Z 33	18 K-6 BU	-
DR 7 BC	Z 32	18 K-7 BU	-
DR 8 BC	Z 32	18 K-7 BU	-
F 005 X04 828	GN 061	-	-
F 005 X04 868	GN 101	-	-
F 005 X04 869	GN 102	-	-
F 005 X12 968	GV 892	-	-
F 005 X12 977	GN 101	-	-
F 005 X12 978	GN 102	-	-
F 005 X12 981	GN 854	-	-
F 005 X12 995	GV 896	-	-
F 005 X13 002	GN 043	-	-
F 005 X13 006	GN 065	-	-
F 03 DAR	Z 14	14 F-7 LDUR4	UXT 1/UXT 3
F 04 DAR	Z 14	14 F-7 LDUR4	UXT 1/UXT 3
F 5 DC	Z 29	14 F-5 DU	UXT 5
F 5 KPP332	Z 347	14 F-5 DPUR02	-
F 5 KPP332SBN	Z 347	14 F-5 DPUR02	-
F 6 DCO	Z 24	14 FR-6 DU	UXT 5
F 6 DCOR	Z 24	14 FR-6 DU	UXT 5
F 6 DPP 332	Z 322	14 F-6 KPURW2	UXT 10
F 6 DSR	Z 105	14 F-6 DSR	UXT 5
F 6 DTC	Z 52	14 F-6 DTU	UXT 5
F 6 DTC	Z 53	14 F-6 DTU	UXT 5
F 6 LTRC	Z 89	14 FGH-6 DTUR	UXT 5
F 7 DC	Z 63	14 F-7 DU	UXT 1/UXT 3
F 7 DCO	Z 64	14 F-7 DU0	UXT 1/UXT 3
F 7 DCOR	Z 13	14 F-7 DUOR	UXT 1/UXT 3
F 7 DCX	Z 63	14 F-7 DU	UXT 1/UXT 3
F 7 DPER	Z 282	14 FGH-7 DPURX2	UXT 9
F 7 DPP 222T	Z 188	14 F-7 DPUR02	UXT 10
F 7 HER2	Z 200	14 F-7 HUR2	-
F 7 HPP22	Z 176	14 F-7 HPURX2	-
F 7 HPP222	Z 176	14 F-7 HPURX2	-
F 7 HPP222U	Z 176	14 F-7 HPURX2	-
F 7 KPP 332U	Z 321	14 F-7 KPPRU2	UXT 10
F 7 KTRC	Z 120	14 FGH-7 DTURX0	UXT 9
F 7 LDCR	Z 14	14 F-7 LDUR4	UXT 1/UXT 3
F 7 LTRC	Z 90	14 FGH-7 DTURX	UXT 1/UXT 3
F 8 DC	Z 71	14 F-8 DU	UXT 1/UXT 3
F 8 DC4	Z 100	14 F-8 DU4	UXT 1/UXT 3

BOSCH	BERU		
F 8 DCO	Z 5	14 F-8 DU0	UXT 1/UXT 3
F 8 DER	Z 227	14 F-8 DUR	UXT 1/UXT 3
F 8 DPER	Z 122	14 FGH-8 DPURX2	UXT 9
F 8 DPP 222U	Z 122	14 FGH-8 DPURX2	UXT 9
F 8 DPP 332	Z 122	14 FGH-8 DPURX2	UXT 9
F 8 DPP33	Z 122	14 FGH-8 DPURX2	UXT 9
F 8 KTRC	Z 121	14 FGH-8 DTURX0	UXT 9
F 8 LCR	Z 4	14 F-8 LUR	UXT 1/UXT 3
F 9 DCO	Z 79	14 F-9 DU0	UXT 1/UXT 3
FGR 6 HQE0	Z 300	14 FGR-6 HQU	-
FGR 6 KQC	Z 129	14 FGR-6 KQU	-
FGR 6 NQE0	Z 294	14 FGR-5 NTE	-
FGR 7 DQC	Z 60	14 FGR-7 CTU	-
FGR 7 DQE+	UXT 1	-	-
FGR 7 DQE0	Z 145	14 FGR-6 DDU	-
FGR 7 DQP	Z 237	14 FR-7 DQUP7	-
FGR 7 DQP+	Z 237	14 FR-7 DQUP7	-
FGR 7 KQE	Z 172	14 FGR-7 KQU	-
FGR 8 DE	UXT 9	-	-
FGR 8 KQC	Z 173	14 FGR-8 KQU	-
FGR 8 KQE	Z 173	14 FGR-8 KQU	-
FGR 8 KQE 0	Z 173	14 FGR-8 KQU	-
FGR 8 MQPE	Z 211	14 FGR-8 MQPU	-
FLR 8 LDCU+	Z 74	14 FR-8 LDUOX4	UXT 1/UXT 3
FQR 7 ME	Z 184	14 FR-7 MU2	UXT 13
FQR 8 DE	Z 227	14 F-8 DUR	UXT 1/UXT 3
FQR 8 LE2	Z 287	14 FR-8 LU2T	-
FQR 8 LEU2	Z 203	14 FR-8 LU2	-
FR 5 DC	Z 30	14 FR-5 DU	UXT 5
FR 5 DP1	Z 130	14 FR-5 DPUX	-
FR 5 DP1X	Z 130	14 FR-5 DPUX	-
FR 5 DTC	Z 45	14 FR-5 DTU	UXT 5
FR 5 LDC	Z 192	14 FR-5 LDU	-
FR 56	UXT 5	-	-
FR 6 DC	UXT 5	-	-
FR 6 DC	Z 24	14 FR-6 DU	UXT 5
FR 6 DC	Z 252	14 FR-6 DUW	UXT 5
FR 6 DC+	Z 24	14 FR-6 DU	UXT 5
FR 6 DP	Z 151	14 FR-7 KPU	UXT 9
FR 6 DP 1	Z 151	14 FR-7 KPU	UXT 9
FR 6 DPP22	Z 221	14 FR-6 DPUX02	UXT 14
FR 6 DPP22U	Z 221	14 FR-6 DPUX02	UXT 14
FR 6 DPP33X	Z 284	14 FR-6 DPOX	-
FR 6 KDE0	Z 194	14 FR-6 LDU3	UXT 5
FR 6 KPP 33x+	Z 313	14 FR-6 DPUX2	-
FR 6 LDC	Z 116	14 FR-6 LDU	UXT 5
FR 6 LDC	Z 245	14 FR-6 LDUW	UXT 5
FR 6 MPP332	Z 226	14 FR-6 MPU2	-
FR 7 DC	Z 15	14 FR-7 DU	UXT 1/UXT 3
FR 7 DC	Z 250	14 FR-7 DU2S	UXT 1/UXT 3
FR 7 DC 9	Z 15	14 FR-7 DU	UXT 1/UXT 3
FR 7 DC 9	Z 247	14 FR-7 DUW	UXT 1/UXT 3
FR 7 DC+	Z 15	14 FR-7 DU	UXT 1/UXT 3
FR 7 DC+	Z 247	14 FR-7 DUW	UXT 1/UXT 3
FR 7 DC2	Z 193	14 FR-7 DU2	UXT 1/UXT 3
FR 7 DCO	Z 15	14 FR-7 DU	UXT 1/UXT 3
FR 7 DCX	Z 16	14 FR-7 DUX	UXT 1/UXT 3
FR 7 DCX+	Z 16	14 FR-7 DUX	UXT 1/UXT 3
FR 7 DE	Z 15	14 FR-7 DU	UXT 1/UXT 3
FR 7 DE2	Z 193	14 FR-7 DU2	UXT 1/UXT 3
FR 7 DPP 332	Z 282	14 FGH-7 DPURX2	UXT 9
FR 7 DPP+	Z 206	14 FR-7 DPPUS2	UXT 10
FR 7 DPP10	Z 206	14 FR-7 DPPUS2	UXT 10
FR 7 DPP22U	Z 228	14 FR-7 DPUX02	UXT 11
FR 7 DPP33	Z 206	14 FR-7 DPPUS2	UXT 10
FR 7 HC+	Z 225	14 FR-7 HUX	-

BOSCH	BERU		
FR 7 HCOX	Z 225	14 FR-7 HUX	–
FR 7 HE2	Z 200	14 F-7 HUR2	–
FR 7 HPP222	Z 176	14 F-7 HPURX2	–
FR 7 HPP33+	Z 176	14 F-7 HPURX2	–
FR 7 KC	Z 155	14 FR-7 KU	UXT 10
FR 7 KC	Z 156	14 FR-7 KU0	UXT 10
FR 7 KC+	Z 155	14 FR-7 KU	UXT 10
FR 7 KCW	Z 150	14 FR-7 KPUV	–
FR 7 KCX	Z 157	14 FR-7 KUOX	UXT 11
FR 7 KCX+	UXT 11	–	–
FR 7 KCX+	Z 157	14 FR-7 KUOX	UXT 11
FR 7 KPP 332	Z 301	14 FR-7 LPUX02	–
FR 7 KPP 33U	Z 171	14 F-7 DPURX2	UXT 9
FR 7 KPP33+	Z 188	14 F-7 DPUR02	UXT 10
FR 7 LCX	Z 158	14 FR-7 LUX	–
FR 7 LCX+	Z 158	14 FR-7 LUX	–
FR 7 LDC	Z 98	14 FR-7 LDU	UXT 1/UXT 3
FR 7 LDC+	Z 257	14 FR-7 LDUW	UXT 1/UXT 3
FR 7 LDC+	Z 98	14 FR-7 LDU	UXT 1/UXT 3
FR 7 ME	Z 184	14 FR-7 MU2	UXT 13
FR 7 MPP 10	Z 326	14 FR-7 MPUS	UXT 13
FR 7 NPP33	Z 235	14 FR-7 SPUX03	–
FR 7 NPP332	Z 235	14 FR-7 SPUX03	–
FR 7 SE	Z 235	14 FR-7 SPUX03	UXT 13
FR 78	UXT 1/UXT 3	–	–
FR 78 X	UXT 1/UXT 3	–	–
FR 8 DC	Z 254	14 FR-8 DUS	UXT 1/UXT 3
FR 8 DC	Z 255	14 FR-8 DUW	UXT 1/UXT 3
FR 8 DC	Z 72	14 FR-8 DU	UXT 1/UXT 3
FR 8 DC+	Z 72	14 FR-8 DU	UXT 1/UXT 3
FR 8 DCX+	Z 73	14 FR-8 DUX	UXT 1/UXT 3
FR 8 DE	Z 254	14 FR-8 DUS	UXT 1/UXT 3
FR 8 DE	Z 255	14 FR-8 DUW	UXT 1/UXT 3
FR 8 DE	Z 72	14 FR-8 DU	UXT 1/UXT 3
FR 8 DPP 33+	Z 240	14 F-8 DPURX02	UXT 9
FR 8 DPP33	Z 240	14 F-8 DPURX02	UXT 9
FR 8 HC	Z 248	14 FR-8 HUT	–
FR 8 HDC	Z 208	14 FR-8 LDU3	–
FR 8 HDC+	Z 208	14 FR-8 LDU3	–
FR 8 KC+	Z 153	14 FR-8 KU	UXT 10
FR 8 KCO	Z 154	14 FR-8 KU0	UXT 9
FR 8 KCU	Z 249	14 FR-8 KUOU	–
FR 8 KTC	Z 121	14 FGH-8 DTURX0	UXT 9
FR 8 KTC+	Z 121	14 FGH-8 DTURX0	UXT 9
FR 8 LC	Z 4	14 F-8 LUR	UXT 1/UXT 3
FR 8 LPX	Z 229	14 FR-8 LPU0	–
FR 8 ME	Z 183	14 FR-8 MU2	UXT 13
FR 8 SE	UXT 13	–	–
FR 91	UXT 1/UXT 3	–	–
FR 91 X	UXT 1/UXT 3	–	–
GLP 137	GN 070	–	–
GLP 194	GE 115	–	–
GPM 902	GN 067	–	–
GS 2 A S 5	GD 255	–	–
GS 2 A S 6	GD 255	–	–
GS 2 A S 7	GD 255	–	–
GS 2 A S 8	GD 318	–	–
GS 2 A S 10	GD 318	–	–
GS 2 D 6	GD 318	–	–
GS 2 D 11	GD 220	–	–
GS 2 D 14	GD 318	–	–
GS 2 D 17	GD 255	–	–
GS 2 D 18	GD 255	–	–
GS 2 D 21	GD 255	–	–
GS 2 D 22	GD 318	–	–
GS 2 D 30	GD 294	–	–

BOSCH	BERU		
GS 2 D 4	GD 255	–	–
GS 2 D 5	GD 255	–	–
GS 2 D 7	GD 255	–	–
GS 2 D 8	GD 318	–	–
GSA 10/1	GV 107	–	–
GSA 9/1	GV 108	–	–
GSA 9/10	GV 197	–	–
GSA 9/16	GV 119	–	–
GSA 9/17	GV 136	–	–
GSA 9/28	GV 142	–	–
GSA 9/31	GV 155	–	–
GSA 10/2	GV 123	–	–
GSA 10/16	GV 119	–	–
GSA 11/13	GV 186	–	–
GSA 11/29	GV 112	–	–
GSA 12/14	GV 196	–	–
GSA 18/10	GV 390	–	–
GSD 24	GD 255	–	–
GSD 26	GD 318	–	–
GSD 27	GD 318	–	–
GSD 30	GD 294	–	–
H 5 DC	Z 31	14 K-5 DU	UXK 56
H 5 DCO	Z 46	14 K-5 DUO	UXK 56
H 56	UXK 56	–	–
H 6 DC	Z 25	14 K-6 DU	UXK 56
H 6 DCO	Z 56	14 K-6 DUO	UXK 56
H 7 DC	Z 17	14 K-7 DU	UXT 4
H 7 DCO	Z 18	14 K-7 DUO	UXT 4
H 8 DC	Z 6	14 K-8 DU	UXT 4
H 8 DC	Z 7	14 K-8 DUO	UXT 4
H 8 DCO	Z 7	14 K-8 DUO	UXT 4
H 9 DC	Z 80	14 K-9 DU	UXT 4
H 9 DC	Z 81	14 K-9 DUO	UXT 4
H 9 DCO	Z 81	14 K-9 DUO	UXT 4
HGR 6 KQC	Z 144	14 KGR-6 KQU	–
HGR 7 HQPEO	Z 309	14 KR-8 LQU07	–
HLR 8 STEX	Z 222	14 KR-8 STUX	–
HR 6 BC	Z 49	14 KR-6 BU	–
HR 6 DC	Z 26	14 KR-6 DU	UXK 56
HR 6 DC+	Z 26	14 KR-6 DU	UXK 56
HR 6 DPP33V	Z 230	14 KR-6 KPUV02	–
HR 7 DC	Z 95	14 KR-7 DU	UXT 4
HR 7 DC+	Z 95	14 KR-7 DU	UXT 4
HR 7 DCX	Z 67	14 KR-7 DUX	UXT 4
HR 7 DCX+	Z 67	14 KR-7 DUX	UXT 4
HR 7 DPP22	Z 209	14 KR-6 DPUV02	UXT 15
HR 7 KPP 33+	UXT 15	–	–
HR 7 MPP 22 U	Z 97	14 KR-8 MPX	UXT 8
HR 7 MPP+	Z 97	14 KR-8 MPX	UXT 8
HR 78	UXT 4	–	–
HR 8 DC+	UXT 4	–	–
HR 8 DCX	Z 67	14 KR-7 DUX	UXT 4
HR 8 DCX+	Z 67	14 KR-7 DUX	UXT 4
HR 8 DPP 15V	UXT 15	–	–
HR 8 DPP15V	Z 148	14 KR-8 DPU0V	UXT 15
HR 8 MCV+	Z 177	14 KR-8 MUV	UXT 7
HR 8 MEV	Z 177	14 KR-8 MUV	UXT 7
HR 9 DCX	Z 117	14 KR-9 DUX	UXT 4
KE/GA 1/(21/1)	GD 348	–	–
KE/GA 1/8	GD 214	–	–
KE/GA 1/19	GD 341	–	–
KE/GA 1/21	GD 348	–	–
KE/GA 1/24	GD 318	–	–
KE/GA 2/1	GD 294	–	–
KE/GA 2/2	GD 318	–	–
KE/GA 2/4	GD 255	–	–

BOSCH	BERU		
KE/GA 2/12	GD 318	-	-
KE/GA 2/15	GD 220	-	-
KE/GA 2/16	GD 255	-	-
KE/GE 1/1	GV 199	-	-
KE/GSA 10/1J	GV 107	-	-
KE/GSA 10/3	GV 110	-	-
KE/GSA 10/7	GV 175	-	-
KE/GSA 10/8	GV 119	-	-
KE/GSA 10/8 J	GV 119	-	-
KE/GSA 10/10	GV 170	-	-
KE/GSA 10/11	GV 198	-	-
KE/GSA 12/2	GV 123	-	-
KE/GSA 22/1	GV 117	-	-
KE/GSA 24/5	GV 128	-	-
M 10 AC	Z 88	18-10 AU	-
M 10 ACO	Z 88	18-10 AU	-
M 95 T 1	Z 88	18-10 AU	-
M 95 T 5	Z 88	18-10 AU	-
MA 175 T 7	Z 32	18 K-7 BU	-
MA 200 T 7	Z 33	18 K-6 BU	-
MAG 310 T 2 SP	Z 108	G 3/18	-
MAG 340 T 2 SP	Z 108	G 3/18	-
N 01	Z 250	14 FR-7 DU2S	UXT 1/UXT 3
N 02	Z 20	14 R-7 DU	UXT 2/UXT 6
N 03	Z 74	14 FR-8 LDUOX4	UXT 1/UXT 3
N 04	Z 98	14 FR-7 LDU	UXT 1/UXT 3
N 05	Z 91	14 GH-7 DTUR	UXT 2/UXT 6
N 06	Z 16	14 FR-7 DUX	UXT 1/UXT 3
N 07	Z 8	14 R-8 DU	UXT 2/UXT 6
N 08	Z 72	14 FR-8 DU	UXT 1/UXT 3
N 09	Z 177	14 KR-8 MUV	UXT 7
N 10	Z 95	14 KR-7 DU	UXT 4
N 11	Z 9	14 R-8 DUX	UXT 2/UXT 6
N 12	Z 24	14 FR-6 DU	UXT 5
N 13	Z 67	14 KR-7 DUX	UXT 4
N 14	Z 94	14 GR-8 DTU	UXT 2/UXT 6
N 15	Z 27	14 R-6 DU	UX 56
N 16	Z 176	14 F-7 HPURX2	-
N 17	Z 19	14 R-7 BU	-
N 18	Z 121	14 FGH-8 DTURX0	UXT 9
N 19	Z 21	14 R-7 DUX	UXT 2/UXT 6
N 20	UXT 1	-	-
N 21	Z 82	14 R-9 DU	UXT 2/UXT 6
N 22	Z 68	14-8 AU	-
N 23	Z 73	14 FR-8 DUX	UXT 1/UXT 3
N 24	Z 95	14 KR-7 DU	UXT 4
N 25	Z 234	12 FR-7 DU	-
N 26	Z 19	14 R-7 BU	-
N 27	Z 30	14 FR-5 DU	UXT 5
N 28	Z 183	14 FR-8 MU2	UXT 13
N 29	Z 26	14 KR-6 DU	UXK 56
N 30	Z 188	14 F-7 DPUR02	UXT 10
N 34	Z 243	12 VR-8 SE	-
N 35	Z 150	14 FR-7 KPUV	-
N 36	Z 11	14-7 DU	UXT 2/UXT 6
N 38	Z 10	14-7 BU	-
SHWJ 7H 12Z	KOBS 1-0940	-	-
SHWJ 7H 15Z	KOS 10/30	-	-
SHWJ 7H 18Z	KOS 12/15	-	-
SHWJ 7L 2Z	KOBS	-	-
SHWJ 7L 12Z	KOBS 1-0940	-	-
SHWJ 7L 15Z	KOS 10/30	-	-
SHWJ 7L 18Z	KOS 12/15	-	-
SHWJ 7L 32Z	KOBS 065/52	-	-
SHWJ 10 H 4Z	WT 35/38	-	-
SHWJ 27/1..4Z	KOBS/1	-	-

BOSCH	BERU		
SHWJ 27L 6Z	KOBS/1	-	-
SHWJ 27L 7Z	KOBS/1	-	-
SWJ 10/4z	WT 35/38	-	-
SWJ 27L 5Z	KOBS/1	-	-
UR 4 AC	Z 199	10 FR-4 AU	-
UR 6 DE	Z 210	10 FR-6 CPU03	-
VR 8 SC+	Z 243	12 VR-8 SE	-
VR 8 SEW	Z 243	12 VR-8 SE	-
VR 8 SEW	Z 243 SB	12 VR-8 SE SB	-
W 3 AC	Z 37	14 Z-3 AU	-
W 3 CC	Z 38	14 Z-3 CU	-
W 4 AC	Z 39	14 Z-4 AU	-
W 4 CC	Z 38	14 Z-3 CU	-
W 5 AC	Z 40	14-5 AU	-
W 5 BC	Z 41	14-5 BU	-
W 5 DC	Z 42	14-5 DU	UX 56
W 5 DCO	Z 42	14-5 DU	UX 56
W 5 DTC	Z 44	14-5 DTU	UX 56
W 6 BC	Z 48	14-6 BU	-
W 6 DC	Z 22	14-6 DU	UX 56
W 6 DCO	Z 22	14-6 DU	UX 56
W 6 DPO	Z 104	14-6 DPO	-
W 6 DTC	Z 51	14-6 DTU	UX 56
W 7 AC	Z 57	14-7 AU	-
W 7 BC	Z 10	14-7 BU	-
W 7 CC	Z 58	14-7 CU	-
W 7 CCO	Z 58	14-7 CU	-
W 7 DC	Z 11	14-7 DU	UXT 2/UXT 6
W 7 DCO	Z 61	14-7 DU0	UXT 2/UXT 6
W 7 DCO	Z 62	14-7 DU0	UXT 2/UXT 6
W 7 DCX	Z 11	14-7 DU	UXT 2/UXT 6
W 7 DTC	Z 12	14-7 DTU	UXT 2/UXT 6
W 7 EC	Z 267	14 S-7 EU0	-
W 7 LTCR	Z 91	14 GH-7 DTUR	UXT 2/UXT 6
W 8 AC	Z 68	14-8 AU	-
W 8 BC	Z 118	14-8 BU	-
W 8 CC	Z 58	14-7 CU	-
W 8 DC	Z 1	14-8 DU	UXT 2/UXT 6
W 8 DCO	Z 69	14-8 DU0	UXT 2/UXT 6
W 8 DCX	Z 1	14-8 DU	UXT 2/UXT 6
W 8 DTC	Z 2	14-8 DTU	UXT 2/UXT 6
W 8 EC	Z 112	14-8 E	-
W 8 LCR	Z 3	14-8 LUR	UXT 2/UXT 6
W 8 LTCR	Z 92	14 GH-8 DTUR	UXT 2/UXT 6
W 8 LTCR	Z 93	14 GH-8 DTURX	UXT 2/UXT 6
W 9 AC	Z 85	14 X-AU	-
W 9 ACO	Z 85	14 X-AU	-
W 9 DC	Z 76	14-9 DU	UXT 2/UXT 6
W 9 DCO	Z 76	14-9 DU	UXT 2/UXT 6
W 9 DTC	Z 78	14-9 DTU	UXT 2/UXT 6
W 9 EC	Z 262	14 S-9 E0	-
W 9 ECO	Z 262	14 S-9 E0	-
W 9 LC	Z 3	14-8 LUR	UXT 2/UXT 6
W 10 A	Z 85	14 X-AU	-
W 10 AC	Z 85	14 X-AU	-
W 56	UX 56	-	-
W 95 T 1	Z 85	14 X-AU	-
W 125 T 1	Z 85	14 X-AU	-
W 125 T 30	Z 76	14-9 DU	UXT 2/UXT 6
W 125 T 4	Z 85	14 X-AU	-
W 125 TR 30	Z 82	14 R-9 DU	UXT 2/UXT 6
W 145 M 1	Z 68	14-8 AU	-
W 145 M 2	Z 58	14-7 CU	-
W 145 T 1	Z 68	14-8 AU	-
W 145 T 2	Z 58	14-7 CU	-
W 145 T 3	Z 112	14-8 E	-



BOSCH	BERU		
W 145 T 30	Z 1	14-8 DU	UXT 2/UXT 6
W 145 T 35	Z 118	14-8 BU	–
W 145 TR 2	Z 59	14 R-7 CU	–
W 145 TR 30	Z 8	14 R-8 DU	UXT 2/UXT 6
W 175 M 2	Z 58	14-7 CU	–
W 175 T 1	Z 57	14-7 AU	–
W 175 T 2	Z 58	14-7 CU	–
W 175 T 27	Z 62	14-7 DU0	UXT 2/UXT 6
W 175 T 30	Z 11	14-7 DU	UXT 2/UXT 6
W 175 T 35	Z 10	14-7 BU	–
W 175 TR 2	Z 59	14 R-7 CU	–
W 175 TR 35	Z 19	14 R-7 BU	–
W 190 M 11 S	Z 57	14-7 AU	–
W 200 RT 27	Z 27	14 R-6 DU	UX 56
W 200 RT 30	Z 27	14 R-6 DU	UX 56
W 200 T 27	Z 22	14-6 DU	UX 56
W 200 T 30	Z 22	14-6 DU	UX 56
W 200 T 35	Z 48	14-6 BU	–
W 215 P 21	Z 104	14-6 DPO	–
W 215 T 30	Z 22	14-6 DU	UX 56
W 225 P 11 S	Z 40	14-5 AU	–
W 225 T 1	Z 40	14-5 AU	–
W 225 T 27	Z 42	14-5 DU	UX 56
W 225 T 28	Z 42	14-5 DU	UX 56
W 225 T 30	Z 29	14 F-5 DU	UXT 5
W 225 T 35	Z 41	14-5 BU	–
W 225 T 7	Z 41	14-5 BU	–
W 225 TR 30	Z 47	14 R-5 DU	UX 56
W 230 T 30	Z 29	14 F-5 DU	UXT 5
W 240 P 11 S	Z 39	14 Z-4 AU	–
W 240 T 1	Z 39	14 Z-4 AU	–
W 250 T 1	Z 39	14 Z-4 AU	–
W 260 T 1	Z 39	14 Z-4 AU	–
W 260 T 2	Z 38	14 Z-3 CU	–
W 275 T 1	Z 37	14 Z-3 AU	–
W 275 T 2	Z 38	14 Z-3 CU	–
WA 125 T 30	Z 80	14 K-9 DU	UXT 4
WA 125 TR 30	Z 117	14 KR-9 DUX	UXT 4
WA 175 T30	Z 17	14 K-7 DU	UXT 4
WA 200 T 30	Z 25	14 K-6 DU	UXK 56
WA 200 T 40	Z 49	14 KR-6 BU	–
WA 200 TR 30	Z 26	14 KR-6 DU	UXK 56
WA 200 TR 40	Z 49	14 KR-6 BU	–
WA 225 T 30	Z 31	14 K-5 DU	UXK 56
WKA 145 T 6	Z 132	14 S-7 F	–
WKA 175 T 6	Z 132	14 S-7 F	–
WKA 200 TR 6	Z 260	14 SR-5 F	–
WKA 225 T 6	Z 260	14 SR-5 F	–
WR 4 AC	Z 39	14 Z-4 AU	–
WR 5 DC	Z 47	14 R-5 DU	UX 56
WR 5 DC+	Z 47	14 R-5 DU	UX 56
WR 6 DC	Z 27	14 R-6 DU	UX 56
WR 6 DC+	Z 27	14 R-6 DU	UX 56
WR 6 DCX	Z 28	14 R-6 DUX	UX 56
WR 7 BC	Z 19	14 R-7 BU	–
WR 7 BC+	Z 19	14 R-7 BU	–
WR 7 CC	Z 59	14 R-7 CU	–
WR 7 CCX	Z 59	14 R-7 CU	–
WR 7 DC	Z 20	14 R-7 DU	UXT 2/UXT 6
WR 7 DC+	Z 20	14 R-7 DU	UXT 2/UXT 6
WR 7 DCX+	Z 21	14 R-7 DUX	UXT 2/UXT 6
WR 7 LTC+	Z 91	14 GH-7 DTUR	UXT 2/UXT 6
WR 8 BC	Z 19	14 R-7 BU	–
WR 8 DC+	Z 8	14 R-8 DU	UXT 2/UXT 6
WR 8 DC4	Z 119	14 R-8 DU4	UXT 2/UXT 6
WR 8 DCX	Z 9	14 R-8 DUX	UXT 2/UXT 6

BOSCH	BERU		
WR 8 DCX+	Z 9	14 R-8 DUX	UXT 2/UXT 6
WR 8 DP	Z 311	14 R-8 DPUU	UXT 2/UXT 6
WR 8 LTC+	Z 92	14 GH-8 DTUR	UXT 2/UXT 6
WR 8 LTC+	Z 94	14 GR-8 DTU	UXT 2/UXT 6
WR 9 DC+	Z 82	14 R-9 DU	UXT 2/UXT 6
WR 9 DCX	Z 82	14 R-9 DU	UXT 2/UXT 6
WR 9 DCX+	Z 82	14 R-9 DU	UXT 2/UXT 6
WR 9 EC	Z 269	14 SR-9 E0	–
WR 9 ECO	Z 262	14 S-9 E0	–
WR 9 ECO	Z 269	14 SR-9 E0	–
WR 11 E0	Z 261	14 SR-10 E0	–
WR 56	UX 56		UX 56
WR 78	UXT 2	–	–
WR 78X	UXT 2	–	–
WR 175 TR 30	Z 20	14 R-7 DU	UXT 2/UXT 6
WS 5 F	Z 265	14 S-5 F	–
WS 7 F	Z 132	14 S-7 F	–
WS 8 E	Z 266	14 S-7 E	–
WS 8 F	Z 132	14 S-7 F	–
WS 9 EC	Z 266	14 S-7 E	–
WSR 5 F	Z 260	14 SR-5 F	–
WSR 6 F	Z 260	14 SR-5 F	–
WSR 7 F	Z 260	14 SR-5 F	–
WSR 9 EC	Z 269	14 SR-9 E0	–
YR 7 DC+	Z 234	12 FR-7 DU	–
YR 7 DE	Z 234	12 FR-7 DU	–
ZR 8 TPP15	Z 242	12 ZR-8 TP	–

BOSCH (USA)	BERU		
80002	GD 348	–	–
80003	GD 382	–	–
80004	GV 108	–	–
80005	GV 108	–	–
80006	GV 603	–	–
80007	GV 636	–	–
80008	GN 909	–	–
80009	GN 858	–	–
80010	GN 857	–	–
80011	GN 860	–	–
80012	GN 855	–	–
80013	GN 948	–	–
80014	GV 685	–	–
80015	GV 705	–	–
80016	GV 749	–	–
80017	GV 888	–	–
80018	GV 886	–	–
80019	GV 894	–	–
80024	GV 835	–	–
80027	GV 823	–	–
80028	GN 928	–	–
80031	GN 858	–	–

### BRISK → PAL

BRÜGGEMANN	BERU		
D 04	GD 255	–	–
D 4	GD 255	–	–
D 22	GD 214	–	–
D 30	GD 294	–	–

CATERPILLAR	BERU		
1P 7324	GN 071		
3S 9624	GN 071		
3T 9562	GN 071		
4S 7824	GN 071		
9H 4577	GN 071		
243-4291	Z 202	18 GZ 6-77-2	-

CHAMPION	BERU		
3071	Z 150	14 FR-7 KPUV	-
BL 15Y	Z 174	14 K-9 BU	-
BN 6 Y	Z 31	14 K-5 DU	UXK 56
BN 7 Y	Z 31	14 K-5 DU	UXK 56
BN 9 Y	Z 25	14 K-6 DU	UXK 56
BN 12 Y	Z 17	14 K-7 DU	UXT 4
BN 79 Y	Z 31	14 K-5 DU	UXK 56
C 6 BYC	Z 52	14 F-6 DTU	UXT 5
C 6 YCC	Z 29	14 F-5 DU	UXT 5
C 6 YCX	Z 29	14 F-5 DU	UXT 5
C 7 YC	Z 24	14 FR-6 DU	UXT 5
C 7 YCC	Z 24	14 FR-6 DU	UXT 5
C 7 YCX	Z 24	14 FR-6 DU	UXT 5
C 9 BMC	Z 14	14 F-7 LDUR4	UXT 1/UXT 3
C 9 YC	Z 63	14 F-7 DU	UXT 1/UXT 3
C 9 YCC	Z 64	14 F-7 DU0	UXT 1/UXT 3
C 9 YCX	Z 64	14 F-7 DU0	UXT 1/UXT 3
C 10 YCC	Z 5	14 F-8 DU0	UXT 1/UXT 3
C 11 YCC	Z 100	14 F-8 DU4	UXT 1/UXT 3
C 12 YCC	Z 79	14 F-9 DU0	UXT 1/UXT 3
C 281 YC	Z 63	14 F-7 DU	UXT 1/UXT 3
CJ 6 Y	Z 265	14 S-5 F	-
CJ 8	Z 266	14 S-7 E	-
EON 1	UXT 5	-	-
EON 2	UXT 1	-	-
EON 2	UXT 3	-	-
EON 3	UXT 4	-	-
EON 4	Z 97	14 KR-8 MPX	UXT 8
EON 5	UX 56	-	-
EON 6	UXT 2	-	-
F 7 Y	Z 33	18 K-6 BU	-
F 7 YC	Z 33	18 K-6 BU	-
F 9 Y	Z 32	18 K-7 BU	-
F 9 Y	Z 32	18 K-7 BU	-
F 9 YC	Z 32	18 K-7 BU	-
F 9 YC	Z 32	18 K-7 BU	-
H 88	Z 57	14-7 AU	-
J 17 LM	Z 262	14 S-9 E0	-
J 19 LM	Z 270	14 S-10 E0	-
J 6 J	Z 267	14 S-7 EU0	-
J 7	Z 112	14-8 E	-
J 8	Z 112	14-8 E	-
J 8 C	Z 112	14-8 E	-
J 8 J	Z 112	14-8 E	-
J 9	Z 112	14-8 E	-
KC 8 ZMCC	Z 200	14 F-7 HUR2	-
KC 8 ZPYPB4	Z 176	14 F-7 HPURX2	-
L 4 G	Z 39	14 Z-4 AU	-
L 4 J	Z 39	14 Z-4 AU	-
L 5	Z 39	14 Z-4 AU	-
L 6 G	Z 40	14-5 AU	-
L 7	Z 57	14-7 AU	-
L 7 J	Z 57	14-7 AU	-
L 9 G	Z 57	14-7 AU	-
L 11 S	Z 40	14-5 AU	-
L 12 Y	Z 10	14-7 BU	-

CHAMPION	BERU		
L 60 R	Z 39	14 Z-4 AU	-
L 62 R	Z 39	14 Z-4 AU	-
L 66 Y	Z 48	14-6 BU	-
L 77 JC	Z 37	14 Z-3 AU	-
L 77 JC4	Z 37	14 Z-3 AU	-
L 81	Z 40	14-5 AU	-
L 82	Z 40	14-5 AU	-
L 82 C	Z 40	14-5 AU	-
L 82 Y	Z 41	14-5 BU	-
L 82 YC	Z 48	14-6 BU	-
L 82 YCC	Z 48	14-6 BU	-
L 85	Z 57	14-7 AU	-
L 86	Z 57	14-7 AU	-
L 86 C	Z 68	14-8 AU	-
L 86 CC	Z 68	14-8 AU	-
L 87 Y	Z 10	14-7 BU	-
L 87 YC	Z 10	14-7 BU	-
L 87 YCC	Z 10	14-7 BU	-
L 88	Z 57	14-7 AU	-
L 88 A	Z 57	14-7 AU	-
L 89 CM	Z 57	14-7 AU	-
L 92 Y	Z 118	14-8 BU	-
L 92 YC	Z 118	14-8 BU	-
L 95 Y	Z 118	14-8 BU	-
L 288	Z 57	14-7 AU	-
N 2	Z 38	14 Z-3 CU	-
N 2 C	Z 38	14 Z-3 CU	-
N 2 G	Z 38	14 Z-3 CU	-
N 3	Z 38	14 Z-3 CU	-
N 4	Z 58	14-7 CU	-
N 4 C	Z 58	14-7 CU	-
N 5	Z 58	14-7 CU	-
N 5 C	Z 58	14-7 CU	-
N 6	Z 58	14-7 CU	-
N 6 BYC	Z 44	14-5 DTU	UX 56
N 6 Y	Z 42	14-5 DU	UX 56
N 6 YC	Z 42	14-5 DU	UX 56
N 6 YCC	Z 42	14-5 DU	UX 56
N 6 YCX	Z 42	14-5 DU	UX 56
N 7	Z 58	14-7 CU	-
N 7 BMC	Z 91	14 GH-7 DTUR	UXT 2/UXT 6
N 7 BYC	Z 12	14-7 DTU	UXT 2/UXT 6
N 7 Y	Z 22	14-6 DU	UX 56
N 7 YC	Z 22	14-6 DU	UX 56
N 7 YCC	Z 22	14-6 DU	UX 56
N 7 YCX	Z 22	14-6 DU	UX 56
N 8	Z 58	14-7 CU	-
N 8 B	Z 58	14-7 CU	-
N 8 Y	Z 22	14-6 DU	UX 56
N 9 BMC	Z 75	14 G-8 DTU	UXT 2/UXT 6
N 9 BYC	Z 2	14-8 DTU	UXT 2/UXT 6
N 9 BYC 4	Z 2	14-8 DTU	UXT 2/UXT 6
N 9 Y	Z 11	14-7 DU	UXT 2/UXT 6
N 9 YC	Z 11	14-7 DU	UXT 2/UXT 6
N 9 YC 4	Z 21	14 R-7 DUX	UXT 2/UXT 6
N 9 YCC	Z 62	14-7 DU0	UXT 2/UXT 6
N 9 YCX	Z 62	14-7 DU0	UXT 2/UXT 6
N 10 Y	Z 11	14-7 DU	UXT 2/UXT 6
N 11 Y	Z 1	14-8 DU	UXT 2/UXT 6
N 11 YC	Z 1	14-8 DU	UXT 2/UXT 6
N 11 YC4	Z 9	14 R-8 DUX	UXT 2/UXT 6
N 11 YCC	Z 76	14-9 DU	UXT 2/UXT 6
N 12 Y	Z 1	14-8 DU	UXT 2/UXT 6
N 12 YC	Z 1	14-8 DU	UXT 2/UXT 6
N 12 YCC	Z 1	14-8 DU	UXT 2/UXT 6
N 13 Y	Z 76	14-9 DU	UXT 2/UXT 6

CHAMPION	BERU		
N 13 YC	Z 76	14-9 DU	UXT 2/UXT 6
N 14 Y	Z 76	14-9 DU	UXT 2/UXT 6
N 14 YC	Z 76	14-9 DU	UXT 2/UXT 6
N 14 YCC	Z 76	14-9 DU	UXT 2/UXT 6
N 16 YC	Z 76	14-9 DU	UXT 2/UXT 6
N 62 R	Z 38	14 Z-3 CU	–
N 64 Y	Z 42	14-5 DU	UX 56
N 64 YCC	Z 42	14-5 DU	UX 56
N 79 Y	Z 11	14-7 DU	UXT 2/UXT 6
N 79 YC	Z 11	14-7 DU	UXT 2/UXT 6
N 88	Z 58	14-7 CU	–
N 89 Y	Z 11	14-7 DU	UXT 2/UXT 6
N 92 Y	Z 76	14-9 DU	UXT 2/UXT 6
N 178 B	Z 38	14 Z-3 CU	–
N 179 BC	Z 38	14 Z-3 CU	–
N 180 B	Z 38	14 Z-3 CU	–
N 279 YC	Z 22	14-6 DU	UX 56
N 281 YC	Z 69	14-8 DU0	UXT 2/UXT 6
N 288	Z 58	14-7 CU	–
OE 003	Z 63	14 F-7 DU	UXT 1/UXT 3
OE 004	Z 20	14 R-7 DU	UXT 2/UXT 6
OE 005	Z 15	14 FR-7 DU	UXT 1/UXT 3
OE 006	Z 20	14 R-7 DU	UXT 2/UXT 6
OE 007	Z 10	14-7 BU	–
OE 010	Z 22	14-6 DU	UX 56
OE 011	Z 95	14 KR-7 DU	UXT 4
OE 012	Z 12	14-7 DTU	UXT 2/UXT 6
OE 013	Z 72	14 FR-8 DU	UXT 1/UXT 3
OE 014	Z 24	14 FR-6 DU	UXT 5
OE 015	Z 1	14-8 DU	UXT 2/UXT 6
OE 016	Z 72	14 FR-8 DU	UXT 1/UXT 3
OE 019	Z 74	14 FR-8 LDUOX4	UXT 1/UXT 3
OE 020	Z 95	14 KR-7 DU	UXT 4
OE 021	Z 116	14 FR-6 LDU	UXT 5
OE 022	Z 62	14-7 DU0	UXT 2/UXT 6
OE 024	Z 16	14 FR-7 DUX	UXT 1/UXT 3
OE 026	Z 14	14 F-7 LDUR4	UXT 1/UXT 3
OE 027	Z 92	14 GH-8 DTUR	UXT 2/UXT 6
OE 028	Z 2	14-8 DTU	UXT 2/UXT 6
OE 029	Z 97	14 KR-8 MPX	UXT 8
OE 030	Z 245	14 FR-6 LDUW	UXT 5
OE 030	Z 98	14 FR-7 LDU	UXT 1/UXT 3
OE 031	Z 177	14 KR-8 MUV	UXT 7
OE 032	Z 90	14 FGH-7 DTURX	UXT 1/UXT 3
OE 033	Z 15	14 FR-7 DU	UXT 1/UXT 3
OE 034	Z 193	14 FR-7 DU2	UXT 1/UXT 3
OE 036	Z 18	14 K-7 DU0	UXT 4
OE 037	Z 10	14-7 BU	–
OE 042	Z 82	14 R-9 DU	UXT 2/UXT 6
OE 043	Z 252	14 FR-6 DUW	UXT 5
OE 044	Z 2	14-8 DTU	UXT 2/UXT 6
OE 048	Z 21	14 R-7 DUX	UXT 2/UXT 6
OE 052	Z 234	12 FR-7 DU	–
OE 054	Z 32	18 K-7 BU	–
OE 055	Z 1	14-8 DU	UXT 2/UXT 6
OE 064	Z 19	14 R-7 BU	–
OE 071	Z 19	14 R-7 BU	–
OE 084	Z 42	14-5 DU	UX 56
OE 089	Z 225	14 FR-7 HUX	–
OE 093	Z 151	14 FR-7 KPU	UXT 9
OE 100	Z 75	14 G-8 DTU	UXT 2/UXT 6
OE 105	Z 285	14 R-9 KPUV2	–
OE 120	Z 204	14 FGR-8 CTU	–
OE 122	Z 210	10 FR-6 CPU03	–
OE 124	Z 228	14 FR-7 DPUX02	UXT 11
OE 130	Z 243	12 VR-8 SE	–

CHAMPION	BERU		
OE 130	Z 243 SB	12 VR-8 SE SB	–
OE 136	Z 188	14 F-7 DPUR02	UXT 10
OE 145	Z 238	14 FR-8 DPU2	UXT 10
OE 154	Z 220	14 FR-9 KUX2	–
OE 163	Z 216	14 KR-10 SUV2	–
OE 176	Z 176	14 F-7 HPURX2	–
OE 177	Z 200	14 F-7 HUR2	–
OE 178	Z 223	14 FR-8 NQU23	–
ON 11 Y	Z 8	14 R-8 DU	UXT 2/UXT 6
ON 12 Y	Z 8	14 R-8 DU	UXT 2/UXT 6
QL 77 JC 4	Z 39	14 Z-4 AU	–
QN 3	Z 38	14 Z-3 CU	–
RA 4 HCX	Z 234	12 FR-7 DU	–
RB 75 WPC	Z 161	18 GZ 5-77	–
RB 75 WPCC	Z 161	18 GZ 5-77	–
RB 76 N	Z 168	18 GZ 7	–
RB 77 WPC	Z 162	18 GZ 6-77	–
RB 77 WPCC	Z 162	18 GZ 6-77	–
RBN 9 Y	Z 26	14 KR-6 DU	UXK 56
RBN 13 Y	Z 26	14 KR-6 DU	UXK 56
RBN 14 Y 4	Z 117	14 KR-9 DUX	UXT 4
RC 6 YC	Z 30	14 FR-5 DU	UXT 5
RC 6 YCC	Z 30	14 FR-5 DU	UXT 5
RC 7 BMC	Z 116	14 FR-6 LDU	UXT 5
RC 7 YC	Z 24	14 FR-6 DU	UXT 5
RC 7 YC	Z 252	14 FR-6 DUW	UXT 5
RC 7 YC4	Z 99	14 FR-6 DUX	UXT 5
RC 7 YCC	Z 24	14 FR-6 DU	UXT 5
RC 7 YCC	Z 252	14 FR-6 DUW	UXT 5
RC 7 YCC4	Z 99	14 FR-6 DUX	UXT 5
RC 8 BYC	Z 245	14 FR-6 LDUW	UXT 5
RC 8 BYC	Z 98	14 FR-7 LDU	UXT 1/UXT 3
RC 8 DMC	Z 14	14 F-7 LDUR4	UXT 1/UXT 3
RC 8 PYP	Z 188	14 F-7 DPUR02	UXT 10
RC 8 VTYC4	Z 90	14 FGH-7 DTURX	UXT 1/UXT 3
RC 8 YC4	Z 73	14 FR-8 DUX	UXT 1/UXT 3
RC 8 YCL	Z 193	14 FR-7 DU2	UXT 1/UXT 3
RC 9 MCC4	Z 225	14 FR-7 HUX	–
RC 9 YC	Z 15	14 FR-7 DU	UXT 1/UXT 3
RC 9 YC 4	Z 16	14 FR-7 DUX	UXT 1/UXT 3
RC 9 YCC	Z 15	14 FR-7 DU	UXT 1/UXT 3
RC 10 DMC	Z 74	14 FR-8 LDUOX4	UXT 1/UXT 3
RC 10 PYP4	Z 228	14 FR-7 DPUX02	UXT 11
RC 10 VTYC4	Z 90	14 FGH-7 DTURX	UXT 1/UXT 3
RC 10 YC	Z 72	14 FR-8 DU	UXT 1/UXT 3
RC 10 YCC	Z 72	14 FR-8 DU	UXT 1/UXT 3
RC 10 YCL	Z 15	14 FR-7 DU	UXT 1/UXT 3
RC 11 PYPB4	Z 122	14 FGH-8 DPURX2	UXT 9
RC 12 LYC	Z 152	14 FR-8 HU	–
RC 12 MCC4	Z 220	14 FR-9 KUX2	–
RC 12 PYP	Z 150	14 FR-7 KPUV	–
RC 12 YC	Z 72	14 FR-8 DU	UXT 1/UXT 3
RC 12Y C	Z 73	14 FR-8 DUX	UXT 1/UXT 3
RC 78 PYP	Z 189	14 FR-4 DPU0	–
RC 78 PYP15	Z 189	14 FR-4 DPU0	–
RC 89 PYC	Z 238	14 FR-8 DPU2	UXT 10
RC 89 TMC	Z 204	14 FGR-8 CTU	–
RC 89 YCC	Z 151	14 FR-7 KPU	UXT 9
RC 9 BMC	Z 98	14 FR-7 LDU	UXT 1/UXT 3
RCJ 6 Y	Z 260	14 SR-5 F	–
RCJ 7 Y	Z 260	14 SR-5 F	–
RCJ 8	Z 271	14 SR-7 E	–
RCJ 8 Y	Z 263	14 SR-7 F	–
RE 7 PYC5	Z 97	14 KR-8 MPX	UXT 8
RE 7 YCC	Z 97	14 KR-8 MPX	UXT 8
RE 14 MCC5	Z 216	14 KR-10 SUV2	–

CHAMPION	BERU		
REA 8 MCL	Z 243	12 VR-8 SE	–
REC 9 MCLX	Z 223	14 FR-8 NQU23	–
RES 9 YCC4	Z 177	14 KR-8 MUV	UXT 7
RF 7 YC	Z 32	18 K-7 BU	–
RF 7 YCC	Z 33	18 K-6 BU	–
RF 7YC	Z 33	18 K-6 BU	–
RF 9 Y	Z 32	18 K-7 BU	–
RF 9 Y	Z 32	18 K-7 BU	–
RF 9 Y 4	Z 32	18 K-7 BU	–
RF 9 Y 5	Z 32	18 K-7 BU	–
RF 9 Y4	Z 32	18 K-7 BU	–
RF 9 YC	Z 32	18 K-7 BU	–
RF 9 YC	Z 32	18 K-7 BU	–
RF 9 Y5	Z 32	18 K-7 BU	–
RF 11 YC	Z 175	18 K-9 BU	–
RJ 8 C	Z 112	14-8 E	–
RJ 17 LM	Z 269	14 SR-9 E0	–
RJ 19 LM	Z 261	14 SR-10 E0	–
RL 82	Z 40	14-5 AU	–
RL 82 C	Z 40	14-5 AU	–
RL 82 YC	Z 19	14 R-7 BU	–
RL 85	Z 57	14-7 AU	–
RL 85 G	Z 146	14 R-4 ADP	–
RL 86 C	Z 57	14-7 AU	–
RL 87 Y	Z 19	14 R-7 BU	–
RL 87 YC	Z 19	14 R-7 BU	–
RM 77 N	Z 182	18 GZ 22	–
RN 3	Z 38	14 Z-3 CU	–
RN 3 C	Z 38	14 Z-3 CU	–
RN 3 G	Z 38	14 Z-3 CU	–
RN 4	Z 59	14 R-7 CU	–
RN 4 C	Z 59	14 R-7 CU	–
RN 5 C	Z 59	14 R-7 CU	–
RN 6 Y	Z 47	14 R-5 DU	UX 56
RN 6 YC	Z 47	14 R-5 DU	UX 56
RN 7 Y	Z 27	14 R-6 DU	UX 56
RN 7 YC	Z 27	14 R-6 DU	UX 56
RN 7 YC4	Z 28	14 R-6 DUX	UX 56
RN 7 YCC	Z 27	14 R-6 DU	UX 56
RN 8	Z 59	14 R-7 CU	–
RN 8 VTYC4	Z 91	14 GH-7 DTUR	UXT 2/UXT 6
RN 9 Y	Z 20	14 R-7 DU	UXT 2/UXT 6
RN 9 YC	Z 20	14 R-7 DU	UXT 2/UXT 6
RN 9 YC4	Z 21	14 R-7 DUX	UXT 2/UXT 6
RN 9 YCC	Z 20	14 R-7 DU	UXT 2/UXT 6
RN 9 YCC4	Z 21	14 R-7 DUX	UXT 2/UXT 6
RN 10 PYP4	Z 311	14 R-8 DPUU	UXT 2/UXT 6
RN 10 VTYC4	Z 92	14 GH-8 DTUR	UXT 2/UXT 6
RN 10 Y	Z 20	14 R-7 DU	UXT 2/UXT 6
RN 10 Y 4	Z 21	14 R-7 DUX	UXT 2/UXT 6
RN 11 Y	Z 8	14 R-8 DU	UXT 2/UXT 6
RN 11 YC	Z 8	14 R-8 DU	UXT 2/UXT 6
RN 11 YC 4	Z 9	14 R-8 DUX	UXT 2/UXT 6
RN 11 YCC	Z 82	14 R-9 DU	UXT 2/UXT 6
RN 12 Y	Z 82	14 R-9 DU	UXT 2/UXT 6
RN 12 YC	Z 82	14 R-9 DU	UXT 2/UXT 6
RN 12 YCC	Z 82	14 R-9 DU	UXT 2/UXT 6
RN 13 Y	Z 82	14 R-9 DU	UXT 2/UXT 6
RN 14 PMP5	Z 285	14 R-9 KPUV2	–
RN 14 Y	Z 82	14 R-9 DU	UXT 2/UXT 6
RN 14 YC	Z 82	14 R-9 DU	UXT 2/UXT 6
RN 79 G	Z 147	14 R-4 CDP	–
RN 79 PYP	Z 187	14 R-4 CIU	–
RS 9 PYC	Z 148	14 KR-8 DPU0V	UXT 15
RS 9 PYP4	Z 209	14 KR-6 DPUV02	UXT 15
RS 9 YC	Z 95	14 KR-7 DU	UXT 4

CHAMPION	BERU		
RS 9 YCC	Z 95	14 KR-7 DU	UXT 4
RS 9 YCC4	Z 67	14 KR-7 DUX	UXT 4
RS 12 YC	Z 95	14 KR-7 DU	UXT 4
RTL 85 G	Z 218	14 GZ 40	–
RTM 77 N	Z 196	18 GZ 34	–
RTM 77 PP	Z 197	18 GZ 35	–
RTN 79 G	Z 217	14 GZ 39	–
RV 9 YC	Z 49	14 KR-6 BU	–
RV 9 YCC	Z 49	14 KR-6 BU	–
RV 12 YC	Z 49	14 KR-6 BU	–
S 6 YC	Z 31	14 K-5 DU	UXK 56
S 6 YCC	Z 46	14 K-5 DU0	UXK 56
S 7 YC	Z 25	14 K-6 DU	UXK 56
S 7 YCC	Z 56	14 K-6 DU0	UXK 56
S 9 YC	Z 17	14 K-7 DU	UXT 4
S 9 YCC	Z 18	14 K-7 DU0	UXT 4
S 10 YC	Z 6	14 K-8 DU	UXT 4
S 10 YCC	Z 7	14 K-8 DU0	UXT 4
S 12 YC	Z 6	14 K-8 DU	UXT 4
S 12 YCC	Z 7	14 K-8 DU0	UXT 4
S 279 YC	Z 25	14 K-6 DU	UXK 56
S 281 YC	Z 25	14 K-6 DU	UXK 56
S 379 YC	Z 31	14 K-5 DU	UXK 56
UF 9 Y	Z 32	18 K-7 BU	–
UL 4 J	Z 39	14 Z-4 AU	–
UL 81 C	Z 39	14 Z-4 AU	–
UL 81 J	Z 39	14 Z-4 AU	–
UN 8 Y	Z 22	14-6 DU	UX 56
Z 9 Y	Z 199	10 FR-4 AU	–

CHEVROLET	BERU		
89 417 515 81	GN 061		
EC 229626	Z 74	14 FR-8 LDUOX4	UXT 1/UXT 3

CHRYSLER	BERU		
05066840 AA	GN 055		
4727114	Z 285	14 R-9 KPUV2	–
56027275	Z 152	14 FR-8 HU	–
56028189	Z 248	14 FR-8 HUT	–
56028236 AA	Z 220	14 FR-9 KUX2	–
S2RE 14 MCC5	Z 216	14 KR-10 SUV2	–
T0701 130	GN 909		

CITROËN	BERU		
5 403 277	Z 48	14-6 BU	–
5 403 277 X	Z 48	14-6 BU	–
5 414 326	GV 130		
5 415 813	GV 107		
5 415 813	GV 108		
5 416 222 D	Z 57	14-7 AU	–
5 417 768	Z 11	14-7 DU	UXT 2/UXT 6
5 417 768 H	Z 11	14-7 DU	UXT 2/UXT 6
5 417 769 U	Z 11	14-7 DU	UXT 2/UXT 6
5 417 998	Z 11	14-7 DU	UXT 2/UXT 6
5 417 998 H	Z 11	14-7 DU	UXT 2/UXT 6
5 425 202	Z 11	14-7 DU	UXT 2/UXT 6
5 425 202 H	Z 11	14-7 DU	UXT 2/UXT 6
5 425 202 M	Z 11	14-7 DU	UXT 2/UXT 6
5 432 057 Y	Z 1	14-8 DU	UXT 2/UXT 6
5 433 737	Z 48	14-6 BU	–
5 433 737 J	Z 48	14-6 BU	–
5 433 738	Z 48	14-6 BU	–

CITROËN	BERU		
5 433 738 V	Z 48	14-6 BU	–
5 451 444	Z 41	14-5 BU	–
5 451 444 B	Z 41	14-5 BU	–
5 460 556	GV 130		
5 477 234	GV 130		
5 491 387	GV 130		
5 500 842	GV 130		
5960 01	Z 242	12 ZR-8 TP	–
5960 19	GN 047		
5960 54	Z 223	14 FR-8 NQU23	–
5960 64	GN 054		
5960 65	GN 054		
5960 66	GN 027		
5960 67	GN 027		
5960 69	GN 016		
5960 73	Z 223	14 FR-8 NQU23	–
5960 77	GN 045		
5960 78	GN 056		
5960 84	Z 243	12 VR-8 SE	–
5960 90	Z 184	14 FR-7 MU2	UXT 13
5960 91	Z 184	14 FR-7 MU2	UXT 13
5960 99	GN 063		
5960 A4	GN 037		
5960 F4	GN 054		
5960 L3	Z 320	12 ZR-8 STP	–
5961 05	GV 107		
5961 18	GV 155		
5961 22	GV 107		
5961 54	GV 642		
5962 008	GV 636		
5962 58	GN 909		
5962 1P	GN 964		
5962 1Q	GN 964		
5962 1R	GV 603		
5962 1S	GV 631		
5962 1T	GV 642		
5962 1V	GV 663		
5962 1W	GV 666		
5962 1X	GV 844		
5962 1Y	GV 852		
5962 1Z	GN 857		
5962 2Z	GN 016		
5962 3C	GN 027		
5962 3E	GN 027		
5962 3H	GN 013		
5962 3J	GN 013		
5962 5A	GN 012		
5962 5G	Z 193	14 FR-7 DU2	UXT 1/UXT 3
5962 5M	Z 183	14 FR-8 MU2	UXT 13
5962 7E	Z 211	14 FGR-8 MQPU	–
5962 7F	GN 027		
5962 7G	GN 027		
5962 7S	Z 193	14 FR-7 DU2	UXT 1/UXT 3
5962 7W	Z 184	14 FR-7 MU2	UXT 13
5962 8A	Z 211	14 FGR-8 MQPU	–
5962 C7	GV 107		
5962 H8	Z 255	14 FR-8 DUW	UXT 1/UXT 3
5962 J3	GV 661		
5962 J4	GV 642		
5962 J4	GN 909		
5962 J7	GN 857		
5962 R8	GN 909		
5962 S8	GN 909		
5962 S9	Z 24	14 FR-6 DU	UXT 5
5962 T1	GV 852		
5962 T1	GN 909		

CITROËN	BERU		
5962 T2	GV 844		
5962 T3	GV 749		
5962 W2	GN 912		
5962 W8	GV 636		
5962 X1	GV 602		
5962 X1	GV 642		
5962 X1	GN 909		
5981 10	GR 059		
5981 13	GR 059		
5981 15	GR 065		
5981 19	GR 034		
5981 21	GR 054		
5981 27	GR 054		
75 491 694	Z 22	14-6 DU	UX 56
75 491 695	Z 22	14-6 DU	UX 56
75 491 697	Z 22	14-6 DU	UX 56
75 492 325	GV 130		
75 492 406	Z 31	14 K-5 DU	UXK 56
75 492 437	Z 48	14-6 BU	–
75 492 438	Z 25	14 K-6 DU	UXK 56
78 260 993 00	Z 11	14-7 DU	UXT 2/UXT 6
79 100 129 96	Z 25	14 K-6 DU	UXK 56
79 100 129 98	Z 25	14 K-6 DU	UXK 56
79 100 329 20	Z 31	14 K-5 DU	UXK 56
79 200 765 93	GR 059		
90 041 002 80	GV 661		
91 506 338	Z 25	14 K-6 DU	UXK 56
91 515 869	GR 065		
91 517 002	Z 11	14-7 DU	UXT 2/UXT 6
91 517 008	Z 17	14 K-7 DU	UXT 4
91 517 014	Z 25	14 K-6 DU	UXK 56
91 536 646	GV 636		
91 538 910 99	GV 661		
92 508 832 80	GR 059		
92 508 882 80	GR 059		
92 515 867	GR 065		
92 515 867 80	GR 065		
92 515 869	GR 065		
95 492 862	Z 31	14 K-5 DU	UXK 56
95 492 99 580	GR 059		
95 493 206	GV 602		
95 493 206	GV 642		
95 493 206	GN 909		
95 496 692	Z 41	14-5 BU	–
95 534 787	GR 059		
95 534 788	GV 602		
95 534 788	GV 642		
95 534 788	GN 909		
95 605 398	Z 40	14-5 AU	–
95 611 941	Z 17	14 K-7 DU	UXT 4
95 618 380	Z 10	14-7 BU	–
95 619 043	Z 11	14-7 DU	UXT 2/UXT 6
96 009 090	Z 13	14 F-7 DUOR	UXT 1/UXT 3
96 020 779	Z 29	14 F-5 DU	UXT 5
96 037 952	Z 71	14 F-8 DU	UXT 1/UXT 3
96 040 824	Z 15	14 FR-7 DU	UXT 1/UXT 3
96 064 066	Z 13	14 F-7 DUOR	UXT 1/UXT 3
96 070 388 80	GV 661		
96 073 353	Z 60	14 FGR-7 CTU	–
96 076 258	GV 661		
96 076 258	GN 909		
96 088 669	Z 24	14 FR-6 DU	UXT 5
96 141 677	GR 034		
96 141 678	GN 909		
96 145 071	Z 60	14 FGR-7 CTU	–
96 162 800 80	GR 054		

CITROËN	BERU		
96 165 724	GN 909		
96 165 823 80	GR 054		
96 236 383	GN 027		
96 316 589 80	GN 912		
96 332 143 80	GN 013		
96 389 858	GN 027		
97 533 994	Z 25	14 K-6 DU	UXK 56
97 535 383	Z 17	14 K-7 DU	UXT 4
A 212 7C	Z 39	14 Z-4 AU	-
AM 212 207 A	Z 40	14-5 AU	-
AYB 212-7	Z 39	14 Z-4 AU	-
AZ 212 7A	Z 39	14 Z-4 AU	-
DS 212 7G	Z 10	14-7 BU	-
DV 212 207 A	Z 10	14-7 BU	-
DX 212 7A	Z 10	14-7 BU	-
DX 212 7B	Z 57	14-7 AU	-
DX 212 7C	Z 10	14-7 BU	-
DY 212 207 A	Z 41	14-5 BU	-
GX 06 188 02 A	Z 38	14 Z-3 CU	-
GX 06 188 06 1	Z 41	14-5 BU	-
GX 06 188 08 A	Z 22	14-6 DU	UX 56
GX 06 188 10 A	Z 42	14-5 DU	UX 56
HG 2621	GV 107		
MKP 000 65	GV 642		
MKP 000 65	GN 909		
MKP 000 70	GD 382		
MKP 000 71	GN 857		
MKP 000 73	Z 42	14-5 DU	UX 56
ZA 3406 176	Z 22	14-6 DU	UX 56
ZA 4233 922	Z 22	14-6 DU	UX 56
ZC 9456 074 U	Z 39	14 Z-4 AU	-
ZC 9457 707 U	Z 39	14 Z-4 AU	-
ZC 9852 109 U	Z 39	14 Z-4 AU	-
ZC 9862 090 U	Z 1	14-8 DU	UXT 2/UXT 6
ZCT 000 012	Z 22	14-6 DU	UX 56

DACIA	BERU		
82 00 662 185	Z 243	12 VR-8 SE	-
82 00 682 592	GE 110		
82 00 794 920	GE 111		

DAF	BERU		
0192618	GN 954		
105977	GV 603		
117501	GH 010		
1343069	GH 401		
1353958	GN 954		
1378163	GH 401		
215206	Z 58	14-7 CU	-
225190	Z 57	14-7 AU	-
611065	GH 010		

DAIHATSU	BERU		
19850-54030-000	GV 688		
19850-54050-000	GV 894		
19850-54071-000	GV 886		
19850-54090-000	GV 968		
19850-58030-000	GV 678		
19850-64010-000	GV 886		
19850-64020-000	GV 967		
19850-68010	GV 897		
19850-68030-000	GV 678		
19850-68060-000	GV 895		

DAIHATSU	BERU		
19850-87309-000	GV 678		
19850-87701 000	GV 886		
19850-87702-000	GV 967		
90048-51163	Z 157	14 FR-7 KU0X	UXT 11
90048-51197	Z 234	12 FR-7 DU	-

DEERE	BERU		
13546/3	GV 110		
AT 16 490	GV 186		

DENSO	BERU		
16	Z 97	14 KR-8 MPX	UXT 8
3374	Z 299	14 FR-7 LUX0	-
3427	Z 243	12 VR-8 SE	-
D 110	Z 299	14 FR-7 LUX0	-
GE 3-1	Z 187	14 R-4 CIU	-
GE 3-5	Z 281	14 R-4 DIU3	-
GE 3-5A	Z 281	14 R-4 DIU3	-
GE 5-1	Z 205	14 R-4 CIU	-
GI 3-1A	Z 202	18 GZ 6-77-2	-
GI 3-3A	Z 202	18 GZ 6-77-2	-
GI 3-5A	Z 202	18 GZ 6-77-2	-
GK 3-1A	Z 189	14 FR-4 DPU0	-
GK 3-5	Z 290	14 FR-4 DIU3	-
GK 3-5A	Z 212	14 FR-4 DIU	-
GL 3-1A	Z 179	18 GZ 4-77	-
GL 3-3A	Z 179	18 GZ 4-77	-
GL 3-5	Z 201	18 GZ 5-77-2	-
GL 3-5A	Z 201	18 GZ 5-77-2	-
GN 3-1A	Z 195	14 R-5 BIU	-
K 16 HPR-U11	Z 183	14 FR-8 MU2	UXT 13
K 16 PR-U	Z 15	14 FR-7 DU	UXT 1/UXT 3
K 16 PR-U 11	Z 16	14 FR-7 DUX	UXT 1/UXT 3
K 16 R-U	Z 155	14 FR-7 KU	UXT 10
K 16 TR 11	Z 208	14 FR-8 LDU3	-
K 16R-U11	Z 249	14 FR-8 KU0U	-
K 20 HR-U 11	Z 223	14 FR-8 NQU23	-
K 20 PR-U	Z 15	14 FR-7 DU	UXT 1/UXT 3
K 20 PR-U 11	Z 16	14 FR-7 DUX	UXT 1/UXT 3
K 20 R-U	Z 155	14 FR-7 KU	UXT 10
K 20 R-U 11	Z 157	14 FR-7 KU0X	UXT 11
K 20 TXR	Z 204	14 FGR-8 CTU	-
K 22 TNR-S	Z 192	14 FR-5 LDU	-
KJ 16 CR-L 11	Z 158	14 FR-7 LUX	-
KJ 20 CR-L 11	Z 158	14 FR-7 LUX	-
KJ 20 DR-M 11	Z 299	14 FR-7 LUX0	-
P 16 PR 11	Z 311	14 R-8 DPUU	UXT 2/UXT 6
PK 20 PR-11	Z 228	14 FR-7 DPUX02	UXT 11
PK 20 R 13	Z 150	14 FR-7 KPUV	-
PKJ 16 CR-8	Z 229	14 FR-8 LPU0	-
Q 14 R-U 11	Z 73	14 FR-8 DUX	UXT 1/UXT 3
Q 16 PR-U 11	Z 73	14 FR-8 DUX	UXT 1/UXT 3
Q 16 R-U 11	Z 73	14 FR-8 DUX	UXT 1/UXT 3
Q 20 PR-U	Z 15	14 FR-7 DU	UXT 1/UXT 3
Q 20 PR-U 11	Z 16	14 FR-7 DUX	UXT 1/UXT 3
Q 20 P-U	Z 63	14 F-7 DU	UXT 1/UXT 3
Q 20 R-U	Z 15	14 FR-7 DU	UXT 1/UXT 3
Q 20 RU-11	Z 16	14 FR-7 DUX	UXT 1/UXT 3
QJ 16AR-U	Z 248	14 FR-8 HUT	-
SK 16 PR-E 13	Z 307	14 FR-7 DPUV02	-
SKJ 20 DR-M 11	Z 297	14 FR-7 LPUX0	-
T 16 EPR-U	Z 95	14 KR-7 DU	UXT 4
T 16 EPR-U 15	Z 95	14 KR-7 DU	UXT 4

DENSO	BERU		
T 16 VR-U 10	Z 222	14 KR-8 STUX	–
T 20 EPR-U	Z 95	14 KR-7 DU	UXT 4
T 20 EPR-U 15	Z 95	14 KR-7 DU	UXT 4
T 20 EP-U	Z 18	14 K-7 DU0	UXT 4
T 20 PU	Z 32	18 K-7 BU	–
TU 22	Z 210	10 FR-6 CPU03	–
W 14 EP	Z 1	14-8 DU	UXT 2/UXT 6
W 14 EPR-U	Z 82	14 R-9 DU	UXT 2/UXT 6
W 14 EXR-U	Z 82	14 R-9 DU	UXT 2/UXT 6
W 14 EX-U	Z 1	14-8 DU	UXT 2/UXT 6
W 14 FP	Z 10	14-7 BU	–
W 14 F-U	Z 57	14-7 AU	–
W 16 EP	Z 11	14-7 DU	UXT 2/UXT 6
W 16 EPB-10	Z 2	14-8 DTU	UXT 2/UXT 6
W 16 EPR-U	Z 8	14 R-8 DU	UXT 2/UXT 6
W 16 EP-U	Z 1	14-8 DU	UXT 2/UXT 6
W 16 ES-L	Z 58	14-7 CU	–
W 16 EX	Z 1	14-8 DU	UXT 2/UXT 6
W 16 EXR-U	Z 8	14 R-8 DU	UXT 2/UXT 6
W 16 EXR-U 11	Z 9	14 R-8 DUX	UXT 2/UXT 6
W 16 EXR-W	Z 8	14 R-8 DU	UXT 2/UXT 6
W 16 EX-U	Z 1	14-8 DU	UXT 2/UXT 6
W 16 EX-U 11	Z 9	14 R-8 DUX	UXT 2/UXT 6
W 17	Z 112	14-8 E	–
W 17 ES	Z 58	14-7 CU	–
W 17 EV	Z 58	14-7 CU	–
W 20 EKR-S11	Z 47	14 R-5 DU	UX 56
W 20 EP	Z 11	14-7 DU	UXT 2/UXT 6
W 20 EPR-U 11	Z 21	14 R-7 DUX	UXT 2/UXT 6
W 20 EP-U	Z 11	14-7 DU	UXT 2/UXT 6
W 20 ET	Z 22	14-6 DU	UX 56
W 20 EX	Z 22	14-6 DU	UX 56
W 20 EXR-U 11	Z 21	14 R-7 DUX	UXT 2/UXT 6
W 20 EXR-U 13	Z 21	14 R-7 DUX	UXT 2/UXT 6
W 20 EX-U	Z 11	14-7 DU	UXT 2/UXT 6
W 20 FP	Z 48	14-6 BU	–
W 20 FP-U	Z 10	14-7 BU	–
W 20 FS-U	Z 57	14-7 AU	–
W 22 EP	Z 42	14-5 DU	UX 56
W 22 EPR-U	Z 27	14 R-6 DU	UX 56
W 22 ES	Z 38	14 Z-3 CU	–
W 22 ES-ZU	Z 104	14-6 DPO	–
W 22 FS-U	Z 40	14-5 AU	–
W 24 ES	Z 38	14 Z-3 CU	–
W 27 ES-U	Z 38	14 Z-3 CU	–
XE 20 HR-U9	Z 243	12 VR-8 SE	–
XE 20 HR-U9	Z 243 SB	12 VR-8 SE SB	–
XU 22 PR 9	Z 234	12 FR-7 DU	–

DUCELLIER	BERU		
599247	Z 42	14-5 DU	UX 56
599248	Z 22	14-6 DU	UX 56
599249	Z 22	14-6 DU	UX 56
599250	Z 11	14-7 DU	UXT 2/UXT 6
599251	Z 1	14-8 DU	UXT 2/UXT 6
599252	Z 11	14-7 DU	UXT 2/UXT 6
599253	Z 31	14 K-5 DU	UXK 56
599254	Z 31	14 K-5 DU	UXK 56
599255	Z 25	14 K-6 DU	UXK 56
599256	Z 10	14-7 BU	–
599257	Z 57	14-7 AU	–
599258	Z 10	14-7 BU	–
599301	Z 42	14-5 DU	UX 56
599302	Z 22	14-6 DU	UX 56

DUCELLIER	BERU		
599303	Z 22	14-6 DU	UX 56
599304	Z 11	14-7 DU	UXT 2/UXT 6
599305	Z 1	14-8 DU	UXT 2/UXT 6
599306	Z 11	14-7 DU	UXT 2/UXT 6
599307	Z 31	14 K-5 DU	UXK 56
599308	Z 31	14 K-5 DU	UXK 56
599309	Z 25	14 K-6 DU	UXK 56
599310	Z 10	14-7 BU	–
599311	Z 57	14-7 AU	–
599312	Z 10	14-7 BU	–
599313	Z 33	18 K-6 BU	–
599314	Z 11	14-7 DU	UXT 2/UXT 6
599316	Z 57	14-7 AU	–
599323	Z 41	14-5 BU	–
599330	Z 27	14 R-6 DU	UX 56
599331	Z 20	14 R-7 DU	UXT 2/UXT 6
599332	Z 26	14 KR-6 DU	UXK 56
599528	Z 10	14-7 BU	–

EBERSPÄCHER	BERU		
100	GH 408	–	–
101	GH 191	–	–
20 1105 10 00 11	Z 110	EBE 514	–
20 1156 00 00 06	GF 163	–	–
20 1205 09 02 00	GH 195	–	–
20 1289 00 00 09	GH 13	–	–
20 1305 00 00 19	GH 30	–	–
20 1390 00 00 06	GH 195	–	–
20 1415 00 00 08	GH 16	–	–
20 1451 01 00 09	GH 30	–	–
20 1549 01 00 05	GH 203	–	–
20 1593 01 00 03	GH 191	–	–
20 1593 01 00 04	GH 191	–	–
20 1634 01 00 03	GH 202	–	–
20 1643 01 00 11	GH 30	–	–
25 1156 00 00 06	GF 163	–	–
25 1177 00 00 05	GH 345	–	–
25 1179 00 00 03	GH 359	–	–
25 1228 01 00 09	GF 186	–	–
25 1380 01 00 03	GH 402	–	–
25 1384 01 00 02	GH 408	–	–
25 1384 01 00 10	GH 408	–	–
25 1422 01 00 07	GH 407	–	–
25 1425 01 00 02	GH 30	–	–
25 1431 01 00 03	GH 201	–	–
25 1490 00 00 05	GH 648	–	–
25 1494 00 00 05	GH 648	–	–
25 1634 00 00 02	GH 648	–	–
25 1688 01 00 05/2/A	GHA 408	–	–
25 1806 01 02 00	GH 931	–	–
25 1816 01 01 00	GH 008	–	–
25 1830 01 01 00	GHA 408	–	–
25 1831 01 01 00	GH 931	–	–
25 1864 01 10 00	GH 001	–	–
25 1864 01 10 00 2 E	GH 001	–	–
25 1997 01 01 00	GH 009	–	–
25 1997 99 01 01	GH 009	–	–
37 30 104	GH 306	–	–
37 30 624	GH 306	–	–
E 109	GH 008	–	–
E 129	GH 009	–	–

EYQUEM	BERU		
60 L	Z 58	14-7 CU	-
60 LS	Z 1	14-8 DU	UXT 2/UXT 6
75 LS	Z 11	14-7 DU	UXT 2/UXT 6
80 LS	Z 22	14-6 DU	UX 56
80 LW	Z 38	14 Z-3 CU	-
200	Z 85	14 X-AU	-
406	Z 57	14-7 AU	-
500	Z 57	14-7 AU	-
500 C	Z 112	14-8 E	-
500 CM	Z 112	14-8 E	-
502	Z 68	14-8 AU	-
502 CT	Z 262	14 S-9 E0	-
550 LS	Z 76	14-9 DU	UXT 2/UXT 6
550 S	Z 10	14-7 BU	-
580 L	Z 58	14-7 CU	-
580 LS	Z 1	14-8 DU	UXT 2/UXT 6
580 S	Z 10	14-7 BU	-
600 L	Z 58	14-7 CU	-
600 LS	Z 1	14-8 DU	UXT 2/UXT 6
600 S	Z 10	14-7 BU	-
700	Z 57	14-7 AU	-
700 CTS	Z 260	14 SR-5 F	-
705 L	Z 58	14-7 CU	-
705 S	Z 48	14-6 BU	-
707 LS	Z 11	14-7 DU	UXT 2/UXT 6
707 LSX	Z 11	14-7 DU	UXT 2/UXT 6
750	Z 57	14-7 AU	-
750 LS	Z 11	14-7 DU	UXT 2/UXT 6
753 LJS	Z 25	14 K-6 DU	UXK 56
755	Z 40	14-5 AU	-
755 L	Z 38	14 Z-3 CU	-
755 LJS	Z 25	14 K-6 DU	UXK 56
755 LS	Z 22	14-6 DU	UX 56
755 S	Z 41	14-5 BU	-
755 SX	Z 41	14-5 BU	-
755 X	Z 40	14-5 AU	-
800 LJ	Z 31	14 K-5 DU	UXK 56
800 LJS	Z 31	14 K-5 DU	UXK 56
800 LS	Z 22	14-6 DU	UX 56
802 L	Z 38	14 Z-3 CU	-
803 LJS	Z 31	14 K-5 DU	UXK 56
805 L	Z 38	14 Z-3 CU	-
850	Z 39	14 Z-4 AU	-
850 LS	Z 42	14-5 DU	UX 56
1000	Z 39	14 Z-4 AU	-
1000 L	Z 38	14 Z-3 CU	-
1100	Z 37	14 Z-3 AU	-
1100 L	Z 38	14 Z-3 CU	-
75806	Z 116	14 FR-6 LDU	UXT 5
80266	Z 24	14 FR-6 DU	UXT 5
A 71	Z 252	14 FR-6 DUW	UXT 5
A 100	Z 223	14 FR-8 NQU23	-
A 179	Z 222	14 KR-8 STUX	-
A 183	Z 200	14 F-7 HUR2	-
A 188	Z 229	14 FR-8 LPU0	-
A 189	Z 233	12 ZR-6 SPO3	-
A 190	Z 234	12 FR-7 DU	-
A 191	Z 235	14 FR-7 SPUX03	-
A 192	Z 236	14 F-6 HTPRX02	-
A 193	Z 237	14 FR-7 DQP7	-
A 194	Z 238	14 FR-8 DPU2	UXT 10
A 195	Z 240	14 F-8 DPURX02	UXT 9
A 197	Z 243	12 VR-8 SE	-
A 199	Z 210	10 FR-6 CPU03	-
A 500	Z 288	12 ZR-7 SPO3	-
C 30 LS	Z 76	14-9 DU	UXT 2/UXT 6

EYQUEM	BERU		
C 32	Z 68	14-8 AU	-
C 32 LS	Z 76	14-9 DU	UXT 2/UXT 6
C 32 S	Z 118	14-8 BU	-
C 42	Z 57	14-7 AU	-
C 42 LJS3	Z 207	14 KG-8 DTU	-
C 42 S	Z 10	14-7 BU	-
C 52 LJS	Z 17	14 K-7 DU	UXT 4
C 52 LJS	Z 18	14 K-7 DU0	UXT 4
C 52 LS	Z 1	14-8 DU	UXT 2/UXT 6
C 52 LS 3X	Z 2	14-8 DTU	UXT 2/UXT 6
C 62	Z 40	14-5 AU	-
C 62 LJS	Z 17	14 K-7 DU	UXT 4
C 62 LS	Z 11	14-7 DU	UXT 2/UXT 6
C 62 LS 3X	Z 12	14-7 DTU	UXT 2/UXT 6
C 62 S	Z 48	14-6 BU	-
C 72	Z 39	14 Z-4 AU	-
C 72 LJS	Z 25	14 K-6 DU	UXK 56
C 72 LS	Z 22	14-6 DU	UX 56
C 72 LS 3X	Z 51	14-6 DTU	UX 56
C 80 LJS	Z 31	14 K-5 DU	UXK 56
C 82	Z 37	14 Z-3 AU	-
C 82 LJS	Z 31	14 K-5 DU	UXK 56
C 82 LS	Z 42	14-5 DU	UX 56
C 82 LS 3X	Z 44	14-5 DTU	UX 56
F 54	Z 63	14 F-7 DU	UXT 1/UXT 3
F 86	Z 29	14 F-5 DU	UXT 5
FC 42 LS	Z 100	14 F-8 DU4	UXT 1/UXT 3
FC 42 LS	Z 71	14 F-8 DU	UXT 1/UXT 3
FC 52 LS	Z 63	14 F-7 DU	UXT 1/UXT 3
FC 58 LS	Z 63	14 F-7 DU	UXT 1/UXT 3
FC 58 LS 3X	Z 60	14 FGR-7 CTU	-
FC 62 LS	Z 24	14 FR-6 DU	UXT 5
FC 62 LS 3X	Z 52	14 F-6 DTU	UXT 5
FC 62 LS 3X	Z 53	14 F-6 DTU	UXT 5
FC 72 LS	Z 29	14 F-5 DU	UXT 5
FC 82 LS	Z 29	14 F-5 DU	UXT 5
FC 82 LS1	Z 29	14 F-5 DU	UXT 5
FC 82 LS2	Z 29	14 F-5 DU	UXT 5
FN 42 LZDPR 5	Z 240	14 F-8 DPURX02	UXT 9
FN 52 LS	Z 63	14 F-7 DU	UXT 1/UXT 3
FN 62 LZFDPR2A	Z 236	14 F-6 HTPRX02	-
J 65	Z 17	14 K-7 DU	UXT 4
J 87	Z 31	14 K-5 DU	UXK 56
K 300 M	Z 88	18-10 AU	-
K 450 JS	Z 32	18 K-7 BU	-
K 550 JS	Z 32	18 K-7 BU	-
KC 42 JS	Z 175	18 K-9 BU	-
KC 52 JS	Z 32	18 K-7 BU	-
KC 62 JS	Z 33	18 K-6 BU	-
L 65	Z 11	14-7 DU	UXT 2/UXT 6
L 87	Z 42	14-5 DU	UX 56
N 43	Z 10	14-7 BU	-
R 850	Z 39	14 Z-4 AU	-
R 1000	Z 37	14 Z-3 AU	-
RC 32 LS	Z 82	14 R-9 DU	UXT 2/UXT 6
RC 32 LS5	Z 82	14 R-9 DU	UXT 2/UXT 6
RC 42 HJS3E5	Z 222	14 KR-8 STUX	-
RC 42 S	Z 19	14 R-7 BU	-
RC 52 LJS	Z 95	14 KR-7 DU	UXT 4
RC 52 LJS 5	Z 67	14 KR-7 DUX	UXT 4
RC 52 LS	Z 119	14 R-8 DU4	UXT 2/UXT 6
RC 52 LS 5	Z 9	14 R-8 DUX	UXT 2/UXT 6
RC 52 LZ 3 EX	Z 75	14 G-8 DTU	UXT 2/UXT 6
RC 52 LZ 3 EX	Z 94	14 GR-8 DTU	UXT 2/UXT 6
RC 52 LZ E	Z 3	14-8 LUR	UXT 2/UXT 6
RC 58 LZ 3 EX	Z 92	14 GH-8 DTUR	UXT 2/UXT 6



EYQUEM	BERU		
RC 58 LZ3EX	Z 91	14 GH-7 DTUR	UXT 2/UXT 6
RC 62 HJS6	Z 177	14 KR-8 MUV	UXT 7
RC 62 HJSDP	Z 97	14 KR-8 MPX	UXT 8
RC 62 LJS	Z 95	14 KR-7 DU	UXT 4
RC 62 LS	Z 20	14 R-7 DU	UXT 2/UXT 6
RC 62 LS 5	Z 21	14 R-7 DUX	UXT 2/UXT 6
RC 62 S	Z 48	14-6 BU	–
RC 72	Z 39	14 Z-4 AU	–
RC 72 LJS	Z 26	14 KR-6 DU	UXK 56
RC 72 LS	Z 27	14 R-6 DU	UX 56
RC 72 LS 5	Z 28	14 R-6 DUX	UX 56
RC 82	Z 37	14 Z-3 AU	–
RC 82 L	Z 38	14 Z-3 CU	–
RC 82 LS	Z 47	14 R-5 DU	UX 56
RFC 42 HZDP5	Z 219	14 FR-8 MPUX02	UXT 13
RFC 42 LS	Z 72	14 FR-8 DU	UXT 1/UXT 3
RFC 42 LS 2E	Z 74	14 FR-8 LDUOX4	UXT 1/UXT 3
RFC 42 LS 5	Z 73	14 FR-8 DUX	UXT 1/UXT 3
RFC 42 LZ 2E	Z 74	14 FR-8 LDUOX4	UXT 1/UXT 3
RFC 42 LZDP	Z 229	14 FR-8 LPU0	–
RFC 50 LZ 2E	Z 74	14 FR-8 LDUOX4	UXT 1/UXT 3
RFC 52 LS	Z 15	14 FR-7 DU	UXT 1/UXT 3
RFC 52 LS 2E	Z 98	14 FR-7 LDU	UXT 1/UXT 3
RFC 52 LS 3	Z 204	14 FGR-8 CTU	–
RFC 52 LS5	Z 16	14 FR-7 DUX	UXT 1/UXT 3
RFC 52 LSP	Z 224	14 FR-7 DPU3	UXT 9
RFC 52 LZ	Z 227	14 F-8 DUR	UXT 1/UXT 3
RFC 52 LZ E	Z 4	14 F-8 LUR	UXT 1/UXT 3
RFC 52 LZDP	Z 151	14 FR-7 KPU	UXT 9
RFC 52 LZDP5	Z 149	14 FR-7 KPUX	UXT 11
RFC 58 HZEDP5	Z 235	14 FR-7 SPUX03	–
RFC 58 LS	Z 13	14 F-7 DUOR	UXT 1/UXT 3
RFC 58 LS	Z 15	14 FR-7 DU	UXT 1/UXT 3
RFC 58 LS 2E	Z 98	14 FR-7 LDU	UXT 1/UXT 3
RFC 58 LS 3	Z 60	14 FGR-7 CTU	–
RFC 58 LS 3X	Z 60	14 FGR-7 CTU	–
RFC 58 LS2E	Z 257	14 FR-7 LDUW	UXT 1/UXT 3
RFC 58 LS5	Z 16	14 FR-7 DUX	UXT 1/UXT 3
RFC 58 LZ	Z 155	14 FR-7 KU	UXT 10
RFC 58 LZ	Z 156	14 FR-7 KU0	UXT 10
RFC 58 LZ 2E	Z 14	14 F-7 LDUR4	UXT 1/UXT 3
RFC 58 LZ 3EX	Z 90	14 FGH-7 DTURX	UXT 1/UXT 3
RFC 58 LZ2	Z 123	14 FR-7 KDU	UXT 9
RFC 58 LZ3EX	Z 120	14 FGH-7 DTURX0	UXT 9
RFC 58 LZ5	Z 157	14 FR-7 KUOX	UXT 11
RFC 58 LZDP	Z 224	14 FR-7 DPU3	UXT 9
RFC 58 LZE5	Z 158	14 FR-7 LUX	–
RFC 58 LZF5	Z 225	14 FR-7 HUX	–
RFC 58 LZK	Z 158	14 FR-7 LUX	–
RFC 58 LZP	Z 224	14 FR-7 DPU3	UXT 9
RFC 58 LZP4	Z 237	14 FR-7 DQUP7	–
RFC 62 LS	Z 24	14 FR-6 DU	UXT 5
RFC 62 LS 3	Z 52	14 F-6 DTU	UXT 5
RFC 62 LS 3X	Z 52	14 F-6 DTU	UXT 5
RFC 62 LS 5	Z 99	14 FR-6 DUX	UXT 5
RFC 62 LZ 3 EX	Z 89	14 FGH-6 DTUR	UXT 5
RFC 62 LZ2	Z 145	14 FGR-6 DDU	–
RFC 82 LS	Z 30	14 FR-5 DU	UXT 5
RFC 82 LS 3	Z 45	14 FR-5 DTU	UXT 5
RFN 42 LZG5	Z 248	14 FR-8 HUT	–
RFN 42 LZP	Z 238	14 FR-8 DPU2	UXT 10
RFN 52 HZ	Z 183	14 FR-8 MU2	UXT 13
RFN 52 HZ3A	Z 223	14 FR-8 NQU23	–
RFN 52 LZ	Z 193	14 FR-7 DU2	UXT 1/UXT 3
RFN 52 LZDPF5	Z 176	14 F-7 HPURX2	–
RFN 58 HZ	Z 184	14 FR-7 MU2	UXT 13

EYQUEM	BERU		
RFN 58 LZ	Z 193	14 FR-7 DU2	UXT 1/UXT 3
RFN 58 LZDP5	Z 228	14 FR-7 DPUX02	UXT 11
RFN 62 LZ	Z 24	14 FR-6 DU	UXT 5
RFN 62 LZ	Z 252	14 FR-6 DUW	UXT 5
RFN 62 LZDP5	Z 221	14 FR-6 DPUX02	UXT 14
RKC 52 JS	Z 32	18 K-7 BU	–
RKC 52 JS	Z 32	18 K-7 BU	–
RKC 62 JS	Z 33	18 K-6 BU	–
RN 22 HJSE6	Z 216	14 KR-10 SUV2	–
RWC 52 HSK	Z 243	12 VR-8 SE	–
RXC 58 HSEDP	Z 288	12 ZR-7 SP03	–
RXC 62 HSEDP	Z 233	12 ZR-6 SP03	–
RZC 58 LS	Z 234	12 FR-7 DU	–
XKC 52 JS	Z 32	18 K-7 BU	–
XKC 62 JS	Z 33	18 K-6 BU	–
XRC 52 JS	Z 32	18 K-7 BU	–

FAUN	BERU
17 14-022	GV 380
17 14-052	GF 167
17 14-061	GV 390

FENDT	BERU
F 139 000 020 021	GV 119
F 139 903 020 021	GV 119
F 238 900 020 130	GV 129
F 278 201 090 030	GF 154
F 284 200 181 010	GF 138
X 830 030 126	GF 683

FERRARI	BERU
113538	Z 58 14-7 CU –

FIAT	BERU		
1 L 4 J	Z 11	14-7 DU	UXT 2/UXT 6
1 L 4 JR	Z 20	14 R-7 DU	UXT 2/UXT 6
1 L 45 J	Z 22	14-6 DU	UX 56
1 L 45 JR	Z 27	14 R-6 DU	UX 56
1 S 3	Z 57	14-7 AU	–
1 S 5 J	Z 41	14-5 BU	–
7 FYSSR	Z 27	14 R-6 DU	UX 56
7 GBMSR	Z 98	14 FR-7 LDU	UXT 1/UXT 3
7 GYSSR	Z 24	14 FR-6 DU	UXT 5
9 FY	Z 11	14-7 DU	UXT 2/UXT 6
9 FYSR	Z 20	14 R-7 DU	UXT 2/UXT 6
9 FYSSR	Z 20	14 R-7 DU	UXT 2/UXT 6
9 GYSSR	Z 193	14 FR-7 DU2	UXT 1/UXT 3
F 2 VB	GV 602		
F 4 VB	GV 602		
FU 2 A	GV 663		
FU 4 A	GV 642		
V 45 LSR	Z 27	14 R-6 DU	UX 56
07029585	GV 602		
2284662	Z 22	14-6 DU	UX 56
2301710	Z 42	14-5 DU	UX 56
2301711	Z 22	14-6 DU	UX 56
3233922	Z 22	14-6 DU	UX 56
4113022	Z 57	14-7 AU	–
4129674	GV 128		
4170472	Z 42	14-5 DU	UX 56

FIAT	BERU		
4172173	Z 42	14-5 DU	UX 56
4249164	Z 22	14-6 DU	UX 56
4345041	Z 22	14-6 DU	UX 56
4346196	Z 20	14 R-7 DU	UXT 2/UXT 6
4346796	Z 20	14 R-7 DU	UXT 2/UXT 6
4346797	Z 27	14 R-6 DU	UX 56
4347776	Z 27	14 R-6 DU	UX 56
4359422	Z 11	14-7 DU	UXT 2/UXT 6
4359423	Z 11	14-7 DU	UXT 2/UXT 6
4359424	Z 20	14 R-7 DU	UXT 2/UXT 6
4361799	Z 10	14-7 BU	-
4361800	Z 10	14-7 BU	-
4378107	Z 19	14 R-7 BU	-
4393814	GV 602		
4401547	Z 41	14-5 BU	-
4401549	Z 11	14-7 DU	UXT 2/UXT 6
4401550	Z 20	14 R-7 DU	UXT 2/UXT 6
4401551	Z 11	14-7 DU	UXT 2/UXT 6
4401552	Z 27	14 R-6 DU	UX 56
4401586	Z 57	14-7 AU	-
4425057	Z 41	14-5 BU	-
4474413	GV 642		
46417010	Z 255	14 FR-8 DUW	UXT 1/UXT 3
46423043	GR 054		
46447610	GN 970		
46451951	GN 017		
46461873	Z 234	12 FR-7 DU	-
46463801	Z 98	14 FR-7 LDU	UXT 1/UXT 3
46472021	Z 98	14 FR-7 LDU	UXT 1/UXT 3
46480307	Z 98	14 FR-7 LDU	UXT 1/UXT 3
46480362	Z 15	14 FR-7 DU	UXT 1/UXT 3
46480363	Z 15	14 FR-7 DU	UXT 1/UXT 3
46531917	Z 234	12 FR-7 DU	-
46531918	Z 255	14 FR-8 DUW	UXT 1/UXT 3
46531919	Z 234	12 FR-7 DU	-
46531935	Z 255	14 FR-8 DUW	UXT 1/UXT 3
46750545	Z 291	12 FR-5 DU	-
46751764	GN 030		
46754154	GN 041		
46779614	GN 053		
46792355	GN 059		
46796050	GN 053		
46799928	Z 234	12 FR-7 DU	-
46823299	Z 234	12 FR-7 DU	-
4714294	GV 602		
4729585	GV 602		
4754011	GV 602		
4774412	GV 602		
4774413	GV 642		
4776085	GF 683		
4781356	GV 642		
4781356	GN 909		
4792112	GR 065		
4832279	GF 683		
4849406	GV 727		
500303569	GF 683		
500314583	GF 006		
500316493	GN 012		
500351992	GN 037		
5415813	GV 108		
5493206	GV 602		
5500842	GV 130		
55187863	GN 059		
55188857	Z 292	12 FR-6 DU	-
55190788	Z 293	12 FR-6 LUX	-
55198201	Z 234	12 FR-7 DU	-

FIAT	BERU		
5882087	Z 10	14-7 BU	-
5894586	Z 193	14 FR-7 DU2	UXT 1/UXT 3
5894587	Z 20	14 R-7 DU	UXT 2/UXT 6
5894588	Z 24	14 FR-6 DU	UXT 5
5896177	Z 98	14 FR-7 LDU	UXT 1/UXT 3
5896824-1	Z 98	14 FR-7 LDU	UXT 1/UXT 3
5946920	GR 065		
5950464	GV 602		
5951861	GV 602		
5951879	GV 602		
5951881	GV 663		
5951882	GV 642		
5984036	Z 20	14 R-7 DU	UXT 2/UXT 6
5990986	GR 065		
60504563	Z 42	14-5 DU	UX 56
60507123	GV 657		
60512848	Z 29	14 F-5 DU	UXT 5
60512929	Z 42	14-5 DU	UX 56
60569957	Z 130	14 FR-5 DPUX	-
60596245	GN 909		
60597490	Z 29	14 F-5 DU	UXT 5
60617002	GN 007		
60800325	Z 27	14 R-6 DU	UX 56
60810689	Z 130	14 FR-5 DPUX	-
60812292	GN 908		
60814613	GN 017		
60815294	GN 020		
71377139	Z 234	12 FR-7 DU	-
71711638	Z 15	14 FR-7 DU	UXT 1/UXT 3
71711639	Z 27	14 R-6 DU	UX 56
71711640	Z 20	14 R-7 DU	UXT 2/UXT 6
71711806	Z 20	14 R-7 DU	UXT 2/UXT 6
71713981	GN 020		
71719015	GV 663		
71719244	Z 255	14 FR-8 DUW	UXT 1/UXT 3
71735460	GN 927		
71735461	GN 908		
71735462	GN 012		
71735464	GN 030		
71736278	Z 27	14 R-6 DU	UX 56
72002410	Z 38	14 Z-3 CU	-
7546519	Z 15	14 FR-7 DU	UXT 1/UXT 3
7554419	Z 22	14-6 DU	UX 56
7554420	Z 11	14-7 DU	UXT 2/UXT 6
7554421	Z 11	14-7 DU	UXT 2/UXT 6
7554436	Z 27	14 R-6 DU	UX 56
7554437	Z 27	14 R-6 DU	UX 56
7554438	Z 42	14-5 DU	UX 56
7554444	Z 20	14 R-7 DU	UXT 2/UXT 6
7554445	Z 48	14-6 BU	-
7554447	Z 10	14-7 BU	-
7554448	Z 10	14-7 BU	-
7554449	Z 47	14 R-5 DU	UX 56
7554451	Z 20	14 R-7 DU	UXT 2/UXT 6
7554452	Z 42	14-5 DU	UX 56
7554453	Z 22	14-6 DU	UX 56
7563225100	GV 155		
7565476	Z 38	14 Z-3 CU	-
7565853	Z 52	14 F-6 DTU	UXT 5
7571541	Z 255	14 FR-8 DUW	UXT 1/UXT 3
7632587	GV 730		
7702960	GV 663		
7735920	GN 908		
77359200	GN 909		
7760381	Z 27	14 R-6 DU	UX 56
7760382	Z 20	14 R-7 DU	UXT 2/UXT 6

FIAT	BERU		
7760383	Z 15	14 FR-7 DU	UXT 1/UXT 3
7760384	Z 24	14 FR-6 DU	UXT 5
7769243	Z 98	14 FR-7 LDU	UXT 1/UXT 3
7772453	Z 24	14 FR-6 DU	UXT 5
7772515	Z 27	14 R-6 DU	UX 56
7777837	GN 927		
8122193	GF 683		
88900066	GV 170		
9151700180	Z 70	14-8 DU0	UXT 2/UXT 6
96 515 836 80	GN 054		
961416778	GR 034		
9614738680	Z 98	14 FR-7 LDU	UXT 1/UXT 3
9615938380	GR 054		
96165724	GN 909		
9616572480	GN 013		
9619624580	Z 74	14 FR-8 LDUOX4	UXT 1/UXT 3
9623638380	GN 027		
9628000280	Z 14	14 F-7 LDUR4	UXT 1/UXT 3
9631658980	GN 016		
9633214380	GN 013		
9636393480	Z 183	14 FR-8 MU2	UXT 13
9638985980	GN 027		
9650100080	GN 056		
9651029780	GN 027		
9651029880	GN 016		
98459883	GN 925		
98462490	GN 917		
98462492	GN 925		
98498630	GN 927		
99444499	GF 981		
99450392	GF 978		
99450393	GF 007		
99450394	GF 979		
99450396	GF 974		
99473620	GF 984		

FORD	BERU		
0 150 581 2	Z 326	14 FR-7 MPUS	UXT 13
1 000 996	Z 284	14 FR-6 DPOX	-
1 001 049	GN 022		
1 008 792	GN 022		
1 012 639	Z 95	14 KR-7 DU	UXT 4
1 023 706	Z 159	14 FR-6 DPUX	UXT 14
1 032 705	Z 173	14 FGR-8 KQU	-
1 037 204	GN 855		
1 045 261	GN 022		
1 056 857	GN 022		
1 079 401	GN 993		
1 086 020	Z 228	14 FR-7 DPUX02	UXT 11
1 088 847	Z 177	14 KR-8 MUV	UXT 7
1 097 080	Z 177	14 KR-8 MUV	UXT 7
1 120 170	Z 176	14 F-7 HPURX2	-
1 120 818	Z 32	18 K-7 BU	-
1 120 818	Z 32	18 K-7 BU	-
1 128 053	Z 209	14 KR-6 DPUV02	UXT 15
1 148 105	GN 047		
1 202 935	Z 177	14 KR-8 MUV	UXT 7
1 204 572	Z 209	14 KR-6 DPUV02	UXT 15
1 207 068	GN 046		
1 233 897	Z 177	14 KR-8 MUV	UXT 7
1 240 5AD	Z 32	18 K-7 BU	-
1 240 5JE	Z 33	18 K-6 BU	-
1 255 464	Z 177	14 KR-8 MUV	UXT 7
1 257 205	GH 001		
1 307 093	Z 209	14 KR-6 DPUV02	UXT 15

FORD	BERU		
1 309 471	GN 939		
1 313 809	GN 054		
1 315 691	Z 148	14 KR-8 DPU0V	UXT 15
1 324 211	Z 309	14 KR-8 LQU07	-
1 327 341	Z 177	14 KR-8 MUV	UXT 7
1 335 367	Z 177	14 KR-8 MUV	UXT 7
1 350 742	Z 177	14 KR-8 MUV	UXT 7
1 362 012	Z 177	14 KR-8 MUV	UXT 7
1 369 704	Z 230	14 KR-6 KPUV02	-
1 447128	GN 056		
1 506 413	Z 22	14-6 DU	UX 56
1 506 415	Z 11	14-7 DU	UXT 2/UXT 6
1 507 572	Z 33	18 K-6 BU	-
1 518 878	Z 27	14 R-6 DU	UX 56
1 523 608	Z 20	14 R-7 DU	UXT 2/UXT 6
1 542 499	Z 293	12 FR-6 LUX	-
1 587 444	GV 602		
1 590 417	GV 631		
1 669 977	GN 855		
1 690 048	GN 007		
1 836 600 C1	GN 036		
1 843 286 C1	GN 049		
1 843 286 C2	GN 049		
1 952 464	GN 854		
1M50 12405 CA	Z 177	14 KR-8 MUV	UXT 7
1S7J 12405 DA	Z 209	14 KR-6 DPUV02	UXT 15
1S7J 12405 EB	Z 209	14 KR-6 DPUV02	UXT 15
2S6Q 6M090 AA	GN 047		
2S6Q 6M090 BB	GN 056		
2S7 12405 AC	Z 309	14 KR-8 LQU07	-
2S7E 12405 AA	Z 296	14 KR-7 DPUV	UXT 15
2S7E 12405 AB	Z 296	14 KR-7 DPUV	UXT 15
2U7J 12405 AA	Z 177	14 KR-8 MUV	UXT 7
3M5Q 6M090AB	GN 054		
4 025 139	GN 005		
4 440 367	Z 296	14 KR-7 DPUV	UXT 15
4 454 955	Z 296	14 KR-7 DPUV	UXT 15
4 612 191	GN 939		
4C3Z 12A342 AA	GN 049		
4M5G 12405 XA	Z 177	14 KR-8 MUV	UXT 7
4M5G 12405 XB	Z 177	14 KR-8 MUV	UXT 7
4M5G 12405 XC	Z 177	14 KR-8 MUV	UXT 7
4U3Q 6M090 AA	GN 045		
4U3Q 6M090 AB	GN 045		
4U3Q AA	GN 045		
4U3Q AB	GN 045		
5 099 295	Z 24	14 FR-6 DU	UXT 5
5 099 721	Z 15	14 FR-7 DU	UXT 1/UXT 3
5 099 727	Z 24	14 FR-6 DU	UXT 5
5 099 728	Z 99	14 FR-6 DUX	UXT 5
5 099 731	Z 32	18 K-7 BU	-
5 099 731	Z 32	18 K-7 BU	-
5 099 732	Z 32	18 K-7 BU	-
5 099 732	Z 32	18 K-7 BU	-
5 099 733	Z 32	18 K-7 BU	-
5 099 733	Z 32	18 K-7 BU	-
5 099 735	Z 32	18 K-7 BU	-
5 099 735	Z 32	18 K-7 BU	-
5 099 741	Z 95	14 KR-7 DU	UXT 4
5 099 846	Z 32	18 K-7 BU	-
5 099 846	Z 32	18 K-7 BU	-
5 099 848	Z 32	18 K-7 BU	-
5 099 848	Z 32	18 K-7 BU	-
5 099 884	Z 20	14 R-7 DU	UXT 2/UXT 6
5 099 885	Z 11	14-7 DU	UXT 2/UXT 6
5 099 937	Z 26	14 KR-6 DU	UXK 56

FORD	BERU		
5 099 949	Z 42	14-5 DU	UX 56
5 099 950	Z 47	14 R-5 DU	UX 56
5 099 952	Z 24	14 FR-6 DU	UXT 5
5 099 961	Z 22	14-6 DU	UX 56
5 099 962	Z 27	14 R-6 DU	UX 56
5M5G 12405 AA	Z 230	14 KR-6 KPUV02	-
6 048 827	GV 107		
6 063 505	GV 602		
6 073 379	Z 27	14 R-6 DU	UX 56
6 075 812	GV 604		
6 075 812	GV 631		
6 075 812	GN 927		
6 080 256	Z 24	14 FR-6 DU	UXT 5
6 080 256	Z 24	14 FR-6 DU	UXT 5
6 132 244	GV 631		
6 132 246	GV 631		
6 143 688	GR 064		
6 154 593	GN 909		
6 163 811	GV 666		
6 163 811	G 10 SB		
6 173 150	Z 95	14 KR-7 DU	UXT 4
6 188 591	GR 064		
6 194 291	GR 033		
6 726 180	Z 97	14 KR-8 MPX	UXT 8
6 748 697	GF 859		
6 756 611	GR 033		
6 756 612	GR 033		
6M5J 12405 AA	Z 326	14 FR-7 MPUS	UXT 13
7 072 673	GN 909		
7 088 988	GV 666		
7 335 128	Z 130	14 FR-5 DPUX	-
71 F 6L055 AC	GH 760		
715 F 11390 CA	GH 760		
715 F 62055 AA	GH 760		
73 OF 12405 AA	Z 33	18 K-6 BU	-
73 OF 12405 JA	Z 24	14 FR-6 DU	UXT 5
77 BF 12405 AA	Z 26	14 KR-6 DU	UXK 56
78 GB 12405 CA	Z 27	14 R-6 DU	UX 56
78 GB 12405 HA	Z 27	14 R-6 DU	UX 56
78 GB 6M 090 BA	GV 107		
78 GB 6M 090 CA	GV 602		
78 HF 12405 AA	Z 32	18 K-7 BU	-
78 HF 12405 AA	Z 32	18 K-7 BU	-
78 IF 12405 AA	Z 47	14 R-5 DU	UX 56
78 IF 12405 BA	Z 27	14 R-6 DU	UX 56
78 TF 12405 AA	Z 27	14 R-6 DU	UX 56
78 TF 12405 BA	Z 20	14 R-7 DU	UXT 2/UXT 6
785 F 6M 090 BA	GV 602		
785 F 6M 090 CB	GV 602		
786 B 6M 090 CA	GV 602		
79 OF 12405 ACA	Z 27	14 R-6 DU	UX 56
79 OF 12405 YA	Z 27	14 R-6 DU	UX 56
795 F 6M 090 AA	GV 604		
795 F 6M 090 CA	GV 604		
795F 6M 090 AA	GV 631		
80 GB 12405 AA	Z 47	14 R-5 DU	UX 56
80 OF 12405 CA	Z 30	14 FR-5 DU	UXT 5
80 OF 12405 DA	Z 47	14 R-5 DU	UX 56
80 OF 12405 EA	Z 42	14-5 DU	UX 56
81 GB 12405 AA	Z 27	14 R-6 DU	UX 56
81 OF 12405 AAA	Z 24	14 FR-6 DU	UXT 5
81 SF 12405 BA	Z 24	14 FR-6 DU	UXT 5
81 SF 12405 DA	Z 30	14 FR-5 DU	UXT 5
83 956 253	GF 154		
83 BB 12405 CA	Z 32	18 K-7 BU	-
83 BB 12405 CA	Z 32	18 K-7 BU	-

FORD	BERU		
83 BB 6 M 092 A1A	GR 064		
83 BB 6 M 092 AA	GR 064		
83 BB 6 M 092 BA	GR 064		
83 BB 6M090 A1A	GV 636		
83 BB 6M090 A2A	GV 636		
83 OF	Z 33	18 K-6 BU	-
83 SF 12405 GA	Z 30	14 FR-5 DU	UXT 5
84 BB 6M 090 AA	GV 636		
84 BB 6M 090 AA	GN 909		
84 FF 6M 090 B1A	GV 631		
84 FF 6M 090 B2A	GV 631		
84 FF 6M 090 B2A	GN 909		
84 FF 6M 091 BA	GV 631		
840F 12405 JD	Z 32	18 K-7 BU	-
844 FF 9N 424 AA	GF 859		
88 BB 6 M 092 BA	GR 064		
88 BG 8 B 658 AA	GR 064		
88 HF	Z 32	18 K-7 BU	-
89 FB 6M 092 AA	GR 033		
89 FF 6M 090 AA	GV 666		
89 FF 6M 090 AA	G 10 SB		
89 FF 6M 091 AA	GV 666		
89 FF 6M 091 AA	GN 909		
89 FF 6M 091 AA	G 10 SB		
8C 3Z 12 A34 2A	GN 049		
90 BB 6M 092 AA	GR 033		
90 BB 6M 092 BA	GR 033		
90 BB 6M 092 BB	GR 033		
90 BB 6M 092 CA	GR 033		
910 X 6M 090 AA	GV 852		
910 X 6M 090 BA	GV 602		
92 VB 9424 AA	GF 859		
92 VB 9N 424 BA	GF 859		
93 FF 6M 090 AA	GV 666		
94 DD 6M 090 AA	GN 909		
95 DD 6M 090 AA	GN 007		
95 VB 9N 424 AA	GF 859		
95 VB-9N 424 AB	GF 982		
95 VB-9N 424 BA	GF 983		
95 VB-9N 424 BB	GF 983		
95 VW 6M 090 AA	GN 855		
95 VW 6M 090 AB	GN 855		
959 F 12405 AA	Z 284	14 FR-6 DPOX	-
96 FF 6M 090 AA	GN 022		
96 FF 6M 090 AB	GN 022		
96 FF 6M 090 BA	GN 022		
96 FF 6M 090 BB	GN 022		
96 FF 6M 090 CA	GN 022		
96 XF 12405 BB	Z 228	14 FR-7 DPUX02	UXT 11
986 T 9N 424 AA	GF 976		
99 FF 6M 090 AA	GN 022		
D 3 PF 12405 BA	Z 47	14 R-5 DU	UX 56
DZPF 12405	Z 33	18 K-6 BU	-
DZPF 12405 BUA	Z 33	18 K-6 BU	-
F4TZ 12A342A	GV 819		
XM 34 12A342 BA	GN 005		
XS 4U 6M 090 AB	GN 993		
XS 7H 6M 090 AA	GN 984		
XS 7U 6M 090 BA	GN 939		
XS 7U 6M 090 BB	GN 939		
XS6F 12405 BA	Z 177	14 KR-8 MUV	UXT 7
XS6F 12405 CA	Z 177	14 KR-8 MUV	UXT 7
YN2F 12405 AA	Z 177	14 KR-8 MUV	UXT 7
YN2J 12405 AA	Z 177	14 KR-8 MUV	UXT 7

FORD USA	BERU
3C 3Z 12 A342 AA	GN 036
E 2 TZ 12A342 A	GV 823
E 4 TZ 12A342 A	GV 823
E 5 TZ 12A342 A	GV 835
E 7 TZ 12A342 A	GV 823
F 2 TZ 12A342 A	GV 823

GM	BERU		
12 563 554	GV 004		
25 168 651	GV 004		
25 324 618	Z 222	14 KR-8 STUX	-
55 564 162	GE 114		
55 564 163	PSG 001		
55 564 219	GE 112		
55 577 419	PSG 003		
88 900 715	GN 003		
88 900 716	GN 007		
88 900 717	GN 008		
88 900 718	GN 010		
88 900 719	GN 015		
88 900 720	GN 022		
88 900 721	GN 024		
88 900 722	GN 855		
88 900 723	GN 857		
88 900 724	GN 860		
88 900 728	GN 954		
88 900 729	GN 970		
88 900 730	GV 602		
88 900 731	GV 603		
88 900 732	GV 631		
88 900 734	GV 642		
88 900 735	GV 661		
88 900 736	GV 663		
88 900 737	GV 666		
88 900 739	GV 749		
88 900 741	GN 858		
90 464 737	GN 944		
90 487 858	GV 719		
90 569 338	GN 992		
91 111 45	GN 927		
91 153 919	GN 007		
91 182 01	GN 992		
91 611 11	GF 984		
91 966 69	GN 033		
91 990 38	Z 222	14 KR-8 STUX	-
92 016 98	GN 026		
92 702 93	Z 206	14 FR-7 DPPUS2	UXT 10
93 161 342	GN 026		
93 161 489	GN 026		
93 175 994	Z 206	14 FR-7 DPPUS2	UXT 10
93 178 047	GN 053		
93 178 225	GN 033		
93 178 411	GN 059		
93 180 485	Z 287	14 FR-8 LU2T	-
93 183 739	GN 103		
93 183 990	GN 944		
93 187 927	GN 104		
94 133 759	GN 061		
94 140 115	GN 061		
94 175 158	GN 061		
97 080 554	GN 103		
97 210 818	GN 104		
97 226 202	GN 032		
97 326 305	GE 106		

GM	BERU
97 358 626	GN 104
97 389 905	GN 104
97 464 737	GN 033

HANOMAG	BERU		
114 906 181	GV 142		
135 906 129	GV 107		
135 906 143	GV 110		
151 120 106	GV 108		
151 123 014	Z 57	14-7 AU	-
151 126 000	GD 214		
975 411 001	GD 294		

HERTH u. BUSS	BERU		
10 899 039	GR 079	-	-
10 899 149	GR 076	-	-
10 899 151	GR 073	-	-
10 899 152	GR 075	-	-
10 899 153	GR 074	-	-
10 899 179	GR 069	-	-
10 899 180	GR 071	-	-
10 899 195	GR 070	-	-
70 596 019	AK 167 SK	-	-
LOPK 20R13	Z 150	14 FR-7 KPUV	-

HELLA	BERU		
4RV 008 188-001	GR 069	-	-
4RV 008 188-011	GR 070	-	-
4RV 008 188-021	GR 071	-	-
4RV 008 188-041	GR 073	-	-
4RV 008 188-051	GR 074	-	-
4RV 008 188-061	GR 075	-	-
4RV 008 188-071	GR 076	-	-
4RV 008 188-081	GR 059	-	-
4RV 008 188-091	GR 065	-	-
4RV 008 188-101	GR 066	-	-
4RV 008 188-161	GR 064	-	-
4RV 008 188-171	GR 001	-	-
4RV 008 188-181	GR 031	-	-
4RV 008 188-221	GR 033	-	-
4RV 008 188-241	GR 067	-	-
4RV 008 188-281	GR 034	-	-
4RV 008 188-321	GR 054	-	-
4RV 008 188-351	GR 061	-	-

HERCULES	BERU		
029 808 70 06	Z 57	14-7 AU	-
099 800 40 01	Z 57	14-7 AU	-

HINO	BERU
1985A-56021	GV 678
1985A-56022	GV 678
1985A-64060	GV 895
1985A-68060	GV 895

HITACHI	BERU		
L 43	Z 38	14 Z-3 CU	-
L 44	Z 38	14 Z-3 CU	-
L 44 P	Z 42	14-5 DU	UX 56
L 45 PW	Z 22	14-6 DU	UX 56

HITACHI	BERU		
L 45 PW-11	Z 11	14-7 DU	UXT 2/UXT 6
L 45 PX	Z 11	14-7 DU	UXT 2/UXT 6
L 45 W	Z 58	14-7 CU	-
L 45 X	Z 58	14-7 CU	-
L 46 X	Z 58	14-7 CU	-
M 43 W	Z 39	14 Z-4 AU	-
M 44	Z 57	14-7 AU	-
M 44 P	Z 41	14-5 BU	-
M 44 W	Z 57	14-7 AU	-
M 45	Z 57	14-7 AU	-
M 45 PW	Z 57	14-7 AU	-
M 46	Z 57	14-7 AU	-

HONDA	BERU		
12290-PNE004	Z 299	14 FR-7 LUXO	-
12291-PLZ-D00	GN 104		
12291-RBD-E01	GN 073		
31812-ZG5-0030	GV 967		
98073-54744	Z 269	14 SR-9 E0	-
98079-55846	Z 20	14 R-7 DU	UXT 2/UXT 6
98079-55871	Z 20	14 R-7 DU	UXT 2/UXT 6
98079-55881	Z 20	14 R-7 DU	UXT 2/UXT 6
98079-55946	Z 20	14 R-7 DU	UXT 2/UXT 6
98079-56148	Z 99	14 FR-6 DUX	UXT 5
98079-561-4E	Z 158	14 FR-7 LUX	-
98079-561-4G	Z 158	14 FR-7 LUX	-
98079-561-4P	Z 158	14 FR-7 LUX	-
98079-56832	Z 20	14 R-7 DU	UXT 2/UXT 6
98079-56846	Z 20	14 R-7 DU	UXT 2/UXT 6
98079-56846-02	Z 20	14 R-7 DU	UXT 2/UXT 6
98079-56946	Z 20	14 R-7 DU	UXT 2/UXT 6
9807B-5615-P	Z 299	14 FR-7 LUXO	-
9807B-5615-W	Z 297	14 FR-7 LPUXO	-

HÜCO	BERU		
13 2030	GR 069	-	-
13 2031	GR 070	-	-
13 2032	GR 071	-	-
13 2034	GR 073	-	-
13 2035	GR 074	-	-
13 2036	GR 075	-	-
13 2037	GR 076	-	-
13 2050	GR 059	-	-
13 2051	GR 065	-	-
13 2052	GR 066	-	-
13 2060	GR 064	-	-
13 2061	GR 001	-	-
13 2073	GR 061	-	-
13 2075	GR 067	-	-
13 2081	GR 034	-	-
13 2085	GR 054	-	-

HYUNDAI	BERU		
18811-11061	Z 9	14 R-8 DUX	UXT 2/UXT 6
18814-11051	Z 73	14 FR-8 DUX	UXT 1/UXT 3
18817-11051	Z 228	14 FR-7 DPUX02	UXT 11
18825-11101	Z 311	14 R-8 DPUU	UXT 2/UXT 6
18826-11101	Z 228	14 FR-7 DPUX02	UXT 11
18829-11050	Z 158	14 FR-7 LUX	-
36710-27000	GN 035		
36710-27010	GN 035		
36710-2A100	GN 062		
36710-3A000	GE 113		

HYUNDAI	BERU		
36710-42000	GN 955		
36710-42010	GN 955		
36710-42020	GN 955		
36710-42021	GN 955		
36710-42060	GN 955		
36710-42500	GN 107		
36710-42510	GN 955		
36710-4A 000	GN 057		
36710-4A100	GN 057		

IFA	BERU		
834019	GN 857		

INT. HARVESTER	BERU		
3 041 31 R 2	GV 134		
3 055 603 R 91	GD 203		
3 055 659 R 91	GD 203		
7 103 48 R 1	GD 214		
7 638 37 R 92	GD 318		

ISKRA	BERU		
F 50	Z 68	14-8 AU	-
F 55 PS	Z 118	14-8 BU	-
F 65 P	Z 48	14-6 BU	-
F 65 PRS	Z 19	14 R-7 BU	-
F 65 PS	Z 10	14-7 BU	-
F 70	Z 57	14-7 AU	-
F 70	Z 68	14-8 AU	-
F 80 S	Z 40	14-5 AU	-
F 85 PS	Z 48	14-6 BU	-
F 95 PS	Z 41	14-5 BU	-
F 100 S	Z 39	14 Z-4 AU	-
FE 45 P	Z 76	14-9 DU	UXT 2/UXT 6
FE 55 P	Z 11	14-7 DU	UXT 2/UXT 6
FE 55 PRS	Z 8	14 R-8 DU	UXT 2/UXT 6
FE 55 PS	Z 1	14-8 DU	UXT 2/UXT 6
FE 55 PTS	Z 2	14-8 DTU	UXT 2/UXT 6
FE 65 P	Z 11	14-7 DU	UXT 2/UXT 6
FE 65 PRS	Z 20	14 R-7 DU	UXT 2/UXT 6
FE 65 PS	Z 11	14-7 DU	UXT 2/UXT 6
FE 65 PTS	Z 12	14-7 DTU	UXT 2/UXT 6
FE 75 RS	Z 59	14 R-7 CU	-
FE 75 S	Z 58	14-7 CU	-
FE 85 PRS	Z 27	14 R-6 DU	UX 56
FE 85 PS	Z 22	14-6 DU	UX 56
FE 85 PTS	Z 51	14-6 DTU	UX 56
FE 100 S	Z 38	14 Z-3 CU	-
FET 55 PS	Z 6	14 K-8 DU	UXT 4
FET 55 PRS	Z 7	14 K-8 DU0	UXT 4
FET 65 PRS	Z 95	14 KR-7 DU	UXT 4
FET 65 PS	Z 17	14 K-7 DU	UXT 4
FET 75 P	Z 31	14 K-5 DU	UXK 56
FET 75 PRS	Z 26	14 KR-6 DU	UXK 56
FET 75 PS	Z 25	14 K-6 DU	UXK 56
FS 70	Z 112	14-8 E	-
MT 65 PS	Z 32	18 K-7 BU	-
MT 65 RS	Z 32	18 K-7 BU	-
SFE 55 PS	Z 71	14 F-8 DU	UXT 1/UXT 3
SFE 65 PRS	Z 15	14 FR-7 DU	UXT 1/UXT 3
SFE 65 PS	Z 11	14-7 DU	UXT 2/UXT 6
SFE 85 PRS	Z 24	14 FR-6 DU	UXT 5
SFE 85 PS	Z 24	14 FR-6 DU	UXT 5
SFE 85 PTS	Z 52	14 F-6 DTU	UXT 5

ISUZU	BERU
1 82513 043 0	GN 074
1 82513 044 0	GN 074
5 81410 040 0	GV 897
5 81410 044 0	GN 077
5 81410 045 0	GN 077
5 81410 057 3	GN 008
8 94133 759 0	GN 061
8 94133 759 1	GN 061
8 94133 759 2	GN 061
8 94133 759 3	GN 061
8 94133 759 4	GN 061
8 94133 759 5	GN 061
8 94133 759 6	GN 061
8 94133 759 7	GN 061
8 94140 153	GN 061
8 94144 412 0	GV 946
8 94175 158 0	GN 061
8 94241 490	GV 749
8 94249 692 1	GV 749
8 94319 700 1	GV 946
8 94319 700 2	GV 946
8 94402 303 1	GV 945
8 94481 972 0	GV 947
8 94751 581	GN 061
8 97073 641 0	GN 061
8 97080 554 0	GN 103
8 97143 674 1	GN 997
8 97210 818 2	GN 104
8 97226 202 2	GN 032
8 97326 305 2	GE 106
8 97364 968 0	GE 109
8 97364 968 1	GE 109
8 97389 905 0	GN 104
8 98013 392 0	GN 095
8 98174 898 0	GN 095
9 82511 957 0	GV 749
9 82511 964 0	GV 749
9 82511 965 0	GN 077
9 82511 978 0	GV 749
9 82511 978 1	GV 749
9 82511 978 2	GV 749
9 82511 978 3	GV 749
9 82511 979 0	GN 077
9 82513 928 0	GN 074
9 82513 928 2	GN 074
9 82513 928 3	GN 074
9 82513 928 4	GN 074
9 82513 928 5	GN 074
9 82513 928 6	GN 074
9 82513 928 7	GN 074
9 82513 928 8	GN 074
9 82513 928 9	GN 074
9 82513 959 0	GN 077
9 82513 959 1	GN 077
9 82513 959 2	GN 077
9 82513 959 3	GN 077
9 82513 959 4	GN 077

IVECO	BERU
08030405	Z 231 14 FR-4 DPU -
2525786	AK 167 SK
27600323	GN 037
4729585	GV 602
4792112	GR 065
4832279	GF 683

IVECO	BERU
4841294	GV 642
4849406	GV 727
4849601	GF 984
500303569	GF 683
500314583	GF 006
500316493	GN 012
500351992	GN 037
7632587	GV 730
8030405	Z 231 14 FR-4 DPU -
9462703	GR 065
98459883	GN 927
98462490	GN 917
98462492	GN 925
98498630	GN 927
99444499	GF 981
99450392	GF 978
99450393	GF 007
99450394	GF 979
99450396	GF 974

JAGUAR	BERU
02 JD 61164	GN 939
02 JD 61604	GN 045
EBL 11480	Z 15 14 FR-7 DU UXT 1/UXT 3
EBL 2230	Z 15 14 FR-7 DU UXT 1/UXT 3

JEEP	BERU
0 486 3826	GN 007
0 486 3826 AA	GN 007
0 506 6840 AA	GN 055
0 508 0047 AA	GN 003
0 508 0047 AB	GN 003
0 517 5756 AA	GE 105
5 602 7275	Z 152 14 FR-8 HU -

JENBACHER	BERU
P 1	Z 168 18 GZ 7 -

KAESSBOHRER	BERU
737515000	GR 071
7375155000	GR 071
73751591000	GR 069

KHD	BERU
0 009 720 203	GV 119
0 117 9016	GH 760
0 117 9367	MV 116
0 117 9570	GF 817
0 118 0400	GN 960
0 118 0400	GN 960
0 118 0897	GN 002
0 118 0898	GN 001
0 118 0899	GN 002
0 419 9716	GF 972
0 422 9132	Z 214 14 GZ-3/ Platin -
0 426 9126	Z 244 14 GZ 6-77-2 -
112 1094	GD 294
116 1112	KOS 17
116 1134	GF 683
116 1135	GF 167

KHD	BERU		
116 1637	GF 630		
116 2144	BW 45/12/1		
116 3586	GV 144		
116 3694	GH 760		
116 9117	GV 108		
117 0058	GV 197		
117 0059	GV 136		
117 0060	GV 191		
117 0749	GV 191		
117 0841	GD 214		
117 1352	GV 144		
117 1686	GV 179		
117 1687	GV 181		
117 3108	GV 390		
117 4599	GF 630		
117 5818	GH 760		
117 8543	GF 667		
117 9370	GN 870		
117 9570	GF 817		
118 0400	GN 960		
118 0400	GN 960		
120 4170 9	GV 361		
121 5398 7	GD 255		
127 7452	GH 359		
224 3042	GH 18		
244 6328	GD 214		
345 9769	Z 57	14-7 AU	-
350 3132	Z 57	14-7 AU	-
419 1168 0	Z 57	14-7 AU	-
472 9585	GV 602		
478 1356	GV 642		
812 2193	GF 683		
A DIN 72520	GD 294		
B 12 VH 7632	GF 683		
B 24 VH 7632	GF 167		
D 11 H 7631	GH 760		
DZ 12041709	GV 361		
S 18 LH 7631 BO	GV 191		
S 95 H 7631	GV 108		

KIA	BERU		
36710-2A100	GN 062		
36710-3A000	GE 113		
36710-42000	GN 955		
36710-42010	GN 955		
36710-42020	GN 955		
36710-42021	GN 955		
36710-42060	GN 955		
36710-42500	GN 107		
36710-4A000	GN 057		
36710-4A100	GN 057		
OK 054-18-140	GN 005		
OK 710-18-140	GN 005		
OK 710-18-140 A	GN 005		
OK 75A-18-140	GN 005		

KREIDLER	BERU		
08 11 03	Z 57	14-7 AU	-
215 02 03	Z 57	14-7 AU	-

KUBOTA	BERU		
15221-6551-0	GN 080		
15221-6551-2	GN 080		

KUBOTA	BERU		
15221-6551-3	GN 080		
16098-04171	GN 040		
16241-6551-1	GN 081		
16241-6551-2	GN 081		
16851-6551-2	GN 082		
1G911-65510	GN 040		
1G911-65512	GN 040		

LADA	BERU		
2112-3707010	Z 16	14 FR-7 DUX	UXT 1/UXT 3

LAMBORGHINI	BERU		
276590130	GF 683		

LANCIA	BERU		
2 284 662	Z 22	14-6 DU	UX 56
2 301 710	Z 42	14-5 DU	UX 56
2 301 711	Z 22	14-6 DU	UX 56
4 170 472	Z 42	14-5 DU	UX 56
4 172 173	Z 42	14-5 DU	UX 56
4 233 922	Z 22	14-6 DU	UX 56
4 249 164	Z 22	14-6 DU	UX 56
4 345 040	Z 22	14-6 DU	UX 56
4 345 041	Z 22	14-6 DU	UX 56
4 781 356	GV 642		
4 781 356	GN 909		
4 849 06	GN 925		
4 849 406	GV 642		
5 500 842	GV 130		
5 894 585	Z 27	14 R-6 DU	UX 56
5 894 586	Z 24	14 FR-6 DU	UXT 5
5 894 587	Z 20	14 R-7 DU	UXT 2/UXT 6
5 896 177	Z 98	14 FR-7 LDU	UXT 1/UXT 3
5 946 920	GR 065		
5 984 036	Z 20	14 R-7 DU	UXT 2/UXT 6
5 990 986	GR 065		
7 544 444	Z 20	14 R-7 DU	UXT 2/UXT 6
7 544 445	Z 48	14-6 BU	-
7 546 519	Z 15	14 FR-7 DU	UXT 1/UXT 3
7 554 436	Z 27	14 R-6 DU	UX 56
7 565 476	Z 38	14 Z-3 CU	-
7 632 587	GV 730		
7 735 920	GN 908		
7 760 381	Z 27	14 R-6 DU	UX 56
7 760 382	Z 20	14 R-7 DU	UXT 2/UXT 6
7 760 383	Z 15	14 FR-7 DU	UXT 1/UXT 3
7 760 384	Z 24	14 FR-6 DU	UXT 5
7 772 453	Z 24	14 FR-6 DU	UXT 5
46 229 251	Z 11	14-7 DU	UXT 2/UXT 6
46 447 610	GN 970		
46 451 951	GN 017		
60 504 563	Z 42	14-5 DU	UX 56
60 512 848	Z 29	14 F-5 DU	UXT 5
60 512 929	Z 42	14-5 DU	UX 56
60 597 490	Z 29	14 F-5 DU	UXT 5
60 617 002	GN 007		
60 800 325	Z 27	14 R-6 DU	UX 56
60 810 689	Z 130	14 FR-5 DPUX	-
60 812 292	GN 908		
71 711 638	Z 15	14 FR-7 DU	UXT 1/UXT 3
71 711 639	Z 27	14 R-6 DU	UX 56
71 711 640	Z 20	14 R-7 DU	UXT 2/UXT 6
71 711 806	Z 20	14 R-7 DU	UXT 2/UXT 6



LANCIA		BERU	
77 359 200		GN 909	
91 517 001 80	Z 70	14-8 DU0	UXT 2/UXT 6
96 147 386 80	Z 98	14 FR-7 LDU	UXT 1/UXT 3
96 196 245 80	Z 74	14 FR-8 LDUOX4	UXT 1/UXT 3
96 236 383 80		GN 027	
96 280 002 80	Z 14	14 F-7 LDUR4	UXT 1/UXT 3
98 462 492		GN 925	

LEYLAND		BERU	
075 95 77		GV 798	

LIEBHERR		BERU	
600 00 97		GF 167	

LUCAS		BERU	
DSC 03	GR 066	-	-
DSC 08	GR 064	-	-
HDC 101	GR 059	-	-
HDC 102	GR 065	-	-
HDC 103	GR 066	-	-
HDC 106	GR 064	-	-
HDC 108	GR 064	-	-
HDC 116	GR 069	-	-
HDC 117	GR 071	-	-
HDC 118	GR 070	-	-
HDC 124	GR 067	-	-
HDC 125	GR 054	-	-
HDC 127	GR 031	-	-
R 04090001 B	GR 054	-	-
R 0409001 B	GR 054	-	-

MAGIRUS		BERU	
2525786		AK 167 SK	
4792112		GR 065	

MAGNETI MARELLI		BERU	
7 LC	Z 24	14 FR-6 DU	UXT 5
7 LCR	Z 24	14 FR-6 DU	UXT 5
CW 4 C	Z 112	14-8 E	-
CW 4 CJ	Z 112	14-8 E	-
CW 5 N	Z 57	14-7 AU	-
CW 6 L	Z 58	14-7 CU	-
CW 6 LP	Z 1	14-8 DU	UXT 2/UXT 6
CW 6 N	Z 57	14-7 AU	-
CW 6 NP	Z 48	14-6 BU	-
CW 7 LP	Z 11	14-7 DU	UXT 2/UXT 6
CW 7 N	Z 39	14 Z-4 AU	-
CW 7 NJ	Z 39	14 Z-4 AU	-
CW 7 NP	Z 48	14-6 BU	-
CW 8 J	Z 38	14 Z-3 CU	-
CW 8 LP	Z 42	14-5 DU	UX 56
CW 8 LPS	Z 42	14-5 DU	UX 56
CW 8 N	Z 39	14 Z-4 AU	-
CW 8 NP	Z 41	14-5 BU	-
CW 9 L	Z 38	14 Z-3 CU	-
CW 10 L	Z 38	14 Z-3 CU	-
CW 55 N	Z 57	14-7 AU	-
CW 78 LP	Z 22	14-6 DU	UX 56
CW 89 LP	Z 42	14-5 DU	UX 56
CWP 7 L	Z 22	14-6 DU	UX 56

MAGNETI MARELLI		BERU	
F 6 NC	Z 10	14-7 BU	-
F 7 LCR	Z 20	14 R-7 DU	UXT 2/UXT 6
F 8 LCR	Z 27	14 R-6 DU	UX 56
REP 1A	GR 059	-	-

MAN		BERU	
000 159 24 01		GD 214	
000 159 2501		GD 348	
000 159 6001		GD 382	
000 159 6101		GD 382	
000 159 63 01		GV 165	
000 159 7801		GH 18	
000 159 8101		GV 603	
000 159 83 01		GV 603	
000 835 0026		GH 359	
11 22020 0003		GD 294	
11 22020 0006		GD 255	
51 25902 0068		MV 129	
51 25902 0081		MV 129	
51 25902 0118		MV 129	
51 25923 0020	Z 22	14-6 DU	UX 56
51 25923 0022	Z 22	14-6 DU	UX 56
51 25923 0023	Z 22	14-6 DU	UX 56
51 25923 0052	Z 258	14 R-4 DIU2	-
51 25923 0054	Z 259	14 R-4 DIU2	-
51 26803 008		GF 111	
51 2603 0015		GF 111	
51 2603 0019		GF 111	
51 26803 0011		GF 667	
51 26803 0015		GF 699	
51 26803 0020		GH 010	
51 26803 0021		GF 111	
51 26803 0021		GF 699	
51 26803 0022		GF 111	
51 26803 0023		GF 667	
51 26803 0028		GF 529	
51 26803 0033		GF 529	
51 26803 0042		GF 529	
51.268 03-0041		GF 002	
81 26803 0003		GH 359	
81 26803 0005		GF 111	
81 26803 0008		GF 111	
81 26803 0009		GF 163	
90 80112 4105		GD 214	
90 80112 4111		GD 294	
90 80112 4113		GD 318	
90 80112 4125		GH 345	
90 80112 4128		GV 357	
90 80112 4136		GD 255	
90 80112 4161		GF 111	
90 81616 2136		KOSK 17	
90 81616 2137		KOS 08/50	
90 81616 3116		BW 45/23/1	
A 5 000 04 1358		GF 154	

MAZDA		BERU	
1A02-18-110	Z 234	12 FR-7 DU	-
3-953-18 -110	Z 8	14 R-8 DU	UXT 2/UXT 6
8-914-18-110	Z 8	14 R-8 DU	UXT 2/UXT 6
BP 01-18-110	Z 73	14 FR-8 DUX	UXT 1/UXT 3
BP 02-18-110	Z 16	14 FR-7 DUX	UXT 1/UXT 3
BP 03-18-110	Z 16	14 FR-7 DUX	UXT 1/UXT 3
BP 04-18-110	Z 16	14 FR-7 DUX	UXT 1/UXT 3
C 401-18-110	Z 177	14 KR-8 MUV	UXT 7

MAZDA	BERU		
C 402-18-110 A	Z 177	14 KR-8 MUV	UXT 7
C 402-18-110A	Z 177	14 KR-8 MUV	UXT 7
F 201-18-101	Z 158	14 FR-7 LUX	-
F 220-18-110	Z 16	14 FR-7 DUX	UXT 1/UXT 3
F 285 18-110	Z 158	14 FR-7 LUX	-
F 286 18-110	Z 158	14 FR-7 LUX	-
F 287 18-110	Z 158	14 FR-7 LUX	-
F 288 18-110	Z 158	14 FR-7 LUX	-
JE 41-18-110	Z 228	14 FR-7 DPX02	UXT 11
KJ 14-18- 110	Z 229	14 FR-8 LPU0	-
L 303-18-110	Z 298	14 KR-8 DPUV	UXT 15
L 813-18-110	Z 230	14 KR-6 KPUV02	-
RF 1M-18-601	GN 005		
RF 2A-18-601	GN 064		
RFG 1-18-601	GN 005		
RFN 1-18-601	GN 005		
RFR 1-18-601	GN 005		
S 210-18-140	GN 005		
SE 01-18-140 A	GV 880		
WL 01-18-601	GN 005		
WL 03-18-601	GN 005		
Y 401-18-601	GN 047		
ZJ 46-18-110	Z 307	14 FR-7 DPUV02	-
ZJY 6-18-110	Z 307	14 FR-7 DPUV02	-

MCI	BERU		
93 2151-0286	Z 215	14 R-4 CIU2	-
93 2151-0288	Z 215	14 R-4 CIU2	-

MERCEDES-BENZ	BERU		
000 150 01 81	SR 039		
000 150 02 81	SR 040		
000 158 25 45	WZ 02-2		
000 158 32 45	WU 45/15		
000 158 37 45	WU 30/15		
000 158 39 45	WU 45/15		
000 159 04 01	GV 736		
000 159 06 01	GD 214		
000 159 10 03	Z 11	14-7 DU	UXT 2/UXT 6
000 159 12 03	Z 57	14-7 AU	-
000 159 13 01	GD 255		
000 159 15 03	Z 41	14-5 BU	-
000 159 18 01	GD 255		
000 159 24 01	GD 214		
000 159 25 01	GD 348		
000 159 26 01	GD 348		
000 159 36 03	Z 39	14 Z-4 AU	-
000 159 41 01	GV 170		
000 159 43 03	Z 10	14-7 BU	-
000 159 51 01	GV 109		
000 159 54 03	Z 27	14 R-6 DU	UX 56
000 159 60 01	GD 382		
000 159 61 01	GD 382		
000 159 62 01	GV 165		
000 159 63 01	GV 165		
000 159 65 03	Z 10	14-7 BU	-
000 159 66 01	GV 182		
000 159 68 03	Z 11	14-7 DU	UXT 2/UXT 6
000 159 71 03	Z 38	14 Z-3 CU	-
000 159 72 03	Z 10	14-7 BU	-
000 159 74 01	GH 760		
000 159 74 03	Z 38	14 Z-3 CU	-

MERCEDES-BENZ	BERU		
000 159 75 01	GV 603		
000 159 77 01	GV 636		
000 159 78 01	GH 18		
000 159 79 03	Z 57	14-7 AU	-
000 159 81 01	GV 603		
000 159 81 01	GN 909		
000 159 82 01	GV 736		
000 159 83 01	GV 603		
000 159 90 01	GD 348		
000 159 91 01	GV 626		
000 159 94 03	Z 27	14 R-6 DU	UX 56
000 159 96 01	GV 691		
000 159 98 03	Z 38	14 Z-3 CU	-
000 159 99 01	GV 691		
000 162 94 01	Z 6	14 K-8 DU	UXT 4
000 162 94 01	Z 7	14 K-8 DUO	UXT 4
000 545 16 18	BW 09/40		
000 545 18 20	KOBS/1		
000 545 34 20	KOBS 065/52		
000 835 00 26	GH 359		
000 835 10 26	GH 847		
000 835 11 26	GH 201		
001 158 88 03	Z 42	14-5 DU	UX 56
001 159 00 01	GN 858		
001 159 02 01	GV 724		
001 159 04 01	GV 736		
001 159 08 01	GH 011		
001 159 14 01	GN 066		
001 159 15 01	GN 860		
001 159 16 01	GN 860		
001 159 17 01	GN 858		
001 159 19 03	Z 42	14-5 DU	UX 56
001 159 20 01	GN 948		
001 159 21 01	GN 948		
001 159 22 01	GN 909		
001 159 25 01	GV 197		
001 159 26 01	GN 961		
001 159 27 01	GN 010		
001 159 27 03	Z 42	14-5 DU	UX 56
001 159 28 01	GN 003		
001 159 29 03	Z 57	14-7 AU	-
001 159 31 03	Z 42	14-5 DU	UX 56
001 159 34 03	Z 42	14-5 DU	UX 56
001 159 35 01	GN 909		
001 159 36 01	GN 858		
001 159 37 01	GN 003		
001 159 38 01	GN 003		
001 159 42 01	GN 003		
001 159 45 03	Z 42	14-5 DU	UX 56
001 159 46 01	GN 058		
001 159 47 03	Z 22	14-6 DU	UX 56
001 159 48 01	GN 003		
001 159 49 01	GN 003		
001 159 50 01	GE 105		
001 159 50 03	Z 42	14-5 DU	UX 56
001 159 51 01	GE 116		
001 159 51 03	Z 22	14-6 DU	UX 56
001 159 52 01	GE 104		
001 159 52 03	Z 42	14-5 DU	UX 56
001 159 53 03	Z 42	14-5 DU	UX 56
001 159 55 03	Z 42	14-5 DU	UX 56
001 159 60 03	Z 57	14-7 AU	-
001 159 61 03	Z 42	14-5 DU	UX 56
001 159 62 03	Z 42	14-5 DU	UX 56
001 159 65 03	Z 58	14-7 CU	-
001 159 68 03	Z 22	14-6 DU	UX 56

MERCEDES-BENZ	BERU		
001 159 69 03	Z 42	14-5 DU	UX 56
001 159 71 03	Z 22	14-6 DU	UX 56
001 159 76 03	Z 121	14 FGH-8 DTURXO	UXT 9
001 159 81 03	Z 11	14-7 DU	UXT 2/UXT 6
001 159 82 03	Z 11	14-7 DU	UXT 2/UXT 6
001 159 84 03	Z 22	14-6 DU	UX 56
001 159 84 04	Z 42	14-5 DU	UX 56
001 159 85 03	Z 22	14-6 DU	UX 56
001 159 87 03	Z 42	14-5 DU	UX 56
001 159 88 03	Z 42	14-5 DU	UX 56
001 159 89 03	Z 42	14-5 DU	UX 56
001 159 93 03	Z 42	14-5 DU	UX 56
001 159 94 03	Z 22	14-6 DU	UX 56
001 159 95 03	Z 11	14-7 DU	UXT 2/UXT 6
001 545 05 32	GR 071		
001 545 06 32	GR 071		
001 545 97 32	GR 069		
001 545 98 32	GR 071		
001 635 400	Z 17	14 K-7 DU	UXT 4
001 690 400	Z 25	14 K-6 DU	UXK 56
002 159 04 03	Z 1	14-8 DU	UXT 2/UXT 6
002 159 05 03	Z 1	14-8 DU	UXT 2/UXT 6
002 159 06 03	Z 1	14-8 DU	UXT 2/UXT 6
002 159 07 03	Z 1	14-8 DU	UXT 2/UXT 6
002 159 08 03	Z 22	14-6 DU	UX 56
002 159 09 03	Z 22	14-6 DU	UX 56
002 159 10 03	Z 11	14-7 DU	UXT 2/UXT 6
002 159 11 03	Z 11	14-7 DU	UXT 2/UXT 6
002 159 14 03	Z 22	14-6 DU	UX 56
002 159 15 03	Z 22	14-6 DU	UX 56
002 159 16 03	Z 1	14-8 DU	UXT 2/UXT 6
002 159 17 03	Z 1	14-8 DU	UXT 2/UXT 6
002 159 18 03	Z 42	14-5 DU	UX 56
002 159 19 03	Z 11	14-7 DU	UXT 2/UXT 6
002 159 20 03	Z 11	14-7 DU	UXT 2/UXT 6
002 159 21 03	Z 11	14-7 DU	UXT 2/UXT 6
002 159 24 03	Z 11	14-7 DU	UXT 2/UXT 6
002 159 25 03	Z 76	14-9 DU	UXT 2/UXT 6
002 159 26 03	Z 76	14-9 DU	UXT 2/UXT 6
002 159 27 03	Z 42	14-5 DU	UX 56
002 159 28 03	Z 11	14-7 DU	UXT 2/UXT 6
002 159 29 03	Z 76	14-9 DU	UXT 2/UXT 6
002 159 30 03	Z 76	14-9 DU	UXT 2/UXT 6
002 159 31 03	Z 76	14-9 DU	UXT 2/UXT 6
002 159 35 03	Z 17	14 K-7 DU	UXT 4
002 159 36 03	Z 25	14 K-6 DU	UXK 56
002 159 37 03	Z 17	14 K-7 DU	UXT 4
002 159 41 03	Z 22	14-6 DU	UX 56
002 159 42 03	Z 22	14-6 DU	UX 56
002 159 43 03	Z 25	14 K-6 DU	UXK 56
002 159 47 03	Z 76	14-9 DU	UXT 2/UXT 6
002 159 48 03	Z 1	14-8 DU	UXT 2/UXT 6
002 159 49 03	Z 17	14 K-7 DU	UXT 4
002 159 51 03	Z 42	14-5 DU	UX 56
002 159 54 03	Z 6	14 K-8 DU	UXT 4
002 159 54 03	Z 7	14 K-8 DUO	UXT 4
002 159 56 03	Z 17	14 K-7 DU	UXT 4
002 159 57 03	Z 6	14 K-8 DU	UXT 4
002 159 57 03	Z 7	14 K-8 DUO	UXT 4
002 159 58 03	Z 6	14 K-8 DU	UXT 4
002 159 58 03	Z 7	14 K-8 DUO	UXT 4
002 159 59 03	Z 69	14-8 DUO	UXT 2/UXT 6
002 159 60 03	Z 1	14-8 DU	UXT 2/UXT 6
002 159 61 03	Z 11	14-7 DU	UXT 2/UXT 6
002 159 62 03	Z 42	14-5 DU	UX 56
002 159 63 03	Z 42	14-5 DU	UX 56

MERCEDES-BENZ	BERU		
002 159 64 03	Z 31	14 K-5 DU	UXK 56
002 159 65 03	Z 31	14 K-5 DU	UXK 56
002 159 66 03	Z 17	14 K-7 DU	UXT 4
002 159 67 03	Z 31	14 K-5 DU	UXK 56
002 159 68 03	Z 25	14 K-6 DU	UXK 56
002 159 69 03	Z 25	14 K-6 DU	UXK 56
002 159 72 03	Z 10	14-7 BU	-
002 159 74 03	Z 58	14-7 CU	-
002 159 75 03	Z 38	14 Z-3 CU	-
002 159 76 03	Z 81	14 K-9 DUO	UXT 4
002 159 76 07	Z 81	14 K-9 DUO	UXT 4
002 159 77 03	Z 81	14 K-9 DUO	UXT 4
002 159 78 03	Z 6	14 K-8 DU	UXT 4
002 159 78 03	Z 7	14 K-8 DUO	UXT 4
002 545 05 32	GR 069		
002 545 06 32	GR 071		
002 545 08 32	GR 069		
002 545 09 32	GR 071		
002 545 41 32	GR 069		
002 545 42 32	GR 070		
002 545 43 32	GR 070		
003 159 04 03	Z 81	14 K-9 DUO	UXT 4
003 159 05 03	Z 7	14 K-8 DUO	UXT 4
003 159 06 03	Z 18	14 K-7 DUO	UXT 4
003 159 07 03	Z 56	14 K-6 DUO	UXK 56
003 159 08 03	Z 46	14 K-5 DUO	UXK 56
003 159 10 03	Z 76	14-9 DU	UXT 2/UXT 6
003 159 11 03	Z 69	14-8 DUO	UXT 2/UXT 6
003 159 11 03	Z 70	14-8 DUO	UXT 2/UXT 6
003 159 13 03	Z 22	14-6 DU	UX 56
003 159 14 03	Z 42	14-5 DU	UX 56
003 159 16 03	Z 64	14 F-7 DUO	UXT 1/UXT 3
003 159 23 03	Z 18	14 K-7 DUO	UXT 4
003 159 24 03	Z 7	14 K-8 DUO	UXT 4
003 159 25 03	Z 46	14 K-5 DUO	UXK 56
003 159 27 03	Z 76	14-9 DU	UXT 2/UXT 6
003 159 28 03	Z 7	14 K-8 DUO	UXT 4
003 159 29 03	Z 69	14-8 DUO	UXT 2/UXT 6
003 159 29 03	Z 70	14-8 DUO	UXT 2/UXT 6
003 159 30 03	Z 5	14 F-8 DUO	UXT 1/UXT 3
003 159 31 03	Z 79	14 F-9 DUO	UXT 1/UXT 3
003 159 32 03	Z 42	14-5 DU	UX 56
003 159 33 03	Z 46	14 K-5 DUO	UXK 56
003 159 34 03	Z 56	14 K-6 DUO	UXK 56
003 159 35 03	Z 18	14 K-7 DUO	UXT 4
003 159 36 03	Z 7	14 K-8 DUO	UXT 4
003 159 37 03	Z 81	14 K-9 DUO	UXT 4
003 159 40 03	Z 64	14 F-7 DUO	UXT 1/UXT 3
003 159 41 03	Z 5	14 F-8 DUO	UXT 1/UXT 3
003 159 42 03	Z 79	14 F-9 DUO	UXT 1/UXT 3
003 159 45 03	Z 62	14-7 DUO	UXT 2/UXT 6
003 159 46 03	Z 69	14-8 DUO	UXT 2/UXT 6
003 159 46 03	Z 70	14-8 DUO	UXT 2/UXT 6
003 159 47 03	Z 76	14-9 DU	UXT 2/UXT 6
003 159 53 03	Z 5	14 F-8 DUO	UXT 1/UXT 3
003 159 56 03	Z 42	14-5 DU	UX 56
003 159 57 03	Z 22	14-6 DU	UX 56
003 159 58 03	Z 22	14-6 DU	UX 56
003 159 59 03	Z 56	14 K-6 DUO	UXK 56
003 159 60 03	Z 64	14 F-7 DUO	UXT 1/UXT 3
003 159 62 03	Z 57	14-7 AU	-
003 159 64 03	Z 111	14 C-7 D	-
003 159 65 03	Z 101	14 F-8 LDUSR	UXT 1/UXT 3
003 159 66 03	Z 122	14 FGH-8 DPURX2	UXT 9
003 159 66 03	Z 240	14 F-8 DPURX02	UXT 9
003 159 67 03	Z 100	14 F-8 DU4	UXT 1/UXT 3

MERCEDES-BENZ	BERU		
003 159 68 03	Z 100	14 F-8 DU4	UXT 1/UXT 3
003 159 71 03	Z 100	14 F-8 DU4	UXT 1/UXT 3
003 159 72 03	Z 120	14 FGH-7 DTURX0	UXT 9
003 159 75 03	Z 121	14 FGH-8 DTURX0	UXT 9
003 159 76 03	Z 121	14 FGH-8 DTURX0	UXT 9
003 159 78 03	Z 120	14 FGH-7 DTURX0	UXT 9
003 159 80 03	Z 282	14 FGH-7 DPURX2	UXT 9
003 159 81 03	Z 122	14 FGH-8 DPURX2	UXT 9
003 159 93 03	Z 170	14 F-7 DPURU2	UXT 12
003 159 94 03	Z 240	14 F-8 DPURX02	UXT 9
003 159 96 03	Z 122	14 FGH-8 DPURX2	UXT 9
003 159 97 03	Z 170	14 F-7 DPURU2	UXT 12
003 159 97 03 26	Z 170	14 F-7 DPURU2	UXT 12
003 159 97 03 98	Z 170	14 F-7 DPURU2	UXT 12
004 159 00 03	Z 232	14 F-7 DPUR2	-
004 159 07 03	Z 171	14 F-7 DPURX2	UXT 9
004 159 13 03	Z 226	14 FR-6 MPU2	-
004 159 19 03	Z 122	14 FGH-8 DPURX2	UXT 9
004 159 19 03	Z 240	14 F-8 DPURX02	UXT 9
004 159 20 03	Z 282	14 FGH-7 DPURX2	UXT 9
004 159 23 03	Z 226	14 FR-6 MPU2	-
004 159 26 03	Z 227	14 F-8 DUR	UXT 1/UXT 3
004 159 30 03	Z 227	14 F-8 DUR	UXT 1/UXT 3
004 159 36 03	Z 227	14 F-8 DUR	UXT 1/UXT 3
004 159 41 03	Z 232	14 F-7 DPUR2	-
004 159 43 03	Z 322	14 F-6 KPURW2	UXT 10
004 159 45 03	Z 226	14 FR-6 MPU2	-
004 159 81 03	Z 122	14 FGH-8 DPURX2	UXT 9
005 545 40 32	GR 075		
006 545 88 32	GR 074		
006 545 89 32	GR 073		
006 545 90 32	GR 075		
007 545 16 32	GR 076		
007 545 98 32	GR 073		
007 545 99 32	GR 075		
008 545 00 32	GR 074		
012 545 88 32	GR 079		
013 545 24 32	GR 075		
018 545 72 32	GR 080		
025 545 54 32	GR 049		
032 545 05 32	GSE 104		
050 981 67 AA	Z 240	14 F-8 DPURX02	UXT 9
102 159 00 03	Z 17	14 K-7 DU	UXT 4
102 159 01 03	Z 17	14 K-7 DU	UXT 4
102 159 02 03	Z 81	14 K-9 DU0	UXT 4
102 159 03 03	Z 7	14 K-8 DU0	UXT 4
102 159 04 03	Z 31	14 K-5 DU	UXK 56
102 159 05 03	Z 81	14 K-9 DU0	UXT 4
102 159 06 03	Z 7	14 K-8 DU0	UXT 4
102 159 09 03	Z 31	14 K-5 DU	UXK 56
102 159 10 03	Z 81	14 K-9 DU0	UXT 4
102 159 11 03	Z 7	14 K-8 DU0	UXT 4
102 159 12 03	Z 25	14 K-6 DU	UXK 56
103 159 00 01	Z 17	14 K-7 DU	UXT 4
103 159 00 03	Z 17	14 K-7 DU	UXT 4
110 159 00 03	Z 22	14-6 DU	UX 56
116 159 00 03	Z 11	14-7 DU	UXT 2/UXT 6
116 159 01 03	Z 1	14-8 DU	UXT 2/UXT 6
116 159 02 03	Z 76	14-9 DU	UXT 2/UXT 6
116 159 99 93	Z 11	14-7 DU	UXT 2/UXT 6
364 159 03 01	GF 002		
364 159 04 01	GF 002		
366 159 02 01	GF 002		
366 159 03 01	GF 002		
366 159 04 01	GF 002		
376 159 72 03	Z 328	14 FR-4 DIU02	-

MERCEDES-BENZ	BERU		
660 159 00 01	GN 015		
660 159 02 01	GN 015		
906 159 01 01	GF 002		
A 000 159 13 01	GD 255		
A 000 159 18 01	GD 255		
A 000 159 75 01	GV 603		
A 000 159 81 01	GV 603		
A 000 159 83 01	GV 603		
A 000 835 31 26	GH 001		
A 001 159 04 01	GV 736		
A 001 159 08 01	GH 011		
A 001 159 14 01	GN 066		
A 001 159 27 01	GN 010		
A 001 159 28 01	GN 003		
A 001 159 37 01	GN 003		
A 001 159 38 01	GN 003		
A 001 159 42 01	GN 003		
A 001 159 48 01	GN 003		
A 001 159 49 01	GN 003		
A 001 159 50 01	GE 105		
A 001 159 51 01	GE 116		
A 001 159 52 01	GE 104		
A 001 159 76 03	Z 121	14 FGH-8 DTURX0	UXT 9
A 003 159 14 03	Z 42	14-5 DU	UX 56
A 003 159 33 03	Z 46	14 K-5 DU0	UXK 56
A 003 159 35 03	Z 18	14 K-7 DU0	UXT 4
A 003 159 36 03	Z 7	14 K-8 DU0	UXT 4
A 003 159 37 03	Z 81	14 K-9 DU0	UXT 4
A 003 159 40 03	Z 64	14 F-7 DU0	UXT 1/UXT 3
A 003 159 41 03	Z 5	14 F-8 DU0	UXT 1/UXT 3
A 003 159 45 03	Z 62	14-7 DU0	UXT 2/UXT 6
A 003 159 46 03	Z 69	14-8 DU0	UXT 2/UXT 6
A 003 159 46 03	Z 70	14-8 DU0	UXT 2/UXT 6
A 003 159 56 03	Z 42	14-5 DU	UX 56
A 003 159 57 03	Z 22	14-6 DU	UX 56
A 003 159 64 03	Z 111	14 C-7 D	-
A 003 159 65 03	Z 101	14 F-8 LDUSR	UXT 1/UXT 3
A 003 159 66 03	Z 240	14 F-8 DPURX02	UXT 9
A 003 159 67 03	Z 100	14 F-8 DU4	UXT 1/UXT 3
A 003 159 67 03 26	Z 100	14 F-8 DU4	UXT 1/UXT 3
A 003 159 68 03	Z 100	14 F-8 DU4	UXT 1/UXT 3
A 003 159 71 03	Z 100	14 F-8 DU4	UXT 1/UXT 3
A 003 159 76 03	Z 121	14 FGH-8 DTURX0	UXT 9
A 003 159 80 03	Z 282	14 FGH-7 DPURX2	UXT 9
A 003 159 81 03	Z 122	14 FGH-8 DPURX2	UXT 9
A 003 159 93 03	Z 170	14 F-7 DPURU2	UXT 12
A 003 159 94 03	Z 240	14 F-8 DPURX02	UXT 9
A 003 159 97 03	Z 170	14 F-7 DPURU2	UXT 12
A 003 159 97 03 26	Z 170	14 F-7 DPURU2	UXT 12
A 003 159 97 03 98	Z 170	14 F-7 DPURU2	UXT 12
A 004 159 00 03	Z 232	14 F-7 DPUR2	-
A 004 159 07 03	Z 171	14 F-7 DPURX2	UXT 9
A 004 159 13 03	Z 226	14 FR-6 MPU2	-
A 004 159 19 03	Z 240	14 F-8 DPURX02	UXT 9
A 004 159 19 03 26	Z 240	14 F-8 DPURX02	UXT 9
A 004 159 20 03	Z 282	14 FGH-7 DPURX2	UXT 9
A 004 159 23 03	Z 226	14 FR-6 MPU2	-
A 004 159 26 03	Z 227	14 F-8 DUR	UXT 1/UXT 3
A 004 159 30 03	Z 227	14 F-8 DUR	UXT 1/UXT 3
A 004 159 30 03 26	Z 227	14 F-8 DUR	UXT 1/UXT 3
A 004 159 36 03	Z 227	14 F-8 DUR	UXT 1/UXT 3
A 004 159 41 03	Z 232	14 F-7 DPUR2	-
A 004 159 43 03	Z 322	14 F-6 KPURW2	UXT 10
A 004 159 45 03	Z 226	14 FR-6 MPU2	-
A 004 159 45 03 26	Z 226	14 FR-6 MPU2	-
A 012 545 88 32	GR 079		

MERCEDES-BENZ	BERU		
A 018 545 72 32	GR 080		
A 032 545 05 32	GSE 104		
A 364 159 03 01	GF 002		
A 364 159 04 01	GF 002		
A 366 159 04 01	GF 002		
A 376 159 72 03	Z 328	14 FR-4 DIU02	–
A 660 159 00 01	GN 015		
A 660 159 02 01	GN 015		
A 906 159 01 01	GF 002		

MINI	BERU		
V 75 70 259	Z 233	12 ZR-6 SP03	–
V 75 77 104	Z 233	12 ZR-6 SP03	–

MITSUBISHI	BERU		
31166-03101	GN 078		
31166-03104	GN 078		
31366-02100	GN 076		
31366-02109	GN 076		
31366-14700	GN 076		
31366-14701	GN 076		
31666-02100	GN 076		
31666-02109	GN 076		
36710-42500	GN 107		
M 816 732	GN 857		
M 883 828	GN 018		
MA 848 593	Z 235	14 FR-7 SPUX03	–
MD 014 997	GV 898		
MD 050 212	GV 673		
MD 070 194	GV 921		
MD 077 167	GV 921		
MD 092 392	GV 898		
MD 197 511	GN 107		
MD 301950	GN 107		
MD 313 443	Z 228	14 FR-7 DPUX02	UXT 11
MD 344 469	GN 107		
MD 354 500	GN 107		
MD 360 019	Z 279	14 FR-7 LPU02	–
MD 360 383	Z 278	14 FR-8 LPU02	–
ME 007 545	GN 076		
ME 007 547	GN 076		
ME 067 459	GN 078		
ME 201 632	GN 067		
ME 202 785	GN 067		
ME 203 539	GN 070		
ME 203 583	GN 067		
ME 203 754	GN 067		
ME 967 559	GN 078		
MM 105 560	GN 076		
MM 401 625	GN 076		
MN 128 362	Z 235	14 FR-7 SPUX03	–
MN 128 363	Z 235	14 FR-7 SPUX03	–
MN 960 270	GN 058		
MN 980 234	GE 101		
MQ 901 659	GN 005		
MR 577 131	GN 107		
MS 851 183	Z 11	14-7 DU	UXT 2/UXT 6
MS 851 232	Z 20	14 R-7 DU	UXT 2/UXT 6
MS 851 233	Z 20	14 R-7 DU	UXT 2/UXT 6
MS 851 234	Z 47	14 R-5 DU	UX 56
MS 851 237	Z 9	14 R-8 DUX	UXT 2/UXT 6
MS 851 238	Z 21	14 R-7 DUX	UXT 2/UXT 6
MS 851 335	Z 130	14 FR-5 DPUX	–

MITSUBISHI	BERU		
MS 851 336	Z 228	14 FR-7 DPUX02	UXT 11
MS 851 357	Z 16	14 FR-7 DUX	UXT 1/UXT 3
MS 851 358	Z 16	14 FR-7 DUX	UXT 1/UXT 3
MS 851 412	Z 20	14 R-7 DU	UXT 2/UXT 6
MS 851 413	Z 47	14 R-5 DU	UX 56
MS 851 473	Z 228	14 FR-7 DPUX02	UXT 11
MS 851 501	Z 130	14 FR-5 DPUX	–
MS 851 502	Z 228	14 FR-7 DPUX02	UXT 11
MS 851 728	Z 16	14 FR-7 DUX	UXT 1/UXT 3

MONARK	BERU		
90 290 001	GR 001	–	–
90 577 012	KOBS 1-0940	–	–

MOTORCRAFT	BERU		
A 7 N	Z 262	14 S-9 E0	–
A 7 NX	Z 262	14 S-9 E0	–
AE 2	Z 39	14 Z-4 AU	–
AE 3	Z 57	14-7 AU	–
AE 4	Z 57	14-7 AU	–
AE 6	Z 57	14-7 AU	–
AE 22	Z 48	14-6 BU	–
AE 32	Z 10	14-7 BU	–
AE 42	Z 10	14-7 BU	–
AE 52	Z 57	14-7 AU	–
AE 62	Z 57	14-7 AU	–
AE 82	Z 57	14-7 AU	–
AE 901 Racing	Z 37	14 Z-3 AU	–
AER 32	Z 19	14 R-7 BU	–
AG 2	Z 58	14-7 CU	–
AG 22	Z 22	14-6 DU	UX 56
AG 22 C	Z 22	14-6 DU	UX 56
AG 3	Z 58	14-7 CU	–
AG 12 C	Z 42	14-5 DU	UX 56
AG 12 Racing	Z 42	14-5 DU	UX 56
AG 32	Z 11	14-7 DU	UXT 2/UXT 6
AG 42	Z 76	14-9 DU	UXT 2/UXT 6
AG 52	Z 1	14-8 DU	UXT 2/UXT 6
AGF 22	Z 25	14 K-6 DU	UXK 56
AGF 22 C	Z 25	14 K-6 DU	UXK 56
AGFS 22 C	Z 95	14 KR-7 DU	UXT 4
AGFS 22 C 1	Z 67	14 KR-7 DUX	UXT 4
AGFS 32 C 1	Z 117	14 KR-9 DUX	UXT 4
AGFS K022FQ16B	Z 309	14 KR-8 LQU07	–
AGN 42	Z 1	14-8 DU	UXT 2/UXT 6
AGP 12 C	Z 29	14 F-5 DU	UXT 5
AGP 22 C	Z 24	14 FR-6 DU	UXT 5
AGP 22 CD	Z 24	14 FR-6 DU	UXT 5
AGP 32 C	Z 63	14 F-7 DU	UXT 1/UXT 3
AGPR 12 C	Z 30	14 FR-5 DU	UXT 5
AGPR 12 C 1	Z 30	14 FR-5 DU	UXT 5
AGPR 12 P	Z 130	14 FR-5 DPUX	–
AGPR 22 C	Z 24	14 FR-6 DU	UXT 5
AGPR 22 C 1	Z 99	14 FR-6 DUX	UXT 5
AGPR 22 CD	Z 24	14 FR-6 DU	UXT 5
AGPR 22 CD 1	Z 99	14 FR-6 DUX	UXT 5
AGPR 22 P 1	Z 159	14 FR-6 DPUX	UXT 14
AGPR 22 PP	Z 159	14 FR-6 DPUX	UXT 14
AGPR 22 PPJ	Z 284	14 FR-6 DPOX	–
AGPR 32 C	Z 15	14 FR-7 DU	UXT 1/UXT 3
AGPR 32 C 1	Z 16	14 FR-7 DUX	UXT 1/UXT 3
AGPR 32 CD	Z 15	14 FR-7 DU	UXT 1/UXT 3
AGPR 32 CD 1	Z 16	14 FR-7 DUX	UXT 1/UXT 3

MOTORCRAFT	BERU		
AGPR 32 PD	Z 173	14 FGR-8 KQU	–
AGPS 12 C	Z 30	14 FR-5 DU	UXT 5
AGPS 12 C 1	Z 253	14 FR-5 DUU	UXT 5
AGPS 12 P 1	Z 130	14 FR-5 DPUX	–
AGPS 22 C	Z 24	14 FR-6 DU	UXT 5
AGPS 22 C 1	Z 99	14 FR-6 DUX	UXT 5
AGPS 22 P 1	Z 159	14 FR-6 DPUX	UXT 14
AGPS 32 C 1	Z 16	14 FR-7 DUX	UXT 1/UXT 3
AGPS 44 F11J	Z 176	14 F-7 HPURX2	–
AGR 12 C	Z 47	14 R-5 DU	UX 56
AGR 22	Z 20	14 R-7 DU	UXT 2/UXT 6
AGR 22 BC	Z 27	14 R-6 DU	UX 56
AGR 22 C	Z 20	14 R-7 DU	UXT 2/UXT 6
AGR 22-3 C	Z 27	14 R-6 DU	UX 56
AGR 31	Z 8	14 R-8 DU	UXT 2/UXT 6
AGR 32	Z 8	14 R-8 DU	UXT 2/UXT 6
AGR 32 C	Z 8	14 R-8 DU	UXT 2/UXT 6
AGR 42	Z 82	14 R-9 DU	UXT 2/UXT 6
AGR 42 C	Z 82	14 R-9 DU	UXT 2/UXT 6
AGR 52	Z 82	14 R-9 DU	UXT 2/UXT 6
AGR 52-6	Z 8	14 R-8 DU	UXT 2/UXT 6
AGR 252 C	Z 20	14 R-7 DU	UXT 2/UXT 6
AGRF 22	Z 95	14 KR-7 DU	UXT 4
AGRF 22 C	Z 95	14 KR-7 DU	UXT 4
AGRF 22 C 1	Z 67	14 KR-7 DUX	UXT 4
AGRF 22 CD	Z 95	14 KR-7 DU	UXT 4
AGRF 22 CD 1	Z 67	14 KR-7 DUX	UXT 4
AGRF 32 C 1	Z 117	14 KR-9 DUX	UXT 4
AGRF 52	Z 80	14 K-9 DU	UXT 4
AGS 22 C	Z 20	14 R-7 DU	UXT 2/UXT 6
AGS 42 C	Z 82	14 R-9 DU	UXT 2/UXT 6
AGSF 22 FE13J	Z 209	14 KR-6 DPUV02	UXT 15
AGSF 22 FSCM	Z 296	14 KR-7 DPUV	UXT 15
AGSF 22 PPJ	Z 209	14 KR-6 DPUV02	UXT 15
AGSF 32 FM	Z 148	14 KR-8 DPU0V	UXT 15
AGSP 092 P	Z 130	14 FR-5 DPUX	–
AGSP 32	Z 24	14 FR-6 DU	UXT 5
AGSP 32 C	Z 24	14 FR-6 DU	UXT 5
AGSP 33 C	Z 158	14 FR-7 LUX	–
AJFS 32 CJ	Z 177	14 KR-8 MUV	UXT 7
AWF 22	Z 25	14 K-6 DU	UXK 56
AWRF 42	Z 95	14 KR-7 DU	UXT 4
AWSF 22	Z 31	14 K-5 DU	UXK 56
AWSF 22 C	Z 31	14 K-5 DU	UXK 56
AWSF 32	Z 17	14 K-7 DU	UXT 4
AWSF 32 C	Z 17	14 K-7 DU	UXT 4
AWSF 32 F	Z 148	14 KR-8 DPU0V	UXT 15
AWSF 42	Z 95	14 KR-7 DU	UXT 4
AWSF 42 C	Z 95	14 KR-7 DU	UXT 4
AWSF 52	Z 117	14 KR-9 DUX	UXT 4
AWSF 52 C	Z 117	14 KR-9 DUX	UXT 4
AYFS 22 C	Z 177	14 KR-8 MUV	UXT 7
AYFS 22 CB	Z 177	14 KR-8 MUV	UXT 7
AYFS 22 CJ	Z 305	14 KR-6 MUU	UXT 8
AYFS 22 F	Z 97	14 KR-8 MPX	UXT 8
AYFS 22 PP 1	Z 97	14 KR-8 MPX	UXT 8
AYFS 32 CJ	Z 177	14 KR-8 MUV	UXT 7
AYRF 22 FF	Z 97	14 KR-8 MPX	UXT 8
AYRF 22 PP	Z 97	14 KR-8 MPX	UXT 8
BF 22	Z 33	18 K-6 BU	–
BF 22 C	Z 33	18 K-6 BU	–
BF 22 CX	Z 33	18 K-6 BU	–
BF 32	Z 32	18 K-7 BU	–
BF 32	Z 32	18 K-7 BU	–
BF 32 C	Z 32	18 K-7 BU	–
BF 32 C	Z 32	18 K-7 BU	–

MOTORCRAFT	BERU		
BF 32 CX	Z 32	18 K-7 BU	–
BF 32 CX	Z 32	18 K-7 BU	–
BF 42	Z 32	18 K-7 BU	–
BF 42	Z 32	18 K-7 BU	–
BFS 22 C	Z 33	18 K-6 BU	–
BFS 32 C	Z 32	18 K-7 BU	–
BFS 32 C	Z 32	18 K-7 BU	–
BFS 32 C1	Z 32	18 K-7 BU	–
BRF 22	Z 32	18 K-7 BU	–
BRF 22 C	Z 32	18 K-7 BU	–
BRF 22 CX	Z 32	18 K-7 BU	–
BRF 22 X	Z 33	18 K-6 BU	–
BRF 32	Z 32	18 K-7 BU	–
BRF 32 C	Z 32	18 K-7 BU	–
BRF 32 CX	Z 32	18 K-7 BU	–
BRF 32 X	Z 32	18 K-7 BU	–
BRF 42	Z 32	18 K-7 BU	–
BRF 42 C	Z 32	18 K-7 BU	–
BRF 42 X	Z 32	18 K-7 BU	–
BSF 42	Z 32	18 K-7 BU	–
BT 10	Z 88	18-10 AU	–

MULTICAR	BERU
MC 02	GV 02
MC 03	GV 910

MWM	BERU
12041709	GV 361
3 0579 419 0002	GD 294
6 0578 075 0001	KOBS 1-0940
6 0579 410 0004	GV 119
6 0579 410 0007	GV 129
6 0579 410 0009	GF 138
6 0579 411 0003	GD 214
6 0579 412 0003	GD 294
6 0579 414 0008	GF 167
6 0579 415 0007	Z 39 14 Z-4 AU
DZ 12041709	GV 361

NANJING LD	BERU
A 7 RTC	Z 199 10 FR-4 AU
D 7	–
D 8 TC	–
E 5 T	Z 19 14 R-7 BU
E 6 RTC	Z 19 14 R-7 BU
E 6 TC	Z 19 14 R-7 BU
E 7 T C	–
F 6 RTC	Z 8 14 R-8 DU UXT 2/UXT 6
F 6 TC	Z 8 14 R-8 DU UXT 2/UXT 6
F 7 TC	Z 20 14 R-7 DU UXT 2/UXT 6
G 6	Z 112 14-8 E
H 5	Z 85 14 X-AU
K 6 RF-11	Z 73 14 FR-8 DUX UXT 1/UXT 3
K 6 RTC	Z 254 14 FR-8 DU UXT 1/UXT 3
K 6 TC	Z 15 14 FR-7 DU UXT 1/UXT 3
K 6 TJC	Z 24 14 FR-6 DU UXT 5
K 7 RF-11	Z 16 14 FR-7 DUX UXT 1/UXT 3
K 7 TC	Z 15 14 FR-7 DU UXT 1/UXT 3
K 9 TC	Z 30 14 FR-5 DU UXT 5
T 5 RTC	Z 32 18 K-7 BU

NGK	BERU		
201	Z 38	14 Z-3 CU	–
203	Z 57	14-7 AU	–
204	Z 40	14-5 AU	–
205	Z 39	14 Z-4 AU	–
206	Z 22	14-6 DU	UX 56
208	Z 38	14 Z-3 CU	–
214	Z 19	14 R-7 BU	–
301	Z 262	14 S-9 E0	–
302	Z 267	14 S-7 EU0	–
303	Z 266	14 S-7 E	–
304	Z 263	14 SR-7 F	–
305	Z 265	14 S-5 F	–
307	Z 271	14 SR-7 E	–
308	Z 263	14 SR-7 F	–
309	Z 260	14 SR-5 F	–
0005	Z 97	14 KR-8 MPX	UXT 8
1015	Z 38	14 Z-3 CU	–
1029	Z 263	14 SR-7 F	–
1041	Z 158	14 FR-7 LUX	–
1048	Z 148	14 KR-8 DPUOV	UXT 15
1080	Z 63	14 F-7 DU	UXT 1/UXT 3
1095	Z 30	14 FR-5 DU	UXT 5
1146	Z 155	14 FR-7 KU	UXT 10
1147	Z 270	14 S-10 E0	–
1149	Z 28	14 R-6 DUX	UX 56
1183	Z 95	14 KR-7 DU	UXT 4
1208	Z 235	14 FR-7 SPUX03	–
1212	Z 21	14 R-7 DUX	UXT 2/UXT 6
1228	Z 262	14 S-9 E0	–
1263	Z 51	14-6 DTU	UX 56
1266	Z 72	14 FR-8 DU	UXT 1/UXT 3
1267	Z 99	14 FR-6 DUX	UXT 5
1272	Z 24	14 FR-6 DU	UXT 5
1273	Z 73	14 FR-8 DUX	UXT 1/UXT 3
1662	Z 73	14 FR-8 DUX	UXT 1/UXT 3
1664	Z 176	14 F-7 HPURX2	–
1667	Z 72	14 FR-8 DU	UXT 1/UXT 3
1675	Z 347	14 F-5 DPUR02	–
1691	Z 293	12 FR-6 LUX	–
2023	Z 27	14 R-6 DU	UX 56
2074	Z 248	14 FR-8 HUT	–
2078	Z 52	14 F-6 DTU	UXT 5
2087	Z 154	14 FR-8 KU0	UXT 9
2128	Z 82	14 R-9 DU	UXT 2/UXT 6
2164	Z 45	14 FR-5 DTU	UXT 5
2197	Z 204	14 FGR-8 CTU	–
2215	Z 151	14 FR-7 KPU	UXT 9
2249	Z 156	14 FR-7 KU0	UXT 10
2262	Z 158	14 FR-7 LUX	–
2268	Z 20	14 R-7 DU	UXT 2/UXT 6
2288	Z 14	14 F-7 LDUR4	UXT 1/UXT 3
2288	Z 257	14 FR-7 LDUW	UXT 1/UXT 3
2319	Z 267	14 S-7 EU0	–
2330	Z 15	14 FR-7 DU	UXT 1/UXT 3
2351	Z 79	14 F-9 DU0	UXT 1/UXT 3
2357	Z 42	14-5 DU	UX 56
2364	Z 1	14-8 DU	UXT 2/UXT 6
2382	Z 73	14 FR-8 DUX	UXT 1/UXT 3
2397	Z 90	14 FGH-7 DTURX	UXT 1/UXT 3
2411	Z 38	14 Z-3 CU	–
2412	Z 22	14-6 DU	UX 56
2417	Z 57	14-7 AU	–
2467	Z 97	14 KR-8 MPX	UXT 8
2470	Z 92	14 GH-8 DTUR	UXT 2/UXT 6
2513	Z 237	14 FR-7 DQUP7	–
2526	Z 249	14 FR-8 KUOU	–

NGK	BERU		
2550	Z 150	14 FR-7 KPUV	–
2609	Z 95	14 KR-7 DU	UXT 4
2611	Z 38	14 Z-3 CU	–
2621	Z 39	14 Z-4 AU	–
2623	Z 49	14 KR-6 BU	–
2647	Z 228	14 FR-7 DPUX02	UXT 11
2680	Z 266	14 S-7 E	–
2710	Z 33	18 K-6 BU	–
2721	Z 37	14 Z-3 AU	–
2756	Z 16	14 FR-7 DUX	UXT 10
2789	Z 246	14 FGH-8 DTURW	UXT 1/UXT 3
2792	Z 40	14-5 AU	–
2828	Z 8	14 R-8 DU	UXT 2/UXT 6
2848	Z 98	14 FR-7 LDU	UXT 1/UXT 3
2876	Z 91	14 GH-7 DTUR	UXT 2/UXT 6
2890	Z 173	14 FGR-8 KQU	–
2921	Z 58	14-7 CU	–
2941	Z 3	14-8 LUR	UXT 2/UXT 6
2963	Z 263	14 SR-7 F	–
3014	Z 39	14 Z-4 AU	–
3028	Z 9	14 R-8 DUX	UXT 2/UXT 6
3045	Z 90	14 FGH-7 DTURX	UXT 1/UXT 3
3116	Z 279	14 FR-7 LPU02	–
3121	Z 38	14 Z-3 CU	–
3132	Z 16	14 FR-7 DUX	UXT 1/UXT 3
3153	Z 8	14 R-8 DU	UXT 2/UXT 6
3172	Z 91	14 GH-7 DTUR	UXT 2/UXT 6
3199	Z 237	14 FR-7 DQUP7	–
3201	Z 265	14 S-5 F	–
3210	Z 112	14-8 E	–
3232	Z 28	14 R-6 DUX	UX 56
3306	UXT 1/UXT 3	–	–
3311	Z 10	14-7 BU	–
3321	Z 38	14 Z-3 CU	–
3330	Z 30	14 FR-5 DU	UXT 5
3350	Z 149	14 FR-7 KPUX	UXT 11
3355	Z 22	14-6 DU	UX 56
3377	Z 92	14 GH-8 DTUR	UXT 2/UXT 6
3410	Z 262	14 S-9 E0	–
3500	Z 188	14 F-7 DPUR02	UXT 10
3510	Z 267	14 S-7 EU0	–
3524	Z 73	14 FR-8 DUX	UXT 1/UXT 3
3526	Z 31	14 K-5 DU	UXK 56
3539	Z 206	14 FR-7 DPPUS2	UXT 10
3540	Z 159	14 FR-6 DPUX	UXT 14
3568	Z 269	14 SR-9 E0	–
3577	Z 21	14 R-7 DUX	UXT 2/UXT 6
3583	Z 98	14 FR-7 LDU	UXT 1/UXT 3
3584	Z 145	14 FGR-6 DDU	–
3586	Z 176	14 F-7 HPURX2	–
3588	Z 226	14 FR-6 MPU2	–
3611	Z 10	14-7 BU	–
3623	Z 95	14 KR-7 DU	UXT 4
3696	Z 155	14 FR-7 KU	UXT 10
3712	Z 6	14 K-8 DU	UXT 4
3720	Z 157	14 FR-7 KUOX	UXT 11
3783	Z 15	14 FR-7 DU	UXT 1/UXT 3
3784	Z 67	14 KR-7 DUX	UXT 4
3812	Z 18	14 K-7 DU0	UXT 4
3837	Z 150	14 FR-7 KPUV	–
3850	Z 271	14 SR-7 E	–
3923	Z 47	14 R-5 DU	UX 56
3932	Z 234	12 FR-7 DU	–
3967	Z 208	14 FR-8 LDU3	–
3975	Z 10	14-7 BU	–
3978	Z 221	14 FR-6 DPUX02	UXT 14

NGK	BERU		
3988	Z 38	14 Z-3 CU	–
4045	Z 313	14 FR-6 DPUX2	–
4073	Z 157	14 FR-7 KUOX	UXT 11
4080	Z 278	14 FR-8 LPU02	–
4114	Z 263	14 SR-7 F	–
4120	Z 73	14 FR-8 DUX	UXT 1/UXT 3
4133	Z 269	14 SR-9 E0	–
4179	Z 234	12 FR-7 DU	–
4210	Z 68	14-8 AU	–
4228	Z 21	14 R-7 DUX	UXT 2/UXT 6
4259	Z 210	10 FR-6 CPU03	–
4291	Z 158	14 FR-7 LUX	–
4292	Z 240	14 F-8 DPURX02	UXT 9
4294	Z 301	14 FR-7 LPUX02	–
4339	Z 234	12 FR-7 DU	–
4345	Z 260	14 SR-5 F	–
4368	Z 157	14 FR-7 KUOX	UXT 11
4377	Z 206	14 FR-7 DPPUS2	UXT 10
4388	Z 14	14 F-7 LDUR4	UXT 1/UXT 3
4392	Z 95	14 KR-7 DU	UXT 4
4421	Z 72	14 FR-8 DU	UXT 1/UXT 3
4424	Z 9	14 R-8 DUX	UXT 2/UXT 6
4435	Z 225	14 FR-7 HUX	–
4477	UXT 15	–	–
4483	Z 74	14 FR-8 LDUOX4	UXT 1/UXT 3
4510	Z 57	14-7 AU	–
4511	Z 10	14-7 BU	–
4549	Z 199	10 FR-4 AU	–
4553	Z 19	14 R-7 BU	–
4559	Z 177	14 KR-8 MUV	UXT 7
4563	UXT 1/UXT 3	–	–
4589	Z 280	14 FR-7 KPUX02	–
4619	Z 193	14 FR-7 DU2	UXT 1/UXT 3
4626	Z 260	14 SR-5 F	–
4629	Z 199	10 FR-4 AU	–
4632	Z 48	14-6 BU	–
4685	Z 159	14 FR-6 DPUX	UXT 14
4691	Z 76	14-9 DU	UXT 2/UXT 6
4696	Z 122	14 FGH-8 DPURX2	UXT 9
4704	Z 294	14 FGR-5 NTE	–
4775	Z 302	14 FR-8 MPUX2	UXT 13
4783	Z 100	14 F-8 DU4	UXT 1/UXT 3
4824	Z 21	14 R-7 DUX	UXT 2/UXT 6
4856	Z 15	14 FR-7 DU	UXT 1/UXT 3
4922	Z 59	14 R-7 CU	–
4930	Z 63	14 F-7 DU	UXT 1/UXT 3
4983	Z 292	12 FR-6 DU	–
5030	Z 29	14 F-5 DU	UXT 5
5110	Z 40	14-5 AU	–
5111	Z 41	14-5 BU	–
5156	Z 2	14-8 DTU	UXT 2/UXT 6
5165	Z 152	14 FR-8 HU	–
5214	Z 286	12 FR-5 SDU	–
5216	Z 74	14 FR-8 LDUOX4	UXT 1/UXT 3
5282	Z 16	14 FR-7 DUX	UXT 1/UXT 3
5328	Z 22	14-6 DU	UX 56
5339	Z 21	14 R-7 DUX	UXT 2/UXT 6
5343	Z 19	14 R-7 BU	–
5344	Z 170	14 F-7 DPURU2	UXT 12
5411	Z 76	14-9 DU	UXT 2/UXT 6
5428	Z 28	14 R-6 DUX	UX 56
5444	Z 216	14 KR-10 SUV2	–
5461	Z 90	14 FGH-7 DTURX	UXT 1/UXT 3
5510	Z 39	14 Z-4 AU	–
5521	Z 51	14-6 DTU	UX 56
5539	Z 39	14 Z-4 AU	–

NGK	BERU		
5547	Z 295	14 F-6 DTPR02	UXT 12
5555	Z 221	14 FR-6 DPUX02	UXT 14
5584	Z 158	14 FR-7 LUX	–
5585	Z 158	14 FR-7 LUX	–
5621	Z 51	14-6 DTU	UX 56
5637	Z 11	14-7 DU	UXT 2/UXT 6
5649	Z 194	14 FR-6 LDU3	UXT 5
5685	Z 94	14 GR-8 DTU	UXT 2/UXT 6
5692	Z 291	12 FR-5 DU	–
5722	Z 38	14 Z-3 CU	–
5724	Z 16	14 FR-7 DUX	UXT 1/UXT 3
5730	Z 47	14 R-5 DU	UX 56
5760	Z 311	14 R-8 DPUU	UXT 2/UXT 6
5773	Z 188	14 F-7 DPUR02	UXT 10
5776	Z 249	14 FR-8 KUOU	–
5798	Z 261	14 SR-10 E0	–
5811	Z 1	14-8 DU	UXT 2/UXT 6
5823	Z 20	14 R-7 DU	UXT 2/UXT 6
5832	Z 104	14-6 DPO	–
5839	Z 3	14-8 LUR	UXT 2/UXT 6
5921	Z 266	14 S-7 E	–
5932	Z 93	14 GH-8 DTURX	UXT 2/UXT 6
6002	Z 239	14 FGR-7 KQE	–
6044	Z 298	14 KR-8 DPUV	UXT 15
6097	Z 24	14 FR-6 DU	UXT 5
6129	Z 15	14 FR-7 DU	UXT 1/UXT 3
6129	Z 252	14 FR-6 DUW	UXT 5
6130	Z 72	14 FR-8 DU	UXT 1/UXT 3
6211	Z 11	14-7 DU	UXT 2/UXT 6
6223	Z 21	14 R-7 DUX	UXT 2/UXT 6
6237	Z 63	14 F-7 DU	UXT 1/UXT 3
6240	Z 219	14 FR-8 MPUX02	UXT 13
6262	Z 99	14 FR-6 DUX	UXT 5
6290	UXT 14	–	–
6342	Z 246	14 FGH-8 DTURW	UXT 1/UXT 3
6343	Z 237	14 FR-7 DQUP7	–
6344	Z 67	14 KR-7 DUX	UXT 4
6345	Z 72	14 FR-8 DU	UXT 1/UXT 3
6376	Z 303	14 FR-7 MUX2	UXT 13
6410	Z 58	14-7 CU	–
6411	Z 11	14-7 DU	UXT 2/UXT 6
6427	Z 20	14 R-7 DU	UXT 2/UXT 6
6437	Z 90	14 FGH-7 DTURX	UXT 1/UXT 3
6458	Z 188	14 F-7 DPUR02	UXT 10
6465	UXT 11	–	–
6465	Z 16	14 FR-7 DUX	UXT 1/UXT 3
6466	Z 18	14 K-7 DU0	UXT 4
6511	Z 1	14-8 DU	UXT 2/UXT 6
6714	Z 72	14 FR-8 DU	UXT 1/UXT 3
6717	Z 15	14 FR-7 DU	UXT 1/UXT 3
6717	Z 193	14 FR-7 DU2	UXT 1/UXT 3
6723	Z 20	14 R-7 DU	UXT 2/UXT 6
6726	Z 263	14 SR-7 F	–
6799	Z 243	12 VR-8 SE	–
6837	Z 127	14 KGR-7 KQU	–
6872	Z 239	14 FGR-7 KQE	–
6893	Z 200	14 F-7 HUR2	–
6895	Z 98	14 FR-7 LDU	UXT 1/UXT 3
6928	Z 76	14-9 DU	UXT 2/UXT 6
6953	Z 73	14 FR-8 DUX	UXT 1/UXT 3
6962	Z 15	14 FR-7 DU	UXT 1/UXT 3
6994	Z 297	14 FR-7 LPUX0	–
7022	Z 19	14 R-7 BU	–
7038	Z 82	14 R-9 DU	UXT 2/UXT 6
7113	Z 183	14 FR-8 MU2	UXT 13
7121	Z 99	14 FR-6 DUX	UXT 5



NGK	BERU		
7164	Z 148	14 KR-8 DPUOV	UXT 15
7210	Z 63	14 F-7 DU	UXT 1/UXT 3
7222	Z 82	14 R-9 DU	UXT 2/UXT 6
7226	Z 28	14 R-6 DUX	UX 56
7264	Z 93	14 GH-8 DTURX	UXT 2/UXT 6
7265	Z 27	14 R-6 DU	UX 56
7281	Z 119	14 R-8 DU4	UXT 2/UXT 6
7281	Z 8	14 R-8 DU	UXT 2/UXT 6
7310	Z 58	14-7 CU	–
7311	Z 9	14 R-8 DUX	UXT 2/UXT 6
7321	Z 265	14 S-5 F	–
7327	Z 1	14-8 DU	UXT 2/UXT 6
7354	Z 198	14 FR-5 LDU3	UXT 5
7390	Z 153	14 FR-8 KU	UXT 10
7421	Z 271	14 SR-7 E	–
7422	Z 8	14 R-8 DU	UXT 2/UXT 6
7496	Z 100	14 F-8 DU4	UXT 1/UXT 3
7550	Z 229	14 FR-8 LPU0	–
7569	Z 209	14 KR-6 DPUV02	UXT 15
7586	Z 97	14 KR-8 MPX	UXT 8
7642	Z 72	14 FR-8 DU	UXT 1/UXT 3
7727	Z 11	14-7 DU	UXT 2/UXT 6
7742	Z 236	14 F-6 HTPRX02	–
7743	Z 176	14 F-7 HPURX2	–
7810	Z 73	14 FR-8 DUX	UXT 1/UXT 3
7811	Z 11	14-7 DU	UXT 2/UXT 6
7822	Z 20	14 R-7 DU	UXT 2/UXT 6
7873	Z 89	14 FGH-6 DTUR	UXT 5
7938	Z 254	14 FR-8 DUS	UXT 1/UXT 3
7938	Z 255	14 FR-8 DUW	UXT 1/UXT 3
7938	Z 72	14 FR-8 DU	UXT 1/UXT 3
7956	Z 74	14 FR-8 LDUOX4	UXT 1/UXT 3
7968	Z 176	14 F-7 HPURX2	–
7994	Z 73	14 FR-8 DUX	UXT 1/UXT 3
AP 6 FS	Z 33	18 K-6 BU	–
B 2 LM	Z 270	14 S-10 E0	–
B 4	Z 112	14-8 E	–
B 4 LM	Z 262	14 S-9 E0	–
B 5 ES	Z 58	14-7 CU	–
B 5 HS	Z 68	14-8 AU	–
B 6 E	Z 58	14-7 CU	–
B 6 EB	Z 58	14-7 CU	–
B 6 EM	Z 58	14-7 CU	–
B 6 ES	Z 58	14-7 CU	–
B 6 H	Z 57	14-7 AU	–
B 6 HS	Z 57	14-7 AU	–
B 6 S	Z 267	14 S-7 EU0	–
B 7 E	Z 58	14-7 CU	–
B 7 EM	Z 38	14 Z-3 CU	–
B 7 ET	Z 38	14 Z-3 CU	–
B 7 H	Z 39	14 Z-4 AU	–
B 7 HC	Z 57	14-7 AU	–
B 7 HS	Z 40	14-5 AU	–
B 7 HV	Z 39	14 Z-4 AU	–
B 7 HZ	Z 39	14 Z-4 AU	–
B 8 EE	Z 38	14 Z-3 CU	–
B 8 ES	Z 38	14 Z-3 CU	–
B 8 EV	Z 38	14 Z-3 CU	–
B 8 H	Z 39	14 Z-4 AU	–
B 8 HCS	Z 39	14 Z-4 AU	–
B 8 HS	Z 39	14 Z-4 AU	–
B 9 E	Z 38	14 Z-3 CU	–
B 9 ES	Z 38	14 Z-3 CU	–
B 9 HCS	Z 37	14 Z-3 AU	–
B 77 EC	Z 38	14 Z-3 CU	–
BCP 4 ES	Z 79	14 F-9 DU0	UXT 1/UXT 3

NGK	BERU		
BCP 5 E	Z 71	14 F-8 DU	UXT 1/UXT 3
BCP 5 ES	Z 100	14 F-8 DU4	UXT 1/UXT 3
BCP 5 ES	Z 5	14 F-8 DU0	UXT 1/UXT 3
BCP 5 ES	Z 71	14 F-8 DU	UXT 1/UXT 3
BCP 5 ES-11	Z 73	14 FR-8 DUX	UXT 1/UXT 3
BCP 6 E	Z 63	14 F-7 DU	UXT 1/UXT 3
BCP 6 E-11	Z 63	14 F-7 DU	UXT 1/UXT 3
BCP 6 ES	Z 63	14 F-7 DU	UXT 1/UXT 3
BCP 6 ES	Z 64	14 F-7 DU0	UXT 1/UXT 3
BCP 6 ES-11	Z 63	14 F-7 DU	UXT 1/UXT 3
BCP 6 ET	UXT 1/UXT 3	–	–
BCP 6 EY	Z 63	14 F-7 DU	UXT 1/UXT 3
BCP 7 ES	Z 29	14 F-5 DU	UXT 5
BCP 7 ET	Z 52	14 F-6 DTU	UXT 5
BCPR 5 E	Z 72	14 FR-8 DU	UXT 1/UXT 3
BCPR 5 E-11	Z 73	14 FR-8 DUX	UXT 1/UXT 3
BCPR 5 EIX-11	UXT 1/UXT 3	–	–
BCPR 5 ES	Z 72	14 FR-8 DU	UXT 1/UXT 3
BCPR 5 ES-11	Z 73	14 FR-8 DUX	UXT 1/UXT 3
BCPR 5 EY	Z 72	14 FR-8 DU	UXT 1/UXT 3
BCPR 5 EY-11	Z 73	14 FR-8 DUX	UXT 1/UXT 3
BCPR 6 E	Z 15	14 FR-7 DU	UXT 1/UXT 3
BCPR 6 E-11	Z 16	14 FR-7 DUX	UXT 1/UXT 3
BCPR 6 EP-11	Z 149	14 FR-7 KPUX	UXT 11
BCPR 6 EP-13	Z 150	14 FR-7 KPUV	–
BCPR 6 ER	Z 14	14 F-7 LDUR4	UXT 1/UXT 3
BCPR 6 ES	Z 15	14 FR-7 DU	UXT 1/UXT 3
BCPR 6 ES-11	Z 99	14 FR-6 DUX	UXT 5
BCPR 6 ET	Z 204	14 FGR-8 CTU	–
BCPR 6 EY	Z 155	14 FR-7 KU	UXT 10
BCPR 6 EY-11	Z 157	14 FR-7 KUOX	UXT 11
BCPR 6 EY-N-11	Z 99	14 FR-6 DUX	UXT 5
BCPR 7 E	Z 24	14 FR-6 DU	UXT 5
BCPR 7 E-11	Z 99	14 FR-6 DUX	UXT 5
BCPR 7 ER	Z 14	14 F-7 LDUR4	UXT 1/UXT 3
BCPR 7 ES	Z 30	14 FR-5 DU	UXT 5
BCPR 7 ES-11	Z 30	14 FR-5 DU	UXT 5
BCPR 7 ET	Z 45	14 FR-5 DTU	UXT 5
BCRE 527Y	Z 248	14 FR-8 HUT	–
BKR 4 E	Z 72	14 FR-8 DU	UXT 1/UXT 3
BKR 5 E	Z 72	14 FR-8 DU	UXT 1/UXT 3
BKR 5 E-11	Z 73	14 FR-8 DUX	UXT 1/UXT 3
BKR 5 EK	Z 74	14 FR-8 LDUOX4	UXT 1/UXT 3
BKR 5 EKB-11	Z 208	14 FR-8 LDU3	–
BKR 5 EKC	Z 74	14 FR-8 LDUOX4	UXT 1/UXT 3
BKR 5 EKUP	Z 173	14 FGR-8 KQU	–
BKR 5 ES	Z 254	14 FR-8 DUS	UXT 1/UXT 3
BKR 5 ES	Z 255	14 FR-8 DUW	UXT 1/UXT 3
BKR 5 ES	Z 72	14 FR-8 DU	UXT 1/UXT 3
BKR 5 ES-11	Z 73	14 FR-8 DUX	UXT 1/UXT 3
BKR 5 EY	Z 153	14 FR-8 KU	UXT 10
BKR 5 EYA	Z 154	14 FR-8 KUO	UXT 9
BKR 5 EYA-11	Z 249	14 FR-8 KUOU	–
BKR 5 EZ	Z 72	14 FR-8 DU	UXT 1/UXT 3
BKR 6 E	Z 15	14 FR-7 DU	UXT 1/UXT 3
BKR 6 E-11	Z 16	14 FR-7 DUX	UXT 11
BKR 6 EK	Z 257	14 FR-7 LDUW	UXT 1/UXT 3
BKR 6 EK	Z 14	14 F-7 LDUR4	UXT 1/UXT 3
BKR 6 EKB-11	Z 98	14 FR-7 LDU	UXT 1/UXT 3
BKR 6 EKC	Z 98	14 FR-7 LDU	UXT 1/UXT 3
BKR 6 EKE	Z 194	14 FR-6 LDU3	UXT 5
BKR 6 EKPA	Z 237	14 FR-7 DQUP7	–
BKR 6 EKUB	Z 145	14 FGR-6 DDU	–
BKR 6 EKUE	Z 213	14 FGR-7 KDU6	–
BKR 6 E-N-11	Z 16	14 FR-7 DUX	UXT 1/UXT 3
BKR 6 EP-8	Z 151	14 FR-7 KPU	UXT 9

NGK	BERU		
BKR 6 EP-13	Z 150	14 FR-7 KPUV	–
BKR 6 EQU	Z 239	14 FGR-7 KQE	–
BKR 6 EQUA	Z 239	14 FGR-7 KQE	–
BKR 6 EQUIP	Z 237	14 FR-7 DQUP7	–
BKR 6 ES	Z 15	14 FR-7 DU	UXT 1/UXT 3
BKR 6 EVX	Z 206	14 FR-7 DPPUS2	UXT 10
BKR 6 EVX-11	Z 159	14 FR-6 DPUX	UXT 14
BKR 6 EY	Z 155	14 FR-7 KU	UXT 10
BKR 6 EY-11	Z 157	14 FR-7 KUOX	UXT 11
BKR 6 EYA	Z 156	14 FR-7 KU0	UXT 10
BKR 6 EYA-11	Z 157	14 FR-7 KUOX	UXT 11
BKR 6 EZ	Z 193	14 FR-7 DU2	UXT 1/UXT 3
BKR 7 E	Z 24	14 FR-6 DU	UXT 5
BKR 7 E-11	Z 24	14 FR-6 DU	UXT 5
BKR 7 EKC	Z 198	14 FR-5 LDU3	UXT 5
BKR 7 EVX-11	Z 159	14 FR-6 DPUX	UXT 14
BKUR 5 ET	Z 246	14 FGH-8 DTURW	UXT 1/UXT 3
BKUR 5 ET-10	Z 121	14 FGH-8 DTURX0	UXT 9
BKUR 6 EK	Z 98	14 FR-7 LDU	UXT 1/UXT 3
BKUR 6 ET	Z 90	14 FGH-7 DTURX	UXT 1/UXT 3
BKUR 6 ET-10	Z 90	14 FGH-7 DTURX	UXT 1/UXT 3
BKUR 7 ET	Z 89	14 FGH-6 DTUR	UXT 5
BM 6 A	Z 266	14 S-7 E	–
BMR 4 A	Z 269	14 SR-9 E0	–
BMR 6 A	Z 271	14 SR-7 E	–
BP 2 E	Z 76	14-9 DU	UXT 2/UXT 6
BP 4 E	Z 1	14-8 DU	UXT 2/UXT 6
BP 4 ES	Z 76	14-9 DU	UXT 2/UXT 6
BP 4 H	Z 10	14-7 BU	–
BP 4 HS	Z 10	14-7 BU	–
BP 5 E	Z 1	14-8 DU	UXT 2/UXT 6
BP 5 EA	Z 1	14-8 DU	UXT 2/UXT 6
BP 5 EA-L	Z 11	14-7 DU	UXT 2/UXT 6
BP 5 EA-L-11	Z 11	14-7 DU	UXT 2/UXT 6
BP 5 EFS	Z 6	14 K-8 DU	UXT 4
BP 5 EFS	Z 7	14 K-8 DU0	UXT 4
BP 5 EK-A	Z 12	14-7 DTU	UXT 2/UXT 6
BP 5 ES	Z 1	14-8 DU	UXT 2/UXT 6
BP 5 ES-11	Z 9	14 R-8 DUX	UXT 2/UXT 6
BP 5 ESZ	Z 76	14-9 DU	UXT 2/UXT 6
BP 5 ET-10	Z 2	14-8 DTU	UXT 2/UXT 6
BP 5 EY	Z 1	14-8 DU	UXT 2/UXT 6
BP 5 EZ	Z 1	14-8 DU	UXT 2/UXT 6
BP 6 E	Z 11	14-7 DU	UXT 2/UXT 6
BP 6 EF	Z 17	14 K-7 DU	UXT 4
BP 6 EFS	Z 17	14 K-7 DU	UXT 4
BP 6 EFS	Z 18	14 K-7 DU0	UXT 4
BP 6 EK	Z 51	14-6 DTU	UX 56
BP 6 EK-A	Z 51	14-6 DTU	UX 56
BP 6 ES	Z 11	14-7 DU	UXT 2/UXT 6
BP 6 ES-11	Z 21	14 R-7 DUX	UXT 2/UXT 6
BP 6 ESZ	Z 61	14-7 DU0	UXT 2/UXT 6
BP 6 ESZ	Z 62	14-7 DU0	UXT 2/UXT 6
BP 6 ET	Z 51	14-6 DTU	UX 56
BP 6 EVX	Z 104	14-6 DPO	–
BP 6 EY	Z 11	14-7 DU	UXT 2/UXT 6
BP 6 EZ	Z 11	14-7 DU	UXT 2/UXT 6
BP 6 FS	Z 49	14 KR-6 BU	–
BP 6 H	Z 10	14-7 BU	–
BP 6 HS	Z 10	14-7 BU	–
BP 7 E	Z 42	14-5 DU	UX 56
BP 7 EFS	Z 31	14 K-5 DU	UXK 56
BP 7 EFS	Z 46	14 K-5 DU0	UXK 56
BP 7 ES	Z 22	14-6 DU	UX 56
BP 7 HS	Z 41	14-5 BU	–
BPM 7 A	Z 265	14 S-5 F	–

NGK	BERU		
BPMR 6 A	Z 263	14 SR-7 F	–
BPMR 7 A	Z 260	14 SR-5 F	–
BPR 2 E	Z 82	14 R-9 DU	UXT 2/UXT 6
BPR 4 E	Z 82	14 R-9 DU	UXT 2/UXT 6
BPR 4 ES	Z 82	14 R-9 DU	UXT 2/UXT 6
BPR 4 EY	Z 82	14 R-9 DU	UXT 2/UXT 6
BPR 5 E	Z 8	14 R-8 DU	UXT 2/UXT 6
BPR 5 EA-11	Z 9	14 R-8 DUX	UXT 2/UXT 6
BPR 5 EA-L	Z 20	14 R-7 DU	UXT 2/UXT 6
BPR 5 EA-L-11	Z 21	14 R-7 DUX	UXT 2/UXT 6
BPR 5 EKA	Z 94	14 GR-8 DTU	UXT 2/UXT 6
BPR 5 ES	Z 8	14 R-8 DU	UXT 2/UXT 6
BPR 5 ES-11	Z 9	14 R-8 DUX	UXT 2/UXT 6
BPR 5 EY	Z 8	14 R-8 DU	UXT 2/UXT 6
BPR 5 EY-11	Z 9	14 R-8 DUX	UXT 2/UXT 6
BPR 6 E	Z 20	14 R-7 DU	UXT 2/UXT 6
BPR 6 E-11	Z 21	14 R-7 DUX	UXT 2/UXT 6
BPR 6 EF	Z 95	14 KR-7 DU	UXT 4
BPR 6 EFS	Z 95	14 KR-7 DU	UXT 4
BPR 6 ES	Z 20	14 R-7 DU	UXT 2/UXT 6
BPR 6 ES-11	Z 21	14 R-7 DUX	UXT 2/UXT 6
BPR 6 ES-13	Z 21	14 R-7 DUX	UXT 2/UXT 6
BPR 6 ES-N-11	Z 21	14 R-7 DUX	UXT 2/UXT 6
BPR 6 EY	Z 20	14 R-7 DU	UXT 2/UXT 6
BPR 6 EY-11	Z 21	14 R-7 DUX	UXT 2/UXT 6
BPR 6 FS	Z 49	14 KR-6 BU	–
BPR 6 H	Z 19	14 R-7 BU	–
BPR 6 HS	Z 19	14 R-7 BU	–
BPR 6 HSA	Z 48	14-6 BU	–
BPR 7 E	Z 27	14 R-6 DU	UX 56
BPR 7 ES	Z 27	14 R-6 DU	UX 56
BPR 7 ES-11	Z 28	14 R-6 DUX	UX 56
BPR 7 EY-11	Z 28	14 R-6 DUX	UX 56
BPR 8 ES	Z 47	14 R-5 DU	UX 56
BR 2 LM	Z 261	14 SR-10 E0	–
BR 4 LM	Z 269	14 SR-9 E0	–
BR 6 EB	Z 20	14 R-7 DU	UXT 2/UXT 6
BR 6 EB-11	Z 21	14 R-7 DUX	UXT 2/UXT 6
BR 6 ES	Z 59	14 R-7 CU	–
BR 8 HSA	Z 39	14 Z-4 AU	–
BR 9 ES	Z 38	14 Z-3 CU	–
BU 5 EB-11	Z 22	14-6 DU	UX 56
BU 6 EA-11	Z 22	14-6 DU	UX 56
BU 6 EB-11	Z 42	14-5 DU	UX 56
BU 7 EA-11	Z 42	14-5 DU	UX 56
BU 7 EB-11	Z 38	14 Z-3 CU	–
BUR 5 EB-11	Z 28	14 R-6 DUX	UX 56
BUR 5 ET	Z 92	14 GH-8 DTUR	UXT 2/UXT 6
BUR 5 ET-10	Z 93	14 GH-8 DTURX	UXT 2/UXT 6
BUR 6 EA-11	Z 28	14 R-6 DUX	UX 56
BUR 6 EB-11	Z 47	14 R-5 DU	UX 56
BUR 6 EFSZ	Z 127	14 KGR-7 KQU	–
BUR 6 ET	Z 91	14 GH-7 DTUR	UXT 2/UXT 6
C 7 HSA	Z 199	10 FR-4 AU	–
CR 7 HSA	Z 199	10 FR-4 AU	–
DCPR 7 E	Z 234	12 FR-7 DU	–
DCPR 7 EN-10	Z 292	12 FR-6 DU	–
DCPR 8 E	Z 234	12 FR-7 DU	–
DCPR 8 E-N	Z 291	12 FR-5 DU	–
GR 4	Z 82	14 R-9 DU	UXT 2/UXT 6
IFR 5 D 10	Z 122	14 FGH-8 DPURX2	UXT 9
IFR 5 E-11	Z 73	14 FR-8 DUX	UXT 1/UXT 3
IFR 6 D 10	Z 170	14 F-7 DPURU2	UXT 12
IFR 6 T-11	Z 280	14 FR-7 KPUX02	–
ILFR 6 A	Z 226	14 FR-6 MPU2	–
ILZFR 6 D-11	Z 235	14 FR-7 SPUX03	–

NGK	BERU		
ITR 5 F-13	Z 298	14 KR-8 DPUV	UXT 15
ITR 6 F-13	Z 230	14 KR-6 KPUV02	UXT 15
IZFR 5 B	Z 278	14 FR-8 LPU02	–
IZFR 6 B	Z 279	14 FR-7 LPU02	–
IZFR 6 H-11	Z 301	14 FR-7 LPUX02	–
IZFR 6 K-11	Z 297	14 FR-7 LPUX0	–
LFR 5 A-11	Z 303	14 FR-7 MUX2	UXT 13
LFR 5 AP-11	Z 302	14 FR-8 MPUX2	UXT 13
LFR 5 B	Z 183	14 FR-8 MU2	UXT 13
LFR 6 D	Z 294	14 FGR-5 NTE	–
LKR 8 A	Z 286	12 FR-5 SDU	–
LZKAR 7A	Z 243	12 VR-8 SE	–
LZTR 4 A-11	Z 216	14 KR-10 SUV2	–
PFR 5 R-11	Z 240	14 F-8 DPURX02	UXT 9
PFR 5 G-11	Z 228	14 FR-7 DPURX02	UXT 11
PFR 6 A-11	Z 313	14 FR-6 DPURX2	–
PFR 6 G-9	Z 206	14 FR-7 DPPUS2	UXT 10
PFR 6 G-11	UXT 9	–	–
PFR 6 H-10	UXT 14	–	–
PFR 6 B	Z 188	14 F-7 DPUR02	UXT 10
PFR 6 G-11	Z 221	14 FR-6 DPURX02	UXT 14
PFR 6 Q	Z 188	14 F-7 DPUR02	UXT 10
PFR 6 W-TG	Z 295	14 F-6 DTPR02	UXT 12
PFR 7 H-10	Z 221	14 FR-6 DPURX02	UXT 14
PFR 7 S-8EG	Z 347	14 F-5 DPUR02	–
PGR 5 C-11	Z 311	14 R-8 DPUU	UXT 2/UXT 6
PLFR 5 A-11	Z 219	14 FR-8 MPUX02	UXT 13
PMR 7 A	Z 210	10 FR-6 CPU03	–
PTR 5 A-10	Z 97	14 KR-8 MPX	UXT 8
PTR 5 A-13	Z 97	14 KR-8 MPX	UXT 8
PTR 5 D-10	Z 67	14 KR-7 DUX	UXT 4
PTR 6 F-13	Z 209	14 KR-6 DPUV02	UXT 15
PZFR 5 J-11	Z 176	14 F-7 HPURX2	–
PZFR 5 N-11T	Z 236	14 F-6 HTPRX02	–
PZFR 5 N-11TG	Z 236	14 F-6 HTPRX02	–
PZFR 6 F	Z 229	14 FR-8 LPU0	–
PZFR 5 D-11	Z 176	14 F-7 HPURX2	–
PZFR 6 J-11	Z 176	14 F-7 HPURX2	–
T 7204 A	Z 328	14 FR-4 DIU02	–
TR 4	Z 95	14 KR-7 DU	UXT 4
TR 5 A-10	Z 97	14 KR-8 MPX	UXT 8
TR 5 B-13	Z 177	14 KR-8 MUV	UXT 7
TR 6 B	Z 305	14 KR-6 MUJ	UXT 8
TR 55	Z 148	14 KR-8 DPUOV	UXT 15
TR 55 IX	Z 148	14 KR-8 DPUOV	UXT 15
V-Line 1	Z 91	14 GH-7 DTUR	UXT 2/UXT 6
V-Line 2	Z 20	14 R-7 DU	UXT 2/UXT 6
V-Line 3	Z 19	14 R-7 BU	–
V-Line 4	Z 11	14-7 DU	UXT 2/UXT 6
V-Line 5	Z 17	14 K-7 DU	UXT 4
V-Line 5	Z 18	14 K-7 DU0	UXT 4
V-Line 6	Z 119	14 R-8 DU4	UXT 2/UXT 6
V-Line 6	Z 8	14 R-8 DU	UXT 2/UXT 6
V-Line 7	Z 95	14 KR-7 DU	UXT 4
V-Line 8	Z 1	14-8 DU	UXT 2/UXT 6
V-Line 9	Z 2	14-8 DTU	UXT 2/UXT 6
V-Line 9	Z 8	14 R-8 DU	UXT 2/UXT 6
V-Line 10	Z 21	14 R-7 DUX	UXT 2/UXT 6
V-Line 11	Z 16	14 FR-7 DUX	UXT 1/UXT 3
V-Line 12	Z 15	14 FR-7 DU	UXT 1/UXT 3
V-Line 13	Z 21	14 R-7 DUX	UXT 2/UXT 6
V-Line 14	Z 16	14 FR-7 DUX	UXT 11
V-Line 15	Z 3	14-8 LUR	UXT 2/UXT 6
V-Line 16	Z 100	14 F-8 DU4	UXT 1/UXT 3
V-Line 16	Z 71	14 F-8 DU	UXT 1/UXT 3
V-Line 17	Z 63	14 F-7 DU	UXT 1/UXT 3

NGK	BERU		
V-Line 18	Z 10	14-7 BU	–
V-Line 19	Z 27	14 R-6 DU	UX 56
V-Line 20	Z 14	14 F-7 LDUR4	UXT 1/UXT 3
V-Line 21	Z 93	14 GH-8 DTURX	UXT 2/UXT 6
V-Line 22	Z 92	14 GH-8 DTUR	UXT 2/UXT 6
V-Line 23	Z 74	14 FR-8 LDUOX4	UXT 1/UXT 3
V-Line 24	Z 90	14 FGH-7 DTURX	UXT 1/UXT 3
V-Line 25	Z 97	14 KR-8 MPX	UXT 8
V-Line 26	Z 98	14 FR-7 LDU	UXT 1/UXT 3
V-Line 27	Z 90	14 FGH-7 DTURX	UXT 1/UXT 3
V-Line 28	Z 15	14 FR-7 DU	UXT 1/UXT 3
V-Line 29	Z 246	14 FGH-8 DTURW	UXT 1/UXT 3
V-Line 30	Z 237	14 FR-7 DQUP7	–
V-Line 31	Z 67	14 KR-7 DUX	UXT 4
V-Line 32	Z 72	14 FR-8 DU	UXT 1/UXT 3
V-Line 33	Z 73	14 FR-8 DUX	UXT 1/UXT 3
V-Line 34	Z 176	14 F-7 HPURX2	–
V-Line 35	Z 72	14 FR-8 DU	UXT 1/UXT 3
V-Line 36	Z 72	14 FR-8 DU	UXT 1/UXT 3
V-Line 37	Z 188	14 F-7 DPUR02	UXT 10
V-Line 38	Z 193	14 FR-7 DU2	UXT 1/UXT 3
V-Line 39	Z 249	14 FR-8 KUOU	–
ZF 5 A-11	Z 4	14 F-8 LUR	UXT 1/UXT 3
ZFR 5 E-11	Z 225	14 FR-7 HUX	–
ZFR 5 F	Z 152	14 FR-8 HU	–
ZFR 5 F-11	Z 158	14 FR-7 LUX	UXT 1/UXT 3
ZFR 5 J-11	Z 158	14 FR-7 LUX	–
ZFR 5 P-G	Z 200	14 F-7 HUR2	–
ZFR 6 A-11	Z 158	14 FR-7 LUX	–
ZFR 6 F-11	Z 158	14 FR-7 LUX	UXT 1/UXT 3
ZFR 6 F-11G	Z 158	14 FR-7 LUX	–
ZFR 6 FR	Z 98	14 FR-7 LDU	UXT 1/UXT 3
ZFR 6 J-11	Z 158	14 FR-7 LUX	–
ZGR 5 A	Z 3	14-8 LUR	UXT 2/UXT 6
ZKR 7 A-10	Z 293	12 FR-6 LUX	–

NISSAN	BERU		
11065-00Q00	GN 018		
11065-00Q0A	GN 026		
11065-00QAA	GN 018		
11065-00QAF	GN 018		
11065-00QAG	GN 018		
11065-10G00	GV 920		
11065-10T01	GV 922		
11065-16A05	GV 685		
11065-16A15	GV 685		
11065-2W202	GN 072		
11065-2W204	GN 072		
11065-2W211	GN 072		
11065-31N00	GN 854		
11065-34W00	GV 889		
11065-43G01	GV 921		
11065-4P400	GN 075		
11065-57J00	GN 102		
11065-5C900	GN 102		
11065-63G00	GV 921		
11065-7C000	GN 039		
11065-7F400	GN 994		
11065-9C600	GN 853		
11065-AD200	GN 109		
11065-AD201	GN 109		
11065-AD20A	GN 109		
11065-BN 701	GN 018		
11065-C8600	GN 044		
11065-D 9701	GV 728		

NISSAN	BERU		
11065-D 9702	GV 728		
11065-G 5501	GN 101		
11065-G2400	GN 854		
11065-HA300	GN 005		
11065-T3470	GV 887		
11065-T8200	GV 892		
11065-T8201	GV 890		
11065-T8202	GV 892		
11065-T8203	GV 890		
11065-V0700	GV 689		
11065-V0710	GV 689		
11065-W2500	GV 888		
11065-W2510	GV 888		
11065-W3400	GV 888		
11065-W3410	GV 888		
11065-Y9703	GN 857		
22401-01P15	Z 73	14 FR-8 DUX	UXT 1/UXT 3
22401-01P16	Z 16	14 FR-7 DUX	UXT 1/UXT 3
22401-20305	Z 153	14 FR-8 KU	UXT 10
22401-20J05	Z 15	14 FR-7 DU	UXT 1/UXT 3
22401-20J06	Z 16	14 FR-7 DUX	UXT 1/UXT 3
22401-2F200	Z 225	14 FR-7 HUX	-
22401-53305	Z 153	14 FR-8 KU	UXT 10
22401-53306	Z 155	14 FR-7 KU	UXT 10
22401-53J05	Z 153	14 FR-8 KU	UXT 10
22401-53J06	Z 155	14 FR-7 KU	UXT 10
22401-58S16	Z 313	14 FR-6 DPUX2	-
22401-8H315	Z 302	14 FR-8 MPUX2	UXT 13
22401-8H514	Z 184	14 FR-7 MU2	UXT 13
22401-8H515	Z 303	14 FR-7 MUX2	UXT 13
22401-8H516	Z 184	14 FR-7 MU2	UXT 13
22401-AX015	Z 302	14 FR-8 MPUX2	UXT 13
22401-BC05A	Z 302	14 FR-8 MPUX2	UXT 13
58000-12-1	GV 776		
75000-054-0	GF 833		
75000-055-0	GF 830		
75000-057-0	GF 831		
75800-005-1/2	GR 065		
75800-006-0	GV 636		
82000-46337	Z 206	14 FR-7 DPPUS2	UXT 10

NSU	BERU		
11 17 00 068	Z 57	14-7 AU	-
48 17 00 003	Z 39	14 Z-4 AU	-

O & K	BERU		
244 934 4	GH 760		

OPEL	BERU		
12 14 000	Z 74	14 FR-8 LDUOX4	UXT 1/UXT 3
12 14 002	Z 8	14 R-8 DU	UXT 2/UXT 6
12 14 003	Z 98	14 FR-7 LDU	UXT 1/UXT 3
12 14 005	Z 74	14 FR-8 LDUOX4	UXT 1/UXT 3
12 14 007	Z 21	14 R-7 DUX	UXT 2/UXT 6
12 14 008	Z 21	14 R-7 DUX	UXT 2/UXT 6
12 14 009	Z 16	14 FR-7 DUX	UXT 1/UXT 3
12 14 011	Z 173	14 FGR-8 KQU	-
12 14 012	Z 222	14 KR-8 STUX	-
12 14 013	Z 222	14 KR-8 STUX	-
12 14 015	Z 74	14 FR-8 LDUOX4	UXT 1/UXT 3
12 14 018	GN 024		

OPEL	BERU		
12 14 019	Z 48	14-6 BU	-
12 14 020	Z 57	14-7 AU	-
12 14 021	Z 48	14-6 BU	-
12 14 023	Z 48	14-6 BU	-
12 14 025	Z 22	14-6 DU	UX 56
12 14 026	Z 206	14 FR-7 DPPUS2	UXT 10
12 14 027	Z 190	14 FGR-8 DQU7	UXT 1/UXT 3
12 14 028	GN 106		
12 14 029	Z 206	14 FR-7 DPPUS2	UXT 10
12 14 031	Z 203	14 FR-8 LU2	-
12 14 032	GN 053		
12 14 033	GN 033		
12 14 034	GN 059		
12 14 035	GN 104		
12 14 036	GN 106		
12 14 039	Z 22	14-6 DU	UX 56
12 14 040	GN 041		
12 14 041	Z 287	14 FR-8 LU2T	-
12 14 042	GV 947		
12 14 043	GN 103		
12 14 045	GN 944		
12 14 046	Z 57	14-7 AU	-
12 14 061	PSG 003		
12 14 062	GN 104		
12 14 063	GN 104		
12 14 108	Z 27	14 R-6 DU	UX 56
12 14 110	Z 22	14-6 DU	UX 56
12 14 112	Z 27	14 R-6 DU	UX 56
12 14 119	Z 27	14 R-6 DU	UX 56
12 14 122	Z 27	14 R-6 DU	UX 56
12 14 123	Z 112	14-8 E	-
12 14 132	Z 27	14 R-6 DU	UX 56
12 14 139	Z 20	14 R-7 DU	UXT 2/UXT 6
12 14 144	Z 15	14 FR-7 DU	UXT 1/UXT 3
12 14 145	Z 158	14 FR-7 LUX	-
12 14 148	Z 16	14 FR-7 DUX	UXT 1/UXT 3
12 14 149	Z 119	14 R-8 DU4	UXT 2/UXT 6
12 14 193	Z 20	14 R-7 DU	UXT 2/UXT 6
12 14 300	GV 107		
12 14 301	GN 104		
12 14 302	GV 106		
12 14 303	GV 137		
12 14 304	GV 602		
12 14 305	GN 033		
12 14 306	GV 636		
12 14 307	GV 636		
12 14 308	GV 749		
12 14 309	GV 945		
12 14 310	GV 947		
12 14 311	GV 946		
12 14 312	GV 946		
12 14 316	GN 103		
12 14 317	GV 719		
12 14 319	GN 954		
12 14 321	GN 061		
12 14 322	GN 944		
12 14 323	GN 061		
12 14 324	GV 719		
12 14 334	GE 114		
12 14 427	GN 007		
12 14 455	Z 74	14 FR-8 LDUOX4	UXT 1/UXT 3
12 14 457	GN 992		
12 14 459	GN 997		
12 14 462	Z 228	14 FR-7 DPUX02	UXT 11
12 14 527	Z 235	14 FR-7 SPUX03	-
12 14 702	Z 27	14 R-6 DU	UX 56

OPEL	BERU		
12 14 802	Z 27	14 R-6 DU	UX 56
12 14 803	Z 21	14 R-7 DUX	UXT 2/UXT 6
12 14 804	Z 15	14 FR-7 DU	UXT 1/UXT 3
12 14 805	Z 19	14 R-7 BU	–
12 14 806	Z 27	14 R-6 DU	UX 56
12 14 807	Z 20	14 R-7 DU	UXT 2/UXT 6
12 38 532	GR 064		
12 38 537	GR 064		
12 38 565	GR 064		
12 38 627	GR 064		
12 78 888 4	Z 235	14 FR-7 SPUX03	–
18 26 354	PSG 001		
18 26 357	GE 112		
34 48 796	GV 106		
43 00 425	GN 061		
43 00 615	GN 061		
44 02 945	GN 963		
44 03 145	GN 927		
44 30 069	GN 026		
44 30 920	GN 026		
45 00 811	GF 984		
45 06 155	GN 026		
56 13 680	GV 835		
56 14 217	GD 382		
56 14 218	GV 603		
56 14 220	GV 823		
56 14 221	GV 749		
62 37 339	GR 064		
91 10 945	GN 963		
91 11 145	GN 927		
91 18 201	GN 992		
91 46 369	Z 74	14 FR-8 LDUOX4	UXT 1/UXT 3
05 614 017	GV 003		
09 110 945	GN 963		
55 187 863	GN 059		
55 350 481	Z 190	14 FGR-8 DQU7	UXT 1/UXT 3
88 900 715	GN 003		
88 900 716	GN 007		
88 900 717	GN 008		
88 900 718	GN 010		
88 900 719	GN 015		
88 900 720	GN 022		
88 900 721	GN 024		
88 900 722	GN 855		
88 900 723	GN 857		
88 900 724	GN 860		
88 900 725	GN 954		
88 900 728	GN 954		
88 900 729	GN 970		
88 900 730	GV 602		
88 900 731	GV 603		
88 900 732	GV 631		
88 900 734	GV 642		
88 900 735	GV 661		
88 900 736	GV 663		
88 900 737	GV 666		
88 900 739	GV 749		
88 900 740	GV 852		
88 900 741	GN 858		
88 900 743	GV 946		
90 003 450	GV 106		
90 019 495	GV 137		
90 033 357	GV 137		
90 040 991	GV 631		
90 040 992	GR 064		
90 051 950	GV 602		

OPEL	BERU		
90 093 867	GV 602		
90 093 897	GV 602		
90 166 155	GV 636		
90 166 155	GN 954		
90 210 824	GV 636		
90 228 928	GR 064		
90 240 651	GR 064		
90 276 101	GR 064		
90 341 822	GR 064		
90 350 018	Z 20	14 R-7 DU	UXT 2/UXT 6
90 359 815	Z 8	14 R-8 DU	UXT 2/UXT 6
90 444 723	Z 74	14 FR-8 LDUOX4	UXT 1/UXT 3
90 464 952	GR 064		
90 487 858	GV 719		
90 510 924	GN 954		
90 540 864	GV 719		
90 569 338	GN 992		
93 171 875	GN 024		
93 175 880	Z 190	14 FGR-8 DQU7	UXT 1/UXT 3
93 175 935	Z 190	14 FGR-8 DQU7	UXT 1/UXT 3
93 176 801	Z 203	14 FR-8 LU2	–
93 178 047	GN 053		
93 178 411	GN 059		
93 180 295	GN 041		
93 190 948	Z 177	14 KR-8 MUV	UXT 7
94 319 700	GV 946		
94 402 303	GV 945		
94 422 171 9	GV 749		
94 439 218	GV 749		
94 481 972	GV 947		
97 125 696	Z 228	14 FR-7 DPUX02	UXT 11
97 127 646	GN 106		
97 143 674	GN 997		
97 357 290	GN 106		

PAL	BERU		
D 12 YC	Z 29	14 F-5 DU	UXT 5
D 14 Y	Z 24	14 FR-6 DU	UXT 5
D 14 YC	Z 24	14 FR-6 DU	UXT 5
D 15 Y	Z 63	14 F-7 DU	UXT 1/UXT 3
D 15 YC	Z 63	14 F-7 DU	UXT 1/UXT 3
D 17 Y	Z 71	14 F-8 DU	UXT 1/UXT 3
D 17 YC	Z 71	14 F-8 DU	UXT 1/UXT 3
DR 14 YC	Z 24	14 FR-6 DU	UXT 5
DR 15 TC	Z 238	14 FR-8 DPU2	UXT 10
DR 15 YC	Z 15	14 FR-7 DU	UXT 1/UXT 3
DR 17 YC	Z 72	14 FR-8 DU	UXT 1/UXT 3
F 14 YC	Z 33	18 K-6 BU	–
F 15 YC	Z 32	18 K-7 BU	–
F 17 YC	Z 175	18 K-9 BU	–
G 12 YC	Z 31	14 K-5 DU	UXK 56
G 14 Y	Z 25	14 K-6 DU	UXK 56
G 14 YC	Z 25	14 K-6 DU	UXK 56
G 15 Y	Z 17	14 K-7 DU	UXT 4
G 15 YC	Z 17	14 K-7 DU	UXT 4
G 17 Y	Z 6	14 K-8 DU	UXT 4
G 17 Y	Z 7	14 K-8 DU0	UXT 4
G 17 YC	Z 6	14 K-8 DU	UXT 4
G 17 YC	Z 7	14 K-8 DU0	UXT 4
GR 14 YC	Z 26	14 KR-6 DU	UXK 56
GR 15 YC	Z 17	14 K-7 DU	UXT 4
J 17	Z 262	14 S-9 E0	–
J 19	Z 270	14 S-10 E0	–
JR 17	Z 269	14 SR-9 E0	–

<b>PAL</b>	<b>BERU</b>		
JR 19	Z 261	14 SR-10 E0	–
K 17 C	Z 267	14 S-7 EU0	–
L 5 Y	Z 76	14-9 DU	UXT 2/UXT 6
L 7 Y	Z 1	14-8 DU	UXT 2/UXT 6
L 8	Z 58	14-7 CU	–
L 8 Y	Z 42	14-5 DU	UX 56
L 12 Y	Z 42	14-5 DU	UX 56
L 12 YC	Z 42	14-5 DU	UX 56
L 14 Y	Z 22	14-6 DU	UX 56
L 14 YC	Z 22	14-6 DU	UX 56
L 15	Z 58	14-7 CU	–
L 15 C	Z 58	14-7 CU	–
L 15 Y	Z 11	14-7 DU	UXT 2/UXT 6
L 15 YC	Z 11	14-7 DU	UXT 2/UXT 6
L 17	Z 58	14-7 CU	–
L 17 C	Z 58	14-7 CU	–
L 17 Y	Z 1	14-8 DU	UXT 2/UXT 6
L 17 YC	Z 76	14-9 DU	UXT 2/UXT 6
L 19 C	Z 58	14-7 CU	–
LR 14 YC	Z 27	14 R-6 DU	UX 56
LR 15 YC	Z 20	14 R-7 DU	UXT 2/UXT 6
LR 17 YC	Z 82	14 R-9 DU	UXT 2/UXT 6
N 7	Z 57	14-7 AU	–
N 7 Y	Z 10	14-7 BU	–
N 8	Z 40	14-5 AU	–
N 8 Y	Z 41	14-5 BU	–
N 12 Y	Z 41	14-5 BU	–
N 12 YC	Z 41	14-5 BU	–
N 14	Z 40	14-5 AU	–
N 14 C	Z 40	14-5 AU	–
N 15	Z 57	14-7 AU	–
N 15 C	Z 57	14-7 AU	–
N 15 Y	Z 10	14-7 BU	–
N 15 YC	Z 10	14-7 BU	–
N 17	Z 57	14-7 AU	–
N 17 C	Z 57	14-7 AU	–
N 17 Y	Z 10	14-7 BU	–
N 17 YC	Z 10	14-7 BU	–
NR 15 YC	Z 19	14 R-7 BU	–
P 15 Y	Z 265	14 S-5 F	–
P 17	Z 266	14 S-7 E	–
PR 15 Y	Z 260	14 SR-5 F	–
PR 17	Z 271	14 SR-7 E	–
PR 18 Y	Z 263	14 SR-7 F	–

<b>PARIS RHONE</b>	<b>BERU</b>		
102180 M	GR 059	–	–
102696	GR 065	–	–
105857	GR 059	–	–

<b>PERKINS</b>	<b>BERU</b>		
185 366 190	GN 023		
2666 103	GF 154		
2666 108	GF 154		
2666 A004	GV 798		
K 166 AF 01	GV 636		

<b>PEUGEOT</b>	<b>BERU</b>		
0269 03	Z 25	14 K-6 DU	UXK 56
5960 02	Z 242	12 ZR-8 TP	–
5960 12	GN 047		
5960 15	Z 193	14 FR-7 DU2	UXT 1/UXT 3

<b>PEUGEOT</b>	<b>BERU</b>		
5960 16	Z 184	14 FR-7 MU2	UXT 13
5960 17	Z 183	14 FR-8 MU2	UXT 13
5960 18	Z 123	14 FR-7 KDU	UXT 9
5960 53	Z 223	14 FR-8 NQU23	–
5960 64	GN 054		
5960 65	GN 054		
5960 66	GN 027		
5960 67	GN 027		
5960 75	Z 223	14 FR-8 NQU23	–
5960 76	GN 045		
5960 79	GN 056		
5960 83	Z 243	12 VR-8 SE	–
5960 90	Z 184	14 FR-7 MU2	UXT 13
5960 91	Z 184	14 FR-7 MU2	UXT 13
5960 99	GN 063		
5960 A4	GN 037		
5960 E1	Z 288	12 ZR-7 SP03	–
5960 E2	Z 288	12 ZR-7 SP03	–
5960 E9	GN 047		
5960 F4	GN 054		
5960 K9	Z 318	12 ZR-6 SPP2	–
5960 L3	Z 320	12 ZR-8 STP	–
5961 05	GV 107		
5961 07	Z 39	14 Z-4 AU	–
5961 08	Z 57	14-7 AU	–
5961 09	Z 57	14-7 AU	–
5961 10	Z 39	14 Z-4 AU	–
5961 12	Z 58	14-7 CU	–
5961 15	Z 58	14-7 CU	–
5961 18	GV 155		
5961 19	Z 11	14-7 DU	UXT 2/UXT 6
5961 20	Z 42	14-5 DU	UX 56
5961 22	GV 107		
5961 22	GV 108		
5961 23	Z 58	14-7 CU	–
5961 26	Z 42	14-5 DU	UX 56
5961 27	Z 22	14-6 DU	UX 56
5961 28	Z 38	14 Z-3 CU	–
5961 29	Z 42	14-5 DU	UX 56
5961 30	Z 25	14 K-6 DU	UXK 56
5961 33	Z 25	14 K-6 DU	UXK 56
5961 35	GV 108		
5961 39	GV 636		
5961 40	GV 602		
5961 41	Z 42	14-5 DU	UX 56
5961 42	Z 42	14-5 DU	UX 56
5961 43	Z 22	14-6 DU	UX 56
5961 44	Z 25	14 K-6 DU	UXK 56
5961 47	Z 11	14-7 DU	UXT 2/UXT 6
5961 48	Z 42	14-5 DU	UX 56
5961 49	Z 25	14 K-6 DU	UXK 56
5961 50	Z 31	14 K-5 DU	UXK 56
5961 52	Z 25	14 K-6 DU	UXK 56
5961 53	GV 636		
5961 54	GV 602		
5961 54	GV 642		
5961 54	GN 909		
5961 57	GV 636		
5961 58	GV 602		
5961 60	Z 31	14 K-5 DU	UXK 56
5961 92	Z 31	14 K-5 DU	UXK 56
5961 93	Z 11	14-7 DU	UXT 2/UXT 6
5961 95	GV 153		
5961 96	Z 11	14-7 DU	UXT 2/UXT 6
5962 03	GN 013		
5962 05	Z 17	14 K-7 DU	UXT 4

PEUGEOT	BERU		
5962 07	Z 25	14 K-6 DU	UXK 56
5962 09	Z 25	14 K-6 DU	UXK 56
5962 11	Z 11	14-7 DU	UXT 2/UXT 6
5962 13	Z 11	14-7 DU	UXT 2/UXT 6
5962 14	Z 31	14 K-5 DU	UXK 56
5962 15	Z 25	14 K-6 DU	UXK 56
5962 16	Z 22	14-6 DU	UX 56
5962 19	Z 11	14-7 DU	UXT 2/UXT 6
5962 21	Z 12	14-7 DTU	UXT 2/UXT 6
5962 30	Z 25	14 K-6 DU	UXK 56
5962 31	Z 25	14 K-6 DU	UXK 56
5962 35	GV 663		
5962 36	Z 25	14 K-6 DU	UXK 56
5962 37	Z 25	14 K-6 DU	UXK 56
5962 44	Z 42	14-5 DU	UX 56
5962 45	Z 22	14-6 DU	UX 56
5962 46	Z 25	14 K-6 DU	UXK 56
5962 47	Z 17	14 K-7 DU	UXT 4
5962 48	Z 17	14 K-7 DU	UXT 4
5962 49	Z 25	14 K-6 DU	UXK 56
5962 50	Z 25	14 K-6 DU	UXK 56
5962 51	Z 11	14-7 DU	UXT 2/UXT 6
5962 52	Z 11	14-7 DU	UXT 2/UXT 6
5962 57	Z 31	14 K-5 DU	UXK 56
5962 58	Z 57	14-7 AU	–
5962 59	Z 31	14 K-5 DU	UXK 56
5962 60	Z 11	14-7 DU	UXT 2/UXT 6
5962 61	Z 25	14 K-6 DU	UXK 56
5962 63	Z 31	14 K-5 DU	UXK 56
5962 65	Z 22	14-6 DU	UX 56
5962 67	Z 57	14-7 AU	–
5962 68	Z 17	14 K-7 DU	UXT 4
5962 69	Z 25	14 K-6 DU	UXK 56
5962 70	Z 11	14-7 DU	UXT 2/UXT 6
5962 71	Z 13	14 F-7 DUOR	UXT 1/UXT 3
5962 72	Z 17	14 K-7 DU	UXT 4
5962 74	GV 636		
5962 87	Z 25	14 K-6 DU	UXK 56
5962 1P	GN 964		
5962 1Q	GN 964		
5962 1Z	GN 857		
5962 2Y	GN 912		
5962 3C	GN 027		
5962 3E	GN 027		
5962 3H	GN 013		
5962 3J	GN 013		
5962 4Z	GN 012		
5962 5M	Z 183	14 FR-8 MU2	UXT 13
5962 6K	Z 193	14 FR-7 DU2	UXT 1/UXT 3
5962 7A	GN 013		
5962 7E	Z 211	14 FGR-8 MQPU	–
5962 7F	GN 027		
5962 7G	GN 027		
5962 7R	Z 193	14 FR-7 DU2	UXT 1/UXT 3
5962 7W	Z 184	14 FR-7 MU2	UXT 13
5962 8A	Z 211	14 FGR-8 MQPU	–
5962 A0	Z 42	14-5 DU	UX 56
5962 A1	Z 22	14-6 DU	UX 56
5962 A2	Z 1	14-8 DU	UXT 2/UXT 6
5962 A3	Z 10	14-7 BU	–
5962 A4	Z 11	14-7 DU	UXT 2/UXT 6
5962 C0	Z 17	14 K-7 DU	UXT 4
5962 C1	Z 26	14 KR-6 DU	UXK 56
5962 C2	Z 26	14 KR-6 DU	UXK 56
5962 C5	Z 24	14 FR-6 DU	UXT 5
5962 C7	GV 107		

PEUGEOT	BERU		
5962 C8	Z 29	14 F-5 DU	UXT 5
5962 E2	Z 71	14 F-8 DU	UXT 1/UXT 3
5962 F6	Z 24	14 FR-6 DU	UXT 5
5962 F8	Z 64	14 F-7 DUO	UXT 1/UXT 3
5962 H1	Z 31	14 K-5 DU	UXK 56
5962 H2	Z 13	14 F-7 DUOR	UXT 1/UXT 3
5962 H3	Z 29	14 F-5 DU	UXT 5
5962 H7	Z 60	14 FGR-7 CTU	–
5962 H8	Z 255	14 FR-8 DUW	UXT 1/UXT 3
5962 H9	Z 15	14 FR-7 DU	UXT 1/UXT 3
5962 J1	Z 72	14 FR-8 DU	UXT 1/UXT 3
5962 J2	GV 852		
5962 J3	GV 661		
5962 J3	GN 909		
5962 J4	GV 642		
5962 J4	GN 909		
5962 J5	GV 603		
5962 J6	GV 663		
5962 J7	GN 857		
5962 K0	Z 15	14 FR-7 DU	UXT 1/UXT 3
5962 K1	Z 24	14 FR-6 DU	UXT 5
5962 K4	Z 15	14 FR-7 DU	UXT 1/UXT 3
5962 K5	GV 636		
5962 K7	Z 60	14 FGR-7 CTU	–
5962 R5	Z 60	14 FGR-7 CTU	–
5962 R8	GN 909		
5962 S8	GN 909		
5962 T1	GV 852		
5962 T2	GV 844		
5962 T3	GV 749		
5962 T7	GV 666		
5962 W3	GN 912		
5962 X1	GV 642		
5981 10	GR 059		
5981 11	GR 065		
5981 13	GR 059		
5981 15	GR 065		
5981 19	GR 034		
5981 21	GR 054		
5981 26	GR 054		
5981 27	GR 054		
5414 326	GV 130		
5415 813	GV 107		
5460 556	GV 130		
5477 234	GV 130		
5491 387	GV 130		
5500 842	GV 130		
7549 2325	GV 130		
9549 3206	GN 909		
9553 4787	GR 059		
9553 4788	GV 602		
9553 4788	GN 909		
9594 3206	GV 642		
9600 9783	GN 909		
9600 9783	GN 927		
9607 6258	GN 909		
9614 1677	GR 034		
9614 1678	GN 909		
9616 5724	GN 909		
9623 6383	GN 027		
9625 2036	GR 034		
9638 9858	GN 027		
1105 693 600	Z 57	14-7 AU	–
5932 565 882	GV 108		
7401 269 280	Z 31	14 K-5 DU	UXK 56
7401 269 915	Z 26	14 KR-6 DU	UXK 56

PEUGEOT	BERU		
7563 225 100	GV 155		
7910 026 903	Z 25	14 K-6 DU	UXK 56
7920 076 593	GR 059		
7932 565 492	GV 155		
7932 565 563	GV 155		
7932 565 882	GV 108		
7932 567 619	GV 107		
7932 567 718	GV 602		
9150 860 280	GV 636		
9150 861 080	GV 636		
9151 400 080	Z 11	14-7 DU	UXT 2/UXT 6
9151 586 980	GR 065		
9151 700 080	Z 11	14-7 DU	UXT 2/UXT 6
9151 700 380	Z 17	14 K-7 DU	UXT 4
9151 700 680	Z 17	14 K-7 DU	UXT 4
9151 700 980	Z 25	14 K-6 DU	UXK 56
9151 701 280	Z 25	14 K-6 DU	UXK 56
9151 873 580	Z 12	14-7 DTU	UXT 2/UXT 6
9151 873 580	Z 12	14-7 DTU	UXT 2/UXT 6
9151 944 680	Z 17	14 K-7 DU	UXT 4
9152 106 780	Z 11	14-7 DU	UXT 2/UXT 6
9152 184 980	GV 636		
9153 664 680	GV 636		
9250 883 280	GR 059		
9250 888 280	GR 059		
9251 586 780	GR 065		
9251 586 980	GR 065		
9561 837 880	Z 22	14-6 DU	UX 56
9616 280 080	GR 054		
9616 582 380	GR 054		
9625 203 680	GR 034		
9631 658 980	GN 912		
9633 214 380	GN 013		
AOP	Z 22	14-6 DU	UX 56
CC 8	Z 25	14 K-6 DU	UXK 56
CC 10	Z 17	14 K-7 DU	UXT 4
CP 10	Z 11	14-7 DU	UXT 2/UXT 6
HG 262 1	GV 107		
MKP 000 065	GV 642		
MKP 000 65	GN 909		
MKP 000 70	GD 382		
MKP 000 71	GN 857		
Super 14-7	Z 57	14-7 AU	-
Super 14-8	Z 39	14 Z-4 AU	-
Super 14-9	Z 39	14 Z-4 AU	-
XC 6	Z 25	14 K-6 DU	UXK 56

POCLAIN	BERU		
0 004 15 06	GF 167		

PORSCHE	BERU		
905 071 4	Z 1	14-8 DU	UXT 2/UXT 6
928 094 602 03	Z 11	14-7 DU	UXT 2/UXT 6
955 170 320 90	GE 115		
999 020 802 10	Z 57	14-7 AU	-
999 170 002 90	Z 41	14-5 BU	-
999 170 007 90	Z 38	14 Z-3 CU	-
999 170 014 90	Z 38	14 Z-3 CU	-
999 170 023 90	Z 40	14-5 AU	-
999 170 044 90	Z 38	14 Z-3 CU	-
999 170 050 90	Z 42	14-5 DU	UX 56
999 170 051 90	Z 42	14-5 DU	UX 56
999 170 052 90	Z 42	14-5 DU	UX 56

PORSCHE	BERU		
999 170 055 90	Z 42	14-5 DU	UX 56
999 170 056 90	Z 42	14-5 DU	UX 56
999 170 060 90	Z 38	14 Z-3 CU	-
999 170 068 90	Z 38	14 Z-3 CU	-
999 170 111 90	Z 42	14-5 DU	UX 56
999 170 116 90	Z 38	14 Z-3 CU	-
999 170 119 90	Z 11	14-7 DU	UXT 2/UXT 6
999 170 126 90	Z 11	14-7 DU	UXT 2/UXT 6
999 170 132 90	Z 1	14-8 DU	UXT 2/UXT 6
999 170 133 90	Z 1	14-8 DU	UXT 2/UXT 6
999 170 135 90	Z 42	14-5 DU	UX 56
999 170 136 90	Z 1	14-8 DU	UXT 2/UXT 6
999 170 138 90	Z 22	14-6 DU	UX 56
999 170 139 90	Z 22	14-6 DU	UX 56
999 170 140 90	Z 38	14 Z-3 CU	-
999 170 141 90	Z 20	14 R-7 DU	UXT 2/UXT 6
999 170 142 90	Z 20	14 R-7 DU	UXT 2/UXT 6
999 170 146 90	Z 11	14-7 DU	UXT 2/UXT 6
999 170 148 90	Z 11	14-7 DU	UXT 2/UXT 6
999 170 150 90	Z 38	14 Z-3 CU	-
999 170 156 90	Z 20	14 R-7 DU	UXT 2/UXT 6
999 170 158 90	Z 20	14 R-7 DU	UXT 2/UXT 6
999 170 162 90	Z 38	14 Z-3 CU	-
999 170 165 90	Z 42	14-5 DU	UX 56
999 170 167 90	Z 48	14-6 BU	-
999 170 168 90	Z 22	14-6 DU	UX 56
999 170 170 90	Z 1	14-8 DU	UXT 2/UXT 6
999 170 182 90	Z 45	14 FR-5 DTU	UXT 5
999 170 183 90	Z 45	14 FR-5 DTU	UXT 5
999 170 195 90	Z 116	14 FR-6 LDU	UXT 5
999 170 201 90	Z 98	14 FR-7 LDU	UXT 1/UXT 3
999 170 207 91	Z 129	14 FGR-6 KQU	-
999 170 210 90	Z 192	14 FR-5 LDU	-
999 170 216 90	Z 192	14 FR-5 LDU	-
999 170 218 90	Z 129	14 FGR-6 KQU	-
999 170 219 90	Z 129	14 FGR-6 KQU	-
999 170 220 90	Z 116	14 FR-6 LDU	UXT 5
999 170 221 90	Z 185	14 F-6 DPUR021	-
999 170 229 90	Z 277	14 F-5 MPUR03	-

PRESTOLITE	BERU		
14 E 4	Z 57	14-7 AU	-
14 E 22	Z 48	14-6 BU	-
14 E 42	Z 10	14-7 BU	-
14 G 2	Z 58	14-7 CU	-
14 G 22	Z 22	14-6 DU	UX 56
14 G 32	Z 11	14-7 DU	UXT 2/UXT 6
14 G 42	Z 1	14-8 DU	UXT 2/UXT 6
14 G 52	Z 1	14-8 DU	UXT 2/UXT 6
18 F 82	Z 32	18 K-7 BU	-

PSA	BERU		
5960 88	GN 939		
5960 89	GN 939		
9637 469 980	GN 047		
9673 806 380	Z 320	12 ZR-8 STP	-

PUCH	BERU		
000 159 61 01	GD 382		
159 61 01	GD 382		
905 07 14	Z 1	14-8 DU	UXT 2/UXT 6



RENAULT	BERU		
00 26 325 033	GH 010		
01 22 999 900	GV 119		
08 51 798 700	Z 57	14-7 AU	–
08 51 798 800	Z 48	14-6 BU	–
08 54 407 100	Z 57	14-7 AU	–
08 54 864 700	Z 57	14-7 AU	–
08 54 997 100	GV 107		
08 55 800 600	Z 58	14-7 CU	–
08 55 836 400	Z 10	14-7 BU	–
08 55 836 500	Z 10	14-7 BU	–
08 55 939 100	Z 58	14-7 CU	–
50 00 270 881	GF 111		
50 00 274 232	GF 667		
50 00 590 058	GF 111		
50 01 001 587	GV 602		
50 01 005 897 8	GV 664		
50 01 829 283	GV 107		
50 10 438 495	Z 191	14 R-4 CDP	–
60 00 007 570	Z 31	14 K-5 DU	UXK 56
60 01 040 356	Z 60	14 FGR-7 CTU	–
60 01 040 357	Z 60	14 FGR-7 CTU	–
60 01 040 543	Z 7	14 K-8 DU0	UXT 4
73 10 012 998	Z 25	14 K-6 DU	UXK 56
74 33 517 980	Z 15	14 FR-7 DU	UXT 1/UXT 3
74 39 146 775	Z 60	14 FGR-7 CTU	–
77 00 100 403	Z 257	14 FR-7 LDUJW	UXT 1/UXT 3
77 00 100 558	GN 963		
77 00 100 586	GN 999		
77 00 100 635	GN 019		
77 00 101 401	Z 15	14 FR-7 DU	UXT 1/UXT 3
77 00 103 502	Z 119	14 R-8 DU4	UXT 2/UXT 6
77 00 103 503	Z 119	14 R-8 DU4	UXT 2/UXT 6
77 00 103 533	Z 74	14 FR-8 LDUOX4	UXT 1/UXT 3
77 00 103 674	GN 026		
77 00 105 290	GN 991		
77 00 107 916	Z 74	14 FR-8 LDUOX4	UXT 1/UXT 3
77 00 111 323	GN 018		
77 00 111 940	GN 019		
77 00 115 827	Z 257	14 FR-7 LDUJW	UXT 1/UXT 3
77 00 245 703	Z 25	14 K-6 DU	UXK 56
77 00 260 637	Z 45	14 FR-5 DTU	UXT 5
77 00 266 295	Z 26	14 KR-6 DU	UXK 56
77 00 267 140	Z 26	14 KR-6 DU	UXK 56
77 00 268 704	Z 31	14 K-5 DU	UXK 56
77 00 273 462	Z 72	14 FR-8 DU	UXT 1/UXT 3
77 00 273 490	Z 15	14 FR-7 DU	UXT 1/UXT 3
77 00 274 004	Z 15	14 FR-7 DU	UXT 1/UXT 3
77 00 274 154	Z 193	14 FR-7 DU2	UXT 1/UXT 3
77 00 500 000	Z 11	14-7 DU	UXT 2/UXT 6
77 00 500 012	Z 76	14-9 DU	UXT 2/UXT 6
77 00 500 024	Z 42	14-5 DU	UX 56
77 00 500 048	Z 119	14 R-8 DU4	UXT 2/UXT 6
77 00 500 072	Z 18	14 K-7 DU0	UXT 4
77 00 500 108	Z 31	14 K-5 DU	UXK 56
77 00 500 120	Z 27	14 R-6 DU	UX 56
77 00 500 132	Z 60	14 FGR-7 CTU	–
77 00 500 155	Z 193	14 FR-7 DU2	UXT 1/UXT 3
77 00 500 168	Z 14	14 F-7 LDUR4	UXT 1/UXT 3
77 00 500 180	Z 15	14 FR-7 DU	UXT 1/UXT 3
77 00 500 204	Z 207	14 KG-8 DTU	–
77 00 529 980	Z 48	14-6 BU	–
77 00 546 241	Z 48	14-6 BU	–
77 00 553 622	Z 11	14-7 DU	UXT 2/UXT 6
77 00 558 395	Z 10	14-7 BU	–
77 00 565 155	Z 38	14 Z-3 CU	–
77 00 571 635	Z 48	14-6 BU	–

RENAULT	BERU		
77 00 580 479	Z 10	14-7 BU	–
77 00 583 895	Z 11	14-7 DU	UXT 2/UXT 6
77 00 612 290	Z 11	14-7 DU	UXT 2/UXT 6
77 00 613 828	Z 1	14-8 DU	UXT 2/UXT 6
77 00 616 459	Z 10	14-7 BU	–
77 00 619 329	Z 57	14-7 AU	–
77 00 621 029	Z 10	14-7 BU	–
77 00 632 185	Z 25	14 K-6 DU	UXK 56
77 00 647 263	Z 48	14-6 BU	–
77 00 647 265	Z 1	14-8 DU	UXT 2/UXT 6
77 00 647 267	Z 10	14-7 BU	–
77 00 647 268	Z 25	14 K-6 DU	UXK 56
77 00 647 269	Z 57	14-7 AU	–
77 00 647 270	Z 10	14-7 BU	–
77 00 647 272	Z 11	14-7 DU	UXT 2/UXT 6
77 00 647 273	Z 22	14-6 DU	UX 56
77 00 647 275	Z 57	14-7 AU	–
77 00 647 276	Z 10	14-7 BU	–
77 00 647 278	Z 48	14-6 BU	–
77 00 647 279	Z 48	14-6 BU	–
77 00 647 280	Z 57	14-7 AU	–
77 00 647 284	Z 57	14-7 AU	–
77 00 647 285	Z 48	14-6 BU	–
77 00 647 286	Z 10	14-7 BU	–
77 00 659 130	Z 76	14-9 DU	UXT 2/UXT 6
77 00 659 152	Z 22	14-6 DU	UX 56
77 00 659 262	Z 57	14-7 AU	–
77 00 660 006	Z 11	14-7 DU	UXT 2/UXT 6
77 00 661 294	Z 31	14 K-5 DU	UXK 56
77 00 661 752	Z 1	14-8 DU	UXT 2/UXT 6
77 00 662 199	GV 602		
77 00 662 849	Z 10	14-7 BU	–
77 00 664 569	Z 19	14 R-7 BU	–
77 00 670 733	Z 25	14 K-6 DU	UXK 56
77 00 670 734	Z 1	14-8 DU	UXT 2/UXT 6
77 00 670 763	Z 25	14 K-6 DU	UXK 56
77 00 673 874	GV 602		
77 00 673 874	GV 642		
77 00 673 874	GN 909		
77 00 681 298	Z 20	14 R-7 DU	UXT 2/UXT 6
77 00 681 299	Z 8	14 R-8 DU	UXT 2/UXT 6
77 00 683 771	Z 1	14-8 DU	UXT 2/UXT 6
77 00 683 772	Z 10	14-7 BU	–
77 00 692 428	Z 8	14 R-8 DU	UXT 2/UXT 6
77 00 693 102	Z 25	14 K-6 DU	UXK 56
77 00 701 130	GV 642		
77 00 701 130	GN 909		
77 00 702 747	GR 066		
77 00 704 185	GN 909		
77 00 714 317	Z 95	14 KR-7 DU	UXT 4
77 00 714 540	Z 95	14 KR-7 DU	UXT 4
77 00 715 768	GV 642		
77 00 715 768	GN 909		
77 00 722 095	Z 25	14 K-6 DU	UXK 56
77 00 724 821	Z 70	14-8 DU0	UXT 2/UXT 6
77 00 724 822	Z 1	14-8 DU	UXT 2/UXT 6
77 00 725 302	Z 82	14 R-9 DU	UXT 2/UXT 6
77 00 726 503	Z 31	14 K-5 DU	UXK 56
77 00 726 703	Z 31	14 K-5 DU	UXK 56
77 00 727 383	Z 20	14 R-7 DU	UXT 2/UXT 6
77 00 731 583	Z 31	14 K-5 DU	UXK 56
77 00 732 626	Z 42	14-5 DU	UX 56
77 00 733 076	GV 642		
77 00 733 422	Z 118	14-8 BU	–
77 00 734 956	GV 852		
77 00 736 149	Z 31	14 K-5 DU	UXK 56

RENAULT	BERU		
77 00 736 150	Z 25	14 K-6 DU	UXK 56
77 00 737 457	Z 25	14 K-6 DU	UXK 56
77 00 737 459	Z 42	14-5 DU	UX 56
77 00 737 612	Z 63	14 F-7 DU	UXT 1/UXT 3
77 00 741 144	GV 642		
77 00 741 144	GN 909		
77 00 742 094	Z 27	14 R-6 DU	UX 56
77 00 743 137	Z 71	14 F-8 DU	UXT 1/UXT 3
77 00 743 920	Z 1	14-8 DU	UXT 2/UXT 6
77 00 745 305	Z 24	14 FR-6 DU	UXT 5
77 00 749 163	Z 71	14 F-8 DU	UXT 1/UXT 3
77 00 751 089	GR 066		
77 00 757 776	GR 066		
77 00 790 579	GR 067		
77 00 824 821	Z 70	14-8 DU0	UXT 2/UXT 6
77 00 851 443	GR 067		
77 00 852 522	Z 25	14 K-6 DU	UXK 56
77 00 854 538	GV 844		
77 00 855 463	Z 52	14 F-6 DTU	UXT 5
77 00 855 865	GN 909		
77 00 855 918	Z 17	14 K-7 DU	UXT 4
77 00 856 238	GN 909		
77 00 856 292	GV 844		
77 00 856 342	Z 52	14 F-6 DTU	UXT 5
77 00 856 789	GR 067		
77 00 858 208	GN 905		
77 00 858 444	Z 60	14 FGR-7 CTU	-
77 00 859 967	Z 76	14-9 DU	UXT 2/UXT 6
77 00 860 235	Z 76	14-9 DU	UXT 2/UXT 6
77 00 860 796	GN 905		
77 00 861 471	Z 22	14-6 DU	UX 56
77 00 861 472	Z 62	14-7 DU0	UXT 2/UXT 6
77 00 861 906	GN 999		
77 00 862 054	Z 1	14-8 DU	UXT 2/UXT 6
77 00 863 454	GR 067		
77 00 866 723	GR 061		
77 00 866 727	GR 061		
77 00 867 002	GN 991		
77 00 867 374	GR 067		
77 00 867 617	GN 959		
77 00 868 864	Z 27	14 R-6 DU	UX 56
77 00 869 200	Z 63	14 F-7 DU	UXT 1/UXT 3
77 00 870 715	GR 063		
77 00 874 336	GN 991		
77 01 021 767	Z 25	14 K-6 DU	UXK 56
77 01 023 079	Z 11	14-7 DU	UXT 2/UXT 6
77 01 023 080	Z 11	14-7 DU	UXT 2/UXT 6
77 01 023 325	Z 1	14-8 DU	UXT 2/UXT 6
77 01 023 334	Z 25	14 K-6 DU	UXK 56
77 01 023 391	Z 10	14-7 BU	-
77 01 029 762	GV 642		
77 01 032 921	Z 31	14 K-5 DU	UXK 56
77 01 035 956	GV 727		
77 01 039 387	GN 909		
77 01 039 387	GN 917		
77 01 040 208	GN 927		
77 01 041 214	Z 1	14-8 DU	UXT 2/UXT 6
77 01 041 215	Z 17	14 K-7 DU	UXT 4
77 01 042 816	Z 15	14 FR-7 DU	UXT 1/UXT 3
77 01 043 624	Z 116	14 FR-6 LDU	UXT 5
77 01 045 018	Z 25	14 K-6 DU	UXK 56
77 01 052 949	GN 106		
77 01 057 806	GN 106		
77 01 069 731	GN 909		
77 01 268 704	Z 25	14 K-6 DU	UXK 56
77 01 349 475	GV 642		

RENAULT	BERU		
77 01 349 475	GN 909		
77 01 349 943	GN 909		
77 01 349 949	GV 844		
77 01 365 111	Z 42	14-5 DU	UX 56
77 01 365 437	Z 25	14 K-6 DU	UXK 56
77 01 366 057	Z 10	14-7 BU	-
77 01 366 086	Z 22	14-6 DU	UX 56
77 01 366 087	Z 22	14-6 DU	UX 56
77 01 366 137	Z 56	14 K-6 DU0	UXK 56
77 01 366 138	Z 22	14-6 DU	UX 56
77 01 366 267	Z 10	14-7 BU	-
77 01 366 268	Z 22	14-6 DU	UX 56
77 01 366 269	Z 62	14-7 DU0	UXT 2/UXT 6
77 01 366 270	Z 17	14 K-7 DU	UXT 4
77 01 366 513	Z 118	14-8 BU	-
77 01 366 514	Z 18	14 K-7 DU0	UXT 4
77 01 366 515	Z 10	14-7 BU	-
77 01 366 516	Z 11	14-7 DU	UXT 2/UXT 6
77 01 366 533	Z 68	14-8 AU	-
77 01 366 539	Z 76	14-9 DU	UXT 2/UXT 6
77 01 366 903	Z 76	14-9 DU	UXT 2/UXT 6
77 01 392 263	Z 40	14-5 AU	-
77 01 414 022	Z 118	14-8 BU	-
77 01 414 023	Z 62	14-7 DU0	UXT 2/UXT 6
77 01 414 024	Z 42	14-5 DU	UX 56
77 01 414 026	Z 69	14-8 DU0	UXT 2/UXT 6
77 01 414 027	Z 25	14 K-6 DU	UXK 56
77 01 414 028	Z 25	14 K-6 DU	UXK 56
77 01 414 029	Z 31	14 K-5 DU	UXK 56
77 01 414 030	Z 95	14 KR-7 DU	UXT 4
77 01 414 031	Z 20	14 R-7 DU	UXT 2/UXT 6
77 01 414 032	Z 82	14 R-9 DU	UXT 2/UXT 6
77 01 414 036	Z 48	14-6 BU	-
77 01 414 037	Z 40	14-5 AU	-
77 01 414 038	Z 17	14 K-7 DU	UXT 4
77 01 414 039	Z 63	14 F-7 DU	UXT 1/UXT 3
77 01 414 040	Z 15	14 FR-7 DU	UXT 1/UXT 3
77 01 414 044	Z 22	14-6 DU	UX 56
77 01 414 058	Z 17	14 K-7 DU	UXT 4
77 01 414 062	Z 63	14 F-7 DU	UXT 1/UXT 3
77 01 414 065	Z 29	14 F-5 DU	UXT 5
77 01 414 072	GV 636		
77 01 414 076	GV 602		
77 01 414 077	GN 857		
77 01 414 078	GV 631		
77 01 414 079	GV 603		
77 01 414 080	GV 663		
77 01 414 081	GV 666		
77 01 414 083	GV 661		
77 01 414 084	GV 657		
77 01 414 086	GV 636		
77 01 414 088	GN 857		
77 01 414 089	GV 661		
77 01 414 089	GN 909		
77 01 414 105	Z 76	14-9 DU	UXT 2/UXT 6
77 01 414 108	GV 719		
77 01 414 110	Z 72	14 FR-8 DU	UXT 1/UXT 3
77 01 414 111	Z 15	14 FR-7 DU	UXT 1/UXT 3
77 01 414 112	Z 15	14 FR-7 DU	UXT 1/UXT 3
77 01 414 113	Z 20	14 R-7 DU	UXT 2/UXT 6
77 01 414 114	Z 12	14-7 DTU	UXT 2/UXT 6
77 01 414 118	Z 63	14 F-7 DU	UXT 1/UXT 3
77 01 414 119	Z 51	14-6 DTU	UX 56
77 01 414 121	Z 33	18 K-6 BU	-
77 01 414 123	GN 909		
77 01 414 138	Z 95	14 KR-7 DU	UXT 4

RENAULT	BERU		
77 01 414 139	Z 15	14 FR-7 DU	UXT 1/UXT 3
77 01 414 140	Z 12	14-7 DTU	UXT 2/UXT 6
77 01 414 141	Z 24	14 FR-6 DU	UXT 5
77 01 414 142	Z 20	14 R-7 DU	UXT 2/UXT 6
77 01 414 143	Z 27	14 R-6 DU	UX 56
77 01 414 144	Z 10	14-7 BU	–
77 01 414 145	Z 72	14 FR-8 DU	UXT 1/UXT 3
77 01 414 157	GN 858		
77 01 414 162	GN 909		
77 01 414 162	GN 954		
77 01 417 539	Z 31	14 K-5 DU	UXK 56
77 01 417 651	Z 17	14 K-7 DU	UXT 4
77 01 417 653	Z 31	14 K-5 DU	UXK 56
77 01 417 654	Z 42	14-5 DU	UX 56
77 01 612 290	Z 11	14-7 DU	UXT 2/UXT 6
77 01 742 094	Z 27	14 R-6 DU	UX 56
77 02 124 101	Z 1	14-8 BU	UXT 2/UXT 6
77 02 125 001	Z 10	14-7 BU	–
77 51 023 082	Z 11	14-7 DU	UXT 2/UXT 6
79 10 012 996	Z 25	14 K-6 DU	UXK 56
79 10 245 703	Z 25	14 K-6 DU	UXK 56
79 32 563 970	GV 107		
79 32 563 970	GV 108		
79 32 567 717	GN 954		
82 00 012 099	GN 026		
82 00 020 796	Z 193	14 FR-7 DU2	UXT 1/UXT 3
82 00 030 765	Z 243	12 VR-8 SE	–
82 00 046 337	Z 206	14 FR-7 DPPUS2	UXT 10
82 00 090 817	GN 909		
82 00 209 310	Z 193	14 FR-7 DU2	UXT 1/UXT 3
82 00 307 688	Z 224	14 FR-7 DPU3	UXT 9
82 00 363 384	Z 206	14 FR-7 DPPUS2	UXT 10
82 00 421 091	GN 855		
82 00 423 224	GN 963		
82 00 423 227	GN 963		
82 00 434 855	GN 018		
82 00 445 627	GN 026		
82 00 464 077	GN 018		
82 00 490 950	GN 018		
82 00 492 426	Z 206	14 FR-7 DPPUS2	UXT 10
82 00 517 313	GN 026		
82 00 662 185	Z 243	12 VR-8 SE	–
82 00 682 592	GE 110		
82 00 787 721	GN 019		
82 00 794 920	GE 111		
83 04 504 277	Z 152	14 FR-8 HU	–
86 71 004 016	GN 857		
86 71 004 018	GN 954		
89 33 003 862	Z 15	14 FR-7 DU	UXT 1/UXT 3
96 26 195 980	Z 123	14 FR-7 KDU	UXT 9
96 26 575 480	Z 123	14 FR-7 KDU	UXT 9
96 36 415 880	Z 211	14 FGR-8 MQPU	–

ROTAX	BERU		
297 310	Z 57	14-7 AU	–
899 121	Z 39	14 Z-4 AU	–
899 570	Z 38	14 Z-3 CU	–
899 721	Z 38	14 Z-3 CU	–
999 190	Z 39	14 Z-4 AU	–
999 370	Z 57	14-7 AU	–

ROVER	BERU		
ERC 8450	GV 602		
ERR 4084	GN 926		

ROVER	BERU		
ERR 6066	GN 985		
ETC 8847	GV 783		
GSP 66527	Z 228	14 FR-7 DPUX02	UXT 11
GSP 9652	Z 228	14 FR-7 DPUX02	UXT 11
NCC 100050	GN 905		
NCC 100120	GN 024		
NCC 100120 L	GN 024		
NCJ 100110	GR 054		
NPL 100190	Z 228	14 FR-7 DPUX02	UXT 11
PRC 5020	GR 065		
PRC 5020	GR 066		

SAAB	BERU		
7504442	Z 29	14 F-5 DU	UXT 5
7505142	Z 24	14 FR-6 DU	UXT 5
8355007	Z 11	14-7 DU	UXT 2/UXT 6
9188681	Z 221	14 FR-6 DPUX02	UXT 14
9399866	Z 221	14 FR-6 DPUX02	UXT 14
23412600	Z 57	14-7 AU	–
23413800	Z 41	14-5 BU	–
23415300	Z 41	14-5 BU	–
97357290	GN 106		
T 40 238 921 001	Z 11	14-7 DU	UXT 2/UXT 6
T 40 238 924 005	Z 11	14-7 DU	UXT 2/UXT 6

SACHS	BERU		
0 265 156 004	Z 39	14 Z-4 AU	–
0 265 156 015	Z 39	14 Z-4 AU	–
0 298 087 002	Z 57	14-7 AU	–
0 298 087 003	Z 57	14-7 AU	–
0 298 087 006	Z 57	14-7 AU	–
0 298 087 008	Z 39	14 Z-4 AU	–
0 298 087 009	Z 39	14 Z-4 AU	–
0 298 087 011	Z 39	14 Z-4 AU	–
0 298 087 012	Z 39	14 Z-4 AU	–
0 965 155 000	Z 57	14-7 AU	–
0 998 004 000	Z 57	14-7 AU	–
0 998 004 001	Z 57	14-7 AU	–
2 765 045 000	Z 10	14-7 BU	–
2 865 022 002	Z 41	14-5 BU	–
3 665 013 000	Z 38	14 Z-3 CU	–
3 665 013 001	Z 38	14 Z-3 CU	–
80 480 305	Z 57	14-7 AU	–

**SAGEM → EYQUEM**

SAME	BERU		
000871074	GR 066		
276590130	GF 683		

SAVIEM	BERU		
50 00 270 881	GF 111		
79 32 563 970	GV 107		
79 32 563 970	GV 108		
85 49 971 00	GV 107		

SCANIA	BERU		
389847	GF 111		

SEAT	BERU		
000 390 117 1	Z 22	14-6 DU	UX 56
000 390 885 7	Z 1	14-8 DU	UXT 2/UXT 6
000 391 064 9	Z 22	14-6 DU	UX 56
000 391 139 8	Z 11	14-7 DU	UXT 2/UXT 6
000 394 068 5	GV 602		
000 435 942 4	Z 20	14 R-7 DU	UXT 2/UXT 6
058 1CR 01	GR 065		
101 000 035 AH	Z 173	14 FGR-8 KQU	–
101 000 040 AC	Z 92	14 GH-8 DTUR	UXT 2/UXT 6
101 000 040 AD	Z 91	14 GH-7 DTUR	UXT 2/UXT 6
101 905 603 B	Z 200	14 F-7 HUR2	–
EA 919 000 04	Z 58	14-7 CU	–
FH 919 000 02	Z 11	14-7 DU	UXT 2/UXT 6
N 105 792 01	GN 046		
N 105 792 02	GN 046		
SE 138 919 000 A	GV 602		
X 039 494 050	Z 29	14 F-5 DU	UXT 5
X 039 655 020	GV 663		

SEV	BERU		
4 N	Z 39	14 Z-4 AU	–
5 N	Z 48	14-6 BU	–
6 H	Z 42	14-5 DU	UX 56
6 N	Z 57	14-7 AU	–
7 H	Z 42	14-5 DU	UX 56
8 H	Z 22	14-6 DU	UX 56
9 H	Z 11	14-7 DU	UXT 2/UXT 6
34 HS	Z 38	14 Z-3 CU	–
34 S	Z 39	14 Z-4 AU	–
34/5 HS	Z 38	14 Z-3 CU	–
35	Z 39	14 Z-4 AU	–
35 B	Z 57	14-7 AU	–
35 S	Z 39	14 Z-4 AU	–
35/1	Z 48	14-6 BU	–
35/1 B	Z 48	14-6 BU	–
35/36	Z 48	14-6 BU	–
35/36 R	Z 10	14-7 BU	–
36	Z 57	14-7 AU	–
36 B	Z 57	14-7 AU	–
36 HS	Z 58	14-7 CU	–
37 S	Z 57	14-7 AU	–
C 7 H	Z 31	14 K-5 DU	UXK 56
GT 34	Z 41	14-5 BU	–
GT 34 D	Z 41	14-5 BU	–
GT 34 H	Z 42	14-5 DU	UX 56
GT 34 HD	Z 42	14-5 DU	UX 56
GT 34.2 H	Z 22	14-6 DU	UX 56
GT 34.5	Z 48	14-6 BU	–
GT 34.5 H	Z 11	14-7 DU	UXT 2/UXT 6
GT 34.5 HA	Z 11	14-7 DU	UXT 2/UXT 6
GT 35 D	Z 10	14-7 BU	–
H 33 RG	Z 38	14 Z-3 CU	–
H 34 F	Z 38	14 Z-3 CU	–
HF 34 F	Z 38	14 Z-3 CU	–
SCGT 34.5 H	Z 31	14 K-5 DU	UXK 56
SCGT 35 H	Z 25	14 K-6 DU	UXK 56

SKODA	BERU		
101 000 040 AD	Z 91	14 GH-7 DTUR	UXT 2/UXT 6
101 000 049 AC	Z 238	14 FR-8 DPU2	UXT 10
101 000 060 AA	Z 238	14 FR-8 DPU2	UXT 10
101 905 603 B	Z 200	14 F-7 HUR2	–
BBC 057 008	Z 41	14-5 BU	–
BBC 057 009	Z 10	14-7 BU	–

SKODA	BERU		
BBC 057 010	Z 63	14 F-7 DU	UXT 1/UXT 3
BBC 057 011	Z 72	14 FR-8 DU	UXT 1/UXT 3
BBC 057 012	Z 15	14 FR-7 DU	UXT 1/UXT 3

SMART	BERU		
000 308 5V0 05	Z 194	14 FR-6 LDU3	UXT 5
000 456 2V0 030 000 00	GN 015		
135 150 01 18	Z 235	14 FR-7 SPUX03	–
A 001 159 46 01	GN 058		
A 135 150 01 18	Z 235	14 FR-7 SPUX03	–
Q 000 308 5V0 050 000 00	Z 194	14 FR-6 LDU3	UXT 5
Q 001 246 8V0 020 000 00	Z 286	12 FR-5 SDU	–

SOLO	BERU		
23 00 101	Z 57	14-7 AU	–
23 00 103	Z 39	14 Z-4 AU	–
23 00 106	Z 57	14-7 AU	–
23 00 323	Z 39	14 Z-4 AU	–
23 00 428	Z 10	14-7 BU	–
23 00 441	Z 57	14-7 AU	–
23 00 500	Z 39	14 Z-4 AU	–

SSANGYONG	BERU		
664 159 00 01	GN 060		
664 159 01 01	GN 060		
665 159 00 01	GN 060		
665 159 01 01	GN 060		
A 003 159 41 03	Z 5	14 F-8 DU0	UXT 1/UXT 3
A 003 159 68 03	Z 100	14 F-8 DU4	UXT 1/UXT 3
A 664 159 00 01	GN 060		
A 664 159 01 01	GN 060		
A 665 159 00 01	GN 060		
A 665 159 01 01	GN 060		

STEINBOCK	BERU		
007 488	GD 214		
014 046	Z 57	14-7 AU	–
024 153	Z 27	14 R-6 DU	UX 56

STEYR	BERU		
213 009 00 28	GD 294		
23 733	Z 39	14 Z-4 AU	–
754 516 32	GR 076		
754 599 32	GR 075		
902 0724	Z 57	14-7 AU	–
902 0726	Z 57	14-7 AU	–
902 0741	Z 39	14 Z-4 AU	–
904 0784	Z 48	14-6 BU	–
905 0702	Z 58	14-7 CU	–
905 0703	Z 58	14-7 CU	–
905 0711	Z 22	14-6 DU	UX 56

STIHL	BERU		
0000 405 0101	Z 41	14-5 BU	–
0000 405 0102	Z 39	14 Z-4 AU	–
0000 405 0107	Z 39	14 Z-4 AU	–
1107 400 7000	Z 57	14-7 AU	–

STRIEBEL	BERU		
899 019	GR 064	-	-
899 020	GR 064	-	-
899 026 01	GR 031	-	-
899 102	GR 064	-	-
899 121	GR 064	-	-
899 125	GR 064	-	-
899 189	GR 064	-	-

SUBARU	BERU		
22401 AA 310	Z 151	14 FR-7 KPU	UXT 9
22401 AA 501	Z 149	14 FR-7 KPUX	UXT 11
22401 KA 210	Z 16	14 FR-7 DUX	UXT 1/UXT 3

SUZUKI	BERU		
09482-00527	Z 234	12 FR-7 DU	-
09900-HD101	GN 027		
18550-67G11	GN 054		
18550-78E00	GN 005		
18550-78E10	GN 005		
18550-78E11	GN 005		
18550-80KA0-000	GE 111		
18550-84A51-000	GN 018		
90482-00448	Z 234	12 FR-7 DU	-
9050712	Z 19	14 R-7 BU	-
9482369	Z 234	12 FR-7 DU	-

TALBOT	BERU		
00 00 VSP 118	Z 20	14 R-7 DU	UXT 2/UXT 6
00 00 VSP 120	Z 27	14 R-6 DU	UX 56
00 023 988 00	Z 38	14 Z-3 CU	-
00 043 456 00	Z 22	14-6 DU	UX 56
00 044 629 00	Z 42	14-5 DU	UX 56
00 131 120 00	Z 22	14-6 DU	UX 56
00 136 956 00	Z 10	14-7 BU	-
00 157 973 00	Z 11	14-7 DU	UXT 2/UXT 6
00 165 081 00	Z 11	14-7 DU	UXT 2/UXT 6
00 166 316 00	Z 22	14-6 DU	UX 56
00 429 049 00	Z 11	14-7 DU	UXT 2/UXT 6
00 553 549 00	Z 11	14-7 DU	UXT 2/UXT 6
00 553 552 00	Z 42	14-5 DU	UX 56
00 566 133 00	Z 11	14-7 DU	UXT 2/UXT 6
00 792 270 42	Z 20	14 R-7 DU	UXT 2/UXT 6
00 792 270 44	Z 27	14 R-6 DU	UX 56
91 215 869 80	GR 065		
91 507 715 80	GV 636		
91 507 719 80	GV 636		
92 515 867 80	GR 065		
92 515 869 80	GR 065		
96 141 677 80	GR 034		
A 519 383 80	Z 12	14-7 DTU	UXT 2/UXT 6
B 515 867	GR 065		
G 517 562 80	Z 11	14-7 DU	UXT 2/UXT 6

TOYOTA	BERU		
19850-0L010	GN 068		
19850-0R020	GN 108		
19850-0W010	GN 042		
19850-26010	GN 108		
19850-27010	GN 065		
19850-30010	GN 068		
19850-45030	GV 688		
19850-45031	GV 688		

TOYOTA	BERU		
19850-54030	GV 688		
19850-54031	GV 688		
19850-54050	GV 894		
19850-54060	GV 896		
19850-54070	GV 001		
19850-54071	GV 001		
19850-54090	GV 968		
19850-56021	GV 678		
19850-56022	GV 678		
19850-58010	GV 969		
19850-64010	GV 886		
19850-64020	GV 967		
19850-64030	GN 043		
19850-64031	GN 043		
19850-64031 B	GN 043		
19850-64050	GN 043		
19850-67020	GN 110		
19850-67030	GN 110		
19850-68010	GV 897		
19850-68020	GV 969		
19850-68030	GV 678		
19850-68060	GV 895		
19850-87309	GV 678		
90080-91194	Z 249	14 FR-8 KUOU	-
90919-01020	Z 1	14-8 DU	UXT 2/UXT 6
90919-01056	Z 1	14-8 DU	UXT 2/UXT 6
90919-01059	Z 1	14-8 DU	UXT 2/UXT 6
90919-01121	Z 130	14 FR-5 DPUX	-
90919-01127	Z 149	14 FR-7 KPUX	UXT 11
90919-01128	Z 151	14 FR-7 KPU	UXT 9
90919-01155	Z 248	14 FR-8 HUT	-
90919-01166	Z 156	14 FR-7 KUO	UXT 10
90919-01168	Z 154	14 FR-8 KUO	UXT 9
90919-01176	Z 156	14 FR-7 KUO	UXT 10
90919-01180	Z 151	14 FR-7 KPU	UXT 9
90919-01182	Z 150	14 FR-7 KPUV	-
90919-01184	Z 157	14 FR-7 KUOX	UXT 11
90919-01191	Z 155	14 FR-7 KU	UXT 10
90919-01192	Z 208	14 FR-8 LDU3	-
90919-01211	Z 280	14 FR-7 KPUX02	-
90919-01238	Z 280	14 FR-7 KPUX02	-
SU001-00671	GN 047		

UNIPART	BERU		
GSP 634	Z 73	14 FR-8 DUX	UXT 1/UXT 3
GSP 664	Z 15	14 FR-7 DU	UXT 1/UXT 3
GSP 665	Z 63	14 F-7 DU	UXT 1/UXT 3
GSP 684	Z 24	14 FR-6 DU	UXT 5
GSP 685	Z 24	14 FR-6 DU	UXT 5
GSP 4154	Z 33	18 K-6 BU	-
GSP 4352	Z 22	14-6 DU	UX 56
GSP 4356	Z 41	14-5 BU	-
GSP 4362	Z 11	14-7 DU	UXT 2/UXT 6
GSP 4366	Z 10	14-7 BU	-
GSP 4382	Z 1	14-8 DU	UXT 2/UXT 6
GSP 4452	Z 27	14 R-6 DU	UX 56
GSP 4462	Z 20	14 R-7 DU	UXT 2/UXT 6
GSP 4472	Z 8	14 R-8 DU	UXT 2/UXT 6
GSP 4482	Z 82	14 R-9 DU	UXT 2/UXT 6
GSP 4562	Z 63	14 F-7 DU	UXT 1/UXT 3
GSP 4652	Z 24	14 FR-6 DU	UXT 5
GSP 4662	Z 15	14 FR-7 DU	UXT 1/UXT 3
GSP 4663	Z 26	14 KR-6 DU	UXK 56
GSP 5658	Z 16	14 FR-7 DUX	UXT 1/UXT 3

UNIPART	BERU		
GSP 6662	Z 72	14 FR-8 DU	UXT 1/UXT 3
GSP 7664	Z 158	14 FR-7 LUX	-
GSP 9652	Z 149	14 FR-7 KPUX	UXT 11

VALEO	BERU		
10 21 80	GR 059	-	-
10 26 96	GR 065	-	-
13 10 10 02	GR 059	-	-
24 56 00	GR 059	-	-
24 56 03	GR 065	-	-
24 56 04	GR 066	-	-
73 10 01 22	GR 059	-	-
73 10 34 02	GR 065	-	-
73 10 48 22	GR 066	-	-
73 10 49 02	GR 054	-	-
73 10 50 02	GR 065	-	-
90 H	Z 76	14-9 DU	UXT 2/UXT 6
90 H	Z 76	14-9 DU	UXT 2/UXT 6
C 60 H	Z 31	14 K-5 DU	UXK 56
C 60 H	Z 46	14 K-5 DUO	UXK 56
C 64 H	Z 25	14 K-6 DU	UXK 56
C 64 H	Z 56	14 K-6 DUO	UXK 56
C 72 H	Z 17	14 K-7 DU	UXT 4
C 72 H	Z 18	14 K-7 DUO	UXT 4
F 64 H	Z 29	14 F-5 DU	UXT 5
F 72 H	Z 24	14 FR-6 DU	UXT 5
F 72 H3E	Z 52	14 F-6 DTU	UXT 5
F 74 H	Z 13	14 F-7 DUOR	UXT 1/UXT 3
F 74 H	Z 63	14 F-7 DU	UXT 1/UXT 3
F 74 H	Z 64	14 F-7 DUO	UXT 1/UXT 3
F 80 H	Z 13	14 F-7 DUOR	UXT 1/UXT 3
F 80 H	Z 63	14 F-7 DU	UXT 1/UXT 3
F 80 H	Z 64	14 F-7 DUO	UXT 1/UXT 3
F 82 H	Z 100	14 F-8 DU4	UXT 1/UXT 3
F 82 H	Z 5	14 F-8 DUO	UXT 1/UXT 3
F 82 H	Z 71	14 F-8 DU	UXT 1/UXT 3
GC 68 N	Z 32	18 K-7 BU	-
GC 68 N	Z 32	18 K-7 BU	-
GC 68 N	Z 33	18 K-6 BU	-
R 64 H	Z 47	14 R-5 DU	UX 56
R 70 H	Z 27	14 R-6 DU	UX 56
R 70 H11	Z 28	14 R-6 DUX	UX 56
R 76 H	Z 20	14 R-7 DU	UXT 2/UXT 6
R 76 H11	Z 21	14 R-7 DUX	UXT 2/UXT 6
R 84 H	Z 119	14 R-8 DU4	UXT 2/UXT 6
R 84 H	Z 8	14 R-8 DU	UXT 2/UXT 6
R 84 H11	Z 9	14 R-8 DUX	UXT 2/UXT 6
R 88 N	Z 19	14 R-7 BU	-
R 90 H	Z 82	14 R-9 DU	UXT 2/UXT 6
RC 64 H	Z 26	14 KR-6 DU	UXK 56
RC 68 LPP	Z 97	14 KR-8 MPX	UXT 8
RC 72 H	Z 95	14 KR-7 DU	UXT 4
RC 72 H11	Z 67	14 KR-7 DUX	UXT 4
RF 74 H	Z 24	14 FR-6 DU	UXT 5
RF 74 H11	Z 99	14 FR-6 DUX	UXT 5
RF 80 H	Z 15	14 FR-7 DU	UXT 1/UXT 3
RF 82 H	Z 72	14 FR-8 DU	UXT 1/UXT 3
T 9	Z 262	14 S-9 E0	-

VAUXHALL	BERU		
90033357	GV 602		
90093897	GV 602		
90210824	GV 636		
90509739	Z 98	14 FR-7 LDU	UXT 1/UXT 3

VAUXHALL	BERU		
93175935	Z 190	14 FGR-8 DQU7	UXT 1/UXT 3
97125969	Z 228	14 FR-7 DPUX02	UXT 11
090040992	GR 064		
090228928	GR 064		
090341822	GR 064		
091097769	GR 064		
091108750	GR 064		

VM	BERU		
46 072 004 F	GV 776		
46 072 007 F	GN 055		

VOLVO	BERU		
72153	Z 57	14-7 AU	-
135827	Z 48	14-6 BU	-
238624	Z 39	14 Z-4 AU	-
238808	Z 39	14 Z-4 AU	-
239446	Z 57	14-7 AU	-
241402	Z 48	14-6 BU	-
241627	Z 41	14-5 BU	-
241946	Z 10	14-7 BU	-
245703	Z 25	14 K-6 DU	UXK 56
246106	Z 25	14 K-6 DU	UXK 56
269465	Z 31	14 K-5 DU	UXK 56
270746-1	Z 20	14 R-7 DU	UXT 2/UXT 6
271239	Z 279	14 FR-7 LPU02	-
271239-6	Z 279	14 FR-7 LPU02	-
271409	Z 20	14 R-7 DU	UXT 2/UXT 6
271410	Z 41	14-5 BU	-
271411	Z 48	14-6 BU	-
271412	Z 10	14-7 BU	-
271636-3	Z 15	14 FR-7 DU	UXT 1/UXT 3
271727-0	Z 16	14 FR-7 DUX	UXT 1/UXT 3
272207	Z 204	14 FGR-8 CTU	-
272344	Z 206	14 FR-7 DPPUS2	UXT 10
273525	Z 10	14-7 BU	-
273546	Z 22	14-6 DU	UX 56
273558	Z 10	14-7 BU	-
273579	Z 31	14 K-5 DU	UXK 56
273591	Z 22	14-6 DU	UX 56
273596	Z 22	14-6 DU	UX 56
273599	Z 25	14 K-6 DU	UXK 56
460540	Z 41	14-5 BU	-
463511	Z 11	14-7 DU	UXT 2/UXT 6
463512	Z 22	14-6 DU	UX 56
463513	Z 42	14-5 DU	UX 56
570306	Z 57	14-7 AU	-
570334	Z 39	14 Z-4 AU	-
829859	GV 153		
840643	GV 602		
870325	GD 214		
870680	GV 107		
870681	GV 117		
870846	GV 107		
870846	GV 108		
1257141	GN 857		
1257889	GN 857		
1269280	Z 31	14 K-5 DU	UXK 56
1269915	Z 26	14 KR-6 DU	UXK 56
1276056	Z 11	14-7 DU	UXT 2/UXT 6
1276057	Z 42	14-5 DU	UX 56
1276058	Z 42	14-5 DU	UX 56
1276514	Z 22	14-6 DU	UX 56

VOLVO	BERU		
1306604	Z 22	14-6 DU	UX 56
1306605	Z 11	14-7 DU	UXT 2/UXT 6
1346541	Z 20	14 R-7 DU	UXT 2/UXT 6
1357828	Z 10	14-7 BU	–
1367528	Z 20	14 R-7 DU	UXT 2/UXT 6
1367529	Z 27	14 R-6 DU	UX 56
1457826	Z 41	14-5 BU	–
1467015	Z 27	14 R-6 DU	UX 56
1542319	GV 657		
1542411	GV 657		
2301710	Z 42	14-5 DU	UX 56
3104124	Z 57	14-7 AU	–
3104530	Z 10	14-7 BU	–
3551943	Z 39	14 Z-4 AU	–
3551945	Z 39	14 Z-4 AU	–
3551946	Z 39	14 Z-4 AU	–
3576753	Z 41	14-5 BU	–
3576846	Z 10	14-7 BU	–
3714076	GH 649		
3716085	GH 22		
3730104	GH 306		
7072153	Z 57	14-7 AU	–
8631607	GN 045		
8642660	Z 204	14 FGR-8 CTU	–
8642661	Z 204	14 FGR-8 CTU	–
8653698	GN 054		
8670057	Z 206	14 FR-7 DPPUS2	UXT 10
8684293	GH 306		
8692070	Z 206	14 FR-7 DPPUS2	UXT 10
9146775	Z 204	14 FGR-8 CTU	–
30637385	Z 294	14 FGR-5 NTE	–
30650379	Z 326	14 FR-7 MPUS	UXT 13
30650843	Z 294	14 FGR-5 NTE	–
30725069	GN 054		
30731425	Z 177	14 KR-8 MUV	UXT 7
30731877	Z 177	14 KR-8 MUV	UXT 7
30735760	Z 177	14 KR-8 MUV	UXT 7
30862690	GN 999		
3121624-8	GN 047		
3344898-6	Z 20	14 R-7 DU	UXT 2/UXT 6
35601160	GR 064		
36501116	GR 064		
RF 80 H3	Z 204	14 FGR-8 CTU	–
X 9146775	Z 204	14 FGR-8 CTU	–

VW AG	BERU		
000 057 001	Z 57	14-7 AU	–
000 057 001 A	Z 57	14-7 AU	–
000 057 003	Z 57	14-7 AU	–
000 057 004	Z 57	14-7 AU	–
000 057 005	Z 58	14-7 CU	–
000 057 006	Z 58	14-7 CU	–
000 057 007	Z 58	14-7 CU	–
000 057 011	Z 11	14-7 DU	UXT 2/UXT 6
000 057 015	Z 57	14-7 AU	–
000 057 022	Z 22	14-6 DU	UX 56
000 057 023 A	Z 22	14-6 DU	UX 56
000 057 066 A	Z 2	14-8 DTU	UXT 2/UXT 6
000 057 067 A	Z 12	14-7 DTU	UXT 2/UXT 6
028 998 019	SR 028		
03G 907 282	GSE 100		
03L 905 061 D	PSG 002		
03L 905 061 E	PSG 002		
03L 905 061 F	PSG 002		

VW AG	BERU		
03L 963 319	GE 115		
03L 963 319 A	GE 115		
059 963 319	GN 008		
059 963 319 A	GN 008		
059 963 319 C	GE 115		
059 963 319 E	GE 115		
059 963 319 F	GE 115		
059 963 319 H	GN 008		
059 963 319 J	GE 115		
06H 905 601 A	Z 347	14 F-5 DPUR02	
06H 905 611	Z 347	14 F-5 DPUR02	
06H 905 621	Z 347	14 F-5 DPUR02	
06K 905 621	Z 348	14 F-5 MPUR2L	
062 905 061	GN 989		
062 905 061 A	GN 050		
068 905 061	GN 857		
079 905 626 B	Z 339	14 F-4 NBPR	
079 905 626 D	Z 345	14 F-4 NBPR2LS	
079 905 626 E	Z 339	14 F-4 NBPR	
079 905 626 G	Z 345	14 F-4 NBPR2LS	
101 000 000 AA	Z 42	14-5 DU	UX 56
101 000 000 AB	Z 61	14-7 DU0	UXT 2/UXT 6
101 000 000 AC	Z 70	14-8 DU0	UXT 2/UXT 6
101 000 001 AA	Z 44	14-5 DTU	UX 56
101 000 001 AB	Z 51	14-6 DTU	UX 56
101 000 001 AC	Z 12	14-7 DTU	UXT 2/UXT 6
101 000 001 AD	Z 2	14-8 DTU	UXT 2/UXT 6
101 000 001 AE	Z 2	14-8 DTU	UXT 2/UXT 6
101 000 002 AA	Z 70	14-8 DU0	UXT 2/UXT 6
101 000 002 AA	Z 69	14-8 DU0	UXT 2/UXT 6
101 000 002 AB	Z 61	14-7 DU0	UXT 2/UXT 6
101 000 002 AC	Z 22	14-6 DU	UX 56
101 000 002 AD	Z 42	14-5 DU	UX 56
101 000 002 AE	Z 104	14-6 DPO	–
101 000 003 AA	Z 52	14 F-6 DTU	UXT 5
101 000 003 AB	Z 52	14 F-6 DTU	UXT 5
101 000 004 AA	Z 52	14 F-6 DTU	UXT 5
101 000 005 AA	Z 51	14-6 DTU	UX 56
101 000 005 AB	Z 12	14-7 DTU	UXT 2/UXT 6
101 000 005 AC	Z 44	14-5 DTU	UX 56
101 000 005 AD	Z 2	14-8 DTU	UXT 2/UXT 6
101 000 005 AE	Z 2	14-8 DTU	UXT 2/UXT 6
101 000 005 AF	Z 78	14-9 DTU	UXT 2/UXT 6
101 000 005 AF	Z 78	14-9 DTU	UXT 2/UXT 6
101 000 006 AA	Z 42	14-5 DU	UX 56
101 000 006 AB	Z 22	14-6 DU	UX 56
101 000 006 AC	Z 61	14-7 DU0	UXT 2/UXT 6
101 000 006 AD	Z 70	14-8 DU0	UXT 2/UXT 6
101 000 006 AF	Z 104	14-6 DPO	–
101 000 007 AA	Z 44	14-5 DTU	UX 56
101 000 007 AB	Z 12	14-7 DTU	UXT 2/UXT 6
101 000 007 AC	Z 2	14-8 DTU	UXT 2/UXT 6
101 000 007 AD	Z 2	14-8 DTU	UXT 2/UXT 6
101 000 009 AA	Z 58	14-7 CU	–
101 000 012 AA	Z 58	14-7 CU	–
101 000 013 AA	Z 105	14 F-6 DSR	UXT 5
101 000 014 AA	Z 105	14 F-6 DSR	UXT 5
101 000 015 AA	Z 18	14 K-7 DU0	UXT 4
101 000 015 AB	Z 56	14 K-6 DU0	UXK 56
101 000 015 AC	Z 7	14 K-8 DU0	UXT 4
101 000 017 AA	Z 52	14 F-6 DTU	UXT 5
101 000 018 AA	Z 1	14-8 DU	UXT 2/UXT 6
101 000 019 AA	Z 1	14-8 DU	UXT 2/UXT 6
101 000 020 AA	Z 1	14-8 DU	UXT 2/UXT 6
101 000 026 AA	Z 75	14 G-8 DTU	UXT 2/UXT 6
101 000 026 AB	Z 91	14 GH-7 DTUR	UXT 2/UXT 6

VW AG	BERU		
101 000 027 AA	Z 12	14-7 DTU	UXT 2/UXT 6
101 000 027 AB	Z 2	14-8 DTU	UXT 2/UXT 6
101 000 027 AC	Z 2	14-8 DTU	UXT 2/UXT 6
101 000 029 AB	Z 127	14 KGR-7 KQU	–
101 000 033 AA	Z 90	14 FGH-7 DTURX	UXT 1/UXT 3
101 000 033 AB	Z 89	14 FGH-6 DTUR	UXT 5
101 000 033 AC	Z 246	14 FGH-8 DTURW	UXT 1/UXT 3
101 000 033 AF	Z 90	14 FGH-7 DTURX	UXT 1/UXT 3
101 000 033 AG	Z 121	14 FGH-8 DTURXO	UXT 9
101 000 034 AA	Z 61	14-7 DUO	UXT 2/UXT 6
101 000 035 AB	Z 128	14 FG-8 DTU	UXT 1/UXT 3
101 000 035 AH	Z 173	14 FGR-8 KQU	–
101 000 035 HJ	Z 145	14 FGR-6 DDU	–
101 000 036 AA	Z 91	14 GH-7 DTUR	UXT 2/UXT 6
101 000 036 AB	Z 92	14 GH-8 DTUR	UXT 2/UXT 6
101 000 036 AC	Z 93	14 GH-8 DTURX	UXT 2/UXT 6
101 000 038 AA	Z 75	14 G-8 DTU	UXT 2/UXT 6
101 000 038 AB	Z 94	14 GR-8 DTU	UXT 2/UXT 6
101 000 039 AA	Z 75	14 G-8 DTU	UXT 2/UXT 6
101 000 039 AB	Z 94	14 GR-8 DTU	UXT 2/UXT 6
101 000 040 AC	Z 92	14 GH-8 DTUR	UXT 2/UXT 6
101 000 040 AD	Z 91	14 GH-7 DTUR	UXT 2/UXT 6
101 000 040 AE	Z 93	14 GH-8 DTURX	UXT 2/UXT 6
101 000 041 AC	Z 90	14 FGH-7 DTURX	UXT 1/UXT 3
101 000 041 AE	Z 89	14 FGH-6 DTUR	UXT 5
101 000 041 AF	Z 246	14 FGH-8 DTURW	UXT 1/UXT 3
101 000 041 AG	Z 121	14 FGH-8 DTURXO	UXT 9
101 000 045 AA	Z 90	14 FGH-7 DTURX	UXT 1/UXT 3
101 000 050 AA	Z 92	14 GH-8 DTUR	UXT 2/UXT 6
101 000 050 AB	Z 92	14 GH-8 DTUR	UXT 2/UXT 6
101 000 050 AC	Z 91	14 GH-7 DTUR	UXT 2/UXT 6
101 000 051 AA	Z 90	14 FGH-7 DTURX	UXT 1/UXT 3
101 000 052 AA	Z 127	14 KGR-7 KQU	–
101 000 052 AB	Z 144	14 KGR-6 KQU	–
101 000 053 AA	Z 79	14 F-9 DUO	UXT 1/UXT 3
101 000 054 AC	Z 172	14 FGR-7 KQU	–
101 000 055 AA	Z 101	14 F-8 LDUSR	UXT 1/UXT 3
101 000 062 AB	Z 176	14 F-7 HPURX2	–
101 000 063 AA	Z 188	14 F-7 DPUR02	UXT 10
101 000 065 AA	Z 188	14 F-7 DPUR02	UXT 10
101 000 068 AA	Z 300	14 FGR-6 HQU	–
101 905 600	Z 176	14 F-7 HPURX2	–
101 905 600 A	Z 176	14 F-7 HPURX2	–
101 905 600 C	Z 176	14 F-7 HPURX2	–
101 905 601	Z 176	14 F-7 HPURX2	–
101 905 601 B	Z 200	14 F-7 HUR2	–
101 905 601 F	Z 200	14 F-7 HUR2	–
101 905 603 B	Z 200	14 F-7 HUR2	–
101 905 607	Z 213	14 FGR-7 KDU6	–
101 905 610 A	Z 193	14 FR-7 DU2	UXT 1/UXT 3
101 905 615 A	Z 239	14 FGR-7 KQE	–
101 905 616	Z 239	14 FGR-7 KQE	–
101 905 617	Z 200	14 F-7 HUR2	–
101 905 620	Z 236	14 F-6 HTPRX02	–
101 905 621 A	Z 295	14 F-6 DTPR02	UXT 12
101 905 621 B	Z 295	14 F-6 DTPR02	UXT 12
101 905 631	Z 347	14 F-5 DPUR02	
101 905 631 B	Z 347	14 F-5 DPUR02	
101 905 631 H	Z 347	14 F-5 DPUR02	
101 905 631 F	Z 321	14 F-7 KPPRU2	UXT 10
101 905 640 D	Z 295	14 F-6 DTPR02	UXT 12
101 905 641	Z 339	14 F-4 NBPR	
171 911 261 A	GR 001		
171 911 261 B	GR 001		
171 911 261 D	GR 031		
171 911 261 E	GR 031		

VW AG	BERU		
191 905 450	Z 51	14-6 DTU	UX 56
191 905 450 A	Z 12	14-7 DTU	UXT 2/UXT 6
191 905 450 B	Z 2	14-8 DTU	UXT 2/UXT 6
191 905 450 C	Z 44	14-5 DTU	UX 56
191 905 450 G	Z 52	14 F-6 DTU	UXT 5
191 905 450 H	Z 12	14-7 DTU	UXT 2/UXT 6
191 905 450 J	Z 52	14 F-6 DTU	UXT 5
191 905 450 K	Z 2	14-8 DTU	UXT 2/UXT 6
191 905 450 L	Z 42	14-5 DU	UX 56
191 905 450 M	Z 22	14-6 DU	UX 56
191 905 450 N	Z 61	14-7 DUO	UXT 2/UXT 6
191 905 450 P	Z 69	14-8 DUO	UXT 2/UXT 6
191 905 452	Z 42	14-5 DU	UX 56
191 905 452 A	Z 22	14-6 DU	UX 56
191 905 452 B	Z 61	14-7 DUO	UXT 2/UXT 6
191 905 452 C	Z 69	14-8 DUO	UXT 2/UXT 6
191 905 452 D	Z 44	14-5 DTU	UX 56
191 905 452 E	Z 51	14-6 DTU	UX 56
191 905 452 F	Z 12	14-7 DTU	UXT 2/UXT 6
191 905 452 G	Z 2	14-8 DTU	UXT 2/UXT 6
191 905 452 H	Z 52	14 F-6 DTU	UXT 5
191 911 261 A	GR 031		
191 911 261 C	GR 031		
211 963 319	GH 16		
211 963 319 A	GH 22		
251 963 311 A	GH 648		
251 963 319 A	GH 648		
251 963 319 C	GH 30		
251 963 319 D	GH 408		
251 963 319 E	GH 847		
251 963 319 F	GH 648		
311 963 091 D	GH 195		
321 911 261	GR 031		
321 911 261 C	GR 031		
411 963 319	GH 13		
443 911 261	GR 031		
443 911 261 C	GR 031		
637 060 1	GD 214		
701 963 319	GHA 408		
7D0 963 319	GH 001		
867 911 261 C	GR 031		
8E0 963 115	GH 306		
N 012 812 36	Z 11	14-7 DU	UXT 2/UXT 6
N 017 801 1	Z 57	14-7 AU	–
N 017 801 2	Z 57	14-7 AU	–
N 017 801 3	Z 39	14 Z-4 AU	–
N 017 801 7	Z 57	14-7 AU	–
N 017 801 8	Z 57	14-7 AU	–
N 017 801 11	Z 57	14-7 AU	–
N 017 801 13	Z 57	14-7 AU	–
N 017 802 1	Z 57	14-7 AU	–
N 017 802 13	Z 57	14-7 AU	–
N 017 803 9	Z 57	14-7 AU	–
N 017 811 1	Z 58	14-7 CU	–
N 017 811 6	Z 42	14-5 DU	UX 56
N 017 811 8	Z 58	14-7 CU	–
N 017 811 11	Z 38	14 Z-3 CU	–
N 017 811 12	Z 22	14-6 DU	UX 56
N 017 811 13	Z 22	14-6 DU	UX 56
N 017 811 14	Z 22	14-6 DU	UX 56
N 017 811 16	Z 38	14 Z-3 CU	–
N 017 811 17	Z 58	14-7 CU	–
N 017 811 18	Z 22	14-6 DU	UX 56
N 017 811 19	Z 58	14-7 CU	–
N 017 811 20	Z 22	14-6 DU	UX 56
N 017 811 21	Z 11	14-7 DU	UXT 2/UXT 6



VW AG	BERU		
N 017 811 22	Z 22	14-6 DU	UX 56
N 017 811 23	Z 42	14-5 DU	UX 56
N 017 811 24	Z 58	14-7 CU	–
N 017 811 25	Z 42	14-5 DU	UX 56
N 017 811 26	Z 1	14-8 DU	UXT 2/UXT 6
N 017 811 27	Z 11	14-7 DU	UXT 2/UXT 6
N 017 811 28	Z 11	14-7 DU	UXT 2/UXT 6
N 017 811 30	Z 58	14-7 CU	–
N 017 811 31	Z 11	14-7 DU	UXT 2/UXT 6
N 017 811 32	Z 42	14-5 DU	UX 56
N 017 811 36	Z 1	14-8 DU	UXT 2/UXT 6
N 017 811 39	Z 11	14-7 DU	UXT 2/UXT 6
N 017 811 40	Z 12	14-7 DTU	UXT 2/UXT 6
N 017 811 41	Z 22	14-6 DU	UX 56
N 017 811 47	Z 1	14-8 DU	UXT 2/UXT 6
N 017 811 48	Z 1	14-8 DU	UXT 2/UXT 6
N 017 811 49	Z 42	14-5 DU	UX 56
N 017 811 50	Z 22	14-6 DU	UX 56
N 017 811 51	Z 11	14-7 DU	UXT 2/UXT 6
N 017 811 52	Z 22	14-6 DU	UX 56
N 017 811 53	Z 1	14-8 DU	UXT 2/UXT 6
N 017 811 54	Z 12	14-7 DTU	UXT 2/UXT 6
N 017 811 55	Z 22	14-6 DU	UX 56
N 017 811 56	Z 2	14-8 DTU	UXT 2/UXT 6
N 017 811 57	Z 51	14-6 DTU	UX 56
N 017 811 58	Z 2	14-8 DTU	UXT 2/UXT 6
N 017 811 59	Z 42	14-5 DU	UX 56
N 017 811 60	Z 51	14-6 DTU	UX 56
N 017 811 61	Z 51	14-6 DTU	UX 56
N 017 811 63	Z 76	14-9 DU	UXT 2/UXT 6
N 017 811 64	Z 12	14-7 DTU	UXT 2/UXT 6
N 017 811 65	Z 2	14-8 DTU	UXT 2/UXT 6
N 017 811 66	Z 11	14-7 DU	UXT 2/UXT 6
N 017 811 67	Z 44	14-5 DTU	UX 56
N 017 811 68	Z 12	14-7 DTU	UXT 2/UXT 6
N 017 811 69	Z 44	14-5 DTU	UX 56
N 017 811 70	Z 58	14-7 CU	–
N 017 811 71	Z 42	14-5 DU	UX 56
N 017 811 72	Z 12	14-7 DTU	UXT 2/UXT 6
N 017 811 73	Z 51	14-6 DTU	UX 56
N 017 811 74	Z 51	14-6 DTU	UX 56
N 017 811 75	Z 1	14-8 DU	UXT 2/UXT 6
N 017 811 76	Z 42	14-5 DU	UX 56
N 017 811 77	Z 22	14-6 DU	UX 56
N 017 811 78	Z 61	14-7 DUO	UXT 2/UXT 6
N 017 811 79	Z 69	14-8 DUO	UXT 2/UXT 6
N 017 812 1	Z 58	14-7 CU	–
N 017 812 4	Z 22	14-6 DU	UX 56
N 017 812 6	Z 42	14-5 DU	UX 56
N 017 812 7	Z 12	14-7 DTU	UXT 2/UXT 6
N 017 812 9	Z 42	14-5 DU	UX 56
N 017 812 11	Z 38	14 Z-3 CU	–
N 017 812 12	Z 22	14-6 DU	UX 56
N 017 812 13	Z 22	14-6 DU	UX 56
N 017 812 15	Z 58	14-7 CU	–
N 017 812 18	Z 42	14-5 DU	UX 56
N 017 812 19	Z 11	14-7 DU	UXT 2/UXT 6
N 017 812 20	Z 22	14-6 DU	UX 56
N 017 812 21	Z 42	14-5 DU	UX 56
N 017 812 22	Z 58	14-7 CU	–
N 017 812 23	Z 22	14-6 DU	UX 56
N 017 812 24	Z 1	14-8 DU	UXT 2/UXT 6
N 017 812 25	Z 58	14-7 CU	–
N 017 812 27	Z 11	14-7 DU	UXT 2/UXT 6
N 017 812 30	Z 11	14-7 DU	UXT 2/UXT 6
N 017 812 34	Z 1	14-8 DU	UXT 2/UXT 6

VW AG	BERU		
N 017 812 35	Z 42	14-5 DU	UX 56
N 017 812 36	Z 11	14-7 DU	UXT 2/UXT 6
N 017 812 37	Z 22	14-6 DU	UX 56
N 017 812 39	Z 42	14-5 DU	UX 56
N 017 812 40	Z 22	14-6 DU	UX 56
N 017 812 41	Z 1	14-8 DU	UXT 2/UXT 6
N 017 812 44	Z 42	14-5 DU	UX 56
N 017 812 46	Z 12	14-7 DTU	UXT 2/UXT 6
N 017 812 47	Z 44	14-5 DTU	UX 56
N 017 812 48	Z 51	14-6 DTU	UX 56
N 017 812 49	Z 12	14-7 DTU	UXT 2/UXT 6
N 017 812 50	Z 2	14-8 DTU	UXT 2/UXT 6
N 017 812 51	Z 44	14-5 DTU	UX 56
N 017 812 52	Z 12	14-7 DTU	UXT 2/UXT 6
N 017 812 56	Z 2	14-8 DTU	UXT 2/UXT 6
N 017 812 57	Z 69	14-8 DUO	UXT 2/UXT 6
N 017 812 58	Z 61	14-7 DUO	UXT 2/UXT 6
N 017 812 60	Z 42	14-5 DU	UX 56
N 017 813 1	Z 58	14-7 CU	–
N 017 813 3	Z 58	14-7 CU	–
N 017 813 6	Z 22	14-6 DU	UX 56
N 017 813 7	Z 22	14-6 DU	UX 56
N 017 813 8	Z 42	14-5 DU	UX 56
N 017 813 9	Z 22	14-6 DU	UX 56
N 017 813 10	Z 22	14-6 DU	UX 56
N 017 813 11	Z 1	14-8 DU	UXT 2/UXT 6
N 017 813 12	Z 22	14-6 DU	UX 56
N 017 813 13	Z 22	14-6 DU	UX 56
N 017 813 14	Z 58	14-7 CU	–
N 017 813 15	Z 58	14-7 CU	–
N 017 813 16	Z 42	14-5 DU	UX 56
N 017 813 17	Z 42	14-5 DU	UX 56
N 017 813 18	Z 22	14-6 DU	UX 56
N 017 813 19	Z 11	14-7 DU	UXT 2/UXT 6
N 017 813 20	Z 11	14-7 DU	UXT 2/UXT 6
N 017 813 24	Z 22	14-6 DU	UX 56
N 017 813 26	Z 11	14-7 DU	UXT 2/UXT 6
N 017 813 30	Z 22	14-6 DU	UX 56
N 017 813 32	Z 42	14-5 DU	UX 56
N 017 813 33	Z 11	14-7 DU	UXT 2/UXT 6
N 017 813 39	Z 42	14-5 DU	UX 56
N 017 813 40	Z 11	14-7 DU	UXT 2/UXT 6
N 017 813 42	Z 11	14-7 DU	UXT 2/UXT 6
N 017 813 43	Z 42	14-5 DU	UX 56
N 017 813 45	Z 44	14-5 DTU	UX 56
N 017 813 46	Z 51	14-6 DTU	UX 56
N 017 813 47	Z 12	14-7 DTU	UXT 2/UXT 6
N 017 813 50	Z 12	14-7 DTU	UXT 2/UXT 6
N 017 813 53	Z 42	14-5 DU	UX 56
N 017 813 54	Z 22	14-6 DU	UX 56
N 017 813 55	Z 69	14-8 DUO	UXT 2/UXT 6
N 017 821 1	Z 11	14-7 DU	UXT 2/UXT 6
N 017 832 1	Z 42	14-5 DU	UX 56
N 017 832 2	Z 42	14-5 DU	UX 56
N 019 081 1	GN 857		
N 019 081 2	GN 857		
N 019 081 4	GN 857		
N 019 097 1	GN 857		
N 019 100 01	GN 857		
N 019 100 2	GN 857		
N 019 100 5	GN 857		
N 019 100 6	GN 857		
N 100 807 1	Z 52	14 F-6 DTU	UXT 5
N 100 807 02	Z 52	14 F-6 DTU	UXT 5
N 101 172 01	Z 52	14 F-6 DTU	UXT 5
N 101 251 05	Z 18	14 K-7 DUO	UXT 4

VW AG	BERU		
N 101 401 01	GN 855		
N 101 401 02	GN 855		
N 101 401 03	GN 855		
N 101 401 04	GN 855		
N 101 401 05	GN 855		
N 102 130 01	GN 857		
N 102 130 02	GN 857		
N 103 021 01	GN 928		
N 103 021 02	GN 928		
N 105 792 01	GN 046		
N 105 792 02	GN 046		
N 105 798 02	GE 101		
N 105 916 02	GE 100		
N 105 916 03	GE 100		
Z 057 003	Z 57	14-7 AU	-
Z 057 004	Z 58	14-7 CU	-
Z 057 005	Z 1	14-8 DU	UXT 2/UXT 6
Z 057 008	Z 58	14-7 CU	-
Z 057 011	Z 11	14-7 DU	UXT 2/UXT 6
Z 057 012	Z 42	14-5 DU	UX 56
Z 057 020	Z 52	14 F-6 DTU	UXT 5
Z 057 023	Z 22	14-6 DU	UX 56
Z 057 037	Z 58	14-7 CU	-
Z 057 040	Z 22	14-6 DU	UX 56
Z 057 047	Z 108	G 3/18	-
Z 057 056	Z 11	14-7 DU	UXT 2/UXT 6
Z 057 057	Z 58	14-7 CU	-
Z 057 058	Z 42	14-5 DU	UX 56
Z 057 059	Z 58	14-7 CU	-
Z 057 060	Z 57	14-7 AU	-
Z 057 062	Z 22	14-6 DU	UX 56
Z 057 064	Z 57	14-7 AU	-
Z 057 065	Z 58	14-7 CU	-
Z 057 066	Z 44	14-5 DTU	UX 56
Z 057 067	Z 51	14-6 DTU	UX 56
Z 057 068	Z 12	14-7 DTU	UXT 2/UXT 6
Z 057 069	Z 2	14-8 DTU	UXT 2/UXT 6
Z 057 073	Z 52	14 F-6 DTU	UXT 5
Z 057 127	Z 1	14-8 DU	UXT 2/UXT 6
Z 057 136	Z 1	14-8 DU	UXT 2/UXT 6
Z 057 140	Z 42	14-5 DU	UX 56
Z 057 141	Z 22	14-6 DU	UX 56
Z 057 142	Z 61	14-7 DUO	UXT 2/UXT 6
Z 057 143	Z 69	14-8 DUO	UXT 2/UXT 6
Z 057 145	Z 18	14 K-7 DUO	UXT 4
Z 057 173	Z 105	14 F-6 DSR	UXT 5
Z 057 200		SR 028	

WÄRTSILÄ	BERU		
12041709	GV 361		
DZ 12041709	GV 361		

WAUKESHA	BERU		
60999 Z	Z 202	18 GZ 6-77-2	-
69919 A	Z 179	18 GZ 4-77	-
69919 C	Z 179	18 GZ 4-77	-
69919 D	Z 202	18 GZ 6-77-2	-

WEBASTO	BERU		
122 793	GH 846	-	-
157 915	GH 846	-	-
169 587	GH 359	-	-
270 067	GH 18	-	-

WEBASTO	BERU		
277 584	GH 21	-	-
331 414	GH 18	-	-
400 211	GH 409	-	-
400 238	GH 410	-	-
462 799	GH 847	-	-
479 594	GH 847	-	-

WEHRLE	BERU		
51 216 001	GR 064	-	-
51 216 003	GR 064	-	-
51 216 901	GR 064	-	-

ZETTELMAYER	BERU		
M 96 521	GV 136		

ZUENDAPP	BERU		
247 07 106	Z 57	14-7 AU	-
250 07 604	Z 57	14-7 AU	-
265 07 101	Z 57	14-7 AU	-
276 07 106	Z 39	14 Z-4 AU	-
280 07 140	Z 58	14-7 CU	-
280 07 142	Z 11	14-7 DU	UXT 2/UXT 6
280 07 143	Z 42	14-5 DU	UX 56
284 07 125	Z 38	14 Z-3 CU	-
285 07 172	Z 38	14 Z-3 CU	-

- \* установить расстояние между электродами
- \*\* Учитывать состояние программного обеспечения!
- не требуется
- нет в программе
- 14 Транзисторное устройство зажигания
- 15 Устройство предварительного нагрева охлаждающей воды
- 16 Отопление при неработающем двигателе
- 17 частично
- 18 жарозащитная труба
- 19 Крепление посредством накидной гайки
- 20 пока хватит запаса
- 21 без спецификации автомобиля
- 22 Моноблок / гайка SAE не отвинчивается
- 23 Все модели
- 24 Старые модели
- 25 Ведомственные автомобили
- 26 № заказа
- 27 синий
- 28 Практичный измерительный инструмент для измерения и настройки межэлектродного расстояния
- 29 Крышка
- 30 уплотняющее кольцо
- 31 уплотняющее кольцо /графитное кольцо
- 32 Гибкое вспомогательное приспособление для монтажа обеспечивает быстрое и надежное ввинчивание и отвинчивание свечей зажигания. Свечи необходимо лишь ослабить или, соответственно, затянуть (соблюдать крутящие моменты затяжки, указанные изготовителем). Идеально подходит для труднодоступных мест монтажа. Предотвращается повреждение резьбы головки цилиндра и свечи зажигания в результате неровной посадки. Свечи зажигания не могут упасть в отсек двигателя. Сохраняется постоянное межэлектродное расстояние.
- 33 Прессштулка
- 34 Шаблон межэлектродного расстояния
- 35 Запасная кнопка из бакелита
- 36 Запасная кнопка из резины
- 37 Цилиндрическая уплотнительная посадка
- 38 для грузовых автомобилей, автобусов и т.п.
- 39 для устройств управления магнитных клапанов
- 40 для тракторов с резьбовым креплением
- 41 Герметичное исполнение с изоляцией подключений
- 42 Герметичное исполнение с биметаллическим контактом
- 43 желтый
- 44 Резьба
- 45 Резьбовое крепление M 26 x 1, кабельное подключение с изоляцией контактов по DIN 72 525 FS для пластмассовой приборной панели
- 46 Пусковые переключатели накаливания
- 47 Оснастка свечей накаливания и запасные части
- 48 Устройство контроля зажигания
- 49 Ножницы для подрезки кустарника
- 50 Двигатели малой мощности
- 51 Компостирующая машина
- 52 Компрессоры
- 53 конус
- 54 Зерноуборочный комбайн
- 55 Косилка
- 56 Тракторная косилка
- 57 Усиленная металлическая крышка
- 58 с регулированием подачи топлива в зависимости от температуры (биметаллический клапан)
- 59 план
- 60 Гайка с накаткой
- 61 Машина для пневматической подачи травы
- 62 Машина для всасывания и пневматической подачи травы
- 63 Двигатели гоночных автомобилей
- 64 Роторная газонокосилка
- 65 Стержневые пламенные свечи накаливания для устройств управления магнитных клапанов
- 66 Стационарные двигатели
- 67 Моторный вагон
- 68 перестроить
- 69 Негерметичное исполнение
- 70 Сопротивления предварительных цепей свечей накаливания
- 71 Предварительное сопротивление
- 72 Стержневые пламенные свечи накаливания со спиралью
- 73 аналогично KOB5, но для приборной панели из листового металла
- 74 Вспомогательное приспособление для монтажа свечей зажигания
- 75 Стержневые свечи накаливания – двухполюсные
- 76 коническая уплотнительная посадка
- 77 сокращенное название
- 78 Детальный разрез
- 79 Выдавленная стрелка направления потока
- 80 Плоский штекер по DIN
- 81 Направление потока
- 82 глубина
- 83 2-стержневые типы
- 84 12-вольтовые системы
- 85 24-вольтовые системы
- 86 Гайка свечи SAE
- 87 Перекодировка № заказа первого оборудования (OE) → № торгового заказа (AM)
- 88 Платиновые свечи зажигания
- 89 Специальные свечи зажигания
- 90 Ширина зева ключа: 14 мм
- 102 Кабель
- 110 двойное зажигание
- 111 Автомобили с блокировкой запуска двигателя
- 112 Запасные типы
- 151 Кольцевая проушина
- 153 Для простой и надежной замены свечей зажигания без перекоса ключа и без трещин в изоляторе
- 154 Смазка для штекера провода к свече зажигания
- 155 – предотвращает перебои искрообразования и пробои высокого напряжения
- 156 – предотвращает спекание штекера провода и свечи зажигания, что облегчает съем штекера и снижает опасность его повреждения
- 157 – для оптимальной электроизоляции
- 158 При каждой замене свечей зажигания смазать (изнутри) штекер свечи зажигания.
- 159 10 г в тубике.
- 160 Система Instant Start System (ISS) фирмы Beru
- 161 Переналадка возможна лишь до 4 цилиндров, 12 В
- 171 12-гранный ключ BERU для 12-гранных свечей зажигания
- 172 – приводная квадратная головка 3/8"
- 173 – удерживающий магнит: для надежной фиксации даже замазанных свечей
- 174 – шестигранник с наружным размером 17 мм на конце привода
- 175 – скругленные углы: чтобы исключить повреждение свечей зажигания
- 176 – высококачественная хром-ванадиевая сталь, блестящая хромированная поверхность
- 181 Ассортименты изготовителя – Свечи накаливания
- 182 Ассортименты изготовителя – Реле времени накаливания
- 183 Ассортименты изготовителя – Свечи зажигания
- 201 Свечи накаливания - инструменты
- 202 Развертка
- 205 Кольцевой динамометрический ключ
- 211 Винтовая резьба
- 212 Круглый штекерный соединитель
- 213 Транспортное средство, специальное
- 225 Факельная свеча накаливания
- 226 Лампа
- 227 Выключатель
- 228 Электромагнитный клапан
- 238 Перекодирование деталей других изготовителей → BERU
- 251 Смазка для штекера свечи зажигания
- 252 Смазать тонким слоем головку свечи зажигания, вставить штекер. Предотвращает коррозию точек контакта. Обеспечивает 100%-ную изоляцию. тубик 10 г
- 298 Пусковые устройства воспламенения
- 299 Металлоокисный очиститель
- 300 Песок для устройства пескоструйной очистки и контроля свечей зажигания
- 302 короткий
- 303 длинный
- 304 автоматическая система накаливания
- 305 без устройства облегчения пуска
- 306 с устройством облегчения пуска

Beneficiarse de la ayuda de ventas planificada de BERU!

Approfittate dell'efficiente supporto vendite BERU!

Продуманная поддержка продажи БЕРУ выгодна для Вас!

### 1.) Display:

Presente un total de 180 envases de 4 bujías sobre una superficie de ventas mínima. Formato: anchura 50 cm, altura 180 cm, profundidad 34 cm

### 1.) Espositore:

Presentate fino a 180 confezioni di candele di accensione da 4 unità in uno spazio di vendita minimo! Formato: larghezza 50 cm, altezza 180 cm, profondità 34 cm

### 1.) Display:

Презентируйте на минимальной торговой площади до 180 упаковок по 4 свечи зажигания. Формат: ширина 50 см, высота 180 см, глубина 34 см

### 2.) Estantería de pared:

Estantería de pared para 200 bujías de encendido o bujías de incandescencia envasadas en cartones de 10 unidades, en envases SB de 4 unidades o bolsitas individuales. Con múltiples aplicaciones – de pie sobre el mostrador, montado en la pared o colgado en un sistema SB. Formato: anchura 50 cm, altura 45 cm, profundidad 20 cm

### 2.) Scaffale a parete:

Scaffale a muro per 200 candele di accensione o ad incandescenza confezionate in cartoni da 10 pezzi, in confezioni SB da 4 unità o in singole scatole pieghevoli. Uso versatile – da banco, appesi al muro o agganciati in un sistema SB. Formato: larghezza 50 cm, altezza 45 cm, profondità 20 cm

### 2.) Настенная полка:

Настенный стеллаж для 200 свеч зажигания или ламп накаливания, упакованных в картонные коробки по 10 штук, в упаковки SB по 4 штуки или в отдельные складные картонные коробки. Разностороннее применение - установка на прилавке, монтаж на стене или навешивание в систему SB. Формат: ширина 50 см, высота 45 см, глубина 20 см

1



## Federal-Mogul Product Warranty

The products listed in this catalog can be used in all vehicles/engines in accordance with our recommendation. Recognisable mistakes or obvious printing errors are subject to the diligence of the user. Federal-Mogul warrants the faultless performance and specified properties according to the respective standards of technology. If BERU products which are used in accordance with our recommendations are proven to have caused damage to an engine, we will cover the resulting costs of rectifying the damage in line with our Federal-Mogul Terms and Conditions of Sale which can be obtained from [www.federalmogul.com/en/AftermarketSolutions/EMEA](http://www.federalmogul.com/en/AftermarketSolutions/EMEA). Following submission of BERU products claimed to be defective as well as damaged engine parts and repair bills, we reserve the right to examine the claims and to decide based on the outcome of our analysis whether or not reimbursements will be made. Generally prerequisite is the correct use of the BERU products. The warranty period for material flaws or faulty workmanship is 24 months from the date of purchase. Normal wear and tear are excluded.

## Federal-Mogul Produktgewährleistung

Die in diesem Katalog aufgeführten Produkte können in allen Fahrzeugen/Motoren entsprechend unserer Empfehlung verwendet werden. Erkennbarer Irrtum oder offensichtliche Druckfehler unterliegen der Sorgfaltpflicht des Verwenders. Für die Fehlerfreiheit leistet Federal-Mogul Gewähr entsprechend dem jeweiligen Stand der Technik. Werden BERU Produkte gemäß unseren Empfehlungen verwendet und entstehen hierdurch trotzdem nachweisbare Schäden am Motor, übernehmen wir die entstandenen Kosten für die Behebung des Schadens gemäß den Federal-Mogul Geschäfts- und Lieferbedingungen. Die Allgemeinen Geschäfts- und Lieferbedingungen sind nachzulesen unter [www.federalmogul.com/en/AftermarketSolutions/EMEA](http://www.federalmogul.com/en/AftermarketSolutions/EMEA). Nach Vorlage beanstandeter BERU Produkte, beschädigter Motorenteile und Reparaturbelege trifft Federal-Mogul die Entscheidung über eine Kostenübernahme. Grundvoraussetzung dafür ist generell die sachgemäße Handhabung der BERU Produkte. Die Gewährleistungsfrist für mangelhafte Produkte beträgt 24 Monate ab Kaufdatum. Ausgenommen davon ist normaler Verschleiß.

## Garantie produit Federal-Mogul

Les produits figurant dans ce catalogue peuvent être utilisés dans tous les véhicules/moteurs selon nos recommandations. Les erreurs reconnaissables ou les erreurs d'impression évidentes tombent sous l'obligation d'attention de l'utilisateur. Federal-Mogul garantit l'absence d'erreurs et les propriétés annoncées sur la base de l'état de la technique existante. Lorsque les produits BERU sont utilisés conformément à nos recommandations et que, suite à cela, le moteur subit malgré tout des dommages pouvant être prouvés, nous supportons les coûts engendrés pour éliminer ces dommages en accord avec les conditions de vente de Federal-Mogul qui sont disponibles sur [www.federalmogul.com/en/AftermarketSolutions/EMEA](http://www.federalmogul.com/en/AftermarketSolutions/EMEA). Après présentation des produits BERU faisant l'objet d'une réclamation, des pièces de moteur endommagées et des factures de réparation, Federal-Mogul prend la décision concernant la prise en charge des coûts. La condition préalable fondamentale pour cela est en général l'utilisation conforme des produits BERU. La période de garantie de nos produits est de 24 mois à partir de la date d'achat. L'usure normale en est exclue.

## Гарантия на продукцию Federal-Mogul

Указанные в данном каталоге изделия могут использоваться во всех транспортных средствах/двигателях согласно нашим рекомендациям. Federal-Mogul не несет ответственности за явные недоразумения и опечатки, их обнаружение входит в обязанности пользователя. Federal-Mogul гарантирует безотказную работу изделий в соответствии со спецификациями и установленными стандартами существующих технологий. Если изделия BERU, несмотря на применение в соответствии с нашими рекомендациями, оказались подтвержденной причиной повреждения двигателя, Federal-Mogul возьмет на себя расходы по устранению повреждения в строгом соответствии с положениями Условий делового сотрудничества с Federal-Mogul. Данная информация доступна по ссылке [www.federalmogul.com/en/AftermarketSolutions/EMEA](http://www.federalmogul.com/en/AftermarketSolutions/EMEA). После предоставления изделий BERU с предположительным дефектом изготовления, а также поврежденных деталей двигателя и документов, подтверждающих выполнение ремонта, Federal-Mogul оставляет за собой право проанализировать претензии и принять решение на основании проведенного анализа о необходимости возмещения ущерба. Неотъемлемым условием признания гарантийного характера поломки является правильность применения изделий BERU. Гарантийный срок на повреждения, вызванные недостатками материала или качества изготовления, составляет 24 месяца с даты покупки изделия и не распространяется на нормальный износ.

## Federal-Mogul termékjótállás

Az ebben a katalógusban felsorolt termékek minden általunk javasolt járműben/ motorban használhatóak. Felismerhető tévedések vagy nyilvánvaló nyomdahibák esetén, a felhasználók gondossági kötelezettsége érvényesül. A Federal-Mogul garantiája a hibamentes működést és a feltüntetett tulajdonságokat a mindenkori technika standardja szerint. Ha a BERU termékeket az ajánlásunknak megfelelően alkalmazzák és a motoron ennek ellenére bizonyítható meghibásodás lép fel, akkor teljes mértékben vagy részben átvesszük a hibák elhárításának a költségét a [www.federalmogul.com/en/AftermarketSolutions/EMEA](http://www.federalmogul.com/en/AftermarketSolutions/EMEA) weblapról letölthető Federal-Mogul Általános Üzleti Feltételek szerint. Kifogásolt BERU termékek, vagy meghibásodott motorrészek és javítási számlák felmutatása után, a Federal-Mogul jogosult azokat megvizsgálni majd dönt a költségek átvállalásáról. Ennek alapvető feltétele mindig a BERU termékek szakszerű használata. A hibás termékek miatti jótállási idő 24 hónap a beszerzéstől számítva. Kivételt képez ez alól a természetes elhasználódás.

## Garanzia sui prodotti Federal-Mogul

I prodotti contenuti nel presente catalogo possono essere utilizzati in tutti i veicoli/motori secondo le nostre raccomandazioni. I prodotti Federal-Mogul non risponde per errori di contenuto o di stampa palesi, il cui riconoscimento cade sotto la perizia dell'utilizzatore. Federal-Mogul garantisce l'integrità assicurata nell'ambito dei relativi standard tecnologici. Se è possibile comprovare che il motore ha subito danni nonostante che i prodotti BERU siano stati usati rispettando le nostre raccomandazioni, ci prendiamo carico parzialmente o totalmente delle spese causate per la riparazione del danno in linea con i termini e le condizioni di vendita Federal-Mogul reperibili dal sito [www.federalmogul.com/en/AftermarketSolutions/EMEA](http://www.federalmogul.com/en/AftermarketSolutions/EMEA). Federal-Mogul decide sul risarcimento dei danni dietro presentazione dei prodotti BERU reclamati, dei componenti del motore danneggiati e delle relative fatture, a condizione che i prodotti BERU siano stati manipolati correttamente. Come dalle nostre condizioni generali di contratto, la garanzia per prodotti difettosi è di 24 mesi, decorrenti dalla data dell'acquisto, ad eccezione di danni o difetti causati da normale usura.

## Federal-Mogul Garantía de producto

Los productos incluidos en este catálogo, deben utilizarse en los vehículos / motores según y conforme las recomendaciones descritas en la aplicación. Los errores identificables o posibles faltas de impresión evidentes, quedan sujetas al examen esmerado por parte del usuario. Federal-Mogul garantiza el funcionamiento sin fallos y especifica las propiedades de sus productos de acuerdo con los respectivos estándares tecnológicos establecidos. Si en el uso y aplicación de los productos BERU, conforme a las recomendaciones especificadas, surgen daños demostrables en el motor, la empresa asumirá total o parcialmente los costes de los efectos de la avería, en línea con las condiciones y términos de venta establecidos por Federal-Mogul, disponibles en: [www.federalmogul.com/en/AftermarketSolutions/EMEA](http://www.federalmogul.com/en/AftermarketSolutions/EMEA), y tras el análisis de las causas aportadas en la reclamación, piezas dañadas y comprobantes de la reparación. La compañía resolverá la decisión sobre la aceptación de los costes de la avería. Condición básica para ello es por norma el tratamiento técnicamente correcto de los productos BERU. El plazo de garantía sobre productos defectuosos es de 24 meses , desde la fecha de adquisición, Se exceptúa de ello el desgaste previsto del uso normal del producto.

## Εγγύηση προϊόντων Federal-Mogul

Τα προϊόντα, τα οποία αναφέρονται στον κατάλογο αυτό, μπορούν να χρησιμοποιηθούν σε όλα τα οχήματα/κινητήρες σύμφωνα με τη σύστασή μας. Αναγνωρίσιμα λάθη, ή προφανή τυπογραφικά λάθη υπόκεινται στην επιμέλεια του χρήστη. Η Federal-Mogul εγγυάται την αλόγιστατη απόδοση της εκάστοτε ιδιαίτερότητες σύμφωνα με τις αντίστοιχες τεχνολογικές προδιαγραφές. Σε περίπτωση που αποδεδειγμένα προκληθούν ζημιές στον κινητήρα, παρά το γεγονός ότι η χρήση των προϊόντων BERU έγινε σύμφωνα με τις συστάσεις μας, θα καλύψουμε τις προκύπτουσες δαπάνες για την αποκατάσταση της ζημίας, όπως ορίζεται από τους όρους και τις προϋποθέσεις πώλησης των προϊόντων της Federal-Mogul στο [www.federalmogul.com/en/AftermarketSolutions/EMEA](http://www.federalmogul.com/en/AftermarketSolutions/EMEA). Κατόπιν επίδειξης των ελαττωματικών προϊόντων BERU, των εξαρτημάτων κινητήρα με εμφανή ζημία και των αποδεικτικών επισκευής, διατηρούμε το δικαίωμα να εξετάσουμε τη εκάστοτε αξιώσεις και να αποφασίσουμε βασίζομενοι στην έκβασή της ανάλυσής μας εάν οι αποζημιώσεις θα πραγματοποιηθούν ή όχι. Η περίοδος της εγγύησης για ελαττωματικά προϊόντα ανέρχεται σε 24 μήνες από την ημερομηνία της αγοράς .Φυσιολογικές φθορές λόγω χρήσεις αποκλείονται.

## Federal-Mogul Ürün Garantisi

Bu katalogta belirtilen ürünler, yaptığımız öneriye göre tüm araçlar/motolarda kullanılabilir. Belirlenebilen hatalar veya açık baskı hataları, kullancının özeneli davranma yükümlülüğüne tabidir. Federal-Mogul, hatasızlık konusunda mevcut teknolojijk düzeyi uygun olarak garanti vermektedir. BERU ürünleri önerilerimize göre kullanılırsa ve buna rağmen motorda ispatlanbilen hasarlar oluşursa, hasarın giderilmesi için oluşan masrafları Federal-Mogul'un Satış Koşulları çerçevesinde tamamen veya kısmen üstlenmekteyiz. Daha fazla bilgi için [www.federalmogul.com/en/AftermarketSolutions/EMEA](http://www.federalmogul.com/en/AftermarketSolutions/EMEA) sitesini ziyaret ediniz. Şikayet konusu BERU ürünlerinin, hasarlı motor parçalarının ve onarım belgelerinin belgelenmesinden sonra, masrafları üstlenen konusunda karar verilir. Bunun önkoşulu, genel olarak BERU ürünlerinin usulüne uygun şekilde kullanılmasıdır. Kusurlu ürünler için garanti süresi, genel çalışma koşullarımız satın alma tarihinden itibaren 24 aydır. Normal aşınma ve yıpranma bunun dışındadır.

## Gwarancja na produkty Federal-Mogul

Wymienione w niniejszym katalogu produkty mogą być stosowane we wszystkich pojazdach/silnikach zgodnie z naszymi zaleceniami. W ramach obowiązku należytej staranności użytkownika znajduję się wykluczenie dostrzegalnych pomyłek lub widocznych błędów w druku. Firma Federal-Mogul udziela gwarancji na bezusterkowe działanie oraz dotrzymanie deklarowanych właściwości produktów, zgodnie z odpowiednimi standardami technologicznymi. Jeżeli produkty BERU będą stosowane zgodnie z naszymi zaleceniami i pomimo tego dojdzie do dających się udowodnić uszkodzeń silnika, wówczas pokryjemy koszty wynikające z naprawy tych uszkodzeń zgodnie z naszymi Warunkami Sprzedaży, które są dostępne na stronie internetowej: [www.federalmogul.com/en/AftermarketSolutions/EMEA](http://www.federalmogul.com/en/AftermarketSolutions/EMEA) . Po przedłożeniu reklamowanych produktów BERU, a także ewentualnych uszkodzonych części silnika oraz rachunków potwierdzających koszty dokonanych napraw, zastrzegamy sobie prawo do zbadania reklamowanych produktów i na podstawie wyników naszych badań i analiz zdecydowania, czy zwrot kosztów naprawy będzie miał miejsce. Podstawowym warunkiem jest prawidłowe użycie produktów BERU. Okres gwarancji na wady materiałowe i błędy produkcyjne wynosi 24 miesiące od daty zakupu. Gwarancja nie obejmuje zużycia produktu w wyniku eksploatacji.

## Federal-Mogul productgarantie

De in deze catalogus vermelde producten kunnen in alle voertuigen/motoren, mits in overeenstemming met onze aanbevelingen, worden toegepast. Het herkennen van- en het op de juiste wijze omgaan met duidelijk als dusdanig herkenbare vergissingen of drukfouten vallen onder de verantwoordelijkheid van de gebruiker. Federal-Mogul staat garant voor het correct functioneren in overeenstemming met de respectieve stand van de techniek. Als BERU-producten die volgens onze aanbevelingen worden gebruikt, aantoonbaar tot schade aan een motor hebben geleid, worden de kosten voor herstel vergoed op basis van de algemene voorwaarden van Federal-Mogul (zie [www.federalmogul.com/en/AftermarketSolutions/EMEA](http://www.federalmogul.com/en/AftermarketSolutions/EMEA)). Na het overleggen van de bekritiseerde BERU producten, beschadigde motoronderdelen en reparatiefacturen, houden wij ons het recht voor om de claim te onderzoeken en op basis daarvan te besluiten of er een vergoeding wordt verstrekt. Een eerste vereiste daarvoor in het algemeen is het deskundige gebruik van de BERU producten. De garantietermijn voor materiaal- of fabricagefouten bedraagt 24 maanden, op basis van onze algemene voorwaarden en vanaf de datum van aanschaf. Uitgezonderd daarvan is normale slijtage en ondeskundig gebruik.

© Federal-Mogul Global Aftermarket EMEA bvba

All rights reserved. Duplicating, microfilming or storing and processing in electronic systems is not permitted without prior written consent.

© Federal-Mogul Global Aftermarket EMEA bvba

Alle Rechte vorbehalten. Vervielfältigung, Mikroverfilmung und die Einspeicherung und Verarbeitung in elektronischen Systemen ist ohne vorherige schriftliche Zustimmung verboten.

© Federal-Mogul Global Aftermarket EMEA bvba

Tous droits réservés. Duplication, microfilm ou stockage et traitement dans les systèmes électroniques est interdite sans autorisation écrite préalable.

© Federal-Mogul Global Aftermarket EMEA bvba

Все права защищены. Запрещается копирование, микросъемка, хранение и обработка приведенной информации в электронном виде без предварительного письменного разрешения Federal-Mogul.

© Federal-Mogul Global Aftermarket EMEA bvba

Minden jog, fenntartva. Másolás, mikrofilmre vitele vagy tárolása és elektronikus rendszerben felhasználása előzetes írásos engedély nélkül tilos.

© Federal-Mogul Global Aftermarket EMEA bvba

Tutti i diritti riservati. Duplicare, filmare o archiviare elettronicamente per rielaborare i contenuti non è permesso senza la preventiva autorizzazione rilasciata per iscritto.

© Federal-Mogul Global Aftermarket EMEA bvba

Todos los derechos reservados. Cualquier duplicado, microfilmación o reproducción digital queda explícitamente prohibida sin previa autorización escrita

© Federal-Mogul Global Aftermarket EMEA bvba

Όλα τα δικαιώματα προστατεύονται. Η αναπαραγωγή, η φωτογράφιση σε μικροφίλμ ή η αποθήκευση και η επεξεργασία σε ηλεκτρονικά συστήματα δεν επιτρέπονται χωρίς προηγούμενη γραπτή συγκατάθεση.

© Federal-Mogul Global Aftermarket EMEA bvba

Turn hakları saklıdır. Çoğaltma, kopyalama, elektronik sistemlerde kaydetme ve işletmeye yazılı onay bulunmadığı sürece izin verilmemektedir.

© Federal-Mogul Global Aftermarket EMEA bvba

Wszystkie prawa zastrzeżone. Powielanie, wykonywanie mikrofilmów lub przechowywanie i przetwarzanie w systemach elektronicznych nie jest dozwolone bez uprzedniej pisemnej zgody.

© Federal-Mogul Global Aftermarket EMEA bvba

Alle rechten voorbehouden. Vervielfoudigen, op microfilm vastleggen of opslaan en verwerken in elektronische systemen is niet toegestaan zonder voorafgaande schriftelijke toestemming.



Printed in Germany · 16.04.13 · Bestell-Nr. 5 000 004 001  
BERU® is a Registered Trademark of BorgWarner BERU Systems GmbH  
CATBU1302



Global Aftermarket EMEA bvba  
Prins Boudewijnlaan 5  
2550 Kontich • Belgium

[www.federalmogul.com](http://www.federalmogul.com)  
[beru.federalmogul.com](http://beru.federalmogul.com)

[beru@federalmogul.com](mailto:beru@federalmogul.com)

 [www.fmecat.eu](http://www.fmecat.eu)

Perfection  
built in

