



















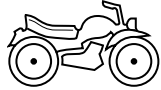



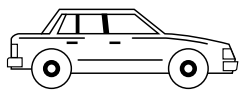

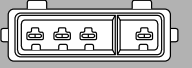
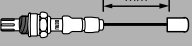















Sensoren
Sensors
Capteurs
Sensoren
Sensores
Sensori
Сенсоры
Czujniki
Αισθητρες
Érzékelok



			18									
			74									
			138									
			176									
			178									
			180									
			181									
			182									
			183									
				Nm			185					
				Nm			242					
				MHz			266					
Ersatztypen	Cross reference list Tipos de recambio Typy zastępcze	Types de remplacement Sistemi di vendita Τύποι ανταλλακτικών	Lijst reserveonderdelen Запасные типы cseretípusok				281					
										282		
D	→	GB	USA	F	NL	E	I	RUS	PL	GR	H	308

Ausgabe 9/07
Mit Erscheinen dieser Ausgabe werden alle seitherigen Ausgaben ungültig.

With the publication of this issue, all previous issues become invalid.

Cette nouvelle édition rend caduques les éditions précédentes

Met het verschijnen van deze uitgave worden alle voorgaande uitgaven ongeldig

Con la publicación de esta edición pierden su validez todas las ediciones publicadas hasta ahora.

Con la comparsa della presente edizione tutte le edizioni precedenti non sono più valide.

С опубликованием данного издания все предыдущие издания теряют силу.

Wraz z ukazaniem się niniejszego wydania wszystkie poprzednie tracą ważność.

Με την κυκλοφορία της παρούσας έκδοσης ακυρώνονται όλες οι προηγούμενες εκδόσεις.

Ennek a kiadásnak a megjelenésé val az összes korábban közölt adat elveszíti érvényességét.



OZH 110	0 824 010 144	Opel, Vauxhall	221
OZH 111	0 824 010 145	Opel	221
OZH 112	0 824 010 146	Opel	221
OZH 113	0 824 010 147	Opel	221
OZH 114	0 824 010 148	Opel	222
OZH 115	0 824 010 149	Opel	222
OZH 118	0 824 010 152	Fiat, Lancia	222
OZH 120	0 824 010 154	Honda, Rover	222
OZH 121	0 824 010 155	Honda	222
OZH 122	0 824 010 156	Honda	223
OZH 123	0 824 010 157	Honda	223
OZH 124	0 824 010 158	Mercedes	223
OZH 125	0 824 010 159	Renault	223
OZH 127	0 824 010 161	Seat, VW	223
OZH 128	0 824 010 162	Audi, Seat, Skoda, VW	224
OZH 130	0 824 010 164	Volvo	224
OZH 131	0 824 010 165	VW	224
OZH 132	0 824 010 166	Opel, Vauxhall	224
OZH 134	0 824 010 168	VW	224
OZH 135	0 824 010 169	Fiat, Lancia	225
OZH 136	0 824 010 170	Fiat	225
OZH 137	0 824 010 171	Fiat	225
OZH 138	0 824 010 172	Lancia	225
OZH 143	0 824 010 177	Mercedes	225
OZH 144	0 824 010 178	Mercedes	226
OZH 145	0 824 010 179	Mercedes	226
OZH 146	0 824 010 180	Mercedes, VW	226
OZH 147	0 824 010 181	Opel	226
OZH 148	0 824 010 182	Opel, Vauxhall	226
OZH 150	0 824 010 184	Seat, VW	227
OZH 151	0 824 010 185	Audi, Ford, Seat, VW	227
OZH 152	0 824 010 186	Audi, VW	227
OZH 153	0 824 010 187	Mazda	227
OZH 154	0 824 010 188	Saab	227
OZH 155	0 824 010 189	Volvo	228
OZH 156	0 824 010 190	Saab	228
OZH 157	0 824 010 191	Saab	228
OZH 158	0 824 010 192	Saab	228
OZH 159	0 824 010 193	Citroën, Fiat, Lancia, Peugeot	228
OZH 160	0 824 010 194	Renault	229
OZH 161	0 824 010 195	Volvo	229
OZH 163	0 824 010 197	Mazda	229
OZH 164	0 824 010 198	Seat	229
OZH 165	0 824 010 199	VW	229
OZH 166	0 824 010 200	Citroën	230
OZH 167	0 824 010 201	BMW	230
OZH 168	0 824 010 202	BMW	230
OZH 169	0 824 010 203	Audi, Seat, Skoda, VW	230
OZH 173	0 824 010 207	Alpina, BMW, Landrover	230
OZH 176	0 824 010 210	Ford	231
OZH 177	0 824 010 211	Audi, Seat, Skoda, VW	231
OZH 178	0 824 010 212	Audi, VW	231
OZH 179	0 824 010 213	Seat, VW	231
OZH 180	0 824 010 214	Fiat, Lancia	231
OZH 181	0 824 010 215	Audi, Ford, VW	232
OZH 182	0 824 010 216	Seat, VW	232
OZH 184	0 824 010 218	Renault	232
OZH 190	0 824 010 224	Audi, VW	232
OZH 192	0 824 010 226	Alfa Romeo	232
OZH 193	0 824 010 227	BMW	233
OZH 194	0 824 010 228	Citroën, Peugeot	233
OZH 196	0 824 010 230	Mercedes	233
OZH 198	0 824 010 232	Mercedes	233

OZH 199	0 824 010 233	BMW	233
OZH 200	0 824 010 234	Mazda, Mercedes	234
OZH 201	0 824 010 235	Nissan	234
OZH 203	0 824 010 237	Nissan	234
OZH 204	0 824 010 238	KIA	234
OZH 205	0 824 010 239	Peugeot	234
OZH 206	0 824 010 240	Peugeot	235
OZH 207	0 824 010 241	KIA	235
OZH 208	0 824 010 242	Renault	235
OZH 209	0 824 010 243	Volvo	235
OZH 210	0 824 010 244	Volvo	235
OZH 215	0 824 010 249	VW	236
OZH 217	0 824 010 251	Alfa Romeo	236
OZH 218	0 824 010 252	BMW	236
OZH 220	0 824 010 254	Mercedes	236
OZH 222	0 824 010 256	BMW	236
OZH 223	0 824 010 257	BMW	237
OZH 224	0 824 010 258	BMW	237
OZH 225	0 824 010 259	Nissan	237
OZH 226	0 824 010 260	Nissan	237
OZH 227	0 824 010 261	Nissan	237
OZH 228	0 824 010 262	Nissan	238
OZH 229	0 824 010 263	Nissan	238



RDE 007	0 532 207 007	Audi, Bentley, Porsche, Volkswagen	270
RDE 008	0 532 207 008	BMW (USA)	270



SD 007	0 192 114 006	Ford	250
SD 008	0 191 315 002	BMW	250
SD 009	0 191 325 007	Mercedes	251
SD 010	0 192 115 013	Mercedes	251



SPR 005	0 824 331 018	Fiat-Allis, MAN, Mercedes	272
SPR 006	0 824 331 021	Mercedes	272
SPR 007	0 824 331 014	Büssing, DAF, Eicher, Hanomag Henschel, Henschel, Ikarus, Kaelble, Kaelble-Gmeinder, Kaessbohrer, KHD, Krupp, Magirus Deutz, MAN, Mercedes, Renault Saviem, Scania, Volvo	272
SPR 008	0 824 331 015	Fiat, Iveco, Henschel, KHD, Mercedes, Saurer, Scania, Volvo	272



SPR 001	0 824 331 004	NSU, Volvo, VW, Agria, Fendt, Hanomag Rheinstahl, Henschel, KHD, MWM	273
SPR 002	0 824 331 011	Audi, Porsche, BOMAG, KHD, Steinbock, Steyr (Steyr-Daimler-Puch AG)	273
SPR 003	0 824 331 010	VW, Porsche	273
SPR 004	0 824 331 025	Audi, Volvo, VW, KHD	273
SPR 009	0 824 331 026	Daihatsu, Subaru, Toyota	273
SPR 010	0 824 331 027	Mitsubishi, Suzuki	273
SPR 011	0 824 331 028	Daihatsu, Isuzu, Toyota	273
SPR 012	0 824 331 029	Daihatsu, Mazda	273
SPR 013	0 824 331 030	Daihatsu, Mazda, Suzuki	274
SPR 014	0 824 331 031	Honda	274
SPR 015	0 824 331 032	Honda, Mazda, Subaru	274
SPR 016	0 824 331 033	Nissan	274
SPR 017	0 824 331 034	Audi, Seat, VW	274
SPR 018	0 824 331 039	GM/Opel, Renault	274
SPR 019	0 824 331 040	Mercedes	274
SPR 020	0 824 331 036	Ford	274
SPR 021	0 824 331 037	Audi, Seat, Skoda, VW	275
SPR 022	0 824 331 038	Audi, Ford, Seat, Skoda, VW	275



ST 089	0 824 111 030	GM/Opel, SAAB	261	●	●						
ST 090	0 824 121 139	Deutz 1012, 1013	262				●				
ST 097	0 824 121 154	Fiat	262		●						
ST 098	0 824 121 155	Ford	262		●						
ST 100	0 824 121 157	Audi, Porsche, Skoda, VW	262		●				●		
ST 101	0 824 121 158	Citroen, Ford, Peugeot, Renault	262						●		
ST 102	0 824 121 159	Seat, Skoda, VW	263		●				●		
ST 103	0 824 121 160	VW	263		●				●		
ST 104	0 824 121 161	VW	263		●				●		
ST 105	0 824 121 162	VW	263		●				●		
ST 106	0 824 121 163	VW	263		●				●		
ST 107	0 824 121 164	VW	263				●				
ST 108	0 824 121 165	Audi, Seat, Skoda, VW	263		●				●		
ST 109	0 824 112 012	Eberspächer B4WSC - 12V	263								●
ST 110	0 824 121 028	BMW	264				●				
ST 112	0 824 111 033	Audi, Seat, Skoda, VW	264	●	●						
ST 113	0 824 111 034	Audi, Seat, Skoda, VW	264	●							
ST 114	0 824 121 168	Audi, Seat, Skoda, VW	264		●						
ST 115	0 824 121 169	Audi, Seat, VW	264		●						
ST 116	0 824 121 170	VW	264				●				
ST 117	0 824 121 171	BMW	264		●						
ST 118	0 824 121 172	VW	264								
ST 119	0 824 121 173	Audi, Seat, Skoda, VW	265		●						
ST 120	0 824 121 174	VW	265				●				
ST 121	0 824 121 175	Audi, Seat, Skoda, VW	265		●						
ST 122	0 824 121 176	Audi	265		●						
ST 123	0 824 121 177	Opel	265						●		

**D**

Ersatztypen	281
Herstellerbezogene Sortimente	276
Produktinformationen	
Bremslichtschalter	272
Lambda-Sonden, Einbauanleitung	193
Öldruckschalter	273
Reifendruck-Kontrollsystem TSS	266
Sensoren	242
Übersetzungen	308
Übersicht nach Typ und Bestellnummer	9
Umschlüsselung Fremdteile → Beru	282
Verwendung	
Bremslichtschalter	178
Lambda-Sonden	18
Öldruckschalter	138
Reifendruck-Kontrollsystem TSS	183
Sensoren	
für Pkw/Nkw	74
für Standheizungen	182
für Stationärmotoren	181
für Lkw, Busse, Traktoren	176
für Motorräder	180

GB USA

Applications	
Brake light switch	178
Lambda Sensors	18
Oil pressure switch	138
Sensors	
for auxiliary heaters	182
for motorbikes	180
for passenger and commercial vehicles	74
for stationary motors	181
for trucks, buses, boats, tractors	176
Tire Safety System TSS	183
Cross reference list	281
General Information	
Brake light switch	272
Lambda Sensors, Installation instructions	193
Oil pressure switch	273
Sensors	242
Tire Safety System TSS	266
Overview by type and order no.	9
Product ranges according to manufacturer	276
Re-coding bought-in parts → BERU	282
Translations	308

F

Assortiments en fonction du fabricant	276
Décryptage pièces d'autres marques → BERU	282
Récapitulatif par type et référence	9
Remarques générales	
Capteurs	242
Interrupteur des feux de freins	272

Pressostat d'huile	273
Sondes Lambda, Notice de montage	193
Système de contrôle de pression de gonflage TSS	266
Traductions	308
Types de remplacement	281
Utilisation	
Capteurs	
pour chauffages auxiliaires	182
pour camions, bus, bateaux, tracteurs	176
pour moteurs stationnaires	181
pour motos	180
pour voitures de tourisme/véhicules utilitaires	74
Interrupteur des feux de freins	178
Pressostat d'huile	138
Sondes Lambda	18
Système de contrôle de pression de gonflage TSS	183

NL

Algemene aanwijzingen	
Bandenspanningscontrolesysteem TSS	266
Lambdasondes, Inbouwhandleiding	193
Oliedrukschakelaar	273
Remlichtschakelaar	272
Sensoren	242
Assortimenten fabrikant	276
Gebruik	
Bandenspanningscontrolesysteem TSS	183
Lambdasondes	18
Oliedrukschakelaar	138
Remlichtschakelaar	178
Sensoren	
voor hulpverwarming	182
voor motorfietsen	180
voor personenwagens/bedrijfsauto's	74
voor stationaire motoren	181
voor vrachtwagens, bussen, boten, tractoren	176
Lijst reserveonderdelen	281
Nieuwe codering van externe onderdelen → BERU	282
Overbrengingen	308
Overzicht naar type en bestelnummer	9

E

Cambio de clave, piezas ajenas → BERU	282
Indicaciones generales	
Interruptor de control de la presión de aceite	273
Interruptor luces freno	272
Sensores	242
Sistema de control de presión de neumáticos TSS	266
Sondas Lambda, Instrucciones de montaje	193
Relación general según modelo y núm. de pedido	9
Surtidos clasificados por marcas	276
Tipos de recambio	281
Traducciones	308
Utilización	
Interruptor de control de la presión de aceite	138
Interruptor luces freno	178
Sensores	



Weitere Anwendungen siehe auch
For further applications see
Pour déterminer les autres affectations veuillez vous référer à
Zie voor verdere toepassingen ook
Para más aplicaciones véase también
Altre applicazioni vedi
Дальнейшие использования см. также
Pozostałe zastosowanie patrz również
Περαιτέρω εφαρμογές βλέπε επίσης στο
További alkalmazásokat lásd-nál

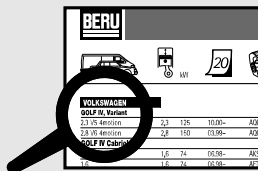

www.beru.com/produktfinder

www.tecdoc.net



Para automóviles, vehículos industriales	74
Para calefacciones auxiliares	182
Para camiones, autobuses, botes, tractores	176
Para motocicletas	180
Para motores estacionarios	181
Sistema de control de presión de neumáticos TSS	183
Sondas Lambda	18

I

Assortimenti riferiti ai produttori	276
Indicazioni generali	
Interruttore luci d'arresto	272
Interruttore pressione olio	273
Sensori	242
Sistema di controllo pressione pneumatici TSS	266
Sonde Lambda, Istruzioni di montaggio	193
Identificazione in chiave di componenti di altri produttori → BERU	282
Impiego	
Interruttore luci d'arresto	178
Interruttore pressione olio	138
Sensori	
per camion, bus, imbarcazioni e trattori	176
per motociclette	180
per motori stazionari	181
per riscaldamenti termoautonomi	182
per vetture e veicoli industriali	74
Sistema di controllo pressione pneumatici TSS	183
Sonde Lambda	18
Panoramica secondo tipo e numero di ordinazione	9
Tipi di sostituzione	281
Traduzioni	308

RUS

Ассортименты изготовителя	276
Запасные типы	281
Информация о продукте	
выключатель стоп-сигнала	272
гидравлический выключатель	273
Лямбда-зонды, Инструкция по монтажу	193
Сенсоры	242
Система контроля давления в шинах TSS	266
Использование	
выключатель стоп-сигнала	178
гидравлический выключатель	138
Лямбда-зонды	18
Сенсоры	
для стационарных двигателей	181
для легковых/транспортных автомобилей	74
для отопления при неработающем двигателе	182
для мотоциклов	180
для грузовых машин, автобусов, лодок, тракторов	176
Система контроля давления в шинах TSS	183
Переводы	308
Перекодирование деталей других изготовителей → BERU	282
Перечень по типам и № для заказа	9

PL

Część zamienna innego producenta → BERU	282
Informacja o produkcie	
CzuJNIKI	242
Sondy lamda, Instrukcja montaży	193
System kontroli ciśnienia w ogumieniu TSS	266

Wyłącznik ciśnienia oleju	273
Wyłącznik światła stopu	272
Przełożenia	308
Typy zastępcze	281
Zastosowanie	
CzuJNIKI	
do motocykli	180
do ogrzewania postojowego	182
do samochodów osobowych/dostawczych	74
do samochodów ciężarowych, autobusów, łodzi, traktorów	176
do silników stacjonarnych	181
Sondy lamda	18
System kontroli ciśnienia w ogumieniu TSS	183
Wyłącznik ciśnienia oleju	138
Wyłącznik światła stopu	178
Zestawienie wg typu i numeru katalogowego	9
Zestawy elementów dostarczanych przez producenta	276

GR

Αξεσουάρ του εργοστασίου κατασκευής	276
Αλλαγή κωδικού ξένων εξαρτημάτων → BERU	282
Επισκόπηση ανά τύπο και αρ. παραγγ.	9
Μετατροπές αριθμών στροφών	308
Πληροφορία προϊόντος	
Αισθητήρες	242
Αισθητήρες λάμδα, Οδηγίες εγκατάστασης	193
Διακόπτης πίεσης λαδιού	273
Διακόπτης φώτων φρένων	272
Σύστημα ελέγχου πίεσης ελαστικών TSS	266
Τύποι ανταλλακτικών	281
Χρήση	
Αισθητήρες	
Για μοτοσικλές	180
Για σταθερούς κινητήρες	181
για βοηθητικές θερμάνσεις	182
για Ι.Χ./φορτηγά	74
για φορτηγά, λεωφορεία, βάρκες, τρακτέρ	176
Αισθητήρες λάμδα	18
Διακόπτης πίεσης λαδιού	138
Διακόπτης φώτων φρένων	178
Σύστημα ελέγχου πίεσης ελαστικών TSS	183

H

Agyártókhöz kapcsolódó választék	276
Alkalmazás	
Abroncsnyomás-ellenőrző rendszer TSS	183
Érzékelők	
állófűtésekhez	182
helyben maradó motorokhoz	181
motorkerékpárokhoz	180
szg/hgk részére	74
tehergépkocsik, buszok, motorcsónakok, traktorok részére	176
Féklámpakapcsoló	178
Olajnyomáskapcsoló	138
Lambdaszondák	18
Áttekintés típus és megrendelési szám szerint	9
Cseretípusok	281
Fordítások	308
Gyártmánytájékoztató	
Abroncsnyomás-ellenőrző rendszer TSS	266
Érzékelők	242
Féklámpakapcsoló	272
Lambdaszondák, Beszerelési utasítás	193

	Hubraum Capacity Cylindrée Motorinhoud Cilindrada Cilindrata Рабочий объем pojemnosc skokowa Κυβισμός Lökettérfogat		Rechtslenker Right-hand drive Volant à droite Besturing rechts Volante a la derecha Veicolo con guida a destra правостороннее рулевое управление Kierownica z prawej strony Δεξιότιμονο Jobbkormányos
	Baujahr Year Année de fabrication Bouwjaar Año de modelo Anno di costr. Год изготовления rok produkcji Έτος κατασκευής Gyártási év		Linkslenker Left-hand drive Volant à gauche Besturing links Volante a la izquierda Veicolo con guida a sinistra левостороннее рулевое управление Kierownica z lewej strony Αριστεροτίμονο Balkormányos
	Motorbezeichnung Engine type Désignation du moteur Motoraand. Designación del motor Denom. Motore Обозн. двигателя ozn. silnika Όνομ. κινητήρα Motormegj.		Gewindelänge Thread length Longueur du filetage Draadlengte Largo de la rosca Lunghezza filetto Длина резьбы Długość gwintu Μήκος σπειρώματος Menethosszuság
	Allgemeine Industrie General industry Industrie générale Algemene industrie Industria general Industria generale общая промышленность Przemysł ogólnie Γενική βιομηχανία Általános ipar		Gewindedurchmesser Thread diameter Diamètre du filetage Schroefdraaddiameter Diámetro de la rosca Diametro filetto Диаметр резьбы Średnica gwintu Σταθερό κινητήρες Menetátmérő
	Standheizung Auxiliary heating Chauffage additionnel Standverwarming Calefacción independiente Riscaldamento statico Отопление при неработающем двигателе ogrzewanie postojowe Βοηθητικό σύστημα θέρμανσης Beépített fűtés		Innengewinde Internal thread Taraudage Inwendig schroefdraad Rosca interior Filetto interno внутренняя резьба Gwint wewnetrzny Εσωτερικό σπείρωμα Belső menet
	Schlüsselweite Across flats Ouverture de clé Sleutelbreedte Boca de llave Grandezza chiave Раствор ключа Rozmiar klucza Ανοίγμα κλειδιού kulcsnyílás	<p style="font-size: 2em; text-align: center;">Nm</p>	Anzugsdrehmoment in Newtonmeter Tightening torque in Newtonmeters (Nm) Couple de serrage en Nm Koppel in Nm Par de apriete en metro Newton Coppia di serraggio in Newton/metro Момент затяжки в ньютон-метре Moment dociągania w Nm Ροπή σύσφιξης σε Newtonmeter Forgatónyomaték Newton méterben
	Stationärmotoren stationary motors Moteurs stationnaires Stationaire motoren Motores estacionarios motori stazionari Стационарные двигатели Silniki stacjonarne Στασιμοί κινητήρες stabil motorok		Länge Anschlußleitung Cable length Longueur de câble Leidinglengte Longitud de cable Lunghezza cavi Длина кабеля Długość przewodu Μήκος αγωγού Vezeték hossza

Symbole	Symbols Symboles Symbolen	Símbolos Simboli Символы	Symbole Σύμβολα jelképek
	<p>Einbauposition Lambda-Sonde Oxygen sensor installation position Position de montage de la sonde lambda Inbouwpositie lambdasonde Posición de montaje de la sonda lambda Posizione di montaggio della sonda Lambda: позиция установки лямбда-зонда Pozycja montażowa sondy lambda Θέση εγκατάστασης αισθητήρα λάμδα A lambda-szonda beépítési pozíciója</p>		<p>Radelektronik Wheel electronics Electronique de roue Wielelektronica Componente electrónico Unità elettronica per le ruote Электроника колес Elektronika kola Ηλεκτρονικό κύκλωμα τροχού Kerékelektronika</p>
	<p>Schaltpunkt 1/Schaltpunkt 2 Shift point 1/Shift point 2 Point de contact 1/Point de contact 2 Schakelpunt 1/Schakelpunt 2 Posición de funcionamiento 1/Posición de funcionamiento 2 Punto di intervento 1/Punto di intervento 2 Точка переключения 1/Точка переключения 2 Punkt przełączania 1/Punkt przełączania 2 Σημείο ζεύξης 1/Σημείο ζεύξης 2 Kapcsolópont 1/Kapcsolópont 2</p>		<p>Ventil Valve Valve Ventiel Válvula Valvola Клапан Zawór Βαλβίδα Szelep</p>
	<p>minimale/maximale Temperatur Minimum/maximum temperature Température minimale/maximale Minimale/maximale temperatuur Temperatura máxima/mínima Temperatura minima/massima Минимальная/максимальная температура Temperatura minimalna/maksymalna Ελάχιστη/Μέγιστη θερμοκρασία Minimális/maximális hőmérséklet</p>		<p>Lambda-Sonden Lambda Sensors Sondes lambda Lambdasondes Sondas Lambda Sonde Lambda Лямбда-зонды Sonda lambda Αισθητήρες λάμδα Lambdaszondák</p>
	<p>Regelsonde Control sensor Sonde de réglage Regelsonde Sonda de regulación Sonda di regolazione регулирующий датчик Sonda regulacyjna Αισθητήρας ρύθμισης Szabályzó szonda</p>		<p>Sensoren Sensors Capteurs Sensoren Sensores Sensori Сенсоры Czujniki Αισθητήρες Erzékelők</p>
	<p>Diagnosesonde Diagnosis sensor Sonde de diagnostic Diagnosesonde Sonda de diagnóstico Sonda di diagnosi диагностический датчик Sonda diagnostyczna Αισθητήρας διάγνωσης Diagnosztikai szonda</p>		
	<p>Kabelanzahl Number of cables Nombre de câbles Aantal kabel Número de cable Numero cavo Количество проводов Ilość kabli Αριθμός καλωδίων Kábelek száma</p>		
	<p>Länge Ventil Length valve Longueur de valve Lengte ventiel Longitud de la válvula Lunghezza valvola Длина клапана Długość zaworu Μήκος βαλβίδας Szelep hossza</p>		

	Drehzahlsensor Engine-speed sensor Capteur de vitesse Toerentalsensor Sensor de revoluciones Sensore di velocità Датчик числа оборотов Czujnik prędkości obrotowej Αισθητήρας στροφών Fordulatszám érzékelő	Erfassung von Drehzahl und/oder Position Measurement of speed and/or position Détection du régime et/ou de la position Registratie van toerental en/of positie Registro del número de revoluciones y/o posición Rilevamento della velocità e/o della posizione Регистрация частоты вращения и/или положения Rejestracja prędkości obrotowej i/lub pozycji Εξακρίβωση αριθμού στροφών και/ή θέσης Fordulatszám és/vagy helyzet felismerése	- Anzeige Drehzahl - Speed indicator - Affichage du régime - Weergave toerental - Anuncio número de revoluciones - Indicatore di velocità - Индикация частоты вращения - Wskazanie prędkości obrotowej - Ένδειξη αριθμού στροφών - Fordulatszám kijelzés	- Regelung Motormanagement - Control function in engine management - Régulation de la gestion du moteur - Regeling motormanagement - Regulación mando del motor - Regolazione gestione motore - Регулир. управления мотором - regulacja układu rozrządu silnika - Ένδειξη αριθμού στροφών - Motorirányítás szabályozása
	Temperatursensor Temperature sensor Capteur de température Temperatuursensor Sensor de temperatura Sensore di temperatura Температурный датчик Czujnik temperatury Αισθητήρας θερμοκρασίας Hőmérsékletérzékelő	Erfassung der Ansauglufttemperatur Sense the intake-air temperature Mesure de la température de l'air d'admission Vastlegging van de aanzuigluchttemperatuur Registro de la temperatura del aire de aspiración Rilevazione delle temperatura dell'aria di aspirazione Регистр. темп-ры всасыв. воздуха Pomiar temperatury zasysanego powietrza Υπολογισμός της θερμοκρασίας αέρα εισαγωγής A szívó levegő hőmérsékletének rögzítése	- Regelung Motormanagement - Control function in engine management - Régulation de la gestion du moteur - Regeling motormanagement - Regulación mando del motor - Regolazione gestione motore - Регулир. управления мотором - regulacja układu rozrządu silnika - Ρύθμιση διαχείρισης κινητήρα - Motorirányítás szabályozása	- Anzeige Motortemperatur - Indicate the engine temperature - Affichage de la température du moteur - Indicatie motortemperatuur - Indicación temperatura del motor - Indicazione temperatura motore - Индикация темп-ры мотора - wskazanie temperatury silnika - Ένδειξη θερμοκρασίας κινητήρα - Motorhőmérséklet kijelzése
	Temperatursensor Temperature sensor Capteur de température Temperatuursensor Sensor de temperatura Sensore di temperatura Температурный датчик Czujnik temperatury Αισθητήρας θερμοκρασίας Hőmérsékletérzékelő	Erfassung der Kühlmitteltemperatur Sense the coolant temperature Mesure de la température du liquide de refroidissement Vastlegging van de gemiddelde koeltemperatuur Registro de la temperatura del refrigerante Rilevazione delle temperatura del fluido di raffreddamento Регистр. темп-ры охлад. жидкости Pomiar temperatury chłodziwa Υπολογισμός της θερμοκρασίας ψυκτικού A hűtőközeg hőmérsékletének rögzítése	- Anzeige Motortemperatur - Indicate the engine temperature - Affichage de la température du moteur - Indicatie motortemperatuur - Indicación temperatura del motor - Indicazione temperatura motore - Индикация темп-ры мотора - wskazanie temperatury silnika - Ένδειξη θερμοκρασίας κινητήρα - Motorhőmérséklet kijelzése	- Regelung Motormanagement - Control function in engine management - Régulation de la gestion du moteur - Regeling motormanagement - Regulación mando del motor - Regolazione gestione motore - Регулир. управления мотором - regulacja układu rozrządu silnika - Ρύθμιση διαχείρισης κινητήρα - Motorirányítás szabályozása
	Temperatursensor Temperature sensor Capteur de température Temperatuursensor Sensor de temperatura Sensore di temperatura Температурный датчик Czujnik temperatury Αισθητήρας θερμοκρασίας Hőmérsékletérzékelő	Erfassung der Kühlmitteltemperatur Sense the coolant temperature Mesure de la température du liquide de refr. Vastlegging van de koelmiddeltemperatuur Registro de la temperatura del refrigerante Rilevazione delle temperatura del fluido di raffr. Регистр. темп-ры охлад. жидкости Pomiar temperatury chłodziwa Υπολογισμός της θερμοκρασίας ψυκτικού A hűtőközeg hőmérsékletének rögzítése	- Anzeige Motortemperatur - Indicate the engine temperature - Affichage de la température du moteur - Indicatie motortemperatuur - Indicación temperatura del motor - Indicazione temperatura motore - Индикация темп-ры мотора - wskazanie temperatury silnika - Ένδειξη θερμοκρασίας κινητήρα - Motorhőmérséklet kijelzése	- Regelung Motormanagement - Control function in engine management - Régulation de la gestion du moteur - Regeling motormanagement - Regulación mando del motor - Regolazione gestione motore - Регулир. управления мотором - regulacja układu rozrządu silnika - Ρύθμιση διαχείρισης κινητήρα - Motorirányítás szabályozása
	Temperatursensor Temperature sensor Capteur de température Temperatuursensor Sensor de temperatura Sensore di temperatura Температурный датчик Czujnik temperatury Αισθητήρας θερμοκρασίας Hőmérsékletérzékelő	Erfassung der Kühlmitteltemperatur Sense the coolant temperature Mesure de la température du liquide de refroidissement Vastlegging van de koelmiddeltemperatuur Registro de la temperatura del refrigerante Rilevazione delle temperatura del fluido di raffreddamento Регистр. темп-ры охлад. жидкости Pomiar temperatury chłodziwa Υπολογισμός της θερμοκρασίας ψυκτικού A hűtőközeg hőmérsékletének rögzítése	- Regelung Motormanagement - Control function in engine management - Régulation de la gestion du moteur - Regeling motormanagement - Regulación mando del motor - Regolazione gestione motore - Регулир. управления мотором - regulacja układu rozrządu silnika - Ρύθμιση διαχείρισης κινητήρα - Motorirányítás szabályozása	- Regelung Motormanagement - Control function in engine management - Régulation de la gestion du moteur - Regeling motormanagement - Regulación mando del motor - Regolazione gestione motore - Регулир. управления мотором - regulacja układu rozrządu silnika - Ρύθμιση διαχείρισης κινητήρα - Motorirányítás szabályozása
	Temperatursensor Temperature sensor Capteur de température Temperatuursensor Sensor de temperatura Sensore di temperatura Температурный датчик Czujnik temperatury Αισθητήρας θερμοκρασίας Hőmérsékletérzékelő	Erfassung der Motoröltemperatur Sense the engine-oil temperature Mesure de la température de l'huile moteur Vastlegging van de motorolietemperatuur Registro de la temperatura del aceite de motor Rilevazione delle temperatura dell'olio del motore Регистр. темп-ры моторного масла Pomiar temperatury oleju silnikowego Υπολογισμός της θερμοκρασίας λαδιού κινητήρα A motorolaj hőmérsékletének rögzítése	- Anzeige Motoröltemperatur - Indicate the engine-oil temperature - Affichage de la temp. de l'huile moteur - Indicatie motorolietemperatuur - Indicación temperatura aceite de motor - Indicazione temperatura olio motore - Индикация темп-ры моторного масла - wskazanie temperatury oleju silnikowego - Ένδειξη θερμοκρασίας λαδιού κινητήρα - Motorolaj hőmérsékletének kijelzése	- Regelung Motormanagement - Control function in engine management - Régulation de la gestion du moteur - Regeling motormanagement - Regulación mando del motor - Regolazione gestione motore - Регулир. управления мотором - regulacja układu rozrządu silnika - Ρύθμιση διαχείρισης κινητήρα - Motorirányítás szabályozása
	Temperatursensor Temperature sensor Capteur de température Temperatuursensor Sensor de temperatura Sensore di temperatura Температурный датчик Czujnik temperatury Αισθητήρας θερμοκρασίας Hőmérsékletérzékelő	Erfassung der Gehäusetemperatur Measurement of the housing temperature Mesure de la température de l'habitable registreren van de temperatuur van het blok Registración de la temperatura de la carcasa Rilevamento della temperatura della scatola Регистрация температуры корпуса Czujnik temperatury silnika/korpusu Μέτρηση της θερμοκρασίας του περιβλήματος Hőmérséklet jeladó	- Regelung Motormanagement - Control function in engine management - Régulation de la gestion du moteur - Regeling motormanagement - Regulación mando del motor - Regolazione gestione motore - Регулир. управления мотором - regulacja układu rozrządu silnika - Ρύθμιση διαχείρισης κινητήρα - Motorirányítás szabályozása	- Regelung Standheizung - Regulation Stand heater - Régulation Chauffage d'arrêt - Regeling Standverwarming - Reglamentación Calefacción del puesto - Regolazione Riscaldamento supplementare - Регулировка Автономное отопление - regulacja Ogrzewanie postojowe - Κύκλωμα ελέγχου Πρόσθετη θέρμανση - Szabályozás Allóütés
	Temperatursensor Temperature sensor Capteur de température Temperatuursensor Sensor de temperatura Sensore di temperatura Температурный датчик Czujnik temperatury Αισθητήρας θερμοκρασίας Hőmérsékletérzékelő	Erfassung der Kühlmitteltemperatur Sense the coolant temperature Mesure de la température du liquide de refroidissement Vastlegging van de koelmiddeltemperatuur Registro de la temperatura del refrigerante Rilevazione delle temperatura del fluido di raffreddamento Регистр. темп-ры охлад. жидкости Pomiar temperatury chłodziwa Υπολογισμός της θερμοκρασίας ψυκτικού A hűtőközeg hőmérsékletének rögzítése	- Temperaturschalter Kühlerlüfter - Radiator fan temperature switch - Contacteur de température de ventilateur de refroidisseur - Temperatuurschakelaar koelingsventilator - Conmutador de temperatura ventilador refrescador - Interruttore termico ventola di raffreddamento - Температурный выключатель вентилятора радиатора - Wyłącznik termiczny wentylatora chłodnicy - Διακόπτης θερμοκρασίας φτερωτής ψυγείου - Hőmérséklet kapcsoló hűtőventilátor	- Regelung Motormanagement - Control function in engine management - Régulation de la gestion du moteur - Regeling motormanagement - Regulación mando del motor - Regolazione gestione motore - Регулир. управления мотором - regulacja układu rozrządu silnika - Ρύθμιση διαχείρισης κινητήρα - Motorirányítás szabályozása
	Bremslichtschalter Brake light switch Interrupteur des feux de freins Remlichtschakelaar Interruptor luces freno Interruttore luci d'arresto выключатель стоп-сигнала Wyłącznik światła stopu Διακόπτης φώτων φρένων Féklámpakapcsoló	Erfassung der Gehäusetemperatur Measurement of the housing temperature Mesure de la température de l'habitable registreren van de temperatuur van het blok Registración de la temperatura de la carcasa Rilevamento della temperatura della scatola Регистрация температуры корпуса Czujnik temperatury silnika/korpusu Μέτρηση της θερμοκρασίας του περιβλήματος Hőmérséklet jeladó	- Regelung Motormanagement - Control function in engine management - Régulation de la gestion du moteur - Regeling motormanagement - Regulación mando del motor - Regolazione gestione motore - Регулир. управления мотором - regulacja układu rozrządu silnika - Ρύθμιση διαχείρισης κινητήρα - Motorirányítás szabályozása	- Regelung Standheizung - Regulation Stand heater - Régulation Chauffage d'arrêt - Regeling Standverwarming - Reglamentación Calefacción del puesto - Regolazione Riscaldamento supplementare - Регулировка Автономное отопление - regulacja Ogrzewanie postojowe - Κύκλωμα ελέγχου Πρόσθετη θέρμανση - Szabályozás Allóütés
	Öldruckschalter Oil pressure switch Pressostat d'huile Oliedrukschakelaar Interruptor de control de la presión de aceite Interruttore pressione olio гидравлический выключатель Wyłącznik ciśnienia oleju Διακόπτης πίεσης λαδιού Olajnyomáskapcsoló	Erfassung der Gehäusetemperatur Measurement of the housing temperature Mesure de la température de l'habitable registreren van de temperatuur van het blok Registración de la temperatura de la carcasa Rilevamento della temperatura della scatola Регистрация температуры корпуса Czujnik temperatury silnika/korpusu Μέτρηση της θερμοκρασίας του περιβλήματος Hőmérséklet jeladó	- Regelung Motormanagement - Control function in engine management - Régulation de la gestion du moteur - Regeling motormanagement - Regulación mando del motor - Regolazione gestione motore - Регулир. управления мотором - regulacja układu rozrządu silnika - Ρύθμιση διαχείρισης κινητήρα - Motorirányítás szabályozása	- Regelung Standheizung - Regulation Stand heater - Régulation Chauffage d'arrêt - Regeling Standverwarming - Reglamentación Calefacción del puesto - Regolazione Riscaldamento supplementare - Регулировка Автономное отопление - regulacja Ogrzewanie postojowe - Κύκλωμα ελέγχου Πρόσθετη θέρμανση - Szabályozás Allóütés

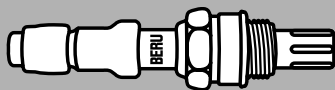

OZH 001	0 824 010 002	BMW	203
OZH 002	0 824 010 003	BMW	203
OZH 003	0 824 010 004	Alfa Romeo, Audi, Volvo	203
OZH 004	0 824 010 005	BMW	203
OZH 005	0 824 010 006	Citroën, Peugeot	203
OZH 006	0 824 010 007	Ford, Honda	204
OZH 007	0 824 010 008	Mercedes	204
OZH 008	0 824 010 009	Seat, VW	204
OZH 009	0 824 010 010	Honda, Seat, VW	204
OZH 010	0 824 010 011	VW	204
OZH 011	0 824 010 012	Nissan	205
OZH 012	0 824 010 013	Nissan, Seat, VW	205
OZH 014	0 824 010 015	Ford	205
OZH 016	0 824 010 017	Mercedes	205
OZH 017	0 824 010 018	Audi	205
OZH 018	0 824 010 019	Mercedes	206
OZH 019	0 824 010 020	Opel, Renault, Vauxhall	206
OZH 020	0 824 010 021	Ford, Honda	206
OZH 021	0 824 010 022	Ford, Mercedes	206
OZH 022	0 824 010 023	Mazda, VW	206
OZH 023	0 824 010 024	BMW, Mercedes	207
OZH 024	0 824 010 025	Seat, VW	207
OZH 025	0 824 010 026	Mercedes	207
OZH 026	0 824 010 027	Mercedes	207
OZH 027	0 824 010 028	Audi, VW	207
OZH 028	0 824 010 030	Honda, Opel, Vauxhall, VW	208
OZH 029	0 824 010 031	Peugeot	208
OZH 030	0 824 010 032	BMW	208
OZH 031	0 824 010 033	VW	208
OZH 032	0 824 010 034	Mercedes	208
OZH 033	0 824 010 035	Alpina, Chevrolet, Mercedes, Renault	209
OZH 034	0 824 010 036	Citroën, Fiat, Lancia, Peugeot	209
OZH 035	0 824 010 037	Alfa Romeo, Audi, Ferrari, Fiat, Lancia, Volvo	209
OZH 036	0 824 010 038	Bertone, BMW	209
OZH 037	0 824 010 039	Alfa Romeo, Audi, Daimler, Ferrari, Fiat, Hyundai, Lancia, Saab, Seat, Skoda, Volvo, VW	209
OZH 038	0 824 010 040	Citroën, Peugeot	210
OZH 039	0 824 010 041	BMW	210
OZH 040	0 824 010 042	Opel, Vauxhall	210
OZH 041	0 824 010 043	Mercedes	210
OZH 042	0 824 010 044	Mercedes	210
OZH 043	0 824 010 045	Mazda, Seat, Skoda, VW	211
OZH 044	0 824 010 046	Alpine, Audi, Chrysler, Peugeot, Renault, Zastava	211
OZH 045	0 824 010 047	Ford	211
OZH 046	0 824 010 048	Alfa Romeo, Audi, Fiat, Lancia, Saab, Seat, Volvo	211
OZH 047	0 824 010 049	VW	211
OZH 048	0 824 010 050	VW	212
OZH 049	0 824 010 051	Fiat	212
OZH 050	0 824 010 052	Ford	212
OZH 051	0 824 010 056	Mercedes	212
OZH 052	0 824 010 057	Alfa Romeo, Fiat, Lancia	212
OZH 053	0 824 010 058	MG, Rover	213
OZH 054	0 824 010 059	Alfa Romeo, Fiat	213
OZH 055	0 824 010 060	Alfa Romeo, Fiat, Lancia	213
OZH 056	0 824 010 061	Alfa Romeo, Fiat, Lancia	213
OZH 057	0 824 010 062	Rover	213
OZH 058	0 824 010 063	Renault	214
OZH 059	0 824 010 065	Ford	214

OZH 060	0 824 010 066	Universal (3-polig ²⁰)	214
OZH 061	0 824 010 067	Universal (4-polig ²⁰)	214
OZH 064	0 824 010 070	Fiat	214
OZH 065	0 824 010 071	Lancia	215
OZH 066	0 824 010 072	Fiat, Peugeot	215
OZH 067	0 824 010 073	Alfa Romeo, Rover	215
OZH 068	0 824 010 074	Audi, VW	215
OZH 069	0 824 010 075	Audi, VW	215
OZH 070	0 824 010 076	Audi, Seat, VW	216
OZH 071	0 824 010 077	Audi, Seat, VW	216
OZH 072	0 824 010 078	Peugeot	216
OZH 073	0 824 010 079	Volvo	216
OZH 074	0 824 010 080	Citroën, Peugeot	216
OZH 075	0 824 010 081	Ford	217
OZH 076	0 824 010 084	Mazda	217
OZH 079	0 824 010 089	Citroën, Peugeot	217
OZH 083	0 824 010 098	Renault	217
OZH 084	0 824 010 099	Fiat, Lancia	217
OZH 086	0 824 010 102	Audi, VW	218
OZH 087	0 824 010 105	Renault	218
OZH 088	0 824 010 106	Fiat, Lancia	218
OZH 092	0 824 010 112	Renault	218
OZH 094	0 824 010 114	Rover	218
OZH 095	0 824 010 117	Mazda	219
OZH 096	0 824 010 118	Renault	219
OZH 098	0 824 010 120	Mercedes	219
OZH 099	0 824 010 121	Honda, Skoda, VW	219
OZH 100	0 824 010 124	Mazda	219
OZH 101	0 824 010 125	Renault	220
OZH 103	0 824 010 128	Audi	220
OZH 104	0 824 010 129	Citroën, Peugeot	220
OZH 107	0 824 010 139	Citroën, Renault	220
OZH 108	0 824 010 107	Renault	220
OZH 109	0 824 010 127	Renault	221
OZH 110	0 824 010 144	Opel, Vauxhall	221
OZH 111	0 824 010 145	Opel	221
OZH 112	0 824 010 146	Opel	221
OZH 113	0 824 010 147	Opel	221
OZH 114	0 824 010 148	Opel	222
OZH 115	0 824 010 149	Opel	222
OZH 118	0 824 010 152	Fiat, Lancia	222
OZH 120	0 824 010 154	Honda, Rover	222
OZH 121	0 824 010 155	Honda	222
OZH 122	0 824 010 156	Honda	223
OZH 123	0 824 010 157	Honda	223
OZH 124	0 824 010 158	Mercedes	223
OZH 125	0 824 010 159	Renault	223
OZH 127	0 824 010 161	Seat, VW	223
OZH 128	0 824 010 162	Audi, Seat, Skoda, VW	224
OZH 130	0 824 010 164	Volvo	224
OZH 131	0 824 010 165	VW	224
OZH 132	0 824 010 166	Opel, Vauxhall	224
OZH 134	0 824 010 168	VW	224
OZH 135	0 824 010 169	Fiat, Lancia	225
OZH 136	0 824 010 170	Fiat	225
OZH 137	0 824 010 171	Fiat	225
OZH 138	0 824 010 172	Lancia	225
OZH 143	0 824 010 177	Mercedes	225
OZH 144	0 824 010 178	Mercedes	226
OZH 145	0 824 010 179	Mercedes	226
OZH 146	0 824 010 180	Mercedes, VW	226
OZH 147	0 824 010 181	Opel	226
OZH 148	0 824 010 182	Opel, Vauxhall	226

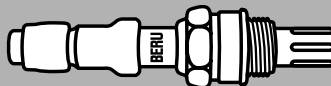

OZH 150	0 824 010 184	Seat, VW	227
OZH 151	0 824 010 185	Audi, Ford, Seat, VW	227
OZH 152	0 824 010 186	Audi, VW	227
OZH 153	0 824 010 187	Mazda	227
OZH 154	0 824 010 188	Saab	227
OZH 155	0 824 010 189	Volvo	228
OZH 156	0 824 010 190	Saab	228
OZH 157	0 824 010 191	Saab	228
OZH 158	0 824 010 192	Saab	228
OZH 159	0 824 010 193	Citroën, Fiat, Peugeot	228
OZH 160	0 824 010 194	Renault	229
OZH 161	0 824 010 195	Volvo	229
OZH 163	0 824 010 197	Mazda	229
OZH 164	0 824 010 198	Seat	229
OZH 165	0 824 010 199	VW	229
OZH 166	0 824 010 200	Citroën	230
OZH 167	0 824 010 201	BMW	230
OZH 168	0 824 010 202	BMW	230
OZH 169	0 824 010 203	Audi, Seat, Skoda, VW	230
OZH 173	0 824 010 207	Alpina, BMW, Landrover	230
OZH 176	0 824 010 210	Ford	231
OZH 177	0 824 010 211	Audi, Seat, Skoda, VW	231
OZH 178	0 824 010 212	Audi, VW	231
OZH 179	0 824 010 213	Seat, VW	231
OZH 180	0 824 010 214	Fiat, Lancia	231
OZH 181	0 824 010 215	Audi, Ford, VW	232
OZH 182	0 824 010 216	Seat, VW	232
OZH 184	0 824 010 218	Renault	232
OZH 190	0 824 010 224	Audi, VW	232
OZH 192	0 824 010 226	Alfa Romeo	232
OZH 193	0 824 010 227	BMW	233
OZH 194	0 824 010 228	Citroën, Peugeot	233
OZH 196	0 824 010 230	Mercedes	233
OZH 198	0 824 010 232	Mercedes	233
OZH 199	0 824 010 233	BMW	233
OZH 200	0 824 010 234	Mazda, Mercedes	234
OZH 201	0 824 010 235	Nissan	234
OZH 203	0 824 010 237	Nissan	234
OZH 204	0 824 010 238	Kia	234
OZH 205	0 824 010 239	Peugeot	234
OZH 206	0 824 010 240	Peugeot	235
OZH 207	0 824 010 241	Kia	235
OZH 208	0 824 010 242	Renault	235
OZH 209	0 824 010 243	Volvo	235
OZH 210	0 824 010 244	Volvo	235
OZH 215	0 824 010 249	VW	236
OZH 217	0 824 010 251	Alfa Romeo	236
OZH 218	0 824 010 252	BMW	236
OZH 220	0 824 010 254	Mercedes	236
OZH 222	0 824 010 256	BMW	236
OZH 223	0 824 010 257	BMW	237
OZH 224	0 824 010 258	BMW	237
OZH 225	0 824 010 259	Nissan	237
OZH 226	0 824 010 260	Nissan	237
OZH 227	0 824 010 261	Nissan	237
OZH 228	0 824 010 262	Nissan	238
OZH 229	0 824 010 263	Nissan	238
OZU 001	0 824 010 001	Audi, BMW, Daihatsu, De Lorean, Fiat, Honda, Hyundai, Lancia, Mazda, Mercedes, Mitsubishi, Nissan, Opel, Peugeot, Renault, Saab, Seat, VW	239
OZU 003	0 824 010 053	Seat, VW	239

OZU 004	0 824 010 054	Rover	239
OZU 005	0 824 010 055	Daewoo, Opel, VAUHALL	239
OZU 006	0 824 010 064	Fiat	239
OZU 007	0 824 010 141	Universal (2-polig ²⁰)	240
OZU 010	0 824 010 090	Nissan	240
OZU 012	0 824 010 096	Mazda	240
OZU 014	0 824 010 104	Honda, Suzuki	240
OZU 015	0 824 010 111	Suzuki	240
OZU 021	0 824 010 131	Mazda, Saab	241
OZU 022	0 824 010 094	Audi, Fiat, Lancia, Renault, Seat, VW	241
OZU 023	0 824 010 136	Opel, Vauxhall	241
OZU 024	0 824 010 133	Nissan	241
OZU 025	0 824 010 143	Renault	241

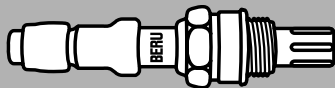



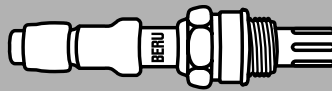

0 824 010 001	OZU 001	Audi, BMW, Daihatsu, De Lorean, Fiat, Honda, Hyundai, Lancia, Mazda, Mercedes, Mitsubishi, Nissan, Opel, Peugeot, Renault, Saab, Seat, VW	239	0 824 010 057	OZH 052	Alfa Romeo, Fiat, Lancia	212
0 824 010 002	OZH 001	BMW	203	0 824 010 058	OZH 053	MG, Rover	213
0 824 010 003	OZH 002	BMW	203	0 824 010 059	OZH 054	Alfa Romeo, Fiat	213
0 824 010 004	OZH 003	Alfa Romeo, Audi, Volvo	203	0 824 010 060	OZH 055	Alfa Romeo, Fiat, Lancia	213
0 824 010 005	OZH 004	BMW	203	0 824 010 061	OZH 056	Alfa Romeo, Fiat, Lancia	213
0 824 010 006	OZH 005	Citroën, Peugeot	203	0 824 010 062	OZH 057	Rover	213
0 824 010 007	OZH 006	Ford, Honda	204	0 824 010 063	OZH 058	Renault	214
0 824 010 008	OZH 007	Mercedes	204	0 824 010 064	OZU 006	Fiat	239
0 824 010 009	OZH 008	Seat, VW	204	0 824 010 065	OZH 059	Ford	214
0 824 010 010	OZH 009	Honda, Seat, VW	204	0 824 010 066	OZH 060	Universal (3-polig ²⁰)	214
0 824 010 011	OZH 010	VW	204	0 824 010 067	OZH 061	Universal (4-polig ²⁰)	214
0 824 010 012	OZH 011	Nissan	205	0 824 010 070	OZH 064	Fiat	214
0 824 010 013	OZH 012	Nissan, Seat, VW	205	0 824 010 071	OZH 065	Lancia	215
0 824 010 015	OZH 014	Ford	205	0 824 010 072	OZH 066	Fiat, Peugeot	215
0 824 010 017	OZH 016	Mercedes	205	0 824 010 073	OZH 067	Alfa Romeo, Rover	215
0 824 010 018	OZH 017	Audi	205	0 824 010 074	OZH 068	Audi, VW	215
0 824 010 019	OZH 018	Mercedes	206	0 824 010 075	OZH 069	Audi, VW	215
0 824 010 020	OZH 019	Opel, Renault, Vauxhall	206	0 824 010 076	OZH 070	Audi, Seat, VW	216
0 824 010 021	OZH 020	Ford, Honda	206	0 824 010 077	OZH 071	Audi, Seat, VW	216
0 824 010 022	OZH 021	Ford, Mercedes	206	0 824 010 078	OZH 072	Peugeot	216
0 824 010 023	OZH 022	Mazda, VW	206	0 824 010 079	OZH 073	Volvo	216
0 824 010 024	OZH 023	BMW, Mercedes	207	0 824 010 080	OZH 074	Citroën, Peugeot	216
0 824 010 025	OZH 024	Seat, VW	207	0 824 010 081	OZH 075	Ford	217
0 824 010 026	OZH 025	Mercedes	207	0 824 010 084	OZH 076	Mazda	217
0 824 010 027	OZH 026	Mercedes	207	0 824 010 089	OZH 079	Citroën, Peugeot	217
0 824 010 028	OZH 027	Audi, VW	207	0 824 010 090	OZU 010	Nissan	240
0 824 010 030	OZH 028	Honda, Opel, Vauxhall, VW	208	0 824 010 094	OZU 022	Audi, Fiat, Lancia, Renault, Seat, VW	241
0 824 010 031	OZH 029	Peugeot	208	0 824 010 096	OZU 012	Mazda	240
0 824 010 032	OZH 030	BMW	208	0 824 010 098	OZH 083	Renault	217
0 824 010 033	OZH 031	VW	208	0 824 010 099	OZH 084	Fiat, Lancia	217
0 824 010 034	OZH 032	Mercedes	208	0 824 010 102	OZH 086	Audi, VW	218
0 824 010 035	OZH 033	Alpina, Chevrolet, Mercedes, Renault	209	0 824 010 104	OZU 014	Honda, Suzuki	240
0 824 010 036	OZH 034	Citroën, Fiat, Lancia, Peugeot	209	0 824 010 105	OZH 087	Renault	218
0 824 010 037	OZH 035	Alfa Romeo, Audi, Ferrari, Fiat, Lancia, Volvo	209	0 824 010 106	OZH 088	Fiat, Lancia	218
0 824 010 038	OZH 036	Bertone, BMW	209	0 824 010 107	OZH 108	Renault	220
0 824 010 039	OZH 037	Alfa Romeo, Audi, Daimler, Ferrari, Fiat, Hyundai, Lancia, Saab, Seat, Skoda, Volvo, VW	209	0 824 010 111	OZU 015	Suzuki	240
0 824 010 040	OZH 038	Citroën, Peugeot	210	0 824 010 112	OZH 092	Renault	218
0 824 010 041	OZH 039	BMW	210	0 824 010 114	OZH 094	Rover	218
0 824 010 042	OZH 040	Opel, Vauxhall	210	0 824 010 117	OZH 095	Mazda	219
0 824 010 043	OZH 041	Mercedes	210	0 824 010 118	OZH 096	Renault	219
0 824 010 044	OZH 042	Mercedes	210	0 824 010 120	OZH 098	Mercedes	219
0 824 010 045	OZH 043	Mazda, Seat, Skoda, VW	211	0 824 010 121	OZH 099	Honda, Skoda, VW	219
0 824 010 046	OZH 044	Alpine, Audi, Chrysler, Peugeot, Renault, Zastava	211	0 824 010 124	OZH 100	Mazda	219
0 824 010 047	OZH 045	Ford	211	0 824 010 125	OZH 101	Renault	220
0 824 010 048	OZH 046	Alfa Romeo, Audi, Fiat, Lancia, Saab, Seat, Volvo	211	0 824 010 127	OZH 109	Renault	221
0 824 010 049	OZH 047	VW	211	0 824 010 128	OZH 103	Audi	220
0 824 010 050	OZH 048	VW	212	0 824 010 129	OZH 104	Citroën, Peugeot	220
0 824 010 051	OZH 049	Fiat	212	0 824 010 131	OZU 021	Mazda, Saab	241
0 824 010 052	OZH 050	Ford	212	0 824 010 133	OZU 024	Nissan	241
0 824 010 053	OZU 003	Seat, VW	239	0 824 010 136	OZU 023	Opel, Vauxhall	241
0 824 010 054	OZU 004	Rover	239	0 824 010 139	OZH 107	Citroën, Renault	220
0 824 010 055	OZU 005	Daewoo, Opel, VAUHAL	239	0 824 010 141	OZU 007	Universal (2-polig ²⁰)	240
0 824 010 056	OZH 051	Mercedes	212	0 824 010 143	OZU 025	Renault	241
				0 824 010 144	OZH 110	Opel, Vauxhall	221
				0 824 010 145	OZH 111	Opel	221
				0 824 010 146	OZH 112	Opel	221
				0 824 010 147	OZH 113	Opel	221
				0 824 010 148	OZH 114	Opel	222
				0 824 010 149	OZH 115	Opel	222
				0 824 010 152	OZH 118	Fiat, Lancia	222
				0 824 010 154	OZH 120	Honda, Rover	222
				0 824 010 155	OZH 121	Honda	222









0 824 010 156	OZH 122	Honda	223
0 824 010 157	OZH 123	Honda	223
0 824 010 158	OZH 124	Mercedes	223
0 824 010 159	OZH 125	Renault	223
0 824 010 161	OZH 127	Seat, VW	223
0 824 010 162	OZH 128	Audi, Seat, Skoda, VW	224
0 824 010 164	OZH 130	Volvo	224
0 824 010 165	OZH 131	VW	224
0 824 010 166	OZH 132	Opel, Vauxhall	224
0 824 010 168	OZH 134	VW	224
0 824 010 169	OZH 135	Fiat, Lancia	225
0 824 010 170	OZH 136	Fiat	225
0 824 010 171	OZH 137	Fiat	225
0 824 010 172	OZH 138	Lancia	225
0 824 010 177	OZH 143	Mercedes	225
0 824 010 178	OZH 144	Mercedes	226
0 824 010 179	OZH 145	Mercedes	226
0 824 010 180	OZH 146	Mercedes, VW	226
0 824 010 181	OZH 147	Opel	226
0 824 010 182	OZH 148	Opel, Vauxhall	226
0 824 010 184	OZH 150	Seat, VW	227
0 824 010 185	OZH 151	Audi, Ford, Seat, VW	227
0 824 010 186	OZH 152	Audi, VW	227
0 824 010 187	OZH 153	Mazda	227
0 824 010 188	OZH 154	Saab	227
0 824 010 189	OZH 155	Volvo	228
0 824 010 190	OZH 156	Saab	228
0 824 010 191	OZH 157	Saab	228
0 824 010 192	OZH 158	Saab	228
0 824 010 193	OZH 159	Citroën, Fiat, Peugeot	228
0 824 010 194	OZH 160	Renault	229
0 824 010 195	OZH 161	Volvo	229
0 824 010 197	OZH 163	Mazda	229
0 824 010 198	OZH 164	Seat	229
0 824 010 199	OZH 165	VW	229
0 824 010 200	OZH 166	Citroën	230
0 824 010 201	OZH 167	BMW	230
0 824 010 202	OZH 168	BMW	230
0 824 010 203	OZH 169	Audi, Seat, Skoda, VW	230
0 824 010 207	OZH 173	Alpina, BMW, Landrover	230
0 824 010 210	OZH 176	Ford	231
0 824 010 211	OZH 177	Audi, Seat, Skoda, VW	231
0 824 010 212	OZH 178	Audi, VW	231
0 824 010 213	OZH 179	Seat, VW	231
0 824 010 214	OZH 180	Fiat, Lancia	231
0 824 010 215	OZH 181	Audi, Ford, VW	232
0 824 010 216	OZH 182	Seat, VW	232
0 824 010 218	OZH 184	Renault	232
0 824 010 224	OZH 190	Audi, VW	232
0 824 010 226	OZH 192	Alfa Romeo	232
0 824 010 227	OZH 193	BMW	233
0 824 010 228	OZH 194	Citroën, Peugeot	233
0 824 010 230	OZH 196	Mercedes	233
0 824 010 232	OZH 198	Mercedes	233
0 824 010 233	OZH 199	BMW	233
0 824 010 234	OZH 200	Mazda, Mercedes	234
0 824 010 235	OZH 201	Nissan	234
0 824 010 237	OZH 203	Nissan	234
0 824 010 238	OZH 204	Kia	234
0 824 010 239	OZH 205	Peugeot	234
0 824 010 240	OZH 206	Peugeot	235
0 824 010 241	OZH 207	Kia	235
0 824 010 242	OZH 208	Renault	235

0 824 010 243	OZH 209	Volvo	235
0 824 010 244	OZH 210	Volvo	235
0 824 010 249	OZH 215	VW	236
0 824 010 251	OZH 217	Alfa Romeo	236
0 824 010 252	OZH 218	BMW	236
0 824 010 254	OZH 220	Mercedes	236
0 824 010 256	OZH 222	BMW	236
0 824 010 257	OZH 223	BMW	237
0 824 010 258	OZH 224	BMW	237
0 824 010 259	OZH 225	Nissan	237
0 824 010 260	OZH 226	Nissan	237
0 824 010 261	OZH 227	Nissan	237
0 824 010 262	OZH 228	Nissan	238
0 824 010 263	OZH 229	Nissan	238



SD 001	0 192 115 012	Iveco	250	ST 048	0 824 121 097	Alfa Romeo	257
SD 002	0 191 325 002	Mercedes	250	ST 049	0 824 121 098	Citroën, Fiat, Peugeot, Talbot	257
SD 003	0 191 325 004	Mercedes	250	ST 050	0 824 121 099	Seat, VW	257
SD 004	0 191 325 006	Mercedes	250	ST 051	0 824 121 100	Ford	257
SD 005	0 192 115 001	Mercedes	250	ST 052	0 824 121 101	Saab	257
SD 006	0 192 114 007	Deutz	250	ST 053	0 824 121 102	Audi, Seat, VW	257
SD 007	0 192 114 006	Ford	250	ST 054	0 824 121 103	Audi, VW, Volvo	257
SD 008	0 191 315 002	BMW 	250	ST 055	0 824 121 104	Ford	257
SD 009	0 191 325 007	Mercedes	251	ST 056	0 824 121 105	BMW	258
SD 010	0 192 115 013	Mercedes	251	ST 057	0 824 121 106	Mercedes	258
ST 001	0 824 121 001	Mercedes	251	ST 058	0 824 121 107	Fiat, Lancia	258
ST 002	0 824 121 020	Mercedes	251	ST 059	0 824 121 090	Mercedes	258
ST 003	0 824 121 003	BMW	251	ST 060	0 824 121 108	Audi, BMW, Ford, Seat	258
ST 004	0 824 111 006	Mercedes	251	ST 061	0 824 121 109	Volvo	258
ST 005	0 824 111 003	BMW	251	ST 062	0 824 121 110	Volvo	258
ST 007	0 824 121 058	Mercedes	251	ST 063	0 824 121 111	Fiat, Lancia	258
ST 008	0 824 121 040	Mercedes	252	ST 065	0 824 131 034	Audi, VW	258
ST 009	0 824 121 046	Mercedes	252	ST 066	0 824 121 114	Mitsubishi, Opel	259
ST 010	0 824 111 004	BMW	252	ST 067	0 824 121 115	Nissan	259
ST 011	0 824 121 051	Mercedes	252	ST 068	0 824 121 116	Jaguar, Lexus, Mazda, Suzuki, Toyota	259
ST 012	0 824 121 072	Citroën, Peugeot	252	ST 069	0 824 121 117	Daewoo, Opel, Vauxhall	259
ST 013	0 824 121 073	Audi, Seat, VW	252	ST 070	0 824 121 118	Audi, VW	259
ST 014	0 824 121 074	Ford	252	ST 071	0 824 121 119	Audi, VW	259
ST 015	0 824 121 075	Renault, Volvo	252	ST 072	0 824 121 120	Alfa Romeo, Fiat, Lancia, Peugeot	259
ST 016	0 824 121 016	Kässbohrer, Liebherr	253	ST 073	0 824 121 122	Alfa Romeo, Fiat, Lancia, Seat, Volvo	259
ST 017	0 824 121 076	Ford	253	ST 074	0 824 122 013	Fiat	260
ST 018	0 824 121 077	Fiat, Lancia	253	ST 075	0 824 121 123	Opel, Vauxhall	260
ST 019	0 824 121 019	Kässbohrer	253	ST 076	0 824 121 124	Opel, Vauxhall	260
ST 020	0 824 102 007	Eberspächer 	253	ST 077	0 824 121 125	Opel, Fiat	260
ST 021	0 824 102 008	Eberspächer 	253	ST 078	0 824 121 126	Citroën, Fiat, Peugeot	260
ST 022	0 824 112 005	Eberspächer 	253	ST 079	0 824 121 127	Opel, Vauxhall	260
ST 023	0 824 121 005	Kramer	253	ST 080	0 824 121 128	Opel, Vauxhall	260
ST 024	0 824 121 031	Iveco, Renault 	254	ST 081	0 824 121 129	Opel	260
ST 025	0 824 121 032	Iveco, Renault 	254	ST 082	0 824 121 130	Opel, Vauxhall	261
ST 026	0 824 131 021	Porsche	254	ST 083	0 824 121 131	Opel	261
ST 027	0 824 112 006	Eberspächer 	254	ST 084	0 824 121 132	Volvo	261
ST 028	0 824 121 078	Alfa Romeo, Citroën, Fiat, Hyundai, Lancia, Opel, Peugeot, Porsche, Saab, Seat, Skoda, Vauxhall, VW, Volvo, Zastava	254	ST 085	0 824 121 133	Opel, Vauxhall	261
ST 029	0 824 121 080	Citroën, Peugeot	254	ST 086	0 824 121 134	Opel	261
ST 030	0 824 121 081	Seat, VW	254	ST 087	0 824 121 135	Opel, Vauxhall	261
ST 031	0 824 121 082	Seat, VW	254	ST 088	0 824 121 146	Fiat, Lancia, Opel	261
ST 032	0 824 111 007	Renault	255	ST 089	0 824 111 030	GM/Opel, Saab	261
ST 033	0 824 111 008	Ford	255	ST 090	0 824 121 139	Deutz 1012, 1013 	262
ST 034	0 824 111 009	Citroën, Peugeot	255	ST 091	0 824 121 148	BMW	262
ST 035	0 824 111 010	Alfa Romeo, Fiat, Ford, Lancia	255	ST 092	0 824 121 149	BMW	262
ST 036	0 824 111 011	Alfa Romeo, Ferrari, Opel, Porsche, Seat, VW	255	ST 093	0 824 121 150	BMW	262
ST 037	0 824 121 083	Daewoo, Opel, Vauxhall	255	ST 094	0 824 121 151	BMW	262
ST 038	0 824 121 084	Audi, VW, Volvo	255	ST 095	0 824 121 152	BMW	262
ST 039	0 824 121 085	Daihatsu, Honda, Mazda, Suzuki	255	ST 096	0 824 121 153	BMW	262
ST 040	0 824 121 086	Ford	256	ST 097	0 824 121 154	Fiat	262
ST 041	0 824 121 087	Mitsubishi, Toyota	256	ST 098	0 824 121 155	Ford	262
ST 042	0 824 121 088	Daihatsu, Toyota, Subaru	256	ST 100	0 824 121 157	Audi, Porsche, Skoda, VW	262
ST 043	0 824 121 089	Citroën, Fiat, Peugeot, Renault	256	ST 101	0 824 121 158	Citroën, Ford, Peugeot, Renault	262
ST 044	0 824 121 091	Citroën, Dacia, Peugeot, Renault, Talbot	256	ST 102	0 824 121 159	Seat, Skoda, VW	263
ST 045	0 824 121 092	Alfa Romeo, Innocenti, Seat	256	ST 103	0 824 121 160	VW	263
ST 046	0 824 121 093	Fiat, Lada, Lancia, Zastava	256	ST 104	0 824 121 161	VW	263
ST 047	0 824 121 094	Ford	256	ST 105	0 824 121 162	VW	263
				ST 106	0 824 121 163	VW	263
				ST 107	0 824 121 164	VW	263
				ST 108	0 824 121 165	Audi, Seat, Skoda, VW	263







ST 109	0 824 112 012	Eberspächer B4WSC - 12V 	263
ST 110	0 824 121 028	BMW	264
ST 112	0 824 111 033	Audi, Seat, Skoda, VW	264
ST 113	0 824 111 034	Audi, Seat, Skoda, VW	264
ST 114	0 824 121 168	Audi, Seat, Skoda, VW	264
ST 115	0 824 121 169	Audi, Seat, VW	264
ST 116	0 824 121 170	VW	264
ST 117	0 824 121 171	BMW	264
ST 118	0 824 121 172	VW	264
ST 119	0 824 121 173	Audi, Seat, Skoda, VW	265
ST 120	0 824 121 174	VW	265
ST 121	0 824 121 175	Audi, Seat, Skoda, VW	265
ST 122	0 824 121 176	Audi	265
ST 123	0 824 121 177	Opel	265
ST 124	0 824 131 029		265
ST 125	0 824 121 179	VW	265
SPR 001	0 824 331 004	NSU, Volvo, VW, Agria, Fendt, Hanomag Rheinstahl, Henschel, KHD, MWM	273
SPR 002	0 824 331 011	Audi, Porsche, BOMAG, KHD, Steinbock, Steyr (Steyr-Daimler-Puch AG)	273
SPR 003	0 824 331 010	VW, Porsche	273
SPR 004	0 824 331 025	Audi, Volvo, VW, KHD	273
SPR 005	0 824 331 018	Fiat-Allis, MAN, Mercedes 	272
SPR 006	0 824 331 021	Mercedes 	272
SPR 007	0 824 331 014	Büssing, DAF, Eicher, Hano- mag Henschel, Henschel, Ikarus, Kaelble, Kaelble- Gmeinder, Kaessbohrer, KHD, Krupp, Magirus Deutz, MAN, Mercedes, Renault Saviem, Scania, Volvo 	272
SPR 008	0 824 331 015	Fiat, Iveco, Henschel, KHD, Mercedes, Saurer, Scania, Volvo 	272
SPR 009	0 824 331 026	Daihatsu, Subaru, Toyota	273
SPR 010	0 824 331 027	Mitsubishi, Suzuki	273
SPR 011	0 824 331 028	Daihatsu, Isuzu, Toyota	273
SPR 012	0 824 331 029	Daihatsu, Mazda	273
SPR 013	0 824 331 030	Daihatsu, Mazda, Suzuki	274
SPR 014	0 824 331 031	Honda	274
SPR 015	0 824 331 032	Honda, Mazda, Subaru	274
SPR 016	0 824 331 033	Nissan	274
SPR 017	0 824 331 034	Audi, Seat, VW	274
SPR 018	0 824 331 039	GM/Opel, Renault	274
SPR 019	0 824 331 040	Mercedes	274
SPR 020	0 824 331 036	Ford	274
SPR 021	0 824 331 037	Audi, Seat, Skoda, VW	275
SPR 022	0 824 331 038	Audi, Ford, Seat, Skoda, VW	275



0 191 315 002	SD 008	BMW	250
0 191 325 002	SD 002	Mercedes	250
0 191 325 004	SD 003	Mercedes	250
0 191 325 006	SD 004	Mercedes	250
0 191 325 007	SD 009	Mercedes	251
0 192 114 006	SD 007	Ford	250
0 192 114 007	SD 006	Deutz	250
0 192 115 001	SD 005	Mercedes	250
0 192 115 012	SD 001	Iveco	250
0 192 115 013	SD 010	Mercedes	251
0 824 102 007	ST 020	Eberspächer	253
0 824 102 008	ST 021	Eberspächer	253
0 824 111 003	ST 005	BMW	251
0 824 111 004	ST 010	BMW	252
0 824 111 006	ST 004	Mercedes	251
0 824 111 007	ST 032	Renault	255
0 824 111 008	ST 033	Ford	255
0 824 111 009	ST 034	Citroën, Peugeot	255
0 824 111 010	ST 035	Alfa Romeo, Fiat, Ford, Lancia	255
0 824 111 011	ST 036	Alfa Romeo, Ferrari, Opel, Porsche, Seat, VW	255
0 824 111 030	ST 089	GM/Opel, Saab	261
0 824 111 033	ST 112	Audi, Seat, Skoda, VW	264
0 824 111 034	ST 113	Audi, Seat, Skoda, VW	264
0 824 112 005	ST 022	Eberspächer	253
0 824 112 006	ST 027	Eberspächer	254
0 824 112 012	ST 109	Eberspächer B4WSC - 12V	263
0 824 121 001	ST 001	Mercedes	251
0 824 121 003	ST 003	BMW	251
0 824 121 005	ST 023	Kramer	253
0 824 121 016	ST 016	Kässbohrer, Liebherr	253
0 824 121 019	ST 019	Kässbohrer	253
0 824 121 020	ST 002	Mercedes	251
0 824 121 028	ST 110	BMW	264
0 824 121 031	ST 024	Iveco, Renault	254
0 824 121 032	ST 025	Iveco, Renault	254
0 824 121 040	ST 008	Mercedes	252
0 824 121 046	ST 009	Mercedes	252
0 824 121 051	ST 011	Mercedes	252
0 824 121 058	ST 007	Mercedes	251
0 824 121 072	ST 012	Citroën, Peugeot	252
0 824 121 073	ST 013	Audi, Seat, VW	252
0 824 121 074	ST 014	Ford	252
0 824 121 075	ST 015	Renault, Volvo	252
0 824 121 076	ST 017	Ford	253
0 824 121 077	ST 018	Fiat, Lancia	253
0 824 121 078	ST 028	Alfa Romeo, Citroën, Fiat, Hyundai, Lancia, Opel, Peugeot, Porsche, Saab, Seat, Skoda, Vauxhall, VW, Volvo, Zastava	254
0 824 121 080	ST 029	Citroën, Peugeot	254
0 824 121 081	ST 030	Seat, VW	254
0 824 121 082	ST 031	Seat, VW	254
0 824 121 083	ST 037	Daewoo, Opel, Vauxhall	255
0 824 121 084	ST 038	Audi, VW, Volvo	255
0 824 121 085	ST 039	Daihatsu, Honda, Mazda, Suzuki	255
0 824 121 086	ST 040	Ford	256
0 824 121 087	ST 041	Mitsubishi, Toyota	256
0 824 121 088	ST 042	Daihatsu, Toyota, Subaru	256
0 824 121 089	ST 043	Citroën, Fiat, Peugeot, Renault	256

0 824 121 090	ST 059	Mercedes	258
0 824 121 091	ST 044	Citroën, Dacia, Peugeot, Renault, Talbot	256
0 824 121 092	ST 045	Alfa Romeo, Innocenti, Seat	256
0 824 121 093	ST 046	Fiat, Lada, Lancia, Zastava	256
0 824 121 094	ST 047	Ford	256
0 824 121 097	ST 048	Alfa Romeo	257
0 824 121 098	ST 049	Citroën, Fiat, Peugeot, Talbot	257
0 824 121 099	ST 050	Seat, VW	257
0 824 121 100	ST 051	Ford	257
0 824 121 101	ST 052	Saab	257
0 824 121 102	ST 053	Audi, Seat, VW	257
0 824 121 103	ST 054	Audi, VW, Volvo	257
0 824 121 104	ST 055	Ford	257
0 824 121 105	ST 056	BMW	258
0 824 121 106	ST 057	Mercedes	258
0 824 121 107	ST 058	Fiat, Lancia	258
0 824 121 108	ST 060	Audi, BMW, Ford, Seat	258
0 824 121 109	ST 061	Volvo	258
0 824 121 110	ST 062	Volvo	258
0 824 121 111	ST 063	Fiat, Lancia	258
0 824 121 114	ST 066	Mitsubishi, Opel	259
0 824 121 115	ST 067	Nissan	259
0 824 121 116	ST 068	Jaguar, Lexus, Mazda, Suzuki, Toyota	259
0 824 121 117	ST 069	Daewoo, Opel, Vauxhall	259
0 824 121 118	ST 070	Audi, VW	259
0 824 121 119	ST 071	Audi, VW	259
0 824 121 120	ST 072	Alfa Romeo, Fiat, Lancia, Peugeot	259
0 824 121 122	ST 073	Alfa Romeo, Fiat, Lancia, Seat, Volvo	259
0 824 121 123	ST 075	Opel, Vauxhall	260
0 824 121 124	ST 076	Opel, Vauxhall	260
0 824 121 125	ST 077	Opel, Fiat	260
0 824 121 126	ST 078	Citroën, Fiat, Peugeot	260
0 824 121 127	ST 079	Opel, Vauxhall	260
0 824 121 128	ST 080	Opel, Vauxhall	260
0 824 121 129	ST 081	Opel	260
0 824 121 130	ST 082	Opel, Vauxhall	261
0 824 121 131	ST 083	Opel	261
0 824 121 132	ST 084	Volvo	261
0 824 121 133	ST 085	Opel, Vauxhall	261
0 824 121 134	ST 086	Opel	261
0 824 121 135	ST 087	Opel, Vauxhall	261
0 824 121 139	ST 090	Deutz 1012, 1013	262
0 824 121 146	ST 088	Fiat, Lancia, Opel	261
0 824 121 148	ST 091	BMW	262
0 824 121 149	ST 092	BMW	262
0 824 121 150	ST 093	BMW	262
0 824 121 151	ST 094	BMW	262
0 824 121 152	ST 095	BMW	262
0 824 121 153	ST 096	BMW	262
0 824 121 154	ST 097	Fiat	262
0 824 121 155	ST 098	Ford	262
0 824 121 157	ST 100	Audi, Porsche, Skoda, VW	262
0 824 121 158	ST 101	Citroën, Ford, Peugeot, Renault	262
0 824 121 159	ST 102	Seat, Skoda, VW	263
0 824 121 160	ST 103	VW	263
0 824 121 161	ST 104	VW	263
0 824 121 162	ST 105	VW	263
0 824 121 163	ST 106	VW	263



0 824 121 164	ST 107	VW	263
0 824 121 165	ST 108	Audi, Seat, Skoda, VW	263
0 824 121 168	ST 114	Audi, Seat, Skoda, VW	264
0 824 121 169	ST 115	Audi, Seat, VW	264
0 824 121 170	ST 116	VW	264
0 824 121 171	ST 117	BMW	264
0 824 121 172	ST 118	VW	264
0 824 121 173	ST 119	Audi, Seat, Skoda, VW	265
0 824 121 174	ST 120	VW	265
0 824 121 175	ST 121	Audi, Seat, Skoda, VW	265
0 824 121 176	ST 122	Audi	265
0 824 121 177	ST 123	Opel	265
0 824 121 179	ST 125	VW	265
0 824 122 013	ST 074	Fiat	260
0 824 131 021	ST 026	Porsche	254
0 824 131 029	ST 124	 Audi, VW	265
0 824 131 034	ST 065	Audi, VW	258
0 824 331 004	SPR 001	NSU, Volvo, VW, Agria, Fendt, Hanomag Rheinstahl, Henschel, KHD, MWM	273
0 824 331 010	SPR 003	VW, Porsche	273
0 824 331 011	SPR 002	Audi, Porsche, BOMAG, KHD, Steinbock, Steyr (Steyr-Daimler-Puch AG)	273
0 824 331 014	SPR 007	Büssing, DAF, Eicher, Hanomag Henschel, Henschel, Ikarus, Kaelble, Kaelble-Gmeinder, Kaessbohrer, KHD, Krupp, Magirus Deutz, MAN, Mercedes, Renault Saviem, Scania, Volvo 	272
0 824 331 015	SPR 008	Fiat, Iveco, Henschel, KHD, Mercedes, Saurer, Scania, Volvo 	272
0 824 331 018	SPR 005	Fiat-Allis, MAN, Mercedes 	272
0 824 331 021	SPR 006	Mercedes 	272
0 824 331 025	SPR 004	Audi, Volvo, VW, KHD	273
0 824 331 026	SPR 009	Daihatsu, Subaru, Toyota	273
0 824 331 027	SPR 010	Mitsubishi, Suzuki	273
0 824 331 028	SPR 011	Daihatsu, Isuzu, Toyota	273
0 824 331 029	SPR 012	Daihatsu, Mazda	273
0 824 331 030	SPR 013	Daihatsu, Mazda, Suzuki	274
0 824 331 031	SPR 014	Honda	274
0 824 331 032	SPR 015	Honda, Mazda, Subaru	274
0 824 331 033	SPR 016	Nissan	274
0 824 331 034	SPR 017	Audi, Seat, VW	274
0 824 331 036	SPR 020	Ford	274
0 824 331 037	SPR 021	Audi, Seat, Skoda, VW	275
0 824 331 038	SPR 022	Audi, Ford, Seat, Skoda, VW	275
0 824 331 039	SPR 018	GM/Opel, Renault	274
0 824 331 040	SPR 019	Mercedes	274



RDE 001	0 532 207 001	Audi, Bentley, Ferrari, Maserati, Maybach, Mercedes Benz, Porsche, VW	270
RDE 002	0 532 207 002	BMW	270
RDE 003	0 532 207 003	BMW, Land Rover	270
RDE 004	0 532 107 001	Audi-, Mercedes Benz- (USA, Canada)	270
RDE 005	0 532 207 005	Ferrari, Porsche, VW	270
RDE 007	0 532 207 007	Audi, Bentley	270
RDE 008	0 532 207 008	BMW (USA)	270

RDV 001	0 535 007 001	Audi, BMW, Porsche, VW	271
RDV 002	0 535 007 002	BMW	271
RDV 003	0 535 007 003	BMW, Mercedes Benz	271
RDV 004	0 535 007 004	BMW	271



0 535 007 001	RDV 001	Audi, BMW, Porsche, VW	271
0 535 007 002	RDV 002	BMW	271
0 535 007 003	RDV 003	BMW, Mercedes Benz	271
0 535 007 004	RDV 004	BMW	271



0 532 107 001	RDE 004	Audi-, Mercedes Benz- (USA, Canada)	270
0 532 207 001	RDE 001	Audi, Bentley, Ferrari, Maserati, Maybach, Mercedes Benz, Porsche, VW	270
0 532 207 002	RDE 002	BMW	270
0 532 207 003	RDE 003	BMW, Land Rover	270
0 532 207 005	RDE 005	Ferrari, Porsche, VW	270
0 532 207 007	RDE 007	Audi, Bentley	270
0 532 207 008	RDE 008	BMW (USA)	270

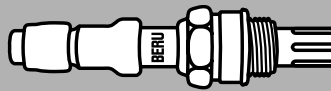

kW

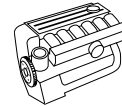

Zyl.
Cyl.
Cil.



ALFA ROMEO

33							
1.4 i.e.	1,4		65	09.91-12.91	AR 30755	4	OZH 003
1.4 i.e.	1,4		66	06.91-12.91	AR 30755	4	OZH 003
1.5 i.e.	1,5		71	01.90-03.92	AR 30751	4	OZH 003
1.5 i.e.	1,5		71	04.92-09.94	AR 30751	4	OZH 067
1.7 i.e.	1,7		77	09.88-12.89	AR 30558	4	OZH 003
1.7 i.e.	1,7		77	04.92-09.94	AR 30737 A	4	OZH 067
1.7 i.e.	1,7		79	01.90-03.92	AR 30737	4	OZH 003
1.7 16V	1,7		95	01.90-09.94	AR 30747	4	OZH 003
1.7 16V	1,7		97	01.90-03.92	AR 30747	4	OZH 003
33 Sportwagon							
1.4 i.e.	1,4		65	09.91-12.91	AR 30755	4	OZH 003
1.4 i.e.	1,4		66	06.91-12.91	AR 30755	4	OZH 003
1.5 i.e.	1,5		71	01.90-03.92	AR 30751	4	OZH 003
1.5 i.e.	1,5		71	04.92-09.94	AR 30751	4	OZH 067
1.7 i.e.	1,7		77	09.88-12.89	AR 30558	4	OZH 003
1.7 i.e.	1,7		77	04.92-09.94	AR 30737	4	OZH 067
1.7 i.e.	1,7		79	07.90-03.92	AR 30737	4	OZH 003
1.7 16V	1,7		95	01.90-09.94	AR 30747	4	OZH 003
1.7 16V	1,7		97	01.90-09.94	AR 30747	4	OZH 003
75							
1.6 KAT	1,6		81	05.89-02.92	AR 61101	4	OZH 037
1.8	1,8		90	08.89-02.92	AR 61201	4	OZH 037
2.0 T.S.	2,0		107	01.87-05.90	AR 06166	4	OZH 046
2.5 V6	2,5		115	02.86-08.86	AR 01911	6	OZH 192
2.5 V6 KAT	2,5		113	09.86-04.89	AR 01648	6	OZH 192
3.0 V6	3,0		136	01.87-02.92	AR 06124	6	OZH 037
3.0 V6	3,0		141	02.90-02.92	AR 61503	6	OZH 037
90							
2.0 i.e.	2,0		97	05.85-01.87	AR 06210	6	OZH 192
2.5 i.e. V6	2,5		110	02.86-07.87	AR 01911	6	OZH 192
2.5 i.e. V6	2,5		114	10.84-07.87	AR 01911	6	OZH 192
145							
1.4 i.e.	1,4		66	07.94-12.96	AR 33501	4	OZH 054
1.4 i.e. 16V T.S.	1,4		76	12.96-01.99	AR 33503	4	OZH 056
1.4 i.e. 16V T.S.	1,4		76	02.99-10.99	AR 33503	4	OZH 052
1.4 i.e. 16V T.S.	1,4		76	02.99-01.01	AR 38501	4	OZH 052
1.6 i.e.	1,6		76	10.94-12.94	AR 33201	4	OZH 056
1.6 i.e. 16V T.S.	1,6		88	12.96-01.99	AR 67601/AR 38201	4	OZH 056
1.6 i.e. 16V T.S.	1,6		88	02.99-01.01	AR 67601/AR 38201	4	OZH 052
1.7 i.e. 16V	1,7		95	10.94-12.96	AR 33401	4	OZH 056
1.8 i.e. 16V T.S.	1,8		103	12.96-12.98	AR 38401/AR 67106	4	OZH 056
2.0 16V Quadrifoglio	2,0		114	03.98-01.01	AR 32301	4	OZH 056
2.0 16V T.S.	2,0		110	10.95-01.01	AR 67204	4	OZH 056
146							
1.4 i.e.	1,4		66	12.94-12.96	AR 33501	4	OZH 054
1.4 i.e. 16V T.S.	1,4		76	11.96-01.01	AR 33503	4	OZH 052
1.4 i.e. 16V T.S.	1,4		76	11.96-01.01	AR 38501	4	OZH 056
1.6 i.e. 16V T.S.	1,6		88	11.96-01.01	AR 67601/AR 38201	4	OZH 056
1.7 i.e. 16V	1,7		96	12.94-12.96	AR 33401	4	OZH 056
1.8 i.e. 16V T.S.	1,8		103	11.96-01.01	AR 38401/AR 67106	4	OZH 056
2.0 16V T.S.	2,0		110	10.95-01.01	AR 67204	4	OZH 056
2.0 16V Quadrifoglio	2,0		114	03.98-01.01	AR 32301	4	OZH 056
155							
1.6 16V T.S.	1,6		88	05.96-01.98	AR 67601	4	OZH 056
1.7 T.S.	1,7		85	04.93-04.96	AR 67105	4	OZH 055
1.7 T.S. 16V	1,7		103	05.96-12.97	AR 67106	4	OZH 056
1.8 T.S.	1,8		77	02.92-04.96	AR 67402	4	OZH 055
1.8 T.S. Sport	1,8		93	01.92-04.96	AR 67101/AR 67102	4	OZH 055
1.8 T.S.	1,8		95	02.92-03.93	AR 67101	4	OZH 055
2.0 T.S.	2,0		104	04.93-02.95	AR 67202	4	OZH 055
2.0 T.S. 16V	2,0		110	05.96-12.97	AR 67204	4	OZH 056

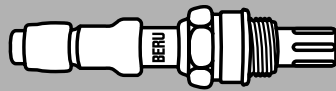
**BERU**

kW

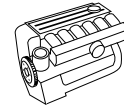
Zyl.
Cyl.
Cil.**ALFA ROMEO****155**

2.0 16V Turbo Q4	2,0	137	01.92-12.97	AR 67203	4	OZH 037
2.0 16V Turbo Q4	2,0	140	01.92-12.97	AR 67203	4	OZH 037
2.5 V6	2,5	120	05.96-12.97	AR 67303	6	OZH 035
2.5 V6	2,5	121	02.92-04.96	AR 67301	6	OZH 055

156

1.6 16V T.SPARK	1,6	88	09.97-09.00	AR 67601 VET0012329 → VET0023372	4	OZH 217
1.6 16V T.SPARK	1,6	88	09.97-09.00	AR 67601 VET0023373 →	4	OZH 056
1.8 16V T.SPARK	1,8	106	09.97-10.00	AR 32201	4	OZH 056
2.0 16V T.SPARK	2,0	114	09.97-10.00	AR 32301	4	OZH 056

164

2.0 T.S.	2,0	105	06.87-09.92	AR 06416	4	OZH 037
2.0 T.S.	2,0	106	12.93-09.98	AR 64103	4	OZH 035
2.0 V6 Turbo	2,0	148	09.92-09.98	AR 64102	6	OZH 046
3.0 V6	3,0	132	09.92-09.98	AR 66303/AR 64305	6	OZH 055
3.0 V6	3,0	135	06.87-05.91	AR 06412	6	OZH 037
3.0 V6	3,0	135	06.91-09.92	AR 06412	6	OZH 046
3.0 i.e. QV	3,0	147	09.90-05.91	AR 64301/AR 06430	6	OZH 037
3.0 i.e. QV	3,0	147	06.91-09.92	AR 64301/AR 06430	6	OZH 046
3.0 24V	3,0	155	09.92-09.98	AR 66301/AR 66302	6	OZH 055
3.0 24V Q4	3,0	170	02.94-09.98	AR 64308/AR 64307	6	OZH 035
3.0 24V QV	3,0	171	12.93-09.98	AR 64304	6	OZH 035

166

2.0 T.SPARK	2,0	114	09.98-10.00	AR 34103	4	OZH 056
2.0 V6	2,0	151	09.98-	AR 34102	6	OZH 056
2.5 V6 24V	2,5	140	09.98-10.00	AR 34201	6	OZH 056
3.0 V6 24V	3,0	166	09.98-10.00	AR 34301	6	OZH 056

ALFASUD Sprint

1.7 i.e.	1,7	77	10.87-12.89	AR 30558	4	OZH 003
----------	-----	----	-------------	----------	---	----------------

GTV

1.8 16V	1,8	106	05.98-	AR 32201	4	OZH 056
2.0 T.SPARK 16V	2,0	110	06.95-	AR 16201/AR 32310	4	OZH 056
2.0 V6 Turbo	2,0	148	06.95-	AR 16202 6003389 →	6	OZH 052
3.0 V6 24V	3,0	162	10.96-10.00	AR 16102	6	OZH 056

SPIDER

1.8 16V	1,8	106	05.98-	AR 32201	4	OZH 056
2000	2,0	85	08.86-12.89	AR 01544	4	OZH 192
2000	2,0	88	01.90-12.93	AR 01588	4	OZH 037
2.0 T.SPARK 16V	2,0	110	06.95-	AR 16201/AR 32310	4	OZH 052
3.0 V6	3,0	141	06.95-	AR 16101	6	OZH 052

ALPINA**ROADSTER (Z8)**

4.8 V8	4,8	280	06.02-		8	OZH 173
--------	-----	-----	--------	--	---	----------------

ALPINE**V6**

2.5 TURBO	2,5	136	06.87-12.90	Z7U-734	6	OZH 044
-----------	-----	-----	-------------	---------	---	----------------

A610

3.0 TURBO	3,0	184	03.91-04.95		6	OZH 033
-----------	-----	-----	-------------	--	---	----------------

AUDI**A3**

1.6	1,6	74	09.96-08.00	AKL/APF/AEH	4	OZH 169
1.8	1,8	92	09.96-04.97	AGN	4	OZH 177
1.8	1,8	92	05.97-	AGN	4	OZH 128
1.8 quattro	1,8	92	08.98-	AGN	4	OZH 128
1.8 T	1,8	110	12.96-07.97	AGU → 8LV.. 150 000	4	OZH 152
1.8 T	1,8	110	08.97-06.03	AGU 8LV.. 150 001 → 8LW.. 00 000	4	OZH 128

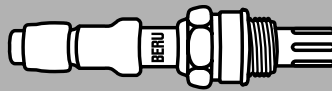

kW

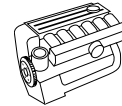
 Zyl.
Cyl.
Cil.

AUDI							
A3							
1.8 T	1,8		110	08.97-	AGU 8L.W.. 00 001 →	4	OZH 177
1.8 T quattro	1,8		110	12.96-07.97	AGU → 8L.V.. 150 000	4	OZH 152
1.8 T quattro	1,8		110	08.97-06.03	AGU 8L.V.. 150 001 → 8L.W.. 00 000	4	OZH 128
1.8 T quattro	1,8		110	08.97-	AGU 8L.W.. 00 001 →	4	OZH 177
A4, Avant							
1.6	1,6		74	01.95-10.96	ADP	4	OZH 069
1.6	1,6		74	07.99-07.00	ANA	4	OZH 178
1.6	1,6	D1	74	07.99-07.00	ANA	4	OZH 190
1.8	1,8		92	01.95-11.00	ADR/APT/ARG	4	OZH 069
1.8 quattro	1,8		92	01.95-11.00	ADR/APT/ARG	4	OZH 069
1.8 T	1,8		110	01.95-11.00	AEB	4	OZH 152
1.8 T quattro	1,8		110	01.95-11.00	AEB	4	OZH 152
2.6	2,6		110	01.95-11.00	ABC	6	OZH 103
2.6 quattro	2,6		110	01.95-11.00	ABC	6	OZH 103
2.8	2,8		128	09.95-07.97	AAH	6	OZH 103
2.8 quattro	2,8		128	01.95-07.97	AAH	6	OZH 103
2.8	2,8		142	10.96-11.00	ACK , ALG	6	OZH 071
2.8 quattro	2,8		142	08.97-11.00	ACK , ALG	6	OZH 071
A6, Avant							
1.8	1,8		92	12.95-02.97	ADR	4	OZH 070
1.8 quattro	1,8		92	12.95-02.97	ADR	4	OZH 070
2.0	2,0		74	06.94-08.96	AAE	4	OZH 027
2.0	2,0		85	06.94-02.97	ABK	4	OZH 037
2.0 16V	2,0		103	06.94-02.97	ACE	4	OZH 037
2.0 16V quattro	2,0		103	06.94-02.97	ACE	4	OZH 037
2.3	2,3		98	06.94-12.95	AAR	5	OZH 046
2.3 quattro	2,3		98	06.94-07.95	AAR	5	OZH 046
2.4	2,4		121	02.97-01.05	AGA	6	OZH 086
2.4 quattro	2,4		121	02.97-01.05	AGA	6	OZH 086
2.6	2,6	ohne Kat. ¹¹	110	06.94-07.95	ABC	6	OZH 017
2.6	2,6		110	06.94-02.97	ABC	6	OZH 044
2.6 quattro	2,6		110	09.94-02.97	ABC 4A-S-026 715	6	OZH 017
2.8	2,8		128	06.94-02.97	AEJ/AAH	6	OZH 017
2.8 quattro	2,8		128	06.94-02.97	AEJ/AAH	6	OZH 017
2.8	2,8		132	10.97-07.98	AGE	6	OZH 071
2.8	2,8		142	02.97-01.05	ACK , ALG	6	OZH 086
2.8 quattro	2,8		142	02.97-01.05	ACK , ALG	6	OZH 086
2.8	2,8		142	12.95-02.97	ACK	6	OZH 071
2.8 quattro	2,8		142	12.95-02.97	ACK	6	OZH 071
4.2 S6 Plus quattro	4,2		240	04.96-02.97	AHK	8	OZH 181
A8							
2.8	2,8		120	07.95-03.96	AEJ	6	OZH 017
2.8 quattro	2,8		120	07.95-03.96	AEJ	6	OZH 017
2.8	2,8		128	03.94-03.96	AAH	6	OZH 017
2.8 quattro	2,8		128	03.94-03.96	AAH	6	OZH 017
2.8	2,8		142	04.96-09.02	ACK , ALG	6	OZH 071
2.8 quattro	2,8		142	04.96-12.98	ACK → 4D-X-004999	6	OZH 071
3.7	3,7		169	07.95-12.98	AEW → 4B..X.004 499	8	OZH 151
3.7 quattro	3,7		169	07.95-11.98	AEW → 4B..X.004 499	8	OZH 151
4.2 quattro	4,2		180	03.94-07.96	AEM	8	OZH 151
4.2 quattro	4,2		220	03.94-11.98	AKG/ABZ	8	OZH 151
4.2 S 8 quattro	4,2		250	07.96-06.99	AHC/AKH	8	OZH 151
CABRIOLET							
1.8	1,8		92	01.97-08.00	ADR	4	OZH 068
2.0 E	2,0	ohne Kat. ¹¹	85	01.93-07.98	ABK	4	OZH 027
2.0 E	2,0		85	01.93-07.98	ABK	4	OZH 037
2.0 16V	2,0		103	06.95-07.96	ACE	4	OZH 037
2.3 E	2,3		98	05.91-07.94	NG	5	OZH 046
2.6	2,6	ohne Kat. ¹¹	110	06.93-08.00	ABC	6	OZH 017
2.6	2,6		110	06.93-08.00	ABC	6	OZH 044

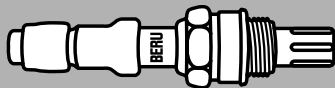

kW

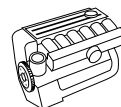

Zyl.
Cyl.
Cil.



AUDI

CABRIOLET

2.8	2,8		128	11.92-08.00	AAH	6	OZH 017
-----	-----	--	-----	-------------	-----	---	----------------

COUPE

1.8 GT	1,8		68	01.85-07.88	JN	4	OZU 022
1.8 GT	1,8		79	08.86-10.87	PV	4	OZH 037
2.0	2,0		85	05.89-12.96	ABK/AAD	4	OZH 037
2.0 16 V	2,0		101	01.92-07.92	6A	4	OZH 037
2.0 16 V	2,0		103	08.92-12.96	ACE	4	OZH 037
2.2 GT	2,2		85	01.84-10.87	KX	5	OZU 022
2.2 quattro	2,2		88	08.85-10.88	JT	5	OZH 037
2.2 S2 quattro	2,2		162	09.90-09.92	3B	5	OZH 037
2.2 S2 quattro	2,2	ohne Kat. ¹¹	169	10.92-12.96	ABY	5	OZH 027
2.2 S2 quattro	2,2		169	10.92-12.96	ABY	5	OZH 037
2.3	2,3		98	03.90-07.94	NG	5	OZH 046
2.3 quattro	2,3		98	05.90-07.94	NG	5	OZH 046
2.3	2,3		100	01.87-10.88	NG	5	OZH 003
2.3 quattro	2,3		100	01.87-10.88	NG	5	OZH 003
2.3	2,3		100	10.88-07.89	NG	5	OZH 003
2.3	2,3		100	08.89-07.94	NG	5	OZH 046
2.3 quattro	2,3		100	11.88-07.89	NG	5	OZH 003
2.3 quattro	2,3		100	08.89-12.92	NG	5	OZH 046
2.3 20V	2,3		123	08.90-07.91	7A 8B-L-000 001	5	OZH 046
2.3 20V quattro	2,3		123	05.90-07.91	7A 8B-L-000 001	5	OZH 046
2.3 20V	2,3		125	08.89-07.91	7A 8B-L-000 001	5	OZH 046
2.3 20V quattro	2,3		125	11.88-07.91	7A 8B-L-000 001	5	OZH 046
2.6	2,6	ohne Kat. ¹¹	110	08.92-12.96	ABC	6	OZH 017
2.6	2,6		110	08.92-12.96	ABC	6	OZH 044
2.6 quattro	2,6	ohne Kat. ¹¹	110	08.92-08.94	ABC	6	OZH 017
2.6 quattro	2,6		110	08.92-12.96	ABC	6	OZH 044
2.8	2,8		128	09.91-12.92	AAH	6	OZH 044
2.8	2,8		128	01.93-12.96	AAH	6	OZH 017
2.8 quattro	2,8		128	08.91-12.92	AAH	6	OZH 044
2.8 quattro	2,8		128	01.93-12.96	AAH	6	OZH 017

QUATTRO

2.2 20V	2,2		162	08.89-07.90	RR	5	OZH 046
2.2 20V	2,2		162	08.90-07.91	RR	5	OZH 037

V8

3.6 quattro	3,6	ohne Kat. ¹¹	184	10.88-02.94	PT	8	OZH 027
3.6 quattro	3,6		184	10.88-02.94	PT	8	OZH 037
4.2 quattro	4,2	ohne Kat. ¹¹	206	10.91-02.94	ABH	8	OZH 027
4.2 quattro	4,2		206	10.91-02.94	ABH	8	OZH 037

80, Avant

1.6	1,6		52	01.92-12.94	ABM	4	OZH 017
1.6 E	1,6		74	06.93-12.94	ADA	4	OZH 037
1.8 S	1,8	ohne Kat. ¹¹	66	03.88-10.91	NE/JN	4	OZH 027
1.8 S	1,8		66	03.88-10.91	PM	4	OZU 022
1.8 S quattro	1,8	ohne Kat. ¹¹	66	03.88-10.91	NE/JN	4	OZH 027
1.8 S quattro	1,8		66	03.88-10.91	PM	4	OZU 022
1.8	1,8		68	08.83-08.86	JN	4	OZU 001
1.8 CC quattro	1,8		68	08.85-08.86	JN	4	OZH 037
1.8 GTE	1,8		81	08.85-07.86	PV	4	OZH 037
1.8 GTE quattro	1,8		81	03.85-08.86	PV	4	OZH 037
1.8 GTE	1,8		82	10.84-08.86	DZ	4	OZU 001
1.8	1,8		83	09.86-08.87	SD	4	OZH 046
1.8	1,8		83	09.87-07.88	SD	4	OZH 037
1.8 quattro	1,8		83	09.86-08.87	SD	4	OZH 046
1.8 quattro	1,8		83	09.87-07.88	SD	4	OZH 037
2.0	2,0	ohne Kat. ¹¹	66	09.91-12.94	ABT	4	OZH 017
2.0	2,0		66	09.91-12.94	ABT	4	OZH 044
2.0	2,0		82	10.90-08.91	AAD	4	OZH 037
2.0 quattro	2,0		82	10.90-08.91	3A	4	OZH 046
2.0 E	2,0		83	08.88-10.90	3A	4	OZH 037

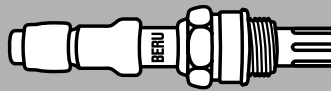

kW

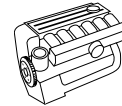
 Zyl.
Cyl.
Cil.

AUDI							
80, Avant							
2.0 E quattro	2,0		83	08.88-09.90	3A	4	OZH 037
2.0 E	2,0	ohne Kat. ¹¹	85	09.91-12.94	ABK	4	OZH 027
2.0 E	2,0		85	09.91-12.94	ABK	4	OZH 037
2.0 E quattro	2,0	ohne Kat. ¹¹	85	09.91-12.94	ABK	4	OZH 027
2.0 E quattro	2,0		85	09.91-12.94	ABK	4	OZH 037
2.0 quattro	2,0		85	10.90-08.91	AAD	4	OZH 037
2.0 E 16V	2,0		101	03.90-09.91	6A	4	OZH 037
2.0 E 16V quattro	2,0		101	03.90-08.91	6A	4	OZH 037
2.0 E 16V	2,0		103	08.92-12.94	ACE	4	OZH 037
2.0 E 16V quattro	2,0		103	04.92-12.94	ACE	4	OZH 037
S2 quattro	2,2		169	02.93-12.94	ABY	5	OZH 037
2.3 E	2,3		98	09.91-12.94	NG	5	OZH 046
2.3 E quattro	2,3		98	09.91-12.94	NG	5	OZH 046
2.6	2,6	ohne Kat. ¹¹	110	07.92-12.94	ABC	6	OZH 017
2.6	2,6		110	07.92-12.94	ABC	6	OZH 044
2.6 quattro	2,6	ohne Kat. ¹¹	110	06.92-12.94	ABC	6	OZH 017
2.6 quattro	2,6		110	06.92-12.94	ABC	6	OZH 044
2.8	2,8		128	08.92-12.94	AAH	6	OZH 017
2.8 quattro	2,8		128	08.92-12.94	AAH	6	OZH 017
90							
2.0	2,0		83	03.86-03.87	SK	5	OZU 022
2.0	2,0		85	07.88-09.91	PS	5	OZH 046
2.2	2,2		85	01.85-03.87	KX	5	OZU 022
2.2 E quattro	2,2		88	08.85-03.87	JT	5	OZH 037
2.3 E	2,3		100	04.87-07.91	NG	5	OZH 046
2.3 E quattro	2,3		100	04.87-07.91	NG	5	OZH 046
2.3 E 20V	2,3		125	08.88-07.91	7A	5	OZH 037
2.3 E 20V quattro	2,3		125	06.88-09.91	7A	5	OZH 037
2.3 E	2,3		98	04.87-09.91	NG	5	OZH 046
2.3 E quattro	2,3		98	04.87-09.91	NG	5	OZH 046
100, Avant							
1.8	1,8		66	08.83-07.89	NP/DS	4	OZU 022
1.8 KAT	1,8		66	03.85-10.89	4B, PH	4	OZU 022
1.8 quattro KAT	1,8		66	08.85-10.89	4B, PH	4	OZU 022
2.0	2,0		74	12.90-06.94	AAE	4	OZH 027
2.0	2,0		74	12.90-06.94	AAE.	4	OZH 044
2.0 E	2,0	ohne Kat. ¹¹	85	12.90-06.94	AAD	4	OZH 027
2.0 E quattro	2,0	ohne Kat. ¹¹	85	12.90-07.92	AAD	4	OZH 027
2.0 KAT	2,0		85	01.88-11.90	RT	5	OZH 037
2.0 E	2,0		85	12.90-06.94	ABK	4	OZH 037
2.0 E	2,0		85	12.90-06.94	AAD	4	OZH 027
2.0 E quattro	2,0		85	12.90-07.92	AAD	4	OZH 037
2.0 E 16V	2,0		101	01.92-06.94	ACE	4	OZH 037
2.0 E 16V quattro	2,0		103	07.92-06.94	ACE	4	OZH 037
2.2 Turbo	2,2		121	08.86-11.90	MC	5	OZH 037
2.2 E Turbo quattro	2,2		121	08.86-11.88	MC → K-038261	5	OZH 037
2.2 E Turbo quattro	2,2		121	11.88-11.90	MC K-038262 →	5	OZH 046
S4 Turbo quattro	2,2	ohne Kat. ¹¹	169	08.91-06.94	AAN	5	OZH 027
S4 Turbo quattro	2,2		169	08.91-06.94	AAN	5	OZH 046
2.2	2,2		85	10.84-09.86	KZ	5	OZU 022
2.2 E quattro	2,2		88	08.85-07.86	PX	5	OZH 037
2.3 E	2,3		98	12.90-06.94	AAR	5	OZH 046
2.3 E quattro	2,3		98	12.90-06.94	AAR	5	OZH 046
2.3 E	2,3		100	08.86-07.89	NF → 44-K-300000	5	OZH 003
2.3 E	2,3		100	07.89-11.90	NF 44-L-000001 →	5	OZH 046
2.3 E quattro	2,3		100	08.86-07.89	NF → 44-K-300000	5	OZH 003
2.3 E quattro	2,3		100	07.89-11.90	NF 44-L-000001 →	5	OZH 046
2.6	2,6	ohne Kat. ¹¹	110	03.92-06.94	ABC	6	OZH 017
2.6	2,6		110	03.92-06.94	ABC	6	OZH 044
2.6 quattro	2,6	ohne Kat. ¹¹	110	04.92-06.94	ABC	6	OZH 017
2.6 quattro	2,6		110	04.92-06.94	ABC	6	OZH 044

BERU

kW

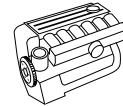
 Zyl.
Cyl.
Cil.

AUDI
100, Avant

2.8 E	2,8	ohne Kat. ¹¹	128	12.90-06.94	AAH	6	OZH 017
2.8 E	2,8		128	12.90-08.92	AAH → 4A-P-022-306	6	OZH 044
2.8 E	2,8		128	09.92-06.94	AAH 4A-P-022-307 →	6	OZH 017
2.8 E quattro	2,8		128	12.90-06.94	AAH → 4A-P-022-306	6	OZH 044
2.8 E quattro	2,8		128	12.90-06.94	AAH 4A-P-022-307 →	6	OZH 017

200, Avant

2.2 Turbo	2,2		121	08.85-09.91	MC	5	OZH 037
2.2 Turbo quattro	2,2		121	01.85-11.88	MC → 44-K-038261	5	OZH 035
2.2 Turbo quattro	2,2		121	11.88-12.90	MC 44-K-038262 →	5	OZH 046
2.2 20V Turbo quattro	2,2		162	03.89-12.90	3B	5	OZH 046

BERTONE
FREECLIMBER 2

1.6	1,6		74	03.92-	BMW 161 E1	4	OZH 036
-----	-----	--	----	--------	------------	---	----------------

BMW
3 (E30)

316 i	1,6	Kat. ⁸	73	09.88-12.90	M 40 B 16	4	OZH 039
316 i	1,6		75	09.88-10.90	M 40 B 16	4	OZH 039
318 i	1,8	Kat. ⁸	75	05.86-08.87	M 10 B 18 (L-Jetronic)/ M 10 B 18 (L-Jetronic)	4	OZH 001
316 i 1.8	1,8	Kat. ⁸	75	08.87-08.88	M 10 B 18 (L-Jetronic)	4	OZH 001
318 i	1,8		77	05.86-08.87	M 10 B 18 (K-Jetronic)	4	OZH 001
318 is	1,8		100	09.89-08.90	M 42 B 18	4	OZH 039
318 i	1,8	Kat. ⁸	83	09.87-06.91	M 40 B 18	4	OZH 039
318 i	1,8		85	09.87-06.91	M 40 B 18	4	OZH 039
320 i	2,0	Kat. ⁸	95	10.87-06.91	M 20 B 20 (L-Jetronic)/ M 20 B 20 (Motronic)	6	OZH 036
325 i X	2,5	Kat. ⁸	125	10.87-08.91	M 20 B 25	6	OZH 036
325 i	2,5	Kat. ⁸	125	10.87-06.91	M 20 B 25	6	OZH 036
325 i X	2,5		126	10.87-12.87	M 20 B 25	6	OZH 036
325 i	2,5		126	10.87-11.89	M 20 B 25	6	OZH 036
325 e 2.7	2,7	Kat. ⁸	90	10.83-09.87	M 20 B 27	6	OZH 039
325 e 2.7	2,7	Kat. ⁸	90	10.87-12.88	M 20 B 27	6	OZH 036

3 Cabriolet (E30)

318 i	1,8	Kat. ⁸	83	09.90-10.93	M 40 B 18	4	OZH 039
320 i	2,0	Kat. ⁸	95	10.87-10.93	M 20 B 20 (Motronic)	6	OZH 036
325 i	2,5	Kat. ⁸	125	09.87-10.93	M 20 B 25	6	OZH 036

3 Touring (E30)

316 i	1,6	Kat. ⁸	73	09.91-12.93	M 40 B 16	4	OZH 039
316 i	1,6		75	09.91-06.94	M 40 B 16	4	OZH 039
318 i	1,8	Kat. ⁸	83	04.89-06.94	M 40 B 18	4	OZH 039
318 i	1,8		85	04.89-06.91	M 40 B 18	4	OZH 039
320 i	2,0	Kat. ⁸	95	01.88-12.91	M 20 B 20 (Motronic)	6	OZH 036
325 i	2,5	Kat. ⁸	125	10.87-03.93	M 20 B 25	6	OZH 036
325 i X	2,5	Kat. ⁸	125	06.88-10.93	M 20 B 25	6	OZH 036

3 (E36)

316 i	1,6	Kat. ⁸	73	12.90-09.93	M 40 B 16	4	OZH 036
316 i	1,6		75	07.93-09.95	M 43 B 16	4	OZH 004
316 i	1,6		75	10.95-02.98	M 43 B 16	4	OZH 023
316 i	1,6		75	12.90-09.93	M 40 B 16	4	OZH 036
318 is	1,8		103	09.93-09.97	M 42 B 18	4	OZH 036
318 i	1,8	Kat. ⁸	83	12.90-10.93	M 40 B 18	4	OZH 036
318 i	1,8		85	10.93-09.95	M 43 B 18	4	OZH 023
318 i	1,8		85	10.95-02.98	M 43 B 18	4	OZH 036
318 is	1,9		103	09.95-02.98	M 44 B 19	4	OZH 173
320 i	2,0		110	09.90-08.92	M 50 B (20 6 S2) Vanos/ M 52 B (20 6 S3) Vanos/ M 50 B (20 6 S1)	6	OZH 036
325 i	2,5		141	09.90-09.95	M 50 B 25/M 50 B 25 (Vanos)	6	OZH 036
M3 3.0	3,0		210	08.94-09.95	S 50 B 30	6	OZH 036

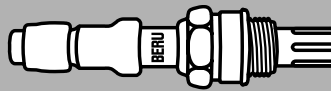

kW

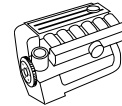
 Zyl.
Cyl.
Cil.

BMW							
3 Cabriolet (E36)							
318 i	1,8		85	01.94–09.95		4	OZH 023
318 i	1,8		85	10.95–04.99	M 43 B 18	4	OZH 036
325 i	2,5		141	03.93–03.95	M 50 B 25	6	OZH 036
M3 3.0	3,0		210	01.94–10.95	S 50 B 30	6	OZH 036
3 Compact (E36)							
316 i	1,6		75	03.94–09.95	M 43 B 16	4	OZH 023
316 i	1,6		75	10.95–08.00	M 43 B 16	4	OZH 036
316 g	1,6		75	12.95–08.00		4	OZH 023
318 ti	1,8		103	11.94–08.95	M 42 B 18	4	OZH 036
318 ti	1,9		103	07.95–08.00	M 44 B 19	4	OZH 173
318 ti	1,9	D1	103	12.95–08.00	M 44 B 19	4	OZH 199
316 i	1,9		77	12.98–08.00	M43164E3	4	OZH 173
3 Coupe (E36)							
316 i	1,6		75	09.93–09.95	M 43 B 16	4	OZH 036
316 i	1,6		75	10.95–04.99	M 43 B 16	4	OZH 023
318 is	1,8		103	03.92–10.95	M 42 B 18	4	OZH 036
318 is	1,9		103	09.95–04.99	M 44 B 19	4	OZH 173
318 is	1,9	D1	103	09.95–04.99	M 44 B 19	4	OZH 199
320 i	2,0		110	03.92–08.92	M 50 B (20 6 S2) Vanos/ M 52 B (20 6 S3) Vanos/ M 50 B (20 6 S1)	6	OZH 036
325 i	2,5		141	03.92–04.99	M 52 B 25 (Vanos)/ M 50 B 25 (Vanos)	6	OZH 036
M3 3.0	3,0		210	10.92–01.95	S 50 B 30	6	OZH 036
M3 3.0	3,0		217	01.95–10.95	S 50 B 30	6	OZH 036
3 Touring (E36)							
316 i	1,6		75	02.97–10.99	M 43 B 16	4	OZH 023
318 i	1,8		85	07.95–09.95	M 43 B 18	4	OZH 036
318 i	1,8		85	10.95–10.99	M 43 B 18	4	OZH 023
3 (E46)							
316 i	1,6		77	04.00–02.05	M 43 B 16 (16 4 E3)	4	OZH 173
316 i	1,6	D1	77	04.00–09.02	M 43 B 16 (16 4 E3)	4	OZH 199
316 i	1,6		85	06.02–03.04	N45B16A	4	OZH 223
316 i	1,8	D2	85	02.02–03.04	N 42 B 18 Euro 4 (D4)	4	OZH 223
316 i	1,8	D1	85	02.02–03.04	N 42 B 18 Euro 4 (D4)	4	OZH 224
316 i	1,9		77	09.98–02.05	M43164E3	4	OZH 173
316 i	1,9	D1	77	09.98–09.02	M43164E3	4	OZH 199
318 i	1,9		87	02.98–09.01	M 43 B 19	4	OZH 173
318 i	1,9	D1	87	02.98–09.01	M 43 B 19	4	OZH 199
320 i	2,0		110	03.98–09.00	M 52 B (20 6 S3) Vanos	6	OZH 173
320 i	2,0	D1	110	03.98–09.00	M 52 B (20 6 S3) Vanos	6	OZH 168
320 i	2,0		110	03.98–09.00	M 52 B (20 6 S3) Vanos	6	OZH 218
320 i	2,0	D1,	110	03.98–09.00	M 52 B (20 6 S3) Vanos	6	OZH 199
318 i	2,0	D1	105	09.01–03.04	N 42 B 20 Euro 4 (D4)	4	OZH 224
318 i	2,0	D2	105	09.01–03.04	N 42 B 20 Euro 4 (D4)	4	OZH 223
320 i	2,2		125	09.00–02.05	M54226S1	6	OZH 173
320 i	2,2	D1	125	09.00–02.05	M54226S1	6	OZH 168
320 i	2,2		125	09.00–02.05	M54226S1	6	OZH 218
320 i	2,2		125	09.00–02.05	M54226S1	6	OZH 222
323 i	2,5		125	03.98–09.00	M 52 B 25 (Vanos)	6	OZH 173
323 i	2,5	D1	125	03.98–09.00	M 52 B 25 (Vanos)	6	OZH 168
323 i	2,5		125	03.98–09.00	M 52 B 25 (Vanos)	6	OZH 218
323 i	2,5	D1,	125	03.98–09.00	M 52 B 25 (Vanos)	6	OZH 199
325 i	2,5		141	09.00–02.05	M54256S5	6	OZH 173
325 i	2,5	D1	141	09.00–02.05	M54256S5	6	OZH 168
325 i	2,5		141	09.00–02.05	M54256S5	6	OZH 218
325 xi	2,5		141	09.00–02.05	M54256S5	6	OZH 173
325 xi	2,5	D1	141	09.00–02.05	M54256S5	6	OZH 168
328 i	2,8		142	02.98–06.00	M 52 B 28	6	OZH 173
328 i	2,8	D1	142	02.98–06.00	M 52 B 28	6	OZH 168
328 i	2,8		142	02.98–06.00	M 52 B 28	6	OZH 218

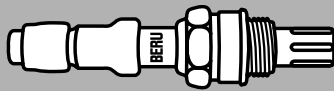
**BERU**

kW

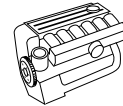
Zyl.
Cyl.
Cil.**BMW****3 (E46)**

328 i	2,8	D1,	142	02.98-06.00	M 52 B 28	6	OZH 199
330 xi	3,0		170	06.00-02.05	M54306S3	6	OZH 173
330 xi	3,0	D1	170	06.00-02.05	M54306S3	6	OZH 168
330 i	3,0		170	06.00-02.05	M54306S3	6	OZH 173
330 i	3,0	D1	170	06.00-02.05	M54306S3	6	OZH 168
330 i	3,0		170	06.00-02.05	M54306S3	6	OZH 218
330 i	3,0		170	10.00-02.05	M54306S3	6	OZH 222
330 i	3,0	D1,	170	06.00-09.00	M54306S3	6	OZH 199

3 Cabriolet (E46)

318 Ci	2,0	D1	105	09.01-03.04	N 42 B 20 Euro 4 (D4)	4	OZH 224
318 Ci	2,0	D2	105	09.01-03.04	N 42 B 20 Euro 4 (D4)	4	OZH 223
318 Ci	2,0	D2	110	02.05-	Euro 3 (D3)	6	OZH 223
318 Ci	2,0	D1	110	02.05-	Euro 4 (D4)	6	OZH 224
318 Ci	2,0	D2	110	02.05-	Euro 4 (D4)	6	OZH 223
320 Ci	2,2		125	09.00-	M54226S1/M 54 B 22	6	OZH 173
320 Ci	2,2	D1	125	09.00-	M54226S1/M 54 B 22	6	OZH 168
320 Ci	2,2		125	09.00-	M54226S1/M 54 B 22	6	OZH 218
320 Ci	2,2		125	09.00-	M54226S1/M 54 B 22	6	OZH 222
323 Ci	2,5		125	04.00-09.00	M 52 B 25 (Vanos)	6	OZH 173
323 Ci	2,5	D1	125	04.00-09.00	M 52 B 25 (Vanos)	6	OZH 168
323 Ci	2,5		125	04.00-09.00	M 52 B 25 (Vanos)	6	OZH 218
323 Ci	2,5	D1,	125	04.00-09.00	M 52 B 25 (Vanos)	6	OZH 199
325 Ci	2,5		141	09.00-	M54256S5	6	OZH 173
325 Ci	2,5	D1	141	09.00-	M54256S5	6	OZH 168
325 Ci	2,5		141	09.00-	M54256S5	6	OZH 218
325 Ci	2,5		141	09.00-	M54256S5	6	OZH 222
330 Ci	3,0		170	06.00-	M54306S3	6	OZH 173
330 Ci	3,0	D1	170	06.00-	M54306S3	6	OZH 168
330 Ci	3,0		170	06.00-	M54306S3	6	OZH 218
330 Ci	3,0		170	10.00-	M54306S3	6	OZH 222
330 Ci	3,0	D1,	170	06.00-	M54306S3	6	OZH 199

3 Compact (E46)

316 ti	1,8	D1	85	06.01-03.04	N 42 B 18 Euro 4 (D4)	4	OZH 224
316 ti	1,8	D2	85	06.01-03.04	N 42 B 18 Euro 4 (D4)	4	OZH 223
318 ti	2,0	D1	105	09.01-03.04	N 42 B 20 Euro 4 (D4)	4	OZH 224
318 ti	2,0	D2	105	09.01-03.04	N 42 B 20 Euro 4 (D4)	4	OZH 223
325 ti	2,5		141	06.01-02.05	M54256S5	6	OZH 173
325 ti	2,5	D1	141	06.01-02.05	M54256S5	6	OZH 168
325 ti	2,5		141	06.01-12.04	M54256S5	6	OZH 218
325 ti	2,5		141	06.01-12.04	M54256S5	6	OZH 222

3 Coupe (E46)

316 Ci	1,6		77	04.00-	M 43 B 16 (16 4 E3)	4	OZH 173
316 Ci	1,6	D1	77	04.00-09.02	M 43 B 16 (16 4 E3)	4	OZH 199
316 Ci	1,6		85	06.02-03.04	N45B16A	4	OZH 223
318 Ci	1,9		87	11.99-09.01	M 43 B 19	4	OZH 173
318 Ci	1,9	D1	87	11.99-09.01	M 43 B 19	4	OZH 199
318 Ci	2,0	D1	105	09.01-03.04	N 42 B 20 Euro 4 (D4)	4	OZH 224
318 Ci	2,0	D2	105	09.01-03.04	N 42 B 20	4	OZH 223
320 Ci	2,0		110	08.99-09.00	M 52 B (20 6 S4)	6	OZH 173
320 Ci	2,0	D1	110	08.99-09.00	M 52 B (20 6 S4)	6	OZH 168
320 Ci	2,2		125	09.00-	M54226S1	6	OZH 173
320 Ci	2,2	D1	125	09.00-	M54226S1	6	OZH 168
320 Ci	2,2		125	09.00-09.06	M54226S1	6	OZH 218
320 Ci	2,2		125	09.00-09.06	M54226S1	6	OZH 222
323 Ci	2,5		125	04.99-09.00	M 52 B 25 (Vanos)	6	OZH 173
323 Ci	2,5	D1	125	04.99-09.00	M 52 B 25 (Vanos)	6	OZH 168
323 Ci	2,5		125	04.99-09.00	M 52 B 25 (Vanos)	6	OZH 218
323 Ci	2,5	D1,	125	04.99-09.00	M 52 B 25 (Vanos)	6	OZH 199
325 Ci	2,5		141	09.00-	M54256S5	6	OZH 173
325 Ci	2,5	D1	141	09.00-	M54256S5	6	OZH 168
325 Ci	2,5		141	09.00-09.06	M54256S5	6	OZH 218

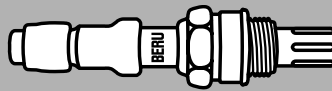

kW

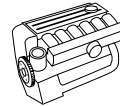
 Zyl.
Cyl.
Cil.

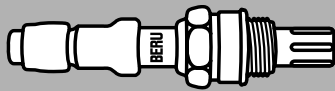

BMW							
3 Coupe (E46)							
325 Ci	2,5		141	09.00–09.06	M54256S5	6	OZH 222
328 Ci	2,8		142	04.99–06.00	M 52 B 28	6	OZH 173
328 Ci	2,8	D1	142	04.99–06.00	M 52 B 28	6	OZH 168
328 Ci	2,8		142	04.99–06.00	M 52 B 28	6	OZH 218
328 Ci	2,8	D1,	142	04.99–06.00	M 52 B 28	6	OZH 199
330 Ci	3,0		170	06.00–	M54306S3	6	OZH 173
330 Ci	3,0	D1	170	06.00–	M54306S3	6	OZH 168
330 Ci	3,0		170	06.00–09.06	M54306S3	6	OZH 218
330 Ci	3,0		170	06.00–09.06	M54306S3	6	OZH 222
330 Ci	3,0	D1,	170	06.00–	M54306S3	6	OZH 199
3 Touring (E46)							
316 i	1,8	D1	85	03.02–03.04	N 42 B 18 Euro 4 (D4)	4	OZH 224
316 i	1,8	D2	85	03.02–03.04	N 42 B 18 Euro 4 (D4)	4	OZH 223
318 i	1,9		87	10.99–09.01	M 43 B 19	4	OZH 173
318 i	1,9	D1	87	10.99–09.01	M 43 B 19	4	OZH 199
318 i	2,0	D1	105	09.01–03.04	N 42 B 20 Euro 4 (D4)	4	OZH 224
318 i	2,0	D2	105	09.01–03.04	N 42 B 20 Euro 4 (D4)	4	OZH 223
320 i	2,0		110	10.99–09.00	M 52 B (20 6 S3) Vanos	6	OZH 173
320 i	2,0	D1	110	10.99–09.00	M 52 B (20 6 S3) Vanos	6	OZH 168
320 i	2,2		125	09.00–	M54226S1	6	OZH 173
320 i	2,2	D1	125	09.00–	M54226S1	6	OZH 168
320 i	2,2		125	09.00–09.05	M54226S1	6	OZH 218
320 i	2,2		125	09.00–09.05	M54226S1	6	OZH 222
325 i	2,5		141	09.00–	M54256S5	6	OZH 173
325 i	2,5	D1	141	09.00–	M54256S5	6	OZH 168
325 i	2,5		141	09.00–12.04	M54256S5	6	OZH 218
325 i	2,5		141	09.00–09.05	M54256S5	6	OZH 222
325 xi	2,5		141	09.00–	M54256S5	6	OZH 173
325 xi	2,5	D1	141	09.00–	M54256S5	6	OZH 168
328 i	2,8		142	10.99–06.00	M 52 B 28	6	OZH 173
328 i	2,8	D1	142	10.99–06.00	M 52 B 28	6	OZH 168
328 i	2,8		142	10.99–06.00	M 52 B 28	6	OZH 218
328 i	2,8	D1,	142	10.99–06.00	M 52 B 28	6	OZH 199
330 xi	3,0		170	06.00–	M54306S3	6	OZH 173
330 xi	3,0	D1	170	06.00–	M54306S3	6	OZH 168
330 i	3,0		170	06.00–	M54306S3	6	OZH 173
330 i	3,0	D1	170	06.00–	M54306S3	6	OZH 168
330 i	3,0		170	06.00–09.05	M54306S3	6	OZH 218
330 i	3,0		170	06.00–09.05	M54306S3	6	OZH 222
330 i	3,0	D1,	170	06.00–09.02	M54306S3	6	OZH 199
5 (E28)							
525 e 2.7	2,7	Kat. ^B	90	12.84–11.86	M 20 B 27	6	OZU 001
525 e 2.7	2,7		95	12.84–11.86	M 20 B 27	6	OZU 001
5 (E34)							
518 i	1,8	Kat. ^B	83	08.89–06.94	M 40 B 18	4	OZH 039
518 i	1,8		85	12.93–09.95	M 43 B 18	4	OZH 039
520 i	2,0	Kat. ^B	95	01.88–12.90	M 20 B 20 (Motronic)	6	OZH 004
520 i 24V	2,0		110	09.89–06.92	M 50 B (20 6 S2) Vanos/ M 50 B (20 6 S1)	6	OZH 030
525 i	2,5	Kat. ^B	125	01.88–12.90	M 20 B 25	6	OZH 004
525 i 24V	2,5		141	09.89–09.95	M 50 B 25	6	OZH 030
525 i X 24V	2,5		141	10.91–09.95	M 52 B 25 (Vanos)	6	OZH 030
530 i	3,0	Kat. ^B	138	01.88–12.90	M 30 B 30	6	OZH 002
530 i V8	3,0		160	09.92–06.94	M 60 B 30	8	OZH 036
530 i V8	3,0		160	07.94–09.95	M 60 B 30	8	OZH 023
535 i	3,4	Kat. ^B	155	01.88–12.93	M 30 B 35 (Motronic,9:1)	6	OZH 002
M5 3.6 KAT	3,6	Kat. ^B	232	10.88–05.92	S 38 B 36	6	OZH 002
M5 3.8	3,8		250	03.92–09.95	S 38 B 38	6	OZH 002
540 i V8	4,0		210	09.92–06.94	M 60 B 40	8	OZH 036
540 i V8	4,0		210	07.94–09.95	M 60 B 40	8	OZH 023



BERU

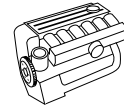

kW



Zyl.
Cyl.
Cil.



BMW

5 Touring (E34)

518 i	1,8	Kat. ⁹	83	03.93-09.94	M 40 B 18	4	OZH 039
518 g	1,8		85	11.95-06.96	M 43 B 18	4	OZH 039
520 i	2,0		110	11.91-06.92	M 50 B (20 6 S2) Vanos/ M 50 B (20 6 S1)	6	OZH 030
525 i	2,5		141	11.91-01.97	M 50 B 25	6	OZH 030
525 i X	2,5		141	02.92-01.97	M 50 B 25	6	OZH 030
530 i V8	3,0		160	09.92-06.94	M 60 B 30	8	OZH 036
530 i V8	3,0		160	07.94-01.97	M 60 B 30	8	OZH 023
M5 3.8	3,8		250	09.94-12.95	S 38 B 38	6	OZH 002
540 i	4,0		210	09.93-06.94	M 60 B 40	8	OZH 036
540 i	4,0		210	07.94-01.97	M 60 B 40	8	OZH 023

5 (E39)

520 i	2,0		110	01.96-09.00	M 52 B (20 6 S4)/ M 52 B (20 6 S3) Vanos	6	OZH 173
520 i	2,0	D1	110	01.96-09.00	M 52 B (20 6 S4)/ M 52 B (20 6 S3) Vanos	6	OZH 168
520 i	2,0		110	10.98-09.00	M 52 B (20 6 S4)/ M 52 B (20 6 S3) Vanos	6	OZH 218
520 i	2,2		125	09.00-06.03	M 54 B 22	6	OZH 173
520 i	2,2	D1	125	09.00-06.03	M 54 B 22	6	OZH 168
520 i	2,2		125	09.00-06.03	M 54 B 22	6	OZH 222
523 i	2,5		125	11.95-09.00	M 52 B 25 (Vanos)	6	OZH 173
523 i	2,5	D1	125	11.95-09.00	M 52 B 25 (Vanos)	6	OZH 168
523 i	2,5		125	10.98-09.00	M 52 B 25 (Vanos)	6	OZH 218
525 i	2,5		141	09.00-06.03	M54256S5	6	OZH 173
525 i	2,5	D1	141	09.00-06.03	M54256S5	6	OZH 168
525 i	2,5		141	09.00-06.03	M54256S5	6	OZH 222
528 i	2,8		142	10.98-09.00	M 52 B 28	6	OZH 173
528 i	2,8	D1	142	10.98-09.00	M 52 B 28	6	OZH 168
528 i	2,8		142	10.98-09.00	M 52 B 28	6	OZH 218
530 i	3,0		170	09.00-06.03	M54306S3	6	OZH 173
530 i	3,0	D1	170	09.00-06.03	M54306S3	6	OZH 168
530 i	3,0		170	09.00-06.03	M54306S3	6	OZH 222
535 i	3,5		173	09.98-03.99	M 62 B (35 8 S1)	8	OZH 173
535 i	3,5	D1	173	09.98-03.99	M 62 B (35 8 S1)	8	OZH 167
535 i	3,5		180	04.99-06.03	M 62 B (35 8 S2)	8	OZH 173
535 i	3,5	D1	180	04.99-06.03	M 62 B (35 8 S2)	8	OZH 167
540 i	4,4		210	09.98-06.03	M 62 B 44	8	OZH 173
540 i	4,4	D1	210	09.98-06.03	M 62 B 44	8	OZH 167
M5	4,9		294	10.98-06.03	S 38 B 49	8	OZH 173
M5	4,9	D1	294	10.98-06.03	S 38 B 49	8	OZH 167

5 Touring (E39)

520 i	2,0		110	01.97-09.00	M 52 B (20 6 S4)/ M 52 B (20 6 S3) Vanos	6	OZH 173
520 i	2,0	D1	110	01.97-09.00	M 52 B (20 6 S4)/ M 52 B (20 6 S3) Vanos	6	OZH 168
520 i	2,0		110	10.98-09.00	M 52 B (20 6 S4)/ M 52 B (20 6 S3) Vanos	6	OZH 218
520 i	2,2		125	09.00-05.04	M 54 B 22	6	OZH 173
520 i	2,2	D1	125	09.00-05.04	M 54 B 22	6	OZH 168
520 i	2,2		125	09.00-05.04	M 54 B 22	6	OZH 222
523 i	2,5		125	01.97-09.00	M 52 B 25 (Vanos)	6	OZH 173
523 i	2,5	D1	125	01.97-09.00	M 52 B 25 (Vanos)	6	OZH 168
523 i	2,5		125	10.98-09.00	M 52 B 25 (Vanos)	6	OZH 218
525 i	2,5		141	09.00-05.04	M54256S5	6	OZH 173
525 i	2,5	D1	141	09.00-05.04	M54256S5	6	OZH 168
525 i	2,5		141	09.00-05.04	M54256S5	6	OZH 222
528 i	2,8		142	01.97-09.00	M 52 B 28	6	OZH 173
528 i	2,8	D1	142	01.97-09.00	M 52 B 28	6	OZH 168
528 i	2,8		142	10.98-09.00	M 52 B 28	6	OZH 218
530 i	3,0		170	09.00-05.04	M54306S3	6	OZH 173

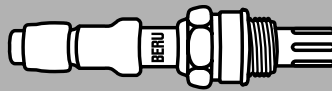

kW

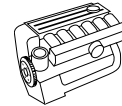
 Zyl.
Cyl.
Cil.

BMW							
5 Touring (E39)							
530 i	3,0	D1	170	09.00–05.04	M54306S3	6	OZH 168
530 i	3,0		170	09.00–05.04	M54306S3	6	OZH 222
540 i	4,4		210	09.98–05.04	M 62 B 44	8	OZH 173
540 i	4,4	D1	210	09.98–05.04	M 62 B 44	8	OZH 167
5 (E60)							
520i	2,2		125	07.03–	M54226S1	6	OZH 173
520i	2,2		125	07.03–03.05	M54226S1	6	OZH 222
525i	2,5		141	09.03–	M54256S5	6	OZH 173
525i	2,5		141	09.03–03.05	M54256S5	6	OZH 222
530i	3,0		170	07.03–	M54306S3	6	OZH 173
530i	3,0		170	07.03–03.05	M54306S3	6	OZH 222
5 Touring (E61)							
525i	2,5		141	06.04–03.05	M54256S5	6	OZH 222
6 (E24)							
635 CSi	3,4		141	01.88–04.89		6	OZH 002
635 CSi	3,4	Kat. ^B	136	01.88–05.89	M 30 B 35 (Motronic,8:1)	6	OZH 002
635 CSi	3,4	Kat. ^B	155	01.88–04.89	M 30 B 35 (Motronic,9:1)	6	OZH 002
7 (E32)							
730 i,iL	3,0	Kat. ^B	138	12.86–09.87	M 30 B 30	6	OZH 193
730 i,iL	3,0	Kat. ^B	138	10.87–09.94	M 30 B 30	6	OZH 002
730 i,iL	3,0		145	12.86–09.87	M 30 B 30	6	OZH 193
730 i,iL	3,0		145	10.87–09.94	M 30 B 30	6	OZH 002
730 i,iL V8	3,0		160	04.92–09.94	M 60 B 30	8	OZH 036
735 i,iL	3,4	Kat. ^B	155	09.86–09.87	M 30 B 35 (Motronic,9:1)	6	OZH 193
735 i,iL	3,4	Kat. ^B	155	10.87–09.92	M 30 B 35 (Motronic,9:1)	6	OZH 002
735 i,iL	3,4		162	09.86–12.87	M 30 B 35 (Motronic,9.2:1)	6	OZH 193
740 i,iL V8	4,0		210	04.92–09.94	M 60 B 40	8	OZH 036
750 i,iL V12	5,0		220	09.87–09.94	M 70 B 50	12	OZH 036
7 (E38)							
728 i,iL	2,8		142	08.95–11.01	M 52 B 28	6	OZH 173
728 i,iL	2,8	D1	142	08.95–11.01	M 52 B 28	6	OZH 168
728 i,iL	2,8		142	10.98–11.01	M 52 B 28	6	OZH 218
730 i,iL	3,0		155	10.94–11.01	M 60 B 30	8	OZH 023
730 i,iL	3,0		160	10.94–11.01	M 60 B 30	8	OZH 023
735 i,iL	3,5		173	09.98–11.01	M 62 B (35 8 S1)	8	OZH 173
735 i,iL	3,5	D1	173	09.98–11.01	M 62 B (35 8 S1)	8	OZH 167
740 i,iL	4,0		210	10.94–11.01	M 60 B 40	8	OZH 023
740 i,iL	4,4		210	09.98–11.01	M 62 B 44	8	OZH 173
740 i,iL	4,4	D1	210	09.98–11.01	M 62 B 44	8	OZH 167
750 i,iL	5,4		240	12.94–11.01	M 73 B 54	12	OZH 173
750 i,iL	5,4	D1	240	12.94–09.98	M 73 B 54	12	OZH 167
750 i,iL	5,4	D1	240	10.98–11.01	M 73 B 54	12	OZH 199
7 (E65, E66)							
730 i,Li	3,0		170	03.03–	M54306S3	6	OZH 173
730 i,Li	3,0		170	03.03–03.05	M54306S3	6	OZH 222
8 (E31)							
840 i	4,0	Automatic ³	210	05.94–02.96	M 60 B 40	8	OZH 023
840 i	4,0		210	02.93–02.96	M 60 B 40	8	OZH 036
840 Ci	4,4	Automatic ³	210	01.96–12.99	M 62 B 44	8	OZH 173
850 i,Ci	5,0		220	04.90–10.94	M 70 B 50	12	OZH 036
850 Ci	5,4		240	09.94–12.99	M 73 B 54	12	OZH 173
850 CSi	5,5		280	04.93–12.96	M 70 B 56	12	OZH 039
X3 (E83)							
2.5 i	2,5		141	01.04–	M54256S5	6	OZH 173
3.0 i	3,0		170	01.04–	M54306S3	6	OZH 173
X5 (E53)							
3.0 i	3,0		163	05.00–	M54306S3	6	OZH 173
3.0 i	3,0	D1	163	05.00–	M54306S3	6	OZH 168
3.0 i	3,0		170	05.00–	M54306S3	6	OZH 173
4.4 i	4,4		210	05.00–09.03	M 62 B 44	8	OZH 173
4.4 i	4,4	D1	235	12.03–	N62B44A	8	OZH 224

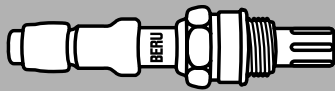
BERU

kW

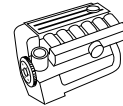
 Zyl.
Cyl.
Cil.

BMW
X5 (E53)

4.6 is	4,6		255	02.02-09.03	M67468S1	8	OZH 173
4.6 is	4,6	D1	255	02.02-09.03	M67468S1	8	OZH 199
4.8 is	4,8	D1	265	04.04-	N62B48A	8	OZH 224

Z1

2.5	2,5	Kat. ⁸	125	06.88-06.91	M 20 B 25	6	OZH 036
-----	-----	-------------------	-----	-------------	-----------	---	----------------

Z3

1.8	1,8		85	01.96-10.98	M 43 B 18	4	OZH 023
1.9	1,9		103	10.95-03.99	M 44 B 19	4	OZH 173
1.9	1,9		87	07.98-	M 43 B 19/M43194E1	4	OZH 173
2.0	2,0		110	04.99-	M 52 B (20 6 S3) Vanos	6	OZH 173
2.0	2,0	D1	110	04.99-	M 52 B (20 6 S3) Vanos	6	OZH 168
2.0	2,0		110	04.99-12.00	M 52 B (20 6 S3) Vanos	6	OZH 218
2.0	2,0	D1,	110	04.99-12.00	M 52 B (20 6 S3) Vanos	6	OZH 199
2.2	2,2		125	08.00-	M54226S1/M 54 B 22	6	OZH 173
2.2	2,2	D1	125	08.00-	M54226S1/M 54 B 22	6	OZH 168
2.2	2,2		125	08.00-12.02	M54226S1/M 54 B 22	6	OZH 218
2.2	2,2		125	08.00-12.02	M54226S1/M 54 B 22	6	OZH 222
2.8	2,8		141	04.97-06.00	M 52 B 28	6	OZH 173
2.8	2,8	D1	141	04.97-06.00	M 52 B 28	6	OZH 168
2.8	2,8		141	10.98-06.00	M 52 B 28	6	OZH 218
2.8	2,8	D1,	141	10.98-06.00	M 52 B 28	6	OZH 199
3.0	3,0		170	06.00-	M54306S3	6	OZH 173
3.0	3,0	D1	170	06.00-	M54306S3	6	OZH 168
3.0	3,0		170	06.00-12.02	M54306S3	6	OZH 218
3.0	3,0		170	06.00-12.02	M54306S3	6	OZH 222
3.0	3,0	D1,	170	06.00-09.00	M54306S3	6	OZH 199

Z3 Coupe

2.8	2,8		141	07.97-06.00	M 52 B 28	6	OZH 173
2.8	2,8	D1	141	07.97-06.00	M 52 B 28	6	OZH 168
3.0	3,0		170	06.00-	M54306S3	6	OZH 173
3.0	3,0	D1	170	06.00-	M54306S3	6	OZH 168

Z4 (E85)

2.2 i	2,2		125	10.03-	M54226S1	6	OZH 173
2.2 i	2,2		125	10.03-01.06	M54226S1	6	OZH 218
2.2 i	2,2		125	10.03-01.06	M54226S1	6	OZH 222
2.5 i	2,5		141	02.03-	M54256S5	6	OZH 173
2.5 i	2,5		141	02.03-01.06	M54256S5	6	OZH 218
2.5 i	2,5		141	02.03-01.06	M54256S5	6	OZH 222
3.0 i	3,0		170	02.03-	M54306S3	6	OZH 173
3.0 i	3,0		170	02.03-01.06	M54306S3	6	OZH 218
3.0 i	3,0		170	02.03-01.06	M54306S3	6	OZH 222

Z8

4.9	4,9		294	06.00-06.03	S 38 B 49	8	OZH 173
-----	-----	--	-----	-------------	-----------	---	----------------

CHEVROLET
CORVETTE '83

5.6	5,6		179	08.88-08.91		8	OZH 033
5.7	5,7		182	01.89-08.91	L98	8	OZH 033

CHRYSLER
STRATUS Cabriolet (JX)

2.0 LE	2,0		96	01.98-12.99	420X	4	OZH 024
2.5 LX	2,5		120	01.98-12.99	625H	6	OZH 044

CITROËN
AX

10	1,0		33	07.92-01.95	CDY (TU9M) → 6629	4	OZH 034
10	1,0		33	02.95-12.98	CDY (TU9M) 6630 →	4	OZH 079
10	1,0		37	02.87-01.95	CDZ (TU9M) → 6629	4	OZH 034
10	1,0		37	02.95-12.98	CDZ (TU9M) 6630 →	4	OZH 079
11	1,1		44	09.86-05.91	HDZ (TU1M)/H1B → 5292	4	OZH 005

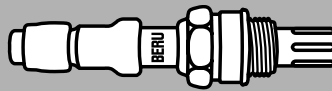

kW

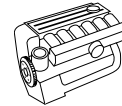

 Zyl.
Cyl.
Cil.

CITROËN

AX							
11	1,1		44	06.91-04.92	HDZ (TU1M)/H1B 5293 → 6629	4	OZH 034
11	1,1		44	02.95-12.97	HDZ (TU1M)/H1B 6630 →	4	OZH 079
14	1,4		55	06.90-05.91	KDY (TU3FM)/KDZ (TU3M/Z)/ KDY (TU3M) → 5292	4	OZH 005
14	1,4		55	01.93-01.95	KDY (TU3FM)/KDX (TU3M/Z)/ KDY (TU3M) 5293 → 6629	4	OZH 034
14	1,4		55	02.95-04.97	KDY (TU3FM)/KDX (TU3M/Z)/ KDY (TU3M) 6630 →	4	OZH 079
1.4 GTi	1,4		66	08.91-01.95	KFY (TU3FJ2) → 6629	4	OZH 038
1.4 GTi	1,4		66	02.95-12.96	KFY (TU3FJ2) 6630 →	4	OZH 079
1.4 GTi	1,4		69	06.91-01.95	KFZ (TU3FJ2) → 6629	4	OZH 038
1.4 GTi	1,4		69	02.95-12.96	KFZ (TU3FJ2) 6630 →	4	OZH 079
BERLINGO							
1.1 i	1,1		44	07.96-	HDZ (TU1M)/HFX (TU1JP)	4	OZH 074
1.4 i	1,4		55	07.96-06.98	KFX (TU3JP)/KFW (TU3JP) → 7874	4	OZH 074
BX, Break							
14	1,4		55	01.89-02.93	KDZ (TU3M/Z)/KDY (TU3M)	4	OZH 005
16 E	1,6		65	05.89-10.91	BDY (XU5M)/BDZ (XU5M)	4	OZH 005
19 GTi 16V	1,9		108	03.88-02.93	DFW (XU9J4)	4	OZH 005
19 E	1,9		80	06.88-02.93	DDZ (XU9M)	4	OZH 005
19 GTi	1,9		88	06.88-02.93	DKZ (XU9JA)	4	OZH 005
19 GTi 4x4	1,9		88	06.88-02.93	DKZ (XU9JA)	4	OZH 005
C15							
1.1 i	1,1		44	06.89-04.92	HDZ (TU1M) → 5856	4	OZH 005
1.1 i	1,1		44	04.92-12.96	HDZ (TU1M) 5857 →	4	OZH 034
1.4 E	1,4		40	07.87-12.96	K3A	4	OZH 005
1.4 i	1,4		55	01.92-04.92	KDY (TU3FM)/KDY (TU3M) → 5856	4	OZH 005
1.4 i	1,4		55	04.92-12.96	KDY (TU3FM)/ KDY (TU3M) 5857 →	4	OZH 034
C25							
2.0 E	2,0		58	09.81-02.94	170B (XN1T)/170A (XN1T)	4	OZH 005
2.0	2,0		62	02.91-02.94	170C (XN1T)	4	OZH 005
CX II, Break							
25 GTi	2,5		89	05.86-12.92	M25-668	4	OZH 005
25 i	2,5		89	05.86-12.92	M25-668	4	OZH 005
EVASION							
1.8	1,8		73	05.97-07.02	LFZ (XU7JP)	4	OZH 159
2.0 Turbo C.T.	2,0		108	05.97-07.02	RGX (XU10J2TE)	4	OZH 159
2.0	2,0		89	05.97-07.02	RFU (XU10J2/C)	4	OZH 159
JUMPER							
2.0	2,0		80	02.94-04.02	RFW (XU10J2U) → 15267330	4	OZH 034
2.0	2,0		80	02.94-04.02	RFW (XU10J2U) 15267331 →	4	OZH 159
JUMPY							
1.6	1,6		58	10.95-	220 A2.000/1580 SPI	4	OZH 159
SAXO							
1.1 X,SX	1,1		40	05.96-	HDZ (TU1M)	4	OZH 074
1.1 X,SX	1,1		44	05.96-	HDZ (TU1M)/HFX (TU1JP)	4	OZH 074
1.4 VTS	1,4		55	05.96-	KFX (TU3JP)/KFW (TU3JP)	4	OZH 074
1.6 VTL,VTR	1,6		65	05.96-	NFZ (TU5JP)	4	OZH 074
1.6 VTS	1,6		87	06.96-	NFX (TU5JP4)	4	OZH 104
1.0 X	1,0		33	05.96-	CDZ (TU9M)	4	OZH 074
XANTIA, Break							
1.6 i	1,6		65	03.93-05.95	BFZ (XU5JP) → 6779	4	OZH 038
1.6 i	1,6		65	06.95-01.98	BFZ (XU5JP) 6780 →	4	OZH 104
1.8 i	1,8		74	03.93-05.95	LFZ (XU7JP) → 6779	4	OZH 038
1.8 i	1,8		74	06.95-01.98	LFZ (XU7JP) 6780 →	4	OZH 104
1.8 i 16V	1,8		81	06.95-10.96	LFY (XU7JP4) → 7250	4	OZH 104
2.0 Turbo	2,0		108	06.95-01.98	RGX (XU10J2TE)	4	OZH 104

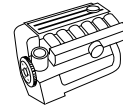

BERU

kW

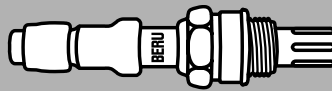

 Zyl.
Cyl.
Cil.

CITROËN

XANTIA, Break							
2.0 i 16V	2,0		110	06.94-12.96	RFT (XU10J4/Z)	4	OZH 034
2.0 i 16V	2,0		112	03.93-12.96	RFY (XU10J4/Z)	4	OZH 034
2.0 i	2,0		89	03.93-05.95	RFX (XU10J2C) → 6779	4	OZH 038
2.0 i	2,0		89	06.95-01.98	RFX (XU10J2C) 6780 →	4	OZH 107
2.0 i 16V	2,0		97	06.95-01.98	RFV (XU10J4R)	4	OZH 159
2.0 Turbo	2,0		108	01.98-	RGX (XU10J2TE)	4	OZH 104
2.0 i	2,0		89	01.98-	RFX (XU10J2C)	4	OZH 104
XM, Break							
2.0 i Turbo	2,0		104	09.92-06.94	RGY (XU10J2TE/Z)	4	OZH 034
2.0 i	2,0		79	05.89-04.94	RDZ (XU10MZ)	4	OZH 194
2.0 i	2,0		89	05.89-05.91	RFZ (XU10J2) → 5336	4	OZH 194
2.0 i	2,0		89	05.91-06.94	RFZ (XU10J2) 5337→	4	OZH 034
3.0 V6	3,0		123	05.89-05.91	UFZ (ZPJ/Z)/SFZ (ZPJ/Z)	6	OZH 166
3.0 V6 24V	3,0		147	07.90-05.91	UKZ (ZPJ4/Z)/SKZ (ZPJ4/Z)	6	OZH 166
2.0 Turbo	2,0		108	05.94-10.00	RGX (XU10J2TE)	4	OZH 159
2.0 i 16V	2,0		97	05.94-10.00	RFV (XU10J4R) → 15267330	4	OZH 034
2.0 i 16V	2,0		97	05.94-10.00	RFV (XU10J4R) 15267331 →	4	OZH 159
XSARA, Break							
1.4 i	1,4		55	04.97-05.98	KFX (TU3JP)/KFW (TU3JP)	4	OZH 074
1.6 i	1,6		65	04.97-12.97	NFZ (TU5JP)	4	OZH 074
1.8 i Aut.	1,8		74	04.97-09.00	LFZ (XU7JP)	4	OZH 079
2.0 16V	2,0		120	04.97-09.00	RFS (XU10J4RS)	4	OZH 079
2.0 16V	2,0		97	07.98-09.00	RFV (XU10J4R)	4	OZH 104
ZX, Break							
1.1	1,1		44	10.91-03.94	HDZ (TU1M)	4	OZH 034
1.4 i	1,4		55	08.92-06.95	KDZ (TU3M/Z)/KFX (TU3JP)/ KDX (TU3M/Z)5538 → 6808	4	OZH 034
1.4 i	1,4		55	09.94-06.95	KDX (TU3M/Z)6506 → 6808	4	OZH 038
1.4 i	1,4		55	07.95-06.97	KDZ (TU3M/Z)/KFX (TU3JP)/ KDX (TU3M/Z)6809 →	4	OZH 079
1.6 i	1,6		65	07.93-04.95	BFZ (XU5JP)5538 → 6748	4	OZH 034
1.6 i	1,6		65	05.95-06.97	BFZ (XU5JP)6749 →	4	OZH 079
1.6 i	1,6		65	03.91-01.92	BDY (XU5M)	4	OZH 194
1.8 i	1,8		74	07.92-04.95	LFZ (XU7JP) → 6748	4	OZH 034
1.8 i	1,8		74	05.95-06.97	LFZ (XU7JP) 6749 →	4	OZH 079
1.8 i 16V	1,8		81	01.96-06.97	LFY (XU7JP4)	4	OZH 079
1.9 i	1,9		88	03.91-04.95	DKZ (XU9JA) → 6748	4	OZH 034
1.9 i	1,9		88	03.91-05.95	DKZ (XU9JA) 6749 →	4	OZH 079
2.0 i 16V	2,0		110	06.94-04.95	RFT (XU10J4/Z) → 6748	4	OZH 034
2.0 i 16V	2,0		110	05.95-06.97	RFT (XU10J4/Z) 6749 →	4	OZH 079
2.0 i	2,0		89	07.92-04.95	RFX (XU10J2C) → 6748	4	OZH 034
2.0 i	2,0		89	05.95-06.97	RFX (XU10J2C) 6749 →	4	OZH 079
DAEWOO							
ESPERO							
1.5 16V	1,5		66	02.95-06.99	A15MF	4	OZU 005
1.8	1,8		66	02.95-09.99	C18LE	4	OZU 005
1.8	1,8		70	02.95-06.99	C18LE	4	OZU 005
2.0	2,0		77	02.95-06.99	C20LE	4	OZU 005
NEXIA							
1.5	1,5		52	02.95-08.97	G15MF	4	OZU 005
1.5	1,5		55	02.95-08.97	G15MF	4	OZU 005
1.5 16V	1,5		66	02.95-08.97	A15MF	4	OZU 005
DAIHATSU							
APPLAUSE I							
1.6 16V	1,6		77	06.89-07.97	HD-E	4	OZU 001
1.6 16V 4WD	1,6		77	06.89-07.97	HD-E	4	OZU 001

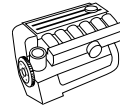

kW

Zyl.
Cyl.
Cil.**DAIHATSU****CHARADE III**

1.0	1,0	40	11.90-12.92	CB 90	3	OZU 001
1.3 i	1,3	66	06.88-12.92	HCE	4	OZU 001
1.3 i 4WD	1,3	66	06.88-10.90	HCE	4	OZU 001

CUORE IV

0.8	0,8	32	01.95-11.96	ED 20	3	OZU 001
-----	-----	----	-------------	-------	---	----------------

CUORE V

0.8	0,8	31	11.96-10.98	EF-EL	3	OZU 001
-----	-----	----	-------------	-------	---	----------------

FEROZA Hard Top

1.6 i 16V	1,6	70	09.90-08.93	HD-E	4	OZU 001
-----------	-----	----	-------------	------	---	----------------

MOVE

0.8	0,8	31	10.96-09.98		3	OZU 001
-----	-----	----	-------------	--	---	----------------

DAIMLER**XJ 40, 81**

Sovereign 3.6	3,6	136	10.86-09.89		6	OZH 037
---------------	-----	-----	-------------	--	---	----------------

DE LOREAN**DMC-12**

2.9	2,9	97	01.81-10.82		6	OZU 001
-----	-----	----	-------------	--	---	----------------

FERRARI**348 TB**

3.4	3,4	221	02.90-10.93	F 119 F 000	8	OZH 035
3.4	3,4	235	10.93-04.94	F 119 D 040	8	OZH 035

348 TS

3.4	3,4	221	08.90-10.93	F 119 F 000	8	OZH 035
3.4	3,4	235	10.93-12.95	F 119 D 040	8	OZH 035

512 TR

5.0	5,0	315	01.92-10.94	F 113 D 00/40	12	OZH 035
-----	-----	-----	-------------	---------------	----	----------------

MONDIAL

3.2 Quattrovalvole	3,2	199	10.85-12.88	F 105 C..	8	OZH 037
--------------------	-----	-----	-------------	-----------	---	----------------

MONDIAL Cabriolet

3.2 Quattrovalvole	3,2	199	09.85-12.88	F 105 C..	8	OZH 037
--------------------	-----	-----	-------------	-----------	---	----------------

TESTAROSSA

5.0	5,0	272	08.86-10.91	F 113 B..	12	OZH 037
-----	-----	-----	-------------	-----------	----	----------------

FIAT**BARCETTA**

1.8 16V	1,8	96	06.98-	183 A1.000	4	OZH 064
---------	-----	----	--------	------------	---	----------------

BRAVA

1.4	1,4	55	10.95-10.98	182 A5.000 → 4029959	4	OZH 136
1.4	1,4	55	10.95-10.98	182 A5.000 4029960 →	4	OZH 064
1.4 12 V	1,4	59	10.95-10.98	182 A3.000 → 4029959	4	OZH 136
1.4 12 V	1,4	59	10.95-10.98	182 A3.000 4029960 →	4	OZH 064
1.6 16V	1,6	66	10.95-10.01	182 A6.000	4	OZH 084
1.6 16V	1,6	76	02.96-10.98	182 A4.000	4	OZH 084
1.6 16V	1,6	76	11.98-10.01	182 A4.000	4	OZH 118
1.8 GT 16V	1,8	83	10.95-10.01	182 A2.000	4	OZH 088

BRAVO

1.4	1,4	55	10.95-10.98	182 A5.000 → 4029959	4	OZH 136
1.4	1,4	55	10.95-10.98	182 A5.000 4029960 →	4	OZH 064
1.4	1,4	59	10.95-10.01	182 A3.000 → 4029959	4	OZH 136
1.4	1,4	59	10.95-10.01	182 A3.000 4029960 →	4	OZH 064
1.6 16V	1,6	66	10.95-04.98	182 A6.000	4	OZH 084
1.6 16V	1,6	76	03.96-10.98	182 A4.000	4	OZH 084
1.6 16V	1,6	76	11.98-10.01	182 A4.000	4	OZH 118
1.8 GT	1,8	83	10.95-10.01	182 A2.000	4	OZH 088
2.0 HGT 20V	2,0	108	10.95-07.98	182 A1.000	5	OZH 056

CINQUECENTO

0.7 i	0,7	22	07.94-01.98	170 A.046	2	OZU 006
-------	-----	----	-------------	-----------	---	----------------

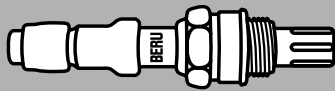
BERU

kW

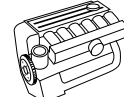
 Zyl.
Cyl.
Cil.

FIAT
CINQUECENTO

0.9 i.e. S	0,9	29	07.91-01.98	1170 A1.000/1170 A1.046 → Mot.Nr. 9147274	4	OZH 035
0.9 i.e. S	0,9	29	07.91-01.98	1170 A1.000/1170 A1.046 Mot.Nr. 9147275 →	4	OZH 056
0.9 i.e.	0,9	30	07.91-12.93	170 A1.046 → Mot.Nr. 9147274	4	OZH 035
0.9 i.e.	0,9	30	07.91-12.93	170 A1.046 Mot.Nr. 9147275 →	4	OZH 056
1.1 Sporting	1,1	40	10.94-01.98	176 B2.000	4	OZH 064

COUPE

1.8 16V	1,8	96	03.96-04.98	183 A1.000 → Mot.Nr. 10704425	4	OZH 088
1.8 16V	1,8	96	05.98-	183 A1.000 Mot.Nr. 10704426 →	4	OZH 056
2.0 16V	2,0	102	11.93-04.95	836 A3.000	4	OZH 046
2.0 16V	2,0	102	05.95-08.96	836 A3.000	4	OZH 052
2.0 20V	2,0	108	08.96-04.98	182 A1.000	5	OZH 056
2.0 16V Turbo	2,0	140	11.93-08.96	175 A1.000	4	OZH 037

CROMA

2000 i.e.	2,0	83	03.86-09.90	834 B.048	4	OZH 037
2000 i.e.	2,0	85	10.87-08.96	154 C3.046/834 B.146	4	OZH 037
2000 16V	2,0	101	11.92-08.96	154 E1.000	4	OZH 035
2000 i.e. Turbo	2,0	110	06.87-08.96	154 C4.046/834 C.146	4	OZH 037
2000 i.e. Turbo	2,0	111	11.86-11.88	834 C.146	4	OZH 037
2500 V6	2,5	119	06.93-08.96	834 G.000 → VET 001 4972	6	OZH 055
2500 V6	2,5	119	06.93-08.96	834 G.000 VET 001 4973 →	6	OZH 056

DUCATO

2.0	2,0	62	09.88-03.94	170 D	4	OZH 066
2.0 Panorama/Combinato	2,0	80	03.94-04.02	RFW → 5267331	4	OZH 034
2.0 Panorama/Combinato	2,0	80	03.94-04.02	RFW 5267332 →	4	OZH 159

FIORINO

1.5	1,5	55	01.88-08.93	149 C1.000	4	OZH 037
70 i.e. 1.4	1,4	49	05.94-05.01	146 C5.000/146 D5.000	4	OZH 037
75 i.e. 1.5	1,5	55	05.88-12.93	149 C1.000	4	OZH 037
75 i.e. 1.6	1,6	55	10.93-05.01	146 C6.000	4	OZH 037
75 i.e. 1.6	1,6	55	10.93-05.01	146 D6.000	4	OZH 056

FIORINO Pick up

1.4	1,4	49	05.94-05.01	146 D5.000	4	OZH 056
1.6	1,6	55	01.94-05.01		4	OZH 037

MAREA, Weekend

1.4 80 12V	1,4	59	09.96-	182 A3.000	4	OZH 064
1.6 100 16V	1,6	76	09.96-10.98	182 A4.000	4	OZH 084
1.6 100 16V	1,6	76	11.98-10.00	182 A4.000	4	OZH 118
1.6 100 16V	1,6	76	11.00-	182 A4.000	4	OZH 180
1.6 100 16V Bipower	1,6	76	04.99-10.99	186 A4.000/185 A3.000	4	OZH 084
1.8 115 16V	1,8	83	09.96-	182 A2.000	4	OZH 088
2.0 150 20V	2,0	108	09.96-04.99	182 A1.000	5	OZH 056

MULTIPLA

1.6 16V Blupower	1,6	70	04.99-	186 A3.000	4	OZH 056
1.6 100 16V	1,6	76	04.99-	182 A4.000	4	OZH 056
1.6 16V Bipower	1,6	76	04.99-	186 A4.000	4	OZH 056
1.6 16V Bipower	1,6	76	10.01-	182 B6.000	4	OZH 180

PALIO, Weekend

1.6 16V	1,6	74	04.96-	178 B3.000	4	OZH 056
1.6 16V	1,6	74	04.96-09.99	178 B3.000	4	OZH 056
1.6 16V	1,6	74	10.99-02.01	178 B3.000	4	OZH 137

PANDA

900	0,9	29	04.92-12.96	1170 A1.046 → Mot.Nr. 9117331	4	OZH 035
900	0,9	29	04.92-12.96	1170 A1.046 Mot.Nr. 9117332 →	4	OZH 056
1000 4x4	1,0	33	05.86-12.94	156 A2.246	4	OZH 037
1000 4x4	1,0	33	05.86-12.94	141 C2.000	4	OZH 056
1000 i.e. KAT	1,0	33	10.87-08.98	141 C2.000/156 A2.246 (Inj. Weber)	4	OZH 035

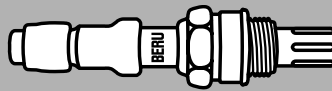

kW

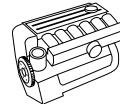
 Zyl.
Cyl.
Cil.

FIAT							
PANDA							
1000 i.e. KAT	1,0		33	10.87-08.98	141 C2.000/156 A2.246 (Inj. Bosch)	4	OZH 037
1100 Trekking 4x4	1,1		37	10.91-	156 C.046	4	OZH 037
1100	1,1		37	05.91-12.99	156 C.046 (Inj. Weber)	4	OZH 035
1100	1,1		37	05.91-12.99	156 C.046 (Inj. Bosch)	4	OZH 037
1100	1,1		40	02.95-09.03	187 A1.000/176 B2.000	4	OZH 056
1100 4x4	1,1		40	02.95-	176 B2.000	4	OZH 056
PANDA Van							
1000 i.e	1,0		33	08.92-	156 A2.246 (Inj. Weber)	4	OZH 035
1000 i.e	1,0		33	08.92-	156 A2.246 (Inj. Bosch)	4	OZH 037
PUNTO							
55 1.1	1,1		40	09.93-09.99	176 A6.000/ 176 B2.000 → Mot.Nr. 5795653	4	OZH 035
55 1.1	1,1		40	09.93-09.99	176 A6.000/ 176 B2.000 Mot.Nr. 5795654 →	4	OZH 056
60 1.2	1,2		43	01.94-09.99	176 A7.000 → Mot.Nr. 5795653	4	OZH 035
60 1.2	1,2		43	01.94-09.99	176 A7.000 Mot.Nr. 5795654 →	4	OZH 056
60 1.2	1,2		44	03.94-09.99	176 B1.000/176 B4.000 → Mot.Nr. 5795653	4	OZH 035
60 1.2	1,2		44	03.94-09.99	176 B1.000/ 176 B4.000 Mot.Nr. 5795654 →	4	OZH 056
75 1.2	1,2		54	01.94-09.99	176 A8.000 → Mot.Nr. 5795653	4	OZH 035
75 1.2	1,2		54	01.94-09.99	176 A8.000 Mot.Nr. 5795654 →	4	OZH 056
85 16V 1.2	1,2		63	04.97-09.99	176 B9.000	4	OZH 135
90 1.6	1,6		65	01.94-04.97	176 A9.000	4	OZH 054
1.4 GT Turbo	1,4		96	09.96-09.99	176 B6.000	4	OZH 056
1.4 GT Turbo	1,4		98	01.94-12.94	176 A4.000	4	OZH 035
1.4 GT Turbo	1,4		98	01.95-09.96	176 A4.000	4	OZH 056
1.8 130 HGT	1,8		96	09.99-	183 A1.000/188 A6.000	4	OZH 118
PUNTO Cabriolet							
60 1.2	1,2		43	04.94-06.00	176 A7.000 → Mot.Nr. 5795653	4	OZH 035
60 1.2	1,2		43	04.94-06.00	176 A7.000 Mot.Nr. 5795654 →	4	OZH 056
60 1.2	1,2		44	05.95-06.00	176 B1.000/ 176 B4.000 → Mot.Nr. 5795653	4	OZH 035
60 1.2	1,2		44	05.95-06.00	176 B1.000/ 176 B4.000 Mot.Nr. 5795654 →	4	OZH 056
85 16V 1.2	1,2		63	04.97-06.00	176 B9.000	4	OZH 135
90 1.6	1,6		65	04.94-04.97	176 A9.000	4	OZH 054
PUNTO Van							
1.1	1,1		40	04.96-02.00	176 B2.000	4	OZH 056
REGATA, Weekend							
75 i.e. 1.5	1,5		55	07.85-07.89	149 C1.000	4	OZH 037
75 i.e. 1.5	1,5		55	07.85-07.89	138 C2.048	4	OZU 022
90 i.e. 1.6	1,6		66	01.87-07.89	149 C2.000	4	OZU 001
RITMO I							
75 i.e. 1.5	1,5		55	10.85-05.87	138 C2.048	4	OZU 001
90 i.e. 1.6	1,6		66	05.87-12.87	149 C2.000	4	OZH 037
RITMO II							
75 1.5 KAT	1,5		55	09.85-12.88	149 C1.000	4	OZH 037
75 1.5 KAT	1,5		55	09.85-12.88	138 C2.048	4	OZU 022
SCUDO Combinato							
1.6	1,6		58	02.96-	220 A 2.000	4	OZH 159
SEICENTO							
0.9	0,9		29	01.98-	1170 A1.046	4	OZH 056
1.1	1,1		40	01.98-	187 A1.000/176 B2.000	4	OZH 064
STILO							
1.8 16V	1,8	D1	98	10.01-	192 A4.000	4	OZH 180
TEMPRA							
1.4 i.e.	1,4		51	03.92-08.96	160 A1.046	4	OZH 037
1.4 i.e.	1,4		51	03.92-08.96	836 A4.000	4	OZH 056
1.6 i.e.	1,6	Automatic ³	55	06.92-08.96	159 A3.048/835 C1.000	4	OZH 037

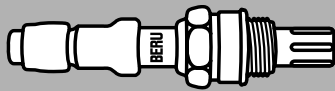
**BERU**

kW

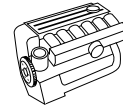
Zyl.
Cyl.
Cil.**FIAT****TEMPRA**

1.6 i.e.	1,6		55	04.93-12.94	835 C1.000	4	OZH 035
1.6 i.e.	1,6		55	01.95-08.96	835 C1.000 VET-Nr. 7559353	4	OZH 056
1.6 i.e.	1,6		57	06.90-07.92	159 A3.046	4	OZH 037
1.8 i.e.	1,8		66	09.93-08.96	835 C4.000	4	OZH 035
1.8 i.e.	1,8		77	04.93-08.96	159 A4.046	4	OZH 035
2.0 i.e.	2,0		83	10.90-08.96	159 A6.046	4	OZH 037

TEMPRA S.W.

1.4 i.e.	1,4		51	10.92-08.96	160 A1.046	4	OZH 037
1.4 i.e.	1,4		51	10.92-08.96	836 A4.000	4	OZH 056
1.6 i.e.	1,6	Automatic ³	55	10.92-08.96	159 A3.048/835 C1.000	4	OZH 037
1.6 i.e.	1,6		55	10.92-12.94	159 A3.048/835 C1.000	4	OZH 035
1.6 i.e.	1,6		55	01.95-08.96	835 C1.000 VET-Nr. 7559353	4	OZH 056
1.6 i.e.	1,6		57	10.90-07.92	159 A3.046	4	OZH 037
1.8 i.e.	1,8		66	09.93-08.96	835 C4.000	4	OZH 035
1.8 i.e.	1,8		76	09.93-08.96	835 C2.000	4	OZH 035
1.8 i.e.	1,8		77	04.93-12.93	159 A4.046	4	OZH 035
2.0 i.e.	2,0		83	01.91-03.95	159 A6.046	4	OZH 037
2.0 i.e. 4x4	2,0		83	03.92-03.95	159 A6.046	4	OZH 037

TIPO

1.4 i.e.	1,4		51	05.89-04.95	160 A1.046	4	OZH 037
1.4 i.e.	1,4		51	05.89-04.95	836 A4.000	4	OZH 056
1.6 i.e.	1,6		55	10.92-04.95	835 C1.000	4	OZH 035
1.6 i.e.	1,6		55	10.92-04.95	159 A3.048	4	OZH 037
1.6 i.e.	1,6		57	07.90-01.93	159 A3.046	4	OZH 037
1.8 i.e.	1,8		76	04.93-04.95	835 C2.000	4	OZH 037
1.8 i.e.	1,8		77	10.90-06.93	159 A4.046	4	OZH 037
2.0 i.e.	2,0		83	03.90-04.95	159 A6.046	4	OZH 037
2.0 i.e. 16V Sport	2,0		102	03.93-12.94	836 A3.000	4	OZH 046
2.0 i.e. 16V Sport	2,0		102	01.95-04.95	836 A3.000	4	OZH 052

ULYSSE

1.8	1,8		73	05.97-08.02	LFW	4	OZH 159
2.0 Turbo	2,0		108	06.94-08.02	RGX (XU10J2CTE)	4	OZH 159
2.0	2,0		89	06.94-08.02	RFU (XU10J2C)	4	OZH 159

UNO

45 1.0	1,0		32	10.87-08.89	156 A2.048/156 A2.100	4	OZU 001
45 i.e. 1.0	1,0		33	09.89-12.94	156 A2.246	4	OZH 037
45 1.0 8V	1,0		36	01.93-03.94	146 C7.0000	4	OZH 049
50 1.1	1,1		37	01.90-12.93	156 C.046	4	OZH 037
50 i.e. 1.1	1,1		36	06.92-12.93	146 C3.000	4	OZH 037
70 i.e. 1.4	1,4		51	09.89-12.93	160 A1.046	4	OZH 037
75 i.e. 1.5	1,5		55	10.85-12.93	149 C1.000	4	OZH 037
75 i.e. 1.5	1,5		55	10.85-12.93	138 C2.048	4	OZU 022
1.3 Turbo i.e.	1,3		73	01.87-12.87	146 A2.146	4	OZH 037
1.3 Turbo i.e.	1,3		74	09.89-03.91	146 A2.246	4	OZH 037
1.4 Turbo i.e.	1,4		82	09.89-09.93	146 A8.046	4	OZH 037

FORD**COUGAR**

2.0 16V	2,0		96	08.98-12.01	EDBB/EDBC/EDBD/EDBA	4	OZH 176
2.5 V6 24V	2,5		125	08.98-12.01	LCBA	6	OZH 176

ESCORT '91 Express

1.4	1,4		52	07.90-09.92	F6F/F6G	4	OZH 059
1.4	1,4		52	10.92-12.94	F6F/F6G	4	OZH 045

ESCORT IV

1.4	1,4		54	01.86-12.86	F6D/F6B	4	OZH 006
1.4	1,4		54	01.87-07.89	F6D/F6B	4	OZH 075
1.4	1,4		54	08.89-07.90	F6D/F6B	4	OZH 059
1.6 i	1,6		66	01.86-05.90	L4B	4	OZH 006
1.6 i	1,6		75	08.89-07.90	LJB	4	OZH 006
1.6 i	1,6		75	08.89-07.90	LJB	4	OZH 045
1.6 i	1,6		75	08.89-07.90	LJB	4	OZH 059

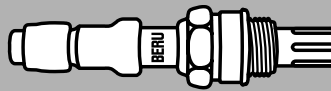

kW

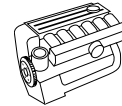
 Zyl.
Cyl.
Cil.

FORD
ESCORT IV Cabriolet

1.4	1,4	54	02.87-07.90	F6D/F6B	4	OZH 006
1.4	1,4	54	01.87-07.89	F6D/F6B	4	OZH 075
1.4	1,4	54	08.89-07.90	F6D/F6B	4	OZH 059
1.6 i	1,6	66	01.86-07.90	L4B	4	OZH 006
1.6 i	1,6	75	08.89-07.90	LJB	4	OZH 006
1.6 i	1,6	75	08.89-07.90	LJB	4	OZH 059

ESCORT IV Kombi

1.4	1,4	54	01.86-12.86	F6D/F6B	4	OZH 006
1.4	1,4	54	01.87-07.89	F6D/F6B	4	OZH 075
1.4	1,4	54	08.89-07.90	F6D/F6B	4	OZH 059
1.6 i	1,6	66	01.86-07.90	L4B	4	OZH 006

ESCORT V

1.3	1,3	44	05.91-09.92	J6A	4	OZH 059
1.4	1,4	52	07.90-09.92	F6F/F6G	4	OZH 059
1.6	1,6	77	07.90-12.92	LJF	4	OZH 059
1.8 16V XR3i	1,8	77	02.92-12.92	RDA	4	OZH 050
1.8 16V XR3i	1,8	96	02.92-12.92	RQB	4	OZH 050
RS 2000	2,0	110	05.91-12.92	N7A	4	OZH 014

ESCORT V Cabriolet

1.4	1,4	52	07.90-09.92	F6F/F6G	4	OZH 059
1.4	1,4	52	10.92-12.92	F6F/F6G	4	OZH 045
1.6	1,6	77	07.90-12.92	LJF	4	OZH 059
1.8 16V XR3i	1,8	77	02.92-12.92	RDA	4	OZH 050
1.8 16V XR3i	1,8	96	02.92-12.92	RQB	4	OZH 050

ESCORT V Kombi

1.3	1,3	44	09.91-09.92	J6A	4	OZH 059
1.4	1,4	52	07.90-09.92	F6F/F6G	4	OZH 059
1.6	1,6	77	07.90-09.92	LJF	4	OZH 059
1.8 16V	1,8	77	02.92-12.92	RDA	4	OZH 050

ESCORT VI

1.3	1,3	44	09.92-01.95	J6A/J4B	4	OZH 045
1.4	1,4	52	09.92-01.95	F6F/F6G	4	OZH 045
1.6 i 16V	1,6	66	09.92-01.95	L1E	4	OZH 050
1.8 i 16V	1,8	77	09.92-01.95	RDA	4	OZH 050
1.8 XR3i 16V 4x4	1,8	77	08.93-01.95	RDA	4	OZH 050
1.8 XR3i 16V 4x4	1,8	96	08.93-01.95	RQB	4	OZH 050
RS 2000 4x4	2,0	110	08.93-01.95	N7A	4	OZH 014

ESCORT VI Cabriolet

1.4 i	1,4	55	07.93-01.95	F4B	4	OZH 045
1.6 16V XR3i	1,6	66	12.92-01.95	L1E	4	OZH 050
1.8 16V XR3i	1,8	77	12.92-01.95		4	OZH 050
1.8 16V XR3i	1,8	96	12.92-01.95	RQB	4	OZH 050

ESCORT VI Kombi

1.3	1,3	44	09.92-01.95	J6A/J4B	4	OZH 045
1.4	1,4	52	09.92-01.94	F6F/F6G	4	OZH 045
1.4	1,4	55	01.94-01.95	F4B	4	OZH 045
1.6 i 16V	1,6	66	09.92-01.95	L1E	4	OZH 050
1.8 i 16V	1,8	96	02.93-01.95	RQB	4	OZH 050

ESCORT VI Stufenheck

1.3	1,3	44	08.93-01.95	J6A/J4B	4	OZH 045
1.4	1,4	52	08.93-04.94	F6F/F6G	4	OZH 045
1.4	1,4	55	08.93-01.95	F4B	4	OZH 045
1.6 i 16V	1,6	66	08.93-01.95	L1E/L1K	4	OZH 050
1.8 i 16V	1,8	77	08.93-01.95	RDA	4	OZH 050

ESCORT VII

1.3	1,3	44	01.95-10.98	J6A/J4B	4	OZH 045
1.6 16V 4x4	1,6	66	01.95-10.98	L1E	4	OZH 050
1.6 16V	1,6	66	01.95-10.98	L1E	4	OZH 050

ESCORT VII Cabriolet

1.4	1,4	55	02.95-08.98	F4B	4	OZH 045
1.6 16V XR3i	1,6	66	02.95-09.99	L1E	4	OZH 050

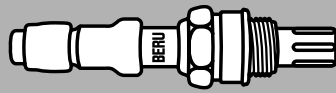

kW

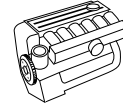
Zyl.
Cyl.
Cil.**FORD****ESCORT VII Cabriolet**1.8 16V XR3i 1,8 96 02.95-08.00 RQB 4 **OZH 050****ESCORT VII Kombi**1.6 16V 1,6 66 01.95-02.99 L1E 4 **OZH 050****ESCORT VII Stufenheck**1.6 i 16V 1,6 66 01.95-02.99 L1E/L1K 4 **OZH 050****FIESTA Courier**1.3 1,3 44 09.91-12.92 J6B 4 **OZH 059**1.3 1,3 44 01.93-02.96 J6B 4 **OZH 045**1.3 1,3 44 02.96- J4C 4 **OZH 045****FIESTA II**1.4 1,4 52 10.86-02.89 F6C/F6A 4 **OZH 006****FIESTA III**1.1 1,1 37 03.89-12.92 G6A 4 **OZH 059**1.1 1,1 37 01.93-12.95 G6A 4 **OZH 045**1.3 KAT 1,3 44 05.91-12.92 J6B 4 **OZH 059**1.3 KAT 1,3 44 01.93-12.95 J6B 4 **OZH 045**1.4 1,4 52 03.89-12.92 F6E 4 **OZH 059**1.4 1,4 52 01.93-12.95 F6E 4 **OZH 045**1.6 XR2i 1,6 76 03.89-12.92 LJD 4 **OZH 059**1.6 XR2i 1,6 76 01.93-03.93 LJD 4 **OZH 045**1.8 16V 1,8 77 01.94-12.95 RDB 4 **OZH 059**1.8 XR2i 16V 1,8 96 01.94-12.95 RQC 4 **OZH 059****FIESTA IV**1.25 i 16V 1,2 55 08.95-01.00 DHG/DHB/DHC/DHE/DHF/DHA/DHD 4 **OZH 176**1.3 i 1,3 37 08.95-01.02 JJA/JJE/JJM/JJC/JJJ/JJK 4 **OZH 045**1.3 i 1,3 44 08.95-01.02 J4R/J4C/J4L/J4J/J4Q/J4T 4 **OZH 045****FOCUS, Kombi**1.4 16V 1,4 55 02.99-11.04 FXDA/FXDD/FXDC/FXDB 4 **OZH 176**1.6 16V 1,6 74 02.99-11.04 FYDA/FYDB/FYDD/FYDC 4 **OZH 176**1.8 16V 1,8 85 02.99-11.04 EYDD/EYDC/EYDE/EYDF/EYDB 4 **OZH 176**2.0 16V 2,0 96 02.99-11.04 EDDC/EDDB/EDDD/EDDF 4 **OZH 176****GALAXY**2.8 i V6 2,8 128 11.95-12.95 AAA 6 **OZH 181**2.8 i V6 2,8 128 01.96-10.97 AAA 6 **OZH 151**2.8 i V6 4x4 2,8 128 04.96-10.97 AAA 6 **OZH 151****KA**1.3 i 1,3 37 09.96- JJB 4 **OZH 045**1.3 i 1,3 44 09.96-12.98 J4S/J4K/J4M/J4P/J4N/J4D 4 **OZH 020****MONDEO I, Kombi**1.6 i 16V 1,6 65 07.94-08.96 L1J 4 **OZH 045**1.6 i 16V 1,6 66 02.93-08.96 L1F 4 **OZH 045**1.6 i 16V 1,6 66 02.93-08.96 L1F 4 **OZH 059**1.8 i 16V 1,8 82 07.94-08.96 RKB 4 **OZH 045**1.8 i 16V 1,8 85 02.93-08.96 RKA 4 **OZH 045**1.8 i 16V 1,8 85 02.93-08.96 RKA 4 **OZH 059**2.0 i 16V 2,0 100 02.93-08.96 NGA 4 **OZH 045****MONDEO II, Kombi**1.6 i 1,6 66 09.96-07.98 L1J 4 **OZH 045**1.6 i 1,6 66 08.98-11.00 L1J 4 **OZH 176**1.8 i 1,8 85 09.96-07.98 RKB 4 **OZH 045**1.8 i 1,8 85 08.98-11.00 RKB 4 **OZH 176**2.0 i 2,0 96 09.96-07.98 NGA/NGB/NGD/NGC 4 **OZH 014**2.0 i 2,0 96 08.98-11.00 NGA/NGB/NGD/NGC 4 **OZH 176**2.5 24V 2,5 125 09.96-11.00 SEA 6 **OZH 045****ORION II**1.4 1,4 52 10.87-07.90 4 **OZH 006**1.4 KAT 1,4 54 10.87-07.90 F6D/F6B 4 **OZH 006**1.6 i KAT 1,6 66 03.86-07.90 L4B 4 **OZH 006**1.6 i 1,6 75 08.89-07.90 LJB 4 **OZH 059****ORION III**1.3 1,3 44 05.91-12.91 J6A 4 **OZH 045**

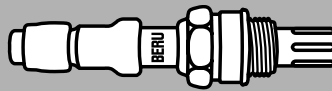

kW

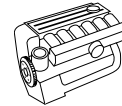
 Zyl.
Cyl.
Cil.

FORD
ORION III

1.3	1,3	44	01.92-12.93	J6A	4	OZH 059
1.4	1,4	52	05.91-12.91	F6F/F6G	4	OZH 045
1.4	1,4	52	01.92-12.93	F6F/F6G	4	OZH 059
1.6 i 16V	1,6	66	07.92-08.93	L1E/L1K	4	OZH 050
1.6 i	1,6	77	05.91-12.91	LJF	4	OZH 045
1.6 i	1,6	77	01.92-09.92	LJF	4	OZH 059
1.8 i 16V	1,8	77	02.92-08.93	RDA	4	OZH 050
1.8 i 16V	1,8	96	01.92-08.92	RQB	4	OZH 050

PUMA

1.6 16V	1,6	76	08.00-	L1W	4	OZH 176
---------	-----	----	--------	-----	---	----------------

SCORPIO I, Kombi

2.0 i	2,0	74	10.85-05.89	NRC	4	OZH 006
2.0	2,0	77	04.85-08.89	NEL	4	OZH 006
2.0 i	2,0	85	04.85-05.89	NRA	4	OZH 006
2.0 i	2,0	85	02.92-01.93	NRI/NRA	4	OZH 014
2.0 i	2,0	88	05.89-09.94	N9D	4	OZH 059
2.4 i	2,4	92	10.88-07.89	ARD	6	OZH 006
2.4 i KAT	2,4	92	10.88-07.89	ARD	6	OZH 006

SCORPIO II

2.9 i	2,9	110	02.95-08.98	BRG	6	OZH 021
-------	-----	-----	-------------	-----	---	----------------

SIERRA, Kombi

1.6 i	1,6	59	01.90-02.93	L6B	4	OZH 014
2.0	2,0	74	10.85-12.86	NRD	4	OZH 006
2.0 i	2,0	74	01.87-11.91	NE5/NEJ	4	OZH 006
2.0 i	2,0	74	05.89-01.90	NE5/NEJ	4	OZH 075
2.0 i	2,0	74	01.90-10.91	NE5/NEJ	4	OZH 014
2.0 i	2,0	74	11.91-02.93	NE5/NEJ	4	OZH 045
2.0 i KAT	2,0	74	01.87-10.91	N4B	4	OZH 006
2.0 i KAT	2,0	74	05.89-10.91	N4B	4	OZH 075
2.0 i KAT	2,0	74	11.91-02.93	N4B	4	OZH 045
2.0 i	2,0	85	01.87-11.91	N4I/N4A	4	OZH 006
2.0	2,0	85	10.85-12.86	NR2	4	OZH 006
2.0 i	2,0	88	05.89-01.90	N9C	4	OZH 075
2.0 i	2,0	88	01.90-02.93	N9C	4	OZH 014
2.9	2,9	107	08.88-11.89	B4B/B4C	6	OZH 006

TRANSIT

2.0 i	2,0	72	09.91-07.94	NCA	4	OZH 020
-------	-----	----	-------------	-----	---	----------------

HONDA
ACCORD III

2.0 EX	2,0	75	10.87-12.89	A20A1	4	OZU 001
2.0 EX	2,0	76	10.87-12.89	A20A1	4	OZU 001
2.0 EX	2,0	78	10.87-05.89	A20A2	4	OZU 001

ACCORD III Aerodeck

2.0 EX	2,0	75	10.87-12.89	A20A1	4	OZU 001
2.0 EX	2,0	76	10.87-12.89	A20A1	4	OZU 001
2.0 EX	2,0	78	11.85-05.89	A20A2	4	OZU 001

ACCORD IV Aerodeck

2.2 i 16V	2,2	108	01.91-12.93	F22A8	4	OZH 009
2.2 i 16V	2,2	110	01.91-12.93	F22A7	4	OZH 009

ACCORD IV Coupe

2.0 i 16V	2,0	98	01.92-09.93	F20A7	4	OZH 009
-----------	-----	----	-------------	-------	---	----------------

ACCORD V

2.0 i	2,0	85	03.93-09.95	F20Z2	4	OZH 009
2.0 i S	2,0	96	03.93-09.95	F20Z1	4	OZH 009

ACCORD V Aerodeck

2.0 i LS 16V	2,0	100	09.93-02.98	F20B3	4	OZH 120
--------------	-----	-----	-------------	-------	---	----------------

ACCORD V Coupe

2.0	2,0	100	09.93-12.97	F20B3	4	OZH 120
-----	-----	-----	-------------	-------	---	----------------

ACCORD VI

1.9 i	1,9	85	02.96-10.98	F18A3	4	OZH 120
-------	-----	----	-------------	-------	---	----------------

**BERU**

kW

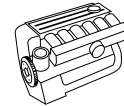
Zyl.
Cyl.
Cil.**HONDA****ACCORD VII**

1.8 i	1,8		100	10.98-	F18B2	4	OZH 121
2.2 Type-R	2,2		156	02.99-	H22A7	4	OZH 121
2.2 Type-R	2,2	D1	156	02.99-	H22A7	4	OZH 099

ACCORD VII Coupe

3.0 V6 24V	3,0		147	02.98-12.00	J30A1	6	OZH 028
------------	-----	--	-----	-------------	-------	---	----------------

ACCORD VII Hatchback

1.8 i	1,8		100	12.99-		4	OZH 121
-------	-----	--	-----	--------	--	---	----------------

CIVIC IV Coupe

1.5 i LSi	1,5		74	01.94-11.95	D15B7	4	OZH 006
-----------	-----	--	----	-------------	-------	---	----------------

CIVIC V

1.4 i	1,4		66	02.99-02.01	D14A4	4	OZH 123
1.4 i	1,4	D1	66	02.99-02.01	D14A4	4	OZH 121
1.5 i	1,5		84	02.99-02.01	D15Z6	4	OZH 122

CIVIC V Aerodeck

1.4 16V	1,4		55	02.99-02.01	D14A7	4	OZH 123
1.4 16V	1,4	D1	55	02.99-02.01	D14A7	4	OZH 121
1.4 16V	1,4		66	02.99-02.01	D14A8	4	OZH 123
1.4 16V	1,4	D1	66	02.99-02.01	D14A8	4	OZH 121
1.5 16V	1,5		84	02.99-02.01	D15Z8	4	OZH 122
1.8 16V	1,8		124	04.98-02.01	B18C4	4	OZH 121

CIVIC V Fastback

1.4 16V	1,4		55	02.99-02.01	D14A7	4	OZH 123
1.4 16V	1,4		55	02.99-02.01	D14A7	4	OZH 121
1.4 16V	1,4		66	02.99-02.01	D14A8	4	OZH 123
1.4 16V	1,4		66	02.99-02.01	D14A8	4	OZH 121
1.5 16V	1,5		84	02.99-02.01	D15Z8	4	OZH 122
1.8 16V	1,8		124	01.97-02.01		4	OZH 121

CIVIC V Hatchback

1.4 i	1,4		55	02.99-02.01	D14A3	4	OZH 123
1.4 i	1,4	D1	55	02.99-02.01	D14A3	4	OZH 121
1.4 i S	1,4		66	02.99-02.01	D14A4	4	OZH 123
1.4 i S	1,4	D1	66	02.99-02.01	D14A4	4	OZH 121
1.5 i	1,5		84	02.99-02.01	D15Z6	4	OZH 122
1.6 i	1,6		84	11.95-02.01	D16Y5	4	OZH 123

CONCERTO

1.5 i 16V	1,5		66	08.89-03.95	D15B2	4	OZU 001
1.6 16V	1,6		78	08.89-03.95		4	OZU 001
1.6 i 16V	1,6		82	08.89-03.95	D16Z2	4	OZU 001
1.6 i 16V	1,6		90	08.89-03.95	D16A8	4	OZU 001

CRX II

1.6 i 16V	1,6		91	10.88-02.92	D16Z5	4	OZU 001
1.6 i 16V	1,6		96	10.88-12.89	D16A9	4	OZU 001

HR-V

1.6 16V	1,6		77	03.99-12.99	D16W1	4	OZH 006
1.6 16V 4WD	1,6		77	03.99-12.99	D16W1	4	OZH 006

LEGEND I

2.5 i	2,5		110	01.86-12.87	C25A1	6	OZU 001
2.7 i 24V	2,7		124	01.88-12.90	C27A1	6	OZU 001

LEGEND I Coupe

2.7 i 24V	2,7		124	10.87-12.90	C27A1	6	OZU 001
-----------	-----	--	-----	-------------	-------	---	----------------

PRELUDE II

1.8 EX	1,8		74	11.85-04.87	ET3/ET4	4	OZU 014
--------	-----	--	----	-------------	---------	---	----------------

PRELUDE III

2.0 i EX 16V	2,0		101	04.86-12.87	B20A1	4	OZU 001
2.0 i EX 16V KAT	2,0		101	04.87-01.92	B20A5	4	OZU 001

PRELUDE IV

2.0 i 16V	2,0		98	02.92-09.96	F20A4	4	OZU 001
-----------	-----	--	----	-------------	-------	---	----------------

PRELUDE V

2.0 16V	2,0		98	10.96-	F20A4	4	OZU 001
2.2 16V	2,2		136	10.96-10.98	H22A5	4	OZH 020
2.2 16V	2,2		147	10.96-10.98	H22A5	4	OZH 020

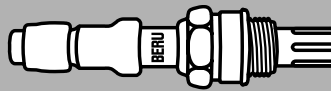

kW

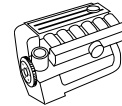
 Zyl.
Cyl.
Cil.

HYUNDAI

H100							
2.4	2,4		84	01.97-03.00	G4CS	4	OZU 001
2.4	2,4		90	07.93-03.00	G4CS	4	OZU 001
PONY							
1.5	1,5		53	10.89-07.94	G15B/G4DJ	4	OZU 001
1.5 i	1,5		61	10.89-07.94	G15B/G4DJ	4	OZU 001
1.5 i	1,5		62	10.89-07.94	G15B/G4DJ	4	OZU 001
PONY/EXCEL							
1.5	1,5		53	01.90-07.94	G15B/G4DJ	4	OZU 001
1.5 i	1,5		61	01.90-07.94	G15B/G4DJ	4	OZU 001
1.5 i	1,5		62	01.90-07.94	G15B/G4DJ	4	OZU 001
S COUPE (SLC)							
1.5 i	1,5		65	04.92-06.93	G4EK	4	OZH 037
1.5 i Turbo	1,5		85	04.91-06.93	G4EK-TC	4	OZH 037

KIA

SPORTAGE							
2.0 i 4WD	2,0		70	03.95-09.98	FE	4	OZH 207
CLARUS							
1.8 i 16V	1,8		85	07.96-05.98	T8	4	OZH 204
2.0 i 16V	2,0		98	07.96-05.98	FE	4	OZH 204

LANCIA

DEDRA							
1.6 i.e.	1,6		55	04.93-10.94	835 C1.000	4	OZH 035
1.6 i.e.	1,6		57	08.89-03.93	835 A1.046	4	OZH 037
1.6 16V	1,6		76	06.96-04.98	182 A4.000	4	OZH 084
1.6 16V	1,6		76	05.98-07.99	182 A4.000	4	OZH 118
1.8 i.e.	1,8		66	10.94-12.95	835 C5.000	4	OZH 056
1.8 i.e.	1,8		74	10.94-12.95	836 A5.000	4	OZH 056
1.8 i.e.	1,8		77	09.89-10.94	835 A2.046	4	OZH 037
1.8 16V LE	1,8		83	09.96-07.99	182 A2.000	4	OZH 088
1.8 GT 16V	1,8		96	03.96-07.99	183 A1.000	4	OZH 052
2.0 i.e.	2,0		83	09.89-07.99	835 A5.046	4	OZH 037
2.0 16V	2,0		102	07.94-07.99	836 A3.000	4	OZH 052
2.0 i.e. Turbo	2,0		119	04.91-10.94	835 A8.046	4	OZH 037
2.0 HF Integrale	2,0		124	04.91-07.94	835 A7.046	4	OZH 037
DEDRA SW							
1.6 16V	1,6		76	06.96-04.98	182 A4.000	4	OZH 084
1.6 16V	1,6		76	05.98-07.99	182 A4.000	4	OZH 118
1.8 16V LE	1,8		83	06.96-07.99	182 A2.000	4	OZH 088
1.8 GT 16V	1,8		96	03.96-07.99	183 A1.000	4	OZH 052
1.8 i.e.	1,8		74	10.94-12.95	836 A5.000	4	OZH 056
2.0 Integrale	2,0		102	07.94-07.99	836 A3.000	4	OZH 052
2.0 16V	2,0		102	07.94-07.99	836 A3.000	4	OZH 052
DELTA I							
1.6 HF Turbo	1,6		103	08.86-08.88	831 B3.000	4	OZH 037
1.6 HF Turbo	1,6		97	04.87-03.89	831 B7.046	4	OZH 037
2.0 16V HF Evo Integrale	2,0		155	06.93-01.94	831 E5.046/831 E5.000	4	OZH 037
2.0 HF Integrale	2,0		130	12.86-12.92	831 C5.046	4	OZH 037
DELTA II							
1.4 i.e.	1,4		51	10.94-08.99	836 A4.000/160 A1.046	4	OZH 035
1.6 i.e.	1,6		55	06.93-12.95	835 C1.000	4	OZH 035
1.6 i.e. 16V	1,6		76	06.96-04.98	182 A4.000	4	OZH 084
1.6 i.e. 16V	1,6		76	05.98-08.99	182 A4.000	4	OZH 118
1.8 i.e.	1,8		66	07.94-12.94	835 C4.000/836 C4.000/ 836 A6.000	4	OZH 035
1.8 i.e.	1,8		66	01.95-08.99	835 C4.000/836 C4.000/ 836 A6.000	4	OZH 056
1.8 i.e.	1,8		76	06.93-12.94	835 C2.000	4	OZH 035
1.8 i.e. 16V	1,8		83	06.96-08.99	182 A2.000	4	OZH 088
1.8 i.e. 16V GT	1,8		96	06.96-08.99	183 A1.000	4	OZH 088

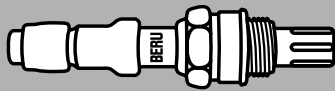

BERU



kW

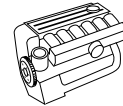

Zyl.
Cyl.
Cil.



LANCIA

DELTA II

2.0 16V	2,0	102	06.93-12.94	836 A3.000	4	OZH 037
2.0 16V	2,0	102	01.95-12.95	836 A3.000	4	OZH 052
2.0 16V Turbo	2,0	137	06.93-08.99	836 A2.000	4	OZH 037
2.0 16V Turbo	2,0	142	07.96-08.99	175 A4.000	4	OZH 037

KAPPA

2.0 16V Turbo	2,0	151	02.95-10.01	838 A4.000	4	OZH 056
2.0 20V	2,0	107	10.94-06.96	838 A1.000 MPI-Bosch	5	OZH 056
2.0 20V	2,0	114	07.96-10.01	838 A6.000	5	OZH 056
2.0 20V Turbo	2,0	162	06.98-12.00	175 A3.000 → VET 2084573	5	OZH 056
2.0 20V Turbo	2,0	162	06.98-12.00	175 A3.000 VET 2084574 →	5	OZH 138
3.0 24V	2,9	150	08.94-06.98	838 B.000	6	OZH 056

KAPPA Coupe

2.0 20V	2,0	114	07.96-03.01	838 A6.000	5	OZH 056
2.0 16V Turbo	2,0	151	11.96-03.01	838 A4.000	4	OZH 056
2.4 20V	2,4	129	11.96-03.01	838 A2.000	5	OZH 056
3.0 24V	2,9	150	11.96-03.01	838 B.000	6	OZH 056

KAPPA SW

2.0 20V	2,0	114	07.96-10.01	838 A6.000	5	OZH 056
2.0 16V Turbo	2,0	151	07.96-10.01	838 A4.000	4	OZH 056
2.0 20V Turbo	2,0	162	06.98-06.00	175 A3.000 → VET 2084573	5	OZH 056
2.0 20V Turbo	2,0	162	06.98-06.00	175 A3.000 VET 2084574 →	5	OZH 138
2.4 20V	2,4	129	07.96-10.01	838 A2.000	5	OZH 056
3.0 24V	2,9	150	07.96-12.00	838 B.000	6	OZH 056

LYBRA

1.6 16V	1,6	76	07.99-	182 A4.000/182 B6.000	4	OZH 118
1.8 16V	1,8	96	07.99-10.00	839 A7.000/839 A4.000	4	OZH 056
1.8 16V	1,8	96	11.00-	839 A7.000	4	OZH 180

LYBRA SW

1.6 16V	1,6	76	07.99-	182 A4.000/182 B6.000	4	OZH 118
1.8 16V	1,8	96	07.99-10.00	839 A7.000/839 A4.000	4	OZH 056
1.8 16V	1,8	96	11.00-	839 A7.000	4	OZH 180

PRISMA

1.5	1,5	55	12.85-12.86	138 C2.048	4	OZU 022
1.6 i.e.	1,6	80	05.86-12.89	831 B7.000	4	OZU 001
1.6 i.e. Super	1,6	66	05.87-12.89	149 C2.000	4	OZU 001
2.0 i.e. 4WD	2,0	85	07.87-12.89	831 B4.000	4	OZH 046

THEMA

2000 i.e.	2,0	83	03.86-09.88	834 B.048	4	OZH 037
2000 i.e.	2,0	85	09.87-05.92	834 B.146	4	OZH 037
2000 i.e.	2,0	88	03.86-09.88	834 B.000	4	OZH 037
2000 i.e. 16V	2,0	108	05.88-08.92	834 B2.000	4	OZH 037
2000 i.e. Turbo	2,0	110	07.86-05.90	834 C.146	4	OZH 037
2000 16V	2,0	112	08.92-12.93	834 F1.000	4	OZH 035
2000 i.e. 16V Turbo	2,0	130	04.89-05.92	834 C1.246	4	OZH 037
2850 V6 i.e.	2,8	108	06.88-09.91	834 E.146	6	OZH 046
3000 V6	2,9	126	08.92-07.94	834 F.000	6	OZH 055
8.32	2,9	151	12.87-12.90	F 105 L.046	8	OZH 046
8.32	2,9	158	12.87-05.89	F 105 L	8	OZH 046

THEMA SW

2000 Turbo	2,0	110	01.89-05.90	834 C.146	4	OZH 037
2000 16V	2,0	112	05.92-07.94	834 F1.000	4	OZH 035
2000 i.e. 16V Turbo	2,0	130	04.89-03.93	834 C1.246	4	OZH 037
3000 V6	2,9	126	09.92-07.94	834 F.000	6	OZH 055

Y

1.1	1,1	40	11.95-06.00	176 B2.000	4	OZH 138
1.2	1,2	44	03.96-10.96	840 A3.000/ 188 A4.000 → VET 2084573	4	OZH 056

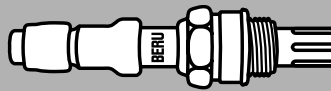

kW

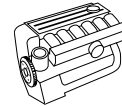
 Zyl.
Cyl.
Cil.

LANCIA

Y							
1.2	1,2	44	10.96–06.00	840 A3.000/ 188 A4.000 VET 2084574 →	4		OZH 138
1.2 16V	1,2	63	04.97–06.00	176 B9.000	4		OZH 135
1.4 12V	1,4	55	03.96–	840 A4.000	4		OZH 056
1.4 12V	1,4	59	10.96–	840 A2.000	4		OZH 056
Y10							
1.0 Fire	1,0	32	06.85–06.91	156 A2.100	4		OZH 037
1.0 Fire KAT	1,0	33	10.87–02.92	156 A2.246	4		OZH 037
1.1 i.e. Fire	1,1	37	07.89–09.92	156 C.046	4		OZH 037
1.1 i.e. Fire	1,1	37	09.92–09.95	156 C.046	4		OZH 035
1.1 i.e. Fire 4WD	1,1	37	09.92–09.95	156 C.046	4		OZH 035
1.1 Avenue	1,1	40	01.95–12.95	176 B2.000	4		OZH 056
1.1 Avenue 4WD	1,1	40	01.95–12.95	176 B2.000	4		OZH 056
1.1 i.e	1,1	42	08.89–06.92	156 C.000	4		OZH 065
1.1 i.e 4WD	1,1	42	08.89–06.92	156 C.000	4		OZH 065
1.3 i.e. Fire	1,3	53	02.89–12.95	156 B.000/146 A 5.046	4		OZH 037
ZETA							
2.0 Turbo	2,0	108	05.95–04.98	RGX	4		OZH 159
2.0 Turbo	2,0	108	05.95–04.98	RGX Inj. MPI-Bosch	4		OZH 034

LANDROVER

RANGE ROVER III (LM)							
4.4	4,4	210	03.02–		8		OZH 173

MAZDA

121 II							
1.3 16V	1,3	39	11.90–03.96	B3 (16V)	4		OZH 095
1.3 16V	1,3	53	11.90–03.96	B3 (16V)	4		OZH 095
323 III							
1.6 GT Turbo	1,6	103	06.87–05.89	B6	4		OZU 001
323 III Hatchback							
1.6 GT Turbo	1,6	103	06.87–05.89	B6	4		OZU 001
1.6 GT Turbo 4WD	1,6	103	10.87–05.89	B6	4		OZU 001
323 III Station Wagon							
1.6	1,6	63	07.87–10.95	B65M /B6E	4		OZU 001
1.6 4x4	1,6	63	05.90–03.93	B65M /B6E	4		OZU 001
323 C IV							
1.3	1,3	49	09.89–07.94	B3E	4		OZU 012
1.3 16V	1,3	54	08.91–07.94	B3	4		OZU 012
1.6	1,6	62	09.89–06.91	B6E	4		OZU 012
1.6 16V	1,6	65	03.91–10.94	B6	4		OZU 012
1.8 16V 4WD	1,8	76	11.91–12.93	BP	4		OZU 001
1.8 16V GT	1,8	94	09.89–03.93	B5	4		OZU 012
323 C V							
1.5 16V	1,5	65	08.94–09.98	Z5-DE → 194444	4		OZH 100
323 F IV							
1.6	1,6	62	09.89–06.91	B6E	4		OZU 012
1.6 16V	1,6	65	03.91–10.94	B6	4		OZU 012
1.8 4WD	1,8	76	06.91–04.94		4		OZU 001
1.8 16V	1,8	76	03.91–05.94	BP	4		OZU 001
1.8 16V GT	1,8	94	03.91–07.94	BP (DOHC)	4		OZU 001
323 F V							
1.5 16V	1,5	65	07.94–09.98	Z5-DE → 194444	4		OZH 100
323 S IV							
1.3	1,3	49	09.89–06.91	B3E/B383	4		OZU 012
1.3 16V	1,3	54	04.91–07.94	B3 (16V)	4		OZU 012
1.6	1,6	62	09.89–06.91	B6E	4		OZU 012
1.6 16V	1,6	65	08.89–10.94	B6	4		OZU 012
1.8 16V	1,8	76	04.91–07.94	BP52	4		OZU 001
1.8 16V 4WD	1,8	76	09.91–07.94	BP52	4		OZU 001

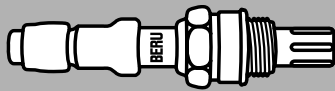
BERU

kW

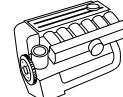

 Zyl.
Cyl.
Cil.

MAZDA
323 S V

1.5 16V	1,5		65	08.94-09.98	Z5-DE → 194444	4	OZH 100
626 III							
2.0	2,0		66	01.89-10.90	FE 500001 →	4	OZU 021
626 III Hatchback							
2.0	2,0		66	01.89-10.90	FE 500001 →	4	OZU 021
626 III Station Wagon							
2.0	2,0		66	01.89-09.97	FE 200001 →	4	OZU 021
626 IV							
1.8 i	1,8		66	08.94-04.97		4	OZH 163
1.8 i	1,8		77	01.92-05.94	FP	4	OZH 163
2.0 i	2,0		85	01.92-05.94	FS	4	OZH 076
626 IV Hatchback							
1.8	1,8		66	08.94-04.97		4	OZH 163
1.8	1,8		77	08.91-05.94	FP	4	OZH 163
2.0 i	2,0		85	08.91-05.94	FS	4	OZH 076
2.0 i 4WD	2,0		85	04.92-05.94	FS	4	OZH 076
2.5 24V	2,5		121	01.92-05.94	KL	6	OZH 163
929 III							
3.0	2,9		125	01.88-05.89	JE3	6	OZH 022
MX-3							
1.6 i	1,6		65	07.91-	B69	4	OZU 012
MX-5 I							
1.6	1,6		66	01.95-04.98		4	OZH 153
1.6	1,6		85	05.90-08.93	B64F	4	OZU 001
1.8	1,8		96	02.94-04.98	BPF1	4	OZH 153
MX-6							
2.0	2,0		85	02.92-06.94	FS	4	OZH 076
2.5 24V	2,5		121	01.94-06.94	KL	6	OZH 163
2.5 i 24V	2,5		120	08.94-06.97	KL	6	OZH 163
XEDOS 6							
1.6 16V	1,6		79	06.94-04.96	B6 CA 122.107.58 → CA 122.129.84	4	OZH 043
2.0 V6	2,0		106	01.92-05.94	KF1	6	OZH 163
XEDOS 9							
2.3 24V	2,3		155	02.95-07.98	KJ -ZEM	6	OZH 200

MERCEDES
C-KLASSE (W202)

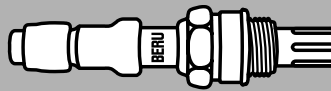
C 180	1,8		89	11.94-05.00	M 111.921	4	OZH 025
C 180	1,8	Automatic ³	90	03.93-05.00	M 111.920 → Mot.Nr. M 111.920xx050883	4	OZH 042
C 180	1,8	Automatic ³	90	03.93-05.00	M 111.920 Mot.Nr. M 111.920xx050884 →	4	OZH 021
C 180	1,8		90	03.93-05.00	M 111.920 → Mot.Nr. M 111.920xx117655	4	OZH 042
C 180	1,8		90	03.93-05.00	M 111.920 Mot.Nr. M 111.920xx177656 →	4	OZH 021
C 200	2,0	Automatic ³	100	01.94-05.00	M 111.941 → Mot.Nr. M 111.941xx015981	4	OZH 042
C 200	2,0	Automatic ³	100	01.94-05.00	M 111.941 Mot.Nr. M 111.941xx015982 →	4	OZH 021
C 200	2,0		100	01.94-05.00	M 111.941 → Mot.Nr. M 111.941xx014845	4	OZH 042
C 200	2,0		100	01.94-05.00	M 111.941 Mot.Nr. M 111.941xx014846 →	4	OZH 021
C 200 Kompressor	2,0	Automatic ³	132	10.95-05.00	M 111.944 → Mot.Nr. 000054	4	OZH 025
C 200 Kompressor	2,0	Automatic ³	132	10.95-05.00	M 111.944 Mot.Nr. 000055 →	4	OZH 098
C 200 Kompressor	2,0		132	10.95-05.00	M 111.944 → Mot.Nr. 003872	4	OZH 025
C 200 Kompressor	2,0		132	10.95-05.00	M 111.944 Mot.Nr. 003872 →	4	OZH 098
C 200 Kompressor	2,0	Automatic ³	141	11.96-05.00	M 111.944 → Mot.Nr. 000054	4	OZH 025
C 200 Kompressor	2,0	Automatic ³	141	11.96-05.00	M 111.944 Mot.Nr. 000055 →	4	OZH 098



kW

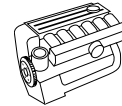

Zyl.
Cyl.
Cil.



MERCEDES

C-KLASSE (W202)

C 200 Kompressor	2,0		141	11.96-05.00	M 111.944 → Mot.Nr. 003872	4	OZH 025
C 200 Kompressor	2,0		141	11.96-05.00	M 111.944 Mot.Nr. 003872 →	4	OZH 098
C 220	2,2	Automatic ³	110	03.93-05.00	M 111.961 → Mot.Nr. M 111.961xx050895	4	OZH 042
C 220	2,2	Automatic ³	110	03.93-09.96	M 111.961 Mot.Nr. M 111.961xx050896 →	4	OZH 021
C 220	2,2		110	03.93-05.00	M 111.961 → Mot.Nr. M 111.961xx017341	4	OZH 042
C 220	2,2		110	03.93-09.96	M 111.961 Mot.Nr. M 111.961xx017342 →	4	OZH 021
C 230	2,3	Automatic ³	110	06.96-06.97	M 111.974 → Mot.Nr. 004991	4	OZH 025
C 230	2,3	Automatic ³	110	06.96-06.97	M 111.974 Mot.Nr. 004992 →	4	OZH 098
C 230	2,3		110	06.96-06.97	M 111.974 → Mot.Nr. 001871	4	OZH 025
C 230	2,3		110	06.96-06.97	M 111.974 Mot.Nr. 001872 →	4	OZH 098
C 230 Kompressor	2,3	Automatic ³	142	10.95-05.00	M 111.975 → Mot.Nr. 000555	4	OZH 025
C 230 Kompressor	2,3	Automatic ³	142	10.95-05.00	M 111.975 Mot.Nr. 000556 →	4	OZH 098
C 230 Kompressor	2,3		142	10.95-05.00	M 111.975 → Mot.Nr. 005799	4	OZH 025
C 230 Kompressor	2,3		142	10.95-05.00	M 111.975 Mot.Nr. 005800 →	4	OZH 098
C 280	2,8		142	05.93-05.97	M 104.941	6	OZH 018
C 36 AMG	3,6		206	05.94-05.97	M 104.941 (AMG 3.6)	6	OZH 018

C-KLASSE Kombi (S202)

C 180 T	1,8	Automatic ³	90	03.93-05.00	M 111.920 → Mot.Nr. M 111.920xx050883	4	OZH 042
C 180 T	1,8	Automatic ³	90	03.93-05.00	M 111.920 Mot.Nr. M 111.920xx050884 →	4	OZH 021
C 180 T	1,8		90	03.93-05.00	M 111.920 → Mot.Nr. M 111.920xx117655	4	OZH 042
C 180 T	1,8		90	03.93-05.00	M 111.920 Mot.Nr. M 111.920xx177656 →	4	OZH 021
C 180 T	1,8	Automatic ³	90	06.96-09.00	M 111.921 Mot.Nr. M 111.921xx004127 →	4	OZH 098
C 180 T	1,8		90	06.96-09.00	M 111.921 Mot.Nr. M 111.921xx007269 →	4	OZH 098
C 200 T	2,0	Automatic ³	100	06.96-03.01	M 111.941 → Mot.Nr. M 111.941xx015981	4	OZH 042
C 200 T	2,0	Automatic ³	100	06.96-03.01	M 111.941 Mot.Nr. M 111.941xx015982 →	4	OZH 021
C 200 T	2,0		100	06.96-03.01	M 111.941 → Mot.Nr. M 111.941xx014845	4	OZH 042
C 200 T	2,0		100	06.96-03.01	M 111.941 Mot.Nr. M 111.941xx014846 →	4	OZH 021
C 200 T	2,0		100	06.96-03.01	M 111.945 Mot.Nr. 111.945xx003753 →	4	OZH 098
C 200 T	2,0		100	06.96-03.01	M 111.945 Mot.Nr. 111.945xx001913 →	4	OZH 098
C 200 T Kompressor	2,0	Automatic ³	141	11.96-03.01	M 111.944 → Mot.Nr. 000054	4	OZH 025
C 200 T Kompressor	2,0	Automatic ³	141	11.96-03.01	M 111.944 Mot.Nr. 000055 →	4	OZH 098
C 200 T Kompressor	2,0		141	11.96-03.01	M 111.944 → Mot.Nr. 003872	4	OZH 025
C 200 T Kompressor	2,0		141	11.96-03.01	M 111.944 Mot.Nr. 003872 →	4	OZH 098
C 230 T	2,3	Automatic ³	110	06.96-06.98	M 111.974 → Mot.Nr. 004991	4	OZH 025
C 230 T	2,3	Automatic ³	110	06.96-06.98	M 111.974 Mot.Nr. 004992 →	4	OZH 098
C 230 T	2,3		110	06.96-06.98	M 111.974 → Mot.Nr. 001871	4	OZH 025
C 230 T	2,3		110	06.96-06.98	M 111.974 Mot.Nr. 001872 →	4	OZH 098
C 230 T Kompressor	2,3	Automatic ³	142	06.97-09.00	M 111.975 → Mot.Nr. 000555	4	OZH 025
C 230 T Kompressor	2,3	Automatic ³	142	06.97-09.00	M 111.975 Mot.Nr. 000556 →	4	OZH 098
C 230 T Kompressor	2,3		142	06.97-09.00	M 111.975 → Mot.Nr. 005799	4	OZH 025
C 230 T Kompressor	2,3		142	06.97-09.00	M 111.975 Mot.Nr. 005800 →	4	OZH 098

CLK (C208)

200	2,0	Automatic ³	100	06.97-06.02	M 111.945 → Mot.Nr. 003752	4	OZH 025
200	2,0	Automatic ³	100	06.97-06.02	M 111.945 Mot.Nr. 003753 →	4	OZH 098
200	2,0		100	06.97-06.02	M 111.945 → Mot.Nr. 001912	4	OZH 025

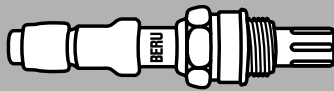
BERU

kW

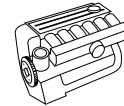
 Zyl.
Cyl.
Cil.

MERCEDES
CLK (C208)

200	2,0		100	06.97-06.02	M 111.945 Mot.Nr. 001913 →	4	OZH 098
200 Kompressor	2,0	Automatic ³	141	06.97-06.00	M 111.944 → Mot.Nr. 000054	4	OZH 025
200 Kompressor	2,0	Automatic ³	141	06.97-06.00	M 111.944 Mot.Nr. 000055 →	4	OZH 098
200 Kompressor	2,0		141	06.97-06.00	M 111.944 → Mot.Nr. 003872	4	OZH 025
200 Kompressor	2,0		141	06.97-06.00	M 111.944 Mot.Nr 003873 →	4	OZH 098
230 Kompressor	2,3	Automatic ³	142	06.97-06.00	M 111.975 → Mot.Nr. 000555	4	OZH 025
230 Kompressor	2,3	Automatic ³	142	06.97-06.00	M 111.975 Mot.Nr 000556 →	4	OZH 098
230 Kompressor	2,3		142	06.97-06.00	M 111.975 → Mot.Nr. 005799	4	OZH 025
230 Kompressor	2,3		142	06.97-06.00	M 111.975 Mot.Nr. 005800 →	4	OZH 098

CLK Cabriolet (A208)

200	2,0	Automatic ³	100	03.98-03.02	M 111.945 → Mot.Nr. 003752	4	OZH 025
200	2,0	Automatic ³	100	03.98-03.02	M 111.945 Mot.Nr. 003753 →	4	OZH 098
200	2,0		100	03.98-03.02	M 111.945 → Mot.Nr. 001912	4	OZH 025
200	2,0		100	03.98-03.02	M 111.945 Mot.Nr. 001913 →	4	OZH 098
200 Kompressor	2,0	Automatic ³	141	03.98-06.00	M 111.944 → Mot.Nr. 000054	4	OZH 025
200 Kompressor	2,0	Automatic ³	141	03.98-06.00	M 111.944 Mot.Nr. 000055 →	4	OZH 098
200 Kompressor	2,0		141	03.98-06.00	M 111.944 → Mot.Nr. 003872	4	OZH 025
200 Kompressor	2,0		141	03.98-06.00	M 111.944 Mot.Nr 003873 →	4	OZH 098
230 Kompressor	2,3	Automatic ³	142	03.98-06.00	M 111.975 → Mot.Nr. 000555	4	OZH 025
230 Kompressor	2,3	Automatic ³	142	03.98-06.00	M 111.975 Mot.Nr 000556 →	4	OZH 098
230 Kompressor	2,3		142	03.98-06.00	M 111.975 → Mot.Nr. 005799	4	OZH 025
230 Kompressor	2,3		142	03.98-06.00	M 111.975 Mot.Nr. 005800 →	4	OZH 098

E-KLASSE (W124)

E 200	2,0		100	06.93-06.95	M 111.940	4	OZH 041
E 220	2,2		110	06.93-06.95	M 111.960	4	OZH 041
E 280	2,8		145	06.93-06.95	M 104.942	6	OZH 016
E 280 lang	2,8		142	06.93-06.95	M 104.942	6	OZH 016
E 320	3,2		162	06.93-06.95	M 104.992	6	OZH 016

E-KLASSE Cabriolet (A124)

E 200	2,0		100	06.93-03.98	M 111.940	4	OZH 041
E 220	2,2		110	06.93-03.98	M 111.960	4	OZH 041
E 320	3,2		162	06.93-03.98	M 104.992/M 104.995	6	OZH 016
E 36 AMG	3,6		200	05.94-03.98	M 104.992 (AMG 3.6)	6	OZH 016

E-KLASSE Coupé (C124)

E 200	2,0		100	06.93-06.96	M 111.940	4	OZH 041
E 220	2,2		110	06.93-06.96	M 111.960	4	OZH 041
E 320	3,2		162	06.93-06.96	M 104.992	6	OZH 016
E 36 AMG	3,6		200	05.94-09.96	M 104.992 (AMG 3.6)	6	OZH 016

E-KLASSE Kombi (S124)

E 200 T	2,0		100	06.93-06.96	M 111.940	4	OZH 041
E 220 T	2,2		110	06.93-06.96	M 111.960	4	OZH 041
E 280 T	2,8		142	06.93-06.96	M 104.942	6	OZH 016
E 280 T	2,8		145	06.93-06.96	M 104.942	6	OZH 016
E 300 TE-24 AMG	3,0		162	06.93-06.96	M 104.980	6	OZH 026
E 320 T	3,2		162	06.93-06.96	M 104.992	6	OZH 016
E 36 T AMG	3,6		200	05.94-06.96	M 104.992 (AMG 3.6)	6	OZH 016

E-KLASSE (W210)

E 200	2,0		100	06.95-08.00	M 111.942	4	OZH 145
E 200 Kompressor	2,0		137	06.97-03.02	M 111.947	4	OZH 145
E 200 Kompressor	2,0		137	06.97-03.02	M 111.947	4	OZH 098
E 230	2,3		110	06.95-06.97	M 111.970	4	OZH 200
E 240	2,4		125	06.97-06.99	M 112.911	6	OZH 124
E 240	2,4	D1 (2x)	125	06.97-06.99	M 112.911	6	OZH 143
E 280	2,8		142	01.96-06.97	M 104.945	6	OZH 023
E 280	2,8		150	12.96-05.99	M 112.921	6	OZH 023
E 280	2,8		150	06.99-03.02	M 112.921 → B 173999	6	OZH 023
E 280	2,8		150	12.96-05.99	M 112.921	6	OZH 124
E 280	2,8		150	06.99-03.02	M 112.921 → B 173999	6	OZH 124
E 280	2,8	D1 (2x)	150	12.96-03.02	M 112.921	6	OZH 143
E 280 4-matic	2,8		150	12.96-05.99	M 112.921	6	OZH 023
E 280 4-matic	2,8		150	06.99-03.02	M 112.921 → B 173999	6	OZH 023

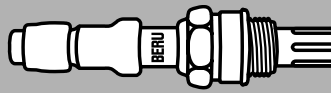

kW

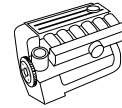
 Zyl.
Cyl.
Cil.

MERCEDES
E-KLASSE (W210)

E 280 4-matic	2,8	D1	150	12.96-05.99	M 112.921	6	OZH 124
E 280 4-matic	2,8		150	06.99-03.02	M 112.921 → B 173999	6	OZH 124
E 280 4-matic	2,8	D1 (2x)	150	12.96-03.02	M 112.921	6	OZH 143
E 320	3,2		162	06.95-08.96	M 104.992	6	OZH 023
E 320	3,2		162	09.96-06.97	M 104.992	6	OZH 124
E 320	2,8		150	06.99-03.02	M 112.941 → B 173999	6	OZH 023
E 320	2,8		150	06.99-03.02	M 112.941 → B 173999	6	OZH 124
E 320	2,8	D1 (2x)	150	12.96-03.02	M 112.941	6	OZH 143
E 320 4-matic	2,8		150	06.99-03.02	M 112.941 → B 173999	6	OZH 023
E 320 4-matic	2,8		150	06.99-03.02	M 112.941 → B 173999	6	OZH 124
E 320 4-matic	2,8	D1 (2x)	150	12.96-03.02	M 112.941	6	OZH 143
E 420	4,2		205	01.96-06.97	M 119.985 → A 962231	8	OZH 021
E 420	4,2		205	01.96-06.97	M 119.985 → A 32402/J 020295	8	OZH 124
E 420	4,2	D1 (2x)	205	01.96-06.97	M 119.985	8	OZH 143
E 420	4,2	D1	205	01.96-06.97	M 119.985 → Fgst. B 17367	8	OZH 145
E 430	4,3		205	06.97-03.02	M 113.940	8	OZH 124
E 430	4,3	D1 (2x)	205	06.97-03.02	M 113.940	8	OZH 143
E 430 4-matic	4,3		205	05.99-03.02	M 113.940 → Fgst. B 17367	8	OZH 124
E 430 4-matic	4,3	D1 (2x)	205	05.99-03.02	M 113.940	8	OZH 143
E 50 AMG	5,0		255	02.96-08.97	M 119.985 (AMG 5.0) → A 32402/J 020295	8	OZH 124
E 55 AMG	5,5		260	08.97-03.02	M 113.980	8	OZH 124
E 55 AMG	5,5	D1 (2x)	260	07.99-03.02	M 113.980	8	OZH 143

E-KLASSE Kombi (S210)

E 200 T	2,0		100	06.96-08.00	M 111.942	4	OZH 145
E 200 T Kompressor	2,0		137	06.97-03.03	M 111.947	4	OZH 145
E 200 T Kompressor	2,0		137	06.97-03.03	M 111.947	4	OZH 098
E 230 T	2,3		110	06.96-06.97	M 111.970	4	OZH 200
E 240 T	2,4		125	06.97-03.03	M 112.911 → A 962231	6	OZH 021
E 240 T	2,4		125	06.97-03.03	M 112.911	6	OZH 124
E 240 T	2,4	D1 (2x)	125	06.97-03.03	M 112.911	6	OZH 143
E 240 T	2,4	D1 (2x)	125	06.97-03.03	M 112.911 → B 17367	6	OZH 145
E 280 T	2,8		150	12.96-03.03	M 112.921	6	OZH 124
E 280 T	2,8	D1 (2x)	150	12.96-03.03	M 112.921	6	OZH 143
E 280 T 4-matic	2,8		150	12.96-03.03	M 112.921	6	OZH 124
E 280 T 4-matic	2,8	D1 (2x)	150	12.96-03.03	M 112.921	6	OZH 143
E 320 T	3,2		165	12.96-03.03	M 112.941 → A 962231	6	OZH 021
E 320 T	3,2		165	12.96-03.03	M 112.941	6	OZH 124
E 320 T	3,2	D1 (2x)	165	01.98-03.03	M 112.941	6	OZH 143
E 320 T	3,2	D1	165	12.96-03.03	M 112.941 → B 17367	6	OZH 145
E 320 T 4-matic	3,2		165	12.96-03.03	M 112.941 → A 962231	6	OZH 021
E 320 T 4-matic	3,2		165	12.96-03.03	M 112.941	6	OZH 124
E 320 T 4-matic	3,2	D1 (2x)	165	01.98-03.03	M 112.941	6	OZH 143
E 320 T 4-matic	3,2	D1	165	12.96-03.03	M 112.941 → B 17367	6	OZH 145
E 420 T	4,2		205	06.96-06.97	M 119.985 → A 962231	8	OZH 021
E 420 T	4,2		205	06.96-06.97	M 119.985 → B 17367	8	OZH 145
E 430 T	4,3		205	06.97-03.03	M 113.940 → A 962231	8	OZH 021
E 430 T	4,3		205	06.97-03.03	M 113.940	8	OZH 124
E 430 T	4,3	D1 (2x)	205	06.97-03.03	M 113.940	8	OZH 143
E 430 T	4,3	D1	205	06.97-03.03	M 113.940 → Fgst. B 17367	8	OZH 145
E 430 T 4-matic	4,3		205	05.99-03.03	M 113.940	8	OZH 124
E 430 T 4-matic	4,3	D1 (2x)	205	05.99-03.03	M 113.940	8	OZH 143
E 55 T AMG	5,5		260	08.97-03.03	M 113.980 → A 962231	8	OZH 021
E 55 T AMG	5,5		260	03.98-03.03	M 113.980	8	OZH 124
E 55 T AMG	5,5	D1 (2x)	260	07.99-03.03	M 113.980	8	OZH 143
E 55 T AMG	5,5	D1	260	08.97-03.03	M 113.980 → Fgst. B 17367	8	OZH 145

M-KLASSE (W163)

ML 320	3,2	R (2x)	160	02.98-08.02	M 112.942	6	OZH 220
ML 320	3,2	R (2x)	160	02.98-08.02	M 112.942	6	OZH 143
ML 320	3,2	D1 (2x)	160	02.98-08.02	M 112.942	6	OZH 143
ML 55 AMG	5,5	R (2x)	255	02.00-06.05	M 113.981	8	OZH 143

BERU

kW

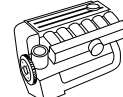
 Zyl.
Cyl.
Cil.

MERCEDES
M-KLASSE (W163)

ML 55 AMG	5,5	D1 (2x)	255	02.00-06.05	M 113.981	8	OZH 220
-----------	-----	---------	-----	-------------	-----------	---	----------------

S-KLASSE (W140)

300 SE 2.8	2,8		145	01.93-05.93	M 104.944	6	OZH 018
300 SE 2.8	2,8		145	01.93-10.98	M 104.944	6	OZH 144
300 SE,SEL/S320	3,2		170	03.91-05.93	M 104.990/M 104.994	6	OZH 018
300 SE,SEL/S320	3,2		170	03.91-10.98	M 104.990/M 104.994	6	OZH 144
S 280	2,8		142	02.93-05.93	M 104.944	6	OZH 018
S 280	2,8		142	02.93-10.98	M 104.944	6	OZH 144

S-KLASSE (W220)

S 280	2,8	D1 (2x)	150	10.98-08.02	M 112.922 → A 138350	6	OZH 143
S 320	3,2	D1 (2x)	165	10.98-08.02	M 112.944 → A 138350	6	OZH 143
S 430	4,3	D1 (2x)	205	10.98-08.05	M 113.941 → A 138350	8	OZH 143
S 500	5,0	D1 (2x)	225	10.98-08.05	M 113.960 → A 138350	8	OZH 143

SL (R107)

300 SL	3,0		132	09.85-08.89	M 103.982	6	OZH 026
300 SL	3,0		138	09.85-08.89	M 103.982	6	OZH 026

SL (R129)

280	2,8		150	05.98-10.01	M 112.923/M 112.925 → A 962231	6	OZH 021
280	2,8		150	05.98-10.01	M 112.923/M 112.925	6	OZH 124
280	2,8	D1 (2x)	150	05.98-10.01	M 112.923/M 112.925	6	OZH 143
280	2,8	D1	150	05.98-10.01	M 112.923/M 112.925 → B 17367	6	OZH 145
320	3,2	D1 (2x)	165	05.98-10.01	M 112.943	6	OZH 124
500	5,0		225	05.98-10.01	M 113.961 → A 962231	8	OZH 021
500	5,0	D1	225	05.98-10.01	M 113.961 → B 17367	8	OZH 145
600	6,0		290	07.92-10.01	M 120.983/M 120.981	12	OZH 016
300 SL	3,0		140	03.89-08.93	M 103.984	6	OZH 033
500 SL	5,0		240	09.89-08.92	M 119.960/M 119.972	8	OZH 033

SLK (R170)

200	2,0		100	09.96-03.00	M 111.946	4	OZH 144
200 Kompressor	2,0		141	10.96-03.00	M 111.943	4	OZH 144

SPRINTER 2-t (901, 902)

214	2,3		105	02.95-03.00	M 111.979/M 111.984	4	OZH 146
-----	-----	--	-----	-------------	---------------------	---	----------------

SPRINTER 3-t (903)

314	2,3		105	02.95-08.02	M 111.979/M 111.984	4	OZH 146
-----	-----	--	-----	-------------	---------------------	---	----------------

SPRINTER 4-t (904)

414	2,3		105	02.96-03.00	M 111.979/M 111.984	4	OZH 146
-----	-----	--	-----	-------------	---------------------	---	----------------

190 (W201)

2.0	2,0		75	09.88-08.89	M 102.924	4	OZH 007
2.0	2,0	ohne Kat. ¹¹	75	01.86-05.90	M 102.924	4	OZH 051
2.0	2,0		77	09.88-09.89	M 102.924	4	OZH 007
2.0	2,0	ohne Kat. ¹¹	77	09.84-05.90	M 102.924	4	OZH 051
E 1.8	1,8		80	04.90-08.93	M 102.910	4	OZH 032
E 2.0	2,0		83	02.85-09.85	M 102.961/M 102.962 → A 528957	4	OZH 007
E 2.0	2,0		85	09.85-12.86	M 102.962 → A 528957	4	OZH 007
E 2.0	2,0		87	09.88-08.89	M 102.962 → A 528957	4	OZH 007
E 2.0	2,0		87	09.89-08.93	M 102.962 Mot.Nr. 122336 →	4	OZH 032
E 2.0	2,0		87	09.89-08.93	M 102.962 Mot.Nr. 236839 →	4	OZH 032
E 2.0	2,0		90	09.85-08.89	M 102.961/M 102.962 → A 528957	4	OZH 007
E 2.0	2,0		90	09.89-06.93	M 102.961/M 102.962 122336 →	4	OZH 032
E 2.0	2,0		90	09.89-06.93	M 102.961/M 102.962 236839 →	4	OZH 032
E 2.3	2,3		100	10.86-08.89	M 102.985 → A 528957	4	OZH 007
E 2.3	2,3		100	10.86-08.89	M 102.985	4	OZH 026
E 2.3	2,3		100	09.89-08.93	M 102.985 Mot.Nr. 033730 →	4	OZH 032
E 2.3	2,3		100	09.89-08.93	M 102.985 Mot.Nr. 080065 →	4	OZH 032
E 2.3	2,3		97	09.86-08.89	M 102.985 → A 528957	4	OZH 007
E 2.3	2,3		97	09.86-08.89	M 102.985	4	OZH 026
E 2.3	2,3		97	09.89-08.91	M 102.985 Mot.Nr. 033730 →	4	OZH 032

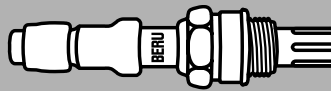

kW

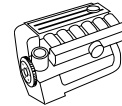

Zyl.
Cyl.
Cil.



MERCEDES

190 (W201)

E 2.3	2,3		97	09.89-08.91	M 102.985 Mot.Nr. 080065 →	4	OZH 032
E 2.3-16	2,3	Kat. ⁸	125	09.85-12.87	M 102.983	4	OZH 007
E 2.3-16	2,3		125	09.85-12.87	M 102.983	4	OZH 026
E 2.3-16	2,3	Kat. ⁸	130	09.85-08.88	M 102.983	4	OZH 007
E 2.3-16	2,3		130	09.85-08.88	M 102.983	4	OZH 026
E 2.3-16	2,3	Kat. ⁸	136	09.85-01.87	M 102.983	4	OZH 007
E 2.3-16	2,3		136	09.85-01.87	M 102.983	4	OZH 026
E 2.5-16	2,5		143	03.89-04.90	M 102.991	4	OZH 007
E 2.5-16	2,5		150	09.88-08.93	M 102.990	4	OZH 007
E 2.6	2,6		122	09.86-12.89	M 103.942	6	OZH 007
E 2.6	2,6		118	09.86-08.93	M 103.942	6	OZH 007
E Evolution II 2.5	2,5		173	05.90-08.93	M 102.992	4	OZH 007

230 E (W123)

230 E	2,3		100	04.81-12.85	M 102.980	4	OZU 001
-------	-----	--	-----	-------------	-----------	---	----------------

230 CE (W123)

230 CE	2,3		100	04.80-12.85	M 102.980	4	OZU 001
--------	-----	--	-----	-------------	-----------	---	----------------

230 TE (S123)

230 TE	2,3		100	04.81-11.85	M 102.980	4	OZU 001
--------	-----	--	-----	-------------	-----------	---	----------------

200 (W124)

200	2,0		75	01.86-05.90	M 102.922 B 065854 →	4	OZH 196
200	2,0		77	01.86-08.89	M 102.922	4	OZH 026
200	2,0		77	09.89-05.90	M 102.922	4	OZH 196
200	2,0		80	12.85-08.89	M 102.922	4	OZH 026
200	2,0		80	09.89-05.90	M 102.922	4	OZH 196

200 E (W124)

200 E	2,0		87	09.88-08.89	M 102.963	4	OZH 026
200 E	2,0		87	09.89-08.92	M 102.963	4	OZH 032
200 E	2,0	Automatic ³	90	09.88-12.89	M 102.963 Mot.Nr. 096990 →	4	OZH 032
200 E	2,0		90	09.88-12.89	M 102.963 Mot.Nr. 036322 →	4	OZH 032

200 T (S124)

200 T	2,0		77	01.86-08.89	M 102.922	4	OZH 026
200 T	2,0		77	09.89-05.90	M 102.922	4	OZH 196
200 T	2,0		80	09.85-08.89	M 102.922	4	OZH 026
200 T	2,0		80	09.89-08.89	M 102.922	4	OZH 196

200 TE (S124)

200 TE	2,0		87	09.88-08.92	M 102.963	4	OZH 032
220 TE	2,2		110	10.92-05.93	M 111.960	4	OZH 041

220 CE COUPE (C124)

220 CE	2,2		110	10.92-05.93	M 111.960	4	OZH 041
--------	-----	--	-----	-------------	-----------	---	----------------

220 E (W124)

220 E	2,2		110	10.92-06.93	M 111.960	4	OZH 041
-------	-----	--	-----	-------------	-----------	---	----------------

230 CE COUPE (C124)

230 CE	2,3		100	03.87-08.88	M 102.982	4	OZH 026
230 CE	2,3		100	09.88-12.92	M 102.982	4	OZH 032
230 CE	2,3		97	03.87-12.92	M 102.982	4	OZH 032
230 CE	2,3		97	06.89-12.92	M 102.982	4	OZH 032

230 E (W124)

230 E	2,3		100	05.85-08.88	M 102.982	4	OZH 026
230 E	2,3	Automatic ³	100	05.85-08.92	M 102.982 Mot.Nr. 147102→	4	OZH 032
230 E	2,3		100	09.89-08.92	M 102.982 Mot.Nr. 146597→	4	OZH 032
230 E	2,3		97	05.85-08.88	M 102.982	4	OZH 026
230 E	2,3	Automatic ³	97	09.89-03.92	M 102.982 Mot.Nr. 147102→	4	OZH 032
230 E	2,3		97	09.89-03.92	M 102.982 Mot.Nr. 146597→	4	OZH 032
230 E KAT	2,3		97	06.89-06.93	M 102.982	4	OZH 032

230 TE (S124)

230 TE	2,3		100	09.85-08.88	M 102.982	4	OZH 026
230 TE	2,3		100	09.88-08.92	M 102.982	4	OZH 032
230 TE	2,3		97	06.89-08.92	M 102.982	4	OZH 032

260 E (W124)

260 E	2,6		118	09.85-08.92	M 103.940	6	OZH 026
260 E	2,6		122	09.85-12.89	M 103.940	6	OZH 026

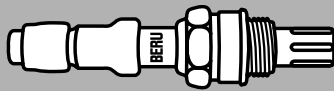
BERU

kW

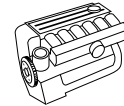
 Zyl.
Cyl.
Cil.

MERCEDES
260 E (W124)

 260 E 4-matic 2,6 122 12.86-12.89 M 103.940 6 **OZH 026**
260 TE (S124)

 260 TE 2,6 118 09.89-08.92 M 103.940 6 **OZH 026**

 260 TE 2,6 122 09.85-12.89 M 103.940 6 **OZH 026**
280 E (W124)

 280 E 2,8 145 10.92-06.93 M 104.942 6 **OZH 016**
280 TE (S124)

 280 TE 2,8 145 10.92-06.93 M 104.942 6 **OZH 016**
300 CE CABRIOLET (A124)

 300 CE-24 3,0 162 04.92-06.93 M 104.980 6 **OZH 026**
300 CE COUPE (C124)

 300 CE 3,0 138 03.87-12.89 M 103.983 6 **OZH 026**

 300 CE 3,0 132 03.87-08.92 M 103.983 6 **OZH 026**

 300 CE-24 3,0 162 09.89-12.92 M 104.980 6 **OZH 026**
300 E (W124)

 300 E 3,0 132 08.85-08.92 M 103.983 6 **OZH 026**

 300 E 3,0 138 06.85-08.92 M 103.983 6 **OZH 026**

 300 E 4-matic 3,0 138 09.86-02.92 M 103.983 6 **OZH 026**

 300 E 4-matic 3,0 132 09.86-06.93 M 103.985 6 **OZH 026**

 300 E-24 3,0 162 09.88-08.89 M 104.980 6 **OZH 016**

 300 E-24 3,0 162 09.89-08.92 M 104.980 6 **OZH 026**
300 TE (S124)

 300 TE 3,0 138 01.86-12.89 M 103.983 6 **OZH 026**

 300 TE 3,0 132 01.86-08.92 M 103.983 6 **OZH 026**

 300 TE 4-matic 3,0 132 09.86-06.93 M 103.985 6 **OZH 026**

 300 TE 4-matic 3,0 138 09.86-12.89 M 103.983 6 **OZH 026**

 300 TE-24 3,0 162 09.89-08.92 M 104.980 6 **OZH 026**
320 CE COUPE (C124)

 320 CE 3,2 162 10.92-05.93 M 104.992 6 **OZH 016**
320 E (W124)

 320 E 3,2 162 10.92-06.93 M 104.992 6 **OZH 016**
320 TE (S124)

 320 TE 3,2 162 10.92-06.93 M 104.992 6 **OZH 016**
MG
MGF

 1.8 i 16V 1,8 88 03.95-03.02 18 K4F 4 **OZH 053**

 1.8 i VVC 1,8 107 12.95-03.02 18 K4K (VVC) 4 **OZH 053**
MG TF

 120 1,8 88 03.02- 18 K4F → YD 522 572 4 **OZH 053**

 135 1,8 100 03.02- 18 K4F → YD 522 572 4 **OZH 053**
MG ZR

 105 1,4 76 10.01- → YD 471 564 4 **OZH 053**

 120 1,8 86 10.01- 18 K4F → YD 471 564 4 **OZH 053**
MITSUBISHI
COLT III

 1.3 1,3 51 04.88-05.90 4 G 13 4 **OZU 001**

 1.3 GL 1,3 44 04.88-05.90 4 G 13 4 **OZU 001**
NISSAN
100 NX

 1.6 1,6 66 10.90-10.92 GA16DS 4 **OZU 001**

 1.6 SR 1,6 75 09.93-10.94 GA16DE 4 **OZH 011**
ALMERA II

 1.8 1,8 84 03.01-07.02 QG18DE 4 **OZH 225**

 1.8 D1 1,8 84 03.01-07.02 QG18DE 4 **OZH 226**
ALMERA II Hatchback

 1.5 1,5 66 11.00-07.02 QG15DE 4 **OZH 225**

 1.5 D1 1,5 66 11.00-07.02 QG15DE 4 **OZH 226**

 1.8 1,8 84 11.00-07.02 QG18DE 4 **OZH 225**

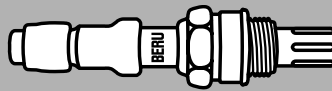

kW

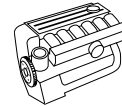

 Zyl.
Cyl.
Cil.

NISSAN

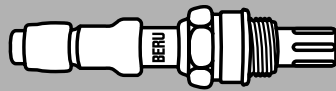
Model	Power (kW)	Engine Code	Power (kW)	Year Range	Engine Code	Cyl.	Part No.
ALMERA II Hatchback							
1.8	1,8	D1	84	11.00-07.02	QG18DE	4	OZH 226
ALMERA TINO							
1.8	1,8		84	08.00-02.03	QG18DE	4	OZH 225
1.8	1,8		85	12.02-02.03		4	OZH 225
BLUEBIRD							
1.8 i 16V	1,8		95	02.89-12.90	CA18D	4	OZU 024
2.0 i	2,0		77	03.86-12.90	CA20E	4	OZU 010
2.0 i	2,0		77	01.86-01.88	CA20E	4	OZU 001
BLUEBIRD Hatchback							
1.8 i 16V	1,8		95	02.89-12.90	CA18D	4	OZU 024
2.0 i	2,0		77	03.86-12.90	CA20E	4	OZU 010
BLUEBIRD Station Wagon							
2.0 i	2,0		77	03.86-12.90	CA20E	4	OZU 010
MAXIMA QX							
2.0	2,0		103	02.95-01.00	VQ20DE	6	OZH 012
3.0	3,0		142	01.95-08.00	VQ30DE	6	OZH 012
MAXIMA Station Wagon							
2.0 QX	2,0		103	10.97-01.00	VQ20DE	6	OZH 012
3.0 QX	3,0		142	10.97-	VQ30DE	6	OZH 012
MICRA							
1.0	1,0		37	12.82-12.89	MA10S	4	OZU 010
1.0	1,0		40	12.82-05.89	MA10S	4	OZU 010
1.0 i 16V	1,0		40	08.92-09.00	CG10DE	4	OZH 011
1.0 i 16V	1,0		44	09.00-11.00	CG10DE	4	OZH 011
1.0 i 16V	1,0		44	12.00-10.02	CG10DE	4	OZH 228
1.0 i 16V	1,0	D1	44	12.00-10.02	CG10DE	4	OZH 229
1.2	1,2		40	07.86-07.92	MA12S	4	OZU 010
1.2	1,2		44	07.86-07.92	MA12S	4	OZU 001
1.3 i 16V	1,3		55	08.92-09.00	CG13DE	4	OZH 011
1.4 i 16V	1,4		60	12.00-10.02	CGA3DE	4	OZH 228
1.4 i 16V	1,4	D1	60	12.00-10.02	CGA3DE	4	OZH 229
PICK UP (D21)							
2.4 i 12V	2,4		91	04.92-02.98	KA24E	4	OZU 010
2.4 i 12V 4WD	2,4		93	04.92-05.94	KA24E	4	OZU 010
2.4 i 4WD	2,4		74	03.86-04.92	Z24i	4	OZU 024
PRAIRIE PRO							
2.0 i	2,0		72	10.88-04.92	CA20E	4	OZU 010
PRIMERA , Hatchback, Traveller							
1.6	1,6		66	06.90-04.93	GA16DS	4	OZU 024
1.6 16V	1,6		78	09.00-12.01	QG16DE	4	OZH 225
1.6 16V	1,6	D1	78	09.00-12.01	QG16DE	4	OZH 226
1.8 16V	1,8		84	10.00-12.01	QG18DE	4	OZH 225
1.8 16V	1,8	D1	84	10.00-12.01	QG18DE	4	OZH 226
2.0 16V	2,0	Automatic ³	85	09.96-10.97	SR20DE	4	OZH 201
2.0 i	2,0		92	01.95-06.96	SR20DE	4	OZH 203
2.0 16V	2,0		96	10.97-06.99	SR 20 DEL	4	OZH 201
2.0 16V	2,0	Automatic ³	96	09.96-10.97	SR 20 DE	4	OZH 201
2.0 16V	2,0		103	10.00-12.01	SR20DE	4	OZH 225
2.0 16V	2,0	D1	103	10.00-09.01	SR20DE	4	OZH 227
2.0 16V	2,0	D1	103	10.01-12.01	SR20DE	4	OZH 226
2.0 GT	2,0		110	05.95-01.96	SR20DE	4	OZH 203
SUNNY II							
1.6 i	1,6		54	06.86-10.90	E16i	4	OZU 024
1.6 i 12V	1,6		66	10.88-08.90	GA16i	4	OZU 001
SUNNY II Coupe							
1.6 i	1,6		54	06.86-05.89	E16i	4	OZU 024
1.6 i 12V	1,6		66	10.88-09.90	GA16i	4	OZU 001
1.6 GTI 16V	1,6		81	05.87-05.89	CA16D	4	OZU 024
1.8 GTI 16V	1,8		92	01.89-06.91	CA18D	4	OZU 024

BERU

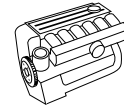
kW

 Zyl.
Cyl.
Cil.

NISSAN
SUNNY II Hatchback

1.6 i	1,6		54	06.86-10.90	E16i	4	OZU 024
1.8 GTI 16V	1,8		92	01.89-08.90	CA18D	4	OZU 001

SUNNY II Traveller

1.6 i	1,6		54	08.86-05.89	E16i	4	OZU 024
1.6 i 12V	1,6		66	10.88-09.90	GA16i	4	OZU 001

SUNNY III

1.4 i	1,4		55	10.90-05.95	GA14DE /GA14DS	4	OZU 001
1.6 i	1,6		66	10.90-05.95	GA16DS	4	OZU 024

SUNNY III Hatchback

1.4 i	1,4		55	10.90-05.95	GA14DE /GA14DS	4	OZU 001
1.6 i	1,6		66	10.90-05.95	GA16DS	4	OZU 024

SUNNY III Liftback

1.4 i	1,4		55	10.90-05.95	GA14DE /GA14DS	4	OZU 001
1.6 i	1,6		66	10.90-05.95	GA16DS	4	OZU 024

SUNNY III Traveller

1.6 i	1,6		66	06.91-	GA16DS	4	OZU 024
-------	-----	--	----	--------	--------	---	----------------

TERRANO I

2.4 i 4WD	2,4		76	10.87-07.92	Z24i	4	OZU 024
-----------	-----	--	----	-------------	------	---	----------------

VANETTE

2.4 i	2,4		74	10.86-09.87	Z24i	4	OZU 010
2.4 i	2,4		74	09.87-12.95	Z24i	4	OZU 024

VANETTE Bus (C22)

2.4 i (SLC22)	2,4		77	10.86-09.87	Z24i	4	OZU 010
2.4 i (SLC22)	2,4		77	09.87-12.95	Z24i	4	OZU 024

OPEL
ASCONA C

1.6 i	1,6		55	09.87-08.88	E 16 NZ	4	OZU 005
1.6 i KAT	1,6		55	09.86-08.88	C 16 NZ/C 16 LZ	4	OZU 005
1.8 E	1,8		74	01.85-08.86	S 18 NV/C 18 NE	4	OZH 040
2.0 i	2,0		85	09.86-08.88	20 NE	4	OZH 040
2.0 i KAT	2,0		85	09.86-08.88	C 20 NE	4	OZH 040

ASTRA F, Caravan

1.4 i	1,4		44	09.91-09.98	C 14 NZ	4	OZU 005
1.4 i 16V	1,4		66	02.96-03.01	X 14 XE	4	OZU 005
1.4 Si	1,4		60	03.92-03.01	C 14 SE	4	OZU 005
1.6 i	1,6		52	05.93-08.96	X 16 SZ	4	OZU 005
1.6 i	1,6		55	09.91-03.01	C 16 NZ	4	OZU 005
1.6 i 16V	1,6		74	08.94-09.98	X 16 XEL → S 2531218/ S 5223656	4	OZU 023
1.6 i 16V	1,6		74	08.94-09.98	X 16 XEL S 2531219/ S 5223657→	4	OZU 005
1.6 i 16V	1,6		74	01.98-	X 16 XEL	4	OZU 005
1.6 Si	1,6		74	05.92-12.94	C 16 SE	4	OZU 001
1.8 i	1,8		66	09.91-09.98	C 18 NZ	4	OZU 005
2.0 i 16V	2,0		110	03.93-01.98	C 20 XE	4	OZH 040
2.0 GSI 16V	2,0		110	09.91-01.98	C 20 XE	4	OZH 040
2.0 i	2,0		85	09.91-09.98	C 20 NE	4	OZH 040

ASTRA G, Caravan

1.4 16V	1,4		66	02.98-09.00	Z 14 XE → 1899999	4	OZH 132
1.4 16V	1,4		66	09.98-08.00	X 14 XE 22022221 →	4	OZH 110
1.4 16V	1,4	D1	66	09.00-	Z 14 XE → 1899999	4	OZH 111
1.4 16V	1,4		66	02.98-	X 14 XE	4	OZH 148
1.6	1,6		55	02.98-09.00	X 16 SZR	4	OZU 005
1.6	1,6		62	09.00-	Z 16 SE	4	OZH 110
1.6	1,6	D1	62	09.00-	Z 16 SE	4	OZH 110
1.6 16V	1,6		74	03.01-	Z 16 XE	4	OZH 132
1.6 16V	1,6	D1	74	03.01-	Z 16 XE	4	OZH 111
1.6 16V	1,6		74	09.98-08.00	Z 16 XE	4	OZH 110
1.8 16V	1,8	Automatic ³	92	09.00-	Z 18 XE	4	OZH 114
1.8 16V	1,8		92	09.00-	Z 18 XE	4	OZH 113

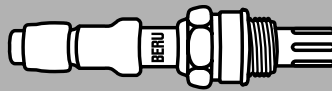

kW

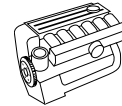
 Zyl.
Cyl.
Cil.

OPEL
ASTRA G, Caravan

1.8 16V	1,8	D1	92	09.00-	Z 18 XE	4	OZH 115
1.8 16V	1,8	Automatic ³	92	09.00-	Z 18 XE	4	OZH 114
1.8 16V	1,8		92	09.00-	Z 18 XE	4	OZH 113
1.8 16V	1,8	D1	92	09.00-	Z 18 XE	4	OZH 115

CALIBRA A

2.0 i	2,0		85	06.90-07.97	C 20 NE	4	OZH 040
2.0 i 16V	2,0		110	06.90-02.94	C 20 XE	4	OZH 040
2.0 i Turbo 4x4	2,0		150	03.92-07.97	C 20 LET	4	OZH 028
2.5 i V6	2,5		125	04.93-07.97	C 25 XE	6	OZH 040
2.5 i V6	2,5		125	04.93-07.97	X 25 XE	6	OZH 147

COMBO

1.2	1,2		33	07.94-10.01	C 12 NZ/X 12 SZ	4	OZU 005
1.4	1,4		44	07.94-10.01	C 14 NZ/X 14 SZ	4	OZU 005
1.4	1,4		60	07.94-10.01	C 14 SE	4	OZU 005

CORSA A

1.2 i	1,2		33	09.89-03.93	C 12 NZ	4	OZU 005
1.3 i	1,3		44	09.86-09.90	C 13 N	4	OZU 005
1.4 i	1,4		44	01.90-03.93	C 14 NZ	4	OZU 005
1.6 GSI	1,6		72	09.89-03.93	C 16 SEI	4	OZH 040
1.6 GSI	1,6		74	05.88-03.92	E 16 SE	4	OZH 040
1.6 GSI KAT	1,6		74	02.92-03.93	C 16 SE	4	OZH 040

CORSA B

1.0 i 16V	1,0		40	11.96-09.00	X 10 XE	4	OZH 111
1.2 i	1,2		33	03.93-09.00	C 12 NZ/X 12 SZ	4	OZU 005
1.4 i	1,4		44	03.93-09.00	C 14 NZ/X 14 SZ	4	OZU 005
1.4 Si	1,4		60	03.93-09.00	C 14 SE	4	OZU 005
1.4 i 16V	1,4		63	08.97-09.00	C 14 SEL → S 4269627/ S 6011904	4	OZU 023
1.4 i 16V	1,4		63	08.97-09.00	C 14 SEL S 4269628/ S 6011905 →	4	OZU 005
1.4 i 16V	1,4		66	09.94-09.00	X 14 XE → S 4269627/ S 6011904	4	OZU 023
1.4 i 16V	1,4		66	09.94-09.00	X 14 XE S 4269628/ S 6011905 →	4	OZU 005
1.4 i 16V	1,4		63	08.97-09.00	C 14 SEL → S 4269627/ S 6011904	4	OZU 023
1.4 i 16V	1,4		63	08.97-09.00	C 14 SEL S 4269628/ S 6011905 →	4	OZU 005
1.6 i 16V	1,6		74	08.97-09.00	C 16 SEL → S 4269627/ S 6011904	4	OZU 023
1.6 i 16V	1,6		74	08.97-09.00	C 16 SEL S 4269628/ S 6011905 →	4	OZU 005
1.6 i 16V	1,6		78	09.94-09.00	X 16 XE → S 4269627/ S 6011904	4	OZU 023
1.6 i 16V	1,6		78	09.94-09.00	X 16 XE S 4269628/ S 6011905 →	4	OZU 005
1.6 GSI 16V	1,6		80	03.93-09.00	C 16 XE → S 4269627/ S 6011904	4	OZU 023
1.6 GSI 16V	1,6		80	03.93-09.00	C 16 XE S 4269628/ S 6011905 →	4	OZU 005

CORSA C

1.4	1,4		66	09.00-	Z 14 XE	4	OZH 132
1.4	1,4	D1	66	09.00-	Z 14 XE	4	OZH 111

FRONTERA A

2.2 i	2,2		100	03.95-10.98	X 22 XE	4	OZH 019
-------	-----	--	-----	-------------	---------	---	----------------

FRONTERA A Sport

2.0 i	2,0		85	03.92-10.98	C 20 NE	4	OZH 028
2.0 i	2,0		85	02.95-10.98	X 20 SE	4	OZH 019

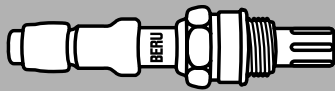
BERU

kW

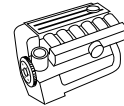
 Zyl.
Cyl.
Cil.

OPEL
KADETT E, Caravan

1.3 i KAT	1,3		44	09.85-08.91	C 13 N	4	OZU 005
1.6 i	1,6		55	09.86-08.91	E 16 NZ	4	OZU 005
1.6 i KAT	1,6		55	09.86-08.91	C 16 NZ/C 16 LZ	4	OZU 005
1.8 E	1,8		74	10.85-08.86	C 18 NE	4	OZH 040
1.8 i	1,8		66	06.85-08.91	C 18 NT	4	OZH 040
1.8 i	1,8		66	06.85-08.91	C 18 NZ	4	OZU 005
1.8 i	1,8		74	10.85-08.86	C 18 NE	4	OZH 040
2.0 GSI KAT	2,0		85	09.86-08.91	C 20 NE	4	OZH 040
2.0 i	2,0		85	10.86-02.93	20 NE	4	OZH 040
2.0 GSI 16V KAT	2,0		110	03.88-08.91	C 20 XE	4	OZH 040
2.0 GSI 16V	2,0		110	03.88-08.91	20 XEJ	4	OZH 040
2.0 GSI 16V	2,0		115	12.87-08.91	20 XE	4	OZH 040

MERIVA

1.6	1,6		64	05.03-	Z 16 SE	4	OZH 110
1.6 16V	1,6		74	05.03-	Z 16 XE	4	OZH 132
1.6 16V	1,6	D1	74	05.03-	Z 16 XE	4	OZH 110

OMEGA A, Caravan

2.0	2,0		73	09.90-03.94	C 20 NEJ	4	OZH 028
2.0	2,0		74	09.90-03.94	C 20 NEF	4	OZH 028
2.0 i	2,0		73	09.90-03.94	C 20 NEJ	4	OZH 028
2.0 i	2,0		85	09.86-03.94	C 20 NE	4	OZH 028
2.6 i	2,6		110	09.90-03.94	C 26 NE	6	OZH 040
3.0	3,0		115	03.87-03.94	C 30 LE	6	OZH 040
3.0 KAT	3,0		130	03.87-03.94	C 30 NE	6	OZH 040
3.0 24V	3,0		147	09.89-03.94	C 30 SEJ	6	OZH 040
3.0 24V (3000)	3,0		147	09.89-03.94	C 30 SEJ	6	OZH 040
3.0 24V (3000)	3,0		150	09.89-03.94	C 30 SE	6	OZH 040

OMEGA B, Caravan

2.0	2,0		85	03.94-09.99	X 20 SE	4	OZH 019
2.5 V6	2,5		125	03.94-09.00	X 25 XE	6	OZH 019
3.0 V6	3,0		155	04.94-02.01	X 30 XE	6	OZH 019

REKORD E, Caravan

1.8 E	1,8		74	05.85-08.86	C 18 NV	4	OZH 028
-------	-----	--	----	-------------	---------	---	----------------

SENATOR B

2.6 i	2,6		110	09.90-09.93	C 26 NE	6	OZH 040
3.0	3,0		115	09.87-09.93	C 30 LE → M 100000	6	OZH 040
3.0 24V	3,0		150	09.89-09.93	C 30 SE	6	OZH 040
3.0 i KAT	3,0		130	01.88-09.93	C 30 NE	6	OZH 040

SINTRA

2.2 i 16V	2,2		104	11.96-04.99	X 22 XE	4	OZH 040
3.0 i 24V	3,0		148	11.96-04.99	X 30 XE	6	OZH 019

TIGRA (95)

1.4 16V	1,4		63	08.97-12.00	X 14 XE → S 4269627/ S 6011904	4	OZU 023
1.4 16V	1,4		63	08.97-12.00	X 14 XE S 4269628/ S 6011905 →	4	OZU 005
1.4 16V	1,4		66	07.94-12.00	X 14 XE → S 4269627/ S 6011904	4	OZU 023
1.4 16V	1,4		66	07.94-12.00	X 14 XE S 4269628/ S 6011905 →	4	OZU 005
1.6 16V	1,6		74	08.97-08.98	C 16 SEL → S 4269627/ S 6011904	4	OZU 023
1.6 16V	1,6		74	08.97-08.98	C 16 SEL S 4269628/ S 6011905 →	4	OZU 005
1.6 16V	1,6		78	07.94-08.98	X 16 XE → S 4269627/ S 6011904	4	OZU 023
1.6 16V	1,6		78	07.94-08.98	X 16 XE S 4269628/ S 6011905 →	4	OZU 005

VECTRA A

1.6 i	1,6		52	09.93-11.95	X 16 SZ	4	OZU 005
1.6 i	1,6		55	09.88-10.90	E 16 NZ	4	OZU 005

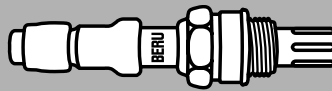

kW

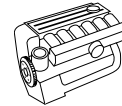
 Zyl.
Cyl.
Cil.

OPEL
VECTRA A

1.6 i KAT	1,6		55	09.88-11.95	C 16 NZ2/C 16 NZ	4	OZU 005
1.8 i KAT	1,8		66	03.90-11.95	C 18 NZ	4	OZU 005
2.0 i	2,0		85	09.88-10.90	20 NE	4	OZU 005
2.0 i	2,0		85	09.88-10.90	20 NE	4	OZH 040
2.0 i KAT	2,0		85	09.88-11.95	C 20 NE	4	OZH 040
2.0 i 16V	2,0		110	02.89-10.90	20 XEJ	4	OZH 040
2.0 i 16V KAT	2,0		110	02.90-11.95	C 20 XE	4	OZH 040

VECTRA B

1.6 i	1,6		55	10.95-04.02	X 16 SZR	4	OZU 005
1.6 i 16V	1,6		74	10.95-04.02	X 16 XEL	4	OZU 005
1.6 i 16V	1,6		74	11.96-07.02	Z 16 XE/Y 16 XE	4	OZH 111
1.6 i 16V	1,6	D1	74	04.99-04.02	Z 16 XE/Y 16 XE	4	OZH 111
1.6 i 16V	1,6		74	04.99-04.02	Z 16 XE/Y 16 XE	4	OZH 112
1.6 i 16V	1,6		74	10.95-08.00	X 16 XEL	4	OZH 148
1.8 i 16V	1,8	Automatic ³	92	09.00-07.03	Z 18 XE	4	OZH 114
1.8 i 16V	1,8		92	09.00-07.03	Z 18 XE	4	OZH 113
1.8 i 16V	1,8	D1	92	09.00-07.03	Z 18 XE	4	OZH 115
2.5 i V6 Rechtslenker	2,5		125	10.95-09.00	X 25 XE	6	OZH 019
2.5 i V6	2,5		125	10.95-10.96	X 25 XE	6	OZH 040
2.5 i V6	2,5		125	11.96-09.00	X 25 XE	6	OZH 147
i 500 2.5	2,5		143	05.98-09.00	X 25 XE	6	OZH 147

VECTRA C

1.6 16V	1,6		74	06.04-	Z 16 XE	4	OZH 132
1.6 16V	1,6	D1	74	06.04-	Z 16 XE	4	OZH 110

ZAFIRA

1.6 CNG	1,6		71	09.01-	Z 16 YNG	4	OZH 132
1.6 CNG	1,6	D1	71	09.01-	Z 16 YNG	4	OZH 111
1.6 16V	1,6		74	04.99-08.99	X 16 XEL	4	OZH 148
1.6 16V	1,6		74	04.99-08.99	Z 16 XE 22000001 →	4	OZH 110
1.6 16V	1,6		74	09.00-	Z 16 XE	4	OZH 132
1.6 16V	1,6	D1	74	09.00-	Z 16 XE	4	OZH 111
1.8 16V	1,8	Automatic ³	92	09.00-	Z 18 XE	4	OZH 114
1.8 16V	1,8		92	09.00-	Z 18 XE	4	OZH 113
1.8 16V	1,8	D1	92	09.00-	Z 18 XE	4	OZH 115

PEUGEOT
106 I

1.0	1,0		33	07.92-06.95	CDY (TU9M)	4	OZH 072
1.0	1,0		33	07.95-04.96	CDY (TU9M)	4	OZH 074
1.0	1,0		37	07.92-06.95		4	OZH 072
1.0	1,0		37	07.95-04.96		4	OZH 074
1.1	1,1		44	09.91-06.95	HDZ (TU1M)	4	OZH 072
1.1	1,1		44	07.95-04.96	HDZ (TU1M)	4	OZH 074
1.3	1,3		72	10.93-06.95	TU2J2	4	OZH 072
1.3	1,3		72	07.95-04.96	TU2J2	4	OZH 074
1.4	1,4		55	10.92-06.95	KDX (TU3MC)/KDY (TU3M)	4	OZH 072
1.4	1,4		55	07.95-04.96	KDX (TU3MC)/KDY (TU3M)	4	OZH 074
1.4	1,4		69	09.91-06.95	KFZ (TU3J2/Z)	4	OZH 072
1.4	1,4		69	07.95-04.96	KFZ (TU3J2/Z)	4	OZH 074
1.6	1,6		65	06.93-06.95	NFZ (TU5JP)	4	OZH 072
1.6	1,6		65	07.95-04.96	NFZ (TU5JP)	4	OZH 074
1.6	1,6		76	01.94-06.95	NFY (TU5J2)	4	OZH 072
1.6	1,6		76	07.95-04.96	NFY (TU5J2)	4	OZH 074

106 II

1.0 i	1,0		33	05.96-	CDY (TU9M)	4	OZH 074
1.0 i	1,0		37	01.97-	CDZ (TU9M)	4	OZH 074
1.1 i	1,1		44	05.96-03.00	HDZ (TU1M)	4	OZH 074
1.1 i	1,1		40	01.97-	HDY (TU1M)	4	OZH 074
1.4 i	1,4		55	05.96-	KFX (TU3JP)/KFW (TU3JP)	4	OZH 074
1.6 i	1,6		65	05.96-	NFZ (TU5JP)	4	OZH 074
1.6 i	1,6		74	05.96-	NFW (TU5J2)/NFY (TU5J2)	4	OZH 074

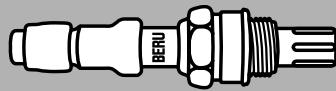
BERU

kW

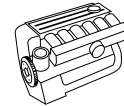
 Zyl.
Cyl.
Cil.

PEUGEOT
106 II

1.6 S16	1,6	87	05.96-01.99	NFX (TU5J4)	4	OZH 104
1.6 S16	1,6	87	11.99-05.05	NFX (TU5J4)	4	OZH 205

205 I

1.4	1,4	44	02.83-10.87	150D (XY7)/150G (XY7)	4	OZH 066
1.6	1,6	53	03.87-10.87	B1E (XU51C)	4	OZH 066
1.6	1,6	55	08.86-10.87	BAZ (XU5CP)	4	OZH 066
1.9 GTI	1,9	75	03.87-10.87	DFZ (XU9J1)	4	OZH 066

205 I Cabriolet

1.1 CJ	1,1	44	10.89-12.94	HDZ (TU1M)	4	OZH 029
1.4 CJ	1,4	55	05.91-12.94	KDZ (TU3M)/KDY (TU3M)	4	OZH 029
1.4 CJ KAT	1,4	44	01.89-10.90	KAY (TU3CP)	4	OZH 066
1.6 CJ	1,6	65	08.92-12.94	BDY (XU5M3Z)	4	OZH 029
1.9 CTI	1,9	75	10.87-12.94	DFZ (XU9J1)	4	OZH 066

205 II

1.0	1,0	33	07.92-09.98	TU9	4	OZH 029
1.1	1,1	44	07.89-09.98	HDZ (TU1M)	4	OZH 029
1.4	1,4	55	07.88-10.90	KFX (TU3JP)/KDZ (TU3M)/ KDY (TU3M)	4	OZH 029

1.4 KAT	1,4	44	01.89-10.90	KAY (TU3CP)	4	OZH 066
1.6 Aut.	1,6	65	05.90-09.98	BDY (XU5M2Z)/BDY (XU5M3Z)	4	OZH 029
1.9 GTI	1,9	75	10.87-05.89	D2A (XU92C)	4	OZH 066
1.9 GTI	1,9	88	10.87-10.94	DKZ (XU9JAZ)	4	OZH 066
1.9 GTI KAT	1,9	75	10.87-07.94	DFZ (XU9J1)	4	OZH 066

305 II, Break

1.6	1,6	54	11.86-12.88	BAZ (XU5CP)	4	OZH 066
1.9	1,9	72	11.86-12.88	DFZ (XU9J1)	4	OZH 066

306

1.1	1,1	44	06.94-02.95	HDZ (TU1M)	4	OZH 038
1.1	1,1	44	03.95-04.97	HDZ (TU1M)	4	OZH 074
1.4	1,4	55	05.93-02.95	KDX (TU3MC)/KFX (TU3JP)/ KFW (TU3JP)	4	OZH 038

1.4	1,4	55	03.95-04.97	KDX (TU3MC)/KFX (TU3JP)/ KFW (TU3JP)	4	OZH 074
-----	-----	----	-------------	---	---	----------------

1.4 SL	1,4	55	06.94-02.95	KDX (TU3MC)/KFX (TU3JP)/ KFW (TU3JP)	4	OZH 038
--------	-----	----	-------------	---	---	----------------

1.4 SL	1,4	55	03.95-04.97	KDX (TU3MC)/KFX (TU3JP)/ KFW (TU3JP)	4	OZH 074
--------	-----	----	-------------	---	---	----------------

1.6	1,6	65	05.93-02.95	NFZ (TU5JP)	4	OZH 038
-----	-----	----	-------------	-------------	---	----------------

1.6	1,6	65	03.95-04.97	NFZ (TU5JP)	4	OZH 074
-----	-----	----	-------------	-------------	---	----------------

1.6 SR	1,6	65	06.94-02.95	NFZ (TU5JP)	4	OZH 038
--------	-----	----	-------------	-------------	---	----------------

1.6 SR	1,6	65	03.95-04.97	NFZ (TU5JP)	4	OZH 074
--------	-----	----	-------------	-------------	---	----------------

1.8	1,8	74	05.93-02.95	LFZ (XU7JP)	4	OZH 034
-----	-----	----	-------------	-------------	---	----------------

1.8	1,8	74	03.95-04.97	LFZ (XU7JP)	4	OZH 104
-----	-----	----	-------------	-------------	---	----------------

1.8	1,8	74	05.97-	LFZ (XU7JP)	4	OZH 074
-----	-----	----	--------	-------------	---	----------------

1.8 ST	1,8	74	06.94-02.95	LFZ (XU7JP)	4	OZH 034
--------	-----	----	-------------	-------------	---	----------------

1.8 ST	1,8	74	03.95-04.97	LFZ (XU7JP)	4	OZH 104
--------	-----	----	-------------	-------------	---	----------------

1.8 ST	1,8	74	05.97-	LFZ (XU7JP)	4	OZH 074
--------	-----	----	--------	-------------	---	----------------

2.0 ST	2,0	89	07.94-02.95	RFX (XU10J2)	4	OZH 034
--------	-----	----	-------------	--------------	---	----------------

2.0 ST	2,0	89	03.95-04.97	RFX (XU10J2)	4	OZH 104
--------	-----	----	-------------	--------------	---	----------------

2.0 XSi	2,0	89	05.93-02.95	RFX (XU10J2)	4	OZH 034
---------	-----	----	-------------	--------------	---	----------------

2.0 XSi	2,0	89	03.95-04.97	RFX (XU10J2)	4	OZH 104
---------	-----	----	-------------	--------------	---	----------------

2.0 16V	2,0	97	03.97-	RFV (XU10J4R)	4	OZH 104
---------	-----	----	--------	---------------	---	----------------

2.0 S16	2,0	110	06.94-02.95	RFT (XU10J4)	4	OZH 034
---------	-----	-----	-------------	--------------	---	----------------

2.0 S16	2,0	110	03.95-04.97	RFT (XU10J4)	4	OZH 104
---------	-----	-----	-------------	--------------	---	----------------

2.0 S16	2,0	112	05.93-02.95	RFY (XU10J4Z)	4	OZH 034
---------	-----	-----	-------------	---------------	---	----------------

2.0 S16	2,0	112	03.95-04.97	RFY (XU10J4Z)	4	OZH 104
---------	-----	-----	-------------	---------------	---	----------------

2.0 S16	2,0	120	07.96-04.97	RFS (XU10J4RS)	4	OZH 079
---------	-----	-----	-------------	----------------	---	----------------

306 Break

1.4	1,4	55	03.97-	KFX (TU3JP)/KFW (TU3JP)	4	OZH 074
-----	-----	----	--------	-------------------------	---	----------------

1.6	1,6	65	03.97-10.00	NFZ (TU5JP)	4	OZH 074
-----	-----	----	-------------	-------------	---	----------------

1.8	1,8	74	03.97-04.97	LFZ (XU7JP)	4	OZH 104
-----	-----	----	-------------	-------------	---	----------------

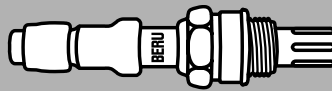

kW

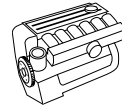
Zyl.
Cyl.
Cil.**PEUGEOT****306 Break**

1.8	1,8	74	05.97-	LFZ (XU7JP)	4	OZH 074
2.0	2,0	97	03.97-	RFV (XU10J4R)	4	OZH 104

306 Cabriolet

1.6	1,6	65	04.96-04.97	NFZ (TU5JP)	4	OZH 074
1.8	1,8	74	03.94-04.97	LFZ (XU7JP)	4	OZH 104
1.8	1,8	74	05.97-	LFZ (XU7JP)	4	OZH 074
2.0	2,0	89	03.94-02.95	RFX (XU10J2)	4	OZH 034
2.0	2,0	89	03.95-04.97	RFX (XU10J2)	4	OZH 104
2.0 16V	2,0	97	03.97-	RFV (XU10J4R)	4	OZH 104

309 I

1.4	1,4	55	03.89-07.89	KDZ (TU3M)/KDY (TU3M)	4	OZH 029
1.6	1,6	53	08.87-07.89	B1E (XU51C)	4	OZH 066
1.6 KAT	1,6	55	09.86-06.88	BAZ (XU5CP)	4	OZH 066
1.9	1,9	72	03.86-07.89	DFZ (XU9J1)	4	OZH 066
1.9	1,9	80	07.88-07.89	DDZ (XU9M)	4	OZH 029
1.9 GTI	1,9	88	07.88-07.89	DKZ (XU9JAZ)	4	OZH 029

309 II

1.1	1,1	44	10.90-12.93	HDZ (TU1M)	4	OZH 029
1.4	1,4	55	07.89-10.90	KDZ (TU3M)/KDY (TU3M)	4	OZH 029
1.6	1,6	65	07.89-03.91	BDY (XU5M2Z)/BDZ (XU5M)/ BDY (XU5M3Z)	4	OZH 029
1.9	1,9	72	08.89-12.93	DFZ (XU9J1)	4	OZH 066
1.9	1,9	80	10.90-12.93	DDZ (XU9M)	4	OZH 029
1.9 GTI	1,9	88	07.89-12.93	DKZ (XU9JAZ)	4	OZH 029
1.9 GTI 16V	1,9	108	10.90-12.93	DFW (XU9J4Z)	4	OZH 029

405 I, Break

1.6	1,6	65	07.89-09.90	BDY (XU5M2Z)/BDZ (XU5M)/ BDY (XU5M3Z)	4	OZH 005
1.6	1,6	66	10.89-09.90	BDZ (XU5M)	4	OZH 005
1.9	1,9	77	10.88-01.89	DFZ (XU9J1)	4	OZH 066
1.9	1,9	80	07.88-01.89	DDZ (XU9M)	4	OZH 029
1.9	1,9	80	01.89-12.92	DDZ (XU9M)	4	OZH 005
1.9	1,9	88	07.88-01.89	DKZ (XU9JAZ)	4	OZH 005
1.9	1,9	88	01.89-12.92	DKZ (XU9JAZ)	4	OZH 029
1.9 Sport MI-16	1,9	108	04.88-01.89	DFW (XU9J4Z)	4	OZH 029
1.9 Sport MI-16	1,9	108	01.89-12.92	DFW (XU9J4Z)	4	OZH 005

405 II, Break

1.4	1,4	55	08.92-10.96	KDX (TU3MC)	4	OZH 034
1.6	1,6	65	08.92-06.95	BFZ (XU5JP)/BDZ (XU5M)	4	OZH 034
1.6	1,6	65	07.95-10.96	BFZ (XU5JP)/BDZ (XU5M)	4	OZH 079
1.8	1,8	74	08.92-06.95	LFZ (XU7JP)	4	OZH 034
1.8	1,8	74	07.95-10.95	LFZ (XU7JP)	4	OZH 079
2.0	2,0	89	08.92-06.95	RFX (XU10J2)	4	OZH 034
2.0	2,0	89	07.95-10.96	RFX (XU10J2)	4	OZH 079
2.0 16V	2,0	110	06.94-06.95	RFT (XU10J4)	4	OZH 034
2.0 16V	2,0	110	07.95-10.95	RFT (XU10J4)	4	OZH 079
2.0 MI-16	2,0	112	08.92-06.95	RFY (XU10J4Z)	4	OZH 034
2.0 MI-16	2,0	112	07.95-10.95	RFY (XU10J4Z)	4	OZH 079
2.0 T 16 X4	2,0	144	08.92-06.95	RGZ (XU10J4TE/Z)	4	OZH 034
2.0 T 16 X4	2,0	144	07.95-10.95	RGZ (XU10J4TE/Z)	4	OZH 079

406, Break

1.6	1,6	65	11.95-03.96	BFZ (XU5JP)	4	OZH 104
-----	-----	----	-------------	-------------	---	----------------

406, Break

1.6	1,6	65	04.96-05.04	BFZ (XU5JP)	4	OZH 074
1.8 16V	1,8	81	11.95-03.96	LFY (XU7JP4)	4	OZH 104
2.0 16V	2,0	97	11.95-03.99	RFV (XU10J4R)	4	OZH 079
2.0 16V	2,0	97	04.99-05.04	RFV (XU10J4R)	4	OZH 206
2.0 Turbo	2,0	108	04.96-05.04	RGX (XU10J2TE)	4	OZH 104

406 Coupe

2.0 16V	2,0	97	03.97-03.99	RFV (XU10J4R)	4	OZH 079
2.0 16V	2,0	97	04.99-02.05	RFV (XU10J4R)	4	OZH 206

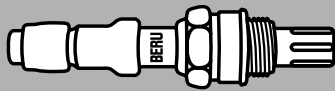
**BERU**

kW

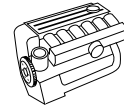
Zyl.
Cyl.
Cil.**PEUGEOT****505**

2.0	2,0	71	11.80-04.85	106 (XN1)	4	OZU 001
2.0	2,0	71	05.85-12.85	106 (XN1)	4	OZH 044
2.2	2,2	84	03.86-12.93	851X (ZDJL)	4	OZH 066
2.2 Turbo Injection	2,2	114	03.84-06.86	176B (N9TE)	4	OZH 044
2.2 Turbo Injection	2,2	114	07.86-10.88	176B (N9TE)	4	OZH 066
2.2 Turbo Injection	2,2	110	01.86-06.86	176X (N9TE)	4	OZH 044
2.2 Turbo Injection	2,2	110	07.86-12.87	176X (N9TE)	4	OZH 066
2.2 Turbo Injection	2,2	128	06.87-12.88	176W (N9TEA)	4	OZH 066
2.8 GTI V6	2,8	105	06.86-12.93	154X (ZN3J)	6	OZH 066

505 Break

2.0	2,0	72	09.85-11.87	106E (XN1A)	4	OZH 044
2.2	2,2	84	03.86-12.93	851X (ZDJL)	4	OZH 066

605

2.0	2,0	89	06.89-03.91	RFZ (XU10J2Z)	4	OZH 194
2.0	2,0	89	03.91-06.94	RFZ (XU10J2Z)	4	OZH 034
2.0 Turbo	2,0	104	07.92-06.94	RGY (XU10J2TE)	4	OZH 034
2.0 Turbo	2,0	108	07.91-09.99	RGX (XU10J2TE)	4	OZH 159

806

1.8	1,8	73	07.95-08.02	LFW (XU7JP)	4	OZH 159
2.0	2,0	89	06.94-08.02	RFU (XU10J2)	4	OZH 159
2.0 16V	2,0	97	05.98-09.00	RFV (XU10J4R)	4	OZH 159
2.0 Turbo	2,0	108	06.94-08.02	RGX (XU10J2TE)	4	OZH 159

BOXER

2.0 i	2,0	80	03.94-12.95	RFW (XU10J2)	4	OZH 034
2.0 i	2,0	80	01.96-04.02	RFW (XU10J2)	4	OZH 159

EXPERT

1.6	1,6	58	02.96-	222A2 (1580 SPI)	4	OZH 159
-----	-----	----	--------	------------------	---	----------------

J5

2.0	2,0	62	10.90-12.93	170D (XN1TACP)	4	OZH 066
-----	-----	----	-------------	----------------	---	----------------

PARTNER

1.1	1,1	44	06.96-	HDZ (TU1M)/HFX (TU1JP)	4	OZH 074
1.4	1,4	55	06.96-	KFX (TU3JP)/KFW (TU3JP)	4	OZH 074

RENAULT**CLIO I**

1.2	1,2	40	04.96-02.98	D7F 730	4	OZH 160
1.2	1,2	40	01.96-03.96	C3G 720	4	OZU 001
1.2	1,2	40	01.91-01.96	E7F 706	4	OZH 033
1.2	1,2	43	04.96-02.98	D7F 730	4	OZH 160
1.2	1,2	43	05.90-09.98	E7F 750/E7F 700/E7F 708	4	OZH 033
1.4	1,4	58	01.91-03.96	E7J 719 /E7J 718/E7J 754	4	OZH 033
1.4	1,4	58	04.96-09.98	E7J 719 /E7J 718/E7J 754	4	OZH 108
1.8	1,8	66	08.94-03.96	F3P 755 /F3P 754	4	OZH 033
1.8	1,8	65	01.91-09.98	F3P 710 /F3P 714	4	OZH 033
1.8 16V	1,8	99	08.91-06.94	F7P 722	4	OZH 033
1.8 Rsi	1,8	80	01.93-08.95	F3P 712	4	OZH 033
1.8 Rsi	1,8	79	08.95-09.98	F3P 758	4	OZH 033
2.0 Williams	2,0	108	01.94-03.96	F7R 700	4	OZH 033

CLIO II

1.2	1,2	43	09.98-	D7F 710/D7F 720	4	OZH 107
1.2	1,2	43	09.98-	D7F 710/D7F 720	4	OZH 160
1.2	1,2	43	09.98-	D7F 726	4	OZH 184
1.4	1,4	55	09.98-	E7J 780	4	OZH 125
1.2 16V	1,2	55	06.01-	D4F 714/D4F 712	4	OZH 184
1.6	1,6	66	09.98-	K7M 744/K7M 745	4	OZH 125

ESPACE I

2.2	2,2	79	07.86-12.90	J7T 770	4	OZU 022
2.2 Quadra	2,2	79	01.88-12.90	J7T 770	4	OZU 022

ESPACE II

2.2	2,2	79	01.91-04.91	J7T 772/J7T 776/J7T 773	4	OZU 001
2.2	2,2	79	05.91-10.96	J7T 772/J7T 776/J7T 773	4	OZH 033

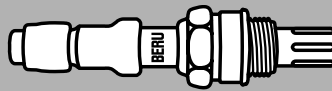

kW

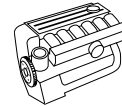
 Zyl.
Cyl.
Cil.

RENAULT
ESPACE II

2.0	2,0	76	01.91-02.93	J7R 768	4	OZH 044
2.0	2,0	76	03.93-10.96	J7R 768	4	OZH 033
2.8 V6	2,8	110	01.91-07.94	Z7W 717/Z7W 712/Z7W 713	6	OZH 044
2.8 V6	2,8	110	08.94-10.96	Z7W 717/Z7W 712/Z7W 713	6	OZH 033

ESPACE III

2.0	2,0	84	11.96-10.00	F3R 769/F3R 728/F3R 742/ F3R 729/F3R 768	4	OZH 101
3.0 V6 24V	2,9	140	10.98-10.02	L7X 727	6	OZH 208

KANGOO

1.2	1,2	43	03.98-	D7F 710/D7F 744/D7F 722/ D7F 720/D7F 746	4	OZH 160
1.2	1,2	43	03.98-	D7F 726	4	OZH 184
1.2 16V	1,2	55	06.01-	D4F 712/D4F 714	4	OZH 184
1.4	1,4	55	03.98-	E7J 634/K7J 701/E7J 635/ E7J 780/K7J 700	4	OZH 109
1.4	1,4	55	03.98-	E7J 634/K7J 701/E7J 635/ E7J 780/K7J 700	4	OZH 125

KANGOO Rapid

1.2	1,2	43	03.98-	D7F 710/D7F 744/D7F 722/ D7F 720/D7F 726/D7F 746	4	OZH 160
1.2 16V	1,2	55	10.01-	D4F 714/D4F 712	4	OZH 184
1.4	1,4	55	03.98-	E7J 634/K7J 701/E7J 635/E7J 780	4	OZH 109
1.4	1,4	55	03.98-	E7J 634/K7J 701/E7J 635/E7J 780	4	OZH 125

LAGUNA

1.8	1,8	66	11.93-03.01	F3P 720/F3P 724	4	OZH 019
1.8	1,8	66	08.95-03.01	F3P 678/F3P 670	4	OZH 101
1.8	1,8	69	08.95-03.01	F3P 720/F3P 724	4	OZH 019
1.8 16V	1,8	88	04.98-03.01	F4P 760	4	OZH 019
2.0	2,0	83	11.93-03.01	F3R 722/F3R 723	4	OZH 109
2.0 16V	2,0	102	06.95-03.01	N7Q 700/N7Q 704	4	OZH 087
3.0	3,0	123	10.96-03.01	Z7X767	6	OZH 096
3.0 24V	2,9	140	03.97-03.01	L7X 700/L7X 701	6	OZH 208

LAGUNA Grandtour

1.8	1,8	66	09.95-03.01	F3P 678/F3P 670	4	OZH 101
1.8	1,8	69	09.95-03.01	F3P 720/F3P 724	4	OZH 019
2.0	2,0	83	09.95-03.01	F3R 722/F3R 723	4	OZH 101
2.0 16V	2,0	102	09.95-03.01	N7Q 700/N7Q 704	4	OZH 087
3.0	3,0	123	10.96-03.01	Z7X767	6	OZH 096
3.0 24V	2,9	140	03.97-03.01	L7X 700/L7X 701	6	OZH 208

MEGANE Cabriolet

1.6 e	1,6	66	10.96-03.99	K7M 702/K7M 703	4	OZH 058
2.0 i	2,0	80	03.99-	F3R 791/F3R 796	4	OZH 101
2.0	2,0	84	04.97-	F3R 750	4	OZH 101
2.0 16V	2,0	108	10.96-11.99	F7R 710/F7R 714	4	OZH 101

MEGANE Classic

1.4	1,4	55	09.96-	E7J 626/E7J 764	4	OZH 058
1.6 i	1,6	55	09.96-03.99	K7M 720	4	OZH 058
1.6 e	1,6	66	09.96-03.99	K7M 702/K7M 703/K7M 790	4	OZH 058
2.0 i	2,0	84	09.96-	F3R 751/F3R 750	4	OZH 101

MEGANE Coach

1.6 e	1,6	66	03.96-03.99	K7M 702/K7M 703	4	OZH 058
2.0 16V	2,0	108	03.96-11.99	F7R 710/F7R 714	4	OZH 101

MEGANE Grandtour

1.6 e	1,6	66	03.99-	K7M 702/K7M 703	4	OZH 033
-------	-----	----	--------	-----------------	---	----------------

MEGANE Scenic

1.4 i	1,4	55	01.97-09.99	E7J 764	4	OZH 058
1.6 i	1,6	55	01.97-09.99	K7M 720	4	OZH 058
1.6 e	1,6	66	01.97-09.99	K7M 702/K7M 703	4	OZH 058
2.0 i	2,0	84	01.97-09.99	F3R 751/F3R 750	4	OZH 101

MEGANE I

1.4 Eco	1,4	52	01.96-03.99	E7J 624	4	OZH 058
---------	-----	----	-------------	---------	---	----------------

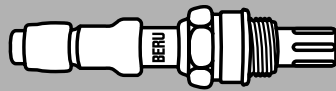
BERU

kW

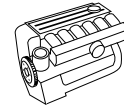
 Zyl.
Cyl.
Cil.

RENAULT
MEGANE I

1.4 e	1,4	55	01.96-	E7J 626/E7J 764	4	OZH 058
1.6 i	1,6	55	01.96-03.99	K7M 720	4	OZH 058
1.6 e	1,6	66	01.96-03.99	K7M 702/K7M 703/K7M 790	4	OZH 058
2.0 i	2,0	84	01.96-	F3R 751/F3R 750	4	OZH 101
2.0 16V	2,0	108	07.96-	F7R 710/F7R 714	4	OZH 101

RAPID Kasten

1.2	1,2	40	09.91-10.97	C3G 712/C3G 710	4	OZU 001
1.4	1,4	55	09.91-03.98	E7J 720/E7J 773/E7J 724/E7J 726	4	OZH 033
1.4	1,4	58	01.94-03.98	E7J 728	4	OZH 033
1.4 KAT	1,4	43	08.88-05.95	C3J 762/C3J 700/C3J 702/C3J 760	4	OZU 022
1.4 KAT	1,4	43	06.95-03.98	C3J 762	4	OZH 033

SAFRANE I

2.0	2,0	77	11.92-07.96	J7R 732/J7R 733	4	OZH 058
2.0 12V	2,0	97	04.92-07.96	J7R 735/J7R 734	4	OZH 058
2.2	2,2	79	04.92-07.96	J7T 762	4	OZH 058
2.2	2,2	101	04.92-07.96	J7T 760/J7T 761	4	OZH 058
3.0 V6	3,0	123	12.92-07.96	Z7X 721/Z7X 723/Z7X 722	6	OZH 058

SAFRANE II

2.0 16V	2,0	100	10.96-12.00	N7Q 710/N7Q 711	4	OZH 092
2.9 24V	2,9	140	03.99-12.00	L7X 713	6	OZH 208
3.0 V6	3,0	123	07.96-12.00	Z7X755	6	OZH 101

SCÉNIC

1.4 16V	1,4	70	09.99-	K4J 714/K4J 750	4	OZH 184
1.6 16V	1,6	79	09.99-	K4M 704/K4M 700/K4M 708/ K4M 701	4	OZH 184

SPORT SPIDER

2.0 16V	2,0	110	03.95-10.99		4	OZH 101
---------	-----	-----	-------------	--	---	----------------

SUPER 5

1.4 KAT	1,4	43	10.85-12.96	C3J 700/C3J 702/C3J 760	4	OZU 022
1.7	1,7	54	10.86-03.95	F3N 716 /F3N 717	4	OZU 001
1.7 i	1,7	69	10.86-08.91	F3N 722/F3N 702 → F00004690	4	OZU 001
1.7 i	1,7	69	10.86-08.91	F3N 722/F3N 702 F00004691 → F00004822	4	OZH 033
1.7 i	1,7	69	10.86-08.91	F3N 722/F3N 702 F00004823 →	4	OZH 044

TRAFIC

2.2	2,2	70	05.89-06.94	J7T 780	4	OZU 001
2.2	2,2	74	06.94-10.97	J7T 600	4	OZH 058

TWINGO

1.2	1,2	40	05.94-10.96	C3G 702	4	OZH 083
1.2	1,2	40	03.93-06.95	C3G 700	4	OZU 025
1.2	1,2	40	05.96-11.99	D7F 700/D7F 701	4	OZH 107
1.2	1,2	40	12.99-	D7F 700/D7F 701	4	OZH 184
1.2	1,2	43	05.96-11.99	D7F 700/D7F 701	4	OZH 160
1.2	1,2	43	12.99-	D7F 700/D7F 701	4	OZH 184
1.2 16V	1,2	55	01.01-	D4F 704/D4F 702	4	OZH 184

R 9

1.7	1,7	54	10.86-12.88	F3N 718	4	OZU 001
1.7	1,7	69	06.87-11.88	F3N 708	4	OZU 001
1.7	1,7	69	12.88-12.88	F3N 708	4	OZH 033

R 11

1.7	1,7	55	10.84-12.88	F3N 718	4	OZU 001
1.7	1,7	69	06.87-11.88	F3N 708	4	OZU 001
1.7	1,7	69	12.88-12.88	F3N 708	4	OZH 033

R 18

2.2 i	2,2	76	06.84-07.86		4	OZU 001
-------	-----	----	-------------	--	---	----------------

R 18 Variable

2.2 i	2,2	76	06.84-07.86		4	OZU 001
-------	-----	----	-------------	--	---	----------------

R 19 I

1.4 KAT	1,4	43	01.89-04.92	C3J 710	4	OZU 001
---------	-----	----	-------------	---------	---	----------------

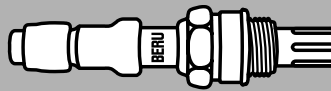

kW

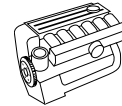

 Zyl.
Cyl.
Cil.

RENAULT

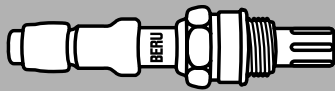
R 19 I							
1.7	1,7		54	09.88-04.92	F3N 741/F3N 740	4	OZU 001
1.7	1,7		66	09.88-04.92	F3N 743/F3N 742	4	OZH 033
1.8 16V	1,8		99	06.89-04.92	F7P 704	4	OZH 033
R 19 I Cabriolet							
1.7	1,7		70	07.91-04.92	F3N 743/F3N 742	4	OZH 033
1.8 16V	1,8		101	07.91-04.92	F7P 704	4	OZH 033
R 19 I Chamade							
1.4	1,4		43	10.89-04.92	C3J 710/C2J 772	4	OZU 001
1.7	1,7		54	10.89-04.92	F3N 741/F3N 740	4	OZU 001
1.7	1,7		66	07.88-04.92	F3N 743/F3N 742	4	OZH 033
1.8 16V	1,8		99	10.89-04.92	F7P 704	4	OZH 033
R 19 II							
1.4	1,4		43	04.92-07.93	C3J 710	4	OZU 001
1.4	1,4		43	08.93-12.95	C3J 710	4	OZH 033
1.4	1,4		55	01.92-12.95	E7J 742	4	OZH 033
1.7	1,7		54	04.92-12.95	F3N 741/F3N 740	4	OZU 022
1.8	1,8		65	04.92-12.95	F3P 706/F3P 707/F3P 760/ F3P 708	4	OZH 033
1.8	1,8		66	04.92-12.95	F3P 706/F3P 760	4	OZH 033
1.8	1,8		79	05.94-12.95	F3P 765/F3P 682	4	OZH 033
1.8	1,8		81	04.92-05.94	F3P 700	4	OZH 033
1.8 16V	1,8		99	04.92-12.95	F7P 704	4	OZH 033
R 19 II Cabriolet							
1.7	1,7		66	04.92-09.93	F3N 743/F3N 742	4	OZH 033
1.8	1,8		65	04.92-06.96	F3P 704/F3P 706/F3P 707/ F3P 760/F3P 708/F3P 705	4	OZH 033
1.8	1,8		66	09.93-06.96	F3P 706/F3P 760	4	OZH 033
1.8	1,8		79	07.94-06.96	F3P 765/F3P 682/F3P 764	4	OZH 033
1.8 16V	1,8		99	04.92-06.96	F7P 704	4	OZH 033
R 19 II Chamade							
1.4	1,4		43	04.92-07.93	C3J 710	4	OZU 001
1.4	1,4		43	08.93-12.95	C3J 710	4	OZH 033
1.4	1,4		55	11.93-12.95	E7J 742	4	OZH 033
1.7	1,7		54	04.92-12.95	F3N 741/F3N 740	4	OZU 022
1.8	1,8		65	04.92-12.95	F3P 704/F3P 706/F3P 707/ F3P 760/F3P 708/F3P 705	4	OZH 033
1.8	1,8		66	04.92-12.95	F3P 706/F3P 760	4	OZH 033
1.8	1,8		81	04.92-05.94	F3P 700	4	OZH 033
1.8	1,8		79	05.94-12.95	F3P 682	4	OZH 033
1.8 16V	1,8		99	04.92-12.95	F7P 704	4	OZH 033
R 21, Kombi							
1.7	1,7		54	09.89-10.92	F3N 726	4	OZU 022
1.7	1,7		66	09.89-06.94	F3N 723/F3N 722 → H 9000, S 1240	4	OZU 001
1.7	1,7		66	09.89-06.94	F3N 723/F3N 722 H 9001, S 1241	4	OZH 033
1.7	1,7		66	09.89-06.94	F3N 723/F3N 722 → H 00006443	4	OZU 001
1.7	1,7		66	09.89-06.94	F3N 723/F3N 722 H 00006444 →	4	OZH 044
2,2	2,2		79	09.89-06.94	J7T 754/J7T 755 → S 00006709	4	OZH 033
2,2	2,2		79	09.89-06.94	J7T 754/J7T 755 S 00006710	4	OZU 022
2,0	2,0		88	09.89-12.93	J7R 747/J7R 746	4	OZH 033
2,0	2,0		99	02.90-10.92	J7R 740	4	OZH 033
2,2	2,2		79	07.90-06.94	J7T 754/J7T 755 → S 00006709	4	OZU 022
2,2	2,2		79	07.90-06.94	J7T 754/J7T 755 S 00006710	4	OZH 033

BERU

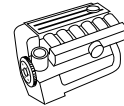
kW



 Zyl.
Cyl.
Cil.

RENAULT

R 25							
2.0 12V	2,0	99	06.89-12.92	J7R 726	4	OZH 033	
2,2	2,2	76	11.85-03.89		4	OZU 022	
2,2	2,2	79	09.86-12.92	J7T 732/J7T 733	4	OZU 022	
2.5 V6 Turbo	2,5	151	01.90-12.92	Z7U 700	6	OZH 033	
2.8 V6	2,8	115	05.89-02.90	Z7W 700	6	OZH 033	
2.8 V6 Injection	2,8	100	06.86-06.87	Z7W 702	6	OZU 001	
2.8 V6 Injection	2,8	110	06.87-12.92	Z7W 706/Z7W 707/Z7W 709	6	OZH 044	

ROVER

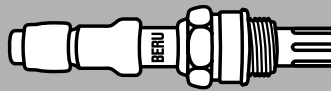
25							
1.4 16V	1,4	62	10.99-	14 K4M → YD 471564	4	OZH 053	
1.4 16V	1,4	76	10.99-	14 K4F → YD 471564	4	OZH 053	
1.6 16V	1,6	80	10.99-	16 K4F → YD 471564	4	OZH 053	
1.8 16V	1,8	85	10.99-	18 K4F → YD 471564	4	OZH 053	
1.8 16V	1,8	107	02.00-	18 K4K → YD 471564	4	OZH 053	
45 (RT)							
1.4	1,4	76	02.00-	14 K4F → YD 471063	4	OZH 053	
1.4	1,4	76	02.00-	14 K4F YD 471064 →	4	OZH 067	
1.6	1,6	80	02.00-	16 K4F → YD 471063	4	OZH 053	
1.6	1,6	80	02.00-	16 K4F YD 471064 →	4	OZH 067	
2.0 V6	2,0	110	02.00-	20 K4F	6	OZH 067	
100							
111 C/L/S	1,1	44	03.90-12.98	11 K2D/11 K2A	4	OZH 057	
114 S/L/GTA	1,4	55	03.90-12.98	14 K2D/14 K2A	4	OZH 057	
114 GTI/GT 16V KAT	1,4	66	03.90-12.98	14 K4C/14 K4D	4	OZH 057	
114 GTI 16V	1,4	69	03.90-08.91	14 K4C/14 K4D	4	OZH 057	
114 GSi	1,4	76	10.94-10.95	14 K4F	4	OZH 057	
114 GTI 16V	1,4	76	08.91-12.98	14 K4F	4	OZH 057	
100 Cabriolet							
111	1,1	44	04.94-	11 K2D	4	OZH 057	
114	1,4	55	04.94-	14 K2D/14 K2A	4	OZH 057	
114	1,4	75	03.97-10.98	14 K4F	4	OZH 057	
200							
211	1,1	44	01.98-03.00	11 K2D → YD 471564	4	OZH 053	
214	1,4	55	09.93-10.95	14 K2D/14 K2A	4	OZH 057	
214 i	1,4	55	11.95-03.00	14 K2F → YD 471564	4	OZH 053	
214 Si/Gsi	1,4	66	10.89-10.95	14 K4C/14 K4D	4	OZH 057	
214 GSi/Si	1,4	70	01.90-10.95	14 K4C	4	OZH 057	
214 GSi/Si	1,4	76	12.92-10.95	14 K4F	4	OZH 057	
214 Si	1,4	76	11.95-03.00	14 K4F → YD 471564	4	OZH 053	
218 K Vi	1,8	107	11.95-03.00	18 K4K → YD 471564	4	OZH 053	
220 GTi	2,0	100	01.93-10.95	20 T4H	4	OZH 094	
220 GTi	2,0	103	09.91-10.95	20 M4F	4	OZH 053	
220 GTi	2,0	103	10.92-10.95	20 M4F	4	OZH 094	
220 Turbo	2,0	147	01.93-10.95	20 T4G	4	OZH 057	
200 CABRIOLET							
214 1.4	1,4	66	01.92-11.99	14 K4C/14 K4D	4	OZH 057	
214 1.4i 16V	1,4	76	01.93-11.99	14 K4F	4	OZH 057	
200 Coupe							
220 GSi	2,0	100	05.94-	20 T4H	4	OZH 094	
220 Turbo	2,0	147	10.92-	20 T4G	4	OZH 057	
400							
414 GSi/Si	1,4	66	04.90-04.95	14 K4C/14 K4D	4	OZH 057	
414 GSi/Si KAT	1,4	76	01.93-04.95	14 K4F	4	OZH 057	
414 Si	1,4	76	05.95-03.00	14 K4F	4	OZH 057	
416 GSi	1,6	82	04.90-04.95	D16Z2	4	OZU 004	
416 Si	1,6	82	05.95-03.00	16 K4F → YD 471013	4	OZH 053	
416 GTI	1,6	90	04.90-04.95	D16A8	4	OZU 004	
420 GSi/SLI/GTI/Vite	2,0	100	01.93-04.95	20 T4H	4	OZH 053	
420 GSi/SLI/GTI/Vite	2,0	100	01.93-04.95	20 T4H	4	OZH 094	
420 GTI/GSi/Vitesse	2,0	103	02.92-08.92	20 M4F	4	OZH 094	

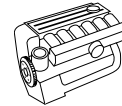

kW

 Zyl.
Cyl.
Cil.

ROVER

400						
420 GTI/GSI/Vitesse	2,0	103	02.92-04.95	20 M4F	4	OZH 053
420 Turbo	2,0	147	01.93-04.95	20 T4G	4	OZH 057
400 Tourer						
1.6 i	1,6	82	05.94-11.98		4	OZU 004
1.6 i	1,6	90	05.94-11.98	D16A8	4	OZU 004
1.8 i	1,8	107	06.96-11.98	18 K4K	4	OZH 053
600						
618 i/Si	1,8	85	03.96-02.99	F 18 A3	4	OZH 120
620 i	2,0	85	01.96-06.96	F 20 Z2	4	OZH 120
620 Si	2,0	96	01.96-02.99	F 20 Z1	4	OZH 120
800						
820 I/SI (RS)	2,0	100	01.92-01.96	20 T4H → AM 152056	4	OZH 053
820 I/SI (RS)	2,0	100	01.92-01.96	20 T4H AM 152057 →	4	OZH 094
820 16V Turbo (RS)	2,0	132	01.92-01.96	T 16 RS 100318 → 230966	4	OZH 057
820 Sport	2,0	145	04.94-03.96	RS 100318 → 230966	4	OZH 057

COUPE

1.8 16 V	1,8	107	03.96-11.99		4	OZH 053
----------	-----	-----	-------------	--	---	----------------

MINI MK I

1300	1,3	37	10.92-09.00	12 A2B	4	OZH 057
1300	1,3	39	01.92-04.95	12 A2D	4	OZH 057
1300	1,3	46	01.92-	12 A2E	4	OZH 057

MINI MK I Cabriolet

1300	1,3	46	09.92-04.95	12 A2E	4	OZH 057
------	-----	----	-------------	--------	---	----------------

SAAB

900 I						
2.0 i	2,0	81	09.85-08.87	B201	4	OZU 001
2.0 i	2,0	81	09.87-08.90	B201	4	OZH 046
2.0 -16	2,0	93	01.89-12.93	B202I	4	OZH 046
2.0 Turbo	2,0	103	10.86-08.87	B201XL	4	OZU 001
2.0 Turbo	2,0	103	09.87-12.91	B201XL	4	OZH 046
2.0 Turbo-16	2,0	118	11.85-08.89	B202XL	4	OZH 046
2.1 -16	2,1	100	08.90-08.93	B212I	4	OZH 046
900 I Cabriolet						
2.0 -16	2,0	93	01.90-08.93	B202I	4	OZH 046
2.0 Turbo-16	2,0	118	11.86-08.89	B202XL	4	OZH 046
2.1 -16	2,1	100	08.90-08.93	B212I	4	OZH 046
900 I Combi Coupe						
2.0 i	2,0	81	09.85-08.87	B201	4	OZU 001
2.0 i	2,0	81	09.87-08.90	B201	4	OZH 046
2.0 -16	2,0	93	01.89-08.92	B202I	4	OZH 046
2.0 Turbo	2,0	103	10.86-08.88	B201XL	4	OZU 001
2.0 Turbo	2,0	103	09.88-12.91	B201XL	4	OZH 046
2.0 Turbo-16	2,0	118	11.85-08.89	B202XL	4	OZH 046
2.1 -16	2,1	100	09.90-07.93	B212I	4	OZH 046
900 II						
2.0 i	2,0	96	08.94-02.98	B204I	4	OZH 157
2.0 -16 Turbo	2,0	136	07.93-09.95	B204L	4	OZH 156
2.0 -16 Turbo	2,0	136	07.93-09.95	B204L	4	OZH 157
2.3 -16	2,3	110	07.93-02.98	B234I	4	OZH 157
2.5 -24 V6	2,5	125	07.93-02.98	B258I	6	OZH 154
900 II Cabriolet						
2.0 i	2,0	96	12.93-02.98	B204I	4	OZH 157
2.0 -16 Turbo	2,0	136	12.93-09.95	B204L	4	OZH 156
2.0 -16 Turbo	2,0	136	12.93-09.95	B204L	4	OZH 157
2.3 -16	2,3	110	12.93-02.98	B234I	4	OZH 157
900 II Coupe						
2.0 i	2,0	96	08.94-02.98	B204I	4	OZH 157
2.0 i	2,0	98	07.93-07.94	B206I	4	OZH 157
2.0 -16 Turbo	2,0	136	12.93-09.95	B204L	4	OZH 156

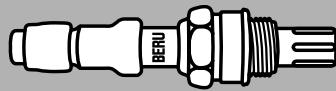
BERU

kW

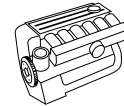

 Zyl.
Cyl.
Cil.

SAAB

900 II Coupe						
2.0 -16 Turbo	2,0		136	12.93-09.95	B204L	4 OZH 157
2.3 -16	2,3		110	12.93-02.98	B234I	4 OZH 157
9000						
2.0 -16	2,0	Kat. ⁸	92	12.85-08.86	B202XI	4 OZH 046
2.0 -16	2,0	Kat. ⁸	92	09.86-12.88	B202XI	4 OZH 037
2.0 -16	2,0		94	12.85-08.96	B202XI	4 OZH 046
2.0 -16	2,0		94	09.86-08.88	B202XI	4 OZH 037
2.0 -16	2,0		94	01.89-01.93	B202I	4 OZH 046
2.0 -16 CS	2,0		94	01.89-08.91	B202I	4 OZH 046
2.0 -16 CS	2,0		94	09.91-12.98	B202I	4 OZH 037
2.0 -16 CD	2,0		96	09.93-12.98	B204I	4 OZH 157
2.0 -16 CD	2,0		96	09.93-12.98	B204I	4 OZH 158
2.0 -16 CS	2,0		96	09.93-12.98	B204I	4 OZH 157
2.0 -16 CS	2,0		96	09.93-12.98	B204I	4 OZH 158
2.0 -16 Turbo CD	2,0		108	09.92-12.98	B204E/B202S	4 OZH 157
2.0 -16 CD	2,0		110	09.93-12.98	B204E	4 OZH 157
2.0 -16 ND Turbo	2,0		110	09.93-12.98	B204E/B202S	4 OZH 157
2.0 -16 Turbo	2,0		118	09.84-08.91	B202XL	4 OZH 046
2.0 -16 Turbo	2,0		118	09.84-08.91	B202XL	4 OZH 157
2.0 -16 Turbo	2,0		127	06.89-12.92	B202	4 OZH 157
2.3 -16 CD	2,3		107	08.89-08.91	B234I	4 OZH 046
2.3 -16 CD	2,3		107	09.91-12.98	B234I	4 OZH 157
2.3 -16 CD	2,3		107	09.91-12.98	B234I	4 OZH 158
2.3 -16 CS	2,3		107	09.89-08.91	B234I	4 OZH 046
2.3 -16 CS	2,3		107	09.91-12.98	B234I	4 OZH 157
2.3 -16 CS	2,3		107	09.91-12.98	B234I	4 OZH 158
2.3 -16 CDE	2,3		108	09.93-12.98	B234I	4 OZH 157
2.3 -16 CDE	2,3		108	09.93-12.98	B234I	4 OZH 158
2.3 -16 CSE	2,3		108	09.93-12.98	B234I	4 OZH 157
2.3 -16 CSE	2,3		108	09.93-12.98	B234I	4 OZH 158
2.3 -16 CSE Eco Power	2,3		125	09.93-12.98	B234E	4 OZH 157
2.3 -16 Turbo	2,3		143	09.90-08.91	B234L	4 OZH 046
2.3 -16 Turbo	2,3		143	09.90-08.91	B234L	4 OZH 157
2.3 -16 CD Turbo	2,3		147	07.90-12.98	B234L	4 OZH 157
2.3 -16 Turbo CSE	2,3		147	09.93-12.98	B234L	4 OZH 157
2.3 -16 Aero CS	2,3		162	02.93-12.98	B234R	4 OZH 157
2.3 -16 Aero CS	2,3		165	02.93-12.98	B234R	4 OZH 157
3.0 -24 V6 CD/CDE/CS/CSE	3,0		155	07.94-12.98	B308I	6 OZH 154
9-3						
2.0 i	2,0		96	02.98-09.02	B204I	4 OZH 157
2.3 i	2,3		110	02.98-09.02	B234I	4 OZH 157
9-3 Cabriolet						
2.0 i	2,0		96	02.98-08.03	B204I	4 OZU 021
2.3 i	2,3		110	02.98-08.03	B234I	4 OZH 157

SEAT

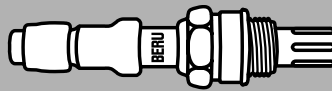
AROSA						
1.0	1,0		37	05.97-	AHT/AER/ANV/ALD/ALL/AUC	4 OZH 169
1.4	1,4		44	05.97-	AEX/AKV/ANW/AKK/APQ/AUD	4 OZH 177
1.4 16V	1,4		74	01.00-	ANM/AFK/AUB/AQQ	4 OZH 177
CORDOBA						
1.0 i	1,0		37	09.96-05.97	AER → 6K-V-165 000	4 OZH 071
1.0 i	1,0		37	05.97-10.98	AER 6K-V-165 000 → 6K-X-127 000	4 OZH 151
1.4	1,4		44	06.99-10.02	ANW/AKK/AUD	4 OZH 177
1.4 i	1,4	ohne Kat. ¹¹	44	06.94-12.94	ABD → 6K-ZR 700 000	4 OZH 024
1.4 i	1,4		44	06.94-12.94	ABD → 6K-ZR 700 000	4 OZH 043
1.4 i	1,4		44	12.94-05.97	AEX → 6K-V-165 000	4 OZH 071
1.4 i	1,4		44	05.97-06.99	AEX	4 OZH 151
1.4 i	1,4		44	12.97-09.98	AKV, APQ, ANX	4 OZH 151
1.4 16V	1,4	D1	55	09.02-	BBY	4 OZH 179

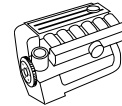

kW

Zyl.
Cyl.
Cil.**SEAT****CORDOBA**

1.6 i	1,6		55	02.93–06.99	ABU	4	OZH 043
1.6 i	1,6		55	02.93–06.99	AEE, ALM	4	OZH 070
1.8 i	1,8	Automatic ³ , ohne Kat. ¹¹	66	02.93–06.99	ADZ/ABS	4	OZH 012
1.8 i	1,8	Automatic ³	66	09.93–07.94	ABS	4	OZH 164
1.8 i	1,8	ohne Kat. ¹¹	66	02.93–06.99	ABS	4	OZU 003
1.8 i	1,8		66	02.93–07.94	ABS	4	OZU 001
1.8 i	1,8		66	02.93–06.99	ADZ	4	OZH 071
1.8 i 16V	1,8		95	10.93–08.96	ADL	4	OZH 043
2.0 i 16V	2,0		110	08.96–06.99	ABF	4	OZH 150

IBIZA I

1.5	1,5		63	10.86–05.93	021 A 2000	4	OZH 037
1.5 i KAT	1,5		66	10.86–05.93	021 C.2000	4	OZH 046

IBIZA II

1.0	1,0	ohne Kat. ¹¹	33	03.93–09.96	AAU	4	OZH 024
1.0	1,0		33	03.93–09.96	AAU	4	OZH 043
1.0 i	1,0		37	05.97–10.98	AER 6K-V-165 000 → 6K-X-127 000	4	OZH 151
1.0 i	1,0		37	10.98–08.99	AER	4	OZH 177
1.3 i	1,3		40	03.93–07.94	AAV	4	OZH 043
1.4 i	1,4	ohne Kat. ¹¹	44	09.93–12.95	AEX/AKV/ABD/APQ	4	OZH 024
1.4 i	1,4		44	09.93–12.95	AEX/AKV/ABD/APQ	4	OZH 043
1.4 i	1,4		44	12.97–09.98	AEX/AKV/APQ	4	OZH 151
1.6 i	1,6		55	03.93–07.94	ABU	4	OZH 043
1.8 i	1,8	Automatic ³ , ohne Kat. ¹¹	66	03.93–08.99	ADZ/ABS	4	OZH 012
1.8 i	1,8	Automatic ³	66	03.93–08.99	ABS	4	OZH 009
1.8 i	1,8	ohne Kat. ¹¹	66	03.93–08.99	ABS	4	OZU 003
1.8 i	1,8		66	03.93–07.94	ABS	4	OZU 001
1.8 i	1,8		66	03.93–07.94	ABS	4	OZH 164
2.0 i 16V	2,0		110	08.96–08.99	ABF	4	OZH 150

IBIZA IV

1.4 16V	1,4	D1	55	02.02–	BBY	4	OZH 179
---------	-----	----	----	--------	-----	---	----------------

INCA

1.6 i	1,6		55	11.95–05.97	1F	4	OZH 071
-------	-----	--	----	-------------	----	---	----------------

LEON

1.8 20V	1,8		92	11.99–	AGN	4	OZH 128
---------	-----	--	----	--------	-----	---	----------------

MALAGA

1.2 i	1,2		52	12.89–12.93	021 C.1000	4	OZH 037
1.5 i KAT	1,5		66	10.86–12.93	021 A 2000/021 C.2000/ 021 D.2000	4	OZH 037

TOLEDO I

1.6 i	1,6		55	01.93–11.93	1F	4	OZU 022
1.6 i	1,6		55	11.93–03.99	1F	4	OZU 003
1.8 16V	1,8		92	05.91–03.99	PL	4	OZH 037
1.8 i	1,8		65	05.91–11.93	RP → 1L-ZD 308 450	4	OZU 022
1.8 i	1,8	ohne Kat. ¹¹	65	05.91–11.93	RP → 1L-ZD 308 450	4	OZH 008
1.8 i	1,8	Automatic ³ , ohne Kat. ¹¹	66	11.93–12.96	ADZ/ABS	4	OZH 012
1.8 i	1,8	Automatic ³	66	11.93–12.96	ABS	4	OZH 009
1.8 i	1,8	ohne Kat. ¹¹	66	11.93–12.96	ABS	4	OZU 003
1.8 i	1,8		66	11.93–07.94	ABS	4	OZU 001
2.0 i	2,0		85	05.91–03.94	2 E → 1L-ZD 320 000	4	OZH 009
2.0 i	2,0	ohne Kat. ¹¹	85	03.94–06.96	2E/AGG	4	OZH 024

TOLEDO II

1.6 16V	1,6		77	09.00–	AUS/AZD	4	OZH 182
1.8 20V	1,8		92	04.99–	AGN/APG	4	OZH 177
2.3 V5	2,3		110	04.99–05.01	AGZ	5	OZH 177

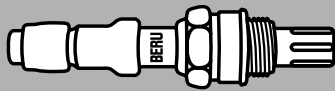
**BERU**

kW

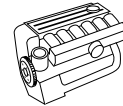
Zyl.
Cyl.
Cil.**SKODA****FAVORIT**

1.3 135 X,LX,GLX	1,3		40	01.90-09.94	781.135E	4	OZH 037
1.3	1,3		50	01.94-09.94	136B	4	OZH 043

FAVORIT Forman

1.3	1,3		40	09.91-09.94	781.135E	4	OZH 043
1.3	1,3		50	01.94-09.94	136B	4	OZH 043

FAVORIT Pick-up

1.3	1,3		40	07.93-06.97	135B	4	OZH 043
1.3	1,3		50	12.92-06.97	136B	4	OZH 043

FELICIA I

1.3	1,3		40	08.96-03.98	135B/AMG	4	OZH 099
1.3	1,3		50	08.96-03.98	136B/AMH	4	OZH 099
1.6 LX	1,6		55	09.95-03.98	AEE	4	OZH 099

FELICIA I Fun

1.6	1,6		55	06.97-	AEE	4	OZH 099
-----	-----	--	----	--------	-----	---	----------------

OCTAVIA

1.6	1,6		55	09.96-09.00	AEE	4	OZH 177
1.6	1,6		74	02.97-	AKL/AEH	4	OZH 169
1.8	1,8		92	09.96-	AGN	4	OZH 177
1.8 T	1,8		110	08.97-	AGU	4	OZH 128
1.8 T	1,8		110	08.97-	ARX/ARZ/AUM	4	OZH 177

OCTAVIA Combi

1.6	1,6		74	07.98-	AKL/AEH	4	OZH 169
1.8 20V	1,8		92	07.98-	AGN	4	OZH 177
1.8 T	1,8		110	07.98-	ARX/ARZ/AGU/AUM	4	OZH 177

SUZUKI**SWIFT II**

1.3 GTi	1,3		74	03.89-05.01	G13B	4	OZU 015
---------	-----	--	----	-------------	------	---	----------------

VITARA

1.6	1,6		60	07.88-12.91	G16A	4	OZU 014
-----	-----	--	----	-------------	------	---	----------------

VITARA Cabrio

1.6	1,6		59	07.88-12.91	G16A	4	OZU 014
-----	-----	--	----	-------------	------	---	----------------

VAUXHALL**ASTRA Mk II Convertible**

1.6 i	1,6		55	01.91-08.93	E 16 NZ	4	OZU 005
1.6 i KAT	1,6		55	10.87-02.93	C 16 NZ/C 16 LZ	4	OZU 005
2.0 i	2,0		85	01.87-12.91	20 NE	4	OZH 040
2.0 i KAT	2,0		85	01.91-08.93	C 20 NE	4	OZH 040

ASTRA Mk III

1.4 i 16V	1,4		66	02.96-02.98	X 14 XE	4	OZU 005
-----------	-----	--	----	-------------	---------	---	----------------

ASTRA Mk IV

1.4 16V	1,4		66	09.98-08.00	X 14 XE/Z 14 XE → 18999999	4	OZH 148
1.4 16V	1,4		66	09.00-	X 14 XE/Z 14 XE → 18999999	4	OZH 132
1.6	1,6		62	09.00-	Z 16 SE	4	OZH 110
1.6 16V	1,6		74	09.98-08.00	Z 16 XE/X 16 XEL → 18999999	4	OZH 148

ASTRA MK IV Convertible

1.6 16V	1,6		74	03.01-	Z 16 XE	4	OZH 132
---------	-----	--	----	--------	---------	---	----------------

ASTRA Mk IV Estate

1.4 16V	1,4		66	02.98-08.00	X 14 XE/Z 14 XE → 18999999	4	OZH 148
1.4 16V	1,4		66	09.00-	X 14 XE/Z 14 XE → 18999999	4	OZH 132
1.6	1,6		62	09.00-	Z 16 SE	4	OZH 110
1.6	1,6	D1	62	09.00-	Z 16 SE	4	OZH 110
1.6 16V	1,6		74	02.98-08.00	Z 16 XE/X 16 XEL → 18999999	4	OZH 148
1.6 Dualfuel	1,6		63	09.02-	Z 16 XE	4	OZH 132

ASTRAVAN Mk IV

1.6 i	1,6		62	09.00-	Z 16 SE	4	OZH 110
1.6 i	1,6	D1	62	09.00-	Z 16 SE	4	OZH 110

CORSA

1.4 i 16V	1,4		66	09.94-09.00	X 14 XE → S 4269627/ S 601 1904	4	OZU 023
-----------	-----	--	----	-------------	------------------------------------	---	----------------

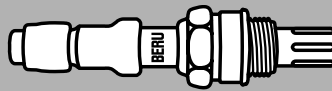

kW

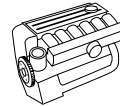
 Zyl.
Cyl.
Cil.

VAUXHALL
CORSA

1.4 i 16V	1,4		66	09.94–09.00	X 14 XE S 4269628/ S 601 1905 →	4	OZU 005
1.6 GSI 16V	1,6		80	03.93–09.00	C 16 XE → S 4269627/ S 601 1904	4	OZU 023
1.6 GSI 16V	1,6		80	03.93–09.00	C 16 XE S 4269628/ S 601 1905 →	4	OZU 005

CORSA Convertible

1.4 i 16V	1,4		66	01.98–	X 14 XE → S 4269627/ S 601 1904	4	OZU 023
1.4 i 16V	1,4		66	01.98–	X 14 XE S 4269628/ S 601 1905 →	4	OZU 005

CORSA Mk II

1.4 16V	1,4		66	09.00–	Z 14 XE	4	OZH 132
---------	-----	--	----	--------	---------	---	----------------

FRONTERA Sport

2.0 i	2,0		85	03.92–01.95	C 20 NE/X 20 SE	4	OZH 028
2.0 i	2,0		85	02.95–10.98	C 20 NE/X 20 SE	4	OZH 019

MERIVA

1.6 i 16V	1,6		74	05.03–	Z 16 XE	4	OZH 132
-----------	-----	--	----	--------	---------	---	----------------

OMEGA

2.0	2,0		85	03.94–09.99	X 20 SE	4	OZH 019
2.5 V6	2,5	Automatic ³	125	03.94–08.94	X 25 XE	6	OZH 019

OMEGA Estate

2.0	2,0		85	03.94–09.99	X 20 SE	4	OZH 019
2.5 V6	2,5	Automatic ³	125	03.94–08.94	X 25 XE	6	OZH 019

SINTRA

2.2 i 16 V	2,2		104	11.96–04.99	X 22 XE	4	OZH 040
------------	-----	--	-----	-------------	---------	---	----------------

TIGRA

1.4 16V	1,4		66	07.94–	X 14 XE → S 4269627/ S 601 1904	4	OZU 023
1.4 16V	1,4		66	07.94–	X 14 XE S 4269628/ S 601 1905 →	4	OZU 005
1.6 16V	1,6		78	07.94–	X 16 XE → S 4269627/ S 601 1904	4	OZU 023
1.6 16V	1,6		78	07.94–	X 16 XE S 4269628/ S 601 1905 →	4	OZU 005

VECTRA

1.6 i 16V	1,6		74	10.95–08.00	X 16 XEL	4	OZH 148
-----------	-----	--	----	-------------	----------	---	----------------

VECTRA Estate

1.6 i 16V	1,6		74	11.96–08.00	X 16 XEL	4	OZH 148
-----------	-----	--	----	-------------	----------	---	----------------

ZAFIRA

1.6 16V	1,6		74	04.99–08.99	X 16 XEL → 18999999	4	OZH 148
---------	-----	--	----	-------------	---------------------	---	----------------

VOLVO
240

2.3	2,3		83	08.86–07.87	B 230 F	4	OZH 003
2.3 i KAT	2,3		85	08.86–07.93	B 230 F	4	OZH 003

340-360

2.0	2,0		80	08.88–07.89	B 200 F	4	OZH 037
-----	-----	--	----	-------------	---------	---	----------------

440 K

1.6	1,6		61	09.93–12.96	B 16 F → 358975	4	OZH 003
1.7	1,7		70	08.88–07.89	B 18 F	4	OZH 003
1.7 Turbo	1,7		88	08.88–07.96	B 18 FT	4	OZH 003
1.7 Turbo	1,7		90	01.91–07.96	B 18 FT	4	OZH 003
1.8	1,8		66	08.91–07.96	B 18 U	4	OZH 003

460 L

1.6	1,6		61	09.93–07.96	B 16 F → 358975	4	OZH 003
1.7	1,7		75	08.89–08.91	B 18 EP	4	OZH 037
1.7	1,7		75	09.91–07.92	B 18 EP	4	OZH 003
1.7 Turbo	1,7		88	08.89–08.91	B 18 FT	4	OZH 037
1.7 Turbo	1,7		88	09.91–07.96	B 18 FT	4	OZH 003
1.8	1,8		66	08.91–07.96	B 18 U	4	OZH 003

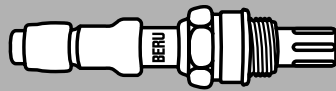
**BERU**

kW

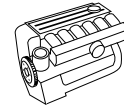
Zyl.
Cyl.
Cil.**VOLVO****460 L**

2.0	2,0		80	08.92-07.96	B 20 F	4	OZH 003
-----	-----	--	----	-------------	--------	---	----------------

480 E

1.7	1,7		70	08.87-07.89	B 18 F	4	OZH 003
1.7 Turbo	1,7		88	08.88-08.95	B 18 FT	4	OZH 003
1.7 Turbo	1,7		90	01.91-08.95	B 18 FT	4	OZH 003
2.0	2,0		81	08.92-09.95	B 20 F	4	OZH 003

740

2.3	2,3		85	08.87-07.92	B 230 F	4	OZH 003
2.3	2,3		111	08.88-08.92	B 234 F	4	OZH 003
2.3	2,3		114	08.88-07.91	B 234 F	4	OZH 003
2.3	2,3		117	08.87-07.89	B 234 F	4	OZH 003
2.3 Turbo	2,3		121	08.89-07.90	B 230 FT	4	OZH 037

740 Kombi

2.0	2,0		82	08.89-07.91	B 200 F	4	OZH 003
2.3	2,3		83	08.88-12.89	B 230 F	4	OZH 037
2.3	2,3		85	08.87-07.92	B 230 F	4	OZH 003
2.3	2,3		111	07.89-08.92	B 234 F	4	OZH 003
2.3	2,3		114	08.88-07.90	B 234 F	4	OZH 003
2.3	2,3		117	08.87-07.89	B 234 F	4	OZH 003
2.3 Turbo	2,3		121	08.89-07.90	B 230 GT/B 230 FT	4	OZH 037

760

2.8	2,8		105	05.86-10.86	B 280 F	6	OZH 003
2.8	2,8		108	08.86-07.90	B 280 F	6	OZH 003

760 Kombi

2.8	2,8		105	05.86-10.86	B 280 F	6	OZH 003
-----	-----	--	-----	-------------	---------	---	----------------

780

2.9	2,9		108	08.87-07.90	B 280 F	6	OZH 003
-----	-----	--	-----	-------------	---------	---	----------------

850

2.0	2,0		105	06.91-12.96	B 5204 F	5	OZH 035
2.0 Turbo	2,0		155	01.95-12.96	B 5204 T/B 5204 FT	5	OZH 073
2.3 T5	2,3		166	09.4-07.96	B 5234 FT	5	OZH 073
2.5	2,5		125	08.91-12.96	B 5254 S	5	OZH 161
2.5	2,5	D1	125	08.91-12.96	B 5254 S	5	OZH 209

850 Kombi

2.0	2,0		105	02.93-12.96	B 5204 F	5	OZH 161
2.0 Turbo	2,0		155	01.95-12.96	B 5204 T/B 5204 FT	5	OZH 073
2.5	2,5		125	09.92-07.96	B 5254 S 822 →	5	OZH 161
2.5	2,5	D1	125	09.92-12.96	B 5254 S	5	OZH 209
2.5 AWD	2,5		142	09.96-12.96	B 5254 T	5	OZH 210

940, Kombi

2.0	2,0		82	01.92-07.94	B 200 F	4	OZH 003
2.3	2,3		114	08.90-07.91	B 234 F /B 234 G	4	OZH 003
2.3	2,3		96	08.90-12.94	B 230 G/B 230 FB	4	OZH 003
2.3 Turbo	2,3		121	08.90-08.93	B 230 FT	4	OZH 046
2.3 Turbo	2,3		121	09.93-07.94	B 230 FT	4	OZH 155

940 II, Kombi

2.3 ti	2,3		99	01.95-08.96	B 230 FK	4	OZH 155
2.3 Turbo	2,3		121	08.94-08.97	B 230 FT	4	OZH 155

C70 Cabriolet

2.0	2,0		132	03.98-07.98	B 5204 T2	5	OZH 210
-----	-----	--	-----	-------------	-----------	---	----------------

C70 Coupe

2.0	2,0		132	03.97-07.98	B 5204 T2	5	OZH 210
2.0 T	2,0		166	03.97-07.98	B 5204 T3	5	OZH 210
2.3 T-5	2,3		176	07.97-07.98	B 5234 T3	5	OZH 210
2.5 T	2,5		142	01.98-07.98	B 5254 T	5	OZH 210

S40 I

1.6	1,6		77	09.95-08.99	B 4164 S	4	OZH 130
1.8	1,8		85	07.95-08.99	B 4184 S3/B 4184 S	4	OZH 130
2.0	2,0		100	07.95-12.03	B 4204 S2/B 4204 S	4	OZH 130

S70

2.0	2,0		105	01.97-07.98	B 5204 F	5	OZH 209
-----	-----	--	-----	-------------	----------	---	----------------

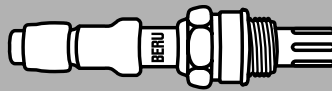

kW

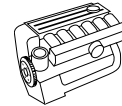

 Zyl.
Cyl.
Cil.

VOLVO

S70							
2.0	2,0		132	01.97-07.98	B 5204 T2	5	OZH 210
2.0 Turbo	2,0		155	01.97-11.00	B 5204 T	5	OZH 073
2.0 Turbo	2,0	D1	155	01.97-07.98	B 5204 T	5	OZH 210
2.0 Turbo	2,0		166	01.97-11.00	B 5204 T3	5	OZH 073
2.3 T-5	2,3		176	01.97-11.00	B 5234 T3	5	OZH 073
2.3 T-5	2,3	D1	176	01.97-07.98	B 5234 T3	5	OZH 210
2.3 Turbo	2,3		184	01.97-07.98	B 5234 FT+	5	OZH 210
2.4	2,4		125	01.97-11.00	B 5254 S	5	OZH 073
2.4 Turbo	2,4		142	01.97-07.98	B 5254 T	5	OZH 210
2.5	2,5		121	06.98-07.98		5	OZH 209
V40 Kombi							
1.6	1,6		77	12.95-08.99	B 4164 S	4	OZH 130
1.8	1,8		85	07.95-08.99	B 4184 S3/B 4184 S	4	OZH 130
2.0	2,0		100	07.95-	B 4204 S	4	OZH 130
V70 I Kombi							
2.0	2,0		105	01.97-07.98		5	OZH 209
2.0	2,0		132	01.97-07.98	B 5204 T2	5	OZH 210
2.0 Turbo	2,0		155	01.97-03.00	B 5204 T	5	OZH 073
2.0 Turbo	2,0	D1	155	01.97-07.98		5	OZH 210
2.0 Turbo	2,0		166	01.97-03.00	B 5204 T3	5	OZH 073
2.0 Turbo	2,0	D1	166	01.97-07.98	B 5204 T3	5	OZH 210
2.0 Turbo AWD	2,0		166	01.97-03.00	B 5204 T3	5	OZH 073
2.0 Turbo AWD	2,0	D1	166	01.97-07.98	B 5204 T3	5	OZH 210
2.3 T AWD	2,3		184	04.97-03.00	B 5234 FT+	5	OZH 073
2.3 T AWD	2,3	D1	184	08.97-07.98	B 5234 FT+	5	OZH 210
2.3 T-5	2,3		176	01.97-03.00	B 5234 T3	5	OZH 073
2.3 T-5	2,3	D1	176	01.97-07.98	B 5234 T3	5	OZH 210
2.3 T-5 AWD	2,3		176	01.97-03.00	B 5234 T3	5	OZH 073
2.3 T-5 AWD	2,3	D1	176	01.97-07.98	B 5234 T3	5	OZH 210
2.3 Turbo	2,3		184	01.97-03.00	B 5234 FT+	5	OZH 073
2.3 Turbo	2,3	D1	184	01.97-07.98	B 5234 FT+	5	OZH 210
2.4	2,4		125	01.97-05.00	B 5254 S	5	OZH 073
2.4 Turbo	2,4		142	01.97-03.00	B 5254 T/B 5244 T	5	OZH 073
2.4 Turbo	2,4	D1	142	01.97-07.98	B 5254 T	5	OZH 210
2.5	2,5		121	06.98-07.98		5	OZH 209
2.5 Turbo AWD	2,5		142	01.97-05.00	B 5254 T/B 5244 T	5	OZH 073
2.5 Turbo AWD	2,5	D1	142	01.97-07.98	B 5254 T	5	OZH 210

VW

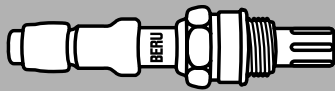
BORA, Kombi							
1.6	1,6		74	10.98-05.05	AEH, AKL	4	OZH 127
1.6 16V	1,6		77	05.00-05.05	AUS/ATN/AZD	4	OZH 182
1.8	1,8		92	10.98-05.05	AGN	4	OZH 128
1.8 4motion	1,8		92	02.99-05.05	AGN	4	OZH 177
1.8 T	1,8		110	05.00-05.05	AGU	4	OZH 128
2.3 V5	2,3		110	10.98-10.00	AGZ	5	OZH 177
2.3 V5 4motion	2,3		110	12.98-10.00	AGZ	5	OZH 177
CADDY I							
1.8	1,8		70	08.85-07.92	JH	4	OZU 022
CADDY II							
1.4	1,4		44	11.95-05.97	AEX	4	OZH 071
1.4	1,4		44	06.97-12.97	AEX	4	OZH 151
1.4	1,4		44	11.97-10.98	AEX/AKV	4	OZH 151
1.6	1,6		55	06.97-09.00	AEE	4	OZH 099
60 1.4	1,4		44	11.95-05.97	AEX → 9K-W-502 300	4	OZH 071
60 1.4	1,4		44	06.97-12.97	AEX 9K-W-502 301 → 9K-X-521 000	4	OZH 151
60 1.4	1,4		44	11.97-10.98	APQ	4	OZH 151
75 1.6	1,6		55	06.96-09.00	AEE	4	OZH 099
CORRADO							
1.8 G60	1,8		118	09.88-06.89	PG → 50K-011579	4	OZH 047

BERU

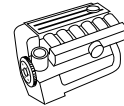

kW

 Zyl.
Cyl.
Cil.

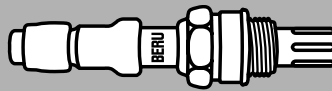

VW						
CORRADO						
1.8 G60	1,8		118	07.89-09.93	PG 50K-011580 →	4 OZH 131
2.0 i 16V	2,0		100	08.91-12.95	9A	4 OZH 131
2.9 VR6	2,9		140	08.91-12.95	ABV	6 OZH 024
FOX						
1.2	1,2		40	04.05-	BMD	3 OZH 128
GOLF I Cabriolet						
1.8	1,8		70	08.83-04.93	JH	4 OZU 022
1.8	1,8		72	08.89-03.93	2H	4 OZH 009
GOLF II						
1.3	1,3		40	08.83-06.87	MH/HK	4 OZH 047
1.3 KAT	1,3		40	02.87-07.87	NZ	4 OZH 047
1.3 KAT	1,3		40	08.87-07.90	NZ	4 OZH 048
1.3 KAT	1,3		40	08.90-07.92	NZ	4 OZH 031
1.6	1,6		51	10.86-07.92	PN	4 OZU 022
1.8 i KAT	1,8		66	08.87-10.91	GX/RP	4 OZH 027
1.8	1,8		66	08.84-05.88	GX	4 OZU 022
1.8 Syncro	1,8		66	02.86-07.91	GX	4 OZH 037
1.8 Syncro	1,8		72	08.88-07.91	1P	4 OZH 047
1.8 GTI	1,8		79	08.85-10.87	RD	4 OZH 037
1.8 GTI	1,8		82	01.87-10.91	EV/GZ/PB/DX	4 OZU 022
1.8 GTI 16V	1,8		95	02.86-10.91	PL	4 OZH 037
1.8 GTI 16V	1,8		102	02.86-06.90	KR	4 OZU 022
1.8 GTI G60	1,8	ohne Kat. ¹¹	118	04.90-07.91	PG	4 OZH 008
1.8 GTI G60	1,8	Kat. ⁸	118	04.90-07.91	PG	4 OZH 009
1.8 GTI G60	1,8		118	04.90-07.91	PG	4 OZH 131
1.8 GTI G60 Syncro	1,8		118	04.89-12.89	PG/1H	4 OZH 047
GOLF III, Variant						
1.4	1,4	ohne Kat. ¹¹	40	11.91-09.94	AEX/ABD → 1H-S-120000	4 OZH 024
1.4	1,4	Kat. ⁸	40	11.91-09.94	AEX/ABD → 1H-S-120000	4 OZH 043
1.4	1,4	Kat. ⁸	40	09.94-07.95	AEX/ABD 1H-S-120001 →	4 OZH 070
1.4	1,4	ohne Kat. ¹¹	44	10.91-09.94	ABD → 1H-S-120000	4 OZH 024
1.4	1,4	ohne Kat. ¹¹	44	10.94-07.95	ABD Fgst.Nr. 1H-S-120001 →	4 OZH 151
1.4	1,4	Kat. ⁸	44	10.91-09.94	AEX/ABD → 1H-S-120000	4 OZH 043
1.4	1,4	Kat. ⁸	44	09.94-07.95	ABD Fgst.Nr. 1H-S-120001 →	4 OZH 070
1.4	1,4		44	07.95-08.97	AEX	4 OZH 181
1.6	1,6		55	09.92-09.94	ABU → 1H-S-120000	4 OZH 043
1.6	1,6		55	10.94-08.97	ABU 1H-S-120001 →	4 OZH 070
1.6	1,6		55	07.95-08.97	AEE → 1H-S-120000	4 OZH 070
1.6	1,6		74	12.95-08.97	AFT	4 OZH 022
1.8	1,8	Automatic ³	55	11.91-09.94	AAM → 1H-S-120000	4 OZH 009
1.8	1,8	ohne Kat. ¹¹	55	11.91-09.94	AAM → 1H-S-120000	4 OZH 012
1.8	1,8		55	11.91-09.94	AAM → 1H-S-120000	4 OZU 003
1.8	1,8		55	09.94-08.97	AAM 1H-S-120001 →	4 OZH 071
1.8	1,8	Automatic ³	66	11.91-09.94	ABS → 1H-S-120000	4 OZH 009
1.8	1,8	ohne Kat. ¹¹	66	11.91-09.94	ABS → 1H-S-120000	4 OZH 012
1.8	1,8		66	11.91-09.94	ABS → 1H-S-120000	4 OZU 003
1.8	1,8		66	11.91-09.94	ABS 1H-S-120001 →	4 OZH 071
1.8 Syncro Autmatic	1,8		66	01.93-09.94	ABS → 1H-S-120000	4 OZH 009
1.8 Syncro	1,8	ohne Kat. ¹¹	66	01.93-09.94	ABS → 1H-S-120000	4 OZH 012
1.8 Syncro	1,8		66	01.93-09.94	ABS → 1H-S-120000	4 OZU 003
1.8 Syncro	1,8		66	10.94-08.97	ADZ 1H-S-120001 →	4 OZH 071
2.0	2,0	ohne Kat. ¹¹	85	11.91-09.94	2E → 1H-S-120000	4 OZH 024
2.0	2,0		85	10.94-08.97	ADY, AKR	4 OZH 022
2.0 Syncro	2,0		85	08.95-08.97	AGG	4 OZH 022
2.0 GTI 16V	2,0	ohne Kat. ¹¹	110	08.92-09.94	ABF	4 OZH 024
2.0 GTI 16V	2,0		110	08.92-09.94	ABF	4 OZH 043
2.0 GTI 16V	2,0		110	08.92-12.94	ABF → 1H-S-120000	4 OZH 165
2.0 GTI 16V	2,0		110	01.95-08.97	ABF 1H-S-120001 →	4 OZH 150
2.8 VR6	2,8	ohne Kat. ¹¹	128	01.92-09.94	AAA	6 OZH 024
2.8 VR6	2,8		128	01.92-08.94	AAA	6 OZH 043
2.8 VR6	2,8		128	09.94-06.95	AAA	6 OZH 022

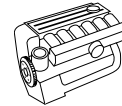

kW

 Zyl.
Cyl.
Cil.

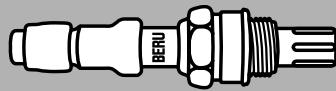
VW							
GOLF III, Variant							
2.8 VR6	2,8		128	07.95–08.97	AAA	6	OZH 151
2.9 VR6 Syncro	2,9		140	07.95–08.97	ABV	6	OZH 181
GOLF III Cabriolet							
1.6	1,6		74	12.95–05.98	AFT	4	OZH 022
1.8	1,8	Automatic ³	55	09.93–05.98	AAM	4	OZH 009
1.8	1,8		55	07.93–05.98	AAM 1E-S-012001 → 1E-S-024273	4	OZH 071
1.8	1,8		55	07.93–05.98	AAM 1E-S-024274 → 1E-S-050000	4	OZH 086
1.8	1,8	Automatic ³	66	09.93–07.95	ABS	4	OZH 009
1.8	1,8	ohne Kat. ¹¹	66	07.93–05.98	ABS	4	OZH 012
1.8	1,8		66	07.93–05.98	ADZ/ABS 1E-S-012001 → 1E-S-024273	4	OZH 071
1.8	1,8		66	07.93–05.98	ADZ/ABS 1E-S-024274 →	4	OZH 086
2.0	2,0		85	07.93–05.98	ADY/GG	4	OZH 022
GOLF IV, Variant							
1.6	1,6		74	08.97–08.98	AKL	4	OZH 169
1.6	1,6		74	08.97–02.00	AEH → Fgst. Nr. 1J.X.132 000	4	OZH 169
1.6	1,6		74	08.97–02.00	AEH Fgst. Nr. 1J.X.132 001 →	4	OZH 169
1.6 16V	1,6		77	02.00–06.05	AUS/ATN/AZD	4	OZH 182
1.8	1,8		92	08.97–06.05	AGN/BAF	4	OZH 177
1.8 4motion	1,8		92	05.98–06.05	AGN	4	OZH 128
1.8 T	1,8		110	08.97–06.05	AGU	4	OZH 128
1.8 T	1,8		110	08.97–06.05	ARZ/AUM	4	OZH 177
2.3 V5	2,3		110	08.97–10.00	AGZ	5	OZH 177
JETTA II							
1.3	1,3		40	01.84–06.87	MH/HK	4	OZH 047
1.3 KAT	1,3		40	06.87–07.87	NZ	4	OZH 047
1.3 KAT	1,3		40	08.87–07.90	NZ	4	OZH 048
1.3 KAT	1,3		40	08.90–12.91	NZ	4	OZH 031
1.6	1,6		51	10.86–10.91	PN	4	OZU 022
1.8	1,8		66	08.84–10.87	GX	4	OZU 022
1.8	1,8		79	08.85–10.87	RD	4	OZH 037
1.8	1,8		82	02.87–10.91	PB	4	OZU 022
1.8 KAT	1,8		66	11.87–10.91	GX/RP	4	OZU 022
1.8 KAT	1,8		79	01.87–10.91	PF	4	OZH 047
1.8 Syncro	1,8		66	08.87–12.88	RP	4	OZH 037
1.8 Syncro	1,8		72	08.88–07.91	1P	4	OZH 047
1.8 16V	1,8		102	06.87–12.89	KR	4	OZU 022
1.8 16V	1,8		95	08.86–10.91	PL	4	OZH 037
KAEFER							
1600 i (Mexico)	1,6		34	10.92–09.95	ACD	4	OZH 047
1600 i (Mexico)	1,6		34	08.96–07.03	ACD	4	OZH 043
LT 28 I							
2.4 i	2,4		69	08.89–06.96	1E	6	OZH 047
LT 28-35 I							
2.4 i	2,4		69	03.94–06.96	1E	6	OZH 047
LT 28-35 II							
2.3	2,3		105	05.96–11.01	AGL	4	OZH 146
LT 40-55 I							
2.4 i	2,4		69	01.93–06.96	1E	6	OZH 047
LUPO							
1.0	1,0		37	09.98–07.05	AER	4	OZH 169
1.0	1,0		37	09.98–07.05	ALL	4	OZH 177
1.4 16V	1,4	Automatic ³	55	09.98–07.05	AHW/APE/BBY/AKQ/AUA	4	OZH 179
1.4 16V	1,4		55	09.98–07.05	AHW/APE/BBY/AKQ/AUA	4	OZH 177
1.4 16V	1,4	D1	55	09.98–07.05	BBY	4	OZH 179
1.4 16V	1,4	Automatic ³	74	08.99–07.05	ANM/AFK/AUB/AQQ	4	OZH 179
1.4 16V	1,4		74	08.99–07.05	ANM/AFK/AUB/AQQ	4	OZH 177
1.4 16V	1,4	D1	74	08.99–07.05	ANM/AFK/AUB/AQQ	4	OZH 179

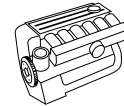

kW

Zyl.
Cyl.
Cil.**VW****PASSAT, Variant**

1.6	1,6		51	08.87-03.88	PP	4	OZU 001
1.6	1,6		53	08.88-04.90	1F	4	OZU 022
1.6	1,6		74	10.96-11.00	AHL/ADP/ARM	4	OZH 068
1.6	1,6		74	06.99-11.00	ANA	4	OZH 190
1.8	1,8	Automatic ³	55	08.90-08.96	AAM	4	OZH 009
1.8	1,8		55	08.90-07.91	AAM	4	OZU 001
1.8	1,8		55	09.94-06.95	AAM	4	OZH 071
1.8	1,8		55	07.95-08.96	AAM	4	OZH 086
1.8	1,8		66	08.84-03.88	JN	4	OZU 022
1.8	1,8	Automatic ³ , ohne Kat. ¹¹	66	08.91-09.94	ABS	4	OZH 009
1.8	1,8	ohne Kat. ¹¹	66	08.91-09.94	ABS	4	OZU 003
1.8	1,8		66	04.88-04.90	RP	4	OZU 022
1.8	1,8		79	04.88-07.90	PF	4	OZH 047
1.8	1,8		82	04.88-07.92	PB	4	OZH 047
1.8	1,8		92	10.96-11.00	ADR/APT/ARG	4	OZH 069
1.8 Syncro/4motion	1,8		92	10.96-11.00	ADR/APT/ARG	4	OZH 069
1.8 16V	1,8		100	04.88-12.89	KR	4	OZH 037
1.8 T	1,8		110	10.96-11.00	AEB	4	OZH 152
1.8 G60 Syncro	1,8		118	09.89-07.93	PG	4	OZH 008
2.0	2,0	ohne Kat. ¹¹	85	08.90-09.94	2E	4	OZH 008
2.0	2,0		85	08.90-07.94	2E	4	OZH 009
2.0	2,0		85	08.94-09.94	2E	4	OZH 043
2.0	2,0		85	07.94-09.94	2E	4	OZH 165
2.0	2,0		85	10.94-08.96	ADY/AGG	4	OZH 022
2.0 Syncro	2,0	ohne Kat. ¹¹	85	10.90-09.94	2E	4	OZH 008
2.0 Syncro	2,0		85	10.90-07.94	2E	4	OZH 009
2.0 Syncro	2,0		85	08.94-09.94	2E	4	OZH 043
2.0 Syncro	2,0		85	07.94-09.94	2E	4	OZH 165
2.0 Syncro	2,0		85	10.94-08.96	ADY/AGG	4	OZH 022
2.0	2,0		88	04.00-11.00	ASU	4	OZH 178
2.0 4motion	2,0		88	04.00-11.00		4	OZH 178
2.0 4motion	2,0	D1	88	04.00-11.00		4	OZH 190
2.0 16V	2,0		100	08.88-07.90	9A	4	OZH 037
2.0 16V	2,0		100	08.90-09.93	9A	4	OZH 009
2.0 16V	2,0		110	01.94-09.94	ABF	4	OZH 043
2.0 16V	2,0		110	09.94-08.96	ABF	4	OZH 150
2.2	2,2		85	08.85-03.88	KX	5	OZU 022
2.8 VR6	2,8	ohne Kat. ¹¹	128	06.91-07.94	AAA	6	OZH 024
2.8 VR6	2,8		128	07.94-07.95	AAA	6	OZH 022
2.8 VR6	2,8		128	08.95-08.96	AAA	6	OZH 151
2.8 V6 Syncro/4motion	2,8		142	01.97-04.97	APR/ACK/ALG/AQD	6	OZH 086
2.8 V6	2,8		142	05.97-11.00	ACK/AQD	6	OZH 071

POLO

1.0 KAT	1,0		33	10.90-09.94	AAU	4	OZH 031
1.2	1,2		40	01.02-	BMD	3	OZH 128
1.3 KAT	1,3		40	07.87-09.87	NZ	4	OZH 047
1.3 KAT	1,3		40	10.87-09.90	NZ	4	OZH 048
1.3 KAT	1,3		40	10.90-12.92	NZ	4	OZH 031
1.3 KAT	1,3		55	10.90-03.91	3F	4	OZH 031
1.4 16V	1,4	Automatic ³	55	10.99-09.01	AHW/AUA	4	OZH 179
1.4 16V	1,4	Automatic ³	74	10.99-09.01	AFK/AUB	4	OZH 179
45 1.0	1,0		33	10.94-09.96	AEV	4	OZH 068
50 1.0	1,0		37	09.96-10.99	AER	4	OZH 169
50 1.0	1,0		37	09.96-10.99	ALL	4	OZH 177
55 1.3	1,3	ohne Kat. ¹¹	40	10.94-07.95	ADX	4	OZH 181
55 1.3	1,3		40	10.94-07.95	ADX	4	OZH 068
60 1.4	1,4		44	07.95-05.96	AEX	4	OZH 068
60 1.4	1,4		44	05.96-04.98	AEX	4	OZH 151
60 1.4	1,4		44	05.98-10.99	AEX	4	OZH 177
60 1.4	1,4		44	05.98-10.99	AEX	4	OZH 181

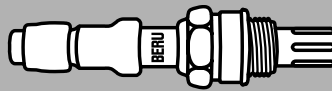

kW

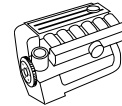
 Zyl.
Cyl.
Cil.

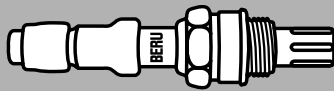

VW							
POLO							
75 1.6	1,6		55	10.94-07.95	AEA	4	OZH 068
75 1.6	1,6		55	10.94-04.97	AEE/AHS	4	OZH 068
75 1.6	1,6		55	05.97-10.99	AEE/AHS	4	OZH 215
100 1.4 16V	1,4		74	04.96-04.97	AFH	4	OZH 068
100 1.4 16V	1,4		74	05.97-04.98	AFH	4	OZH 215
100 1.4 16V	1,4		74	05.98-10.99	AFH	4	OZH 177
120 1.6 16V GTI	1,6		88	09.98-10.99	AJV	4	OZH 177
POLO CLASSIC							
60 1.4	1,4		44	12.95-05.97	AEX	4	OZH 071
60 1.4	1,4		44	06.97-10.98	AKV, ANX, AEX, APQ	4	OZH 151
60 1.4	1,4		44	11.98-09.01	AEX, AKV, APQ, ANX	4	OZH 177
75 1.6	1,6		55	11.95-09.01	ALM/AEE	4	OZH 070
75 1.6	1,6		55	11.95-09.97	1F	4	OZH 071
100 1.6	1,6		74	05.98-09.01	AKL/APF/AEH/AUR/AFT	4	OZH 022
POLO Coupe							
1.0 KAT	1,0		33	10.90-09.94	AAU	4	OZH 031
1.3	1,3		40	08.83-06.87	MH/HK	4	OZH 047
1.3 KAT	1,3		40	07.87-09.87	NZ	4	OZH 047
1.3 KAT	1,3		40	10.87-09.90	NZ	4	OZH 048
1.3 KAT	1,3		40	10.90-12.92	NZ	4	OZH 031
1.3 KAT	1,3		40	01.91-07.91	AAV	4	OZH 031
1.3 KAT	1,3		55	10.90-09.94	3F	4	OZH 031
1.3 G40	1,3	ohne Kat. ¹¹	83	10.90-09.94	PY	4	OZH 008
1.3 G40	1,3		83	08.90-09.94	PY	4	OZH 031
SCIROCCO							
1.8	1,8		70	11.85-07.92	JH	4	OZU 022
1.8 16V	1,8		95	03.86-07.92	PL	4	OZH 037
SHARAN							
2.8 VR6	2,8		128	09.95-12.95	AAA	6	OZH 181
2.8 VR6	2,8		128	01.96-02.98	AAA	6	OZH 151
TRANSPORTER T3							
1.9	1,9		61	01.83-07.85	DH	4	OZU 001
2.1	2,1		64	10.86-07.92	SR	4	OZH 037
2.1 i	2,1		68	07.89-07.92	SS	4	OZH 037
2.1	2,1		70	08.85-07.92	MV	4	OZH 037
2.1 Syncro	2,1		64	10.86-07.92	SR	4	OZH 037
2.1 Syncro	2,1		70	08.85-07.92	MV	4	OZH 037
TRANSPORTER T4							
2.0	2,0		62	09.90-12.95	AAC	4	OZH 010
2.0	2,0		62	01.96-	AAC	4	OZH 028
2.5	2,5	ohne Kat. ¹¹	81	11.90-12.93	AAF	5	OZH 134
2.5	2,5	ohne Kat. ¹¹	81	01.94-12.95	ACU	5	OZH 134
2.5	2,5		81	11.90-12.95	AAF, ACU	5	OZH 010
2.5	2,5		81	01.96-10.96	ACU	5	OZH 028
2.5 Syncro	2,5	ohne Kat. ¹¹	81	11.92-10.96	AEN/AAF/ACU/AEU	5	OZH 134
2.5 Syncro	2,5		81	11.92-12.95	AAF/ACU	5	OZH 010
2.5 Syncro	2,5		81	01.96-10.96	ACU	5	OZH 028
2.8 VR 6	2,8		103	11.95-04.00	AES	6	OZH 151
VENTO							
1.4	1,4	ohne Kat. ¹¹	40	11.91-09.94	AEX/ABD	4	OZH 024
1.4	1,4		40	11.91-09.94	AEX/ABD	4	OZH 043
1.4	1,4	ohne Kat. ¹¹	44	11.91-09.94	ABD	4	OZH 024
1.4	1,4	ohne Kat. ¹¹	44	10.94-07.95	ABD	4	OZH 151
1.4	1,4		44	11.91-09.94	ABD	4	OZH 043
1.4	1,4		44	09.94-07.95	ABD	4	OZH 070
1.4	1,4		44	07.95-12.97	AEX/ABD	4	OZH 181
1.6	1,6		55	09.92-09.94	ABU	4	OZH 043
1.6	1,6		74	12.95-09.98	AFT	4	OZH 022
1.8	1,8	Automatic ³	55	11.91-09.94	AAM	4	OZH 009
1.8	1,8		55	11.91-09.94	AAM	4	OZU 003
1.8	1,8		55	09.94-09.98	AAM	4	OZH 071



BERU

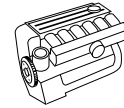

kW



Zyl.
Cyl.
Cil.



VW

VENTO

1.8	1,8	Automatic ³	66	11.91-09.94	ABS	4	OZH 009
1.8	1,8	ohne Kat. ¹¹	66	11.91-09.94	ADZ/ABS	4	OZH 012
1.8	1,8		66	11.91-09.94	ABS	4	OZU 003
1.8	1,8		66	11.91-09.98	ADZ	4	OZH 071
2.0	2,0	ohne Kat. ¹¹	85	11.91-09.94	2E	4	OZH 024
2.0	2,0		85	10.94-12.97	ADY, AGG, AKR	4	OZH 022
2.8 VR6	2,8	ohne Kat. ¹¹	128	01.92-09.94	AAA	6	OZH 024
2.8 VR6	2,8		128	01.92-09.94	AAA	6	OZH 043
2.8 VR6	2,8		128	09.94-07.95	AAA	6	OZH 022
2.8 VR6	2,8		128	05.96-12.97	AAA	6	OZH 151

ZASTAVA

YUGO

1.3 65 EFI	1,3		48	08.91-06.95	13 E 1.064	4	OZH 044
YUGO FLORIDA							
1.3	1,3		50	03.91-	13 E.3.064	4	OZH 044



kW

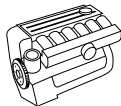

Zyl.
Cyl.
Cil.



ALFA ROMEO

33										
1.4 i.e., 4X4	1,4	65-66	06.91-09.94	AR 30587/AR 30753/ AR 30755	4			ST 048	ST 028	ST 073
1.5 i.e.	1,5	71	01.90-09.94	AR 30751	4			ST 048		ST 073
1.5 i.e.	1,5	74	07.90-08.91	AR 30750	4			ST 048	ST 028	
1.7 i.e., 4X4	1,7	77	09.88-12.89	AR 30558	4			ST 048	ST 028	
1.7 i.e.	1,7	77	04.92-09.94	AR 30737/AR 30737 A	4		ST 036	ST 048		ST 073
1.7 i.e., 4X4	1,7	79	01.90-03.92	AR 30736/AR 30737	4			ST 048	ST 028	ST 073
1.7 16V, 4X4	1,7	95-97	01.90-09.94	AR 30747	4			ST 048	ST 028	ST 073
1.7 16V, 4X4	1,7	101	01.90-09.94	AR 30746	4			ST 048		
1.8 TD	1,8	62	07.90-09.94	VM 96 A	4					ST 073
75										
1.6	1,6	76-81	05.85-02.92	AR 06100, AR 61101	4			ST 045		
1.8	1,8	85-95	09.85-02.92	AR 06168/AR 61102/ AR 06202	4			ST 045		
1.8	1,8	90	08.89-02.92	AR 61201	4			ST 045	ST 028	
1.8 Turbo, i.e.	1,8	110-114	02.86-02.92	AR 06134/AR 06158	4			ST 045		
2.0	2,0	94	05.85-10.88	AR 06212	4			ST 045		
2.0 T.S.	2,0	107-109	05.85-02.92	AR 06166/AR 06224	4			ST 045	ST 028	
3.0 V6	3,0	141	02.90-02.92	AR 61503	6				ST 028	
90										
1.8	1,8	85-89	10.84-07.87	AR 06202	4			ST 045		
2.0 i.e.	2,0	94	10.84-07.87	AR 01713/AR 06212	4			ST 045		
2.0 i.e.	2,0	97	10.84-07.87	AR 06210	6			ST 045		
2.4 TD	2,4	81	10.84-07.87	VM 81 A	4			ST 045		
145/146										
1.4 i.e.	1,4	66	07.94-12.96	AR 33501	4			ST 048		
1.4 i.e. 16V T.S.	1,4	76	11.96-01.01	AR 33503/AR 38501	4			ST 048	ST 028	
1.6 i.e.	1,6	76	10.94-12.96	AR 33201	4			ST 048	ST 028	
1.6 i.e. 16V T.S.	1,6	88	11.96-01.01	AR 67601/AR 38201	4			ST 048	ST 028	
1.7 i.e. 16V	1,7	95	10.94-12.96	AR 33401	4			ST 048	ST 028	
1.7 i.e. 16V T.S.	1,7	103	11.96-01.01	AR 67106/AR 38401	4			ST 048	ST 028	
1.7 i.e. 16V, T.S.	1,7	106	03.98-01.01	AR 32201	4			ST 048		
1.9 TD	1,9	66	10.94-02.99	AR 67501/AR 33601	4			ST 048		
147										
1.6 16V T.SPARK ECO	1,6	76	01.01-	AR 37203	4					ST 072
1.6 16V T.SPARK	1,6	88	01.01-	AR 32104	4					ST 072
1.9 JTD	1,9	81-85	01.01-	AR 37101/937 A2.000	4					ST 072
2.0 16V T.SPARK	2,0	110	01.01-	AR 32310	4					ST 072
155										
1.6 16V T.S.	1,6	88	05.96-01.98	AR 67601	4				ST 028	
1.7 T.S.	1,7	83	04.93-04.96	AR 67103	4			ST 048		
1.7 T.S.	1,7	85	04.93-04.96	AR 67105	4			ST 048	ST 028	ST 073
1.7 T.S. 16V	1,7	103	05.96-12.97	AR 67106	4			ST 048	ST 028	ST 073
1.8 T.S.	1,8	77	02.92-12.97	AR 67402	4			ST 048	ST 028	ST 073
1.8 T.S. Sport	1,8	93	01.92-12.96	AR 67101/AR 67102	4			ST 048	ST 028	ST 073
1.8 T.S.	1,8	95	02.92-06.93	AR 67101	4			ST 048	ST 028	ST 073
2.0 T.S.	2,0	104-106	02.92-02.95	AR 67202/AR 67201	4			ST 048	ST 028	ST 073
2.0 T.S. 16V	2,0	110	03.95-12.97	AR 67204	4			ST 048	ST 028	ST 073
2.0 16V Turbo Q4	2,0	137-140	01.94-12.97	AR 67203	4		ST 035		ST 088	ST 073
2.5 V6	2,5	120-121	02.92-12.97	AR 67301/AR 67302/ AR 67303	6				ST 028	ST 073
156										
1.6 16V T.SPARK	1,6	88	09.97-	AR 67601/AR 32102/ AR 32104/AR 32103	4					ST 072
1.8 16V T.SPARK	1,7	103-106	09.97-	AR 32201/AR 32205	4					ST 072
1.9 JTD	1,9	77-81	09.97-05.01	AR 32302/AR 37101	4					ST 072
2.0 16V T.SPARK	2,0	110-114	09.97-03.02	AR 32301/AR 32310	4					ST 072
2.4 JTD	2,4	100-103	09.97-	AR 32501/839 A6.000	5					ST 072
2.5 V6 24V	2,5	140-141	09.97-	AR 32401/AR 32405	6					ST 072

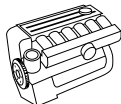

kW

Zyl.
Cyl.
Cil.**ALFA ROMEO****164**

2.0 T.S.	2,0	105-109	06.87-09.98	AR 06416/AR 06420/ AR 64103	4			ST 048	ST 028		
3.0 V6	3,0	132-141	06.87-09.92	AR 06410/AR 06412/ AR 66303/AR 64305	6					ST 028	
3.0 i.e. QV	3,0	147	09.90-09.92	AR 06430/AR 64301	6					ST 028	
3.0 24V	3,0	155-171	09.92-09.98	AR 64304/AR 64308/ AR 64307/AR 66301/ AR 66302	6					ST 028	

166

2.0 T.Spark	2,0	110-114	09.98-	AR 34103/AR 36301	4						ST 072
2.0 V6	2,0	151	09.98-	AR 34102	6		ST 036				ST 072
2.4 JTD	2,4	100-103	09.98-	AR 34202/AR 36202	5						ST 072
2.5 V6 24V	2,5	138-140	09.98-	AR 34201/AR 36201	6						ST 072
3.0 V6 24V	3,0	162-166	09.98-	AR 34301/AR 36101	6						ST 072

ALFASUD

1.2, ti	1,2	44-50	06.72-09.84	AR 30102/AR 30102 S/ AR 30104	4			ST 048			
1.3, Sprint, Super, SC/ ti Super, ti	1,3	48-63	09.76-12.84	AR 30160/AR 30164/ AR 30168/AR 30180	4			ST 048			
1.4 Sprint	1,4	55-63	05.78-12.89	AR 30164/AR 30168	4			ST 048			
1.5, ti, ti Sprint, Veloce	1,5	61-77	05.78-12.87	AR 30124/AR 30128/ AR 30146	4			ST 048			
1.7 i.e. Sprint	1,7	77	10.87-12.89	AR 30558	4			ST 048	ST 028		
1.7 Sprint	1,7	87	03.87-12.89	AR 30550	4			ST 048			

ALFETTA

1.6, GT	1,6	79	01.75-12.84	AR 01600	4			ST 045			
1.8, GT	1,8	85-89	01.74-12.84	AR 01608/AR 01608 X/ AR 01678	4			ST 045			
2.0, GT	2,0	89-96	03.77-01.86	AR 01623/AR 01655/ AR 01713/AR 10520	4			ST 045			

GIULIA

1300 TI, Super, GT	1,3	62-64	04.69-12.78	AR 00530	4			ST 045			
1600 Super, GT	1,6	71-76	06.64-12.78	AR 00526	4			ST 045			
1.8 D	1,8	38	06.76-12.78	Perkins 4.108	4			ST 045			

GT

1300 Junior	1,3	64	01.66-12.77	AR 00530	4			ST 045			
-------------	-----	----	-------------	----------	---	--	--	---------------	--	--	--

GTV

1.8 16V	1,7	106	05.98-03.03	AR 32201	4						ST 072
2.0 T.SPARK 16V	2,0	110-114	06.95-08.00	AR 32310/AR 32301	4				ST 028		ST 072
2.0 T.SPARK 16V	2,0	110	08.00-	AR 32310	4						ST 072
2.0 V6 Turbo	2,0	148	06.95-	AR 16202	6						ST 072
3.0 V6 24V	3,0	160-162	10.96-	AR 16102/AR 16105	6						ST 072

SPIDER

1.8 16V	1,7	106	05.98-	AR 32201	4						ST 072
2000	2,0	88-93	01.90-12.93	AR 01588/AR 01590	4				ST 028		
2.0 T.SPARK 16V	2,0	110-114	06.95-08.00	AR 16201/AR 32301	4				ST 028		ST 072
2.0 V6 Turbo	2,0	148	05.98-	AR 16202	6						ST 072
3.0 V6	3,0	141	06.95-	AR 16101	6				ST 028		ST 072
3.0 V6, 24V	3,0	160-162	01.99-	AR 16102/AR 16105	6						ST 072

ALPINA**A310**

2.7 V6	2,7	110	01.76-12.84		6			ST 043			
--------	-----	-----	-------------	--	---	--	--	---------------	--	--	--

V6

2.5 TURBO	2,5	136-147	01.85-12.90	Z7U/Z7U-734	6			ST 015			
-----------	-----	---------	-------------	-------------	---	--	--	---------------	--	--	--

AUDI**A2**

1.2 TDI	1,2	45	03.01-08.05	ANY	3			ST 119			
1.4	1,4	55	02.00-08.05	BBY/AUA	4			ST 119			
1.4 TDI	1,4	55	02.00-08.05	AMF/BHC	3			ST 119			



kW

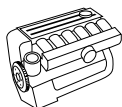

Zyl.
Cyl.
Cil.



AUDI									
A2									
1.4 TDI	1,4	66	11.03-08.05	ATL	3				ST 119
1.6 FSI	1,6	81	05.02-08.05	BAD	4				ST 119
A3									
1.6	1,6	74	09.96-08.00	AKL/APF/AEH	4		ST 112		ST 104
1.6	1,595	74	09.96-08.00	AKL/APF/AEH → 8L-X-035 000	4		ST 121		
1.6	1,595	74	09.96-08.00	AKL/APF/AEH 8L-X-035 001 →	4		ST 119		
1.6	1,595	75	08.00-	AVU/BFQ	4		ST 112	ST 114 ST 119	ST 104
1.8, quattro	1,8	92	09.96-	AGN/APG	4		ST 112		ST 104
1.8, quattro	1,781	92	09.96-	AGN/APG → 8L-X-035 000	4		ST 121		
1.8, quattro	1,781	92	09.96-	AGN/APG 8L-X-035 001 →	4		ST 119		
1.8 T, quattro	1,8	110	12.96-	ARX/ARZ/AQA/AGU/AUM	4		ST 112	ST 121	ST 104
1.8 T, quattro	1,781	110	12.96-	ARX/ARZ/AQA/AGU/AUM → 8L-X-035 000	4		ST 121		
1.8 T, quattro	1,781	110	12.96-	ARX/ARZ/AQA/AGU/AUM 8L-X-035 001 →	4		ST 119		
1.8 T, quattro	1,8	132	10.98-	AJQ/APP/ARY/AUQ	4		ST 112	ST 121	ST 104
1.8 T, quattro	1,781	132	10.98-	AJQ/APP/ARY/AUQ → 8L-X-035 000	4		ST 121		
1.8 T, quattro	1,781	132	10.98-	AJQ/APP/ARY/AUQ 8L-X-035 001 →	4		ST 119		
1.9 TDI	1,896	66	09.96-07.01	AGR/ALH	4		ST 112		ST 104
1.9 TDI	1,896	66	09.96-07.01	AGR/ALH → 8L-X-035 000	4		ST 121		
1.9 TDI	1,896	66	09.96-07.01	AGR/ALH 8L-X-035 001 →	4		ST 119		
1.9 TDI	1,896	74	10.00-	AXR/ATD	4		ST 112	ST 119	ST 104
1.9 TDI	1,896	81	08.97-07.01	AHF/ASV	4		ST 112		ST 104
1.9 TDI	1,896	81	08.97-07.01	AHF/ASV → 8L-X-035 000	4		ST 121		
1.9 TDI	1,896	81	08.97-07.01	AHF/ASV 8L-X-035 001 →	4		ST 119		
1.9 TDI, quattro	1,896	96	08.00-	ASZ	4		ST 112	ST 119	ST 104
2.0 TDI, 16V, 16V quattro	2,0	100-103	05.03-	AZV/BKD	4			ST 114	
2.0 TFSI, quattro	2,0	147	09.04-	AXX → 8P-6A185 000	4		ST 113		
S3 quattro	1,8	154	03.99-	APY → 8L-X-035 000	4				
S3 quattro	1,781	154	03.99-	AMK/APY/AUL 8L-X-035 001 →	4				
S3 quattro, (AC)	1,8	154	03.99-	AMK/APY/AUL F 8L-Y-000 001 →	4		ST 112		
S3 quattro, (AC)	1,8	165	10.01-	BAM 8L-X-035 001 →	4		ST 112		
A3 Sportback									
2.0 TDI 16V	2,0	103	09.04-	BKD	4			ST 114	
2.0 TFSI, quattro	2,0	147	09.04-	AXX → 8P-6A185 000	4		ST 113		
A4									
1.6	1,6	74-75	01.95-12.04	ADP/AHL/ALZ/ANA/ARM → 8D-X-500 000	4				ST 065
1.6	1,6	74-75	01.95-12.04	ADP/AHL/ALZ/ANA/ARM 8D-Y-000 001 →	4				ST 065
1.8, quattro	1,8	85-92	04.95-09.01	ADR/APT/ARG/AVV/AFY → 8D-X-500 000	4				ST 065
1.8, quattro	1,8	85-92	04.95-09.01	ADR/APT/ARG/AVV/AFY 8D-Y-000 001 →	4				ST 065
1.8	1,8	95	01.95-11.00		4				ST 065
1.8 T, quattro	1,8	110	01.95-11.00	ARK/AEB/ANB/APU/AWT 8D-V-000 001 →	4				



kW

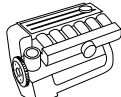

Zyl.
Cyl.
Cil.



AUDI									
A6									
1.9 TDI	1,9	81-85	02.97-01.05	AFN/AJM/AVG → 4B-X-200 000	4			ST 121	ST 065
1.9 TDI	1,9	81-85	02.97-01.05	AFN/AJM/AVG 4B-Y-000 001 →	4			ST 119	ST 065
1.9 TDI	1,9	96	08.01-01.05	AWX/AVF	4			ST 119	ST 065
2.0	2,0	74-85	06.94-12.97	AAE/ABK	4			ST 122	ST 065
2.0	2,0	96	08.01-01.05	ALT	4			ST 114	ST 065
2.0 16V quattro	2,0	103	06.94-12.97	ACE	4				ST 065
2.0 TFSI	2,0	125	06.05-	BPJ	4			ST 113	
2.3, quattro	2,3	98	06.94-12.95	AAR	5				ST 065
2.4, quattro	2,4	100-125	02.97-01.05	AGA/ALF/AJG/ALW/AML/ AMM/ARN/APC/APS/APZ/ ARN/ASM/ARJ → 4B-X-200 000	6			ST 121	ST 065
2.4, quattro	2,4	100-125	02.97-01.05	AGA/ALF/AJG/ALW/AML/ AMM/ARN/APC/APS/APZ/ ARN/ASM/ARJ 4B-Y-000 001 →	6			ST 119	ST 065
2.4, quattro	2,4	125	08.01-01.05	BDV	6			ST 119	ST 065
2.4	2,4	130	01.05-	BDW	6			ST 114	
2.5 TDI, quattro	2,5	84-103	06.94-02.97	AAT/AEL	5				ST 060 ST 065
2.5 TDI, quattro	2,5	110-132	07.97-01.05	AFB/AKN/BAU/AKE/BND/ BDH → 4B-X-200 000	6			ST 121	ST 065
2.5 TDI, quattro	2,5	110-132	07.97-01.05	AFB/AKN/BAU/AKE/BND/ BDH 4B-Y-000 001 →	6			ST 119	ST 065
2.5 TDI	2,5	114-120	08.01-01.05	AYM/BCZ/BDG/BFC	6			ST 119	ST 065
2.6, quattro	2,6	102-110	06.94-12.97	ABC/ACZ 4A-V-000 001 →	6			ST 121	ST 065
2.7 T, quattro	2,7	169	12.97-01.05	AJK/AZA → 4B-X-200 000	6			ST 121	ST 065
2.7 T, quattro	2,7	169	12.97-01.05	AJK/AZA 4B-Y-000 001 →	6			ST 119	ST 065
2.7 T quattro	2,7	184	08.01-01.05	BES/ARE	6			ST 119	ST 065
2.8		128	06.94-12.97	AAH/AEJ 4A-V-000 001 →	6			ST 121	ST 065
2.8, quattro		132-142	02.97-01.05	AGE/ATX/APR/ACK/ALG/ AQD/AMX/BBG/ATX → 4B-X-200 000	6			ST 121	ST 065
2.8, quattro		132-142	02.97-01.05	AGE/BBG/ATX/APR/ACK/ ALG/AQD/AMX/BBG/ATX 4B-Y-000 001 →	6			ST 119	ST 065
2.8	2,8	142	12.95-12.97	ACK	6			ST 121	ST 065
3.0, quattro	3,0	162	08.01-01.05	ASN	6			ST 114 ST 119	ST 065
3.2 FSI, quattro	3,1	188	05.04-	AUK/BKH	6			ST 114	
3.7, quattro	3,7	191	03.99-	AQG	8				ST 065
4.2 quattro	4,2	220	11.98-01.05	ARS/AWN/ASG	8			ST 119	ST 065
RS6	4,2	331	07.02-	BCY	8				ST 065
S6 Turbo quattro	2,2	169	06.94-02.97	AAN	5				ST 060 ST 065
S6 4.2 quattro	4,2	213	06.94-02.97	AEC	8				ST 060 ST 065
S6 Plus quattro	4,2	240	04.96-02.97	AHK	8				ST 060 ST 065
S6 quattro	4,2	250	09.99-01.05	ANK	8			ST 119	ST 065
A6									
S6 quattro	4,2	250	09.99-01.05	AQJ	8				ST 065
A8									
2.5 TDI, quattro	2,5	110	01.97-04.00	AFB/AKN	6			ST 119	ST 065
2.5 TDI, quattro	2,5	132	09.00-09.02	AKE	6				ST 065
2.8, quattro	2,8	120-142	03.94-09.02	AAH/ACK/AEJ/ALG 4D-T-000 001 →	6			ST 121	
2.8, quattro	2,8	120-142	03.94-09.02	AAH/ACK/AEJ/ALG/AMX/ APR/AQD	6				ST 065



kW

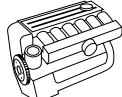

Zyl.
Cyl.
Cil.



AUDI

A8

3.0	3,0	162	08.03-	ASN	6	ST 112	ST 114				
3.3 TDI quattro	3,3	165	06.00-	AKF	8						ST 065
3.7, quattro	3,7	169	07.95-11.98	AEW	8					ST 060	ST 065
3.7, quattro	3,7	191	11.98-09.02	AKC	8						ST 065
3.7, quattro	3,7	191	11.98-09.02	AQG	8		ST 119				ST 065
4.2 quattro	4,2	175	02.99-04.00	ARU	8		ST 119				
4.2 quattro	4,2	175-228	11.98-09.02	AUX/AUW	8		ST 119				ST 065
4.2 quattro	4,2	180-220	03.94-11.98	ABZ/AEM	8				ST 060		ST 065
4.2 quattro	4,2	228	11.98-09.02	AQF	8		ST 119				
6.0 W12 quattro	6,0	309	01.01-	AZC	12						ST 065
S 8 quattro	4,2	250	07.96-06.99	AHC	8				ST 060		ST 065
S 8 quattro	4,2	265	06.99-	AVP	8						ST 065
S 8 quattro	4,2	265	06.99-09.02	AQH	8		ST 119				ST 065

V8

3.6 quattro	3,6	180-184	04.93-02.94	PT	8					ST 060	
4.2 quattro	4,2	206	10.91-02.94	ABH	8					ST 060	

50

1.1, 1.3	1,1	37-44	08.74-07.78	HB/HC/HH	4						ST 070 ST 100
----------	-----	-------	-------------	----------	---	--	--	--	--	--	--------------------------------

80

1.3	1,3	40-44	05.72-07.86	FY/FZ	4		ST 053				ST 065
1.3	1,3	40-44	05.72-07.85	EP/ZA/ZF	4		ST 053				ST 065 ST 100
1.5	1,5	55-63	05.72-07.76	ZB/ZC/YJ	4		ST 053				ST 100
1.6 D	1,6	40	09.86-08.91	JK	4						ST 065 ST 071
1.6 D,TD	1,6	40-51	01.82-08.86	CR/CY/JK	4						ST 065
1.6	1,6	51-55	09.86-09.91	PP/RN	4		ST 053		ST 065		ST 071
							ST 122				
1.6	1,6	52	09.91-12.94	ABM	4		ST 122				ST 065 ST 108
1.6, Automatik, GLE	1,6	54-81	01.82-12.86	DT/SA/WV/YN/YP/YZ	4		ST 038				ST 065
1.6	1,6	55	09.75-07.78	YN	4						ST 100
1.6 TD	1,6	59	09.86-08.91	RA/SB	4		ST 053		ST 065		ST 071
							ST 122				
1.6 E	1,6	74	09.91-01.96	ADA	4						ST 065
1.6	1,6	75	08.90-10.91	ABB	4		ST 122				
1.8, E, S	1,8	55-82	06.86-08.91	DZ/RU/SF	4		ST 053		ST 065		ST 071
							ST 122				
1.8, CC quattro, GTE, GTE quattro	1,8	65-82	08.84-08.86	DZ/NE/SF	4		ST 053				ST 065
1.8 S	1,8	66	09.86-10.91	NE/PM/JN	4		ST 122				
1.8	1,8	66	01.83-08.86	DS	4						ST 065
1.8, CC quattro, GTE, GTE quattro	1,8	68-81	08.83-08.86	JN/PV	4		ST 053		ST 013		ST 065
1.8	1,8	83	09.86-07.88	SD	4						ST 100
1.9 D, TD,TDI	1,9	50-66	08.89-01.96	AAZ/1Y/1Z	4		ST 053				ST 065 ST 071
1.9 TD	1,9	55	08.89-12.94	1Y/AAZ	4		ST 122				ST 108
1.9 TD (AC)	1,9	55	09.91-12.94	AAZ	4		ST 115				
1.9 TDI	1,9	66	09.91-01.96	1Z	4		ST 122				ST 108
1.9 TDI (AC)	1,9	66	07.92-12.94	1Z	4		ST 115				
1.9 CD-5S	1,9	85	09.81-07.83	WN	5		ST 038				
2.0, E, quattro	2,0	66-85	09.91-01.96	ABK/ABT	4		ST 122				ST 065
2.0, quattro, E, E quattro, E 16V, E 16V quattro	2,0	82-101	08.88-09.91	AAD/3A/6A	4		ST 122		ST 013		ST 065 ST 071
2.0 E		83	08.88-10.90	3A 8A-L-000 001 →	4		ST 122				
2.0, quattro	2,0	85	10.83-09.84	HP/JS	5		ST 038				ST 065
2.0 E, quattro	2,0	85	09.91-01.96	ABK	4		ST 122				ST 108
2.0 E 16V, quattro	2,0	101	03.90-09.91	6A	4		ST 122				ST 108
2.0 E 16V, quattro	2,0	103	04.92-01.96	ACE	4				ST 013		ST 065
2.2, quattro	2,1	85-100	10.80-07.84	KK/WE	5		ST 038				ST 065
2.3 E, quattro	2,3	98	09.91-01.96	NG, (KAT)	5						ST 065 ST 108
2.6, quattro	2,6	110	07.92-01.96	ABC	6						ST 065
2.8, quattro	2,8	128	09.91-01.96	AAH	6						ST 065 ST 108





kW

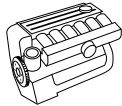

Zyl.
Cyl.
Cil.



AUDI									
80									
RS2 quattro, S2 quattro	2,2	169-232	02.93-07.95	ABY/ADU	5				ST 065
90									
1.6 TD	1,6	51-59	10.85-09.91	CY/RA/SB	4				ST 065 ST 071
1.6 TD		59	04.87-09.91	SB 8A-L-000 001 →	4		ST 122		
2.0, 20 V, 20 V quattro	2,0	83-118	10.84-09.91	HP/JS/NM/SK	5		ST 053		ST 065 ST 071
2.0	2,0	85	07.88-09.91	PS	5		ST 053	ST 013	ST 065 ST 071
2.2, E, E quattro	2,2	85-100	10.84-09.91	HY/JT/KV/KX	5		ST 053		ST 065 ST 071
2.3 E, E quattro, E 20V, E 20V quattro	2,3	98-125	04.87-09.91	7A/NG/NG (KAT)	5		ST 053		ST 065 ST 071
100									
1.6		63	01.75-07.76	YM	4		ST 053		ST 100
1.6		63	08.76-02.83	YV → 438 230 0000	4		ST 053		ST 100
1.6	1,6	63	01.80-02.83	YV	4		ST 053		ST 071
1.8, quattro	1,8	55-65	08.82-08.87	DR/RS/SH	4		ST 053		ST 071
1.8, LS	1,8	63-74	10.70-07.76	ZU/ZZ	4		ST 054		ST 100
1.8, quattro, -KAT	1,8	66	08.83-11.90	DS/JW/NP/4B/PH	4		ST 053	ST 013	ST 071
1.9	1,9	74	08.80-07.82	WH	5				ST 071
1.9	1,9	74	08.82-07.84	WH	5		ST 053		ST 071
1.9, GL	1,9	82-85	01.70-12.76	ZJ/ZP	4		ST 054		
2.0 D	2,0	51	01.80-02.83	CN	5				ST 071
2.0 D, D Turbo, TD	2,0	51-74	08.82-11.90	CN/DE/NC	5		ST 053		ST 071
2.0, E, 16V, -quattro	2,0	74-103	12.90-06.94	AA/DAE/ABK/ACE	4		ST 122		ST 065 ST 108
2.0	2,0	83-85	08.84-12.87	KP/SL	5				ST 071
2.0 KAT	2,0	85	01.88-11.90	RT	5		ST 053		ST 071
2.0	2,0	85	06.76-08.78	WA → 438 230 0000	4				ST 100
2.1	2,1	85-100	01.80-07.84	KF/WB/WC/WE/WG	5				ST 071
2.1	2,144	85-100	10.77-07.82	WB/WC/WE/WG → 438 230 0000	5				ST 100
2.2, E, Turbo, -quattro	2,2	101-121	08.84-11.90	KU, (KAT)/MC	5		ST 053		ST 071
2.2, E quattro	2,2	85-88	10.84-09.86	KZ/PX	5				ST 071
S4 Turbo quattro	2,2	169	08.91-06.94	AAN	5				ST 065
2.3, E, -quattro	2,3	98	08.86-11.90	NF	5		ST 053		ST 071
2.3 E, -quattro	2,3	98	12.90-06.94	AAR	5				ST 065 ST 108
2.4 D	2,4	60	08.89-07.91	3D	5		ST 053		ST 071
2.4 D	2,4	60	05.91-06.94	AAS	5				ST 065 ST 108
2.5 TDI	2,5	85	06.91-06.94	AAT/ABP	5				ST 065
2.5 TDI	2,5	88	01.90-11.90	1T	5				ST 071
2.6, quattro	2,6	110	03.92-06.94	ABC	6			ST 013	ST 065
2.8 E, quattro	2,8	128	09.91-06.94	AAH	6			ST 013	ST 065
S4 V8 quattro	4,2	206-213	10.92-06.94	ABH/AEC	8				ST 065
200									
2.1 5 E, 5 T	2,1	100-125	10.79-09.82	WC/WJ	5		ST 038		
2.2, Turbo, -quattro	2,2	101-121	08.84-12.87	KU/MC	5		ST 038		
2.2 Turbo, 20V Turbo, -quattro	2,2	121-162	01.88-12.91	1B/2B/3B/MC	5		ST 053		
ALLROAD									
2.5 TDI quattro	2,5	120-132	05.00-08.05	BAU/BCZ/AKE	6		ST 119		
CABRIOLET									
1.8	1,8	92	01.97-08.00	ADR	4		ST 122		ST 065
1.8 T, quattro	1,8	120	07.02-	BFB	4		ST 114		
1.9 TDI	1,9	66	06.95-08.00	1Z/AHU	4				ST 065
2.0 E, 16V	2,0	85-103	01.93-07.98	ABK/ACE	4		ST 122		ST 065
2.0 TFSI	2,0	147	01.06-	BWE	4		ST 113		
2.3 E	2,3	98	05.91-07.94	NG (KAT)	5				ST 065
2.5 TDI	2,5	120	08.02-	BCZ/BDG/BFC	6		ST 119		
2.6	2,598	102-110	06.93-08.00	ABC/ACZ 8G-V-000 001 →	6		ST 121		ST 065
2.8	2,771	128	11.92-08.00	AAH 8G-V-000 001 →	6		ST 121		ST 065
COUPE									
1.6	1,6	55	07.80-08.81	YN	4		ST 038		
1.8	1,8	55	08.81-07.83	DD	4		ST 053		





kW

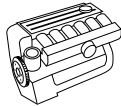

Zyl.
Cyl.
Cil.



BMW										
3										
318 i	1,8	75	12.84-08.88	M 10 B 18 (L-Jetronic), (L-Jetronic, Kat.)	4					ST 028
318 i	1,8	75-77	09.82-08.88	M 10 B 18 (L-Jetronic), (L-Jetronic, Kat.), (K-Jetronic)	4			ST 003		ST 028
318 i, is	1,8	83-100	09.87-06.94	M 40 B 18, (Kat.)	4			ST 117		ST 028
318 i	1,8	85	01.90-06.91	M 40 B 18	4			ST 117		
318 i	1,8	85	10.93-10.99	M 43 B 18	4			ST 117		
318 is, ti	1,8	103	03.92-09.97	M 42 B 18	4			ST 117		
320/6	2,0	90-95	09.77-10.93	M 20 B 20, (L-Jetronic), (Motronic, Kat.)	6			ST 003		ST 028
320 i	2,0	92	10.75-08.77	M 10 B 20 (K-Jetronic)	4			ST 003		
320 i	2,0	92	09.82-12.85	M 20 B 20 (L-Jetronic)	6					ST 028
320 i	2,0	110	09.90-04.99	M 50 B (20 6 S1)/ M 50 B (20 6 S2) Vanos/ M 52 B (20 6 S3) Vanos/ M 50 B (20 6 S1)	6		ST 010	ST 117		ST 028
323 i	2,3	102-110	01.78-08.86	M 20 B 23, (K-Jetronic), (L-Jetronic)	6			ST 003		
323 i	2,3	110	09.84-08.86	M 20 B 23 (L-Jetronic)	6			ST 003		ST 028
324 d, td	2,4	63-85	09.85-08.91	M 21 D 24/M 21 D 24 W/M 21 D 24 WA	6			ST 003		ST 110
325 td, tds	2,5	85-105	09.91-10.99	M 51 D 25, (Inter.)	6		ST 005	ST 117		
325 i	2,5	141	09.90-04.99	M 50 B 25/M 52 B 25 (Vanos)	6		ST 010			ST 028
325 e 2.7	2,7	90-95	10.83-12.88	M 20 B 27, (Kat)	6					ST 028
M3 2.3, EVO 2.3	2,3	143-162	07.86-06.91	S 14 B 23, (Kat), (EVO I)	4					ST 028
M3 EVO II 2.5	2,5	175	01.90-01.92	S 14 B 25 (EVO II)	4					ST 028
M3 3.0	3,0	210-217	10.92-10.95	S 50 B 30	6		ST 010	ST 117		ST 028
M3 3.2	3,2	236	09.95-04.99	S 50 B 32	6		ST 010			
5										
518	1,8	66	06.81-08.84	M 10 B 18 (2B4)	4			ST 003		ST 028
518, i	1,8	66-77	07.74-12.87	M 10 B 18, (38 PDSI), (32/32 DIDTA), (L-Jetro- nic)	4			ST 003		
518 g, i	1,8	83-85	08.89-01.97	M 40 B 18 (Kat.)/M 43 B 18	4			ST 117		ST 028
520 i, /6	2,0	90-95	09.77-12.87	M 20 B 20, (4A1), (K-Jetronic), (L-Jetronic)	6			ST 003		ST 028
520 i	2,0	95	08.85-08.91	M 20 B 20 (Motronic, Kat.)	6			ST 003		ST 028
520 i, 24V	2,0	110	09.89-01.97	M 50 B (20 6 S1), (20 6 S2) Vanos	6		ST 010			ST 028
520 i	2,0	110	09.95-01.97	M 50 B (20 6 S2) Vanos/ M 50 B (20 6 S1)	6			ST 117		
524 d	2,4	63	03.86-12.87	M 21 D 24	6			ST 003		
524 td	2,4	85	03.88-09.95	M 21 D 24/M 21 D 24 (Kat.)	6					ST 060
524 td	2,4	85	03.88-09.95	M 21 D 24/M 21 D 24 WA	6					ST 110
525 td, tds	2,5	85-105	09.91-05.04	M 51 D 25, (Inter.)	6		ST 005			
525	2,5	110	08.76-05.81	M 30 B 25 (4A1)	6			ST 003		
525 i	2,5	125	01.88-08.91	M 20 B 25 (Kat.)	6			ST 117		ST 028
525 i, X, X 24V	2,5	141	09.89-01.97	M 50 B 25/M 52 B 25 (Vanos)	6		ST 010	ST 117		ST 028
525 e 2.7	2,7	90-95	09.81-12.87	M 20 B 27, (Kat)	6			ST 003		ST 028
528 i	2,8	130-135	04.77-12.87	M 30 B 28 (L-Jetronic)	6			ST 003		
530 i	3,0	138	01.88-08.91	M 30 B 30 (Kat.)	6			ST 117		
535 i	3,4	155	01.88-09.95	M 30 B 35 (Motronic, 9:1, Kat.)	6			ST 117		

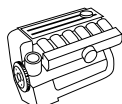

kW

Zyl.
Cyl.
Cil.**BMW**

5									
M 535 i	3,5	160	06.80-08.81	M 30 B 35 (Motronic, 9.3:1)	6				ST 003
M5 3.6	3,5	232	10.88-05.92	S 38 B 36, (Kat)	6				ST 117
M5 3.8	3,8	250	09.94-01.97	S 38 B 38	6				ST 117
7									
728 i	2,8	135	07.78-08.86	M 30 B 28 (L-Jetronic)	6				ST 003
730 i,iL	3,0	138-145	12.86-09.94	M 30 B 30, (Kat.)	6				ST 117
730 i,iL	3,0	155-160	10.94-11.01	M 60 B 30	8			ST 010	ST 117
730 i,iL V8	3,0	160	04.92-09.94	M 60 B 30	8				ST 117
735 i,iL	3,4	155	09.86-01.91	M 30 B 35 (Motronic, 9:1, Kat.)	6				ST 117
									ST 060
735 i,iL	3,4	155	09.86-09.92	M 30 B 35 (Motronic, 9:1, Kat.)	6				ST 117
									ST 028
735 i,iL	3,4	162	09.86-12.87	M 30 B 35 (Motronic, 9.2:1)	6				ST 117
									ST 028
740 i,iL V8	4,0	210	04.92-09.94	M 60 B 40	8				ST 117
740 i,iL	4,0	210	10.94-11.01	M 60 B 40	8			ST 010	ST 117
740 i,iL	4,4	210	01.96-11.01	M 62 B 44	8				ST 010
									ST 060
750 i,iL V12	5,0	220	09.87-09.94	M 70 B 50	12				ST 010
									ST 117
8									
840 i	4,0	210	02.93-02.96	M 60 B 40	8				ST 010
									ST 117
850 i,Ci	5,0	220	04.90-10.94	M 70 B 50	12				ST 010
									ST 117
850 CSi	5,6	280	04.93-12.96	M 70 B 56	12				ST 010
									ST 117
Z1									
2.5	2,5	125	06.88-06.91	M 20 B 25 (Kat.)	6				ST 028
Z3									
M 3.2, Coupe	3,2	236	03.97-06.01	S 50 B 32	6				ST 010

CITROËN

AX									
10	1,0	33	07.86-12.98	CDY (TU9M)	4			ST 049	ST 028
10	1,0	37	07.92-12.98	CDZ (TU9M)	4				ST 028
10 E	1,0	30	12.86-12.88	C3A	4				ST 049
11, KAT	1,1	40-44	09.88-12.97	HAZ (TU1CP)/HDZ (TU1M)	4				ST 049
1.3 Sport	1,3	70	04.87-12.88	M4A	4				ST 049
14	1,4	44	12.86-12.88	KAY (TU3CP)	4				ST 049
1.4 GTi	1,4	66-69	06.91-12.96	KFY (TU3FJ2)/KFZ (TU3FJ2)	4			ST 034	ST 049
									ST 012
1.4 GTi	1,4	74	06.91-12.92	KFZ (TU3FJ2)	4			ST 034	ST 049
14, 4X4	1,4	55	08.91-12.96	KDZ (TU3M/Z)/KDY (TU3FM)/KDX (TU3M/Z)/KDY (TU3M)	4				ST 049
									ST 028
15 D	1,5	40-43	08.94-12.97	VJY (TUD5)/VJZ (TUD5)	4				ST 029

BERLINGO

1.8 D	1,8	43	07.98-00.00	A9A (XUD7)	4				ST 029
1.9 D, 4WD	1,9	50-51	07.96-	D9B (XUD9A/L)/DJY (XUD9A)/WJZ (DW8)/WJY (DW8B)	4				ST 029

BX

14	1,4	47	01.89-12.89	K1H (TU3A)	4				ST 049
									ST 101
14	1,4	55	01.89-02.93	KDZ (TU3M/Z)/KDY (TU3M)	4				ST 049
									ST 012
15, 16	1,6	59-53	10.87-12.94	B1E (XU51C)	4				ST 049
16, E	1,6	65	05.89-12.94	BDZ (XU5M)/BDY (XU5M)	4				ST 049
16	1,6	76	03.86-12.94	180Z	4				ST 028
TRD Turbo	1,8	66	03.88-02.93	A8A (XUD7TE)/AJZ (XUD7TE)	4				ST 049
19 D	1,9	51	03.87-12.94	D9B (XUD9A/U)	4				ST 049

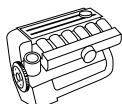

kW

 Zyl.
Cyl.
Cil.

FIAT									
CINQUECENTO									
1.1 Sporting	1,1	40	10.94-01.98	176 B2.000	4			ST 088	ST 073
COUPE									
1.8 16V	1,7	96	03.96-00.00	183 A1.000	4			ST 028	ST 072
1.8 16V	1,7	96	03.96-00.00	183 A1.000	4			ST 088	
2.0 16V, Turbo	2,0	102-143	11.93-00.00	175 A1.000/836 A3.000	4		ST 046	ST 088	ST 072
2.0 20V, Turbo	2,0	108-162	08.96-00.00	175 A3.000/182 A1.000/ 182 B3.000	5				ST 072
CROMA									
1600	1,6	61	12.85-12.90	154 A.048	4				ST 073
2000 CHT	2,0	66-74	12.85-09.92	154 A1.000	4				ST 073
2000 i.e.	2,0	83	03.86-09.90	834 B.048	4			ST 028	ST 073
2000 i.e.	2,0	85-88	03.87-08.96	154 C3.046/834 B.000/ 834 B.146	4		ST 035	ST 028	ST 073
2000 i.e.	2,0	85-88	03.87-08.96	154 C3.046/834 B.000/ 834 B.146	4		ST 035	ST 088	ST 073
2000 16V, i.e. Turbo	2,0	101-114	12.85-08.96	154 A2.000/154 C4.046/ 154 E1.000/834 C.146	4			ST 028	ST 073
2000 16V, i.e. Turbo	2,0	101-114	12.85-08.96	154 A2.000/154 C4.046/ 154 E1.000/834 C.146	4			ST 088	ST 073
2500 V6	2,5	119	06.93-08.96	834 G.000	6			ST 028	
DUNA									
60 1.1	1,1	43	01.87-12.91	146 A6.000	4		ST 046		ST 073
70 1.3	1,3	49	01.87-12.91	146 A5.000	4		ST 046		ST 073
DS 1.7	1,7	44	01.87-12.91	149 B3.000	4		ST 046		ST 074
FIORINO									
1.0	1,0	37-41	01.80-04.88	127 A.000/156 A.000	4				ST 073
1.1 60	1,1	40	11.86-12.93	146 A9.000	4				ST 073
1.3 Diesel	1,3	33	03.82-12.87		4				ST 073
1.3, 1.3 70	1,3	49	12.87-12.94	146 A5.000	4				ST 073
1.4, 1.4 70 i.e.	1,4	49	10.89-12.98	146 C5.000/146 D5.000	4			ST 028	ST 073
1.5, 1.5 75 i.e.	1,5	55	01.88-12.93	149 C1.000	4			ST 028	ST 073
1.6, 1.6 75 i.e.	1,6	55	10.93-12.96	146 C6.000/146 D6.000	4			ST 028	ST 073
1.7 D, 1.7 D 60	1,7	42	05.88-12.97	146 B2.000	4				ST 074
1.7 Diesel	1,7	42-44	12.87-12.90		4				ST 073
1.7 D, TD, 1.7 D 60, 1.7 TD 65	1,7	44-46	05.88-12.98	149 B3.000/146 D7.000	4				ST 073
MAREA									
1.2 16V	1,2	60	10.98-00.00	182 B2.000	4				ST 072
1.4 80 12V	1,4	59	09.96-00.00	182 A3.000	4		ST 046	ST 028	ST 072
1.6 100 16V, Bipower	1,6	76	09.96-00.00	182 A4.000/186 A4.000/ 185 A3.000	4		ST 046		ST 072
1.8 115 16V	1,7	83	09.96-00.00	182 A2.000	4		ST 046		ST 072
1.9 TD 75, TD 100	1,9	55-74	09.96-00.00	182 A7.000/182 A8.000	4		ST 046		ST 072
1.9 JTD 105, JTD 110	1,9	77-81	04.99-00.00	186 A6.000	4				ST 072
2.0 150 20V	2,0	108	09.96-04.99	182 A1.000	5		ST 046	ST 028	ST 072
2.0 150 20V	2,0	110	01.01-	185 A8.000	5				ST 072
2.0 155 20V	2,0	113	04.99-01.01		5		ST 046		ST 072
2.4 TD 125, JTD 130	2,4	91-96	09.96-00.00	185 A2.000/839 A5.000	5				ST 072
MULTIPLA									
1.6 100 16V, 16V Blupower	1,6	70-76	04.99-00.00	182 A4.000/186 A3.000/ 186 A4.000	4				ST 072
1.9 JTD 105, JTD 110	1,9	77-81	04.99-00.00	182 B4.000, 186 A6.000	4				ST 072
PALIO Weekend									
1.2	1,2	54	04.96-02.01	178 B5.000	4		ST 046		ST 072
1.6 16V	1,6	74	04.96-02.01	178 B3.000	4		ST 046		
1.7 TD	1,7	51	04.96-03.01	176 A3.000	4		ST 046		
PANDA									
750	0,8	25	01.86-01.95	141 B.000/156 A4.000	4		ST 046		ST 073
750	0,8	25	01.86-04.91	156 A4.000	4		ST 097		
750 KAT	0,8	25	01.95-12.97	156 A4.048	4		ST 046		



kw

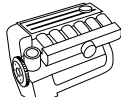

Zyl.
Cyl.
Cil.



FIAT										
TEMPRA										
1.6	1,6	63	03.90-04.93	159 A3.000	4			ST 046		ST 073
1.6 i.e.	1,6	63-66	06.94-08.96	159 B9.000	4				ST 018	ST 073
1.8 i.e.	1,8	66-76	09.93-08.96	835 C2.000/835 C4.000/ 836 A5.000	4			ST 046	ST 088	ST 073
1.8 i.e.	1,8	77	03.92-08.96	159 A4.046	4		ST 035	ST 046	ST 088	ST 073
1.9 TD	1,9	59-66	05.90-08.96	160 D1.000/160 A6.000/ 160 B6.046	4			ST 058		ST 073
2.0 i.e., 4X4	2,0	83	10.90-08.96	159 A6.046	4		ST 035	ST 046	ST 088	ST 073
TIPO										
1.1	1,1	41	01.88-05.91	160 A3.000	4			ST 097	ST 018	ST 073
TIPO										
1.1	1,1	41	06.91-10.91	160 A3.000	4			ST 046	ST 018	ST 073
1.4, i.e.	1,4	51-57	07.87-04.95	160 A1.000/160 A1.046/ 160 A1.048/836 A4.000	4			ST 046	ST 018	ST 073
1.6, i.e.	1,6	55-61	01.88-04.95	159 A3.046/159 A3.048/ 160 A2.000/835 C1.000	4			ST 046	ST 018	ST 073
1.6 i.e.	1,6	66	02.88-05.91	149 C2.046	4			ST 046		ST 073
1.7 D	1,7	43-55	01.88-10.95	149 B4.000	4			ST 046		ST 073
1.8 i.e., 16V Sport	1,8	77-100	11.89-06.93	159 A4.046/160 A5.000	4		ST 035	ST 046	ST 088	ST 073
1.8 i.e.	1,8	66	09.93-04.95	835 C4.000	4		ST 035		ST 088	ST 073
1.8 i.e.	1,8	74-76	04.93-04.95	159 A4.000/835 C2.000	4				ST 088	ST 073
1.9 TD	1,9	59-66	09.90-04.95	160 A6.046/160 D1.000/ 160 A6.000/160 B6.046	4			ST 058		ST 073
2.0 i.e.	2,0	80	06.90-03.92	159 A5.046	4		ST 035		ST 088	ST 073
2.0 16V, i.e., i.e. 16V Sport	2,0	83-107	03.90-04.95	159 A6.046/160 A8.046	4		ST 035	ST 046	ST 088	ST 073
ULYSSE										
1.8	1,8	73	05.97-00.00	LFW	4					ST 072
1.9 TD	1,9	66	02.95-00.00	DHX (XUD9TF/L)	4					ST 072
2.0 JTD	2,0	80	10.99-00.00		4					ST 072
2.0, 16V, Turbo	2,0	89-108	06.94-09.00	RFN/RFU (XU10J2C)/RGX (XU10J2CTE)/RFV	4					ST 072
2.1 TD	2,1	80	03.96-10.99	P8C	4					ST 072
UNO										
45 0.9	0,9	33	03.83-09.92	146 A.000/146 A.1000	4					ST 073
45 1.0	1,0	32	06.91-12.93	156 A2.048/156 A2.100	4			ST 046		ST 073
45 1.0	1,0	32	06.86-05.91	156 A2.048/156 A2.100	4			ST 097		
45 i.e. 1.0	1,0	33	06.91-09.92	156 A2.246	4			ST 046	ST 028	ST 073
45 i.e. 1.0	1,0	33	04.84-05.91	156 A2.246 → 2124683, 0121897	4			ST 097		
50 1.1, i.e.	1,1	36-37	01.90-12.93	146 A4.044/146 C3.000/ 156 C.046	4				ST 018	ST 073
55 1.1	1,1	40	01.83-08.89	138 B.000	4			ST 046		ST 073
60 1.1	1,1	42-43	05.85-12.92	146 A4.048	4			ST 046	ST 018	ST 073
1.3 Super Diesel	1,3	33	06.83-03.92	146 B1.000/127 A5.000	4					ST 074
70 1.3	1,3	48	05.85-08.89	149 A7.000	4			ST 046		ST 073
70 1.3	1,3	48	01.88-08.89	149 A7.000	4			ST 063	ST 018	ST 073
70 1.3	1,3	50	01.83-04.85	138 B2.000	4			ST 046		
1.3 Turbo i.e.	1,3	73-74	01.87-03.91	146 A2.146/146 A2.246	4				ST 028	ST 073
1.3 Turbo i.e.	1,3	77	04.85-08.89	146 A2.000	4			ST 063	ST 028	ST 074
70 i.e. 1.4	1,4	51-53	09.89-12.93	160 A1.046	4			ST 046	ST 028	ST 073
70 TD 1.4	1,4	52	10.86-10.90	146 B.000/146 B3.000	4			ST 046		ST 074
70 S 1.4	1,4	52	09.89-10.92	160 A1.048	4					ST 073
1.4 Turbo i.e.	1,4	82	09.89-09.93	146 A8.046	4			ST 046		ST 074
75 i.e. 1.5	1,5	55	10.85-12.93	138 C2.048/149 C1.000	4			ST 063	ST 018	ST 073
75 i.e. 1.5	1,5	55	10.85-12.93	138 C2.048/149 C1.000	4			ST 046	ST 018	ST 073
60 Diesel 1.7	1,7	42-44	07.86-12.93	146 B2.000/149 B3.000	4			ST 046		ST 074
1.9 D	1,9	44	09.89-03.94	149 B5.046	4			ST 046		ST 074
X 1/9										
1.3	1,3	54	10.75-06.78	128 AS.000	4			ST 046		
1.5 Five Speed	1,5	63	11.78-12.89	138 AS.000	4			ST 046		

**BERU**

kW

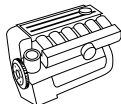
Zyl.
Cyl.
Cil.**HONDA****QUINTET**

1.6 EX	1,6	59	02.80-12.84	EL	4	ST 039			
--------	-----	----	-------------	----	---	---------------	--	--	--

INNOCENTI**MINI**

0.6	0,5	24	01.87-12.91		3	ST 039			
0.7	0,7	23	01.90-01.95		3	ST 039			
0.7	0,6	23	01.84-12.87		3	ST 041			
1.0	1,0	32-39	05.74-02.82	BLM C 99 H	4	ST 045			
1.3 De Tomaso	1,3	51	08.76-02.82	BLM C 99 H	4	ST 045			

JAGUAR**XJ**

12 6.0	6,0	229	11.94-00.00	8E	12			ST 068	
--------	-----	-----	-------------	----	----	--	--	---------------	--

LADA**1200-1500**

1200	1,2	44	09.73-08.84	BA3 2101	4	ST 046			
1500	1,5	54	09.73-06.85	BA3 2103	4	ST 046			

1200-1600

1200 L/S	1,2	44	01.70-06.86	BA3 2101	4	ST 046			
1300	1,3	48-51	08.74-01.87	BA3 21011/BA3 2105	4	ST 046			
1500, N/S	1,5	55	09.72-10.86	BA3 2103	4	ST 046			
1600 N/L	1,6	57-58	09.72-10.86	BA3 2106	4	ST 046			

NIVA

1600	1,6	54-56	12.76-03.95	BA3 2121	4	ST 046			
------	-----	-------	-------------	----------	---	---------------	--	--	--

SAMARA

1100	1,1	39-43	02.88-00.00	BA3 21081, (KAT)	4	ST 046			
1300	1,3	45-50	01.86-00.00	BA3 2108, (KAT)/ BA3 21115	4	ST 046			
1500	1,5	50-53	01.88-00.00	BA3 21083, (KAT)/ BA3 2111	4	ST 046			

LANCIA**A 112**

0.9 Junior	0,9	29	03.81-06.86	A112 A5.000/A112 A.000/A112 B2.000	4	ST 046			
1.0 LX, Abarth	1,1	35-51	03.78-12.86	A112 A2.000/A112 B1.000	4	ST 046			

BETA

1300	1,4	62	12.81-12.84	828 D3.000	4	ST 046			
1600	1,6	74	08.73-12.84	828 B.000	4	ST 046			
2000, i.e.	2,0	85-90	04.76-10.86	828 B1.000	4	ST 046			

DEDRA

1.6 i.e.	1,6	55-66	08.89-07.99	835 A1.000/835 A1.046/ 835 C1.000	4			ST 018	ST 073
1.6, 16V, LE KAT	1,6	66-76	07.94-07.99	159 B9.000/182 A4.000	4				ST 073
1.8 i.e.	1,8	66	08.93-07.99	835 C5.000	4			ST 088	ST 073
1.8 i.e.	1,8	66	08.93-07.99	835 C5.000	4			ST 018	ST 073
1.8 i.e.	1,8	74-77	09.89-07.99	835 A2.046/836 A5.000	4	ST 035		ST 088	ST 073
1.8 i.e.	1,8	77	09.89-07.99	835 A2.046	4	ST 035		ST 018	ST 073
1.8 i.e.	1,8	80	09.89-06.94	835 A2.000	4			ST 088	ST 073
1.8 i.e.	1,8	80	09.89-06.94	835 A2.000	4			ST 018	ST 073
1.8 16V LE, GT 16V	1,7	83-96	03.96-07.99	183 A1.000/182 A2.000	4				ST 073
1.9 TDS	1,9	66	07.94-07.99	835 A4.000/160 D1.000/ 835 A4.046	4		ST 058		ST 073
2.0 i.e.	2,0	83	09.89-07.99	835 A5.046	4	ST 035		ST 088	ST 073
2.0 i.e.	2,0	86	09.89-07.92	835 A5.000	4			ST 088	ST 073
2.0 16V, Integrale	2,0	102	07.94-07.99	836 A3.000	4	ST 035		ST 088	ST 073
2.0 Turbo, i.e.Turbo, i.e.Turbo Integrale	2,0	119-130	05.90-07.99	835 A7.000/835 A8.000/ 835 A8.046	4			ST 088	ST 073
2.0 HF Integrale	2,0	124	11.90-07.94	835 A7.046	4	ST 035		ST 088	ST 073





kW

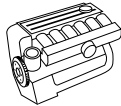

Zyl.
Cyl.
Cil.



MERCEDES

190 (Typ 201)

D 2.5	2,5	69	08.89-08.93	OM 602.911	5	SD 009	ST 057				
Turbo-D 2.5	2,5	90	02.88-08.93	OM 602.961	5	SD 005	ST 057				
Turbo-D 2.5	2,5	90	02.88-08.93	OM 602.961	5	SD 009	ST 057				
Turbo-D 2.5	2,5	93	02.88-08.93	OM 602.961	5	SD 005	ST 057				
Turbo-D 2.5	2,5	93	02.88-08.93	OM 602.961	5	SD 009	ST 057				
E 1.8	1,8	80	04.90-08.93	M 102.910	4	SD 004		ST 001	ST 002		
E 2.0	2,0	83	02.85-12.86	M 102.962 (KAT)/ M 102.961	4	SD 004		ST 001	ST 002		
E 2.0	2,0	85	02.85-12.86	M 102.962	4	SD 004		ST 001	ST 002		
E 2.0	2,0	87	01.85-08.93	M 102.962 (KAT)	4	SD 004		ST 001	ST 002		
E 2.0	2,0	90	10.82-06.93	M 102.962/M 102.961	4	SD 004		ST 001	ST 002		
E 2.0	2,0	93	10.82-06.93		4			ST 001			
E 2.3	2,3	97	09.86-08.91	M 102.985	4	SD 004		ST 001	ST 002		
E 2.3	2,3	100	10.86-08.93	M 102.985	4	SD 004		ST 001	ST 002		
E 2.3-16	2,3	125	09.85-12.87	M 102.983 (KAT)	4	SD 004		ST 001			
E 2.3-16	2,3	130	09.85-08.88	M 102.983	4	SD 004		ST 001			
E 2.3-16	2,3	136	04.84-01.87	M 102.983	4			ST 001			
E 2.5-16	2,5	143	03.89-08.93	M 102.991	4	SD 004		ST 001	ST 002		
E 2.5-16	2,5	150	09.88-08.93	M 102.990	4	SD 004		ST 001	ST 002		
E 2.6	2,6	118	09.86-08.93	M 103.942 (KAT)	6	SD 004		ST 001	ST 002		
E 2.6	2,6	122	09.86-12.89	M 103.942	6	SD 004		ST 001	ST 002		
E Evolution II 2.5	2,5	173	05.90-08.93	M 102.992	4	SD 004		ST 001	ST 002		
200 (Typ 123)											
200	2,0	62-69	02.76-08.80	M 115.938/M 115.939	4			ST 001			
200, T	2,0	74-80	06.80-11.85	M 102.920/M 102.939	4	SD 003		ST 001			
230 (Typ 123)											
230, C, T	2,3	80	02.76-03.81	M 115.954	4			ST 001			
230 E, CE, TE	2,3	100	04.80-12.85	M 102.980	4	SD 003					
240 (Typ 123)											
240 D, T D	2,4	48-53	02.76-12.85	OM 616.912	4			ST 001			
250 (Typ 123)											
250, T	2,5	95-103	02.76-07.85	M 123.921	6			ST 001			
280 (Typ 123)											
280, C	2,7	115	02.76-08.81	M 110.923	6	SD 003		ST 001			
280 E, CE	2,7	136	02.76-11.85	M 110.988/M 110.984	6	SD 003					
300 (Typ 123)											
300 D, T D	3,0	59-65	02.76-11.85	OM 617.912	5			ST 001			
300 Turbo-D, C Turbo-D, T Turbo-D	3,0	92	10.80-11.85	OM 617.952	5	SD 003					
300 C Turbo-D, T Turbo-D	3,0	92	10.80-11.85	OM 617.952	5	SD 010					
200 (Typ 124)											
200 D, T D	2,0	53-55	12.84-06.93	OM 601.912	4	SD 005	ST 057				
200, T	2,0	75-80	09.85-05.90	M 102.922	4	SD 004		ST 001			
200 E, TE	2,0	87-90	09.88-08.92	M 102.962/M 102.963	4	SD 004		ST 001	ST 002		
200 E, TE	2,0	100	10.92-06.93	M 111.940	4			ST 001	ST 002		
220 (Typ 124)											
220 E, CE	2,2	110	10.92-06.93	M 111.960	4			ST 001	ST 008		
220 TE	2,2	110	10.92-05.93		4	SD 004		ST 001	ST 008		
230 (Typ 124)											
230 E, CE, TE	2,3	97-100	12.84-06.93	M 102.982, (KAT)	4	SD 004		ST 001	ST 002		
250 (Typ 124)											
250 D, T D	2,5	66-69	04.85-06.93	OM 602.912	5	SD 005	ST 057				
250 Turbo-D	2,5	93	09.88-06.93	OM 602.962	5		ST 057				
260 (Typ 124)											
260 E, E 4-matic, TE	2,6	118-122	09.85-08.92	M 103.940, (KAT)/M 103.943	6			ST 001	ST 002		
280 (Typ 124)											
280 E, TE	2,8	145	10.92-06.93	M 104.942	6			ST 001			
300 (Typ 124)											
300 CE	3,0	132-138	03.87-05.93	M 103.983, (KAT)	6	SD 004		ST 001	ST 002		

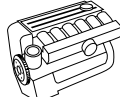

kW

Zyl.
Cyl.
Cil.**MERCEDES****300 (Typ 124)**

300 CE-24	3,0	162	09.89-06.93	M 104.980	6	SD 004			ST 002
300 D, T D	3,0	80-83	12.84-06.93	OM 603.912	6	SD 005		ST 007	
300 D, D 4-matic, T D	3,0	80-83	12.84-06.93	OM 603.912/OM 603.913	6	SD 005		ST 001	
300 Turbo-D, Turbo-D 4-matic, T	3,0	105-108	09.86-06.93	OM 603.960/OM 603.963	6	SD 005		ST 007	
300 E, 4-matic, TE	3,0	132-138	06.85-08.92	M 103.983 (KAT)/M 103.985	6	SD 004		ST 001	ST 002
300 E-24, TE-24	3,0	162	09.88-08.92	M 104.980	6	SD 004			ST 002

320 (Typ 124)

320 E, CE, TE	3,2	162	10.92-06.93	M 104.992	6				ST 008
---------------	-----	-----	-------------	-----------	---	--	--	--	---------------

C-Klasse (Typ 202)

C 180	1,8	89	11.94-05.00	M 111.921	4			ST 011	
C 180, T	1,8	90	03.93-09.00	M 111.920/M 111.921	4			ST 011	ST 001 ST 008
C 200 D	2,0	55	03.93-05.00	OM 601.913/OM 601.915	4	SD 010		ST 011	ST 002
C 200 D	2,0	65	10.96-05.00	OM 604.915	4			ST 011	
C 200, T	2,0	100	01.94-09.00	M 111.941/M 111.945	4			ST 011	ST 001 ST 008
C 220 D, T D	2,2	55-70	08.93-03.01	OM 604.910	4	SD 010		ST 011	ST 007 ST 008
C 220	2,2	110	03.93-05.00	M 111.961	4				ST 001 ST 008
C 230, T	2,3	110	06.96-03.01	M 111.974	4			ST 011	
C 230 Kompressor, T Kompressor	2,3	142	10.95-09.00	M 111.975	4			ST 011	
C 250 D	2,5	83	05.93-05.00	OM 605.910	5	SD 010			ST 007 ST 008
C 280	2,8	142	05.93-05.00	M 104.941	6			ST 011	ST 001 ST 008
C 36 AMG	3,6	206	05.94-05.00	M 104.941 (AMG 3.6)	6			ST 011	ST 001 ST 008

CLK (Typ 208)

200	2,0	100	06.97-06.02	M 111.941/M 111.945	4				ST 001 ST 008
-----	-----	-----	-------------	---------------------	---	--	--	--	-----------------------------

E-Klasse (Typ 124)

E 200 D	2,0	55	06.93-06.95	OM 601.912	4	SD 005		ST 057	
E 200 D	2,0	55	06.93-06.95	OM 601.912	4	SD 009		ST 057	
E 200, T	2,0	100	06.93-03.98	M 111.940	4				ST 001 ST 008
E 220, T	2,2	110	06.93-03.98	M 111.960	4				ST 001 ST 008
E 250, D, TD	2,5	83	06.93-06.96	OM 605.911	5	SD 010			ST 007
E 250 Turbo-D	2,5	93	06.93-06.95	OM 602.962	5	SD 009		ST 057	
E 280, T	2,8	142-145	06.93-06.96	M 104.942	6				ST 001 ST 008
E 300 D, T D	3,0	100	06.93-06.96	OM 606.910	6	SD 010			ST 007
E 300 Turbo-D, T Turbo-D	3,0	108	06.93-06.96	OM 603.960	6	SD 005			ST 007
E 300 Turbo-D, T Turbo-D	3,0	108	06.93-06.96	OM 603.960	6	SD 005			ST 001
E 300 Turbo-D 4-matic, T Turbo-D 4-matic	3,0	108	06.93-06.96	OM 603.963	6	SD 005			ST 001
E 320, T	3,2	162	06.93-03.98	M 104.992/M 104.995	6				ST 008
E 36 AMG, T AMG	3,6	200	05.94-03.98	M 104.992 (AMG 3.6)	6				ST 008

E-Klasse (Typ 210)

E 200 D	2,0	65	01.96-03.02	OM 604.917	4			ST 011	
E 200, T	2,0	100	06.95-08.00	M 111.942	4			ST 011	
E 220 D	2,2	70	06.95-07.99	OM 604.912	4			ST 011	
E 250 D, T D	2,5	83	06.95-07.99	OM 605.912	5			ST 011	
E 250 Turbo-D, T Turbo-D	2,5	110	06.97-07.99	OM 605.962	5			ST 011	
E 280	2,8	142	01.96-06.97	M 104.945	6				ST 001
E 280, T, 4-matic	2,8	150	12.96-03.02	M 112.921	6				ST 008
E 290 Turbo-D, T Turbo-D	2,9	95	03.96-07.99	OM 602.982	5			ST 011	
E 300 D (210.020)	3,0	100	06.95-06.97	OM 606.912	6				ST 007 ST 002
E 300 Turbo-D, T Turbo-D	3,0	130	12.96-07.99	OM 606.962	6			ST 011	
E 320	3,2	162	06.95-06.97	M 104.992	6				ST 008
E 36 AMG	3,6	200	02.96-03.02	M 104.992 (AMG 3.6)	6				ST 008

G-Klasse (Typ 460)

230 G	2,3	66	03.79-07.93	M 115.973	4	SD 004			ST 001
230 G	2,3	75	02.80-07.87		4				ST 001
230 GE	2,3	90	05.87-08.92	M 102.979/M 102.987	4	SD 004			ST 001
230 GE	2,3	92	04.82-08.92	M 102.981/M 102.987	4	SD 004			ST 001





kW

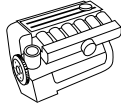

Zyl.
Cyl.
Cil.



MERCEDES

G-Klasse (Typ 460)

240 GD	2,4	53	03.79-08.87	OM 616.936	4	SD 004		ST 001		
250 GD	2,5	62	10.87-12.92	OM 602.930	5	SD 009		ST 057		
250 GD	2,5	68	12.88-08.92	OM 602.930	5	SD 009		ST 057		
250 GD	2,5	68	02.90-	OM 602.939	5	SD 009				
280 GE	2,7	110	08.84-08.89	M 110.994	6	SD 004		ST 001		
280 GE	2,7	115	11.79-08.89	M 110.994	6	SD 004		ST 001		
300 GD	3,0	83	03.79-07.93	OM 603.912	6	SD 005		ST 007		

G-Klasse (Typ 461)

G 290 TD	2,9	88	07.97-	OM 602.983	5			ST 001		
----------	-----	----	--------	------------	---	--	--	---------------	--	--

G-Klasse (Typ 463)

230 GE	2,3	93	06.90-06.93	M 102.989	4				ST 002	
250 GD	2,5	69	06.90-	OM 602.931	5	SD 009				
300 GD	3,0	83	09.89-	OM 603.931	6	SD 010				
G 300 TD	3,0	130	08.96-	OM 606.964	6			ST 011		
G 320, 320 GE	3,2	155	09.94-12.97	M 104.996	6			ST 001	ST 008	
350 G Turbo D	3,4	100	09.91-	OM 603.972	6	SD 010				

S-Klasse (Typ 126)

260 SE	2,6	118-122	09.85-06.91	M 103.941	6	SD 009			ST 002	
280 SE, SEL	2,7	136	10.79-07.85	M 110.987/M 110.989	6	SD 003		ST 001		
300 SE, SEL	3,0	132-138	09.85-06.91	M 103.981, (KAT)	6	SD 009		ST 001	ST 002	
380 SE, SEC, SEL	3,8	150	12.79-08.85	M 116.963	8	SD 002		ST 001		
380 SE, SEL	3,8	160	12.85-12.86	M 116.961	8	SD 002				
420 SEC	4,2	150-165	10.85-06.91	M 116.965	8	SD 009				
420 SE, SEC, SEL	4,2	150-170	10.85-06.91	M 116.965, (KAT)	8	SD 003		ST 001	ST 002	
500 SE, SEC, SEL	5,0	164	09.85-06.91	M 117.965	8	SD 003		ST 001	ST 002	
500 SE, SEC, SEL	5,0	170-177	12.79-08.85	M 117.961/M 117.963	8	SD 002		ST 001	ST 002	
500 SE, SEC, SEL	5,0	180-195	09.85-06.91	M 117.965, (KAT)	8	SD 003		ST 001	ST 002	
560 SE, SEC, SEL	5,5	178-220	10.85-06.91	M 117.968, (KAT)	8	SD 009		ST 001	ST 002	

S-Klasse (Typ 140)

S 300 Turbo-D	3,0	130	05.96-10.98	OM 606.961	6			ST 011		
300 SE, SEL/S320	3,2	170	03.91-10.98	M 104.990/M 104.994	6	SD 004			ST 002	
S 420, SEC/CL 420	4,2	205	01.93-02.99	M 119.971	8	SD 004				
400 SE, SEL/S420	4,2	210	02.91-10.98	M 119.971	8	SD 004				
S 500, SEC/CL 500	5,0	235	10.92-02.99	M 119.970	8	SD 004		ST 001	ST 002	
500 SE, SEL	5,0	240	02.91-10.98	M 119.970	8	SD 004		ST 001	ST 002	
S 600, SEC/CL 600, 600 SE, SEL	6,0	290-300	04.91-02.99	M 120.980	12			ST 001	ST 002	

SL (Typ 129)

280	2,8	142	08.93-10.01	M 104.943	6				ST 008	
-----	-----	-----	-------------	-----------	---	--	--	--	---------------	--



100										
D	2,4	53-55	02.88-02.96	OM 616/OM 616.963	4				ST 001	

MB										
130 D, 140 D, 150 D, 170 D	2,4	53	12.80-01.85	OM 616.963	4				ST 001	

SPRINTER 2-t

208 D	2,3	58	01.95-04.00	OM 601.943	4	SD 010			ST 007	
210 D	2,9	75	01.97-04.00	OM 602.980	5	SD 010				
212 D	2,9	90	02.95-04.00	OM 602.980	5	SD 010		ST 011	ST 007	ST 008
212 D	2,9	90	02.95-04.00	OM 602.980	5	SD 010		ST 011	ST 001	ST 008
214	2,3	105	02.95-	M 111.979	4			ST 011		

SPRINTER 3-t

308 D, D 2.3	2,3	58	02.95-04.00	OM 601.943	4	SD 010			ST 007	
310 D 2.9, 4X4	2,9	75	02.95-08.02	OM 602.980	5	SD 010				
312 D 2.9	2,9	90	02.95-04.00	OM 602.980	5	SD 010			ST 007	ST 008
312 D 2.9, 4X4	2,9	90	02.95-08.02	OM 602.980	5	SD 010			ST 001	ST 008

SPRINTER 4-t

408 D	2,3	58	02.96-05.06	OM 601.943	4	SD 010				
410 D	2,9	75	02.96-05.06	OM 602.980	5	SD 010				



kw

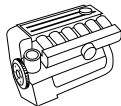

Zyl.
Cyl.
Cil.



MITSUBISHI



L 300							
1.6	1,6	48-51	05.80-02.87	4 G 32	4		ST 041
1.8 4X4	1,8	60	08.84-02.87	4 G 62	4		ST 041
2.0 4X4	2,0	65	08.84-02.87	4 G 63	4		ST 041
2.3 D	2,3	50	04.83-10.86	4 D 55	4		ST 041

NISSAN

PRIMERA

2.0 16V, 4X4	2,0	85	06.90-06.96	SR20DI (SPI)	4		ST 067
--------------	-----	----	-------------	--------------	---	--	---------------

OPEL

ADMIRAL B

2.8 E, S	2,8	95-121	03.69-01.78	28 E/28 H/28 S	6		ST 037
----------	-----	--------	-------------	----------------	---	--	---------------

AGILA

1.0 12V	1,0	43	09.00-	Z 10 XE	3		ST 089
1.2 16V	1,2	55	09.00-	Z 12 XE	4		ST 089

ASCONA

1.2, S	1,2	40-44	09.75-02.79	12 N/12 S	4		ST 037
1.3 N, S	1,3	44-55	03.79-08.88	13 N (44KW)/ 13 S (55KW)	4		ST 037
1.6 D	1,6	40	03.82-08.88	16 D/16 DA	4		ST 037
1.6 N, S	1,6	44-55	09.75-08.81	16 N (44KW)/ 16 S (55KW)	4		ST 037
1.6, i, i KAT	1,6	55	09.81-09.87	16 N (55KW)/C 16 LZ/ C 16 NZ/E 16 NZ	4		ST 037
1.6, S	1,6	60-66	09.81-08.88	16 SH/16 SV	4		ST 037
1.8	1,8	62	09.87-08.88	E 18 NV	4		ST 037
1.8 E, 1.8 i	1,8	74-85	09.82-08.86	18 E/C 18 NE	4		ST 037 ST 028
1.9 N, S	1,9	55-66	09.75-08.81	19 N/19 S	4		ST 037
2.0 D	2,0	43	08.78-08.81	20 D	4		ST 037
2.0 N, S, i	2,0	66-74	08.77-08.88	20 N/20 S/C 20 NEF	4		ST 037
2.0 E, i, i KAT, i GT	2,0	81-95	08.79-08.88	20 E/20 NE/20 SEH/ C 20 NE	4		ST 037 ST 028
2.4 400	2,4	106	07.80-08.81	24 E	4		ST 037 ST 028

ASTRA

1.4 i	1,4	44	01.98-03.01	X 14 NZ	4		ST 081
1.4 i, Si	1,4	44-60	09.91-03.01	C 14 NZ/C 14 SE	4		ST 037 ST 081
1.4 i, Si	1,4	44-60	09.91-03.01	C 14 NZ/C 14 SE	4		ST 037 ST 087
1.4	1,4	55-60	09.91-09.98	14 NV/14 SE	4		ST 081
1.4 i 16V	1,4	66	01.96-03.01	X 14 XE	4		ST 037 ST 081
1.4 i 16V	1,4	66	01.96-03.01	X 14 XE	4		ST 037 ST 087
1.6 i	1,6	52	03.93-08.96	X 16 SZ	4		ST 037 ST 081
1.6 i	1,6	52	03.93-08.96	X 16 SZ	4		ST 037 ST 087
1.6	1,6	55	09.95-09.98	16 LZ2/16 NZR	4		ST 081
1.6 i	1,6	55	09.91-09.98	C 16 NZ/X 16 SZR	4		ST 037 ST 081
1.6 i	1,6	55	09.91-09.98	C 16 NZ/X 16 SZR	4		ST 037 ST 087
1.6 i	1,6	55	01.98-	X 16 SZR	4		ST 081
1.6, 1.6 i 16V	1,6	60-74	09.91-03.01	16 SV/X 16 XEL	4		ST 081
1.6 i 16V, 1.6 Si	1,6	74	03.92-09.98	X 16 XEL/C 16 SE	4		ST 037 ST 081
1.6 i 16V, 1.6 Si	1,6	74	08.94-01.98	X 16 XEL	4		ST 037 ST 087
1.7 D	1,7	42-44	12.91-09.98	17 D/17 DR	4		ST 037 ST 080
1.7 D	1,7	42-44	12.91-09.98	17 D/17 DR	4		ST 037 ST 081
1.7 D	1,7	42-44	12.91-09.98	17 D/17 DR	4		ST 037 ST 087
1.7 TD	1,7	50	08.94-01.99	X 17 DTL	4		ST 037 ST 079
1.7 TD	1,7	50	08.94-01.99	X 17 DTL	4		ST 037 ST 081
1.7 DTI 16V	1,7	55	02.00-	Y 17 DT	4		ST 069
1.7 TDS	1,7	60	12.91-09.98	17 DT (TC4EE1)/ X 17 DT (TC4EE1)	4		ST 037 ST 079
1.7 TDS	1,7	60	12.91-09.98	17 DT (TC4EE1)/ X 17 DT (TC4EE1)	4		ST 037 ST 081

**BERU**

kW

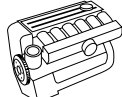
Zyl.
Cyl.
Cil.**OPEL****ASTRA**

1.8 i	1,8	66	09.91-09.98	C 18 NZ/C 18 XE/ C 18 XEL/X 18 XE	4			ST 037				ST 080
1.8 i	1,8	66	09.91-09.98	C 18 NZ/C 18 XE/ C 18 XEL/X 18 XE	4			ST 037				ST 081
1.8 i	1,8	66	09.91-09.98	C 18 NZ	4			ST 037				ST 087
1.8 i 16V	1,8	92	06.93-01.98	C 18 XE	4			ST 037		ST 088		ST 075
2.0 i, 2.0 i 16V, 2.0 GSI 16V	2,0	85-110	06.90-09.98	C 20 NE/C 20 XE	4			ST 037				ST 075
2.0 i, 2.0 i 16V, 2.0 GSI 16V	2,0	85-110	09.91-01.98	C 20 NE/C 20 XE/ X 20 XEV	4			ST 037				ST 080
2.0 i, 2.0 i 16V, 2.0 GSI 16V	2,0	85-110	09.91-01.98	C 20 NE/C 20 XE/ X 20 XEV	4			ST 037				ST 081
2.0 i 16V	2,0	100	02.95-09.98	X 20 XEV	4			ST 037		ST 088		ST 080

ASTRA F

1.4 i	1,4	44	09.91-01.99	C 14 NZ	4			ST 089				
1.4 Si	1,4	60	05.93-03.01	C 14 SE	4			ST 089				
1.4 i 16V	1,4	66	01.96-03.01	X 14 XE	4			ST 089				
1.6 i	1,6	52	02.93-07.96	X 16 SZ	4			ST 089				
1.6 i	1,6	55	09.91-03.01	C 16 NZ/X 16 SZR	4			ST 089				
1.6 Si	1,6	74	03.92-09.98	C 16 SE/X 16 XEL	4			ST 089				
1.7 D	1,7	42	12.91-09.92	17 D	4			ST 089				
1.7 D	1,7	44	07.92-01.99	17 DR	4			ST 089				
1.7 TD	1,7	50	08.94-01.99	X 17 DTL	4			ST 089				
1.7 TDS	1,7	60	12.91-09.98	17 DT (TC4EE1)/ X 17 DT (TC4EE1)	4			ST 089				

1.8 i	1,8	66	09.91-09.98	C 18 NZ	4			ST 089				
1.8 i 16V	1,8	85	07.94-03.01	C 18 XEL/X 18 XE	4			ST 089				
1.8 i 16V	1,8	92	06.93-01.98	C 18 XE	4			ST 089				
2.0 i	2,0	85	09.91-09.98	C 20 NE	4			ST 089				
2.0 i 16V	2,0	100	02.95-09.98	X 20 XEV	4			ST 089				
2.0 i 16V, GSI 16V	2,0	110	09.91-01.98	C 20 XE	4			ST 089				

ASTRA G

1.2 16V	1,2	48	02.98-09.00	X 12 XE	4			ST 089				
1.2 16V	1,2	55	09.00-	Z 12 XE	4			ST 089				
1.4 16V	1,4	66	02.98-	X 14 XE/Z 14 XE	4			ST 089				
1.6	1,6	55	02.98-09.00	X 16 SZR	4			ST 089				
1.6	1,6	62	09.00-	Z 16 SE	4			ST 089				
1.6 CNG	1,6	71	03.03-	Z 16 YNG	4			ST 089				
1.6 16V	1,6	74	02.98-	Z 16 XE/X 16 XEL	4			ST 089				
1.7 TD	1,7	50	02.98-08.00	X 17 DTL	4			ST 089				
1.7 DTI 16V	1,7	55	02.00-	Y 17 DT	4			ST 089				
1.8 16V	1,8	85	02.98-10.00	X 18 XE1	4			ST 089				
1.8 16V	1,8	92	09.00-	Z 18 XE	4			ST 089				
2.0 DI	2,0	60	02.98-	X 20 DTL/Y 20 DTL	4			ST 089				
2.0 DTI 16V	2,0	74	08.99-	Y 20 DTH/X 20 DTH	4			ST 089				
2.0 16V	2,0	100	02.98-	X 20 XEV	4			ST 089				
2.0 16V OPC	2,0	118	11.99-09.02	X 20 XER	4			ST 089				
2.0 16V Turbo	2,0	140	09.00-08.01	Z 20 LET	4			ST 089				
2.0 16V Turbo	2,0	141	08.01-	Z 20 LET	4			ST 089				
2.0 OPC	2,0	141	03.02-	Z 20 LET	4			ST 089				
2.2 DTI	2,2	92	09.02-	Y 22 DTR	4			ST 089				
2.2 16V	2,2	108	09.00-	Z 22 SE	4			ST 089				

CALIBRA

2.0 i, 2.0 i 16V, 2.0 i 16V 4X4	2,0	85-110	06.90-07.97	C 20 NE/C 20 XE/ X 20 XEV	4			ST 089	ST 037			ST 079
2.0 i, 2.0 i 16V, 2.0 i 16V 4X4	2,0	85-110	06.90-07.97	C 20 NE/C 20 XE/ X 20 XEV	4			ST 089	ST 037			ST 081
2.0 i 16V, 4X4	2,0	100	02.94-07.97	X 20 XEV	4			ST 089	ST 037	ST 088		ST 081
2.0 i 16V, 4X4	2,0	100-110	06.90-07.97	C 20 XE/X 20 XEV	4			ST 089	ST 037			ST 085
2.0 i Turbo 4x4	2,0	150	01.93-07.97	C 20 LET	4			ST 089	ST 037			ST 079
2.0 i Turbo 4X4	2,0	150	03.92-07.97	C 20 LET	4			ST 036	ST 037			ST 079





kw

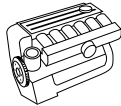

Zyl.
Cyl.
Cil.



OPEL

CALIBRA

2.5 i V6	2,5	125	04.93-07.97	X 25 XE/C 25 XE	6	ST 089	ST 037			ST 080
2.5 i V6	2,5	125	04.93-07.97	X 25 XE/C 25 XE	6	ST 089	ST 037			ST 081

COMMODORE

2.5, S, GS	2,5	85-96	08.67-12.82	25 H/25 S	6		ST 037			
2.5 E	2,5	96	12.80-12.82	25 E (L-Jettr.)	6		ST 037		ST 028	
2.8 GS, 2.8 GS/E	2,8	107	05.70-07.78	28 E/28 EC/28 HC/28 HL	6		ST 037			

COMBO

1.2	1,2	33	07.94-10.01	C 12 NZ/X 12 SZ	4		ST 089			
1.4	1,4	44	07.94-10.01	C 14 NZ/X 14 SZ	4		ST 089			
1.4	1,4	60	07.94-10.01	C 14 SE	4		ST 089			
1.7 D	1,7	44	07.94-10.01	17 D (4EE1)/ X 17 D (4EE1)	4		ST 089			

CORSA

1.0 i 12V	1,0	40	11.96-09.00	X 10 XE	3		ST 089			ST 081
1.0	1,0	33	09.82-03.93	10 S	4			ST 037		ST 075
1.2 i		33	03.93-09.00	C 12 NZ/X 12 SZ	4		ST 089	ST 037		ST 075
1.2, 1.2 N	1,2	33-38	01.85-10.89	12 NC/12 NV/E 12 GV	4			ST 037		ST 075
1.2 i, 1.2 S	1,2	33-43	09.82-03.93	C 12 NZ	4			ST 037		ST 075
1.2, S	1,2	40	09.82-03.93	12 ST	4			ST 037		ST 075
1.2 i 16V	1,2	48	03.98-09.00	X 12 XE	4		ST 089			ST 081
1.3, i, S	1,3	44-51	09.82-09.90	13 SB/C 13 N	4			ST 037		ST 075
1.3	1,3	44	09.85-10.89	13 NB	4			ST 037		
1.4 i, S, Si	1,4	40-60	01.85-09.00	14 NV/C 14 SE/C 14 NZ/ X 14 SZ	4		ST 089	ST 037		
1.4 i, S, Si	1,4	40-60	01.90-09.00	14 NV/C 14 SE/C 14 NZ	4		ST 089	ST 037		ST 075
1.4 i	1,4	44	03.93-09.00	C 14 NZ/X 14 SZ	4		ST 089			
1.4 i 16V	1,4	66	09.94-09.00	X 14 XE	4		ST 089			
1.5 D, TD	1,5	37-49	06.87-09.00	15 D (4EC1)/15 DT (T4EC1)	4		ST 089	ST 037		
1.5 TD	1,5	49	03.93-09.00	15 DT (T4EC1)/X 15 DT (T4EC1)	4		ST 089	ST 037		ST 080
1.6 GSI, KAT	1,6	55-74	08.88-03.93	C 16 NZ/C 16 SE/ C 16 SEI	4			ST 037		
1.6 GSI, 16V	1,6	74-80	05.88-09.00	C 16 XE/E 16 SE	4		ST 089	ST 037		ST 075
1.6 i 16V	1,6	78	09.94-09.00	X 16 XE	4		ST 089			
1.7 D	1,7	44	02.96-09.00	17 D (4EE1)/ X 17 D (4EE1)	4		ST 089	ST 037		
1.7 DI 16V, 1.7 DTI 16V	1,7	48-55	09.00-	Y 17 DT/Y 17 DTL	4				ST 069	

DIPLOMAT B

2.8 E	2,8	121	03.69-02.75	28 E	6			ST 037		
-------	-----	-----	-------------	------	---	--	--	---------------	--	--

FRONTERA

2.0 i	2,0	85	03.92-10.98	X 20 SE/C 20 NE	4			ST 037		
2.2 DTI	2,2	85	10.98-09.02	X 22 DTH/Y 22 DTH	4		ST 089			
2.2 DTI	2,2	88	09.02-	Y 22 DTH	4		ST 089			
2.2 i	2,2	100	10.98-	X 22 SE/Y 22 SE	4		ST 089			
2.3 TD	2,3	74	03.92-10.98	23 DTR	4			ST 037		
2.4 i	2,4	92	03.92-10.98	C 24 NE	4			ST 037		
2.5 TDS	2,5	85	09.96-10.98	25TDS (VM41B)	4					ST 082
3.2 i	3,2	151	10.98-	6 VD1/Y 32 NE	6		ST 089		ST 069	

GT

1.1	1,1	44	09.68-12.70	11 SR	4			ST 037		
1.9	1,9	66	09.68-08.73	19 S	4			ST 037		

KADETT

1.0	1,0	29	01.74-07.79	10 N	4			ST 037		
1.2, 1.2 S	1,2	38-44	08.73-07.86	12 N/12 S/12 SC/12 ST	4			ST 037		
1.3 N, S	1,3	44-55	08.79-08.84	13 N (44KW)/ 13 S (55KW)	4			ST 037		
1.3 N, S, 1.3 i KAT	1,3	44-55	09.84-02.93	C 13 N/13 N (44KW)/ 13 NB/13 S (55KW)	4			ST 037		ST 075
1.4 S, 1.4 i	1,4	44-55	01.90-08.91	C 14 NZ/14 NV	4			ST 037		ST 075
1.4 i	1,4	44	08.91-07.94	C 14 NZ	4			ST 037		



kw

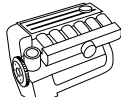

Zyl.
Cyl.
Cil.



OPEL

OMEGA

2.6 V6	2,6	132	09.00-07.03	Y 26 SE	6	ST 089			ST 081
3.0 (3000)	3,0	115	03.87-12.87	C 30 LE	6		ST 037		
3.0, (3000)	3,0	115	03.87-03.94	C 30 LE	6		ST 037		ST 076
3.0, (3000)	3,0	130	03.87-09.90	30 NE	6		ST 037		ST 076
3.0, (3000) KAT	3,0	130	03.87-03.94	C 30 NE	6		ST 037		ST 076
3.0 24V, (3000)	3,0	147-150	09.89-03.94	C 30 SE/C 30 SEJ	6		ST 037		
3.0 V6	3,0	155	04.94-02.01	X 30 XE	6	ST 089			ST 076
3.0 V6	3,0	155	04.94-02.01	X 30 XE	6	ST 089			ST 081
3.0 V6	3,0	155	04.94-02.01	X 30 XE	6	ST 089			ST 083
3.2 V6	3,2	160	02.01-07.03	Y 32 SE	6	ST 089			ST 081
3.6 24V Lotus	3,6	277	08.90-09.92	C 36 GET	6			ST 069	

REKORD

1.7, S	1,7	44-61	01.72-10.82	17 N/17 S	4		ST 037		
1.8 E	1,8	74	05.85-08.86	C 18 NV	4		ST 037	ST 028	
1.8, S	1,8	55-66	11.82-08.86	18 N/18 S	4		ST 037		
1.9, S	1,9	55-71	01.72-10.82	19 N/19 SH	4		ST 037		
2.0 D	2,0	40-43	08.74-10.82	20 D	4		ST 037		
2.0, S	2,0	66-74	09.75-08.86	20 N/20 S	4		ST 037		
2.0 E	2,0	81	09.77-10.84	20 E	4		ST 037	ST 028	
2.1 D	2,1	44	09.72-07.78	21 D	4		ST 037		
2.2 E	2,2	85	11.84-08.86	22 E	4		ST 037		
2.2 D, TD	2,3	48-63	08.78-08.86	23 D (48KW)/ 23 D (52KW)/23 TD	4		ST 037		
2.3 D	2,3	52	11.82-08.86	23 D (52KW)	4		ST 037		

SENATOR

2.0 E	2,0	85	03.83-10.84	H 20 E	4		ST 037	ST 028	
2.2 TD	2,3	63	11.84-08.87	23 TD	4		ST 037		
2.2 E	2,2	85	11.84-08.87	22 E	4		ST 037		
2.5, E	2,5	85-103	05.78-08.87	25 E (LE-Jettr.)	6		ST 037		
2.5 E	2,5	100	01.83-08.84	H 25 E	6		ST 037	ST 028	
2.5 i	2,5	103	09.90-09.93	25 NE	6		ST 037		ST 076
2.6 i	2,6	110	09.90-09.93	C 26 NE	6		ST 037		ST 076
2.8	2,8	103	02.78-04.81	28 H	6		ST 037		
3.0 E	3,0	132	02.78-12.86	30 E	6		ST 037	ST 028	
3.0	3,0	110-115	04.78-08.87	30 H/C 30 LE	6		ST 037		
3.0, 3.0 i KAT, 3.0 24V	3,0	115-150	09.87-09.93	30 NE/C 30 LE/C 30 NE/ C 30 SE	6		ST 037		ST 076

SINTRA

2.2 i 16V	2,2	104	11.96-04.99	X 22 XE	4				ST 076
2.2 i 16V	2,2	104	11.96-04.99	X 22 XE	4				ST 081
3.0 i 24V	3,0	148	11.96-04.99	X 30 XE	6				ST 081

TIGRA

1.4 16V	1,4	66	07.94-12.00	X 14 XE	4	ST 089	ST 037		ST 075
1.6 16V	1,6	78	07.94-08.98	X 16 XE	4	ST 089	ST 037		ST 075

VECTRA

1.4 S	1,4	55	04.88-06.92	14 NV	4		ST 037		
1.6, i, S, 1.6 i KAT	1,6	52-60	09.88-11.95	16 SV/E 16 NZ/C 16 NZ/ C 16 NZ2/X 16 SZ	4	ST 089	ST 037	ST 028	ST 075
1.6, i, S, 1.6 i KAT	1,6	52-60	09.88-11.95	16 SV/E 16 NZ/C 16 NZ/ C 16 NZ2/X 16 SZ	4	ST 089	ST 037	ST 028	ST 085
1.6 i	1,6	55	09.93-11.95	16 LZ2	4		ST 037		ST 075
1.6 i, i 16V	1,6	55-74	10.95-07.03	16 LZ2/X 16 SZR/X 16 XEL/Y 16 XE/Z 16 XE	4	ST 089	ST 037		ST 123
1.7 D, TD	1,7	42-60	09.88-11.95	17 D/17 DR/ 17 DT (TC4EE1)/ X 17 DT (TC4EE1)	4	ST 089	ST 037		
1.7 TD	1,7	60	10.95-12.98	X 17 DT (TC4EE1)	4	ST 089	ST 037		ST 080
1.8 i, i KAT, S, S 4X4	1,8	65-66	09.88-11.95	18 SV/C 18 NZ/E 18 NVR	4	ST 089	ST 037	ST 028	ST 085
1.8 i 16V	1,8	85	10.95-09.00	X 18 XE/X 18 XE1	4	ST 089	ST 037	ST 088	ST 123
1.8 i 16V	1,8	92	09.00-07.03	Z 18 XE	4				ST 123

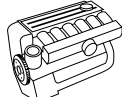

kW

Zyl.
Cyl.
Cil.**OPEL****VECTRA**

2.0 DTI 16V, 2.0 DI 16V	2,0	60-74	11.96-04.02	X 20 DTH/Y 20 DTH/ X 20 DTL	4	ST 089	ST 037		ST 123
2.0	2,0	74	04.88-09.89	C 20 NEF	4		ST 037		ST 085
2.0 i	2,0	82	10.95-04.02	20 NEJ	4		ST 037		ST 123
2.0 i, 4X4	2,0	85	09.88-10.90	20 NE	4		ST 037	ST 028	ST 075
2.0 i KAT, 4X4	2,0	85	09.88-11.95	C 20 NE	4	ST 089	ST 037	ST 028	ST 075
2.0 i KAT, 4X4	2,0	85	09.88-11.95	C 20 NE	4	ST 089	ST 037	ST 028	ST 085
2.0 i KAT	2,0	85	09.88-11.95	C 20 NE	4	ST 089	ST 037	ST 028	ST 081
2.0 i, GT,16V, 4X4	2,0	95-110	09.88-11.95	20 SEH/20 XEJ	4	ST 089	ST 037	ST 028	ST 082
2.0 i, GT,16V, 4X4	2,0	95-110	09.88-11.95	20 SEH/20 XEJ	4	ST 089	ST 037	ST 028	ST 085
2.0 i 16V, 4X4	2,0	100	06.94-11.95	X 20 XEV	4	ST 089	ST 037	ST 088	ST 075
2.0 i 16V, 4X4	2,0	100	06.94-11.95	X 20 XEV	4	ST 089	ST 037	ST 088	ST 079
2.0 i 16V, 4X4	2,0	100	06.94-11.95	X 20 XEV	4	ST 089	ST 037	ST 088	ST 081
2.0 i 16V, 4X4	2,0	100	06.94-11.95	X 20 XEV	4	ST 089	ST 037	ST 088	ST 085
2.0 i 16V	2,0	100	10.95-09.00	X 20 XEV, C 20 SEL	4	ST 089	ST 037	ST 088	ST 123
2.0 i 16V KAT, 4X4	2,0	110	02.90-11.95	C 20 XE	4	ST 089	ST 037	ST 028	ST 075
2.0 i 16V KAT	2,0	110	02.90-11.95	C 20 XE	4	ST 089	ST 037	ST 028	ST 079
2.0 i 16V KAT	2,0	110	02.90-11.95	C 20 XE	4	ST 089	ST 037	ST 028	ST 081
2.0 i 16v 4X4 KAT	2,0	110	02.90-11.95	C 20 XE	4	ST 089	ST 037	ST 028	ST 085
2.0 i Turbo 4X4	2,0	150	06.94-11.95	C 20 LET	4	ST 089	ST 037		ST 086
2000/GT 16V	2,0	110	01.93-06.94	20 XEJ	4	ST 089			
2000/GT 16V KAT, 4x4	2,0	110	01.93-11.95	C 20 XE	4	ST 089			
2.2 DTI 16V	2,2	92	09.00-04.02	Y 22 DTR	4	ST 089			
2.2 i 16V	2,2	108	09.00-04.02	Z 22 SE	4	ST 089			
2.5 i V6	2,5	125	10.95-09.00	X 25 XE	6	ST 089	ST 037		ST 123
2.5 i V6	2,5	125	10.95-09.00	X 25 XE	6	ST 089	ST 037		ST 080
2.5 V6	2,5	125	02.93-11.95	C 25 XE	6	ST 089	ST 037		ST 081
i 500 2.5	2,5	143	05.98-09.00	X 25 XE	6	ST 089			ST 123
2.6 i V6	2,6	125	09.00-07.03	Y 26 SE	6	ST 089			ST 123

ZAFIRA

1.6 CNG	1,6	71	09.01-	Z 16 YNG	4	ST 089			
1.6 16V	1,6	74	04.99-	Z 16 XE/X 16 XEL	4	ST 089			
1.8 16V	1,8	85-92	04.99-	X 18 XE1/Z 18 XE	4	ST 089			
2.0 DI 16V, 2.0 DTI 16V	2,0	60-74	10.99-	X 20 DTL/Y 20 DTH	4	ST 089			
2.0 OPC	2,0	141	09.01-	Z 20 LET	4	ST 089			
2.2 DTI 16V	2,2	92	01.02-	Y 22 DTR	4	ST 089			
2.2 16V	2,2	108	09.00-	Z 22 SE	4	ST 089			

PEUGEOT**104**

0.9	1,0	32-34	10.72-10.83	108 (XV3)/108 (XV5)/ 108C (XV8)	4		ST 044		ST 101
1.1	1,1	37-49	09.73-07.85	109 (XW3)/109F (XW7)/ 121 (XW3S)/XW3S	4		ST 044		ST 101
1.2	1,2	42	08.79-06.83	129 (XZ5)	4		ST 044		ST 101
1.4	1,4	53	08.79-06.84	150 (XY6B)	4		ST 044		ST 101

106

1.0	1,0	33	09.91-04.96	CDY (TU9M)	4			ST 028	
1.1	1,1	44	09.91-04.96	HDZ (TU1M)	4			ST 012	
1.1	1,1	44	09.91-04.96	HDZ (TU1M)	4			ST 028	
1.3	1,3	72	10.93-04.96	TU2J2	4			ST 028	
1.4	1,4	55	09.91-04.96	KDX (TU3MC)/KDY (TU3M)/KFZ (TU3J2/Z)	4			ST 012	
1.4	1,4	55	09.91-04.96	KDX (TU3MC)/KDY (TU3M)	4			ST 028	
1.5 D	1,5	40-43	06.94-10.00	VJY (TUD5)	4			ST 029	
1.6	1,6	65	06.93-04.96	NFZ (TU5JP)	4			ST 028	
1.6 i	1,6	65	05.96-	NFZ (TU5JP)	4	ST 034			
1.6	1,6	76	01.94-04.96	NFY (TU5J2)	4	ST 034		ST 028	
1.6 i, S16	1,6	74-87	05.96-10.00	NFW (TU5J2)/NFX (TU5J4) /NFY (TU5J2)	4	ST 034			





kw

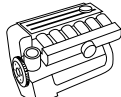

Zyl.
Cyl.
Cil.



PEUGEOT

Model	Year	Power (kw)	Year Range	Engine	Cyl.	Accessories
204						
1.1	1,1	40-43	07.69-07.77	XK4/XK5	4	ST 044
1.2 D	1,3	29	05.68-05.73	XLD	4	ST 044
1.3 D	1,4	33	01.73-10.77	XL4D	4	ST 044
205						
1.0	1,0	33	10.87-09.98	TU9	4	ST 049 ST 028 ST 101
1.0	1,0	33	02.83-10.87	108C (XV8)	4	ST 101
1.1	1,1	36	02.83-07.90	109N (XW7)	4	ST 101
1.1	1,1	37	02.83-10.87	109F (XW7)	4	ST 101
1.1	1,1	40	10.87-10.90	H1B (TU1)	4	ST 049 ST 101
1.1	1,1	44	07.89-09.98	HDZ (TU1M)	4	ST 049 ST 012 ST 101
1.1	1,1	44	07.89-09.98	HDZ (TU1M)	4	ST 049 ST 028 ST 101
1.3 Rallye	1,3	74	10.87-10.90	TU24	4	ST 049
1.4, KAT	1,4	44-62	06.87-09.93	K1D (TU3A)/K2B (TU3S)/KAY (TU3CP)	4	ST 049 ST 101
1.4	1,4	55	07.88-09.98	KDZ (TU3M)/KDY (TU3M)/KFX (TU3JP)	4	ST 049 ST 028 ST 101
1.6	1,6	53	10.87-09.98	B1E (XU51C)	4	ST 049 ST 101
1.6	1,6	55	10.87-12.89	B1A (XU51C)	4	ST 049 ST 101
1.6	1,6	55	10.87-09.98	BAZ (XU5CP)	4	ST 034 ST 101
1.6	1,6	65	05.90-09.98	BDY (XU5M3Z)/BDY (XU5M2Z)	4	ST 034 ST 049 ST 012 ST 101
1.6 GTI	1,6	76	12.84-10.90	180A (XU5J)/180Z (XU5J)	4	ST 049 ST 028 ST 101
1.7 Diesel, 1.7 TD	1,8	44-57	03.94-10.00	161A (XUD7)/A8B (XUD7TE)	4	ST 049
1.9 Diesel	1,9	47	10.87-09.98	DJZ (XUD9Y)	4	ST 049
1.9 GTI	1,9	75	03.87-10.87	DFZ (XU9J1)	4	ST 028 ST 101
1.9 CTI	1,9	75	10.87-12.94	DFZ (XU9J1)/D2A (XU92C)	4	ST 049 ST 028 ST 101
1.9 GTI	1,9	88	10.87-10.94	DKZ (XU9JAZ)	4	ST 049 ST 028 ST 101
1.9 GTI	1,9	94	10.86-10.87	D6B (XU9JA (ohne KAT))	4	ST 028 ST 101
1.9 GTI	1,9	94	10.87-09.98	D6B (XU9JA (G-KAT))	4	ST 049 ST 028 ST 101
304						
1.1	1,1	43	10.76-10.80	XK5	4	ST 043 ST 101
1.3, GL	1,3	48	09.70-10.80	XL5	4	ST 043 ST 101
1.3, GT	1,3	48-55	10.69-07.76	XL3/XL5S	4	ST 044
1.4 D	1,4	33	10.76-10.79	XL4D	4	ST 043 ST 101
305						
1.3	1,3	44	11.77-09.82	118 (XL5)	4	ST 043 ST 101
1.3	1,3	44	10.82-08.85	118 (XL5)	4	ST 049 ST 101
1.5 Diesel	1,5	36	11.77-09.82	149 (XID)	4	ST 043
1.5	1,5	50	09.85-07.90	142 (XR5A)	4	ST 049
1.5	1,5	54-65	11.79-09.82	117 (XR5S)/142 (XR5)	4	ST 043
1.5	1,5	54	10.82-07.84	142 (XR5)	4	ST 101
1.6	1,6	55-71	10.82-07.84	B1A (XU51C)/171 (XU5S)	4	ST 101
1.9 Diesel	1,9	47-48	10.82-12.88	162 (XUD9)/D9A (XUD9)/162 (XUD9)	4	ST 049
1.9	1,9	72	11.86-12.88	DFZ (XU9J1)	4	ST 049 ST 028
1.9	1,9	75	10.82-07.83	159 (XU9S)	4	ST 101
306						
1.1	1,1	44	06.94-10.00	HDZ (TU1M)	4	ST 012
1.1	1,1	44	06.94-10.00	HDZ (TU1M)	4	ST 028
1.4, SL	1,4	55	05.93-10.00	KDX (TU3MC)/KFX (TU3JP)/KFW (TU3JP)	4	ST 012
1.4, SL	1,4	55	05.93-10.00	KDX (TU3MC)/KFX (TU3JP)/KFW (TU3JP)	4	ST 028
1.6, SR	1,6	65	05.93-10.00	NFZ (TU5JP)	4	ST 034 ST 028
309						
1.1	1,1	40	10.85-07.89	E1	4	ST 049 ST 101
1.3	1,3	47	10.85-07.89	G1A	4	ST 049 ST 101
1.1	1,1	44	08.90-12.93	HDZ (TU1M)	4	ST 049 ST 028 ST 101
1.4	1,4	49	07.90-12.93	K1D (TU3A)	4	ST 049 ST 101



kW

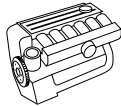

Zyl.
Cyl.
Cil.



PEUGEOT

505									
2.3	2,3	59	09.80-06.86	147 (XD2S)	4				ST 049
2.5 Diesel, Turbo Diesel	2,5	51-77	06.81-12.93	152A (XD3T)/ 152B (XD3TE)/155 (XD3)	4				ST 049
604									
2.3 TD	2,3	59	09.79-05.83	147 (XD2S)	4				ST 043
2.5 TD	2,5	66	08.83-12.86	152A (XD3T)	4				ST 049 ST 101
2.7 SL, 2.7 TI, STI	2,7	100-106	08.77-05.83	112 (ZM)/140 (ZMJ)	6				ST 049 ST 101
2.8 GTI	2,8	110	09.83-07.87	154A (ZMJK)	6				ST 049 ST 101
605									
2.0	2,0	89	06.89-09.99	RFZ (XU10J2Z)	4				ST 034 ST 012
3.0	3,0	123	10.89-09.99	UFZ (ZPJ)	6				ST 012
3.0 SV 24	3,0	147	06.90-09.99	UKZ (ZPJ4/Z)	6				ST 034 ST 012



BOXER									
1.9 D, 1.9 TD, 1.9 TD 4x4	1,9	51-66	03.94-04.02	D8C (XUD9AU)/DHY (XUD9TE)/DJY (XUD9A)	4				ST 072
1.9 D, 1.9 TD, 1.9 TD 4x4	1,9	51-66	03.94-04.02	D8C (XUD9AU)/DHY (XUD9TE)/DJY (XUD9A)	4				ST 078
2.0 i, 4X4	2,0	80	03.94-04.02	RFW (XU10J2)	4				ST 072
2.4 D, 2.4 TD, TDI, -4X4	2,4	63-79	03.94-04.02	T8A (DJ5T)/T9A (DJ5)/ THX (DJ5TED)	4				ST 072
2.4 D, 2.4 TD, TDI, -4X4	2,4	63-79	03.94-04.02	T8A (DJ5T)/T9A (DJ5)/ THX (DJ5TED)	4				ST 078
2.8 HDI	2,8	94	11.00-		4				ST 072
2.8 HDI	2,8	94	11.00-		4				ST 078
J5									
1.8	1,8	51	01.83-11.88	169B (XM7T)	4				ST 043
2.0	2,0	55-58	09.81-09.90	170 (XN1T)/170B (XN1T)	4				ST 043
2.5 D	2,5	54	09.81-09.90	CRD93 (U25/661)	4				ST 044
J7									
1.5	1,5	61	08.68-07.70	XB5P	4				ST 044
1.6	1,6	44-50	07.70-03.80	XC5P/XC7P	4				ST 044
1.8	1,8	48	07.70-03.80	XM7P	4				ST 044
1.9 D	1,9	40	08.68-07.78	XDP88	4				ST 043
2.1 D	2,1	42	08.68-07.77	XDP90	4				ST 043
2.3 D	2,3	49	07.77-03.80	XD2P94	4				ST 043
J9									
1.6	1,6	44	03.80-06.87	XC7P	4				ST 049
2.0	2,0	57	03.80-06.87	XN1P	4				ST 049
2.1 D	2,1	41	03.80-06.87	XDPX90	4				ST 044
2.1 D	2,1	41	03.80-06.87	XDPX90	4				ST 049
2.3 D	2,3	49	03.80-07.82	XD2PX94	4				ST 044
2.3 D	2,3	49	03.80-07.82	XD2PX94	4				ST 049
2.5 D	2,5	53	07.82-06.87	XD3P	4				ST 044
2.5 D	2,5	53	07.82-06.87	XD3P	4				ST 049

PORSCHE

356									
B 1600, Super 75, Super 90, C 1600	1,6	44-66	01.59-12.63		4				ST 026
911									
3.3 Turbo	3,3	235	08.90-09.93	M 30.69	6				ST 028
3.6 Turbo	3,6	265	01.93-09.93	M 64.50	6				ST 028
924									
2.0, Turbo	2,0	92-125	11.75-08.89	M 31.01/XJ	4				ST 100
2.5 S	2,5	110-120	09.85-12.90	M 44.01/M 44.03/ M 44.07/M 44.08/ M 44.09/M 44.10	4				ST 028 ST 100
928									
4.6 S	4,7	228	08.83-07.86	M 28.21/M 28.22	8				ST 036

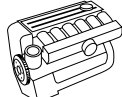

kW

Zyl.
Cyl.
Cil.**PORSCHE****928**4.9 S 5,0 212 09.85-05.94 M 28.45/M 28.46 8 **ST 036****944**2.5 2,5 110-120 06.81-07.87 M 44.02/M 44.05/
M 44.06 4 **ST 100**2.5 2,5 110 01.85-07.87 M 44.02/M 44.04/
M 44.07/M 44.08 4 **ST 028**2.5 2,5 118 08.87-12.90 M 44.05/M 44.09/
M 44.10 4 **ST 028**2.5 2,5 120 06.81-07.87 M 44.01/M 44.03/
M 44.05/M 44.06 4 **ST 028**2.5 S 2,5 140 08.86-07.88 M 44.40 4 **ST 028**2.5 Turbo 2,5 162-184 08.85-07.91 M 44.50/M 44.51/
M 44.52 4 **ST 028**2.7 2,7 121 11.88-08.89 M 44.11/M 44.12 4 **ST 028**3.0 S2 3,0 155 12.88-07.91 M 44.41 4 **ST 028****959**2.8 2,9 330 01.86-04.91 959.50 6 **ST 028****968**3.0 3,0 176 06.91-11.95 M 44.43/M 44.44 4 **ST 028****RENAULT ALPIN****A310**2.7 V6 2,7 110 01.76-12.84 6 **ST 043****V6**2.5 TURBO 2,5 136-147 01.85-12.90 Z7U/Z7U-734 6 **ST 015****RENAULT CLIO**1.4 1,4 58 01.91-09.98 E7J 718/E7J 719 /
E7J 754 4 **ST 032**1.8 1,8 65-66 01.91-09.98 F3P 710 /F3P 714/
F3P 755 /F3P 754 4 **ST 015**1.8 16V 1,8 99 08.91-06.94 F7P 722 4 **ST 032 ST 015**1.8 Rsi 1,8 79-80 01.93-09.98 F3P 712/F3P 758 4 **ST 015**Williams 2,0 108 01.94-09.98 F7R 700 4 **ST 032 ST 015****ESPACE**2.0 2,0 76 01.91-10.96 J7R 768 4 **ST 015**2.2, 4X4 2,2 79 01.91-12.96 J7T 772/J7T 776/J7T 773 4 **ST 015**2.8 V6 2,8 110 01.91-10.96 Z7W 712/Z7W 713 6 **ST 015****ESTAFETTE**1.1 1,1 29 02.62-12.81 4 **ST 044**1.3 1,3 29 08.69-12.81 4 **ST 044****FUEGO**1.4 TL/GTL 1,4 47 02.80-10.85 847 720 4 **ST 043 ST 101**1.6 TS/GTS, Turbo 1,6 71-97 10.80-10.85 843 723/843 724/A6M
725/A6M 726/A5L 750 4 **ST 043 ST 101**2.0 TX/GTX 2,0 81 10.80-10.85 J6R 713/J6R 726/
J6R 715/J6R 710/
J6R 712/829 710 4 **ST 101**2.1 TD 2,1 65 08.82-10.85 J8S 712 4 **ST 043 ST 101****LAGUNA**1.8 1,8 66-69 08.95-03.01 F3P 720/F3P 724/
F3P 670/F3P 678 4 **ST 015**2.0 2,0 83 11.93-03.01 F3R 722/F3R 723 4 **ST 015**3.0 3,0 123 11.93-03.01 Z7X 760/Z7X 765 6 **ST 032 ST 015****MEGANE**1.6 e, i 1,6 55-66 01.96-03.99 K7M 702/K7M 703/
K7M 720/K7M 790 4 **ST 015**2.0, i 2,0 84 01.96-09.99 F3R 750/F3R 751 4 **ST 015**2.0 16V 2,0 108 03.96-11.99 F7R 710/F7R 714 4 **ST 015**



kW

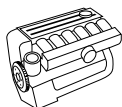

Zyl.
Cyl.
Cil.



RENAULT

SAFRANE

2.0 12V	2,0	97	04.92-07.96	J7R 734/J7R 735	4	ST 032			
2.2	2,2	79-101	04.92-07.96	J7T 760/J7T 761/ J7T 762/J7T 763	4	ST 032	ST 015		
3.0 Biturbo 4x4	3,0	193	02.93-07.96	Z7X 726	6		ST 015		
3.0 V6, 4x4	3,0	123	12.92-12.00	Z7X 721/Z7X 722/Z7X 723	6	ST 032	ST 015		

R 5

1.1	1,1	33	09.80-12.85	C1E 726/688 713	4		ST 044		
1.3	1,3	31-47	09.75-09.84	810 719/810 725/810 726/810 729	4		ST 044		
1.4	1,4	43-46	01.82-12.85	847 712/847 725/C2J 713	4		ST 044		
1.4 Alpine A5, Alpine Turbo	1,4	68-79	09.77-09.81	840 725/840 726/ C6J 750	4		ST 044		
1.4 Turbo	1,4	118	06.80-01.85	840 730	4		ST 044		

R 6

0.8	0,8	25	10.69-04.80		4				ST 101
1.1	1,1	33	08.70-04.87		4				ST 101
1.1	1,1	35	07.71-04.80		4				ST 101

R 9

1.1	1,1	35	09.81-05.87	C1E 715/C1E 720	4				ST 101
1.4, Turbo	1,4	44-85	12.81-12.89	C1J 715/760/764/792/ 796, C2J 717/718/720/ 730/755/757/766/767/ 768	4		ST 043		ST 101
1.6 D	1,6	40	10.82-12.88	F8M 700/F8M 720/ F8M 730	4		ST 043		ST 101

R 11

1.1	1,1	35	03.83-06.86	C1E 715/C1E 720	4		ST 043		
1.2	1,2	40	10.84-12.88	C1G 700/C1G 710	4		ST 043		
1.4 Turbo	1,4	77	04.84-12.86	C1J 760/C1J 764	4		ST 043		
1.6 D	1,6	40	08.83-12.88	F8M 700/F8M 720/ F8M 730	4		ST 043		
1.7	1,7	54-59	10.83-12.88	F2N 700/F2N 704/ F3N 718/F2N 730	4		ST 043		

R 12

1.3	1,3	37-44	10.70-08.80	810-02/810-06/97	4		ST 044		
-----	-----	-------	-------------	------------------	---	--	---------------	--	--

R 14

1.2	1,2	42-43	05.76-12.83	129	4				ST 101
1.4	1,4	44-52	09.79-12.83	X5J/150	4		ST 044		ST 101

R 15

1.3	1,3	44	03.72-10.80		4		ST 044		
1.6	1,6	66	03.72-10.80		4		ST 044		

R 16

1.6 TL	1,6	40-48	01.71-08.80	821	4		ST 044		
--------	-----	-------	-------------	-----	---	--	---------------	--	--

R 17

1.6	1,6	66	03.72-10.80		4		ST 044		
-----	-----	----	-------------	--	---	--	---------------	--	--

R 18

1.4	1,4	47	04.78-07.86	847 720/847 722	4		ST 043		ST 101
1.4	1,4	47	04.78-07.86	847 720/847 722	4		ST 044		ST 101
1.6, 4x4	1,6	54-58	04.78-07.86	841 717/A2M 723/ 841 726/841 725	4		ST 043		ST 101
1.6 TS, Turbo	1,6	71-92	05.82-07.86	A6M 725/A6M 726/807 727/A5L 717/A5L 718	4		ST 043		
2.0	2,0	77	10.81-07.86	J6R 716	4		ST 043		ST 101
2.1 Diesel, TD	2,1	49-65	05.79-07.86	852 710/J8S 711	4		ST 043		
2.2 i	2,2	76	06.84-07.86		4				ST 101

R 19

1.4, KAT	1,4	43	01.89-04.92	C2J 772/C3J 710	4		ST 032		
1.4	1,4	43-55	01.92-12.95	C2J 772/C3J 710/ E7J 742	4		ST 032		

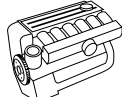

kW

Zyl.
Cyl.
Cil.**SEAT****ALTEA**

1.9 TDI	1,9	77	04.04-05.06	BKC/BJB	4	ST 113	ST 114				
2.0 FSI	2,0	110	05.04-11.05	BLR/BLY	4	ST 113					
2.0 TDI	2,0	100-125	03.04-	BKD/AZV	4	ST 113	ST 114				
2.0 TFSI	2,0	147	04.06-		4	ST 113					

AROSA

1.0	1,0	37	05.97-	AER/ANV/AHT/ALD/ALL/AUC	4	ST 112	ST 114	ST 030			
1.0	1,0	37	05.97-	AER/ANV/AHT/ALD/ALL/AUC	4	ST 112	ST 119	ST 030			
1.4	1,4	44	05.97-	AEX/APQ	4	ST 112		ST 030			ST 104
1.4	1,4	44	05.97-	ANW/AKK → 6H-X-035 000	4	ST 112	ST 121	ST 030			
1.4	1,4	44	05.97-	ANW/AKK/AUD 6H-Y-000 001 →	4	ST 112	ST 119	ST 030			
1.4 TDI	1,4	55	01.00-	AMF	3	ST 112					ST 104
1.4 16V	1,4	74	01.00-	ANM/AFK/AUB/AQQ	4	ST 112	ST 114				ST 104
1.4 16V	1,4	74	01.00-	AFK	4	ST 112	ST 119				ST 104
1.4 16V	1,4	74	01.00-	AFK	4	ST 112	ST 121				ST 104
1.7 SDI	1,7	44	08.97-	AKU	4	ST 112		ST 030			ST 104

CORDOBA

1.0 i	1,0	37	09.96-06.99	AER	4						ST 104
1.0 i	1,0	37	09.96-06.99	AER	4						ST 125
1.2	1,2	47	10.02-	AZQ	3	ST 112					
1.2 12V	1,2	51	05.06-	BXV	3	ST 112					
1.4	1,4	44	06.99-10.02	ANW/AKK/AUD	4			ST 121			
1.4 i	1,4	44	06.94-06.99	AEX/AKV/ABD/ANX/APQ	4			ST 030			ST 102
1.4 i	1,4	44	06.94-06.99	AEX/AKV/ABD/ANX/APQ	4			ST 030			ST 104
1.4 i	1,4	44	06.94-06.99	AEX/AKV/ABD/ANX/APQ	4			ST 030			ST 125
1.4 TDI	1,4	55	10.02-	AMF	3	ST 112					
1.4 16V	1,4	55	05.00-10.02	APE/AUA	4			ST 119			
1.4 16V	1,4	55	05.00-10.02	APE/AUA	4			ST 121			
1.4 16V	1,4	55	09.02-	BBY	4	ST 112	ST 114				
1.4 TDI	1,4	59	06.05-	BMS/BNV	3	ST 112					
1.4 16V	1,4	63	05.06-	BXW	4	ST 112					
1.4 16V	1,4	74	02.00-10.02	AQQ	4			ST 119			
1.4 16V	1,4	74	02.00-10.02	AQQ	4			ST 121			
1.4 16V	1,4	74	10.02-	BBZ	4	ST 112	ST 114				
1.4 i 16V	1,4	74	09.96-06.99	AFH	4			ST 030			ST 104
1.4 i 16V	1,4	74	09.96-06.99	AFH	4			ST 030			ST 125
1.6, i	1,6	55	02.93-06.99	1F/ABU/AEE/ALM	4			ST 050	ST 030		
1.6, i	1,6	55	02.93-06.99	ABU/ALM/AEE	4			ST 050	ST 030		ST 102
1.6, i	1,6	55	02.93-06.99	ABU/ALM/AEE	4			ST 050	ST 030		ST 125
1.6	1,6	55	06.99-10.02	ALM	4			ST 119	ST 030		ST 102
1.6	1,6	55	06.99-10.02	ALM	4			ST 119	ST 030		ST 125
1.6 i	1,6	55	05.94-06.99	1F	4			ST 050	ST 030		ST 125
1.6	1,595	74	06.99-10.02	AKL → 6K-X-448 600	4			ST 121			
1.6	1,6	74	04.03-	BAH	4	ST 112	ST 114				
1.6 i	1,6	74	07.96-06.99	AFT	4	ST 036		ST 030			ST 102
1.6 i	1,6	74	07.96-06.99	AFT	4	ST 036		ST 030			ST 104
1.6 i	1,6	74	07.96-06.99	AFT	4	ST 036		ST 030			ST 125
1.6 16V	1,6	77	11.06-	BTS	4	ST 112					
1.8 i	1,8	66	02.93-06.99	ADZ/ABS	4			ST 050	ST 030		ST 102
1.8 i	1,8	66	02.93-06.99	ADZ/ABS	4			ST 050	ST 030		ST 104
1.8 i	1,8	66	02.93-06.99	ADZ/ABS	4			ST 050	ST 030		ST 125
1.8 i 16V	1,8	95	10.93-08.96	ADL	4			ST 050	ST 030		ST 102
1.8 i 16V	1,8	95	10.93-08.96	ADL	4			ST 050	ST 030		ST 104
1.8 i 16V	1,8	95	10.93-08.96	ADL	4			ST 050	ST 030		ST 125
1.9 D, SDI	1,9	47	01.96-06.99	1Y/AEY/AEF	4			ST 050			ST 104
1.9 SDI	1,9	47	09.02-	ASY	4	ST 112					
1.9 SDI	1,9	50	06.99-10.02	AQM/AGP	4			ST 121			
1.9 TD	1,9	55	02.93-08.96	AAZ	4			ST 050	ST 031		ST 104



kw

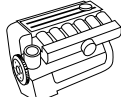

Zyl.
Cyl.
Cil.



SEAT

CORDOBA

1.9 TDI	1,9	66	08.96-06.99	1Z/AHU	4			ST 050		ST 104
1.9 TDI	1,9	66	06.99-10.02	AGR/ALH	4			ST 121		
1.9 TDI	1,9	74	09.02-	ATD	4		ST 112			
1.9 TDI	1,9	81	03.97-06.99	AFN	4			ST 114		ST 104
1.9 TDI	1,896	81	06.99-10.02	ASV → 6K-X-448 600	4			ST 121		
1.9 TDI	1,9	96	10.02-	ASZ	4		ST 112			
2.0	2,0	85	09.02-	AZL/BBX	4		ST 112			
2.0 i	2,0	85	02.93-06.99	2E/AGG	4			ST 050	ST 030	ST 104
2.0 i	2,0	85	02.93-06.99	2E/AGG	4			ST 050	ST 030	ST 125
2.0 i 16V	2,0	110	08.96-06.99	ABF	4					ST 104
2.0 i 16V	2,0	110	08.96-06.99	ABF	4					ST 125

IBIZA

1.0	1,0	33	03.93-09.96	AAU	4					ST 102
1.0	1,0	33	03.93-09.96	AAU	4					ST 108
1.0, i	1,0	33-37	03.93-08.99	AAU/AER	4					ST 104
1.0 i	1,0	37	09.96-08.99	AER	4					ST 125
1.0	1,0	37	08.99-02.02	ANV/ALD/AUC	4			ST 114		
1.2, i	1,2	44-52	11.84-12.93	021 A 1000/021 C.1000	4			ST 045		
1.2	1,2	47	02.02-	AZQ	3		ST 112			
1.2 12V	1,2	51	05.06-	BXV	3		ST 113			
1.3 i	1,3	40	03.93-08.99	AAV	4					ST 102
1.3 i	1,3	40	03.93-08.99	AAV	4					ST 104
1.3 i	1,3	40	03.93-08.99	AAV	4					ST 108
1.3 i	1,3	40	03.93-12.96	AAV	4			ST 115		
1.4 i	1,4	44	09.93-08.99	AEX/AKV/ABD/APQ	4				ST 030	ST 102
1.4 i	1,4	44	09.93-08.99	AEX/AKV/ABD/APQ	4				ST 030	ST 104
1.4 i	1,4	44	09.93-08.99	AEX/AKV/APQ	4				ST 030	ST 125
1.4	1,4	44	08.99-02.02	ANW/AKK	4			ST 121		
1.4 TDI	1,4	51	05.05-	BNM	3		ST 113			
1.4 16V	1,4	55	05.00-02.02	AUA	4			ST 114		
1.4 16V	1,4	55	05.00-02.02	APE	4			ST 119		
1.4 16V	1,4	55	05.00-02.02	APE	4			ST 121		
1.4 16V	1,4	55	02.02-	BBY	4		ST 112	ST 114		
1.4 16V	1,4	55	02.02-04.04	BBY	4		ST 113	ST 114		
1.4 TDI	1,4	55	05.02-	AMF	3		ST 112			
1.4 TDI	1,4	55	05.02-12.05	AMF	3		ST 113			
1.4 TDI	1,4	59	06.05-	BMS/BNV	3		ST 113			
1.4 i 16V	1,4	74	09.96-08.99	AFH	4					ST 104
1.4 i 16V	1,4	74	09.96-08.99	AFH	4					ST 125
1.4 16V	1,4	74	08.99-02.02	AUB	4			ST 114		
1.4 16V	1,4	74	08.99-02.02	AQQ	4			ST 119		
1.4 16V	1,4	74	08.99-02.02	AQQ	4			ST 121		
1.4 16V	1,4	74	02.02-	BBZ/AUB	4		ST 112			
1.4 16V	1,4	74	02.02-	BBZ/AUB	4		ST 113			
1.4 16V	1,4	74	02.02-	BBZ/AUB	4			ST 114		
1.5, i, i KAT	1,5	63-74	11.84-05.93	021 A 2000/021 B.2000/ 021 C.2000/021 D.2000	4			ST 045		
1.6 i	1,6	55	09.94-06.99	1F	4			ST 050		ST 125
1.6 i	1,6	55	03.93-08.99	ABU/ALM/AEE	4			ST 050		ST 102
1.6 i	1,6	55	03.93-08.99	AEE	4					ST 104
1.6 i	1,6	55	03.93-08.99	ABU	4					ST 108
1.6 i	1,6	55	03.93-08.99	AEE/ALM	4					ST 125
1.6	1,6	55	08.99-02.02	ALM	4			ST 119		ST 104
1.6 i	1,6	74	04.96-08.99	AFT	4		ST 036		ST 030	ST 104
1.6 i	1,6	74	04.96-08.99	AFT	4		ST 036		ST 030	ST 125
1.6	1,595	74	08.99-02.02	AKL → 6K-X-448 600	4			ST 121		
1.6	1,6	74	02.03-	BAH	4		ST 112			
1.6	1,6	74	02.03-	BAH	4			ST 114		
1.6 16V	1,6	77	11.06-	BTS	4		ST 113			
1.7 D	1,7	40-42	06.84-05.93	022 A.5000	4			ST 045		
1.7 D	1,7	40-42	06.84-05.93	022 A.5000	4			ST 053		



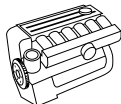

kW

Zyl.
Cyl.
Cil.**SEAT****IBIZA**

1.7	1,7	72-76	01.91-05.93	021 A.3000/021 B.3000	4			ST 045			
1.8 i	1,8	66	03.93-08.99	ABS/ADZ	4			ST 050 ST 030			ST 102
1.8 i	1,8	66	03.93-08.99	ABS/ADZ	4			ST 050 ST 030			ST 104
1.8 i	1,8	66	03.93-08.99	ABS	4			ST 050 ST 030			ST 108
1.8 i	1,8	66	03.93-08.99	ADZ	4			ST 050 ST 030			ST 125
1.8 i 16V	1,8	95	11.93-08.96	ADL	4						ST 102
1.8 i 16V	1,8	95	11.93-08.96	ADL	4						ST 104
1.8 T FR	1,8	110	12.03-	BKV/BJX	4			ST 112			
1.8 T FR	1,8	110	12.03-	BKV/BJX	4			ST 113			
1.8 T Cupra R	1,8	132	01.04-	BBU	4			ST 112			
1.8 T Cupra R	1,8	132	05.04-	BBU	4			ST 113			
1.9 SDI	1,9	47	08.96-08.99	AEY	4			ST 050			ST 104
1.9 SDI	1,9	47	08.96-08.99	AEY	4			ST 050			ST 125
1.9 D	1,9	47	04.93-08.96	1Y	4			ST 050 ST 031			ST 104
1.9 D	1,9	47	04.93-08.96	1Y	4			ST 050 ST 031			ST 108
1.9 SDI	1,9	47	02.02-	ASY	4			ST 112			
1.9 SDI	1,9	47	02.02-12.05	ASY	4			ST 113			
1.9 D	1,9	50	10.94-08.96	1Y	4			ST 050			ST 108
1.9 SDI	1,896	50	08.99-02.02	AQM/AGP → 6K-X-448 600	4			ST 121			
1.9 TD	1,9	55	03.93-08.96	AAZ	4			ST 050 ST 031			ST 104
1.9 TD	1,9	55	03.93-08.96	AAZ	4			ST 050 ST 031			ST 125
1.9 TDI	1,9	66	08.96-08.99	1Z/AHU	4			ST 050 ST 030			ST 104
1.9 TDI	1,9	66	08.96-08.99	1Z/AHU	4			ST 050 ST 030			ST 125
1.9 TDI	1,896	66	08.99-02.02	AGR/ALH → 6K-X-448 600	4			ST 121			
1.9 TDI	1,9	74	02.02-	ATD	4			ST 112			
1.9 TDI	1,9	74	02.02-05.05	ATD	4			ST 113			
1.9 TDI	1,9	81	02.97-08.99	AFN	4				ST 030		ST 104
1.9 TDI	1,9	81	02.97-08.99	AFN	4				ST 030		ST 125
1.9 TDI	1,896	81	08.99-02.02	ASV → 6K-X-448 600	4			ST 121			
1.9 TDI	1,9	96	02.02-	ASZ	4			ST 112			
1.9 TDI	1,9	96	02.02-09.05	ASZ	4			ST 113			
1.9 TDI Cupra R	1,9	110	01.04-	ARL	4			ST 112			
1.9 TDI Cupra R	1,9	118	03.04-	BPX	4			ST 112			
1.9 TDI Cupra R	1,9	118	03.04-11.05	BPX	4			ST 113			
2.0 i	2,0	85	03.93-08.99	2E/AGG	4			ST 050			ST 104
2.0 i	2,0	85	03.93-08.99	2E	4			ST 050			ST 108
2.0 i	2,0	85	03.93-08.99	AGG	4			ST 050			ST 125
2.0 i 16V	2,0	110	08.96-08.99	ABF	4			ST 050			ST 104
2.0 i 16V	2,0	110	08.96-08.99	ABF	4			ST 050			ST 125

INCA

1.4 i	1,4	44	11.95-	AEX/AKV/APQ	4						ST 104
1.4 i	1,4	44	11.95-	AEX/AKV/APQ/AUD	4						ST 125
1.4 16V	1,4	55	04.00-	AUA	4			ST 114			ST 104
1.4 16V	1,4	55	04.00-	AUA	4			ST 114			ST 125
1.6 i	1,6	55	11.95-05.98	1F	4						ST 104
1.6 i	1,6	55	11.95-05.98	1F	4						ST 125
1.6 i	1,6	55	11.95-05.98	AEE	4						ST 125
1.7 D	1,7	42	09.96-	AHB	4			ST 050			ST 104
1.9 D, SDI	1,9	47	11.95-	1Y/AEY/AYQ	4			ST 050 ST 031			ST 104

LEON

1.4 16V	1,4	55	11.99-	AHW/AXP	4			ST 112 ST 119			ST 104
1.4 16V	1,4	55	11.99-	AHW/AXP/BCA/APE	4			ST 112 ST 114			ST 104
1.6	1,6	74	11.99-	AKL/AEH	4			ST 112 ST 119			ST 104
1.6	1,6	75	09.05-	BSF/BSE	4			ST 112			
1.6	1,6	75	09.05-	BSF/BSE	4			ST 113			
1.6 16V	1,6	77	09.05-		4			ST 112			
1.6 16V	1,6	77	09.00-	AZD	4						ST 104
1.6 16V	1,6	77	09.00-	AUS/BCB/AZD	4			ST 112			
1.8 20V	1,8	92	11.99-	AGN/APG	4			ST 112 ST 119			ST 104



kw

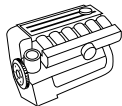

Zyl.
Cyl.
Cil.



SEAT

LEON										
1.8 20V T	1,8	132	11.99-	AUQ	4	ST 112				ST 104
1.8 20V T	1,8	132	11.99-	APP	4	ST 112	ST 119			ST 104
1.8 20V T 4	1,8	132	03.00-	AJQ/ARY	4	ST 112				ST 104
1.8 T 20V	1,8	132	09.05-		4	ST 112				
1.8 T Cupra R	1,8	154	02.02-	AMK	4	ST 112				
1.8 T Cupra R	1,8	165	07.03-	BAM	4	ST 112				
1.8 T 20V	1,8	165	09.05-		4	ST 112				
1.9 SDI	1,9	50	06.04-	AQM	4	ST 112				ST 104
1.9 TDI	1,9	66	11.99-	ALH	4	ST 112				ST 104
1.9 TDI	1,9	66	11.99-	AGR	4	ST 112	ST 119			ST 104
1.9 TDI	1,9	77	09.05-	BKC/BLS	4	ST 112				
1.9 TDI	1,9	77	09.05-	BKC/BLS	4	ST 113				
1.9 TDI	1,9	81	11.99-	ASV	4	ST 112				ST 104
1.9 TDI	1,9	81	11.99-	AHF	4	ST 112	ST 119			ST 104
1.9 TDI	1,9	81-110	09.05-		4	ST 112				
1.9 TDI	1,9	96	05.03-	ASZ	4	ST 112				
1.9 TDI, Syncro	1,9	110	02.01-	ARL	4	ST 112				ST 104
2.0 TDI 16V	2,0	103	09.05-	BKD	4	ST 112				
2.0 TDI 16V	2,0	103	09.05-	BKD	4	ST 113				
2.0 FSI	2,0	110	09.05-	BLR/BLY/BVZ/BVY	4	ST 112				
2.0 FSI	2,0	110	09.05-	BLR/BLY/BVZ/BVY	4	ST 113				
2.0 TDI	2,0	125	02.06-	BMN	4	ST 113				
2.0 TFSI	2,0	136	09.05-		4	ST 112				
2.0 TFSI	2,0	147	09.05-	BWA	4	ST 113				
2.0 TFSI	2,0	177	11.06-	BWJ	4	ST 113				
2.8 Cupra 4	2,8	150	02.01-	AUE	6	ST 112				ST 104

MALAGA

1.2, i	1,2	44-52	11.84-12.93	021 A 1000/021 C.1000	4			ST 045		
1.4, i, i KAT	1,5	63-74	05.85-12.93	021 A 2000/021 B.2000/ 021 C.2000/021 D.2000	4			ST 045		
1.7 D	1,7	40-42	05.85-12.93	022 A.5000	4			ST 045		
1.7 D	1,7	40-42	05.85-12.93	022 A.5000	4			ST 053		

TERRA

1.3 D	1,3	33	03.90-12.94	MN	4			ST 053		
1.4 D	1,4	35	10.90-12.95	1 W	4			ST 053		

TOLEDO

1.4 16V	1,4	55	07.99-	AHW	4	ST 112	ST 119			
1.4 16V	1,4	55	01.00-	AXP	4	ST 112				
1.6 i	1,6	52-55	05.91-12.93	EZ /1F/ABN	4			ST 053	ST 013	
1.6 i	1,6	52-55	05.91-12.93	EZ /1F/ABN	4			ST 053	ST 060	
1.6 i	1,6	52-55	05.91-12.93	EZ /1F/ABN	4			ST 115	ST 013	
1.6 i	1,6	52-55	05.91-12.93	EZ /1F/ABN	4			ST 115	ST 060	
1.6	1,6	74	01-10.05	AKL/AEH	4	ST 112	ST 119			
1.6 i	1,6	74	11.96-03.99	AFT	4	ST 036	ST 050	ST 030		
1.6	1,6	75	10.04-	BGU/BSF/BSE	4	ST 113				
1.6 16V	1,6	77	09.00-	AUS/AZD	4	ST 112				
1.8 i	1,8	65	05.91-12.96	RP	4			ST 053	ST 013	
1.8 i	1,8	65	05.91-12.96	RP	4			ST 053	ST 060	
1.8 i	1,8	65	05.91-12.96	RP	4			ST 115	ST 013	
1.8 i	1,8	65	05.91-12.96	RP	4			ST 115	ST 060	
1.8 i	1,8	66	11.93-12.94	ABS	4			ST 050	ST 060	
1.8 i	1,8	66	11.93-12.94	ABS	4			ST 053	ST 060	
1.8 i	1,8	66	11.93-12.94	ABS	4			ST 115	ST 060	
1.8 i	1,8	66	11.93-12.96	ADZ	4			ST 050	ST 060	
1.8 i	1,8	66	11.93-12.96	ADZ	4			ST 053	ST 060	
1.8 16V	1,8	92	05.91-12.94	PL	4			ST 053	ST 060	
1.8 16V	1,8	92	05.91-12.94	PL	4			ST 115	ST 060	
1.8 20V	1,8	92	04.99-	AGN/APG	4	ST 112	ST 119			
1.8 16V	1,8	92-98	05.91-03.99	KR/PL	4			ST 053	ST 060	
1.8 16V	1,8	98	05.91-12.93	KR	4			ST 115		
1.8 20VT	1,8	132	05.01-	AUQ	4	ST 112				

**BERU**

kW

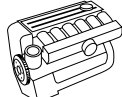
Zyl.
Cyl.
Cil.**SEAT****TOLEDO**

1.9 D,TD	1,9	47-55	05.91-03.99	1Y/AAZ	4			ST 050	ST 031		
1.9 SDI	1,9	50	11.99-06.04		4		ST 112				
1.9 TDI	1,9	66	04.99-	AGR/ALH	4		ST 112	ST 119			
1.9 TDI	1,9	66-81	08.95-03.99	1Z/AFN/AHU	4			ST 050	ST 030		
1.9 TDI	1,9	77	10.04-09.05	BJB	4		ST 113	ST 114			
1.9 TDI	1,9	77	10.04-02.06	BKC	4		ST 113	ST 114			
1.9 TDI	1,9	81	04.99-	ASV	4		ST 112				
1.9 TDI	1,9	81	04.99-	AHF	4		ST 112	ST 119			
1.9 TDI	1,9	96	05.03-	ASZ	4		ST 112				
1.9 TDI	1,9	110	10.00-	ARL	4		ST 112				
2.0 i	2,0	85	05.91-03.99	2E	4			ST 050	ST 030		
2.0 i	2,0	85	01.93-03.99	2E	4			ST 053	ST 030		
2.0 i	2,0	85	05.91-03.99	2E	4			ST 115	ST 030		
2.0 i	2,0	85	05.91-03.99	AGG	4			ST 053			ST 125
2.0 i 16V	2,0	110	11.93-03.99	ABF	4			ST 050		ST 060	
2.0 i 16V	2,0	110	11.93-03.99	ABF	4			ST 053		ST 060	
2.0 FSI	2,0	110	10.04-	BLR/BLY	4		ST 113				
2.0 TDI	2,0	103	10.04-	BKD	4		ST 113	ST 114			
2.3 V5	2,3	110	04.99-05.01	AGZ → 1M-X-010 000	5		ST 112	ST 121			
2.3 V5 20V	2,3	125	05.01-	AQN	5		ST 112				

SKODA**105**

1.0 105 GL, L, S, S	1,0	33-34	08.76-12.90	742,10	4						ST 100
---------------------	-----	-------	-------------	--------	---	--	--	--	--	--	---------------

120

1.2 120 GLS, L, LS	1,2	35-43	08.76-12.90	742,12	4						ST 100
--------------------	-----	-------	-------------	--------	---	--	--	--	--	--	---------------

FABIA

1.0	1,0	37	10.00-08.02	ATY/AQV/ARV	4		ST 112				
1.2	1,2	40	08.02-	AWY/BMD	3		ST 112				
1.2	1,2	47	01.03-	AZQ/BME	3		ST 112				
1.4	1,4	44	04.00-08.02	AZF/AZE	4		ST 112				
1.4	1,4	50	08.99-	AME/ATZ/AQW	4		ST 112				
1.4 TDI	1,4	51	10.05-	BNM	3		ST 112				
1.4 16V	1,4	55	10.99-	BBY/BKY/AUA	4		ST 112				
1.4 16V	1,4	55	10.99-	AUA	4			ST 114			
1.4 TDI	1,4	55	04.03-	AMF	3		ST 112				
1.4 16V	1,4	74	12.99-	BBZ/AUB	4		ST 112				
1.4 16V	1,4	74	12.99-	AUB	4			ST 114			
1.9 SDI	1,9	47	11.99-	ASY	4		ST 112				
1.9 TDI	1,9	74	01.00-	ATD	4		ST 112				
1.9 TDI RS	1,9	96	06.03-	ASZ	4		ST 112				
2.0	2,0	85	12.99-	AQY/AZL	4		ST 112				
2.0	2,0	85	12.99-	AZL	4		ST 112				

FAVORIT

1.3	1,3	40-50	12.92-06.95	781.135E/136B	4				ST 028		
-----	-----	-------	-------------	---------------	---	--	--	--	---------------	--	--

FELICIA

1.6, LX	1,6	55	08.95-06.01	AEE	4						ST 108
---------	-----	----	-------------	-----	---	--	--	--	--	--	---------------

OCTAVIA

1.4	1,4	44	04.99-	AMD	4		ST 112				
1.4	1,4	44	08.00-03.01	AMD	4		ST 113				
1.4	1,4	44	04.99-	AMD → 1U-X-134 201	4				ST 119		
1.4 16V	1,4	55	09.00-	AXP/BCA	4		ST 112	ST 119			
1.4 16V	1,4	55	09.00-09.04	AXP/BCA	4		ST 113	ST 119			
1.4	1,4	55	06.04-	BCA	4		ST 112	ST 114			
1.6	1,598	55	09.96-09.00	AEE → 1U-X-134 200	4		ST 112	ST 121			
1.6	1,598	55	09.96-09.00	AEE F 1U-X- 228 001 →	4		ST 112				
1.6	1,595	74	02.97-	AKL/AEH	4		ST 113	ST 121			
1.6	1,595	74	02.97-	→ 1U-X-134 200	4						
1.6	1,595	74	02.97-	AKL/AEH	4		ST 113	ST 119			ST 104
				1U-X-134 201 →							



kw

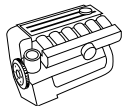

Zyl.
Cyl.
Cil.



**SKODA
OCTAVIA**

1.6	1,595	74	02.97-	AKL/AEH F 1U-X- 228 001 →	4	ST 112						
1.6	1,6	75	09.00-	AVU/BFQ	4	ST 112	ST 119					
1.6	1,6	75	09.00-09.04	AVU/BFQ	4	ST 113	ST 119					
1.6	1,6	75	06.04-	BGU	4	ST 112						
1.6 FSI	1,6	85	06.04-	BLF	4	ST 112						
1.8	1,781	92	09.96-	AGN → 1U-X-134 200	4		ST 121					ST 104
1.8	1,781	92	09.96-	AGN 1U-X-134 201 →	4		ST 119					ST 104
1.8	1,781	92	09.96-	AGN F 1U-X- 228 001 →	4	ST 112						
1.8 T 4x4	1,8	110	05.01-	AUM	4	ST 112						
1.8 T 4x4	1,8	110	05.01-	AUM	4	ST 113						
1.8 T 4x4	1,8	110	05.01-	ARX	4	ST 112	ST 119					
1.8 T 4x4	1,8	110	05.01-	ARX	4	ST 113	ST 119					
1.8 T	1,8	110	08.97-	AGU	4	ST 113	ST 119					ST 104
1.8 T	1,8	110	08.97-	AGU	4	ST 113	ST 121					ST 104
1.8 T	1,8	110	08.97-	ARX/ARZ/AGU/AUM	4	ST 113						
1.8 T	1,781	110	08.97-	ARX/ARZ/AGU/AUM F 1U-X- 228 001 →	4	ST 112						
1.8 T	1,781	110	08.97-	ARX/ARZ/AGU/AUM → 1U-X-134 200	4		ST 121					
1.8 T	1,781	110	08.97-	ARX/ARZ/AGU/AUM 1U-X-134 201 →	4		ST 119					
1.8 T	1,8	110	08.97-	ARZ	4		ST 119					
1.8 T	1,8	110	08.97-	ARZ	4		ST 121					
1.8 T	1,8	110	08.97-	AUM	4	ST 113						
RS 1.8 T	1,8	132	05.01-	AUQ	4	ST 112	ST 119					
RS 1.8 T	1,8	132	05.01-01.06	AUQ	4	ST 113						
1.9 SDI	1,9	50	06.97-	AQM/AGP	4	ST 112	ST 119					ST 104
1.9 SDI	1,9	50	06.97-	AQM/AGP	4	ST 113	ST 119					ST 104
1.9 SDI	1,9	50	06.97-	AQM/AGP	4	ST 112	ST 121					ST 104
1.9 SDI	1,9	50	06.97-	AQM/AGP	4	ST 113	ST 121					ST 104
1.9 TDI, 4x4	1,9	66	09.96-	AGR/ALH	4	ST 112	ST 119					ST 104
1.9 TDI, 4x4	1,9	66	09.96-	AGR/ALH	4	ST 113	ST 119					ST 104
1.9 TDI, 4x4	1,9	66	09.96-	AGR/ALH	4	ST 112	ST 121					ST 104
1.9 TDI, 4x4	1,9	66	09.96-	AGR/ALH	4	ST 113	ST 121					ST 104
1.9 TDI, 4x4	1,9	74	09.00-	ATD	4	ST 112	ST 119					
1.9 TDI, 4x4	1,9	74	09.00-	ATD	4	ST 113	ST 119					
1.9 TDI, 4x4	1,9	77	06.04-	BKC/BJB	4	ST 112						
1.9 TDI	1,9	81	08.97-	AHF/ASV	4	ST 112	ST 119					ST 104
1.9 TDI	1,9	81	08.97-	AHF/ASV	4	ST 113	ST 119					ST 104
1.9 TDI	1,9	81	08.97-	AHF/ASV	4	ST 112	ST 121					ST 104
1.9 TDI	1,9	81	08.97-	AHF/ASV	4	ST 113	ST 121					ST 104
1.9 TDI	1,9	96	01.03-	ASZ	4	ST 112						
1.9 TDI	1,9	96	01.03-09.04	ASZ	4	ST 113						
2.0, 4x4	2,0	85	04.99-	APK/AZH/AQY/AEG	4	ST 112	ST 119					
2.0, 4x4	2,0	85	04.99-	APK/AZH/AQY/AEG	4	ST 113	ST 119					
2.0, 4x4	2,0	85	04.99-	APK/AZH/AQY/AEG	4	ST 112	ST 121					
2.0, 4x4	2,0	85	04.99-	APK/AZH/AQY/AEG	4	ST 113	ST 121					
2.0 TDI 16V	2,0	103	06.04-	BKD	4	ST 112						
2.0 FSI, 4x4	2,0	110	11.04-	BLY/BLR	4	ST 112						
SUPERB												
1.8 T	1,8	110	02.02-	AWT F 3U-29007 773 →	4		ST 113	ST 119				
1.9 TDI	1,9	74	08.02-10.05	AVB F 3U-29007 773 →	4		ST 113	ST 119				
1.9 TDI	1,9	96	02.02-	AWX/AVF F 3U-29007 773 →	4		ST 113	ST 119				
2.0	2,0	85	02.02-	AZM F 3U-29007 773 →	4		ST 113	ST 119				
2.0 TDI	2,0	103	10.05-	BSS F 3U-29007 773 →	4		ST 113					
2.5 TDI	2,5	114	02.02-	AYM F 3U-29007 773 →	6		ST 113	ST 119				
2.5 TDI	2,5	120	06.03-	BDG F 3U-29007 773 →	6		ST 113					
2.8 V6	2,8	142	02.02-	AMX F 3U-29007 773 →	6		ST 113	ST 119				

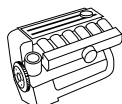

kW

Zyl.
Cyl.
Cil.

SUBARU										
LEONE										
1600, 4WD	1,6	52-63	03.79-10.84	EA71	4					ST 042
1800, 4WD	1,8	59-60	09.80-10.84	EA81	4					ST 042
1800 XT COUPE										
Turbo 4WD	1,8	88-100	11.84-12.90	EA82	4					ST 042
SUZUKI										
CARRY										
0.8	0,8	27	11.80-10.85	F8A	4					ST 039
1.0	1,0	33	10.85-03.99	F10A	4					ST 039
LJ 80										
0.8	0,8	29	01.80-01.84	F8A	4					ST 039
SAMURAI										
1.0	1,0	33	11.88-03.02	F10A	4					ST 039
1.3	1,3	44-51	11.88-03.02	G13A/G13B/G13BA	4					ST 068
SWIFT										
1.3, Gti	1,3	50-74	03.89-03.02	G13A/G13B	4					ST 068
VITARA										
1.6	1,6	59-71	07.88-03.99	G16A/G16B	4					ST 068
GRAND VITARA										
2.0 TD Intercooler	2,0	64	03.98-	RF	4					ST 098
TALBOT										
1307-1510										
Simca 1307 1.3, S	1,3	40-60	07.75-08.81	6G1D	4					ST 049
Simca 1510 1.4	1,4	51-63	11.78-04.84	6G1/6Y2/6Y2D	4					ST 049
Simca 1510 1.6	1,6	54-66	10.78-12.83	6J1/6J2/6J2A	4					ST 049
HORIZON										
1.1	1,1	40-43	01.79-09.84	E1B	4					ST 049
1.3	1,3	40-50	02.78-06.86	2G1/2G1-BTC	4					ST 049
1.4	1,4	48-61	07.79-06.86	2Y1/2Y1B/2Y2/Y2	4					ST 049
1.6	1,6	66	07.82-06.86	6J2A/J2A	4					ST 049
1.9 Diesel	1,9	47-48	07.82-06.86	XUD9	4					ST 049
SAMBA										
0.9	0,9	31	01.81-12.85	5C1(XV5)/5C1(XV8)	4					ST 044
1.1	1,1	37	01.81-06.86	XW7	4					ST 044
1.2 Rallye	1,2	65	01.83-10.86	129 D	4					ST 044
1.4, Rallye	1,4	44-58	06.83-10.86	150 D/XY7/XY8	4					ST 044
SIMCA 1000-1100										
0.9, 1.1, 1.2, 1.3, 1005, 1006	0,0	29-76	10.71-01.80	1D1/1G1/3E1/3E1A/3G4	4					ST 049
SOLARA										
1.3	1,3	40	02.80-07.86	6G1D/VP	4					ST 049
1.6	1,6	51-66	02.80-07.86	J1B/6J1/6J2/J1/J2	4					ST 049
TAGORA										
2.1	2,2	85	06.80-12.83	5N2	4					ST 049
2.3 Turbo Diesel	2,3	59	08.81-12.87	XD2S	4					ST 049
2.6	2,6	122	08.81-10.83	9L6	6					ST 049
TOYOTA										
CAMRY										
1.8 Turbo-D	1,8	54	11.83-01.88	1C-TL	4					ST 041
2.0 Turbo-D	2,0	62-63	11.86-05.91	2C-T	4					ST 041
2.0	2,0	73	04.86-01.88	2S-E	4					ST 041
2.0 GLI	2,0	79	03.83-10.86	2S-EL	4					ST 041
2.2	2,2	96	08.96-11.01	5S-FE	4					ST 068
2.2	2,2	100	06.91-08.96	5S-FE	4					ST 041 ST 068
3.0, 24V	3,0	138-140	06.91-11.01	3VZ-FE/1MZ-FE	6					ST 068
CARINA										
1.6	1,6	54-55	01.78-09.83	2T	4					ST 041
1.6	1,6	55-63	05.73-03.78	2T/2TB	4					ST 042
1.8	1,8	57-63	01.78-02.87	3T-C/3T	4					ST 041



kw

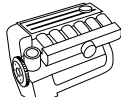

Zyl.
Cyl.
Cil.



TOYOTA

CELICA

1.6 LS, LT, GT	1,6	55-79	05.73-03.78	2T/2TB/2T-G	4	ST 042	
1.6 LS, LT, GT	1,6	55-81	04.78-07.83	2TB/2T-G	4	ST 041	
1.6 STI	1,6	77	10.89-01.94	4A-FE	4		ST 068
1.8 i 16V	1,8	85	11.93-11.99	7A-FE	4		ST 068
2.0	2,0	63	10.75-07.77	18R	4	ST 042	
2.0 XT	2,0	65-66	02.79-07.85	18R	4	ST 041	
2.0 Turbo 4WD	2,0	150-153	10.89-01.94	3S-GTE	4	ST 041	ST 068
2.8 i	2,8	125	05.82-10.86	5M-GE	6	ST 041	

COROLLA

1.2	1,2	40	08.74-12.80	3K-B/3K-C/3K-H	4	ST 042	
1.3, i	1,3	55	08.87-06.92	2E/2E-E	4	ST 041	
1.6	1,6	53-66	06.83-04.92	4A-F/4A-L/4A-LC	4	ST 041	
1.6	1,6	54-62	09.76-01.80	2T/2TB	4	ST 042	
1.6, XLI 4X4, i 4WD	1,6	77	10.87-06.93	4A-FE	4	ST 041	ST 068
1.6 GLI, Si	1,6	81-84	07.92-02.00	4A-FE	4		ST 068
1.6 Gti	1,6	85-92	07.87-06.93	4A-GE	4	ST 041	
1.8 D	1,8	43-49	01.83-06.93	1C/1C-L	4	ST 041	
1.8 16V 4WD	1,8	81	09.95-01.02	7A-FE	4		ST 068

CORONA

1.8	1,8	63	06.79-07.81	3T	4	ST 041	
2.0, Mark II	2,0	65	12.75-10.77	18R	4	ST 042	

CRESSIDA

2.0	2,0	66	07.77-07.81	18R	4	ST 041	
2.0	2,0	66	07.77-07.81	18R	4	ST 042	
2.0	2,0	77	05.81-03.85	21R/21R-C	4	ST 041	
2.2 D	2,2	49	09.80-03.85	L	4	ST 041	

LAND CRUISER

3.9	3,9	96	03.69-01.75	F	6	ST 042	
4.0 (FJ80_)	4,0	115	01.90-08.92	3F-E	6		ST 068
4.2	4,2	89	01.75-04.86	2F	6	ST 042	
4.5 24V	4,5	151	08.92-12.97	1FZ-FE	6		ST 068

MR 2

1.6 16V	1,6	85-91	11.84-06.90	4A-GEL/4A-GELC	4	ST 041	
---------	-----	-------	-------------	----------------	---	--------	--

PASEO

1.5 16V	1,5	66	08.95-07.99	5E-FE	4		ST 068
---------	-----	----	-------------	-------	---	--	--------

PREVIA

2.4, 4WD	2,4	97	05.90-08.00	2TZ-FE	4		ST 068
----------	-----	----	-------------	--------	---	--	--------

SUPRA

3.0 Turbo	3,0	173-243	09.87-08.98	7M-GTE/2JZ-GTE	6		ST 068
-----------	-----	---------	-------------	----------------	---	--	--------

4 RUNNER

2.4	2,4	82-84	08.87-03.96	22REC/22RE	4	ST 041	
3.0 V6	3,0	105	07.90-11.95	3VZ-E	6	ST 041	ST 068

HIACE

2.0	2,0	65	07.77-03.83	18R	4	ST 041	
2.2 D	2,2	46	01.79-03.83	L	4	ST 041	

LITEACE

1.3	1,3	42	10.79-10.86	4K/4K-C	4	ST 041	
-----	-----	----	-------------	---------	---	--------	--

TRIUMPH

ACCLAIM

1.3	1,3	51	01.82-12.85	EJ	4	ST 039	
-----	-----	----	-------------	----	---	--------	--

VAUXHALL

ASTRA

1.4 i	1,4	44	01.90-08.91	C 14 NZ	4	ST 037	
1.4 i	1,4	44-60	03.91-03.01	C 14 NZ/C 14 SE	4	ST 037	ST 075
1.4 i	1,4	44-60	03.91-03.01	C 14 NZ/C 14 SE	4	ST 037	ST 087
1.4 i 16V	1,4	66	01.96-03.01	X 14 XE	4		ST 075
1.4 i 16V	1,4	66	01.96-03.01	X 14 XE	4		ST 087
1.4 S	1,4	55	01.90-08.91	14 NV	4	ST 037	
1.4 S	1,4	55	09.91-02.98	14 NV	4	ST 037	ST 075

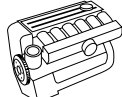

kW

Zyl.
Cyl.
Cil.**VOLKSWAGEN****EOS**

1.6 FSI	1,6	85	06.06-	BLF	4	ST 113			
2.0 TDI	2,0	103	06.06-	BMM	4	ST 113			
2.0 FSI	2,0	110	03.06-		4	ST 113			
2.0 TFSI	2,0	147	03.06-		4	ST 113			
3.2 V6	3,2	184	06.06-	BUB	6	ST 113			

FOX

1.2 (AC)	1,2	40	04.05-	BMD	3	ST 112			
1.4 TDI (AC)	1,4	51	04.05-	BNM	3	ST 112			
1.4 (AC)	1,4	55	04.05-	BKR	4	ST 112			

GOLF

Citystromer		20	11.94-08.97						ST 102
Citystromer		20	11.94-08.97						ST 104
1.0	1,0	33-37	11.83-10.91	GN/HZ	4				ST 070
1.0	1,0	37	08.85-10.91	HZ	4	ST 115			ST 071
1.1	1,1	37	04.74-08.78	GG/FA	4				ST 100
1.1	1,1	37	08.79-07.83	GG	4				ST 070
1.1	1,1	38-44	01.81-07.83	FJ/HC	4				ST 070
1.3, KAT	1,3	37-44	08.83-12.92	GTHK/MH/MH (KAT)/NU/ NZ/2G	4				ST 070
1.3 KAT	1,3	40	06.86-12.92	NZ/2G	4	ST 115			ST 125
1.3, KAT	1,3	40	08.83-12.92	HK/MH/MH (KAT)/NZ/2G	4				ST 071
1.3	1,3	44	08.79-07.83	GF	4				ST 070
1.4	1,4	40	01.92-08.97	AEX/ABD	4				ST 102
1.4	1,4	40	01.92-08.97	AEX/ABD	4				ST 106
1.4	1,4	40	11.91-08.97		4				ST 070
1.4	1,4	40	10.91-12.94	ABD	4	ST 030			ST 070
1.4	1,4	40	01.94-04.99	ABD	4				ST 102
1.4	1,4	40	07.93-04.99	ABD	4				ST 104
1.4	1,4	40	07.93-04.99	ABD	4				ST 106
1.4	1,4	40	07.93-04.99	ABD	4				ST 125
1.4	1,4	44	10.91-08.97	AEX/ABD	4				ST 102
1.4	1,4	44	10.91-08.97	AEX/ABD	4				ST 104
1.4	1,4	44	01.92-08.97	AEX/ABD	4				ST 106
1.4	1,4	44	10.91-08.97	ABD	4				ST 125
1.4	1,4	44	01.94-04.99	AEX/ABD/APQ	4				ST 102
1.4	1,4	44	07.93-04.99	AEX/APQ	4				ST 104
1.4	1,4	44	07.93-04.99	AEX/ABD/APQ	4				ST 106
1.4 16V	1,4	55	08.97-06.05	AHW/AXP/BCA/APE/AKQ	4	ST 112			
1.4 16V	1,4	55	05.02-06.05	AHW//BCA	4	ST 113			
1.4 16V, Plus	1,4	55	10.03-05.06	BCA	4	ST 113			
1.4 16V, Plus	1,4	55	01.05-05.06	BCA	4	ST 112			
1.4 16V, Plus	1,4	59	05.06-	BUD	4	ST 112			
1.4 16V	1,4	59	05.06-11.06	BUD	4	ST 113			
1.4 FSI	1,4	66	12.04-07.06	BLN	4	ST 113			
1.4 FSI	1,4	66	10.03-12.04	BKG	4	ST 113			
1.4 TSI, Plus	1,4	103	05.06-	BMV	4	ST 112			
1.4 TSI, Plus	1,4	103	05.06-	BMV	4	ST 113			
1.4 TSI, Plus	1,4	125	05.06-	BLG	4	ST 112			
1.4 TSI, Plus	1,4	125	11.05-	BLG	4	ST 113			
1.5 D	1,5	37	08.76-07.80	CK	4		ST 053		
1.5 D	1,5	37	08.76-07.80	CK	4		ST 054		
1.5	1,5	51	04.74-12.75	FH	4				ST 100
1.5	1,5	51	08.77-11.83	JB	4				ST 070
1.6 D, TD	1,6	37-59	08.83-10.91	1V/CR/JK/CY/JP/ME/ME/ JR/MF/MF/RA/SB	4				ST 070
1.6 D, TD	1,6	37-59	08.83-10.91	1V/CR/JK/CY/JP/ME/ME/ JR/MF/MF/RA/SB	4				ST 071
1.6 D	1,6	40	01.89-10.91	ME/JP	4	ST 115			ST 125
1.6 TD	1,6	44	08.89-10.91	1V	4				ST 125
1.6 TD	1,6	51	01.89-10.91	JR/MF	4	ST 115			ST 125
1.6	1,6	51	01.89-12.92	PN	4	ST 115			ST 125



kw

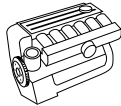

Zyl.
Cyl.
Cil.



VOLKSWAGEN

GOLF									
1.6	1,6	51-53	02.86-12.92	PN/RE/RF (KAT)	4				ST 070
1.6	1,6	51-53	02.86-12.92	PN/RE/RF (KAT)	4				ST 071
1.6	1,6	53	02.86-12.88	RF	4		ST 053		ST 125
1.6	1,6	53	01.89-10.91	RF	4		ST 115		ST 125
1.6	1,6	55	08.75-02.84	FN/FP/EM	4				ST 100
1.6	1,6	55	08.83-04.92	EW/EZ /HM/HM	4				ST 070
1.6	1,6	55	08.83-04.92	EW/EZ /HM/HM	4				ST 071
1.6	1,6	55	09.92-08.97	AEA/ABU/AEE	4		ST 030		ST 070
1.6	1,6	55	01.89-07.92	EZ	4		ST 115		
1.6	1,6	55	01.94-08.97	ABU/AEA/AEE	4				ST 102
1.6	1,6	55	09.92-12.97	ABU/AEA/AEE	4				ST 104
1.6	1,6	55	09.92-08.97	ABU/AEA/AEE	4				ST 106
1.6	1,6	55	08.83-07.92	ABN	4				ST 125
1.6	1,6	55	09.92-12.97	ABU	4				ST 125
1.6 TD	1,6	59	04.89-10.91	RA/SB	4				ST 125
1.6	1,6	74	07.94-04.99	AEK/AFT/AKS	4		ST 036		ST 070
1.6	1,6	74	07.95-08.97	AEK/AFT/AKS	4		ST 036		ST 102
1.6	1,6	74	07.95-08.97	AEK/AFT/AKS	4		ST 036		ST 104
1.6	1,6	74	07.95-08.97	AEK/AFT/AKS	4		ST 036		ST 106
1.6	1,6	74	08.97-02.00	AKL/APF/AEH	4		ST 112		ST 104
1.6	1,6	75	08.00-06.05	AVU/BFQ/BJH	4		ST 112		ST 104
1.6	1,6	75	05.02-06.05	BFQ	4		ST 113		
1.6	1,6	75	01.04-	BGU/BSF/BSE	4		ST 113		
1.6, Plus	1,6	75	05.05-	BSF/BSE	4		ST 112		
1.6 16V	1,6	77	02.00-06.05	AUS/ATN/BCB/AZD	4		ST 112		ST 104
1.6 16V	1,6	77	05.02-06.05	BCB	4		ST 113		
1.6	1,6	81	01.80-07.82	EG	4				ST 071
1.6, GTI	1,6	81	08.76-07.82	EG	4				ST 070
1.6 GTI	1,6	81	08.76-07.82	EG	4				ST 100
1.6 FSI	1,6	81	01.02-06.05	BAD	4		ST 112		ST 104
1.6 FSI	1,6	81	05.02-06.05	BAD	4		ST 113		ST 104
1.6 FSI	1,6	85	10.03-	BAG	4		ST 113		
1.6 FSI Plus	1,6	85	01.05-	BLF	4		ST 112		
1.6 FSI Plus	1,6	85	01.05-	BLF	4		ST 113		
1.8	1,8	55	11.91-08.97	AAM	4				ST 102
1.8	1,8	55	11.91-08.97	AAM	4				ST 104
1.8	1,8	55	01.92-08.97	AAM	4				ST 106
1.8	1,8	55	11.91-08.97	AAM	4				ST 125
1.8	1,8	55-66	11.91-07.93	AAM/ABS/ADZ	4		ST 030	ST 013	ST 070
1.8	1,8	55-66	07.93-05.98	AAM/ABS/ADZ	4		ST 030	ST 013	
1.8	1,8	62	01.89-01.90	RH	4		ST 115		
1.8, i, i Syncro - (KAT)	1,8	62-82	08.82-04.93	EX/DX/EV/PB/GX/HV/RH/ RP/GU/JH/1P/2H	4				ST 070
1.8, i, i Syncro - (KAT)	1,8	62-82	08.82-04.93	EX/DX/EV/PB/GX/HV/RH/ RP/GU/JH/1P/2H	4				ST 071
1.8 Syncro	1,8	66	01.89-07.91	GU	4		ST 115		
1.8, i Syncro KAT	1,8	66	08.84-10.91	GX/GU/HV/RP	4		ST 125		
1.8	1,8	66	11.91-08.97	ACC/ADZ/ABS	4				ST 102
1.8, Syncro	1,8	66	11.91-08.97	ACC/ADZ/ABS	4				ST 104
1.8	1,8	66	01.92-08.97	ACC/ADZ/ABS	4				ST 106
1.8	1,8	66	11.91-08.97	ABS	4				ST 125
1.8 Syncro	1,8	66	01.94-08.97	ADZ	4		ST 115	ST 013	ST 070
1.8 Syncro	1,8	72	08.88-07.91	1P	4				ST 125
1.8 GTI KAT	1,8	79	01.87-10.91	PF	4		ST 115		ST 125
1.8 GTI, 16V -(KAT)	1,8	79-102	08.82-10.91	DX/EV/GZ/RD/PF/PL/KR/ PB	4				ST 070
1.8 GTI, 16V -(KAT)	1,8	79-102	08.82-10.91	DX/EV/GZ/RD/PF/PL/KR/ PB	4				ST 071
1.8 GTI	1,8	82	08.83-10.91	PB	4				ST 125
1.8	1,8	92	08.97-06.05	AGN/BAF	4		ST 112		ST 104
1.8 GTI 16V	1,8	95	02.86-10.91	PL/KR	4		ST 115		ST 125

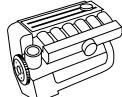

kW

Zyl.
Cyl.
Cil.**VOLKSWAGEN****PASSAT**

2.3 V5, 4motion	2,3	125	01.01-05.05	AZX	5	ST 113						ST 102
2.5 TDI, Syncro/4motion	2,5	110	07.98-11.00	AKN/AFB	6							ST 102
2.5 TDI, Syncro/4motion	2,5	110	07.98-11.00	AKN/AFB	6						ST 065	
2.5 TDI, 4motion	2,5	110	11.00-05.05	AKN/AFB	6							ST 102
2.5 TDI 4motion	2,5	132	01.03-05.05	BAU/BDH	6	ST 113						
2.5 TDI	2,5	120	05.03-05.05	BDG	6	ST 113						
2.8 V6, Syncro/4motion	2,8	132-140	08.96-11.00	ACK/APR/AQD/ALG/AGE/ ATX	6						ST 065	
2.8 VR6	2,8	128	06.91-08.96	AAA	6	ST 036					ST 065	ST 070
2.8 VR6	2,8	128	01.94-08.96	AAA	6							ST 102
2.8 VR6	2,8	128	06.91-08.96	AAA	6							ST 104
2.8 VR6	2,8	128	01.94-08.96	AAA	6							ST 106
2.8 V6 Syncro/4motion	2,8	142	10.96-11.00	APR/ACK/ALG/AQD	6							ST 102
2.8 4motion	2,8	142	11.00-05.05	ATQ/AMX	6	ST 113						ST 102
2.9 VR6 Syncro	2,9	135	01.94-05.97	ABV	6	ST 036					ST 065	
3.2 FSI, 4motion	3,2	184	11.05-	AXZ	6	ST 113						

PHAETON

3.0 V6 TDI 4motion	3,0	165	09.04-05.05	BMK	6	ST 112						
3.2 V6	3,2	177	04.02-05.05	AYT	6	ST 112						
3.2 V6 4motion	3,2	177	02.04-	BRK/BKL	6	ST 112						
4.2 V8 4motion	4,2	246	05.03-	BGJ/BGH	8	ST 112						
5.0 V10 TDI 4motion	4,9	230	11.02-10.06	AJS	10	ST 112						
6.0 W12 4motion	6,0	309	04.02-05.05	BAN	12	ST 112						

POLO

0.9	0,9	29	09.75-12.78	HA	4							ST 100
0.9	0,9	29	09.75-09.81	HA	4							ST 070
0.9	0,9	29	10.81-12.81	HA	4							ST 071
1.0	1,0	29	10.81-10.86	GL	4		ST 115					ST 104
1.0, KAT	1,0	33	10.81-12.94	AAK/ACM/AAU/GL/HZ	4		ST 115					ST 070
1.0, KAT	1,0	33	10.81-12.94	AAK/ACM/AAU/GL/HZ	4		ST 115					ST 071
45 1.0	1,0	33	10.94-09.96	AEV	4		ST 115					ST 104
1.0	1,0	33	08.85-01.92	HZ	4		ST 115					ST 104
50 1.0	1,0	37	09.96-10.99	AER/ALL	4			ST 030				ST 104
1.0	1,0	37	10.99-09.01	ALD/AUC	4	ST 112						ST 104
1.1	1,1	37	10.81-09.89	HB	4		ST 115					ST 070
1.1	1,1	37	10.81-09.89	HB	4		ST 115					ST 071
1.1	1,1	37	03.75-12.78	HB	4		ST 115					ST 100
1.1	1,1	37-44	03.75-09.81	HC	4							ST 070
1.1	1,1	44	03.75-12.78	HC	4							ST 100
1.2	1,2	40	01.02-	AWY/BMD	3	ST 112						
1.2	1,2	40	01.02-	AWY/BMD	3	ST 113						
1.2	1,2	47	10.01-	AZQ/BME	3	ST 112						
1.2	1,2	47	10.01-	AZQ/BME	3	ST 113						
1.3 D	1,3	33	08.86-08.90	MN	4		ST 115					ST 070
1.3 D	1,3	33	08.86-08.90	MN	4		ST 115					ST 071
1.3 KAT	1,3	40	01.85-09.94	NZ/2G/MH/AAV K-000 001 →	4		ST 115					
1.3	1,3	40	04.93-12.94	AAV	4		ST 115					
55 1.3	1,3	40	10.94-07.95	ADX	4			ST 030				ST 104
1.3, KAT, 1.3 G40	1,3	40-85	10.81-07.88	3F/HH/HK/MH/MH (KAT)/ NZ/2G/AAV/PY	4							ST 070
1.3, KAT, 1.3 G40	1,3	40-85	10.81-07.88	3F/HH/HK/MH/MH (KAT)/ NZ/2G/AAV/PY	4							ST 071
1.3	1,3	44	12.76-12.78	HH	4		ST 115					ST 100
1.3	1,3	44	12.76-09.81	HH	4		ST 115					ST 070
1.3 KAT	1,3	55	01.90-12.90	3F K-000 001 →	4		ST 115					
1.3	1,3	55	09.82-09.89	GK K-000 001 →	4		ST 115					
1.3 G40	1,3	85	01.87-08.90	PY K-000 001 →	4		ST 115					
55 1.4	1,3	40	08.95-10.99	AEX	4							ST 104
1.4 D	1,4	35	10.90-09.94	1W	4		ST 115					ST 070
1.4 D	1,4	35	10.90-09.94	1W	4		ST 115					ST 071





kw

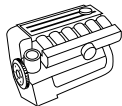

Zyl.
Cyl.
Cil.



VOLKSWAGEN

POLO																				
1.4	1,4	40	10.99-09.01	AKP	4			ST 112	ST 119											ST 104
1.4, 55 1.4, 60 1.4, 100 1.4 16V	1,4	40-74	07.95-09.01	AFH/AEX/AKV/AKK/AUD/ANW/ANX/APQ	4							ST 030								
60 1.4	1,4	44	07.95-10.99	AEX/AKV/APQ	4					ST 121										ST 104
1.4	1,4	44	10.99-09.01	AKK/AUD	4			ST 112	ST 119											ST 104
75 1.4 16V	1,4	55	10.99-09.01	APE/AUA	4					ST 119										ST 104
75 1.4 16V	1,4	55	10.99-09.01	APE/AUA	4						ST 121									ST 104
1.4	1,4	55	07.03-	BBY	4			ST 112												
1.4	1,4	55	07.03-05.04	BBY	4			ST 113												
1.4 TDI	1,4	55	10.99-09.01	AMF	3			ST 112	ST 119											ST 104
1.4 TDI	1,4	55	10.01-05.05	AMF/BAY	3			ST 112												
1.4 TDI	1,4	55	10.01-05.05	AMF/BAY	3			ST 113												
1.4 16V	1,4	59	05.06-	BUD	4			ST 113												
1.4 TDI	1,4	59	04.05-	BMS/BNV	3			ST 112												
1.4 TDI	1,4	59	04.05-	BMS/BNV	3			ST 113												
1.4 FSI	1,4	63	05.02-	AXU	4			ST 112												
1.4 FSI	1,4	63	05.02-05.06	AXU	4			ST 113												
100 1.4 16V	1,4	74	04.96-10.99	AFH	4															ST 104
1.4 16V	1,4	74	10.99-09.01	AFK/AUB	4															ST 104
1.4 16V	1,4	74	10.99-09.01	AFK/AUB/AQQ	4			ST 112												
1.4, 16V	1,4	74	10.01-	BBZ/AUB	4			ST 112												
1.4, 16V	1,4	74	10.01-	BBZ/AUB	4			ST 113												
75 1.6	1,6	55	11.95-09.97	1F	4															ST 125
75 1.6	1,6	55	10.94-10.99	AEA/AEE/AHS	4															ST 104
75 1.6	1,6	55	11.95-09.01	ALM/AEE	4					ST 119										ST 104
75 1.6	1,6	55	11.95-09.01	ALM/AEE	4															ST 125
75 1.6	1,6	55	10.94-10.99	AEA/AEE/AHS	4							ST 030								
1.6, 100 1.6	1,6	74	12.95-09.01	AFT/AEH/AKL/APF/AUR	4			ST 036				ST 030								
100 1.6	1,6	74	12.95-09.01	AKL/APF/AEH/AUR/AFT	4															ST 104
100 1.6	1,6	74	12.95-09.01	AKL → 6K-Y-503 400	4					ST 121										
100 1.6	1,6	74	12.95-09.01	AKL/APF/AEH/AUR K-000 001 →	4					ST 119										
100 1.6	1,6	74	12.95-09.01	AFT	4															ST 125
1.6 16V	1,6	77	05.06-	BTS	4			ST 113												
120 1.6 16V GTI	1,6	88	09.98-10.99	AJV	4					ST 121										ST 104
1.6 16V GTI	1,6	92	10.99-09.01	AVY/ARC	4			ST 112	ST 119											ST 104
1.7 SDI	1,7	42	04.97-10.99	AHG	4															ST 104
57 1.7 SDI	1,7	42	07.97-09.01	AKW	4															ST 104
60 1.7 SDI	1,7	44	08.97-04.00	AKU	4			ST 112												ST 104
1.8 GTI	1,8	110	09.05-	BJX	4			ST 113												
1.9 D, 64 1.9 D	1,9	47	10.94-10.99	AEF	4							ST 031								
68 1.9 SDI	1,9	50	08.99-09.01	AGP/AQM	4															ST 104
68 1.9 SDI	1,9	50	08.99-09.01	AGP/AQM → 6K-Y-503 400	4					ST 121										
68 1.9 SDI	1,9	50	08.99-09.01	AGP/AQM 6K-Y-503 401 →	4					ST 119										
90 1.9 TDI	1,9	66	09.96-09.01	ALE/AHU/AGR/ALH	4					ST 114										ST 104
90 1.9 TDI	1,9	66	09.96-09.01	ALE/AHU/AGR/ALH 6K-Y-503 401 →	4					ST 119										
90 1.9 TDI	1,9	66	09.96-09.01	AGR/ALH → 6K-Y-503 400	4					ST 121										
90 1.9 TDI	1,9	66	09.96-09.01	AGR/ALH 6K-Y-503 401 →	4					ST 119										
1.9 TDI	1,9	74	10.01-	AXR/ATD	4			ST 112												
1.9 TDI	1,9	74	10.01-	AXR/ATD	4			ST 113												
110 1.9 TDI	1,9	81	06.98-09.01	AFN/ASV	4					ST 114										ST 104
110 1.9 TDI	1,9	81	06.98-09.01	ASV → 6K-Y-503 400	4					ST 121										
110 1.9 TDI	1,9	81	06.98-09.01	ASV 6K-Y-503 401 →	4					ST 119										
1.9 TDI	1,9	96	11.03-	BLT/ASZ	4			ST 112												
1.9 TDI	1,9	96	11.03-	BLT/ASZ	4			ST 113												



kw

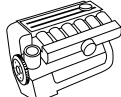

Zyl.
Cyl.
Cil.



VOLKSWAGEN

TOURAN

1.9 TDI	1,9	74	02.03-05.04	AVQ	4	ST 113			
1.9 TDI	1,9	77	08.03-	BKC	4	ST 112			
1.9 TDI	1,9	77	08.03-02.06	BKC	4	ST 113			
2.0 EcoFuel	2,0	80	02.06-	BSX	4	ST 113			
2.0 TDI	2,0	100	02.03-	AZV	4	ST 112			
2.0 TDI	2,0	100	02.03-	AZV	4	ST 113			
2.0 TDI 16V	2,0	103	08.03-	BKD	4	ST 112			
2.0 TDI 16V	2,0	103	08.03-	BKD	4	ST 113			
2.0 FSI	2,0	110	10.03-	BLX/BLY/BLR/AXW	4	ST 112			
2.0 FSI	2,0	110	10.03-11.05	BLX/BLY/BLR/AXW	4	ST 113			
2.0 TDI	2,0	125	12.05-	BMN	4	ST 113			

VENTO

1.4	1,4	40	11.91-09.98	AEX/ABD	4				ST 102
1.4	1,4	40	01.92-09.98	AEX/ABD	4				ST 106
1.4	1,4	40	11.91-09.98		4				ST 070
1.4	1,4	40	11.91-09.98		4				ST 071
1.4	1,4	44	11.91-09.98	AEX/ABD	4				ST 102
1.4	1,4	44	11.91-09.98	AEX/ABD	4				ST 104
1.4	1,4	44	01.92-09.98	AEX/ABD	4				ST 106
1.4	1,4	44	11.91-09.98	ABD/AEX	4				ST 070
1.4	1,4	44	11.91-09.98	ABD/AEX	4				ST 071
1.6	1,6	55	09.92-09.98	AEA/ABU/AEE	4				ST 070
1.6	1,6	55	01.94-09.98	ABU/AEA/AEE	4				ST 102
1.6	1,6	55	09.92-09.98	ABU/AEA/AEE	4				ST 104
1.6	1,6	55	09.92-09.98	ABU/AEA/AEE	4				ST 106
1.6	1,6	74	10.94-09.98	AEK/AFT	4	ST 036			ST 070
1.6	1,6	74	10.94-09.98	AEK/AFT	4	ST 036			ST 102
1.6	1,6	74	10.94-09.98	AEK/AFT	4	ST 036			ST 104
1.6	1,6	74	10.94-09.98	AEK/AFT	4	ST 036			ST 106
1.8	1,8	55	11.91-09.98	AAM	4				ST 102
1.8	1,8	55	11.91-09.98	AAM	4				ST 104
1.8	1,8	55	01.92-09.98	AAM	4				ST 106
1.8	1,8	66	11.91-09.98	ADZ/ABS	4				ST 102
1.8	1,8	66	11.91-09.98	ADZ/ABS	4				ST 104
1.8	1,8	66	01.92-09.98	ADZ/ABS	4				ST 106
1.8	1,8	55-66	11.91-09.98	AAM/ABS/ADZ	4			ST 013	ST 070
1.8	1,8	55-66	11.91-09.98	AAM/ABS/ADZ	4			ST 013	ST 071
1.8	1,8	66	01.94-09.98	ADZ	4	ST 115			
1.9 D	1,9	48	11.91-09.98	1Y	4				ST 102
1.9 D	1,9	48	11.91-09.98	1Y	4				ST 104
1.9 D	1,9	48	01.92-09.98	1Y	4				ST 106
1.9 TD	1,9	55	11.91-09.98	AAZ	4				ST 102
1.9 TD	1,9	55	11.91-09.98	AAZ	4				ST 104
1.9 TD	1,9	55	01.92-09.98	AAZ	4				ST 106
1.9 D, TD	1,9	48-55	11.91-09.98	1Y/AAZ	4			ST 031	ST 070
1.9 D, TD	1,9	48-55	11.91-09.98	1Y/AAZ	4			ST 031	ST 071
1.9 TDI	1,9	66	01.94-09.98	ALE/1Z/AHU	4	ST 114			ST 102
1.9 TDI	1,9	66	09.93-09.98	ALE/1Z/AHU	4	ST 114			ST 104
1.9 TDI	1,9	66	09.93-09.98	ALE/1Z/AHU	4	ST 114			ST 106
1.9 TDI	1,9	66	09.93-09.98	1Z/AHU/ALE	4				ST 070
1.9 TDI	1,9	81	04.96-09.98	AFN	4	ST 114			ST 102
1.9 TDI	1,9	81	04.96-09.98	AFN	4	ST 114			ST 104
1.9 TDI	1,9	81	04.96-09.98	AFN	4	ST 114			ST 106
1.9 SDI	1,9	47	04.97-09.98	AEY	4				ST 102
1.9 SDI	1,9	47	04.97-09.98	AEY	4				ST 104
1.9 SDI	1,9	47	04.97-09.98	AEY	4				ST 106
2.0	2,0	85	11.91-09.98	ADY/AKR/2E/AGG	4				ST 102
2.0	2,0	85	11.91-09.98	ADY/AKR/2E/AGG	4				ST 104
2.0	2,0	85	01.92-09.98	ADY/AKR/2E/AGG	4				ST 106
2.0	2,0	85	11.91-09.98	2E/ADY/AGG/AKR	4				ST 070
2.0	2,0	85	11.91-09.98	2E/ADY/AGG/AKR	4				ST 071





kW

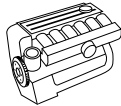

Zyl.
Cyl.
Cil.



VOLKSWAGEN

TRANSPORTER T6

1.9 TDI	1,9	77	04.03-	AXB	4	ST 112			
---------	-----	----	--------	-----	---	---------------	--	--	--

TRANSPORTER T7

2.5 TDI, 4motion	2,5	96	04.03-	AXD	5	ST 112			
------------------	-----	----	--------	-----	---	---------------	--	--	--

TRANSPORTER T8

2.5 TDI, 4motion	2,5	128	04.03-	AXE	5	ST 112			
------------------	-----	-----	--------	-----	---	---------------	--	--	--

TRANSPORTER T9

2.0	2,0	85	11.03-	AXA	4	ST 112	ST 121		
-----	-----	----	--------	-----	---	---------------	---------------	--	--

TRANSPORTER T11

3.2 V6	3,2	170	04.03-	BDL	6	ST 112	ST 114		
--------	-----	-----	--------	-----	---	---------------	---------------	--	--

TRANSPORTER T13

3.2 V6	3,2	173	08.03-	BKK	6	ST 112	ST 114		
--------	-----	-----	--------	-----	---	---------------	---------------	--	--

KAEFER

1600 i	1,6	34	06.95-07.03	ACD	4			ST 107	
--------	-----	----	-------------	-----	---	--	--	---------------	--

VOLKSWAGEN (Mexico)

KAEFER

1600 i	1,6	34	06.95-07.03	ACD	4			ST 107	
--------	-----	----	-------------	-----	---	--	--	---------------	--

VOLVO

140									
------------	--	--	--	--	--	--	--	--	--

2.0, S	2,0	60-91	08.68-04.75	B 20 A/B 20 E	4	ST 061			
--------	-----	-------	-------------	---------------	---	---------------	--	--	--

164									
------------	--	--	--	--	--	--	--	--	--

2.9	3,0	118	08.72-07.74	B 30 E	6	ST 061			
-----	-----	-----	-------------	--------	---	---------------	--	--	--

240									
------------	--	--	--	--	--	--	--	--	--

2.0	2,0	60-76	08.74-07.76	B 19 A/B 20 A/B 200 K	4	ST 038			
-----	-----	-------	-------------	-----------------------	---	---------------	--	--	--

2.1, Turbo	2,1	71-114	08.74-07.84	B 21 A/B 21 E/B 21 ET	4	ST 038			
------------	-----	--------	-------------	-----------------------	---	---------------	--	--	--

2.3	2,3	81-103	08.80-07.93	B 23 A/B 23 E/B 230 A/ B 230 E/B 230 F/B 230 K	4	ST 038			
-----	-----	--------	-------------	---	---	---------------	--	--	--

2.4 Diesel	2,4	58-60	08.78-08.93	D 24	6	ST 038			
------------	-----	-------	-------------	------	---	---------------	--	--	--

2.4 Diesel	2,4	60	08.78-08.93	D 24	6	ST 054			
------------	-----	----	-------------	------	---	---------------	--	--	--

2.7 GLT6	2,7	104	08.79-07.80	B 27 E	6	ST 038			
----------	-----	-----	-------------	--------	---	---------------	--	--	--

260									
------------	--	--	--	--	--	--	--	--	--

2.7	2,7	92-109	08.74-07.82	B 27 A/B 27 E	6	ST 038			
-----	-----	--------	-------------	---------------	---	---------------	--	--	--

2.8	2,8	95-114	08.80-07.82	B 28 A/B 28 E	6	ST 038			
-----	-----	--------	-------------	---------------	---	---------------	--	--	--

340-360									
----------------	--	--	--	--	--	--	--	--	--

1.4	1,4	46-53	08.82-12.88	B 14.3 E/B 14.4 S	4	ST 062			
-----	-----	-------	-------------	-------------------	---	---------------	--	--	--

1.6 Diesel	1,6	40	08.84-07.91	D 16	4	ST 062			
------------	-----	----	-------------	------	---	---------------	--	--	--

1.7	1,7	59	08.85-07.91	B 17 2 K	4	ST 062			
-----	-----	----	-------------	----------	---	---------------	--	--	--

2.0	2,0	65-87	08.80-07.84	B 19 A/B 19 E/B 200 K	4	ST 061			
-----	-----	-------	-------------	-----------------------	---	---------------	--	--	--

2.0	2,0	80	08.84-07.89	B 200 E/B 200 EA/ B 200 F	4		ST 028		
-----	-----	----	-------------	------------------------------	---	--	---------------	--	--

440									
------------	--	--	--	--	--	--	--	--	--

1.6	1,6	61	09.88-12.96	B 16 F	4	ST 015			
-----	-----	----	-------------	--------	---	---------------	--	--	--

1.7	1,7	64-78	09.88-12.96	B 18 KP/B 18 EP/B 18 F/ B 18 FP	4	ST 015			
-----	-----	-------	-------------	------------------------------------	---	---------------	--	--	--

1.7 Turbo	1,7	88-90	08.88-12.96	B 18 FT	4			ST 084	
-----------	-----	-------	-------------	---------	---	--	--	---------------	--

1.8	1,8	66	08.91-07.96	B 18 U	4	ST 015			
-----	-----	----	-------------	--------	---	---------------	--	--	--

2.0	2,0	80-81	08.92-07.96	B 20 F	4	ST 015			
-----	-----	-------	-------------	--------	---	---------------	--	--	--

460 L									
--------------	--	--	--	--	--	--	--	--	--

1.6	1,6	61	07.92-07.96		4	ST 015			
-----	-----	----	-------------	--	---	---------------	--	--	--

1.7	1,7	75	08.89-07.92	B 18 EP	4	ST 015			
-----	-----	----	-------------	---------	---	---------------	--	--	--

1.7 Turbo	1,7	88-90	08.89-07.96	B 18 FT	4			ST 084	
-----------	-----	-------	-------------	---------	---	--	--	---------------	--

1.8	1,8	66	08.91-07.96	B 18 U	4	ST 015			
-----	-----	----	-------------	--------	---	---------------	--	--	--

2.0	2,0	80-81	08.92-07.96	B 20 F	4	ST 015			
-----	-----	-------	-------------	--------	---	---------------	--	--	--

480 E									
--------------	--	--	--	--	--	--	--	--	--

1.7	1,7	70-80	04.86-07.90	B 18 E/B 18 EP/B 18 F	4	ST 062			
-----	-----	-------	-------------	-----------------------	---	---------------	--	--	--

1.7 Turbo	1,7	88-90	08.87-07.96	B 18 FT	4	ST 062		ST 084	
-----------	-----	-------	-------------	---------	---	---------------	--	---------------	--

740									
------------	--	--	--	--	--	--	--	--	--

2.3	2,3	84	08.84-07.90	B 23 A/B 230 F	4	ST 061			
-----	-----	----	-------------	----------------	---	---------------	--	--	--



kW

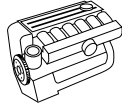

Zyl.
Cyl.
Cil.



VOLVO

760

2.3 Turbo

2,3

127

08.82-07.84

B 23 ET

4

ST 028

ZASTAVA

101

1.1, Super

1,1

37-47

06.73-12.93

128 A.000/128 A.064/
128 AC 5000

4

ST 046



kW

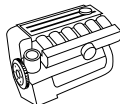

Zyl.
Cyl.
Cil.



ALFA ROMEO

33						
1.8 TD	1,8	54	01.86-06.90	VM 82 A		4 SPR 001
1.8 TD	1,8	62	07.90-09.94	VM 96 A		4 SPR 001
75						
1.6	1,6	81	05.85-09.89	AR 06100		4 SPR 001
1.6 KAT	1,6	81	05.89-02.92	AR 61101		4 SPR 001
1.8	1,8	85	09.85-06.89	AR 06202		4 SPR 001
1.8	1,8	88	09.88-02.92	AR 06168/AR 61102		4 SPR 001
1.8	1,8	90	08.89-02.92	AR 61201		4 SPR 001
1.8 Turbo	1,8	110	09.86-02.92	AR 06134		4 SPR 001
2.0 TD	2,0	70	05.85-09.92	VM 80 A		4 SPR 001
2.0 T.S.	2,0	107	01.87-02.92	AR 06166/AR 06224		4 SPR 001
2.0 T.S.	2,0	109	01.87-12.88	AR 06224		4 SPR 001
2.0 T.S. KAT	2,0	109	05.85-02.92	AR 06224		4 SPR 001
3.0 V6	3,0	136	01.87-12.90	AR 06120		6 SPR 001
3.0 V6	3,0	141	02.90-02.92	AR 61503		6 SPR 001
3.0 V6 KAT	3,0	136	01.87-02.92	AR 06124		6 SPR 001
90						
2.0 i.e.	2,0	97	10.84-07.87	AR 06210		6 SPR 001
2.4 TD	2,4	81	10.84-07.87	VM 81 A		4 SPR 001
155						
1.7 T.S.	1,7	85	04.93-04.96	AR 67105		4 SPR 001
1.8 T.S. Sport	1,8	93	01.92-12.96	AR 67101/AR 67102		4 SPR 001
2.0 T.S.	2,0	104	02.92-02.95	AR 67202		4 SPR 001
2.0 T.S.	2,0	106	02.92-04.93	AR 67201		4 SPR 001
2.5 TD	2,5	92	04.93-12.97	VM 07 B/VM 31 B		4 SPR 001
164						
2.0 T.S.	2,0	106	09.92-09.98	AR 64103		4 SPR 001
2.0 V6 Turbo	2,0	148	09.92-09.98	AR 64102		6 SPR 001
2.5 TD	2,5	92	09.92-09.98	VM 08 B/VM 32 B		4 SPR 001
166						
2.0 V6	2,0	151	09.98-	AR 34102		6 SPR 001
ALFASUD						
1,2	1,2	44	03.80-09.84	AR 30102 S		4 SPR 018
1,2	1,2	46	06.72-09.84	AR 30102		4 SPR 018
1,2 ti	1,2	50	11.73-09.84	AR 30104		4 SPR 018
1,3	1,3	50	01.78-02.80	AR 30180		4 SPR 018
1,3 ti	1,3	55	09.77-09.84	AR 30184		4 SPR 018
1,3 Super	1,3	51	01.79-09.84	AR 30160		4 SPR 018
1,3 ti	1,3	63	03.80-12.84	AR 30168		4 SPR 018
1,5 ti	1,5	61	01.79-09.84	AR 30124		4 SPR 018
1,5 ti	1,5	70	03.80-12.84	AR 30128		4 SPR 018
1,5 ti Sprint	1,5	77	01.83-12.84	AR 30146		4 SPR 018
ALFASUD Sprint						
1,7 i.e.	1,7	77	10.87-12.89	AR 30558		4 SPR 018
1,7	1,7	87	03.87-12.89	AR 30550		4 SPR 018
ALFETTA						
2,0 TD	2,0	60	10.79-03.83	VM4HT/2		4 SPR 001
GIULIETTA						
1,8	1,8	90	04.79-04.85	AR 01678		4 SPR 001
2,0	2,0	96	06.80-04.85	AR 01655/AR 11671		4 SPR 001
GTV						
2,0 V6 Turbo	2,0	148	06.95-	AR 16202		6 SPR 001
SPIDER						
1600	1,6	76	03.76-12.90	AR 00526		4 SPR 001
1600	1,6	79	01.90-12.93	AR 01563		4 SPR 001
2000	2,0	88	01.90-12.93	AR 01588		4 SPR 001
2,0 V6 Turbo	2,0	148	05.98-	AR 16202		6 SPR 001
SZ						
3,0 V6 Zagato	3,0	152	09.88-08.94	AR 61501		6 SPR 001

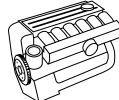

kW

Zyl.
Cyl.
Cil.**AUDI****A3**

1.6	1.6	74	09.96-08.00	AKL/APF/AEH	→ Fg.Nr. 8 L-W 150 000	4	SPR 021
1.6	1.6	75	08.00-	AVU/BFQ	→ Fg.Nr. 8 L-W 150 000	4	SPR 021
1.8	1.8	92	09.96-	AGN/APG	→ Fg.Nr. 8 L-W 150 000	4	SPR 021
1.8 T	1.8	110	12.96-	ARZ/AQA/AGU/AUM	→ Fg.Nr. 8 L-W 150 000	4	SPR 021
1.8 T quattro	1.8	110	12.96-	ARX/AQA/AGU	→ Fg.Nr. 8 L-W 150 000	4	SPR 021
1.8 T	1.8	132	12.98-	AJQ/APP/ARY/AUQ	→ Fg.Nr. 8 L-W 150 000	4	SPR 021
1.8 T quattro	1.8	132	10.98-	AJQ/ARY	→ Fg.Nr. 8 L-W 150 000	4	SPR 021
1.9 TDI	1.9	66	09.96-01.06	AGR	→ Fg.Nr. 8 L-V 150 000	4	SPR 022
1.9 TDI	1.9	81	08.97-01.06	AHF/ASV	→ Fg.Nr. 8 L-V 150 000	4	SPR 022
S3 quattro	1.8	154	03.99-	AMK/APY/AUL	→ Fg.Nr. 8 L-W 150 000	4	SPR 021

A4

1.6	1.6	74	01.95-07.00	AHL/ADP/ARM/ANA		4	SPR 021
1.6	1.6	75	07.00-11.00	ALZ		4	SPR 021
1.8, quattro	1.8	85	04.95-11.00	AFY		4	SPR 021
1.8	1.8	92	01.95-11.00	AVV/ADR/APT/ARG		4	SPR 021
1.8 quattro	1.8	92	01.95-11.00	ADR/APT/ARG		4	SPR 021
1.8 T, quattro	1.8	110	01.95-11.00	ARK/AEB/ANB/APU/AWT		4	SPR 021
1.8 T, quattro	1.8	132	12.97-11.00	AJL		4	SPR 021
1.9 TDI	1.9	55	12.95-11.00	AFF		4	SPR 022
1.9 TDI	1.9	66	01.95-11.00	1Z/AHU/AHH		4	SPR 022
1.9 TDI	1.9	81	10.95-11.00	AVG/AFN		4	SPR 022
1.9 TDI	1.9	85	03.00-11.00	AJM		4	SPR 022
1.9 TDI quattro	1.9	85	03.00-11.00	ATJ/AJM		4	SPR 022
2.4, quattro	2.4	121	03.97-11.00	AML/ARJ/ALF/AGA/APS		6	SPR 021
2.6, quattro	2.6	110	01.95-11.00	ABC	→ Fg.Nr. 8 D-V 054 232	6	SPR 017
2.6, quattro	2.6	110	01.95-11.00	ABC	Fg.Nr. 8 D-V 054 232 →	6	SPR 021
2.7 T quattro	2.7	169	02.99-11.00	AJK	→ Fg.Nr. 8 D-V 054 232	6	SPR 017
S4 quattro	2.7	195	09.97-11.00	AGB	→ Fg.Nr. 8 D-V 054 232	6	SPR 017
S4 quattro	2.7	195	09.97-11.00	AGB	Fg.Nr. 8 D-V 054 232 →	6	SPR 021
2.8, quattro	2.8	128	09.95-07.97	AAH	→ Fg.Nr. 8 D-V 054 232	6	SPR 017
2.8, quattro	2.8	128	09.95-07.97	AAH	Fg.Nr. 8 D-V 054 232 →	6	SPR 021
2.8, quattro	2.8	142	10.96-11.00	ACK/ALG/AMX/APR/AQD	→ Fg.Nr. 8 D-V 054 232	6	SPR 017
2.8, quattro	2.8	142	10.96-11.00	APR/ACK/ALG/AQD/AMX	Fg.Nr. 8 D-V 054 232 →	6	SPR 021

A6

1.8	1.8	92	07.97-	ANQ/ARH/AJP/AQE		4	SPR 021
1.8 T, quattro	1.8	110	01.97-	ARK/AEB/ANB/APU/AWT		4	SPR 021
1.8 T, quattro	1.8	132	12.97-	AJL		4	SPR 021
1.9 TDI	1.9	66	06.94-02.97	1Z/AHU		4	SPR 022
2.0 16V, quattro	2.0	103	06.94-02.97	ACE		4	SPR 021
2.3, quattro	2.3	98	06.94-12.95	AAR		5	SPR 021
2.5 TDI	2.5	84	01.95-02.97	AAT		5	SPR 022
2.5 TDI	2.5	85	06.94-02.97	AAT		5	SPR 022
2.5 TDI	2.5	103	08.94-02.97	AEL		5	SPR 022
2.6	2.6	102	06.94-02.97	ACZ		6	SPR 017
2.6	2.6	102	06.94-02.97	ACZ		6	SPR 021
2.6, quattro	2.6	110	06.94-02.97	ABC		6	SPR 017
2.6, quattro	2.6	110	06.94-02.97	ABC		6	SPR 021
2.8, quattro	2.8	128	06.94-02.97	AAH/AEJ		6	SPR 017
2.8, quattro	2.8	128	06.94-02.97	AEJ/AAH		6	SPR 021
2.8	2.8	132	10.97-07.98	AGE		6	SPR 017
2.8, quattro	2.8	142	12.95-02.97	ACK		6	SPR 017
2.8, quattro	2.8	142	12.95-02.97	ACK		6	SPR 021
2.8, quattro	2.8	142	02.97-	ACK		6	SPR 021
S6 Turbo quattro	2.2	169	06.94-02.97	AAN		5	SPR 021
S6 4.2 quattro	4.2	213	06.94-02.97	AEC		8	SPR 017
1.9 TDI	1.9	81	02.97-	AVG/AFN		4	SPR 021

A6, Avant

2.8	2.8	128	06.94-07.96	AAH/AEJ		6	SPR 004
2.8	2.8	142	12.95-02.97	ACK		6	SPR 004
2.8 quattro	2.8	128	07.96-02.97	AAH/AEJ		6	SPR 004
2.8, quattro	2.8	128	06.94-12.97	AAH/AEJ		6	SPR 017



kW

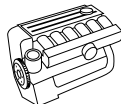

Zyl.
Cyl.
Cil.



AUDI							
A8							
2.8	2,8	120	07.95-03.96	AEJ		6	SPR 004
2.8	2,8	128	03.94-03.96	AAH		6	SPR 004
2.8	2,8	142	04.96-12.98	ACK		6	SPR 004
2.8 quattro	2,8	142	04.96-09.98	ACK		6	SPR 004
3.7	3,7	169	07.95-12.98	AEW		8	SPR 004
3.7	3,7	169	07.95-12.98	AEW		8	SPR 017
3.7 quattro	3,7	169	10.95-11.98	AEW/AKJ		8	SPR 004
3.7 quattro	3,7	169	07.95-11.98	AEW/AKJ		8	SPR 017
4.2 quattro	4,2	180	06.94-07.96	AEM		8	SPR 004
4.2 quattro	4,2	220	06.94-11.98	ABZ/AKG		8	SPR 004
S 8 quattro	4,2	250	09.96-06.99	AHC/AKH		8	SPR 004
V8							
3.6 quattro	3,6	180	04.93-11.93	PT		8	SPR 004
3.6 quattro	3,6	184	10.88-11.93	PT		8	SPR 004
4.2 quattro	4,2	206	10.91-11.93	ABH		8	SPR 004
50							
1.1	1,1	37	08.74-07.78	HB		4	SPR 004
1.1	1,1	44	08.74-07.77	HC		4	SPR 004
60, Variant							
1.5	1,5	40	10.69-09.72			4	SPR 002
75, Variant							
1.7 L	1,7	55	09.68-09.72			4	SPR 002
80							
1.3	1,3	40	09.78-07.81	FY		4	SPR 004
1.3	1,3	40	09.78-07.81	FY		4	SPR 017
1.3	1,3	40	09.78-07.81	FY		4	SPR 021
1.3	1,3	44	09.78-07.86	EP		4	SPR 004
1.3	1,3	44	08.83-07.86	EP		4	SPR 017
1.3	1,3	44	08.83-07.86	EP		4	SPR 021
1.3	1,3	44	09.78-07.81	FZ		4	SPR 017
1.4	1,4	48	08.86-07.88	SE		4	SPR 017
1.6	1,6	51	08.78-07.81	YT/YY		4	SPR 017
1.6	1,6	51	08.87-09.91	PP		4	SPR 004
1.6	1,6	51	08.87-09.91	PP		4	SPR 017
1.6	1,6	51	08.87-09.91	PP		4	SPR 021
1.6	1,6	52	01.92-12.94	ABM		4	SPR 004
1.6	1,6	52	09.91-12.94	ABM		4	SPR 017
1.6	1,6	54	02.86-07.86	SA		4	SPR 004
1.6	1,6	54	02.86-07.86	SA		4	SPR 017
1.6	1,6	54	02.86-07.86	SA		4	SPR 021
1.6	1,6	55	08.78-07.86	DT		4	SPR 004
1.6	1,6	55	08.83-07.86	DT		4	SPR 021
1.6	1,6	55	08.78-07.86	WV/YN		4	SPR 017
1.6	1,6	55	09.86-08.91	RN		4	SPR 004
1.6	1,6	55	09.86-08.91	RN		4	SPR 017
1.6	1,6	55	09.86-08.91	RN		4	SPR 021
1.6	1,6	63	08.78-02.83	YP		4	SPR 004
1.6	1,6	63	08.78-02.83	YP		4	SPR 017
1.6	1,6	63	08.78-02.83	YP		4	SPR 021
1.6	1,6	75	08.90-10.91	ABB		4	SPR 017
1.6 E	1,6	74	06.93-12.94	ADA		4	SPR 004
1.6 E	1,6	74	06.93-12.94	ADA		4	SPR 017
1.6 E	1,6	74	06.93-12.94	ADA		4	SPR 021
1.6 GLE	1,6	81	01.79-06.82	YZ		4	SPR 004
1.6 D	1,6	40	08.83-08.86	CR/JK		4	SPR 017
1.6 D	1,6	40	08.83-08.86	JK/CR		4	SPR 021
1.6 D	1,6	40	09.86-08.91	JK		4	SPR 004
1.6 D	1,6	40	09.86-08.91	JK		4	SPR 017
1.6 D	1,6	40	09.86-08.91	JK		4	SPR 021
1.6 TD	1,6	51	06.24-05.86	CY		4	SPR 017
1.6 TD	1,6	51	08.83-05.86	CY		4	SPR 021

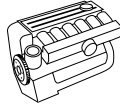

kW

Zyl.
Cyl.
Cil.**AUDI****80**

1.6 TD	1,6	59	04.88-08.91	RA/SB	4	SPR 004
1.8	1,8	55	10.86-01.90	RU	4	SPR 004
1.8	1,8	55	10.86-01.90	RU	4	SPR 017
1.8	1,8	55	10.86-01.90	RU	4	SPR 021
1.8	1,8	65	02.86-07.86	SF	4	SPR 004
1.8	1,8	66	01.83-08.86	DS	4	SPR 004
1.8	1,8	66	08.83-08.86	DS	4	SPR 017
1.8	1,8	66	08.83-08.86	DS	4	SPR 021
1.8	1,8	68	08.83-08.86	JN	4	SPR 004
1.8	1,8	68	08.83-08.86	JN	4	SPR 021
1.8	1,8	83	09.87-07.88	SD	4	SPR 004
1.8	1,8	65	02.86-07.86	SF	4	SPR 021
1.8 CC quattro	1,8	66	08.84-08.86	NE	4	SPR 004
1.8 CC quattro	1,8	66	08.84-08.86	NE	4	SPR 017
1.8 CC quattro	1,8	66	08.84-08.86	NE	4	SPR 021
1.8 CC quattro	1,8	68	08.85-08.86	JN	4	SPR 004
1.8 CC quattro	1,8	68	08.85-08.86	JN	4	SPR 017
1.8 CC quattro	1,8	68	08.85-08.86	JN	4	SPR 021
1.8 E,quattro	1,8	82	09.86-08.91	DZ	4	SPR 004
1.8 E, quattro	1,8	82	09.86-08.91	DZ	4	SPR 017
1.8 E, quattro	1,8	82	06.86-08.91	DZ	4	SPR 021
1.8 GTE	1,8	81	08.85-07.86	PV	4	SPR 004
1.8 GTE	1,8	81	08.85-07.86	PV	4	SPR 017
1.8 GTE	1,8	81	08.85-07.86	PV	4	SPR 021
1.8 GTE	1,8	82	10.84-08.86	DZ	4	SPR 004
1.8 GTE	1,8	82	10.84-08.86	DZ	4	SPR 021
1.8 GTE quattro	1,8	81	03.85-08.86	PV	4	SPR 004
1.8 GTE quattro	1,8	81	03.85-08.86	PV	4	SPR 017
1.8 GTE quattro	1,8	81	03.85-08.86	PV	4	SPR 021
1.8 GTE quattro	1,8	82	08.84-08.86	DZ	4	SPR 004
1.8 GTE quattro	1,8	82	08.84-08.86	DZ	4	SPR 017
1.8 GTE quattro	1,8	82	08.84-08.86	DZ	4	SPR 021
1.8 S, quattro	1,8	65	09.86-01.90	SF	4	SPR 004
1.8 S, quattro	1,8	65	09.86-07.90	SF	4	SPR 017
1.8 S, quattro	1,8	66	09.86-08.91	JN/NE/PM	4	SPR 004
1.8 S, quattro	1,8	66	09.86-09.91	JN/NE/PM	4	SPR 017
1.9 CD-5S	1,9	85	09.81-07.83	WN	5	SPR 004
1.9 CD-5S	1,9	85	09.81-07.83	WN	5	SPR 017
1.9 CD-5S	1,9	85	09.81-07.83	WN	5	SPR 021
1.9 D	1,9	50	08.89-08.91	1Y	4	SPR 004
1.9 D	1,9	50	08.89-08.91	1Y	4	SPR 017
1.9 D	1,9	50	08.89-08.91	1Y	4	SPR 021
1.9 TD	1,9	55	09.91-12.94	AAZ	4	SPR 004
1.9 TD	1,9	55	09.91-12.94	AAZ	4	SPR 017
1.9 TD	1,9	55	09.91-12.94	AAZ	4	SPR 021
1.9 TDI	1,9	66	09.91-12.94	1Z	4	SPR 004
1.9 TDI	1,9	66	09.91-12.94	1Z	4	SPR 017
1.9 TDI	1,9	66	09.91-12.94	1Z	4	SPR 021
2.0	2,0	66	09.91-12.94	ABT	4	SPR 004
2.0	2,0	66	09.91-12.94	ABT	4	SPR 017
2.0	2,0	66	09.91-12.94	ABT	4	SPR 021
2.0	2,0	82	10.90-08.91	AAD	4	SPR 004
2.0	2,0	82	10.90-08.91	AAD	4	SPR 017
2.0	2,0	82	10.90-08.91	AAD	4	SPR 021
2.0	2,0	85	10.83-07.84	HP/JS	5	SPR 004
2.0, quattro	2,0	85	10.83-09.84	HP/JS	5	SPR 017
2.0 E, quattro	2,0	83	08.88-09.90	3A	4	SPR 004
2.0 E, quattro	2,0	83	08.88-09.90	3A	4	SPR 017
2.0 E, quattro	2,0	83	08.88-10.90	3A	4	SPR 021
2.0 E, quattro	2,0	85	09.91-12.94	ABK	4	SPR 004
2.0 E, quattro	2,0	85	09.91-12.94	ABK	4	SPR 017

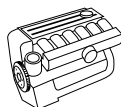

kW

Zyl.
Cyl.
Cil.

AUDI							
80							
2.0 E	2.0	85	09.91-12.94	ABK		4	SPR 021
2.0 E 16V, quattro	2.0	101	03.90-08.91	6A		4	SPR 017
2.0 E 16V, quattro	2.0	101	03.90-09.91	6A		4	SPR 021
2.0 E 16V, quattro	2.0	103	08.92-12.94	ACE		4	SPR 004
2.0 E 16V, quattro	2.0	103	08.92-12.94	ACE		4	SPR 017
2.0 E 16V	2.0	103	08.92-12.94	ACE		4	SPR 021
2.0 quattro	2.0	85	10.83-07.84	JS		5	SPR 004
2.0 quattro	2.0	85	10.90-08.91	AAD		4	SPR 017
2.2	2.2	85	10.80-07.83	WE		5	SPR 017
2.2	2.2	85	10.80-07.83	WE		5	SPR 021
2.2 quattro	2.2	96	08.82-07.84	KL		5	SPR 017
2.2 quattro	2.2	100	08.82-07.84	KK		5	SPR 004
2.2 quattro	2.2	100	08.83-07.84	KK		5	SPR 021
S2 quattro	2.2	169	02.93-12.94	ABY		5	SPR 017
S2 quattro	2.2	169	02.93-12.94	ABY		5	SPR 021
2.3 E,quattro	2.3	98	09.91-12.94	NG		5	SPR 004
2.3 E, quattro	2.3	98	09.91-12.94	NG		5	SPR 017
2.3 E	2.3	98	09.91-12.94	NG		5	SPR 021
2.6	2.6	110	07.92-12.94	ABC		6	SPR 004
2.6, quattro	2.6	110	07.92-12.94	ABC		6	SPR 017
2.6	2.6	110	07.92-12.94	ABC		6	SPR 021
2.8 ,quattro	2.8	128	09.91-12.94	AAH		6	SPR 004
2.8, quattro	2.8	128	09.91-12.94	AAH		6	SPR 017
2.8	2.8	128	09.91-12.94	AAH		6	SPR 021
80 CABRIOLET							
1.9 TDI	1.9	66	07.96-01.99	AHU	→ Fg.Nr. 8 G-X 001 000	4	SPR 004
2.0 E	2.0	85	01.93-07.98	ABK	→ Fg.Nr. 8 G-X 001 000	4	SPR 004
2.3 E	2.3	98	05.91-07.94	NG		5	SPR 004
2.6	2.6	110	01.94-08.00	ABC		6	SPR 004
2.8	2.8	128	11.92-07.98	AAH		6	SPR 004
80 COUPE							
1.6	1.6	55	04.81-08.81	YN		4	SPR 004
1.8	1.8	55	08.81-08.82	DD		4	SPR 004
1.8 GT	1.8	65	04.86-10.88	SF		4	SPR 004
1.8 GT	1.8	66	09.82-10.88	DS/JV		4	SPR 004
1.8 GT	1.8	68	01.85-07.88	JN		4	SPR 004
1.8 GT	1.8	79	08.86-10.87	PV		4	SPR 004
1.8 GT	1.8	82	08.86-10.88	DZ		4	SPR 004
1.9	1.9	85	08.80-07.83	WN		5	SPR 004
2.0	2.0	83	03.86-07.86	SK		5	SPR 004
2.0	2.0	85	09.83-07.86	HP/JS		5	SPR 004
2.0 16 V	2.0	101	01.92-07.92	6A		4	SPR 004
2.0 16 V	2.0	103	08.92-08.94	ACE		4	SPR 004
2.0 20 V quattro	2.0	118	08.89-07.91	NM		5	SPR 004
2.1 GT	2.1	96	09.82-08.84	KE/KL		5	SPR 004
2.2 GT	2.2	85	01.84-10.87	KX		5	SPR 004
2.2 GT	2.2	100	09.84-10.88	KV		5	SPR 004
2.2 quattro	2.2	88	08.85-10.88	JT		5	SPR 004
2.2 quattro	2.2	100	12.84-10.88	KV		5	SPR 004
2.3	2.3	98	03.90-07.94	NG		5	SPR 004
2.3	2.3	100	11.88-07.94	NG		5	SPR 004
2.3 20V	2.3	123	08.90-07.91	7A		5	SPR 004
2.3 20V	2.3	125	08.89-07.91	7A		5	SPR 004
2.3 quattro	2.3	98	05.90-07.94	NG		5	SPR 004
2.3 quattro	2.3	100	01.87-12.92	NG		5	SPR 004
2.6 ,quattro	2.6	110	08.92-05.95	ABC		6	SPR 004
2.8 ,quattro	2.8	128	09.91-05.95	AAH		6	SPR 004
90							
1.6 TD	1.6	59	07.87-07.91	RA/SB		4	SPR 004
1.8 Super	1.8	66	12.66-09.71			4	SPR 002
2.0	2.0	85	07.88-07.91	PS		5	SPR 004

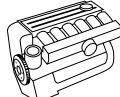

kW

Zyl.
Cyl.
Cil.**AUDI****90**

2.0 20 V, quattro	2,0	118	08.89-07.91	NM	5	SPR 004
2.0 20 V, quattro	2,0	118	08.89-07.91	NM	5	SPR 017
2.0 20 V	2,0	118	08.89-07.91	NM	5	SPR 021
2.2 E, quattro	2,2	100	04.87-07.91	KV	5	SPR 004
2.3 E, quattro	2,3	98	03.90-07.91	NG	5	SPR 004
2.3 E, quattro	2,3	100	04.87-07.91	NG	5	SPR 004
2.3 E 20V, quattro	2,3	123	04.90-07.91	7A	5	SPR 004
2.3 E 20V, quattro	2,3	125	08.88-07.91	7A	5	SPR 004

100

1.6	1,6	63	01.75-07.76	YM	4	SPR 002
1.6	1,6	63	08.76-07.82	YV	4	SPR 004
1.8	1,8	55	08.82-12.87	DR/RS	4	SPR 017
1.8	1,8	59	12.68-08.71		4	SPR 002
1.8	1,8	63	09.71-07.74	ZU	4	SPR 002
1.8, quattro	1,8	65	08.86-07.88	SH	4	SPR 017
1.8	1,8	66	12.68-08.71		4	SPR 002
1.8	1,8	66	08.83-07.89	DS/JW /NP	4	SPR 017
1.8 KAT	1,8	66	03.85-11.90	4B/PH	4	SPR 017
1.8 quattro	1,8	66	10.84-07.88	JW /NP	4	SPR 017
1.8 quattro KAT	1,8	66	08.85-11.90	4B/PH	4	SPR 017
1.8 LS	1,8	74	09.71-07.76	ZZ	4	SPR 002
1.9	1,9	74	08.80-07.84	WH	5	SPR 004
1.9 GL	1,9	82	09.71-07.76	ZJ	4	SPR 002
2.0	2,0	74	12.90-06.94	AAE	4	SPR 004
2.0	2,0	74	12.90-06.94	AAE	4	SPR 017
2.0	2,0	74	12.90-06.94	AAE	4	SPR 022
2.0	2,0	83	08.86-11.87	SL	5	SPR 017
2.0	2,0	85	08.76-08.78	WA	4	SPR 004
2.0	2,0	85	08.84-10.87	KP	5	SPR 004
2.0	2,0	85	08.84-12.87	KP	5	SPR 017
2.0 D	2,0	51	08.82-07.88	CN	5	SPR 004
2.0 D	2,0	51	08.82-07.88	CN	5	SPR 017
2.0 D Turbo	2,0	64	08.82-12.87	DE	5	SPR 004
2.0 D Turbo	2,0	64	08.82-02.88	DE	5	SPR 017
2.0 D Turbo	2,0	74	03.88-11.90	NC	5	SPR 004
2.0 D Turbo	2,0	74	03.88-11.90	NC	5	SPR 017
2.0 E quattro	2,0	85	12.90-07.92	AAD	4	SPR 004
2.0 E quattro	2,0	85	12.90-07.92	AAD	4	SPR 017
2.0 E quattro	2,0	85	12.90-07.92	AAD	4	SPR 022
2.0 E 16V	2,0	101	01.92-06.94	ACE	4	SPR 004
2.0 E 16V	2,0	101	01.92-06.94	ACE	4	SPR 017
2.0 E 16V	2,0	101	01.92-06.94	ACE	4	SPR 022
2.0 E 16V quattro	2,0	103	07.92-06.94	ACE	4	SPR 017
2.0 KAT	2,0	85	01.88-11.90	RT	5	SPR 004
2.0 KAT	2,0	85	01.88-11.90	RT	5	SPR 017
2.1	2,1	85	01.78-07.82	WB/WE	5	SPR 004
2.1	2,1	100	03.77-07.82	WC/WG	5	SPR 004
2.1	2,1	100	08.82-07.84	WC	5	SPR 004
2.1	2,1	100	08.82-07.84	WC	5	SPR 017
2.2	2,2	79	08.82-07.84	WU	5	SPR 017
2.2	2,2	85	10.84-09.86	KZ	5	SPR 004
2.2	2,2	85	10.84-09.86	KZ	5	SPR 017
2.2	2,2	96	08.82-07.84	KF	5	SPR 017
2.2	2,2	101	08.84-12.88	KU	5	SPR 004
2.2	2,2	101	08.84-12.88	KU	5	SPR 017
2.2 E quattro	2,2	88	08.85-07.86	PX	5	SPR 004
2.2 E quattro	2,2	88	08.85-07.86	PX	5	SPR 017
2.2 E Turbo quattro	2,2	121	08.86-11.90	MC	5	SPR 004
2.2 E Turbo quattro	2,2	121	08.86-11.90	MC	5	SPR 017
2.2 KAT	2,2	101	06.89-11.90	KU	5	SPR 004
2.2 KAT	2,2	101	06.89-11.90	KU	5	SPR 017



kW

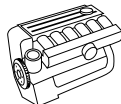

Zyl.
Cyl.
Cil.



AUDI							
100							
2.2 quattro	2,2	101	08.84-12.88	KU		5	SPR 004
2.2 quattro	2,2	101	08.84-12.88	KU		5	SPR 017
2.2 quattro KAT	2,2	101	06.89-11.90	KU		5	SPR 004
2.2 quattro KAT	2,2	101	06.89-11.90	KU		5	SPR 017
2.2 Turbo	2,2	121	08.86-11.90	MC		5	SPR 004
2.2 Turbo	2,2	121	08.86-11.90	MC		5	SPR 017
S4 Turbo quattro	2,2	169	08.91-06.94	AAN		5	SPR 017
S4 Turbo quattro	2,2	169	08.91-06.94	AAN		5	SPR 022
2.3 E	2,3	98	12.90-06.94	AAR		5	SPR 017
2.3 E	2,3	98	12.90-06.94	AAR		5	SPR 022
2.3 E	2,3	100	10.86-11.90	NF		5	SPR 004
2.3 E, quattro	2,3	100	10.86-11.90	NF		5	SPR 017
2.3 E, quattro	2,3	98	01.90-11.90			5	SPR 017
2.3 E quattro	2,3	98	12.90-06.94	AAR		5	SPR 017
2.3 E quattro	2,3	100	08.86-11.90	NF		5	SPR 004
2.4 D	2,4	60	08.89-11.90	3D		5	SPR 004
2.4 D	2,4	60	08.89-07.91	3D		5	SPR 017
2.4 D	2,4	60	12.90-06.94	AAS		5	SPR 004
2.4 D	2,4	60	12.90-06.94	AAS		5	SPR 017
2.4 D	2,4	60	12.90-06.94	AAS		5	SPR 022
2.5 TDI	2,5	85	12.90-06.94	AAT/ABP		5	SPR 004
2.5 TDI	2,5	85	12.90-06.94	AAT/ABP		5	SPR 017
2.5 TDI	2,5	85	12.90-06.94	AAT/ABP		5	SPR 022
2.5 TDI	2,5	88	01.90-11.90	1T		5	SPR 004
2.5 TDI	2,5	88	01.90-11.90	1T		5	SPR 017
2.6	2,6	102	07.93-06.94	ACZ		6	SPR 017
2.6	2,6	102	07.93-06.94	ACZ		6	SPR 022
2.6, quattro	2,6	110	04.92-06.94	ABC		6	SPR 004
2.6, quattro	2,6	110	04.92-06.94	ABC		6	SPR 017
2.6	2,6	110	03.92-06.94	ABC		6	SPR 022
2.6 quattro	2,6	110	04.92-06.94	ABC		6	SPR 004
2.8 E	2,8	128	12.90-06.94	AAH		6	SPR 004
2.8 E, quattro	2,8	128	12.90-06.94	AAH		6	SPR 017
2.8 E	2,8	128	12.90-06.94	AAH		6	SPR 022
S4 V8 quattro	4,2	206	10.92-06.94	ABH		8	SPR 017
S4 V8 quattro	4,2	213	03.94-06.94	AEC		8	SPR 017
100 Coupe							
1.9	1,9	82	08.71-12.76	ZJ		4	SPR 002
1.9	1,9	85	09.70-07.71	ZP		4	SPR 002
200							
2.1 5 E	2,1	100	10.79-09.82	WC		5	SPR 004
2.1 5 E	2,1	100	08.83-07.84	WC		5	SPR 017
2.1 5 E	2,1	100	08.83-07.84	WC		5	SPR 021
2.1 5 T	2,1	125	10.79-08.82	WJ		5	SPR 004
2.1 Turbo, quattro	2,1	134	11.84-09.86	KG		5	SPR 004
2.1 Turbo, quattro	2,1	134	08.83-09.86	KG		5	SPR 017
2.1 Turbo	2,1	134	08.83-01.88	KG		5	SPR 021
2.2	2,2	101	08.84-07.85	KU		5	SPR 004
2.2	2,2	101	08.84-07.85	KU		5	SPR 017
2.2	2,2	101	08.84-07.85	KU		5	SPR 021
2.2 Turbo	2,2	121	08.85-09.91	MC		5	SPR 021
2.2 Turbo	2,2	140	02.88-12.90	2B		5	SPR 004
2.2 Turbo	2,2	140	02.88-12.90	2B		5	SPR 017
2.2 Turbo	2,2	140	02.88-12.90	2B		5	SPR 021
2.2 Turbo	2,2	147	02.88-12.90	1B		5	SPR 004
2.2 Turbo	2,2	147	02.88-12.90	1B		5	SPR 017
2.2 Turbo	2,2	147	02.88-12.90	1B		5	SPR 021
2.2 Turbo, quattro	2,2	121	08.85-12.90	MC		5	SPR 004
2.2 Turbo	2,2	121	08.85-09.91	MC		5	SPR 017
2.2 Turbo quattro	2,2	147	02.88-11.90	1B		5	SPR 004
2.2 Turbo quattro	2,2	147	02.88-11.90	1B		5	SPR 017

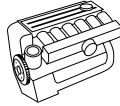

kW

Zyl.
Cyl.
Cil.**AUDI****200**

2.2 Turbo quattro	2,2	147	02.88-11.90	1B	5	SPR 021
2.2 20V Turbo quattro	2,2	162	03.89-12.90	3B	5	SPR 004
2.2 20V Turbo quattro	2,2	162	03.89-12.90	3B	5	SPR 017
2.2 20V Turbo quattro	2,2	162	03.89-12.90	3B	5	SPR 021
2.3	2,3	100	11.86-11.90	NF	5	SPR 004
2.3	2,3	100	11.86-09.91	NF	5	SPR 017

CABRIOLET

1.8	1,8	92	01.97-08.00	ADR	4	SPR 017
1.9 TDI	1,9	66	06.95-08.00	1Z/AHU	4	SPR 017
2.0 E	2,0	85	01.93-07.98	ABK	4	SPR 017
2.0 16V	2,0	103	06.95-07.96	ACE	4	SPR 017
2.3 E	2,3	98	05.91-07.94	NG	5	SPR 017
2.6	2,6	102	05.95-08.00	ACZ	6	SPR 017
2.6	2,6	110	06.93-08.00	ABC	6	SPR 017
2.8	2,8	128	11.92-08.00	AAH	6	SPR 017

COUPE

1.6	1,6	55	07.80-08.81	YN	4	SPR 017
1.8	1,8	55	08.81-07.83	DD	4	SPR 017
1.8	1,8	82	08.89-07.91	DZ	4	SPR 017
1.8	1,8	82	08.89-07.91	DZ	4	SPR 021
1.8 GT	1,8	65	04.86-10.88	SF	4	SPR 017
1.8 GT	1,8	65	04.86-10.88	SF	4	SPR 021
1.8 GT	1,8	66	09.82-10.88	DS/JV	4	SPR 017
1.8 GT	1,8	66	09.82-10.88	DS/JV	4	SPR 021
1.8 GT quattro	1,8	66	09.85-10.88	DS/JN/NE	4	SPR 017
1.8 GT	1,8	68	01.85-07.88	JN	4	SPR 017
1.8 GT	1,8	68	01.85-07.88	JN	4	SPR 021
1.8 GT	1,8	79	08.86-10.87	PV	4	SPR 017
1.8 GT	1,8	79	08.86-10.87	PV	4	SPR 021
1.8 GT, quattro	1,8	82	08.86-10.88	DZ	4	SPR 017
1.8 GT	1,8	82	08.86-10.88	DZ	4	SPR 021
1.9	1,9	85	08.80-07.83	WN	5	SPR 017
1.9	1,9	85	08.80-07.83	WN	5	SPR 021
2.0	2,0	83	03.86-04.88	SK	5	SPR 017
2.0	2,0	85	09.83-07.86	HP/JS	5	SPR 017
2.0	2,0	85	09.83-07.86	JS/HP	5	SPR 021
2.0	2,0	85	05.89-12.96	3A/AAD/ABK	4	SPR 017
2.0 16 V	2,0	101	01.92-07.92	6A	4	SPR 017
2.0 16 V	2,0	101	01.92-07.92	6A	4	SPR 021
2.0 16 V	2,0	103	08.92-12.96	ACE	4	SPR 017
2.0 20 V, quattro	2,0	118	08.89-07.91	NM	5	SPR 017
2.0 20 V quattro	2,0	118	08.89-07.91	NM	5	SPR 021
2.1 GT	2,1	79	01.81-07.83	WE	5	SPR 017
2.1 GT	2,1	96	09.82-08.84	KE/KL	5	SPR 017
2.1 GT	2,1	96	09.82-08.84	KE/KL	5	SPR 021
2.2 quattro	2,2	88	08.85-10.88	JT	5	SPR 017
2.2 quattro	2,2	88	08.85-10.88	JT	5	SPR 021
2.2 GT	2,2	100	09.84-10.88	KV	5	SPR 017
2.2 GT	2,2	100	09.84-10.88	KV	5	SPR 021
S2 quattro	2,2	162	09.90-09.92	3B	5	SPR 017
S2 quattro	2,2	162	09.90-09.92	3B	5	SPR 021
S2 quattro	2,2	169	10.92-12.96	ABY	5	SPR 017
S2 quattro	2,2	169	10.92-12.96	ABY	5	SPR 021
2.3	2,3	100	01.87-07.94	NG	5	SPR 017
2.3	2,3	100	01.87-10.88	NG	5	SPR 021
2.3, quattro	2,3	98	05.90-12.96	NG	5	SPR 017
2.3 quattro	2,3	100	01.87-12.92	NG	5	SPR 017
2.3 quattro	2,3	100	01.87-10.88	NG	5	SPR 021
2.3 20V	2,3	123	08.90-07.91	7A	5	SPR 017
2.3 20V	2,3	123	08.90-07.91	7A	5	SPR 021
2.3 20V quattro	2,3	123	05.90-12.96	7A	5	SPR 017

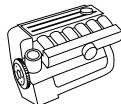

kW

 Zyl.
Cyl.
Cil.

AUDI							
COUPE							
2.3 20V quattro	2,3	123	05.90-12.96	7A		5	SPR 021
2.3 20V	2,3	125	08.89-07.91	7A		5	SPR 017
2.3 20V	2,3	125	08.89-07.91	7A		5	SPR 021
2.3 20V quattro	2,3	125	11.88-07.91	7A		5	SPR 017
2.3 20V quattro	2,3	125	11.88-07.91	7A		5	SPR 021
2.6	2,6	110	08.92-12.96	ABC		6	SPR 017
2.6 quattro	2,6	110	08.92-12.96	ABC		6	SPR 001
2.6 quattro	2,6	110	08.92-12.96	ABC		6	SPR 017
2.8 quattro	2,8	128	08.91-12.96	AAH		6	SPR 001
2.8 quattro	2,8	128	09.91-12.96	AAH		6	SPR 017
QUATTRO							
2.1 Turbo	2,1	147	07.80-07.87	GV/WR		5	SPR 017
2.1 Turbo	2,1	147	07.80-07.87	WR/GV		5	SPR 021
2.1 20V Turbo	2,1	225	05.84-07.87	KW		5	SPR 017
2.1 20V Turbo	2,1	225	05.84-07.87	KW		5	SPR 021
2.2 Turbo	2,2	147	08.87-07.89	1B/MB		5	SPR 017
2.2 Turbo	2,2	147	08.87-07.89	MB/1B		5	SPR 021
2.2 20V	2,2	162	08.89-07.91	RR		5	SPR 017
2.2 20V	2,2	162	08.89-07.91	RR		5	SPR 021
DAIHATSU							
CHARADE III							
1.0	1,0	38	03.87-10.90	CB 23		3	SPR 013
1.0	1,0	38	11.90-12.92	CB 23		3	SPR 012
1.0	1,0	40	11.90-12.92	CB 90		3	SPR 013
1.0	1,0	41	11.90-12.92	CB 90		3	SPR 013
1.0 Turbo	1,0	50	03.87-10.90	CB 61		3	SPR 012
1.0 GTi	1,0	74	03.87-12.92	CB 80		3	SPR 012
CHARADE IV							
1.0	1,0	38	09.94-10.95	CB 22		3	SPR 012
CHARMANT							
1.3	1,3	48	11.81-07.87	4K		4	SPR 009
1.6	1,6	55	12.81-08.83	2T		4	SPR 009
1.6	1,6	57	09.85-07.87	4A		4	SPR 009
1.6	1,6	60	05.86-07.87	4A		4	SPR 009
1.6	1,6	61	08.83-07.87	4A		4	SPR 009
CUORE IV							
0.8	0,8	32	01.95-11.96	ED 20		3	SPR 012
CUORE V							
0.8	0,8	31	11.96-10.98	EF-EL		3	SPR 012
CUORE VI							
1.0 i	1,0	41	10.98-03.03	EJDE		3	SPR 012
MOVE							
1.0 i	1,0	41	10.98-09.00	EJDE		3	SPR 012
ROCKY							
2.0	2,0	65	02.85-04.93	3Y		4	SPR 009
2.8 D	2,8	54	02.85-04.85	DL		4	SPR 009
2.8 D	2,8	54	04.85-04.93	DL		4	SPR 011
2.8 TD	2,8	67	12.87-04.93	DL 51		4	SPR 011
2.8 TD	2,8	72	05.93-06.01	DL 52		4	SPR 011
2.8 TD	2,8	75	09.91-04.93	DL 52		4	SPR 011
SIRION							
1.0 i	1,0	41	04.98-05.00	EJDE		3	SPR 012
1.0 i 4WD	1,0	41	04.99-05.00	EJDE		3	SPR 012
1.0 i	1,0	43	09.00-	EJ-VE		3	SPR 012
1.0 i 4WD	1,0	43	09.00-12.01	EJ-VE		3	SPR 012
1.3 Sport	1,3	75	08.00-	K3-VE2		4	SPR 012
1.3 Sport 4WD	1,3	75	08.00-	K3-VE2		4	SPR 012
WILDCAT/ROCKY							
2.7 TD	2,7	65	09.85-04.87	DL 50		4	SPR 011
2.8 TD	2,8	65	09.85-04.87	DL 50		4	SPR 011

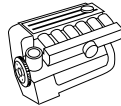

kW

Zyl.
Cyl.
Cil.**FORD****CAPRI II**

1.3	1.3	42	02.74-08.77	J1E	4	SPR 020
1.6	1.6	50	09.74-12.77	LAC	4	SPR 020
1.6	1.6	53	02.74-12.77	LCE	4	SPR 020
2.0	2.0	72	04.74-12.77	OHC TL 20 H	4	SPR 020
2.0	2.0	66	04.76-12.77	NYL/NWN	6	SPR 020
2.3	2.3	79	02.74-12.77	YYE	6	SPR 020
3.0	3.0	101	02.74-12.77	HYF	6	SPR 020

CAPRI III

1.3	1.3	40	01.78-06.85	J1E	4	SPR 020
1.6	1.6	54	01.78-04.87	LCN	4	SPR 020
2.0	2.0	74	01.78-12.85	NEN/OHC TL 20 H	4	SPR 020
2.3 Super	2.3	84	06.79-12.85	YYN	6	SPR 020
2.8 Super Injection	2.8	118	01.81-04.87	PRN	6	SPR 020
2.8 i Turbo	2.8	138	01.82-04.87		6	SPR 020
3.0	3.0	101	01.78-12.81		6	SPR 020

CONSUL

1700	1.7	48	01.72-12.75		4	SPR 020
2000	2.0	60	01.72-12.74		4	SPR 020
2000	2.0	66	09.74-12.75		6	SPR 020
2000	2.0	73	01.72-12.75		4	SPR 020
2300	2.3	79	01.72-12.75		6	SPR 020
2500	2.5	88	01.72-12.74		6	SPR 020
3000	3.0	101	01.72-12.74		6	SPR 020

ESCORT II

1.1	1.1	32	12.74-08.80	G1	4	SPR 020
1.1	1.1	35	12.74-08.80	G2	4	SPR 020
1.3	1.3	40	12.74-08.80	J1F	4	SPR 020
1.3	1.3	42	12.74-08.80	J2	4	SPR 020
1.3	1.3	51	12.74-08.80	J3	4	SPR 020
1.6 RS	1.6	62	12.74-08.80	LC	4	SPR 020
RS 1800	1.8	92	03.75-08.77		4	SPR 020
2.0 RS	2.0	80	08.75-08.80	NE	4	SPR 020

ESCORT III

1.1	1.1	37	08.83-12.85	GSE	4	SPR 020
1.1	1.1	40	09.80-08.83	GMA/GLB	4	SPR 020
1.1	1.1	43	09.80-08.83	GPA	4	SPR 020
1.3	1.3	51	09.80-12.85	JPA	4	SPR 020
1.6	1.6	58	09.80-12.85	LP1/LPA	4	SPR 020
1.6 i	1.6	66	07.85-12.85	L4B	4	SPR 020
1.6	1.6	71	09.80-10.82	LUA	4	SPR 020
1.6 XR3i	1.6	77	10.82-12.85	LRA/LR1	4	SPR 020
RS 1600i	1.6	85	05.82-12.85		4	SPR 020
1.6 RS Turbo	1.6	97	11.84-12.85	LNA	4	SPR 020
1.6 D	1.6	40	02.84-12.85	LTA	4	SPR 020

ESCORT IV

1.1	1.1	37	12.85-07.90	GSG	4	SPR 020
1.3	1.3	44	01.86-07.90	JLA/JBB/JLB	4	SPR 020
1.4	1.4	51	10.85-10.90	FUAA	4	SPR 020
1.4	1.4	54	01.86-07.90	F6D/F6B/FUC	4	SPR 020
1.4	1.4	55	01.86-07.90	FUA	4	SPR 020
1.6	1.6	58	01.86-12.88	LP2	4	SPR 020
1.6	1.6	65	04.89-07.90	LUG	4	SPR 020
1.6 i	1.6	66	01.86-05.90	L4B	4	SPR 020
1.6 i	1.6	75	08.89-07.90	LJB	4	SPR 020
1.6 XR3i	1.6	77	01.86-08.89	LRB/LR2	4	SPR 020
1.6 Turbo RS	1.6	97	01.86-07.90	LNB	4	SPR 020
1.6 D	1.6	40	01.86-01.89	LTC	4	SPR 020
1.8 D	1.8	44	01.89-07.90	RTA/RTB	4	SPR 020

ESCORT V

1.3	1.3	44	07.90-09.92	J6A/J4B	4	SPR 020
1.4	1.4	52	07.90-09.92	F6F/F6G	4	SPR 020

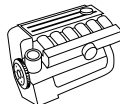

kW

Zyl.
Cyl.
Cil.**FORD****ESCORT V**

1.6	1.6	66	07.90-08.92	LUJ/LUK	4	SPR 020
1.6	1.6	77	07.90-12.92	LJF	4	SPR 020
1.8 16V XR3i	1,8	77	02.92-12.92	RDA	4	SPR 020
1.8 16V XR3i	1,8	96	02.92-12.92	RQB	4	SPR 020
1.8 D	1,8	44	07.90-12.92	RTH/RTF/RTE	4	SPR 020
RS 2000	2.0	110	05.91-12.92	N7A	4	SPR 020

ESCORT VI

1.3	1.3	44	09.92-01.95	J6A/J4B	4	SPR 020
1.4	1.4	52	09.92-01.95	F6F/F6G	4	SPR 020
1.4	1.4	55	01.94-01.95	FUH	4	SPR 020
1.6 i 16V	1.6	65	01.94-01.95	L1H	4	SPR 020
1.6 i 16V	1.6	66	09.92-01.95	L1E	4	SPR 020
1.8 i 16V	1,8	77	09.92-01.95	RDA	4	SPR 020
1.8 XR3i 16V 4x4	1,8	77	08.93-01.95	RDA	4	SPR 020
1.8 XR3i 16V 4x4	1,8	96	08.93-01.95	RQB	4	SPR 020
1.8 D	1,8	44	09.92-01.95	RTH/RTF/RTE	4	SPR 020
1.8 TD	1,8	66	02.93-01.95	RFS/RFD/RFK	4	SPR 020
RS 2000	2.0	110	09.92-01.95	N7A	4	SPR 020
RS 2000 4x4	2.0	110	08.93-01.95	N7A	4	SPR 020
RS Cosworth 4x4	2.0	162	09.92-01.95	N5F	4	SPR 020

ESCORT VII

1.3	1.3	44	01.95-10.98	J6A/J4B	4	SPR 020
1.4	1.4	55	01.95-10.98	F4B	4	SPR 020
1.6 i 16V	1.6	65	01.95-08.95	L1H	4	SPR 020
1.6 16V	1.6	66	01.95-10.98	L1E	4	SPR 020
1.6 16V 4x4	1.6	66	01.95-10.98	L1E	4	SPR 020
1.8 16V	1,8	77	01.95-08.95	RDA	4	SPR 020
1.8 16V	1,8	85	01.95-04.98	RKC	4	SPR 020
1.8 D	1,8	44	01.95-12.96	RTH/RTF/RTE	4	SPR 020
1.8 Turbo D	1,8	51	12.95-10.98	RVA	4	SPR 020
1.8 TD	1,8	66	01.95-10.98	RFD/RFK	4	SPR 020
RS 2000	2.0	110	02.95-02.98	N7A	4	SPR 020
RS 2000 4x4	2.0	110	02.95-10.98	N7A	4	SPR 020
RS Cosworth 4x4	2.0	162	02.95-10.98	N5F	4	SPR 020

FIESTA I

0.9	0.9	29	05.76-08.83	TKW/TKA	4	SPR 020
0.9	0.9	33	05.76-08.83	TLA	4	SPR 020
1.1	1.1	39	05.76-08.83	GLA	4	SPR 020
1.3	1.3	49	08.77-08.83	J3E	4	SPR 020
1.6 XR2	1.6	62	08.81-08.83	L3E	4	SPR 020

FIESTA II

1.0	0.9	33	09.83-02.89	TKB	4	SPR 020
1.4	1.4	55	10.85-11.89	FUB	4	SPR 020
1.6 XR2	1.6	71	04.84-02.89	LUB/LUD	4	SPR 020
1.6 D	1.6	40	04.84-02.89	LTB	4	SPR 020

FIESTA III

1.0	1.0	33	03.89-12.95	TLB	4	SPR 020
1.1	1.1	37	03.89-12.95	G6A	4	SPR 020
1.1	1.1	40	03.89-12.95	GUD/GUE	4	SPR 020
1.3	1.3	44	03.89-12.92	JBC	4	SPR 020
1.3 KAT	1.3	44	05.91-12.95	J6B	4	SPR 020
1.4	1.4	52	03.89-12.95	F6E	4	SPR 020
1.4	1.4	54	03.89-12.95	FUG/FUJ	4	SPR 020
1.4 KAT	1.4	54	03.89-12.95	F4A	4	SPR 020
1.6	1.6	65	01.89-01.94	LUH	4	SPR 020
1.6 i 16V	1.6	65	01.94-12.95	L1G	4	SPR 020
1.6 XR2i	1.6	76	03.89-03.93	LJD	4	SPR 020
1.6 XR2i	1.6	81	03.89-01.94	LJC	4	SPR 020
1.6 Turbo	1.6	96	03.90-10.92	LHA	4	SPR 020
1.8 16V	1,8	77	02.92-12.95	RDB	4	SPR 020
1.8 XR2i 16V	1,8	96	02.92-12.95	RQC	4	SPR 020

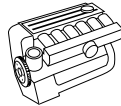

kW

Zyl.
Cyl.
Cil.**FORD****FIESTA III**

1.8 D	1,8	44	03.89-12.95	RTD/RTG/RTC	4	SPR 020
-------	-----	----	-------------	-------------	---	----------------

FIESTA IV

1.25 i 16V	1,2	55	08.95-01.02	DHG/DHB/DHC/DHE/DHF	4	SPR 020
1.8 D	1,8	44	08.95-04.00	RTK/RTJ	4	SPR 020

GALAXY

1.9 TDI	1,9	66	03.95-	ANU/AHU/1Z	4	SPR 022
1.9 TDI	1,9	81	08.97-04.00	AVG/AFN	4	SPR 022
2.0 i	2,0	85	11.95-	NSE/ZVSA	4	SPR 020
2.3 16V	2,3	107	01.97-	Y5B/E5SA	4	SPR 020

GRANADA

1.7	1,7	51	12.74-08.77	MWB	4	SPR 020
1.7	1,7	55	03.72-02.75	TV 17 H	4	SPR 020
2.0	2,0	66	01.75-08.77	NY	6	SPR 020
2.3	2,3	79	01.75-08.77	YYH	6	SPR 020
2.6	2,6	92	01.72-02.76		6	SPR 020
3.0	3,0	101	01.72-02.76		6	SPR 020
1.6	1,6	55	07.81-08.85	LCK	4	SPR 020
1.7	1,7	54	08.77-07.81	MY	4	SPR 020
2.0	2,0	66	08.77-08.85	NYP	6	SPR 020
2.0	2,0	74	08.79-08.85	NEP	4	SPR 020
2.0	2,0	77	08.81-08.85	NEK	4	SPR 020
2.3	2,3	79	08.77-06.79	YYH	6	SPR 020
2.3	2,3	82	06.81-08.85	YYU	6	SPR 020
2.3	2,3	84	06.79-08.85	YYP	6	SPR 020
2.8	2,8	97	06.81-08.85	PYU	6	SPR 020
2.8	2,8	99	08.77-08.85	PYA	6	SPR 020
2.8 i	2,8	108	08.77-08.85	PRD	6	SPR 020

KA

1.0 i	1,0	38	07.97-09.99		4	SPR 020
1.3 i	1,3	36	06.98-	JJH/JJD/JJF/JJG/JJL	4	SPR 020
1.3 i	1,3	37	09.96-	JJB	4	SPR 020
1.3 i	1,3	44	09.96-	J4S/BAA/J4K/J4M/J4P/J4N	4	SPR 020

MONDEO I

1.6 i 16V	1,6	65	07.94-08.96	L1J	4	SPR 020
1.6 i 16V	1,6	66	02.93-08.96	L1F	4	SPR 020
1.8 i 16V	1,8	82	07.94-08.96	RKB	4	SPR 020
1.8 i 16V	1,8	85	02.93-08.96	RKA	4	SPR 020
2.0 i 16V	2,0	100	02.93-08.96	NGA	4	SPR 020
2.5 i 24V	2,5	125	07.94-08.96	SEA	6	SPR 020
1.8 TD	1,8	65	06.93-08.96	RFM/RFN	4	SPR 020

MONDEO II

1.6 i	1,6	66	09.96-04.98	L1J	4	SPR 020
1.8 i	1,8	85	09.96-04.98	RKK/RKJ/RKB/RKF/RKH	4	SPR 020
2.0 i	2,0	96	09.96-04.98	NGA/NGB/NGD/NGC	4	SPR 020
2.5 24V	2,5	125	09.96-11.00	SEA	6	SPR 020
2.5 ST 200	2,5	151	05.99-11.00	SGA	6	SPR 020
1.8 TD	1,8	66	09.96-11.00	RFN	4	SPR 020

ORION I

1.3	1,3	51	07.83-03.86	JPA	4	SPR 020
1.6	1,6	58	07.83-03.86	LP1/LPA	4	SPR 020
1.6 i	1,6	77	07.83-03.86	LRA/LR1	4	SPR 020
1.6 D	1,6	40	02.84-03.86	LTA	4	SPR 020

ORION II

1.3	1,3	44	12.85-07.90	JLA/JBB/JLB	4	SPR 020
1.4	1,4	54	01.86-07.90	FUC	4	SPR 020
1.4 KAT	1,4	54	02.87-07.90	F6D/F6B	4	SPR 020
1.4	1,4	55	12.85-07.90	FUA	4	SPR 020
1.6	1,6	66	12.85-07.90	LUC	4	SPR 020
1.6 i KAT	1,6	66	03.86-07.90	L4B	4	SPR 020
1.6 i	1,6	75	08.89-07.90	LJB	4	SPR 020
1.6 i	1,6	77	03.86-07.90	LRB	4	SPR 020



kW

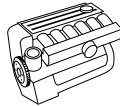

Zyl.
Cyl.
Cil.



FORD

ORION II

1.6 D	1.6	40	12.85-01.89	LTC	4	SPR 020
1.8 D	1,8	44	01.89-07.90	RTA/RTB	4	SPR 020

ORION III

1.3	1.3	44	07.90-12.93	J6A/J4B	4	SPR 020
1.4	1.4	52	07.90-12.93	F6F/F6G	4	SPR 020
1.4	1.4	54	07.90-12.93	FUH	4	SPR 020
1.6 i 16V	1.6	66	07.92-12.93	L1E/L1K	4	SPR 020
1.6	1.6	66	07.90-12.92	LUJ/LUK	4	SPR 020
1.6 i	1.6	77	07.90-09.92	LJF	4	SPR 020
1.8 i 16V	1,8	77	02.92-12.93	RDA	4	SPR 020
1.8 i 16V	1,8	96	01.92-12.93	RQB	4	SPR 020
1.8 D	1,8	44	11.90-12.93	RTH/RTF/RTE	4	SPR 020
1.8 TD	1,8	66	03.92-12.93	RFD/RFK	4	SPR 020

SCORPIO I

1.8	1,8	66	04.85-02.92	REC	4	SPR 020
2.0 i	2.0	74	10.85-12.90	NRC	4	SPR 020
2.0	2.0	77	04.85-08.89	N8D/NEL	4	SPR 020
2.0 i	2.0	85	04.85-02.92	NRI/NRA	4	SPR 020
2.0 i	2.0	85	02.92-09.94	NRI/NRA	4	SPR 020
2.0 i	2.0	88	05.89-09.94	N9D	4	SPR 020
2.4 i KAT	2,4	92	10.88-09.94	ARD	6	SPR 020
2.4 i	2,4	96	09.86-09.88	ARC	6	SPR 020
2.8 i	2,8	110	04.85-11.86	PRE	6	SPR 020
2.9 i	2,9	107	09.86-09.94	BRD/BRE/BRF	6	SPR 020
2.9 i	2,9	110	09.86-09.94	BRC	6	SPR 020
2.9 i 24V	2,9	143	04.91-09.94	BOA	6	SPR 020
2.5 D	2.5	51	12.85-02.92	STR	4	SPR 020
2.5 TD	2.5	68	06.88-07.93	SFA/SFB	4	SPR 020
2.5 TD	2.5	85	08.93-09.94	SCB	4	SPR 020

SCORPIO II

2.0 i	2.0	85	10.94-08.98	NSD	4	SPR 020
2.0 i 16V	2.0	100	10.94-08.98	N3A	4	SPR 020
2.3 i 16V	2.3	108	06.96-08.98	Y5A	4	SPR 020
2.5 TD	2.5	85	10.94-08.98	SCC	4	SPR 020
2.5 TD	2.5	92	09.96-08.98	VM	4	SPR 020
2.9 i	2,9	110	02.95-08.98	BRG	6	SPR 020
2.9 i 24V	2,9	152	10.94-08.98	BOB	6	SPR 020

SIERRA Schrägheck (GBC)

1.3	1.3	44	08.82-12.86	JCT	4	SPR 020
1.6	1.6	55	08.82-12.86	LCS/LCT/LSD	4	SPR 020
1.8	1,8	66	10.84-12.86	REB	4	SPR 020
2.0	2.0	66	08.82-10.84	NYT	6	SPR 020
2.0	2.0	74	10.85-12.86	NRD	4	SPR 020
2.0	2.0	77	08.82-12.86	NET	4	SPR 020
2.0 i	2.0	85	03.85-12.86	NR2/NRB	4	SPR 020
2.3	2.3	84	08.82-12.86	YYT	6	SPR 020
2.3 D	2.3	49	08.82-12.86	YTT	4	SPR 020
2.8 XR4i	2,8	105	08.82-12.86	PR6	6	SPR 020
2.8 XR4i	2,8	110	08.82-12.86	PRT	6	SPR 020

SIERRA (GBG, GB4)

1.6	1.6	53	01.88-02.93	LSF	4	SPR 020
1.6	1.6	55	01.87-02.93	LSE	4	SPR 020
1.6 i	1.6	59	10.89-02.93	L6B	4	SPR 020
1.8	1,8	64	05.88-02.93	R2C/R6A	4	SPR 020
1.8	1,8	59	10.87-09.89	RED/REF	4	SPR 020
1.8	1,8	66	01.87-05.88	RED/R2A	4	SPR 020
1.8 TD	1,8	55	08.88-02.93	RFA/RFB/RFL	4	SPR 020
2.0 i	2.0	74	01.87-12.89	NE5/NEJ	4	SPR 020
2.0 i KAT	2.0	74	01.87-02.93	N4B	4	SPR 020
2.0	2.0	77	01.87-02.93	N8C/NES	4	SPR 020
2.0 i	2.0	85	01.87-02.93	N4I/N4A	4	SPR 020

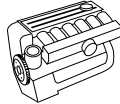

kW

Zyl.
Cyl.
Cil.**FORD****SIERRA (GBG, GB4)**

2.0 i	2.0	88	01.90-02.93	N9C	4	SPR 020
2.0 i	2.0	92	01.90-02.93	N9C	4	SPR 020
2.3 D	2.3	49	01.87-09.89	YTR/YTT	4	SPR 020
2.9 i	2.9	107	08.88-02.93	B4B/B4C	6	SPR 020
2.9 i	2.9	110	08.88-02.93	B4B/B4C	6	SPR 020

TAUNUS

1.3	1.3	40	09.76-07.79		4	SPR 020
1.3	1.3	40	05.75-07.79	JAC	4	SPR 020
1.6	1.6	50	05.75-07.79	LAD	4	SPR 020
1.6	1.6	53	05.75-07.79	LCJ	4	SPR 020
2.0	2.0	66	05.75-07.79	NYR	6	SPR 020
2.3	2.3	79	05.75-07.79	YYF	6	SPR 020

TAUNUS '80

1.3	1.3	43	07.79-07.82	JCC	4	SPR 020
1.6	1.6	51	07.79-07.82	LAR	4	SPR 020
1.6	1.6	54	07.79-07.82	LCJ	4	SPR 020
2.0	2.0	74	07.79-07.82	NER	4	SPR 020
2.0	2.0	66	07.79-07.82	NWR	6	SPR 020
2.3	2.3	84	07.79-07.82	YYR	6	SPR 020

TRANSIT

1.6	1.6	48	12.77-10.86	4RB	4	SPR 020
2.0	2.0	43	12.77-07.82	4RC	4	SPR 020
2.0	2.0	55	11.77-10.86	4RC	4	SPR 020
2.0	2.0	57	11.77-10.86	4RC	4	SPR 020
2.0	2.0	66	09.91-09.94	NBA	4	SPR 020
2.0 i	2.0	72	09.91-07.94	NCA	4	SPR 020
2.0	2.0	84	09.95-03.00	NSF/NSG	4	SPR 020
2.0 CNG	2.0	84	06.94-03.00	NSH	4	SPR 020
2.4 D	2.4	46	12.77-10.86	4AA	4	SPR 020
2.5 D	2.5	50	10.83-10.86	4AB	4	SPR 020
2.5 DI	2.5	51	08.91-07.94	4FA /4BC/4CC	4	SPR 020
2.5 DI	2.5	51	08.94-03.00	4FA /4FB/4FD/4FC	4	SPR 020
2.5 DI	2.5	56	07.94-03.00	4HC /4HB	4	SPR 020
2.5 DI	2.5	59	09.91-07.94	4DA	4	SPR 020
2.5 TD	2.5	63	10.92-07.94	4GB/4GC /4GA	4	SPR 020
2.5 TD	2.5	63	01.95-03.00	4GF/4GB/4GC /4GA/4GE	4	SPR 020
2.5 TD	2.5	74	09.91-07.94	4EA	4	SPR 020
2.5 TD	2.5	74	07.94-03.00	4EB/4EC	4	SPR 020
2.5 DI E146	2.5	85	08.97-03.00	4ED	4	SPR 020
2.9 i	2.9	107	01.91-	BRT	6	SPR 020

HONDA**ACCORD II**

1.8 EX	1,8	74	09.83-10.85	ET1	4	SPR 014
--------	-----	----	-------------	-----	---	---------

ACCORD II Hatchback

1.6 EX	1,6	65	09.83-10.85	EZ	4	SPR 014
1.8 EX	1,8	74	09.83-10.85	ET1	4	SPR 014

ACCORD III

1.6 L	1,6	65	11.85-12.89	A16A1	4	SPR 014
2.0 EX	2,0	75	10.87-12.89	A20A1	4	SPR 014
2.0 EX	2,0	76	10.87-12.89	A20A1	4	SPR 014
2.0 EX	2,0	78	10.87-05.89	A20A2	4	SPR 014
2.0 EXi	2,0	85	10.86-12.89	A20A3	4	SPR 014
2.0 EXi	2,0	90	11.85-12.87	A20A4	4	SPR 014
2.0 i 16V	2,0	98	10.87-12.89	B20A8	4	SPR 014
2.0 i 16V	2,0	101	01.87-12.87	B20A2	4	SPR 014

ACCORD III Aerodeck

1.6 L	1,6	65	11.85-12.89		4	SPR 014
2.0 EX	2,0	75	10.87-12.89	A20A1	4	SPR 014
2.0 EX	2,0	76	10.87-12.89	A20A1	4	SPR 014
2.0 EX	2,0	78	11.85-05.89	A20A2	4	SPR 014

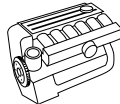

kW

 Zyl.
Cyl.
Cil.

HONDA
ACCORD III Aerodeck

2.0 EXi	2,0	85	10.87-12.89	A20A3	4	SPR 014
2.0 EXi	2,0	90	10.87-12.87	A20A4	4	SPR 014

ACCORD IV

2.0 16V	2,0	66	01.90-03.93	F20A6	4	SPR 014
2.0 16V	2,0	81	01.90-03.93	F20A2	4	SPR 014
2.0 i 16V	2,0	98	01.90-03.93	F20A4/F20A8	4	SPR 014
2.2 i 16V Automatik	2,2	108	01.90-03.93	F22A3	4	SPR 014
2.2 i 16V	2,2	110	01.90-03.93	F22A3	4	SPR 014

CIVIC I

1300 L	1,3	33	09.82-09.83	EN 2	4	SPR 015
1300 L	1,3	44	09.80-09.83	EN 1	4	SPR 015
1300 S	1,3	52	10.79-09.83	EN 4	4	SPR 015

CIVIC I Shuttle

1.5 4WD	1,5	63	01.85-10.87	EW2	4	SPR 014
---------	-----	----	-------------	-----	---	----------------

CIVIC II

1.2	1,2	40	01.85-10.87	ZA2	4	SPR 014
1.3	1,3	52	10.83-10.87	EV2	4	SPR 014
1.5 GL	1,5	63	10.83-10.87	EW2	4	SPR 014
1.5 GTI	1,5	66	03.86-10.87	EW4	4	SPR 014
1.5 GT	1,5	74	01.85-10.87	EW3	4	SPR 014

CIVIC II Hatchback

1.5 GL	1,5	63	10.83-10.87	EW2	4	SPR 014
1.5 GT	1,5	74	01.85-10.87	EW3	4	SPR 014

CIVIC II Shuttle

1.5 i 16V	1,5	69	01.88-11.91	D15B2	4	SPR 014
1.6 i 16V 4WD	1,6	81	01.88-02.95	D16A6	4	SPR 014

CIVIC III

1.3	1,3	55	10.87-12.89	D13B1	4	SPR 014
1.4 L	1,4	66	10.87-12.89	D14A1	4	SPR 014
1.5 i 16V	1,5	66	10.87-09.91	D15B2	4	SPR 014
1.6 i 16V	1,6	80	11.87-12.89	D16A6	4	SPR 014
1.6 i 16V 4x4	1,6	80	10.89-12.89	D16A6	4	SPR 014
1.6 i 16V	1,6	81	10.87-09.91	D16Z2	4	SPR 014

CIVIC III Hatchback

1.4 L	1,4	66	10.87-12.89	D14A1	4	SPR 014
1.5 i 16V	1,5	69	10.88-09.91	D15B2	4	SPR 014
1.6 i 16V	1,6	80	10.87-09.91	D16A6	4	SPR 014
1.6 i 16V	1,6	81	10.87-09.91	D16Z2	4	SPR 014
1.6 i 16V Vtec	1,6	110	10.89-09.91	B16A1	4	SPR 014

CONCERTO

1.5 i 16V	1,5	66	08.89-03.95	D15B2	4	SPR 014
1.6 i 16V	1,6	82	08.89-03.95	D16Z2	4	SPR 014
1.6 i 16V	1,6	90	08.89-03.95	D16A8	4	SPR 014

CRX I

1.5 i	1,5	74	10.83-12.85	EW3	4	SPR 014
-------	-----	----	-------------	-----	---	----------------

CRX II

1.6 i 16V	1,6	91	10.88-02.92	D16Z5	4	SPR 014
1.6 i 16V	1,6	96	10.88-12.89	D16A9	4	SPR 014

JAZZ

45 1.2	1,2	33	01.85-10.86	ER 2	4	SPR 015
55 1.2	1,2	40	09.84-10.86	ER 4	4	SPR 015
56 1.2	1,2	41	10.83-10.86	ER 1	4	SPR 015

LEGEND I Coupe

2.7 i 24V	2,7	124	10.87-12.90	C27A1	6	SPR 015
-----------	-----	-----	-------------	-------	---	----------------

PRELUDE II

1.8 EX	1,8	74	11.85-04.87	ET4	4	SPR 014
1.8 EX	1,8	77	11.83-10.85	ET2	4	SPR 015
1.8 EX	1,8	77	11.85-04.87	ET2	4	SPR 014

QUINTET

1.6 EX	1,6	59	10.81-12.84	EL	4	SPR 015
--------	-----	----	-------------	----	---	----------------

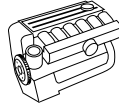

kW

Zyl.
Cyl.
Cil.**ISUZU****TROOPER**

2.8 TD	2,8	71	01.88-12.91	4JB1T		4	SPR 011
2.8 TD	2,8	78	08.89-12.91	4JB1TC		4	SPR 011

TROOPER Soft Top

2.2 TD	2,2	53	03.84-12.91	C223T		4	SPR 011
2.6 i	2,2	85	01.88-12.91	4ZE1		4	SPR 011

LEXUS**LS**

400	4,0	180	12.89-08.92	1UZ-FE		8	SPR 009
-----	-----	-----	-------------	--------	--	---	----------------

MAZDA**121 I**

1.1	1,1	42	10.87-03.89	B1		4	SPR 012
1.1	1,1	42	04.89-10.90	B1/B116	→ Fg. Nr. 203040	4	SPR 013
1.3	1,3	40	04.89-10.90	B3	→ Fg. Nr. 203040	4	SPR 013
1.3	1,3	44	10.87-03.89	B3		4	SPR 012
1.3	1,3	44	04.89-10.90	B3	→ Fg. Nr. 203040	4	SPR 013

323 I Station Wagon

1.3	1,3	44	12.84-10.85	TC		4	SPR 012
1.5	1,5	52	12.84-10.85	D5		4	SPR 012

323 III

1.1	1,1	40	08.85-04.90			4	SPR 012
1.3	1,3	44	08.85-07.87	E3		4	SPR 012
1.5	1,5	54	09.87-05.89	B5		4	SPR 012
1.5	1,5	55	08.85-07.87	E5		4	SPR 012
1.6 GT	1,6	63	11.86-05.89	B6		4	SPR 012
1.6 GT	1,6	77	01.86-12.88	B6		4	SPR 012
1.6 GT Turbo	1,6	103	06.87-05.89	B6		4	SPR 012
1.7 D	1,7	40	09.86-05.89	PN27		4	SPR 012

323 III Hatchback

1.1	1,1	40	09.85-10.89	E1		4	SPR 012
1.3	1,3	44	09.85-07.87	E3		4	SPR 012
1.5	1,5	54	09.87-05.89	B5		4	SPR 012
1.5	1,5	55	08.85-07.87	E5		4	SPR 012
1.6 GT	1,6	63	09.87-05.89	B6		4	SPR 012
1.6 GT Turbo 4WD	1,6	110	08.87-05.89			4	SPR 012
1.6 GT	1,6	77	08.85-12.88	B6		4	SPR 012
1.6 GT Turbo	1,6	103	06.87-05.89	B6		4	SPR 012
1.6 GT Turbo 4WD	1,6	103	10.87-05.89	B6		4	SPR 012
1.7 D	1,7	40	04.86-05.89	PN27		4	SPR 012
1.7 D	1,7	42	01.87-05.89	PN46		4	SPR 012

323 III Station Wagon

1.3	1,3	44	07.86-08.89			4	SPR 012
1.5	1,5	54	01.87-05.89	B5/B50/B53		4	SPR 012
1.5	1,5	55	05.86-05.89	B50/B53/E5		4	SPR 012
1.6	1,6	63	07.87-08.89	B6E		4	SPR 012
1.7 D	1,7	40	11.86-06.87	PN26		4	SPR 012
1.7 D	1,7	41	10.89-03.93	PN26	→ Fg. Nr. 528760	4	SPR 013
1.7 D	1,7	42	07.87-08.89	PN26		4	SPR 012
1.7 D	1,7	42	09.89-10.89	PN26		4	SPR 013

323 C IV

1.3	1,3	49	09.89-03.91	B3E	→ Fg.Nr. 103362	4	SPR 013
1.6	1,6	62	09.89-03.91	B6E	→ Fg.Nr. 103362	4	SPR 013
1.7 D	1,7	41	08.89-07.94			4	SPR 013

323 F IV

1.6	1,6	62	09.89-03.91	B6E	→ Fg.Nr. 103362	4	SPR 013
-----	-----	----	-------------	-----	-----------------	---	----------------

323 S IV

1.3	1,3	49	09.89-03.91	B383 /B3E	→ Fg.Nr. 103362	4	SPR 013
1.6	1,6	62	09.89-03.91	B6E	→ Fg.Nr. 103362	4	SPR 013
1.7 D	1,7	41	08.89-05.94	PN46/PN62		4	SPR 013

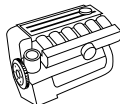

kW

Zyl.
Cyl.
Cil.**MAZDA****323 S V**

2.0 D	2,0	52	03.97-04.98		4	SPR 012
-------	-----	----	-------------	--	---	----------------

626 II

1.6	1,6	59	07.85-06.87	F6	4	SPR 015
-----	-----	----	-------------	----	---	----------------

2.0	2,0	74	07.85-06.87	FE	4	SPR 015
-----	-----	----	-------------	----	---	----------------

2.0	2,0	88	01.86-06.87	FE	4	SPR 015
-----	-----	----	-------------	----	---	----------------

2.0 D	2,0	46	01.83-06.87	RF46	4	SPR 012
-------	-----	----	-------------	------	---	----------------

626 II Hatchback

1.6	1,6	55	07.85-06.87		4	SPR 015
-----	-----	----	-------------	--	---	----------------

1.6	1,6	59	07.85-06.87	F6	4	SPR 015
-----	-----	----	-------------	----	---	----------------

2.0	2,0	74	07.85-06.87	FE	4	SPR 015
-----	-----	----	-------------	----	---	----------------

2.0	2,0	88	01.86-06.87	FE	4	SPR 015
-----	-----	----	-------------	----	---	----------------

2.0 D	2,0	46	07.85-06.87	RF46	4	SPR 012
-------	-----	----	-------------	------	---	----------------

626 III

1.6	1,6	60	03.88-08.89		4	SPR 015
-----	-----	----	-------------	--	---	----------------

1.6	1,6	60	08.89-07.91		4	SPR 013
-----	-----	----	-------------	--	---	----------------

1.8	1,8	65	11.87-08.89	F8	4	SPR 015
-----	-----	----	-------------	----	---	----------------

1.8	1,8	65	08.89-07.91	F8	4	SPR 013
-----	-----	----	-------------	----	---	----------------

2.0	2,0	66	09.87-08.89	FE KAT.	4	SPR 015
-----	-----	----	-------------	---------	---	----------------

2.0	2,0	66	08.89-10.90	FE Kat.	4	SPR 013
-----	-----	----	-------------	---------	---	----------------

2.0 12V	2,0	79	09.87-08.89	FE (12V)	4	SPR 015
---------	-----	----	-------------	----------	---	----------------

2.0 12V	2,0	79	08.89-07.91	FE (12V)	4	SPR 013
---------	-----	----	-------------	----------	---	----------------

2.0 16V	2,0	103	11.87-08.89	FE KAT. (16V)	4	SPR 015
---------	-----	-----	-------------	---------------	---	----------------

2.0 16V	2,0	103	08.89-07.91	FE Kat. (16V)	4	SPR 013
---------	-----	-----	-------------	---------------	---	----------------

2.0 D	2,0	44	07.87-07.91	RF-N	4	SPR 012
-------	-----	----	-------------	------	---	----------------

2.2 12V	2,2	85	11.87-08.89	F2	4	SPR 015
---------	-----	----	-------------	----	---	----------------

2.2 12V	2,2	85	08.89.07.91	F2	4	SPR 013
---------	-----	----	-------------	----	---	----------------

626 III Coupe

2.0	2,0	66	09.87-08.89	FE KAT.	4	SPR 015
-----	-----	----	-------------	---------	---	----------------

2.0	2,0	66	08.89-10.90	FE Kat.	4	SPR 013
-----	-----	----	-------------	---------	---	----------------

2.0 12V	2,0	79	09.87-12.88	FE (12V)	4	SPR 015
---------	-----	----	-------------	----------	---	----------------

2.0 16V	2,0	103	12.87-08.89	FE KAT. (16V)	4	SPR 015
---------	-----	-----	-------------	---------------	---	----------------

2.0 16V	2,0	103	08.89-10.90	FE Kat. (16V)	4	SPR 013
---------	-----	-----	-------------	---------------	---	----------------

2.2 12V	2,2	85	04.88-07.91	F2	4	SPR 013
---------	-----	----	-------------	----	---	----------------

626 III Hatchback

1.6	1,6	60	03.88-08.89		4	SPR 015
-----	-----	----	-------------	--	---	----------------

1.6	1,6	60	08.89-07.91		4	SPR 013
-----	-----	----	-------------	--	---	----------------

1.8	1,8	65	11.87-08.89	F8	4	SPR 015
-----	-----	----	-------------	----	---	----------------

1.8	1,8	65	08.89-07.91	F8	4	SPR 013
-----	-----	----	-------------	----	---	----------------

2.0	2,0	66	09.87-08.89	FE KAT.	4	SPR 015
-----	-----	----	-------------	---------	---	----------------

2.0	2,0	66	08.89-10.90	FE Kat.	4	SPR 013
-----	-----	----	-------------	---------	---	----------------

2.0 12V	2,0	79	11.87-08.89	FE (12V)	4	SPR 015
---------	-----	----	-------------	----------	---	----------------

2.0 12V	2,0	79	08.89-07.91	FE (12V)	4	SPR 013
---------	-----	----	-------------	----------	---	----------------

2.0 16V	2,0	103	11.87-08.89	FE KAT. (16V)	4	SPR 015
---------	-----	-----	-------------	---------------	---	----------------

2.0 16V	2,0	103	08.89-10.90	FE Kat. (16V)	4	SPR 013
---------	-----	-----	-------------	---------------	---	----------------

2.0 D	2,0	44	07.87-07.91	RF-N	4	SPR 012
-------	-----	----	-------------	------	---	----------------

2.2 12V	2,2	85	06.88-08.89	F2	4	SPR 015
---------	-----	----	-------------	----	---	----------------

2.2 12V	2,2	85	08.89-07.91	F2	4	SPR 013
---------	-----	----	-------------	----	---	----------------

626 III Station Wagon

2.0	2,0	66	10.88-10.89	FE KAT.	4	SPR 015
-----	-----	----	-------------	---------	---	----------------

2.0	2,0	66	10.89-09.97	FE Kat.	4	SPR 013
-----	-----	----	-------------	---------	---	----------------

2.0 i	2,0	110	11.94-02.95		4	SPR 013
-------	-----	-----	-------------	--	---	----------------

2.0 16V	2,0	103	03.88-10.89	FE KAT. (16V)	4	SPR 015
---------	-----	-----	-------------	---------------	---	----------------

2.0 16V	2,0	103	10.89-03.92	FE Kat. (16V)	4	SPR 013
---------	-----	-----	-------------	---------------	---	----------------

2.0 D Complex	2,0	55	05.93-11.96	RF-CX	4	SPR 012
---------------	-----	----	-------------	-------	---	----------------

2.0 D	2,0	60	11.94-09.97		4	SPR 012
-------	-----	----	-------------	--	---	----------------

2.2 12V	2,2	85	03.89-10.89	F2 / F2 KAT.	4	SPR 015
---------	-----	----	-------------	--------------	---	----------------

2.2 12V	2,2	85	10.89-11.96	F2 /F2 Kat.	4	SPR 013
---------	-----	----	-------------	-------------	---	----------------

2.2 12V 4WD	2,2	85	03.92-11.92	F2 Kat.	4	SPR 013
-------------	-----	----	-------------	---------	---	----------------

626 IV

2.0 D GLX Complex	2,0	55	10.92-05.94	RF OHC	4	SPR 012
-------------------	-----	----	-------------	--------	---	----------------

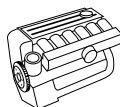

kW

Zyl.
Cyl.
Cil.**MAZDA**

626 IV Hatchback							
2.0 D GLX Complex	2,0	55	01.93-05.94	RF OHC		4	SPR 012
929 II Station Wagon							
2.0	2,0	66	01.83-12.87	HEE/MA	Fg.Nr. LA 4 MV 841381 →	4	SPR 012
929 III							
2.2 12V	2,2	94	06.89-06.91	F2-C		4	SPR 013
E 2000, 2200 Bus							
2.0	2,0	63	11.84-02.88	FE18 / FEV4	Fg.Nr. SDX 0815 000 83 →	4	SPR 015
2.0 4WD	2,0	60	10.88-07.89	FEBN		4	SPR 015
2.2 D	2,2	46	01.84-02.88	R207	Fg.Nr. SDX 0815 000 83 →	4	SPR 015
E 2000, 2200 Kasten							
2.0	2,0	60	03.91-05.94	FE60 / FE61		4	SPR 015
2.0	2,0	63	05.85-02.88	FE18 / FE58	Fg.Nr. SDX 0815 000 83 →	4	SPR 015
2.0	2,0	70	06.94-04.97	FE Kat.	→ Fg.Nr. SR 1 C 2708636	4	SPR 012
2.2 D	2,2	46	05.85-02.88	R203 / R207	Fg.Nr. SDX 0815 000 83 →	4	SPR 015
2,2 D	2,2	47	03.91-04.97	R203 / R207		4	SPR 015

MERCEDES

190 (W201)							
E 1.8	1,8	80	04.90-08.93	M 102.910		4	SPR 019
2.0	2,0	66	10.82-10.84	M 102.921		4	SPR 019
2.0	2,0	75	01.86-05.90	M 102.924		4	SPR 019
2.0	2,0	77	09.84-05.90	M 102.924		4	SPR 019
E 2.0	2,0	83	02.85-12.86	M 102.961/M 102.962		4	SPR 019
E 2.0	2,0	85	02.85-12.86	M 102.962		4	SPR 019
E 2.0	2,0	87	01.85-08.93	M 102.962		4	SPR 019
E 2.0	2,0	90	10.82-06.93	M 102.961/M 102.962		4	SPR 019
E 2.3	2,3	97	09.86-08.91	M 102.985		4	SPR 019
E 2.3	2,3	100	10.86-03.93	M 102.985		4	SPR 019
E 2.3-16	2,3	125	09.85-12.87	M 102.983		4	SPR 019
E 2.3-16	2,3	130	09.85-08.88	M 102.983		4	SPR 019
E 2.3-16	2,3	136	04.84-01.87	M 102.983		4	SPR 019
E 2.5-16	2,5	143	03.89-08.93	M 102.991		4	SPR 019
E 2.5-16	2,5	150	09.88-08.93	M 102.990		4	SPR 019
E Evolution II 2.5	2,5	173	05.90-08.93	M 102.992		4	SPR 019
E 2.6	2,6	118	09.86-08.93	M 103.942		6	SPR 019
E 2.6	2,6	122	09.86-12.89	M 103.942		6	SPR 019
D 2.0	2,0	53	08.83-08.89	OM 601.911		4	SPR 019
D 2.0	2,0	55	08.89-08.93	OM 601.911		4	SPR 019
D 2.5	2,5	66	04.85-08.93	OM 602.911		5	SPR 019
D 2.5	2,5	69	08.89-08.93	OM 602.911		5	SPR 019
Turbo-D 2.5	2,5	90	02.88-08.93	OM 602.961		5	SPR 019
Turbo-D 2.5	2,5	93	02.88-08.93	OM 602.961		5	SPR 019

MITSUBISHI

CARISMA							
1.6	1,6	66	07.95-	4 G 92		4	SPR 010
1.6	1,6	73	05.97-	4 G 92		4	SPR 010
1.8	1,8	85	07.95-	4 G 93		4	SPR 010
1.8 16V	1,8	103	07.95-	4 G 93		4	SPR 010
1.8 16V GDI	1,8	92	09.97-	4 G 93 (GDI)		4	SPR 010
COLT IV							
1.6 GLXi 16V	1,6	83	04.92-04.96	4 G 92		4	SPR 010
GALANT V							
1.8	1,8	85	02.94-08.96	4 G 93		4	SPR 010
1.8 GLSi	1,8	93	11.92-08.96	4 G 93 (GDI)		4	SPR 010
LANCER IV							
1.6 GLi 16V	1,6	83	06.92-05.94	4 G 92		4	SPR 010
LANCER V							
1.6 16V 4WD	1,6	83	06.92-	4 G 92		4	SPR 010
SIGMA							
3.0 V6	3,0	130	12.90-07.96	6 G 72		6	SPR 010

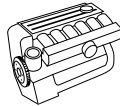

kW

 Zyl.
Cyl.
Cil.

MITSUBISHI
SPACE WAGON

1.8	1,8	90	10.91-10.98	4 G 93	4	SPR 010
1.8 4x4	1,8	90	10.91-10.98	4 G 93	4	SPR 010
SPACE RUNNER						
1.8	1,8	90	10.91-08.99	4 G 93	4	SPR 010
1.8 4x4	1,8	90	10.91-08.99	4 G 93	4	SPR 010
SPACE STAR						
1.8 GDI	1,8	90	06.98-	4 G 93 (GDI)	4	SPR 010

NISSAN
CHERRY

1.0	1,0	37	05.82-05.84	E10	4	SPR 016
1.3 Coupe	1,3	44	05.82-09.82	E13	4	SPR 016
1.3 Traveller	1,3	44	05.82-12.83	E13	4	SPR 016
1.5	1,5	55	11.83-05.84	E15S	4	SPR 016
1.5 Turbo	1,5	77	07.83-05.84	E15ET	4	SPR 016
1.7 D	1,7	40	10.82-05.84	CD17	4	SPR 016

CHERRY Hatchback

1.2	1,2	38	08.78-07.81	A12	4	SPR 014
-----	-----	----	-------------	-----	---	----------------

LAUREL

2.0	2,0	71	01.81-12.82	L20A	6	SPR 016
2.4	2,4	83	01.81-12.82	L24	6	SPR 016
2.8 D	2,8	62	01.81-12.82	LD28	6	SPR 016

MICRA

1.0	1,0	37-40	12.82-11.88	MA10S	4	SPR 016
1.2	1,2	40-44	07.86-11.88	MA12S	4	SPR 016

PICK UP

1.8	1,8	59	01.83-09.85	L18	4	SPR 016
2.2 4WD	2,2	71	04.83-09.85	Z22	4	SPR 016
2.3 D	2,3	51	04.83-09.85	SD23	4	SPR 016
2.5 D 4WD	2,5	53	04.83-09.85	SD25	4	SPR 016

PRAIRIE

1.5 S	1,5	55	01.84-02.85	E15S	4	SPR 016
1.8 SGL	1,8	65	07.83-02.85	CA18S	4	SPR 016

PRIMERA

2.0 D	2,0	55	05.93-09.94	CD20	4	SPR 016
2.0 D Traveller	2,0	55	07.90-12.95	CD20	4	SPR 016

STANZA

1.6	1,6	60	08.81-12.85	CA16S	4	SPR 016
1.8 Hatchback	1,8	65-66	08.81-12.85	CA18, CA18S	4	SPR 016
1.8 SGL	1,8	66	03.83-12.85	CA18S	4	SPR 016

SUNNY I

1.3	1,3	44	03.82-02.84	E13	4	SPR 016
1.5 Coupe	1,5	55	03.82-02.84	E15S	4	SPR 016
1.7 D	1,7	40	08.82-02.84	CD17	4	SPR 016
1.7 D Kasten	1,7	40	05.92-04.98	CD17	4	SPR 016

URVAN

2.0 Kasten	2,0	55	07.81-04.82	H20	4	SPR 016
2.0 Kasten	2,0	64	05.87-01.95	Z20	4	SPR 016
2.2 D	2,2	47	07.81-04.82	-	4	SPR 016
2.3 D Bus	2,3	50-51	04.85-02.87	SD23	4	SPR 016
2.3 D Kasten	2,3	51	01.88-03.89	TD23	4	SPR 016
2.4 i	2,4	74	05.89-11.95	Z24i	4	SPR 016
2.5 D Kasten	2,5	59	05.89-05.97	TD25	4	SPR 016

VANETTE

1.5 Bus	1,5	51	01.83-06.87	A 15	4	SPR 016
---------	-----	----	-------------	------	---	----------------

NSU

1000						
C	1,0	29	09.69-12.72		4	SPR 001
1200						
C	1,2	40	09.69-11.71		4	SPR 001

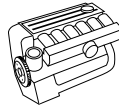

kW

Zyl.
Cyl.
Cil.

NSU						
PRINZ						
600	0,6	22	09.69-11.71		2	SPR 001
1000	1,0	29	09.69-01.73		4	SPR 001
TT						
1.2	1,2	48	09.67-11.71		4	SPR 001
TTS						
1.0	1,0	52	01.70-11.71		4	SPR 001
OPEL						
ASCONA A						
1.2 S	1,2	44	04.72-08.75	12 S	4	SPR 018
1.6 N	1.6	44	03.75-08.75	16 N	4	SPR 018
1.6 N	1.6	50	10.70-02.75	16 N	4	SPR 018
1.6 S	1.6	55	03.75-08.75	16 S	4	SPR 018
1.6 S	1.6	59	10.70-02.75	16 S	4	SPR 018
1.9 SR	1.9	65	03.75-08.75	19 S	4	SPR 018
1.9 SR	1.9	66	03.71-02.75	19 S	4	SPR 018
ASCONA B						
1.2	1,2	40	08.76-02.79	12 N	4	SPR 018
1.2 S	1,2	44	09.75-02.79	12 S	4	SPR 018
1.3 N	1.3	44	03.79-08.81	13 N	4	SPR 018
1.3 S	1.3	55	08.79-08.81	13 S	4	SPR 018
1.6 N	1.6	44	09.75-08.81	16 N	4	SPR 018
1.6 S	1.6	55	09.75-08.81	16 S	4	SPR 018
1.9 N	1.9	55	08.76-08.81	19 N	4	SPR 018
1.9 S	1.9	66	09.75-08.81	19 S	4	SPR 018
2.0 N	2.0	66	08.77-08.81	20 N	4	SPR 018
2.0 S	2.0	74	08.77-08.81	20 S	4	SPR 018
2.0 E	2.0	81	08.79-08.81	20 E	4	SPR 018
2.4 400	2,4	106	07.80-08.81	24 E	4	SPR 018
2.0 D	2.0	43	08.78-08.81	20 D	4	SPR 018
ASCONA C						
1.3 N	1.3	44	09.81-08.86	13 N	4	SPR 018
1.3 S	1.3	55	09.81-08.88	13 S	4	SPR 018
1.6	1.6	55	09.81-09.87	16 N	4	SPR 018
1.6 i	1.6	55	09.87-08.88	E 16 NZ	4	SPR 018
1.6 i KAT	1.6	55	09.86-08.88	C 16 NZ/C 16 LZ	4	SPR 018
1.6	1.6	60	09.86-08.88	16 SV	4	SPR 018
1.6 S	1.6	66	09.81-08.86	16 SH	4	SPR 018
1.6 D	1.6	40	03.82-08.88	16 DA/16 D	4	SPR 018
1.8	1,8	62	09.87-08.88	E 18 NV	4	SPR 018
1.8 E	1,8	74	01.85-08.86	S 18 NV/C 18 NE	4	SPR 018
1.8 i	1,8	85	09.82-08.86	18 E	4	SPR 018
2.0 i	2.0	74	08.87-08.88	C 20 NEF	4	SPR 018
2.0 i	2.0	85	09.86-08.88	20 NE	4	SPR 018
2.0 i KAT	2.0	85	09.86-08.88	C 20 NE	4	SPR 018
2.0 i GT	2.0	95	03.87-08.88	20 SEH	4	SPR 018
COMMODORE B						
2.5	2,5	85	01.72-07.78	25 S	6	SPR 018
2.5 GS	2,5	96	01.72-08.75	25 H	6	SPR 018
2.8 GS	2,8	104	01.72-07.78	28 HC	6	SPR 018
2.8 GS/E	2,8	118	07.72-02.75	28 E/28 EC	6	SPR 018
COMMODORE C						
2.5 S	2,5	85	08.78-12.82	25 S	6	SPR 018
2.5 E	2,5	96	05.81-12.82	25 E	6	SPR 018
CORSA A						
1.0	1,0	33	09.82-07.87	10 S	4	SPR 018
1.2	1,2	33	09.82-07.87	E 12 GV/12 NC	4	SPR 018
1.2 S	1,2	40	09.82-07.87	12 ST	4	SPR 018
1.3	1,3	44	09.85-07.87	13 NB	4	SPR 018
1.3 S	1,3	51	09.82-07.87	13 SB	4	SPR 018
1.4 i	1,4	40	01.85-07.87		4	SPR 018



kW

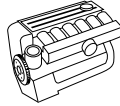

Zyl.
Cyl.
Cil.



OPEL

KADETT B

1.1	1.1	33	09.65-07.71	11 N	4	SPR 018
1.1	1.1	37	08.71-08.73	11 N	4	SPR 018
1.1 S	1.1	40	09.65-07.71	11 S	4	SPR 018
1.1 SR	1.1	44	11.66-07.71	11 SR	4	SPR 018
1.2 S	1.2	44	08.71-08.73	12 S	4	SPR 018
1.7	1.7	55	08.67-08.71		4	SPR 018

KADETT C

1.0	1.0	29	01.74-07.79	10 N	4	SPR 018
1.2	1.2	38	08.73-04.77	12 N	4	SPR 018
1.2	1.2	40	08.73-07.79	12 N	4	SPR 018
1.2 S	1.2	44	08.73-07.79	12 S	4	SPR 018
1.6 S	1.6	55	05.77-07.79	16 S	4	SPR 018

KADETT C Coupe

1.9 GT/E	1.9	77	09.75-07.77	19 E	4	SPR 018
2.0 E Rallye	2.0	81	08.77-07.79	20 E	4	SPR 018
2.0 GT/E	2.0	85	08.77-07.79	20 EH	4	SPR 018

KADETT D

1.2	1.2	39	08.79-07.82	12 N	4	SPR 018
1.2	1.2	40	08.82-08.84	12 ST	4	SPR 018
1.2 S	1.2	44	08.79-08.84	12 S	4	SPR 018
1.3 N	1.3	44	08.79-08.84	13 N	4	SPR 018
1.3 S	1.3	55	08.79-08.84	13 S	4	SPR 018
1.6 S	1.6	66	09.81-08.84	16 SH	4	SPR 018
1.6 D	1.6	40	03.82-08.84	16 D	4	SPR 018

KADETT E

1.2	1.2	40	09.84-07.86	12 SC	4	SPR 018
1.3 N	1.3	44	09.84-07.87	13 NB/13 N	4	SPR 018
1.3 i KAT	1.3	44	09.85-07.87	C 13 N	4	SPR 018
1.3 S	1.3	55	09.84-07.87	13 S	4	SPR 018
1.6 i	1.6	55	09.86-07.87	E 16 NZ	4	SPR 018
1.6 i KAT	1.6	55	09.86-07.87	C 16 NZ/C 16 LZ	4	SPR 018
1.6 S	1.6	60	09.86-07.87	16 SV	4	SPR 018
1.6 S	1.6	66	09.84-08.86	16 SH	4	SPR 018
1.8 i	1.8	74	10.85-08.86	C 18 NE	4	SPR 018
1.8 i	1.8	85	09.84-08.86	18 E	4	SPR 018
2.0 i	2.0	85	03.87-07.87	20 NE	4	SPR 018
2.0 i KAT	2.0	85	03.87-07.87	C 20 NE	4	SPR 018

MANTA A

1.2	1.2	44	04.72-08.75	12 S	4	SPR 018
1.6	1.6	44	02.75-08.75	16 N	4	SPR 018
1.6	1.6	50	09.70-08.75	16 N	4	SPR 018
1.6	1.6	55	02.75-08.75	16 S	4	SPR 018
1.6 S	1.6	59	09.70-08.75	16 S	4	SPR 018
1.9 S	1.9	66	09.70-08.75	19 S	4	SPR 018
1.9 GT/E	1.9	77	02.74-08.75	19 E	4	SPR 018

MANTA B

1.2 N	1.2	40	08.76-07.83	12 N	4	SPR 018
1.2 S	1.2	44	09.75-02.79	12 S	4	SPR 018
1.3 N	1.3	44	03.79-12.80	13 N	4	SPR 018
1.3 S	1.3	55	08.81-08.86	13 S	4	SPR 018
1.6 N	1.6	44	09.75-12.80	16 N	4	SPR 018
1.6 S	1.6	55	09.75-12.81	16 S	4	SPR 018
1.8 S	1.8	66	07.82-08.87	18 S	4	SPR 018
1.9 N	1.9	55	08.76-12.81	19 N	4	SPR 018
1.9 S	1.9	66	09.75-12.80	19 S	4	SPR 018
1.9 E	1.9	77	09.75-08.77	19 E	4	SPR 018
2.0	2.0	66	08.77-12.80	20 N	4	SPR 018
2.0 S	2.0	74	08.77-08.84	20 S	4	SPR 018
2.0 E	2.0	81	08.77-08.88	20 E	4	SPR 018
2.4 400	2.4	106	07.80-08.84	24 E	4	SPR 018

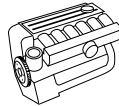

kW

Zyl.
Cyl.
Cil.**OPEL****MONZA A**

2.0 E	2.0	85	03.83-10.84	H 20 E	4	SPR 018
2.2 E	2,2	85	11.84-08.86	22 E	4	SPR 018
2.5 E	2.5	100	05.81-08.86	H 25 E	6	SPR 018
2.5 E	2.5	103	06.84-08.86	25 E	6	SPR 018
2.8	2,8	103	02.78-04.81	28 H	6	SPR 018
3.0	3.0	110	04.78-07.82	30 H	6	SPR 018
3.0 GSE	3.0	132	02.78-08.86	30 E	6	SPR 018
3.0 GSE	3.0	115	09.85-08.86	C 30 LE	6	SPR 018

OMEGA A

1.8 N	1,8	60	09.86-08.87	18 NV	4	SPR 018
1.8	1,8	65	09.87-01.88	E 18 NVR	4	SPR 018
1.8 S	1,8	66	09.86-01.88	18 SV	4	SPR 018
1.8	1,8	85	09.86-01.88	18 SEH	4	SPR 018
2.0 i	2.0	85	09.86-01.88	C 20 NE	4	SPR 018
2.0	2.0	90	09.86-01.88	20 SE	4	SPR 018

REKORD D

1.7	1.7	44	03.75-08.77	17 N	4	SPR 018
1.7	1.7	49	01.72-02.75	17 N	4	SPR 018
1.7 S	1.7	61	01.72-02.75	17 S	4	SPR 018
1.9	1.9	55	03.75-08.77	19 N	4	SPR 018
1.9	1.9	66	03.75-08.77	19 SH	4	SPR 018
1.9 S	1.9	71	01.72-02.75	19 SH	4	SPR 018
2.0	2.0	74	09.75-08.77	20 S	4	SPR 018
2.0 D	2.0	40	08.74-08.77	20 D	4	SPR 018
2.1 D	2,1	44	09.72-08.77	21 D	4	SPR 018

REKORD E

1.7	1.7	44	09.77-10.82	17 N	4	SPR 018
1.8	1,8	55	11.82-08.86	18 N	4	SPR 018
1.8 S	1,8	66	11.82-08.86	18 S	4	SPR 018
1.8 E	1,8	74	05.85-08.86	C 18 NV	4	SPR 018
1.9	1.9	55	09.77-10.82	19 N	4	SPR 018
2.0	2.0	66	09.77-10.82	20 N	4	SPR 018
2.0 S	2.0	74	08.77-08.86	20 S	4	SPR 018
2.0 E	2.0	81	09.77-10.84	20 E	4	SPR 018
2.2 E	2,2	85	11.84-08.86	22 E	4	SPR 018
2.0 D	2.0	43	09.77-10.82	20 D	4	SPR 018
2.1 D	2,1	44	09.77-07.78	21 D	4	SPR 018
2.2 D	2,2	48	08.78-08.83	23 D	4	SPR 018
2.2 D	2,2	52	11.82-08.86	23 D	4	SPR 018
2.2 TD	2,2	63	06.84-08.86	23 TD	4	SPR 018

SENATOR A

2.0 E	2.0	85	03.83-10.84	H 20 E	4	SPR 018
2.2 E	2,2	85	11.84-08.87	22 E	4	SPR 018
2.5	2.5	85	05.78-12.80	25 S	6	SPR 018
2.5 E	2.5	100	01.83-08.84	H 25 E	6	SPR 018
2.5 E	2.5	103	09.84-08.87	25 E	6	SPR 018
2.8	2,8	103	02.78-04.81	28 H	6	SPR 018
3.0	3.0	110	04.78-07.82	30 H	6	SPR 018
3.0	3.0	115	09.85-08.87	C 30 LE	6	SPR 018
3.0 E	3.0	132	02.78-12.86	30 E	6	SPR 018
2.2 TD	2,2	63	11.84-08.87	23 TD	4	SPR 018

PORSCHE**911**

2.2 T	2,2	92	01.70-08.71		6	SPR 002
2.3 E	2,3	121	08.71-08.73	911.52/911.62	6	SPR 003
2.3 S	2,3	140	08.71-08.73	911.53/911.63	6	SPR 003
2.3 T	2,3	103	09.71-08.73		6	SPR 002
2.7	2,7	110	09.74-08.75		6	SPR 002
2.7	2,7	121	09.75-06.77		6	SPR 002
2.7 SC Carrera RS	2,7	154	08.72-08.75	911.83	6	SPR 003



kW

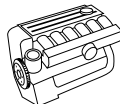

Zyl.
Cyl.
Cil.



PORSCHE

911						
3.0 SC Carrera	3,0	147	09.75-06.77		6	SPR 003
3.0 Turbo	3,0	191	01.75-08.76		6	SPR 003
911 Targa						
2.2 E	2,2	114	09.69-08.71	911.01/911.04	6	SPR 002
2.2 S	2,2	132	09.69-08.71	911.02	6	SPR 002
2.2 T	2,2	92	01.70-08.71		6	SPR 002
2.3 E	2,3	121	08.71-08.73	911.52/911.62	6	SPR 003
2.7	2,7	110	09.74-08.75		6	SPR 002
2.7	2,7	121	09.75-06.77		6	SPR 002
2.7 SC Carrera RS	2,7	154	08.72-08.75	911.83	6	SPR 003
3.0 SC Carrera	3,0	147	09.75-06.77		6	SPR 003
914						
/6 2.0	2,0	81	12.69-08.72	901.36/901.37	6	SPR 002

SEAT

ALHAMBRA

1.9 TDI	1,9	66	04.96-02.00	ANU/1Z/AHU	4	SPR 022	
1.9 TDI	1,9	81	05.97-02.00	AFN	4	SPR 004	
1.9 TDI	1,9	81	05.97-02.00	AFN	4	SPR 022	
2.0 i	2,0	85	04.96-07.98	ADY/ATM	→ Fg.Nr. 7 M-X 505 549	4	SPR 004

CORDOBA

1.0 i	1,0	37	09.96-06.99	AER	4	SPR 004	
1.4 i	1,4	44	06.94-12.97	ABD/AEX	4	SPR 004	
1.4 i Vario	1,4	44	09.96-06.99	AEX/AKV/ANX/APQ	4	SPR 022	
1.6 i	1,6	55	09.93-06.99	ABU	4	SPR 004	
1.6 i	1,6	55	02.93-06.99	ABU/AEE/ALM	4	SPR 017	
1.6 i	1,6	55	02.96-06.99	1F	4	SPR 017	
1.6 i	1,6	74	07.96-06.99	AFT	4	SPR 004	
1.6 i	1,6	74	07.96-06.99	AFT	4	SPR 017	
1.8 i	1,8	66	09.93-06.99	ABS/ADZ	4	SPR 004	
1.8 i	1,8	66	02.93-06.99	ABS/ADZ	4	SPR 017	
1.8 i 16V	1,8	95	10.93-06.96	ADL	4	SPR 004	
1.8 i 16V	1,8	95	10.93-08.96	ADL	4	SPR 017	
1.9 D	1,9	47	01.96-08.96	1Y	4	SPR 004	
1.9 D	1,9	47	01.96-08.96	1Y	4	SPR 022	
1.9 D	1,9	50	09.93-08.96	1Y	4	SPR 004	
1.9 SDI	1,9	47	08.96-07.98	AEF/AEY	→ Fg.Nr. 6 K-X 068 400	4	SPR 004
1.9 TD	1,9	55	09.93-08.96	AAZ	4	SPR 004	
1.9 TD	1,9	55	09.93-08.96	AAZ	4	SPR 022	
1.9 TDI	1,9	66	08.96-06.99	1Z/AHU	4	SPR 022	
1.9 TDI	1,9	81	03.97-07.98	AFN	→ Fg.Nr. 6 K-X 068 400	4	SPR 004
2.0 i	2,0	85	09.93-06.99	2E/AGG	4	SPR 004	
2.0 i	2,0	85	02.93-06.99	2E/AGG	4	SPR 017	
2.0 i 16V	2,0	110	08.96-06.99	ABF	4	SPR 004	
2.0 i 16V	2,0	110	08.96-06.99	ABF	4	SPR 017	

IBIZA II

1.0	1,0	33	03.93-09.96	AAU	4	SPR 022	
1.3 i	1,3	40	03.93-08.99	AAV	4	SPR 022	
1.4 i	1,4	44	09.93-08.99	AEX/AKV/ABD/APQ	4	SPR 022	
1.6 i	1,6	55	03.93-08.99	ABU/ALM/AEE	4	SPR 022	
1.6 i	1,6	74	04.96-08.99	AFT	4	SPR 017	
1.8 i	1,8	66	03.93-08.99	ABS/ADZ	4	SPR 017	
1.9 D	1,9	47	04.93-08.96	1Y	4	SPR 004	
1.9 D	1,9	47	04.93-08.96	1Y	4	SPR 022	
1.9 D	1,9	50	10.94-08.96	1Y	4	SPR 004	
1.9 D	1,9	50	10.94-08.96	1Y	4	SPR 022	
1.9 SDI	1,9	47	08.96-07.98	AEF/AEY	→ Fg.Nr. 6 K-X 068 400	4	SPR 004
1.9 TD	1,9	55	03.93-08.96	AAZ	4	SPR 004	
1.9 TD	1,9	55	03.93-08.96	AAZ	4	SPR 022	
1.9 TDI	1,9	66	08.96-08.99	1Z/AHU	4	SPR 022	
1.9 TDI	1,9	81	02.97-08.99	AFN	4	SPR 022	

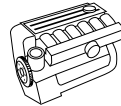

kW

Zyl.
Cyl.
Cil.**SEAT****IBIZA II**

2.0 i	2,0	85	03.93-08.99	2E/AGG	4	SPR 017
2.0 i 16V	2,0	110	08.96-08.99	ABF	4	SPR 017

INCA

1.7 D	1,7	42	09.96-	AHB	4	SPR 022
1.9 D	1,9	47	11.95-	1Y	4	SPR 022
1.9 SDI	1,9	47	11.95-	AYQ/AEY	4	SPR 022

TOLEDO I

1.6 i	1,6	52	05.91-12.93	1F	4	SPR 004
1.6 i	1,6	52	05.91-12.93	1F	4	SPR 022
1.6 i	1,6	54	05.91-03.99	EZ/ABN/1F	4	SPR 022
1.6 i	1,6	55	01.93-07.94	1F	4	SPR 004
1.6 i	1,6	55	01.93-07.94	1F	4	SPR 022
1.8 i	1,8	65	05.91-11.93	RP	4	SPR 004
1.8 i	1,8	66	11.93-07.94	ABS	4	SPR 004
1.8 16V	1,8	92	05.91-03.94	PL	4	SPR 004
1.8 16V	1,8	92	05.91-03.94	PL	4	SPR 022
1.8 16V	1,8	98	05.91-11.92	KR	4	SPR 004
1.8 16V	1,8	98	05.91-03.99	KR	4	SPR 022
1.9 D	1,9	47	12.95-10.98	1Y	4	SPR 004
1.9 D	1,9	47	12.95-10.98	1Y	4	SPR 022
1.9 D	1,9	50	05.91-10.98	1Y	4	SPR 004
1.9 D	1,9	50	05.91-03.99	1Y	4	SPR 022
1.9 TD	1,9	55	05.91-04.97	AAZ	4	SPR 004
1.9 TD	1,9	55	05.91-03.99	AAZ	4	SPR 022
1.9 TDI	1,9	66	08.95-03.99	1Z/AHU	4	SPR 022
1.9 TDI	1,9	81	11.96-10.98	AFN	4	SPR 004
1.9 TDI	1,9	81	11.96-10.98	AFN	4	SPR 022

SKODA**FELICIA I**

1.6 LX	1,6	55	08.95-03.98	AEE	4	SPR 004
1.9 D	1,9	47	05.96-03.98	AEF	4	SPR 004

FELICIA I Fun

1.6	1,6	55	06.97-	AEE	4	SPR 004
1.9 D	1,9	47	06.97-	AEF	4	SPR 004

FELICIA I Kombi

1.6 GLX	1,6	55	08.95-03.98	AEE	4	SPR 004
1.9 D	1,9	47	05.96-03.98	AEF	4	SPR 004

FELICIA II

1.6	1,6	55	03.98-06.01	AEE	4	SPR 004
1.9 D	1,9	47	03.98-06.01	AEF	4	SPR 004

FELICIA II Kombi

1.6	1,6	55	03.98-06.01	AEE	4	SPR 004
-----	-----	----	-------------	-----	---	----------------

OCTAVIA

1.4	1,4	44	04.99-	AMD	4	SPR 021
1.4 16V	1,4	55	09.00-	AXP/BCA	4	SPR 021
1.6	1,6	55	09.96-09.00	AEE	4	SPR 021
1.6	1,6	74	02.97-	AKL/AEH	4	SPR 021
1.8	1,8	92	09.96-	AGN	4	SPR 021
1.8 T	1,8	110	08.97-	ARX/ARZ/AGU/AUM	4	SPR 021

100

1.0	1,0	29	01.70-12.77	OHV	4	SPR 002
1.0	1,0	31	01.70-12.77	OHV	4	SPR 002

110

1.1 L	1,1	33	01.70-12.79		4	SPR 002
1.1 L	1,1	35	01.70-12.79		4	SPR 002
1.1 LS	1,1	38	07.70-12.79	OHV	4	SPR 002

110 Coupe

1.1 R	1,1	38	08.70-12.81	OHV	4	SPR 002
-------	-----	----	-------------	-----	---	----------------



kW

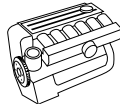

Zyl.
Cyl.
Cil.



SUBARU

JUSTY I

1000	1,0	37	05.87-05.88	EF10		3	SPR 016
1000 4WD	1,0	37	05.87-05.88	EF10		3	SPR 016
1000	1,0	40	11.84-05.88	EF10		3	SPR 016
1000 4WD	1,0	40	11.84-05.88	EF10		3	SPR 016
1200	1,2	49	05.87-10.95	EF12		3	SPR 016
1200 4WD	1,2	49	05.87-05.91	EF12		3	SPR 016
1200 4WD	1,2	50	05.87-12.90	EF12		3	SPR 016
1200 4WD	1,2	55	05.91-12.94	EF12		3	SPR 016

LIBERO Bus

1.0 4WD	1,0	37	10.83-06.87	EF10		3	SPR 016
1.2 4WD	1,2	38	10.86-06.87	EF12		3	SPR 016
1.2 i 4WD	1,2	40	05.93-02.00	EF12		3	SPR 016

SUZUKI

ALTO II

0.8	0,8	29	01.86-11.93	F8B		3	SPR 013
-----	-----	----	-------------	-----	--	---	----------------

ALTO IV

1.1	1,1	46	06.02-			4	SPR 013
-----	-----	----	--------	--	--	---	----------------

BALENO

1.3 i 16V	1,3	63	07.95-	G13B		4	SPR 013
1.6 i 16V	1,6	72	07.95-	G16B		4	SPR 013
1.6 i 16V 4x4	1,6	72	07.95-	G16B		4	SPR 013
1.8 GT	1,8	89	03.96-	J18A		4	SPR 013

BALENO Kombi

1.3 16V	1,3	63	09.97-			4	SPR 013
1.6 i 16V	1,6	72	08.96-	G16B		4	SPR 013
1.6 i 16V 4x4	1,6	72	08.96-	G16B		4	SPR 013

BALENO Schrägheck

1.3 i 16V	1,3	63	07.95-	G13B		4	SPR 013
1.6 i 16V	1,6	72	07.95-	G16B		4	SPR 013
1.6 i 16V 4x4	1,6	72	07.95-	G16B		4	SPR 013
1.8 GT	1,8	89	03.96-	J18A		4	SPR 013

CARRY Kasten

1.3	1,3	58	03.99-	G13B		4	SPR 013
-----	-----	----	--------	------	--	---	----------------

GRAND VITARA

1.6	1,6	69	03.98-			4	SPR 013
2.0	2,0	94	03.98-			4	SPR 013
2.5 V6 24V	2,5	106	04.98-			6	SPR 013
2.7 V6	2,7	127	09.01-			6	SPR 013
2.7 XL-7	2,7	135	04.03-			6	SPR 013

IGNIS

1.3	1,3	61	10.00-09.03			4	SPR 013
1.3 4WD	1,3	61	10.00-09.03			4	SPR 013

IGNIS II

1.3	1,3	69	09.03-			4	SPR 013
-----	-----	----	--------	--	--	---	----------------

JIMNY

1.3 16V	1,3	59	10.98-	G13BB		4	SPR 013
1.3 16V 4WD	1,3	59	10.98-	G13BB		4	SPR 013
1.3 16V	1,3	60	02.01-			4	SPR 013

LIANA

1.3	1,3	66	03.02-			4	SPR 013
1.6	1,6	76	03.02-			4	SPR 013
1.6 4WD	1,6	76	03.02-			4	SPR 013
1.6	1,6	78	04.02-			4	SPR 013
1.6 4WD	1,6	78	04.02-			4	SPR 013

LIANA Kombi

1.3	1,3	66	07.01-			4	SPR 013
1.6	1,6	76	07.01-			4	SPR 013
1.6 4WD	1,6	76	07.01-			4	SPR 013
1.6	1,6	78	04.02-			4	SPR 013
1.6 4WD	1,6	78	04.02-			4	SPR 013

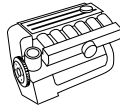

kW

Zyl.
Cyl.
Cil.**SUZUKI****LJ 80**

0,8	0,8	29	01.80-10.82	F8A		4	SPR 010
-----	-----	----	-------------	-----	--	---	----------------

SAMURAI

1,3	1,3	44	11.88-	G13A		4	SPR 013
1,3	1,3	47	11.88-	G13A		4	SPR 013
1,3	1,3	51	08.93-	G13BA		4	SPR 013
1,9 TD	1,9	46	11.98-	XUD9		4	SPR 013

SJ 410

1,0	1,0	33	09.81-12.88	F10A		4	SPR 013
-----	-----	----	-------------	------	--	---	----------------

SJ 410 Cabrio

1,0	1,0	33	09.81-12.88	F10A		4	SPR 013
-----	-----	----	-------------	------	--	---	----------------

SWIFT I

1,0	1,0	37	10.84-03.89	G10A		3	SPR 013
1,3	1,3	50	10.84-03.89	G13A		4	SPR 013
1,3	1,3	54	10.84-03.89	G13A		4	SPR 013
1,3 GTi/GXi	1,3	74	08.86-03.89	G13B		4	SPR 013

SWIFT II

1,3	1,3	50	10.89-12.91	G13A		4	SPR 013
1,3	1,3	52	10.89-12.91	G13A		4	SPR 013
1,6 i	1,6	68	09.91-09.95	G16B		4	SPR 013
1,6 i	1,6	68	09.91-09.95	G16B		4	SPR 013
1,6	1,6	70	09.91-12.91	G16B		4	SPR 013

SWIFT Cabriolet

1,3	1,3	50	03.96-	G13B		4	SPR 013
-----	-----	----	--------	------	--	---	----------------

VITARA

1,6 16V	1,6	71	02.91-12.94	G16B		4	SPR 013
2,0 V6 24V	2,0	100	03.95-03.98	H20A		6	SPR 013
2,5 V6 24V	2,5	118	12.95-03.98			6	SPR 013

WAGON R+

1,3	1,3	56	05.00-			4	SPR 013
1,3 4WD	1,3	56	10.01-			4	SPR 013
1,3	1,3	69	09.03-			4	SPR 013

X-90

1,6 i 16V 4x4	1,6	71	09.95-	G16B		4	SPR 013
1,6 i 16V	1,6	71	09.95-	G16B		4	SPR 013

TOYOTA**CAMRY**

1,8 i	1,8	66	10.86-08.88	1S-L		4	SPR 009
2,0	2,0	94	11.86-05.91	3S-FE		4	SPR 009
2,0 Gli 16V	2,0	89	11.86-05.91	3S-FE		4	SPR 009
2,0 Turbo-D	2,0	62	11.86-05.91	2C-T		4	SPR 009
2,0 Turbo-D	2,0	63	11.88-05.91	2C-T		4	SPR 009
2,2	2,2	100	06.91-08.92	5S-FE		4	SPR 009
2,5 V6 GXI	2,5	118	02.88-05.91	2VZ-FE		6	SPR 009
3,0	3,0	138	06.91-08.92	3VZ-FE		6	SPR 009

CAMRY Stufenheck

1,8	1,8	66	02.83-10.86	1S-L		4	SPR 009
1,8 Turbo-D	1,8	54	11.83-08.85	1C-TL		4	SPR 009
2,0	2,0	73	04.86-07.86	2S-E		4	SPR 009
2,0 GLI	2,0	79	03.83-10.86	2S-EL		4	SPR 009

CARINA

1,8	1,8	63	01.82-09.83	3T		4	SPR 009
-----	-----	----	-------------	----	--	---	----------------

CARINA II

1,6	1,6	55	10.83-08.86	4A-LC		4	SPR 009
1,6	1,6	62	10.83-11.87	4A-L		4	SPR 009
1,6	1,6	63	10.86-11.87	4A-L		4	SPR 009
1,6	1,6	66	12.87-11.89	4A-F		4	SPR 011
1,6	1,6	72	12.87-03.90	4A-FE		4	SPR 011
1,6	1,6	75	12.87-03.90	4A-FE		4	SPR 011
1,8 GLI	1,8	74	08.85-11.87	1S-L		4	SPR 009
2,0 D	2,0	50	02.84-11.87	2C-L		4	SPR 011



kW

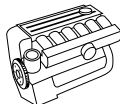

Zyl.
Cyl.
Cil.



TOYOTA

CARINA II

2.0 D	2,0	51	12.85-11.87	2C-L	4	SPR 011
2.0 D	2,0	54	03.88-01.92	2C-L	4	SPR 011
2.0 GLI	2,0	89	12.87-01.92	3S-FE	4	SPR 009

CARINA E

2.0 D	2,0	54	10.94-01.96	2C	4	SPR 011
2.0 TD	2,0	61	01.96-09.97	2C-T	4	SPR 011

CELICA

2.0	2,0	110	01.87-08.89	3S-GEL	4	SPR 009
2.0 XT	2,0	77	02.82-07.85	21R-C	4	SPR 009

CELICA Cabriolet

2.0 GT	2,0	103	10.86-08.89	3S-GELC	4	SPR 009
2.0 GT	2,0	110	10.86-08.89	3S-GEL	4	SPR 009
2.0 GTi	2,0	115	05.91-10.93	3S-GE	4	SPR 009

CELICA Coupe

1.6	1,6	91	12.83-07.85	4A-GE	4	SPR 009
1.6 LT	1,6	55	08.81-07.83	2TB	4	SPR 009
1.6 ST	1,6	66	08.81-08.83	2T	4	SPR 009
2.0	2,0	77	01.82-08.83	21R-U	4	SPR 009
2.0	2,0	88	01.82-07.85	18R-G	4	SPR 009
2.0 GTi	2,0	115	10.89-10.93	3S-GE	4	SPR 009
2.0 Turbo 4WD	2,0	150	10.89-10.93	3S-GTE	4	SPR 009
2.0 Turbo 4WD	2,0	153	10.89-10.93	3S-GTE	4	SPR 009

CELICA Liftback

2.0 GT	2,0	103	10.86-08.89	3S-GELC	4	SPR 009
2.0 GT	2,0	110	08.85-08.89	3S-GEL	4	SPR 009

CELICA SUPRA

2.8 i	2,8	125	05.82-08.83	5M-GE	6	SPR 011
2.8 i	2,8	125	08.83-10.86	5M-GE	6	SPR 009

COROLLA

1.3	1,3	44	09.79-06.83	4K	4	SPR 009
1.3	1,3	48	02.82-06.83	4K	4	SPR 009
1.3	1,3	51	06.83-10.84	2A-L	4	SPR 009
1.3	1,3	55	10.84-04.87	2E-L/2E-LC	4	SPR 009
1.3 i	1,3	55	08.87-04.92	2E/2E-E	4	SPR 009
1.6	1,6	53	08.85-04.87	4A-LC	4	SPR 009
1.6	1,6	54	12.85-04.87	4A-LC	4	SPR 009
1.6	1,6	55	10.82-05.83	2T	4	SPR 009
1.6	1,6	62	06.83-04.87	4A-L	4	SPR 009
1.6	1,6	66	08.87-12.89	4A-F	4	SPR 011
1.6 i	1,6	77	11.89-04.92	4A-FE	4	SPR 011
1.8 D	1,8	43	01.83-05.83	1C	4	SPR 011
1.8 D	1,8	43	06.83-04.87	1C	4	SPR 011
1.8 D	1,8	47	07.85-04.87	1C-L	4	SPR 011
1.8 D	1,8	47	07.87-04.92	1C	4	SPR 011
1.8 D	1,8	49	11.89-04.92	1C	4	SPR 011

COROLLA Compact

1.3	1,3	55	08.87-12.89	2E	4	SPR 009
1.3 i	1,3	55	08.89-04.92	2E-E	4	SPR 009
1.6	1,6	66	08.87-04.92	4A-F	4	SPR 011
1.8 D	1,8	47	08.87-04.92	1C	4	SPR 011
1.8 D	1,8	49	08.89-04.92	1C	4	SPR 011

COROLLA Coupe

1.6 16V	1,6	85	12.85-04.87	4A-GEC	4	SPR 009
1.6 GT 16V	1,6	91	08.83-04.87	4A-GE	4	SPR 009

COROLLA FX Compact

1.3	1,3	55	08.85-04.87	2E-L	4	SPR 009
1.6 GT 16V	1,6	89	08.85-04.87	4A-GEL	4	SPR 009
1.8 D	1,8	43	01.85-04.87	1C	4	SPR 011
1.8 D	1,8	47	08.85-04.87	1C-L	4	SPR 011

COROLLA Liftback

1.3	1,3	44	09.79-01.82	4K	4	SPR 009
-----	-----	----	-------------	----	---	----------------

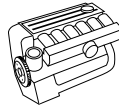

kW

Zyl.
Cyl.
Cil.**TOYOTA****COROLLA Liftback**

1.3	1,3	48	02.82-05.83	4K	4	SPR 009
1.3	1,3	51	06.83-09.84	2A-L	4	SPR 009
1.3	1,3	55	01.85-04.87	2E-L/2E-LC	4	SPR 009
1.3 i	1,3	55	08.87-04.92	2E/2E-E	4	SPR 009
1.6	1,6	54	09.79-05.83	2T	4	SPR 009
1.6	1,6	54	08.85-04.87	4A-LC	4	SPR 009
1.6	1,6	55	09.79-05.83	2T	4	SPR 009
1.6	1,6	62	06.83-04.87	4A-L	4	SPR 009
1.6	1,6	63	09.79-05.83	2TB	4	SPR 009
1.6	1,6	63	07.85-04.87		4	SPR 009
1.6	1,6	77	08.89-04.92	4A-FE	4	SPR 011
1.6 GT	1,6	81	05.80-05.83	2T-G	4	SPR 009
1.6 GTI	1,6	92	07.87-04.92	4A-GE	4	SPR 011
1.8 D	1,8	43	06.83-04.87	1C	4	SPR 011
1.8 D	1,8	47	06.83-04.87	1C-L	4	SPR 011
1.8 D	1,8	47	08.87-04.92	1C	4	SPR 011
1.8 D	1,8	48	01.83-05.83	1C	4	SPR 011
1.8 D	1,8	49	08.89-04.92	1C	4	SPR 011

CORONA

2.0	2,0	65	01.76-08.78	18R	4	SPR 011
-----	-----	----	-------------	-----	---	----------------

CRESSIDA

2.2 D	2,2	49	09.80-07.84	L	4	SPR 011
-------	-----	----	-------------	---	---	----------------

CROWN

2.8 SI	2,8	107	04.80-07.83	5M-E	6	SPR 011
--------	-----	-----	-------------	------	---	----------------

HIACE II Wagon

2.0	2,0	65	08.87-08.89	3Y	4	SPR 009
2.4 D	2,4	55	08.87-08.89	2L	4	SPR 011
2.4 D 4WD	2,4	54	08.87-01.88		4	SPR 011

HIACE III Kasten

2.0	2,0	74	02.90-05.92	1RZ	4	SPR 009
2.4	2,4	88	08.89-05.92	2RZ-E	4	SPR 009
2.4 4WD	2,4	88	08.89-05.92	2RZ-E	4	SPR 009
2.4 Diesel	2,4	55	02.90-07.95	2L	4	SPR 011

HIACE III Wagon

2.0	2,0	74	08.89-05.92	1RZ	4	SPR 009
2.4 4WD	2,4	88	08.89-05.92	2RZ-E	4	SPR 009
2.4 D	2,4	55	08.89-07.95	2L	4	SPR 011
2.4 D	2,4	57	10.93-07.95		4	SPR 011

HIACE IV Kasten

2.4 TD	2,4	66	08.95-08.01	2L-T	4	SPR 011
2.4 TD 4WD	2,4	66	08.96-08.01	2L-T	4	SPR 011

HIACE IV Wagon

2.4 D	2,4	55	07.99-08.01		4	SPR 011
2.4 D	2,4	58	08.95-08.01	2L	4	SPR 011
2.4 TD	2,4	66	08.95-08.01	2L-T	4	SPR 011

HILUX Pick-up

1.8	1,8	61	08.88-08.92	2Y	4	SPR 009
2.2 4WD	2,2	69	08.88-12.89	4Y	4	SPR 009
2.4 D	2,4	61	03.89-02.97	2L	4	SPR 011
2.4 D 4WD	2,4	61	08.88-08.97	2L	4	SPR 011
2.4 i 4WD	2,4	84	08.89-08.92	22R	4	SPR 009
2.4 i 4WD	2,4	84	08.89-08.92	22R	4	SPR 009

LAND CRUISER

2.4	2,4	77	10.85-08.86	22R	4	SPR 009
2.4	2,4	81	10.85-08.86	22R	4	SPR 009
2.4 D	2,4	53	11.84-10.85	2L	4	SPR 011
2.4 TD	2,4	63	10.85-12.89	2L-T	4	SPR 011
3.4 D	3,4	70	11.84-12.89	3B	4	SPR 011
3.4 TD	3,4	91	10.85-08.86	13BT	4	SPR 011
4.0 Diesel	4,0	77	10.81-11.84	2H	6	SPR 011
4.2 D	4,2	99	01.90-12.97	1H-Z	6	SPR 011



kW

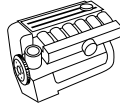

Zyl.
Cyl.
Cil.



TOYOTA

LAND CRUISER							
4.2 TD	4,2	96	01.90-08.99	1H-Z		6	SPR 011
LITEACE Bus							
1.5	1,5	51	10.85-08.88	5K		4	SPR 009
1.5	1,5	52	07.89-01.92	5K		4	SPR 009
2.0 D	2,0	53	08.88-01.92	2C		4	SPR 011
LITEACE Kasten							
1.8 D	1,8	46	10.85-08.88	1C		4	SPR 011
MODELL F Bus							
1.8 De Luxe	1,8	58	11.82-08.84	2Y/2Y-C		4	SPR 009
2.0 Super	2,0	65	08.84-08.88	3Y/3Y-C		4	SPR 009
2.0	2,0	66	08.88-01.90	3Y		4	SPR 009
2,2	2,2	72	08.87-08.88	4Y-EC		4	SPR 009
MR 2							
2.0 16V	2,0	115	12.89-11.92	3S-GE		4	SPR 009
2.0 16V	2,0	125	12.89-11.92	3S-GE		4	SPR 009
PREVIA							
2.4	2,4	97	05.90-11.91	2TZ-FE		4	SPR 009
2.4 4WD	2,4	97	05.90-11.91	2TZ-FE		4	SPR 009
STARLET							
1.0	1,0	40	10.84-11.89	1E-L		4	SPR 009
1.0	1,0	40	12.89-12.92	1E		4	SPR 009
1.3	1,3	55	10.84-11.89	2E-LC		4	SPR 009
1.3 12V	1,3	55	12.89-12.92			4	SPR 009
1.3 12V KAT	1,3	55	12.89-12.92	2E-E		4	SPR 009
1.5 D	1,5	40	12.86-11.89	1N		4	SPR 009
TERCEL							
1.3	1,3	48	10.82-08.84	2A		4	SPR 009
1.5 4WD	1,5	50	05.86-09.87	3A-C		4	SPR 009
1.5 4WD	1,5	50	09.87-01.88	3A-C		4	SPR 011
1.5 4WD	1,5	52	10.82-09.87	3A		4	SPR 009
1.5 4WD	1,5	52	09.87-01.88	3A		4	SPR 011
1000							
1.0	1,0	33	04.69-02.78	2K		4	SPR 009
1000 Kasten							
1.0	1,0	33	11.69-08.88	2K		4	SPR 009
VOLVO							
140							
2.0	2,0	60	08.70-07.74	B 20 A		4	SPR 001
2.0	2,0	70	08.71-05.72	B 20 D		4	SPR 001
2.0 S	2,0	74	08.70-09.72	B 20 B		4	SPR 001
2.0 S	2,0	85	09.72-07.73	B 20 F		4	SPR 001
2.0	2,0	91	09.70-07.74	B 20 E		4	SPR 001
140 Kombi							
2.0 S	2,0	60	08.70-07.74	B 20 A		4	SPR 001
2.0 S	2,0	73	08.72-07.73	B 20 B		4	SPR 001
2.0 S	2,0	74	08.72-07.73	B 20 B		4	SPR 001
164							
2.9 E	2,9	96	08.68-07.73	B 30 A		6	SPR 001
2.9	2,9	118	08.72-07.74	B 30 E		6	SPR 001
240, Kombi							
2.0	2,0	60	08.74-07.75	B 20 A		4	SPR 001
2.4 Diesel	2,4	58	08.87-08.93	D 24		6	SPR 004
2.4 Diesel	2,4	60	04.79-07.85	D 24		6	SPR 004
2.4 Diesel	2,4	58	08.88-08.93	D 24		6	SPR 004
2.4 Diesel	2,4	60	04.79-08.93	D 24		6	SPR 004
740							
2.4 Diesel	2,4	60	08.84-07.92	D 24		6	SPR 004
740 Kombi							
2.4 Diesel	2,4	60	08.85-07.88	D 24		6	SPR 004
2.4 Turbo-Diesel	2,4	80	09.85-07.92	D 24 T		6	SPR 004

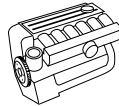

kW

Zyl.
Cyl.
Cil.**VOLVO**

740 Kombi							
2.4 TD Interc.	2,4	90	08.87-07.88	D 24 TIC		6	SPR 004
760							
2.4 Turbo Diesel	2,4	80	04.87-07.87	D 24 T		6	SPR 004
2.4 Turbo Diesel	2,4	82	08.82-07.87	D 24 T		6	SPR 004
2.4 TD Interc.	2,4	85	08.87-07.92	D 24 TIC		6	SPR 004
760 Kombi							
2.4 TD Interc.	2,4	85	08.87-07.92	D 24 TIC		6	SPR 004
940							
2.4 D	2,4	60	09.90-08.93	D 24		6	SPR 004
2.4 Turbo Diesel	2,4	80	09.90-08.93	D 24 T		6	SPR 004
2.4 TD Intercooler	2,4	90	08.90-12.94	D 24 TIC		6	SPR 004
940 Kombi							
2.4 Turbo Diesel	2,4	80	09.90-08.93	D 24 T		6	SPR 004
940 II							
2.4 TD Interc.	2,4	90	08.94-08.97	D 24 TIC		6	SPR 004
940 II Kombi							
2.4 TD Interc.	2,4	90	08.94-08.97	D 24 TIC		6	SPR 004
960							
2.4 TD Interc.	2,4	85	09.91-07.94	D 24 TIC		6	SPR 004
960 Kombi							
2.4 TD Interc.	2,4	85	09.91-07.94	D 24 TIC		6	SPR 004
P 1800							
2.0 ES	2,0	91	04.72-07.73			4	SPR 001

VW

BORA							
1.6	1,6	74	10.98-	AKL/APF/AEH		4	SPR 021
1.8	1,8	92	10.98-	AGN/BAF		4	SPR 021
1.8 4motion	1,8	92	02.99-	AGN		4	SPR 021
CADDY I							
1.5	1,5	51	08.82-07.83	JB		4	SPR 004
1.5	1,5	51	08.82-07.83	JB		4	SPR 017
1.5	1,5	51	08.82-07.83	JB		4	SPR 021
1.6	1,6	55	01.83-07.92	EM/EW		4	SPR 004
1.6	1,6	55	01.83-07.92	EM/EW		4	SPR 017
1.6	1,6	55	01.83-07.92	EW		4	SPR 021
1.6 D	1,6	40	08.82-07.92	JK/ME		4	SPR 004
1.6 D	1,6	40	08.82-07.92	JK/ME		4	SPR 017
1.6 D	1,6	40	08.82-07.92	JK/ME		4	SPR 021
1.8	1,8	70	08.85-07.92	JH		4	SPR 004
1.8	1,8	70	08.85-07.92	JH		4	SPR 017
1.8	1,8	70	08.85-07.92	JH		4	SPR 021
CADDY II Kasten							
60 1.4	1,4	44	11.95-07.98	AEX/AKV/APQ/AUD	→ Fg.Nr. 9 K-X 512 800	4	SPR 004
75 1.6	1,6	55	06.96-	AEE		4	SPR 004
1.9 D	1,9	47	11.95-	1Y		4	SPR 004
1.9 SDI	1,9	47	11.95-07.98	AEY/AYQ	→ Fg.Nr. 9 K-X 512 800	4	SPR 004
CADDY II Pick-up							
1.6	1,6	55	10.97-	AEE		4	SPR 004
1.9 D	1,9	47	10.97-	AEF		4	SPR 004
CORRADO							
1.8 16V	1,8	100	04.89-07.92	KR		4	SPR 004
1.8 16V	1,8	100	04.89-07.92	KR		4	SPR 017
1.8 G60	1,8	118	09.88-09.93	PG		4	SPR 004
1.8 G60	1,8	118	09.88-09.93	PG		4	SPR 017
2.0 i	2,0	85	04.93-09.94	2E		4	SPR 004
2.0 i	2,0	85	04.93-12.95	2E/ADY		4	SPR 017
2.0 i 16V	2,0	100	08.91-07.95	9A		4	SPR 004
2.0 i 16V	2,0	100	08.91-12.95	9A		4	SPR 017
2.9 VR6	2,9	140	08.91-07.95	ABV		6	SPR 004
2.9 VR6	2,9	140	08.91-12.95	ABV		6	SPR 017



kW

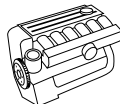

Zyl.
Cyl.
Cil.



VW

DERBY

0.9	0,9	29	02.77-09.81	HA	4	SPR 004
1.0	1,0	29	10.81-12.84	GL	4	SPR 004
1.0	1,0	29	10.81-12.84	GL	4	SPR 017
1.0	1,0	29	10.81-12.84	GL	4	SPR 021
1.0	1,0	33	08.81-12.84	HZ	4	SPR 017
1.1	1,1	37	02.77-07.83	HB	4	SPR 004
1.1	1,1	37	10.81-07.83	HB	4	SPR 021
1.3	1,3	40	08.83-12.84	HK	4	SPR 004
1.3	1,3	40	08.83-12.84	HK	4	SPR 017
1.3	1,3	40	08.83-12.84	HK	4	SPR 021
1.3	1,3	44	02.77-07.83	HH	4	SPR 004
1.3	1,3	55	09.82-12.84	GK	4	SPR 004
1.3	1,3	55	09.82-12.84	GK	4	SPR 017
1.3	1,3	55	09.82-12.84	GK	4	SPR 021

GOLF I

1.1	1,1	37	04.74-07.83	FA/GG	4	SPR 004
1.1	1,1	37	04.74-07.83	FA/GG	4	SPR 017
1.1	1,1	38	01.81-07.83	FJ	4	SPR 017
1.1	1,1	38	01.81-07.83	FJ	4	SPR 021
1.1	1,1	44	01.81-07.83	HC	4	SPR 017
1.1	1,1	44	01.81-07.83	HC	4	SPR 021
1.3	1,3	44	09.79-07.83	GF	4	SPR 004
1.3	1,3	44	01.81-07.83	GF	4	SPR 017
1.3	1,3	44	01.81-07.83	GF	4	SPR 021
1.5	1,5	51	08.78-07.83	JB	4	SPR 004
1.5	1,5	51	01.81-07.83	JB	4	SPR 017
1.5	1,5	51	01.81-07.83	JB	4	SPR 021
1.5	1,5	51	04.74-12.75	FH	4	SPR 004
1.5	1,5	51	04.74-12.75	FH	4	SPR 017
1.5 D	1,5	37	08.78-07.80	CK	4	SPR 004
1.5 D	1,5	37	08.76-07.80	CK	4	SPR 017
1.6	1,6	55	08.75-07.76	FP	4	SPR 004
1.6	1,6	55	08.75-07.77	FP	4	SPR 017
1.6 D	1,6	40	08.80-07.83	CR/JK	4	SPR 004
1.6 D	1,6	40	01.81-07.83	CR/JK	4	SPR 017
1.6 D	1,6	40	01.81-07.83	JK/CR	4	SPR 021
1.6 TD	1,6	51	03.82-07.83	CY	4	SPR 004
1.6 TD	1,6	51	03.82-07.83	CY	4	SPR 017
1.6 TD	1,6	51	03.82-07.83	CY	4	SPR 021
1.6 GTI	1,6	81	08.78-07.82	EG	4	SPR 004
1.6 GTI	1,6	81	01.81-07.82	EG	4	SPR 017
1.6 GTI	1,6	81	01.81-07.82	EG	4	SPR 021
1.8 GTI	1,8	82	08.82-07.83	DX	4	SPR 004
1.8 GTI	1,8	82	08.82-12.83	DX	4	SPR 017

GOLF I Cabriolet

1.5	1,5	51	01.79-07.83	JB	4	SPR 004
1.5	1,5	51	08.82-11.83	JB	4	SPR 017
1.6	1,6	53	04.86-02.90	RE	4	SPR 004
1.6	1,6	53	04.86-02.90	RE	4	SPR 017
1.6	1,6	55	08.83-04.92	EW	4	SPR 004
1.6	1,6	55	08.83-04.92	EW	4	SPR 017
1.6	1,6	81	08.79-07.82	EG	4	SPR 004
1.6	1,6	81	08.79-07.82	EG	4	SPR 017
1.8	1,8	66	08.83-09.92	EX	4	SPR 004
1.8	1,8	66	08.83-09.92	EX	4	SPR 017
1.8	1,8	70	08.83-04.93	JH	4	SPR 004
1.8	1,8	70	08.83-04.93	JH	4	SPR 017
1.8	1,8	72	08.89-03.93	2H	4	SPR 004
1.8	1,8	72	08.89-03.93	2H	4	SPR 017
1.8	1,8	82	08.82-12.89	DX/EV/PB	4	SPR 004
1.8	1,8	82	08.82-12.89	DX/EV/PB	4	SPR 017

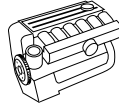

kW

Zyl.
Cyl.
Cil.**VW****GOLF II**

1.0	1,0	33	11.83-08.85	GN	4	SPR 004
1.0	1,0	33	11.83-08.85	GN	4	SPR 017
1.0	1,0	37	10.85-10.91	HZ	4	SPR 004
1.0	1,0	37	08.85-10.91	HZ	4	SPR 017
1.3	1,3	37	08.85-12.87	NU	4	SPR 017
1.3	1,3	40	08.83-06.87	HK/MH	4	SPR 004
1.3	1,3	40	08.83-06.87	HK/MH	4	SPR 017
1.3	1,3	44	08.83-10.86	GT	4	SPR 017
1.3 KAT	1,3	40	06.86-07.92	2G/MH/NZ	4	SPR 004
1.3 KAT	1,3	40	06.86-12.92	2G/MH/NZ	4	SPR 017
1.6	1,6	51	10.86-07.92	PN	4	SPR 004
1.6	1,6	51	10.86-12.92	PN	4	SPR 017
1.6	1,6	53	02.86-10.91	RF (KAT)	4	SPR 004
1.6	1,6	53	02.86-10.91	RF (KAT)	4	SPR 017
1.6	1,6	55	08.83-08.91	EZ /HM	4	SPR 004
1.6	1,6	55	08.83-08.91	EZ /HM	4	SPR 017
1.6 D	1,6	37	08.83-10.91		4	SPR 017
1.6 D	1,6	40	08.83-10.91	JP/ME	4	SPR 004
1.6 D	1,6	40	08.83-10.91	JP/ME	4	SPR 017
1.6 D	1,6	40	08.83-10.91	ME/JP	4	SPR 021
1.6 TD	1,6	44	08.89-10.91	1V	4	SPR 004
1.6 TD	1,6	44	08.89-10.91	1V	4	SPR 017
1.6 TD	1,6	44	08.89-10.91	1V	4	SPR 021
1.6 TD	1,6	51	08.83-10.91	JR/MF	4	SPR 004
1.6 TD	1,6	51	08.83-10.91	JR/MF	4	SPR 017
1.6 TD	1,6	51	08.83-10.91	JR/MF	4	SPR 022
1.6 TD	1,6	59	04.89-10.91	RA/SB	4	SPR 004
1.6 TD	1,6	59	04.89-10.91	RA/SB	4	SPR 017
1.6 TD	1,6	59	04.89-10.91	RA/SB	4	SPR 022
1.8	1,8	62	08.86-01.90	RH	4	SPR 004
1.8	1,8	62	08.86-01.90	RH	4	SPR 017
1.8	1,8	66	08.84-10.91	GU	4	SPR 004
1.8	1,8	66	08.84-10.91	GU/GX/HV	4	SPR 017
1.8 i KAT	1,8	66	08.87-10.91	GX/RP	4	SPR 004
1.8 i KAT	1,8	66	08.87-10.91	GX/RP	4	SPR 017
1.8 Syncro	1,8	66	02.86-07.91	GU/GX	4	SPR 004
1.8 Syncro	1,8	66	02.86-07.91	GU/GX	4	SPR 017
1.8 i Syncro KAT	1,8	66	08.87-10.91	RP	4	SPR 004
1.8 i Syncro KAT	1,8	66	08.87-10.91	RP	4	SPR 017
1.8 Syncro	1,8	72	08.88-07.91	1P	4	SPR 004
1.8 Syncro	1,8	72	08.88-07.91	1P	4	SPR 017
1.8 GTI	1,8	79	08.85-10.87	RD	4	SPR 004
1.8 GTI	1,8	79	08.85-10.87	RD	4	SPR 017
1.8 GTI	1,8	82	08.83-10.91	DX/EV/GZ/PB	4	SPR 017
1.8 GTI KAT	1,8	79	01.87-10.91	PF	4	SPR 004
1.8 GTI KAT	1,8	79	01.87-10.91	PF	4	SPR 017
1.8 GTI 16V	1,8	95	02.86-10.91	PL	4	SPR 004
1.8 GTI 16V	1,8	95	02.86-10.91	PL	4	SPR 017
1.8 GTI 16V	1,8	102	02.86-06.90	KR	4	SPR 004
1.8 GTI 16V	1,8	102	02.86-06.90	KR	4	SPR 017
1.8 GTI G60 Syncro	1,8	118	08.90-07.91	PG	4	SPR 004
1.8 GTI G60, Syncro	1,8	118	04.90-07.91	PG	4	SPR 017

GOLF III

1.4	1,4	40	11.91-08.97		4	SPR 017
1.4	1,4	44	11.91-08.97	ABD/AEX	4	SPR 004
1.4	1,4	44	10.91-08.97	ABD/AEX	4	SPR 017
1.4	1,4	44	11.91-08.97	AEX/ABD	4	SPR 022
1.6	1,6	55	09.92-08.97	ABU/AEA/AEE	4	SPR 017
1.6	1,6	55	09.92-08.97	ABU/AEA/AEE	4	SPR 021
1.6	1,6	55	09.92-08.97	ABU/AEA/AEE	4	SPR 022
1.6	1,6	74	07.95-08.97	AEK/AFT/AKS	4	SPR 004



kW

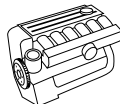

Zyl.
Cyl.
Cil.



VW						
GOLF III						
1.6	1,6	74	07.95-08.97	AEK/AFT/AKS	4	SPR 017
1,6	1,6	74	07.95-08.97	AEK/AFT/AKS	4	SPR 022
1.8	1,8	55	11.91-08.97	AAM	4	SPR 004
1.8	1,8	55	11.91-08.97	AAM	4	SPR 017
1.8	1,8	66	11.91-08.97	ABS/ADZ	4	SPR 004
1.8	1,8	66	11.91-08.97	ABS/ADZ	4	SPR 017
1.8 Syncro	1,8	66	01.93-08.97	ABS/ADZ	4	SPR 017
1.9 D	1,9	48	11.91-08.97	1Y	4	SPR 004
1.9 D	1,9	48	11.91-08.97	1Y	4	SPR 017
1.9 D	1,9	48	11.91-08.97	1Y	4	SPR 022
1.9 SDI	1,9	47	04.97-08.97	AEY	4	SPR 004
1.9 SDI	1,9	47	04.97-08.97	AEY	4	SPR 017
1.9 SDI	1,9	47	04.97-08.97	AEY	4	SPR 022
1.9 TD,GTD	1,9	55	11.91-08.97	AAZ	4	SPR 004
1.9 TD,GTD	1,9	55	11.91-08.97	AAZ	4	SPR 017
1.9 TD,GTD	1,9	55	11.91-08.97	AAZ	4	SPR 022
1.9 TDI	1,9	66	09.93-08.97	1Z/AHU/ALE	4	SPR 004
1.9 TDI	1,9	66	09.93-08.97	1Z/AHU/ALE	4	SPR 017
1.9 TDI	1,9	66	09.93-08.97	ALE/1Z/AHU	4	SPR 022
1.9 TDI	1,9	81	04.96-08.97	AFN	4	SPR 004
1.9 TDI	1,9	81	04.96-08.97	AFN	4	SPR 017
1.9 TDI	1,9	81	04.96-08.97	AFN	4	SPR 022
2.0	2,0	85	11.91-08.97	2E/ADY/AGG/AKR	4	SPR 004
2.0	2,0	85	11.91-08.97	2E/ADY/AGG/AKR	4	SPR 017
2.0 GTI 16V	2,0	110	08.92-08.97	ABF	4	SPR 004
2.0 Syncro	2,0	85	08.95-08.97	AGG	4	SPR 004
2.0 Syncro	2,0	85	08.95-08.97	AGG	4	SPR 017
2.8 VR6	2,8	128	01.92-08.97	AAA	6	SPR 004
2.8 VR6	2,8	128	01.92-08.97	AAA	6	SPR 017
2.8 VR6	2,8	128	01.92-08.97	AAA	6	SPR 021
2.9 VR6 Syncro	2,9	140	10.94-08.97	ABV	6	SPR 004
2.9 VR6 Syncro	2,9	140	10.94-08.97	ABV	6	SPR 017
GOLF III Cabriolet						
1.6	1,6	74	10.94-05.98	AEK/AFT/AKS	4	SPR 017
1.8	1,8	55	07.93-05.98	AAM	4	SPR 017
1.8	1,8	55	09.93-04.98	AAM	4	SPR 004
1.8	1,8	66	09.93-04.97	ABS/ADZ	4	SPR 004
1.8	1,8	66	07.93-05.98	ABS/ADZ	4	SPR 017
1.9 TDI	1,9	66	08.95-05.98	1Z/AHU	4	SPR 017
1.9 TDI	1,9	81	09.96-04.98	AFN	4	SPR 004
1.9 TDI	1,9	81	07.96-05.98	AFN	4	SPR 017
2.0	2,0	85	09.93-04.98	2E/ADY/AGG	4	SPR 004
2.0	1,9	85	07.93-05.98	2E/ADY/AGG/AKR	4	SPR 017
GOLF IV						
1.6	1,6	74	08.97-02.00	AKL/APF/AEH	4	SPR 021
1.8	1,8	92	08.97-	AGN/BAF	4	SPR 021
1.8 4motion	1,8	92	05.98-	AGN	4	SPR 021
1.8 T	1,8	110	08.97-	ARZ/AGU/AUM	4	SPR 021
ILTIS						
1.7	1,7	55	03.79-12.88	YX	4	SPR 004
JETTA I						
1.1	1,1	37	08.80-12.83	GG	4	SPR 004
1.1	1,1	37	08.82-12.83	GG	4	SPR 017
1.3	1,3	44	08.79-12.83	GF	4	SPR 004
1.3	1,3	44	08.82-12.83	GF	4	SPR 017
1.5	1,5	51	08.79-12.83	JB	4	SPR 004
1.5	1,5	51	08.82-12.83	JB	4	SPR 017
1.5 D	1,5	37	08.79-07.80	CK	4	SPR 017
1.6	1,6	63	08.80-12.83	FR	4	SPR 004
1.6	1,6	63	08.82-12.83	FR	4	SPR 017
1.6 D	1,6	40	08.80-12.83	CR/JK	4	SPR 004

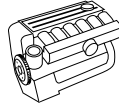

kW

Zyl.
Cyl.
Cil.**VW****JETTA I**

1.6 D	1,6	40	08.82-12.83	CR/JK	4	SPR 017
1.6 GLI	1,6	81	08.79-07.82	EG	4	SPR 004
1.6 GLI	1,6	81	08.79-07.82	EG	4	SPR 017
1.6 TD	1,6	51	03.82-12.83	CY	4	SPR 004
1.6 TD	1,6	51	08.82-12.83	CY	4	SPR 017
1.8	1,8	82	08.82-12.83	DX	4	SPR 004
1.8	1,8	82	08.82-12.83	DX	4	SPR 017

JETTA II

1.3	1,3	40	01.84-06.87	HK/MH	4	SPR 004
1.3	1,3	40	01.84-06.87	HK/MH	4	SPR 017
1.3	1,3	44	01.84-10.86	GT	4	SPR 017
1.3 KAT	1,3	40	06.87-12.91	2G/MH/NZ	4	SPR 004
1.3 KAT	1,3	40	06.87-12.91	2G/MH/NZ	4	SPR 017
1.6	1,6	51	10.86-10.91	PN	4	SPR 004
1.6	1,6	51	10.86-10.91	PN	4	SPR 017
1.6	1,6	53	03.86-10.91	RF (KAT)	4	SPR 004
1.6	1,6	53	03.86-10.91	RF (KAT)	4	SPR 017
1.6	1,6	55	01.84-08.91	EZ /HM	4	SPR 004
1.6	1,6	55	01.84-08.91	EZ /HM	4	SPR 017
1.6 D	1,6	40	01.84-10.91	JP/ME	4	SPR 004
1.6 D	1,6	40	01.84-10.91	JP/ME	4	SPR 017
1.6 D	1,6	40	01.84-10.91	ME/JP	4	SPR 021
1.6 TD	1,6	44	01.90-10.91	1V	4	SPR 004
1.6 TD	1,6	44	01.90-10.91	1V	4	SPR 017
1.6 TD	1,6	44	01.90-10.91	1V	4	SPR 021
1.6 TD	1,6	51	01.84-10.91	JR/MF	4	SPR 004
1.6 TD	1,6	51	01.84-10.91	JR/MF	4	SPR 017
1.6 TD	1,6	51	01.84-10.91	JR/MF	4	SPR 022
1.6 TD	1,6	59	04.89-10.91	RA/SB	4	SPR 004
1.6 TD	1,6	59	04.89-10.91	RA/SB	4	SPR 017
1.6 TD	1,6	59	04.89-10.91	RA/SB	4	SPR 022
1.8	1,8	62	08.86-01.90	RH	4	SPR 004
1.8	1,8	62	08.86-01.90	RH	4	SPR 017
1.8	1,8	66	08.84-10.91	GU/GX/HV	4	SPR 004
1.8	1,8	66	08.84-10.91	GU/GX/HV	4	SPR 017
1.8	1,8	66	08.84-10.91	GX/GU/HV	4	SPR 021
1.8	1,8	79	08.85-10.87	RD	4	SPR 004
1.8	1,8	79	08.85-10.87	RD	4	SPR 017
1.8	1,8	82	01.84-10.91	EV/GZ/PB	4	SPR 004
1.8	1,8	82	01.84-10.91	EV/GZ/PB	4	SPR 017
1.8 16V	1,8	95	08.86-10.91	PL	4	SPR 004
1.8 16V	1,8	95	08.86-10.91	PL	4	SPR 017
1.8 16V	1,8	102	06.87-12.89	KR	4	SPR 004
1.8 16V	1,8	102	06.87-12.89	KR	4	SPR 017
1.8 KAT	1,8	66	08.87-10.91	GX/RP	4	SPR 004
1.8 KAT	1,8	66	08.87-10.91	GX/RP	4	SPR 017
1.8 KAT	1,8	79	02.87-10.91	PF	4	SPR 004
1.8 KAT	1,8	79	01.87-10.91	PF	4	SPR 017
1.8 Syncro	1,8	66	10.87-12.88	RP	4	SPR 004
1.8 Syncro	1,8	66	08.87-12.88	RP	4	SPR 017
1.8 Syncro	1,8	72	08.88-07.91	1P	4	SPR 004
1.8 Syncro	1,8	72	08.88-07.91	1P	4	SPR 017

K 70

1.6	1,6	66	08.70-07.71	DA	4	SPR 001
1.8	1,8	74	08.73-10.74	DC	4	SPR 003

LT 28 I

2.0	2,0	55	05.75-11.82	CH	4	SPR 004
2.4	2,4	66	12.82-07.92	DL	6	SPR 004
2.4 i	2,4	69	08.89-04.96	1E	6	SPR 004
2.4 D	2,4	55	01.79-07.92	CP/DW	6	SPR 004
2.4 TD	2,4	75	12.82-07.89	DV	6	SPR 004



kW

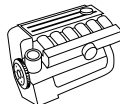

Zyl.
Cyl.
Cil.



VW

LT 28-35 I

2.0	2,0	55	05.75-11.82	CH	4	SPR 004
2.4	2,4	66	12.82-07.92	DL	6	SPR 004
2.4 i	2,4	69	03.94-04.96	1E	6	SPR 004
2.4 D	2,4	55	01.79-07.92	CP/DW	6	SPR 004
2.4 TD	2,4	75	02.86-08.92	DV	6	SPR 004
2.7 D	2,7	48	01.76-01.80	CG	4	SPR 003

LT 40-55 I

2.4	2,4	66	12.82-07.92	DL	6	SPR 004
2.4 i	2,4	69	01.93-04.96	1E	6	SPR 004
2.4 D	2,4	55	01.79-07.92	CP/DW	6	SPR 004
2.4 D 4WD	2,4	55	01.79-03.86	DW	6	SPR 004
2.4 TD	2,4	75	02.86-08.92	DV	6	SPR 004

PASSAT

1.3	1,3	40	08.80-07.83	FY	4	SPR 004
1.3	1,3	40	08.82-07.83	FY	4	SPR 017
1.3	1,3	44	08.80-07.86	EP/EU/FZ	4	SPR 004
1.3	1,3	44	08.82-07.86	EP/EU/FZ	4	SPR 017
1.6	1,6	51	08.87-03.88	PP	4	SPR 004
1.6	1,6	51	08.87-03.88	PP	4	SPR 017
1.6	1,6	53	02.86-03.88	RF /RL	4	SPR 017
1.6	1,6	53	08.88-07.90	1F/EZ	4	SPR 004
1.6	1,6	55	08.80-03.88	DT	4	SPR 017
1.6	1,6	55	08.82-03.88	WV/YN	4	SPR 017
1.6	1,6	55	04.88-12.88	EZ	4	SPR 004
1.6	1,6	63	08.78-07.80	YP	4	SPR 004
1.6	1,6	63	08.82-02.83	YP	4	SPR 017
1.6	1,6	74	10.94-08.96	AEK/AFT	4	SPR 017
1.6 D	1,6	40	08.80-03.88	CR/JK	4	SPR 017
1.6 TD	1,6	51	08.83-03.88	CY	4	SPR 004
1.6 TD	1,6	51	04.82-03.88	CY	4	SPR 017
1.6 TD	1,6	59	05.86-03.88	RA	4	SPR 017
1.6 TD	1,6	59	08.88-09.93	RA/SB	4	SPR 004
1.8	1,8	55	08.90-08.96	AAM	4	SPR 004
1.8	1,8	64	05.86-03.88	RM	4	SPR 004
1.8	1,8	64	05.86-03.88	RM	4	SPR 017
1.8	1,8	66	01.83-03.88	DS/JN	4	SPR 004
1.8	1,8	66	01.83-03.88	DS/JN	4	SPR 017
1.8	1,8	79	04.88-07.90	PF	4	SPR 004
1.8	1,8	82	12.83-07.84	DZ	4	SPR 004
1.8	1,8	82	12.83-03.88	DZ	4	SPR 017
1.8	1,8	82	04.88-07.92	PB (KAT)	4	SPR 004
1.8 16V	1,8	100	04.88-12.89	KR	4	SPR 004
1.8 G60 Syncro	1,8	118	09.89-07.93	PG	4	SPR 004
1.9	1,9	85	01.81-07.83	WN	5	SPR 004
1.9	1,9	85	08.82-07.83	WN	5	SPR 017
1.9 D	1,9	50	05.89-10.93	1Y	4	SPR 004
1.9 D	1,9	50	05.89-10.93	1Y	4	SPR 022
1.9 TD	1,9	55	03.91-08.96	AAZ	4	SPR 004
1.9 TD	1,9	55	03.91-08.96	AAZ	4	SPR 022
1.9 TDI	1,9	66	10.96-04.98	AHH/AHU	4	SPR 004
1.9 TDI	1,9	66	10.93-08.96	1Z	4	SPR 022
1.9 TDI	1,9	81	03.96-08.96	AFN	4	SPR 022
1.9 TDI	1,9	81	10.96-04.98	AFN	4	SPR 004
2.0	2,0	79	03.95-08.96	AEP	4	SPR 004
2.0	2,0	85	08.83-03.88	HP/JS	5	SPR 004
2.0	2,0	85	08.83-03.88	HP/JS	5	SPR 017
2.0	2,0	85	03.90-08.96	2E/ADY/AGG	4	SPR 004
2.0 16V	2,0	100	08.88-09.93	9A	4	SPR 004
2.0 16V	2,0	110	01.94-08.96	ABF	4	SPR 017
2.0 Syncro	2,0	85	10.90-09.94	2E	4	SPR 004
2.1	2,1	85	01.81-07.83	WE	5	SPR 017

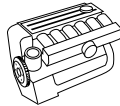

kW

Zyl.
Cyl.
Cil.**VW****PASSAT**

2.2	2,2	85	08.85-03.88	KX		5	SPR 004
2.2	2,2	85	08.85-03.88	KX		5	SPR 017
2.2	2,2	100	01.85-03.88	KV		5	SPR 004
2.2	2,2	100	01.85-03.88	KV		5	SPR 017
2.8 VR6	2,8	128	06.91-08.96	AAA		6	SPR 004
2.8 VR6	2,8	128	06.91-08.96	AAA		6	SPR 021

POLO

0.9	0,9	29	09.75-09.81	HA		4	SPR 004
0.9	0,9	29	10.81-12.81	HA		4	SPR 017
1.0	1,0	29	10.81-10.86	GL		4	SPR 004
1.0	1,0	29	10.81-10.86	GL		4	SPR 017
1.0	1,0	33	08.85-01.92	HZ		4	SPR 017
1.0 KAT	1,0	33	01.90-08.90	AAK		4	SPR 004
1.0 KAT	1,0	33	10.90-09.94	AAU		4	SPR 004
1.0 KAT	1,0	33	08.89-09.94	AAK/AAU/ACM		4	SPR 017
1.1	1,1	37	04.75-09.81	HB		4	SPR 004
1.1	1,1	37	10.81-09.89	HB		4	SPR 017
1.1	1,1	44	04.75-07.77	HC		4	SPR 004
1.3	1,3	40	08.83-07.88	HK/MH		4	SPR 004
1.3	1,3	40	08.83-07.88	HK/MH		4	SPR 017
1.3	1,3	43	10.81-07.82	HJ		4	SPR 017
1.3	1,3	44	10.81-07.83	HH		4	SPR 004
1.3	1,3	44	10.81-07.83	HH		4	SPR 017
1.3	1,3	55	09.82-09.89	GK		4	SPR 004
1.3	1,3	55	09.82-09.89	GK		4	SPR 017
1.3 D	1,3	33	08.86-07.90	MN		4	SPR 004
1.3 D	1,3	33	08.86-07.90	MN		4	SPR 017
1.3 KAT	1,3	40	07.87-09.94	2G/AAV/MH/NZ		4	SPR 017
1.3 KAT	1,3	55	10.89-03.91	3F		4	SPR 017
1.4 Variant	1,4	44	05.97-01.06	AEX/AKV/ANW/AKK		4	SPR 022
1.4 D	1,4	35	10.90-09.94	1W		4	SPR 017
45 1.0	1,0	33	10.94-09.96	AEV	→ Fg.Nr. 6 N-V 350 000	4	SPR 004
50 1.0	1,0	37	09.96-04.97	AER	→ Fg.Nr. 6 N-V 350 000	4	SPR 004
55 1.3	1,3	40	10.94-07.95	ADX	→ Fg.Nr. 6 N-V 350 000	4	SPR 004
60 1.4	1,4	44	07.95-04.97	AEX/AKV/APQ	→ Fg.Nr. 6 N-V 350 000	4	SPR 004
60 1.7 SDI	1,7	44	08.97-10.99	AKU		4	SPR 022
64 1.9 D	1,9	47	10.94-04.97	AEF	→ Fg.Nr. 6 N-V 350 000	4	SPR 004
64 1.9 SDI	1,9	47	07.96-04.97	AGD	→ Fg.Nr. 6 N-V 350 000	4	SPR 004
75 1.6	1,6	55	10.94-04.97	AEA/AEE/AHS	→ Fg.Nr. 6 N-V 350 000	4	SPR 004
100 1.4 16V	1,4	74	04.96-04.97	AFH	→ Fg.Nr. 6 N-V 350 000	4	SPR 004

POLO CLASSIC

1.0	1,0	29	01.85-10.86	GL		4	SPR 004
1.0	1,0	29	01.85-10.86	GL		4	SPR 017
1.0	1,0	33	08.85-09.94	AAK/AAU/HZ		4	SPR 004
1.0	1,0	33	01.85-09.94	AAK/AAU/HZ		4	SPR 017
1.3	1,3	40	01.85-07.85	HK/MH		4	SPR 004
1.3	1,3	40	01.85-07.87	HK/MH		4	SPR 017
1.3 D	1,3	33	08.86-12.88	MN		4	SPR 004
1.3 D	1,3	33	08.86-12.88	MN		4	SPR 017
1.3 KAT	1,3	40	07.87-09.94	MH/NZ		4	SPR 017
1.4 D	1,4	35	10.90-09.94	1W		4	SPR 017
57 1.7 SDI	1,7	42	11.97-07.98	AKW		4	SPR 004
60 1.4	1,4	44	12.95-07.98	AEX, AKV, ANX, APQ	→ Fg.Nr. 6 K-X 520 000	4	SPR 004
64 1.9 SDI	1,9	47	12.95-07.98	1Y/AEY	→ Fg.Nr. 6 K-X 520 000	4	SPR 004
75 1.6	1,6	55	11.95-09.97	1F		4	SPR 004
75 1.6	1,6	55	11.95-09.01	AEE/ALM		4	SPR 004
75 1.6	1,6	55	11.95-09.01	AEE/ALM		4	SPR 017
90 1.8	1,8	66	03.98-09.01	ADD/ADZ		4	SPR 004
90 1.9 TDI	1,9	66	09.96-07.98	AHU, ALE	→ Fg.Nr. 6 K-X 520 000	4	SPR 004
100 1.6	1,6	74	12.95-07.98	AFT	→ Fg.Nr. 6 K-X 520 000	4	SPR 004
100 1.6	1,6	74	12.95-09.01	AEH/AFT/AKL/APF/AUR		4	SPR 017



kW

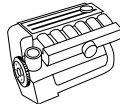

Zyl.
Cyl.
Cil.



VW

POLO Coupe

1.0	1,0	29	05.82-10.86	GL		4	SPR 004
1.0	1,0	29	05.82-10.86	GL		4	SPR 017
1.0	1,0	33	08.85-01.92	HZ		4	SPR 017
1.0 KAT	1,0	33	10.90-09.94	AAU		4	SPR 004
1.0 KAT	1,0	33	08.89-09.94	AAK/AAU/ACM		4	SPR 017
1.1	1,1	37	10.81-07.83	HB		4	SPR 017
1.3	1,3	40	08.83-06.87	HK/MH		4	SPR 004
1.3	1,3	40	08.83-06.87	HK/MH		4	SPR 017
1.3	1,3	44	10.81-07.83	HH		4	SPR 004
1.3	1,3	44	10.81-07.83	HH		4	SPR 017
1.3	1,3	55	09.82-09.89	GK		4	SPR 004
1.3	1,3	55	09.82-09.89	GK		4	SPR 017
1.3	1,3	57	03.91-09.94	3F		4	SPR 017
1.3 D	1,3	33	08.86-08.90	MN		4	SPR 004
1.3 D	1,3	33	08.86-08.90	MN		4	SPR 017
1.3 G40	1,3	83	01.87-09.94	PY		4	SPR 004
1.3 G40	1,3	83	08.90-09.94	PY		4	SPR 017
1.3 G40	1,3	85	01.87-08.90	PY		4	SPR 017
1.3 KAT	1,3	40	07.87-08.94	2G/AAV/MH/NZ		4	SPR 004
1.3 KAT	1,3	40	07.87-08.94	2G/AAV/MH/NZ		4	SPR 017
1.3 KAT	1,3	55	10.89-09.94	3F		4	SPR 017
1.4 D	1,4	35	08.90-09.94	1W		4	SPR 017

POLO Kasten

1.0	1,0	33	04.93-09.94	AAU		4	SPR 004
1.3	1,3	40	04.93-09.94	AAV		4	SPR 004
1.9 D	1,9	47	10.94-04.97	AEF	→ Fg.Nr. 6 N-V 350 000	4	SPR 004
1.9 SDI	1,9	47	07.96-04.97	AGD	→ Fg.Nr. 6 N-V 350 000	4	SPR 004

SANTANA

1.3	1,3	44	08.82-07.83	FZ		4	SPR 017
1.6	1,6	55	08.81-12.84	DT		4	SPR 017
1.6	1,6	63	08.81-07.82	YP		4	SPR 004
1.6	1,6	63	08.82-12.82	YP		4	SPR 017
1.6 D	1,6	40	08.83-12.84	JK		4	SPR 004
1.6 TD	1,6	51	08.83-12.84	CY		4	SPR 004
1.8	1,8	66	01.83-12.84	DS		4	SPR 017
1.9	1,9	85	08.81-07.82	WN		5	SPR 004
1.9	1,9	85	08.82-07.83	WN		5	SPR 017
2.0	2,0	85	08.83-12.84	HP/JS		5	SPR 017

SCIROCCO

1.1	1,1	37	08.77-07.79	FA		4	SPR 004
1.3	1,3	44	08.79-07.80	GF		4	SPR 004
1.3	1,3	44	08.82-12.83	GF		4	SPR 017
1.5	1,5	51	02.74-07.75	FH		4	SPR 003
1.5	1,5	51	08.77-07.82	JB		4	SPR 004
1.6	1,6	53	04.86-07.90	RE		4	SPR 017
1.6	1,6	55	01.83-12.89	EW		4	SPR 017
1.6	1,6	63	08.75-07.79	FR		4	SPR 003
1.6	1,6	63	08.80-07.82	FR		4	SPR 004
1.6	1,6	63	08.82-04.84	FR		4	SPR 017
1.6	1,6	81	08.77-07.80	EG		4	SPR 004
1.8	1,8	66	08.83-07.92	EX		4	SPR 017
1.8	1,8	70	11.85-07.92	JH		4	SPR 017
1.8	1,8	82	08.82-12.89	DX/EV/PB		4	SPR 017
1.8 16V	1,8	95	03.86-07.92	PL		4	SPR 017
1.8 16V	1,8	102	10.85-07.89	KR		4	SPR 017

SHARAN

1.8 T 20V	1,8	110	11.97-04.98	AJH	→ Fg.Nr. 7 M-W 070 000	4	SPR 004
1.9 TDI	1,9	66	09.95-04.00	1Z, AHU		4	SPR 004
1.9 TDI	1,9	81	09.96-04.00	AFN		4	SPR 004
2.0	2,0	85	09.95-01.00	ADY/ATM		4	SPR 004
2.8 VR6	2,8	128	09.95-04.00	AAA		6	SPR 004

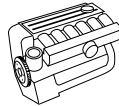

kW

Zyl.
Cyl.
Cil.**VW**

TRANSPORTER T3							
1.6 D	1,6	37	08.84-07.87	CS		4	SPR 004
1.6 TD	1,6	51	08.84-07.92	JX		4	SPR 004
1.7 D	1,7	42	10.86-07.92	KY		4	SPR 004
1.9	1,9	44	08.82-07.92	DF		4	SPR 004
1.9	1,9	57	09.82-07.92	DG		4	SPR 004
1.9	1,9	61	01.83-07.85	DH		4	SPR 004
1.9	1,9	66	08.83-07.85	GW		4	SPR 004
TRANSPORTER T4							
1.8	1,8	49	12.90-07.92	PD		4	SPR 017
1.9 D	1,9	44	09.90-04.97	1X		4	SPR 004
1.9 D	1,9	44	09.90-04.97	1X		4	SPR 022
1.9 TD	1,9	50	10.92-	ABL		4	SPR 004
1.9 TD	1,9	50	10.92-	ABL		4	SPR 022
2.0	2,0	62	09.90-	AAC		4	SPR 004
2.0	2,0	62	09.90-	AAC		4	SPR 017
2.4 D	2,4	55	08.97-	AJA		5	SPR 004
2.4 D	2,4	55	08.97-	AJA		5	SPR 022
2.4 D	2,4	57	09.90-05.98	AAB		5	SPR 022
2.5	2,5	81	11.90-	AAF/ACU/AEN/AEU		5	SPR 017
2.5	2,5	85	08.96-	AET		5	SPR 004
2.5	2,5	85	08.96-	AET/APL/AVT		5	SPR 017
2.5 TDI	2,5	65	05.98-	AJT/AYY		5	SPR 004
2.5 TDI	2,5	65	05.98-	AJT/AYY		5	SPR 022
2.5 TDI	2,5	75	09.95-	ACV		5	SPR 004
2.5 TDI Syncro	2,5	75	01.96-	AXL/ACV		5	SPR 022
2.5 TDI	2,5	111	05.98-	AHY/AXG		5	SPR 004
2.5 TDI	2,5	111	05.98-	AXG/AHY		5	SPR 022
2.8 VR 6	2,8	103	11.95-04.00	AES		6	SPR 004
VENTO							
1.4	1,4	40	11.91-09.98			4	SPR 017
1.4	1,4	44	11.91-12.97	ABD/AEX		4	SPR 004
1.4	1,4	44	11.91-09.98	ABD/AEX		4	SPR 017
1.6	1,6	55	10.94-12.97	AEA, AEE		4	SPR 004
1.6	1,6	55	09.92-09.98	ABU/AEA/AEE		4	SPR 017
1.6	1,6	74	10.94-12.97	AEK/AFT		4	SPR 004
1.6	1,6	74	10.94-09.98	AEK/AFT		4	SPR 017
1.6	1,6	74	10.94-12.97	AEK/AFT		4	SPR 022
1.8	1,8	55	11.91-12.97	AAM		4	SPR 004
1.8	1,8	55	11.91-09.98	AAM		4	SPR 017
1.8	1,8	66	11.91-12.97	ABS/ADZ		4	SPR 004
1.8	1,8	66	11.91-09.98	ABS/ADZ		4	SPR 017
1.9 D	1,9	48	11.91-12.97	1Y		4	SPR 004
1.9 D	1,9	48	11.91-12.97	1Y		4	SPR 022
1.9 SDI	1,9	47	04.97-12.97	AEY		4	SPR 004
1.9 SDI	1,9	47	04.97-12.97	AEY		4	SPR 022
1.9 TD	1,9	55	11.91-12.97	AAZ		4	SPR 004
1.9 TD	1,9	55	11.91-12.97	AAZ		4	SPR 022
1.9 TDI	1,9	66	09.93-07.96	1Z		4	SPR 004
1.9 TDI	1,9	66	05.97-12.97	ALE		4	SPR 004
1.9 TDI	1,9	81	04.96-12.97	AFN		4	SPR 004
1.9 TDI	1,9	81	04.96-12.97	AFN		4	SPR 022
2.0	2,0	85	11.91-12.97	2E/ADY/AGG/AKR		4	SPR 004
2.0	2,0	85	11.91-09.98	2E/ADY/AGG/AKR		4	SPR 017
2.8 VR6	2,8	128	01.92-12.97	AAA		6	SPR 004

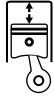

kW

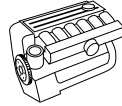

Zyl.
Cyl.
Cil.



LIEBHERR

Flammstartanlage⁵

691180308

ST 016

MERCEDES

1834	11,0	250	01.91-	OM 445.920	6	ST 004				
1844	15,0	320	11.91-	OM 446.922	10	ST 004				
1853	15,0	390	01.96-	OM 446.920	10	ST 004				
2044	15,0	320	01.92-	OM 446.922	10	ST 004				
2050	15,0	362-390	01.91-	OM 446.920	10	ST 004				
208 D	2,3	58-60	10.88-02.96	OM 601.940	4			ST 001		
210 D	2,9	70-72	11.88-02.96	OM 602.940	5			ST 001		
2544	15,0	320	01.92-	OM 446.922	10	ST 004				
2550	15,0	370-390	01.91-	OM 446.920	10	ST 004				
2553	15,0	390	01.96-	OM 446.920	10	ST 004				
2631	11,0	230-250	06.92-	OM 445.920	6	ST 004				
2644	15,0	320	01.92-	OM 446.922	10	ST 004				
308 D	2,3	58-60	06.89-02.96	OM 601.940	4			ST 001		
310 D	2,9	70-72	06.89-02.96	OM 602.940	5			ST 001		
3234	11,0	250	02.92-	OM 445.922	6	ST 004				
3235	15,0	390	01.96-	OM 446.920	10	ST 004				
3534	11,0	250	10.93-	OM 445.922	6	ST 004				
407 D	2,4	48-53	01.75-12.88	OM 616.910	4			ST 001		
Omnibus										
O 405, O 405 N, O 405 ST	12,0	157	12.84-	OM 447.913	6			ST 009		
O - Serie				OM 613.355				ST 009		
O - Serie				OM 613.385				ST 009		
O - Serie				OM 671.000				ST 009		
O - Serie				OM 671.005				ST 009		
O - Serie				OM 699.005				ST 009		
O - Serie				OM 699.006				ST 009		
Unimog										
U 1400	6,0	100	01.88-	OM 357.912	4			ST 009		
				OM 357.913	4			ST 009		
				OM 364.959	4			ST 009		
				OM 364.983	4			ST 009		

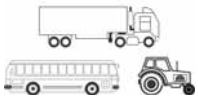

kW

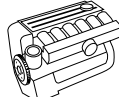

MAN						
SD 200	11,0	129-141	04.74-09.75	D 2566 MXUH-175 / D 2566 MXUH-192		SPR 007
SD 200	11,4	128-147	10.75-11.86	D 2566 MUH-175 / D 2566 MUH-192 / D 2566 MUH-200		SPR 007
SG 220	11,4	147-162	07.76-01.85	D 2566 MUM-200		SPR 007
SG 240 HÜ	11,4	206	09.81-01.86	D 2566 MTUH-280		SPR 007
SL 200	11,4	147-177	05.80-04.87	D 2566 MUH-200 / D 2566 MUH-240		SPR 007
SL 200	12,0	177	01.86-04.87	D 2866 UH-240		SPR 007
SÜ 240	11,4	147-177	10.75-11.83	D 2566 MUH-200 / D 2566 MUH-240		SPR 007

MERCEDES BENZ						
1013	5,7	96	02.76-12.84	OM 353.942 / OM 353.943 / OM 353.945 / OM 353.946		SPR 008
1017	5,7	124	11.75-02.91	OM 353.950 / OM 353.952 / OM 353.953 / OM 353.975		SPR 008
1017	5,7	124	04.77-09.96	OM 353.970 / OM 353.971		SPR 008
1213	5,7	96	09.75-05.86	OM 353.943 / OM 353.944 / OM 353.945 / OM 353.946		SPR 008
1217	5,7	124	10.76-09.96	OM 353.950 / OM 353.951 / OM 353.952 / OM 353.953 / OM 353.970 / OM 353.971		SPR 008
1219	9,6	141	09.75-09.84	OM 401.914 / OM 401.915 / OM 401.918 / OM 401.919		SPR 008
1219	9,6	141	09.75-12.82	OM 401.905		SPR 008
1413	5,7	96	09.75-12.84	OM 353.944 / OM 353.946 / OM 353.964		SPR 008
1417	5,8	124	05.75-12.84	OM 353.951 / OM 353.953 / OM 353.971		SPR 008
1419	9,6	141	08.73-09.96	OM 401.914		SPR 008
1419	9,6	141	05.75-12.82	OM 401.905 / OM 401.919		SPR 008
1424	12,8	176	07.75-09.96	OM 402.910 / OM 402.911 / OM 402.919		SPR 008
1425	14,6	184	08.73-09.96	OM 422.909		SPR 008
1613	5,7	96	08.73-09.96	OM 353.944 / OM 353.946		SPR 008
1617	5,7	124	01.75-09.96	OM 353.951 / OM 353.953 / OM 353.971		SPR 008
1619	9,6	141	11.74-12.82	OM 401.905 / OM 401.914		SPR 008
1624	12,8	176	07.75-09.96	OM 402.910 / OM 402.911 / OM 402.923		SPR 008
1625	14,6	184	08.73-09.96	OM 422.909		SPR 008
1628	14,6	206	08.73-09.96	OM 422.905 / OM 422.906 / OM 422.911 / OM 422.913		SPR 008
1633	14,6	243	08.73-09.96	OM 422.952 / OM 422.954 / OM 422.956 / OM 422.957 / OM 422.958		SPR 008
1636	18,3	261	08.73-09.96	OM 423.905 / OM 423.908		SPR 008
1638	14,6	276	08.73-09.96	OM 422.953 / OM 422.955 / OM 422.959		SPR 008
1922	11,0	141	10.81-10.90	OM 421.905		SPR 008
1928	14,6	206	01.80-05.89	OM 422.905 / OM 422.907 / OM 422.913		SPR 008
1928	14,6	206	08.81-01.89	OM 422.906 / OM 422.911		SPR 008
1933	14,6	243	03.73-09.96	OM 422.952 / OM 422.954 / OM 422.956 / OM 422.957 / OM 422.958		SPR 008
1936	18,3	261	08.73-09.96	OM 423.905 / OM 423.906 / OM 423.908		SPR 008
1938	14,6	276	08.73-09.96	OM 422.906 / OM 422.907 / OM 422.953 / OM 422.959		SPR 008
2025	14,6	184	08.83-03.91	OM 422.909		SPR 008
2026	12,8	188	10.76-10.80	OM 402.912 / OM 402.916		SPR 008
2028	14,6	206	01.80-06.89	OM 422.905 / OM 422.906 / OM 422.910 / OM 422.911		SPR 008
2033	14,6	243	12.81-12.87	OM 422.952 / OM 422.956		SPR 008
2036	18,3	261	03.84-03.91	OM 423.905 / OM 423.908		SPR 008
2224	12,8	176	05.75-03.84	OM 402.910 / OM 402.911 / OM 402.914 / OM 402.927 / OM 402.928		SPR 008
2225	14,6	184	08.83-03.91	OM 422.909 / OM 422.912		SPR 008
2226	12,8	188	09.75-12.80	OM 402.912 / OM 402.916 / OM 402.924		SPR 008
2228	14,6	206	08.73-09.96	OM 422.905 / OM 422.906 / OM 422.911		SPR 008
2233	14,6	243	08.73-09.96	OM 422.952 / OM 422.954 / OM 422.957 / OM 422.958		SPR 008
2236	18,3	261	09.82-03.91	OM 423.905 / OM 423.908		SPR 008
2238	14,6	276	08.73-09.96	OM 422.953 / OM 422.955 / OM 422.959		SPR 008

**BERU**

kW

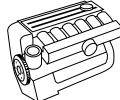
**MERCEDES BENZ**

2628	14,6	206	02.80-03.91	OM 422.907 / OM 422.913 / OM 422.916		SPR 008
2633	14,6	243	05.82-05.87	OM 422.952 / OM 422.954 / OM 422.956 / OM 422.957		SPR 008
2636	18,2	261	11.81-03.91	OM 423.905 / OM 423.907		SPR 008
2638	14,6	276	01.81-12.86	OM 422.953 / OM 422.955		SPR 008
3328	14,6	206	07.82-07.87	OM 422.914 / OM 422.919		SPR 008
3333	14,6	243	12.82-11.91	OM 422.954		SPR 008
3336	18,3	261	12.82-11.91	OM 423.905 / OM 423.907		SPR 008
L 408	3,8	63	01.70-12.74	OM 314.948	für Linkslenker ¹³	SPR 008
L 608	3,8	63	01.70-08.82	OM 314.948 / OM 314.967	für Linkslenker ¹³	SPR 008
LPS 811	5,7	81	10.69-02.73	OM 352		SPR 005
O 302	5,7	96	11.64-11.75	OM 352.980		SPR 006
O 303	9,6	141	10.74-06.83	OM 401.907 / OM 401.908 / OM 401.912		SPR 008
O 303	11,0	159	01.80-01.89	OM 421.908 / OM 441.908 / OM 441.909 / OM 441.911 / OM 441.918		SPR 008
O 303	12,8	188	03.75-06.83	OM 402.907		SPR 008
O 303	14,6	206-243	01.80-09.87	OM 422.908 / OM 422.917 / OM 422.951 / OM 422.963		SPR 008
O 303	15,9	236	07.72-06.83	OM 403.918		SPR 008
O 305 ST	8,7	125	01.69-05.73	OM 360.911		SPR 008
O 305 ST	11,0	132-'155	04.73-07.77	OM 407.905'OM 407.909 / OM 407.910 / OM 407.911		SPR 008
O 305 ST	11,4	147-177	11.76-05.87	OM 407.913 / OM 407.914 / OM 407.917		SPR 008
O 307	11,0	132	04.73-07.77	OM 407.905		SPR 006
O 307	11,0	155	04.73-07.77	OM 407.907		SPR 008
O 307	11,4	147	11.76-07.87	OM 407.915		SPR 008

VOLVO

F 408	3,6	80-81	04.78-02.86	TD 40 A		SPR 007
F 610	5,5	108-113	02.80-02.86	TD 60 C		SPR 007
F 611	5,5	88-113	09.75-02.86	D 60 A / TD 60 C		SPR 007
F 612	5,5	108	04.83-02.86	TD 60 C		SPR 007
F 613,F 614	5,5	128-132	12.78-02.86	TD 60 B		SPR 007
F 615 S	5,5	132	12.78-10.81	TD 60 B		SPR 007
F 616	5,5	128	02.81-02.86	TD 60 B		SPR 007
F 617 S	5,5	132	12.78-02.86	TD 60 B		SPR 007
F 88/260	9,6	190	08.65-06.77	TD 100 A		SPR 007
F 89/330	12,0	243	10.70-06.77	TD 120 A		SPR 007

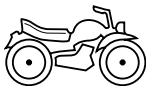

kW

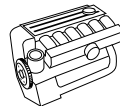

Zyl.
Cyl.
Cil.



BMW							
K 1100 LT/RS	1100			01.91-12.99		2	SD 008
K 1200 LT	1200			01.98-		2	SD 008
R 850 R/RT/GS	850			01.94-		2	SD 008
R 1100 GS/R/RT	1100			01.94-		2	SD 008
R 1100 RS	1100			01.92-		2	SD 008
R 1100 S	1100			01.98-		2	SD 008
R 1150 GS	1150			01.99-		2	SD 008
R 1150 GS Adventure	1150			01.01-		2	SD 008
R 1200 GT/RS	1200			01.01-		2	SD 008



MHz

**AUDI**

A4 (8E) / S4 / Avant / Cabrio / quattro	11.04–	433 MHz	RDE 007
A6 (4F) / S6 / Avant / quattro	05.04–	433 MHz	RDE 007
A6 Allroad (4B)	04.00–08.05	433 MHz	RDE 001
A6 Allroad (4F)	05.06–	433 MHz	RDE 007
A8 / S8 (4D, D2)	09.99–09.02	433 MHz	RDE 001
A8 / S8 (4E, D3)	10.02–	433 MHz	RDE 001
Q7 (4L)	09.05–	433 MHz	RDE 007
RS4 (8E) / Avant / Cabrio / quattro	05.06–	433 MHz	RDE 007
RS6, RS6 plus (4B, C5)	04.00–	433 MHz	RDE 001

AUDI (USA/CDN)

A6 Allroad (4B)	04.00–	315 MHz	RDE 004
A8 (D2)	09.99–	315 MHz	RDE 004

BENTLEY

Continental Flying Spur (611)	04.05–	433 MHz	RDE 007
Continental GT (614)	09.03–05.05	433 MHz	RDE 001
Continental GT (614)	06.05–	433 MHz	RDE 007

BMW

3 (E46)	03.99–12.04	433 MHz	RDE 002
5 (E39)	09.98–07.03	433 MHz	RDE 002
7 (E38)	09.98–10.01	433 MHz	RDE 002
7 (E65)	11.01–11.03	433 MHz	RDE 002
X5 (E53)	10.99–04.04	433 MHz mit verstärkter Sendeleistung ¹⁷	RDE 003

BMW (USA)

3 (E90)	09.06–	433 MHz	RDE 008
3 (E91) Touring	09.06–	433 MHz	RDE 008
3 (E92) Coupe	06.06–	433 MHz	RDE 008
3 (E93) Cabrio	12.06–	433 MHz	RDE 008
5 (E60)	03.06–	433 MHz	RDE 008
5 (E61) Touring	03.06–	433 MHz	RDE 008
6 (E63)	03.06–	433 MHz	RDE 008
6 (E64)	03.06–	433 MHz	RDE 008
7 (E65)	03.06–	433 MHz	RDE 008
7-L (E66)	03.06–	433 MHz	RDE 008
7-Hydrogen (E68)	12.06–	433 MHz	RDE 008
M5 (E60)	09.06–	433 MHz	RDE 008
M6 (E63)	09.06–	433 MHz	RDE 008
X3 (E83)	03.06–	433 MHz	RDE 008
X5 (E70)	10.06–	433 MHz	RDE 008
Z4 (E85)	10.06–	433 MHz	RDE 008

FERRARI

550 Maranello Evoluzione	03.02–	433 MHz	RDE 001
575 M-Maranello	09.02–	433 MHz	RDE 001
Enzo	06.03–	433 MHz mit verstärkter Sendeleistung ¹⁷	RDE 005
612 Scaglietti	03.04–	433 MHz	RDE 001
F430 / F 430 Spider	09.05–	433 MHz	RDE 001
FFX	07.05–	433 MHz mit verstärkter Sendeleistung ¹⁷	RDE 005

LAND ROVER

Range Rover (L30)	03.02–02.03	433 MHz mit verstärkter Sendeleistung ¹⁷	RDE 003
-------------------	-------------	---	----------------

MASERATI

Quattroporte III	04.04–	433 MHz	RDE 001
------------------	--------	---------	----------------

MAYBACH

Maybach (240) 57, 57S	10.02–	433 MHz	RDE 001
Maybach (240) 62	10.02–	433 MHz	RDE 001



MHz

**MERCEDES-BENZ**

CLS (C219)	10.04–06.05	433 MHz	RDE 001
E (W210/AMG)	07.99–03.02	433 MHz	RDE 001
E (W211)	03.02–06.05	433 MHz	RDE 001
S (W220)	07.99–09.05	433 MHz	RDE 001
S Coupé (C215)	07.99–09.05	433 MHz	RDE 001
SLR (R199)	04.04–	433 MHz	RDE 001
SL Roadster (R230)	10.01–05.05	433 MHz	RDE 001

MERCEDES-BENZ (USA/CDN)

E (W210/AMG)	07.99–	315 MHz	RDE 004
S (W220)	07.99–	315 MHz	RDE 004
S Coupé (W215)	07.99–	315 MHz	RDE 004
SL Roadster (R230)	10.01–	315 MHz	RDE 004

PORSCHE

911 (997)	02.05–	433 MHz	RDE 001
Boxster (987)	02.05–	433 MHz	RDE 001
Carrera GT	09.03–	433 MHz	RDE 001
Cayenne	12.02–	433 MHz mit verstärkter Sendeleistung ¹⁷	RDE 005
Cayman	11.05–	433 MHz	RDE 001

VOLKSWAGEN

Phaeton (3D2)	06.02–	433 MHz	RDE 001
Touareg (7LA)	11.02–	433 MHz mit verstärkter Sendeleistung ¹⁷	RDE 005

- Pro Fahrzeug werden 4 Radelektroniken benötigt. Bei Nachrüsträdern ist die genaue Zuordnung der Ventile und Distanzscheiben aus dem Radgutachten oder der ABE zu entnehmen oder beim Radhersteller zu erfragen. Eine detaillierte Montage- und Kalibrierungsanleitung finden Sie unter www.beru.com/tss.
- 4 wheel electronic units are required per vehicle. In the case of retrofitted wheels, ascertain the exact allocation of valves and spacers from the wheel certificate or the ABE (German general certification), or ask the wheel manufacturer. Detailed fitting and calibration instructions can be found at www.beru.com/tss.
- Il faut 4 modules électroniques de roue par véhicule. Sur les roues montées en accessoires, l'affectation exacte des valves et des écarteurs figure dans l'homologation de roue ou dans ABE ou doit être demandée auprès du fabricant de roue. Vous trouverez des instructions de montage et de calibrage détaillées à l'adresse www.beru.com/tss.
- Per voertuig zijn 4 wielelektronica-elementen nog. Bij het achteraf aanbrengen vindt u de exacte plaats van de ventielen en afstandsringen in het bandenrapport of de ABE, of u kunt dit navragen bij uw bandenfabrikant. Een uitgebreide montage- en afstelhandleiding vindt u onder www.beru.com/tss.
- Se necesitan 4 componentes electrónicos de rueda por coche. En el caso de las ruedas de reequipamiento la coordinación exacta de las válvulas y discos distanciadores se debe tomar del dictámen de las ruedas o del ABE, o bien preguntar al fabricante de las ruedas. Encontrará unas instrucciones detalladas de calibrado y montaje en www.beru.com/tss.
- Per ogni veicolo sono necessarie 4 unità elettroniche per le ruote. In caso di conversioni ad altre ruote, per l'esatta corrispondenza di valvole e distanziali fare riferimento ai dati tecnici o ABE, oppure richiederli al produttore della ruota. Per istruzioni di montaggio e calibrazione dettagliate, visitare il sito www.beru.com/tss.
- Для одного автомобиля требуется 4 колесных электронных устройства. В случае дополнительных колес данные о точном согласовании клапанов и распорных шайб взять из экспертизы колеса или ABE, либо запросить производителя колеса. Детальное руководство по монтажу и калибровке Вы найдете по адресу www.beru.com/tss.
- Dla każdego pojazdu potrzebne są 4 układy elektroniki koła. W przypadku uzupełniania wyposażenia kół należy zapoznać się z dokładnym przyporządkowaniem zaworów i podkładek dystansowych w atescie lub dopuszczeniu (ABE) koła albo pozyskać te informacje od producenta koła. Szczegółowa instrukcja montażu i kalibracji dostępna jest pod www.beru.com/tss.
- Ανά όχημα απαιτούνται 4 ηλεκτρονικά κυκλώματα τροχού. Αν το όχημα έχει μετεξοπλιστεί με νέους τροχούς, διαφορετικούς από τον αρχικό εξοπλισμό του, απαραίτητα είναι τα ακριβή στοιχεία για τη διάταξη των βαλβίδων και των ροδέλων απόστασης (αναφέρονται στα έγγραφα που συνοδεύουν τους τροχούς ή μπορείτε να τα πληροφορηθείτε από τον κατασκευαστή των τροχών). Για λεπτομερείς οδηγίες σχετικά με τη συναρμολόγηση και το καλιμπράρισμα πληκτρολογήστε www.beru.com/tss.
- Járművenként 4 kerékelektronikára van szükség. Új csere kerekek esetében a szelepek és a távolsági tárcsa pontos illesztését a kerékhez fűződő szakírásban és az általaános üzemelési engedélyben olvashatja, vagy a kerékgyártónál kérdezhet utána. Egy részletes szerelési- és kalibrációs utasításban a www.beru.com/tss cím alatt találja.

**Лямбда-зонды BERU
первоклассного качества от
завода-изготовителя**

В дополнение к быстроизнашивающимся частям для систем зажигания, а также свечам и катушкам зажигания фирма BERU предлагает теперь обширный ассортимент лямбда-зондов, который поможет Вам полностью оснастить автопарк практически из любых европейских автомобилей!

**Лямбда-зонды BERU –
преимущества для мастерских
и специализированной
торговли**

Практически все автомобили в Европе оснащены регулируемыми катализаторами (и соответственно лямбда-зондами). Постоянно растущие потребности по дооборудованию, из которых Вы можете извлечь прибыль: благодаря 195 типам различных лямбда-зондов фирмы BERU!

Точно подходящие штекеры: использование переходников ушло в прошлое! Никаких работ по установке штекеров, никаких холодных точек сварки, никаких потерь напряжения, никакого снижения работоспособности! Вместо этого: чистый, абсолютно технически грамотный ремонт, который к тому же экономит время.

В индивидуальной упаковке с понятной и детальной инструкцией по установке.

**Sondy lambda BERU to jakość
wyposażenia fabrycznego**

Uzupełniająco do zużywających się części układów zapłonowych, świec zapłonowych i cewek zapłonowych, firma BERU oferuje teraz dopasowany do wymagań asortyment sond lambda, pozwalający na fachowe wyposażenie praktycznie wszystkich pojazdów produkowanych w Europie!

**Sondy lambda BERU –
to korzyść dla warsztatu i handlu
specjalistycznego**

Zwarty i przejrzysty asortyment o maksymalnym horyzoncie zastosowań: Niemal wszystkie samochody w Europie są wyposażone w regulowany katalizator (a tym samym w sondy lambda). Stanowi to ciągle zwiększający się potencjał dodatkowego wyposażania, z którego powinniście Państwo skorzystać: dzięki 195 typom z programu sond lambda BERU!

Dokładnie dopasowane wtyczki: w ten sposób przystawki stały się przeszłością! Bez konieczności montowania wtyczek, dzięki czemu brak występowania zimnych lutowań, strat napięcia lub niewłaściwego działania.

Zamiast tego: czysta, bezkompromisowa, fachowa naprawa, pozwalająca dodatkowo zaoszczędzić czas.

W opakowaniu jednostkowych z rzeczową i pełną informacją instrukcją zabudowy.

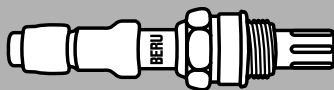

**BERU**

OZH 001	0 824 010 002	BMW	203
OZH 002	0 824 010 003	BMW	203
OZH 003	0 824 010 004	Alfa Romeo, Audi, Volvo	203
OZH 004	0 824 010 005	BMW	203
OZH 005	0 824 010 006	Citroën, Peugeot	203
OZH 006	0 824 010 007	Ford, Honda	204
OZH 007	0 824 010 008	Mercedes	204
OZH 008	0 824 010 009	Seat, VW	204
OZH 009	0 824 010 010	Honda, Seat, VW	204
OZH 010	0 824 010 011	VW	204
OZH 011	0 824 010 012	Nissan	205
OZH 012	0 824 010 013	Nissan, Seat, VW	205
OZH 014	0 824 010 015	Ford	205
OZH 016	0 824 010 017	Mercedes	205
OZH 017	0 824 010 018	Audi	205
OZH 018	0 824 010 019	Mercedes	206
OZH 019	0 824 010 020	Opel, Renault, Vauxhall	206
OZH 020	0 824 010 021	Ford, Honda	206
OZH 021	0 824 010 022	Ford, Mercedes	206
OZH 022	0 824 010 023	Mazda, VW	206
OZH 023	0 824 010 024	BMW, Mercedes	207
OZH 024	0 824 010 025	Seat, VW	207
OZH 025	0 824 010 026	Mercedes	207
OZH 026	0 824 010 027	Mercedes	207
OZH 027	0 824 010 028	Audi, VW	207
OZH 028	0 824 010 030	Honda, Opel, Vauxhall, VW	208
OZH 029	0 824 010 031	Peugeot	208
OZH 030	0 824 010 032	BMW	208
OZH 031	0 824 010 033	VW	208
OZH 032	0 824 010 034	Mercedes	208
OZH 033	0 824 010 035	Alpina, Chevrolet, Mercedes, Renault	209
OZH 034	0 824 010 036	Citroën, Fiat, Lancia, Peugeot	209
OZH 035	0 824 010 037	Alfa Romeo, Audi, Ferrari, Fiat, Lancia, Volvo	209
OZH 036	0 824 010 038	Bertone, BMW	209
OZH 037	0 824 010 039	Alfa Romeo, Audi, Daimler, Ferrari, Fiat, Hyundai, Lancia, Saab, Seat, Skoda, Volvo, VW	209
OZH 038	0 824 010 040	Citroën, Peugeot	210
OZH 039	0 824 010 041	BMW	210
OZH 040	0 824 010 042	Opel, Vauxhall	210
OZH 041	0 824 010 043	Mercedes	210
OZH 042	0 824 010 044	Mercedes	210
OZH 043	0 824 010 045	Mazda, Seat, Skoda, VW	211
OZH 044	0 824 010 046	Alpine, Audi, Chrysler, Peugeot, Renault, Zastava	211
OZH 045	0 824 010 047	Ford	211
OZH 046	0 824 010 048	Alfa Romeo, Audi, Fiat, Lancia, Saab, Seat, Volvo	211
OZH 047	0 824 010 049	VW	211
OZH 048	0 824 010 050	VW	212
OZH 049	0 824 010 051	Fiat	212
OZH 050	0 824 010 052	Ford	212
OZH 051	0 824 010 056	Mercedes	212
OZH 052	0 824 010 057	Alfa Romeo, Fiat, Lancia	212
OZH 053	0 824 010 058	MG, Rover	213
OZH 054	0 824 010 059	Alfa Romeo, Fiat	213
OZH 055	0 824 010 060	Alfa Romeo, Fiat, Lancia	213
OZH 056	0 824 010 061	Alfa Romeo, Fiat, Lancia	213
OZH 057	0 824 010 062	Rover	213
OZH 058	0 824 010 063	Renault	214
OZH 059	0 824 010 065	Ford	214

OZH 060	0 824 010 066	Universal (3-polig ²⁰)	214
OZH 061	0 824 010 067	Universal (4-polig ²⁰)	214
OZH 064	0 824 010 070	Fiat	214
OZH 065	0 824 010 071	Lancia	215
OZH 066	0 824 010 072	Fiat, Peugeot	215
OZH 067	0 824 010 073	Alfa Romeo, Rover	215
OZH 068	0 824 010 074	Audi, VW	215
OZH 069	0 824 010 075	Audi, VW	215
OZH 070	0 824 010 076	Audi, Seat, VW	216
OZH 071	0 824 010 077	Audi, Seat, VW	216
OZH 072	0 824 010 078	Peugeot	216
OZH 073	0 824 010 079	Volvo	216
OZH 074	0 824 010 080	Citroën, Peugeot	216
OZH 075	0 824 010 081	Ford	217
OZH 076	0 824 010 084	Mazda	217
OZH 079	0 824 010 089	Citroën, Peugeot	217
OZH 083	0 824 010 098	Renault	217
OZH 084	0 824 010 099	Fiat, Lancia	217
OZH 086	0 824 010 102	Audi, VW	218
OZH 087	0 824 010 105	Renault	218
OZH 088	0 824 010 106	Fiat, Lancia	218
OZH 092	0 824 010 112	Renault	218
OZH 094	0 824 010 114	Rover	218
OZH 095	0 824 010 117	Mazda	219
OZH 096	0 824 010 118	Renault	219
OZH 098	0 824 010 120	Mercedes	219
OZH 099	0 824 010 121	Honda, Skoda, VW	219
OZH 100	0 824 010 124	Mazda	219
OZH 101	0 824 010 125	Renault	220
OZH 103	0 824 010 128	Audi	220
OZH 104	0 824 010 129	Citroën, Peugeot	220
OZH 107	0 824 010 139	Citroën, Renault	220
OZH 108	0 824 010 107	Renault	220
OZH 109	0 824 010 127	Renault	221
OZH 110	0 824 010 144	Opel, Vauxhall	221
OZH 111	0 824 010 145	Opel	221
OZH 112	0 824 010 146	Opel	221
OZH 113	0 824 010 147	Opel	221
OZH 114	0 824 010 148	Opel	222
OZH 115	0 824 010 149	Opel	222
OZH 118	0 824 010 152	Fiat, Lancia	222
OZH 120	0 824 010 154	Honda, Rover	222
OZH 121	0 824 010 155	Honda	222
OZH 122	0 824 010 156	Honda	223
OZH 123	0 824 010 157	Honda	223
OZH 124	0 824 010 158	Mercedes	223
OZH 125	0 824 010 159	Renault	223
OZH 127	0 824 010 161	Seat, VW	223
OZH 128	0 824 010 162	Audi, Seat, Skoda, VW	224
OZH 130	0 824 010 164	Volvo	224
OZH 131	0 824 010 165	VW	224
OZH 132	0 824 010 166	Opel, Vauxhall	224
OZH 134	0 824 010 168	VW	224
OZH 135	0 824 010 169	Fiat, Lancia	225
OZH 136	0 824 010 170	Fiat	225
OZH 137	0 824 010 171	Fiat	225
OZH 138	0 824 010 172	Lancia	225
OZH 143	0 824 010 177	Mercedes	225
OZH 144	0 824 010 178	Mercedes	226
OZH 145	0 824 010 179	Mercedes	226
OZH 146	0 824 010 180	Mercedes, VW	226
OZH 147	0 824 010 181	Opel	226
OZH 148	0 824 010 182	Opel, Vauxhall	226

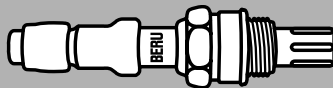

OZH 150	0 824 010 184	Seat, VW	227
OZH 151	0 824 010 185	Audi, Ford, Seat, VW	227
OZH 152	0 824 010 186	Audi, VW	227
OZH 153	0 824 010 187	Mazda	227
OZH 154	0 824 010 188	Saab	227
OZH 155	0 824 010 189	Volvo	228
OZH 156	0 824 010 190	Saab	228
OZH 157	0 824 010 191	Saab	228
OZH 158	0 824 010 192	Saab	228
OZH 159	0 824 010 193	Citroën, Fiat, Peugeot	228
OZH 160	0 824 010 194	Renault	229
OZH 161	0 824 010 195	Volvo	229
OZH 163	0 824 010 197	Mazda	229
OZH 164	0 824 010 198	Seat	229
OZH 165	0 824 010 199	VW	229
OZH 166	0 824 010 200	Citroën	230
OZH 167	0 824 010 201	BMW	230
OZH 168	0 824 010 202	BMW	230
OZH 169	0 824 010 203	Audi, Seat, Skoda, VW	230
OZH 173	0 824 010 207	Alpina, BMW, Landrover	230
OZH 176	0 824 010 210	Ford	231
OZH 177	0 824 010 211	Audi, Seat, Skoda, VW	231
OZH 178	0 824 010 212	Audi, VW	231
OZH 179	0 824 010 213	Seat, VW	231
OZH 180	0 824 010 214	Fiat, Lancia	231
OZH 181	0 824 010 215	Audi, Ford, VW	232
OZH 182	0 824 010 216	Seat, VW	232
OZH 184	0 824 010 218	Renault	232
OZH 190	0 824 010 224	Audi, VW	232
OZH 192	0 824 010 226	Alfa Romeo	232
OZH 193	0 824 010 227	BMW	233
OZH 194	0 824 010 228	Citroën, Peugeot	233
OZH 196	0 824 010 230	Mercedes	233
OZH 198	0 824 010 232	Mercedes	233
OZH 199	0 824 010 233	BMW	233
OZH 200	0 824 010 234	Mazda, Mercedes	234
OZH 201	0 824 010 235	Nissan	234
OZH 203	0 824 010 237	Nissan	234
OZH 204	0 824 010 238	Kia	234
OZH 205	0 824 010 239	Peugeot	234
OZH 206	0 824 010 240	Peugeot	235
OZH 207	0 824 010 241	Kia	235
OZH 208	0 824 010 242	Renault	235
OZH 209	0 824 010 243	Volvo	235
OZH 210	0 824 010 244	Volvo	235
OZH 215	0 824 010 249	VW	236
OZH 217	0 824 010 251	Alfa Romeo	236
OZH 218	0 824 010 252	BMW	236
OZH 220	0 824 010 254	Mercedes	236
OZH 222	0 824 010 256	BMW	236
OZH 223	0 824 010 257	BMW	237
OZH 224	0 824 010 258	BMW	237
OZH 225	0 824 010 259	Nissan	237
OZH 226	0 824 010 260	Nissan	237
OZH 227	0 824 010 261	Nissan	237
OZH 228	0 824 010 262	Nissan	238
OZH 229	0 824 010 263	Nissan	238
OZU 001	0 824 010 001	Audi, BMW, Daihatsu, De Lorean, Fiat, Honda, Hyundai, Lancia, Mazda, Mercedes, Mitsubishi, Nissan, Opel, Peugeot, Renault, Saab, Seat, VW	239
OZU 003	0 824 010 053	Seat, VW	239

OZU 004	0 824 010 054	Rover	239
OZU 005	0 824 010 055	Daewoo, Opel, VAUHALL	239
OZU 006	0 824 010 064	Fiat	239
OZU 007	0 824 010 141	Universal (2-polig ²⁰)	240
OZU 010	0 824 010 090	Nissan	240
OZU 012	0 824 010 096	Mazda	240
OZU 014	0 824 010 104	Honda, Suzuki	240
OZU 015	0 824 010 111	Suzuki	240
OZU 021	0 824 010 131	Mazda, Saab	241
OZU 022	0 824 010 094	Audi, Fiat, Lancia, Renault, Seat, VW	241
OZU 023	0 824 010 136	Opel, Vauxhall	241
OZU 024	0 824 010 133	Nissan	241
OZU 025	0 824 010 143	Renault	241

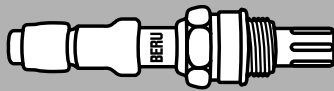

0 824 010 001	OZU 001	Audi, BMW, Daihatsu, De Lorean, Fiat, Honda, Hyundai, Lancia, Mazda, Mercedes, Mitsubishi, Nissan, Opel, Peugeot, Renault, Saab, Seat, VW	239	0 824 010 057	OZH 052	Alfa Romeo, Fiat, Lancia	212
				0 824 010 058	OZH 053	MG, Rover	213
				0 824 010 059	OZH 054	Alfa Romeo, Fiat	213
				0 824 010 060	OZH 055	Alfa Romeo, Fiat, Lancia	213
				0 824 010 061	OZH 056	Alfa Romeo, Fiat, Lancia	213
0 824 010 002	OZH 001	BMW	203	0 824 010 062	OZH 057	Rover	213
0 824 010 003	OZH 002	BMW	203	0 824 010 063	OZH 058	Renault	214
0 824 010 004	OZH 003	Alfa Romeo, Audi, Volvo	203	0 824 010 064	OZU 006	Fiat	239
0 824 010 005	OZH 004	BMW	203	0 824 010 065	OZH 059	Ford	214
0 824 010 006	OZH 005	Citroën, Peugeot	203	0 824 010 066	OZH 060	Universal (3-polig ²⁰)	214
0 824 010 007	OZH 006	Ford, Honda	204	0 824 010 067	OZH 061	Universal (4-polig ²⁰)	214
0 824 010 008	OZH 007	Mercedes	204	0 824 010 070	OZH 064	Fiat	214
0 824 010 009	OZH 008	Seat, VW	204	0 824 010 071	OZH 065	Lancia	215
0 824 010 010	OZH 009	Honda, Seat, VW	204	0 824 010 072	OZH 066	Fiat, Peugeot	215
0 824 010 011	OZH 010	VW	204	0 824 010 073	OZH 067	Alfa Romeo, Rover	215
0 824 010 012	OZH 011	Nissan	205	0 824 010 074	OZH 068	Audi, VW	215
0 824 010 013	OZH 012	Nissan, Seat, VW	205	0 824 010 075	OZH 069	Audi, VW	215
0 824 010 015	OZH 014	Ford	205	0 824 010 076	OZH 070	Audi, Seat, VW	216
0 824 010 017	OZH 016	Mercedes	205	0 824 010 077	OZH 071	Audi, Seat, VW	216
0 824 010 018	OZH 017	Audi	205	0 824 010 078	OZH 072	Peugeot	216
0 824 010 019	OZH 018	Mercedes	206	0 824 010 079	OZH 073	Volvo	216
0 824 010 020	OZH 019	Opel, Renault, Vauxhall	206	0 824 010 080	OZH 074	Citroën, Peugeot	216
0 824 010 021	OZH 020	Ford, Honda	206	0 824 010 081	OZH 075	Ford	217
0 824 010 022	OZH 021	Ford, Mercedes	206	0 824 010 084	OZH 076	Mazda	217
0 824 010 023	OZH 022	Mazda, VW	206	0 824 010 089	OZH 079	Citroën, Peugeot	217
0 824 010 024	OZH 023	BMW, Mercedes	207	0 824 010 090	OZU 010	Nissan	240
0 824 010 025	OZH 024	Seat, VW	207	0 824 010 094	OZU 022	Audi, Fiat, Lancia, Renault, Seat, VW	241
0 824 010 026	OZH 025	Mercedes	207				
0 824 010 027	OZH 026	Mercedes	207	0 824 010 096	OZU 012	Mazda	240
0 824 010 028	OZH 027	Audi, VW	207	0 824 010 098	OZH 083	Renault	217
0 824 010 030	OZH 028	Honda, Opel, Vauxhall, VW	208	0 824 010 099	OZH 084	Fiat, Lancia	217
0 824 010 031	OZH 029	Peugeot	208	0 824 010 102	OZH 086	Audi, VW	218
0 824 010 032	OZH 030	BMW	208	0 824 010 104	OZU 014	Honda, Suzuki	240
0 824 010 033	OZH 031	VW	208	0 824 010 105	OZH 087	Renault	218
0 824 010 034	OZH 032	Mercedes	208	0 824 010 106	OZH 088	Fiat, Lancia	218
0 824 010 035	OZH 033	Alpina, Chevrolet, Mercedes, Renault	209	0 824 010 107	OZH 108	Renault	220
				0 824 010 111	OZU 015	Suzuki	240
0 824 010 036	OZH 034	Citroën, Fiat, Lancia, Peugeot	209	0 824 010 112	OZH 092	Renault	218
0 824 010 037	OZH 035	Alfa Romeo, Audi, Ferrari, Fiat, Lancia, Volvo	209	0 824 010 114	OZH 094	Rover	218
				0 824 010 117	OZH 095	Mazda	219
0 824 010 038	OZH 036	Bertone, BMW	209	0 824 010 118	OZH 096	Renault	219
0 824 010 039	OZH 037	Alfa Romeo, Audi, Daimler, Ferrari, Fiat, Hyundai, Lancia, Saab, Seat, Skoda, Volvo, VW	209	0 824 010 120	OZH 098	Mercedes	219
				0 824 010 121	OZH 099	Honda, Skoda, VW	219
0 824 010 040	OZH 038	Citroën, Peugeot	210	0 824 010 124	OZH 100	Mazda	219
0 824 010 041	OZH 039	BMW	210	0 824 010 125	OZH 101	Renault	220
0 824 010 042	OZH 040	Opel, Vauxhall	210	0 824 010 127	OZH 109	Renault	221
0 824 010 043	OZH 041	Mercedes	210	0 824 010 128	OZH 103	Audi	220
0 824 010 044	OZH 042	Mercedes	210	0 824 010 129	OZH 104	Citroën, Peugeot	220
0 824 010 045	OZH 043	Mazda, Seat, Skoda, VW	211	0 824 010 131	OZU 021	Mazda, Saab	241
0 824 010 046	OZH 044	Alpine, Audi, Chrysler, Peugeot, Renault, Zastava	211	0 824 010 133	OZU 024	Nissan	241
				0 824 010 136	OZU 023	Opel, Vauxhall	241
0 824 010 047	OZH 045	Ford	211	0 824 010 139	OZH 107	Citroën, Renault	220
0 824 010 048	OZH 046	Alfa Romeo, Audi, Fiat, Lancia, Saab, Seat, Volvo	211	0 824 010 141	OZU 007	Universal (2-polig ²⁰)	240
				0 824 010 143	OZU 025	Renault	241
0 824 010 049	OZH 047	VW	211	0 824 010 144	OZH 110	Opel, Vauxhall	221
0 824 010 050	OZH 048	VW	212	0 824 010 145	OZH 111	Opel	221
0 824 010 051	OZH 049	Fiat	212	0 824 010 146	OZH 112	Opel	221
0 824 010 052	OZH 050	Ford	212	0 824 010 147	OZH 113	Opel	221
0 824 010 053	OZU 003	Seat, VW	239	0 824 010 148	OZH 114	Opel	222
0 824 010 054	OZU 004	Rover	239	0 824 010 149	OZH 115	Opel	222
0 824 010 055	OZU 005	Daewoo, Opel, VAUHALL	239	0 824 010 152	OZH 118	Fiat, Lancia	222
0 824 010 056	OZH 051	Mercedes	212	0 824 010 154	OZH 120	Honda, Rover	222
				0 824 010 155	OZH 121	Honda	222

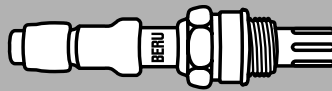

0 824 010 156	OZH 122	Honda	223
0 824 010 157	OZH 123	Honda	223
0 824 010 158	OZH 124	Mercedes	223
0 824 010 159	OZH 125	Renault	223
0 824 010 161	OZH 127	Seat, VW	223
0 824 010 162	OZH 128	Audi, Seat, Skoda, VW	224
0 824 010 164	OZH 130	Volvo	224
0 824 010 165	OZH 131	VW	224
0 824 010 166	OZH 132	Opel, Vauxhall	224
0 824 010 168	OZH 134	VW	224
0 824 010 169	OZH 135	Fiat, Lancia	225
0 824 010 170	OZH 136	Fiat	225
0 824 010 171	OZH 137	Fiat	225
0 824 010 172	OZH 138	Lancia	225
0 824 010 177	OZH 143	Mercedes	225
0 824 010 178	OZH 144	Mercedes	226
0 824 010 179	OZH 145	Mercedes	226
0 824 010 180	OZH 146	Mercedes, VW	226
0 824 010 181	OZH 147	Opel	226
0 824 010 182	OZH 148	Opel, Vauxhall	226
0 824 010 184	OZH 150	Seat, VW	227
0 824 010 185	OZH 151	Audi, Ford, Seat, VW	227
0 824 010 186	OZH 152	Audi, VW	227
0 824 010 187	OZH 153	Mazda	227
0 824 010 188	OZH 154	Saab	227
0 824 010 189	OZH 155	Volvo	228
0 824 010 190	OZH 156	Saab	228
0 824 010 191	OZH 157	Saab	228
0 824 010 192	OZH 158	Saab	228
0 824 010 193	OZH 159	Citroën, Fiat, Peugeot	228
0 824 010 194	OZH 160	Renault	229
0 824 010 195	OZH 161	Volvo	229
0 824 010 197	OZH 163	Mazda	229
0 824 010 198	OZH 164	Seat	229
0 824 010 199	OZH 165	VW	229
0 824 010 200	OZH 166	Citroën	230
0 824 010 201	OZH 167	BMW	230
0 824 010 202	OZH 168	BMW	230
0 824 010 203	OZH 169	Audi, Seat, Skoda, VW	230
0 824 010 207	OZH 173	Alpina, BMW, Landrover	230
0 824 010 210	OZH 176	Ford	231
0 824 010 211	OZH 177	Audi, Seat, Skoda, VW	231
0 824 010 212	OZH 178	Audi, VW	231
0 824 010 213	OZH 179	Seat, VW	231
0 824 010 214	OZH 180	Fiat, Lancia	231
0 824 010 215	OZH 181	Audi, Ford, VW	232
0 824 010 216	OZH 182	Seat, VW	232
0 824 010 218	OZH 184	Renault	232
0 824 010 224	OZH 190	Audi, VW	232
0 824 010 226	OZH 192	Alfa Romeo	232
0 824 010 227	OZH 193	BMW	233
0 824 010 228	OZH 194	Citroën, Peugeot	233
0 824 010 230	OZH 196	Mercedes	233
0 824 010 232	OZH 198	Mercedes	233
0 824 010 233	OZH 199	BMW	233
0 824 010 234	OZH 200	Mazda, Mercedes	234
0 824 010 235	OZH 201	Nissan	234
0 824 010 237	OZH 203	Nissan	234
0 824 010 238	OZH 204	Kia	234
0 824 010 239	OZH 205	Peugeot	234
0 824 010 240	OZH 206	Peugeot	235
0 824 010 241	OZH 207	Kia	235
0 824 010 242	OZH 208	Renault	235

0 824 010 243	OZH 209	Volvo	235
0 824 010 244	OZH 210	Volvo	235
0 824 010 249	OZH 215	VW	236
0 824 010 251	OZH 217	Alfa Romeo	236
0 824 010 252	OZH 218	BMW	236
0 824 010 254	OZH 220	Mercedes	236
0 824 010 256	OZH 222	BMW	236
0 824 010 257	OZH 223	BMW	237
0 824 010 258	OZH 224	BMW	237
0 824 010 259	OZH 225	Nissan	237
0 824 010 260	OZH 226	Nissan	237
0 824 010 261	OZH 227	Nissan	237
0 824 010 262	OZH 228	Nissan	238
0 824 010 263	OZH 229	Nissan	238

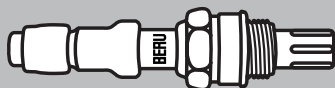

Инструкция по монтажу

Ваш автомобиль оборудован лямбда-зондом, который в исправном состоянии гарантирует оптимальное использование мощности, оптимальные экологические характеристики и оптимальный расход топлива.

Дефектный лямбда-зонд может привести к тому, что в отработавших газах Вашего автомобиля будет превышено допустимое содержание вредных веществ. Для замены дефектного лямбда-зонда использовать только лямбда-зонд, указанный в каталоге BERU для Вашего автомобиля, соблюдая при этом следующие правила:

- Использовать поврежденные или подвергнувшиеся падению лямбда-зонды запрещается.
- Удостовериться в том, что кабель подключения не поврежден, не перекручен и не растянут.
- Зонды "Лямбда" снабжаются предварительно смазанной резьбой или приложенной смазочной капсулой. В случае с приложенной смазочной капсулой следует обрабатывать смазкой ввинчивающуюся резьбу зонда "Лямбда" лишь непосредственно перед началом монтажа. Зонд "Лямбда" можно монтировать только с обработанной смазкой ввинчивающейся резьбой.
- Перед монтажом нового лямбда-зонда необходимо с помощью метчика (M18x1,5) и плоского шпателя удалить окалину из резьбы и из области уплотнения.
- Не допускайте контакта лямбда-зонда с водой, смазкой, чистящими и антикоррозионными средствами и т.п. (за исключением ввинчиваемой резьбы).
- Прокладку кабеля подключения лямбда-зонда BERU выполнять по возможности в точности также, как был проложен кабель лямбда-зонда, установленного изготовителем. В случае, если кабель лямбда-зонда BERU имеет избыточную длину, его необходимо уложить петлей, используя имеющиеся в комплекте поставки кабельные стяжки. Петлю уложить на максимально возможном удалении от корпуса зонда и отрезать выступающие концы кабельных стяжек.
- Обеспечить, чтобы кабель подключения не касался горячих и движущихся деталей (например, системы выпуска отработавших газов, турбокомпрессора, ремней, вентиляторов) и не проходил по острым кромкам.
- Прокладку кабеля подключения следует выполнять, обеспечив достаточное свободное пространство, чтобы не произошел обрыв кабеля в результате вибрации системы выпуска отработавших газов.
- Для монтажа использовать только подходящий инструмент, чтобы исключить опасность ранений и повреждения лямбда-зонда.
- **Момент затяжки для резьбы M18x1,5 должен составлять 45-50 Нм.**
- При эксплуатации Вашего автомобиля категорически запрещается применять этилированный бензин, присадки на основе металлов и силиконы.



Монтаж лямбда-зондов BERU производится следующим образом:

при монтаже лямбда-зондов с оригинальным штекером подключения

- 1) Выключить двигатель
- 2) Отключить клеммы аккумулятора
- 3) Отсоединить подключения дефектного лямбда-зонда
- 4) Демонтировать дефектный лямбда-зонд
- 5) Ввинтить лямбда-зонд BERU с учетом приведенных выше указаний по монтажу с предварительной смазкой соединительной резьбы, (кроме OZU 023, OZU 025, OZH 107) обеспечить требуемый момент затяжки
- 6) Подсоединить электрические подключения лямбда-зонда BERU
- 7) Снова подключить клеммы аккумулятора.

Тестер лямбда-зондов BERU OST 02.



Для проверки лямбда-зондов на наличие механических повреждений и на работоспособность удобно использовать тестер от BERU (№ для заказа: 0 810 800 002). Обе измерительные линии из термостойкого силикона подключаются быстро: крокодил на массу, иглочатый наконечник в сигнальную линию зонда... и можно начинать измерения. После того, как зонд достиг своей рабочей температуры (2-3 мин.), начинается регулировка исправного зонда: Стрелка измерительного прибора колеблется между зелеными секторами. Если стрелка остановится в красном секторе шкалы, то зонд слишком инертный, состарился, закоптился или просто неисправен.



**OZH 001**

0 824 010 002

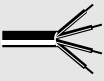
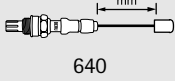

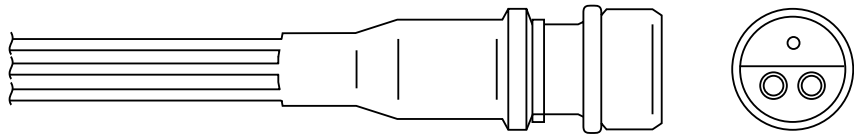

 3	 640
 M 18 x 1,5	 22 Nm 45

**OZH 002**

0 824 010 003

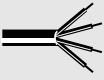
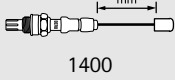

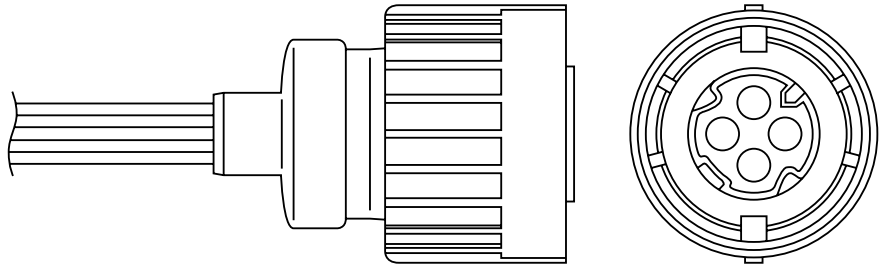

 4	 1400
 M 18 x 1,5	 22 Nm 45

**OZH 003**

0 824 010 004

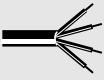
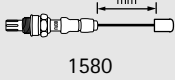

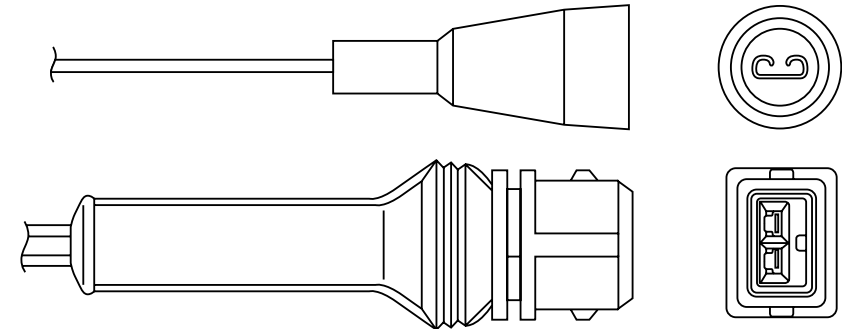

 3	 1580
 M 18 x 1,5	 22 Nm 45

**OZH 004**

0 824 010 005

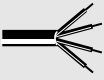
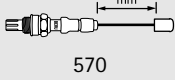

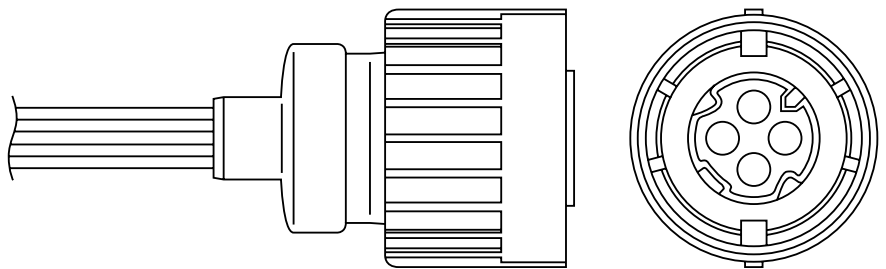

 4	 570
 M 18 x 1,5	 22 Nm 45

**OZH 005**

0 824 010 006

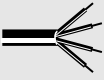
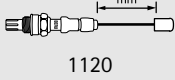

 4	 1120
 M 18 x 1,5	 22 Nm 45

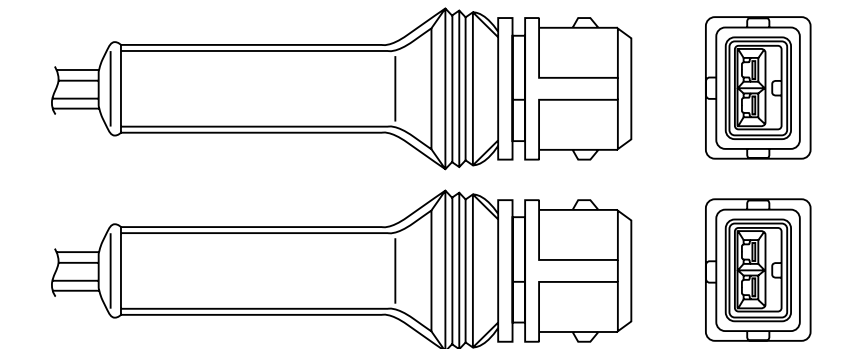

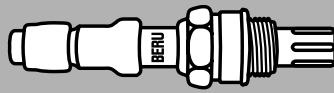



OZH 006

0 824 010 007

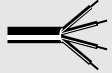
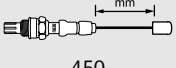

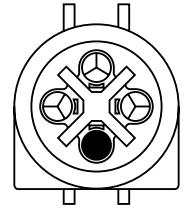

 3	 mm 450
 M 18 x 1,5	 22 Nm 45



OZH 007

0 824 010 008

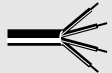
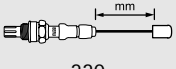



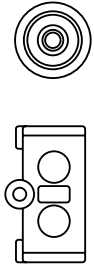
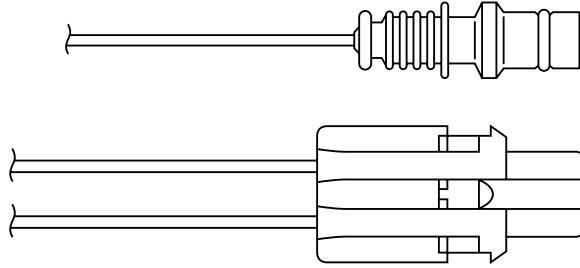

 3	 mm 220
 M 18 x 1,5	 22 Nm 45

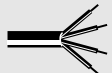

OZH 008

0 824 010 009



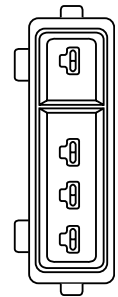
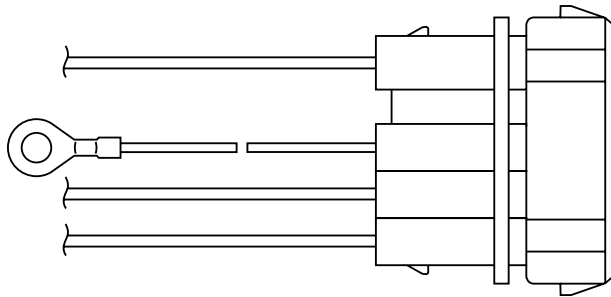

 3	 mm 900
 M 18 x 1,5	 22 Nm 45



OZH 009

0 824 010 010

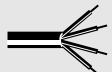
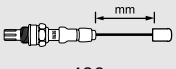

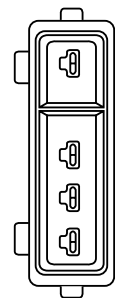
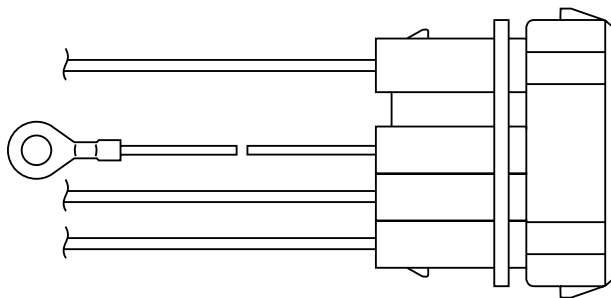

 3	 mm 490
 M 18 x 1,5	 22 Nm 45



OZH 010

0 824 010 011

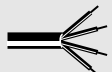
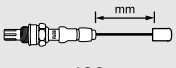

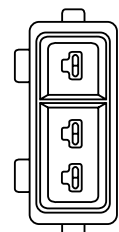
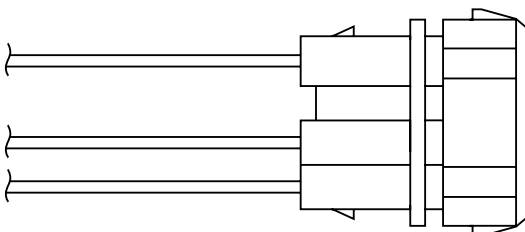

 3	 mm 490
 M 18 x 1,5	 22 Nm 45

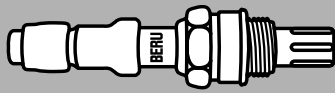

**OZH 011**

0 824 010 012

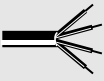
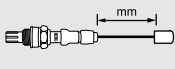

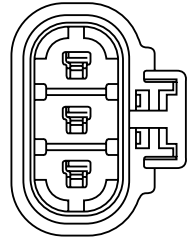
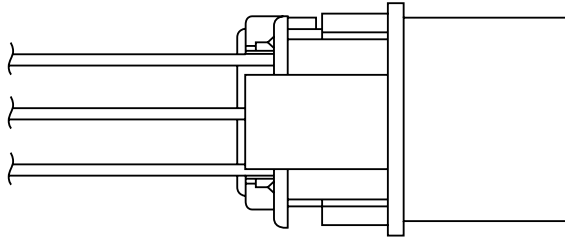

 3	 mm 275
 M 18 x 1,5	 22 Nm 45

**OZH 012**

0 824 010 013

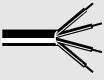
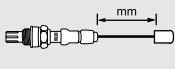

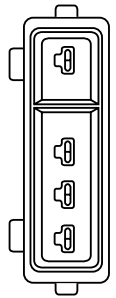
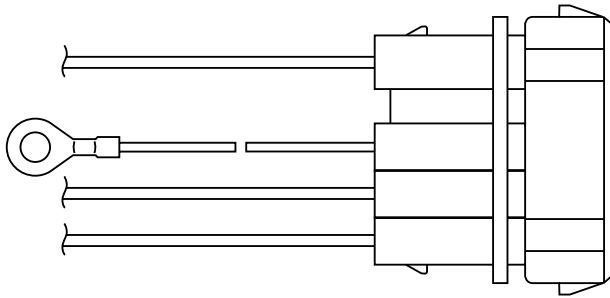

 3	 mm 390
 M 18 x 1,5	 22 Nm 45

**OZH 014**

0 824 010 015

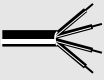
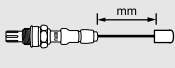

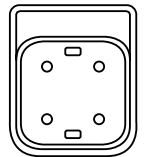
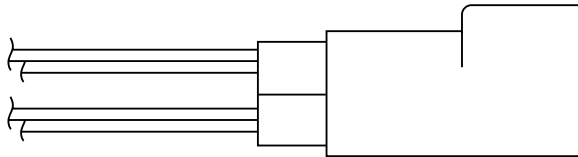

 4	 mm 620
 M 18 x 1,5	 22 Nm 45

**OZH 016**

0 824 010 017

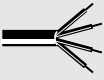
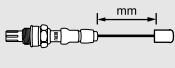

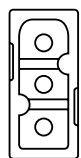
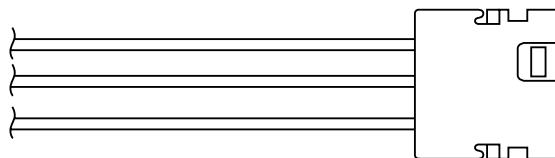
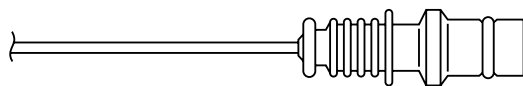

 4	 mm 670
 M 18 x 1,5	 22 Nm 45

**OZH 017**

0 824 010 018

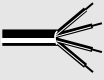
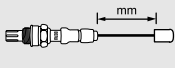

 3	 mm 590
 M 18 x 1,5	 22 Nm 45

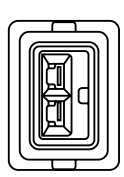
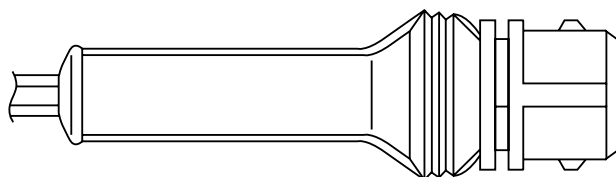
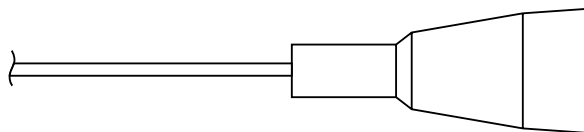

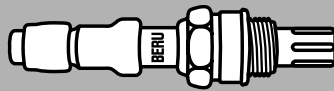
**OZH 018**

0 824 010 019

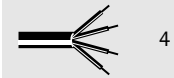

4

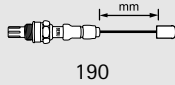

190



M 18 x 1,5



22

Nm

45

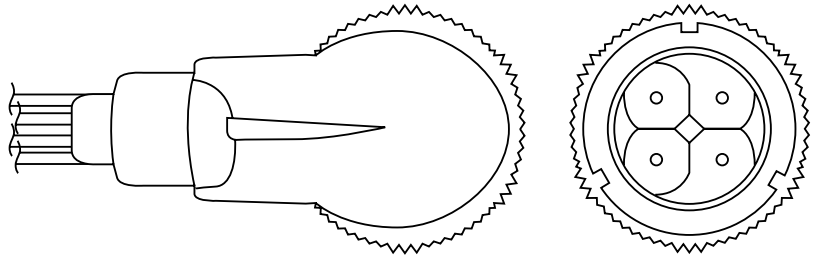
**OZH 019**

0 824 010 020



3

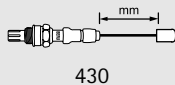

430

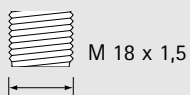

M 18 x 1,5



22

Nm

45

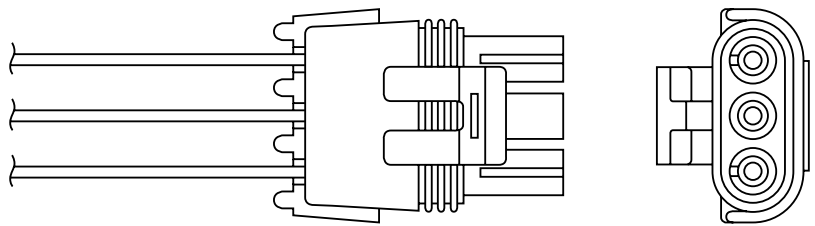
**OZH 020**

0 824 010 021



4

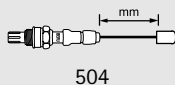

504

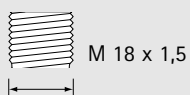

M 18 x 1,5



22

Nm

45

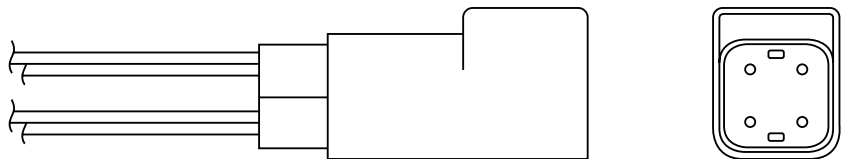
**OZH 021**

0 824 010 022



4

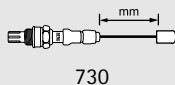

730



M 18 x 1,5



22

Nm

45

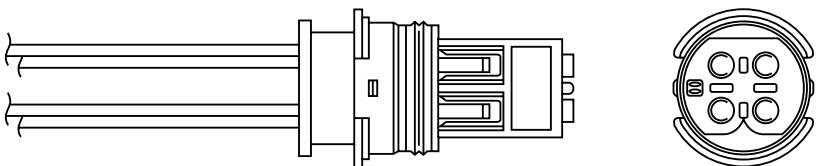
**OZH 022**

0 824 010 023



4

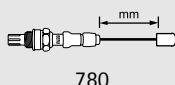

780

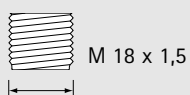

M 18 x 1,5



22

Nm

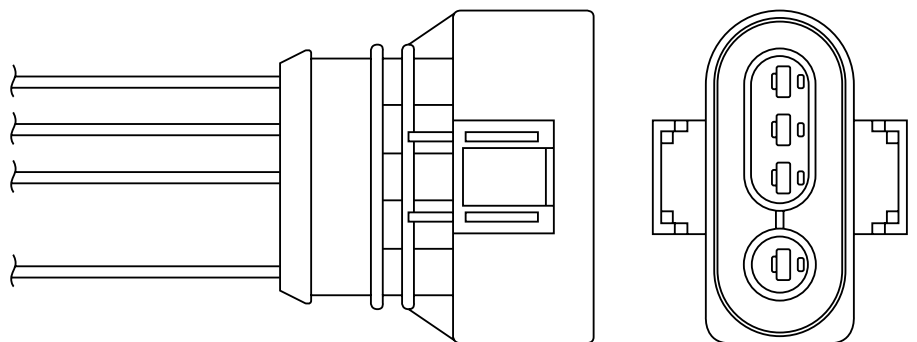

45

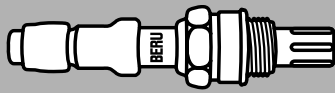

**OZH 023**

0 824 010 024

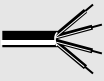
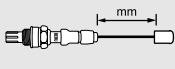

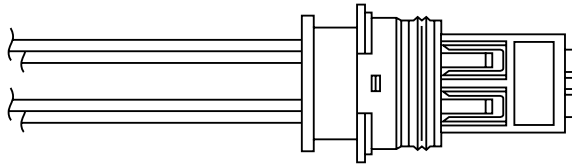

 4	 470
 M 18 x 1,5	 22 Nm 45

**OZH 024**

0 824 010 025

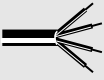
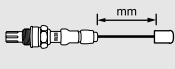

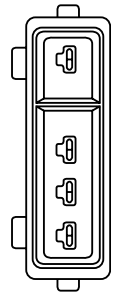
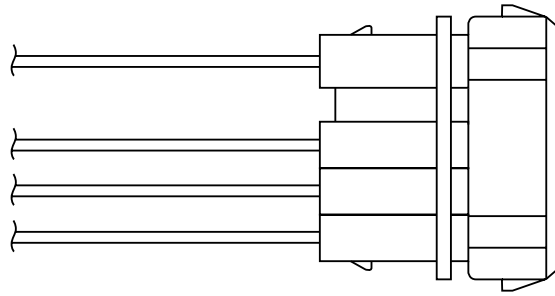

 4	 990
 M 18 x 1,5	 22 Nm 45

**OZH 025**

0 824 010 026

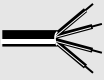
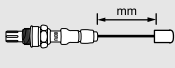

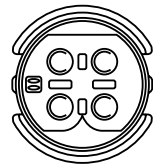
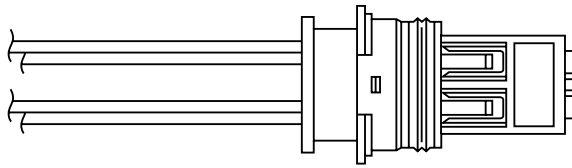

 4	 900
 M 18 x 1,5	 22 Nm 45

**OZH 026**

0 824 010 027

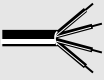
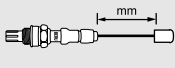

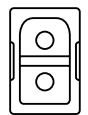
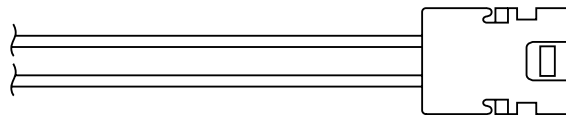
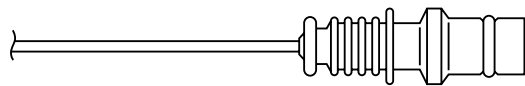

 3	 665
 M 18 x 1,5	 22 Nm 45

**OZH 027**

0 824 010 028

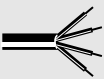
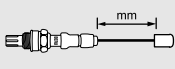

 3	 890
 M 18 x 1,5	 22 Nm 45

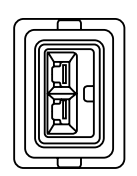
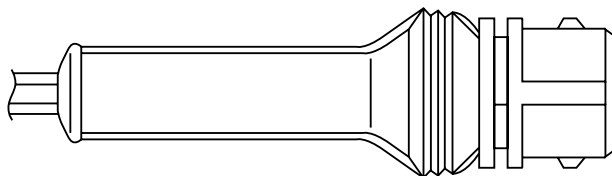
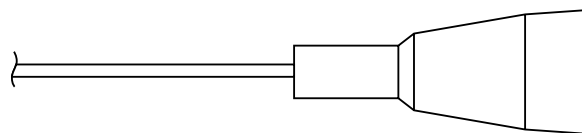

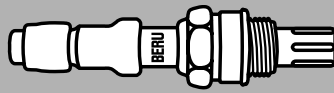

OZH 028

0 824 010 030



3	mm 1120
M 18 x 1,5	22 Nm 45

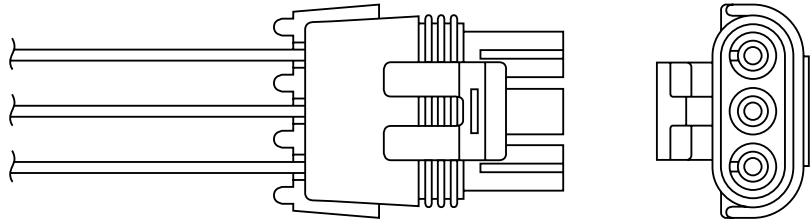

OZH 029

0 824 010 031



4	mm 420/320
M 18 x 1,5	22 Nm 45

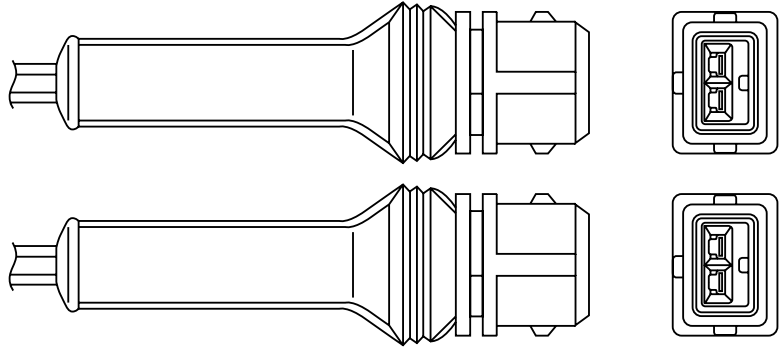

OZH 030

0 824 010 032



4	mm 1320
M 18 x 1,5	22 Nm 45

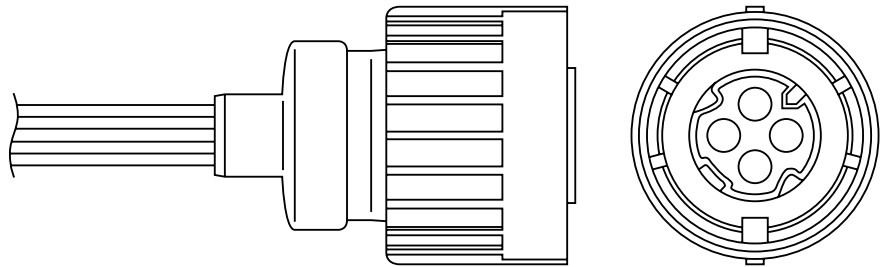

OZH 031

0 824 010 033



3	mm 830
M 18 x 1,5	22 Nm 45

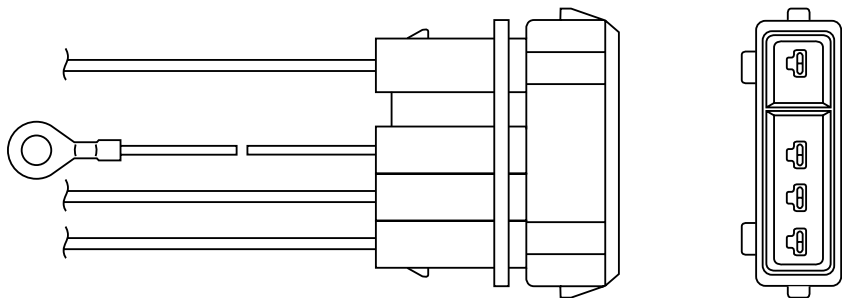

OZH 032

0 824 010 034



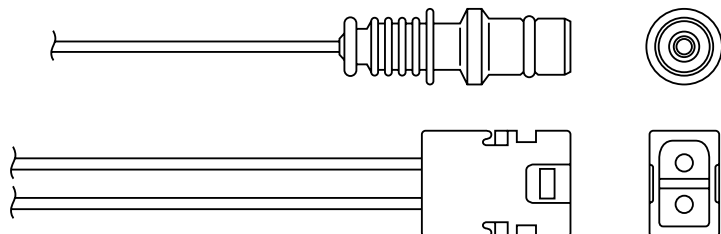

3	mm 430
M 18 x 1,5	22 Nm 45

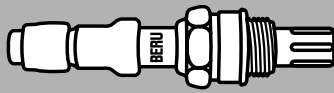

**OZH 033**

0 824 010 035

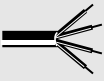
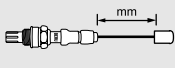

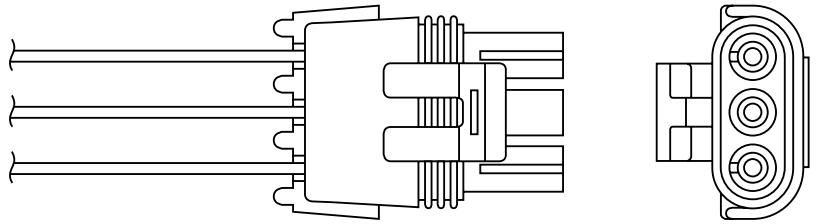

 3	 mm 270
 M 18 x 1,5	 22 Nm 45

**OZH 034**

0 824 010 036

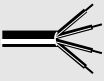
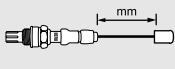

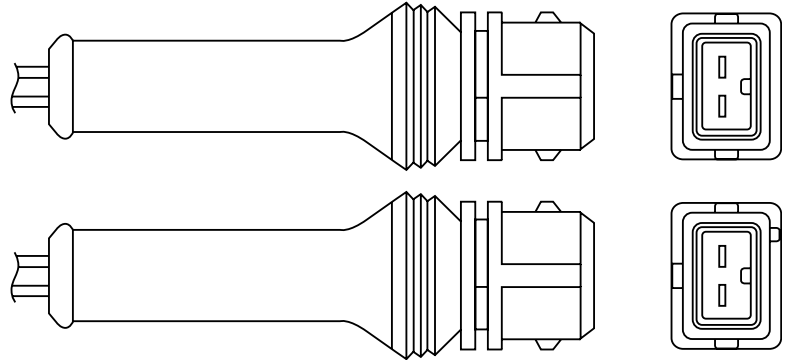

 4	 mm 1390
 M 18 x 1,5	 22 Nm 45

**OZH 035**

0 824 010 037

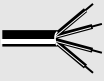
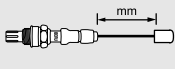

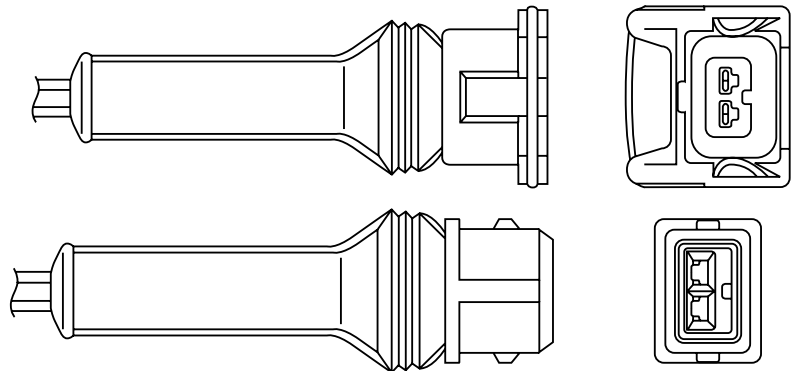

 4	 mm 800
 M 18 x 1,5	 22 Nm 45

**OZH 036**

0 824 010 038

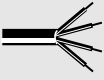
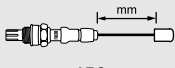

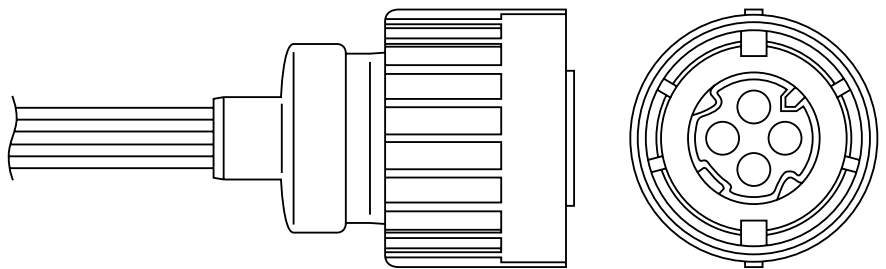

 4	 mm 450
 M 18 x 1,5	 22 Nm 45

**OZH 037**

0 824 010 039

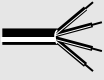
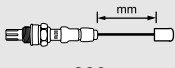

 3	 mm 880
 M 18 x 1,5	 22 Nm 45

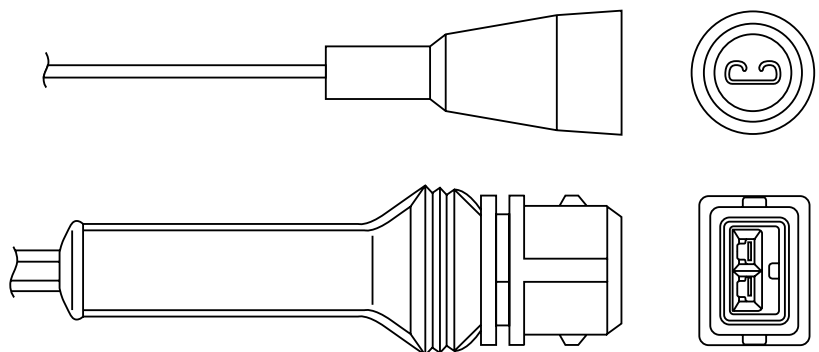

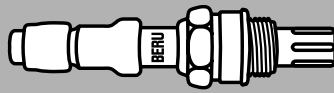

OZH 038

0 824 010 040

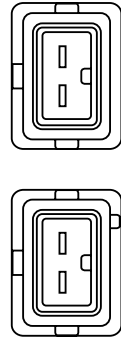
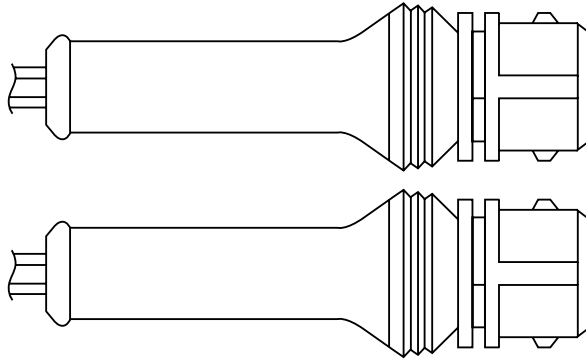
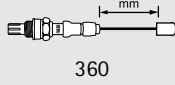

OZH 039

0 824 010 041

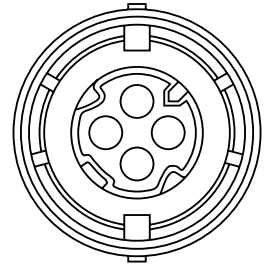
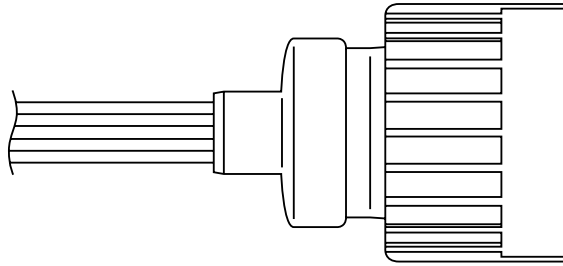
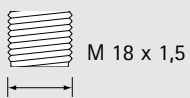
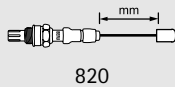

OZH 040

0 824 010 042

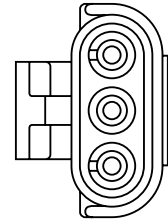
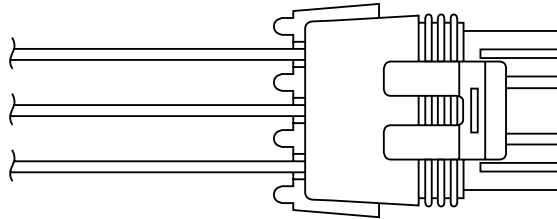
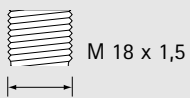
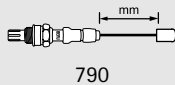

OZH 041

0 824 010 043

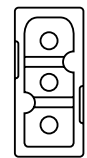
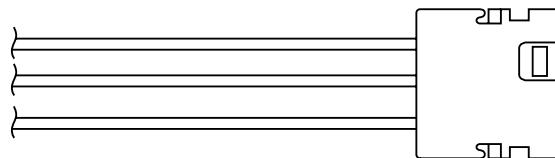
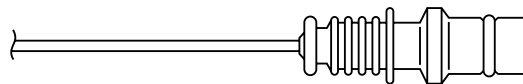
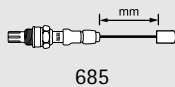

OZH 042

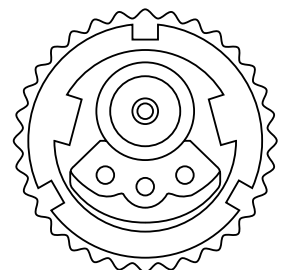
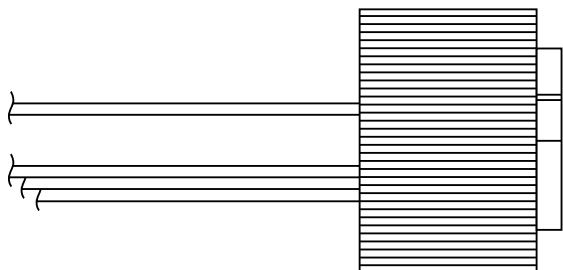
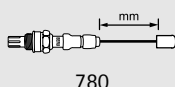

0 824 010 044

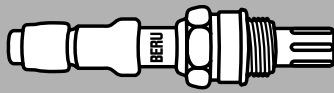

**OZH 043**

0 824 010 045

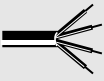
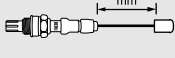

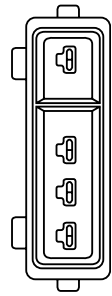
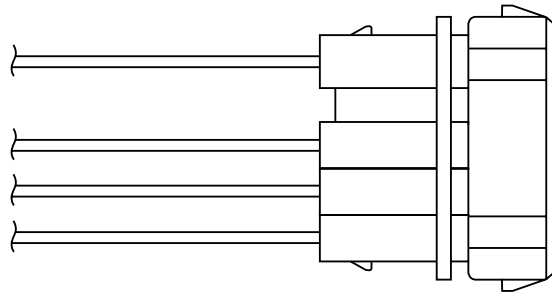

 4	 mm 530
 M 18 x 1,5	 22 Nm 45

**OZH 044**

0 824 010 046

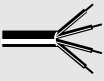
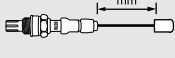

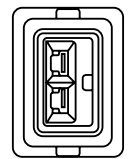
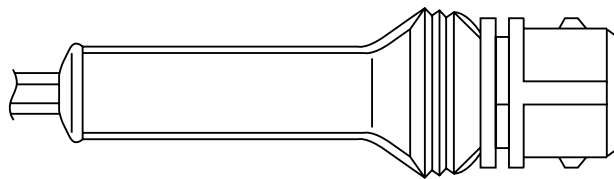
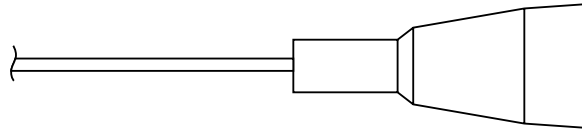

 3	 mm 400
 M 18 x 1,5	 22 Nm 45

**OZH 045**

0 824 010 047

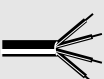
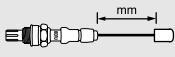

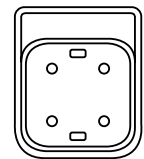
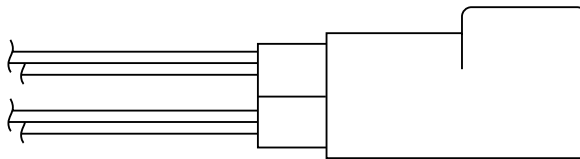

 4	 mm 265
 M 18 x 1,5	 22 Nm 45

**OZH 046**

0 824 010 048

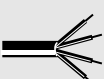
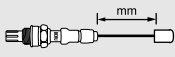

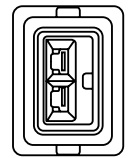
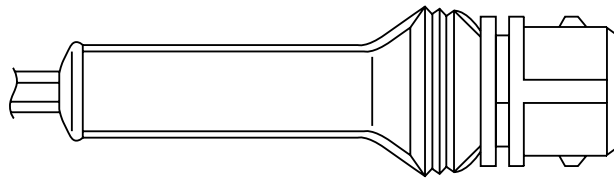
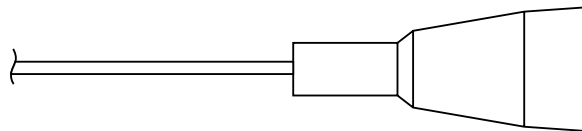

 3	 mm 1130
 M 18 x 1,5	 22 Nm 45

**OZH 047**

0 824 010 049

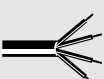
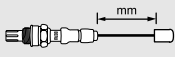

 3	 mm 1290
 M 18 x 1,5	 22 Nm 45

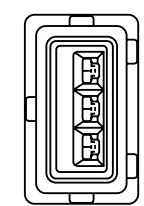
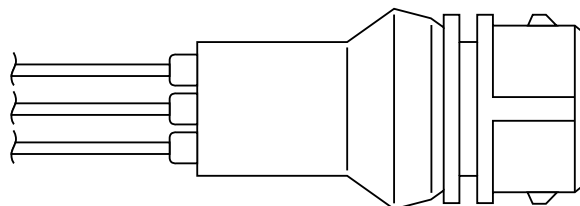

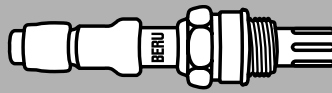
**OZH 048**

0 824 010 050

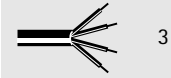

3

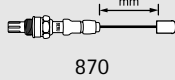

mm

870



M 18 x 1,5



22

Nm

45

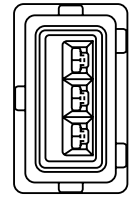
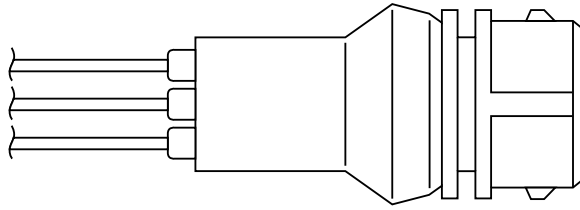
**OZH 049**

0 824 010 051



4

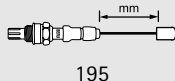

mm

195



M 18 x 1,5



22

Nm

45

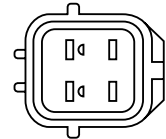
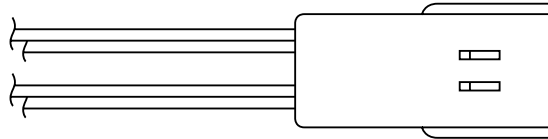
**OZH 050**

0 824 010 052



4

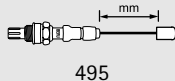

mm

495



M 18 x 1,5



22

Nm

45

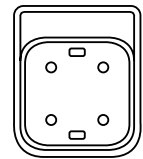
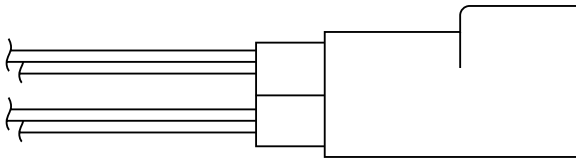
**OZH 051**

0 824 010 056



3

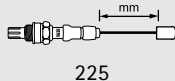

mm

225



M 18 x 1,5



22

Nm

45

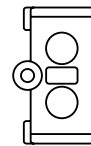
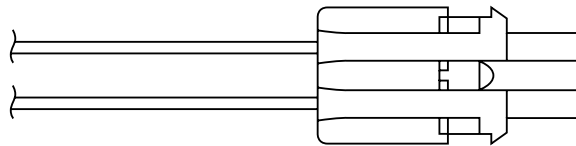
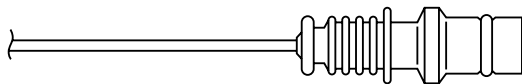
**OZH 052**

0 824 010 057



3

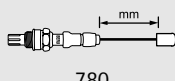

mm

780



M 18 x 1,5



22

Nm

45

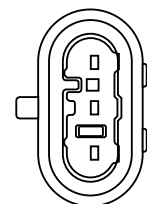
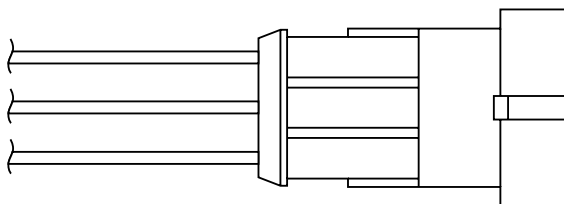

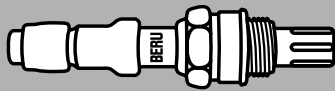



OZH 053

0 824 010 058

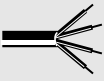
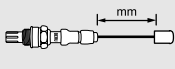

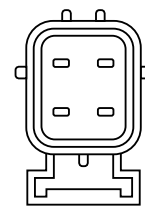
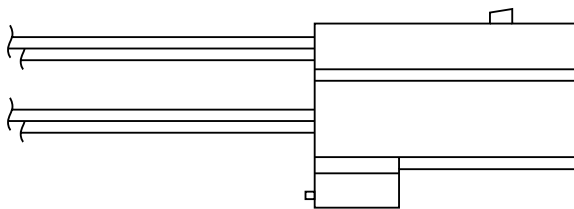

 4	 495
 M 18 x 1,5	 22 Nm 45



OZH 054

0 824 010 059

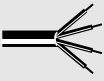
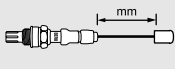

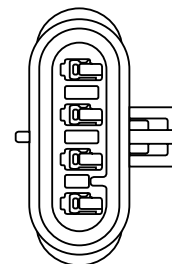
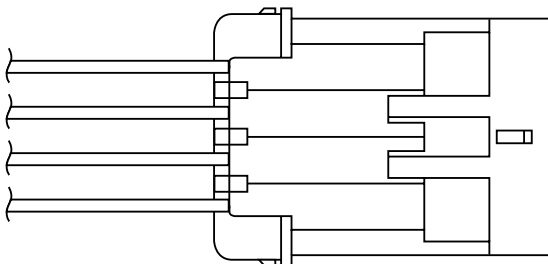

 4	 710
 M 18 x 1,5	 22 Nm 45



OZH 055

0 824 010 060

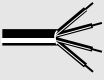
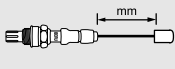

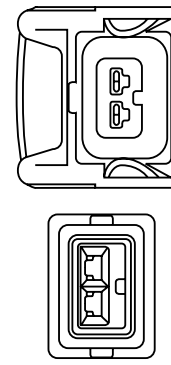
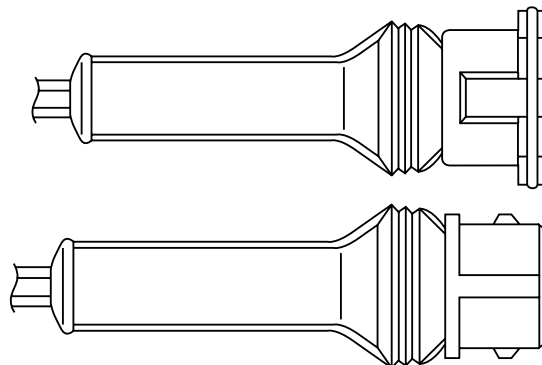

 4	 1030
 M 18 x 1,5	 22 Nm 45



OZH 056

0 824 010 061

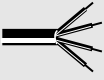
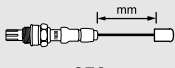

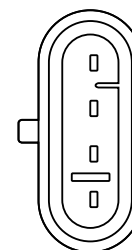
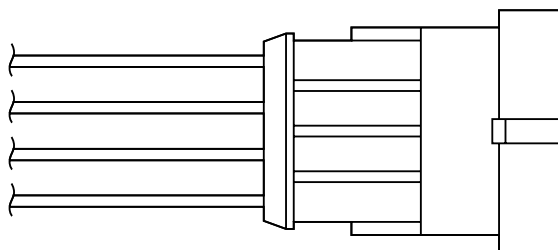

 4	 870
 M 18 x 1,5	 22 Nm 45



OZH 057

0 824 010 062

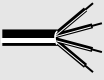
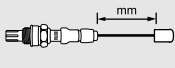

 4	 295
 M 18 x 1,5	 22 Nm 45

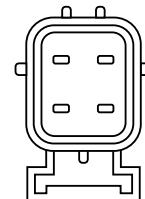
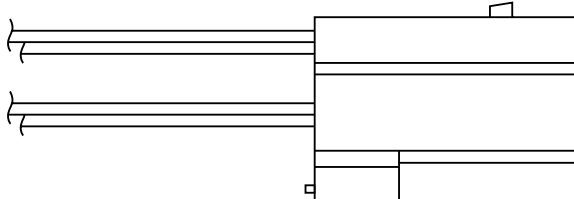

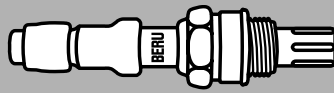

OZH 058

0 824 010 063



3	mm 190
M 18 x 1,5	22 Nm 45

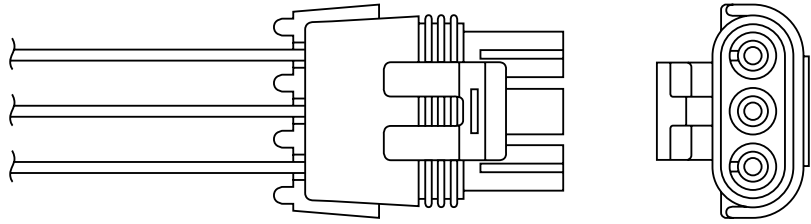

OZH 059

0 824 010 065



4	mm 200
M 18 x 1,5	22 Nm 45

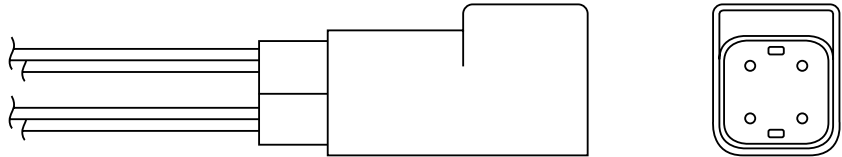

OZH 060

0 824 010 066



3	mm 240
M 18 x 1,5	22 Nm 45

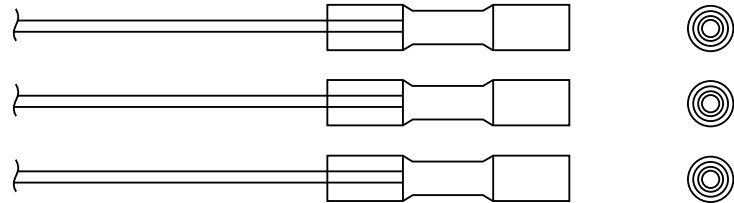

OZH 061

0 824 010 067



4	mm 240
M 18 x 1,5	22 Nm 45

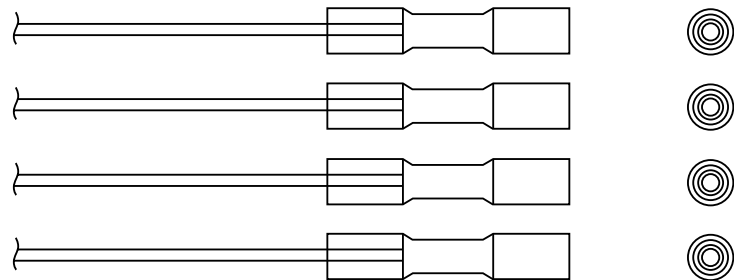

OZH 064

0 824 010 070



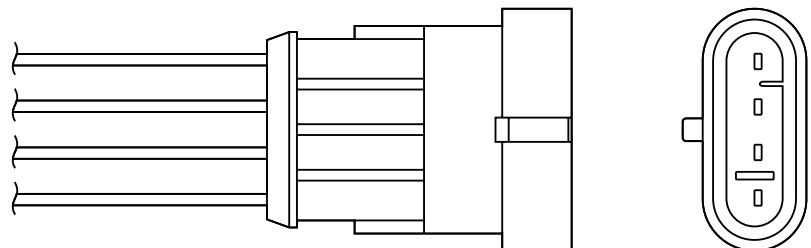

4	mm 265
M 18 x 1,5	22 Nm 45

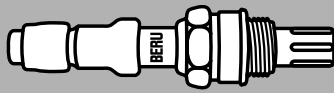

**OZH 065**

0 824 010 071

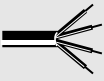
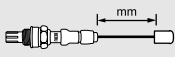

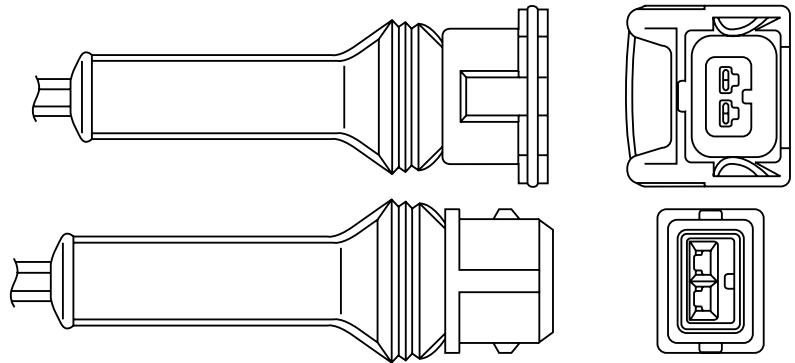

 4	 mm 530
 M 18 x 1,5	 22 Nm 45

**OZH 066**

0 824 010 072

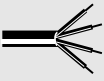
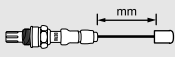

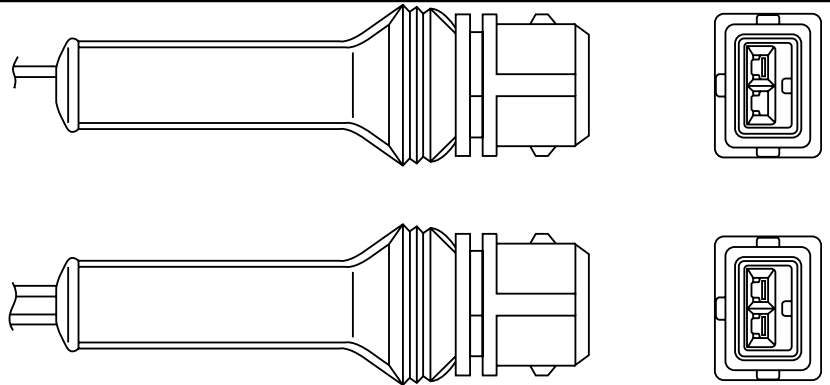

 3	 mm 420/300
 M 18 x 1,5	 22 Nm 45

**OZH 067**

0 824 010 073

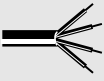
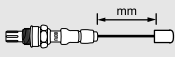

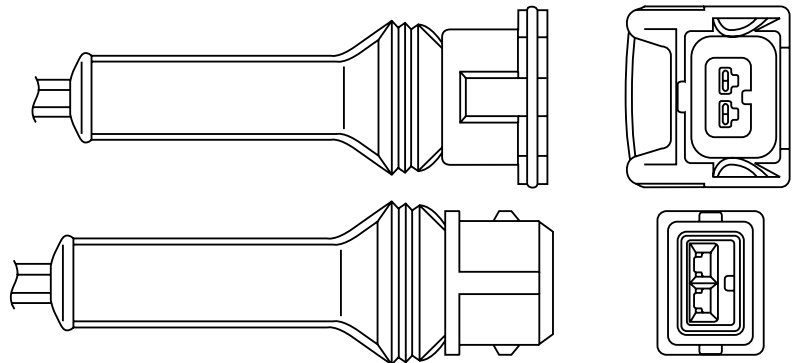

 4	 mm 1590
 M 18 x 1,5	 22 Nm 45

**OZH 068**

0 824 010 074

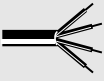
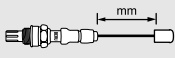

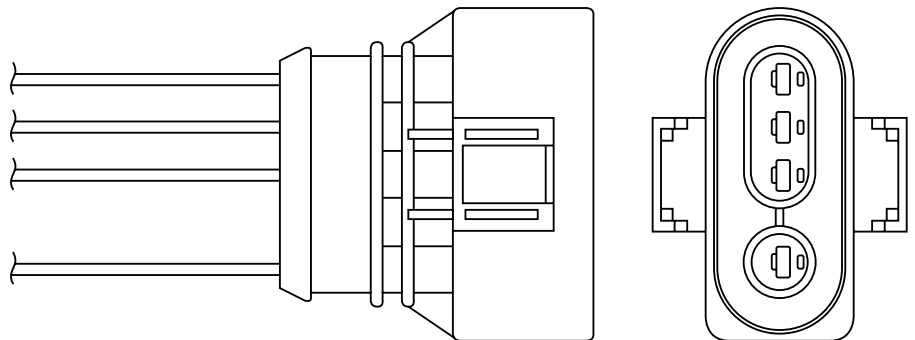

 4	 mm 880
 M 18 x 1,5	 22 Nm 45

**OZH 069**

0 824 010 075

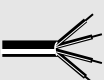
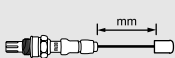

 4	 mm 865
 M 18 x 1,5	 22 Nm 45

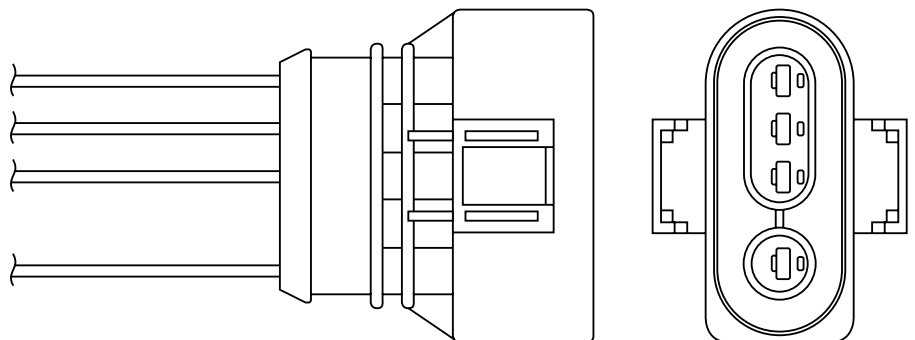

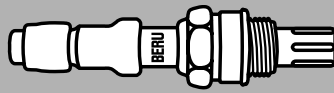

OZH 070

0 824 010 076

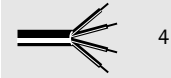

4

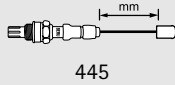

445



M 18 x 1,5



22

Nm

45

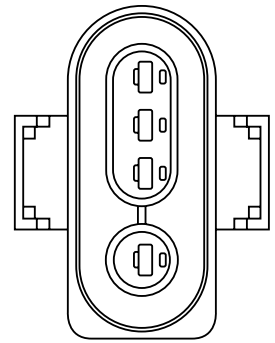
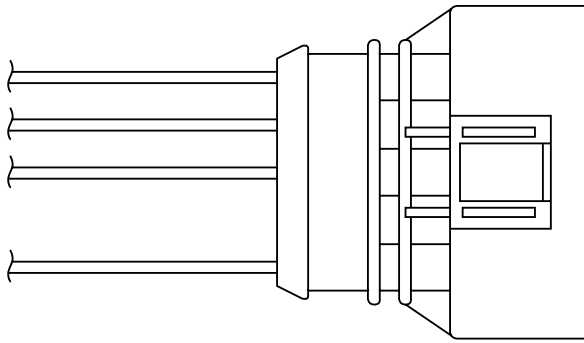

OZH 071

0 824 010 077

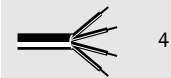

4

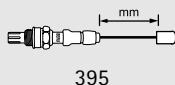

395



M 18 x 1,5



22

Nm

45

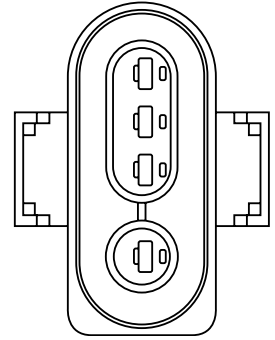
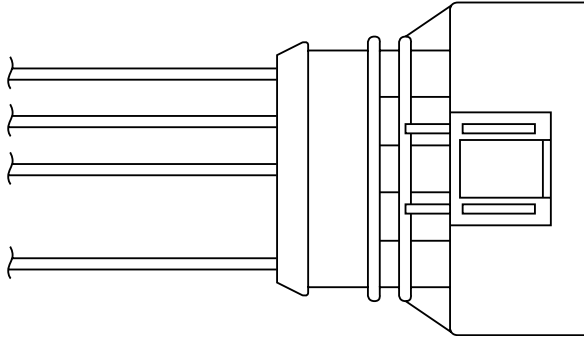

OZH 072

0 824 010 078



4

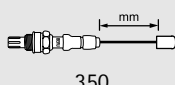

350



M 18 x 1,5



22

Nm

45

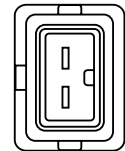
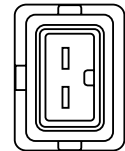
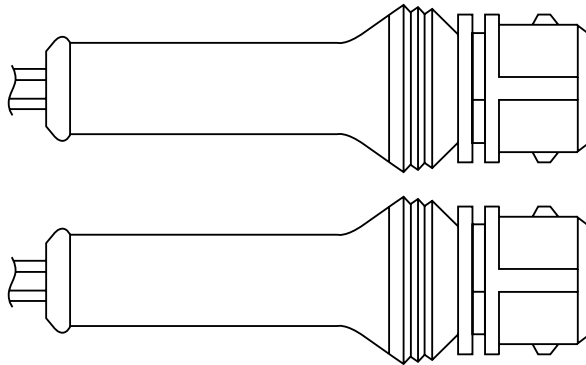

OZH 073

0 824 010 079



4

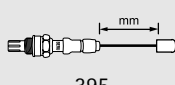

395



M 18 x 1,5



22

Nm

45

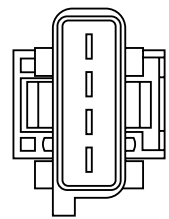
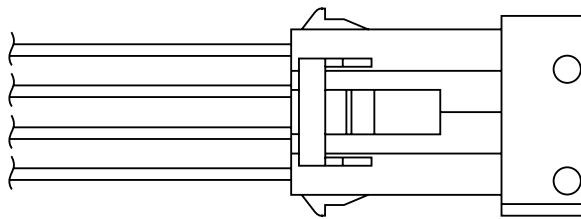

OZH 074

0 824 010 080



4

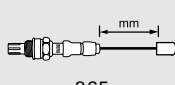

265



M 18 x 1,5



22

Nm

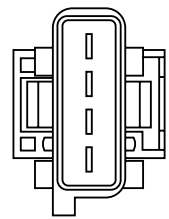
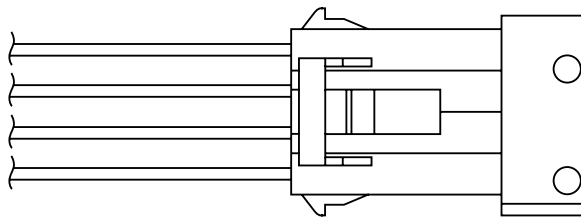

45

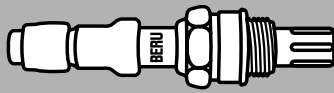

**OZH 075**

0 824 010 081

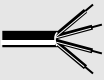
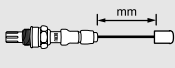

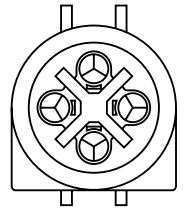
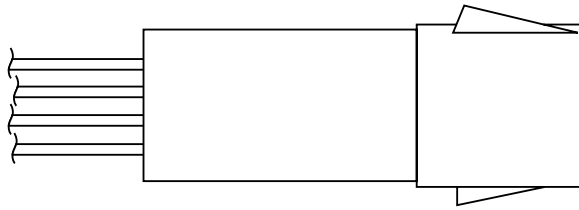

 4	 600
 M 18 x 1,5	 22 Nm 45

**OZH 076**

0 824 010 084

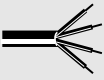
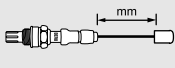

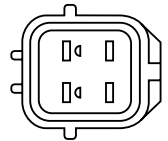
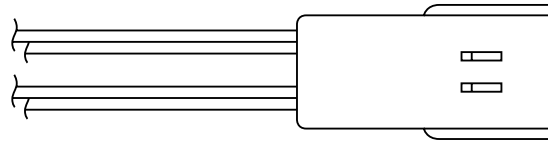

 4	 160
 M 18 x 1,5	 22 Nm 45

**OZH 079**

0 824 010 089

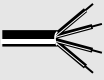
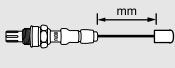

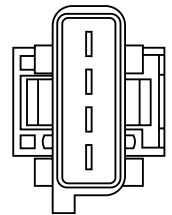
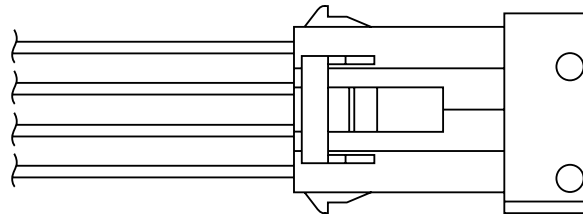

 4	 1120
 M 18 x 1,5	 22 Nm 45

**OZH 083**

0 824 010 098

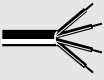
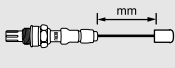

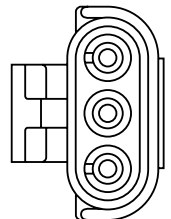
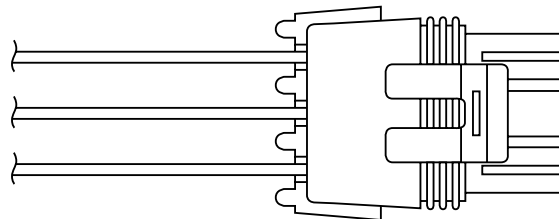

 3	 135
 M 18 x 1,5	 22 Nm 45

**OZH 084**

0 824 010 099

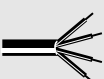
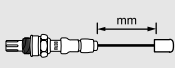

 4	 760
 M 18 x 1,5	 22 Nm 45

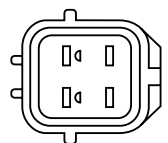
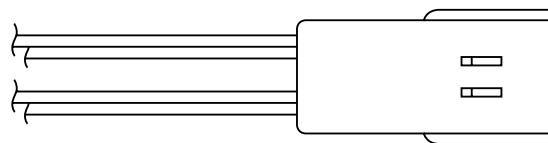

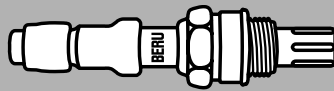

OZH 086

0 824 010 102



4	mm 420
M 18 x 1,5	22 Nm 45

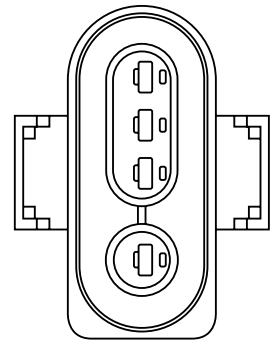
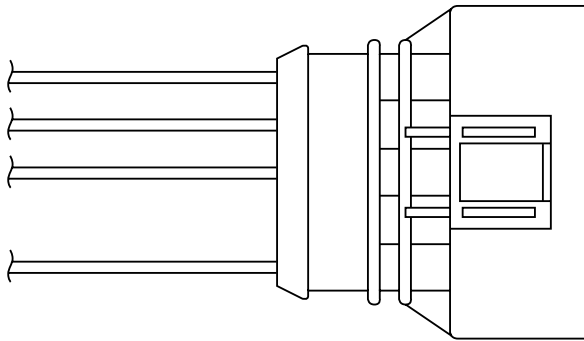

OZH 087

0 824 010 105



4	mm 370
M 18 x 1,5	22 Nm 45

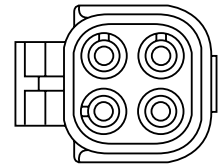
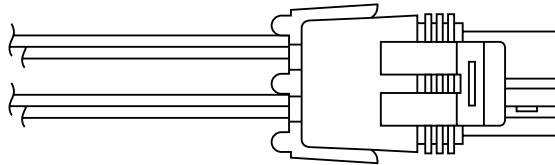

OZH 088

0 824 010 106



4	mm 500
M 18 x 1,5	22 Nm 45

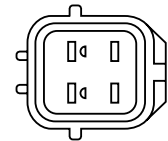
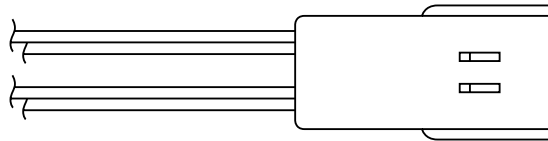

OZH 092

0 824 010 112



4	mm 220
M 18 x 1,5	22 Nm 45

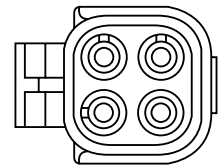
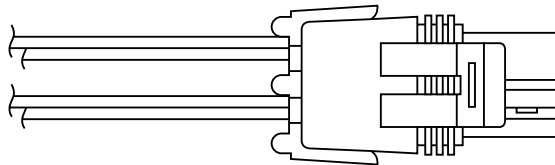

OZH 094

0 824 010 114



4	mm 450
M 18 x 1,5	22 Nm 45

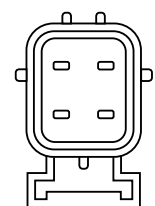
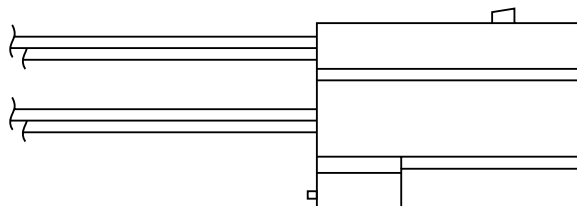

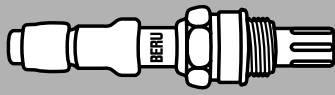



OZH 095

0 824 010 117

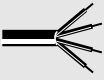
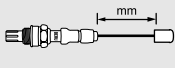

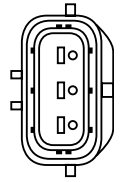
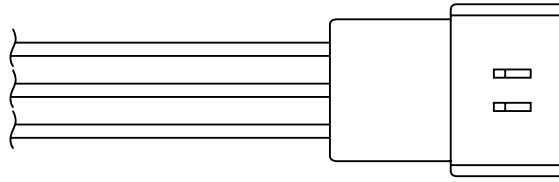

 3	 260
 M 18 x 1,5	 22 Nm 45



OZH 096

0 824 010 118

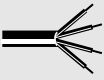
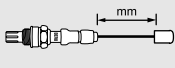

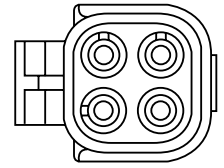
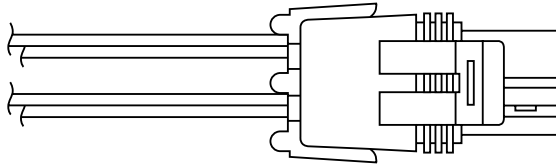

 4	 265
 M 18 x 1,5	 22 Nm 45



OZH 098

0 824 010 120

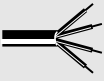
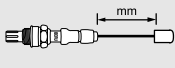

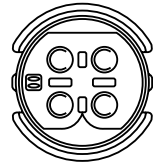
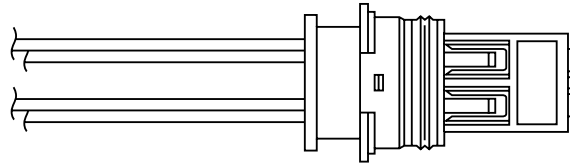

 4	 1040
 M 18 x 1,5	 22 Nm 45

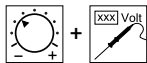

OZH 099

0 824 010 121

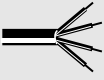
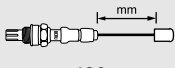

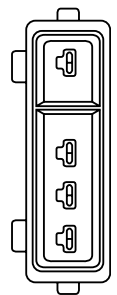
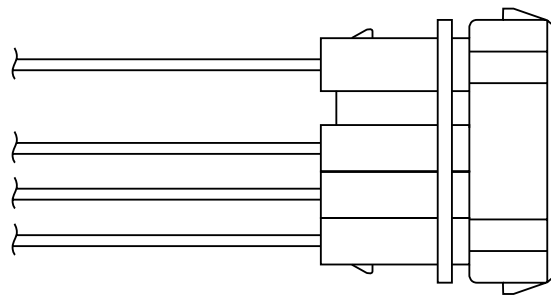

 4	 420
 M 18 x 1,5	 22 Nm 45



OZH 100

0 824 010 124

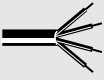
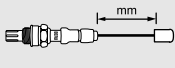

 3	 290
 M 18 x 1,5	 22 Nm 45

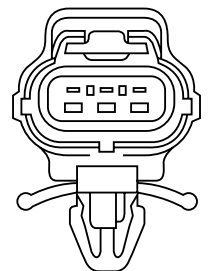
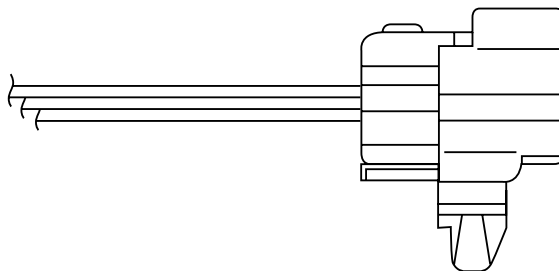

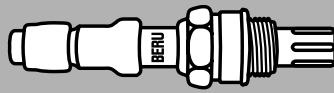

OZH 101

0 824 010 125



4

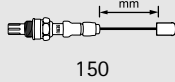

150

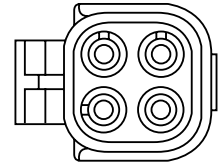
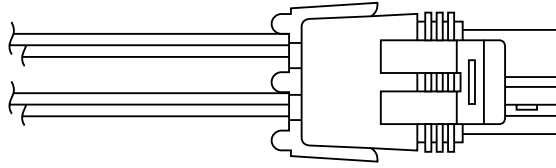

M 18 x 1,5



22

Nm

45

OZH 103

0 824 010 128



4

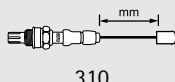

310

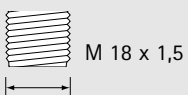
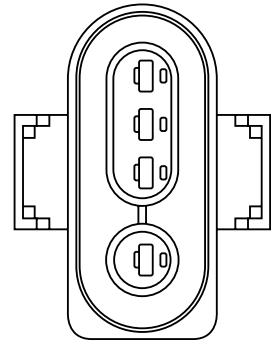
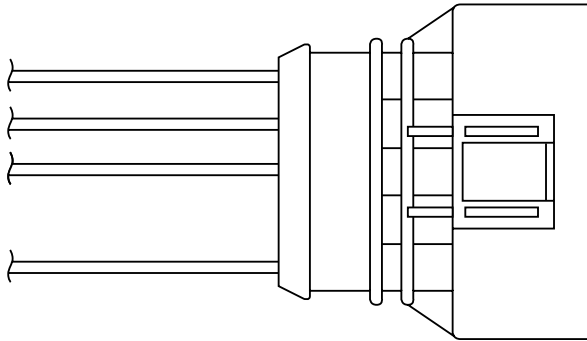

M 18 x 1,5



22

Nm

45

OZH 104

0 824 010 129



4

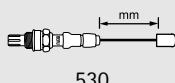

530

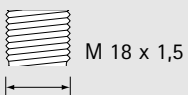
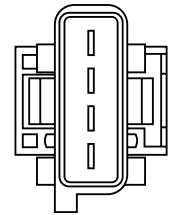
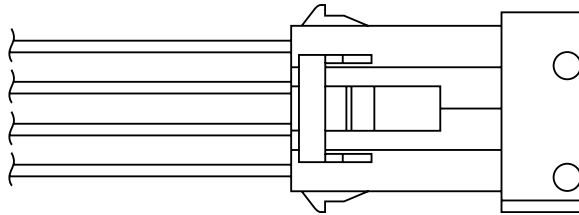

M 18 x 1,5



22

Nm

45

OZH 107

0 824 010 139



3

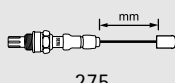

275

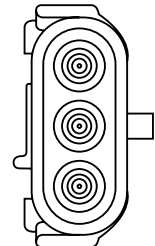
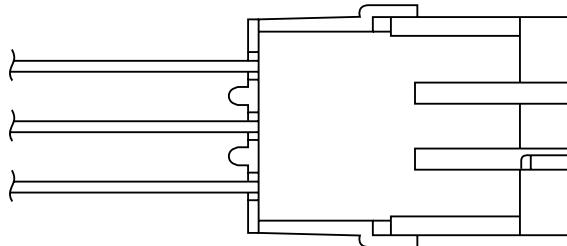

M 18 x 1,5



22

Nm

45

OZH 108

0 824 010 107



3

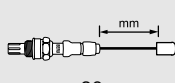

80

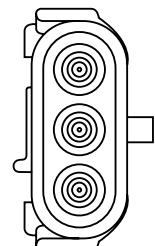
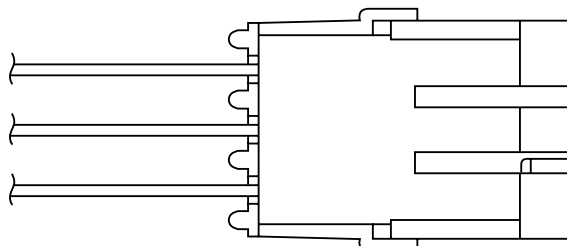

M 18 x 1,5



22

Nm

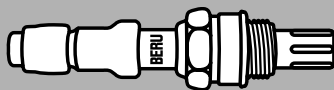

45



OZH 109

0 824 010 127

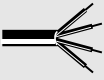
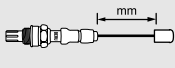

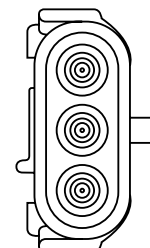
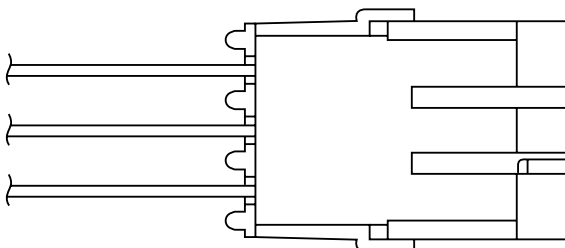

 3	 mm 150
 M 18 x 1,5	 22 Nm 45

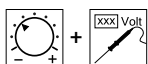

OZH 110

0 824 010 144

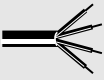
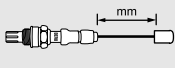

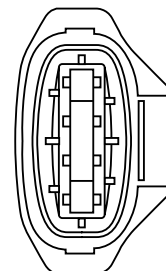
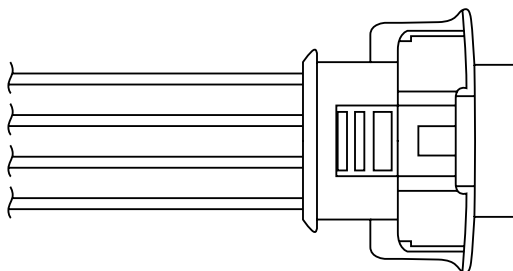

 4	 mm 200
 M 18 x 1,5	 22 Nm 45

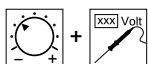

OZH 111

0 824 010 145

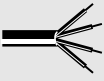
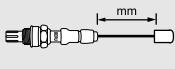

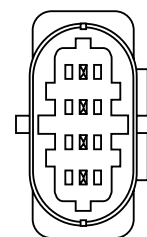
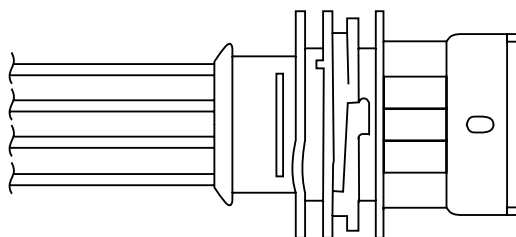

 4	 mm 540
 M 18 x 1,5	 22 Nm 45



OZH 112

0 824 010 146

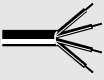
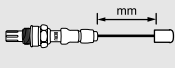

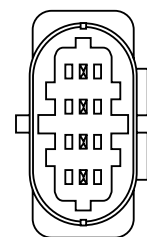
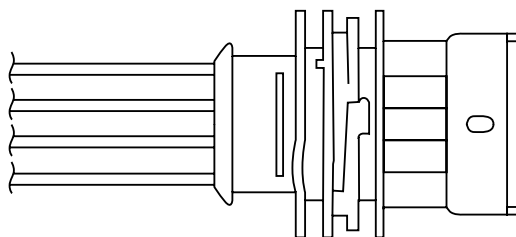

 4	 mm 660
 M 18 x 1,5	 22 Nm 45



OZH 113

0 824 010 147

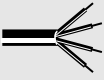
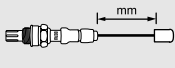

 4	 mm 655
 M 18 x 1,5	 22 Nm 45

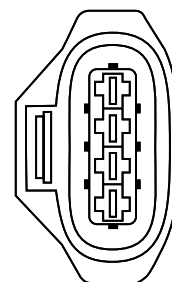
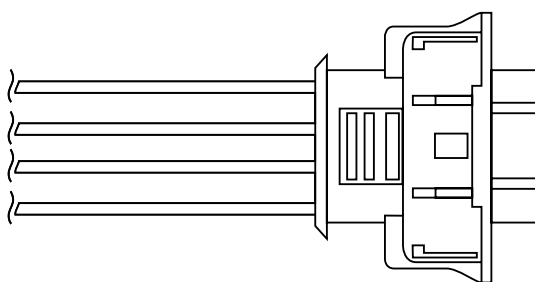

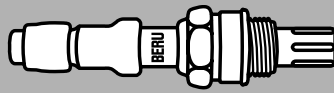

OZH 114

0 824 010 148



4	mm 485
M 18 x 1,5	22 Nm 45

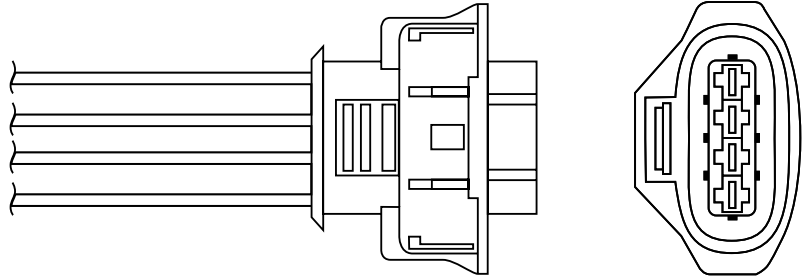

OZH 115

0 824 010 149



4	mm 320
M 18 x 1,5	22 Nm 45

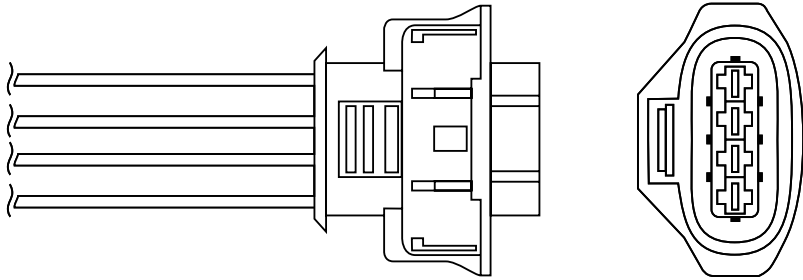

OZH 118

0 824 010 152



4	mm 550
M 18 x 1,5	22 Nm 45

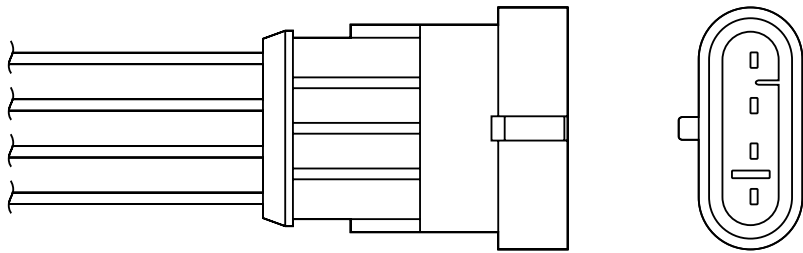

OZH 120

0 824 010 154



4	mm 325
M 18 x 1,5	22 Nm 45

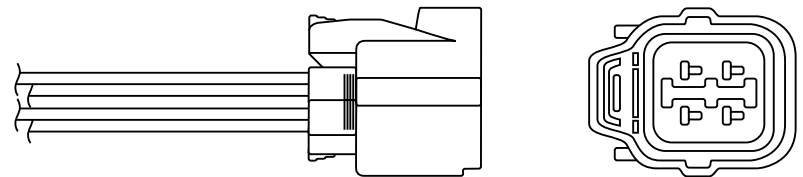

OZH 121

0 824 010 155

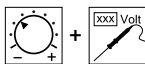

4	mm 155
M 18 x 1,5	22 Nm 45

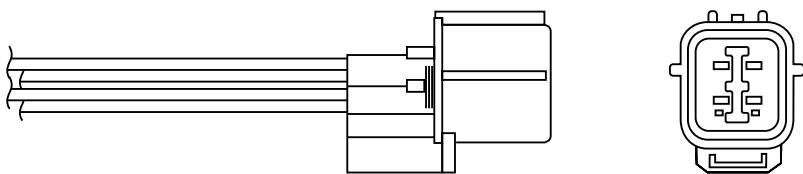

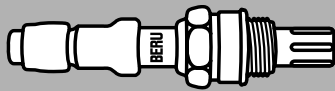



OZH 122

0 824 010 156

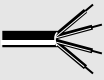
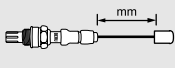

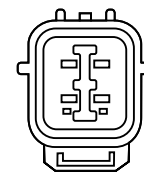
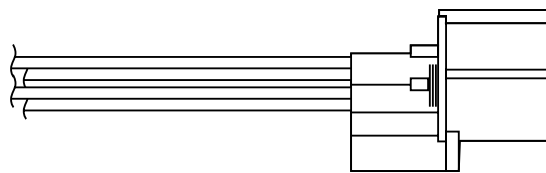

 4	 320
 M 18 x 1,5	 22 Nm 45



OZH 123

0 824 010 157

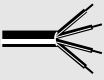
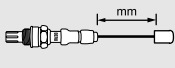

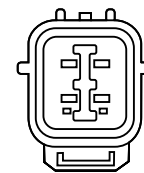
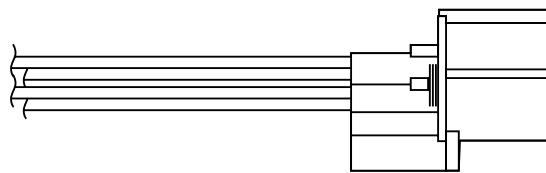

 4	 230
 M 18 x 1,5	 22 Nm 45



OZH 124

0 824 010 158

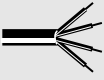
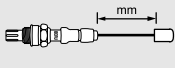

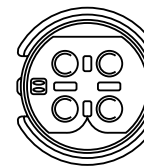
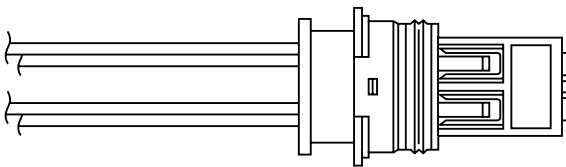

 4	 575
 M 18 x 1,5	 22 Nm 45



OZH 125

0 824 010 159

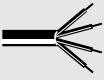
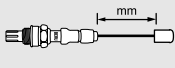

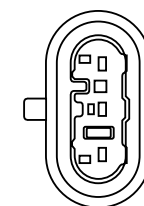
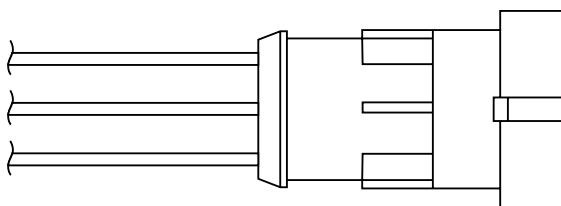

 3	 150
 M 18 x 1,5	 22 Nm 45



OZH 127

0 824 010 161

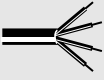
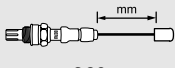

 4	 360
 M 18 x 1,5	 22 Nm 45

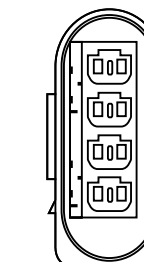
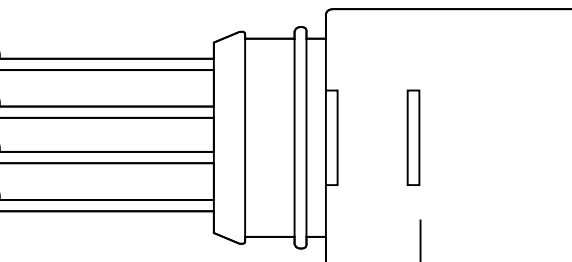

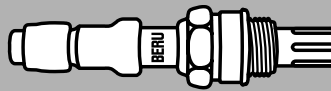

OZH 128

0 824 010 162



4	510
M 18 x 1,5	22 Nm 45

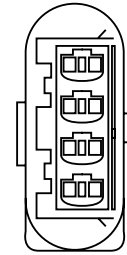
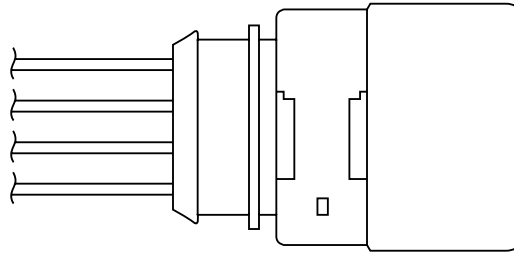

OZH 130

0 824 010 164



4	955
M 18 x 1,5	22 Nm 45

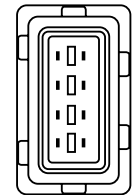
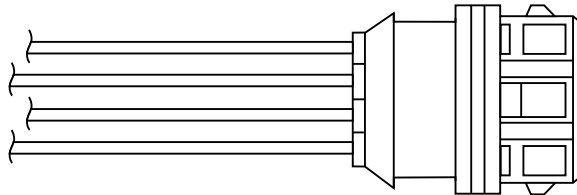

OZH 131

0 824 010 165



3	335
M 18 x 1,5	22 Nm 45

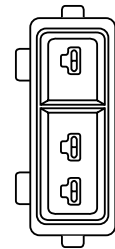
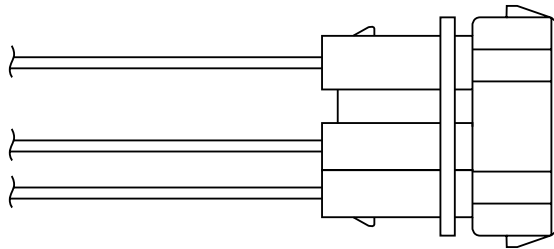

OZH 132

0 824 010 166



4	400
M 18 x 1,5	22 Nm 45

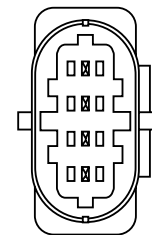
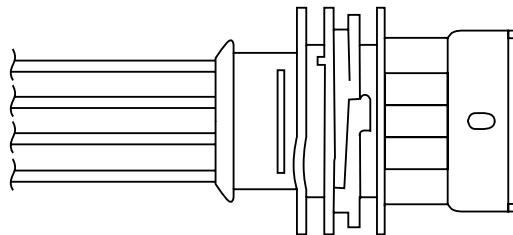

OZH 134

0 824 010 168



3	240
M 18 x 1,5	22 Nm 45

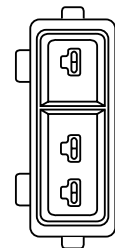
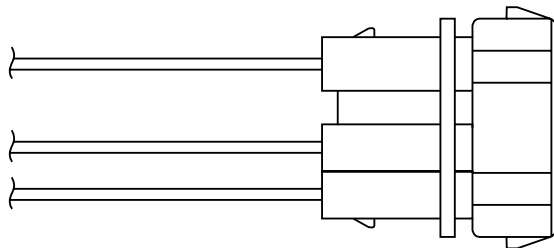

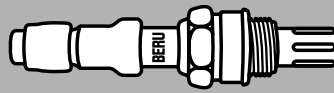

OZH 135

0 824 010 169



4	mm 190
M 18 x 1,5	22 Nm 45

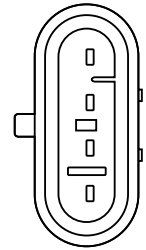
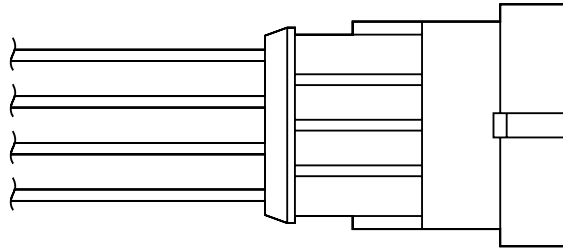

OZH 136

0 824 010 170



4	mm 470
M 18 x 1,5	22 Nm 45

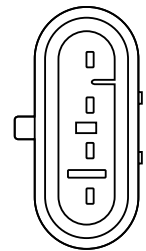
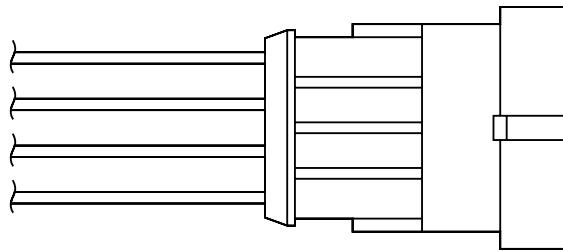

OZH 137

0 824 010 171



4	mm 710
M 18 x 1,5	22 Nm 45

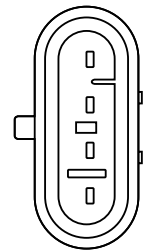
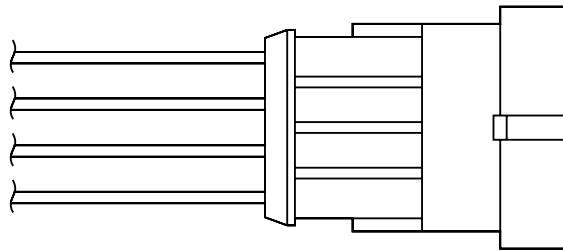

OZH 138

0 824 010 172



4	mm 780
M 18 x 1,5	22 Nm 45

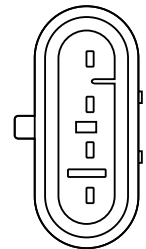
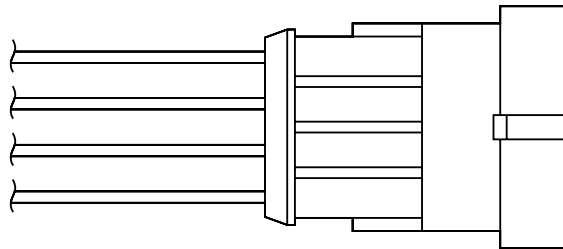

OZH 143

0 824 010 177

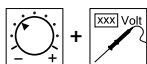

4	mm 220
M 18 x 1,5	22 Nm 45

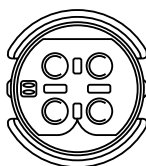
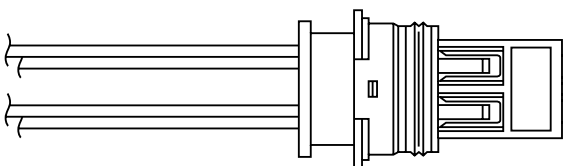

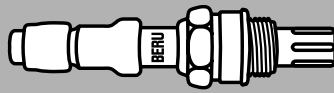

OZH 144

0 824 010 178



4	310
M 18 x 1,5	22 Nm 45

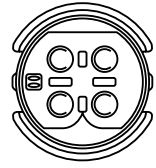
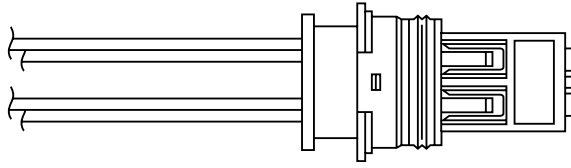

OZH 145

0 824 010 179

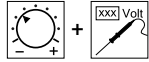

4	530
M 18 x 1,5	22 Nm 45

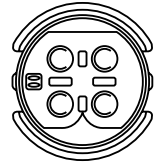
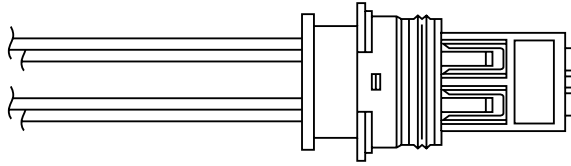

OZH 146

0 824 010 180



4	875
M 18 x 1,5	22 Nm 45

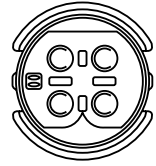
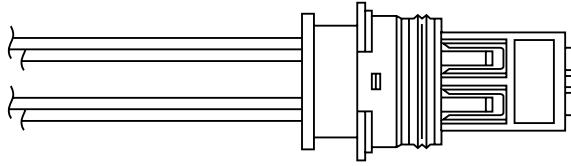

OZH 147

0 824 010 181



3	310
M 18 x 1,5	22 Nm 45

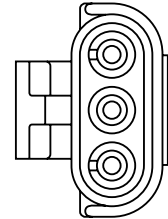
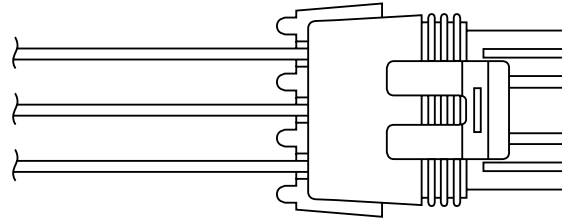

OZH 148

0 824 010 182



4	210
M 18 x 1,5	22 Nm 45

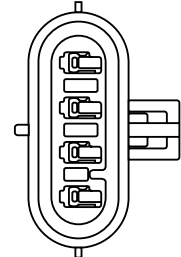
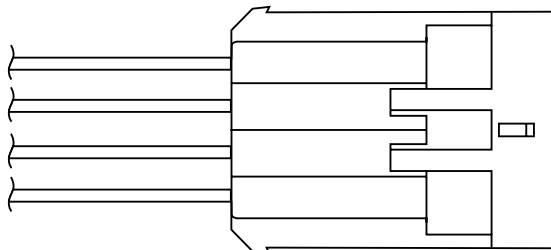

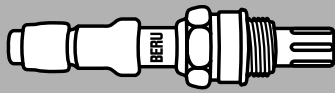

OZH 150

0 824 010 184



4	mm 560
M 18 x 1,5	22 Nm 45

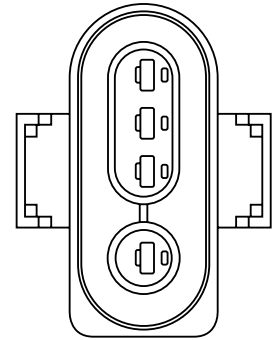
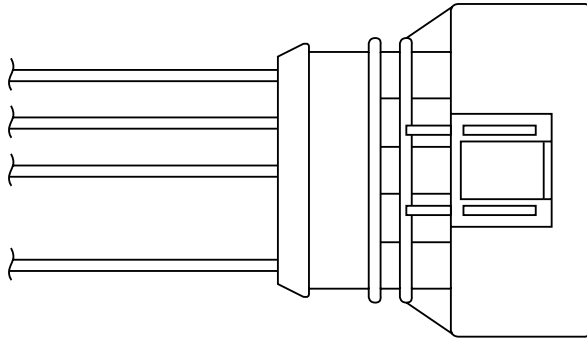

OZH 151

0 824 010 185



4	mm 650
M 18 x 1,5	22 Nm 45

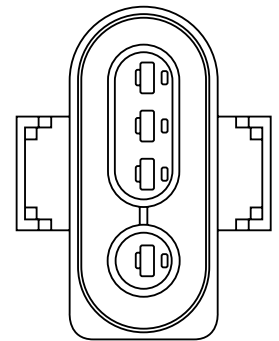
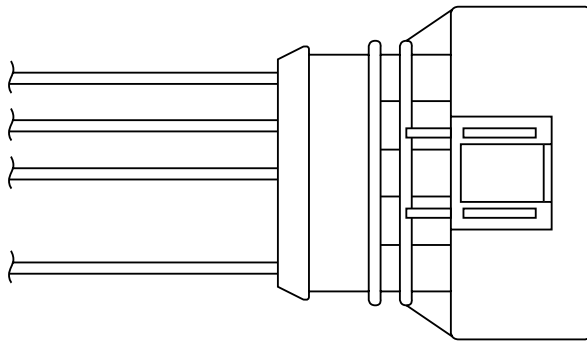

OZH 152

0 824 010 186



4	mm 1060
M 18 x 1,5	22 Nm 45

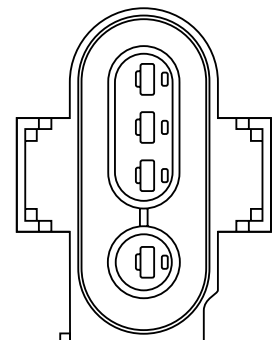
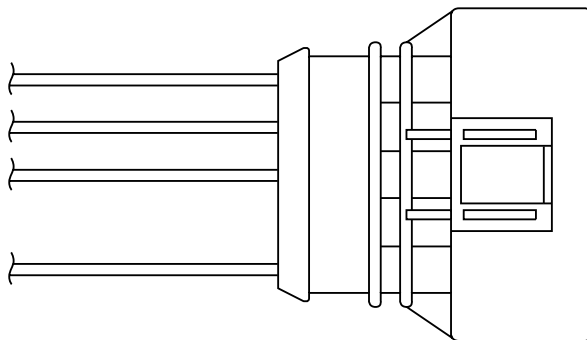

OZH 153

0 824 010 187



4	mm 1610
M 18 x 1,5	22 Nm 45

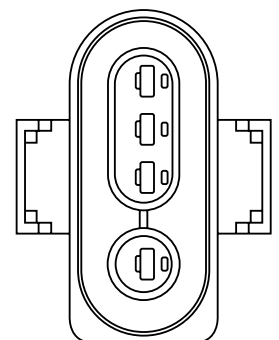
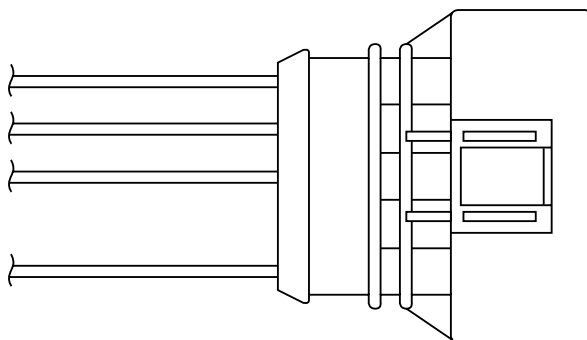

OZH 154

0 824 010 188



3	mm 370
M 18 x 1,5	22 Nm 45

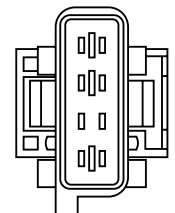
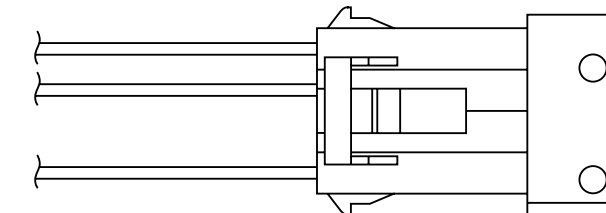

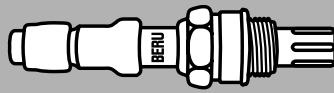

OZH 155

0 824 010 189



3	mm 790
M 18 x 1,5	22 Nm 45

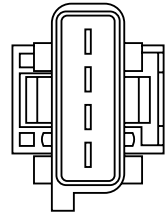
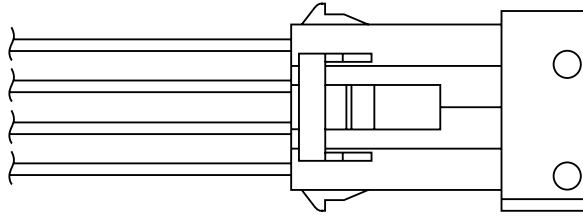

OZH 156

0 824 010 190



4	mm 990
M 18 x 1,5	22 Nm 45

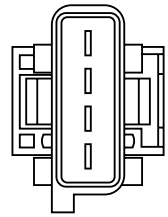
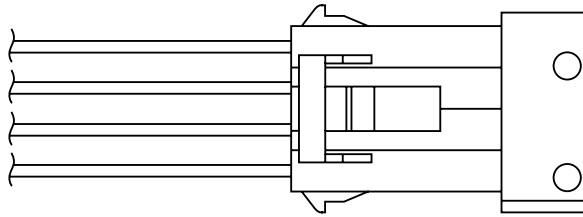

OZH 157

0 824 010 191



3	mm 1000
M 18 x 1,5	22 Nm 45

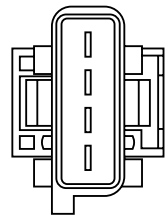
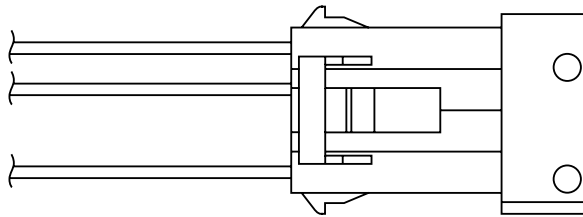

OZH 158

0 824 010 192



3	mm 1340
M 18 x 1,5	22 Nm 45

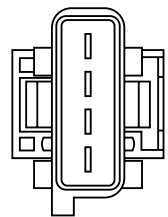
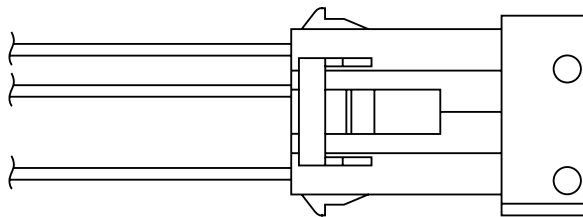

OZH 159

0 824 010 193



4	mm 1380
M 18 x 1,5	22 Nm 45

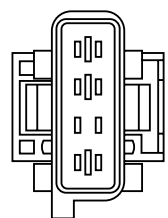
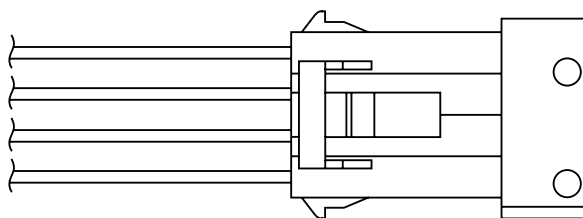

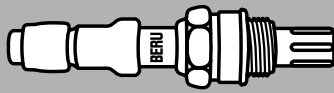



OZH 160

0 824 010 194

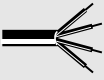
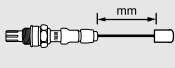

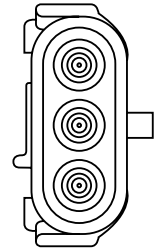
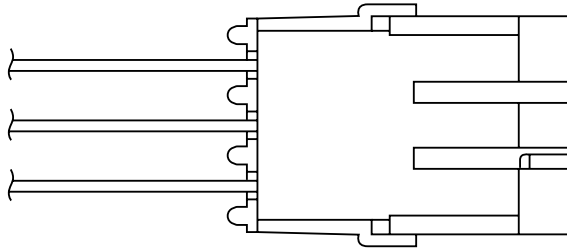

 3	 570
 M 18 x 1,5	 22 Nm 45



OZH 161

0 824 010 195

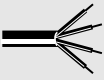
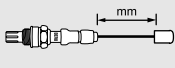

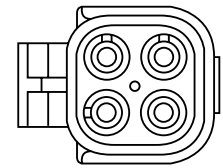
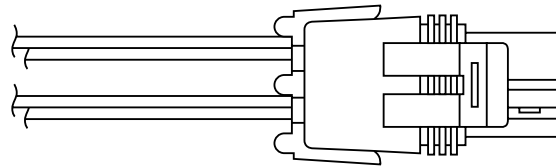

 4	 90
 M 18 x 1,5	 22 Nm 45



OZH 163

0 824 010 197

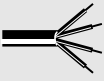
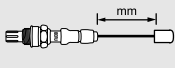

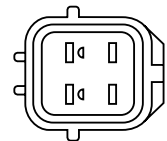
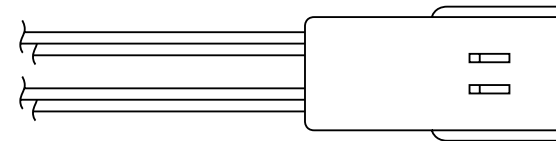

 4	 390
 M 18 x 1,5	 22 Nm 45



OZH 164

0 824 010 198

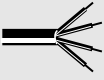
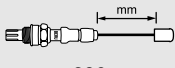

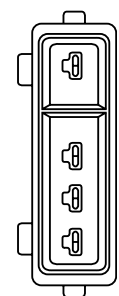
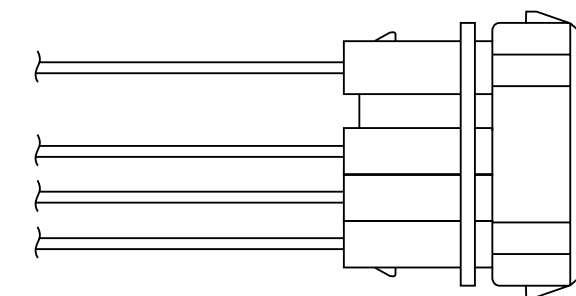

 4	 290
 M 18 x 1,5	 22 Nm 45



OZH 165

0 824 010 199

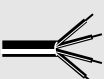
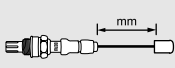

 4	 870
 M 18 x 1,5	 22 Nm 45

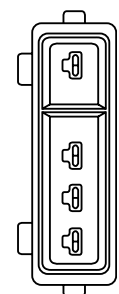
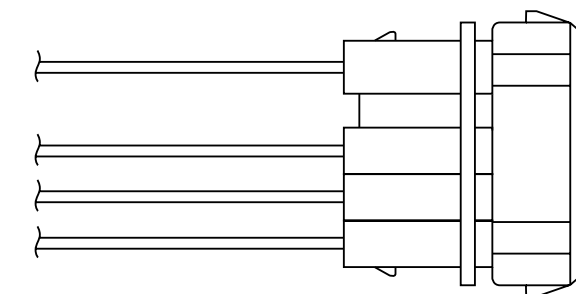

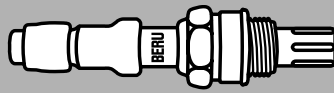

OZH 166

0 824 010 200



4

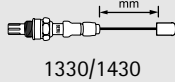

1330/1430



M 18 x 1,5



22

Nm

45

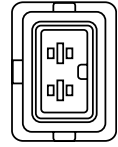
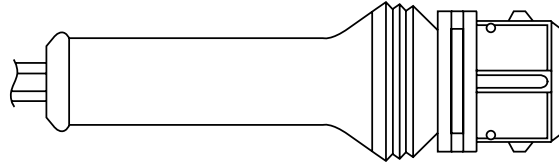
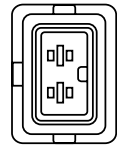
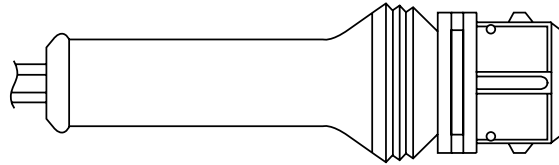

OZH 167

0 824 010 201

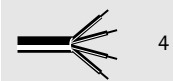
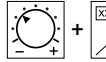

4

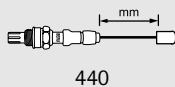

440



M 18 x 1,5



22

Nm

45

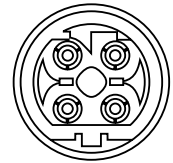
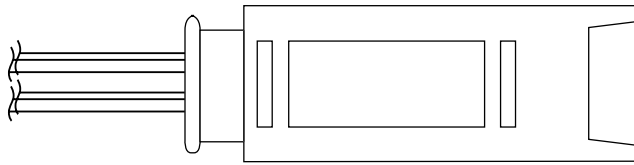

OZH 168

0 824 010 202



4

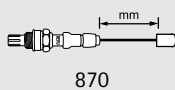

870



M 18 x 1,5



22

Nm

45

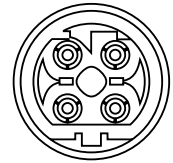
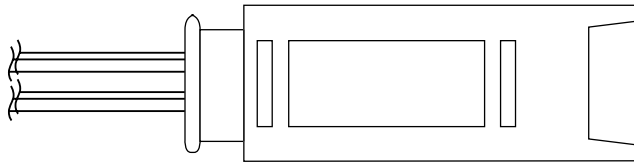

OZH 169

0 824 010 203



4

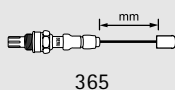

365



M 18 x 1,5



22

Nm

45

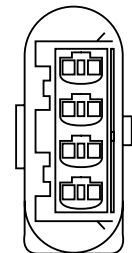
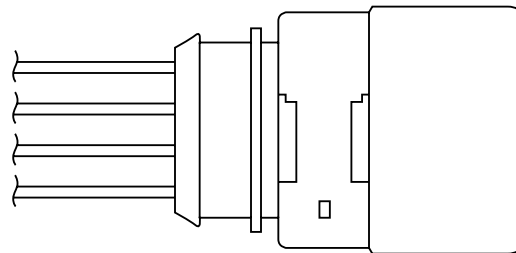

OZH 173

0 824 010 207



4

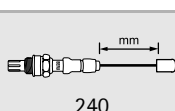

240



M 18 x 1,5



22

Nm

45

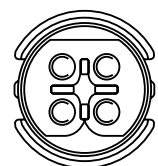
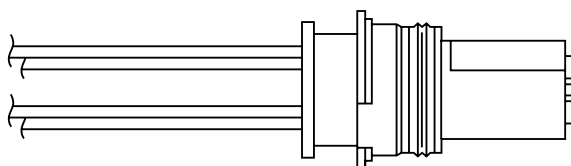

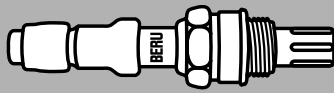
**OZH 176**

0 824 010 210

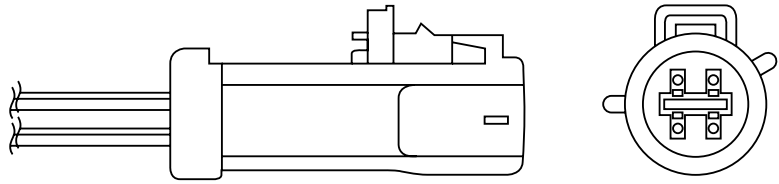

4	mm 270
M 18 x 1,5	22 Nm 45

**OZH 177**

0 824 010 211

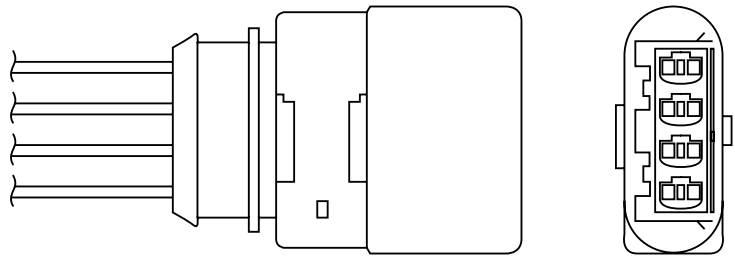

4	mm 590
M 18 x 1,5	22 Nm 45

**OZH 178**

0 824 010 212

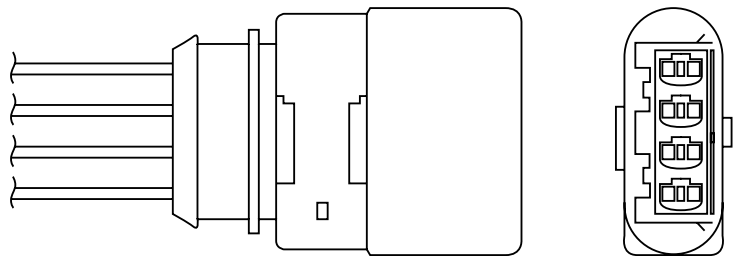

4	mm 950
M 18 x 1,5	22 Nm 45

**OZH 179**

0 824 010 213

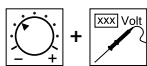

4	mm 1500
M 18 x 1,5	22 Nm 45

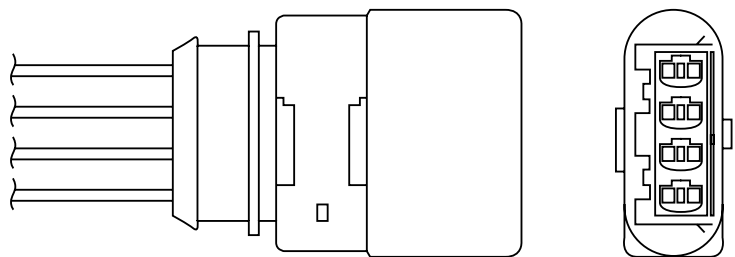
**OZH 180**

0 824 010 214

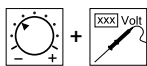

4	mm 520
M 18 x 1,5	22 Nm 45

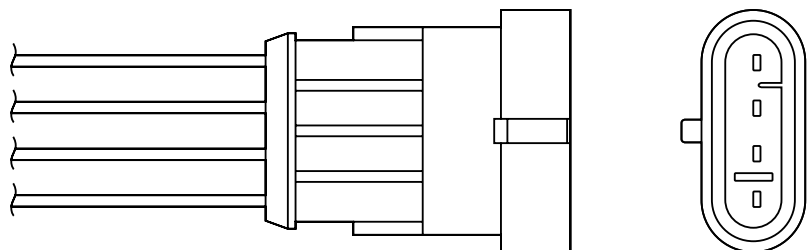

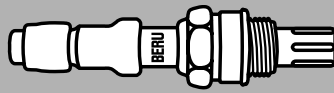

OZH 181

0 824 010 215



4

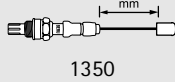

1350



M 18 x 1,5



22

Nm

45

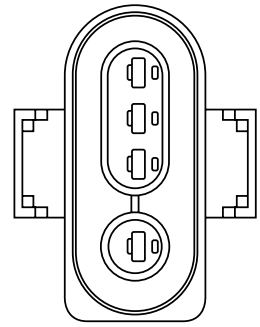
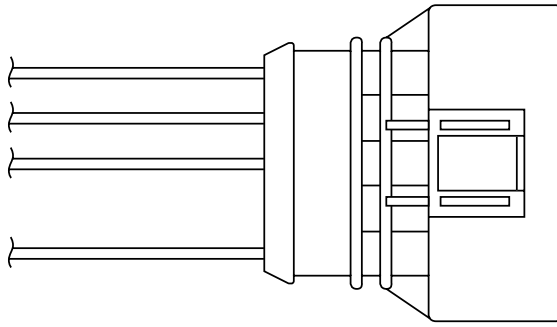

OZH 182

0 824 010 216



4

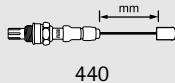

440



M 18 x 1,5



22

Nm

45

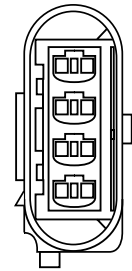
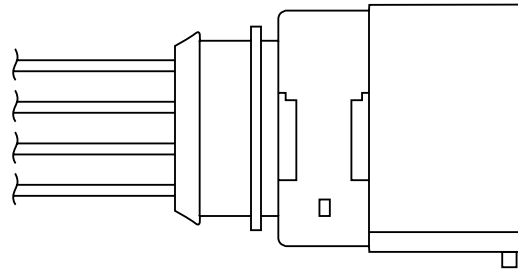

OZH 184

0 824 010 218



4



340



M 18 x 1,5



22

Nm

45

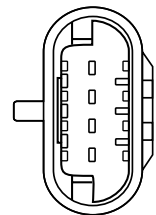
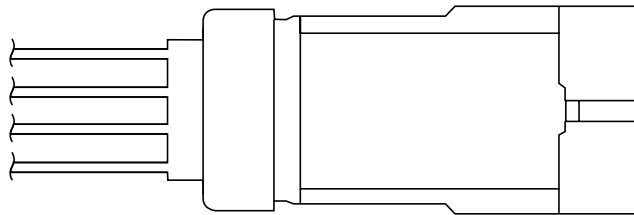

OZH 190

0 824 010 224



4

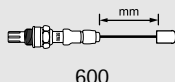

600



M 18 x 1,5



22

Nm

45

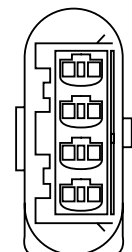
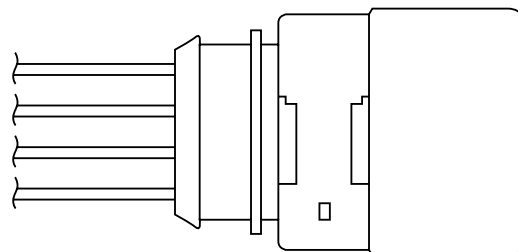

OZH 192

0 824 010 226



3

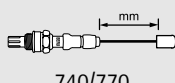

740/770

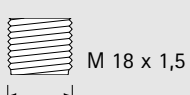

M 18 x 1,5



22

Nm

45

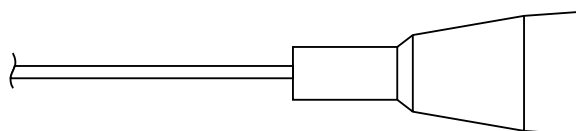
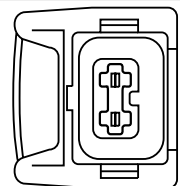
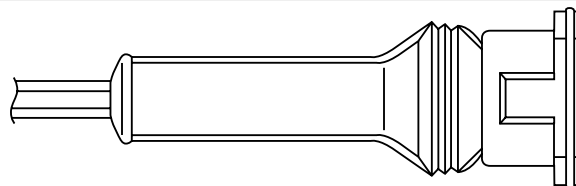

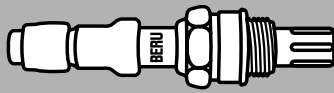



OZH 193

0 824 010 227

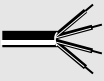
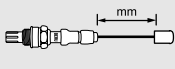

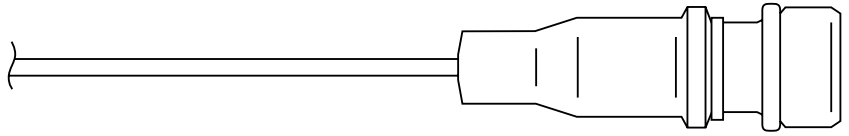

 4	 mm 1465
 M 18 x 1,5	 22 Nm 45



OZH 194

0 824 010 228

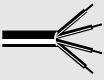
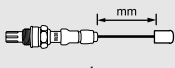

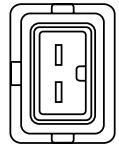
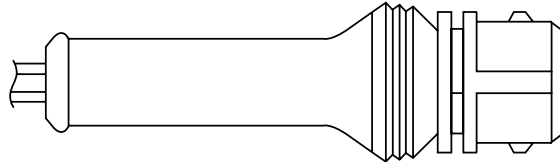
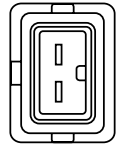
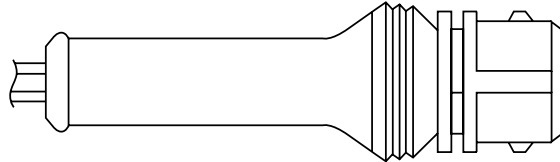

 4	 mm 1380/1470
 M 18 x 1,5	 22 Nm 45



OZH 196

0 824 010 230

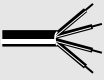
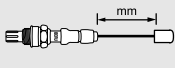

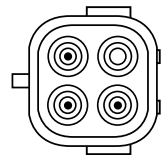
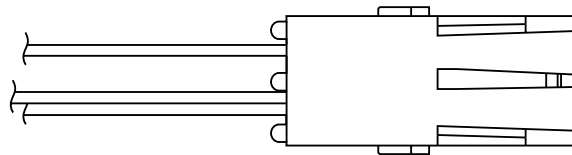

 3	 mm 200
 M 18 x 1,5	 22 Nm 45



OZH 198

0 824 010 232

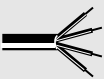
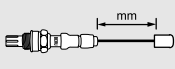

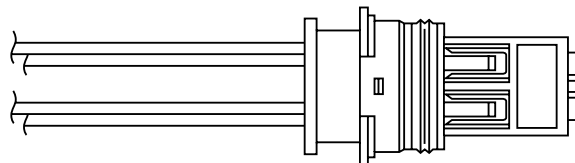

 4	 mm 90
 M 18 x 1,5	 22 Nm 45



OZH 199

0 824 010 233

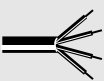
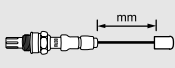

 4	 mm 630
 M 18 x 1,5	 22 Nm 45

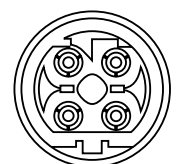
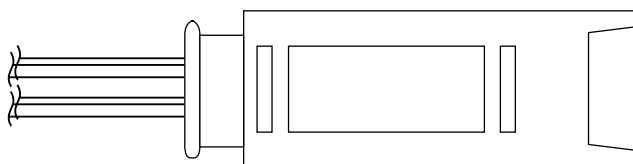

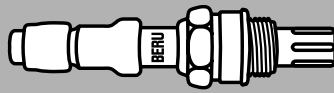



OZH 200

0 824 010 234

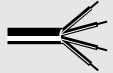
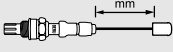

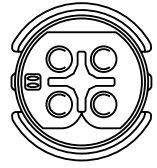
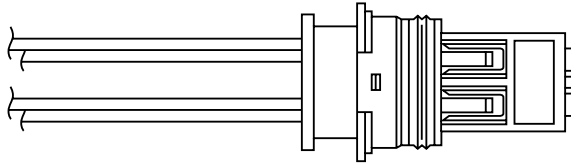

 4	 mm 385
 M 18 x 1,5	 22 Nm 45



OZH 201

0 824 010 235

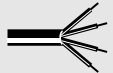
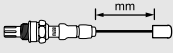

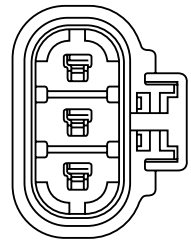
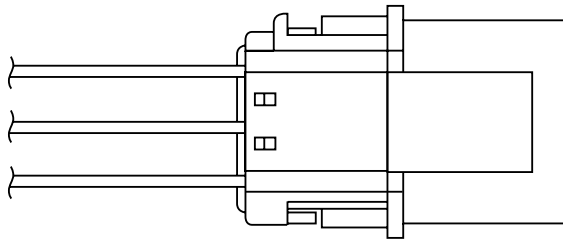

 3	 mm 150
 M 18 x 1,5	 22 Nm 45



OZH 203

0 824 010 237

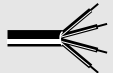
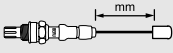

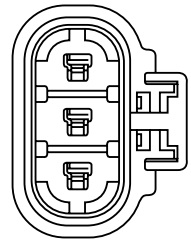
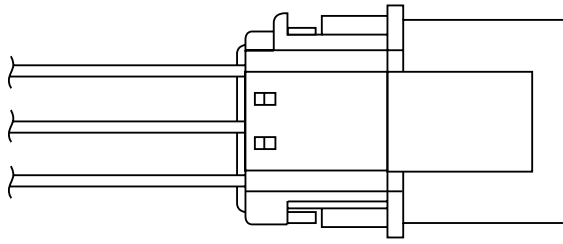

 3	 mm 420
 M 18 x 1,5	 22 Nm 45



OZH 204

0 824 010 238

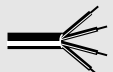
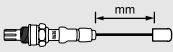

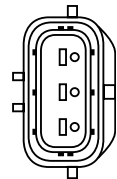
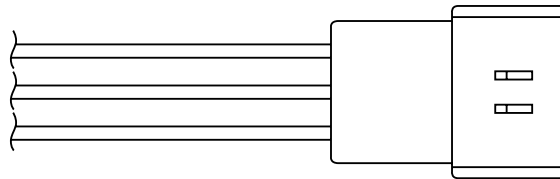

 3	 mm 420
 M 18 x 1,5	 22 Nm 45



OZH 205

0 824 010 239

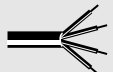
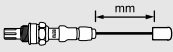

 4	 mm 430
 M 18 x 1,5	 22 Nm 45

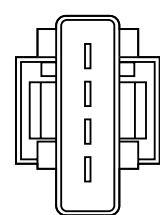
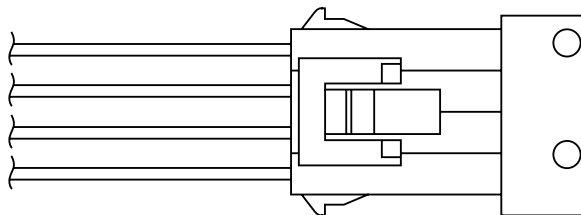

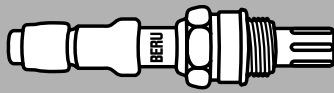

OZH 206

0 824 010 240



4	1120
M 18 x 1,5	22 Nm 45

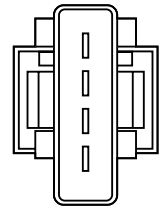
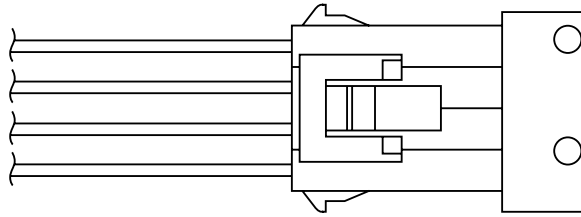

OZH 207

0 824 010 241



3	480
M 18 x 1,5	22 Nm 45

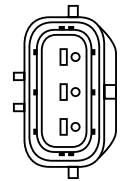
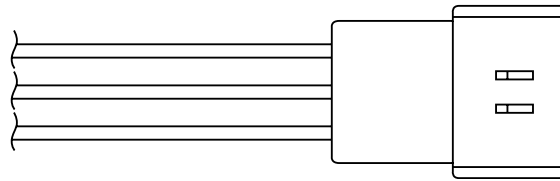

OZH 208

0 824 010 242



4	310
M 18 x 1,5	22 Nm 45

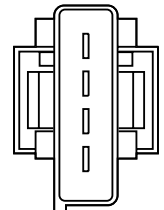
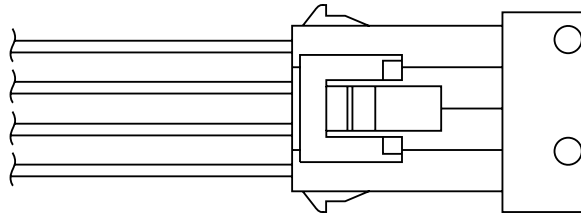

OZH 209

0 824 010 243



4	1640
M 18 x 1,5	22 Nm 45

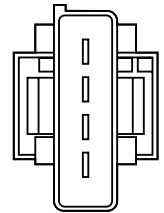
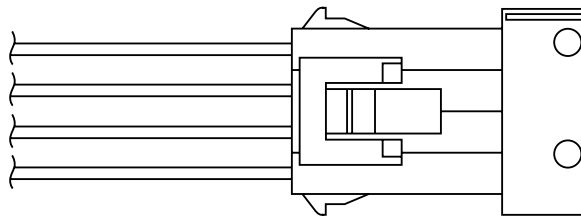

OZH 210

0 824 010 244



4	560
M 18 x 1,5	22 Nm 45

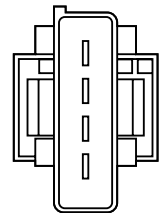
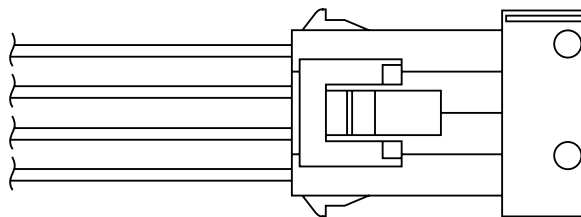

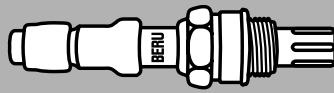



OZH 215

0 824 010 249

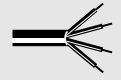
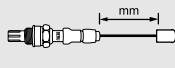

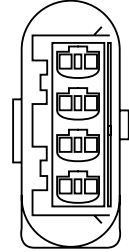
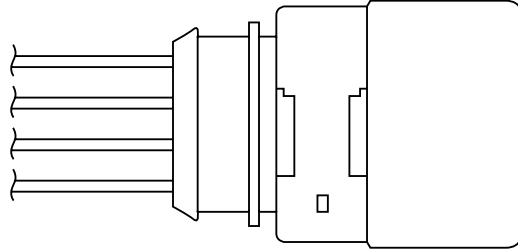

 4	 mm 875
 M 18 x 1,5	 22 Nm 45



OZH 217

0 824 010 251

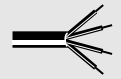
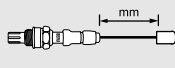
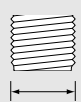

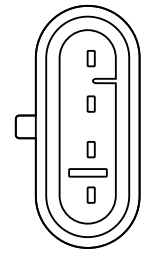
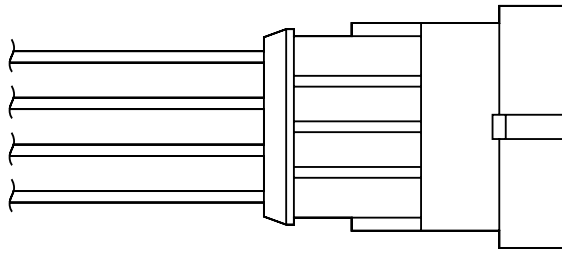

 4	 mm 1080
 M 18 x 1,5	 22 Nm 45



OZH 218

0 824 010 252

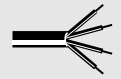
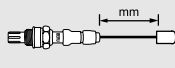

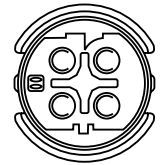
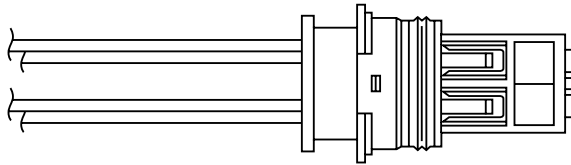

 4	 mm 880
 M 18 x 1,5	 22 Nm 45



OHZ 220

0 824 010 254

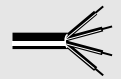
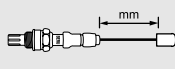

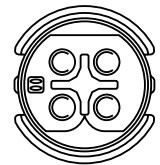
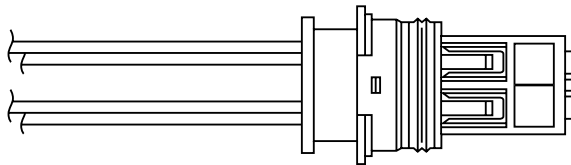

 4	 mm 130
 M 18 x 1,5	 22 Nm 45



OZH 222

0 824 010 256

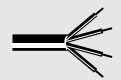
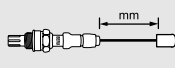

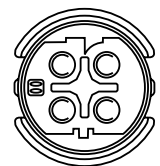
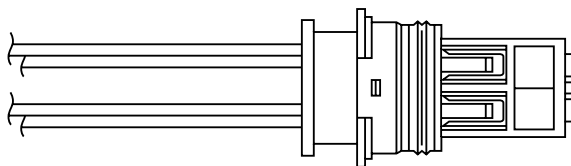

 4	 mm 450
 M 18 x 1,5	 22 Nm 45

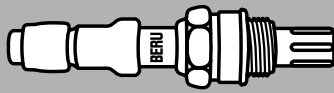

**OZH 223**

0 824 010 257

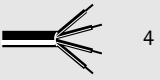
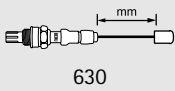

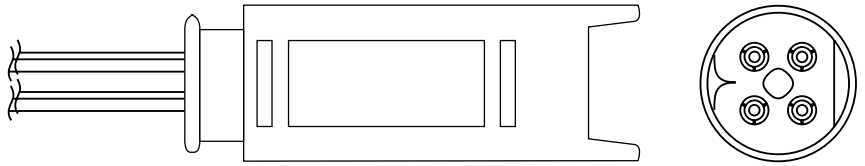

 4	 630
 M 18 x 1,5	 22 Nm 45

**OZH 224**

0 824 010 258

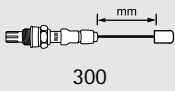
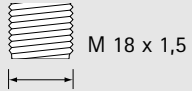

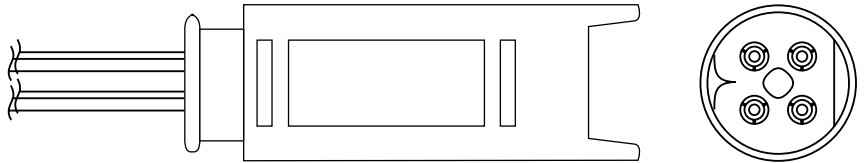

 4	 300
 M 18 x 1,5	 22 Nm 45

**OZH 225**

0 824 010 259

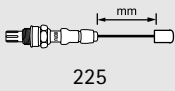
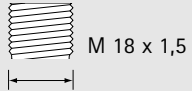

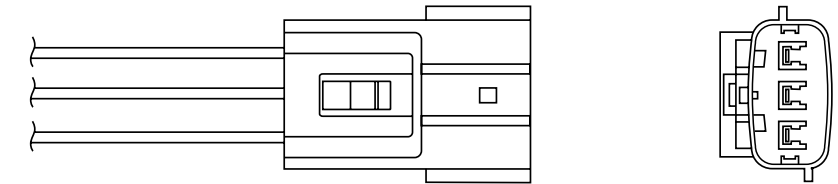

 3	 225
 M 18 x 1,5	 22 Nm 45

**OZH 226**

0 824 010 260

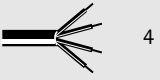
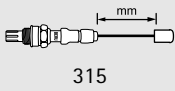
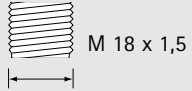

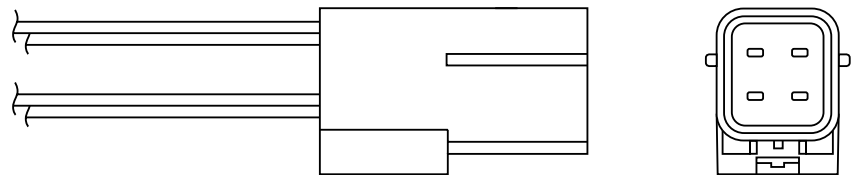

 4	 315
 M 18 x 1,5	 22 Nm 45

**OZH 227**

0 824 010 261

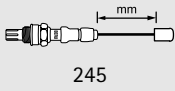
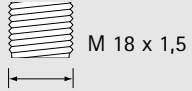

 4	 245
 M 18 x 1,5	 22 Nm 45

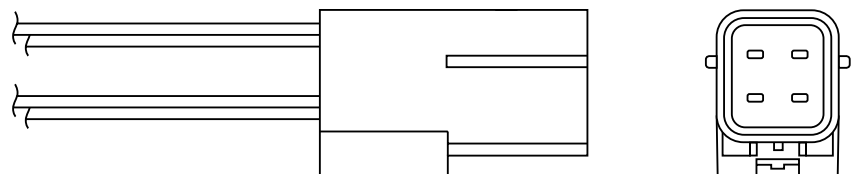

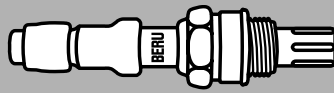

OZH 228

0 824 010 262

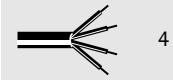

4

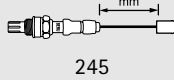

mm
245



M 18 x 1,5



22

Nm

45

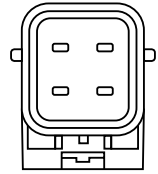
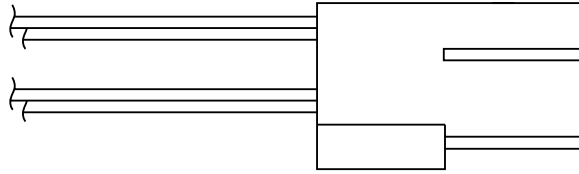

OZH 229

0 824 010 263



4

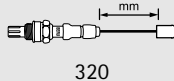

mm
320



M 18 x 1,5



22

Nm

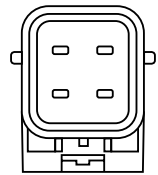
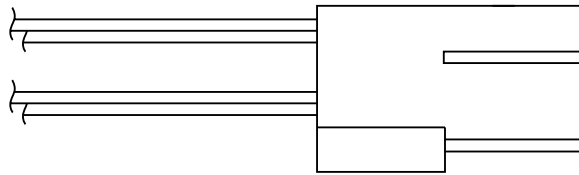

45

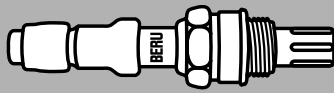

**OZU 001**

0 824 010 001

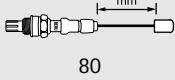



 1	 mm 80
 M 18 x 1,5	 22 Nm 45

**OZU 003**

0 824 010 053

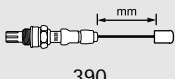

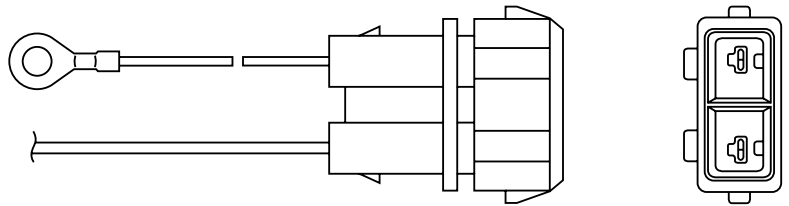

 1	 mm 390
 M 18 x 1,5	 22 Nm 45

**OZU 004**

0 824 010 054

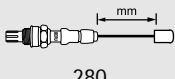

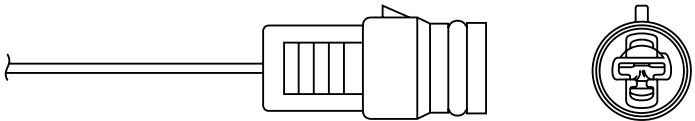

 1	 mm 280
 M 18 x 1,5	 22 Nm 45

**OZU 005**

0 824 010 055

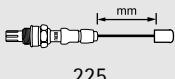

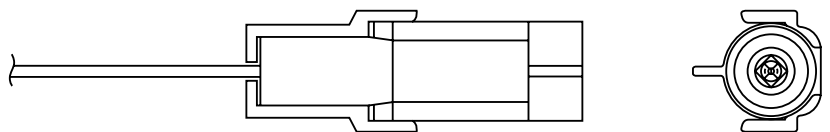

 1	 mm 225
 M 18 x 1,5	 22 Nm 45

**OZU 006**

0 824 010 064

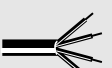
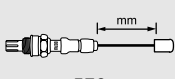

 1	 mm 570
 M 18 x 1,5	 22 Nm 45

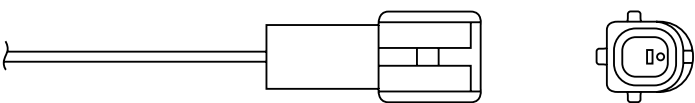

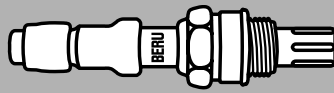

OZU 007

0 824 010 141

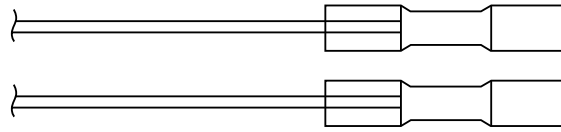
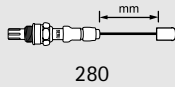
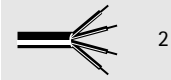

OZU 010

0 824 010 090

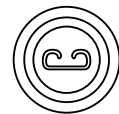
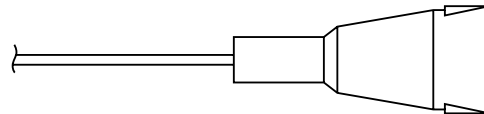
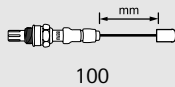
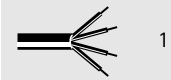

OZU 012

0 824 010 096

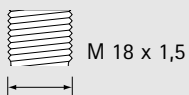
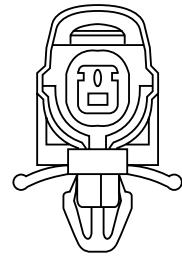
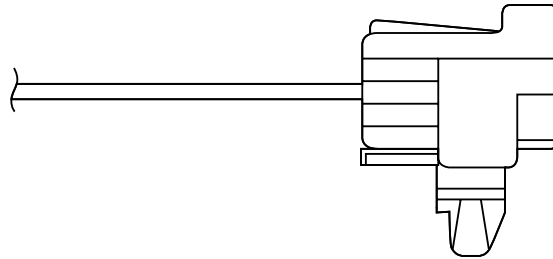
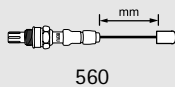

OZU 014

0 824 010 104

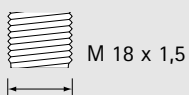
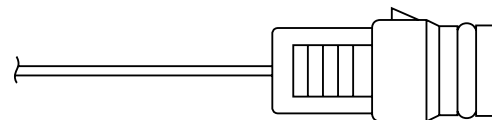
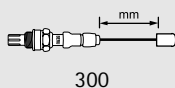

OZU 015

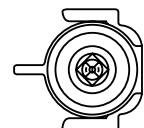
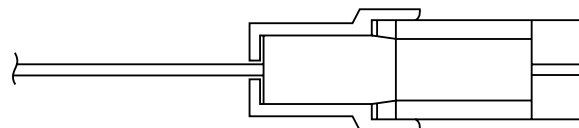
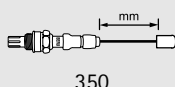

0 824 010 111

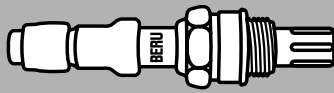

**OZU 021**

0 824 010 131

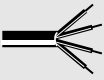
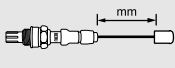

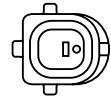
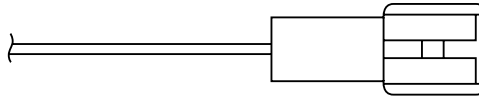

 1	 mm 470
 M 18 x 1,5	 22 Nm 45

**OZU 022**

0 824 010 094

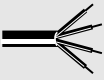
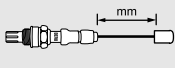

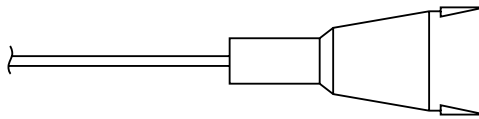

 1	 mm 400
 M 18 x 1,5	 22 Nm 45

**OZU 023**

0 824 010 136

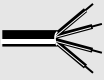
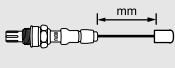

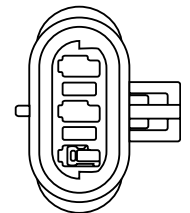
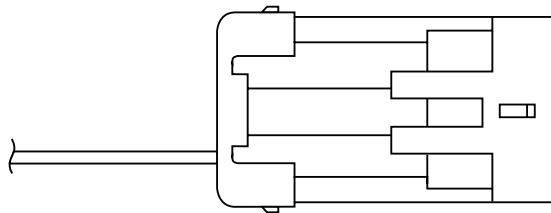

 1	 mm 215
 M 18 x 1,5	 22 Nm 45

**OZU 024**

0 824 010 133

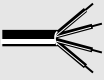
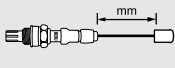

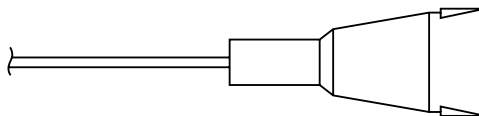

 1	 mm 130
 M 18 x 1,5	 22 Nm 45

**OZU 025**

0 824 010 143

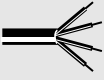
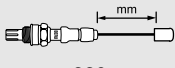

 2	 mm 280
 M 18 x 1,5	 22 Nm 45

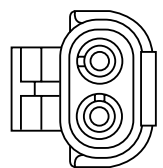
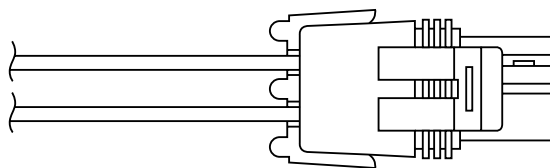

I sensori sono rilevatori ad alta sensibilità, impiegati sempre più frequentemente nei veicoli, per monitorare parametri importanti, come ad esempio temperatura, velocità e dati di posizione. I sensori BERU sono sviluppati in stretta collaborazione con l'industria automobilistica.

BERU è un'azienda pionieristica nello sviluppo e nella lavorazione di prodotti high-tech ed ha accumulato un'esperienza ultraventennale nel campo della tecnologia dei sensori. Questo settore di produzione è stato potenziato continuamente e le tecnologie sono state costantemente migliorate.

Al momento vengono prodotti sensori per la temperatura di aria, olio e acqua, nonché sensori induttivi per il rilevamento della velocità e della posizione, ad es. per alberi a gomito/camme e per ruote dentate.

Grazie a numerose tecnologie, i sensori BERU sono progettati appositamente per soddisfare i requisiti e le estreme condizioni di utilizzo dei veicoli e si distinguono particolarmente per la resistenza alle vibrazioni, ai fluidi e per l'elevata affidabilità.

Сенсоры представляют собой высокочувствительные измерительные датчики, которые все больше применяются в автомобилях для контроля таких важных параметров, как температура, частота вращения и позиционные данные. Сенсоры BERU разрабатываются в тесном сотрудничестве с предприятиями автомобильной промышленности.

Фирма BERU является пионером в разработке и производстве высокотехнологичных продуктов и имеет более чем двадцатилетний опыт в области сенсорной техники. Таким образом, эта отрасль производства непрерывно модернизировалась и технологии постоянно улучшались.

В настоящее время производятся датчики температуры воздуха, масла и воды, а также индуктивные датчики для регистрации частоты вращения и положения, например, для распределительных и коленчатых валов и шестеренок коробки передач.

Благодаря применению различных технологий сенсоры BERU точно адаптированы к жестким требованиям и экстремальным условиям эксплуатации в автомобиле и особенно отличаются своей стойкостью к вибрациям, надежностью и устойчивостью к различной среде.

Czujniki to wysokoczułe jednostki pomiarowe, stosowane coraz częściej w pojazdach do nadzoru ważnych parametrów, np. temperatur, prędkości obrotowej lub do sygnalizowania pozycji. Czujniki BERU są opracowywane przy ścisłej współpracy z przemysłem motoryzacyjnym.

Firma BERU jest pionierem w zakresie opracowywania oraz wytwarzania produktów Hightech i dysponuje ponad dwudziestoletnim doświadczeniem w zakresie sensoryki. Ta gałąź produkcji była więc ciągle rozbudowywana przy równoczesnym stałym ulepszaniu technologii.

Obecnie produkowane są czujniki temperatury powietrza, oleju i wody oraz indukcyjne czujniki bezdotykowe do pomiaru prędkości obrotowej i detekcji pozycji, np. wałków rozrządu, wałów korbowych i kół zębatych w skrzyniach biegów.

Dzięki zróżnicowanym technologiom, czujniki BERU są dokładnie dopasowane do wymagań i ekstremalnych warunków zastosowania w pojazdach i odznaczają się szczególną odpornością na drgania oraz wyjątkową niezawodnością i odpornością na media.

Οι αισθητήρες είναι υπερευαίσθητα εξαρτήματα μέτρησης, τα οποία χρησιμοποιούνται ολοένα και περισσότερο στα οχήματα για την επιτήρηση σημαντικών μεγεθών, όπως π.χ. διάφορες θερμοκρασίες, αριθμός στροφών και στοιχεία για τη θέση ποικίλων εξαρτημάτων. Η BERU αναπτύσσει τους αισθητήρες της σε στενή συνεργασία με την αυτοκινητοβιομηχανία.

Ως πρωτοπόρος στην ανάπτυξη και την παραγωγή προϊόντων Hightech, η BERU έχει πάνω από είκοσι χρόνια πείρας στον τομέα των αισθητήρων. Σε αυτό το διάστημα επέκτεινε ουσιαστικά αυτό τον κλάδο παραγωγής βελτιστοποιώντας συνεχώς την τεχνολογία των προϊόντων που περιλαμβάνει.

Προς το παρόν κατασκευάζει αισθητήρες για την εξακρίβωση της θερμοκρασίας του αέρα, του λαδιού και του νερού, καθώς και επαγωγικούς αισθητήρες για τον υπολογισμό του αριθμού στροφών και της θέσης, π.χ. του εκκεντροφόρου και του στροφαλοφόρου άξονα ή των γραναζιών του κιβωτίου ταχυτήτων.

Χάρη στην πολυδιάστατη τεχνολογία τους, οι αισθητήρες BERU είναι μελετημένοι για απόλυτη προσαρμογή στις απαιτήσεις των σύγχρονων οχημάτων και για χρήση σε σκληρές συνθήκες και χαρακτηρίζονται ιδιαίτερα από την αντοχή τους στους κραδασμούς, την αξιόπιστη συμπεριφορά και τη φέρουσα ανθεκτικότητά τους.

Αζ έρζέκελό ναγρον έρζέκενυ έρζέκελόελεμ, αμυλετ εγρε γυακρabban αλκαμζανκ α τάρμύεκεβν φοντοσ ιελλεγέρτεκε μιντ πλ. α ήμέρσεκελετ, φορδυλατσζάμ έσ ηελεζεταδατοκ ελενονρζέσεζε. Α BERU έρζέκελόκετ σζοροσ εγυύττμύκεδεσβεν α τάρμύιπαρραλ φελεζστέκ.

BERU νεζετό σζερεπετ τóλετ βε α μαγασ σζίννεβαλού τεχνολόγια τερμέκεκ φελεζστέσεβεν έσ γυάρτασάβαν έσ τóβε μιντ κέτ ένετιζεδεσ ταπασζαλατταλ ρενδελκεζικ αζ έρζέκελόκ τερýλετέν. ίγυ εζ α τερμελέσι άγ άλλαλό φελεζστέσε αλαττ υολτ έσ α τεχνολόγιακατ φολυτο- νοσαν τóκελέτεσιθέκετέκ.

Πιλλανατνυιλαγ γυάρτανακ λεβεγó-, ολαζ- έσ υίζ ήμέρσεκελετ έρζέκελόκετ βαλαμιντ ινδυκτίβ ιελαδαόκατ α φορδυλατσζάμ- έσ ηελεζεταέρζέκελεσεζ μιντ πλ. α νεζερμύ-/φοργαττυύσ τεγγελε έσ σεβεσσέγγαλότó φογασκερεκεκ εσετέβεν.

Α BERU έρζέκελόκ α κýλονβóζó τεχνολόγιακ αλκαμζασάβαλ ποντοσιν μέρετεζε βαλλακ α τάρμύ κóβετελενεγειρε έσ εστρέμ ηασζναλατι φελετέελειρε έσ κýλονóσεν ρεζέγεσ ελελλι βιζτοσιόττοσάγγυκ, μεγβιζηαόσάγγυκ έσ κóβεζε ελεναλλάσυκ ιελλεμζικ όκετ.

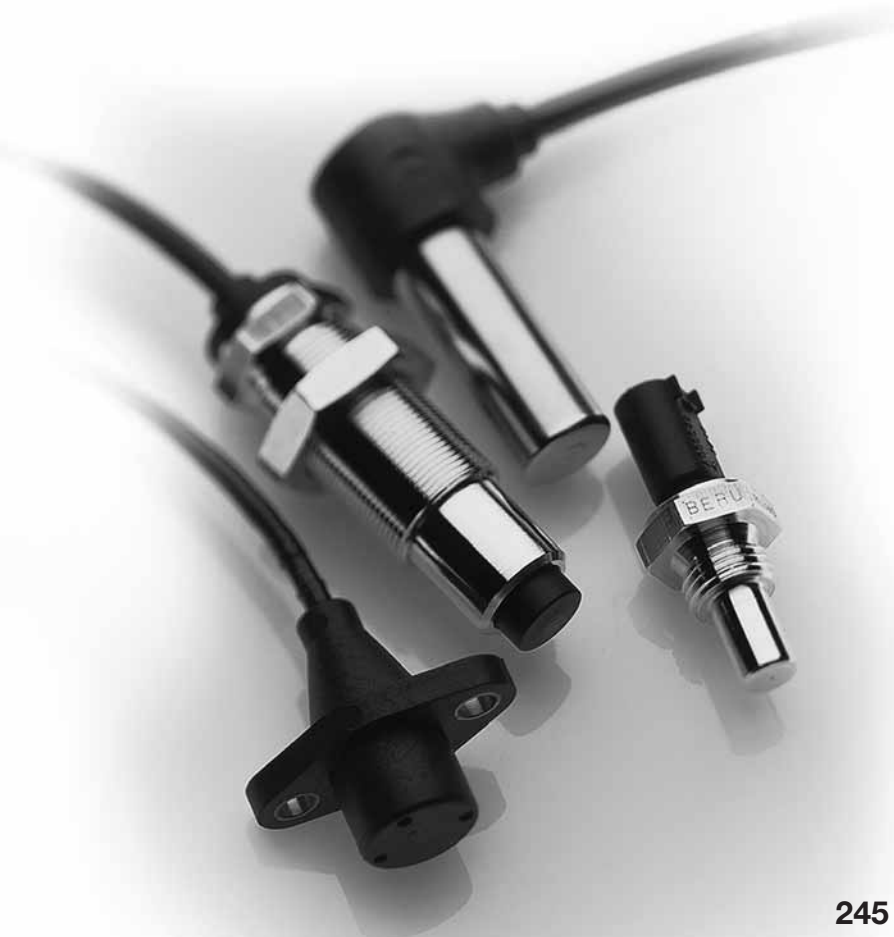











SD 001	0 192 115 012	Iveco	250	ST 048	0 824 121 097	Alfa Romeo	257
SD 002	0 191 325 002	Mercedes	250	ST 049	0 824 121 098	Citroën, Fiat, Peugeot, Talbot	257
SD 003	0 191 325 004	Mercedes	250	ST 050	0 824 121 099	Seat, VW	257
SD 004	0 191 325 006	Mercedes	250	ST 051	0 824 121 100	Ford	257
SD 005	0 192 115 001	Mercedes	250	ST 052	0 824 121 101	Saab	257
SD 006	0 192 114 007	Deutz	250	ST 053	0 824 121 102	Audi, Seat, VW	257
SD 007	0 192 114 006	Ford	250	ST 054	0 824 121 103	Audi, VW, Volvo	257
SD 008	0 191 315 002	BMW	250	ST 055	0 824 121 104	Ford	257
SD 009	0 191 325 007	Mercedes	251	ST 056	0 824 121 105	BMW	258
SD 010	0 192 115 013	Mercedes	251	ST 057	0 824 121 106	Mercedes	258
ST 001	0 824 121 001	Mercedes	251	ST 058	0 824 121 107	Fiat, Lancia	258
ST 002	0 824 121 020	Mercedes	251	ST 059	0 824 121 090	Mercedes	258
ST 003	0 824 121 003	BMW	251	ST 060	0 824 121 108	Audi, BMW, Ford, Seat	258
ST 004	0 824 111 006	Mercedes	251	ST 061	0 824 121 109	Volvo	258
ST 005	0 824 111 003	BMW	251	ST 062	0 824 121 110	Volvo	258
ST 007	0 824 121 058	Mercedes	251	ST 063	0 824 121 111	Fiat, Lancia	258
ST 008	0 824 121 040	Mercedes	252	ST 065	0 824 131 034	Audi, VW	258
ST 009	0 824 121 046	Mercedes	252	ST 066	0 824 121 114	Mitsubishi, Opel	259
ST 010	0 824 111 004	BMW	252	ST 067	0 824 121 115	Nissan	259
ST 011	0 824 121 051	Mercedes	252	ST 068	0 824 121 116	Jaguar, Lexus, Mazda, Suzuki, Toyota	259
ST 012	0 824 121 072	Citroën, Peugeot	252	ST 069	0 824 121 117	Daewoo, Opel, Vauxhall	259
ST 013	0 824 121 073	Audi, Seat, VW	252	ST 070	0 824 121 118	Audi, VW	259
ST 014	0 824 121 074	Ford	252	ST 071	0 824 121 119	Audi, VW	259
ST 015	0 824 121 075	Renault, Volvo	252	ST 072	0 824 121 120	Alfa Romeo, Fiat, Lancia, Peugeot	259
ST 016	0 824 121 016	Kässbohrer, Liebherr	253	ST 073	0 824 121 122	Alfa Romeo, Fiat, Lancia, Seat, Volvo	259
ST 017	0 824 121 076	Ford	253	ST 074	0 824 122 013	Fiat	260
ST 018	0 824 121 077	Fiat, Lancia	253	ST 075	0 824 121 123	Opel, Vauxhall	260
ST 019	0 824 121 019	Kässbohrer	253	ST 076	0 824 121 124	Opel, Vauxhall	260
ST 020	0 824 102 007	Eberspächer	253	ST 077	0 824 121 125	Opel, Fiat	260
ST 021	0 824 102 008	Eberspächer	253	ST 078	0 824 121 126	Citroën, Fiat, Peugeot	260
ST 022	0 824 112 005	Eberspächer	253	ST 079	0 824 121 127	Opel, Vauxhall	260
ST 023	0 824 121 005	Kramer	253	ST 080	0 824 121 128	Opel, Vauxhall	260
ST 024	0 824 121 031	Iveco, Renault	254	ST 081	0 824 121 129	Opel	260
ST 025	0 824 121 032	Iveco, Renault	254	ST 082	0 824 121 130	Opel, Vauxhall	261
ST 026	0 824 131 021	Porsche	254	ST 083	0 824 121 131	Opel	261
ST 027	0 824 112 006	Eberspächer	254	ST 084	0 824 121 132	Volvo	261
ST 028	0 824 121 078	Alfa Romeo, Citroën, Fiat, Hyundai, Lancia, Opel, Peugeot, Porsche, Saab, Seat, Skoda, Vauxhall, VW, Volvo, Zastava	254	ST 085	0 824 121 133	Opel, Vauxhall	261
ST 029	0 824 121 080	Citroën, Peugeot	254	ST 086	0 824 121 134	Opel	261
ST 030	0 824 121 081	Seat, VW	254	ST 087	0 824 121 135	Opel, Vauxhall	261
ST 031	0 824 121 082	Seat, VW	254	ST 088	0 824 121 146	Fiat, Lancia, Opel	261
ST 032	0 824 111 007	Renault	255	ST 089	0 824 111 030	GM/Opel, Saab	261
ST 033	0 824 111 008	Ford	255	ST 090	0 824 121 139	Deutz 1012, 1013	262
ST 034	0 824 111 009	Citroën, Peugeot	255	ST 091	0 824 121 148	BMW	262
ST 035	0 824 111 010	Alfa Romeo, Fiat, Ford, Lancia	255	ST 092	0 824 121 149	BMW	262
ST 036	0 824 111 011	Alfa Romeo, Ferrari, Opel, Porsche, Seat, VW	255	ST 093	0 824 121 150	BMW	262
ST 037	0 824 121 083	Daewoo, Opel, Vauxhall	255	ST 094	0 824 121 151	BMW	262
ST 038	0 824 121 084	Audi, VW, Volvo	255	ST 095	0 824 121 152	BMW	262
ST 039	0 824 121 085	Daihatsu, Honda, Mazda, Suzuki	255	ST 096	0 824 121 153	BMW	262
ST 040	0 824 121 086	Ford	256	ST 097	0 824 121 154	Fiat	262
ST 041	0 824 121 087	Mitsubishi, Toyota	256	ST 098	0 824 121 155	Ford	262
ST 042	0 824 121 088	Daihatsu, Toyota, Subaru	256	ST 100	0 824 121 157	Audi, Porsche, Skoda, VW	262
ST 043	0 824 121 089	Citroën, Fiat, Peugeot, Renault	256	ST 101	0 824 121 158	Citroën, Ford, Peugeot, Renault	262
ST 044	0 824 121 091	Citroën, Dacia, Peugeot, Renault, Talbot	256	ST 102	0 824 121 159	Seat, Skoda, VW	263
ST 045	0 824 121 092	Alfa Romeo, Innocenti, Seat	256	ST 103	0 824 121 160	VW	263
ST 046	0 824 121 093	Fiat, Lada, Lancia, Zastava	256	ST 104	0 824 121 161	VW	263
ST 047	0 824 121 094	Ford	256	ST 105	0 824 121 162	VW	263
				ST 106	0 824 121 163	VW	263
				ST 107	0 824 121 164	VW	263
				ST 108	0 824 121 165	Audi, Seat, Skoda, VW	263



ST 109	0 824 112 012	Eberspächer B4WSC - 12V 	263
ST 110	0 824 121 028	BMW	264
ST 112	0 824 111 033	Audi, Seat, Skoda, VW	264
ST 113	0 824 111 034	Audi, Seat, Skoda, VW	264
ST 114	0 824 121 168	Audi, Seat, Skoda, VW	264
ST 115	0 824 121 169	Audi, Seat, VW	264
ST 116	0 824 121 170	VW	264
ST 117	0 824 121 171	BMW	264
ST 118	0 824 121 172	VW	264
ST 119	0 824 121 173	Audi, Seat, Skoda, VW	265
ST 120	0 824 121 174	VW	265
ST 121	0 824 121 175	Audi, Seat, Skoda, VW	265
ST 122	0 824 121 176	Audi	265
ST 123	0 824 121 177	Opel	265
ST 124	0 824 131 029		265
ST 125	0 824 121 179	VW	265
SPR 001	0 824 331 004	NSU, Volvo, VW, Agria, Fendt, Hanomag Rheinstahl, Henschel, KHD, MWM	273
SPR 002	0 824 331 011	Audi, Porsche, BOMAG, KHD, Steinbock, Steyr (Steyr-Daimler-Puch AG)	273
SPR 003	0 824 331 010	VW, Porsche	273
SPR 004	0 824 331 025	Audi, Volvo, VW, KHD	273
SPR 005	0 824 331 018	Fiat-Allis, MAN, Mercedes 	272
SPR 006	0 824 331 021	Mercedes 	272
SPR 007	0 824 331 014	Büssing, DAF, Eicher, Hanomag Henschel, Henschel, Ikarus, Kaelble, Kaelble- Gmeinder, Kaessbohrer, KHD, Krupp, Magirus Deutz, MAN, Mercedes, Renault Saviem, Scania, Volvo 	272
SPR 008	0 824 331 015	Fiat, Iveco, Henschel, KHD, Mercedes, Saurer, Scania, Volvo 	272
SPR 009	0 824 331 026	Daihatsu, Subaru, Toyota	273
SPR 010	0 824 331 027	Mitsubishi, Suzuki	273
SPR 011	0 824 331 028	Daihatsu, Isuzu, Toyota	273
SPR 012	0 824 331 029	Daihatsu, Mazda	273
SPR 013	0 824 331 030	Daihatsu, Mazda, Suzuki	274
SPR 014	0 824 331 031	Honda	274
SPR 015	0 824 331 032	Honda, Mazda, Subaru	274
SPR 016	0 824 331 033	Nissan	274
SPR 017	0 824 331 034	Audi, Seat, VW	274
SPR 018	0 824 331 039	GM/Opel, Renault	274
SPR 019	0 824 331 040	Mercedes	274
SPR 020	0 824 331 036	Ford	274
SPR 021	0 824 331 037	Audi, Seat, Skoda, VW	275
SPR 022	0 824 331 038	Audi, Ford, Seat, Skoda, VW	275



0 191 315 002	SD 008	BMW 	250	0 824 121 090	ST 059	Mercedes	258
0 191 325 002	SD 002	Mercedes	250	0 824 121 091	ST 044	Citroën, Dacia, Peugeot, Renault, Talbot	256
0 191 325 004	SD 003	Mercedes	250	0 824 121 092	ST 045	Alfa Romeo, Innocenti, Seat	256
0 191 325 006	SD 004	Mercedes	250	0 824 121 093	ST 046	Fiat, Lada, Lancia, Zastava	256
0 191 325 007	SD 009	Mercedes	251	0 824 121 094	ST 047	Ford	256
0 192 114 006	SD 007	Ford	250	0 824 121 097	ST 048	Alfa Romeo	257
0 192 114 007	SD 006	Deutz	250	0 824 121 098	ST 049	Citroën, Fiat, Peugeot, Talbot	257
0 192 115 001	SD 005	Mercedes	250	0 824 121 099	ST 050	Seat, VW	257
0 192 115 012	SD 001	Iveco	250	0 824 121 100	ST 051	Ford	257
0 192 115 013	SD 010	Mercedes	251	0 824 121 101	ST 052	Saab	257
0 824 102 007	ST 020	Eberspächer 	253	0 824 121 102	ST 053	Audi, Seat, VW	257
0 824 102 008	ST 021	Eberspächer 	253	0 824 121 103	ST 054	Audi, VW, Volvo	257
0 824 111 003	ST 005	BMW	251	0 824 121 104	ST 055	Ford	257
0 824 111 004	ST 010	BMW	252	0 824 121 105	ST 056	BMW	258
0 824 111 006	ST 004	Mercedes	251	0 824 121 106	ST 057	Mercedes	258
0 824 111 007	ST 032	Renault	255	0 824 121 107	ST 058	Fiat, Lancia	258
0 824 111 008	ST 033	Ford	255	0 824 121 108	ST 060	Audi, BMW, Ford, Seat	258
0 824 111 009	ST 034	Citroën, Peugeot	255	0 824 121 109	ST 061	Volvo	258
0 824 111 010	ST 035	Alfa Romeo, Fiat, Ford, Lancia	255	0 824 121 110	ST 062	Volvo	258
0 824 111 011	ST 036	Alfa Romeo, Ferrari, Opel, Porsche, Seat, VW	255	0 824 121 111	ST 063	Fiat, Lancia	258
0 824 111 030	ST 089	GM/Opel, Saab	261	0 824 121 114	ST 066	Mitsubishi, Opel	259
0 824 111 033	ST 112	Audi, Seat, Skoda, VW	264	0 824 121 115	ST 067	Nissan	259
0 824 111 034	ST 113	Audi, Seat, Skoda, VW	264	0 824 121 116	ST 068	Jaguar, Lexus, Mazda, Suzuki, Toyota	259
0 824 112 005	ST 022	Eberspächer 	253	0 824 121 117	ST 069	Daewoo, Opel, Vauxhall	259
0 824 112 006	ST 027	Eberspächer 	254	0 824 121 118	ST 070	Audi, VW	259
0 824 112 012	ST 109	Eberspächer B4WSC - 12V 	263	0 824 121 119	ST 071	Audi, VW	259
0 824 121 001	ST 001	Mercedes	251	0 824 121 120	ST 072	Alfa Romeo, Fiat, Lancia, Peugeot	259
0 824 121 003	ST 003	BMW	251	0 824 121 122	ST 073	Alfa Romeo, Fiat, Lancia, Seat, Volvo	259
0 824 121 005	ST 023	Kramer	253	0 824 121 123	ST 075	Opel, Vauxhall	260
0 824 121 016	ST 016	Kässbohrer, Liebherr	253	0 824 121 124	ST 076	Opel, Vauxhall	260
0 824 121 019	ST 019	Kässbohrer	253	0 824 121 125	ST 077	Opel, Fiat	260
0 824 121 020	ST 002	Mercedes	251	0 824 121 126	ST 078	Citroën, Fiat, Peugeot	260
0 824 121 028	ST 110	BMW	264	0 824 121 127	ST 079	Opel, Vauxhall	260
0 824 121 031	ST 024	Iveco, Renault 	254	0 824 121 128	ST 080	Opel, Vauxhall	260
0 824 121 032	ST 025	Iveco, Renault 	254	0 824 121 129	ST 081	Opel	260
0 824 121 040	ST 008	Mercedes	252	0 824 121 130	ST 082	Opel, Vauxhall	261
0 824 121 046	ST 009	Mercedes	252	0 824 121 131	ST 083	Opel	261
0 824 121 051	ST 011	Mercedes	252	0 824 121 132	ST 084	Volvo	261
0 824 121 058	ST 007	Mercedes	251	0 824 121 133	ST 085	Opel, Vauxhall	261
0 824 121 072	ST 012	Citroën, Peugeot	252	0 824 121 134	ST 086	Opel	261
0 824 121 073	ST 013	Audi, Seat, VW	252	0 824 121 135	ST 087	Opel, Vauxhall	261
0 824 121 074	ST 014	Ford	252	0 824 121 139	ST 090	Deutz 1012, 1013 	262
0 824 121 075	ST 015	Renault, Volvo	252	0 824 121 146	ST 088	Fiat, Lancia, Opel	261
0 824 121 076	ST 017	Ford	253	0 824 121 148	ST 091	BMW	262
0 824 121 077	ST 018	Fiat, Lancia	253	0 824 121 149	ST 092	BMW	262
0 824 121 078	ST 028	Alfa Romeo, Citroën, Fiat, Hyundai, Lancia, Opel, Peugeot, Porsche, Saab, Seat, Skoda, Vauxhall, VW, Volvo, Zastava	254	0 824 121 150	ST 093	BMW	262
0 824 121 080	ST 029	Citroën, Peugeot	254	0 824 121 151	ST 094	BMW	262
0 824 121 081	ST 030	Seat, VW	254	0 824 121 152	ST 095	BMW	262
0 824 121 082	ST 031	Seat, VW	254	0 824 121 153	ST 096	BMW	262
0 824 121 083	ST 037	Daewoo, Opel, Vauxhall	255	0 824 121 154	ST 097	Fiat	262
0 824 121 084	ST 038	Audi, VW, Volvo	255	0 824 121 155	ST 098	Ford	262
0 824 121 085	ST 039	Daihatsu, Honda, Mazda, Suzuki	255	0 824 121 157	ST 100	Audi, Porsche, Skoda, VW	262
0 824 121 086	ST 040	Ford	256	0 824 121 158	ST 101	Citroën, Ford, Peugeot, Renault	262
0 824 121 087	ST 041	Mitsubishi, Toyota	256	0 824 121 159	ST 102	Seat, Skoda, VW	263
0 824 121 088	ST 042	Daihatsu, Toyota, Subaru	256	0 824 121 160	ST 103	VW	263
0 824 121 089	ST 043	Citroën, Fiat, Peugeot, Renault	256	0 824 121 161	ST 104	VW	263
				0 824 121 162	ST 105	VW	263
				0 824 121 163	ST 106	VW	263



0 824 121 164	ST 107	VW	263
0 824 121 165	ST 108	Audi, Seat, Skoda, VW	263
0 824 121 168	ST 114	Audi, Seat, Skoda, VW	264
0 824 121 169	ST 115	Audi, Seat, VW	264
0 824 121 170	ST 116	VW	264
0 824 121 171	ST 117	BMW	264
0 824 121 172	ST 118	VW	264
0 824 121 173	ST 119	Audi, Seat, Skoda, VW	265
0 824 121 174	ST 120	VW	265
0 824 121 175	ST 121	Audi, Seat, Skoda, VW	265
0 824 121 176	ST 122	Audi	265
0 824 121 177	ST 123	Opel	265
0 824 121 179	ST 125	VW	265
0 824 122 013	ST 074	Fiat	260
0 824 131 021	ST 026	Porsche	254
0 824 131 029	ST 124	Audi, VW	265
0 824 131 034	ST 065	Audi, VW	258
0 824 331 004	SPR 001	NSU, Volvo, VW, Agria, Fendt, Hanomag Rheinstahl, Henschel, KHD, MWM	273
0 824 331 010	SPR 003	VW, Porsche	273
0 824 331 011	SPR 002	Audi, Porsche, BOMAG, KHD, Steinbock, Steyr (Steyr-Daimler-Puch AG)	273
0 824 331 014	SPR 007	Büssing, DAF, Eicher, Hanomag Henschel, Henschel, Ikarus, Kaelble, Kaelble-Gmeinder, Kaessbohrer, KHD, Krupp, Magirus Deutz, MAN, Mercedes, Renault Saviem, Scania, Volvo	272
0 824 331 015	SPR 008	Fiat, Iveco, Henschel, KHD, Mercedes, Saurer, Scania, Volvo	272
0 824 331 018	SPR 005	Fiat-Allis, MAN, Mercedes	272
0 824 331 021	SPR 006	Mercedes	272
0 824 331 025	SPR 004	Audi, Volvo, VW, KHD	273
0 824 331 026	SPR 009	Daihatsu, Subaru, Toyota	273
0 824 331 027	SPR 010	Mitsubishi, Suzuki	273
0 824 331 028	SPR 011	Daihatsu, Isuzu, Toyota	273
0 824 331 029	SPR 012	Daihatsu, Mazda	273
0 824 331 030	SPR 013	Daihatsu, Mazda, Suzuki	274
0 824 331 031	SPR 014	Honda	274
0 824 331 032	SPR 015	Honda, Mazda, Subaru	274
0 824 331 033	SPR 016	Nissan	274
0 824 331 034	SPR 017	Audi, Seat, VW	274
0 824 331 036	SPR 020	Ford	274
0 824 331 037	SPR 021	Audi, Seat, Skoda, VW	275
0 824 331 038	SPR 022	Audi, Ford, Seat, Skoda, VW	275
0 824 331 039	SPR 018	GM/Opel, Renault	274
0 824 331 040	SPR 019	Mercedes	274



SD 001

0 192 115 012



Nm ≤ 5/40

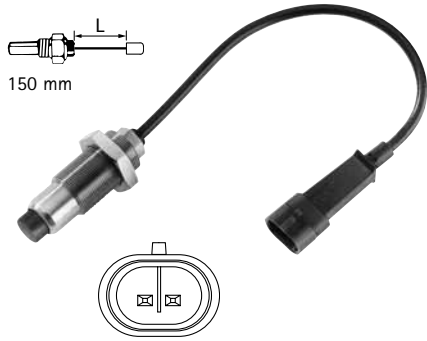
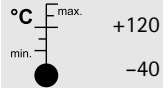

CODE

1 0 1 4 3

Messing¹⁵

Iveco 4861291

SD 005 (gelb³⁴)

0 192 115 001

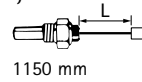

1150 mm

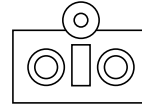
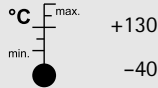

CODE

1 0 2 4 8

Mercedes-Benz A 006 542 28 17

SD 002

0 191 325 002

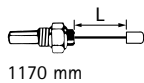

1170 mm

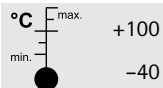

CODE

1 0 4 4 8

Mercedes-Benz A 001 153 74 28

SD 006

0 192 114 007

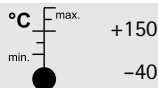

CODE

1 0 2 4 8

ohne O-Ring¹⁹

Deutz 04364426, 01319347

SD 003

0 191 325 004

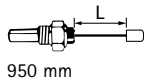

950 mm

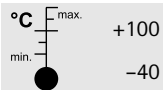

CODE

1 0 4 4 8

Mercedes-Benz A 001 153 84 28

SD 007 ★

0 192 114 006

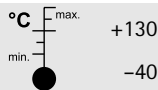

CODE

1 0 2 5 1

Ford 6635407, 90TF6C315 AB, -A2B, F0TZ6C315 D, -DA

SD 004

0 191 325 006

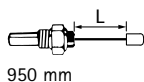

950 mm

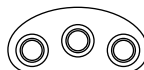
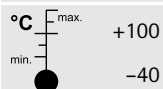

CODE

1 0 4 4 8

Mercedes-Benz A 002 153 13 28

SD 008 ★

0 191 315 002

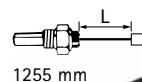

1255 mm

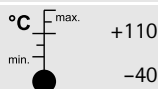

CODE

1 0 2 7 14



BMW 2 306 316, 2 331 289, 34 52 2 306 316, 34 52 2 331 289



SD 009 ★

0 191 325 007

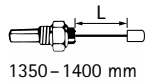

1350-1400 mm

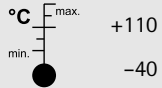
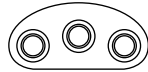

CODE

1 0 4 4 8

Mercedes Benz A 002 153 46 28, 002 153 46 28

ST 003

0 824 121 003

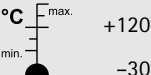

CODE

2 1 0 3 5

Messing¹⁵

BMW 62 11 0 788 115



SD 010 ★

0 192 115 013

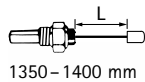

1350-1400 mm

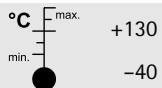
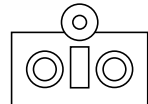

CODE

1 0 2 1 0

Mercedes Benz A 010 542 22 17, 010 542 22 17

ST 004

0 824 111 006

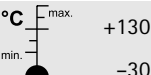
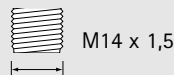

CODE

2 3 0 5 1

Stahl (Oberfläche verzinkt)²⁶

Mercedes-Benz A 004 153 03 28

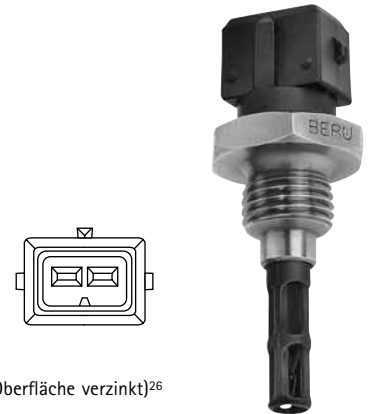

ST 001

0 824 121 001

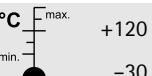
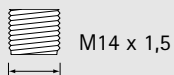

CODE

2 1 0 8 9

Messing¹⁵

Mercedes-Benz A 005 542 10 17, A 005 542 26 17



ST 005

0 824 111 003

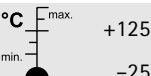
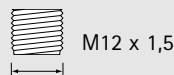

CODE

2 3 0 5 1

Stahl (Oberfläche verzinkt)²⁶

BMW 13 62 2 243 946

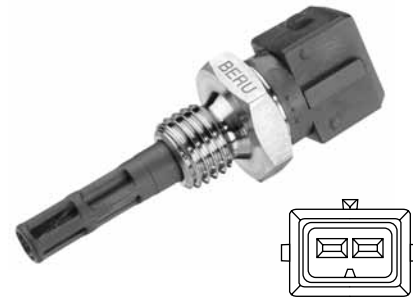

ST 002

0 824 121 020

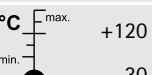

CODE

2 1 0 5 1

Messing¹⁵

Mercedes-Benz A 008 542 32 17



ST 007 (türkis³⁵)

0 824 121 058

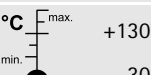

CODE

2 1 2 2 7

Messing¹⁵

Mercedes-Benz A 008 542 56 17
MWM 9.0569.50.0.0015

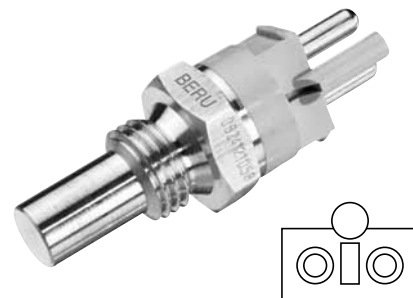



ST 008

0 824 121 040

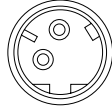
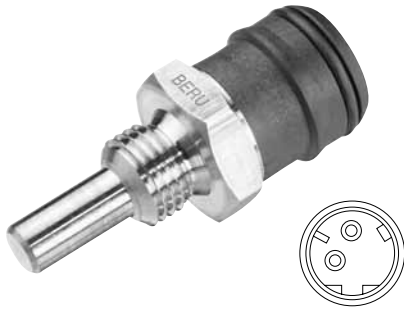
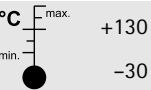
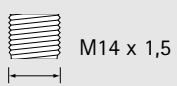

CODE

2 1 0 5 1

Messing¹⁵

Mercedes-Benz A 009 542 35 17

ST 012 (grün³²)

0 824 121 072

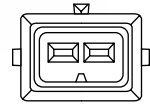
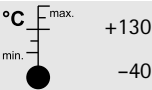
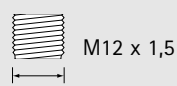

CODE

2 1 0 5 1

Messing¹⁵

Citroën 1920.C4, 95640493
Peugeot 1920.C4

ST 009

0 824 121 046

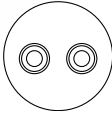
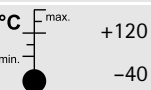
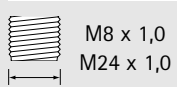

CODE

2 2 0 3 12

Stahl (Oberfläche verzinkt)²⁶

Mercedes-Benz A 011 542 74 17

ST 013

0 824 121 073

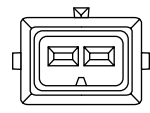
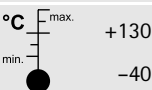
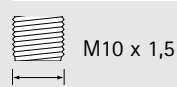

CODE

2 1 0 5 1

Messing¹⁵

VW 26906161

ST 010

0 824 111 004

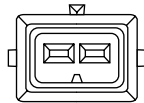
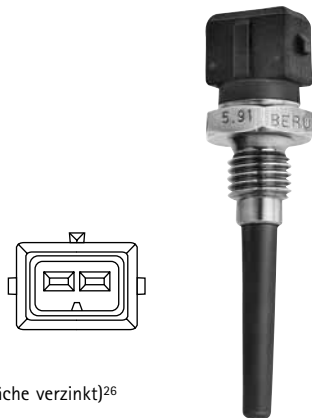
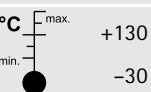
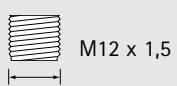

CODE

2 3 0 5 1

Stahl (Oberfläche verzinkt)²⁶

BMW 13 62 1 725 323

ST 014

0 824 121 074

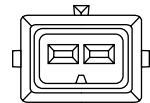
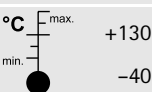
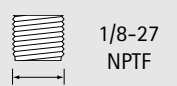

CODE

2 1 0 1 5

Messing¹⁵

Ford 6193368, 91AB10884AA

ST 011

0 824 121 051

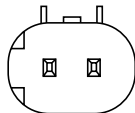
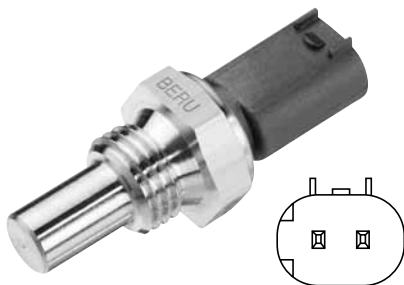
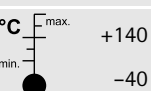

CODE

2 1 0 1 5

Messing¹⁵

Mercedes-Benz A 000 542 62 18, A 000 153 63 28

ST 015

0 824 121 075

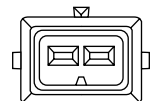
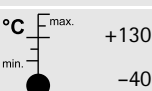

CODE

2 1 0 1 5

Messing¹⁵

Renault 7700737571
Volvo 3344169



ST 016

0 824 121 016

	M14 x 1,5
	19
Nm	30
°C	
max.	+120
min.	-30

Messing¹⁵

CODE

2 1 0 7 2

Kässbohrer 8.749.060.000.0
Liebherr 691180308



ST 020

0 824 102 007

°C	
max.	+400
min.	-40

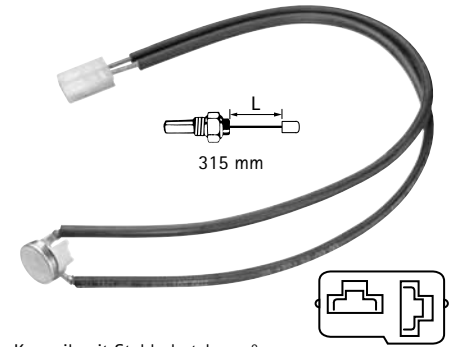

Keramik mit Stahlschutzkappe⁹

CODE

2 2 3 3 13



Eberspächer 25 1729 37 00 00

ST 017 (grau³⁶)

0 824 121 076

	3/8-27 NPTF
	25
Nm	30
°C	
max.	+130
min.	-40

Messing¹⁵

CODE

2 1 0 5 1

Ford 6810428, F2AF12A648AA



ST 021

0 824 102 008

°C	
max.	+400
min.	-40

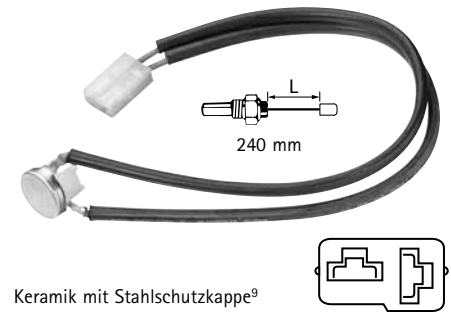

Keramik mit Stahlschutzkappe⁹

CODE

2 2 3 3 13



Eberspächer 25 1895 35 00 00

ST 018 (blau³⁷)

0 824 121 077

	M18 x 1,5
	19
Nm	30
°C	
max.	+130
min.	-40

Messing¹⁵

CODE

2 1 0 5 1

Fiat 7669143

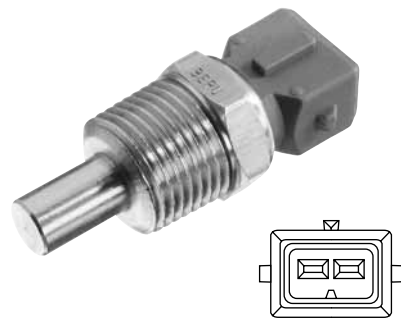

ST 022 (rot³³)

0 824 112 005

°C	
max.	+135
min.	-40

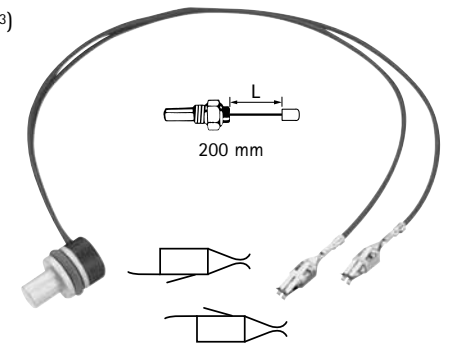

Aluminium (eloxiert)¹

CODE

2 1 0 3 13



Eberspächer 25 1864 40 01 00

ST 019

0 824 121 019

	M14 x 1,5
	22
Nm	20
°C	
max.	+120
min.	-40

Messing¹⁵

CODE

2 1 0 7 2

Kässbohrer 8.749.125.000.0

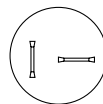

ST 023

0 824 121 005

	M14 x 1,5
	19
Nm	25
°C	
max.	+150
min.	-30

Messing¹⁵

CODE

2 1 0 3 11

Kramer 3360703





ST 024

0 824 121 031

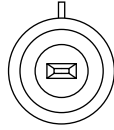
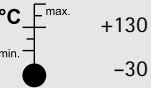
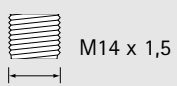

Messing¹⁵

CODE

2 1 0 3 5



Iveco 4857248
Renault 5010293265

ST 028 (blau³⁷)

0 824 121 078

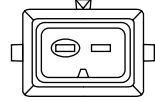
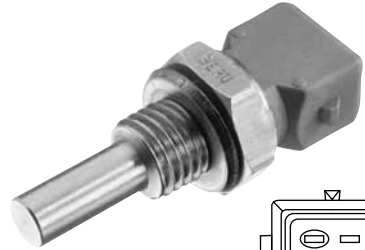
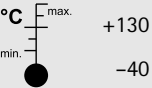
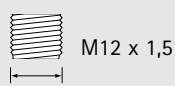

Messing¹⁵

CODE

2 1 0 5 1

Alfa Romeo 605132050, 195321101000
Citroën 91040370, 91414549, 91514549
Daewoo 280130026
Fiat 46125769, 5972332, 60513205, 60800167, 60808142

ST 025

0 824 121 032

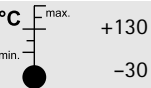
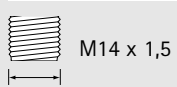

Messing¹⁵

CODE

2 1 0 3 5



Iveco 4857250

ST 029 (grün³²)

0 824 121 080

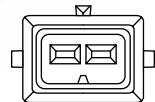
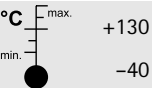
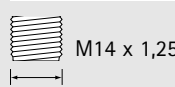

Messing¹⁵

CODE

2 1 0 5 1

Citroën/Peugeot 1338.47, 1338.78

ST 026

0 824 131 021

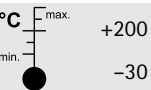
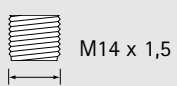

Messing¹⁵

CODE

2 1 0 3 11

PORSCHE 616.107.805.01

ST 030 (gelb³⁴)

0 824 121 081

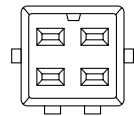
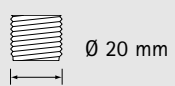

CODE

2 1 0 2 6
+10

VW 357 919 501 A, 640 919 501 B

ST 027 (blau³⁷)

0 824 112 006

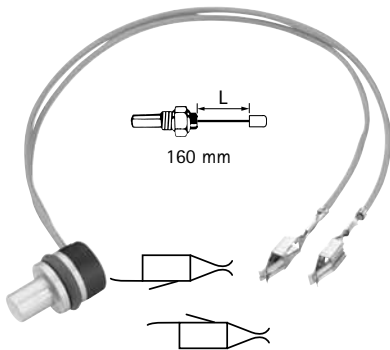

Aluminium (eloxiert)¹

CODE

2 1 0 3 13



Eberspächer 25 1864 40 02 00

ST 031 (grün³²)

0 824 121 082

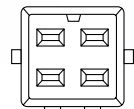
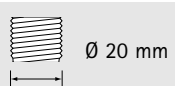

CODE

2 1 0 2 6
+11

VW 357919501

**ST 032**

0 824 111 007

	M14 x 1,5
	21
Nm	25
°C	
max.	+130
min.	-40

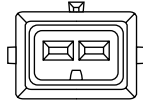

CODE

2 3 0 5 1Messing¹⁵

Renault 77 00 737 572

ST 036

0 824 111 011

	M12 x 1,5
	19
Nm	22
°C	
max.	+130
min.	-40

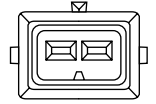
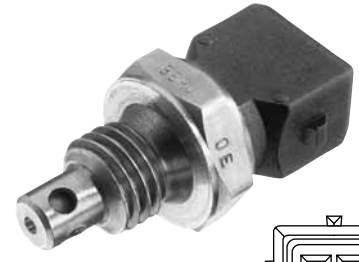
Messing¹⁵

CODE

2 3 0 5 1Alfa Romeo 46433052
Opel 1338458
VW 46905379**ST 033** (weiss³⁸)

0 824 111 008

	3/8-18 NPTF
	25
Nm	30
°C	
max.	+130
min.	-40

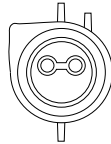
Messing¹⁵

CODE

2 3 0 5 1Ford 6740335 (F2DF12A697-AA), 694335
Ford (BR) 026.906.161.6
VW (BR) 026.906.161.6**ST 037**

0 824 121 083

	1/8-27 NPT
	1/2"
Nm	



CODE

2 1 0 1 5Opel 13 42 561, 13 42 567, 13 42 568
GM 3439088, 94472002**ST 034**

0 824 111 009

	M12 x 1,5
	19
Nm	22
°C	
max.	+130
min.	-40

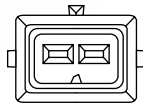
Messing¹⁵

CODE

2 3 0 5 1

Citroën/Peugeot 1920.C5, 95.640.497

ST 038

0 824 121 084

	M10 x 1,0
	12
Nm	



CODE

2 1 0 1 5Volvo 1328397-3
VW 028 919 501-1, 035 919 501**ST 035** (braun³⁹)

0 824 111 010

	M14 x 1,5
	19
Nm	25
°C	
max.	+130
min.	-40

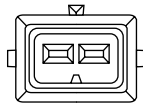
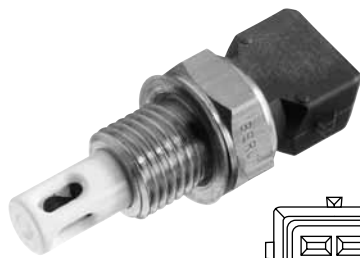
Messing¹⁵

CODE

2 3 0 5 1

Fiat/ Lancia 7547976

ST 039

0 824 121 085

	M16 x 1,5
	17
Nm	



CODE

2 1 0 1 5Daihatsu 83420-87701-000
Honda 37750-611-154
Mazda 0118-18-510, 0118-89-181
Suzuki 34850-65011



ST 040

0 824 121 086



CODE

2 1 0 1 5

Ford 6058836, 6098273, 1583836, 77FB10884AA, 81EB10884AA

ST 044

0 824 121 091



CODE

2 1 0 1 5

Citroën 95548678, 95581212
Peugeot 0242.14
Renault 7700503200, 7701349086, 7702002661
Talbot 7810240000

ST 041

0 824 121 087



CODE

2 1 0 1 5

Mitsubishi MD 001 380, MD 603 427
Toyota 83420-20010, 83420-16010, 83420-20020

ST 045 (schwarz³¹)

0 824 121 092



CODE

2 1 0 1 5

Alfa Romeo 105000632200, 60515838, 60515839
Innocenti 34362106
Seat SE-021947000C

ST 042

0 824 121 088



CODE

2 1 0 1 5

Subaru 21203AA000, 82080-4150
Toyota 83420-12010, 83420-20011

ST 046 (rot³³)

0 824 121 093

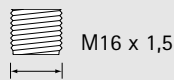

CODE

2 1 0 1 5

Fiat 4108672, 4414600
Lada 2101-380-8600

ST 043

0 824 121 089

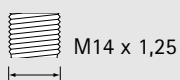

CODE

2 1 0 1 5

Fiat 7910247507, 7910247507
Renault 7700767336, 7701348143, 791024551, 791024553

ST 047

0 824 121 094

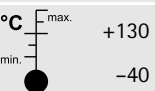

CODE

2 1 0 1 5

Messing¹⁵
Ford 6076967, 81AB10884AA



ST 048

0 824 121 097

M14 x 1,5

16

Nm

max. +130
min. -40



CODE

2 1 0 1 5

Messing¹⁵

Alfa Romeo 530438, 60504210

ST 052

0 824 121 101

1/8-27
NPT

1/2"

Nm

max. +130
min. -40



CODE

2 1 0 1 5

Messing¹⁵

Saab 8800914, 8859233, 9108291

ST 049

0 824 121 098

M14 x 1,25

16

Nm



CODE

2 1 0 1 5

Citroën 97509510, 97519138

Fiat 9750951080

Peugeot 0242.63, 1337.72, 1338.02

Talbot 15794500, 521548200

ST 053

0 824 121 102

M10 x 1,0

14

Nm



CODE

2 1 0 1 5

Seat SE-0219470001

VW 049919501, 175919501, 27919501

ST 050

0 824 121 099

M10 x 1,0

14

Nm



CODE

2 1 0 1 5

VW 1H0919563

ST 054

0 824 121 103

M10 x 1,0

13

Nm



CODE

2 1 0 1 5

Volvo 1257617-9, 3517501

VW 028919501A

ST 051 (grün³²)

0 824 121 100

1/8-27
NPT

1/2"

Nm

max. +130
min. -40



CODE

2 1 0 1 5

Ford 1657685

ST 055 (rot³³)

0 824 121 104

1/8-27
NPT

1/2"

Nm 12

max. +130
min. -40



CODE

2 1 0 1 5

Messing¹⁵

Ford 6136366, 86AB10884AA



ST 057

0 824 121 106

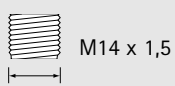

CODE

2 1 0 1 5

Mercedes-Benz 005 545 03 24

ST 061

0 824 121 109

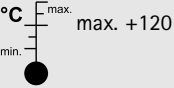
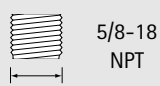

CODE

2 1 0 1 5

Messing¹⁵

Volvo 460191-0

ST 058

0 824 121 107

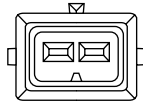
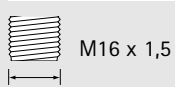

CODE

2 1 0 1 5

Fiat/Lancia 7735919

ST 062

0 824 121 110

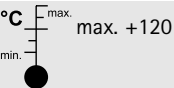
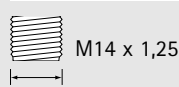

CODE

2 1 0 1 5

Messing¹⁵

Volvo 3432833-6, 3433761-8

ST 059

0 824 121 090

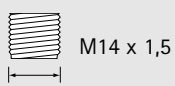

CODE

2 1 0 1 5

Mercedes-Benz 0015422317

ST 063 (weiss³⁸)

0 824 121 111

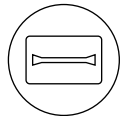
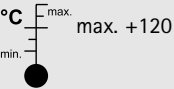

CODE

2 1 0 1 5

Messing¹⁵

Fiat 4418305

ST 060 (weiss³⁸)

0 824 121 108

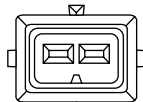
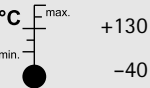
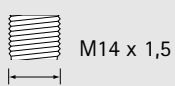

Messing¹⁵

CODE

2 1 0 5 9

BMW 12621288158
Ford 1626473
VW 035919369M

ST 065

0 824 131 034

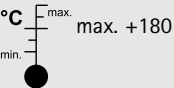

CODE

2 1 0 1 11

Messing¹⁵

VW 049919563-B

**ST 066**

0 824 121 114

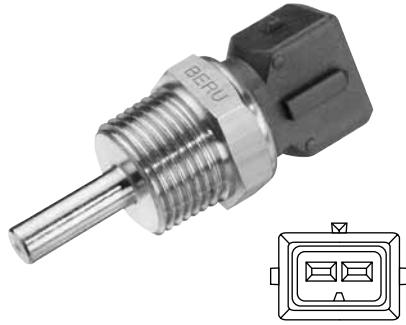
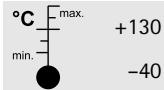
Messing¹⁵

CODE

2 1 0 5 9Mitsubishi MD-149338
Opel 1341038, 1341031**ST 070** (weiss³⁸)

0 824 121 118

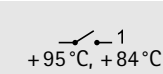
Messing¹⁵

CODE

2 1 0 6 4Seat 321.959.481.E
VW 191.959.481 B**ST 067** (rot³³)

0 824 121 115

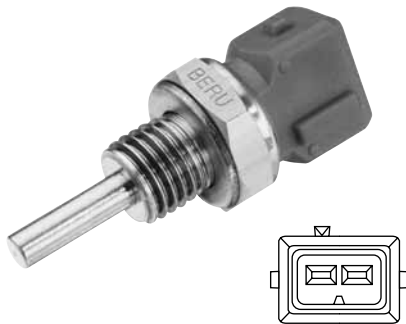
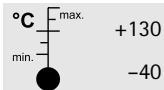
Messing¹⁵

CODE

2 1 0 5 9

Nissan 22630-70J00

ST 071

0 824 121 119

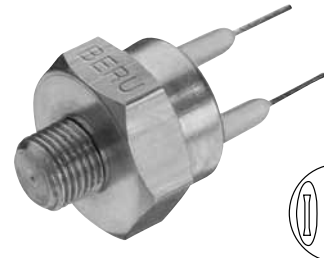
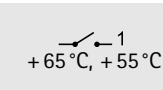
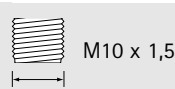
Messing¹⁵

CODE

2 1 0 6 4

Audi 035.919.369 C

ST 068 (grün³²)

0 824 121 116

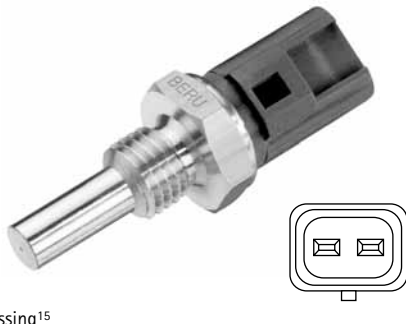
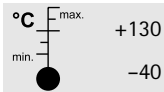
Messing¹⁵

CODE

2 1 0 5 9Mazda B3C8-18840, NF02-18840, B593-18840A
Suzuki 13650-61B00, 13650-71C00
Toyota 89422-20010, 89422-35010**ST 072** (blau³⁷)

0 824 121 120

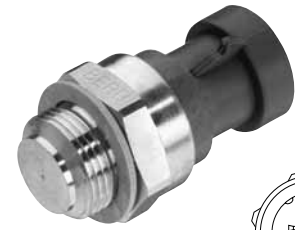
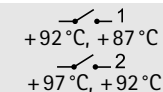
Messing¹⁵

CODE

2 1 0 6 4Alfa Romeo 60809247, 46477717
Fiat 7655732, 7738582
Lancia 7738582
Peugeot 1264.33**ST 069**

0 824 121 117

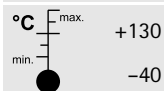
Messing¹⁵

CODE

2 1 0 5 9Daewoo 25036979
Isuzu 825036-979-0
Opel 6238236, 1338450, 1236302**ST 073** (schwarz³¹)

0 824 121 122

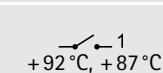
Messing¹⁵

CODE

2 1 0 6 4Alfa Romeo 60585603, 60808223
Fiat/Lancia 05992746, 07728057, 5992746, 7728057,
82436410, 82465533, 82477919
Iveco 82436410
Seat SE021952600A
Volvo 3416584



ST 074

0 824 122 013



1
+88 °C, +83 °C
2
+92 °C, +87 °C

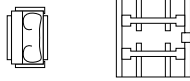
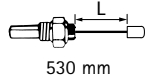

CODE

2 1 0 6 4

Messing¹⁵

Fiat 7628799, 5958828, 7576281

ST 078 (schwarz³¹)

0 824 121 126



1
+88 °C, +83 °C
2
+92 °C, +87 °C

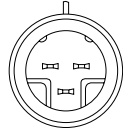

CODE

2 1 0 6 4

Messing¹⁵

Citroën/Peugeot 1264.34
Fiat 7642522, 46478033

ST 075 (schwarz³¹)

0 824 121 123

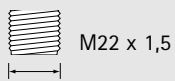

1
+100 °C, +95 °C

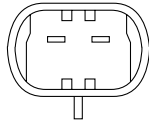

CODE

2 1 0 6 4

Messing¹⁵

GM 90242277
Opel 1341011

ST 079 (weiss³⁸)

0 824 121 127

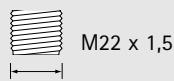

1
+95 °C, +90 °C
2
+105 °C, +100 °C

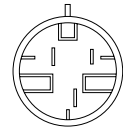

CODE

2 1 0 6 4

Messing¹⁵

GM 90339409, 90355880
Opel 1341026, 1341039

ST 076

0 824 121 124



1
+105 °C, +100 °C

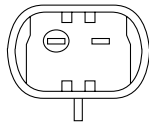

CODE

2 1 0 6 4

Messing¹⁵

GM 90277288
Opel 1341017

ST 080 (grau³⁶)

0 824 121 128



1
+100 °C, +95 °C
2
+110 °C, +105 °C

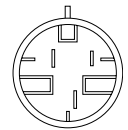

CODE

2 1 0 6 4

Messing¹⁵

GM 90339408, 90335879
Opel 1341025, 1341027

ST 077 (weiss³⁸)

0 824 121 125

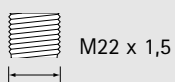

1
+97 °C, +92 °C

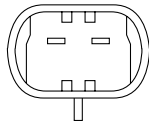

CODE

2 1 0 6 4

Messing¹⁵

Fiat 7570837
GM 90307873
Opel 1341021

ST 081 (braun³⁹)

0 824 121 129

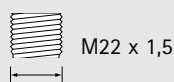

1
+105 °C, +100 °C
2
+120 °C, +115 °C

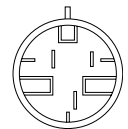

CODE



2 1 0 6 4

Messing¹⁵

GM 90376209
Opel 1846325



ST 082 (gelb³⁴, grün³²)
0 824 121 130

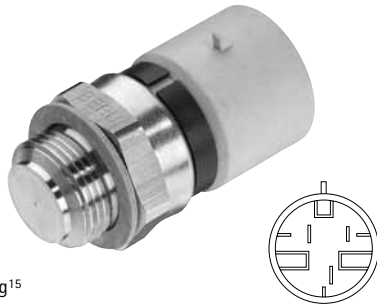

	M22 x 1,5
	29
Nm	34
1	+88 °C, +83 °C
2	+95 °C, +90 °C



Messing¹⁵

CODE
2 1 0 6 4
GM 90341759
Opel 1341033
Volvo 30853464

ST 086 (blau³⁷)
0 824 121 134

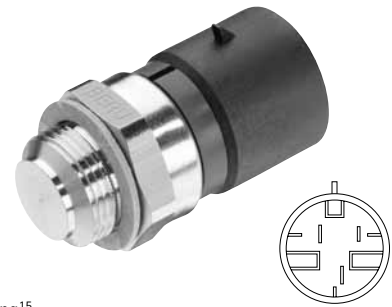

	M22 x 1,5
	29
Nm	34
1	+95 °C, +90 °C
2	+120 °C, +115 °C



Messing¹⁵

CODE
2 1 0 6 4
GM 90357304
Opel 1846326

ST 083 (braun³⁹, grün³²)
0 824 121 131

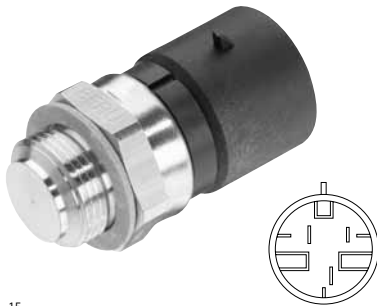

	M22 x 1,5
	29
Nm	34
1	+100 °C, +95 °C
2	+120 °C, +115 °C



Messing¹⁵

CODE
2 1 0 6 4
GM 90492454
Opel 1846341

ST 087 (schwarz³¹)
0 824 121 135

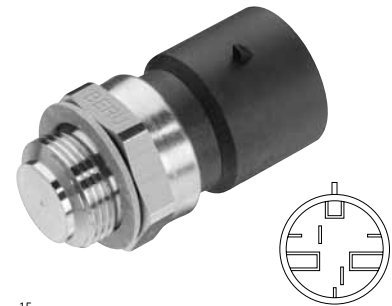

	M22 x 1,5
	29
Nm	34
1	+100 °C, +95 °C



Messing¹⁵

CODE
2 1 0 6 4
GM 90449435
Opel 1341030

ST 084 (schwarz³¹)
0 824 121 132

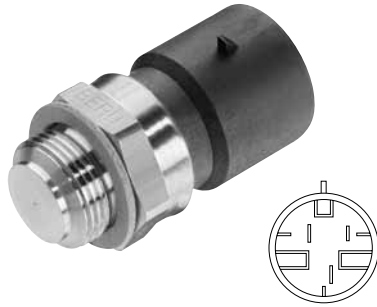

	M22 x 1,5
	29
Nm	34
1	+92 °C, +87 °C
2	+101 °C, +96 °C



Messing¹⁵

CODE
2 1 0 6 4
Volvo 3463731, 3463731-4

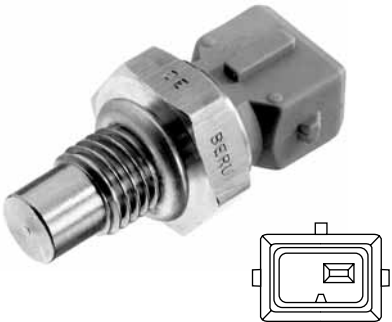

ST 088 (blau³⁷)
0 824 121 146

	M12 x 1,5
	21
Nm	22
°C	max. +130
min.	-40



CODE
2 1 0 5 10
Fiat 7547977, 46477022
GM 90411977
Opel 1342850

ST 085 (gelb³⁴)
0 824 121 133

	M22 x 1,5
	29
Nm	34
1	+100 °C, +95 °C

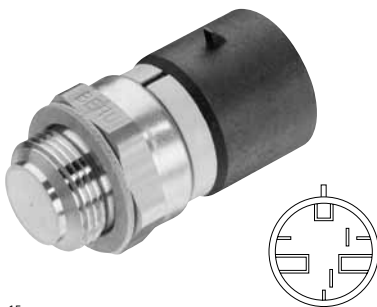

Messing¹⁵

CODE
2 1 0 6 4
GM 90338500
Opel 1341023

ST 089 ★
0 824 111 030



Kunststoff⁵¹

CODE
2 3 0 1 0
GM 90257163, 90477289, 9152245
Opel 1236284, 1236307



ST 090 ★

0 824 121 139



Nm 25

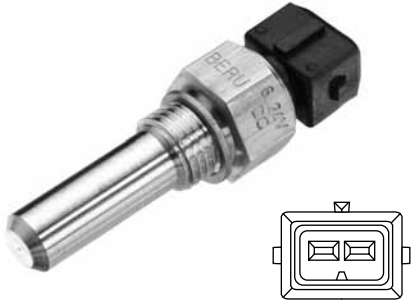

CODE

2 1 0 5 1 0



Deutz 04199382

ST 097 ★

0 824 121 154



Nm 20



CODE

2 1 0 1 5

Messing¹⁵

Fiat 7548005, 0007548005, 7588883, 0007588883

ST 091 (rot³³) ●

0 824 121 148



Nm 15

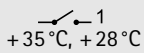

CODE

2 1 0 6 4

Messing¹⁵

BMW 1252 1 741 900

ST 098 ★

0 824 121 155



Nm 12



CODE

2 1 0 1 5

Messing¹⁵

Ford 6107551, 06107551, 6083015, 06083015, 82GB 10884 AB

ST 092 (schwarz³¹) ●

0 824 121 149



Nm 15

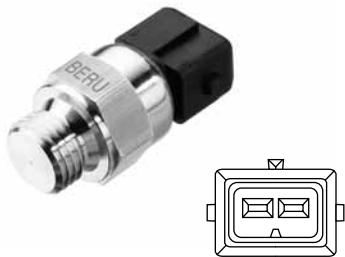
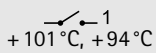

CODE

2 1 0 6 4

Messing¹⁵

BMW 1263 2 243 815, 2 243 815

ST 100 ★

0 824 121 157



Nm 30

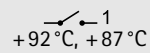

CODE

2 1 0 6 4

Messing¹⁵

Porsche 944.606.481.00
Skoda 113 095 090
VW 823 959 481,-A, -F, -L

ST 096 (blau³⁷) ●

0 824 121 153



Nm 15

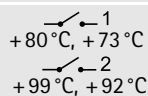

CODE

2 1 0 6 4

Messing¹⁵

BMW 6131 8 386 135, 8 386 135

ST 101 ★

0 824 121 158

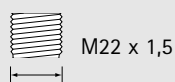

Nm 30

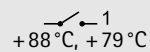

CODE

2 1 0 6 4

Messing¹⁵

Citroen/Peugeot 1264.03, 1264.14, 91514046
Ford 6120663, 83GB-8B607-A2B
Renault 7701348194



ST 102 ★

0 824 121 159



Nm 23,0 ± 3

1
+90°C, +80°C
2
+97°C, +87°C

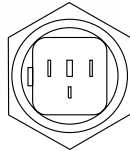

CODE

2 1 0 6 4

Messing¹⁵

VW 1H0 959 481 C

ST 106 ★

0 824 121 163



Nm 23,0 ± 3

1
+95°C, +90°C



CODE

2 1 0 6 4

Messing¹⁵

VW 867 959 481

ST 103 ★

0 824 121 160

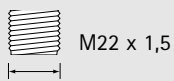

Nm 23,0 ± 3

1
+87°C, +77°C
2
+92°C, +82°C



CODE

2 1 0 6 4

Messing¹⁵

VW 701 959 481

ST 107 (weiss³⁸) ★

0 824 121 164



Nm 22

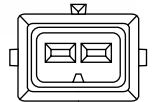

CODE

2 2 3 5 1

Messing¹⁵

VW 113 906 161

ST 104 ★

0 824 121 161

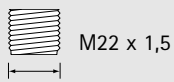

Nm 23,0 ± 3

1
+95°C, +85°C
2
+102°C, +92°C



CODE

2 1 0 6 4

Messing¹⁵

VW 1H0 959 481 B

ST 108 (anthrazit⁴⁰) ★

0 824 121 165



Nm 34

1
+95°C, +84°C
2
+102°C, +91°C



CODE

2 1 0 6 4

Messing¹⁵

VW 191 959 481 C, 321 959 481 D

ST 105 ★

0 824 121 162



Nm 23,0 ± 3

1
+80°C, +75°C
2
+87°C, +82°C



CODE

2 1 0 6 4

Messing¹⁵

VW 701 959 481 C

ST 109 ★

0 824 112 012



Nm 9

°C max. +530
min. -50

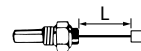

CODE

2 2 3 3 13

Eberspächer 25 1920 35 0000, 25 1920 35 0002 D



★ = neu⁵⁰
● = Abverkauf⁵²





ST 110 ★

0 824 121 028



Nm 20

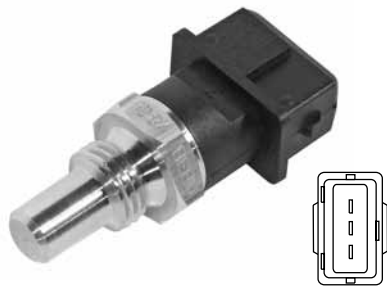

Messing¹⁵

CODE

2 1 0 5 1 0

BMW 1262 2 242 630, 2 242 630, 1262 2 242 631, 2 242 631

ST 115 ★

0 824 121 169



CODE

2 1 0 1 5

Messing¹⁵

VW 251 919 501 A, 251 919 501 D

ST 112 ★

0 824 111 033



CODE

2 3 0 1 0

Kunststoff⁵¹

VW 1J0 919 379A

ST 116 ★

0 824 121 170

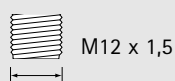

Nm 22

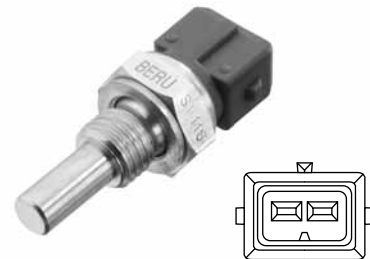

CODE

2 1 0 5 1 0

Messing¹⁵

VW 025 906 041

ST 113 ★

0 824 111 034



CODE

2 3 0 5 1 0

Kunststoff⁵¹

VW 06B 905 379, 06B 905 379 A, 06B 905 379 C, 06B 905 379 D

ST 117 ★

0 824 121 171

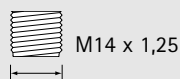

Nm 24



CODE

2 1 0 5 1 0

Messing¹⁵

BMW 1262 1 747 281, 1262 1 710 535

ST 114 ★

0 824 121 168



CODE

2 1 0 5 1 0

Messing¹⁵

VW 06A 919 501, 06A 919 501 A

ST 118 ★

0 824 121 172



Nm 12



CODE

2 1 0 1 5

Messing¹⁵

VW 028 905 501 C



ST 119 (grün³²) ★
0 824 121 173

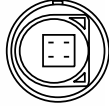

CODE
2 1 0 2 1 0

VW 059 919 501 A, 078 919 501 C

ST 123 (grau³⁶, braun³⁹) ★
0 824 121 177

M22 x 1,5

29
Nm 34

1
+ 100 °C, + 95 ° C
 2
+ 105 ° C, + 100 ° C

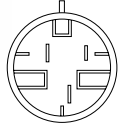

CODE
2 1 0 6 4

Messing¹⁵
GM 90506498
Opel 1341042

ST 120 ★
0 824 121 174



CODE
2 1 0 2 1 0

VW 074 919 501

ST 124 ★
0 824 131 029

M27 x 1,0

27
Nm 40

°C max. +150-180
min. -30



Messing¹⁵

CODE
2 1 0 1 1 1

ZF 0 501 317 259

ST 121 ★
0 824 121 175

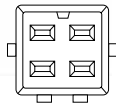

CODE
2 1 0 2 1 0

VW 059 919 501, 4A0 919 501 A

ST 125 (gelb³⁴) ★
0 824 121 179

M10 x 1,0

19
Nm 12

1
100 ° C



CODE
2 1 0 6 5

Messing¹⁵
VW 191 919 521 D

ST 122 ★
0 824 121 176

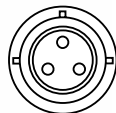

CODE
2 1 0 5 1 0

Audi 053 919 501 A



Il sistema di controllo della pressione degli pneumatici BERU TSS (Tire Safety System)
Система контроля давления в шинах TSS (Tire Safety System) фирмы BERU
System kontroli ciśnienia w ogumieniu BERU TSS (Tire Safety System)

Per maggiore sicurezza, comfort e convenienza

Il sistema di controllo della pressione degli pneumatici BERU (TSS) viene utilizzato nelle autovetture Audi, Bentley, BMW, Bugatti, Ferrari, Land Rover, Maserati, Maybach, Mercedes-Benz, Porsche e VW. Il controllo permanente della pressione di gonfiaggio e della temperatura degli pneumatici offre al pilota numerosi vantaggi:

Maggiore sicurezza di guida

L'informazione immediata all'automobilista che la pressione dei pneumatici sta variando, rispetto al valore prescritto, ha permesso di evitare circa 250.000 casi di forature o di scoppi pericolosi di pneumatici nella sola Germania, nel corso di un anno. In ambito europeo il valore succitato equivale a circa 1,2 milioni di forature o scoppi di pneumatici.

Comfort elevato

La spiacevole operazione di controllo della pressione degli pneumatici viene svolta totalmente dal sistema TSS di BERU.

Maggiore convenienza

Durata degli pneumatici prolungata: la scarsa pressione riduce la durata utile degli pneumatici: una pressione di 0,2 bar riduce la durata del 10%, 0,6 bar di quasi il 50%. Una pressione bassa costante aumenta la compressione. La conseguenza è un invecchiamento precoce del materiale fino all'esplosione dello pneumatico.

Consumo di carburante ridotto: la pressione bassa fa aumentare il consumo di carburante fino al 4 %.

Importante per il cambio stagionale di pneumatici: Le valvole di regolazione della pressione degli pneumatici e l'elettronica dei cerchi sono necessarie per entrambi i tipi di pneumatici. Il nostro consiglio: rifornitevi per tempo e in quantità sufficiente con questi componenti soggetti a usura!

Per un corretto funzionamento di BERU TSS occorre rispettare scrupolosamente le istruzioni aggiornate, di montaggio e calibrazione, che si trovano su www.beru.com/tss.

Еще больше безопасности, комфорта и экономичности

Система контроля давления в шинах BERU (TSS) применяется в автомобилях марок Audi, Bentley, BMW, Bugatti, Ferrari, Land Rover, Maserati, Maybach, Mercedes-Benz, Porsche и Volkswagen. Постоянный контроль давления накачки шин и температуры дает водителю существенные преимущества:

Больше безопасности при движении

Благодаря информации от водителя в случае отклонения от заданного давления или при опускании ниже определенных предельных значений только в Германии могло бы быть предотвращено ежегодно около 250 000 опасных аварий и разрывов шин. Для всей Европы это означает около 1,2 млн. аварий и разрывов шин, которые могут быть предотвращены.

Повышенный комфорт

Все трудности контроля давления в шинах берет на себя система контроля давления в шинах BERU TSS.

Повышение экономичности

Увеличение срока службы шин: пониженное давление в шинах сокращает срок их службы – 0,2 бар на 10 %, 0,6 бар – почти на 50 %. Постоянное пониженное давление увеличивает работу деформации. Следствием является преждевременная усталость материала, которая может привести к разрыву шины.

Понижение расхода топлива:

Пониженное давление увеличивает расход топлива до 4 %.

Важно перед сезонной заменой шин: Предлагаемые BERU клапаны давления в шинах и электронные устройства для колес требуются для обоих комплектов шин.

Поэтому наш совет: своевременно обеспечьте достаточный запас этих быстроизнашивающихся деталей!

Актуальные руководства по монтажу и калибровке Вы найдете по адресу www.beru.com/tss. Для правильной работы BERU TSS просим Вас точно соблюдать эти руководства.

Zwiększa bezpieczeństwo, komfort i ekonomiczność

System kontroli ciśnienia w ogumieniu BERU (TSS) stosowany jest w pojazdach marki Audi, Bentley, BMW, Bugatti, Ferrari, Land Rover, Maserati, Maybach, Mercedes-Benz, Porsche i VW. Ciągły nadzór ciśnienia w ogumieniu oraz temperatury gwarantują kierowcy szerokie zalety:

Większe bezpieczeństwo jazdy

Dzięki informowaniu kierowcy w razie odchyleniu od wartości wymaganej ciśnienia lub w razie spadku ciśnienia poniżej ustalonych wartości granicznych można by tylko w Niemczech zapobiec rocznie ok. 250 000 awarii ogumienia i rozerwań opon. W przeliczeniu na Europę oznaczałoby to ok. 1,2 mln awarii ogumienia i rozerwań opon, którym można byłoby ewentualnie zapobiec.

Zwiększony komfort

Niewygodne sprawdzenie ciśnienia w ogumieniu przejęte zostało przez system kontroli ciśnienia w ogumieniu BERU TSS.

Polepszona ekonomiczność

Wydłużona żywotność opon: zbyt niskie ciśnienie skraca żywotność opony – 0,2 bar o 10 %, 0,6 bar o prawie 50 %. Ciągły niedomiar ciśnienia powoduje zwiększenie pracy odkształcania ogumienia. Konsekwencją jest wcześniejsze zmęczenie materiału, mogące powodować nawet rozerwanie opony.

Zmniejszone zużycie paliwa:

Za niskie ciśnienie w ogumieniu zwiększa zużycie paliwa nawet do 4 %.

tych instrukcji. Ważne przed sezonową zmianą opon: zawory z pomiarem ciśnienia w oponie i elektronika koła BERU potrzebne są dla obu zestawów ogumienia. Dlatego nasza wskazówka: zgromadzić sobie wystarczająco wcześnie odpowiedni zapas tych części!

Aktualne instrukcje montażu i kalibracji znajdziecie Państwo w Internecie pod www.beru.com/tss. Dla zapewnienia poprawnego działania systemu BERU TSS należy dokładnie zastosować się do tych instrukcji.

Για μεγαλύτερη ασφάλεια, άνεση και οικονομία

Το σύστημα ελέγχου πίεσης ελαστικών (TSS) της BERU εφαρμόζεται σε αυτοκίνητα της Audi, της Bentley, της BMW, της Bugatti, της Ferrari, της Land Rover, της Maserati, της Maybach, της Mercedes-Benz, της Porsche και της Volkswagen. Η συνεχής επιτήρηση της πίεσης των ελαστικών και της θερμοκρασίας προσφέρει στον οδηγό σημαντικά πλεονεκτήματα:

Μεγαλύτερη ασφάλεια στην οδήγηση

Με την ενημέρωση του οδηγού για την απόκλιση από την προδιαγραφόμενη πίεση ή την ανεπάρκεια των οριακών τιμών, θα μπορούσαν να αποφευχθούν μόνο στη Γερμανία περίπου 250.000 επικίνδυνες βλάβες και σκασίματα λάστιχων ετησίως. Με χονδρικό υπολογισμό για την Ευρώπη αυτός ο αριθμός φτάνει σε 1,2 εκατομμύρια βλάβες και σκασίματα λάστιχων που μπορούν να αποφευχθούν.

Αυξημένη άνεση

Το σύστημα ελέγχου πίεσης ελαστικών TSS της BERU αναλαμβάνει αυτή τη δυσάρεστη διαδικασία.

Βελτιωμένη οικονομία

Μεγαλύτερη διάρκεια ζωής των ελαστικών: η μειωμένη πίεση των ελαστικών μικραίνει τη διάρκεια της ζωής τους – 0,2 bar κατά 10 %, 0,6 bar σχεδόν κατά 50 %. Η συνεχώς μειωμένη πίεση επιφορτίζει τη λειτουργία των ελαστικών. Αυτό συνεπάγεται την πρόωρη φθορά του υλικού κατασκευής, η οποία μπορεί να οδηγήσει μέχρι και σε σκάσιμο του λάστιχου.

Μικρότερη κατανάλωση καυσίμου: Η μειωμένη πίεση των ελαστικών αυξάνει την κατανάλωση καυσίμου έως και 4 %.

Σημαντικό πριν την εποχιακή αλλαγή των ελαστικών: Οι βαλβίδες πίεσης ελαστικών και τα ηλεκτρονικά συστήματα για τους τροχούς από την BERU απαιτούνται και για τα δύο σετ ελαστικών. Η συμβουλή μας: προμηθευτείτε έγκαιρα και σε επαρκή ποσότητα αυτά τα εξαρτήματα!

Για επίκαιρες οδηγίες σχετικά με τη συναρμολόγηση και το καλιμπράρισμα πληκτρολογήστε www.beru.com/tss. Για τη σωστή λειτουργία του TSS της BERU θα πρέπει να ακολουθήσετε με ακρίβεια αυτές τις οδηγίες.

Τöbb biztonságot, komfortot és gazdaságosságot nyújt

A BERU abroncsnyomás-ellenőrző rendszert (TSS) az Audi, Bentley, BMW, Bugatti, Ferrari, Land Rover, Maserati, Maybach, Mercedes-Benz, Porsche és VW márkák járműveiben alkalmazzák. Az abroncsnyomás és hőmérséklet állandó ellenőrzése nagy előnyöket nyújt a vezetőknek:

Több biztonságot menet közben

Csak Németországban meg lehetne előzni évente kb. 250 000 veszélyes gumidefektet és abroncs robbanást, ha a vezetőt azonnal tájékoztatnák az előírt nyomástól való eltérésekről ill. bizonyos határértékek el neméréséről. Európában számítva ez kb. 1,2 millió gumidefektet és abroncs robbanást jelentene, amely valószínűleg elkerülhető lenne.

Növelt kényelem

A nem kedvelt abroncsnyomás-ellenőrzéseket a BERU abroncsnyomás-ellenőrző rendszer TSS veszi át.

Fokozott gazdaságosság

Meghosszabított abroncs élettartam: Alacsony abroncsnyomás lerövidíti az abroncs élettartamát – 0,2 bar 10 %-al, 0,6 bar majdnem 50 %-al. Állandó alacsony nyomás növeli a gyúrási munkát. Ennek a következménye egy időelőtti anyagfáradás, amely az abroncs robbanásához is vezethet. Csökkentett üzemanyag fogyasztás: Az alacsony nyomás növeli az üzemanyag fogyasztást 4 %-ig.

Fontos az időnyi abroncs csere előtt: Mindkét abroncskészlethez szükséges BERU abroncsnyomás-szelepek és kerékelektronika. Ezért a mi javaslatunk: Tartalékoljon idejében és elegendő mennyiséget ezekből az alkatrészekből!

Az aktuális szerelési- és kalibrációs utasításokat a www.beru.com/tss cím alatt találja meg. A BERU TSS helyes működésének biztosítása céljából tartsa be pontosan az ebben az útmutatóba leírt utasításokat.





RDE 001

0 532 207 001

433 MHz

Ferrari 185189
Maserati 185189
Mercedes Benz
A 000 822 33 06
Porsche 955 606 021 00
VW 4 D0 907 275



RDE 002

0 532 207 002

433 MHz

BMW 8 378 682



RDE 003

0 532 207 003

433 MHz
verstärkte Sendeleistung¹⁷

BMW 36 146 752 128
Land Rover YDB 0000 60



RDE 004

0 532 107 001

315 MHz
USA/CDN

Mercedes Benz
A 000 822 34 06
VW 4 D0 907 275 A



RDE 005

0 532 207 005

433 MHz
verstärkte Sendeleistung¹⁷

Ferrari 193867
Porsche 955 361 661 00
VW 7 L0 907 275



RDE 007 ★

0 532 207 007

433 MHz

VW 4F0 907 275,
4F0 907 275 B



RDE 008 ★

0 532 207 008

433 MHz
USA

BMW 6 779 490, 6 771 034,
36 23 6 779 490,
36 23 6 771 034



★ = neu⁵⁰

**BERU****RDV 001**

0 535 007 001

BMW 36 111 095 375
Porsche 3 DO 601 361
VW 3 DO 601 361**RDV 002** (grün)³²

0 535 007 002



BMW 36 111 096 449

RDV 003 (schwarz)³¹

0 535 007 003

BMW 36 111 095 374
Mercedes Benz
A 001 401 27 13**RDV 004** (rot)³³

0 535 007 004



BMW 36 111 095 373

- Pro Fahrzeug werden 4 Radelektroniken benötigt. Bei Nachrüsträdern ist die genaue Zuordnung der Ventile und Distanzscheiben aus dem Radgutachten oder der ABE zu entnehmen oder beim Radhersteller zu erfragen. Eine detaillierte Montage- und Kalibrierungsanleitung finden Sie unter www.beru.com/tss.
- 4 wheel electronic units are required per vehicle. In the case of retrofitted wheels, ascertain the exact allocation of valves and spacers from the wheel certificate or the ABE (German general certification), or ask the wheel manufacturer. Detailed fitting and calibration instructions can be found at www.beru.com/tss.
- Il faut 4 modules électroniques de roue par véhicule. Sur les roues montées en accessoires, l'affectation exacte des valves et des écarteurs figure dans l'homologation de roue ou dans ABE ou doit être demandée auprès du fabricant de roue. Vous trouverez des instructions de montage et de calibrage détaillées à l'adresse www.beru.com/tss.
- Per voertuig zijn 4 wielelektronica-elementen nog. Bij het achteraf aanbrengen vindt u de exacte plaats van de ventielen en afstandsringen in het bandenrapport of de ABE, of u kunt dit navragen bij uw bandenfabrikant. Een uitgebreide montage- en afstelhandleiding vindt u onder www.beru.com/tss.
- Se necesitan 4 componentes electrónicos de rueda por coche. En el caso de las ruedas de reequipamiento la coordinación exacta de las válvulas y discos distanciadores se debe tomar del dictámen de las ruedas o del ABE, o bien preguntar al fabricante de las ruedas. Encontrará unas instrucciones detalladas de calibrado y montaje en www.beru.com/tss.
- Per ogni veicolo sono necessarie 4 unità elettroniche per le ruote. In caso di conversioni ad altre ruote, per l'esatta corrispondenza di valvole e distanziali fare riferimento ai dati tecnici o ABE, oppure richiederli al produttore della ruota. Per istruzioni di montaggio e calibrazione dettagliate, visitare il sito www.beru.com/tss.
- Для одного автомобиля требуется 4 колесных электронных устройства. В случае дополнительных колес данные о точном согласовании клапанов и распорных шайб взять из экспертизы колеса или ABE, либо запросить производителя колеса. Детальное руководство по монтажу и калибровке Вы найдете по адресу www.beru.com/tss.
- Dla każdego pojazdu potrzebne są 4 układy elektroniki koła. W przypadku uzupełniania wyposażenia kół należy zapoznać się z dokładnym przyporządkowaniem zaworów i podkładek dystansowych w atestacji lub dopuszczeniu (ABE) koła albo pozyskać te informacje od producenta koła. Szczegółowa instrukcja montażu i kalibracji dostępna jest pod www.beru.com/tss.
- Ανά όχημα απαιτούνται 4 ηλεκτρονικά κυκλώματα τροχού. Αν το όχημα έχει μετεξοπλιστεί με νέους τροχούς, διαφορετικούς από τον αρχικό εξοπλισμό του, απαραίτητα είναι τα ακριβή στοιχεία για τη διάταξη των βαλβίδων και των ροδέλων απόστασης (αναφέρονται στα έγγραφα που συνοδεύουν τους τροχούς ή μπορείτε να τα πληροφορηθείτε από τον κατασκευαστή των τροχών). Για λεπτομερείς οδηγίες σχετικά με τη συναρμολόγηση και το καλιμπράρισμα πληκτρολογήστε www.beru.com/tss.
- Járművenként 4 kerélektronikára van szükség. Új csere kerekek esetében a szelepek és a távolsági tárcsa pontos illesztését a kerékhez fűződő szakírásban és az általános üzemelési engedélyben olvashatja, vagy a kerékgyártónál kérdezhet utána. Egy részletes szerelési- és kalibrációs utasításban a www.beru.com/tss cím alatt találja.

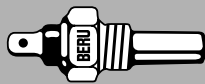

SPR 005

0 824 331 018

M10 x 1,0

24
Nm 30

°C
min. 2,0-4,0



D/C 001 545 08 09, A 001 545 08 09
FIAT 76008494
IVECO 76008494
Kässbohrer 7 314 005 000
MAN 81 25505 0237
Renault 50 00 278 328



SPR 006

0 824 331 021

M10 x 1,0
M27 x 1,0

27
Nm 30

°C
min. 2,0-5,0



D/C 000 545 59 09, A 000 545 59 09
FIAT 41822307
IVECO 41822307
KHD 41822307
MAN 81 25520 0054, 81 25520 6007



SPR 007

0 824 331 014

M12 x 1,5

24
Nm 30

°C
min. 0,1-0,5



DAF 533633, D/C 000 763 1410, A 000 763 1410
FAUN 1726 129, 0118 159, FIAT / IVECO 3416590
Kälble-Gmeinder 037 00227 00
KHD 341 6590, 5145 80 16 41
Kässbohrer 7 314 002 100
Orenstein/Koppel 118 159, Perkins 2848073
Renault 50 00 080 230, 50 00 271 900
Saurer 244 0645 002, Saviem 50 00 257 029
Scania 158717, Steyr 991 14 71 0001
Volvo 1571540, 240112, 241374



SPR 008

0 824 331 015

M27 x 1,0
M12 x 1,5

27
Nm 30

°C
min. 0,1-0,5



D/C 000 545 45 09, A 000 545 45 09, 000 545 60 09,
A 000 545 60 09
FIAT 41822309
IVECO 41822309, 42533916
Henschel 915 559
KHD 4182 2309
Saurer 244 0645 015
Scania 422208
Volvo 298004





SPR 001

0 824 331 004

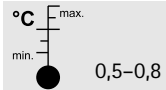

Agria 384 52
Fendt F 020 200 110 011
Hanomag Rhein Stahl 2992 199 M 1, X 88 0001 0849 26
Henschel 1 084 926
KHD 0144 39 07 44, 2936 7029, 336 0189
MWM 6 0578 20 1 0016
Volvo 239669

SPR 009

0 824 331 026

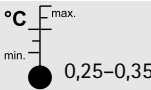
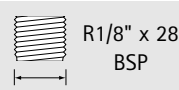

Daihatsu 83530 10020 000, 83530 12040 000,
83530 14030 000, 83530 36011 000, 83530 87702 000
Subaru 8299 56100
Toyota 83530 10010, 83530 10020, 83530 12010,
83530 12020, 83530 12040, 83530 14010,
83530 14020, 83530 14030, 83530 14040,
83530 30030, 83530 30043, 83530 30080

SPR 002

0 824 331 011

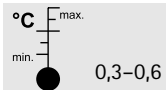

Porsche 911 613 571 00
Bomag 058 320 01
KHD 116 8500, 116 9902, 5107 80 04 21, EM 10 H4207
Steinbock 019427
Steyr (Steyr-Daimler-Puch AG) 609 F 07 0074

SPR 010

0 824 331 027

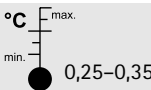
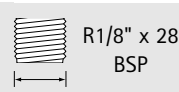

Mitsubishi MC 017430, MC 840219, MD 001482,
MD 001483, MD 021566, MD 138993, MD 138994

SPR 003

0 824 331 010

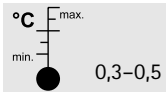

VW 028 919 081 A, 028 919 081 B, 028 919 081 C,
061 919 081

SPR 011

0 824 331 028

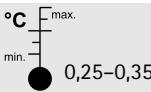
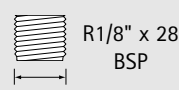

Daihatsu 83530 30060 000, 83530 87701 000,
83530 87706 000
Isuzu 9 82720 209 2
Toyota 83530 30010, 83530 30020, 83530 30021,
83530 30022, 83530 30040, 83530 30041, 83530
30042, 83530 30050, 83530 30060, 83530 36010,
83530 36011

SPR 004

0 824 331 025

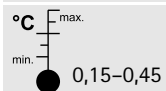

Volvo 1257137
VW 056 919 081 A, 021 919 081 C, 028 919 081 D,
056 919 081 C
KHD 117 8933

SPR 012

0 824 331 029

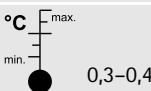
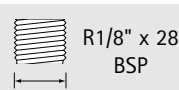

Daihatsu 83530 87201 000, 83530 87205 000,
83530 87703 000
Mazda E5D3 18 501

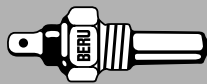

SPR 013

0 824 331 030

R1/8" x 28
BSP

24

Nm 30

°C
min. max.
● 0,25-0,35



Daihatsu 83530 87102 000, 83530 87705 000
Hino 83530 1080
Honda 37240 634 305
Mazda B366 18 501
Subaru 25240 KA020
Suzuki 37820 73002, 37820 82000, 37820 82001

SPR 017

0 824 331 034

M10 x 1,0

24

Nm 30

°C
min. max.
● 1,7-1,9



VW 056 919 081 E

SPR 014

0 824 331 031

R1/8" x 28
BSP

24

Nm 30

°C
min. max.
● 0,25-0,35



Honda 37240 PD2 003, 37240 PD2 004,
37240 PTO 003

SPR 018

0 824 331 039

M14 x 1,5

24

Nm 55

°C
min. max.
● 0,3-0,55



GM/Opel 1252506, 8954566
Renault 7701 348 032

SPR 015

0 824 331 032

R1/8" x 28
BSP

24

Nm 30

°C
min. max.
● 0,3-0,4



Hino 83530 1070
Honda 37240 657 013, 37240 PA6 004, 37240 PI3 003
Mazda R207 18 501
Subaru 4299 55500
Suzuki 37820 80001

SPR 019

0 824 331 040

M14 x 1,5

24

Nm 55

°C
min. max.
● 0,3-0,55



Mercedes Benz A 004 542 59 17, 004 542 59 17

SPR 016

0 824 331 033

R1/8" x 28
BSP

24

Nm 30

°C
min. max.
● 0,3-0,4



Nissan 15160-90001, 25240-89901, 25240-89902,
25240-89910

SPR 020

0 824 331 036

1/4 -18
NPTF

24

Nm 55

°C
min. max.
● 0,2-0,6



Ford 1066811, 6499475, 6170902, 6539971,
6716335



SPR 021

0 824 331 037



M10 x 1,0



24

Nm

30

°C

max.

min.

1,3-1,5



VW 068 919 081

SPR 022

0 824 331 038



M10 x 1,0



24

Nm

30

°C

max.

min.

0,8-1,0



Ford 1669964
VW 068 919 081 A

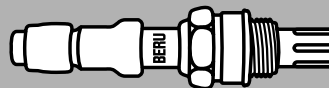

ALFA ROMEO	OZH 003, OZH 035, OZH 037, OZH 046, OZH 052, OZH 054, OZH 055, OZH 056, OZH 067, OZH 192, OZH 217
ALPINA	OZH 173
ALPINE	OZH 033, OZH 044
AUDI	OZH 003, OZH 017, OZH 027, OZH 035, OZH 037, OZH 044, OZH 046, OZH 068, OZH 069, OZH 070, OZH 071, OZH 086, OZH 103, OZH 128, OZH 151, OZH 152, OZH 169, OZH 177, OZH 178, OZH 181, OZH 190, OZU 001, OZU 022
BERTONE	OZH 036
BMW	OZH 001, OZH 002, OZH 004, OZH 023, OZH 030, OZH 036, OZH 039, OZH 167, OZH 168, OZH 173, OZH 193, OZH 199, OZH 218, OZH 222, OZH 223, OZH 224, OZU 001
CHEVROLET	OZH 033
CHRYSLER	OZH 024, OZH 044
CITROËN	OZH 005, OZH 034, OZH 038, OZH 074, OZH 079, OZH 104, OZH 107, OZH 159, OZH 166, OZH 194
DAEWOO	OZU 005
DAIHATSU	OZU 001
DAIMLER	OZH 037
DE LOREAN	OZU 001
FERRARI	OZH 035, OZH 037
FIAT	OZH 034, OZH 035, OZH 037, OZH 046, OZH 049, OZH 052, OZH 054, OZH 055, OZH 056, OZH 064, OZH 066, OZH 084, OZH 088, OZH 118, OZH 135, OZH 136, OZH 137, OZH 159, OZH 180, OZU 001, OZU 006, OZU 022
FORD	OZH 006, OZH 014, OZH 020, OZH 021, OZH 045, OZH 050, OZH 059, OZH 075, OZH 151, OZH 176, OZH 181
HONDA	OZH 006, OZH 009, OZH 020, OZH 028, OZH 099, OZH 120, OZH 121, OZH 122, OZH 123, OZU 001, OZU 014
HYUNDAI	OZH 037, OZU 001
KIA	OZH 204, OZH 207
LANCIA	OZH 034, OZH 035, OZH 037, OZH 046, OZH 052, OZH 055, OZH 056, OZH 065, OZH 084, OZH 088, OZH 118, OZH 135, OZH 138, OZH 159, OZH 180, OZU 001, OZU 022
LANDROVER	OZH 173
MAZDA	OZH 022, OZH 043, OZH 076, OZH 095, OZH 100, OZH 153, OZH 163, OZH 200, OZU 001, OZU 012, OZU 021
MERCEDES	OZH 007, OZH 016, OZH 018, OZH 021, OZH 023, OZH 025, OZH 026, OZH 032, OZH 033, OZH 041, OZH 042, OZH 051, OZH 098, OZH 124, OZH 143, OZH 144, OZH 145, OZH 146, OZH 196, OZH 200, OZH 220, OZH 220, OZU 001
MG	OZH 053
MINI	OZU 001
NISSAN	OZH 011, OZH 012, OZH 201, OZH 203, OZH 225, OZH 226, OZH 227, OZH 228, OZH 229, OZU 001, OZU 010, OZU 024
OPEL	OZH 019, OZH 028, OZH 040, OZH 110, OZH 111, OZH 112, OZH 113, OZH 114, OZH 115, OZH 132, OZH 147, OZH 148, OZU 001, OZU 005, OZU 023
PEUGEOT	OZH 005, OZH 029, OZH 034, OZH 038, OZH 044, OZH 066, OZH 072, OZH 074, OZH 079, OZH 104, OZH 159, OZH 194, OZH 205, OZH 206, OZU 001
RENAULT	OZH 019, OZH 033, OZH 044, OZH 058, OZH 083, OZH 087, OZH 092, OZH 096, OZH 101, OZH 107, OZH 108, OZH 109, OZH 125, OZH 160, OZH 184, OZH 208, OZU 001, OZU 022, OZU 025
ROVER	OZH 053, OZH 057, OZH 067, OZH 094, OZH 120, OZU 004
SAAB	OZH 037, OZH 046, OZH 154, OZH 156, OZH 157, OZH 158, OZU 001, OZU 021
SEAT	OZH 008, OZH 009, OZH 012, OZH 024, OZH 037, OZH 043, OZH 046, OZH 070, OZH 071, OZH 127, OZH 128, OZH 150, OZH 151, OZH 164, OZH 169, OZH 177, OZH 179, OZH 182, OZU 001, OZU 003, OZU 022
SKODA	OZH 037, OZH 043, OZH 099, OZH 128, OZH 169, OZH 177
SUZUKI	OZU 014, OZU 015
VAUXHALL	OZH 019, OZH 028, OZH 040, OZH 110, OZH 132, OZH 148, OZU 005, OZU 023
VOLVO	OZH 003, OZH 035, OZH 037, OZH 046, OZH 073, OZH 130, OZH 155, OZH 161, OZH 209, OZH 210

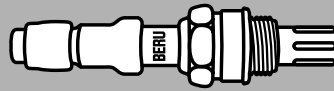

VW

OZH 008, OZH 009, OZH 010, OZH 012, OZH 022, OZH 024, OZH 027, OZH 028, OZH 031, OZH 037, OZH 043, OZH 047, OZH 048, OZH 068, OZH 069, OZH 070, OZH 071, OZH 086, OZH 099, OZH 127, OZH 128, OZH 131, OZH 134, OZH 146, OZH 150, OZH 151, OZH 152, OZH 165, OZH 169, OZH 177, OZH 178, OZH 179, OZH 181, OZH 182, OZH 190, OZH 215, OZU 001, OZU 003, OZU 022

ZASTAVA

OZH 044



AGRIA	SPR 001
ALFA ROMEO	ST 028, ST 035, ST 036, ST 045, ST 048, ST 072, ST 073
AUDI	RDE 001, RDE 004, RDE 007, RDV 001, SPR 002, SPR 004, SPR 017, SPR 021, SPR 022, ST 013, ST 038, ST 053, ST 054, ST 060, ST 065, ST 070, ST 071, ST 100, ST 108, ST 112, ST 113, ST 114, ST 115, ST 119, ST 121, ST 122
BENTLEY	RDE 001, RDE 007
BMW	RDE 002, RDE 003, RDE 008, RDV 001, RDV 002, RDV 003, RDV 004, SD 008, ST 003, ST 005, ST 010, ST 056, ST 060, ST 110, ST 117
BOMAG	SPR 002
BÜSSING	SPR 007
CITROËN	ST 012, ST 028, ST 029, ST 034, ST 043, ST 044, ST 049, ST 078, ST 101
DACIA	ST 044
DAEWOO	ST 037, ST 069
DAF	SPR 007
DAIHATSU	SPR 009, SPR 011, SPR 012, SPR 013, ST 039, ST 042
DEUTZ	SD 006, ST 090
EBERSPÄCHER	ST 020, ST 021, ST 022, ST 27, ST 109
EICHER	SPR 007
FENDT	SPR 001,
FERRARI	RDE 001, RDE 005, ST 036
FIAT	SPR 005, SPR 008, ST 018, ST 028, ST 035, ST 043, ST 046, ST 049, ST 058, ST 063, ST 072, ST 073, ST 074, ST 077, ST 078, ST 088, ST 097
FORD	SD 007, SPR 020, SPR 022, ST 014, ST 017, ST 033, ST 035, ST 040, ST 047, ST 051, ST 055, ST 060, ST 098, ST 101
GENERAL MOTORS	SPR 018, ST 089
HANOMAG	SPR 001, SPR 007
HENSCHEL	SPR 001, SPR 007, SPR 008
HONDA	SPR 014, SPR 015, ST 039
HYUNDAI	ST 028
IKARUS	SPR 007
INNOCENTI-LEYLAND	ST 045
ISUZU	SPR 011
IVECO	SD 001, SPR 008, ST 024, ST 025
JAGUAR	ST 068
KAELBLE	SPR 007
KÄSBOHRER	SPR 007, ST 016, ST 019
KHD	SPR 001, SPR 002, SPR 004, SPR 007, SPR 008, ST 090
KRAMER	ST 023
KRUPP	SPR 007
LADA	ST 046
LANCIA	ST 018, ST 028, ST 035, ST 046, ST 058, ST 063, ST 072, ST 073, ST 088
LAND ROVER	RDE 003
LEXUS	ST 068
LIEBHERR	ST 016
MAGIRUS DEUTZ	SPR 007
MAN	SPR 005, SPR 007
MASERATI	RDE 001



MAYBACH	RDE 001
MAZDA	SPR 012, SPR 013, SPR 015, ST 039, ST 068
MERCEDES	RDE 001, RDE 004, RDV 003, SD 002, SD 003, SD 004, SD 005, SD 009, SD 010, SPR 005, SPR 006, SPR 007, SPR 008, SPR 019, ST 001, ST 002, ST 004, ST 007, ST 008, ST 009, ST 011, ST 057, ST 059
MITSUBISHI	SPR 010, ST 041, ST 066
MWM	SPR 001,
NISSAN	SPR 016, ST 067
NSU	SPR 001
OPEL	SPR 018, ST 028, ST 036, ST 037, ST 066, ST 069, ST 075, ST 076, ST 077, ST 079, ST 080, ST 081, ST 082, ST 083, ST 085, ST 086, ST 087, ST 088, ST 089, ST 123
PEUGEOT	ST 012, ST 028, ST 029, ST 034, ST 043, ST 044, ST 049, ST 072, ST 078, ST 101
PORSCHE	RDE 001, RDE 005, RDV 001, SPR 002, SPR 003, ST 026, ST 028, ST 036, ST 100
RENAULT	SPR 007, SPR 018, ST 015, ST 024, ST 025, ST 032, ST 043, ST 044, ST 101
SAAB	ST 028, ST 052, ST 089
SAUER	SPR 008
SCANIA	SPR 007, SPR 008
SEAT	SPR 017, SPR 021, SPR 022, ST 013, ST 028, ST 030, ST 031, ST 036, ST 045, ST 050, ST 053, ST 060, ST 073, ST 102, ST 108, ST 112, ST 113, ST 114, ST 115, ST 116, ST 119, ST 121
SKODA	SPR 021, SPR 022, ST 028, ST 100, ST 102, ST 108, ST 112, ST 113, ST 114, ST 119, ST 121
STEINBOCK	SPR 002
STEYR-DAIMLER-PUCH	SPR 002
SUBARU	SPR 009, SPR 015, ST 042
SUZUKI	SPR 010, SPR 013, ST 039, ST 068
TALBOT	ST 044, ST 049
TOYOTA	SPR 009, SPR 011, ST 041, ST 042, ST 068
VAUXHALL	ST 028, ST 037, ST 069, ST 075, ST 076, ST 079, ST 080, ST 082, ST 085, ST 087
VOLKSWAGEN	RDE 001, RDE 005, RDV 001, SPR 001, SPR 003, SPR 004, SPR 017, SPR 021, SPR 022, ST 013, ST 028, ST 030, ST 031, ST 036, ST 038, ST 050, ST 053, ST 054, ST 065, ST 070, ST 071, ST 100, ST 102, ST 103, ST 104, ST 105, ST 106, ST 107, ST 108, ST 112, ST 113, ST 114, ST 115, ST 116, ST 118, ST 119, ST 120, ST 121, ST 125
VOLVO	SPR 001, SPR 004, SPR 007, SPR 008, ST 015, ST 028, ST 038, ST 054, ST 061, ST 062, ST 073, ST 084
ZASTAVA	ST 028, ST 046

D Wichtiger Hinweis:

Diese Vergleichsliste ist nur eine Orientierungshilfe. Benützen Sie die aktuellen Beru Verwendungslisten um das verbindliche Produkt festzustellen. Eine Rückumschlüsselung von Beru zu Fremdtypen ist nicht erlaubt. Aus einer falschen Umschlüsselung können keine Gewährleistungsansprüche abgeleitet werden.

GB Important note:

This comparison list is only an aid. Refer to the current Beru application lists to find the binding product. Reverse conversion from Beru to types from other manufacturers is not permitted. No liability claims can be derived from an incorrect conversion.

F Important:

Cette liste comparative vous est donnée à titre indicatif. Pour déterminer le produit adéquat, veuillez vous référer aux listes d'affectations Beru en vigueur. L'utilisation de la liste d'équivalences dans l'autre sens (de Beru vers les autres marques) n'est pas possible. Une conversion erronée rend tout droit à la garantie caduque.

NL Waarschuwing:

Deze vergelijkingslijst is slechts bedoeld als oriënteringhulp. Gebruik de actuele Beru-toepassingslijsten om het goedgekeurde product vast te stellen. Terugomzetten van Beru naar types van andere fabrikanten is niet toegestaan. Er kunnen geen garantieaanspraken afgeleid worden van een verkeerde omzetting.

E Nota importante:

Esta lista comparativa sirve únicamente como referencia. Utilice las listas de aplicación actuales de Beru para determinar el producto adecuado. No se permite el uso inverso de la lista de equivalencias (de Beru a otras marcas). De una conversión errónea no se puede derivar ningún tipo de derechos de garantía.

I Indicazione importante:

Questa lista di confronto serve solo a scopo di riferimento. Per definire in maniera vincolante il prodotto giusto utilizzate le liste di applicazione Beru più attuali. La riconversione dei codici Beru in codici di altri produttori non è ammessa. In caso di errori nella conversione dei codici decade qualsiasi diritto di garanzia.

GUS Важное указание!

Настоящий перечень сравнительных данных представляет собой лишь вспомогательное средство для ориентации. Следует использовать актуальный перечень фирмы Beru с описанием применений с тем, чтобы определить продукт, связанный гарантийными обязательствами. Не разрешается перекодирование Beru в другой тип. Неправильное перекодирование исключает право на гарантийные обязательства.

PL Ważne zalecenie:

Niniejsza lista porównawcza stanowi jedynie pomoc orientacyjną. W celu ustalenia obowiązującego produktu należy stosować aktualne listy zastosowań wyrobów firmy Beru. Niedozwolone jest wtórne zastępowanie wyrobów firmy Beru wyrobami innych firm. Nieprawidłowe zastąpienie powoduje przepadek roszczeń gwarancyjnych.

GR Σημαντική υπόδειξη:

Αυτός ο κατάλογος σύγκρισης αποτελεί μόνο βοήθεια προσανατολισμού. Για να εξακριβώσετε το αυθεντικό προϊόν χρησιμοποιήστε τους επίκαιρους καταλόγους χρήσης της Beru. Δεν επιτρέπεται η διακωδικοποίηση από προϊόντα της Beru σε προϊόντα ξένων κατασκευαστών. Από εσφαλμένη διακωδικοποίηση δεν μπορούν να συναχθούν εγγυητικές αξιώσεις.

H Fontos figyelemztetés:

Ez az összehasonlító lista kizárólag a tájékozódást segíti. A megfelelő termék kiválasztásához használja a Beru aktuális alkalmazási listáit. A Beru típusait nem szabad más gyártók típusaival helyettesíteni. Téves behelyettesítésből nem vezethet le jótállási igényt.

Ersatztypen⁴

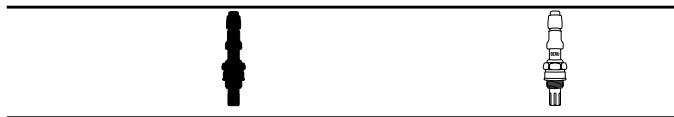

OZH 013	0 824 010 014	OZH 059	0 824 010 065
OZH 015	0 824 010 016	OZH 059	0 824 010 065
OZH 062	0 824 010 068	OZH 035	0 824 010 037
OZH 063	0 824 010 069	OZH 056	0 824 010 061



0 192 114 001	SD 006	0 192 114 007
0 192 114 005	SD 007	0 192 114 006
0 824 111 016	ST 074	0 824 122 013
0 824 111 017	ST 075	0 824 121 123
0 824 111 028	ST 086	0 824 121 134
0 824 121 017	ST 075	0 824 121 123
0 824 121 113	ST 065	0 824 131 034
0 824 121 156	ST 099	○



0 532 207 006	RDE 006	○
---------------	----------------	---



DG 001	0 192 115 012	SD 001
DG 002	0 191 325 002	SD 002
DG 003	0 191 325 004	SD 003
DG 004	0 191 325 006	SD 004
DG 005	0 192 115 001	SD 005
DG 006	0 192 114 007	SD 006
OT 007	0 191 325 007	SD 009
TF 001	0 824 121 001	ST 001
TF 002	0 824 121 020	ST 002
TF 003	0 824 121 003	ST 003
TF 004	0 824 111 006	ST 004
TF 005	0 824 111 003	ST 005
TF 007	0 824 121 058	ST 007
TF 008	0 824 121 040	ST 008
TF 009	0 824 121 046	ST 009
TF 010	0 824 111 004	ST 010
TF 011	0 824 121 051	ST 011
TF 012	0 824 121 072	ST 012
TF 013	0 824 121 073	ST 013
TF 014	0 824 121 074	ST 014
TF 015	0 824 121 075	ST 015
TF 016	0 824 121 016	ST 016

TF 017	0 824 121 076	ST 017
TF 018	0 824 121 077	ST 018
TF 019	0 824 121 019	ST 019
TF 020	0 824 102 007	ST 020
TF 021	0 824 102 008	ST 021
TF 022	0 824 112 005	ST 022
TF 023	0 824 121 005	ST 023
TF 024	0 824 121 031	ST 024
TF 025	0 824 121 032	ST 025
TF 026	0 824 131 021	ST 026
TF 027	0 824 112 006	ST 027
TF 028	0 824 121 078	ST 028
TF 029	0 824 121 080	ST 029
TF 030	0 824 121 081	ST 030
TF 031	0 824 121 082	ST 031
TF 032	0 824 111 007	ST 032
TF 033	0 824 111 008	ST 033
TF 034	0 824 111 009	ST 034
TF 035	0 824 111 010	ST 035
TF 036	0 824 111 011	ST 036

Umschlüsselung Erstausrüstungs-Bestell-Nr. (OE)
→ Handels-Bestell-Nr. (AM)²⁷



0 532 207 009	RDE 008	0 532 207 008
---------------	----------------	---------------

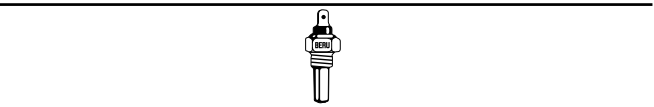

0 824 121 026	ST 007	0 824 121 058
---------------	---------------	---------------

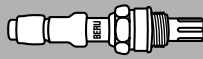

AGRIA	BERU	
38452	SPR 001	0824331004

ALFA	BERU	
105000632200	ST 045	0824121092
112016	OZU 022	0824010094
1168511016	OZU 001	0824010001
161241101601	OZH 037	0824010039
162281101600	OZH 037	0824010039
195321101000	ST 028	0824121078
46417969	OZH 056	0824010061
46433052	ST 036	0824111011
46452598	OZH 138	0824010172
46477717	ST 072	0824121120
530438	ST 048	0824121097
548193	OZH 003	0824010004
59635160	OZU 022	0824010094
60504210	ST 048	0824121097
605076900	OZH 037	0824010039
605132050	ST 028	0824121078
60515838	ST 045	0824121092
60515839	ST 045	0824121092
60537650	OZH 003	0824010004
60567759	OZH 046	0824010048
60585603	ST 073	0824121122
60587697	OZH 067	0824010073
60751206	ST 048	0824121097
60808223	ST 073	0824121122
60808350	OZH 055	0824010060
60809012	OZH 037	0824010039
60809247	ST 072	0824121120
60812162	OZH 052	0824010057
6193040	OZH 065	0824010071
7555123	OZH 037	0824010039
75551290	OZH 037	0824010039
76193030	OZH 037	0824010039
76193040	OZH 065	0824010071
76303320	OZH 046	0824010048
76400820	OZH 037	0824010039
7707638	OZH 037	0824010039
7785973	OZH 052	0824010057
96138608	OZH 034	0824010036

AUDI	BERU	
025 906 265	OZU 001	0824010001
028 919 501 1	ST 038	0824121084
028 919 501 A	ST 054	0824121103
035 906 265 B	OZU 022	0824010094
035 919 501	ST 038	0824121084
048 906 265 B	OZH 017	0824010018
049 919 501	ST 053	0824121102
175 919 501	ST 053	0824121102
279 195 01	ST 053	0824121102
4D0 907 275	RDE 001	0532207001
7L0 907 275	RDE 005	0532207005

BEHR	BERU	
8.123.23	ST 100	0824121157
8.130.29.325	ST 101	0824121158
8.135.10	ST 070	0824121118
8.140.11.325	ST 075	0824121123
8.143.11	ST 085	0824121133

BEHR	BERU	
8.146.10.325	ST 106	0824121163
8.170.02	ST 108	0824121165
8.177.01.325	ST 079	0824121127
8.177.05.325	ST 080	0824121128
8.177.25.325	ST 082	0824121130
8.210.02	ST 104	0824121161

BMW	BERU	
1 277 565	OZU 001	0824010001
1 741 900	ST 091	0824121148
11 76 1 277 565	OZU 001	0824010001
11 78 1 247 235	OZH 036	0824010038
11 78 1 247 406	OZH 173	0824010207
11 78 1 247 475	OZH 023	0824010024
11 78 1 433 159	OZH 023	0824010024
11 78 1 433 940	OZH 168	0824010202
11 78 1 437 586	OZH 218	0824010252
11 78 1 702 931	OZH 036	0824010038
11 78 1 704 259	OZH 023	0824010024
11 78 1 714 873	OZH 193	0824010227
11 78 1 720 536	OZH 036	0824010038
11 78 1 720 537	OZH 002	0824010003
11 78 1 720 672	OZH 004	0824010005
11 78 1 720 845	OZH 036	0824010038
11 78 1 720 860	OZH 039	0824010041
11 78 1 721 125	OZH 039	0824010041
11 78 1 725 676	OZH 036	0824010038
11 78 1 726 321	OZH 030	0824010032
11 78 1 730 005	OZH 036	0824010038
11 78 1 730 007	OZH 004	0824010005
11 78 1 733 628	OZH 036	0824010038
11 78 1 734 345	OZH 036	0824010038
11 78 1 734 390	OZH 036	0824010038
11 78 1 734 393	OZH 036	0824010038
11 78 1 734 796	OZH 039	0824010041
11 78 1 735 345	OZH 036	0824010038
11 78 1 735 499	OZH 036	0824010038
11 78 1 735 500	OZH 036	0824010038
11 78 1 735 680	OZH 030	0824010032
11 78 1 735 710	OZH 030	0824010032
11 78 1 739 005	OZH 036	0824010038
11 78 1 739 642	OZH 036	0824010038
11 78 1 739 845	OZH 199	0824010233
11 78 1 741 317	OZH 023	0824010024
11 78 1 742 023	OZH 023	0824010024
11 78 1 742 050	OZH 173	0824010207
11 78 1 742 051	OZH 167	0824010201
11 78 1 747 005	OZH 036	0824010038
11 78 1 747 579	OZH 036	0824010038
11 78 7 503 441	OZH 222	0824010256
11 78 7 506 531	OZH 223	0824010257
11 78 7 506 539	OZH 224	0824010258
12 52 1 741 900	ST 091	0824121148
12 62 1 288 158	ST 060	0824121108
12 62 1 710 535	ST 117	0824121171
12 62 1 747 281	ST 117	0824121171
12 62 2 241 791	Auf Anfrage ¹⁸	
12 62 2 242 630	ST 110	0824121028
12 62 2 242 630	ST 110	0824121028
12 62 2 242 631	ST 110	0824121028
12 62 2 243 815	ST 092	0824121149
12 62 2 306 316	SD 008	0191315002
12 62 2 331 289	SD 008	0191315002

BMW	BERU	
12 62 2 243 815	ST 092	0824121149
13 62 1 284 397	ST 028	0824121078
13 62 1 709 966	ST 028	0824121078
13 62 1 725 323	ST 010	0824111004
13 62 2 243 946	ST 005	0824111003
34 32 7 670 028	Auf Anfrage ¹⁸	
34 52 2 306 316	SD 008	0191315002
34 52 2 331 289	SD 008	0191315002
34 52 2 333 484	Auf Anfrage ¹⁸	
34 52 2 333 490	Auf Anfrage ¹⁸	
34 52 7 675 199	Auf Anfrage ¹⁸	
36 14 67 52 128	RDE 003	0532207003
61 31 8 360 857	ST 093	0824121150
61 31 8 363 677	ST 095	0824121152
61 31 8 376 440	ST 094	0824121151
61 31 8 386 135	ST 096	0824121153
62 11 0 788 115	ST 003	0824121003
8 360 857	ST 093	0824121150
8 363 677	ST 095	0824121152
8 376 440	ST 094	0824121151
8 378 682	RDE 002	0532207002
8 386 135	ST 096	0824121153

BOMAG	BERU	
058 320 01	SPR 002	0824331011

BOSCH	BERU	
0 258 001 025	OZU 001	0824010001
0 258 001 026	OZU 022	0824010094
0 258 001 027	OZU 001	0824010001
0 258 001 028	OZU 001	0824010001
0 258 001 030	OZU 001	0824010001
0 258 001 031	OZU 001	0824010001
0 258 001 032	OZU 001	0824010001
0 258 001 035	OZU 010	0824010090
0 258 001 037	OZU 001	0824010001
0 258 001 038	OZU 001	0824010001
0 258 001 039	OZU 001	0824010001
0 258 001 040	OZU 001	0824010001
0 258 001 041	OZU 001	0824010001
0 258 001 042	OZU 001	0824010001
0 258 001 043	OZU 022	0824010094
0 258 001 047	OZU 001	0824010001
0 258 001 051	OZU 022	0824010094
0 258 001 052	OZU 022	0824010094
0 258 001 929	OZU 001	0824010001
0 258 001 960	OZU 001	0824010001
0 258 001 961	OZU 001	0824010001
0 258 001 962	OZU 001	0824010001
0 258 001 963	OZU 001	0824010001
0 258 001 964	OZU 001	0824010001
0 258 002 012	OZU 001	0824010001
0 258 002 014	OZU 005	0824010055
0 258 002 015	OZU 001	0824010001
0 258 002 017	OZU 001	0824010001
0 258 002 018	OZU 001	0824010001
0 258 002 020	OZU 001	0824010001
0 258 002 021	OZU 001	0824010001
0 258 002 022	OZU 001	0824010001
0 258 002 023	OZU 001	0824010001
0 258 002 024	OZU 001	0824010001
0 258 002 025	OZU 001	0824010001



BOSCH	BERU	
0 258 002 026	OZU 001	0824010001
0 258 002 027	OZU 001	0824010001
0 258 002 028	OZU 001	0824010001
0 258 002 029	OZU 001	0824010001
0 258 002 031	OZU 001	0824010001
0 258 002 032	OZU 001	0824010001
0 258 002 033	OZU 001	0824010001
0 258 002 035	OZU 022	0824010094
0 258 002 036	OZU 001	0824010001
0 258 002 038	OZU 001	0824010001
0 258 002 039	OZU 001	0824010001
0 258 002 040	OZU 003	0824010053
0 258 002 041	OZU 003	0824010053
0 258 002 042	OZU 001	0824010001
0 258 002 044	OZU 001	0824010001
0 258 002 045	OZU 001	0824010001
0 258 002 046	OZU 001	0824010001
0 258 002 049	OZU 001	0824010001
0 258 002 908	OZU 001	0824010001
0 258 002 909	OZU 001	0824010001
0 258 002 919	OZU 001	0824010001
0 258 003 004	OZH 044	0824010046
0 258 003 005	OZH 192	0824010226
0 258 003 006	OZH 037	0824010039
0 258 003 009	OZH 037	0824010039
0 258 003 013	OZH 006	0824010007
0 258 003 014	OZH 037	0824010039
0 258 003 016	OZH 007	0824010008
0 258 003 017	OZH 040	0824010042
0 258 003 019	OZH 037	0824010039
0 258 003 020	OZH 003	0824010004
0 258 003 021	OZH 028	0824010030
0 258 003 027	OZH 003	0824010004
0 258 003 028	OZH 046	0824010048
0 258 003 032	OZH 037	0824010039
0 258 003 034	OZH 003	0824010004
0 258 003 035	OZH 006	0824010007
0 258 003 037	OZH 193	0824010227
0 258 003 040	OZH 037	0824010039
0 258 003 044	OZH 005	0824010006
0 258 003 046	OZH 066	0824010072
0 258 003 047	OZH 001	0824010002
0 258 003 052	OZH 002	0824010003
0 258 003 057	OZH 046	0824010048
0 258 003 060	OZH 003	0824010004
0 258 003 061	OZH 037	0824010039
0 258 003 063	OZH 044	0824010046
0 258 003 064	OZH 036	0824010038
0 258 003 067	OZH 039	0824010041
0 258 003 068	OZH 004	0824010005
0 258 003 069	OZH 039	0824010041
0 258 003 074	OZH 029	0824010031
0 258 003 075	OZH 037	0824010039
0 258 003 077	OZH 033	0824010035
0 258 003 078	OZH 005	0824010006
0 258 003 081	OZH 033	0824010035
0 258 003 082	OZH 040	0824010042
0 258 003 083	OZH 027	0824010028
0 258 003 085	OZH 027	0824010028
0 258 003 086	OZH 033	0824010035
0 258 003 087	OZH 194	0824010228
0 258 003 088	OZH 166	0824010200
0 258 003 090	OZH 037	0824010039
0 258 003 095	OZH 027	0824010028
0 258 003 096	OZH 006	0824010007

BOSCH	BERU	
0 258 003 097	OZH 006	0824010007
0 258 003 101	OZH 046	0824010048
0 258 003 103	OZH 035	0824010037
0 258 003 108	OZH 030	0824010032
0 258 003 110	OZH 009	0824010010
0 258 003 112	OZH 008	0824010009
0 258 003 114	OZH 031	0824010033
0 258 003 115	OZH 030	0824010032
0 258 003 116	OZH 008	0824010009
0 258 003 118	OZH 075	0824010081
0 258 003 119	OZH 003	0824010004
0 258 003 120	OZH 035	0824010037
0 258 003 130	OZH 026	0824010027
0 258 003 132	OZH 026	0824010027
0 258 003 134	OZH 007	0824010008
0 258 003 139	OZH 040	0824010042
0 258 003 141	OZH 028	0824010030
0 258 003 144	OZH 051	0824010056
0 258 003 146	OZH 026	0824010027
0 258 003 154	OZH 196	0824010230
0 258 003 156	OZH 032	0824010034
0 258 003 157	OZH 032	0824010034
0 258 003 160	OZH 033	0824010035
0 258 003 164	OZH 044	0824010046
0 258 003 165	OZH 009	0824010010
0 258 003 167	OZH 009	0824010010
0 258 003 169	OZH 009	0824010010
0 258 003 171	OZH 008	0824010009
0 258 003 172	OZH 008	0824010009
0 258 003 175	OZH 037	0824010039
0 258 003 179	OZH 009	0824010010
0 258 003 181	OZH 009	0824010010
0 258 003 189	OZH 033	0824010035
0 258 003 191	OZH 008	0824010009
0 258 003 193	OZH 057	0824010062
0 258 003 194	OZH 044	0824010046
0 258 003 199	OZH 018	0824010019
0 258 003 201	OZH 033	0824010035
0 258 003 203	OZH 034	0824010036
0 258 003 206	OZH 037	0824010039
0 258 003 207	OZH 010	0824010011
0 258 003 211	OZH 010	0824010011
0 258 003 213	OZH 010	0824010011
0 258 003 215	OZH 036	0824010038
0 258 003 216	OZH 043	0824010045
0 258 003 219	OZH 036	0824010038
0 258 003 220	OZH 036	0824010038
0 258 003 222	OZH 035	0824010037
0 258 003 229	OZH 053	0824010058
0 258 003 231	OZH 036	0824010038
0 258 003 232	OZH 010	0824010011
0 258 003 234	OZH 037	0824010039
0 258 003 235	OZH 037	0824010039
0 258 003 239	OZH 038	0824010040
0 258 003 240	OZH 035	0824010037
0 258 003 241	OZH 027	0824010028
0 258 003 243	OZH 028	0824010030
0 258 003 244	OZH 036	0824010038
0 258 003 246	OZH 003	0824010004
0 258 003 247	OZH 012	0824010013
0 258 003 248	OZH 012	0824010013
0 258 003 254	OZH 027	0824010028
0 258 003 256	OZH 011	0824010012
0 258 003 259	OZH 013	0824010014
0 258 003 260	OZH 044	0824010046

BOSCH	BERU	
0 258 003 261	OZH 039	0824010041
0 258 003 262	OZH 035	0824010037
0 258 003 263	OZH 009	0824010010
0 258 003 265	OZH 043	0824010045
0 258 003 266	OZH 043	0824010045
0 258 003 267	OZH 043	0824010045
0 258 003 269	OZH 024	0824010025
0 258 003 271	OZH 024	0824010025
0 258 003 273	OZH 012	0824010013
0 258 003 279	OZH 044	0824010046
0 258 003 280	OZH 044	0824010046
0 258 003 281	OZH 017	0824010018
0 258 003 288	OZH 043	0824010045
0 258 003 290	OZH 067	0824010073
0 258 003 291	OZH 013	0824010014
0 258 003 292	OZH 014	0824010015
0 258 003 295	OZH 017	0824010018
0 258 003 298	OZH 037	0824010039
0 258 003 300	OZH 040	0824010042
0 258 003 301	OZH 055	0824010060
0 258 003 303	OZH 165	0824010199
0 258 003 305	OZH 134	0824010168
0 258 003 307	OZH 015	0824010016
0 258 003 307	OZH 059	0824010065
0 258 003 310	OZH 036	0824010038
0 258 003 313	OZH 037	0824010039
0 258 003 314	OZH 016	0824010017
0 258 003 320	OZH 041	0824010043
0 258 003 321	OZH 041	0824010043
0 258 003 322	OZH 041	0824010043
0 258 003 324	OZH 042	0824010044
0 258 003 325	OZH 042	0824010044
0 258 003 331	OZH 009	0824010010
0 258 003 333	OZH 094	0824010114
0 258 003 334	OZH 043	0824010045
0 258 003 337	OZH 157	0824010191
0 258 003 338	OZH 036	0824010038
0 258 003 339	OZH 045	0824010047
0 258 003 340	OZH 020	0824010021
0 258 003 342	OZH 045	0824010047
0 258 003 343	OZH 020	0824010021
0 258 003 344	OZH 017	0824010018
0 258 003 357	OZH 036	0824010038
0 258 003 371	OZH 043	0824010045
0 258 003 373	OZH 161	0824010195
0 258 003 374	OZH 156	0824010190
0 258 003 381	OZH 155	0824010189
0 258 003 392	OZH 045	0824010047
0 258 003 393	OZH 158	0824010192
0 258 003 396	OZH 017	0824010018
0 258 003 412	OZH 036	0824010038
0 258 003 420	OZH 011	0824010012
0 258 003 426	OZH 036	0824010038
0 258 003 427	OZH 018	0824010019
0 258 003 433	OZH 198	0824010232
0 258 003 437	OZH 043	0824010045
0 258 003 439	OZH 043	0824010045
0 258 003 443	OZH 018	0824010019
0 258 003 446	OZH 019	0824010020
0 258 003 447	OZH 019	0824010020
0 258 003 448	OZH 019	0824010020
0 258 003 456	OZH 045	0824010047
0 258 003 457	OZH 045	0824010047
0 258 003 460	OZH 036	0824010038
0 258 003 466	OZH 056	0824010061

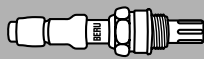

BOSCH	BERU	
0 258 003 475	OZH 167	0824010201
0 258 003 476	OZH 167	0824010201
0 258 003 477	OZH 173	0824010207
0 258 003 478	OZH 068	0824010074
0 258 003 484	OZH 045	0824010047
0 258 003 485	OZH 020	0824010021
0 258 003 486	OZH 045	0824010047
0 258 003 505	OZH 154	0824010188
0 258 003 508	OZH 044	0824010046
0 258 003 510	OZH 044	0824010046
0 258 003 511	OZH 044	0824010046
0 258 003 512	OZH 036	0824010038
0 258 003 513	OZH 021	0824010022
0 258 003 515	OZH 146	0824010180
0 258 003 518	OZH 069	0824010075
0 258 003 519	OZH 069	0824010075
0 258 003 524	OZH 103	0824010128
0 258 003 542	OZH 070	0824010076
0 258 003 544	OZH 071	0824010077
0 258 003 546	OZH 022	0824010023
0 258 003 548	OZH 022	0824010023
0 258 003 550	OZH 153	0824010187
0 258 003 560	OZH 056	0824010061
0 258 003 561	OZH 199	0824010233
0 258 003 567	OZH 072	0824010078
0 258 003 569	OZH 052	0824010057
0 258 003 571	OZH 200	0824010234
0 258 003 573	OZH 026	0824010027
0 258 003 578	OZH 062	0824010068
0 258 003 579	OZH 056	0824010061
0 258 003 584	OZH 150	0824010184
0 258 003 586	OZH 022	0824010023
0 258 003 597	OZH 023	0824010024
0 258 003 599	OZH 145	0824010179
0 258 003 605	OZH 022	0824010023
0 258 003 624	OZH 201	0824010235
0 258 003 626	OZH 073	0824010079
0 258 003 627	OZH 064	0824010070
0 258 003 630	OZH 181	0824010215
0 258 003 634	OZH 203	0824010237
0 258 003 638	OZH 016	0824010017
0 258 003 644	OZH 101	0824010125
0 258 003 646	OZH 151	0824010185
0 258 003 648	OZH 164	0824010198
0 258 003 653	OZH 204	0824010238
0 258 003 666	OZH 099	0824010121
0 258 003 667	OZH 074	0824010080
0 258 003 668	OZH 104	0824010129
0 258 003 669	OZH 079	0824010089
0 258 003 672	OZH 205	0824010239
0 258 003 673	OZH 206	0824010240
0 258 003 694	OZH 151	0824010185
0 258 003 696	OZH 151	0824010185
0 258 003 704	OZH 207	0824010241
0 258 003 713	OZH 045	0824010047
0 258 003 714	OZH 045	0824010047
0 258 003 715	OZH 107	0824010139
0 258 003 716	OZH 074	0824010080
0 258 003 717	OZH 104	0824010129
0 258 003 718	OZH 079	0824010089
0 258 003 719	OZH 159	0824010193
0 258 003 734	OZH 151	0824010185
0 258 003 738	OZH 151	0824010185
0 258 003 740	OZH 152	0824010186
0 258 003 744	OZH 033	0824010035

BOSCH	BERU	
0 258 003 745	OZH 099	0824010121
0 258 003 759	OZH 071	0824010077
0 258 003 763	OZH 040	0824010042
0 258 003 766	OZH 019	0824010020
0 258 003 769	OZH 136	0824010170
0 258 003 770	OZH 138	0824010172
0 258 003 772	OZH 056	0824010061
0 258 003 779	OZH 050	0824010052
0 258 003 780	OZH 045	0824010047
0 258 003 781	OZH 045	0824010047
0 258 003 782	OZH 143	0824010177
0 258 003 784	OZH 144	0824010178
0 258 003 800	OZH 050	0824010052
0 258 003 801	OZH 059	0824010065
0 258 003 805	OZH 064	0824010070
0 258 003 829	OZH 024	0824010025
0 258 003 842	OZH 151	0824010185
0 258 003 862	OZH 124	0824010158
0 258 003 870	OZH 025	0824010026
0 258 003 892	OZH 160	0824010194
0 258 003 913	OZH 006	0824010007
0 258 003 915	OZH 051	0824010056
0 258 003 925	OZH 026	0824010027
0 258 003 930	OZH 026	0824010027
0 258 003 931	OZH 037	0824010039
0 258 003 936	OZH 047	0824010049
0 258 003 957	OZH 046	0824010048
0 258 003 965	OZH 027	0824010028
0 258 003 973	OZH 047	0824010049
0 258 003 979	OZH 048	0824010050
0 258 003 995	OZH 027	0824010028
0 258 004 001	OZH 065	0824010071
0 258 005 001	OZH 098	0824010120
0 258 005 003	OZH 145	0824010179
0 258 005 007	OZH 111	0824010145
0 258 005 030	OZH 208	0824010242
0 258 005 054	OZH 167	0824010201
0 258 005 055	OZH 148	0824010182
0 258 005 062	OZH 209	0824010243
0 258 005 063	OZH 210	0824010244
0 258 005 066	OZH 151	0824010185
0 258 005 068	OZH 151	0824010185
0 258 005 079	OZH 169	0824010203
0 258 005 081	OZH 177	0824010211
0 258 005 083	OZH 098	0824010120
0 258 005 087	OZH 135	0824010169
0 258 005 088	OZH 021	0824010022
0 258 005 097	OZH 073	0824010079
0 258 005 101	OZH 046	0824010048
0 258 005 109	OZH 168	0824010202
0 258 005 115	OZH 169	0824010203
0 258 005 123	OZH 215	0824010249
0 258 005 135	OZH 184	0824010218
0 258 005 156	OZH 217	0824010251
0 258 005 158	OZH 151	0824010185
0 258 005 177	OZH 218	0824010252
0 258 005 191	OZH 056	0824010061
0 258 005 192	OZH 056	0824010061
0 258 005 202	OZH 220	0824010254
0 258 005 234	OZH 112	0824010146
0 258 005 235	OZH 111	0824010145
0 258 005 249	OZH 084	0824010099
0 258 005 253	OZH 076	0824010084
0 258 005 256	OZH 132	0824010166
0 258 005 258	OZH 056	0824010061

BOSCH	BERU	
0 258 005 259	OZH 222	0824010256
0 258 005 270	OZH 223	0824010257
0 258 005 271	OZH 224	0824010258
0 258 005 274	OZH 225	0824010259
0 258 005 278	OZH 226	0824010260
0 258 005 286	OZH 227	0824010261
0 258 005 291	OZH 110	0824010144
0 258 005 293	OZH 228	0824010262
0 258 005 295	OZH 229	0824010263
0 258 005 324	OZH 036	0824010038
0 258 005 334	OZH 157	0824010191
0 258 005 651	OZH 137	0824010171
0 258 005 708	OZH 163	0824010197
0 258 006 190	OZH 056	0824010061
0 258 010 134	OZH 184	0824010218
0 258 010 810	OZH 023	0824010024
0 280 130 026	ST 028	0824121078
0 280 130 039	ST 036	0824111011
0 280 130 040	ST 013	0824121073
0 344 004 006	SPR 006	0824331021
0 344 004 007	SPR 005	0824331018
0 344 004 012	SPR 005	0824331018
0 344 004 015	SPR 006	0824331021
0 344 101 001	SPR 002	0824331011
0 344 101 007	SPR 001	0824331004
0 344 101 033	SPR 001	0824331004
0 344 101 036	SPR 018	0824331039
0 344 101 047	SPR 003	0824331010
0 344 101 051	SPR 002	0824331011
0 344 101 056	SPR 003	0824331010
0 344 101 057	SPR 003	0824331010
0 344 101 072	SPR 004	0824331025
0 344 101 078	SPR 017	0824331034
0 344 101 080	SPR 019	0824331040
0 344 101 082	SPR 004	0824331025
0 344 400 006	SPR 007	0824331014
0 344 400 008	SPR 007	0824331014
0 344 400 010	SPR 008	0824331015
0 986 258 024	OZU 023	0824010136
0 986 344 033	SPR 001	0824331004
0 986 344 036	SPR 018	0824331039
0 986 344 051	SPR 002	0824331011
0 986 344 056	SPR 003	0824331010
0 986 344 080	SPR 019	0824331040
0 986 344 082	SPR 004	0824331025
0 986 344 086	SPR 020	0824331036
0 986 345 000	SPR 011	0824331028
0 986 345 001	SPR 009	0824331026
0 986 345 003	SPR 016	0824331033
0 986 345 005	SPR 012	0824331029
0 986 345 006	SPR 015	0824331032
0 986 345 008	SPR 013	0824331030
0 986 345 009	SPR 014	0824331031
0 986 345 017	SPR 010	0824331027
0 986 345 112	SPR 005	0824331018
0 986 345 115	SPR 006	0824331021
0 986 345 408	SPR 007	0824331014
0 986 345 410	SPR 008	0824331015

BREMI	BERU	
10750/29	SPR 020	0824331036

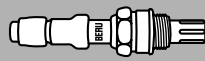

BUGIAD	BERU	
BTS 65086	ST 106	0824121163
BTS 65154	ST 123	0824121177
BTS 65251	ST 116	0824121170
BTS 65269	ST 030	0824121081
BTS 65287	ST 107	0824121164
BTS 65298	ST 115	0824121169
BTS 65306	ST 121	0824121175
BTS 65307	ST 119	0824121173
BTS 65312	ST 117	0824121171
BTS 65358	ST 122	0824121176

CATERPILLAR	BERU	
101-9646	Auf Anfrage ¹⁸	

CHEVROLET	BERU	
90 448 458	OZH 040	0824010042
93 232 414	OZU 001	0824010001

CITROËN	BERU	
1264.03	ST 101	0824121158
1264.14	ST 101	0824121158
1264.34	ST 078	0824121126
1338.47	ST 029	0824121080
1628 34	OZH 029	0824010031
1628 3W	OZH 072	0824010078
1628 6R	OZH 074	0824010080
1628 6W	OZH 079	0824010089
1628 9T	OZH 159	0824010193
1628 9V	OZH 104	0824010129
1628 A4	OZH 066	0824010072
1628 HT	OZH 104	0824010129
1628 J4	OZH 029	0824010031
1628 L4	OZH 005	0824010006
1628 L6	OZH 166	0824010200
1628 T2	OZH 034	0824010036
1628 V4	OZH 038	0824010040
1920 C4	ST 012	0824121072
1920 C5	ST 034	0824111009
91 040 370	ST 028	0824121078
91 414 549	ST 028	0824121078
91 514 046	ST 101	0824121158
91 514 549	ST 028	0824121078
91 540 672	OZH 066	0824010072
95 494 924	OZU 001	0824010001
95 548 678	ST 044	0824121091
95 581 212	ST 044	0824121091
95 635 047	OZH 046	0824010048
95 640 493	ST 012	0824121072
95 640 497	ST 034	0824111009
96 027 244	OZH 029	0824010031
96 036 827	OZH 005	0824010006
96 039 269	OZH 166	0824010200
96 051 883	OZH 194	0824010228
96 127 346	OZH 038	0824010040
96 127 817	OZH 038	0824010040
96 211 179	OZH 072	0824010078
96 211 180	OZH 072	0824010078
96 211 180 80	OZH 072	0824010078
96 229 969	OZH 074	0824010080

CITROËN	BERU	
96 229 969 80	OZH 074	0824010080
96 229 970	OZH 104	0824010129
96 229 971	OZH 079	0824010089
96 229 971 80	OZH 079	0824010089
96 229 974	OZH 046	0824010048
96 284 480	OZH 104	0824010129
96 284 480 80	OZH 104	0824010129
96 356 573	OZH 104	0824010129
97 509 510	ST 049	0824121098
97 519 138	ST 049	0824121098

DAEWOO	BERU	
02 801 300 26	ST 028	0824121078
25 036 979	ST 069	0824121117
25 106 073	OZU 005	0824010055
25 162 753	OZU 001	0824010001
96 335 925	OZU 001	0824010001

DAF	BERU	
1292638	OZH 037	0824010039
533633	SPR 007	0824331014

DAIHATSU	BERU	
83420 87701 000	ST 039	0824121085
83530 10020 000	SPR 009	0824331026
83530 12040 000	SPR 009	0824331026
83530 14030 000	SPR 009	0824331026
83530 30060 000	SPR 011	0824331028
83530 36011 000	SPR 009	0824331026
83530 87102 000	SPR 013	0824331030
83530 87201 000	SPR 012	0824331029
83530 87205 000	SPR 012	0824331029
83530 87701 000	SPR 011	0824331028
83530 87702 000	SPR 009	0824331026
83530 87703 000	SPR 012	0824331029
83530 87705 000	SPR 013	0824331030
83530 87706 000	SPR 011	0824331028
89465 87101 000	OZU 001	0824010001
89465 87105 000	OZU 001	0824010001
89465 87202 000	OZU 001	0824010001
89465 87211 000	OZU 001	0824010001
89465 87601 000	OZU 001	0824010001
89465 87704 000	OZU 001	0824010001

DEUTZ AG	BERU	
0 131 9347	DG 006	0192114007
0 224 4960	Auf Anfrage ¹⁸	
0 224 8959	Auf Anfrage ¹⁸	
0 224 9021	Auf Anfrage ¹⁸	
0 224 9022	Auf Anfrage ¹⁸	
0 224 9023	Auf Anfrage ¹⁸	
0 224 9024	Auf Anfrage ¹⁸	
0 224 9029	Auf Anfrage ¹⁸	
0 224 9601	Auf Anfrage ¹⁸	
0 418 9848	Auf Anfrage ¹⁸	
0 419 0087	Auf Anfrage ¹⁸	
0 419 0089	Auf Anfrage ¹⁸	
0 419 0201	Auf Anfrage ¹⁸	
0 419 4021	Auf Anfrage ¹⁸	
0 419 9143	Auf Anfrage ¹⁸	

DEUTZ AG	BERU	
0 419 9207	Auf Anfrage ¹⁸	
0 419 9260	Auf Anfrage ¹⁸	
0 419 9363	Auf Anfrage ¹⁸	
0 419 9382	ST 090	0824121139
0 419 9384	Auf Anfrage ¹⁸	
0 419 9410	Auf Anfrage ¹⁸	
0 419 9792	Auf Anfrage ¹⁸	
0 436 4426	DG 006	0192114007
2 249 029	Auf Anfrage ¹⁸	
2 249 600	Auf Anfrage ¹⁸	

EBERSPÄCHER	BERU	
25 1729 37 00 00	ST 020	0824102007
25 1864 40 01	ST 022	0824112005
25 1864 40 02 00	ST 027	0824112006
25 1895 35 00 00	ST 021	0824102008
25 1920 35 00 00	ST 109	0824112012
25 1920 35 00 00 0 D	ST 109	0824112012
L07 188 971	OZH 028	0824010030
L07 288 971	OZH 040	0824010042
L08 488 971	OZH 040	0824010042
L21 189 971	OZH 030	0824010032
L21 190 971	OZH 036	0824010038
L21 286 971	OZH 039	0824010041
L21 288 971	OZH 004	0824010005
L21 386 972	OZH 036	0824010038
L21 490 971	OZH 036	0824010038
L23 192 971	OZH 018	0824010019
L23 279 971	OZH 007	0824010008
L23 288 971	OZH 032	0824010034
L23 692 971	OZH 016	0824010017

FACET	BERU	
1.830.146	ST 030	0824121081
1.850.651	ST 103	0824121160
530 146	ST 030	0824121081
550 651	ST 103	0824121160
7.0007	SPR 001	0824331004
7.0008	SPR 004	0824331025
7.0011	SPR 020	0824331036
7.0014	SPR 013	0824331030
7.0014	SPR 015	0824331032
7.0015	SPR 014	0824331031
7.0015	SPR 016	0824331033
7.0016	SPR 011	0824331028
7.0016	SPR 012	0824331029
7.0017	SPR 009	0824331026
7.0023	SPR 018	0824331039
7.0045	SPR 017	0824331034
7.0046	SPR 021	0824331037
7.0074	SPR 019	0824331040
7.0094	SPR 010	0824331027
7.0095	SPR 022	0824331038
7.3015	ST 003	0824121003
7.3066	ST 003	0824121003
7.3084	ST 097	0824121154
7.3086	ST 115	0824121169
7.3088	ST 001	0824121001
7.3115	ST 098	0824121155
7.3128	ST 028	0824121078
7.3140	ST 007	0824121058
7.3146	ST 030	0824121081
7.3151	ST 002	0824121020

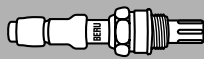

FACET	BERU	
7.3171	ST 013	0824121073
7.3176	ST 117	0824121171
7.3183	ST 008	0824121040
7.3258	ST 119	0824121173
7.3260	ST 121	0824121175
7.3262	ST 018	0824121077
7.3278	ST 114	0824121168
7.3533	ST 122	0824121176
7.4081	ST 092	0824121149
7.4112	ST 071	0824121119
7.5005	ST 100	0824121157
7.5007	ST 101	0824121158
7.5027	ST 070	0824121118
7.5031	ST 073	0824121122
7.5103	ST 077	0824121125
7.5117	ST 075	0824121123
7.5136	ST 077	0824121125
7.5197	ST 106	0824121163
7.5241	ST 076	0824121124
7.5602	ST 074	0824122013
7.5622	ST 078	0824121126
7.5635	ST 108	0824121165
7.5642	ST 078	0824121126
7.5643	ST 072	0824121120
7.5650	ST 102	0824121159
7.5651	ST 103	0824121160
7.5652	ST 104	0824121161
7.5654	ST 105	0824121162
7.5674	ST 123	0824121177
7.5681	ST 072	0824121120
7.5683	ST 093	0824121150
7.5684	ST 095	0824121152
7.5691	ST 094	0824121151
7.5694	ST 096	0824121153
10.7020	OZH 138	0824010172
10.7034	OZH 165	0824010199
10.7067	OZH 161	0824010195
10.7087	OZH 181	0824010215
10.7090	OZH 182	0824010216
10.7097	OZH 184	0824010218
10.7103	OZH 154	0824010188
10.7106	OZH 157	0824010191
10.7163	OZH 169	0824010203
10.7214	OZH 180	0824010214
10.7221	OZH 158	0824010192
10.7222	OZH 155	0824010189
10.7255	OZH 168	0824010202
10.7282	OZH 184	0824010218
10.7298	OZH 173	0824010207
10.7304	OZH 152	0824010186
10.7356	OZH 178	0824010212
10.7357	OZH 179	0824010213
10.7362	OZH 190	0824010224
10.7406	OZH 143	0824010177
10.7411	OZH 146	0824010180
10.7422	OZH 145	0824010179
10.7594	OZH 184	0824010218
10.7926	OZH 144	0824010178

FAUN	BERU	
0118 159	SPR 007	0824331014
1726 129	SPR 007	0824331014

FEBI BILSTEIN	BERU	
01300	ST 059	0824121090
01528	ST 108	0824121165
01651	ST 037	0824121083
01804	ST 047	0824121094
01806	ST 055	0824121104
01840	ST 089	0824111030
01939	ST 053	0824121102
02754	ST 070	0824121118
02916	ST 057	0824121106
04726	SPR 018	0824331039
04777	ST 075	0824121123
05283	ST 071	0824121119
07015	ST 002	0824121020
07788	ST 051	0824121100
07803	ST 040	0824121086
08444	SPR 022	0824331038
08484	SPR 021	0824331037
08485	SPR 017	0824331034
08668	ST 001	0824121001
08675	SPR 019	0824331040
10114	ST 104	0824121161
11915	ST 087	0824121135
11964	ST 073	0824121122
17693	ST 080	0824121128
17696	ST 079	0824121127
18666	ST 115	0824121169
18987	ST 029	0824121080
19036	ST 030	0824121081

FENDT	BERU	
F 020 200 110 011	SPR 001	0824331004

FERRARI	BERU	
121515	OZH 037	0824010039
125769	ST 028	0824121078
142514	OZH 035	0824010037
185189	RDE 001	0532207001
193867	RDE 005	0532207005

FIAT	BERU	
0007548005	ST 097	0824121154
0007588883	ST 097	0824121154
05992746	ST 073	0824121122
07728057	ST 073	0824121122
112016	OZU 022	0824010094
3416590	SPR 007	0824331014
41822307	SPR 006	0824331021
41822309	SPR 008	0824331015
4414600	ST 046	0824121093
4418305	ST 063	0824121111
4430291	OZU 022	0824010094
4448131	ST 046	0824121093
46125769	ST 028	0824121078
46408449	OZH 056	0824010061
46417969	OZH 056	0824010061
46418568	OZH 064	0824010070
46418813	OZH 088	0824010106
46419222	OZH 049	0824010051
46420612	OZH 062	0824010068
46422649	OZH 054	0824010059

FIAT	BERU	
46423798	OZH 062	0824010068
46424723	OZH 056	0824010061
46444284	OZH 056	0824010061
46449401	OZH 064	0824010070
46452598	OZH 138	0824010172
46452813	OZH 136	0824010170
46455802	OZH 064	0824010070
46460055	OZH 135	0824010169
46462006	OZH 056	0824010061
46477022	ST 088	0824121146
46478033	ST 078	0824121126
46521170	OZH 118	0824010152
46523129	OZH 056	0824010061
46523497	OZH 032	0824010034
46523497	OZH 217	0824010251
46555846	OZH 137	0824010171
46750249	OZH 180	0824010214
5958828	ST 074	0824122013
5963516	OZU 022	0824010094
5972332	ST 028	0824121078
5992746	ST 073	0824121122
60507630	OZH 037	0824010039
60507690	OZH 037	0824010039
60513205	ST 028	0824121078
60537650	OZH 003	0824010004
60562536	OZH 035	0824010037
60567759	OZH 037	0824010039
60574613	OZH 066	0824010072
60578768	OZH 055	0824010060
60583122	OZH 035	0824010037
60587697	OZH 067	0824010073
60733358	OZU 001	0824010001
60800167	ST 028	0824121078
60805428	OZH 037	0824010039
60808142	ST 028	0824121078
60808350	OZH 055	0824010060
60808457	OZH 046	0824010048
60809012	OZH 037	0824010039
60810814	OZH 056	0824010061
60812162	OZH 052	0824010057
60812717	OZH 056	0824010061
73127291	SPR 005	0824331018
7547976	ST 035	0824111010
7547977	ST 088	0824121146
7548005	ST 097	0824121154
7555129	OZH 037	0824010039
7570837	ST 077	0824121125
7576281	ST 074	0824122013
7588883	ST 097	0824121154
76008494	SPR 005	0824331018
7619303	OZH 037	0824010039
7619304	OZH 065	0824010071
7628799	ST 074	0824122013
7630332	OZH 046	0824010048
7640082	OZH 037	0824010039
7642522	ST 078	0824121126
7654221	OZH 046	0824010048
7655732	ST 072	0824121120
7668286	OZH 035	0824010037
7669143	ST 018	0824121077
7674048	OZH 027	0824010028
7706754	OZU 006	0824010064
7707638	OZH 037	0824010039
7728057	ST 073	0824121122
7735919	ST 058	0824121107

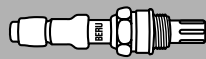

FIAT	BERU	
7738582	ST 072	0824121120
7751308	OZH 084	0824010099
7755123	OZH 037	0824010039
7785973	OZH 052	0824010057
7789741	OZH 056	0824010061
7910247507	ST 043	0824121089
82436410	ST 073	0824121122
82465533	ST 073	0824121122
82477919	ST 073	0824121122
9154067280	OZH 066	0824010072
96138608	OZH 034	0824010036
9628448280	OZH 159	0824010193
9750951080	ST 049	0824121098

FORD	BERU	
01 053 108	OZH 176	0824010210
02 690 616 16	ST 033	0824111008
06 083 015	ST 098	0824121155
06 107 551	ST 098	0824121155
07 325 143	OZH 181	0824010215
09 293 952 1	Auf Anfrage ¹⁸	
1 001 702	OZH 045	0824010047
1 025 958	OZH 014	0824010015
1 066 811	SPR 020	0824331036
1 583 836	ST 040	0824121086
1 626 473	ST 060	0824121108
1 640 552	OZH 006	0824010007
1 657 685	ST 051	0824121100
1 669 948	ST 030	0824121081
1 669 964	SPR 022	0824331038
6 058 836	ST 040	0824121086
6 076 967	ST 047	0824121094
6 083 015	ST 098	0824121155
6 098 273	ST 040	0824121086
6 107 551	ST 098	0824121155
6 120 663	ST 101	0824121158
6 136 366	ST 055	0824121104
6 164 926	OZH 006	0824010007
6 170 902	SPR 020	0824331036
6 193 368	ST 014	0824121074
6 499 475	SPR 020	0824331036
6 539 971	SPR 020	0824331036
6 635 407	SD 007	0192114006
6 716 335	SPR 020	0824331036
6 740 335	ST 033	0824111008
6 810 428	ST 017	0824121076
6 847 910	OZH 059	0824010065
7 089 574	OZH 045	0824010047
77 FB 10884 AA	ST 040	0824121086
81 AB 10884 AA	ST 047	0824121094
81 EB 1088 4AA	ST 040	0824121086
82 GB 10884 AB	ST 098	0824121155
83 GB 8B607 A2B	ST 101	0824121158
86 AB 10884 AA	ST 055	0824121104
87 GB 9F472 AA	OZH 006	0824010007
89 BB 9F472 AA	OZH 075	0824010081
89 FB 9F472 AC	OZH 013	0824010014
89 FB 9F472 BA	OZH 013	0824010014
89 FB 9F472 CA	OZH 015	0824010016
89 GB 9F472 AA	OZH 006	0824010007
90 BB 9F472 AB	OZH 014	0824010015
90 TF 6C315 A2B	SD 007	0192114006
90 TF 6C315 AB	SD 007	0192114006
91 AB10884 AA	ST 014	0824121074

FORD	BERU	
92 AB 9F492 AA	OZH 050	0824010052
93 AB 9F472 AA	OZH 050	0824010052
93 AB 9F492 AA	OZH 050	0824010052
93 BB 9F472 AA	OZH 054	0824010059
93 BB 9F472 AA	OZH 059	0824010065
93 Fb 9F472 AA	OZH 013	0824010014
93 GB 9F472 AA	OZH 045	0824010047
93 GB 9F472 BA	OZH 020	0824010021
93 VB 9F472 AA	OZH 020	0824010021
95 FB 9F472 BA	OZH 045	0824010047
95 FB 9F472 CB	OZH 020	0824010021
95 FB 9F472 DB	OZH 045	0824010047
95 FB 9F472 EA	OZH 045	0824010047
95 VW 9F472 EA	OZH 022	0824010023
95 VW 9F472 FA	OZH 151	0824010185
95 VW 10884 AA	ST 030	0824121081
96 BB 9F472 BA	OZH 031	0824010033
96 FB 9F472 CA	OZH 045	0824010047
96 FB 9F472 DA	OZH 045	0824010047
96 GB 9F472 AA	OZH 050	0824010052
97 VW 9F472 AA	OZH 150	0824010184
98 AB 9F472 BB	OZH 176	0824010210
E4ZF 9F472 AA	OZH 006	0824010007
E59F 9F472 A1A	OZH 006	0824010007
E67F 9F472 AA	OZH 006	0824010007
E6ZF 9F472 AB	OZU 001	0824010001
E6ZZ 9F472 A	OZU 001	0824010001
F2AF12A648 AA	ST 017	0824121076
F2DF12A697 AA	ST 033	0824111008
FOTZ 6C315 D	SD 007	0192114006
FOTZ 6C315 DA	SD 007	0192114006

FRANCISCO ALBERO S.A	BERU	
10250	SPR 019	0824331040
11410	SPR 018	0824331039
12900	SPR 021	0824331037
12930	SPR 022	0824331038
13520	SPR 020	0824331036
32560	ST 117	0824121171
33010	ST 116	0824121170
33515	ST 112	0824111033
33620	ST 115	0824121169
33782	ST 121	0824121175
33783	ST 119	0824121173
33784	ST 114	0824121168
34220	ST 122	0824121176
38360	ST 123	0824121177

GMC	BERU	
13338451	ST 028	0824121078
1338444	ST 028	0824121078
1338451	ST 028	0824121078
1338548	ST 028	0824121078
241333391	OZU 001	0824010001
3439088	ST 037	0824121083
8954566	SPR 018	0824331039
90080039	ST 028	0824121078
90080939	ST 028	0824121078
90242277	ST 075	0824121123
90257163	ST 089	0824111030
90277288	ST 076	0824121124
90307873	ST 077	0824121125

GMC	BERU	
90335879	ST 080	0824121128
90338500	ST 085	0824121133
90339408	ST 080	0824121128
90339409	ST 079	0824121127
90341759	ST 082	0824121130
90355880	ST 079	0824121127
90357304	ST 086	0824121134
90376209	ST 081	0824121129
90410792	ST 028	0824121078
90411977	ST 088	0824121146
90449435	ST 087	0824121135
90477289	ST 089	0824111030
90492454	ST 083	0824121131
90506498	ST 123	0824121177
90510850	ST 037	0824121083
9152245	ST 089	0824111030
9703606	ST 066	0824121114

HANOMAG	BERU	
2992 199 M 1	SPR 001	0824331004
X 88 0001 0849 26	SPR 001	0824331004
X 88 5954 7036 85	SPR 007	0824331014

HAVAM	BERU	
1800011	SPR 020	0824331036
1800023	SPR 018	0824331039
1800074	SPR 019	0824331040
1830086	ST 115	0824121169
1830128	ST 116	0824121170
1830176	ST 117	0824121171
1830258	ST 119	0824121173
1830260	ST 121	0824121175
1830278	ST 114	0824121168
1830533	ST 122	0824121176
1850674	ST 123	0824121177

HELLA	BERU	
6PA 009 165-001	OZU 005	0824010055
6PA 009 165-011	OZH 045	0824010047
6PA 009 165-021	OZH 037	0824010039
6PA 009 165-031	OZH 067	0824010073
6PA 009 165-041	OZH 074	0824010080
6PA 009 165-051	OZH 056	0824010061
6PA 009 165-061	OZH 033	0824010035
6PA 009 165-071	OZU 022	0824010094
6PA 009 165-081	OZH 035	0824010037
6PA 009 165-091	OZH 050	0824010052
6PA 009 165-101	OZH 036	0824010038
6PA 009 165-111	OZH 058	0824010063
6PA 009 165-131	OZH 031	0824010033
6PA 009 165-141	OZH 057	0824010062
6PA 009 165-151	OZH 043	0824010045
6PA 009 165-161	OZH 068	0824010074
6PA 009 165-171	OZH 029	0824010031
6PA 009 165-181	OZH 011	0824010012
6PA 009 165-191	OZH 009	0824010010
6PA 009 165-201	OZH 040	0824010042
6PA 009 165-211	OZH 038	0824010040
6PA 009 165-221	OZH 069	0824010075
6PA 009 165-231	OZH 034	0824010036
6PA 009 165-241	OZH 047	0824010049
6PA 009 165-251	OZH 107	0824010139

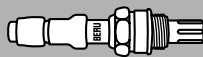

HELLA	BERU	
6PA 009 165-261	OZH 021	0824010022
6PA 009 165-271	OZH 003	0824010004
6PA 009 165-281	OZH 024	0824010025
6PA 009 165-291	OZH 006	0824010007
6PA 009 165-301	OZU 010	0824010090
6PA 009 165-311	OZH 032	0824010034
6PA 009 165-321	OZH 071	0824010077
6PA 009 165-331	OZU 003	0824010053
6PA 009 165-341	OZH 079	0824010089
6PA 009 165-351	OZH 019	0824010020
6PA 009 165-361	OZH 048	0824010050
6PA 009 165-371	OZH 070	0824010076
6PA 009 165-381	OZH 027	0824010028
6PA 009 165-391	OZU 012	0824010096
6PA 009 165-401	OZH 026	0824010027
6PA 009 165-411	OZH 104	0824010129
6PA 009 165-421	OZH 046	0824010048
6PA 009 165-431	OZH 028	0824010030
6PA 009 165-441	OZH 064	0824010070
6PA 009 165-451	OZH 023	0824010024
6PA 009 165-461	OZH 084	0824010099
6PA 009 165-471	OZH 083	0824010098
6PA 009 165-481	OZU 025	0824010143
6PA 009 165-491	OZH 039	0824010041
6PA 009 165-501	OZU 023	0824010136
6PA 009 165-511	OZH 044	0824010046
6PA 009 165-521	OZH 101	0824010125
6PA 009 165-531	OZH 012	0824010013
6PA 009 165-541	OZH 005	0824010006
6PA 009 165-551	OZH 022	0824010023
6PA 009 165-561	OZH 059	0824010065
6PA 009 165-571	OZH 014	0824010015
6PA 009 165-581	OZH 007	0824010008
6PA 009 165-591	OZH 030	0824010032
6PA 009 165-601	OZU 024	0824010133
6PA 009 165-611	OZH 072	0824010078
6PA 009 165-621	OZH 017	0824010018
6PA 009 165-631	OZU 004	0824010054
6PA 009 165-641	OZH 099	0824010121
6PA 009 165-651	OZH 053	0824010058
6PA 009 165-661	OZH 008	0824010009
6PA 009 165-671	OZH 108	0824010107
6PA 009 166-001	OZH 100	0824010124
6PA 009 166-011	OZH 041	0824010043
6PA 009 166-021	OZH 062	0824010068
6PA 009 166-031	OZH 086	0824010102
6PA 009 166-041	OZH 015	0824010016
6PA 009 166-051	OZH 004	0824010005
6PA 009 166-061	OZH 002	0824010003
6PA 009 166-071	OZU 021	0824010131
6PA 009 166-081	OZH 066	0824010072
6PA 009 166-091	OZH 075	0824010081
6PA 009 166-101	OZU 006	0824010064
6PA 009 166-111	OZH 055	0824010060
6PA 009 166-121	OZH 010	0824010011
6PA 009 166-131	OZH 001	0824010002
6PA 009 166-141	OZH 098	0824010120
6PA 009 166-151	OZH 088	0824010106
6PA 009 166-161	OZU 014	0824010104
6PA 009 166-171	OZH 052	0824010057
6PA 009 166-181	OZH 073	0824010079
6PA 009 166-191	OZH 076	0824010084
6PA 009 166-201	OZH 095	0824010117
6PA 009 166-211	OZH 094	0824010114
6PA 009 166-221	OZH 025	0824010026

HELLA	BERU	
6PA 009 166-231	OZH 016	0824010017
6PA 009 166-241	OZH 109	0824010127
6PA 009 166-251	OZH 054	0824010059
6PA 009 166-261	OZH 087	0824010105
6PA 009 166-271	OZH 103	0824010128
6PA 009 166-281	OZU 015	0824010111
6PA 009 166-291	OZH 065	0824010071
6PA 009 166-301	OZH 051	0824010056
6PA 009 166-311	OZH 020	0824010021
6PA 009 166-321	OZH 092	0824010112
6PA 009 166-331	OZH 096	0824010118
6PA 009 166-361	OZH 049	0824010051
6PA 009 166-381	OZU 001	0824010001
6PA 009 166-391	OZU 007	0824010141
6PA 009 166-401	OZH 060	0824010066
6PA 009 166-411	OZH 006	0824010007
6PT 009 104-001	ST 015	0824121075
6PT 009 104-011	ST 089	0824111030
6PT 009 104-021	ST 032	0824111007
6PT 009 107-041	ST 107	0824121164
6PT 009 107-141	ST 119	0824121173
6PT 009 107-151	ST 046	0824121093
6PT 009 107-161	ST 037	0824121083
6PT 009 107-171	ST 049	0824121098
6PT 009 107-181	ST 052	0824121101
6PT 009 107-191	ST 040	0824121086
6PT 009 107-231	ST 055	0824121104
6PT 009 107-241	ST 115	0824121169
6PT 009 107-251	ST 001	0824121001
6PT 009 107-301	ST 012	0824121072
6PT 009 107-351	ST 060	0824121108
6PT 009 107-361	ST 028	0824121078
6PT 009 107-371	ST 057	0824121106
6PT 009 107-381	ST 051	0824121100
6PT 009 107-391	ST 007	0824121058
6PT 009 107-411	ST 066	0824121114
6PT 009 107-421	ST 030	0824121081
6PT 009 107-451	ST 014	0824121074
6PT 009 107-461	ST 031	0824121082
6PT 009 107-471	ST 117	0824121171
6PT 009 107-481	ST 068	0824121116
6PT 009 107-491	ST 008	0824121040
6PT 009 107-541	ST 121	0824121175
6PT 009 107-561	ST 013	0824121073
6PT 009 107-621	ST 097	0824121154
6PT 009 107-631	ST 041	0824121087
6PT 009 107-661	ST 065	0824131034
6PT 009 107-671	ST 048	0824121097
6PT 009 107-751	ST 002	0824121020
6PT 009 107-761	ST 011	0824121051
6PT 009 109-041	ST 005	0824111003
6PT 009 109-141	ST 005	0824111003
6PT 009 109-151	ST 010	0824111004
6ZF 007 392-001	SPR 009	0824331026
6ZF 007 392-001	SPR 013	0824331030
6ZF 007 395-001	SPR 019	0824331040
6ZL 003 259-031	SPR 003	0824331010
6ZL 003 259-171	SPR 018	0824331039
6ZL 003 259-321	SPR 011	0824331028
6ZL 003 259-321	SPR 012	0824331029
6ZL 003 259-331	SPR 014	0824331031
6ZL 003 259-351	SPR 003	0824331010
6ZL 003 259-411	SPR 004	0824331025
6ZL 003 259-421	SPR 020	0824331036
6ZL 003 259-441	SPR 017	0824331034

HELLA	BERU	
6ZL 003 259-471	SPR 021	0824331037
6ZL 003 259-481	SPR 022	0824331038
6ZL 003 259-531	SPR 010	0824331027
6ZL 003 259-611	SPR 003	0824331010
6ZL 003 260-001	SPR 002	0824331011
6ZT 007 800-031	ST 101	0824121158
6ZT 007 801-001	ST 070	0824121118
6ZT 007 801-021	ST 073	0824121122
6ZT 007 802-021	ST 108	0824121165
6ZT 007 807-001	ST 075	0824121123
6ZT 007 807-001	ST 076	0824121124
6ZT 007 807-021	ST 087	0824121135
6ZT 007 807-041	ST 106	0824121163
6ZT 007 808-031	ST 085	0824121133
6ZT 007 835-001	ST 074	0824122013
6ZT 007 837-011	ST 080	0824121128
6ZT 007 837-021	ST 079	0824121127
6ZT 007 837-031	ST 078	0824121126
6ZT 007 837-051	ST 102	0824121159
6ZT 007 837-071	ST 103	0824121160
6ZT 007 837-081	ST 123	0824121177
6ZT 007 837-111	ST 072	0824121120

HENSCHEL	BERU	
1 084 926	SPR 001	0824331004
915 559	SPR 008	0824331015

HERTH u. BUSS	BERU	
70 541 049	SPR 017	0824331034
70 495 221	SPR 007	0824331014
70 511 077	ST 101	0824121158
70 511 109	ST 106	0824121163
70 511 110	ST 028	0824121078
70 511 198	ST 108	0824121165
70 511 263	ST 030	0824121081
70 511 264	ST 117	0824121171
70 511 509	ST 115	0824121169
70 511 511	ST 119	0824121173
70 511 512	ST 121	0824121175
70 541 019	SPR 004	0824331025
70 541 025	SPR 003	0824331010
70 541 043	SPR 003	0824331010
70 541 043/03	SPR 003	0824331010
70 541 075	SPR 016	0824331033
J5614000	SPR 009	0824331026
J5614000	SPR 015	0824331032
J5610502	SPR 013	0824331030
J5611000	SPR 014	0824331031
J5611000	SPR 016	0824331033
J5612008	SPR 011	0824331028
J5613001	SPR 012	0824331029
J5614001	SPR 010	0824331027

HINO	BERU	
83530 1070	SPR 015	0824331032
83530 1080	SPR 013	0824331030

HONDA	BERU	
36531 P01 G01	OZU 001	0824010001
36531 P01 G02	OZU 001	0824010001
36531 P06 A01	OZU 001	0824010001

**BERU**

HONDA	BERU	
36531 P06 A02	OZU 001	0824010001
36531 P3Y G01	OZU 001	0824010001
36531 P3Y G02	OZU 001	0824010001
36531 PC7 664	OZU 001	0824010001
36531 PE7 662	OZU 001	0824010001
36531 PH2 024	OZU 001	0824010001
36531 PH4 661	OZU 001	0824010001
36531 PH4 662	OZU 001	0824010001
36531 PH7 003	OZU 001	0824010001
36531 PK 014	OZU 001	0824010001
36531 PL2 003	OZU 001	0824010001
36531 PL2 013	OZU 001	0824010001
36531 PM5 A01	OZU 001	0824010001
36531 PM8 305	OZU 001	0824010001
36531 PM8 A03	OZU 001	0824010001
36531 P06-A11	OZH 017	0824010018
36531 P06-A12	OZH 006	0824010007
36531 P12-A02	OZH 010	0824010011
36531 P1K-E030-M2	OZH 123	0824010157
36531 P45-G02	OZH 120	0824010154
36531 P45-G012	OZH 120	0824010154
36531 P5S-G012	OZH 121	0824010155
36531 P8C-A01	OZH 028	0824010030
36531 P9K-E01	OZH 121	0824010155
36531 P9K-E011	OZH 121	0824010155
36531 P9L-E02	OZH 122	0824010156
36531 P9L-E011	OZH 122	0824010156
36531 P9L-E020-M2	OZH 122	0824010156
36531 PDA-E020-M2	OZH 121	0824010155
36531 PDE-E010-M2	OZH 121	0824010155
36531 PM8-A03	OZU 004	0824010054
36531 PT2-J04	OZH 009	0824010010
36531 PT2-J05	OZH 009	0824010010
36532 P8C-A01	OZH 035	0824010037
36532 PDE-E010-M2	OZH 120	0824010154
36561 P2R-A01	OZH 006	0824010007
37240 634 305	SPR 013	0824331030
37240 657 013	SPR 015	0824331032
37240 PA6 004	SPR 015	0824331032
37240 PD2 003	SPR 014	0824331031
37240 PD2 004	SPR 014	0824331031
37240 PI3 003	SPR 015	0824331032
37240 PT0 003	SPR 014	0824331031
37750 611 154	ST 039	0824121085

HYUNDAI	BERU	
39210 22100	OZH 037	0824010039
39210 24550	OZU 001	0824010001
39210 32630	OZU 001	0824010001
39220-22000	ST 028	0824121078
39350 32510	OZU 001	0824010001

INNOCENTI	BERU	
34362106	ST 045	0824121092

INTERMOTOR	BERU	
16300	OZU 001	0824010001
16301	OZU 001	0824010001
163011	OZH 040	0824010042
16302	OZH 040	0824010042
16303	OZH 037	0824010039

INTERMOTOR	BERU	
16304	OZH 037	0824010039
16305	OZH 037	0824010039
16306	OZH 037	0824010039
16308	OZH 039	0824010041
16309	OZH 029	0824010031
16310	OZH 005	0824010006
16312	OZH 034	0824010036
16313	OZH 037	0824010039
16314	OZH 003	0824010004
16315	OZH 020	0824010021
16316	OZH 046	0824010048
16317	OZH 033	0824010035
16318	OZH 035	0824010037
16319	OZH 057	0824010062
16320	OZH 038	0824010040
16321	OZH 013	0824010014
16322	OZH 045	0824010047
16324	OZH 045	0824010047
16329	OZU 005	0824010055
16340	OZH 040	0824010042
16341	OZH 015	0824010016
16342	OZH 023	0824010024
16343	OZH 022	0824010023
16344	OZH 036	0824010038
16345	OZH 031	0824010033
16346	OZH 045	0824010047
50498	ST 123	0824121177
50590	SPR 020	0824331036
50930	SPR 018	0824331039
52340	ST 001	0824121001
55142	ST 119	0824121173
55450	ST 116	0824121170
55474	ST 117	0824121171

ISUZU	BERU	
8 25036 979 0	ST 069	0824121117
9 82720 209 2	SPR 011	0824331028

IVECO	BERU	
082436410	ST 073	0824121122
092939521	Auf Anfrage ¹⁸	
2249601	Auf Anfrage ¹⁸	
3416590	SPR 007	0824331014
41822307	SPR 006	0824331021
41822309	SPR 008	0824331015
42530924	SPR 006	0824331021
42533916	SPR 008	0824331015
4854644	Auf Anfrage ¹⁸	
4857248	ST 024	0824121031
4857250	ST 025	0824121032
4861291	DG 001	0192115012
5963516	OZU 022	0824010094
7555129	OZH 037	0824010039
76008494	SPR 005	0824331018
7619303	OZH 037	0824010039
7619304	OZH 065	0824010071
7630332	OZH 046	0824010048
7640082	OZH 037	0824010039
76400820	OZH 037	0824010039
7654221	OZH 046	0824010048
7668286	OZH 035	0824010037
7674048	OZH 027	0824010028
773607	Auf Anfrage ¹⁸	

IVECO	BERU	
773607.00	Auf Anfrage ¹⁸	

JAGUAR	BERU	
AGU 1870	OZH 037	0824010039
DBC 10744	OZH 037	0824010039
DBC 4138	OZH 037	0824010039
DBC 6907	OZH 037	0824010039
LNA 1600 AA	ST 068	0824121116

JOHN DEERE	BERU	
AZ 35440	Auf Anfrage ¹⁸	
RE 500844	Auf Anfrage ¹⁸	
RE 503882	Auf Anfrage ¹⁸	
RE 503883	Auf Anfrage ¹⁸	
RE 504207	Auf Anfrage ¹⁸	
RE 504208	Auf Anfrage ¹⁸	
RE 517130	Auf Anfrage ¹⁸	
RE 51774	Auf Anfrage ¹⁸	
RE 62474	Auf Anfrage ¹⁸	
RE 65836	Auf Anfrage ¹⁸	

KAEUBLE GMEINER	BERU	
037 00227 00	SPR 007	0824331014

KAESSBOHRER	BERU	
7314002100	SPR 007	0824331014
7314005000	SPR 005	0824331018
87490600000	ST 016	0824121016
87491250000	ST 019	0824121019

KHD	BERU	
0144 39 07 44	SPR 001	0824331004
116 8500	SPR 002	0824331011
116 9902	SPR 002	0824331011
117 8933	SPR 004	0824331025
336 0189	SPR 001	0824331004
341 6590	SPR 007	0824331014
2936 7029	SPR 001	0824331004
4182 2307	SPR 006	0824331021
4182 2309	SPR 008	0824331015
5107 80 04 21	SPR 002	0824331011
5145 80 16 41	SPR 007	0824331014
EM 10 H4207	SPR 002	0824331011

KIA	BERU	
OK 011-18-861	OZH 207	0824010241
OK 9A 518861	OZH 204	0824010238
OK 737-18-840	ST 028	0824121078

KRAMER	BERU	
0003360703	ST 023	0824121005

LADA	BERU	
2101-380-8600	ST 046	0824121093



LANCIA	BERU	
05992746	ST 073	0824121122
07728057	ST 073	0824121122
07738582	ST 072	0824121120
3416590	SPR 007	0824331014
41822307	SPR 006	0824331021
41822309	SPR 008	0824331015
4430291	OZU 022	0824010094
46417969	OZH 056	0824010061
46418568	OZH 064	0824010070
46418813	OZH 088	0824010106
46420612	OZH 062	0824010068
46423798	OZH 062	0824010068
46424723	OZH 056	0824010061
46449401	OZH 064	0824010070
46452598	OZH 138	0824010172
46455802	OZH 064	0824010070
5972332	ST 028	0824121078
5992746	ST 073	0824121122
60537650	OZH 003	0824010004
60567759	OZH 046	0824010048
60583122	OZH 035	0824010037
60808457	OZH 046	0824010048
60812162	OZH 052	0824010057
7555123	OZH 037	0824010039
7555129	OZH 037	0824010039
7619304	OZH 065	0824010071
7640082	OZH 037	0824010039
7654221	OZH 046	0824010048
7674048	OZH 027	0824010028
7707638	OZH 037	0824010039
7728057	ST 073	0824121122
7735919	ST 058	0824121107
7751308	OZH 084	0824010099
7785973	OZH 052	0824010057
7789741	OZH 056	0824010061
82436410	ST 073	0824121122
82465533	ST 073	0824121122
82477919	ST 073	0824121122
96138608	OZH 034	0824010036

LANDROVER	BERU	
6670669	ST 005	0824111003
NSC 50050	ST 005	0824111003
YDB 0000 60	RDE 003	0532207003

LIEBHERR	BERU	
691180308	ST 016	0824121016

LUCAS	BERU	
SEB 102	OZU 010	0824010090
SEB 128	OZH 044	0824010046
SEB 130	OZH 006	0824010007
SEB 132	OZH 040	0824010042
SEB 135	OZH 036	0824010038
SEB 136	OZH 039	0824010041
SEB 137	OZH 039	0824010041
SEB 138	OZH 047	0824010049
SNB 806	ST 013	0824121073
SNB 809	ST 028	0824121078
SNB 813	ST 012	0824121072
SNB 818	ST 032	0824111007
SNB 819	ST 035	0824111010
SNB 821	ST 036	0824111011

MAGIRUS	BERU	
2249601	Auf Anfrage ¹⁸	
4854644	Auf Anfrage ¹⁸	
773607	Auf Anfrage ¹⁸	
773607.00	Auf Anfrage ¹⁸	

MAGNET MARELLI	BERU	
460000124010	OZH 130	0824010164
460000146010	OZH 084	0824010099

MAN	BERU	
16 15000 9007 71	Auf Anfrage ¹⁸	
81 25505 0237	SPR 005	0824331018
81 25520 0010	SPR 007	0824331014
81 25520 0021	SPR 007	0824331014
81 25520 0054	SPR 006	0824331021
81 25520 6006	SPR 007	0824331014
81 25520 6007	SPR 006	0824331021

MASERATI	BERU	
185189	RDE 001	0532207001

MAZDA	BERU	
0118-18-510	ST 039	0824121085
0118-89-181	ST 039	0824121085
B366 18 501	SPR 013	0824331030
B3C7-18-861 A	OZH 095	0824010117
B3C8 18 840	ST 068	0824121116
B593 18 840 A	ST 068	0824121116
B601 18 861	OZU 001	0824010001
B61R 18 861 A	OZU 001	0824010001
B61Z 18 861 A	OZU 001	0824010001
B64N 18 861	OZU 001	0824010001
B64N 18-861	OZU 021	0824010131
B6B1 18 861	OZU 001	0824010001
B6B3 18 861 A	OZU 001	0824010001
B6DC 18-861 A	OZH 100	0824010124
BP03 18 861 B	OZU 001	0824010001
BP03 18 861 B	OZU 012	0824010096
BPE8 18 861 A	OZH 153	0824010187
E5D3 18 501	SPR 012	0824331029
F201 18 861 A	OZU 001	0824010001
FEH1 18 861	OZU 001	0824010001
JE-08-18-861 B	OZH 022	0824010023
JE-46-18-86 Z	OZU 022	0824010094
JE-49-18 861 A	OZH 163	0824010197
JE-50-18-861 A	OZH 076	0824010084
K802 18 861 C	OZH 163	0824010197
N350 18 861	OZU 001	0824010001
NF02 18 840	ST 068	0824121116
R207 18 501	SPR 015	0824331032

MEAT u. DORIA	BERU	
82033	ST 116	0824121170
82038	ST 115	0824121169
82105	ST 119	0824121173
82128	ST 114	0824121168
82185	ST 112	0824111033

MERCEDES	BERU	
000 540 27 17	OZH 018	0824010019
000 540 29 17	OZH 044	0824010046
000 540 38 17	OZH 016	0824010017
000 540 39 17	OZH 041	0824010043
000 540 40 17	OZH 042	0824010044
000 540 42 17	OZH 041	0824010043
000 540 49 17	OZH 198	0824010232
000 540 55 17	OZH 018	0824010019
000 540 56 17	OZH 018	0824010019
000 540 57 17	OZH 200	0824010234
000 540 59 17	OZH 023	0824010024
000 540 62 17	OZH 145	0824010179
000 540 64 17	OZH 021	0824010022
000 540 65 17	OZH 146	0824010180
000 540 81 17	OZH 143	0824010177
000 540 82 17	OZH 144	0824010178
000 540 90 17	OZH 124	0824010158
000 540 92 17	OZH 025	0824010026
000 540 95 17	OZH 098	0824010120
000 542 62 18	ST 011	0824121051
000 545 45 09	SPR 008	0824331015
000 545 59 09	SPR 006	0824331021
000 545 60 09	SPR 008	0824331015
000 763 14 10	SPR 007	0824331014
000 822 33 06	RDE 001	0532207001
000 822 34 06	RDE 004	0532107001
001 153 74 28	SD 002	0191325002
001 153 84 28	SD 003	0191325004
001 540 04 17	OZH 098	0824010120
001 540 13 17	OZH 018	0824010019
001 540 28 17	OZH 220	0824010254
001 542 23 17	ST 059	0824121090
001 545 08 09	SPR 005	0824331018
002 153 13 28	SD 004	0191325006
002 153 46 28	SD 009	0191325007
002 542 10 17	ST 001	0824121001
003 542 28 18	RDE 006	0532207006
004 153 03 28	ST 004	0824111006
004 542 59 17	SPR 019	0824331040
005 153 63 28	ST 011	0824121051
005 542 10 17	ST 001	0824121001
005 542 26 17	ST 001	0824121001
005 542 31 17	OZH 026	0824010027
005 545 03 24	ST 057	0824121106
006 542 28 17	SD 005	0192115001
007 542 68 17	OZU 001	0824010001
008 542 32 17	ST 002	0824121020
008 542 56 17	ST 007	0824121058
008 542 91 17	OZH 026	0824010027
009 542 06 17	OZH 033	0824010035
009 542 35 17	ST 008	0824121040
009 542 41 17	OZH 007	0824010008
009 542 86 17	OZH 196	0824010230
009 542 87 17	OZH 032	0824010034
009 542 90 17	OZH 026	0824010027
010 542 22 17	SD 010	0192115013
011 542 74 17	ST 009	0824121046
A 000 336 16 03	Auf Anfrage ¹⁸	
A 000 540 49 17	OZH 198	0824010232
A 000 540 57 17	OZH 200	0824010234
A 000 540 62 17	OZH 145	0824010179
A 000 540 65 17	OZH 146	0824010180
A 000 540 81 17	OZH 143	0824010177
A 000 540 82 17	OZH 144	0824010178
A 000 542 62 18	ST 011	0824121051



MERCEDES	BERU	
A 000 545 45 09	SPR 008	0824331015
A 000 545 59 09	SPR 006	0824331021
A 000 545 60 09	SPR 008	0824331015
A 000 763 14 10	SPR 007	0824331014
A 000 822 33 06	RDE 001	0532207001
A 000 822 34 06	RDE 004	0532107001
A 001 153 03 20	Auf Anfrage ¹⁸	
A 001 153 05 20	Auf Anfrage ¹⁸	
A 001 153 31 20	Auf Anfrage ¹⁸	
A 001 153 74 28	SD 002	0191325002
A 001 153 84 28	SD 003	0191325004
A 001 540 28 17	OZH 220	0824010254
A 001 542 23 17	ST 059	0824121090
A 001 545 08 09	SPR 005	0824331018
A 002 153 02 28	Auf Anfrage ¹⁸	
A 002 153 13 28	SD 004	0191325006
A 002 153 46 28	SD 009	0191325007
A 002 542 63 18	Auf Anfrage ¹⁸	
A 003 153 04 28	Auf Anfrage ¹⁸	
A 003 153 20 28	Auf Anfrage ¹⁸	
A 003 153 33 73	Auf Anfrage ¹⁸	
A 003 153 94 28	Auf Anfrage ¹⁸	
A 004 153 03 28	ST 004	0824111006
A 004 153 04 28	Auf Anfrage ¹⁸	
A 004 153 11 28	Auf Anfrage ¹⁸	
A 004 153 16 28	Auf Anfrage ¹⁸	
A 004 153 42 28	Auf Anfrage ¹⁸	
A 004 542 59 17	SPR 019	0824331040
A 005 153 63 28	ST 011	0824121051
A 005 542 10 17	ST 001	0824121001
A 005 542 26 17	ST 001	0824121001
A 005 545 03 24	ST 057	0824121106
A 006 542 28 17	SD 009	0192115001
A 008 542 17 17	Auf Anfrage ¹⁸	
A 008 542 32 17	ST 002	0824121020
A 008 542 56 17	ST 007	0824121058
A 008 542 57 17	Auf Anfrage ¹⁸	
A 009 542 14 17	Auf Anfrage ¹⁸	
A 009 542 35 17	ST 008	0824121040
A 009 542 86 17	OZH 196	0824010230
A 010 542 22 17	SD 010	0192115013
A 011 542 16 17	Auf Anfrage ¹⁸	
A 011 542 74 17	ST 009	0824121046

MEYLE	BERU	
014 054 0013	ST 001	0824121001
100 919 0010	ST 122	0824121176
100 919 0017	ST 119	0824121173
100 919 0023	ST 030	0824121081
100 919 0024	ST 115	0824121169
100 919 0028	ST 112	0824111033
100 919 0032	ST 114	0824121168
100 959 0001	ST 104	0824121161
314 126 0000	ST 117	0824121171
314 136 2102	ST 116	0824121170

MITSUBISHI	BERU	
MC 017430	SPR 010	0824331027
MC 840219	SPR 010	0824331027
MD 001380	ST 041	0824121087
MD 001482	SPR 010	0824331027
MD 001483	SPR 010	0824331027
MD 021566	SPR 010	0824331027

MITSUBISHI	BERU	
MD 073546	OZU 001	0824010001
MD 076706	OZU 001	0824010001
MD 078791	OZU 001	0824010001
MD 088616	OZU 001	0824010001
MD 089922	OZU 001	0824010001
MD 107793	OZU 001	0824010001
MD 108934	OZU 001	0824010001
MD 109613	OZU 001	0824010001
MD 110492	OZU 001	0824010001
MD 117240	OZU 001	0824010001
MD 119210	OZU 001	0824010001
MD 119609	OZU 001	0824010001
MD 127062	OZU 001	0824010001
MD 128262	OZU 001	0824010001
MD 138993	SPR 010	0824331027
MD 138994	SPR 010	0824331027
MD 149338	ST 066	0824121114
MD 149813	OZU 001	0824010001
MD 149888	OZU 003	0824010053
MD 603427	ST 041	0824121087

MWM	BERU	
6 0578 20 1 0016	SPR 001	0824331004
9 0569 50 0 0015	ST 007	0824121058

NISSAN	BERU	
15160-90001	SPR 016	0824331033
22630-70J00	ST 067	0824121115
22690-06F00	OZU 010	0824010090
22690-07G00	OZU 022	0824010094
22690-0J000	OZH 203	0824010237
22690-17B00	OZU 010	0824010090
22690-19B10	OZU 010	0824010090
22690-1F701	OZH 228	0824010262
22690-3J410	OZH 201	0824010235
22690-40F00	OZU 010	0824010090
22690-40U10	OZH 012	0824010013
22690-61A00	OZH 028	0824010030
22690-64Y12	OZU 001	0824010001
22690-69A01	OZH 028	0824010030
22690-73C00	OZU 001	0824010001
22690-73C00	OZH 011	0824010012
22690-76J00	OZH 011	0824010012
22690-81N00	OZU 024	0824010133
22690-95E00	OZU 001	0824010001
22690-99B00	OZH 011	0824010012
22690-9F601	OZH 225	0824010259
22690-F5300	OZU 010	0824010090
22690-J8000	OZU 001	0824010001
22690-J9200	OZU 001	0824010001
226A01-F701	OZH 229	0824010263
226A07-J503	OZH 227	0824010261
226A07-J601	OZH 226	0824010260
25240-89901	SPR 016	0824331033
25240-89902	SPR 016	0824331033
25240-89910	SPR 016	0824331033

NISSAN MOTOR IBERICA	BERU	
74300096-0	Auf Anfrage ¹⁸	

NTK	BERU	
0122	OZH 076	0824010084
0123	OZH 033	0824010035
0124	OZH 130	0824010164
0125	OZH 014	0824010015
0126	OZH 125	0824010159
0127	OZH 023	0824010024
0128	OZH 019	0824010020
0129	OZH 069	0824010075
0130	OZH 079	0824010089
0131	OZU 010	0824010090
0135	OZH 045	0824010047
0136	OZH 094	0824010114
0137	OZH 123	0824010157
0138	OZH 004	0824010005
0139	OZH 006	0824010007
0141	OZH 064	0824010070
0142	OZU 024	0824010133
0143	OZU 012	0824010096
0145	OZH 083	0824010098
0146	OZH 084	0824010099
0147	OZH 058	0824010063
0148	OZH 122	0824010156
0149	OZH 036	0824010038
0150	OZH 009	0824010010
0151	OZH 086	0824010102
0153	OZU 004	0824010054
0154	OZU 014	0824010104
0155	OZH 011	0824010012
0156	OZH 087	0824010105
0157	OZH 088	0824010106
0158	OZH 108	0824010107
0159	OZH 121	0824010155
0160	OZH 016	0824010017
0161	OZH 043	0824010045
0162	OZH 037	0824010039
0166	OZU 015	0824010111
0167	OZH 092	0824010112
0169	OZH 120	0824010154
0171	OZH 021	0824010022
0172	OZH 022	0824010023
0173	OZH 094	0824010114
0177	OZH 095	0824010117
0178	OZH 096	0824010118
0180	OZH 121	0824010155
0182	OZH 098	0824010120
0183	OZH 099	0824010121
0184	OZH 074	0824010080
0188	OZH 100	0824010124
0189	OZH 101	0824010125
0190	OZH 045	0824010047
0191	OZH 109	0824010127
0193	OZH 019	0824010020
0194	OZH 103	0824010128
0195	OZH 104	0824010129
0198	OZU 021	0824010131
0199	OZH 059	0824010065
0201	OZH 034	0824010036
0204	OZH 017	0824010018
0205	OZH 022	0824010023
0206	OZH 025	0824010026
0209	OZH 036	0824010038
0212	OZH 122	0824010156
0213	OZH 056	0824010061
0215	OZH 010	0824010011
0216	OZH 023	0824010024

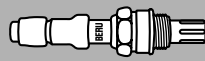

NTK			BERU			NTK			BERU			NTK			BERU		
0217	OZH 056	0824010061	0480	OZH 184	0824010218	OZA 83-R1	OZH 087	0824010105									
0218	OZH 035	0824010037	0489	OZH 180	0824010214	OZA 83-R2	OZH 092	0824010112									
0220	OZH 038	0824010040	0494	OZH 152	0824010186	OZA 83-R3	OZH 096	0824010118									
0226	OZH 131	0824010165	0498	OZH 053	0824010058	OZA 83-R4	OZH 101	0824010125									
0227	OZH 124	0824010158	1777	OZH 023	0824010024	OZA 89-D1	OZH 059	0824010065									
0234	OZH 056	0824010061	1778	OZH 128	0824010162	OZA 89-D2	OZH 045	0824010047									
0237	OZH 010	0824010011	1801	OZH 038	0824010040	OZA 112-A1	OZH 084	0824010099									
0238	OZH 039	0824010041	1802	OZU 022	0824010094	OZA 112-A3	OZH 088	0824010106									
0239	OZH 020	0824010021	1803	OZH 034	0824010036	OZA 114-A1	OZH 049	0824010051									
0242	OZH 036	0824010038	1805	OZH 044	0824010046	OZA 186-F5	OZH 100	0824010124									
0244	OZH 176	0824010210	1806	OZH 029	0824010031	OZA 216-D2	OZH 045	0824010047									
0245	OZH 064	0824010070	1807	OZU 025	0824010143	OZA 216-D3	OZH 014	0824010015									
0248	OZH 043	0824010045	1810	OZH 012	0824010013	OZA 222-RV1	OZH 094	0824010114									
0249	OZH 005	0824010006	1812	OZH 036	0824010038	OZA 236-R1	OZH 058	0824010063									
0251	OZH 022	0824010023	1821	OZH 043	0824010045	OZA 236-R2	OZH 108	0824010107									
0252	OZH 036	0824010038	1822	OZU 003	0824010053	OZA 245-H1	OZH 120	0824010154									
0253	OZH 055	0824010060	1823	OZH 035	0824010037	OZA 245-H2	OZH 121	0824010155									
0254	OZH 043	0824010045	1826	OZH 051	0824010056	OZA 253-F6	OZH 076	0824010084									
0255	OZH 121	0824010155	1827	OZH 033	0824010035	OZA 277-R2	OZH 184	0824010218									
0258	OZH 027	0824010028	1828	OZU 004	0824010054	OZA 311-R1	OZH 109	0824010127									
0259	OZH 070	0824010076	1830	OZH 059	0824010065	OZA 334-A2	OZH 056	0824010061									
0260	OZH 020	0824010021	1832	OZH 055	0824010060	OZA 334-A3	OZH 064	0824010070									
0263	OZH 041	0824010043	1833	OZH 037	0824010039	OZA 334-AU1	OZH 190	0824010224									
0264	OZH 039	0824010041	1834	OZH 053	0824010058	OZA 401-E2	OZU 022	0824010094									
0265	OZH 029	0824010031	1837	OZH 026	0824010027	OZA 401-E4	OZU 003	0824010053									
0269	OZH 027	0824010028	1838	OZH 046	0824010048	OZA 401-E5	OZU 004	0824010054									
0270	OZH 127	0824010161	1839	OZH 039	0824010041	OZA 401-E6	OZU 005	0824010055									
0271	OZH 020	0824010021	1843	OZH 041	0824010043	OZA 401-E50	OZU 010	0824010090									
0273	OZH 039	0824010041	1848	OZH 047	0824010049	OZA 401-E51	OZU 024	0824010133									
0274	OZH 005	0824010006	1849	OZH 030	0824010032	OZA 401-E55	OZU 012	0824010096									
0277	OZH 120	0824010154	1850	OZH 031	0824010033	OZA 401-E56	OZU 014	0824010104									
0280	OZH 066	0824010072	1854	OZH 042	0824010044	OZA 401-E57	OZU 004	0824010054									
0281	OZH 128	0824010162	1855	OZH 037	0824010039	OZA 401-E58	OZU 015	0824010111									
0282	OZH 092	0824010112	1856	OZH 049	0824010051	OZA 428-E1	OZU 025	0824010143									
0283	OZH 043	0824010045	1859	OZH 046	0824010048	OZA 445-E2	OZH 012	0824010013									
0284	OZH 057	0824010062	1860	OZH 048	0824010050	OZA 445-E3	OZH 048	0824010050									
0285	OZH 021	0824010022	1861	OZH 040	0824010042	OZA 445-E4	OZH 031	0824010033									
0287	OZH 056	0824010061	1865	OZH 045	0824010047	OZA 445-E6	OZH 027	0824010028									
0288	OZH 121	0824010155	1866	OZH 028	0824010030	OZA 445-E7	OZH 027	0824010028									
0291	OZH 003	0824010004	1867	OZH 050	0824010052	OZA 446-E1	OZH 037	0824010039									
0293	OZH 045	0824010047	1872	OZH 032	0824010034	OZA 446-E2	OZH 037	0824010039									
0295	OZH 030	0824010032	1876	OZH 056	0824010061	OZA 446-E3	OZH 028	0824010030									
0296	OZH 064	0824010070	1877	OZH 037	0824010039	OZA 446-E4	OZH 037	0824010039									
0298	OZH 074	0824010080	1878	OZH 058	0824010063	OZA 446-E5	OZH 046	0824010048									
0299	OZH 123	0824010157	1882	OZU 005	0824010055	OZA 446-E6	OZH 040	0824010042									
0402	OZH 179	0824010213	1883	OZH 179	0824010213	OZA 446-E7	OZH 032	0824010034									
0404	OZH 148	0824010182	1887	OZH 052	0824010057	OZA 446-E8	OZH 033	0824010035									
0405	OZH 111	0824010145	1888	OZH 036	0824010038	OZA 446-E11	OZH 044	0824010046									
0415	OZH 184	0824010218	1889	OZU 006	0824010064	OZA 446-E12	OZH 044	0824010046									
0416	OZH 173	0824010207	1890	OZH 059	0824010065	OZA 446-E13	OZH 051	0824010056									
0423	OZH 022	0824010023	1893	OZH 054	0824010059	OZA 446-E14	OZH 026	0824010027									
0424	OZH 182	0824010216	1894	OZH 057	0824010062	OZA 446-E15	OZH 047	0824010049									
0426	OZH 169	0824010203	1898	OZH 044	0824010046	OZA 446-E16	OZH 046	0824010048									
0427	OZH 173	0824010207	1899	OZH 039	0824010041	OZA 446-E18	OZH 052	0824010057									
0430	OZH 094	0824010114	1909	OZH 228	0824010262	OZA 446-E40	OZH 019	0824010020									
0434	OZH 104	0824010129	1950	OZH 181	0824010215	OZA 446-E41	OZH 019	0824010020									
0438	OZH 168	0824010202	OZA 16-D2	OZH 059	0824010065	OZA 446-E42	OZH 009	0824010010									
0445	OZH 079	0824010089	OZA 25-F12	OZU 021	0824010131	OZA 446-E43	OZH 103	0824010128									
0452	OZH 178	0824010212	OZA 33-D5	OZH 059	0824010065	OZA 446-E44	OZH 037	0824010039									
0455	OZH 043	0824010045	OZA 33-D8	OZH 050	0824010052	OZA 446-E45	OZH 011	0824010012									
0459	OZH 144	0824010178	OZA 55-R1	OZH 058	0824010063	OZA 446-E46	OZH 006	0824010007									
0463	OZH 042	0824010044	OZA 55-R2	OZH 033	0824010035	OZA 446-E48	OZH 066	0824010072									
0468	OZH 184	0824010218	OZA 55-R4	OZH 083	0824010098	OZA 446-E49	OZH 003	0824010004									
0471	OZH 177	0824010211	OZA 65-A2	OZU 006	0824010064	OZA 446-E50	OZH 017	0824010018									
0474	OZH 190	0824010224	OZA 73-F1	OZH 095	0824010117	OZA 446-E51	OZH 010	0824010011									



NTK	BERU	
OZA 446-E53	OZH 010	0824010011
OZA 447-E1	OZH 036	0824010038
OZA 447-E2	OZH 039	0824010041
OZA 447-E3	OZH 030	0824010032
OZA 447-E4	OZH 036	0824010038
OZA 447-E5	OZH 043	0824010045
OZA 447-E7	OZH 043	0824010045
OZA 447-E9	OZH 023	0824010024
OZA 447-E10	OZH 004	0824010005
OZA 447-E11	OZH 036	0824010038
OZA 447-E12	OZH 022	0824010023
OZA 447-E13	OZH 099	0824010121
OZA 447-E14	OZH 069	0824010075
OZA 447-E16	OZH 070	0824010076
OZA 447-E18	OZH 128	0824010162
OZA 447-E20	OZH 022	0824010023
OZA 447-E21	OZH 023	0824010024
OZA 447-E23	OZH 039	0824010041
OZA 447-E26	OZH 111	0824010145
OZA 447-E27	OZH 173	0824010207
OZA 447-E28	OZH 173	0824010207
OZA 447-E29	OZH 168	0824010202
OZA 447-E32	OZH 177	0824010211
OZA 447-E36	OZH 181	0824010215
OZA 448-E1	OZH 029	0824010031
OZA 448-E3	OZH 034	0824010036
OZA 448-E4	OZH 035	0824010037
OZA 448-E5	OZH 055	0824010060
OZA 448-E6	OZH 042	0824010044
OZA 448-E7	OZH 056	0824010061
OZA 448-E9	OZH 057	0824010062
OZA 448-E10	OZH 053	0824010058
OZA 448-E11	OZH 041	0824010043
OZA 448-E12	OZH 045	0824010047
OZA 448-E13	OZH 054	0824010059
OZA 448-E14	OZH 038	0824010040
OZA 448-E16	OZH 039	0824010041
OZA 448-E28	OZH 021	0824010022
OZA 448-E29	OZH 098	0824010120
OZA 448-E30	OZH 043	0824010045
OZA 448-E31	OZH 086	0824010102
OZA 448-E32	OZH 074	0824010080
OZA 448-E33	OZH 104	0824010129
OZA 448-E34	OZH 079	0824010089
OZA 448-E35	OZH 094	0824010114
OZA 448-E36	OZH 064	0824010070
OZA 448-E38	OZH 016	0824010017
OZA 448-E40	OZH 005	0824010006
OZA 448-E41	OZH 020	0824010021
OZA 448-E42	OZH 020	0824010021
OZA 448-E43	OZH 092	0824010112
OZA 448-E44	OZH 045	0824010047
OZA 448-E45	OZH 025	0824010026
OZA 448-E46	OZH 056	0824010061
OZA 448-E48	OZH 020	0824010021
OZA 448-E50	OZH 184	0824010218
OZA 448-E51	OZH 169	0824010203
OZA 448-E56	OZH 159	0824010193
OZA 448-E58	OZH 228	0824010262
OZA 507-R2	OZH 184	0824010218
OZA 510-V2	OZH 179	0824010213
OZA 510-V4	OZH 182	0824010216
OZA 510-V10	OZH 179	0824010213
OZA 516-AU1	OZH 178	0824010212
OZA 519-D1	OZH 176	0824010210

NTK	BERU	
OZA 527-E2	OZH 029	0824010031
OZA 527-E3	OZH 034	0824010036
OZA 527-E4	OZH 035	0824010037
OZA 527-E5	OZH 055	0824010060
OZA 527-E6	OZH 042	0824010044
OZA 527-E7	OZH 056	0824010061
OZA 527-E8	OZH 057	0824010062
OZA 527-E9	OZH 053	0824010058
OZA 527-E10	OZH 041	0824010043
OZA 527-E12	OZH 038	0824010040
OZA 527-E13	OZH 021	0824010022
OZA 527-E14	OZH 043	0824010045
OZA 527-E15	OZH 074	0824010080
OZA 527-E16	OZH 104	0824010129
OZA 527-E17	OZH 079	0824010089
OZA 527-E18	OZH 094	0824010114
OZA 527-E19	OZH 064	0824010070
OZA 527-E22	OZH 005	0824010006
OZA 527-E24	OZH 056	0824010061
OZA 532-A2	OZH 180	0824010214
OZA 534-V1	OZH 128	0824010162
OZA 572-E1	OZH 043	0824010045
OZA 572-E11	OZH 022	0824010023
OZA 572-E12	OZH 039	0824010041
OZA 572-E13	OZH 043	0824010045
OZA 572-E2	OZH 036	0824010038
OZA 572-E3	OZH 039	0824010041
OZA 572-E4	OZH 030	0824010032
OZA 572-E5	OZH 036	0824010038
OZA 572-E6	OZH 023	0824010024
OZA 572-E8	OZH 036	0824010038
OZA 572-E9	OZH 022	0824010023

OPEL	BERU	
08 55 353	OZH 111	0824010145
08 55 360	OZH 112	0824010146
08 55 366	OZH 110	0824010144
08 55 375	OZH 132	0824010166
08 55 390	OZH 110	0824010144
10 09 612 9	OZH 033	0824010035
12 36 284	ST 089	0824111030
12 36 302	ST 069	0824121117
12 36 307	ST 089	0824111030
12 52 506	SPR 018	0824331039
13 38 450	ST 069	0824121117
13 38 458	ST 036	0824111011
13 41 011	ST 075	0824121123
13 41 017	ST 076	0824121124
13 41 021	ST 077	0824121125
13 41 023	ST 085	0824121133
13 41 025	ST 080	0824121128
13 41 026	ST 079	0824121127
13 41 027	ST 080	0824121128
13 41 030	ST 087	0824121135
13 41 031	ST 066	0824121114
13 41 033	ST 082	0824121130
13 41 038	ST 066	0824121114
13 41 039	ST 079	0824121127
13 41 042	ST 123	0824121177
13 42 561	ST 037	0824121083
13 42 569	ST 037	0824121083
13 42 850	ST 088	0824121146
18 46 325	ST 081	0824121129
18 46 326	ST 086	0824121134

OPEL	BERU	
18 46 341	ST 083	0824121131
23 36 121	OZH 028	0824010030
24 13 33 91	OZU 001	0824010001
25 10 60 73	OZU 005	0824010055
25 13 36 07	OZU 023	0824010136
25 16 36 13	OZU 023	0824010136
25 16 45 96	OZU 005	0824010055
62 38 23 6	ST 069	0824121117
85 50 02	OZH 028	0824010030
85 53 00	OZH 040	0824010042
85 53 02	OZH 028	0824010030
85 53 05	OZU 005	0824010055
85 53 06	OZH 040	0824010042
85 53 15	OZU 005	0824010055
85 53 21	OZU 023	0824010136
85 53 22	OZH 019	0824010020
85 53 23	OZH 019	0824010020
85 53 32	OZU 023	0824010136
85 53 33	OZU 005	0824010055
85 53 41	OZH 111	0824010145
85 53 45	OZH 148	0824010182
85 53 56	OZH 113	0824010147
85 53 57	OZH 114	0824010148
85 53 58	OZH 115	0824010149
90 009 053	OZH 040	0824010042
90 010 999	OZH 028	0824010030
90 019 999	OZH 028	0824010030
90 231 073	OZH 040	0824010042
90 234 326	OZH 028	0824010030
90 397 523	OZH 040	0824010042
90 397 524	OZH 028	0824010030
90 409 385	OZH 040	0824010042
90 409 521	OZH 028	0824010030
90 448 458	OZH 040	0824010042
90 499 265	OZH 019	0824010020
90 499 266	OZH 019	0824010020
90 499 267	OZH 019	0824010020
90 509 169	OZH 019	0824010020
90 509 274	OZH 019	0824010020
90 509 275	OZH 019	0824010020
90 510 147	OZH 040	0824010042
90 530 068	OZH 111	0824010145
90 541 303	OZH 147	0824010181
90 541 304	OZH 147	0824010181
90 543 281	OZH 111	0824010145
90 570 417	OZH 147	0824010181
91 142 813	OZH 028	0824010030
91 186 98	OZH 148	0824010182
97 036 06	ST 066	0824121114

O & K	BERU	
118 159	SPR 007	0824331014

PERKINS	BERU	
2848073	SPR 007	0824331014

PEUGEOT	BERU	
0242.14	ST 044	0824121091
0242.20	ST 043	0824121089
0242.63	ST 049	0824121098
1264.03	ST 101	0824121158
1264.14	ST 101	0824121158



PEUGEOT	BERU	
1264.33	ST 072	0824121120
1264.34	ST 078	0824121126
1337.72	ST 049	0824121098
1338.02	ST 049	0824121098
1338.47	ST 029	0824121080
1338.78	ST 029	0824121080
1628 34	OZH 029	0824010031
1628 3W	OZH 072	0824010078
1628 58	OZU 001	0824010001
1628 6W	OZH 079	0824010089
1628 83	OZH 044	0824010046
1628 8C	OZH 206	0824010240
1628 9A	OZH 205	0824010239
1628 9T	OZH 159	0824010193
1628 9V	OZH 104	0824010129
1628 A4	OZH 066	0824010072
1628 HT	OZH 104	0824010129
1628 J4	OZH 029	0824010031
1628 L4	OZH 005	0824010006
1628 L6	OZH 166	0824010200
1628 SW	OZH 184	0824010218
1628 V4	OZH 038	0824010040
1920 C4	ST 012	0824121072
1920 C5	ST 034	0824111009
91 514 046	ST 101	0824121158
91 514 549	ST 028	0824121078
91 517 978 80	OZU 001	0824010001
91 518 193 80	OZH 044	0824010046
91 535 718 80	OZH 044	0824010046
91 540 672	OZH 066	0824010072
95 494 924	OZU 001	0824010001
95 635 047	OZH 046	0824010048
96 027 244	OZH 029	0824010031
96 036 827	OZH 005	0824010006
96 039 269	OZH 166	0824010200
96 127 346	OZH 072	0824010078
96 127 817	OZH 038	0824010040
96 138 599	OZH 034	0824010036
96 138 608	OZH 034	0824010036
96 211 180	OZH 072	0824010078
96 211 180 80	OZH 072	0824010078
96 229 969	OZH 074	0824010080
96 229 970	OZH 104	0824010129
96 229 971	OZH 079	0824010089
96 229 971 80	OZH 079	0824010089
96 229 974	OZH 046	0824010048
96 284 480	OZH 104	0824010129
96 284 480 80	OZH 104	0824010129
96 356 573	OZH 104	0824010129

PEX	BERU	
3.00.007	SPR 001	0824331004
3.00.008	SPR 004	0824331025
3.00.010	SPR 003	0824331010
3.00.023	SPR 018	0824331039
3.00.039	SPR 002	0824331011
3.40.078	ST 055	0824121104
3.40.080	ST 097	0824121154
3.40.084	ST 001	0824121001
3.40.119	ST 060	0824121108
3.40.121	ST 028	0824121078
3.40.180	ST 098	0824121155
3.60.076	ST 092	0824121149

PEX	BERU	
3.60.111	ST 121	0824121175
3.70.008	ST 101	0824121158
3.70.029	ST 073	0824121122
3.70.100	ST 077	0824121125
3.70.114	ST 075	0824121123
3.70.133	ST 077	0824121125
3.70.144	ST 085	0824121133
3.80.003	ST 074	0824122013
3.80.033	ST 080	0824121128
3.80.035	ST 108	0824121165
3.80.039	ST 079	0824121127
300014	SPR 013	0824331030
300014	SPR 015	0824331032
300015	SPR 014	0824331031
300015	SPR 016	0824331033
300016	SPR 011	0824331028
300016	SPR 012	0824331029
300017	SPR 009	0824331026
300045	SPR 017	0824331034
300046	SPR 021	0824331037
300074	SPR 019	0824331040
300093	SPR 010	0824331027
300094	SPR 022	0824331038
340013	ST 063	0824121111
340030	ST 061	0824121109
340072	ST 062	0824121110
340089	ST 065	0824131034
340122	ST 069	0824121117
340136	ST 066	0824121114

PONTIAC	BERU	
100 421 86	OZU 005	0824010055

PORSCHE	BERU	
616 107 805 01	ST 026	0824131021
901 741 632 00	Auf Anfrage ¹⁸	
911 606 123 00	OZU 001	0824010001
911 613 571 00	SPR 002	0824331011
944 606 125 00	ST 028	0824121078
944 606 133 00	OZU 001	0824010001
944 606 481 00	ST 100	0824121157
955 361 661 00	RDE 005	0532207005
997 606 021 00	RDE 001	0532207001

QUINTON HAZELL	BERU	
XEFS 4	ST 101	0824121158
XEFS 26	ST 073	0824121122
XEFS 54	ST 108	0824121165
XEFS 62	ST 075	0824121123
XEFS 108	ST 074	0824122013
XEFS 157	ST 078	0824121126
XEFS 203	ST 080	0824121128
XEFS 211	ST 085	0824121133
XEFS 211	ST 087	0824121135
XEFS 226	ST 072	0824121120
XEFS 238	ST 079	0824121127
XEFS 239	ST 081	0824121129
XEFS 240	ST 083	0824121131
XEFS 242	ST 106	0824121163

QUINTON HAZELL	BERU	
XEFS 249	ST 082	0824121130
XEFS 264	ST 103	0824121160
XEFS 268	ST 105	0824121162
XEFS 278	ST 086	0824121134
XEFS 281	ST 123	0824121177
XEFS 287	ST 084	0824121132
XEFS 295	ST 104	0824121161
XEMS 3	ST 028	0824121078
XEMS 31	ST 071	0824121119
XEMS 37	ST 068	0824121116
XEMS 41	ST 030	0824121081
XEMS 42	ST 060	0824121108
XEMS 51	ST 066	0824121114
XEMS 58	ST 067	0824121115
XEMS 67	ST 069	0824121117
XOPS 6	SPR 003	0824331010
XOPS 9	SPR 020	0824331036
XOPS 12	SPR 016	0824331033
XOPS 14	SPR 011	0824331028
XOPS 15	SPR 009	0824331026
XOPS 15	SPR 013	0824331030
XOPS 20	SPR 001	0824331004
XOPS 20	SPR 004	0824331025
XOPS 23	SPR 004	0824331025
XOPS 27	SPR 018	0824331039
XOPS 29	SPR 017	0824331034
XOPS 55	SPR 021	0824331037
XOPS 68	SPR 012	0824331029
XOPS 78	SPR 004	0824331025
XOPS 79	SPR 022	0824331038
XOPS 94	SPR 019	0824331040
XOPS 110	SPR 010	0824331027
XTS 59	ST 092	0824121149
XTT 1	ST 044	0824121091
XTT 2	ST 043	0824121089
XTT 3	ST 046	0824121093
XTT 5	ST 039	0824121085
XTT 6	ST 042	0824121088
XTT 8	ST 047	0824121094
XTT 9	ST 040	0824121086
XTT 20	ST 037	0824121083
XTT 27	ST 045	0824121092
XTT 28	ST 049	0824121098
XTT 30	ST 051	0824121100
XTT 30	ST 053	0824121102
XTT 35	ST 061	0824121109
XTT 38	ST 054	0824121103
XTT 46	ST 052	0824121101
XTT 55	ST 041	0824121087
XTT 71	ST 055	0824121104
XTT 81	ST 097	0824121154
XTT 85	ST 098	0824121155
XTT 90	ST 062	0824121110
XTT 95	ST 001	0824121001
XTT 99	ST 115	0824121169
XTT 102	ST 057	0824121106
XTT 103	ST 050	0824121099
XTT 104	ST 065	0824131034
XTT 106	ST 048	0824121097
XTT 122	ST 063	0824121111
XTT 126	ST 058	0824121107
XTTs 19	ST 122	0824121176

**RENAULT** **BERU**

50 00 080 230	SPR 007	0824331014
50 00 271 900	SPR 007	0824331014
50 00 278 328	SPR 005	0824331018
50 10 293 265	ST 024	0824121031
60 01 009 534	OZH 044	0824010046
77 00 100 713	OZH 101	0824010125
77 00 101 345	OZH 160	0824010194
77 00 105 557	OZH 208	0824010242
77 00 107 434	OZH 184	0824010218
77 00 108 027	OZH 184	0824010218
77 00 260 909	OZH 044	0824010046
77 00 266 922	OZH 044	0824010046
77 00 267 388	ST 028	0824121078
77 00 273 273	OZH 108	0824010107
77 00 273 715	OZH 125	0824010159
77 00 503 200	ST 044	0824121091
77 00 708 605	OZU 022	0824010094
77 00 708 955	OZU 010	0824010090
77 00 729 063	OZU 001	0824010001
77 00 729 963	OZU 022	0824010094
77 00 737 571	ST 015	0824121075
77 00 737 572	ST 032	0824111007
77 00 746 375	OZH 033	0824010035
77 00 767 336	ST 043	0824121089
77 00 851 303	OZH 033	0824010035
77 00 854 136	OZU 022	0824010094
77 00 854 148	OZH 033	0824010035
77 00 854 506	OZH 058	0824010063
77 00 860 246	OZU 025	0824010143
77 00 862 426	OZH 033	0824010035
77 00 864 987	OZH 033	0824010035
77 00 867 295	OZH 083	0824010098
77 00 867 408	OZH 087	0824010105
77 00 869 034	OZU 001	0824010001
77 00 870 318	OZH 058	0824010063
77 00 872 820	OZH 109	0824010127
77 00 872 878	OZH 107	0824010139
77 00 874 327	OZH 092	0824010112
77 00 874 600	OZH 096	0824010118
77 01 348 032	SPR 018	0824331039
77 01 348 143	ST 043	0824121089
77 01 348 194	ST 101	0824121158
77 01 349 086	ST 044	0824121091
77 02 002 661	ST 044	0824121091
79 10 245 51	ST 043	0824121089
79 10 245 553	ST 043	0824121089
89 33 002 455	OZU 001	0824010001

ROLLS ROYCE **BERU**

UE 71610	ST 028	0824121078
UR 26474	OZU 001	0824010001
UT 10094	OZH 156	0824010190

ROVER **BERU**

210002488	ST 005	0824111003
ERR 2081	ST 028	0824121078
NNK 000050	ST 005	0824111003
MHK 10004	OZH 057	0824010062
MHK 10006	OZH 053	0824010058
MHK 10021	OZH 094	0824010114
MHK 10023	OZU 004	0824010054
MHK 10030	OZH 094	0824010114
MZY 10021	OZH 094	0824010114

SAAB **BERU**

41 64 323	OZH 157	0824010191
42 39 588	OZH 157	0824010191
42 39 596	OZH 154	0824010188
42 39 661	OZH 158	0824010192
43 01 305	OZH 158	0824010192
72 25 603	OZH 037	0824010039
72 25 751	OZH 037	0824010039
75 25 603	OZH 037	0824010039
75 25 751	OZH 037	0824010039
75 30 140	OZU 022	0824010094
75 34 795	OZU 001	0824010001
88 00 914	ST 052	0824121101
88 59 233	ST 052	0824121101
91 08 291	ST 052	0824121101
91 29 743	OZH 027	0824010028
91 32 564	OZH 157	0824010191
91 46 937	OZH 157	0824010191
91 46 945	OZH 158	0824010192
91 46 952	OZH 156	0824010190
93 17 751	OZU 022	0824010094
93 37 726	OZU 022	0824010094
93 92 762	OZH 046	0824010048

SAURER **BERU**

244 0645 002	SPR 007	0824331014
244 0645 015	SPR 008	0824331015

SCANIA **BERU**

1358968	Auf Anfrage ¹⁸	
1358969	Auf Anfrage ¹⁸	
1377928	Auf Anfrage ¹⁸	
1377930	Auf Anfrage ¹⁸	
1383580	Auf Anfrage ¹⁸	
1384809	Auf Anfrage ¹⁸	
1397851	Auf Anfrage ¹⁸	
1397852	Auf Anfrage ¹⁸	
1408048	Auf Anfrage ¹⁸	
1408049	Auf Anfrage ¹⁸	
1413120	Auf Anfrage ¹⁸	
1413121	Auf Anfrage ¹⁸	
1413382	Auf Anfrage ¹⁸	
1413847	Auf Anfrage ¹⁸	
1413848	Auf Anfrage ¹⁸	
1426365	Auf Anfrage ¹⁸	
1442096	Auf Anfrage ¹⁸	
1445040	Auf Anfrage ¹⁸	
1491408	Auf Anfrage ¹⁸	
1492239	Auf Anfrage ¹⁸	
158717	SPR 007	0824331014
30548563	OZH 156	0824010190
422208	SPR 008	0824331015

SAVIEM **BERU**

50 00 080 230	SPR 007	0824331014
50 00 257 029	SPR 007	0824331014
50 00 271 900	SPR 007	0824331014
50 00 278 328	SPR 005	0824331018

SEAT **BERU**

025 906 041	ST 116	0824121170
026 906 161	ST 013	0824121073
030 906 265 E	OZU 003	0824010053
030 906 265 J	OZH 031	0824010033
030 906 265 Q	OZH 012	0824010013
035 919 369 M	ST 060	0824121108
046 905 379	ST 036	0824111011
051 906 265 E	OZU 001	0824010001
051 906 265 E	OZU 003	0824010053
053 919 501 A	ST 122	0824121176
059 919 501	ST 121	0824121175
059 919 501 A	ST 119	0824121173
068 919 081 A	SPR 022	0824331038
06A 919 501	ST 114	0824121168
06B 905 379	ST 113	0824111034
06B 905 379 A	ST 113	0824111034
06B 905 379 C	ST 113	0824111034
06B 905 379 D	ST 113	0824111034
074 919 501	ST 120	0824121174
078 919 501 C	ST 119	0824121173
1H0 919 563	ST 050	0824121099
1J0 919 379 A	ST 112	0824111033
251 919 501 A	ST 115	0824121169
251 919 501 D	ST 115	0824121169
321 959 481 E	ST 070	0824121118
357 919 501	ST 031	0824121082
357 919 501 A	ST 030	0824121081
4A0 919 501 A	ST 121	0824121175
6U0 919 501 B	ST 030	0824121081
SE 021 947 0001	ST 053	0824121102
SE 021 947 000C	ST 045	0824121092
SE 021 952 600 A	ST 073	0824121122

SKODA **BERU**

004 165 009	OZH 037	0824010039
025 906 041	ST 116	0824121170
030 906 265 E	OZU 003	0824010053
051 906 265 E	OZU 003	0824010053
053 919 501 A	ST 122	0824121176
059 919 501	ST 121	0824121175
059 919 501 A	ST 119	0824121173
068 919 081 A	SPR 022	0824331038
06A 919 501	ST 114	0824121168
06B 905 379	ST 113	0824111034
06B 905 379 A	ST 113	0824111034
06B 905 379 C	ST 113	0824111034
06B 905 379 D	ST 113	0824111034
074 919 501	ST 120	0824121174
078 919 501 C	ST 119	0824121173
113 095 090	ST 100	0824121157
1J0 919 379 A	ST 112	0824111033
251 919 501 A	ST 115	0824121169
251 919 501 D	ST 115	0824121169
357 919 501 A	ST 030	0824121081
441 04165-0196	OZH 043	0824010045
4A0 919 501 A	ST 121	0824121175
6U0 906 265 C	OZH 099	0824010121
6U0 919 501 B	ST 030	0824121081

STEIN **BERU**

019427	SPR 002	0824331011
--------	---------	------------



STEYR	BERU	
161 50 00 9007 71	Auf Anfrage ¹⁸	
609 F 07 0074	SPR 002	0824331011
991 14 71 0001	SPR 007	0824331014

SUBARU	BERU	
18213-60B00	OZU 005	0824010055
21203 AA000	ST 042	0824121088
22690 AA 120	OZU 001	0824010001
22690 KA 000	OZU 022	0824010094
22690 KA 020	OZU 001	0824010001
22690 KA 060	OZU 001	0824010001
22690 KA 081	OZU 001	0824010001
25240 KA020	SPR 013	0824331030
4299 55500	SPR 015	0824331032
8208 04150	ST 042	0824121088
8299 56100	SPR 009	0824331026

SUZUKI	BERU	
13650 61B00	ST 068	0824121116
13650 71C00	ST 068	0824121116
18213 57B10	OZU 001	0824010001
18213 58B20	OZH 047	0824010049
18213 60B00	OZU 005	0824010055
18213 61A10	OZU 014	0824010104
18213 64B00	OZU 005	0824010055
18213 82010	OZU 001	0824010001
19213 64B00	OZU 015	0824010111
34850 65011	ST 039	0824121085
37820 73002	SPR 013	0824331030
37820 80001	SPR 015	0824331032
37820 82000	SPR 013	0824331030
37820 82001	SPR 013	0824331030

SWAG	BERU	
30 23 0001	SPR 017	0824331034
30 91 8666	ST 115	0824121169
30 91 9036	ST 030	0824121081
50 23 0003	ST 055	0824121104
99 90 1528	ST 108	0824121165
99 90 1840	ST 089	0824111030
99 91 0114	ST 104	0824121161

TALBOT	BERU	
0015794500	ST 049	0824121098
0521548200	ST 049	0824121098
7810240000	ST 044	0824121091
96027244	OZH 029	0824010031
96138608	OZH 034	0824010036

TOYOTA	BERU	
83420 12010	ST 042	0824121088
83420 16010	ST 041	0824121087
83420 20010	ST 041	0824121087
83420 20011	ST 042	0824121088
83420 20020	ST 041	0824121087
83530 10010	SPR 009	0824331026
83530 10020	SPR 009	0824331026
83530 12010	SPR 009	0824331026
83530 12020	SPR 009	0824331026
83530 12040	SPR 009	0824331026

TOYOTA	BERU	
83530 14010	SPR 009	0824331026
83530 14020	SPR 009	0824331026
83530 14030	SPR 009	0824331026
83530 14040	SPR 009	0824331026
83530 30010	SPR 011	0824331028
83530 30020	SPR 011	0824331028
83530 30021	SPR 011	0824331028
83530 30022	SPR 011	0824331028
83530 30030	SPR 009	0824331026
83530 30040	SPR 011	0824331028
83530 30041	SPR 011	0824331028
83530 30042	SPR 011	0824331028
83530 30043	SPR 009	0824331026
83530 30050	SPR 011	0824331028
83530 30060	SPR 011	0824331028
83530 30080	SPR 009	0824331026
83530 36010	SPR 011	0824331028
83530 36011	SPR 011	0824331028
89422-20010	ST 068	0824121116
89422-35010	ST 068	0824121116
89465 19295	OZH 069	0824010075
89465 19366	OZH 103	0824010128
89465 39355	OZH 010	0824010011
89465 69115	OZH 033	0824010035
89465 69125	OZH 033	0824010035
89465 87707	OZU 001	0824010001

TTC	BERU	
07.42.011	ST 030	0824121081

VALEO	BERU	
819757	ST 101	0824121158
819769	ST 108	0824121165
820034	ST 106	0824121163
820035	ST 030	0824121081
820224	ST 103	0824121160
820225	ST 102	0824121159
820235	ST 104	0824121161
820303	ST 105	0824121162

VDO	BERU	
323-801-020-002 D	ST 001	0824121001
323-804-006-005 D	ST 053	0824121102
324-804-006-001 D	ST 054	0824121103

VERNET	BERU	
2647	ST 123	0824121177

VIEROL AG	BERU	
10-72-0910	ST 030	0824121081
10-72-0911	ST 122	0824121176
10-72-0955	ST 119	0824121173
10-72-0956	ST 112	0824111033
10-99-0001	ST 114	0824121168
10-99-0002	ST 120	0824121174
10-99-0907	ST 121	0824121175
15-99-1951	ST 108	0824121165
15-99-1977	ST 104	0824121161
15-99-1991	ST 103	0824121160

VIEROL AG	BERU	
15-99-1995	SPR 017	0824331034
20-72-0433	ST 116	0824121170
20-72-0444	ST 117	0824121171

VOLVO	BERU	
1257137	SPR 004	0824331025
1257617-9	ST 054	0824121103
1271998	OZH 073	0824010079
1274367	OZU 001	0824010001
1274746	OZU 001	0824010001
1275610	OZH 210	0824010244
1276951	OZU 001	0824010001
1326578	OZH 044	0824010046
1328397-3	ST 038	0824121084
1346738	OZH 037	0824010039
1346962	OZH 037	0824010039
1378123	OZH 003	0824010004
1571540	SPR 007	0824331014
239669	SPR 001	0824331004
240112	SPR 007	0824331014
241374	SPR 007	0824331014
298004	SPR 008	0824331015
30814907	OZH 130	0824010164
30853464	ST 082	0824121130
3092454	SPR 007	0824331014
3342945	OZH 037	0824010039
3344169	ST 015	0824121075
3416584	ST 073	0824121122
3432833-6	ST 062	0824121110
3433761-8	ST 062	0824121110
3462685	OZH 003	0824010004
3463731	ST 084	0824121132
3463731-4	ST 084	0824121132
3474457	OZH 003	0824010004
3501753	OZH 003	0824010004
3517501	ST 054	0824121103
3517778	OZH 027	0824010028
3531075	OZH 035	0824010037
3531400	OZH 037	0824010039
460191-0	ST 061	0824121109
462 685	OZH 003	0824010004
9125371	OZH 209	0824010243
9135664	OZH 161	0824010195
9135794	OZH 155	0824010189

VW AG	BERU	
021 906 265 AC	OZH 181	0824010215
021 906 265 AD	OZH 151	0824010185
021 906 265 AG	OZH 152	0824010186
021 906 265 AK	OZH 150	0824010184
021 906 265 AR	OZH 151	0824010185
021 906 265 B	OZH 043	0824010045
021 906 265 C	OZH 165	0824010199
021 906 265 M	OZH 165	0824010199
021 906 265 R	OZH 165	0824010199
021 906 265 T	OZH 151	0824010185
021 919 081 C	SPR 004	0824331025
023 906 205 H	OZH 010	0824010011
023 906 265 A	OZH 134	0824010168
025 906 041	ST 116	0824121170
025 906 265	OZU 001	0824010001

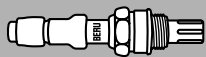

VW AG	BERU	
025 906 265 B	OZH 037	0824010039
025 906 265 M	OZH 043	0824010045
026 906 161	ST 013	0824121073
026.906.161.6	ST 033	0824111008
028 919 081 A	SPR 003	0824331010
028 919 081 B	SPR 003	0824331010
028 919 081 C	SPR 003	0824331010
028 919 081 D	SPR 004	0824331025
028 919 501 1	ST 038	0824121084
028 919 501 A	ST 054	0824121103
028 919 501 C	ST 118	0824121172
030 906 262 F	OZH 179	0824010213
030 906 265	OZH 047	0824010049
030 906 265 AA	OZH 009	0824010010
030 906 265 AB	OZH 012	0824010013
030 906 265 AC	OZH 024	0824010025
030 906 265 AD	OZH 070	0824010076
030 906 265 AE	OZH 071	0824010077
030 906 265 AN	OZH 028	0824010030
030 906 265 AP	OZH 022	0824010023
030 906 265 B	OZH 047	0824010049
030 906 265 BD	OZH 022	0824010023
030 906 265 BG	OZH 151	0824010185
030 906 265 BH	OZH 086	0824010102
030 906 265 BM	OZH 151	0824010185
030 906 265 BR	OZH 151	0824010185
030 906 265 C	OZH 048	0824010050
030 906 265 CB	OZH 169	0824010203
030 906 265 G	OZH 010	0824010011
030 906 265 J	OZH 031	0824010033
030 906 265 K	OZH 009	0824010010
030 906 265 M	OZH 008	0824010009
030 906 265 N	OZH 043	0824010045
030 906 265 P	OZH 009	0824010010
030 906 265 Q	OZH 012	0824010013
030 906 265 T	OZH 043	0824010045
032 906 265	OZH 068	0824010074
032 906 265 C	OZH 215	0824010249
032 906 265 D	OZH 215	0824010249
034 906 265	OZH 037	0824010039
034 906 265 A	OZH 037	0824010039
034 906 265 C	OZH 037	0824010039
034 906 265 D	OZH 003	0824010004
034 906 265 E	OZH 044	0824010046
034 906 265 F	OZH 046	0824010048
035 133 533 A	OZU 022	0824010094
035 906 265	OZU 022	0824010094
035 906 265 B	OZU 022	0824010094
035 906 265 C	OZU 001	0824010001
035 906 265 D	OZH 037	0824010039
035 919 369 C	ST 071	0824121119
035 919 369 M	ST 060	0824121108
035 919 501	ST 038	0824121084
036 906 262 F	OZH 182	0824010216
037 906 265	OZH 009	0824010010
037 906 265 AA	OZH 164	0824010198
037 906 265 AB	OZH 151	0824010185
037 906 265 C	OZH 009	0824010010
037 906 265 E	OZH 131	0824010165
037 906 265 F	OZH 010	0824010011
037 906 265 G	OZH 010	0824010011
037 906 265 J	OZH 024	0824010025
03D 906 265 B	OZH 128	0824010162
046 905 379	ST 036	0824111011
048 906 265	OZH 044	0824010046

VW AG	BERU	
048 906 265 A	OZH 044	0824010046
048 906 265 B	OZH 017	0824010018
049 919 501	ST 053	0824121102
049 919 563 B	ST 065	0824131034
050 906 265	OZU 001	0824010001
051 906 265 C	OZU 001	0824010001
051 906 265 D	OZH 027	0824010028
051 906 265 E	OZU 001	0824010001
051 906 265 E	OZU 003	0824010053
053 906 265	OZH 027	0824010028
053 919 501 A	ST 122	0824121176
056 919 081 A	SPR 004	0824331025
056 919 081 C	SPR 004	0824331025
056 919 081 E	SPR 017	0824331034
058 906 265 A	OZH 069	0824010075
059 919 501	ST 121	0824121175
059 919 501 A	ST 119	0824121173
061 919 081	SPR 003	0824331010
068 919 081	SPR 021	0824331037
068 919 081 A	SPR 022	0824331038
06A 906 265 E	OZH 169	0824010203
06A 906 265 F	OZH 177	0824010211
06A 906 265 H	OZH 128	0824010162
06A 919 501	ST 114	0824121168
06B 905 379	ST 113	0824111034
06B 905 379 A	ST 113	0824111034
06B 905 379 C	ST 113	0824111034
06B 905 379 D	ST 113	0824111034
06B 906 265 A	OZH 190	0824010224
06B 906 265 B	OZH 178	0824010212
074 919 501	ST 120	0824121174
077 906 265	OZH 037	0824010039
077 906 265 A	OZH 037	0824010039
077 906 265 B	OZH 027	0824010028
077 906 265 D	OZH 151	0824010185
078 906 265	OZH 017	0824010018
078 906 265 A	OZH 017	0824010018
078 906 265 B	OZH 017	0824010018
078 906 265 D	OZH 103	0824010128
078 906 265 L	OZH 151	0824010185
078 919 501 C	ST 119	0824121173
113 906 161	ST 107	0824121164
175 919 501	ST 053	0824121102
191 959 481 B	ST 070	0824121118
191 959 481 C	ST 108	0824121165
1H0 919 563	ST 050	0824121099
1H0 959 481 B	ST 104	0824121161
1H0 959 481 C	ST 102	0824121159
1J0 919 379 A	ST 112	0824111033
251 919 501 A	ST 115	0824121169
251 919 501 D	ST 115	0824121169
279 195 01	ST 053	0824121102
2D0 906 265	OZH 146	0824010180
357 919 501	ST 031	0824121082
357 919 501 A	ST 030	0824121081
4A0 919 501 A	ST 121	0824121175
4D0 907 275	RDE 001	0532207001
4D0 907 275 A	RDE 004	0532107001
4F0 907 275	RDE 007	0532207007
4F0 907 275 B	RDE 007	0532207007
6K0 906 265 A	OZH 151	0824010185
6U0 906 265 C	OZH 099	0824010121
6U0 919 501 B	ST 030	0824121081
701 959 481	ST 103	0824121160
701 959 481 C	ST 105	0824121162

VW AG	BERU	
7L0 907 275	RDE 005	0532207005
7L0 907 275	RDE 005	0532207005
823 959 481	ST 100	0824121157
823 959 481 A	ST 100	0824121157
823 959 481 F	ST 100	0824121157
823 959 481 L	ST 100	0824121157
867 959 481	ST 106	0824121163
J89 422 200 10	ST 068	0824121116
X03 961 005	OZH 037	0824010039

WAHLER	BERU	
6010.92 D	ST 100	0824121157
6020.95 D	ST 070	0824121118
6031.100 D	ST 075	0824121123
6031.105 D	ST 076	0824121124
6033.88	ST 074	0824122013
6037.95 D	ST 104	0824121161
6039.95 D	ST 106	0824121163

WALKER	BERU	
250-2101	OZU 001	0824010001
250-2102	OZU 001	0824010001
250-2103	OZU 001	0824010001
250-2104	OZU 001	0824010001
250-2107	OZU 001	0824010001
250-2111	OZU 001	0824010001
250-2113	OZU 001	0824010001
250-2115	OZU 001	0824010001
250-2117	OZU 001	0824010001
250-2118	OZU 001	0824010001
250-2121	OZU 001	0824010001
250-2122	OZU 001	0824010001
250-2123	OZU 001	0824010001
250-2124	OZU 001	0824010001
250-2127	OZU 001	0824010001
250-2201	OZU 001	0824010001
250-2202	OZU 001	0824010001
250-2205	OZU 001	0824010001
250-2208	OZU 001	0824010001
250-2255	OZU 001	0824010001
250-2301	OZH 037	0824010039
250-2305	OZH 033	0824010035
250-2312	OZH 010	0824010011
250-2313	OZH 010	0824010011
250-2314	OZH 009	0824010010
250-2315	OZH 001	0824010002
250-2319	OZH 046	0824010048
250-2321	OZH 046	0824010048
250-2323	OZH 009	0824010010
250-2328	OZH 037	0824010039
250-2332	OZH 043	0824010045
250-2333	OZH 037	0824010039
250-2336	OZH 051	0824010056
250-2337	OZH 026	0824010027
250-2348	OZH 003	0824010004
250-2366	OZH 032	0824010034
250-2415	OZH 045	0824010047
250-2421	OZH 002	0824010003
250-2424	OZH 039	0824010041
250-2430	OZH 005	0824010006



WALKER	BERU	
250-2434	OZH 016	0824010017
250-2435	OZH 036	0824010038
250-2439	OZH 018	0824010019
250-2441	OZH 035	0824010037
250-2466	OZH 043	0824010045
250-2502	OZH 028	0824010030
250-2605	OZH 036	0824010038
250-2607	OZH 036	0824010038
250-2609	OZH 023	0824010024
250-2610	OZH 023	0824010024
250-2611	OZH 023	0824010024
250-8005	OZH 057	0824010062

ZF GETRIEBE	BERU	
0 501 317 259	ST 124	0824131029

- 1 Alluminio (anodizzato)
- 2 Su richiesta
- 3 cambio automatico
- 4 Tipi di sostituzione
- 5 Kit di termoavviatori a fiamma
- 6 Motore in ghisa
- 7 in preparazione
- 8 Catalizzatore
- 9 Ceramica con copertura protettiva in acciaio
- 10 climatizzatore
- 11 Compressore
- 12 montaggio a sinistra
- 13 guida a sinistra
- 14 Aria
- 15 Ottone
- 16 con sistema di iniezione Bosch
- 17 Con maggiore potenza di trasmissione
- 18 senza catalizzatore
- 19 senza o-ring
- 20 pin
- 21 Pala caricatrice gommata
- 22 montaggio a destra
- 23 guida a destra anteriore
- 24 cambio manuale
- 25 servo
- 26 Acciaio (superficie zincata)
- 27 Chiave di decodificazione n° d'ordine primo montaggio (OE)
→ n° d'ordine distributore (AM)
- 28 immobilizzatore
- 29 Diagnosesonde
- 30 Sonda di regolazione
- 31 nero
- 32 verde
- 33 rosso
- 34 giallo
- 35 turchese
- 36 grigio
- 37 blu
- 38 bianco
- 39 marrone
- 40 antracite
- 50 Novità
- 51 Materiale plastico
- 52 Smercio
- 60 Assortimenti riferiti ai produttori

- 1 Алюминий (анодированный)
- 2 По запросу
- 3 автоматическая коробка передач
- 4 Запасные типы
- 5 Пусковые устройства воспламенения
- 6 Литой двигатель
- 7 в стадии подготовки
- 8 Катализатор
- 9 Керамика со стальным колпачком
- 10 кондиционер
- 11 Компрессор
- 12 левосторонний монтаж
- 13 автомобиль с левым расположением руля
- 14 Воздух
- 15 Латунь
- 16 с системой впрыскивания топлива Bosch
- 17 с увеличенной мощностью передатчика
- 18 без катализатора
- 19 без кольца круглого сечения
- 20 полюсн
- 21 Подшипник колеса
- 22 правосторонний монтаж
- 23 автомобиль с правосторонним расположением руля впереди
- 24 механическая коробка передач
- 25 сервоусилитель
- 26 Сталь (оцинкованная поверхность)
- 27 Перекодировка № заказа первого оборудования (OE)
→ № торгового заказа (AM)
- 28 блокировка пуска двигателя
- 29 диагностический датчик
- 30 регулирующий датчик
- 31 черный
- 32 Зеленая
- 33 красный
- 34 желтый
- 35 бирюзовый
- 36 серый
- 37 синий
- 38 белый
- 39 коричневый
- 40 антрацит
- 50 Новинки
- 51 пластмасса
- 52 распродажа
- 60 Ассортименты изготовителя

**BERU**

I	1 Velocità	0 -	0 -
	2 Temperatura	1 Indicatore	1 Impianto d'iniezion
	0 -	2 Indicatore/Regolazione	2 Kit di termoavviatori a fiamma
	1 Liquido	3 Rilevamento	3 Ruota dentata sensore
2 Alloggiamento	4 Generatore di impulsi	4 Ventola di raffreddamento	
3 Aria	5 Regolazione	5 Temperatura refrigerante	
0 -	6 Interruttore	6 Temperatura refrigerante/Impianto d'iniezione	
1 Velocità/Posizione	7 Comando	7 Temperatura refrigerante/Relè tempo di accensione	
2 Velocità	8 Controllo	8 Albero a gomito	
3 Superficie		9 Sistema di raffreddamento motore	
4 Marcatura PMS		10 Gestione motore	
		11 Temperatura olio motore	
		12 Temperatura motore	
		13 Riscaldamento supplementare	
		14 ABS	

RUS	1 Частота вращения	0 -	0 -
	2 Температура	1 Индикация	1 Система впрыска
	0 -	2 Индикация/регулировка	2 Пусковые устройства воспламенения
	1 Жидкость	3 Регистрация	3 Зубчатое колесо датчика
2 Корпус	4 Импульсный датчик	4 Вентилятор радиатора	
3 Воздух	5 Регулировка	5 Температура охлаждающей жидкости	
0 -	6 Выключатель	6 Температура охлаждающей жидкости/система впрыска	
1 Частота вращения/положение	7 Управление	7 Температура охлаждающей жидкости/реле времени накопления	
2 Частота вращения	8 Контроль	8 Коленчатый вал	
3 Поверхность		9 Система охлаждения двигателя	
4 Отметка в.м.т.		10 Управление двигателем	
		11 Температура масла двигателя	
		12 Температура двигателя	
		13 Автономное отопление	
		14 ABS	

PL	1 Prędkość obrotowa	0 -	0 -
	2 Temperatura	1 Wskaźnik	1 Układ wtryskowy
	0 -	2 Wskaźnik/regulacja	2 Pnomiennych urządzeń zapłonowych
	1 Ciecz	3 Rejestracja	3 Koło zębate nadajnika
2 Obudowa	4 Nadajnik impulsów	4 Wentylator chłodnicy	
3 Powietrze	5 Regulacja	5 Temperatura chłodziwa	
0 -	6 Przełącznik	6 Temperatura chłodziwa/układ wtryskowy	
1 Prędkość obrotowa/pozycja	7 Sterownik	7 Temperatura chłodziwa/przełącznik czasu żarzenia	
2 Prędkość obrotowa	8 Nadzór	8 Wał korbowy	
3 Powierzchnia		9 Układ chłodzenia silnika	
4 Znacznik GM		10 Układ sterowania silnikiem	
		11 Temperatura oleju silnikowego	
		12 Temperatura silnika	
		13 Ogrzewanie postojowe	
		14 ABS	

GR	1 Αριθμός στροφών	0 -	0 -
	2 Θερμοκρασία	1 Ένδειξη	1 Σύστημα ψεκασμού
	0 -	2 Ένδειξη/Κύκλωμα ελέγχου	2 Προθερμαντήρας εκκίνησης με φλόγα
	1 Υγρό	3 Εξακρίβωση	3 Γρανάζι δότη
2 Περιβλήμα	4 Παλμοδότης	4 Φτερωτή ψυγείου	
3 Αέρας	5 Κύκλωμα ελέγχου	5 Θερμοκρασία ψυκτικού υγρού	
0 -	6 Διακόπτης	6 Θερμοκρασία ψυκτικού υγρού/Σύστημα ψεκασμού	
1 Αριθμός στροφών/Θέση	7 Χειρισμός	7 Θερμοκρασία ψυκτικού υγρού/Ρελέ προθέρμανσης	
2 Σύστημα ψεκασμού	8 Επιτήρηση	8 Στροφαλοφόρος άξονας	
3 Επιφάνεια		9 Σύστημα ψύξης κινητήρα	
4 Σήμανση άνω νεκρού σημείου		10 Διαχείριση κινητήρα	
		11 Θερμοκρασία λαδιού κινητήρα	
		12 Θερμοκρασία κινητήρα	
		13 Πρόσθετη θέρμανση	
		14 ABS	

H	1 Fordulatszám	0 -	0 -
	2 Hőmérséklet	1 Kijelzés	1 Befecskendező berendezés
	0 -	2 Kijelzés/szabályozás	2 Lángsugaras hidegindító berendezések
	1 Folyadék	3 Felismerés	3 Jeladó fogaskerék
2 Ház	4 Impulzus jeladó	4 Hűtőventilátor	
3 Levegő	5 Szabályozás	5 Hűtőközeg hőmérséklet	
0 -	6 Kapcsoló	6 Hűtőközeg hőmérséklet/befecskendező berendezés	
1 Fordulatszám/helyzet	7 Vezérlés	7 Hűtőközeg hőmérséklet/izzító relé	
2 Fordulatszám	8 Felügyelet	8 Forgattyústengely	
3 Felület		9 Motor hűtőrendszer	
4 FHP-jelölés		10 Motorvezérlés	
		11 Motorolaj hőmérséklet	
		12 Motor hőmérséklet	
		13 Állófűtés	
		14 ABS	

Symbole



**Symbols
Symboles
Symbolen**

**Símbolos
Simboli
Символы**

**Symbole
Σύμβολα
jelképek**



	<p>Drehzahlsensor Engine-speed sensor Capteur de vitesse Toerentalsensor Sensor de revoluciones Sensore di velocità Датчик числа оборотов Czujnik prędkości obrotowej Αισθητήρας στροφών Fordulatszám érzékelő</p>	<p>Erfassung von Drehzahl und/oder Position Measurement of speed and/or position Détection du régime et/ou de la position Registratie van toerental en/of positie Registro del número de revoluciones y/o posición Rilevamento della velocità e/o della posizione Регистрация частоты вращения и/или положения Rejestracja prędkości obrotowej i/lub pozycji Εξακριβίωση αριθμού στροφών και/ή θέσης Fordulatszám és/vagy helyzet felismerése</p>	<p>- Anzeige Drehzahl - Speed indicator - Affichage du régime - Weergave toerental - Anuncio número de revoluciones - Indicatore di velocità - Индикация частоты вращения - Wskazanie prędkości obrotowej - Ένδειξη αριθμού στροφών - Fordulatszám kijelzés</p>	<p>- Regelung Motormanagement - Control function in engine management - Régulation de la gestion du moteur - Regolazione gestione motore - Regulación mando del motor - Regolazione gestione motore - Регулир. управления мотором - regulacja układu rozrządu silnika - Ρύθμιση διαχείρισης κινητήρα - Motorirányítás szabályozása</p>
	<p>Temperatursensor Temperature sensor Capteur de température Temperatursensor Sensor de temperatura Sensore di temperatura Температурный датчик Czujnik temperatury Αισθητήρας θερμοκρασίας Hőmérsékletérzékelő</p>	<p>Erfassung der Ansauglufttemperatur Sense the intake-air temperature Mesure de la température de l'air d'admission Vastlegging van de aanzuigluchttemperatuur Registro de la temperatura del aire de aspiración Rilevazione delle temperatura dell'aria di aspirazione Регистр. темп-ры всасыв. воздуха Pomiary temperatury zasysanego powietrza Υπολογισμός της θερμοκρασίας αέρα εισαγωγής A szívólevegő hőmérsékletének rögzítése</p>	<p>- Regelung Motormanagement - Control function in engine management - Régulation de la gestion du moteur - Regeling motormanagement - Regulación mando del motor - Regolazione gestione motore - Регулир. управления мотором - regulacja układu rozrządu silnika - Ρύθμιση διαχείρισης κινητήρα - Motorirányítás szabályozása</p>	<p>- Regelung Motormanagement - Control function in engine management - Régulation de la gestion du moteur - Regeling motormanagement - Regulación mando del motor - Regolazione gestione motore - Регулир. управления мотором - regulacja układu rozrządu silnika - Ρύθμιση διαχείρισης κινητήρα - Motorirányítás szabályozása</p>
	<p>Temperatursensor Temperature sensor Capteur de température Temperatursensor Sensor de temperatura Sensore di temperatura Температурный датчик Czujnik temperatury Αισθητήρας θερμοκρασίας Hőmérsékletérzékelő</p>	<p>Erfassung der Kühlmitteltemperatur Sense the coolant temperature Mesure de la température du liquide de refroidissement Vastlegging van de gemiddelde koeltemperatuur Registro de la temperatura del refrigerante Rilevazione delle temperatura del fluido di raffreddamento Регистр. темп-ры охлад. жидкости Pomiary temperatury chłodziwa Υπολογισμός της θερμοκρασίας ψυκτικού A hűtőközeg hőmérsékletének rögzítése</p>	<p>- Anzeige Motortemperatur - Indicate the engine temperature - Affichage de la température du moteur - Indicatie motortemperatuur - Indicación temperatura del motor - Indicazione temperatura motore - Индикация темп-ры мотора - wskazanie temperatury silnika - Ένδειξη θερμοκρασίας κινητήρα - Motorhőmérséklet kijelzése</p>	<p>- Anzeige Motortemperatur - Indicate the engine temperature - Affichage de la température du moteur - Indicatie motortemperatuur - Indicación temperatura del motor - Indicazione temperatura motore - Индикация темп-ры мотора - wskazanie temperatury silnika - Ένδειξη θερμοκρασίας κινητήρα - Motorhőmérséklet kijelzése</p>
	<p>Temperatursensor Temperature sensor Capteur de température Temperatursensor Sensor de temperatura Sensore di temperatura Температурный датчик Czujnik temperatury Αισθητήρας θερμοκρασίας Hőmérsékletérzékelő</p>	<p>Erfassung der Kühlmitteltemperatur Sense the coolant temperature Mesure de la température du liquide de refr. Vastlegging van de koelmiddeltemperatuur Registro de la temperatura del refrigerante Rilevazione delle temperatura del fluido di raffr. Регистр. темп-ры охлад. жидкости Pomiary temperatury chłodziwa Υπολογισμός της θερμοκρασίας ψυκτικού A hűtőközeg hőmérsékletének rögzítése</p>	<p>- Anzeige Motortemperatur - Indicate the engine temperature - Affichage de la température du moteur - Indicatie motortemperatuur - Indicación temperatura del motor - Indicazione temperatura motore - Индикация темп-ры мотора - wskazanie temperatury silnika - Ένδειξη θερμοκρασίας κινητήρα - Motorhőmérséklet kijelzése</p>	<p>- Regelung Motormanagement - Control function in engine management - Régulation de la gestion du moteur - Regeling motormanagement - Regulación mando del motor - Regolazione gestione motore - Regulación mando del motor - Regulazione gestione motore - Регулир. управления мотором - regulacja układu rozrządu silnika - Ρύθμιση διαχείρισης κινητήρα - Motorirányítás szabályozása</p>
	<p>Temperatursensor Temperature sensor Capteur de température Temperatursensor Sensor de temperatura Sensore di temperatura Температурный датчик Czujnik temperatury Αισθητήρας θερμοκρασίας Hőmérsékletérzékelő</p>	<p>Erfassung der Kühlmitteltemperatur Sense the coolant temperature Mesure de la température du liquide de refroidissement Vastlegging van de koelmiddeltemperatuur Registro de la temperatura del refrigerante Rilevazione delle temperatura del fluido di raffreddamento Регистр. темп-ры охлад. жидкости Pomiary temperatury chłodziwa Υπολογισμός της θερμοκρασίας ψυκτικού A hűtőközeg hőmérsékletének rögzítése</p>	<p>- Regelung Motormanagement - Control function in engine management - Régulation de la gestion du moteur - Regeling motormanagement - Regulación mando del motor - Regolazione gestione motore - Регулир. управления мотором - regulacja układu rozrządu silnika - Ρύθμιση διαχείρισης κινητήρα - Motorirányítás szabályozása</p>	<p>- Regelung Motormanagement - Control function in engine management - Régulation de la gestion du moteur - Regeling motormanagement - Regulación mando del motor - Regolazione gestione motore - Regulación mando del motor - Regulazione gestione motore - Регулир. управления мотором - regulacja układu rozrządu silnika - Ρύθμιση διαχείρισης κινητήρα - Motorirányítás szabályozása</p>
	<p>Temperatursensor Temperature sensor Capteur de température Temperatursensor Sensor de temperatura Sensore di temperatura Температурный датчик Czujnik temperatury Αισθητήρας θερμοκρασίας Hőmérsékletérzékelő</p>	<p>Erfassung der Motoröltemperatur Sense the engine-oil temperature Mesure de la température de l'huile moteur Vastlegging van de motorolietemperatuur Registro de la temperatura del aceite de motor Rilevazione delle temperatura dell'olio del motore Регистр. темп-ры моторного масла Pomiary temperatury oleju silnikowego Υπολογισμός της θερμοκρασίας λαδιού κινητήρα A motorolaj hőmérsékletének rögzítése</p>	<p>- Anzeige Motoröltemperatur - Indicate the engine-oil temperature - Affichage de la temp. de l'huile moteur - Indicatie motorolietemperatuur - Indicación temperatura aceite de motor - Indicazione temperatura olio motore - Индикация темп-ры моторного масла - wskazanie temperatury oleju silnikowego - Ένδειξη θερμοκρασίας λαδιού κινητήρα - Motorolaj hőmérsékletének kijelzése</p>	<p>- Anzeige Motoröltemperatur - Indicate the engine-oil temperature - Affichage de la temp. de l'huile moteur - Indicatie motorolietemperatuur - Indicación temperatura aceite de motor - Indicazione temperatura olio motore - Индикация темп-ры моторного масла - wskazanie temperatury oleju silnikowego - Ένδειξη θερμοκρασίας λαδιού κινητήρα - Motorolaj hőmérsékletének kijelzése</p>
	<p>Temperatursensor Temperature sensor Capteur de température Temperatursensor Sensor de temperatura Sensore di temperatura Температурный датчик Czujnik temperatury Αισθητήρας θερμοκρασίας Hőmérsékletérzékelő</p>	<p>Erfassung der Gehäusetemperatur Measurement of the housing temperature Mesure de la température de l'habitaclé registreren van de temperatuur van het blok Registración de la temperatura de la carcasa Rilevamento della temperatura della scatola Регистрация температуры корпуса Czujnik temperatury silnika/korpusu Μέτρηση της θερμοκρασίας του περιβλήματος Hőmérséklet jeladó</p>	<p>- Regelung Motormanagement - Control function in engine management - Régulation de la gestion du moteur - Regeling motormanagement - Regulación mando del motor - Regolazione gestione motore - Регулир. управления мотором - Ρύθμιση διαχείρισης κινητήρα - Motorirányítás szabályozása</p>	<p>- Regelung Motormanagement - Control function in engine management - Régulation de la gestion du moteur - Regeling motormanagement - Regulación mando del motor - Regulazione gestione motore - Regulación mando del motor - Regulazione gestione motore - Regulazione Riscaldamento supplementare - Regulacja Ogrzewanie dodatkowe - Kúrközlő eléghető Próbvető hőmérséklet - Szabályozás Alófitűtés</p>
	<p>Temperatursensor Temperature sensor Capteur de température Temperatursensor Sensor de temperatura Sensore di temperatura Температурный датчик Czujnik temperatury Αισθητήρας θερμοκρασίας Hőmérsékletérzékelő</p>	<p>Erfassung der Kühlmitteltemperatur Sense the coolant temperature Mesure de la température du liquide de refroidissement Vastlegging van de koelmiddeltemperatuur Registro de la temperatura del refrigerante Rilevazione delle temperatura del fluido di raffreddamento Регистр. темп-ры охлад. жидкости Pomiary temperatury chłodziwa Υπολογισμός της θερμοκρασίας ψυκτικού A hűtőközeg hőmérsékletének rögzítése</p>	<p>- Temperaturschalter Kühlerlüfter - Radiator fan temperature switch - Contacteur de température de ventilateur de refroidisseur - Temperaturschakelaar koelingsventilator - Conmutador de temperatura ventilador refrescador - Interruttore termico ventola di raffreddamento - Температурный выключатель вентилятора радиатора - Wyłącznik termiczny wentylatora chłodnicy - Διακόπτης θερμοκρασίας φερωτής ψυγείου - Hőmérséklet kapcsoló hűtőventilátor</p>	<p>- Regelung Motormanagement - Control function in engine management - Régulation de la gestion du moteur - Regeling motormanagement - Regulación mando del motor - Regolazione gestione motore - Regulación mando del motor - Regulazione gestione motore - Regulazione Riscaldamento supplementare - Regulacja Ogrzewanie dodatkowe - Kúrközlő eléghető Próbvető hőmérséklet - Szabályozás Alófitűtés</p>
	<p>Bremslichtschalter Brake light switch Interrupteur des feux de freins Remlichtschakelaar Interruptor luces freno Interruttore luci d'arresto выключатель стоп-сигнала Wyłącznik światła stopu Διακόπτης φώτων φρένων Féklámpakapcsoló</p>	<p></p>	<p></p>	<p></p>
	<p>Öldruckschalter Oil pressure switch Pressostat d'huile Olidedruckschakelaar Interruptor de control de la presión de aceite Interruttore pressione olio гидравлический выключатель Wyłącznik ciśnienia oleju Διακόπτης πίεσης λαδιού Olajnyomáskapcsoló</p>	<p></p>	<p></p>	<p></p>

Cos'hanno in comune i costruttori di automobili in tutto il mondo?

Essi richiedono affidabilità assoluta e si assicurano la multiennale esperienza di specialisti. Essi promuovono il pensiero innovativo ed un'eccellente qualità di prodotto. Per tale motivo essi equipaggiano i vostri veicoli con prodotti originali di marca BERU. La BERU investe in maniera permanente in tutta una serie di provvedimenti per l'assicurazione della qualità e la protezione dell'ambiente. Gli tabilimenti del gruppo BERU sono certificati secondo le norme di qualità valide in tutto il mondo come ad es. DIN ISO 9001:2000. In Germania si adempie anche ai requisiti ISO/TS 16949 e DIN EN ISO 14001. I certificati vengono sostituiti regolarmente ed in relazione allo stato attuale corrispondente. Con ogni prodotto originale di marca BERU i nostri clienti nei primi montaggi, nel commercio e nelle officine ottengono la sicurezza di un'alta qualità di prodotto, di una ottimale disponibilità e un ottimo rapporto prezzo/prodotto.

Garanzia di prodotto BERU

I sensori riportati nel presente catalogo possono essere utilizzati in tutti i motori nell'ambito delle nostre raccomandazioni. La BERU non risponde per errori di contenuto o di stampa palesi, il cui riconoscimento cade sotto l'obbligo di diligenza dell'utilizzatore. La BERU risponde per l'integrità assicurata nell'ambito dello stato odierno della tecnica. Se è possibile comprovare che il motore ha subito danni nonostante che i prodotti BERU siano stati usati rispettando le nostre raccomandazioni, ci prendiamo carico parzialmente o totalmente delle spese causate per la riparazione del danno. La BERU decide sul risarcimento dei danni dietro presentazione dei prodotti BERU reclamati, dei componenti del motore danneggiati e delle relative fatture, a condizione che i prodotti BERU siano stati manipolati correttamente. Come dalle nostre condizioni generali di contratto, la garanzia per prodotti difettosi è di 24 mesi, a eccezione dei difetti causati da normale usura.

Что общего у изготовителей автомобилей во всем мире?

Они требуют абсолютной надежности и заручаются многолетним опытом специалистов. Они нуждаются в инновационном мышлении и высочайшем качестве продукции. Поэтому они оборудуют свои автомобили фирменными изделиями BERU. Фирма BERU постоянно развивает средства в широкомасштабные мероприятия по обеспечению качества и охране окружающей среды. Изделия группы BERU сертифицируются по признанным во всем мире нормам качества как, например, DIN ISO 9001:2000. Кроме того, в Германии они удовлетворяют требования ISO/TS 16949 и DIN EN ISO 14001. Сертификаты регулярно обновляются и соответствуют актуальному уровню. Приобретая каждое фирменное изделие BERU, наши заказчики на предприятиях первой сборки, в торговле и в авторемонтных мастерских получают гарантию высокого качества, оптимальной эксплуатационной готовности в сочетании с прекрасным соотношением цены и эксплуатационных характеристик.

Гарантия на продукцию BERU

Приведенные в данном каталоге датчики свечи зажигания, свечи накаливания и комплектующие детали могут быть использованы во всех двигателях в соответствии с нашими рекомендациями. На явные ошибки и очевидные опечатки распространяется обязанность внимательного подхода со стороны потребителя. Фирма BERU несет гарантийную ответственность за отсутствие дефектов и гарантированные характеристики согласно соответствующему уровню техники. В случае, если доказано возникновение ущерба двигателя несмотря на выполнение наших рекомендаций по использованию продукции BERU, мы полностью или частично компенсируем затраты по устранению ущерба. После получения рекламированной продукции BERU, поврежденных деталей двигателя и ремонтной документации фирма BERU принимает решение о компенсации затрат. Основным условием для этого является надлежащее обращение с продукцией BERU. Гарантийный срок на неисправные продукты составляет 24 месяца согласно нашим общим условиям заключения сделок. На нормальный износ гарантия не распространяется.

Co wspólnego mają producenci samochodów na całym świecie?

Wymagają absolutnej niezawodności i korzystają z wieloletnich doświadczeń specjalistów. Żądają innowacyjnego myślenia i produktów o doskonałej jakości. Dlatego instalują w swoich pojazdach oryginalne produkty marki BERU. BERU stale inwestuje w cały szereg przedsięwzięć, mających na celu zapewnienie najwyższej jakości oraz ochrony środowiska naturalnego. Zakłady Grupy BERU posiadają ważne na całym świecie certyfikaty spełnienia norm jakościowych np. DIN ISO 9001:2000, a wszystkie niemieckie zakłady BERU spełniają wymagania norm ISO/TS 16949, oraz DIN EN ISO 14001. Certyfikaty te są regularnie odnawiane każdorazowo zgodnie z aktualnymi wymaganiami. Z każdym oryginalnym produktem marki BERU, czy to w formie oryginalnego wyposażenia pojazdu, czy też nabywanym w handlu lub instalowanym w warsztacie samochodowym, dostają nasi klienci pewność najwyższej jakości, optymalną dostępność oraz doskonały stosunek ceny do właściwości użytkowych wyrobu.

Gwarancja na produkty BERU

Wymienione w tym katalogu czujniki mogą być stosowane do wszystkich silników zgodnie z naszymi zaleceniami. W ramach obowiązku staranności użytkownika leży wykluczenie dostrzegalnych pomyłek lub widocznych błędów w druku. Firma BERU udziela gwarancji na bezusterkowość oraz deklarowane właściwości produktów, zgodnie z aktualnym stanem techniki. Jeżeli produkty BERU będą stosowane zgodnie z naszymi zaleceniami i pomimo tego dojdzie do dających się udowodnić uszkodzeń silnika, wówczas przejmujemy w całości lub częściowo koszty związane z usunięciem tych szkód. Firma BERU podejmie decyzję o pokryciu kosztów po przedłożeniu reklamowanych produktów BERU, uszkodzonych części silnika oraz rachunków za przeprowadzone naprawy. Podstawowym tego warunkiem jest prawidłowe posługiwanie się produktami BERU. Okres gwarancji na wadliwe wyroby wynosi 24 miesiące zgodnie z naszymi ogólnymi warunkami handlowymi. Gwarancja nie obejmuje normalnego zużycia się części na skutek eksploatacji.

Τι κοινό έχουν οι κατασκευαστές αυτοκινήτων σε όλον τον κόσμο?

Απαιτούν τέλεια ποιότητα και αξιοπιστία και διασφαλίζουν τις απαιτήσεις τους με την πολυετή πείρα των ειδικών. Απαιτούν καινοτομία σκέψης και άσογη ποιότητα προϊόντων. Για όλους αυτούς τους λόγους εξοπλίζουν τα οχήματά τους με γνήσια προϊόντα ποιότητας BERU. Η εταιρία BERU επενδύει συνεχώς σε μία σειρά εκτενών μέτρων με σκοπό τη διασφάλιση ποιότητας και την προστασία του περιβάλλοντος. Στα εργοστάσια του Ομίλου BERU έχουν απονεμηθεί τίτλοι πιστοποίησης ποιότητας με παγκόσμια ισχύ όπως π.χ. το πρότυπο DIN ISO 9001:2000. Στη Γερμανία παράλληλα εκπληρώνονται οι απαιτήσεις σύμφωνα με τα πρότυπα ISO/TS 16949, και DIN EN ISO 14001. Οι τίτλοι πιστοποίησης ποιότητας ανανεώνονται τακτικά και ανταποκρίνονται στην εκάστοτε ενημερωμένη κατάσταση. Με κάθε γνήσιο προϊόν ποιότητας BERU οι πελάτες μας της αυτοκινητοβιομηχανίας, το εμπόριο και τα συνεργεία αποκτούν τη διασφάλιση ύψιστης ποιότητας προϊόντος, άριστου τρόπου διάθεσης και εξοχής σχέσης μεταξύ τιμής και προσφοράς.

Εγγύηση προϊόντων BERU

Οι αισθητήρες που αναφέρονται στον παρόντα κατάλογο, μπορούν σύμφωνα με τις συστάσεις μας να χρησιμοποιηθούν σε όλα τα είδη των κινητήρων. Η ευδιάκριτη πλάνη ή τα προφανή τυπογραφικά λάθη υπόκεινται στην υποχρέωση καταβολής επιμέλειας του χρήστη. Για τη λειτουργία χωρίς βλάβες η εταιρία BERU παρέχει εγγύηση σύμφωνα με την εκάστοτε εξέλιξη της τεχνολογίας. Σε περίπτωση που προκληθούν αποδεδειγμένες βλάβες στον κινητήρα, παρά το γεγονός ότι η χρήση των προϊόντων BERU έγινε σύμφωνα με τις συστάσεις μας, αναλαμβάνουμε εξ ολοκλήρου ή εν μέρει τα έξοδα για την αποκατάσταση της βλάβης. Κατόπιν επίδειξης των ελαττωματικών προϊόντων BERU, των εξαρτημάτων κινητήρα με εμφανή βλάβη και των αποδεικτικών επισκευής, η εταιρία BERU αποφασίζει για την ανάληψη των εξόδων. Βασική προϋπόθεση για την ανάληψη των εξόδων είναι ο κανονικός χειρισμός των προϊόντων BERU. Η προθεσμία παροχής εγγύησης για ελαττωματικά προϊόντα ανέρχεται σε 24 μήνες σύμφωνα με τους γενικούς όρους συναλλαγών μας. Από την περίπτωση αυτή αποκλείονται οι φυσιολογικές φθορές.

Miben egyeznek meg világszerte a gépkocsigyártó cégek?

Teljes megbízhatóságot várnak el és biztosítják a maguk számára specialisták sokévi tapasztalatát. Innovatív gondolkodást és kiváló termékminőséget követelnek. Ezért szerelik fel a gépkocsikat originál BERU márkatermékekkel. A BERU cég a minőségbiztosítás és a környezettudéelem érdekében állandó jelleggel egy sor átfogó intézkedésbe investál. A BERU Gruppe üzemei megkapták a világszerte érvényes minőség normát mint például a DIN ISO 9001:2000.

Ezenkívül Németországban megfelelnek az ISO/TS 16949 és a DIN EN ISO 14001 követelményeknek. A tanúsítvány-okat rendszeresen újítják és ezek megfelelnek a mindenkor legaktuálisabb szintnek.

Vevőink minden egyes eredeti BERU márkatermékkel a gyári felszerelésben, a kereskedelemben és a javítóműhelyben a kimagasló termékminőség, az optimális rendelkezésre állás és a kiváló árérteljestmény arány biztonságát élvezhetik.

BERU termékjótállás

Az ebben a katalógusban felsorolt érzékelők és alkatrészek az ajánlásunknak megfelelően minden motorban alkalmazhatók. Felismerető tévedések vagy nyilvánvaló nyomdahiábok esetén a felhasználók gondossági kötelezettsége érvényesül. A hibamentességért és a biztosított tulajdonságokért a BERU a technika mindenkori állásának megfelelően jótáll. Ha a BERU termékeit az ajánlásunknak megfelelően alkalmazzák és ezáltal a motoron ennek ellenére bizonyítható meghibásodások lépnek fel, akkor teljes mértékben vagy részben át vesszük a hibák elhárításának a költségeit. Kifogásolt BERU termékek, vagy meghibásodott motorrészek és javítási nyugták felmutatása után a BERU dönt a költségek átvállalásáról. Ennek alapvető feltétele mindig a BERU termékek szakszerű használata. A hibás termékek miatti jótállási idő 24 hónap cégünk általános üzleti feltételei alapján. Kivételt képez ez alól a természetes elhasználódás.



Printed in Germany · 12.09.07 · Bestell-Nr. 5 000 004 017
BERU® is a Registered Trademark of BorgWarner BERU Systems GmbH
CATBU701

 **FEDERAL
MOGUL**

Global Aftermarket EMEA bvba
Prins Boudewijnlaan 5
2550 Kontich • Belgium

www.federalmogul.com
www.beru.com

 www.fmecat.eu

Perfection
built in

 **BERU**[®]