

**CORTECO GmbH**  
Badener Straße 4  
69493 Hirschberg  
Germany  
Tel. +49-6201-259640  
Fax +49-6201-2596411

**CORTECO S.A.S.**  
Z.A. La Couture  
87140 Nantiat  
France  
Tel. +33-5-55536800  
Fax +33-5-55536888

**CORTECO S.r.l.u.**  
Corso Torino 420/D  
10064 Pinerolo (TO)  
Italy  
Tel. +39-0121-369269  
Fax +39-0121-369299

**CORTECO Ltd.**  
Unit 6, Wycliffe Industrial Park  
Lutterworth  
Leicestershire  
LE17 4HG  
United Kingdom  
Tel. +44-1455-550000  
Fax +44-1455-550066

**CORTECO Spain & Portugal**  
Freudenberg Iberica  
Pol. Ind. Can Volart  
C/ Gurri 1  
08150 Parets del Vallés (Barcelona)  
España  
Tel. +34-93-5738741  
Fax +34-93-5624676

**CORTECO Eastern Europe**  
Freudenberg Simrit  
111141 Moscow, Elektrodnyaya str. 2,  
Building 12-13-14  
Russia  
Tel. +7-495-3800650  
Fax +7-495-3800651

**CORTECO Poland**  
53-014 Wrocław  
Ul. Warsztatowa 11  
Poland  
Tel. +48-71-3399755  
Fax +48-71-3399700

**CORTECO Balkan States**  
Gajeva 27.  
21208 Sremska Kamenica (Novi Sad)  
Serbia  
Tel. +381-21-465268  
Fax +381-21-465268

**CORTECO Asia**  
18 Tractor Road  
Singapore 627976  
Singapore  
Tel. +65-6561-6651  
Fax +65-6561-6862

**CORTECO China Co. Ltd.**  
Room 3505, 35/F, Tower B,  
Center Plaza,  
No. 161 Lin He Xi Road  
Tianhe District  
Guangzhou, China  
Tel. +86-2038-324968  
Fax +86-2038-258548

**CORTECO USA**  
11617 State Route 13  
Millan, Ohio 44846  
USA  
Tel. +1-419-4992502  
Fax +1-419-4992804

**CORTECO South America**  
Av. Piraporinha, 411  
09950-902 São Paulo / Diadema  
Brasil  
Tel. +55-11-40728010  
Fax +55-11-40752535

CABIN AIR FILTER | INNENRAUMFILTER | FILTRES D'HABITACLE | FILTRO ARIA ABITACOLO

micronAir



## CABIN AIR FILTER

INNENRAUMFILTER

FILTRES D'HABITACLE

FILTRO ARIA ABITACOLO



The Perfect Change.

www.corteco.com



The Perfect Change.

# CORTECO®

## THE COMPANY

DAS UNTERNEHMEN | L'ENTREPRISE | SOCIETÀ

**E**

CORTECO as a member of the global Freudenberg Group is specialised in products for the Independent Aftermarket. The CORTECO range comprises automotive spare parts in the areas of sealing and vibration control technology as well as service parts. The Freudenberg Group is a leading Original Equipment Manufacturer and employs around 32,000 people in 52 countries. Independent garages trusting in CORTECO spare parts therefore profit from original quality made by Freudenberg.

More than 18,000 references support CORTECO's position as one of the leading companies in the Independent Aftermarket. The company sells spare parts and service kits worldwide from six European and a further four non-European locations.

**F**

CORTECO est le spécialiste au sein du groupe Freudenberg de la distribution de pièces de rechange automobile (aftermarket). Le groupe Freudenberg est un des leaders mondial en équipement d'origine et emploie 32.000 personnes dans 52 pays. Les gammes CORTECO s'appliquent notamment dans les domaines de l'étanchéité, des pièces antivibratoires et de la filtration d'habitacle. Ainsi, les clients utilisant des pièces CORTECO bénéficient d'une qualité « made by Freudenberg ».

Acteur majeur de la rechange indépendante avec plus de 18.000 références, CORTECO s'appuie sur une logistique renforcée comprenant six sites européens et quatre hors Europe.

**D**

CORTECO ist der Spezialist der global aufgestellten Unternehmensgruppe Freudenberg für den freien Automobilersatzteilmarkt. Das CORTECO Sortiment umfasst Automobilersatzteile für die Dichtungs- und Schwingungstechnik sowie Serviceteile. Die Freudenberg Gruppe ist ein führender Erstausrüster der Automobilhersteller und beschäftigt rund 32.000 Mitarbeiter in 52 Ländern. Freie Werkstätten profitieren bei CORTECO somit von Ersatzteilen in Original-Qualität aus dem Hause Freudenberg.

Über 18.000 Referenzen unterstreichen die Position von CORTECO als eines der führenden Unternehmen im freien Ersatzteilhandel. Mit fünf Standorten in Europa und vier weiteren außereuropäischen Standorten vertreibt das Unternehmen weltweit Ersatzteile und Service Kits.

**I**

La CORTECO, società del gruppo Freudenberg, è specializzata nella distribuzione di prodotti tecnici per l'Aftermarket Indipendente. La gamma CORTECO comprende parti di ricambio per le linee di prodotto specializzate nel settore degli elementi di tenuta, smorzamento delle vibrazioni e parti di servizio per tutte le principali applicazioni del mercato «Automotive». Il Gruppo Freudenberg, di cui fa parte, è uno dei principali fornitori di componentistica di primo equipaggiamento e occupa circa 32.000 dipendenti in 52 paesi. E' proprio per questo che le officine indipendenti si fidano dei prodotti CORTECO, perché sono prodotti di qualità originale Freudenberg.

Più di 18.000 articoli disponibili a gamma permettono a CORTECO di posizionarsi tra i principali fornitori leader nel mercato dell'Aftermarket indipendente. Il gruppo CORTECO distribuisce da sei siti Europei e da ben quattro siti extra Europei le sue parti di ricambio singole ed i suoi kit di manutenzione in tutte le parti del mondo.

## SIGNS AND SYMBOLS

ZEICHENERKLÄRUNG | SIGNES ET SYMBOLES | SEGNI E SIMBOLI



Vehicle model  
Fahrzeugmodell  
Modèle  
Modello



With / Without air-conditioning  
Mit / Ohne Klimaanlage  
Avec / Sans climatisation  
Con / Senza aria condizionata



Installation position in the vehicle  
Einbauposition im Fahrzeug  
Localisations dans le véhicule  
Posizionamento nel veicolo



Year of construction  
Baujahr  
Année de fabrication  
Anno di costruzione



Particle Filter  
Partikelfilter  
Filtre à particules  
Filtro particellare



Installation time  
Einbauzeit  
Temps d'installation  
Tempo di sostituzione



Information  
Information  
Information  
Informazione



Combi Filter  
Kombifilter  
Filtre combiné  
Filtro combinato





Pictures  
Produktbilder  
Photos des filtres  
Foto

	<b>E</b>	<b>D</b>	<b>F</b>	<b>I</b>
<b>+ MAN AC</b>	with manual air-conditioning	mit manueller Klimaanlage	avec climatisation manuelle	con condizionatore manuale
<b>+ AUT AC</b>	with automatic air-conditioning	mit manueller Klimaanlage	avec climatisation automatique	con condizionatore automatico
<b>roof AC</b>	roof air conditioning	Dachklimaanlage	climatisation de toit	tetto di aria condizionata
<b>RHD</b>	right hand drive	Rechtslenker	conduite à droite	guida a destra
<b>LHD</b>	left hand drive	Linkslenker	conduite à gauche	guida a sinistra
<b>Set</b>	set	Set	jeu	set
<b>3-Set</b>	set includes 3 filters	Set beinhaltet 3 Filter	jeu de 3 filtres	il set contiene 3 filtri
<b>2 !</b>	2 filters needed	2 Filter werden benötigt	2 filtres sont nécessaires	necessita di 2 filtri
<b>w/o F</b>	without frame	ohne Rahmen	sans cadre	senza telaio
<b>w F</b>	with frame	mit Rahmen	avec cadre	con telaio
<b>ocv</b>	only for construction vehicles	nur für Baustellenfahrzeuge	uniquement pour les véhicules de chantier	solo macchine movimento terra
<b>+ Part no.</b>	additional to part no.	zusätzlich zu Artikelnr.	en complément de la référence	aggiuntivo per codice
<b>od</b>	on demand	auf Anfrage	sur demande	su richiesta
<b>rv</b>	rounded version	runde Version	version ronde	versione circolare
<b>NR</b>	alternative filter	Alternativfilter	alternative au filtre d'origine	alternativo filtri

# CONTENT

INHALT | SOMMAIRE | INDICE

<b>THE COMPANY</b>	<b>2</b>
DAS UNTERNEHMEN   L'ENTREPRISE   SOCIETÀ	
<b>PRODUCT OVERVIEW</b>	<b>4</b>
PRODUKTPROGRAMM   L'OFFRE PRODUITS   CATALOGO PRODOTTI	
<b>SAFETY THROUGH ORIGINAL QUALITY</b>	<b>6</b>
SICHERHEIT DURCH ORIGINALQUALITÄT	7
LA SÉCURITÉ DE LA QUALITÉ D'ORIGINE	8
SICUREZZA MEDIANTE QUALITÀ ORIGINALE	9
<b>VEHICLE APPLICATIONS</b>	<b>11</b>
FAHRZEUGANWENDUNGEN   APPLICATIONS   APPLICAZIONI	 
<b>VEHICLE APPLICATIONS</b>	<b>49</b>
FAHRZEUGANWENDUNGEN   APPLICATIONS   APPLICAZIONI	
<b>OE-NUMBERS</b>	<b>59</b>
OE-NUMMERN   CORRESPONDANCES CORTECO-ORIGINE   TABELLE COMPARATIVE CORTECO-OEM	
<b>CROSS REFERENCE LIST</b>	<b>69</b>
VERGLEICHSLISTE   CORRESPONDANCES CORTECO   TABELLE COMPARATIVE CORTECO	
<b>DISCLAIMER</b>	<b>97</b>
RECHTLICHE HINWEISE   INFORMATIONS LÉGALES   AVVERTENZE	
<b>INSTALLATION INSTRUCTIONS</b>	<b>98</b>
EINBAUPOSITIONEN   LOCALISATIONS DANS LE VÉHICULE   POSIZIONAMENTO NEL VEICOLO	
<b>SIGNS AND SYMBOLS</b>	<b>99</b>
ZEICHENERKLÄRUNG   SIGNES ET SYMBOLES   SEGNI E SIMBOLI	

# PRODUCT OVERVIEW

PRODUKTPROGRAMM | L'OFFRE PRODUITS | CATALOGO PRODOTTI

E

No matter which products you choose from the CORTECO product portfolio, you always get outstanding original quality. This high quality standard characterises our comprehensive spare parts range. CORTECO offers more than 18,000 products and service kits to garages - among them leading brands such as the Simmerring® radial shaft seal. Our extensive product programme comprises Simmerrings, valve stem seals, flat gaskets and engine kits, vibration control technology such as engine mounts, pulleys and suspension mounts as well as cabin air filters and brake hoses.

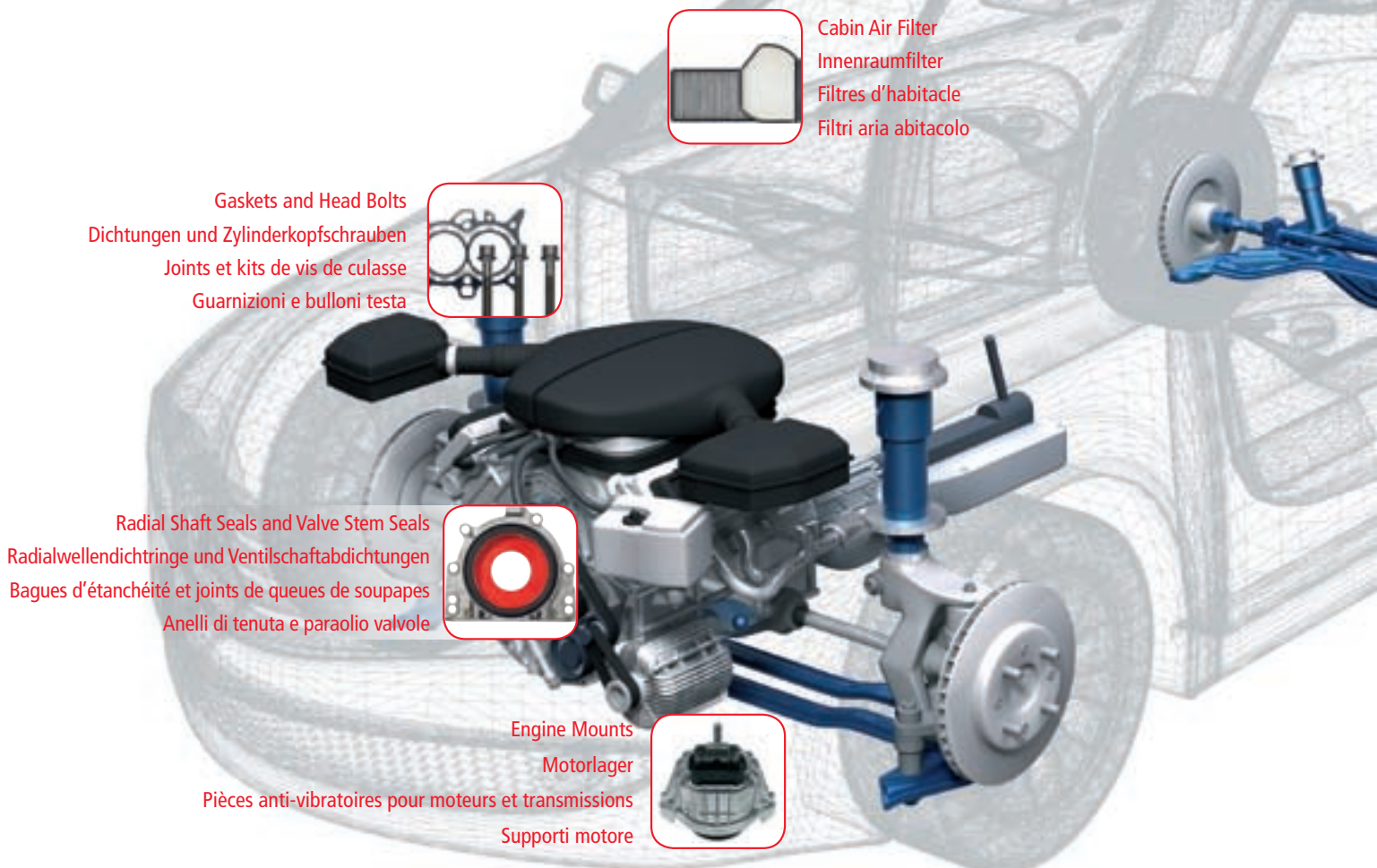

Cabin Air Filter  
Innenraumfilter  
Filtres d'habitacle  
Filtri aria abitacolo



Gaskets and Head Bolts  
Dichtungen und Zylinderkopfschrauben  
Joints et kits de vis de culasse  
Guarnizioni e bulloni testa



Radial Shaft Seals and Valve Stem Seals  
Radialwellendichtringe und Ventilschaftabdichtungen  
Bagues d'étanchéité et joints de queues de soupapes  
Anelli di tenuta e paraolio valvole



Engine Mounts  
Motorlager  
Pièces anti-vibratoires pour moteurs et transmissions  
Supporti motore

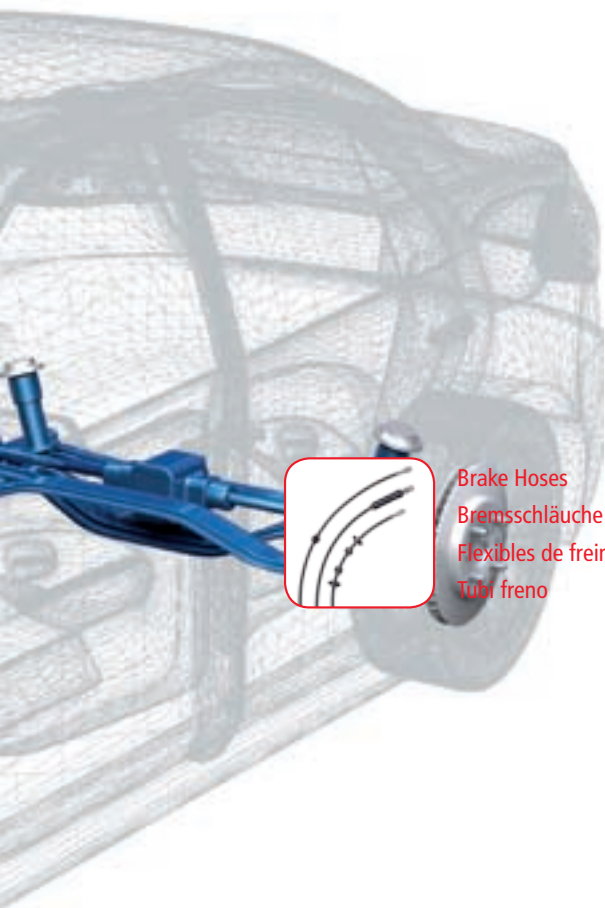

## D

Für welches Produkt Sie sich aus der CORTECO-Produktfamilie auch entscheiden, Sie erhalten immer herausragende Original-Qualität. Dieser hohe Qualitätsstandard kennzeichnet unser umfangreiches Ersatzteil-Sortiment. CORTECO bietet Werkstätten mehr als 18.000 Produkte und Service Kits - unter ihnen führende Marken wie z. B. den Simmerring® Radialwellendichtring. Unser breites Produktsortiment umfasst Simmerringe, Ventilschaftabdichtungen, Flachdichtungen und Motorsätze, Schwingungstechnik wie Motorlager, Riemenscheiben und Fahrwerkslager sowie Innenraumfilter und Bremschläuche.

## F

Quelque soit le produit CORTECO que vous choisissez, vous achetez toujours la qualité d'origine. CORTECO offre plus de 18.000 références de qualité, parmi lesquelles des marques leaders comme les bagues d'étanchéité Simmerring®. Nos gammes comprennent des bagues d'étanchéité dynamique, des joints de queue de soupapes, des joints et kits de joints, des pièces antivibratoires pour moteur, transmission ou châssis, des filtres d'habitacle ou encore des flexibles de freins.

## I

Qualunque prodotto scegliate dalla gamma CORTECO, troverete sempre la necessaria qualità originale. La nostra gamma è caratterizzata da prodotti di alta qualità. CORTECO offre più di 18.000 parti di ricambio e kit riparazione alle officine, tra i quali importanti marchi depositati come Simmerring® e CORTECO® per gli anelli di tenuta. Il nostro programma di vendita include anelli di tenuta, paraolio stelo valvola, guarnizioni piane e kit guarnizioni motore, supporti motore, pulegge, supporti sospensioni ed anche ricambi di servizio come filtri aria abitacolo e tubi freno.



# SAFETY THROUGH ORIGINAL QUALITY

Cabin air filters clean the air which passes through the ventilation or air conditioning system of the vehicle, into the passenger compartment. It offers a high degree of security against pollen, dust and airborne particles. According to the specifications of vehicle manufacturers, CORTECO micronAir® cabin filters offer an almost 100% filtering of harmful substances. Furthermore it acts against the accumulation of dirt on the inside of windows and on the heating, ventilation and air conditioning systems. CORTECO micronAir® cabin filters contribute to ensuring a clear view and heightened wellbeing for the driver and passengers, thereby also improving driving safety. A regular change of these safety-critical components protects the heating, ventilation and air conditioning system and can lengthen their service life. According to the recommendation of all transport and health professionals a cabin air filter should be changed every 15,000 km.

When changing the cabin air filter, an original OE quality product should be fitted. The original micronAir® cabin filters by Freudenberg are developed according to the specifications of automotive manufacturers, produced and sold worldwide to them. More than half of all new vehicles are fitted with a micronAir® cabin filter.

Independent garages receive a micronAir® cabin filter in original quality from CORTECO. Thanks to their exact fitting precision, a CORTECO cabin air filter ensures minimum installation and handling time with every vehicle.

A comparison between the original CORTECO micronAir® cabin filter for the Mercedes C-Class and a copy illustrates how significant the differences are.

The CORTECO cabin filter has a total of 39 pleats which, compared to its competitor filter with only 22 pleats, gives approximately an 80% larger filter area. A small filter area can have multiple effects on the filtration rate: The cabin air filter can absorb less dirt and dust particles, which entails a shorter life-cycle. Equally this results in an increased pressure drop by reducing the supply of fresh air in the passenger compartment. This causes a greater strain on the ventilation and air conditioning systems and also reduces their life-cycle.

The competition filter shows significant gaps in the frame/medium build process, which can also be a cause of decreased filtration performance. The frame, which is bonded together by several individual components is less dimensionally stable and could break easily during the installation. The filter medium is just glued into the frame, while the medium of the CORTECO micronAir® cabin filter exists as one component, an injection molding frame made of plastic. With increasing dust exposure this type of integration avoids a potential filter medium that peels away from the frame and allows the infiltration of dust and dirt into the vehicle passenger compartment.



**micronAir®**

Many pleats = Large filter area = high filtration performance

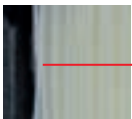

Filter medium and injection molding frame are one component

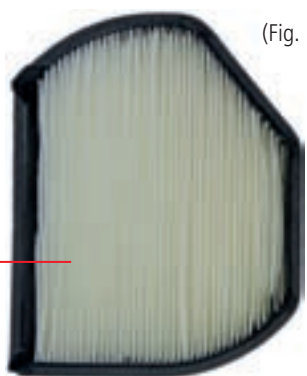

(Fig. 1)



(Fig. 2)

Few pleats = Small filter area = low filtration performance

Gaps in the frame/medium build process

Remains of glue



## CORTECO Service:

In the independent aftermarket the CORTECO product range offers you a broad range of cabin air filter in original quality. The entire filter program currently includes 655 cabin air filters for more than 4,000 vehicle applications.

All cabin air filters are stocked with installation instructions.

## Security by the original micronAir® cabin air filters:

- High efficiency in filtering pollutants from modern nonwoven technology.
- Precisely adjusted for various vehicle types.
- CORTECO cabin air filters are subjected to the most stringent quality control tests.

# SICHERHEIT DURCH ORIGINALQUALITÄT

Innenraumfilter reinigen die Luft die durch das Belüftungssystem bzw. durch die Klimaanlage des Fahrzeuges in den Fahrzeuginnenraum geführt wird. Sie bieten ein erhöhtes Maß an Schutz vor Pollen, Staub und lungengängigen Partikeln. Entsprechend der Spezifikationen der Fahrzeughersteller, bieten CORTECO micronAir® Innenraumfilter eine nahezu 100%-ige Filterung der schädlichen Stoffe. Des Weiteren wirken sie einer Verschmutzung der Scheibeninnenseiten, sowie der Heizungs- und Klimaanlage entgegen. Sie tragen dazu bei, für Fahrer und Beifahrer klare Sicht und ein erhöhtes Wohlbefinden zu gewährleisten und damit auch die Fahrsicherheit zu verbessern. Ein regelmäßiges Auswechseln dieser sicherheitsrelevanten Bauteile, schont Heizungs- und Klimaanlage und kann deren Lebensdauer verlängern. Innenraumfilter, so die Empfehlung aller Verkehrs- und Gesundheitsexperten, sollten alle 15.000 Kilometer gewechselt werden.

Bei einem Wechsel der Innenraumfilter sollte auf Original-Erstausrüsterqualität geachtet werden. Die original micronAir® Innenraumfilter werden von Freudenberg nach den Spezifikationen der Automobilhersteller entwickelt, produziert und weltweit an diese geliefert. Mehr als die Hälfte aller Neufahrzeuge sind mit einem micronAir® Innenraumfilter ausgestattet.

Ein Vergleich zwischen dem original micronAir® Innenraumfilter von CORTECO (Abb.1) für den Mercedes C-Klasse (W202) und dessen Nachbau (Abb.2) verdeutlicht, wie signifikant die Unterschiede sind.

Der CORTECO Innenraumfilter verfügt mit insgesamt 39 Faltungen des Filtermediums gegenüber dem Wettbewerbsfilter mit lediglich 22 Faltungen über eine ca. 80% größere Filterfläche. Eine geringe Filterfläche kann mehrere Auswirkungen auf die Filterleistung haben: Der Innenraumfilter kann weniger Schmutz- und Staubpartikel aufnehmen, was eine kürzere Lebensdauer zur Folge hat. Ebenso resultiert daraus ein erhöhter Druckverlust, wodurch sich die Frischluftzufuhr in den Fahrzeuginnenraum verringert. Dies verursacht eine stärkere Beanspruchung der Belüftungs- bzw. Klimaanlage und reduziert ebenso deren Lebensdauer.

Der Wettbewerbsfilter lässt weiterhin gravierende Defizite in der Verarbeitung erkennen, was ebenso Ursache für eine verminderte Filtrationsleistung sein kann. Der aus mehreren Einzelkomponenten zusammengeklebte Rahmen des Nachbaufilters ist weniger formstabil, und könnte beim Einbau leicht brechen. Das Filtermedium ist dabei lediglich in den Rahmen eingeklebt, während das Medium des CORTECO micronAir® Innenraumfilter direkt in einen, aus einem Bauteil bestehenden, Spritzguss-Rahmen aus Kunststoff integriert ist. Diese Integration vermeidet ein potentielles Ablösen des Filtermediums vom Rahmen mit zunehmender Staubbelastung und verhindert dadurch das Eindringen von Staub und Schmutz in den Fahrzeuginnenraum.



**micronAir®**

Viele Faltungen =  
Große Filterfläche =  
Hohe Filterleistung

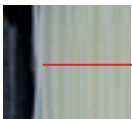

Filtermedium direkt in den Spritzguss-  
rahmen integriert

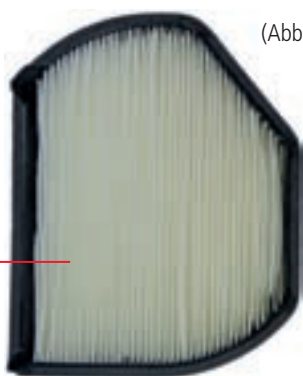

(Abb. 1)



(Abb. 2)

Wenige Faltungen =  
Kleine Filterfläche =  
Geringe Filterleistung

Defizite in der  
Verarbeitung des  
Spritzgussrahmen

Klebereste



## CORTECO Service:

Das CORTECO Produktprogramm bietet Ihnen auf dem freien Ersatzteilmarkt das umfassendste Angebot an Innenraumfilter in Original Qualität. Das gesamte Filterprogramm umfasst derzeit 655 Innenraumfilter für mehr als 4.000 Fahrzeuganwendungen.

Alle Innenraumfilter werden mit Einbauanleitungen geliefert.

## Sicherheit durch den Original micronAir® Innenraumfilter:

- Hoher Wirkungsgrad bei der Filterung von Schadstoffen durch moderne Vliesstofftechnologie.
- Optimal auf die verschiedenen Kraftfahrzeug-Typen abgestimmt.
- CORTECO Innenraumfilter unterliegen in jeder Fertigungsphase strengsten Qualitätskontrollen.

# LA SÉCURITÉ DE LA QUALITÉ D'ORIGINE

Les filtres d'habitacle purifient l'air qui passe par le système de ventilation ou de climatisation des véhicules. Ils permettent une protection performante et importante contre les pollens, les poussières industrielles ou toutes autres particules volatiles nocives. Conformément aux spécifications des constructeurs, les filtres d'habitacle CORTECO micronAir® apportent une filtration presque totale des substances nocives. De plus, ils agissent contre l'accumulation de saleté sur la face intérieure du pare-brise et dans les systèmes de chauffage, de ventilation et de climatisation. Les filtres d'habitacle CORTECO micronAir® contribuent ainsi à assurer une bonne visibilité et le bien-être du conducteur et des passagers, améliorant ainsi la sécurité de conduite. Un changement régulier de ces composants préserve les systèmes de chauffage, de ventilation et de climatisation et peut allonger leur durée de vie. Selon les recommandations des professionnels du transport et de la santé, un filtre d'habitacle devrait être changé tous les 15 000 kms ou 10 000 kms en milieu urbain.

Lors du changement du filtre d'habitacle, un produit de qualité origine doit être monté pour être efficace. Les filtres d'habitacle micronAir® vendus à travers le monde en équipement d'origine sont développés en respectant les spécifications des constructeurs automobiles. Plus de la moitié des nouveaux véhicules vendus sont équipés d'un filtre d'habitacle micronAir®. Les garages indépendants obtiennent les filtres d'habitacle micronAir® en qualité origine par le biais de CORTECO. Grâce à leur ajustement précis, les filtres d'habitacle CORTECO permettent une installation rapide sur chaque véhicule.

Une comparaison entre le filtre d'habitacle origine CORTECO micronAir® pour la Mercedes Classe C et une copie de celui-ci illustre véritablement les différences.

Le filtre d'habitacle CORTECO possède 39 plis, comparé au filtre concurrent qui ne possède que 22 plis, ce qui donne une surface de filtration plus importante de 80%. Une surface de filtration réduite peut avoir de multiples effets sur le taux de filtration : le filtre d'habitacle absorbe moins d'impuretés et de poussières ce qui diminue sa durée de vie. Cela entraîne également une baisse de pression qui restreint l'afflux d'air frais dans l'habitacle. Cela exige des efforts plus importants des systèmes de ventilation et de climatisation et raccourcit ainsi leur durée de vie.

Le filtre concurrent présente des écarts significatifs dans l'assemblage du cadre et du média filtrant, ce qui peut être une des causes d'une plus faible performance de filtration. L'armature, qui est assemblée avec plusieurs composants possède des dimensions moins stables. Celui-ci pourrait alors casser facilement durant l'installation. En effet, le média filtrant concurrent est uniquement collé à l'intérieur du cadre, alors que celui du filtre d'habitacle CORTECO micronAir® est inséré lors de l'injection du cadre en plastique ce qui donne un unique composant. Cette technique d'assemblage monobloc évite au média de se détacher du cadre, suite à l'accumulation des poussières. Cela empêche ainsi l'infiltration des poussières et des saletés dans l'habitacle.



**micronAir®**

Nombreux plis = large zone de filtration = haute performance de filtration



Le média filtrant et le cadre moulé par injection ne forment qu'une pièce

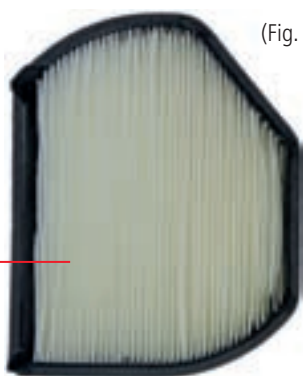

(Fig. 1)

(Fig. 2)



Peu de plis = petite surface de filtration = basse performance de filtration

Espaces entre le cadre et le média filtrant

Traces de colle



## Service CORTECO:

Sur le marché de la rechange indépendante, CORTECO vous offre une large gamme de filtres d'habitacle de qualité origine. La gamme complète des filtres inclut actuellement 655 références pour plus de 4000 applications véhicules.

Tous les filtres d'habitacle sont conditionnés avec leurs notices de montage.

## La sécurité grâce aux filtres d'habitacle micronAir®:

- Grande efficacité dans la filtration des émissions polluantes grâce à une technologie novatrice.
- Parfaitement dimensionnés pour différents types de véhicules.
- Les filtres d'habitacle CORTECO sont soumis aux tests de contrôle Qualité les plus sévères.



## SICUREZZA MEDIANTE QUALITA' ORIGINALE

I filtri aria abitacolo purificano l'aria che circola attraverso la ventilazione o il sistema di condizionamento del veicolo, mantenendo l'abitacolo della vettura fresco e pulito. Offrono un alto grado di protezione contro i pollini, la polvere e le particelle aeree. Secondo le specifiche dei costruttori di veicoli, i filtri CORTECO micronAir® offrono il 100% circa di filtrazione delle sostanze dannose e, allo stesso tempo, impediscono allo sporco di depositarsi sui finestrini, sul parabrezza o nell'impianto di riscaldamento, ventilazione e condizionamento. I filtri CORTECO micronAir® contribuiscono ad assicurare una visuale limpida e ad accrescere il benessere del guidatore e dei passeggeri, aumentando la sicurezza di guida. Una sostituzione regolare di questi componenti «critici» per la sicurezza, protegge il sistema di riscaldamento, ventilazione e aria condizionata e ne prolunga la durata di servizio. Secondo quanto raccomandato da tutti i professionisti del settore salute e trasporti, un filtro aria abitacolo dovrebbe essere cambiato ogni 15.000 Km.

Il filtro aria abitacolo dovrebbe essere sostituito con uno di qualità originale. Il filtro originale CORTECO micronAir® di Freudenberg viene prodotto e venduto a tutti i costruttori di autoveicoli in tutto il mondo, seguendo le loro specifiche. Più della metà dei nuovi veicoli è equipaggiata con un filtro aria abitacolo micronAir®.

Le officine indipendenti ricevono i filtri aria abitacolo micronAir® di qualità originale attraverso CORTECO. Grazie alla sua precisione di montaggio, il filtro aria abitacolo CORTECO micronAir® assicura il minimo tempo di manutenzione e installazione su ogni tipo di veicolo.



**micronAir®**

Molte pieghe = Ampia area filtrante = elevate performance di filtrazione

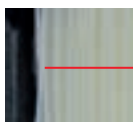

Materiale filtrante e supporto laterale di contenimento per processo di co-stampaggio danno un unico componente

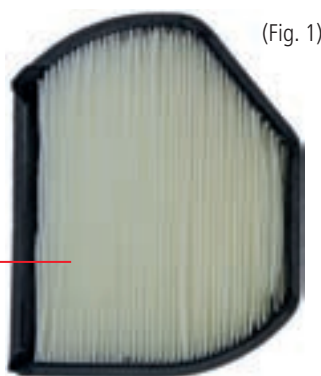

(Fig. 1)

(Fig. 2)

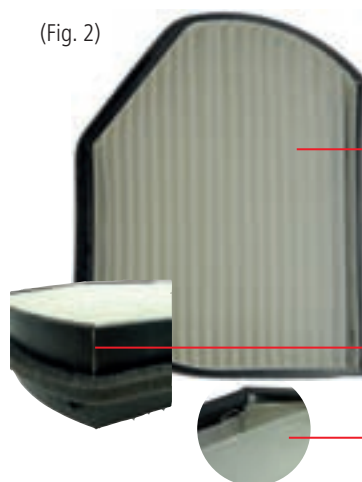

Poche pieghe = Ridotta area filtrante = Limitate performance di filtrazione

Presenza di fessure nel supporto laterale

Residui di colla



### Servizio CORTECO:

Nell'Aftermarket Indipendente il portfolio prodotti di CORTECO include un'ampia gamma di filtri aria abitacolo di qualità originale. L'intero programma attualmente comprende 655 filtri aria abitacolo per oltre 4.000 applicazioni veicolo diverse.

Da notare che in tutte le confezioni dei filtri aria abitacolo sono presenti le relative istruzioni di montaggio.

Il confronto tra il filtro aria abitacolo originale CORTECO micronAir® per la Mercedes C-Class e una sua copia, illustra molto bene quali sono le differenze.

Il filtro aria abitacolo CORTECO ha un totale di 39 pieghe le quali, in confronto alle 22 del filtro di un concorrente, danno un'area filtrante approssimativamente più grande di circa l'80%.

Una piccola area filtrante può avere effetti multipli sul grado di filtrazione; un filtro aria abitacolo di questo tipo assorbe meno particelle di polvere e di sporco e la sua durata è ridotta. Contemporaneamente si verifica una riduzione della pressione, e questo causa un limitato passaggio di aria fresca all'interno dell'abitacolo dell'autovettura. In questo modo si provoca una sollecitazione sui sistemi di ventilazione e di condizionamento e si riduce la loro durata di servizio.

Il filtro del concorrente mostra un'importante differenza nel processo di fabbricazione, la quale può causare un decremento delle performance di filtrazione. La struttura del filtro, che è allestito per collatura di diversi componenti individuali, è dimensionalmente meno stabile e può rompersi facilmente durante l'installazione. Il materiale filtrante è solamente incollato alla struttura, mentre l'elemento filtrante di CORTECO micronAir® è realizzato all'origine in un unico pezzo, prodotto per iniezione di materiale plastico sul contorno del materiale filtrante attraverso un processo di co-stampaggio. Con l'aumento dell'esposizione allo sporco questo tipo di assemblaggio evita al filtro intermedio di «scollarsi» dalla struttura ed evita anche l'infiltrazione di polvere e sporco all'interno dell'abitacolo.

### Sicurezza dai filtri aria abitacolo originali micronAir®:

- alta efficienza nella filtrazione dalle sostanze inquinanti
- montaggio adattato con precisione ai vari tipi di veicolo
- rispetto dei più severi test di controllo qualità



# VEHICLE APPLICATIONS

FAHRZEUGANWENDUNGEN | APPLICATIONS | APPLICAZIONI

---



# VEHICLE APPLICATIONS

FAHRZEUGANWENDUNGEN | APPLICATIONS | APPLICAZIONI



Alfa Romeo										
145	07.94 → 12.00		+	8	10-20	CP1031 21651915		CC1031 21651951		385x170x17
146	12.94 → 12.00		+	8	10-20	CP1031 21651915		CC1031 21651951		385x170x17
147	01.01 →	Set	+	4	> 20	CP1202 80000375		CC1202 21652352		175x140x30
155	01.93 → 12.97		+	8	10-20	CP1031 21651915		CC1031 21651951		385x170x17
156 (+ Sportwagon)	09.97 → 12.01		+	8	10-20	CP1026 21651901		CC1026 21651952		290x160x30
156	01.98 → 05.06	RHD	+	8	10-20	CP1038 21651970		CC1038 21651953		240x170x17
156 (+ Sportwagon)	01.02 → 05.06	Set	+	8	10-20	CP1202 80000375		CC1202 21652352		175x140x30
159 (+ Sportwagon)	09.05 →		+	10	10-20	CP1192 80000345		CC1192 80000346		215x200x30
164	01.93 → 09.98		+	4	10-20	CP1021 21651896		-		288x225x13
166	09.98 →		+	3	10-20	CP1203 80000376		CC1203 21651954		292x225x20
Brera	01.06 →		+	10	10-20	CP1192 80000345		CC1192 80000346		215x200x30
GT	11.03 →	Set	+	4	10-20	CP1202 80000375		CC1202 21652352		175x140x30
GTV-Coupé	09.94 →		+	8	10-20	CP1031 21651915		CC1031 21651951		385x170x17
Mito	09.08 →		+			CP1221 80000541		CC1221 80000777		215x265x21
Spider (916)	09.94 → 04.05		+	8	10-20	CP1031 21651915		CC1031 21651951		385x170x17
Spider	09.06 →					CP1192 80000345		CC1192 80000346		215x200x30
Audi										
80, 90, Coupé, Cabriolet	06.93 → 08.00		+ / -	4	10-20	CP1015 21651890		CC1015 21651956		385x145x25
A2	02.00 → 08.05		+ / -	11	10-20	CP1074 21652356		CC1074 21652357		252x216x32



Audi										
A3 (8L1)	09.96 → 05.03		+ / -	4	10-20	CP1027 21651912		CC1027 21651955		279x207x25
A3 (8P1)	05.03 →		+	11	10-20	CP1129 21653024		CC1129 21653008		207x269x34
A3 (8P1)	05.03 →	RHD	+	11	10-20	- -		CC1298 80000602		207x269x34
A4 (8D2, B5)	01.95 → 09.01		+ / -	4	10-20	CP1015 21651890		CC1015 21651956		385x145x25
A4 (8E2, B6)	11.00 → 12.04		+ / -	4	10-20	CP1088 21652689		CC1088 21652713		300x203x30
A4 (8EC, 8ED)	11.04 →		+ / -	4	10-20	CP1088 21652689		CC1088 21652713		300x203x30
A4 (8K2)	11.07 →		+ / -			CP1309 80000879		CC1309 80000880		278x240x35
A4 Allroad (8KH)	04.09 →		+ / -			CP1309 80000879		CC1309 80000880		278x240x35
A5 (8T)	06.07 →		+ / -			CP1309 80000879		CC1309 80000880		278x240x35
A5 Cabriolet (8F)	03.09 →		+ / -			CP1309 80000879		CC1309 80000880		278x240x35
A6 (C4)	06.94 → 12.97		+	7	10-20	CP1029 21651913		CC1029 21651958		342x212x20
A6 (C4)	06.94 → 12.97		-	7	10-20	CP1030 21651914		CC1030 21651957		306x192x30
A6 (C5 - up to Chassis No.: → 4BX045000)	01.97 → 10.98		+ / -	7	10-20	CP1030 21651914		CC1030 21651957		306x192x30
A6 (C5 - from Chassis No.: 4BX045001 →)	10.98 → 01.05		+ / -	7	10-20	CP1088 21652689		CC1088 21652713		300x203x30
A6 (C6)	05.04 →	2 !	+	7	10-20	CP1139 21653067		CC1139 21653066		306x101x30
A8 (4D2, 4D8)	03.94 → 09.02	Set	-	14	10-20	CP1128 21653023		CC1128 21652552		270x193x20
A8 (4E_)	10.02 →		+	14	10-20	CP1191 80000343		CC1191 21652898		403x180x40
Allroad	05.00 → 08.05		+	7	10-20	CP1088 21652689		CC1088 21652713		300x203x30
Q5	11.08 →		+ / -			CP1309 80000879		CC1309 80000880		278x240x35
Q7	03.06 →		+ / -	11		CP1125 21653020		CC1125 21653015		275x217x30





























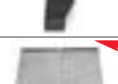













Audi											
R8	05.07 →		2 !	+			CP1139 21653067		CC1139 21653066		306x101x30
TT	10.98 →			+ / -	4	10-20	CP1027 21651912		CC1027 21651955		279x207x25
TT (8J3, 8J9)	10.06 →						CP1129 21653024		CC1129 21653008		207x269x34
BMW											
1er/1 series (E87)	09.04 →			+	8	< 10	CP1154 80000063		CC1154 80000064		831x156x32
3er/3 series (E30)	09.82 → 03.92			+ / -			CP1376 80001488		-		324x157x40
3er/3 series (E36)	09.90 → 10.99	Set		-	10	10-20	CP1158 80000073		-		179x179x73
3er/3 series (E36) (no compact)	09.90 → 10.99			+	10	> 20	CP1009 21651198		CC1009 80000359		300x168x26
3er/3 serie (E36) (compact)	03.94 → 08.00	Set		+	10	> 20	CP1149 80000022		-		148x123x35
3er/3 series (E46)	02.98 → 02.05			+ / -	3	< 10	CP1037 21651969		CC1037 21652336		676x120x19
3er/3 series (E90, E91)	01.05 →			+	3	10-20	CP1154 80000063		CC1154 80000064		831x156x32
3er/3 series M-Version (E90-E92-E93)	03.07 →	Set		+ / -			-		CC1377 80001029		240x195x22
5er/5 series (E34)	01.88 → 11.95			+ / -	10	10-20	CP1008 21651197		CC1008 80000377		337x166x34
5er/5 series (E34)	01.88 → 11.95	RHD		+ / -	10	10-20	CP1014 21651888		-		327x165x23
5er/5 series (E39)	11.95 → 05.04	Set		+ / -	2 / 4	10-20	CP1022 21651897		CC1022 21651882		274x204x34
5er/5 series (E60-E61)	07.03 →	Set		+ / -	2 / 4	10-20	CP1138 21653063		CC1138 21653064		327x180x31
5er/5 series (F10)	10.09 ->	Set		+ / -			CP1342 80001210		CC1342 80001211		247x206x30
5er/5 series (GT)	10.09 ->	Set		+ / -			CP1342 80001210		CC1342 80001211		247x206x30
6er/6 series (E63-E64)	01.04 →	Set		+ / -	2 / 4	10-20	CP1138 21653063		CC1138 21653064		327x180x31
7er/7 series (E32)	09.86 → 09.94			+ / -	10	10-20	CP1008 21651197		CC1008 80000377		337x166x34
7er/7 series (E32)	09.86 → 09.94	RHD		+ / -	10	10-20	CP1014 21651888		-		327x165x23



BMW										
7er/7 series (E38)	10.94 → 11.01	Set	+ / -	2 / 4	10-20	CP1135 21653030		CC1135 21651881		374x181x35
7er/7 series (E65-E66-E67)	11.01 →	Set	+ / -	2 / 4	10-20	CP1093 21652848		CC1093 21652851		328x166x30
7er/7 series (F01-F02)	10.08 →	Set	+ / -			CP1342 80001210	<b>NEW</b>	CC1342 80001211	<b>NEW</b>	247x206x30
Mini (R50)	06.01 →		+ / -	1	10-20	CP1095 21652850		CC1095 21652853		458x117x30
Mini (R56)	01.06 →		+ / -	1	10-20	CP1265 80000740		CC1265 80000741		440x117x30
X1	10.09 →		+			CP1154 80000063		CC1154 80000064		831x156x32
X3 (E83)	03.03 →		+ / -	3	10-20	CP1037 21651969		CC1037 21652336		676x120x19
X5 (E53)	05.00 →		+ / -	3	10-20	CP1155 80000065		CC1155 21652916		539x242x30
X5 (E70)	03.07 →	Set	+ / -			CP1283 80000847		CC1283 80000848		295x145x41
X6 (E71)	05.08 →	Set	+ / -			CP1283 80000847		CC1283 80000848		295x145x41
Z4 (E85)	02.03 → 04.09		+ / -	3	10-20	CP1094 21652849		CC1094 21652852		261x233x30
Z4 (E89)	05.09 →		+ / -	3	10-20	CP1094 21652849		CC1094 21652852		261x233x30
Chevrolet										
Aveo	05.05 →		+ / -			CP1168 80000155		CC1168 80000773		230x200x20
Captiva	06.06 →		+ / -			CP1308 80000877		CC1308 80000878		277x206x27
Epica	01.05 →		+			CP1406 80001738	<b>NEW</b>	-		299x185x30
Evanda	03.05 →		+			CP1406 80001738	<b>NEW</b>	-		299x185x30
Lacetti	03.05 →		+	11	10-20	CP1268 80000804		CC1268 80000783		189x223x25
Matiz	03.05 →		-	11	10-20	CP1306 80000867		CC1306 80000868		167x116x36
Matiz	03.05 →		+	10	10-20	CP1307 80000869		CC1307 80000870		210x205x10
Rezzo	03.05 →	Set	+ / -		> 20	CP1321 80001033		-		343x134x30



Chevrolet										
Spark	03.10 →		+ / -			CP1402 80001722	 <small>NEW</small>	CC1402 80001723	 <small>NEW</small>	212x198x18
Chrysler										
300C	09.04 →		+	4	10-20	CP1205 80000407		CC1205 80000408		310x212x30
Crossfire	07.03 →	LHD + RHD	+	11	> 20	CP1007 21651196		CC1007 21651961		222x279x54
Dodge Caliber	06.06 →		+ / -			CP1337 80001189		CC1337 80001190		215x203x25
Dodge Journey	06.08 →		+ / -			CP1337 80001189		CC1337 80001190		215x203x25
Dodge Nitro	05.07 →	Set	+ / -			CP1400 80001718	 <small>NEW</small>	CC1400 80001719	 <small>NEW</small>	181x91x20
Grand Voyager	01.08 →		+ / -			CP1330 80001174		CC1330 80001175		230x200x30
Jeep Compass	08.06 →		+ / -			CP1337 80001189		CC1337 80001190		215x203x25
Jeep Grand Cherokee II	10.98 →		+	4		CP1162 80000079		CC1162 80000415		469x78x40
Jeep Grand Cherokee III	06.05 →	Set	+ / -			CP1400 80001718	 <small>NEW</small>	CC1400 80001719	 <small>NEW</small>	181x91x20
Jeep Patriot	01.08 →		+ / -			CP1337 80001189		CC1337 80001190		215x203x25
PT Cruiser	06.00 →		+ / -	7		CP1164 80000082		CC1164 80000759		226x115x30
Voyager III (RG)	02.00 →		+ / -	10	> 20	CP1148 21653151		CC1148 21652854		300x235x17
Voyager III (RG)	02.00 →	RHD	+ / -	10	> 20	CP1275 80000811		CC1275 21652855		300x217x24
Citroën										
Berlingo (MF)	07.96 → 12.00		+	11	10-20	CP1024 21651899		CC1024 80000077		194x195x20
Berlingo (MF)	12.00 → 11.02		+	11	10-20	CP1133 21653028		CC1133 21653146		225x222x32
Berlingo II	11.02 →		+	11	10-20	CP1133 21653028		CC1133 21653146		225x222x32
Berlingo Kasten	04.08 →	Set	+	11	10-20	CP1282 80000839		CC1282 80000615		330x96x30
C1	06.05 →		+ / -	11	10-20	CP1259 80000662		CC1259 80000784		226x165x45
C2	09.03 →		+ / -	4	10-20	CP1082 21652548		CC1082 21652540		285x177x35



## Citroën

C3 (+ Pluriel)	02.02 →		+ / -	4	10-20	<b>CP1082</b> 21652548		<b>CC1082</b> 21652540		285x177x35
C4	06.04 →		+ / -	4	10-20	<b>CP1082</b> 21652548		<b>CC1082</b> 21652540		285x177x35
C4 Picasso (+ Grand Picasso)	10.06 →	Set	+	11	10-20	<b>CP1282</b> 80000839		<b>CC1282</b> 80000615		330x96x30
C5 (DC_, DE_)	03.01 → 09.04		+	12	10-20	<b>CP1144</b> 21653141		<b>CC1144</b> 21653142		330x168x78
C5 (RC_, RE_)	09.04 →		+ / -	12	10-20	<b>CP1271</b> 80000807		<b>CC1271</b> 21653102		315x154x35
C5 (RD_, TD_)	02.08 →		+ / -			<b>CP1371</b> 80001458	<b>NEW</b>	<b>CC1371</b> 80001459	<b>NEW</b>	269x196x30
C6 (up to Chassis No.: → 11557)	09.05 → 07.08		+ / -	12	10-20	<b>CP1271</b> 80000807		<b>CC1271</b> 21653102		315x154x35
C6 (from Chassis No.: 11557 →)	07.08 →		+ / -			<b>CP1371</b> 80001458	<b>NEW</b>	<b>CC1371</b> 80001459	<b>NEW</b>	269x196x30
C8	07.02 →		+ / -	2	10-20	<b>CP1096</b> 21652856		<b>CC1096</b> 21653147		405x165x32
C-Crosser	02.07 →		+ / -			<b>CP1284</b> 80000853		<b>CC1284</b> 80000854		215x200x30
DS 3	04.10 →	Set	+ / -			<b>CP1260</b> 80000666		<b>CC1260</b> 80000667		150x158x30 200x158x30
Evasion	06.94 → 07.02	3-Set	+	3	10-20	<b>CP1066</b> 21652342		<b>CC1066</b> 80000765		184x93x30
Jumper (230)	02.94 → 04.02		+	4	10-20	<b>CP1056</b> 21651994		<b>CC1056</b> 80000432		435x144x17
Jumper (244)	04.02 → 03.06		+	4	10-20	<b>CP1056</b> 21651994		<b>CC1056</b> 80000432		435x144x17
Jumper	04.06 →		+ / -	12	10-20	<b>CP1278</b> 80000815		<b>CC1278</b> 80000816		235x250x25
Jumpy	06.94 → 12.06	3-Set	+	3	10-20	<b>CP1066</b> 21652342		<b>CC1066</b> 80000765		184x93x30
Jumpy	01.07 →		+ / -	8	10-20	<b>CP1305</b> 80000865		<b>CC1305</b> 80000866		376x176x49
Nemo	02.08 →		+ / -			<b>CP1316</b> 80001027		<b>CC1316</b> 80001171		220x177x30
Xantia	03.93 → 01.98		+	11	> 20	<b>CP1024</b> 21651899		<b>CC1024</b> 80000077		194x195x20
Xsara (N1)	04.97 → 04.05		+ / -	11	10-20	<b>CP1024</b> 21651899		<b>CC1024</b> 80000077		194x195x20



Citröen										
Xsara	08.00 → 08.05		-	11	10-20	CP1024 21651899		CC1024 8000077		194x195x20
Xsara	08.00 → 08.05	+ MAN AC	+	11	10-20	CP1136 21653032		CC1136 80000344		270x193x20
Xsara	08.00 → 08.05	+ AUT AC	+	11	10-20	CP1133 21653028		CC1133 21653146		225x222x32
Xsara Picasso	11.99 →		+ / -	3	10-20	CP1079 21652543		CC1079 80000429		257x202x30
Dacia										
Logan	09.04 →					CP1050 21651983		CC1050 80000114		228x160x30
Sandero	06.08 →		+ / -			CP1159 80000074		- -		223x190x45
Daewoo										
Evanda	03.05 →		+			CP1406 80001738		- -		299x185x30
Kalos	09.02 →		+ / -	10	10-20	CP1168 80000155		CC1168 80000773		230x200x20
Lacetti	02.04 →		+	10	10-20	CP1268 80000804		CC1268 80000783		189x223x25
Leganza	06.97 → 12.02		+ / -	4	10-20	CP1064 21652340		- -		260x200x25
Leganza	06.97 → 12.02	RHD	+ / -	4	10-20	CP1065 21652341		- -		260x200x25
Nubira	05.97 →		+ / -	4	10-20	CP1062 21652338		- -		215x187x25
Nubira	05.97 →	RHD	+ / -	4	10-20	CP1063 21652339		- -		215x187x25
Rezzo	09.00 →	Set	+ / -		> 20	CP1321 80001033		- -		343x134x30
Daihatsu										
Cuore VII	05.03 →		+ / -	10	< 10	CP1276 80000812		CC1276 21653033		155x140x20
Cuore VIII	10.07 →		+	10		CP1226 80000603		CC1226 80000763		185x178x30
Materia	10.06 →		+ / -			CP1319 80001037		CC1319 80001038		161x133x18
Sirion	01.05 →		+ / -	4	< 10	- -		CC1299 80000617		155x158x19
Terios	05.06 →		+	10	< 10	CP1226 80000603		CC1226 80000763		185x178x30



**Daihatsu**

Trevis	06.06 →		+ / -			<b>CP1319</b> 80001037		<b>CC1319</b> 80001038		161x133x18
--------	---------	--	-------	--	--	---------------------------	--	---------------------------	--	------------

**Ferrari**

360 Challenge	01.99 →					<b>CP1261</b> 80000668		<b>CC1261</b> 80000778		372x86x30
360 GT	01.99 →					<b>CP1261</b> 80000668		<b>CC1261</b> 80000778		372x86x30
360 Modena	03.99 →					<b>CP1261</b> 80000668		<b>CC1261</b> 80000778		372x86x30
360 Spider	02.00 →					<b>CP1261</b> 80000668		<b>CC1261</b> 80000778		372x86x30
612 Scaglietti	04.04 →					- -		<b>CC1292</b> 80000669		250x215x40
Challenge Stradale	01.99 →					<b>CP1261</b> 80000668		<b>CC1261</b> 80000778		372x86x30
Enzo Ferrari	09.03 →					<b>CP1261</b> 80000668		<b>CC1261</b> 80000778		372x86x30
F131	01.99 →					<b>CP1261</b> 80000668		<b>CC1261</b> 80000778		372x86x30









































**Fiat**

500	10.07 →		+ / -	11		<b>CP1131</b> 21653026		<b>CC1131</b> 80000754		205x177x20
Barchetta	03.95 →		+	8	10-20	<b>CP1019</b> 21651894		<b>CC1019</b> 80000433		308x140x18
Brava / Bravo	10.95 → 10.01		+	8	< 10	<b>CP1026</b> 21651901		<b>CC1026</b> 21651952		290x160x30
Brava / Bravo	10.95 → 10.01	RHD	+	8	< 10	<b>CP1038</b> 21651970		<b>CC1038</b> 21651953		240x170x17
Bravo	04.07 →					<b>CP1132</b> 21653027		<b>CC1132</b> 21652538		233x182x22
Coupé	11.93 → 08.00		+	8	< 10	<b>CP1031</b> 21651915		<b>CC1031</b> 21651951		385x170x17
Croma (154)	12.85 → 12.96		+	4	10-20	<b>CP1021</b> 21651896		- -		288x225x13
Croma (194)	06.05 →		+	8	10-20	- -		<b>CC1291</b> 80000621		330x163x30
Dobló (119, 223)	03.01 →		+	11	10-20	<b>CP1080</b> 21652544		<b>CC1080</b> 21651296		216x163x25
Dobló (152, 263)	02.10 →		+ / -			<b>CP1316</b> 80001027		<b>CC1316</b> 80001171		220x177x30
Ducato (230)	01.94 → 04.02		+	4	10-20	<b>CP1056</b> 21651994		<b>CC1056</b> 80000432		435x144x17



Fiat										
Ducato (244)	04.02 →		+	4	10-20	<b>CP1056</b> 21651994		<b>CC1056</b> 80000432		435x144x17
Ducato	06.06 →		+	12	10-20	<b>CP1278</b> 80000815		<b>CC1278</b> 80000816		235x250x25
Fiorino	02.08 →		+ / -			<b>CP1316</b> 80001027		<b>CC1316</b> 80001171		220x177x30
Fiorino	02.08 →		+			<b>CP1221</b> 80000541		<b>CC1221</b> 80000777		215x265x21
Grande Punto	10.05 →		+	10	10-20	<b>CP1221</b> 80000541		<b>CC1221</b> 80000777		215x265x21
Idea	01.04 →		+	11	< 10	<b>CP1080</b> 21652544		<b>CC1080</b> 21651296		216x163x25
Linea	06.07 →		+ / -			<b>CP1316</b> 80001027		<b>CC1316</b> 80001171		220x177x30
Marea	09.96 →		+	8	< 10	<b>CP1026</b> 21651901		<b>CC1026</b> 21651952		290x160x30
Marea	09.96 →	RHD	+	8	< 10	<b>CP1038</b> 21651970		<b>CC1038</b> 21651953		240x170x17
Multipla	04.99 →		+ / -	4	10-20	<b>CP1059</b> 21652308		<b>CC1059</b> 80000430		293x160x35
Palio	12.95 → 05.99		+	12	> 20	<b>CP1108</b> 21652899		<b>CC1108</b> 80000755		234x213x12
Palio	05.99 → 03.01		+	12	> 20	<b>CP1109</b> 21652900		-		405x212x60
Panda (169)	09.03 →		+ / -	11	10-20	<b>CP1131</b> 21653026		<b>CC1131</b> 80000754		205x177x20
Punto (176)	09.93 → 06.00		+	8	10-20	<b>CP1019</b> 21651894		<b>CC1019</b> 80000433		308x140x18
Punto (188)	09.99 →		+	11	10-20	<b>CP1080</b> 21652544		<b>CC1080</b> 21651296		216x163x25
Punto Evo	10.09 →		+			<b>CP1221</b> 80000541		<b>CC1221</b> 80000777		215x265x21
Scudo	02.96 →	3-Set	+	3	10-20	<b>CP1066</b> 21652342		<b>CC1066</b> 80000765		184x93x30
Scudo	01.04 →		+	2	10-20	<b>CP1096</b> 21652856		<b>CC1096</b> 21653147		405x165x32
Scudo	01.07 →		+ / -	8		<b>CP1305</b> 80000865		<b>CC1305</b> 80000866		376x176x49
Sedici	01.06 →		+	10	10-20	<b>CP1226</b> 80000603		<b>CC1226</b> 80000763		185x178x30



Fiat										
Stilo (+ Multiwagon)	10.01 →		+ / -	11	10-20	<b>CP1132</b> 21653027		<b>CC1132</b> 21652538		233x182x22
Strada	06.99 →		+	10	> 20	<b>CP1240</b> 80000637		<b>CC1240</b> 80000779		258x164x22
Tempra	03.90 → 08.97		+	8	10-20	<b>CP1031</b> 21651915		<b>CC1031</b> 21651951		385x170x17
Tipo	07.87 → 04.95		+	8	10-20	<b>CP1031</b> 21651915		<b>CC1031</b> 21651951		385x170x17
Ulysse (220)	06.94 → 08.02	3-Set	+	3	10-20	<b>CP1066</b> 21652342		<b>CC1066</b> 80000765		184x93x30
Ulysse (179AX)	08.02 →		+	2	> 20	<b>CP1096</b> 21652856		<b>CC1096</b> 21653147		405x165x32
Ford										
Cougar	10.98 → 04.02		+ / -	4	10-20	<b>CP1000</b> 21650107		<b>CC1000</b> 21652959		505x102x30
Escape (US-Vehicle)	01.01 →		+ / -	4		<b>CP1112</b> 21652993		<b>CC1112</b> 80000284		280x162x30
Fiesta Courier	02.96 →		+ / -	4	10-20	<b>CP1018</b> 21651893		<b>CC1018</b> 21652355		350x151x30
Fiesta IV	06.95 → 12.01		+ / -	4	10-20	<b>CP1018</b> 21651893		<b>CC1018</b> 21652355		350x151x30
Fiesta V	11.01 →		+ / -	12	> 20	<b>CP1097</b> 21652857		<b>CC1097</b> 21652858		242x186x35
Fiesta VI	10.08 →		+ / -			<b>CP1326</b> 80001128		<b>CC1326</b> 80001129		240x190x22
Focus	10.98 → 11.04		+ / -	4	10-20	<b>CP1057</b> 21651995		<b>CC1057</b> 21652354		350x160x30
Focus C-Max	10.03 → 10.07		+ / -	12	> 20	<b>CP1137</b> 21653034		<b>CC1137</b> 21653035		240x208x35
Focus S-Max	05.06 →		+ / -	12		<b>CP1137</b> 21653034		<b>CC1137</b> 21653035		240x208x35
Focus II	11.04 →		+	12	> 20	<b>CP1153</b> 80000061		<b>CC1153</b> 80000062		235x209x35
Fusion	08.02 →		+ / -	12	> 20	<b>CP1097</b> 21652857		<b>CC1097</b> 21652858		242x186x35
Galaxy	03.95 → 05.06		+ / -	4	10-20	<b>CP1020</b> 21651895		<b>CC1020</b> 21651960		537x110x25
Galaxy	05.06 →		+ / -	12	> 20	<b>CP1137</b> 21653034		<b>CC1137</b> 21653035		240x208x35
Ka	09.96 →		+ / -	8	10-20	<b>CP1018</b> 21651893		<b>CC1018</b> 21652355		350x151x30



































Ford										
Ka	02.09 →		+ / -			CP1131 21653026		CC1131 80000754		205x177x20
Kuga	03.08 →		+ / -			CP1137 21653034		CC1137 21653035		240x208x35
Maverick	02.93 → 04.98		+	10	> 20	CP1069 21652347		CC1069 80000416		262x193x20
Maverick	02.01 →		+ / -	4	> 20	CP1112 21652993		CC1112 80000284		280x162x30
Mondeo I	01.93 → 08.96		+ / -	4	10-20	CP1000 21650107		CC1000 21652959		505x102x30
Mondeo II	09.96 → 11.00		+ / -	4	10-20	CP1000 21650107		CC1000 21652959		505x102x30
Mondeo III	11.00 →		+ / -	4	10-20	CP1089 21652709		CC1089 21652361		509x100x35
Mondeo IV	03.07 →		+ / -	12	> 20	CP1137 21653034		CC1137 21653035		240x208x35
Puma	03.97 → 06.02		+ / -	8	10-20	CP1018 21651893		CC1018 21652355		350x151x30
Scorpio II	10.94 → 08.98	3-Set	+	4	10-20	CP1039 21651971		CC1039 80000793		129x102x20
Tourneo	01.00 →		+	3	10-20	CP1077 21652360		CC1077 80000751		354x120x24
Tourneo Connect	09.02 →		+	3	10-20	CP1057 21651995		CC1057 21652354		350x160x30
Transit	01.00 →		+	3	10-20	CP1077 21652360		CC1077 80000751		354x120x24
Transit Connect	09.02 →		+	3	10-20	CP1057 21651995		CC1057 21652354		350x160x30
Honda										
Accord VII Coupé	02.98 → 06.03	Set	+	10	10-20	CP1169 80000156		CC1169 80000791		295x96x30
Accord VII (no Coupé)	10.98 → 12.02		+	10	> 20	CP1076 21652359		CC1076 80000431		277x202x17
Accord VIII	02.03 →		+	10	> 20	CP1179 80000330		CC1179 80000404		234x224x28
Civic IV	09.94 → 01.97		+	11	> 20	CP1067 21652345		CC1067 80000428		223x198x30
Civic (5 Türer / 5-door)	11.95 → 02.01		-	10	> 20	CP1040 21651972		CC1040 80000742		212x211x30
Civic UK	02.01 →	Set, LHD + RHD	+ / -	10	> 20	CP1081 21652546		CC1081 80000148		225x112x30



Honda										
Civic VII	09.05 →		+	10	> 20	CP1234 80000620		CC1234 80000622		204x197x30
CR-V I	10.95 → 02.02		+	10	> 20	CP1067 21652345		CC1067 80000428		223x198x30
CR-V I	10.95 → 02.02		-	11	> 20	CP1040 21651972		CC1040 80000742		212x211x30
CR-V II	03.02 → 09.06	Set, LHD + RHD	+ / -	10	> 20	CP1081 21652546		CC1081 80000148		225x112x30
CR-V III	01.07 →		+ / -	10		CP1179 80000330		CC1179 80000404		234x224x28
FR-V	01.05 →	Set, LHD + RHD	+ / -	10	> 20	CP1081 21652546		CC1081 80000148		225x112x30
HR-V	03.99 →	2 !	+ / -	10	> 20	CP1111 21652990		CC1111 80000439		180x95x30
Insight (ZE)	08.00 → 12.06		+	11	> 20	CP1067 21652345		CC1067 80000428		223x198x30
Insight	04.09 →		+ / -			CP1334 80001183		CC1334 80001184		205x211x28
Jazz	03.02 →		+	10	> 20	CP1110 21652989		CC1110 80000437		178x183x29
Jazz	09.08 →		+ / -			CP1334 80001183		CC1334 80001184		205x211x28
Legend III	02.96 → 12.04	Set	-	10	> 20	CP1178 80000179		CC1178 80000790		200x103x25
S2000 Cabriolet	06.99 →		+	4	10-20	CP1207 80000410		CC1207 80000411		160x150x20
Stream	05.01 →	Set, LHD + RHD	+ / -	10	> 20	CP1081 21652546		CC1081 80000148		225x112x30
Hyundai										
Accent	10.94 → 01.00		+ / -	10	10-20	CP1170 80000157		CC1170 80000400		245x195x24
Accent II	01.00 →	Set	+	10	10-20	CP1166 80000084		CC1166 80000441		244x102x12
Accent III	11.05 →		+ / -	10	10-20	CP1277 80000813		CC1277 80000814		236x199x20
Coupé (GK)	02.02 →		+	10	> 20	CP1165 80000083		CC1165 80000440		266x234x30
Elantra	06.00 → 10.03		+	10	10-20	CP1165 80000083		CC1165 80000440		266x234x30
Elantra	10.03 → 10.06		+	10	10-20	CP1304 80000852		-		260x208x25





Hyundai										
Elantra	11.06 →		+ / -	10		<b>CP1343</b> 80001212		<b>CC1343</b> 80001213		195x240x20
Getz	08.02 →	Set	+	10	10-20	<b>CP1166</b> 80000084		<b>CC1166</b> 80000441		244x102x12
Getz	08.02 →		-			<b>CP1405</b> 80001739		-		150x112x25
Getz	10.05 →	Set	+	10	10-20	<b>CP1251</b> 80000650		-		236x105x12
H 1	10.97 →		+ / -			<b>CP1322</b> 80001034		-		200x168x40
H 1	02.08 →	Set	+ / -	10		<b>CP1327</b> 80001130		<b>CC1327</b> 80001131		220x120x20
H-100	07.93 →		+ / -			<b>CP1322</b> 80001034		-		200x168x40
i 10	12.07 →		+ / -			<b>CP1237</b> 80000634		-		175x175x12
i 20	09.08 →	Set	+ / -			<b>CP1366</b> 80001448		<b>CC1366</b> 80001449		288x82x19
i 30	10.07 →	LHD	+ / -	10		<b>CP1285</b> 80000871		<b>CC1285</b> 80000872		246x173x21
i 30	10.07 →	Set, RHD	+ / -			<b>CP1409</b> 80001734		<b>CC1409</b> 80001733		190x145x20 190x73x20
ix 55	09.08 →		+ / -			<b>CP1360</b> 80001437		<b>CC1360</b> 80001438		251x201x31
Matrix	06.01 →		+	10	10-20	<b>CP1165</b> 80000083		<b>CC1165</b> 80000440		266x234x30
Santa Fé	02.01 →		+	10	> 20	<b>CP1171</b> 80000158		<b>CC1171</b> 80000402		245x188x38
Santa Fé	03.06 →		+	10	> 20	<b>CP1266</b> 80000767		<b>CC1266</b> 80000764		223x256x30
Sonata III	03.98 → 09.01		+	10	> 20	<b>CP1171</b> 80000158		<b>CC1171</b> 80000402		245x188x38
Sonata IV	10.01 → 12.04	Set	+	10	> 20	<b>CP1222</b> 80000546		-		258x102x38
Sonata V	01.05 →		+ / -	10	> 20	<b>CP1266</b> 80000767		<b>CC1266</b> 80000764		223x256x30
Sonata VI	08.08 →		+ / -			<b>CP1331</b> 80001176		<b>CC1331</b> 80001177		230x262x35
Terracan	12.01 →		+ / -	10	10-20	<b>CP1172</b> 80000159		<b>CC1172</b> 80000401		236x200x25



Hyundai										
Terracan	01.05 →	Set	+	10	10-20	CP1252 80000651		- -		236x100x25
Trajet	03.00 →		+	10	10-20	CP1171 80000158		CC1171 80000402		245x188x38
Tucson	08.04 →	Set	+ / -	10		CP1310 80000911		CC1310 80000912		217x107x17
Tucson	08.04 → 01.06		+	10	10-20	CP1253 80000652		CC1253 80000780		225x203x17
Tucson	02.06 →		+ / -	10		CP1344 80001214	<b>NEW</b>	CC1344 80001215	<b>NEW</b>	187x238x19
XG 30/300	12.98 →		+	10	10-20	CP1171 80000158		CC1171 80000402		245x188x38
Infiniti										
FX	01.03 →	LHD + RHD	+ / -	10		CP1068 21652346		CC1068 80000746		222x200x30
Isuzu										
D-Max	05.02 →		+ / -			CP1412 80001731	<b>NEW</b>	- -		221x211x20
Trooper	08.91 → 08.99		+	10		CP1174 80000161		CC1174 80000774		230x100x20
Trooper	04.00 →	Set	+ / -	10		CP1173 80000160		CC1173 80000792		230x100x20
Iveco										
Daily 2	05.99 →		+			CP1026 21651901		CC1026 21651952		290x160x30
Daily 3	05.06 →		+ / -			CP1311 80000915		CC1311 80000916		291x191x30
Jaguar										
S-Type	01.99 → 05.02		+	4	10-20	CP1228 80000607		- -		310x226x31
S-Type	05.02 →		+	4	> 20	CP1273 80000809		CC1273 21652859		260x184x43
XF	03.08 →		+ / -			CP1332 80001178		CC1332 80001179		197x192x200
XJ X350	01.02 →		+ / -	4	10-20	CP1272 80000808		CC1272 21652991		290x203x45
XK8	01.01 →		+	3	10-20	CP1090 21652710		CC1090 80000756		411x120x17
XK8	01.01 →	RHD	+	3	10-20	CP1091 21652711		CC1091 80000757		411x120x17
XK9	03.06 →		+			- -		CC1290 80000606		250x182x45

**Jaguar**

X-Type	06.01 →		+ / -	4	> 20	<b>CP1089</b> 21652709		<b>CC1089</b> 21652361		509x100x35
--------	---------	--	-------	---	------	---------------------------	--	---------------------------	--	------------

**Kia**

Carens I	11.00 → 07.02	Set	+	10	10-20	<b>CP1223</b> 80000547		<b>CC1223</b> 80000798		257x107x12
Carens II	07.02 →	Set	+	10	10-20	<b>CP1224</b> 80000548		<b>CC1224</b> 80000797		253x109x20
Carnival I	08.99 → 10.01		+	10	10-20	<b>CP1219</b> 80000537		<b>CC1219</b> 80000776		266x225x21
Carnival II	10.01 →		+	10	10-20	<b>CP1219</b> 80000537		<b>CC1219</b> 80000776		266x225x21
Carnival III	06.06 →		+	10		<b>CP1256</b> 80000655		<b>CC1256</b> 80000781		240x211x17
Carnival III	06.06 →		+	10		<b>CP1362</b> 80001441	<small>NEW</small>	<b>CC1362</b> 80001442	<small>NEW</small>	211x113x18
Cee'd	12.06 →	Set, RHD	+ / -			<b>CP1409</b> 80001734	<small>NEW</small>	<b>CC1409</b> 80001733	<small>NEW</small>	190x145x20 190x73x20
Cee'd	01.07 →	LHD	+ / -	10		<b>CP1285</b> 80000871		<b>CC1285</b> 80000872		246x173x21
Cerato	04.04 →		+	10	10-20	<b>CP1256</b> 80000655		<b>CC1256</b> 80000781		240x211x17
Cerato	04.04 →		+	10	10-20	<b>CP1362</b> 80001441	<small>NEW</small>	<b>CC1362</b> 80001442	<small>NEW</small>	211x113x18
Clarus	07.96 →	Set	+	10	10-20	<b>CP1247</b> 80000644		<b>CC1247</b> 80000801		230x113x20
Magentis I	05.01 →		+	10	10-20	<b>CP1171</b> 80000158		<b>CC1171</b> 80000402		245x188x38
Magentis II	11.05 →		+	10	10-20	<b>CP1266</b> 80000767		<b>CC1266</b> 80000764		223x256x30
Magentis III	11.09 →		+ / -			<b>CP1331</b> 80001176		<b>CC1331</b> 80001177		230x262x35
Opirius	09.03 →		+	10		<b>CP1243</b> 80000640		<b>CC1243</b> 80000630		260x230x40
Picanto	04.04 →		+	10	10-20	<b>CP1237</b> 80000634		-		175x175x12
Rio I	08.00 → 03.05	Set	+	10	10-20	<b>CP1255</b> 80000654		<b>CC1255</b> 80000795		226x102x25
Rio II	03.05 →		+	10	10-20	<b>CP1253</b> 80000652		<b>CC1253</b> 80000780		225x203x17
Shuma I	03.96 → 05.01	Set	+	10		<b>CP1257</b> 80000656		<b>CC1257</b> 80000799		241x105x20



Kia										
Shuma II	05.01 → 08.04	Set	+	10		CP1257 80000656		CC1257 80000799		241x105x20
Sorento (JC)	08.02 →		+	10	10-20	CP1171 80000158		CC1171 80000402		245x188x38
Sorento (JC, Facelift)	12.06 →	Set, + AUT AC	+ / -	10		CP1310 80000911		CC1310 80000912		217x107x17
Sorento (XM)	11.09 →		+	10		CP1256 80000655		CC1256 80000781		240x211x17
Sorento (XM)	11.09 →		+ / -			CP1362 80001441	NEW	CC1362 80001442	NEW	211x113x18
Soul	02.09 →		+ / -			CP1340 80001206	NEW	CC1340 80001207	NEW	182x160x25
Sportage	09.04 →	Set	+ / -	10	10-20	CP1310 80000911		CC1310 80000912		217x107x17
Sportage	09.04 →		+	10	10-20	CP1253 80000652		CC1253 80000780		225x203x17
Venga	02.10 →		-			CP1369 80001454	NEW	CC1369 80001455	NEW	230x180x20
Lada										
110	01.95 →		-	9	10-20	-		CC1293 80000671		236x184x40
111	01.95 →		-	9	10-20	-		CC1293 80000671		236x184x40
112	01.95 →		-	9	10-20	-		CC1293 80000671		236x184x40
Kalina	10.04 →					CP1313 80000998		CC1313 80000999		250x150x35
Lancia										
Dedra	01.89 → 07.99		+	8	10-20	CP1031 21651915		CC1031 21651951		385x170x17
Delta II	06.93 → 08.99		+	8	10-20	CP1031 21651915		CC1031 21651951		385x170x17
Delta III	09.08 →		+ / -			CP1132 21653027		CC1132 21652538		233x182x22
Kappa	08.94 → 10.01		+	2	10-20	CP1017 21651892		CC1017 80000760		279x218x17
Kappa (SW / Coupé)	06.96 → 10.01		+	3	10-20	CP1203 80000376		CC1203 21651954		292x225x20
Lybra	07.99 →		+	8	10-20	CP1026 21651901		CC1026 21651952		290x160x30
Musa	10.04 →		+	11	10-20	CP1080 21652544		CC1080 21651296		216x163x25



Lancia										
Phedra	09.02 →		+ / -	2	10-20	CP1096 21652856		CC1096 21653147		405x165x32
Thema	03.87 → 07.94		+	4	10-20	CP1021 21651896		- -		288x225x13
Thesis	07.02 →		+ / -	12	10-20	CP1269 80000805		CC1269 21652694		320x190x30
Ypsilon	11.95 →		+	8	10-20	CP1019 21651894		CC1019 80000433		308x140x18
Ypsilon	09.03 →		+ / -	11	10-20	CP1080 21652544		CC1080 21651296		216x163x25
Zeta	05.95 → 09.02	3-Set	+	3	10-20	CP1066 21652342		CC1066 80000765		184x93x30
Land Rover										
Discovery III	10.04 →		+	11	10-20	CP1199 80000360		CC1199 80000361		270x155x30
Freelander I (V6 and TD4)	02.98 →		+ / -	11	10-20	CP1152 80000060		CC1152 80000775		243x223x75
Freelander II	02.06 →		+	11		CP1264 80000712		CC1264 80000713		270x193x30
Range Rover II	07.94 → 03.02	2 !	+	2 / 4	10-20	CP1156 80000066		CC1156 80000772		217x198x21
Range Rover III	03.02 →		+	3	10-20	CP1155 80000065		CC1155 21652916		539x242x30
Lexus										
GS (GRS_UZS_)	04.05 →		+	10		CP1227 80000604		CC1227 80000605		209x194x30
GS300	08.97 → 10.00		+	10		CP1175 80000162		CC1175 80000771		235x215x17
GS300	10.00 →		+ / -	10		- -		CC1296 80000165		217x227x30
GS430	11.00 →		+ / -	10		- -		CC1296 80000165		217x227x30
GS430	11.00 →	RHD	+ / -	10		- -		CC1296 80000165		217x227x30
IS (GXE10)	04.99 →		+	10		CP1175 80000162		CC1175 80000771		235x215x17
IS Sport Cross	10.01 →		+	10		CP1175 80000162		CC1175 80000771		235x215x17
IS	10.05 →		+	10		CP1227 80000604		CC1227 80000605		209x194x30
LS (UCF20)	10.94 → 10.00		+	10		CP1175 80000162		CC1175 80000771		235x215x17



Lexus										
LS (FE)	10.00 →		+ / -	10		-		CC1296 80000165		217x227x30
LS (FE)	10.00 →	RHD	+ / -	10		-		CC1296 80000165		217x227x30
RX (U1)	08.97 → 05.03		+	10		CP1175 80000162		CC1175 80000771		235x215x17
RX II (MCU)	05.03 →	LHD + RHD	+			CP1078 21652539		CC1078 80000745		217x213x17
SC430	08.01 →		+ / -	10		-		CC1296 80000165		217x227x30
Maserati										
3200 GT / 4200	10.98 → 03.02		+	3	10-20	CP1203 80000376		CC1203 21651954		292x225x20
612 Scaglietti	01.04 →		+			-		- od		
Quattroporte III	03.04 →		+	4	10-20	-		CC1292 80000669		250x215x40
Mazda										
121 III	01.96 →		+ / -	4	10-20	CP1018 21651893		CC1018 21652355		350x151x30
2	04.03 → 10.07		+	10	10-20	CP1146 21653145		CC1146 21652992		196x216x25
2	10.07 →	Set	+ / -			CP1378 80001489		CC1378 80001743		189x216x25
323 F VI	09.98 → 05.04	Set	+ / -	10	10-20	CP1098 21652860		CC1098 80000403		120x218x25
3	10.03 →	Set	+	11	10-20	CP1204 80000405		CC1204 80000406		236x100x22
3	06.09 →	Set	+ / -			CP1408 80001736		CC1408 80001735		251x105x17
5	02.05 →	Set	+	11	10-20	CP1204 80000405		CC1204 80000406		236x100x22
626 V (GF)	05.97 → 10.02	Set	+ / -	11	10-20	CP1098 21652860		CC1098 80000403		120x218x25
6	06.02 →		+ / -	11	> 20	CP1146 21653145		CC1146 21652992		196x216x25
6	02.08 →		+ / -	10		CP1320 80001039		CC1320 80001040		215x193x25
CX7	10.07 →		+ / -	10		CP1146 21653145		CC1146 21652992		196x216x25
Demio (up to Chassis No.: → 300 000)	10.96 → 08.98	Set	+ / -			CP1407 80001737		-		215x190x20



**Mazda**

Demio (from Chassis No.: 300 001 →)	08.98 →	Set	+ / -	11		-		CC1312 80000849		232x111x22
MPV II (from Chassis No.: 107753 →)	09.99 →		+ / -	10		CP1176 80000163		CC1176 80000208		219x100x25
Premacy	07.99 →	Set	+ / -	11	10-20	CP1098 21652860		CC1098 80000403		120x218x25
RX8 (from Chassis No.: 107753 →)	10.03 →		+ / -	10	10-20	CP1176 80000163		CC1176 80000208		219x100x25
Tribute	03.00 →		+ / -	4	10-20	CP1112 21652993		CC1112 80000284		280x162x30
Xedos 9 (TA)	08.93 → 01.00	Set	-	11		CP1263 80000689		-		226x128x22



























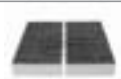

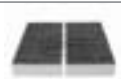

**MCC**

Smart Coupe / Cabrio / Crossblade	07.98 → 01.04		+ / -	1	> 20	CP1186 80000338		CC1186 21653014		200x203x40
Smart	10.98 → 01.04		+ / -	1	> 20	CP1186 80000338		CC1186 21653014		200x203x40
Smart Fortwo	01.07 →		+	12		CP1323 80001724		CC1323 80001035		212x215x25
Smart Roadster / Coupé / For Four	05.03 →		+ / -	11	10-20	CP1180 80000331		CC1180 21653013		178x204x40























**Mercedes**

A-Klasse/A-class (W168)	07.97 → 08.04		+ / -	3	> 20	CP1087 21652688		CC1087 21651292		364x246x30
A-Klasse/A-class (W169)	09.04 →		+ / -	8	10-20	CP1145 21653144		CC1145 21653143		395x184x32
B-Klasse/B-class (W245)	03.05 →		+ / -	8	10-20	CP1145 21653144		CC1145 21653143		395x184x32
C-Klasse/C-class (W202)	03.93 → 05.00	LHD + RHD	+ / -	11	> 20	CP1007 21651196		CC1007 21651961		222x279x54
C-Klasse/C-class (W203)	04.00 →		+ / -	11	10-20	CP1075 21652358		CC1075 21652861		334x191x25
C-Klasse/C-class (W203)	04.00 →	RHD	+ / -	11	10-20	CP1061 21652335		CC1061 21652862		334x191x25
C-Klasse/C-class (W204)	01.07 →		+	11		-		CC1379 80001527		282x260x77
CLK (208)	06.97 → 06.02	LHD + RHD	+ / -	11	10-20	CP1007 21651196		CC1007 21651961		222x279x54
E-Klasse/E-class (W124)	06.93 → 06.95	Set	+ / -	3	> 20	CP1010 21651199		-		374x76x31
E-Klasse/E-class (W210)	06.95 → 03.02	Set	+ / -	11	> 20	CP1006 21651195		CC1006 80000421		255x114x30

**Mercedes**

E-Klasse/E-class (W210)	06.95 → 03.02	Set, + AUT AC	+			-		<b>CC1404</b> 80001740	 <b>NEW</b>	227x210x45
E-Klasse/E-class (W210)	06.95 → 03.02	LHD + RHD	+ / -	11	> 20	<b>CP1007</b> 21651196		<b>CC1007</b> 21651961		222x279x54
E-Klasse/E-class (S210)	06.96 → 03.03	Set, + AUT AC	+			-		<b>CC1404</b> 80001740	 <b>NEW</b>	227x210x45
E-Klasse/E-class (W211, S211)	03.02 →		+ / -	4 / 11	10-20	<b>CP1099</b> 21652863		<b>CC1099</b> 21652865		312x257x35
E-Klasse/E-class (W211, S211)	03.02 →	RHD	+ / -	4 / 11	10-20	<b>CP1100</b> 21652864		-		312x257x35
E-Klasse/E-class (W212)	01.09 →		+	11		-		<b>CC1379</b> 80001527		282x260x77
E-Klasse/E-class (C207)	01.09 →		+	11		-		<b>CC1379</b> 80001527		282x260x77
G-Klasse/G-class (W463)	04.98 →		+	11	> 20	<b>CP1074</b> 21652356		<b>CC1074</b> 21652357		252x216x32
GL-Klasse/GL-class (X164)	03.06 →	Set	+	10	> 20	<b>CP1300</b> 80001490	 <b>NEW</b>	<b>CC1300</b> 80000647		248x133x40
GL-Klasse/GL-class (X204)	06.08 →		+	11		-		<b>CC1379</b> 80001527		282x260x77
M-Klasse/M-class (W163)	02.98 → 06.05		+ / -	11	10-20	<b>CP1134</b> 21653029		<b>CC1134</b> 21651294		225x204x40
M-Klasse/M-class (W164)	07.05 →	Set	+	10	> 20	<b>CP1300</b> 80001490	 <b>NEW</b>	<b>CC1300</b> 80000647		248x133x40
R-Klasse/R-class (W251, V251)	09.05 →	Set	+	10	> 20	<b>CP1300</b> 80001490	 <b>NEW</b>	<b>CC1300</b> 80000647		248x133x40
S-Klasse/S-class (W140)	02.91 → 10.98		+	4	10-20	<b>CP1013</b> 21651887		<b>CC1013</b> 21653010		391x257x43
S-Klasse/S-class (W140-Fresh Air Filter)	02.91 → 10.98	+ 21651887	+	11	> 20	<b>CP1117</b> 21653002		-		223x144x8
S-Klasse/S-class (W140)	02.91 → 10.98	RHD	+	4	10-20	<b>CP1042</b> 21651974		<b>CC1042</b> 21653011		391x257x43
S-Klasse/S-class (W220)	10.98 → 08.05	Set	+	10	> 20	<b>CP1006</b> 21651195		<b>CC1006</b> 80000421		255x114x30
S-Klasse/S-class (W220)	10.98 → 08.05	Set, + AUT AC	+			-		<b>CC1404</b> 80001740	 <b>NEW</b>	227x210x45
S-Klasse/S-class (C215)	03.99 → 03.06	Set, + AUT AC	+			-		<b>CC1404</b> 80001740	 <b>NEW</b>	227x210x45
S-Klasse/S-class (W221)	10.05 →	Set	+	11	10-20	<b>CP1297</b> 80001491	 <b>NEW</b>	<b>CC1297</b> 80000538		260x183x30

**Mercedes**

S-Klasse/S-class (C216)	05.06 →		+ / -			<b>CP1297</b> 80001491		<b>CC1297</b> 80000538		260x183x30
SL (R129)	03.89 → 10.01		+ / -	3	> 20	<b>CP1055</b> 21651993		<b>CC1055</b> 80000382		498x98x43
SL	10.01 →	Set	+	11	10-20	-		<b>CC1288</b> 21652812		215x190x40
SLK (R170)	04.96 → 04.04	LHD + RHD	+ / -	11	> 20	<b>CP1007</b> 21651196		<b>CC1007</b> 21651961		222x279x54
SLK (R171)	03.04 →		+	11	> 20	<b>CP1270</b> 80000806		<b>CC1270</b> 80000071		360x179x35
Sprinter	01.95 → 06.06		+ / -	3	> 20	<b>CP1044</b> 21651976		<b>CC1044</b> 21652985		379x163x25
Sprinter	01.95 → 06.06	roof AC	+			<b>CP1414</b> 80001729		-		527x144x8
Sprinter (T1N)	01.02 →		+ / -	3	> 20	<b>CP1044</b> 21651976		<b>CC1044</b> 21652985		379x163x25
Sprinter	06.05 →		+			<b>CP1233</b> 80000614		<b>CC1233</b> 80000616		352x234x35
Sprinter	06.06 →	roof AC	+			<b>CP1415</b> 80001728		-		260x130x10
Vaneo	01.97 →		+ / -	3	10-20	<b>CP1087</b> 21652688		<b>CC1087</b> 21651292		364x246x30
Viano, Vito (W639)	09.03 →		+ / -	11	10-20	<b>CP1130</b> 21653025		<b>CC1130</b> 21653009		348x203x34
Vito, V-Klasse (W638)	11.95 → 07.03		+ / -	11	10-20	<b>CP1058</b> 21652045		<b>CC1058</b> 80000427		374x218x28

**Mitsubishi**

Carisma	07.95 → 06.06	Set	+	10	> 20	<b>CP1101</b> 21652867		<b>CC1101</b> 80000397		234x208x37
Carisma	07.95 → 06.07		-			<b>CP1281</b> 80000825		-		202x180x51
Colt V	09.95 → 05.04	Set	+	10	> 20	<b>CP1101</b> 21652867		<b>CC1101</b> 80000397		234x208x37
Colt VI	04.04 →		+ / -	11	10-20	<b>CP1180</b> 80000331		<b>CC1180</b> 21653013		178x204x40
Galant Vi	09.96 → 10.04		+	10	> 20	<b>CP1102</b> 21652868		-		276x176x56
Grandis	04.04 →		+			-		<b>CC1301</b> 80000648		228x227x74
L 200	06.96 →	Set	+	10	> 20	<b>CP1101</b> 21652867		<b>CC1101</b> 80000397		234x208x37

**Mitsubishi**

Lancer	12.95 → 10.03	Set	+	10	> 20	CP1101 21652867		CC1101 80000397		234x208x37
Lancer	10.03 →		+	10		- -		CC1301 80000648		228x227x74
Lancer	01.08 →		+ / -	10		CP1284 80000853		CC1284 80000854		215x200x30
Outlander	05.03 →		+	10		- -		CC1301 80000648		228x227x74
Outlander	02.07 →		+ / -	10		CP1284 80000853		CC1284 80000854		215x200x30
Pajero II	12.90 → 04.00		+	10		- -		CC1295 80000068		200x215x30
Pajero III	04.00 →		+	10		- -		CC1295 80000068		200x215x30
Pajero Pinin	10.99 →	Set	+	10		CP1246 80000643		CC1246 80000794		192x93x25
Pajero Sport	11.98 →	Set	+	10	> 20	CP1101 21652867		CC1101 80000397		234x208x37
Space Runner	08.99 →		+	10		CP1280 80000824		- -		224x207x35
Space Star	06.98 →	Set	+	10	> 20	CP1101 21652867		CC1101 80000397		234x208x37
Space Star	06.98 →		-	10		CP1281 80000825		- -		202x180x51
Space Wagon	10.98 →		+	10		CP1280 80000824		- -		224x207x35

**Nissan**





























Almera I	07.95 → 07.00		+ / -		10-20	CP1318 80001041		- -		252x215x23
Almera II / Almera Tino	03.00 →	LHD + RHD	+ / -	10	10-20	CP1068 21652346		CC1068 80000746		222x200x30
Cube	03.10 →		+ / -			CP1401 80001720		CC1401 80001721		150x260x25
G-TR	02.09 →		+ / -			CP1413 80001730		- -		230x200x30
Kubistar	08.03 →		+	1		CP1050 21651983		CC1050 80000114		228x160x30
Maxima (A33)	03.00 →	2 !	+	10		CP1274 80000810		CC1274 80000067		243x85x28
Micra (K11)	08.92 → 02.03		+	10	10-20	CP1103 21652870		- -		241x202x20



## Nissan

Micra (K12)	01.03 →		+	10	10-20	CP1159 80000074		- -		223x190x45
Murano	03.05 →	LHD + RHD	+ / -	10		CP1068 21652346		CC1068 80000746		222x200x30
Murano	11.07 →		+ / -			CP1339 80001204	NEW	CC1339 80001205	NEW	270x281x20
Navarra	07.05 →	2 !		10		CP1250 80000649		CC1250 80000786		264x100x25
Note	03.06 →		+	10	10-20	CP1159 80000074		- -		223x190x45
Pathfinder	03.05 →	2 !	+ / -	11	> 20	CP1250 80000649		CC1250 80000786		264x100x25
Patrol GR II	06.97 →	Set	+ / -		10-20	CP1325 80001024		- -		270x220x24
Pixo	03.09 →		+ / -			CP1364 80001444	NEW	CC1364 80001445	NEW	193x162x18
Primastar	09.02 →		+ / -	1	10-20	CP1157 80000072		CC1157 80001170		340x191x45
Primera (P10, W10)	06.90 → 06.96		+ / -		10-20	CP1229 80000610		- -		206x193x16
Primera (P11, WP11)	06.96 → 12.01		+ / -	10	10-20	CP1069 21652347		CC1069 80000416		262x193x20
Primera (P12, WP12)	03.02 →	LHD + RHD	+ / -	10	10-20	CP1068 21652346		CC1068 80000746		222x200x30
Qashqai	02.07 →		+ / -	12		CP1286 80000874		CC1286 80000875		192x267x20
Serena	07.92 →		+ / -		10-20	CP1231 80000612		- -		232x202x16
Sunny III	10.90 → 12.95		+ / -			CP1230 80000611		- -		204x189x16
Terrano II	02.93 →		+	10	10-20	CP1069 21652347		CC1069 80000416		262x193x20
Tiida	09.07 →		+ / -			CP1363 80001443	NEW	- -		210x168x35
X-Trail	07.01 →	LHD + RHD	+	10	10-20	CP1068 21652346		CC1068 80000746		222x200x30
X-Trail	02.07 →		+ / -	12		CP1286 80000874		CC1286 80000875		192x267x20
<b>Opel</b>										
Agila	09.00 →		+ / -	11	> 20	CP1072 21652350		CC1072 80000758		235x193x15



Opel										
Agila II	09.07 →		+ / -	10		<b>CP1324</b> 80001036		<b>CC1324</b> 80001744	 <small>NEW</small>	230x142x30
Antara	05.06 →		+ / -			<b>CP1308</b> 80000877		<b>CC1308</b> 80000878		277x206x27
Astra F	09.91 → 09.98		+ / -	3	< 10	<b>CP1001</b> 21651182		<b>CC1001</b> 21651964		411x145x17
Astra G (Behr)	02.98 → 02.04		+ / -	10	10-20	<b>CP1047</b> 21651980		<b>CC1047</b> 80000113		258x231x30
Astra G (Delphi)	02.98 → 02.04		+ / -	10	10-20	<b>CP1046</b> 21651979		<b>CC1046</b> 80000021		294x200x30
Astra H (Behr)	03.04 →		+	10	10-20	<b>CP1047</b> 21651980		<b>CC1047</b> 80000113		258x231x30
Astra H (Delphi)	03.04 →		+	10	10-20	<b>CP1046</b> 21651979		<b>CC1046</b> 80000021		294x200x30
Astra J	12.09 →		+ / -			<b>CP1335</b> 80001185		<b>CC1335</b> 80001186		240x204x35
Calibra	06.90 → 07.97		+ / -	3	< 10	<b>CP1001</b> 21651182		<b>CC1001</b> 21651964		411x145x17
Combo	07.94 → 10.01		+	3	< 10	<b>CP1001</b> 21651182		<b>CC1001</b> 21651964		411x145x17
Combo	07.94 → 10.01		-	3	< 10	<b>CP1004</b> 21651184		<b>CC1004</b> 21651965		330x188x17
Corsa B	03.93 → 09.00		-	3	< 10	<b>CP1004</b> 21651184		<b>CC1004</b> 21651965		330x188x17
Corsa B	01.95 → 09.00	RHD	+	3	< 10	<b>CP1048</b> 21651981		<b>CC1048</b> 80000761		226x206x25
Corsa C	09.00 →		+ / -	3	< 10	<b>CP1092</b> 21652714		<b>CC1092</b> 21652715		330x163x30
Corsa D	07.06 →		+	10	10-20	<b>CP1221</b> 80000541		<b>CC1221</b> 80000777		215x265x21
Insignia	07.08 →		+ / -			<b>CP1335</b> 80001185		<b>CC1335</b> 80001186		240x204x35
Meriva	05.03 →		+ / -	3	< 10	<b>CP1113</b> 21652994		<b>CC1113</b> 21652995		210x242x32
Monterey B	07.98 → 08.99	Set	+ / -	10	10-20	<b>CP1173</b> 80000160		<b>CC1173</b> 80000792		230x100x20
Omega B	03.94 → 09.99		+ / -	8	> 20	<b>CP1002</b> 21651183		- -		290x226x17
Omega B	10.99 → 07.03		+ / -	8	> 20	- -		<b>CC1294</b> 21652353		290x226x17





Opel										
Signum	05.03 →		+	3	< 10	CP1092 21652714		CC1092 21652715		330x163x30
Sintra	11.96 → 04.99	Set	+	10	10-20	CP1049 21651982		CC1049 21652046		220x95x58
Tigra	07.94 → 12.00		-	3	< 10	CP1004 21651184		CC1004 21651965		330x188x17
Tigra	04.98 → 12.00		+	3	< 10	CP1001 21651182		CC1001 21651964		411x145x17
Vectra B	10.95 → 07.03		+ / -	3	< 10	CP1005 21651185		CC1005 21651966		410x145x25
Vectra (C-Epsilon)	04.02 →		+ / -	3	< 10	CP1092 21652714		CC1092 21652715		330x163x30
Vivaro	03.01 →		+	1	> 20	CP1157 80000072		CC1157 80001170		340x191x45
Vivaro	08.01 →		+ / -	1	> 20	CP1157 80000072		CC1157 80001170		340x191x45
Zafira (Behr)	04.99 → 06.05		+ / -	10	> 20	CP1047 21651980		CC1047 80000113		258x231x30
Zafira (Delphi)	04.99 → 06.06		+	10	> 20	CP1046 21651979		CC1046 80000021		294x200x30
Zafira II	07.05 →			10	> 20	CP1047 21651980		CC1047 80000113		258x231x30
Peugeot										
107	06.05 →		+	11	10-20	CP1259 80000662		CC1259 80000784		226x165x45
1007	04.05 →		+ / -	8	> 20	CP1082 21652548		CC1082 21652540		285x177x35
206	08.98 →		+ / -	4	10-20	CP1011 21651293		CC1011 21653068		346x171x31
207	02.06 →	Set	+ / -	4		CP1260 80000666		CC1260 80000667		150x158x30 200x158x30
306	05.93 → 05.01		+ / -	4		CP1150 80000027		CC1150 80000624		332x104x30
307	08.00 →		+ / -	8	10-20	CP1082 21652548		CC1082 21652540		285x177x35
308	09.07 →		+ / -	8		CP1082 21652548		CC1082 21652540		285x177x35
3008	06.09 →	Set	+	11	10-20	CP1282 80000839		CC1282 80000615		330x96x30
405	08.92 → 10.96		+ / -	4	10-20	CP1016 21651891		CC1016 80000743		265x172x30



## Peugeot





































406	10.95 → 05.04		+ / -	4	10-20	<b>CP1036</b> 21651920		<b>CC1036</b> 21652541		328x159x30
407 (up to Chassis No.: → 11438)	04.04 → 03.08		+ / -	12	10-20	<b>CP1271</b> 80000807		<b>CC1271</b> 21653102		315x154x35
407 (from Chassis No.: 11438 →)	03.08 →		+ / -			<b>CP1371</b> 80001458	<b>NEW</b>	<b>CC1371</b> 80001459	<b>NEW</b>	269x196x30
4007	02.07 →		+ / -	10		<b>CP1284</b> 80000853		<b>CC1284</b> 80000854		215x200x30
5008	09.09 →	Set	+	11	10-20	<b>CP1282</b> 80000839		<b>CC1282</b> 80000615		330x96x30
605	06.89 → 09.99		+ / -	4	10-20	<b>CP1035</b> 21651919		<b>CC1035</b> 80000748		429x171x32
607	02.00 →		+	4	10-20	<b>CP1147</b> 21653148		<b>CC1147</b> 21653149		517x146x40
806	06.94 → 08.02	3-Set	+	3	10-20	<b>CP1066</b> 21652342		<b>CC1066</b> 80000765		184x93x30
807	06.02 →		+ / -	2	10-20	<b>CP1096</b> 21652856		<b>CC1096</b> 21653147		405x165x32
Bipper	02.08 →		+ / -			<b>CP1316</b> 80001027		<b>CC1316</b> 80001171		220x177x30
Boxer (230)	02.94 → 04.02		+	4	10-20	<b>CP1056</b> 21651994		<b>CC1056</b> 80000432		435x144x17
Boxer (244)	04.02 → 04.06		+	4	10-20	<b>CP1056</b> 21651994		<b>CC1056</b> 80000432		435x144x17
Boxer	04.06 →		+ / -	12	10-20	<b>CP1278</b> 80000815		<b>CC1278</b> 80000816		235x250x25
Expert	07.95 →	3-Set	+	3	10-20	<b>CP1066</b> 21652342		<b>CC1066</b> 80000765		184x93x30
Expert	01.07 →		+ / -	8		<b>CP1305</b> 80000865		<b>CC1305</b> 80000866		376x176x49
Partner / Ranch	06.96 →		+	11	10-20	<b>CP1024</b> 21651899		<b>CC1024</b> 80000077		194x195x20
Partner II / Ranch	08.01 →		+/-	11	10-20	<b>CP1133</b> 21653028		<b>CC1133</b> 21653146		225x222x32
Partner Kasten	04.08 →	Set	+	11	10-20	<b>CP1282</b> 80000839		<b>CC1282</b> 80000615		330x96x30
<b>Porsche</b>										
Boxster, 911 (Typ 996)	09.97 →		+ / -	9		<b>CP1036</b> 21651920		<b>CC1036</b> 21652541		328x159x30
Carrera GT (Typ 980)	07.03 →		+			<b>CP1267</b> 80000803		<b>CC1267</b> 80000347		170x225x35



Porsche										
Cayenne	09.02 →		+ / -	11		CP1125 21653020		CC1125 21653015		275x217x30
Cayenne	06.10 →					CP1403 80001742		CC1403 80001741		276x217x5
Panamera	09.09 →		+ / -			CP1074 21652356		CC1074 21652357		252x216x32
Renault										
Avantime	09.01 → 05.03	Set	+ / -	1		CP1086 21652687		CC1086 21653070		192x180x45
Clio I	05.90 → 09.98	Set	+	1	10-20	CP1083 21652549		CC1083 80000766		177x65x20
Clio II	09.98 → 12.04		-	4	10-20	CP1050 21651983		CC1050 80000114		228x160x30
Clio II	08.04 → 08.05		+	1	10-20	CP1159 80000074		-	-	223x190x45
Clio III	06.05 →		+ / -	11	10-20	CP1159 80000074		-	-	223x190x45
Espace II	01.91 → 12.96	Set	+ / -	1	> 20	CP1086 21652687		CC1086 21653070		192x180x45
Espace III	11.96 → 10.02	Set	+ / -	1	> 20	CP1086 21652687		CC1086 21653070		192x180x45
Espace IV	11.02 →		+	1	10-20	CP1104 21652871		CC1104 21652872		375x140x75
Fluence	02.10 →		+ / -			CP1372 80001460		CC1372 80001461		263x170x35
Grand Scénic (JM 0/1_)	04.04 →			8	10-20	CP1163 80000080		-	-	239x239x47
Grand Scénic (JZ 0/1_)	02.09 →		+ / -			CP1367 80001450		CC1367 80001451		262x193x37
Kangoo (KC 0/1_)	08.97 →		+	4	10-20	CP1050 21651983		CC1050 80000114		228x160x30
Kangoo	02.08 →	Set	+ / -			CP1370 80001456		CC1370 80001457		239x108x23 275x23x12
Koleos	09.08 →		+ / -			CP1336 80001187		CC1336 80001188		248x181x20
Laguna I	11.93 → 03.01		+	4	10-20	CP1032 21651916		CC1032 80000434		249x182x17
Laguna I	11.93 → 03.01	RHD	+	4	10-20	CP1012 21651298		CC1012 80000747		249x182x17
Laguna II	03.01 →		+	10	10-20	CP1084 21652550		CC1084 21652542		210x204x30



## Renault

Laguna III	10.07 →	Set	+ / -	10		<b>CP1314</b> 80001030		<b>CC1314</b> 80001031		343x134x30
Mégane I	11.95 → 04.98		+	3	10-20	<b>CP1033</b> 21651917		<b>CC1033</b> 80000435		292x172x17
Mégane I	05.98 → 08.03		+	11	10-20	<b>CP1070</b> 21652348		<b>CC1070</b> 80000750		243x169x16
Mégane I	05.98 → 08.03		-	2	10-20	<b>CP1050</b> 21651983		<b>CC1050</b> 80000114		228x160x30
Mégane II	11.02 →		+ / -	11	10-20	<b>CP1140</b> 21653071		<b>CC1140</b> 80000670		274x187x40
Mégane III	11.08 →					<b>CP1372</b> 80001460	 <small>NEW</small>	<b>CC1372</b> 80001461	 <small>NEW</small>	263x170x35
Mégane Scénic	01.97 → 01.98		+	11	10-20	<b>CP1143</b> 21653140		<b>CC1143</b> 80000762		252x227x19
Mégane Scénic	02.98 → 09.99		+	11	10-20	<b>CP1051</b> 21651984		<b>CC1051</b> 80000436		235x220x19
Mégane Scénic	01.97 → 09.99		-	11	10-20	<b>CP1201</b> 80000373		-		289x208x20
Mégane Scénic	01.97 → 09.99	RHD	+	11	10-20	<b>CP1218</b> 80000536		<b>CC1218</b> 80000788		221x221x20
Modus	10.04 →		+	10	10-20	<b>CP1159</b> 80000074		-		223x190x45
Safrane I	04.92 → 07.96		+	4	10-20	<b>CP1025</b> 21651900		<b>CC1025</b> 80000753		234x187x23
Scénic	08.99 → 08.03		+	11	10-20	<b>CP1071</b> 21652349		<b>CC1071</b> 80000418		229x196x30
Scénic	01.99 → 08.03	RHD	+	11	10-20	<b>CP1218</b> 80000536		<b>CC1218</b> 80000788		221x221x20
Scénic II	02.03 →		+ / -	11	10-20	<b>CP1163</b> 80000080		-		239x239x47
Scénic III	05.09 →		+ / -			<b>CP1367</b> 80001450	 <small>NEW</small>	<b>CC1367</b> 80001451	 <small>NEW</small>	262x193x37
Trafic II	02.01 →		+ / -	1	10-20	<b>CP1157</b> 80000072		<b>CC1157</b> 80001170		340x191x45
Twingo (C06_)	03.93 →		+	7	10-20	<b>CP1054</b> 21651991		<b>CC1054</b> 80000752		264x118x30
Twingo (CNO_)	03.07 →		+ / -			<b>CP1159</b> 80000074		-		223x190x45
Vel Satis	06.02 →		+	10	10-20	<b>CP1084</b> 21652550		<b>CC1084</b> 21652542		210x204x30



Rover										
25	10.99 →		+	10	10-20	<b>CP1151</b> 80000029		<b>CC1151</b> 80000749		225x190x32
45	02.00 →		+	10	> 20	<b>CP1067</b> 21652345		<b>CC1067</b> 80000428		223x198x30
45	02.00 →		-	10	> 20	<b>CP1040</b> 21651972		<b>CC1040</b> 80000742		212x211x30
75	02.99 →		+ / -	4	10-20	<b>CP1122</b> 21653017		<b>CC1122</b> 80000070		397x262x32
200	11.95 → 03.00		+	10	10-20	<b>CP1151</b> 80000029		<b>CC1151</b> 80000749		225x190x32
400	01.93 → 04.95		+	10		<b>CP1151</b> 80000029		<b>CC1151</b> 80000749		225x190x32
400	05.95 → 03.00		+	10	> 20	<b>CP1067</b> 21652345		<b>CC1067</b> 80000428		223x198x30
400	05.95 → 03.00		-	10	> 20	<b>CP1040</b> 21651972		<b>CC1040</b> 80000742		212x211x30
Cabriolet	01.93 → 11.99		+	10		<b>CP1151</b> 80000029		<b>CC1151</b> 80000749		225x190x32
Streetwise	08.03 →		+	10	10-20	<b>CP1151</b> 80000029		<b>CC1151</b> 80000749		225x190x32
Saab										
900 I	01.89 → 07.93		+ / -	4		<b>CP1141</b> 21653114		-		441x126x30
900 II	07.93 → 02.98		+ / -	4		<b>CP1141</b> 21653114		-		441x126x30
9000	09.84 → 09.91		+	3	10-20	<b>CP1021</b> 21651896		-		288x225x13
9000	04.85 → 12.98		-	4	10-20	<b>CP1034</b> 21651918		<b>CC1034</b> 80000417		330x198x29
9-3 (YS3D)	02.98 → 08.03		+ / -	3	< 10	<b>CP1141</b> 21653114		-		441x126x30
9-3 (YS3F)	09.02 →		+	4	< 10	<b>CP1092</b> 21652714		<b>CC1092</b> 21652715		330x163x30
9-5	09.97 →		+ / -	10	> 20	<b>CP1206</b> 80000409		<b>CC1206</b> 21653115		319x186x52
Seat										
Alhambra	01.96 →		+ / -	4	10-20	<b>CP1020</b> 21651895		<b>CC1020</b> 21651960		537x110x25
Altea	03.04 →		+ / -	11	10-20	<b>CP1129</b> 21653024		<b>CC1129</b> 21653008		207x269x34
Altea	03.04 →	RHD	+ / -	11	10-20	-		<b>CC1298</b> 80000602		207x269x34



Seat										
Arosa	02.97 → 06.04		+ / -	4	10-20	CP1027 21651912		CC1027 21651955		279x207x25
Arosa	02.97 → 06.04	w F	+ / -	4	10-20	CP1279 80000817		- -		296x227x28
Cordoba	02.93 → 09.02		+ / -	4	10-20	CP1027 21651912		CC1027 21651955		279x207x25
Cordoba	02.93 → 09.02	w F	+ / -	4	10-20	CP1279 80000817		- -		296x227x28
Cordoba	09.02 →		+ / -	11	10-20	CP1074 21652356		CC1074 21652357		252x216x32
Ibiza II	09.93 → 08.99		+ / -	4	10-20	CP1027 21651912		CC1027 21651955		279x207x25
Ibiza II	09.93 → 08.99	w F	+ / -	4	10-20	CP1279 80000817		- -		296x227x28
Ibiza IV	02.02 → 03.08		+ / -	11	> 20	CP1074 21652356		CC1074 21652357		252x216x32
Ibiza V	03.08 →		+ / -			CP1074 21652356		CC1074 21652357		252x216x32
Inca	11.95 →		+ / -	4	10-20	CP1027 21651912		CC1027 21651955		279x207x25
Inca	11.95 →	w F	+ / -	4	10-20	CP1279 80000817		- -		296x227x28
León	09.99 →		+ / -	4	10-20	CP1027 21651912		CC1028 21651967		279x207x25
León	09.99 →	w F	+ / -	4	10-20	CP1279 80000817		- -		296x227x28
León II	09.05 →		+ / -	11	< 10	CP1129 21653024		CC1129 21653008		207x269x34
Toledo II	04.99 → 05.06		+ / -	4	10-20	CP1027 21651912		CC1027 21651955		279x207x25
Toledo II	04.99 → 05.06	w F	+ / -	4	10-20	CP1279 80000817		- -		296x227x28
Toledo III	10.04 →		+ / -	11	> 20	CP1129 21653024		CC1129 21653008		207x269x34
Toledo III	10.04 →	RHD	+ / -	11	> 20	- -		CC1298 80000602		207x269x34
Skoda										
Fabia I	08.99 →		+ / -	11	10-20	CP1074 21652356		CC1074 21652357		252x216x32
Fabia II	12.06 →		+ / -	11	10-20	CP1074 21652356		CC1074 21652357		252x216x32





Skoda										
Octavia	09.96 →		+ / -	4	> 20	CP1027 21651912		CC1027 21651955		279x207x25
Octavia	09.96 →	w F	+ / -	4	> 20	CP1279 80000817		- -		296x227x28
Octavia II	06.04 →		+ / -	11	10-20	CP1129 21653024		CC1129 21653008		207x269x34
Octavia II	06.04 →	RHD	+ / -	11	10-20	- -		CC1298 80000602		207x269x34
Roomster	09.06 →		+ / -	11		CP1074 21652356		CC1074 21652357		252x216x32
Superb	02.02 →		+ / -	4	> 20	CP1027 21651912		CC1027 21651955		279x207x25
Superb	07.08 →		+ / -			CP1129 21653024		CC1129 21653008		207x269x34
Ssangyong										
Actyon	11.05 →	Set	+ / -			CP1361 80001439	<b>NEW</b>	CC1361 80001440	<b>NEW</b>	221x96x25
Kryon	05.05 →	Set	+ / -			CP1361 80001439	<b>NEW</b>	CC1361 80001440	<b>NEW</b>	221x96x25
Rexton (manuel)	04.02 →	Set		10		CP1254 80000653		CC1254 80000800		270x99x20
Subaru										
Impreza	10.00 →		-	10		CP1177 80000164		- -		210x185x30
Justy III	09.03 →		+	11		CP1072 21652350		CC1072 80000758		235x193x15
Legacy IV	09.03 →	LHD + RHD	+	10		CP1078 21652539		CC1078 80000745		217x213x17
Legacy V	09.09 →		+			CP1227 80000604		CC1227 80000605		209x194x30
Outback	10.00 → 08.03	LHD + RHD	+	10		CP1078 21652539		CC1078 80000745		217x213x17
Outback II	09.03 →	LHD + RHD	+	10		CP1078 21652539		CC1078 80000745		217x213x17
Tribeca	01.05 →	LHD + RHD	+			CP1078 21652539		CC1078 80000745		217x213x17
Suzuki										
Alto	01.09 →		+ / -			CP1364 80001444	<b>NEW</b>	CC1364 80001445	<b>NEW</b>	193x162x18
Grand Vitara	10.05 →		+ / -	10	> 20	CP1262 80000676		CC1262 80000770		194x270x20

**Suzuki**































Grand Vitara (FT / GT)	03.98 → 11.02	Set	+ / -	10			<b>CP1317</b> 80001023		- -		230x110x18
Grand Vitara (FT / GT)	11.02 → 10.05		+ / -	10	> 20		<b>CP1258</b> 80000657		<b>CC1258</b> 80000785		258x198x30
Ignis II	09.03 →		+	11	> 20		<b>CP1072</b> 21652350		<b>CC1072</b> 80000758		235x193x15
Jimny	09.98 →		+ / -				<b>CP1365</b> 80001446		<b>CC1365</b> 80001447		215x185x20
Liana	07.01 →		+ / -				<b>CP1329</b> 80001172		<b>CC1329</b> 80001173		200x190x17
Splash	01.08 →		+ / -	10			<b>CP1324</b> 80001036		<b>CC1324</b> 80001744		230x142x30
Swift III	01.05 →		+	11	10-20		<b>CP1226</b> 80000603		<b>CC1226</b> 80000763		185x178x30
SX4	06.06 →		+	10	10-20		<b>CP1226</b> 80000603		<b>CC1226</b> 80000763		185x178x30
Wagon R (EM)	02.98 → 05.00		+	11	> 20		<b>CP1072</b> 21652350		<b>CC1072</b> 80000758		235x193x15

**Toyota**











4 Runner	01.03 →	LHD + RHD	+				<b>CP1078</b> 21652539		<b>CC1078</b> 80000745		217x213x17
Auris	03.07 →		+	10			<b>CP1227</b> 80000604		<b>CC1227</b> 80000605		209x194x30
Avensis I	09.97 → 02.03	Set	+	10	> 20		<b>CP1107</b> 21652897		- -		239x292x19
Avensis II	04.03 →	LHD + RHD	+	10	> 20		<b>CP1106</b> 21652874		<b>CC1106</b> 80000438		200x220x20
Avensis Verso	08.01 →	LHD + RHD	+ / -	10	> 20		<b>CP1078</b> 21652539		<b>CC1078</b> 80000745		217x213x17
Aygo	07.05 →		+	11	10-20		<b>CP1259</b> 80000662		<b>CC1259</b> 80000784		226x165x45
Camry	08.01 →	LHD + RHD	+ / -	10			<b>CP1078</b> 21652539		<b>CC1078</b> 80000745		217x213x17
Carina	12.97 →	Set	+ / -	10	> 20		<b>CP1107</b> 21652897		- -		239x292x19
Celicia	11.99 →	LHD + RHD	+ / -	10	> 20		<b>CP1078</b> 21652539		<b>CC1078</b> 80000745		217x213x17
Corolla (E11)	04.97 → 01.02		+ / -	10	> 20		<b>CP1105</b> 21652873		- -		206x220x20
Corolla (E12)	01.02 →	LHD + RHD	+ / -	10	> 20		<b>CP1106</b> 21652874		<b>CC1106</b> 80000438		200x220x20



## Toyota

Corolla Verso	03.04 ->		+ / -			<b>CP1368</b> 80001452	 <b>NEW</b>	<b>CC1368</b> 80001453	 <b>NEW</b>	194x213x20
iQ	01.09 ->		+ / -			<b>CP1341</b> 80001208	 <b>NEW</b>	<b>CC1341</b> 80001209	 <b>NEW</b>	273x167x10
Land Cruiser	01.03 ->	LHD + RHD	+ / -	10	> 20	<b>CP1078</b> 21652539		<b>CC1078</b> 80000745		217x213x17
Picnic	05.01 ->	LHD + RHD	+ / -	10	> 20	<b>CP1085</b> 21652551		<b>CC1085</b> 80000419		214x213x17
Previa	08.00 ->	LHD + RHD	+ / -	10	> 20	<b>CP1078</b> 21652539		<b>CC1078</b> 80000745		217x213x17
Prius	05.00 -> 12.03	LHD + RHD	+ / -	10	> 20	<b>CP1085</b> 21652551		<b>CC1085</b> 80000419		214x213x17
Prius	01.04 ->	LHD + RHD	+ / -	10	> 20	<b>CP1078</b> 21652539		<b>CC1078</b> 80000745		217x213x17
Prius	01.09 ->		+ / -			<b>CP1227</b> 80000604		<b>CC1227</b> 80000605		209x194x30
RAV 4 II	06.00 -> 03.06	LHD + RHD	+ / -	10	> 20	<b>CP1085</b> 21652551		<b>CC1085</b> 80000419		214x213x17
RAV 4 III	04.06 ->		+ / -	10		<b>CP1227</b> 80000604		<b>CC1227</b> 80000605		209x194x30
Urban Cruiser	04.09 ->		+ / -			<b>CP1227</b> 80000604		<b>CC1227</b> 80000605		209x194x30
Verso	04.09 ->		+ / -			<b>CP1227</b> 80000604		<b>CC1227</b> 80000605		209x194x30
Yaris / Yaris Verso (french production)	04.99 ->	LHD + RHD	+ / -	10	> 20	<b>CP1078</b> 21652539		<b>CC1078</b> 80000745		217x213x17
Yaris / Yaris Verso (japanese production)	04.99 ->	LHD + RHD	+ / -	10	> 20	<b>CP1085</b> 21652551		<b>CC1085</b> 80000419		214x213x17
Yaris	01.06 ->		+ / -	10		<b>CP1227</b> 80000604		<b>CC1227</b> 80000605		209x194x30

## Volvo

440 / 460 / 480	04.86 -> 12.96		+ / -		< 10	<b>CP1315</b> 80001025		-		335x106x29
850	06.91 -> 12.96		+ / -	4	10-20	<b>CP1052</b> 21651986		<b>CC1052</b> 80000744		270x169x30
C70	06.97 -> 06.00		+ / -	4	10-20	<b>CP1052</b> 21651986		<b>CC1052</b> 80000744		270x169x30
C70	07.00 ->		+	11	10-20	<b>CP1060</b> 21652317		<b>CC1060</b> 21652996		241x272x25
C70	07.00 ->	RHD	+	11	10-20	<b>CP1208</b> 80000412		<b>CC1208</b> 80000069		275x242x25



Volvo										
C70 II Cabrio	03.06 →		+	12		<b>CP1153</b> 80000061		<b>CC1153</b> 80000062		235x209x35
S40	07.95 → 12.03		+	11	< 10	<b>CP1073</b> 21652351		<b>CC1073</b> 21653069		203x219x19
S40	01.04 →		+	12	> 20	<b>CP1153</b> 80000061		<b>CC1153</b> 80000062		235x209x35
S60	11.00 →		+	11	10-20	<b>CP1060</b> 21652317		<b>CC1060</b> 21652996		241x272x25
S60	11.00 →	RHD	+	11	10-20	<b>CP1208</b> 80000412		<b>CC1208</b> 80000069		275x242x25
S70	06.97 → 11.00		+ / -	4	10-20	<b>CP1052</b> 21651986		<b>CC1052</b> 80000744		270x169x30
S70	07.00 →		+	11	10-20	<b>CP1060</b> 21652317		<b>CC1060</b> 21652996		241x272x25
S70	07.00 →	RHD	+	11	10-20	<b>CP1208</b> 80000412		<b>CC1208</b> 80000069		275x242x25
S80	05.98 → 07.06		+	11	10-20	<b>CP1060</b> 21652317		<b>CC1060</b> 21652996		241x272x25
S80	05.98 → 07.06	RHD	+	11	10-20	<b>CP1208</b> 80000412		<b>CC1208</b> 80000069		275x242x25
S80 II	03.06 →		+	11		<b>CP1264</b> 80000712		<b>CC1264</b> 80000713		270x193x30
S90 / V90	01.97 → 05.98		+ / -	3	> 20	<b>CP1052</b> 21651986		<b>CC1052</b> 80000744		270x169x30
V40	07.95 → 06.04		+	11	< 10	<b>CP1073</b> 21652351		<b>CC1073</b> 21653069		203x219x19
V50	04.04 →		+	12	> 20	<b>CP1153</b> 80000061		<b>CC1153</b> 80000062		235x209x35
V70 I	01.97 → 05.00		+ / -	4	10-20	<b>CP1052</b> 21651986		<b>CC1052</b> 80000744		270x169x30
V70 II	03.00 →		+	11	10-20	<b>CP1060</b> 21652317		<b>CC1060</b> 21652996		241x272x25
V70 II	03.00 →	RHD	+	11	10-20	<b>CP1208</b> 80000412		<b>CC1208</b> 80000069		275x242x25
V70 III	08.07 →		+	11		<b>CP1264</b> 80000712		<b>CC1264</b> 80000713		270x193x30
XC70 Cross Country	03.00 →		+ / -	10	10-20	<b>CP1060</b> 21652317		<b>CC1060</b> 21652996		241x272x25
XC70 Cross Country	03.00 →	RHD	+	10	10-20	<b>CP1208</b> 80000412		<b>CC1208</b> 80000069		275x242x25



Volvo										
XC70 II	08.07 →		+	11		CP1264 80000712		CC1264 80000713		270x193x30
XC90	10.02 →		+ / -	11	10-20	CP1060 21652317		CC1060 21652996		241x272x25
XC90	10.02 →	RHD	+	11	10-20	CP1208 80000412		CC1208 80000069		275x242x25
VW										
Beetle	01.98 →		+ / -	4	10-20	CP1027 21651912		CC1028 21651967		279x207x25
Bora	10.98 → 05.05		+ / -	4	10-20	CP1027 21651912		CC1028 21651967		279x207x25
Caddy II	11.95 → 01.04		+ / -	4	10-20	CP1027 21651912		CC1027 21651955		279x207x25
Caddy II	11.95 → 01.04	w F	+ / -	4	10-20	CP1279 80000817		- -		296x227x28
Caddy III	03.04 →		+ / -	11	10-20	CP1129 21653024		CC1129 21653008		207x269x34
Caddy III	03.04 →	RHD	+	11	10-20	- -		CC1298 80000602		207x269x34
Crafter	06.05 →		+	1		CP1233 80000614		CC1233 80000616		352x234x35
Eos	03.06 →		+ / -	11		CP1129 21653024		CC1129 21653008		207x269x34
Fox	04.05 →		+ / -	11		CP1074 21652356		CC1074 21652357		252x216x32
Golf I / II	01.84 → 08.93		+ / -	4		CP1239 80000636		CC1239 80000628		180x190x37
Golf III	07.93 → 04.99		+ / -	4	10-20	CP1027 21651912		CC1027 21651955		279x207x25
Golf III	07.93 → 04.99	w F	+ / -	4	10-20	CP1279 80000817		- -		296x227x28
Golf IV	08.97 → 06.05		+ / -	4	10-20	CP1027 21651912		CC1028 21651967		279x207x25
Golf IV	08.97 → 06.05	w F	+ / -	4	10-20	CP1279 80000817		- -		296x227x28
Golf V	10.03 →		+ / -	11	10-20	CP1129 21653024		CC1129 21653008		207x269x34
Golf V	10.03 →	RHD	+	11	10-20	- -		CC1298 80000602		207x269x34
Golf V Plus	01.05 →		+ / -	11	10-20	CP1129 21653024		CC1129 21653008		207x269x34



VW										
Golf V Plus	01.05 →	RHD	+	11	10-20	-		CC1298 80000602		207x269x34
Golf VI	08.08 →		+ / -	10		CP1129 21653024		CC1129 21653008		207x269x34
Jetta III	08.05 →		+ / -	11	10-20	CP1129 21653024		CC1129 21653008		207x269x34
Jetta III	08.05 →	RHD	+ / -	11	10-20	-		CC1298 80000602		207x269x34
LT II	05.96 →		+ / -	1	10-20	CP1044 21651976		CC1044 21652985		379x163x25
Lupo	09.98 → 07.05		+ / -	4	10-20	CP1027 21651912		CC1028 21651967		279x207x25
Passat B4 (3A2-3A5-35I)	08.90 → 07.94	rv	+ / -	4	10-20	CP1225 80000594		-		261x190x67
Passat B4 (3A2-3A5-35I)	08.94 → 05.97		+ / -	4	10-20	CP1023 21651898		CC1023 21651968		248x181x30
Passat (B5)	10.96 → 10.00		+ / -	7	10-20	CP1015 21651890		CC1015 21651956		385x145x25
Passat (B6)	10.00 → 05.05		+ / -	7	10-20	CP1027 21651912		CC1027 21651955		279x207x25
Passat (B7)	03.05 →		+ / -	11		CP1129 21653024		CC1129 21653008		207x269x34
Passat (B7)	03.05 →	RHD	+	11		-		CC1298 80000602		207x269x34
Phaeton	04.02 →	Set	+ / -	14	< 10	-		CC1289 21653031		345x221x30 170x221x30
Polo (6N1, 6N2)	11.94 → 09.01		+ / -	4	10-20	CP1027 21651912		CC1027 21651955		279x207x25
Polo (6N1, 6N2)	11.94 → 09.01	w F	+ / -	4	10-20	CP1279 80000817		-		296x227x28
Polo (9N_)	10.01 →		+ / -	11	10-20	CP1074 21652356		CC1074 21652357		252x216x32
Polo (6R_)	06.09 →		+ / -	11	10-20	CP1074 21652356		CC1074 21652357		252x216x32
Scirocco	09.08 ->		+ / -			CP1129 21653024		CC1129 21653008		207x269x34
Sharan	05.95 →		+ / -	4	10-20	CP1020 21651895		CC1020 21651960		537x110x25
T4, Caravelle	01.96 → 04.03			4	10-20	CP1053 21651987		CC1053 80000028		203x203x103





VW										
T5	04.03 →		+ / -	11	> 20	CP1125 21653020		CC1125 21653015		275x217x30
Tiguan	09.07 →		+ / -			CP1129 21653024		CC1129 21653008		207x269x34
Touareg	10.02 →		+ / -	11	> 20	CP1125 21653020		CC1125 21653015		275x217x30
Touareg	04.10 →		+ / -			CP1403 80001742	NEW	CC1403 80001741	NEW	276x217x5
Touran	02.03 →		+ / -	11	10-20	CP1129 21653024		CC1129 21653008		207x269x34
Touran	02.03 →	RHD	+	11	10-20	-		CC1298 80000602		207x269x34
Vento	11.91 → 09.98		+ / -	4	10-20	CP1027 21651912		CC1027 21651955		279x207x25
Vento	11.91 → 09.98	w F	+ / -	4	10-20	CP1279 80000817		-		296x227x28

# VEHICLE APPLICATIONS

FAHRZEUGANWENDUNGEN | APPLICATIONS | APPLICAZIONI

---



# VEHICLE APPLICATIONS

FAHRZEUGANWENDUNGEN | APPLICATIONS | APPLICAZIONI



Claas								
Mähdrescher / Reaper (all models)			2 !	CP1216 80000449		- -		550x130x29
DAF								
65 CF	02.98 → 12.00		+	CP1126 21653021		- -		432x169x25
75 CF	02.98 → 12.00		+	CP1126 21653021		- -		432x169x25
85 CF	03.98 → 12.00		+	CP1126 21653021		- -		432x169x25
95	09.87 → 01.98		+	CP1196 80000354		- -		265x215x27
CF 85	01.01 →		+	CP1114 21652997		CC1114 80000626		267x157x30
LF 45	01.01 →		+	CP1248 80000645		- -		225x205x20
LF 55	01.01 →		+	CP1248 80000645		- -		225x205x20
XF 95	09.98 → 12.00		+	CP1127 21653022		CC1127 80000623		330x241x25
XF 95	09.02 →		+	CP1114 21652997		CC1114 80000626		267x157x30
Dreiha								
Stadtbus / Citybus	01.95 →		+	CP1197 80000356		CC1197 80000768		448x236x30
Ikarus								
Ikarus				od		- -		
Iveco								
EuroStar	01.93 → 01.04			CP1160 80000075		- -		435x99x35
EuroTech MH	09.98 → 01.04			CP1160 80000075		- -		435x99x35
EuroTech MP	01.92 → 01.04			CP1160 80000075		- -		435x99x35
EuroTech MT	01.92 → 01.04			CP1160 80000075		- -		435x99x35
EuroTrakker	01.93 → 01.04			CP1160 80000075		- -		435x99x35

























Iveco								
Irisbus Access Bus (Roof AC Webasto Aerosphere)	01.02 →		+	CP1184 80000336		- -	455x152x14	
Irisbus Agora (Front Cabinet)	01.03 →			CP1328 80001182		- -	420x100x20	
Irisbus Agora (Roof AC Webasto Aerosphere)	01.03 →		+	CP1184 80000336		- -	455x152x14	
Irisbus Arway (Roof AC Webasto Aerosphere)	01.06 →		+	CP1184 80000336		- -	455x152x14	
Irisbus Axer (Roof AC Webasto Aerosphere)	10.03 → 01.07		+	CP1184 80000336		- -	455x152x14	
Irisbus Citelis (Front Cabinet)	01.05 →		+/-	CP1328 80001182		- -	420x100x20	
Irisbus Citelis (Roof AC Webasto Aerosphere)	09.05 →		+	CP1184 80000336		- -	455x152x14	
Irisbus Domino (Roof AC Webasto Aerosphere)	10.03 →		+	CP1184 80000336		- -	455x152x14	
Irisbus Evadys (Roof AC Webasto Aerosphere)	10.03 →		+	CP1184 80000336		- -	455x152x14	
Irisbus Recreo (Roof AC Webasto Aerosphere)	10.03 → 01.07		+	CP1184 80000336		- -	455x152x14	
Stralis	02.02 →		+	CP1181 80000333		CC1181 80001127		450x206x25
Trakker	10.04 →			CP1181 80000333		CC1181 80001127		450x206x25
John Deere								
5000-6000 series				CP1211 80000444		CC1211 80000627		205x130x40
6010-6610 series	01.99 →	Set	+/-	CP1217 80000535		CC1217 80000796		190x153x30
8010-8020-9000 series			+/-	CP1167 80000115		- -		318x165x48
Komatsu								
Construction vehicle				CP1182 80000334		- -		194x190x15
Construction vehicle				CP1183 80000335		- -		300x200x16
Construction vehicle (D41-D85) series 15			+	CP1212 80000445		- -		251x139x20
Construction vehicle (PC160-340) series 7			+/-	CP1212 80000445		- -		251x139x20
Construction vehicle (WA270-320) series 3		w/o F	+/-	CP1214 80000447		- -		410x140x20























Komatsu								
Construction vehicle (WA320-470) series 3			+/-	<b>CP1213</b> 80000446		- -		250x197x20
Q7			+/-	<b>CP1215</b> 80000448		- -		235x140x20
Linde								
39X series			+	<b>CP1209</b> 80000442		- -		220x118x30
Stapler / Forklift H25T-30			+	<b>CP1210</b> 80000443		- -		168x110x20
MAN								
33 t series	05.94 → 06.96		+	<b>CP1041</b> 21651973		- -		403x181x40
F2000	01.94 →		+	<b>CP1041</b> 21651973		- -		403x181x40
FE series	09.00 →		+	<b>CP1041</b> 21651973		- -		403x181x40
L2000	01.94 →		+	<b>CP1121</b> 21653016		- -		361x158x37
LE series	09.00 →		+	<b>CP1041</b> 21651973		- -		403x181x40
Lions City (Roof AC Konvekta P600 / P700 / P800 / HZ700)	01.04 →		+/-	<b>CP1385</b> 80001583	<b>NEW</b>	- -		390x145x33
Lions Coach	09.95 → 08.02		+	<b>CP1198</b> 80000357		<b>CC1198</b> 80000625		846x247x20
Lions Coach	09.02 →		+	<b>CP1161</b> 80000076		- -		400x132x20
Lions Coach (Roof AC Konvekta ACX632)	01.00 →		+/-	<b>CP1387</b> 80001584	<b>NEW</b>	- -		390x155x17
Lions Coach (Roof AC Webasto Aerosphere Top 2000)	01.00 →		+/-	<b>CP1380</b> 80001579	<b>NEW</b>	- -		490x144x12
Lions Comfort	09.96 →		+	<b>CP1161</b> 80000076		- -		400x132x20
Lions Star	09.95 →		+	<b>CP1198</b> 80000357		<b>CC1198</b> 80000625		846x247x20
M2000	05.94 →		+	<b>CP1041</b> 21651973		- -		403x181x40
ME series	09.00 →		+	<b>CP1041</b> 21651973		- -		403x181x40
NG-NL-NM-NÜ series	09.89 → 07.98		+	<b>CP1197</b> 80000356		<b>CC1197</b> 80000768		448x236x30
NG-NL-NM-NÜ series (Roof AC Konvekta P600 / P700 / P800 / HZ700)	01.98 →		+/-	<b>CP1385</b> 80001583	<b>NEW</b>	- -		390x145x33







MAN								
NG-NL-NM-NÜ series (Roof AC Webasto Aerosphere)	07.98 →		+	<b>CP1184</b> 80000336		- -		455x152x14
TG-A	04.00 →		+	<b>CP1119</b> 21653005		<b>CC1119</b> 80000364		465x179x69
Mercedes - Bus								
Evobus (O404 Fresh Air Filter)	01.91 →			<b>CP1187</b> 80000339		- -		528x220x45
Evobus (O404-O350 Circulation Air Filter)	01.91 →			<b>CP1188</b> 80000340		- -		340x135x34
Evobus (O405-O407-O408)	01.85 →			<b>CP1189</b> 80000341		- -		428x230x40
Evobus Citaro O530	01.98 →			<b>CP1161</b> 80000076		- -		400x132x20
Evobus Citaro O530	01.98 →		+	<b>CP1185</b> 80000337		- -		495x225x48
Evobus Citaro O530 (Roof AC Konvekta P600 / P700 / P800 / HZ700)	01.98 →		+/-	<b>CP1385</b> 80001583	 <b>NEW</b>	- -		390x145x33
Evobus Citaro O530 (Roof AC Webasto Aerosphere Top 2000)	01.98 →		+/-	<b>CP1380</b> 80001579	 <b>NEW</b>	- -		490x144x12
Evobus Citaro O530 (Roof AC Webasto Aerosphere)	01.98 →		+	<b>CP1184</b> 80000336		- -		455x152x14
Evobus Citaro O530 (Front Cabinet AC Webasto Aerosphere)	01.05 →		+/-	<b>CP1395</b> 80001622	 <b>NEW</b>	- -		470x230x20
Evobus Citaro O530 (Front Cabinet AC Webasto)	01.07 →		+/-	<b>CP1386</b> 80001626	 <b>NEW</b>	- -		500x234x50
Evobus Conecto O345 (Roof AC Webasto Aerosphere)	11.01 →		+	<b>CP1184</b> 80000336		- -		455x152x14
Evobus Integro O550	01.91 →		+	<b>CP1124</b> 21653019		- -		337x175x29
Evobus Integro O550 (Roof AC Webasto Aerosphere VT641)	01.97 → 01.06		+/-	<b>CP1394</b> 80001621	 <b>NEW</b>	- -		1550x240x20
Evobus Integro O550	01.06 →		+	<b>CP1242</b> 80000639		<b>CC1242</b> 80000629		492x145x30
Evobus Integro O550 (Roof AC Konvekta P600 / P700 / P800 / HZ700)	01.06 →		+/-	<b>CP1385</b> 80001583	 <b>NEW</b>	- -		390x145x33
Evobus Integro O550 (Roof AC Webasto)	01.06 →		+	<b>CP1244</b> 80000641		<b>CC1244</b> 80000631		454x147x30
Evobus Medio 0815 / 0818	01.00 →		+/-	<b>CP1333</b> 80001180		<b>CC1333</b> 80001181		558x148x40
Evobus Setra				<b>CP1193</b> 80000348		- -		1640x150x12

**Mercedes - Bus**

Evobus Setra 300 series				<b>CP1238</b> 80000635		- -		1490x152x5
Evobus Setra 300 series (Roof AC Webasto Aerosphere VT641)	01.97 → 01.06		+/-	<b>CP1394</b> 80001621	 <b>NEW</b>	- -		1550x240x20
Evobus Setra 400 series	01.01 →			<b>CP1190</b> 80000342		- -		260x150x13
Evobus Setra 400 series	01.01 →		+	<b>CP1242</b> 80000639		<b>CC1242</b> 80000629		492x145x30
Evobus Setra 400 series (Roof AC Webasto)	01.01 →		+	<b>CP1244</b> 80000641		<b>CC1244</b> 80000631		454x147x30
Evobus Setra 400 series (Roof AC Webasto Aerosphere World, Aquasphere-/TopAir)	10.01 →		+/-	<b>CP1390</b> 80001629	 <b>NEW</b>	- -		317x137x7
Evobus Setra 400 series (Roof AC Webasto Aquasphere TC400)	10.02 →		+/-	<b>CP1389</b> 80001628	 <b>NEW</b>	- -		275x116x12
Evobus Setra 400 series (Roof AC Webasto Aquasphere TC400)	10.02 →		+/-	<b>CP1388</b> 80001627	 <b>NEW</b>	-		596x116x12
Evobus Setra 400 series (Roof AC Konvekta P600 / P700 / P800 / HZ700)	01.03 →		+/-	<b>CP1385</b> 80001583	 <b>NEW</b>	- -		390x145x33
Evobus Tourismo O530 (Roof AC Webasto Aerosphere Top 2000)	08.95 →		+/-	<b>CP1380</b> 80001579	 <b>NEW</b>	- -		490x144x12
Evobus Travego O580	10.99 →		+	<b>CP1242</b> 80000639		<b>CC1242</b> 80000629		492x145x30
Evobus Travego O580 (Roof AC Konvekta P600 / P700 / P800 / HZ700)	10.99 →		+/-	<b>CP1385</b> 80001583	 <b>NEW</b>	- -		390x145x33
Evobus Travego O580 (Roof AC Thermoking)	10.99 →			<b>CP1220</b> 80000539		<b>CC1220</b> 80000787		545x200x20
Evobus Travego O580 (Roof AC Thermoking)	10.99 →		+/-	<b>CP1396</b> 80001623	 <b>NEW</b>	- -		1555x150x12
Evobus Travego O580 (Roof AC Webasto Aerosphere)	10.99 →		+	<b>CP1184</b> 80000336		- -		455x152x14
Evobus Travego O580 (Roof AC Webasto)	10.99 →		+	<b>CP1244</b> 80000641		<b>CC1244</b> 80000631		454x147x30

**Mercedes - Truck**

Actros (1831-1835-1840-1843-1848-1853-2031)	01.96 → 10.02	ocv	+	<b>CP1118</b> 21653003		<b>CC1118</b> 21653006		390x145x40
Actros	09.96 → 10.02		+/-	<b>CP1045</b> 21651977		- -		380x133x36
Actros	09.96 → 10.02	w/o F	+	<b>CP1194</b> 80000349		- -		335x100x10
Actros MP2	10.02 →		+/-	<b>CP1045</b> 21651977		- -		380x133x36







## Mercedes - Truck

Actros MP2	10.02 →	w/o F	+	<b>CP1194</b> 80000349		- -		335x100x10
Actros MP2 (1831-1835-1840-1843-1848-1853-2031)	10.02 →	ocv	+	<b>CP1118</b> 21653003		<b>CC1118</b> 21653006		390x145x40
Atego-Axor-Econic (958-860, 972-890, 972-899, 375-830, 375-850)	01.98 → 10.04		+	<b>CP1115</b> 21652998		<b>CC1115</b> 21652999		570x157x40
Atego-Axor-Econic (958-860, 972-890, 972-899, 375-830, 375-850)	01.98 → 10.04	ocv	+	<b>CP1116</b> 21653001		- -		572x160x40
Atego-Axor-Econic (958-870, 958-880, 375-810, 375-820, 375-860, 375-840, 944-899, 944-890, 940-899, 940-890)	01.98 → 10.04		+	<b>CP1120</b> 21653007		<b>CC1120</b> 21653000		456x184x56
Atego-Axor-Econic (958-870, 958-880, 375-810, 375-820, 375-860, 375-840, 944-899, 944-890, 940-899, 940-890)	01.98 → 10.04	ocv	+	<b>CP1287</b> 21652002		- -		446x183x57

## Neoplan

Centroliner	10.98 →		+	<b>CP1197</b> 80000356		<b>CC1197</b> 80000768		448x236x30
Centroliner (Roof AC Webasto Aerosphere)	10.98 →		+	<b>CP1184</b> 80000336		- -		455x152x14
Cityliner (Front Cabinet Heating Webasto)	01.01 → 01.06			<b>CP1382</b> 80001581	<b>NEW</b>	- -		450x190x30
Cityliner	09.04 →		+	<b>CP1198</b> 80000357		<b>CC1198</b> 80000625		846x247x20
Euroliner				<b>CP1198</b> 80000357		<b>CC1198</b> 80000625		846x247x20
Skyliner	09.96 →		+/-	<b>CP1397</b> 80001624	<b>NEW</b>	- -		785x85x15 740x85x15
Skyliner	09.04 →		+	<b>CP1198</b> 80000357		<b>CC1198</b> 80000625		846x247x20
Skyliner (Front Cabinet Heating Webasto)	01.07 →		+/-	<b>CP1382</b> 80001581	<b>NEW</b>	- -		450x190x30
Starliner (Front Cabinet Heating Webasto)	09.96 →		+/-	- -		<b>CC1382</b> 80001580	<b>NEW</b>	395x255x30
Starliner (Rear AC Webasto)	09.96 →		+/-	<b>CP1384</b> 80001582	<b>NEW</b>	- -		290x150x20
Tourliner			+	<b>CP1123</b> 21653018		- -		220x149x20
Tourliner (Roof AC Konvekta ACX632)	01.00 →		+/-	<b>CP1387</b> 80001584	<b>NEW</b>	- -		390x155x17
Tourliner	01.03 →		+	<b>CP1197</b> 80000356		<b>CC1197</b> 80000768		448x236x30
Tourliner (Roof AC Webasto Aerosphere Top 2000)	01.03 →		+/-	<b>CP1380</b> 80001579	<b>NEW</b>	- -		490x144x12

**Neoplan**

Transliner (Front Cabinet Heating Webasto)	09.90 →		+/-	<b>CP1382</b> 80001581		- -		450x190x30
Trendliner	09.04 →		+	<b>CP1198</b> 80000357		<b>CC1198</b> 80000625		846x247x20









**New Holland**

TS-A series	01.03 →		+/-	<b>CP1245</b> 80000642		<b>CC1245</b> 80000789		530x102x60
-------------	---------	--	-----	---------------------------	--	---------------------------	--	------------





**Renault - Bus**

Ares	01.97 →		+/-	<b>CP1232</b> 80000613		<b>CC1232</b> 80000769		390x120x30
------	---------	--	-----	---------------------------	--	---------------------------	---	------------

**Renault - Truck**

Kerax	01.01 → 01.06		+	<b>CP1248</b> 80000645		- -		225x205x20
Kerax	01.06 →		+/-	<b>CP1392</b> 80001586		- -		200x90x20
Magnum	09.90 →		+/-	<b>CP1391</b> 80001585		- -		292x117x20
Midlum	01.00 →		+	<b>CP1248</b> 80000645		- -		225x205x20
Midlum II	01.06 →		+/-	<b>CP1392</b> 80001586		- -		200x90x20
Premium	01.01 →		+	<b>CP1248</b> 80000645		- -		225x205x20
Premium Distribution / Route	01.05 →		+/-	<b>CP1392</b> 80001586		- -		200x90x20
Premium Lander	01.05 →		+/-	<b>CP1392</b> 80001586		- -		200x90x20

**Scania**

94-114-124-144-164 series	01.96 →		+/-	<b>CP1200</b> 80000362		- -		237x177x70
Series 2 and 3	01.76 → 05.88		+	<b>CP1249</b> 80000646		- -		355x250x50
Series 4 (E/R)	09.95 → 09.04		+	<b>CP1195</b> 80000350		- -		232x162x10
Series P, G, R, T	03.04 →		+/-	<b>CP1410</b> 80001732		- -		378x138x20

**Van Hool**

A-series / A308-A330-AG300 (Roof AC Webasto Aerosphere World, Aquasphere-/TopAir)			+/-	<b>CP1390</b> 80001629		- -		317x137x7
---	--	--	-----	---------------------------	--	--------	--	-----------

**Volvo - Truck**

7700 - 8700 - 9700	01.99 →		+	<b>CP1241</b> 80000638		<b>CC1241</b> 80000782		410x180x30
--------------------	---------	--	---	---------------------------	--	---------------------------	---	------------

**Volvo - Truck**

F7 - F10 - F12 - F16	08.77 → 12.94			<b>CP1236</b> 80000633		- -		260x183x46
FE	05.06 →		+/-	<b>CP1392</b> 80001586	<b>NEW</b>	- -		200x90x20
FH12 - FH16 - FH - FM7 - FM9 - FM	08.93 →		+/-	<b>CP1142</b> 21653139		- -		197x197x50
FL2	05.06 →		+/-	<b>CP1392</b> 80001586	<b>NEW</b>	- -		200x90x20
FL4 - FL6 - FL10 - FL - FLC - FS7	09.85 →			<b>CP1235</b> 80000632		- -		235x122x37
Mähdrescher / Reaper (all models)				<b>CP1393</b> 80001620	<b>NEW</b>	- -		395x332x70



# OE-NUMBERS

OE-NUMMERN | CORRESPONDANCES CORTECO-ORIGINE |  
TABELLE COMPARATIVE CORTECO-OEM

---

# OE-NUMBERS

## OE-NUMMERN | CORRESPONDANCES CORTECO-ORIGINE | TABELLE COMPARATIVE CORTECO-OEM



OE	NR	CORTECO	SET
<b>Alfa Romeo</b>			
46409630		21651915	Partikel
46409630	•	21651951	Combi
46721923		21651915	Partikel
46722335		21651954	Combi
46722335	•	80000376	Partikel
46799653		21652352	Combi
46799653	•	80000375	Partikel
52407563		80000346	Combi
55702456	•	80000777	Combi
55702468	•	80000777	Combi
6065364		21651952	Combi
60653641	•	21651901	Partikel
60653641		21651952	Combi
60653642		21651953	Combi
60653642	•	21651970	Partikel
60814643		21651954	Combi
60814643	•	80000376	Partikel
60815647	•	21651901	Partikel
60815647		21651952	Combi
71712595		21651915	Partikel
71712595	•	21651951	Combi
71712596		21651915	Partikel
71712596	•	21651951	Combi
77343481		80000345	Partikel
77363370		80000346	Combi
7797229		21651896	Partikel
82398550		21651896	Partikel
E3146721923	•	21651951	Combi
<b>Audi</b>			
1H0819638A		21651912	Partikel
1H0819644		21651912	Partikel
1H0819644A		21651912	Partikel
1H0819644B		21651912	Partikel
1K0819644		21653024	Partikel
1K0819644A		21653024	Partikel
1K0819644B		21653024	Partikel
4A0091800		21651958	Combi
4A0819430A	•	21651957	Combi
4A0819439A		21651914	Partikel
4A1820367		21651913	Partikel
4B0091800		21651957	Combi
4B0819439A	•	21651957	Combi
4B0819439C		21652713	Combi
4D0819439		21653023	Partikel
4D0819439A		21652552	Combi
4E0819439A		21652898	Combi
4E0819439A	•	80000343	Partikel
4F0819439		21653067	Partikel
4F0819439A		21653066	Combi
6Q0819653		21652357	Combi
6Q0820367		21652356	Partikel
6Q0820367S		21652357	Combi
6R0819653		21652356	Partikel
6R0819653		21652357	Combi
7H0819631A		21653015	Combi
893091700		21651956	Combi

OE	NR	CORTECO	SET
<b>Audi</b>			
893819429		21651956	Combi
8A0819439		21651890	Partikel
8A0819439A		21651890	Partikel
8D0091800		21651956	Combi
8E0819439		21652689	Partikel
8K0819439		80000879	Partikel
8K0819439A		80000880	Combi
8L0091800		21651955	Combi
<b>BMW</b>			
64110008138		21651882	Combi
64111393241		80000073	Partikel
64111393489		21651198	Partikel
64111393489	•	80000359	Combi
64116915763		21652849	Partikel
64116915764		21652852	Combi
64116921018		21652848	Partikel
64116921019		21652851	Combi
64116945593		80000847	Partikel
64116945594		80000848	Combi
64118363274		80000022	Partikel
64118390377		21653030	Partikel
64118390447		21651881	Combi
64118391198		21651897	Partikel
64118391200		21651882	Combi
64119069895		21651198	Partikel
64119069895	•	80000359	Combi
64119070073		21651882	Combi
64119163328	•	80001210	Partikel
64119163329		80001211	Combi
64119404386		80000073	Partikel
64311000004		21651969	Partikel
64311390836		21651197	Partikel
64311390836	•	80000377	Combi
64311394093		80001488	Partikel
64311496710		21652850	Partikel
64311496711		21652853	Combi
64316915763		21652849	Partikel
64316915764		21652852	Combi
64316935822		21653063	Partikel
64316935823		21653064	Combi
64316945585		80000847	Partikel
64316945586		80000848	Combi
64316946628		80000064	Combi
64316946629		80000063	Partikel
64316962549		80000064	Combi
64318350016		21651888	Partikel
64318361899		21651969	Partikel
64318363274		80000022	Partikel
64318409043		80000065	Partikel
64318409044		21652916	Combi
64319069926		21651881	Combi
64319069927		21651897	Partikel
64319070072		21651881	Combi
64319071933		80000022	Partikel
64319071934		21651969	Partikel
64319071935		21652336	Combi

OE	NR	CORTECO	SET
<b>BMW</b>			
64319127515		80000740	Partikel
64319127516		80000741	Combi
64319142114		80000063	Partikel
64319142115		80000064	Combi
64319159606		80001029	Combi
64319195193		21652849	Partikel
64319195194		21652852	Combi
<b>Chevrolet</b>			
4803883		80000877	Partikel
95947238		80001722	Partikel
95947238		80001723	Combi
96296618		80001738	Partikel
96327366		80001738	Partikel
96425700		80000869	Partikel
96425700	•	80000870	Combi
96440878		80000877	Partikel
96539649		80000155	Partikel
96555003		80000867	Partikel
96555003	•	80000868	Combi
96629614		80000877	Partikel
96800069		80000877	Partikel
<b>Chrysler</b>			
04596501AB	•	80000407	Partikel
04596501AB		80000408	Combi
05013595AA		80000079	Partikel
05013595AA	•	80000415	Combi
05013595AB		80000079	Partikel
05013595AB	•	80000415	Combi
05058040AA		80000082	Partikel
05058040AA	•	80000759	Combi
05058381AA		80001189	Partikel
05058381AA	•	80001190	Combi
05058693AA		80001189	Partikel
05058693AA	•	80001190	Combi
05072176AA		21652855	Combi
05072176AA	•	80000811	Partikel
2108300818		21651961	Combi
2108300918		21651961	Combi
2108301218		21651961	Combi
68033193AA		80001718	Partikel
68033193AA	•	80001719	Combi
68042866AB		80001174	Partikel
68042866AB	•	80001175	Combi
82204691		80000079	Partikel
82204691	•	80000415	Combi
82205905		21652854	Combi
82205905		21653151	Partikel
82208300		80000079	Partikel
82208300	•	80000415	Combi
B66809901		21651961	Combi
B66809902		21651961	Combi
<b>Citroën</b>			
6441H7		21651899	Partikel
6447AK		21651899	Partikel
6447EJ		21653102	Combi
6447EJ	•	80000807	Partikel

Citroën			
6447FF	21652543	Partikel	
6447FG	21653032	Partikel	
6447FG	• 80000344	Combi	
6447H0	21652342	Partikel	•
6447H0	• 80000765	Combi	•
6447H1	21652342	Partikel	•
6447H1	• 80000765	Combi	•
6447HP	21653028	Partikel	
6447HT	21653141	Partikel	
6447HV	21653142	Combi	
6447J0	21651994	Partikel	
6447J0	• 80000432	Combi	
6447KR	21653028	Partikel	
6447LN	80000429	Combi	
6447LV	21651899	Partikel	
6447LZ	21652856	Partikel	
6447NT	21652548	Partikel	
6447NV	21652540	Combi	
6447SP	21653147	Combi	
6447SQ	21653146	Combi	
6447SR	80000077	Combi	
6447SY	21651994	Partikel	
6447SZ	21653146	Combi	
6447TA	21653147	Combi	
6447TC	21653102	Combi	
6447TC	• 80000807	Partikel	
6447TV	80000662	Partikel	
6447TV	• 80000784	Combi	
6447TY	• 80000432	Combi	
6447VX	80000667	Combi	•
6447VY	80000666	Partikel	•
6447XF	80000839	Partikel	•
6447XG	80000615	Combi	•
6447YC	80000815	Partikel	
6447YC	• 80000816	Combi	
6447YK	80000865	Partikel	
6447YN	80000866	Combi	
6447Z4	21651899	Partikel	
6447Z5	21651899	Partikel	
6447ZY	80000853	Partikel	
6447ZY	• 80000854	Combi	
6477TY	21651994	Partikel	
647945	• 80001458	Partikel	
647945	80001459	Combi	
647962	80001027	Partikel	
647962	• 80001171	Combi	
647963	80001027	Partikel	
647963	• 80001171	Combi	
6479A5	80000662	Partikel	
6479A5	80000784	Combi	
95667986	21651899	Partikel	
9636086280	21653028	Partikel	
9682603680	• 80001458	Partikel	
9682603680	80001459	Combi	
Class			
715250	80000449	Partikel	
715251	80000449	Partikel	
Dacia			
7700424098	21651983	Partikel	
7701042499	21651983	Partikel	
Daewoo			
96190645	21652338	Partikel	

Daewoo			
96190646	21652339	Partikel	
96207422	21652340	Partikel	
96207423	21652341	Partikel	
96296618	80001738	Partikel	
96327366	80001738	Partikel	
96331028	80001033	Partikel	•
96539649	80000155	Partikel	
96539649	• 80000773	Combi	
96554378	• 80000783	Combi	
96554421	80000804	Partikel	
DAF			
1322255	21653022	Partikel	
1322255	• 80000623	Combi	
1322259	21653021	Partikel	
1347068	80000354	Partikel	
1362124	21652997	Partikel	
1362168	80000626	Combi	
1600428	80000645	Partikel	
1658991	21653022	Partikel	
1658991	• 80000623	Combi	
1659691	21653021	Partikel	
1791192	21652997	Partikel	
1825427	21653022	Partikel	
1825427	• 80000623	Combi	
1825428	21653021	Partikel	
Daihatsu			
08975B4000100	80000603	Partikel	
08975B4000100	• 80000763	Combi	
99906850M2036	21653033	Combi	
99906850M2036	• 80000812	Partikel	
99906850M2037	• 80001037	Partikel	
99906850M2037	80001038	Combi	
99906850M2038	80000617	Combi	
Dreiha			
300142A	80000356	Partikel	
Ferrari			
65384300	80000668	Partikel	
65384300	• 80000778	Combi	
66855200	80000669	Combi	
Fiat			
1312764080	21651994	Partikel	
1312764080	• 80000432	Combi	
1312766080	21651994	Partikel	
1312766080	• 80000432	Combi	
1475478080	21652342	Partikel	•
1475478080	• 80000765	Combi	•
1475479080	21652342	Partikel	•
1475479080	• 80000765	Combi	•
1484383080	21652856	Partikel	
1497497080	80000865	Partikel	
1497498080	80000866	Combi	
46409630	21651915	Partikel	
46412715	• 21651953	Combi	
46412715	21651970	Partikel	
46442422	21651901	Partikel	
46442422	• 21651952	Combi	
46442422	• 21651953	Combi	
46513960	21652308	Partikel	
46513960	• 80000430	Combi	
46721371	21651894	Partikel	
46721371	• 80000433	Combi	
46721374	21651894	Partikel	

Fiat			
46721374	• 80000433	Combi	
46722862	21651296	Combi	
46723245	21651296	Combi	
46723321	21653026	Partikel	
46723321	• 80000754	Combi	
46723331	• 21651296	Combi	
46723331	21652544	Partikel	
46723435	• 21652538	Combi	
46723435	21653027	Partikel	
46768502	21651901	Partikel	
46768502	• 21651952	Combi	
46770829	21651296	Combi	
46770834	21651296	Combi	
46794399	21652308	Partikel	
46794399	• 80000430	Combi	
46844822	80000621	Combi	
55702456	80000541	Partikel	
55702456	• 80000777	Combi	
55702468	80000541	Partikel	
55702468	• 80000777	Combi	
5908409	21651894	Partikel	
5908409	• 80000433	Combi	
60811242	21651896	Partikel	
60812197	21651915	Partikel	
60812197	• 21651951	Combi	
6447SP	21653147	Combi	
6447TA	21653147	Combi	
7078711	21652899	Partikel	
7078711	• 80000755	Combi	
7079682	21652900	Partikel	
7082301	80000637	Partikel	
7082301	• 80000779	Combi	
71736776	21653027	Partikel	
71736776	• 21653027	Partikel	
71743821	80000603	Partikel	
77362394	21652544	Partikel	
77364063	80000815	Partikel	
77364561	80001027	Partikel	
77364561	• 80001171	Combi	
Ford			
1004051	21651893	Partikel	
1054468	21651895	Partikel	
1054491	21651971	Partikel	•
1062253	21651995	Partikel	
1097670	21650107	Partikel	
1111785	21652959	Combi	
1113627	21651960	Combi	
1119613	21652709	Partikel	
1119616	21652361	Combi	
1120475	21652355	Combi	
1121106	21652354	Combi	
1132312	21652959	Combi	
1132445	21652959	Combi	
1139655	21652355	Combi	
1148366	21651960	Combi	
1204459	21652857	Partikel	
1204464	21652858	Combi	
1221520	21650107	Partikel	
1253223	21650107	Partikel	
1315686	21653034	Partikel	
1315687	21653035	Combi	
1349791	21652361	Combi	





Ford			
1353267		21652360	Partikel
1353267	•	80000751	Combi
1353269		21652858	Combi
1353271		21651893	Partikel
1354952		80000061	Partikel
1354953		80000062	Combi
1557375		80000754	Combi
157H16N619AC		21652709	Partikel
256H19G244AA		21652858	Combi
3401703		21650107	Partikel
3M5J18D543BA		21653034	Partikel
3M5J19G244AA		21653035	Combi
4042703		21652360	Partikel
4042703	•	80000751	Combi
4416570		21652993	Partikel
4416570	•	80000284	Combi
4M5J19G244AA		80000062	Combi
457J19G244AA		21652361	Combi
5029916		21652347	Partikel
5029916	•	80000416	Combi
7180932		21650107	Partikel
7221435		21651971	Partikel
7221435	•	80000793	Combi
8V5118D543		80001128	Partikel
8V5118D543AA		80001128	Partikel
8V5J19G244		80001129	Combi
8V5J19G244AA		80001129	Combi
94BW19N619AB		21650107	Partikel
955116N619AA		80000754	Combi
95GX18N405AC		21651971	Partikel
95VW19N551AA		21651895	Partikel
96FW16N619AB		21651893	Partikel
XS4H16N619AB		21651995	Partikel
YC1H19N619AB		21652360	Partikel
YC1H19N619AB	•	80000751	Combi
YL8419N619AA		21652993	Partikel
YL8419N619AA	•	80000284	Combi
YL8Z19N619AB		21652993	Partikel
YL8Z19N619AB	•	80000284	Combi
Honda			
08R795T3600		21651972	Partikel
08R795T3600	•	80000742	Combi
79370S1AG01		21652359	Partikel
79370S1AG01	•	80000431	Combi
79371SZ3A01		80000179	Partikel
79371SZ3A01	•	80000790	Combi
79831S04003		21651972	Partikel
79831S04003	•	80000742	Combi
79831S2A003		80000410	Partikel
79831S2A003	•	80000411	Combi
79831ST3E01		21651972	Partikel
79831ST3E01	•	80000742	Combi
79831STE010M1		21651972	Partikel
79831STE010M1	•	80000742	Combi
80290ST3E01		21652345	Partikel
80290ST3E01	•	80000428	Combi
80291S2H505		21652990	Partikel
80291S2H505	•	80000439	Combi
80291S2HE01		21652990	Partikel
80291S2HE01	•	80000439	Combi
80291S84A01		80000156	Partikel
80291S84A01	•	80000791	Combi



Honda			
80291S84A010		80000156	Partikel
80291S84A010	•	80000791	Combi
80291SAA505HE		21652989	Partikel
80291SAA505HE	•	80000437	Combi
80291SAAE01		21652989	Partikel
80291SAAE01	•	80000437	Combi
80291ST3505		21652345	Partikel
80291ST3505	•	80000428	Combi
80291ST3515		21652345	Partikel
80291ST3E01		21652345	Partikel
80291ST3E01	•	80000428	Combi
80292S5A003		21652546	Partikel
80292S5A003	•	80000148	Combi
80292S5DA01		21652546	Partikel
80292S5DA01	•	80000148	Combi
80292S6DGG01		21652546	Partikel
80292S6DGG01	•	80000148	Combi
80292S7A003		80000148	Combi
80292SCAE11		21652546	Partikel
80292SCAE11	•	80000148	Combi
80292SDC505HE		80000330	Partikel
80292SDC505HE	•	80000404	Combi
80292SDCA01		80000330	Partikel
80292SDCA01	•	80000404	Combi
80292SHJA41		80000330	Partikel
80292SHJA41	•	80000404	Combi
80292SMGE01		80000620	Partikel
80292SMGE01	•	80000622	Combi
80292SWWG01		80000330	Partikel
80292SWWG01	•	80000404	Combi
80292TF0G01		80001183	Partikel
80292TF0G01	•	80001184	Combi
Hyundai			
97030H1726		80000159	Partikel
97030H1726	•	80000401	Combi
97030H1742		80000651	Partikel
971331E000		80000813	Partikel
971331E000	•	80000814	Combi
971331H000		80000871	Partikel
971331H000	•	80000872	Combi
971331L000		80000872	Combi
971332D000		80000083	Partikel
971332D000	•	80000440	Combi
971332D200		80000852	Partikel
971332E200		80000780	Combi
971332E205		80000652	Partikel
971332E210		80000780	Combi
971332E250		80001214	Partikel
971332E250	•	80001215	Combi
971332E900		80000911	Partikel
971332E900	•	80000912	Combi
971332E910		80000911	Partikel
971332E910	•	80000912	Combi
971332G000		80001176	Partikel
971332G000	•	80001177	Combi
971332H000		80001212	Partikel
971332H000	•	80001213	Combi
971332L000		80000871	Partikel
971333J000		80001448	Partikel
971333J000	•	80001449	Combi
971333J100		80001437	Partikel
971333J100	•	80001438	Combi



Hyundai			
971333K000	•	80000764	Combi
971333K000		80000767	Partikel
974064A900		80001034	Partikel
9761037000		80000157	Partikel
9761037000	•	80000400	Combi
976171C000		80000084	Partikel
976171C000	•	80000441	Combi
976171C200		80000650	Partikel
9761725000		80000157	Partikel
9761725000	•	80000400	Combi
976174H000		80001130	Partikel
976174H000	•	80001131	Combi
976174H900		80001130	Partikel
976174H900	•	80001131	Combi
9761938100		80000158	Partikel
9761938100	•	80000402	Combi
976193C100		80000158	Partikel
976193C100	•	80000402	Combi
976193D000		80000546	Partikel
976193D100		80000546	Partikel
976193D200		80000546	Partikel
99030H1726		80000159	Partikel
99030H1726	•	80000401	Combi
9999Z07008		80001034	Partikel
9999Z07011		80000157	Partikel
9999Z07011	•	80000400	Combi
9999Z07015		80000083	Partikel
9999Z07015	•	80000440	Combi
9999Z07016		80000159	Partikel
9999Z07016	•	80000401	Combi
9999Z07017		80000084	Partikel
9999Z07017	•	80000441	Combi
9999Z07019		80001739	Partikel
9999Z07026		80001214	Partikel
9999Z07026	•	80001215	Combi
Isuzu			
8971117880		80000161	Partikel
8971117880	•	80000774	Combi
8971708040		80000160	Partikel
8971708040	•	80000792	Combi
8973561270		80001731	Partikel
Iveco			
2994583		80001127	Combi
2994769		80000916	Combi
2995965		21651901	Partikel
2995965	•	21651952	Combi
2995966		80000075	Partikel
3799020		80000075	Partikel
3802821		80000915	Partikel
500314688		21651901	Partikel
500314688	•	21651952	Combi
500387947		80000075	Partikel
5006175605		80001182	Partikel
504024890		80000333	Partikel
93162385		80000075	Partikel
93162491		21651901	Partikel
93162491	•	21651952	Combi
Jaguar			
2W9319G244AA		21652991	Combi
2W9319G244AA	•	80000808	Partikel
6W8318D483AA		80000606	Combi
C2C6884		21652991	Combi

Jaguar			
C2C6884	•	80000808	Partikel
C2P2410		80000606	Combi
C2S8619		21652361	Combi
C2S8619		21652709	Partikel
C2Z6525	•	80001178	Partikel
C2Z6525		80001179	Combi
MJD6862		21652711	Partikel
MJD6862	•	80000757	Combi
MJD6863		21652710	Partikel
MJD6863	•	80000756	Combi
XR830254		21652859	Combi
XR830254	•	80000809	Partikel
XR838396		80000607	Partikel
XR849205		21652859	Combi
Jeep			
05013595AA	•	80000415	Combi
05013595AB	•	80000415	Combi
05058381AA		80001189	Partikel
05058693AA		80001189	Partikel
82204691	•	80000415	Combi
82208300	•	80000415	Combi
John Deere			
AL71259		80000535	Partikel •
AL71259	•	80000796	Combi •
L155288		80000444	Partikel
L155288	•	80000627	Combi
RE187966		80000115	Partikel
Kia			
0K2C06152X		80000547	Partikel •
0K2C06152X	•	80000798	Combi •
0K2C06153X		80000547	Partikel •
0K2FA6152X		80000548	Partikel •
0K2FA6152X	•	80000797	Combi •
0K2N16152X		80000656	Partikel •
0K2N16152X	•	80000799	Combi •
0K55361C14		80000537	Partikel
0K55361C14	•	80000776	Combi
0K9A46152X		80000644	Partikel •
0K9A46152X	•	80000801	Combi •
0K9A46152XA		80000644	Partikel •
0K9A46152XA	•	80000801	Combi •
971143B000	•	80000630	Combi
971143B000		80000640	Partikel
9713307000		80000634	Partikel
971331H000		80000871	Partikel
971331H000	•	80000872	Combi
971331H500	•	80001733	Combi •
971331H500		80001734	Partikel •
971331P000		80001454	Partikel
971331P000	•	80001455	Combi
971332E200		80000652	Partikel
971332E200	•	80000780	Combi
971332E210	•	80000780	Combi
971332E900		80000911	Partikel •
971332E900	•	80000912	Combi •
971332E910		80000911	Partikel •
971332E910	•	80000912	Combi •
971332F000		80000655	Partikel
971332F000		80001441	Partikel
971332F000	•	80001442	Combi
971332G000		80001176	Partikel
971332G000	•	80001177	Combi

Kia			
971332K000		80001206	Partikel
971332K000	•	80001207	Combi
971333E270		80001441	Partikel
971333E270	•	80001442	Combi
971333K000		80000767	Partikel
97619FD200		80000654	Partikel •
97619FD200	•	80000795	Combi •
9999207010		80000158	Partikel
9999207010	•	80000402	Combi
Komatsu			
20Y9796261		80000445	Partikel
42356HOP08		80000446	Partikel
42Y07HOP00		80000447	Partikel
42Y07HOP20		80000448	Partikel
77Z9700010		80000334	Partikel
77Z9700020		80000335	Partikel
Konvekta			
H14002484		80000337	Partikel
H14002499		80000076	Partikel
H14003495		80001583	Partikel
Lada			
11188122010		80000998	Partikel
11188122010	•	80000999	Combi
211812202010		80000671	Combi
Lancia			
1475478080		21652342	Partikel •
1475478080	•	80000765	Partikel •
1475479080		21652342	Partikel •
1475479080	•	80000765	Partikel •
1484383080		21652856	Partikel
46409630		21651915	Partikel
46721047		21651892	Partikel
46721047	•	80000760	Combi
467211374		21651894	Partikel
467211374	•	80000433	Combi
46722335		21651954	Combi
46723024		21652694	Combi
46723024	•	80000805	Partikel
46723331		21652544	Partikel
46723435	•	21652538	Combi
60653641	•	21651901	Partikel
60653641		21651952	Combi
60812197		21651915	Partikel
60812197	•	21651951	Combi
60814643		21651954	Combi
60815647	•	21651901	Partikel
60815647		21651952	Combi
77362394		21652544	Partikel
82472557		21651896	Partikel
Landrover			
6G9N180543BA		80000712	Partikel
6G9N19N619		80000713	Combi
BTR8037		80000066	Partikel
BTR8037	•	80000772	Combi
JKR100280		80000060	Partikel
JKR100280	•	80000775	Combi
JKR500010		80000360	Partikel
JKR500020		80000361	Combi
JM0000010		21652916	Combi
JM0000010	•	80000065	Partikel
Lexus			
72880AG000	•	80000745	Combi

Lexus			
72880AG0009P	•	80000745	Combi
8713902020	•	80000605	Combi
8713930010		80000162	Partikel
8713930010	•	80000771	Combi
8713930040	•	80000605	Combi
8713930070	•	80000605	Combi
8713948020		80000162	Partikel
871394802083		80000162	Partikel
8713950030		80000165	Combi
87139YZZ01		80000165	Combi
87139YZZ04		80000162	Partikel
87139YZZ04	•	80000771	Combi
8888020050		80000165	Combi
Linde			
9830210		80000443	Partikel
9832067		80000442	Partikel
MAN			
180412720		80001624	Partikel •
81619100011		21651973	Partikel
81619100018		21653005	Partikel
81619100019		80000364	Combi
81779100012		80000356	Partikel
81779100012	•	80000768	Combi
81779100016		80000336	Partikel
81779720121		80000357	Partikel
81779720121	•	80000625	Combi
81779720148		80000336	Partikel
81779720155		80000356	Partikel
83779100519		80001584	Partikel
83779720608		80001579	Partikel
83779720656		80001583	Partikel
85619500025		21653016	Partikel
88779100002		80000076	Partikel
88779100003		21653018	Partikel
N1011033284		80001624	Partikel •
Maserati			
573228900		21651954	Combi
573228900	•	80000376	Partikel
66855200		80000669	Combi
Mazda			
1E0061J6Y		21652355	Combi
410077732		21651893	Partikel
410077732	•	21652355	Combi
BBP261J6X		80001735	Combi •
BBP261J6X		80001736	Partikel •
BP4K61J6X		80000405	Partikel •
CB1261J6X		80000403	Combi •
CB1261J6X9A		80000403	Combi •
CC2961J6X	•	80000406	Combi •
D65161J6X		80001489	Partikel •
D65161J6X		80001743	Combi •
D65161J6X9A		80001489	Partikel •
D65161J6X9A		80001743	Combi •
DC2161J6X		80001737	Partikel •
DC3561J6X		80000849	Combi •
DD1061P11	•	21652992	Combi
DD1061P11		21653145	Partikel
EC136114Y		21652993	Partikel
EC136114Y	•	80000284	Combi
EC1361J6QA		21652993	Partikel
EC1361J6QA	•	80000284	Combi
EC1361J6XA		21652993	Partikel



Mazda			
EC1361J6XA	•	80000284	Combi
GE6T61J6X		21652860	Partikel •
GE6T61J6X9A		21652860	Partikel •
GE6T61J6X9B		21652860	Partikel •
GE6T61J6XA9A		21652860	Partikel •
GE6T61J6XA9B		21652860	Partikel •
GJ6A61P11		21652992	Combi
GJ6A61P11	•	21653145	Partikel
GJ6A61P119A	•	21652992	Combi
GJ6A61P119A		21653145	Partikel
GJ6A61P11A9B	•	21652992	Combi
GJ6A61P11A9B		21653145	Partikel
GS1D61P11		80001039	Partikel
GS1D61P11	•	80001040	Combi
LDY361J6X		80000208	Combi
LDY461J6X		80000163	Partikel
TA0561J6X		80000689	Partikel •
Mercedes			
0008301118		21651977	Partikel
0008301218		21653003	Partikel
0008301318		21653006	Combi
0008301518		on demand	Partikel
0008303318		21651976	Partikel
0008303418		21653006	Combi
0008356947		21653019	Partikel
0008357047		21653019	Partikel
0018255447		80000336	Partikel
0018350547		80000341	Partikel
0018350647		80001729	Partikel
0018350747		80000349	Partikel
0018351347		80001621	Partikel
0018351547		80000337	Partikel
0018352747		80000076	Partikel
0018353047		21652045	Partikel
0018353047	•	80000427	Combi
0018353447		80001622	Partikel
0018354147		80000342	Partikel
0018354647		80001623	Partikel
0018354747		80000539	Partikel
0018354747	•	80000787	Combi
0018354947		80001579	Partikel
0018355447		80000336	Partikel
0018355547		80001579	Partikel
0018355847		80001629	Partikel
0018356147		80001627	Partikel
0018356247		80001628	Partikel
0018357047	•	80000631	Combi
0018357047		80000641	Partikel
0018357147	•	80000629	Combi
0018357147		80000639	Partikel
0018358747		80001728	Partikel
0018359147		80001626	Partikel
0018359247		80001583	Partikel
0020401236		80000336	Partikel
0066809903		21651294	Combi
1248300118		21651199	Partikel •
1248350047		21651199	Partikel •
1298350047		21651993	Partikel
1298350047	•	80000382	Combi
1408350047		21651887	Partikel
1408350147		21653010	Combi
1408350247		21653002	Partikel



Mercedes			
1408350447		21653011	Combi
1408350547		21651974	Partikel
1638350047		21653029	Partikel
1638350247		21653029	Partikel
1648300218		80000647	Combi •
1648300218	•	80001490	Partikel •
164830021864		80000647	Combi •
164830021864	•	80001490	Partikel •
1688300018		21652688	Partikel
1688300818		21651292	Combi
1698300118		21653144	Partikel
1698300218		21653143	Combi
1718300218		80000806	Partikel
1718300418		80000071	Combi
2028300018		21651196	Partikel
2028300118		21652358	Partikel
2028300218		21652335	Partikel
2028300918		21652861	Combi
2028301018		21652862	Combi
2048300018		80001527	Combi
2048300518		80001527	Combi
2108300018		21651195	Partikel •
2108300018	•	80000421	Combi •
2108300218		80001740	Combi •
2108300318		80001740	Combi •
2108300618		21651196	Partikel
2108300818		21651961	Combi
2108300918		21651961	Combi
2108301018		21651195	Partikel •
2108301018	•	80000421	Combi •
2108301118		80001740	Combi •
2108301218		21651961	Combi •
2118300018		21652865	Combi
2118300218		21652863	Partikel
2118300318		21652865	Combi
2118300418		21652864	Partikel
2118300818		21652865	Combi
2128300018		80001527	Combi
2128300218		80001527	Combi
2218300018		80000538	Combi •
2218300018	•	80001491	Partikel •
2218300718		80000538	Combi •
2308300418		21652812	Combi •
325462150012		80000348	Partikel
3568303118		80000339	Partikel
3568303818		on demand	Partikel
3568303918		on demand	Partikel
3568304218		80000340	Partikel
4638300018	•	21652356	Partikel
4638300018		21652357	Combi
6278350447		80000336	Partikel
6298306560		80000342	Partikel
6388350047		21652045	Partikel
6388350047	•	80000427	Combi
6398350247		21653025	Partikel
6398350347		21653009	Combi
68951A		80000342	Partikel
8441000941		80001621	Partikel
87540008760		80000635	Partikel
9018300018		21651976	Partikel
9018300418		21652985	Combi
9018300518		21651976	Partikel



Mercedes			
9068300218		80000614	Partikel
9068300318		80000616	Combi
9408350047		21653007	Partikel
9408350147		21653000	Combi
9408350247		21652002	Partikel
9738350147		21652998	Partikel
9738350247		21653001	Partikel
9738350347		21652999	Combi
B66809901		21651961	Combi
B66809902		21651961	Combi
B66809903		21651294	Combi
B67582414		21653000	Combi
B67582415		21652002	Partikel
Mini			
64311496710		21652850	Partikel
Mitsubishi			
7803A004		80000853	Partikel
7803A005		80000854	Combi
7803A028		80000068	Combi
MR262425		80000825	Partikel
MR315172		80000643	Partikel •
MR360889		80000824	Partikel
MR398288		80000648	Combi
MR460201		21652867	Partikel •
MR460201	•	80000397	Combi •
MR500058		80000068	Combi
MR958017		21653013	Combi
MR958017	•	80000331	Partikel
MZ311916		80000825	Partikel
MZ311917		21652867	Partikel •
MZ311917	•	80000397	Combi •
MZ3600031		80000824	Partikel
MZ600138		80000824	Partikel
XR315172		80000643	Partikel •
XR315172D		80000643	Partikel •
XR315172D	•	80000794	Combi •
XR315876		21652868	Partikel
XR360889		80000824	Partikel
XR500058		80000068	Combi
XZ311916		80000825	Partikel
XZ311917		21652867	Partikel •
XZ311917	•	80000397	Combi •
Neoplan			
170740200		80001581	Partikel
180412710		80001582	Partikel
180412720		on demand	Partikel
180740200		80001581	Partikel
180740300		80001580	Combi
36779100009		80001581	Partikel
81779100012		80000356	Partikel
81779100012	•	80000768	Combi
8177920121		80000357	Partikel
8177920121	•	80000625	Combi
8177920155		80000356	Partikel
8377920608		80001579	Partikel
N1011033282		80001582	Partikel
N1011034375		80001581	Partikel
N1011034376		80001580	Combi
New Holland			
82034664		80000642	Partikel
82034664	•	80000789	Combi

Nissan			
272743Y700	80000067	Combi	
272747J125	80001024	Partikel	•
27274EA000	80000649	Partikel	
27274EA000	• 80000786	Combi	
272751N626	80001041	Partikel	•
272773Y525	80000810	Partikel	
27277EG000	80001730	Partikel	
27277EN000	80000874	Partikel	
27277EN000	• 80000875	Combi	
27277EN025	80000874	Partikel	
27277EN025	• 80000875	Combi	
27277JN20A	80001204	Partikel	
27277JN20A	• 80001205	Combi	
2729800QAA	80000072	Partikel	
2729800QAA	• 80001170	Combi	
27891-EL00A	80001443	Partikel	
2789100QAA	21651983	Partikel	
2789100QAA	• 80000114	Combi	
278911FE0A	80001720	Partikel	
278911FE0A	• 80001721	Combi	
278914A00C	80001444	Partikel	
27891AX010	80000074	Partikel	
27891BM400	21652346	Partikel	
27891BM400	• 80000746	Combi	
27891BM401	21652346	Partikel	
27891BM401	• 80000746	Combi	
27891BM401KE	21652346	Partikel	
27891BM401KE	• 80000746	Combi	
27891BM410	21652346	Partikel	
278936F600	21652870	Partikel	
278936F600KE	21652870	Partikel	
278939F500	21652347	Partikel	
278939F500	• 80000416	Combi	
278939F500KE	21652347	Partikel	
278939F500KE	• 80000416	Combi	
278939F900	21652347	Partikel	
278939F900	• 80000416	Combi	
95861M68K10	80001444	Partikel	
B72003Y000	80000067	Combi	
B72005M000	21652346	Partikel	
B7277JN20A	80001204	Partikel	
B7277JN20A	• 80001205	Combi	
B727A79925	21652346	Partikel	
B727C79925	80001024	Partikel	•
B729800QAA	21651983	Partikel	
B729800QAA	• 80000114	Combi	
B78911FC0A	80001720	Partikel	
B78911FC0A	• 80001721	Combi	
KE27819C00	80000612	Partikel	
KE27860C00	80000611	Partikel	
KE27870J00	80000610	Partikel	
Opel			
12368753	21651982	Partikel	•
13175553	21651979	Partikel	
13175554	80000021	Combi	
13271190	80001185	Partikel	
13271191	80001186	Combi	
13271192	80001186	Combi	
1718042	80000113	Combi	
1718044	21651964	Combi	
1718045	21651965	Combi	
1718046	80000021	Combi	

Opel			
1718668	80000113	Combi	
1718962	21652046	Combi	•
1808149	21651982	Partikel	•
1808246	80001186	Combi	
1808524	80001185	Partikel	
1808600	21651182	Partikel	
1808602	21651182	Partikel	
1808604	21651184	Partikel	
1808605	21651183	Partikel	
1808606	21651981	Partikel	
1808606	• 80000761	Combi	
1808607	21651185	Partikel	
1808608	21651966	Combi	
1808609	21651982	Partikel	•
1808610	21651979	Partikel	
1808612	21651980	Partikel	
1808613	80000160	Partikel	•
1808617	21652715	Combi	
1808618	21652353	Combi	
1808619	21652714	Partikel	
1808624	21652715	Combi	
4408840	80000072	Partikel	
4408840	• 80001170	Combi	
470483	80000758	Combi	
4705463	21652350	Partikel	
4710210	80001036	Partikel	
4710210	• 80001744	Combi	
4803883	80000877	Partikel	
4803883	• 80000878	Combi	
52420930	80001186	Combi	
52425938	80001185	Partikel	
52470574	21651982	Partikel	•
55702456	80000541	Partikel	
6806612	21651184	Partikel	
6808600	21651182	Partikel	
6808601	21652714	Partikel	
6808604	21652994	Partikel	
6808605	21652995	Combi	
6808606	21651979	Partikel	
6808607	80000021	Combi	
6808610	21651182	Partikel	
6808611	21651980	Partikel	
6808612	21651184	Partikel	
6808613	21651183	Partikel	
6808614	21652353	Combi	
6808615	80000072	Partikel	
6808616	21651966	Combi	
6808617	21652715	Combi	
6808618	21652995	Combi	
6808623	80000541	Partikel	
6808623	• 80000777	Combi	
90360171	21651182	Partikel	
90486282	21651182	Partikel	
90509367	21651184	Partikel	
90510338	21651183	Partikel	
90512706	21651981	Partikel	
90512706	• 80000761	Combi	
90512779	21651185	Partikel	
90520689	21651979	Partikel	
90541317	21651966	Combi	
90559549	21651980	Partikel	
91132374	21652046	Combi	•

Opel			
9118699	80000113	Combi	
9121625	21651964	Combi	
9121626	21651965	Combi	
9121627	80000021	Combi	
9121653	21652046	Combi	•
9162646	21652353	Combi	
9196805	21652350	Partikel	
93165208	21652353	Combi	
93182435	21651182	Partikel	
93182437	21651184	Partikel	
93182438	21651183	Partikel	
93194847	80001036	Partikel	
93194847	• 80001744	Combi	
96440878	80000877	Partikel	
96440878	• 80000878	Combi	
96629614	80000877	Partikel	
96629614	• 80000878	Combi	
96800069	80000877	Partikel	
96800069	• 80000878	Combi	
97170804	80000160	Partikel	•
Peugeot			
002435	21653068	Combi	
002440	21651919	Partikel	
002440	• 80000748	Combi	
002442	80000624	Combi	
002484	80000027	Partikel	
6441EJ	• 80000807	Partikel	
6441H7	21651899	Partikel	
644793	21651891	Partikel	
6447AK	21651899	Partikel	
6447AJ	21651293	Partikel	
6447EZ	21653102	Combi	
6447F2	80000743	Combi	
6447GW	• 21653148	Partikel	
6447GW	21653149	Combi	
6447HP	21653028	Partikel	
6447J0	21651994	Partikel	
6447J0	• 80000432	Combi	
6447K6	21651919	Partikel	
6447K6	• 80000748	Combi	
6447KK	21652548	Partikel	
6447KL	21652540	Combi	
6447KR	21653028	Partikel	
6447LV	21651899	Partikel	
6447LY	21652856	Partikel	
6447P2	21652342	Partikel	•
6447P2	• 80000765	Combi	•
6447P3	21652342	Partikel	•
6447P3	• 80000765	Combi	•
6447PE	21653068	Combi	
6447PG	21652541	Combi	
6447RG	21653102	Combi	
6447S5	21651920	Partikel	
6447SP	21653147	Combi	
6447SQ	21653146	Combi	
6447SR	80000077	Combi	
6447SY	21651994	Partikel	
6447SZ	21653146	Combi	
6447TA	21653147	Combi	
6447TT	80000662	Partikel	
6447TY	21651994	Partikel	
6447TY	• 80000432	Combi	





Peugeot			
6447VX	80000667	Combi	•
6447VY	80000666	Partikel	•
6447XG	80000615	Combi	•
6447YA	80000815	Partikel	
6447YA	• 80000816	Combi	
6447YJ	80000865	Partikel	
6447YL	80000866	Combi	
6447Z4	21651899	Partikel	
6447Z5	21651899	Partikel	
6447ZX	80000853	Partikel	
6447ZX	• 80000854	Combi	
647846	• 80001458	Partikel	
647904	• 80000807	Partikel	
647946	80001459	Combi	
647962	80001027	Partikel	
647962	• 80001171	Combi	
647963	80001027	Partikel	
647963	• 80001171	Combi	
95667986	21651899	Partikel	
9636086280	21653028	Partikel	
Porsche			
95557221910	21653015	Combi	
9587221900	80001741	Combi	
9587221900	• 80001742	Partikel	
98057141901	80000347	Combi	
98057141901	• 80000803	Partikel	
99657121900	21652541	Combi	
99657121901	21652541	Combi	
99657121903	21652541	Combi	
99657221902	21651920	Partikel	
99757121900	21652541	Combi	
Renault			
272770001R	• 80001030	Partikel	•
272770001R	80001031	Combi	•
272771128R	80001450	Partikel	
272771128R	80001451	Combi	
272775374R	80000074	Partikel	
272778970R	• 80001460	Partikel	
272778970R	80001461	Combi	
27891JY10A	• 80001187	Partikel	
27891JY10A	80001188	Combi	
5001010063	80000645	Partikel	
5001823129	80001585	Partikel	
5001833354	80000645	Partikel	
5001844054	80001585	Partikel	
5001867491	80001586	Partikel	
5010502404	80000613	Partikel	
5010502404	• 80000769	Combi	
6025300301	21652687	Partikel	•
6025370624	21652687	Partikel	•
6025372486	21653070	Combi	•
7700424093	21652348	Partikel	
7700424093	• 80000750	Combi	
7700424098	21651983	Partikel	
7700424098	• 80000114	Combi	
7700428820	21651984	Partikel	
7700428820	• 80000436	Combi	
7700834816	21651916	Partikel	
7700834816	• 80000434	Combi	
7700835266	21651298	Partikel	
7700835266	• 80000747	Combi	
7700845219	80000373	Partikel	



Renault			
7700845222	21653140	Partikel	
7700845222	• 80000762	Combi	
7700845811	21651917	Partikel	
7700845811	• 80000435	Combi	
7700846236	80000536	Partikel	
7700846236	• 80000788	Combi	
7701040543	21651917	Partikel	
7701040573	• 80000435	Combi	
7701042499	21651983	Partikel	
7701042499	• 80000114	Combi	
7701047513	21652349	Partikel	
7701047513	• 80000418	Combi	
7701048748	21652550	Partikel	
7701048749	21652542	Combi	
7701050319	80000072	Partikel	
7701050319	• 80001170	Combi	
7701055109	21653071	Partikel	
7701055110	80000080	Partikel	
7701056389	21652871	Partikel	
7701056390	21652872	Combi	
7701059997	80000074	Partikel	
7701062227	80000074	Partikel	
7701064235	80000670	Combi	
7701205278	21651917	Partikel	
7701205278	• 80000435	Combi	
7701205279	80000373	Partikel	
7701205280	80000536	Partikel	
7701205280	• 80000788	Combi	
7701205281	21653140	Partikel	
7701205281	• 80000762	Combi	
7701209837	80001456	Partikel	
7701209837	• 80001457	Combi	
7701409324	21651991	Partikel	
7701409324	• 80000752	Combi	
7701418727	21651900	Partikel	
7701418727	• 80000753	Combi	
7711211700	21652549	Partikel	•
7711211700	• 80000766	Combi	•
Rover			
JKR000030	21653017	Partikel	
JKR100020	80000029	Partikel	
JKR100020	• 80000749	Combi	
JKR100080	21652345	Partikel	
JKR100080	• 80000428	Combi	
JKR100183	21653017	Partikel	
JKR100193	80000070	Combi	
JKX100010	21651972	Partikel	
JKX100010	• 80000742	Combi	
JKY100020	80000029	Partikel	
JKY100020	• 80000749	Combi	
Saab			
12758727	21653115	Combi	
12758727	• 80000409	Partikel	
12758729	21653115	Combi	
12758729	• 80000409	Partikel	
4072211	21651918	Partikel	
4072211	• 80000417	Combi	
4072393	21651918	Partikel	
4072393	• 80000417	Combi	
4541546	21653115	Combi	
4541546	• 80000409	Partikel	
4632493	21653114	Partikel	



Saab			
5047113	21653114	Partikel	
5335948	21653115	Combi	
5335948	• 80000409	Partikel	
5335955	21653115	Combi	
5335955	• 80000409	Partikel	
9179905	21652714	Partikel	
9196343	21652715	Combi	
9625674	21651896	Partikel	
Scania			
1326180	80000350	Partikel	
1379952	80000362	Partikel	
1420197	80000362	Partikel	
1770813	80001732	Partikel	
1791445	80000336	Partikel	
1913500	80001732	Partikel	
1913503	80000362	Partikel	
303520	80000646	Partikel	
Seat			
191091700	80000636	Partikel	
191819638	80000636	Partikel	
1H0091800SE	21651955	Combi	
1H0819638A	21651912	Partikel	
1H0819644	21651912	Partikel	
1H0819644A	21651912	Partikel	
1H0819644B	21651912	Partikel	
1K0819644	21653024	Partikel	
1K0819644A	21653024	Partikel	
1K0819644B	21653024	Partikel	
1K1819653	21653008	Combi	
1K1819653A	21653008	Combi	
1K1819653B	21653008	Combi	
6Q0819653	21652357	Combi	
6Q0820367	21652356	Partikel	
6Q0820367S	21652357	Combi	
6R0819653	21652356	Partikel	
6R0819653	21652357	Combi	
7M0091800SE	21651960	Combi	
7M0819638A	21651895	Partikel	
Skoda			
1H0091800SE	21651955	Combi	
1H0819638A	21651912	Partikel	
1H0819644	21651912	Partikel	
1H0819644A	21651912	Partikel	
1H0819644B	21651912	Partikel	
1K0819644	21653024	Partikel	
1K0819644A	21653024	Partikel	
1K0819644B	21653024	Partikel	
1K1819653	21653008	Combi	
1K1819653A	21653008	Combi	
1K1819653B	21653008	Combi	
6Q0819653	21652357	Combi	
6Q0820367	21652356	Partikel	
6Q0820367S	21652357	Combi	
6R0819653	21652356	Partikel	
6R0819653	21652357	Combi	
Smart (MCC)			
0001110V003	21653014	Combi	
0001110V003	• 80000338	Partikel	
0001110V004	21653014	Combi	
0001110V004	• 80000338	Partikel	
0013871V001	21653013	Combi	
0013871V001	• 80000331	Partikel	

Smart (MCC)			
4518300018	80001035	Combi	
4518350247	80001724	Partikel	
A4548300018	21653013	Combi	
A4548300018	• 80000331	Partikel	
Ssangyong			
68111091A0	80001439	Partikel	•
68111091A0	• 80001440	Combi	
6812008130	80000653	Partikel	•
6812008130	• 80000800	Combi	•
Subaru			
72880AG000	21652539	Partikel	
72880AG000	• 80000745	Combi	
72880AG0009P	21652539	Partikel	
72880AG0009P	• 80000745	Combi	
72880AJ000	80000604	Partikel	
72880AJ000	• 80000605	Combi	
72880FE000	80000164	Partikel	
9586078F10	21652350	Partikel	
GE3210AE000	21652539	Partikel	
Suzuki			
278914A00C	80001444	Partikel	
278914A00C	• 80001445	Combi	
9586062J00000	21652989	Partikel	
9586062J00000	• 80000437	Combi	
9586078F000	21652350	Partikel	
9586081A01	80001446	Partikel	
9586081A01	• 80001447	Combi	
9586081A10	80001446	Partikel	
9586081A10	• 80001447	Combi	
9586081A20	80001446	Partikel	
9586081A20	• 80001447	Combi	
9586154G00	80001172	Partikel	
9586154G00	• 80001173	Combi	
9586154G00000	80001172	Partikel	
9586154G00000	• 80001173	Combi	
9586154J00	80000657	Partikel	
9586154J00	• 80000785	Combi	
9586154J00000	80000657	Partikel	
9586154J00000	• 80000785	Combi	
9586164J00	80000676	Partikel	
9586164J00000	• 80000770	Combi	
9586165D00000	80001023	Partikel	•
95861M68K10	80001444	Partikel	
95861M68K10	• 80001445	Combi	
99000990N0F10	80001023	Partikel	•
Toyota			
72880AG000	• 80000745	Combi	
72880AG0009P	• 80000745	Combi	
8713902020	• 80000605	Combi	
871390D010	80000604	Partikel	
8713930040	• 80000605	Combi	
8713947010	21652539	Partikel	
871394701083	21652539	Partikel	
8713952020	80000604	Partikel	
87139Y7706	80001452	Partikel	
87139Y7706	• 80001453	Combi	
87139Y7713	80001452	Partikel	
87139Y7713	• 80001453	Combi	
87139YZZ08	80000604	Partikel	
885080H010	80000662	Partikel	
8850812010	21652873	Partikel	
8850813010	80001452	Partikel	

Toyota			
8850813010	• 80001453	Combi	
8850820120	21652539	Partikel	
8856802030	21652874	Partikel	
8856802030	• 80000438	Combi	
8856813010	80001452	Partikel	
8856813010	• 80001453	Combi	
8856852010	21652551	Partikel	
8856852010	• 80000419	Combi	
885685201083	21652551	Partikel	
885685201083	• 80000419	Combi	
8856874010	80001208	Partikel	
8856874010	• 80001209	Combi	
8888020020	21652897	Partikel	•
8888020060	21652897	Partikel	•
8888020100	21652897	Partikel	•
8888020110	21652897	Partikel	•
Vauxhall			
1808600	21651182	Partikel	
1808602	21651182	Partikel	
1808607	21651185	Partikel	
1808613	80000160	Partikel	•
1808617	21652715	Combi	
1808624	21652715	Combi	
4803883	80000877	Partikel	
6808600	21651182	Partikel	
6808605	21652995	Combi	
6808610	21651182	Partikel	
6808617	21652715	Combi	
6808618	21652995	Combi	
6808623	• 80000777	Combi	
90360171	21651182	Partikel	
90486282	21651182	Partikel	
90512779	21651185	Partikel	
91160128	80000072	Partikel	
91160128	• 80001170	Combi	
93182435	21651182	Partikel	
96440878	80000877	Partikel	
96629614	80000877	Partikel	
96800069	80000877	Partikel	
97170804	80000160	Partikel	•
Volkswagen			
191091700	• 80000628	Combi	
191091700	80000636	Partikel	
191819638	• 80000628	Combi	
191819638	80000636	Partikel	
1H0091800	21651955	Combi	
1H0819638A	21651912	Partikel	
1H0819638A	80000817	Partikel	
1H0819644	21651912	Partikel	
1H0819644	80000817	Partikel	
1H0819644A	21651912	Partikel	
1H0819644A	80000817	Partikel	
1H0819644B	21651912	Partikel	
1H0819644B	80000817	Partikel	
1J0819644	21651967	Combi	
1J0819644A	21651967	Combi	
1K0819644	21653024	Partikel	
1K0819644A	21653024	Partikel	
1K0819644B	21653024	Partikel	
1K1819653	21653008	Combi	
1K1819653A	21653008	Combi	
1K1819653B	21653008	Combi	

Volkswagen			
1K2819653	80000602	Combi	
1K2819653A	80000602	Combi	
2D0819638	21651976	Partikel	
2D0819638	• 21652985	Combi	
2D0819638A	21651976	Partikel	
2D0819638A	• 21652985	Combi	
2E0819638	80000614	Partikel	
2E0819638A	80000616	Combi	
357091700	80000594	Partikel	
357819638	80000594	Partikel	
3A0091800	21651968	Combi	
3A0819638	21651898	Partikel	
3A0819644	21651898	Partikel	
3B0091800	21651956	Combi	
3D0898644	21653031	Combi	•
6Q0819653	21652357	Combi	
6Q0820367	21652356	Partikel	
6Q0820367S	21652357	Combi	
6R0819653	21652356	Partikel	
6R0819653	21652357	Combi	
703819989	21651987	Partikel	
703819989	• 80000028	Combi	
7D0819989	21651987	Partikel	
7D0819989	• 80000028	Combi	
7H0819631	21653020	Partikel	
7H0819631A	21653015	Combi	
7M0091800	21651960	Combi	
7M0819638A	21651895	Partikel	
7M0819644	21651895	Partikel	
7M3819644	21651960	Combi	
7M3819644A	21651960	Combi	
7P0819631	80001741	Combi	
7P0819631	• 80001742	Partikel	
893091700	21651956	Combi	
893819429	21651956	Combi	
8A0819439A	21651890	Partikel	
Volvo			
10058971	80000633	Partikel	
11005897	80000633	Partikel	
110058971	80000633	Partikel	
11007388	80000633	Partikel	
110073889	80000633	Partikel	
11007848	80001620	Partikel	
1343232	21651986	Partikel	
13432323	21651986	Partikel	
1584575	80000633	Partikel	
15845753	80000633	Partikel	
20559447	80001586	Partikel	
20746873	80000638	Partikel	
20746873	• 80000782	Combi	
21130158	80000638	Partikel	
30612666	21652351	Partikel	
30662349	21653069	Combi	
30676413	21652996	Combi	
30676419	80000069	Combi	
30676484	80000062	Combi	
30767022	80000712	Partikel	
30767024	80000713	Combi	
30780376	80000061	Partikel	
30883952	21653069	Combi	
3465418	80001025	Partikel	
4771477	80000633	Partikel	

Volvo			
47714773		80000633	Partikel
47714779		80000633	Partikel
67744524		80000632	Partikel
70326723		80000638	Partikel
8143691		21653139	Partikel
8687389		80000061	Partikel
9171296		21651986	Partikel
9171756		21652996	Combi
9171757		80000069	Combi
9204626		21652317	Partikel
9204627		80000412	Partikel
9488527	•	80000744	Combi
Webasto			
1100372A		80000336	Partikel

Webasto			
1100372B		80000336	Partikel
1100807A		80001629	Partikel
1100895A		80001628	Partikel
1100895B		80001628	Partikel
1101120A		80001627	Partikel
1101193A		80000336	Partikel
1101194A		80001579	Partikel
1101194B		80001579	Partikel
1101891A	•	80000631	Combi
1101891A		80000641	Partikel
1101891B	•	80000631	Combi
1101891B		80000641	Partikel
1101892A	•	80000629	Combi
1101892A		80000639	Partikel

Webasto			
1102574A		80001180	Partikel
1102574A	•	80001181	Combi
11033282		80001582	Partikel
11033284		80001624	Partikel
11034375		80001581	Partikel
11034376		80001580	Combi
1103462A		80001579	Partikel
1302907A		80001626	Partikel
1302907B		80001626	Partikel
89697A		80001621	Partikel
93350A		80000336	Partikel
94839A		80001622	Partikel



# CROSS REFERENCE LIST

VERGLEICHSLISTE | CORRESPONDANCES CORTECO |

TABELLE COMPARATIVE CORTECO

---

# CROSS REFERENCE LIST

VERGLEICHSLISTE | CORRESPONDANCES CORTECO |  
TABELLE COMPARATIVE CORTECO



Airmatic			
IF0001	21651182	Partikel	
IF0005	21651912	Partikel	
IF0006	21651893	Partikel	
IF0009	21651890	Partikel	
IF0010	21651199	Partikel	•
IF0011	21651198	Partikel	
IF0012	21651197	Partikel	
IF0016	21651894	Partikel	
IF0018	21651899	Partikel	
IF0021	21651898	Partikel	
IF0022	21651916	Partikel	
IF0028	21651913	Partikel	
IF0029	21651914	Partikel	
IF0032	21651979	Partikel	
IF0033	21651980	Partikel	
IF0036	21651987	Partikel	
IF0037	21651897	Partikel	•
IF0041	21651995	Partikel	
IF0046	21652688	Partikel	
IF0049	21651920	Partikel	
IF0050	21651972	Partikel	
IF0054	21651891	Partikel	
IF0055	21651969	Partikel	
IF0058	21652709	Partikel	
IF0059	21652360	Partikel	
IF0061	21652350	Partikel	
IF0062	21652543	Partikel	
IF0063	21652356	Partikel	
IF0064	21652346	Partikel	
IF0065	21652308	Partikel	
IF0068	21652714	Partikel	
IF0069	21652349	Partikel	
IF0070	21652550	Partikel	
IF0071	21652689	Partikel	
IF0072	21651293	Partikel	
IF0074	21652857	Partikel	
IF0075	21652358	Partikel	
IF0079	21652548	Partikel	
IF0080	21653030	Partikel	•
IF0081	80000073	Partikel	•
IF0087	21652994	Partikel	
IF0088	21652546	Partikel	•
IF0103	21653034	Partikel	
IF0104	21653020	Partikel	
IF0107	21652544	Partikel	
IF0108	21653026	Partikel	
IF0117	21652871	Partikel	
IF0126	80000061	Partikel	
IF0137	80000345	Partikel	
IF0141	80000655	Partikel	
IF0142	80000620	Partikel	
IF0143	80000604	Partikel	
IF0147	80000666	Partikel	•
IF0149	80000541	Partikel	
IF0156	80000767	Partikel	
IF0800	21651196	Partikel	



Airmatic			
IF0812	80000084	Partikel	•
IF1001	21651964	Combi	
IF1005	21651955	Combi	
IF1009	21651956	Combi	
IF1015	21651952	Combi	
IF1018	80000077	Combi	
IF1021	21651968	Combi	
IF1028	21651958	Combi	
IF1029	21651957	Combi	
IF1037	21651882	Combi	•
IF1046	21651292	Combi	
IF1058	21652361	Combi	
IF1063	21652357	Combi	
IF1066	21652352	Combi	•
IF1067	21653014	Combi	
IF1068	21652715	Combi	
IF1070	21652542	Combi	
IF1075	21652861	Combi	
IF1076	21653146	Combi	
IF1079	21652540	Combi	
IF1080	21651881	Combi	•
IF1083	21651294	Combi	
IF1087	21652995	Combi	
IF1090	21652538	Combi	
IF1091	21651296	Combi	
IF1093	21652851	Combi	•
IF1095	21653147	Combi	
IF1103	21653035	Combi	
IF1112	21653102	Combi	
IF1117	21652872	Combi	
IF1124	21653013	Combi	
IF1125	21653143	Combi	
IF1126	80000062	Combi	
IF1137	80000346	Combi	
IF1147	80000667	Combi	•
IF115	21653071	Partikel	
IF1800	21651961	Combi	
Bosch			
0986475801	21653068	Combi	
0986AF4000	80000546	Partikel	•
0986AF4006	80000764	Combi	
0986AF4008	80000797	Combi	•
0986AF4010	80001442	Combi	
0986AF4011	80001440	Combi	
0986AF4016	80000330	Partikel	
0986AF4017	21652339	Partikel	
0986AF4099	80000538	Combi	•
0986AF4100	80000083	Partikel	
0986AF4102	80000546	Partikel	•
0986AF4104	80000158	Partikel	
0986AF4105	80000764	Combi	
0986AF4151	80000158	Partikel	
0986AF4163	80000813	Partikel	
0986AF5008	21652992	Combi	
0986AF5020	80000605	Combi	
0986AF5028	21652346	Partikel	



Bosch			
0986AF5040	80000164	Partikel	
0986AF5403	80000636	Partikel	
0986AF5404	21651893	Partikel	
0986AF5405	21651967	Combi	
0986AF5410	21652356	Partikel	
0986AF5412	21651890	Partikel	
0986AF5415	80000403	Combi	•
0986AF5430	21652357	Combi	
0986AF5431	21653024	Partikel	
0986AF5432	21653008	Combi	
0986AF5433	21653066	Combi	
0986BF0538	21651296	Combi	
0986BF0709	21651968	Combi	
0986BF0710	21651954	Combi	
0986BF0711	21651967	Combi	
0986BF0713	21652538	Combi	
1987431001	21651196	Partikel	
1987431002	21651198	Partikel	
1987431003	21651901	Partikel	
1987431005	21651896	Partikel	
1987431006	21651893	Partikel	
1987431007	21651920	Partikel	
1987431008	21651919	Partikel	
1987431009	21651917	Partikel	
1987431010	21651182	Partikel	
1987431011	80000636	Partikel	
1987431012	21651912	Partikel	
1987431013	80000594	Partikel	
1987431014	21651915	Partikel	
1987431015	21651184	Partikel	
1987431016	21651183	Partikel	
1987431017	21651890	Partikel	
1987431018	21650107	Partikel	
1987431019	21651894	Partikel	
1987431020	21651195	Partikel	•
1987431021	21651899	Partikel	
1987431022	21651891	Partikel	
1987431023	21651900	Partikel	
1987431024	21651914	Partikel	
1987431025	21651971	Partikel	•
1987431026	21651972	Partikel	
1987431027	21651916	Partikel	
1987431028	21651895	Partikel	
1987431029	21651892	Partikel	
1987431030	21651185	Partikel	
1987431031	21651981	Partikel	
1987431032	21651197	Partikel	
1987431033	21651913	Partikel	
1987431034	21651984	Partikel	
1987431036	21651969	Partikel	
1987431037	21652688	Partikel	
1987431038	21651980	Partikel	
1987431039	21651983	Partikel	
1987431040	21651979	Partikel	
1987431041	21651888	Partikel	
1987431042	21651994	Partikel	

Bosch			
1987431043	21651976	Partikel	
1987431044	21652045	Partikel	
1987431045	21651995	Partikel	
1987431046	21651918	Partikel	
1987431047	21651986	Partikel	
1987431048	21651293	Partikel	
1987431049	21652687	Partikel	•
1987431050	21651298	Partikel	
1987431051	21651199	Partikel	•
1987431052	21651982	Partikel	•
1987431053	21652345	Partikel	
1987431054	21652543	Partikel	
1987431055	21652359	Partikel	
1987431056	21651987	Partikel	
1987431057	21652356	Partikel	
1987431058	21652347	Partikel	
1987431059	21652308	Partikel	
1987431060	21652342	Partikel	•
1987431061	21652348	Partikel	
1987431062	21651986	Partikel	
1987431063	21652351	Partikel	
1987431064	21652996	Combi	
1987431066	21652350	Partikel	
1987431069	21652349	Partikel	
1987431070	21652358	Partikel	
1987431071	21652689	Partikel	
1987431072	21652544	Partikel	
1987431073	21652709	Partikel	
1987431074	21652546	Partikel	•
1987431075	21652346	Partikel	
1987431076	21652714	Partikel	
1987431079	21652548	Partikel	
1987431081	21652863	Partikel	
1987431082	21652850	Partikel	
1987431083	21653028	Partikel	
1987431084	21652551	Partikel	
1987431085	21652539	Partikel	
1987431088	21652874	Partikel	
1987431091	21652856	Partikel	
1987431093	21653071	Partikel	
1987431094	80000080	Partikel	
1987431095	21651991	Partikel	
1987431096	21653114	Partikel	
1987431097	21653024	Partikel	
1987431113	80000061	Partikel	
1987431150	21651977	Partikel	
1987431151	21651973	Partikel	
1987431152	21653022	Partikel	
1987431153	80000362	Partikel	
1987431154	21653003	Partikel	
1987431155	21652002	Partikel	
1987431156	21653001	Partikel	
1987431157	21652998	Partikel	
1987431159	80000633	Partikel	
1987431162	21653016	Partikel	
1987431163	21653005	Partikel	
1987431164	21653021	Partikel	
1987431166	80000333	Partikel	
1987431168	21653007	Partikel	
1987431169	21652997	Partikel	
1987431300	21651967	Combi	
1987431301	21651961	Combi	

Bosch			
1987431303	21651952	Combi	
1987431306	21652355	Combi	
1987431307	21652541	Combi	
1987431310	21651964	Combi	
1987431312	21651955	Combi	
1987431313	21651968	Combi	
1987431314	21651951	Combi	
1987431315	21651965	Combi	
1987431317	21651956	Combi	
1987431318	21652959	Combi	
1987431324	21651957	Combi	
1987431328	21651960	Combi	
1987431330	21651966	Combi	
1987431333	21651958	Combi	
1987431335	21651961	Combi	
1987431336	21652336	Combi	
1987431337	21651292	Combi	
1987431345	21652354	Combi	
1987431354	80000429	Combi	
1987431357	21652357	Combi	
1987431360	21651954	Combi	
1987431361	21651882	Combi	•
1987431362	21651881	Combi	•
1987431364	21651294	Combi	
1987431365	21651296	Combi	
1987431366	21652353	Combi	
1987431367	21652552	Combi	•
1987431370	21652861	Combi	
1987431371	21652713	Combi	
1987431373	21652361	Combi	
1987431376	21652715	Combi	
1987431377	21652538	Combi	
1987431378	21653014	Combi	
1987431379	21652540	Combi	
1987431380	21652542	Combi	
1987431382	21652853	Combi	
1987431386	21652352	Combi	•
1987431387	21652858	Combi	
1987431397	21653008	Combi	
1987431400	21652872	Combi	
1987431401	21653115	Combi	
1987431409	21653035	Combi	
1987431413	80000062	Combi	
1987431452	80000626	Combi	
1987431454	21653006	Combi	
1987431456	21652999	Combi	
1987431457	21653000	Combi	
1987431458	80000364	Combi	
1987431550	80000158	Partikel	
1987431551	80000400	Combi	
1987431553	80000083	Partikel	
1987431570	80000441	Combi	•
1987431571	80000773	Combi	
1987431953	21652539	Partikel	
1987431955	21652874	Partikel	
1987431963	21652546	Partikel	•
1987432001	21651196	Partikel	
1987432002	21651198	Partikel	
1987432003	21651901	Partikel	
1987432005	21651896	Partikel	
1987432006	21651893	Partikel	
1987432007	21651920	Partikel	

Bosch			
1987432008	21651919	Partikel	
1987432009	21651917	Partikel	
1987432010	21651182	Partikel	
1987432011	80000636	Partikel	
1987432012	21651912	Partikel	
1987432013	80000594	Partikel	
1987432014	21651915	Partikel	
1987432015	21651184	Partikel	
1987432016	21651183	Partikel	
1987432017	21651890	Partikel	
1987432018	21650107	Partikel	
1987432019	21651894	Partikel	
1987432020	21651195	Partikel	•
1987432021	21651899	Partikel	
1987432022	21651891	Partikel	
1987432023	21651900	Partikel	
1987432024	21651914	Partikel	
1987432025	21651971	Partikel	•
1987432026	21651972	Partikel	
1987432027	21651916	Partikel	
1987432028	21651895	Partikel	
1987432029	21651892	Partikel	
1987432030	21651185	Partikel	
1987432031	21651981	Partikel	
1987432032	21651197	Partikel	
1987432033	21651913	Partikel	
1987432034	21651984	Partikel	
1987432036	21651969	Partikel	
1987432037	21652688	Partikel	
1987432038	21651980	Partikel	
1987432039	21651983	Partikel	
1987432040	21651979	Partikel	
1987432041	21651888	Partikel	
1987432042	21651994	Partikel	
1987432043	21651976	Partikel	
1987432044	21652045	Partikel	
1987432045	21651995	Partikel	
1987432046	21651918	Partikel	
1987432048	21651293	Partikel	
1987432049	21652687	Partikel	•
1987432050	21651298	Partikel	
1987432051	21651199	Partikel	•
1987432052	21651982	Partikel	•
1987432053	21652345	Partikel	
1987432054	21652543	Partikel	
1987432055	21652359	Partikel	
1987432056	21651987	Partikel	
1987432057	21652356	Partikel	
1987432058	21652347	Partikel	
1987432059	21652308	Partikel	
1987432060	21652342	Partikel	•
1987432061	21651897	Partikel	•
1987432062	21651986	Partikel	
1987432063	21652351	Partikel	
1987432064	21652317	Partikel	
1987432066	21652350	Partikel	
1987432069	21652349	Partikel	
1987432070	21652358	Partikel	
1987432071	21652689	Partikel	
1987432072	21651296	Combi	
1987432073	21652709	Partikel	
1987432074	21652546	Partikel	•

Bosch			
1987432075	21652346	Partikel	
1987432076	21652714	Partikel	
1987432079	21652548	Partikel	
1987432081	21652863	Partikel	
1987432082	21652850	Partikel	
1987432083	21653028	Partikel	
1987432084	21652551	Partikel	
1987432085	21652539	Partikel	
1987432088	21652874	Partikel	
1987432089	21653140	Partikel	
1987432090	21651984	Partikel	
1987432091	21652856	Partikel	
1987432093	21653071	Partikel	
1987432094	80000080	Partikel	
1987432095	21651991	Partikel	
1987432096	21653114	Partikel	
1987432097	21653024	Partikel	
1987432102	21653063	Partikel	•
1987432103	21652848	Partikel	•
1987432104	80000073	Partikel	•
1987432105	21652338	Partikel	
1987432106	21653026	Partikel	
1987432107	21652899	Partikel	
1987432108	21652900	Partikel	
1987432111	21652994	Partikel	
1987432113	80000061	Partikel	
1987432114	21653020	Partikel	
1987432115	21652989	Partikel	
1987432117	80000403	Combi	•
1987432118	80001041	Partikel	•
1987432119	21652870	Partikel	
1987432120	80000074	Partikel	
1987432121	21652345	Partikel	
1987432150	21651977	Partikel	
1987432151	21651973	Partikel	
1987432152	21653022	Partikel	
1987432153	80000362	Partikel	
1987432155	21652873	Partikel	
1987432156	80001446	Partikel	
1987432157	80000825	Partikel	
1987432158	80000083	Partikel	
1987432159	21652897	Partikel	•
1987432160	80001176	Partikel	
1987432161	80000084	Partikel	•
1987432163	80000405	Partikel	•
1987432164	80000634	Partikel	
1987432166	80000330	Partikel	
1987432167	21652990	Partikel	
1987432170	80000652	Partikel	
1987432171	80000869	Partikel	
1987432172	80001172	Partikel	
1987432173	80000603	Partikel	
1987432175	21652340	Partikel	
1987432176	80000644	Partikel	•
1987432182	21653017	Partikel	
1987432183	80000637	Partikel	
1987432188	80000541	Partikel	
1987432189	80000662	Partikel	
1987432300	21651967	Combi	
1987432301	21651961	Combi	
1987432303	21651952	Combi	
1987432306	21652355	Combi	

Bosch			
1987432307	21652541	Combi	
1987432310	21651964	Combi	
1987432312	21651955	Combi	
1987432313	21651968	Combi	
1987432314	21651951	Combi	
1987432315	21651965	Combi	
1987432317	21651956	Combi	
1987432318	21652959	Combi	
1987432324	21651957	Combi	
1987432328	21651960	Combi	
1987432330	21651966	Combi	
1987432333	21651958	Combi	
1987432335	21651961	Combi	
1987432336	21652336	Combi	
1987432337	21651292	Combi	
1987432345	21652354	Combi	
1987432354	80000429	Combi	
1987432357	21652357	Combi	
1987432360	21651954	Combi	
1987432361	21651882	Combi	•
1987432362	21651881	Combi	•
1987432364	21651294	Combi	
1987432365	21651296	Combi	
1987432366	21652353	Combi	
1987432367	21652552	Combi	•
1987432370	21652861	Combi	
1987432371	21652713	Combi	
1987432373	21652361	Combi	
1987432376	80000621	Combi	
1987432377	21652538	Combi	
1987432378	21653014	Combi	
1987432379	21652540	Combi	
1987432380	21652542	Combi	
1987432382	21652853	Combi	
1987432386	21652352	Combi	•
1987432387	21652858	Combi	
1987432397	21653008	Combi	
1987432398	21653142	Combi	
1987432399	21653149	Combi	
1987432400	21652872	Combi	
1987432401	21653115	Combi	
1987432402	21653064	Combi	•
1987432409	21653035	Combi	
1987432410	21653143	Combi	
1987432411	21652995	Combi	
1987432412	21653102	Combi	
1987432413	80000062	Combi	
1987432422	21653066	Combi	
1987432423	21652898	Combi	
1987432424	80000064	Combi	
1987432425	21652916	Combi	
1987432426	80000648	Combi	
1987432428	21652859	Combi	
1987432431	21653015	Combi	
1987432434	21653013	Combi	
1987432435	80000671	Combi	
1987432436	80000667	Combi	•
1987432437	80000615	Combi	•
1987432482	80000070	Combi	
1987432560	21652338	Partikel	
1987432561	21652340	Partikel	

Cooper			
ACE001	21651890	Partikel	
ACE002	21651912	Partikel	
ACE003	21651182	Partikel	
ACE004	21651899	Partikel	
ACE007	21650107	Partikel	
ACE008	21651184	Partikel	
ACE009	21651896	Partikel	
ACE010	21651196	Partikel	
ACE011	21651919	Partikel	
ACE012	21651920	Partikel	
ACE013	21651900	Partikel	
ACE014	21651916	Partikel	
ACE015	21651983	Partikel	
ACE016	21651895	Partikel	
ACE017	21651893	Partikel	
ACE018	21651971	Partikel	•
ACE020	21651185	Partikel	
ACE021	21651891	Partikel	
ACE022	21651972	Partikel	
ACE023	21651198	Partikel	
ACE024	21651915	Partikel	
ACE025	21651914	Partikel	
ACE026	21651901	Partikel	
ACE027	21651894	Partikel	
ACE028	21651183	Partikel	
ACE029	21651917	Partikel	
ACE032	21651195	Partikel	•
ACE033	21651986	Partikel	
ACE034	21652688	Partikel	
ACE036	21651995	Partikel	
ACE037	21652687	Partikel	•
ACE038	21651954	Combi	
ACE039	21651979	Partikel	
ACE040	21651957	Combi	
ACE041	21651961	Combi	
ACE042	21651960	Combi	
ACE043	21651966	Combi	
ACE044	21651965	Combi	
ACE046	21651977	Partikel	
ACE047	21651967	Combi	
ACE048	21651955	Combi	
ACE049	21651952	Combi	
ACE053	21652959	Combi	
ACE056	21651956	Combi	
ACE057	21652308	Partikel	
ACE058	21652045	Partikel	
ACE061	21651197	Partikel	
ACE066	21652342	Partikel	•
ACE068	21651976	Partikel	
ACE069	21651293	Partikel	
ACE070	21652350	Partikel	
ACE071	21652351	Partikel	
ACE072	21652347	Partikel	
ACE073	21652543	Partikel	
ACE074	21652361	Combi	
ACE075	21653141	Partikel	
ACE076	21652539	Partikel	
ACE077	21652360	Partikel	
ACE078	21652339	Partikel	
ACE079	21653017	Partikel	
ACE080	21652355	Combi	
ACE081	21651973	Partikel	

Cooper			
ACE082	21652873	Partikel	
ACE084	21653005	Partikel	
ACE085	21652916	Combi	
ACE086	21652714	Partikel	
ACE087	21652689	Partikel	
ACE088	21652850	Partikel	
ACE089	21652356	Partikel	
ACE090	21652357	Combi	
ACE091	21651981	Partikel	
ACE092	21651970	Partikel	
Delphi			
LW21059	21653068	Combi	
TSP0325001	21651896	Partikel	
TSP0325002	21651915	Partikel	
TSP0325003	21651890	Partikel	
TSP0325003C	21651956	Combi	
TSP0325004	21651912	Partikel	
TSP0325004C	21651912	Partikel	
TSP0325005	21651198	Partikel	
TSP0325005C	21651198	Partikel	
TSP0325006	21651197	Partikel	
TSP0325007	21651899	Partikel	
TSP0325007C	21651899	Partikel	
TSP0325009	21651901	Partikel	
TSP0325009C	21651952	Combi	
TSP0325010	21651894	Partikel	
TSP0325010C	21651894	Partikel	
TSP0325011	21650107	Partikel	
TSP0325011C	21650107	Partikel	
TSP0325012	21651893	Partikel	
TSP0325012C	21651893	Partikel	
TSP0325013	21651892	Partikel	
TSP0325014	80000376	Partikel	
TSP0325015	21651182	Partikel	
TSP0325015C	21651964	Combi	
TSP0325016	21651184	Partikel	
TSP0325017	21651183	Partikel	
TSP0325018	21651891	Partikel	
TSP0325019	21651920	Partikel	
TSP0325019C	21652541	Combi	
TSP0325020	21651916	Partikel	
TSP0325021	21651917	Partikel	
TSP0325022	80000636	Partikel	
TSP0325024	80000594	Partikel	
TSP0325025	21651898	Partikel	
TSP0325026	21651185	Partikel	
TSP0325027	21651967	Combi	
TSP0325027C	21651967	Combi	
TSP0325028	21651979	Partikel	
TSP0325028C	21651979	Partikel	
TSP0325029	21651895	Partikel	
TSP0325029C	21651895	Partikel	
TSP0325031	21651984	Partikel	
TSP0325031C	21651984	Partikel	
TSP0325032	80000029	Partikel	
TSP0325033	21651972	Partikel	
TSP0325034	21651983	Partikel	
TSP0325034C	21651983	Partikel	
TSP0325035	21653140	Partikel	
TSP0325036	21652687	Partikel	•
TSP0325037	21652348	Partikel	
TSP0325038	21651897	Partikel	•

Delphi			
TSP0325038C	21651882	Combi	•
TSP0325039	21651914	Partikel	
TSP0325040	21651913	Partikel	
TSP0325042	21651994	Partikel	
TSP0325043	21652899	Partikel	
TSP0325044	21652308	Partikel	
TSP0325044C	21652308	Partikel	
TSP0325045	80000075	Partikel	
TSP0325047	21651195	Partikel	•
TSP0325047C	21651195	Partikel	•
TSP0325048	21651995	Partikel	
TSP0325048C	21652354	Combi	
TSP0325050	21652870	Partikel	
TSP0325051	21651980	Partikel	
TSP0325051C	80000113	Combi	
TSP0325052	21652338	Partikel	
TSP0325053	21652340	Partikel	
TSP0325055	21653114	Partikel	
TSP0325056	80000409	Partikel	
TSP0325057	21651986	Partikel	
TSP0325058	21651986	Partikel	
TSP0325058C	21651986	Partikel	
TSP0325059	21652345	Partikel	
TSP0325059C	21652345	Partikel	
TSP0325060	21652342	Partikel	•
TSP0325061	21652688	Partikel	
TSP0325061C	21651292	Combi	
TSP0325062	21651293	Partikel	
TSP0325062C	21653068	Combi	
TSP0325064	21651971	Partikel	•
TSP0325065	21653023	Partikel	•
TSP0325066	21653019	Partikel	
TSP0325070	21651993	Partikel	
TSP0325072	80000062	Combi	
TSP0325072C	21652347	Partikel	
TSP0325077	21651976	Partikel	
TSP0325079	21651296	Combi	
TSP0325080	80000338	Partikel	
TSP0325080C	21653014	Combi	
TSP0325081	21651919	Partikel	
TSP0325083	21652358	Partikel	
TSP0325083C	21652861	Combi	
TSP0325084	21652349	Partikel	
TSP0325085	21652543	Partikel	
TSP0325085C	80000429	Combi	
TSP0325086	21653017	Partikel	
TSP0325088C	21652996	Combi	
TSP0325089	21651900	Partikel	
TSP0325092	80000027	Partikel	
TSP0325096	21651298	Partikel	
TSP0325098	21651982	Partikel	•
TSP0325102	21652350	Partikel	
TSP0325105	21651991	Partikel	
TSP0325106	21652351	Partikel	
TSP0325107	21651196	Partikel	
TSP0325107C	21651961	Combi	
TSP0325108	21652346	Partikel	
TSP0325110	80000375	Partikel	•
TSP0325110C	21652352	Combi	•
TSP0325111	21652356	Partikel	
TSP0325111C	21652357	Combi	
TSP0325112	21652689	Partikel	

Delphi			
TSP0325112C	21652713	Combi	
TSP0325113	21653028	Partikel	
TSP0325113C	21653146	Combi	
TSP0325114	21653032	Partikel	
TSP0325115	21651296	Combi	
TSP0325115C	21651296	Combi	
TSP0325116	21653027	Partikel	
TSP0325116C	21652538	Combi	
TSP0325119	80000403	Combi	•
TSP0325122	80000621	Combi	
TSP0325122C	80000621	Combi	
TSP0325123	21653028	Partikel	
TSP0325123C	21652540	Combi	
TSP0325124	21652550	Partikel	
TSP0325124C	21652542	Combi	
TSP0325129	21652317	Partikel	
TSP0325133	21653151	Partikel	
TSP0325133C	21652854	Combi	
TSP0325139	21652857	Partikel	
TSP0325139C	21652858	Combi	
TSP0325140	21652360	Partikel	
TSP0325141	21652990	Partikel	
TSP0325141C	21652546	Partikel	•
TSP0325148	21652874	Partikel	
TSP0325148C	21652874	Partikel	
TSP0325149	21652551	Partikel	
TSP0325151	21651987	Partikel	
TSP0325152	21651296	Combi	
TSP0325152C	21652544	Partikel	
TSP0325153	80000330	Partikel	
TSP0325154	21651970	Partikel	
TSP0325155	21651969	Partikel	
TSP0325155C	21652336	Combi	
TSP0325158	21652045	Partikel	
TSP0325159	21652850	Partikel	
TSP0325161	80000065	Partikel	
TSP0325162	21652856	Partikel	
TSP0325163	21653026	Partikel	
TSP0325163C	21653026	Partikel	
TSP0325164	21653034	Partikel	
TSP0325164C	21653035	Combi	
TSP0325165	21652990	Partikel	
TSP0325165C	21652990	Partikel	
TSP0325166	80000805	Partikel	
TSP0325167	80000060	Partikel	
TSP0325167C	80000060	Partikel	
TSP0325168	80000066	Partikel	
TSP0325171	21652994	Partikel	
TSP0325171C	21652995	Combi	
TSP0325172	21652871	Partikel	
TSP0325172C	21652872	Combi	
TSP0325173	21652551	Partikel	
TSP0325173C	21652551	Partikel	
TSP0325174	21653024	Partikel	
TSP0325174C	21653008	Combi	
TSP0325175	21652539	Partikel	
TSP0325175C	21652539	Partikel	
TSP0325176	21652992	Combi	
TSP0325176C	21653145	Partikel	
TSP0325178	80000074	Partikel	
TSP0325178C	80000074	Partikel	
TSP0325179	80000546	Partikel	•



Delphi			
TSP0325180	80000061	Partikel	
TSP0325180C	80000062	Combi	
TSP0325181	80001041	Partikel	•
TSP0325182	80000634	Partikel	
TSP0325183	80000807	Partikel	
TSP0325183C	21653102	Combi	
TSP0325184	80000063	Partikel	
TSP0325184C	80000064	Combi	
TSP0325185	80000331	Partikel	
TSP0325185C	21653013	Combi	
TSP0325186	21653144	Partikel	
TSP0325186C	21653144	Partikel	
TSP0325188	21653067	Partikel	
TSP0325189	21651979	Partikel	
TSP0325189C	80000021	Combi	
TSP0325190	80000082	Partikel	
TSP0325191	21653025	Partikel	
TSP0325193	80000072	Partikel	
TSP0325194	21653071	Partikel	
TSP0325194C	21653071	Partikel	
TSP0325195	80000080	Partikel	
TSP0325195C	80000080	Partikel	
TSP0325196	21651294	Combi	
TSP0325196C	21651294	Combi	
TSP0325198C	80000071	Combi	
TSP0325199C	80000647	Combi	•
TSP0325201	80000164	Partikel	
TSP0325202	80000405	Partikel	•
TSP0325203	80000548	Partikel	•
TSP0325204	80000620	Partikel	
TSP0325204C	80000620	Partikel	
TSP0325205	80000541	Partikel	
TSP0325205C	80000777	Combi	
TSP0325206	80000662	Partikel	
TSP0325206C	80000662	Partikel	
TSP0325207C	80000346	Combi	
TSP0325208	21652863	Partikel	
TSP0325208C	21652865	Combi	
TSP0325209	80000155	Partikel	
TSP0325210	80001033	Partikel	•
TSP0325211	80000083	Partikel	
TSP0325212	21653063	Partikel	•
TSP0325212C	21653064	Combi	•
TSP0325213	21653141	Partikel	
TSP0325213C	21653142	Combi	
TSP0325218	80000603	Partikel	
TSP0325218C	80000603	Partikel	
TSP0325219	21652989	Partikel	
TSP0325220	80000084	Partikel	•
TSP0325221	80000871	Partikel	
TSP0325221C	80000871	Partikel	
TSP0325222	80000652	Partikel	
TSP0325223	80000158	Partikel	
TSP0325223C	80000158	Partikel	
TSP0325225	80000360	Partikel	
TSP0325225C	80000361	Combi	
TSP0325226	80000712	Partikel	
TSP0325226C	80000713	Combi	
TSP0325227	80000874	Partikel	
TSP0325227C	80000874	Partikel	
TSP0325228	21652346	Partikel	
TSP0325229	80000666	Partikel	•

Delphi			
TSP0325229C	80000667	Combi	•
TSP0325231	80000676	Partikel	
TSP0325231C	80000676	Partikel	
TSP0325232	80000604	Partikel	
TSP0325232C	80000605	Combi	
TSP0325238	80000869	Partikel	
TSP0325239	80000879	Partikel	
TSP0325239C	80000880	Combi	
TSP0325240	21653020	Partikel	
TSP0325240C	21653015	Combi	
TSP0325243	80000407	Partikel	
TSP0325244	80000815	Partikel	
TSP0325245	80000865	Partikel	
TSP0325246	80000839	Partikel	•
TSP0325246C	80000615	Combi	•
TSP0325247	80000812	Partikel	
TSP0325250	80000813	Partikel	
TSP0325251	80001034	Partikel	
TSP0325252C	80000764	Combi	
TSP0325254	80000915	Partikel	
TSP0325254C	80000916	Combi	
TSP0325255	80000808	Partikel	
TSP0325256	80000655	Partikel	
TSP0325257	80000162	Partikel	
TSP0325259	80000614	Partikel	
TSP0325259C	80000616	Combi	
TSP0325260	80000740	Partikel	
TSP0325260C	80000741	Combi	
TSP0325262	80000649	Partikel	
TSP0325263	80000877	Partikel	
TSP0325263C	80000877	Partikel	
TSP0325264	21653148	Partikel	
TSP0325264C	21653148	Partikel	
TSP0325265	80000853	Partikel	
TSP0325265C	80000853	Partikel	
TSP0325286C	80001214	Partikel	
TSP0325291C	21653115	Combi	
TSP0325296	21652714	Partikel	
TSP0325296C	21651296	Combi	
TSP0325300	80000084	Partikel	•
TSP0325302	21651971	Partikel	•
TSP0325304	21651987	Partikel	
TSP0325305	21653034	Partikel	
TSP0325305C	21653035	Combi	
TSP0325308	21651916	Partikel	
TSP0325309	21652348	Partikel	
TSP0325312	80001036	Partikel	
TSP0325312C	80001036	Partikel	
TSP0325313	80001456	Partikel	
TSP0325314C	80001030	Partikel	•
TSP0325315C	80001460	Partikel	
TSP0325316C	80001208	Partikel	
TSP0325317	80001448	Partikel	
TSP0325318	80001027	Partikel	
Febi			
09140	21650107	Partikel	
09186	21651198	Partikel	
09187	21651197	Partikel	
09408	21651893	Partikel	
09409	21651895	Partikel	
09410	21650107	Partikel	
09429	21651182	Partikel	

Febi			
09430	21651184	Partikel	
09431	21651183	Partikel	
09432	21651185	Partikel	
09433	21651916	Partikel	
09435	21651891	Partikel	
09436	21651971	Partikel	•
09437	21651196	Partikel	
09439	21651195	Partikel	•
09440	21653019	Partikel	
09441	21653019	Partikel	
09443	21651973	Partikel	
09445	21651199	Partikel	•
09446	21651912	Partikel	
09447	21651890	Partikel	
09448	21651913	Partikel	
09449	21651914	Partikel	
09450	21653023	Partikel	•
09466	80000594	Partikel	
09485	21651887	Partikel	
10148	80000633	Partikel	
10152	21653139	Partikel	
11104	21651976	Partikel	
11233	21651979	Partikel	
11235	21651980	Partikel	
11236	21651980	Partikel	
11264	21651917	Partikel	
11265	21653140	Partikel	
11507	21651894	Partikel	
11508	21651896	Partikel	
11509	21651915	Partikel	
11510	21651952	Combi	
11566	21651967	Combi	
11567	21651987	Partikel	
11741	21653010	Combi	
11779	21651974	Partikel	
11981	21652045	Partikel	
12263	21651897	Partikel	•
12264	21651882	Combi	•
12618	21651195	Partikel	•
12711	21651969	Partikel	
14490	21651977	Partikel	
14749	21651986	Partikel	
14770	21651994	Partikel	
14808	21651896	Partikel	
14809	21651918	Partikel	
14815	21650107	Partikel	
14816	21651995	Partikel	
14817	21651292	Combi	
15935	21651991	Partikel	
15939	21651983	Partikel	
15941	21651991	Partikel	
15943	21651983	Partikel	
17151	21651961	Combi	
17159	21651961	Combi	
17160	21652688	Partikel	
17161	21651993	Partikel	
17263	21652715	Combi	
17264	80000621	Combi	
17311	21651899	Partikel	
17312	21651920	Partikel	
17313	80000624	Combi	
17420	21653022	Partikel	

Febi			
17461	21653021	Partikel	
17474	21651296	Combi	
17553	21652354	Combi	
17554	21651960	Combi	
17555	21652959	Combi	
17556	21652355	Combi	
17796	21651957	Combi	
18541	80000364	Combi	
18542	21653016	Partikel	
18543	80000357	Partikel	
18641	21652336	Combi	
18739	80000356	Partikel	
18759	21653005	Partikel	
18877	21651881	Combi	•
18915	21651293	Partikel	
19358	21652317	Partikel	
19409	21652714	Partikel	
19411	21653017	Partikel	
19438	21652360	Partikel	
19439	21652857	Partikel	
19440	21652858	Combi	
19441	21651984	Partikel	
19442	21652346	Partikel	
19446	21652351	Partikel	
19474	80000073	Partikel	•
19538	21652996	Combi	
19588	21652713	Combi	
19590	21652356	Partikel	
19592	21652357	Combi	
19663	21652687	Partikel	•
19726	21652689	Partikel	
19793	21652358	Partikel	
19794	21652335	Partikel	
19967	21652709	Partikel	
19971	21652361	Combi	
19984	21652550	Partikel	
19985	21652542	Combi	
21125	21652916	Combi	
21137	21652548	Partikel	
21139	21652540	Combi	
21289	21653069	Combi	
21308	21653031	Combi	•
21312	21653024	Partikel	
21314	21653008	Combi	
21316	21653020	Partikel	
21318	21653015	Combi	
21361	21652992	Combi	
21601	80000022	Partikel	•
21642	21652861	Combi	
21643	21651294	Combi	
21650	21652851	Combi	•
21651	21652848	Partikel	•
21702	21652552	Combi	•
21742	21652862	Combi	
21930	21652994	Partikel	
21932	21652350	Partikel	
21935	21652349	Partikel	
21952	21653030	Partikel	•
21956	21652348	Partikel	
22009	21652997	Partikel	
22069	21653063	Partikel	•
22070	21653064	Combi	•

Febi			
22095	80000362	Partikel	
22165	21653034	Partikel	
22166	21653035	Combi	
22282	21653067	Partikel	
22284	21653066	Combi	
22378	80000065	Partikel	
22440	21653014	Combi	
22441	21653013	Combi	
22442	21653029	Partikel	
22444	21652985	Combi	
22467	21653114	Partikel	
22793	21653014	Combi	
22841	80000336	Partikel	
23230	80000333	Partikel	
23307	80000076	Partikel	
23407	21652853	Combi	
23409	21652850	Partikel	
23581	80000645	Partikel	
23683	80000064	Combi	
23684	80000063	Partikel	
23716	21652863	Partikel	
23717	80000072	Partikel	
23782	21652865	Combi	
23788	21653013	Combi	
23795	80000074	Partikel	
23802	21653071	Partikel	
23921	80000071	Combi	
24180	80000080	Partikel	
2435	21653068	Combi	
2440	21651919	Partikel	
24411	21652874	Partikel	
24415	21652546	Partikel	•
24423	21652345	Partikel	
24425	21652989	Partikel	
24426	21652990	Partikel	
24427	80000156	Partikel	•
24433	21652551	Partikel	
24434	80000745	Combi	
24439	80000083	Partikel	
24440	80000158	Partikel	
24457	21651972	Partikel	
24490	21652873	Partikel	
24526	80000330	Partikel	
24540	21653102	Combi	
24542	80000546	Partikel	•
24554	21652868	Partikel	
24567	80000634	Partikel	
24569	80000654	Partikel	•
24810	80000403	Combi	•
24827	80000662	Partikel	
26195	80000655	Partikel	
26417	21652856	Partikel	
26419	21652543	Partikel	
26441	21653028	Partikel	
26452	21653032	Partikel	
26678	21653115	Combi	
27243	80000405	Partikel	•
27423	80000780	Combi	
27465	80000605	Combi	
27466	80000159	Partikel	
27529	80000163	Partikel	
9186	21651198	Partikel	

Febi			
9187	21651197	Partikel	
9408	21651893	Partikel	
9409	21651895	Partikel	
9410	21650107	Partikel	
9429	21651182	Partikel	
9430	21651184	Partikel	
9431	21651183	Partikel	
9432	21651185	Partikel	
9433	21651916	Partikel	
9434	21651919	Partikel	
9435	21651891	Partikel	
9436	21651971	Partikel	•
9437	21651196	Partikel	
9440	21653019	Partikel	
9441	21653019	Partikel	
9443	21651973	Partikel	
9445	21651199	Partikel	•
9446	21651912	Partikel	
9447	21651890	Partikel	
9448	21651913	Partikel	
9449	21651914	Partikel	
9450	21653023	Partikel	•
9466	21651898	Partikel	
9476	21651900	Partikel	
9485	21651887	Partikel	
9644	80000594	Partikel	
Fiaam PC			
8002	21651182	Partikel	
8003	21651899	Partikel	
8004	21651890	Partikel	
8005	21651912	Partikel	
8006	21650107	Partikel	
8007	21651184	Partikel	
8008	21651896	Partikel	
8009	21651913	Partikel	
8010	21651183	Partikel	
8011	21651901	Partikel	
8012	21651893	Partikel	
8013	21651915	Partikel	
8014	21651894	Partikel	
8015	21651198	Partikel	
8016	21651196	Partikel	
8017	21651972	Partikel	
8018	21651891	Partikel	
8019	21651919	Partikel	
8020	21651920	Partikel	
8021	21651900	Partikel	
8022	21651916	Partikel	
8023	21651917	Partikel	
8024	21651895	Partikel	
8025	21651892	Partikel	
8026	21651971	Partikel	•
8028	21651185	Partikel	
8030	21652348	Partikel	
8031	21651197	Partikel	
8032	21651914	Partikel	
8033	21651195	Partikel	•
8034	80000636	Partikel	
8035	21652688	Partikel	
8037	21651977	Partikel	
8038	21651984	Partikel	
8039	21651973	Partikel	



Fiaam PC			
8040	80000409	Partikel	
8041	21652687	Partikel	•
8043	21651995	Partikel	
8044	21652308	Partikel	
8045	21651967	Combi	
8046	21651980	Partikel	
8047	21651979	Partikel	
8050	21651986	Partikel	
8051	21651994	Partikel	
8052	21651982	Partikel	•
8053	21651969	Partikel	
8054	21651882	Combi	•
8056	21652342	Partikel	•
8058	21651976	Partikel	
8059	21651983	Partikel	
8060	21651293	Partikel	
8061	80000373	Partikel	
8062	21651957	Combi	
8065	21651961	Combi	
8066	21651960	Combi	
8071	21651956	Combi	
8072	21651955	Combi	
8075	21652349	Partikel	
8076	21653028	Partikel	
8077	21652356	Partikel	
8078	21651881	Combi	•
8080	21652345	Partikel	
8081	21652347	Partikel	
8082	21652351	Partikel	
8083	21652346	Partikel	
8084	21652550	Partikel	
8089	21652359	Partikel	
8091	21652543	Partikel	
8093	21652544	Partikel	
8098	21652360	Partikel	
8100	21652538	Combi	
8103	21652713	Combi	
8107	21651987	Partikel	
8109	21652540	Combi	
8110	21653141	Partikel	
8112	21651991	Partikel	
8115	21652045	Partikel	
8117	21652689	Partikel	
8125	21653005	Partikel	
8128	80000074	Partikel	
8139	21653034	Partikel	
K8036	21651954	Combi	
K8044	80000430	Combi	
K8068	21651952	Combi	
K8070	21651951	Combi	
K8090	21652352	Combi	•
K8097	80000621	Combi	
Filtron			
K1000	21651182	Partikel	
K1000A	21651964	Combi	
K1001	21651183	Partikel	
K1001A	21652353	Combi	
K1002	21651184	Partikel	
K1002A	21651965	Combi	
K1004	21651890	Partikel	
K1004A	21651956	Combi	
K1006	21651912	Partikel	

Filtron			
K1006A	21651955	Combi	
K1007	21651899	Partikel	
K1008	21650107	Partikel	
K1008A	21652959	Combi	
K1009	21651185	Partikel	
K1010	21651893	Partikel	
K1010A	21652355	Combi	
K1011	21652338	Partikel	
K1013	21652340	Partikel	
K1014	21651979	Partikel	
K1014A	80000021	Combi	
K1015	21651198	Partikel	
K1016	21651196	Partikel	
K1016A	21651961	Combi	
K1017	21651972	Partikel	
K1018	21651891	Partikel	
K1019	21651919	Partikel	
K1020	21651920	Partikel	
K1020A	21652541	Combi	
K1021	21651900	Partikel	
K1022	21651916	Partikel	
K1023	21651917	Partikel	
K1024	21651895	Partikel	
K1024A	21651960	Combi	
K1025	21651892	Partikel	
K10263x	21651971	Partikel	•
K1028	21651896	Partikel	
K1029	21653139	Partikel	
K1030	21652348	Partikel	
K1031	21651197	Partikel	
K1032	21651914	Partikel	
K1032A	21651958	Combi	
K1033	21651915	Partikel	
K1034	21651894	Partikel	
K1035	21651901	Partikel	
K1035A	21651952	Combi	
K1036	21651913	Partikel	
K1037	21651987	Partikel	
K1038	21652899	Partikel	
K1039	21651887	Partikel	
K10402x	21652687	Partikel	•
K1041	21651973	Partikel	
K1042	21651977	Partikel	
K1042A	21653006	Combi	
K10442x	21651982	Partikel	•
K1045	21651898	Partikel	
K1045A	21651968	Combi	
K1049	21653016	Partikel	
K1051	21651984	Partikel	
K1052	21651983	Partikel	
K10532x	21651195	Partikel	•
K1054	21651995	Partikel	
K1054A	21652354	Combi	
K1055	21651980	Partikel	
K1056	21651994	Partikel	
K1058	21651991	Partikel	
K1059	80000636	Partikel	
K1060	21652346	Partikel	
K10622x	21652342	Partikel	•
K1063	21652342	Partikel	•
K1064	21653114	Partikel	
K1065	21652688	Partikel	

Filtron			
K1065A	21651292	Combi	
K1066	21651293	Partikel	
K1067	80000373	Partikel	
K1068	80000594	Partikel	
K10692x	21653023	Partikel	•
K1069A2x	21652552	Combi	•
K1070	21651298	Partikel	
K1071	80000027	Partikel	
K10722x	80000022	Partikel	•
K1073A2x	21651881	Combi	•
K1075A2x	21651882	Combi	•
K1076A	21652308	Partikel	
K1078	21652689	Partikel	
K1078A	21652713	Combi	
K1079	21652356	Partikel	
K1079A	21652357	Combi	
K1081	21652714	Partikel	
K1081A	80000621	Combi	
K1082	21652345	Partikel	
K1083	80000745	Combi	
K1087	80000428	Combi	
K1088	21651976	Partikel	
K1088A	21652985	Combi	
K1089	21652550	Partikel	
K1089A	21652542	Combi	
K1090	21652350	Partikel	
K1091	21653022	Partikel	
K1092	21653019	Partikel	
K1093	21653028	Partikel	
K1093A	21652540	Combi	
K1094	80000362	Partikel	
K1095	21653140	Partikel	
K1096	21652347	Partikel	
K1097	21652349	Partikel	
K1101	21652544	Partikel	
K1102	21652543	Partikel	
K1103A	21652538	Combi	
K1104A	21651296	Combi	
K1105A2x	21652352	Combi	•
K1106	21652358	Partikel	
K1106A	21652861	Combi	
K1107	21653032	Partikel	
K1108	21652045	Partikel	
K11092x	80001041	Partikel	•
K1110	21652857	Partikel	
K1110A	21652858	Combi	
K1111	21653024	Partikel	
K1111A	21653008	Combi	
K1113	21652360	Partikel	
K1115	21652351	Partikel	
K1115A	21653069	Combi	
K1116A	21651954	Combi	
K1117A	80000744	Combi	
K1118A	21652898	Combi	
K1119	21652850	Partikel	
K1119A	21652853	Combi	
K1120A	21651294	Combi	
K1121	80000072	Partikel	
K1122	21653026	Partikel	
K1123	21652874	Partikel	
K1125	21653141	Partikel	
K1125A	21653142	Combi	

Filtron			
K1126	21652317	Partikel	
K1126A	21652996	Combi	
K1128	21652856	Partikel	
K1130	21653071	Partikel	
K1131A	21652871	Partikel	
K1133	21653005	Partikel	
K1133A	80000364	Combi	
K11342x	21652897	Partikel	•
K1136	21651969	Partikel	
K1136A	21652336	Combi	
K1137A	21653148	Partikel	
K1138	21652994	Partikel	
K1138A	21652995	Combi	
K1139	21653021	Partikel	
K1140	80000158	Partikel	
K1142	21652998	Partikel	
K1145	21653017	Partikel	
K1145A	80000070	Combi	
K1146A	21652865	Combi	
K1147A	21653102	Combi	
K1149	80000083	Partikel	
K1150	80000061	Partikel	
K1150A	80000062	Combi	
K1151	80000536	Partikel	
K1152	80000074	Partikel	
K1153	21653003	Partikel	
K1154	21653034	Partikel	
K1154A	21653035	Combi	
K1155	21653020	Partikel	
K1155A	21653015	Combi	
K11582x	80001033	Partikel	•
K1159A	21653115	Combi	
K11602x	21653063	Partikel	•
K1160A2x	21653064	Combi	•
K1161	21653145	Partikel	
K1161A	21652992	Combi	
K11622x	21653067	Partikel	
K1162A2x	21653066	Combi	
K1164	21652989	Partikel	
K11652x	21652848	Partikel	•
K1165A2x	21652851	Combi	•
K1168A	21652854	Combi	
K1169	80000063	Partikel	
K1174	21652870	Partikel	
K1176	21652900	Partikel	
K11792x	80000666	Partikel	•
K1179A2x	80000667	Combi	•
K1181	80000164	Partikel	
K1188	21653025	Partikel	
K11982x	21652546	Partikel	•
K1200A2x	80000647	Combi	•
K1201A2x	80000538	Combi	•
K1202A	21653143	Combi	
K12032x	80000548	Partikel	•
K1204A	21653014	Combi	
K1205A	80000071	Combi	
K1207	80000662	Partikel	
K12082x	80000654	Partikel	•
K1209	80000637	Partikel	
K1210	80000604	Partikel	
K12122x	80000405	Partikel	•
K1213	80000657	Partikel	

Filtron			
K1214	80000157	Partikel	
K1215	80000825	Partikel	
K1216A	21653013	Combi	
K1219	80000764	Combi	
K1232	80000652	Partikel	
K1233	80000780	Combi	
K1236	80000603	Partikel	
K1238A	80000866	Combi	
K1240A	80000648	Combi	
Fram			
CF5475	21651182	Partikel	
CF5551	21651899	Partikel	
CF5662	21651890	Partikel	
CF5663	21651912	Partikel	
CF5664	21650107	Partikel	
CF5665	21651184	Partikel	
CF5816	21651183	Partikel	
CF5817	21651893	Partikel	
CF5818	21651894	Partikel	
CF5819	21651901	Partikel	
CF5823	21651915	Partikel	
CF5824	21651913	Partikel	
CF5841	21651896	Partikel	
CF5842	21651196	Partikel	
CF5845	21651919	Partikel	
CF5846	21651920	Partikel	
CF5847	21651900	Partikel	
CF5848	21651916	Partikel	
CF5849	21651917	Partikel	
CF5850	21651895	Partikel	
CF5851	21651892	Partikel	
CF5852A	21651971	Partikel	•
CF5863	21651185	Partikel	
CF5864	21651891	Partikel	
CF5865	21651972	Partikel	
CF5893	21652348	Partikel	
CF5935	21651197	Partikel	
CF5942	21651914	Partikel	
CF5972	21651195	Partikel	•
CF8103	21651198	Partikel	
CF8714	21651986	Partikel	
CF8717	21653029	Partikel	
CF8719	80000066	Partikel	
CF8750	21653032	Partikel	
CF8773	21651977	Partikel	
CF8777	21652688	Partikel	
CF8778	80000409	Partikel	
CF8799	21651984	Partikel	
CF8800	21651973	Partikel	
CF8831	21651995	Partikel	
CF8832	21652687	Partikel	•
CF8838	21651983	Partikel	
CF8867	21651980	Partikel	
CF8868	21651979	Partikel	
CF8890	21651994	Partikel	
CF8913	21651969	Partikel	
CF8914	21651982	Partikel	•
CF8947	21652342	Partikel	•
CF8948	21652342	Partikel	•
CF9051	21651976	Partikel	
CF9071	21651293	Partikel	
CF9077	21652308	Partikel	

Fram			
CF9293	21652349	Partikel	
CF9294	21653028	Partikel	
CF9323	21652356	Partikel	
CF9335	21652350	Partikel	
CF9336	21652351	Partikel	
CF9337	21652347	Partikel	
CF9338	21652345	Partikel	
CF9363	21652346	Partikel	
CF9364	21652550	Partikel	
CF9383	21652045	Partikel	
CF9386	21653021	Partikel	
CF9387	21653022	Partikel	
CF9394	21652340	Partikel	
CF9395	21652338	Partikel	
CF9396	21652317	Partikel	
CF9398	21652548	Partikel	
CF9399	21652359	Partikel	
CF9406	21652543	Partikel	
CF9414	21651968	Combi	
CF9466	21652551	Partikel	
CF9485	21652360	Partikel	
CF9495	21652714	Partikel	
CF9509	21651298	Partikel	
CF9534	21652709	Partikel	
CF9546	80000373	Partikel	
CF9562	21653141	Partikel	
CF9569	21653005	Partikel	
CF9579	21651987	Partikel	
CF9586	21652856	Partikel	
CF9594	21652850	Partikel	
CF9640	21653017	Partikel	
CF9642	21652339	Partikel	
CF9645	21652689	Partikel	
CF9659	21652873	Partikel	
CF9666	21652857	Partikel	
CF9691	80000074	Partikel	
CF9714	21651981	Partikel	
CF9731	21651970	Partikel	
CF9740	21652897	Partikel	•
CF9756	80000158	Partikel	
CF9787	21653034	Partikel	
CF98192	21652546	Partikel	•
CF9827	21652871	Partikel	
CF9846	21652539	Partikel	
CF9881	21653020	Partikel	
CF9922	21653024	Partikel	
CFA8046	21650107	Partikel	
CFA8788	21651954	Combi	
CFA8849	21653006	Combi	
CFA8869	21651967	Combi	
CFA8875	21651964	Combi	
CFA8876	21651957	Combi	
CFA8877	21651961	Combi	
CFA8878	21651895	Partikel	
CFA8879	21651966	Combi	
CFA8880	21651965	Combi	
CFA8882	21651956	Combi	
CFA8893	21651955	Combi	
CFA8894	21651952	Combi	
CFA8912	21651882	Combi	•
CFA8913	21652336	Combi	
CFA9322	21651881	Combi	•

Fram			
CFA9404	21652357	Combi	
CFA9405	21652352	Combi	•
CFA9408	21651296	Combi	
CFA9445	21653014	Combi	
CFA9495	80000621	Combi	
CFA9533	21652538	Combi	
CFA9534	21652361	Combi	
CFA9548	21652713	Combi	
CFA9562	21653142	Combi	
CFA9587	21652540	Combi	
CFA9623	21652355	Combi	
CFA9665	21652992	Combi	
CFA9666	21652858	Combi	
CFA9827	21652872	Combi	
CFA9921	21653008	Combi	
H+B Jakoparts			
J1340300	80000547	Partikel	•
J1340301	80000656	Partikel	•
J1340302	80000537	Partikel	
J1340303	80000547	Partikel	•
J1340304	80000548	Partikel	•
J1340305	80000634	Partikel	
J1340306	80000655	Partikel	
J1340307	80000654	Partikel	•
J1340308	80000656	Partikel	•
J1340310	80000871	Partikel	
J1340500	80000158	Partikel	
J1340501	80000157	Partikel	
J1340503	80000083	Partikel	
J1340504	80000084	Partikel	•
J1340505	80000159	Partikel	
J1340506	80000852	Partikel	
J1340507	80000652	Partikel	
J1340508	80000546	Partikel	•
J1340509	80000764	Combi	
J1340511	80000813	Partikel	
J1341002	21652346	Partikel	
J1341003	21652347	Partikel	
J1341005	21652870	Partikel	
J1341009	80000810	Partikel	
J1341011	80000610	Partikel	
J1341014	80000072	Partikel	
J1341015	80000074	Partikel	
J1341016	21651983	Partikel	
J1341018	80000649	Partikel	
J1341020	80000874	Partikel	
J1342000	21652897	Partikel	•
J1342001	21652551	Partikel	
J1342002	21652873	Partikel	
J1342004	80000162	Partikel	
J1342009	80000165	Combi	
J1342010	80000162	Partikel	
J1342011	21652874	Partikel	
J1342018	21652539	Partikel	
J1342024	80000605	Combi	
J1342025	80000662	Partikel	
J1342028	80000605	Combi	
J1343005	80000403	Combi	•
J1343010	21652992	Combi	
J1343012	80000163	Partikel	
J1343014	80000689	Partikel	•
J1343015	21652993	Partikel	

H+B Jakoparts			
J1343017	80000406	Combi	•
J1343018	21652993	Partikel	
J1344000	21652990	Partikel	
J1344003	21652345	Partikel	
J1344004	21651972	Partikel	
J1344006	21652546	Partikel	•
J1344007	21652989	Partikel	
J1344008	80000148	Combi	•
J1344009	80000156	Partikel	•
J1344010	80000330	Partikel	
J1344012	80000620	Partikel	
J1345001	80000825	Partikel	
J1345002	80000824	Partikel	
J1345006	80000068	Combi	
J1345007	80000643	Partikel	•
J1345008	80000648	Combi	
J1345009	21653013	Combi	
J1347002	80000745	Combi	
J1348003	80000657	Partikel	
J1348005	21652989	Partikel	
J1348006	80000676	Partikel	
Hengst			
E1901LI	21652360	Partikel	
E1903LC	21652858	Combi	
E1903LI	21652857	Partikel	
E1904LI	80000349	Partikel	
E1905LI	80000633	Partikel	
E1906LI	21652990	Partikel	
E1907LC	21653035	Combi	
E1907LI	21653034	Partikel	
E1908LC	80001127	Combi	
E1908LI	80000333	Partikel	
E1909LC	21653064	Combi	•
E1909LI	21653063	Partikel	•
E1910LC	21653015	Combi	
E1910LI	21653020	Partikel	
E1911LC	21652540	Combi	
E1911LI	21653063	Partikel	•
E1912LC	21651294	Combi	
E1912LI	21651294	Combi	
E1913LI	21651199	Partikel	•
E1914LC	21652995	Combi	
E1914LI	21652994	Partikel	
E1915LC	21653146	Combi	
E1915LI	21653028	Partikel	
E1916LC	21652996	Combi	
E1916LC01	21652995	Combi	
E1916LI	21652317	Partikel	
E1918LC	21653143	Combi	
E1918LI	21653144	Partikel	
E1919LC	21652812	Combi	•
E1920LC	21652851	Combi	•
E1920LI	21652848	Partikel	•
E1921LI	21651915	Partikel	
E1923LI	80001579	Partikel	
E1925LC	21652872	Combi	
E1925LI	21652871	Partikel	
E1926LC	21652992	Combi	
E1926LI	21652992	Combi	
E1927LI	21652874	Partikel	
E1928LC	21653013	Combi	
E1929LI	21653026	Partikel	

Hengst			
E1930LC	21652352	Combi	•
E1931LI	80001629	Partikel	
E1932LC	80000070	Combi	
E1932LI	21653017	Partikel	
E1933LC	21652552	Combi	•
E1934LC	21651952	Combi	
E1935LC	21653031	Combi	•
E1936LI	80000357	Partikel	
E1937LI	80000159	Partikel	
E1938LC	80000403	Combi	•
E1938LI	21652860	Partikel	•
E1939LI	21653071	Partikel	
E1942LI	80000636	Partikel	
E1943LC	21652916	Combi	
E1943LI	80000065	Partikel	
E1944LC	21653066	Combi	
E1944LI	21653067	Partikel	
E1945LI	21652002	Partikel	
E1946LI	80000022	Partikel	•
E1946LI2	80000022	Partikel	•
E1947LI	21651901	Partikel	
E1948LC	80000430	Combi	
E1948LI	21652308	Partikel	
E1949LC	80000208	Combi	
E1950LI	21652993	Partikel	
E1951LI	21651972	Partikel	
E1953LI	80000331	Partikel	
E1954LI	80000156	Partikel	•
E1955LC	21653069	Combi	
E1955LI	21652351	Partikel	
E1956LI	80001585	Partikel	
E1958LI	21653018	Partikel	
E1959LC	80000064	Combi	
E1959LI	80000063	Partikel	
E1960LI	21652342	Partikel	•
E1961LI	21652349	Partikel	
E1962LC	21651296	Combi	
E1962LI	21651296	Combi	
E1963LI	21652856	Partikel	
E1965LC	80000068	Combi	
E1965LC01	80000068	Combi	
E1966LI	80000643	Partikel	•
E1967LI	80000824	Partikel	
E1970LI	80000350	Partikel	
E1971LI	80000334	Partikel	
E1972LI	80000335	Partikel	
E1975LI	21652347	Partikel	
E1976LI	80000634	Partikel	
E1977LI	80000536	Partikel	
E1978LC	21652898	Combi	
E1981LI	21652867	Partikel	•
E1982LI	80000115	Partikel	
E1983LI	80000642	Partikel	
E1984LI	80000072	Partikel	
E1985LI	21651993	Partikel	
E1987LI	21652347	Partikel	
E1988LC	21653115	Combi	
E1989LI	80000160	Partikel	•
E1990LC	80000062	Combi	
E1990LI	80000061	Partikel	
E1991LI	80000348	Partikel	
E1992LI	80000635	Partikel	

Hengst			
E1993LI	80001623	Partikel	
E1994LI	80000641	Partikel	
E1995LI	80000354	Partikel	
E1996LI	80000079	Partikel	
E1997LI	80000644	Partikel	•
E1998LC	80000648	Combi	
E1999LI	80000537	Partikel	
E21L	80000632	Partikel	
E2900LI	80000073	Partikel	•
E2902LI	21651981	Partikel	
E2904LC	80000071	Combi	
E2905LI	80000074	Partikel	
E2906LI	80000662	Partikel	
E2907LI	80000158	Partikel	
E2908LI	80001446	Partikel	
E2909LI	21652873	Partikel	
E2910LI	80000657	Partikel	
E2911LI	80000638	Partikel	
E2912LC	80000647	Combi	•
E2912LC2	80000647	Combi	•
E2913LC	21653009	Combi	
E2913LI	21653025	Partikel	
E2914LI	21652338	Partikel	
E2915LI	21652539	Partikel	
E2916LC	80000616	Combi	
E2916LI	80000614	Partikel	
E2917LI	21653032	Partikel	
E2918LI	80000620	Partikel	
E2919LC	80000538	Combi	•
E2920LI	80000649	Partikel	
E2925LI	80000780	Combi	
E2926LI	80001586	Partikel	
E2927LI	80000645	Partikel	
E2928LI	21652345	Partikel	
E2929LI	21652870	Partikel	
E2930LI	21652989	Partikel	
E2932LI	21651971	Partikel	•
E2933LC	21652852	Combi	
E2933LI	21652849	Partikel	
E2934LI	21652897	Partikel	•
E2935LI	21651972	Partikel	
E2936LI	21653071	Partikel	
E2937LC	21653149	Combi	
E2938LI	80001627	Partikel	
E2939LC	80000777	Combi	
E2939LI	80000541	Partikel	
E2940LI	80000815	Partikel	
E2941LI	80001583	Partikel	
E2942LI	80000639	Partikel	
E2943LC	80000667	Combi	•
E2943LI	80000666	Partikel	•
E2944LC	80000848	Combi	•
E2944LI	80000847	Partikel	•
E2945LI	80000604	Partikel	
E2946LC	80001035	Combi	
E2947LI	80000740	Partikel	
E2949LC	80000713	Combi	
E2949LI	80000712	Partikel	
E2950LI	80001626	Partikel	
E2951LC	80000866	Combi	
E2951LI	80000865	Partikel	
E2952LI	80001628	Partikel	

Hengst			
E2953LI	80000915	Partikel	
E2955LI	80000877	Partikel	
E2956LI	80000082	Partikel	
E2957LI	80000603	Partikel	
E2958LI	80001041	Partikel	•
E2959LI	80000603	Partikel	
E2961LI	21651920	Partikel	
E2962LI	80001185	Partikel	
E2963LC	21653064	Combi	•
E2963LI	21653063	Partikel	•
E2964LI	80001128	Partikel	
E568L	21652993	Partikel	
E638L	21652551	Partikel	
E900LC	21651955	Combi	
E900LI	21651912	Partikel	
E901LC	21651964	Combi	
E901LI	21651182	Partikel	
E902LC	21651965	Combi	
E902LI	21651184	Partikel	
E903LC	21652353	Combi	
E903LI	21653024	Partikel	
E904LC	21651966	Combi	
E904LI	21652709	Partikel	
E905LC	21651957	Combi	
E905LI	21651914	Partikel	
E906LI	21651973	Partikel	
E907LC	21652959	Combi	
E907LI	21650107	Partikel	
E908LC	21652355	Combi	
E908LI	21651893	Partikel	
E909LI	21651982	Partikel	•
E910LC	80000021	Combi	
E910LI	21651979	Partikel	
E911LC	80000113	Combi	
E911LI	21651979	Partikel	
E912LC	21652985	Combi	
E912LI	21651976	Partikel	
E913LC	21651292	Combi	
E913LI	21652688	Partikel	
E914LC	21651961	Combi	
E914LC01	21651961	Combi	
E914LI	21651196	Partikel	
E915LC	21651958	Combi	
E915LI	21651914	Partikel	
E916LC	21653070	Combi	•
E916LI	21652687	Partikel	•
E917LI	21651991	Partikel	
E919LC	21651960	Combi	
E919LI	21651895	Partikel	
E920LC	80000744	Combi	
E920LI	21651986	Partikel	
E921LC	21651968	Combi	
E921LI	80000594	Partikel	
E922LI	21651987	Partikel	
E924LI	80001582	Partikel	
E925LC	80001580	Combi	
E926LI	80001624	Partikel	•
E927LI	80000339	Partikel	
E928LI	80000340	Partikel	
E929LI	80000336	Partikel	
E931LC	21653006	Combi	
E931LI	21651977	Partikel	

Hengst			
E932LI	21653019	Partikel	
E932LI01	21653019	Partikel	
E933LC	21652999	Combi	
E933LI	21652998	Partikel	
E933LI01	21653001	Partikel	
E934LI	21651901	Partikel	
E935LI	80000065	Partikel	
E936LC	21651958	Combi	
E936LI	21651914	Partikel	
E937LI	80000075	Partikel	
E938LI	21651920	Partikel	
E939LI	21651198	Partikel	
E940LI	21651899	Partikel	
E941LC	21652354	Combi	
E941LI	21651995	Partikel	
E942LI	21651195	Partikel	•
E943LI	21651901	Partikel	
E944LI	21653022	Partikel	
E945LI	21653021	Partikel	
E947LI	21653139	Partikel	
E948LI	80000632	Partikel	
E949LI	21653016	Partikel	
E950LI	21652849	Partikel	
E951LC	21652541	Combi	
E951LI	21651920	Partikel	
E952LI	21651916	Partikel	
E953LI	21651994	Partikel	
E954LC	80000364	Combi	
E954LI	21653005	Partikel	
E955LC	21651957	Combi	
E955LI	21652689	Partikel	
E956LI	80000362	Partikel	
E956LI01	80000362	Partikel	
E957LC	21653010	Combi	
E957LC01	21653011	Combi	
E957LI	21651887	Partikel	
E958LI	80000341	Partikel	
E959LI	21651197	Partikel	
E960LC	21651882	Combi	•
E960LI	21651897	Partikel	•
E961LC	21652357	Combi	
E961LI	21651912	Partikel	
E962LC	80000114	Combi	
E962LI	21651983	Partikel	
E963LI	21652045	Partikel	
E964LC	21653014	Combi	
E965LI	21651983	Partikel	
E966LI	80000356	Partikel	
E967LI	21652348	Partikel	
E968LC	21652361	Combi	
E968LI	21652709	Partikel	
E969LC	80000626	Combi	
E969LI	21652997	Partikel	
E970LC	21652861	Combi	
E970LC01	21652861	Combi	
E970LC02	21652862	Combi	
E970LI	21652358	Partikel	
E970LI01	21652335	Partikel	
E971LC01	21653068	Combi	
E971LI	21651293	Partikel	
E971LI01	21651293	Partikel	
E972LC	80000621	Combi	



Hengst			
E972LI	21652714	Partikel	
E973LI	21651896	Partikel	
E974LI	80000373	Partikel	
E975LI	21651972	Partikel	
E976LI	80000376	Partikel	
E977LC	21652336	Combi	
E977LI	21651969	Partikel	
E978LI	21652543	Partikel	
E979LI	21652348	Partikel	
E980LC	21653000	Combi	
E980LI	21653007	Partikel	
E981LI	21651984	Partikel	
E982LI	21653003	Partikel	
E983LC	21651881	Combi	•
E983LI	21653030	Partikel	•
E989LC	21652865	Combi	
E989LI	21652863	Partikel	
E989LI01	21652864	Partikel	
E990LC	80000765	Combi	•
E990LC01	21653102	Combi	
E990LC02	21653102	Combi	
E990LI	21652342	Partikel	•
E991LI	80000825	Partikel	
E992LC	21652538	Combi	
E993LI	80000342	Partikel	
E994LC	21652853	Combi	
E994LC01	21652853	Combi	
E994LI	21652850	Partikel	
E994LI01	21652850	Partikel	
E995LI	80000076	Partikel	
E997LC	21652542	Combi	
E997LI	21652550	Partikel	
E998LC	21653008	Combi	
E998LC01	80000602	Combi	
E998LI	21653024	Partikel	
E999LI	80000337	Partikel	
Knecht-Mahle			
06413223	21653026	Partikel	
06413322	21651891	Partikel	
06415988	21653139	Partikel	
06416705	80000632	Partikel	
06416937	80000633	Partikel	
06417117	80000594	Partikel	
06417133	80000636	Partikel	
06417158	21651184	Partikel	
06417232	21651182	Partikel	
06417299	21651900	Partikel	
06417315	21651899	Partikel	
06417372	21651915	Partikel	
06417398	21651196	Partikel	
06417414	21651183	Partikel	
06417430	21651890	Partikel	
06417471	21651898	Partikel	
06417497	21651185	Partikel	
06417513	21651895	Partikel	
06417588	21650107	Partikel	
06417604	21651919	Partikel	
06417620	21651298	Partikel	
06417646	21651916	Partikel	
06417661	21651195	Partikel	•
06417687	21651987	Partikel	
06417703	21651901	Partikel	

Knecht-Mahle			
06417745	21651894	Partikel	
06417802	21651981	Partikel	
06417869	21651917	Partikel	
06417885	80000373	Partikel	
06417901	21653140	Partikel	
06417927	80000403	Combi	•
06417943	21651184	Partikel	
06417968	21651979	Partikel	
06417984	21651983	Partikel	
06418008	21651976	Partikel	
06418024	80000029	Partikel	
06418040	21651994	Partikel	
06418081	21652346	Partikel	
06418107	21652714	Partikel	
06418123	21652356	Partikel	
06418149	21651984	Partikel	
06418180	21651995	Partikel	
06418206	21651893	Partikel	
06418222	21651972	Partikel	
06418248	21651971	Partikel	•
06418289	21651920	Partikel	
06418305	80000027	Partikel	
06418388	21651973	Partikel	
06418420	21652687	Partikel	•
06418446	21651986	Partikel	
06418487	21652998	Partikel	
06418503	21652689	Partikel	
06418545	21652308	Partikel	
06418560	21651972	Partikel	
06418586	21652348	Partikel	
06418628	21652360	Partikel	
06418644	21651970	Partikel	
06418669	21652347	Partikel	
06418685	21652539	Partikel	
06418701	21652349	Partikel	
06418727	21653032	Partikel	
06418743	21652550	Partikel	
06418768	21652548	Partikel	
06418784	21652544	Partikel	
06418792	21651901	Partikel	
06418818	21652543	Partikel	
06418834	21652989	Partikel	
06418859	21652874	Partikel	
06418875	21653145	Partikel	
06418891	21652856	Partikel	
06418917	21652990	Partikel	
06418933	21652857	Partikel	
06418958	80000333	Partikel	
06418974	80000156	Partikel	•
06418990	80000082	Partikel	
06419014	21652993	Partikel	
06419030	21653028	Partikel	
06419071	80000330	Partikel	
06419097	80000080	Partikel	
06419139	21652350	Partikel	
06419154	21653005	Partikel	
06419170	21653020	Partikel	
06419196	21652994	Partikel	
06419212	21653034	Partikel	
06419238	21653025	Partikel	
06419253	21653067	Partikel	
06419279	21652709	Partikel	

Knecht-Mahle			
06421200	21651991	Partikel	
06421655	80000163	Partikel	
06515225	21652348	Partikel	
06531446	21652544	Partikel	
06531453	21652308	Partikel	
06531479	21653139	Partikel	
06536130	80000632	Partikel	
06540132	21652550	Partikel	
06540231	21652540	Combi	
06540264	21652548	Partikel	
06544704	21652542	Combi	
06544712	80000148	Combi	•
06558662	21651970	Partikel	
06588404	21651920	Partikel	
06598767	21652342	Partikel	•
06599765	21652347	Partikel	
06605406	21652992	Combi	
06606099	21651972	Partikel	
06606164	21652349	Partikel	
06606172	21653032	Partikel	
06606180	21651986	Partikel	
06606198	21651901	Partikel	
06606271	21652856	Partikel	
06608160	21652687	Partikel	•
06608400	21651920	Partikel	
06610968	21652860	Partikel	•
06611941	80000364	Combi	
06612279	80000403	Combi	•
06612303	80000156	Partikel	•
06612659	21651981	Partikel	
06626089	21652998	Partikel	
06628473	21652543	Partikel	
06634620	21651198	Partikel	
06634679	21652898	Combi	
06634687	80000333	Partikel	
06639785	21652539	Partikel	
06640104	21652997	Partikel	
06640163	21652997	Partikel	
06642300	21653029	Partikel	
06643845	21652992	Combi	
06655773	80000330	Partikel	
06656029	21653031	Combi	•
06658389	21651977	Partikel	
06693352	80000765	Combi	•
06693386	80000347	Combi	
06693501	80000080	Partikel	
06786362	21652873	Partikel	
06786370	21652812	Combi	•
06787147	21652859	Combi	
06787162	21651197	Partikel	
06787170	21652991	Combi	
06807366	80000063	Partikel	
06808315	21653015	Combi	
06808349	21653016	Partikel	
06818819	21653071	Partikel	
06818850	21652852	Combi	
06818876	21652849	Partikel	
06822324	80000082	Partikel	
06827851	21653028	Partikel	
06827869	21652993	Partikel	
06827885	21652989	Partikel	
06827950	21653115	Combi	

Knecht-Mahle			
06828677	21652897	Partikel	•
06830087	21652874	Partikel	
06830772	21652853	Combi	
06830780	21652850	Partikel	
06831010	21652862	Combi	
06831028	21652861	Combi	
06831036	21652864	Partikel	
06831044	21652863	Partikel	
06831531	21653102	Combi	
06831630	21652851	Combi	•
06831861	21652853	Combi	
06831887	21653064	Combi	•
06831903	21653031	Combi	•
06831929	21652852	Combi	
06831945	80000347	Combi	
06832067	21651961	Combi	
06832083	80000410	Partikel	
06832109	21652351	Partikel	
06832125	21653069	Combi	
06832315	21652361	Combi	
06832331	21652357	Combi	
06832356	80000361	Combi	
06832703	21653024	Partikel	
06833024	80000602	Combi	
06833040	21653009	Combi	
06833065	21652985	Combi	
06878813	80000064	Combi	
06886568	21653013	Combi	
06886733	21652352	Combi	•
06886782	21652872	Combi	
06886964	21653035	Combi	
06886980	21651969	Partikel	
06887103	80000071	Combi	
06887129	21653143	Combi	
06887228	21653066	Combi	
06887608	21652538	Combi	
06887624	80000208	Combi	
06887988	21652354	Combi	
06888002	21651960	Combi	
06888028	21652996	Combi	
06888069	21651292	Combi	
06888168	21653068	Combi	
06888184	21651293	Partikel	
06888200	21651882	Combi	•
06888226	21652355	Combi	
06888242	21652540	Combi	
06888267	21651294	Combi	
06888283	21652542	Combi	
06888325	21652992	Combi	
06888366	80000403	Combi	•
06888382	80000429	Combi	
06888424	21652858	Combi	
06888440	21652995	Combi	
06888465	21651960	Combi	
06888481	21651960	Combi	
06888507	21653008	Combi	
06888523	80000113	Combi	
06888549	80000021	Combi	
06888580	21652336	Combi	
06888606	21653149	Combi	
06888622	21653014	Combi	
06888648	21653006	Combi	

Knecht-Mahle			
06888663	80000621	Combi	
06888689	21652999	Combi	
06888705	21652358	Partikel	
06888721	21652335	Partikel	
06888747	21651964	Combi	
06888762	21651965	Combi	
06888788	21652959	Combi	
06888804	21652353	Combi	
06888820	21653003	Partikel	
06888846	21651955	Combi	
06888861	21652541	Combi	
06888887	21651968	Combi	
06888903	21651966	Combi	
06888945	21652541	Combi	
06888960	21651956	Combi	
06889000	21652317	Partikel	
06889026	21651967	Combi	
06889273	21651198	Partikel	
06889331	21652850	Partikel	
06889356	21653071	Partikel	
06889398	21653063	Partikel	•
06889430	21652849	Partikel	
06889455	21652861	Combi	
08162158	21651917	Partikel	
08169625	80000373	Partikel	
08169633	21653140	Partikel	
08169674	80000536	Partikel	
08437352	80000113	Combi	
08437360	80000021	Combi	
08437378	21652713	Combi	
08437386	21651184	Partikel	
08437394	21651979	Partikel	
08437964	21653022	Partikel	
08444093	21651983	Partikel	
08445660	21651976	Partikel	
08445710	21652336	Combi	
08457160	80000029	Partikel	
08457913	80000633	Partikel	
08459778	21653149	Combi	
08464562	21653014	Combi	
08518086	21653006	Combi	
08559767	21651994	Partikel	
08559775	21652546	Partikel	•
08561847	21652346	Partikel	
08564874	21652360	Partikel	
08567695	21652045	Partikel	
08567711	21651296	Combi	
08571895	80000621	Combi	
08571903	21652714	Partikel	
08571911	21652356	Partikel	
08573701	21652358	Partikel	
08573719	21652335	Partikel	
08594905	21652551	Partikel	
08598930	21652999	Combi	
08658213	80000594	Partikel	
08658239	80000636	Partikel	
08659492	21651184	Partikel	
08672040	21650107	Partikel	
08672222	21651182	Partikel	
08673899	21651900	Partikel	
08673907	21651891	Partikel	
08673915	21651899	Partikel	

Knecht-Mahle			
08688533	21651890	Partikel	
08698920	21651919	Partikel	
08698938	21651912	Partikel	
08705576	21651196	Partikel	
08708778	21651183	Partikel	
08718645	21651916	Partikel	
08718652	21651298	Partikel	
08751398	21651890	Partikel	
08751406	21651914	Partikel	
08752479	21651898	Partikel	
08758807	80000027	Partikel	
08771800	21651964	Combi	
08771826	21651965	Combi	
08771842	21652959	Combi	
08771867	21652353	Combi	
08791022	21651185	Partikel	
08796989	21651195	Partikel	•
08798258	21653023	Partikel	•
09601972	21651895	Partikel	
09622366	21651913	Partikel	
09625203	21653003	Partikel	
09625229	21651977	Partikel	
09635830	21651955	Combi	
09637042	21652541	Combi	
09637059	21651968	Combi	
09637067	21651966	Combi	
09637075	21651957	Combi	
09655358	21651956	Combi	
09655366	21652541	Combi	
09689167	21651987	Partikel	
09689407	21651952	Combi	
09689464	21651915	Partikel	
09689472	21651894	Partikel	
09689480	80000412	Partikel	
09689498	21652317	Partikel	
09691379	21651967	Combi	
09691874	21651973	Partikel	
09693573	80000624	Combi	
09805250	21651952	Combi	
09807629	21651293	Partikel	
09807637	21651984	Partikel	
09810888	21651882	Combi	•
09817289	21653068	Combi	
09821893	21651957	Combi	
09824491	80000535	Partikel	•
09830548	21653021	Partikel	
09833567	21651954	Combi	
09834805	21651995	Partikel	
09838699	21651292	Combi	
09838707	21651893	Partikel	
09842451	21651961	Combi	
09857657	80000069	Combi	
09857681	21652996	Combi	
09858150	21651972	Partikel	
09881475	21651960	Combi	
09881483	21652354	Combi	
09883398	21652916	Combi	
09889452	21651971	Partikel	•
6531479	21653139	Partikel	
6533327	21652355	Combi	
6540272	21651294	Combi	
6606099	21652345	Partikel	



Knecht-Mahle			
70316792	80000070	Combi	
70316889	21652871	Partikel	
70316896	21651888	Partikel	
70317360	21651887	Partikel	
70317366	80000066	Partikel	
70318188	21652865	Combi	
70318195	21652863	Partikel	
70320894	80000649	Partikel	
70323024	21652340	Partikel	
70323488	80000062	Combi	
70324998	21652867	Partikel	•
70325568	80000538	Combi	•
70325628	80000647	Combi	•
70325642	21653147	Combi	
70327586	80000360	Partikel	
70328552	80000074	Partikel	
70328864	80000667	Combi	•
70329163	80000408	Combi	
70329438	80000666	Partikel	•
70330471	80000655	Partikel	
70342646	21653146	Combi	
70342689	80000652	Partikel	
70345861	80000620	Partikel	
70345873	80000767	Partikel	
70346564	80000405	Partikel	•
70347247	80000606	Combi	
70347250	80000155	Partikel	
70347253	80000336	Partikel	
70347257	80000340	Partikel	
70347261	80000060	Partikel	
70347264	80000662	Partikel	
70347281	80000651	Partikel	•
70347764	80001172	Partikel	
70348547	80000616	Combi	
70348559	80000614	Partikel	
70349337	21651920	Partikel	
70350374	80000339	Partikel	
70350376	21653000	Combi	
70350378	21653019	Partikel	
70350382	80000337	Partikel	
70350384	21653007	Partikel	
70350574	21652860	Partikel	•
70350716	80000539	Partikel	
70351041	80000541	Partikel	
70351689	80000084	Partikel	•
70351692	80000607	Partikel	
70352090	21653017	Partikel	
70352092	21653019	Partikel	
70352788	80000825	Partikel	
70353868	80000643	Partikel	•
70354940	80000848	Combi	•
70354942	80000847	Partikel	•
70356496	21652868	Partikel	
70356513	80000160	Partikel	•
70356516	80000604	Partikel	
70356519	80000874	Partikel	
70356523	80000341	Partikel	
70356526	80000342	Partikel	
70360564	80000852	Partikel	
70360567	80001033	Partikel	•
70360572	21652870	Partikel	
70360574	80000670	Combi	

Knecht-Mahle			
70364755	21652346	Partikel	
70366157	80000644	Partikel	•
70366567	80000676	Partikel	
70367807	80000877	Partikel	
70370618	80000915	Partikel	
70371286	80000362	Partikel	
70371662	80000866	Combi	
70371991	80000813	Partikel	
70372530	80000548	Partikel	•
70372977	80000839	Partikel	•
70373062	80000866	Combi	
70373162	80001031	Combi	•
70374099	21652900	Partikel	
70374132	80000815	Partikel	
70374181	80000865	Partikel	
70374236	80001034	Partikel	
70374638	80000853	Partikel	
70374659	80000865	Partikel	
70376890	80000911	Partikel	•
70377385	80000083	Partikel	
70378486	80001039	Partikel	
70380340	80000824	Partikel	
70381211	80000634	Partikel	
70381279	80001035	Combi	
70381704	80000062	Combi	
76421655	80000163	Partikel	
8169633	21653140	Partikel	
8457160	80000029	Partikel	
8571911	21652356	Partikel	
8573701	21652358	Partikel	
LA10	21651900	Partikel	
LA100	21651972	Partikel	
LA102	21651969	Partikel	
LA107	21652351	Partikel	
LA108	21652348	Partikel	
LA109	80001172	Partikel	
LA11	21651182	Partikel	
LA117	21652714	Partikel	
LA118	21652360	Partikel	
LA119	21652346	Partikel	
LA120	21652356	Partikel	
LA121	21652045	Partikel	
LA122	21652546	Partikel	•
LA123	21651994	Partikel	
LA126	21651970	Partikel	
LA127	21652342	Partikel	•
LA129	21652358	Partikel	
LA1291	21652335	Partikel	
LA130	21652347	Partikel	
LA131	21652539	Partikel	
LA134	21652349	Partikel	
LA135	21653032	Partikel	
LA136	21652550	Partikel	
LA137	21651981	Partikel	
LA138	21652548	Partikel	
LA143	21652350	Partikel	
LA144	21652544	Partikel	
LA148	21653139	Partikel	
LA151	80000632	Partikel	
LA152	21651901	Partikel	
LA153	21652543	Partikel	
LA154	21653005	Partikel	

Knecht-Mahle			
LA155	21652989	Partikel	
LA156	21652863	Partikel	
LA1561	21652864	Partikel	
LA157	21652874	Partikel	
LA158	21653145	Partikel	
LA166	80000410	Partikel	
LA167	21652856	Partikel	
LA168S	21652990	Partikel	
LA169	21652857	Partikel	
LA170	80000333	Partikel	
LA171	21652850	Partikel	
LA172	80000156	Partikel	•
LA175	21653071	Partikel	
LA177	21651197	Partikel	
LA1771	21651888	Partikel	
LA18	80000594	Partikel	
LA180	80000082	Partikel	
LA181	21653024	Partikel	
LA182	21653020	Partikel	
LA183	21652993	Partikel	
LA184	21653028	Partikel	
LA186S	21652897	Partikel	•
LA189	21652994	Partikel	
LA19	80000636	Partikel	
LA191S	80000666	Partikel	•
LA195S	80000084	Partikel	•
LA196	21652871	Partikel	
LA197	21653063	Partikel	•
LA21	21651184	Partikel	
LA216	80000330	Partikel	
LA220	21653034	Partikel	
LA221S	80000847	Partikel	•
LA225S	21653031	Combi	•
LA227	80000080	Partikel	
LA229	21653025	Partikel	
LA23	21651916	Partikel	
LA230	80000074	Partikel	
LA234	21652849	Partikel	
LA235S	80000163	Partikel	
LA237	21651991	Partikel	
LA239	21653067	Partikel	
LA24	21651890	Partikel	
LA241	21653026	Partikel	
LA242	21652709	Partikel	
LA243	21653017	Partikel	
LA248	80000063	Partikel	
LA25	21650107	Partikel	
LA26	21651919	Partikel	
LA269	21652873	Partikel	
LA27	21651298	Partikel	
LA279	21653016	Partikel	
LA280	80000360	Partikel	
LA282	80000636	Partikel	
LA287	21651887	Partikel	
LA288	80000066	Partikel	
LA289	80000649	Partikel	
LA291	21652340	Partikel	
LA296S	21652867	Partikel	•
LA298	80000655	Partikel	
LA301	80000652	Partikel	
LA304	80000662	Partikel	
LA306	80000541	Partikel	

Knecht-Mahle		
LA307	80000614	Partikel
LA31	21651912	Partikel
LA32	21651920	Partikel
LA322	21651920	Partikel
LA323	21651920	Partikel
LA33	21651917	Partikel
LA34	21651915	Partikel
LA343	80000767	Partikel
LA344	80000620	Partikel
LA345	80000164	Partikel
LA346S	80000405	Partikel •
LA348	80001452	Partikel
LA349S	80000159	Partikel
LA35	21651894	Partikel
LA350	80000340	Partikel
LA351	80000339	Partikel
LA353	21653019	Partikel
LA354	80001579	Partikel
LA355	80000336	Partikel
LA356S	80000644	Partikel •
LA357	80000337	Partikel
LA358	21653007	Partikel
LA36	21651183	Partikel
LA360	80000060	Partikel
LA361	80000155	Partikel
LA365S	80000548	Partikel •
LA366S	80000643	Partikel •
LA367	80000812	Partikel
LA37	21651196	Partikel
LA370	80000539	Partikel
LA371	21652346	Partikel
LA372	80001582	Partikel
LA376	80000825	Partikel
LA377	80001033	Partikel •
LA378	21653019	Partikel
LA379	80000607	Partikel
LA38	80000027	Partikel
LA382	80000072	Partikel
LA384	21652868	Partikel
LA387	80000712	Partikel
LA39	80000373	Partikel
LA392S	80001439	Partikel •
LA393	80001627	Partikel
LA394S	80000160	Partikel •
LA395	80000604	Partikel
LA396	80000874	Partikel
LA397	80000341	Partikel
LA398	80000342	Partikel
LA40	21653140	Partikel
LA400	80001739	Partikel
LA401	80000852	Partikel
LA402S	80001033	Partikel •
LA404	21652870	Partikel
LA408	80000676	Partikel
LA41	80000536	Partikel
LA410	80000865	Partikel
LA411	80000815	Partikel
LA412	80000865	Partikel
LA42	21651977	Partikel
LA421	80000877	Partikel
LA422	21652900	Partikel
LA424	80000853	Partikel

Knecht-Mahle		
LA428S	80000839	Partikel •
LA43	21653003	Partikel
LA432	80000362	Partikel
LA435	80000330	Partikel
LA438	80000613	Partikel
LA439	80000915	Partikel
LA44	21651898	Partikel
LA440	80000083	Partikel
LA441	80000871	Partikel
LA443	80001039	Partikel
LA444S	80000911	Partikel •
LA447	80000813	Partikel
LA45	21651890	Partikel
LA451	80000824	Partikel
LA453	80001034	Partikel
LA457	80001027	Partikel
LA46	21651914	Partikel
LA460	80001174	Partikel
LA462	80001183	Partikel
LA463	80001128	Partikel
LA471	80000634	Partikel
LA472	80001185	Partikel
LA475	80001208	Partikel
LA476	21652338	Partikel
LA477	21652539	Partikel
LA47S	21651195	Partikel •
LA480	80001443	Partikel
LA482	80001212	Partikel
LA483S	80001489	Partikel •
LA484	80000157	Partikel
LA49	21651185	Partikel
LA492	80000639	Partikel
LA494	80001626	Partikel
LA49S	80001448	Partikel
LA50	21653022	Partikel
LA500	80001444	Partikel
LA501	21653022	Partikel
LA501S	80001736	Partikel •
LA502	80001732	Partikel
LA506	21653114	Partikel
LA51S	21653023	Partikel •
LA52	21651895	Partikel
LA531	80001206	Partikel
LA53S	80000535	Partikel •
LA54	21652317	Partikel
LA541	80000412	Partikel
LA55	21653021	Partikel
LA56	21651901	Partikel
LA57	21651293	Partikel
LA570S	80001734	Partikel •
LA58	21651913	Partikel
LA60	21651984	Partikel
LA65	21651987	Partikel
LA67	21651973	Partikel
LA71	21652997	Partikel
LA74	21651184	Partikel
LA75	21651979	Partikel
LA76S	21652687	Partikel •
LA77	21651893	Partikel
LA78	21651995	Partikel
LA79	21651986	Partikel
LA8	21651899	Partikel

Knecht-Mahle		
LA80	21651198	Partikel
LA82	21651972	Partikel
LA83	21651976	Partikel
LA84	80000029	Partikel
LA85	21652998	Partikel
LA86S	21651971	Partikel •
LA87	21651983	Partikel
LA9	21651891	Partikel
LA93	21652689	Partikel
LA95	80001446	Partikel
LA97	21652308	Partikel
LA98	21653029	Partikel
LA99	80000633	Partikel
LAG113S	21652860	Partikel •
LAK102	21652336	Combi
LAK107	21653069	Combi
LAK11	21651964	Combi
LAK117	80000621	Combi
LAK120	21652357	Combi
LAK122	80000148	Combi •
LAK124	21651296	Combi
LAK127	80000765	Combi •
LAK129	21652861	Combi
LAK1291	21652862	Combi
LAK136	21652542	Combi
LAK138	21652540	Combi
LAK141	21652352	Combi •
LAK142	21652538	Combi
LAK152	21651952	Combi
LAK153	80000429	Combi
LAK154	80000364	Combi
LAK156	21652865	Combi
LAK158	21652992	Combi
LAK167	21653147	Combi
LAK169	21652858	Combi
LAK171	21652853	Combi
LAK173	21652851	Combi •
LAK175	80000670	Combi
LAK176	21652898	Combi
LAK181	21653008	Combi
LAK1811	80000602	Combi
LAK182	21653015	Combi
LAK183	80000284	Combi
LAK184	21653146	Combi
LAK189	21652995	Combi
LAK19	80000628	Combi
LAK191S	80000667	Combi •
LAK196	21652872	Combi
LAK197	21653064	Combi •
LAK21	21651965	Combi
LAK220	21653035	Combi
LAK221S	80000848	Combi •
LAK225	21653115	Combi
LAK225S	21653031	Combi •
LAK226	21651960	Combi
LAK228	21651960	Combi
LAK229	21653009	Combi
LAK232	21653102	Combi
LAK234	21652852	Combi
LAK235S	80000208	Combi
LAK238	80000347	Combi
LAK239	21653066	Combi

Knecht-Mahle			
LAK242	21652361	Combi	
LAK243	80000070	Combi	
LAK246	80000071	Combi	
LAK247	80000408	Combi	
LAK248	80000064	Combi	
LAK249	21652991	Combi	
LAK25	21652959	Combi	
LAK250	21652859	Combi	
LAK251	21653013	Combi	
LAK252	21653143	Combi	
LAK255	21653115	Combi	
LAK265	80000431	Combi	
LAK2785	21652812	Combi	•
LAK280	80000361	Combi	
LAK2925	80000538	Combi	•
LAK293	80000062	Combi	
LAK2955	80000647	Combi	•
LAK307	80000616	Combi	
LAK31	21651955	Combi	
LAK321	21652541	Combi	
LAK358	21653000	Combi	
LAK36	21652353	Combi	
LAK364	80000606	Combi	
LAK37	21651961	Combi	
LAK373	80000777	Combi	
LAK38	80000624	Combi	
LAK387	80000713	Combi	
LAK410	80000866	Combi	
LAK412	80000866	Combi	
LAK4265	80001031	Combi	•
LAK4285	80000615	Combi	•
LAK43	21653006	Combi	
LAK430	80001035	Combi	
LAK436	80000854	Combi	
LAK437	80001459	Combi	
LAK44	21651968	Combi	
LAK45	21651956	Combi	
LAK454	80001179	Combi	
LAK46	21651957	Combi	
LAK463	80001129	Combi	
LAK472	80001186	Combi	
LAK478	80000068	Combi	
LAK485	80000648	Combi	
LAK49	21651966	Combi	
LAK52	21651960	Combi	
LAK54	21652996	Combi	
LAK541	80000069	Combi	
LAK56	21651952	Combi	
LAK57	21653068	Combi	
LAK58	21651957	Combi	
LAK59	21652541	Combi	
LAK62	21652916	Combi	
LAK63	21651967	Combi	
LAK64	21651954	Combi	
LAK70	21653149	Combi	
LAK735	21651882	Combi	•
LAK74	80000113	Combi	
LAK75	80000021	Combi	
LAK77	21652355	Combi	
LAK78	21652354	Combi	
LAK81	21651292	Combi	
LAK83	21652985	Combi	

Knecht-Mahle			
LAK85	21652999	Combi	
LAK93	21652713	Combi	
LAK96	21653014	Combi	
LAK98	21651294	Combi	
LAKG1135	80000403	Combi	•
LAP1	80001586	Partikel	
Mann			
CU10062	80000022	Partikel	•
CU1009	80000066	Partikel	
CU13133	21651971	Partikel	•
CU1519	80001739	Partikel	
CU1546	21651983	Partikel	
CU155003710	80001621	Partikel	
CU15600222	80001623	Partikel	
CU16400242	80000348	Partikel	
CU1719	80000804	Partikel	
CU17202	80000073	Partikel	•
CU1722	80000362	Partikel	
CU1738	21651987	Partikel	
CU18062	80001737	Partikel	•
CU18112	80001718	Partikel	•
CU1823	21652990	Partikel	
CU1827	80000603	Partikel	
CU1828	21652539	Partikel	
CU1829	80000074	Partikel	
CU1835	21652989	Partikel	
CU190003	21652342	Partikel	•
CU1910	80000634	Partikel	
CU1912	80001452	Partikel	
CU1915	80000825	Partikel	
CU1919	80000604	Partikel	
CU19302	80000535	Partikel	•
CU19312	21652687	Partikel	•
CU1936	80000874	Partikel	
CU2015	21652873	Partikel	
CU2026	21653026	Partikel	
CU2027	80001172	Partikel	
CU2028	80001036	Partikel	
CU20332	21652860	Partikel	•
CU2035	21652874	Partikel	
CU2038	80000636	Partikel	
CU2040	80001027	Partikel	
CU2043	21653145	Partikel	
CU210002	80000666	Partikel	•
CU210012	21652897	Partikel	•
CU2101	80001586	Partikel	
CU21062	80000643	Partikel	•
CU2129	80001446	Partikel	
CU2131	21652539	Partikel	
CU2132	80001724	Partikel	
CU2136	80000444	Partikel	
CU2137	21652351	Partikel	
CU2138	80000676	Partikel	
CU2141	80000853	Partikel	
CU2143	21652994	Partikel	
CU2145	80000164	Partikel	
CU2149	21652550	Partikel	
CU2184	21653139	Partikel	
CU220012	80000405	Partikel	•
CU220022	80001023	Partikel	•
CU22162	80000160	Partikel	•
CU2218	21653018	Partikel	

Mann			
CU22242	21651982	Partikel	•
CU2225	21651899	Partikel	
CU2240	21652349	Partikel	
CU2243	80000541	Partikel	
CU2245	21653028	Partikel	
CU2252	21652346	Partikel	
CU2253	21651972	Partikel	
CU230002	21652867	Partikel	•
CU230012	80001489	Partikel	•
CU2303	80000645	Partikel	
CU2304	80000350	Partikel	
CU2316	21653071	Partikel	
CU2317	80000662	Partikel	
CU2326	21652350	Partikel	
CU2327	21652546	Partikel	•
CU23272	21652546	Partikel	•
CU2329	80000082	Partikel	
CU2330	80000155	Partikel	
CU2331	80000813	Partikel	
CU2335	21652544	Partikel	
CU2336	80000652	Partikel	
CU2337	21652338	Partikel	
CU23371	21652339	Partikel	
CU2338	21653029	Partikel	
CU2339	21652849	Partikel	
CU2344	21652899	Partikel	
CU2345	21652346	Partikel	
CU2349	21651981	Partikel	
CU2351	21652345	Partikel	
CU2356	80000083	Partikel	
CU2358	80000330	Partikel	
CU2362	80000767	Partikel	
CU2422	21653027	Partikel	
CU2423	80000060	Partikel	
CU2424	21652348	Partikel	
CU2425	80000536	Partikel	
CU2430	80000080	Partikel	
CU2431	21652350	Partikel	
CU2433	21652857	Partikel	
CU2435	21651984	Partikel	
CU2436	80001128	Partikel	
CU2440	80000061	Partikel	
CU2441	80000159	Partikel	
CU2442	80001185	Partikel	
CU2450	80000879	Partikel	
CU2454	80000620	Partikel	
CU2504	21652900	Partikel	
CU25062	80000084	Partikel	•
CU2513	80000657	Partikel	
CU2516	21652870	Partikel	
CU2520	80000029	Partikel	
CU25212	80000644	Partikel	•
CU2525	21651916	Partikel	
CU25251	21651298	Partikel	
CU2530	21652347	Partikel	
CU2531	21651900	Partikel	
CU2532	80000871	Partikel	
CU2534	21652997	Partikel	
CU25422	80000546	Partikel	•
CU2544	80000815	Partikel	
CU2545	21652356	Partikel	
CU2559	21653034	Partikel	

Mann			
CU25911	21651970	Partikel	
CU260002	80000548	Partikel	•
CU260310	80001728	Partikel	
CU2622	80000877	Partikel	
CU2623	80000649	Partikel	
CU2628	80000157	Partikel	
CU2629	80000637	Partikel	
CU2630	21653032	Partikel	
CU2634	80000852	Partikel	
CU2640	80000537	Partikel	
CU2642	21651991	Partikel	
CU2645	21652340	Partikel	
CU26451	21652341	Partikel	
CU2647	80000158	Partikel	
CU2650	21651986	Partikel	
CU2672	21651898	Partikel	
CU2680	21652543	Partikel	
CU2733	80000712	Partikel	
CU2734	21651984	Partikel	
CU27452	21651195	Partikel	•
CU2746	21652993	Partikel	
CU2747	80000360	Partikel	
CU2750	80000594	Partikel	
CU2757	21651980	Partikel	
CU2785	80000633	Partikel	
CU28082	80001024	Partikel	•
CU2835	21651198	Partikel	
CU2839	21652359	Partikel	
CU2842	21653020	Partikel	
CU2855	21652317	Partikel	
CU28551	80000412	Partikel	
CU2861	21651891	Partikel	
CU2882	21651912	Partikel	
CU2897	21651196	Partikel	
CU2916	80001628	Partikel	
CU2930	80000373	Partikel	
CU2939	21653024	Partikel	
CU2940	21653028	Partikel	
CU29412	80000847	Partikel	•
CU2945	21651983	Partikel	
CU2949	21653023	Partikel	•
CU29492	21653023	Partikel	•
CU2951	21651901	Partikel	
CU29511	21651970	Partikel	
CU2952	80000915	Partikel	
CU2956	21651901	Partikel	
CU3001	80001585	Partikel	
CU3020	21652308	Partikel	
CU3023	21653067	Partikel	
CU30232	21653067	Partikel	
CU3032	21651917	Partikel	
CU3037	21652689	Partikel	
CU30392	80000839	Partikel	•
CU3040	80001738	Partikel	
CU3042	21651892	Partikel	
CU3054	21651979	Partikel	
CU3059	21651183	Partikel	
CU31242	21652848	Partikel	•
CU3132	21653022	Partikel	
CU3136	21651896	Partikel	
CU3138	21651894	Partikel	
CU3139	21653063	Partikel	•

Mann			
CU31392	21653063	Partikel	•
CU3146	80000409	Partikel	
CU3172	21652863	Partikel	
CU31721	21652864	Partikel	
CU3192	21651914	Partikel	
CU3240	80000807	Partikel	
CU3243	80001629	Partikel	
CU3260	21651918	Partikel	
CU3337	21652714	Partikel	
CU3338	21651197	Partikel	
CU3340	21651920	Partikel	
CU3350	80001488	Partikel	
CU3360	21651920	Partikel	
CU340310	80000349	Partikel	
CU3411	80001025	Partikel	
CU3415	80000340	Partikel	
CU3423	21653019	Partikel	
CU3435	80000027	Partikel	
CU3448	21651293	Partikel	
CU3454	80000072	Partikel	
CU3455	21651184	Partikel	
CU3461	21652358	Partikel	
CU34611	21652335	Partikel	
CU3466	80000632	Partikel	
CU3478	21653019	Partikel	
CU3518	21653141	Partikel	
CU3540	21653025	Partikel	
CU3553	21651893	Partikel	
CU3554	21651893	Partikel	
CU3562	21651913	Partikel	
CU3567	21651995	Partikel	
CU3569	80000614	Partikel	
CU36422	21653030	Partikel	•
CU3649	21652360	Partikel	
CU37001	80001732	Partikel	
CU37230	21653016	Partikel	
CU3759	21652045	Partikel	
CU3780	21652688	Partikel	
CU38222	21651199	Partikel	•
CU3840	21652871	Partikel	
CU3847	80000865	Partikel	
CU3855	21653003	Partikel	
CU3858	21651976	Partikel	
CU3869	21651977	Partikel	
CU3933	80001584	Partikel	
CU3942	21651915	Partikel	
CU3943	21653017	Partikel	
CU3944	80001582	Partikel	
CU3955	21651890	Partikel	
CU3959	80001583	Partikel	
CU3979	21651890	Partikel	
CU4007	21651887	Partikel	
CU40071	21651974	Partikel	
CU40110	21651973	Partikel	
CU4036	80000076	Partikel	
CU4054	21653144	Partikel	
CU4150	80000638	Partikel	
CU4151	21651185	Partikel	
CU4179	21652856	Partikel	
CU42001	80001182	Partikel	
CU4228	21653021	Partikel	
CU4236	80000341	Partikel	

Mann			
CU4251	21651182	Partikel	
CU4260	21651919	Partikel	
CU4408	21652002	Partikel	
CU4416	21653114	Partikel	
CU4436	80000740	Partikel	
CU4442	21651994	Partikel	
CU4469	21653007	Partikel	
CU45120	80000356	Partikel	
CU4580	80001581	Partikel	
CU4594	80000333	Partikel	
CU4603203	80000336	Partikel	
CU4624	21652850	Partikel	
CU4627	80000336	Partikel	
CU46276	80000336	Partikel	
CU4662	80000641	Partikel	
CU4727	80000079	Partikel	
CU4795	21653005	Partikel	
CU481110	80001622	Partikel	
CU4926	80001579	Partikel	
CU50102	80001626	Partikel	
CU5041	21651993	Partikel	
CU5067	80000639	Partikel	
CU5096	80000337	Partikel	
CU5141	21652709	Partikel	
CU5257	21650107	Partikel	
CU5346	80000339	Partikel	
CU5366	80000065	Partikel	
CU540710	80001729	Partikel	
CU5476	80000539	Partikel	
CU5480	21651895	Partikel	
CU5809	21653001	Partikel	
CU5877	21652998	Partikel	
CU6034	80001627	Partikel	
CU6724	21651969	Partikel	
CU810004	80001624	Partikel	•
CU8430	80000063	Partikel	
CU8541	80000357	Partikel	
CUK1611	80000617	Combi	
CUK18202	21652352	Combi	•
CUK1830	21653013	Combi	
CUK19312	21653070	Combi	•
CUK200002	21652861	Combi	
CUK2030	80001179	Combi	
CUK2032	21653014	Combi	
CUK20332	80000403	Combi	•
CUK210002	80000667	Combi	•
CUK21002	80000667	Combi	•
CUK2137	21653069	Combi	
CUK2141	80000854	Combi	
CUK2143	21652995	Combi	
CUK2149	21652542	Combi	
CUK220002	80001740	Combi	•
CUK22242	21652046	Combi	•
CUK2230	80000068	Combi	
CUK2231	80000648	Combi	
CUK22412	21652812	Combi	•
CUK2243	80000777	Combi	
CUK2245	21653146	Combi	
CUK2335	21651296	Combi	
CUK2338	21651294	Combi	
CUK2339	21652852	Combi	
CUK2422	21652538	Combi	



Mann			
CUK2433	21652858	Combi	
CUK2436	80001129	Combi	
CUK2440	80000062	Combi	
CUK2442	80001186	Combi	
CUK2450	80000880	Combi	
CUK2534	80000626	Combi	
CUK2545	21652357	Combi	
CUK2559	21653035	Combi	
CUK2620	80001188	Combi	
CUK2639	80001461	Combi	
CUK26462	80000647	Combi	•
CUK2672	21651968	Combi	
CUK2680	80000429	Combi	
CUK27222	80000538	Combi	•
CUK27232	80001031	Combi	•
CUK2733	80000713	Combi	
CUK27362	21651882	Combi	•
CUK2742	80001459	Combi	
CUK2747	80000361	Combi	
CUK2757	80000113	Combi	
CUK2842	21653015	Combi	
CUK2847	80001741	Combi	
CUK2855	21652996	Combi	
CUK28551	80000069	Combi	
CUK2862	21651967	Combi	
CUK2882	21651955	Combi	
CUK2897	21651961	Combi	
CUK28971	21651961	Combi	
CUK2939	21653008	Combi	
CUK29391	80000602	Combi	
CUK2940	21652540	Combi	
CUK29412	80000848	Combi	•
CUK2949	21652552	Combi	•
CUK29492	21652552	Combi	•
CUK2950	21652991	Combi	
CUK2951	21651952	Combi	
CUK2956	21651952	Combi	
CUK3020	80000430	Combi	
CUK3023	21653066	Combi	
CUK30232	21653066	Combi	
CUK3037	21651957	Combi	
CUK30392	80000615	Combi	•
CUK3042	21651954	Combi	
CUK3054	80000021	Combi	
CUK3059	21652353	Combi	
CUK31242	21652851	Combi	•
CUK3137	80000408	Combi	
CUK3139	21653064	Combi	•
CUK31392	21653064	Combi	•
CUK3142	21652854	Combi	
CUK3172	21652865	Combi	
CUK3192	21651958	Combi	
CUK3220	21653115	Combi	
CUK3240	21653102	Combi	
CUK3241	21652694	Combi	
CUK3337	80000621	Combi	
CUK3340	21652541	Combi	
CUK3360	21652541	Combi	
CUK3448	21653068	Combi	
CUK3455	21651965	Combi	
CUK3461	21652861	Combi	
CUK34611	21652862	Combi	

Mann			
CUK350002	21653031	Combi	•
CUK3518	21653142	Combi	
CUK3540	21653009	Combi	
CUK3554	21652355	Combi	
CUK3562	21651958	Combi	
CUK3567	21652354	Combi	
CUK3569	80000616	Combi	
CUK3621	80000071	Combi	
CUK36422	21651881	Combi	•
CUK3780	21651292	Combi	
CUK3823	21653006	Combi	
CUK3840	21652872	Combi	
CUK3847	80000866	Combi	
CUK3858	21652985	Combi	
CUK3943	80000070	Combi	
CUK3955	21651956	Combi	
CUK3979	21651956	Combi	
CUK4007	21653010	Combi	
CUK40071	21653011	Combi	
CUK4054	21653143	Combi	
CUK4062	80001580	Combi	
CUK4136	21652898	Combi	
CUK4151	21651966	Combi	
CUK4251	21651964	Combi	
CUK4436	80000741	Combi	
CUK4469	21653000	Combi	
CUK4594	80001127	Combi	
CUK4624	21652853	Combi	
CUK4795	80000364	Combi	
CUK5141	21652361	Combi	
CUK5257	21652959	Combi	
CUK5258	21653149	Combi	
CUK5366	21652916	Combi	
CUK5480	21651960	Combi	
CUK5877	21652999	Combi	
CUK6724	21652336	Combi	
CUK8430	80000064	Combi	
LA120	21652356	Partikel	
LAK77	21652355	Combi	
Marelli BCF			
100	21651198	Partikel	
101	21651196	Partikel	
102	21651971	Partikel	•
104	21651182	Partikel	
105	21651890	Partikel	
106	21651891	Partikel	
107	21650107	Partikel	
108	21651183	Partikel	
109	21651892	Partikel	
110	21651893	Partikel	
111	21651184	Partikel	
112	21651894	Partikel	
113	21651895	Partikel	
114	21651896	Partikel	
116	21651972	Partikel	
117	21651898	Partikel	
118	21651185	Partikel	
119	21651899	Partikel	
120	21651900	Partikel	
121	21651901	Partikel	
122	21651912	Partikel	
123	21651914	Partikel	

Marelli BCF			
124	21651915	Partikel	
125	21651916	Partikel	
126	21651917	Partikel	
127	21651919	Partikel	
128	21651920	Partikel	
130	80000376	Partikel	
131	21651994	Partikel	
132	21651197	Partikel	
133	21651195	Partikel	•
134	21651913	Partikel	
138	21651981	Partikel	
139	21651970	Partikel	
140	21651982	Partikel	•
141	21651976	Partikel	
142	21651983	Partikel	
145	21652356	Partikel	
146	21651969	Partikel	
147	21651897	Partikel	•
148	21652342	Partikel	•
150	21652543	Partikel	
151	21652308	Partikel	
152	21652544	Partikel	
153	21651995	Partikel	
154	21652359	Partikel	
155	21652345	Partikel	
156	21652688	Partikel	
157	21652358	Partikel	
158	21652045	Partikel	
159	21652346	Partikel	
160	21652347	Partikel	
161	21651979	Partikel	
162	21651980	Partikel	
163	21651293	Partikel	
164	21652687	Partikel	•
165	21652348	Partikel	
166	21651984	Partikel	
167	21652349	Partikel	
169	21651986	Partikel	
199	80000061	Partikel	
301	21651961	Combi	
304	21651964	Combi	
305	21651956	Combi	
307	21652959	Combi	
311	21651965	Combi	
313	21651960	Combi	
317	21651968	Combi	
318	21651966	Combi	
321	21651952	Combi	
322	21651955	Combi	
323	21651957	Combi	
324	21651951	Combi	
334	21651958	Combi	
339	21651953	Combi	
340	21651967	Combi	
341	21652361	Combi	
345	21652357	Combi	
346	21652336	Combi	
347	21651882	Combi	•
348	21652352	Combi	•
349	21653014	Combi	
351	21652353	Combi	
352	21651296	Combi	

Marelli BCF			
353	21652354	Combi	
356	21651292	Combi	
540	21651991	Partikel	
Meritor			
C17724	21651894	Partikel	
C17926	21651895	Partikel	
C18080	21651982	Partikel	•
C18081	21652687	Partikel	•
C18085	21651881	Combi	•
C18086	21652688	Partikel	
C18128	21652347	Partikel	
C18129	21651951	Combi	
C18151	21652342	Partikel	•
C18156	21651993	Partikel	
C18160	21651994	Partikel	
C18200	21652352	Combi	•
C18203	21652361	Combi	
C25483	21651986	Partikel	
C27645	21651198	Partikel	
C27723	21651915	Partikel	
C27727	21651952	Combi	
C27744	21651891	Partikel	
C27745	21652541	Combi	
C27924	21651893	Partikel	
C28149	21651898	Partikel	
C28154	21651900	Partikel	
C28155	21651917	Partikel	
C28169	21652348	Partikel	
C28172	21651995	Partikel	
C28178	21651293	Partikel	
C28191	21652349	Partikel	
C28213	21651919	Partikel	
C28224	21652359	Partikel	
C28226	21652540	Combi	
C28233	21651987	Partikel	
C28906	21651890	Partikel	
C37646	21651916	Partikel	
C37725	21651896	Partikel	
C37726	21651892	Partikel	
C38145	21651954	Combi	
C38167	21651984	Partikel	
C38170	21651972	Partikel	
C38171	21651979	Partikel	
C38173	21652338	Partikel	
C38182	21652317	Partikel	
C38184	21651294	Combi	
C38186	21652346	Partikel	
C38193	21652543	Partikel	
C38202	21652550	Partikel	
C38210	21652351	Partikel	
C47925	21651897	Partikel	•
Orione			
S014	80000359	Combi	
S017	80000594	Partikel	
S018	21651964	Combi	
S019	21651965	Combi	
S0231	80000377	Combi	
S028	21652959	Combi	
S101	80000433	Combi	
S105	21651961	Combi	
S106	21651292	Combi	
S113	80000421	Combi	•

Orione			
S114	80000743	Combi	
S115	80000402	Combi	
S117	21651968	Combi	
S119	80000113	Combi	
S120	21651958	Combi	
S121	80000077	Combi	
S124	80000440	Combi	
S126	80000438	Combi	
S128	21653070	Combi	•
S129	80000762	Combi	
S130	80000436	Combi	
S1300	21651896	Partikel	
S1314	21651198	Partikel	
S1317	80000594	Partikel	
S1318	21651182	Partikel	
S1319	21651184	Partikel	
S13231	21651197	Partikel	
S13231R	21651888	Partikel	
S1323R1	21651888	Partikel	
S1328	21650107	Partikel	
S134	80000416	Combi	
S136	21651966	Combi	
S138	80000434	Combi	
S140	21652541	Combi	
S1400	21651918	Partikel	
S1401	21651894	Partikel	
S14021	21651890	Partikel	
S1405	21651196	Partikel	
S1406	21652688	Partikel	
S1407	80000164	Partikel	
S14111	21651912	Partikel	
S1413	21651195	Partikel	•
S1414	21651891	Partikel	
S1415	80000158	Partikel	
S14162	21652897	Partikel	•
S1417	21651898	Partikel	
S14181	21651979	Partikel	
S1419	21651980	Partikel	
S142	21652357	Combi	
S1420	21651913	Partikel	
S1421	21651899	Partikel	
S1422	21651972	Partikel	
S1423	80000157	Partikel	
S1424	80000083	Partikel	
S1426	21652874	Partikel	
S1427	21652350	Partikel	
S1428	21652687	Partikel	•
S1429	21653140	Partikel	
S1430	21651984	Partikel	
S1433	21653019	Partikel	
S1434	21652347	Partikel	
S1436	21651185	Partikel	
S1438	21651916	Partikel	
S1438R	21651298	Partikel	
S1439	21651900	Partikel	
S144	80000428	Combi	
S1440	21651920	Partikel	
S1441	80000537	Partikel	
S1442	21652356	Partikel	
S1443	80000066	Partikel	
S1444	80000029	Partikel	
S1446	80000409	Partikel	

Orione			
S1447	80000409	Partikel	
S14482	21653114	Partikel	
S1449	80001025	Partikel	
S1451	21652539	Partikel	
S14531	21652873	Partikel	
S1455	80000075	Partikel	
S1456	21653030	Partikel	•
S1457	21652848	Partikel	•
S1458	21651969	Partikel	
S1459	21651882	Combi	•
S146	21653115	Combi	
S1460	80000079	Partikel	
S1463	21653005	Partikel	
S1465	21651919	Partikel	
S1467	21651976	Partikel	
S1468	21652045	Partikel	
S1470	21651973	Partikel	
S1471	21653007	Partikel	
S14721	21652714	Partikel	
S1473	21651183	Partikel	
S1474	21651991	Partikel	
S14761	80000362	Partikel	
S1478	21652998	Partikel	
S1479	21652857	Partikel	
S14801	80000376	Partikel	
S1481	21651901	Partikel	
S1482	80000084	Partikel	•
S1483	21652342	Partikel	•
S1484	21651987	Partikel	
S1485	21653003	Partikel	
S14861	21653114	Partikel	
S1487	21653023	Partikel	•
S1488	80000375	Partikel	•
S1490	21652548	Partikel	
S1491	21653141	Partikel	
S1492	21653028	Partikel	
S1494	21652543	Partikel	
S1496	21653151	Partikel	
S1497	80000338	Partikel	
S1498	21652900	Partikel	
S1499	21652899	Partikel	
S1500	21652308	Partikel	
S1501	21651296	Combi	
S1502	21651901	Partikel	
S1504	21652348	Partikel	
S1506	21652349	Partikel	
S1507	21653016	Partikel	
S1508	21652550	Partikel	
S15091	21651983	Partikel	
S1510	21651293	Partikel	
S1512	21652317	Partikel	
S1512R	80000412	Partikel	
S1513	80000657	Partikel	
S15141	80000022	Partikel	•
S1515	80000632	Partikel	
S1516	80000633	Partikel	
S1517	21653139	Partikel	
S1518	21652850	Partikel	
S1520	21651914	Partikel	
S1521	21652689	Partikel	
S1522	21652856	Partikel	
S1523	80001034	Partikel	



Orione			
S1524	21651995	Partikel	
S1526	21651986	Partikel	
S1529	21651917	Partikel	
S1531	21651893	Partikel	
S1532	21651895	Partikel	
S1534	21652338	Partikel	
S1534R	21652339	Partikel	
S1535	21652340	Partikel	
S1535R	21652341	Partikel	
S1537	80001033	Partikel	•
S1540	21651994	Partikel	
S1542	21652356	Partikel	
S1543	80001023	Partikel	•
S1544	21653032	Partikel	
S1545	80000158	Partikel	
S1546	21652359	Partikel	
S1547	80000548	Partikel	•
S1548	80000654	Partikel	•
S1549	21652997	Partikel	
S1550	21652358	Partikel	
S1550R	21652335	Partikel	
S1551	21652992	Combi	
S1552	80000634	Partikel	
S1553	21652863	Partikel	
S1553R	21652864	Partikel	
S1554	21653020	Partikel	
S1555	80000065	Partikel	
S1556	21653071	Partikel	
S1557	80000645	Partikel	
S1558	21651986	Partikel	
S1559	21653022	Partikel	
S156	21651881	Combi	•
S1560	80000155	Partikel	
S1561	80000074	Partikel	
S1562	21652346	Partikel	
S1564	80000159	Partikel	
S1565	80000082	Partikel	
S1566	80000405	Partikel	•
S1567	80000061	Partikel	
S1568	21653034	Partikel	
S1569	80000349	Partikel	
S157	21652851	Combi	•
S1570	21651977	Partikel	
S1571	21652546	Partikel	•
S1572	21653144	Partikel	
S1573	21653027	Partikel	
S1574	21652989	Partikel	
S1575	80000080	Partikel	
S1576	80000333	Partikel	
S1577	21652990	Partikel	
S1578	21652871	Partikel	
S1579	80000652	Partikel	
S158	21652336	Combi	
S1581	21652867	Partikel	•
S1583	80000643	Partikel	•
S1584	80000824	Partikel	
S1585	21653063	Partikel	•
S1586	80000331	Partikel	
S1588	80000807	Partikel	
S1589	21651294	Combi	
S159	21651882	Combi	•
S1590	21653025	Partikel	

Orione			
S1591	80000403	Combi	•
S1592	21653026	Partikel	
S1593	80000804	Partikel	
S1594	80000160	Partikel	•
S1596	80000354	Partikel	
S1597	80000646	Partikel	
S1598	80000655	Partikel	
S1599	80000330	Partikel	
S160	80000415	Combi	
S1600	21653067	Partikel	
S1601	21652544	Partikel	
S1602	80000063	Partikel	
S1603	21652539	Partikel	
S1606	80000060	Partikel	
S1607	21653148	Partikel	
S1609	21652994	Partikel	
S1610	21653017	Partikel	
S1611	21653024	Partikel	
S1612	80000356	Partikel	
S1613	80000546	Partikel	•
S1614	21652849	Partikel	
S1616	80000603	Partikel	
S1619	80000163	Partikel	
S1620	80000082	Partikel	
S1621	80000360	Partikel	
S1623	80000662	Partikel	
S1624	21652868	Partikel	
S1625	21651915	Partikel	
S1626	80000676	Partikel	
S1627	80000156	Partikel	•
S1629	80000345	Partikel	
S163	80000364	Combi	
S1630	80000620	Partikel	
S1631	80000162	Partikel	
S1632	21652351	Partikel	
S1634	80000541	Partikel	
S1635	21652360	Partikel	
S1636	80000605	Combi	
S1637	80000767	Partikel	
S1639	80000666	Partikel	•
S1641	80000813	Partikel	
S1642	21652551	Partikel	
S1644	80001439	Partikel	•
S1647	80000871	Partikel	
S1648	80000815	Partikel	
S1649	80000853	Partikel	
S1650	21652870	Partikel	
S1651	80001041	Partikel	•
S1652	21652345	Partikel	
S1654	80000614	Partikel	
S1655	80000915	Partikel	
S1657	80000839	Partikel	•
S1659	80000712	Partikel	
S1662	80000877	Partikel	
S1664	80000874	Partikel	
S1665	80000865	Partikel	
S1667	80001036	Partikel	
S1668	80000869	Partikel	
S1669	80000740	Partikel	
S167	21652985	Combi	
S1670	80000879	Partikel	
S1671	80001027	Partikel	

Orione			
S1672	80000847	Partikel	•
S1674	80001128	Partikel	
S1675	80001183	Partikel	
S1676	80001214	Partikel	
S1678	80001130	Partikel	•
S168	80000427	Combi	
S1680	80001185	Partikel	
S171	21653000	Combi	
S173	21652353	Combi	
S1761	80000364	Combi	
S178	21652999	Combi	•
S179	21652858	Combi	
S1801	80000376	Partikel	
S182	80000441	Combi	•
S184	80000028	Combi	
S187	21652552	Combi	•
S188	21652352	Combi	•
S190	21652540	Combi	
S191	21653142	Combi	
S192	21653146	Combi	
S194	80000429	Combi	
S196	21652854	Combi	
S197	21653014	Combi	
S200	80000430	Combi	
S201	21651296	Combi	
S202	21651952	Combi	
S206	80000418	Combi	
S208	21652542	Combi	
S2091	80000114	Combi	
S210	21653068	Combi	
S211	21651967	Combi	
S212	21652996	Combi	
S212R	80000412	Partikel	
S2141	80000022	Partikel	•
S218	21652853	Combi	
S220	21651957	Combi	
S221	21652713	Combi	
S222	21653147	Combi	
S224	21652354	Combi	
S229	80000435	Combi	
S231	21652355	Combi	
S232	21651960	Combi	
S240	80000432	Combi	
S242	21652357	Combi	
S244	80000344	Combi	
S246	80000431	Combi	
S249	80000626	Combi	
S250	21652861	Combi	
S251	21652992	Combi	
S253	21652865	Combi	
S254	21653015	Combi	
S255	21652916	Combi	
S256	80000670	Combi	
S258	80000744	Combi	
S259	80000623	Combi	
S264	80000401	Combi	
S265	80000759	Combi	
S266	80000406	Combi	•
S267	80000062	Combi	
S267S268	80000062	Combi	
S268	21653035	Combi	
S270	21653006	Combi	

Orione			
S271	80000148	Combi	•
S272	21653143	Combi	
S273	21652538	Combi	
S274	80000437	Combi	
S276	80001127	Combi	
S277	80000439	Combi	
S278	21652872	Combi	
S281	80000397	Combi	•
S282	80000068	Combi	
S285	21653064	Combi	•
S286	21653013	Combi	
S287	80000648	Combi	
S288	21653102	Combi	
S289	21651294	Combi	
S290	21653009	Combi	
S291	80000403	Combi	•
S293	80000783	Combi	
S294	80000792	Combi	•
S299	80000404	Combi	
S300	21653066	Combi	
S302	80000064	Combi	
S307	21653149	Combi	
S309	21652995	Combi	
S310	80000070	Combi	
S311	21653008	Combi	
S314	21652852	Combi	
S315	80000071	Combi	
S317	80000849	Combi	•
S319	80000208	Combi	
S321	80000361	Combi	
S325	21651951	Combi	
S329	80000346	Combi	
S330	80000622	Combi	
S332	21653069	Combi	
S333	80000605	Combi	
S334	80000777	Combi	
S339	80000667	Combi	•
S341	80000814	Combi	
S342	80000419	Combi	
S343	80000647	Combi	•
S349	80000854	Combi	
S352	21652346	Partikel	
S354	80000616	Combi	
S355	80000916	Combi	
S357	80000615	Combi	•
S359	80000713	Combi	
S363	80001035	Combi	
S365	80000866	Combi	
S369	80000741	Combi	
S370	80000880	Combi	
S372	80000848	Combi	•
S373	80001459	Combi	
S374	80001129	Combi	
S380	80001186	Combi	
S384	80001211	Combi	•
PBR AH			
7001	21651182	Partikel	
7002	21650107	Partikel	
7003	21651912	Partikel	
7004	21651891	Partikel	
7005	21651890	Partikel	
7006	21651183	Partikel	

PBR AH			
7007	21651898	Partikel	
7008	21651914	Partikel	
7009	21651196	Partikel	
7010	21651184	Partikel	
7011	21651899	Partikel	
7013	21651916	Partikel	
7014	21651917	Partikel	
7015	21651920	Partikel	
7016	21651195	Partikel	•
7017	21651893	Partikel	
7018	21651969	Partikel	
7019	21651882	Combi	•
7020	21651881	Combi	•
7021	21651967	Combi	
7023	21651894	Partikel	
7024	21651919	Partikel	
7025	21651901	Partikel	
7026	21651913	Partikel	
7027	21651957	Combi	
7028	21651185	Partikel	
7030	21651198	Partikel	
7031	21651900	Partikel	
7034	21651979	Partikel	
7035	21651980	Partikel	
7036	21652688	Partikel	
7038	21651197	Partikel	
7040	21651954	Combi	
7044	21652687	Partikel	•
7045	21651995	Partikel	
7046	21651986	Partikel	
7047	21651994	Partikel	
7048	21651982	Partikel	•
7056	21652959	Combi	
7057	21651964	Combi	
7058	21651961	Combi	
7059	21651960	Combi	
7060	21651966	Combi	
7061	21651952	Combi	
7063	21651965	Combi	
7064	21651951	Combi	
7065	21651956	Combi	
7066	21651955	Combi	
7081	21651293	Partikel	
Purflux			
AH101	21651899	Partikel	
AH102	21651920	Partikel	
AH103	21650107	Partikel	
AH104	21651912	Partikel	
AH105	21651184	Partikel	
AH106	21651964	Combi	
AH107	21651901	Partikel	
AH108	21651894	Partikel	
AH109	21651896	Partikel	
AH110	21651915	Partikel	
AH111	21651892	Partikel	
AH114	21651891	Partikel	
AH115	21651919	Partikel	
AH116	21651917	Partikel	
AH117	21651916	Partikel	
AH118	21651900	Partikel	
AH119	21651890	Partikel	
AH120	21651198	Partikel	

Purflux			
AH121	21651915	Partikel	
AH122	21651893	Partikel	
AH123	21651971	Partikel	•
AH124	21651185	Partikel	
AH125	80000594	Partikel	
AH126	21652688	Partikel	
AH127	21651972	Partikel	
AH128	21651183	Partikel	
AH129	21651895	Partikel	
AH130	21651197	Partikel	
AH132	80000373	Partikel	
AH133	21653140	Partikel	
AH135	80000636	Partikel	
AH137	21651195	Partikel	•
AH138	21651196	Partikel	
AH139	21651913	Partikel	
AH140	21651293	Partikel	
AH142	21651991	Partikel	
AH143	21651983	Partikel	
AH144	21651984	Partikel	
AH147	21651914	Partikel	
AH150	21652348	Partikel	
AH151	21652897	Partikel	•
AH157	21651982	Partikel	•
AH158	21651976	Partikel	
AH159	21652045	Partikel	
AH160	21652551	Partikel	
AH163	21652687	Partikel	•
AH165	21652345	Partikel	
AH166	21652543	Partikel	
AH167	21651995	Partikel	
AH169	21652349	Partikel	
AH170	21651979	Partikel	
AH171	21651980	Partikel	
AH173	21652317	Partikel	
AH174	21652899	Partikel	
AH175	21652350	Partikel	
AH179	21652548	Partikel	
AH180	21653032	Partikel	
AH182	21651987	Partikel	
AH184	21652689	Partikel	
AH185	21652550	Partikel	
AH186	80000072	Partikel	
AH189	80001452	Partikel	
AH191	21652356	Partikel	
AH193	21653028	Partikel	
AH194	21652358	Partikel	
AH198	21652714	Partikel	
AH199	21653071	Partikel	
AH201	21651296	Combi	
AH202	21653024	Partikel	
AH203	21652871	Partikel	
AH204	21652346	Partikel	
AH205	21652856	Partikel	
AH206	21652994	Partikel	
AH207	80000074	Partikel	
AH209	21653020	Partikel	
AH210	21652539	Partikel	
AH212	21653034	Partikel	
AH214	21652359	Partikel	
AH220	21652546	Partikel	•
AH221	80000330	Partikel	

Purflux			
AH223	80000662	Partikel	
AH224	21652360	Partikel	
AH225	21652347	Partikel	
AH226	21652338	Partikel	
AH227	21653017	Partikel	
AH228	21653114	Partikel	
AH230	80000158	Partikel	
AH231	21651994	Partikel	
AH233	21653026	Partikel	
AH234	80000080	Partikel	
AH238	80000061	Partikel	
AH244	80000541	Partikel	
AH245	80000666	Partikel	•
AH248	80000652	Partikel	
AH249	80000603	Partikel	
AH251	80000405	Partikel	•
AH255	80001452	Partikel	
AH256	80000604	Partikel	
AH257	80000083	Partikel	
AH260	80000767	Partikel	
AH261	80000839	Partikel	•
AH262	80000853	Partikel	
AH263	80000815	Partikel	
AH265	80001027	Partikel	
AH266	80000620	Partikel	
AH267	80000712	Partikel	
AH270	80000871	Partikel	
AH271	80001039	Partikel	
AH273	80001456	Partikel	
AH280	21653025	Partikel	
AH282	80001128	Partikel	
AHC101	80000077	Combi	
AHC102	21652541	Combi	
AHC103	21652959	Combi	
AHC105	21651965	Combi	
AHC107	21651952	Combi	
AHC112	80000765	Combi	•
AHC113	80000765	Combi	•
AHC119	21651956	Combi	
AHC120	80000359	Combi	
AHC122	21652355	Combi	
AHC124	21651185	Partikel	
AHC126	21651292	Combi	
AHC128	21651183	Partikel	
AHC129	21651960	Combi	
AHC130	80000377	Combi	
AHC134	21651882	Combi	•
AHC136	21651968	Combi	
AHC140	21653068	Combi	
AHC142	80000752	Combi	
AHC147	21651958	Combi	
AHC149	80000744	Combi	
AHC153	80000430	Combi	
AHC154	21651296	Combi	
AHC156	21651954	Combi	
AHC166	80000429	Combi	
AHC167	21652354	Combi	
AHC177	21652352	Combi	•
AHC178	21651967	Combi	
AHC179	21652540	Combi	
AHC181	21653149	Combi	
AHC183	21653142	Combi	

Purflux			
AHC184	21652713	Combi	
AHC185	21652542	Combi	
AHC187	21652336	Combi	
AHC188	21653014	Combi	
AHC190	21652538	Combi	
AHC191	21652357	Combi	
AHC192	21652853	Combi	
AHC195	21652857	Partikel	
AHC198	80000621	Combi	
AHC199	80000670	Combi	
AHC202	21653008	Combi	
AHC203	21652872	Combi	
AHC208	21652992	Combi	
AHC211	21652865	Combi	
AHC212	21653035	Combi	
AHC213	21653102	Combi	
AHC219	21653064	Combi	•
AHC237	21653143	Combi	
AHC238	80000062	Combi	
AHC239	21651882	Combi	•
AHC245	80000667	Combi	•
AHC246	80000064	Combi	
AHC247	21653067	Partikel	
AHC250	80000346	Combi	
AHC258	80000866	Combi	
AHC261	80000615	Combi	•
AHC264	80001031	Combi	•
AHC267	80000713	Combi	
AHC268	80000616	Combi	
AHC272	80001459	Combi	
AHC277	80001035	Combi	
AHC278	21653013	Combi	
AHC281	80001461	Combi	
Purolator			
C14860	21650107	Partikel	
C17724	21651894	Partikel	
C18079	80000430	Combi	
C18082	21651971	Partikel	•
C18085	21651881	Combi	•
C18086	21652688	Partikel	
C18116	21651984	Partikel	
C18117	21651967	Combi	
C18118	21651293	Partikel	
C18119	21651980	Partikel	
C18120	21651979	Partikel	
C18121	21651995	Partikel	
C18122	21651913	Partikel	
C18124	21651986	Partikel	
C18126	21651954	Combi	
C18127	21652336	Combi	
C18163	21651185	Partikel	
C27645	21651198	Partikel	
C27723	21651915	Partikel	
C27727	21651952	Combi	
C27744	21651891	Partikel	
C27745	21651920	Partikel	
C27924	21651893	Partikel	
C28169	21652348	Partikel	
C28187	21652350	Partikel	
C28195	21652714	Partikel	
C28231	21652538	Combi	
C28902	21651182	Partikel	

Purolator			
C28904	21651898	Partikel	
C28906	21651890	Partikel	
C28909	21651197	Partikel	
C28910	21651184	Partikel	
C37615	21651183	Partikel	
C37647	21651899	Partikel	
C37725	21651896	Partikel	
C37726	21651892	Partikel	
C38164	21651980	Partikel	
C38180	21651296	Combi	
C38198	21652356	Partikel	
C38206	21652353	Combi	
C38907	21651912	Partikel	
C38908	21651196	Partikel	
C47935	21651882	Combi	•
QH			
93116E	21651973	Partikel	
93135E	21653139	Partikel	
93211E	21653016	Partikel	
93212E	21653022	Partikel	
93221E	80000362	Partikel	
93223E	21651977	Partikel	
93224E	21653019	Partikel	
93227E	21653005	Partikel	
93228E	80000364	Combi	
93229E	21653021	Partikel	
93233E	21652998	Partikel	
93234E	21653003	Partikel	
93237E	21653006	Combi	
93501E	80000333	Partikel	
BWC3597	21653068	Combi	
CA3373	80000632	Partikel	
CF10067	80000080	Partikel	
CF10080	80000662	Partikel	
CF5473	21651956	Combi	
CF5475	21651182	Partikel	
CF5551	21651899	Partikel	
CF5662	21651890	Partikel	
CF5663	21651912	Partikel	
CF5664	21652709	Partikel	
CF5665	21651184	Partikel	
CF5816	21651183	Partikel	
CF5817	21651893	Partikel	
CF5818	21651894	Partikel	
CF5819	21651952	Combi	
CF5823	21651915	Partikel	
CF5824	21651913	Partikel	
CF5841	21651896	Partikel	
CF5842	21651196	Partikel	
CF5845	21651919	Partikel	
CF5846	21651920	Partikel	
CF5847	21651900	Partikel	
CF5848	21651916	Partikel	
CF5850	21651895	Partikel	
CF5852	21651971	Partikel	•
CF5863	21651185	Partikel	
CF5864	21651891	Partikel	
CF5865	21651972	Partikel	
CF5893	21652348	Partikel	
CF5935	21651197	Partikel	
CF5942	21651914	Partikel	
CF5972	21651195	Partikel	•

QH		
CF8103	21651198	Partikel
CF8714	21651986	Partikel
CF8750	21653032	Partikel
CF8777	21652688	Partikel
CF8778	21653115	Combi
CF8799	21653140	Partikel
CF8831	21651995	Partikel
CF8832	21652687	Partikel •
CF8838	21651983	Partikel
CF8867	21651980	Partikel
CF8868	21651979	Partikel
CF8890	21651994	Partikel
CF8913	21651969	Partikel
CF8914	21651982	Partikel •
CF8947	21652342	Partikel •
CF8948	21652342	Partikel •
CF8989	21652899	Partikel
CF9051	21651976	Partikel
CF9071	21651293	Partikel
CF9077	21652308	Partikel
CF9293	21652349	Partikel
CF9294	21653028	Partikel
CF9323	21652356	Partikel
CF9335	21652350	Partikel
CF9336	21652351	Partikel
CF9337	21652347	Partikel
CF9338	21652345	Partikel
CF9363	21652346	Partikel
CF9364	21652550	Partikel
CF9383	21652045	Partikel
CF9396	21652317	Partikel
CF9398	21653028	Partikel
CF9399	21652359	Partikel
CF9406	21652543	Partikel
CF9408	21651296	Combi
CF9414	21651968	Combi
CF9442	21653071	Partikel
CF9485	21652360	Partikel
CF9495	21652714	Partikel
CF9531	21652714	Partikel
CF9545	21651917	Partikel
CF9546	80000373	Partikel
CF9562	21653141	Partikel
CF9579	21651987	Partikel
CF9586	21652856	Partikel
CF9594	21652850	Partikel
CF9595	21651991	Partikel
CF9640	21653017	Partikel
CF9645	21652689	Partikel
CF9659	21652873	Partikel
CF9666	21652857	Partikel
CF9691	80000074	Partikel
CF9724	21653114	Partikel
CF9756	80000158	Partikel
CF9787	21653034	Partikel
CF9846	21652539	Partikel
CF9881	21653020	Partikel
CF9904	21652994	Partikel
CF9905	21652358	Partikel
CF9922	21653024	Partikel
CF9934	80000072	Partikel
CFA8046	21650107	Partikel

QH		
CFA8788	21651954	Combi
CFA8831	21652354	Combi
CFA8869	21651967	Combi
CFA8874	21652353	Combi
CFA8875	21651964	Combi
CFA8876	21651957	Combi
CFA8877	21651961	Combi
CFA8878	21651895	Partikel
CFA8879	21651966	Combi
CFA8880	21651965	Combi
CFA8882	21651956	Combi
CFA8893	21651955	Combi
CFA8894	21651955	Combi
CFA89122	21651882	Combi •
CFA8913	21652336	Combi
CFA9322	21651881	Combi •
CFA9364	21652542	Combi
CFA9404	21652357	Combi
CFA9405	21652352	Combi •
CFA9408	21651296	Combi
CFA9445	21653014	Combi
CFA9495	80000621	Combi
CFA9533	21652538	Combi
CFA9534	21652361	Combi
CFA9548	21652713	Combi
CFA9562	21653142	Combi
CFA9587	21652540	Combi
CFA9623	21652355	Combi
CFA9665	21652992	Combi
CFA9909	80000069	Combi
CFA9920	21653102	Combi
CFA9921	21653008	Combi
QAP200	21651182	Partikel
QAP201	21651184	Partikel
QAP202	21651957	Combi
QAP204	21651894	Partikel
QAP205	21651198	Partikel
QAP206	21651896	Partikel
QAP207	21650107	Partikel
QAP208	21651915	Partikel
QAP212	21651899	Partikel
QAP213	21651912	Partikel
QAP214	21651890	Partikel
QAP215	21651986	Partikel
QAP216	21651197	Partikel
QAP217	21651952	Combi
QAP219	21651185	Partikel
QAP220	21651893	Partikel
QAP221	21652347	Partikel
QAP223	21651971	Partikel •
QAP224	21651917	Partikel
QAP225	21651183	Partikel
QAP227	21651916	Partikel
QAP228	21651920	Partikel
QAP231	21651900	Partikel
QAP232	21651895	Partikel
QAP234	80000029	Partikel
QAP235	21653114	Partikel
QAP237	21651994	Partikel
QAP238	21651897	Partikel •
QAP242	21651891	Partikel
QAP244	21652342	Partikel •

QH		
QAP246	21651986	Partikel
QAP247	21652345	Partikel
QAP248	21651952	Combi
QAP249	21651915	Partikel
QAP252	21651954	Combi
QAP253	21651976	Partikel
QAP256	21651913	Partikel
QAP257	21651993	Partikel
QAP259	21653140	Partikel
QAP261	21651980	Partikel
QAP262	21653115	Combi
QAP263	21651984	Partikel
QAP264	21652348	Partikel
QAP265	21651972	Partikel
QAP266	21651979	Partikel
QAP267	21651995	Partikel
QAP271	21652688	Partikel
QAP273	21651293	Partikel
QAP275	21653023	Partikel •
QAP276	21651296	Combi
QAP277	21651969	Partikel
QAP278	21652900	Partikel
QAP279	21652317	Partikel
QAP281	21651195	Partikel •
QAP284	21652687	Partikel •
QAP285	21651983	Partikel
QAP286	80001024	Partikel •
QAP287	21651881	Combi •
QAP298	80000022	Partikel •
QAP309	21652308	Partikel
QAP311	21652358	Partikel
QAP313	21652346	Partikel
QAP314	21652350	Partikel
QAP315	80000027	Partikel
QAP316	21651991	Partikel
QAP317	21652349	Partikel
QAP318	21652551	Partikel
QAP319	21653017	Partikel
QAP320	21652543	Partikel
QAP321	21652996	Combi
QAP322	80000621	Combi
QAP324	21652356	Partikel
QAP325	80000079	Partikel
QAP326	21652352	Combi •
QAP327	21651982	Partikel •
QAP328	21652689	Partikel
QAP329	21652550	Partikel
QAP330	21652361	Combi
QAP332	80000810	Partikel
QAP334	80000065	Partikel
QAP335	21652709	Partikel
QAP336	21651919	Partikel
QAP337	21651296	Combi
QAP338	21653028	Partikel
QAP340	80000403	Combi •
QAP341	21652870	Partikel
QAP342	21653032	Partikel
QAP344	21652548	Partikel
QAP345	80000083	Partikel
QAP346	80000158	Partikel
QAP347	21652539	Partikel
QAP348	21652897	Partikel •



QH			
QAP349	21652538	Combi	
QAP351	21652867	Partikel	•
QAP352	21651987	Partikel	
QAP353	21652990	Partikel	
QAP354	21652546	Partikel	•
QAP355	21652874	Partikel	
QAP356	21652848	Partikel	•
QAP357	21652865	Combi	
QAP359	21652694	Combi	
QAP360	80000157	Partikel	
QAP361	80000159	Partikel	
QAP362	21652856	Partikel	
QAP363	21652360	Partikel	
QAP364	21652714	Partikel	
QAP365	80000084	Partikel	•
QAP366	21652857	Partikel	
QAP367	21653024	Partikel	
QAP368	21652346	Partikel	
QAP370	21653015	Combi	
QAP371	21652994	Partikel	
QAP372	21652992	Combi	
QAP373	80000074	Partikel	
QAP374	21652871	Partikel	
QAP375	80000080	Partikel	
QAP376	21653071	Partikel	
QAP379	21651952	Combi	
QAP381	80000603	Partikel	
QAP385	80000654	Partikel	•
QAP387	21653026	Partikel	
QAP388	21652850	Partikel	
QAP389	21653141	Partikel	
QAP390	21653034	Partikel	
QAP391	80000082	Partikel	
QAP392	21653025	Partikel	
QAP393	21653067	Partikel	
QAP394	80000330	Partikel	
QAP395	80000284	Combi	
QAP396	21653063	Partikel	•
QAP397	80000405	Partikel	•
QAP400	80000634	Partikel	
QAP402	80000780	Combi	
QAP404	80000061	Partikel	
QAP405	80000745	Combi	
QAP406	80000807	Partikel	
QAP408	80000655	Partikel	
QAP409	80000063	Partikel	
QAP410	80000649	Partikel	
QAP411	80000647	Combi	•
QAP412	80000546	Partikel	•
QAP413	80001033	Partikel	•
QAP414	21652849	Partikel	
QAP415	80000662	Partikel	
QAP417	80000360	Partikel	
QAP418	80000538	Combi	•
QAP419	80000764	Combi	
QAP420	80000777	Combi	
QAP421	80001214	Partikel	
QAP422	80000068	Combi	
QAP423	80000605	Combi	
QAP424	80000869	Partikel	
QAP425	80000915	Partikel	
QAP427	80000813	Partikel	

QH			
QAP428	80000614	Partikel	
QAP429	80000620	Partikel	
QAP430	80000815	Partikel	
QAP431	80000854	Combi	
QAP432	80000740	Partikel	
QAP433	80000839	Partikel	•
QAP434	80000666	Partikel	•
QAP436	80000847	Partikel	•
QAP438	80001027	Partikel	
QAP439	80001036	Partikel	
QAP500	21651964	Combi	
QAP501	21651965	Combi	
QAP512	80000077	Combi	
QAP514	21651956	Combi	
QAP517	21651953	Combi	
QAP519	21651966	Combi	
QAP528	21652541	Combi	
QAP532	21651960	Combi	
QAP533	21651961	Combi	
QAP545	21651967	Combi	
QAP553	21652985	Combi	
QAP556	21651957	Combi	
QAP561	80000113	Combi	
QAP562	21653115	Combi	
QAP566	80000021	Combi	
QAP571	21651292	Combi	
QAP575	21652552	Combi	•
QAP577	21652336	Combi	
QAP580	21653014	Combi	
QAP584	21653070	Combi	•
QAP587	21651881	Combi	•
QAP602	21653010	Combi	
QAP611	21652861	Combi	
QAP612	21651294	Combi	
QAP614	21652350	Partikel	
QAP622	21652715	Combi	
QAP624	21652357	Combi	
QAP626	21652352	Combi	•
QAP627	21652046	Combi	•
QAP628	21652713	Combi	
QAP629	21652542	Combi	
QAP631	21652353	Combi	
QAP634	21652916	Combi	
QAP638	21653146	Combi	
QAP639	21652854	Combi	
QAP644	21652540	Combi	
QAP649	21652538	Combi	
QAP650	80000068	Combi	
QAP656	21652851	Combi	•
QAP657	21652865	Combi	
QAP658	80000148	Combi	•
QAP662	21652856	Partikel	
QAP666	21652858	Combi	
QAP667	21653008	Combi	
QAP670	21653015	Combi	
QAP671	21652995	Combi	
QAP674	21652872	Combi	
QAP677	80000071	Combi	
QAP686	21653148	Partikel	
QAP688	21652853	Combi	
QAP689	21653142	Combi	
QAP690	21653035	Combi	

QH			
QAP692	21653009	Combi	
QAP693	21653066	Combi	
QAP696	21653064	Combi	•
QAP703	21653144	Partikel	
QAP706	21653102	Combi	
QAP707	21653013	Combi	
QAP709	80000064	Combi	
QAP711	80000647	Combi	•
QAP714	21652852	Combi	
QAP720	80000777	Combi	
QAP731	80000866	Combi	
QAP732	80000741	Combi	
QAP733	80000615	Combi	•
QAP734	80000667	Combi	•
QAP736	80000848	Combi	•
QAP740	80001030	Partikel	•
QAP741	80001458	Partikel	
RF25031	21653068	Combi	
WA6161	80000632	Partikel	
WP6161	80000632	Partikel	
WP6800	21651182	Partikel	
WP6801	21651964	Combi	
WP6802	21651183	Partikel	
WP6803	21652353	Combi	
WP6804	21651184	Partikel	
WP6805	21651965	Combi	
WP6806	21651956	Combi	
WP6808	21651956	Combi	
WP6809	21651956	Combi	
WP6812	21651912	Partikel	
WP6813	21651955	Combi	
WP6814	21651899	Partikel	
WP6816	21650107	Partikel	
WP6817	21650107	Partikel	
WP6818	21651185	Partikel	
WP6819	21651966	Combi	
WP6820	21651893	Partikel	
WP6821	21651893	Partikel	
WP6822	21652338	Partikel	
WP6826	21652340	Partikel	
WP6828	21651979	Partikel	
WP6829	80000021	Combi	
WP6830	21651198	Partikel	
WP6832	21651196	Partikel	
WP6833	21651961	Combi	
WP6834	21651972	Partikel	
WP6836	21651891	Partikel	
WP6838	21651919	Partikel	
WP6840	21651920	Partikel	
WP6841	21652541	Combi	
WP6842	21651900	Partikel	
WP6844	21651916	Partikel	
WP6846	21653140	Partikel	
WP6848	21651895	Partikel	
WP6849	21651895	Partikel	
WP6850	21651892	Partikel	
WP6852	21651971	Partikel	•
WP6854	21651986	Partikel	
WP6856	21651896	Partikel	
WP6860	21652348	Partikel	
WP6864	21651914	Partikel	
WP6865	21651958	Combi	

QH			
WP6866	21651915	Partikel	
WP6868	21651894	Partikel	
WP6870	21651952	Combi	
WP6871	21651952	Combi	
WP6872	21651913	Partikel	
WP6874	21651987	Partikel	
WP6876	21652899	Partikel	
WP6878	21651887	Partikel	
WP6880	21652687	Partikel	•
WP6888	21651982	Partikel	•
WP6890	21651898	Partikel	
WP6891	21651968	Combi	
WP6893	21651961	Combi	
WP6895	21651967	Combi	
WP6898	80000636	Partikel	
WP6900	21651197	Partikel	
WP6906	21652342	Partikel	•
WP6908	21652342	Partikel	•
WP6910	21653114	Partikel	
WP6912	21651994	Partikel	
WP6914	21652688	Partikel	
WP6915	21651292	Combi	
WP6918	21651979	Partikel	
WP6920	21651983	Partikel	
WP6924	21651991	Partikel	
WP6926	21651293	Partikel	
WP6927	21653068	Combi	
WP6928	21651983	Partikel	
WP6930	80000373	Partikel	
WP6932	21651984	Partikel	
WP6934	21652345	Partikel	
WP6936	21651995	Partikel	
WP6937	21652354	Combi	
WP6938	21652349	Partikel	
WP6940	80000594	Partikel	
WP6942	21653023	Partikel	•
WP6943	21652552	Combi	•
WP6944	21651298	Partikel	
WP6946	80000027	Partikel	
WP6948	80000022	Partikel	•
WP6951	21651881	Combi	•
WP6955	21651882	Combi	•
WP6957	21652308	Partikel	
WP6964	21651893	Partikel	
WP6966	21653140	Partikel	
WP6969	21651954	Combi	
WP6973	21652916	Combi	
WP6976	21653063	Partikel	•
WP6977	21653063	Partikel	•
WP6978	21652045	Partikel	
WP6980	21652347	Partikel	
WP6984	21651976	Partikel	
WP6985	21652985	Combi	
WP6990	80000074	Partikel	
WP6994	80000029	Partikel	
WP6998	21652689	Partikel	
WP6999	21652713	Combi	
WP9001	21651296	Combi	
WP9002	21651969	Partikel	
WP9003	21652336	Combi	
WP9009	21653014	Combi	
WP9021	21651294	Combi	

QH			
WP9024	21652350	Partikel	
WP9026	80000745	Combi	
WP9028	21653017	Partikel	
WP9029	80000070	Combi	
WP9034	21652714	Partikel	
WP9035	80000621	Combi	
WP9036	21652356	Partikel	
WP9037	21652357	Combi	
WP9063	21652356	Partikel	
WP9090	21652351	Partikel	
WP9091	21653069	Combi	
WP9092	21651953	Combi	
WP9094	21651298	Partikel	
WP9096	21652360	Partikel	
WP9100	21652317	Partikel	
WP9101	21652996	Combi	
WP9102	21652358	Partikel	
WP9103	21652861	Combi	
WP9104	21652346	Partikel	
WP9106	21652550	Partikel	
WP9107	21652542	Combi	
WP9108	21652345	Partikel	
WP9110	21652857	Partikel	
WP9111	21652858	Combi	
WP9112	21653028	Partikel	
WP9113	21652540	Combi	
WP9114	21652543	Partikel	
WP9115	80000429	Combi	
WP9117	21652538	Combi	
WP9118	21653032	Partikel	
WP9120	80001041	Partikel	•
WP9125	21652352	Combi	•
WP9128	21653141	Partikel	
WP9129	21653141	Partikel	
WP9130	21651296	Combi	
WP9134	21651986	Partikel	
WP9135	21651986	Partikel	
WP9136	21652874	Partikel	
WP9140	21652850	Partikel	
WP9141	21652853	Combi	
WP9142	21653028	Partikel	
WP9144	21652342	Partikel	•
WP9146	21653024	Partikel	
WP9147	21653008	Combi	
WP9148	21652863	Partikel	
WP9149	21652865	Combi	
WP9160	21652345	Partikel	
WP9162	21652709	Partikel	
WP9163	21652361	Combi	
WP9164	21653034	Partikel	
WP9165	21653034	Partikel	
WP9166	21653020	Partikel	
WP9167	21653015	Combi	
WP9168	21652848	Partikel	•
WP9169	21652851	Combi	•
WP9170	80000158	Partikel	
WP9171	21653148	Partikel	
WP9173	21652898	Combi	
WP9174	21653071	Partikel	
WP9175	80000670	Combi	
WP9176	21652871	Partikel	
WP9177	21652871	Partikel	

QH			
WP9178	21652994	Partikel	
WP9179	21652994	Partikel	
WP9181	21653115	Combi	
WP9183	21653102	Combi	
WP9184	80001033	Partikel	•
WP9186	21653145	Partikel	
WP9187	21652992	Combi	
WP9188	21653067	Partikel	
WP9189	21653066	Combi	
WP9192	21652551	Partikel	
WP9200	80000083	Partikel	
WP9202	80000536	Partikel	
WP9204	21652897	Partikel	•
WP9206	21652546	Partikel	•
WP9208	21652856	Partikel	
WP9209	21653147	Combi	
WP9210	21653026	Partikel	
WP9212	80000080	Partikel	
WP9214	21651952	Combi	
WP9216	21652989	Partikel	
WP9222	21653025	Partikel	
WP9229	21652854	Combi	
WP9230	80000061	Partikel	
WP9231	80000062	Combi	
WP9232	80000063	Partikel	
WP9233	80000064	Combi	
WP9236	21652870	Partikel	
WP9242	21652900	Partikel	
WP9244	80000084	Partikel	•
WP9246	80000072	Partikel	
WP9250	80000777	Combi	
WP9256	80000666	Partikel	•
WP9258	80000164	Partikel	
WP9260	80000345	Partikel	
WP9263	80000647	Combi	•
WP9265	80000538	Combi	•
WP9267	21653143	Combi	
WP9268	80000548	Partikel	•
WP9271	21653014	Combi	
WP9273	80000071	Combi	
WP9276	80000662	Partikel	
WP9278	80000654	Partikel	•
WP9280	80000637	Partikel	
WP9282	80000405	Partikel	•
WP9284	80000657	Partikel	
WP9286	80000157	Partikel	
WP9288	80000825	Partikel	
WP9290	80000604	Partikel	
WP9293	21653013	Combi	
WP9294	21652346	Partikel	
WP9298	80000764	Combi	
WP9302	80000652	Partikel	
WP9304	80000780	Combi	
WP9308	80000712	Partikel	
WP9309	80000713	Combi	
WP9311	80000866	Combi	
WP9313	80000648	Combi	
WP9314	80000603	Partikel	
WP9320	80001027	Partikel	
WP9322	80000853	Partikel	
WP9324	80000871	Partikel	
WP9327	80000065	Partikel	



QH			
WP9330	80000614	Partikel	
WP9332	21651199	Partikel	•
WP9336	80001456	Partikel	
WP9338	80000847	Partikel	•
WP9339	80000848	Combi	•
WP9340	80000073	Partikel	•
WP9343	80000361	Combi	
Technocar			
E302	21651894	Partikel	
E303	21651892	Partikel	
E304	21651896	Partikel	
E305	21651901	Partikel	
E306	21651920	Partikel	
E307	21651182	Partikel	
E308	21651899	Partikel	
E309	21651915	Partikel	
E310	21651184	Partikel	
E311	21651912	Partikel	
E312	21650107	Partikel	
E313	21651890	Partikel	
E314	21651915	Partikel	
E315	21652342	Partikel	•
E316	21652342	Partikel	•
E317	21651891	Partikel	
E318	21651919	Partikel	
E319	21651917	Partikel	
E320	21651916	Partikel	
E321	21651900	Partikel	
E322	21651198	Partikel	
E323	21651893	Partikel	
E324	21651971	Partikel	•
E325	21651185	Partikel	
E326	80000594	Partikel	
E327	21652688	Partikel	
E328	21651972	Partikel	
E329	21651895	Partikel	
E330	21651197	Partikel	
E331	80000373	Partikel	
E332	21653140	Partikel	
E333	21651897	Partikel	•
E334	80000636	Partikel	
E335	21651898	Partikel	
E336	21651195	Partikel	•
E337	21651196	Partikel	
E341	21651293	Partikel	
E343	21651991	Partikel	
E344	21651983	Partikel	
E345	21651984	Partikel	
E346	21651183	Partikel	
E347	21651913	Partikel	
E348	21652348	Partikel	
E353	21651914	Partikel	
E354	21652687	Partikel	•
E356	21651982	Partikel	•
E359	21652551	Partikel	
E362	21652345	Partikel	
E363	21651995	Partikel	
E365	21652349	Partikel	
E366	21651979	Partikel	
E367	21651980	Partikel	
E369	21652317	Partikel	
E371	21652899	Partikel	

Technocar			
E372	21652543	Partikel	
E373	21652350	Partikel	
E382	21652548	Partikel	
E383	21653032	Partikel	
E388	21652550	Partikel	
E389	80000072	Partikel	
E397	21652358	Partikel	
E403	21652544	Partikel	
E411	80000074	Partikel	
E416	21653034	Partikel	
EC305	21651952	Combi	
EC333	21651882	Combi	•
EC355	21651954	Combi	
EC357	80000430	Combi	
EC358	21651296	Combi	
EC380	21652352	Combi	•
EC381	21651967	Combi	
EC382	21652540	Combi	
EC387	21652713	Combi	
EC388	21652542	Combi	
EC391	21653014	Combi	
EC393	21652538	Combi	
EC398	21652858	Combi	
EC400	80000621	Combi	
Valeo			
402266	21653068	Combi	
656135	21651899	Partikel	
656135L	21651899	Partikel	
698146	21651899	Partikel	
698149	21651917	Partikel	
698159	21651912	Partikel	
698160	21651912	Partikel	
698163	80000594	Partikel	
698164	21651914	Partikel	
698165	21651182	Partikel	
698166	21651184	Partikel	
698167	21651183	Partikel	
698168	21650107	Partikel	
698169	21651196	Partikel	
698170	21651197	Partikel	
698171	21651198	Partikel	
698172	21651918	Partikel	
698173	21651916	Partikel	
698174	21651915	Partikel	
698175	80000536	Partikel	
698176	80000373	Partikel	
698177	21653140	Partikel	
698196	21651972	Partikel	
698197	21651901	Partikel	
698198	21651894	Partikel	
698199	21651896	Partikel	
698200	80000376	Partikel	
698201	21651893	Partikel	
698202	21651185	Partikel	
698203	21651920	Partikel	
698235	21651891	Partikel	
698246	21651882	Combi	•
698247	21651895	Partikel	
698255	21651983	Partikel	
698276	21652348	Partikel	
698279	21652348	Partikel	
698290	21652687	Partikel	•

Valeo			
698389	21651970	Partikel	
698454	21652308	Partikel	
698469	80000022	Partikel	•
698470	21651881	Combi	•
698471	21652308	Partikel	
698472	21651971	Partikel	•
698475	21652688	Partikel	
698478	21651982	Partikel	•
698487	21651995	Partikel	
698488	21651293	Partikel	
698489	21651969	Partikel	
698512	21652349	Partikel	
698535	21651296	Combi	
698540	21653141	Partikel	
698541	21653142	Combi	
698594	21652550	Partikel	
698606	21652689	Partikel	
698657	21653028	Partikel	
698662	21651979	Partikel	
698663	21651980	Partikel	
698664	21652548	Partikel	
698679	21651912	Partikel	
698680	21652543	Partikel	
698681	21652551	Partikel	
698682	21651957	Combi	
698683	21652713	Combi	
698684	21651958	Combi	
698685	21651912	Partikel	
698686	21651955	Combi	
698687	21651952	Combi	
698688	21651954	Combi	
698689	21651970	Partikel	
698690	21652900	Partikel	
698691	21652899	Partikel	
698692	21652538	Combi	
698693	21652858	Combi	
698694	21652857	Partikel	
698695	21652354	Combi	
698696	21651960	Combi	
698697	21651961	Combi	
698700	21652358	Partikel	
698701	21652335	Partikel	
698702	21652863	Partikel	
698703	21653010	Combi	
698704	21651887	Partikel	
698705	21653011	Combi	
698706	21651974	Partikel	
698707	21652347	Partikel	
698708	80000113	Combi	
698709	80000021	Combi	
698710	80000621	Combi	
698711	21652714	Partikel	
698712	21651982	Partikel	•
698713	21653149	Combi	
698714	21652540	Combi	
698715	21652542	Combi	
698716	21651967	Combi	
698723	21653115	Combi	
698724	21652850	Partikel	
698725	21652853	Combi	
698730	21653071	Partikel	
698731	21653032	Partikel	

Valeo			
698732	21652342	Partikel	•
698734	21652346	Partikel	
698735	21652546	Partikel	•
698736	80000080	Partikel	
698737	21652871	Partikel	
698738	21652856	Partikel	
698739	21652357	Combi	
698741	21652865	Combi	
698743	21652861	Combi	
698744	21651292	Combi	
698745	21652361	Combi	
698747	21652352	Combi	•
698748	21652541	Combi	
698749	21653068	Combi	
698750	21652336	Combi	
698751	21652694	Combi	
698753	80000074	Partikel	
698762	21652360	Partikel	
698768	21653015	Combi	
698769	21652351	Partikel	
698770	21651986	Partikel	
698771	21652317	Partikel	
698773	21652350	Partikel	
698774	21653014	Combi	
698775	80000065	Partikel	
698776	21652916	Combi	
698777	21651294	Combi	
698778	21651294	Combi	
698779	21652709	Partikel	
698790	21653023	Partikel	•
698791	21652552	Combi	•
698792	21652898	Combi	
698793	21653031	Combi	•
698794	21651987	Partikel	
698795	21652874	Partikel	
698796	21652539	Partikel	
698797	21653002	Partikel	
698800	21653024	Partikel	
698801	21653008	Combi	
698802	21653013	Combi	
698815	21651919	Partikel	
698817	80000060	Partikel	
698819	21651972	Partikel	
698838	21653030	Partikel	•
698839	21651296	Combi	
698840	21651976	Partikel	
698856	21652848	Partikel	•
698857	21652851	Combi	•
698858	21651994	Partikel	
698859	21652340	Partikel	
698860	21652338	Partikel	
698861	21652849	Partikel	
698862	21652852	Combi	
698863	21653063	Partikel	•
698864	21653064	Combi	•
698865	21652854	Combi	
698866	21653026	Partikel	
698867	21651296	Combi	
698868	80000330	Partikel	
698869	21651972	Partikel	
698870	21653145	Partikel	
698871	21653025	Partikel	

Valeo			
698872	21653009	Combi	
698873	80000067	Combi	
698874	21651979	Partikel	
698875	80000021	Combi	
698876	21652994	Partikel	
698877	21652995	Combi	
698878	21651991	Partikel	
698879	21653017	Partikel	
698880	80000070	Combi	
698882	21653034	Partikel	
698883	21653035	Combi	
698884	21653102	Combi	
698885	21651912	Partikel	
698886	80000603	Partikel	
698887	80000537	Partikel	
698888	80000158	Partikel	
698890	80000403	Combi	•
698891	80000403	Combi	•
698892	80000405	Partikel	•
698893	21652993	Partikel	
698894	80000657	Partikel	
698895	80000655	Partikel	
708146	21651899	Partikel	
708149	21651917	Partikel	
708160	21651912	Partikel	
708163	80000594	Partikel	
708164	21651890	Partikel	
708165	21651182	Partikel	
708166	21651184	Partikel	
708167	21651183	Partikel	
708168	21650107	Partikel	
708169	21651196	Partikel	
708170	21651197	Partikel	
708171	21651198	Partikel	
708173	21651916	Partikel	
708174	21651915	Partikel	
708176	80000373	Partikel	
708177	21653140	Partikel	
708196	21651972	Partikel	
708198	21651894	Partikel	
708199	21651896	Partikel	
708200	21651954	Combi	
708201	21651893	Partikel	
708202	21651185	Partikel	
708203	21651920	Partikel	
708235	21651891	Partikel	
708247	21651895	Partikel	
708255	21651983	Partikel	
708279	21651984	Partikel	
708290	21652687	Partikel	•
708454	21652308	Partikel	
708475	21652688	Partikel	
708487	21651995	Partikel	
708488	21651293	Partikel	
708512	21652349	Partikel	
708515	80000662	Partikel	•
708530	21652342	Partikel	•
708541	21653142	Combi	
708594	21652550	Partikel	
708606	21652689	Partikel	
708657	21653028	Partikel	
708662	21651979	Partikel	

Valeo			
708663	21651980	Partikel	
708664	21652548	Partikel	
708679	21651912	Partikel	
708680	21652543	Partikel	
708681	21652551	Partikel	
708682	21651957	Combi	
708683	21652713	Combi	
708685	21652356	Partikel	
708686	21651955	Combi	
708693	21652858	Combi	
708694	21652857	Partikel	
708695	21652354	Combi	
708696	21651960	Combi	
708700	21652358	Partikel	
708707	21652347	Partikel	
708708	80000113	Combi	
708709	80000021	Combi	
708710	80000621	Combi	
708711	21652714	Partikel	
708713	21653149	Combi	
708714	21652540	Combi	
708715	21652542	Combi	
708716	21651967	Combi	
708731	21653032	Partikel	
708735	21652546	Partikel	•
708736	80000080	Partikel	
708737	21652872	Combi	
708738	21652856	Partikel	
708741	21652865	Combi	
708745	21652361	Combi	
708747	21652352	Combi	•
708748	21652541	Combi	
708749	21653068	Combi	
708750	21652336	Combi	
708753	80000074	Partikel	
708796	21652539	Partikel	
708801	21653008	Combi	
708815	21651919	Partikel	
708866	21653026	Partikel	
708867	21651296	Combi	
708876	21652994	Partikel	
708878	21651991	Partikel	
708884	21653102	Combi	
715500	21653067	Partikel	
715501	21653066	Combi	
715502	80000063	Partikel	
715503	80000064	Combi	
715504	21652991	Combi	
715505	21652859	Combi	
715506	21653144	Partikel	
715507	21653143	Combi	
715508	80000071	Combi	
715509	80000068	Combi	
715510	80000061	Partikel	
715511	80000062	Combi	
715512	21652996	Combi	
715513	80000072	Partikel	
715514	21653114	Partikel	
715515	80000662	Partikel	
715516	80000157	Partikel	
715517	80000083	Partikel	
715518	80000360	Partikel	

Valeo			
715519	80000361	Combi	
715520	80000649	Partikel	
715521	80000652	Partikel	
715522	80000548	Partikel	•
715523	80000644	Partikel	•
715524	80000634	Partikel	
715525	80000084	Partikel	•
715526	80000804	Partikel	
715527	80000159	Partikel	
715529	80000158	Partikel	
715530	21652342	Partikel	•
715531	21651195	Partikel	•
715533	80000346	Combi	
715534	80000082	Partikel	
715535	80000155	Partikel	
715539	80000670	Combi	
715540	80000620	Partikel	
715541	80000764	Combi	
715542	80000162	Partikel	
715544	80000647	Combi	•
715545	80000643	Partikel	•
715546	80000648	Combi	
715547	80000824	Partikel	
715548	80000825	Partikel	
715549	21652870	Partikel	
715550	80000605	Combi	
715551	80000164	Partikel	
715552	80000541	Partikel	
715553	80000777	Combi	
715554	80000839	Partikel	•
715555	80000615	Combi	•

Valeo			
715558	21653147	Combi	
715559	80000874	Partikel	
715561	80001024	Partikel	•
715562	21652871	Partikel	
715564	80000657	Partikel	
715565	21652873	Partikel	
715568	21653070	Combi	•
715569	80000160	Partikel	•
715570	80000807	Partikel	
715571	80000069	Combi	
715572	21652897	Partikel	•
715574	80000163	Partikel	
715575	80001041	Partikel	•
715577	21652045	Partikel	
715578	21651956	Combi	
715579	80000879	Partikel	
715580	80000880	Combi	
715581	21653020	Partikel	
715583	80000847	Partikel	•
715584	80000848	Combi	•
715585	80000740	Partikel	
715586	80000741	Combi	
715588	80000869	Partikel	
715590	80000812	Partikel	
715591	80000852	Partikel	
715592	80000813	Partikel	
715593	80000156	Partikel	•
715594	21652990	Partikel	
715595	80000915	Partikel	
715596	80000871	Partikel	
715597	80000712	Partikel	

Valeo			
715598	80000066	Partikel	
715601	80000614	Partikel	
715602	80000616	Combi	
715607	80001031	Combi	•
715608	80001035	Combi	
715609	80000676	Partikel	
715612	80000429	Combi	
715613	80000866	Combi	
715614	80000865	Partikel	
715615	80000637	Partikel	
715616	80001027	Partikel	
715617	21652355	Combi	
715619	80000745	Combi	
715621	21652812	Combi	•
715627	80000061	Partikel	
715628	80000062	Combi	
715629	21653146	Combi	
715630	80000854	Combi	
715631	80000853	Partikel	
715632	21651964	Combi	
715636	80000815	Partikel	
715639	80000911	Partikel	•
715640	80000606	Combi	
715641	80000165	Combi	
715643	80000538	Combi	•
716004	21653021	Partikel	
716005	80000354	Partikel	
716006	21653022	Partikel	
716007	21652997	Partikel	
716008	80000626	Combi	

# DISCLAIMER

RECHTLICHE HINWEISE | INFORMATIONS LÉGALES | AVVERTENZE

E

Every care has been taken to assure the information in this catalogue is correct, but we cannot accept any responsibility for errors. All particulars subject to alteration. This catalogue contains products in original quality. We reserve the right to make technical changes. Original numbers from automobile manufacturers only serve as a cross-reference comparison with the CORTECO-No. and should not be used in delivery notes and invoices to vehicle owners.

Full or partial reproduction permitted only with our written approval.

F

L'exactitude des données de ce catalogue a été vérifiée avec le plus grand soin. Néanmoins, tout droit à indemnité lié aux indications du présent catalogue est exclu. Ce catalogue comporte des produits de qualité d'équipement d'origine. Nous nous réservons le droit de procéder à des modifications de construction. Si nous référons dans nos documents au numéro de pièce de rechange du fabricant automobile, nous le faisons uniquement à des fins de comparaison. Il est interdit de faire usage de telles données dans des factures adressées au propriétaire du véhicule. Toute réimpression, même sous forme d'extraits, requiert notre autorisation.

D

Die Angaben in diesem Katalog wurden mit größter Sorgfalt auf ihre Richtigkeit überprüft. Trotzdem können Ersatzansprüche auf Grund von Angaben aus diesem Katalog nicht anerkannt werden. Alle Angaben erfolgen ohne Gewähr. Dieser Katalog enthält Produkte in Original-Qualität.

Konstruktionsänderungen bleiben vorbehalten. Soweit wir in unseren Unterlagen Bezug auf die Ersatzteilnummer des Fahrzeugherstellers nehmen, dient diese nur zu Vergleichszwecken. Eine Verwendung derartiger Angaben in Rechnungen an den Fahrzeugbesitzer ist nicht statthaft. Der Nachdruck, auch auszugsweise, ist nur mit unserer schriftlichen Genehmigung gestattet.

I

Ci siamo adoperati affinché i dati contenuti in questo catalogo siano i più esatti possibili. Tuttavia decliniamo ogni responsabilità per eventuali inesattezze, non verranno da noi riconosciuti diritti di risarcimento di qualsiasi sorta causati da errori od omissioni. Questo catalogo contiene prodotti di qualità "primo equipaggiamento". Ci riserviamo il diritto di apportare modifiche tecniche. I numeri originali e i nomi dei fabbricanti citati in questo catalogo servono esclusivamente a scopo comparativo e non possono essere utilizzati sulle bolle di accompagnamento e fatture ai proprietari di autoveicoli. La riproduzione, anche sommaria, è concessa solo dietro nostra autorizzazione.

# INSTALLATION INSTRUCTIONS

## EINBAUPOSITIONEN | LOCALISATIONS DANS LE VÉHICULE | POSIZIONAMENTO NEL VEICOLO

The filter is located | Der Filter befindet sich | Le filtre se trouve | Il filtro si trova

- 1** in the engine compartment  
im Motorraum  
dans le compartiment moteur  
nel vano motore
- 2** in the engine compartment on the driver's side under the cowl panel  
im Motorraum auf der Fahrerseite unter der Windlaufblende  
dans le compartiment moteur, côté conducteur, sous le panneau d'auvent  
nel vano motore, lato guidatore, sotto il cruscotto
- 3** in the engine compartment centrally under the cowl panel  
im Motorraum mittig unter der Windlaufblende  
dans le compartiment moteur, au centre, sous le panneau d'auvent  
nel vano motore, centrale, sotto il cruscotto
- 4** in the engine compartment on the passenger's side under the cowl panel  
im Motorraum auf der Beifahrerseite unter der Windlaufblende  
dans le compartiment moteur, côté passager, sous l'auvent  
nel vano motore, lato passeggero, sotto il cruscotto
- 5** in the engine compartment on the driver's side under the radiator tank cover  
im Motorraum auf der Fahrerseite unter der Wasserkastenabdeckung  
dans le compartiment moteur, côté conducteur, sous la protection du réservoir du radiateur  
nel vano motore, lato guidatore, sotto il coperchio del serbatoio del radiatore
- 6** in the engine compartment centrally under the radiator tank cover  
im Motorraum mittig unter der Wasserkastenabdeckung  
dans le compartiment moteur, au centre, sous la protection du réservoir du radiateur  
nel vano motore, centrale, sotto il coperchio del serbatoio del radiatore
- 7** in the engine compartment on the passenger's side under the radiator tank cover  
im Motorraum auf der Beifahrerseite unter der Wasserkastenabdeckung  
dans le compartiment moteur, côté passager, sous le réservoir du radiateur  
nel vano motore, lato passeggero, sotto il coperchio del serbatoio del radiatore
- 8** in the engine compartment behind the ventilation grilles  
im Motorraum hinter den Lüftungsgittern  
dans le compartiment moteur, derrière les grilles de ventilation  
nel vano motore, dietro la griglia di ventilazione
- 9** in the engine compartment at the heater (air-conditioner)  
im Motorraum beim Heizungssystem (Klimaanlage)  
dans le compartiment moteur, au niveau du radiateur de chauffage (air conditionné)  
nel vano motore, adiacente al sistema di riscaldamento (condizionatore)
- 10** in the passenger compartment behind the glove compartment  
im Fahrgastraum hinter dem Handschuhfach  
dans l'habitacle, derrière la boîte à gants côté passager  
nell'abitacolo, dietro il vano porta oggetti
- 11** in the passenger compartment under the glove compartment  
im Fahrgastraum unter dem Handschuhfach  
dans l'habitacle, sous la boîte à gants, côté passager  
nell'abitacolo, sotto il vano porta oggetti
- 12** in the passenger compartment on the driver's side  
im Fahrgastraum auf der Fahrerseite  
dans l'habitacle, côté conducteur  
nell'abitacolo, lato guidatore
- 13** in the grille under the windscreen wiper on the driver's side  
im Gitter unter dem Scheibenwischer auf der Fahrerseite  
dans la grille de ventilation, sous l'essuie-glace, côté conducteur  
nella griglia del tergicristallo, lato guidatore
- 14** under the hood  
unter der Motorhaube  
sous le capot  
sotto il cofano

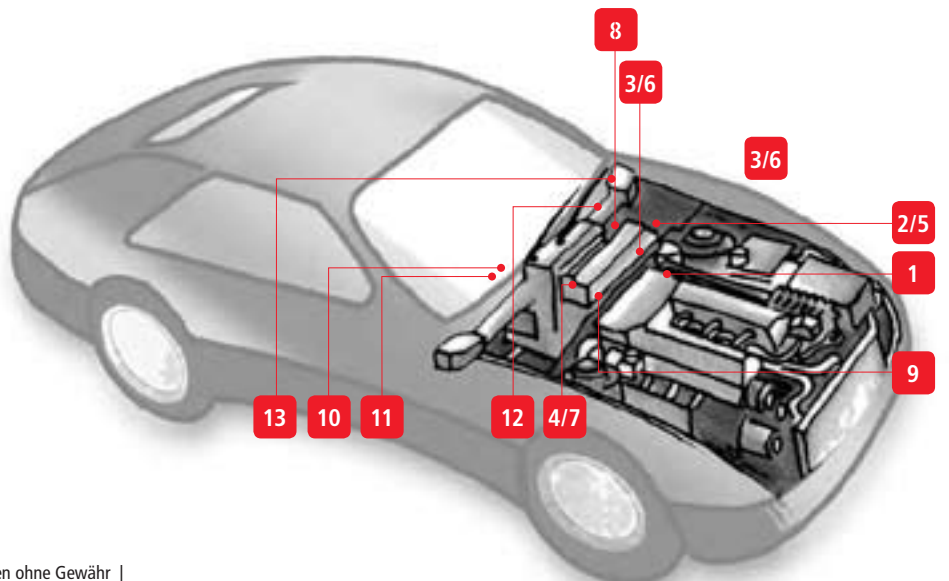

All particulars subject to alteration | Alle Angaben ohne Gewähr |  
Tous les détails peuvent être soumis à changement | Tutti i dettagli possono essere soggetti a modifiche.