

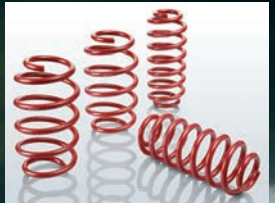

PRO-KIT



SPORTLINE



ANTI-ROLL-KIT



PRO-SPACER



B12 PRO-KIT



B12 SPORTLINE



PRO-STREET-S

PRODUKTKATALOG 2014
PRODUCT CATALOG 2014

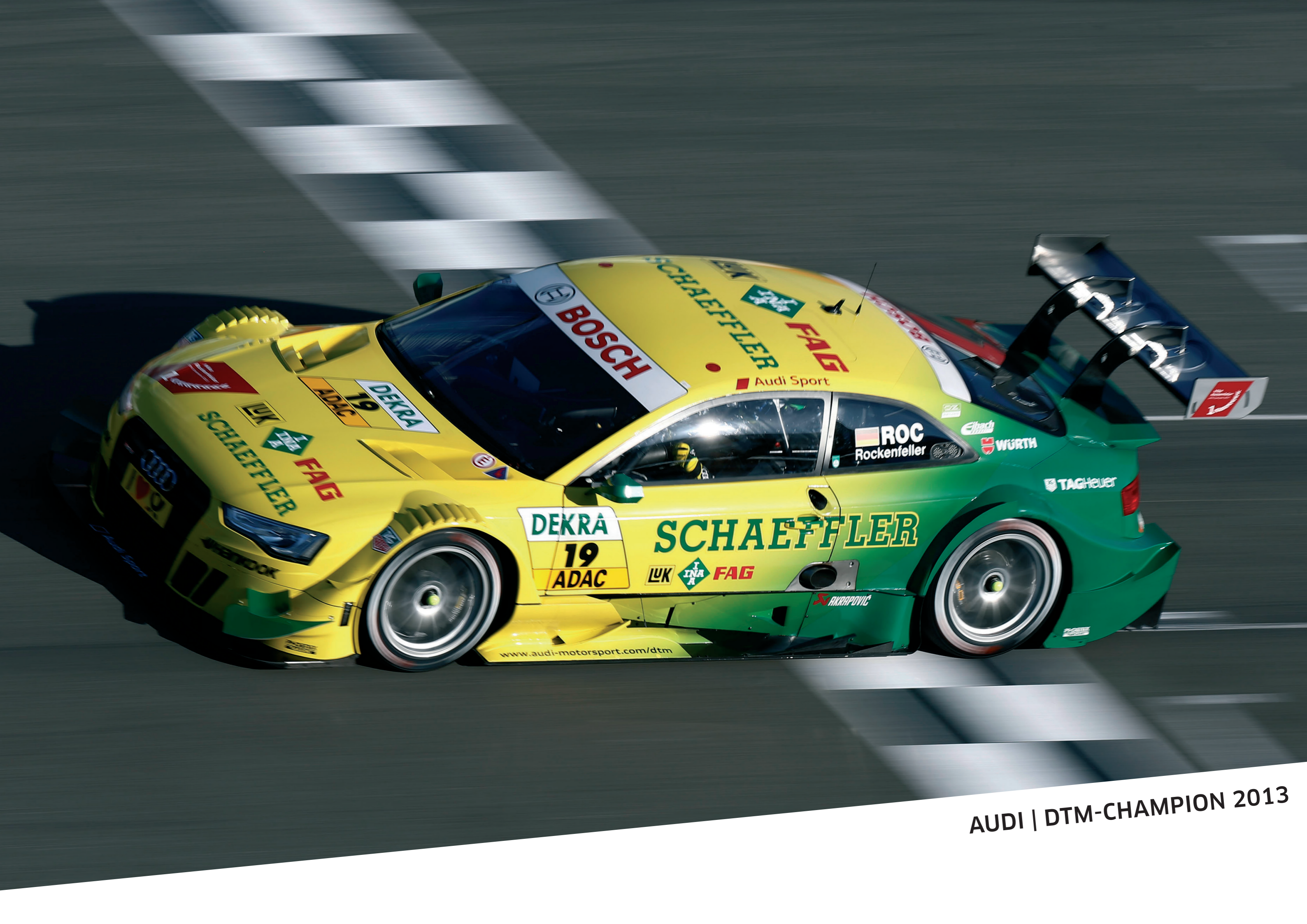

DEKRA
19
ADAC

LUK INA FAG

SCHAEFFLER

BOSCH

Audi Sport

ROC
Rockenfeller

WÜRTH

TAG Heuer

AKRAPOVIC

www.audi-motorsport.com/dtm

AUDI | DTM-CHAMPION 2013



DOMINATE THE TRACK. RULE THE STREET.

Performance für Motorsport & Straße

Zu unseren Kunden zählen seit Jahren nahezu alle Teams aus der Formel1, der DTM, der Rallye WM, NASCAR und der Tourenwagen WM.

Es gibt kaum eine nationale oder internationale Rennserie, in der Teams und Fahrer nicht auf Eibach Rennsportprodukte vertrauen.

Wir entwickeln, testen und produzieren für die größten Tuner weltweit. Dabei setzen wir auf einen aktiven Austausch mit den Kunden und fertigen speziell nach Wunsch und Vorgabe. Für die Automobilbranche sind wir ein zuverlässiger Partner. Sonderserien, Spezialentwicklungen, sportliches Zubehör - wir liefern in Erstserienqualität und sorgen für beste „Performance ab Werk“.

Performance for Motorsports and Street Performance

For years, our clientele has included almost all the teams from the worlds of Formula 1, DTM, WRC, NASCAR and the Touring Car World Championship.

There are almost no race series at either national or international level where the teams and drivers are not aware and familiar with Eibach Racing Sport products and their high standards.

We develop, test and produce for the greatest tuners - globally. We rely on an active exchange of information with our clients and manufacture to their special wishes and specifications. We are a reliable partner to the automotive industry. Special series, special developments, sporty accessories - we supply products in original equipment quality and ensure "top performance ex works".

INHALT | CONTENT

The Look that really Performs	4
Performance Guide	5
PRO-KIT Performance Fahrwerksfedern <i>Performance Springs</i>	8
SPORTLINE Performance Fahrwerksfedern Sport <i>Sport Performance Springs</i>	8
ANTI-ROLL-KIT Performance Stabilisatoren <i>Performance Sway Bars</i>	9
PRO-SPACER Spurverbreiterungen <i>Wheel Spacers</i>	9
B12 PRO-KIT Performance Komplettfahrwerke <i>Performance Springs+Shocks</i>	10
B12 SPORTLINE Performance Komplettfahrwerke Sport <i>Sport Performance Springs+Shocks</i>	10
PRO-STREET-S Gewindefahrwerke - höhenverstellbar <i>Coil-Overs - Adjustable Ride Height</i>	11
PRO-TRONIC Elektronisches Fahrwerksmodul <i>Electronic Suspension Module</i>	11
PRO-LIFT-KIT Performance Höherlegung <i>Performance Lift Springs</i>	12
Fahrzeugschein-Zulassungsbescheinigung <i>Registration Document-National Car License</i>	14
Eibach-Produktsuche Online <i>Productfinder Online</i>	15-17
Typenliste <i>Applications</i>	18-243
PRO-SPACER Systemerklärung <i>System Description</i>	246-247
PRO-SPACER Kitbestückung <i>Bill of Materials</i>	248-249
Anleitung zum Ausmessen eines Fahrzeuges zur Ermittlung der passenden PRO-SPACER <i>Manual for Measurement of a Vehicle to Detect the Matching PRO-SPACER</i>	252-253
PRO-SPACER Checkliste <i>Checklist</i>	254-255
Nummernschlüssel Radschrauben+Spurverbreiterungen <i>Coding of Bolt Numbers+Wheel Spacers</i>	258-259
PRO-SPACER Schrauben <i>Bolts</i>	260-263
PRO-SPACER-Liste <i>Applications</i>	266-323
Hinweise <i>Instructions</i>	326-331

THE LOOK THAT REALLY PERFORMS

Unsere Produkte beeinflussen nicht nur die Performance Ihres Fahrzeuges, sondern verschaffen ihm auch eine sportlichere Optik. Nutzen Sie den vorher | nachher Vergleich und die Checkliste auf der gegenüberliegenden Seite, um das passende Eibach Produkt für Ihre individuellen Ansprüche zu finden.

vorher | Serienabstimmung

Hersteller entwickeln ihre Produkte, um einer möglichst breiten Masse gerecht zu werden. Dabei werden bewusst Reserven eingeplant im Hinblick auf Handling, Ansprechverhalten und Optik.



nachher | mit Pro-Kit Federn

Sie werden den Unterschied deutlich spüren. Handling, Bremsvermögen und Ansprechverhalten sind klar verbessert. Dazu eine sportlichere Optik im Vergleich zum Serienfahrwerk.



nachher | mit Sportline Federn

Für alle, die einen aggressiven Look bevorzugen und auch im Hinblick auf das Handling eine möglichst sportliche Abstimmung bevorzugen.



A big part of suspension performance is the appearance that comes with it. Use the before and after guide below and the performance chart on the next page to determine which Eibach suspension kit fits your level of style and performance best.

Before | Stock

The OEM's design their suspension to appeal to the masses. They leave lots of room for improvements in handling, responsiveness and "get-rid-of-the-fender-gap" appearance that every enthusiast wants.







After | with Pro-Kit

You will instantly notice the significant improvement in handling, braking and responsiveness. Not to mention the "no-more-fender-gap" appearance.

After | with Sportline

For those looking for a little bit more aggressiveness in handling and appearance, this is definitely the answer.

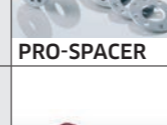
PERFORMANCE GUIDE

Produktlinie Product Line	Produkt Product	Beschreibung Description	Fahreigenschaften Ride Quality	Straßenperformance Street Performance	Aggressive Performance Aggressive Performance	Straßen- und Rennsportperformance Street & Track	Tieferlegung (fahrzeugabhängig) Average Lowering (depending on application)	Höhenverstellbarkeit Adjustable Ride Height
Federn Springs	 PRO-KIT	Der erste Schritt zur besseren Performance. Perfekt für den täglichen Gebrauch in Kombination mit guten Erstserien- oder Zubehördämpfern The first step in suspension performance. Perfect for the daily driver with good stock or aftermarket shocks.	excellent, hoher Restkomfort Excellent	✓			25-40 mm	
	 SPORTLINE		sportlich, Motorsporthandling Sport Performance	✓	✓		30-50 mm	
Komplettfahrwerke Springs + Shocks	 B12 PRO-KIT	Aufeinander abgestimmte Feder-Dämpfereinheit für eine optimale Performance und Fahrqualität Tuned performance spring and shock package for the performance you crave and the ride quality you need.	excellent, hoher Restkomfort Excellent	✓	✓	✓	25-40 mm	
	 B12 SPORTLINE		sportlich, Motorsporthandling Sport Performance	✓	✓	✓	30-50 mm	
Spurverbreiterungen Wheel Spacers	 PRO-SPACER	Ideale Ergänzung zu unseren Federn oder Fahrwerken, um eine noch bessere Optik zu erzielen The Eibach Pro-Spacers give your vehicle the final line in styling	optimiertes Fahrverhalten Optimized ride quality	✓			5-30 mm (Breite Width)	
Stabilisatoren Sway Bars	 ANTI-ROLL-KIT	Der letzte Schliff zur Verbesserung der Fahreigenschaften The Eibach Anti-Roll-Kit allows critical fine-tuning of your car's handling characteristics	Reduzierung der Seitenneigung Reduction of body roll	✓	✓	✓		
Gewindefahrwerke Coil-Overs - Adjustable Ride Height	 PRO-STREET-S	Individuelle Anpassung der Tieferlegung durch Höhenverstellbarkeit Individual height adjustment	Sportlich-komfortabel im Normalbereich; straff im Grenzbereich Sporty and comfortable in the normal range, appealingly taut in the threshold	✓	✓	✓	20-70 mm	✓



More Video-Infos:

eibach.com

eibach.com



PRO-KIT

Performance Fahrwerksfedern

- Top-Performance Handling
- Absenkung des Fahrzeugschwerpunktes um bis zu 40 mm
- Progressive Federungscharakteristik
- Optimale Fahrqualität
- Komponente des B12 Pro-Kit

Performance Springs

- Top-performance handling
- Lower centre of gravity - lowers vehicle up to 40 mm
- Progressive spring design
- Excellent ride quality
- Part of the B12 Pro-Kit

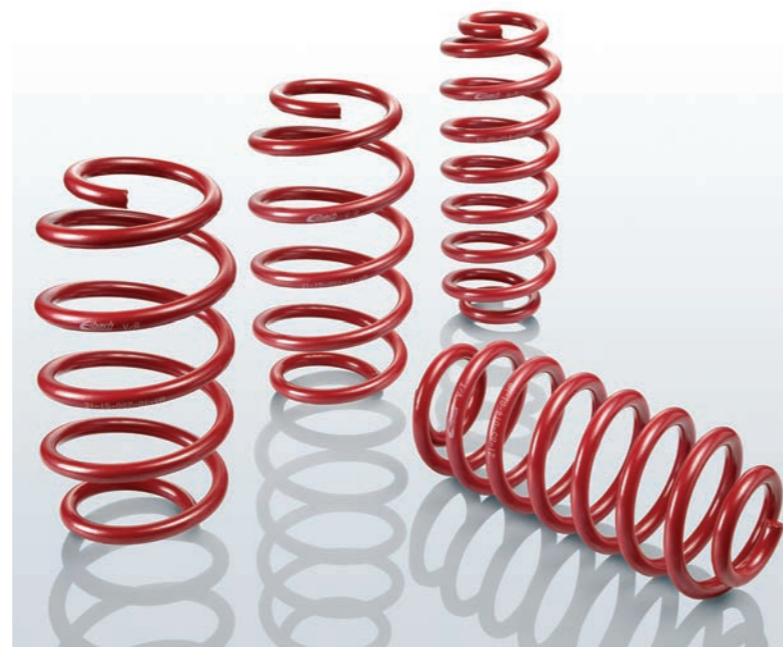

SPORTLINE

Performance Fahrwerksfedern Sport

- Tieferlegung des Fahrzeuges bis zu 50 mm - für die aggressive Optik
- Progressives Federsystem
- Performance und Optik pur
- Optimale Fahrqualität
- Handling wie im Motorsport
- Komponente des B12 Sportline

Sport Performance Springs

- Lowers vehicle up to 50 mm
- Progressive spring design
- Extreme performance meets extreme style
- Excellent ride quality
- Race car-like handling
- Part of the B12 Sportline



ANTI-ROLL-KIT

Performance Stabilisatoren

- Reduzierung der Seitenneigung bei Kurvenfahrten und anderen schnellen Richtungswechseln
- Unverminderter Federungskomfort bei beidseitiger Einfederung
- Verringerung der Lastunterschiede zwischen kurveninnerem und -äußerem Rad
- Positive Beeinflussung der Unterbeziehungsweise Übersteuerungstendenzen (Eigenlenkverhalten)

Performance Sway Bars

- Reduction of body roll when driving in curves and during fast changes of direction
- Unimpaired spring comfort at bilateral spring deflection
- Decreasing the load difference between the wheels inside and outside the curve
- Impacting the under- or over-steering tendency positively (auto-steering behaviour)



PRO-SPACER

Spurverbreiterungen

- Verbreitern Sie Ihre Spur für besseres Handling und sportlichere Optik
- Gefertigt aus hochfestem Aluminium
- Formvollendete Passform durch geringste Fertigungstoleranzen, resultierend in ausgewogener Radbalance
- Dauerfestigkeit aller Typen nach modernsten Verfahren geprüft
- Hochwertiger Korrosionsschutz durch Spezialbeschichtung (Salzsprühtest nach DIN 50021)
- Hoher Gewichtsvorteil gegenüber Spurverbreiterungen aus Stahl

Wheel Spacers

- Widen your stance - for better handling and appearance
- Made from high-tensile-strength aluminum alloy
- Exact fitment by using minimal production tolerances, resulting in exceptional wheel balance
- All applications tested in rigid durability- and fatigue tests
- High-grade corrosion protection through a special coating process (salt spray test according to DIN 50021)
- Significant weight advantage compared to wheel-spacers made from steel



B12 PRO-KIT

Performance Komplettfahrwerke

- Professional Cornering System PCS
- Präzises Ansprechverhalten, exzellente Fahrdynamik und hohe Sicherheitsreserven
- Gleichmäßige Tieferlegung bis zu 40 mm
- EIBACH Pro-Kit Performance Fahrwerkfeder mit progressiver Charakteristik
- Feder und Dämpfer im Fahrversuch exakt aufeinander abgestimmt
- BILSTEIN-Gasdrucktechnologie
- BILSTEIN-Einrohr-/Upside-Down-Technik
- TÜV-Gutachten
- Made in Germany

Performance Springs+Shocks

- Professional Cornering System PCS
- Precise response, excellent driving performance and high reserves of safety
- Lowering up to 40 mm
- EIBACH Pro-Kit performance spring with progressive characteristic
- Spring and shock absorber road-tested and fine-tuned to complement one other perfectly
- BILSTEIN gas pressure technology
- BILSTEIN mono-tube/Upside-Down technology
- German TÜV certificate
- Made in Germany



B12 SPORTLINE

Performance Komplettfahrwerke Sport

- Professional Cornering System Sport PCSS
- Direktes Ansprechverhalten, gute Fahrdynamik und sportliche Optik
- Gleichmäßige Tieferlegung bis zu 50 mm
- EIBACH Sportline Performance Fahrwerkfeder Sport mit progressiver Charakteristik
- Feder und Dämpfer im Fahrversuch exakt aufeinander abgestimmt
- BILSTEIN-Gasdrucktechnologie
- BILSTEIN-Einrohr-/Upside-Down-Technik
- TÜV-Gutachten
- Made in Germany

Sport Performance Springs+Shocks

- Professional Cornering System Sport PCSS
- Direct response, good driving performance and sporty look
- Lowering up to 50 mm
- EIBACH Sportline performance sport spring with progressive characteristic
- Spring and shock absorber road-tested and fine-tuned to complement one other perfectly
- BILSTEIN gas pressure technology
- BILSTEIN mono-tube/Upside-Down technology
- German TÜV certificate
- Made in Germany



PRO-STREET-S

Gewindefahrwerke – höhenverstellbar

- Höhenverstellung von 20 bis 70 mm Fahrzeugabsenkung (je nach Fahrzeugtyp)
- Rostfreie Edelstahlausführung
- Sportlich-komfortabel im Normal-, ansprechend straff im Grenzbereich
- Federelemente angelehnt an unser ERS-Programm
- TÜV-geprüfter Verstellbereich und komplette Dokumentation für einfache Handhabung

Coil-Overs – Adjustable Ride Height

- Height adjustment from 20 to 70 mm vehicle lowering (depending upon vehicle type)
- Rust-free stainless steel design
- Sporty and comfortable in the normal range, appealingly taut in the threshold
- Spring elements drawing on our ERS program
- TÜV-certified adjustment area and complete documentation for an easy handling



PRO-TRONIC

Elektronisches Fahrwerksmodul

- Beim technisch unbedenklichen Tausch von elektronisch regelbaren Dämpfern zu höherwertigen, individuellen Fahrwerkssystemen kann es zu Fehlermeldungen in der Anzeige kommen
- Mit Pro-Tronic wird die serienmäßige Dämpferregulierung de-aktiviert und somit eine Fehlermeldung verhindert
 - Die Funktion anderer Steuer- und sonstiger Regelsysteme bleibt erhalten
 - Pro-Tronic kann auch für Fahrwerke anderer Hersteller, inklusive OE Sportfahrwerke, verwendet werden

Electronic Suspension Module

- Removing the standard electronic adjustable dampers in exchange for high-performance adjustable suspension systems is usually a simple process. However, during the installation, error message from the on-board computer may be experienced
- With Pro-Tronic, the standard damper regulation is de-activated and prevents an error message
 - The functions of the controller and/or regulating systems are preserved and remain operational
 - Pro-Tronic can also be used with suspension systems from other manufacturers, incl. OE Sport Suspension Systems



PRO-LIFT-KIT

Performance Höherlegung

- Top-Performance Handling
- Erhöhung der Bodenfreiheit bis 30 mm
- Optimale Fahrqualität
- Beibehaltung des Serienkomforts

Performance Lift Springs

- Top-performance handling
- Increase of ride height up to 30 mm
- Excellent ride quality
- Perpetuation of suspension behavior



TROPHY TRUCK ARMIN SCHWARZ | AGM

FAHRZEUGSCHEIN - ZULASSUNGSBESCHEINIGUNG REGISTRATION DOCUMENT - NATIONAL CAR LICENSE

Neu | New (Zulassungsbescheinigung | National Car License)

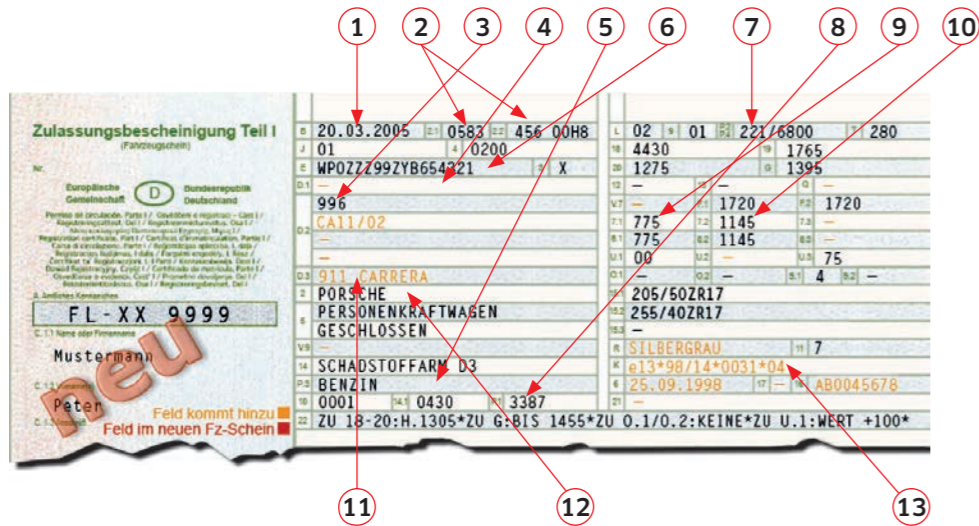

- 1 Erstzulassung | Registration Date
- 2 Schlüsselnummer (KBA Nummer) 2.1 + 2.2 | KBA Number 2.1 + 2.2
- 3 Typ | Version | Type | Version
- 4 Marke | Brand
- 5 Kraftstoffart | Fuel Type
- 6 Fahrgestell-Nr. | Chassis Number
- 7 Leistung in kW bei min⁻¹ | kW min⁻¹
- 8 Hubraum | Cubic Capacity
- 9 Achslast Vorne | Front Axle Load
- 10 Achslast Hinten | Rear Axle Load
- 11 Handelsbezeichnung | Trade Name
- 12 Hersteller-Kurzbezeichnung | Manufacturer-Abbreviation
- 13 EG-Typgenehmigungsnummer | EG Type Approval Number

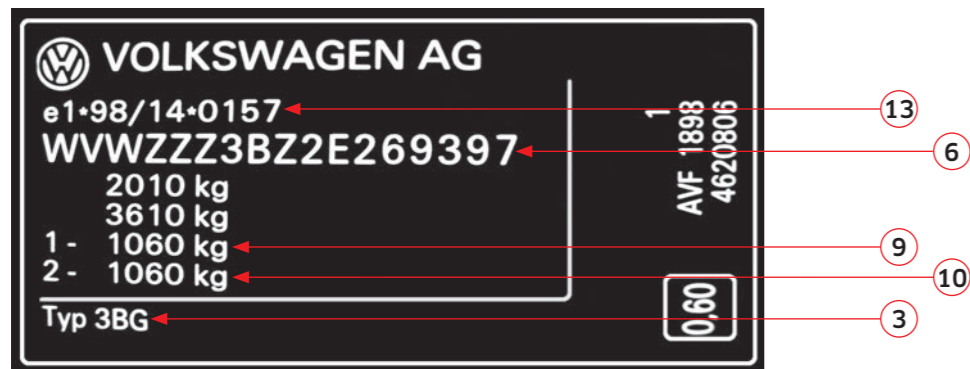

PRODUKTSUCHE ONLINE PRODUCTFINDER ONLINE



Step 1

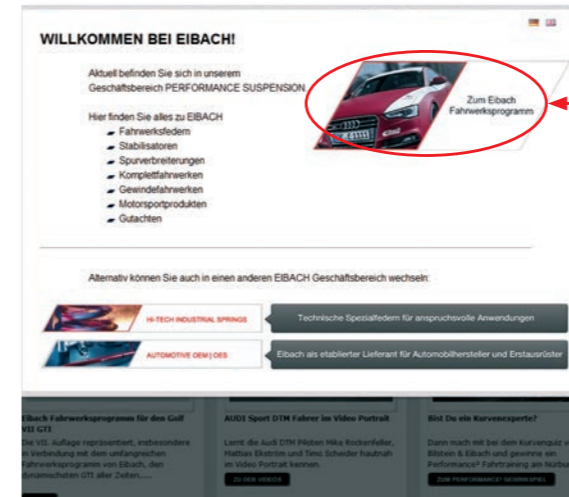

eibach.com
Zum Eibach Fahrwerksprogramm |
To Eibach Suspension Program

Step 2

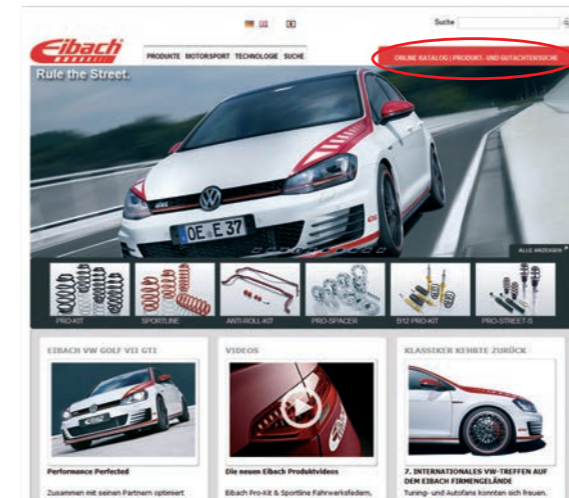

ONLINE KATALOG | PRODUKT- UND GUTACHTENSUCHE |
ONLINE CATALOG | PRODUCT & HOMOLOGATION SEARCH

Step 3

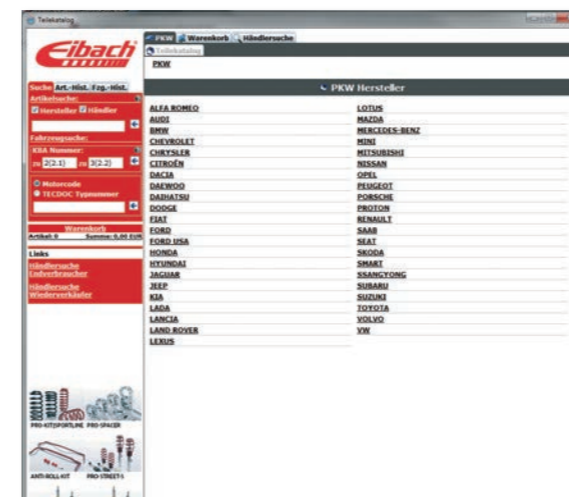

Online Katlog | Catalog:

eibach.com



PRODUKTSUCHE ONLINE PRODUCTFINDER ONLINE

A) FAHRZEUGSUCHE NACH SCHLÜSSELNUMMER | KBA-NUMMER | VEHICLE SEARCH BY KEY NUMBER | KBA-NUMBER

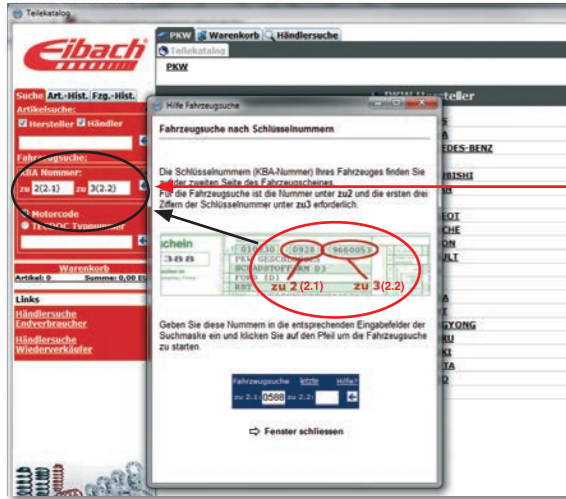

Eintragen der KBA-Nummer |
Registering the KBA-Number

B) FAHRZEUGSUCHE DIREKT IM TEILEKATALOG ÜBER DEN HERSTELLER | VEHICLE SEARCH DIRECTLY IN PARTS CATALOG OF MANUFACTURER

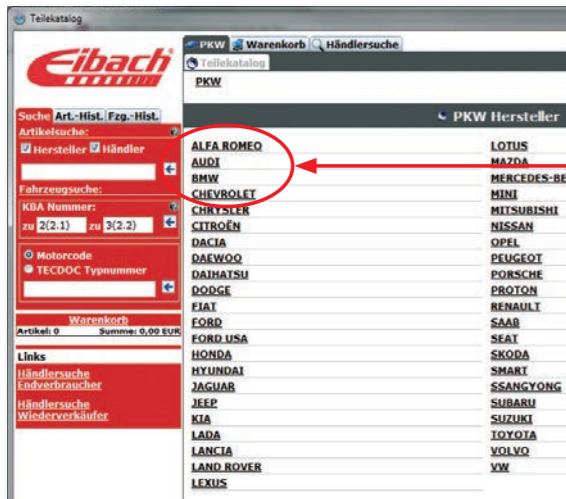

Auswahl: PKW Hersteller - am Beispiel Audi |
Selection: Passenger car Manufacturer - example of Audi

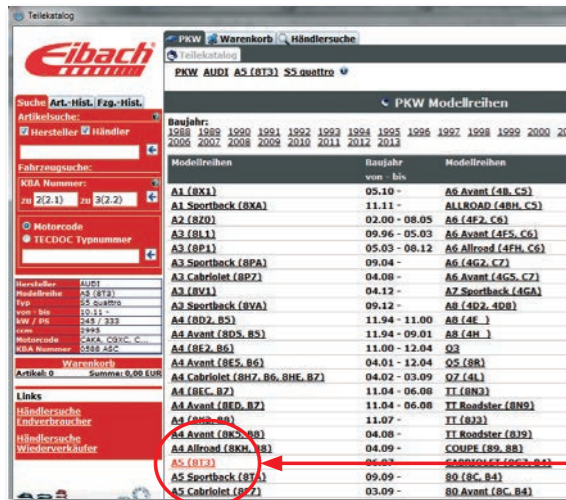

Auswahl: PKW Modellreihen |
Selection: Passenger car Model series

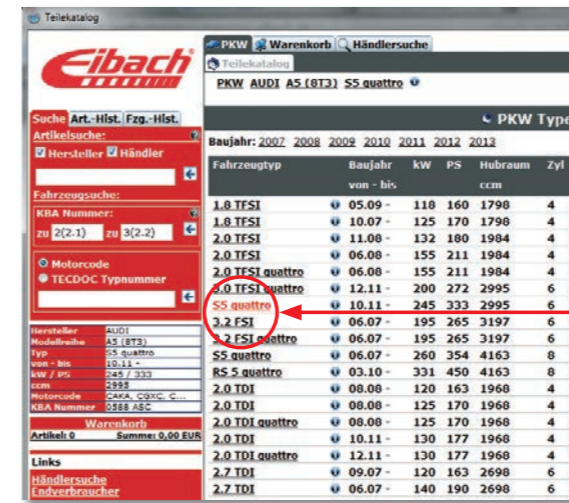

Auswahl: PKW Typen |
Selection: Passenger car Types

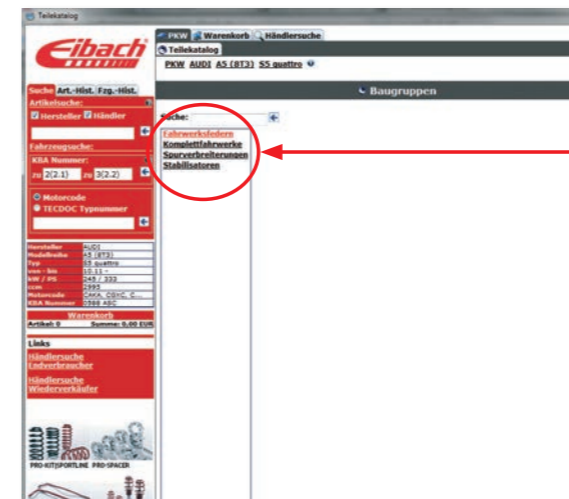

Auswahl: Baugruppe |
Selection: Product groups

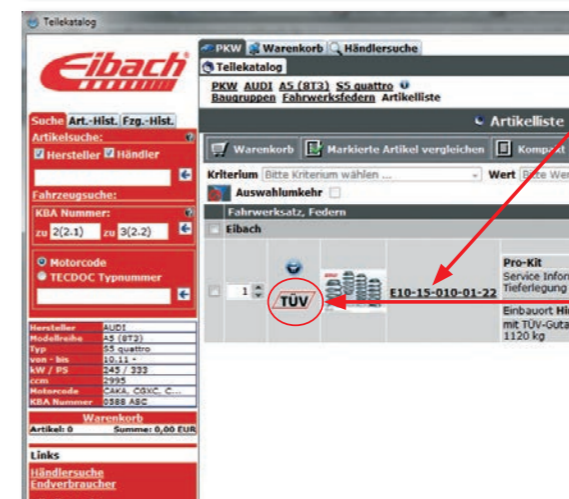

Auswahl: Artikelliste |
Selection: Parts list

Gutachten | ABE | Homologation



Detailansicht | Details

Modell	Baujahr	Achslast Vorne kg	Achslast Hinten kg	Artikel-Nr.	Hinweise	ca. Tieferl. Vorne mm	ca. Tieferl. Hinten mm	Ø Vorne mm	Ø Hinten mm	Verstellbarkeit Vorne	Verstellbarkeit Hinten	Ersatzteilbezeichnung Vorne	Ersatzteilbezeichnung Hinten	Gutachten
Model	Year	Front Axle Load kg	Rear Axle Load kg	Part-No.	Notes	ca. Lowering Front mm	ca. Lowering Rear mm	Ø Front mm	Ø Rear mm	Adjustable Front	Adjustable Rear	Spare Part Marking Front	Spare Part Marking Rear	Homologation
75 (162B) Pro-Kit (Performance Fahrwerksfedern Performance Springs) 1.6, 1.6 KAT, 1.8, 1.8 Turbo, 1.8 Turbo i.e., 2.0, 2.0 T.S. KAT, 2.0 T.S., 2.0 TD, 2.4 TD, 2.5 V6, 2.5 V6 KAT, 3.0 V6, 3.0 V6 KAT 1.6, 1.6 CAT, 1.8, 1.8 Turbo, 1.8 Turbo i.e., 2.0, 2.0 T.S. CAT, 2.0 T.S., 2.0 TD, 2.4 TD, 2.5 V6, 2.5 V6 CAT, 3.0 V6, 3.0 V6 CAT	05.85 - 12.92	850	930	E1004-120	A, 18, 20	30	30					Drehstabverstellung torsion bar	F1004002	T
145 (930) Pro-Kit (Performance Fahrwerksfedern Performance Springs) 1.4 i.e., 1.4 i.e. 16V T.S., 1.6 i.e., 1.6 i.e. 16V T.S., 1.7 i.e. 16V, 1.8 i.e. 16V T.S., 1.9 TD	07.94 - 01.01	950	900	E1016-240	A, 18, 20	30	30					F1016001	F3008002	T
1.4 i.e. 16V T.S., 1.6 16V T.S., 1.6 i.e. 16V T.S., 1.8 i.e. 16V, 1.8 i.e. 16V T.S., 1.9 JTD, 1.9 TD, 2.0 16V Quadrifoglio, 2.0 16V T.S.	02.97 - 01.01	950	900	E1019-140	A, 18, 20	30	30					F1013101	F3008002	T
Anti-Roll-Kit (Performance Stabilisatoren Performance Sway Bars) 1.4 i.e., 1.4 i.e. 16V T.S., 1.6 16V T.S., 1.6 i.e., 1.6 i.e. 16V T.S., 1.7 i.e. 16V, 1.8 i.e. 16V, 1.8 i.e. 16V T.S., 1.9 JTD, 1.9 TD, 2.0 16V Quadrifoglio, 2.0 16V T.S.	07.94 - 01.01			E1013-320	A, 18, 20, 22, 45			26	22	nicht verstellbar not adjustable	nicht verstellbar not adjustable	AS1013320VA	AS1013320HA	T
146 (930) Pro-Kit (Performance Fahrwerksfedern Performance Springs) 1.4 i.e., 1.4 i.e. 16V T.S., 1.6 i.e., 1.6 i.e. 16V T.S., 1.7 i.e. 16V, 1.8 i.e. 16V T.S., 1.9 TD	12.94 - 01.01	950	900	E1016-240	A, 18, 20	30	30					F1016001	F3008002	T
1.4 i.e. 16V T.S., 1.6 16V T.S., 1.6 i.e. 16V T.S., 1.8 i.e. 16V T.S., 1.9 JTD, 1.9 TD, 2.0 16V Quadrifoglio, 2.0 16V T.S.	02.97 - 01.01	950	900	E1019-140	A, 18, 20	30	30					F1013101	F3008002	T
Anti-Roll-Kit (Performance Stabilisatoren Performance Sway Bars) 1.4 i.e., 1.4 i.e. 16V T.S., 1.6 16V T.S., 1.6 i.e., 1.6 i.e. 16V T.S., 1.7 i.e. 16V, 1.8 i.e. 16V T.S., 1.9 JTD, 1.9 TD, 2.0 16V Quadrifoglio, 2.0 16V T.S.	12.94 - 01.01			E1013-320	A, 18, 20, 22, 45			26	22	nicht verstellbar not adjustable	nicht verstellbar not adjustable	AS1013320VA	AS1013320HA	T
147 (937) Pro-Kit (Performance Fahrwerksfedern Performance Springs) 1.6 16V T.SPARK, 1.6 16V T.SPARK ECO, 2.0, 2.0 16V T.SPARK	01.01 - 03.10	980	980	E10-10-001-01-22	A, 18, 20	30	30					F11-10-001-01-VA	F11-10-001-01-HA	T
1.9 JTD, 1.9 JTD 16V, 1.9 JTDM, 1.9 JTDM 16V, 1.9 JTDM 8V, 3.2 GTA	11.00 - 03.10	1040	980	E10-10-001-02-22	A, 18, 20	30	30					F1020001	F11-10-001-01-HA	T
Sportline (Performance Fahrwerksfedern Sport Sport Performance Springs) 1.6 16V T.SPARK, 1.6 16V T.SPARK ECO, 1.9 JTD, 1.9 JTD 16V, 1.9 JTDM, 1.9 JTDM 16V, 1.9 JTDM 8V, 2.0 16V T.SPARK	01.01 - 03.10	1040	980	E20-10-001-02-22	A, 18, 20	45-50	40					F21-10-001-01-VA	F21-10-001-01-HA	T
Anti-Roll-Kit (Performance Stabilisatoren Performance Sway Bars) 1.6 16V T.SPARK, 1.6 16V T.SPARK ECO, 1.9 JTD, 1.9 JTD 16V, 1.9 JTDM, 1.9 JTDM 16V, 1.9 JTDM 8V, 2.0, 2.0 16V T.SPARK, 3.2 GTA	11.00 - 03.10			E40-10-001-01-11	A, 18, 20, 22, 45			26	18	nicht verstellbar not adjustable	2-fach verstellbar 2-way adjustable	AS1020320VA	AS41-10-001-01-HA	T
B12 Pro-Kit (Performance Komplettfahrwerke Performance Springs+Shocks) 1.6 16V T.SPARK, 1.6 16V T.SPARK ECO, 2.0, 2.0 16V T.SPARK	01.01 - 03.10	980	980	E90-10-001-01-22	A, 18, 20, 78, 161	30	30							T
1.9 JTD, 1.9 JTD 16V, 1.9 JTDM, 1.9 JTDM 16V, 1.9 JTDM 8V, 3.2 GTA	11.00 - 03.10	1040	980	E90-10-001-02-22	A, 18, 20, 78, 161	30	30							T
B12 Sportline (Performance Komplettfahrwerke Sport Sport Performance Springs+Shocks) 1.6 16V T.SPARK, 1.6 16V T.SPARK ECO, 1.9 JTD, 1.9 JTD 16V, 1.9 JTDM, 1.9 JTDM 16V, 1.9 JTDM 8V, 2.0 16V T.SPARK	11.00 - 03.10	1040	980	E95-10-001-02-22	A, 18, 20, 78, 161	45-50	40							T
Pro-Street-S (Gewindefahrwerke - höhenverstellbar Coil-Overs-Adjustable Ride Height) 1.6 16V T.SPARK, 1.6 16V T.SPARK ECO, 1.9 JTD, 1.9 JTD 16V, 1.9 JTDM, 1.9 JTDM 16V, 1.9 JTDM 8V, 2.0, 2.0 16V T.SPARK	11.00 - 03.10	990	980	PSS65-10-001-01-22	A, 23, 45, 160	35-60	35-60							T
3.2 GTA	02.03 - 03.10	1040	980	PSS65-10-001-02-22	A, 23, 45, 160	20-55	20-55							T
155 (167) Pro-Kit (Performance Fahrwerksfedern Performance Springs) 1.6 16V T.S., 1.7 T.S., 1.7 T.S. 16V, 1.8 T.S., 1.8 T.S. Sport, 2.0 T.S., 2.0 T.S. 16V	01.92 - 12.97	965	965	E1013-240	A, 18, 20	35	30					F1013101	F1013002	T
Anti-Roll-Kit (Performance Stabilisatoren Performance Sway Bars) 1.6 16V T.S., 1.7 T.S., 1.7 T.S. 16V, 1.8 T.S., 1.8 T.S. Sport, 1.9 TD, 2.0 T.S., 2.0 T.S. 16V, 2.5 TD, 2.5 V6	01.92 - 12.97			E1013-320	A, 18, 20, 22, 45			26	22	nicht verstellbar not adjustable	nicht verstellbar not adjustable	AS1013320VA	AS1013320HA	T
156 (932) Pro-Kit (Performance Fahrwerksfedern Performance Springs) 1.6 16V T.SPARK, 1.8 16V T.SPARK, 2.0 16V T.SPARK, 2.0 JTS, 2.0 Twin Spark	09.97 - 09.05	1060	1000	E1020-140	A, 18, 20	30	30					F1020001	F1020002	T
1.9 JTD, 1.9 JTD 16V, 2.4 JTD, 2.5 V6 24V, 3.2 GTA	09.97 - 09.05	1060	1000	E1021-140	A, 18, 20	30	30					F1021001	F1020002	T
Sportline (Performance Fahrwerksfedern Sport Sport Performance Springs) 1.9 JTD, 1.9 JTD 16V, 2.4 JTD, 2.5 V6 24V, 3.2 GTA	09.97 - 09.05	1060	980	E20-10-002-02-22	A, 18, 20	45-50	45-50					F21-10-002-02-VA	F21-10-002-01-HA	T
Anti-Roll-Kit (Performance Stabilisatoren Performance Sway Bars) 1.6 16V T.SPARK, 1.8 16V T.SPARK, 1.9 JTD, 1.9 JTD 16V, 2.0 16V T.SPARK, 2.0 JTS, 2.0 Twin Spark, 2.4 JTD, 2.5 V6 24V, 3.2 GTA	09.97 - 09.05			E1020-320	A, 18, 20, 22, 45			26	18	nicht verstellbar not adjustable	2-fach verstellbar 2-way adjustable	AS1020320VA	AS1020320HA	T
B12 Pro-Kit (Performance Komplettfahrwerke Performance Springs+Shocks) 1.6 16V T.SPARK, 1.8 16V T.SPARK, 2.0 16V T.SPARK, 2.0 JTS, 2.0 Twin Spark	09.97 - 09.05	1060	1000	E90-10-002-01-22	A, 18, 20, 78, 161	30	30							T
1.9 JTD, 1.9 JTD 16V, 2.4 JTD, 2.5 V6 24V, 3.2 GTA	09.97 - 09.05	1060	1000	E90-10-002-02-22	A, 18, 20, 78, 161	30	30							T
B12 Sportline (Performance Komplettfahrwerke Sport Sport Performance Springs+Shocks) 1.9 JTD, 1.9 JTD 16V, 2.4 JTD, 2.5 V6 24V, 3.2 GTA	09.97 - 09.05	1060	980	E95-10-002-02-22	A, 18, 20, 78, 161	45-50	45-50							T
Pro-Street-S (Gewindefahrwerke - höhenverstellbar Coil-Overs-Adjustable Ride Height) 1.6 16V T.SPARK, 1.8 16V T.SPARK, 1.9 JTD, 1.9 JTD 16V, 2.0 16V T.SPARK, 2.0 JTS, 2.0 Twin Spark, 2.4 JTD, 2.5 V6 24V	09.97 - 09.05	965	980	PSS65-10-002-01-22	A, 23, 45, 160	35-65	35-65							T
1.6 16V T.SPARK, 1.8 16V T.SPARK, 1.9 JTD, 1.9 JTD 16V, 2.0 16V T.SPARK, 2.0 JTS, 2.0 Twin Spark, 2.4 JTD, 2.5 V6 24V, 3.2 GTA	09.97 - 09.05	1060	980	PSS65-10-002-02-22	A, 23, 45, 160	35-65	35-65							T

Modell	Baujahr	Achslast Vorne kg	Achslast Hinten kg	Artikel-Nr.	Hinweise	ca. Tieferl. Vorne mm	ca. Tieferl. Hinten mm	Ø Vorne mm	Ø Hinten mm	Verstellbarkeit Vorne	Verstellbarkeit Hinten	Ersatzteilbezeichnung Vorne	Ersatzteilbezeichnung Hinten	Gutachten
Model	Year	Front Axle Load kg	Rear Axle Load kg	Part-No.	Notes	ca. Lowering Front mm	ca. Lowering Rear mm	Ø Front mm	Ø Rear mm	Adjustable Front	Adjustable Rear	Spare Part Marking Front	Spare Part Marking Rear	Homologation
156 Sportwagon (932) Pro-Kit (Performance Fahrwerksfedern Performance Springs) 1.6 16V T.SPARK, 1.6 16V T.SPARK., 1.8 16V T.SPARK, 2.0, 2.0 16V T.SPARK, 2.0 JTS	09.97 - 05.06	1060		E1020-120	A, 20	30						F1020001		T
1.9 JTD, 1.9 JTD 16V, 2.4 JTD, 2.5 V6 24V, 3.2 GTA	05.00 - 05.06	1060		E1021-120	A, 20	30						F1021001		T
1.6 16V T.SPARK, 1.6 16V T.SPARK., 1.8 16V T.SPARK, 2.0, 2.0 16V T.SPARK, 2.0 JTS	09.97 - 05.06	1060	1000	E1020-140	A, 18, 20	30	30					F1020001	F1020002	T
1.9 JTD, 1.9 JTD 16V, 2.4 JTD, 2.5 V6 24V, 3.2 GTA	05.00 - 05.06	1060	1000	E1021-140	A, 18, 20	30	30					F1021001	F1020002	T
Sportline (Performance Fahrwerksfedern Sport Sport Performance Springs) 1.9 JTD, 1.9 JTD 16V, 2.4 JTD, 2.5 V6 24V, 3.2 GTA	05.00 - 05.06	1060	980	E20-10-002-02-22	A, 18, 20	45-50	45-50					F21-10-002-02-VA	F21-10-002-01-HA	T
Anti-Roll-Kit (Performance Stabilisatoren Performance Sway Bars) 1.6 16V T.SPARK, 1.6 16V T.SPARK., 1.8 16V T.SPARK, 1.9 JTD, 1.9 JTD 16V, 2.0, 2.0 16V T.SPARK, 2.0 JTS, 2.4 JTD, 2.5 V6 24V, 3.2 GTA	09.97 - 05.06			E1020-320	A, 18, 20, 22, 45			26	18	nicht verstellbar not adjustable	2-fach verstellbar 2-way adjustable	AS1020320VA	AS1020320HA	T
B12 Pro-Kit (Performance Komplettfahrwerke Performance Springs+Shocks) 1.6 16V T.SPARK., 1.8 16V T.SPARK, 2.0 16V T.SPARK, 2.0 JTS	05.00 - 05.06	1060	1000	E90-10-002-01-22	A, 18, 20, 78, 161	30	30							T
1.9 JTD, 1.9 JTD 16V, 2.4 JTD, 2.5 V6 24V, 3.2 GTA	05.00 - 05.06	1060	1000	E90-10-002-02-22	A, 18, 20, 78, 161	30	30							T
B12 Sportline (Performance Komplettfahrwerke Sport Sport Performance Springs+Shocks) 1.9 JTD, 1.9 JTD 16V, 2.4 JTD, 2.5 V6 24V, 3.2 GTA	05.00 - 05.06	1060	980	E95-10-002-02-22	A, 18, 20, 78, 161	45-50	45-50							T
Pro-Street-S (Gewindefahrwerke - höhenverstellbar Coil-Overs-Adjustable Ride Height) 1.6 16V T.SPARK, 1.6 16V T.SPARK., 1.8 16V T.SPARK, 1.9 JTD, 1.9 JTD 16V, 1.9 JTD 16V Q4, 2.0, 2.0 16V T.SPARK, 2.0 JTS, 2.4 JTD, 2.5 V6 24V	09.97 - 05.06	965	980	PSS65-10-002-01-22	A, 23, 45, 160	35-65	35-65							T
1.6 16V T.SPARK, 1.6 16V T.SPARK., 1.8 16V T.SPARK, 1.9 JTD, 1.9 JTD 16V, 1.9 JTD 16V Q4, 2.0, 2.0 16V T.SPARK, 2.0 JTS, 2.4 JTD, 2.5 V6 24V, 3.2 GTA	09.97 - 05.06	1060	980	PSS65-10-002-02-22	A, 23, 45, 160	35-65	35-65							T
159 (939) Pro-Kit (Performance Fahrwerksfedern Performance Springs) 1.8 MPI, 1.8 Tbi, 1.9 JTDM 16V, 1.9 JTDM 8V, 1.9 JTS, 2.0 JTDM, 2.2 JTS	09.05 - 11.11	1200	1100	E10-10-005-01-22	A, 18, 20	30-35	30-35					F11-10-005-01-VA	F11-10-005-01-HA	T
2.4 JTDM, 3.2 JTS	09.05 - 11.11	1300	1100	E10-10-005-02-22	A, 18, 20	30-35	30-35					F11-10-005-02-VA	F11-10-005-01-HA	T
2.4 JTDM Q4, 3.2 JTS Q4	12.05 - 11.11	1300	1100	E10-10-005-05-22	A, 18	30-35	30					F11-10-005-02-VA	F11-10-005-05-HA	T
Anti-Roll-Kit (Performance Stabilisatoren Performance Sway Bars) 1.8 MPI, 1.8 Tbi, 1.9 JTDM 16V, 1.9 JTDM 8V, 1.9 JTS, 2.0 JTDM, 2.2 JTS, 2.4 JTDM, 3.2 JTS	09.05 - 11.11			E40-10-005-01-11	A, 18, 20, 22, 45			25	24	2-fach verstellbar 2-way adjustable	2-fach verstellbar 2-way adjustable	AS41-10-005-01-VA	AS41-10-005-01-HA	T
B12 Pro-Kit (Performance Komplettfahrwerke Performance Springs+Shocks) 1.8 MPI, 1.8 Tbi, 1.9 JTDM 16V, 1.9 JTDM 8V, 1.9 JTS, 2.0 JTDM, 2.2 JTS	09.05 - 11.11	1200	1100	E90-10-005-01-22	A, 18, 20, 21, 78, 161	30-35	30-35							T
2.4 JTDM, 3.2 JTS	09.05 - 11.11	1300	1100	E90-10-005-02-22	A, 18, 20, 21, 78, 161	30-35	30-35							T
2.4 JTDM Q4, 3.2 JTS Q4	12.05 - 11.11	1300	1100	E90-10-005-05-22	A, 18, 78, 161	30-35	30							T
Pro-Street-S (Gewindefahrwerke - höhenverstellbar Coil-Overs-Adjustable Ride Height) 1.9 JTDM 16V, 1.9 JTDM 8V, 1.9 JTS, 2.2 JTS	09.05 - 11.11	1250	1100	PSS65-10-005-01-22	A, 18, 24, 45, 160	25-55	25-55							T
2.4 JTDM, 2.4 JTDM Q4, 3.2 JTS, 3.2 JTS Q4	09.05 - 11.11	1300	1100	PSS65-10-005-02-22	A, 18, 24, 45, 160	25-55	25-55							T
159 Sportwagon (939) Pro-Kit (Performance Fahrwerksfedern Performance Springs) 1.8 MPI, 1.8 Tbi, 1.9 JTDM 16V, 1.9 JTDM 8V, 1.9 JTS, 2.0 JTDM, 2.2 JTS	03.06 - 11.11	1200	1100	E10-10-005-03-22	A, 18, 20	30-35	25-30					F11-10-005-01-VA	F11-10-005-05-HA	T
2.4 JTDM, 3.2 JTS	03.06 - 11.11	1300	1100	E10-10-005-04-22	A, 18, 20	30-35	25-30					F11-10-005-02-VA	F11-10-005-05-HA	T
2.4 JTDM Q4, 3.2 JTS Q4	03.06 - 11.11	1300	1100	E10-10-005-06-22	A, 18	30-35	30					F11-10-005-02-VA	F11-10-005-05-HA	T
Anti-Roll-Kit (Performance Stabilisatoren Performance Sway Bars) 1.8 MPI, 1.8 Tbi, 1.9 JTDM 16V, 1.9 JTDM 8V, 1.9 JTS, 2.0 JTDM, 2.2 JTS, 2.4 JTDM, 3.2 JTS	03.06 - 11.11			E40-10-005-01-11	A, 18, 20, 22, 45			25	24	2-fach verstellbar 2-way adjustable	2-fach verstellbar 2-way adjustable	AS41-10-005-01-VA	AS41-10-005-01-HA	T
B12 Pro-Kit (Performance Komplettfahrwerke Performance Springs+Shocks) 1.8 MPI, 1.8 Tbi, 1.9 JTDM 16V, 1.9 JTDM 8V, 1.9 JTS, 2.0 JTDM, 2.2 JTS	03.06 - 11.11	1200	1100	E90-10-005-03-22	A, 18, 20, 21, 78, 161	30-35	25-30							T
2.4 JTDM, 3.2 JTS	03.06 - 11.11	1300	1100	E90-10-005-04-22	A, 18, 20, 21, 78, 161	30-35	25-30							T
2.4 JTDM Q4, 3.2 JTS Q4	03.06 - 11.11	1300	1100	E90-10-005-06-22	A, 18, 78, 161	30-35	30							T
Pro-Street-S (Gewindefahrwerke - höhenverstellbar Coil-Overs-Adjustable Ride Height) 1.9 JTDM 16V, 1.9 JTDM 8V, 1.9 JTS, 2.2 JTS	03.06 - 11.11	1250	1100	PSS65-10-005-03-22	A, 18, 24, 45, 160	35-65	35-65							T
2.4 JTDM, 2.4 JTDM Q4, 3.2 JTS, 3.2 JTS Q4	03.06 - 11.11	1300	1100	PSS65-10-005-04-22	A, 18, 24, 45, 160	35-65	35-65							T
166 (936) Pro-Kit (Performance Fahrwerksfedern Performance Springs) 2.0 TSpark, 2.0 V6, 2.4 JTD, 2.5 V6 24V, 3.0 V6 24V, 3.2 V6 24V	09.98 - 06.07	1100	1100	E1023-140	A, 18, 20	30	30					F1022101	F1022002	T
BRERA Pro-Kit (Performance Fahrwerksfedern Performance Springs) 2.4 JTDM 20V, 3.2 JTS	01.06 -	1300	1100	E10-10-006-03-22	A, 18, 20	25-30	18-25					F11-10-005-02-VA	F11-10-006-01-HA	T
2.4 JTDM 20V, 3.2 JTS Q4	01.06 -	1300	1100	E10-10-006-02-22	A, 18	25-30	18-25					F11-10-005-02-VA	F11-10-005-05-HA	T
B12 Pro-Kit (Performance Komplettfahrwerke Performance Springs+Shocks) 2.4 JTDM 20V, 3.2 JTS	01.06 -	1300	1100	E90-10-006-03-22	A, 18, 20, 21, 73, 78, 161	25-30	25							T
2.4 JTDM 20V, 3.2 JTS Q4	01.06 -	1300	1100	E90-10-006-02-22	A, 18, 21, 69, 78, 161	25-30	25							T

Modell	Baujahr	Achslast Vorne kg	Achslast Hinten kg	Artikel-Nr.	Hinweise	ca. Tieferl. Vorne mm	ca. Tieferl. Hinten mm	Ø Vorne mm	Ø Hinten mm	Verstellbarkeit Vorne	Verstellbarkeit Hinten	Ersatzteilbezeichnung Vorne	Ersatzteilbezeichnung Hinten	Gutachten
Model	Year	Front Axle Load kg	Rear Axle Load kg	Part-No.	Notes	ca. Lowering Front mm	ca. Lowering Rear mm	Ø Front mm	Ø Rear mm	Adjustable Front	Adjustable Rear	Spare Part Marking Front	Spare Part Marking Rear	Homologation
BRERA Pro-Street-S (Gewindefahrwerke - höhenverstellbar Coil-Overs-Adjustable Ride Height) 2.2 JTS	01.06 -	1250	1100	PSS65-10-005-01-22	A, 18, 24, 45, 160	25-55	25-55							T
2.4 JTDM 20V, 3.2 JTS, 3.2 JTS Q4	01.06 -	1300	1100	PSS65-10-005-02-22	A, 18, 24, 45, 160	25-55	25-55							T
GIULIETTA (940) Pro-Kit (Performance Fahrwerksfedern Performance Springs) 1.4 TB	04.10 -	1100	850	E10-10-009-03-22	A, 18, 20	30-35	25					F11-10-009-03-VA	F11-10-009-01-HA	T
1.6 JTDM, 1.8 TBI, 2.0 JTDM	04.10 -	1100	850	E10-10-009-01-22	A, 18, 20	30-35	25					F11-10-009-01-VA	F11-10-009-01-HA	T
B12 Pro-Kit (Performance Komplettfahrwerke Performance Springs+Shocks) 1.6 JTDM, 1.8 TBI, 2.0 JTDM	04.10 -	1100	850	E90-10-009-01-22	A, 18, 20, 78, 161	30-35	30							T
Pro-Street-S (Gewindefahrwerke - höhenverstellbar Coil-Overs-Adjustable Ride Height) 1.4 TB, 1.6 JTDM, 1.8 TBI, 2.0 JTDM	04.10 -	1100	850	PSS65-10-009-01-22	A, 18, 24, 45, 160	35-55	30-50							T
GT (937) Pro-Kit (Performance Fahrwerksfedern Performance Springs) 1.8 TS, 1.9 JTD, 2.0 JTS	11.03 - 09.10	990	980	E10-10-004-01-22	A, 18, 20	25	25					F1020001	F1020002	T
3.2 GTA	11.03 - 09.10	1040	980	E10-10-004-02-22	A, 18, 20	20	25					F1021001	F1020002	T
Anti-Roll-Kit (Performance Stabilisatoren Performance Sway Bars) 1.8 TS, 1.9 JTD, 2.0 JTS, 3.2 GTA	11.03 - 09.10			E1020-320	A, 18, 20, 22, 45			26	18	nicht verstellbar not adjustable	2-fach verstellbar 2-way adjustable	AS1020320VA	AS1020320HA	T
B12 Pro-Kit (Performance Komplettfahrwerke Performance Springs+Shocks) 1.8 TS, 1.9 JTD, 2.0 JTS	11.03 - 09.10	990	980	E90-10-004-01-22	A, 18, 20, 78, 161	25	25							T
3.2 GTA	11.03 - 09.10	1040	980	E90-10-004-02-22	A, 18, 20, 78, 161	20	25							T
GTV (916C.) Pro-Kit (Performance Fahrwerksfedern Performance Springs) 2.0 V6 Turbo, 3.0 V6 24V	06.95 - 10.05	1060	1000	E1018-140	A, 18, 20	20	20					F1018001	F1018102	T
1.8 16V, 2.0 JTS, 2.0 T.SPARK 16V, 2.0 V6 Turbo, 3.2 V6 24V	06.95 - 10.05	1060	1000	E1024-140	A, 18, 20	20	20					F1024001	F1018102	T
MITO (955) Pro-Kit (Performance Fahrwerksfedern Performance Springs) 1.3 JTDM, 1.4, 1.4 TB, 1.4 Turbo	09.08 -	955	850	E10-10-008-01-22	A, 18, 20	30	30					F11-10-008-01-VA	F11-10-008-01-HA	T
1.6 JTDM	09.08 -	1000	850	E10-10-008-02-22	A, 18, 20	30	30					F11-10-008-02-VA	F11-10-008-01-HA	T
B12 Pro-Kit (Performance Komplettfahrwerke Performance Springs+Shocks) 0.9, 1.3 JTDM, 1.4, 1.4 TB, 1.4 Turbo	09.08 -	955	850	E90-10-008-01-22	A, 18, 20, 21, 78, 161	30	30							T
1.6 JTDM	09.08 -	1000	850	E90-10-008-02-22	A, 18, 20, 21, 78, 161	30	30							T
Pro-Street-S (Gewindefahrwerke - höhenverstellbar Coil-Overs-Adjustable Ride Height) 1.3 JTDM, 1.4, 1.4 TB, 1.4 Turbo, 1.6 JTDM	09.08 -	900	850	PSS65-10-008-01-22	A, 45, 160	20-50	30-55							T
1.3 JTDM, 1.4, 1.4 TB, 1.4 Turbo, 1.6 JTDM	09.08 -	1000	850	PSS65-10-008-02-22	A, 45, 160	20-50	30-55							T
SPIDER (916S.) Pro-Kit (Performance Fahrwerksfedern Performance Springs) 2.0 T.SPARK 16V, 3.0 V6, 3.0 V6 24V	06.95 - 10.00	1060	1000	E1018-140	A, 18, 20	20	20					F1018001	F1018102	T
1.8 16V, 2.0 JTS, 2.0 T.SPARK 16V, 2.0 V6 Turbo, 3.0 V6, 3.2 V6 24V	06.95 - 04.05	1060	1000	E1024-140	A, 18, 20	20	20					F1024001	F1018102	T
SPIDER (939) Pro-Kit (Performance Fahrwerksfedern Performance Springs) 2.4 JTDM, 3.2 JTS	04.07 -	1300	1100	E10-10-007-03-22	A, 18, 20	20	20					F11-10-005-02-VA	F11-10-006-01-HA	T
3.2 JTS Q4	09.06 -	1300	1100	E10-10-007-02-22	A, 18	20	20					F11-10-005-02-VA	F11-10-005-05-HA	T
B12 Pro-Kit (Performance Komplettfahrwerke Performance Springs+Shocks) 2.4 JTDM, 3.2 JTS	04.07 -	1300	1100	E90-10-007-03-22	A, 18, 20, 73, 78, 161	20	20							T
3.2 JTS Q4	09.06 -	1300	1100	E90-10-007-02-22	A, 18, 20, 49, 78, 161	20	20							T
80 (8C, B4) Pro-Kit (Performance Fahrwerksfedern Performance Springs) 1.6, 1.6 E, 1.9 TD, 1.9 TDI, 2.0, 2.0 E, 2.0 E 16V, 2.3 E	09.91 - 12.94	1000	900	E1519-240	A, 12, 18, 20	30-35	30					F1518001	F1519002	T
2.6, 2.8	09.91 - 12.94	1050	900	E1519-140	A, 12, 18, 20	30-35	30					F1508001	F1519002	T
100 (4A, C4) Pro-Kit (Performance Fahrwerksfedern Performance Springs) 2.3 E, 2.4 D, 2.5 TDI, 2.6, 2.8 E	12.90 - 06.94	1160	1080	E1515-140	A, 15, 18, 20	35	30					F1515001	F1515002	T
2.3 E Automatik, 2.4 D Automatik, 2.5 TDI Automatik, 2.6 Automatik, 2.8 E Automatik	12.90 - 06.94	1160	1080	E1527-140	A, 18, 20	35	30					F1527001	F1515002	T
2.3 E automatic transmission, 2.4 D automatic transmission, 2.5 TDI automatic transmission, 2.6 automatic transmission, 2.8 E automatic transmission	12.90 - 06.94	1240	1200	E1516-140	A, 15, 18	35	30					F1515001	F1516002	T
2.3 E quattro, 2.6 quattro, 2.8 E quattro, S4 Turbo quattro, S4 V8 quattro	12.90 - 06.94	1240	1200	E1528-140	A, 18	35	30					F1527001	F1516002	T
2.3 E quattro Automatik, 2.6 quattro Automatik, 2.8 E quattro Automatik, S4 Turbo quattro Automatik, S4 V8 quattro Automatik	12.90 - 06.94	1240	1200	E1528-140	A, 18	35	30					F1527001	F1516002	T
2.3 E quattro automatic transmission, 2.6 quattro automatic transmission, 2.8 E quattro automatic transmission, S4 Turbo quattro automatic transmission, S4 V8 quattro automatic transmission	12.90 - 06.94	1240	1200	E90-15-012-06-22	A, 18, 72, 78, 161	35	30							T
B12 Pro-Kit (Performance Komplettfahrwerke Performance Springs+Shocks) 2.3 E quattro, 2.6 quattro, 2.8 E quattro, S4 Turbo quattro	12.90 - 06.94	1240	1200	E90-15-012-06-22	A, 18, 72, 78, 161	35	30							T
2.3 E quattro, 2.6 quattro, 2.8 E quattro, S4 Turbo quattro	12.90 - 06.94	1240	1200	E90-15-012-02-22	A, 18, 76, 78, 161	35	30							T

Modell	Baujahr	Achslast Vorne kg	Achslast Hinten kg	Artikel-Nr.	Hinweise	ca. Tieferl. Vorne mm	ca. Tieferl. Hinten mm	Ø Vorne mm	Ø Hinten mm	Verstellbarkeit Vorne	Verstellbarkeit Hinten	Ersatzteilbezeichnung Vorne	Ersatzteilbezeichnung Hinten	Gutachten
Model	Year	Front Axle Load kg	Rear Axle Load kg	Part-No.	Notes	ca. Lowering Front mm	ca. Lowering Rear mm	Ø Front mm	Ø Rear mm	Adjustable Front	Adjustable Rear	Spare Part Marking Front	Spare Part Marking Rear	Homologation
100 Avant (4A, C4) Pro-Kit (Performance Fahrwerksfedern Performance Springs) 2.3 E, 2.4 D, 2.5 TDI, 2.6, 2.8 E	12.90 - 06.94	1160	1080	E1517-140	A, 15, 18, 20	35	30					F1515001	F1517002	T
2.3 E Automatik, 2.4 D Automatik, 2.5 TDI Automatik, 2.6 Automatik, 2.8 E Automatik 2.3 E automatic transmission, 2.4 D automatic transmission, 2.5 TDI automatic transmission, 2.6 automatic transmission, 2.8 E automatic transmission	12.90 - 06.94	1160	1080	E1529-140	A, 18, 20	35	30					F1527001	F1517002	T
2.3 E quattro, 2.6 E quattro, 2.6 quattro, 2.8 E quattro, S4 Turbo quattro, S4 V8 quattro	09.91 - 07.94	1240	1200	E1521-140	A, 15, 18	35	30					F1515001	F1521002	T
2.3 E quattro Automatik, 2.6 E quattro Automatik, 2.6 quattro Automatik, 2.8 E quattro Automatik, S4 Turbo quattro Automatik, S4 V8 quattro Automatik 2.3 E quattro automatic transmission, 2.6 E quattro automatic transmission, 2.6 quattro automatic transmission, 2.8 E quattro automatic transmission, S4 Turbo quattro automatic transmission, S4 V8 quattro automatic transmission	09.91 - 07.94	1240	1200	E1530-140	A, 18	35	30					F1527001	F1521002	T
A1 (8X1) Pro-Kit (Performance Fahrwerksfedern Performance Springs) 1.2 TFSI, 1.4 TFSI	05.10 -	880	800	E10-15-014-01-22	A, 18, 20	20	20					F11-15-014-01-VA	F11-85-008-01-HA	T
1.4 TFSI, 1.6 TDI	05.10 -	930	800	E10-15-014-02-22	A, 18, 20	20	20					F11-15-014-02-VA	F11-85-008-01-HA	T
1.4 TFSI, 1.6 TDI, 2.0 TDI	05.10 -	960	800	E10-15-014-03-22	A, 18, 20	20	20					F11-81-010-05-VA	F11-85-008-01-HA	T
Anti-Roll-Kit (Performance Stabilisatoren Performance Sway Bars) 1.2 TFSI, 1.4 TFSI, 1.6 TDI, 2.0 TDI	05.10 -			E40-85-008-01-10	A, 18, 20, 22, 45			22		nicht verstellbar not adjustable		AS41-85-008-01-VA		T
B12 Pro-Kit (Performance Komplettfahrwerke Performance Springs+Shocks) 1.2 TFSI, 1.4 TFSI	05.10 -	880	800	E90-15-014-01-22	A, 18, 20, 78, 161	20	15							T
1.4 TFSI, 1.6 TDI	05.10 -	930	800	E90-15-014-02-22	A, 18, 20, 78, 161	20	15							T
Pro-Street-S (Gewindefahrwerke - höhenverstellbar Coil-Overs-Adjustable Ride Height) 1.2 TFSI, 1.4 TFSI, 1.6 TDI	05.10 -	900	790	PSS65-81-010-01-22	A, 24, 25, 45, 160	15-50	15-50							T
1.2 TFSI, 1.4 TFSI, 1.6 TDI, 2.0 TDI	05.10 -	960	790	PSS65-81-010-02-22	A, 24, 25, 45, 160	15-50	15-50							T
A1 Sportback (8XA) Pro-Kit (Performance Fahrwerksfedern Performance Springs) 1.2 TFSI, 1.4 TFSI	11.11 -	880	800	E10-15-014-01-22	A, 18, 20	20	20					F11-15-014-01-VA	F11-85-008-01-HA	T
1.4 TFSI, 1.6 TDI	11.11 -	930	800	E10-15-014-02-22	A, 18, 20	20	20					F11-15-014-02-VA	F11-85-008-01-HA	T
1.4 TFSI, 1.6 TDI, 2.0 TDI	09.11 -	960	800	E10-15-014-03-22	A, 18, 20	20	20					F11-81-010-05-VA	F11-85-008-01-HA	T
Anti-Roll-Kit (Performance Stabilisatoren Performance Sway Bars) 1.2 TFSI, 1.4 TFSI, 1.6 TDI, 2.0 TDI	09.11 -			E40-85-008-01-10	A, 18, 20, 22, 45			22		nicht verstellbar not adjustable		AS41-85-008-01-VA		T
B12 Pro-Kit (Performance Komplettfahrwerke Performance Springs+Shocks) 1.2 TFSI, 1.4 TFSI	11.11 -	880	800	E90-15-014-01-22	A, 18, 20, 78, 161	20	15							T
1.4 TFSI, 1.6 TDI	11.11 -	930	800	E90-15-014-02-22	A, 18, 20, 78, 161	20	15							T
Pro-Street-S (Gewindefahrwerke - höhenverstellbar Coil-Overs-Adjustable Ride Height) 1.2 TFSI, 1.4 TFSI, 1.6 TDI	11.11 -	900	790	PSS65-81-010-01-22	A, 24, 25, 45, 160	15-50	15-50							T
1.2 TFSI, 1.4 TFSI, 1.6 TDI	11.11 -	960	790	PSS65-81-010-02-22	A, 24, 25, 45, 160	15-50	15-50							T
A3 (8L1) Pro-Kit (Performance Fahrwerksfedern Performance Springs) 1.6, 1.8, 1.8 T	09.96 - 05.03	990	930	E1540-140	A, 18, 20, 26	30	25					F1540001	F1540002	T
1.9 TDI	09.96 - 05.03	990	930	E1545-140	A, 18, 20, 26	30	25					F1545001	F1540002	T
1.8 T, 1.9 TDI	09.96 - 05.03	1020	930	E10-15-004-01-22	A, 18, 20, 26	30	25					F8592001	F1540002	T
1.8 T quattro, 1.9 TDI quattro	12.96 - 05.03	1050	1120	E10-15-004-02-22	A, 18	30	25					F8592001	F11-15-001-02-HA	T
S3 quattro	03.99 - 05.03	1050	1120	E10-15-004-03-22	A, 18	25	20					F8547001	F11-15-001-02-HA	T
Sportline (Performance Fahrwerksfedern Sport Sport Performance Springs) 1.6, 1.8, 1.8 T, 1.9 TDI	09.96 - 05.03	950	1000	E20-15-004-01-22	A, 20, 26	45-50	35-40					F21-85-001-01-VA	F21-85-001-01-HA	T
1.8, 1.8 T, 1.9 TDI	09.96 - 05.03	1000	1000	E20-15-004-02-22	A, 20, 26	45-50	35-40					F21-85-003-01-VA	F21-85-001-01-HA	T
Anti-Roll-Kit (Performance Stabilisatoren Performance Sway Bars) 1.6, 1.8, 1.8 T	09.96 - 05.03			E1540-321	A, 18, 20, 22, 45			22		nicht verstellbar not adjustable		AS1540310VA		T
1.6, 1.8, 1.8 T	09.96 - 05.03			E1540-320	A, 18, 20, 22, 45			22	25	nicht verstellbar not adjustable	nicht verstellbar not adjustable	AS1540310VA	AS1540320HA	T
1.9 TDI	09.96 - 05.03			E40-85-005-01-10	A, 18, 20, 22, 45			25		nicht verstellbar not adjustable		AS41-85-005-01-VA		T
1.9 TDI	09.96 - 05.03			E40-85-005-01-11	A, 18, 20, 22, 45			25	25	nicht verstellbar not adjustable	nicht verstellbar not adjustable	AS41-85-005-01-VA	AS1540320HA	T
B12 Pro-Kit (Performance Komplettfahrwerke Performance Springs+Shocks) 1.6 Schaltgetriebe, 1.8 Schaltgetriebe, 1.8 T Schaltgetriebe 1.6 manual transmission, 1.8 T manual transmission, 1.8 manual transmission	09.96 - 05.03	990	930	E90-15-004-01-22	A, 18, 20, 26, 71, 78, 161	30	25							T
1.9 TDI Schaltgetriebe 1.9 TDI manual transmission	09.96 - 05.03	990	930	E90-15-004-02-22	A, 18, 20, 26, 71, 78, 161	30	25							T
1.8 T, 1.9 TDI	09.96 - 05.03	1020	930	E90-15-004-03-22	A, 18, 20, 26, 72, 78, 161	30	30							T
1.8 T quattro, 1.9 TDI quattro	12.96 - 05.03	1050	1120	E90-15-004-04-22	A, 18, 26, 78, 161	30	25							T
S3 quattro	03.99 - 05.03	1050	1120	E90-15-004-05-22	A, 18, 26, 78, 161	25	20							T
B12 Sportline (Performance Komplettfahrwerke Sport Sport Performance Springs+Shocks) 1.6, 1.8, 1.8 T, 1.9 TDI	09.96 - 05.03	950	1000	E95-15-004-01-22	A, 18, 20, 26, 78, 161	45-50	35-40							T

Modell	Baujahr	Achslast Vorne kg	Achslast Hinten kg	Artikel-Nr.	Hinweise	ca. Tieferl. Vorne mm	ca. Tieferl. Hinten mm	Ø Vorne mm	Ø Hinten mm	Verstellbarkeit Vorne	Verstellbarkeit Hinten	Ersatzteilbezeichnung Vorne	Ersatzteilbezeichnung Hinten	Gutachten
Model	Year	Front Axle Load kg	Rear Axle Load kg	Part-No.	Notes	ca. Lowering Front mm	ca. Lowering Rear mm	Ø Front mm	Ø Rear mm	Adjustable Front	Adjustable Rear	Spare Part Marking Front	Spare Part Marking Rear	Homologation
A3 (8L1) B12 Sportline (Performance Komplettfahrwerke Sport Sport Performance Springs+Shocks) 1.8, 1.8 T, 1.9 TDI	09.96 - 05.03	1000	1000	E95-15-004-02-22	A, 18, 20, 26, 78, 161	45-50	35-40							T
Pro-Street-S (Gewindefahrwerke - höhenverstellbar Coil-Overs-Adjustable Ride Height) 1.6, 1.8, 1.8 T, 1.9 TDI	09.96 - 05.03	1020	1025	PSS65-85-001-01-22	A, 20, 24, 25, 26, 45, 160	30-70	30-70							T
1.8 T quattro, 1.9 TDI quattro, S3 quattro	12.96 - 05.03	1040	1050	PSS65-85-001-02-22	A, 24, 25, 45, 160	25-50	25-50							T
A3 (8P1) Pro-Kit (Performance Fahrwerksfedern Performance Springs) 1.2 TFSI, 1.4 TFSI, 1.6, 1.6 FSI, 1.9 TDI, 2.0, 2.0 FSI	05.03 - 08.12	980	1005	E10-15-007-01-22	A, 18, 20	30	30					F11-15-007-01-VA	F11-15-007-01-HA	ABE
1.2 TFSI, 1.4 TFSI, 1.6, 1.6 FSI, 1.6 TDI, 1.8 T, 1.8 TFSI, 1.9 TDI, 2.0, 2.0 FSI, 2.0 TFSI	05.03 - 08.12	1065	1005	E10-15-007-02-22	A, 18, 20	30	30					F11-15-007-02-VA	F11-15-007-01-HA	ABE
S3 quattro	11.06 - 08.12	1155		E10-15-007-14-20	A, 18	20						F11-15-007-14-VA		ABE
1.6 TDI, 1.8 T, 1.8 TFSI, 2.0 TDI, 2.0 TDI 16V, 2.0 TFSI	05.03 - 08.12	1155	1005	E10-15-007-03-22	A, 18, 20	30	30					F11-15-007-03-VA	F11-15-007-01-HA	ABE
1.8 TFSI quattro, 2.0 TDI 16V quattro, 2.0 TDI quattro, 2.0 TFSI quattro	05.03 - 08.12	1155	1125	E10-15-007-09-22	A, 18	30	30					F11-15-007-03-VA	F11-15-007-04-HA	ABE
3.2 V6 quattro	07.03 - 05.09	1155	1125	E10-15-007-04-22	A, 18	30	30					F11-15-007-04-VA	F11-15-007-04-HA	ABE
Sportline (Performance Fahrwerksfedern Sport Sport Performance Springs) 1.2 TFSI, 1.4 TFSI, 1.6, 1.6 FSI, 1.6 TDI, 1.8 T, 1.8 TFSI, 1.9 TDI, 2.0, 2.0 FSI	05.03 - 08.12	1040	1010	E20-15-007-01-22	A, 18, 20	45-50	35-40					F21-15-007-01-VA	F21-15-007-01-HA	ABE
1.6 TDI, 1.8 T, 1.8 TFSI, 2.0 TDI, 2.0 TDI 16V, 2.0 TFSI	05.03 - 08.12	1130	1010	E20-15-007-02-22	A, 18, 20	45-50	35-40					F21-15-007-02-VA	F21-15-007-01-HA	ABE
Anti-Roll-Kit (Performance Stabilisatoren Performance Sway Bars) 1.2 TFSI, 1.4 TFSI, 1.6, 1.6 FSI, 1.6 TDI, 1.8 T, 1.8 TFSI, 1.9 TDI, 2.0, 2.0 FSI, 2.0 TDI, 2.0 TDI 16V, 2.0 TFSI	05.03 - 08.12			E40-15-007-01-11	A, 18, 20, 22, 45			26	23	2-fach verstellbar 2-way adjustable	2-fach verstellbar 2-way adjustable	AS41-85-014-01-VA	AS41-85-014-01-HA	T
B12 Pro-Kit (Performance Komplettfahrwerke Performance Springs+Shocks) 1.6 FSI Schaltgetriebe, 1.6 Schaltgetriebe	05.03 - 08.12	980	1005	E90-15-007-02-22	A, 18, 20, 34, 78, 122, 124, 161	30	30							T
1.6 FSI manual transmission, 1.6 manual transmission 1.6 FSI Schaltgetriebe, 1.6 Schaltgetriebe	05.03 - 08.12	980	1005	E90-15-007-01-22	A, 18, 20, 78, 161	30	30							T
1.6 FSI manual transmission, 1.6 manual transmission 1.2 TFSI, 1.4 TFSI, 1.6, 1.6 FSI, 1.6 TDI, 1.8 T, 1.8 TFSI, 1.9 TDI, 2.0, 2.0 FSI, 2.0 TFSI	05.03 - 08.12	1065	1005	E90-15-007-04-22	A, 18, 20, 34, 78, 124, 161	30	30							T
1.2 TFSI, 1.4 TFSI, 1.6, 1.6 FSI, 1.6 TDI, 1.8 T, 1.8 TFSI, 1.9 TDI, 2.0, 2.0 FSI, 2.0 TFSI	05.03 - 08.12	1065	1005	E90-15-007-03-22	A, 18, 20, 35, 78, 122, 161	30	30							T
1.6 TDI, 1.8 T, 1.8 TFSI, 1.9 TDI, 2.0, 2.0 FSI, 2.0 TDI, 2.0 TFSI	05.03 - 08.12	1155	1005	E90-15-007-06-22	A, 18, 20, 34, 78, 124, 161	30	30							T
1.6 TDI, 1.8 T, 1.8 TFSI, 1.9 TDI, 2.0, 2.0 FSI, 2.0 TDI, 2.0 TFSI	05.03 - 08.12	1155	1005	E90-15-007-05-22	A, 18, 20, 35, 78, 122, 161	30	30							T
1.8 TFSI quattro, 2.0 TDI 16V quattro, 2.0 TDI quattro, 2.0 TFSI quattro	05.03 - 08.12	1155	1125	E90-15-007-09-22	A, 18, 34, 78, 124, 161	30	30							T
1.8 TFSI quattro, 2.0 TDI 16V quattro, 2.0 TDI quattro, 2.0 TFSI quattro	05.03 - 08.12	1155	1125	E90-15-007-08-22	A, 18, 35, 78, 122, 161	30	30							T
3.2 V6 quattro	07.03 - 05.09	1155	1125	E90-15-007-07-22	A, 18, 34, 78, 124, 161	30	30							T
B12 Sportline (Performance Komplettfahrwerke Sport Sport Performance Springs+Shocks) 1.2 TFSI, 1.4 TFSI, 1.6, 1.6 FSI, 1.9 TDI, 2.0, 2.0 FSI	05.03 - 08.12	1040	1010	E95-15-007-02-22	A, 18, 20, 34, 78, 124, 161	45-50	35-40							T
1.2 TFSI, 1.4 TFSI, 1.6, 1.6 FSI, 1.6 TDI, 1.9 TDI, 2.0, 2.0 FSI	05.03 - 08.12	1040	1010	E95-15-007-01-22	A, 18, 20, 35, 78, 122, 161	45-50	35-40							T
1.8 T, 1.8 TFSI, 1.9 TDI, 2.0, 2.0 FSI, 2.0 TDI, 2.0 TDI 16V, 2.0 TFSI	05.03 - 08.12	1130	1010	E95-15-007-04-22	A, 18, 20, 34, 78, 124, 161	45-50	35-40							T
1.6 TDI, 1.8 T, 1.8 TFSI, 1.9 TDI, 2.0, 2.0 FSI, 2.0 TDI, 2.0 TDI 16V, 2.0 TFSI	05.03 - 08.12	1130	1010	E95-15-007-03-22	A, 18, 20, 35, 78, 122, 161	45-50	35-40							T
Pro-Street-S (Gewindefahrwerke - höhenverstellbar Coil-Overs-Adjustable Ride Height) 1.2 TFSI, 1.4 TFSI, 1.6, 1.6 FSI, 1.6 TDI, 1.8 T, 1.8 TFSI, 1.9 TDI, 2.0, 2.0 FSI, 2.0 TDI, 2.0 TDI 16V, 2.0 TFSI	05.03 - 08.12	1035	1150	PSS65-85-014-01-22	A, 20, 24, 34, 45, 70, 160	35-65	35-65							T
1.2 TFSI, 1.4 TFSI, 1.6, 1.6 FSI, 1.6 TDI, 1.8 T, 1.8 TFSI, 1.9 TDI, 2.0, 2.0 FSI, 2.0 TDI, 2.0 TDI 16V, 2.0 TFSI	05.03 - 08.12	1035	1150	PSS65-85-014-02-22	A, 20, 24, 35, 45, 70, 160	35-65	35-65							T
1.2 TFSI, 1.4 TFSI, 1.6, 1.6 FSI, 1.6 TDI, 1.8 T, 1.8 TFSI, 1.9 TDI, 2.0, 2.0 FSI, 2.0 TDI, 2.0 TDI 16V, 2.0 TFSI	05.03 - 08.12	1105	1150	PSS65-85-014-03-22	A, 20, 24, 34, 45, 70, 160	35-65	35-65							T
1.2 TFSI, 1.4 TFSI, 1.6, 1.6 FSI, 1.6 TDI, 1.8 T, 1.8 TFSI, 1.9 TDI, 2.0, 2.0 FSI, 2.0 TDI, 2.0 TDI 16V, 2.0 TFSI	05.03 - 08.12	1105	1150	PSS65-85-014-04-22	A, 20, 24, 35, 45, 70, 160	35-65	35-65							T
1.8 TFSI quattro, 2.0 TFSI quattro	09.04 - 08.12	1105	1160	PSS65-15-007-01-22	A, 24, 45, 160	35-65	35-65							T
1.2 TFSI, 1.4 TFSI, 1.6, 1.6 FSI, 1.6 TDI, 1.8 T, 1.8 TFSI, 1.9 TDI, 2.0, 2.0 FSI, 2.0 TDI, 2.0 TDI 16V, 2.0 TFSI	05.03 - 08.12	1170	1150	PSS65-85-014-05-22	A, 20, 24, 34, 45, 70, 160	35-65	35-65							T
1.2 TFSI, 1.4 TFSI, 1.6, 1.6 FSI, 1.6 TDI, 1.8 T, 1.8 TFSI, 1.9 TDI, 2.0, 2.0 FSI, 2.0 TDI, 2.0 TDI 16V, 2.0 TFSI	05.03 - 08.12	1170	1150	PSS65-85-014-06-22	A, 20, 24, 35, 45, 70, 160	35-65	35-65							T
2.0 TDI 16V quattro, 2.0 TDI quattro, 3.2 V6 quattro	05.03 - 08.12	1170	1160	PSS65-15-007-02-22	A, 24, 45, 160	35-65	35-65							T
Pro-Tronic (Elektronische Performance Fahrwerksmodule Electronic Performance Suspension Moduls) Alle Motorisierungen all motorisation	05.03 -			AM65-15-007-01-22	A, 175									
A3 (8V1) Pro-Kit (Performance Fahrwerksfedern Performance Springs) 1.2 TFSI, 1.4 TFSI, 1.6 TDI, 1.8 TFSI	04.12 -	985	990	E10-15-021-03-22	A, 18, 20, 171	30	30					F11-15-021-01-VA	F1540002	T
1.2 TFSI, 1.4 TFSI, 1.6 TDI, 1.8 TFSI	04.12 -	985	1000	E10-15-021-01-22	A, 18, 20, 170	30	30					F11-15-021-01-VA	F11-15-021-01-HA	T
1.6 TDI, 1.8 TFSI, 2.0 TDI	04.12 -	1070	990	E10-15-021-04-22	A, 18, 20, 171	30	30					F11-15-021-02-VA	F1540002	T

Modell	Baujahr	Achslast Vorne kg	Achslast Hinten kg	Artikel-Nr.	Hinweise	ca. Tieferl. Vorne mm	ca. Tieferl. Hinten mm	Ø Vorne mm	Ø Hinten mm	Verstellbarkeit Vorne	Verstellbarkeit Hinten	Ersatzteilbezeichnung Vorne	Ersatzteilbezeichnung Hinten	Gutachten
Model	Year	Front Axle Load kg	Rear Axle Load kg	Part-No.	Notes	ca. Lowering Front mm	ca. Lowering Rear mm	Ø Front mm	Ø Rear mm	Adjustable Front	Adjustable Rear	Spare Part Marking Front	Spare Part Marking Rear	Homologation
A3 (8V1) <i>Pro-Kit (Performance Fahrwerksfedern Performance Springs)</i> 1.6 TDI, 1.8 TFSI, 2.0 TDI	04.12 -	1070	1000	E10-15-021-02-22	A, 18, 20, 170	30	30					F11-15-021-02-VA	F11-15-021-01-HA	T
1.8 TFSI quattro, 2.0 TDI quattro	08.12 -	1070	1010	E10-15-021-10-22	A, 18, 170	30	30					F11-15-021-02-VA	F11-15-007-15-HA	T
<i>Anti-Roll-Kit (Performance Stabilisatoren Performance Sway Bars)</i> 1.2 TFSI, 1.4 TFSI, 1.6 TDI, 1.8 TFSI, 2.0 TDI	04.12 -			E40-15-021-01-11	A, 18, 20, 22, 45, 170			28 Rohr 28 tube	25 Rohr 25 tube	2-fach verstellbar 2-way adjustable	nicht verstellbar not adjustable	AS41-15-021-01-VA	AS41-15-021-01-HA	T
1.2 TFSI, 1.4 TFSI, 1.6 TDI, 1.8 TFSI, 2.0 TDI	04.12 -			E40-15-021-03-11	A, 18, 20, 22, 45, 171			28 Rohr 28 tube	25	2-fach verstellbar 2-way adjustable	nicht verstellbar not adjustable	AS41-15-021-01-VA	AS41-15-021-03-HA	T
A3 Cabriolet (8P7) A3 Convertible (8P7) <i>Pro-Kit (Performance Fahrwerksfedern Performance Springs)</i> 1.6 TDI, 1.8 TFSI, 1.9 TDI, 2.0 TDI, 2.0 TFSI	04.08 -	1155	985	E10-15-007-15-22	A, 18, 20	25	25					F11-15-007-03-VA	F11-15-007-15-HA	ABE
<i>B12 Pro-Kit (Performance Komplettfahrwerke Performance Springs+Shocks)</i> 1.6 TDI, 1.8 TFSI, 1.9 TDI, 2.0 TDI, 2.0 TFSI	04.08 -	1155	985	E90-15-007-15-22	A, 18, 20, 34, 78, 124, 161	25	25							T
<i>Pro-Street-S (Gewindefahrwerke - höhenverstellbar Coil-Overs-Adjustable Ride Height)</i> 1.8 TFSI, 1.9 TDI, 2.0 TFSI	04.08 -	1105	1160	PSS65-15-007-01-22	A, 24, 45, 160	35-65	35-65							T
2.0 TDI	04.08 -	1170	1160	PSS65-15-007-02-22	A, 24, 45, 160	35-65	35-65							T
<i>Pro-Tronic (Elektronische Performance Fahrwerksmodule Electronic Performance Suspension Modul)</i> Alle Motorisierungen / all motorisation	04.08 -			AM65-15-007-01-22	A, 175									
A3 Limousine (8VS) <i>Pro-Kit (Performance Fahrwerksfedern Performance Springs)</i> 1.4 TFSI, 1.8 TFSI	05.13 -	985	1000	E10-15-021-05-22	A, 18, 20, 170	30	30					F11-15-021-01-VA	F11-15-021-05-HA	T
1.8 TFSI, 2.0 TDI	05.13 -	1070	1000	E10-15-021-06-22	A, 18, 20, 170	30	30					F11-15-021-02-VA	F11-15-021-05-HA	T
<i>Anti-Roll-Kit (Performance Stabilisatoren Performance Sway Bars)</i> 1.4 TFSI, 1.8 TFSI, 2.0 TDI	05.13 -			E40-15-021-01-11	A, 18, 20, 22, 45, 170			28 Rohr 28 tube	25 Rohr 25 tube	2-fach verstellbar 2-way adjustable	nicht verstellbar not adjustable	AS41-15-021-01-VA	AS41-15-021-01-HA	T
1.4 TFSI, 1.8 TFSI, 2.0 TDI	05.13 -			E40-15-021-03-11	A, 18, 20, 22, 45, 171			28 Rohr 28 tube	25	2-fach verstellbar 2-way adjustable	nicht verstellbar not adjustable	AS41-15-021-01-VA	AS41-15-021-03-HA	T
A3 Sportback (8PA) <i>Pro-Kit (Performance Fahrwerksfedern Performance Springs)</i> 1.2 TSI, 1.6, 1.6 FSI	09.04 -	980	1005	E10-15-007-05-22	A, 18, 20	30	30					F11-15-007-01-VA	F11-15-007-01-HA	ABE
1.2 TSI, 1.4 TFSI, 1.6, 1.6 FSI, 1.6 TDI, 1.8 TFSI, 1.9 TDI, 2.0, 2.0 FSI, 2.0 TFSI	09.04 -	1065	1005	E10-15-007-06-22	A, 18, 20	30	30					F11-15-007-02-VA	F11-15-007-01-HA	ABE
S3 quattro	06.08 -	1155		E10-15-007-14-20	A, 18	20						F11-15-007-14-VA		ABE
1.6 TDI, 1.8 TFSI, 2.0 TDI, 2.0 TDI 16V, 2.0 TFSI	09.04 -	1155	1005	E10-15-007-07-22	A, 18, 20	30	30					F11-15-007-03-VA	F11-15-007-01-HA	ABE
1.8 TFSI quattro, 2.0 TDI 16V quattro, 2.0 TDI quattro, 2.0 TFSI quattro	09.04 -	1155	1125	E10-15-007-10-22	A, 18	30	30					F11-15-007-03-VA	F11-15-007-04-HA	ABE
3.2 V6 quattro	09.04 - 05.09	1155	1125	E10-15-007-08-22	A, 18	30	30					F11-15-007-04-VA	F11-15-007-04-HA	ABE
<i>Sportline (Performance Fahrwerksfedern Sport Sport Performance Springs)</i> 1.2 TSI, 1.4 TFSI, 1.6, 1.6 FSI, 1.9 TDI, 2.0, 2.0 FSI	09.04 -	1040	1005	E20-15-007-03-22	A, 18, 20	45-50	35-40					F21-15-007-01-VA	F21-15-007-03-HA	ABE
1.4 TFSI, 1.6 TDI, 1.8 TFSI, 1.9 TDI, 2.0, 2.0 FSI, 2.0 TDI, 2.0 TDI 16V, 2.0 TFSI	09.04 -	1130	1005	E20-15-007-04-22	A, 18, 20	45-50	35-40					F21-15-007-02-VA	F21-15-007-03-HA	ABE
<i>Anti-Roll-Kit (Performance Stabilisatoren Performance Sway Bars)</i> 1.2 TSI, 1.4 TFSI, 1.6, 1.6 FSI, 1.6 TDI, 1.8 TFSI, 1.9 TDI, 2.0, 2.0 FSI, 2.0 TDI, 2.0 TDI 16V, 2.0 TFSI	09.04 -			E40-15-007-01-11	A, 18, 20, 22, 45			26	23	2-fach verstellbar 2-way adjustable	2-fach verstellbar 2-way adjustable	AS41-85-014-01-VA	AS41-85-014-01-HA	T
<i>B12 Pro-Kit (Performance Komplettfahrwerke Performance Springs+Shocks)</i> 1.6 FSI Schaltgetriebe, 1.6 Schaltgetriebe 1.6 FSI manual transmission, 1.6 manual transmission 1.6 FSI Schaltgetriebe, 1.6 Schaltgetriebe 1.6 FSI manual transmission, 1.6 manual transmission 1.4 TFSI, 1.6, 1.6 FSI, 1.6 TDI, 1.8 TFSI, 1.9 TDI, 2.0, 2.0 FSI, 2.0 TFSI	09.04 - 09.04 - 09.04 -	980 980 1065	1005 1005 1005	E90-15-007-11-22 E90-15-007-10-22 E90-15-007-13-22	A, 18, 20, 34, 78, 124, 161 A, 18, 20, 35, 78, 122, 161 A, 18, 20, 34, 78, 124, 161	30 30 30	30 30 30							T T T
1.4 TFSI, 1.6, 1.6 FSI, 1.6 TDI, 1.8 TFSI, 1.9 TDI, 2.0, 2.0 FSI, 2.0 TFSI	09.04 -	1065	1005	E90-15-007-12-22	A, 18, 20, 35, 78, 122, 161	30	30							T
1.6 TDI, 1.8 TFSI, 2.0 TDI, 2.0 TDI 16V, 2.0 TFSI	09.04 -	1155	1005	E90-15-007-19-22	A, 18, 20, 34, 78, 124, 161	30	30							T
1.6 TDI, 1.8 TFSI, 2.0 TDI, 2.0 TDI 16V, 2.0 TFSI	09.04 -	1155	1005	E90-15-007-14-22	A, 18, 20, 35, 78, 122, 161	30	30							T
1.8 TFSI quattro, 2.0 TDI 16V quattro, 2.0 TDI quattro, 2.0 TFSI quattro	09.04 -	1155	1125	E90-15-007-18-22	A, 18, 34, 78, 124, 161	30	30							T
1.8 TFSI quattro, 2.0 TDI 16V quattro, 2.0 TDI quattro, 2.0 TFSI quattro	09.04 -	1155	1125	E90-15-007-17-22	A, 18, 35, 78, 122, 161	30	30							T
3.2 V6 quattro	09.04 - 05.09	1155	1125	E90-15-007-16-22	A, 18, 34, 78, 124, 161	30	30							T
<i>B12 Sportline (Performance Komplettfahrwerke Sport Sport Performance Springs+Shocks)</i> 1.4 TFSI, 1.6, 1.6 FSI, 1.6 TDI, 1.9 TDI, 2.0, 2.0 FSI	09.04 -	1040	1005	E95-15-007-05-22	A, 18, 20, 35, 78, 122, 161	45-50	35-40							T
1.4 TFSI, 1.6, 1.6 FSI, 1.6 TDI, 1.9 TDI, 2.0, 2.0 FSI	09.04 -	1040	1010	E95-15-007-06-22	A, 18, 20, 34, 78, 124, 161	45-50	35-40							T
1.4 TFSI, 1.6 TDI, 1.8 TFSI, 1.9 TDI, 2.0, 2.0 FSI, 2.0 TDI, 2.0 TDI 16V, 2.0 TFSI	09.04 -	1130	1005	E95-15-007-07-22	A, 18, 20, 35, 78, 122, 161	45-50	35-40							T
1.4 TFSI, 1.6 TDI, 1.8 TFSI, 1.9 TDI, 2.0, 2.0 FSI, 2.0 TDI, 2.0 TDI 16V, 2.0 TFSI	09.04 -	1130	1010	E95-15-007-08-22	A, 18, 20, 34, 78, 124, 161	45-50	35-40							T
<i>Pro-Street-S (Gewindefahrwerke - höhenverstellbar Coil-Overs-Adjustable Ride Height)</i> 1.2 TSI, 1.4 TFSI, 1.6, 1.6 FSI, 1.6 TDI, 1.8 TFSI, 1.9 TDI, 2.0, 2.0 FSI, 2.0 TDI, 2.0 TDI 16V	09.04 -	1035	1150	PSS65-85-014-01-22	A, 20, 24, 34, 45, 70, 160	35-65	35-65							T
1.2 TSI, 1.4 TFSI, 1.6, 1.6 FSI, 1.6 TDI, 1.8 TFSI, 1.9 TDI, 2.0, 2.0 FSI, 2.0 TDI, 2.0 TDI 16V	09.04 -	1035	1150	PSS65-85-014-02-22	A, 20, 24, 35, 45, 70, 160	35-65	35-65							T
1.2 TSI, 1.4 TFSI, 1.6, 1.6 FSI, 1.6 TDI, 1.8 TFSI, 1.9 TDI, 2.0, 2.0 FSI, 2.0 TDI, 2.0 TDI 16V	09.04 -	1105	1150	PSS65-85-014-03-22	A, 20, 24, 34, 45, 70, 160	35-65	35-65							T

Modell	Baujahr	Achslast Vorne kg	Achslast Hinten kg	Artikel-Nr.	Hinweise	ca. Tieferl. Vorne mm	ca. Tieferl. Hinten mm	Ø Vorne mm	Ø Hinten mm	Verstellbarkeit Vorne	Verstellbarkeit Hinten	Ersatzteilbezeichnung Vorne	Ersatzteilbezeichnung Hinten	Gutachten
Model	Year	Front Axle Load kg	Rear Axle Load kg	Part-No.	Notes	ca. Lowering Front mm	ca. Lowering Rear mm	Ø Front mm	Ø Rear mm	Adjustable Front	Adjustable Rear	Spare Part Marking Front	Spare Part Marking Rear	Homologation
A3 Sportback (8PA) Pro-Street-S (Gewindefahrwerke - höhenverstellbar Coil-Overs-Adjustable Ride Height) 1.2 TSI, 1.4 TFSI, 1.6, 1.6 FSI, 1.6 TDI, 1.8 TFSI, 1.9 TDI, 2.0, 2.0 FSI, 2.0 TDI, 2.0 TDI 16V	09.04 -	1105	1150	PSS65-85-014-04-22	A, 20, 24, 35, 45, 70, 160	35-65	35-65							T
1.8 TFSI quattro, 2.0 TFSI quattro	09.04 -	1105	1160	PSS65-15-007-01-22	A, 24, 45, 160	35-65	35-65							T
1.2 TSI, 1.4 TFSI, 1.6, 1.6 FSI, 1.6 TDI, 1.8 TFSI, 1.9 TDI, 2.0, 2.0 FSI, 2.0 TDI, 2.0 TDI 16V	09.04 -	1170	1150	PSS65-85-014-05-22	A, 20, 24, 34, 45, 70, 160	35-65	35-65							T
1.2 TSI, 1.4 TFSI, 1.6, 1.6 FSI, 1.6 TDI, 1.8 TFSI, 1.9 TDI, 2.0, 2.0 FSI, 2.0 TDI, 2.0 TDI 16V	09.04 -	1170	1150	PSS65-85-014-06-22	A, 20, 24, 35, 45, 70, 160	35-65	35-65							T
2.0 TDI 16V quattro, 2.0 TDI quattro, 3.2 V6 quattro	09.04 -	1170	1160	PSS65-15-007-02-22	A, 24, 45, 160	35-65	35-65							T
Pro-Tronic (Elektronische Performance Fahrwerksmodule Electronic Performance Suspension Moduls) Alle Motorisierungen / all motorisation	09.04 -			AM65-15-007-01-22	A, 175									
A3 Sportback (8VA) Pro-Kit (Performance Fahrwerksfedern Performance Springs) 1.2 TFSI, 1.4 TFSI, 1.6 TDI, 1.8 TFSI	09.12 -	985	1000	E10-15-021-05-22	A, 18, 20, 170	30	30					F11-15-021-01-VA	F11-15-021-05-HA	T
1.2 TFSI, 1.4 TFSI, 1.6 TDI, 1.8 TFSI	09.12 -	985	1000	E10-15-021-08-22	A, 18, 20, 171	30	30					F11-15-021-01-VA	F7907002	T
1.6 TDI, 1.8 TFSI, 2.0 TDI	09.12 -	1070	1000	E10-15-021-06-22	A, 18, 20, 170	30	30					F11-15-021-02-VA	F11-15-021-05-HA	T
1.6 TDI, 1.8 TFSI, 2.0 TDI	09.12 -	1070	1000	E10-15-021-09-22	A, 18, 20, 171	30	30					F11-15-021-02-VA	F7907002	T
1.8 TFSI quattro, 2.0 TDI quattro	01.13 -	1070	1010	E10-15-021-10-22	A, 18, 170	30	30					F11-15-021-02-VA	F11-15-007-15-HA	T
Anti-Roll-Kit (Performance Stabilisatoren Performance Sway Bars) 1.2 TFSI, 1.4 TFSI, 1.6 TDI, 1.8 TFSI, 2.0 TDI	09.12 -			E40-15-021-01-11	A, 18, 20, 22, 45, 170			28 Rohr 28 tube	25 Rohr 25 tube	2-fach verstellbar 2-way adjustable	nicht verstellbar not adjustable	AS41-15-021-01-VA	AS41-15-021-01-HA	T
1.2 TFSI, 1.4 TFSI, 1.6 TDI, 1.8 TFSI, 2.0 TDI	09.12 -			E40-15-021-03-11	A, 18, 20, 22, 45, 171			28 Rohr 28 tube	25 Rohr 25 tube	2-fach verstellbar 2-way adjustable	nicht verstellbar not adjustable	AS41-15-021-01-VA	AS41-15-021-03-HA	T
A4 (8D2, B5) Pro-Kit (Performance Fahrwerksfedern Performance Springs) 1.6, 1.8, 1.8 T	11.94 - 11.00	995	970	E1531-140	A, 18, 20	30	30					F1531001	F1531002	T
1.8 T quattro, 1.8 quattro	01.95 - 11.00	995	1080	E1534-140	A, 18	30	30					F1531001	F1534002	T
1.8, 1.8 T, 1.9 TDI, 2.4, 2.6, 2.8, 2.8 24V	01.95 - 11.00	1055	970	E1532-140	A, 18, 20	30	30					F1532001	F1531002	T
1.8 T quattro, 1.8 quattro, 1.9 TDI quattro, 2.4 quattro, 2.6 quattro, 2.8 quattro	01.95 - 08.01	1055	1080	E1535-140	A, 18	30	30					F1532001	F1534002	T
2.4, 2.5 TDI, 2.6, 2.8, 2.8 24V	01.95 - 11.00	1150	970	E1541-140	A, 18, 20	30	30					F1541001	F1531002	T
2.4 quattro, 2.5 TDI quattro, 2.6 quattro, 2.8 quattro	01.95 - 08.01	1150	1080	E1542-140	A, 18	30	30					F1541001	F1534002	T
Sportline (Performance Fahrwerksfedern Sport Sport Performance Springs) 1.6, 1.8, 1.8 T, 1.9 TDI, 2.4, 2.6, 2.8, 2.8 24V	11.94 - 11.00	1070	1010	E20-15-003-01-22	A, 20	45-50	35-40					F21-15-003-01-VA	F21-15-003-01-HA	T
Anti-Roll-Kit (Performance Stabilisatoren Performance Sway Bars) 1.6, 1.8, 1.8 T, 1.9 TDI, 2.4, 2.4 quattro, 2.5 TDI, 2.6, 2.6 quattro, 2.8, 2.8 24V, 2.8 quattro	11.94 - 08.01			E1531-310	A, 18, 20, 22, 45			32		2-fach verstellbar 2-way adjustable		AS1531310VA		T
1.8 T quattro, 1.8 quattro, 1.9 TDI quattro, 2.5 TDI quattro, 2.7 Bi Turbo quattro, 2.7 Turbo quattro, S4 quattro	01.95 - 09.01			E1531-310	A, 18, 22, 45			32		2-fach verstellbar 2-way adjustable		AS1531310VA		T
B12 Pro-Kit (Performance Komplettfahrwerke Performance Springs+Shocks) 1.8 quattro	01.95 - 07.00	955	970	E90-15-003-11-22	A, 18, 140, 161	30	30							T
1.8 quattro	01.95 - 06.00	955	970	E90-15-003-10-22	A, 18, 78, 110, 161	30	30							T
1.8 T quattro Schaltgetriebe, ohne Klimaanlage 1.8 T quattro manual transmission, without air conditioner	01.95 - 06.00	955	970	E90-15-003-10-22	A, 18, 75, 78, 110, 161	30	30							T
1.8 T quattro Schaltgetriebe, ohne Klimaanlage 1.8 T quattro manual transmission, without air conditioner	01.95 - 07.00	955	970	E90-15-003-11-22	A, 18, 75, 78, 140, 161	30	30							T
1.6, 1.8	11.94 - 01.99	995	970	E90-15-003-01-22	A, 18, 20, 74, 78, 112, 161	30	30							T
1.6, 1.8	02.99 - 11.00	995	970	E90-15-003-02-22	A, 18, 20, 74, 78, 144, 161	30	30							T
1.6, 1.8	07.00 - 11.00	995	970	E90-15-003-03-22	A, 18, 20, 78, 140, 161	30	30							T
1.8 T Schaltgetriebe, ohne Klimaanlage 1.8 T manual transmission, without air conditioner	01.95 - 01.99	995	970	E90-15-003-01-22	A, 18, 20, 74, 75, 78, 112, 161	30	30							T
1.8 T Schaltgetriebe, ohne Klimaanlage 1.8 T manual transmission, without air conditioner	02.99 - 11.00	995	970	E90-15-003-02-22	A, 18, 20, 74, 75, 78, 144, 161	30	30							T
1.8 T Schaltgetriebe, ohne Klimaanlage 1.8 T manual transmission, without air conditioner	07.00 - 11.00	995	970	E90-15-003-03-22	A, 18, 20, 75, 78, 140, 161	30	30							T
1.8, 1.8 T, 1.9 TDI, 2.4, 2.6, 2.8 Schaltgetriebe 1.8, 1.8 T, 1.9 TDI, 2.4, 2.6, 2.8 Schaltgetriebe	02.99 - 11.00	1055	970	E90-15-003-05-22	A, 18, 20, 73, 78, 144, 161	30	30							T
1.8, 1.8 T, 1.9 TDI, 2.4, 2.6, 2.8 Schaltgetriebe 1.8, 1.8 T, 1.9 TDI, 2.4, 2.6, 2.8 Schaltgetriebe	01.95 - 01.99	1055	970	E90-15-003-04-22	A, 18, 20, 74, 78, 112, 161	30	30							T
1.8, 1.8 T, 1.9 TDI, 2.4, 2.6, 2.8 Schaltgetriebe 1.8, 1.8 T, 1.9 TDI, 2.4, 2.6, 2.8 Schaltgetriebe	07.00 - 11.00	1055	970	E90-15-003-06-22	A, 18, 20, 78, 140, 161	30	30							T
1.8 T quattro, 1.8 quattro, 1.9 TDI quattro, 2.4 quattro, 2.6 quattro, 2.8 quattro Schaltgetriebe 1.8 T quattro, 1.8 quattro, 1.9 TDI quattro, 2.4 quattro, 2.6 quattro, 2.8 quattro Schaltgetriebe	01.95 - 06.00	1055	1080	E90-15-003-12-22	A, 18, 78, 110, 161	30	30							T
1.8 T quattro, 1.8 quattro, 1.9 TDI quattro, 2.4 quattro, 2.6 quattro, 2.8 quattro Schaltgetriebe 1.8 T quattro, 1.8 quattro, 1.9 TDI quattro, 2.4 quattro, 2.6 quattro, 2.8 quattro Schaltgetriebe	07.00 - 08.01	1055	1080	E90-15-003-13-22	A, 18, 78, 140, 161	30	30							T
2.5 TDI Schaltgetriebe 2.5 TDI manual transmission	09.97 - 01.99	1150	970	E90-15-003-07-22	A, 18, 20, 78, 112, 161	30	30							T

Modell	Baujahr	Achslast Vorne kg	Achslast Hinten kg	Artikel-Nr.	Hinweise	ca. Tieferl. Vorne mm	ca. Tieferl. Hinten mm	Ø Vorne mm	Ø Hinten mm	Verstellbarkeit Vorne	Verstellbarkeit Hinten	Ersatzteilbezeichnung Vorne	Ersatzteilbezeichnung Hinten	Gutachten
Model	Year	Front Axle Load kg	Rear Axle Load kg	Part-No.	Notes	ca. Lowering Front mm	ca. Lowering Rear mm	Ø Front mm	Ø Rear mm	Adjustable Front	Adjustable Rear	Spare Part Marking Front	Spare Part Marking Rear	Homologation
A4 (8D2, B5) B12 Pro-Kit (Performance Komplettfahrwerke Performance Springs+Shocks) 2.4, 2.6, 2.8	01.95 - 01.99	1150	970	E90-15-003-07-22	A, 18, 20, 75, 80, 112, 161	30	30							T
2.4, 2.5 TDI Schaltgetriebe, 2.6, 2.8 2.4, 2.5 TDI manual transmission, 2.6, 2.8	07.00 - 11.00	1150	970	E90-15-003-09-22	A, 18, 20, 78, 140, 161	30	30							T
2.4, 2.5 TDI Schaltgetriebe, 2.6, 2.8 2.4, 2.5 TDI manual transmission, 2.6, 2.8	02.99 - 06.00	1150	970	E90-15-003-08-22	A, 18, 20, 78, 144, 161	30	30							T
2.5 TDI quattro Schaltgetriebe 2.5 TDI quattro manual transmission	09.97 - 06.00	1150	1080	E90-15-003-14-22	A, 18, 74, 110, 161	30	30							T
2.4 quattro, 2.6 quattro, 2.8 quattro	01.95 - 06.00	1150	1080	E90-15-003-14-22	A, 18, 74, 78, 110, 161	30	30							T
2.4 quattro, 2.5 TDI quattro Schaltgetriebe, 2.6 quattro, 2.8 quattro 2.4 quattro, 2.5 TDI quattro manual transmission, 2.6 quattro, 2.8 quattro	01.95 - 08.01	1150	1080	E90-15-003-15-22	A, 18, 78, 141, 161	30	30							T
B12 Sportline (Performance Komplettfahrwerke Sport Sport Performance Springs+Shocks) 1.6, 1.8, 1.8 T, 1.9 TDI, 2.4, 2.8 Schaltgetriebe 1.6, 1.8, 1.8 T, 1.9 TDI, 2.4, 2.8 manual transmission	11.94 - 01.99	1070	1010	E95-15-003-01-22	A, 18, 20, 74, 78, 112, 161	45-50	35-40							T
1.6, 1.8, 1.8 T, 1.9 TDI, 2.4, 2.6, 2.8 Schaltgetriebe 1.6, 1.8, 1.8 T, 1.9 TDI, 2.4, 2.6, 2.8 manual transmission	02.99 - 11.00	1070	1010	E95-15-003-02-22	A, 18, 20, 74, 78, 144, 161	45-50	35-40							T
1.6, 1.8, 1.8 T, 1.9 TDI, 2.4, 2.6, 2.8 Schaltgetriebe 1.6, 1.8, 1.8 T, 1.9 TDI, 2.4, 2.6, 2.8 manual transmission	07.00 - 11.00	1070	1010	E95-15-003-03-22	A, 18, 20, 78, 140, 161	45-50	35-40							T
Pro-Street-S (Gewindefahrwerke - höhenverstellbar Coil-Overs-Adjustable Ride Height) 1.8 T quattro, 1.8 quattro, 1.9 TDI quattro, 2.4 quattro, 2.5 TDI quattro, 2.6 quattro, 2.7 Bi Turbo quattro, 2.7 Turbo quattro, 2.8 quattro, S4 quattro	01.95 - 09.01	1080	1140	PSS65-15-003-06-22	A, 18, 23, 25, 45, 160	40-75	40-75							T
1.6, 1.8, 1.8 T, 1.9 TDI, 2.4, 2.5 TDI, 2.6, 2.8, 2.8 24V	11.94 - 01.99	1080	1185	PSS65-15-003-04-22	A, 18, 20, 23, 25, 45, 160	40-75	40-75							T
1.6, 1.8, 1.8 T, 1.9 TDI, 2.4, 2.5 TDI, 2.6, 2.8, 2.8 24V	01.99 - 11.00	1080	1185	PSS65-15-003-05-22	A, 18, 20, 23, 25, 45, 160	40-75	40-75							T
1.8 T quattro, 1.8 quattro, 1.9 TDI quattro, 2.4 quattro, 2.5 TDI quattro, 2.6 quattro, 2.7 Bi Turbo quattro, 2.7 Turbo quattro, 2.8 quattro, S4 quattro	01.95 - 09.01	1150	1140	PSS65-15-003-03-22	A, 18, 23, 25, 45, 160	40-75	40-75							T
1.6, 1.8, 1.8 T, 1.9 TDI, 2.4, 2.5 TDI, 2.6, 2.8, 2.8 24V	11.94 - 01.99	1150	1185	PSS65-15-003-01-22	A, 18, 20, 23, 25, 45, 160	40-75	40-75							T
1.6, 1.8, 1.8 T, 1.9 TDI, 2.4, 2.5 TDI, 2.6, 2.8, 2.8 24V	01.99 - 11.00	1150	1185	PSS65-15-003-02-22	A, 18, 20, 23, 25, 45, 160	40-75	40-75							T
A4 (8E2, B6) Pro-Kit (Performance Fahrwerksfedern Performance Springs) 1.6, 1.8 T, 2.0, 2.0 FSI	11.00 - 12.04	1090	1035	E10-15-003-01-22	A, 18, 20	30	30					F11-15-003-01-VA	F11-15-003-01-HA	T
1.8 T quattro	11.00 - 12.04	1090	1135	E10-15-003-04-22	A, 18	30	30					F11-15-003-01-VA	F11-15-003-03-HA	T
1.9 TDI, 2.4, 3.0	11.00 - 12.04	1165	1035	E10-15-003-02-22	A, 18, 20	30	30					F1568001	F11-15-003-01-HA	T
1.8 T quattro, 1.9 TDI quattro, 3.0 quattro	11.00 - 12.04	1165	1135	E10-15-003-05-22	A, 18	30	30					F1568001	F11-15-003-03-HA	T
2.5 TDI	08.01 - 12.04	1230	1035	E10-15-003-06-22	A, 18, 20	30	30					F11-15-003-03-VA	F11-15-003-01-HA	T
2.5 TDI quattro	11.00 - 12.04	1230	1135	E10-15-003-03-22	A, 18	30	30					F11-15-003-03-VA	F11-15-003-03-HA	T
Sportline (Performance Fahrwerksfedern Sport Sport Performance Springs) 1.6, 1.8 T, 1.9 TDI, 2.0, 2.0 FSI	11.00 - 12.04	1090	1035	E20-15-003-02-22	A, 18, 20	45-50	35-40					F21-15-003-02-VA	F21-15-003-02-HA	T
1.9 TDI, 2.4, 3.0	11.00 - 12.04	1140	1035	E20-15-003-03-22	A, 18, 20	45-50	35-40					F21-15-003-03-VA	F21-15-003-02-HA	T
Anti-Roll-Kit (Performance Stabilisatoren Performance Sway Bars) 1.6, 1.8 T, 1.8 T quattro, 1.9 TDI, 1.9 TDI quattro, 2.0, 2.0 FSI, 2.4, 2.5 TDI, 2.5 TDI quattro, 3.0, 3.0 quattro	11.00 - 12.04			E40-15-003-01-11	A, 18, 22, 45			32	24	nicht verstellbar not adjustable	2-fach verstellbar 2-way adjustable	AS41-15-003-01-VA	AS41-15-003-01-HA	T
B12 Pro-Kit (Performance Komplettfahrwerke Performance Springs+Shocks) 1.6, 1.8 T, 2.0, 2.0 FSI	11.00 - 09.02	1090	1035	E90-15-006-01-22	A, 18, 20, 78, 113, 161	30	30							T
1.6, 1.8 T, 2.0, 2.0 FSI	10.02 - 12.04	1090	1035	E90-15-006-02-22	A, 18, 20, 78, 145, 161	30	30							T
1.8 T quattro	11.00 - 09.02	1090	1135	E90-15-006-07-22	A, 18, 78, 113, 161	30	30							T
1.8 T quattro	10.02 - 12.04	1090	1135	E90-15-006-08-22	A, 18, 78, 145, 161	30	30							T
1.9 TDI, 2.4, 3.0	11.00 - 09.02	1165	1035	E90-15-006-03-22	A, 18, 20, 78, 113, 161	30	30							T
1.9 TDI, 2.4, 3.0	10.02 - 12.04	1165	1035	E90-15-006-04-22	A, 18, 20, 78, 145, 161	30	30							T
1.8 T quattro, 1.9 TDI quattro, 3.0 quattro	11.00 - 09.02	1165	1135	E90-15-006-09-22	A, 18, 78, 113, 161	30	30							T
1.8 T quattro, 1.9 TDI quattro, 3.0 quattro	10.02 - 12.04	1165	1135	E90-15-006-10-22	A, 18, 78, 145, 161	30	30							T
2.5 TDI	08.01 - 09.02	1230	1035	E90-15-006-11-22	A, 18, 20, 78, 113, 161	30	30							T
2.5 TDI	10.02 - 12.04	1230	1035	E90-15-006-12-22	A, 18, 20, 78, 145, 161	30	30							T
2.5 TDI quattro	11.00 - 09.02	1230	1135	E90-15-006-05-22	A, 18, 78, 113, 161	30	30							T
2.5 TDI quattro	10.02 - 12.04	1230	1135	E90-15-006-06-22	A, 18, 78, 145, 161	30	30							T
B12 Sportline (Performance Komplettfahrwerke Sport Sport Performance Springs+Shocks) 1.6, 1.8 T, 2.0, 2.0 FSI	11.00 - 09.02	1090	1035	E95-15-006-01-22	A, 18, 20, 78, 113, 161	45-50	35-40							T
1.6, 1.8 T, 2.0, 2.0 FSI	10.02 - 12.04	1090	1035	E95-15-006-02-22	A, 18, 20, 78, 145, 161	45-50	35-40							T
1.9 TDI, 2.4, 3.0	11.00 - 09.02	1140	1035	E95-15-006-03-22	A, 18, 20, 78, 113, 161	45-50	35-40							T
1.9 TDI, 2.4, 3.0	10.02 - 12.04	1140	1035	E95-15-006-04-22	A, 18, 20, 78, 145, 161	45-50	35-40							T
Pro-Street-S (Gewindefahrwerke - höhenverstellbar Coil-Overs-Adjustable Ride Height) 1.6, 1.8 T, 1.9 TDI, 2.0, 2.0 FSI, 2.4, 2.5 TDI, 3.0	11.00 - 12.04	1080	1150	PSS65-15-006-01-22	A, 18, 20, 23, 25, 45, 160	35-65	35-65							T
1.8 T quattro, 1.9 TDI quattro, 2.5 TDI quattro, 3.0 quattro	11.00 - 12.04	1080	1165	PSS65-15-006-05-22	A, 18, 23, 25, 45, 160	35-65	35-65							T

Modell	Baujahr	Achslast Vorne kg	Achslast Hinten kg	Artikel-Nr.	Hinweise	ca. Tieferl. Vorne mm	ca. Tieferl. Hinten mm	Ø Vorne mm	Ø Hinten mm	Verstellbarkeit Vorne	Verstellbarkeit Hinten	Ersatzteilbezeichnung Vorne	Ersatzteilbezeichnung Hinten	Gutachten
Model	Year	Front Axle Load kg	Rear Axle Load kg	Part-No.	Notes	ca. Lowering Front mm	ca. Lowering Rear mm	Ø Front mm	Ø Rear mm	Adjustable Front	Adjustable Rear	Spare Part Marking Front	Spare Part Marking Rear	Homologation
A4 (8E2, B6) Pro-Street-S (Gewindefahrwerke - höhenverstellbar Coil-Overs-Adjustable Ride Height) 1.6, 1.8 T, 1.9 TDI, 2.0, 2.0 FSI, 2.4, 2.5 TDI, 3.0	11.00 - 12.04	1220	1150	PSS65-15-006-02-22	A, 18, 20, 23, 25, 45, 160	35-65	35-65							T
1.8 T quattro, 1.9 TDI quattro, 2.5 TDI quattro, 3.0 quattro	11.00 - 12.04	1230	1165	PSS65-15-006-06-22	A, 18, 23, 25, 45, 160	35-65	35-65							T
A4 (8EC, B7) Pro-Kit (Performance Fahrwerksfedern Performance Springs) 1.6, 1.8 T, 2.0, 2.0 TFSI	11.04 - 06.08	1090	1035	E10-15-003-01-22	A, 18, 20	30	30					F11-15-003-01-VA	F11-15-003-01-HA	T
1.8 T quattro, 2.0 TFSI quattro	11.04 - 06.08	1090	1135	E10-15-003-04-22	A, 18	30	30					F11-15-003-01-VA	F11-15-003-03-HA	T
1.9 TDI, 2.0 TDI, 2.0 TDI 16V, 2.0 TFSI, 3.0, 3.2 FSI	11.04 - 06.08	1165	1035	E10-15-003-02-22	A, 18, 20	30	30					F1568001	F11-15-003-01-HA	T
1.8 T quattro, 2.0 TDI quattro, 2.0 TFSI quattro, 3.0 quattro, 3.2 FSI quattro	11.04 - 06.08	1165	1135	E10-15-003-05-22	A, 18	30	30					F1568001	F11-15-003-03-HA	T
2.5 TDI, 2.7 TDI	11.04 - 06.08	1230	1035	E10-15-003-06-22	A, 18, 20	30	30					F11-15-003-03-VA	F11-15-003-01-HA	T
3.0 TDI quattro	11.04 - 06.08	1230	1135	E10-15-003-03-22	A, 18	30	30					F11-15-003-03-VA	F11-15-003-03-HA	T
Sportline (Performance Fahrwerksfedern Sport Sport Performance Springs) 1.6, 1.8 T, 2.0, 2.0 TFSI	11.04 - 06.08	1090	1035	E20-15-003-02-22	A, 20	45-50	35-40					F21-15-003-02-VA	F21-15-003-02-HA	T
1.9 TDI, 2.0 TDI, 2.0 TDI 16V, 2.0 TFSI, 3.0, 3.2 FSI	11.04 - 06.08	1140	1035	E20-15-003-03-22	A, 20	45-50	35-40					F21-15-003-03-VA	F21-15-003-02-HA	T
Anti-Roll-Kit (Performance Stabilisatoren Performance Sway Bars) 1.6, 1.8 T, 1.8 T quattro, 1.9 TDI, 2.0, 2.0 TDI, 2.0 TDI 16V, 2.0 TDI quattro, 2.0 TFSI, 2.0 TFSI quattro, 2.5 TDI, 2.7 TDI, 3.0, 3.0 TDI quattro, 3.0 quattro, 3.2 FSI, 3.2 FSI quattro	11.04 - 06.08			E40-15-003-01-11	A, 18, 22, 45			32	24	nicht verstellbar not adjustable	2-fach verstellbar 2-way adjustable	AS41-15-003-01-VA	AS41-15-003-01-HA	T
B12 Pro-Kit (Performance Komplettfahrwerke Performance Springs+Shocks) 1.6, 1.8 T, 2.0, 2.0 TFSI	11.04 - 06.08	1090	1035	E90-15-006-02-22	A, 18, 20, 78, 161	30	30							T
1.8 T quattro, 2.0 TFSI quattro	11.04 - 06.08	1090	1130	E90-15-006-08-22	A, 18, 78, 161	30	30							T
1.9 TDI, 2.0 TDI, 2.0 TDI 16V, 2.0 TFSI, 3.0, 3.2 FSI	11.04 - 06.08	1165	1035	E90-15-006-04-22	A, 18, 20, 78, 161	30	30							T
1.8 T quattro, 2.0 TDI quattro, 2.0 TFSI quattro, 3.0 quattro, 3.2 FSI quattro	11.04 - 06.08	1165	1130	E90-15-006-10-22	A, 18, 78, 161	30	30							T
2.5 TDI, 2.7 TDI	11.04 - 06.08	1230	1035	E90-15-006-12-22	A, 18, 20, 78, 161	30	30							T
3.0 TDI quattro	11.04 - 06.08	1230	1130	E90-15-006-06-22	A, 18, 78, 161	30	30							T
B12 Sportline (Performance Komplettfahrwerke Sport Sport Performance Springs+Shocks) 1.6, 1.8 T, 2.0, 2.0 TFSI	11.04 - 06.08	1090	1035	E95-15-006-02-22	A, 18, 20, 78, 161	45-50	35-40							T
1.9 TDI, 2.0 TDI, 2.0 TFSI, 3.0, 3.2 FSI	11.04 - 06.08	1140	1035	E95-15-006-04-22	A, 18, 20, 78, 161	45-50	35-40							T
Pro-Street-S (Gewindefahrwerke - höhenverstellbar Coil-Overs-Adjustable Ride Height) 1.6, 1.8 T, 1.9 TDI, 2.0, 2.0 TDI, 2.0 TDI 16V, 2.0 TFSI, 2.5 TDI, 3.0	11.04 - 06.08	1080	1150	PSS65-15-006-01-22	A, 18, 20, 23, 25, 45, 160	35-65	35-65							T
1.8 T quattro, 2.0 TFSI quattro, 3.0 TDI quattro, 3.0 quattro	11.04 - 06.08	1080	1165	PSS65-15-006-05-22	A, 18, 23, 25, 45, 160	35-65	35-65							T
1.6, 1.8 T, 1.9 TDI, 2.0, 2.0 TDI, 2.0 TDI 16V, 2.0 TFSI, 2.5 TDI, 3.0	11.04 - 06.08	1220	1150	PSS65-15-006-02-22	A, 18, 20, 23, 25, 45, 160	35-65	35-65							T
1.8 T quattro, 2.0 TFSI quattro, 3.0 TDI quattro, 3.0 quattro	11.04 - 06.08	1230	1165	PSS65-15-006-06-22	A, 18, 23, 25, 45, 160	35-65	35-65							T
A4 (8K2, B8) Pro-Kit (Performance Fahrwerksfedern Performance Springs) 1.8 TFSI, 2.0 TDI, 2.0 TFSI, 2.0 TFSI flexible fuel, 3.2 FSI Schaltgetriebe 1.8 TFSI, 2.0 TDI, 2.0 TFSI, 2.0 TFSI flexible fuel, 3.2 FSI manual transmission	11.07 -	1105	1160	E10-15-011-01-22	A, 12, 18, 20	35	30					F11-15-011-01-VA	F11-15-011-01-HA	ABE
1.8 TFSI quattro, 2.0 TDI quattro, 2.0 TDI quattro, 2.0 TFSI flexible fuel quattro, 2.0 TFSI quattro, 3.2 FSI quattro	11.07 -	1105	1160	E10-15-011-01-22	A, 12, 18	35	35					F11-15-011-01-VA	F11-15-011-01-HA	ABE
2.7 TDI, 3.0 TDI, 3.2 FSI Automatik 2.7 TDI, 3.0 TDI, 3.2 FSI automatic transmission	11.07 -	1215	1160	E10-15-011-02-22	A, 12, 18, 20	35	30					F11-15-011-02-VA	F11-15-011-01-HA	ABE
3.0 TDI quattro, 3.0 TFSI quattro, 3.2 FSI quattro Automatik 3.0 TDI quattro, 3.0 TFSI quattro, 3.2 FSI quattro automatic transmission	11.07 -	1215	1160	E10-15-011-02-22	A, 12, 18	35	35					F11-15-011-02-VA	F11-15-011-01-HA	ABE
S4 quattro	11.08 -	1215	1160	E10-15-011-02-22	A, 12, 18	20	15					F11-15-011-02-VA	F11-15-011-01-HA	ABE
Sportline (Performance Fahrwerksfedern Sport Sport Performance Springs) 1.8 TFSI, 2.0 TDI, 2.0 TFSI, 2.0 TFSI flexible fuel, 3.2 FSI	11.07 -	1105	1155	E20-15-011-01-22	A, 18, 20	45	35					F21-15-011-01-VA	F21-15-011-01-HA	T
1.8 TFSI quattro, 2.0 TDI quattro, 2.0 TDI quattro, 2.0 TFSI flexible fuel quattro, 2.0 TFSI quattro, 3.2 FSI quattro	11.07 -	1105	1155	E20-15-011-01-22	A, 18	45	35					F21-15-011-01-VA	F21-15-011-01-HA	T
Anti-Roll-Kit (Performance Stabilisatoren Performance Sway Bars) 1.8 TFSI, 1.8 TFSI quattro, 2.0 TDI, 2.0 TDI quattro, 2.0 TDI quattro, 2.0 TFSI, 2.0 TFSI flexible fuel, 2.0 TFSI flexible fuel quattro, 2.0 TFSI quattro, 2.7 TDI, 3.0 TDI, 3.0 TDI quattro, 3.0 TFSI quattro, 3.2 FSI, 3.2 FSI quattro, S4 quattro	11.07 -			E40-15-011-01-11	A, 18, 22, 45			28	23	nicht verstellbar not adjustable	nicht verstellbar not adjustable	AS41-15-011-01-VA	AS41-15-011-01-HA	T
B12 Pro-Kit (Performance Komplettfahrwerke Performance Springs+Shocks) 1.8 TFSI, 2.0 TDI, 2.0 TFSI, 2.0 TFSI flexible fuel, 3.2 FSI	11.07 -	1105	1160	E90-15-011-01-22	A, 12, 18, 20, 21, 78, 88, 161	35	30							T
1.8 TFSI quattro, 2.0 TDI quattro, 2.0 TFSI flexible fuel quattro, 2.0 TFSI quattro, 3.0 TFSI quattro, 3.2 FSI quattro	11.07 -	1105	1160	E90-15-011-01-22	A, 12, 18, 21, 78, 88, 161	35	30							T
2.7 TDI, 3.0 TDI, 3.2 FSI	11.07 -	1215	1160	E90-15-011-02-22	A, 12, 18, 20, 21, 78, 88, 161	35	30							T
3.0 TDI quattro, 3.0 TFSI quattro, 3.2 FSI quattro, S4 quattro	11.07 -	1215	1160	E90-15-011-02-22	A, 12, 18, 21, 78, 88, 161	35	30							T
B12 Sportline (Performance Komplettfahrwerke Sport Sport Performance Springs+Shocks) 1.8 TFSI, 2.0 TDI	11.11 -	1105	1155	E95-15-011-01-22	A, 12, 18, 20, 21, 78, 161	45	35							T

Modell	Baujahr	Achslast Vorne kg	Achslast Hinten kg	Artikel-Nr.	Hinweise	ca. Tieferl. Vorne mm	ca. Tieferl. Hinten mm	Ø Vorne mm	Ø Hinten mm	Verstellbarkeit Vorne	Verstellbarkeit Hinten	Ersatzteilbezeichnung Vorne	Ersatzteilbezeichnung Hinten	Gutachten
Model	Year	Front Axle Load kg	Rear Axle Load kg	Part-No.	Notes	ca. Lowering Front mm	ca. Lowering Rear mm	Ø Front mm	Ø Rear mm	Adjustable Front	Adjustable Rear	Spare Part Marking Front	Spare Part Marking Rear	Homologation
A4 (8K2, B8) B12 Sportline (Performance Komplettfahrwerke Sport Sport Performance Springs+Shocks) 1.8 TFSI, 1.8 TFSI quattro, 2.0 TDI, 2.0 TDI quattro, 2.0 TDi quattro, 2.0 TFSI, 2.0 TFSI flexible fuel, 2.0 TFSI flexible fuel quattro, 2.0 TFSI quattro, 3.0 TFSI quattro, 3.2 FSI, 3.2 FSI quattro	11.07 -	1105	1155	E95-15-011-01-22	A, 12, 18, 21, 78, 88, 161	45	35							T
2.0 TFSI	05.13 -	1105	1155	E95-15-011-01-22	A, 12, 18, 20, 21, 78, 88, 161	45	35							T
Pro-Street-S (Gewindefahrwerke - höhenverstellbar Coil-Overs-Adjustable Ride Height) 1.8 TFSI, 1.8 TFSI quattro, 2.0 TDI, 2.0 TDI quattro, 2.0 TDi quattro, 2.0 TFSI, 2.0 TFSI flexible fuel, 2.0 TFSI flexible fuel quattro, 2.0 TFSI quattro, 2.7 TDI, 3.0 TDI, 3.0 TDI quattro, 3.0 TFSI quattro, 3.2 FSI, 3.2 FSI quattro	11.07 -	1080	1215	PSS65-15-011-01-22	A, 18, 20, 24, 25, 45, 160	20-40	10-40							T
1.8 TFSI, 2.0 TDI, 2.0 TFSI, 2.0 TFSI flexible fuel, 2.7 TDI, 3.0 TDI, 3.2 FSI	11.07 -	1180	1215	PSS65-15-011-02-22	A, 18, 20, 24, 25, 45, 160	20-40	10-40							T
1.8 TFSI quattro, 2.0 TDI quattro, 2.0 TDi quattro, 2.0 TFSI flexible fuel quattro, 2.0 TFSI quattro, 3.0 TDI quattro, 3.0 TFSI quattro, 3.2 FSI quattro, S4 quattro	11.07 -	1225	1215	PSS65-15-011-02-22	A, 18, 24, 25, 45, 160	20-40	10-40							T
Pro-Tronic (Elektronische Performance Fahrwerksmodule Electronic Performance Suspension Modul) Alle Motorisierungen / all motorisation	11.07 -			AM65-15-011-01-22	A, 175									
A4 Avant (8D5, B5) Pro-Kit (Performance Fahrwerksfedern Performance Springs) 1.6, 1.8, 1.8 T	11.94 - 09.01	995	1045	E1536-140	A, 18, 20	30	30					F1531001	F1536002	T
1.8 T quattro, 1.8 quattro	07.95 - 09.01	995	1115	E1538-140	A, 18	30	30					F1531001	F1538002	T
1.8, 1.8 T, 1.9 TDI, 2.4, 2.6, 2.8	07.95 - 09.01	1055	1045	E1537-140	A, 18, 20	30	30					F1532001	F1536002	T
1.8 T quattro, 1.8 quattro, 1.9 TDI quattro, 2.4 quattro, 2.6 quattro, 2.8 quattro	07.95 - 09.01	1055	1115	E1539-140	A, 18	30	30					F1532001	F1538002	T
2.4, 2.5 TDI, 2.6, 2.8	07.95 - 09.01	1150	1045	E1543-140	A, 18, 20	30	30					F1541001	F1536002	T
2.4 quattro, 2.5 TDI quattro, 2.6 quattro, 2.8 quattro	01.96 - 09.01	1150	1115	E1544-140	A, 18	30	30					F1541001	F1538002	T
S4 quattro	09.97 - 09.01	1150	1130	E1569-140	A, 18	20	20					F1568001	F1538002	T
Sportline (Performance Fahrwerksfedern Sport Sport Performance Springs) 1.6, 1.8, 1.8 T, 1.9 TDI, 2.4, 2.6, 2.8	11.94 - 09.01	1070	1010	E20-15-003-01-22	A, 20	45-50	35-40					F21-15-003-01-VA	F21-15-003-01-HA	T
Anti-Roll-Kit (Performance Stabilisatoren Performance Sway Bars) 1.6, 1.8, 1.8 T, 1.9 TDI, 2.4, 2.5 TDI, 2.6, 2.8	11.94 - 09.01			E1531-310	A, 18, 20, 22, 45			32		2-fach verstellbar 2-way adjustable		AS1531310VA		T
1.8 T quattro, 1.8 quattro, 1.9 TDI quattro, 2.4 quattro, 2.5 TDI quattro, 2.6 quattro, 2.8 quattro, S4 quattro	07.95 - 09.01			E1531-310	A, 18, 22, 45			32		2-fach verstellbar 2-way adjustable		AS1531310VA		T
B12 Pro-Kit (Performance Komplettfahrwerke Performance Springs+Shocks) 1.6, 1.8	01.96 - 01.99	995	1045	E90-15-003-16-22	A, 18, 20, 74, 78, 112, 161	30	30							T
1.6, 1.8	02.99 - 06.00	995	1045	E90-15-003-17-22	A, 18, 20, 74, 78, 144, 161	30	30							T
1.6, 1.8	07.00 - 09.01	995	1045	E90-15-003-18-22	A, 18, 20, 78, 140, 161	30	30							T
1.8 T Schaltgetriebe, ohne Klimaanlage 1.8 T manual transmission, without air conditioner	02.99 - 06.00	995	1045	E90-15-003-17-22	A, 18, 20, 74, 75, 78, 144, 161	30	30							T
1.8 T Schaltgetriebe, ohne Klimaanlage 1.8 T manual transmission, without air conditioner	07.00 - 09.01	995	1045	E90-15-003-18-22	A, 18, 20, 75, 78, 140, 161	30	30							T
1.8 quattro 1.8 quattro	03.98 - 09.01	995	1115	E90-15-003-25-22	A, 18, 74, 78, 142, 161	30	30							T
1.8 quattro	07.00 - 09.01	995	1115	E90-15-003-26-22	A, 18, 78, 140, 161	30	30							T
1.8 T quattro Schaltgetriebe, ohne Klimaanlage 1.8 T quattro manual transmission, without air conditioner	03.98 - 09.01	995	1115	E90-15-003-25-22	A, 18, 74, 75, 78, 142, 161	30	30							T
1.8 T quattro Schaltgetriebe, ohne Klimaanlage 1.8 T quattro manual transmission, without air conditioner	07.00 - 09.01	995	1115	E90-15-003-26-22	A, 18, 75, 78, 140, 161	30	30							T
1.8, 1.8 T, 1.9 TDI, 2.4, 2.6, 2.8 Schaltgetriebe 1.8, 1.8 T, 1.9 TDI, 2.4, 2.6, 2.8 manual transmission	01.96 - 01.99	1055	1045	E90-15-003-19-22	A, 18, 20, 74, 78, 143, 161	30	30							T
1.8, 1.8 T, 1.9 TDI, 2.4, 2.6, 2.8 Schaltgetriebe 1.8, 1.8 T, 1.9 TDI, 2.4, 2.6, 2.8 manual transmission	02.99 - 06.00	1055	1045	E90-15-003-20-22	A, 18, 20, 74, 78, 144, 161	30	30							T
1.8, 1.8 T, 1.9 TDI, 2.4, 2.6, 2.8 Schaltgetriebe 1.8, 1.8 T, 1.9 TDI, 2.4, 2.6, 2.8 manual transmission	07.00 - 09.01	1055	1045	E90-15-003-21-22	A, 18, 20, 78, 140, 161	30	30							T
1.8 T quattro, 1.8 quattro, 1.9 TDI quattro, 2.4 quattro, 2.6 quattro, 2.8 quattro Schaltgetriebe 1.8 T quattro, 1.8 quattro, 1.9 TDI quattro, 2.4 quattro, 2.6 quattro, 2.8 quattro manual transmission	03.98 - 09.01	1055	1115	E90-15-003-27-22	A, 18, 74, 78, 139, 161	30	30							T
1.8 T quattro, 1.8 quattro, 1.9 TDI quattro, 2.4 quattro, 2.6 quattro	07.00 - 09.01	1055	1115	E90-15-003-28-22	A, 18, 78, 140, 161	30	30							T
2.8 quattro Schaltgetriebe 2.8 quattro manual transmission	07.00 - 09.01	1055	1115	E90-15-003-28-22	A, 18, 74, 78, 140, 161	30	30							T
2.4, 2.5 TDI Schaltgetriebe, 2.6, 2.8 2.4, 2.5 TDI manual transmission, 2.6, 2.8	01.96 - 01.99	1150	1045	E90-15-003-22-22	A, 18, 20, 74, 78, 143, 161	30	30							T
2.4, 2.5 TDI Schaltgetriebe, 2.6, 2.8 2.4, 2.5 TDI manual transmission, 2.6, 2.8	02.99 - 06.00	1150	1045	E90-15-003-23-22	A, 18, 20, 74, 78, 144, 161	30	30							T
2.4, 2.5 TDI Schaltgetriebe, 2.6, 2.8 2.4, 2.5 TDI manual transmission, 2.6, 2.8	07.00 - 09.01	1150	1045	E90-15-003-24-22	A, 18, 20, 78, 140, 161	30	30							T
2.5 TDI quattro Schaltgetriebe 2.5 TDI quattro manual transmission	07.00 - 09.01	1150	1115	E90-15-003-30-22	A, 18, 74, 78, 140, 161	30	30							T
2.4 quattro, 2.5 TDI quattro Schaltgetriebe, 2.6 quattro, 2.8 quattro 2.4 quattro, 2.5 TDI quattro manual transmission, 2.6 quattro, 2.8 quattro	03.98 - 09.01	1150	1115	E90-15-003-29-22	A, 18, 74, 78, 142, 161	30	30							T
2.4 quattro, 2.6 quattro, 2.8 quattro	07.00 - 09.01	1150	1115	E90-15-003-30-22	A, 18, 78, 140, 161	30	30							T
S4 quattro	09.97 - 09.01	1150	1130	E90-15-003-31-22	A, 18, 74, 78, 161	20	20							T
B12 Sportline (Performance Komplettfahrwerke Sport Sport Performance Springs+Shocks) 1.6, 1.8, 1.8 T, 1.9 TDI, 2.4, 2.6, 2.8	01.96 - 01.99	1070	1010	E95-15-003-01-22	A, 18, 20, 74, 78, 112, 161	45-50	35-40							T

Modell	Baujahr	Achslast Vorne kg	Achslast Hinten kg	Artikel-Nr.	Hinweise	ca. Tieferl. Vorne mm	ca. Tieferl. Hinten mm	Ø Vorne mm	Ø Hinten mm	Verstellbarkeit Vorne	Verstellbarkeit Hinten	Ersatzteilbezeichnung Vorne	Ersatzteilbezeichnung Hinten	Gutachten
Model	Year	Front Axle Load kg	Rear Axle Load kg	Part-No.	Notes	ca. Lowering Front mm	ca. Lowering Rear mm	Ø Front mm	Ø Rear mm	Adjustable Front	Adjustable Rear	Spare Part Marking Front	Spare Part Marking Rear	Homologation
A4 Avant (8D5, B5) B12 Sportline (Performance Komplettfahrwerke Sport Sport Performance Springs+Shocks) 1.6, 1.8, 1.8 T, 1.9 TDI, 2.4, 2.6, 2.8 Schaltgetriebe 1.6, 1.8, 1.8 T, 1.9 TDI, 2.4, 2.6, 2.8 manual transmission	02.99 - 06.00	1070	1010	E95-15-003-02-22	A, 18, 20, 74, 78, 144, 161	45-50	35-40							T
1.6, 1.8, 1.8 T, 1.9 TDI, 2.4, 2.6, 2.8 Schaltgetriebe 1.6, 1.8, 1.8 T, 1.9 TDI, 2.4, 2.6, 2.8 manual transmission	07.00 - 09.01	1070	1010	E95-15-003-03-22	A, 18, 20, 74, 78, 111, 161	45-50	35-40							T
Pro-Street-S (Gewindefahrwerke - höhenverstellbar Coil-Overs-Adjustable Ride Height) 1.8 T quattro, 1.8 quattro, 1.9 TDI quattro, 2.4 quattro, 2.5 TDI quattro, 2.6 quattro, 2.8 quattro, S4 quattro	07.95 - 09.01	1080	1140	PSS65-15-003-06-22	A, 18, 23, 25, 45, 160	40-75	40-75							T
1.6, 1.8, 1.8 T, 1.9 TDI, 2.4, 2.5 TDI, 2.6, 2.8	11.94 - 01.99	1080	1185	PSS65-15-003-04-22	A, 18, 20, 23, 25, 45, 160	40-75	40-75							T
1.6, 1.8, 1.8 T, 1.9 TDI, 2.4, 2.5 TDI, 2.6, 2.8	01.99 - 09.01	1080	1185	PSS65-15-003-05-22	A, 18, 20, 23, 25, 45, 160	40-75	40-75							T
1.8 T quattro, 1.8 quattro, 1.9 TDI quattro, 2.4 quattro, 2.5 TDI quattro, 2.6 quattro, 2.8 quattro, S4 quattro	07.95 - 09.01	1150	1140	PSS65-15-003-03-22	A, 18, 23, 25, 45, 160	40-75	40-75							T
1.6, 1.8, 1.8 T, 1.9 TDI, 2.4, 2.5 TDI, 2.6, 2.8	11.94 - 01.99	1150	1185	PSS65-15-003-01-22	A, 18, 20, 23, 25, 45, 160	40-75	40-75							T
1.6, 1.8, 1.8 T, 1.9 TDI, 2.4, 2.5 TDI, 2.6, 2.8	01.99 - 09.01	1150	1185	PSS65-15-003-02-22	A, 18, 20, 23, 25, 45, 160	40-75	40-75							T
A4 Avant (8E5, B6) Pro-Kit (Performance Fahrwerksfedern Performance Springs) 1.6, 1.8 T, 2.0, 2.0 FSI	09.01 - 12.04	1090	1135	E10-15-003-07-22	A, 18, 20	30	30					F11-15-003-01-VA	F11-15-003-03-HA	T
1.8 T quattro	09.01 - 12.04	1090	1150	E10-15-003-11-22	A, 18	30	30					F11-15-003-01-VA	F11-15-003-10-HA	T
1.9 TDI, 2.4, 3.0	04.01 - 12.04	1165	1135	E10-15-003-08-22	A, 18, 20	30	30					F1568001	F11-15-003-03-HA	T
1.8 T quattro, 1.9 TDI quattro, 3.0 quattro	04.01 - 12.04	1165	1150	E10-15-003-12-22	A, 18	30	30					F1568001	F11-15-003-10-HA	T
2.5 TDI, 2.5 TDI	10.00 - 12.04	1230	1135	E10-15-003-09-22	A, 18, 20	30	30					F11-15-003-03-VA	F11-15-003-03-HA	T
2.5 TDI quattro	09.01 - 12.04	1230	1150	E10-15-003-10-22	A, 18	30	30					F11-15-003-03-VA	F11-15-003-10-HA	T
Sportline (Performance Fahrwerksfedern Sport Sport Performance Springs) 1.6, 1.8 T, 2.0, 2.0 FSI	09.01 - 12.04	1090	1135	E20-15-003-04-22	A, 18, 20	45-50	35-40					F21-15-003-02-VA	F21-15-003-04-HA	T
1.9 TDI, 2.4, 3.0	04.01 - 12.04	1140	1135	E20-15-003-05-22	A, 18, 20	45-50	35-40					F21-15-003-03-VA	F21-15-003-04-HA	T
Anti-Roll-Kit (Performance Stabilisatoren Performance Sway Bars) 1.6, 1.8 T, 1.8 T quattro, 1.9 TDI, 1.9 TDI quattro, 2.0, 2.0 FSI, 2.4, 2.5 TDI, 2.5 TDI quattro, 2.5 TDI, 3.0, 3.0 quattro	10.00 - 12.04			E40-15-003-01-11	A, 18, 22, 45			32	24	nicht verstellbar not adjustable	2-fach verstellbar 2-way adjustable	AS41-15-003-01-VA	AS41-15-003-01-HA	T
B12 Pro-Kit (Performance Komplettfahrwerke Performance Springs+Shocks) 1.6, 1.8 T, 2.0, 2.0 FSI	09.01 - 12.05	1090	1130	E90-15-006-13-22	A, 18, 20, 78, 114, 161	30	30							T
1.8 T, 2.0, 2.0 FSI	09.01 - 12.04	1090	1130	E90-15-006-14-22	A, 18, 20, 78, 146, 161	30	30							T
1.8 T quattro	09.01 - 12.05	1090	1150	E90-15-006-21-22	A, 18, 78, 114, 161	30	30							T
1.8 T quattro	09.01 - 12.04	1090	1150	E90-15-006-22-22	A, 18, 78, 146, 161	30	30							T
1.9 TDI, 2.4, 3.0	04.01 - 12.05	1165	1130	E90-15-006-15-22	A, 18, 20, 78, 114, 161	30	30							T
1.9 TDI, 2.4, 3.0	04.01 - 12.04	1165	1130	E90-15-006-16-22	A, 18, 20, 78, 146, 161	30	30							T
1.8 T quattro, 1.9 TDI quattro, 3.0 quattro	04.01 - 12.05	1165	1150	E90-15-006-23-22	A, 18, 78, 114, 161	30	30							T
1.8 T quattro, 1.9 TDI quattro, 3.0 quattro	04.01 - 12.04	1165	1150	E90-15-006-24-22	A, 18, 78, 146, 161	30	30							T
2.5 TDI, 2.5 TDI	10.00 - 12.05	1230	1130	E90-15-006-17-22	A, 18, 20, 78, 114, 161	30	30							T
2.5 TDI, 2.5 TDI	10.00 - 12.04	1230	1130	E90-15-006-18-22	A, 18, 20, 78, 146, 161	30	30							T
2.5 TDI quattro	09.01 - 12.05	1230	1150	E90-15-006-19-22	A, 18, 78, 114, 161	30	30							T
2.5 TDI quattro	09.01 - 12.04	1230	1150	E90-15-006-20-22	A, 18, 78, 146, 161	30	30							T
B12 Sportline (Performance Komplettfahrwerke Sport Sport Performance Springs+Shocks) 1.6, 1.8 T, 2.0, 2.0 FSI	09.01 - 12.05	1090	1090	E95-15-006-05-22	A, 18, 20, 78, 114, 161	45-50	35-40							T
1.6, 1.8 T, 2.0, 2.0 FSI	09.01 - 12.04	1090	1090	E95-15-006-06-22	A, 18, 20, 78, 146, 161	45-50	35-40							T
1.9 TDI, 2.4, 3.0	04.01 - 12.05	1140	1090	E95-15-006-07-22	A, 18, 20, 78, 114, 161	45-50	35-40							T
1.9 TDI, 2.4, 3.0	04.01 - 12.04	1140	1090	E95-15-006-08-22	A, 18, 20, 78, 146, 161	45-50	35-40							T
Pro-Street-S (Gewindefahrwerke - höhenverstellbar Coil-Overs-Adjustable Ride Height) 1.6, 1.8 T, 1.9 TDI, 2.0, 2.0 FSI, 2.4, 2.5 TDI, 2.5 TDI, 3.0	10.00 - 12.04	1080	1150	PSS65-15-006-03-22	A, 18, 20, 23, 25, 45, 160	35-65	35-60							T
1.8 T quattro, 1.9 TDI quattro, 2.5 TDI quattro, 3.0 quattro	04.01 - 12.04	1080	1165	PSS65-15-006-07-22	A, 18, 23, 25, 45, 160	35-65	35-65							T
1.6, 1.8 T, 1.9 TDI, 2.0, 2.0 FSI, 2.4, 2.5 TDI, 2.5 TDI, 3.0	10.00 - 12.04	1230	1150	PSS65-15-006-04-22	A, 18, 20, 23, 25, 45, 160	35-65	35-60							T
1.8 T quattro, 1.9 TDI quattro, 2.5 TDI quattro, 3.0 quattro	04.01 - 12.04	1230	1165	PSS65-15-006-08-22	A, 18, 23, 25, 45, 160	35-65	35-65							T
A4 Avant (8ED, B7) Pro-Kit (Performance Fahrwerksfedern Performance Springs) 1.6, 1.8 T, 2.0, 2.0 TFSI	11.04 - 06.08	1090	1135	E10-15-003-07-22	A, 18, 20	30	30					F11-15-003-01-VA	F11-15-003-03-HA	T
1.8 T quattro, 2.0 TFSI quattro	11.04 - 06.08	1090	1150	E10-15-003-11-22	A, 18	30	30					F11-15-003-01-VA	F11-15-003-10-HA	T
1.9 TDI, 2.0 TDI, 2.0 TDI 16V, 2.0 TFSI, 3.0, 3.2 FSI	11.04 - 06.08	1165	1135	E10-15-003-08-22	A, 18, 20	30	30					F1568001	F11-15-003-03-HA	T
1.8 T quattro, 2.0 TDI quattro, 2.0 TFSI quattro, 3.0 quattro, 3.2 FSI quattro	11.04 - 06.08	1165	1150	E10-15-003-12-22	A, 18	30	30					F1568001	F11-15-003-10-HA	T
2.5 TDI, 2.7 TDI, 2.7 TDI	11.04 - 06.08	1230	1135	E10-15-003-09-22	A, 18, 20	30	30					F11-15-003-03-VA	F11-15-003-03-HA	T

Modell	Baujahr	Achslast Vorne kg	Achslast Hinten kg	Artikel-Nr.	Hinweise	ca. Tieferl. Vorne mm	ca. Tieferl. Hinten mm	Ø Vorne mm	Ø Hinten mm	Verstellbarkeit Vorne	Verstellbarkeit Hinten	Ersatzteilbezeichnung Vorne	Ersatzteilbezeichnung Hinten	Gutachten
Model	Year	Front Axle Load kg	Rear Axle Load kg	Part-No.	Notes	ca. Lowering Front mm	ca. Lowering Rear mm	Ø Front mm	Ø Rear mm	Adjustable Front	Adjustable Rear	Spare Part Marking Front	Spare Part Marking Rear	Homologation
A4 Avant (8ED, B7) Pro-Kit (Performance Fahrwerksfedern Performance Springs) 3.0 TDI quattro	11.04 - 06.08	1230	1150	E10-15-003-10-22	A, 18	30	30					F11-15-003-03-VA	F11-15-003-10-HA	T
Sportline (Performance Fahrwerksfedern Sport Sport Performance Springs) 1.6, 1.8 T, 2.0, 2.0 TFSI	11.04 - 06.08	1090	1135	E20-15-003-04-22	A, 20	45-50	35-40					F21-15-003-02-VA	F21-15-003-04-HA	T
1.9 TDI, 2.0 TDI, 2.0 TDI 16V, 2.0 TFSI, 3.0, 3.2 FSI	11.04 - 06.08	1140	1135	E20-15-003-05-22	A, 20	45-50	35-40					F21-15-003-03-VA	F21-15-003-04-HA	T
Anti-Roll-Kit (Performance Stabilisatoren Performance Sway Bars) 1.6, 1.8 T, 1.8 T quattro, 1.9 TDI, 2.0, 2.0 TDI, 2.0 TDI 16V, 2.0 TDI quattro, 2.0 TFSI, 2.0 TFSI quattro, 2.5 TDI, 2.7 TDI, 2.7 TDI, 3.0, 3.0 TDI quattro, 3.0 quattro, 3.2 FSI, 3.2 FSI quattro	11.04 - 06.08			E40-15-003-01-11	A, 18, 22, 45			32	24	nicht verstellbar not adjustable	2-fach verstellbar 2-way adjustable	AS41-15-003-01-VA	AS41-15-003-01-HA	T
B12 Pro-Kit (Performance Komplettfahrwerke Performance Springs+Shocks) 1.6, 1.8 T, 2.0, 2.0 TFSI	11.04 - 06.08	1090	1130	E90-15-006-14-22	A, 18, 20, 78, 161	30	30							T
1.8 T quattro, 2.0 TFSI quattro	11.04 - 06.08	1090	1150	E90-15-006-22-22	A, 18, 78, 161	30	30							T
1.9 TDI, 2.0 TDI, 2.0 TDI 16V, 2.0 TFSI, 3.0, 3.2 FSI	11.04 - 06.08	1165	1130	E90-15-006-16-22	A, 18, 20, 78, 161	30	30							T
1.8 T quattro, 2.0 TDI quattro, 2.0 TFSI quattro, 3.0 quattro, 3.2 FSI quattro	11.04 - 06.08	1165	1150	E90-15-006-24-22	A, 18, 78, 161	30	30							T
2.5 TDI, 2.7 TDI, 2.7 TDI	11.04 - 06.08	1230	1130	E90-15-006-18-22	A, 18, 20, 78, 161	30	30							T
3.0 TDI quattro	11.04 - 06.08	1230	1150	E90-15-006-20-22	A, 18, 78, 161	30	30							T
B12 Sportline (Performance Komplettfahrwerke Sport Sport Performance Springs+Shocks) 1.6, 1.8 T, 2.0, 2.0 TFSI	11.04 - 06.08	1090	1090	E95-15-006-06-22	A, 18, 20, 78, 161	45-50	35-40							T
1.9 TDI, 2.0 TDI, 2.0 TDI 16V, 2.0 TFSI, 3.0, 3.2 FSI	11.04 - 06.08	1140	1090	E95-15-006-08-22	A, 18, 20, 78, 161	45-50	35-40							T
Pro-Street-S (Gewindefahrwerke - höhenverstellbar Coil-Overs-Adjustable Ride Height) 1.6, 1.8 T, 1.9 TDI, 2.0, 2.0 TDI, 2.0 TDI 16V, 2.0 TFSI, 2.5 TDI, 3.0, 3.2 FSI	11.04 - 06.08	1080	1150	PSS65-15-006-03-22	A, 18, 20, 23, 25, 45, 160	35-65	35-60							T
1.8 T quattro, 2.0 TFSI quattro, 3.0 TDI quattro, 3.0 quattro	11.04 - 06.08	1080	1165	PSS65-15-006-07-22	A, 18, 23, 25, 45, 160	35-65	35-65							T
1.6, 1.8 T, 1.9 TDI, 2.0, 2.0 TDI, 2.0 TDI 16V, 2.0 TFSI, 2.5 TDI, 3.0, 3.2 FSI	11.04 - 06.08	1230	1150	PSS65-15-006-04-22	A, 18, 20, 23, 25, 45, 160	35-65	35-60							T
1.8 T quattro, 2.0 TFSI quattro, 3.0 TDI quattro, 3.0 quattro	11.04 - 06.08	1230	1165	PSS65-15-006-08-22	A, 18, 23, 25, 45, 160	35-65	35-65							T
A4 Avant (8K5, B8) Pro-Kit (Performance Fahrwerksfedern Performance Springs) 1.8 TFSI, 2.0 TDI, 2.0 TFSI, 2.0 TFSI flexible fuel, 3.2 FSI Schaltgetriebe 1.8 TFSI, 2.0 TDI, 2.0 TFSI, 2.0 TFSI flexible fuel, 3.2 FSI manual transmission 1.8 TFSI quattro, 2.0 TDI quattro, 2.0 TFSI flexible fuel quattro, 2.0 TFSI quattro, 3.2 FSI quattro Automatik 1.8 TFSI quattro, 2.0 TDI quattro, 2.0 TFSI flexible fuel quattro, 2.0 TFSI quattro, 3.2 FSI quattro automatic transmission 2.7 TDI, 3.0 TDI, 3.2 FSI Automatik 2.7 TDI, 3.0 TDI, 3.2 FSI automatic transmission 3.0 TDI quattro, 3.0 TFSI quattro, 3.2 FSI quattro	11.07 - 04.08 - 04.08 - 04.08 -	1105 1105 1215 1215	1160 1240 1160 1240	E10-15-011-01-22 E10-15-011-03-22 E10-15-011-02-22 E10-15-011-04-22	A, 12, 18, 20 A, 12, 18 A, 12, 18, 20 A, 12, 18	35 30 35 30	30 30 30 30					F11-15-011-01-VA F11-15-011-01-VA F11-15-011-02-VA F11-15-011-02-VA	F11-15-011-01-HA F11-15-011-03-HA F11-15-011-01-HA F11-15-011-03-HA	ABE ABE ABE ABE
S4 quattro	11.08 -	1215	1240	E10-15-011-04-22	A, 12, 18	20	15					F11-15-011-02-VA	F11-15-011-03-HA	ABE
Sportline (Performance Fahrwerksfedern Sport Sport Performance Springs) 1.8 TFSI, 2.0 TDI, 2.0 TFSI, 2.0 TFSI flexible fuel, 3.2 FSI	11.07 -	1105	1155	E20-15-011-01-22	A, 18, 20	45	35					F21-15-011-01-VA	F21-15-011-01-HA	T
Anti-Roll-Kit (Performance Stabilisatoren Performance Sway Bars) 1.8 TFSI, 1.8 TFSI quattro, 2.0 TDI, 2.0 TDI quattro, 2.0 TFSI, 2.0 TFSI flexible fuel, 2.0 TFSI flexible fuel quattro, 2.0 TFSI quattro, 2.7 TDI, 3.0 TDI, 3.0 TDI quattro, 3.0 TFSI quattro, 3.2 FSI, 3.2 FSI quattro, S4 quattro	11.07 -			E40-15-011-01-11	A, 18, 22, 45			28	23	nicht verstellbar not adjustable	nicht verstellbar not adjustable	AS41-15-011-01-VA	AS41-15-011-01-HA	T
B12 Pro-Kit (Performance Komplettfahrwerke Performance Springs+Shocks) 1.8 TFSI	04.08 -	1105	1160	E90-15-011-01-22	A, 12, 18, 20, 21, 78, 161	35	30							T
1.8 TFSI, 2.0 TDI, 2.0 TFSI, 2.0 TFSI flexible fuel	11.07 -	1105	1160	E90-15-011-01-22	A, 12, 18, 20, 21, 78, 88, 161	35	30							T
1.8 TFSI quattro, 2.0 TDI quattro, 2.0 TFSI flexible fuel quattro, 2.0 TFSI quattro, 3.0 TFSI quattro, 3.2 FSI quattro	04.08 -	1105	1225	E90-15-011-03-22	A, 12, 18, 21, 78, 88, 161	30	30							T
2.7 TDI, 3.0 TDI, 3.2 FSI	04.08 -	1215	1160	E90-15-011-02-22	A, 12, 18, 20, 21, 78, 88, 161	35	30							T
3.0 TDI quattro, 3.0 TFSI quattro, 3.2 FSI quattro, S4 quattro	04.08 -	1215	1225	E90-15-011-04-22	A, 12, 18, 21, 78, 88, 161	30	30							T
B12 Sportline (Performance Komplettfahrwerke Sport Sport Performance Springs+Shocks) 1.8 TFSI, 2.0 TDI, 2.0 TFSI, 2.0 TFSI flexible fuel	11.07 -	1105	1155	E95-15-011-01-22	A, 12, 18, 20, 21, 78, 161	45	35							T
2.0 TDI, 2.0 TFSI	05.13 -	1105	1155	E95-15-011-01-22	A, 12, 18, 20, 21, 78, 88, 161	45	35							T
Pro-Street-S (Gewindefahrwerke - höhenverstellbar Coil-Overs-Adjustable Ride Height) 1.8 TFSI, 1.8 TFSI quattro, 2.0 TDI, 2.0 TDI quattro, 2.0 TFSI, 2.0 TFSI flexible fuel, 2.0 TFSI flexible fuel quattro, 2.0 TFSI quattro, 2.7 TDI, 3.0 TDI, 3.0 TDI quattro, 3.0 TFSI quattro, 3.2 FSI, 3.2 FSI quattro	11.07 -	1080	1215	PSS65-15-011-03-22	A, 18, 24, 25, 45, 160	20-40	10-40							T
1.8 TFSI, 2.0 TDI, 2.0 TFSI, 2.0 TFSI flexible fuel, 2.7 TDI, 3.0 TDI, 3.2 FSI	11.07 -	1180	1215	PSS65-15-011-04-22	A, 18, 20, 24, 25, 45, 160	20-40	10-40							T
1.8 TFSI quattro, 2.0 TDI quattro, 2.0 TFSI flexible fuel quattro, 2.0 TFSI quattro, 3.0 TDI quattro, 3.0 TFSI quattro, 3.2 FSI quattro, S4 quattro	04.08 -	1215	1225	PSS65-15-011-04-22	A, 18, 24, 25, 45, 160	20-40	10-40							T
Pro-Tronic (Elektronische Performance Fahrwerksmodule Electronic Performance Suspension Moduls) Alle Motorisierungen all motorisation	04.08 -			AM65-15-011-01-22	A, 175									

Modell	Baujahr	Achslast Vorne kg	Achslast Hinten kg	Artikel-Nr.	Hinweise	ca. Tieferl. Vorne mm	ca. Tieferl. Hinten mm	Ø Vorne mm	Ø Hinten mm	Verstellbarkeit Vorne	Verstellbarkeit Hinten	Ersatzteilbezeichnung Vorne	Ersatzteilbezeichnung Hinten	Gutachten
Model	Year	Front Axle Load kg	Rear Axle Load kg	Part-No.	Notes	ca. Lowering Front mm	ca. Lowering Rear mm	Ø Front mm	Ø Rear mm	Adjustable Front	Adjustable Rear	Spare Part Marking Front	Spare Part Marking Rear	Homologation
A4 Cabriolet (8H7, B6, 8HE, B7) A4 Convertible (8H7, B6, 8HE, B7) Pro-Kit (Performance Fahrwerksfedern Performance Springs) 1.8, 1.8 T, 2.0, 2.0 TDI, 2.0 TFSI 16V	07.02 - 03.09	1150	1100	E10-15-003-14-22	A, 18, 20	20	20					F11-15-003-01-VA	F11-15-003-10-HA	T
2.4, 2.5 TDI, 2.7 TDI, 3.0, 3.2 FSI	04.02 - 03.09	1230	1100	E10-15-003-13-22	A, 18, 20	20	20					F1568001	F11-15-003-10-HA	T
Anti-Roll-Kit (Performance Stabilisatoren Performance Sway Bars) 1.8, 1.8 T, 1.8 T quattro, 2.0, 2.0 TDI, 2.0 TFSI 16V, 2.0 TFSI quattro, 2.4, 2.5 TDI, 2.7 TDI, 3.0, 3.0 quattro, 3.2 FSI, 3.2 FSI quattro	04.02 - 03.09			E40-15-003-01-11	A, 18, 22, 45			32	24	nicht verstellbar not adjustable	2-fach verstellbar 2-way adjustable	AS41-15-003-01-VA	AS41-15-003-01-HA	T
B12 Pro-Kit (Performance Komplettfahrwerke Performance Springs+Shocks) 1.8, 1.8 T, 2.0, 2.0 TFSI 16V	07.02 - 12.06	1150	1100	E90-15-006-28-22	A, 18, 20, 78, 115,	161	20	20						T
1.8 T, 2.0 TDI, 2.0 TFSI 16V	01.07 - 03.09	1150	1100	E90-15-006-26-22	A, 18, 20, 78, 147,	161	20	20						T
2.4, 2.5 TDI, 2.7 TDI, 3.0, 3.2 FSI	04.02 - 12.06	1230	1100	E90-15-006-27-22	A, 18, 20, 78, 115,	161	20	20						T
2.7 TDI, 3.2 FSI	01.07 - 03.09	1230	1100	E90-15-006-25-22	A, 18, 20, 78, 147,	161	20	20						T
Pro-Street-S (Gewindefahrwerke - höhenverstellbar Coil-Overs-Adjustable Ride Height) 1.8, 1.8 T, 2.4, 2.5 TDI, 3.0	04.02 - 03.09	1080	1150	PSS65-15-006-03-22	A, 18, 20, 23, 25,	45, 160	35-65	35-60						T
1.8 T quattro, 3.0 quattro, S4 quattro	05.03 - 03.09	1080	1165	PSS65-15-006-07-22	A, 18, 23, 25, 45,	160	35-65	35-65						T
1.8, 1.8 T, 2.4, 2.5 TDI, 3.0	04.02 - 03.09	1230	1150	PSS65-15-006-04-22	A, 18, 20, 23, 25,	45, 160	35-65	35-60						T
1.8 T quattro, 3.0 quattro, S4 quattro	05.03 - 03.09	1230	1165	PSS65-15-006-08-22	A, 18, 23, 25, 45,	160	35-65	35-65						T
A5 (8T3) Pro-Kit (Performance Fahrwerksfedern Performance Springs) 1.8 TFSI, 2.0 TDI, 2.0 TDI quattro, 2.0 TFSI, 2.0 TFSI quattro, 3.2 FSI	06.07 -	1120	1120	E10-15-010-02-22	A, 18	20-25	15-20					F11-15-011-01-VA	F11-15-010-01-HA	T
3.0 TFSI quattro, 3.2 FSI quattro	06.07 -	1120	1120	E10-15-010-02-22	A, 18	20-25	20					F11-15-011-01-VA	F11-15-010-01-HA	T
2.7 TDI, 3.0 TDI, 3.0 TDI quattro, 3.0 TFSI quattro, 3.2 FSI quattro, S5 quattro	06.07 -	1205	1120	E10-15-010-01-22	A, 18	25	20					F11-15-010-01-VA	F11-15-010-01-HA	T
3.2 FSI	06.07 -	1205	1120	E10-15-010-01-22	A, 18	25	15-20					F11-15-010-01-VA	F11-15-010-01-HA	T
Anti-Roll-Kit (Performance Stabilisatoren Performance Sway Bars) 1.8 TFSI, 2.0 TDI, 2.0 TDI quattro, 2.0 TFSI, 2.0 TFSI quattro, 2.7 TDI, 3.0 TDI, 3.0 TDI quattro, 3.0 TFSI quattro, 3.2 FSI, 3.2 FSI quattro, S5 quattro	06.07 -			E40-15-011-01-11	A, 18, 22, 45			28	23	nicht verstellbar not adjustable	nicht verstellbar not adjustable	AS41-15-011-01-VA	AS41-15-011-01-HA	T
B12 Pro-Kit (Performance Komplettfahrwerke Performance Springs+Shocks) 1.8 TFSI, 2.0 TDI, 2.0 TDI quattro, 2.0 TFSI, 2.0 TFSI quattro, 3.2 FSI	06.07 -	1120	1095	E90-15-010-02-22	A, 18, 21, 78, 161	20-25	15-20							T
2.7 TDI, 3.0 TDI, 3.0 TDI quattro, 3.0 TFSI quattro, 3.2 FSI quattro, RS 5 quattro, S5 quattro	06.07 -	1205	1095	E90-15-010-01-22	A, 18, 21, 78, 161	25	20							T
Pro-Street-S (Gewindefahrwerke - höhenverstellbar Coil-Overs-Adjustable Ride Height) 1.8 TFSI, 2.0 TDI, 2.0 TFSI, 2.7 TDI, 3.0 TDI, 3.2 FSI	06.07 -	1080	1240	PSS65-15-011-01-22	A, 18, 20, 24, 25,	45, 160	25-55	25-55						T
2.0 TDI quattro, 2.0 TFSI quattro, 3.0 TDI quattro, 3.0 TFSI quattro, 3.2 FSI quattro, S5 quattro	06.07 -	1245	1240	PSS65-15-011-02-22	A, 18, 24, 25, 45,	160	25-55	25-55						T
Pro-Tronic (Elektronische Performance Fahrwerksmodule Electronic Performance Suspension Modul) Alle Motorisierungen / all motorisation	06.07 -			AM65-15-011-01-22	A, 175									
A5 Cabriolet (8F7) A5 Convertible (8F7) Pro-Kit (Performance Fahrwerksfedern Performance Springs) 1.8 TFSI, 2.0 TDI, 2.0 TFSI, 2.0 TFSI quattro	03.09 -	1120	1240	E10-15-010-03-22	A, 18	20-25	15					F11-15-011-01-VA	F11-15-010-05-HA	T
2.0 TDI, 2.7 TDI, 3.0 TDI, 3.2 FSI	03.09 -	1205	1240	E10-15-010-04-22	A, 18, 20	20-25	15					F11-15-010-01-VA	F11-15-010-05-HA	T
2.0 TDI quattro, 3.2 FSI quattro	03.09 -	1205	1240	E10-15-010-05-22	A, 18	20-25	20					F11-15-010-01-VA	F11-15-010-05-HA	T
2.0 TFSI quattro	03.09 -	1205	1240	E10-15-010-05-22	A, 18	20-25	15					F11-15-010-01-VA	F11-15-010-05-HA	T
3.0 TDI quattro, 3.0 TFSI quattro, S5 quattro	03.09 -	1245	1240	E10-15-010-06-22	A, 18	25	15					F11-15-010-06-VA	F11-15-010-05-HA	T
Anti-Roll-Kit (Performance Stabilisatoren Performance Sway Bars) 1.8 TFSI, 2.0 TDI, 2.0 TDI quattro, 2.0 TFSI, 2.0 TFSI quattro, 2.7 TDI, 3.0 TDI, 3.0 TDI quattro, 3.0 TFSI quattro, 3.2 FSI, 3.2 FSI quattro, S5 quattro	03.09 -			E40-15-011-01-11	A, 18, 22, 45			28	23	nicht verstellbar not adjustable	nicht verstellbar not adjustable	AS41-15-011-01-VA	AS41-15-011-01-HA	T
B12 Pro-Kit (Performance Komplettfahrwerke Performance Springs+Shocks) 1.8 TFSI, 2.0 TDI, 2.0 TFSI	03.09 -	1120	1240	E90-15-010-03-22	A, 18, 20, 21, 78,	161	20-25	15						T
2.0 TDI, 2.0 TFSI	05.13 -	1120	1240	E90-15-010-03-22	A, 18, 21, 78, 161	20-25	15							T
2.7 TDI, 3.0 TDI, 3.2 FSI	03.09 -	1205	1240	E90-15-010-04-22	A, 18, 20, 21, 78,	161	20-25	15						T
2.0 TFSI quattro, 3.0 TFSI quattro, 3.2 FSI quattro	03.09 -	1205	1240	E90-15-010-05-22	A, 18, 21, 78, 161	20-25	20							T
3.0 TDI quattro, S5 quattro	03.09 -	1245	1240	E90-15-010-06-22	A, 18, 21, 78, 161	25	15							T
Pro-Street-S (Gewindefahrwerke - höhenverstellbar Coil-Overs-Adjustable Ride Height) 1.8 TFSI, 2.0 TDI, 2.0 TFSI, 2.7 TDI, 3.0 TDI, 3.2 FSI	03.09 -	1080	1240	PSS65-15-011-01-22	A, 18, 20, 24, 25,	45, 160	25-55	25-55						T
2.0 TDI quattro, 2.0 TFSI quattro, 3.0 TDI quattro, 3.0 TFSI quattro, 3.2 FSI quattro, S5 quattro	03.09 -	1245	1240	PSS65-15-011-02-22	A, 18, 24, 25, 45,	160	25-55	25-55						T
Pro-Tronic (Elektronische Performance Fahrwerksmodule Electronic Performance Suspension Modul) Alle Motorisierungen / all motorisation	09.09 -			AM65-15-011-01-22	A, 175									
A5 Sportback (8TA) Pro-Kit (Performance Fahrwerksfedern Performance Springs) 1.8 TFSI, 2.0 TDI, 2.0 TDI quattro, 2.0 TFSI, 2.0 TFSI quattro	09.09 -	1120	1200	E10-15-010-07-22	A, 18	25	25					F11-15-011-01-VA	F11-15-011-01-HA	T

Modell	Baujahr	Achslast Vorne kg	Achslast Hinten kg	Artikel-Nr.	Hinweise	ca. Tieferl. Vorne mm	ca. Tieferl. Hinten mm	Ø Vorne mm	Ø Hinten mm	Verstellbarkeit Vorne	Verstellbarkeit Hinten	Ersatzteilbezeichnung Vorne	Ersatzteilbezeichnung Hinten	Gutachten
Model	Year	Front Axle Load kg	Rear Axle Load kg	Part-No.	Notes	ca. Lowering Front mm	ca. Lowering Rear mm	Ø Front mm	Ø Rear mm	Adjustable Front	Adjustable Rear	Spare Part Marking Front	Spare Part Marking Rear	Homologation
A5 Sportback (8TA) Pro-Kit (Performance Fahrwerksfedern Performance Springs) 2.7 TDI, 3.0 TDI, 3.0 TDI quattro, 3.0 TFSI quattro, 3.2 FSI quattro, S5 quattro	09.09 -	1205	1200	E10-15-010-08-22	A, 18	25	25					F11-15-010-01-VA	F11-15-011-01-HA	T
Anti-Roll-Kit (Performance Stabilisatoren Performance Sway Bars) 1.8 TFSI, 2.0 TDI, 2.0 TDI quattro, 2.0 TFSI, 2.0 TFSI quattro, 2.7 TDI, 3.0 TDI, 3.0 TDI quattro, 3.0 TFSI quattro, 3.2 FSI quattro, S5 quattro	09.09 -			E40-15-011-01-11	A, 18, 22, 45			28	23	nicht verstellbar not adjustable	nicht verstellbar not adjustable	AS41-15-011-01-VA	AS41-15-011-01-HA	T
B12 Pro-Kit (Performance Komplettfahrwerke Performance Springs+Shocks) 1.8 TFSI, 2.0 TDI, 2.0 TDI quattro, 2.0 TFSI, 2.0 TFSI quattro	09.09 -	1120	1155	E90-15-010-07-22	A, 18, 21, 78, 161	25	25							T
2.7 TDI, 3.0 TDI, 3.0 TDI quattro, 3.0 TFSI quattro, 3.2 FSI quattro, S5 quattro	09.09 -	1205	1155	E90-15-010-08-22	A, 18, 21, 78, 161	25	25							T
Pro-Street-S (Gewindefahrwerke - höhenverstellbar Coil-Overs-Adjustable Ride Height) 1.8 TFSI, 2.0 TDI, 2.0 TFSI, 2.7 TDI	09.09 -	1080	1240	PSS65-15-011-01-22	A, 18, 20, 24, 25, 45, 160	25-55	25-55							T
2.0 TDI quattro, 2.0 TFSI quattro, 3.0 TDI, 3.0 TDI quattro, 3.0 TFSI quattro, 3.2 FSI quattro, S5 quattro	09.09 -	1245	1240	PSS65-15-011-02-22	A, 18, 24, 25, 45, 160	25-55	25-55							T
Pro-Tronic (Elektronische Performance Fahrwerksmodule Electronic Performance Suspension Moduls) Alle Motorisierungen / all motorisation	09.09 -			AM65-15-011-01-22	A, 175									
A6 (4A, C4) Pro-Kit (Performance Fahrwerksfedern Performance Springs) 2.3, 2.4, 2.5 TDI, 2.6, 2.8	06.94 - 10.97	1160	1080	E1515-140	A, 15, 18, 20	35	30					F1515001	F1515002	T
2.3 Automatik, 2.4 Automatik, 2.5 TDI Automatik, 2.6 Automatik, 2.8 Automatik 2.3 automatic transmission, 2.4 automatic transmission, 2.5 TDI automatic transmission, 2.6 automatic transmission, 2.8 automatic transmission	06.94 - 10.97	1160	1080	E1527-140	A, 18, 20	35	30					F1527001	F1515002	T
2.3 quattro, 2.5 TDI quattro, 2.6 quattro, 2.8 quattro	06.94 - 10.97	1240	1200	E1516-140	A, 15, 18	35	30					F1515001	F1516002	T
2.3 quattro Automatik, 2.5 TDI quattro Automatik, 2.6 quattro Automatik, 2.8 quattro Automatik, S6 4.2 quattro, S6 Plus quattro, S6 Turbo quattro 2.3 quattro automatic transmission, 2.5 TDI quattro automatic transmission, 2.6 quattro automatic transmission, 2.8 quattro automatic transmission, S6 4.2 quattro, S6 Plus quattro, S6 Turbo quattro	06.94 - 10.97	1240	1200	E1528-140	A, 18	35	30					F1527001	F1516002	T
B12 Pro-Kit (Performance Komplettfahrwerke Performance Springs+Shocks) 2.3 Automatik, 2.4 Automatik, 2.5 TDI Automatik, 2.6 Automatik, 2.8 Automatik 2.3 automatic transmission, 2.4 automatic transmission, 2.5 TDI automatic transmission, 2.6 automatic transmission, 2.8 automatic transmission	06.94 - 10.97	1160	1080	E90-15-012-05-22	A, 18, 20, 72, 78, 161	35	30							T
2.3, 2.5 TDI, 2.6, 2.8	06.94 - 10.97	1160	1080	E90-15-012-01-22	A, 18, 20, 78, 161	35	30							T
2.3 quattro Automatik, 2.5 TDI quattro Automatik, 2.6 quattro Automatik, 2.8 quattro Automatik, S6 4.2 quattro, S6 Plus quattro, S6 Turbo quattro 2.3 quattro automatic transmission, 2.5 TDI quattro automatic transmission, 2.6 quattro automatic transmission, 2.8 quattro automatic transmission, S6 4.2 quattro, S6 Plus quattro, S6 Turbo quattro	06.94 - 10.97	1240	1200	E90-15-012-06-22	A, 18, 72, 78, 161	35	30							T
2.3 quattro, 2.5 TDI quattro, 2.6 quattro, 2.8 quattro	06.94 - 10.97	1240	1200	E90-15-012-02-22	A, 18, 76, 78, 161	35	30							T
A6 (4B, C5) Pro-Kit (Performance Fahrwerksfedern Performance Springs) 1.8, 1.8 T, 1.9 TDI, 2.0	01.97 - 01.05	1150	1090	E1558-140	A, 15, 18, 20	30	30					F1541001	F1558002	T
1.8 T quattro	02.97 - 01.05	1150	1175	E1561-140	A, 18	30	30					F1541001	F1561002	T
2.4, 2.5 TDI, 2.7, 2.7 T, 2.8, 2.8 24V, 3.0, 3.7	02.97 - 01.05	1230	1090	E1559-140	A, 15, 18, 20	30	30					F1558001	F1558002	T
2.4 quattro, 2.5 TDI quattro, 2.7 T quattro, 2.7 quattro, 2.8 quattro, 3.0 quattro	02.97 - 01.05	1230	1175	E1562-140	A, 18	30	30					F1558001	F1561002	T
B12 Pro-Kit (Performance Komplettfahrwerke Performance Springs+Shocks) 1.8, 1.8 T, 1.9 TDI	01.97 - 12.00	1150	1090	E90-15-005-01-22	A, 18, 20, 74, 78, 108, 161	30	30							T
1.8, 1.8 T, 1.9 TDI	01.01 - 01.05	1150	1090	E90-15-005-02-22	A, 18, 20, 74, 78, 134, 161	30	30							T
1.8 T quattro	12.98 - 12.00	1150	1175	E90-15-005-05-22	A, 18, 74, 78, 134, 161	30	30							T
1.8 T quattro	01.01 - 01.05	1150	1175	E90-15-005-06-22	A, 18, 74, 78, 135, 161	30	30							T
2.4, 2.5 TDI, 2.7 T, 2.8	02.97 - 12.00	1230	1090	E90-15-005-03-22	A, 18, 20, 74, 78, 108, 161	30	30							T
2.4, 2.5 TDI, 2.7, 2.7 T, 2.8, 3.0, 3.7	01.01 - 01.05	1230	1090	E90-15-005-04-22	A, 18, 20, 74, 78, 134, 161	30	30							T
2.4 quattro, 2.5 TDI quattro, 2.7 T quattro, 2.7 quattro, 2.8 quattro, 3.0 quattro	01.01 - 01.05	1230	1175	E90-15-005-08-22	A, 18, 74, 78, 134, 161	30	30							T
2.4 quattro, 2.5 TDI quattro, 2.7 T quattro, 2.8 quattro	12.98 - 12.00	1230	1175	E90-15-005-07-22	A, 18, 74, 78, 136, 161	30	30							T
Pro-Street-S (Gewindefahrwerke - höhenverstellbar Coil-Overs-Adjustable Ride Height) 1.8, 1.8 T, 1.9 TDI, 2.0, 2.4, 2.5 TDI, 2.7, 2.7 T, 2.8, 2.8 24V, 3.0, 3.7	01.97 - 01.05	1100	1185	PSS65-15-005-01-22	A, 18, 20, 23, 25, 45, 160	40-75	40-75							T
1.8 T quattro, 2.4 quattro, 2.5 TDI quattro, 2.7 T quattro, 2.7 quattro, 2.8 quattro, 3.0 quattro	02.97 - 01.05	1100	1300	PSS65-15-005-03-22	A, 18, 22, 25, 45, 160	40-75	40-75							T
1.8, 1.8 T, 1.9 TDI, 2.0, 2.4, 2.5 TDI, 2.7, 2.7 T, 2.8, 2.8 24V, 3.0, 3.7	01.97 - 01.05	1250	1185	PSS65-15-005-02-22	A, 18, 20, 23, 25, 45, 160	40-75	40-75							T
1.8 T quattro, 2.4 quattro, 2.5 TDI quattro, 2.7 T quattro, 2.7 quattro, 2.8 quattro, 3.0 quattro, S6 quattro	02.97 - 01.05	1350	1300	PSS65-15-005-04-22	A, 18, 22, 25, 45, 160	40-75	40-75							T
A6 (4F2, C6) Pro-Kit (Performance Fahrwerksfedern Performance Springs) 2.0 TDI, 2.0 TFSI, 2.4, 2.8 FSI, 3.0, 3.2 FSI	05.04 - 03.11	1215	1130	E10-15-008-01-22	A, 18, 20	30	30					F1533101	F11-15-008-01-HA	T
2.4 quattro, 2.8 FSI quattro, 3.0 quattro, 3.2 FSI quattro	05.04 - 03.11	1215	1240	E10-15-008-02-22	A, 18	30	30					F1533101	F11-15-008-02-HA	T
2.7 TDI, 3.0 TDI	11.04 - 03.11	1350	1130	E10-15-008-04-22	A, 18, 20	30	30					F11-15-008-03-VA	F11-15-008-01-HA	T
2.7 TDI quattro, 3.0 TDI quattro, 3.0 TFSI quattro, 4.2 FSI quattro, 4.2 quattro	05.04 - 03.11	1350	1240	E10-15-008-03-22	A, 18	30	30					F11-15-008-03-VA	F11-15-008-02-HA	T
B12 Pro-Kit (Performance Komplettfahrwerke Performance Springs+Shocks) 2.0 TDI, 2.0 TFSI, 2.4, 2.8 FSI, 3.0, 3.2 FSI	05.04 - 03.11	1215	1130	E90-15-008-01-22	A, 18, 20, 76, 78, 161	30	30							T

Modell	Baujahr	Achslast Vorne kg	Achslast Hinten kg	Artikel-Nr.	Hinweise	ca. Tieferl. Vorne mm	ca. Tieferl. Hinten mm	Ø Vorne mm	Ø Hinten mm	Verstellbarkeit Vorne	Verstellbarkeit Hinten	Ersatzteilbezeichnung Vorne	Ersatzteilbezeichnung Hinten	Gutachten
Model	Year	Front Axle Load kg	Rear Axle Load kg	Part-No.	Notes	ca. Lowering Front mm	ca. Lowering Rear mm	Ø Front mm	Ø Rear mm	Adjustable Front	Adjustable Rear	Spare Part Marking Front	Spare Part Marking Rear	Homologation
A6 (4F2, C6)														
B12 Pro-Kit (Performance Komplettfahrwerke Performance Springs+Shocks)														
2.4 quattro, 2.8 FSI quattro, 3.0 TFSI quattro, 3.0 quattro, 3.2 FSI quattro	05.04 - 03.11	1215	1240	E90-15-008-02-22	A, 18, 76, 78, 161	30	30							T
2.7 TDI	11.04 - 03.11	1350	1130	E90-15-008-04-22	A, 18, 20, 76, 78, 161	30	30							T
3.0 TFSI quattro	10.08 - 03.11	1350	1240	E90-15-008-03-22	A, 18, 78, 161	30	30							T
2.7 TDI quattro, 3.0 TDI quattro, 4.2 quattro	05.04 - 03.11	1350	1240	E90-15-008-03-22	A, 18, 76, 78, 161	30	30							T
A6 (4G2, C7)														
Pro-Kit (Performance Fahrwerksfedern Performance Springs)														
2.0 TDI, 2.0 TFSI, 2.8 FSI	03.11 -	1140	1190	E10-15-018-08-22	A, 18, 20	30	25					F11-15-011-01-VA	F11-15-018-01-HA	T
2.0 TDI, 2.8 FSI	03.11 -	1185	1190	E10-15-018-01-22	A, 18, 20	30	25					F11-15-018-01-VA	F11-15-018-01-HA	T
2.8 FSI quattro	03.11 -	1185	1315	E10-15-018-04-22	A, 18	30	25					F11-15-018-01-VA	F11-15-018-03-HA	T
3.0 TDI	11.10 -	1270	1190	E10-15-018-02-22	A, 18, 20	30	25					F11-15-018-03-VA	F11-15-018-01-HA	T
3.0 TDI quattro, 3.0 TFSI quattro	11.10 -	1270	1315	E10-15-018-03-22	A, 18	30	25					F11-15-018-03-VA	F11-15-018-03-HA	T
A6 Avant (4A, C4)														
Pro-Kit (Performance Fahrwerksfedern Performance Springs)														
2.3, 2.4, 2.5 TDI, 2.6, 2.8	06.94 - 12.97	1160	1080	E1517-140	A, 15, 18, 20	35	30					F1515001	F1517002	T
2.3 Automatik, 2.4 Automatik, 2.5 TDI Automatik, 2.6 Automatik, 2.8 Automatik 2.3 automatic transmission, 2.4 automatic transmission, 2.5 TDI automatic transmission, 2.6 automatic transmission, 2.8 automatic transmission	06.94 - 12.97	1160	1080	E1529-140	A, 18, 20	35	30					F1527001	F1517002	T
2.3 quattro, 2.5 TDI quattro, 2.6 quattro, 2.8 quattro	06.94 - 12.97	1240	1200	E1521-140	A, 15, 18	35	30					F1515001	F1521002	T
2.3 quattro Automatik, 2.5 TDI quattro Automatik, 2.6 quattro Automatik, 2.8 quattro Automatik, S6 4.2 quattro, S6 Plus quattro, S6 Turbo quattro 2.3 quattro automatic transmission, 2.5 TDI quattro automatic transmission, 2.6 quattro automatic transmission, 2.8 quattro automatic transmission, S6 4.2 quattro, S6 Plus quattro, S6 Turbo quattro	06.94 - 12.97	1240	1200	E1530-140	A, 18	35	30					F1527001	F1521002	T
B12 Pro-Kit (Performance Komplettfahrwerke Performance Springs+Shocks)														
2.3, 2.5 TDI, 2.6, 2.8	06.94 - 12.97	1160	1080	E90-15-012-03-22	A, 15, 18, 20, 78, 161	35	30							T
2.3, 2.5 TDI, 2.6, 2.8	06.94 - 12.97	1160	1080	E90-15-012-07-22	A, 18, 20, 71, 78, 161	35	30							T
2.3 quattro, 2.5 TDI quattro, 2.6 quattro, 2.8 quattro	06.94 - 12.97	1240	1200	E90-15-012-04-22	A, 15, 18, 76, 78, 161	35	30							T
2.3 quattro, 2.5 TDI quattro, 2.6 quattro, 2.8 quattro, S6 4.2 quattro, S6 Plus quattro, S6 Turbo quattro	06.94 - 12.97	1240	1200	E90-15-012-08-22	A, 18, 72, 76, 78, 161	35	30							T
A6 Avant (4B, C5)														
Pro-Kit (Performance Fahrwerksfedern Performance Springs)														
1.8, 1.8 T, 1.9 TDI, 2.0	12.97 - 01.05	1150	1130	E1563-140	A, 18, 20	30	30					F1541001	F1563002	T
1.8 T quattro	12.97 - 01.05	1150	1230	E1565-140	A, 18	30	30					F1541001	F1565002	T
2.4, 2.5 TDI, 2.7 T, 2.8, 3.0	12.97 - 01.05	1230	1130	E1564-140	A, 18, 20	30	30					F1558001	F1563002	T
2.4 quattro, 2.5 TDI quattro, 2.7 T quattro, 2.8 quattro, 3.0 quattro	12.97 - 01.05	1230	1230	E1566-140	A, 18	30	30					F1558001	F1565002	T
B12 Pro-Kit (Performance Komplettfahrwerke Performance Springs+Shocks)														
1.8, 1.8 T, 1.9 TDI	12.97 - 12.00	1150	1130	E90-15-005-09-22	A, 18, 20, 74, 78, 108, 161	30	30							T
1.8, 1.8 T, 1.9 TDI, 2.0	01.01 - 01.05	1150	1130	E90-15-005-10-22	A, 18, 20, 74, 78, 134, 161	30	30							T
1.8 T quattro	01.01 - 01.05	1150	1230	E90-15-005-14-22	A, 18, 74, 78, 134, 161	30	30							T
1.8 T quattro	12.98 - 12.00	1150	1230	E90-15-005-13-22	A, 18, 74, 78, 136, 161	30	30							T
2.4, 2.5 TDI, 2.7 T, 2.8	12.97 - 12.00	1230	1130	E90-15-005-11-22	A, 18, 20, 74, 78, 108, 161	30	30							T
2.4, 2.5 TDI, 2.7 T, 2.8, 3.0	01.01 - 01.05	1230	1130	E90-15-005-12-22	A, 18, 20, 74, 78, 134, 161	30	30							T
2.4 quattro, 2.5 TDI quattro, 2.7 T quattro, 2.8 quattro, 3.0 quattro	01.01 - 01.05	1230	1230	E90-15-005-16-22	A, 18, 74, 78, 134, 161	30	30							T
2.4 quattro, 2.5 TDI quattro, 2.7 T quattro, 2.8 quattro	12.98 - 12.00	1230	1230	E90-15-005-15-22	A, 18, 74, 78, 136, 161	30	30							T
Pro-Street-S (Gewindefahrwerke - höhenverstellbar Coil-Overs-Adjustable Ride Height)														
1.8, 1.8 T, 1.9 TDI, 2.0, 2.4, 2.5 TDI, 2.7 T, 2.8, 3.0, 3.7	12.97 - 01.05	1100	1185	PSS65-15-005-01-22	A, 18, 20, 23, 25, 45, 160	40-75	40-75							T
1.8 T quattro, 2.4 quattro, 2.5 TDI quattro, 2.7 T quattro, 2.8 quattro, 3.0 quattro	12.97 - 01.05	1100	1300	PSS65-15-005-03-22	A, 18, 22, 25, 45, 160	40-75	40-75							T
1.8, 1.8 T, 1.9 TDI, 2.0, 2.4, 2.5 TDI, 2.7 T, 2.8, 3.0, 3.7	12.97 - 01.05	1250	1185	PSS65-15-005-02-22	A, 18, 20, 23, 25, 45, 160	40-75	40-75							T
1.8 T quattro, 2.4 quattro, 2.5 TDI quattro, 2.7 T quattro, 2.8 quattro, 3.0 quattro, S6 quattro	12.97 - 01.05	1350	1300	PSS65-15-005-04-22	A, 18, 22, 25, 45, 160	40-75	40-75							T
A6 Avant (4F5, C6)														
Pro-Kit (Performance Fahrwerksfedern Performance Springs)														
2.0 TDI, 2.0 TFSI, 2.4, 2.8 FSI, 3.0, 3.2 FSI	03.05 - 08.11	1215	1240	E10-15-008-05-22	A, 18, 20	30	30					F1533101	F11-15-008-02-HA	T
2.4 quattro, 2.8 FSI quattro, 3.0 quattro, 3.2 FSI quattro	03.05 - 08.11	1215	1335	E10-15-008-07-22	A, 18	30	30					F1533101	F11-15-008-07-HA	T
2.7 TDI, 3.0 TDI	03.05 - 08.11	1350	1240	E10-15-008-06-22	A, 18, 20	30	30					F11-15-008-03-VA	F11-15-008-02-HA	T
2.7 TDI quattro, 3.0 TDI quattro, 3.0 TFSI quattro, 4.2 FSI quattro, 4.2 quattro	03.05 - 08.11	1350	1335	E10-15-008-08-22	A, 18	30	30					F11-15-008-03-VA	F11-15-008-07-HA	T
S6 quattro	03.06 - 08.11	1350	1335	E10-15-008-09-22	A, 18	20	10					F11-15-008-03-VA	F11-15-008-07-HA	T
B12 Pro-Kit (Performance Komplettfahrwerke Performance Springs+Shocks)														
2.0 TDI, 2.0 TFSI, 2.4, 2.8 FSI, 3.0, 3.2 FSI	03.05 - 08.11	1215	1240	E90-15-008-05-22	A, 18, 20, 76, 78, 161	30	30							T

Modell	Baujahr	Achslast Vorne kg	Achslast Hinten kg	Artikel-Nr.	Hinweise	ca. Tieferl. Vorne mm	ca. Tieferl. Hinten mm	Ø Vorne mm	Ø Hinten mm	Verstellbarkeit Vorne	Verstellbarkeit Hinten	Ersatzteilbezeichnung Vorne	Ersatzteilbezeichnung Hinten	Gutachten
Model	Year	Front Axle Load kg	Rear Axle Load kg	Part-No.	Notes	ca. Lowering Front mm	ca. Lowering Rear mm	Ø Front mm	Ø Rear mm	Adjustable Front	Adjustable Rear	Spare Part Marking Front	Spare Part Marking Rear	Homologation
A6 Avant (4F5, C6) B12 Pro-Kit (Performance Komplettfahrwerke Performance Springs+Shocks) 2.4 quattro, 2.8 FSI quattro, 3.0 quattro, 3.2 FSI quattro	03.05 - 08.11	1215	1335	E90-15-008-07-22	A, 18, 76, 78, 161	30	30							T
2.7 TDI	03.05 - 08.11	1350	1240	E90-15-008-06-22	A, 18, 20, 76, 78, 161	30	30							T
3.0 TDi	06.06 - 08.11	1350	1240	E90-15-008-06-22	A, 18, 20, 78, 161	30	30							T
2.7 TDI quattro, 3.0 TDI quattro, 3.0 TFSI quattro, 4.2 FSI quattro, 4.2 quattro	03.05 - 08.11	1350	1335	E90-15-008-08-22	A, 18, 76, 78, 161	30	30							T
S6 quattro	03.06 - 08.11	1350	1335	E90-15-008-09-22	A, 18, 76, 78, 161	20	10							T
A6 Avant (4G5, C7) Pro-Kit (Performance Fahrwerksfedern Performance Springs) 2.0 TDI, 2.0 TFSI, 2.8 FSI	05.11 -	1140	1360	E10-15-018-09-22	A, 18, 20	30	25-30					F11-15-011-01-VA	F11-15-018-06-HA	T
2.0 TDI, 2.8 FSI, 3.0 TDI	05.11 -	1185	1360	E10-15-018-06-22	A, 18, 20	30	25-30					F11-15-018-01-VA	F11-15-018-06-HA	T
2.8 FSI quattro	05.11 -	1185	1360	E10-15-018-06-22	A, 18	30	25-30					F11-15-018-01-VA	F11-15-018-06-HA	T
3.0 TDI	05.11 -	1270	1360	E10-15-018-07-22	A, 18, 20	30	25-30					F11-15-018-03-VA	F11-15-018-06-HA	T
3.0 TDI quattro, 3.0 TFSI quattro	05.11 -	1270	1360	E10-15-018-07-22	A, 18	30	25-30					F11-15-018-03-VA	F11-15-018-06-HA	T
A7 Sportback (4GA) Pro-Kit (Performance Fahrwerksfedern Performance Springs) 2.8 FSI, 2.8 FSI quattro, 3.0 TDI	10.10 -	1185	1315	E10-15-018-05-22	A, 18	30	25					F11-15-018-01-VA	F11-15-018-03-HA	T
3.0 TDI quattro, 3.0 TFSI quattro	10.10 -	1270	1315	E10-15-018-03-22	A, 18	30	25					F11-15-018-03-VA	F11-15-018-03-HA	T
A8 (4D2, 4D8) Pro-Kit (Performance Fahrwerksfedern Performance Springs) 2.5 TDI, 2.5 TDI quattro, 2.8, 2.8 quattro	03.94 - 09.02	1255	1230	E1533-240	A, 18	25	25					F1533101	F1533002	T
3.7, 3.7 quattro, 4.2 quattro	03.94 - 09.02	1255	1230	E1533-140	A, 18	25	25					F1533001	F1533002	T
B12 Pro-Kit (Performance Komplettfahrwerke Performance Springs+Shocks) 2.5 TDI, 2.5 TDI quattro, 2.8, 2.8 quattro	03.94 - 04.00	1255	1230	E90-15-019-03-22	A, 18, 78, 109, 161	25	25							T
2.5 TDI, 2.5 TDI quattro, 2.8, 2.8 quattro	05.00 - 09.02	1255	1230	E90-15-019-04-22	A, 18, 78, 137, 161	25	25							T
3.7, 3.7 quattro, 4.2 quattro	03.94 - 04.00	1255	1230	E90-15-019-01-22	A, 18, 78, 109, 161	25	25							T
3.7, 3.7 quattro, 4.2 quattro	05.00 - 09.02	1255	1230	E90-15-019-02-22	A, 18, 78, 137, 161	25	25							T
CABRIOLET (8G7, B4) Pro-Kit (Performance Fahrwerksfedern Performance Springs) 1.8, 1.9 TDI, 2.0 16V, 2.0 E, 2.3 E	05.91 - 08.00	1100	870	E1518-140	A, 12, 18, 20	20	20					F1518001	F1518002	T
2.6, 2.8	11.92 - 08.00	1100	870	E1518-240	A, 12, 18, 20	20	20					F1508001	F1518002	T
B12 Pro-Kit (Performance Komplettfahrwerke Performance Springs+Shocks) 1.8, 1.9 TDI, 2.0 16V, 2.0 E, 2.3 E	05.91 - 08.00	1100	870	E90-15-016-01-22	A, 12, 18, 20, 35, 78, 161	20	20							T
2.6, 2.8	11.92 - 08.00	1100	870	E90-15-016-02-22	A, 12, 18, 20, 35, 78, 161	20	20							T
Q3 (8U) Pro-Kit (Performance Fahrwerksfedern Performance Springs) 2.0 TDI	09.11 -	1100	1035	E10-15-020-01-22	A, 18, 20	25	25					F11-15-007-03-VA	F11-15-007-01-HA	T
2.0 TFSI quattro	06.11 -	1100	1115	E10-15-020-02-22	A, 18	25	25					F11-15-007-03-VA	F11-85-012-01-HA	T
2.0 TDI quattro, 2.0 TFSI quattro	06.11 -	1165	1115	E10-15-020-03-22	A, 18	25	25					F11-85-012-02-VA	F11-85-012-01-HA	T
Q5 (8R) Pro-Kit (Performance Fahrwerksfedern Performance Springs) 2.0 TDI, 2.0 TDI quattro, 2.0 TFSI quattro, 3.2 FSI quattro	11.08 -	1235	1345	E10-15-013-01-22	A, 18	30	25					F11-15-013-01-VA	F11-15-013-01-HA	T
3.0 TDI quattro, 3.0 TFSI quattro, SQ5 quattro	11.08 -	1315	1345	E10-15-013-02-22	A, 18	30	25					F11-15-013-02-VA	F11-15-013-01-HA	T
B12 Pro-Kit (Performance Komplettfahrwerke Performance Springs+Shocks) 2.0 TDI, 2.0 TDI quattro, 2.0 TFSI quattro, 3.2 FSI quattro	11.08 -	1235	1345	E90-15-013-01-22	A, 18, 21, 78, 161	30	25							T
3.0 TDI quattro, 3.0 TFSI quattro, SQ5 quattro	11.08 -	1315	1345	E90-15-013-02-22	A, 18, 21, 78, 161	30	25							T
TT (8N3) Pro-Kit (Performance Fahrwerksfedern Performance Springs) 1.8 T	10.98 - 06.06	980	760	E1567-140	A, 18, 20	25	25					F1567001	F8570002	T
1.8 T quattro	10.98 - 06.06	1050	920	E1570-140	A	25	25					F8592001	F11-15-001-02-HA	T
Anti-Roll-Kit (Performance Stabilisatoren Performance Sway Bars) 1.8 T	10.98 - 06.06			E1567-320	A, 18, 20, 22, 45			22	25	2-fach verstellbar 2-way adjustable	nicht verstellbar not adjustable	AS1567320VA	AS1540320HA	T
1.8 T, 1.8 T quattro	10.98 - 06.06			E1567-310	A, 18, 22, 45			22		2-fach verstellbar 2-way adjustable		AS1567320VA		T
B12 Pro-Kit (Performance Komplettfahrwerke Performance Springs+Shocks) 1.8 T	10.98 - 06.06	980	760	E90-15-001-01-22	A, 18, 20, 78, 161	25	25							T
1.8 T quattro	10.98 - 06.06	1050	920	E90-15-001-02-22	A, 78, 161	25	25							T
Pro-Street-S (Gewindefahrwerke - höhenverstellbar Coil-Overs-Adjustable Ride Height) 1.8 T	10.98 - 06.06	1030	845	PSS65-85-001-01-22	A, 23, 25, 28, 45, 160	20-45	20-45							T
1.8 T quattro	10.98 - 06.06	1040	900	PSS65-15-001-01-22	A, 23, 25, 28, 45, 160	25-55	25-55							T
3.2 VR6 quattro	07.03 - 06.06	1100	920	PSS65-85-001-04-22	A, 23, 25, 28, 45, 160	25-50	25-50							T

Modell	Baujahr	Achslast Vorne kg	Achslast Hinten kg	Artikel-Nr.	Hinweise	ca. Tieferl. Vorne mm	ca. Tieferl. Hinten mm	Ø Vorne mm	Ø Hinten mm	Verstellbarkeit Vorne	Verstellbarkeit Hinten	Ersatzteilbezeichnung Vorne	Ersatzteilbezeichnung Hinten	Gutachten
Model	Year	Front Axle Load kg	Rear Axle Load kg	Part-No.	Notes	ca. Lowering Front mm	ca. Lowering Rear mm	Ø Front mm	Ø Rear mm	Adjustable Front	Adjustable Rear	Spare Part Marking Front	Spare Part Marking Rear	Homologation
TT (8J3) Pro-Kit (Performance Fahrwerksfedern Performance Springs) 1.8 TFSI, 2.0 TFSI	08.06 -	1005	785	E10-15-009-01-22	A, 18, 20	25	20					F11-15-009-01-VA	F11-15-009-01-HA	T
2.0 TDI quattro, 2.0 TFSI quattro, 2.0 quattro	05.08 -	1005	885	E10-15-009-05-22	A	25	20					F11-15-009-01-VA	F11-15-009-02-HA	T
3.2 V6 quattro	08.06 - 06.10	1040	885	E10-15-009-02-22	A	25	20					F11-15-009-02-VA	F11-15-009-02-HA	T
B12 Pro-Kit (Performance Komplettfahrwerke Performance Springs+Shocks) 1.8 TFSI, 2.0 TFSI	08.06 -	1005	785	E90-15-009-01-22	A, 18, 20, 77, 78, 161	25	20							T
2.0 TDI quattro, 2.0 TFSI quattro	05.08 -	1005	885	E90-15-009-05-22	A, 77, 78, 161	25	20							T
3.2 V6 quattro	08.06 - 06.10	1040	885	E90-15-009-02-22	A, 77, 78, 161	25	20							T
Pro-Street-S (Gewindefahrwerke - höhenverstellbar Coil-Overs-Adjustable Ride Height) 1.8 TFSI, 2.0 TDI quattro, 2.0 TFSI, 2.0 TFSI quattro	08.06 -	965	885	PSS65-81-009-01-22	A, 24, 25, 34, 45, 70, 160	20-50	20-50							T
2.5 TFSI RS quattro	07.09 -	1035	870	PSS65-81-009-02-22	A, 24, 25, 34, 45, 70, 160	5-25	5-20							T
2.0 TFSI quattro, 2.0 quattro, 3.2 V6 quattro	08.06 -	1035	885	PSS65-81-009-02-22	A, 24, 25, 34, 45, 70, 160	10-35	5-30							T
Pro-Tronic (Elektronische Performance Fahrwerksmodule Electronic Performance Suspension Modul) Alle Motorisierungen / all motorisation	08.06 -			AM65-15-007-01-22	A, 175									
TT Roadster (8N9) Pro-Kit (Performance Fahrwerksfedern Performance Springs) 1.8 T	10.99 - 06.06	1040	820	E10-15-001-01-22	A, 18, 20	25	25					F8592001	F11-15-001-01-HA	T
1.8 T quattro	10.99 - 06.06	1050	920	E1570-140	A	25	25					F8592001	F11-15-001-02-HA	T
Anti-Roll-Kit (Performance Stabilisatoren Performance Sway Bars) 1.8 T	10.99 - 06.06			E1567-320	A, 18, 20, 22, 45			22	25	2-fach verstellbar 2-way adjustable	nicht verstellbar not adjustable	AS1567320VA	AS1540320HA	T
1.8 T, 1.8 T quattro	10.99 - 06.06			E1567-310	A, 18, 22, 45			22		2-fach verstellbar 2-way adjustable		AS1567320VA		T
B12 Pro-Kit (Performance Komplettfahrwerke Performance Springs+Shocks) 1.8 T	10.99 - 06.06	1040	820	E90-15-001-04-22	A, 18, 20, 78, 161	25	25							T
1.8 T quattro	10.99 - 06.06	1050	920	E90-15-001-02-22	A, 78, 161	25	25							T
Pro-Street-S (Gewindefahrwerke - höhenverstellbar Coil-Overs-Adjustable Ride Height) 1.8 T	10.99 - 06.06	1030	845	PSS65-85-001-01-22	A, 23, 25, 28, 45, 160	20-45	20-45							T
1.8 T quattro	10.99 - 06.06	1040	900	PSS65-15-001-01-22	A, 23, 25, 28, 45, 160	25-55	25-55							T
3.2 VR6 quattro	07.03 - 06.06	1100	920	PSS65-85-001-04-22	A, 23, 25, 28, 45, 160	25-50	25-50							T
TT Roadster (8J9) Pro-Kit (Performance Fahrwerksfedern Performance Springs) 1.8 TFSI, 2.0 TFSI	03.07 -	1005	785	E10-15-009-03-22	A, 18, 20	25	20					F11-15-009-01-VA	F11-15-009-01-HA	T
2.0 TDI quattro, 2.0 TFSI quattro, 2.0 quattro	05.08 -	1005	885	E10-15-009-05-22	A	25	20					F11-15-009-01-VA	F11-15-009-02-HA	T
3.2 V6 quattro	03.07 - 06.10	1040	885	E10-15-009-04-22	A	25	20					F11-15-009-02-VA	F11-15-009-02-HA	T
B12 Pro-Kit (Performance Komplettfahrwerke Performance Springs+Shocks) 1.8 TFSI	06.08 -	1005	785	E90-15-009-03-22	A, 18, 20, 77, 78, 161	25	20							T
2.0 TDI quattro, 2.0 TFSI quattro, 2.0 quattro	05.08 -	1005	885	E90-15-009-05-22	A, 77, 78, 161	25	20							T
3.2 V6 quattro	03.07 - 06.10	1040	885	E90-15-009-04-22	A, 77, 78, 161	25	20							T
Pro-Street-S (Gewindefahrwerke - höhenverstellbar Coil-Overs-Adjustable Ride Height) 1.8 TFSI, 2.0 TDI quattro, 2.0 TFSI, 2.0 TFSI quattro, 3.2 V6 quattro	03.07 -	965	1150	PSS65-85-014-01-22	A, 24, 25, 34, 45, 70, 160	20-50	20-50							T
1.8 TFSI, 2.0 TDI quattro, 2.0 TFSI, 2.0 TFSI quattro, 3.2 V6 quattro	03.07 -	965	1150	PSS65-85-014-02-22	A, 24, 25, 35, 45, 70, 160	20-50	20-50							T
1.8 TFSI, 2.0 TDI quattro, 2.0 TFSI, 2.0 TFSI quattro, 3.2 V6 quattro	03.07 -	1040	1150	PSS65-85-014-03-22	A, 24, 25, 34, 45, 70, 160	20-50	20-50							T
1.8 TFSI, 2.0 TDI quattro, 2.0 TFSI, 2.0 TFSI quattro, 3.2 V6 quattro	03.07 -	1040	1150	PSS65-85-014-04-22	A, 24, 25, 35, 45, 70, 160	20-50	20-50							T
2.0 TFSI quattro, 2.0 quattro	05.08 -	1040	1150	PSS65-85-014-03-22	A, 24, 25, 34, 45, 70, 160	10-35	5-30							T
2.0 TFSI quattro, 2.0 quattro	05.08 -	1040	1150	PSS65-85-014-04-22	A, 24, 25, 35, 45, 70, 160	10-35	5-30							T
2.5 TFSI RS quattro	07.09 -	1040	1150	PSS65-85-014-03-22	A, 24, 25, 34, 45, 70, 160	0-25	0-20							T
2.5 TFSI RS quattro	07.09 -	1040	1150	PSS65-85-014-04-22	A, 24, 25, 35, 45, 70, 160	0-25	0-20							T
Pro-Tronic (Elektronische Performance Fahrwerksmodule Electronic Performance Suspension Modul) Alle Motorisierungen / all motorisation	03.07 -			AM65-15-007-01-22	A, 175									
1 (E87) Pro-Kit (Performance Fahrwerksfedern Performance Springs) 116 i, 118 i, 120 i	11.03 - 09.12	875	1060	E10-20-013-01-22	A, 18, 20, 68	30	25					F11-20-013-01-VA	F11-20-013-01-HA	T
116 d, 118 d, 120 d, 123 d, 130 i	11.03 - 09.12	920	1060	E10-20-013-02-22	A, 18, 20, 68	30	25					F11-20-013-02-VA	F11-20-013-01-HA	T
Sportline (Performance Fahrwerksfedern Sport Sport Performance Springs) 116 i, 118 i, 120 i	11.03 - 09.12	895	1060	E20-20-013-01-22	A, 18, 20, 68	45-50	35					F21-20-013-01-VA	F21-20-013-01-HA	ABE
116 d, 118 d, 120 d, 123 d, 130 i	11.03 - 09.12	920	1060	E20-20-013-02-22	A, 18, 20, 68	45-50	35					F21-20-013-02-VA	F21-20-013-01-HA	ABE
Anti-Roll-Kit (Performance Stabilisatoren Performance Sway Bars) 116 d, 116 i, 118 d, 118 i, 120 d, 120 i, 123 d, 130 i	11.03 - 09.12			E40-20-013-01-11	A, 18, 20, 22, 45			28	15	nicht verstellbar not adjustable	nicht verstellbar not adjustable	AS41-20-013-01-VA	AS41-20-013-01-HA	T

Modell	Baujahr	Achslast Vorne kg	Achslast Hinten kg	Artikel-Nr.	Hinweise	ca. Tieferl. Vorne mm	ca. Tieferl. Hinten mm	Ø Vorne mm	Ø Hinten mm	Verstellbarkeit Vorne	Verstellbarkeit Hinten	Ersatzteilbezeichnung Vorne	Ersatzteilbezeichnung Hinten	Gutachten
Model	Year	Front Axle Load kg	Rear Axle Load kg	Part-No.	Notes	ca. Lowering Front mm	ca. Lowering Rear mm	Ø Front mm	Ø Rear mm	Adjustable Front	Adjustable Rear	Spare Part Marking Front	Spare Part Marking Rear	Homologation
1 (E87) B12 Pro-Kit (Performance Komplettfahrwerke Performance Springs+Shocks) 116 i, 118 i, 120 i	11.03 - 09.12	875	1060	E90-20-013-01-22	A, 18, 20, 68, 78, 161	30	25							T
116 d, 118 d, 120 d, 123 d, 130 i	11.03 - 09.12	920	1060	E90-20-013-02-22	A, 18, 20, 68, 78, 161	30	25							T
B12 Sportline (Performance Komplettfahrwerke Sport Sport Performance Springs+Shocks) 116 i, 118 i, 120 i	11.03 - 09.12	895	1060	E95-20-013-01-22	A, 18, 20, 68, 78, 161	45-50	35							T
116 d, 118 d, 120 d, 123 d, 130 i	11.03 - 09.12	920	1060	E95-20-013-02-22	A, 18, 20, 68, 78, 161	45-50	35							T
Pro-Street-S (Gewindefahrwerke - höhenverstellbar Coil-Overs-Adjustable Ride Height) 116 d, 116 i, 118 d, 118 i, 120 d, 120 i, 123 d, 130 i	11.03 - 09.12	945	1070	PSS65-20-013-01-22	A, 18, 20, 24, 25, 45, 160	35-65	35-65							T
1 (E81) Pro-Kit (Performance Fahrwerksfedern Performance Springs) 116 i, 118 i, 120 i	09.06 - 09.12	875	1060	E10-20-013-01-22	A, 18, 20, 68	30	25					F11-20-013-01-VA	F11-20-013-01-HA	T
116 d, 118 d, 120 d, 123 d, 130 i	09.06 - 09.12	920	1060	E10-20-013-02-22	A, 18, 20, 68	30	25					F11-20-013-02-VA	F11-20-013-02-HA	T
Sportline (Performance Fahrwerksfedern Sport Sport Performance Springs) 116 i, 118 i, 120 i	09.06 - 09.12	895	1060	E20-20-013-01-22	A, 18, 20, 68	45-50	35					F21-20-013-01-VA	F21-20-013-01-HA	ABE
116 d, 118 d, 120 d, 123 d, 130 i	09.06 - 09.12	920	1060	E20-20-013-02-22	A, 18, 20, 68	45-50	35					F21-20-013-02-VA	F21-20-013-02-HA	ABE
Anti-Roll-Kit (Performance Stabilisatoren Performance Sway Bars) 116 d, 116 i, 118 d, 118 i, 120 d, 120 i, 123 d, 130 i	09.06 - 09.12			E40-20-013-01-11	A, 18, 20, 22, 45			28	15	nicht verstellbar not adjustable	nicht verstellbar not adjustable	AS41-20-013-01-VA	AS41-20-013-01-HA	T
B12 Pro-Kit (Performance Komplettfahrwerke Performance Springs+Shocks) 116 i, 118 i, 120 i	09.06 - 09.12	875	1060	E90-20-013-01-22	A, 18, 20, 68, 78, 161	30	25							T
116 d, 118 d, 120 d, 123 d, 130 i	09.06 - 09.12	920	1060	E90-20-013-02-22	A, 18, 20, 68, 78, 161	30	25							T
B12 Sportline (Performance Komplettfahrwerke Sport Sport Performance Springs+Shocks) 116 i, 118 i, 120 i	09.06 - 09.12	895	1060	E95-20-013-01-22	A, 18, 20, 68, 78, 161	45-50	35							T
116 d, 118 d, 120 d, 123 d, 130 i	09.06 - 09.12	920	1060	E95-20-013-02-22	A, 18, 20, 68, 78, 161	45-50	35							T
Pro-Street-S (Gewindefahrwerke - höhenverstellbar Coil-Overs-Adjustable Ride Height) 116 d, 116 i, 118 d, 118 i, 120 d, 120 i, 123 d, 130 i	09.06 - 09.12	945	1070	PSS65-20-013-01-22	A, 18, 20, 24, 25, 45, 160	35-65	35-65							T
1 (F20) Pro-Kit (Performance Fahrwerksfedern Performance Springs) 114 d, 114 i, 116 d, 116 i, 118 d, 118 i, 120 d, 125 d, 125 i	11.10 -	905	1110	E10-20-030-01-22	A, 18, 20	25	30					F11-20-030-01-VA	F11-20-030-01-HA	ABE
118 d xDrive, 120 d xDrive	02.12 -	960	1110	E10-20-030-02-22	A, 18	15	25					F11-20-031-02-VA	F11-20-030-01-HA	T
125 d	08.11 -	960	1110	E10-20-030-02-22	A, 18	25	30					F11-20-031-02-VA	F11-20-030-01-HA	T
M 135 i	11.11 -	960	1110	E10-20-030-02-22	A, 18, 20	15	15					F11-20-031-02-VA	F11-20-030-01-HA	T
M 135 i xDrive	02.12 -	1010	1110	E10-20-030-03-22	A, 18	25	15					F11-20-030-03-VA	F11-20-030-01-HA	T
Sportline (Performance Fahrwerksfedern Sport Sport Performance Springs) 114 d, 114 i, 116 d, 116 i, 118 d, 118 i, 120 d, 125 d, 125 i	11.10 -	905	1090	E20-20-030-01-22	A, 18, 20	40	40					F21-20-030-01-VA	F21-20-030-01-HA	T
Anti-Roll-Kit (Performance Stabilisatoren Performance Sway Bars) 114 d, 114 i, 116 d, 116 i, 118 d, 118 i, 120 d, 125 d, 125 i	11.10 -			E40-20-031-02-11	A, 18, 20, 22, 45			28 Rohr 28 tube	16	2-fach verstellbar 2-way adjustable	nicht verstellbar not adjustable	AS41-20-031-02-VA	AS41-20-031-01-HA	T
M 135 i	11.11 -			E40-20-031-01-11	A, 18, 20, 22, 45			28 Rohr 28 tube	16	2-fach verstellbar 2-way adjustable	nicht verstellbar not adjustable	AS41-20-031-01-VA	AS41-20-031-01-HA	T
B12 Pro-Kit (Performance Komplettfahrwerke Performance Springs+Shocks) 120 d xDrive	02.12 -	960	1110	E90-20-030-02-22	A, 18, 78, 161	25	30							T
125 i, M 135 i	08.11 -	960	1110	E90-20-030-04-22	A, 18, 20, 78, 161	25	30							T
M 135 i xDrive	02.12 -	1010	1110	E90-20-030-03-22	A, 18, 78, 161	15	15							T
B12 Sportline (Performance Komplettfahrwerke Sport Sport Performance Springs+Shocks) 114 d, 114 i, 116 d, 116 i, 118 d, 118 i, 120 d, 125 d, 125 i	11.10 -	905	1090	E95-20-030-01-22	A, 18, 20, 78, 161	40	40							T
Pro-Tronic (Elektronische Performance Fahrwerksmodule Electronic Performance Suspension Moduls) Alle Motorisierungen / all motorisation	11.10 -			AM65-20-030-01-22	A, 175									
1 (F21) Pro-Kit (Performance Fahrwerksfedern Performance Springs) 114 d, 114 i, 116 d, 116 i, 118 d, 118 i, 120 d, 125 d, 125 i	12.11 -	905	1110	E10-20-030-01-22	A, 18, 20	25	30					F11-20-030-01-VA	F11-20-030-01-HA	ABE
118 d xDrive, 120 d xDrive	02.12 -	960	1110	E10-20-030-02-22	A, 18	25	25					F11-20-031-02-VA	F11-20-030-01-HA	T
125 d	12.11 -	960	1110	E10-20-030-02-22	A, 18	25	30					F11-20-031-02-VA	F11-20-030-01-HA	T
M 135 i	12.11 -	960	1110	E10-20-030-02-22	A, 18, 20	25	15					F11-20-031-02-VA	F11-20-030-01-HA	T
M 135 i xDrive	02.12 -	1010	1110	E10-20-030-03-22	A, 18	15	15					F11-20-030-03-VA	F11-20-030-01-HA	T
Sportline (Performance Fahrwerksfedern Sport Sport Performance Springs) 114 d, 114 i, 116 d, 116 i, 118 d, 118 i, 120 d, 125 d, 125 i	12.11 -	905	1090	E20-20-030-01-22	A, 18, 20	40	40					F21-20-030-01-VA	F21-20-030-01-HA	T
Anti-Roll-Kit (Performance Stabilisatoren Performance Sway Bars) 114 d, 114 i, 116 d, 116 i, 118 d, 118 i, 120 d, 125 d, 125 i	12.11 -			E40-20-031-02-11	A, 18, 20, 22, 45			28 Rohr 28 tube	16	2-fach verstellbar 2-way adjustable	nicht verstellbar not adjustable	AS41-20-031-02-VA	AS41-20-031-01-HA	T
M 135 i	12.11 -			E40-20-031-01-11	A, 18, 20, 22, 45			28 Rohr 28 tube	16	2-fach verstellbar 2-way adjustable	nicht verstellbar not adjustable	AS41-20-031-01-VA	AS41-20-031-01-HA	T
B12 Pro-Kit (Performance Komplettfahrwerke Performance Springs+Shocks) 118 d xDrive, 120 d xDrive	02.12 -	960	1110	E90-20-030-02-22	A, 18, 78, 161	25	30							T
125 i, M 135 i	12.11 -	1010	1110	E90-20-030-04-22	A, 18, 20, 78, 161	15	15							T

Modell	Baujahr	Achslast Vorne kg	Achslast Hinten kg	Artikel-Nr.	Hinweise	ca. Tieferl. Vorne mm	ca. Tieferl. Hinten mm	Ø Vorne mm	Ø Hinten mm	Verstellbarkeit Vorne	Verstellbarkeit Hinten	Ersatzteilbezeichnung Vorne	Ersatzteilbezeichnung Hinten	Gutachten
Model	Year	Front Axle Load kg	Rear Axle Load kg	Part-No.	Notes	ca. Lowering Front mm	ca. Lowering Rear mm	Ø Front mm	Ø Rear mm	Adjustable Front	Adjustable Rear	Spare Part Marking Front	Spare Part Marking Rear	Homologation
1 (F21) B12 Pro-Kit (Performance Komplettfahrwerke Performance Springs+Shocks) M 135 i xDrive	02.12 -	1010	1110	E90-20-030-03-22	A, 18, 78, 161	15	15							T
B12 Sportline (Performance Komplettfahrwerke Sport Sport Performance Springs+Shocks) 114 d, 114 i, 116 d, 116 i, 118 d, 118 i, 120 d, 125 d, 125 i	12.11 -	905	1090	E95-20-030-01-22	A, 18, 20, 78, 161	40	40							T
Pro-Tronic (Elektronische Performance Fahrwerksmodule Electronic Performance Suspension Moduls) Alle Motorisierungen / all motorisation	11.10 -			AM65-20-030-01-22	A, 175									
1 Cabriolet (E88) 1 Convertible (E88) Pro-Kit (Performance Fahrwerksfedern Performance Springs) 118 d, 118 i, 120 d, 120 i, 123 d, 125 i, 135 i	03.08 -	945	1120	E10-20-016-02-22	A, 18, 20	30	30					F11-20-013-01-VA	F11-20-014-01-HA	T
Anti-Roll-Kit (Performance Stabilisatoren Performance Sway Bars) 118 d, 118 i, 120 d, 120 i, 123 d, 125 i, 135 i	03.08 -			E40-20-013-01-11	A, 18, 20, 22, 45			28	15	nicht verstellbar not adjustable	nicht verstellbar not adjustable	AS41-20-013-01-VA	AS41-20-013-01-HA	T
B12 Pro-Kit (Performance Komplettfahrwerke Performance Springs+Shocks) 118 d, 118 i, 120 d, 120 i, 123 d, 125 i	03.08 -	945	1120	E90-20-016-02-22	A, 18, 20, 78, 161	30	30							T
1 Coupe (E82) Pro-Kit (Performance Fahrwerksfedern Performance Springs) M	04.11 - 06.12	940	1030	E10-20-016-03-22	A, 18, 20	25	10					F11-20-016-03-VA	F11-20-016-03-HA	T
118 d, 120 d, 120 i, 123 d, 125 i, 135 i	10.07 -	945	1030	E10-20-016-01-22	A, 18, 20	30-35	30-35					F11-20-013-01-VA	F11-20-016-01-HA	T
Anti-Roll-Kit (Performance Stabilisatoren Performance Sway Bars) 118 d, 120 d, 120 i, 123 d, 125 i, 135 i	10.07 -			E40-20-013-01-11	A, 18, 20, 22, 45			28	15	nicht verstellbar not adjustable	nicht verstellbar not adjustable	AS41-20-013-01-VA	AS41-20-013-01-HA	T
B12 Pro-Kit (Performance Komplettfahrwerke Performance Springs+Shocks) 118 d, 120 d, 123 d, 125 i, 135 i	10.07 -	945	1030	E90-20-016-01-22	A, 18, 20, 78, 161	30-35	30-35							T
Pro-Street-S (Gewindefahrwerke - höhenverstellbar Coil-Overs-Adjustable Ride Height) 118 d, 120 d, 120 i, 123 d, 125 i, 135 i	10.07 -	945	1070	PSS65-20-013-01-22	A, 18, 20, 24, 25, 45, 160	35-65	35-65							T
3 (E30) Pro-Kit (Performance Fahrwerksfedern Performance Springs) 316 i, 318 i, 318 is	09.82 - 08.91	805	905	E2003-240	A, 18, 20	30-40	30					F2003201	F2003102	T
320 i, 323 i, 325 e 2.7, 325 i	09.82 - 06.91	825	905	E2003-140	A, 18, 20	30-40	30					F2003001	F2003102	T
320 i, 324 d, 324 td, 325 i	09.83 - 08.91	865	945	E2019-140	A, 18, 20	30-40	30					F2019001	F2019002	T
Anti-Roll-Kit (Performance Stabilisatoren Performance Sway Bars) 316 i, 318 i, 318 is, 320 i, 323 i, 324 d, 324 td, 325 e 2.7	09.82 - 08.91			E2003-320	A, 18, 20, 22, 45			20	16	3-fach verstellbar 3-way adjustable	3-fach verstellbar 3-way adjustable	AS2003320VA	AS2003320HA	T
B12 Pro-Kit (Performance Komplettfahrwerke Performance Springs+Shocks) 316 i, 318 i, 318 is	09.82 - 08.91	805	905	E90-20-007-01-22	A, 18, 20, 77, 78, 161	30-40	30							T
316 i, 318 i, 318 is	09.82 - 08.91	805	905	E90-20-007-02-22	A, 18, 20, 78, 161	30-40	30							T
320 i, 323 i	09.82 - 06.91	825	905	E90-20-007-03-22	A, 18, 20, 77, 78, 161	30-40	30							T
320 i, 323 i, 325 e 2.7, 325 i	09.82 - 06.91	825	905	E90-20-007-04-22	A, 18, 20, 78, 161	30-40	30							T
320 i, 323 i, 324 d, 324 td, 325 e 2.7, 325 i	09.82 - 08.91	865	905	E90-20-007-06-22	A, 18, 20, 78, 161	30-40	30							T
320 i	09.82 - 06.91	865	945	E90-20-007-05-22	A, 18, 20, 77, 78, 161	30-40	30							T
3 (E36) Pro-Kit (Performance Fahrwerksfedern Performance Springs) 316 i, 318 i, 318 is	09.90 - 02.98	830	1070	E2021-240	A, 18, 20, 68	30	30					F2021101	F2021002	ABE
320 i, 325 i, 325 td	09.90 - 02.98	890	1070	E2021-140	A, 18, 20, 68	30	30					F2021001	F2021002	ABE
318 tds, 320 i, 323 i 2.5, 325 i, 325 td, 325 tds, 328 i	09.90 - 02.98	900	1070	E2033-140	A, 18, 20, 68	35	30					F2033001	F2021002	ABE
M3 3.0	08.94 - 09.95	910	1090	E2041-140	A, 18, 20	25	15					F2019001	F2021002	T
M3 3.2	09.95 - 02.98	920	1130	E2059-140	A, 18, 20	25	15					F2059001	F2042002	T
Sportline (Performance Fahrwerksfedern Sport Sport Performance Springs) 316 i, 318 i, 318 is	09.90 - 02.98	830	1070	E20-20-004-01-22	A, 20, 68	45-50	30					F21-20-004-01-VA	F21-20-004-02-HA	T
318 tds, 320 i, 323 i 2.5, 325 i, 325 td, 325 tds, 328 i	09.90 - 02.98	900	1070	E20-20-004-02-22	A, 20, 68	45-50	30					F21-20-004-02-VA	F21-20-004-02-HA	T
Anti-Roll-Kit (Performance Stabilisatoren Performance Sway Bars) 316 i, 318 i, 318 is, 318 tds, 320 i, 323 i 2.5, 325 i, 325 td, 325 tds, 328 i	11.91 - 02.98			E2021-321	A, 18, 20, 22, 45			28	21	2-fach verstellbar 2-way adjustable	2-fach verstellbar 2-way adjustable	AS2021321VA	AS2021320HA	T
B12 Pro-Kit (Performance Komplettfahrwerke Performance Springs+Shocks) 316 i, 318 i	09.90 - 05.92	830	1070	E90-20-004-01-22	A, 18, 20, 68, 78, 161	30	30							T
316 i, 318 i, 318 is	06.92 - 02.98	830	1070	E90-20-004-02-22	A, 18, 20, 68, 78, 161	30	30							T
320 i, 325 i, 325 td	09.90 - 05.92	890	1070	E90-20-004-03-22	A, 18, 20, 68, 78, 161	30	30							T
318 tds, 320 i, 323 i 2.5, 325 i, 325 td, 325 tds, 328 i	06.92 - 02.98	900	1070	E90-20-004-04-22	A, 18, 20, 68, 78, 161	30	30							T
M3 3.0	08.94 - 09.95	910	1090	E90-20-004-11-22	A, 18, 20, 78, 79, 161	25	15							T
M3 3.2	09.95 - 02.98	920	1130	E90-20-004-12-22	A, 18, 20, 78, 79, 161	25	15							T
B12 Sportline (Performance Komplettfahrwerke Sport Sport Performance Springs+Shocks) 316 i Schaltgetriebe, 318 i Schaltgetriebe 316 i manual transmission, 318 i manual transmission	09.90 - 05.92	830	1070	E95-20-004-01-22	A, 18, 20, 68, 71, 78, 161	45-50	30							T
316 i Schaltgetriebe, 318 i Schaltgetriebe, 318 is Schaltgetriebe 316 i manual transmission, 318 i manual transmission, 318 is manual transmission	06.92 - 02.98	830	1070	E95-20-004-02-22	A, 18, 20, 68, 71, 78, 161	45-50	30							T

Modell	Baujahr	Achslast Vorne kg	Achslast Hinten kg	Artikel-Nr.	Hinweise	ca. Tieferl. Vorne mm	ca. Tieferl. Hinten mm	Ø Vorne mm	Ø Hinten mm	Verstellbarkeit Vorne	Verstellbarkeit Hinten	Ersatzteilbezeichnung Vorne	Ersatzteilbezeichnung Hinten	Gutachten
Model	Year	Front Axle Load kg	Rear Axle Load kg	Part-No.	Notes	ca. Lowering Front mm	ca. Lowering Rear mm	Ø Front mm	Ø Rear mm	Adjustable Front	Adjustable Rear	Spare Part Marking Front	Spare Part Marking Rear	Homologation
3 (E36) B12 Sportline (Performance Komplettfahrwerke Sport Sport Performance Springs+Shocks) 320 i, 325 i, 325 td	09.90 - 05.92	900	1070	E95-20-004-03-22	A, 18, 20, 68, 78, 161	45-50	30							T
318 tds, 320 i, 323 i 2.5, 325 i, 325 td, 325 tds, 328 i	06.92 - 02.98	900	1070	E95-20-004-04-22	A, 18, 20, 68, 78, 161	45-50	30							T
Pro-Street-S (Gewindefahrwerke - höhenverstellbar Coil-Overs-Adjustable Ride Height) 316 i, 318 i, 318 is, 318 tds, 320 i, 323 i 2.5, 325 i, 325 td, 325 tds, 328 i	06.92 - 02.98	890	1150	PSS65-20-004-01-22	A, 24, 25, 45, 160	40-80	40-80							T
M3 3.0, M3 3.2	10.92 - 04.99	920	1130	PSS65-20-004-02-22	A, 24, 25, 45, 160	30-60	30-60							T
3 (E46) Pro-Kit (Performance Fahrwerksfedern Performance Springs) 316 i, 318 i	02.98 - 02.05	895	1100	E2066-140	A, 18, 20, 68	30	20-25					F2066001	F2067102	T
318 d, 320 d, 320 i, 323 i, 325 i, 328 i, 330 i	02.98 - 04.05	970	1100	E2067-140	A, 18, 20, 68	30	20-25					F2067001	F2067102	T
325 xi, 330 xi	06.00 - 02.05	1010	1250	E10-20-001-03-22	A, 18	30	20-25					F2067001	F2067102	T
330 d	10.99 - 02.05	1030	1100	E10-20-001-01-22	A, 18, 20, 68	30	20-25					F11-20-001-01-VA	F2067102	T
330 xd	06.00 - 02.05	1065	1250	E10-20-001-04-22	A, 18	30	20-25					F11-20-001-01-VA	F2067102	T
Sportline (Performance Fahrwerksfedern Sport Sport Performance Springs) 316 i, 318 i	02.98 - 02.05	895	1045	E20-20-001-01-22	A, 20, 68	45-50	30					F21-20-001-01-VA	F21-20-001-01-HA	T
318 d, 320 d, 320 i, 323 i, 325 i, 328 i, 330 i	02.98 - 04.05	935	1190	E20-20-001-03-22	A, 20, 68	45-50	20-25					F21-20-001-02-VA	F21-20-001-02-HA	T
Anti-Roll-Kit (Performance Stabilisatoren Performance Sway Bars) 316 i, 318 d, 318 i, 320 d, 320 i, 323 i, 325 i, 328 i, 330 d, 330 i	02.98 - 04.05			E2066-320	A, 18, 20, 22, 45			27	21	2-fach verstellbar 2-way adjustable	nicht verstellbar not adjustable	AS2066320VA	AS2066320HA	T
B12 Pro-Kit (Performance Komplettfahrwerke Performance Springs+Shocks) 316 i, 318 i	02.98 - 02.05	895	1190	E90-20-001-01-22	A, 18, 20, 68, 78, 161	30	20-25							T
318 d, 320 d, 320 i, 323 i, 325 i, 328 i, 330 i	02.98 - 04.05	970	1190	E90-20-001-02-22	A, 18, 20, 68, 78, 161	30	20-25							T
325 xi, 330 xi	06.00 - 02.05	1010	1250	E90-20-001-05-22	A, 18, 74, 78, 161	30	20-25							T
330 d	10.99 - 02.05	1030	1190	E90-20-001-03-22	A, 18, 20, 68, 78, 161	30	20-25							T
330 xd	06.00 - 02.05	1065	1250	E90-20-001-06-22	A, 18, 74, 78, 161	30	20-25							T
B12 Sportline (Performance Komplettfahrwerke Sport Sport Performance Springs+Shocks) 316 i, 318 i	02.98 - 02.05	895	1045	E95-20-001-01-22	A, 18, 20, 68, 78, 161	45-50	20-25							T
318 d, 320 d, 320 i, 323 i, 325 i, 328 i	02.98 - 04.05	935	1190	E95-20-001-03-22	A, 18, 20, 68, 78, 161	45-50	20-25							T
330 i Schaltgetriebe 330 i manual transmission	06.00 - 02.05	935	1190	E95-20-001-03-22	A, 18, 20, 68, 71, 78, 161	45-50	20-25							T
Pro-Street-S (Gewindefahrwerke - höhenverstellbar Coil-Overs-Adjustable Ride Height) 316 i, 318 d, 318 i, 320 d, 320 i, 323 i, 325 i, 328 i	02.98 - 04.05	910	1215	PSS65-20-001-01-22	A, 24, 25, 45, 160	40-75	40-75							T
316 i, 318 d, 318 i, 320 d, 320 i, 323 i, 325 i, 328 i, 330 d, 330 i	02.98 - 04.05	1000	1215	PSS65-20-001-02-22	A, 24, 25, 45, 160	40-75	40-75							T
3 (E90) Pro-Kit (Performance Fahrwerksfedern Performance Springs) 318 i, 320 i, 320 si	01.05 - 12.11	935	1085	E10-20-014-01-22	A, 18, 20	30	25					F11-20-013-01-VA	F11-20-014-01-HA	ABE
316 d, 318 d, 320 d, 323 i, 325 i, 330 i	01.05 - 12.11	1045	1135	E10-20-014-02-22	A, 18, 20	30	25					F11-20-013-02-VA	F11-20-013-01-HA	ABE
320 d xDrive, 320 xd, 325 i xDrive, 325 xi, 330 i xDrive, 330 xi	01.05 - 12.11	1045	1200	E10-20-014-08-22	A, 18	30	15-20					F11-20-013-02-VA	F11-20-014-05-HA	ABE
M3 4.0	03.07 - 12.11	1060	1190	E10-20-014-17-22	A, 18, 20	20	15					F11-20-014-17-VA	F11-20-014-17-HA	T
325 d, 330 d	09.05 - 12.11	1090	1135	E10-20-014-04-22	A, 18, 20	30	25					F11-20-014-04-VA	F11-20-013-01-HA	ABE
335 d, 335 i	09.06 - 12.11	1090	1135	E10-20-014-04-22	A, 18, 20	20	0					F11-20-014-04-VA	F11-20-013-01-HA	ABE
330 d xDrive, 330 xd	09.05 - 12.11	1090	1200	E10-20-014-09-22	A, 18	30	15-20					F11-20-014-04-VA	F11-20-014-05-HA	ABE
Sportline (Performance Fahrwerksfedern Sport Sport Performance Springs) 318 i, 320 i, 320 si	01.05 - 12.11	935	1085	E20-20-014-01-22	A, 18, 20	45-50	35					F21-20-013-01-VA	F21-20-014-01-HA	ABE
316 d, 318 d, 320 d, 323 i, 325 i, 330 i	01.05 - 12.11	955	1135	E20-20-014-02-22	A, 18, 20	45-50	35					F21-20-013-02-VA	F21-20-013-01-HA	ABE
Anti-Roll-Kit (Performance Stabilisatoren Performance Sway Bars) 316 d, 318 d, 318 i, 320 d, 320 i, 320 si, 323 i, 325 d, 325 i, 330 d, 330 i, 335 d, 335 i	01.05 - 12.11			E40-20-013-01-11	A, 18, 20, 22, 45			28	15	nicht verstellbar not adjustable	nicht verstellbar not adjustable	AS41-20-013-01-VA	AS41-20-013-01-HA	T
B12 Pro-Kit (Performance Komplettfahrwerke Performance Springs+Shocks) 318 i, 320 i, 320 si	01.05 - 12.11	935	1085	E90-20-014-01-22	A, 18, 20, 78, 161	30	25							T
316 d, 318 d, 320 d, 323 i, 325 i, 330 i	01.05 - 12.11	1045	1135	E90-20-014-02-22	A, 18, 20, 78, 161	30	25							T
320 d xDrive, 320 xd, 325 i xDrive, 325 xi, 330 i xDrive, 330 xi	01.05 - 12.11	1045	1200	E90-20-014-08-22	A, 18, 78, 161	30	15-20							T
M3 4.0	03.07 - 12.11	1060	1190	E90-20-014-17-22	A, 18, 20, 21, 78, 159, 161	20	15							T
325 d, 330 d, 335 d, 335 i	09.05 - 12.11	1090	1135	E90-20-014-04-22	A, 18, 20, 78, 161	20	0							T
330 d xDrive, 330 xd	09.05 - 12.11	1090	1200	E90-20-014-09-22	A, 18, 78, 161	30	15-20							T
B12 Sportline (Performance Komplettfahrwerke Sport Sport Performance Springs+Shocks) 318 i, 320 i, 320 si	01.05 - 12.11	935	1085	E95-20-014-01-22	A, 18, 20, 78, 161	45-50	35							T
316 d, 318 d, 320 d, 323 i, 325 i, 330 i	01.05 - 12.11	955	1135	E95-20-014-02-22	A, 18, 20, 78, 161	45-50	35							T

Modell	Baujahr	Achslast Vorne kg	Achslast Hinten kg	Artikel-Nr.	Hinweise	ca. Tieferl. Vorne mm	ca. Tieferl. Hinten mm	Ø Vorne mm	Ø Hinten mm	Verstellbarkeit Vorne	Verstellbarkeit Hinten	Ersatzteilbezeichnung Vorne	Ersatzteilbezeichnung Hinten	Gutachten
Model	Year	Front Axle Load kg	Rear Axle Load kg	Part-No.	Notes	ca. Lowering Front mm	ca. Lowering Rear mm	Ø Front mm	Ø Rear mm	Adjustable Front	Adjustable Rear	Spare Part Marking Front	Spare Part Marking Rear	Homologation
3 (E90) Pro-Street-S (Gewindefahrwerke - höhenverstellbar Coil-Overs-Adjustable Ride Height) 316 d, 320 d, 320 i, 320 si, 323 i, 325 i, 330 i	01.05 - 12.11	1015	1120	PSS65-20-013-01-22	A, 18, 20, 24, 25, 45, 160	30-60	30-60							T
3 (F30) Pro-Kit (Performance Fahrwerksfedern Performance Springs) 316 d, 316 i, 318 d, 320 d, 320 i, 328 i	10.11 -	965	1170	E10-20-031-01-22	A, 18, 20	25-30	25					F11-20-031-01-VA	F11-20-031-01-HA	ABE
318 d xDrive, 320 i xDrive	11.11 -	965	1265	E10-20-031-03-22	A, 18	20	15					F11-20-031-01-VA	F11-20-031-03-HA	T
325 d, 330 d, 335 i	10.11 -	1000	1170	E10-20-031-02-22	A, 18, 20	35	40					F11-20-031-02-VA	F11-20-031-01-HA	ABE
320 d xDrive, 328 i xDrive	10.11 -	1000	1265	E10-20-031-04-22	A, 18, 20	20	15					F11-20-031-02-VA	F11-20-031-03-HA	T
ActiveHybrid	01.12 -	1030	1265	E10-20-031-05-22	A, 18, 20	35	25					F11-20-030-03-VA	F11-20-031-03-HA	T
330 d xDrive, 335 i xDrive	10.11 -	1060	1265	E10-20-031-06-22	A, 18	20	15					F11-20-031-06-VA	F11-20-031-03-HA	T
Sportline (Performance Fahrwerksfedern Sport Sport Performance Springs) 316 d, 316 i, 318 d, 320 d, 320 i, 328 i	10.11 -	950	1160	E20-20-031-01-22	A, 18, 20	40	40					F21-20-031-01-VA	F21-20-031-01-HA	T
Anti-Roll-Kit (Performance Stabilisatoren Performance Sway Bars) 316 d, 316 i, 318 d, 320 d, 320 i, 325 d, 328 i	10.11 -			E40-20-031-02-11	A, 18, 20, 22, 45			28 Rohr 28 tube	16	2-fach verstellbar 2-way adjustable	nicht verstellbar not adjustable	AS41-20-031-02-VA	AS41-20-031-01-HA	T
330 d, 335 i, ActiveHybrid	10.11 -			E40-20-031-01-11	A, 18, 20, 22, 45			28 Rohr 28 tube	16	2-fach verstellbar 2-way adjustable	nicht verstellbar not adjustable	AS41-20-031-01-VA	AS41-20-031-01-HA	T
B12 Pro-Kit (Performance Komplettfahrwerke Performance Springs+Shocks) 316 d, 316 i, 318 d, 320 d, 320 i, 328 i	10.11 -	965	1170	E90-20-031-01-22	A, 18, 20, 78, 161	25-30	25							T
ActiveHybrid	01.12 -	1030	1265	E90-20-031-05-22	A, 18, 20, 78, 161	35	25							T
B12 Sportline (Performance Komplettfahrwerke Sport Sport Performance Springs+Shocks) 316 d, 316 i, 318 d, 320 d, 320 i, 325 d, 328 i	10.11 -	950	116	E95-20-031-01-22	A, 18, 20, 78, 161	40	40							T
Pro-Tronic (Elektronische Performance Fahrwerksmodule Electronic Performance Suspension Modul) Alle Motorisierungen / all motorisation	10.11 -			AM65-20-030-01-22	A, 175									
3 Cabriolet (E30) 3 Convertible (E30) Pro-Kit (Performance Fahrwerksfedern Performance Springs) 318 i	06.88 - 10.93	790	945	E2010-240	A, 18, 20	30	30					F2019001	F2010002	T
320 i, 325 i	12.85 - 10.93	865	945	E2010-140	A, 18, 20	30-40	30					F2010001	F2010002	T
Anti-Roll-Kit (Performance Stabilisatoren Performance Sway Bars) 318 i, 320 i, 325 i	12.85 - 10.93			E2003-320	A, 18, 20, 22, 45			20	16	3-fach verstellbar 3-way adjustable	3-fach verstellbar 3-way adjustable	AS2003320VA	AS2003320HA	T
B12 Pro-Kit (Performance Komplettfahrwerke Performance Springs+Shocks) 318 i	06.88 - 10.93	790	945	E90-20-007-07-22	A, 18, 20, 77, 78, 161	30	30							T
318 i	06.88 - 10.93	790	945	E90-20-007-08-22	A, 18, 20, 78, 161	30	30							T
320 i, 325 i	12.85 - 10.93	865	945	E90-20-007-09-22	A, 18, 20, 77, 78, 161	30-40	30							T
320 i, 325 i	12.85 - 10.93	865	945	E90-20-007-10-22	A, 18, 20, 78, 161	30-40	30							T
3 Cabriolet (E36) 3 Convertible (E36) Pro-Kit (Performance Fahrwerksfedern Performance Springs) 318 i	01.94 - 04.99	830	1115	E2043-140	A, 18, 20, 68	30	30					F2021101	F2042002	ABE
320 i, 323 i, 325 i, 328 i	03.93 - 04.99	900	1115	E2042-140	A, 18, 20, 68	30	30					F2033001	F2042002	ABE
M3 3.0	01.94 - 10.95	910	1090	E2041-140	A, 18, 20	25	15					F2019001	F2021002	T
M3 3.2	10.95 - 04.99	920	1130	E2059-140	A, 18, 20	25	15					F2059001	F2042002	T
Sportline (Performance Fahrwerksfedern Sport Sport Performance Springs) 318 i	01.94 - 04.99	830	1070	E20-20-004-05-22	A, 20	45-50	30					F21-20-004-01-VA	F21-20-004-04-HA	T
320 i, 323 i, 325 i, 328 i	03.93 - 04.99	900	1070	E20-20-004-06-22	A, 20	45-50	30					F21-20-004-02-VA	F21-20-004-04-HA	T
Anti-Roll-Kit (Performance Stabilisatoren Performance Sway Bars) 318 i, 320 i, 323 i, 325 i, 328 i	05.93 - 04.99			E2021-321	A, 18, 20, 22, 45			28	21	2-fach verstellbar 2-way adjustable	2-fach verstellbar 2-way adjustable	AS2021321VA	AS2021320HA	T
B12 Pro-Kit (Performance Komplettfahrwerke Performance Springs+Shocks) 318 i	01.94 - 04.99	830	1115	E90-20-004-07-22	A, 18, 20, 68, 78, 161	30	30							T
320 i, 323 i, 325 i, 328 i	03.93 - 04.99	900	1115	E90-20-004-08-22	A, 18, 20, 68, 78, 161	30	30							T
M3 3.0	01.94 - 10.95	910	1090	E90-20-004-11-22	A, 18, 20, 78, 161	25	15							T
M3 3.2	10.95 - 04.99	920	1130	E90-20-004-12-22	A, 18, 20, 78, 161	25	15							T
B12 Sportline (Performance Komplettfahrwerke Sport Sport Performance Springs+Shocks) 318 i Schaltgetriebe 318 i manual transmission	01.94 - 04.99	830	1070	E95-20-004-07-22	A, 18, 20, 68, 71, 78, 161	45-50	30							T
320 i, 323 i, 325 i, 328 i	03.93 - 04.99	900	1070	E95-20-004-08-22	A, 18, 20, 68, 78, 161	45-50	30							T
Pro-Street-S (Gewindefahrwerke - höhenverstellbar Coil-Overs-Adjustable Ride Height) 318 i, 320 i, 323 i, 325 i, 328 i	05.93 - 04.99	890	1150	PSS65-20-004-01-22	A, 24, 25, 45, 160	40-80	40-80							T
M3 3.0, M3 3.2	01.94 - 04.99	920	1130	PSS65-20-004-02-22	A, 24, 25, 45, 160	30-60	30-60							T
3 Cabriolet (E46) 3 Convertible (E46) Pro-Kit (Performance Fahrwerksfedern Performance Springs) 318 Ci	09.01 -	895	1190	E2066-140	A, 18, 20, 68	30	15-20					F2066001	F2067102	T

Modell	Baujahr	Achslast Vorne kg	Achslast Hinten kg	Artikel-Nr.	Hinweise	ca. Tieferl. Vorne mm	ca. Tieferl. Hinten mm	Ø Vorne mm	Ø Hinten mm	Verstellbarkeit Vorne	Verstellbarkeit Hinten	Ersatzteilbezeichnung Vorne	Ersatzteilbezeichnung Hinten	Gutachten
Model	Year	Front Axle Load kg	Rear Axle Load kg	Part-No.	Notes	ca. Lowering Front mm	ca. Lowering Rear mm	Ø Front mm	Ø Rear mm	Adjustable Front	Adjustable Rear	Spare Part Marking Front	Spare Part Marking Rear	Homologation
3 Cabriolet (E46) 3 Convertible (E46) Pro-Kit (Performance Fahrwerksfedern Performance Springs) 320 Cd, 320 Ci, 323 Ci, 325 Ci, 330 Ci	04.00 -	970	1190	E2067-140	A, 18, 20, 68	40	20-25					F2067001	F2067102	T
M3 3.2	04.01 -	990	1170	E10-20-001-02-22	A, 18, 20	20	10					F11-20-001-02-VA	F11-20-001-02-HA	T
330 Cd	08.05 -	1030	1190	E10-20-001-01-22	A, 18, 20, 68	30	20-25					F11-20-001-01-VA	F2067102	T
Anti-Roll-Kit (Performance Stabilisatoren Performance Sway Bars) 318 Ci, 320 Cd, 320 Ci, 323 Ci, 325 Ci, 330 Cd, 330 Ci	04.00 -			E2066-320	A, 18, 20, 22, 45			27	21	2-fach verstellbar 2-way adjustable	nicht verstellbar not adjustable	AS2066320VA	AS2066320HA	T
M3 3.2	04.01 -			E40-20-001-01-11	A, 18, 20, 22, 45			29	25	2-fach verstellbar 2-way adjustable	nicht verstellbar not adjustable	AS41-20-001-01-VA	AS41-20-001-01-HA	T
B12 Pro-Kit (Performance Komplettfahrwerke Performance Springs+Shocks) 318 Ci	09.01 -	895	1190	E90-20-001-01-22	A, 18, 20, 68, 78, 161	30	15-20							T
320 Cd, 320 Ci, 323 Ci, 325 Ci, 330 Ci	04.00 -	970	1190	E90-20-001-02-22	A, 18, 20, 68, 78, 161	40	20-25							T
M3 3.2	04.01 -	990	1170	E90-20-001-04-22	A, 18, 20, 78, 155, 161	20	10							T
330 Cd	08.05 -	1030	1190	E90-20-001-03-22	A, 18, 20, 68, 78, 161	30	20-25							T
Pro-Street-S (Gewindefahrwerke - höhenverstellbar Coil-Overs-Adjustable Ride Height) 318 Ci, 320 Ci, 323 Ci, 325 Ci	04.00 -	910	1215	PSS65-20-001-01-22	A, 24, 25, 45, 160	40-75	40-75							T
318 Ci, 320 Ci, 323 Ci, 325 Ci, 330 Ci	04.00 -	1000	1215	PSS65-20-001-02-22	A, 24, 25, 45, 160	40-75	40-75							T
3 Cabriolet (E93) 3 Convertible (E93) Pro-Kit (Performance Fahrwerksfedern Performance Springs) 318 i, 320 d, 320 i	01.07 -	930	1200	E10-20-014-14-22	A, 18, 20	30	10-15					F11-20-013-01-VA	F11-20-014-14-HA	T
323 i, 325 i, 330 i, 335 i	03.07 -	990	1200	E10-20-014-15-22	A, 18, 20	30	10-15					F11-20-013-02-VA	F11-20-014-14-HA	T
325 d, 330 d	03.07 -	1085	1200	E10-20-014-16-22	A, 18, 20	30	10-15					F11-20-014-04-VA	F11-20-014-14-HA	T
Anti-Roll-Kit (Performance Stabilisatoren Performance Sway Bars) 318 i, 320 d, 320 i, 323 i, 325 d, 325 i, 330 d, 330 i, 335 i	01.07 -			E40-20-013-01-11	A, 18, 20, 22, 45			28	15	nicht verstellbar not adjustable	nicht verstellbar not adjustable	AS41-20-013-01-VA	AS41-20-013-01-HA	T
B12 Pro-Kit (Performance Komplettfahrwerke Performance Springs+Shocks) 318 i, 320 d, 320 i	03.07 -	930	1200	E90-20-014-14-22	A, 18, 20, 78, 161	30	10-15							T
323 i, 325 i, 330 i, 335 i	03.07 -	990	1200	E90-20-014-15-22	A, 18, 20, 78, 161	30	10-15							T
325 d, 330 d	03.07 -	1085	1200	E90-20-014-16-22	A, 18, 20, 78, 161	30	10-15							T
Pro-Street-S (Gewindefahrwerke - höhenverstellbar Coil-Overs-Adjustable Ride Height) 318 i, 320 d, 320 i, 323 i, 325 d, 325 i, 330 d, 330 i, 335 i	01.07 -	1020	1200	PSS65-20-014-02-22	A, 18, 20, 24, 25, 45, 160	30-60	30-60							T
3 Compact (E36) Pro-Kit (Performance Fahrwerksfedern Performance Springs) 316 i, 318 ti	03.94 - 08.00	830	970	E2044-140	A, 18, 20, 68	30	30					F2021101	F2019002	ABE
318 tds, 323 ti	01.95 - 08.00	900	970	E2051-140	A, 18, 20, 68	30	30					F2033001	F2019002	ABE
Sportline (Performance Fahrwerksfedern Sport Sport Performance Springs) 316 i, 318 ti	03.94 - 08.00	830	970	E20-20-004-07-22	A, 20, 68	45-50	30					F21-20-004-01-VA	F21-20-004-08-HA	T
318 tds, 323 ti	01.95 - 08.00	900	970	E20-20-004-08-22	A, 20, 68	45-50	30					F21-20-004-02-VA	F21-20-004-08-HA	T
B12 Pro-Kit (Performance Komplettfahrwerke Performance Springs+Shocks) 316 i, 318 ti	03.94 - 08.00	830	970	E90-20-004-09-22	A, 18, 20, 68, 78, 161	30	30							T
318 tds, 323 ti	01.95 - 08.00	900	970	E90-20-004-10-22	A, 18, 20, 68, 78, 161	30	30							T
B12 Sportline (Performance Komplettfahrwerke Sport Sport Performance Springs+Shocks) 316 i Schaltgetriebe, 318 ti Schaltgetriebe 316 i manual transmission, 318 ti manual transmission 318 tds, 323 ti	03.94 - 08.00	830	970	E95-20-004-09-22	A, 18, 20, 68, 71, 78, 161	45-50	30							T
01.95 - 08.00	900	970	E95-20-004-10-22	A, 18, 20, 68, 78, 161	45-50	30								T
3 Compact (E46) Pro-Kit (Performance Fahrwerksfedern Performance Springs) 316 ti, 318 ti	06.01 - 02.05	895	1045	E10-20-001-08-22	A, 18, 20, 68	25	15					F2066001	F11-20-001-09-HA	T
318 td, 320 td, 325 ti	06.01 - 02.05	970	1045	E10-20-001-09-22	A, 18, 20, 68	25	15					F2067001	F11-20-001-09-HA	T
Sportline (Performance Fahrwerksfedern Sport Sport Performance Springs) 316 ti, 318 ti	06.01 - 02.05	895	1190	E20-20-001-04-22	A, 20, 68	30-35	15					F21-20-001-01-VA	F21-20-001-02-HA	T
318 td, 320 td, 325 ti	06.01 - 02.05	935	1190	E20-20-001-02-22	A, 20, 68	30-35	15					F21-20-001-02-VA	F21-20-001-02-HA	T
Anti-Roll-Kit (Performance Stabilisatoren Performance Sway Bars) 316 ti, 318 td, 318 ti, 320 td, 325 ti	06.01 - 02.05			E40-20-001-02-11	A, 18, 20, 22, 45			27	23	2-fach verstellbar 2-way adjustable	nicht verstellbar not adjustable	AS2066320VA	AS41-20-001-02-HA	T
B12 Pro-Kit (Performance Komplettfahrwerke Performance Springs+Shocks) 316 ti, 318 ti	06.01 - 02.05	895	1045	E90-20-001-07-22	A, 18, 20, 68, 78, 161	25	15							T
318 td, 320 td, 325 ti	06.01 - 02.05	970	1045	E90-20-001-08-22	A, 18, 20, 68, 78, 161	25	15							T
B12 Sportline (Performance Komplettfahrwerke Sport Sport Performance Springs+Shocks) 316 ti, 318 ti	06.01 - 02.05	895	1190	E95-20-001-05-22	A, 18, 20, 68, 78, 161	30-35	15							T
318 td, 320 td, 325 ti Schaltgetriebe 318 td, 320 td, 325 ti manual transmission	06.01 - 02.05	935	1190	E95-20-001-02-22	A, 18, 20, 68, 71, 78, 161	30-35	15							T
3 Coupe (E36) Pro-Kit (Performance Fahrwerksfedern Performance Springs) 316 i, 318 is	03.92 - 04.99	830	1070	E2021-240	A, 18, 20, 68	30	15					F2021101	F2021002	ABE

Modell	Baujahr	Achslast Vorne kg	Achslast Hinten kg	Artikel-Nr.	Hinweise	ca. Tieferl. Vorne mm	ca. Tieferl. Hinten mm	Ø Vorne mm	Ø Hinten mm	Verstellbarkeit Vorne	Verstellbarkeit Hinten	Ersatzteilbezeichnung Vorne	Ersatzteilbezeichnung Hinten	Gutachten
Model	Year	Front Axle Load kg	Rear Axle Load kg	Part-No.	Notes	ca. Lowering Front mm	ca. Lowering Rear mm	Ø Front mm	Ø Rear mm	Adjustable Front	Adjustable Rear	Spare Part Marking Front	Spare Part Marking Rear	Homologation
3 Coupe (E36) Pro-Kit (Performance Fahrwerksfedern Performance Springs) 320 i, 323 i, 325 i, 328 i	03.92 - 04.99	900	1070	E2033-140	A, 18, 20, 68	30	15					F2033001	F2021002	ABE
M3 3.0	10.92 - 10.95	910	1090	E2041-140	A, 18, 20	25	15					F2019001	F2021002	T
M3 3.2	10.95 - 04.99	920	1130	E2059-140	A, 18, 20	25	15					F2059001	F2042002	T
Sportline (Performance Fahrwerksfedern Sport Sport Performance Springs) 316 i, 318 is	03.92 - 04.99	830	1070	E20-20-004-01-22	A, 20, 68	45-50	30					F21-20-004-01-VA	F21-20-004-02-HA	T
320 i, 323 i, 325 i, 328 i	03.92 - 04.99	900	1070	E20-20-004-02-22	A, 20, 68	45-50	30					F21-20-004-02-VA	F21-20-004-02-HA	T
Anti-Roll-Kit (Performance Stabilisatoren Performance Sway Bars) 316 i, 318 is, 320 i, 323 i, 325 i, 328 i	03.92 - 04.99			E2021-321	A, 18, 20, 22, 45			28	21	2-fach verstellbar 2-way adjustable	2-fach verstellbar 2-way adjustable	AS2021321VA	AS2021320HA	T
B12 Pro-Kit (Performance Komplettfahrwerke Performance Springs+Shocks) 318 is	03.92 - 05.92	830	1070	E90-20-004-01-22	A, 18, 20, 68, 78, 161	30	15							T
316 i, 318 is	06.92 - 04.99	830	1070	E90-20-004-02-22	A, 18, 20, 68, 78, 161	30	15							T
320 i, 323 i, 325 i, 328 i	06.92 - 04.99	900	1070	E90-20-004-04-22	A, 18, 20, 68, 78, 161	30	15							T
M3 3.0	10.92 - 10.95	910	1090	E90-20-004-11-22	A, 18, 20, 78, 161	25	15							T
M3 3.2	10.95 - 04.99	920	1130	E90-20-004-12-22	A, 18, 20, 78, 161	25	15							T
B12 Sportline (Performance Komplettfahrwerke Sport Sport Performance Springs+Shocks) 318 is Schaltgetriebe 318 is manual transmission	03.92 - 05.92	830	1070	E95-20-004-01-22	A, 18, 20, 68, 71, 78, 161	45	30							T
316 i Schaltgetriebe, 318 is Schaltgetriebe 316 i manual transmission, 318 is manual transmission	06.92 - 04.99	830	1070	E95-20-004-02-22	A, 18, 20, 68, 71, 78, 161	45	15							T
320 i, 325 i	03.92 - 05.92	900	1070	E95-20-004-03-22	A, 18, 20, 68, 78, 161	45	15							T
320 i, 323 i, 325 i, 328 i	06.92 - 04.99	900	1070	E95-20-004-04-22	A, 18, 20, 68, 78, 161	45	15							T
Pro-Street-S (Gewindefahrwerke - höhenverstellbar Coil-Overs-Adjustable Ride Height) 316 i, 318 is, 320 i, 323 i, 325 i, 328 i	03.92 - 04.99	890	1150	PSS65-20-004-01-22	A, 24, 25, 45, 160	40-80	40-80							T
M3 3.0, M3 3.2	10.92 - 04.99	920	1130	PSS65-20-004-02-22	A, 24, 25, 45, 160	30-60	30-60							T
3 Coupe (E46) Pro-Kit (Performance Fahrwerksfedern Performance Springs) 316 Ci, 318 Ci	11.99 -	895	1100	E2066-140	A, 18, 20, 68	25	10					F2066001	F2067102	T
320 Cd, 320 Ci, 323 Ci, 325 Ci, 328 Ci, 330 Ci	04.99 -	970	1100	E2067-140	A, 18, 20, 68	25	10					F2067001	F2067102	T
M3 3.2	06.00 -	990	1170	E10-20-001-02-22	A, 18, 20	20	10					F11-20-001-02-VA	F11-20-001-02-HA	T
330 Cd	03.03 -	1030	1100	E10-20-001-01-22	A, 18, 20, 68	25	10					F11-20-001-01-VA	F2067102	T
Sportline (Performance Fahrwerksfedern Sport Sport Performance Springs) 316 Ci, 318 Ci	11.99 -	895	1045	E20-20-001-01-22	A, 20, 68	30-35	15					F21-20-001-01-VA	F21-20-001-01-HA	T
320 Ci, 323 Ci, 325 Ci, 328 Ci, 330 Ci	04.99 -	935	1190	E20-20-001-03-22	A, 20, 68	30-35	15					F21-20-001-02-VA	F21-20-001-02-HA	T
Anti-Roll-Kit (Performance Stabilisatoren Performance Sway Bars) 316 Ci, 318 Ci, 320 Cd, 320 Ci, 323 Ci, 325 Ci, 328 Ci, 330 Ci	04.99 -			E2066-320	A, 18, 20, 22, 45			27	21	2-fach verstellbar 2-way adjustable	nicht verstellbar not adjustable	AS2066320VA	AS2066320HA	T
330 Cd	03.03 -			E2066-320	A, 18, 22, 45			27	21	2-fach verstellbar 2-way adjustable	nicht verstellbar not adjustable	AS2066320VA	AS2066320HA	T
M3 3.2	06.00 -			E40-20-001-01-11	A, 18, 20, 22, 45			29	25	2-fach verstellbar 2-way adjustable	nicht verstellbar not adjustable	AS41-20-001-01-VA	AS41-20-001-01-HA	T
B12 Pro-Kit (Performance Komplettfahrwerke Performance Springs+Shocks) 316 Ci, 318 Ci	11.99 -	895	1190	E90-20-001-01-22	A, 18, 20, 68, 78, 161	25	10							T
320 Cd, 320 Ci, 323 Ci, 325 Ci, 328 Ci, 330 Ci	04.99 -	970	1190	E90-20-001-02-22	A, 18, 20, 68, 78, 161	25	10							T
M3 3.2	06.00 -	990	1170	E90-20-001-04-22	A, 18, 20, 78, 155, 161	20	10							T
330 Cd	03.03 -	1030	1190	E90-20-001-03-22	A, 18, 20, 68, 78, 161	25	10							T
B12 Sportline (Performance Komplettfahrwerke Sport Sport Performance Springs+Shocks) 316 Ci, 318 Ci	11.99 -	895	1045	E95-20-001-01-22	A, 18, 20, 68, 78, 161	30-35	15							T
320 Ci, 323 Ci, 325 Ci, 328 Ci	04.99 -	935	1190	E95-20-001-03-22	A, 18, 20, 68, 78, 161	30-35	15							T
330 Ci Schaltgetriebe 330 Ci manual transmission	06.00 -	935	1190	E95-20-001-03-22	A, 18, 20, 68, 71, 78, 161	30-35	15							T
Pro-Street-S (Gewindefahrwerke - höhenverstellbar Coil-Overs-Adjustable Ride Height) 316 Ci, 318 Ci, 320 Cd, 320 Ci, 323 Ci, 325 Ci, 328 Ci	04.99 -	910	1215	PSS65-20-001-01-22	A, 24, 25, 45, 160	40-75	40-75							T
316 Ci, 318 Ci, 320 Cd, 320 Ci, 323 Ci, 325 Ci, 328 Ci, 330 Cd, 330 Ci	04.99 -	1000	1215	PSS65-20-001-02-22	A, 24, 25, 45, 160	40-75	40-75							T
3 Coupe (E92) Pro-Kit (Performance Fahrwerksfedern Performance Springs) 318 i, 320 d, 320 i, 323 i, 325 i, 328 i, 330 i	06.06 -	930	1090	E10-20-014-12-22	A, 18, 20	35	25					F11-20-013-01-VA	F11-20-013-01-HA	T
325 d, 330 d, 335 d, 335 i	09.06 -	990	1090	E10-20-014-13-22	A, 18, 20	35	25					F11-20-013-02-VA	F11-20-013-01-HA	T
M	03.07 -	1060	1190	E10-20-014-17-22	A, 18, 20	20	15					F11-20-014-17-VA	F11-20-014-17-HA	T
Anti-Roll-Kit (Performance Stabilisatoren Performance Sway Bars) 318 i, 320 d, 320 i, 323 i, 325 d, 325 i, 328 i, 330 d, 330 i, 335 d, 335 i	06.06 -			E40-20-013-01-11	A, 18, 20, 22, 45			28	15	nicht verstellbar not adjustable	nicht verstellbar not adjustable	AS41-20-013-01-VA	AS41-20-013-01-HA	T
B12 Pro-Kit (Performance Komplettfahrwerke Performance Springs+Shocks) 316 i, 318 i, 320 d, 320 i, 323 i, 325 i, 328 i, 330 i	06.06 -	930	1090	E90-20-014-12-22	A, 18, 20, 78, 161	35	25							T

Modell	Baujahr	Achslast Vorne kg	Achslast Hinten kg	Artikel-Nr.	Hinweise	ca. Tieferl. Vorne mm	ca. Tieferl. Hinten mm	Ø Vorne mm	Ø Hinten mm	Verstellbarkeit Vorne	Verstellbarkeit Hinten	Ersatzteilbezeichnung Vorne	Ersatzteilbezeichnung Hinten	Gutachten
Model	Year	Front Axle Load kg	Rear Axle Load kg	Part-No.	Notes	ca. Lowering Front mm	ca. Lowering Rear mm	Ø Front mm	Ø Rear mm	Adjustable Front	Adjustable Rear	Spare Part Marking Front	Spare Part Marking Rear	Homologation
3 Coupe (E92) B12 Pro-Kit (Performance Komplettfahrwerke Performance Springs+Shocks) 325 d, 330 d, 335 d, 335 i	09.06 -	990	1090	E90-20-014-13-22	A, 18, 20, 78, 161	35	25							T
M	03.07 -	1060	1190	E90-20-014-17-22	A, 18, 20, 21, 78, 159, 161	20	15							T
Pro-Street-S (Gewindefahrwerke - höhenverstellbar Coil-Overs-Adjustable Ride Height) 318 i, 320 d, 320 i, 323 i, 325 d, 325 i, 328 i, 330 d, 330 i, 335 d, 335 i	06.06 -	990	1085	PSS65-20-013-01-22	A, 18, 20, 24, 25, 45, 160	20-50	20-50							T
3 GRAN TURISMO (F34) Pro-Kit (Performance Fahrwerksfedern Performance Springs) 318 d, 320 d, 320 i, 328 i	03.13 -	965	1265	E10-20-031-03-22	A, 18, 20	30-40	25-30					F11-20-031-01-VA	F11-20-031-03-HA	T
325 d, 335 i	03.13 -	1000	1265	E10-20-031-04-22	A, 18, 20	30-40	25-30					F11-20-031-02-VA	F11-20-031-03-HA	T
Sportline (Performance Fahrwerksfedern Sport Sport Performance Springs) 318 d, 320 d, 320 i, 328 i	03.13 -	950	1265	E20-20-031-02-22	A, 18, 20	40-50	35-40					F21-20-031-01-VA	F21-20-031-02-HA	T
Anti-Roll-Kit (Performance Stabilisatoren Performance Sway Bars) 318 d, 320 d, 320 i, 325 d, 328 i	03.13 -			E40-20-031-02-11	A, 18, 20, 22, 45			28 Rohr 28 tube	16	2-fach verstellbar 2-way adjustable	nicht verstellbar not adjustable	AS41-20-031-02-VA	AS41-20-031-01-HA	T
335 i	03.13 -			E40-20-031-01-11	A, 18, 20, 22, 45			28 Rohr 28 tube	16	2-fach verstellbar 2-way adjustable	nicht verstellbar not adjustable	AS41-20-031-01-VA	AS41-20-031-01-HA	T
B12 Pro-Kit (Performance Komplettfahrwerke Performance Springs+Shocks) 318 d, 320 d, 320 i, 328 i	03.13 -	965	1265	E90-20-031-03-22	A, 18, 20, 78, 161	25-30	25							T
325 d, 335 i	03.13 -	990	1265	E90-20-031-04-22	A, 18, 20, 78, 161	25-30	25							T
B12 Sportline (Performance Komplettfahrwerke Sport Sport Performance Springs+Shocks) 318 d, 320 d, 320 i, 325 d, 328 i	03.13 -	950	1265	E95-20-031-02-22	A, 18, 20, 78, 161	40-50	35-40							T
3 Touring (E30) Anti-Roll-Kit (Performance Stabilisatoren Performance Sway Bars) 316 i, 318 i, 320 i, 324 td, 325 i	07.87 - 06.94			E2003-320	A, 18, 20, 22, 45			20	16	3-fach verstellbar 3-way adjustable	3-fach verstellbar 3-way adjustable	AS2003320VA	AS2003320HA	T
3 Touring (E36) Pro-Kit (Performance Fahrwerksfedern Performance Springs) 316 i, 318 i	07.95 - 10.99	830	1115	E2052-140	A, 18, 20, 68	30	30					F2021101	F2042002	ABE
318 tds, 320 i, 323 i, 325 tds, 328 i	01.95 - 10.99	900	1115	E2050-140	A, 18, 20, 68	30	30					F2033001	F2042002	ABE
Sportline (Performance Fahrwerksfedern Sport Sport Performance Springs) 316 i, 318 i	07.95 - 10.99	830	1115	E20-20-004-03-22	A, 20, 68	45-50	30					F21-20-004-01-VA	F21-20-004-04-HA	T
318 tds, 320 i, 323 i, 325 tds, 328 i	01.95 - 10.99	900	1115	E20-20-004-04-22	A, 20, 68	45-50	30					F21-20-004-02-VA	F21-20-004-04-HA	T
Anti-Roll-Kit (Performance Stabilisatoren Performance Sway Bars) 316 i, 318 i, 318 tds, 320 i, 323 i, 325 tds, 328 i	03.93 - 10.99			E2021-321	A, 18, 20, 22, 45			28	21	2-fach verstellbar 2-way adjustable	2-fach verstellbar 2-way adjustable	AS2021321VA	AS2021320HA	T
B12 Pro-Kit (Performance Komplettfahrwerke Performance Springs+Shocks) 316 i, 318 i	07.95 - 10.99	830	1115	E90-20-004-05-22	A, 18, 20, 68, 78, 161	30	30							T
318 tds, 320 i, 323 i, 325 tds, 328 i	01.95 - 10.99	900	1115	E90-20-004-06-22	A, 18, 20, 68, 78, 161	30	30							T
B12 Sportline (Performance Komplettfahrwerke Sport Sport Performance Springs+Shocks) 316 i Schaltgetriebe, 318 i Schaltgetriebe 316 i manual transmission, 318 i manual transmission 318 tds, 320 i, 323 i, 325 tds, 328 i	07.95 - 10.99	830	1115	E95-20-004-05-22	A, 18, 20, 68, 71, 78, 161	45-30	30							T
	01.95 - 10.99	900	1115	E95-20-004-06-22	A, 18, 20, 68, 78, 161	45-30	30							T
Pro-Street-S (Gewindefahrwerke - höhenverstellbar Coil-Overs-Adjustable Ride Height) 316 i, 318 i, 318 tds, 320 i, 323 i, 325 tds, 328 i	01.95 - 10.99	890	1150	PSS65-20-004-01-22	A, 24, 25, 45, 160	40-80	40-80							T
3 Touring (E46) Pro-Kit (Performance Fahrwerksfedern Performance Springs) 316 i, 318 i	10.99 - 02.05	895	1190	E2066-140	A, 18, 20, 68	30	20-25					F2066001	F2067102	T
318 d, 320 d, 320 i, 325 i, 328 i, 330 i	10.99 - 02.05	970	1190	E2067-140	A, 18, 20, 68	30	20-25					F2067001	F2067102	T
325 xi, 330 xi	06.00 - 02.05	1010	1250	E10-20-001-05-22	A, 18	30	20-25					F2067001	F11-20-001-03-HA	T
330 d	10.99 - 02.05	1030	1190	E10-20-001-01-22	A, 18, 20, 68	30	20-25					F11-20-001-01-VA	F2067102	T
330 xd	06.00 - 02.05	1075	1250	E10-20-001-06-22	A, 18	30	20-25					F11-20-001-01-VA	F11-20-001-03-HA	T
Sportline (Performance Fahrwerksfedern Sport Sport Performance Springs) 316 i, 318 i	10.99 - 02.05	895	1190	E20-20-001-04-22	A, 20, 68	45-50	30					F21-20-001-01-VA	F21-20-001-02-HA	T
318 d, 320 d, 320 i, 325 i, 328 i, 330 i	10.99 - 02.05	935	1190	E20-20-001-03-22	A, 20, 68	45-50	30					F21-20-001-02-VA	F21-20-001-02-HA	T
Anti-Roll-Kit (Performance Stabilisatoren Performance Sway Bars) 316 i, 318 d, 318 i, 320 d, 320 i, 325 i, 328 i, 330 d, 330 i	10.99 - 02.05			E2066-320	A, 18, 20, 22, 45			27	21	2-fach verstellbar 2-way adjustable	nicht verstellbar not adjustable	AS2066320VA	AS2066320HA	T
B12 Pro-Kit (Performance Komplettfahrwerke Performance Springs+Shocks) 316 i, 318 i	10.99 - 02.05	895	1190	E90-20-001-01-22	A, 18, 20, 68, 78, 161	30	20-25							T
318 d, 320 d, 320 i, 325 i, 328 i, 330 i	10.99 - 02.05	970	1190	E90-20-001-02-22	A, 18, 20, 68, 78, 161	30	20-25							T
330 d	10.99 - 02.05	1030	1190	E90-20-001-03-22	A, 18, 20, 68, 78, 161	30	20-25							T
B12 Sportline (Performance Komplettfahrwerke Sport Sport Performance Springs+Shocks) 316 i, 318 i	10.99 - 02.05	895	1190	E95-20-001-04-22	A, 18, 20, 68, 78, 161	45-50	30							T
318 d, 320 d, 320 i, 325 i, 328 i	10.99 - 02.05	935	1190	E95-20-001-03-22	A, 18, 20, 68, 78, 161	45-50	30							T
330 i	06.00 - 02.05	935	1190	E95-20-001-03-22	A, 18, 20, 68, 71, 78, 161	45-50	30							T
Pro-Street-S (Gewindefahrwerke - höhenverstellbar Coil-Overs-Adjustable Ride Height) 316 i, 318 d, 318 i, 320 d, 320 i, 325 i, 328 i	10.99 - 02.05	910	1215	PSS65-20-001-01-22	A, 24, 25, 45, 160	40-75	40-75							T

Modell	Baujahr	Achslast Vorne kg	Achslast Hinten kg	Artikel-Nr.	Hinweise	ca. Tieferl. Vorne mm	ca. Tieferl. Hinten mm	Ø Vorne mm	Ø Hinten mm	Verstellbarkeit Vorne	Verstellbarkeit Hinten	Ersatzteilbezeichnung Vorne	Ersatzteilbezeichnung Hinten	Gutachten
Model	Year	Front Axle Load kg	Rear Axle Load kg	Part-No.	Notes	ca. Lowering Front mm	ca. Lowering Rear mm	Ø Front mm	Ø Rear mm	Adjustable Front	Adjustable Rear	Spare Part Marking Front	Spare Part Marking Rear	Homologation
3 Touring (E46) <i>Pro-Street-S (Gewindefahrwerke - höhenverstellbar Coil-Overs-Adjustable Ride Height)</i> 316 i, 318 d, 318 i, 320 d, 320 i, 325 i, 328 i, 330 d, 330 i	10.99 - 02.05	1000	1215	PSS65-20-001-02-22	A, 24, 25, 45, 160	40-75	40-75							T
3 Touring (E91) <i>Pro-Kit (Performance Fahrwerksfedern Performance Springs)</i> 318 i, 320 i	09.05 -	935	1135	E10-20-014-05-22	A, 18, 20	30	25					F11-20-013-01-VA	F11-20-013-01-HA	ABE
316 d, 318 d, 320 d, 323 i, 325 i, 330 i	09.05 -	1045	1200	E10-20-014-06-22	A, 18, 20	30	25					F11-20-013-02-VA	F11-20-014-05-HA	ABE
320 d xDrive, 320 xd, 320d xDrive, 325 i xDrive, 325 xi, 330 i xDrive, 330 xi	09.05 -	1045	1200	E10-20-014-10-22	A, 18	30	25					F11-20-013-02-VA	F11-20-014-10-HA	ABE
325 d, 330 d	09.05 -	1090	1200	E10-20-014-07-22	A, 18, 20	30	25					F11-20-014-04-VA	F11-20-014-05-HA	ABE
330 xDrive, 330 xd	09.05 -	1090	1200	E10-20-014-11-22	A, 18	30	25					F11-20-014-04-VA	F11-20-014-10-HA	ABE
335 d, 335 i	09.06 -	1090	1200	E10-20-014-07-22	A, 18, 20	20	0					F11-20-014-04-VA	F11-20-014-05-HA	ABE
335 i xDrive, 335 xi	09.07 -	1090	1200	E10-20-014-11-22	A, 18	20	10					F11-20-014-04-VA	F11-20-014-10-HA	ABE
Sportline (Performance Fahrwerksfedern Sport Sport Performance Springs) 318 i, 320 i	09.05 -	935	1135	E20-20-014-03-22	A, 18, 20	45-50	35					F21-20-013-01-VA	F21-20-013-01-HA	ABE
316 d, 318 d, 320 d, 323 i, 325 i, 330 i	09.05 -	955	1175	E20-20-014-04-22	A, 18, 20	45-50	35					F21-20-013-02-VA	F21-20-014-03-HA	ABE
Anti-Roll-Kit (Performance Stabilisatoren Performance Sway Bars) 316 d, 318 d, 318 i, 320 d, 320 i, 323 i, 325 d, 325 i, 330 d, 330 i, 335 d, 335 i	09.05 -			E40-20-013-01-11	A, 18, 20, 22, 45			28	15	nicht verstellbar not adjustable	nicht verstellbar not adjustable	AS41-20-013-01-VA	AS41-20-013-01-HA	T
B12 Pro-Kit (Performance Komplettfahrwerke Performance Springs+Shocks) 316 i, 318 i, 320 i	09.05 -	935	1135	E90-20-014-05-22	A, 18, 20, 78, 161	30	25							T
316 d, 318 d, 320 d, 323 i, 325 i, 330 i	09.05 -	1045	1200	E90-20-014-06-22	A, 18, 20, 78, 161	30	25							T
320 d xDrive, 320 xd, 320d xDrive, 325 i xDrive, 325 xi, 330 i xDrive, 330 xi	09.05 -	1045	1200	E90-20-014-10-22	A, 18, 78, 161	30	25							T
325 d, 330 d, 335 d, 335 i	09.05 -	1090	1200	E90-20-014-07-22	A, 18, 20, 78, 161	30	25							T
330 xDrive, 330 xd, 335 i xDrive, 335 xi	09.05 -	1090	1200	E90-20-014-11-22	A, 18, 78, 161	30	25							T
B12 Sportline (Performance Komplettfahrwerke Sport Sport Performance Springs+Shocks) 316 i, 318 i, 320 i	09.05 -	935	1135	E95-20-014-03-22	A, 18, 20, 78, 161	45-50	35							T
316 d, 318 d, 320 d, 323 i, 325 i, 330 i, 335 i	09.05 -	955	1175	E95-20-014-04-22	A, 18, 20, 78, 161	45-50	35							T
Pro-Street-S (Gewindefahrwerke - höhenverstellbar Coil-Overs-Adjustable Ride Height) 316 d, 318 d, 318 i, 320 d, 320 i, 323 i, 325 i, 330 i	09.05 -	1020	1200	PSS65-20-014-02-22	A, 18, 20, 24, 25, 45, 160	30-60	30-60							T
3 Touring (F31) <i>Pro-Kit (Performance Fahrwerksfedern Performance Springs)</i> 316 d, 316 i, 318 d, 320 d, 320 i, 328 i	06.12 -	965	1265	E10-20-031-03-22	A, 18, 20	25-30	25					F11-20-031-01-VA	F11-20-031-03-HA	ABE
325 d, 330 d, 335 i	06.12 -	1000	1265	E10-20-031-04-22	A, 18, 20	25-30	25					F11-20-031-02-VA	F11-20-031-03-HA	ABE
Sportline (Performance Fahrwerksfedern Sport Sport Performance Springs) 320 d	06.12 -	950	1265	E20-20-031-02-22	A, 18, 20	35	35					F21-20-031-01-VA	F21-20-031-02-HA	T
316 d, 316 i, 318 d, 320 i, 328 i	06.12 -	950	1265	E20-20-031-02-22	A, 18, 20	40	35					F21-20-031-01-VA	F21-20-031-02-HA	T
Anti-Roll-Kit (Performance Stabilisatoren Performance Sway Bars) 316 d, 316 i, 318 d, 320 d, 320 i, 325 d, 328 i	06.12 -			E40-20-031-02-11	A, 18, 20, 22, 45			28 Rohr 28 tube	16	2-fach verstellbar 2-way adjustable	nicht verstellbar not adjustable	AS41-20-031-02-VA	AS41-20-031-01-HA	T
330 d, 335 i	06.12 -			E40-20-031-01-11	A, 18, 20, 22, 45			28 Rohr 28 tube	16	2-fach verstellbar 2-way adjustable	nicht verstellbar not adjustable	AS41-20-031-01-VA	AS41-20-031-01-HA	T
B12 Pro-Kit (Performance Komplettfahrwerke Performance Springs+Shocks) 316 d, 316 i, 318 d, 320 d, 320 i, 328 i	06.12 -	965	1265	E90-20-031-03-22	A, 18, 20, 78, 161	25-30	25							T
325 d, 330 d, 335 i	06.12 -	990	1265	E90-20-031-04-22	A, 18, 20, 78, 161	25-30	25							T
B12 Sportline (Performance Komplettfahrwerke Sport Sport Performance Springs+Shocks) 316 d, 316 i, 318 d, 320 d, 320 i, 325 d, 328 i	06.12 -	950	1265	E95-20-031-02-22	A, 18, 20, 78, 161	40	35							T
Pro-Tronic (Elektronische Performance Fahrwerksmodule Electronic Performance Suspension Modul) Alle Motorisierungen / all motorisation	06.12 -			AM65-20-030-01-22	A, 175									
4 Coupe (F32) <i>Pro-Kit (Performance Fahrwerksfedern Performance Springs)</i> 420 d, 428 i	07.13 -	965	1170	E10-20-031-01-22	A, 18, 20	15-20	5-10					F11-20-031-01-VA	F11-20-031-01-HA	T
435 i	07.13 -	1000	1170	E10-20-031-02-22	A, 18, 20	15-20	5-10					F11-20-031-02-VA	F11-20-031-01-HA	T
Sportline (Performance Fahrwerksfedern Sport Sport Performance Springs) 420 d, 428 i	07.13 -	950	1160	E20-20-031-01-22	A, 18, 20	25	20					F21-20-031-01-VA	F21-20-031-01-HA	T
Anti-Roll-Kit (Performance Stabilisatoren Performance Sway Bars) 420 d, 428 i	07.13 -			E40-20-031-02-11	A, 18, 20, 22, 45			28 Rohr 28 tube	16	2-fach verstellbar 2-way adjustable	nicht verstellbar not adjustable	AS41-20-031-02-VA	AS41-20-031-01-HA	T
435 i	07.13 -			E40-20-031-01-11	A, 18, 20, 22, 45			28 Rohr 28 tube	16	2-fach verstellbar 2-way adjustable	nicht verstellbar not adjustable	AS41-20-031-01-VA	AS41-20-031-01-HA	T
5 (E34) <i>Pro-Kit (Performance Fahrwerksfedern Performance Springs)</i> 518 i, 520 i, 520 i 24V, 525 i, 525 i 24V	01.88 - 09.95	970	1300	E2014-140	A, 18, 20	25-35	20-30					F2014001	F2013002	ABE
524 td, 525 td, 525 tds, 530 i, 530 i V8, 535 i, 540 i V8	01.88 - 09.95	1060	1300	E2013-140	A, 18, 20	25-35	20-30					F2013101	F2013002	ABE
Sportline (Performance Fahrwerksfedern Sport Sport Performance Springs) 518 i, 520 i, 520 i 24V, 524 td, 525 i, 525 i 24V, 525 td, 525 tds, 530 i, 535 i	01.88 - 09.95	975	1300	E20-20-003-01-22	A, 18, 20	45-50	30					F21-20-003-01-VA	F21-20-003-01-HA	T

Modell	Baujahr	Achslast Vorne kg	Achslast Hinten kg	Artikel-Nr.	Hinweise	ca. Tieferl. Vorne mm	ca. Tieferl. Hinten mm	Ø Vorne mm	Ø Hinten mm	Verstellbarkeit Vorne	Verstellbarkeit Hinten	Ersatzteilbezeichnung Vorne	Ersatzteilbezeichnung Hinten	Gutachten
Model	Year	Front Axle Load kg	Rear Axle Load kg	Part-No.	Notes	ca. Lowering Front mm	ca. Lowering Rear mm	Ø Front mm	Ø Rear mm	Adjustable Front	Adjustable Rear	Spare Part Marking Front	Spare Part Marking Rear	Homologation
5 (E34) B12 Pro-Kit (Performance Komplettfahrwerke Performance Springs+Shocks) 518 i, 520 i, 520 i 24V, 525 i 24V	01.88 - 09.95	970	1300	E90-20-003-01-22	A, 18, 20, 78, 161	25-35	20-30							T
525 i, 525 i 24V	01.88 - 07.90	970	1300	E90-20-003-02-22	A, 18, 20, 78, 161	25-35	20-30							T
525 i, 525 i 24V	08.90 - 09.92	970	1300	E90-20-003-03-22	A, 18, 20, 78, 161	25-35	20-30							T
524 td, 525 tds, 530 i, 535 i	01.88 - 09.95	1060	1300	E90-20-003-06-22	A, 18, 20, 78, 131, 161	25-35	20-30							T
524 td, 525 td, 525 tds	03.88 - 09.95	1060	1300	E90-20-003-04-22	A, 18, 20, 78, 132, 161	25-35	20-30							T
524 td, 530 i, 535 i	01.88 - 07.90	1060	1300	E90-20-003-05-22	A, 18, 20, 78, 161	25-35	20-30							T
B12 Sportline (Performance Komplettfahrwerke Sport Sport Performance Springs+Shocks) 518 i, 520 i, 520 i 24V, 525 i 24V, 525 td, 525 tds	01.88 - 09.95	975	1300	E95-20-003-01-22	A, 18, 20, 78, 161	45-50	30							T
524 td, 525 i, 525 i 24V, 530 i, 535 i	01.88 - 07.90	975	1300	E95-20-003-02-22	A, 18, 20, 78, 161	45-50	30							T
524 td, 525 i, 525 i 24V, 525 tds, 530 i, 535 i	01.88 - 09.95	975	1300	E95-20-003-03-22	A, 18, 20, 78, 161	45-50	30							T
5 (E39) Pro-Kit (Performance Fahrwerksfedern Performance Springs) 520 d, 520 i, 523 i, 525 i, 525 td, 525 tds, 528 i, 530 i	11.95 - 06.03	1065	1290	E2053-140	A, 12, 18, 20, 21	30	20-25					F2067001	F2053002	T
525 d, 530 d	08.98 - 06.03	1100	1290	E2069-140	A, 12, 18, 20, 21	30	20-25					F2069001	F2053002	T
535 i, 540 i	04.96 - 06.03	1110	1290	E2063-140	A, 20, 21	30	20-25					F2054001	F2063002	T
Sportline (Performance Fahrwerksfedern Sport Sport Performance Springs) 520 d, 520 i, 523 i, 525 i, 525 td, 525 tds, 528 i, 530 i	11.95 - 06.03	1040	1170	E20-20-005-01-22	A, 20, 21, 68	45-50	30					F21-20-005-01-VA	F21-20-005-01-HA	T
Anti-Roll-Kit (Performance Stabilisatoren Performance Sway Bars) 520 d, 520 i, 523 i, 525 d, 525 i, 525 td, 525 tds, 528 i, 530 d, 530 i	11.95 - 06.03			E2053-320	A, 18, 20, 22, 45			27	18	2-fach verstellbar 2-way adjustable	nicht verstellbar not adjustable	AS2053320VA	AS2053320HA	T
535 i, 540 i	04.96 - 06.03			E2054-320	A, 18, 20, 22, 45			28	18	nicht verstellbar not adjustable	nicht verstellbar not adjustable	AS2054320VA	AS2053320HA	T
B12 Pro-Kit (Performance Komplettfahrwerke Performance Springs+Shocks) 520 d, 520 i, 523 i, 525 i, 525 td, 525 tds, 528 i, 530 i	11.95 - 06.03	1065	1290	E90-20-005-01-22	A, 12, 18, 20, 21, 78, 161	30	20-25							T
525 d, 530 d	08.98 - 06.03	1100	1290	E90-20-005-02-22	A, 12, 18, 20, 21, 78, 161	30	20-25							T
535 i, 540 i	04.96 - 06.03	1100	1290	E90-20-005-03-22	A, 18, 20, 21, 78, 161	30	20-25							T
B12 Sportline (Performance Komplettfahrwerke Sport Sport Performance Springs+Shocks) 520 d, 520 i, 523 i, 525 i, 525 td, 525 tds, 528 i, 530 i	11.95 - 06.03	1040	1170	E95-20-005-01-22	A, 18, 20, 21, 68, 78, 161	45-50	30							T
Pro-Street-S (Gewindefahrwerke - höhenverstellbar Coil-Overs-Adjustable Ride Height) 520 d, 520 i, 523 i, 525 d, 525 i, 525 td, 525 tds, 528 i, 530 i	11.95 - 06.03	1020	1200	PSS65-20-005-01-22	A, 18, 20, 23, 25, 36, 45, 160	35-65	35-65							T
520 d, 520 i, 523 i, 525 d, 525 i, 525 td, 525 tds, 528 i, 530 i, 535 i, 540 i	11.95 - 06.03	1090	1200	PSS65-20-005-02-22	A, 18, 20, 23, 25, 36, 45, 160	35-65	35-65							T
5 (E60) Pro-Kit (Performance Fahrwerksfedern Performance Springs) 520 d, 520 i, 523 i, 525 i, 530 i	07.03 - 03.10	990	1245	E10-20-011-01-22	A, 18, 20, 21	30	30					F2067001	F11-20-011-01-HA	T
525 d, 530 d, 535 d	07.03 - 03.10	1070	1245	E10-20-011-02-22	A, 18, 20, 21	30	30					F2069001	F11-20-011-01-HA	T
540 i, 545 i, 550 i	09.03 - 03.10	1070	1275	E10-20-011-03-22	A, 18, 20, 21	30	30					F2069001	F11-20-011-03-HA	T
M	09.04 - 03.10	1090	1270	E10-20-011-06-22	A, 18, 20	30	15					F11-20-011-06-VA	F11-20-011-06-HA	T
Sportline (Performance Fahrwerksfedern Sport Sport Performance Springs) 520 d, 520 i, 523 i, 525 i, 530 i	07.03 - 03.10	990	1300	E20-20-011-01-22	A, 18, 20, 21	45-50	30					F21-20-005-01-VA	F21-20-011-01-HA	T
525 d, 530 d, 535 d, 540 i, 545 i, 550 i	07.03 - 03.10	1070	1300	E20-20-011-02-22	A, 18, 20, 21	45-50	30					F21-20-011-02-VA	F21-20-011-01-HA	T
Anti-Roll-Kit (Performance Stabilisatoren Performance Sway Bars) 520 d, 520 i, 523 i, 525 d, 525 i, 530 d, 530 i, 535 d, 540 i, 545 i, 550 i	07.03 - 03.10			E40-20-011-01-11	A, 18, 20, 22, 45			26	16	nicht verstellbar not adjustable	3-fach verstellbar 3-way adjustable	AS41-20-011-01-VA	AS41-20-011-01-HA	T
B12 Pro-Kit (Performance Komplettfahrwerke Performance Springs+Shocks) 520 d, 520 i, 523 i, 525 i, 530 i	07.03 - 03.10	990	1245	E90-20-011-01-22	A, 18, 20, 21, 78, 161	30	30							T
525 d, 530 d, 535 d	07.03 - 03.10	1070	1245	E90-20-011-02-22	A, 18, 20, 21, 78, 161	30	30							T
540 i, 545 i, 550 i	09.03 - 03.10	1070	1275	E90-20-011-03-22	A, 18, 20, 21, 78, 161	30	30							T
B12 Sportline (Performance Komplettfahrwerke Sport Sport Performance Springs+Shocks) 520 d, 520 i, 523 i, 525 i, 530 i	07.03 - 03.10	990	1300	E95-20-011-01-22	A, 18, 20, 21, 78, 161	45-50	30							T
525 d, 530 d, 535 d, 540 i, 545 i, 550 i	07.03 - 03.10	1070	1300	E95-20-011-02-22	A, 18, 20, 21, 78, 161	45-50	30							T
Pro-Street-S (Gewindefahrwerke - höhenverstellbar Coil-Overs-Adjustable Ride Height) 520 d, 520 i, 523 i, 525 d, 525 i, 530 d, 530 i, 535 d, 540 i, 545 i, 550 i	07.03 - 03.10	1070	1235	PSS65-20-011-01-22	A, 18, 20, 25, 45, 160	25-55	25-55							T
5 (F10) Pro-Kit (Performance Fahrwerksfedern Performance Springs) 518 d, 520 d, 520 i, 523 i, 528 i, 530 i	03.10 -	1070	1310	E10-20-022-01-22	A, 18, 20	30	30					F11-20-022-01-VA	F11-20-022-01-HA	T
518 d, 520 d, 520 i, 523 i, 528 i, 530 i	03.10 -	1070	1410	E10-20-022-04-20	A	30	25					F11-20-022-01-VA	Luftfederverstellung air suspension	T
520 d xDrive, 525 d xDrive, 528 i xDrive, 535 i xDrive	03.10 -	1170	1340	E10-20-022-10-22	A	30	30					F11-20-022-01-VA	F11-20-022-03-HA	T
520 d xDrive, 525 d xDrive, 528 i xDrive, 535 i xDrive	03.10 -	1170	1410	E10-20-022-04-20	A	30	25					F11-20-022-01-VA	Luftfederverstellung air suspension	T
M	06.11 -	1180	1260	E10-20-022-09-22	A, 18, 20	25	25					F11-20-022-09-VA	F11-20-022-09-HA	T

Modell	Baujahr	Achslast Vorne kg	Achslast Hinten kg	Artikel-Nr.	Hinweise	ca. Tieferl. Vorne mm	ca. Tieferl. Hinten mm	Ø Vorne mm	Ø Hinten mm	Verstellbarkeit Vorne	Verstellbarkeit Hinten	Ersatzteilbezeichnung Vorne	Ersatzteilbezeichnung Hinten	Gutachten
Model	Year	Front Axle Load kg	Rear Axle Load kg	Part-No.	Notes	ca. Lowering Front mm	ca. Lowering Rear mm	Ø Front mm	Ø Rear mm	Adjustable Front	Adjustable Rear	Spare Part Marking Front	Spare Part Marking Rear	Homologation
5 (F10) Pro-Kit (Performance Fahrwerksfedern Performance Springs) 525 d, 530 d, 535 d, 535 i	03.10 -	1200	1310	E10-20-022-02-22	A, 18	30	30					F11-20-022-02-VA	F11-20-022-01-HA	T
525 d, 530 d, 535 d, 535 i	03.10 -	1200	1410	E10-20-022-05-20	A, 20	30	25					F11-20-022-02-VA	Luftfederverstellung air suspension	T
550 i	03.10 -	1250	1340	E10-20-022-03-22	A, 18	30	30					F11-20-022-03-VA	F11-20-022-03-HA	T
530 d xDrive, 535 d xDrive, 550 i xDrive, M 550 d xDrive	09.10 -	1250	1340	E10-20-022-11-22	A	30	30					F11-20-022-02-VA	F11-20-022-03-HA	T
550 i	03.10 -	1250	1410	E10-20-022-08-20	A	30	25					F11-20-022-03-VA	Luftfederverstellung air suspension	T
530 d xDrive, 535 d xDrive, 550 i xDrive, M 550 d xDrive	09.10 -	1250	1410	E10-20-022-05-20	A, 20	30	25					F11-20-022-02-VA	Luftfederverstellung air suspension	T
B12 Pro-Kit (Performance Komplettfahrwerke Performance Springs+Shocks) 520 i, 523 i, 528 i	03.10 -	1070	1310	E90-20-022-01-22	A, 18, 20, 21, 78, 161	30	30							T
520 d, 528 i	03.10 -	1070	1310	E90-20-022-01-22	A, 20, 21, 78, 161	30	30							T
525 d, 530 d, 530 i, 535 d, 535 i	03.10 -	1190	1310	E90-20-022-02-22	A, 18, 20, 21, 78, 161	30	30							T
525 d, 530 d	03.10 -	1190	1310	E90-20-022-02-22	A, 20, 21, 78, 161	30	30							T
550 i	03.10 -	1250	1320	E90-20-022-03-22	A, 20, 21, 78, 161	30	30							T
5 GRAN TURISMO (F07) Pro-Kit (Performance Fahrwerksfedern Performance Springs) 530 d, 530 d xDrive, 535 d, 535 d xDrive, 535 i, 535 i xDrive	10.09 -	1235	1500	E10-20-018-03-20	A	25	10-15					F11-20-018-01-VA	Luftfederverstellung air suspension	T
550 i, 550 i xDrive	10.09 -	1340	1500	E10-20-018-04-20	A	25	10-15					F11-20-018-02-VA	Luftfederverstellung air suspension	T
5 Touring (E34) Pro-Kit (Performance Fahrwerksfedern Performance Springs) 518 g, 518 i, 520 i, 525 i	11.91 - 01.97	970	1300	E2014-140	A, 18, 20	25-35	20-30					F2014001	F2013002	ABE
525 td, 525 tds, 530 i V8, 540 i	12.91 - 01.97	1060	1300	E2013-140	A, 18, 20	25-35	20-30					F2013101	F2013002	ABE
B12 Pro-Kit (Performance Komplettfahrwerke Performance Springs+Shocks) 518 i, 520 i, 525 i	11.91 - 01.97	970	1300	E90-20-003-01-22	A, 18, 20, 78, 161	25-35	20-30							T
525 td, 525 tds, 530 i V8, 540 i	12.91 - 01.97	1060	1300	E90-20-003-06-22	A, 18, 20, 78, 161	25-35	20-30							T
5 Touring (E39) Pro-Kit (Performance Fahrwerksfedern Performance Springs) 520 d, 520 i, 523 i, 525 i, 525 tds, 528 i, 530 i	01.97 - 05.04	1065	1390	E2061-140	A, 12, 18, 20, 21	30	25-30					F2067001	F2061002	T
520 d, 520 i, 523 i, 525 i, 525 tds, 528 i, 530 i	01.97 - 05.04	1065	1390	E2064-120	A, 20, 21	30	25					F2067001	Luftfederverstellung air suspension	T
525 d, 530 d	08.98 - 05.04	1100	1390	E2070-140	A, 12, 18, 20, 21	30	25-30					F2069001	F2061002	T
525 d, 530 d	08.98 - 05.04	1100	1390	E2071-120	A, 12, 20, 21	30	25					F2069001	Luftfederverstellung air suspension	T
540 i	01.97 - 05.04	1100	1390	E2065-120	A, 20, 21	30	25					F2054001	Luftfederverstellung air suspension	T
Anti-Roll-Kit (Performance Stabilisatoren Performance Sway Bars) 520 d, 520 i, 523 i, 525 d, 525 i, 525 tds, 528 i, 530 d, 530 i	01.97 - 05.04			E2053-320	A, 18, 20, 22, 45			27	18	2-fach verstellbar 2-way adjustable	nicht verstellbar not adjustable	AS2053320VA	AS2053320HA	T
540 i	01.97 - 05.04			E2054-320	A, 18, 20, 22, 45			28	18	nicht verstellbar not adjustable	nicht verstellbar not adjustable	AS2054320VA	AS2053320HA	T
B12 Pro-Kit (Performance Komplettfahrwerke Performance Springs+Shocks) 520 d, 520 i, 523 i, 525 i, 525 tds, 528 i, 530 i	01.97 - 05.04	1065	1390	E90-20-005-04-22	A, 12, 18, 20, 21, 76, 78, 161	30	25							T
520 d, 520 i, 523 i, 525 i, 525 tds, 528 i, 530 i	01.97 - 05.04	1065	1390	E90-20-005-05-20	A, 20, 21, 78, 85, 161	30	25							T
525 d, 530 d	08.98 - 05.04	1100	1390	E90-20-005-06-22	A, 12, 18, 20, 21, 76, 78, 161	30	25-30							T
525 d, 530 d	08.98 - 05.04	1100	1390	E90-20-005-07-20	A, 20, 21, 78, 85, 161	30	25							T
540 i	01.97 - 05.04	1100	1390	E90-20-005-08-20	A, 20, 21, 78, 85, 161	30	25							T
5 Touring (E61) Pro-Kit (Performance Fahrwerksfedern Performance Springs) 520 d, 520 i, 523 i, 525 i, 530 i	06.04 -	990	1300	E10-20-011-04-20	A, 20	30	30					F2067001	Luftfederverstellung air suspension	T
525 d, 530 d, 535 d, 545 i, 550 i	06.04 -	1070	1300	E10-20-011-05-20	A, 20	30	30					F2069001	Luftfederverstellung air suspension	T
B12 Pro-Kit (Performance Komplettfahrwerke Performance Springs+Shocks) 520 d, 520 i, 523 i, 525 i, 530 i	06.04 -	990	1300	E90-20-011-04-20	A, 20, 21, 78, 161	30	30							T
525 d, 530 d, 535 d, 545 i, 550 i	06.04 -	1070	1300	E90-20-011-05-20	A, 20, 21, 78, 161	30	30							T
Pro-Street-S (Gewindefahrwerke - höhenverstellbar Coil-Overs-Adjustable Ride Height) 520 d, 520 i, 523 i, 525 d, 525 i, 530 d, 530 i, 535 d, 545 i, 550 i	06.04 -	1070	1300	PSS65-20-011-02-22	A, 18, 20, 25, 45, 160	25-45	25-45							T
5 Touring (F11) Pro-Kit (Performance Fahrwerksfedern Performance Springs) 518 d, 520 d, 520 i, 523 i, 528 i, 530 i	09.10 -	1070	1410	E10-20-022-04-20	A	30	25					F11-20-022-01-VA	Luftfederverstellung air suspension	T
520 d xDrive, 525 d xDrive, 528 i xDrive, 530 d xDrive, 535 i xDrive	09.11 -	1170	1410	E10-20-022-04-20	A	30	25					F11-20-022-01-VA	Luftfederverstellung air suspension	T
525 d, 530 d, 535 d, 535 i	09.10 -	1200	1410	E10-20-022-05-20	A, 20	30	25					F11-20-022-02-VA	Luftfederverstellung air suspension	T
535 d xDrive	09.11 -	1250	1410	E10-20-022-05-20	A	30	25					F11-20-022-02-VA	Luftfederverstellung air suspension	T
550 i	09.10 -	1250	1410	E10-20-022-08-20	A	30	25					F11-20-022-03-VA	Luftfederverstellung air suspension	T

Modell	Baujahr	Achslast Vorne kg	Achslast Hinten kg	Artikel-Nr.	Hinweise	ca. Tieferl. Vorne mm	ca. Tieferl. Hinten mm	Ø Vorne mm	Ø Hinten mm	Verstellbarkeit Vorne	Verstellbarkeit Hinten	Ersatzteilbezeichnung Vorne	Ersatzteilbezeichnung Hinten	Gutachten
Model	Year	Front Axle Load kg	Rear Axle Load kg	Part-No.	Notes	ca. Lowering Front mm	ca. Lowering Rear mm	Ø Front mm	Ø Rear mm	Adjustable Front	Adjustable Rear	Spare Part Marking Front	Spare Part Marking Rear	Homologation
5 Touring (F11) Pro-Kit (Performance Fahrwerksfedern Performance Springs) M 550 d xDrive	01.12 -	1250	1410	E10-20-022-05-20	A, 20	30	25					F11-20-022-02-VA	Luftfederverstellung dir suspension	T
B12 Pro-Kit (Performance Komplettfahrwerke Performance Springs+Shocks) 518 d, 520 i, 525 d, 528 i, 530 i	09.11 -	1070	1410	E90-20-022-08-20	A, 20, 21, 78, 161	30	25							T
520 d, 523 i, 528 i	09.10 -	1070	1410	E90-20-022-08-20	A, 20, 21, 78, 85, 161	30	25							T
530 d, 535 d	09.11 -	1200	1410	E90-20-022-09-20	A, 20, 21, 78, 161	30	25							T
525 d, 530 d, 535 d, 535 i	09.10 -	1200	1410	E90-20-022-09-20	A, 20, 21, 78, 85, 161	30	25							T
6 (E63) Pro-Kit (Performance Fahrwerksfedern Performance Springs) 630 i	09.04 -	980	1170	E10-20-012-04-22	A, 18, 20	25	20					F11-20-012-04-VA	F11-20-012-01-HA	T
635 d, 645 Ci, 650 i	01.04 -	1070	1170	E10-20-012-01-22	A, 18, 20	30	25-30					F11-20-012-01-VA	F11-20-012-01-HA	T
M	09.05 -	1120	1200	E10-20-012-03-22	A, 18, 20	25	15					F11-20-012-03-VA	F11-20-012-03-HA	T
B12 Pro-Kit (Performance Komplettfahrwerke Performance Springs+Shocks) 630 i	09.04 -	980	1170	E90-20-012-04-22	A, 18, 20, 78, 161	25	20							T
635 d, 645 Ci, 650 i	01.04 -	1070	1170	E90-20-012-01-22	A, 18, 20, 78, 161	30	25-30							T
6 Cabriolet (E64) 6 Convertible (E64) Pro-Kit (Performance Fahrwerksfedern Performance Springs) 630 i	09.04 -	1070	1270	E10-20-012-05-22	A, 18, 20	25	20					F11-20-012-01-VA	F11-20-012-02-HA	T
635 d, 645 Ci, 650 i	04.04 -	1100	1270	E10-20-012-02-22	A, 18, 20	30	25-30					F11-20-012-02-VA	F11-20-012-02-HA	T
B12 Pro-Kit (Performance Komplettfahrwerke Performance Springs+Shocks) 630 i	09.04 -	1070	1270	E90-20-012-05-22	A, 18, 20, 78, 161	25	20							T
635 d, 645 Ci, 650 i	04.04 -	1100	1270	E90-20-012-02-22	A, 18, 20, 78, 161	30	25-30							T
6 Cabriolet (F12) 6 Convertible (F12) Pro-Kit (Performance Fahrwerksfedern Performance Springs) 640 i	03.11 -	1140	1350	E10-20-029-01-22	A, 18, 20	25	20					F11-20-029-01-VA	F11-20-029-01-HA	T
640 d	09.11 -	1260	1350	E10-20-029-02-22	A, 18, 20	25	20					F11-20-029-02-VA	F11-20-029-01-HA	T
640 d xDrive, 640 i xDrive, 650 i, 650 i xDrive	03.11 -	1260	1350	E10-20-029-02-22	A, 18	25	20					F11-20-029-02-VA	F11-20-029-01-HA	T
6 Coupe (F13) Pro-Kit (Performance Fahrwerksfedern Performance Springs) 640 d, 640 i	11.10 -	1140	1330	E10-20-029-03-22	A, 18, 20	25	20					F11-20-029-01-VA	F11-20-029-03-HA	T
640 d xDrive, 640 i xDrive, 650 i, 650 i xDrive	11.10 -	1260	1330	E10-20-029-04-22	A, 18	25	20					F11-20-029-02-VA	F11-20-029-03-HA	T
6 Gran Coupe (F06) Pro-Kit (Performance Fahrwerksfedern Performance Springs) 640 d, 640 i	11.10 -	1140	1350	E10-20-029-01-22	A, 18, 20	25	20					F11-20-029-01-VA	F11-20-029-01-HA	T
M	12.12 -	1180	1260	E10-20-029-07-22	A, 18, 20	20	20					F11-20-029-07-VA	F11-20-029-07-HA	T
650 i, 650 i xDrive	11.11 -	1260	1350	E10-20-029-02-22	A, 18	25	20					F11-20-029-02-VA	F11-20-029-01-HA	T
7 (E32) Pro-Kit (Performance Fahrwerksfedern Performance Springs) 730 i,iL, 730 i,iL V8, 735 i,iL	09.86 - 09.94	1110	1280	E2016-140	A, 18, 20	25-35	25-30					F2016001	F2009002	T
740 i,iL V8	04.92 - 09.94	1110	1280	E2037-140	A, 18, 20	30	25					F2016001	F2009002	T
B12 Pro-Kit (Performance Komplettfahrwerke Performance Springs+Shocks) 730 i,iL, 735 i,iL	03.88 - 07.90	1110	1280	E90-20-026-01-22	A, 18, 20, 78, 121, 161	25-35	25-30							T
730 i,iL, 730 i,iL V8, 735 i,iL	08.90 - 09.94	1110	1280	E90-20-026-02-22	A, 18, 20, 78, 121, 161	25-35	25-30							T
740 i,iL V8	08.90 - 09.94	1110	1280	E90-20-026-03-22	A, 18, 20, 78, 121, 161	30	25							T
7 (E38) Pro-Kit (Performance Fahrwerksfedern Performance Springs) 730 i,iL, 735 i,iL, 740 i,iL, 750 i,iL	10.94 - 11.01	1230	1370	E2048-140	A, 18, 20, 68	30	30					F2048001	F2048002	T
730 i,iL, 735 i,iL, 740 i,iL, 750 i,iL	10.94 - 11.01	1230	1370	E2049-140	A, 20, 68	30	30					F2048001	F2049002	T
B12 Pro-Kit (Performance Komplettfahrwerke Performance Springs+Shocks) 730 i,iL, 740 i,iL, 750 i,iL	10.94 - 11.01	1230	1370	E90-20-027-01-22	A, 18, 20, 68, 78, 130, 161	30	25							T
7 (E65, E66) Pro-Kit (Performance Fahrwerksfedern Performance Springs) 730 d, 735 i, 735 i,Li, 740 i,Li, 745 i,Li, 750 i,Li	11.01 -	1215	1400	E10-20-006-01-22	A, 18, 20	25	25					F11-20-006-01-VA	F11-20-006-01-HA	T
730 d, 735 i, 735 i,Li, 740 i,Li, 745 i,Li, 750 i,Li	11.01 -	1215	1400	E10-20-006-05-20	A, 20	25	25					F11-20-006-01-VA	Luftfederverstellung air suspension	T
740 d, 745 d	10.02 -	1295	1400	E10-20-006-03-22	A, 18, 20	25	25					F11-20-006-03-VA	F11-20-006-01-HA	T
740 d, 745 d, 760 i,Li	10.02 -	1295	1400	E10-20-006-04-20	A, 20	25	25					F11-20-006-03-VA	Luftfederverstellung air suspension	T
7 (F01, F02, F03, F04) Pro-Kit (Performance Fahrwerksfedern Performance Springs) 730 d, 730 d xDrive, 730 i, 740 d, 740 d xDrive, 740 i	06.08 -	1235	1500	E10-20-018-03-20	A	25	20					F11-20-018-01-VA	Luftfederverstellung air suspension	T
730 d, 730 d xDrive, 730 i, 740 d, 740 d xDrive, 740 i	06.08 -	1235	1500	E10-20-018-01-22	A, 18	25	20					F11-20-018-01-VA	F11-20-018-01-HA	T

Modell	Baujahr	Achslast Vorne kg	Achslast Hinten kg	Artikel-Nr.	Hinweise	ca. Tieferl. Vorne mm	ca. Tieferl. Hinten mm	Ø Vorne mm	Ø Hinten mm	Verstellbarkeit Vorne	Verstellbarkeit Hinten	Ersatzteilbezeichnung Vorne	Ersatzteilbezeichnung Hinten	Gutachten
Model	Year	Front Axle Load kg	Rear Axle Load kg	Part-No.	Notes	ca. Lowering Front mm	ca. Lowering Rear mm	Ø Front mm	Ø Rear mm	Adjustable Front	Adjustable Rear	Spare Part Marking Front	Spare Part Marking Rear	Homologation
7 (F01, F02, F03, F04) Pro-Kit (Performance Fahrwerksfedern Performance Springs) 750 d xDrive, 750 i, 750 i xDrive	10.08 -	1340	1500	E10-20-018-04-20	A	25	20					F11-20-018-02-VA	Luftfederverstellung air suspension	T
750 i	10.08 -	1340	1500	E10-20-018-02-22	A, 18	25	20					F11-20-018-02-VA	F11-20-018-01-HA	T
8 (E31) Pro-Kit (Performance Fahrwerksfedern Performance Springs) 840 Ci, 840 i, 850 CSI, 850 Ci, 850 i, Ci	04.90 - 12.99	1150	1200	E2022-140	A, 18, 20	25	15-20					F2022001	F2022002	T
B12 Pro-Kit (Performance Komplettfahrwerke Performance Springs+Shocks) 840 Ci, 840 i, 850 CSI, 850 Ci	02.93 - 12.99	1150	1200	E90-20-028-01-22	A, 18, 20, 21, 68, 78, 161	25	15-20							T
850 i, Ci	04.90 - 10.94	1150	1200	E90-20-028-01-22	A, 18, 20, 21, 68, 78, 156, 161	25	15-20							T
X1 (E84) Pro-Kit (Performance Fahrwerksfedern Performance Springs) sDrive 16 d, sDrive 18 d, sDrive 18 i, sDrive 20 d, sDrive 20 i	03.09 -	940	1180	E10-20-020-01-22	A, 18, 20	25	25					F11-20-020-01-VA	F11-20-020-01-HA	T
xDrive 18 d, xDrive 20 d, xDrive 20 i, xDrive 23 d, xDrive 25 d, xDrive 25 i, xDrive 28 i	03.09 -	1030	1180	E10-20-020-02-22	A, 18	25	25					F11-20-020-02-VA	F11-20-020-01-HA	T
B12 Pro-Kit (Performance Komplettfahrwerke Performance Springs+Shocks) sDrive 18 d, sDrive 18 i, sDrive 20 d, sDrive 20 i	03.09 -	940	1180	E90-20-020-01-22	A, 18, 20, 78, 161	30	30							T
xDrive 18 d, xDrive 20 d, xDrive 20 i, xDrive 23 d, xDrive 25 d, xDrive 25 i, xDrive 28 i	03.09 -	1030	1180	E90-20-020-04-22	A, 18, 78, 161	30	30							T
X3 (E83) Pro-Kit (Performance Fahrwerksfedern Performance Springs) 2.0 d, 2.5 i, 2.5 si, 3.0 d, 3.0 i, 3.0 sd, 3.0 si, xDrive 20 d, xDrive 25 i, xDrive 30 d, xDrive 30 i	01.04 -	1177	1285	E10-20-009-04-22	A, 18	30-40	30					F11-20-009-04-VA	F11-20-009-04-HA	T
Anti-Roll-Kit (Performance Stabilisatoren Performance Sway Bars) 2.0 d, 2.0 i, 2.5 i, 2.5 si, 3.0 i, 3.0 si	01.04 -			E40-20-009-04-11	A, 18, 22, 45			27	23	nicht verstellbar not adjustable	nicht verstellbar not adjustable	AS41-20-009-04-VA	AS41-20-009-04-HA	T
B12 Pro-Kit (Performance Komplettfahrwerke Performance Springs+Shocks) 2.0 d, 2.5 i, 2.5 si, 3.0 d, 3.0 i, 3.0 sd, 3.0 si, xDrive 18 d, xDrive 20 d, xDrive 25 i, xDrive 30 d, xDrive 30 i, xDrive 35 d	01.04 -	1177	1285	E90-20-009-04-22	A, 18, 76, 78, 161	30-40	30							T
X3 (F25) Pro-Kit (Performance Fahrwerksfedern Performance Springs) xDrive 20 d, xDrive 20 i, xDrive 28 i	09.10 -	1080	1320	E10-20-024-01-22	A, 18	30	30					F11-20-024-01-VA	F11-20-024-01-HA	T
xDrive 30 d, xDrive 35 d, xDrive 35 i	09.10 -	1160	1320	E10-20-024-02-22	A, 18	30	30					F11-20-024-02-VA	F11-20-024-01-HA	T
X5 (E53) Pro-Kit (Performance Fahrwerksfedern Performance Springs) 3.0 i	05.00 -	1230	1630	E10-20-009-06-20	A	30	30					F11-20-009-01-VA	Luftfederverstellung air suspension	T
3.0 i	05.00 -	1230	1630	E10-20-009-01-22	A, 18	30	30					F11-20-009-01-VA	F11-20-009-01-HA	T
3.0 d	05.01 -	1250	1630	E10-20-009-02-22	A, 18	30	30					F11-20-009-02-VA	F11-20-009-01-HA	T
3.0 d, 4.4 i, 4.6 is	05.00 -	1250	1630	E10-20-009-03-20	A	30	30					F11-20-009-02-VA	Luftfederverstellung air suspension	T
Anti-Roll-Kit (Performance Stabilisatoren Performance Sway Bars) 3.0 d, 3.0 i, 4.4 i, 4.6 is	05.00 -			E40-20-009-01-11	A, 18, 22, 45			34	26	nicht verstellbar not adjustable	nicht verstellbar not adjustable	AS41-20-009-01-VA	AS41-20-009-01-HA	T
B12 Pro-Kit (Performance Komplettfahrwerke Performance Springs+Shocks) 3.0 i	05.00 -	1230	1630	E90-20-009-01-22	A, 18, 76, 78, 161	30	30							T
3.0 d	05.01 -	1250	1630	E90-20-009-02-22	A, 18, 76, 78, 161	30	30							T
X5 (E70) Pro-Kit (Performance Fahrwerksfedern Performance Springs) M	09.09 -	1400	1755	E10-20-015-03-20	A	20	15-20					F11-20-017-03-VA	Luftfederverstellung air suspension	T
3.0 d, 3.0 sd, 3.0 si, 4.8 i, M 50 d, xDrive 30 d, xDrive 30 i, xDrive 30d, xDrive 35 d, xDrive 35 i, xDrive 40 d, xDrive 48 i, xDrive 50 i	02.07 -	1400	1755	E10-20-015-02-20	A	30-40	15-20					F11-20-015-01-VA	Luftfederverstellung air suspension	T
3.0 d, 3.0 sd, 3.0 si, xDrive 30 d, xDrive 30 i, xDrive 30d, xDrive 35 d, xDrive 35 i, xDrive 40 d	02.07 -	1400	1755	E10-20-015-01-22	A, 18	30-40	25					F11-20-015-01-VA	F11-20-015-01-HA	T
B12 Pro-Kit (Performance Komplettfahrwerke Performance Springs+Shocks) 3.0 d ohne 3. Sitzreihe, 3.0 sd ohne 3. Sitzreihe, 3.0 si ohne 3. Sitzreihe, xDrive 30 d ohne 3. Sitzreihe, xDrive 30 i ohne 3. Sitzreihe, xDrive 30d ohne 3. Sitzreihe, xDrive 35 d ohne 3. Sitzreihe, xDrive 35 i ohne 3. Sitzreihe, xDrive 40 d ohne 3. Sitzreihe 3.0 d without 3rd seating row, 3.0 sd without 3rd seating row, 3.0 si without 3rd seating row, xDrive 30 d without 3rd seating row, xDrive 30 i without 3rd seating row, xDrive 30d without 3rd seating row, xDrive 35 d without 3rd seating row, xDrive 35 i without 3rd seating row, xDrive 40 d without 3rd seating row	02.07 -	1400	1755	E90-20-015-01-22	A, 18, 78, 81, 161	30-40	25							T
X6 (E71, E72) Pro-Kit (Performance Fahrwerksfedern Performance Springs) 30 d, 35 d, 35 i, 50 i, M 50 d, xDrive 30 d, xDrive 35 d, xDrive 35 i, xDrive 40 d, xDrive 50 i	05.08 -	1365	1520	E10-20-017-02-20	A	20	15-20					F11-20-017-01-VA	Luftfederverstellung air suspension	T
30 d, 35 d, 35 i, 50 i, M 50 d, xDrive 30 d, xDrive 35 d, xDrive 35 i, xDrive 40 d, xDrive 50 i	05.08 -	1365	1520	E10-20-017-01-22	A, 18	20	20					F11-20-017-01-VA	F11-20-017-01-HA	T
50 i, M, xDrive 50 i	05.08 -	1400	1520	E10-20-017-04-20	A	20	15-20					F11-20-017-03-VA	Luftfederverstellung air suspension	T
50 i, xDrive 50 i	05.08 -	1400	1520	E10-20-017-03-22	A, 18	20	20					F11-20-017-03-VA	F11-20-017-01-HA	T

Modell	Baujahr	Achslast Vorne kg	Achslast Hinten kg	Artikel-Nr.	Hinweise	ca. Tieferl. Vorne mm	ca. Tieferl. Hinten mm	Ø Vorne mm	Ø Hinten mm	Verstellbarkeit Vorne	Verstellbarkeit Hinten	Ersatzteilbezeichnung Vorne	Ersatzteilbezeichnung Hinten	Gutachten
Model	Year	Front Axle Load kg	Rear Axle Load kg	Part-No.	Notes	ca. Lowering Front mm	ca. Lowering Rear mm	Ø Front mm	Ø Rear mm	Adjustable Front	Adjustable Rear	Spare Part Marking Front	Spare Part Marking Rear	Homologation
X6 (E71, E72) B12 Pro-Kit (Performance Komplettfahrwerke Performance Springs+Shocks) 30 d ohne 3. Sitzreihe, 35 d ohne 3. Sitzreihe, 35 i ohne 3. Sitzreihe, 50 i ohne 3. Sitzreihe, xDrive 30 d ohne 3. Sitzreihe, xDrive 35 d ohne 3. Sitzreihe, xDrive 35 i ohne 3. Sitzreihe, xDrive 40 d ohne 3. Sitzreihe, xDrive 50 i ohne 3. Sitzreihe 30 d without 3rd seating row, 35 d without 3rd seating row, 35 i without 3rd seating row, 50 i without 3rd seating row, xDrive 30 d without 3rd seating row, xDrive 35 d without 3rd seating row, xDrive 35 i without 3rd seating row, xDrive 40 d without 3rd seating row, xDrive 50 i without 3rd seating row	05.08 -	1365	1520	E90-20-017-01-22	A, 18, 78, 81, 161	20	20							T
Z3 (E36) Pro-Kit (Performance Fahrwerksfedern Performance Springs) 1.8, 1.9	10.95 - 01.03	755	870	E2060-140	A, 18, 20	30	30					F2021101	F2003102	T
2.0, 2.2, 2.8, 3.0	04.97 - 01.03	830	870	E2062-140	A, 18, 20	30	30					F2062001	F2003102	T
B12 Pro-Kit (Performance Komplettfahrwerke Performance Springs+Shocks) 1.8, 1.9	10.95 - 01.03	755	870	E90-20-002-01-22	A, 18, 20, 78, 161	30	30							T
2.0, 2.2, 2.8, 3.0	04.97 - 01.03	830	870	E90-20-002-02-22	A, 18, 20, 78, 161	30	30							T
Z3 Coupe (E36) Pro-Kit (Performance Fahrwerksfedern Performance Springs) 2.8, 3.0	07.97 - 06.03	830	870	E2068-140	A, 18, 20	30	30					F2062001	F2003102	T
B12 Pro-Kit (Performance Komplettfahrwerke Performance Springs+Shocks) 2.8, 3.0	07.97 - 06.03	830	870	E90-20-002-03-22	A, 18, 20, 78, 161	30	30							T
Z4 (E85) Pro-Kit (Performance Fahrwerksfedern Performance Springs) 2.2 i, 2.5 i, 2.5 si, 3.0 i, 3.0 si	02.03 -	790	860	E10-20-010-01-22	A, 18, 20	30	30					F11-20-010-01-VA	F11-20-010-01-HA	T
M	03.06 -	855	935	E10-20-010-04-22	A, 18, 20	20	10					F11-20-010-04-VA	F11-20-010-04-HA	T
B12 Pro-Kit (Performance Komplettfahrwerke Performance Springs+Shocks) 2.2 i, 2.5 i, 2.5 si, 3.0 i, 3.0 si	02.03 -	790	860	E90-20-010-01-22	A, 18, 20, 78, 161	30	30							T
M	03.06 -	855	935	E90-20-010-03-22	A, 18, 20, 78, 161	20	10							T
Z4 (E89) Pro-Kit (Performance Fahrwerksfedern Performance Springs) sDrive 18 i, sDrive 20 i, sDrive 23 i, sDrive 28 i, sDrive 30 i	05.09 -	800	975	E10-20-019-01-22	A, 18, 20	25	15					F11-20-019-01-VA	F11-20-019-01-HA	T
sDrive 35 i, sDrive 35 is	05.09 -	870	1000	E10-20-019-02-22	A, 18, 20	20	10					F11-20-013-01-VA	F11-20-001-02-HA	T
B12 Pro-Kit (Performance Komplettfahrwerke Performance Springs+Shocks) sDrive 20 i, sDrive 23 i, sDrive 28 i, sDrive 30 i	05.09 -	800	975	E90-20-019-01-22	A, 18, 20, 21, 78, 161	25	15							T
sDrive 35 i, sDrive 35 is	05.09 -	870	1000	E90-20-019-02-22	A, 18, 20, 21, 78, 161	20	20							T
Z4 Coupe (E86) Pro-Kit (Performance Fahrwerksfedern Performance Springs) 3.0 si	03.06 -	790	890	E10-20-010-05-22	A, 18, 20	30	20					F11-20-010-01-VA	F11-20-010-04-HA	T
M	03.06 -	855	935	E10-20-010-04-22	A, 18, 20	20	10					F11-20-010-04-VA	F11-20-010-04-HA	T
B12 Pro-Kit (Performance Komplettfahrwerke Performance Springs+Shocks) 3.0 si	03.06 -	790	890	E90-20-010-02-22	A, 18, 20, 78, 161	30	20							T
M	03.06 -	855	935	E90-20-010-03-22	A, 18, 20, 78, 161	20	10							T
CAPTIVA (C100, C140) Pro-Kit (Performance Fahrwerksfedern Performance Springs) 2.0 D, 2.0 D 4WD, 2.2 D, 2.2 D 4WD, 2.4, 2.4 4WD, 3.0 4WD, 3.2 4WD	06.06 -	1250	1350	E10-23-006-01-22	A, 18, 48	30	30					F11-23-006-01-VA	F11-23-006-01-HA	T
CRUZE (J300) Pro-Kit (Performance Fahrwerksfedern Performance Springs) 1.6, 1.8	05.09 -	1220	1000	E10-23-009-01-22	A, 18, 20	30	30					F11-65-019-04-VA	F6549002	T
Pro-Street-S (Gewindefahrwerke - höhenverstellbar Coil-Overs-Adjustable Ride Height) 1.6, 1.7 D, 1.8, 2.0 CDI	05.09 -	1220	1000	PSS65-65-020-01-22	A, 18, 20, 24, 25, 45, 160	40-70	45-75							T
CRUZE Schrägheck (J305) CRUZE Hatchback (J305) Pro-Kit (Performance Fahrwerksfedern Performance Springs) 1.4, 1.6, 1.8	06.11 -	1220	1000	E10-23-009-01-22	A, 18, 20	30	30					F11-65-019-04-VA	F6549002	T
Pro-Street-S (Gewindefahrwerke - höhenverstellbar Coil-Overs-Adjustable Ride Height) 1.4, 1.6, 1.7 D, 1.8, 2.0 CDI	06.11 -	1220	1000	PSS65-65-020-01-22	A, 18, 20, 24, 25, 45, 160	40-70	45-75							T
CRUZE Station Wagon (J308) Pro-Kit (Performance Fahrwerksfedern Performance Springs) 1.4, 1.6, 1.7 TD, 1.8, 2.0 TD	08.12 -	1220	1000	E10-23-009-03-22	A, 18, 20	30	30					F11-65-019-04-VA	F11-23-007-01-HA	T
Espero (KLEJ) Pro-Kit (Performance Fahrwerksfedern Performance Springs) 1.5, 1.8, 2.0	10.91 - 09.99	860	890	E2302-140	A, 18, 20	30	30					F6518001	F6522102	T
1.5 16V, 1.8	02.95 - 08.97	830	830	E2301-140	A, 18, 20	30	30					F6517001	F7804002	T
B12 Pro-Kit (Performance Komplettfahrwerke Performance Springs+Shocks) 1.5, 1.8, 2.0	10.93 - 09.99	860	890	E90-23-010-01-22	A, 18, 20, 78, 161	30	30							T
1.5 16V, 1.8	02.95 - 08.97	830	830	E90-23-011-02-22	A, 18, 20, 78, 161	30	30							T

Modell	Baujahr	Achslast Vorne kg	Achslast Hinten kg	Artikel-Nr.	Hinweise	ca. Tieferl. Vorne mm	ca. Tieferl. Hinten mm	Ø Vorne mm	Ø Hinten mm	Verstellbarkeit Vorne	Verstellbarkeit Hinten	Ersatzteilbezeichnung Vorne	Ersatzteilbezeichnung Hinten	Gutachten
Model	Year	Front Axle Load kg	Rear Axle Load kg	Part-No.	Notes	ca. Lowering Front mm	ca. Lowering Rear mm	Ø Front mm	Ø Rear mm	Adjustable Front	Adjustable Rear	Spare Part Marking Front	Spare Part Marking Rear	Homologation
LACETTI (J200) Pro-Kit (Performance Fahrwerksfedern Performance Springs) 1.4 16V, 1.6, 1.8	03.05 -	920	845	E10-23-003-01-22	A, 18, 20	30	30					F11-23-002-01-VA	F11-23-002-01-HA	T
Nexia (KLETN) Pro-Kit (Performance Fahrwerksfedern Performance Springs) 1.5, 1.5 16V	02.95 - 08.97	760	830	E2301-240	A, 18, 20	30	30					F6518001	F7804002	T
1.5 16V, 1.8	02.95 - 08.97	830	830	E2301-140	A, 18, 20	30	30					F6517001	F7804002	T
B12 Pro-Kit (Performance Komplettfahrwerke Performance Springs+Shocks) 1.5, 1.5 16V	02.95 - 08.97	760	830	E90-23-011-01-22	A, 18, 20, 78, 161	30	30							T
1.5 16V, 1.8	02.95 - 08.97	830	830	E90-23-011-02-22	A, 18, 20, 78, 161	30	30							T
NUBIRA Stufenheck NUBIRA Saloon Pro-Kit (Performance Fahrwerksfedern Performance Springs) 1.6, 1.8	03.05 -	920	845	E10-23-002-01-22	A, 18, 20	30	30					F11-23-002-01-VA	F11-23-002-01-HA	T
TRAX Pro-Kit (Performance Fahrwerksfedern Performance Springs) 1.4, 1.4 AWD, 1.6, 1.6 AWD, 1.8, 1.8 AWD	12.12 -	1065	995	E10-65-029-01-22	A, 18	25	25					F11-65-029-01-VA	F11-65-029-01-HA	T
1.7 TD, 1.7 TD AWD	12.12 -	1065	995	E10-65-029-02-22	A, 18	25	25					F11-65-029-02-VA	F11-65-029-01-HA	T
300 C (LX) Pro-Kit (Performance Fahrwerksfedern Performance Springs) 2.7, 3.0 CRD, 3.0 V6 CRD, 3.5, 5.7 SRT8	09.04 - 11.12	1275	1275	E10-28-011-03-22	A, 18, 20, 44	35	35					F11-28-011-03-VA	F11-28-011-03-HA	T
300 C Touring (LX) Pro-Kit (Performance Fahrwerksfedern Performance Springs) 2.7, 3.0 CRD, 3.5, 5.7	09.04 - 12.10	1275	1275	E10-28-011-03-22	A, 18, 20, 44	35	35					F11-28-011-03-VA	F11-28-011-03-HA	T
CROSSFIRE Pro-Kit (Performance Fahrwerksfedern Performance Springs) 3.2	07.03 - 12.07	845	820	E10-28-009-01-22	A, 18, 20	30	30					F2552101	F2552102	T
B12 Pro-Kit (Performance Komplettfahrwerke Performance Springs+Shocks) 3.2	07.03 - 12.07	845	820	E90-28-009-01-22	A, 18, 20, 78, 161	30	30							T
CROSSFIRE Roadster Pro-Kit (Performance Fahrwerksfedern Performance Springs) 3.2	05.04 - 12.07	845	820	E10-28-009-01-22	A, 18, 20	30	30					F2552101	F2552102	T
B12 Pro-Kit (Performance Komplettfahrwerke Performance Springs+Shocks) 3.2	05.04 - 12.07	845	820	E90-28-009-01-22	A, 18, 20, 78, 161	30	30							T
PT CRUISER (PT.) Pro-Kit (Performance Fahrwerksfedern Performance Springs) 1.6, 2.0, 2.2 CRD, 2.4, GT 2.4	06.00 - 12.10	1115	980	E10-28-002-02-22	A, 18, 20	30	30					F11-28-002-02-VA	F11-28-002-02-HA	T
Pro-Street-S (Gewindefahrwerke - höhenverstellbar Coil-Overs-Adjustable Ride Height) 1.6, 2.0, 2.2 CRD, 2.4, GT 2.4	06.00 - 12.10	1115	980	PSS65-28-002-01-22	A, 24, 25, 45, 160	40-70	40-70							T
PT CRUISER Cabriolet PT CRUISER Convertible Pro-Kit (Performance Fahrwerksfedern Performance Springs) 2.4, 2.4 GT	03.04 - 03.08	1115	980	E10-28-002-02-22	A, 18, 20	30	30					F11-28-002-02-VA	F11-28-002-02-HA	T
Pro-Street-S (Gewindefahrwerke - höhenverstellbar Coil-Overs-Adjustable Ride Height) 2.4, 2.4 GT	03.04 - 03.08	1115	980	PSS65-28-002-01-22	A, 24, 25, 45, 160	40-70	40-70							T
AX (ZA-) Pro-Kit (Performance Fahrwerksfedern Performance Springs) 1.4 Allure, 10, 10 E, 11, 11 KAT, 14, 14 D 1.4 Allure, 10, 10 E, 11, 11 KAT, 14, 14 D	07.86 - 12.98	605	585	E2201-120	A, 18, 20	25-30	25-30					F2201001	Drehstabverstellung torsion bar	T
B12 Pro-Kit (Performance Komplettfahrwerke Performance Springs+Shocks) 10, 10 E, 11, 11 KAT, 14, 14 D 10, 10 E, 11, 11 KAT, 14, 14 D	07.86 - 12.98	605	585	E90-22-004-01-20	A, 18, 20, 78, 161	25-30	30							T
BERLINGO (MF) Pro-Kit (Performance Fahrwerksfedern Performance Springs) 1.1 i, 1.4, 1.4 i, 1.6 16V, 1.6 HDi 110, 1.6 HDi 75, 1.6 HDi 90, 1.8 D, 1.8 i, 1.9 D, 2.0 HDi 90	03.03 -	1000	1000	E10-22-005-01-20	A, 18, 20	30	30					F7010001	Drehstabverstellung torsion bar	T
1.1 i, 1.4, 1.4 i, 1.6 16V, 1.8 D, 1.8 i, 1.9 D, 2.0 HDi 90	07.96 - 02.03	1000	1000	E2206-120	A, 18, 20	25	25					F7011001	Drehstabverstellung torsion bar	T
BERLINGO Pro-Kit (Performance Fahrwerksfedern Performance Springs) 1.4 Sitzplätze 5, 1.6 HDi 110 Sitzplätze 5, 1.6 HDi 115 Sitzplätze 5, 1.6 HDi 75 Sitzplätze 5, 1.6 HDi 90 Sitzplätze 5, 1.6 Sitzplätze 5, 1.6 VTI 120 Sitzplätze 5, 1.6 VTI 95 Sitzplätze 5, 1.4 Seats 5, 1.6 HDi 110 Seats 5, 1.6 HDi 115 Seats 5, 1.6 HDi 75 Seats 5, 1.6 HDi 90 Seats 5, 1.6 Seats 5, 1.6 VTI 120 Seats 5, 1.6 VTI 95 Seats 5	04.08 -	1170	1000	E10-22-007-03-22	A, 18, 20, 66	30	10					F11-22-007-03-VA	F11-22-007-03-HA	T
1.4 Anzahl Sitzplätze 7, 1.6 Anzahl Sitzplätze 7, 1.6 HDi 110 Anzahl Sitzplätze 7, 1.6 HDi 115 Anzahl Sitzplätze 7, 1.6 HDi 75 Anzahl Sitzplätze 7, 1.6 HDi 90 Anzahl Sitzplätze 7, 1.6 VTI 120 Anzahl Sitzplätze 7, 1.6 VTI 95 Anzahl Sitzplätze 7, 1.4 Number of Seats 7, 1.6 HDi 110 Number of Seats 7, 1.6 HDi 115 Number of Seats 7, 1.6 HDi 75 Number of Seats 7, 1.6 HDi 90 Number of Seats 7, 1.6 Number of Seats 7, 1.6 VTI 120 Number of Seats 7, 1.6 VTI 95 Number of Seats 7	04.08 -	1170	1230	E10-22-007-05-22	A, 18, 20, 67	30	10					F11-22-007-03-VA	F11-22-007-05-HA	T
BERLINGO Kasten (M.) BERLINGO Box (M.) Pro-Kit (Performance Fahrwerksfedern Performance Springs) 1.1 i, 1.4, 1.4 i, 1.6 16V, 1.6 HDi 75, 1.6 HDi 90, 1.8 D, 1.9 D, 1.9 D 70, 2.0 HDi 90	03.03 -	1000	1000	E10-22-005-01-20	A, 18, 20	30	30					F7010001	Drehstabverstellung torsion bar	T

Modell	Baujahr	Achslast Vorne kg	Achslast Hinten kg	Artikel-Nr.	Hinweise	ca. Tieferl. Vorne mm	ca. Tieferl. Hinten mm	Ø Vorne mm	Ø Hinten mm	Verstellbarkeit Vorne	Verstellbarkeit Hinten	Ersatzteilbezeichnung Vorne	Ersatzteilbezeichnung Hinten	Gutachten
Model	Year	Front Axle Load kg	Rear Axle Load kg	Part-No.	Notes	ca. Lowering Front mm	ca. Lowering Rear mm	Ø Front mm	Ø Rear mm	Adjustable Front	Adjustable Rear	Spare Part Marking Front	Spare Part Marking Rear	Homologation
BERLINGO Kasten (M.) BERLINGO Box (M.) Pro-Kit (Performance Fahrwerksfedern Performance Springs) 1.1 i, 1.4, 1.4 i, 1.6 16V, 1.8 D, 1.8 i, 1.9 D, 1.9 D 70, 2.0 HDi 90	07.96 - 02.03	1000	1000	E2206-120	A, 18, 20	25	25					F7011001	Drehstabverstellung torsion bar	T
BERLINGO Kasten BERLINGO Box Pro-Kit (Performance Fahrwerksfedern Performance Springs) 1.6 HDi 110 Sitzplätze 5, 1.6 HDi 75 Sitzplätze 5, 1.6 HDi 90 Sitzplätze 5, 1.6 VTI 95 Sitzplätze 5 1.6 HDi 110 Seats 5, 1.6 HDi 75 Seats 5, 1.6 HDi 90 Seats 5, 1.6 Seats 5, 1.6 VTI 95 Seats 5 1.6 Anzahl Sitzplätze 7, 1.6 HDi 110 Anzahl Sitzplätze 7, 1.6 HDi 75 Anzahl Sitzplätze 7, 1.6 HDi 90 Anzahl Sitzplätze 7, 1.6 VTI 95 Anzahl Sitzplätze 7 1.6 HDi 110 Number of Seats 7, 1.6 HDi 75 Number of Seats 7, 1.6 HDi 90 Number of Seats 7, 1.6 Number of Seats 7, 1.6 VTI 95 Number of Seats 7	04.08 -	1170	1000	E10-22-007-03-22	A, 18, 20, 66	30	10					F11-22-007-03-VA	F11-22-007-03-HA	T
	04.08 -	1170	1230	E10-22-007-05-22	A, 18, 20, 67	30	10					F11-22-007-03-VA	F11-22-007-05-HA	T
C-CROSSER (EP.) Pro-Kit (Performance Fahrwerksfedern Performance Springs) 2.2 HDi	02.07 -	1150	1300	E10-70-011-01-22	A, 18, 174	25	20					F11-70-011-01-VA	F11-70-011-01-HA	T
C-CROSSER ENTERPRISE Pro-Kit (Performance Fahrwerksfedern Performance Springs) 2.2 HDi, 2.4 16V	01.09 -	1150	1300	E10-70-011-01-22	A, 18, 174	25	20					F11-70-011-01-VA	F11-70-011-01-HA	T
C1 (PM., PN.) Pro-Kit (Performance Fahrwerksfedern Performance Springs) 1.0, 1.4 HDi	06.05 -	695	695	E10-22-008-01-22	A, 18, 20	30	30					F11-70-008-01-VA	F11-70-008-01-HA	T
B12 Pro-Kit (Performance Komplettfahrwerke Performance Springs+Shocks) 1.0, 1.4 HDi	06.05 -	695	695	E90-22-008-01-22	A, 18, 20, 78, 161	30	30							T
C2 (JM.) Pro-Kit (Performance Fahrwerksfedern Performance Springs) 1.1, 1.4, 1.4 16V, 1.4 HDi, 1.6, 1.6 VTS	09.03 -	850	820	E10-22-003-01-22	A, 18, 20	30	30					F11-22-003-01-VA	F11-22-003-01-HA	T
Sportline (Performance Fahrwerksfedern Sport Sport Performance Springs) 1.1, 1.4, 1.4 16V, 1.4 HDi, 1.6, 1.6 HDi, 1.6 VTS	09.03 -	820	735	E20-22-003-01-22	A, 20	45-50	30					F21-22-003-01-VA	F21-22-003-01-HA	T
B12 Pro-Kit (Performance Komplettfahrwerke Performance Springs+Shocks) 1.1, 1.4, 1.4 16V, 1.4 HDi, 1.6, 1.6 VTS	09.03 -	850	820	E90-22-003-01-22	A, 18, 20, 78, 161	30	30							T
B12 Sportline (Performance Komplettfahrwerke Sport Sport Performance Springs+Shocks) 1.1, 1.4, 1.4 16V, 1.4 HDi, 1.6, 1.6 HDi, 1.6 VTS	09.03 -	820	735	E95-22-003-01-22	A, 20, 78, 161	45-50	30							T
C2 ENTERPRISE Pro-Kit (Performance Fahrwerksfedern Performance Springs) 1.4 HDi	04.09 -	850	820	E10-22-003-01-22	A, 18, 20	30	30					F11-22-003-01-VA	F11-22-003-01-HA	T
Sportline (Performance Fahrwerksfedern Sport Sport Performance Springs) 1.4 HDi	04.09 -	820	735	E20-22-003-01-22	A, 20	45-50	30					F21-22-003-01-VA	F21-22-003-01-HA	T
C3 (FC.) Pro-Kit (Performance Fahrwerksfedern Performance Springs) 1.1 i, 1.4 16V, 1.4 16V HDi, 1.4 HDi, 1.4 i, 1.4 i Bivalent, 1.6 16V	02.02 -	850	820	E10-22-003-01-22	A, 18, 20	30	30					F11-22-003-01-VA	F11-22-003-01-HA	T
Sportline (Performance Fahrwerksfedern Sport Sport Performance Springs) 1.1 i, 1.4 16V, 1.4 16V HDi, 1.4 HDi, 1.4 i, 1.4 i Bivalent, 1.6 16V	02.02 -	820	735	E20-22-003-01-22	A, 20	45-50	30					F21-22-003-01-VA	F21-22-003-01-HA	T
B12 Pro-Kit (Performance Komplettfahrwerke Performance Springs+Shocks) 1.1 i, 1.4 16V, 1.4 16V HDi, 1.4 Bioflex, 1.4 HDi, 1.4 i, 1.6 16V, 1.6 Bioflex	02.02 -	850	820	E90-22-003-01-22	A, 18, 20, 78, 161	30	30							T
B12 Sportline (Performance Komplettfahrwerke Sport Sport Performance Springs+Shocks) 1.1 i, 1.4 16V, 1.4 16V HDi, 1.4 Bioflex, 1.4 HDi, 1.4 i, 1.6 16V, 1.6 Bioflex	02.02 -	820	735	E95-22-003-01-22	A, 20, 78, 161	45-50	30							T
C3 II Pro-Kit (Performance Fahrwerksfedern Performance Springs) 1.1, 1.1 BiFuel, 1.4, 1.4 HDi 70, 1.4 VTI 95, 1.6 HDi, 1.6 HDi 110, 1.6 HDi 90, 1.6 VTI 120	11.09 -	920	825	E10-70-009-01-22	A, 18, 20	30	30					F11-70-009-01-VA	F11-70-009-01-HA	T
C3 Picasso Pro-Kit (Performance Fahrwerksfedern Performance Springs) 1.4 VTI 95, 1.6 HDi 90, 1.6 HDi, 1.6 HDi 110, 1.6 HDi 115, 1.6 VTI 120	02.09 -	1000	900	E10-22-010-01-22	A, 18, 20	40	30					F11-22-010-01-VA	F11-22-010-01-HA	T
C3 Pluriel (HB.) Pro-Kit (Performance Fahrwerksfedern Performance Springs) 1.4, 1.4 HDi, 1.6	05.03 -	850	820	E10-22-003-01-22	A, 18, 20	30	30					F11-22-003-01-VA	F11-22-003-01-HA	T
Sportline (Performance Fahrwerksfedern Sport Sport Performance Springs) 1.4, 1.4 HDi, 1.6	05.03 -	820	735	E20-22-003-01-22	A, 20	45-50	30					F21-22-003-01-VA	F21-22-003-01-HA	T
C4 (LC.) Pro-Kit (Performance Fahrwerksfedern Performance Springs) 1.4 16V, 1.6 16V, 1.6 16V Bio-Flex, 1.6 THP 140, 1.6 THP 150, 1.6 VTI 120	11.04 -	1010	920	E10-22-007-01-22	A, 18, 20	30	25					F11-22-007-01-VA	F11-70-004-01-HA	T
1.6 16V, 1.6 16V Bio-Flex, 1.6 HDi, 1.6 THP 140, 1.6 THP 150, 1.6 VTI 120, 2.0 16V, 2.0 HDi	11.04 -	1120	920	E10-22-007-02-22	A, 18, 20	30	25					F11-70-004-01-VA	F11-70-004-01-HA	T
B12 Pro-Kit (Performance Komplettfahrwerke Performance Springs+Shocks) 1.4 16V, 1.6 16V Bio-Flex Schaltgetriebe, 1.6 16V Schaltgetriebe, 1.6 THP 140, 1.6 THP 150, 1.6 VTI 120 1.4 16V, 1.6 16V Bio-Flex manual transmission, 1.6 16V manual transmission, 1.6 THP 140, 1.6 THP 150, 1.6 VTI 120	11.04 -	1010	920	E90-22-007-01-22	A, 18, 20, 78, 161	30	25							T
1.6 16V, 1.6 16V Bio-Flex, 1.6 HDi, 1.6 THP 140, 1.6 THP 150, 1.6 VTI 120, 2.0 16V, 2.0 HDi	11.04 -	1120	920	E90-22-007-02-22	A, 18, 20, 78, 161	30	25							T

Modell	Baujahr	Achslast Vorne kg	Achslast Hinten kg	Artikel-Nr.	Hinweise	ca. Tieferl. Vorne mm	ca. Tieferl. Hinten mm	Ø Vorne mm	Ø Hinten mm	Verstellbarkeit Vorne	Verstellbarkeit Hinten	Ersatzteilbezeichnung Vorne	Ersatzteilbezeichnung Hinten	Gutachten
Model	Year	Front Axle Load kg	Rear Axle Load kg	Part-No.	Notes	ca. Lowering Front mm	ca. Lowering Rear mm	Ø Front mm	Ø Rear mm	Adjustable Front	Adjustable Rear	Spare Part Marking Front	Spare Part Marking Rear	Homologation
C4 (B7) Pro-Kit (Performance Fahrwerksfedern Performance Springs) 1.6 THP 155, 1.6 VTi 120	11.09 -	990	900	E10-22-011-01-22	A, 18, 20	30	25					F11-22-011-01-VA	F11-15-001-01-HA	T
1.6 HDi 110, 1.6 HDi 115, 1.6 HDi 90, 2.0 HDi 150	11.09 -	1070	900	E10-22-011-02-22	A, 18, 20	30	25					F11-70-012-01-VA	F11-15-001-01-HA	T
C4 AIRCROSS Pro-Kit (Performance Fahrwerksfedern Performance Springs) 1.6	04.12 -	1020	1000	E10-60-016-01-22	A, 18, 20	30	25					F11-60-016-01-VA	F11-60-013-01-HA	T
1.6 HDi 115, 1.6 HDi 115 AWC, 1.8 HDi 150, 1.8 HDi 150 AWC	04.12 -	1130	1000	E10-60-016-02-22	A, 18	30	25					F11-60-013-02-VA	F11-60-013-01-HA	T
C4 Coupe (LA.) Pro-Kit (Performance Fahrwerksfedern Performance Springs) 1.4 16V, 1.6 16V, 1.6 THP 150, 1.6 VTi 120	11.04 -	1010	920	E10-22-007-01-22	A, 18, 20	30	25					F11-22-007-01-VA	F11-70-004-01-HA	T
1.6 16V, 1.6 HDi, 1.6 THP 150, 1.6 VTi 120, 2.0 16V, 2.0 HDi	11.04 -	1120	920	E10-22-007-02-22	A, 18, 20	30	25					F11-70-004-01-VA	F11-70-004-01-HA	T
B12 Pro-Kit (Performance Komplettfahrwerke Performance Springs+Shocks) 1.4 16V, 1.6 THP 150, 1.6 VTi 120	11.04 -	1010	920	E90-22-007-01-22	A, 18, 20, 78, 161	30	25							T
1.6 16V Schaltgetriebe 1.6 16V manual transmission	11.04 -	1010	920	E90-22-007-01-22	A, 18, 20, 71, 78, 161	30	25							T
1.6 16V	11.04 -	1120	920	E90-22-007-02-22	A, 18, 20, 71, 78, 161	30	25							T
1.6 HDi, 1.6 THP 150, 1.6 VTi 120, 2.0 16V, 2.0 HDi	11.04 -	1120	920	E90-22-007-02-22	A, 18, 20, 78, 161	30	25							T
C4 Grand Picasso (UA.) Pro-Kit (Performance Fahrwerksfedern Performance Springs) 1.6 16V Anzahl Sitzplätze 7, 1.6 HDi 110 Anzahl Sitzplätze 7, 1.6 HDi Anzahl Sitzplätze 7, 1.6 THP 155 Anzahl Sitzplätze 7, 1.6 VTi 120 Anzahl Sitzplätze 7, 1.6 e-HDi 110 Anzahl Sitzplätze 7, 1.8 i 16V Anzahl Sitzplätze 7, 2.0 i 16V Anzahl Sitzplätze 7, 1.6 16V Number of Seats 7, 1.6 HDi 110 Number of Seats 7, 1.6 HDi Number of Seats 7, 1.6 THP 155 Number of Seats 7, 1.6 VTi 120 Number of Seats 7, 1.6 e-HDi 110 Number of Seats 7, 1.8 i 16V Number of Seats 7, 2.0 i 16V Number of Seats 7	10.06 -	1170	1230	E10-22-007-05-22	A, 18, 20, 67	30	10					F11-22-007-03-VA	F11-22-007-05-HA	T
C4 Picasso (UD.) Pro-Kit (Performance Fahrwerksfedern Performance Springs) 1.6 HDi, 1.8 i 16V, 2.0 i 16V	02.07 -	1170	1000	E10-22-007-03-22	A, 18, 20, 66	30	30					F11-22-007-03-VA	F11-22-007-03-HA	T
2.0 HDi 138, 2.0 HDi 150, 2.0 i 16V	02.07 -	1200	1000	E10-22-007-04-22	A, 18, 20, 66	30	30					F11-22-007-04-VA	F11-22-007-03-HA	T
C4 Stufenheck C4 Saloon Pro-Kit (Performance Fahrwerksfedern Performance Springs) 1.6 16V	07.06 -	1010	920	E10-22-007-01-22	A, 18, 20	30	25					F11-22-007-01-VA	F11-70-004-01-HA	T
1.6 16V, 1.6 HDi, 2.0 16V	07.06 -	1120	920	E10-22-007-02-22	A, 18, 20	30	25					F11-70-004-01-VA	F11-70-004-01-HA	T
B12 Pro-Kit (Performance Komplettfahrwerke Performance Springs+Shocks) 1.6 16V, 2.0 16V	07.06 -	1010	920	E90-22-007-01-22	A, 18, 20, 78, 161	30	25							T
1.6 HDi	07.06 -	1120	920	E90-22-007-02-22	A, 18, 20, 78, 161	30	25							T
C5 (RD.) Pro-Kit (Performance Fahrwerksfedern Performance Springs) 2.0 HDi, 2.0 HDi 140, 2.0 HDi 165	02.08 -	1280	1045	E10-22-009-02-22	A, 18, 20	40	35					F11-22-009-02-VA	F11-22-009-01-HA	T
B12 Pro-Kit (Performance Komplettfahrwerke Performance Springs+Shocks) 2.0 HDi, 2.0 HDi 140, 2.0 HDi 165	02.08 -	1280	1045	E90-22-009-02-22	A, 18, 20, 78, 161	40	35							T
C8 (EA., EB.) Pro-Kit (Performance Fahrwerksfedern Performance Springs) 2.0, 2.0 16V, 2.0 HDi, 2.0 HDi 135, 2.0 HDi 165, 2.2, 2.2 HDi, 3.0 V6	07.02 -	1370	1300	E10-70-005-01-22	A, 18, 20	30	10					F3015001	F3015002	T
DS3 Pro-Kit (Performance Fahrwerksfedern Performance Springs) 1.2 VTi 82, 1.4 HDi 70, 1.4 VTi 95, 1.4 VTi 98, 1.6 HDi 110, 1.6 HDi 115, 1.6 HDi 90, 1.6 THP 150, 1.6 THP 155, 1.6 VTi 120	11.09 -	920	825	E10-70-009-01-22	A, 18, 20, 71	20-25	10					F11-70-009-01-VA	F11-70-009-01-HA	T
DS4 Pro-Kit (Performance Fahrwerksfedern Performance Springs) 1.6 VTi 120	04.11 -	990	900	E10-22-013-01-22	A, 18, 20	25	25					F11-22-011-01-VA	F11-70-004-05-HA	T
1.6 HDi 110, 1.6 HDi 115, 1.6 HDi 90, 1.6 THP 155, 1.6 THP 160, 1.6 THP 200, 2.0 HDi 135, 2.0 HDi 165	04.11 -	1070	900	E10-22-013-02-22	A, 18, 20	25	25					F11-70-012-01-VA	F11-70-004-05-HA	T
DS5 Pro-Kit (Performance Fahrwerksfedern Performance Springs) 1.6 HDi 110, 1.6 HDi 115, 1.6 THP 155, 1.6 THP 200	11.11 -	1130	1050	E10-22-014-01-22	A, 18, 20	20	25					F11-70-012-02-VA	F11-22-014-01-HA	T
2.0 HDi 135, 2.0 HDi 165	11.11 -	1200	1050	E10-22-014-02-22	A, 18, 20	20	25					F11-70-013-02-VA	F11-22-014-01-HA	T
EVASION (22, U6) Pro-Kit (Performance Fahrwerksfedern Performance Springs) 1.8, 1.9 TD, 2.0, 2.0 16V, 2.0 HDi, 2.0 HDi 16V, 2.0 Turbo C.T., 2.1 TD	06.94 - 07.02	1230	1300	E2203-140	A, 18, 20	30	30					F3015001	F3015002	T
JUMPY (U6U) Pro-Kit (Performance Fahrwerksfedern Performance Springs) 1.6, 1.9 D, 1.9 D 70, 1.9 TD, 2.0, 2.0 HDi 110, 2.0 HDi 95, 2.0 i 16V, 2.2 HDi	10.95 -	1230	1100	E2203-140	A, 18, 20	30	30					F3015001	F3015002	T
JUMPY Kasten (BS., BT., BY., BZ.) JUMPY Box (BS., BT., BY., BZ.) Pro-Kit (Performance Fahrwerksfedern Performance Springs) 1.6, 1.6 i, 1.9 D, 1.9 D 70, 1.9 DT, 1.9 TD, 2.0 HDi 110, 2.0 HDi 95, 2.0 i 16V, 2.2 HDi	10.95 -	1230	1100	E2203-140	A, 18, 20	30	30					F3015001	F3015002	T

Modell	Baujahr	Achslast Vorne kg	Achslast Hinten kg	Artikel-Nr.	Hinweise	ca. Tieferl. Vorne mm	ca. Tieferl. Hinten mm	Ø Vorne mm	Ø Hinten mm	Verstellbarkeit Vorne	Verstellbarkeit Hinten	Ersatzteilbezeichnung Vorne	Ersatzteilbezeichnung Hinten	Gutachten
Model	Year	Front Axle Load kg	Rear Axle Load kg	Part-No.	Notes	ca. Lowering Front mm	ca. Lowering Rear mm	Ø Front mm	Ø Rear mm	Adjustable Front	Adjustable Rear	Spare Part Marking Front	Spare Part Marking Rear	Homologation
JUMPY Pritsche/Fahrgestell (BU., BV., BW., BX.) JUMPY Platform/Chassis (BU., BV., BW., BX.) Pro-Kit (Performance Fahrwerksfedern Performance Springs) 1.9 TD, 2.0, 2.0 HDi 110 16V, 2.0 HDi 95	10.99 -	1230	1100	E2203-140	A, 18, 20	30	30					F3015001	F3015002	T
SAXO (S0, S1) Pro-Kit (Performance Fahrwerksfedern Performance Springs) 1.0 X, 1.1 X, SX, 1.4 VTS, 1.5 D, 1.6, 1.6 VTL, VTR, 1.6 VTR, 1.6 VTS	02.96 - 04.04	785	700	E2204-120	A, 18, 20	30	25-30					F2204001	Drehstabverstellung torsion bar	T
Sportline (Performance Fahrwerksfedern Sport Sport Performance Springs) 1.0 X, 1.1 X, SX, 1.4 VTS, 1.5 D, 1.6, 1.6 VTL, VTR, 1.6 VTR, 1.6 VTS	02.96 - 04.04	785	700	E20-22-002-01-20	A, 20	45-50	30					F21-70-002-01-VA	Drehstabverstellung torsion bar	T
B12 Pro-Kit (Performance Komplettfahrwerke Performance Springs+Shocks) 1.0 X, 1.1 X, SX, 1.4 VTS, 1.5 D, 1.6, 1.6 VTL, VTR, 1.6 VTR, 1.6 VTS	02.96 - 04.04	785	700	E90-22-002-01-20	A, 18, 20, 78, 161	30	25-30							T
B12 Sportline (Performance Komplettfahrwerke Sport Sport Performance Springs+Shocks) 1.0 X, 1.1 X, SX, 1.4 VTS, 1.5 D, 1.6, 1.6 VTL, VTR, 1.6 VTR, 1.6 VTS	02.96 - 04.04	785	700	E95-22-002-01-20	A, 18, 20, 78, 161	45-50	30							T
XSARA (N1) Pro-Kit (Performance Fahrwerksfedern Performance Springs) 1.4 HDi, 1.4 i, 1.5 D, 1.6 16V, 1.6 i, 1.8 D, 1.8 TD, 1.8 VTS, 1.8 i, 1.8 i 16V, 1.8 i Aut., 1.9 D, 1.9 SD, 1.9 TD, 2.0 16V, 2.0 HDi 109, 2.0 HDi 90	04.97 - 03.05	950	870	E2205-120	A, 18, 20	30	30					F2205001	Drehstabverstellung torsion bar	T
B12 Pro-Kit (Performance Komplettfahrwerke Performance Springs+Shocks) 1.4 i, 1.5 D, 1.6 16V, 1.6 i, 1.8 D, 1.8 TD, 1.8 VTS, 1.8 i, 1.8 i 16V, 1.8 i Aut., 1.9 D, 1.9 SD, 1.9 TD, 2.0 16V, 2.0 HDi 90	04.97 - 09.00	950	870	E90-22-001-01-20	A, 18, 20, 78, 161	30	30							T
XSARA Break (N2) Pro-Kit (Performance Fahrwerksfedern Performance Springs) 1.4 HDi, 1.4 i, 1.5 D, 1.6 16V, 1.6 i, 1.8 D, 1.8 i, 1.8 i 16V, 1.8 i Aut., 1.9 D, 1.9 TD, 2.0 16V, 2.0 HDi 90, 2.0 HDi 109	10.97 - 08.05	950	870	E2205-120	A, 18, 20	30	30					F2205001	Drehstabverstellung torsion bar	T
B12 Pro-Kit (Performance Komplettfahrwerke Performance Springs+Shocks) 1.4 i, 1.5 D, 1.6 16V, 1.6 i, 1.8 D, 1.8 i, 1.8 i 16V, 1.8 i Aut., 1.9 D, 1.9 TD, 2.0 16V, 2.0 HDi 90	10.97 - 09.00	950	870	E90-22-001-01-20	A, 18, 20, 78, 161	30	30							T
XSARA Coupe (N0) Pro-Kit (Performance Fahrwerksfedern Performance Springs) 1.4 HDi, 1.4 i, 1.6 16V, 1.6 i, 1.8 i, 1.8 i 16V, 1.9 D, 1.9 TD, 2.0, 2.0 16V, 2.0 HDi 90, 2.0 HDi 109, 2.0 i 16V	02.98 - 03.05	950	870	E2205-120	A, 18, 20	30	30					F2205001	Drehstabverstellung torsion bar	T
B12 Pro-Kit (Performance Komplettfahrwerke Performance Springs+Shocks) 1.4 i, 1.6 16V, 1.6 i, 1.8 i, 1.8 i 16V, 1.9 D, 1.9 TD, 2.0, 2.0 16V, 2.0 HDi 90, 2.0 i 16V	02.98 - 09.00	950	870	E90-22-001-01-20	A, 18, 20, 78, 161	30	30							T
DOKKER Pro-Kit (Performance Fahrwerksfedern Performance Springs) 1.2 Tce, 1.5 dCi, 1.6 16V	11.12 -	965	1105	E10-26-004-01-22	A, 18, 20	25	10					F11-26-004-01-VA	F11-26-004-01-HA	T
DOKKER Express Pro-Kit (Performance Fahrwerksfedern Performance Springs) 1.2 Tce 115, 1.5 dCi, 1.6 16V	12.12 -	965	1105	E10-26-004-01-22	A, 18, 20	25	10					F11-26-004-01-VA	F11-26-004-01-HA	T
DUSTER Pro-Kit (Performance Fahrwerksfedern Performance Springs) 1.5 dCi, 1.6 16V, 1.6 16V Flexifuel	04.10 -	940	910	E10-26-003-01-22	A, 18, 20	30	30					F11-26-003-01-VA	F11-26-003-01-HA	T
1.5 dCi 4x4, 1.6 16V 4x4	06.10 -	940	980	E10-26-003-02-22	A, 18	30	30					F11-26-003-01-VA	F11-26-003-02-HA	T
Pro-Lift-Kit (Performance Höherlegung Performance Lift Springs) 1.5 dCi 4x4, 1.6 16V 4x4	06.10 -	970	980	E30-26-003-01-22	A, 18	+25	+25					F31-26-003-01-VA	F31-26-003-01-HA	T
B12 Pro-Kit (Performance Komplettfahrwerke Performance Springs+Shocks) 1.5 dCi, 1.6 16V, 1.6 16V Flexifuel	04.10 -	940	910	E90-26-003-01-22	A, 18, 78, 161	30	30							T
1.5 dCi 4x4, 1.6 16V 4x4	06.10 -	940	980	E90-26-003-02-22	A, 18, 78, 161	30	30							T
LOGGY Pro-Kit (Performance Fahrwerksfedern Performance Springs) 1.2 Tce, 1.5 dCi, 1.6	06.10 -	965	1105	E10-26-004-01-22	A, 18, 20	25	10					F11-26-004-01-VA	F11-26-004-01-HA	T
LOGAN (LS.) Pro-Kit (Performance Fahrwerksfedern Performance Springs) 1.4, 1.5 dCi, 1.6, 1.6 16V, 1.6 16V Flexifuel, 1.6 MPI 85	09.04 -	930	880	E10-26-001-01-22	A, 18, 20	35	35					F11-26-001-01-VA	F11-26-001-01-HA	T
B12 Pro-Kit (Performance Komplettfahrwerke Performance Springs+Shocks) 1.4, 1.5 dCi, 1.6, 1.6 16V, 1.6 MPI 85	09.04 -	930	880	E90-26-001-01-22	A, 18, 20, 78, 161	35	35							T
SANDERO Pro-Kit (Performance Fahrwerksfedern Performance Springs) 1.2 16V, 1.4, 1.6, 1.6 16V, 1.6 MPI 85	06.08 -	860	880	E10-26-001-03-22	A, 18, 20	30	30					F11-26-001-03-VA	F11-26-001-01-HA	T
B12 Pro-Kit (Performance Komplettfahrwerke Performance Springs+Shocks) 1.2 16V, 1.2 16V LPG, 1.4, 1.4 MPI LPG, 1.5 dCi, 1.6, 1.6 MPI 85	06.08 -	860	880	E90-26-001-03-22	A, 18, 20, 78, 161	30	30							T

Modell	Baujahr	Achslast Vorne kg	Achslast Hinten kg	Artikel-Nr.	Hinweise	ca. Tieferl. Vorne mm	ca. Tieferl. Hinten mm	Ø Vorne mm	Ø Hinten mm	Verstellbarkeit Vorne	Verstellbarkeit Hinten	Ersatzteilbezeichnung Vorne	Ersatzteilbezeichnung Hinten	Gutachten
Model	Year	Front Axle Load kg	Rear Axle Load kg	Part-No.	Notes	ca. Lowering Front mm	ca. Lowering Rear mm	Ø Front mm	Ø Rear mm	Adjustable Front	Adjustable Rear	Spare Part Marking Front	Spare Part Marking Rear	Homologation
CHARADE Pro-Kit (Performance Fahrwerksfedern Performance Springs) 1.33 16V	05.11 -	895	905	E10-82-019-01-22	A, 18, 20	25	25					F11-82-019-01-VA	F11-82-019-01-HA	T
CUORE VIII Pro-Kit (Performance Fahrwerksfedern Performance Springs) 1.0	04.07 -	650	650	E10-24-011-01-22	A, 18, 20	30	20					F11-24-011-01-VA	F11-24-011-01-HA	T
MATERIA (M4.) Pro-Kit (Performance Fahrwerksfedern Performance Springs) 1.3, 1.5	10.06 -	830	830	E10-24-010-01-22	A, 18, 20	30	15					F11-24-010-01-VA	F11-24-010-01-HA	T
JOURNEY Pro-Kit (Performance Fahrwerksfedern Performance Springs) 2.0 CRD	06.08 -	1250	1315	E10-27-003-01-22	A, 18, 20	30	30					F11-27-003-01-VA	F11-27-003-01-HA	T
500 Pro-Kit (Performance Fahrwerksfedern Performance Springs) 0.9, 1.2, 1.3 D Multijet, 1.4	10.07 -	830	640	E10-30-013-01-22	A, 18, 20	30	25					F11-30-013-01-VA	F11-30-013-01-HA	T
1.4 Abarth	08.08 -	830	640	E10-30-013-01-22	A, 18, 20	20	20					F11-30-013-01-VA	F11-30-013-01-HA	T
Sportline (Performance Fahrwerksfedern Sport Sport Performance Springs) 0.9, 1.2, 1.3 D Multijet, 1.4	10.07 -	830	640	E20-30-013-01-22	A, 18, 20	45-50	30					F21-30-013-01-VA	F21-30-013-01-HA	T
Pro-Street-S (Gewindefahrwerke - höhenverstellbar Coil-Overs-Adjustable Ride Height) 0.9, 1.2, 1.3 D Multijet, 1.4, 1.4 Abarth	10.07 -	830	735	PSS65-30-013-01-22	A, 25, 37, 45, 160	25-55	25-55							T
500 c Pro-Kit (Performance Fahrwerksfedern Performance Springs) 0.9, 1.2, 1.3 D Multijet, 1.4	09.09 -	830	640	E10-30-013-01-22	A, 18, 20	30	25					F11-30-013-01-VA	F11-30-013-01-HA	T
1.4 Abarth	09.09 -	830	640	E10-30-013-01-22	A, 18, 20	20	20					F11-30-013-01-VA	F11-30-013-01-HA	T
Sportline (Performance Fahrwerksfedern Sport Sport Performance Springs) 0.9, 1.2, 1.3 D Multijet, 1.4	09.09 -	830	640	E20-30-013-01-22	A, 18, 20	45-50	30					F21-30-013-01-VA	F21-30-013-01-HA	T
500L Pro-Kit (Performance Fahrwerksfedern Performance Springs) 1.3 D Multijet, 1.6 D Multijet	09.12 -	1050	1000	E10-30-013-06-22	A, 18, 20	25	20					F11-30-013-06-VA	F11-30-013-05-HA	T
0.9, 1.4	09.12 -	1050	1000	E10-30-013-05-22	A, 18, 20	25	20					F11-30-013-05-VA	F11-30-013-05-HA	T
BARCETTA (183) Pro-Kit (Performance Fahrwerksfedern Performance Springs) 1.8 16V	04.95 - 05.05	850	700	E3018-240	A, 18, 20	30	30					F3018101	F3018102	T
B12 Pro-Kit (Performance Komplettfahrwerke Performance Springs+Shocks) 1.8 16V	04.95 - 05.05	850	700	E90-30-015-01-22	A, 18, 20, 78, 161	30	30							T
BRAVA (182) Pro-Kit (Performance Fahrwerksfedern Performance Springs) 1.2 16V 80	12.98 - 12.02	920	920	E3034-140	A, 18, 20, 68	30	30					F1016001	F3008002	T
1.4, 1.4 12 V, 1.6 16V, 1.8 GT 16V	10.95 - 12.02	920	920	E3016-140	A, 18, 20, 68	30	30					F3007001	F3008002	T
Anti-Roll-Kit (Performance Stabilisatoren Performance Sway Bars) 1.2 16V 80, 1.4, 1.4 12 V, 1.6 16V, 1.8 GT 16V, 1.9 D, 1.9 JTD, 1.9 JTD 105, 1.9 TD 100 S, 1.9 TD 75 S	10.95 - 12.02			E1013-320	A, 18, 20, 22, 45			26	22	nicht verstellbar not adjustable	nicht verstellbar not adjustable	AS1013320VA	AS1013320HA	T
BRAVO I (182) Pro-Kit (Performance Fahrwerksfedern Performance Springs) 1.2 16V 80	12.98 - 10.01	920	920	E3034-140	A, 18, 20, 68	30	30					F1016001	F3008002	T
1.4, 1.6, 1.6 16V, 1.8 GT	10.95 - 02.02	920	920	E3016-140	A, 18, 20, 68	30	30					F3007001	F3008002	T
Anti-Roll-Kit (Performance Stabilisatoren Performance Sway Bars) 1.2 16V 80, 1.4, 1.6, 1.6 16V, 1.8 GT, 1.9 D, 1.9 JTD, 1.9 JTD 105, 1.9 TD 100 S, 1.9 TD 75 S	10.95 - 02.02			E1013-320	A, 18, 20, 22, 45			26	22	nicht verstellbar not adjustable	nicht verstellbar not adjustable	AS1013320VA	AS1013320HA	T
BRAVO II (198) Pro-Kit (Performance Fahrwerksfedern Performance Springs) 1.4, 1.4 16V, 1.4 T-Jet	04.07 -	1000	880	E10-30-012-01-22	A, 18, 20	30	30					F11-30-012-01-VA	F11-30-012-01-HA	T
1.6 D Multijet, 1.9 D Multijet, 2.0 D Multijet	11.06 -	1090	880	E10-30-012-02-22	A, 18, 20	30	30					F11-30-012-02-VA	F11-30-012-01-HA	T
Sportline (Performance Fahrwerksfedern Sport Sport Performance Springs) 1.4, 1.4 16V, 1.4 T-Jet	04.07 -	1000	880	E20-30-012-01-22	A, 20	45-50	30					F21-30-001-02-VA	F21-30-001-02-HA	T

Modell	Baujahr	Achslast Vorne kg	Achslast Hinten kg	Artikel-Nr.	Hinweise	ca. Tieferl. Vorne mm	ca. Tieferl. Hinten mm	Ø Vorne mm	Ø Hinten mm	Verstellbarkeit Vorne	Verstellbarkeit Hinten	Ersatzteilbezeichnung Vorne	Ersatzteilbezeichnung Hinten	Gutachten
Model	Year	Front Axle Load kg	Rear Axle Load kg	Part-No.	Notes	ca. Lowering Front mm	ca. Lowering Rear mm	Ø Front mm	Ø Rear mm	Adjustable Front	Adjustable Rear	Spare Part Marking Front	Spare Part Marking Rear	Homologation
BRAVO II (198) <i>Sportline (Performance Fahrwerksfedern Sport Sport Performance Springs)</i> 1.6 D Multijet, 1.9 D Multijet, 2.0 D Multijet	11.06 -	1060	880	E20-30-012-02-22	A, 20	45-50	30					F21-30-001-03-VA	F21-30-001-02-HA	T
B12 Pro-Kit (Performance Komplettfahrwerke Performance Springs+Shocks) 1.4, 1.4 16V, 1.4 T-Jet	04.07 -	1000	880	E90-30-012-01-22	A, 18, 20, 78, 82,	30	30							T
1.6 D Multijet, 1.9 D Multijet	11.06 -	1090	880	E90-30-012-02-22	A, 18, 20, 78, 82,	30	30							T
B12 Sportline (Performance Komplettfahrwerke Sport Sport Performance Springs+Shocks) 1.4, 1.4 16V, 1.4 T-Jet	04.07 -	1000	880	E95-30-012-01-22	A, 18, 20, 78, 82,	45-50	30							T
1.6 D Multijet, 1.9 D Multijet	11.06 -	1090	880	E95-30-012-02-22	A, 18, 20, 78, 82,	45-50	30							T
CINQUECENTO (170) <i>Pro-Kit (Performance Fahrwerksfedern Performance Springs)</i> 0.7, 0.7 i, 0.9, 0.9 i.e., 0.9 i.e. S	07.91 - 07.99	610	630	E3011-140	A, 18, 20	30	30					F3011001	F3011002	T
1.1 Sporting	10.94 - 01.98	610	630	E3011-140	A, 18, 20	10-15	10-15					F3011001	F3011002	T
COUPE (FA/175) <i>Pro-Kit (Performance Fahrwerksfedern Performance Springs)</i> 1.8 16V, 2.0 16V, 2.0 20V, 2.0 20V Turbo	11.93 - 08.00	1030	800	E3014-240	A, 18, 20	30	30					F1016001	F3014002	T
2.0 16V Turbo	11.93 - 08.96	1030	800	E3014-140	A, 18, 20	30	30					F3007001	F3014002	T
Anti-Roll-Kit (Performance Stabilisatoren Performance Sway Bars) 1.8 16V, 2.0 16V, 2.0 16V Turbo, 2.0 20V, 2.0 20V Turbo	11.93 - 08.00			E1013-320	A, 18, 20, 22, 45			26	22	nicht verstellbar not adjustable	nicht verstellbar not adjustable	AS1013320VA	AS1013320HA	T
CROMA (194) <i>Pro-Kit (Performance Fahrwerksfedern Performance Springs)</i> 1.9 D Multijet, 2.2 16V	06.05 -	1150	1120	E10-30-009-01-22	A, 18, 20	30-35	25-30					F11-65-007-02-VA	F6549002	T
2.4 D Multijet	06.05 -	1200	1120	E10-30-009-02-22	A, 18, 20	30-35	25-30					F11-65-007-07-VA	F6549002	T
B12 Pro-Kit (Performance Komplettfahrwerke Performance Springs+Shocks) 1.9 D Multijet, 2.2 16V	06.05 -	1150	1120	E90-30-009-01-22	A, 18, 20, 78, 161	30-35	25-30							T
2.4 D Multijet	06.05 -	1200	1120	E90-30-009-02-22	A, 18, 20, 78, 161	30-35	25-30							T
IDEA <i>Pro-Kit (Performance Fahrwerksfedern Performance Springs)</i> 1.3 D Multijet, 1.3 JTD, 1.4, 1.4 16V, 1.6 D Multijet, 1.9 JTD	12.03 -	1000	805	E10-30-008-01-22	A, 18, 20	25-30	25					F3033001	F3032002	T
LINEA (323) <i>Pro-Kit (Performance Fahrwerksfedern Performance Springs)</i> 1.3 D Multijet, 1.4, 1.4 T-Jet	06.07 -	1000	850	E10-30-014-01-22	A, 18, 20	30	30					F11-30-010-01-VA	F11-30-012-01-HA	T
PANDA (169) <i>Pro-Kit (Performance Fahrwerksfedern Performance Springs)</i> 1.1, 1.2, 1.3 D Multijet, 1.4	09.03 -	750	680	E10-30-007-01-22	A, 18, 20	30	30					F11-30-007-01-VA	F11-30-007-01-HA	T
B12 Pro-Kit (Performance Komplettfahrwerke Performance Springs+Shocks) 1.1, 1.2, 1.2 Bi-Power / Natural Power, 1.2 LPG	09.03 -	750	680	E90-30-007-01-22	A, 18, 20, 78, 161	30	30							T
PANDA (312) <i>Pro-Kit (Performance Fahrwerksfedern Performance Springs)</i> 0.9, 1.2	02.12 -	770	810	E10-49-004-02-22	A, 18, 20	25	20					F11-49-004-02-VA	F11-49-004-01-HA	T
B12 Pro-Kit (Performance Komplettfahrwerke Performance Springs+Shocks) 0.9, 0.9 4x4, 0.9 Natural Power, 1.2	02.12 -	770	810	E90-49-004-02-22	A, 18, 20, 78, 161	25	25							T
PANDA Van (169) <i>Pro-Kit (Performance Fahrwerksfedern Performance Springs)</i> 1.1, 1.2, 1.3 JTD	03.04 -	750	680	E10-30-007-01-22	A, 18, 20	30	30					F11-30-007-01-VA	F11-30-007-01-HA	T
PUNTO (176) <i>Pro-Kit (Performance Fahrwerksfedern Performance Springs)</i> 55 1.1	09.93 - 09.99	820	750	E3025-140	A, 18, 20	30	30					F3013201	F3013002	T
1.2 16V, 1.4 GT Turbo, 1.6, 60 1.2, 75 1.2	10.93 - 09.99	850	750	E3013-240	A, 18, 20	30	30					F3013101	F3013002	T
PUNTO (188) <i>Pro-Kit (Performance Fahrwerksfedern Performance Springs)</i> 1.2 16V 80, 1.2 60, 1.3 JTD 16V, 1.4	09.99 -	900	870	E3032-140	A, 18, 20	25-30	25					F3032001	F3032002	T
1.8 130 HGT, 1.9 DS 60, 1.9 JTD, 1.9 JTD 80	09.99 -	900	870	E3033-140	A, 18, 20	25-30	25					F3033001	F3032002	T
Sportline (Performance Fahrwerksfedern Sport Sport Performance Springs) 1.2 16V 80, 1.2 60, 1.3 JTD 16V, 1.4, 1.8 130 HGT, 1.9 DS 60, 1.9 JTD, 1.9 JTD 80	09.99 -	900	750	E20-30-001-01-22	A, 20	45-50	35-40					F21-30-001-01-VA	F21-30-001-01-HA	T
B12 Pro-Kit (Performance Komplettfahrwerke Performance Springs+Shocks) 1.2 16V 80, 1.2 60, 1.2 Bifuel, 1.3 JTD 16V, 1.4	09.99 -	900	870	E90-30-006-01-22	A, 18, 20, 78, 161	25-30	25							T
1.8 130 HGT, 1.9 DS 60, 1.9 JTD, 1.9 JTD 80	09.99 -	900	870	E90-30-006-02-22	A, 18, 20, 78, 161	25-30	25							T
B12 Sportline (Performance Komplettfahrwerke Sport Sport Performance Springs+Shocks) 1.2 16V 80, 1.2 60, 1.2 Bifuel, 1.3 JTD 16V, 1.4, 1.8 130 HGT, 1.9 DS 60, 1.9 JTD, 1.9 JTD 80	09.99 -	900	750	E95-30-006-01-22	A, 20, 78, 161	45-50	35-40							T
Pro-Street-S (Gewindefahrwerke - höhenverstellbar Coil-Overs-Adjustable Ride Height) 1.2 16V 80, 1.2 60, 1.3 JTD 16V, 1.4, 1.8 130 HGT, 1.9 DS 60, 1.9 JTD, 1.9 JTD 80	09.99 -	900	750	PSS65-30-006-01-22	A, 25, 37, 45, 160	30-60	30-60							T
PUNTO (199) <i>Pro-Kit (Performance Fahrwerksfedern Performance Springs)</i> 0.9 Twinair Turbo, 1.2, 1.4, 1.4 Multi Air, 1.4 Turbo Multi Air	03.12 -	950	950	E10-30-010-01-22	A, 18, 20	25-30	30					F11-30-010-01-VA	F11-30-010-01-HA	T

Modell	Baujahr	Achslast Vorne kg	Achslast Hinten kg	Artikel-Nr.	Hinweise	ca. Tieferl. Vorne mm	ca. Tieferl. Hinten mm	Ø Vorne mm	Ø Hinten mm	Verstellbarkeit Vorne	Verstellbarkeit Hinten	Ersatzteilbezeichnung Vorne	Ersatzteilbezeichnung Hinten	Gutachten
Model	Year	Front Axle Load kg	Rear Axle Load kg	Part-No.	Notes	ca. Lowering Front mm	ca. Lowering Rear mm	Ø Front mm	Ø Rear mm	Adjustable Front	Adjustable Rear	Spare Part Marking Front	Spare Part Marking Rear	Homologation
PUNTO (199) Pro-Kit (Performance Fahrwerksfedern Performance Springs) 1.3 D Multijet, 1.4 Turbo Multi Air	03.12 -	1000	950	E10-30-010-02-22	A, 18, 20	25-30	30					F11-30-010-02-VA	F11-30-010-01-HA	T
Sportline (Performance Fahrwerksfedern Sport Sport Performance Springs) 0.9 Twinair Turbo, 1.2, 1.4, 1.4 Multi Air, 1.4 Turbo Multi Air	03.12 -	950	850	E20-30-010-01-22	A, 18, 20	40-45	30					F21-30-010-01-VA	F21-30-010-01-HA	T
1.3 D Multijet, 1.4 Turbo Multi Air	03.12 -	1000	850	E20-30-010-02-22	A, 18, 20	40-45	30					F21-30-010-02-VA	F21-30-010-01-HA	T
Pro-Street-S (Gewindefahrwerke - höhenverstellbar Coil-Overs-Adjustable Ride Height) 0.9 Twinair Turbo, 1.2, 1.4, 1.4 Multi Air, 1.4 Turbo Multi Air	03.12 -	900	850	PSS65-30-010-01-22	A, 25, 45, 160	35-65	35-65							T
1.3 D Multijet, 1.4 Turbo Multi Air	03.12 -	1000	850	PSS65-30-010-02-22	A, 25, 45, 160	35-65	35-65							T
PUNTO / GRANDE PUNTO (199) Pro-Kit (Performance Fahrwerksfedern Performance Springs) 1.2, 1.4, 1.4 16V	10.05 -	950	950	E10-30-010-01-22	A, 18, 20	25-30	30					F11-30-010-01-VA	F11-30-010-01-HA	T
1.3 D Multijet, 1.4 T-Jet, 1.6 D Multijet, 1.9 D Multijet	10.05 -	1000	950	E10-30-010-02-22	A, 18, 20	25-30	30					F11-30-010-02-VA	F11-30-010-01-HA	T
1.4 Abarth	12.07 -	1000	950	E10-30-010-02-22	A, 18, 20	20-25	30					F11-30-010-02-VA	F11-30-010-01-HA	T
Sportline (Performance Fahrwerksfedern Sport Sport Performance Springs) 1.2, 1.4, 1.4 16V	10.05 -	950	850	E20-30-010-01-22	A, 18, 20	40-45	30					F21-30-010-01-VA	F21-30-010-01-HA	T
1.3 D Multijet, 1.4 T-Jet, 1.6 D Multijet, 1.9 D Multijet	10.05 -	1000	850	E20-30-010-02-22	A, 18, 20	40-45	30					F21-30-010-02-VA	F21-30-010-01-HA	T
1.4 Abarth	12.07 -	1000	850	E20-30-010-02-22	A, 18, 20	30-35	20					F21-30-010-02-VA	F21-30-010-01-HA	T
B12 Pro-Kit (Performance Komplettfahrwerke Performance Springs+Shocks) 1.2, 1.4, 1.4 16V	10.05 -	950	950	E90-30-010-01-22	A, 18, 20, 78, 161	25-30	30							T
1.3 D Multijet, 1.4 Abarth, 1.4 T-Jet, 1.6 D Multijet, 1.9 D Multijet	10.05 -	1000	950	E90-30-010-02-22	A, 18, 20, 78, 161	25-30	30							T
B12 Sportline (Performance Komplettfahrwerke Sport Sport Performance Springs+Shocks) 1.2, 1.4, 1.4 16V, 1.4 T-Jet	10.05 -	950	950	E95-30-010-01-22	A, 18, 20, 78, 161	40-45	30							T
1.3 D Multijet, 1.4, 1.4 16V, 1.4 Abarth, 1.4 T-Jet, 1.6 D Multijet, 1.9 D Multijet	10.05 -	1000	950	E95-30-010-02-22	A, 18, 20, 78, 161	40-45	30							T
Pro-Street-S (Gewindefahrwerke - höhenverstellbar Coil-Overs-Adjustable Ride Height) 1.2, 1.4, 1.4 16V	10.05 -	900	850	PSS65-30-010-01-22	A, 25, 45, 160	35-65	35-65							T
1.4 Abarth	12.07 -	900	850	PSS65-30-010-02-22	A, 25, 45, 160	35-65	35-65							T
1.3 D Multijet, 1.4 T-Jet, 1.6 D Multijet, 1.9 D Multijet	10.05 -	1000	850	PSS65-30-010-02-22	A, 25, 45, 160	35-65	35-65							T
PUNTO Cabriolet (176C) PUNTO Convertible (176C) Pro-Kit (Performance Fahrwerksfedern Performance Springs) 60 1.2, 85 16V 1.2, 90 1.6	04.94 - 06.00	850	750	E3013-240	A, 18, 20	30	30					F3013101	F3013002	T
PUNTO EVO (199) Pro-Kit (Performance Fahrwerksfedern Performance Springs) 0.9 Twinair Turbo, 1.2, 1.4, 1.4 16V	07.09 - 03.12	950	950	E10-30-010-01-22	A, 18, 20	25-30	30					F11-30-010-01-VA	F11-30-010-01-HA	T
1.3 D Multijet, 1.6 D Multijet	07.08 - 02.12	1000	950	E10-30-010-02-22	A, 18, 20	25-30	30					F11-30-010-02-VA	F11-30-010-01-HA	T
Sportline (Performance Fahrwerksfedern Sport Sport Performance Springs) 0.9 Twinair Turbo, 1.2, 1.4, 1.4 16V	07.09 - 03.12	950	850	E20-30-010-01-22	A, 18, 20	40-45	30					F21-30-010-01-VA	F21-30-010-01-HA	T
1.3 D Multijet, 1.6 D Multijet	07.08 - 02.12	1000	850	E20-30-010-02-22	A, 18, 20	40-45	30					F21-30-010-02-VA	F21-30-010-01-HA	T
B12 Pro-Kit (Performance Komplettfahrwerke Performance Springs+Shocks) 1.2, 1.4, 1.4 16V, 1.4 Abarth	07.09 - 02.12	950	950	E90-30-010-01-22	A, 18, 20, 78, 161	25-30	30							T
1.3 D Multijet, 1.6 D Multijet	07.08 - 02.12	1000	950	E90-30-010-02-22	A, 18, 20, 78, 161	25-30	30							T
B12 Sportline (Performance Komplettfahrwerke Sport Sport Performance Springs+Shocks) 1.2, 1.4, 1.4 16V, 1.4 Abarth	07.09 - 02.12	950	950	E95-30-010-01-22	A, 18, 20, 78, 161	40-45	30							T
1.3 D Multijet, 1.6 D Multijet	07.08 - 02.12	1000	950	E95-30-010-02-22	A, 18, 20, 78, 161	40-45	30							T
Pro-Street-S (Gewindefahrwerke - höhenverstellbar Coil-Overs-Adjustable Ride Height) 0.9 Twinair Turbo, 1.2, 1.4, 1.4 16V	07.09 - 03.12	900	850	PSS65-30-010-01-22	A, 25, 45, 160	35-65	35-65							T
1.3 D Multijet, 1.6 D Multijet	07.08 - 02.12	1000	850	PSS65-30-010-02-22	A, 25, 45, 160	35-65	35-65							T
PUNTO EVO Kasten (199) PUNTO EVO Box (199) Pro-Kit (Performance Fahrwerksfedern Performance Springs) 1.4	03.09 -	950	950	E10-30-010-01-22	A, 18, 20	25-30	30					F11-30-010-01-VA	F11-30-010-01-HA	T
1.3 D Multijet	03.09 -	1000	950	E10-30-010-02-22	A, 18, 20	25-30	30					F11-30-010-02-VA	F11-30-010-01-HA	T
Sportline (Performance Fahrwerksfedern Sport Sport Performance Springs) 1.4	03.09 -	950	850	E20-30-010-01-22	A, 18, 20	40-45	30					F21-30-010-01-VA	F21-30-010-01-HA	T
1.3 D Multijet	03.09 -	1000	850	E20-30-010-02-22	A, 18, 20	40-45	30					F21-30-010-02-VA	F21-30-010-01-HA	T
Pro-Street-S (Gewindefahrwerke - höhenverstellbar Coil-Overs-Adjustable Ride Height) 1.4	03.09 -	900	850	PSS65-30-010-01-22	A, 25, 45, 160	35-65	35-65							T
1.3 D Multijet	03.09 -	1000	850	PSS65-30-010-02-22	A, 25, 45, 160	35-65	35-65							T
PUNTO Van (199) Pro-Kit (Performance Fahrwerksfedern Performance Springs) 1.3 D Multijet	03.09 -	1000	950	E10-30-010-02-22	A, 18, 20	25-30	30					F11-30-010-02-VA	F11-30-010-01-HA	T

Modell	Baujahr	Achslast Vorne kg	Achslast Hinten kg	Artikel-Nr.	Hinweise	ca. Tieferl. Vorne mm	ca. Tieferl. Hinten mm	Ø Vorne mm	Ø Hinten mm	Verstellbarkeit Vorne	Verstellbarkeit Hinten	Ersatzteilbezeichnung Vorne	Ersatzteilbezeichnung Hinten	Gutachten
Model	Year	Front Axle Load kg	Rear Axle Load kg	Part-No.	Notes	ca. Lowering Front mm	ca. Lowering Rear mm	Ø Front mm	Ø Rear mm	Adjustable Front	Adjustable Rear	Spare Part Marking Front	Spare Part Marking Rear	Homologation
PUNTO Van (199) <i>Sportline (Performance Fahrwerksfedern Sport Sport Performance Springs)</i> 1.3 D Multijet	03.09 -	1000	850	E20-30-010-02-22	A, 18, 20	40-45	30					F21-30-010-02-VA	F21-30-010-01-HA	T
<i>Pro-Street-S (Gewindefahrwerke - höhenverstellbar Coil-Overs-Adjustable Ride High)</i> 1.3 D Multijet	03.09 -	1000	850	PSS65-30-010-02-22	A, 25, 45, 160	35-65	35-65							T
SCUDO Combinato (220P) <i>Pro-Kit (Performance Fahrwerksfedern Performance Springs)</i> 1.6, 1.9 D, 1.9 TD, 1.9 TD Eco, 2.0 JTD, 2.0 JTD 16V	02.96 - 12.06	1230	1100	E3015-140	A, 18, 20	25-30	30					F3015001	F3015002	T
SCUDO Kasten (220L) <i>SCUDO Box (220L)</i> <i>Pro-Kit (Performance Fahrwerksfedern Performance Springs)</i> 1.6, 1.9 D, 1.9 TD, 2.0, 2.0 JTD, 2.0 JTD 16V	02.96 - 12.06	1230	1100	E3015-140	A, 18, 20	25-30	30					F3015001	F3015002	T
SEDICI <i>Pro-Kit (Performance Fahrwerksfedern Performance Springs)</i> 1.6 16V	06.06 -	870	880	E10-80-009-01-22	A, 18, 20	25	25					F11-80-009-01-VA	F11-80-009-01-HA	T
SEICENTO (187) <i>Pro-Kit (Performance Fahrwerksfedern Performance Springs)</i> 0.9, 1.1	01.98 - 01.10	610	630	E3029-140	A, 18, 20, 68	30	30					F3011001	F3011002	T
SEICENTO Van (187) <i>Pro-Kit (Performance Fahrwerksfedern Performance Springs)</i> 0.9, 1.1	01.98 - 01.10	610	630	E3029-140	A, 18, 20, 68	30	30					F3011001	F3011002	T
STILO (192) <i>Pro-Kit (Performance Fahrwerksfedern Performance Springs)</i> 1.2 16V, 1.4 16V, 1.6 16V, 1.8 16V, 1.9 D Multijet, 1.9 JTD	10.01 - 11.06	1020	940	E10-30-001-01-22	A, 18, 20	30	30					F11-30-001-01-VA	F11-30-001-01-HA	T
1.9 JTD, 2.4 20V	10.01 - 11.06	1030	940	E10-30-001-02-22	A, 18, 20	30	30					F11-30-001-02-VA	F11-30-001-01-HA	T
<i>Sportline (Performance Fahrwerksfedern Sport Sport Performance Springs)</i> 1.2 16V, 1.4 16V, 1.6 16V, 1.8 16V, 1.9 D Multijet, 1.9 JTD	10.01 - 11.06	1020	940	E20-30-001-02-22	A, 18, 20	45-50	30					F21-30-001-02-VA	F21-30-001-02-HA	T
1.9 JTD, 2.4 20V	10.01 - 11.06	1030	940	E20-30-001-03-22	A, 18, 20	45-50	30					F21-30-001-03-VA	F21-30-001-02-HA	T
<i>B12 Pro-Kit (Performance Komplettfahrwerke Performance Springs+Shocks)</i> 1.2 16V, 1.4 16V, 1.6 16V, 1.9 D Multijet, 1.9 JTD	10.01 - 11.06	1020	940	E90-30-001-01-22	A, 18, 20, 78, 82,	30	30							T
1.9 JTD	10.01 - 11.06	1030	940	E90-30-001-03-22	A, 18, 20, 78, 82,	30	30							T
<i>B12 Sportline (Performance Komplettfahrwerke Sport Sport Performance Springs+Shocks)</i> 1.2 16V, 1.4 16V, 1.6 16V, 1.8 16V, 1.9 D Multijet, 1.9 JTD	10.01 - 11.06	1020	940	E95-30-001-01-22	A, 18, 20, 78, 82,	45-50	30							T
1.9 JTD	10.01 - 11.06	1030	940	E95-30-001-03-22	A, 18, 20, 78, 82,	45-50	30							T
STILO Multi Wagon (192) <i>Pro-Kit (Performance Fahrwerksfedern Performance Springs)</i> 1.4 16V, 1.6 16V, 1.8 16V, 1.9 D, 1.9 D Multijet, 1.9 JTD	01.03 - 08.08	1020	980	E10-30-001-04-22	A, 18, 20	30	30					F11-30-001-01-VA	F11-30-001-04-HA	T
1.9 JTD	01.03 - 08.08	1030	980	E10-30-001-05-22	A, 18, 20	30	30					F11-30-001-02-VA	F11-30-001-04-HA	T
<i>B12 Pro-Kit (Performance Komplettfahrwerke Performance Springs+Shocks)</i> 1.4 16V, 1.6 16V, 1.8 16V, 1.9 D, 1.9 D Multijet, 1.9 JTD	01.03 - 08.08	1020	980	E90-30-001-05-22	A, 18, 20, 78, 82,	30	30							T
1.9 JTD	09.03 - 08.08	1030	980	E90-30-001-06-22	A, 18, 20, 78, 82,	30	30							T
ULYSSE (220) <i>Pro-Kit (Performance Fahrwerksfedern Performance Springs)</i> 1.8, 1.9 TD, 2.0, 2.0 16V, 2.0 JTD, 2.0 JTD 16V, 2.0 Turbo, 2.1 TD	06.94 - 08.02	1230	1300	E3015-140	A, 18, 20	30	10					F3015001	F3015002	T
ULYSSE (179AX) <i>Pro-Kit (Performance Fahrwerksfedern Performance Springs)</i> 2.0, 2.0 D Multijet, 2.0 JTD, 2.2 D Multijet, 2.2 JTD, 3.0	08.02 - 06.11	1370	1300	E10-70-005-01-22	A, 18, 20	30	10					F3015001	F3015002	T
B-MAX <i>Pro-Kit (Performance Fahrwerksfedern Performance Springs)</i> 1.0 EcoBoost, 1.4, 1.5 TDCi, 1.6 TDCi, 1.6 Ti	10.12 -	915	925	E10-35-027-01-22	A, 18, 20	25	25					F11-35-027-01-VA	F11-15-001-01-HA	T
C-MAX <i>Pro-Kit (Performance Fahrwerksfedern Performance Springs)</i> 1.6, 1.8, 1.8 Flexifuel, 2.0	02.07 -	1015	1070	E10-35-014-01-22	A, 18, 20	30	30					F11-35-014-01-VA	F11-35-014-01-HA	ABE
1.6 TDCi, 1.8 TDCi, 2.0 TDCi	02.07 -	1070	1070	E10-35-014-02-22	A, 18, 20	30	30					F11-35-014-02-VA	F11-35-014-01-HA	ABE
<i>B12 Pro-Kit (Performance Komplettfahrwerke Performance Springs+Shocks)</i> 1.6, 1.8, 2.0	02.07 -	990	1065	E90-35-014-01-22	A, 18, 20, 69, 78,	30	30							T
1.6 TDCi, 1.8 TDCi, 2.0 TDCi	02.07 -	1070	1070	E90-35-014-02-22	A, 18, 20, 69, 78,	30	30							T
C-MAX II <i>Pro-Kit (Performance Fahrwerksfedern Performance Springs)</i> 1.6 EcoBoost, 1.6 Flexifuel, 1.6 Ti	12.10 -	995	1020	E10-35-024-01-22	A, 18, 20	25	25					F11-35-023-01-VA	F11-55-009-01-HA	T
1.6 EcoBoost, 1.6 Flexifuel, 1.6 TDCi, 1.6 Ti	12.10 -	1055	1020	E10-35-024-02-22	A, 18, 20	25	25					F11-84-006-07-VA	F11-55-009-01-HA	T
2.0 TDCi	12.10 -	1175	1020	E10-35-024-03-22	A, 18, 20	25	25					F11-35-014-02-VA	F11-55-009-01-HA	T
FIESTA IV (JA, JB) <i>Pro-Kit (Performance Fahrwerksfedern Performance Springs)</i> 1.25 i 16V, 1.3 i, 1.4 i 16V, 1.6, 1.6 16V Sport	08.95 - 01.02	790	710	E3595-140	A, 18, 20	30	30					F3569001	F3581002	T
FIESTA V (JH, JD) <i>Pro-Kit (Performance Fahrwerksfedern Performance Springs)</i> 1.0, 1.25 16V, 1.3, 1.4 16V, 1.6 16V	11.01 -	820	800	E10-35-010-01-22	A, 18, 20	35	30					F11-35-010-01-VA	F11-35-010-01-HA	ABE

Modell	Baujahr	Achslast Vorne kg	Achslast Hinten kg	Artikel-Nr.	Hinweise	ca. Tieferl. Vorne mm	ca. Tieferl. Hinten mm	Ø Vorne mm	Ø Hinten mm	Verstellbarkeit Vorne	Verstellbarkeit Hinten	Ersatzteilbezeichnung Vorne	Ersatzteilbezeichnung Hinten	Gutachten
Model	Year	Front Axle Load kg	Rear Axle Load kg	Part-No.	Notes	ca. Lowering Front mm	ca. Lowering Rear mm	Ø Front mm	Ø Rear mm	Adjustable Front	Adjustable Rear	Spare Part Marking Front	Spare Part Marking Rear	Homologation
FIESTA V (JH., JD.) Pro-Kit (Performance Fahrwerksfedern Performance Springs) 1.4 TDCi, 1.6 16V, ST150	11.01 -	860	800	E10-35-010-02-22	A, 18, 20	35	30					F11-35-010-02-VA	F11-35-010-01-HA	ABE
B12 Pro-Kit (Performance Komplettfahrwerke Performance Springs+Shocks) 1.25 16V, 1.3, 1.4 16V	11.01 -	820	800	E90-35-010-01-22	A, 18, 20, 78, 161	35	30							T
1.4 TDCi, 1.6 16V, 1.6 TDCi, ST150	11.01 -	860	800	E90-35-010-02-22	A, 18, 20, 78, 161	35	30							T
FIESTA VI Pro-Kit (Performance Fahrwerksfedern Performance Springs) 1.4 TDCi, 1.6 TDCi	10.08 -	850	785	E10-35-020-02-22	A, 18, 20	30	30					F11-35-020-02-VA	F11-35-020-01-HA	T
1.0, 1.0 EcoBoost, 1.25, 1.4, 1.6, 1.6 Ti	10.08 -	850	785	E10-35-020-01-22	A, 18, 20	30	30					F11-35-020-01-VA	F11-35-020-01-HA	T
Pro-Street-S (Gewindefahrwerke - höhenverstellbar Coil-Overs-Adjustable Ride Height) 1.0, 1.0 EcoBoost, 1.25, 1.4, 1.4 TDCi, 1.6, 1.6 TDCi, 1.6 Ti	10.08 -	850	765	PSS65-35-020-01-22	A, 18, 20, 24, 25, 45, 160	30-55	30-60							T
FOCUS (DAW, DBW) Pro-Kit (Performance Fahrwerksfedern Performance Springs) 1.4 16V, 1.6 16V, 1.6 16V Flexifuel	10.98 - 11.04	855	905	E3587-140	A, 18, 20	30	30					F3587001	F3587002	ABE
1.8 16V, 2.0 16V	10.98 - 11.04	915	905	E3588-140	A, 18, 20	30	30					F3588001	F3587002	ABE
ST170	03.02 - 11.04	915	905	E3588-140	A, 18, 20	20-25	20					F3588001	F3587002	ABE
1.8 DI / TDDi, 1.8 TDCi, 1.8 Turbo DI / TDDi	10.98 - 11.04	965	905	E3592-140	A, 18, 20	30	30					F3590001	F3587002	ABE
Anti-Roll-Kit (Performance Stabilisatoren Performance Sway Bars) 1.4 16V, 1.6 16V, 1.6 16V Flexifuel, 1.8 16V, 1.8 DI / TDDi, 1.8 TDCi, 1.8 Turbo DI / TDDi, 2.0 16V	10.98 - 11.04			E40-35-001-01-11	A, 18, 20, 22, 45			23	26	nicht verstellbar not adjustable	nicht verstellbar not adjustable	AS41-35-001-01-VA	AS41-35-001-01-HA	T
B12 Pro-Kit (Performance Komplettfahrwerke Performance Springs+Shocks) 1.4 16V, 1.6 16V	10.98 - 11.04	855	905	E90-35-001-01-22	A, 18, 20, 78, 161	30	30							T
1.8 16V, 2.0 16V	10.98 - 11.04	915	905	E90-35-001-02-22	A, 18, 20, 78, 161	30	30							T
ST170	03.02 - 11.04	915	905	E90-35-001-02-22	A, 18, 20, 78, 161	20-25	30							T
1.8 DI / TDDi, 1.8 TDCi, 1.8 Turbo DI / TDDi	10.98 - 11.04	965	905	E90-35-001-05-22	A, 18, 20, 78, 161	30	30							T
Pro-Street-S (Gewindefahrwerke - höhenverstellbar Coil-Overs-Adjustable Ride Height) 1.4 16V, 1.6 16V, 1.6 16V Flexifuel, 1.8 16V, 1.8 DI / TDDi, 1.8 TDCi, 1.8 Turbo DI / TDDi, 2.0 16V	10.98 - 11.04	965	930	PSS65-35-001-01-22	A, 24, 25, 45, 160	35-65	35-65							T
FOCUS C-MAX Pro-Kit (Performance Fahrwerksfedern Performance Springs) 1.6, 1.6 Ti, 1.8, 1.8 Flexifuel, 2.0	10.03 - 03.07	1015	1070	E10-35-014-01-22	A, 18, 20	30	30					F11-35-014-01-VA	F11-35-014-01-HA	ABE
1.6 TDCi, 1.8 TDCi, 2.0 TDCi	10.03 - 03.07	1070	1070	E10-35-014-02-22	A, 18, 20	30	30					F11-35-014-02-VA	F11-35-014-01-HA	ABE
B12 Pro-Kit (Performance Komplettfahrwerke Performance Springs+Shocks) 1.6, 1.6 Ti, 1.8, 1.8 Flexifuel, 2.0	10.03 - 03.07	1015	1070	E90-35-014-01-22	A, 18, 20, 69, 78, 161	30	30							T
1.6 TDCi, 1.8 TDCi, 2.0 TDCi	10.03 - 03.07	1070	1070	E90-35-014-02-22	A, 18, 20, 69, 78, 161	30	30							T
FOCUS II (DA.) Pro-Kit (Performance Fahrwerksfedern Performance Springs) 1.4, 1.6, 1.6 Ti, 1.8, 1.8 Flexifuel	11.04 -	1005	1015	E10-35-016-01-22	A, 18, 20	30	30					F11-55-008-02-VA	F11-35-016-01-HA	ABE
2.5 RS	01.09 -	1040	920	E10-35-016-09-22	A, 18, 20	25	15					F11-35-016-09-VA	F11-35-016-09-HA	T
2.5 ST	10.05 -	1050	915	E10-35-016-05-22	A, 18, 20	20	25					F11-84-006-07-VA	F11-35-016-05-HA	ABE
1.6 TDCi, 1.8 TDCi, 2.0, 2.0 TDCi	11.04 -	1070	1015	E10-35-016-02-22	A, 18, 20	30	30					F11-35-014-02-VA	F11-35-016-01-HA	ABE
B12 Pro-Kit (Performance Komplettfahrwerke Performance Springs+Shocks) 1.4, 1.6, 1.6 Ti, 1.8	11.04 -	1005	1015	E90-35-016-01-22	A, 18, 20, 78, 161	30	30							T
2.5 ST	10.05 -	1050	915	E90-35-016-05-22	A, 18, 20, 78, 161	20	25							T
1.6 TDCi, 1.8 TDCi, 2.0, 2.0 TDCi	11.04 -	1070	1015	E90-35-016-02-22	A, 18, 20, 78, 161	30	30							T
Pro-Street-S (Gewindefahrwerke - höhenverstellbar Coil-Overs-Adjustable Ride Height) 1.4, 1.6, 1.6 TDCi, 1.6 Ti, 1.8, 1.8 Flexifuel, 1.8 TDCi, 2.0, 2.0 TDCi, 2.5 ST	11.04 -	1070	1015	PSS65-35-016-01-22	A, 18, 20, 23, 25, 45, 160	35-65	35-65							T
FOCUS II Cabriolet FOCUS II Convertible Pro-Kit (Performance Fahrwerksfedern Performance Springs) 1.6, 2.0	10.06 -	990	1065	E10-35-016-06-22	A, 18, 20	30	30					F11-35-014-01-VA	F11-35-014-01-HA	T
2.0 TDCi	10.06 -	1070	1065	E10-35-016-07-22	A, 18, 20	30	30					F11-35-014-02-VA	F11-35-014-01-HA	T
B12 Pro-Kit (Performance Komplettfahrwerke Performance Springs+Shocks) 1.6, 2.0	10.06 -	990	1065	E90-35-016-06-22	A, 18, 20, 78, 161	30	30							T
2.0 TDCi	10.06 -	1070	1065	E90-35-016-07-22	A, 18, 20, 78, 161	30	30							T
FOCUS II Kombi (DA.) FOCUS II Estate (DA.) Pro-Kit (Performance Fahrwerksfedern Performance Springs) 1.4, 1.6, 1.6 Ti, 1.8, 1.8 Flexifuel	11.04 -	1005	1090	E10-35-016-03-22	A, 18, 20	30	30					F11-55-008-02-VA	F11-35-016-03-HA	ABE
1.6 TDCi, 1.8 TDCi, 2.0, 2.0 TDCi	11.04 -	1070	1090	E10-35-016-04-22	A, 18, 20	30	30					F11-35-014-02-VA	F11-35-016-03-HA	ABE
B12 Pro-Kit (Performance Komplettfahrwerke Performance Springs+Shocks) 1.4, 1.6, 1.6 Ti, 1.8	11.04 -	1005	1090	E90-35-016-03-22	A, 18, 20, 78, 161	30	30							T

Modell	Baujahr	Achslast Vorne kg	Achslast Hinten kg	Artikel-Nr.	Hinweise	ca. Tieferl. Vorne mm	ca. Tieferl. Hinten mm	Ø Vorne mm	Ø Hinten mm	Verstellbarkeit Vorne	Verstellbarkeit Hinten	Ersatzteilbezeichnung Vorne	Ersatzteilbezeichnung Hinten	Gutachten
Model	Year	Front Axle Load kg	Rear Axle Load kg	Part-No.	Notes	ca. Lowering Front mm	ca. Lowering Rear mm	Ø Front mm	Ø Rear mm	Adjustable Front	Adjustable Rear	Spare Part Marking Front	Spare Part Marking Rear	Homologation
FOCUS II Kombi (DA) FOCUS II Estate (DA) B12 Pro-Kit (Performance Komplettfahrwerke Performance Springs+Shocks) 1.6 TDCi, 1.8 TDCi, 2.0, 2.0 TDCi	11.04 -	1070	1090	E90-35-016-04-22	A, 18, 20, 78, 161	30	30							T
FOCUS II Stufenheck (DA) FOCUS II Saloon (DA) Pro-Kit (Performance Fahrwerksfedern Performance Springs) 1.4, 1.6, 1.6 Ti, 1.8, 1.8 Flexifuel	04.05 -	1005	1015	E10-35-016-01-22	A, 18, 20	30	30					F11-55-008-02-VA	F11-35-016-01-HA	ABE
1.6 TDCi, 1.8 TDCi, 2.0, 2.0 TDCi	04.05 -	1070	1015	E10-35-016-02-22	A, 18, 20	30	30					F11-35-014-02-VA	F11-35-016-01-HA	ABE
B12 Pro-Kit (Performance Komplettfahrwerke Performance Springs+Shocks) 1.4, 1.6, 1.6 Ti, 1.8	04.05 -	1005	1015	E90-35-016-01-22	A, 18, 20, 78, 161	30	30							T
1.6 TDCi, 1.8 TDCi, 2.0, 2.0 TDCi	04.05 -	1070	1015	E90-35-016-02-22	A, 18, 20, 78, 161	30	30							T
Pro-Street-S (Gewindefahrwerke - höhenverstellbar Coil-Overs-Adjustable Ride Height) 1.4, 1.6, 1.6 TDCi, 1.6 Ti, 1.8, 1.8 Flexifuel, 1.8 TDCi, 2.0, 2.0 TDCi	04.05 -	1070	1015	PSS65-35-016-01-22	A, 18, 20, 23, 25, 45, 160	35-65	35-65							T
FOCUS III Pro-Kit (Performance Fahrwerksfedern Performance Springs) 1.0 EcoBoost, 1.6 EcoBoost, 1.6 Flexifuel, 1.6 TDCi, 1.6 TDCi ECONetic, 1.6 Ti	04.11 -	985	1025	E10-35-023-01-22	A, 18, 20	25	25					F11-35-023-01-VA	F11-35-014-01-HA	T
1.6 EcoBoost, 1.6 Flexifuel, 1.6 Ti, 2.0 GDI, 2.0 TDCi	04.11 -	1100	1025	E10-35-023-02-22	A, 18, 20	25	25					F11-84-006-07-VA	F11-35-014-01-HA	T
2.0 ST	07.12 -	1100	1025	E10-35-023-02-22	A, 18, 20	25	10					F11-84-006-07-VA	F11-35-014-01-HA	T
Pro-Street-S (Gewindefahrwerke - höhenverstellbar Coil-Overs-Adjustable Ride Height) 1.6 EcoBoost, 1.6 Flexifuel, 1.6 TDCi, 1.6 TDCi ECONetic, 1.6 Ti	04.11 -	1000	1025	PSS65-35-023-01-22	A, 18, 20, 24, 45	30-50	40-55							T
1.6 EcoBoost, 1.6 Flexifuel, 1.6 Ti, 2.0 GDI, 2.0 TDCi	04.11 -	1100	1025	PSS65-35-023-02-22	A, 18, 20, 24, 45	30-50	40-55							T
FOCUS III Stufenheck FOCUS III Saloon Pro-Kit (Performance Fahrwerksfedern Performance Springs) 1.0 EcoBoost, 1.6 EcoBoost, 1.6 Flexifuel, 1.6 TDCi, 1.6 Ti	04.11 -	985	1025	E10-35-023-01-22	A, 18, 20	25	25					F11-35-023-01-VA	F11-35-014-01-HA	T
1.6 EcoBoost, 1.6 Flexifuel, 1.6 Ti, 2.0 TDCi	04.11 -	1100	1025	E10-35-023-02-22	A, 18, 20	25	25					F11-84-006-07-VA	F11-35-014-01-HA	T
Pro-Street-S (Gewindefahrwerke - höhenverstellbar Coil-Overs-Adjustable Ride Height) 1.6 EcoBoost, 1.6 Flexifuel, 1.6 TDCi, 1.6 Ti	04.11 -	1000	1025	PSS65-35-023-01-22	A, 18, 20, 24, 45	30-50	40-55							T
1.6 EcoBoost, 1.6 Flexifuel, 1.6 Ti, 2.0 TDCi	04.11 -	1100	1025	PSS65-35-023-02-22	A, 18, 20, 24, 45	30-50	40-55							T
FOCUS III Turnier Pro-Kit (Performance Fahrwerksfedern Performance Springs) 1.0 EcoBoost, 1.6 EcoBoost, 1.6 Flexifuel, 1.6 TDCi, 1.6 TDCi ECONetic, 1.6 Ti	05.11 -	985	1070	E10-35-023-03-22	A, 18, 20, 68	25	25					F11-35-023-01-VA	F11-35-023-03-HA	T
1.6 EcoBoost, 1.6 Flexifuel, 1.6 TDCi, 1.6 TDCi ECONetic, 1.6 Ti, 2.0 TDCi	05.11 -	1100	1070	E10-35-023-04-22	A, 18, 20, 68	25	25					F11-84-006-07-VA	F11-35-023-03-HA	T
2.0 ST	07.12 -	1100	1070	E10-35-023-04-22	A, 18, 20, 68	25	10					F11-84-006-07-VA	F11-35-023-03-HA	T
FOCUS Kombi (DNW) FOCUS Estate (DNW) Pro-Kit (Performance Fahrwerksfedern Performance Springs) 1.4 16V, 1.6 16V, 1.6 16V Flexifuel	02.99 - 11.04	855	1010	E3590-140	A, 18, 20	30	30					F3587001	F3590002	ABE
1.8 16V, 2.0 16V, ST170	02.99 - 11.04	915	1010	E3591-140	A, 18, 20	30	30					F3588001	F3590002	ABE
1.8 DI / TDDi, 1.8 TDCi, 1.8 Turbo DI / TDDi	02.99 - 11.04	965	1010	E3593-140	A, 18, 20	30	30					F3590001	F3590002	ABE
Anti-Roll-Kit (Performance Stabilisatoren Performance Sway Bars) 1.4 16V, 1.6 16V, 1.6 16V Flexifuel, 1.8 16V, 1.8 DI / TDDi, 1.8 Turbo DI / TDDi, 2.0 16V	02.99 - 11.04			E40-35-001-01-11	A, 18, 20, 22, 45			23	26	nicht verstellbar not adjustable	nicht verstellbar not adjustable	AS41-35-001-01-VA	AS41-35-001-01-HA	T
B12 Pro-Kit (Performance Komplettfahrwerke Performance Springs+Shocks) 1.4 16V, 1.6 16V, 1.6 16V Flexifuel	02.99 - 11.04	855	1010	E90-35-001-03-22	A, 18, 20, 78, 161	30	30							T
1.8 16V, 2.0 16V, ST170	02.99 - 11.04	915	1010	E90-35-001-04-22	A, 18, 20, 78, 161	30	30							T
1.8 DI / TDDi, 1.8 TDCi, 1.8 Turbo DI / TDDi	02.99 - 11.04	965	1010	E90-35-001-06-22	A, 18, 20, 78, 161	30	30							T
FOCUS Stufenheck (DFW) FOCUS Saloon (DFW) Pro-Kit (Performance Fahrwerksfedern Performance Springs) 1.4 16V, 1.6 16V	02.99 - 11.04	855	905	E3587-140	A, 18, 20	30	30					F3587001	F3587002	ABE
1.8 16V, 2.0 16V	02.99 - 11.04	915	905	E3588-140	A, 18, 20	30	30					F3588001	F3587002	ABE
1.8 TDCi, 1.8 Turbo DI / TDDi	02.99 - 03.05	965	905	E3592-140	A, 18, 20	30	30					F3590001	F3587002	ABE
Anti-Roll-Kit (Performance Stabilisatoren Performance Sway Bars) 1.4 16V, 1.6 16V, 1.8 16V, 1.8 TDCi, 1.8 Turbo DI / TDDi, 2.0 16V	02.99 - 03.05			E40-35-001-01-11	A, 18, 20, 22, 45			23	26	nicht verstellbar not adjustable	nicht verstellbar not adjustable	AS41-35-001-01-VA	AS41-35-001-01-HA	T
B12 Pro-Kit (Performance Komplettfahrwerke Performance Springs+Shocks) 1.4 16V, 1.6 16V	02.99 - 11.04	855	905	E90-35-001-01-22	A, 18, 20, 78, 161	30	30							T
1.8 16V, 2.0 16V	02.99 - 11.04	915	905	E90-35-001-02-22	A, 18, 20, 78, 161	30	30							T
1.8 TDCi, 1.8 Turbo DI / TDDi	02.99 - 11.04	965	905	E90-35-001-05-22	A, 18, 20, 78, 161	30	30							T
GALAXY (WGR) Pro-Kit (Performance Fahrwerksfedern Performance Springs) 2.0 i, 2.3 16V	11.95 - 05.06	1240	1355	E3566-140	A, 18, 20	30	30					F8549001	F8549002	T
1.9 TDI, 2.8 V6, 2.8 i V6	03.95 - 05.06	1260	1355	E3574-140	A, 18, 20	30	30					F8552001	F8549002	T

Modell	Baujahr	Achslast Vorne kg	Achslast Hinten kg	Artikel-Nr.	Hinweise	ca. Tieferl. Vorne mm	ca. Tieferl. Hinten mm	Ø Vorne mm	Ø Hinten mm	Verstellbarkeit Vorne	Verstellbarkeit Hinten	Ersatzteilbezeichnung Vorne	Ersatzteilbezeichnung Hinten	Gutachten
Model	Year	Front Axle Load kg	Rear Axle Load kg	Part-No.	Notes	ca. Lowering Front mm	ca. Lowering Rear mm	Ø Front mm	Ø Rear mm	Adjustable Front	Adjustable Rear	Spare Part Marking Front	Spare Part Marking Rear	Homologation
GALAXY (WGR) B12 Pro-Kit (Performance Komplettfahrwerke Performance Springs+Shocks) 2.0 i, 2.3 16V	11.95 - 05.06	1240	1355	E90-35-025-01-22	A, 18, 20, 78, 161	30	30							T
1.9 TDI, 2.8 V6, 2.8 i V6	03.95 - 05.06	1260	1355	E90-35-025-02-22	A, 18, 20, 78, 161	30	30							T
GALAXY Pro-Kit (Performance Fahrwerksfedern Performance Springs) 1.6 EcoBoost, 2.0, 2.0 EcoBoost, 2.0 Flexifuel, 2.3	05.06 -	1300	1405	E10-35-018-01-22	A, 18, 20	30	25					F11-35-017-01-VA	F11-35-017-01-HA	T
1.6 TDCi, 1.8 TDCi, 2.0 TDCi, 2.2 TDCi	05.06 -	1300	1405	E10-35-018-02-22	A, 18, 20	30	25					F11-35-017-02-VA	F11-35-017-01-HA	T
B12 Pro-Kit (Performance Komplettfahrwerke Performance Springs+Shocks) 1.6 EcoBoost, 2.0, 2.0 EcoBoost, 2.0 Flexifuel, 2.3	05.06 -	1300	1405	E90-35-018-01-22	A, 18, 20, 78, 161	30	25							T
1.6 TDCi, 1.8 TDCi, 2.0 TDCi, 2.2 TDCi	05.06 -	1300	1405	E90-35-018-02-22	A, 18, 20, 78, 161	30	25							T
GRAND C-MAX Pro-Kit (Performance Fahrwerksfedern Performance Springs) 1.6 EcoBoost, 1.6 Ti	12.10 -	995	1250	E10-35-024-04-22	A, 18, 20	25	25					F11-35-023-01-VA	F11-84-010-01-HA	T
1.6 EcoBoost, 1.6 TDCi, 1.6 Ti	12.10 -	1055	1250	E10-35-024-05-22	A, 18, 20	25	25					F11-84-006-07-VA	F11-84-010-01-HA	T
2.0 TDCi	12.10 -	1175	1250	E10-35-024-06-22	A, 18, 20	25	25					F11-35-014-02-VA	F11-84-010-01-HA	T
KA (RB.) Pro-Kit (Performance Fahrwerksfedern Performance Springs) 1.0 i, 1.3 i, 1.6 i	09.96 - 11.08	760	610	E10-35-003-01-22	A, 18, 20	30	30					F3569001	F11-35-003-01-HA	ABE
KA Pro-Kit (Performance Fahrwerksfedern Performance Springs) 1.2	10.08 -	770	640	E10-35-022-01-22	A, 18, 20	25	25					F11-35-022-01-VA	F11-35-022-01-HA	T
1.3 TDCi	10.08 -	830	640	E10-35-022-02-22	A, 18, 20	25	25					F11-35-022-02-VA	F11-35-022-01-HA	T
KUGA I Pro-Kit (Performance Fahrwerksfedern Performance Springs) 2.0 TDCi, 2.0 TDCi 4x4, 2.5, 2.5 4x4	03.08 -	1210	1150	E10-35-021-01-22	A, 18	30	30					F11-35-021-01-VA	F11-35-021-01-HA	T
KUGA II Pro-Kit (Performance Fahrwerksfedern Performance Springs) 1.6 EcoBoost, 1.6 EcoBoost 4x4, 2.0 TDCi, 2.0 TDCi 4x4	03.13 -	1210	1150	E10-35-021-01-22	A, 18	30	30-40					F11-35-021-01-VA	F11-35-021-01-HA	T
MONDEO II (BAP) Pro-Kit (Performance Fahrwerksfedern Performance Springs) 1.6 i, 1.6 i 16V, 1.8 i, 2.0 i	09.96 - 11.00	1020	915	E3575-140	A, 18, 20	30	30					F3575001	F3548002	T
MONDEO II Stufenheck (BFP) MONDEO II Saloon (BFP) Pro-Kit (Performance Fahrwerksfedern Performance Springs) 1.6 i, 1.6 i 16V, 1.8 i, 2.0 i	09.96 - 11.00	1020	915	E3575-140	A, 18, 20	30	30					F3575001	F3548002	T
MONDEO III (B5Y) Pro-Kit (Performance Fahrwerksfedern Performance Springs) 1.8 16V, 1.8 SCi, 2.0 16V	11.00 - 08.07	1065	1015	E10-35-004-01-22	A, 18, 20	40	30					F11-35-004-01-VA	F11-35-004-01-HA	ABE
1.8 16V, 1.8 SCi, 2.0 16V, 2.0 16V DI / TDDi / TDCi, 2.0 16V TDDi / TDCi, 2.0 TDCi, 2.2 TDCi, 2.5 V6 24V, 3.0 V6 24V	11.00 - 08.07	1200	1015	E10-35-004-02-22	A, 18, 20	40	30					F11-35-004-02-VA	F11-35-004-01-HA	ABE
MONDEO III Kombi (BWY) MONDEO III Estate (BWY) Pro-Kit (Performance Fahrwerksfedern Performance Springs) 1.8 16V, 1.8 SCi, 2.0 16V	11.00 - 08.07	1065	1140	E10-35-004-03-22	A, 18, 20	40	30					F11-35-004-01-VA	F11-35-004-03-HA	ABE
1.8 16V, 1.8 SCi, 2.0 16V, 2.0 16V DI / TDDi / TDCi, 2.0 16V TDDi / TDCi, 2.0 TDCi, 2.2 TDCi, 2.5 V6 24V, 3.0 V6 24V	11.00 - 08.07	1200	1140	E10-35-004-04-22	A, 18, 20	40	30					F11-35-004-02-VA	F11-35-004-03-HA	ABE
B12 Pro-Kit (Performance Komplettfahrwerke Performance Springs+Shocks) 1.8 16V, 1.8 SCi, 2.0 16V	11.00 - 08.07	1065	1140	E90-35-004-03-22	A, 18, 20, 78, 161	40	30							T
1.8 16V, 1.8 SCi, 2.0 16V, 2.0 16V DI / TDDi / TDCi, 2.0 16V TDDi / TDCi, 2.0 TDCi, 2.2 TDCi, 2.5 V6 24V, 3.0 V6 24V	11.00 - 08.07	1200	1140	E90-35-004-04-22	A, 18, 20, 78, 161	40	30							T
MONDEO III Stufenheck (B4Y) MONDEO III Saloon (B4Y) Pro-Kit (Performance Fahrwerksfedern Performance Springs) 1.8 16V, 1.8 SCi, 2.0 16V	11.00 - 08.07	1065	1015	E10-35-004-01-22	A, 18, 20	40	30					F11-35-004-01-VA	F11-35-004-01-HA	ABE
1.8 16V, 1.8 SCi, 2.0 16V, 2.0 16V DI / TDDi / TDCi, 2.0 16V TDDi / TDCi, 2.0 TDCi, 2.2 TDCi, 2.5 V6 24V, 3.0 V6 24V	11.00 - 08.07	1200	1015	E10-35-004-02-22	A, 18, 20	40	30					F11-35-004-02-VA	F11-35-004-01-HA	ABE
MONDEO IV Pro-Kit (Performance Fahrwerksfedern Performance Springs) 1.6 EcoBoost, 1.6 Ti, 2.0, 2.0 EcoBoost, 2.0 Flexifuel, 2.0 SCTi	03.07 -	1100	1115	E10-35-019-01-22	A, 18, 20	30	30					F11-35-019-01-VA	F11-84-010-01-HA	T
1.6 TDCi, 1.8 TDCi, 2.0 TDCi, 2.2 TDCi, 2.3, 2.5	03.07 -	1215	1115	E10-35-019-02-22	A, 18, 20	30	30					F11-35-019-02-VA	F11-84-010-01-HA	T
B12 Pro-Kit (Performance Komplettfahrwerke Performance Springs+Shocks) 1.6 EcoBoost, 1.6 Ti, 2.0, 2.0 EcoBoost, 2.0 Flexifuel, 2.0 SCTi	03.07 -	1100	1115	E90-35-019-01-22	A, 18, 20, 78, 161	30	30							T
1.6 TDCi, 1.8 TDCi, 2.0 TDCi, 2.2 TDCi, 2.3, 2.5	03.07 -	1215	1115	E90-35-019-02-22	A, 18, 20, 78, 161	30	30							T
MONDEO IV Stufenheck MONDEO IV Saloon Pro-Kit (Performance Fahrwerksfedern Performance Springs) 1.6 Ti, 2.0, 2.0 Flexifuel	03.07 -	1100	1115	E10-35-019-01-22	A, 18, 20	30	30					F11-35-019-01-VA	F11-84-010-01-HA	T
1.8 TDCi, 2.0 TDCi, 2.2 TDCi, 2.3, 2.5	03.07 -	1215	1115	E10-35-019-02-22	A, 18, 20	30	30					F11-35-019-02-VA	F11-84-010-01-HA	T

Modell	Baujahr	Achslast Vorne kg	Achslast Hinten kg	Artikel-Nr.	Hinweise	ca. Tieferl. Vorne mm	ca. Tieferl. Hinten mm	Ø Vorne mm	Ø Hinten mm	Verstellbarkeit Vorne	Verstellbarkeit Hinten	Ersatzteilbezeichnung Vorne	Ersatzteilbezeichnung Hinten	Gutachten
Model	Year	Front Axle Load kg	Rear Axle Load kg	Part-No.	Notes	ca. Lowering Front mm	ca. Lowering Rear mm	Ø Front mm	Ø Rear mm	Adjustable Front	Adjustable Rear	Spare Part Marking Front	Spare Part Marking Rear	Homologation
MONDEO IV Stufenheck MONDEO IV Saloon B12 Pro-Kit (Performance Komplettfahrwerke Performance Springs+Shocks) 1.6 Ti, 2.0	03.07 -	1100	1115	E90-35-019-01-22	A, 18, 20, 78, 161	30	30							T
1.8 TDCi, 2.0 TDCi, 2.2 TDCi, 2.3, 2.5	03.07 -	1215	1115	E90-35-019-02-22	A, 18, 20, 78, 161	30	30							T
MONDEO IV Turnier Pro-Kit (Performance Fahrwerksfedern Performance Springs) 1.6 EcoBoost, 1.6 Ti, 2.0, 2.0 EcoBoost, 2.0 Flexifuel, 2.0 SCTi	03.07 -	1100	1220	E10-35-019-03-22	A, 18, 20	30	25-30					F11-35-019-01-VA	F11-35-019-03-HA	T
1.6 TDCi, 1.8 TDCi, 2.0 TDCi, 2.2 TDCi, 2.3, 2.5	03.07 -	1215	1220	E10-35-019-04-22	A, 18, 20	30	25-30					F11-35-019-02-VA	F11-35-019-03-HA	T
B12 Pro-Kit (Performance Komplettfahrwerke Performance Springs+Shocks) 1.6 Ti, 2.0	03.07 -	1100	1220	E90-35-019-03-22	A, 18, 20, 78, 161	30	30							T
1.8 TDCi, 2.0 TDCi, 2.2 TDCi, 2.3, 2.5	03.07 -	1215	1220	E90-35-019-04-22	A, 18, 20, 78, 161	30	30							T
MUSTANG Pro-Kit (Performance Fahrwerksfedern Performance Springs) 4.0 V6, 4.6 V8, 5.4 V8	12.04 -	1070	1116	E10-35-008-01-22	A, 10, 18, 20, 69	25	30					F11-35-008-01-VA	F11-35-008-01-HA	T
B12 Pro-Kit (Performance Komplettfahrwerke Performance Springs+Shocks) 4.0 V6, 4.6 V8, 5.4 V8	12.04 - 12.09	1070	1116	E90-35-008-01-22	A, 18, 20, 69, 78, 161	25	30							T
4.0 V6, 4.6 V8, 5.4 V8	01.10 -	1070	1116	E90-35-008-02-22	A, 18, 20, 69, 78, 161	25	30							T
MUSTANG Cabriolet MUSTANG Convertible Pro-Kit (Performance Fahrwerksfedern Performance Springs) 4.0 V6, 4.6 V8, 5.4 V8	12.05 -	1070	1116	E10-35-008-01-22	A, 10, 18, 20, 69	25	30					F11-35-008-01-VA	F11-35-008-01-HA	T
B12 Pro-Kit (Performance Komplettfahrwerke Performance Springs+Shocks) 4.0 V6, 4.6 V8, 5.4 V8	01.10 -			E90-35-008-02-22	A, 18, 20, 69, 78, 161									T
4.0 V6, 4.6 V8, 5.4 V8	12.05 - 12.09	1070	1116	E90-35-008-01-22	A, 18, 20, 69, 78, 161	25	30							T
PUMA (EC.) Pro-Kit (Performance Fahrwerksfedern Performance Springs) 1.4 16V, 1.6 16V, 1.7 16V	03.97 - 06.02	770	670	E3581-140	A, 18, 20	30	30					F3581001	F3581002	T
S-MAX Pro-Kit (Performance Fahrwerksfedern Performance Springs) 1.6 EcoBoost, 2.0, 2.0 EcoBoost, 2.0 Flexifuel, 2.3	05.06 -	1300	1405	E10-35-017-01-22	A, 18, 20	30	25					F11-35-017-01-VA	F11-35-017-01-HA	T
1.6 TDCi, 1.8 TDCi, 2.0 TDCi, 2.2 TDCi, 2.5 ST	05.06 -	1300	1405	E10-35-017-02-22	A, 18, 20	30	25					F11-35-017-02-VA	F11-35-017-01-HA	T
B12 Pro-Kit (Performance Komplettfahrwerke Performance Springs+Shocks) 1.6 EcoBoost, 2.0, 2.0 EcoBoost, 2.0 Flexifuel	05.06 -	1300	1405	E90-35-017-01-22	A, 18, 20, 78, 161	30	30							T
1.6 TDCi, 1.8 TDCi, 2.0 TDCi, 2.2 TDCi, 2.3, 2.5 ST	05.06 -	1300	1405	E90-35-017-02-22	A, 18, 20, 78, 161	30	30							T
SIERRA (GBG, GB4) Pro-Kit (Performance Fahrwerksfedern Performance Springs) 2.0 RS Cosworth	01.87 - 12.90	850	950	E3503-240	A, 18, 20	20	20					F3503201	F3503202	T
SIERRA Schrägheck (GBC, GBG) SIERRA Hatchback (GBC, GBG) Pro-Kit (Performance Fahrwerksfedern Performance Springs) 2.0 RS Cosworth	11.87 - 01.90	850	950	E3503-240	A, 18, 20	20	20					F3503201	F3503202	T
STREET KA Pro-Kit (Performance Fahrwerksfedern Performance Springs) 1.6	05.03 - 07.05	760	610	E10-35-003-01-22	A, 18, 20	30	30					F3569001	F11-35-003-01-HA	ABE
B12 Pro-Kit (Performance Komplettfahrwerke Performance Springs+Shocks) 1.6	05.03 - 07.05	760	610	E90-35-003-01-22	A, 18, 20, 78, 161	30	30							T
Commodore Pro-Kit (Performance Fahrwerksfedern Performance Springs) VR - VS V6 3.8 Live axle rear	01.93 - 12.96			E3770-140	A, 10	30	30					F3770001	F3771002	
VR - VS V6 3.8 IRS	01.93 - 12.96			E3773-140	A, 10	30	30					F3770001	F2042102	
VR - VS V8 5.0 Live axle rear	01.93 - 12.96			E3771-140	A, 10	30	30					F3770101	F3771002	
VR - VS V8 5.0 IRS	01.93 - 12.96			E3775-140	A, 10	30	30					F3770101	F2042102	
VT, VX, VY, V6 3.8	01.97 -			E3773-140	A, 10	30	30					F3770001	F2042102	
VT, VX, VY, V8 5.7	01.97 -			E3773-140	A, 10	30	30					F3770001	F2042102	
VE V6, V8, non MRC	08.06 -			E10-37-001-01-22	A, 10	35	35					F11-37-001-01-VA	F11-37-001-02-HA	
Commodore Ute Pro-Kit (Performance Fahrwerksfedern Performance Springs) VR - VS V6 3.8	01.93 - 12.00			E3772-140	A, 10	30	30					F3770001	F3770002	
VR - VS V8 5.0	01.93 - 12.00			E3772-240	A, 10	30	30					F3770101	F3770002	
VU V6 3.8	01.01 -			E3776-140	A, 10	30	30					F3770001	F2067102	
VU V8 5.7	01.01 -			E3776-140	A, 10	30	30					F3770001	F2067102	
VE V6, V8	07.07 -			E10-37-001-04-22	A, 10	35	35					F11-37-001-01-VA	F11-37-001-01-HA	

Modell	Baujahr	Achslast Vorne kg	Achslast Hinten kg	Artikel-Nr.	Hinweise	ca. Tieferl. Vorne mm	ca. Tieferl. Hinten mm	Ø Vorne mm	Ø Hinten mm	Verstellbarkeit Vorne	Verstellbarkeit Hinten	Ersatzteilbezeichnung Vorne	Ersatzteilbezeichnung Hinten	Gutachten
Model	Year	Front Axle Load kg	Rear Axle Load kg	Part-No.	Notes	ca. Lowering Front mm	ca. Lowering Rear mm	Ø Front mm	Ø Rear mm	Adjustable Front	Adjustable Rear	Spare Part Marking Front	Spare Part Marking Rear	Homologation
Monaro Pro-Kit (Performance Fahrwerksfedern Performance Springs) CV6	01.01 -			E3773-140	A, 10	30	30					F3770001	F2042102	
CV8	01.01 -			E3773-140	A, 10	30	30					F3770001	F2042102	
Maloo Pro-Kit (Performance Fahrwerksfedern Performance Springs) VE V6, V8	07.07 -			E10-37-001-04-22	A, 10	35	35					F11-37-001-01-VA	F11-37-001-01-HA	
GTS Sedan Pro-Kit (Performance Fahrwerksfedern Performance Springs) E Series V8 (non MRC)	08.06 -			E10-37-001-01-22	A, 10, 21	35	35					F11-37-001-01-VA	F11-37-001-02-HA	
E Series V8 (with MRC)	08.06 -			E10-37-001-02-22	A, 10	35	35					F11-37-001-01-VA	F11-37-001-03-HA	
ACCORD VI (CG, CK) Pro-Kit (Performance Fahrwerksfedern Performance Springs) 1.6 LS, 1.6 i, 1.8 i, 2.0 Turbo Di, 2.0 i, 2.2 Type-R, 2.3	10.98 - 06.03	1040	940	E4040-140	A, 18, 20	30-35	30					F4040001	F4040002	T
B12 Pro-Kit (Performance Komplettfahrwerke Performance Springs+Shocks) 1.6 LS, 1.6 i, 1.8 i, 2.0 Turbo Di, 2.0 i, 2.2 Type-R	10.98 - 12.02	1040	940	E90-40-018-01-22	A, 18, 20, 78, 161, 166	30-35	30							T
ACCORD VI Coupe (CG) Pro-Kit (Performance Fahrwerksfedern Performance Springs) 2.0 i 16V, 3.0 V6 24V	02.98 - 06.03	1040	900	E4026-140	A, 18, 20	30-35	30					F4026001	F4026002	T
ACCORD VI Hatchback (CH) Pro-Kit (Performance Fahrwerksfedern Performance Springs) 1.6, 1.8 i, 2.0, 2.0 TDi, 2.3	12.99 - 12.02	1040	940	E4040-140	A, 18, 20	30-35	30					F4040001	F4040002	T
B12 Pro-Kit (Performance Komplettfahrwerke Performance Springs+Shocks) 1.6, 1.8 i, 2.0, 2.0 TDi, 2.3	12.99 - 12.02	1040	940	E90-40-018-01-22	A, 18, 20, 78, 161, 166	30-35	30							T
ACCORD VII (CM) Pro-Kit (Performance Fahrwerksfedern Performance Springs) 2.4 Vtec E	02.03 - 09.05	1100	920	E10-40-008-03-22	A, 18, 20	30-35	30					F11-40-008-03-VA	F11-40-008-01-HA	T
B12 Pro-Kit (Performance Komplettfahrwerke Performance Springs+Shocks) 2.4 Vtec E	02.03 - 09.05	1100	920	E90-40-008-03-22	A, 18, 20, 78, 84, 161	30-35	30					F11-40-008-03-VA	F11-40-008-01-HA	T
ACCORD VII (CL) Pro-Kit (Performance Fahrwerksfedern Performance Springs) 2.0	02.03 -	1050	920	E10-40-008-01-22	A, 18, 20	35-40	30					F11-40-008-01-VA	F11-40-008-01-HA	T
2.2 i-CTDi, 2.4	02.03 -	1100	920	E10-40-008-03-22	A, 18, 20	30-35	30					F11-40-008-03-VA	F11-40-008-01-HA	T
B12 Pro-Kit (Performance Komplettfahrwerke Performance Springs+Shocks) 2.0 ohne Xenon 2.0 without Xenon	02.03 -	1050	920	E90-40-008-01-22	A, 18, 20, 78, 84, 161	35-40	30							T
2.2 i-CTDi ohne Xenon, 2.4 ohne Xenon 2.2 i-CTDi without Xenon, 2.4 without Xenon	02.03 -	1100	920	E90-40-008-03-22	A, 18, 20, 78, 84, 161	35-40	30							T
ACCORD VIII (CU) Pro-Kit (Performance Fahrwerksfedern Performance Springs) 2.0 i, 2.4 Schaltgetriebe, 2.4 i Schaltgetriebe 2.0 i, 2.4 i manual transmission, 2.4 manual transmission	06.08 -	1055	950	E10-40-013-01-22	A, 18, 20	30	30					F11-40-013-01-VA	F11-40-013-01-HA	T
2.2 i-DTEC, 2.4 Automatik, 2.4 i Automatik 2.2 i-DTEC, 2.4 automatic transmission, 2.4 i automatic transmission	06.08 -	1200	950	E10-40-013-02-22	A, 18, 20	30	30					F11-40-013-02-VA	F11-40-013-01-HA	T
ACCORD VIII Kombi ACCORD VIII Estate Pro-Kit (Performance Fahrwerksfedern Performance Springs) 2.0 i, 2.4 i Schaltgetriebe 2.0 i, 2.4 i manual transmission	07.08 -	1055	1030	E10-40-013-03-22	A, 18, 20	30	30					F11-40-013-01-VA	F11-40-013-03-HA	T
2.2 i-DTEC, 2.4 i Automatik 2.2 i-DTEC, 2.4 i automatic transmission	07.08 -	1200	1030	E10-40-013-04-22	A, 18, 20	30	30					F11-40-013-02-VA	F11-40-013-03-HA	T
CIVIC IV Hatchback (EC, ED, EE) Pro-Kit (Performance Fahrwerksfedern Performance Springs) 1.2, 1.3, 1.4 L, 1.5, 1.5 i 16V, 1.6 i 16V	09.87 - 12.91	725	700	E4007-140	A, 18, 20	30	30					F4007001	F4010002	T
1.2, 1.3, 1.3 16 V CAT, 1.4 L, 1.5, 1.5 i 16V, 1.6 i 16V 1.2, 1.3, 1.3 16 V CAT, 1.4 L, 1.5, 1.5 i 16V, 1.6 i 16V	09.87 - 12.91	725	700	E4010-140	A, 18, 20	30	30					F4010001	F4010002	T
1.6 i 16V Vtec	10.89 - 09.91	850	770	E4012-140	A, 18, 20	30	30					F4007001	F4010002	T
CIVIC IV Stufenheck (ED) CIVIC IV Saloon (ED) Pro-Kit (Performance Fahrwerksfedern Performance Springs) 1.2, 1.3, 1.4 L, 1.5, 1.5 i 16V, 1.6, 1.6 i 16V	09.87 - 12.91	725	700	E4007-140	A, 18, 20	30	30					F4007001	F4010002	T
1.2, 1.3, 1.4 L, 1.5, 1.5 i 16V, 1.6, 1.6 i 16V	09.87 - 12.91	725	700	E4010-140	A, 18, 20	30	30					F4010001	F4010002	T
CIVIC IX (FK) Pro-Kit (Performance Fahrwerksfedern Performance Springs) 1.4 i-VTEC, 1.8 i-VTEC	02.12 -	990	845	E10-40-011-09-22	A, 18, 20	30	25					F11-40-011-09-VA		T
1.6 i-DTEC	02.13 -	1050	845	E10-40-011-11-22	A, 18, 20	30	25					F11-40-011-02-VA		T
2.2 i-DTEC	02.12 -	1090	845	E10-40-011-10-22	A, 18, 20	30	25					F11-40-011-10-VA		T

Modell	Baujahr	Achslast Vorne kg	Achslast Hinten kg	Artikel-Nr.	Hinweise	ca. Tieferl. Vorne mm	ca. Tieferl. Hinten mm	Ø Vorne mm	Ø Hinten mm	Verstellbarkeit Vorne	Verstellbarkeit Hinten	Ersatzteilbezeichnung Vorne	Ersatzteilbezeichnung Hinten	Gutachten
Model	Year	Front Axle Load kg	Rear Axle Load kg	Part-No.	Notes	ca. Lowering Front mm	ca. Lowering Rear mm	Ø Front mm	Ø Rear mm	Adjustable Front	Adjustable Rear	Spare Part Marking Front	Spare Part Marking Rear	Homologation
CIVIC IX (FK) <i>Pro-Street-S (Gewindefahrwerke - höhenverstellbar Coil-Overs-Adjustable Ride Height)</i> 1.4 i-VTEC, 1.6 i-DTEC, 1.8 i-VTEC, 2.2 i-DTEC	02.12 -	1090	845	PSS65-40-011-04-22	A, 18, 23, 25, 45, 160	25-55	15-50							T
CIVIC V Coupe (EJ) <i>Pro-Kit (Performance Fahrwerksfedern Performance Springs)</i> 1.5 i LSi, 1.6 i, 1.6 i Vtec	01.94 - 03.96	835	750	E4015-140	A, 18, 20	30	30					F4015001	F4015002	ABE
B12 Pro-Kit (Performance Komplettfahrwerke Performance Springs+Shocks) 1.5 i LSi, 1.6 i Vtec	01.94 - 03.96	835	750	E90-40-009-01-22	A, 18, 20, 78, 161	30	30							T
CIVIC V Hatchback (EG) <i>Pro-Kit (Performance Fahrwerksfedern Performance Springs)</i> 1.3 16V, 1.4 16V, 1.5 i 16V, 1.6, 1.6 16V Vtec, 1.6 VTi 16V	10.91 - 04.97	835	750	E4015-140	A, 18, 20	30	30					F4015001	F4015002	ABE
B12 Pro-Kit (Performance Komplettfahrwerke Performance Springs+Shocks) 1.3 16V, 1.4 16V, 1.5 i 16V, 1.6, 1.6 16V Vtec, 1.6 VTi 16V	10.91 - 04.97	835	750	E90-40-009-01-22	A, 18, 20, 78, 161	30	30							T
CIVIC V Stufenheck (EG, EH) CIVIC V Saloon (EG, EH) <i>Pro-Kit (Performance Fahrwerksfedern Performance Springs)</i> 1.3, 1.5, 1.5 i 16V, 1.6, 1.6 16V Vtec, 1.6 EX, 1.6 VTi	10.91 - 12.95	835	750	E4015-140	A, 18, 20	30	30					F4015001	F4015002	ABE
B12 Pro-Kit (Performance Komplettfahrwerke Performance Springs+Shocks) 1.3, 1.5, 1.5 i 16V, 1.6, 1.6 16V Vtec, 1.6 EX, 1.6 VTi	10.91 - 12.95	835	750	E90-40-009-01-22	A, 18, 20, 78, 161	30	30							T
CIVIC VI Aerodeck (MB, MC) <i>Pro-Kit (Performance Fahrwerksfedern Performance Springs)</i> 1.4 16V, 1.5 16V, 1.6 16V, 1.8 16V	04.98 - 02.01	880	860	E4024-140	A, 18, 20	30	30					F4015001	F4019002	ABE
CIVIC VI Coupe (EJ, EM1) <i>Pro-Kit (Performance Fahrwerksfedern Performance Springs)</i> 1.6, 1.6 i, 1.6 i Vtec	03.96 - 12.00	860	820	E4020-140	A, 18, 20	35	35					F4015001	F4015002	ABE
CIVIC VI Fastback (MA, MB) <i>Pro-Kit (Performance Fahrwerksfedern Performance Springs)</i> 1.4 i, 1.5 16V, 1.5 i Vtec-E, 1.6, 1.6 16V, 1.6 VTi, 1.6 i, 1.6 i Vtec	09.94 - 02.01	845	840	E4019-140	A, 18, 20	30	30					F4015001	F4019002	ABE
CIVIC VI Hatchback (EJ, EK) <i>Pro-Kit (Performance Fahrwerksfedern Performance Springs)</i> 1.4 i, 1.4 i S, 1.5 i, 1.6, 1.6 VTi, 1.6 i	10.95 - 02.01	860	820	E4020-140	A, 18, 20	35	35					F4015001	F4015002	ABE
CIVIC VI Stufenheck (EJ, EK) CIVIC VI Saloon (EJ, EK) <i>Pro-Kit (Performance Fahrwerksfedern Performance Springs)</i> 1.4, 1.4 i, 1.5 i, 1.6, 1.6 VTi, 1.6 i Vtec	10.95 - 02.01	860	820	E4020-140	A, 18, 20	35	35					F4015001	F4015002	ABE
CIVIC VII Coupe (EM2) <i>Sportline (Performance Fahrwerksfedern Sport Sport Performance Springs)</i> 1.6 i, 1.7 i, 1.7 i VTEC	02.01 - 12.05	855	850	E20-40-001-01-22	A, 20	45-50	30					F21-40-001-01-VA	F21-40-001-01-HA	T
B12 Sportline (Performance Komplettfahrwerke Sport Sport Performance Springs+Shocks) 1.6 i, 1.7 i, 1.7 i VTEC	02.01 - 12.05	855	850	E95-40-001-01-22	A, 20, 78, 85, 161	45-50	30							T
Pro-Street-S (Gewindefahrwerke - höhenverstellbar Coil-Overs-Adjustable Ride Height) 1.6 i, 1.7 i, 1.7 i VTEC	02.01 - 12.05	955	825	PSS65-40-001-01-22	A, 23, 25, 45, 61, 160	35-65	35-65							T
CIVIC VII Hatchback (EU, EP, EV) <i>Pro-Kit (Performance Fahrwerksfedern Performance Springs)</i> 1.4 i, 1.4 i S, 1.6 i	02.01 - 09.05	855	850	E10-40-001-01-22	A, 18, 20	30	30					F11-40-001-01-VA	F11-40-001-01-HA	T
<i>Sportline (Performance Fahrwerksfedern Sport Sport Performance Springs)</i> 1.4 i, 1.4 i S, 1.6 i	02.01 - 09.05	855	850	E20-40-001-01-22	A, 20	45-50	30					F21-40-001-01-VA	F21-40-001-01-HA	T
B12 Pro-Kit (Performance Komplettfahrwerke Performance Springs+Shocks) 1.6 i	02.01 - 09.05	855	850	E90-40-001-01-22	A, 18, 20, 78, 85, 161	30	30							T
1.7	01.00 - 08.05	855	850	E90-40-001-01-22	A, 18, 20, 78, 85, 161	30	30							T
B12 Sportline (Performance Komplettfahrwerke Sport Sport Performance Springs+Shocks) 1.4 i, 1.4 i S, 1.6 i, 1.7	01.00 - 09.05	855	850	E95-40-001-01-22	A, 20, 78, 85, 161	45-50	30							T
Pro-Street-S (Gewindefahrwerke - höhenverstellbar Coil-Overs-Adjustable Ride Height) 1.4 i, 1.4 i S, 1.6 i	02.01 - 09.05	955	825	PSS65-40-001-01-22	A, 23, 25, 45, 61, 160	35-65	35-65							T
1.7 CTDi, 2.0 Type-R, 2.0 i Sport	09.01 - 09.05	955	825	PSS65-40-001-02-22	A, 23, 25, 45, 62, 160	35-65	35-65							T
CIVIC VII Stufenheck (ES) CIVIC VII Saloon (ES) <i>Pro-Kit (Performance Fahrwerksfedern Performance Springs)</i> 1.4, 1.6	12.00 - 09.05	855	850	E10-40-001-01-22	A, 18, 20	30	30					F11-40-001-01-VA	F11-40-001-01-HA	T
<i>Sportline (Performance Fahrwerksfedern Sport Sport Performance Springs)</i> 1.3 IMA, 1.4, 1.6	12.00 - 09.05	855	850	E20-40-001-01-22	A, 20	45-50	30					F21-40-001-01-VA	F21-40-001-01-HA	T
B12 Pro-Kit (Performance Komplettfahrwerke Performance Springs+Shocks) 1.4, 1.6	12.00 - 09.05	855	850	E90-40-001-01-22	A, 18, 20, 78, 85, 161	30	30							T
B12 Sportline (Performance Komplettfahrwerke Sport Sport Performance Springs+Shocks) 1.3 IMA, 1.4, 1.6	12.00 - 09.05	855	850	E95-40-001-01-22	A, 20, 78, 85, 161	45-50	30							T
Pro-Street-S (Gewindefahrwerke - höhenverstellbar Coil-Overs-Adjustable Ride Height) 1.3 IMA, 1.4, 1.6	12.00 - 09.05	955	825	PSS65-40-001-01-22	A, 23, 25, 45, 61, 160	35-65	35-65							T
1.7, 1.8, 2.0	02.01 - 09.05	955	825	PSS65-40-001-02-22	A, 23, 25, 45, 62, 160	35-65	35-65							T

Modell	Baujahr	Achslast Vorne kg	Achslast Hinten kg	Artikel-Nr.	Hinweise	ca. Tieferl. Vorne mm	ca. Tieferl. Hinten mm	Ø Vorne mm	Ø Hinten mm	Verstellbarkeit Vorne	Verstellbarkeit Hinten	Ersatzteilbezeichnung Vorne	Ersatzteilbezeichnung Hinten	Gutachten
Model	Year	Front Axle Load kg	Rear Axle Load kg	Part-No.	Notes	ca. Lowering Front mm	ca. Lowering Rear mm	Ø Front mm	Ø Rear mm	Adjustable Front	Adjustable Rear	Spare Part Marking Front	Spare Part Marking Rear	Homologation
CIVIC VIII Hatchback (FN, FK) Pro-Kit (Performance Fahrwerksfedern Performance Springs) 1.4, 1.6, 1.8, Type R	09.05 -	980	835	E10-40-011-01-22	A, 18, 20	25	25					F11-40-011-01-VA	F11-40-011-01-HA	T
2.2 CTDi	01.06 -	1085	835	E10-40-011-02-22	A, 18, 20	25	25					F11-40-011-02-VA	F11-40-011-01-HA	T
Pro-Street-S (Gewindefahrwerke - höhenverstellbar Coil-Overs-Adjustable Ride Hight) 1.4, 1.6, 1.8	09.05 -	940	835	PSS65-40-011-01-22	A, 18, 23, 25, 45, 160	20-50	20-50							T
2.2 CTDi	01.06 -	1085	835	PSS65-40-011-02-22	A, 18, 23, 25, 45, 160	20-50	20-50							T
CR-V III (RE) Pro-Kit (Performance Fahrwerksfedern Performance Springs) 2.0 i 4WD, 2.2 i-CTDi 4WD, 2.2 i-DTEC 4WD, 2.4, 2.4 i-VTEC 4WD	01.07 -	1140	1040	E10-40-012-01-22	A, 18	30-35	25					F11-40-012-01-VL F11-40-012-01-VR	F11-40-012-01-HA	T
B12 Pro-Kit (Performance Komplettfahrwerke Performance Springs+Shocks) 2.0 i 4WD ohne Xenon, 2.2 i-CTDi 4WD ohne Xenon, 2.2 i-DTEC 4WD ohne Xenon 2.0 i 4WD without Xenon, 2.2 i-CTDi 4WD without Xenon, 2.2 i-DTEC 4WD without Xenon	01.07 -	1140	1040	E90-40-012-01-22	A, 18, 78, 161	30-35	25							T
CR-Z (ZF1) Pro-Kit (Performance Fahrwerksfedern Performance Springs) 1.5 Hybrid	06.10 -	825	705	E10-40-017-01-22	A, 18, 20	25	25					F11-40-014-02-VA	F11-40-017-01-HA	T
INTEGRA Coupe (DC2, DC4) Pro-Kit (Performance Fahrwerksfedern Performance Springs) 1.8 Type-R	11.97 - 10.01	835	750	E4023-140	A, 18, 20	25	25					F4015001	F4015002	ABE
JAZZ II (GD) Pro-Kit (Performance Fahrwerksfedern Performance Springs) 1.2, 1.4	03.02 - 07.08	800	730	E10-40-005-01-22	A, 18, 20	30	30					F11-40-005-01-VA	F11-40-005-01-HA	T
JAZZ III (GE) Pro-Kit (Performance Fahrwerksfedern Performance Springs) 1.2, 1.4 i	07.08 -	840	860	E10-40-014-02-22	A, 18, 20	20	20					F11-40-014-02-VA	F11-40-014-01-HA	T
PRELUDE IV (BB) Pro-Kit (Performance Fahrwerksfedern Performance Springs) 2.0 i 16V, 2.2 i 16V Vtec, 2.3 i 16V	02.92 - 09.96	980	825	E4016-140	A, 18, 20	30	30					F4016001	F4016002	T
PRELUDE V (BB) Pro-Kit (Performance Fahrwerksfedern Performance Springs) 2.0 16V, 2.2 16V	10.96 - 10.00	980	825	E4021-140	A, 18, 20	30	30					F4016001	F4016002	T
S2000 (AP) Pro-Kit (Performance Fahrwerksfedern Performance Springs) 2.0, 2.0 Vtec	03.99 -	750	900	E4043-140	A, 18, 20	25	30					F4043001	F4043002	T
STREAM (RN) Pro-Kit (Performance Fahrwerksfedern Performance Springs) 1.7 16V, 2.0 16V	05.01 -	955	1130	E10-40-003-01-22	A, 18, 20	30	30					F11-40-003-01-VA	F11-40-003-01-HA	T
ACCENT III (MC) Pro-Kit (Performance Fahrwerksfedern Performance Springs) 1.5 CRDi GLS	11.05 - 11.10	910	850	E10-42-014-02-22	A, 18, 20	30	30					F11-42-014-02-VA	F11-42-014-01-HA	T
ACCENT Stufenheck (MC) ACCENT Saloon (MC) Pro-Kit (Performance Fahrwerksfedern Performance Springs) 1.5 CRDi GLS	11.05 - 11.10	910	850	E10-42-014-02-22	A, 18, 20	30	30					F11-42-014-02-VA	F11-42-014-01-HA	T
COUPE (GK) Pro-Kit (Performance Fahrwerksfedern Performance Springs) 2.0, 2.0 GLS, 2.7 V6	08.01 - 08.09	1015	880	E10-42-003-01-22	A, 18, 20	30	30					F11-42-003-01-VA	F11-42-003-01-HA	T
Sportline (Performance Fahrwerksfedern Sport Sport Performance Springs) 2.0, 2.0 GLS, 2.7 V6	08.01 - 08.09	1000	860	E20-42-003-02-22	A, 18, 20	45-50	30					F21-42-003-02-VA	F21-42-003-02-HA	T
B12 Pro-Kit (Performance Komplettfahrwerke Performance Springs+Shocks) 2.0, 2.0 GLS, 2.7 V6	08.01 - 08.09	1015	880	E90-42-003-01-22	A, 18, 20, 78, 161	30	30							T
B12 Sportline (Performance Komplettfahrwerke Sport Sport Performance Springs+Shocks) 2.0, 2.0 GLS, 2.7 V6	08.01 - 08.09	1000	860	E95-42-003-02-22	A, 18, 20, 78, 161	45-50	30							T
GENESIS Coupe Pro-Kit (Performance Fahrwerksfedern Performance Springs) 2.0 T, 3.8 V6	01.08 -	1010	1050	E10-42-019-03-22	A, 18, 20	20	10					F11-42-019-03-VA	F11-42-019-02-HA	T
GETZ (TB) Pro-Kit (Performance Fahrwerksfedern Performance Springs) 1.1, 1.3, 1.3 i, 1.4 i, 1.5 i, 1.6	09.02 - 06.09	860	830	E10-42-008-01-22	A, 18, 20	30	30					F11-42-007-01-VA	F11-42-008-01-HA	T
B12 Pro-Kit (Performance Komplettfahrwerke Performance Springs+Shocks) 1.1, 1.3, 1.3 i, 1.4 i, 1.5 i, 1.6	09.02 - 06.09	860	830	E90-42-008-01-22	A, 18, 20, 78, 161	30	30							T
1.5 CRDi, 1.5 CRDi GLS	03.03 - 06.09	900	830	E90-42-008-02-22	A, 18, 20, 78, 161	30	30							T
i10 Pro-Kit (Performance Fahrwerksfedern Performance Springs) 1.0, 1.1, 1.2	12.07 -	750	750	E10-42-018-01-22	A, 18, 20	25	20					F11-42-007-01-VA	F11-42-018-01-HA	T
i20 (PB, PBT) Pro-Kit (Performance Fahrwerksfedern Performance Springs) 1.2, 1.4, 1.6	09.08 -	850	840	E10-42-020-02-22	A, 18, 20	25	20					F11-46-023-01-VA	F11-42-020-01-HA	T
1.2, 1.4, 1.6	09.08 -	850	840	E10-42-020-01-22	A, 18, 20	20-25	20					F11-42-020-01-VA	F11-42-020-01-HA	T

Modell	Baujahr	Achslast Vorne kg	Achslast Hinten kg	Artikel-Nr.	Hinweise	ca. Tieferl. Vorne mm	ca. Tieferl. Hinten mm	Ø Vorne mm	Ø Hinten mm	Verstellbarkeit Vorne	Verstellbarkeit Hinten	Ersatzteilbezeichnung Vorne	Ersatzteilbezeichnung Hinten	Gutachten
Model	Year	Front Axle Load kg	Rear Axle Load kg	Part-No.	Notes	ca. Lowering Front mm	ca. Lowering Rear mm	Ø Front mm	Ø Rear mm	Adjustable Front	Adjustable Rear	Spare Part Marking Front	Spare Part Marking Rear	Homologation
i30 (FD) Pro-Kit (Performance Fahrwerksfedern Performance Springs) 1.4, 1.6	03.09 - 11.11	1010	940	E10-42-016-05-22	A, 18, 20	30	20					F11-42-016-05-VA	F11-46-015-01-HA	T
1.4, 1.6	10.07 - 11.11	1010	940	E10-42-016-01-22	A, 18, 20	25	20					F11-46-015-01-VA	F11-46-015-01-HA	T
1.6 CRDi, 2.0, 2.0 CRDi	03.09 - 11.11	1090	940	E10-42-016-06-22	A, 18, 20	30	20					F11-42-016-06-VA	F11-46-015-01-HA	T
1.6 CRDi, 2.0, 2.0 CRDi	10.07 - 11.11	1090	940	E10-42-016-02-22	A, 18, 20	25	20					F11-46-015-02-VA	F11-46-015-01-HA	T
i30 (GD) Pro-Kit (Performance Fahrwerksfedern Performance Springs) 1.4, 1.6, 1.6 GDI	11.11 -	960	960	E10-46-025-01-22	A, 18, 20	20	20					F11-46-025-01-VA	F11-46-025-01-HA	T
1.4 CRDi, 1.6 CRDi	11.11 -	1050	960	E10-46-025-02-22	A, 18, 20	20	20					F11-42-024-01-VA	F11-46-025-01-HA	T
i30 CW (FD) Pro-Kit (Performance Fahrwerksfedern Performance Springs) 1.4, 1.6	10.07 - 06.12	1010	1050	E10-42-016-03-22	A, 18, 20	30	20-25					F11-46-015-01-VA	F11-46-015-03-HA	T
1.4, 1.6	03.09 - 06.12	1010	1050	E10-42-016-07-22	A, 18, 20	30	20-25					F11-42-016-05-VA	F11-46-015-03-HA	T
1.6 CRDi, 2.0, 2.0 CRDi	02.08 - 06.12	1090	1050	E10-42-016-04-22	A, 18, 20	30-40	20-25					F11-46-015-02-VA	F11-46-015-03-HA	T
1.6 CRDi, 2.0, 2.0 CRDi	03.09 - 06.12	1090	1050	E10-42-016-08-22	A, 18, 20	30	20-25					F11-42-016-06-VA	F11-46-015-03-HA	T
i30 CW (GD) Pro-Kit (Performance Fahrwerksfedern Performance Springs) 1.4, 1.6, 1.6 GDI	06.12 -	960	1050	E10-46-025-03-22	A, 18, 20	25	25					F11-46-025-01-VA	F11-46-013-01-HA	T
1.4 CRDi, 1.6 CRDi	06.12 -	1050	1050	E10-46-025-04-22	A, 18, 20	20	25					F11-42-024-01-VA	F11-46-013-01-HA	T
i40 (VF) Pro-Kit (Performance Fahrwerksfedern Performance Springs) 1.6 GDI, 1.7 CRDi, 2.0 GDI	03.12 -	1200	1200	E10-42-029-02-22	A, 18, 20	30	25					F11-42-024-05-VA	F11-42-024-01-HA	T
i40 CW (VF) Pro-Kit (Performance Fahrwerksfedern Performance Springs) 1.6 GDI, 1.7 CRDi, 2.0 GDI	07.11 -	1200	1200	E10-42-029-02-22	A, 18, 20	30	25					F11-42-024-05-VA	F11-42-024-01-HA	T
ix20 (JC) Pro-Kit (Performance Fahrwerksfedern Performance Springs) 1.4, 1.6	11.10 -	1030	970	E10-42-026-01-22	A, 18, 20	25	20					F11-42-026-01-VA	F11-46-017-01-HA	T
ix35 (LM) Pro-Kit (Performance Fahrwerksfedern Performance Springs) 1.6, 2.0	01.10 -	1200	1090	E10-42-024-03-22	A, 18, 20	30	25					F11-42-024-01-VA	F11-46-013-01-HA	T
2.0 4WD	01.10 -	1200	1090	E10-42-024-01-22	A, 18	30	25					F11-42-024-01-VA	F11-42-024-01-HA	T
1.7 CRDi, 2.0 CRDi	01.10 -	1200	1090	E10-42-024-04-22	A, 18, 20	30	25					F11-42-024-02-VA	F11-46-013-01-HA	T
2.0 CRDi 4WD	01.10 -	1200	1090	E10-42-024-02-22	A, 18	30	25					F11-42-024-02-VA	F11-42-024-01-HA	T
Pro-Lift-Kit (Performance Höherlegung Performance Lift Springs) 1.6, 2.0	01.10 -	1200	1090	E30-42-024-01-22	A, 10, 18, 20	+25	+25					F31-42-024-01-VA	F31-42-024-01-HA	T
2.0 4WD	01.10 -	1200	1090	E30-42-024-02-22	A, 10, 18	+25	+25					F31-42-024-01-VA	F31-42-024-02-HA	T
1.7 CRDi, 2.0 CRDi	01.10 -	1200	1090	E30-42-024-03-22	A, 10, 18, 20	+25	+25					F31-42-024-03-VA	F31-42-024-01-HA	T
2.0 CRDi 4WD	01.10 -	1200	1090	E30-42-024-04-22	A, 10, 18	+25	+25					F31-42-024-03-VA	F31-42-024-02-HA	T
ix55 Pro-Kit (Performance Fahrwerksfedern Performance Springs) 3.0 V6 CRDi 4WD	09.08 -	1465	1500	E10-42-023-01-22	A, 18	25	30					F11-42-023-01-VA	F11-46-018-01-HA	T
SANTA FÉ II (CM) Pro-Kit (Performance Fahrwerksfedern Performance Springs) 2.2 CRDi, 2.2 CRDi 4x4, 2.2 CRDi GLS, 2.2 CRDi GLS 4x4, 2.4, 2.4 4x4	01.10 -	1350	1450	E10-42-013-02-22	A, 65	25-30	30					F11-46-018-01-VA	F11-42-013-01-HA	T
SANTA FÉ III (DM) Pro-Kit (Performance Fahrwerksfedern Performance Springs) 2.0 CRDi, 2.0 CRDi 4WD, 2.2 CRDi, 2.2 CRDi 4WD, 2.4, 2.4 4WD	09.12 -	1350	1450	E10-46-018-01-22	A, 18	25-30	15-20					F11-46-018-01-VA	F11-46-018-01-HA	T
Pro-Lift-Kit (Performance Höherlegung Performance Lift Springs) 2.0 CRDi, 2.0 CRDi 4WD, 2.2 CRDi, 2.2 CRDi 4WD, 2.4, 2.4 4WD	09.12 -	1350	1450	E30-42-031-01-22	A, 18	+25	+25					F31-42-031-01-VA	F31-42-031-01-HA	T
SONATA V (NF) Pro-Kit (Performance Fahrwerksfedern Performance Springs) 2.0 VVTi GLS, 2.4	01.05 -	1200	1070	E10-42-011-01-22	A, 18, 20	30	30					F4213001	F11-42-011-01-HA	T
TUCSON (JM) Pro-Kit (Performance Fahrwerksfedern Performance Springs) 2.0, 2.0 Allrad, 2.0 CRDi, 2.0 CRDi Allrad, 2.7 Allrad 2.0, 2.0 All-wheel Drive, 2.0 CRDi, 2.0 CRDi All-wheel Drive, 2.7 All-wheel Drive	08.04 - 03.10	1220	1200	E10-42-010-01-22	A	25-35	25					F11-42-010-01-VA	F11-42-010-01-HA	T
VELOSTER (FS) Pro-Kit (Performance Fahrwerksfedern Performance Springs) 1.6 GDI	03.11 -	930	840	E10-42-027-01-22	A, 18, 20	25	20					F11-42-027-01-VA	F11-46-019-01-HA	T

Modell	Baujahr	Achslast Vorne kg	Achslast Hinten kg	Artikel-Nr.	Hinweise	ca. Tieferl. Vorne mm	ca. Tieferl. Hinten mm	Ø Vorne mm	Ø Hinten mm	Verstellbarkeit Vorne	Verstellbarkeit Hinten	Ersatzteilbezeichnung Vorne	Ersatzteilbezeichnung Hinten	Gutachten
Model	Year	Front Axle Load kg	Rear Axle Load kg	Part-No.	Notes	ca. Lowering Front mm	ca. Lowering Rear mm	Ø Front mm	Ø Rear mm	Adjustable Front	Adjustable Rear	Spare Part Marking Front	Spare Part Marking Rear	Homologation
X-TYPE (CF1) Pro-Kit (Performance Fahrwerksfedern Performance Springs) 2.0 D, 2.0 V6, 2.2 D, 2.5 V6, 3.0 V6	06.01 - 11.09	1150	1115	E10-45-002-01-22	A, 18, 21	30-35	25-30					F11-45-002-01-VA	F11-45-002-01-HA	T
B12 Pro-Kit (Performance Komplettfahrwerke Performance Springs+Shocks) 2.0 D, 2.0 V6, 2.2 D, 2.5 V6, 3.0 V6	06.01 - 11.09	1150	1115	E90-45-002-01-22	A, 18, 21, 78, 161	30-35	25-30							T
XF (_J05_, CC9) Pro-Kit (Performance Fahrwerksfedern Performance Springs) 3.0	03.08 -	1090	1230	E10-45-004-02-22	A, 18, 20	30-35	25					F11-45-004-02-VA	F11-45-004-01-HA	T
2.2 D, 2.7 D, 3.0 D, 4.2, 4.2 Kompressor	03.08 -	1215	1230	E10-45-004-01-22	A, 18, 20	30-35	25					F11-45-004-01-VA	F11-45-004-01-HA	T
COMMANDER (XK) Pro-Kit (Performance Fahrwerksfedern Performance Springs) 3.0 CRD, 4.7 V8, 5.7 V8	09.05 - 12.10	1340	1660	E10-28-010-01-22	A, 18	30	30					F11-28-010-01-VA	F11-28-010-01-HA	T
GRAND CHEROKEE II (WJ, WG) Pro-Kit (Performance Fahrwerksfedern Performance Springs) 2.7 CRD 4x4, 2.7 CRD Laredo, 4.0, 4.0 4x4, 4.7, 4.7 V8, 4.7 V8 4x4	10.98 - 09.05	1250	1340	E2837-540	A, 18	30	30					F28375001	F28375002	T
GRAND CHEROKEE III (WH, WK) Pro-Kit (Performance Fahrwerksfedern Performance Springs) 3.0 CRD, 4.7 V8, 5.7 V8	06.05 - 12.10	1340	1660	E10-28-010-01-22	A, 18	30	30					F11-28-010-01-VA	F11-28-010-01-HA	T
CEE'D Pro-Kit (Performance Fahrwerksfedern Performance Springs) 1.4 CVVT, 1.6 CVVT, 1.6 GDI	05.12 -	960	960	E10-46-025-01-22	A, 18, 20	20	20					F11-46-025-01-VA	F11-46-025-01-HA	T
1.6 CRDi 110	05.12 -	1050	960	E10-46-025-02-22	A, 18, 20	25	20					F11-42-024-01-VA	F11-46-025-01-HA	T
1.4 CRDi 90, 1.6 CRDi 115, 1.6 CRDi 128, 1.6 CRDi 90	05.12 -	1050	960	E10-46-025-02-22	A, 18, 20	20	20					F11-42-024-01-VA	F11-46-025-01-HA	T
CEE'D Schrägheck (ED) CEE'D Hatchback (ED) Pro-Kit (Performance Fahrwerksfedern Performance Springs) 1.4, 1.4 CVVT, 1.6, 1.6 CVVT	12.06 -	1010	940	E10-46-015-05-22	A, 18, 20, 63	25	20					F11-42-016-05-VA	F11-46-015-01-HA	T
1.4, 1.6	12.06 - 12.09	1010	940	E10-46-015-01-22	A, 18, 20	30	20					F11-46-015-01-VA	F11-46-015-01-HA	T
1.6 CRDi 115, 1.6 CRDi 128, 1.6 CRDi 90, 2.0, 2.0 CRDi 140	12.06 -	1090	940	E10-46-015-06-22	A, 18, 20, 63	25	20					F11-42-016-06-VA	F11-46-015-01-HA	T
1.6 CRDi 115, 1.6 CRDi 90, 2.0, 2.0 CRDi 140	12.06 - 12.09	1090	940	E10-46-015-02-22	A, 18, 20	30-35	20					F11-46-015-02-VA	F11-46-015-01-HA	T
B12 Pro-Kit (Performance Komplettfahrwerke Performance Springs+Shocks) 1.4, 1.4 CVVT, 1.6	12.06 -	1010	940	E90-46-015-01-22	A, 18, 20, 78, 161	30	20							T
1.4, 1.4 CVVT, 1.6, 1.6 CVVT	12.06 -	1010	940	E90-46-015-05-22	A, 18, 20, 78, 161	25	20							T
1.6 CRDi 115, 1.6 CRDi 128, 1.6 CRDi 90, 2.0, 2.0 CRDi 140	12.06 -	1090	940	E90-46-015-06-22	A, 18, 20, 78, 161	25	20							T
1.6 CRDi 115, 1.6 CRDi 90, 2.0, 2.0 CRDi 140	12.06 -	1090	940	E90-46-015-02-22	A, 18, 20, 78, 161	30-35	20							T
CEE'D SW (ED) Pro-Kit (Performance Fahrwerksfedern Performance Springs) 1.4, 1.6, 1.6 CVVT	09.07 -	1010	1050	E10-46-015-03-22	A, 18, 20	30	20-25					F11-46-015-01-VA	F11-46-015-03-HA	T
1.6 CRDi 115, 1.6 CRDi 128, 1.6 CRDi 90, 2.0, 2.0 CRDi 140	09.07 -	1090	1050	E10-46-015-08-22	A, 18, 20, 63	25	20-25					F11-42-016-06-VA	F11-46-015-03-HA	T
1.6 CRDi 115, 1.6 CRDi 90, 2.0, 2.0 CRDi 140	09.07 - 10.09	1090	1050	E10-46-015-04-22	A, 18, 20	30-35	20-25					F11-46-015-02-VA	F11-46-015-03-HA	T
B12 Pro-Kit (Performance Komplettfahrwerke Performance Springs+Shocks) 1.4, 1.4 CVVT, 1.6, 1.6 CVVT	11.09 -	1010	1050	E90-46-015-07-22	A, 18, 20, 78, 161	30	30							T
1.6 CRDi 115, 1.6 CRDi 128, 1.6 CRDi 90, 2.0, 2.0 CRDi 140	09.07 -	1090	1050	E90-46-015-08-22	A, 18, 20, 78, 161	25	20-25							T
1.6 CRDi 115, 1.6 CRDi 90, 2.0, 2.0 CRDi 140	09.07 -	1090	1050	E90-46-015-04-22	A, 18, 20, 78, 161	30-35	20-25							T
CEE'D Sportswagon Pro-Kit (Performance Fahrwerksfedern Performance Springs) 1.4 CVVT, 1.6 GDI	09.12 -	960	1050	E10-46-025-03-22	A, 18, 20	25	25					F11-46-025-01-VA	F11-46-013-01-HA	T
1.4 CRDi, 1.6 CRDi	09.12 -	1050	1050	E10-46-025-04-22	A, 18, 20	20	25					F11-42-024-01-VA	F11-46-013-01-HA	T
MAGENTIS (MG) Pro-Kit (Performance Fahrwerksfedern Performance Springs) 2.0	11.05 -	1135	1040	E10-46-013-01-22	A, 18, 20	30	30					F11-46-013-01-VA	F11-46-013-01-HA	T
2.0 CRDi, 2.7, 2.7 V6	11.05 -	1135	1040	E10-46-013-02-22	A, 18, 20	30	30					F11-46-013-02-VA	F11-46-013-01-HA	T
OPTIMA Pro-Kit (Performance Fahrwerksfedern Performance Springs) 1.7 CRDi, 2.0, 2.0 CVVL	03.12 -	1200	1010	E10-42-029-01-22	A, 18, 20	30	30					F11-42-024-05-VA	F11-46-020-02-HA	T
PICANTO (TA) Pro-Kit (Performance Fahrwerksfedern Performance Springs) 1.0, 1.2	05.11 -	720	720	E10-46-009-03-22	A, 18, 20	25	25					F11-46-009-03-VA	F11-46-009-03-HA	T
PRO CEE'D (ED) Pro-Kit (Performance Fahrwerksfedern Performance Springs) 1.4, 1.6	02.08 - 12.09	1010	940	E10-46-015-01-22	A, 18, 20	30	25					F11-46-015-01-VA	F11-46-015-01-HA	T
2.0, 1.6 CRDi 115, 1.6 CRDi 90, 2.0 CRDi 140	02.08 - 12.09	1090	940	E10-46-015-02-22	A, 18, 20	30-35	25					F11-46-015-02-VA	F11-46-015-01-HA	T
1.4, 1.4 CVVT, 1.6, 1.6 CVVT	11.09 -	1010	940	E10-46-015-05-22	A, 18, 20, 63	25	25					F11-42-016-05-VA	F11-46-015-01-HA	T
1.6 CRDi 115, 1.6 CRDi 128, 1.6 CRDi 90, 2.0 CRDi 140	11.09 -	1090	940	E10-46-015-06-22	A, 18, 20, 63	25	25					F11-42-016-06-VA	F11-46-015-01-HA	T

Modell	Baujahr	Achslast Vorne kg	Achslast Hinten kg	Artikel-Nr.	Hinweise	ca. Tieferl. Vorne mm	ca. Tieferl. Hinten mm	Ø Vorne mm	Ø Hinten mm	Verstellbarkeit Vorne	Verstellbarkeit Hinten	Ersatzteilbezeichnung Vorne	Ersatzteilbezeichnung Hinten	Gutachten
Model	Year	Front Axle Load kg	Rear Axle Load kg	Part-No.	Notes	ca. Lowering Front mm	ca. Lowering Rear mm	Ø Front mm	Ø Rear mm	Adjustable Front	Adjustable Rear	Spare Part Marking Front	Spare Part Marking Rear	Homologation
PRO CEE'D (ED) B12 Pro-Kit (Performance Komplettfahrwerke Performance Springs+Shocks) 1.4, 1.6	02.08 -	1010	940	E90-46-015-01-22	A, 18, 20, 78, 161	30	30							T
1.6 CRDi 115, 1.6 CRDi 90, 2.0 CRDi 140	02.08 -	1090	940	E90-46-015-02-22	A, 18, 20, 78, 161	30-35	20							T
1.4, 1.4 CVVT, 1.6, 1.6 CVVT	02.08 -	1010	940	E90-46-015-05-22	A, 18, 20, 78, 161	25	20							T
2.0, 1.6 CRDi 115, 1.6 CRDi 128, 1.6 CRDi 90, 2.0 CRDi 140	02.08 -	1090	940	E90-46-015-06-22	A, 18, 20, 78, 161	25	20							T
PRO CEE'D Pro-Kit (Performance Fahrwerksfedern Performance Springs) 1.4 CVVT, 1.6 GDI	03.13 -	960	960	E10-46-025-01-22	A, 18, 20	25	20					F11-46-025-01-VA	F11-46-025-01-HA	T
1.4 CRDi, 1.6 CRDi	03.13 -	1050	960	E10-46-025-02-22	A, 18, 20	25	20					F11-42-024-01-VA	F11-46-025-01-HA	T
RIO III (UB) Pro-Kit (Performance Fahrwerksfedern Performance Springs) 1.1 CRDi, 1.4 CRDi	09.11 -	945	840	E10-46-023-02-22	A, 18, 20	25	25					F11-42-025-02-VA	F11-46-023-01-HA	T
1.25 CVVT, 1.4 CVVT	09.11 -	945	840	E10-46-023-01-22	A, 18, 20	25	25					F11-46-023-01-VA	F11-46-023-01-HA	T
RIO III Stufenheck (UB) RIO III Saloon (UB) Pro-Kit (Performance Fahrwerksfedern Performance Springs) 1.25 CVVT, 1.4 CVVT	10.11 -	945	840	E10-46-023-01-22	A, 18, 20	25	25					F11-46-023-01-VA	F11-46-023-01-HA	T
SORENTO II (XM) Pro-Kit (Performance Fahrwerksfedern Performance Springs) 2.0 CRDi, 2.0 CRDi 4WD, 2.2 CRDi, 2.2 CRDi 4WD, 2.4 CVVT, 2.4 CVVT 4WD, 2.4 GDI, 2.4 GDI 4WD	11.09 -	1350	1450	E10-46-018-01-22	A, 18	25-30	15-20					F11-46-018-01-VA	F11-46-018-01-HA	T
Pro-Lift-Kit (Performance Höherlegung Performance Lift Springs) 2.0 CRDi, 2.0 CRDi 4WD, 2.2 CRDi, 2.2 CRDi 4WD, 2.4 CVVT, 2.4 CVVT 4WD, 2.4 GDI, 2.4 GDI 4WD	11.09 -	1350	1450	E30-42-031-01-22	A, 18	+25	+25					F31-42-031-01-VA	F31-42-031-01-HA	T
SOUL (AM) Pro-Kit (Performance Fahrwerksfedern Performance Springs) 1.6 CRDi 115, 1.6 CRDi 128, 1.6 CVVT, 1.6 GDI	02.09 -	1030	970	E10-46-017-01-22	A, 18, 20	25	25					F11-46-017-01-VA	F11-46-017-01-HA	T
SPORTAGE (JE_) Pro-Kit (Performance Fahrwerksfedern Performance Springs) 2.0 16V 4WD, 2.0 CRDi, 2.0 CRDi 4WD, 2.0 i 16V, 2.7 V6 4WD	09.04 -	1220	1200	E10-46-010-01-22	A, 18	30	30					F11-42-010-01-VA	F11-42-010-01-HA	T
SPORTAGE (SL) Pro-Kit (Performance Fahrwerksfedern Performance Springs) 1.7 CRDi, 2.0 CRDi	07.10 -	1200	1090	E10-42-024-04-22	A, 18, 20	30	25					F11-42-024-02-VA	F11-46-013-01-HA	T
2.0 CRDi AWD	07.10 -	1200	1090	E10-42-024-02-22	A, 18	30	25					F11-42-024-02-VA	F11-42-024-01-HA	T
2.0 CVVT, 1.6 GDI	07.10 -	1200	1090	E10-42-024-03-22	A, 18, 20	30	25					F11-42-024-01-VA	F11-46-013-01-HA	T
2.0 CVVT AWD	07.10 -	1200	1090	E10-42-024-01-22	A, 18	30	25					F11-42-024-01-VA	F11-42-024-01-HA	T
Pro-Lift-Kit (Performance Höherlegung Performance Lift Springs) 1.7 CRDi, 2.0 CRDi	07.10 -	1200	1090	E30-42-024-03-22	A, 10, 18, 20	+25	+25					F31-42-024-03-VA	F31-42-024-01-HA	T
2.0 CRDi AWD	07.10 -	1200	1090	E30-42-024-04-22	A, 10, 18	+25	+25					F31-42-024-03-VA	F31-42-024-02-HA	T
2.0 CVVT, 1.6 GDI	07.10 -	1200	1090	E30-42-024-01-22	A, 10, 18, 20	+25	+25					F31-42-024-01-VA	F31-42-024-01-HA	T
2.0 CVVT AWD	07.10 -	1200	1090	E30-42-024-02-22	A, 10, 18	+25	+25					F31-42-024-01-VA	F31-42-024-02-HA	T
VENGA (YN) Pro-Kit (Performance Fahrwerksfedern Performance Springs) 1.4 CRDi 75, 1.4 CRDi 90, 1.4 CVVT, 1.6 CRDi 115, 1.6 CRDi 128, 1.6 CVVT	02.10 -	1030	970	E10-46-019-01-22	A, 18, 20	30	15					F11-46-019-01-VA	F11-46-019-01-HA	T
110 Pro-Kit (Performance Fahrwerksfedern Performance Springs) 1.5, 1.5 16V, 2.0 i	01.95 -	800	850	E10-47-001-01-22	A, 18, 20	30	30					F11-47-001-01-VA	F11-47-001-01-HA	
Sportline (Performance Fahrwerksfedern Sport Sport Performance Springs) 1.5, 1.5 16V, 2.0 i	01.95 -	800	850	E20-47-001-01-22	A, 18, 20	45-50	45-50					F21-47-001-01-VA	F21-47-001-01-HA	
111 Pro-Kit (Performance Fahrwerksfedern Performance Springs) 1.5, 1.5 16V	01.95 -	800	850	E10-47-001-01-22	A, 18, 20	30	30					F11-47-001-01-VA	F11-47-001-01-HA	
Sportline (Performance Fahrwerksfedern Sport Sport Performance Springs) 1.5, 1.5 16V	01.95 -	800	850	E20-47-001-01-22	A, 18, 20	45-50	45-50					F21-47-001-01-VA	F21-47-001-01-HA	
112 Pro-Kit (Performance Fahrwerksfedern Performance Springs) 1.5, 1.5 16V	01.95 -	800	850	E10-47-001-01-22	A, 18, 20	30	30					F11-47-001-01-VA	F11-47-001-01-HA	
Sportline (Performance Fahrwerksfedern Sport Sport Performance Springs) 1.5, 1.5 16V	01.95 -	800	850	E20-47-001-01-22	A, 18, 20	45-50	45-50					F21-47-001-01-VA	F21-47-001-01-HA	
KALINA Kombi (1117) KALINA Estate (1117) Pro-Kit (Performance Fahrwerksfedern Performance Springs) 1.4 16V	11.08 -	820	850	E10-47-004-01-22	A, 18, 20	30	30					F11-47-005-01-VA	F11-47-001-01-HA	T

Modell	Baujahr	Achslast Vorne kg	Achslast Hinten kg	Artikel-Nr.	Hinweise	ca. Tieferl. Vorne mm	ca. Tieferl. Hinten mm	Ø Vorne mm	Ø Hinten mm	Verstellbarkeit Vorne	Verstellbarkeit Hinten	Ersatzteilbezeichnung Vorne	Ersatzteilbezeichnung Hinten	Gutachten
Model	Year	Front Axle Load kg	Rear Axle Load kg	Part-No.	Notes	ca. Lowering Front mm	ca. Lowering Rear mm	Ø Front mm	Ø Rear mm	Adjustable Front	Adjustable Rear	Spare Part Marking Front	Spare Part Marking Rear	Homologation
KALINA Schrägheck (1119) KALINA Hatchback (1119) <i>Pro-Kit (Performance Fahrwerksfedern Performance Springs)</i> 1.4 16V	11.08 -	820	850	E10-47-004-01-22	A, 18, 20	30	30					F11-47-005-01-VA	F11-47-001-01-HA	T
KALINA Stufenheck (1118) KALINA Saloon (1118) <i>Pro-Kit (Performance Fahrwerksfedern Performance Springs)</i> 1.4 16V	11.08 -	820	850	E10-47-004-01-22	A, 18, 20	30	30					F11-47-005-01-VA	F11-47-001-01-HA	T
PRIORA Kombi (2171) PRIORA Estate (2171) <i>Pro-Kit (Performance Fahrwerksfedern Performance Springs)</i> 1.6	10.09 -	820	835	E10-47-005-01-22	A, 18, 20	30	0					F11-47-005-01-VA	F11-47-005-01-HA	T
PRIORA Schrägheck (2172) PRIORA Hatchback (2172) <i>Pro-Kit (Performance Fahrwerksfedern Performance Springs)</i> 1.6	12.08 -	820	835	E10-47-005-01-22	A, 18, 20	30	0					F11-47-005-01-VA	F11-47-005-01-HA	T
PRIORA Stufenheck (2170) PRIORA Saloon (2170) <i>Pro-Kit (Performance Fahrwerksfedern Performance Springs)</i> 1.6	12.08 -	820	835	E10-47-005-01-22	A, 18, 20	30	0					F11-47-005-01-VA	F11-47-005-01-HA	T
SAMARA (2108, 2109) <i>Pro-Kit (Performance Fahrwerksfedern Performance Springs)</i> 1.5, 1100, 1300, 1500	01.86 -	800	850	E10-47-001-02-22	A, 18, 20	30	30					F11-47-001-02-VA	F11-47-001-02-HA	
<i>Sportline (Performance Fahrwerksfedern Sport Sport Performance Springs)</i> 1.5, 1100, 1300, 1500	01.86 -	800	850	E20-47-001-02-22	A, 18, 20	45-50	45-50					F21-47-001-02-VA	F21-47-001-02-HA	
SAMARA FORMA (21099) <i>Pro-Kit (Performance Fahrwerksfedern Performance Springs)</i> 1.5, 1100, 1300, 1500	05.89 -	800	850	E10-47-001-02-22	A, 18, 20	30	30					F11-47-001-02-VA	F11-47-001-02-HA	
<i>Sportline (Performance Fahrwerksfedern Sport Sport Performance Springs)</i> 1.5, 1100, 1300, 1500	05.89 -	800	850	E20-47-001-02-22	A, 18, 20	45-50	45-50					F21-47-001-02-VA	F21-47-001-02-HA	
DELTA I (831AB0) <i>Pro-Kit (Performance Fahrwerksfedern Performance Springs)</i> 2.0 16V HF Integrale, 2.0 HF Integrale	11.86 - 12.92	930	930	E4901-140	A, 18	25	25					F4901001	F4901002	T
2.0 16V HF Evo Integrale	06.93 - 01.94	1030	1030	E4909-140	A, 18	30	30					F4909001	F4909002	T
DELTA II (836) <i>Pro-Kit (Performance Fahrwerksfedern Performance Springs)</i> 2.0 16V Turbo	06.93 - 08.99	1060	1060	E4911-140	A, 18, 20	30	30					F1013101	F1013002	T
DELTA III (844) <i>Pro-Kit (Performance Fahrwerksfedern Performance Springs)</i> 1.4, 1.4 16V	09.08 -	1090	950	E10-49-002-01-22	A, 18, 20	30	30					F11-30-012-01-VA	F11-30-012-01-HA	T
1.6 D Multijet, 1.8, 1.9 D Multijet, 2.0 D Multijet	08.08 -	1150	950	E10-49-002-02-22	A, 18, 20	30	30					F11-30-012-02-VA	F11-30-012-01-HA	T
PHEDRA (179) <i>Pro-Kit (Performance Fahrwerksfedern Performance Springs)</i> 2.0, 2.0 D Multijet, 2.0 JTD, 2.2 D Multijet, 2.2 JTD, 3.0 V6	09.02 - 11.10	1370	1300	E10-70-005-01-22	A, 18, 20	30	10					F3015001	F3015002	T
PRISMA (831AB0) <i>Pro-Kit (Performance Fahrwerksfedern Performance Springs)</i> 2.0 i.e. Allrad 2.0 i.e. All-wheel Drive	04.86 - 12.89	930	930	E4901-140	A, 18	30-35	30					F4901001	F4901002	T
Y (840A) <i>Pro-Kit (Performance Fahrwerksfedern Performance Springs)</i> 1.1, 1.2, 1.2 16V, 1.4 12V	11.95 - 09.03	850	750	E4915-140	A, 18, 20	30	30					F3013101	F3013002	T
YPSILON (843) <i>Pro-Kit (Performance Fahrwerksfedern Performance Springs)</i> 1.3 D Multijet, 1.3 JTD, 1.4, 1.4 16V	10.03 - 12.11	850	750	E10-49-001-01-22	A, 18, 20	30	30					F3033001	F11-49-001-01-HA	T
YPSILON (846) <i>Pro-Kit (Performance Fahrwerksfedern Performance Springs)</i> 0.9 Twinair, 1.2	05.11 -	800	810	E10-49-004-01-22	A, 18, 20	25	20					F11-49-004-01-VA	F11-49-004-01-HA	T
1.3 Multijet	05.11 -	870	810	E10-49-004-02-22	A, 18, 20	25	20					F11-49-004-02-VA	F11-49-004-01-HA	T
ZETA (220) <i>Pro-Kit (Performance Fahrwerksfedern Performance Springs)</i> 2.0 16V, 2.0 JTD, 2.0 Turbo, 2.1 TD	05.95 - 09.02	1230	1300	E4914-140	A, 18, 20	30	30					F3015001	F3015002	T

Modell	Baujahr	Achslast Vorne kg	Achslast Hinten kg	Artikel-Nr.	Hinweise	ca. Tieferl. Vorne mm	ca. Tieferl. Hinten mm	Ø Vorne mm	Ø Hinten mm	Verstellbarkeit Vorne	Verstellbarkeit Hinten	Ersatzteilbezeichnung Vorne	Ersatzteilbezeichnung Hinten	Gutachten
Model	Year	Front Axle Load kg	Rear Axle Load kg	Part-No.	Notes	ca. Lowering Front mm	ca. Lowering Rear mm	Ø Front mm	Ø Rear mm	Adjustable Front	Adjustable Rear	Spare Part Marking Front	Spare Part Marking Rear	Homologation
RANGE ROVER EVOQUE (LV) Pro-Kit (Performance Fahrwerksfedern Performance Springs) 2.0 4x4, 2.2 SD4 4x4, 2.2 TD4 4x4, 2.2 eD4	06.11 -	1300	1145	E10-47-006-02-22	A, 18	20	25					F11-47-006-02-VA	F11-47-006-02-HA	T
CT (ZWA1) Pro-Kit (Performance Fahrwerksfedern Performance Springs) 200h	12.10 -	1020	980	E10-82-039-01-22	A, 18, 20	20	20					F11-82-024-05-VA	F11-82-021-01-HA	T
IS I (JCE1_, GXE1_) Pro-Kit (Performance Fahrwerksfedern Performance Springs) 200	04.99 - 07.05	1195	1135	E8259-140	A, 12, 18, 20	30	30					F8259001	F8259002	T
IS II (GSE2_, ALE2_, USE2_) Pro-Kit (Performance Fahrwerksfedern Performance Springs) 200d, 220 d, 250	10.05 -	1090	1150	E10-82-009-05-22	A, 18, 20	30	30					F11-82-009-05-VA	F11-82-009-05-HA	T
RX (MHU3_, GSU3_, MCU3_) Pro-Kit (Performance Fahrwerksfedern Performance Springs) 3.3, 3.3 AWD, 300, 350 AWD, 400h, 400h AWD	04.03 - 12.08	1300	1350	E10-82-004-02-22	A, 18	30	30					F11-82-004-02-VA	F11-82-004-01-HA	T
ELISE Pro-Kit (Performance Fahrwerksfedern Performance Springs) 1.6, 1.8	11.00 -	483	743	E10-48-002-01-22	A, 18, 20, 72	25	20					F11-48-002-01-VA	F11-48-002-01-HA	T
EXIGE (SCC) Pro-Kit (Performance Fahrwerksfedern Performance Springs) 1.8 16V, 1.8 265 E, 1.8 Cup 240, 1.8 Cup 260	09.01 - 06.12	483	743	E10-48-002-01-22	A, 18, 20, 72	25	20					F11-48-002-01-VA	F11-48-002-01-HA	T
2 (DV) Pro-Kit (Performance Fahrwerksfedern Performance Springs) 1.2, 1.25, 1.3 L, 1.4, 1.4 CD, 1.5, 1.6	02.03 -	855	815	E10-55-005-01-22	A, 18, 20	30	30					F11-35-010-02-VA	F11-35-010-01-HA	T
2 (DE) Pro-Kit (Performance Fahrwerksfedern Performance Springs) 1.3, 1.3 MZR, 1.5, 1.5 MZR	10.07 -	795	755	E10-55-011-01-22	A, 18, 20, 163	30	30					F11-55-011-01-VA	F11-55-011-01-HA	T
1.3, 1.3 MZR, 1.4 MZR-CD, 1.5, 1.5 MZR	10.07 -	850	755	E10-55-011-02-22	A, 18, 20	30	30					F11-55-011-02-VA	F11-55-011-01-HA	T
Pro-Street-S (Gewindefahrwerke - höhenverstellbar Coil-Overs-Adjustable Ride Height) 1.3, 1.3 MZR, 1.4 MZR-CD, 1.5, 1.5 MZR	10.07 -	850	765	PSS65-35-020-01-22	A, 18, 20, 24, 25, 45, 160	25-50	30-45							T
3 (BK) Pro-Kit (Performance Fahrwerksfedern Performance Springs) 1.4, 1.6, 2.0	10.03 - 06.09	955	915	E10-55-008-01-22	A, 18, 20	30	30					F11-55-008-01-VA	F3587002	T
1.6 DI Turbo	06.04 - 06.09	995	915	E10-55-008-02-22	A, 18, 20	30	30					F11-55-008-02-VA	F3587002	T
2.3 DiSi Turbo MPS, 2.3 MPS	06.06 - 06.09	1070	915	E10-55-008-05-22	A, 18, 20	25	15					F11-55-008-05-VA	F3587002	T
2.0 MZR-CD	12.06 - 06.09	1110	915	E10-55-008-07-22	A, 18, 20	25	25					F11-35-014-02-VA	F3587002	T
B12 Pro-Kit (Performance Komplettfahrwerke Performance Springs+Shocks) 1.4, 1.6, 2.0	10.03 - 06.09	955	915	E90-55-008-01-22	A, 18, 20, 78, 161	30	30							T
1.6 DI Turbo	06.04 - 06.09	955	915	E90-55-008-02-22	A, 18, 20, 78, 161	30	30							T
2.3 DiSi Turbo MPS, 2.3 MPS, 2.3 MZR, 2.3 MZR Sport	10.03 - 06.09	1070	915	E90-55-008-05-22	A, 18, 20, 78, 161	25	15							T
3 (BL) Pro-Kit (Performance Fahrwerksfedern Performance Springs) 1.6 MZR, 1.6 MZR CD	06.09 -	925	925	E10-55-013-01-22	A, 18, 20	30	30					F11-55-008-01-VA	F11-55-013-01-HA	T
1.6 MZR-CD, 2.0 MZR, 2.0 MZR DISI	06.09 -	1005	925	E10-55-013-02-22	A, 18, 20	30	30					F11-55-008-02-VA	F11-55-013-01-HA	T
2.3 MPS Turbo	06.09 -	1075	925	E10-55-013-03-22	A, 18, 20	25	15					F11-55-008-05-VA	F11-55-013-01-HA	T
2.2 MZR-CD	06.09 -	1135	925	E10-55-013-04-22	A, 18, 20	25	15					F11-35-014-02-VA	F11-35-013-01-HA	T

Modell	Baujahr	Achslast Vorne kg	Achslast Hinten kg	Artikel-Nr.	Hinweise	ca. Tieferl. Vorne mm	ca. Tieferl. Hinten mm	Ø Vorne mm	Ø Hinten mm	Verstellbarkeit Vorne	Verstellbarkeit Hinten	Ersatzteilbezeichnung Vorne	Ersatzteilbezeichnung Hinten	Gutachten
Model	Year	Front Axle Load kg	Rear Axle Load kg	Part-No.	Notes	ca. Lowering Front mm	ca. Lowering Rear mm	Ø Front mm	Ø Rear mm	Adjustable Front	Adjustable Rear	Spare Part Marking Front	Spare Part Marking Rear	Homologation
3 Stufenheck (BK)														
3 Saloon (BK)														
Pro-Kit (Performance Fahrwerksfedern Performance Springs)														
1.6, 2.0	02.04 -	955	915	E10-55-008-01-22	A, 18, 20	30	30					F11-55-008-01-VA	F3587002	T
1.6 DI Turbo	06.04 -	995	915	E10-55-008-02-22	A, 18, 20	30	30					F11-55-008-02-VA	F3587002	T
2.3	06.00 - 03.09	1070	915	E10-55-008-05-22	A, 18, 20	25	15					F11-55-008-05-VA	F3587002	T
2.0 MZR-CD	12.06 -	1110	915	E10-55-008-07-22	A, 18, 20	25	25					F11-35-014-02-VA	F3587002	T
B12 Pro-Kit (Performance Komplettfahrwerke Performance Springs+Shocks)														
1.6, 2.0	02.04 -	955	915	E90-55-008-01-22	A, 18, 20, 78, 161	30	30							T
1.6 DI Turbo	06.04 -	955	915	E90-55-008-02-22	A, 18, 20, 78, 161	30	30							T
2.3	06.00 - 03.09	1070	915	E90-55-008-05-22	A, 18, 20, 78, 161	25	15							T
3 Stufenheck (BL)														
3 Saloon (BL)														
Pro-Kit (Performance Fahrwerksfedern Performance Springs)														
1.6 MZR, 1.6 MZR CD	06.09 -	925	925	E10-55-013-01-22	A, 18, 20	30	30					F11-55-008-01-VA	F11-55-013-01-HA	T
2.0 MZR, 2.0 MZR DISI	06.09 -	1005	925	E10-55-013-02-22	A, 18, 20	30	30					F11-55-008-02-VA	F11-55-013-01-HA	T
2.2 MZR-CD	06.09 -	1135	925	E10-55-013-04-22	A, 18, 20	25	15					F11-35-014-02-VA	F11-35-013-01-HA	T
5 (CR19)														
Pro-Kit (Performance Fahrwerksfedern Performance Springs)														
1.8, 2.0	03.05 -	1035	1205	E10-55-009-01-22	A, 18, 20	30	30-35					F11-35-014-01-VA	F11-55-009-01-HA	T
2.0 CD	03.05 -	1130	1205	E10-55-009-02-22	A, 18, 20	30	30-35					F11-35-014-02-VA	F11-55-009-01-HA	T
5 (CW)														
Pro-Kit (Performance Fahrwerksfedern Performance Springs)														
1.8 MZR, 2.0	09.10 -	1035	1205	E10-55-009-01-22	A, 18, 20	30	30-35					F11-35-014-01-VA	F11-55-009-01-HA	T
1.6 CD	09.10 -	1130	1205	E10-55-009-02-22	A, 18, 20	30	30-35					F11-35-014-02-VA	F11-55-009-01-HA	T
6 (GG)														
Pro-Kit (Performance Fahrwerksfedern Performance Springs)														
1.8, 2.0, 2.3, 2.3 MPS Turbo, bis Fahrgestellnr.: 600000 1.8, 2.0, 2.3, 2.3 MPS Turbo, to chassis no.: 600000	06.02 - 08.07	1040	1010	E10-55-004-01-22	A, 18	30	30					F11-55-004-01-VA	F11-55-004-01-HA	T
1.8, 2.0, ab Fahrgestell-Nr.: 600001 1.8, 2.0, beginning chasis-no.: 600001	06.02 - 08.07	1050	1010	E10-55-004-09-22	A, 18, 20	30	30					F11-55-004-09-VA	F11-55-004-01-HA	T
2.0 DI bis Fahrgestellnr.: 600000 2.0 DI to chassis no.: 600000	06.02 - 08.07	1095	1010	E10-55-004-03-22	A, 18, 20	30	30					F11-55-004-03-VA	F11-55-004-01-HA	T
2.0 DI ab Fahrgestell-Nr.: 600001 2.0 DI beginning chasis-no.: 600001	06.02 - 08.07	1135	1010	E10-55-004-11-22	A, 18, 20	30	30					F11-55-004-01-VA	F11-55-004-01-HA	T
2.3 T MPS	10.05 - 08.07	1135	1100	E10-55-004-04-22	A, 18	30	30					F11-55-004-03-VA	F11-55-004-02-HA	T
B12 Pro-Kit (Performance Komplettfahrwerke Performance Springs+Shocks)														
1.8, 2.0, 2.3, bis Fahrgestellnr.: 600000 1.8, 2.0, 2.3, to chassis no.: 600000	06.02 - 02.05	1040	1010	E90-55-004-01-22	A, 18, 20, 78, 161	30	30							T
2.0 DI, bis Fahrgestellnr.: 600000 2.0 DI, to chassis no.: 600000	06.02 - 02.05	1095	1010	E90-55-004-03-22	A, 18, 20, 78, 161	30	30							T
6 (GH)														
Pro-Kit (Performance Fahrwerksfedern Performance Springs)														
1.8 MZR, 2.0 MZR, 2.5 MZR	08.07 -	1060	1040	E10-55-012-01-22	A, 18, 20	30	30					F11-55-012-01-VA	F11-55-012-01-HA	T
2.0 MZR-CD, 2.2 D, 2.2 MZR-CD	08.07 -	1180	1040	E10-55-012-02-22	A, 18, 20	30	30					F11-55-012-02-VA	F11-55-012-01-HA	T
6 Hatchback (GG)														
Pro-Kit (Performance Fahrwerksfedern Performance Springs)														
1.8, 2.0, 2.3, bis Fahrgestellnr.: 600000 1.8, 2.0, 2.3, to chassis no.: 600000	08.02 - 08.07	1040	1010	E10-55-004-01-22	A, 18	30	30					F11-55-004-01-VA	F11-55-004-01-HA	T
1.8, 2.0, ab Fahrgestell-Nr.: 600001 1.8, 2.0, beginning chasis-no.: 600001	08.02 - 08.07	1050	1010	E10-55-004-09-22	A, 18, 20	30	30					F11-55-004-09-VA	F11-55-004-01-HA	T
2.0 DI bis Fahrgestellnr.: 600000 2.0 DI to chassis no.: 600000	08.02 - 08.07	1095	1010	E10-55-004-03-22	A, 18, 20	30	30					F11-55-004-03-VA	F11-55-004-01-HA	T
2.0 DI ab Fahrgestell-Nr.: 600001 2.0 DI beginning chasis-no.: 600001	08.02 - 08.07	1135	1010	E10-55-004-11-22	A, 18, 20	30	30					F11-55-004-01-VA	F11-55-004-01-HA	T
B12 Pro-Kit (Performance Komplettfahrwerke Performance Springs+Shocks)														
1.8, 2.0, 2.3, bis Fahrgestellnr.: 600000 1.8, 2.0, 2.3, to chassis no.: 600000	08.02 - 02.05	1040	1010	E90-55-004-01-22	A, 18, 20, 78, 161	30	30							T
2.0 DI, bis Fahrgestellnr.: 600000 2.0 DI, to chassis no.: 600000	08.02 - 02.05	1095	1010	E90-55-004-03-22	A, 18, 20, 78, 161	30	30							T
6 Kombi (GH)														
6 Estate (GH)														
Pro-Kit (Performance Fahrwerksfedern Performance Springs)														
1.8 MZR, 2.0 MZR, 2.5 MZR	02.08 -	1060	1090	E10-55-012-05-22	A, 18, 20	30	30					F11-55-012-01-VA	F11-55-012-05-HA	T
2.0 MZR-CD, 2.2 D, 2.2 MRZ-CD, 2.2 MZR-CD	02.08 -	1180	1090	E10-55-012-06-22	A, 18, 20	30	30					F11-55-012-02-VA	F11-55-012-05-HA	T
6 Kombi (GJ)														
6 Estate (GJ)														
Pro-Kit (Performance Fahrwerksfedern Performance Springs)														
2.0, 2.5	12.12 -	1050	1100	E10-55-015-03-22	A, 18, 20	30	25					F11-55-015-01-VA	F11-55-015-03-HA	ABE
2.2 D, 2.5	12.12 -	1140	1100	E10-55-015-04-22	A, 18, 20	30	25					F11-55-015-02-VA	F11-55-015-03-HA	ABE
6 Schrägheck (GH)														
6 Hatchback (GH)														
Pro-Kit (Performance Fahrwerksfedern Performance Springs)														
1.8 MZR, 2.0 MZR, 2.5 MZR	08.07 -	1060	1040	E10-55-012-01-22	A, 18, 20	30	30					F11-55-012-01-VA	F11-55-012-01-HA	T
2.0 MZR-CD, 2.2 D, 2.2 MZR-CD	08.07 -	1180	1040	E10-55-012-02-22	A, 18, 20	30	30					F11-55-012-02-VA	F11-55-012-01-HA	T

Modell	Baujahr	Achslast Vorne kg	Achslast Hinten kg	Artikel-Nr.	Hinweise	ca. Tieferl. Vorne mm	ca. Tieferl. Hinten mm	Ø Vorne mm	Ø Hinten mm	Verstellbarkeit Vorne	Verstellbarkeit Hinten	Ersatzteilbezeichnung Vorne	Ersatzteilbezeichnung Hinten	Gutachten
Model	Year	Front Axle Load kg	Rear Axle Load kg	Part-No.	Notes	ca. Lowering Front mm	ca. Lowering Rear mm	Ø Front mm	Ø Rear mm	Adjustable Front	Adjustable Rear	Spare Part Marking Front	Spare Part Marking Rear	Homologation
6 Station Wagon (GY) Pro-Kit (Performance Fahrwerksfedern Performance Springs) 1.8 bis Fahrgestellnr.: 400000, 2.0 bis Fahrgestellnr.: 400000, 2.3 bis Fahrgestellnr.: 400000 1.8 to chassis no.: 400000, 2.0 to chassis no.: 400000, 2.3 to chassis no.: 400000	08.02 - 08.07	1040	1100	E10-55-004-02-22	A, 18, 20	30	30-35					F11-55-004-01-VA	F11-55-004-02-HA	T
1.8, 2.0, 2.3, ab Fahrgestellnr.: 400001 1.8, 2.0, 2.3, ab Fahrgestellnr.: 400001 2.0 DI bis Fahrgestellnr.: 400000 2.0 DI to chassis no.: 400000 2.0 DI	08.02 - 08.07	1050	1100	E10-55-004-10-22	A, 18, 20	30-35	30-35					F11-55-004-09-VA	F11-55-004-02-HA	T
B12 Pro-Kit (Performance Komplettfahrwerke Performance Springs+Shocks) 1.8 bis Fahrgestellnr.: 400000, 2.0 bis Fahrgestellnr.: 400000, 2.3 bis Fahrgestellnr.: 400000 1.8 to chassis no.: 400000, 2.0 to chassis no.: 400000, 2.3 to chassis no.: 400000 2.0 DI bis Fahrgestellnr.: 400000 2.0 DI to chassis no.: 400000	08.02 - 08.07	1095	1100	E10-55-004-04-22	A, 18, 20	30	30-35					F11-55-004-03-VA	F11-55-004-02-HA	T
2.0 DI	08.02 - 08.07	1135	1100	E10-55-004-12-22	A, 18, 20	30-35	30-35					F11-55-004-01-VA	F11-55-004-02-HA	T
1.8 bis Fahrgestellnr.: 400000, 2.0 bis Fahrgestellnr.: 400000, 2.3 bis Fahrgestellnr.: 400000 1.8 to chassis no.: 400000, 2.0 to chassis no.: 400000, 2.3 to chassis no.: 400000 2.0 DI bis Fahrgestellnr.: 400000 2.0 DI to chassis no.: 400000	08.02 - 02.05	1040	1100	E90-55-004-02-22	A, 18, 20, 78, 161	30	30							T
2.0 DI bis Fahrgestellnr.: 400000 2.0 DI to chassis no.: 400000	08.02 - 02.05	1095	1100	E90-55-004-04-22	A, 18, 20, 78, 161	30	30							T
6 Stufenheck (GJ, GH) 6 Saloon (GJ, GH) Pro-Kit (Performance Fahrwerksfedern Performance Springs) 2.0, 2.5	12.12 -	1050	1035	E10-55-015-01-22	A, 18, 20	30	25					F11-55-015-01-VA	F11-55-015-01-HA	ABE
2.2 D, 2.5	12.12 -	1140	1035	E10-55-015-02-22	A, 18, 20	30	25					F11-55-015-02-VA	F11-55-015-01-HA	ABE
323 C V (BA) Pro-Kit (Performance Fahrwerksfedern Performance Springs) 1.3 16V, 1.5 16V, 1.8 16V	08.94 - 09.98	960	840	E5526-140	A, 18, 20	30	30					F5526001	F5526002	T
323 F V (BA) Pro-Kit (Performance Fahrwerksfedern Performance Springs) 1.5 16V, 1.8 16V	07.94 - 09.98	960	840	E5526-140	A, 18, 20	30	30					F5526001	F5526002	T
323 P V (BA) Pro-Kit (Performance Fahrwerksfedern Performance Springs) 1.3 16V, 1.5 16V, 2.0 D	10.96 -	960	840	E5526-140	A, 18, 20	30	30					F5526001	F5526002	T
323 S V (BA) Pro-Kit (Performance Fahrwerksfedern Performance Springs) 1.3 16V, 1.5 16V, 1.6 TD, 1.8, 1.8 16V, 2.0 D	05.94 - 09.98	960	840	E5526-140	A, 18, 20	30	30					F5526001	F5526002	T
CX-5 (KE, GH) Pro-Kit (Performance Fahrwerksfedern Performance Springs) 2.0, 2.0 AWD	11.11 -	1050	1090	E10-55-014-01-22	A, 18	25	25					F11-55-014-01-VA	F11-55-014-01-HA	T
2.2 D, 2.2 D AWD	04.12 -	1145	1090	E10-55-014-02-22	A, 18	25	25					F11-55-014-02-VA	F11-55-014-01-HA	T
MX-3 (EC) Pro-Kit (Performance Fahrwerksfedern Performance Springs) 1.6 i, 1.8 i V6	07.91 -	895	710	E5521-140	A, 18, 20	30	30					F5521001	F5521002	T
MX-5 I (NA) Pro-Kit (Performance Fahrwerksfedern Performance Springs) 1.6, 1.8	05.90 - 04.98	625	645	E5517-140	A, 18, 20	25	25					F5517001	F5517002	T
MX-5 II (NB) Pro-Kit (Performance Fahrwerksfedern Performance Springs) 1.6 16V, 1.8, 1.8 16V	01.98 - 10.05	655	665	E5530-140	A, 18, 20, 32	25	25					F5530001	F5530002	T
MX-5 III (NC) Pro-Kit (Performance Fahrwerksfedern Performance Springs) 1.8, 2.0	03.05 - 12.08	720	720	E10-55-010-01-22	A, 18, 20	30-35	30					F11-55-010-01-VA	F11-55-010-01-HA	T
1.8, 2.0	01.09 -	720	720	E10-55-010-05-22	A, 18, 20	30-35	30					F11-55-010-05-VA	F11-55-010-05-HA	T
Anti-Roll-Kit (Performance Stabilisatoren Performance Sway Bars) 1.8, 2.0	03.05 -			E40-55-010-01-11	A, 18, 20, 22, 45			26 Rohr 26 tube	16	2-fach verstellbar 2-way adjustable	nicht verstellbar not adjustable	AS41-55-010-01-VA	AS41-55-010-01-HA	T
B12 Pro-Kit (Performance Komplettfahrwerke Performance Springs+Shocks) 1.8, 2.0	03.05 -	720	720	E90-55-010-01-22	A, 18, 20, 78, 161	30-35	30							T
RX 8 (SE17) Pro-Kit (Performance Fahrwerksfedern Performance Springs) 2.6 Wankel	10.03 - 06.12	860	1030	E10-55-007-01-22	A, 18, 20	25-30	25					F11-55-007-01-VA	F11-55-007-01-HA	T
B12 Pro-Kit (Performance Komplettfahrwerke Performance Springs+Shocks) 2.6 Wankel	10.03 - 06.12	860	1030	E90-55-007-01-22	A, 18, 20, 78, 161	25-30	25							T

Modell	Baujahr	Achslast Vorne kg	Achslast Hinten kg	Artikel-Nr.	Hinweise	ca. Tieferl. Vorne mm	ca. Tieferl. Hinten mm	Ø Vorne mm	Ø Hinten mm	Verstellbarkeit Vorne	Verstellbarkeit Hinten	Ersatzteilbezeichnung Vorne	Ersatzteilbezeichnung Hinten	Gutachten
Model	Year	Front Axle Load kg	Rear Axle Load kg	Part-No.	Notes	ca. Lowering Front mm	ca. Lowering Rear mm	Ø Front mm	Ø Rear mm	Adjustable Front	Adjustable Rear	Spare Part Marking Front	Spare Part Marking Rear	Homologation
190 (W201) Pro-Kit (Performance Fahrwerksfedern Performance Springs) 2.0, 2.3, D 2.0, D 2.5, E 1.8, E 2.0, E 2.3, E 2.3-16, E 2.5-16	10.82 - 08.93	880	940	E2502-140	A, 7, 18, 20	40	30-40					F2502001	F2502002	T
B12 Pro-Kit (Performance Komplettfahrwerke Performance Springs+Shocks) 2.0, 2.3, D 2.0, D 2.5, E 1.8, E 2.0, E 2.3, E 2.3-16, E 2.5-16	10.82 - 08.93	880	940	E90-25-023-01-22	A, 7, 18, 20, 78, 161	40	30-40							T
A-CLASS (W168) Pro-Kit (Performance Fahrwerksfedern Performance Springs) A 140, A 160, A 160 CDI, A 170 CDI, A 190, A 210	07.97 - 08.04	810	845	E2556-140	A, 7, 18, 20	20	20					F2556101	F2556002	T
B12 Pro-Kit (Performance Komplettfahrwerke Performance Springs+Shocks) A 140, A 160, A 160 CDI, A 170 CDI, A 190, A 210	07.97 - 08.04	810	845	E90-25-006-02-22	A, 7, 18, 20, 78, 86, 161	20	20							T
A-CLASS (W169) Pro-Kit (Performance Fahrwerksfedern Performance Springs) A 150, A 160, A 170, A 180, A 200	09.04 - 06.12	885	900	E10-25-015-02-22	A, 7, 18, 20	30	25					F11-25-015-02-VA	F11-25-015-01-HA	T
A 160 CDI, A 180 CDI, A 200 CDI, A 200 TURBO	09.04 - 06.12	980	900	E10-25-015-01-22	A, 7, 18, 20	30	25					F11-25-015-01-VA	F11-25-015-01-HA	T
B12 Pro-Kit (Performance Komplettfahrwerke Performance Springs+Shocks) A 150, A 170, A 200	09.04 - 06.12	885	900	E90-25-015-02-22	A, 7, 18, 20, 78, 161	30	25							T
A 160 CDI, A 180 CDI, A 200 CDI, A 200 TURBO	09.04 - 06.12	980	900	E90-25-015-01-22	A, 7, 18, 20, 78, 161	30	25							T
A-CLASS (W176) Pro-Kit (Performance Fahrwerksfedern Performance Springs) A 160 CDI, A 180, A 180 CDI, A 200, A 200 CDI, A 220 CDI, A 250	06.12 -	1100	975	E10-25-033-01-22	A, 12, 18, 20	30	25					F11-25-031-01-VA	F11-25-031-01-HA	T
A 160 CDI, A 180, A 180 CDI, A 200, A 200 CDI, A 220 CDI, A 250	06.12 -	1100	975	E10-25-033-02-22	A, 18, 20	15	15					F11-25-033-02-VA	F11-25-033-02-HA	T
Pro-Street-S (Gewindefahrwerke - höhenverstellbar Coil-Overs-Adjustable Ride Height) A 160 CDI, A 180, A 180 CDI, A 200, A 200 CDI, A 220 CDI	06.12 -	1100	945	PSS65-25-033-01-22	A, 18, 24, 25, 45, 160	25-55	30-60							
A 250	06.12 -	1100	945	PSS65-25-033-01-22	A, 18, 24, 25, 45, 88, 160	25-55	30-60							
B-CLASS (W245) Pro-Kit (Performance Fahrwerksfedern Performance Springs) B 150, B 160, B 170, B 180	03.05 - 11.11	950	900	E10-25-016-01-22	A, 7, 18, 20	30	30					F11-25-015-02-VA	F11-25-015-01-HA	T
B 180 CDI, B 200, B 200 CDI, B 200 TURBO	03.05 - 11.11	1005	900	E10-25-016-02-22	A, 7, 18, 20	30	30					F11-25-015-01-VA	F11-25-015-01-HA	T
B12 Pro-Kit (Performance Komplettfahrwerke Performance Springs+Shocks) B 150, B 170	03.05 - 11.11	950	900	E90-25-016-01-22	A, 7, 18, 20, 78, 161	30	30							T
B 180 CDI, B 200, B 200 CDI, B 200 TURBO	03.05 - 11.11	1005	900	E90-25-016-02-22	A, 7, 18, 20, 78, 161	30	30							T
B-CLASS (W246) Pro-Kit (Performance Fahrwerksfedern Performance Springs) B 160 CDI, B 180, B 180 CDI, B 200, B 200 CDI, B 220 CDI, B 250	11.11 -	1100	955	E10-25-031-01-22	A, 18, 20	30	25					F11-25-031-01-VA	F11-25-031-01-HA	T
C-CLASS (W202) Pro-Kit (Performance Fahrwerksfedern Performance Springs) C 180, C 200, C 200 D, C 200 Kompressor, C 220, C 220 D, C 230 Kompressor	03.93 - 05.00	970	1030	E2532-140	A, 7, 18, 20	30	30					F2532001	F2532002	ABE
C 180, C 200, C 200 CDI, C 200 Kompressor, C 220, C 220 CDI, C 220 D, C 230	03.93 - 05.00	990	1070	E2544-140	A, 7, 18, 20	30	30					F2544001	F2544002	T
C 230 Kompressor, C 240, C 250 D, C 250 Turbo-D, C 280	05.93 - 05.00	1010	1070	E2545-140	A, 7, 18, 20	30	30					F2545001	F2544002	T
Sportline (Performance Fahrwerksfedern Sport Sport Performance Springs) C 180, C 200, C 200 CDI, C 200 D, C 200 Kompressor, C 220, C 220 CDI, C 220 D, C 230, C 230 Kompressor, C 240	03.93 - 05.00	1010	1070	E20-25-002-01-22	A, 7, 18, 20	45-50	30-35					F21-25-002-01-VA	F21-25-002-01-HA	T
B12 Pro-Kit (Performance Komplettfahrwerke Performance Springs+Shocks) C 180, C 200, C 200 D, C 200 Kompressor, C 220, C 220 D, C 230 Kompressor	03.93 - 05.00	970	1030	E90-25-002-01-22	A, 7, 18, 20, 78, 161	30	30							T
C 180, C 200, C 200 CDI, C 200 Kompressor, C 220 CDI, C 220 D, C 230	03.93 - 05.00	990	1070	E90-25-002-02-22	A, 7, 18, 20, 78, 161	30	30							T
C 230 Kompressor, C 240, C 250 D, C 250 Turbo-D, C 280	05.93 - 05.00	1010	1070	E90-25-002-03-22	A, 7, 18, 20, 78, 161	30	30							T
B12 Sportline (Performance Komplettfahrwerke Sport Sport Performance Springs+Shocks) C 180, C 200, C 200 CDI, C 200 D, C 200 Kompressor, C 220, C 220 D, C 230, C 230 Kompressor, C 240	03.93 - 05.00	1010	1070	E95-25-002-01-22	A, 7, 18, 20, 78, 161	45-50	30-35							T
C-CLASS (W203) Pro-Kit (Performance Fahrwerksfedern Performance Springs) C 180, C 180 Kompressor, C 200 CDI, C 200 CGI Kompressor, C 200 Kompressor, C 220 CDI, C 230, C 230 Kompressor	05.00 - 02.07	1035	1170	E10-25-001-01-22	A, 7, 18, 20	30	30					F11-25-001-03-VA	F2536002	T
C 240, C 270 CDI, C 280, C 320, C 320 CDI, C 350	05.00 - 02.07	1130	1170	E10-25-001-02-22	A, 7, 18, 20	30	30					F11-25-001-01-VA	F2536002	T
Anti-Roll-Kit (Performance Stabilisatoren Performance Sway Bars) C 180, C 180 Kompressor, C 200 CDI, C 200 Kompressor, C 220 CDI, C 240, C 270 CDI, C 320	05.00 - 06.03			E40-25-001-01-11	A, 18, 20, 22, 45			24	22	2-fach verstellbar 2-way adjustable	nicht verstellbar not adjustable	AS41-25-001-01-VA	AS41-25-001-01-HA	T
C 180 Kompressor, C 200 CDI, C 200 Kompressor, C 220 CDI, C 230, C 230 Kompressor, C 240, C 270 CDI, C 280, C 320, C 320 CDI, C 350	06.03 - 02.07			E40-25-001-07-11	A, 18, 20, 22, 45			24	22	2-fach verstellbar 2-way adjustable	nicht verstellbar not adjustable	AS41-25-001-01-VA	AS41-25-001-01-HA	T
B12 Pro-Kit (Performance Komplettfahrwerke Performance Springs+Shocks) C 180, C 180 Kompressor, C 200 CDI, C 200 CGI Kompressor, C 200 Kompressor, C 220 CDI, C 230, C 230 Kompressor	05.00 - 02.07	1035	1170	E90-25-001-01-22	A, 7, 18, 20, 78, 161	30	30							T
C 240, C 270 CDI, C 280, C 320, C 320 CDI, C 350	05.00 - 02.07	1130	1170	E90-25-001-02-22	A, 7, 18, 20, 78, 161	30	30							T
Pro-Street-S (Gewindefahrwerke - höhenverstellbar Coil-Overs-Adjustable Ride Height) C 180, C 180 Kompressor, C 200 CDI, C 200 CGI Kompressor, C 200 Kompressor, C 220 CDI, C 230, C 230 Kompressor, C 240, C 270 CDI, C 280, C 320, C 320 CDI, C 350	05.00 - 02.07	995	1170	PSS65-25-001-01-22	A, 18, 24, 25, 45, 160	35-65	35-65							T

Modell	Baujahr	Achslast Vorne kg	Achslast Hinten kg	Artikel-Nr.	Hinweise	ca. Tieferl. Vorne mm	ca. Tieferl. Hinten mm	Ø Vorne mm	Ø Hinten mm	Verstellbarkeit Vorne	Verstellbarkeit Hinten	Ersatzteilbezeichnung Vorne	Ersatzteilbezeichnung Hinten	Gutachten
Model	Year	Front Axle Load kg	Rear Axle Load kg	Part-No.	Notes	ca. Lowering Front mm	ca. Lowering Rear mm	Ø Front mm	Ø Rear mm	Adjustable Front	Adjustable Rear	Spare Part Marking Front	Spare Part Marking Rear	Homologation
C-CLASS (W203) Pro-Street-S (Gewindefahrwerke - höhenverstellbar Coil-Overs-Adjustable Ride Height) C 180, C 180 Kompressor, C 200 CDI, C 200 CGI Kompressor, C 200 Kompressor, C 220 CDI, C 230, C 230 Kompressor, C 240, C 270 CDI, C 280, C 320, C 320 CDI, C 350	05.00 - 02.07	1090	1170	PSS65-25-001-02-22	A, 18, 24, 25, 45, 160	35-65	35-65							T
C-CLASS (W204) Pro-Kit (Performance Fahrwerksfedern Performance Springs) C 180 CDI, C 200 CDI, C 220 CDI, C 230, C 250 CDI, C 280, C 300, C 320 CDI, C 350, C 350 CDI, C 350 CGI	01.07 -	1150	1200	E10-25-019-02-22	A, 7, 18, 20, 21	30	30					F11-25-019-02-VA	F11-25-019-01-HA	T
C 180 CGI, C 180 Kompressor, C 200 CGI, C 200 Kompressor, C 250 CGI	01.07 -	1150	1200	E10-25-019-01-22	A, 7, 18, 20, 21	30	30					F11-25-019-01-VA	F11-25-019-01-HA	T
C 220 CDI 4-matic, C 230 4-matic, C 250 CDI 4-matic, C 280 4-matic, C 300 4-matic, C 300 CDI 4-matic, C 320 CDI 4-matic, C 350 4-matic, C 350 CDI 4-matic	07.07 -	1160	1225	E10-25-019-07-22	A, 7, 18, 21	20	20					F11-25-021-02-VA	F11-25-019-03-HA	T
Anti-Roll-Kit (Performance Stabilisatoren Performance Sway Bars) C 180 CDI, C 180 CGI, C 180 Kompressor, C 200 CDI, C 200 CGI, C 200 Kompressor, C 220 CDI, C 230, C 250 CDI, C 250 CGI, C 280, C 300, C 320 CDI, C 350, C 350 CDI, C 350 CGI	01.07 -			E40-25-019-01-11	A, 18, 20, 22, 45			28	21	2-fach verstellbar 2-way adjustable	nicht verstellbar not adjustable	AS41-25-019-01-VA	AS41-25-019-01-HA	T
B12 Pro-Kit (Performance Komplettfahrwerke Performance Springs+Shocks) C 180 CDI, C 200 CDI, C 220 CDI, C 250 CDI, C 280, C 300, C 320 CDI, C 350, C 350 CDI, C 350 CGI	01.07 -	1150	1200	E90-25-019-02-22	A, 7, 18, 20, 21, 78, 161	30	30							T
C 180 CGI, C 180 Kompressor, C 200, C 200 CGI, C 200 Kompressor, C 230, C 250 CGI	01.07 -	1150	1200	E90-25-019-01-22	A, 7, 18, 20, 21, 78, 161	30	30							T
C-CLASS Coupe (CL203) Pro-Kit (Performance Fahrwerksfedern Performance Springs) C 160 Kompressor, C 180, C 180 Kompressor, C 200 CGI Kompressor, C 200 Kompressor, C 220, C 230, C 230 Kompressor	03.01 - 05.08	1070	1035	E10-25-001-04-22	A, 7, 18, 20	25-30	20-25					F11-25-001-03-VA	F2538002	T
C 200 CDI, C 220 CDI, C 320, C 350	03.01 - 05.08	1100	1035	E10-25-001-08-22	A, 7, 18, 20	25-30	20-25					F11-25-001-01-VA	F2538002	T
Anti-Roll-Kit (Performance Stabilisatoren Performance Sway Bars) C 160 Kompressor, C 180, C 180 Kompressor, C 200 CDI, C 200 CGI Kompressor, C 200 Kompressor, C 220, C 220 CDI, C 230 Kompressor, C 320	03.01 - 06.03			E40-25-001-01-11	A, 18, 20, 22, 45			24	22	2-fach verstellbar 2-way adjustable	nicht verstellbar not adjustable	AS41-25-001-01-VA	AS41-25-001-01-HA	T
C 160 Kompressor, C 180 Kompressor, C 200 CDI, C 200 CGI Kompressor, C 200 Kompressor, C 220, C 220 CDI, C 230, C 230 Kompressor, C 320, C 350	06.03 - 05.08			E40-25-001-07-11	A, 18, 20, 22, 45			24	22	2-fach verstellbar 2-way adjustable	nicht verstellbar not adjustable	AS41-25-001-01-VA	AS41-25-001-01-HA	T
B12 Pro-Kit (Performance Komplettfahrwerke Performance Springs+Shocks) C 160 Kompressor, C 180, C 180 Kompressor, C 200 CGI Kompressor, C 200 Kompressor, C 230, C 230 Kompressor	03.01 - 05.08	1070	1035	E90-25-001-04-22	A, 7, 18, 20, 78, 161	25-30	20-25							T
C 200 CDI, C 220 CDI, C 320, C 350	03.01 - 05.08	1100	1035	E90-25-001-08-22	A, 7, 18, 20, 78, 161	25-30	20-25							T
C-CLASS Coupe (C204) Pro-Kit (Performance Fahrwerksfedern Performance Springs) C 180, C 200 CGI, C 250	06.11 -	1150	1230	E10-25-019-03-22	A, 7, 18, 20, 21	25	25					F11-25-019-01-VA	F11-25-019-03-HA	T
C 220 CDI, C 250 CDI, C 350	06.11 -	1150	1230	E10-25-019-04-22	A, 7, 18, 20, 21	25	25					F11-25-019-02-VA	F11-25-019-03-HA	T
Anti-Roll-Kit (Performance Stabilisatoren Performance Sway Bars) C 180, C 200 CGI, C 220 CDI, C 250, C 250 CDI, C 350	06.11 -			E40-25-019-01-11	A, 18, 20, 22, 45			28	21	2-fach verstellbar 2-way adjustable	nicht verstellbar not adjustable	AS41-25-019-01-VA	AS41-25-019-01-HA	T
B12 Pro-Kit (Performance Komplettfahrwerke Performance Springs+Shocks) C 180, C 200 CGI, C 250	06.11 -	1150	1230	E90-25-019-03-22	A, 7, 18, 20, 21, 78, 161	30	30							T
C 220 CDI, C 250 CDI, C 350	06.11 -	1150	1230	E90-25-019-04-22	A, 7, 18, 20, 21, 78, 161	30	30							T
C-CLASS Kombi (S202) C-CLASS Estate (S202) Pro-Kit (Performance Fahrwerksfedern Performance Springs) C 180 T, C 200 T, C 200 T CDI, C 200 T D, C 200 T Kompressor, C 220 T CDI, C 220 T D, C 230 T	06.96 - 03.01	990	1070	E2546-140	A, 7, 18, 20	30	30					F2544001	F2536002	T
C 230 T Kompressor, C 240 T, C 250 T Turbo-D, C 280 T	06.96 - 03.01	1010	1070	E2547-140	A, 7, 18, 20	30	30					F2545001	F2536002	T
B12 Pro-Kit (Performance Komplettfahrwerke Performance Springs+Shocks) C 180 T, C 200 T, C 200 T CDI, C 200 T D, C 200 T Kompressor, C 220 T CDI, C 220 T D, C 230 T	06.96 - 03.01	990	1070	E90-25-002-08-22	A, 7, 18, 20, 78, 161	30	30							T
C 230 T Kompressor, C 240 T, C 250 T Turbo-D, C 280 T	06.96 - 03.01	1010	1070	E90-25-002-09-22	A, 7, 18, 20, 78, 161	30	30							T
C-CLASS T-Model (S203) Pro-Kit (Performance Fahrwerksfedern Performance Springs) C 180, C 180 Kompressor, C 200 CDI, C 200 CGI Kompressor, C 200 Kompressor, C 220 CDI, C 230, C 230 Kompressor	03.01 - 08.07	1015	1170	E10-25-001-05-22	A, 7, 18, 20	30	30					F11-25-001-03-VA	F11-25-001-05-HA	T
C 240, C 270 CDI, C 280, C 320, C 320 CDI, C 350	03.01 - 08.07	1090	1170	E10-25-001-06-22	A, 7, 18, 20	30	30					F11-25-001-01-VA	F11-25-001-05-HA	T
Anti-Roll-Kit (Performance Stabilisatoren Performance Sway Bars) C 180, C 180 Kompressor, C 200 CDI, C 200 Kompressor, C 220 CDI, C 240, C 270 CDI, C 320	03.01 - 06.03			E40-25-001-01-11	A, 18, 20, 22, 45			24	22	2-fach verstellbar 2-way adjustable	nicht verstellbar not adjustable	AS41-25-001-01-VA	AS41-25-001-01-HA	T
C 180 Kompressor, C 200 CDI, C 200 Kompressor, C 220 CDI, C 230, C 230 Kompressor, C 240, C 270 CDI, C 280, C 320, C 320 CDI, C 350	06.03 - 08.07			E40-25-001-07-11	A, 18, 20, 22, 45			24	22	2-fach verstellbar 2-way adjustable	nicht verstellbar not adjustable	AS41-25-001-01-VA	AS41-25-001-01-HA	T
B12 Pro-Kit (Performance Komplettfahrwerke Performance Springs+Shocks) C 180, C 180 Kompressor, C 200 CDI, C 200 Kompressor, C 220 CDI, C 230, C 230 Kompressor	03.01 - 08.07	1015	1170	E90-25-001-05-22	A, 7, 18, 20, 78, 87, 161	30	30							T
C 240, C 270 CDI, C 280, C 320, C 320 CDI, C 350	03.01 - 08.07	1090	1170	E90-25-001-06-22	A, 7, 18, 20, 78, 87, 161	30	30							T

Modell	Baujahr	Achslast Vorne kg	Achslast Hinten kg	Artikel-Nr.	Hinweise	ca. Tieferl. Vorne mm	ca. Tieferl. Hinten mm	Ø Vorne mm	Ø Hinten mm	Verstellbarkeit Vorne	Verstellbarkeit Hinten	Ersatzteilbezeichnung Vorne	Ersatzteilbezeichnung Hinten	Gutachten
Model	Year	Front Axle Load kg	Rear Axle Load kg	Part-No.	Notes	ca. Lowering Front mm	ca. Lowering Rear mm	Ø Front mm	Ø Rear mm	Adjustable Front	Adjustable Rear	Spare Part Marking Front	Spare Part Marking Rear	Homologation
C-CLASS T-Model (S203) <i>Pro-Street-S (Gewindefahrwerke - höhenverstellbar Coil-Overs-Adjustable Ride Height)</i> C 180, C 180 Kompressor, C 200 CDI, C 200 CGI Kompressor, C 200 Kompressor, C 220 CDI, C 230, C 230 Kompressor, C 240, C 270 CDI, C 280, C 320, C 320 CDI, C 350	03.01 - 08.07	995	1170	PSS65-25-001-01-22	A, 18, 24, 25, 45, 160	35-65	35-65							T
C 180, C 180 Kompressor, C 200 CDI, C 200 CGI Kompressor, C 200 Kompressor, C 220 CDI, C 230, C 230 Kompressor, C 240, C 270 CDI, C 280, C 320, C 320 CDI, C 350	03.01 - 08.07	1090	1170	PSS65-25-001-02-22	A, 18, 24, 25, 45, 160	35-65	35-65							T
C-CLASS T-Model (S204) <i>Pro-Kit (Performance Fahrwerksfedern Performance Springs)</i> C 180 CDI, C 200 CDI, C 220 CDI, C 230, C 250 CDI, C 280, C 320 CDI, C 350, C 350 CGI	01.07 -	1150	1230	E10-25-019-04-22	A, 7, 18, 20, 21	30	30					F11-25-019-02-VA	F11-25-019-03-HA	T
C 180 CGI, C 180 Kompressor, C 200 CGI, C 200 Kompressor, C 250 CGI	08.07 -	1150	1230	E10-25-019-03-22	A, 7, 18, 20, 21	30	30					F11-25-019-01-VA	F11-25-019-03-HA	T
C 220 CDI 4-matic, C 250 CDI 4-matic, C 320 CDI 4-matic, C 350 CDI 4-matic	08.07 -	1160	1225	E10-25-019-07-22	A, 7, 18, 21	20	20					F11-25-021-02-VA	F11-25-019-03-HA	T
Anti-Roll-Kit (Performance Stabilisatoren Performance Sway Bars) C 180 CDI, C 180 CGI, C 180 Kompressor, C 200 CDI, C 200 CGI, C 200 Kompressor, C 220 CDI, C 230, C 250 CDI, C 250 CGI, C 280, C 320 CDI, C 350, C 350 CGI	01.07 -			E40-25-019-01-11	A, 18, 20, 22, 45			28	21	2-fach verstellbar 2-way adjustable	nicht verstellbar not adjustable	AS41-25-019-01-VA	AS41-25-019-01-HA	T
B12 Pro-Kit (Performance Komplettfahrwerke Performance Springs+Shocks) C 180 CDI, C 200 CDI, C 220 CDI, C 250 CDI, C 280, C 320 CDI, C 350, C 350 CGI	08.07 -	1150	1230	E90-25-019-04-22	A, 7, 18, 20, 21, 78, 161	30	30							T
C 180 CGI, C 180 Kompressor, C 200 CGI, C 200 Kompressor, C 230, C 250 CGI	08.07 -	1150	1230	E90-25-019-03-22	A, 7, 18, 20, 21, 78, 161	30	30							T
CABRIOLET (A124) <i>Pro-Kit (Performance Fahrwerksfedern Performance Springs)</i> 300 CE-24	04.92 - 06.93	1010	1170	E2517-140	A, 7, 16, 18, 20	35	30-35					F2517001	F2504002	T
300 CE-24	04.92 - 06.93	1010	1230	E2518-140	A, 7, 16, 20	35	25-30					F2517001	F2518002	T
CITAN Kasten (415) CITAN Box (415) <i>Pro-Kit (Performance Fahrwerksfedern Performance Springs)</i> 108 CDI, 109 CDI	11.12 -	1125	1240	E10-25-034-01-22	A, 18, 20	30	20					F11-25-034-01-VA	F11-25-034-01-HA	T
CITAN Kombi (415) CITAN Combi (415) <i>Pro-Kit (Performance Fahrwerksfedern Performance Springs)</i> 108 CDI, 109 CDI	11.12 -	1125	1240	E10-25-034-01-22	A, 18, 20	30	20					F11-25-034-01-VA	F11-25-034-01-HA	T
CITAN Mixto (415) <i>Pro-Kit (Performance Fahrwerksfedern Performance Springs)</i> 109 CDI	11.12 -	1125	1240	E10-25-034-01-22	A, 18, 20	30	20					F11-25-034-01-VA	F11-25-034-01-HA	T
CLA Coupe (C117) <i>Pro-Kit (Performance Fahrwerksfedern Performance Springs)</i> CLA 180, CLA 200, CLA 220 CDI, CLA 250	01.13 -	1100	975	E10-25-033-01-22	A, 12, 18, 20	30	25					F11-25-031-01-VA	F11-25-031-01-HA	T
CLA 180, CLA 200, CLA 220 CDI, CLA 250	01.13 -	1100	975	E10-25-033-02-22	A, 18, 20	15	15					F11-25-033-02-VA	F11-25-033-02-HA	T
Pro-Street-S (Gewindefahrwerke - höhenverstellbar Coil-Overs-Adjustable Ride Height) CLA 180, CLA 200, CLA 220 CDI, CLA 250	01.13 -	1100	945	PSS65-25-033-01-22	A, 18, 24, 25, 45, 160	25-55	30-60							
CLC-CLASS (CL203) <i>Pro-Kit (Performance Fahrwerksfedern Performance Springs)</i> CLC 160, CLC 180 Kompressor, CLC 200 Kompressor, CLC 230	05.08 - 06.11	1070	1035	E10-25-001-04-22	A, 7, 18, 20	25-30	20-25					F11-25-001-03-VA	F2538002	T
CLC 200 CDI, CLC 220 CDI, CLC 350	05.08 - 06.11	1100	1035	E10-25-001-08-22	A, 7, 18, 20	25-30	20-25					F11-25-001-01-VA	F2538002	T
Anti-Roll-Kit (Performance Stabilisatoren Performance Sway Bars) CLC 160, CLC 180 Kompressor, CLC 200 CDI, CLC 200 Kompressor, CLC 220 CDI, CLC 230, CLC 350	06.03 - 06.11			E40-25-001-07-11	A, 18, 20, 22, 45			24	22	2-fach verstellbar 2-way adjustable	nicht verstellbar not adjustable	AS41-25-001-01-VA	AS41-25-001-01-HA	T
B12 Pro-Kit (Performance Komplettfahrwerke Performance Springs+Shocks) CLC 180 Kompressor, CLC 200 Kompressor, CLC 230	05.08 - 06.11	1070	1035	E90-25-001-04-22	A, 7, 18, 20, 78, 161	25-30	20-25							T
CLC 200 CDI, CLC 220 CDI, CLC 350	05.08 - 06.11	1100	1035	E90-25-001-08-22	A, 7, 18, 20, 78, 161	25-30	20-25							T
CLK (C208) <i>Pro-Kit (Performance Fahrwerksfedern Performance Springs)</i> 200, 200 Kompressor	06.97 - 06.02	990	1070	E2554-140	A, 7, 18, 20	30	30					F2544001	F2544002	T
230 Kompressor, 320, 430	06.97 - 06.02	1010	1070	E2555-140	A, 7, 18, 20	30	30					F2545001	F2544002	T
Sportline (Performance Fahrwerksfedern Sport Sport Performance Springs) 200, 200 Kompressor, 230 Kompressor, 320, 430	06.97 - 06.02	1010	1070	E20-25-002-01-22	A, 7, 20	45-50	30-35					F21-25-002-01-VA	F21-25-002-01-HA	T
B12 Pro-Kit (Performance Komplettfahrwerke Performance Springs+Shocks) 200, 200 Kompressor	06.97 - 06.02	990	1070	E90-25-002-04-22	A, 7, 18, 20, 78, 161	30	30							T
230 Kompressor, 320, 430	06.97 - 06.02	1010	1070	E90-25-002-05-22	A, 7, 18, 20, 78, 161	30	30							T
B12 Sportline (Performance Komplettfahrwerke Sport Sport Performance Springs+Shocks) 200, 200 Kompressor, 230 Kompressor, 320, 430	06.97 - 06.02	1010	1070	E95-25-002-02-22	A, 7, 20, 78, 161	45-50	30-35							T
CLK (C209) <i>Pro-Kit (Performance Fahrwerksfedern Performance Springs)</i> 200 CGI, 200 Kompressor, 220 CDI	09.02 - 05.09	1035	1170	E10-25-001-01-22	A, 7, 18, 20	30	30					F11-25-001-03-VA	F2536002	T
240, 270 CDI, 280, 320, 320 CDI, 350, 500	06.02 - 05.09	1130	1170	E10-25-001-02-22	A, 7, 18, 20	30	30					F11-25-001-01-VA	F2536002	T

Modell	Baujahr	Achslast Vorne kg	Achslast Hinten kg	Artikel-Nr.	Hinweise	ca. Tieferl. Vorne mm	ca. Tieferl. Hinten mm	Ø Vorne mm	Ø Hinten mm	Verstellbarkeit Vorne	Verstellbarkeit Hinten	Ersatzteilbezeichnung Vorne	Ersatzteilbezeichnung Hinten	Gutachten
Model	Year	Front Axle Load kg	Rear Axle Load kg	Part-No.	Notes	ca. Lowering Front mm	ca. Lowering Rear mm	Ø Front mm	Ø Rear mm	Adjustable Front	Adjustable Rear	Spare Part Marking Front	Spare Part Marking Rear	Homologation
CLK (C209) Anti-Roll-Kit (Performance Stabilisatoren Performance Sway Bars) 200 Kompressor, 240, 270 CDI, 320, 500	06.02 - 06.03			E40-25-001-01-11	A, 18, 20, 22, 45			24	22	2-fach verstellbar 2-way adjustable	nicht verstellbar not adjustable	AS41-25-001-01-VA	AS41-25-001-01-HA	T
200 CGI, 200 Kompressor, 220 CDI, 240, 270 CDI, 280, 320, 320 CDI, 350, 500	06.03 - 05.09			E40-25-001-07-11	A, 18, 20, 22, 45			24	22	2-fach verstellbar 2-way adjustable	nicht verstellbar not adjustable	AS41-25-001-01-VA	AS41-25-001-01-HA	T
B12 Pro-Kit (Performance Komplettfahrwerke Performance Springs+Shocks) 200 CGI, 200 Kompressor, 220 CDI	09.02 - 05.09	1035	1170	E90-25-001-01-22	A, 7, 18, 20, 21, 78, 161	30	30							T
240, 270 CDI, 280, 320, 320 CDI, 350, 500	06.02 - 05.09	1130	1170	E90-25-001-02-22	A, 7, 18, 20, 21, 78, 161	30	30							T
CLK Cabriolet (A208) CLK Convertible (A208) Pro-Kit (Performance Fahrwerksfedern Performance Springs) 200, 200 Kompressor	03.98 - 03.02	990	1070	E2560-140	A, 7, 18, 20	30	30					F2544001	F2536002	T
230 Kompressor, 320, 430	03.98 - 03.02	1010	1070	E2561-140	A, 7, 18, 20	30	30					F2545001	F2536002	T
Sportline (Performance Fahrwerksfedern Sport Sport Performance Springs) 200, 200 Kompressor, 230 Kompressor, 320, 430	03.98 - 03.02	1010	1070	E20-25-002-01-22	A, 7, 20	45-50	30-35					F21-25-002-01-VA	F21-25-002-01-HA	T
B12 Pro-Kit (Performance Komplettfahrwerke Performance Springs+Shocks) 200, 200 Kompressor	03.98 - 03.02	990	1070	E90-25-002-06-22	A, 7, 18, 20, 78, 161	30	30							T
230 Kompressor, 320, 430	03.98 - 03.02	1010	1070	E90-25-002-07-22	A, 7, 18, 20, 78, 161	30	30							T
B12 Sportline (Performance Komplettfahrwerke Sport Sport Performance Springs+Shocks) 200, 200 Kompressor, 230 Kompressor, 320, 430	03.98 - 03.02	1010	1070	E95-25-002-02-22	A, 7, 20, 78, 161	45-50	30-35							T
CLK Cabriolet (A209) CLK Convertible (A209) Pro-Kit (Performance Fahrwerksfedern Performance Springs) CLK 200 CGI, CLK 200 Kompressor	02.03 - 03.10	1035	1170	E10-25-001-01-22	A, 7, 18, 20	30	30					F11-25-001-03-VA	F2536002	T
CLK 240, CLK 280, CLK 320, CLK 350, CLK 500	02.03 - 03.10	1130	1170	E10-25-001-02-22	A, 7, 18, 20	30	30					F11-25-001-01-VA	F2536002	T
Anti-Roll-Kit (Performance Stabilisatoren Performance Sway Bars) CLK 200 Kompressor, CLK 240, CLK 320, CLK 500	02.03 - 06.03			E40-25-001-01-11	A, 18, 20, 22, 45			24	22	2-fach verstellbar 2-way adjustable	nicht verstellbar not adjustable	AS41-25-001-01-VA	AS41-25-001-01-HA	T
CLK 200 CGI, CLK 200 Kompressor, CLK 240, CLK 280, CLK 320, CLK 350, CLK 500	06.03 - 03.10			E40-25-001-07-11	A, 18, 20, 22, 45			24	22	2-fach verstellbar 2-way adjustable	nicht verstellbar not adjustable	AS41-25-001-01-VA	AS41-25-001-01-HA	T
B12 Pro-Kit (Performance Komplettfahrwerke Performance Springs+Shocks) CLK 200 CGI, CLK 200 Kompressor	02.03 - 03.10	1035	1170	E90-25-001-01-22	A, 7, 18, 20, 21, 78, 161	30	30							T
CLK 240, CLK 280, CLK 320, CLK 350, CLK 500	02.03 - 03.10	1130	1170	E90-25-001-02-22	A, 7, 18, 20, 21, 78, 161	30	30							T
CLS (C219) Pro-Kit (Performance Fahrwerksfedern Performance Springs) CLS 320 CDI, CLS 350, CLS 350 CGI	10.04 - 12.10	1135	1190	E10-25-008-08-22	A, 7, 20	30	25-30					F11-25-008-02-VA	F11-25-008-08-HA	T
Anti-Roll-Kit (Performance Stabilisatoren Performance Sway Bars) CLS 320 CDI, CLS 350, CLS 350 CGI	10.04 - 12.10			E40-25-008-08-11	A, 18, 20, 22, 45			34	21	nicht verstellbar not adjustable	nicht verstellbar not adjustable	AS41-25-008-01-VA	AS41-25-008-01-HA	T
B12 Pro-Kit (Performance Komplettfahrwerke Performance Springs+Shocks) CLS 320 CDI, CLS 350	10.04 - 12.10	1135	1190	E90-25-008-05-22	A, 7, 20, 78, 161	30	25-30							T
CLS (C218) Pro-Kit (Performance Fahrwerksfedern Performance Springs) CLS 250 CDI, CLS 350, CLS 350 BlueTEC, CLS 350 CDI	01.11 -	1160	1200	E10-25-021-01-22	A, 7, 18, 20	30	30					F11-25-021-01-VA	F11-25-021-01-HA	T
CLS Shooting Brake (X218) Pro-Kit (Performance Fahrwerksfedern Performance Springs) CLS 250 CDI, CLS 350	10.12 -	1055	1460	E10-25-021-04-22	A, 7, 20	30	30					F11-25-021-01-VA		T
CLS 350 CDI	10.12 -	1200	1460	E10-25-021-05-22	A, 7, 20	30	30					F11-25-021-02-VA		T
COUPE (C124) Pro-Kit (Performance Fahrwerksfedern Performance Springs) 220 CE, 230 CE, 230 CE KAT 220 CE, 230 CE, 230 CE KAT	03.87 - 05.93	930	985	E2504-140	A, 7, 18, 20	35	30-35					F2504001	F2504002	T
220 CE, 230 CE, 230 CE KAT 220 CE, 230 CE, 230 CE KAT	03.87 - 05.93	950	1230	E2511-140	A, 7, 20	35	25-30					F2504001	F2518002	T
220 CE Sonderausstattung, 230 CE KAT Sonderausstattung, 230 CE Sonderausstattung 220 CE special equipment, 230 CE CAT special equipment, 230 CE special equipment	03.87 - 05.93	1005	1000	E2505-140	A, 7, 16, 18, 20	35	30-35					F2505001	F2504002	T
300 CE, 300 CE-24	03.87 - 05.93	1005	1000	E2505-140	A, 7, 18, 20	35	30-35					F2505001	F2504002	T
220 CE Sonderausstattung, 230 CE KAT Sonderausstattung, 230 CE Sonderausstattung 220 CE special equipment, 230 CE CAT special equipment, 230 CE special equipment	03.87 - 05.93	1005	1230	E2512-140	A, 7, 16, 20	35	25-30					F2505001	F2518002	T
300 CE, 320 CE	03.87 - 05.93	1005	1230	E2512-140	A, 7, 20	35	25-30					F2505001	F2518002	T
300 CE Sonderausstattung, 300 CE-24 Sonderausstattung, 320 CE 300 CE special equipment, 300 CE-24 special equipment, 320 CE	03.87 - 05.93	1010	1170	E2517-140	A, 7, 16, 18, 20	35	30-35					F2517001	F2504002	T
300 CE Sonderausstattung, 300 CE-24 Sonderausstattung, 320 CE 300 CE special equipment, 300 CE-24 special equipment, 320 CE	03.87 - 05.93	1010	1230	E2518-140	A, 7, 16, 20	35	25-30					F2517001	F2518002	T
E-CLASS (W124) Pro-Kit (Performance Fahrwerksfedern Performance Springs) E 200, E 200 D, E 220	06.93 - 06.95	1005	1000	E2505-140	A, 7, 18, 20	35	30-35					F2505001	F2504002	T
E 200, E 200 D, E 220	06.93 - 06.95	1005	1230	E2512-140	A, 7, 20	35	25-30					F2505001	F2518002	T
E 200 D Sonderausstattung, E 250 D, E 250 Turbo-D E 200 D special equipment, E 250 D, E 250 Turbo-D	06.93 - 06.95	1010	1170	E2517-140	A, 7, 16, 18, 20	35	30-35					F2517001	F2504002	T
E 280, E 300 D, E 300 Turbo-D, E 320	06.93 - 06.95	1010	1170	E2517-140	A, 7, 18, 20	35	30-35					F2517001	F2504002	T

Modell	Baujahr	Achslast Vorne kg	Achslast Hinten kg	Artikel-Nr.	Hinweise	ca. Tieferl. Vorne mm	ca. Tieferl. Hinten mm	Ø Vorne mm	Ø Hinten mm	Verstellbarkeit Vorne	Verstellbarkeit Hinten	Ersatzteilbezeichnung Vorne	Ersatzteilbezeichnung Hinten	Gutachten
Model	Year	Front Axle Load kg	Rear Axle Load kg	Part-No.	Notes	ca. Lowering Front mm	ca. Lowering Rear mm	Ø Front mm	Ø Rear mm	Adjustable Front	Adjustable Rear	Spare Part Marking Front	Spare Part Marking Rear	Homologation
E-CLASS (W124)														
Pro-Kit (Performance Fahrwerksfedern Performance Springs)														
E 200 D Sonderausstattung E 200 D special equipment	06.93 - 06.95	1010	1230	E2518-140	A, 7, 16, 20	35	25-30					F2517001	F2518002	T
E 250 D, E 250 Turbo-D, E 280, E 300 D, E 300 Turbo-D, E 320	06.93 - 06.95	1010	1230	E2518-140	A, 7, 20	35	25-30					F2517001	F2518002	T
E-CLASS (W210)														
Pro-Kit (Performance Fahrwerksfedern Performance Springs)														
E 200, E 200 CDI, E 200 D, E 200 Kompressor, E 220 CDI, E 220 D, E 230, E 250 D, E 250 Turbo-D, E 270 CDI, E 290 Turbo-D	06.95 - 03.02	1095	1165	E2536-140	A, 7, 18, 20, 68	35	30					F2536001	F2536002	T
E 200, E 200 CDI, E 200 D, E 200 Kompressor, E 220 CDI, E 220 D, E 230, E 250 D, E 250 Turbo-D, E 270 CDI, E 290 Turbo-D	06.95 - 03.02	1095	1165	E2538-140	A, 7, 20, 68	35	30					F2536001	F2538002	T
E 280	12.96 - 03.02	1095	1165	E2557-140	A, 7, 18, 20, 68	20	30					F2536001	F2536002	T
E 240, E 280, E 320, E 320 CDI, E 430	12.96 - 03.02	1095	1165	E2559-140	A, 7, 20, 68	35	30					F2536001	F2538002	T
E 240, E 280, E 300 D, E 300 Turbo-D, E 320, E 420, E 430	06.95 - 03.02	1095	1165	E2537-140	A, 7, 18, 20, 68	35	30					F2537001	F2536002	T
E 240, E 280, E 300 D, E 300 Turbo-D, E 320, E 420, E 430	06.95 - 03.02	1095	1165	E2539-140	A, 7, 20, 68	35	30					F2537001	F2538002	T
E 240, E 320, E 320 CDI, E 430	06.97 - 03.02	1095	1165	E2557-140	A, 7, 18, 20, 68	35	30					F2536001	F2536002	T
B12 Pro-Kit (Performance Komplettfahrwerke Performance Springs+Shocks)														
E 200, E 200 CDI, E 200 D, E 200 Kompressor, E 220 D, E 270 CDI	07.99 - 03.02	1095	1165	E90-25-004-02-22	A, 7, 18, 20, 68, 78, 149, 161	35	30							T
E 220 CDI	07.99 - 03.02	1095	1165	E90-25-004-02-22	A, 7, 18, 20, 68, 78, 148, 161	35	30							T
E 200, E 200 CDI, E 200 D, E 200 Kompressor, E 220 CDI, E 220 D, E 230, E 250 D, E 250 Turbo-D, E 290 Turbo-D	06.95 - 06.99	1095	1165	E90-25-004-01-22	A, 7, 18, 20, 68, 78, 116, 161	35	30							T
E 240, E 280, E 320, E 430	07.99 - 03.02	1095	1165	E90-25-004-04-22	A, 7, 18, 20, 68, 78, 149, 161	35	30							T
E 240, E 280, E 320, E 430	06.95 - 06.99	1095	1165	E90-25-004-03-22	A, 7, 18, 20, 68, 78, 116, 161	35	30							T
E-CLASS (W211)														
Pro-Kit (Performance Fahrwerksfedern Performance Springs)														
E 200 CDI, E 200 CGI, E 200 Kompressor, E 220 CDI, E 230, E 240, E 280, E 300 BlueTEC, E 320, E 350, E 350 CGI	03.02 - 12.08	1095	1230	E10-25-008-01-22	A, 7, 18, 20	30-35	30					F11-25-008-01-VA	F11-25-008-01-HA	T
E 220 CDI, E 250 CDI, E 270 CDI, E 280 CDI, E 320 CDI	03.02 - 12.08	1160	1230	E10-25-008-02-22	A, 7, 18, 20	35-40	30					F11-25-008-02-VA	F11-25-008-01-HA	T
Anti-Roll-Kit (Performance Stabilisatoren Performance Sway Bars)														
E 200 CDI, E 200 CGI, E 200 Kompressor, E 220 CDI, E 230, E 240, E 250 CDI, E 270 CDI, E 280, E 280 CDI, E 300 BlueTEC, E 320, E 320 CDI, E 350, E 350 CGI	03.02 - 12.08			E40-25-008-01-11	A, 18, 20, 22, 45			34	21	nicht verstellbar not adjustable	nicht verstellbar not adjustable	AS41-25-008-01-VA	AS41-25-008-01-HA	T
B12 Pro-Kit (Performance Komplettfahrwerke Performance Springs+Shocks)														
E 200 CDI, E 200 CGI, E 200 Kompressor, E 220 CDI, E 240, E 350	03.02 - 12.08	1095	1230	E90-25-008-01-22	A, 7, 18, 20, 78, 119, 161	30-35	30							T
E 200 CDI, E 200 CGI, E 200 Kompressor, E 220 CDI, E 240, E 350	03.02 - 12.08	1095	1230	E90-25-008-01-22	A, 7, 18, 20, 78, 119, 161	15-20	15							T
E 220 CDI, E 270 CDI, E 320, E 320 CDI	03.02 - 12.08	1160	1230	E90-25-008-02-22	A, 7, 18, 20, 78, 119, 161	35-40	30							T
E 220 CDI, E 270 CDI, E 320, E 320 CDI	03.02 - 12.08	1160	1230	E90-25-008-02-22	A, 7, 18, 20, 78, 119, 161	20-25	15							T
E-CLASS (W212)														
Pro-Kit (Performance Fahrwerksfedern Performance Springs)														
E 200 CGI, E 250 CGI	01.09 -	1055	1275	E10-25-021-01-22	A, 7, 18, 20	30	30					F11-25-021-01-VA	F11-25-021-01-HA	T
E 200 CDI, E 220 CDI, E 250 CDI, E 300, E 300 CDI, E 350, E 350 BlueTEC, E 350 CDI, E 350 CGI, E 400	01.09 -	1200	1275	E10-25-021-02-22	A, 7, 18, 20	30	30					F11-25-021-02-VA	F11-25-021-01-HA	T
B12 Pro-Kit (Performance Komplettfahrwerke Performance Springs+Shocks)														
E 200 CGI	08.09 -	1055	1275	E90-25-021-01-22	A, 7, 18, 20, 78, 88, 161	30	30							T
E 250 CGI	01.09 -	1055	1275	E90-25-021-01-22	A, 7, 18, 20, 78, 118, 161	30	30							T
E 220 CDI, E 250 CDI	01.09 -	1200	1240	E90-25-021-02-22	A, 7, 18, 20, 78, 88, 161	15	15							T
E 200 CDI, E 300, E 300 CDI, E 350, E 350 BlueTEC, E 350 CDI, E 350 CGI	01.09 -	1200	1240	E90-25-021-02-22	A, 7, 18, 20, 78, 118, 161	15	15							T
E 200 CGI	08.09 -	1200	1275	E90-25-021-02-22	A, 7, 18, 20, 78, 118, 161	15	15							T
E 220 CDI, E 250 CDI	01.09 -	1200	1275	E90-25-021-02-22	A, 7, 18, 20, 78, 88, 161	30	30							T
E 250 CGI	01.09 -	1200	1275	E90-25-021-02-22	A, 7, 18, 20, 78, 88, 161	15	15							T
E 200 CDI, E 300, E 300 CDI, E 350, E 350 BlueTEC, E 350 CDI, E 350 CGI	01.09 -	1200	1275	E90-25-021-02-22	A, 7, 18, 20, 78, 118, 161	30	30							T
E-CLASS Cabriolet (A124)														
E-CLASS Convertible (A124)														
Pro-Kit (Performance Fahrwerksfedern Performance Springs)														
E 200, E 220, E 320	06.93 - 03.98	1010	1170	E2517-140	A, 7, 18, 20	35	30-35					F2517001	F2504002	T
E 200, E 220	06.93 - 03.98	1010	1230	E2518-140	A, 7, 20	35	25-30					F2517001	F2518002	T
E 320	06.93 - 03.98	1010	1230	E2518-140	A, 7, 16, 20	35	25-30					F2517001	F2518002	T
E-CLASS Cabriolet (A207)														
E-CLASS Convertible (A207)														
Pro-Kit (Performance Fahrwerksfedern Performance Springs)														
E 200, E 200 CGI, E 250, E 250 CGI	01.10 -	1150	1200	E10-25-019-01-22	A, 7, 18, 20, 21	30	30					F11-25-019-01-VA	F11-25-019-01-HA	T

Modell	Baujahr	Achslast Vorne kg	Achslast Hinten kg	Artikel-Nr.	Hinweise	ca. Tieferl. Vorne mm	ca. Tieferl. Hinten mm	Ø Vorne mm	Ø Hinten mm	Verstellbarkeit Vorne	Verstellbarkeit Hinten	Ersatzteilbezeichnung Vorne	Ersatzteilbezeichnung Hinten	Gutachten
Model	Year	Front Axle Load kg	Rear Axle Load kg	Part-No.	Notes	ca. Lowering Front mm	ca. Lowering Rear mm	Ø Front mm	Ø Rear mm	Adjustable Front	Adjustable Rear	Spare Part Marking Front	Spare Part Marking Rear	Homologation
E-CLASS Cabriolet (A207) E-CLASS Convertible (A207) Pro-Kit (Performance Fahrwerksfedern Performance Springs) E 220 CDI, E 250 CDI, E 300, E 350, E 350 BlueTEC, E 350 BlueTEC Hybrid, E 350 CDI, E 350 CGI	01.10 -	1150	1200	E10-25-019-02-22	A, 7, 18, 20, 21	30	30					F11-25-019-02-VA	F11-25-019-01-HA	T
B12 Pro-Kit (Performance Komplettfahrwerke Performance Springs+Shocks) E 200 CGI, E 250 CGI	01.10 -	1150	1200	E90-25-019-01-22	A, 7, 18, 20, 21, 78, 161	30	30							T
E 220 CDI, E 250 CDI, E 300, E 350, E 350 CDI, E 350 CGI	01.10 -	1150	1200	E90-25-019-02-22	A, 7, 18, 20, 21, 78, 161	30	30							T
E-CLASS Coupe (C124) Pro-Kit (Performance Fahrwerksfedern Performance Springs) E 200, E 220	06.93 - 06.97	930	985	E2504-140	A, 7, 18, 20	35	30-35					F2504001	F2504002	T
E 200, E 220	06.93 - 06.97	950	1230	E2511-140	A, 7, 20	35	25-30					F2504001	F2518002	T
E 320	06.93 - 06.97	1005	1000	E2505-140	A, 7, 18, 20	35	30-35					F2505001	F2504002	T
E 320	06.93 - 06.97	1005	1230	E2512-140	A, 7, 20	35	25-30					F2505001	F2518002	T
E 320 Sonderausstattung E 320 special equipment	06.93 - 06.97	1010	1170	E2517-140	A, 7, 16, 18, 20	35	30-35					F2517001	F2504002	T
E 320 Sonderausstattung E 320 special equipment	06.93 - 06.97	1010	1230	E2518-140	A, 7, 16, 20	35	25-30					F2517001	F2518002	T
E-CLASS Coupe (C207) Pro-Kit (Performance Fahrwerksfedern Performance Springs) E 200, E 200 CGI, E 250, E 250 CGI	01.09 -	1150	1200	E10-25-019-01-22	A, 7, 18, 20, 21	30	30					F11-25-019-01-VA	F11-25-019-01-HA	T
E 220 CDI, E 250 CDI, E 300, E 350, E 350 BlueTEC, E 350 CDI, E 350 CGI	01.09 -	1150	1200	E10-25-019-02-22	A, 7, 18, 20, 21	30	30					F11-25-019-02-VA	F11-25-019-01-HA	T
B12 Pro-Kit (Performance Komplettfahrwerke Performance Springs+Shocks) E 200 CGI, E 250 CGI	01.09 -	1150	1200	E90-25-019-01-22	A, 7, 18, 20, 21, 78, 161	30	30							T
E 220 CDI, E 250 CDI, E 300, E 350, E 350 CDI, E 350 CGI	01.09 -	1150	1200	E90-25-019-02-22	A, 7, 18, 20, 21, 78, 161	30	30							T
E-CLASS Kombi (S124) E-CLASS Estate (S124) Pro-Kit (Performance Fahrwerksfedern Performance Springs) E 200 T, E 220 T, E 280 T, E 320 T	06.93 - 06.96	1005	1230	E2512-140	A, 7, 20	35	25-30					F2505001	F2518002	T
300 TD T	06.92 - 05.93	1010	1230	E2518-140	A, 7, 20	35	25-30					F2517001	F2518002	T
E 280 T Sonderausstattung, E 320 T Sonderausstattung E 280 T special equipment, E 320 T special equipment	06.93 - 06.96	1010	1230	E2518-140	A, 7, 16, 20	35	25-30					F2517001	F2518002	T
E-CLASS Kombi (S210) E-CLASS Estate (S210) Pro-Kit (Performance Fahrwerksfedern Performance Springs) E 200 T, E 200 T Kompressor, E 220 T CDI, E 230 T, E 250 T D, E 250 T Turbo-D, E 270 T CDI	06.96 - 03.03	1095	1300	E2536-140	A, 7, 20	35	30					F2536001	F2536002	T
E 240 T V-Motor, E 280 T V-Motor, E 320 T V-Motor, E 430 T V-Motor	12.96 - 03.03	1095	1300	E2557-140	A, 7, 20	35	30					F2536001	F2536002	T
E 240 T, E 280 T, E 290 T Turbo-D, E 300 T Turbo-D, E 320 T, E 320 T CDI, E 420 T, E 430 T	06.96 - 03.03	1095	1300	E2537-140	A, 7, 20	35	30					F2537001	F2536002	T
E-CLASS T-Model (S211) Pro-Kit (Performance Fahrwerksfedern Performance Springs) E 200 CDI, E 200 Kompressor, E 200 T Kompressor, E 220 CDI, E 220 T CDI, E 230 T, E 240 T, E 280 T, E 320 T, E 350 T	03.03 - 07.09	1095	1230	E10-25-008-05-20	A, 7, 20	30-35	30					F11-25-008-01-VA	Luftfederverstellung air suspension	T
350 CGI, E 220 CDI, E 220 T CDI, E 270 T CDI, E 280 T CDI, E 320 T, E 320 T CDI, E 350 T	03.03 - 07.09	1160	1230	E10-25-008-06-20	A, 7, 20	30-35	30					F11-25-008-02-VA	Luftfederverstellung air suspension	T
Anti-Roll-Kit (Performance Stabilisatoren Performance Sway Bars) 350 CGI, E 200 CDI, E 200 Kompressor, E 200 T Kompressor, E 220 CDI, E 220 T CDI, E 230 T, E 240 T, E 270 T CDI, E 280 T, E 280 T CDI, E 320 T, E 320 T CDI, E 350 T	03.03 - 07.09			E40-25-008-05-11	A, 18, 20, 22, 45			34	21	nicht verstellbar not adjustable	nicht verstellbar not adjustable	AS41-25-008-01-VA	AS41-25-008-01-HA	T
B12 Pro-Kit (Performance Komplettfahrwerke Performance Springs+Shocks) E 200 T Kompressor, E 220 CDI, E 220 T CDI, E 230 T, E 240 T, E 350 T	03.03 - 07.09	1095	1230	E90-25-008-03-20	A, 7, 18, 20, 78, 161	30-35	30							T
E 220 T CDI, E 270 T CDI	03.03 - 07.09	1160	1230	E90-25-008-04-20	A, 7, 18, 20, 78, 161	30-35	30							T
E 220 T CDI, E 270 T CDI, E 280 T CDI, E 320 T, E 320 T CDI, E 350 T	03.03 - 07.09	1160	1230	E90-25-008-04-20	A, 7, 20, 78, 161	30-35	30							T
E-CLASS T-Model (S212) Pro-Kit (Performance Fahrwerksfedern Performance Springs) E 200, E 200 CGI, E 250, E 250 CGI	11.09 -	1055	1460	E10-25-021-04-22	A, 7, 20	30	30					F11-25-021-01-VA		T
E 200 CDI, E 220 CDI, E 250 CDI, E 300, E 300 CDI, E 350, E 350 BlueTEC, E 350 CDI, E 350 CGI, E 400	08.09 -	1200	1460	E10-25-021-05-22	A, 7, 20	30	30					F11-25-021-02-VA		T
KOMBI Kombi (S124) KOMBI Estate (S124) Pro-Kit (Performance Fahrwerksfedern Performance Springs) 200 E, 200 T, 200 T D, 200 TE, 230 TE, 230 TE KAT, 250 T D 200 E, 200 T, 200 T D, 200 TE, 230 TE, 230 TE CAT, 250 T D 200 E Sonderausstattung, 200 T D Sonderausstattung, 200 T Sonderausstattung, 200 TE Sonderausstattung, 220 TE, 230 TE KAT Sonderausstattung, 230 TE Sonderausstattung 200 E special equipment, 200 T D special equipment, 200 T special equipment, 200 TE special equipment, 220 TE, 230 TE CAT special equipment, 230 TE special equipment	09.85 - 06.93	950	1230	E2511-140	A, 7, 20	35	25-30					F2504001	F2518002	T
200 E Sonderausstattung, 200 T D Sonderausstattung, 200 T Sonderausstattung, 200 TE Sonderausstattung, 220 TE, 230 TE KAT Sonderausstattung, 230 TE Sonderausstattung 200 E special equipment, 200 T D special equipment, 200 T special equipment, 200 TE special equipment, 220 TE, 230 TE CAT special equipment, 230 TE special equipment	09.85 - 06.93	1005	1230	E2512-140	A, 7, 16, 20	35	25-30					F2505001	F2518002	T
250 T D Sonderausstattung, 300 T D, 300 TE, 300 TE-24, 320 TE 250 T D special equipment, 300 T D, 300 TE, 300 TE-24, 320 TE	09.85 - 06.93	1005	1230	E2512-140	A, 7, 20	35	25-30					F2505001	F2518002	T

Modell	Baujahr	Achslast Vorne kg	Achslast Hinten kg	Artikel-Nr.	Hinweise	ca. Tieferl. Vorne mm	ca. Tieferl. Hinten mm	Ø Vorne mm	Ø Hinten mm	Verstellbarkeit Vorne	Verstellbarkeit Hinten	Ersatzteilbezeichnung Vorne	Ersatzteilbezeichnung Hinten	Gutachten
Model	Year	Front Axle Load kg	Rear Axle Load kg	Part-No.	Notes	ca. Lowering Front mm	ca. Lowering Rear mm	Ø Front mm	Ø Rear mm	Adjustable Front	Adjustable Rear	Spare Part Marking Front	Spare Part Marking Rear	Homologation
KOMBI Kombi (S124) KOMBI Estate (S124) Pro-Kit (Performance Fahrwerksfedern Performance Springs) 250 T D, 280 TE, 300 T D Sonderausstattung, 300 T Turbo-D, 300 TD T, 300 TE Sonderausstattung, 300 TE-24 Sonderausstattung, 320 TE Sonderausstattung 250 T D, 280 TE, 300 T D special equipment, 300 T Turbo-D, 300 TD T, 300 TE special equipment, 300 TE-24 special equipment, 320 TE special equipment	09.85 - 06.93	1010	1230	E2518-140	A, 7, 16, 20	35	25-30					F2517001	F2518002	T
M-CLASS (W163) Pro-Kit (Performance Fahrwerksfedern Performance Springs) ML 230, ML 270 CDI, ML 320, ML 350, ML 430	02.98 - 06.05	1430	1600	E2558-120	A, 7, 18	35	30					Drehstabverstellung torsion bar	F2558002	T
M-CLASS (W164) Pro-Kit (Performance Fahrwerksfedern Performance Springs) ML 280 CDI 4-matic, ML 300 CDI 4-matic, ML 320 CDI 4-matic, ML 350 4-matic	07.05 -	1400	1600	E10-25-017-01-22	A, 7, 18	35	35					F11-25-017-01-VA	F11-25-017-01-HA	T
B12 Pro-Kit (Performance Komplettfahrwerke Performance Springs+Shocks) ML 280 CDI 4-matic, ML 320 CDI 4-matic, ML 350 4-matic	07.05 -	1400	1600	E90-25-017-01-22	A, 7, 18, 20, 78, 98, 161	35	35							T
M-CLASS (166) Pro-Kit (Performance Fahrwerksfedern Performance Springs) ML 250 CDI BlueTEC 4-matic, ML 350 4-matic, ML 350 BlueTEC 4-matic	06.11 -	1450	1600	E10-25-030-01-22	A, 7, 18	30-35	25-35					F11-25-030-01-VA	F11-25-030-01-HA	T
R-CLASS (W251, V251) Pro-Kit (Performance Fahrwerksfedern Performance Springs) R 280 CDI, R 280 CDI 4-matic, R 300 CDI, R 300 CDI 4-matic, R 320 CDI 4-matic, R 350, R 350 4-matic, R 500 4-matic	01.06 -	1370	1700	E10-25-018-01-20	A, 7, 59	30	30					F11-25-018-01-VA	Luftfederverstellung air suspension	T
S-CLASS (W126) Pro-Kit (Performance Fahrwerksfedern Performance Springs) 260 SE, 280 S, 280 SE,SEL, 300 SE,SEL, 380 SE,SEL	10.79 - 06.91	1110	1160	E2506-140	A, 7, 18, 20	40-45	30-35					F2506001	F2506002	T
B12 Pro-Kit (Performance Komplettfahrwerke Performance Springs+Shocks) 260 SE, 280 S, 280 SE,SEL, 300 SE,SEL, 380 SE,SEL	10.79 - 06.91	1110	1160	E90-25-024-01-22	A, 7, 18, 20, 78, 161	40-45	30-35							T
S-CLASS Coupe (C126) Pro-Kit (Performance Fahrwerksfedern Performance Springs) 380 SEC	10.81 - 07.85	1110	1160	E2506-140	A, 7, 18, 20	40-45	30-35					F2506001	F2506002	T
B12 Pro-Kit (Performance Komplettfahrwerke Performance Springs+Shocks) 380 SEC	10.81 - 07.85	1110	1160	E90-25-024-01-22	A, 7, 18, 20, 78, 161	40-45	30-35							T
SL (R129) Pro-Kit (Performance Fahrwerksfedern Performance Springs) 280, 300 SL, 300 SL-24, 320, 500, 500 SL	03.89 - 10.01	1080	1190	E2534-140	A, 7, 18, 20	30	30					F2534001	F2534002	T
B12 Pro-Kit (Performance Komplettfahrwerke Performance Springs+Shocks) 280, 320, 500	09.92 - 10.01	1080	1190	E90-25-028-01-22	A, 7, 20, 78, 161	30	30							T
300 SL, 300 SL-24, 500 SL	02.92 - 08.93	1080	1190	E90-25-028-01-22	A, 7, 20, 78, 150, 161	30	30							T
SL (R230) Pro-Kit (Performance Fahrwerksfedern Performance Springs) 350	03.03 - 01.12	1025	1135	E10-25-009-02-22	A, 7, 18, 20	30	30					F11-25-009-02-VA	F11-25-009-02-HA	T
SL (R231) Pro-Kit (Performance Fahrwerksfedern Performance Springs) 350	02.12 -	1005	1150	E10-25-032-01-22	A, 18, 20	25	25					F11-25-032-01-VA	F11-25-032-01-HA	T
500	01.12 -	1075	1150	E10-25-032-02-22	A, 18, 20	25	25					F11-25-032-01-VA	F11-25-032-01-HA	T
SLK (R170) Pro-Kit (Performance Fahrwerksfedern Performance Springs) 200, 200 Kompressor, 230 Kompressor, 320	09.96 - 04.04	845	820	E2552-140	A, 7, 18, 20	30	30					F2552101	F2552102	T
B12 Pro-Kit (Performance Komplettfahrwerke Performance Springs+Shocks) 200, 200 Kompressor, 230 Kompressor, 320	09.96 - 04.04	845	820	E90-25-003-01-22	A, 7, 18, 20, 78, 161	30	30							T
SLK (R171) Pro-Kit (Performance Fahrwerksfedern Performance Springs) 200 Kompressor	03.04 - 02.11	840	940	E10-25-013-01-22	A, 7, 18, 20	25	25					F11-25-013-01-VA	F11-25-013-01-HA	T
280, 300, 350	06.04 - 02.11	910	940	E10-25-013-02-22	A, 7, 18, 20	25	25					F11-25-013-02-VA	F11-25-013-01-HA	T
B12 Pro-Kit (Performance Komplettfahrwerke Performance Springs+Shocks) 200 Kompressor	03.04 - 02.11	840	940	E90-25-013-01-22	A, 7, 18, 20, 78, 161	25	25							T
280, 300, 350	06.04 - 02.11	910	940	E90-25-013-02-22	A, 7, 18, 20, 78, 161	25	25							T
SLK (R172) Pro-Kit (Performance Fahrwerksfedern Performance Springs) 200, 250	02.11 -	940	970	E10-25-026-01-22	A, 7, 18, 20	25-30	25					F11-25-026-01-VA	F11-25-026-01-HA	T
250 CDI, 350	02.11 -	940	970	E10-25-026-02-22	A, 7, 18, 20	25	25					F11-25-026-02-VA	F11-25-026-01-HA	T
Stufenheck (W124) Saloon (W124) Pro-Kit (Performance Fahrwerksfedern Performance Springs) 200, 200 D, 200 E, 230 E, 230 E KAT 200, 200 D, 200 E, 230 E, 230 E CAT 200, 200 D, 200 E, 230 E, 230 E KAT 200, 200 D, 200 E, 230 E, 230 E CAT 200 D Sonderausstattung, 200 E Sonderausstattung, 200 Sonderausstattung, 220 E, 230 E KAT Sonderausstattung, 230 E Sonderausstattung 200 D special equipment, 200 E special equipment, 200 special equipment, 220 E, 230 E CAT special equipment, 230 E special equipment 250 D, 250 Turbo-D, 260 E, 280 E, 300 D, 300 E, 300 E-24, 300 Turbo-D	12.84 - 06.93	930	985	E2504-140	A, 7, 18, 20	35	30-35					F2504001	F2504002	T
	12.84 - 06.93	950	1230	E2511-140	A, 7, 20	35	25-30					F2504001	F2518002	T
	12.84 - 06.93	1005	1000	E2505-140	A, 7, 16, 18, 20	35	30-35					F2505001	F2504002	T
	12.84 - 06.93	1005	1000	E2505-140	A, 7, 18, 20	35	30-35					F2505001	F2504002	T

Modell	Baujahr	Achslast Vorne kg	Achslast Hinten kg	Artikel-Nr.	Hinweise	ca. Tieferl. Vorne mm	ca. Tieferl. Hinten mm	Ø Vorne mm	Ø Hinten mm	Verstellbarkeit Vorne	Verstellbarkeit Hinten	Ersatzteilbezeichnung Vorne	Ersatzteilbezeichnung Hinten	Gutachten
Model	Year	Front Axle Load kg	Rear Axle Load kg	Part-No.	Notes	ca. Lowering Front mm	ca. Lowering Rear mm	Ø Front mm	Ø Rear mm	Adjustable Front	Adjustable Rear	Spare Part Marking Front	Spare Part Marking Rear	Homologation
Stufenheck (W124) Saloon (W124) Pro-Kit (Performance Fahrwerksfedern Performance Springs) 200 D Sonderausstattung, 200 E Sonderausstattung, 200 Sonderausstattung, 220 E, 230 E KAT Sonderausstattung, 230 E Sonderausstattung 200 D special equipment, 200 E special equipment, 200 special equipment, 220 E, 230 E CAT special equipment, 230 E special equipment 250 D, 250 Turbo-D, 260 E, 300 D, 300 E	12.84 - 06.93	1005	1230	E2512-140	A, 7, 16, 20	35	25-30					F2505001	F2518002	T
	12.84 - 06.93	1005	1230	E2512-140	A, 7, 20	35	25-30					F2505001	F2518002	T
250 D Sonderausstattung, 250 Turbo-D Sonderausstattung, 260 E Sonderausstattung, 280 E Sonderausstattung, 300 D Sonderausstattung, 300 E Sonderausstattung, 300 E-24 Sonderausstattung, 300 Turbo-D Sonderausstattung 250 D special equipment, 250 Turbo-D special equipment, 260 E special equipment, 280 E special equipment, 300 D special equipment, 300 E special equipment, 300 E-24 special equipment, 300 Turbo-D special equipment 320 E	12.84 - 06.93	1010	1170	E2517-140	A, 7, 16, 18, 20	35	30-35					F2517001	F2504002	T
250 D Sonderausstattung, 250 Turbo-D Sonderausstattung, 260 E Sonderausstattung, 280 E Sonderausstattung, 300 D Sonderausstattung, 300 E Sonderausstattung, 300 E-24 Sonderausstattung, 300 Turbo-D Sonderausstattung, 320 E 250 D special equipment, 250 Turbo-D special equipment, 260 E special equipment, 280 E special equipment, 300 D special equipment, 300 E special equipment, 300 E-24 special equipment, 300 Turbo-D special equipment, 320 E	10.92 - 06.93	1010	1170	E2517-140	A, 7, 18, 20	35	30-35					F2517001	F2504002	T
250 D Sonderausstattung, 250 Turbo-D Sonderausstattung, 260 E Sonderausstattung, 280 E Sonderausstattung, 300 D Sonderausstattung, 300 E Sonderausstattung, 300 E-24 Sonderausstattung, 300 Turbo-D Sonderausstattung, 320 E 250 D special equipment, 250 Turbo-D special equipment, 260 E special equipment, 280 E special equipment, 300 D special equipment, 300 E special equipment, 300 E-24 special equipment, 300 Turbo-D special equipment, 320 E	12.84 - 06.93	1010	1230	E2518-140	A, 7, 16, 20	35	25-30					F2517001	F2518002	T
VIANO (W639) Pro-Kit (Performance Fahrwerksfedern Performance Springs) 3,0, 3,2, 3,5, 3,7, CDI 2,0, CDI 2,0 4-matic, CDI 2,2, CDI 2,2 4-matic	09.03 - 08.10	1550	1550	E10-25-014-01-22	A, 18, 20	30	30					F11-25-014-01-VA	F11-25-014-01-HA	T
3,0, 3,2, 3,5, 3,7, CDI 2,0, CDI 2,0 4-matic, CDI 2,2, CDI 2,2 4-matic	09.03 - 08.10	1550	1550	E10-25-014-05-22	A, 20, 59	30	30					F11-25-014-01-VA	Luftfederverstellung air suspension	T
3,5, CDI 2,0, CDI 2,0 4-matic, CDI 2,2, CDI 2,2 4-matic	09.10 -	1550	1700	E10-25-022-01-22	A	30	30					F11-25-022-02-VA	F11-25-022-01-HA	T
3,5, CDI 2,0, CDI 2,0 4-matic, CDI 2,2, CDI 2,2 4-matic	09.10 -	1550	1700	E10-25-022-02-22	A, 59	30	30					F11-25-022-02-VA	Luftfederverstellung air suspension	T
VITO / MIXTO Kasten (W639) VITO / MIXTO Box (W639) Pro-Kit (Performance Fahrwerksfedern Performance Springs) 109 CDI, 109 CDI, 111 CDI, 115 CDI, 119, 120 CDI, 122, 123, 126	09.03 - 08.10	1550	1550	E10-25-014-01-22	A, 18, 20	30	30					F11-25-014-01-VA	F11-25-014-01-HA	T
109 CDI, 109 CDI, 111 CDI, 115 CDI, 119, 120 CDI, 122, 123, 126	09.03 - 08.10	1550	1550	E10-25-014-05-22	A, 20, 59	30	30					F11-25-014-01-VA	Luftfederverstellung air suspension	T
110 CDI, 113 CDI, 113 CDI 4x4, 116 CDI, 116 CDI 4x4, 122 CDI, 126	09.10 -	1550	1700	E10-25-022-01-22	A	30	30					F11-25-022-02-VA	F11-25-022-01-HA	T
110 CDI, 113 CDI, 113 CDI 4x4, 116 CDI, 116 CDI 4x4, 122 CDI, 126	09.10 -	1550	1700	E10-25-022-02-22	A, 59	30	30					F11-25-022-02-VA	Luftfederverstellung air suspension	T
VITO Bus (W639) Pro-Kit (Performance Fahrwerksfedern Performance Springs) 109 CDI, 111 CDI, 115 CDI, 119, 120 CDI, 122, 123, 126	09.03 - 08.10	1550	1550	E10-25-014-01-22	A, 18, 20	30	30					F11-25-014-01-VA	F11-25-014-01-HA	T
109 CDI, 111 CDI, 115 CDI, 119, 120 CDI, 122, 123, 126	09.03 - 08.10	1550	1550	E10-25-014-05-22	A, 20, 59	30	30					F11-25-014-01-VA	Luftfederverstellung air suspension	T
110 CDI, 113 CDI, 113 CDI 4x4, 116 CDI, 116 CDI 4x4, 122 CDI, 126	09.10 -	1550	1700	E10-25-022-01-22	A	30	30					F11-25-022-02-VA	F11-25-022-01-HA	T
110 CDI	09.10 -	1550	1700	E10-25-022-02-22	A, 59	30	30					F11-25-022-02-VA		T
113 CDI, 113 CDI 4x4, 116 CDI, 116 CDI 4x4, 122 CDI, 126	09.10 -	1550	1700	E10-25-022-02-22	A, 59	30	30					F11-25-022-02-VA	Luftfederverstellung air suspension	T
MINI (R50, R53) Pro-Kit (Performance Fahrwerksfedern Performance Springs) Cooper, Cooper S, One, One D	03.02 - 09.06	890	800	E10-57-001-03-22	A, 18, 20	30	30					F11-57-001-03-VA	F11-57-001-01-HA	T
Anti-Roll-Kit (Performance Stabilisatoren Performance Sway Bars) Cooper, Cooper S, One, One D	06.01 - 09.06			E40-57-001-01-11	A, 12, 18, 20, 22, 45			26 Rohr 26 tube	19	nicht verstellbar not adjustable	2-fach verstellbar 2-way adjustable	AS41-57-001-01-VA	AS41-57-001-01-HA	T
B12 Pro-Kit (Performance Komplettfahrwerke Performance Springs+Shocks) Cooper, Cooper S, One, One D	03.02 - 11.06	890	800	E90-57-001-03-22	A, 18, 20, 78, 120,	161	30	30						T
Pro-Street-S (Gewindefahrwerke - höhenverstellbar Coil-Overs-Adjustable Ride Height) Cooper, Cooper S, One, One D	06.01 - 09.06	890	800	PSS65-57-001-01-22	A, 23, 39, 45, 160		20-50	20-50						T
MINI (R56) Pro-Kit (Performance Fahrwerksfedern Performance Springs) Cooper, Cooper D, Cooper S, John Cooper Works, John Cooper Works GP, One, One D	10.06 -	905	755	E10-57-002-01-22	A, 18, 20		25-30	25-30				F11-57-002-01-VA	F11-57-002-01-HA	T
Cooper SD	02.11 -	935	755	E10-57-002-03-22	A, 18, 20		25-30	25-30				F11-57-002-03-VA	F11-57-002-01-HA	T
Anti-Roll-Kit (Performance Stabilisatoren Performance Sway Bars) Cooper, Cooper D, Cooper S, Cooper SD, John Cooper Works, John Cooper Works GP, One, One D	10.06 -			E40-57-002-01-11	A, 18, 20, 22, 45			26	20	nicht verstellbar not adjustable	2-fach verstellbar 2-way adjustable	AS41-57-002-01-VA	AS41-57-002-01-HA	T
B12 Pro-Kit (Performance Komplettfahrwerke Performance Springs+Shocks) Cooper, Cooper S, One	03.10 -	905	755	E90-57-002-01-22	A, 18, 20, 78, 161,	164	25-30	25-30						T
Cooper, Cooper D, Cooper S, One, One D	10.06 -	905	755	E90-57-002-01-22	A, 18, 20, 78, 161		25-30	25-30						T
Pro-Street-S (Gewindefahrwerke - höhenverstellbar Coil-Overs-Adjustable Ride Height) Cooper, One	10.06 -	890	800	PSS65-57-002-01-22	A, 23, 45, 160		30-55	30-55						T
MINI Cabriolet (R52) MINI Convertible (R52) Pro-Kit (Performance Fahrwerksfedern Performance Springs) Cooper, Cooper S, One	07.04 - 11.07	890	800	E10-57-001-03-22	A, 18, 20		30	30				F11-57-001-03-VA	F11-57-001-01-HA	T

Modell	Baujahr	Achslast Vorne kg	Achslast Hinten kg	Artikel-Nr.	Hinweise	ca. Tieferl. Vorne mm	ca. Tieferl. Hinten mm	Ø Vorne mm	Ø Hinten mm	Verstellbarkeit Vorne	Verstellbarkeit Hinten	Ersatzteilbezeichnung Vorne	Ersatzteilbezeichnung Hinten	Gutachten
Model	Year	Front Axle Load kg	Rear Axle Load kg	Part-No.	Notes	ca. Lowering Front mm	ca. Lowering Rear mm	Ø Front mm	Ø Rear mm	Adjustable Front	Adjustable Rear	Spare Part Marking Front	Spare Part Marking Rear	Homologation
MINI Cabriolet (R52) MINI Convertible (R52) Anti-Roll-Kit (Performance Stabilisatoren Performance Sway Bars) Cooper, Cooper S, One	07.04 - 11.07			E40-57-001-01-11	A, 18, 20, 22, 45			26 Rohr 26 tube	19	nicht verstellbar not adjustable	2-fach verstellbar 2-way adjustable	AS41-57-001-01-VA	AS41-57-001-01-HA	T
B12 Pro-Kit (Performance Komplettfahrwerke Performance Springs+Shocks) Cooper, Cooper S, One	07.04 - 11.07	890	800	E90-57-001-03-22	A, 18, 20, 78, 120, 161	30	30							T
Pro-Street-S (Gewindefahrwerke - höhenverstellbar Coil-Overs-Adjustable Ride Height) Cooper, Cooper S, One	07.04 - 11.07	890	800	PSS65-57-001-01-22	A, 23, 39, 45, 160	20-50	20-50							T
MINI Cabriolet (R57) MINI Convertible (R57) Pro-Kit (Performance Fahrwerksfedern Performance Springs) Cooper, Cooper D, Cooper S, John Cooper Works, One	03.08 -	905	855	E10-57-002-02-22	A, 18, 20	30	20					F11-57-002-01-VA	F11-57-002-02-HA	T
Cooper SD	02.11 -	935	855	E10-57-002-04-22	A, 18, 20	30	20					F11-57-002-03-VA	F11-57-002-02-HA	T
Anti-Roll-Kit (Performance Stabilisatoren Performance Sway Bars) Cooper, Cooper D, Cooper S, Cooper SD, John Cooper Works, One	03.08 -			E40-57-002-01-11	A, 18, 20, 22, 45			26	20	nicht verstellbar not adjustable	2-fach verstellbar 2-way adjustable	AS41-57-002-01-VA	AS41-57-002-01-HA	T
B12 Pro-Kit (Performance Komplettfahrwerke Performance Springs+Shocks) Cooper, Cooper D, Cooper S, One	07.06 -	905	855	E90-57-002-02-22	A, 18, 20, 78, 161	30	20							T
MINI CLUBMAN (R55) Pro-Kit (Performance Fahrwerksfedern Performance Springs) Cooper, Cooper D, Cooper S, John Cooper Works, One, One D	10.07 -	905	855	E10-57-002-02-22	A, 18, 20	30	20					F11-57-002-01-VA	F11-57-002-02-HA	T
Cooper SD	02.11 -	935	855	E10-57-002-04-22	A, 18, 20	30	20					F11-57-002-03-VA	F11-57-002-02-HA	T
Anti-Roll-Kit (Performance Stabilisatoren Performance Sway Bars) Cooper, Cooper D, Cooper S, Cooper SD, John Cooper Works, One, One D	10.07 -			E40-57-002-01-11	A, 18, 20, 22, 45			26	20	nicht verstellbar not adjustable	2-fach verstellbar 2-way adjustable	AS41-57-002-01-VA	AS41-57-002-01-HA	T
B12 Pro-Kit (Performance Komplettfahrwerke Performance Springs+Shocks) Cooper, Cooper D, Cooper S, Cooper SD, One, One D	10.07 -	905	855	E90-57-002-02-22	A, 18, 20, 78, 161	30	20							T
MINI COUNTRYMAN (R60) Pro-Kit (Performance Fahrwerksfedern Performance Springs) Cooper, Cooper D, Cooper S, Cooper SD, One, One D	06.10 -	1015	880	E10-57-003-01-22	A, 18, 20	30	20					F11-57-003-01-VA	F11-57-003-01-HA	T
Cooper D ALL4, Cooper S ALL4, Cooper S JCW, Cooper SD ALL4	06.10 -	1040	940	E10-57-003-02-22	A, 18	30	20					F11-57-003-02-VA	F11-57-003-02-HA	T
MINI Coupe (R58) Pro-Kit (Performance Fahrwerksfedern Performance Springs) Cooper, Cooper S, Cooper SD, John Cooper Works	09.11 -	905	755	E10-57-002-01-22	A, 18, 20	25-30	25-30					F11-57-002-01-VA	F11-57-002-01-HA	T
Anti-Roll-Kit (Performance Stabilisatoren Performance Sway Bars) Cooper, Cooper S, Cooper SD, John Cooper Works	09.11 -			E40-57-002-01-11	A, 18, 20, 22, 45			26	20	nicht verstellbar not adjustable	2-fach verstellbar 2-way adjustable	AS41-57-002-01-VA	AS41-57-002-01-HA	T
B12 Pro-Kit (Performance Komplettfahrwerke Performance Springs+Shocks) Cooper, Cooper S, Cooper SD, John Cooper Works	09.11 -	905	755	E90-57-002-01-22	A, 18, 20, 78, 161, 164	25-30	25-30							T
MINI PACEMAN (R61) Pro-Kit (Performance Fahrwerksfedern Performance Springs) Cooper, Cooper D, Cooper S, Cooper SD	04.12 -	1015	880	E10-57-003-01-22	A, 18, 20	30	20					F11-57-003-01-VA	F11-57-003-01-HA	T
Cooper D ALL4, Cooper S ALL4, Cooper SD ALL4, John Cooper Works	04.12 -	1040	940	E10-57-003-02-22	A, 18	30	20					F11-57-003-02-VA	F11-57-003-02-HA	T
MINI Roadster (R59) Pro-Kit (Performance Fahrwerksfedern Performance Springs) Cooper, Cooper S, Cooper SD, John Cooper Works	02.12 -	905	755	E10-57-002-01-22	A, 18, 20	25-30	25-30					F11-57-002-01-VA	F11-57-002-01-HA	T
Anti-Roll-Kit (Performance Stabilisatoren Performance Sway Bars) Cooper, Cooper S, Cooper SD, John Cooper Works	02.12 -			E40-57-002-01-11	A, 18, 20, 22, 45			26	20	nicht verstellbar not adjustable	2-fach verstellbar 2-way adjustable	AS41-57-002-01-VA	AS41-57-002-01-HA	T
B12 Pro-Kit (Performance Komplettfahrwerke Performance Springs+Shocks) Cooper, Cooper S, Cooper SD, John Cooper Works	02.12 -	905	755	E90-57-002-01-22	A, 18, 20, 78, 161, 164	25-30	25-30							T
ASX (GA_W.) Pro-Kit (Performance Fahrwerksfedern Performance Springs) 1.6	05.10 -	1020	1000	E10-60-016-01-22	A, 18, 20	30	25					F11-60-016-01-VA	F11-60-013-01-HA	T
1.8 DI-D, 1.8 DI-D 4WD	06.10 -	1130	1000	E10-60-016-02-22	A, 18	30	25					F11-60-013-02-VA	F11-60-013-01-HA	T
ASX Van (GA_W.) Pro-Kit (Performance Fahrwerksfedern Performance Springs) 1.8 DI-D 4WD	06.10 -	1130	1000	E10-60-016-02-22	A, 18	30	25					F11-60-013-02-VA	F11-60-013-01-HA	T
CARISMA (DA.) Pro-Kit (Performance Fahrwerksfedern Performance Springs) 1.6, 1.9 TD	07.95 - 06.06	900	875	E6022-140	A, 18, 20	35	35					F6022001	F6021002	T
CARISMA Stufenheck (DA.) CARISMA Saloon (DA.) Pro-Kit (Performance Fahrwerksfedern Performance Springs) 1.6, 1.9 TD	09.96 - 06.06	900	875	E6022-140	A, 18, 20	35	35					F6022001	F6021002	T
COLT V (CJ., CP.) Pro-Kit (Performance Fahrwerksfedern Performance Springs) 1.3, 1.5, 1300, 1300 GL,GLX, 1500, 1600, 1600 GLX	09.95 - 09.03	820	720	E6025-140	A, 18, 20	30	30					F6022001	F6025002	T
COLT VI (Z3_A, Z2_A) Pro-Kit (Performance Fahrwerksfedern Performance Springs) 1.1, 1.3, 1.5	06.04 -	750	745	E10-60-011-01-22	A, 18, 20	30	25-30					F11-60-011-01-VA	F11-60-011-01-HA	T
1.1 Bifuel, 1.5 CZT, 1.5 DI-D, 1.5 Turbo	08.04 -	880	745	E10-60-011-02-22	A, 18, 20, 60	30	25-30					F11-60-011-02-VA	F11-60-011-01-HA	T

Modell	Baujahr	Achslast Vorne kg	Achslast Hinten kg	Artikel-Nr.	Hinweise	ca. Tieferl. Vorne mm	ca. Tieferl. Hinten mm	Ø Vorne mm	Ø Hinten mm	Verstellbarkeit Vorne	Verstellbarkeit Hinten	Ersatzteilbezeichnung Vorne	Ersatzteilbezeichnung Hinten	Gutachten
Model	Year	Front Axle Load kg	Rear Axle Load kg	Part-No.	Notes	ca. Lowering Front mm	ca. Lowering Rear mm	Ø Front mm	Ø Rear mm	Adjustable Front	Adjustable Rear	Spare Part Marking Front	Spare Part Marking Rear	Homologation
GALANT VI (EA) Pro-Kit (Performance Fahrwerksfedern Performance Springs) 2.4, 2.4 GDI, 2.5 V6 24V	09.96 - 10.04	1025	875	E6028-140	A, 18, 20, 42, 68	30	30					F6026101	F6026102	T
LANCER SPORTBACK (CX_A) Pro-Kit (Performance Fahrwerksfedern Performance Springs) 1.5, 1.6	06.08 -	905	980	E10-60-013-06-22	A, 18, 20	30	25					F11-60-016-01-VA	F11-60-013-03-HA	T
1.8, 1.8 Flex	06.08 -	990	980	E10-60-013-03-22	A, 18, 20	30	25					F11-60-013-01-VA	F11-60-013-03-HA	T
1.8 DI-D, 2.0 DI-D	06.08 -	1080	980	E10-60-013-04-22	A, 18, 20	30	25					F11-60-013-02-VA	F11-60-013-03-HA	T
LANCER Stufenheck (CS_A) LANCER Saloon (CS_A) Pro-Kit (Performance Fahrwerksfedern Performance Springs) 2.0 16V EVO VIII	03.04 -	1015	900	E10-60-005-01-22	A, 18	25	25					F11-60-005-01-VA	F11-60-005-01-HA	T
LANCER Stufenheck (CY/Z_A) LANCER Saloon (CY/Z_A) Pro-Kit (Performance Fahrwerksfedern Performance Springs) 1.5, 1.6	06.08 -	905	980	E10-60-013-07-22	A, 18, 20	30	25					F11-60-016-01-VA	F11-30-013-01-HA	T
1.8, 1.8 Flex	02.08 -	990	980	E10-60-013-01-22	A, 18, 20	30	25					F11-60-013-01-VA	F11-60-013-01-HA	T
1.8 DI-D, 2.0 DI-D	01.08 -	1080	980	E10-60-013-02-22	A, 18, 20	30	25					F11-60-013-02-VA	F11-60-013-01-HA	T
LANCER VI (CJ-CP.) Pro-Kit (Performance Fahrwerksfedern Performance Springs) 2.0 16V EVO	08.96 - 08.03	1015	900	E10-60-005-01-22	A, 18	25	25					F11-60-005-01-VA	F11-60-005-01-HA	T
OUTLANDER II (CW_W) Pro-Kit (Performance Fahrwerksfedern Performance Springs) 2.0	11.06 -	1150		E10-60-014-01-20	A, 18, 20	30						F11-60-014-01-VA		T
2.0 DI-D, 2.2 DI-D, 2.2 DI-D 4WD, 2.4, 2.4 Flex 4WD, 2.4 Mivec 4WD	11.06 -	1150	1300	E10-70-011-01-22	A, 18, 174	25	20					F11-70-011-01-VA	F11-70-011-01-HA	T
OUTLANDER II Van (CW_W) Pro-Kit (Performance Fahrwerksfedern Performance Springs) 2.0 DI-D, 2.2 DI-D 4WD	12.06 -	1150	1300	E10-70-011-01-22	A, 18, 174	25	20					F11-70-011-01-VA	F11-70-011-01-HA	T
SPACE STAR Schrägheck (A05A) SPACE STAR Hatchback (A05A) Pro-Kit (Performance Fahrwerksfedern Performance Springs) 1.0, 1.2	05.12 -	730	670	E10-60-017-01-22	A, 18, 20	25	25					F11-60-017-01-VA	F11-60-017-01-HA	T
350 Z (Z33) Pro-Kit (Performance Fahrwerksfedern Performance Springs) 3.5	10.03 -	975	975	E10-63-013-01-22	A, 18, 20	30	30					F11-63-013-01-VA	F11-63-013-01-HA	T
B12 Pro-Kit (Performance Komplettfahrwerke Performance Springs+Shocks) 3.5	10.03 -	975	975	E90-63-013-01-22	A, 18, 20, 78, 161	30	30							T
Pro-Street-S (Gewindefahrwerke - höhenverstellbar Coil-Overs-Adjustable Ride Height) 3.5	10.03 -	935	975	PSS65-63-013-01-22	A, 24, 25, 45, 160	20-40	20-40							T
350 Z Roadster (Z33) Pro-Kit (Performance Fahrwerksfedern Performance Springs) 3.5	03.05 -	975	975	E10-63-013-01-22	A, 18, 20	30	30					F11-63-013-01-VA	F11-63-013-01-HA	T
B12 Pro-Kit (Performance Komplettfahrwerke Performance Springs+Shocks) 3.5	03.05 -	975	975	E90-63-013-01-22	A, 18, 20, 78, 161	30	30							T
Pro-Street-S (Gewindefahrwerke - höhenverstellbar Coil-Overs-Adjustable Ride Height) 3.5	03.05 -	935	975	PSS65-63-013-01-22	A, 24, 25, 45, 160	20-40	20-40							T
370 Z (Z34) Pro-Kit (Performance Fahrwerksfedern Performance Springs) 3.7	06.09 -	940	940	E10-63-020-01-22	A, 18, 20	25	20					F11-63-020-01-VA	F11-63-020-01-HA	T
370 Z Roadster (Z34) Pro-Kit (Performance Fahrwerksfedern Performance Springs) 3.7	01.10 -	980	1000	E10-63-020-02-22	A, 18, 20	25	20					F11-63-020-02-VA	F11-63-020-02-HA	T
ALMERA II (N16) Pro-Kit (Performance Fahrwerksfedern Performance Springs) 1.5, 1.5 dCi, 1.8	07.00 -	955	970	E10-63-001-01-22	A, 18, 20	30	30					F11-63-001-01-VA	F11-63-001-01-HA	T
ALMERA II Hatchback (N16) Pro-Kit (Performance Fahrwerksfedern Performance Springs) 1.5, 1.5 XL, 1.5 dCi, 1.8	01.00 -	955	970	E10-63-001-01-22	A, 18, 20	30	30					F11-63-001-01-VA	F11-63-001-01-HA	T
CUBE (Z12) Pro-Kit (Performance Fahrwerksfedern Performance Springs) 1.5 dCi, 1.6 16V	03.10 -	985	880	E10-63-017-01-22	A, 18, 20	30	30					F11-63-017-01-VA	F11-63-017-01-HA	T
JUKE Pro-Kit (Performance Fahrwerksfedern Performance Springs) 1.5 dCi, 1.6, 1.6 DIG-T	06.10 -	975	835	E10-63-022-01-22	A, 18, 20	20-25	25					F11-63-016-01-VA	F11-75-008-01-HA	T
1.6 DIG-T 4x4	06.10 -	1010	900	E10-63-022-02-22	A, 18	35	25					F11-63-016-02-VA	F11-63-022-01-HA	T
MAXIMA QX (A33) Pro-Kit (Performance Fahrwerksfedern Performance Springs) 2.0 V6 24V, 2.5 V6 24V, 3.0, 3.0 V6 24V	04.99 - 11.03	1090	1085	E10-63-002-01-22	A, 18, 20	30	30					F11-63-002-01-VA	F11-63-002-01-HA	T
MICRA C+C (K12) Pro-Kit (Performance Fahrwerksfedern Performance Springs) 1.4 16V, 1.6 160 SR	08.05 -	875	800	E10-63-010-03-22	A, 18, 20	30	20					F11-63-010-01-VA	F11-75-008-01-HA	T

Modell	Baujahr	Achslast Vorne kg	Achslast Hinten kg	Artikel-Nr.	Hinweise	ca. Tieferl. Vorne mm	ca. Tieferl. Hinten mm	Ø Vorne mm	Ø Hinten mm	Verstellbarkeit Vorne	Verstellbarkeit Hinten	Ersatzteilbezeichnung Vorne	Ersatzteilbezeichnung Hinten	Gutachten
Model	Year	Front Axle Load kg	Rear Axle Load kg	Part-No.	Notes	ca. Lowering Front mm	ca. Lowering Rear mm	Ø Front mm	Ø Rear mm	Adjustable Front	Adjustable Rear	Spare Part Marking Front	Spare Part Marking Rear	Homologation
MICRA III (K12) Pro-Kit (Performance Fahrwerksfedern Performance Springs) 1.0 16V, 1.2 16V, 1.4 16V, 1.5 dCi	01.03 - 06.10	875	800	E10-63-010-01-22	A, 18, 20	30	30					F11-63-010-01-VA	F11-63-010-01-HA	T
160 SR	05.05 - 06.10	875	800	E10-63-010-01-22	A, 18, 20	25-30	25-30					F11-63-010-01-VA	F11-63-010-01-HA	T
Sportline (Performance Fahrwerksfedern Sport Sport Performance Springs) 1.0 16V, 1.2 16V, 1.4 16V, 1.5 dCi	01.03 - 06.10	860	880	E20-63-010-01-22	A, 18, 20	45-50	40					F21-63-010-01-VA	F21-63-010-01-HA	T
160 SR	05.05 - 06.10	860	880	E20-63-010-01-22	A, 18, 20	40-50	35-40					F21-63-010-01-VA	F21-63-010-01-HA	T
B12 Pro-Kit (Performance Komplettfahrwerke Performance Springs+Shocks) 1.0 16V, 1.2 16V, 1.4 16V, 1.5 dCi	01.03 - 06.10	875	800	E90-63-010-01-22	A, 18, 20, 78, 161	30	30							T
MICRA IV (K13) Pro-Kit (Performance Fahrwerksfedern Performance Springs) 1.2	05.10 -	750	750	E10-63-023-01-22	A, 18, 20	30-35	10					F11-63-023-01-VA	F11-63-023-01-HA	T
1.2 DIG, 1.5	11.10 -	825	750	E10-63-023-02-22	A, 18, 20	30-35	10					F11-63-023-02-VA	F11-63-023-01-HA	T
Note (E11) Pro-Kit (Performance Fahrwerksfedern Performance Springs) 1.4, 1.6	03.06 -	850	800	E10-63-015-01-22	A, 18, 20	30	30					F11-75-008-01-VA	F11-75-008-01-HA	T
1.5 dCi	03.06 -	905	800	E10-63-015-02-22	A, 18, 20	30	30					F11-75-008-02-VA	F11-75-008-01-HA	T
PIXO (UA0) Pro-Kit (Performance Fahrwerksfedern Performance Springs) 1.0	06.09 -	700	650	E10-63-019-01-22	A, 18, 20	25	15					F11-63-019-01-VA	F11-63-019-01-HA	T
PRIMERA (P11) Pro-Kit (Performance Fahrwerksfedern Performance Springs) 1.6 16V, 1.8	06.96 - 07.99	990	875	E6336-140	A, 18, 20	30	30					F6336001	F6336002	T
1.6 16V, 1.8, 1.8 16V	06.96 - 12.01	990	875	E6343-140	A, 18, 20	30	30					F6336001	F6336002	T
PRIMERA Hatchback (P11) Pro-Kit (Performance Fahrwerksfedern Performance Springs) 1.6 16V	09.96 - 07.02	990	875	E6336-140	A, 18, 20	30	30					F6336001	F6336002	T
1.6 16V, 1.8 16V	09.96 - 07.02	990	875	E6343-140	A, 18, 20	30	30					F6336001	F6336002	T
PRIMERA Traveller (WP11) Pro-Kit (Performance Fahrwerksfedern Performance Springs) 1.6 16V, 1.8 16V	06.96 - 07.99	990	875	E6336-140	A, 18, 20	30	30					F6336001	F6336002	T
1.6 16V, 1.8 16V	06.96 - 12.01	990	875	E6343-140	A, 18, 20	30	30					F6336001	F6336002	T
QASHQAI / QASHQAI +2 (J10, JJ10) Pro-Kit (Performance Fahrwerksfedern Performance Springs) 1.6 Sitzplätze 5, 2.0 Allrad Sitzplätze 5, 2.0 Sitzplätze 5 1.6 Seats 5, 2.0 All-wheel Drive Seats 5, 2.0 Seats 5	02.07 -	1175	1100	E10-63-016-01-22	A, 18, 20, 66	30	30					F11-63-016-01-VA	F11-63-016-01-HA	T
1.5 dCi Sitzplätze 5, 1.6 dCi Allrad Sitzplätze 5, 1.6 dCi Sitzplätze 5, 2.0 Allrad Sitzplätze 5, 2.0 Sitzplätze 5, 2.0 dCi Allrad Sitzplätze 5, 2.0 dCi Sitzplätze 5	02.07 -	1230	1100	E10-63-016-02-22	A, 18, 66	30	30					F11-63-016-02-VA	F11-63-016-01-HA	T
1.5 dCi Seats 5, 1.6 dCi All-wheel Drive Seats 5, 1.6 dCi Seats 5, 2.0 All-wheel Drive Seats 5, 2.0 Seats 5, 2.0 dCi All-wheel Drive Seats 5, 2.0 dCi Seats 5	02.07 -	1230	1100	E10-63-016-02-22	A, 18, 66	35-40	30					F11-63-016-02-VA	F11-63-016-01-HA	T
1.6 dCi Allrad Sitzplätze 5, 1.6 dCi Sitzplätze 5 1.6 dCi All-wheel Drive Seats 5, 1.6 dCi Seats 5														
TIIDA Schrägheck TIIDA Hatchback Pro-Kit (Performance Fahrwerksfedern Performance Springs) 1.8	05.04 - 02.07	985	880	E10-63-017-01-22	A, 18, 20	25	20					F11-63-017-01-VA	F11-63-017-01-HA	T
TIIDA Schrägheck (C11X) TIIDA Hatchback (C11X) Pro-Kit (Performance Fahrwerksfedern Performance Springs) 1.6, 1.8	09.07 -	985	880	E10-63-017-01-22	A, 18, 20	25	20					F11-63-017-01-VA	F11-63-017-01-HA	T
TIIDA Stufenheck (SC11X) TIIDA Saloon (SC11X) Pro-Kit (Performance Fahrwerksfedern Performance Springs) 1.6, 1.8	09.07 -	985	880	E10-63-017-01-22	A, 18, 20	25	20					F11-63-017-01-VA	F11-63-017-01-HA	T
X-TRAIL (T30) Pro-Kit (Performance Fahrwerksfedern Performance Springs) 2.0, 2.0 4x4, 2.2 DCI, 2.2 DCI FWD, 2.2 Di 4x4, 2.2 dCi, 2.2 dCi 4x4, 2.5 4x4	06.01 -	1110	1165	E10-63-009-01-22	A, 18	30	30					F11-63-009-01-VA	F11-63-009-01-HA	T
ADAM Pro-Kit (Performance Fahrwerksfedern Performance Springs) 1.2, 1.4	10.12 -	885	845	E10-65-015-01-22	A, 18, 20	15-20	15					F11-65-015-01-VA	F11-65-015-01-HA	T
AGILA (B) (H08) B12 Pro-Kit (Performance Komplettfahrwerke Performance Springs+Shocks) 1.0, 1.2	04.08 -	835	800	E90-65-018-01-22	A, 18, 20, 78, 161	30	30							T
ANTARA Pro-Kit (Performance Fahrwerksfedern Performance Springs) 2.0 CDTi, 2.0 CDTi 4x4, 2.2 CDTi	05.06 -	1250	1350	E10-65-016-01-22	A, 48	30	30					F11-23-006-01-VA	F11-23-006-01-HA	T
2.2 CDTi 4x4, 2.4, 2.4 4x4, 3.0, 3.2 V6	05.06 -	1250	1350	E10-65-016-01-22	A, 18	30	30					F11-23-006-01-VA	F11-23-006-01-HA	T
ASTRA F (56., 57.) Pro-Kit (Performance Fahrwerksfedern Performance Springs) 1.4, 1.4 Si, 1.4 i, 1.4 i 16V, 1.6, 1.6 Si, 1.6 i, 1.6 i 16V, 1.7 D, 1.7 TD, 1.7 TDS, 1.8 i, 2.0 i, 2.0 i 16V	09.91 - 09.98	870	800	E6521-140	A, 18, 20	30	30					F6521001	F6522102	T

Modell	Baujahr	Achslast Vorne kg	Achslast Hinten kg	Artikel-Nr.	Hinweise	ca. Tieferl. Vorne mm	ca. Tieferl. Hinten mm	Ø Vorne mm	Ø Hinten mm	Verstellbarkeit Vorne	Verstellbarkeit Hinten	Ersatzteilbezeichnung Vorne	Ersatzteilbezeichnung Hinten	Gutachten
Model	Year	Front Axle Load kg	Rear Axle Load kg	Part-No.	Notes	ca. Lowering Front mm	ca. Lowering Rear mm	Ø Front mm	Ø Rear mm	Adjustable Front	Adjustable Rear	Spare Part Marking Front	Spare Part Marking Rear	Homologation
ASTRA F (56., 57.) Sportline (Performance Fahrwerksfedern Sport Sport Performance Springs) 1.4, 1.4 Si, 1.4 i, 1.4 i 16V, 1.6, 1.6 Si, 1.6 i, 1.6 i 16V, 1.7 D, 1.7 TD, 1.7 TDS, 1.8 i, 1.8 i 16V, 2.0 i, 2.0 i 16V	09.91 - 09.98	900	800	E20-65-001-02-22	A, 20	45-50	30					F21-65-001-02-VA	F21-65-001-02-HA	T
B12 Pro-Kit (Performance Komplettfahrwerke Performance Springs+Shocks) 1.4, 1.4 Si, 1.4 i, 1.4 i 16V, 1.6, 1.6 Si, 1.6 i, 1.6 i 16V, 1.7 D, 1.7 TD, 1.7 TDS, 1.8 i, 1.8 i 16V, 2.0 i, 2.0 i 16V	09.91 - 09.98	870	800	E90-65-022-01-22	A, 18, 20, 78, 161	30	30							T
B12 Sportline (Performance Komplettfahrwerke Sport Sport Performance Springs+Shocks) 1.4, 1.4 Si, 1.4 i, 1.4 i 16V, 1.6, 1.6 Si, 1.6 i, 1.6 i 16V, 1.7 D, 1.7 TD, 1.7 TDS, 1.8 i, 1.8 i 16V, 2.0 i, 2.0 i 16V	09.91 - 09.98	900	800	E95-65-022-01-22	A, 20, 78, 161	45-50	30							T
ASTRA F Cabriolet (53_B) ASTRA F Convertible (53_B) Pro-Kit (Performance Fahrwerksfedern Performance Springs) 1.4 Si, 1.4 i 16V, 1.6 i, 1.8 i 16V, 2.0 i	03.93 - 03.01	870	800	E6521-140	A, 18, 20	30	30					F6521001	F6522102	T
B12 Pro-Kit (Performance Komplettfahrwerke Performance Springs+Shocks) 1.4 Si, 1.4 i 16V, 1.6 i, 1.8 i 16V, 2.0 i	03.93 - 03.01	870	800	E90-65-022-01-22	A, 18, 20, 78, 161	30	30							T
ASTRA F Caravan (51., 52.) ASTRA F Estate (51., 52.) Pro-Kit (Performance Fahrwerksfedern Performance Springs) 1.4, 1.4 Si, 1.4 i, 1.4 i 16V, 1.6, 1.6 Si, 1.6 i, 1.6 i 16V, 1.7 D, 1.7 TD, 1.7 TDS, 1.8 i, 1.8 i 16V, 2.0 i, 2.0 i 16V	09.91 - 01.98	870	860	E6523-140	A, 18, 20	30	30					F6518001	F6511002	T
B12 Pro-Kit (Performance Komplettfahrwerke Performance Springs+Shocks) 1.4, 1.4 Si, 1.4 i, 1.4 i 16V, 1.6, 1.6 Si, 1.6 i, 1.6 i 16V, 1.7 D, 1.7 TD, 1.7 TDS, 1.8 i, 1.8 i 16V, 2.0 i, 2.0 i 16V	09.91 - 01.98	870	860	E90-65-022-02-22	A, 18, 20, 78, 161	30	30							T
ASTRA F CC (53., 54., 58., 59.) ASTRA F Hatchback (53., 54., 58., 59.) Pro-Kit (Performance Fahrwerksfedern Performance Springs) 1.4, 1.4 Si, 1.4 i, 1.4 i 16V, 1.6, 1.6 Si, 1.6 i, 1.6 i 16V, 1.7 D, 1.7 TD, 1.7 TDS, 1.8 i, 2.0 GSI 16V, 2.0 i, 2.0 i 16V	09.91 - 01.98	870	800	E6521-140	A, 18, 20	30	30					F6521001	F6522102	T
Sportline (Performance Fahrwerksfedern Sport Sport Performance Springs) 1.4, 1.4 Si, 1.4 i, 1.4 i 16V, 1.6, 1.6 Si, 1.6 i, 1.6 i 16V, 1.7 D, 1.7 TD, 1.7 TDS, 1.8 i, 1.8 i 16V, 2.0 GSI 16V, 2.0 i, 2.0 i 16V	09.91 - 01.98	900	800	E20-65-001-02-22	A, 20	45-50	30					F21-65-001-02-VA	F21-65-001-02-HA	T
B12 Pro-Kit (Performance Komplettfahrwerke Performance Springs+Shocks) 1.4, 1.4 Si, 1.4 i, 1.4 i 16V, 1.6, 1.6 Si, 1.6 i, 1.6 i 16V, 1.7 D, 1.7 TD, 1.7 TDS, 1.8 i, 1.8 i 16V, 2.0 GSI 16V, 2.0 i, 2.0 i 16V	09.91 - 01.98	870	800	E90-65-022-01-22	A, 18, 20, 78, 161	30	30							T
B12 Sportline (Performance Komplettfahrwerke Sport Sport Performance Springs+Shocks) 1.4, 1.4 Si, 1.4 i, 1.4 i 16V, 1.6, 1.6 Si, 1.6 i, 1.6 i 16V, 1.7 D, 1.7 TD, 1.7 TDS, 1.8 i, 1.8 i 16V, 2.0 GSI 16V, 2.0 i, 2.0 i 16V	09.91 - 01.98	900	800	E95-65-022-01-22	A, 20, 78, 161	45-50	30							T
ASTRA F CLASSIC Caravan ASTRA F CLASSIC Estate Pro-Kit (Performance Fahrwerksfedern Performance Springs) 1.4 i, 1.6 i, 1.6 i 16V, 1.8	01.98 - 01.05	870	860	E6523-140	A, 18, 20	30	30					F6518001	F6511002	T
ASTRA G Cabriolet ASTRA G Convertible Pro-Kit (Performance Fahrwerksfedern Performance Springs) 1.6, 1.6 16V, 1.8 16V, 2.0 16V Turbo, 2.2 16V	03.01 - 10.05	1015	845	E10-65-001-02-22	A, 18, 20	30	30					F11-65-001-01-VA	F6541002	T
2.2 DTI	09.02 - 10.05	1040	845	E10-65-001-06-22	A, 18, 20	30	30					F6529001	F6541002	T
B12 Pro-Kit (Performance Komplettfahrwerke Performance Springs+Shocks) 1.6, 1.6 16V, 1.8 16V, 2.0 16V Turbo, 2.2 16V	03.01 - 10.05	1015	845	E90-65-001-06-22	A, 18, 20, 78, 161	30	30							T
2.2 DTI	09.02 - 10.05	1040	845	E90-65-001-07-22	A, 18, 20, 78, 161	30	30							T
ASTRA G Caravan (F35.) ASTRA G Estate (F35.) Pro-Kit (Performance Fahrwerksfedern Performance Springs) 1.2 16V, 1.4, 1.4 16V, 1.6, 1.6 16V	02.98 - 12.09	845	885	E6548-140	A, 18, 20, 68	30	30					F6517001	F6542002	T
1.4, 1.4 16V, 1.6, 1.6 16V, 1.7 CDTI, 1.7 DTI 16V, 1.7 TD, 1.8 16V, 2.0 16V	02.98 - 12.09	935	885	E6542-140	A, 18, 20, 68	30	30					F6537001	F6542002	T
1.7 CDTI, 1.7 DTI 16V, 1.7 TD, 1.8 16V, 2.0 16V, 2.0 DI, 2.0 DTI 16V, 2.2 16V, 2.2 DTI	02.98 - 07.09	1035	885	E6544-140	A, 18, 20, 68	30	30					F6529001	F6542002	T
B12 Pro-Kit (Performance Komplettfahrwerke Performance Springs+Shocks) 1.2 16V, 1.4, 1.4 16V, 1.6, 1.6 16V	02.98 - 12.09	845	885	E90-65-001-08-22	A, 18, 20, 68, 78,	30	30							T
1.4, 1.4 16V, 1.6, 1.6 16V, 1.7 DTI 16V, 1.7 TD, 1.8 16V, 2.0 16V	02.98 - 12.09	935	885	E90-65-001-09-22	A, 18, 20, 68, 78,	30	30							T
1.7 DTI 16V, 1.7 TD, 1.8 16V, 2.0 16V, 2.0 DI, 2.0 DTI 16V, 2.2 16V, 2.2 DTI	02.98 - 07.04	1035	885	E90-65-001-10-22	A, 18, 20, 68, 78,	30	30							T
ASTRA G CC (F48., F08.) ASTRA G Hatchback (F48., F08.) Pro-Kit (Performance Fahrwerksfedern Performance Springs) 1.2 16V, 1.4, 1.4 16V, 1.6, 1.6 16V	02.98 - 12.09	845	820	E6547-140	A, 18, 20, 68	30	30					F6517001	F6541002	T
1.4, 1.4 16V, 1.6, 1.6 16V, 1.7 CDTI, 1.7 DTI 16V, 1.7 TD, 1.8 16V, 2.0 16V	02.98 - 12.09	935	820	E6541-140	A, 18, 20, 68	30	30					F6537001	F6541002	T
1.7 CDTI, 1.7 DTI 16V, 1.7 TD, 1.8 16V, 2.0 16V, 2.0 DI, 2.0 DTI 16V, 2.2 16V, 2.2 DTI	02.98 - 01.05	1035	820	E6543-140	A, 18, 20, 68	30	30					F6529001	F6541002	T
Sportline (Performance Fahrwerksfedern Sport Sport Performance Springs) 1.2 16V, 1.4, 1.4 16V, 1.6, 1.6 16V, 1.8 16V, 2.0 16V, 2.2 16V	02.98 - 12.09	965	895	E20-65-001-01-22	A, 20	45-50	30					F21-65-001-01-VA	F21-65-001-01-HA	T
B12 Pro-Kit (Performance Komplettfahrwerke Performance Springs+Shocks) 1.2 16V, 1.4, 1.4 16V, 1.6, 1.6 16V	02.98 - 12.09	845	820	E90-65-001-01-22	A, 18, 20, 68, 78,	30	30							T

Modell	Baujahr	Achslast Vorne kg	Achslast Hinten kg	Artikel-Nr.	Hinweise	ca. Tieferl. Vorne mm	ca. Tieferl. Hinten mm	Ø Vorne mm	Ø Hinten mm	Verstellbarkeit Vorne	Verstellbarkeit Hinten	Ersatzteilbezeichnung Vorne	Ersatzteilbezeichnung Hinten	Gutachten
Model	Year	Front Axle Load kg	Rear Axle Load kg	Part-No.	Notes	ca. Lowering Front mm	ca. Lowering Rear mm	Ø Front mm	Ø Rear mm	Adjustable Front	Adjustable Rear	Spare Part Marking Front	Spare Part Marking Rear	Homologation
ASTRA G CC (F48., F08.) ASTRA G Hatchback (F48., F08.) B12 Pro-Kit (Performance Komplettfahrwerke Performance Springs+Shocks) 1.4, 1.4 16V, 1.6, 1.6 16V, 1.7 CDTi, 1.7 DTI 16V, 1.7 TD, 1.8 16V, 2.0 16V	02.98 - 12.09	935	820	E90-65-001-02-22	A, 18, 20, 68, 78, 161	30	30							T
1.7 CDTi, 1.7 DTI 16V, 1.7 TD, 1.8 16V, 2.0 16V, 2.0 DI, 2.0 DTI 16V, 2.2 16V	02.98 - 01.05	1035	820	E90-65-001-03-22	A, 18, 20, 68, 78, 161	30	30							T
2.2 DTI	09.02 - 01.05	1035	820	E90-65-001-03-22	A, 20, 78, 161	30	30							T
B12 Sportline (Performance Komplettfahrwerke Sport Sport Performance Springs+Shocks) 1.2 16V, 1.4, 1.4 16V, 1.6, 1.6 16V, 1.8 16V, 2.0 16V, 2.2 16V	02.98 - 12.09	965	895	E95-65-001-01-22	A, 20, 78, 161	45-50	30							T
ASTRA G Coupe (F07.) Pro-Kit (Performance Fahrwerksfedern Performance Springs) 1.6 16V, 1.8 16V, 2.0 16V Turbo, 2.2 16V	03.00 - 05.05	1015	780	E10-65-001-01-22	A, 18, 20, 68	30	30					F11-65-001-01-VA	F6541002	T
2.2 DTI	09.02 - 05.05	1040	780	E10-65-001-05-22	A, 18, 20, 68	30	30					F6529001	F6541002	T
B12 Pro-Kit (Performance Komplettfahrwerke Performance Springs+Shocks) 1.6 16V, 1.8 16V, 2.0 16V Turbo, 2.2 16V	03.00 - 05.05	1015	780	E90-65-001-04-22	A, 18, 20, 68, 78, 161	30	30							T
2.2 DTI	09.02 - 05.05	1040	780	E90-65-001-05-22	A, 18, 20, 68, 78, 161	30	30							T
ASTRA G Stufenheck (F69.) ASTRA G Saloon (F69.) Pro-Kit (Performance Fahrwerksfedern Performance Springs) 1.2 16V, 1.4, 1.4 16V, 1.6, 1.6 16V	09.98 - 12.09	845	820	E6547-140	A, 18, 20, 68	30	30					F6517001	F6541002	T
1.4, 1.4 16V, 1.6, 1.6 16V, 1.7 CDTi, 1.7 DTI 16V, 1.7 TD, 1.8 16V, 2.0 16V	09.98 - 12.09	935	820	E6541-140	A, 18, 20, 68	30	30					F6537001	F6541002	T
1.7 CDTi, 1.7 DTI 16V, 1.7 TD, 1.8 16V, 2.0 16V, 2.0 DI, 2.0 DTI 16V, 2.2 16V, 2.2 DTI	09.98 - 01.05	1035	820	E6543-140	A, 18, 20, 68	30	30					F6529001	F6541002	T
Sportline (Performance Fahrwerksfedern Sport Sport Performance Springs) 1.2 16V, 1.4, 1.4 16V, 1.6, 1.6 16V, 1.8 16V, 2.0 16V, 2.2 16V	09.98 - 12.09	965	895	E20-65-001-01-22	A, 20	45-50	30					F21-65-001-01-VA	F21-65-001-01-HA	T
B12 Pro-Kit (Performance Komplettfahrwerke Performance Springs+Shocks) 1.2 16V, 1.4, 1.4 16V, 1.6, 1.6 16V	09.98 - 12.09	845	820	E90-65-001-01-22	A, 18, 20, 68, 78, 161	30	30							T
1.4, 1.4 16V, 1.6, 1.6 16V, 1.7 CDTi, 1.7 DTI 16V, 1.7 TD, 1.8 16V, 2.0 16V	09.98 - 12.09	935	820	E90-65-001-02-22	A, 18, 20, 68, 78, 161	30	30							T
1.7 CDTi, 1.7 DTI 16V, 1.7 TD, 1.8 16V, 2.0 16V, 2.0 DI, 2.0 DTI 16V, 2.2 16V	09.98 - 01.05	1035	820	E90-65-001-03-22	A, 18, 20, 68, 78, 161	30	30							T
2.2 DTI	09.02 - 01.05	1035	820	E90-65-001-03-22	A, 20, 78, 161	30	30							T
B12 Sportline (Performance Komplettfahrwerke Sport Sport Performance Springs+Shocks) 1.2 16V, 1.4, 1.4 16V, 1.6, 1.6 16V, 1.8 16V, 2.0 16V, 2.2 16V	09.98 - 12.09	965	895	E95-65-001-01-22	A, 20, 78, 161	45-50	30							T
ASTRA GTC J Pro-Kit (Performance Fahrwerksfedern Performance Springs) 1.4, 1.6, 1.6 SIDI	10.11 -	1080	930	E10-65-020-01-22	A, 18, 20	30	30					F11-65-019-01-VA	F6549002	ABE
2.0	04.12 -	1160	930	E10-65-020-02-22	A, 18, 20	25	25					F11-65-019-02-VA	F6549002	ABE
1.7 CDTi, 1.8, 2.0 BiTurbo CDTi, 2.0 CDTi	10.11 -	1160	930	E10-65-020-02-22	A, 18, 20							F11-65-019-02-VA	F6549002	ABE
Pro-Tronic (Elektronische Performance Fahrwerksmodule Electronic Performance Suspension Moduls) Alle Motorisierungen / all motorisation	10.11 -			AM65-65-013-01-22	A, 175									
ASTRA H Pro-Kit (Performance Fahrwerksfedern Performance Springs) 1.4, 1.6, 1.8	03.04 -	970	860	E10-65-013-01-22	A, 18, 20, 68	30	30					F11-65-007-05-VA	F6541002	T
1.3 CDTi, 1.6 Turbo, 1.7 CDTi, 1.9 CDTi, 1.9 CDTi 16V, 2.0 Turbo	03.04 -	1075	860	E10-65-013-02-22	A, 18, 20, 68	30	30					F11-65-007-01-VA	F6541002	T
Sportline (Performance Fahrwerksfedern Sport Sport Performance Springs) 1.4, 1.6, 1.8	03.04 -	960	860	E20-65-013-01-22	A, 20, 68	45-50	30					F21-65-013-01-VA	F21-65-001-01-HA	T
1.3 CDTi, 1.6 Turbo, 1.7 CDTi, 2.0 Turbo	03.04 -	1025	860	E20-65-013-02-22	A, 20, 68	45-50	30					F21-65-013-02-VA	F21-65-001-01-HA	T
B12 Pro-Kit (Performance Komplettfahrwerke Performance Springs+Shocks) 1.4, 1.6, 1.8	03.04 -	970	860	E90-65-013-01-22	A, 18, 20, 68, 78, 96, 161	30	30							T
1.3 CDTi, 1.6 Turbo, 1.7 CDTi, 1.9 CDTi, 1.9 CDTi 16V, 2.0 Turbo	03.04 -	1075	860	E90-65-013-02-22	A, 18, 20, 68, 78, 96, 161	30	30							T
B12 Sportline (Performance Komplettfahrwerke Sport Sport Performance Springs+Shocks) 1.4, 1.6, 1.8	03.04 -	960	860	E95-65-013-01-22	A, 18, 20, 68, 78, 96, 161	45-50	30							T
1.3 CDTi, 1.6 Turbo, 1.7 CDTi	03.04 -	1025	860	E95-65-013-02-22	A, 20, 68, 78, 96, 161	45-50	30							T
1.7 CDTi, 2.0 Turbo	03.04 -	1025	860	E95-65-013-02-22	A, 18, 20, 68, 78, 96, 161	45-50	30							T
Pro-Street-S (Gewindefahrwerke - höhenverstellbar Coil-Over-Adjustable Ride Height) 1.3 CDTi, 1.4, 1.6, 1.6 Turbo, 1.7 CDTi, 1.8, 1.9 CDTi, 1.9 CDTi 16V, 2.0 Turbo	03.04 -	1070	955	PSS65-65-013-01-22	A, 21, 24, 25, 45, 160	30-60	30-60							T
Pro-Tronic (Elektronische Performance Fahrwerksmodule Electronic Performance Suspension Moduls) Alle Motorisierungen / all motorisation	03.04 -			AM65-65-013-01-22	A, 175									
ASTRA H Caravan ASTRA H Estate Pro-Kit (Performance Fahrwerksfedern Performance Springs) 1.4, 1.6, 1.8	08.04 -	970	940	E10-65-013-03-22	A, 18, 20, 68	30-35	25-30					F11-65-007-05-VA	F6542002	T
1.3 CDTi, 1.6 Turbo, 1.7 CDTi, 1.9 CDTi, 1.9 CDTi 16V, 1.9 CDTi, 2.0 Turbo	08.04 -	1075	940	E10-65-013-04-22	A, 18, 20, 68	30-35	25-30					F11-65-007-01-VA	F6542002	T
Sportline (Performance Fahrwerksfedern Sport Sport Performance Springs) 1.4, 1.6, 1.8	08.04 -	960	940	E20-65-013-03-22	A, 18, 20, 68	40-45	35					F21-65-013-01-VA	F21-65-013-03-HA	T

Modell	Baujahr	Achslast Vorne kg	Achslast Hinten kg	Artikel-Nr.	Hinweise	ca. Tieferl. Vorne mm	ca. Tieferl. Hinten mm	Ø Vorne mm	Ø Hinten mm	Verstellbarkeit Vorne	Verstellbarkeit Hinten	Ersatzteilbezeichnung Vorne	Ersatzteilbezeichnung Hinten	Gutachten
Model	Year	Front Axle Load kg	Rear Axle Load kg	Part-No.	Notes	ca. Lowering Front mm	ca. Lowering Rear mm	Ø Front mm	Ø Rear mm	Adjustable Front	Adjustable Rear	Spare Part Marking Front	Spare Part Marking Rear	Homologation
ASTRA H Caravan ASTRA H Estate <i>Sportline (Performance Fahrwerksfedern Sport Sport Performance Springs)</i> 1.3 CDTi, 1.6 Turbo, 1.7 CDTi, 2.0 Turbo	08.04 -	1025	940	E20-65-013-04-22	A, 18, 20, 68	40-45	35					F21-65-013-02-VA	F21-65-013-03-HA	T
B12 Pro-Kit (Performance Komplettfahrwerke Performance Springs+Shocks) 1.4, 1.6, 1.8	08.04 -	970	940	E90-65-013-03-22	A, 18, 20, 68, 78, 96, 161	30-35	25-30							T
1.3 CDTi, 1.6 Turbo, 1.7 CDTi, 1.9 CDTi, 1.9 CDTi 16V, 1.9 CDTi, 2.0 Turbo	08.04 -	1075	940	E90-65-013-04-22	A, 18, 20, 68, 78, 96, 161	30-35	25-30							T
B12 Sportline (Performance Komplettfahrwerke Sport Sport Performance Springs+Shocks) 1.4, 1.6, 1.8	08.04 -	970	940	E95-65-013-03-22	A, 18, 20, 68, 78, 96, 161	40-45	35							T
1.3 CDTi, 1.6 Turbo, 1.7 CDTi, 1.9 CDTi, 1.9 CDTi 16V, 1.9 CDTi, 2.0 Turbo	08.04 -	1075	940	E95-65-013-04-22	A, 18, 20, 68, 78, 96, 161	40-45	35							T
Pro-Street-S (Gewindefahrwerke - höhenverstellbar Coil-Overs-Adjustable Ride Height) 1.3 CDTi, 1.4, 1.6, 1.6 Turbo, 1.7 CDTi, 1.8, 1.9 CDTi, 1.9 CDTi 16V, 1.9 CDTi, 2.0 Turbo	08.04 -	1070	955	PSS65-65-013-01-22	A, 21, 24, 25, 45, 160	30-60	30-60							T
Pro-Tronic (Elektronische Performance Fahrwerksmodule Electronic Performance Suspension Modul) Alle Motorisierungen / all motorisation	08.04 -			AM65-65-013-01-22	A, 175									
ASTRA H GTC Pro-Kit (Performance Fahrwerksfedern Performance Springs) 1.4, 1.6, 1.8	03.05 -	970	860	E10-65-013-01-22	A, 18, 20, 68	30	30					F11-65-007-05-VA	F6541002	T
1.3 CDTi, 1.6 Turbo, 1.7 CDTi, 1.7 CDTi, 1.9 CDTi, 1.9 CDTi, 1.9 CDTi 16V, 2.0 Turbo	03.05 -	1075	860	E10-65-013-02-22	A, 18, 20, 68	30	30					F11-65-007-01-VA	F6541002	T
Sportline (Performance Fahrwerksfedern Sport Sport Performance Springs) 1.4, 1.6, 1.8	03.05 -	960	860	E20-65-013-01-22	A, 20, 68	45-50	30					F21-65-013-01-VA	F21-65-001-01-HA	T
1.3 CDTi, 1.6 Turbo, 1.7 CDTi, 1.7 CDTi, 2.0 Turbo	03.05 -	1025	860	E20-65-013-02-22	A, 20, 68	45-50	30					F21-65-013-02-VA	F21-65-001-01-HA	T
B12 Pro-Kit (Performance Komplettfahrwerke Performance Springs+Shocks) 1.4, 1.6, 1.8	03.05 -	970	860	E90-65-013-01-22	A, 18, 20, 68, 78, 96, 161	30	30							T
1.3 CDTi, 1.6 Turbo, 1.7 CDTi, 1.9 CDTi, 1.9 CDTi, 1.9 CDTi 16V, 2.0 Turbo	03.05 -	1075	860	E90-65-013-02-22	A, 18, 20, 68, 78, 96, 161	30	30							T
B12 Sportline (Performance Komplettfahrwerke Sport Sport Performance Springs+Shocks) 1.4, 1.6, 1.8	03.05 -	960	860	E95-65-013-01-22	A, 18, 20, 68, 78, 96, 161	45-50	30							T
1.6, 1.8	01.06 -	960	860	E95-65-013-01-22	A, 20, 68, 78, 96, 161	45-50	30							T
1.3 CDTi, 1.6 Turbo, 1.7 CDTi, 1.7 CDTi, 2.0 Turbo	03.05 -	1025	860	E95-65-013-02-22	A, 18, 20, 68, 78, 96, 161	45-50	30							T
Pro-Street-S (Gewindefahrwerke - höhenverstellbar Coil-Overs-Adjustable Ride Height) 1.3 CDTi, 1.4, 1.6, 1.6 Turbo, 1.7 CDTi, 1.7 CDTi, 1.8, 1.9 CDTi, 1.9 CDTi, 1.9 CDTi 16V, 2.0 Turbo	03.05 -	1070	955	PSS65-65-013-01-22	A, 21, 24, 25, 45, 160	30-60	30-60							T
Pro-Tronic (Elektronische Performance Fahrwerksmodule Electronic Performance Suspension Modul) Alle Motorisierungen / all motorisation	03.05 -			AM65-65-013-01-22	A, 175									
ASTRA H Stufenheck ASTRA H Saloon Pro-Kit (Performance Fahrwerksfedern Performance Springs) 1.6, 1.8	02.07 -	970	860	E10-65-013-01-22	A, 18, 20, 68	30	30					F11-65-007-05-VA	F6541002	T
1.3 CDTi, 1.7 CDTi, 1.7 CDTi	02.07 -	1075	860	E10-65-013-02-22	A, 18, 20, 68	30	30					F11-65-007-01-VA	F6541002	T
Sportline (Performance Fahrwerksfedern Sport Sport Performance Springs) 1.6, 1.8	02.07 -	960	860	E20-65-013-01-22	A, 20, 68	45-50	30					F21-65-013-01-VA	F21-65-001-01-HA	T
1.3 CDTi, 1.7 CDTi, 1.7 CDTi	02.07 -	1025	860	E20-65-013-02-22	A, 20, 68	45-50	30					F21-65-013-02-VA	F21-65-001-01-HA	T
B12 Pro-Kit (Performance Komplettfahrwerke Performance Springs+Shocks) 1.6, 1.8	02.07 -	970	860	E90-65-013-01-22	A, 18, 20, 68, 78, 96, 161	30	30							T
1.3 CDTi, 1.7 CDTi	02.07 -	1075	860	E90-65-013-02-22	A, 18, 20, 68, 78, 96, 161	30	30							T
B12 Sportline (Performance Komplettfahrwerke Sport Sport Performance Springs+Shocks) 1.6	02.07 -	960	860	E95-65-013-01-22	A, 18, 20, 68, 78, 96, 161	45-50	30							T
1.8	02.07 -	960	860	E95-65-013-01-22	A, 20, 68, 78, 96, 161	45-50	30							T
1.3 CDTi, 1.7 CDTi	02.07 -	1025	860	E95-65-013-02-22	A, 18, 20, 68, 78, 96, 161	45-50	30							T
Pro-Street-S (Gewindefahrwerke - höhenverstellbar Coil-Overs-Adjustable Ride Height) 1.3 CDTi, 1.6, 1.7 CDTi, 1.7 CDTi, 1.8	02.07 -	1070	955	PSS65-65-013-01-22	A, 21, 24, 25, 45, 160	30-60	30-60							T
Pro-Tronic (Elektronische Performance Fahrwerksmodule Electronic Performance Suspension Modul) Alle Motorisierungen / all motorisation	02.07 -			AM65-65-013-01-22	A, 175									
ASTRA H TwinTop Pro-Kit (Performance Fahrwerksfedern Performance Springs) 1.6, 1.8	09.05 -	1000	955	E10-65-013-06-22	A, 18, 20	30	30					F11-65-007-01-VA	F6542002	T
1.6 Turbo, 1.9 CDTi, 2.0 Turbo	09.05 -	1070	955	E10-65-013-07-22	A, 18, 20	30	30					F11-65-007-02-VA	F6542002	T
B12 Pro-Kit (Performance Komplettfahrwerke Performance Springs+Shocks) 1.6, 1.8	09.05 -	1000	955	E90-65-013-06-22	A, 18, 20, 78, 96, 161	30	30							T
1.6 Turbo, 1.9 CDTi, 2.0 Turbo	09.05 -	1070	955	E90-65-013-07-22	A, 18, 20, 78, 96, 161	30	30							T
Pro-Street-S (Gewindefahrwerke - höhenverstellbar Coil-Overs-Adjustable Ride Height) 1.6, 1.6 Turbo, 1.8, 1.9 CDTi, 2.0 Turbo	09.05 -	1070	955	PSS65-65-013-01-22	A, 21, 24, 25, 45, 160	30-60	30-60							T

Modell	Baujahr	Achslast Vorne kg	Achslast Hinten kg	Artikel-Nr.	Hinweise	ca. Tieferl. Vorne mm	ca. Tieferl. Hinten mm	Ø Vorne mm	Ø Hinten mm	Verstellbarkeit Vorne	Verstellbarkeit Hinten	Ersatzteilbezeichnung Vorne	Ersatzteilbezeichnung Hinten	Gutachten
Model	Year	Front Axle Load kg	Rear Axle Load kg	Part-No.	Notes	ca. Lowering Front mm	ca. Lowering Rear mm	Ø Front mm	Ø Rear mm	Adjustable Front	Adjustable Rear	Spare Part Marking Front	Spare Part Marking Rear	Homologation
ASTRA H TwinTop <i>Pro-Tronic (Elektronische Performance Fahrwerksmodule Electronic Performance Suspension Modul)</i> Alle Motorisierungen / all motorisation	09.05 -			AM65-65-013-01-22	A, 175									
ASTRA H Van <i>Pro-Kit (Performance Fahrwerksfedern Performance Springs)</i> 1.3 CDTI, 1.7 CDTI, 1.9 CDTI, 1.9 CDTI 16V	03.04 -	1075	940	E10-65-013-04-22	A, 18, 20, 68	30-35	25-30					F11-65-007-01-VA	F6542002	T
Sportline (Performance Fahrwerksfedern Sport Sport Performance Springs) 1.3 CDTI, 1.7 CDTI	03.04 -	1025	940	E20-65-013-04-22	A, 18, 20, 68	40-45	35					F21-65-013-02-VA	F21-65-013-03-HA	T
B12 Pro-Kit (Performance Komplettfahrwerke Performance Springs+Shocks) 1.3 CDTI, 1.7 CDTI, 1.9 CDTI, 1.9 CDTI 16V	03.04 -	1075	940	E90-65-013-04-22	A, 18, 20, 68, 78, 96, 161	30-35	25-30							T
B12 Sportline (Performance Komplettfahrwerke Sport Sport Performance Springs+Shocks) 1.3 CDTI, 1.7 CDTI	03.04 -	1025	945	E95-65-013-04-22	A, 18, 20, 78, 161	40-45	35							T
Pro-Street-S (Gewindefahrwerke - höhenverstellbar Coil-Overs-Adjustable Ride Height) 1.3 CDTI, 1.7 CDTI, 1.9 CDTI, 1.9 CDTI 16V	03.04 -	1070	955	PSS65-65-013-01-22	A, 21, 24, 25, 45, 160	30-60	30-60							T
<i>Pro-Tronic (Elektronische Performance Fahrwerksmodule Electronic Performance Suspension Modul)</i> Alle Motorisierungen / all motorisation	02.04 -			AM65-65-013-01-22	A, 175									
ASTRA J <i>Pro-Kit (Performance Fahrwerksfedern Performance Springs)</i> 1.4, 1.6	12.09 -	995	1020	E10-65-020-01-22	A, 18, 20	40	40					F11-65-019-01-VA	F6549002	ABE
1.3 CDTI, 1.4 Turbo, 1.6 SIDI, 1.6 Turbo	12.09 -	1080	1020	E10-65-020-02-22	A, 18, 20	40	40					F11-65-019-02-VA	F6549002	ABE
1.7 CDTI, 2.0 BiTurbo CDTI, 2.0 CDTI	12.09 -	1175	1020	E10-65-020-03-22	A, 18, 20	40	40					F11-65-019-04-VA	F6549002	ABE
B12 Pro-Kit (Performance Komplettfahrwerke Performance Springs+Shocks) 1.4, 1.4 Turbo, 1.6, 1.6 SIDI	12.09 -	995	1020	E90-65-020-01-22	A, 18, 20, 78, 98, 161	30	30							T
1.3 CDTI, 1.6, 1.6 SIDI, 1.6 Turbo	12.09 -	1080	1020	E90-65-020-02-22	A, 18, 20, 78, 98, 161	30	30							T
1.7 CDTI, 2.0 BiTurbo CDTI, 2.0 CDTI	12.09 -	1175	1020	E90-65-020-03-22	A, 18, 20, 78, 98, 161	30	30							T
Pro-Street-S (Gewindefahrwerke - höhenverstellbar Coil-Overs-Adjustable Ride Height) 1.3 CDTI, 1.4, 1.4 Turbo, 1.6, 1.6 SIDI, 1.6 Turbo, 1.7 CDTI, 2.0 BiTurbo CDTI, 2.0 CDTI	12.09 -	1155	1000	PSS65-65-020-01-22	A, 18, 20, 24, 25, 45, 160	40-70	45-75							T
<i>Pro-Tronic (Elektronische Performance Fahrwerksmodule Electronic Performance Suspension Modul)</i> Alle Motorisierungen / all motorisation	12.09 -			AM65-65-013-01-22	A, 175									
ASTRA J Stufenheck ASTRA J Saloon <i>Pro-Kit (Performance Fahrwerksfedern Performance Springs)</i> 1.4	06.12 -	995	1020	E10-65-020-01-22	A, 18, 20	40	40					F11-65-019-01-VA	F6549002	ABE
1.3 CDTI, 1.4 Turbo, 1.6, 1.6 SIDI, 1.6 Turbo	06.12 -	1080	1020	E10-65-020-02-22	A, 18, 20	40	40					F11-65-019-02-VA	F6549002	ABE
1.7 CDTI	06.12 -	1175	1020	E10-65-020-03-22	A, 18, 20	40	40					F11-65-019-04-VA	F6549002	ABE
B12 Pro-Kit (Performance Komplettfahrwerke Performance Springs+Shocks) 1.3 CDTI, 1.4, 1.4 Turbo, 1.6, 1.6 SIDI, 1.6 Turbo	06.12 -	995	1020	E90-65-020-01-22	A, 18, 20, 78, 98, 161	30	30							T
1.7 CDTI	06.12 -	1175	1020	E90-65-020-03-22	A, 18, 20, 78, 98, 161	30	30							T
Pro-Street-S (Gewindefahrwerke - höhenverstellbar Coil-Overs-Adjustable Ride Height) 1.3 CDTI, 1.4, 1.4 Turbo, 1.6, 1.6 SIDI, 1.6 Turbo, 1.7 CDTI	06.12 -	1155	1000	PSS65-65-020-01-22	A, 18, 20, 24, 25, 45, 160	40-70	45-75							T
<i>Pro-Tronic (Elektronische Performance Fahrwerksmodule Electronic Performance Suspension Modul)</i> Alle Motorisierungen / all motorisation	06.12 -			AM65-65-013-01-22	A, 175									
ASTRA Sports Tourer (J) <i>Pro-Kit (Performance Fahrwerksfedern Performance Springs)</i> 1.4, 1.6	10.10 -	995	1100	E10-65-020-04-22	A, 18, 20	35	35					F11-65-019-01-VA	F11-23-007-01-HA	ABE
1.3 CDTI, 1.4 Turbo, 1.6 SIDI, 1.6 Turbo	10.10 -	1080	1100	E10-65-020-05-22	A, 18, 20	35	35					F11-65-019-02-VA	F11-23-007-01-HA	ABE
1.6 Turbo, 1.7 CDTI, 2.0 BiTurbo CDTI, 2.0 CDTI	10.10 -	1175	1100	E10-65-020-06-22	A, 18, 20	35	35					F11-65-019-04-VA	F11-23-007-01-HA	ABE
<i>Pro-Tronic (Elektronische Performance Fahrwerksmodule Electronic Performance Suspension Modul)</i> Alle Motorisierungen / all motorisation	10.10 -			AM65-65-013-01-22	A, 175									
CALIBRA A (85_) <i>Pro-Kit (Performance Fahrwerksfedern Performance Springs)</i> 2.0 i, 2.0 i 16V, 2.0 i 16V 4x4, 2.0 i 4x4	06.90 - 07.97	885	880	E6518-140	A, 18	30	30					F6518001	F6518002	T
2.0 i Turbo 4x4	03.92 - 07.97	940	880	E6518-240	A, 18	25	25					F6517001	F6518002	T
2.5 i V6	04.93 - 07.97	980	880	E6530-140	A, 18, 20	30	30					F6529001	F6518002	T
B12 Pro-Kit (Performance Komplettfahrwerke Performance Springs+Shocks) 2.0 i, 2.0 i 16V, 2.0 i 16V 4x4, 2.0 i 4x4	06.90 - 07.97	885	880	E90-65-004-01-22	A, 18, 78, 161	30	30							T
2.0 i Turbo 4x4	03.92 - 07.97	940	880	E90-65-004-02-22	A, 18, 78, 161	25	25							T
CASCADA (W13) <i>Pro-Kit (Performance Fahrwerksfedern Performance Springs)</i> 1.4, 1.4 Turbo, 1.6 SIDI	03.13 -	1160	1010	E10-65-020-07-22	A, 18, 20	25	25					F11-65-019-02-VA	F6549002	T
2.0 CDTI	03.13 -	1215	1010	E10-65-020-08-22	A, 18, 20	25	25					F11-65-019-04-VA	F6549002	T
CORSA A CC (93_, 94_, 98_, 99_) CORSA A Hatchback (93_, 94_, 98_, 99_) <i>Sportline (Performance Fahrwerksfedern Sport Sport Performance Springs)</i> 1.0, 1.2, 1.2 N, 1.2 S, 1.2 i, 1.3, 1.3 GL, 1.3 S, 1.3 i, 1.4 S, 1.4 Si, 1.4 i	09.82 - 03.93	790	700	E20-65-002-01-22	A, 20	45-50	30-35					F21-65-002-01-VA	F21-65-002-01-HA	T

Modell	Baujahr	Achslast Vorne kg	Achslast Hinten kg	Artikel-Nr.	Hinweise	ca. Tieferl. Vorne mm	ca. Tieferl. Hinten mm	Ø Vorne mm	Ø Hinten mm	Verstellbarkeit Vorne	Verstellbarkeit Hinten	Ersatzteilbezeichnung Vorne	Ersatzteilbezeichnung Hinten	Gutachten
Model	Year	Front Axle Load kg	Rear Axle Load kg	Part-No.	Notes	ca. Lowering Front mm	ca. Lowering Rear mm	Ø Front mm	Ø Rear mm	Adjustable Front	Adjustable Rear	Spare Part Marking Front	Spare Part Marking Rear	Homologation
CORSA A CC (93., 94., 98., 99.) CORSA A Hatchback (93., 94., 98., 99.) B12 Sportline (Performance Komplettfahrwerke Sport Sport Performance Springs+Shocks) 1.0, 1.2, 1.2 N, 1.2 S, 1.2 i, 1.3, 1.3 GL, 1.3 S, 1.3 i, 1.4 S, 1.4 Si, 1.4 i	09.82 - 03.93	790	700	E95-65-002-01-22	A, 20, 78, 161	45-50	30-35							T
CORSA A TR (91., 92., 96., 97.) Sportline (Performance Fahrwerksfedern Sport Sport Performance Springs) 1.0, 1.2 N, 1.2 S, 1.2 i, 1.3, 1.3 GL, 1.3 S, 1.4 S, 1.4 i	09.82 - 03.93	790	700	E20-65-002-01-22	A, 20	45-50	30-35					F21-65-002-01-VA	F21-65-002-01-HA	T
B12 Sportline (Performance Komplettfahrwerke Sport Sport Performance Springs+Shocks) 1.0, 1.2 N, 1.2 S, 1.2 i, 1.3, 1.3 GL, 1.3 S, 1.4 S, 1.4 i	09.82 - 03.93	790	700	E95-65-002-01-22	A, 20, 78, 161	45-50	30-35							T
CORSA B (73., 78., 79.) Pro-Kit (Performance Fahrwerksfedern Performance Springs) 1.0 i 12V, 1.2 i, 1.2 i 16V, 1.4, 1.4 Si, 1.4 i, 1.4 i 16V, 1.6 GSI 16V, 1.6 i 16V	03.93 - 09.00	790	700	E6528-140	A, 18, 20	30	30					F6528001	F6528102	T
Sportline (Performance Fahrwerksfedern Sport Sport Performance Springs) 1.0 i 12V, 1.2 i, 1.2 i 16V, 1.4, 1.4 Si, 1.4 i, 1.4 i 16V, 1.6 GSI 16V, 1.6 i 16V	03.93 - 09.00	790	700	E20-65-002-01-22	A, 20	45-50	25					F21-65-002-01-VA	F21-65-002-01-HA	T
B12 Pro-Kit (Performance Komplettfahrwerke Performance Springs+Shocks) 1.0 i 12V, 1.2 i, 1.2 i 16V, 1.4, 1.4 Si, 1.4 i, 1.4 i 16V, 1.6 GSI 16V, 1.6 i 16V	03.93 - 09.00	790	700	E90-65-002-01-22	A, 18, 20, 78, 161	30	30							T
B12 Sportline (Performance Komplettfahrwerke Sport Sport Performance Springs+Shocks) 1.0 i 12V, 1.2 i, 1.2 i 16V, 1.4, 1.4 Si, 1.4 i, 1.4 i 16V, 1.6 GSI 16V, 1.6 i 16V	03.93 - 09.00	790	700	E95-65-002-01-22	A, 20, 78, 161	45-50	25							T
CORSA C (F08, F68) Pro-Kit (Performance Fahrwerksfedern Performance Springs) 1.0, 1.2, 1.2 Twinport, 1.4, 1.4 Twinport	09.00 -	820	760	E10-65-002-01-22	A, 18, 20	30	30					F11-65-002-01-VA	F6528102	T
1.3 CDTI, 1.7 CDTI, 1.7 DI, 1.7 DTI, 1.8	09.00 -	940	760	E10-65-002-02-22	A, 18, 20	30	30					F11-65-002-02-VA	F6528102	T
B12 Pro-Kit (Performance Komplettfahrwerke Performance Springs+Shocks) 1.0, 1.2, 1.2 Twinport, 1.4, 1.4 Twinport	09.00 -	820	760	E90-65-002-02-22	A, 18, 20, 78, 89, 161	30	30							T
1.0, 1.2, 1.2 Twinport, 1.4, 1.4 Twinport	09.00 -	820	760	E90-65-002-03-22	A, 18, 20, 78, 90, 161	30	30							T
1.3 CDTI, 1.7 CDTI, 1.7 DI, 1.7 DTI, 1.8	09.00 -	940	760	E90-65-002-04-22	A, 18, 20, 78, 89, 161	30	30							T
1.3 CDTI, 1.7 CDTI, 1.7 DI, 1.7 DTI, 1.8	09.00 -	940	760	E90-65-002-05-22	A, 18, 20, 78, 90, 161	30	30							T
CORSA D Pro-Kit (Performance Fahrwerksfedern Performance Springs) 1.0, 1.2, 1.4	07.06 -	885	845	E10-65-015-01-22	A, 18, 20	30	30					F11-65-015-01-VA	F11-65-015-01-HA	T
1.3 CDTI, 1.6 Turbo, 1.7 CDTI	07.06 -	1000	845	E10-65-015-02-22	A, 18, 20	30	30					F11-65-015-02-VA	F11-65-015-01-HA	T
Sportline (Performance Fahrwerksfedern Sport Sport Performance Springs) 1.0, 1.2, 1.4	07.06 -	885	845	E20-65-015-01-22	A, 18, 20	40	30					F21-65-015-01-VA	F21-65-015-01-HA	T
1.3 CDTI, 1.6 Turbo, 1.7 CDTI	07.06 -	990	845	E20-65-015-02-22	A, 18, 20	40	30					F21-65-015-02-VA	F21-65-015-01-HA	T
B12 Pro-Kit (Performance Komplettfahrwerke Performance Springs+Shocks) 1.0, 1.2, 1.4	07.06 -	885	845	E90-65-015-01-22	A, 18, 20, 78, 161	30	30							T
1.2, 1.3 CDTI, 1.4, 1.7 CDTI	07.06 -	1000	845	E90-65-015-02-22	A, 18, 20, 78, 161	30	30							T
1.6 Turbo	02.07 -	1000	845	E90-65-015-02-22	A, 18, 20, 78, 161	15	15							T
Pro-Street-S (Gewindefahrwerke - höhenverstellbar Coil-Overs-Adjustable Ride Height) 1.0, 1.2, 1.4	07.06 -	855	800	PSS65-30-010-01-22	A, 25, 45, 160	25-55	25-55							T
1.3 CDTI, 1.7 CDTI	07.06 -	990	800	PSS65-30-010-02-22	A, 25, 45, 160	25-55	25-55							T
CORSA D Van Pro-Kit (Performance Fahrwerksfedern Performance Springs) 1.0, 1.2	07.06 -	885	845	E10-65-015-01-22	A, 18, 20	30	30					F11-65-015-01-VA	F11-65-015-01-HA	T
1.3 CDTI	07.06 -	1000	845	E10-65-015-02-22	A, 18, 20	30	30					F11-65-015-02-VA	F11-65-015-01-HA	T
Sportline (Performance Fahrwerksfedern Sport Sport Performance Springs) 1.0, 1.2	07.06 -	885	845	E20-65-015-01-22	A, 18, 20	40	30					F21-65-015-01-VA	F21-65-015-01-HA	T
1.3 CDTI	07.06 -	990	845	E20-65-015-02-22	A, 18, 20	40	30					F21-65-015-02-VA	F21-65-015-01-HA	T
B12 Pro-Kit (Performance Komplettfahrwerke Performance Springs+Shocks) 1.0, 1.2	07.06 -	885	845	E90-65-015-01-22	A, 18, 20, 78, 161	30	30							T
1.3 CDTI	07.06 -	1000	845	E90-65-015-02-22	A, 18, 20, 78, 161	30	30							T
Pro-Street-S (Gewindefahrwerke - höhenverstellbar Coil-Overs-Adjustable Ride Height) 1.0, 1.2	07.06 -	855	800	PSS65-30-010-01-22	A, 25, 45, 160	25-55	25-55							T
1.3 CDTI	07.06 -	990	800	PSS65-30-010-02-22	A, 25, 45, 160	25-55	25-55							T
GT Cabriolet GT Convertible Pro-Kit (Performance Fahrwerksfedern Performance Springs) 2.0	06.07 -	880	900	E10-65-017-01-22	A, 18, 20	25	25					F11-65-017-01-VA	F11-65-017-01-HA	T
INSIGNIA Pro-Kit (Performance Fahrwerksfedern Performance Springs) 1.4, 1.6, 1.8	07.08 -	1030	1160	E10-65-019-01-22	A, 18, 20	30	30					F11-65-019-01-VA	F11-65-011-01-HA	T
1.6 SIDI, 1.6 Turbo, 2.0 Biturbo CDTI, 2.0 CDTI, 2.0 E85 Turbo, 2.0 Turbo	07.08 -	1175	1160	E10-65-019-02-22	A, 18, 20	30	30					F11-65-019-02-VA	F11-65-011-01-HA	T
B12 Pro-Kit (Performance Komplettfahrwerke Performance Springs+Shocks) 1.4, 1.6, 1.8	07.08 -	1030	1160	E90-65-019-01-22	A, 18, 20, 78, 98, 161	30	30							T

Modell	Baujahr	Achslast Vorne kg	Achslast Hinten kg	Artikel-Nr.	Hinweise	ca. Tieferl. Vorne mm	ca. Tieferl. Hinten mm	Ø Vorne mm	Ø Hinten mm	Verstellbarkeit Vorne	Verstellbarkeit Hinten	Ersatzteilbezeichnung Vorne	Ersatzteilbezeichnung Hinten	Gutachten
Model	Year	Front Axle Load kg	Rear Axle Load kg	Part-No.	Notes	ca. Lowering Front mm	ca. Lowering Rear mm	Ø Front mm	Ø Rear mm	Adjustable Front	Adjustable Rear	Spare Part Marking Front	Spare Part Marking Rear	Homologation
INSIGNIA B12 Pro-Kit (Performance Komplettfahrwerke Performance Springs+Shocks) 2.0 Biturbo CDTI	01.12 -	1175	1160	E90-65-019-02-22	A, 18, 20, 21, 78, 161	30	30							T
1.6 Turbo, 2.0 Biturbo CDTI, 2.0 CDTI, 2.0 E85 Turbo, 2.0 Turbo	07.08 -	1175	1160	E90-65-019-02-22	A, 18, 20, 78, 98, 161	30	30							T
INSIGNIA Sports Tourer Pro-Kit (Performance Fahrwerksfedern Performance Springs) 1.4, 1.6, 1.8	07.08 -	1030	1265	E10-65-019-05-22	A, 18, 20	30	30					F11-65-019-01-VA	F11-65-019-05-HA	T
1.6 SIDI, 1.6 Turbo, 2.0 Biturbo CDTI, 2.0 CDTI, 2.0 E85 Turbo, 2.0 Turbo	07.08 -	1175	1265	E10-65-019-06-22	A, 18, 20	30	30					F11-65-019-02-VA	F11-65-019-05-HA	T
2.0 Turbo 4x4	07.08 -	1175	1355	E10-65-019-07-22	A, 18	30	30					F11-65-019-02-VA	F11-65-019-07-HA	T
2.0 Biturbo CDTI 4x4, 2.0 CDTI 4x4, 2.0 Turbo 4x4, 2.8 V6 Turbo 4x4	07.08 -	1240	1355	E10-65-019-08-22	A, 18	30	30					F11-65-019-04-VA	F11-65-019-07-HA	T
B12 Pro-Kit (Performance Komplettfahrwerke Performance Springs+Shocks) 1.6, 1.8	07.08 -	1030	1265	E90-65-019-05-22	A, 18, 20, 78, 98, 161	30	30							T
2.0 Biturbo CDTI	01.12 -	1175	1265	E90-65-019-06-22	A, 18, 20, 21, 78, 161	30	30							T
1.6 Turbo, 2.0 Biturbo CDTI, 2.0 CDTI, 2.0 E85 Turbo, 2.0 Turbo	07.08 -	1175	1265	E90-65-019-06-22	A, 18, 20, 78, 98, 161	30	30							T
2.0 Turbo 4x4	09.11 -	1175	1355	E90-65-019-07-22	A, 18, 21, 78, 161	30	30							T
2.0 Turbo 4x4	07.08 -	1175	1355	E90-65-019-07-22	A, 18, 78, 98, 161	30	30							T
2.0 Biturbo CDTI 4x4, 2.0 Turbo 4x4	09.11 -	1240	1355	E90-65-019-08-22	A, 18, 21, 78, 161	30	30							T
2.0 Biturbo CDTI 4x4, 2.0 CDTI 4x4, 2.0 Turbo 4x4, 2.8 V6 Turbo 4x4	07.08 -	1240	1355	E90-65-019-08-22	A, 18, 78, 98, 161	30	30							T
INSIGNIA Stufenheck INSIGNIA Saloon Pro-Kit (Performance Fahrwerksfedern Performance Springs) 1.4, 1.6, 1.8	07.08 -	1030	1160	E10-65-019-01-22	A, 18, 20	30	30					F11-65-019-01-VA	F11-65-011-01-HA	T
1.6 SIDI, 1.6 Turbo, 2.0 Biturbo CDTI, 2.0 CDTI, 2.0 Turbo, 2.0 Turbo E85	07.08 -	1175	1160	E10-65-019-02-22	A, 18, 20	30	30					F11-65-019-02-VA	F11-65-011-01-HA	T
B12 Pro-Kit (Performance Komplettfahrwerke Performance Springs+Shocks) 1.6, 1.8	07.08 -	1030	1160	E90-65-019-01-22	A, 18, 20, 78, 98, 161	30	30							T
2.0 Biturbo CDTI	01.12 -	1175	1160	E90-65-019-02-22	A, 18, 20, 21, 78, 161	30	30							T
1.6 Turbo, 2.0 Biturbo CDTI, 2.0 CDTI, 2.0 Turbo, 2.0 Turbo E85	07.08 -	1175	1160	E90-65-019-02-22	A, 18, 20, 78, 98, 161	30	30							T
KADETT E (39., 49.) Pro-Kit (Performance Fahrwerksfedern Performance Springs) 1.2, 1.3 N, 1.3 S, 1.3 i KAT, 1.4 S, 1.4 i, 1.6, 1.6 S, 1.6 i, 1.6 i KAT, 1.8, 1.8 S, 1.8 i 1.2, 1.3 N, 1.3 S, 1.3 i CAT, 1.4 S, 1.4 i, 1.6, 1.6 S, 1.6 i, 1.6 i CAT, 1.8, 1.8 S, 1.8 i	09.84 - 08.91	770	715	E6506-140	A, 9, 18, 20	35-40	35-40					F6521001	F6522102	T
KADETT E Caravan (35., 36., 45., 46.) KADETT E Estate (35., 36., 45., 46.) Pro-Kit (Performance Fahrwerksfedern Performance Springs) 1.2, 1.3, 1.3 N, 1.3 S, 1.3 i KAT, 1.4 S, 1.4 i, 1.5 TD, 1.6, 1.6 D, 1.6 S, 1.6 i, 1.6 i KAT, 1.7 D, 1.8 E, 1.8 S, 1.8 i, 2.0 i, 2.0 i KAT 1.2, 1.3, 1.3 N, 1.3 S, 1.3 i CAT, 1.4 S, 1.4 i, 1.5 TD, 1.6, 1.6 D, 1.6 S, 1.6 i, 1.6 i CAT, 1.7 D, 1.8 E, 1.8 S, 1.8 i, 2.0 i, 2.0 i CAT	09.84 - 08.91	770	830	E6511-140	A, 9, 18, 20	35	35					F6521001	F6511002	T
KADETT E CC (33., 34., 43., 44.) KADETT E Hatchback (33., 34., 43., 44.) Pro-Kit (Performance Fahrwerksfedern Performance Springs) 1.2, 1.3, 1.3 N, 1.3 S, 1.3 i KAT, 1.4 S, 1.4 i, 1.6 S, 1.6 i, 1.6 i KAT, 1.8 E, 1.8 GSI, 1.8 S, 1.8 i 1.2, 1.3, 1.3 N, 1.3 S, 1.3 i CAT, 1.4 S, 1.4 i, 1.6 S, 1.6 i, 1.6 i CAT, 1.8 E, 1.8 GSI, 1.8 S, 1.8 i	09.84 - 08.91	770	715	E6506-140	A, 9, 18, 20	35-40	35-40					F6521001	F6522102	T
MERIVA B Pro-Kit (Performance Fahrwerksfedern Performance Springs) 1.3 CDTI, 1.4	06.10 -	1060	1010	E10-65-021-01-22	A, 18, 20	20-25	20-25					F11-65-021-01-VA	F6542002	T
1.7 CDTI	06.10 -	1145	1010	E10-65-021-02-22	A, 18, 20	20-25	20-25					F11-65-014-02-VA	F6542002	T
B12 Pro-Kit (Performance Komplettfahrwerke Performance Springs+Shocks) 1.3 CDTI, 1.4	06.10 -	1060	1010	E90-65-021-01-22	A, 18, 20, 78, 161	20-25	20-25							T
1.7 CDTI	06.10 -	1145	1010	E90-65-021-02-22	A, 18, 20, 78, 161	20-25	20-25							T
MOKKA Pro-Kit (Performance Fahrwerksfedern Performance Springs) 1.4 4x4, 1.6	06.12 -	1065	995	E10-65-029-01-22	A, 18	25	25					F11-65-029-01-VA	F11-65-029-01-HA	T
1.7 CDTI, 1.7 CDTI 4x4	06.12 -	1065	995	E10-65-029-02-22	A, 18	25	25					F11-65-029-02-VA	F11-65-029-01-HA	T
OMEGA B (25., 26., 27.) Pro-Kit (Performance Fahrwerksfedern Performance Springs) 2.0, 2.0 16V, 2.2 16V	03.94 - 07.03	990	1155	E6531-140	A, 18, 20, 68	30	30					F6531001	F2042002	T
2.0 DTI 16V, 2.2 DTI 16V, 2.5 DTI, 2.5 TD, 2.5 V6, 2.6 V6, 3.0 V6, 3.2 V6	03.94 - 07.03	1080	1155	E6532-140	A, 18, 20, 68	30	30					F6532001	F2042002	T
B12 Pro-Kit (Performance Komplettfahrwerke Performance Springs+Shocks) 2.0, 2.0 16V, 2.2 16V	03.94 - 07.03	990	1155	E90-65-026-01-22	A, 18, 20, 78, 68, 161	30	30							T
2.0 DTI 16V, 2.2 DTI 16V, 2.5 DTI, 2.5 TD, 2.5 V6, 2.6 V6, 3.0 V6, 3.2 V6	03.94 - 07.03	1080	1155	E90-65-026-02-22	A, 18, 20, 78, 68, 161	30	30							T
OMEGA B Caravan (21., 22., 23.) OMEGA B Estate (21., 22., 23.) Pro-Kit (Performance Fahrwerksfedern Performance Springs) 2.0, 2.0 16V, 2.2 16V	03.94 - 07.03	990	1290	E6533-140	A, 18, 20, 68	30	30					F6531001	F6533002	T
2.0 DTI 16V, 2.2 DTI 16V, 2.5 DTI, 2.5 TD, 2.5 V6, 2.6 V6, 3.0 V6, 3.2 V6	03.94 - 07.03	1080	1290	E6534-140	A, 18, 20, 68	30	30					F6532001	F6533002	T

Modell	Baujahr	Achslast Vorne kg	Achslast Hinten kg	Artikel-Nr.	Hinweise	ca. Tieferl. Vorne mm	ca. Tieferl. Hinten mm	Ø Vorne mm	Ø Hinten mm	Verstellbarkeit Vorne	Verstellbarkeit Hinten	Ersatzteilbezeichnung Vorne	Ersatzteilbezeichnung Hinten	Gutachten
Model	Year	Front Axle Load kg	Rear Axle Load kg	Part-No.	Notes	ca. Lowering Front mm	ca. Lowering Rear mm	Ø Front mm	Ø Rear mm	Adjustable Front	Adjustable Rear	Spare Part Marking Front	Spare Part Marking Rear	Homologation
OMEGA B Caravan (21., 22., 23.) OMEGA B Estate (21., 22., 23.) B12 Pro-Kit (Performance Komplettfahrwerke Performance Springs+Shocks) 2.0, 2.0 16V, 2.2 16V	03.94 - 07.03	990	1290	E90-65-026-03-22	A, 18, 20, 78, 68, 161	30	30							T
2.0 DTI 16V, 2.2 DTI 16V, 2.5 DTI, 2.5 TD, 2.5 V6, 2.6 V6, 3.0 V6, 3.2 V6	03.94 - 07.03	1080	1290	E90-65-026-04-22	A, 18, 20, 78, 68, 161	30	30							T
SIGNUM Pro-Kit (Performance Fahrwerksfedern Performance Springs) 1.8, 2.2 direct	05.03 -	1060	1215	E10-65-011-01-22	A, 18, 20	30	30					F11-65-007-01-VA	F11-65-011-01-HA	T
1.9 CDTI, 2.0 DTI, 2.0 Turbo, 2.2 DTI, 3.2 V6	05.03 -	1135	1215	E10-65-011-02-22	A, 18, 20	30	30					F11-65-007-02-VA	F11-65-011-01-HA	T
1.9 CDTI, 3.0 V6 CDTI, 3.2 V6	05.03 -	1230	1215	E10-65-011-03-22	A, 18, 20	30	30					F11-65-007-07-VA	F11-65-011-01-HA	T
B12 Pro-Kit (Performance Komplettfahrwerke Performance Springs+Shocks) 1.8, 2.2 direct	05.03 - 09.04	1060	1215	E90-65-011-02-22	A, 18, 20, 78, 21, 106, 161	30	30							T
1.8, 2.2 direct	10.04 -	1060	1215	E90-65-011-01-22	A, 18, 20, 78, 21, 138, 161	30	30							T
1.9 CDTI, 2.0 DTI, 2.0 Turbo, 2.2 DTI, 3.2 V6	05.03 - 09.04	1135	1215	E90-65-011-04-22	A, 18, 20, 78, 21, 106, 161	30	30							T
1.9 CDTI, 2.0 DTI, 2.0 Turbo, 2.2 DTI, 2.8, 2.8 V6 Turbo, 3.2 V6	10.04 -	1135	1215	E90-65-011-03-22	A, 18, 20, 78, 21, 138, 161	30	30							T
1.9 CDTI, 3.0 V6 CDTI	05.03 - 09.04	1230	1215	E90-65-011-06-22	A, 18, 20, 78, 21, 106, 161	30	30							T
1.9 CDTI, 2.8, 2.8 V6 Turbo, 3.0 V6 CDTI, 3.2 V6	10.04 -	1230	1215	E90-65-011-05-22	A, 18, 20, 78, 21, 138, 161	30	30							T
SPEEDSTER Pro-Kit (Performance Fahrwerksfedern Performance Springs) 2.2	09.00 -	450	700	E10-65-008-01-22	A, 18, 20	25	25					F11-65-008-01-VA	F11-65-008-01-HA	T
TIGRA (95.) Pro-Kit (Performance Fahrwerksfedern Performance Springs) 1.4 16V, 1.6 16V	07.94 - 12.00	780	650	E6535-140	A, 18, 20	30	30					F6535001	F6535002	T
TIGRA TwinTop Pro-Kit (Performance Fahrwerksfedern Performance Springs) 1.4, 1.8	06.04 -	865	680	E10-65-005-01-22	A, 18, 20	25-30	25-30					F11-65-002-02-VA	F6528102	T
B12 Pro-Kit (Performance Komplettfahrwerke Performance Springs+Shocks) 1.4, 1.8	06.04 -	865	680	E90-65-005-02-22	A, 18, 20, 78, 89, 91, 161	30	30							T
1.4, 1.8	06.04 -	865	680	E90-65-005-01-22	A, 18, 20, 78, 90, 92, 161	30	30							T
VECTRA A (86., 87.) Pro-Kit (Performance Fahrwerksfedern Performance Springs) 1.4 S, 1.6, 1.6 i, 1.7 D, 1.7 TD, 1.8 S, 1.8 i KAT, 2.0, 2.0 i, 2.0 i 16V, 2.0 i KAT 1.4 S, 1.6, 1.6 i, 1.7 D, 1.7 TD, 1.8 S, 1.8 i CAT, 2.0, 2.0 i, 2.0 i 16V, 2.0 i CAT 2.5 V6	09.88 - 11.95	915	830	E6522-140	A, 18, 20	30	30					F6517001	F6522102	T
	02.93 - 11.95	975	830	E6529-140	A, 18, 20	35	35					F6529001	F6522102	T
B12 Pro-Kit (Performance Komplettfahrwerke Performance Springs+Shocks) 1.4 S, 1.6, 1.6 i, 1.7 D, 1.7 TD, 1.8 S, 1.8 i KAT, 2.0, 2.0 i, 2.0 i 16V, 2.0 i KAT 1.4 S, 1.6, 1.6 i, 1.7 D, 1.7 TD, 1.8 S, 1.8 i CAT, 2.0, 2.0 i, 2.0 i 16V, 2.0 i CAT 2.5 V6	09.88 - 11.95	915	830	E90-65-024-01-22	A, 18, 20, 78, 161	30	30							T
	02.93 - 11.95	975	830	E90-65-024-02-22	A, 18, 20, 78, 161	35	35							T
VECTRA A CC (88., 89.) VECTRA A Hatchback (88., 89.) Pro-Kit (Performance Fahrwerksfedern Performance Springs) 1.4 S, 1.6 S, 1.6 i, 1.6 i KAT, 1.7 D, 1.7 TD, 1.8 S, 1.8 i, 1.8 i KAT, 2.0, 2.0 i, 2.0 i 16V, 2.0 i 16V KAT, 2.0 i GT, 2.0 i KAT 1.4 S, 1.6 S, 1.6 i, 1.6 i CAT, 1.7 D, 1.7 TD, 1.8 S, 1.8 i, 1.8 i CAT, 2.0, 2.0 i, 2.0 i 16V, 2.0 i 16V CAT, 2.0 i CAT, 2.0 i GT 2.5 V6	04.88 - 11.95	915	830	E6522-140	A, 18, 20	30	30					F6517001	F6522102	T
	02.93 - 11.95	975	830	E6529-140	A, 18, 20	35	35					F6529001	F6522102	T
B12 Pro-Kit (Performance Komplettfahrwerke Performance Springs+Shocks) 1.4 S, 1.6 S, 1.6 i, 1.6 i KAT, 1.7 D, 1.7 TD, 1.8 S, 1.8 i, 1.8 i KAT, 2.0, 2.0 i, 2.0 i 16V, 2.0 i 16V KAT, 2.0 i GT, 2.0 i KAT 1.4 S, 1.6 S, 1.6 i, 1.6 i CAT, 1.7 D, 1.7 TD, 1.8 S, 1.8 i, 1.8 i CAT, 2.0, 2.0 i, 2.0 i 16V, 2.0 i 16V CAT, 2.0 i CAT, 2.0 i GT 2.5 V6	04.88 - 11.95	915	830	E90-65-024-01-22	A, 18, 20, 78, 161	30	30							T
	02.93 - 11.95	975	830	E90-65-024-02-22	A, 18, 20, 78, 161	35	35							T
VECTRA B (36.) Pro-Kit (Performance Fahrwerksfedern Performance Springs) 1.6 GL, 1.6 i, 1.6 i 16V	09.95 - 04.02	870	945	E6545-140	A, 18, 20, 68	30	30					F6518001	F6537002	T
1.6 GL, 1.6 i, 1.6 i 16V, 1.7 TD, 1.8 i 16V, 2.0 i, 2.0 i 16V, 2.5 i V6	09.95 - 04.02	975	945	E6537-140	A, 18, 20, 68	35	30					F6537001	F6537002	T
2.2 i 16V	09.00 - 04.02	975	945	E6537-140	A, 18, 20, 68	30	35					F6537001	F6537002	T
1500 2.5	05.98 - 09.00	975	945	E6537-140	A, 18, 20, 68	35	35					F6537001	F6537002	T
2.0 DI 16V, 2.0 DTI 16V, 2.2 DTI 16V, 2.6 i V6, i 500 2.5	11.96 - 04.02	1055	945	E6538-140	A, 18, 20, 68	35	35					F6529001	F6537002	T
2.0 i, 2.0 i 16V, 2.5 i V6	10.95 - 04.02	1055	945	E6538-140	A, 18, 20, 68	35	30					F6529001	F6537002	T
B12 Pro-Kit (Performance Komplettfahrwerke Performance Springs+Shocks) 1.6 GL, 1.6 i, 1.6 i 16V	09.95 - 04.02	870	945	E90-65-025-05-22	A, 18, 20, 68, 78, 161	30	30							T
1.6 GL, 1.6 i, 1.6 i 16V, 1.7 TD, 1.8 i 16V, 2.0 i, 2.0 i 16V, 2.2 i 16V, 2.5 i V6	09.95 - 04.02	975	945	E90-65-025-01-22	A, 18, 20, 68, 78, 161	35	35							T
2.0 DI 16V, 2.0 DTI 16V, 2.0 i, 2.0 i 16V, 2.2 DTI 16V, 2.5 i V6, 2.6 i V6	10.95 - 04.02	1055	945	E90-65-025-02-22	A, 18, 20, 68, 78, 161	35	35							T
VECTRA B Caravan (31.) VECTRA B Estate (31.) Pro-Kit (Performance Fahrwerksfedern Performance Springs) 1.6 i, 1.6 i 16V	11.96 - 07.02	870	1025	E6546-140	A, 18, 20, 68	30	30					F6518001	F6539002	T

Modell	Baujahr	Achslast Vorne kg	Achslast Hinten kg	Artikel-Nr.	Hinweise	ca. Tieferl. Vorne mm	ca. Tieferl. Hinten mm	Ø Vorne mm	Ø Hinten mm	Verstellbarkeit Vorne	Verstellbarkeit Hinten	Ersatzteilbezeichnung Vorne	Ersatzteilbezeichnung Hinten	Gutachten
Model	Year	Front Axle Load kg	Rear Axle Load kg	Part-No.	Notes	ca. Lowering Front mm	ca. Lowering Rear mm	Ø Front mm	Ø Rear mm	Adjustable Front	Adjustable Rear	Spare Part Marking Front	Spare Part Marking Rear	Homologation
VECTRA B Caravan (31_)														
VECTRA B Estate (31_)														
<i>Pro-Kit (Performance Fahrwerksfedern Performance Springs)</i>														
1.6 i, 1.6 i 16V, 1.7 TD, 1.8 i 16V, 2.0 i, 2.0 i 16V, 2.2 i 16V, 2.5 i V6, i 500 2.5	11.96 - 07.03	975	1025	E6539-140	A, 18, 20, 68	30	30					F6537001	F6539002	T
2.0 DI 16V, 2.0 DTI 16V, 2.0 i, 2.0 i 16V, 2.2 DTI 16V, 2.2 i 16V, 2.5 i V6, 2.6 i V6, i 500 2.5	11.96 - 07.03	1055	1025	E6540-140	A, 18, 20, 68	30	30					F6529001	F6539002	T
B12 Pro-Kit (Performance Komplettfahrwerke Performance Springs+Shocks)														
1.6 i, 1.6 i 16V	11.96 - 07.02	870	1025	E90-65-025-06-22	A, 18, 20, 68, 78,	161	30	30						T
1.6 i, 1.6 i 16V, 1.7 TD, 1.8 i 16V, 2.0 i, 2.0 i 16V, 2.2 i 16V, 2.5 i V6	11.96 - 07.03	975	1025	E90-65-025-03-22	A, 18, 20, 68, 78,	161	30	30						T
2.0 DI 16V, 2.0 DTI 16V, 2.0 i, 2.0 i 16V, 2.2 DTI 16V, 2.2 i 16V, 2.5 i V6, 2.6 i V6	11.96 - 07.03	1055	1025	E90-65-025-04-22	A, 18, 20, 68, 78,	161	30	30						T
VECTRA B CC (38_)														
VECTRA B Hatchback (38_)														
<i>Pro-Kit (Performance Fahrwerksfedern Performance Springs)</i>														
1.6 i, 1.6 i 16V	10.95 - 07.03	870	945	E6545-140	A, 18, 20, 68	30	30					F6518001	F6537002	T
1.6 i, 1.6 i 16V, 1.7 TD, 2.0 i, 2.0 i 16V, 2.2 i 16V	10.95 - 07.03	975	945	E6537-140	A, 18, 20, 68	35	30					F6537001	F6537002	T
1.8 i 16V, 2.5, 2.5 i V6	10.95 - 07.03	975	945	E6537-140	A, 18, 20, 68	35	35					F6537001	F6537002	T
2.0 i, 2.0 i 16V	10.95 - 02.02	1055	945	E6538-140	A, 18, 20, 68	35	30					F6529001	F6537002	T
2.0 DI 16V, 2.0 DTI 16V, 2.2 DTI 16V, 2.5, 2.5 i V6, 2.6 i V6	10.95 - 07.03	1055	945	E6538-140	A, 18, 20, 68	35	35					F6529001	F6537002	T
B12 Pro-Kit (Performance Komplettfahrwerke Performance Springs+Shocks)														
1.6 i, 1.6 i 16V	10.95 - 07.03	870	945	E90-65-025-05-22	A, 18, 20, 68, 78,	161	30	30						T
1.6 i, 1.6 i 16V, 1.7 TD, 1.8 i 16V, 2.0 i, 2.0 i 16V, 2.2 i 16V, 2.5 i V6	10.95 - 07.03	975	945	E90-65-025-01-22	A, 18, 20, 78, 161	35	35							T
2.0 DI 16V, 2.0 DTI 16V, 2.0 i, 2.0 i 16V, 2.2 DTI 16V, 2.5 i V6, 2.6 i V6	10.95 - 07.03	1055	945	E90-65-025-02-22	A, 18, 20, 68, 78,	161	35	35						T
VECTRA C														
<i>Pro-Kit (Performance Fahrwerksfedern Performance Springs)</i>														
1.6, 1.6 16V, 1.8, 1.8 16V	04.02 -	965	1035	E10-65-007-05-22	A, 18, 20	30	30					F11-65-007-05-VA	F11-65-007-01-HA	T
1.8, 1.8 16V, 1.9 CDTI, 2.0 16V Turbo, 2.2 16V, 2.2 DTI 16V, 2.2 direct, 3.2 V6	04.02 -	1060	1035	E10-65-007-01-22	A, 18, 20	30	30					F11-65-007-01-VA	F11-65-007-01-HA	T
1.9 CDTI, 2.0 16V Turbo, 2.0 DTI 16V, 2.2 DTI 16V, 3.2 V6	04.02 -	1135	1035	E10-65-007-02-22	A, 18, 20	30	30					F11-65-007-02-VA	F11-65-007-01-HA	T
3.0 CDTI, 3.0 CDTI	06.03 -	1230	1035	E10-65-007-07-22	A, 18, 20	30	30					F11-65-007-07-VA	F11-65-007-01-HA	T
B12 Pro-Kit (Performance Komplettfahrwerke Performance Springs+Shocks)														
1.6 16V, 1.8, 1.8 16V	04.02 - 09.04	965	1035	E90-65-007-05-22	A, 18, 20, 78, 101,	106, 161	30	30						T
1.6, 1.6 16V, 1.8, 1.8 16V	10.04 -	965	1035	E90-65-007-06-22	A, 18, 20, 78, 101,	138, 161	30	30						T
1.6 16V, 1.8, 1.8 16V, 1.9 CDTI, 2.0 16V Turbo, 2.0 DTI 16V, 2.2 16V, 2.2 DTI 16V, 2.2 direct, 3.2 V6	04.02 - 09.04	1060	1035	E90-65-007-01-22	A, 18, 20, 78, 101,	106, 161	30	30						T
1.8, 1.8 16V, 1.9 CDTI, 2.0 16V Turbo, 2.0 DTI 16V, 2.2 16V, 2.2 DTI 16V, 2.2 direct, 3.2 V6	10.04 -	1060	1035	E90-65-007-03-22	A, 18, 20, 78, 101,	138, 161	30	30						T
1.9 CDTI, 2.0 16V Turbo, 2.0 DTI 16V, 2.2 DTI 16V, 3.2 V6	04.02 - 09.04	1135	1035	E90-65-007-02-22	A, 18, 20, 78, 101,	106, 161	30	30						T
1.9 CDTI, 2.0 16V Turbo, 2.0 DTI 16V, 2.2 DTI 16V, 3.2 V6	10.04 -	1135	1035	E90-65-007-04-22	A, 18, 20, 78, 101,	138, 161	30	30						T
3.0 CDTI	06.03 - 09.04	1230	1035	E90-65-007-07-22	A, 18, 20, 78, 101,	106, 161	30	30						T
3.0 CDTI, 3.0 CDTI	10.04 -	1230	1035	E90-65-007-08-22	A, 18, 20, 78, 101,	138, 161	30	30						T
VECTRA C Caravan														
VECTRA C Estate														
<i>Pro-Kit (Performance Fahrwerksfedern Performance Springs)</i>														
1.6, 1.6 16V, 1.8, 1.9 CDTI, 2.0 Turbo, 2.2 DTI, 2.2 direct, 3.2 V6	10.03 -	1060	1215	E10-65-011-01-22	A, 18, 20	30	30					F11-65-007-01-VA	F11-65-011-01-HA	T
1.9 CDTI, 2.0 DTI, 2.0 Turbo, 2.2 DTI, 3.2 V6	10.03 -	1135	1215	E10-65-011-02-22	A, 18, 20	30	30					F11-65-007-02-VA	F11-65-011-01-HA	T
3.0 V6 CDTI	10.03 -	1230	1215	E10-65-011-03-22	A, 18, 20	30	30					F11-65-007-07-VA	F11-65-011-01-HA	T
B12 Pro-Kit (Performance Komplettfahrwerke Performance Springs+Shocks)														
1.6, 1.6 16V, 1.8, 1.9 CDTI, 2.0 DTI, 2.0 Turbo, 2.2 DTI, 2.2 direct, 3.2 V6	10.04 -	1060	1215	E90-65-011-01-22	A, 18, 20, 21, 78,	101, 138, 161	30	30						T
1.6 16V, 1.8, 1.9 CDTI, 2.0 Turbo, 2.2 direct, 3.2 V6	10.03 - 09.04	1060	1215	E90-65-011-02-22	A, 18, 20, 21, 78,	101, 106, 161	30	30						T
1.9 CDTI, 2.0 DTI, 2.0 Turbo, 2.2 DTI, 3.2 V6	10.03 - 09.04	1135	1215	E90-65-011-04-22	A, 18, 20, 21, 78,	101, 106, 161	30	30						T
1.9 CDTI, 2.0 DTI, 2.0 Turbo, 2.2 DTI, 3.2 V6	10.04 -	1135	1215	E90-65-011-03-22	A, 18, 20, 21, 78,	101, 138, 161	30	30						T
3.0 V6 CDTI	10.03 - 09.04	1230	1215	E90-65-011-06-22	A, 18, 20, 21, 78,	101, 106, 161	30	30						T
3.0 V6 CDTI	10.04 -	1230	1215	E90-65-011-05-22	A, 18, 20, 21, 78,	101, 138, 161	30	30						T
VECTRA C GTS														
<i>Pro-Kit (Performance Fahrwerksfedern Performance Springs)</i>														
1.6, 1.8, 1.8 16V	08.02 -	965	1035	E10-65-007-05-22	A, 18, 20	15	15					F11-65-007-05-VA	F11-65-007-01-HA	T
1.8, 1.8 16V, 1.9 CDTI, 2.0 16V Turbo, 2.2 16V, 2.2 DTI 16V, 2.2 direct, 3.2 V6	08.02 -	1060	1035	E10-65-007-01-22	A, 18, 20	15	15					F11-65-007-01-VA	F11-65-007-01-HA	T

Modell	Baujahr	Achslast Vorne kg	Achslast Hinten kg	Artikel-Nr.	Hinweise	ca. Tieferl. Vorne mm	ca. Tieferl. Hinten mm	Ø Vorne mm	Ø Hinten mm	Verstellbarkeit Vorne	Verstellbarkeit Hinten	Ersatzteilbezeichnung Vorne	Ersatzteilbezeichnung Hinten	Gutachten
Model	Year	Front Axle Load kg	Rear Axle Load kg	Part-No.	Notes	ca. Lowering Front mm	ca. Lowering Rear mm	Ø Front mm	Ø Rear mm	Adjustable Front	Adjustable Rear	Spare Part Marking Front	Spare Part Marking Rear	Homologation
VECTRA C GTS <i>Pro-Kit (Performance Fahrwerksfedern Performance Springs)</i> 1.9 CDTI, 2.0 16V Turbo, 2.0 DTI 16V, 2.2 DTI 16V, 3.2 V6	08.02 -	1135	1035	E10-65-007-02-22	A, 18, 20	15	15					F11-65-007-02-VA	F11-65-007-01-HA	T
3.0 CDTI, 3.0 CDTI	06.03 -	1230	1035	E10-65-007-07-22	A, 18, 20	15	15					F11-65-007-07-VA	F11-65-007-01-HA	T
B12 Pro-Kit (Performance Komplettfahrwerke Performance Springs+Shocks) 1.8 16V	08.02 - 09.04	965	1035	E90-65-007-05-22	A, 18, 20, 78, 101, 107, 161	30	30							T
1.8 16V	08.02 - 09.04	965	1035	E90-65-007-05-22	A, 18, 20, 78, 101, 138, 161	30	30							T
1.6, 1.8, 1.8 16V	10.04 -	965	1035	E90-65-007-06-22	A, 18, 20, 78, 101, 138, 161	30	30							T
1.8 16V	08.02 - 09.04	1060	1035	E90-65-007-01-22	A, 18, 20, 78, 101, 138, 161	30	30							T
1.8 16V, 1.9 CDTI, 2.0 16V Turbo, 2.2 16V, 2.2 DTI 16V, 2.2 direct, 3.2 V6	08.02 - 09.04	1060	1035	E90-65-007-01-22	A, 18, 20, 78, 101, 107, 161	30	30							T
1.8, 1.8 16V, 1.9 CDTI, 2.0 16V Turbo, 2.2 16V, 2.2 DTI 16V, 2.2 direct, 3.2 V6	10.04 -	1060	1035	E90-65-007-03-22	A, 18, 20, 78, 101, 138, 161	30	30							T
1.9 CDTI, 2.0 16V Turbo, 2.0 DTI 16V, 2.2 DTI 16V, 3.2 V6	08.02 - 09.04	1135	1035	E90-65-007-02-22	A, 18, 20, 78, 101, 107, 161	30	30							T
1.9 CDTI, 2.0 16V Turbo, 2.0 DTI 16V, 2.2 DTI 16V, 3.2 V6	10.04 -	1135	1035	E90-65-007-04-22	A, 18, 20, 78, 101, 138, 161	30	30							T
3.0 CDTI	06.03 - 09.04	1230	1035	E90-65-007-07-22	A, 18, 20, 78, 101, 107, 161	30	30							T
3.0 CDTI, 3.0 CDTI	10.04 -	1230	1035	E90-65-007-04-22	A, 18, 20, 78, 101, 138, 161	30	30							T
ZAFIRA A (F75) <i>Pro-Kit (Performance Fahrwerksfedern Performance Springs)</i> 1.6 16V, 1.8 16V, 2.0 DI 16V, 2.0 DTI, 2.0 DTI 16V, 2.2 16V, 2.2 DTI 16V	04.99 - 06.05	1075	1130	E6549-140	A, 18, 20	30	30					F6537001	F6549002	T
B12 Pro-Kit (Performance Komplettfahrwerke Performance Springs+Shocks) 1.6 16V, 1.8 16V, 2.0 DI 16V, 2.0 DTI 16V, 2.2 16V, 2.2 DTI 16V	04.99 - 06.05	1075	1130	E90-65-006-01-22	A, 18, 20, 78, 161	30	30							T
ZAFIRA B (A05) <i>Pro-Kit (Performance Fahrwerksfedern Performance Springs)</i> 1.6, 1.6 CNG, 1.8	07.05 -	1030	1230	E10-65-014-01-22	A, 18, 20	30	30-35					F11-65-007-01-VA	F6549002	T
1.7 CDTI, 1.9 CDTI, 2.0, 2.2	07.05 -	1155	1230	E10-65-014-02-22	A, 18, 20	30	30-35					F11-65-014-02-VA	F6549002	T
B12 Pro-Kit (Performance Komplettfahrwerke Performance Springs+Shocks) 1.6, 1.6 CNG, 1.8	07.05 -	1030	1230	E90-65-014-01-22	A, 18, 20, 21, 78, 101, 161	30	30-35							T
1.7 CDTI, 1.9 CDTI, 2.0, 2.2	07.05 -	1155	1230	E90-65-014-02-22	A, 18, 20, 21, 78, 101, 161	30	30-35							T
ZAFIRA B Van <i>Pro-Kit (Performance Fahrwerksfedern Performance Springs)</i> 1.8	07.05 -	1030	1230	E10-65-014-01-22	A, 18, 20	30	30-35					F11-65-007-01-VA	F6549002	T
1.7 CDTI	01.08 -	1155	1230	E10-65-014-02-22	A, 18, 20	30	30-35					F11-65-014-02-VA	F6549002	T
B12 Pro-Kit (Performance Komplettfahrwerke Performance Springs+Shocks) 1.8	07.05 -	1030	1230	E90-65-014-01-22	A, 18, 20, 21, 78, 101, 161	30	30-35							T
1.7 CDTI	01.08 -	1155	1230	E90-65-014-02-22	A, 18, 20, 21, 78, 101, 161	30	30-35							T
ZAFIRA C (P12) <i>Pro-Kit (Performance Fahrwerksfedern Performance Springs)</i> 1.4, 1.6 SIDI, 1.8	10.11 -	1130	1251	E10-65-028-03-22	A, 18, 20, 66	25	20					F11-65-028-01-VA	F11-65-011-01-HA	T
1.4, 1.6 SIDI, 1.8	10.11 -	1130	1251	E10-65-028-01-22	A, 18, 20, 67	25	20					F11-65-028-01-VA	F11-65-011-01-HA	T
1.6 CDTI, 2.0 BiTurbo CDTI, 2.0 CDTI	10.11 -	1250	1251	E10-65-028-04-22	A, 18, 20, 66	25	20					F11-65-028-02-VA	F11-65-011-01-HA	T
1.6 CDTI, 2.0 BiTurbo CDTI, 2.0 CDTI	10.11 -	1250	1251	E10-65-028-02-22	A, 18, 20, 67	25	20					F11-65-028-02-VA	F11-65-011-01-HA	T
106 I (1A, 1C) <i>Pro-Kit (Performance Fahrwerksfedern Performance Springs)</i> 1.1, 1.3, 1.4, 1.6	08.91 - 04.96	640	620	E7001-120	A, 18, 20	25-35	30					F7001001	Drehstabverstellung torsion bar	T
1.0, 1.4, 1.4 D, 1.5 D	08.91 - 04.96	650	640	E7003-120	A, 18, 20	30-40	30					F7003001	Drehstabverstellung torsion bar	T
Sportline (Performance Fahrwerksfedern Sport Sport Performance Springs) 1.0, 1.1, 1.3, 1.4, 1.4 D, 1.5 D, 1.6	08.91 - 04.96	785	640	E20-70-001-01-20	A, 20	45-50	30					F21-70-002-01-VA	Drehstabverstellung torsion bar	T
B12 Pro-Kit (Performance Komplettfahrwerke Performance Springs+Shocks) 1.1, 1.3, 1.4, 1.6	08.91 - 04.96	640	620	E90-70-001-01-20	A, 18, 20, 78, 161	25-35	30							T
1.0, 1.4, 1.4 D, 1.5 D	08.91 - 04.96	650	640	E90-70-001-02-20	A, 18, 20, 78, 161	30-40	30							T
B12 Sportline (Performance Komplettfahrwerke Sport Sport Performance Springs+Shocks) 1.0, 1.1, 1.3, 1.4, 1.4 D, 1.5 D, 1.6	08.91 - 04.96	785	640	E95-70-001-01-20	A, 20, 78, 161	45-50								T
106 II (1) <i>Pro-Kit (Performance Fahrwerksfedern Performance Springs)</i> 1.0 i, 1.1 i, 1.4 i, 1.5 D, 1.6 S16, 1.6 i	05.96 -	785	640	E7016-120	A, 18, 20	20	20					F2204001	Drehstabverstellung torsion bar	T
Sportline (Performance Fahrwerksfedern Sport Sport Performance Springs) 1.0 i, 1.1 i, 1.4 i, 1.5 D, 1.6 S16, 1.6 i	05.96 -	785	640	E20-70-001-01-20	A, 20	45-50	30					F21-70-002-01-VA	Drehstabverstellung torsion bar	T
B12 Pro-Kit (Performance Komplettfahrwerke Performance Springs+Shocks) 1.0 i, 1.1 i, 1.4 i, 1.5 D, 1.6 S16, 1.6 i	05.96 -	640	640	E90-70-001-02-20	A, 18, 20, 78, 161	20	20							T
B12 Sportline (Performance Komplettfahrwerke Sport Sport Performance Springs+Shocks) 1.0 i, 1.1 i, 1.4 i, 1.5 D, 1.6 S16, 1.6 i	05.96 -	785	640	E95-70-001-01-20	A, 20, 78, 161	45-50	30							T

Modell	Baujahr	Achslast Vorne kg	Achslast Hinten kg	Artikel-Nr.	Hinweise	ca. Tieferl. Vorne mm	ca. Tieferl. Hinten mm	Ø Vorne mm	Ø Hinten mm	Verstellbarkeit Vorne	Verstellbarkeit Hinten	Ersatzteilbezeichnung Vorne	Ersatzteilbezeichnung Hinten	Gutachten
Model	Year	Front Axle Load kg	Rear Axle Load kg	Part-No.	Notes	ca. Lowering Front mm	ca. Lowering Rear mm	Ø Front mm	Ø Rear mm	Adjustable Front	Adjustable Rear	Spare Part Marking Front	Spare Part Marking Rear	Homologation
107 Pro-Kit (Performance Fahrwerksfedern Performance Springs) 1.0, 1.4 HDi	06.05 -	695	695	E10-70-008-01-22	A, 18, 20	30-35	25-30					F11-70-008-01-VA	F11-70-008-01-HA	T
B12 Pro-Kit (Performance Komplettfahrwerke Performance Springs+Shocks) 1.0, 1.4 HDi	06.05 -	695	695	E90-70-008-01-22	A, 18, 20, 78, 161	30-35	25-30							T
205 I (741A/C) Pro-Kit (Performance Fahrwerksfedern Performance Springs) 1.6, 1.6 GTI, 1.7 Diesel, 1.9 GTI	02.83 - 10.87	640	620	E7001-120	A, 18, 20	25-35	30					F7001001	Drehstabverstellung torsion bar	T
1.0, 1.1, 1.3, 1.4, 1.5, 1.6	02.83 - 10.87	650	640	E7003-120	A, 18, 20	30-40	30					F7003001	Drehstabverstellung torsion bar	T
205 I Cabriolet (741B, 20D) 205 I Convertible (741B, 20D) Pro-Kit (Performance Fahrwerksfedern Performance Springs) 1.6, 1.6 CJ, 1.6 CTI, 1.9, 1.9 CTI, 1.9 CTi	04.86 - 12.94	640	620	E7001-120	A, 18, 20	25-35	30					F7001001	Drehstabverstellung torsion bar	T
1.1 CJ, 1.4, 1.4 CJ, 1.4 CJ KAT, 1.4 CT, 1.6, 1.6 CJ, 1.6 CTi 1.1 CJ, 1.4, 1.4 CJ, 1.4 CJ KAT, 1.4 CT, 1.6, 1.6 CJ, 1.6 CTi	04.86 - 12.94	650	640	E7003-120	A, 18, 20	30-40	30					F7003001	Drehstabverstellung torsion bar	T
206 CC (2D) Pro-Kit (Performance Fahrwerksfedern Performance Springs) 1.6 16V, 2.0 S16	09.00 -	890	780	E7025-120	A, 18, 20	30	25					F7025001	Drehstabverstellung torsion bar	T
Sportline (Performance Fahrwerksfedern Sport Sport Performance Springs) 1.6 16V, 2.0 S16	09.00 -	890	780	E20-70-002-01-20	A, 20	45-50	30					F21-70-002-01-VA	Drehstabverstellung torsion bar	T
B12 Pro-Kit (Performance Komplettfahrwerke Performance Springs+Shocks) 1.6 16V, 2.0 S16	09.00 -	890	780	E90-70-002-04-20	A, 18, 20, 78, 161	30	30							T
B12 Sportline (Performance Komplettfahrwerke Sport Sport Performance Springs+Shocks) 1.6 16V, 2.0 S16	09.00 -	890	780	E95-70-002-01-20	A, 20, 78, 161	45-50	30							T
Pro-Street-S (Gewindefahrwerke - höhenverstellbar Coil-Overs-Adjustable Ride Height) 1.6 16V, 2.0 S16	09.00 -	890	780	PSS65-70-002-01-22	A, 24, 25, 38, 45, 160	35-65	35-65							T
206 Schrägheck (2A/C) 206 Hatchback (2A/C) Pro-Kit (Performance Fahrwerksfedern Performance Springs) 2.0 RC	07.03 -	850	780	E10-70-002-07-20	A, 18, 20	20-25	20					F11-70-002-07-VA	Drehstabverstellung torsion bar	T
1.0, 1.1, 1.1 i, 1.4 16V, 1.4 i	08.98 -	890	730	E7023-120	A, 18, 20	30	30					F7003001	Drehstabverstellung torsion bar	T
1.6 16V, 1.6 i	09.98 -	890	730	E7024-120	A, 18, 20	30	30					F2204001	Drehstabverstellung torsion bar	T
1.6 HDi 110, 1.9 D, 2.0 HDi 90	09.98 -	890	730	E10-70-002-03-20	A, 18, 20	30	30					F7010001	Drehstabverstellung torsion bar	T
1.4 HDi, 1.4 HDi eco 70, 2.0 S16	04.99 -	890	780	E7025-120	A, 18, 20	25	25					F7025001	Drehstabverstellung torsion bar	T
Sportline (Performance Fahrwerksfedern Sport Sport Performance Springs) 1.0, 1.1, 1.1 i, 1.4 16V, 1.4 HDi, 1.4 HDi eco 70, 1.4 i, 1.6 16V, 1.6 HDi 110, 1.6 i, 1.9 D, 2.0 HDi 90, 2.0 RC, 2.0 S16	08.98 -	890	780	E20-70-002-01-20	A, 20	45-50	30					F21-70-002-01-VA	Drehstabverstellung torsion bar	T
B12 Pro-Kit (Performance Komplettfahrwerke Performance Springs+Shocks) 1.6 16V, 1.6 i	09.98 -	730		E90-70-002-02-20	A, 18, 20, 78, 161	30								T
1.4 HDi, 1.4 HDi eco 70, 2.0 S16	04.99 -	780		E90-70-002-04-20	A, 18, 20, 78, 161	25								T
2.0 RC	07.03 -	850	730	E90-70-002-05-20	A, 18, 20, 78, 161	20-25	20-25							T
1.1, 1.1 i, 1.4 16V, 1.4 i	08.98 -	890	730	E90-70-002-01-20	A, 18, 20, 78, 161	30	30							T
1.6 HDi 110, 1.9 D, 2.0 HDi 90	09.98 -	890	730	E90-70-002-03-20	A, 18, 20, 78, 161	30	30							T
B12 Sportline (Performance Komplettfahrwerke Sport Sport Performance Springs+Shocks) 1.1, 1.1 i, 1.4 16V, 1.4 HDi, 1.4 HDi eco 70, 1.4 i, 1.6 16V, 1.6 i, 1.9 D, 2.0 HDi 90, 2.0 RC, 2.0 S16	08.98 -	890	730	E95-70-002-01-20	A, 20, 78, 161	45-50	30							T
Pro-Street-S (Gewindefahrwerke - höhenverstellbar Coil-Overs-Adjustable Ride Height) 1.0, 1.1, 1.1 i, 1.4 16V, 1.4 HDi, 1.4 HDi eco 70, 1.4 i, 1.6 16V, 1.6 i, 1.9 D, 2.0 HDi 90, 2.0 RC, 2.0 S16	08.98 -	890	780	PSS65-70-002-01-22	A, 24, 25, 38, 45, 160	35-65	35-65							T
206 Stufenheck 206 Saloon Pro-Kit (Performance Fahrwerksfedern Performance Springs) 1.4	03.07 -	890	730	E7023-120	A, 18, 20	30	30					F7003001	Drehstabverstellung torsion bar	T
1.6 16V	03.07 -	890	730	E7024-120	A, 18, 20	30	30					F2204001	Drehstabverstellung torsion bar	T
1.4 HDi eco 70	09.08 -	890	780	E7025-120	A, 18, 20	25	25					F7025001	Drehstabverstellung torsion bar	T
Sportline (Performance Fahrwerksfedern Sport Sport Performance Springs) 1.4 HDi eco 70, 1.6 16V	03.07 -	890	780	E20-70-002-01-20	A, 20	45-50	30					F21-70-002-01-VA	Drehstabverstellung torsion bar	T
B12 Pro-Kit (Performance Komplettfahrwerke Performance Springs+Shocks) 1.4	03.07 -	890	730	E90-70-002-01-20	A, 18, 20, 78, 161	30	30							T
1.6 16V	03.07 -	890	730	E90-70-002-02-20	A, 18, 20, 78, 161	30	30							T
Pro-Street-S (Gewindefahrwerke - höhenverstellbar Coil-Overs-Adjustable Ride Height) 1.4 HDi eco 70, 1.6 16V	03.07 -	890	780	PSS65-70-002-01-22	A, 24, 25, 38, 45, 160	35-65	35-65							T
206 SW (2E/K) Pro-Kit (Performance Fahrwerksfedern Performance Springs) 1.1, 1.4, 1.4 16V	07.02 -	890	730	E7023-120	A, 18, 20	30	30					F7003001	Drehstabverstellung torsion bar	T
1.6 16V	07.02 -	890	730	E7024-120	A, 18, 20	30	30					F2204001	Drehstabverstellung torsion bar	T

Modell	Baujahr	Achslast Vorne kg	Achslast Hinten kg	Artikel-Nr.	Hinweise	ca. Tieferl. Vorne mm	ca. Tieferl. Hinten mm	Ø Vorne mm	Ø Hinten mm	Verstellbarkeit Vorne	Verstellbarkeit Hinten	Ersatzteilbezeichnung Vorne	Ersatzteilbezeichnung Hinten	Gutachten
Model	Year	Front Axle Load kg	Rear Axle Load kg	Part-No.	Notes	ca. Lowering Front mm	ca. Lowering Rear mm	Ø Front mm	Ø Rear mm	Adjustable Front	Adjustable Rear	Spare Part Marking Front	Spare Part Marking Rear	Homologation
206 SW (2E/K) Pro-Kit (Performance Fahrwerksfedern Performance Springs) 1.6 HDi 110, 2.0 HDi	07.02 -	890	730	E10-70-002-03-20	A, 18, 20	30	30					F7010001	Drehstabverstellung torsion bar	T
1.4 HDi, 2.0 16V	07.02 -	890	780	E7025-120	A, 18, 20	30	25					F7025001	Drehstabverstellung torsion bar	T
Sportline (Performance Fahrwerksfedern Sport Sport Performance Springs) 1.1, 1.4, 1.4 16V, 1.4 HDi, 1.6 16V, 1.6 HDi 110, 2.0 16V, 2.0 HDi	07.02 -	890	780	E20-70-002-01-20	A, 20	45-50	30					F21-70-002-01-VA	Drehstabverstellung torsion bar	T
B12 Pro-Kit (Performance Komplettfahrwerke Performance Springs+Shocks) 1.4 HDi, 2.0 16V	07.02 -			E90-70-002-04-20	A, 18, 20, 78, 161									T
1.1, 1.4, 1.4 16V	07.02 -	890	730	E90-70-002-01-20	A, 18, 20, 78, 161	30	30							T
1.6 16V	07.02 -	890	730	E90-70-002-02-20	A, 18, 20, 78, 161	30	30							T
1.6 HDi 110, 2.0 HDi	07.02 -	890	730	E90-70-002-03-20	A, 18, 20, 78, 161	30	30							T
B12 Sportline (Performance Komplettfahrwerke Sport Sport Performance Springs+Shocks) 1.1, 1.4, 1.4 16V, 1.4 HDi, 1.6 16V, 1.6 HDi 110, 2.0 16V, 2.0 HDi	07.02 -	890	730	E95-70-002-01-20	A, 18, 20, 78, 161	30	30							T
Pro-Street-S (Gewindefahrwerke - höhenverstellbar Coil-Overs-Adjustable Ride Height) 1.1, 1.4, 1.4 16V, 1.4 HDi, 1.6 16V, 1.6 HDi 110, 2.0 16V, 2.0 HDi	07.02 -	890	780	PSS65-70-002-01-22	A, 24, 25, 38, 45, 160	35-65	35-65							T
206+ (T3E) Pro-Kit (Performance Fahrwerksfedern Performance Springs) 1.1, 1.4 HDi eco 70, 1.4 i	01.09 -	855	780	E7024-120	A, 18, 20	20-25	10-15					F2204001	Drehstabverstellung torsion bar	T
B12 Pro-Kit (Performance Komplettfahrwerke Performance Springs+Shocks) 1.1, 1.4 HDi eco 70, 1.4 i	01.09 -	890	730	E90-70-002-02-20	A, 18, 20, 78, 161	20-25	10-15							T
207 (WA., WC.) Pro-Kit (Performance Fahrwerksfedern Performance Springs) 1.4, 1.4 16V, 1.4 Bioflex, 1.6 16V, 1.6 16V RC, 1.6 16V Turbo, 1.6 16V VTI	02.06 -	1000	900	E10-70-010-01-22	A, 18, 20	30	30					F11-70-009-01-VA	F11-70-009-01-HA	T
1.4 HDi, 1.6 HDi, 1.6 HDi 110	02.06 -	1050	900	E10-70-010-02-22	A, 18, 20	30	30					F11-70-010-02-VA	F11-70-009-01-HA	T
B12 Pro-Kit (Performance Komplettfahrwerke Performance Springs+Shocks) 1.4	08.08 -	1000	900	E90-70-010-02-22	A, 18, 20, 50, 78, 161	30	30							T
1.4, 1.4 16V, 1.4 Bioflex, 1.6 16V, 1.6 16V Turbo	02.06 -	1000	900	E90-70-010-02-22	A, 18, 20, 78, 78, 161	30	30							T
1.4, 1.4 16V, 1.4 Bioflex, 1.6 16V, 1.6 16V Turbo	02.06 -	1000	900	E90-70-010-01-22	A, 18, 20, 78, 99, 161	30	30							T
1.4 HDi, 1.6 HDi, 1.6 HDi 110	02.06 -	1050	900	E90-70-010-04-22	A, 18, 20, 78, 78, 161	30	30							T
1.4 HDi, 1.6 HDi, 1.6 HDi 110	02.06 -	1050	900	E90-70-010-03-22	A, 18, 20, 78, 99, 161	30	30							T
Pro-Street-S (Gewindefahrwerke - höhenverstellbar Coil-Overs-Adjustable Ride Height) 1.4, 1.4 16V, 1.4 Bioflex, 1.4 HDi, 1.6 16V, 1.6 16V RC, 1.6 16V Turbo, 1.6 16V VTI, 1.6 HDi, 1.6 HDi 110	02.06 -	1000	900	PSS65-70-010-01-22	A, 24, 25, 38, 45, 50, 160	35-65	35-65							T
207 CC (WD.) Pro-Kit (Performance Fahrwerksfedern Performance Springs) 1.6 16V, 1.6 16V Turbo, 1.6 HDi	02.07 -	1050	900	E10-70-010-02-22	A, 18, 20	30	30					F11-70-010-02-VA	F11-70-009-01-HA	T
B12 Pro-Kit (Performance Komplettfahrwerke Performance Springs+Shocks) 1.6 16V, 1.6 16V Turbo, 1.6 HDi	02.07 -	1050	900	E90-70-010-04-22	A, 18, 20, 78, 78, 161	30	30							T
Pro-Street-S (Gewindefahrwerke - höhenverstellbar Coil-Overs-Adjustable Ride Height) 1.6 16V, 1.6 16V Turbo, 1.6 HDi	02.07 -	1000	900	PSS65-70-010-01-22	A, 24, 25, 38, 45, 50, 160	35-65	35-65							T
207 Stufenheck 207 Saloon Pro-Kit (Performance Fahrwerksfedern Performance Springs) 1.4, 1.4 Bioflex, 1.6 Bioflex	12.07 -	1000	900	E10-70-010-01-22	A, 18, 20	30	30					F11-70-009-01-VA	F11-70-009-01-HA	T
207 SW (WK.) Pro-Kit (Performance Fahrwerksfedern Performance Springs) 1.4, 1.4 16V, 1.6 16V, 1.6 16V RC	02.07 -	1000	900	E10-70-010-03-22	A, 18, 20	30	30					F11-70-009-01-VA	F11-70-010-01-HA	T
1.6 HDi	06.07 -	1050	900	E10-70-010-04-22	A, 18, 20	30	30					F11-70-010-02-VA	F11-70-010-01-HA	T
207 Van Pro-Kit (Performance Fahrwerksfedern Performance Springs) 1.4 HDi, 1.6 HDi	04.07 -	1050	900	E10-70-010-04-22	A, 18, 20	30	30					F11-70-010-02-VA	F11-70-010-01-HA	T
208 Pro-Kit (Performance Fahrwerksfedern Performance Springs) 1.0, 1.2, 1.4, 1.4 HDi, 1.6, 1.6 GTi, 1.6 HDi	03.12 -	1000	900	E10-70-010-01-22	A, 18, 20	25	25					F11-70-009-01-VA	F11-70-009-01-HA	T
306 (7B, N3, N5) Pro-Kit (Performance Fahrwerksfedern Performance Springs) 1.1, 1.4 SL, 1.6, 1.6 SR	06.94 - 05.01	950	820	E7010-120	A, 18, 20	30	30					F7010001	Drehstabverstellung torsion bar	T
1.8, 1.8 16V, 1.8 ST, 1.9 D, 1.9 SLD, 1.9 SRDT, 1.9 STD, 2.0, 2.0 HDi 90, 2.0 S16, 2.0 ST	02.94 - 05.01	950	820	E7011-120	A, 18, 20	30	30					F7011001	Drehstabverstellung torsion bar	T
B12 Pro-Kit (Performance Komplettfahrwerke Performance Springs+Shocks) 1.1, 1.4 SL, 1.6, 1.6 SR	06.94 - 05.01	950	820	E90-70-003-01-20	A, 18, 20, 78, 161	30	30							T
1.8, 1.8 16V, 1.8 ST, 1.9 D, 1.9 SLD, 1.9 SRDT, 1.9 STD, 2.0, 2.0 HDi 90, 2.0 S16, 2.0 ST	02.94 - 05.01	950	820	E90-70-003-02-20	A, 18, 20, 78, 161	30	30							T
306 Break (7E, N3, N5) Pro-Kit (Performance Fahrwerksfedern Performance Springs) 1.4, 1.6	03.97 - 04.02	950	820	E7010-120	A, 18, 20	30	30					F7010001	Drehstabverstellung torsion bar	T

Modell	Baujahr	Achslast Vorne kg	Achslast Hinten kg	Artikel-Nr.	Hinweise	ca. Tieferl. Vorne mm	ca. Tieferl. Hinten mm	Ø Vorne mm	Ø Hinten mm	Verstellbarkeit Vorne	Verstellbarkeit Hinten	Ersatzteilbezeichnung Vorne	Ersatzteilbezeichnung Hinten	Gutachten
Model	Year	Front Axle Load kg	Rear Axle Load kg	Part-No.	Notes	ca. Lowering Front mm	ca. Lowering Rear mm	Ø Front mm	Ø Rear mm	Adjustable Front	Adjustable Rear	Spare Part Marking Front	Spare Part Marking Rear	Homologation
306 Break (7E, N3, N5) <i>Pro-Kit (Performance Fahrwerksfedern Performance Springs)</i> 1.8, 1.8 16V, 1.9 D, 1.9 TD, 2.0, 2.0 HDI 90	02.97 - 04.02	950	820	E7011-120	A, 18, 20	30	30					F7011001	Drehstabverstellung torsion bar	T
B12 Pro-Kit (Performance Komplettfahrwerke Performance Springs+Shocks) 1.4, 1.6	03.97 - 04.02	950	820	E90-70-003-01-20	A, 18, 20, 78, 161	30	30							T
1.8, 1.8 16V, 1.9 D, 1.9 TD, 2.0, 2.0 HDI 90	02.97 - 04.02	950	820	E90-70-003-02-20	A, 18, 20, 78, 161	30	30							T
306 Cabriolet (7D, N3, N5) 306 Convertible (7D, N3, N5) <i>Pro-Kit (Performance Fahrwerksfedern Performance Springs)</i> 1.6, 1.8, 1.8 16V, 2.0, 2.0 16V	03.94 - 04.02	950	820	E7011-120	A, 18, 20	30	30					F7011001	Drehstabverstellung torsion bar	T
B12 Pro-Kit (Performance Komplettfahrwerke Performance Springs+Shocks) 1.6, 1.8, 1.8 16V, 2.0, 2.0 16V	03.94 - 04.02	950	820	E90-70-003-02-20	A, 18, 20, 78, 161	30	30							T
306 Schrägheck (7A, 7C, N3, N5) 306 Hatchback (7A, 7C, N3, N5) <i>Pro-Kit (Performance Fahrwerksfedern Performance Springs)</i> 1.1, 1.4, 1.6	05.93 - 05.01	950	820	E7010-120	A, 18, 20	30	30					F7010001	Drehstabverstellung torsion bar	T
1.8, 1.8 16V, 1.8 D, 1.9 D, 1.9 DT, 2.0 16V, 2.0 HDI 90, 2.0 S16, 2.0 XSi	04.93 - 05.01	950	820	E7011-120	A, 18, 20	30	30					F7011001	Drehstabverstellung torsion bar	T
B12 Pro-Kit (Performance Komplettfahrwerke Performance Springs+Shocks) 1.1, 1.4, 1.6	05.93 - 05.01	950	820	E90-70-003-01-20	A, 18, 20, 78, 161	30	30							T
1.8, 1.8 16V, 1.8 D, 1.9 D, 1.9 DT, 2.0 16V, 2.0 HDI 90, 2.0 S16, 2.0 XSi	04.93 - 05.01	950	820	E90-70-003-02-20	A, 18, 20, 78, 161	30	30							T
307 (3A/C) <i>Pro-Kit (Performance Fahrwerksfedern Performance Springs)</i> 1.4, 1.4 16V, 1.6 16V, 1.6 BioFlex, 2.0 16V	08.00 -	1050	900	E10-70-004-01-22	A, 18, 20	30	30					F11-70-004-01-VA	F11-70-004-01-HA	T
1.4 HDi, 1.6 HDi, 1.6 HDi 110, 2.0 HDi 110, 2.0 HDi 135, 2.0 HDi 90	08.00 -	1100	900	E10-70-004-02-22	A, 18, 20	30	30					F11-70-004-02-VA	F11-70-004-01-HA	T
Sportline (Performance Fahrwerksfedern Sport Sport Performance Springs) 1.4, 1.4 16V, 1.4 HDi, 1.6 16V, 1.6 BioFlex, 1.6 HDi, 1.6 HDi 110, 2.0 16V, 2.0 HDi 110, 2.0 HDi 135, 2.0 HDi 90	08.00 -	1020	900	E20-70-004-01-22	A, 20	40-50	30					F21-70-004-01-VA	F21-70-004-01-HA	T
B12 Pro-Kit (Performance Komplettfahrwerke Performance Springs+Shocks) 1.4, 1.4 16V, 1.6 16V, 1.6 BioFlex, 2.0 16V	08.00 -	1050	900	E90-70-004-01-22	A, 18, 20, 78, 161	30	30							T
1.4 HDi, 1.6 HDi, 2.0 HDi 110, 2.0 HDi 135, 2.0 HDi 90	08.00 -	1100	900	E90-70-004-02-22	A, 18, 20, 78, 161	30	30							T
B12 Sportline (Performance Komplettfahrwerke Sport Sport Performance Springs+Shocks) 1.4, 1.4 16V, 1.4 HDi, 1.6 16V, 1.6 BioFlex, 1.6 HDi, 1.6 HDi 110, 2.0 16V, 2.0 HDi 110, 2.0 HDi 135, 2.0 HDi 90	08.00 -	1020	900	E95-70-004-01-22	A, 20, 78, 161	40-50	30							T
Pro-Street-S (Gewindefahrwerke - höhenverstellbar Coil-Overs-Adjustable Ride Height) 1.4, 1.4 16V, 1.4 HDi, 1.6 16V, 1.6 HDi, 1.6 HDi 110, 2.0 16V, 2.0 HDi 110, 2.0 HDi 135, 2.0 HDi 90	08.00 -	1000	850	PSS65-70-004-01-22	A, 24, 25, 45, 160	40-70	40-70							T
307 Break (3E) <i>Pro-Kit (Performance Fahrwerksfedern Performance Springs)</i> 1.4, 1.4 16V, 1.6 16V, 1.6 BioFlex, 2.0, 2.0 16V	03.02 -	1050	1105	E10-70-004-05-22	A, 18, 20	30	30					F11-70-004-01-VA	F11-70-004-05-HA	T
1.4 HDi, 1.6 HDi, 1.6 HDi 110, 2.0 HDi 110, 2.0 HDi 90, 2.0 HDi 135	03.02 -	1100	1105	E10-70-004-06-22	A, 18, 20	30	30					F11-70-004-02-VA	F11-70-004-05-HA	T
Pro-Street-S (Gewindefahrwerke - höhenverstellbar Coil-Overs-Adjustable Ride Height) 1.4, 1.4 16V, 1.4 HDi, 1.6 16V, 1.6 BioFlex, 1.6 HDi, 1.6 HDi 110, 2.0, 2.0 16V, 2.0 HDi 110, 2.0 HDi 90, 2.0 HDi 135	03.02 -	1065	1065	PSS65-70-004-02-22	A, 24, 25, 45, 160	30-70	30-70							T
307 CC (3B) <i>Pro-Kit (Performance Fahrwerksfedern Performance Springs)</i> 1.6 16V, 2.0 16V	10.03 -	1050	1105	E10-70-004-09-22	A, 18, 20	30	30					F11-70-004-01-VA	F11-70-004-05-HA	T
2.0 HDi 135	06.05 -	1100	1105	E10-70-004-10-22	A, 18, 20	30	30					F11-70-004-02-VA	F11-70-004-05-HA	T
Pro-Street-S (Gewindefahrwerke - höhenverstellbar Coil-Overs-Adjustable Ride Height) 1.6 16V, 2.0 16V, 2.0 HDi 135	10.03 -	1100	970	PSS65-70-004-01-22	A, 24, 25, 45, 160	35-65	35-65							T
307 SW (3H) <i>Pro-Kit (Performance Fahrwerksfedern Performance Springs)</i> 1.4, 1.4 16V, 1.6 16V, 1.6 BioFlex, 2.0 16V	03.02 -	1050	1105	E10-70-004-05-22	A, 18, 20	30	30					F11-70-004-01-VA	F11-70-004-05-HA	T
1.6 HDi 110, 1.6 HDi 90, 2.0 HDi 110, 2.0 HDi 90, 2.0 HDi 135	03.02 -	1100	1105	E10-70-004-06-22	A, 18, 20	30	30					F11-70-004-02-VA	F11-70-004-05-HA	T
Pro-Street-S (Gewindefahrwerke - höhenverstellbar Coil-Overs-Adjustable Ride Height) 1.4, 1.4 16V, 1.6 16V, 1.6 BioFlex, 1.6 HDi 110, 1.6 HDi 90, 2.0 16V, 2.0 HDi 110, 2.0 HDi 90, 2.0 HDi 135	03.02 -	1065	1065	PSS65-70-004-02-22	A, 24, 25, 45, 160	30-70	30-70							T
308 (4A, 4C) <i>Pro-Kit (Performance Fahrwerksfedern Performance Springs)</i> 1.4 16V, 1.6, 1.6 16V, 1.6 BioFlex, 1.6 GTi, 1.6 HDi	09.07 -	1100	1020	E10-70-012-01-22	A, 18, 20	30	10					F11-70-012-01-VA	F11-70-012-01-HA	T
1.6, 1.6 16V, 1.6 BioFlex, 1.6 GTi, 1.6 HDi, 2.0 HDi	09.07 -	1200	1020	E10-70-012-02-22	A, 18, 20	30	10					F11-70-012-02-VA	F11-70-012-01-HA	T
308 CC <i>Pro-Kit (Performance Fahrwerksfedern Performance Springs)</i> 1.6 16V, 1.6 THP	06.09 -	1100	1020	E10-70-012-01-22	A, 18, 20	35	20					F11-70-012-01-VA	F11-70-012-01-HA	T
1.6 16V, 1.6 HDi, 1.6 THP, 2.0 HDi	04.09 -	1200	1020	E10-70-012-02-22	A, 18, 20	35	20					F11-70-012-02-VA	F11-70-012-01-HA	T
Pro-Street-S (Gewindefahrwerke - höhenverstellbar Coil-Overs-Adjustable Ride Height) 1.6 16V, 1.6 HDi, 1.6 THP	06.09 -	1100	1020	PSS65-70-004-01-22	A, 24, 25, 45, 160	30-60	30-55							T

Modell	Baujahr	Achslast Vorne kg	Achslast Hinten kg	Artikel-Nr.	Hinweise	ca. Tieferl. Vorne mm	ca. Tieferl. Hinten mm	Ø Vorne mm	Ø Hinten mm	Verstellbarkeit Vorne	Verstellbarkeit Hinten	Ersatzteilbezeichnung Vorne	Ersatzteilbezeichnung Hinten	Gutachten
Model	Year	Front Axle Load kg	Rear Axle Load kg	Part-No.	Notes	ca. Lowering Front mm	ca. Lowering Rear mm	Ø Front mm	Ø Rear mm	Adjustable Front	Adjustable Rear	Spare Part Marking Front	Spare Part Marking Rear	Homologation
308 SW <i>Pro-Kit (Performance Fahrwerksfedern Performance Springs)</i> 1.4 16V, 1.6 16V, 1.6 Bioflex, 1.6 HDi	09.07 -	1100	1200	E10-70-012-04-22	A, 18, 20	30	15					F11-70-012-01-VA	F11-70-012-04-HA	T
1.6 16V, 1.6 Bioflex, 1.6 HDi, 2.0 Bioflex, 2.0 HDi	09.07 -	1200	1200	E10-70-012-05-22	A, 18, 20	30	15					F11-70-012-02-VA	F11-70-012-04-HA	T
309 I (10C, 10A) <i>Pro-Kit (Performance Fahrwerksfedern Performance Springs)</i> 1.9 GTI	10.86 - 07.89	750	750	E7005-120	A, 18, 20	20-30	30					F7005001	Drehstabverstellung torsion bar	T
309 II (3C, 3A) <i>Pro-Kit (Performance Fahrwerksfedern Performance Springs)</i> 1.9 GTI, 1.9 GTI 16V	07.89 - 12.93	750	750	E7005-120	A, 18, 20	20-30	30					F7005001	Drehstabverstellung torsion bar	T
406 (8B) <i>Pro-Kit (Performance Fahrwerksfedern Performance Springs)</i> 1.9 D, 1.9 TD, 2.0, 2.0 16V, 2.0 16V HPI, 2.0 HDi 110, 2.0 HDi 90, 2.0 HDi 110, 2.0 Turbo, 2.1 TD 12V, 2.2, 2.2 HDi, 3.0 24V, 3.0 V6	11.95 - 05.04	1230	1200	E7015-140	A, 18, 20	30	30					F7015001	F7014002	T
406 Coupe (8C) <i>Pro-Kit (Performance Fahrwerksfedern Performance Springs)</i> 2.2 HDi, 3.0 V6, 3.0 V6 24V	03.97 - 12.04	1150	950	E7020-140	A, 18, 20	25	25					F7015001	F7019002	T
407 (6D.) <i>Pro-Kit (Performance Fahrwerksfedern Performance Springs)</i> 2.0 HDi, 2.0 HDi 135, 2.2, 2.2 16V	05.04 -	1220	1120	E10-70-007-02-22	A, 18, 20	30-35	25					F11-70-007-02-VA	F11-70-007-01-HA	T
407 SW (6E.) <i>Pro-Kit (Performance Fahrwerksfedern Performance Springs)</i> 2.0 HDi, 2.0 HDi 135, 2.2, 2.2 16V	05.04 -	1220	1120	E10-70-007-06-22	A, 18, 20	30-35	25					F11-70-007-02-VA	F11-70-007-05-HA	T
508 <i>Pro-Kit (Performance Fahrwerksfedern Performance Springs)</i> 1.6 HDi, 1.6 THP, 1.6 VTi	11.10 -	1250	1100	E10-70-016-03-22	A, 18, 20	25	25					F11-70-016-01-VA	F11-22-009-01-HA	T
2.0 HDi	11.10 -	1250	1100	E10-70-016-04-22	A, 18, 20	25	25					F11-70-016-02-VA	F11-22-009-01-HA	T
508 SW <i>Pro-Kit (Performance Fahrwerksfedern Performance Springs)</i> 1.6 HDi, 1.6 THP, 1.6 VTi	11.10 -	1250	1130	E10-70-016-01-22	A, 18, 20	25	25					F11-70-016-01-VA	F11-70-016-01-HA	T
2.0 HDi	11.10 -	1250	1130	E10-70-016-02-22	A, 18, 20	25	25					F11-70-016-02-VA	F11-70-016-01-HA	T
806 (221) <i>Pro-Kit (Performance Fahrwerksfedern Performance Springs)</i> 1.8, 1.9 TD, 2.0, 2.0 16V, 2.0 HDi, 2.0 HDi 16V, 2.0 Turbo, 2.1 td 12V	06.94 - 08.02	1230	1300	E7012-140	A, 18, 20	30	30					F3015001	F3015002	T
807 (E) <i>Pro-Kit (Performance Fahrwerksfedern Performance Springs)</i> 2.0, 2.0 16V, 2.0 HDi, 2.0 HDi, 2.2, 2.2 HDi, 3.0 V6	06.02 -	1370	1300	E10-70-005-01-22	A, 18, 20	30	10					F3015001	F3015002	T
1007 (KM.) <i>Pro-Kit (Performance Fahrwerksfedern Performance Springs)</i> 1.4, 1.4 16V, 1.4 HDi, 1.6 16V	04.05 -	920	825	E10-70-009-01-22	A, 18, 20	30	30					F11-70-009-01-VA	F11-70-009-01-HA	T
B12 Pro-Kit (Performance Komplettfahrwerke Performance Springs+Shocks) 1.4, 1.4 16V, 1.4 HDi, 1.6 16V	04.05 -	920	825	E90-70-009-01-22	A, 18, 20, 78, 161	30	30							T
2008 <i>Pro-Kit (Performance Fahrwerksfedern Performance Springs)</i> 1.2 VTi, 1.6 VTi	03.13 -	1000	900	E10-70-017-01-22	A, 18, 20	30	30					F11-70-009-01-VA	F11-22-010-01-HA	T
1.4 HDi, 1.6 HDi	03.13 -	1000	900	E10-70-017-02-22	A, 18, 20	30	30					F11-70-010-02-VA	F11-22-010-01-HA	T
3008 <i>Pro-Kit (Performance Fahrwerksfedern Performance Springs)</i> 1.6 THP, 1.6 VTi	06.09 -	1150	1110	E10-70-013-01-22	A, 18, 20	30	30					F11-70-012-02-VA	F11-70-013-01-HA	T
1.6 HDi, 2.0 HDi	06.09 -	1200	1110	E10-70-013-02-22	A, 18, 20	30	30					F11-70-013-02-VA	F11-70-013-01-HA	T
4007 (GP.) <i>Pro-Kit (Performance Fahrwerksfedern Performance Springs)</i> 2.2 HDi, 2.4 16V	02.07 -	1150	1300	E10-70-011-01-22	A, 18, 174	25	20					F11-70-011-01-VA	F11-70-011-01-HA	T
4008 <i>Pro-Kit (Performance Fahrwerksfedern Performance Springs)</i> 1.6 HDi AWC, 1.8 HDi AWC	05.12 -	1130	1000	E10-60-016-02-22	A, 18	30	25					F11-60-013-02-VA	F11-60-013-01-HA	T
5008 <i>Pro-Kit (Performance Fahrwerksfedern Performance Springs)</i> 1.6 16V, 1.6 HDi, 2.0 HDi	06.09 -	1200	1250	E10-70-014-01-22	A, 18, 20	20-25	20-25					F11-70-013-02-VA	F11-70-014-01-HA	T
EXPERT (224) <i>Pro-Kit (Performance Fahrwerksfedern Performance Springs)</i> 1.6, 1.8, 1.9 D, 1.9 TD, 2.0, 2.0 HDi, 2.0 HDi	02.96 -	1230	1100	E7012-140	A, 18, 20	30	30					F3015001	F3015002	T
EXPERT Kasten (222) EXPERT Box (222) <i>Pro-Kit (Performance Fahrwerksfedern Performance Springs)</i> 1.6, 1.8, 1.9 D, 1.9 D 70, 1.9 TD, 2.0, 2.0 HDi	02.96 -	1230	1100	E7012-140	A, 18, 20	30	30					F3015001	F3015002	T
EXPERT Pritsche/Fahrgestell (223) EXPERT Platform/Chassis (223) <i>Pro-Kit (Performance Fahrwerksfedern Performance Springs)</i> 1.6, 1.9 D, 1.9 TD, 2.0 HDi	02.96 -	1230	1100	E7012-140	A, 18, 20	30	30					F3015001	F3015002	T

Modell	Baujahr	Achslast Vorne kg	Achslast Hinten kg	Artikel-Nr.	Hinweise	ca. Tieferl. Vorne mm	ca. Tieferl. Hinten mm	Ø Vorne mm	Ø Hinten mm	Verstellbarkeit Vorne	Verstellbarkeit Hinten	Ersatzteilbezeichnung Vorne	Ersatzteilbezeichnung Hinten	Gutachten
Model	Year	Front Axle Load kg	Rear Axle Load kg	Part-No.	Notes	ca. Lowering Front mm	ca. Lowering Rear mm	Ø Front mm	Ø Rear mm	Adjustable Front	Adjustable Rear	Spare Part Marking Front	Spare Part Marking Rear	Homologation
PARTNER Combispace (5F) Pro-Kit (Performance Fahrwerksfedern Performance Springs) 1.1, 1.4, 1.6 16V, 1.8, 1.9 D, 2.0 HDi	03.03 -	1000	1000	E10-22-005-01-20	A, 18, 20	30	30					F7010001	Drehstabverstellung torsion bar	T
1.6 HDi 75, 1.6 HDi 90	03.03 -	1000	1000	E10-22-005-01-20	A, 18, 20	30	30					F7010001		T
1.1, 1.4, 1.6 16V, 1.8, 1.9 D, 2.0 HDi	05.96 - 02.03	1110	800	E7021-120	A, 18, 20	25	25					F7011001	Drehstabverstellung torsion bar	T
PARTNER Kasten (5) PARTNER Box (5) Pro-Kit (Performance Fahrwerksfedern Performance Springs) 1.1, 1.4, 1.6 HDi 75, 1.6 HDi 90, 1.8 D, 1.9 D, 2.0 HDi	03.03 -	1000	1000	E10-22-005-01-20	A, 18, 20	30	30					F7010001	Drehstabverstellung torsion bar	T
1.1, 1.4, 1.6, 1.8 D, 1.9 D, 2.0 HDi	05.96 - 02.03	1110	800	E7021-120	A, 18, 20	25	25					F7011001	Drehstabverstellung torsion bar	T
PARTNER Kasten PARTNER Box Pro-Kit (Performance Fahrwerksfedern Performance Springs) 1.6 HDi 90 Sitzplätze 5, 1.6 HDi Sitzplätze 5, 1.6 Sitzplätze 5 1.6 HDi 90 Seats 5, 1.6 HDi Seats 5, 1.6 Seats 5	04.08 -	1170	1000	E10-22-007-03-22	A, 18, 20, 66	30	10					F11-22-007-03-VA	F11-22-007-03-HA	T
1.6 Anzahl Sitzplätze 7, 1.6 HDi 90 Anzahl Sitzplätze 7, 1.6 HDi Anzahl Sitzplätze 7 1.6 HDi 90 Number of Seats 7, 1.6 HDi Number of Seats 7, 1.6 Number of Seats 7	04.08 -	1170	1230	E10-22-007-05-22	A, 18, 20, 67	30	10					F11-22-007-03-VA	F11-22-007-05-HA	T
PARTNER Tepee Pro-Kit (Performance Fahrwerksfedern Performance Springs) 1.6 HDi 90 Sitzplätze 5, 1.6 HDi Sitzplätze 5, 1.6 Sitzplätze 5 1.6 HDi 90 Seats 5, 1.6 HDi Seats 5, 1.6 Seats 5	04.08 -	1170	1000	E10-22-007-03-22	A, 18, 20, 66	30	10					F11-22-007-03-VA	F11-22-007-03-HA	T
1.6 Anzahl Sitzplätze 7, 1.6 HDi 90 Anzahl Sitzplätze 7, 1.6 HDi Anzahl Sitzplätze 7 1.6 HDi 90 Number of Seats 7, 1.6 HDi Number of Seats 7, 1.6 Number of Seats 7	04.08 -	1170	1230	E10-22-007-05-22	A, 18, 20, 67	30	10					F11-22-007-03-VA	F11-22-007-05-HA	T
RCZ Pro-Kit (Performance Fahrwerksfedern Performance Springs) 1.6 16V	03.10 -	1100	850	E10-70-015-01-22	A, 18, 20	20	20					F11-70-015-01-VA	F11-70-015-01-HA	T
2.0 HDi	03.10 -	1100	850	E10-70-015-02-22	A, 18, 20	20	20					F11-70-015-02-VA	F11-70-015-01-HA	T
911 (964) Pro-Kit (Performance Fahrwerksfedern Performance Springs) 3.3 Turbo, 3.3 Turbo S, 3.6 Carrera, 3.6 Carrera 4, 3.6 Turbo	12.88 - 09.93	780	1100	E7201-140	A, 18	30-40	30					F7201001	F7201002	
911 (993) Pro-Kit (Performance Fahrwerksfedern Performance Springs) 3.6 Carrera, 3.6 Carrera 4, 3.8 Carrera, 3.8 Carrera 4, 3.8 Carrera RS	10.93 - 09.97	760	1080	E7208-140	A, 18	30	30					F7208001	F7208002	T
B12 Pro-Kit (Performance Komplettfahrwerke Performance Springs+Shocks) 3.6 Carrera, 3.6 Carrera 4, 3.8 Carrera, 3.8 Carrera 4	10.93 - 09.97	760	1080	E90-72-002-01-22	A, 18, 20, 78, 129,	30	30		161					T
911 (996) Pro-Kit (Performance Fahrwerksfedern Performance Springs) 3.4 Carrera, 3.6 Carrera, 3.6 Carrera S	09.97 - 08.05	775	1180	E7213-140	A, 18, 20	30	30					F7213001	F7213002	
911 (997) Pro-Kit (Performance Fahrwerksfedern Performance Springs) 3.6 Carrera, 3.8 Carrera S	07.04 -	775	1220	E10-72-007-01-22	A, 18, 20	30	30					F11-72-007-01-VA	F11-72-007-01-HA	T
3.6 Carrera 4, 3.6 Turbo, 3.8 Carrera 4GTS, 3.8 Carrera 4S, 3.8 Carrera GTS, 3.8 Turbo, 3.8 Turbo S	07.04 -	825	1250	E10-72-007-02-22	A, 18	20	20					F11-72-007-02-VA	F11-72-007-02-HA	T
911 (991) Pro-Kit (Performance Fahrwerksfedern Performance Springs) 3.4 Carrera, 3.8 Carrera S	12.11 -	775	1205	E10-72-012-01-22	A, 18, 20, 168	20-25	15					F11-72-012-01-VA	F11-72-012-01-HA	T
3.4 Carrera 4, 3.8 Carrera 4S	11.12 -	790	1215	E10-72-012-02-22	A, 18, 168	20-25	15					F11-72-012-02-VA	F11-72-012-01-HA	T
911 Cabriolet (964) 911 Convertible (964) Pro-Kit (Performance Fahrwerksfedern Performance Springs) 3.6 Carrera, 3.6 Carrera 4	05.89 - 05.94	780	1100	E7201-140	A, 18	30-40	30					F7201001	F7201002	
911 Cabriolet (993) 911 Convertible (993) Pro-Kit (Performance Fahrwerksfedern Performance Springs) 3.6 Carrera, 3.6 Carrera 4, 3.8 Carrera, 3.8 Carrera 4	07.94 - 09.97	760	1080	E7208-140	A, 18	30	30					F7208001	F7208002	T
B12 Pro-Kit (Performance Komplettfahrwerke Performance Springs+Shocks) 3.6 Carrera, 3.6 Carrera 4, 3.8 Carrera, 3.8 Carrera 4	07.94 - 09.97	760	1080	E90-72-002-01-22	A, 18, 20, 78, 129,	30	30		161					T
911 Cabriolet (997) 911 Convertible (997) Pro-Kit (Performance Fahrwerksfedern Performance Springs) 3.6 Carrera, 3.8 Carrera S	04.05 -	775	1220	E10-72-007-01-22	A, 18, 20	30	30					F11-72-007-01-VA	F11-72-007-01-HA	T
3.6 Carrera 4, 3.8 Carrera 4GTS, 3.8 Carrera 4S	04.05 -	825	1250	E10-72-007-02-22	A, 18	20	20					F11-72-007-02-VA	F11-72-007-02-HA	T
911 Cabriolet (991) 911 Convertible (991) Pro-Kit (Performance Fahrwerksfedern Performance Springs) 3.4 Carrera, 3.8 Carrera S	03.12 -	775	1205	E10-72-012-01-22	A, 18, 20, 168	20-25	15					F11-72-012-01-VA	F11-72-012-01-HA	T
3.4 Carrera 4, 3.8 Carrera 4S	11.12 -	790	1215	E10-72-012-02-22	A, 18, 168	20-25	15					F11-72-012-02-VA	F11-72-012-01-HA	T
911 Targa (993) Pro-Kit (Performance Fahrwerksfedern Performance Springs) 3.6 Carrera, 3.8 Carrera	08.95 - 09.97	760	1080	E7208-140	A, 18	30	30					F7208001	F7208002	T

Modell	Baujahr	Achslast Vorne kg	Achslast Hinten kg	Artikel-Nr.	Hinweise	ca. Tieferl. Vorne mm	ca. Tieferl. Hinten mm	Ø Vorne mm	Ø Hinten mm	Verstellbarkeit Vorne	Verstellbarkeit Hinten	Ersatzteilbezeichnung Vorne	Ersatzteilbezeichnung Hinten	Gutachten
Model	Year	Front Axle Load kg	Rear Axle Load kg	Part-No.	Notes	ca. Lowering Front mm	ca. Lowering Rear mm	Ø Front mm	Ø Rear mm	Adjustable Front	Adjustable Rear	Spare Part Marking Front	Spare Part Marking Rear	Homologation
911 Targa (993) B12 Pro-Kit (Performance Komplettfahrwerke Performance Springs+Shocks) 3.6 Carrera, 3.8 Carrera	08.95 - 09.97	760	1080	E90-72-002-01-22	A, 18, 20, 78, 129, 161	30	30							T
911 Targa (996) Pro-Kit (Performance Fahrwerksfedern Performance Springs) 3.6	12.01 - 08.05	775	1180	E7213-140	A, 18, 20	30	30					F7213001	F7213002	
911 Targa (997) Pro-Kit (Performance Fahrwerksfedern Performance Springs) 3.6 Carrera 4, 3.8 Carrera 4S	07.06 -	825	1250	E10-72-007-02-22	A, 18	20	20					F11-72-007-02-VA	F11-72-007-02-HA	T
BOXSTER (986) Pro-Kit (Performance Fahrwerksfedern Performance Springs) 2.5, 2.7	09.96 - 12.04	775	940	E7212-140	A, 18, 20	25	25					F7212001	F7212002	T
B12 Pro-Kit (Performance Komplettfahrwerke Performance Springs+Shocks) 2.5, 2.7	09.96 - 12.04	775	940	E90-72-004-01-22	A, 18, 20, 78, 161	25	25							T
BOXSTER (987) Pro-Kit (Performance Fahrwerksfedern Performance Springs) 2.7, 2.9, S 3.2, S 3.4, Spyder 3.4	11.04 -	785	940	E10-72-006-01-22	A, 18, 20, 56	30	30					F7212001	F7212002	T
B12 Pro-Kit (Performance Komplettfahrwerke Performance Springs+Shocks) 2.7, 2.9, S 3.2, S 3.4, Spyder 3.4	11.04 -	785	940	E90-72-006-01-22	A, 18, 20, 56, 78, 104, 161	30	30							T
BOXSTER Pro-Kit (Performance Fahrwerksfedern Performance Springs) 2.7, S 3.4	04.12 -	785	945	E10-72-013-01-22	A, 18, 20, 168	20	20					F11-72-013-01-VA	F11-72-013-01-HA	T
CAVENNE (955) Pro-Kit (Performance Fahrwerksfedern Performance Springs) 3.2, S 4.5	09.02 -	1460	1680	E10-72-005-01-22	A, 18	35	35					F11-72-005-01-VA	F11-72-005-01-HA	T
Anti-Roll-Kit (Performance Stabilisatoren Performance Sway Bars) 3.2, S 4.5	09.02 - 01.07			E40-72-005-01-11	A, 18, 22, 45			40 Rohr 40 tube	30 Rohr 30 tube	nicht verstellbar not adjustable	nicht verstellbar not adjustable	AS41-72-005-01-VA	AS41-85-011-01-HA	T
B12 Pro-Kit (Performance Komplettfahrwerke Performance Springs+Shocks) 3.2, S 4.5	09.02 - 01.07	1460	1680	E90-72-005-01-22	A, 18, 76, 78, 161	35	35							T
CAVENNE Pro-Kit (Performance Fahrwerksfedern Performance Springs) 3.0 Diesel, 3.6, 4.8 S	06.10 -	1400	1535	E10-72-011-01-22	A, 18	25	25					F11-72-011-01-VA	F11-72-011-01-HA	T
Anti-Roll-Kit (Performance Stabilisatoren Performance Sway Bars) 3.0 Diesel, 3.6, 4.8 S	06.10 -			E40-72-005-01-11	A, 18, 22, 45			40 Rohr 40 tube	30 Rohr 30 tube	nicht verstellbar not adjustable	nicht verstellbar not adjustable	AS41-72-005-01-VA	AS41-85-011-01-HA	T
Pro-Tronic (Elektronische Performance Fahrwerksmodule Electronic Performance Suspension Moduls) Alle Motorisierungen / all motorisation	06.10 -			AM65-15-011-01-22	A, 175									
CAYMAN (987) Pro-Kit (Performance Fahrwerksfedern Performance Springs) 2.7, 2.9, S 3.4 Sport, S 3.4	11.05 -	785	940	E10-72-008-01-22	A, 18, 20, 56	30	30					F7212001	F11-72-008-01-HA	T
B12 Pro-Kit (Performance Komplettfahrwerke Performance Springs+Shocks) 2.7, 2.9, S 3.4 Sport, S 3.4	11.05 -	785	940	E90-72-008-01-22	A, 18, 20, 56, 78, 104, 161	30	30							T
CAYMAN Pro-Kit (Performance Fahrwerksfedern Performance Springs) 2.7, S 3.4	03.13 -	785	945	E10-72-013-01-22	A, 18, 20, 168	20	10					F11-72-013-01-VA	F11-72-013-01-HA	T
PERSONA 300 (C9_M) Pro-Kit (Performance Fahrwerksfedern Performance Springs) 316, 316 GLXi	03.96 -	880	850	E10-61-001-01-22	A, 18, 20	30	30					F6105001	F6025002	T
PERSONA 400 (C9_S) Pro-Kit (Performance Fahrwerksfedern Performance Springs) 1.8, 416, 416 GLXi, 418, 420 GLS D, 420 TD	01.94 -	830	790	E6105-140	A, 18, 20	30	30					F6105001	F6021002	T
PERSONA 400 Hatchback (C9_C, C9_S) Pro-Kit (Performance Fahrwerksfedern Performance Springs) 1.8, 416 GLXi, 416 i, 418 GLXi, 420 D, 420 GLS D	01.94 -	830	790	E6105-140	A, 18, 20	30	30					F6105001	F6021002	T
CLIO Grandtour (KR0/1_) Pro-Kit (Performance Fahrwerksfedern Performance Springs) 1.2 16V, 1.2 16V Hi-Flex	02.08 - 03.09	850	890	E10-75-008-08-22	A, 18, 20	30	25					F11-75-008-01-VA	F11-75-008-08-HA	T
1.2 16V, 1.2 16V Hi-Flex	04.09 -	850	890	E10-75-008-12-22	A, 18, 20	30	25					F11-75-008-10-VA	F11-75-008-08-HA	T
1.5 dCi, 1.6 16V	02.08 - 06.10	950	890	E10-75-008-09-22	A, 18, 20	30	25					F11-75-008-02-VA	F11-75-008-08-HA	T
1.5 dCi, 1.6 16V	04.09 -	950	890	E10-75-008-13-22	A, 18, 20	30	25					F11-75-008-11-VA	F11-75-008-08-HA	T
CLIO I (B/CS7_, S/357_) Pro-Kit (Performance Fahrwerksfedern Performance Springs) 1.1, 1.2, 1.4, 1.7, 1.8, 1.8 16V, 1.8 Rsi, 1.9 D	05.90 - 09.98	770	685	E7514-120	A, 18, 20	30	30					F7514001	Drehstabverstellung torsion bar	T
Sportline (Performance Fahrwerksfedern Sport Sport Performance Springs) 1.1, 1.2, 1.4, 1.7, 1.8, 1.8 16V, 1.8 Rsi, 1.9 D	05.90 - 09.98	770	725	E20-75-001-01-20	A, 20	45-50	30					F21-75-001-01-VA	Drehstabverstellung torsion bar	T
CLIO II (BB0/1/2_, CB0/1/2_) Pro-Kit (Performance Fahrwerksfedern Performance Springs) 1.2, 1.2 16V	09.98 -	800	785	E10-75-001-01-22	A, 18, 20	30	30					F7513001	F7524002	T

Modell	Baujahr	Achslast Vorne kg	Achslast Hinten kg	Artikel-Nr.	Hinweise	ca. Tieferl. Vorne mm	ca. Tieferl. Hinten mm	Ø Vorne mm	Ø Hinten mm	Verstellbarkeit Vorne	Verstellbarkeit Hinten	Ersatzteilbezeichnung Vorne	Ersatzteilbezeichnung Hinten	Gutachten
Model	Year	Front Axle Load kg	Rear Axle Load kg	Part-No.	Notes	ca. Lowering Front mm	ca. Lowering Rear mm	Ø Front mm	Ø Rear mm	Adjustable Front	Adjustable Rear	Spare Part Marking Front	Spare Part Marking Rear	Homologation
CLIO II (BB0/1/2., CB0/1/2.) <i>Pro-Kit (Performance Fahrwerksfedern Performance Springs)</i> 1.4, 1.4 16V, 1.5 dCi, 1.6, 1.6 16V, 1.9 D, 1.9 dTi, 2.0 16V Sport	09.98 -	860	785	E10-75-001-02-22	A, 18, 20	30	30					F7514001	F7524002	T
<i>Sportline (Performance Fahrwerksfedern Sport Sport Performance Springs)</i> 1.2, 1.2 16V	09.98 -	800	785	E20-75-001-02-22	A, 20	45-50	30					F21-75-001-01-VA	F21-75-001-02-HA	T
1.4, 1.4 16V, 1.5 dCi, 1.6, 1.6 16V, 1.9 D, 1.9 dTi, 2.0 16V Sport	09.98 -	860	785	E20-75-001-03-22	A, 20	45-50	30					F21-75-001-03-VA	F21-75-001-02-HA	T
CLIO III (BR0/1, CR0/1) <i>Pro-Kit (Performance Fahrwerksfedern Performance Springs)</i> 1.2 16V, 1.2 16V Hi-Flex	06.05 - 03.09	850	880	E10-75-008-01-22	A, 18, 20	30	30					F11-75-008-01-VA	F11-75-008-01-HA	T
1.2 16V, 1.2 16V Hi-Flex	04.09 -	850	880	E10-75-008-10-22	A, 18, 20	30	30					F11-75-008-10-VA	F11-75-008-01-HA	T
1.4 16V, 1.5 dCi, 1.6 16V, 1.6 16V GT, 2.0 16V	04.09 -	950	880	E10-75-008-11-22	A, 18, 20	30	30					F11-75-008-11-VA	F11-75-008-01-HA	T
1.4 16V, 1.5 dCi, 1.6 16V, 1.6 16V GT, 1.6 Hi-Flex, 2.0 16V	05.05 - 06.10	950	880	E10-75-008-02-22	A, 18, 20	30	30					F11-75-008-02-VA	F11-75-008-01-HA	T
2.0 16V Sport	02.06 -	1000	880	E10-75-008-07-22	A, 18, 20	20	25					F11-75-008-07-VA	F11-75-008-07-HA	T
2.0 16V Sport	02.06 -	1000	880	E10-75-008-14-22	A, 18, 20	15	25					F11-75-008-14-VA	F11-75-008-07-HA	T
CLIO IV <i>Pro-Kit (Performance Fahrwerksfedern Performance Springs)</i> 0.9 TCe 90, 1.2 16V, 1.2 TCe 120	11.12 -	860	860	E10-75-017-01-22	A, 18, 20	25-30	25					F11-75-017-01-VA	F11-75-017-01-HA	T
1.5 dCi 75, 1.5 dCi 90	11.12 -	920	860	E10-75-017-02-22	A, 18, 20	25-30	25					F11-75-008-10-VA	F11-75-017-01-HA	T
FLUENCE (L30) <i>Pro-Kit (Performance Fahrwerksfedern Performance Springs)</i> 1.5 dCi, 1.6 16V, 2.0 16V	06.05 -	1000	1041	E10-75-012-01-22	A, 18, 20	30	25					F11-75-012-01-VA	F11-75-012-01-HA	T
GRAND SCÉNIC II (JM0/1) <i>Pro-Kit (Performance Fahrwerksfedern Performance Springs)</i> 1.5 dCi, 1.6	04.04 -	1130	1230	E10-75-005-06-22	A, 18, 20	30	30					F11-75-003-01-VA	F11-75-005-06-HA	T
1.9 dCi, 2.0, 2.0 dCi	04.04 -	1185	1230	E10-75-005-07-22	A, 18, 20	30	30					F11-75-003-02-VA	F11-75-005-06-HA	T
GRAND SCÉNIC III (JZ0/1) <i>Pro-Kit (Performance Fahrwerksfedern Performance Springs)</i> 1.4 16V, 1.5 dCi, 1.6 16V, 1.9 dCi, 2.0 16V	02.09 -	1110	1260	E10-75-014-03-22	A, 18, 20	20-30	25					F11-75-012-02-VA	F11-75-014-03-HA	T
1.6 dCi, 2.0 dCi	02.09 -	1230	1260	E10-75-014-04-22	A, 18, 20	25	25					F11-75-014-02-VA	F11-75-014-03-HA	T
KOLEOS (HY) <i>Pro-Kit (Performance Fahrwerksfedern Performance Springs)</i> 2.0 dCi, 2.0 dCi 4x4	09.08 -	1235	1180	E10-75-011-01-22	A, 18	30	25					F11-75-011-01-VA	F11-75-011-01-HA	T
LAGUNA Coupe (DT0/1) <i>Pro-Kit (Performance Fahrwerksfedern Performance Springs)</i> 2.0 16V Turbo, 2.0 GT, 3.5 V6	09.08 -	1160	960	E10-75-010-05-22	A, 18, 20	30	20					F11-75-010-01-VA	F11-75-010-05-HA	T
2.0 dCi, 2.0 dCi GT	03.08 -	1280	960	E10-75-010-06-22	A, 18, 20	30	20					F11-75-010-02-VA	F11-75-010-05-HA	T
LAGUNA II (BG0/1) <i>Pro-Kit (Performance Fahrwerksfedern Performance Springs)</i> 1.6 16V, 1.8 16V, 1.9 dCi, 1.9 dCi, 2.0 16V, 2.0 16V IDE, 2.0 16V Turbo	03.01 -	1090	1110	E10-75-002-01-22	A, 18, 20	30	30					F11-75-002-01-VA	F11-75-002-01-HA	T
2.0 dCi, 2.2 dCi, 3.0 V6 24V	03.01 -	1190	1110	E10-75-002-02-22	A, 18, 20	30	30					F11-75-002-02-VA	F11-75-002-01-HA	T
LAGUNA II Grandtour (KG0/1) <i>Pro-Kit (Performance Fahrwerksfedern Performance Springs)</i> 1.6 16V, 1.8 16V, 1.9 dCi, 1.9 dCi, 2.0 16V, 2.0 16V IDE, 2.0 16V Turbo	03.01 -	1090	1110	E10-75-002-03-22	A, 18, 20	30	30					F11-75-002-01-VA	F11-75-002-01-HA	T
2.0 dCi, 2.2 dCi, 3.0 V6 24V	03.01 -	1190	1110	E10-75-002-04-22	A, 18, 20	30	30					F11-75-002-02-VA	F11-75-002-01-HA	T
LAGUNA III (BT0/1) <i>Pro-Kit (Performance Fahrwerksfedern Performance Springs)</i> 1.5 dCi, 1.6 16V, 2.0 16V, 2.0 16V Hi-Flex, 2.0 16V Turbo, 2.0 GT, 3.5 V6	10.07 -	1160	1113	E10-75-010-01-22	A, 18, 20	30	25					F11-75-010-01-VA	F11-75-010-01-HA	T
2.0 dCi, 2.0 dCi GT	10.07 -	1280	1113	E10-75-010-02-22	A, 18, 20	30	25					F11-75-010-02-VA	F11-75-010-01-HA	T
LAGUNA III Grandtour (KT0/1) <i>Pro-Kit (Performance Fahrwerksfedern Performance Springs)</i> 1.5 dCi, 1.6 16V, 2.0 16V, 2.0 16V Hi-Flex, 2.0 16V Turbo, 2.0 GT, 3.5 V6	10.07 -	1160	1113	E10-75-010-03-22	A, 18, 20	30	30					F11-75-010-01-VA	F11-75-010-01-HA	T
2.0 dCi, 2.0 dCi GT	10.07 -	1280	1113	E10-75-010-04-22	A, 18, 20	30	30					F11-75-010-02-VA	F11-75-010-01-HA	T
MEGANE CC (EZ0/1) <i>Pro-Kit (Performance Fahrwerksfedern Performance Springs)</i> 1.4 TCe, 1.5 dCi, 1.6 16V, 1.6 dCi	06.10 -	1000	1260	E10-75-012-06-22	A, 18, 20	30	30					F11-75-012-01-VA	F11-75-014-03-HA	T
1.5 dCi, 1.6 dCi, 2.0 CVT, 2.0 TCe	06.10 -	1110	1260	E10-75-012-07-22	A, 18, 20	30	30					F11-75-012-02-VA	F11-75-014-03-HA	T
1.9 dCi, 2.0 TCe, 2.0 dCi	06.10 -	1230	1260	E10-75-014-04-22	A, 18, 20	30	30					F11-75-014-02-VA	F11-75-014-03-HA	T
MEGANE I (BA0/1) <i>Pro-Kit (Performance Fahrwerksfedern Performance Springs)</i> 1.4 Eco, 1.4 e, 1.6 e, 1.6 i, 2.0 i	01.96 - 08.03	900	870	E7520-120	A, 18, 20	30	30					F7520001	Drehstabverstellung torsion bar	T
MEGANE I Cabriolet (EA0/1) <i>Pro-Kit (Performance Fahrwerksfedern Performance Springs)</i> 1.6 e, 2.0, 2.0 i	10.96 - 08.03	900	870	E7520-120	A, 18, 20	30	30					F7520001	Drehstabverstellung torsion bar	T
MEGANE I Classic (LA0/1) <i>Pro-Kit (Performance Fahrwerksfedern Performance Springs)</i> 1.4, 1.6 e, 1.6 i, 2.0 i	09.96 - 08.03	900	870	E7520-120	A, 18, 20	30	30					F7520001	Drehstabverstellung torsion bar	T

Modell	Baujahr	Achslast Vorne kg	Achslast Hinten kg	Artikel-Nr.	Hinweise	ca. Tieferl. Vorne mm	ca. Tieferl. Hinten mm	Ø Vorne mm	Ø Hinten mm	Verstellbarkeit Vorne	Verstellbarkeit Hinten	Ersatzteilbezeichnung Vorne	Ersatzteilbezeichnung Hinten	Gutachten
Model	Year	Front Axle Load kg	Rear Axle Load kg	Part-No.	Notes	ca. Lowering Front mm	ca. Lowering Rear mm	Ø Front mm	Ø Rear mm	Adjustable Front	Adjustable Rear	Spare Part Marking Front	Spare Part Marking Rear	Homologation
MEGANE I Coach (DA0/1.) Pro-Kit (Performance Fahrwerksfedern Performance Springs) 1.6 e, 2.0 i	03.96 - 08.03	900	870	E7520-120	A, 18, 20	30	30					F7520001	Drehstabverstellung torsion bar	T
MEGANE II (BM0/1., CM0/1.) Pro-Kit (Performance Fahrwerksfedern Performance Springs) 2.0 Renault Sport	05.04 -	1060	930	E10-75-003-15-22	A, 18, 20	25	25					F11-75-003-15-VA	F11-75-003-15-HA	T
1.4 16V, 1.5 dCi, 1.6, 1.6 16V, 1.6 Flex-Fuel	11.02 -	1130	930	E10-75-003-01-22	A, 18, 20	30	30					F11-75-003-01-VA	F11-75-003-01-HA	T
1.9 dCi, 2.0, 2.0 16V, 2.0 16V Turbo, 2.0 dCi	11.02 -	1185	930	E10-75-003-02-22	A, 18, 20	30	30					F11-75-003-02-VA	F11-75-003-01-HA	T
MEGANE II Coupé-Cabriolet (EM0/1.) Pro-Kit (Performance Fahrwerksfedern Performance Springs) 1.5 dCi, 1.6, 1.6 16V	09.03 -	1130	1025	E10-75-003-09-22	A, 18, 20	30	30					F11-75-003-01-VA	F11-75-005-01-HA	T
1.9 dCi, 2.0, 2.0 16V Turbo, 2.0 dCi	09.03 -	1185	1025	E10-75-003-10-22	A, 18, 20	30	30					F11-75-003-02-VA	F11-75-005-01-HA	T
MEGANE II Kombi (KM0/1.) MEGANE II Estate (KM0/1.) Pro-Kit (Performance Fahrwerksfedern Performance Springs) 1.4, 1.5 dCi, 1.6, 1.6 16V, 1.6 16V Hi-Flex	08.03 -	1130	1010	E10-75-003-05-22	A, 18, 20	30	30					F11-75-003-01-VA	F11-75-003-05-HA	T
1.9 dCi, 2.0, 2.0 dCi	08.03 -	1185	1010	E10-75-003-06-22	A, 18, 20	30	30					F11-75-003-02-VA	F11-75-003-05-HA	T
MEGANE II Stufenheck (LM0/1.) MEGANE II Saloon (LM0/1.) Pro-Kit (Performance Fahrwerksfedern Performance Springs) 1.4, 1.5 dCi, 1.6, 1.6 16V, 1.6 Hi-Flex	09.03 -	1130	1010	E10-75-003-07-22	A, 18, 20	30	25					F11-75-003-01-VA	F11-75-003-05-HA	T
1.9 dCi, 2.0, 2.0 dCi	09.03 -	1185	1010	E10-75-003-08-22	A, 18, 20	30	25					F11-75-003-02-VA	F11-75-003-05-HA	T
MEGANE III Coupe (DZ0/1.) Pro-Kit (Performance Fahrwerksfedern Performance Springs) 1.2 Tce, 1.4 Tce, 1.5 dCi, 1.6 16V, 1.6 dCi, 2.0 CVT, 2.0 Tce	11.08 -	1000	1041	E10-75-012-01-22	A, 18, 20	15	15					F11-75-012-01-VA	F11-75-012-01-HA	T
2.0 R.S.	11.08 -	1102	855	E10-75-012-05-22	A, 18, 20	25	15					F11-75-012-05-VA	F11-75-012-05-HA	T
1.9 dCi, 2.0 CVT, 2.0 Tce, 2.0 dCi	11.08 -	1110	1041	E10-75-012-02-22	A, 18, 20	15	15					F11-75-012-02-VA	F11-75-012-01-HA	T
B12 Pro-Kit (Performance Komplettfahrwerke Performance Springs+Shocks) 2.0 R.S.	11.08 -	1102	855	E90-75-012-05-22	A, 18, 20, 78, 161	25	25							T
MEGANE III Grandtour (KZ0/1.) Pro-Kit (Performance Fahrwerksfedern Performance Springs) 1.4 Tce, 1.5 dCi, 1.6 16V, 1.6 dCi, 2.0 CVT, 2.0 Tce	11.08 -	1000	1065	E10-75-012-03-22	A, 18, 20	30	30					F11-75-012-01-VA	F11-75-014-01-HA	T
1.9 dCi, 2.0 CVT, 2.0 Tce, 2.0 dCi	11.08 -	1110	1065	E10-75-012-04-22	A, 18, 20	30	30					F11-75-012-02-VA	F11-75-014-01-HA	T
MEGANE III Schrägheck (BZ0.) MEGANE III Hatchback (BZ0.) Pro-Kit (Performance Fahrwerksfedern Performance Springs) 1.4 Tce, 1.5 dCi, 1.6 16V, 1.6 Tce, 1.6 dCi, 2.0 CVT, 2.0 Tce	11.08 -	1000	1041	E10-75-012-01-22	A, 18, 20	30	30					F11-75-012-01-VA	F11-75-012-01-HA	T
1.9 dCi, 2.0 CVT, 2.0 Tce, 2.0 dCi	11.08 -	1110	1041	E10-75-012-02-22	A, 18, 20	30	30					F11-75-012-02-VA	F11-75-012-01-HA	T
MEGANE III Stufenheck MEGANE III Saloon Pro-Kit (Performance Fahrwerksfedern Performance Springs) 1.6 16V	06.09 -	1000	1041	E10-75-012-01-22	A, 18, 20	30	30					F11-75-012-01-VA	F11-75-012-01-HA	T
1.9 dCi	06.09 -	1110	1041	E10-75-012-02-22	A, 18, 20	30	30					F11-75-012-02-VA	F11-75-012-01-HA	T
SCÉNIC II (JM0/1.) Pro-Kit (Performance Fahrwerksfedern Performance Springs) 1.4, 1.5 dCi, 1.6, 1.6 16V	06.03 -	1130	1025	E10-75-005-01-22	A, 18, 20	30	30					F11-75-003-01-VA	F11-75-005-01-HA	T
1.9 D, 1.9 dCi, 2.0, 2.0 16V Turbo, 2.0 dCi	06.03 -	1185	1025	E10-75-005-02-22	A, 18, 20	30	30					F11-75-003-02-VA	F11-75-005-01-HA	T
SCÉNIC III (JZ0/1.) Pro-Kit (Performance Fahrwerksfedern Performance Springs) 1.4 16V, 1.5 dCi, 1.6 16V, 1.6 E85, 1.9 dCi, 2.0 16V	02.09 -	1110	1065	E10-75-014-01-22	A, 18, 20	20-30	25					F11-75-012-02-VA	F11-75-014-01-HA	T
1.6 dCi, 2.0 dCi	02.09 -	1230	1065	E10-75-014-02-22	A, 18, 20	25	25					F11-75-014-02-VA	F11-75-014-01-HA	T
TWINGO (C06.) Pro-Kit (Performance Fahrwerksfedern Performance Springs) 1.2, 1.2 16V	03.93 -	700	690	E7518-140	A, 18, 20	30	30					F7518001	F7518002	T
B12 Pro-Kit (Performance Komplettfahrwerke Performance Springs+Shocks) 1.2	03.93 - 08.00	700	690	E90-75-006-02-22	A, 18, 20, 78, 161	30	30							T
Pro-Street-S (Gewindefahrwerke - höhenverstellbar Coil-Overs-Adjustable Ride Height) 1.2, 1.2 16V	03.93 -	700	595	PSS65-75-006-01-22	A, 24, 25, 45, 160	35-65	35-65							T
TWINGO (CNO.) Pro-Kit (Performance Fahrwerksfedern Performance Springs) 1.2, 1.2 16V, 1.2 Tce 100, 1.2 Turbo	03.07 -	810	710	E10-75-009-01-22	A, 18, 20	25	25					F11-75-009-01-VA	F11-75-009-01-HA	T
1.2 16V Automatik, 1.2 Automatik, 1.2 Tce 100 Automatik, 1.2 Turbo Automatik, 1.5 dCi, 1.5 dCi 75, 1.5 dCi 90 1.2 16V automatic transmission, 1.2 Tce 100 automatic transmission, 1.2 Turbo automatic transmission, 1.2 automatic transmission, 1.5 dCi, 1.5 dCi 75, 1.5 dCi 90	03.07 -	870	710	E10-75-009-02-22	A, 18, 20	25	25					F11-75-009-02-VA	F11-75-009-01-HA	T
B12 Pro-Kit (Performance Komplettfahrwerke Performance Springs+Shocks) 1.2 16V Schaltgetriebe, 1.2 Schaltgetriebe, 1.2 Tce 100 Schaltgetriebe, 1.2 Turbo Schaltgetriebe 1.2 16V manual transmission, 1.2 Tce 100 manual transmission, 1.2 Turbo manual transmission, 1.2 manual transmission	03.07 -	810	710	E90-75-009-01-22	A, 18, 20, 78, 161	25	25							T

Modell	Baujahr	Achslast Vorne kg	Achslast Hinten kg	Artikel-Nr.	Hinweise	ca. Tieferl. Vorne mm	ca. Tieferl. Hinten mm	Ø Vorne mm	Ø Hinten mm	Verstellbarkeit Vorne	Verstellbarkeit Hinten	Ersatzteilbezeichnung Vorne	Ersatzteilbezeichnung Hinten	Gutachten
Model	Year	Front Axle Load kg	Rear Axle Load kg	Part-No.	Notes	ca. Lowering Front mm	ca. Lowering Rear mm	Ø Front mm	Ø Rear mm	Adjustable Front	Adjustable Rear	Spare Part Marking Front	Spare Part Marking Rear	Homologation
TWINGO (CNO.) B12 Pro-Kit (Performance Komplettfahrwerke Performance Springs+Shocks) 1.2, 1.2 16V, 1.2 Tce 100, 1.2 Turbo	03.07 -	870	710	E90-75-009-02-22	A, 18, 20, 78, 161	25	25							T
WIND (E4M.) Pro-Kit (Performance Fahrwerksfedern Performance Springs) 1.2, 1.2 Tce 100, 1.6	07.10 -	870	710	E10-75-009-02-22	A, 18, 20	20	20					F11-75-009-02-VA	F11-75-009-01-HA	T
9-3 (YS3D) Pro-Kit (Performance Fahrwerksfedern Performance Springs) 2.0 SE Turbo, 2.0 Turbo, 2.0 i, 2.2 TiD, 2.3, 2.3 Turbo, 2.3 i	02.98 - 09.02	1045	875	E7807-140	A, 18, 20	30	30					F7807001	F7804002	T
9-3 (YS3F) Pro-Kit (Performance Fahrwerksfedern Performance Springs) 1.8t, 1.8t BioPower, 1.8 i, 1.9 TiD, 1.9 TiD, 2.0 t, 2.0 t Bio Power, 2.0 t BioPower, 2.2 TiD	09.02 -	1125	1010	E10-78-003-01-22	A, 18, 20	30	30					F11-65-007-01-VA	F6549002	T
9-3 Cabriolet (YS3D) Pro-Kit (Performance Fahrwerksfedern Performance Springs) 2.0 SE Turbo, 2.0 Turbo, 2.0 i, 2.3, 2.3 Turbo, 2.3 i	02.98 - 08.03	1045	875	E7807-140	A, 18, 20	30	30					F7807001	F7804002	T
9-3 Kombi 9-3 Estate Pro-Kit (Performance Fahrwerksfedern Performance Springs) 1.8 i, 1.9 TiD, 1.9 TiD, 2.0 T, 2.0 T Bio Power, 2.0 t, 2.0 t BioPower, 2.8 Turbo V6	03.05 -	1125	1100	E10-78-003-05-22	A, 18, 20	30	20					F11-65-007-01-VA	F11-78-003-05-HA	T
9-5 (YS3E) Pro-Kit (Performance Fahrwerksfedern Performance Springs) 1.9 TiD, 2.0, 2.0 T, 2.0 T Biopower, 2.0 Turbo SE, 2.0 t, 2.0 t BioPower, 2.2 TiD, 2.3 Turbo, 2.3 t, 2.3 t BioPower, 3.0 TiD, 3.0 V6t	09.97 -	1175	1050	E7806-140	A, 18, 20	30	30					F7806001	F7806002	T
B12 Pro-Kit (Performance Komplettfahrwerke Performance Springs+Shocks) 2.0, 2.0 T, 2.3 Turbo	10.98 - 08.01	1175	1050	E90-78-002-01-22	A, 18, 20, 78, 117, 161	30	30							T
2.0, 2.0 T, 2.0 T Biopower, 2.0 t, 2.0 t BioPower, 2.3 Turbo, 2.3 t, 3.0 TiD, 3.0 V6t	10.98 -	1175	1050	E90-78-002-02-22	A, 18, 20, 78, 151, 161	30	30							T
2.0 Turbo SE, 2.0 t, 2.3 t, 3.0 TiD, 3.0 V6t	09.97 - 08.01	1175	1050	E90-78-002-01-22	A, 18, 20, 78, 161	30	30							T
1.9 TiD, 2.2 TiD, 2.3 Turbo, 2.3 t BioPower	03.02 -	1175	1050	E90-78-002-02-22	A, 18, 20, 78, 161	30	30							T
9-5 Kombi (YS3E) 9-5 Estate (YS3E) Pro-Kit (Performance Fahrwerksfedern Performance Springs) 1.9 TiD, 2.0, 2.0 t, 2.0 t BioPower, 2.0 t Biopower, 2.2 TiD, 2.3, 2.3 Turbo, 2.3 t, 2.3 t BioPower, 3.0 TiD, 3.0 V6t	10.98 -	1175	1125	E7808-140	A, 18, 20	30	30					F7806001	F7808002	T
B12 Pro-Kit (Performance Komplettfahrwerke Performance Springs+Shocks) 2.0 t, 2.3 Turbo, 2.3 t, 3.0 TiD, 3.0 V6t	10.98 - 08.01	1175	1125	E90-78-002-03-22	A, 18, 20, 78, 117, 161	30	30							T
1.9 TiD, 2.2 TiD, 2.3 Turbo, 2.3 t BioPower	09.01 -	1175	1125	E90-78-002-04-22	A, 18, 20, 78, 161	30	30							T
2.3, 2.3 Turbo, 2.3 t, 3.0 TiD, 3.0 V6t	09.01 -	1175	1125	E90-78-002-04-22	A, 18, 20, 78, 151, 161	30	30							T
900 II Pro-Kit (Performance Fahrwerksfedern Performance Springs) 2.0 -16 Turbo, 2.0 i, 2.3 -16, 2.5 -24 V6	07.93 - 02.98	1030	875	E7804-140	A, 18, 20	35	35					F6529001	F7804002	T
900 II Cabriolet 900 II Convertible Pro-Kit (Performance Fahrwerksfedern Performance Springs) 2.0 -16 Turbo, 2.0 i, 2.3 -16, 2.5 -24 V6	12.93 - 02.98	1030	875	E7804-140	A, 18, 20	35	35					F6529001	F7804002	T
900 II Coupe Pro-Kit (Performance Fahrwerksfedern Performance Springs) 2.0 -16 Turbo, 2.0 i, 2.3 -16, 2.5 -24 V6	12.93 - 02.98	1030	875	E7804-140	A, 18, 20	35	35					F6529001	F7804002	T
ALHAMBRA (7V8, 7V9) Pro-Kit (Performance Fahrwerksfedern Performance Springs) 1.8 T 20V, 2.0 i	04.96 - 03.10	1240	1355	E8107-140	A, 18, 20	30	20-25					F8549001	F8549002	T
1.9 TDI, 2.0 TDI, 2.8 V6	04.96 - 03.10	1260	1355	E8110-140	A, 18, 20	30	20-25					F8552001	F8549002	T
B12 Pro-Kit (Performance Komplettfahrwerke Performance Springs+Shocks) 1.8 T 20V, 2.0 i	04.96 - 03.10	1240	1355	E90-81-012-01-22	A, 18, 20, 78, 161	30	20-25							T
1.9 TDI, 2.0 TDI, 2.8 V6	04.96 - 03.10	1260	1355	E90-81-012-02-22	A, 18, 20, 78, 161	30	20-25							T
ALHAMBRA (710) Pro-Kit (Performance Fahrwerksfedern Performance Springs) 1.4 TSI Sitzplätze 5, 1.8 TFSI Sitzplätze 5, 2.0 TDI Sitzplätze 5, 2.0 TSI Sitzplätze 5 1.4 TSI Seats 5, 1.8 TFSI Seats 5, 2.0 TDI Seats 5, 2.0 TSI Seats 5	06.10 -	1220	1150	E10-85-026-01-22	A, 18, 20, 66	25	25					F11-85-012-02-VA	F11-79-008-01-HA	T
1.4 TSI Sitzplätze 5, 1.8 TFSI Sitzplätze 5, 2.0 TDI Sitzplätze 5, 2.0 TSI Sitzplätze 5 1.4 TSI Seats 5, 1.8 TFSI Seats 5, 2.0 TDI Seats 5, 2.0 TSI Seats 5	06.10 -	1300	1150	E10-85-026-02-22	A, 18, 20, 66	25	25					F11-85-012-03-VA	F11-79-008-01-HA	T

Modell	Baujahr	Achslast Vorne kg	Achslast Hinten kg	Artikel-Nr.	Hinweise	ca. Tieferl. Vorne mm	ca. Tieferl. Hinten mm	Ø Vorne mm	Ø Hinten mm	Verstellbarkeit Vorne	Verstellbarkeit Hinten	Ersatzteilbezeichnung Vorne	Ersatzteilbezeichnung Hinten	Gutachten
Model	Year	Front Axle Load kg	Rear Axle Load kg	Part-No.	Notes	ca. Lowering Front mm	ca. Lowering Rear mm	Ø Front mm	Ø Rear mm	Adjustable Front	Adjustable Rear	Spare Part Marking Front	Spare Part Marking Rear	Homologation
ALTEA (5P1) Pro-Kit (Performance Fahrwerksfedern Performance Springs) 1.2 TSI, 1.4 16V, 1.4 TSI, 1.6, 2.0 FSI	03.04 -	1022	998	E10-81-007-01-22	A, 18, 20	30	30					F11-15-007-01-VA	F11-85-014-05-HA	T
1.6 TDI, 1.8 TFSI, 1.9 TDI, 2.0 FSI, 2.0 TDI, 2.0 TDI 16V, 2.0 TFSI	03.04 -	1120	998	E10-81-007-02-22	A, 18, 20	30	30					F11-15-007-03-VA	F11-85-014-05-HA	T
Anti-Roll-Kit (Performance Stabilisatoren Performance Sway Bars) 1.2 TSI, 1.4 16V, 1.4 TSI, 1.6, 1.6 TDI, 1.8 TFSI, 1.9 TDI, 2.0 FSI, 2.0 TDI, 2.0 TDI 16V, 2.0 TFSI	03.04 -			E40-85-014-06-11	A, 18, 20, 22, 45			26	23	2-fach verstellbar 2-way adjustable	2-fach verstellbar 2-way adjustable	AS41-85-014-01-VA	AS41-85-014-01-HA	T
B12 Pro-Kit (Performance Komplettfahrwerke Performance Springs+Shocks) 1.4 TSI, 1.6, 2.0 FSI	03.04 -	1022	998	E90-81-007-02-22	A, 18, 20, 34, 78, 161	30	30							T
1.4 TSI, 1.6, 2.0 FSI	03.04 -	1022	998	E90-81-007-01-22	A, 18, 20, 35, 78, 161	30	30							T
1.8 TFSI, 1.9 TDI, 2.0 FSI, 2.0 TDI, 2.0 TDI 16V, 2.0 TFSI	03.04 -	1120	998	E90-81-007-04-22	A, 18, 20, 34, 78, 161	30	30							T
1.8 TFSI, 1.9 TDI, 2.0 FSI, 2.0 TDI, 2.0 TDI 16V, 2.0 TFSI	03.04 -	1120	998	E90-81-007-03-22	A, 18, 20, 35, 78, 161	30	30							T
Pro-Street-S (Gewindefahrwerke - höhenverstellbar Coil-Overs-Adjustable Ride Height) 1.2 TSI, 1.4 16V, 1.4 TSI, 1.6, 1.6 TDI, 1.8 TFSI, 1.9 TDI, 2.0 FSI, 2.0 TDI, 2.0 TDI 16V, 2.0 TFSI	03.04 -	1035	1150	PSS65-85-014-01-22	A, 20, 24, 34, 45, 70, 160	20-45	30-60							T
1.2 TSI, 1.4 16V, 1.4 TSI, 1.6, 1.6 TDI, 1.8 TFSI, 1.9 TDI, 2.0 FSI, 2.0 TDI, 2.0 TDI 16V, 2.0 TFSI	03.04 -	1035	1150	PSS65-85-014-02-22	A, 20, 24, 35, 45, 70, 160	20-45	30-60							T
1.2 TSI, 1.4 16V, 1.4 TSI, 1.6, 1.6 TDI, 1.8 TFSI, 1.9 TDI, 2.0 FSI, 2.0 TDI, 2.0 TDI 16V, 2.0 TFSI	03.04 -	1105	1150	PSS65-85-014-03-22	A, 20, 24, 34, 45, 70, 160	20-45	30-60							T
1.2 TSI, 1.4 16V, 1.4 TSI, 1.6, 1.6 TDI, 1.8 TFSI, 1.9 TDI, 2.0 FSI, 2.0 TDI, 2.0 TDI 16V, 2.0 TFSI	03.04 -	1105	1150	PSS65-85-014-04-22	A, 20, 24, 35, 45, 70, 160	20-45	30-60							T
1.2 TSI, 1.4 16V, 1.4 TSI, 1.6, 1.6 TDI, 1.8 TFSI, 1.9 TDI, 2.0 FSI, 2.0 TDI, 2.0 TDI 16V, 2.0 TFSI	03.04 -	1170	1150	PSS65-85-014-05-22	A, 20, 24, 34, 45, 70, 160	20-45	30-60							T
1.2 TSI, 1.4 16V, 1.4 TSI, 1.6, 1.6 TDI, 1.8 TFSI, 1.9 TDI, 2.0 FSI, 2.0 TDI, 2.0 TDI 16V, 2.0 TFSI	03.04 -	1170	1150	PSS65-85-014-06-22	A, 20, 24, 35, 45, 70, 160	20-45	30-60							T
ALTEA XL (5P5, 5P8) Pro-Kit (Performance Fahrwerksfedern Performance Springs) 1.2 TSI, 1.4 16V, 1.4 TSI, 1.6, 1.6 Multifuel, 2.0 FSI	10.06 -	1022	1050	E10-81-007-05-22	A, 18, 20	30	30					F11-15-007-01-VA	F11-15-007-01-HA	T
1.6 TDI, 1.8 TFSI, 1.9 TDI, 2.0 FSI, 2.0 TDI, 2.0 TDI 16V	10.06 -	1120	1050	E10-81-007-06-22	A, 18, 20	30	30					F11-15-007-03-VA	F11-15-007-01-HA	T
Anti-Roll-Kit (Performance Stabilisatoren Performance Sway Bars) 1.2 TSI, 1.4 16V, 1.4 TSI, 1.6, 1.6 Multifuel, 1.6 TDI, 1.8 TFSI, 1.9 TDI, 2.0 FSI, 2.0 TDI, 2.0 TDI 16V	10.06 -			E40-85-014-06-11	A, 18, 20, 22, 45			26	23	2-fach verstellbar 2-way adjustable	2-fach verstellbar 2-way adjustable	AS41-85-014-01-VA	AS41-85-014-01-HA	T
B12 Pro-Kit (Performance Komplettfahrwerke Performance Springs+Shocks) 1.4 TSI, 1.6, 2.0 FSI	10.06 -	1022	1050	E90-81-007-05-22	A, 18, 20, 34, 78, 161	30	30							T
1.8 TFSI, 1.9 TDI, 2.0 FSI, 2.0 TDI, 2.0 TDI 16V	10.06 -	1120	1050	E90-81-007-06-22	A, 18, 20, 34, 78, 161	30	30							T
Pro-Street-S (Gewindefahrwerke - höhenverstellbar Coil-Overs-Adjustable Ride Height) 1.2 TSI, 1.4 16V, 1.4 TSI, 1.6, 1.6 Multifuel, 1.6 TDI, 1.8 TFSI, 1.9 TDI, 2.0 FSI, 2.0 TDI, 2.0 TDI 16V	10.06 -	1035	1150	PSS65-85-014-01-22	A, 20, 24, 34, 45, 70, 160	20-45	30-60							T
1.2 TSI, 1.4 16V, 1.4 TSI, 1.6, 1.6 Multifuel, 1.6 TDI, 1.8 TFSI, 1.9 TDI, 2.0 FSI, 2.0 TDI, 2.0 TDI 16V	10.06 -	1035	1150	PSS65-85-014-02-22	A, 20, 24, 35, 45, 70, 160	20-45	30-60							T
1.2 TSI, 1.4 16V, 1.4 TSI, 1.6, 1.6 Multifuel, 1.6 TDI, 1.8 TFSI, 1.9 TDI, 2.0 FSI, 2.0 TDI, 2.0 TDI 16V	10.06 -	1105	1150	PSS65-85-014-03-22	A, 20, 24, 34, 45, 70, 160	20-45	30-60							T
1.2 TSI, 1.4 16V, 1.4 TSI, 1.6, 1.6 Multifuel, 1.6 TDI, 1.8 TFSI, 1.9 TDI, 2.0 FSI, 2.0 TDI, 2.0 TDI 16V	10.06 -	1105	1150	PSS65-85-014-04-22	A, 20, 24, 35, 45, 70, 160	20-45	30-60							T
1.2 TSI, 1.4 16V, 1.4 TSI, 1.6, 1.6 Multifuel, 1.6 TDI, 1.8 TFSI, 1.9 TDI, 2.0 FSI, 2.0 TDI, 2.0 TDI 16V	10.06 -	1170	1150	PSS65-85-014-05-22	A, 20, 24, 34, 45, 70, 160	20-45	30-60							T
1.2 TSI, 1.4 16V, 1.4 TSI, 1.6, 1.6 Multifuel, 1.6 TDI, 1.8 TFSI, 1.9 TDI, 2.0 FSI, 2.0 TDI, 2.0 TDI 16V	10.06 -	1170	1150	PSS65-85-014-06-22	A, 20, 24, 35, 45, 70, 160	20-45	30-60							T
2.0 TDI 16V 4x4 für Fahrzeuge ohne Niveauregulierung, 2.0 TDI 4x4 für Fahrzeuge ohne Niveauregulierung, 2.0 TFSI 4x4 für Fahrzeuge ohne Niveauregulierung, 2.0 TDI 16V 4x4 for vehicles without ride height control, 2.0 TDI 4x4 for vehicles without ride height control, 2.0 TFSI 4x4 for vehicles without ride height control	06.07 -	1180	1230	PSS65-85-016-04-22	A, 18, 24, 45, 160	35-70	35-70							T
AROSA (6H) Pro-Kit (Performance Fahrwerksfedern Performance Springs) 1.0, 1.4, 1.4 16V, 1.4 TDI, 1.7 SDI	05.97 - 06.04	810	690	E8111-140	A, 18, 20	30	20-25					F8546001	F8111002	T
B12 Pro-Kit (Performance Komplettfahrwerke Performance Springs+Shocks) 1.0, 1.4, 1.4 16V, 1.4 TDI, 1.7 SDI	05.97 - 06.04	810	690	E90-81-013-01-22	A, 18, 20, 78, 161	30	20-25							T
CORDOBA (6K1, 6K2) Pro-Kit (Performance Fahrwerksfedern Performance Springs) 1.0 i, 1.4, 1.4 i, 1.4 i 16V, 1.6 i, 1.8 i, 1.8 i 16V, 2.0 i, 2.0 i 16V	02.93 - 10.99	865	810	E8109-140	A, 18, 20	30	20-25					F8502001	F8106002	T
1.7 SDI, 1.9 D, 1.9 SDI, 1.9 TD, 1.9 TDI	02.93 - 06.99	900	810	E8117-140	A, 18, 20	30	20-25					F8530001	F8106002	T
CORDOBA (6K2) Pro-Kit (Performance Fahrwerksfedern Performance Springs) 1.0, 1.4, 1.4 16V, 1.6	06.99 - 10.02	850	810	E10-81-002-01-22	A, 18, 20	30	20-25					F11-81-001-01-VA	F8106002	T
1.9 SDI, 1.9 TDI	06.99 - 10.02	900	810	E10-81-002-02-22	A, 18, 20	30	20-25					F8594001	F8106002	T

Modell	Baujahr	Achslast Vorne kg	Achslast Hinten kg	Artikel-Nr.	Hinweise	ca. Tieferl. Vorne mm	ca. Tieferl. Hinten mm	Ø Vorne mm	Ø Hinten mm	Verstellbarkeit Vorne	Verstellbarkeit Hinten	Ersatzteilbezeichnung Vorne	Ersatzteilbezeichnung Hinten	Gutachten
Model	Year	Front Axle Load kg	Rear Axle Load kg	Part-No.	Notes	ca. Lowering Front mm	ca. Lowering Rear mm	Ø Front mm	Ø Rear mm	Adjustable Front	Adjustable Rear	Spare Part Marking Front	Spare Part Marking Rear	Homologation
CORDOBA (6L2) Pro-Kit (Performance Fahrwerksfedern Performance Springs) 1.2, 1.2 12V, 1.4 16V, 1.6, 1.6 16V	09.02 - 11.09	860	860	E10-81-006-01-22	A, 18, 20	30	20-25					F11-81-005-01-VA	F11-85-008-01-HA	T
1.4 TDI, 1.9 SDI, 1.9 TDI	09.02 - 11.09	960	860	E10-81-006-02-22	A, 18, 20	30	20-25					F11-85-008-01-VA	F11-85-008-01-HA	T
Anti-Roll-Kit (Performance Stabilisatoren Performance Sway Bars) 1.2, 1.2 12V, 1.4 16V, 1.4 TDI, 1.6, 1.6 16V, 1.9 SDI, 1.9 TDI	09.02 - 11.09			E40-85-008-01-10	A, 18, 20, 22, 45			22		nicht verstellbar not adjustable		AS41-85-008-01-VA		T
Pro-Street-S (Gewindefahrwerke - höhenverstellbar Coil-Overs-Adjustable Ride Height) 1.2, 1.2 12V, 1.4 16V, 1.4 TDI, 1.6, 1.6 16V, 1.9 SDI, 1.9 TDI	09.02 - 11.09	955	840	PSS65-85-008-01-22	A, 24, 25, 45, 160	35-65	35-65							T
EXEO (3R2) Pro-Kit (Performance Fahrwerksfedern Performance Springs) 1.6, 1.8 T, 1.8 TSI, 2.0 TFSI	12.08 -	1090	1135	E10-81-011-03-22	A, 18, 20	30-35	25-30					F11-15-003-01-VA	F11-15-003-03-HA	T
2.0 TDI, 2.0 TFSI	12.08 -	1165	1135	E10-81-011-04-22	A, 18, 20	30-35	25-30					F1568001	F11-15-003-03-HA	T
Sportline (Performance Fahrwerksfedern Sport Sport Performance Springs) 1.6, 1.8 T, 1.8 TSI, 2.0 TFSI	12.08 -	1090	1135	E20-15-003-04-22	A, 18, 20	45	30					F21-15-003-02-VA	F21-15-003-04-HA	T
2.0 TDI, 2.0 TFSI	12.08 -	1140	1135	E20-15-003-05-22	A, 18, 20	45	30					F21-15-003-03-VA	F21-15-003-04-HA	T
Anti-Roll-Kit (Performance Stabilisatoren Performance Sway Bars) 1.6, 1.8 T, 1.8 TSI, 2.0 TDI, 2.0 TFSI	12.08 -			E40-15-003-01-11	A, 18, 22, 45			32	24	nicht verstellbar not adjustable	2-fach verstellbar 2-way adjustable	AS41-15-003-01-VA	AS41-15-003-01-HA	T
B12 Pro-Kit (Performance Komplettfahrwerke Performance Springs+Shocks) 1.6, 1.8 T, 1.8 TSI, 2.0 TFSI	12.08 -	1090	1130	E90-81-011-01-22	A, 18, 20, 78, 161	30-35	25-30							T
2.0 TDI, 2.0 TFSI	12.08 -	1165	1130	E90-81-011-02-22	A, 18, 20, 78, 161	30-35	25-30							T
B12 Sportline (Performance Komplettfahrwerke Sport Sport Performance Springs+Shocks) 1.6, 1.8 T, 1.8 TSI, 2.0 TFSI	12.08 -	1090	1135	E95-15-006-06-22	A, 18, 20, 78, 161	45	30							T
2.0 TDI, 2.0 TFSI	12.08 -	1140	1135	E95-15-006-08-22	A, 18, 20, 78, 161	45	30							T
EXEO ST (3R5) Pro-Kit (Performance Fahrwerksfedern Performance Springs) 1.6, 1.8 T, 1.8 TSI, 2.0 TFSI	06.09 -	1090	1135	E10-81-011-03-22	A, 18, 20	30	30					F11-15-003-01-VA	F11-15-003-03-HA	T
2.0 TDI, 2.0 TFSI	05.09 -	1165	1135	E10-81-011-04-22	A, 18, 20	30	30					F1568001	F11-15-003-03-HA	T
Sportline (Performance Fahrwerksfedern Sport Sport Performance Springs) 1.6, 1.8 T, 1.8 TSI, 2.0 TFSI	06.09 -	1090	1135	E20-15-003-04-22	A, 18, 20	45	40					F21-15-003-02-VA	F21-15-003-04-HA	T
2.0 TDI, 2.0 TFSI	05.09 -	1140	1135	E20-15-003-05-22	A, 18, 20	45	40					F21-15-003-03-VA	F21-15-003-04-HA	T
Anti-Roll-Kit (Performance Stabilisatoren Performance Sway Bars) 1.6, 1.8 T, 1.8 TSI, 2.0 TDI, 2.0 TFSI	05.09 -			E40-15-003-01-11	A, 18, 22, 45			32	24	nicht verstellbar not adjustable	2-fach verstellbar 2-way adjustable	AS41-15-003-01-VA	AS41-15-003-01-HA	T
B12 Pro-Kit (Performance Komplettfahrwerke Performance Springs+Shocks) 1.6, 1.8 T, 1.8 TSI, 2.0 TFSI	06.09 -	1090	1130	E90-81-011-01-22	A, 18, 20, 78, 161	30	30							T
2.0 TDI, 2.0 TFSI	05.09 -	1165	1130	E90-81-011-02-22	A, 18, 20, 78, 161	30	30							T
B12 Sportline (Performance Komplettfahrwerke Sport Sport Performance Springs+Shocks) 1.6, 1.8 T, 1.8 TSI, 2.0 TFSI	06.09 -	1090	1135	E95-15-006-06-22	A, 18, 20, 78, 161	45	40							T
2.0 TDI, 2.0 TFSI	05.09 -	1140	1135	E95-15-006-08-22	A, 18, 20, 78, 161	45	40							T
IBIZA II (6K1) Pro-Kit (Performance Fahrwerksfedern Performance Springs) 1.0, 1.0 i, 1.3 i, 1.4, 1.4 i, 1.4 i 16V, 1.6 i, 1.8 i, 1.8 i 16V, 2.0 i, 2.0 i 16V	03.93 - 08.99	865	810	E8108-140	A, 18, 20	30	20-25					F8502001	F8105002	T
1.9 D, 1.9 SDI, 1.9 TD, 1.9 TDI	03.93 - 08.99	900	810	E8116-140	A, 18, 20	30	20-25					F8530001	F8105002	T
IBIZA III (6K1) Pro-Kit (Performance Fahrwerksfedern Performance Springs) 1.8 T 20V Cupra, 1.9 SDI, 1.9 TDI	08.99 - 02.02	900	810	E10-81-001-02-22	A, 18, 20	25	20-25					F11-81-001-01-VA	F8106002	T
B12 Pro-Kit (Performance Komplettfahrwerke Performance Springs+Shocks) 1.8 T 20V Cupra, 1.9 SDI, 1.9 TDI	08.99 - 02.02	900	810	E90-81-001-02-22	A, 18, 20, 78, 161	25	20-25							T
IBIZA IV (6L1) Pro-Kit (Performance Fahrwerksfedern Performance Springs) 1.2, 1.2 12V, 1.4 16V, 1.6, 1.6 16V	02.02 - 11.09	860	860	E10-81-005-01-22	A, 18, 20	30	20-25					F11-81-005-01-VA	F11-85-008-01-HA	T
1.4 TDI, 1.8 T Cupra R, 1.8 T FR, 1.9 SDI, 1.9 TDI	02.02 - 11.09	960	860	E10-81-005-02-22	A, 18, 20	30	20-25					F11-85-008-01-VA	F11-85-008-01-HA	T
Anti-Roll-Kit (Performance Stabilisatoren Performance Sway Bars) 1.2, 1.2 12V, 1.4 16V, 1.4 TDI, 1.6, 1.6 16V, 1.9 SDI, 1.9 TDI	02.02 - 11.09			E40-85-008-01-10	A, 18, 20, 22, 45			22		nicht verstellbar not adjustable		AS41-85-008-01-VA		T
B12 Pro-Kit (Performance Komplettfahrwerke Performance Springs+Shocks) 1.2, 1.2 12V, 1.4 16V, 1.6, 1.6 16V	02.02 - 11.09	860	860	E90-81-005-01-22	A, 18, 20, 78, 161	30	20-25							T
1.4 TDI, 1.8 T FR, 1.9 SDI, 1.9 TDI	02.02 - 11.09	960	860	E90-81-005-02-22	A, 18, 20, 78, 161	30	20-25							T
Pro-Street-S (Gewindefahrwerke - höhenverstellbar Coil-Overs-Adjustable Ride Height) 1.2, 1.2 12V, 1.4 16V, 1.4 TDI, 1.9 SDI, 1.9 TDI	02.02 - 11.09	955	840	PSS65-85-008-01-22	A, 24, 25, 45, 160	35-65	35-65							T
IBIZA V (6J5) Pro-Kit (Performance Fahrwerksfedern Performance Springs) 1.2, 1.2 TDI, 1.2 TSI, 1.4, 1.6, 1.6 TDI	03.08 -	860	820	E10-81-010-04-22	A, 18, 20	25	25					F11-81-010-04-VA	F11-81-010-04-HA	T
1.2 TDI, 1.2 TSI, 1.4 TDI, 1.4 TSI, 1.6, 1.6 TDI, 1.9 TDI	03.08 -	940	820	E10-81-010-05-22	A, 18, 20	25	25					F11-81-010-05-VA	F11-81-010-04-HA	T
Anti-Roll-Kit (Performance Stabilisatoren Performance Sway Bars) 1.2, 1.2 TDI, 1.2 TSI, 1.4, 1.4 TDI, 1.6, 1.6 TDI, 1.9 TDI, 2.0, 2.0 TDI	03.08 -			E40-85-008-01-10	A, 18, 20, 22, 45			22		nicht verstellbar not adjustable		AS41-85-008-01-VA		T

Modell	Baujahr	Achslast Vorne kg	Achslast Hinten kg	Artikel-Nr.	Hinweise	ca. Tieferl. Vorne mm	ca. Tieferl. Hinten mm	Ø Vorne mm	Ø Hinten mm	Verstellbarkeit Vorne	Verstellbarkeit Hinten	Ersatzteilbezeichnung Vorne	Ersatzteilbezeichnung Hinten	Gutachten
Model	Year	Front Axle Load kg	Rear Axle Load kg	Part-No.	Notes	ca. Lowering Front mm	ca. Lowering Rear mm	Ø Front mm	Ø Rear mm	Adjustable Front	Adjustable Rear	Spare Part Marking Front	Spare Part Marking Rear	Homologation
IBIZA V (6J5) B12 Pro-Kit (Performance Komplettfahrwerke Performance Springs+Shocks) 1.2, 1.2 TDI, 1.2 TSI, 1.4, 1.4 TDI, 1.4 TSI, 1.6, 1.6 TDI	03.08 -	860	820	E90-81-010-01-22	A, 18, 20, 78, 161	25	25							T
1.2 TDI, 1.2 TSI, 1.4 TDI, 1.4 TSI, 1.6, 1.6 TDI, 1.9 TDI, 2.0	03.08 -	940	820	E90-81-010-02-22	A, 18, 20, 78, 161	25	25							T
Pro-Street-S (Gewindefahrwerke - höhenverstellbar Coil-Overs-Adjustable Ride Height) 1.2, 1.2 TDI, 1.2 TSI, 1.4, 1.4 TDI, 1.4 TSI, 1.6, 1.6 TDI	03.08 -	860	800	PSS65-81-010-01-22	A, 24, 25, 45, 160	30-60	25-50							T
1.2 TDI, 1.2 TSI, 1.4 TDI, 1.6, 1.6 TDI, 1.9 TDI, 2.0, 2.0 TDI	03.08 -	950	800	PSS65-81-010-02-22	A, 24, 25, 45, 160	30-60	25-50							T
IBIZA V SPORTCOUPE (6J1) Pro-Kit (Performance Fahrwerksfedern Performance Springs) 1.2, 1.2 TDI, 1.2 TSI, 1.4, 1.4 TDI, 1.4 TSI, 1.6, 1.6 TDI	07.08 -	860	820	E10-81-010-04-22	A, 18, 20	25	25					F11-81-010-04-VA	F11-81-010-04-HA	T
1.2 TDI, 1.2 TSI, 1.4 TDI, 1.4 TSI, 1.4 TSI Cupra, 1.6, 1.6 TDI, 1.9 TDI	07.08 -	940	820	E10-81-010-05-22	A, 18, 20	25	25					F11-81-010-05-VA	F11-81-010-04-HA	T
Anti-Roll-Kit (Performance Stabilisatoren Performance Sway Bars) 1.2, 1.2 TDI, 1.2 TSI, 1.4, 1.4 TDI, 1.4 TSI, 1.4 TSI Cupra, 1.6, 1.6 TDI, 1.9 TDI, 2.0, 2.0 TDI	07.08 -			E40-85-008-01-10	A, 18, 20, 22, 45			22		nicht verstellbar not adjustable		AS41-85-008-01-VA		T
B12 Pro-Kit (Performance Komplettfahrwerke Performance Springs+Shocks) 1.2, 1.2 TDI, 1.2 TSI, 1.4, 1.4 TDI, 1.4 TSI, 1.4 TSI Cupra, 1.6, 1.6 TDI	07.08 -	860	820	E90-81-010-01-22	A, 18, 20, 78, 161	25	25							T
1.2 TDI, 1.2 TSI, 1.4 TDI, 1.4 TSI, 1.4 TSI Cupra, 1.6, 1.6 TDI, 1.9 TDI, 2.0	07.08 -	940	820	E90-81-010-02-22	A, 18, 20, 78, 161	25	25							T
Pro-Street-S (Gewindefahrwerke - höhenverstellbar Coil-Overs-Adjustable Ride Height) 1.2, 1.2 TDI, 1.2 TSI, 1.4, 1.4 TDI, 1.4 TSI, 1.6, 1.6 TDI	07.08 -	860	800	PSS65-81-010-01-22	A, 24, 25, 45, 160	30-60	25-50							T
1.2, 1.2 TDI, 1.2 TSI, 1.4, 1.4 TDI, 1.4 TSI, 1.6, 1.6 TDI, 1.9 TDI, 2.0, 2.0 TDI	07.08 -	950	800	PSS65-81-010-02-22	A, 24, 25, 45, 160	30-60	25-50							T
IBIZA V ST (6J8) Pro-Kit (Performance Fahrwerksfedern Performance Springs) 1.2, 1.2 TSI, 1.4	03.10 -	860	820	E10-81-010-04-22	A, 18, 20	25	30					F11-81-010-04-VA	F11-81-010-04-HA	T
1.2 TDI, 1.2 TSI, 1.4 TSI, 1.6, 1.6 TDI	03.10 -	940	820	E10-81-010-05-22	A, 18, 20	25	30					F11-81-010-05-VA	F11-81-010-04-HA	T
Anti-Roll-Kit (Performance Stabilisatoren Performance Sway Bars) 1.2, 1.2 TDI, 1.2 TSI, 1.4, 1.4 TDI, 1.6, 1.6 TDI	03.10 -			E40-85-008-01-10	A, 18, 20, 22, 45			22		nicht verstellbar not adjustable		AS41-85-008-01-VA		T
B12 Pro-Kit (Performance Komplettfahrwerke Performance Springs+Shocks) 1.2, 1.2 TDI, 1.2 TSI, 1.4, 1.4 TDI, 1.6, 1.6 TDI	03.10 -	860	820	E90-81-010-01-22	A, 18, 20, 78, 161	25	25							T
1.2, 1.2 TDI, 1.2 TSI, 1.4, 1.4 TDI, 1.6, 1.6 TDI	03.10 -	940	820	E90-81-010-02-22	A, 18, 20, 78, 161	25	25							T
LEON (1M1) Pro-Kit (Performance Fahrwerksfedern Performance Springs) 1.4 16V, 1.6, 1.6 16 V	11.99 - 06.06	910	985	E8119-140	A, 18, 20	30	20-25					F8560001	F1540002	T
1.8 20V, 1.8 20V T, 1.8 T Cupra R, 1.9 SDI, 1.9 TDI	11.99 - 06.06	982	985	E8120-140	A, 18, 20, 26	30	20-25					F1540001	F1540002	T
1.9 SDI, 1.9 TDI	11.99 - 06.06	1005	985	E8121-140	A, 18, 20, 26	30	20-25					F1545001	F1540002	T
1.9 TDI Syncro, 2.8 Cupra 4	02.01 - 06.06	1050	1070	E10-81-003-02-22	A, 18	20-25	20					F8592001	F11-15-001-02-HA	T
Sportline (Performance Fahrwerksfedern Sport Sport Performance Springs) 1.4 16V, 1.6, 1.6 16 V	11.99 - 06.06	950	1000	E20-81-003-01-22	A, 20, 26	45-50	30					F21-85-001-01-VA	F21-85-001-01-HA	T
1.8 20V, 1.8 20V T, 1.8 T Cupra R, 1.9 SDI, 1.9 TDI	11.99 - 06.06	1000	1000	E20-81-003-02-22	A, 20, 26	45-50	30					F21-85-003-01-VA	F21-85-001-01-HA	T
Anti-Roll-Kit (Performance Stabilisatoren Performance Sway Bars) 1.4 16V, 1.6, 1.6 16 V, 1.8 20V, 1.8 20V T, 1.9 SDI, 1.9 TDI	11.99 - 06.06			E40-85-005-01-10	A, 18, 20, 22, 45			25		nicht verstellbar not adjustable		AS41-85-005-01-VA		T
1.4 16V, 1.6, 1.6 16 V, 1.8 20V, 1.8 20V T, 1.9 SDI, 1.9 TDI	11.99 - 06.06			E40-85-005-01-11	A, 18, 20, 22, 45			25	25	nicht verstellbar not adjustable	nicht verstellbar not adjustable	AS41-85-005-01-VA	AS1540320HA	T
B12 Pro-Kit (Performance Komplettfahrwerke Performance Springs+Shocks) 1.4 16V, 1.6, 1.6 16 V	11.99 - 06.06	910	985	E90-81-003-01-22	A, 18, 20, 78, 161	30	20-25							T
1.8 20V, 1.8 20V T, 1.9 SDI, 1.9 TDI	11.99 - 06.06	982	985	E90-81-003-02-22	A, 18, 20, 26, 78,	30	20-25							T
1.8 T Cupra R	02.02 - 06.06	982	985	E90-81-003-03-22	A, 18, 20, 26, 78,	30	20-25							T
1.9 SDI, 1.9 TDI	11.99 - 06.06	1005	985	E90-81-003-04-22	A, 18, 20, 78, 161	30	20-25							T
1.9 TDI Syncro, 2.8 Cupra 4	02.01 - 06.06	1050	1070	E90-81-003-05-22	A, 18, 78, 161	20-25	20							T
B12 Sportline (Performance Komplettfahrwerke Sport Sport Performance Springs+Shocks) 1.4 16V, 1.6, 1.6 16 V	11.99 - 06.06	950	1000	E95-81-003-01-22	A, 18, 20, 78, 161	45-50	30							T
1.8 20V, 1.8 20V T, 1.9 SDI, 1.9 TDI	11.99 - 06.06	1000	1000	E95-81-003-02-22	A, 18, 20, 26, 78,	45-50	30							T
1.8 T Cupra R	02.02 - 06.06	1000	1000	E95-81-003-03-22	A, 18, 20, 26, 78,	25-30	10							T
Pro-Street-S (Gewindefahrwerke - höhenverstellbar Coil-Overs-Adjustable Ride Height) 1.4 16V, 1.6, 1.6 16 V, 1.8 20V, 1.8 20V T, 1.8 T Cupra R, 1.9 SDI, 1.9 TDI	11.99 - 06.06	1020	1020	PSS65-85-001-01-22	A, 20, 24, 25, 26,	35-65	35-65							T
1.8 20V T 4, 1.9 TDI Syncro	11.99 - 06.06	1030	1020	PSS65-85-001-02-22	A, 24, 25, 45, 160	30-55	30-55							T
2.8 Cupra 4	02.01 - 06.06	1030	1020	PSS65-85-001-05-22	A, 24, 25, 45, 160	30-55	30-55							T
LEON (1P1) Pro-Kit (Performance Fahrwerksfedern Performance Springs) 1.2 TSI, 1.4 16V, 1.4 TSI, 1.6, 1.6 MultiFuel, 1.6 TDI, 1.9 TDI, 1.9 TDI, 2.0 FSI	07.05 -	1022	965	E10-81-009-04-22	A, 18, 20	30	30					F11-15-007-01-VA	F11-85-014-05-HA	T
1.6 TDI, 1.8 TSI, 1.9 TDI, 1.9 TDI, 2.0 FSI, 2.0 TDI, 2.0 TDI 16V	07.05 -	1120	965	E10-81-009-05-22	A, 18, 20	30	30					F11-15-007-03-VA	F11-85-014-05-HA	T

Modell	Baujahr	Achslast Vorne kg	Achslast Hinten kg	Artikel-Nr.	Hinweise	ca. Tieferl. Vorne mm	ca. Tieferl. Hinten mm	Ø Vorne mm	Ø Hinten mm	Verstellbarkeit Vorne	Verstellbarkeit Hinten	Ersatzteilbezeichnung Vorne	Ersatzteilbezeichnung Hinten	Gutachten
Model	Year	Front Axle Load kg	Rear Axle Load kg	Part-No.	Notes	ca. Lowering Front mm	ca. Lowering Rear mm	Ø Front mm	Ø Rear mm	Adjustable Front	Adjustable Rear	Spare Part Marking Front	Spare Part Marking Rear	Homologation
LEON (1P1) Sportline (Performance Fahrwerksfedern Sport Sport Performance Springs) 1.2 TSI, 1.4 16V, 1.4 TSI, 1.6, 1.6 MultiFuel, 1.6 TDI, 1.8 TSI, 1.9 TDI, 1.9 TDI, 2.0 FSI	07.05 -	1040	930	E20-81-009-01-22	A, 18, 20	45-50	35					F21-15-007-01-VA	F21-85-014-01-HA	ABE
1.6 TDI, 1.8 TSI, 1.9 TDI, 1.9 TDI, 2.0 FSI, 2.0 TDI, 2.0 TDI 16V, 2.0 TFSI	05.05 -	1130	930	E20-81-009-02-22	A, 18, 20	45-50	35					F21-15-007-02-VA	F21-85-014-01-HA	ABE
2.0 Cupra R, 2.0 TFSI	11.06 -	1130	930	E20-81-009-02-22	A, 18, 20	20	30					F21-15-007-02-VA	F21-85-014-01-HA	ABE
Anti-Roll-Kit (Performance Stabilisatoren Performance Sway Bars) 1.2 TSI, 1.4 16V, 1.4 TSI, 1.6, 1.6 MultiFuel, 1.6 TDI, 1.8 TSI, 1.9 TDI, 1.9 TDI, 2.0 FSI, 2.0 TDI, 2.0 TDI 16V, 2.0 TFSI	05.05 -			E40-85-014-06-11	A, 18, 20, 22, 45			26	23	2-fach verstellbar 2-way adjustable	2-fach verstellbar 2-way adjustable	AS41-85-014-01-VA	AS41-85-014-01-HA	T
B12 Pro-Kit (Performance Komplettfahrwerke Performance Springs+Shocks) 1.4 16V, 1.4 TSI, 1.6, 1.6 MultiFuel, 2.0 FSI	07.05 -	1022	965	E90-81-009-02-22	A, 18, 20, 34, 78,	161	30							T
1.2 TSI, 1.4 16V, 1.4 TSI, 1.6, 1.6 MultiFuel, 2.0 FSI	07.05 -	1022	965	E90-81-009-01-22	A, 18, 20, 35, 78,	161	30							T
1.6 TDI, 1.8 TSI, 1.9 TDI, 2.0 FSI, 2.0 TDI, 2.0 TDI 16V, 2.0 TFSI	05.05 -	1120	965	E90-81-009-04-22	A, 18, 20, 34, 78,	161	30							T
1.6 TDI, 1.8 TSI, 1.9 TDI, 2.0 FSI, 2.0 TDI, 2.0 TDI 16V, 2.0 TFSI	05.05 -	1120	965	E90-81-009-03-22	A, 18, 20, 35, 78,	161	30							T
B12 Sportline (Performance Komplettfahrwerke Sport Sport Performance Springs+Shocks) 1.4 16V, 1.4 TSI, 1.6, 1.6 MultiFuel, 1.6 TDI, 1.8 TSI, 2.0 FSI	07.05 -	1040	930	E95-81-009-02-22	A, 18, 20, 34, 78,	161	45-50							T
1.2 TSI, 1.4 16V, 1.4 TSI, 1.6, 1.6 MultiFuel, 1.6 TDI, 1.8 TSI, 2.0 FSI	07.05 -	1040	930	E95-81-009-01-22	A, 18, 20, 35, 78,	161	45-50							T
1.6 TDI, 1.8 TSI, 1.9 TDI, 2.0 FSI, 2.0 TDI, 2.0 TDI 16V, 2.0 TFSI	05.05 -	1130	930	E95-81-009-04-22	A, 18, 20, 34, 78,	161	45-50							T
1.6 TDI, 1.8 TSI, 1.9 TDI, 2.0 FSI, 2.0 TDI, 2.0 TDI 16V, 2.0 TFSI	05.05 -	1130	930	E95-81-009-03-22	A, 18, 20, 35, 78,	161	45-50							T
2.0 Cupra R	09.09 -	1130	930	E95-81-009-04-22	A, 18, 20, 34, 78,	161	20							T
Pro-Street-S (Gewindefahrwerke - höhenverstellbar Coil-Overs-Adjustable Ride Height) 1.2 TSI, 1.4 16V, 1.4 TSI, 1.6, 1.6 MultiFuel, 1.6 TDI, 1.8 TSI, 1.9 TDI, 1.9 TDI, 2.0 Cupra R, 2.0 FSI, 2.0 TDI, 2.0 TDI 16V, 2.0 TFSI	05.05 -	1035	1000	PSS65-81-009-01-22	A, 18, 20, 24, 34,	45, 160	35-65	35-65						T
1.2 TSI, 1.4 16V, 1.4 TSI, 1.6, 1.6 MultiFuel, 1.6 TDI, 1.8 TSI, 1.9 TDI, 1.9 TDI, 2.0 Cupra R, 2.0 FSI, 2.0 TDI, 2.0 TDI 16V, 2.0 TFSI	05.05 -	1035	1000	PSS65-81-009-04-22	A, 18, 20, 24, 35,	45, 160	35-65	35-65						T
1.2 TSI, 1.4 16V, 1.4 TSI, 1.6, 1.6 MultiFuel, 1.6 TDI, 1.8 TSI, 1.9 TDI, 1.9 TDI, 2.0 Cupra R, 2.0 FSI, 2.0 TDI, 2.0 TDI 16V, 2.0 TFSI	05.05 -	1105	1000	PSS65-81-009-02-22	A, 18, 20, 24, 34,	45, 160	35-65	35-65						T
1.2 TSI, 1.4 16V, 1.4 TSI, 1.6, 1.6 MultiFuel, 1.6 TDI, 1.8 TSI, 1.9 TDI, 1.9 TDI, 2.0 Cupra R, 2.0 FSI, 2.0 TDI, 2.0 TDI 16V, 2.0 TFSI	05.05 -	1105	1000	PSS65-81-009-05-22	A, 18, 20, 24, 35,	45, 160	35-65	35-65						T
1.2 TSI, 1.4 16V, 1.4 TSI, 1.6, 1.6 MultiFuel, 1.6 TDI, 1.8 TSI, 1.9 TDI, 1.9 TDI, 2.0 Cupra R, 2.0 FSI, 2.0 TDI, 2.0 TDI 16V, 2.0 TFSI	05.05 -	1170	1000	PSS65-81-009-03-22	A, 18, 20, 24, 34,	45, 160	35-65	35-65						T
1.2 TSI, 1.4 16V, 1.4 TSI, 1.6, 1.6 MultiFuel, 1.6 TDI, 1.8 TSI, 1.9 TDI, 1.9 TDI, 2.0 Cupra R, 2.0 FSI, 2.0 TDI, 2.0 TDI 16V, 2.0 TFSI	05.05 -	1170	1000	PSS65-81-009-06-22	A, 18, 20, 24, 35,	45, 160	35-65	35-65						T
LEON (5F1) Pro-Kit (Performance Fahrwerksfedern Performance Springs) 1.2 TSI, 1.4 TSI	09.12 -	985	990	E10-15-021-03-22	A, 18, 20, 171	35	30					F11-15-021-01-VA	F1540002	T
1.2 TSI, 1.4 TSI	09.12 -	985	1000	E10-15-021-01-22	A, 18, 20, 170	35	30					F11-15-021-01-VA	F11-15-021-01-HA	T
1.6 TDI, 1.8 TFSI, 2.0 TDI	09.12 -	1070	990	E10-15-021-04-22	A, 18, 20, 171	35	30					F11-15-021-02-VA	F1540002	T
1.6 TDI, 1.8 TFSI, 2.0 TDI	09.12 -	1070	1000	E10-15-021-02-22	A, 18, 20, 170	35	30					F11-15-021-02-VA	F11-15-021-01-HA	T
Anti-Roll-Kit (Performance Stabilisatoren Performance Sway Bars) 1.2 TSI, 1.4 TSI, 1.6 TDI, 1.8 TFSI, 2.0 TDI	09.12 -			E40-15-021-01-11	A, 18, 20, 22, 45,	170		28 Rohr 28 tube	25 Rohr 25 tube	2-fach verstellbar 2-way adjustable	nicht verstellbar not adjustable	AS41-15-021-01-VA	AS41-15-021-01-HA	T
1.2 TSI, 1.4 TSI, 1.6 TDI, 1.8 TFSI, 2.0 TDI	09.12 -			E40-15-021-03-11	A, 18, 20, 22, 45,	171		28 Rohr 28 tube	25 Rohr 25 tube	2-fach verstellbar 2-way adjustable	nicht verstellbar not adjustable	AS41-15-021-01-VA	AS41-15-021-03-HA	T
LEON SC (5F5) Pro-Kit (Performance Fahrwerksfedern Performance Springs) 1.2 TSI, 1.4 TSI	01.13 -	985	990	E10-15-021-03-22	A, 18, 20, 171	35	30					F11-15-021-01-VA	F1540002	T
1.2 TSI, 1.4 TSI	01.13 -	985	1000	E10-15-021-01-22	A, 18, 20, 170	35	30					F11-15-021-01-VA	F11-15-021-01-HA	T
1.6 TDI, 1.8 TFSI, 2.0 TDI	02.13 -	1070	990	E10-15-021-04-22	A, 18, 20, 171	35	30					F11-15-021-02-VA	F1540002	T
1.6 TDI, 1.8 TFSI, 2.0 TDI	02.13 -	1070	1000	E10-15-021-02-22	A, 18, 20, 170	35	30					F11-15-021-02-VA	F11-15-021-01-HA	T
Anti-Roll-Kit (Performance Stabilisatoren Performance Sway Bars) 1.2 TSI, 1.4 TSI, 1.6 TDI, 1.8 TFSI, 2.0 TDI	01.13 -			E40-15-021-01-11	A, 18, 20, 22, 45,	170		28 Rohr 28 tube	25 Rohr 25 tube	2-fach verstellbar 2-way adjustable	nicht verstellbar not adjustable	AS41-15-021-01-VA	AS41-15-021-01-HA	T
1.2 TSI, 1.4 TSI, 1.6 TDI, 1.8 TFSI, 2.0 TDI	01.13 -			E40-15-021-03-11	A, 18, 20, 22, 45,	171		28 Rohr 28 tube	25 Rohr 25 tube	2-fach verstellbar 2-way adjustable	nicht verstellbar not adjustable	AS41-15-021-01-VA	AS41-15-021-03-HA	T
Mii (KF1) Pro-Kit (Performance Fahrwerksfedern Performance Springs) 1.0	10.11 -	680	640	E10-85-040-01-22	A, 18, 20	20	25					F11-85-040-01-VA	F11-85-040-01-HA	T
TOLEDO II (1M2) Pro-Kit (Performance Fahrwerksfedern Performance Springs) 1.4 16V, 1.6, 1.6 16V	04.99 - 05.06	910	1000	E8113-140	A, 18, 20	30	20-25					F8560001	F7907002	T
1.8 20V, 1.8 20VT, 1.9 SDI, 1.9 TDI	04.99 - 05.06	982	1000	E8114-140	A, 18, 20, 26	30	20-25					F1540001	F7907002	T
1.9 TDI, 2.3 V5, 2.3 V5 20V	04.99 - 05.06	1005	1000	E8115-140	A, 18, 20, 26	30	20-25					F1545001	F7907002	T
Sportline (Performance Fahrwerksfedern Sport Sport Performance Springs) 1.4 16V, 1.6, 1.6 16V, 1.8 20V, 1.8 20VT, 1.9 SDI, 1.9 TDI	04.99 - 05.06	950	1000	E20-81-004-01-22	A, 18, 20, 26	45-50	30					F21-85-001-01-VA	F21-85-001-01-HA	T
1.9 TDI, 2.3 V5, 2.3 V5 20V	04.99 - 05.06	1000	1000	E20-81-004-02-22	A, 18, 20, 26	45-50	30					F21-85-003-01-VA	F21-85-001-01-HA	T

Modell	Baujahr	Achslast Vorne kg	Achslast Hinten kg	Artikel-Nr.	Hinweise	ca. Tieferl. Vorne mm	ca. Tieferl. Hinten mm	Ø Vorne mm	Ø Hinten mm	Verstellbarkeit Vorne	Verstellbarkeit Hinten	Ersatzteilbezeichnung Vorne	Ersatzteilbezeichnung Hinten	Gutachten
Model	Year	Front Axle Load kg	Rear Axle Load kg	Part-No.	Notes	ca. Lowering Front mm	ca. Lowering Rear mm	Ø Front mm	Ø Rear mm	Adjustable Front	Adjustable Rear	Spare Part Marking Front	Spare Part Marking Rear	Homologation
TOLEDO II (1M2) <i>Anti-Roll-Kit (Performance Stabilisatoren Performance Sway Bars)</i> 1.4 16V, 1.6, 1.6 16V, 1.8 20V, 1.8 20VT, 1.9 SDI, 1.9 TDI, 2.3 V5, 2.3 V5 20V	04.99 - 05.06			E40-85-005-01-10	A, 18, 20, 22, 45			25		nicht verstellbar not adjustable		AS41-85-005-01-VA		T
1.4 16V, 1.6, 1.6 16V, 1.8 20V, 1.8 20VT, 1.9 SDI, 1.9 TDI, 2.3 V5, 2.3 V5 20V	04.99 - 05.06			E40-85-005-01-11	A, 18, 20, 22, 45			25	25	nicht verstellbar not adjustable	nicht verstellbar not adjustable	AS41-85-005-01-VA	AS1540320HA	T
B12 Pro-Kit (Performance Komplettfahrwerke Performance Springs+Shocks) 1.4 16V, 1.6, 1.6 16V	04.99 - 05.06	910	1000	E90-81-004-01-22	A, 18, 20, 26, 78, 161	30	20-25							T
1.8 20V, 1.8 20VT, 1.9 SDI, 1.9 TDI	04.99 - 05.06	982	1000	E90-81-004-02-22	A, 18, 20, 26, 78, 161	30	20-25							T
1.9 TDI, 2.3 V5, 2.3 V5 20V	04.99 - 05.06	1005	1000	E90-81-004-03-22	A, 18, 20, 26, 78, 161	30	20-25							T
B12 Sportline (Performance Komplettfahrwerke Sport Sport Performance Springs+Shocks) 1.4 16V, 1.6, 1.6 16V, 1.8 20V, 1.8 20VT, 1.9 SDI, 1.9 TDI	04.99 - 05.06	950	1000	E95-81-004-01-22	A, 18, 20, 26, 78, 161	45-50	30							T
1.9 SDI, 1.9 TDI, 2.3 V5, 2.3 V5 20V	04.99 - 05.06	1000	1000	E95-81-004-02-22	A, 18, 20, 26, 78, 161	45-50	30							T
TOLEDO III (5P2) <i>Pro-Kit (Performance Fahrwerksfedern Performance Springs)</i> 1.6, 2.0 FSI	10.04 - 05.09	1022	1050	E10-81-008-01-22	A, 18, 20	30	30					F11-15-007-01-VA	F11-15-007-01-HA	T
1.8 TFSI, 1.9 TDI, 2.0 FSI, 2.0 TDI, 2.0 TDI 16V, 2.0 TFSI	04.04 - 05.09	1120	1050	E10-81-008-02-22	A, 18, 20	30	30					F11-15-007-03-VA	F11-15-007-01-HA	T
<i>Anti-Roll-Kit (Performance Stabilisatoren Performance Sway Bars)</i> 1.6, 1.8 TFSI, 1.9 TDI, 2.0 FSI, 2.0 TDI, 2.0 TFSI	09.04 - 05.09			E40-85-014-06-11	A, 18, 20, 22, 45			26	23	2-fach verstellbar 2-way adjustable	2-fach verstellbar 2-way adjustable	AS41-85-014-01-VA	AS41-85-014-01-HA	T
B12 Pro-Kit (Performance Komplettfahrwerke Performance Springs+Shocks) 1.6, 2.0 FSI	10.04 - 05.09	1022	1050	E90-81-008-02-22	A, 18, 20, 34, 78, 161	30	30							T
1.6, 2.0 FSI	10.04 - 05.09	1022	1050	E90-81-008-01-22	A, 18, 20, 35, 78, 161	30	30							T
1.8 TFSI, 1.9 TDI, 2.0 FSI, 2.0 TDI, 2.0 TDI 16V, 2.0 TFSI	04.04 - 05.09	1120	1050	E90-81-008-04-22	A, 18, 20, 34, 78, 161	30	30							T
1.8 TFSI, 1.9 TDI, 2.0 FSI, 2.0 TDI, 2.0 TDI 16V, 2.0 TFSI	04.04 - 05.09	1120	1050	E90-81-008-03-22	A, 18, 20, 35, 78, 161	30	30							T
<i>Pro-Street-S (Gewindefahrwerke - höhenverstellbar Coil-Overs-Adjustable Ride Height)</i> 1.6, 1.8 TFSI, 1.9 TDI, 2.0 FSI, 2.0 TDI, 2.0 TDI 16V, 2.0 TFSI	04.04 - 05.09	1035	1150	PSS65-85-014-01-22	A, 20, 24, 34, 45, 70, 160	25-55	30-60							T
1.6, 1.8 TFSI, 1.9 TDI, 2.0 FSI, 2.0 TDI, 2.0 TDI 16V, 2.0 TFSI	04.04 - 05.09	1035	1150	PSS65-85-014-02-22	A, 20, 24, 35, 45, 70, 160	25-55	30-60							T
1.6, 1.8 TFSI, 1.9 TDI, 2.0 FSI, 2.0 TDI, 2.0 TDI 16V, 2.0 TFSI	04.04 - 05.09	1105	1150	PSS65-85-014-03-22	A, 20, 24, 34, 45, 70, 160	25-55	30-60							T
1.6, 1.8 TFSI, 1.9 TDI, 2.0 FSI, 2.0 TDI, 2.0 TDI 16V, 2.0 TFSI	04.04 - 05.09	1105	1150	PSS65-85-014-04-22	A, 20, 24, 35, 45, 70, 160	25-55	30-60							T
1.6, 1.8 TFSI, 1.9 TDI, 2.0 FSI, 2.0 TDI, 2.0 TDI 16V, 2.0 TFSI	04.04 - 05.09	1170	1150	PSS65-85-014-05-22	A, 20, 24, 34, 45, 70, 160	25-55	30-60							T
1.6, 1.8 TFSI, 1.9 TDI, 2.0 FSI, 2.0 TDI, 2.0 TDI 16V, 2.0 TFSI	04.04 - 05.09	1170	1150	PSS65-85-014-06-22	A, 20, 24, 35, 45, 70, 160	25-55	30-60							T
TOLEDO IV (KG3) <i>Pro-Kit (Performance Fahrwerksfedern Performance Springs)</i> 1.2, 1.2 TSI	07.12 -	880	860	E10-79-009-01-22	A, 18, 20	30	30					F11-15-014-01-VA	F1540002	T
1.4 TSI, 1.6 TDI	07.12 -	960	860	E10-79-009-02-22	A, 18, 20	30	30					F11-81-010-05-VA	F1540002	T
CITIGO <i>Pro-Kit (Performance Fahrwerksfedern Performance Springs)</i> 1.0	10.11 -	680	640	E10-85-040-01-22	A, 18, 20	20	25					F11-85-040-01-VA	F11-85-040-01-HA	T
FABIA (6Y2) <i>Pro-Kit (Performance Fahrwerksfedern Performance Springs)</i> 1.0, 1.2, 1.4, 1.4 16V	08.99 - 03.08	900	800	E7910-140	A, 18, 20	30	30					F7910001	F7910002	T
1.4 TDI, 1.9 SDI, 1.9 TDI, 2.0	12.99 - 03.08	900	800	E7911-140	A, 18, 20	30	30					F7911001	F7910002	T
1.9 TDI RS	06.03 - 03.08	960	840	E10-79-001-05-22	A, 18, 20	25	25					F11-85-008-02-VA	F11-85-008-01-HA	T
<i>Anti-Roll-Kit (Performance Stabilisatoren Performance Sway Bars)</i> 1.0, 1.2, 1.4, 1.4 16V, 1.4 TDI, 1.9 SDI, 1.9 TDI, 1.9 TDI RS, 2.0	08.99 - 03.08			E40-85-008-01-10	A, 18, 20, 22, 45			22		nicht verstellbar not adjustable		AS41-85-008-01-VA		T
B12 Pro-Kit (Performance Komplettfahrwerke Performance Springs+Shocks) 1.0, 1.2, 1.4, 1.4 16V	08.99 - 03.08	920	840	E90-79-001-01-22	A, 18, 20, 78, 161	30	30							T
1.4 TDI, 1.9 SDI, 1.9 TDI, 2.0	12.99 - 03.08	960	840	E90-79-001-02-22	A, 18, 20, 78, 161	30	30							T
1.9 TDI RS	06.03 - 03.08	960	840	E90-79-001-05-22	A, 18, 20, 78, 161	25	25							T
FABIA <i>Pro-Kit (Performance Fahrwerksfedern Performance Springs)</i> 1.2, 1.2 12V, 1.2 TSI, 1.4, 1.6	12.06 -	960	840	E10-79-006-01-22	A, 18, 20	30	30					F11-85-008-01-VA	F11-85-008-01-HA	T
1.2 TDI, 1.4 TDI, 1.6 TDI, 1.9 TDI	01.07 -	960	840	E10-79-006-02-22	A, 18, 20	30	30					F11-79-005-01-VA	F11-85-008-01-HA	T
1.4 TSI	05.10 -	960	840	E10-79-006-09-22	A, 18, 20	20	20					F11-15-014-02-VA	F11-85-008-01-HA	T
<i>Anti-Roll-Kit (Performance Stabilisatoren Performance Sway Bars)</i> 1.2, 1.2 12V, 1.2 TDI, 1.2 TSI, 1.4, 1.4 TDI, 1.4 TSI, 1.6, 1.6 TDI, 1.9 TDI	12.06 -			E40-85-008-01-10	A, 18, 20, 22, 45			22		nicht verstellbar not adjustable		AS41-85-008-01-VA		T
B12 Pro-Kit (Performance Komplettfahrwerke Performance Springs+Shocks) 1.2, 1.2 12V, 1.2 TSI, 1.4, 1.4 TDI, 1.6, 1.6 TDI	12.06 -	920	840	E90-79-006-01-22	A, 18, 20, 78, 161	30	30							T
1.4 TDI, 1.6 TDI, 1.9 TDI	01.07 -	960	840	E90-79-006-02-22	A, 18, 20, 78, 161	30	30							T
<i>Pro-Street-S (Gewindefahrwerke - höhenverstellbar Coil-Overs-Adjustable Ride Height)</i> 1.2, 1.4, 1.4 TDI, 1.6, 1.9 TDI	12.06 - 12.08	890	840	PSS65-79-006-01-22	A, 18, 25, 45, 160	30-60	30-60							T
1.2, 1.2 12V, 1.2 TDI, 1.2 TSI, 1.4, 1.4 TDI, 1.4 TSI, 1.6, 1.6 TDI, 1.9 TDI	01.09 -	925	840	PSS65-79-006-03-22	A, 18, 25, 45, 160	30-60	30-60							T

Modell	Baujahr	Achslast Vorne kg	Achslast Hinten kg	Artikel-Nr.	Hinweise	ca. Tieferl. Vorne mm	ca. Tieferl. Hinten mm	Ø Vorne mm	Ø Hinten mm	Verstellbarkeit Vorne	Verstellbarkeit Hinten	Ersatzteilbezeichnung Vorne	Ersatzteilbezeichnung Hinten	Gutachten
Model	Year	Front Axle Load kg	Rear Axle Load kg	Part-No.	Notes	ca. Lowering Front mm	ca. Lowering Rear mm	Ø Front mm	Ø Rear mm	Adjustable Front	Adjustable Rear	Spare Part Marking Front	Spare Part Marking Rear	Homologation
FABIA Pro-Street-S (Gewindefahrwerke - höhenverstellbar Coil-Overs-Adjustable Ride Height) 1.2, 1.4, 1.4 TDI, 1.6, 1.9 TDI	12.06 - 12.08	960	840	PSS65-79-006-02-22	A, 18, 25, 45, 160	30-60	30-60							T
1.2, 1.2 12V, 1.2 TDI, 1.2 TSI, 1.4, 1.4 TDI, 1.4 TSI, 1.6, 1.6 TDI, 1.9 TDI	01.09 -	960	840	PSS65-79-006-04-22	A, 18, 25, 45, 160	30-60	30-60							T
FABIA Combi (6Y5) Pro-Kit (Performance Fahrwerksfedern Performance Springs) 1.2, 1.4, 1.4 16V	04.00 - 12.07	900	875	E10-79-001-01-22	A, 18, 20	30	30					F7910001	F11-79-001-01-HA	T
1.4 TDI, 1.9 SDI, 1.9 TDI, 2.0	04.00 - 12.07	900	875	E10-79-001-02-22	A, 18, 20	30	30					F7911001	F11-79-001-01-HA	T
Anti-Roll-Kit (Performance Stabilisatoren Performance Sway Bars) 1.2, 1.4, 1.4 16V, 1.4 TDI, 1.9 SDI, 1.9 TDI, 2.0	04.00 - 12.07			E40-85-008-01-10	A, 18, 20, 22, 45			22		nicht verstellbar not adjustable		AS41-85-008-01-VA		T
B12 Pro-Kit (Performance Komplettfahrwerke Performance Springs+Shocks) 1.2, 1.4, 1.4 16V	04.00 - 12.07	900	875	E90-79-001-03-22	A, 18, 20, 78, 161	30	30							T
1.4 TDI, 1.9 SDI, 1.9 TDI, 2.0	04.00 - 12.07	900	875	E90-79-001-04-22	A, 18, 20, 78, 161	30	30							T
FABIA Combi Pro-Kit (Performance Fahrwerksfedern Performance Springs) 1.2, 1.2 12V, 1.2 TSI, 1.4, 1.6	10.07 -	960	840	E10-79-006-05-22	A, 18, 20	30	20					F11-85-008-01-VA	F11-79-001-01-HA	T
1.4 TSI	05.10 -	960	840	E10-79-006-10-22	A, 18, 20	20	15					F11-15-014-02-VA	F11-79-001-01-HA	T
1.2 TDI, 1.4 TDI, 1.6, 1.6 TDI, 1.9 TDI	10.07 -	960	840	E10-79-006-06-22	A, 18, 20	30	20					F11-79-005-01-VA	F11-79-001-01-HA	T
Anti-Roll-Kit (Performance Stabilisatoren Performance Sway Bars) 1.2, 1.2 12V, 1.2 TDI, 1.2 TSI, 1.4, 1.4 TDI, 1.4 TSI, 1.6, 1.6 TDI, 1.9 TDI	10.07 -			E40-85-008-01-10	A, 18, 20, 22, 45			22		nicht verstellbar not adjustable		AS41-85-008-01-VA		T
B12 Pro-Kit (Performance Komplettfahrwerke Performance Springs+Shocks) 1.2, 1.2 12V, 1.2 TSI, 1.4, 1.6	10.07 -	920	840	E90-79-006-03-22	A, 18, 20, 78, 161	30	20							T
1.2 TDI, 1.4 TDI, 1.6, 1.6 TDI, 1.9 TDI	10.07 -	960	840	E90-79-006-04-22	A, 18, 20, 78, 161	30	20							T
Pro-Street-S (Gewindefahrwerke - höhenverstellbar Coil-Overs-Adjustable Ride Height) 1.2, 1.4, 1.4 TDI, 1.6, 1.9 TDI	10.07 - 12.08	890	840	PSS65-79-006-01-22	A, 18, 25, 45, 160	30-60	30-60							T
1.2, 1.2 12V, 1.2 TDI, 1.2 TSI, 1.4, 1.4 TDI, 1.4 TSI, 1.6, 1.6 TDI, 1.9 TDI	01.09 -	925	840	PSS65-79-006-03-22	A, 18, 25, 45, 160	30-60	30-60							T
1.2, 1.4, 1.4 TDI, 1.6, 1.9 TDI	10.07 - 12.08	960	840	PSS65-79-006-02-22	A, 18, 25, 45, 160	30-60	30-60							T
1.2, 1.2 12V, 1.2 TDI, 1.2 TSI, 1.4, 1.4 TDI, 1.4 TSI, 1.6, 1.6 TDI, 1.9 TDI	01.09 -	960	840	PSS65-79-006-04-22	A, 18, 25, 45, 160	30-60	30-60							T
FABIA Praktik Anti-Roll-Kit (Performance Stabilisatoren Performance Sway Bars) 1.2, 1.4, 1.4 TDI, 1.9 SDI	07.01 - 12.07			E40-85-008-01-10	A, 18, 20, 22, 45			22		nicht verstellbar not adjustable		AS41-85-008-01-VA		T
FABIA Stufenheck (6Y3) FABIA Saloon (6Y3) Pro-Kit (Performance Fahrwerksfedern Performance Springs) 1.2, 1.4, 1.4 16V	10.99 - 12.07	900	875	E10-79-001-01-22	A, 18, 20	30	30					F7910001	F11-79-001-01-HA	T
1.4 TDI, 1.9 SDI, 1.9 TDI, 2.0	11.99 - 12.07	900	875	E10-79-001-02-22	A, 18, 20	30	30					F7911001	F11-79-001-01-HA	T
Anti-Roll-Kit (Performance Stabilisatoren Performance Sway Bars) 1.2, 1.4, 1.4 16V, 1.4 TDI, 1.9 SDI, 1.9 TDI, 2.0	10.99 - 12.07			E40-85-008-01-10	A, 18, 20, 22, 45			22		nicht verstellbar not adjustable		AS41-85-008-01-VA		T
B12 Pro-Kit (Performance Komplettfahrwerke Performance Springs+Shocks) 1.2, 1.4, 1.4 16V	10.99 - 12.07	900	875	E90-79-001-03-22	A, 18, 20, 78, 161	30	30							T
1.4 TDI, 1.9 SDI, 1.9 TDI, 2.0	11.99 - 12.07	900	875	E90-79-001-04-22	A, 18, 20, 78, 161	30	30							T
OCTAVIA (1U2) Pro-Kit (Performance Fahrwerksfedern Performance Springs) 1.4, 1.4 16V, 1.6, 1.9 SDI, 2.0	09.96 - 12.10	1000	1000	E7905-140	A, 18, 20	30	30					F1540001	F7907002	T
1.8, 1.8 T, 1.9 TDI, 2.0	09.96 - 12.10	1000	1000	E7907-140	A, 18, 20	30	30					F1545001	F7907002	T
Sportline (Performance Fahrwerksfedern Sport Sport Performance Springs) 1.4, 1.4 16V, 1.6, 1.9 SDI, 1.9 TDI, 2.0	09.96 - 12.10	950	1000	E20-79-002-01-22	A, 20	45-50	30					F21-85-001-01-VA	F21-85-001-01-HA	T
1.4, 1.4 16V, 1.6, 1.9 SDI, 1.9 TDI, 2.0	09.96 - 12.10	1000	1000	E20-79-002-02-22	A, 20	45-50	30					F21-85-003-01-VA	F21-85-001-01-HA	T
Anti-Roll-Kit (Performance Stabilisatoren Performance Sway Bars) 1.4, 1.4 16V, 1.6, 1.9 SDI, 1.9 TDI, 2.0	09.96 - 12.10			E40-85-005-01-10	A, 18, 20, 22, 45			25		nicht verstellbar not adjustable		AS41-85-005-01-VA		T
1.4, 1.4 16V, 1.6, 1.9 SDI, 1.9 TDI, 2.0	09.96 - 12.10			E40-85-005-01-11	A, 18, 20, 22, 45			25	25	nicht verstellbar not adjustable	nicht verstellbar not adjustable	AS41-85-005-01-VA	AS1540320HA	T
B12 Pro-Kit (Performance Komplettfahrwerke Performance Springs+Shocks) 1.4, 1.4 16V, 1.6, 1.9 SDI	09.96 - 12.10	1000	1000	E90-79-002-01-22	A, 18, 20, 78, 161	30	30							T
1.8, 1.8 T, 1.9 TDI	09.96 - 12.10	1000	1000	E90-79-002-02-22	A, 18, 20, 78, 161	30	30							T
2.0	04.99 - 05.07	1000	1000	E90-79-002-02-22	A, 18, 20, 72, 78,	161	30							T
2.0 Schaltgetriebe 2.0 manual transmission	04.99 - 05.07	1000	1000	E90-79-002-01-22	A, 18, 20, 72, 78,	161	30							T
B12 Sportline (Performance Komplettfahrwerke Sport Sport Performance Springs+Shocks) 1.4, 1.4 16V, 1.6, 1.8, 1.8 T, 1.9 SDI, 1.9 TDI, 2.0	09.96 - 12.10	950	1000	E95-79-002-01-22	A, 18, 20, 78, 161	45-50	30							T
1.4, 1.4 16V, 1.6, 1.8, 1.8 T, 1.9 SDI, 1.9 TDI, 2.0	09.96 - 12.10	1000	1000	E95-79-002-02-22	A, 18, 20, 78, 161	45-50	30							T
Pro-Street-S (Gewindefahrwerke - höhenverstellbar Coil-Overs-Adjustable Ride Height) 1.4, 1.4 16V, 1.6, 1.8, 1.8 T, 1.9 SDI, 1.9 TDI, 2.0	09.96 - 12.10	1020	1080	PSS65-85-001-03-22	A, 20, 24, 25, 26,	45, 160	35-65	35-65						T

Modell	Baujahr	Achslast Vorne kg	Achslast Hinten kg	Artikel-Nr.	Hinweise	ca. Tieferl. Vorne mm	ca. Tieferl. Hinten mm	Ø Vorne mm	Ø Hinten mm	Verstellbarkeit Vorne	Verstellbarkeit Hinten	Ersatzteilbezeichnung Vorne	Ersatzteilbezeichnung Hinten	Gutachten	
Model	Year	Front Axle Load kg	Rear Axle Load kg	Part-No.	Notes	ca. Lowering Front mm	ca. Lowering Rear mm	Ø Front mm	Ø Rear mm	Adjustable Front	Adjustable Rear	Spare Part Marking Front	Spare Part Marking Rear	Homologation	
OCTAVIA (1Z3)															
Pro-Kit (Performance Fahrwerksfedern Performance Springs)															
1.2 TSI, 1.4, 1.4 TSI, 1.6, 1.6 FSI, 1.6 MultiFuel, 1.6 TDI, 1.8 TSI, 1.9 TDI, 2.0 FSI	02.04 -	1050	1100	E10-79-004-01-22	A, 18, 20	30	30					F11-79-004-01-VA	F11-85-014-05-HA	ABE	
2.0 RS, 2.0 TDI RS	10.05 -	1100	1100	E10-79-004-02-22	A, 18, 20	20	20					F11-79-004-02-VA	F11-85-014-05-HA	ABE	
1.2 TSI mit DSG, 1.6 TDI, 1.9 TDI, 2.0 FSI, 2.0 TDI, 2.0 TDI 16V 1.2 TSI with DSG, 1.6 TDI, 1.9 TDI, 2.0 FSI, 2.0 TDI, 2.0 TDI 16V	02.04 -	1100	1100	E10-79-004-02-22	A, 18, 20	30	30					F11-79-004-02-VA	F11-85-014-05-HA	ABE	
Anti-Roll-Kit (Performance Stabilisatoren Performance Sway Bars)															
1.2 TSI, 1.4, 1.4 TSI, 1.6, 1.6 FSI, 1.6 MultiFuel, 1.6 TDI, 1.8 TSI, 1.9 TDI, 2.0 FSI, 2.0 RS, 2.0 TDI, 2.0 TDI 16V, 2.0 TDI RS	02.04 -			E40-79-004-01-11	A, 18, 20, 22, 45			26	23	2-fach verstellbar 2-way adjustable	2-fach verstellbar 2-way adjustable	AS41-85-014-01-VA	AS41-85-014-01-HA	T	
B12 Pro-Kit (Performance Komplettfahrwerke Performance Springs+Shocks)															
1.2 TSI, 1.4, 1.4 TSI, 1.6, 1.6 FSI	02.04 -	1050	1100	E90-79-004-02-22	A, 18, 20, 34, 78,	161	30	30						T	
1.2 TSI, 1.4, 1.4 TSI, 1.6, 1.6 FSI	02.04 -	1050	1100	E90-79-004-01-22	A, 18, 20, 35, 78,	161	30	30						T	
1.2 TSI, 1.6 TDI, 1.8 TSI, 1.9 TDI, 2.0 FSI, 2.0 RS, 2.0 TDI, 2.0 TDI 16V, 2.0 TDI RS	02.04 -	1100	1100	E90-79-004-04-22	A, 18, 20, 34, 78,	161	30	30						T	
1.2 TSI, 1.6 TDI, 1.8 TSI, 1.9 TDI, 2.0 FSI, 2.0 RS, 2.0 TDI, 2.0 TDI 16V, 2.0 TDI RS	02.04 -	1100	1100	E90-79-004-03-22	A, 18, 20, 35, 78,	161	30	30						T	
Pro-Street-S (Gewindefahrwerke - höhenverstellbar Coil-Overs-Adjustable Ride Height)															
1.2 TSI, 1.4, 1.4 TSI, 1.6, 1.6 FSI, 1.6 MultiFuel, 1.6 TDI, 1.8 TSI, 1.9 TDI, 2.0 FSI, 2.0 TDI, 2.0 TDI 16V	02.04 -	1035	1150	PSS65-85-014-01-22	A, 20, 24, 34, 45,	70, 160	35-65	35-65						T	
1.2 TSI, 1.4, 1.4 TSI, 1.6, 1.6 FSI, 1.6 MultiFuel, 1.6 TDI, 1.8 TSI, 1.9 TDI, 2.0 FSI, 2.0 TDI, 2.0 TDI 16V	02.04 -	1035	1150	PSS65-85-014-02-22	A, 20, 24, 35, 45,	70, 160	35-65	35-65						T	
2.0 RS, 2.0 TDI RS	10.05 -	1035	1150	PSS65-85-014-01-22	A, 20, 24, 34, 45,	70, 160	20-50	30-60						T	
2.0 RS, 2.0 TDI RS	10.05 -	1035	1150	PSS65-85-014-02-22	A, 20, 24, 35, 45,	70, 160	20-50	30-60						T	
1.2 TSI, 1.4, 1.4 TSI, 1.6, 1.6 FSI, 1.6 MultiFuel, 1.6 TDI, 1.8 TSI, 1.9 TDI, 2.0 FSI, 2.0 TDI, 2.0 TDI 16V	02.04 -	1105	1150	PSS65-85-014-03-22	A, 20, 24, 34, 45,	70, 160	35-65	35-65						T	
1.2 TSI, 1.4, 1.4 TSI, 1.6, 1.6 FSI, 1.6 MultiFuel, 1.6 TDI, 1.8 TSI, 1.9 TDI, 2.0 FSI, 2.0 TDI, 2.0 TDI 16V	02.04 -	1105	1150	PSS65-85-014-04-22	A, 20, 24, 35, 45,	70, 160	35-65	35-65						T	
2.0 RS, 2.0 TDI RS	10.05 -	1105	1150	PSS65-85-014-03-22	A, 20, 24, 34, 45,	70, 160	20-50	30-60						T	
2.0 RS, 2.0 TDI RS	10.05 -	1105	1150	PSS65-85-014-04-22	A, 20, 24, 35, 45,	70, 160	20-50	30-60						T	
1.2 TSI, 1.4, 1.4 TSI, 1.6, 1.6 FSI, 1.6 MultiFuel, 1.6 TDI, 1.8 TSI, 1.9 TDI, 2.0 FSI, 2.0 TDI, 2.0 TDI 16V	02.04 -	1170	1150	PSS65-85-014-05-22	A, 20, 24, 34, 45,	70, 160	35-65	35-65						T	
1.2 TSI, 1.4, 1.4 TSI, 1.6, 1.6 FSI, 1.6 MultiFuel, 1.6 TDI, 1.8 TSI, 1.9 TDI, 2.0 FSI, 2.0 TDI, 2.0 TDI 16V	02.04 -	1170	1150	PSS65-85-014-06-22	A, 20, 24, 35, 45,	70, 160	35-65	35-65						T	
2.0 RS, 2.0 TDI RS	10.05 -	1170	1150	PSS65-85-014-05-22	A, 20, 24, 34, 45,	70, 160	20-50	30-60						T	
2.0 RS, 2.0 TDI RS	10.05 -	1170	1150	PSS65-85-014-06-22	A, 20, 24, 35, 45,	70, 160	20-50	30-60						T	
OCTAVIA (5E3)															
Anti-Roll-Kit (Performance Stabilisatoren Performance Sway Bars)															
1.2 TSI, 1.4 TSI, 1.6 TDI, 1.8 TSI, 2.0 TSI RS	11.12 -			E40-15-021-01-11	A, 18, 20, 22, 45,	170			28 Rohr 28 tube	25 Rohr 25 tube	2-fach verstellbar 2-way adjustable	nicht verstellbar not adjustable	AS41-15-021-01-VA	AS41-15-021-01-HA	T
1.2 TSI, 1.4 TSI, 1.6 TDI, 1.8 TSI	11.12 -			E40-15-021-03-11	A, 18, 20, 22, 45,	171			28 Rohr 28 tube	25	2-fach verstellbar 2-way adjustable	nicht verstellbar not adjustable	AS41-15-021-01-VA	AS41-15-021-03-HA	T
OCTAVIA Combi (1U5)															
Pro-Kit (Performance Fahrwerksfedern Performance Springs)															
1.4 16V, 1.6, 1.9 SDI, 2.0	07.98 - 12.10	1000	1020	E7908-140	A, 18, 20	30	30					F1540001	F7908002	T	
1.8 20V, 1.8 T, 1.9 TDI, 2.0	07.98 - 12.10	1000	1020	E7909-140	A, 18, 20	30	30					F1545001	F7908002	T	
Anti-Roll-Kit (Performance Stabilisatoren Performance Sway Bars)															
1.4 16V, 1.6, 1.9 SDI, 1.9 TDI, 2.0	07.98 - 12.10			E40-85-005-01-11	A, 18, 20, 22, 45			25	25	nicht verstellbar not adjustable	nicht verstellbar not adjustable	AS41-85-005-01-VA	AS1540320HA	T	
B12 Pro-Kit (Performance Komplettfahrwerke Performance Springs+Shocks)															
2.0 4x4 Schaltgetriebe, 2.0 Schaltgetriebe 2.0 4x4 manual transmission, 2.0 manual transmission	04.99 - 12.10	1000	1020	E90-79-002-03-22	A, 18, 71, 78, 161	30	30							T	
2.0, 2.0 4x4	04.99 - 12.10	1000	1020	E90-79-002-04-22	A, 18, 72, 78, 161	30	30							T	
1.4 16V, 1.6, 1.9 SDI	07.98 - 12.10	1020	1020	E90-79-002-03-22	A, 18, 20, 78, 161	30	30							T	
1.8 20V, 1.8 T, 1.9 TDI	07.98 - 12.10	1020	1020	E90-79-002-04-22	A, 18, 20, 78, 161	30	30							T	
Pro-Street-S (Gewindefahrwerke - höhenverstellbar Coil-Overs-Adjustable Ride Height)															
1.4 16V, 1.6, 1.8 20V, 1.8 T, 1.9 SDI, 1.9 TDI, 2.0	07.98 - 12.10	1020	1080	PSS65-85-001-03-22	A, 20, 24, 25, 26,	45, 160	35-65	35-65						T	
OCTAVIA Combi (1Z5)															
Pro-Kit (Performance Fahrwerksfedern Performance Springs)															
1.2 TSI, 1.4, 1.4 TSI, 1.6, 1.6 FSI, 1.6 MultiFuel, 1.6 TDI, 1.8 TSI, 1.9 TDI, 2.0 FSI	02.04 -	1050	1150	E10-79-004-03-22	A, 18, 20	30	30					F11-79-004-01-VA	F11-15-007-01-HA	ABE	
2.0 RS, 2.0 TDI RS	10.05 -	1100	1150	E10-79-004-04-22	A, 18, 20	20	20					F11-79-004-02-VA	F11-15-007-01-HA	ABE	
1.2 TSI mit DSG, 1.6 TDI, 1.9 TDI, 2.0 FSI, 2.0 TDI, 2.0 TDI 16V 1.2 TSI with DSG, 1.6 TDI, 1.9 TDI, 2.0 FSI, 2.0 TDI, 2.0 TDI 16V	02.04 -	1100	1150	E10-79-004-04-22	A, 18, 20	30	30					F11-79-004-02-VA	F11-15-007-01-HA	ABE	
Anti-Roll-Kit (Performance Stabilisatoren Performance Sway Bars)															
1.2 TSI, 1.4, 1.4 TSI, 1.6, 1.6 FSI, 1.6 MultiFuel, 1.6 TDI, 1.8 TSI, 1.9 TDI, 2.0 FSI, 2.0 RS, 2.0 TDI, 2.0 TDI 16V, 2.0 TDI RS	02.04 -			E40-79-004-01-11	A, 18, 20, 22, 45			26	23	2-fach verstellbar 2-way adjustable	2-fach verstellbar 2-way adjustable	AS41-85-014-01-VA	AS41-85-014-01-HA	T	
B12 Pro-Kit (Performance Komplettfahrwerke Performance Springs+Shocks)															
1.2 TSI, 1.4, 1.4 TSI, 1.6, 1.6 FSI, 1.8 TSI	02.04 -	1050	1150	E90-79-004-06-22	A, 18, 20, 34, 78,	161	30	30						T	
1.2 TSI, 1.4, 1.4 TSI, 1.6, 1.6 FSI, 1.8 TSI	02.04 -	1050	1150	E90-79-004-05-22	A, 18, 20, 35, 78,	161	30	30						T	
1.2 TSI, 1.6 TDI, 1.9 TDI, 2.0 FSI, 2.0 RS, 2.0 TDI, 2.0 TDI 16V, 2.0 TDI RS	02.04 -	1100	1150	E90-79-004-08-22	A, 18, 20, 34, 78,	161	30	30						T	

Modell	Baujahr	Achslast Vorne kg	Achslast Hinten kg	Artikel-Nr.	Hinweise	ca. Tieferl. Vorne mm	ca. Tieferl. Hinten mm	Ø Vorne mm	Ø Hinten mm	Verstellbarkeit Vorne	Verstellbarkeit Hinten	Ersatzteilbezeichnung Vorne	Ersatzteilbezeichnung Hinten	Gutachten
Model	Year	Front Axle Load kg	Rear Axle Load kg	Part-No.	Notes	ca. Lowering Front mm	ca. Lowering Rear mm	Ø Front mm	Ø Rear mm	Adjustable Front	Adjustable Rear	Spare Part Marking Front	Spare Part Marking Rear	Homologation
OCTAVIA Combi (1Z5) B12 Pro-Kit (Performance Komplettfahrwerke Performance Springs+Shocks) 1.2 TSI, 1.6 TDI, 1.9 TDI, 2.0 FSI, 2.0 RS, 2.0 TDI, 2.0 TDI 16V, 2.0 TDI RS	02.04 -	1100	1150	E90-79-004-07-22	A, 18, 20, 35, 78, 161	30	30							T
Pro-Street-S (Gewindefahrwerke - höhenverstellbar Coil-Overs-Adjustable Ride High) 1.2 TSI, 1.4, 1.4 TSI, 1.6, 1.6 FSI, 1.6 MultiFuel, 1.6 TDI, 1.8 TSI, 1.9 TDI, 2.0 FSI, 2.0 TDI, 2.0 TDI 16V, 2.0 TDI RS	02.04 -	1035	1150	PSS65-85-014-01-22	A, 20, 24, 34, 45, 70, 160	35-65	35-65							T
1.2 TSI, 1.4, 1.4 TSI, 1.6, 1.6 FSI, 1.6 MultiFuel, 1.6 TDI, 1.8 TSI, 1.9 TDI, 2.0 FSI, 2.0 TDI, 2.0 TDI 16V, 2.0 TDI RS	02.04 -	1035	1150	PSS65-85-014-02-22	A, 20, 24, 35, 45, 70, 160	35-65	35-65							T
2.0 RS	10.05 -	1035	1150	PSS65-85-014-01-22	A, 20, 24, 34, 45, 70, 160	20-50	30-60							T
2.0 RS	10.05 -	1035	1150	PSS65-85-014-02-22	A, 20, 24, 35, 45, 70, 160	20-50	30-60							T
1.2 TSI, 1.4, 1.4 TSI, 1.6, 1.6 FSI, 1.6 MultiFuel, 1.6 TDI, 1.8 TSI, 1.9 TDI, 2.0 FSI, 2.0 TDI, 2.0 TDI 16V, 2.0 TDI RS	02.04 -	1105	1150	PSS65-85-014-03-22	A, 20, 24, 34, 45, 70, 160	35-65	35-65							T
1.2 TSI, 1.4, 1.4 TSI, 1.6, 1.6 FSI, 1.6 MultiFuel, 1.6 TDI, 1.8 TSI, 1.9 TDI, 2.0 FSI, 2.0 TDI, 2.0 TDI 16V, 2.0 TDI RS	02.04 -	1105	1150	PSS65-85-014-04-22	A, 20, 24, 35, 45, 70, 160	35-65	35-65							T
2.0 RS	10.05 -	1105	1150	PSS65-85-014-03-22	A, 20, 24, 34, 45, 70, 160	20-50	30-60							T
2.0 RS	10.05 -	1105	1150	PSS65-85-014-04-22	A, 20, 24, 35, 45, 70, 160	20-50	30-60							T
1.2 TSI, 1.4, 1.4 TSI, 1.6, 1.6 FSI, 1.6 MultiFuel, 1.6 TDI, 1.8 TSI, 1.9 TDI, 2.0 FSI, 2.0 TDI, 2.0 TDI 16V, 2.0 TDI RS	02.04 -	1170	1150	PSS65-85-014-05-22	A, 20, 24, 34, 45, 70, 160	35-65	35-65							T
1.2 TSI, 1.4, 1.4 TSI, 1.6, 1.6 FSI, 1.6 MultiFuel, 1.6 TDI, 1.8 TSI, 1.9 TDI, 2.0 FSI, 2.0 TDI, 2.0 TDI 16V, 2.0 TDI RS	02.04 -	1170	1150	PSS65-85-014-06-22	A, 20, 24, 35, 45, 70, 160	35-65	35-65							T
2.0 RS	10.05 -	1170	1150	PSS65-85-014-05-22	A, 20, 24, 34, 45, 70, 160	20-50	30-60							T
2.0 RS	10.05 -	1170	1150	PSS65-85-014-06-22	A, 20, 24, 35, 45, 70, 160	20-50	30-60							T
OCTAVIA Combi (5E5) Pro-Kit (Performance Fahrwerksfedern Performance Springs) 1.2 TSI, 1.4 TSI, 1.6 TDI, 1.8 TSI	11.12 -	985	1030	E10-79-010-01-22	A, 18, 20, 170	30-40	30					F11-15-021-01-VA	F11-15-007-15-HA	T
1.2 TSI, 1.4 TSI, 1.6 TDI, 1.8 TSI	11.12 -	985	1030	E10-79-010-03-22	A, 18, 20, 171	30-40	30					F11-15-021-01-VA	F11-70-012-01-HA	T
1.6 TDI, 1.8 TSI, 2.0 TDI	11.12 -	1070	1030	E10-79-010-02-22	A, 18, 20, 170	30-40	30					F11-15-021-02-VA	F11-15-007-15-HA	T
1.6 TDI, 1.8 TSI, 2.0 TDI	11.12 -	1070	1030	E10-79-010-04-22	A, 18, 20, 171	30-40	30					F11-15-021-02-VA	F11-70-012-01-HA	T
2.0 TSI RS	11.12 -	1070	1030	E10-79-010-02-22	A, 18, 20, 170	20	10					F11-15-021-02-VA	F11-15-007-15-HA	T
Anti-Roll-Kit (Performance Stabilisatoren Performance Sway Bars) 1.2 TSI, 1.4 TSI, 1.6 TDI, 1.8 TSI, 2.0 TDI, 2.0 TSI RS	11.12 -			E40-15-021-01-11	A, 18, 20, 22, 45, 170			28 Rohr 28 tube	25 Rohr 25 tube	2-fach verstellbar 2-way adjustable	nicht verstellbar not adjustable	AS41-15-021-01-VA	AS41-15-021-01-HA	T
1.2 TSI, 1.4 TSI, 1.6 TDI, 1.8 TSI, 2.0 TDI	11.12 -			E40-15-021-03-11	A, 18, 20, 22, 45, 171			28 Rohr 28 tube	25	2-fach verstellbar 2-way adjustable	nicht verstellbar not adjustable	AS41-15-021-01-VA	AS41-15-021-03-HA	T
RAPID Pro-Kit (Performance Fahrwerksfedern Performance Springs) 1.2, 1.2 TSI	07.12 -	880	860	E10-79-009-01-22	A, 18, 20	30	30					F11-15-014-01-VA	F1540002	T
1.4 TSI, 1.6, 1.6 TDI	07.12 -	960	860	E10-79-009-02-22	A, 18, 20	30	30					F11-81-010-05-VA	F1540002	T
ROOMSTER (5J) Pro-Kit (Performance Fahrwerksfedern Performance Springs) 1.2, 1.2 TSI, 1.4, 1.6	05.06 -	960	900	E10-79-005-01-22	A, 18, 20	25	25					F11-79-005-01-VA	F11-79-005-01-HA	T
1.2 TDI, 1.4 TDI, 1.6 TDI, 1.9 TDI	03.06 -	960	900	E10-79-005-02-22	A, 18, 20	25	25					F11-85-008-02-VA	F11-79-005-01-HA	T
Anti-Roll-Kit (Performance Stabilisatoren Performance Sway Bars) 1.2, 1.2 TDI, 1.2 TSI, 1.4, 1.4 TDI, 1.6, 1.6 TDI, 1.9 TDI	03.06 -			E40-85-008-01-10	A, 18, 20, 22, 45			22		nicht verstellbar not adjustable		AS41-85-008-01-VA		T
ROOMSTER Praktik (5J) Anti-Roll-Kit (Performance Stabilisatoren Performance Sway Bars) 1.2, 1.2 TDI, 1.2 TSI, 1.4, 1.4 TDI, 1.6 TDI	03.07 -			E40-85-008-01-10	A, 18, 20, 22, 45			22		nicht verstellbar not adjustable		AS41-85-008-01-VA		T
SUPERB (3U4) Pro-Kit (Performance Fahrwerksfedern Performance Springs) 1.8 T, 1.9 TDI, 2.0	12.01 - 03.08	1160	1090	E10-79-003-01-22	A, 18, 20	30	30					F1541001	F1558002	T
2.5 TDI, 2.8 V6	12.01 - 03.08	1230	1090	E10-79-003-02-22	A, 18, 20	30	30					F1558001	F1558002	T
B12 Pro-Kit (Performance Komplettfahrwerke Performance Springs+Shocks) 1.8 T, 1.9 TDI, 2.0	12.01 - 03.08	1160	1090	E90-79-003-01-22	A, 18, 20, 78, 161	30	30							T
2.5 TDI, 2.8 V6	12.01 - 03.08	1230	1090	E90-79-003-02-22	A, 18, 20, 78, 161	30	30							T
SUPERB (3T4) Pro-Kit (Performance Fahrwerksfedern Performance Springs) 1.4 TSI, 1.6 TDI, 1.8 TSI, 1.9 TDI, 2.0 TDI, 2.0 TDI 16V, 2.0 TSI	03.08 -	1210	1250	E10-79-007-01-22	A, 18	30	30					F11-15-007-03-VA	F11-15-007-15-HA	ABE
1.8 TSI 4x4, 2.0 TDI 16V 4x4, 2.0 TDI 4x4	09.08 -	1210	1250	E10-79-007-01-22	A, 18	30	30					F11-15-007-03-VA	F11-15-007-15-HA	T
Anti-Roll-Kit (Performance Stabilisatoren Performance Sway Bars) 1.4 TSI, 1.6 TDI, 1.8 TSI, 1.8 TSI 4x4, 1.9 TDI, 2.0 TDI, 2.0 TDI 16V, 2.0 TDI 16V 4x4, 2.0 TDI 4x4, 2.0 TSI, 3.6 V6 4x4	03.08 -			E40-79-007-01-11	A, 18, 22, 45			26	22 Rohr 22 tube	2-fach verstellbar 2-way adjustable	2-fach verstellbar 2-way adjustable	AS41-85-014-01-VA	AS41-85-014-02-HA	T
B12 Pro-Kit (Performance Komplettfahrwerke Performance Springs+Shocks) 1.4 TSI, 1.6 TDI, 1.8 TSI, 1.9 TDI, 2.0 TDI, 2.0 TDI 16V, 2.0 TSI	03.08 -	1210	1250	E90-79-007-01-22	A, 18, 20, 34, 78, 161	30	30							T

Modell	Baujahr	Achslast Vorne kg	Achslast Hinten kg	Artikel-Nr.	Hinweise	ca. Tieferl. Vorne mm	ca. Tieferl. Hinten mm	Ø Vorne mm	Ø Hinten mm	Verstellbarkeit Vorne	Verstellbarkeit Hinten	Ersatzteilbezeichnung Vorne	Ersatzteilbezeichnung Hinten	Gutachten
Model	Year	Front Axle Load kg	Rear Axle Load kg	Part-No.	Notes	ca. Lowering Front mm	ca. Lowering Rear mm	Ø Front mm	Ø Rear mm	Adjustable Front	Adjustable Rear	Spare Part Marking Front	Spare Part Marking Rear	Homologation
SUPERB Kombi (3T5) SUPERB Estate (3T5) <i>Pro-Kit (Performance Fahrwerksfedern Performance Springs)</i> 1.4 TSI, 1.6 TDI, 1.8 TSI, 1.9 TDI, 2.0 TDI, 2.0 TDI 16V, 2.0 TSI	10.09 -	1210	1250	E10-79-007-01-22	A, 18	30	30					F11-15-007-03-VA	F11-15-007-15-HA	ABE
1.8 TSI 4x4, 2.0 TDI 16V 4x4, 2.0 TDI 4x4	10.09 -	1210	1250	E10-79-007-01-22	A, 18	30	30					F11-15-007-03-VA	F11-15-007-15-HA	T
Anti-Roll-Kit (Performance Stabilisatoren Performance Sway Bars) 1.4 TSI, 1.6 TDI, 1.8 TSI, 1.8 TSI 4x4, 1.9 TDI, 2.0 TDI, 2.0 TDI 16V, 2.0 TDI 16V 4x4, 2.0 TDI 4x4, 2.0 TSI, 3.6 V6 4x4	10.09 -			E40-79-007-01-11	A, 18, 22, 45			26	22 Rohr 22 tube	2-fach verstellbar 2-way adjustable	2-fach verstellbar 2-way adjustable	AS41-85-014-01-VA	AS41-85-014-02-HA	T
B12 Pro-Kit (Performance Komplettfahrwerke Performance Springs+Shocks) 1.4 TSI, 1.6 TDI, 1.8 TSI, 1.9 TDI, 2.0 TDI, 2.0 TDI 16V, 2.0 TSI	10.09 -	1210	1250	E90-79-007-01-22	A, 18, 20, 34, 78, 161	30	30							T
YETI (5L) <i>Pro-Kit (Performance Fahrwerksfedern Performance Springs)</i> 1.2 TSI, 1.4 TSI, 1.6 TDI, 1.8 TSI 4x4, 2.0 TDI, 2.0 TDI 4x4	05.09 -	1100	1160	E10-79-008-02-22	A, 18	35	30					F11-15-007-03-VA	F11-85-012-01-HA	T
1.8 TSI 4x4, 2.0 TDI 4x4	05.09 -	1200	1250	E10-79-008-01-22	A, 18	30-35	30-35					F11-85-012-03-VA	F11-79-008-01-HA	T
CABRIO (450) <i>Pro-Kit (Performance Fahrwerksfedern Performance Springs)</i> 0.6	03.00 - 01.04	427	610	E10-56-001-01-02	A, 18, 20	30	25						F11-56-001-01-HA	T
0.6, 0.7, 0.8 CDI	03.00 - 01.04	430	610	E10-56-001-02-22	A, 18, 20	25	25					F11-56-001-02-VA	F11-56-001-01-HA	T
B12 Pro-Kit (Performance Komplettfahrwerke Performance Springs+Shocks) 0.6	03.00 - 01.04	427	610	E90-56-001-01-02	A, 18, 20, 78, 161	30-35	25							T
0.6, 0.7, 0.8 CDI	03.00 - 01.04	430	610	E90-56-001-02-22	A, 18, 20, 78, 161	25	25							T
CITY-COUBE (450) <i>Pro-Kit (Performance Fahrwerksfedern Performance Springs)</i> 0.6, 0.8 CDI	07.98 - 01.04	427	610	E10-56-001-01-02	A, 18, 20	30	25						F11-56-001-01-HA	T
0.6, 0.7, 0.8 CDI	07.98 - 01.04	430	610	E10-56-001-02-22	A, 18, 20	25	25					F11-56-001-02-VA	F11-56-001-01-HA	T
B12 Pro-Kit (Performance Komplettfahrwerke Performance Springs+Shocks) 0.6, 0.8 CDI	07.98 - 01.04	427	610	E90-56-001-01-02	A, 18, 20, 78, 161	30-35	25							T
0.6, 0.7, 0.8 CDI	07.98 - 01.04	430	610	E90-56-001-02-22	A, 18, 20, 78, 161	25	25							T
FORTWO Cabrio (450) <i>Pro-Kit (Performance Fahrwerksfedern Performance Springs)</i> 0.7, 0.8 CDI	01.04 - 01.07	430	610	E10-56-001-02-22	A, 18, 20	25	25					F11-56-001-02-VA	F11-56-001-01-HA	T
B12 Pro-Kit (Performance Komplettfahrwerke Performance Springs+Shocks) 0.7, 0.8 CDI	01.04 - 01.07	430	610	E90-56-001-02-22	A, 18, 20, 78, 161	25	25							T
FORTWO Cabrio (451) <i>Pro-Kit (Performance Fahrwerksfedern Performance Springs)</i> 0.8 CDI, 1.0, 1.0 Turbo	01.07 -	440	660	E10-56-002-01-22	A, 18, 20	20	20					F11-56-002-01-VA	F11-56-002-01-HA	T
B12 Pro-Kit (Performance Komplettfahrwerke Performance Springs+Shocks) 0.8 CDI, 1.0, 1.0 Turbo	01.07 -	440	660	E90-56-002-01-22	A, 18, 20, 78, 161	20	20							T
FORTWO Coupe (450) <i>Pro-Kit (Performance Fahrwerksfedern Performance Springs)</i> 0.7, 0.8 CDI	01.04 - 01.07	430	610	E10-56-001-02-22	A, 18, 20	25	25					F11-56-001-02-VA	F11-56-001-01-HA	T
B12 Pro-Kit (Performance Komplettfahrwerke Performance Springs+Shocks) 0.7, 0.8 CDI	01.04 - 01.07	430	610	E90-56-001-02-22	A, 18, 20, 78, 161	25	25							T
FORTWO Coupe (451) <i>Pro-Kit (Performance Fahrwerksfedern Performance Springs)</i> 0.8 CDI, 1.0, 1.0 Turbo	01.07 -	440	660	E10-56-002-01-22	A, 18, 20	20	20					F11-56-002-01-VA	F11-56-002-01-HA	T
B12 Pro-Kit (Performance Komplettfahrwerke Performance Springs+Shocks) 0.8 CDI, 1.0, 1.0 Turbo	01.07 -	440	660	E90-56-002-01-22	A, 18, 20, 78, 161	20	20							T
ROADSTER (452) <i>Pro-Kit (Performance Fahrwerksfedern Performance Springs)</i> 0.7	04.03 - 11.05	465	610	E10-56-001-05-22	A, 18, 20	25	25					F11-56-001-05-VA	F11-56-001-05-HA	T
B12 Pro-Kit (Performance Komplettfahrwerke Performance Springs+Shocks) 0.7	04.03 - 11.05	465	610	E90-56-001-05-22	A, 18, 20, 78, 161	25	25							T
ROADSTER Coupe (452) <i>Pro-Kit (Performance Fahrwerksfedern Performance Springs)</i> 0.7	04.03 - 11.05	465	610	E10-56-001-05-22	A, 18, 20	25	25					F11-56-001-05-VA	F11-56-001-05-HA	T
B12 Pro-Kit (Performance Komplettfahrwerke Performance Springs+Shocks) 0.7	04.03 - 11.05	465	610	E90-56-001-05-22	A, 18, 20, 78, 161	25	25							T
BRZ <i>Pro-Kit (Performance Fahrwerksfedern Performance Springs)</i> 2.0	06.12 -	876	943	E10-82-043-01-22	A, 18, 20	25	20					F11-82-043-01-VA	F11-82-043-01-HA	T
IMPREZA Coupe (GFC) <i>Pro-Kit (Performance Fahrwerksfedern Performance Springs)</i> 1.6, 1.6 4WD, 2.0, 2.0 4WD, 2.0 AWD, 2.0 Turbo 4WD, 2.0 i	11.95 - 12.00	900	900	E7705-140	A, 18	30	30					F7705001	F7705002	T
Anti-Roll-Kit (Performance Stabilisatoren Performance Sway Bars) 1.6, 1.6 4WD, 2.0, 2.0 4WD, 2.0 AWD, 2.0 Turbo 4WD, 2.0 i	11.95 - 12.00			E40-77-001-01-11	A, 45			23	24	nicht verstellbar not adjustable	nicht verstellbar not adjustable	AS41-77-001-01-VA	AS41-77-001-01-HA	T
Pro-Street-S (Gewindefahrwerke - höhenverstellbar Coil-Overs-Adjustable Ride Height) 1.6, 1.6 4WD, 2.0, 2.0 4WD, 2.0 AWD, 2.0 Turbo 4WD, 2.0 i	11.95 - 12.00	900	900	PSS65-77-001-01-22	A, 24, 25, 45, 160	25-50	25-50							T

Modell	Baujahr	Achslast Vorne kg	Achslast Hinten kg	Artikel-Nr.	Hinweise	ca. Tieferl. Vorne mm	ca. Tieferl. Hinten mm	Ø Vorne mm	Ø Hinten mm	Verstellbarkeit Vorne	Verstellbarkeit Hinten	Ersatzteilbezeichnung Vorne	Ersatzteilbezeichnung Hinten	Gutachten
Model	Year	Front Axle Load kg	Rear Axle Load kg	Part-No.	Notes	ca. Lowering Front mm	ca. Lowering Rear mm	Ø Front mm	Ø Rear mm	Adjustable Front	Adjustable Rear	Spare Part Marking Front	Spare Part Marking Rear	Homologation
IMPREZA Schrägheck IMPREZA Hatchback Pro-Kit (Performance Fahrwerksfedern Performance Springs) 2.0 WRX STI Allrad, 2.0 i Allrad, 2.0 i WRX Allrad 2.0 WRX STI All-wheel Drive, 2.0 i All-wheel Drive, 2.0 i WRX All-wheel Drive	12.02 - 12.07	1030	960	E10-77-002-04-22	A, 18	30-35	25-30					F11-77-002-03-VA	F11-77-002-04-HA	T
2.0 WRX STI Allrad, 2.0 i Allrad, 2.0 i WRX Allrad 2.0 WRX STI All-wheel Drive, 2.0 i All-wheel Drive, 2.0 i WRX All-wheel Drive	12.02 - 12.07	1030	960	E10-77-002-06-22	A, 18	30-35	25-30					F11-77-002-03-VA	F11-77-002-06-HA	T
IMPREZA Schrägheck (GR, GH, G3) IMPREZA Hatchback (GR, GH, G3) Pro-Kit (Performance Fahrwerksfedern Performance Springs) 1.5 Allrad, 1.5 F, 2.0, 2.0 i Allrad 1.5 All-wheel Drive, 1.5 F, 2.0, 2.0 i All-wheel Drive 2.5 STI CS400	01.08 -	1040	1040	E10-77-006-01-22	A, 18	30	25					F11-77-006-01-VA	F11-77-006-01-HA	T
1.5 Allrad, 1.5 F, 2.0, 2.0 i Allrad 1.5 All-wheel Drive, 1.5 F, 2.0, 2.0 i All-wheel Drive 2.5 STI CS400	04.10 -	1070	1040	E10-77-009-01-22	A, 18	20	5					F11-77-009-01-VA	F11-77-009-01-HA	T
IMPREZA Schrägheck (GP) IMPREZA Hatchback (GP) Pro-Kit (Performance Fahrwerksfedern Performance Springs) 1.6 i AWD	06.12 -	1040	1000	E10-77-011-01-22	A, 18	25	10					F11-77-011-01-VA	F11-77-011-01-HA	T
Anti-Roll-Kit (Performance Stabilisatoren Performance Sway Bars) 1.6 i AWD	06.12 -			E40-77-011-01-11	A, 45			26	22	nicht verstellbar not adjustable	2-fach verstellbar 2-way adjustable	AS41-77-011-01-VA	AS41-77-011-01-HA	T
IMPREZA Station Wagon (GF) IMPREZA Estate (GF) Pro-Kit (Performance Fahrwerksfedern Performance Springs) 1.6, 1.6 i, 1.6 i 4WD, 1.8 i, 1.8 i 4WD, 2.0, 2.0 Turbo GT 4WD, 2.0 i, 2.0 i 16V AWD, 2.0 i 4WD, 2.0 i Turbo 4WD	08.92 - 12.00	900	900	E7705-140	A, 18	30	30					F7705001	F7705002	T
Anti-Roll-Kit (Performance Stabilisatoren Performance Sway Bars) 1.6, 1.6 i, 1.6 i 4WD, 1.8 i, 1.8 i 4WD, 2.0, 2.0 Turbo GT 4WD, 2.0 i, 2.0 i 16V AWD, 2.0 i 4WD, 2.0 i Turbo 4WD	08.92 - 12.00			E40-77-001-01-11	A, 45			23	24	nicht verstellbar not adjustable	nicht verstellbar not adjustable	AS41-77-001-01-VA	AS41-77-001-01-HA	T
Pro-Street-S (Gewindefahrwerke - höhenverstellbar Coil-Overs-Adjustable Ride Height) 1.6, 1.6 i, 1.6 i 4WD, 1.8 i, 1.8 i 4WD, 2.0, 2.0 Turbo GT 4WD, 2.0 i, 2.0 i 16V AWD, 2.0 i 4WD, 2.0 i Turbo 4WD	08.92 - 12.00	900	900	PSS65-77-001-01-22	A, 24, 25, 45, 160	25-50	25-50							T
IMPREZA Station Wagon (GD, GG) IMPREZA Estate (GD, GG) Pro-Kit (Performance Fahrwerksfedern Performance Springs) 1.6, 2.0, 2.0 Turbo, 2.0 WRX Turbo	12.00 - 12.02	1030	960	E10-77-002-04-22	A, 18	30-35	25-30					F11-77-002-03-VA	F11-77-002-04-HA	T
1.6, 2.0, 2.0 Turbo, 2.0 WRX Turbo	01.03 -	1030	960	E10-77-002-06-22	A, 18	30-35	25-30					F11-77-002-03-VA	F11-77-002-06-HA	T
Pro-Street-S (Gewindefahrwerke - höhenverstellbar Coil-Overs-Adjustable Ride Height) 1.6, 2.0, 2.0 Turbo, 2.0 WRX Turbo	12.00 - 12.02	970	960	PSS65-77-001-02-22	A, 24, 25, 45, 160	20-50	20-50							T
1.6, 2.0, 2.0 Turbo, 2.0 WRX Turbo, 2.0 i R, 2.5 WRX	01.03 - 12.07	990	960	PSS65-77-001-03-22	A, 24, 25, 45, 160	25-55	25-55							T
IMPREZA Stufenheck (GC) IMPREZA Saloon (GC) Pro-Kit (Performance Fahrwerksfedern Performance Springs) 1.6 i, 1.6 i 4WD, 1.8 i, 1.8 i 4WD, 2.0 AWD, 2.0 Turbo GT 4WD, 2.0 i, 2.0 i 4WD	08.92 - 12.00	900	900	E7705-140	A, 18	30	30					F7705001	F7705002	T
Anti-Roll-Kit (Performance Stabilisatoren Performance Sway Bars) 1.6 i, 1.6 i 4WD, 1.8 i, 1.8 i 4WD, 2.0 AWD, 2.0 Turbo GT 4WD, 2.0 i, 2.0 i 4WD	08.92 - 12.00			E40-77-001-01-11	A, 45			23	24	nicht verstellbar not adjustable	nicht verstellbar not adjustable	AS41-77-001-01-VA	AS41-77-001-01-HA	T
Pro-Street-S (Gewindefahrwerke - höhenverstellbar Coil-Overs-Adjustable Ride Height) 1.6 i, 1.6 i 4WD, 1.8 i, 1.8 i 4WD, 2.0 AWD, 2.0 Turbo GT 4WD, 2.0 i, 2.0 i 4WD	08.92 - 12.00	900	900	PSS65-77-001-01-22	A, 24, 25, 45, 160	25-50	25-50							T
IMPREZA Stufenheck (GD, GG) IMPREZA Saloon (GD, GG) Pro-Kit (Performance Fahrwerksfedern Performance Springs) 1.6 AWD, 2.0 WRX Turbo, 2.0 i, 2.0 i Allrad 1.6 AWD, 2.0 WRX Turbo, 2.0 i, 2.0 i All-wheel Drive 1.6 AWD, 2.0 WRX STI, 2.0 WRX Turbo, 2.0 i	12.00 -	1030	960	E10-77-002-04-22	A, 18	30-35	25-30					F11-77-002-03-VA	F11-77-002-04-HA	T
1.6 AWD, 2.0 WRX Turbo, 2.0 i, 2.0 i Allrad 1.6 AWD, 2.0 WRX Turbo, 2.0 i, 2.0 i All-wheel Drive 1.6 AWD, 2.0 WRX STI, 2.0 WRX Turbo, 2.0 i	12.00 -	1030	960	E10-77-002-06-22	A, 18	30-35	25-30					F11-77-002-03-VA	F11-77-002-06-HA	T
Anti-Roll-Kit (Performance Stabilisatoren Performance Sway Bars) 2.0 WRX Turbo	12.00 - 12.02			E40-77-001-02-11	A, 45			23	24	nicht verstellbar not adjustable	nicht verstellbar not adjustable	AS41-77-001-01-VA	AS41-77-001-01-HA	T
2.0 WRX STI, 2.0 WRX Turbo	01.03 - 01.05			E40-77-001-03-11	A, 45			23	24	nicht verstellbar not adjustable	nicht verstellbar not adjustable	AS41-77-001-01-VA	AS41-77-001-01-HA	T
Pro-Street-S (Gewindefahrwerke - höhenverstellbar Coil-Overs-Adjustable Ride Height) 1.6 AWD, 2.0 WRX Turbo, 2.0 i, 2.0 i Allrad 1.6 AWD, 2.0 WRX Turbo, 2.0 i, 2.0 i All-wheel Drive 1.6 AWD, 2.0 WRX Turbo, 2.0 i, 2.0 i R, 2.5 i WRX	12.00 - 12.02	970	960	PSS65-77-001-02-22	A, 24, 25, 45, 160	20-50	20-50							T
1.6 AWD, 2.0 WRX Turbo, 2.0 i, 2.0 i R, 2.5 i WRX	01.03 - 12.07	990	960	PSS65-77-001-03-22	A, 24, 25, 45, 160	25-55	25-55							T
2.5 WRX STI	09.05 -	1030	960	PSS65-77-001-04-22	A, 24, 25, 45, 160	25-55	25-55							T
IMPREZA Stufenheck (GR) IMPREZA Saloon (GR) Pro-Kit (Performance Fahrwerksfedern Performance Springs) 1.5, 1.5 Allrad, 2.0 i AWD 1.5, 1.5 All-wheel Drive, 2.0 i AWD	02.08 -	1040	1040	E10-77-006-01-22	A, 18	30	25					F11-77-006-01-VA	F11-77-006-01-HA	T
1.5, 1.5 Allrad, 2.0 i AWD 1.5, 1.5 All-wheel Drive, 2.0 i AWD	03.11 -	900	825	E10-82-038-01-22	A, 18, 20	20	20					F11-82-019-02-VA	F11-82-019-01-HA	T
TREZIA Pro-Kit (Performance Fahrwerksfedern Performance Springs) 1.3	03.11 -	900	825	E10-82-038-02-22	A, 18, 20	20	20					F11-82-033-01-VA	F11-82-019-01-HA	T
1.4 D	03.11 -	900	825	E10-82-038-02-22	A, 18, 20	20	20					F11-82-033-01-VA	F11-82-019-01-HA	T
XV Pro-Kit (Performance Fahrwerksfedern Performance Springs) 1.6 i, 2.0 i	03.12 -	1075	1060	E10-77-010-01-22	A, 18	25	20					F11-77-010-01-VA	F11-77-010-01-HA	T
1.6 i, 2.0 i	03.12 -	1075	1060	E10-77-010-02-22	A, 18	25	20					F11-77-010-02-VA	F11-77-010-01-HA	T
Anti-Roll-Kit (Performance Stabilisatoren Performance Sway Bars) 1.6 i, 2.0 D, 2.0 i	03.12 -			E40-77-011-01-11	A, 45			26	22	nicht verstellbar not adjustable	2-fach verstellbar 2-way adjustable	AS41-77-011-01-VA	AS41-77-011-01-HA	T

Modell	Baujahr	Achslast Vorne kg	Achslast Hinten kg	Artikel-Nr.	Hinweise	ca. Tieferl. Vorne mm	ca. Tieferl. Hinten mm	Ø Vorne mm	Ø Hinten mm	Verstellbarkeit Vorne	Verstellbarkeit Hinten	Ersatzteilbezeichnung Vorne	Ersatzteilbezeichnung Hinten	Gutachten
Model	Year	Front Axle Load kg	Rear Axle Load kg	Part-No.	Notes	ca. Lowering Front mm	ca. Lowering Rear mm	Ø Front mm	Ø Rear mm	Adjustable Front	Adjustable Rear	Spare Part Marking Front	Spare Part Marking Rear	Homologation
GRAND VITARA II (JT) Pro-Kit (Performance Fahrwerksfedern Performance Springs) 1.6 Allrad, 2.0 Allrad 1.6 All-wheel Drive, 2.0 All-wheel Drive	04.05 -	1050	1210	E10-80-008-01-22	A, 18	30	30					F11-80-008-01-VA	F11-80-008-01-HA	T
IGNIS II Pro-Kit (Performance Fahrwerksfedern Performance Springs) 1.3, 1.3 DDIS, 1.5, 1.5 Sport	09.03 -	800	760	E10-80-001-02-22	A, 18, 20	30	30					F11-80-001-02-VA	F11-80-001-02-HA	T
KIZASHI (FR) Pro-Kit (Performance Fahrwerksfedern Performance Springs) 2.4	10.10 -	1200	1100	E10-80-011-01-22	A, 18, 20	20	20					F11-80-011-01-VA	F11-80-011-01-HA	T
SPLASH B12 Pro-Kit (Performance Komplettfahrwerke Performance Springs+Shocks) 1.0, 1.2	01.08 -	835	800	E90-65-018-01-22	A, 18, 20, 78, 161	30	30							T
SWIFT III (MZ, EZ) Pro-Kit (Performance Fahrwerksfedern Performance Springs) 1.3, 1.3 DDIS, 1.5, 1.6	02.05 -	830	800	E10-80-007-01-22	A, 18, 20	25	25					F11-80-007-01-VA	F11-80-007-01-HA	T
SWIFT IV (FZ, NZ) Pro-Kit (Performance Fahrwerksfedern Performance Springs) 1.2, 1.6	10.10 -	850	830	E10-80-010-01-22	A, 18, 20	30	20					F11-80-010-01-VA	F11-80-010-01-HA	T
1.3 DDIS	10.10 -	850	830	E10-80-010-02-22	A, 18, 20	25	20					F11-80-010-02-VA	F11-80-010-01-HA	T
SX4 (GY) Pro-Kit (Performance Fahrwerksfedern Performance Springs) 1.5, 1.5 VVT, 1.6, 1.6 DDIS, 1.6 VVT, 1.9 DDIS	06.06 -	870	880	E10-80-009-01-22	A, 18, 20	25	25					F11-80-009-01-VA	F11-80-009-01-HA	T
SX4 Stufenheck (GY) SX4 Saloon (GY) Pro-Kit (Performance Fahrwerksfedern Performance Springs) 1.6	10.07 -	870	880	E10-80-009-01-22	A, 18, 20	25	25					F11-80-009-01-VA	F11-80-009-01-HA	T
AURIS (NRE15_, ZZE15_, ADE15_, ZRE15_, NDE15_) Pro-Kit (Performance Fahrwerksfedern Performance Springs) 1.8 Hybrid	09.10 -	1020	980	E10-82-024-08-22	A, 18, 20	30	25					F11-82-024-05-VA	F11-82-024-08-HA	T
1.4 D-4D, 1.4 VVTi, 1.6, 1.6 VVTi, 1.8, 1.8 VVTi	10.06 -	1020	1010	E10-82-024-05-22	A, 18, 20	30	30					F11-82-024-05-VA	F11-82-024-05-HA	T
2.0 D-4D	03.07 -	1100	1010	E10-82-024-06-22	A, 18, 20	30	30					F11-82-024-06-VA	F11-82-024-05-HA	T
2.2 D	03.07 -	1100	1010	E10-82-024-07-22	A, 18, 20	20	20					F11-82-024-06-VA	F11-82-024-07-HA	T
AURIS (NZE18_, ZRE18_) Pro-Kit (Performance Fahrwerksfedern Performance Springs) 1.3, 1.4 D-4D	10.12 -	1020	1010	E10-82-047-01-22	A, 18, 20, 171	30	25					F11-82-047-01-VA	F11-82-024-05-HA	T
1.6	10.12 -	1020	1010	E10-82-047-02-22	A, 18, 20, 170	30	25					F11-82-047-01-VA	F11-82-024-07-HA	T
1.8 Hybrid	10.12 -	1080	1010	E10-82-047-04-22	A, 18, 20, 170	30	25					F11-82-024-05-VA	F11-82-021-01-HA	T
2.0 D-4D	10.12 -	1080	1010	E10-82-047-03-22	A, 18, 20, 170	30	25					F11-82-024-06-VA	F11-82-024-07-HA	T
AURIS TOURING SPORTS (ZWE18_, ZRE18_) Pro-Kit (Performance Fahrwerksfedern Performance Springs) 1.3, 1.4 D-4D	07.13 -	1020	1010	E10-82-047-05-22	A, 18, 20, 171	25	25					F11-82-047-01-VA	F11-82-024-08-HA	T
1.6	07.13 -	1080	1010	E10-82-047-06-22	A, 18, 20, 170	20	20					F11-82-047-01-VA	F11-82-021-01-HA	T
2.0 D-4D	07.13 -	1080	1010	E10-82-047-07-22	A, 18, 20, 170	20	20					F11-82-024-06-VA	F11-82-021-01-HA	T
1.8 Hybrid	07.13 -	1080	1010	E10-82-047-08-22	A, 18, 20, 170	20	20					F11-82-024-05-VA	F11-82-021-03-HA	T
AURIS VAN Kasten (NDE15_) AURIS VAN Box (NDE15_) Pro-Kit (Performance Fahrwerksfedern Performance Springs) 1.4 D-4D	03.07 - 04.13	1020	1010	E10-82-024-05-22	A, 18, 20	30	30					F11-82-024-05-VA	F11-82-024-05-HA	T
AVENSIS (T22_) Pro-Kit (Performance Fahrwerksfedern Performance Springs) 1.6, 1.6 VVT-i, 1.8, 1.8 VVT-i, 1.9 D, 2.0, 2.0 D-4D, 2.0 TD, 2.0 VVT-i	09.97 - 02.03	1010	970	E8255-140	A, 18, 20	30	30					F8255001	F8255002	T
AVENSIS (T25_) Pro-Kit (Performance Fahrwerksfedern Performance Springs) 1.6 VVT-i, 1.8	04.03 - 11.08	1020	1035	E10-82-016-01-22	A, 18, 20	25	25					F11-82-016-01-VA	F11-82-016-01-HA	T
2.0, 2.4	04.03 - 11.08	1020	1035	E10-82-016-02-22	A, 18, 20	25	25					F11-82-016-02-VA	F11-82-016-01-HA	T
2.0 D-4D, 2.2 D-4D, 2.2 D-CAT, 2.2 TD	04.03 - 11.08	1070	1035	E10-82-016-03-22	A, 18, 20	25	25					F11-82-016-03-VA	F11-82-016-01-HA	T
AVENSIS Kombi (T25) AVENSIS Estate (T25) Pro-Kit (Performance Fahrwerksfedern Performance Springs) 1.6 VVT-i, 1.8	04.03 - 11.08	1020	1035	E10-82-016-04-22	A, 18, 20	25	25					F11-82-016-01-VA	F11-82-016-04-HA	T
2.0, 2.4	04.03 - 11.08	1020	1035	E10-82-016-05-22	A, 18, 20	25	25					F11-82-016-02-VA	F11-82-016-04-HA	T
2.0 D-4D, 2.2 D-4D, 2.2 D-CAT, 2.2 TD	04.03 - 11.08	1070	1035	E10-82-016-06-22	A, 18, 20	25	25					F11-82-016-03-VA	F11-82-016-04-HA	T
AVENSIS Liftback (T22_) Pro-Kit (Performance Fahrwerksfedern Performance Springs) 1.6, 1.6 VVT-i, 1.8, 1.8 VVT-i, 2.0, 2.0 D-4D, 2.0 TD, 2.0 VVT-i	09.97 - 02.03	1010	970	E8255-140	A, 18, 20	30	30					F8255001	F8255002	T
AVENSIS Station Wagon (ZRT27, ADT27) AVENSIS Estate (ZRT27, ADT27) Pro-Kit (Performance Fahrwerksfedern Performance Springs) 1.6, 1.8, 2.0	02.09 -	1215	1135	E10-82-021-03-22	A, 18, 20	25	25					F11-82-021-01-VA	F11-82-021-03-HA	T

Modell	Baujahr	Achslast Vorne kg	Achslast Hinten kg	Artikel-Nr.	Hinweise	ca. Tieferl. Vorne mm	ca. Tieferl. Hinten mm	Ø Vorne mm	Ø Hinten mm	Verstellbarkeit Vorne	Verstellbarkeit Hinten	Ersatzteilbezeichnung Vorne	Ersatzteilbezeichnung Hinten	Gutachten
Model	Year	Front Axle Load kg	Rear Axle Load kg	Part-No.	Notes	ca. Lowering Front mm	ca. Lowering Rear mm	Ø Front mm	Ø Rear mm	Adjustable Front	Adjustable Rear	Spare Part Marking Front	Spare Part Marking Rear	Homologation
AVENSIS Station Wagon (ZRT27, ADT27) AVENSIS Estate (ZRT27, ADT27) Pro-Kit (Performance Fahrwerksfedern Performance Springs) 2.0 D-4D, 2.2 D-4D	02.09 -	1215	1135	E10-82-021-04-22	A, 18, 20	25	25					F11-82-021-02-VA	F11-82-021-03-HA	T
AVENSIS Stufenheck (T25) AVENSIS Saloon (T25) Pro-Kit (Performance Fahrwerksfedern Performance Springs) 1.6 VVT-i, 1.8	04.03 - 11.08	1020	1035	E10-82-016-01-22	A, 18, 20	25	25					F11-82-016-01-VA	F11-82-016-01-HA	T
2.0, 2.0 VVTi, 2.4	04.03 - 11.08	1020	1035	E10-82-016-02-22	A, 18, 20	25	25					F11-82-016-02-VA	F11-82-016-01-HA	T
2.0 D-4D, 2.2 D-4D, 2.2 D-CAT, 2.2 TD	04.03 - 11.08	1070	1035	E10-82-016-03-22	A, 18, 20	25	25					F11-82-016-03-VA	F11-82-016-01-HA	T
AVENSIS Stufenheck (ZRT27, ADT27) AVENSIS Saloon (ZRT27, ADT27) Pro-Kit (Performance Fahrwerksfedern Performance Springs) 1.6, 1.8, 2.0	02.09 -	1215	1135	E10-82-021-01-22	A, 18, 20	25	25					F11-82-021-01-VA	F11-82-021-01-HA	T
2.0 D-4D, 2.2 D-4D	02.09 -	1215	1135	E10-82-021-02-22	A, 18, 20	25	25					F11-82-021-02-VA	F11-82-021-01-HA	T
AVENSIS VERSO (CLM2, ACM2) Pro-Kit (Performance Fahrwerksfedern Performance Springs) 2.0 D-4D, 2.0 VVT-i	08.01 - 11.09	1230	1230	E10-82-005-01-22	A, 18, 20	30	30					F11-82-005-01-VA	F11-82-005-01-HA	T
AYGO (WNB1, KGB1) Pro-Kit (Performance Fahrwerksfedern Performance Springs) 1.0, 1.4 HDi	07.05 -	695	695	E10-82-020-03-22	A, 18, 20	30	30					F11-70-008-01-VA	F11-70-008-01-HA	T
B12 Pro-Kit (Performance Komplettfahrwerke Performance Springs+Shocks) 1.0, 1.4 HDi	07.05 -	695	695	E90-82-020-03-22	A, 18, 20, 78, 161	30	30							T
CAMRY (MCV3, ACV3, XV3) Pro-Kit (Performance Fahrwerksfedern Performance Springs) 2.4 VVT-i, 2.4 VVTi LE, 3.0 V6	11.01 - 11.06	1200	1200	E10-82-011-02-22	A, 18, 20	30	30					F11-82-011-02-VA	F11-82-011-02-HA	T
CELICA (ST20, AT20) Pro-Kit (Performance Fahrwerksfedern Performance Springs) 1.8 i 16V	11.93 - 11.99	850	945	E8242-140	A, 18, 20	30	30					F8242001	F8242002	T
CELICA (ZZT23) Pro-Kit (Performance Fahrwerksfedern Performance Springs) 1.8 16V TS, 1.8 16V VT-i	08.99 - 09.05	960	945	E8261-140	A, 18, 20	30	30					F8261001	F8261002	T
COROLLA (E9) Pro-Kit (Performance Fahrwerksfedern Performance Springs) 1.3, 1.3 i, 1.6, 1.6 XL, 1.6 i, 1.8 D	05.87 - 06.93	815	850	E8206-140	A, 18, 20	30	30					F8206001	F8206002	T
COROLLA (E10) Pro-Kit (Performance Fahrwerksfedern Performance Springs) 1.3 12V, 1.3 XLI, 1.3 XLI 16V, 1.6, 1.6 Si, 1.8 i, 2.0 D	05.92 - 04.97	925	925	E8230-140	A, 18, 20	30	30					F8230001	F8230002	T
COROLLA (E11) Pro-Kit (Performance Fahrwerksfedern Performance Springs) 1.4, 1.4 16V, 1.6, 1.6 16V, 1.6 Aut., 1.9 D, 2.0 D, 2.0 D-4D	04.97 - 12.01	920	920	E8250-140	A, 18, 20	30	30					F8250001	F8250002	T
COROLLA (ZZE12, NDE12, ZDE12) Pro-Kit (Performance Fahrwerksfedern Performance Springs) 1.4 VVT-i, 1.6 VVT-i, 1.8 VVTi TS, 1.8 VVTi	01.02 - 02.07	1000	970	E10-82-012-02-22	A, 18, 20	30	30					F11-82-012-02-VA	F11-82-012-02-HA	T
1.4 D, 2.0 D-4D	01.02 - 02.07	1000	970	E10-82-012-03-22	A, 18, 20	30	30					F11-82-012-03-VA	F11-82-012-02-HA	T
B12 Pro-Kit (Performance Komplettfahrwerke Performance Springs+Shocks) 1.4 VVT-i, 1.6 VVT-i, 1.8 VVTi TS, 1.8 VVTi	01.02 - 02.07	1000	970	E90-82-012-02-22	A, 18, 20, 78, 153, 161	30	30							T
1.4 D, 2.0 D-4D	01.02 - 02.07	1000	970	E90-82-012-03-22	A, 18, 20, 78, 153, 161	30	30							T
COROLLA Compact (E9) Pro-Kit (Performance Fahrwerksfedern Performance Springs) 1.3, 1.6, 1.6 GTi, 1.6 XL, 1.6 i, 1.8 D	05.87 - 04.92	815	850	E8206-140	A, 18, 20	30	30					F8206001	F8206002	T
COROLLA Compact (E10) Pro-Kit (Performance Fahrwerksfedern Performance Springs) 1.3 12V, 1.3 XLI, 1.3 XLI 16V, 1.6 Si, 1.8 GT, 2.0 D	07.92 - 04.97	925	925	E8230-140	A, 18, 20	30	30					F8230001	F8230002	T
COROLLA Compact (E11) Pro-Kit (Performance Fahrwerksfedern Performance Springs) 1.4, 1.6, 1.6 Aut., 1.9 D, 2.0 D, 2.0 D-4D	04.97 - 01.02	920	920	E8250-140	A, 18, 20	30	30					F8250001	F8250002	T
COROLLA Kombi (E12J, E12T) COROLLA Estate (E12J, E12T) Pro-Kit (Performance Fahrwerksfedern Performance Springs) 1.4 VVT-i, 1.6 VVT-i, 1.8	01.02 - 02.07	1000	970	E10-82-012-02-22	A, 18, 20	30	30					F11-82-012-02-VA	F11-82-012-02-HA	T
1.4 D4-D, 2.0 D-4D	01.02 - 02.07	1000	970	E10-82-012-03-22	A, 18, 20	30	30					F11-82-012-03-VA	F11-82-012-02-HA	T
B12 Pro-Kit (Performance Komplettfahrwerke Performance Springs+Shocks) 1.4 VVT-i, 1.6 VVT-i, 1.8	01.02 - 02.07	1000	970	E90-82-012-02-22	A, 18, 20, 78, 153, 161	30	30							T
1.4 D4-D, 2.0 D-4D	01.02 - 02.07	1000	970	E90-82-012-03-22	A, 18, 20, 78, 153, 161	30	30							T
COROLLA Liftback (E9) Pro-Kit (Performance Fahrwerksfedern Performance Springs) 1.3, 1.3 i, 1.6, 1.6 GTi, 1.8 D	07.87 - 06.93	815	850	E8206-140	A, 18, 20	30	30					F8206001	F8206002	T
COROLLA Liftback (E10) Pro-Kit (Performance Fahrwerksfedern Performance Springs) 1.3 12V, 1.3 XLI, 1.6 GLI, 1.8 GT, 2.0 D	07.92 - 04.97	925	925	E8230-140	A, 18, 20	30	30					F8230001	F8230002	T

Modell	Baujahr	Achslast Vorne kg	Achslast Hinten kg	Artikel-Nr.	Hinweise	ca. Tieferl. Vorne mm	ca. Tieferl. Hinten mm	Ø Vorne mm	Ø Hinten mm	Verstellbarkeit Vorne	Verstellbarkeit Hinten	Ersatzteilbezeichnung Vorne	Ersatzteilbezeichnung Hinten	Gutachten
Model	Year	Front Axle Load kg	Rear Axle Load kg	Part-No.	Notes	ca. Lowering Front mm	ca. Lowering Rear mm	Ø Front mm	Ø Rear mm	Adjustable Front	Adjustable Rear	Spare Part Marking Front	Spare Part Marking Rear	Homologation
COROLLA Liftback (E11.) Pro-Kit (Performance Fahrwerksfedern Performance Springs) 1.4, 1.6, 1.6 Aut., 1.9 D, 2.0 D, 2.0 D-4D	04.97 - 01.02	920	920	E8250-140	A, 18, 20	30	30					F8250001	F8250002	T
COROLLA Stufenheck (E12J., E12T.) COROLLA Saloon (E12J., E12T.) Pro-Kit (Performance Fahrwerksfedern Performance Springs) 1.4 VVT-i, 1.6 VVT-i, 1.8	11.01 - 07.07	1000	970	E10-82-012-02-22	A, 18, 20	30	30					F11-82-012-02-VA	F11-82-012-02-HA	T
1.4 D-4D, 2.0 D-4D	08.02 - 07.07	1000	970	E10-82-012-03-22	A, 18, 20	30	30					F11-82-012-03-VA	F11-82-012-02-HA	T
B12 Pro-Kit (Performance Komplettfahrwerke Performance Springs+Shocks) 1.4 VVT-i, 1.6 VVT-i, 1.8	11.01 - 07.07	1000	970	E90-82-012-02-22	A, 18, 20, 78, 153, 161	30	30							T
1.4 D-4D, 2.0 D-4D	08.02 - 07.07	1000	970	E90-82-012-03-22	A, 18, 20, 78, 153, 161	30	30							T
COROLLA Stufenheck (E15.) COROLLA Saloon (E15.) Pro-Kit (Performance Fahrwerksfedern Performance Springs) 1.4 D-4D, 1.4 VVT-i, 1.6, 1.6 CNG, 1.6 Dual VVTi, 1.6 VVT-i, 1.8, 1.8 VVTL-i, 1.8 VVTi	01.07 -	1020	1010	E10-82-024-05-22	A, 18, 20	30	30					F11-82-024-05-VA	F11-82-024-05-HA	T
2.0 D-4D	01.07 -	1100	1010	E10-82-024-06-22	A, 18, 20	30	30					F11-82-024-06-VA	F11-82-024-05-HA	T
COROLLA Verso (ZDE12., CDE12.) Pro-Kit (Performance Fahrwerksfedern Performance Springs) 1.4 VVT-i, 1.6 VVT-i, 1.8, 1.8 VVT-i	09.01 - 05.04	1000	970	E10-82-012-02-22	A, 18, 20	30	30					F11-82-012-02-VA	F11-82-012-02-HA	T
1.4 D-4D, 2.0 D-4D	09.01 - 05.04	1000	970	E10-82-012-03-22	A, 18, 20	30	30					F11-82-012-03-VA	F11-82-012-02-HA	T
B12 Pro-Kit (Performance Komplettfahrwerke Performance Springs+Shocks) 1.4 VVT-i, 1.6 VVT-i, 1.8 VVT-i	01.02 - 12.03	1000	970	E90-82-012-02-22	A, 18, 20, 78, 153, 161	30	30							T
1.4 D-4D, 2.0 D-4D	01.02 - 12.03	1000	970	E90-82-012-03-22	A, 18, 20, 78, 153, 161	30	30							T
GT 86 Coupe (ZN6.) Pro-Kit (Performance Fahrwerksfedern Performance Springs) 2.0 GT	03.12 -	876	943	E10-82-043-01-22	A, 18, 20	25	20					F11-82-043-01-VA	F11-82-043-01-HA	T
IQ (KGJ1., NGJ1.) Pro-Kit (Performance Fahrwerksfedern Performance Springs) 1.0	01.09 -	670	630	E10-82-034-01-22	A, 18, 20	25	30					F11-82-034-01-VA	F11-82-034-01-HA	T
1.4 D-4D	01.09 -	670	630	E10-82-034-02-22	A, 18, 20	25	30					F11-82-034-02-VA	F11-82-034-01-HA	T
MR 2 III (ZZW3.) Pro-Kit (Performance Fahrwerksfedern Performance Springs) 1.8 16V VT-i	10.99 - 06.07	540	735	E10-82-001-01-22	A, 18, 20	30	30					F11-82-001-01-VA	F11-82-001-01-HA	T
PRIUS PLUS (ZVW4.) Pro-Kit (Performance Fahrwerksfedern Performance Springs) 1.8 Hybrid	03.12 -	1110	1110	E10-82-045-01-22	A, 18, 20	25	20					F11-82-045-01-VA	F11-82-045-01-HA	T
RAV 4 III (ACA3., ACE., ALA3., GSA3., ZSA3.) Pro-Kit (Performance Fahrwerksfedern Performance Springs) 2.0, 2.0 4WD, 2.0 VVT-i, 2.0 VVT-i 4WD	03.06 -	1185	1150	E10-82-025-01-22	A, 18	25-30	25-30					F11-82-025-01-VA	F11-82-025-01-HA	T
2.2 D-4D, 2.2 D-4D 4WD, 2.2 D-CAT 4WD	03.06 -	1300	1150	E10-82-025-02-22	A, 18	25-30	25-30					F11-82-025-02-VA	F11-82-025-01-HA	T
URBAN CRUISER (NSP1., NLP1., ZSP1., NCP11.) Pro-Kit (Performance Fahrwerksfedern Performance Springs) 1.33	04.09 -	895	825	E10-82-033-01-22	A, 18, 20	20	25					F11-82-033-01-VA	F11-82-033-01-HA	T
VERSO S (NLP12., NCP12., NSP12.) Pro-Kit (Performance Fahrwerksfedern Performance Springs) 1.33, 1.5	11.10 -	900	825	E10-82-038-01-22	A, 18, 20	20	20					F11-82-019-02-VA	F11-82-019-01-HA	T
1.4 D4-D	11.10 -	900	825	E10-82-038-02-22	A, 18, 20	20	20					F11-82-033-01-VA	F11-82-019-01-HA	T
VIOS (SCP4., NCP4., AXP4.) Pro-Kit (Performance Fahrwerksfedern Performance Springs) 1.3 VVTi, 1.5, 1.5 VVTi	07.02 - 01.08	755	755	E8260-140	A, 18, 20	30	30					F8260001	F8260002	
VIOS/YARIS Stufenheck (ZSP9., NCP9.) VIOS/YARIS Saloon (ZSP9., NCP9.) Pro-Kit (Performance Fahrwerksfedern Performance Springs) 1.0, 1.3	08.07 -	895	905	E10-82-019-01-22	A, 18, 20	25	25					F11-82-019-01-VA	F11-82-019-01-HA	T
YARIS (SCP1., NLP1., NCP1.) Pro-Kit (Performance Fahrwerksfedern Performance Springs) 1.0 16V, 1.3, 1.3 16V, 1.4 D-4D, 1.5 TS, 1.5 VVT-i TS	04.99 - 09.05	755	755	E8260-140	A, 18, 20	30	30					F8260001	F8260002	
YARIS (SCP9., NSP9., KSP9., NCP9., ZSP9.) Pro-Kit (Performance Fahrwerksfedern Performance Springs) 1.0 VVT-i, 1.3 VVT-i, 1.33 VVT-i	11.05 -	895	905	E10-82-019-01-22	A, 18, 20	25	25					F11-82-019-01-VA	F11-82-019-01-HA	T
1.4 D-4D	01.06 -	895	905	E10-82-019-02-22	A, 18, 20	25	25					F11-82-019-02-VA	F11-82-019-01-HA	T
B12 Pro-Kit (Performance Komplettfahrwerke Performance Springs+Shocks) 1.0 VVT-i, 1.3 VVT-i, 1.33 VVT-i	11.05 -	895	905	E90-82-019-01-22	A, 18, 20, 78, 161	25	25							T
1.4 D-4D	01.06 -	895	905	E90-82-019-02-22	A, 18, 20, 78, 161	25	25							T
YARIS (NLP13., NSP13., NCP13., KSP13.) Pro-Kit (Performance Fahrwerksfedern Performance Springs) 1.0, 1.3, 1.3 VVT-i	12.10 -	850	825	E10-82-040-01-22	A, 18, 20	25	25					F11-82-040-01-VA	F11-82-040-01-HA	T
1.4 D-4D, 1.5 Hybrid	09.11 -	895	825	E10-82-040-02-22	A, 18, 20	25	25					F11-82-040-02-VA	F11-82-040-01-HA	T

Modell	Baujahr	Achslast Vorne kg	Achslast Hinten kg	Artikel-Nr.	Hinweise	ca. Tieferl. Vorne mm	ca. Tieferl. Hinten mm	Ø Vorne mm	Ø Hinten mm	Verstellbarkeit Vorne	Verstellbarkeit Hinten	Ersatzteilbezeichnung Vorne	Ersatzteilbezeichnung Hinten	Gutachten
Model	Year	Front Axle Load kg	Rear Axle Load kg	Part-No.	Notes	ca. Lowering Front mm	ca. Lowering Rear mm	Ø Front mm	Ø Rear mm	Adjustable Front	Adjustable Rear	Spare Part Marking Front	Spare Part Marking Rear	Homologation
BEETLE (5C1)														
Pro-Kit (Performance Fahrwerksfedern Performance Springs)														
1.2 TSI	07.11 -	980	820	E10-85-039-01-22	A, 18, 20, 171	30	30					F11-79-004-01-VA	F11-35-010-01-HA	T
1.4 TSI, 1.6 TDI	04.11 -	980	820	E10-85-039-01-22	A, 18, 20, 171	20	30					F11-79-004-01-VA	F11-35-010-01-HA	T
1.4 TSI, 2.0 TSI	04.11 -	1030	870	E10-85-021-05-22	A, 18, 20, 170	30	30					F11-15-007-01-VA	F11-15-001-01-HA	T
BORA (1J2)														
Pro-Kit (Performance Fahrwerksfedern Performance Springs)														
1.4 16V, 1.6, 1.6 16V, 1.6 FSI	10.98 - 05.05	930	950	E8574-140	A, 18, 20, 26	30	30					F8560001	F7907002	T
1.8, 1.9 SDI, 1.9 TDI, 2.0	10.98 - 05.05	970	950	E8575-140	A, 18, 20, 26	30	30					F1540001	F7907002	T
1.8 T, 1.9 TDI, 2.3 V5	10.98 - 05.05	1000	950	E8576-140	A, 18, 20, 26	30	30					F1545001	F7907002	T
1.8 4motion, 1.9 TDI 4motion, 2.0 4motion	02.99 - 05.05	1030	1120	E10-85-001-05-22	A, 18	30	30					F1545001	F11-15-001-02-HA	T
1.9 TDI, 2.3 V5	10.98 - 05.05	1050	950	E10-85-001-16-22	A, 18, 20, 26	30	30					F8592001	F7907002	T
1.9 TDI 4motion, 2.3 V5 4motion, 2.8 V6 4motion	12.98 - 05.05	1050	1120	E8591-140	A, 18	30	30					F8592001	F11-15-001-02-HA	T
Sportline (Performance Fahrwerksfedern Sport Sport Performance Springs)														
1.4 16V, 1.6, 1.6 16V, 1.6 FSI, 1.8, 1.8 T, 1.9 SDI, 1.9 TDI, 2.0	10.98 - 05.05	950	1000	E20-85-001-01-22	A, 18, 20, 26	45-50	30-35					F21-85-001-01-VA	F21-85-001-01-HA	T
1.8, 1.8 T, 1.9 TDI, 2.3 V5	10.98 - 05.05	1000	1000	E20-85-001-02-22	A, 18, 20, 26	45-50	30-35					F21-85-003-01-VA	F21-85-001-01-HA	T
Anti-Roll-Kit (Performance Stabilisatoren Performance Sway Bars)														
1.4 16V, 1.6, 1.6 16V, 1.6 FSI, 1.8, 2.0	10.98 - 05.05			E1540-321	A, 18, 20, 22, 45			22		nicht verstellbar not adjustable		AS1540310VA		T
1.4 16V, 1.6, 1.6 16V, 1.6 FSI, 1.8, 2.0	10.98 - 05.05			E1540-320	A, 18, 20, 22, 45			22	25	nicht verstellbar not adjustable	nicht verstellbar not adjustable	AS1540310VA	AS1540320HA	T
1.8 T, 1.9 SDI, 1.9 TDI, 2.3 V5	10.98 - 05.05			E40-85-005-01-10	A, 18, 20, 22, 45			25		nicht verstellbar not adjustable		AS41-85-005-01-VA		T
1.8 T, 1.9 SDI, 1.9 TDI, 2.3 V5	10.98 - 05.05			E40-85-005-01-11	A, 18, 20, 22, 45			25	25	nicht verstellbar not adjustable	nicht verstellbar not adjustable	AS41-85-005-01-VA	AS1540320HA	T
B12 Pro-Kit (Performance Komplettfahrwerke Performance Springs+Shocks)														
1.4 16V, 1.6, 1.6 16V, 1.6 FSI	10.98 - 05.05	930	960	E90-85-001-07-22	A, 18, 20, 26, 78, 161	30	30							T
1.8, 1.9 SDI, 1.9 TDI Schaltgetriebe, 2.0 1.8, 1.9 SDI, 1.9 TDI manual transmission, 2.0	10.98 - 05.05	970	960	E90-85-001-08-22	A, 18, 20, 26, 78, 161	30	30							T
1.8 T, 1.9 TDI, 1.9 TDI Schaltgetriebe, 2.3 V5 Schaltgetriebe 1.8 T, 1.9 TDI, 1.9 TDI manual transmission, 2.3 V5 manual transmission	10.98 - 05.05	1000	960	E90-85-001-09-22	A, 18, 20, 26, 78, 161	30	30							T
1.8 4motion, 1.9 TDI 4motion, 2.0 4motion	02.99 - 05.05	1030	1120	E90-85-001-05-22	A, 18, 78, 161	30	30							T
1.9 TDI, 1.9 TDI Schaltgetriebe, 2.3 V5, 2.3 V5 Schaltgetriebe 1.9 TDI, 1.9 TDI manual transmission, 2.3 V5, 2.3 V5 manual transmission	10.98 - 05.05	1050	960	E90-85-001-10-22	A, 18, 20, 26, 78, 161	30	30							T
1.9 TDI 4motion, 2.3 V5 4motion, 2.8 V6 4motion	12.98 - 05.05	1050	1120	E90-85-001-06-22	A, 18, 78, 161	30	30							T
B12 Sportline (Performance Komplettfahrwerke Sport Sport Performance Springs+Shocks)														
1.4 16V, 1.6, 1.6 16V, 1.6 FSI, 1.8, 1.8 T, 1.9 SDI, 1.9 TDI, 2.0	10.98 - 05.05	950	1000	E95-85-001-01-22	A, 18, 20, 26, 78, 161	45-50	30-35							T
1.8, 1.8 T, 1.9 TDI, 2.0, 2.3 V5	10.98 - 05.05	1000	1000	E95-85-001-02-22	A, 18, 20, 26, 78, 161	45-50	30-35							T
Pro-Street-S (Gewindefahrwerke - höhenverstellbar Coil-Overs-Adjustable Ride Height)														
1.4 16V, 1.6, 1.6 16V, 1.6 FSI, 1.8, 1.8 T, 1.9 SDI, 1.9 TDI, 2.0, 2.3 V5	10.98 - 05.05	1020	1080	PSS65-85-001-03-22	A, 18, 20, 24, 25, 26, 45, 160	35-65	35-65							T
BORA Kombi (1J6)														
BORA Estate (1J6)														
Pro-Kit (Performance Fahrwerksfedern Performance Springs)														
1.4 16V, 1.6, 1.6 16V, 1.6 FSI	05.99 - 05.05	930	1020	E8587-140	A, 18, 20, 26	30	30					F8560001	F7908002	T
1.9 TDI, 2.0	05.99 - 05.05	970	1020	E8588-140	A, 18, 20, 26	30	30					F1540001	F7908002	T
1.8 T, 1.9 TDI, 2.3 V5	05.99 - 05.05	1000	1020	E8589-140	A, 18, 20, 26	30	30					F1545001	F7908002	T
1.8 4motion, 1.9 TDI 4motion, 2.0 4motion	05.99 - 05.05	1030	1120	E10-85-001-05-22	A, 18	30	30					F1545001	F11-15-001-02-HA	T
1.9 TDI, 2.3 V5	05.99 - 05.05	1050	1020	E10-85-001-15-22	A, 18, 20, 26	30	30					F8592001	F7908002	T
1.9 TDI 4motion, 2.3 V5 4motion, 2.8 V6 4motion	05.99 - 05.05	1050	1120	E8591-140	A, 18	30	30					F8592001	F11-15-001-02-HA	T
Anti-Roll-Kit (Performance Stabilisatoren Performance Sway Bars)														
1.4 16V, 1.6, 1.6 16V, 1.6 FSI, 2.0	05.99 - 05.05			E1540-321	A, 18, 20, 22, 45			22		nicht verstellbar not adjustable		AS1540310VA		T
1.4 16V, 1.6, 1.6 16V, 1.6 FSI, 2.0	05.99 - 05.05			E1540-320	A, 18, 20, 22, 45			22	25	nicht verstellbar not adjustable	nicht verstellbar not adjustable	AS1540310VA	AS1540320HA	T
1.8 T, 1.9 TDI, 2.3 V5	05.99 - 05.05			E40-85-005-01-10	A, 18, 20, 22, 45			25		nicht verstellbar not adjustable		AS41-85-005-01-VA		T
1.8 T, 1.9 TDI, 2.3 V5	05.99 - 05.05			E40-85-005-01-11	A, 18, 20, 22, 45			25	25	nicht verstellbar not adjustable	nicht verstellbar not adjustable	AS41-85-005-01-VA	AS1540320HA	T
B12 Pro-Kit (Performance Komplettfahrwerke Performance Springs+Shocks)														
1.4 16V, 1.6, 1.6 16V, 1.6 FSI	05.99 - 05.05	930	1020	E90-85-001-11-22	A, 18, 20, 26, 78, 161	30	30							T
1.9 TDI Schaltgetriebe, 2.0 1.9 TDI manual transmission, 2.0	05.99 - 05.05	970	1020	E90-85-001-12-22	A, 18, 20, 26, 78, 161	30	30							T
1.8 T, 1.9 TDI, 1.9 TDI Schaltgetriebe, 2.3 V5 Schaltgetriebe 1.8 T, 1.9 TDI, 1.9 TDI manual transmission, 2.3 V5 manual transmission	05.99 - 05.05	1000	1020	E90-85-001-13-22	A, 18, 20, 26, 78, 161	30	30							T
1.8 4motion, 1.9 TDI 4motion, 2.0 4motion	05.99 - 05.05	1030	1120	E90-85-001-05-22	A, 18, 78, 161	30	30							T
1.9 TDI, 1.9 TDI Schaltgetriebe, 2.3 V5, 2.3 V5 Schaltgetriebe 1.9 TDI, 1.9 TDI manual transmission, 2.3 V5, 2.3 V5 manual transmission	05.99 - 05.05	1050	1020	E90-85-001-14-22	A, 18, 20, 26, 78, 161	30	30							T
1.9 TDI 4motion, 2.3 V5 4motion, 2.8 V6 4motion	05.99 - 05.05	1050	1120	E90-85-001-06-22	A, 18, 78, 161	30	30							T
Pro-Street-S (Gewindefahrwerke - höhenverstellbar Coil-Overs-Adjustable Ride Height)														
1.4 16V, 1.6, 1.6 16V, 1.6 FSI, 1.8 T, 1.9 TDI, 2.0, 2.3 V5	05.99 - 05.05	1020	1080	PSS65-85-001-03-22	A, 18, 20, 24, 25, 26, 45, 160	35-65	35-65							T

Modell	Baujahr	Achslast Vorne kg	Achslast Hinten kg	Artikel-Nr.	Hinweise	ca. Tieferl. Vorne mm	ca. Tieferl. Hinten mm	Ø Vorne mm	Ø Hinten mm	Verstellbarkeit Vorne	Verstellbarkeit Hinten	Ersatzteilbezeichnung Vorne	Ersatzteilbezeichnung Hinten	Gutachten
Model	Year	Front Axle Load kg	Rear Axle Load kg	Part-No.	Notes	ca. Lowering Front mm	ca. Lowering Rear mm	Ø Front mm	Ø Rear mm	Adjustable Front	Adjustable Rear	Spare Part Marking Front	Spare Part Marking Rear	Homologation
CADDY III Kasten (2KA, 2KH, 2CA, 2CH) CADDY III Box (2KA, 2KH, 2CA, 2CH) <i>Pro-Kit (Performance Fahrwerksfedern Performance Springs)</i> 1.2 TSI, 1.4, 1.4 16V, 1.6, 1.6 BiFuel, 1.6 TDI, 1.9 TDI, 1.9 TDI 4motion, 2.0 EcoFuel, 2.0 SDI, 2.0 TDI, 2.0 TDI 16V, 2.0 TDI 16V 4motion, 2.0 TDI 4motion	03.04 -	1030	1250	E10-85-019-01-22	A, 18, 20, 162	45	45					F11-79-004-02-VA		T
CADDY III Kombi (2KB, 2KJ, 2CB, 2CJ) CADDY III Estate (2KB, 2KJ, 2CB, 2CJ) <i>Pro-Kit (Performance Fahrwerksfedern Performance Springs)</i> 1.2 TSI, 1.4, 1.4 16V, 1.6, 1.6 BiFuel, 1.6 TDI, 1.9 TDI, 1.9 TDI 4motion, 2.0 EcoFuel, 2.0 SDI, 2.0 TDI, 2.0 TDI 16V, 2.0 TDI 16V 4motion, 2.0 TDI 4motion	03.04 -	1030	1250	E10-85-019-01-22	A, 18, 20, 162	45	45					F11-79-004-02-VA		T
CC (358) <i>Pro-Kit (Performance Fahrwerksfedern Performance Springs)</i> 1.4 TSI, 1.8 TSI, 2.0 TDI, 2.0 TSI	11.11 -	1110	1030	E10-85-016-08-22	A, 18, 20	25	20					F11-15-007-02-VA	F11-85-014-05-HA	ABE
2.0 TDI, 2.0 TSI	11.11 -	1170	1030	E10-85-016-13-22	A, 18, 20	25	20					F11-15-007-03-VA	F11-85-014-05-HA	ABE
2.0 TDI 4motion, 3.6 FSI 4motion	11.11 -	1170	1110	E10-85-016-09-22	A, 18	25	25					F11-15-007-03-VA	F11-15-007-15-HA	ABE
Anti-Roll-Kit (Performance Stabilisatoren Performance Sway Bars) 1.4 TSI, 1.8 TSI, 2.0 TDI, 2.0 TSI	11.11 -			E40-85-014-06-11	A, 18, 20, 22, 45			26	23	2-fach verstellbar 2-way adjustable	2-fach verstellbar 2-way adjustable	AS41-85-014-01-VA	AS41-85-014-01-HA	T
CORRADO (53I) <i>Pro-Kit (Performance Fahrwerksfedern Performance Springs)</i> 1.8 16V, 1.8 G60, 2.0 i, 2.0 i 16V, 2.9 VR6	09.88 - 12.95	950	710	E8513-140	A, 18, 20	25-30	25					F8513001	F8513002	T
Anti-Roll-Kit (Performance Stabilisatoren Performance Sway Bars) 1.8 16V, 1.8 G60, 2.0 i, 2.0 i 16V	09.88 - 12.95			E8502-320	A, 18, 20, 22, 45			22	25	nicht verstellbar not adjustable	nicht verstellbar not adjustable	AS8502320VA	AS8502320HA	T
2.9 VR6	08.91 - 12.95			E8530-320	A, 18, 20, 22, 45			22	25	nicht verstellbar not adjustable	nicht verstellbar not adjustable	AS8530320VA	AS8502320HA	T
B12 Pro-Kit (Performance Komplettfahrwerke Performance Springs+Shocks) 1.8 16V, 1.8 G60, 2.0 i, 2.0 i 16V, 2.9 VR6	09.88 - 12.95	950	710	E90-85-033-01-22	A, 18, 20, 78, 93,	161	25-30	25						T
1.8 16V, 1.8 G60, 2.0 i, 2.0 i 16V, 2.9 VR6	09.88 - 12.95	950	710	E90-85-033-02-22	A, 18, 20, 78, 94,	161	25-30	25						T
EOS (1F7, 1F8) <i>Pro-Kit (Performance Fahrwerksfedern Performance Springs)</i> 1.4 TSI, 1.6 FSI	06.06 -	1010	1000	E10-85-018-01-22	A, 18, 20	25-30	25					F11-15-007-01-VA	F11-85-012-01-HA	T
1.4 TSI, 2.0 FSI, 2.0 TDI, 2.0 TDI 16V, 2.0 TFSI, 2.0 TSI	03.06 -	1080	1000	E10-85-018-02-22	A, 18, 20	25-30	25					F11-15-007-02-VA	F11-85-012-01-HA	T
2.0 TDI, 2.0 TDI 16V, 2.0 TFSI, 3.2 V6	03.06 -	1130	1000	E10-85-018-03-22	A, 18, 20	25-30	25					F11-15-007-03-VA	F11-85-012-01-HA	T
Anti-Roll-Kit (Performance Stabilisatoren Performance Sway Bars) 1.4 TSI, 1.6 FSI, 2.0 FSI, 2.0 TDI, 2.0 TDI 16V, 2.0 TFSI, 2.0 TSI, 3.2 V6	03.06 -			E40-85-014-06-11	A, 18, 20, 22, 45			26	23	2-fach verstellbar 2-way adjustable	2-fach verstellbar 2-way adjustable	AS41-85-014-01-VA	AS41-85-014-01-HA	T
B12 Pro-Kit (Performance Komplettfahrwerke Performance Springs+Shocks) 1.4 TSI, 1.6 FSI	06.06 -	1010	1000	E90-85-018-01-22	A, 18, 20, 78, 161	25	25							T
1.4 TSI, 2.0 FSI, 2.0 TDI, 2.0 TDI 16V, 2.0 TFSI, 2.0 TSI	03.06 -	1080	1000	E90-85-018-02-22	A, 18, 20, 78, 161	25	25							T
2.0 TDI 16V mit DSG, 2.0 TDI mit DSG, 2.0 TFSI mit DSG, 3.2 V6 mit DSG 2.0 TDI 16V with DSG, 2.0 TDI with DSG, 2.0 TFSI with DSG, 3.2 V6 with DSG	03.06 -	1130	1000	E90-85-018-03-22	A, 18, 20, 78, 107,	161	25	25						T
Pro-Tronic (Elektronische Performance Fahrwerksmodule Electronic Performance Suspension Moduls) Alle Motorisierungen / all motorisation	03.06 -			AM65-85-022-01-22	A, 175									
FOX (5Z1, 5Z3) <i>Pro-Kit (Performance Fahrwerksfedern Performance Springs)</i> 1.2, 1.4, 1.4 TDI, 1.6, 1.6 Total Flex	10.03 -	870	800	E10-85-017-01-22	A, 18, 20	30	30					F11-85-008-01-VA	F7910002	T
B12 Pro-Kit (Performance Komplettfahrwerke Performance Springs+Shocks) 1.2, 1.4, 1.4 TDI	04.05 -	870	800	E90-85-017-01-22	A, 18, 20, 78, 161	30	30							T
GOLF I (17) <i>Pro-Kit (Performance Fahrwerksfedern Performance Springs)</i> 1.1, 1.3, 1.5, 1.5 D, 1.6, 1.6 D, 1.6 GTI, 1.6 TD, 1.8 GTI	04.74 - 07.85	785	630	E8501-140	A, 18, 20	30-40	30-35					F8501101	F8501002	T
B12 Pro-Kit (Performance Komplettfahrwerke Performance Springs+Shocks) 1.1, 1.3, 1.5, 1.5 D, 1.6, 1.6 D, 1.6 GTI, 1.6 TD, 1.8 GTI	04.74 - 07.85	785	630	E90-85-032-01-22	A, 18, 20, 78, 95,	161	30-40	30-35						T
GOLF I Cabriolet (155) <i>Pro-Kit (Performance Fahrwerksfedern Performance Springs)</i> 1.5, 1.6, 1.8	01.79 - 04.93	785	630	E8510-140	A, 18, 20	30-40	30-35					F8501101	F8510002	T
B12 Pro-Kit (Performance Komplettfahrwerke Performance Springs+Shocks) 1.5, 1.6, 1.8	01.79 - 04.93	785	630	E90-85-032-02-22	A, 18, 20, 78, 95,	161	30-40	30-35						T
GOLF II (19E, 1G1) <i>Pro-Kit (Performance Fahrwerksfedern Performance Springs)</i> 1.0, 1.3, 1.3 KAT, 1.6, 1.8, 1.8 GTI, 1.8 GTI G60, 1.8 GTI KAT, 1.8 i KAT 1.0, 1.3, 1.3 CAT, 1.6, 1.8, 1.8 GTI, 1.8 GTI CAT, 1.8 GTI G60, 1.8 i CAT 1.6 D, 1.6 TD, 1.8 GTI 16V	08.83 - 12.92	840	740	E8502-140	A, 18, 20	30-40	30-35					F8502001	F8502002	T
	08.83 - 10.91	840	740	E8509-140	A, 18, 20	20	20					F8509001	F8502002	T
Anti-Roll-Kit (Performance Stabilisatoren Performance Sway Bars) 1.0, 1.3, 1.3 KAT, 1.6, 1.6 D, 1.6 TD, 1.8, 1.8 GTI, 1.8 GTI 16V, 1.8 GTI G60, 1.8 GTI KAT, 1.8 i KAT 1.0, 1.3, 1.3 CAT, 1.6, 1.6 D, 1.6 TD, 1.8, 1.8 GTI, 1.8 GTI 16V, 1.8 GTI CAT, 1.8 GTI G60, 1.8 i CAT	08.83 - 12.92			E8502-320	A, 18, 20, 22, 45			22	25	nicht verstellbar not adjustable	nicht verstellbar not adjustable	AS8502320VA	AS8502320HA	T
B12 Pro-Kit (Performance Komplettfahrwerke Performance Springs+Shocks) 1.0, 1.3, 1.3 KAT, 1.6, 1.8, 1.8 GTI, 1.8 GTI G60, 1.8 GTI KAT, 1.8 i KAT 1.0, 1.3, 1.3 CAT, 1.6, 1.8, 1.8 GTI, 1.8 GTI CAT, 1.8 GTI G60, 1.8 i CAT 1.6 D, 1.6 TD, 1.8 GTI 16V	08.83 - 12.92	840	740	E90-85-009-01-22	A, 18, 20, 78, 161	30-40	30-35							T
	08.83 - 10.91	840	740	E90-85-009-02-22	A, 18, 20, 78, 161	20	20							T

Modell	Baujahr	Achslast Vorne kg	Achslast Hinten kg	Artikel-Nr.	Hinweise	ca. Tieferl. Vorne mm	ca. Tieferl. Hinten mm	Ø Vorne mm	Ø Hinten mm	Verstellbarkeit Vorne	Verstellbarkeit Hinten	Ersatzteilbezeichnung Vorne	Ersatzteilbezeichnung Hinten	Gutachten
Model	Year	Front Axle Load kg	Rear Axle Load kg	Part-No.	Notes	ca. Lowering Front mm	ca. Lowering Rear mm	Ø Front mm	Ø Rear mm	Adjustable Front	Adjustable Rear	Spare Part Marking Front	Spare Part Marking Rear	Homologation
GOLF II (19E, 1G1) Pro-Street-S (Gewindefahrwerke - höhenverstellbar Coil-Overs-Adjustable Ride Height) 1.0, 1.3, 1.3 KAT, 1.6, 1.6 D, 1.6 TD, 1.8, 1.8 GTI, 1.8 GTI 16V, 1.8 GTI G60, 1.8 GTI KAT, 1.8 i KAT 1.0, 1.3, 1.3 CAT, 1.6, 1.6 D, 1.6 TD, 1.8, 1.8 GTI, 1.8 GTI 16V, 1.8 GTI CAT, 1.8 GTI G60, 1.8 i CAT	08.83 - 12.92	840	740	PSS65-85-003-01-22	A, 24, 25, 26, 45, 160	30-65	30-65							T
GOLF III (1H1) Pro-Kit (Performance Fahrwerksfedern Performance Springs) 1.4, 1.6, 1.8, 1.9 D, 1.9 TD, 1.9 TDI, 2.0, 2.0 GTI 16V, 2.8 VR6	10.91 - 08.94	980	840	E8530-140	A, 18, 19, 20	30	30					F8530001	F8502002	T
1.4, 1.6, 1.8, 1.9 D, 1.9 SDI, 1.9 TD, 1.9 TDI, 2.0, 2.0 GL, 2.0 GTI 16V, 2.8 VR6	10.91 - 09.97	980	840	E8547-140	A, 18, 19, 20	30	30					F8547001	F8502002	T
Sportline (Performance Fahrwerksfedern Sport Sport Performance Springs) 1.4, 1.6, 1.8, 1.9 D, 1.9 SDI, 1.9 TD, 1.9 TDI, 2.0, 2.0 GL, 2.0 GTI 16V, 2.8 VR6	10.91 - 09.97	950	840	E20-85-003-01-22	A, 20	45-50	30-35					F21-85-003-01-VA	F21-85-003-01-HA	T
Anti-Roll-Kit (Performance Stabilisatoren Performance Sway Bars) 1.4, 1.6, 1.8, 1.9 D, 1.9 SDI, 1.9 TD, 1.9 TDI, 2.0	10.91 - 08.97			E8502-320	A, 18, 20, 22, 45			22	25	nicht verstellbar not adjustable	nicht verstellbar not adjustable	AS8502320VA	AS8502320HA	T
2.0 GTI 16V, 2.8 VR6	01.92 - 09.97			E8530-320	A, 18, 20, 22, 45			22	25	nicht verstellbar not adjustable	nicht verstellbar not adjustable	AS8530320VA	AS8502320HA	T
B12 Pro-Kit (Performance Komplettfahrwerke Performance Springs+Shocks) 1.4, 1.6, 1.8, 1.9 D, 1.9 TD, 1.9 TDI, 2.0, 2.0 GTI 16V, 2.8 VR6	10.91 - 08.94	980	840	E90-85-003-01-22	A, 18, 20, 78, 93, 161	30	30							T
1.4, 1.6, 1.8, 1.9 D, 1.9 SDI, 1.9 TD, 1.9 TDI, 1.9 TDI Syncro, 2.0, 2.0 GL, 2.0 GTI 16V, 2.8 VR6	09.94 - 09.97	980	840	E90-85-003-02-22	A, 18, 20, 78, 94, 161	30	30							T
B12 Sportline (Performance Komplettfahrwerke Sport Sport Performance Springs+Shocks) 1.8, 1.9 D, 1.9 TD, 1.9 TDI, 2.0, 2.0 GTI 16V, 2.8 VR6	11.91 - 08.94	950	840	E95-85-003-01-22	A, 18, 20, 78, 93, 161	45-50	30-35							T
1.4, 1.6, 1.8, 1.9 D, 1.9 SDI, 1.9 TD, 1.9 TDI, 2.0, 2.0 GL, 2.0 GTI 16V, 2.8 VR6	09.94 - 09.97	950	840	E95-85-003-03-22	A, 18, 20, 78, 94, 161	45-50	30-35							T
Pro-Street-S (Gewindefahrwerke - höhenverstellbar Coil-Overs-Adjustable Ride Height) 1.4, 1.6, 1.8, 1.9 D, 1.9 SDI, 1.9 TD, 1.9 TDI, 2.0, 2.0 GL, 2.0 GTI 16V, 2.8 VR6	10.91 - 09.97	890	880	PSS65-85-003-01-22	A, 20, 24, 25, 26, 45, 160	45-80	45-80							T
1.4, 1.6, 1.8, 1.9 D, 1.9 SDI, 1.9 TD, 1.9 TDI, 2.0 GL, 2.0 GTI 16V, 2.8 VR6	10.91 - 09.97	980	880	PSS65-85-003-02-22	A, 20, 24, 25, 26, 45, 160	45-80	45-80							T
2.0	11.91 - 08.97	980	880	PSS65-85-003-02-22	A, 20, 24, 25, 26, 45, 160	-80	45-80							T
GOLF III Cabriolet (1E7) Pro-Kit (Performance Fahrwerksfedern Performance Springs) 1.8, 2.0	07.93 - 08.94	980	840	E8530-140	A, 18, 19, 20	30	30					F8530001	F8502002	T
1.6, 1.8, 1.9 TDI, 2.0	09.94 - 05.98	980	840	E8550-140	A, 18, 19, 20	30	30					F8547001	F8550002	T
Anti-Roll-Kit (Performance Stabilisatoren Performance Sway Bars) 1.6, 1.8, 1.9 TDI, 2.0	07.93 - 05.98			E8502-320	A, 18, 20, 22, 45			22	25	nicht verstellbar not adjustable	nicht verstellbar not adjustable	AS8502320VA	AS8502320HA	T
B12 Pro-Kit (Performance Komplettfahrwerke Performance Springs+Shocks) 1.6, 1.8, 1.9 TDI, 2.0	07.93 - 05.98	980	840	E90-85-003-05-22	A, 18, 20, 78, 93, 161	30	30							T
1.8, 2.0	07.93 - 08.94	980	840	E90-85-003-06-22	A, 18, 20, 78, 94, 161	30	30							T
Pro-Street-S (Gewindefahrwerke - höhenverstellbar Coil-Overs-Adjustable Ride Height) 1.6, 1.8, 1.9 TDI, 2.0	07.93 - 05.98	890	880	PSS65-85-003-01-22	A, 20, 24, 25, 26, 45, 160	45-80	45-80							T
1.6, 1.8, 1.9 TDI, 2.0	07.93 - 05.98	980	880	PSS65-85-003-02-22	A, 20, 24, 25, 26, 45, 160	45-80	45-80							T
GOLF III Variant (1H5) Pro-Kit (Performance Fahrwerksfedern Performance Springs) 1.4, 1.6, 1.8, 1.9 D, 1.9 TD, 1.9 TDI, 2.0	07.93 - 08.94	980	925	E8543-140	A, 18, 19, 20	30	30					F8530001	F8543002	T
1.4, 1.6, 1.8, 1.9 D, 1.9 SDI, 1.9 TD, 1.9 TDI, 2.0, 2.9 VR6	07.93 - 04.99	980	925	E8548-140	A, 18, 19, 20	30	30					F8547001	F8543002	T
B12 Pro-Kit (Performance Komplettfahrwerke Performance Springs+Shocks) 1.4, 1.6, 1.8, 1.9 D, 1.9 SDI, 1.9 TD, 1.9 TDI, 2.0, 2.9 VR6	07.93 - 04.99	980	925	E90-85-003-03-22	A, 18, 20, 78, 93, 161	30	30							T
1.4, 1.6, 1.8, 1.9 D, 1.9 SDI, 1.9 TD, 1.9 TDI, 2.0, 2.9 VR6	07.93 - 04.99	980	925	E90-85-003-04-22	A, 18, 20, 78, 94, 161	30	30							T
GOLF IV (1J1) Pro-Kit (Performance Fahrwerksfedern Performance Springs) 1.4 16V, 1.6, 1.6 16V, 1.6 FSI	08.97 - 06.05	930	925	E8560-140	A, 18, 20, 26	30	30					F8560001	F1540002	T
1.8, 1.9 SDI, 1.9 TDI, 2.0	08.97 - 06.05	970	925	E8561-140	A, 18, 20, 26	30	30					F1540001	F1540002	T
1.8 T, 1.8 T GTI, 1.9 TDI, 2.3 V5	08.97 - 06.05	1000	925	E8564-140	A, 18, 20, 26	30	30					F1545001	F1540002	T
1.8 4motion, 1.9 TDI 4motion, 2.0 4motion	05.98 - 06.05	1030	1120	E10-85-001-05-22	A, 18	30	30					F1545001	F11-15-001-02-HA	T
1.9 TDI, 2.3 V5	08.97 - 06.05	1050	925	E10-85-001-14-22	A, 18, 20, 26	30	30					F8592001	F1540002	T
1.9 TDI 4motion, 2.3 V5 4motion, 2.8 V6 4motion	07.98 - 06.05	1050	1120	E8591-140	A, 18	30	30					F8592001	F11-15-001-02-HA	T
Sportline (Performance Fahrwerksfedern Sport Sport Performance Springs) 1.4 16V, 1.6, 1.6 16V, 1.6 FSI, 1.8, 1.8 T, 1.8 T GTI, 1.9 SDI, 1.9 TDI, 2.0	08.97 - 06.05	950	1000	E20-85-001-01-22	A, 18, 20, 26	45-50	30-35					F21-85-001-01-VA	F21-85-001-01-HA	T
1.8, 1.8 T, 1.8 T GTI, 1.9 TDI, 2.3 V5	08.97 - 06.05	1000	1000	E20-85-001-02-22	A, 18, 20, 26	45-50	30-35					F21-85-003-01-VA	F21-85-001-01-HA	T
Anti-Roll-Kit (Performance Stabilisatoren Performance Sway Bars) 1.4 16V, 1.6, 1.6 16V, 1.6 FSI, 1.8, 2.0	08.97 - 06.05			E1540-321	A, 18, 20, 22, 45			22		nicht verstellbar not adjustable		AS1540310VA		T
1.4 16V, 1.6, 1.6 16V, 1.6 FSI, 1.8, 2.0	08.97 - 06.05			E1540-320	A, 18, 20, 22, 45			22	25	nicht verstellbar not adjustable	nicht verstellbar not adjustable	AS1540310VA	AS1540320HA	T
1.8 T, 1.8 T GTI, 1.9 SDI, 1.9 TDI, 2.3 V5	08.97 - 06.05			E40-85-005-01-10	A, 18, 20, 22, 45			25		nicht verstellbar not adjustable		AS41-85-005-01-VA		T
1.8 T, 1.8 T GTI, 1.9 SDI, 1.9 TDI, 2.3 V5	08.97 - 06.05			E40-85-005-01-11	A, 18, 20, 22, 45			25	25	nicht verstellbar not adjustable	nicht verstellbar not adjustable	AS41-85-005-01-VA	AS1540320HA	T
B12 Pro-Kit (Performance Komplettfahrwerke Performance Springs+Shocks) 1.4 16V, 1.6, 1.6 16V, 1.6 FSI	08.97 - 06.05	930	925	E90-85-001-01-22	A, 18, 20, 78, 26, 161	30	30							T

Modell	Baujahr	Achslast Vorne kg	Achslast Hinten kg	Artikel-Nr.	Hinweise	ca. Tieferl. Vorne mm	ca. Tieferl. Hinten mm	Ø Vorne mm	Ø Hinten mm	Verstellbarkeit Vorne	Verstellbarkeit Hinten	Ersatzteilbezeichnung Vorne	Ersatzteilbezeichnung Hinten	Gutachten
<i>Model</i>	<i>Year</i>	<i>Front Axle Load kg</i>	<i>Rear Axle Load kg</i>	<i>Part-No.</i>	<i>Notes</i>	<i>ca. Lowering Front mm</i>	<i>ca. Lowering Rear mm</i>	<i>Ø Front mm</i>	<i>Ø Rear mm</i>	<i>Adjustable Front</i>	<i>Adjustable Rear</i>	<i>Spare Part Marking Front</i>	<i>Spare Part Marking Rear</i>	<i>Homologation</i>
GOLF IV (1J1)														
B12 Pro-Kit (Performance Komplettfahrwerke Performance Springs+Shocks)														
1.8, 1.9 SDI, 1.9 TD Schaltgetriebe, 2.0	08.97 - 06.05	970	925	E90-85-001-02-22	A, 18, 20, 78, 26, 161	30	30							T
1.8, 1.9 SDI, 1.9 TD manual transmission, 2.0	08.97 - 05.04	970	925	E90-85-001-02-22	A, 18, 20, 26, 71, 78, 161	30	30							T
1.9 TDI Schaltgetriebe	08.01 - 06.05	1000	925	E90-85-001-03-22	A, 18, 20, 26, 78, 161	10	10							T
1.9 TDI manual transmission	08.97 - 06.05	1000	925	E90-85-001-03-22	A, 18, 20, 26, 78, 161	30	30							T
1.8 T GTI	05.98 - 06.05	1030	1120	E90-85-001-05-22	A, 18, 78, 161	30	30							T
1.8 T, 1.9 TDI, 1.9 TDI Schaltgetriebe, 2.3 V5 Schaltgetriebe	08.97 - 06.05	1050	925	E90-85-001-04-22	A, 18, 20, 26, 78, 161	30	30							T
1.8 T, 1.9 TDI, 1.9 TDI manual transmission, 2.3 V5 manual transmission	07.98 - 06.05	1050	1120	E90-85-001-06-22	A, 18, 78, 161	30	30							T
1.8 4motion, 1.9 TDI 4motion, 2.0 4motion	08.01 - 06.05	950	1000	E95-85-001-01-22	A, 18, 20, 26, 78, 161	25-30	10-15							T
1.9 TDI, 1.9 TDI Schaltgetriebe, 2.3 V5, 2.3 V5 Schaltgetriebe	08.97 - 06.05	950	1000	E95-85-001-01-22	A, 18, 20, 26, 78, 161	45-50	30-35							T
1.9 TDI, 1.9 TDI manual transmission, 2.3 V5, 2.3 V5 manual transmission	08.01 - 06.05	1000	1000	E95-85-001-02-22	A, 18, 20, 26, 78, 161	25-30	10-15							T
1.9 TDI 4motion, 2.3 V5 4motion, 2.8 V6 4motion	08.97 - 06.05	1000	1000	E95-85-001-02-22	A, 18, 20, 26, 78, 161	45-50	30-35							T
B12 Sportline (Performance Komplettfahrwerke Sport Sport Performance Springs+Shocks)														
1.8 T GTI	08.97 - 06.05	1020	1020	PSS65-85-001-01-22	A, 20, 24, 25, 26, 45, 160	35-65	35-65							T
1.4 16V, 1.6, 1.6 16V, 1.6 FSI, 1.8, 1.8 T, 1.9 SDI, 1.9 TD, 1.9 TDI, 2.0	05.98 - 06.05	1110	1080	PSS65-85-001-02-22	A, 24, 25, 45, 160	35-65	35-65							T
1.8 4motion, 1.9 TDI 4motion, 2.0 4motion	12.98 - 06.05	1110	1080	PSS65-85-001-05-22	A, 24, 25, 45, 160	35-65	35-65							T
2.3 V5 4motion, 2.8 V6 4motion	09.02 - 06.05	1110	1080	PSS65-85-001-04-22	A, 24, 25, 45, 160	35-65	35-65							T
3.2 R32 4motion	09.94 - 06.02	980	840	E8550-140	A, 18, 19, 20	30	30					F8547001	F8550002	T
GOLF IV Cabriolet (1E7)														
Pro-Kit (Performance Fahrwerksfedern Performance Springs)														
1.6, 1.8, 1.9 TDI, 2.0	06.98 - 06.02			E8502-320	A, 18, 20, 22, 45			22	25	nicht verstellbar not adjustable	nicht verstellbar not adjustable	AS8502320VA	AS8502320HA	T
Anti-Roll-Kit (Performance Stabilisatoren Performance Sway Bars)														
1.6, 1.8, 1.9 TDI, 2.0	06.98 - 06.02	980	840	E90-85-003-05-22	A, 18, 20, 78, 94, 161	30	30							T
B12 Pro-Kit (Performance Komplettfahrwerke Performance Springs+Shocks)														
1.6, 1.8, 1.9 TDI, 2.0	06.98 - 06.02	890	880	PSS65-85-003-01-22	A, 20, 24, 25, 26, 45, 160	45-80	45-80							T
Pro-Street-S (Gewindefahrwerke - höhenverstellbar Coil-Overs-Adjustable Ride Height)														
1.6, 1.8, 1.9 TDI, 2.0	06.98 - 06.02	980	880	PSS65-85-003-02-22	A, 20, 24, 25, 26, 45, 160	45-80	45-80							T
1.6, 1.8, 1.9 TDI, 2.0	05.99 - 06.06	930	1020	E8587-140	A, 18, 20, 26	30	30					F8560001	F7908002	T
GOLF IV Variant (1J5)														
Pro-Kit (Performance Fahrwerksfedern Performance Springs)														
1.4 16V, 1.6, 1.6 16V, 1.6 FSI	05.99 - 06.06	970	1020	E8588-140	A, 18, 20, 26	30	30					F1540001	F7908002	T
1.9 SDI, 1.9 TDI, 2.0	05.99 - 06.06	1000	1020	E8589-140	A, 18, 20, 26	30	30					F1545001	F7908002	T
1.8 T, 1.9 TDI, 2.3 V5	05.99 - 06.06	1030	1120	E10-85-001-05-22	A, 18	30	30					F1545001	F11-15-001-02-HA	T
1.8 4motion, 1.9 TDI 4motion, 2.0 4motion	05.99 - 06.06	1050	1020	E10-85-001-15-22	A, 18, 20, 26	30	30					F8592001	F7908002	T
1.9 TDI, 2.3 V5	05.99 - 06.06	1050	1120	E8591-140	A, 18	30	30					F8592001	F11-15-001-02-HA	T
1.9 TDI 4motion, 2.3 V5 4motion, 2.8 V6 4motion	05.99 - 06.06			E1540-321	A, 18, 20, 22, 45			22		nicht verstellbar not adjustable		AS1540310VA		T
Anti-Roll-Kit (Performance Stabilisatoren Performance Sway Bars)														
1.4 16V, 1.6, 1.6 16V, 1.6 FSI, 2.0	05.99 - 06.06			E1540-320	A, 18, 20, 22, 45			22	25	nicht verstellbar not adjustable	nicht verstellbar not adjustable	AS1540310VA	AS1540320HA	T
1.4 16V, 1.6, 1.6 16V, 1.6 FSI, 2.0	05.99 - 06.06			E40-85-005-01-10	A, 18, 20, 22, 45			25		nicht verstellbar not adjustable		AS41-85-005-01-VA		T
1.8 T, 1.9 SDI, 1.9 TDI, 2.3 V5	05.99 - 06.06			E40-85-005-01-11	A, 18, 20, 22, 45			25	25	nicht verstellbar not adjustable	nicht verstellbar not adjustable	AS41-85-005-01-VA	AS1540320HA	T
B12 Pro-Kit (Performance Komplettfahrwerke Performance Springs+Shocks)														
1.4 16V, 1.6, 1.6 16V, 1.6 FSI	05.99 - 06.06	930	1020	E90-85-001-11-22	A, 18, 20, 26, 78, 161	30	30							T
1.9 SDI, 1.9 TDI Schaltgetriebe, 2.0	05.99 - 06.06	970	1020	E90-85-001-12-22	A, 18, 20, 26, 78, 161	30	30							T
1.9 SDI, 1.9 TDI manual transmission, 2.0	05.99 - 06.06	1000	1020	E90-85-001-13-22	A, 18, 20, 26, 78, 161	30	30							T
1.8 T, 1.9 TDI, 1.9 TDI Schaltgetriebe, 2.3 V5 Schaltgetriebe	05.99 - 06.06	1030	1120	E90-85-001-05-22	A, 18, 78, 161	30	30							T
1.8 T, 1.9 TDI, 1.9 TDI manual transmission, 2.3 V5 manual transmission	05.99 - 06.06	1050	1020	E90-85-001-14-22	A, 18, 20, 26, 78, 161	30	30							T
1.8 4motion, 1.9 TDI 4motion, 2.0 4motion	05.99 - 06.06	1050	1120	E90-85-001-06-22	A, 18, 78, 161	30	30							T
Pro-Street-S (Gewindefahrwerke - höhenverstellbar Coil-Overs-Adjustable Ride Height)														
1.4 16V, 1.6, 1.6 16V, 1.6 FSI, 1.8 T, 1.9 SDI, 1.9 TDI, 2.0, 2.3 V5	05.99 - 06.06	1110	1080	PSS65-85-001-03-22	A, 20, 24, 25, 26, 45, 160	35-65	35-65							T
1.8 4motion, 1.9 TDI 4motion, 2.0 4motion	05.99 - 06.06	1110	1080	PSS65-85-001-02-22	A, 24, 25, 45, 160	35-65	35-65							T
2.3 V5 4motion, 2.8 V6 4motion	05.99 - 06.06	1110	1080	PSS65-85-001-05-22	A, 24, 25, 45, 160	35-65	35-65							T
GOLF PLUS (5M1, 521)														
Pro-Kit (Performance Fahrwerksfedern Performance Springs)														
1.2 TSI, 1.4 16V, 1.4 FSI, 1.6, 1.6 FSI, 1.6 MultiFuel	01.05 -	1010	1010	E10-85-014-10-22	A, 18, 20	30	30					F11-15-007-01-VA	F11-85-014-05-HA	ABE
1.2 TSI, 1.4 TSI, 1.6, 1.6 FSI, 1.6 MultiFuel, 1.9 TDI, 2.0 FSI	01.05 -	1080	1010	E10-85-014-11-22	A, 18, 20	30	30					F11-15-007-02-VA	F11-85-014-05-HA	ABE

Modell	Baujahr	Achslast Vorne kg	Achslast Hinten kg	Artikel-Nr.	Hinweise	ca. Tieferl. Vorne mm	ca. Tieferl. Hinten mm	Ø Vorne mm	Ø Hinten mm	Verstellbarkeit Vorne	Verstellbarkeit Hinten	Ersatzteilbezeichnung Vorne	Ersatzteilbezeichnung Hinten	Gutachten
<i>Model</i>	<i>Year</i>	<i>Front Axle Load kg</i>	<i>Rear Axle Load kg</i>	<i>Part-No.</i>	<i>Notes</i>	<i>ca. Lowering Front mm</i>	<i>ca. Lowering Rear mm</i>	<i>Ø Front mm</i>	<i>Ø Rear mm</i>	<i>Adjustable Front</i>	<i>Adjustable Rear</i>	<i>Spare Part Marking Front</i>	<i>Spare Part Marking Rear</i>	<i>Homologation</i>
GOLF PLUS (5M1, 521)														
<i>Pro-Kit (Performance Fahrwerksfedern Performance Springs)</i>														
1.6 TDI, 1.9 TDI, 2.0 TDI, 2.0 TDI 16V	01.05 -	1150	1010	E10-85-014-12-22	A, 18, 20	30	30					F11-15-007-03-VA	F11-85-014-05-HA	ABE
<i>Sportline (Performance Fahrwerksfedern Sport Sport Performance Springs)</i>														
1.2 TSI, 1.4 16V, 1.4 FSI, 1.4 TSI, 1.6, 1.6 FSI, 1.6 MultiFuel	01.05 -	1040	1010	E20-85-014-03-22	A, 18, 20	45-50	30-35					F21-15-007-01-VA	F21-15-007-01-HA	ABE
1.4 TSI, 1.6, 1.6 FSI, 1.6 MultiFuel, 1.6 TDI, 1.9 TDI, 2.0 FSI, 2.0 TDI, 2.0 TDI 16V	01.05 -	1130	1010	E20-85-014-04-22	A, 18, 20	45-50	30-35					F21-15-007-02-VA	F21-15-007-01-HA	T
<i>Anti-Roll-Kit (Performance Stabilisatoren Performance Sway Bars)</i>														
1.2 TSI, 1.4 16V, 1.4 FSI, 1.4 TSI, 1.6, 1.6 FSI, 1.6 MultiFuel, 1.6 TDI, 1.9 TDI, 2.0 FSI, 2.0 TDI, 2.0 TDI 16V	01.05 -			E40-85-014-06-11	A, 18, 20, 22, 45			26	23	2-fach verstellbar 2-way adjustable	2-fach verstellbar 2-way adjustable	AS41-85-014-01-VA	AS41-85-014-01-HA	T
<i>B12 Pro-Kit (Performance Komplettfahrwerke Performance Springs+Shocks)</i>														
1.2 TSI, 1.4 16V, 1.4 FSI, 1.6, 1.6 FSI	01.05 -	1010	1010	E90-85-014-08-22	A, 18, 20, 34, 78, 124, 161	30	30							T
1.2 TSI, 1.4 16V, 1.4 FSI, 1.6, 1.6 FSI	01.05 -	1010	1010	E90-85-014-07-22	A, 18, 20, 35, 78, 122, 161	30	30							T
1.2 TSI mit DSG 1.2 TSI with DSG	11.09 -	1080	1010	E90-85-014-10-22	A, 18, 20, 34, 78, 107, 124, 161	30	30							T
1.2 TSI mit DSG, 1.4 TSI, 1.6, 1.6 FSI, 1.9 TDI, 2.0 FSI 1.2 TSI with DSG, 1.4 TSI, 1.6, 1.6 FSI, 1.9 TDI, 2.0 FSI	01.05 -	1080	1010	E90-85-014-09-22	A, 18, 20, 35, 78, 122, 161	30	30							T
1.4 TSI, 1.6, 1.6 FSI, 1.9 TDI, 2.0 FSI	01.05 -	1080	1010	E90-85-014-10-22	A, 18, 20, 34, 78, 124, 161	30	30							T
1.6 TDI, 2.0 TDI	05.05 -	1150	1010	E90-85-014-12-22	A, 18, 20, 34, 78, 124, 161	30	30							T
1.6 TDI, 2.0 TDI	05.05 -	1150	1010	E90-85-014-11-22	A, 18, 20, 35, 78, 122, 161	30	30							T
1.9 TDI mit DSG 1.9 TDI with DSG	01.05 - 01.09	1150	1010	E90-85-014-12-22	A, 18, 20, 34, 78, 107, 124, 161	30	30							T
1.9 TDI mit DSG 1.9 TDI with DSG	01.05 - 01.09	1150	1010	E90-85-014-11-22	A, 18, 20, 35, 78, 107, 122, 161	30	30							T
<i>B12 Sportline (Performance Komplettfahrwerke Sport Sport Performance Springs+Shocks)</i>														
1.2 TSI, 1.4 16V, 1.4 FSI, 1.4 TSI, 1.6, 1.6 FSI	01.05 -	1040	1010	E95-85-014-06-22	A, 18, 20, 34, 78, 124, 161	45-50	30-35							T
1.2 TSI, 1.4 16V, 1.4 FSI, 1.4 TSI, 1.6, 1.6 FSI, 2.0 TDI	01.05 -	1040	1010	E95-85-014-05-22	A, 18, 20, 35, 78, 122, 161	45-50	30-35							T
1.4 TSI mit DSG 1.4 TSI with DSG	05.06 -	1130	1010	E95-85-014-08-22	A, 18, 20, 34, 78, 107, 124, 161	45-50	30-35							T
1.4 TSI mit DSG 1.4 TSI with DSG	05.06 -	1130	1010	E95-85-014-07-22	A, 18, 20, 35, 78, 107, 122, 161	45-50	30-35							T
1.6, 1.6 FSI, 1.6 TDI, 1.9 TDI, 2.0 FSI, 2.0 TDI	01.05 -	1130	1010	E95-85-014-08-22	A, 18, 20, 34, 78, 124, 161	45-50	30-35							T
1.6, 1.6 FSI, 1.6 TDI, 1.9 TDI, 2.0 FSI, 2.0 TDI	01.05 -	1130	1010	E95-85-014-07-22	A, 18, 20, 35, 78, 122, 161	45-50	30-35							T
<i>Pro-Street-S (Gewindefahrwerke - höhenverstellbar Coil-Overs-Adjustable Ride Height)</i>														
1.2 TSI, 1.4 16V, 1.4 FSI, 1.4 TSI, 1.6, 1.6 FSI, 1.6 MultiFuel, 1.6 TDI, 1.9 TDI, 2.0 FSI, 2.0 TDI, 2.0 TDI 16V	01.05 -	1035	1150	PSS65-85-014-01-22	A, 20, 24, 34, 45, 70, 160	35-65	35-65							T
1.2 TSI, 1.4 16V, 1.4 FSI, 1.4 TSI, 1.6, 1.6 FSI, 1.6 MultiFuel, 1.6 TDI, 1.9 TDI, 2.0 FSI, 2.0 TDI, 2.0 TDI 16V	01.05 -	1035	1150	PSS65-85-014-02-22	A, 20, 24, 35, 45, 70, 160	35-65	35-65							T
1.2 TSI, 1.4 16V, 1.4 FSI, 1.4 TSI, 1.6, 1.6 FSI, 1.6 MultiFuel, 1.6 TDI, 1.9 TDI, 2.0 FSI, 2.0 TDI, 2.0 TDI 16V	01.05 -	1105	1150	PSS65-85-014-03-22	A, 20, 24, 34, 45, 70, 160	35-65	35-65							T
1.2 TSI, 1.4 16V, 1.4 FSI, 1.4 TSI, 1.6, 1.6 FSI, 1.6 MultiFuel, 1.6 TDI, 1.9 TDI, 2.0 FSI, 2.0 TDI, 2.0 TDI 16V	01.05 -	1105	1150	PSS65-85-014-04-22	A, 20, 24, 35, 45, 70, 160	35-65	35-65							T
1.2 TSI, 1.4 16V, 1.4 FSI, 1.4 TSI, 1.6, 1.6 FSI, 1.6 MultiFuel, 1.6 TDI, 1.9 TDI, 2.0 FSI, 2.0 TDI, 2.0 TDI 16V	01.05 -	1170	1150	PSS65-85-014-05-22	A, 20, 24, 34, 45, 70, 160	35-65	35-65							T
1.2 TSI, 1.4 16V, 1.4 FSI, 1.4 TSI, 1.6, 1.6 FSI, 1.6 MultiFuel, 1.6 TDI, 1.9 TDI, 2.0 FSI, 2.0 TDI, 2.0 TDI 16V	01.05 -	1170	1150	PSS65-85-014-06-22	A, 20, 24, 35, 45, 70, 160	35-65	35-65							T
GOLF V (1K1)														
<i>Pro-Kit (Performance Fahrwerksfedern Performance Springs)</i>														
1.4 16V, 1.4 FSI, 1.6, 1.6 FSI, 1.6 MultiFuel	10.03 - 11.08	1010	1010	E10-85-014-05-22	A, 18, 20, 58	30	30					F11-15-007-01-VA	F11-85-014-05-HA	ABE
1.4 TSI, 1.6, 1.6 FSI, 1.6 MultiFuel, 1.9 TDI, 2.0, 2.0 FSI	10.03 - 11.08	1080	1010	E10-85-014-06-22	A, 18, 20, 58	30	30					F11-15-007-02-VA	F11-85-014-05-HA	ABE
1.9 TDI 4motion, 2.0 FSI 4motion, 2.0 TDI 16V 4motion, 2.0 TDI 4motion	08.04 - 11.08	1110	980	E10-85-014-16-22	A, 18	30	30					F11-15-007-02-VA	F11-85-014-05-HA	ABE
1.9 TDI, 2.0 TDI, 2.0 TDI 16V	10.03 - 11.08	1150	1010	E10-85-014-07-22	A, 18, 20, 58	30	30					F11-15-007-03-VA	F11-85-014-05-HA	ABE
<i>Sportline (Performance Fahrwerksfedern Sport Sport Performance Springs)</i>														
1.4 16V, 1.4 FSI, 1.6, 1.6 FSI, 1.6 MultiFuel, 2.0, 2.0 FSI	10.03 - 11.08	1040	930	E20-85-014-01-22	A, 18, 20, 58	45-50	30-35					F21-15-007-01-VA	F21-85-014-01-HA	ABE
1.4 TSI, 1.8 GTI, 2.0 GTI	10.04 - 02.09	1040	930	E20-85-014-01-22	A, 18, 20	20-25	20					F21-15-007-01-VA	F21-85-014-01-HA	ABE
1.4 TSI, 1.8 GTI, 2.0 GTI	10.04 - 02.09	1130	930	E20-85-014-02-22	A, 18, 20	20-25	20					F21-15-007-02-VA	F21-85-014-01-HA	ABE
1.9 TDI, 2.0, 2.0 FSI, 2.0 SDI, 2.0 TDI, 2.0 TDI 16V	10.03 - 11.08	1130	930	E20-85-014-02-22	A, 18, 20, 58	45-50	30-35					F21-15-007-02-VA	F21-85-014-01-HA	ABE
<i>Anti-Roll-Kit (Performance Stabilisatoren Performance Sway Bars)</i>														
1.4 16V, 1.4 FSI, 1.4 TSI, 1.6, 1.6 FSI, 1.6 MultiFuel, 1.9 TDI, 2.0, 2.0 FSI, 2.0 GTI, 2.0 SDI, 2.0 TDI, 2.0 TDI 16V	10.03 - 02.09			E40-85-014-06-11	A, 18, 20, 22, 45			26	23	2-fach verstellbar 2-way adjustable	2-fach verstellbar 2-way adjustable	AS41-85-014-01-VA	AS41-85-014-01-HA	T
1.9 TDI 4motion, 2.0 FSI 4motion, 2.0 TDI 16V 4motion, 2.0 TDI 4motion, 3.2 R32 4motion	01.04 - 11.08			E40-85-014-08-11	A, 18, 22, 45			26 Rohr 26 tube	22 Rohr 22 tube	2-fach verstellbar 2-way adjustable	2-fach verstellbar 2-way adjustable	AS41-85-014-02-VA	AS41-85-014-02-HA	T
<i>B12 Pro-Kit (Performance Komplettfahrwerke Performance Springs+Shocks)</i>														
1.4 16V, 1.4 FSI, 1.6, 1.6 FSI, 1.6 MultiFuel	10.03 - 11.08	1010	1010	E90-85-014-02-22	A, 18, 20, 34, 78, 125, 161	30	30							T

Modell	Baujahr	Achslast Vorne kg	Achslast Hinten kg	Artikel-Nr.	Hinweise	ca. Tieferl. Vorne mm	ca. Tieferl. Hinten mm	Ø Vorne mm	Ø Hinten mm	Verstellbarkeit Vorne	Verstellbarkeit Hinten	Ersatzteilbezeichnung Vorne	Ersatzteilbezeichnung Hinten	Gutachten
Model	Year	Front Axle Load kg	Rear Axle Load kg	Part-No.	Notes	ca. Lowering Front mm	ca. Lowering Rear mm	Ø Front mm	Ø Rear mm	Adjustable Front	Adjustable Rear	Spare Part Marking Front	Spare Part Marking Rear	Homologation
GOLF V (1K1)														
B12 Pro-Kit (Performance Komplettfahrwerke Performance Springs+Shocks)														
1.4 16V, 1.4 FSI, 1.6, 1.6 FSI, 1.6 MultiFuel	10.03 - 11.08	1010	1010	E90-85-014-01-22	A, 18, 20, 35, 78, 122, 161	30	30							T
1.4 TSI, 1.6, 1.6 FSI, 1.6 MultiFuel, 1.9 TDI, 2.0, 2.0 FSI	10.03 - 11.08	1080	1010	E90-85-014-04-22	A, 18, 20, 34, 78, 125, 161	30	30							T
1.4 TSI, 1.6, 1.6 FSI, 1.6 MultiFuel, 1.9 TDI, 2.0, 2.0 FSI	10.03 - 11.08	1080	1010	E90-85-014-03-22	A, 18, 20, 35, 78, 122, 161	30	30							T
1.9 TDI 4motion, 2.0 FSI 4motion, 2.0 TDI 16V 4motion, 2.0 TDI 4motion	08.04 - 11.08	1110	980	E90-85-014-19-22	A, 18, 20, 35, 78, 122, 161	30	30							T
1.9 TDI 4motion, 2.0 FSI 4motion, 2.0 TDI 16V 4motion, 2.0 TDI 4motion	08.04 - 11.08	1110	980	E90-85-014-20-22	A, 18, 20, 34, 78, 122, 161	30	30							T
1.9 TDI, 2.0 SDI, 2.0 TDI, 2.0 TDI 16V	10.03 - 11.08	1150	1010	E90-85-014-06-22	A, 18, 20, 34, 78, 125, 161	30	30							T
1.9 TDI, 2.0 SDI, 2.0 TDI, 2.0 TDI 16V	10.03 - 11.08	1150	1010	E90-85-014-05-22	A, 18, 20, 35, 78, 122, 161	30	30							T
B12 Sportline (Performance Komplettfahrwerke Sport Sport Performance Springs+Shocks)														
1.4 16V, 1.4 FSI, 1.6, 1.6 FSI, 1.6 MultiFuel, 2.0, 2.0 FSI	10.03 - 11.08	1040	930	E95-85-014-02-22	A, 18, 20, 34, 78, 124, 161	45-50	30-35							T
1.4 16V, 1.4 TSI, 1.6, 1.6 FSI, 1.6 MultiFuel, 2.0, 2.0 FSI	10.03 - 11.08	1040	930	E95-85-014-01-22	A, 18, 20, 35, 78, 122, 161	45-50	30-35							T
1.4 TSI	11.05 - 11.08	1040	930	E95-85-014-02-22	A, 18, 20, 34, 78, 126, 161	45-50	30-35							T
1.8 GTI, 2.0 GTI	10.04 - 02.09	1040	930	E95-85-014-02-22	A, 18, 20, 34, 78, 124, 161	20-25	20							T
1.4 TSI, 1.8 GTI, 2.0 GTI	10.04 - 02.09	1040	930	E95-85-014-03-22	A, 18, 20, 35, 78, 122, 161	20-25	20							T
2.0 GTI	10.04 - 02.09	1130	930	E95-85-014-04-22	A, 18, 20, 34, 78, 126, 161	20-25	20							T
1.9 TDI, 2.0 SDI, 2.0 TDI, 2.0 TDI 16V	10.03 - 11.08	1130	930	E95-85-014-04-22	A, 18, 20, 34, 78, 125, 161	45-50	30-35							T
Pro-Street-S (Gewindefahrwerke - höhenverstellbar Coil-Overs-Adjustable Ride Height)														
1.4 16V, 1.4 FSI, 1.4 TSI, 1.6, 1.6 FSI, 1.6 MultiFuel, 1.8 GTI, 1.9 TDI, 2.0, 2.0 FSI, 2.0 SDI, 2.0 TDI, 2.0 TDI 16V	10.03 - 11.08	1035	1150	PSS65-85-014-01-22	A, 20, 24, 34, 45, 70, 160	35-65	35-65							T
1.4 16V, 1.4 FSI, 1.4 TSI, 1.6, 1.6 FSI, 1.6 MultiFuel, 1.8 GTI, 1.9 TDI, 2.0, 2.0 FSI, 2.0 SDI, 2.0 TDI, 2.0 TDI 16V	10.03 - 11.08	1035	1150	PSS65-85-014-02-22	A, 20, 24, 35, 45, 70, 160	35-65	35-65							T
1.4 16V, 1.4 FSI, 1.4 TSI, 1.6, 1.6 FSI, 1.6 MultiFuel, 1.8 GTI, 1.9 TDI, 2.0, 2.0 FSI, 2.0 SDI, 2.0 TDI, 2.0 TDI 16V	10.03 - 11.08	1105	1150	PSS65-85-014-03-22	A, 20, 24, 34, 45, 70, 160	35-65	35-65							T
1.4 16V, 1.4 FSI, 1.4 TSI, 1.6, 1.6 FSI, 1.6 MultiFuel, 1.8 GTI, 1.9 TDI, 2.0, 2.0 FSI, 2.0 SDI, 2.0 TDI, 2.0 TDI 16V	10.03 - 11.08	1105	1150	PSS65-85-014-04-22	A, 20, 24, 35, 45, 70, 160	35-65	35-65							T
1.9 TDI 4motion, 2.0 FSI 4motion, 2.0 TDI 16V 4motion, 2.0 TDI 4motion	08.04 - 11.08	1105	1150	PSS65-85-014-03-22	A, 24, 34, 45, 70, 160	35-65	30-55							T
1.9 TDI 4motion, 2.0 FSI 4motion, 2.0 TDI 16V 4motion, 2.0 TDI 4motion	08.04 - 11.08	1105	1150	PSS65-85-014-04-22	A, 24, 35, 45, 70, 160	35-65	30-55							T
2.0 GTI	09.06 - 12.08	1105	1150	PSS65-85-014-04-22	A, 18, 20, 24, 35, 45, 70, 160	20-45	10-35							T
2.0 GTI	10.04 - 02.09	1105	1150	PSS65-85-014-03-22	A, 20, 24, 34, 45, 70, 160	20-45	10-35							T
2.0 GTI, 3.2 R32 4motion	10.04 - 02.09	1105	1150	PSS65-85-014-05-22	A, 20, 24, 34, 45, 70, 160	20-45	10-35							T
2.0 GTI	10.04 - 02.09	1105	1150	PSS65-85-014-04-22	A, 20, 24, 35, 45, 70, 160	20-45	10-35							T
2.0 GTI, 3.2 R32 4motion	10.04 - 02.09	1105	1150	PSS65-85-014-06-22	A, 20, 24, 35, 45, 70, 160	20-45	10-35							T
3.2 R32 4motion	01.04 - 11.08	1110	1150	PSS65-85-014-05-22	A, 20, 24, 34, 45, 70, 160	20-45	10-35							T
3.2 R32 4motion	01.04 - 11.08	1110	1150	PSS65-85-014-06-22	A, 20, 24, 35, 45, 70, 160	20-45	10-35							T
1.4 16V, 1.4 FSI, 1.4 TSI, 1.6, 1.6 FSI, 1.6 MultiFuel, 1.8 GTI, 1.9 TDI, 2.0, 2.0 FSI, 2.0 SDI, 2.0 TDI, 2.0 TDI 16V	10.03 - 11.08	1170	1150	PSS65-85-014-05-22	A, 20, 24, 34, 45, 70, 160	35-65	35-65							T
1.4 16V, 1.4 FSI, 1.4 TSI, 1.6, 1.6 FSI, 1.6 MultiFuel, 1.8 GTI, 1.9 TDI, 2.0, 2.0 FSI, 2.0 SDI, 2.0 TDI, 2.0 TDI 16V	10.03 - 11.08	1170	1150	PSS65-85-014-06-22	A, 20, 24, 35, 45, 70, 160	35-65	35-65							T
1.9 TDI 4motion, 2.0 FSI 4motion, 2.0 TDI 16V 4motion, 2.0 TDI 4motion	08.04 - 11.08	1170	1150	PSS65-85-014-05-22	A, 24, 34, 45, 70, 160	35-65	30-55							T
1.9 TDI 4motion, 2.0 FSI 4motion, 2.0 TDI 16V 4motion, 2.0 TDI 4motion	08.04 - 11.08	1170	1150	PSS65-85-014-06-22	A, 24, 35, 45, 70, 160	35-65	30-55							T
GOLF V Variant (1K5)														
Pro-Kit (Performance Fahrwerksfedern Performance Springs)														
1.6, 1.6 MultiFuel	06.07 -	1010	1010	E10-85-014-13-22	A, 18, 20, 30, 30							F11-15-007-01-VA	F11-15-007-01-HA	ABE
1.4 TSI, 1.6, 1.6 MultiFuel, 1.9 TDI	06.07 -	1080	1010	E10-85-014-14-22	A, 18, 20, 30, 30							F11-15-007-02-VA	F11-15-007-01-HA	ABE
1.9 TDI, 2.0 TDI, 2.0 TDI 16V	06.07 -	1150	1010	E10-85-014-15-22	A, 18, 20, 30, 30							F11-15-007-03-VA	F11-15-007-01-HA	ABE
Anti-Roll-Kit (Performance Stabilisatoren Performance Sway Bars)														
1.9 TDI 4motion, 2.0 TDI 4motion	06.07 -			E40-85-014-08-11	A, 18, 22, 45			26 Rohr 26 tube	22 Rohr 22 tube	2-fach verstellbar 2-way adjustable	2-fach verstellbar 2-way adjustable	AS41-85-014-02-VA	AS41-85-014-02-HA	T
1.2 TSI, 1.4, 1.4 TSI, 1.6, 1.6 MultiFuel, 2.0 TSI, 2.0 GTI, 1.6 TDI, 2.0 TDI	10.03 - 02.09			E40-85-014-06-11	A, 18, 20, 22, 45			26	23	2-fach verstellbar 2-way adjustable	2-fach verstellbar 2-way adjustable	AS41-85-014-01-VA	AS41-85-014-01-HA	T
B12 Pro-Kit (Performance Komplettfahrwerke Performance Springs+Shocks)														
1.6	06.07 -	1010	1010	E90-85-014-14-22	A, 18, 20, 34, 78, 124, 161	30	30							T
1.6	06.07 -	1010	1010	E90-85-014-13-22	A, 18, 20, 35, 78, 122, 161	30	30							T
1.4 TSI, 1.6, 1.9 TDI	06.07 -	1080	1010	E90-85-014-16-22	A, 18, 20, 34, 78, 124, 161	30	30							T
1.4 TSI, 1.6, 1.9 TDI	06.07 -	1080	1010	E90-85-014-15-22	A, 18, 20, 35, 78, 122, 161	30	30							T
1.9 TDI mit DSG 1.9 TDI with DSG	06.07 -	1150	1010	E90-85-014-18-22	A, 18, 20, 34, 78, 107, 124, 161	30	30							T

Modell	Baujahr	Achslast Vorne kg	Achslast Hinten kg	Artikel-Nr.	Hinweise	ca. Tieferl. Vorne mm	ca. Tieferl. Hinten mm	Ø Vorne mm	Ø Hinten mm	Verstellbarkeit Vorne	Verstellbarkeit Hinten	Ersatzteilbezeichnung Vorne	Ersatzteilbezeichnung Hinten	Gutachten
Model	Year	Front Axle Load kg	Rear Axle Load kg	Part-No.	Notes	ca. Lowering Front mm	ca. Lowering Rear mm	Ø Front mm	Ø Rear mm	Adjustable Front	Adjustable Rear	Spare Part Marking Front	Spare Part Marking Rear	Homologation
GOLF VI Cabriolet (517) GOLF VI Convertible (517) <i>Pro-Kit (Performance Fahrwerksfedern Performance Springs)</i> 1.2 TSI, 1.4 TSI	03.11 -	1010	1000	E10-85-022-03-22	A, 18, 20	25	20					F11-15-007-01-VA	F11-15-007-01-HA	ABE
1.4 TSI, 1.6 TDI, 2.0 TDI	03.11 -	1120	1000	E10-85-022-04-22	A, 18, 20	25	20					F11-15-007-02-VA	F11-15-007-01-HA	ABE
<i>Sportline (Performance Fahrwerksfedern Sport Sport Performance Springs)</i> 1.2 TSI, 1.4 TSI	03.11 -	1040	1005	E20-15-007-03-22	A, 18, 20	35	30					F21-15-007-01-VA	F21-15-007-03-HA	ABE
1.4 TSI, 1.6 TDI, 2.0 TDI	03.11 -	1130	1005	E20-15-007-04-22	A, 18, 20	35	30					F21-15-007-02-VA	F21-15-007-03-HA	ABE
2.0 TSI	11.11 -	1130	1005	E20-15-007-04-22	A, 18, 20	25	15					F21-15-007-02-VA	F21-15-007-03-HA	ABE
<i>Anti-Roll-Kit (Performance Stabilisatoren Performance Sway Bars)</i> 1.2 TSI, 1.4 TSI, 1.6 TDI, 2.0 TDI, 2.0 TSI	03.11 -			E40-85-014-06-11	A, 18, 20, 22, 45			26	23	2-fach verstellbar 2-way adjustable	2-fach verstellbar 2-way adjustable	AS41-85-014-01-VA	AS41-85-014-01-HA	T
<i>B12 Pro-Kit (Performance Komplettfahrwerke Performance Springs+Shocks)</i> 1.2 TSI	03.11 -	1010	1000	E90-85-022-06-22	A, 18, 20, 21, 34, 78, 101, 125, 161	25	20							T
1.2 TSI	03.11 -	1010	1000	E90-85-022-05-22	A, 18, 20, 21, 35, 78, 101, 122, 161	25	20							T
1.4 TSI, 1.6 TDI, 2.0 TDI, 2.0 TSI	03.11 -	1120	1000	E90-85-022-08-22	A, 18, 20, 21, 34, 78, 101, 125, 161	25	20							T
1.4 TSI, 1.6 TDI, 2.0 TDI, 2.0 TSI	03.11 -	1130	1000	E90-85-022-07-22	A, 18, 20, 21, 35, 78, 101, 122, 161	25	20							T
<i>B12 Sportline (Performance Komplettfahrwerke Sport Sport Performance Springs+Shocks)</i> 1.2 TSI, 1.4 TSI, 1.6 TDI, 2.0 TDI, 2.0 TSI	03.11 -	1130	1005	E95-15-007-08-22	A, 18, 20, 34, 78, 125, 161	35	30							T
1.2 TSI, 1.4 TSI, 1.6 TDI, 2.0 TDI, 2.0 TSI	03.11 -	1130	1005	E95-15-007-07-22	A, 18, 20, 35, 78, 122, 161	35	30							T
<i>Pro-Tronic (Elektronische Performance Fahrwerksmodule Electronic Performance Suspension Modul)</i> Alle Motorisierungen / all motorisation	03.11 -			AM65-85-022-01-22	A, 175									
GOLF VI Variant (AJ5) <i>Pro-Kit (Performance Fahrwerksfedern Performance Springs)</i> 1.2 TSI, 1.4, 1.4 TSI, 1.6, 1.6 MultiFuel, 1.6 TDI	07.09 -	1010	1000	E10-85-022-03-22	A, 18, 20	25-30	30					F11-15-007-01-VA	F11-15-007-01-HA	ABE
1.4 TSI, 1.6 TDI, 2.0 TDI, 2.0 TDI 16V, 2.0 TSI	07.09 -	1120	1000	E10-85-022-04-22	A, 18, 20	25-30	30					F11-15-007-02-VA	F11-15-007-01-HA	ABE
<i>Anti-Roll-Kit (Performance Stabilisatoren Performance Sway Bars)</i> 1.2 TSI, 1.4, 1.4 TSI, 1.6, 1.6 MultiFuel, 1.6 TDI, 2.0 TDI, 2.0 TDI 16V, 2.0 TSI	07.09 -			E40-85-014-06-11	A, 18, 20, 22, 45			26	23	2-fach verstellbar 2-way adjustable	2-fach verstellbar 2-way adjustable	AS41-85-014-01-VA	AS41-85-014-01-HA	T
1.6 TDI 4motion	07.09 -			E40-85-014-08-11	A, 18, 22, 45			26 Rohr 26 tube	22 Rohr 22 tube	2-fach verstellbar 2-way adjustable	2-fach verstellbar 2-way adjustable	AS41-85-014-02-VA	AS41-85-014-02-HA	T
<i>B12 Pro-Kit (Performance Komplettfahrwerke Performance Springs+Shocks)</i> 1.2 TSI, 1.4, 1.4 TSI, 1.6, 1.6 MultiFuel, 1.6 TDI	07.09 -	1010	1000	E90-85-022-06-22	A, 18, 20, 21, 34, 78, 101, 125, 161	25-30	30							T
1.2 TSI, 1.4, 1.4 TSI, 1.6, 1.6 MultiFuel, 1.6 TDI	07.09 -	1010	1000	E90-85-022-05-22	A, 18, 20, 21, 35, 78, 101, 122, 161	25-30	30							T
1.4 TSI, 1.6 TDI, 2.0 TDI, 2.0 TDI 16V	07.09 -	1120	1000	E90-85-022-08-22	A, 18, 20, 21, 34, 78, 101, 125, 161	25-30	30							T
1.4 TSI, 1.6 TDI, 2.0 TDI, 2.0 TDI 16V	07.09 -	1120	1000	E90-85-022-07-22	A, 18, 20, 21, 35, 78, 101, 122, 161	25-30	30							T
<i>Pro-Tronic (Elektronische Performance Fahrwerksmodule Electronic Performance Suspension Modul)</i> Alle Motorisierungen / all motorisation	07.09 -			AM65-85-022-01-22	A, 175									
GOLF VII (5G1) <i>Pro-Kit (Performance Fahrwerksfedern Performance Springs)</i> 1.2 TSI, 1.4 TSI, 1.4 TSI MultiFuel	11.12 -	985	990	E10-15-021-03-22	A, 18, 20, 171	35	30					F11-15-021-01-VA	F1540002	T
1.2 TSI, 1.4 TSI, 1.4 TSI MultiFuel	11.12 -	985	1000	E10-15-021-01-22	A, 18, 20, 170	35	30					F11-15-021-01-VA	F11-15-021-01-HA	T
1.6 TDI, 2.0 TDI	08.12 -	1070	990	E10-15-021-04-22	A, 18, 20, 171	35	30					F11-15-021-02-VA	F1540002	T
1.6 TDI, 2.0 TDI	08.12 -	1070	1000	E10-15-021-02-22	A, 18, 20, 170	35	30					F11-15-021-02-VA	F11-15-021-01-HA	T
2.0 GTD, 2.0 GTI	04.13 -	1070	1000	E10-15-021-02-22	A, 18, 20, 170	25-30	15-20					F11-15-021-02-VA	F11-15-021-01-HA	T
<i>Anti-Roll-Kit (Performance Stabilisatoren Performance Sway Bars)</i> 1.2 TSI, 1.4 TSI, 1.4 TSI MultiFuel	11.12 -			E40-15-021-03-11	A, 18, 20, 22, 45, 171			28 Rohr 28 tube	25	2-fach verstellbar 2-way adjustable	nicht verstellbar not adjustable	AS41-15-021-01-VA	AS41-15-021-03-HA	T
1.4 TSI, 1.4 TSI MultiFuel, 1.6 TDI, 2.0 GTD, 2.0 GTI, 2.0 TDI	08.12 -			E40-15-021-01-11	A, 18, 20, 22, 45, 170			28 Rohr 28 tube	25 Rohr 25 tube	2-fach verstellbar 2-way adjustable	nicht verstellbar not adjustable	AS41-15-021-01-VA	AS41-15-021-01-HA	T
<i>B12 Pro-Kit (Performance Komplettfahrwerke Performance Springs+Shocks)</i> 2.0 GTI, 2.0 GTD	04.13 -	1070	1000	E90-15-021-02-22	A, 18, 20, 170									T
GOLF VII Variant (BA5) <i>Pro-Kit (Performance Fahrwerksfedern Performance Springs)</i> 1.2 TSI, 1.2 TSI MultiFuel, 1.4 TSI	04.13 -	985	1030	E10-79-010-03-22	A, 18, 20, 171	30	30					F11-15-021-01-VA	F11-70-012-01-HA	T
1.6 TDI, 2.0 TDI	04.13 -	1070	1030	E10-79-010-04-22	A, 18, 20, 171	30	30					F11-15-021-02-VA	F11-70-012-01-HA	T
<i>Anti-Roll-Kit (Performance Stabilisatoren Performance Sway Bars)</i> 1.2 TSI, 1.2 TSI MultiFuel, 1.4 TSI	04.13 -			E40-15-021-03-11	A, 18, 20, 22, 45, 171			28 Rohr 28 tube	25	2-fach verstellbar 2-way adjustable	nicht verstellbar not adjustable	AS41-15-021-01-VA	AS41-15-021-03-HA	T
1.4 TSI, 1.6 TDI, 2.0 TDI	04.13 -			E40-15-021-01-11	A, 18, 20, 22, 45, 170			28 Rohr 28 tube	25 Rohr 25 tube	2-fach verstellbar 2-way adjustable	nicht verstellbar not adjustable	AS41-15-021-01-VA	AS41-15-021-01-HA	T
JETTA I (16) <i>Pro-Kit (Performance Fahrwerksfedern Performance Springs)</i> 1.1, 1.3, 1.5, 1.5 D, 1.6, 1.6 D, 1.6 GLI, 1.6 TD, 1.8	08.78 - 02.84	785	630	E8501-140	A, 18, 20	30-40	30-35					F8501101	F8501002	T
<i>B12 Pro-Kit (Performance Komplettfahrwerke Performance Springs+Shocks)</i> 1.1, 1.3, 1.5, 1.5 D, 1.6, 1.6 D, 1.6 GLI, 1.6 TD, 1.8	08.78 - 02.84	785	630	E90-85-032-01-22	A, 18, 20, 78, 95, 161	30-40	30-35							T

Modell	Baujahr	Achslast Vorne kg	Achslast Hinten kg	Artikel-Nr.	Hinweise	ca. Tieferl. Vorne mm	ca. Tieferl. Hinten mm	Ø Vorne mm	Ø Hinten mm	Verstellbarkeit Vorne	Verstellbarkeit Hinten	Ersatzteilbezeichnung Vorne	Ersatzteilbezeichnung Hinten	Gutachten
Model	Year	Front Axle Load kg	Rear Axle Load kg	Part-No.	Notes	ca. Lowering Front mm	ca. Lowering Rear mm	Ø Front mm	Ø Rear mm	Adjustable Front	Adjustable Rear	Spare Part Marking Front	Spare Part Marking Rear	Homologation
JETTA II (19E, 1G2, 165)														
Pro-Kit (Performance Fahrwerksfedern Performance Springs)														
1.3, 1.3 KAT, 1.6, 1.8, 1.8 16V, 1.8 KAT	01.84 - 07.92	840	740	E8502-140	A, 18, 20	30-40	30-35					F8502001	F8502002	T
1.3, 1.3 CAT, 1.6, 1.6 D, 1.6 TD, 1.8, 1.8 16V, 1.8 CAT	01.84 - 10.91	840	740	E8509-140	A, 18, 20	20	20					F8509001	F8502002	T
1.6 D, 1.6 TD														
Anti-Roll-Kit (Performance Stabilisatoren Performance Sway Bars)														
1.3, 1.3 KAT, 1.6, 1.6 D, 1.6 TD, 1.8, 1.8 16V, 1.8 KAT	01.84 - 07.92			E8502-320	A, 18, 20, 22, 45			22	25	nicht verstellbar not adjustable	nicht verstellbar not adjustable	AS8502320VA	AS8502320HA	T
1.3, 1.3 CAT, 1.6, 1.6 D, 1.6 TD, 1.8, 1.8 16V, 1.8 CAT														
B12 Pro-Kit (Performance Komplettfahrwerke Performance Springs+Shocks)														
1.3, 1.3 KAT, 1.6, 1.8, 1.8 16V, 1.8 KAT	01.84 - 07.92	840	740	E90-85-009-01-22	A, 18, 20, 78, 161	30-40	30-35							T
1.3, 1.3 CAT, 1.6, 1.8, 1.8 16V, 1.8 CAT	01.84 - 10.91	840	740	E90-85-009-02-22	A, 18, 20, 78, 161	20	20							T
1.6 D, 1.6 TD														
Pro-Street-S (Gewindefahrwerke - höhenverstellbar Coil-Overs-Adjustable Ride Height)														
1.3, 1.3 KAT, 1.6, 1.6 D, 1.6 TD, 1.8, 1.8 16V, 1.8 KAT	01.84 - 07.92	840	740	PSS65-85-003-01-22	A, 20, 24, 25, 26, 45, 160	30-65	30-65							T
1.3, 1.3 CAT, 1.6, 1.6 D, 1.6 TD, 1.8, 1.8 16V, 1.8 CAT														
JETTA III (1K2)														
Pro-Kit (Performance Fahrwerksfedern Performance Springs)														
1.6, 1.6 FSI, 1.6 MultiFuel	09.05 - 10.10	1010	1010	E10-85-015-05-22	A, 18, 20	30	30					F11-15-007-01-VA	F11-85-014-05-HA	ABE
1.4 TSI, 1.6, 1.6 FSI, 1.6 MultiFuel, 1.6 TDI, 1.9 TDI, 2.0 FSI, 2.0 TFSI	08.05 - 10.10	1080	1010	E10-85-015-06-22	A, 18, 20	30	30					F11-15-007-02-VA	F11-85-014-05-HA	ABE
1.9 TDI, 2.0 TDI, 2.0 TDI 16V	08.05 - 10.10	1150	1010	E10-85-015-07-22	A, 18, 20	30	30					F11-15-007-03-VA	F11-85-014-05-HA	ABE
Sportline (Performance Fahrwerksfedern Sport Sport Performance Springs)														
1.4 TSI, 1.6, 1.6 FSI, 1.6 MultiFuel, 1.6 TDI, 1.9 TDI, 2.0 FSI, 2.0 TFSI	08.05 - 10.10	1040	1005	E20-85-015-01-22	A, 18, 20	45-50	30-35					F21-15-007-01-VA	F21-15-007-03-HA	ABE
1.6 TDI, 1.9 TDI, 2.0 FSI, 2.0 TDI, 2.0 TDI 16V, 2.0 TFSI	08.05 - 10.10	1130	1005	E20-85-015-02-22	A, 18, 20	45-50	30-35					F21-15-007-02-VA	F21-15-007-03-HA	ABE
Anti-Roll-Kit (Performance Stabilisatoren Performance Sway Bars)														
1.4 TSI, 1.6, 1.6 FSI, 1.6 MultiFuel, 1.6 TDI, 1.9 TDI, 2.0 FSI, 2.0 TDI, 2.0 TDI 16V, 2.0 TFSI	08.05 - 10.10			E40-85-014-06-11	A, 18, 20, 22, 45			26	23	2-fach verstellbar 2-way adjustable	2-fach verstellbar 2-way adjustable	AS41-85-014-01-VA	AS41-85-014-01-HA	T
B12 Pro-Kit (Performance Komplettfahrwerke Performance Springs+Shocks)														
1.6, 1.6 FSI, 1.6 MultiFuel	09.05 - 10.10	1010	1010	E90-85-015-05-22	A, 18, 20, 34, 78, 161	30	30							T
1.4 TSI, 1.6, 1.6 FSI, 1.6 TDI, 1.9 TDI, 2.0 FSI, 2.0 TFSI	08.05 - 10.10	1080	1010	E90-85-015-06-22	A, 18, 34, 78, 161	30	30							T
1.6 TDI, 2.0 TFSI	07.08 - 10.10	1080	1010	E90-85-015-06-22	A, 18, 20, 34, 78, 161	30	30							T
1.9 TDI mit DSG	08.05 - 10.10	1150	1010	E90-85-015-07-22	A, 18, 20, 34, 78, 107, 161	30	30							T
1.9 TDI with DSG	09.05 - 10.10	1150	1010	E90-85-015-07-22	A, 18, 20, 34, 78, 161	30	30							T
2.0 TDI														
B12 Sportline (Performance Komplettfahrwerke Sport Sport Performance Springs+Shocks)														
1.4 TSI, 1.6, 1.6 FSI, 1.9 TDI, 2.0 FSI, 2.0 TFSI	08.05 - 10.10	1040	1005	E95-85-015-01-22	A, 18, 20, 34, 78, 161	45-50	45-50							T
1.9 TDI, 2.0 TDI, 2.0 TDI 16V, 2.0 TFSI	08.05 - 10.10	1130	1005	E95-85-015-02-22	A, 18, 20, 34, 78, 161	45-50	30-35							T
Pro-Street-S (Gewindefahrwerke - höhenverstellbar Coil-Overs-Adjustable Ride Height)														
1.4 TSI, 1.6, 1.6 FSI, 1.6 MultiFuel, 1.6 TDI, 1.9 TDI, 2.0 FSI, 2.0 TDI, 2.0 TDI 16V, 2.0 TFSI, 2.5 FSI	08.05 - 10.10	1035	1150	PSS65-85-014-01-22	A, 18, 20, 24, 34, 45, 70, 160	35-65	35-65							T
1.4 TSI, 1.6, 1.6 FSI, 1.6 MultiFuel, 1.6 TDI, 1.9 TDI, 2.0 FSI, 2.0 TDI, 2.0 TDI 16V, 2.0 TFSI, 2.5 FSI	08.05 - 10.10	1035	1150	PSS65-85-014-02-22	A, 18, 20, 24, 35, 45, 70, 160	35-65	35-65							T
1.4 TSI, 1.6, 1.6 FSI, 1.6 MultiFuel, 1.6 TDI, 1.9 TDI, 2.0 FSI, 2.0 TDI, 2.0 TDI 16V, 2.0 TFSI, 2.5 FSI	08.05 - 10.10	1105	1150	PSS65-85-014-03-22	A, 18, 20, 24, 34, 45, 70, 160	35-65	35-65							T
1.4 TSI, 1.6, 1.6 FSI, 1.6 MultiFuel, 1.6 TDI, 1.9 TDI, 2.0 FSI, 2.0 TDI, 2.0 TDI 16V, 2.0 TFSI, 2.5 FSI	08.05 - 10.10	1105	1150	PSS65-85-014-04-22	A, 18, 20, 24, 35, 45, 70, 160	35-65	35-65							T
1.4 TSI, 1.6, 1.6 FSI, 1.6 MultiFuel, 1.6 TDI, 1.9 TDI, 2.0 FSI, 2.0 TDI, 2.0 TDI 16V, 2.0 TFSI, 2.5 FSI	08.05 - 10.10	1170	1150	PSS65-85-014-05-22	A, 18, 20, 24, 34, 45, 70, 160	35-65	35-65							T
1.4 TSI, 1.6, 1.6 FSI, 1.6 MultiFuel, 1.6 TDI, 1.9 TDI, 2.0 FSI, 2.0 TDI, 2.0 TDI 16V, 2.0 TFSI, 2.5 FSI	08.05 - 10.10	1170	1150	PSS65-85-014-06-22	A, 18, 20, 24, 35, 45, 70, 160	35-65	35-65							T
JETTA IV (162)														
Pro-Kit (Performance Fahrwerksfedern Performance Springs)														
1.4 TSI Hybrid	04.11 -	990	1080	E10-85-031-03-22	A, 18, 20	35	30					F11-15-007-01-VA	F11-85-014-04-HA	ABE
1.2 TSI, 1.4 TSI, 1.6, 1.6 TDI	02.11 -	1010	980	E10-85-031-01-22	A, 18, 20	20-30	25-30					F11-15-007-01-VA	F11-85-014-05-HA	ABE
1.6 TDI, 2.0, 2.0 TDI, 2.0 TSI	06.10 -	1120	980	E10-85-031-02-22	A, 18, 20	20-30	25-30					F11-15-007-02-VA	F11-85-014-05-HA	ABE
Sportline (Performance Fahrwerksfedern Sport Sport Performance Springs)														
1.2 TSI, 1.4 TSI, 1.6, 1.6 TDI, 2.0, 2.0 TDI, 2.0 TSI	06.10 -	1040	1005	E20-85-015-01-22	A, 18, 20	30-40	30					F21-15-007-01-VA	F21-15-007-03-HA	ABE
1.6 TDI, 2.0, 2.0 TDI, 2.0 TSI	06.10 -	1130	1005	E20-85-015-02-22	A, 18, 20	30-40	30					F21-15-007-02-VA	F21-15-007-03-HA	ABE
Anti-Roll-Kit (Performance Stabilisatoren Performance Sway Bars)														
1.2 TSI, 1.4 TSI, 1.4 TSI Hybrid, 1.6, 1.6 TDI, 2.0, 2.0 TDI, 2.0 TSI	06.10 -			E40-85-014-06-11	A, 18, 20, 22, 45			26	23	2-fach verstellbar 2-way adjustable	2-fach verstellbar 2-way adjustable	AS41-85-014-01-VA	AS41-85-014-01-HA	T
LUPO (6X1, 6E1)														
Pro-Kit (Performance Fahrwerksfedern Performance Springs)														
1.0, 1.4, 1.4 16V, 1.4 TDI, 1.6 GTI, 1.7 SDI	09.98 - 07.05	820	690	E8562-140	A, 18, 20	30	30					F8546001	F8111002	T
B12 Pro-Kit (Performance Komplettfahrwerke Performance Springs+Shocks)														
1.0, 1.4, 1.4 16V, 1.4 FSI, 1.4 TDI, 1.6 GTI, 1.7 SDI	09.98 - 07.05	820	690	E90-85-010-02-22	A, 18, 20, 78, 161	30	30							T
MULTIVAN V (7HM, 7HN, 7HF, 7EF, 7EM, 7EN)														
Pro-Kit (Performance Fahrwerksfedern Performance Springs)														
1.9 TDI, 2.0, 2.0 BiTDI, 2.0 BiTDI 4motion, 2.0 TDI, 2.0 TDI 4motion, 2.0 TSI, 2.0 TSI 4motion	04.03 -	1550	1720	E10-85-013-01-22	A, 12, 18	30	30					F11-85-013-01-VA	F11-85-013-01-HA	T
2.0 BiTDI, 2.0 BiTDI 4motion, 2.0 TDI, 2.0 TDI 4motion, 2.0 TSI, 2.0 TSI 4motion	09.09 -	1710		E10-85-013-04-20	A, 18, 102	35						F11-85-013-02-VA		T

Modell	Baujahr	Achslast Vorne kg	Achslast Hinten kg	Artikel-Nr.	Hinweise	ca. Tieferl. Vorne mm	ca. Tieferl. Hinten mm	Ø Vorne mm	Ø Hinten mm	Verstellbarkeit Vorne	Verstellbarkeit Hinten	Ersatzteilbezeichnung Vorne	Ersatzteilbezeichnung Hinten	Gutachten
Model	Year	Front Axle Load kg	Rear Axle Load kg	Part-No.	Notes	ca. Lowering Front mm	ca. Lowering Rear mm	Ø Front mm	Ø Rear mm	Adjustable Front	Adjustable Rear	Spare Part Marking Front	Spare Part Marking Rear	Homologation
MULTIVAN V (7HM, 7HN, 7HF, 7EF, 7EM, 7EN) <i>Pro-Kit (Performance Fahrwerksfedern Performance Springs)</i> 2.0 BiTDI, 2.0 BiTDI 4motion, 2.0 TDI, 2.0 TDI 4motion, 2.0 TSI, 2.0 TSI 4motion, 2.5 TDI, 2.5 TDI 4motion, 3.2 V6, 3.2 V6 4motion	04.03 -	1710	1720	E10-85-013-02-22	A, 12, 18	35	30					F11-85-013-02-VA	F11-85-013-01-HA	T
B12 Pro-Kit (Performance Komplettfahrwerke Performance Springs+Shocks) 1.9 TDI, 2.0, 2.0 BiTDI, 2.0 BiTDI 4motion, 2.0 TDI, 2.0 TDI 4motion, 2.0 TSI, 2.0 TSI 4motion	04.03 -	1550	1720	E90-85-013-01-22	A, 12, 18, 78, 97, 161	30	30							T
2.0 BiTDI, 2.0 BiTDI 4motion, 2.0 TDI, 2.0 TDI 4motion, 2.5 TDI, 2.5 TDI 4motion, 3.2 V6, 3.2 V6 4motion	04.03 -	1710	1720	E90-85-013-02-22	A, 12, 18, 78, 97, 161	30	30							T
NEW BEETLE (9C1, 1C1) <i>Pro-Kit (Performance Fahrwerksfedern Performance Springs)</i> 1.4, 1.6, 1.8 T, 1.9 TDI, 2.0	01.98 -	1010	850	E8570-140	A, 18, 20	30	30					F1545001	F8570002	T
1.8 T, 1.9 TDI, 2.3 V5	01.98 -	1050	850	E10-85-005-01-22	A, 18, 20	30	30					F8592001	F8570002	T
Anti-Roll-Kit (Performance Stabilisatoren Performance Sway Bars) 1.4, 1.6, 1.8 T, 1.9 TDI, 2.0, 2.3 V5	01.98 -			E40-85-005-01-11	A, 18, 20, 22, 45			25	25	nicht verstellbar not adjustable	nicht verstellbar not adjustable	AS41-85-005-01-VA	AS1540320HA	T
B12 Pro-Kit (Performance Komplettfahrwerke Performance Springs+Shocks) 1.4, 1.6, 1.8 T, 1.9 TDI, 2.0	01.98 -	1010	850	E90-85-005-01-22	A, 18, 20, 78, 161	30	30							T
1.8 T, 1.9 TDI, 2.3 V5	01.98 -	1050	850	E90-85-005-02-22	A, 18, 20, 78, 161	30	30							T
NEW BEETLE Cabriolet (1V7) NEW BEETLE Convertible (1V7) <i>Pro-Kit (Performance Fahrwerksfedern Performance Springs)</i> 1.4, 1.6, 1.9 TDI, 2.0	09.02 - 10.10	1010	870	E10-85-005-02-22	A, 18, 20	25	25					F1567001	F11-15-001-01-HA	T
1.8 T, 1.9 TDI, 2.0	09.02 - 10.10	1050	870	E10-85-005-03-22	A, 18, 20	25	25					F8592001	F11-15-001-01-HA	T
Anti-Roll-Kit (Performance Stabilisatoren Performance Sway Bars) 1.4, 1.6, 1.8 T, 1.9 TDI, 2.0	09.02 - 10.10			E40-85-005-01-11	A, 18, 20, 22, 45			25	25	nicht verstellbar not adjustable	nicht verstellbar not adjustable	AS41-85-005-01-VA	AS1540320HA	T
B12 Pro-Kit (Performance Komplettfahrwerke Performance Springs+Shocks) 1.4, 1.6, 1.9 TDI, 2.0	09.02 - 10.10	1010	870	E90-85-005-03-22	A, 18, 20, 78, 161	25	25							T
1.8 T, 1.9 TDI, 2.0	09.02 - 10.10	1050	870	E90-85-005-04-22	A, 18, 20, 78, 161	25	25							T
PASSAT (3B2) <i>Pro-Kit (Performance Fahrwerksfedern Performance Springs)</i> 1.6, 1.8, 1.8 T	10.96 - 11.00	1020	1010	E8553-140	A, 18, 20	30	30					F1531001	F8553002	T
1.8, 1.8 T, 1.9 TDI, 2.3 VR5	10.96 - 11.00	1090	1010	E8554-140	A, 18, 20	30	30					F1532001	F8553002	T
2.5 TDI	07.98 - 11.00	1190	1010	E8584-140	A, 18, 20	30	30					F1558001	F8553002	T
Anti-Roll-Kit (Performance Stabilisatoren Performance Sway Bars) 1.6, 1.8, 1.8 T, 1.9 TDI, 1.9 TDI 4motion, 2.0 4motion, 2.3 VR5, 2.3 VR5 Syncro/4motion, 2.5 TDI, 2.5 TDI Syncro/4motion, 2.8 V6	08.96 - 11.00			E1531-310	A, 18, 20, 22, 45			32		2-fach verstellbar 2-way adjustable		AS1531310VA		T
1.8 Syncro/4motion, 1.8 T Syncro, 1.9 TDI Syncro/4motion, 2.8 Syncro, 2.8 V6 Syncro/4motion	10.96 - 11.00			E1531-310	A, 18, 22, 45			32		2-fach verstellbar 2-way adjustable		AS1531310VA		T
B12 Pro-Kit (Performance Komplettfahrwerke Performance Springs+Shocks) 1.6, 1.8, 1.8 T	10.96 - 11.00	1020	1010	E90-85-002-01-22	A, 18, 20, 78, 104, 161	30	30							T
1.8, 1.8 T, 1.9 TDI, 2.3 VR5	10.96 - 11.00	1090	1010	E90-85-002-02-22	A, 18, 20, 78, 104, 161	30	30							T
2.5 TDI	07.98 - 11.00	1190	1010	E90-85-002-03-22	A, 18, 20, 78, 104, 161	30	30							T
Pro-Street-S (Gewindefahrwerke - höhenverstellbar Coil-Overs-Adjustable Ride Height) 1.6, 1.8, 1.8 T, 1.9 TDI, 2.0, 2.3 VR5, 2.5 TDI, 2.8 V6	08.96 - 11.00	1100	1080	PSS65-85-002-01-22	A, 18, 20, 24, 25, 45, 160	40-75	40-75							T
1.8 Syncro/4motion, 1.8 T Syncro, 1.9 TDI 4motion, 1.9 TDI Syncro/4motion, 2.0 4motion, 2.3 VR5 Syncro/4motion, 2.5 TDI Syncro/4motion, 2.8 Syncro, 2.8 V6 Syncro/4motion	10.96 - 11.00	1100	1160	PSS65-85-002-03-22	A, 18, 22, 25, 45, 160	40-75	40-75							T
1.8, 1.8 T, 1.9 TDI, 2.0, 2.3 VR5, 2.5 TDI, 2.8 V6	08.96 - 11.00	1200	1080	PSS65-85-002-02-22	A, 18, 20, 24, 25, 45, 160	40-75	40-75							T
1.8 Syncro/4motion, 1.8 T Syncro, 1.9 TDI 4motion, 1.9 TDI Syncro/4motion, 2.0 4motion, 2.3 VR5 Syncro/4motion, 2.5 TDI Syncro/4motion, 2.8 Syncro, 2.8 V6 Syncro/4motion	10.96 - 11.00	1200	1160	PSS65-15-005-03-22	A, 18, 22, 25, 45, 160	40-75	40-75							T
PASSAT (3B3) <i>Pro-Kit (Performance Fahrwerksfedern Performance Springs)</i> 1.6, 1.8, 1.8 T, 1.8 T 20V, 2.0	11.00 - 05.05	1070	1070	E10-85-002-05-22	A, 18, 20	30	30					F1532001	F8553202	T
1.8, 1.8 T, 1.8 T 20V, 1.9 TDI, 2.0 TDI, 2.3 V5	11.00 - 05.05	1175	1070	E10-85-002-06-22	A, 18, 20	30	30					F1541001	F8553202	T
2.3 V5, 2.5 TDI	11.00 - 05.05	1250	1070	E10-85-002-07-22	A, 18, 20	30	30					F1558001	F8553202	T
Anti-Roll-Kit (Performance Stabilisatoren Performance Sway Bars) 1.6, 1.8, 1.8 T, 1.8 T 20V, 1.9 TDI, 1.9 TDI 4motion, 2.0, 2.0 4motion, 2.0 TDI, 2.3 V5, 2.3 V5 4motion, 2.5 TDI, 2.5 TDI 4motion, 2.8 4motion	11.00 - 05.05			E1531-310	A, 18, 20, 22, 45			32		2-fach verstellbar 2-way adjustable		AS1531310VA		T
2.5 TDI 4motion	01.03 - 05.05			E1531-310	A, 18, 22, 45			32		2-fach verstellbar 2-way adjustable		AS1531310VA		T
B12 Pro-Kit (Performance Komplettfahrwerke Performance Springs+Shocks) 1.6, 1.8, 1.8 T, 1.8 T 20V, 2.0	12.00 - 05.05	1070	1070	E90-85-002-10-22	A, 18, 20, 78, 87, 133, 161	30	30							T
1.8, 1.8 T, 1.8 T 20V, 1.9 TDI, 2.0 TDI, 2.3 V5	12.00 - 05.05	1175	1070	E90-85-002-11-22	A, 18, 20, 78, 87, 133, 161	30	30							T
2.3 V5, 2.5 TDI	12.00 - 05.05	1250	1070	E90-85-002-12-22	A, 18, 20, 78, 87, 133, 161	30	30							T

Modell	Baujahr	Achslast Vorne kg	Achslast Hinten kg	Artikel-Nr.	Hinweise	ca. Tieferl. Vorne mm	ca. Tieferl. Hinten mm	Ø Vorne mm	Ø Hinten mm	Verstellbarkeit Vorne	Verstellbarkeit Hinten	Ersatzteilbezeichnung Vorne	Ersatzteilbezeichnung Hinten	Gutachten
Model	Year	Front Axle Load kg	Rear Axle Load kg	Part-No.	Notes	ca. Lowering Front mm	ca. Lowering Rear mm	Ø Front mm	Ø Rear mm	Adjustable Front	Adjustable Rear	Spare Part Marking Front	Spare Part Marking Rear	Homologation
PASSAT (3B3)														
Pro-Street-S (Gewindefahrwerke - höhenverstellbar Coil-Overs-Adjustable Ride Height)														
1.6, 1.8, 1.8 T, 1.8 T 20V, 1.9 TDI, 2.0, 2.0 TDI, 2.3 V5, 2.5 TDI	11.00 - 05.05	1100	1080	PSS65-85-002-01-22	A, 18, 20, 24, 25, 45, 160	40-75	40-75							T
1.8 T, 1.8 T 20V	11.00 - 05.05	1100	1160	PSS65-85-002-03-22	A, 18, 24, 25, 45, 160	40-75	40-75							T
1.8 T 4motion, 1.9 TDI 4motion, 2.0 4motion, 2.3 V5 4motion, 2.5 TDI 4motion, 2.8 4motion	11.00 - 05.05	1100	1160	PSS65-85-002-03-22	A, 18, 22, 25, 45, 160	40-75	40-75							T
1.6, 1.8, 1.8 T, 1.8 T 20V, 1.9 TDI, 2.0, 2.0 TDI, 2.3 V5, 2.5 TDI	11.00 - 05.05	1200	1080	PSS65-85-002-02-22	A, 18, 20, 24, 25, 45, 160	40-75	40-75							T
1.8 T, 1.8 T 20V	11.00 - 05.05	1200	1160	PSS65-15-005-03-22	A, 18, 24, 25, 45, 160	40-75	40-75							T
1.8 T 4motion, 1.9 TDI 4motion, 2.0 4motion, 2.3 V5 4motion, 2.5 TDI 4motion, 2.8 4motion	11.00 - 05.05	1200	1160	PSS65-15-005-03-22	A, 18, 22, 25, 45, 160	40-75	40-75							T
PASSAT (3C2)														
Pro-Kit (Performance Fahrwerksfedern Performance Springs)														
1.4 TSI, 1.6, 1.6 FSI, 2.0 FSI	03.05 - 07.10	1070	1130	E10-85-016-01-22	A, 18, 20	30	30					F11-15-007-02-VA	F11-85-012-01-HA	ABE
1.4 TSI, 1.6 TDI, 1.8 TSI, 1.9 TDI, 2.0 BlueTDI, 2.0 FSI, 2.0 TDI, 2.0 TDI 16V	03.05 -	1180	1130	E10-85-016-02-22	A, 18, 20	30	30					F11-15-007-03-VA	F11-85-012-01-HA	ABE
2.0 FSI 4motion, 2.0 TDI 16V 4motion, 2.0 TDI 4motion, 3.2 FSI 4motion	03.05 -	1180	1230	E10-85-016-10-22	A, 18	30	30					F11-15-007-03-VA	F11-85-016-10-HA	ABE
Anti-Roll-Kit (Performance Stabilisatoren Performance Sway Bars)														
1.4 TSI, 1.6, 1.6 FSI, 1.6 TDI, 1.8 TSI, 1.9 TDI, 2.0 BlueTDI, 2.0 FSI, 2.0 TDI, 2.0 TDI 16V	03.05 -			E40-85-014-06-11	A, 18, 20, 22, 45			26	23	2-fach verstellbar 2-way adjustable	2-fach verstellbar 2-way adjustable	AS41-85-014-01-VA	AS41-85-014-01-HA	T
B12 Pro-Kit (Performance Komplettfahrwerke Performance Springs+Shocks)														
1.4 TSI, 1.4 TSI EcoFuel, 1.6, 1.6 FSI, 2.0 FSI	03.05 - 07.10	1070	1130	E90-85-016-01-22	A, 18, 20, 21, 34, 78, 101, 161	30	30							T
1.4 TSI, 1.4 TSI EcoFuel, 1.6, 1.6 TDI, 1.8 TSI, 1.9 TDI, 2.0 FSI, 2.0 TDI, 2.0 TDI 16V	03.05 -	1180	1130	E90-85-016-02-22	A, 18, 20, 21, 34, 78, 101, 161	30	30							T
2.0 TDI	03.05 - 11.10	1180	1130	E90-85-016-02-22	A, 18, 20, 21, 34, 78, 161	30	30							T
2.0 FSI 4motion, 2.0 TDI 16V 4motion, 2.0 TDI 4motion, 3.2 FSI 4motion	03.05 -	1180	1230	E90-85-016-10-22	A, 18, 21, 34, 78, 101, 161	30	30							T
Pro-Street-S (Gewindefahrwerke - höhenverstellbar Coil-Overs-Adjustable Ride Height)														
1.4 TSI, 1.6, 1.6 FSI, 2.0 FSI	03.05 - 07.10	1060	1230	PSS65-15-007-01-22	A, 18, 24, 45, 160	35-70	35-70							T
1.4 TSI, 1.6, 1.6 FSI, 2.0 FSI, 2.0 FSI 4motion, 2.0 TDI 16V 4motion, 2.0 TDI 4motion, 3.2 FSI 4motion	03.05 -	1060	1230	PSS65-85-016-01-22	A, 18, 24, 45, 160	35-70	35-70							T
1.4 TSI, 1.6 TDI, 1.8 TSI, 1.9 TDI, 2.0 BlueTDI, 2.0 FSI, 2.0 FSI 4motion, 2.0 TDI, 2.0 TDI 16V, 2.0 TDI 16V 4motion, 2.0 TDI 4motion, 3.2 FSI 4motion	03.05 -	1180	1230	PSS65-85-016-02-22	A, 18, 24, 45, 160	35-70	35-70							T
1.4 TSI, 1.6 TDI, 1.8 TSI, 1.9 TDI, 2.0 BlueTDI, 2.0 FSI, 2.0 TDI, 2.0 TDI 16V, 2.0 TDI 16V 4motion, 2.0 TDI 4motion, 3.2 FSI 4motion	03.05 -	1180	1230	PSS65-15-007-02-22	A, 18, 24, 45, 160									T
Pro-Tronic (Elektronische Performance Fahrwerksmodule Electronic Performance Suspension Modul)														
Alle Motorisierungen / all motorisation	03.05 -			AM65-85-022-01-22	A, 175									
PASSAT (362)														
Pro-Kit (Performance Fahrwerksfedern Performance Springs)														
1.4 TSI, 1.4 TSI MultiFuel	08.10 -	1070	1130	E10-85-016-01-22	A, 18, 20	30	25					F11-15-007-02-VA	F11-85-012-01-HA	ABE
1.6 TDI, 1.8 TSI, 2.0 TDI, 2.0 TSI	08.10 -	1180	1130	E10-85-016-02-22	A, 18, 20	30	25					F11-15-007-03-VA	F11-85-012-01-HA	ABE
2.0 TDI 4motion, 3.6 FSI 4motion	08.10 -	1180	1230	E10-85-016-10-22	A, 18	30	25					F11-15-007-03-VA	F11-85-016-10-HA	ABE
Anti-Roll-Kit (Performance Stabilisatoren Performance Sway Bars)														
1.4 TSI, 1.4 TSI MultiFuel, 1.6 TDI, 1.8 TSI, 2.0 TDI, 2.0 TSI	08.10 -			E40-85-014-06-11	A, 18, 20, 22, 45			26	23	2-fach verstellbar 2-way adjustable	2-fach verstellbar 2-way adjustable	AS41-85-014-01-VA	AS41-85-014-01-HA	T
B12 Pro-Kit (Performance Komplettfahrwerke Performance Springs+Shocks)														
1.4 TSI, 1.4 TSI EcoFuel, 1.4 TSI MultiFuel	08.10 -	1070	1130	E90-85-016-01-22	A, 18, 20, 78, 104, 161	30	30							T
1.4 TSI, 1.6 TDI, 1.8 TSI, 2.0 TDI, 2.0 TSI	08.10 -	1180	1130	E90-85-016-02-22	A, 18, 20, 78, 104, 161	30	30							T
2.0 TDI 4motion, 3.6 FSI 4motion	08.10 -	1180	1230	E90-85-016-10-22	A, 18, 20, 78, 104, 161	30	30							T
Pro-Street-S (Gewindefahrwerke - höhenverstellbar Coil-Overs-Adjustable Ride Height)														
1.4 TSI, 1.4 TSI MultiFuel	08.10 -	1060	1230	PSS65-85-016-01-22	A, 18, 24, 45, 160	35-70	35-70							T
1.6 TDI, 1.8 TSI, 2.0 TDI, 2.0 TDI 4motion, 2.0 TSI, 3.6 FSI 4motion	08.10 -	1180	1230	PSS65-85-016-02-22	A, 18, 24, 45, 160	35-70	35-70							T
PASSAT ALLTRACK (365)														
Pro-Kit (Performance Fahrwerksfedern Performance Springs)														
2.0 TSI 4motion	01.12 -	1180	1230	E10-85-016-10-22	A, 18	30	25					F11-15-007-03-VA	F11-85-016-10-HA	ABE
B12 Pro-Kit (Performance Komplettfahrwerke Performance Springs+Shocks)														
2.0 TSI 4motion	01.12 -	1180	1230	E90-85-016-10-22	A, 18, 21, 34, 78, 101, 161	30	30							T
Pro-Street-S (Gewindefahrwerke - höhenverstellbar Coil-Overs-Adjustable Ride Height)														
2.0 TSI 4motion	01.12 -	1180	1230	PSS65-85-016-04-22	A, 18, 24, 45, 160	35-70	35-70							T
PASSAT CC (357)														
Pro-Kit (Performance Fahrwerksfedern Performance Springs)														
1.8 TSI, 2.0 TDI, 2.0 TSI	05.08 -	1110	1030	E10-85-016-08-22	A, 18, 20	25	20					F11-15-007-02-VA	F11-85-014-05-HA	ABE
2.0 TDI, 2.0 TSI	05.08 -	1170	1030	E10-85-016-13-22	A, 18, 20	25	20					F11-15-007-03-VA	F11-85-014-05-HA	ABE
2.0 TDI 4motion, 3.6 FSI 4motion	06.08 -	1170	1110	E10-85-016-09-22	A, 18	25	25					F11-15-007-03-VA	F11-15-007-15-HA	ABE
Anti-Roll-Kit (Performance Stabilisatoren Performance Sway Bars)														
1.8 TSI, 2.0 TDI, 2.0 TSI	05.08 -			E40-85-014-06-11	A, 18, 20, 22, 45			26	23	2-fach verstellbar 2-way adjustable	2-fach verstellbar 2-way adjustable	AS41-85-014-01-VA	AS41-85-014-01-HA	T

Modell	Baujahr	Achslast Vorne kg	Achslast Hinten kg	Artikel-Nr.	Hinweise	ca. Tieferl. Vorne mm	ca. Tieferl. Hinten mm	Ø Vorne mm	Ø Hinten mm	Verstellbarkeit Vorne	Verstellbarkeit Hinten	Ersatzteilbezeichnung Vorne	Ersatzteilbezeichnung Hinten	Gutachten
Model	Year	Front Axle Load kg	Rear Axle Load kg	Part-No.	Notes	ca. Lowering Front mm	ca. Lowering Rear mm	Ø Front mm	Ø Rear mm	Adjustable Front	Adjustable Rear	Spare Part Marking Front	Spare Part Marking Rear	Homologation
PASSAT CC (357) B12 Pro-Kit (Performance Komplettfahrwerke Performance Springs+Shocks) 2.0 TDI 4motion, 3.6 FSI 4motion	06.08 -	1170	1100	E90-85-016-09-22	A, 18, 21, 34, 78, 101, 161	25	25							T
Pro-Tronic (Elektronische Performance Fahrwerksmodule Electronic Performance Suspension Modul) Alle Motorisierungen / all motorisation	05.08 -			AM65-85-022-01-22	A, 175									
PASSAT Variant (3B5) Pro-Kit (Performance Fahrwerksfedern Performance Springs) 1.6, 1.8, 1.8 T	06.97 - 11.00	1020	1080	E8556-140	A, 18, 20	30	30					F1531001	F1558002	T
1.8, 1.8 T, 1.9 TDI, 2.3 VR5	06.97 - 11.00	1090	1080	E8557-140	A, 18, 20	30	30					F1532001	F1558002	T
1.8 Syncro/4motion, 1.9 TDI 4motion, 1.9 TDI Syncro/4motion, 2.0 4motion, 2.3 VR5 Syncro/4motion	06.97 - 11.00	1090	1190	E8565-140	A, 18	30	30					F1532001	F1561002	T
2.8 Syncro, 2.8 V6 Syncro/4motion	05.97 - 11.00	1140	1190	E8566-140	A, 18	30	30					F1541001	F1561002	T
2.5 TDI	07.98 - 11.00	1190	1080	E8585-140	A, 18, 20	30	30					F1558001	F1558002	T
2.5 TDI Syncro/4motion	12.98 - 11.00	1200	1190	E10-85-002-02-22	A, 18	30	30					F1558001	F1561002	T
Anti-Roll-Kit (Performance Stabilisatoren Performance Sway Bars) 1.6, 1.8, 1.8 Syncro/4motion, 1.8 T, 1.9 TDI, 1.9 TDI 4motion, 2.0 4motion, 2.3 VR5, 2.3 VR5 Syncro/4motion, 2.5 TDI, 2.5 TDI Syncro/4motion	06.97 - 11.00			E1531-310	A, 18, 20, 22, 45			32		2-fach verstellbar 2-way adjustable		AS1531310VA		T
1.9 TDI Syncro/4motion, 2.8 Syncro, 2.8 V6 Syncro/4motion	05.97 - 11.00			E1531-310	A, 18, 22, 45			32		2-fach verstellbar 2-way adjustable		AS1531310VA		T
B12 Pro-Kit (Performance Komplettfahrwerke Performance Springs+Shocks) 1.6, 1.8, 1.8 T	06.97 - 11.00	1020	1080	E90-85-002-04-22	A, 18, 20, 74, 78, 87, 103, 161	30	30							T
1.8, 1.8 T, 1.9 TDI, 2.3 VR5	06.97 - 11.00	1090	1080	E90-85-002-05-22	A, 18, 20, 74, 78, 87, 105, 161	30	30							T
1.8 Syncro/4motion, 1.9 TDI Syncro/4motion, 2.3 VR5 Syncro/4motion	12.99 - 11.00	1090	1190	E90-85-002-07-22	A, 18, 78, 87, 133, 161	30	30							T
1.9 TDI 4motion, 2.0 4motion	12.99 - 11.00	1090	1190	E90-85-002-07-22	A, 18, 49, 78, 161	30	30							T
2.8 V6 Syncro/4motion	12.99 - 11.00	1140	1190	E90-85-002-08-22	A, 18, 78, 87, 133, 161	30	30							T
2.5 TDI	07.98 - 11.00	1190	1080	E90-85-002-06-22	A, 18, 20, 74, 78, 87, 105, 161	30	30							T
2.5 TDI Syncro/4motion	12.99 - 11.00	1200	1190	E90-85-002-09-22	A, 18, 78, 87, 133, 161	30	30							T
Pro-Street-S (Gewindefahrwerke - höhenverstellbar Coil-Overs-Adjustable Ride Height) 1.6, 1.8, 1.8 T, 1.9 TDI, 2.0, 2.3 VR5, 2.5 TDI, 2.8 V6	06.97 - 11.00	1100	1080	PSS65-85-002-01-22	A, 18, 20, 24, 25, 45, 160	40-75	40-75							T
1.8 Syncro/4motion, 1.9 TDI 4motion, 1.9 TDI Syncro/4motion, 2.0 4motion, 2.3 VR5 Syncro/4motion, 2.5 TDI Syncro/4motion, 2.8 Syncro, 2.8 V6 Syncro/4motion	05.97 - 11.00	1100	1160	PSS65-85-002-03-22	A, 18, 22, 25, 45, 160	40-75	40-75							T
1.6, 1.8, 1.8 T, 1.9 TDI, 2.0, 2.3 VR5, 2.5 TDI, 2.8 V6	06.97 - 11.00	1200	1080	PSS65-85-002-02-22	A, 18, 20, 24, 25, 45, 160	40-75	40-75							T
1.8 Syncro/4motion, 1.9 TDI 4motion, 1.9 TDI Syncro/4motion, 2.0 4motion, 2.3 VR5 Syncro/4motion, 2.5 TDI Syncro/4motion, 2.8 Syncro, 2.8 V6 Syncro/4motion	05.97 - 11.00	1200	1160	PSS65-15-005-03-22	A, 18, 22, 25, 45, 160	40-75	40-75							T
PASSAT Variant (3B6) Pro-Kit (Performance Fahrwerksfedern Performance Springs) 1.6, 1.8 T, 1.8 T 20V, 2.0	11.00 - 08.05	1070	1200	E10-85-002-08-22	A, 18, 20	30	30					F1532001	F1558002	T
1.9 TDI 4motion, 2.0 4motion, 2.3 VR5 4motion	11.00 - 05.05	1090	1190	E8565-140	A, 18	30	30					F1532001	F1561002	T
2.8 4motion	11.00 - 05.05	1140	1190	E8566-140	A, 18	30	30					F1541001	F1561002	T
1.8 T, 1.8 T 20V, 1.9 TDI, 2.0 TDI, 2.3 VR5	11.00 - 08.05	1175	1200	E10-85-002-09-22	A, 18, 20	30	30					F1541001	F1558002	T
2.5 TDI 4motion	11.00 - 05.05	1200	1190	E10-85-002-02-22	A, 18	30	30					F1558001	F1561002	T
2.3 VR5, 2.5 TDI	11.00 - 05.05	1250	1200	E10-85-002-10-22	A, 18, 20	30	30					F1558001	F1558002	T
Anti-Roll-Kit (Performance Stabilisatoren Performance Sway Bars) 1.6, 1.8 T, 1.8 T 20V, 1.9 TDI, 1.9 TDI 4motion, 2.0, 2.0 4motion, 2.0 TDI, 2.3 VR5, 2.3 VR5 4motion, 2.5 TDI, 2.5 TDI 4motion, 2.8 4motion	11.00 - 08.05			E1531-310	A, 18, 20, 22, 45			32		2-fach verstellbar 2-way adjustable		AS1531310VA		T
2.5 TDI 4motion	01.03 - 05.05			E1531-310	A, 18, 22, 45			32		2-fach verstellbar 2-way adjustable		AS1531310VA		T
B12 Pro-Kit (Performance Komplettfahrwerke Performance Springs+Shocks) 1.6, 1.8 T, 1.8 T 20V, 2.0	11.00 - 08.05	1070	1200	E90-85-002-13-22	A, 18, 20, 78, 161	30	30							T
1.9 TDI 4motion	11.00 - 05.05	1090	1190	E90-85-002-07-22	A, 18, 49, 78, 161	30	30							T
2.0 4motion, 2.3 VR5 4motion	11.00 - 05.05	1090	1190	E90-85-002-07-22	A, 18, 78, 87, 133, 161	30	30							T
2.8 4motion	11.00 - 05.05	1140	1190	E90-85-002-08-22	A, 18, 49, 78, 161	30	30							T
1.8 T, 1.8 T 20V, 1.9 TDI, 2.0 TDI, 2.3 VR5	11.00 - 08.05	1175	1200	E90-85-002-14-22	A, 18, 20, 78, 161	30	30							T
2.5 TDI 4motion	11.00 - 05.05	1200	1190	E90-85-002-09-22	A, 18, 49, 78, 161	30	30							T
2.3 VR5, 2.5 TDI	11.00 - 05.05	1250	1200	E90-85-002-15-22	A, 18, 20, 78, 161	30	30							T
Pro-Street-S (Gewindefahrwerke - höhenverstellbar Coil-Overs-Adjustable Ride Height) 1.6, 1.8 T, 1.8 T 20V, 1.9 TDI, 2.0, 2.0 TDI, 2.3 VR5, 2.5 TDI	11.00 - 08.05	1100	1080	PSS65-85-002-01-22	A, 18, 20, 24, 25, 45, 160	40-75	40-75							T

Modell	Baujahr	Achslast Vorne kg	Achslast Hinten kg	Artikel-Nr.	Hinweise	ca. Tieferl. Vorne mm	ca. Tieferl. Hinten mm	Ø Vorne mm	Ø Hinten mm	Verstellbarkeit Vorne	Verstellbarkeit Hinten	Ersatzteilbezeichnung Vorne	Ersatzteilbezeichnung Hinten	Gutachten
Model	Year	Front Axle Load kg	Rear Axle Load kg	Part-No.	Notes	ca. Lowering Front mm	ca. Lowering Rear mm	Ø Front mm	Ø Rear mm	Adjustable Front	Adjustable Rear	Spare Part Marking Front	Spare Part Marking Rear	Homologation
PASSAT Variant (3B6) <i>Pro-Street-S (Gewindefahrwerke - höhenverstellbar Coil-Overs-Adjustable Ride High)</i> 1.8 4motion, 1.9 TDI 4motion, 2.0 4motion, 2.3 VR5 4motion, 2.5 TDI 4motion, 2.8 4motion	11.00 - 05.05	1100	1160	PSS65-85-002-03-22	A, 18, 22, 25, 45, 160	40-75	40-75							T
1.6, 1.8 T, 1.8 T 20V, 1.9 TDI, 2.0, 2.0 TDI, 2.3 VR5, 2.5 TDI	11.00 - 08.05	1200	1080	PSS65-85-002-02-22	A, 18, 20, 24, 25, 45, 160	40-75	40-75							T
1.8 4motion, 1.9 TDI 4motion, 2.0 4motion, 2.3 VR5 4motion, 2.5 TDI 4motion, 2.8 4motion	11.00 - 05.05	1200	1160	PSS65-15-005-03-22	A, 18, 22, 25, 45, 160	40-75	40-75							T
PASSAT Variant (3C5) <i>Pro-Kit (Performance Fahrwerksfedern Performance Springs)</i> 1.4 TSI, 1.6, 1.6 FSI, 2.0 FSI	08.05 - 11.10	1070	1130	E10-85-016-03-22	A, 18, 20	30	30					F11-15-007-02-VA	F11-85-012-01-HA	ABE
1.4 TSI, 1.6 TDI, 1.8 TSI, 1.9 TDI, 2.0 BlueTDI, 2.0 FSI, 2.0 TDI, 2.0 TDI 16V	08.05 -	1180	1130	E10-85-016-04-22	A, 18, 20	30	30					F11-15-007-03-VA	F11-85-012-01-HA	ABE
2.0 FSI 4motion, 2.0 TDI 16V 4motion, 2.0 TDI 4motion, 3.2 FSI 4motion	08.05 -	1180	1230	E10-85-016-10-22	A, 18	30	30					F11-15-007-03-VA	F11-85-016-10-HA	ABE
<i>Anti-Roll-Kit (Performance Stabilisatoren Performance Sway Bars)</i> 1.4 TSI, 1.6, 1.6 FSI, 1.6 TDI, 1.8 TSI, 1.9 TDI, 2.0 BlueTDI, 2.0 FSI, 2.0 TDI, 2.0 TDI 16V	08.05 -			E40-85-014-06-11	A, 18, 20, 22, 45			26	23	2-fach verstellbar 2-way adjustable	2-fach verstellbar 2-way adjustable	AS41-85-014-01-VA	AS41-85-014-01-HA	T
B12 Pro-Kit (Performance Komplettfahrwerke Performance Springs+Shocks) 1.4 TSI, 1.4 TSI EcoFuel	05.07 - 11.10	1070	1130	E90-85-016-03-22	A, 18, 20, 21, 34, 78, 161	30	30							T
1.6, 1.6 FSI, 1.8 TSI, 2.0 FSI	08.05 - 10.11	1070	1130	E90-85-016-03-22	A, 18, 20, 21, 34, 78, 101, 161	30	30							T
1.4 TSI, 1.4 TSI EcoFuel, 1.6, 1.6 FSI, 1.6 TDI, 1.8 TSI, 1.9 TDI, 2.0 BlueTDI, 2.0 FSI, 2.0 TDI, 2.0 TDI 16V	08.05 -	1180	1130	E90-85-016-04-22	A, 18, 20, 21, 34, 78, 101, 161	30	30							T
2.0 TDI	08.05 -	1180	1130	E90-85-016-04-22	A, 18, 20, 21, 34, 78, 161	30	30							T
2.0 FSI 4motion, 2.0 TDI 16V 4motion, 2.0 TDI 4motion, 3.2 FSI 4motion	08.05 -	1180	1230	E90-85-016-10-22	A, 18, 21, 34, 78, 101, 161	30	30							T
<i>Pro-Street-S (Gewindefahrwerke - höhenverstellbar Coil-Overs-Adjustable Ride High)</i> 1.4 TSI, 1.6, 1.6 FSI, 1.6 TDI, 1.8 TSI, 1.9 TDI, 2.0 BlueTDI, 2.0 FSI, 2.0 FSI 4motion, 2.0 TDI, 2.0 TDI 16V, 2.0 TDI 16V 4motion, 2.0 TDI 4motion	08.05 -	1060	1230	PSS65-85-016-03-22	A, 18, 24, 45, 160	35-70	35-70							T
1.4 TSI, 1.6 TDI, 1.8 TSI, 1.9 TDI, 2.0 BlueTDI, 2.0 FSI, 2.0 FSI 4motion, 2.0 TDI, 2.0 TDI 16V, 2.0 TDI 16V 4motion, 2.0 TDI 4motion	08.05 -	1180	1230	PSS65-85-016-04-22	A, 18, 24, 45, 160	35-70	35-70							T
<i>Pro-Tronic (Elektronische Performance Fahrwerksmodule Electronic Performance Suspension Modul)</i> Alle Motorisierungen / all motorisation	08.05 -			AM65-85-022-01-22	A, 175									
PASSAT Variant (365) <i>Pro-Kit (Performance Fahrwerksfedern Performance Springs)</i> 1.4 TSI, 1.4 TSI MultiFuel	08.10 -	1070	1130	E10-85-016-03-22	A, 18, 20	30	25					F11-15-007-02-VA	F11-85-012-01-HA	ABE
1.6 TDI, 1.8 TSI, 2.0 TDI, 2.0 TSI	08.10 -	1180	1130	E10-85-016-04-22	A, 18, 20	30	25					F11-15-007-03-VA	F11-85-012-01-HA	ABE
2.0 TDI 4motion, 3.6 FSI 4motion	08.10 -	1180	1230	E10-85-016-10-22	A, 18	30	25					F11-15-007-03-VA	F11-85-016-10-HA	ABE
<i>Anti-Roll-Kit (Performance Stabilisatoren Performance Sway Bars)</i> 1.4 TSI, 1.4 TSI MultiFuel, 1.6 TDI, 1.8 TSI, 2.0 TDI, 2.0 TSI	08.10 -			E40-85-014-06-11	A, 18, 20, 22, 45			26	23	2-fach verstellbar 2-way adjustable	2-fach verstellbar 2-way adjustable	AS41-85-014-01-VA	AS41-85-014-01-HA	T
B12 Pro-Kit (Performance Komplettfahrwerke Performance Springs+Shocks) 1.4 TSI, 1.4 TSI EcoFuel, 1.4 TSI MultiFuel	08.10 -	1070	1130	E90-85-016-03-22	A, 18, 20, 21, 34, 78, 161	30	30							T
1.4 TSI, 1.4 TSI EcoFuel, 1.4 TSI MultiFuel, 1.6 TDI, 1.8 TSI, 2.0 TDI, 2.0 TSI	08.10 -	1180	1130	E90-85-016-04-22	A, 18, 20, 21, 34, 78, 161	30	30							T
2.0 TDI 4motion, 3.6 FSI 4motion	08.10 -	1180	1230	E90-85-016-10-22	A, 18, 21, 34, 78, 161	30	30							T
<i>Pro-Street-S (Gewindefahrwerke - höhenverstellbar Coil-Overs-Adjustable Ride High)</i> 1.4 TSI, 1.4 TSI MultiFuel	08.10 -	1060	1230	PSS65-85-016-03-22	A, 18, 24, 45, 160	35-70	35-70							T
1.6 TDI, 1.8 TSI, 2.0 TDI, 2.0 TDI 4motion, 2.0 TSI, 3.6 FSI 4motion	08.10 -	1180	1230	PSS65-85-016-04-22	A, 18, 24, 45, 160	35-70	35-70							T
POLO (86C, 80) <i>Pro-Kit (Performance Fahrwerksfedern Performance Springs)</i> 1.0, 1.0 KAT, 1.3, 1.3 KAT, 1.4 D 1.0, 1.0 CAT, 1.3, 1.3 CAT, 1.4 D	08.85 - 09.94	640	630	E8517-140	A, 18, 20	35-40	30-35					F8517001	F8517002	T
B12 Pro-Kit (Performance Komplettfahrwerke Performance Springs+Shocks) 0.9, 1.0, 1.0 KAT, 1.1, 1.3, 1.3 D, 1.3 KAT, 1.4 D 0.9, 1.0, 1.0 CAT, 1.1, 1.3, 1.3 CAT, 1.3 D, 1.4 D	10.81 - 09.94	640	630	E90-85-036-01-22	A, 18, 20, 78, 161	30-40	30-35							T
POLO (6N1) <i>Pro-Kit (Performance Fahrwerksfedern Performance Springs)</i> 1.7 SDI, 100 1.4 16V, 120 1.6 16V GTI, 45 1.0, 50 1.0, 55 1.3, 55 1.4, 60 1.4, 60 1.7 SDI, 64 1.9 D, 64 1.9 SDI, 75 1.6	10.94 - 10.99	820	750	E8546-140	A, 18, 20	30	30					F8546001	F8546002	T
<i>Sportline (Performance Fahrwerksfedern Sport Sport Performance Springs)</i> 1.7 SDI, 100 1.4 16V, 120 1.6 16V GTI, 45 1.0, 50 1.0, 55 1.3, 55 1.4, 60 1.4, 60 1.7 SDI, 64 1.9 D, 64 1.9 SDI, 75 1.6	10.94 - 10.99	800	750	E20-85-004-01-22	A, 20	45-50	30-35					F21-85-003-01-VA	F21-85-004-01-HA	T
B12 Pro-Kit (Performance Komplettfahrwerke Performance Springs+Shocks) 1.7 SDI, 100 1.4 16V, 120 1.6 16V GTI, 45 1.0, 50 1.0, 55 1.3, 55 1.4, 60 1.4, 60 1.7 SDI, 64 1.9 D, 64 1.9 SDI, 75 1.6	10.94 - 10.99	820	750	E90-85-004-01-22	A, 18, 20, 78, 161	30	30							T
B12 Sportline (Performance Komplettfahrwerke Sport Sport Performance Springs+Shocks) 1.7 SDI, 100 1.4 16V, 120 1.6 16V GTI, 45 1.0, 50 1.0, 55 1.3, 55 1.4, 60 1.4, 60 1.7 SDI, 64 1.9 D, 64 1.9 SDI, 75 1.6	10.94 - 10.99	800	750	E95-85-004-01-22	A, 18, 20, 78, 161	45-50	30-35							T
POLO (6N2) <i>Pro-Kit (Performance Fahrwerksfedern Performance Springs)</i> 1.0, 1.4, 1.4 16V	10.99 - 09.01	800	780	E8595-140	A, 18, 20	30	30					F11-81-001-01-VA	F8594002	T
1.4, 1.4 16V, 1.4 TDI, 1.4 TDI, 1.6 16V GTI, 1.7 SDI, 1.9 D, 1.9 SDI	10.99 - 09.01	850	780	E8594-140	A, 18, 20	30	30					F8594001	F8594002	T

Modell	Baujahr	Achslast Vorne kg	Achslast Hinten kg	Artikel-Nr.	Hinweise	ca. Tieferl. Vorne mm	ca. Tieferl. Hinten mm	Ø Vorne mm	Ø Hinten mm	Verstellbarkeit Vorne	Verstellbarkeit Hinten	Ersatzteilbezeichnung Vorne	Ersatzteilbezeichnung Hinten	Gutachten
Model	Year	Front Axle Load kg	Rear Axle Load kg	Part-No.	Notes	ca. Lowering Front mm	ca. Lowering Rear mm	Ø Front mm	Ø Rear mm	Adjustable Front	Adjustable Rear	Spare Part Marking Front	Spare Part Marking Rear	Homologation
POLO (6N2) Sportline (Performance Fahrwerksfedern Sport Sport Performance Springs) 1.0, 1.4, 1.4 16V, 1.6 16V GTI	10.99 - 09.01	830	780	E20-85-004-02-22	A, 20	45-50	30-35					F21-85-004-02-VA	F21-85-004-02-HA	T
B12 Pro-Kit (Performance Komplettfahrwerke Performance Springs+Shocks) 1.0, 1.2, 1.4, 1.4 16V	10.99 - 10.01	800	780	E90-85-004-02-22	A, 18, 20, 78, 161	30	30							T
1.4, 1.4 16V, 1.4 TDI, 1.4 TDI, 1.6 16V GTI, 1.7 SDI, 1.9 D, 1.9 SDI	10.99 - 09.01	850	780	E90-85-004-03-22	A, 18, 20, 78, 161	30	30							T
B12 Sportline (Performance Komplettfahrwerke Sport Sport Performance Springs+Shocks) 1.0 Schaltgetriebe, 1.2 Schaltgetriebe, 1.4 16V Schaltgetriebe, 1.4 Schaltgetriebe, 1.6 16V GTI Schaltgetriebe 1.0 manual transmission, 1.2 manual transmission, 1.4 16V manual transmission, 1.4 manual transmission, 1.6 16V GTI manual transmission	10.99 - 10.01	830	780	E95-85-004-02-22	A, 18, 20, 71, 78, 161	45-50	30-35							T
POLO (9N) Pro-Kit (Performance Fahrwerksfedern Performance Springs) 1.2, 1.2 12V, 1.4, 1.4 16V, 1.4 FSI, 1.6, 1.6 16V, 1.6 Total Flex	10.01 - 11.09	870	840	E10-85-008-01-22	A, 18, 20, 58	30	30					F11-85-008-01-VA	F11-85-008-01-HA	T
1.8 GTI, 1.8 GTI Cup Edition	09.05 - 11.09	960	840	E10-85-008-02-22	A, 18, 20	20	20					F11-85-008-02-VA	F11-85-008-01-HA	T
1.4 TDI, 1.9 SDI, 1.9 TDI	10.01 - 11.09	960	840	E10-85-008-02-22	A, 18, 20, 58	30	30					F11-85-008-02-VA	F11-85-008-01-HA	T
Sportline (Performance Fahrwerksfedern Sport Sport Performance Springs) 1.2, 1.2 12V, 1.4, 1.4 16V, 1.4 FSI, 1.6, 1.6 16V, 1.6 Total Flex	10.01 - 11.09	870	800	E20-85-008-01-22	A, 20, 58	45-50	30-35					F21-85-008-01-VA	F21-85-008-01-HA	T
Anti-Roll-Kit (Performance Stabilisatoren Performance Sway Bars) 1.2, 1.2 12V, 1.4, 1.4 16V, 1.4 FSI, 1.4 TDI, 1.6, 1.6 16V, 1.6 Total Flex, 1.9 SDI, 1.9 TDI	10.01 - 11.09			E40-85-008-01-10	A, 18, 20, 22, 45			22		nicht verstellbar not adjustable		AS41-85-008-01-VA		T
B12 Pro-Kit (Performance Komplettfahrwerke Performance Springs+Shocks) 1.2 12V Schaltgetriebe, 1.2 Schaltgetriebe, 1.4 16V Schaltgetriebe, 1.4 FSI Schaltgetriebe, 1.6 16V Schaltgetriebe, 1.6 Schaltgetriebe, 1.6 Total Flex Schaltgetriebe 1.2 12V manual transmission, 1.2 manual transmission, 1.4 16V manual transmission, 1.4 FSI manual transmission, 1.6 16V manual transmission, 1.6 Total Flex manual transmission, 1.6 manual transmission	10.01 - 11.09	870	840	E90-85-008-01-22	A, 18, 20, 58, 78, 127, 161	30	30							T
1.4 TDI	10.01 - 11.09	960	840	E90-85-008-02-22	A, 18, 20, 78, 127, 161	30	30							T
1.8 GTI, 1.8 GTI Cup Edition	09.05 - 11.09	960	840	E90-85-008-02-22	A, 18, 20, 78, 161	20	20							T
1.9 SDI, 1.9 TDI	10.01 - 11.09	960	840	E90-85-008-02-22	A, 18, 20, 58, 78, 127, 161	30	30							T
B12 Sportline (Performance Komplettfahrwerke Sport Sport Performance Springs+Shocks) 1.2 12V Schaltgetriebe, 1.2 Schaltgetriebe, 1.4 16V Schaltgetriebe, 1.4 FSI Schaltgetriebe, 1.6 16V Schaltgetriebe, 1.6 Schaltgetriebe, 1.6 Total Flex Schaltgetriebe 1.2 12V manual transmission, 1.2 manual transmission, 1.4 16V manual transmission, 1.4 FSI manual transmission, 1.6 16V manual transmission, 1.6 Total Flex manual transmission, 1.6 manual transmission	10.01 - 11.09	870	800	E95-85-008-01-22	A, 18, 20, 58, 71, 78, 127, 161	45-50	30-35							T
Pro-Street-S (Gewindefahrwerke - höhenverstellbar Coil-Overs-Adjustable Ride Height) 1.2, 1.2 12V, 1.4, 1.4 16V, 1.4 FSI, 1.4 TDI, 1.6, 1.6 16V, 1.6 Total Flex, 1.9 SDI, 1.9 TDI	10.01 - 11.09	960	840	PSS65-85-008-01-22	A, 24, 25, 45, 160	35-65	35-65							T
1.8 GTI, 1.8 GTI Cup Edition	09.05 - 11.09	960	840	PSS65-85-008-01-22	A, 24, 25, 45, 160	10-40	15-45							T
POLO (6R) Pro-Kit (Performance Fahrwerksfedern Performance Springs) 1.2, 1.2 TSI, 1.4	06.09 -	860	820	E10-85-024-01-22	A, 18, 20	25	30					F11-81-010-04-VA	F11-81-010-04-HA	T
1.2 TDI, 1.2 TSI, 1.4 TSI, 1.6 TDI	06.09 -	940	820	E10-85-024-02-22	A, 18, 20	25	30					F11-81-010-05-VA	F11-81-010-04-HA	T
1.4 GTI	05.10 -	940	820	E10-85-024-02-22	A, 18, 20	15	20					F11-81-010-05-VA	F11-81-010-04-HA	T
Anti-Roll-Kit (Performance Stabilisatoren Performance Sway Bars) 1.2, 1.2 TDI, 1.2 TSI, 1.4, 1.4 GTI, 1.4 TSI, 1.6 TDI	06.09 -			E40-85-008-01-10	A, 18, 20, 22, 45			22		nicht verstellbar not adjustable		AS41-85-008-01-VA		T
B12 Pro-Kit (Performance Komplettfahrwerke Performance Springs+Shocks) 1.2, 1.2 TSI Schaltgetriebe, 1.4, 1.4 BiFuel, 1.4 TSI, 1.6 BiFuel 1.2, 1.2 TSI manual transmission, 1.4, 1.4 BiFuel, 1.4 TSI, 1.6 BiFuel	06.09 -	860	820	E90-85-024-01-22	A, 18, 20, 78, 161	25	30							T
1.4 GTI	05.10 -	940	820	E90-85-024-02-22	A, 18, 20, 78, 161	15	20							T
1.2 TDI, 1.2 TSI, 1.6 BiFuel, 1.6 TDI	06.09 -	940	820	E90-85-024-02-22	A, 18, 20, 78, 161	25	30							T
Pro-Street-S (Gewindefahrwerke - höhenverstellbar Coil-Overs-Adjustable Ride Height) 1.2, 1.2 TSI, 1.4	06.09 -	860	770	PSS65-81-010-01-22	A, 24, 25, 45, 160	20-50	40-65							T
1.2 TDI, 1.2 TSI, 1.4 GTI, 1.4 TSI, 1.6 TDI	06.09 -	960	770	PSS65-81-010-02-22	A, 24, 25, 45, 160	20-50	40-65							T
POLO CLASSIC (86C, 80) Pro-Kit (Performance Fahrwerksfedern Performance Springs) 1.0, 1.3 KAT, 1.4 D 1.0, 1.3 CAT, 1.4 D	01.85 - 09.94	640	630	E8517-140	A, 18, 20	35-40	30-35					F8517001	F8517002	T
B12 Pro-Kit (Performance Komplettfahrwerke Performance Springs+Shocks) 1.0, 1.3, 1.3 D, 1.3 KAT, 1.4 D 1.0, 1.3, 1.3 CAT, 1.3 D, 1.4 D	01.85 - 09.94	640	630	E90-85-036-01-22	A, 18, 20, 78, 161	30-40	30-35							T
POLO CLASSIC (6KV2) Pro-Kit (Performance Fahrwerksfedern Performance Springs) 100 1.6, 54 1.4, 60 1.4, 75 1.4 16V, 75 1.6, 90 1.8	11.95 - 09.01	865	790	E8551-140	A, 18, 20	30	30					F8502001	F8106002	T
110 1.9 TDI, 57 1.7 SDI, 64 1.9 SDI, 68 1.9 SDI, 90 1.9 TDI	12.95 - 01.02	900	790	E8586-140	A, 18, 20	30	30					F8530001	F8106002	T
B12 Pro-Kit (Performance Komplettfahrwerke Performance Springs+Shocks) 1.4, 100 1.6, 54 1.4, 60 1.4, 75 1.4 16V, 75 1.6, 90 1.8	11.95 - 07.02	865	790	E90-85-034-01-22	A, 18, 20, 78, 161	30	30							T
1.9 SDI, 110 1.9 TDI, 57 1.7 SDI, 64 1.9 SDI, 68 1.9 SDI, 90 1.9 TDI	12.95 - 01.02	900	790	E90-85-034-02-22	A, 18, 20, 78, 161	30	30							T

Modell	Baujahr	Achslast Vorne kg	Achslast Hinten kg	Artikel-Nr.	Hinweise	ca. Tieferl. Vorne mm	ca. Tieferl. Hinten mm	Ø Vorne mm	Ø Hinten mm	Verstellbarkeit Vorne	Verstellbarkeit Hinten	Ersatzteilbezeichnung Vorne	Ersatzteilbezeichnung Hinten	Gutachten
Model	Year	Front Axle Load kg	Rear Axle Load kg	Part-No.	Notes	ca. Lowering Front mm	ca. Lowering Rear mm	Ø Front mm	Ø Rear mm	Adjustable Front	Adjustable Rear	Spare Part Marking Front	Spare Part Marking Rear	Homologation
POLO Coupe (86C, 80) <i>Pro-Kit (Performance Fahrwerksfedern Performance Springs)</i> 1.0, 1.0 KAT, 1.3, 1.3 D, 1.3 G40, 1.3 KAT, 1.4 D 1.0, 1.0 CAT, 1.3, 1.3 CAT, 1.3 D, 1.3 G40, 1.4 D	08.85 - 09.94	640	630	E8517-140	A, 18, 20	35-40	30-35					F8517001	F8517002	T
B12 Pro-Kit (Performance Komplettfahrwerke Performance Springs+Shocks) 1.0, 1.0 KAT, 1.1, 1.3, 1.3 D, 1.3 G40, 1.3 KAT, 1.4 D 1.0, 1.0 CAT, 1.1, 1.3, 1.3 CAT, 1.3 D, 1.3 G40, 1.4 D	10.81 - 09.94	640	630	E90-85-036-01-22	A, 18, 20, 78, 161	30-40	30-35							T
POLO Stufenheck (9A4) POLO Saloon (9A4) <i>Pro-Kit (Performance Fahrwerksfedern Performance Springs)</i> 1.4	07.03 -	870	840	E10-85-008-01-22	A, 18, 20	30	35					F11-85-008-01-VA	F11-85-008-01-HA	T
1.4 TDI, 1.9 SDI	09.02 -	960	840	E10-85-008-02-22	A, 18, 20	30	35					F11-85-008-02-VA	F11-85-008-01-HA	T
B12 Pro-Kit (Performance Komplettfahrwerke Performance Springs+Shocks) 1.4 Schaltgetriebe 1.4 manual transmission	07.03 -	870	840	E90-85-008-01-22	A, 18, 20, 71, 78, 161	30	30							T
1.4 TDI, 1.9 SDI	09.02 -	960	840	E90-85-008-02-22	A, 18, 20, 78, 161	30	30							T
Pro-Street-S (Gewindefahrwerke - höhenverstellbar Coil-Overs-Adjustable Ride Height) 1.4, 1.4 TDI, 1.9 SDI	09.02 -	960	840	PSS65-85-008-01-22	A, 24, 25, 45, 160	35-65	35-65							T
POLO Stufenheck POLO Saloon <i>Pro-Kit (Performance Fahrwerksfedern Performance Springs)</i> 1.6	05.10 -	860	820	E10-85-024-01-22	A, 18, 20	25	30					F11-81-010-04-VA	F11-81-010-04-HA	T
Anti-Roll-Kit (Performance Stabilisatoren Performance Sway Bars) 1.6	05.10 -			E40-85-008-01-10	A, 18, 20, 22, 45			22		nicht verstellbar not adjustable		AS41-85-008-01-VA		T
Pro-Street-S (Gewindefahrwerke - höhenverstellbar Coil-Overs-Adjustable Ride Height) 1.6	05.10 -	860	770	PSS65-81-010-01-22	A, 24, 25, 45, 160	20-50	40-65							T
SCIROCCO (53) <i>Pro-Kit (Performance Fahrwerksfedern Performance Springs)</i> 1.3, 1.5, 1.6	08.75 - 07.80	785	630	E8501-140	A, 18, 20	30-40	30					F8501101	F8501002	T
B12 Pro-Kit (Performance Komplettfahrwerke Performance Springs+Shocks) 1.3, 1.5, 1.6	02.74 - 07.80	785	630	E90-85-032-01-22	A, 18, 20, 78, 95, 161	30-40	30							T
SCIROCCO (53B) <i>Pro-Kit (Performance Fahrwerksfedern Performance Springs)</i> 1.3, 1.5, 1.6, 1.8, 1.8 16V	08.80 - 07.92	785	630	E8501-140	A, 18, 20	30-40	30					F8501101	F8501002	T
B12 Pro-Kit (Performance Komplettfahrwerke Performance Springs+Shocks) 1.3, 1.5, 1.6, 1.8, 1.8 16V	08.80 - 07.92	785	630	E90-85-032-01-22	A, 18, 20, 78, 95, 161	30-40	30							T
SCIROCCO (137) <i>Pro-Kit (Performance Fahrwerksfedern Performance Springs)</i> 2.0 R	11.09 -	1050	770	E10-85-021-01-22	A, 18, 20	15	10					F11-79-004-01-VA	F11-15-001-01-HA	T
1.4 TSI, 2.0 TDI, 2.0 TSI	05.08 -	1050	770	E10-85-021-01-22	A, 18, 20	25-30	20					F11-79-004-01-VA	F11-15-001-01-HA	T
2.0 R	11.09 -	1080	770	E10-85-021-05-22	A, 18, 20	15	10					F11-15-007-01-VA	F11-15-001-01-HA	T
2.0 TDI	08.08 -	1080	770	E10-85-021-05-22	A, 18, 20	25-30	20					F11-15-007-01-VA	F11-15-001-01-HA	T
Anti-Roll-Kit (Performance Stabilisatoren Performance Sway Bars) 1.4 TSI, 2.0 TDI, 2.0 TSI	05.08 -			E40-85-021-01-11	A, 18, 20, 22, 45			26 Rohr 26 tube	23 Rohr 23 tube	2-fach verstellbar 2-way adjustable	2-fach verstellbar 2-way adjustable	AS41-85-021-01-VA	AS41-85-021-01-HA	T
B12 Pro-Kit (Performance Komplettfahrwerke Performance Springs+Shocks) 1.4 TSI, 2.0 TDI, 2.0 TSI	05.08 -	1050	770	E90-85-021-01-22	A, 18, 20, 78, 101, 161	25-30	20							T
2.0 R	11.09 -	1050	770	E90-85-021-01-22	A, 18, 20, 21, 78, 101, 161	15	10							T
1.4 TSI, 2.0 TDI	08.08 -	1050	770	E90-85-021-01-22	A, 18, 20, 21, 78, 101, 161	25-30	20							T
Pro-Street-S (Gewindefahrwerke - höhenverstellbar Coil-Overs-Adjustable Ride Height) 1.4 TSI	05.08 -	1000	770	PSS65-85-021-01-22	A, 18, 45, 160	20-55	20-55							T
2.0 R	11.09 -	1080	770	PSS65-85-021-02-22	A, 18, 45, 160	10-45	10-45							T
1.4 TSI, 2.0 TDI, 2.0 TSI	05.08 -	1080	770	PSS65-85-021-02-22	A, 18, 45, 160	20-55	20-55							T
Pro-Tronic (Elektronische Performance Fahrwerksmodule Electronic Performance Suspension Moduls) Alle Motorisierungen / all motorisation	05.08 -			AM65-85-022-01-22	A, 175									
SHARAN (7M8, 7M9, 7M6) <i>Pro-Kit (Performance Fahrwerksfedern Performance Springs)</i> 1.8 T 20V, 2.0, 2.0 16V	09.95 - 03.10	1240	1355	E8549-140	A, 18, 20	30	30					F8549001	F8549002	T
1.9 TDI, 2.0 TDI, 2.8 V6 24V, 2.8 VR6	09.95 - 03.10	1260	1355	E8552-140	A, 18, 20	30	30					F8552001	F8549002	T
B12 Pro-Kit (Performance Komplettfahrwerke Performance Springs+Shocks) 1.8 T 20V, 2.0, 2.0 16V	09.95 - 03.10	1240	1355	E90-85-007-01-22	A, 18, 20, 78, 161	30	30							T
1.9 TDI, 2.8 V6 24V, 2.8 VR6	09.95 - 03.10	1260	1355	E90-85-007-02-22	A, 18, 20, 78, 161	30	30							T
SHARAN (7N) <i>Pro-Kit (Performance Fahrwerksfedern Performance Springs)</i> 1.4 TSI Sitzplätze 5, 1.8 TSI Sitzplätze 5, 2.0 TDI Sitzplätze 5, 2.0 TSI Sitzplätze 5 1.4 TSI Seats 5, 1.8 TSI Seats 5, 2.0 TDI Seats 5, 2.0 TSI Seats 5	05.10 -	1220	1150	E10-85-026-01-22	A, 18, 20, 66	25	25					F11-85-012-02-VA	F11-79-008-01-HA	T
1.4 TSI Sitzplätze 5, 1.8 TSI Sitzplätze 5, 2.0 TDI Sitzplätze 5, 2.0 TSI Sitzplätze 5 1.4 TSI Seats 5, 1.8 TSI Seats 5, 2.0 TDI Seats 5, 2.0 TSI Seats 5	05.10 -	1300	1150	E10-85-026-02-22	A, 18, 20, 66	25	25					F11-85-012-03-VA	F11-79-008-01-HA	T
Pro-Tronic (Elektronische Performance Fahrwerksmodule Electronic Performance Suspension Moduls) Alle Motorisierungen / all motorisation	05.10 -			AM65-85-022-01-22	A, 175									

Modell	Baujahr	Achslast Vorne kg	Achslast Hinten kg	Artikel-Nr.	Hinweise	ca. Tieferl. Vorne mm	ca. Tieferl. Hinten mm	Ø Vorne mm	Ø Hinten mm	Verstellbarkeit Vorne	Verstellbarkeit Hinten	Ersatzteilbezeichnung Vorne	Ersatzteilbezeichnung Hinten	Gutachten
Model	Year	Front Axle Load kg	Rear Axle Load kg	Part-No.	Notes	ca. Lowering Front mm	ca. Lowering Rear mm	Ø Front mm	Ø Rear mm	Adjustable Front	Adjustable Rear	Spare Part Marking Front	Spare Part Marking Rear	Homologation
TIGUAN (5N) Pro-Kit (Performance Fahrwerksfedern Performance Springs) 1.4 TSI, 1.4 TSI 4motion, 2.0 TDI, 2.0 TDI 4motion, 2.0 TFSI 4motion, 2.0 TSI 4motion	09.07 -	1190	1130	E10-85-020-01-22	A, 18, 54	30	30					F11-85-012-02-VA	F11-85-012-01-HA	T
TOUAREG (7LA, 7L6, 7L7) Pro-Kit (Performance Fahrwerksfedern Performance Springs) 2.5 R5 TDI, 3.0 TDI, 3.0 V6 TDI, 3.2 V6, 3.6 V6 FSI, 4.2 V8, 4.2 V8 FSI	10.02 - 05.10	1510	1670	E10-85-011-01-22	A, 18	30	30					F11-85-011-01-VA	F11-85-011-01-HA	T
Anti-Roll-Kit (Performance Stabilisatoren Performance Sway Bars) 2.5 R5 TDI, 3.0 TDI, 3.0 V6 TDI, 3.2 V6, 3.6 V6 FSI, 4.2 V8, 4.2 V8 FSI	10.02 - 05.10			E40-85-011-01-11	A, 18, 22, 45			40 Rohr 40 tube	30 Rohr 30 tube	nicht verstellbar not adjustable	nicht verstellbar not adjustable	AS41-72-005-01-VA	AS41-85-011-01-HA	T
B12 Pro-Kit (Performance Komplettfahrwerke Performance Springs+Shocks) 2.5 R5 TDI, 3.0 TDI, 3.0 V6 TDI, 3.2 V6, 3.6 V6 FSI, 4.2 V8, 4.2 V8 FSI	10.02 - 05.10	1510	1670	E90-85-011-01-22	A, 18, 76, 78, 161	30	30							T
TOURAN (1T1, 1T2) Pro-Kit (Performance Fahrwerksfedern Performance Springs) 1.6, 1.6 FSI	02.03 - 05.10	1060	1190	E10-85-012-01-22	A, 18, 20, 58	25	25					F11-79-004-02-VA	F11-85-012-01-HA	T
1.4 FSI, 1.4 TSI, 1.9 TDI, 2.0 FSI, 2.0 TDI, 2.0 TDI 16V	02.03 - 05.10	1160	1190	E10-85-012-02-22	A, 18, 20, 58	25	25					F11-85-012-02-VA	F11-85-012-01-HA	T
1.9 TDI, 2.0 TDI, 2.0 TDI 16V	02.03 - 05.10	1200	1190	E10-85-012-03-22	A, 18, 20, 58	25	25					F11-85-012-03-VA	F11-85-012-01-HA	T
Anti-Roll-Kit (Performance Stabilisatoren Performance Sway Bars) 1.6, 1.6 FSI, 1.9 TDI, 2.0 FSI, 2.0 TDI, 2.0 TDI 16V	02.03 - 05.10			E40-85-014-06-11	A, 18, 20, 22, 45			26	23	2-fach verstellbar 2-way adjustable	2-fach verstellbar 2-way adjustable	AS41-85-014-01-VA	AS41-85-014-01-HA	T
B12 Pro-Kit (Performance Komplettfahrwerke Performance Springs+Shocks) 1.9 TDI Schaltgetriebe 1.9 TDI manual transmission 1.9 TDI, 2.0 TDI, 2.0 TDI 16V	02.03 - 05.10	1160	1190	E90-85-012-02-22	A, 18, 20, 78, 161	30	30							T
02.03 - 05.10	1200	1190	E90-85-012-03-22	A, 18, 20, 78, 161	30	30								T
TOURAN (1T3) Pro-Kit (Performance Fahrwerksfedern Performance Springs) 1.2 TSI	05.10 -	1060	1190	E10-85-012-01-22	A, 18, 20, 58	25	25					F11-79-004-02-VA	F11-85-012-01-HA	T
1.4 TSI, 1.6 TDI, 2.0 TDI	05.10 -	1160	1190	E10-85-012-02-22	A, 18, 20, 58	25	25					F11-85-012-02-VA	F11-85-012-01-HA	T
2.0 TDI	05.10 -	1200	1190	E10-85-012-03-22	A, 18, 20, 58	25	25					F11-85-012-03-VA	F11-85-012-01-HA	T
Anti-Roll-Kit (Performance Stabilisatoren Performance Sway Bars) 1.2 TSI, 1.4 TSI, 1.4 TSI EcoFuel, 1.6 TDI, 2.0 TDI	05.10 -			E40-85-014-06-11	A, 18, 20, 22, 45			26	23	2-fach verstellbar 2-way adjustable	2-fach verstellbar 2-way adjustable	AS41-85-014-01-VA	AS41-85-014-01-HA	T
B12 Pro-Kit (Performance Komplettfahrwerke Performance Springs+Shocks) 2.0 TDI	11.10 -	1200	1190	E90-85-012-03-22	A, 18, 20, 78, 161	30	30							T
TRANSPORTER IV Bus (70XB, 70XC, 7DB, 7DW) Pro-Kit (Performance Fahrwerksfedern Performance Springs) 1.8, 1.9 D, 1.9 TD, 2.0, 2.4 D, 2.4 D Syncro, 2.5, 2.5 Syncro, 2.5 TDI, 2.5 TDI Syncro, 2.8 VR 6, 2.8 VR6, 2.8 VR6 Syncro	09.90 - 04.03	1600	1490	E8539-120	A, 18	40-45	45					Drehstabverstellung torsion bar	F8539002	T
B12 Pro-Kit (Performance Komplettfahrwerke Performance Springs+Shocks) 1.8, 1.9 D, 1.9 TD, 2.0, 2.4 D, 2.4 D Syncro, 2.5, 2.5 Syncro, 2.5 TDI, 2.5 TDI Syncro, 2.8 VR 6, 2.8 VR6, 2.8 VR6 Syncro	09.90 - 04.03	1600	1490	E90-85-035-01-02	A, 18, 78, 161	40-45	45							T
TRANSPORTER IV Kasten (70XA) TRANSPORTER IV Box (70XA) Pro-Kit (Performance Fahrwerksfedern Performance Springs) 1.9 D, 1.9 TD, 2.0, 2.4 D, 2.4 D Syncro, 2.5, 2.5 Syncro, 2.5 TDI, 2.5 TDI Syncro, 2.8 VR6	07.90 - 04.03	1600	1490	E8539-120	A, 18	40-45	45					Drehstabverstellung torsion bar	F8539002	T
B12 Pro-Kit (Performance Komplettfahrwerke Performance Springs+Shocks) 1.9 D, 1.9 TD, 2.0, 2.4 D, 2.4 D Syncro, 2.5, 2.5 Syncro, 2.5 TDI, 2.5 TDI Syncro, 2.8 VR6	07.90 - 04.03	1600	1490	E90-85-035-01-02	A, 18, 78, 161	40-45	45							T
TRANSPORTER IV Pritsche/Fahrgestell (70XD) TRANSPORTER IV Plattform/Chassis (70XD) Pro-Kit (Performance Fahrwerksfedern Performance Springs) 1.8, 1.9 D, 1.9 TD, 2.0, 2.4 D, 2.4 D Syncro, 2.5, 2.5 Syncro, 2.5 TDI, 2.5 TDI Syncro, 2.8, 2.8 VR6	07.90 - 04.03	1600	1490	E8539-120	A, 18	40-45	45					Drehstabverstellung torsion bar	F8539002	T
B12 Pro-Kit (Performance Komplettfahrwerke Performance Springs+Shocks) 1.8, 1.9 D, 1.9 TD, 2.0, 2.4 D, 2.4 D Syncro, 2.5, 2.5 Syncro, 2.5 TDI, 2.5 TDI Syncro, 2.8, 2.8 VR6	07.90 - 04.03	1600	1490	E90-85-035-01-02	A, 18, 78, 161	40-45	45							T
TRANSPORTER V Bus (7HB, 7HJ, 7EB, 7EJ, 7EF) Pro-Kit (Performance Fahrwerksfedern Performance Springs) 1.9 TDI, 2.0, 2.0 BiTDI, 2.0 BiTDI 4motion, 2.0 TDI, 2.0 TDI 4motion, 2.0 TSI, 2.0 TSI 4motion	04.03 -	1550	1720	E10-85-013-01-22	A, 12, 18	30	30					F11-85-013-01-VA	F11-85-013-01-HA	T
2.0 BiTDI, 2.0 BiTDI 4motion, 2.0 TDI, 2.0 TDI 4motion, 2.0 TSI, 2.0 TSI 4motion, 2.5 TDI, 2.5 TDI 4motion, 2.5 TDI, 3.2 V6, 3.2 V6 4motion	04.03 -	1710	1720	E10-85-013-02-22	A, 12, 18	30	30					F11-85-013-02-VA	F11-85-013-01-HA	T
B12 Pro-Kit (Performance Komplettfahrwerke Performance Springs+Shocks) 1.9 TDI, 2.0, 2.0 BiTDI 4motion, 2.0 TDI, 2.0 TDI 4motion, 2.0 TSI, 2.0 TSI 4motion	04.03 -	1550	1720	E90-85-013-01-22	A, 12, 18, 78, 97,	30	30							T
2.0 BiTDI 4motion, 2.0 TDI, 2.0 TDI 4motion, 2.0 TSI 4motion, 2.5 TDI, 2.5 TDI 4motion, 2.5 TDI, 3.2 V6, 3.2 V6 4motion	04.03 -	1710	1720	E90-85-013-02-22	A, 12, 18, 78, 97,	30	30							T
TRANSPORTER V Kasten (7HA, 7HH, 7EA, 7EH) TRANSPORTER V Box (7HA, 7HH, 7EA, 7EH) Pro-Kit (Performance Fahrwerksfedern Performance Springs) 1.9 TDI, 2.0, 2.0 BiTDI, 2.0 BiTDI 4motion, 2.0 TDI, 2.0 TDI 4motion, 2.0 TSI, 2.0 TSI 4motion	04.03 -	1550	1720	E10-85-013-01-22	A, 12, 18	30	30					F11-85-013-01-VA	F11-85-013-01-HA	T
2.0 BiTDI, 2.0 BiTDI 4motion, 2.0 TDI, 2.0 TDI 4motion, 2.0 TSI, 2.0 TSI 4motion, 2.5 TDI, 2.5 TDI 4motion, 3.2 4motion, 3.2 V6	04.03 -	1710	1720	E10-85-013-02-22	A, 12, 18	30	30					F11-85-013-02-VA	F11-85-013-01-HA	T

Modell	Baujahr	Achslast Vorne kg	Achslast Hinten kg	Artikel-Nr.	Hinweise	ca. Tieferl. Vorne mm	ca. Tieferl. Hinten mm	Ø Vorne mm	Ø Hinten mm	Verstellbarkeit Vorne	Verstellbarkeit Hinten	Ersatzteilbezeichnung Vorne	Ersatzteilbezeichnung Hinten	Gutachten	
Model	Year	Front Axle Load kg	Rear Axle Load kg	Part-No.	Notes	ca. Lowering Front mm	ca. Lowering Rear mm	Ø Front mm	Ø Rear mm	Adjustable Front	Adjustable Rear	Spare Part Marking Front	Spare Part Marking Rear	Homologation	
TRANSPORTER V Kasten (7HA, 7HH, 7EA, 7EH) TRANSPORTER V Box (7HA, 7HH, 7EA, 7EH) B12 Pro-Kit (Performance Komplettfahrwerke Performance Springs+Shocks) 1.9 TDI, 2.0, 2.0 BiTDI, 2.0 BiTDI 4motion, 2.0 TDI, 2.0 TDI 4motion, 2.0 TSI, 2.0 TSI 4motion	04.03 -	1550	1720	E90-85-013-01-22	A, 12, 18, 78, 97,	161	30	30						T	
2.0 BiTDI, 2.0 BiTDI 4motion, 2.0 TDI, 2.0 TDI 4motion, 2.5 TDI, 2.5 TDI 4motion, 3.2 4motion, 3.2 V6	04.03 -	1710	1720	E90-85-013-02-22	A, 12, 18, 78, 97,	161	30	30						T	
TRANSPORTER V Pritsche/Fahrgestell (7JD, 7JE, 7JL, 7JY, 7JZ, 7FD, 7FE, 7FL, 7FY, 7FZ) TRANSPORTER V Platform/Chassis (7JD, 7JE, 7JL, 7JY, 7JZ, 7FD, 7FE, 7FL, 7FY, 7FZ) Pro-Kit (Performance Fahrwerksfedern Performance Springs) 1.9 TDI, 2.0, 2.0 BiTDI, 2.0 BiTDI 4motion, 2.0 TDI, 2.0 TDI 4motion, 2.0 TSI	04.03 -	1550	1720	E10-85-013-01-22	A, 12, 18		30	30				F11-85-013-01-VA	F11-85-013-01-HA	T	
2.0 BiTDI, 2.0 BiTDI 4motion, 2.0 TDI, 2.0 TDI 4motion, 2.0 TSI, 2.5 TDI, 2.5 TDI 4motion, 3.2 V6	04.03 -	1710	1720	E10-85-013-02-22	A, 12, 18		30	30				F11-85-013-02-VA	F11-85-013-01-HA	T	
B12 Pro-Kit (Performance Komplettfahrwerke Performance Springs+Shocks) 1.9 TDI, 2.0, 2.0 TDI, 2.0 TDI 4motion	04.03 -	1550	1720	E90-85-013-01-22	A, 12, 18, 78, 97,	161	30	30						T	
2.0 BiTDI, 2.0 BiTDI 4motion, 2.0 TDI, 2.0 TDI 4motion, 2.5 TDI, 2.5 TDI 4motion, 3.2 V6	04.03 -	1710	1720	E90-85-013-02-22	A, 12, 18, 78, 97,	161	30	30						T	
UP Pro-Kit (Performance Fahrwerksfedern Performance Springs) 1.0	12.11 -	680	640	E10-85-040-01-22	A, 18, 20		20	25				F11-85-040-01-VA	F11-85-040-01-HA	T	
VENTO (1H2) Pro-Kit (Performance Fahrwerksfedern Performance Springs) 1.4, 1.6, 1.8, 1.9 D, 1.9 TD, 1.9 TDI, 2.0, 2.0 GL, 2.8 VR6	11.91 - 08.94	980	840	E8530-140	A, 18, 19, 20		30	30				F8530001	F8502002	T	
1.4, 1.6, 1.8, 1.9 D, 1.9 SDI, 1.9 TD, 1.9 TDI, 2.0, 2.0 GL, 2.8 VR6	11.91 - 09.98	980	840	E8547-140	A, 18, 19, 20		30	30				F8547001	F8502002	T	
Sportline (Performance Fahrwerksfedern Sport Sport Performance Springs) 1.4, 1.6, 1.8, 1.9 D, 1.9 SDI, 1.9 TD, 1.9 TDI, 2.0, 2.0 GL, 2.8 VR6	11.91 - 09.98	950	840	E20-85-003-01-22	A, 20		45-50	30-35				F21-85-003-01-VA	F21-85-003-01-HA	T	
Anti-Roll-Kit (Performance Stabilisatoren Performance Sway Bars) 1.4, 1.6, 1.8, 1.9 D, 1.9 SDI, 1.9 TD, 1.9 TDI, 2.0, 2.0 GL	11.91 - 09.98			E8502-320	A, 18, 20, 22, 45				22	25	nicht verstellbar not adjustable	nicht verstellbar not adjustable	AS8502320VA	AS8502320HA	T
2.8 VR6	01.92 - 09.98			E8530-320	A, 18, 20, 22, 45				22	25	nicht verstellbar not adjustable	nicht verstellbar not adjustable	AS8530320VA	AS8502320HA	T
B12 Pro-Kit (Performance Komplettfahrwerke Performance Springs+Shocks) 1.4, 1.6, 1.8, 1.9 D, 1.9 TD, 1.9 TDI, 2.0, 2.0 GL, 2.8 VR6	11.91 - 08.94	980	840	E90-85-003-01-22	A, 18, 20, 78, 93,	161	30	30						T	
1.4, 1.6, 1.8, 1.9 D, 1.9 TD, 1.9 TDI, 2.0, 2.0 GL, 2.8 VR6	11.91 - 09.98	980	840	E90-85-003-02-22	A, 18, 20, 78, 94,	161	30	30						T	
B12 Sportline (Performance Komplettfahrwerke Sport Sport Performance Springs+Shocks) 1.4, 1.6, 1.8, 1.9 D, 1.9 SDI, 1.9 TDI, 1.9 TDI, 2.0, 2.0 GL, 2.8 VR6	11.91 - 09.98	950	840	E95-85-003-01-22	A, 18, 20, 78, 93,	161	45-50	30-35						T	
1.4, 1.6, 1.8, 1.9 D, 1.9 SDI, 1.9 TD, 1.9 TDI, 2.0, 2.0 GL, 2.8 VR6	11.91 - 09.98	950	840	E95-85-003-03-22	A, 18, 20, 78, 94,	161	45-50	30-35						T	
Pro-Street-S (Gewindefahrwerke - höhenverstellbar Coil-Overs-Adjustable Ride Height) 1.4, 1.6, 1.8, 1.9 D, 1.9 SDI, 1.9 TD, 1.9 TDI, 2.0, 2.0 GL, 2.8 VR6	11.91 - 09.98	890	880	PSS65-85-003-01-22	A, 20, 24, 25, 26,	45, 160	45-80	45-80						T	
1.4, 1.6, 1.8, 1.9 D, 1.9 SDI, 1.9 TD, 1.9 TDI, 2.0, 2.0 GL, 2.8 VR6	11.91 - 09.98	980	880	PSS65-85-003-02-22	A, 20, 24, 25, 26,	45, 160	45-80	45-85						T	
850 Kombi (LW) 850 Estate (LW) Pro-Kit (Performance Fahrwerksfedern Performance Springs) 2.0, 2.0 Turbo, 2.3 T5, 2.3 T5 R, 2.3 T5-R, 2.5, 2.5 TDI	08.92 - 10.97	1110	1010	E8410-140	A, 18, 20		30	30				F8417001	F8410002	T	
C30 Pro-Kit (Performance Fahrwerksfedern Performance Springs) 1.6, 1.6 D, 1.6 D2, 1.8, 1.8 FlexFuel, 2.0, 2.0 FlexFuel	10.06 -	1020	900	E10-84-011-03-22	A, 18, 20		30	30				F11-55-008-02-VA	F11-84-011-01-HA	T	
2.0 D, 2.4 i, D3, D4, D5, T5	10.06 -	1140	900	E10-84-011-01-22	A, 18, 20		30	30				F11-84-006-07-VA	F11-84-011-01-HA	T	
B12 Pro-Kit (Performance Komplettfahrwerke Performance Springs+Shocks) 1.6, 1.6 D, 1.6 D2, 1.8, 1.8 FlexFuel, 2.0, 2.0 FlexFuel	10.06 -	1020	900	E90-84-011-03-22	A, 18, 20, 78, 161		30	30						T	
2.0 D, 2.4 i, D3, D4, D5, T5	10.06 -	1140	900	E90-84-011-01-22	A, 18, 20, 78, 161		30	30						T	
C70 I Coupe Pro-Kit (Performance Fahrwerksfedern Performance Springs) 2.0, 2.0 T, 2.3 T-5, 2.5, 2.5 T	03.97 - 09.02	1110	1010	E8420-140	A, 18, 20		20	20				F8417001	F8410002	T	
C70 II Cabriolet C70 II Convertible Pro-Kit (Performance Fahrwerksfedern Performance Springs) 2.0 D, 2.4, 2.4 i, D3, D4, T5	03.06 -	1140	1080	E10-84-009-01-22	A, 18, 20		30	30				F11-84-006-07-VA	F11-35-014-01-HA	T	
S40 I (VS) Pro-Kit (Performance Fahrwerksfedern Performance Springs) 1.6, 1.8, 1.8 i, 1.9 Di, 1.9 T4, 1.9 TD, 2.0, 2.0 T	07.95 - 12.03	960	905	E8415-140	A, 18, 20		30	30				F8415001	F8415002	T	
S40 II (MS) Pro-Kit (Performance Fahrwerksfedern Performance Springs) 1.6, 1.6 D, 1.6 D2, 1.8, 1.8 FlexFuel, 2.0, 2.0 F	04.04 -	1020	1010	E10-84-006-14-22	A, 18, 20		25	25				F11-55-008-02-VA	F11-84-006-07-HA	T	
2.0 D, 2.0 D4, 2.4, 2.4 D5, D3, D4, T5	01.04 -	1140	1010	E10-84-006-07-22	A, 18, 20		25	25				F11-84-006-07-VA	F11-84-006-07-HA	T	
2.4 AWD, T5 AWD	04.04 -	1140	1080	E10-84-006-13-22	A, 18		30	30				F11-84-006-07-VA	F11-35-014-01-HA	T	
B12 Pro-Kit (Performance Komplettfahrwerke Performance Springs+Shocks) 1.6, 1.6 D, 1.6 D2, 1.8, 1.8 FlexFuel, 2.0, 2.0 F	04.04 -	1020	1010	E90-84-006-01-22	A, 18, 20, 78, 161		25	25						T	

Modell	Baujahr	Achslast Vorne kg	Achslast Hinten kg	Artikel-Nr.	Hinweise	ca. Tieferl. Vorne mm	ca. Tieferl. Hinten mm	Ø Vorne mm	Ø Hinten mm	Verstellbarkeit Vorne	Verstellbarkeit Hinten	Ersatzteilbezeichnung Vorne	Ersatzteilbezeichnung Hinten	Gutachten
Model	Year	Front Axle Load kg	Rear Axle Load kg	Part-No.	Notes	ca. Lowering Front mm	ca. Lowering Rear mm	Ø Front mm	Ø Rear mm	Adjustable Front	Adjustable Rear	Spare Part Marking Front	Spare Part Marking Rear	Homologation
S40 II (MS) B12 Pro-Kit (Performance Komplettfahrwerke Performance Springs+Shocks) 2.0 D, 2.0 D4, 2.4, 2.4 D5, D3, D4, T5	01.04 -	1140	1010	E90-84-006-02-22	A, 18, 20, 78, 161	25	25							T
Pro-Street-S (Gewindefahrwerke - höhenverstellbar Coil-Overs-Adjustable Ride High) 2.0 D, 2.0 D4, 2.4, T5	01.04 -	1080	1010	PSS65-84-006-01-22	A, 24, 25, 26, 45, 160	25-55	25-55							T
S60 Pro-Kit (Performance Fahrwerksfedern Performance Springs) 2.0 T, 2.3 T5, 2.4, 2.4 T, 2.4 T5, 2.5 T, T5	07.00 - 04.10	1110	1120	E10-84-004-01-22	A, 18, 20	30	30					F8421001	F11-84-004-01-HA	T
2.4 T AWD	11.01 - 04.10	1110	1170	E10-84-004-05-22	A, 18, 21	30	30					F8421001	F11-84-003-03-HA	T
2.5 T AWD, R 2.5 T AWD	03.03 - 04.10	1110	1170	E10-84-004-08-22	A, 18	30	30					F8421001	F11-84-004-08-HA	T
2.4 D, 2.4 D5	07.01 - 04.10	1120	1120	E10-84-004-02-22	A, 18, 20	30	30					F11-84-003-02-VA	F11-84-004-01-HA	T
B12 Pro-Kit (Performance Komplettfahrwerke Performance Springs+Shocks) 2.0 T, 2.3 T5, 2.4, 2.4 T, 2.4 T5, T5	07.00 - 04.10	1110	1120	E90-84-004-01-22	A, 18, 20, 78, 161	30	30							T
2.4 D, 2.4 D5, 2.5 T	07.01 - 04.10	1110	1120	E90-84-004-02-22	A, 18, 20, 78, 161	30	30							T
S60 II Pro-Kit (Performance Fahrwerksfedern Performance Springs) 2.0 T, D3, D5, DRIVE / D2, T3, T4, T4F, T5	04.10 -	1180	960	E10-84-014-01-22	A, 18, 20	30	30					F11-35-019-02-VA	F11-84-010-01-HA	T
D3, D5	04.10 -	1250	960	E10-84-014-02-22	A, 18, 20	30	30					F11-84-010-01-VA	F11-84-010-01-HA	T
D5 AWD, T6 AWD	04.10 -	1250	1145	E10-84-014-03-22	A, 18	30	30					F11-84-010-01-VA	F11-35-019-03-HA	T
S80 II (AS) Pro-Kit (Performance Fahrwerksfedern Performance Springs) 2.4 D, 2.5 T, 2.5 T AWD, 2.5 T FlexFuel, 3.2, 3.2 AWD, D3, D5, D5 AWD, T6 AWD	03.06 -	1270	1210	E10-84-010-01-22	A, 18	30	30					F11-84-010-01-VA	F11-84-010-01-HA	T
4.4 V8 AWD	03.06 -	1300	1210	E10-84-010-03-22	A, 18	30	30					F11-84-010-03-VA	F11-84-010-01-HA	T
B12 Pro-Kit (Performance Komplettfahrwerke Performance Springs+Shocks) 2.4 D, 2.5 T, 2.5 T FlexFuel, 3.2, D5	03.06 -	1270	1210	E90-84-010-01-22	A, 18, 78, 161	30	30							T
V40 Kombi (VW) V40 Estate (VW) Pro-Kit (Performance Fahrwerksfedern Performance Springs) 1.6, 1.8, 1.8 i, 1.9 Di, 1.9 TD, 2.0, 2.0 T	07.95 - 06.04	960	905	E8415-140	A, 18, 20	30	30					F8415001	F8415002	T
V40 Schrägheck V40 Hatchback Pro-Kit (Performance Fahrwerksfedern Performance Springs) D2, D3, D4, T2 GTDi, T3 GTDi, T4, T4 GTDi	03.12 -	1020	1010	E10-84-006-14-22	A, 18, 20	30	30					F11-55-008-02-VA	F11-84-006-07-HA	T
D2, D3, D4, T4, T5	03.12 -	1140	1010	E10-84-006-07-22	A, 18, 20	30	30					F11-84-006-07-VA	F11-84-006-07-HA	T
T4 AWD, T5 AWD	01.13 -	1140	1080	E10-84-006-13-22	A, 18	30	30					F11-84-006-07-VA	F11-35-014-01-HA	T
V50 (MW) Pro-Kit (Performance Fahrwerksfedern Performance Springs) 1.6, 1.6 D, 1.6 D2, 1.8, 1.8 FlexFuel, 2.0, 2.0 FlexFuel	04.04 -	1020	1010	E10-84-006-14-22	A, 18, 20	25	25					F11-55-008-02-VA	F11-84-006-07-HA	T
2.0 D, 2.4, 2.4 D5, 2.4 Tdi, D3, D4, T5	04.04 -	1140	1010	E10-84-006-07-22	A, 18, 20	25	25					F11-84-006-07-VA	F11-84-006-07-HA	T
2.4 AWD, T5 AWD	04.04 -	1140	1080	E10-84-006-13-22	A, 18	30	30					F11-84-006-07-VA	F11-35-014-01-HA	T
B12 Pro-Kit (Performance Komplettfahrwerke Performance Springs+Shocks) 1.6, 1.6 D, 1.6 D2, 1.8, 1.8 FlexFuel, 2.0, 2.0 FlexFuel	04.04 -	1020	1010	E90-84-006-01-22	A, 18, 20, 78, 161	25	25							T
2.0 D, 2.4, 2.4 D5, 2.4 Tdi, D3, D4, T5	04.04 -	1140	1010	E90-84-006-02-22	A, 18, 20, 78, 161	25	25							T
Pro-Street-S (Gewindefahrwerke - höhenverstellbar Coil-Overs-Adjustable Ride High) 2.0 D, 2.4, 2.4 D5, 2.4 Tdi, D3, D4, T5	04.04 -	1080	1010	PSS65-84-006-01-22	A, 24, 25, 45, 160	25-55	25-55							T
V60 Pro-Kit (Performance Fahrwerksfedern Performance Springs) 1.6 DRIVE, 2.0 T, 2.4 D5, D3 / D4, D5, T3, T4, T4F, T5	09.10 -	1180	1145	E10-84-014-07-22	A, 18, 20	30	30					F11-35-019-02-VA	F11-35-019-03-HA	T
2.4 D5, D3 / D4, D5	09.10 -	1250	1145	E10-84-014-03-22	A, 18, 20	30	30					F11-84-010-01-VA	F11-35-019-03-HA	T
2.4 D5 AWD, D5 AWD, T6 AWD	09.10 -	1250	1145	E10-84-014-03-22	A, 18	30	30					F11-84-010-01-VA	F11-35-019-03-HA	T
V70 I (P80.) Pro-Kit (Performance Fahrwerksfedern Performance Springs) 2.0, 2.0 Turbo, 2.3 T-5, 2.3 Turbo, 2.4, 2.4 Turbo, 2.5 TDI	01.97 - 05.00	1110	1010	E8410-140	A, 18, 20	30	30					F8417001	F8410002	T
V70 II (P80.) Pro-Kit (Performance Fahrwerksfedern Performance Springs) 2.0 T, 2.3 T5, 2.4, 2.4 T, 2.4 T5	03.00 - 08.07	1110	1170	E10-84-003-01-22	A, 18, 20	30	30					F8421001	F11-84-003-01-HA	T
2.4 D, 2.4 D5, 2.5 T, 2.5 TDI	03.00 - 08.07	1120	1170	E10-84-003-02-22	A, 18, 20	30	30					F11-84-003-02-VA	F11-84-003-01-HA	T
B12 Pro-Kit (Performance Komplettfahrwerke Performance Springs+Shocks) 2.0 T, 2.3 T5, 2.4, 2.4 T, 2.4 T5	03.00 - 08.07	1100	1170	E90-84-003-01-22	A, 18, 20, 78, 161	30	30							T
2.4 D, 2.4 D5, 2.5 T, 2.5 TDI	03.00 - 08.07	1120	1170	E90-84-003-02-22	A, 18, 20, 78, 161	30	30							T
V70 III Pro-Kit (Performance Fahrwerksfedern Performance Springs) 2.4 D, 2.5 T, 2.5 T FlexiFuel, 3.2, D3 / D4, D5	08.07 -	1270	1220	E10-84-012-01-22	A, 18, 20	30	30					F11-84-010-01-VA	F11-35-017-01-HA	T
3.2 AWD, T6 AWD	08.07 -	1300	1220	E10-84-012-03-22	A, 18	30	30					F11-84-010-03-VA	F11-35-017-01-HA	T

Modell	Baujahr	Achslast Vorne kg	Achslast Hinten kg	Artikel-Nr.	Hinweise	ca. Tieferl. Vorne mm	ca. Tieferl. Hinten mm	Ø Vorne mm	Ø Hinten mm	Verstellbarkeit Vorne	Verstellbarkeit Hinten	Ersatzteilbezeichnung Vorne	Ersatzteilbezeichnung Hinten	Gutachten
Model	Year	Front Axle Load kg	Rear Axle Load kg	Part-No.	Notes	ca. Lowering Front mm	ca. Lowering Rear mm	Ø Front mm	Ø Rear mm	Adjustable Front	Adjustable Rear	Spare Part Marking Front	Spare Part Marking Rear	Homologation
XC60 Pro-Kit (Performance Fahrwerksfedern Performance Springs) 2.4 D Schaltgetriebe, D3 Schaltgetriebe, T5 Schaltgetriebe 2.4 D manual transmission, D3 manual transmission, T5 manual transmission	07.09 -	1260	1310	E10-84-013-03-22	A, 18, 20	25	25					F11-84-010-01-VA	F11-35-019-03-HA	T
2.4 D, 2.4 D / D3 / D4 AWD, 3.2 AWD, D3, D5, D5 AWD, T5, T6 AWD	05.08 -	1290	1310	E10-84-013-01-22	A, 18	25	25					F11-84-010-03-VA	F11-35-019-03-HA	T
XC70 II Pro-Kit (Performance Fahrwerksfedern Performance Springs) 2.4 D AWD, 3.2 AWD, D3 AWD, D5 AWD, T6 AWD	08.07 -	1270	1210	E10-84-012-05-22	A, 18	25	20					F11-84-010-01-VA	F11-84-010-01-HA	T
XC90 Pro-Kit (Performance Fahrwerksfedern Performance Springs) 2.5 T, 3.2, 3.2 AWD, D3 / D5, D5, T6, V8	10.02 -	1330	1470	E10-84-007-01-22	A, 18, 47	30	30					F11-84-007-01-VA	F11-84-007-01-HA	T



PRO-SPACER

Systemerklärung | System Description

System 1

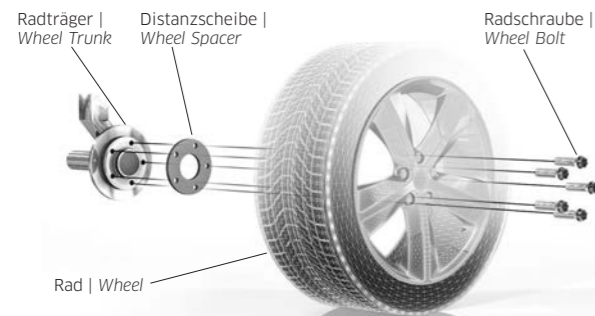

- Scheibe ausgeführt als Durchstecksystem
 - Mit Zentrierbohrung
 - Spurweitenänderung von 10 bis 20 mm (Scheibendicke 5 bis 10 mm)
 - Befestigung mittels längerer Radschrauben
 - **Lieferung ohne Befestigungsteile (gesondert zu bestellen)**
- Disc with a pass-through system
 - With centering boring
 - Track change from 10 to 20 mm (disc thickness from 5 to 10 mm)
 - Fastening by using longer wheel bolts
 - **Delivery without attachment parts (to order separately)**

System 2

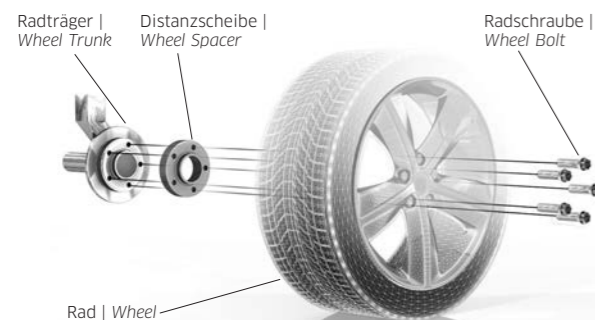

- Scheibe ausgeführt als Durchstecksystem
 - Mit Zentrierbund (Zentriernase)
 - Spurweitenänderung von 14 bis 40 mm (Scheibendicke 7 bis 20 mm)
 - Befestigung mittels längerer Radschrauben
 - **Lieferung ohne Befestigungsteile (gesondert zu bestellen)**
- Disc with a pass-through system
 - With centering collar (centering nose)
 - Track change from 14 to 40 mm (disc thickness from 7 to 20 mm)
 - Fastening by using longer wheel bolts
 - **delivery without attachment parts (to order separately)**

System 3 | 7

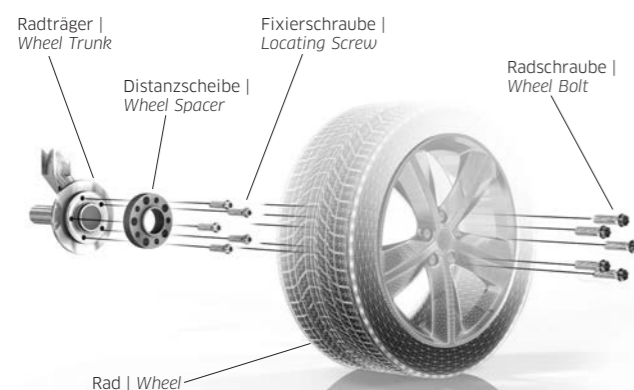

- Scheibe ausgeführt als Schraubsystem
 - Mit Zentrierbund (Zentriernase)
 - Spurweitenänderung von 40 bis 60 mm (Scheibendicke 20 bis 30 mm)
 - Befestigung:
 - a) Scheibe am Radträger: mittels Spezial-Fixierschrauben
 - b) Rad an Scheibe: mittels Serien- (bzw. Zubehör-) schraube
 - **Lieferung inkl. Befestigungsteile**
 - System 7: mit Stahlgewindebuchsen
- Disc with a screw system
 - With centering collar (centering nose)
 - Track change from 40 to 60 mm (disc thickness from 20 to 30 mm)
 - Fastening:
 - a) disc at wheel carrier: by using special fixing bolts
 - b) wheel at disc: by using production (or accessory-wheel-) bolts
 - **Delivery with attachment parts**
 - System 7: with steel bushing

PRO-SPACER

Systemerklärung | System Description

System 4 | 8

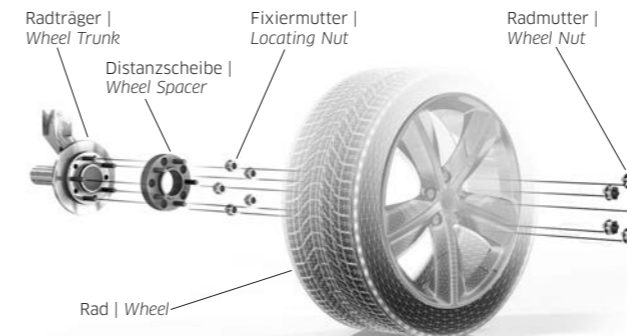

- Scheibe ausgeführt als Schraubsystem
 - Mit Zentrierbund (Zentriernase)
 - Spurweitenänderung von 30 bis 60 mm (Scheibendicke 15 bis 30 mm)
 - Befestigung:
 - a) Scheibe am Radträger: mittels Spezial-Fixiermutter
 - b) Rad an Scheibe: mittels Serien- (bzw. Zubehör-) mutter
 - **Lieferung inkl. Befestigungsteile**
 - **System 8: ohne Zentrierbund (für Geländefahrzeuge)**
- Disc with a screw system
 - With centering collar (centering nose)
 - Track change from 30 to 60 mm (disc thickness from 15 to 30 mm)
 - Fastening:
 - a) disc at wheel carrier: by using special-fixing nut
 - b) wheel at disc: by using production (or accessory) nut
 - **Delivery with attachment parts**
 - **System 8: without centering collar (centeringnose)**

System 5

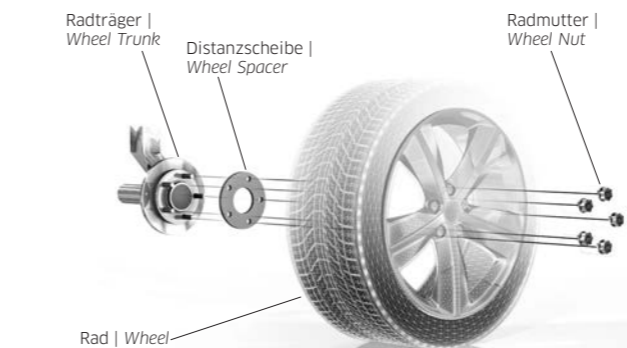

- Scheibe ausgeführt als Durchstecksystem
 - Mit Zentrierbohrung
 - Spurweitenänderung von 10 bis 16 mm (Scheibendicke 5 bis 8 mm)
 - Befestigung mittels längerer Rändelbolzen (am Fahrzeug auszutauschen)
 - **Lieferung inkl. Befestigungsteile (für Serienräder bzw. Räder mit Serienbefestigung)**
- Disc with a pass-through system
 - With centering boring
 - Track change from 10 to 16 mm (disc thickness from 5 to 8 mm)
 - Fastening by using longer knurled stud (to change at the automobile)
 - **Delivery with attachment parts (for standard wheels or wheels with standard fixing)**

System 6

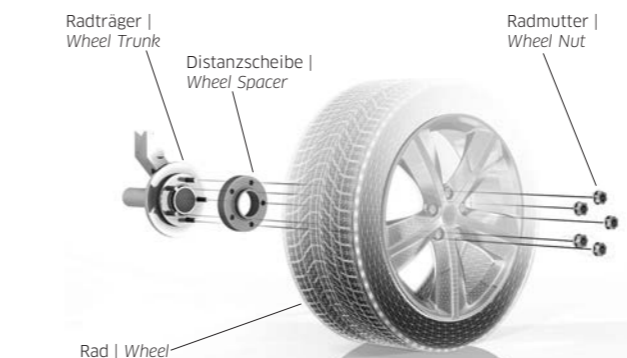

- Scheibe ausgeführt als Durchstecksystem
 - mit Zentrierbund (Zentriernase)
 - Spurweitenänderung von 20 bis 40 mm (Scheibendicke 10 bis 20 mm)
 - Befestigung mittels längerer Rändelbolzen (am Fahrzeug auszutauschen)
 - **Lieferung inkl. Befestigungsteile (für Serienräder bzw. Räder mit Serienbefestigung)**
- Disc with a pass-through system
 - With centering collar (centering nose)
 - Track change from 20 to 40 mm (disc thickness from 10 to 20 mm)
 - Fastening by using longer knurled stud (to change at the automobile)
 - **Delivery with attachment parts (for standard wheels or wheels with standard fixing)**



PRO-SPACER | Kitbestückung

Inhalte der Pro-Spacer-Verpackungen

System 1

- Zwei Pro-Spacer
- Montageanleitung und Gutachten auf CD
- Längere Radschrauben müssen gesondert bestellt werden! Bei Verwendung von Zubehörteilen variieren die Radschrauben. Kopf- und Schaftlänge der Radschraube müssen daher erst ermittelt werden. Bitte die Checkliste ausfüllen!

System 2

- Zwei Pro-Spacer
- Montageanleitung und Gutachten auf CD
- Längere Radschrauben müssen gesondert bestellt werden! Bei Verwendung von Zubehörteilen variieren die Radschrauben. Kopf- und Schaftlänge der Radschraube müssen daher erst ermittelt werden. Bitte die Checkliste ausfüllen!

System 3 | 7

- Zwei Pro-Spacer
- Spezial-Fixierschrauben
- Montageanleitung und Gutachten auf CD

System 4 | 8

- Zwei Pro-Spacer mit bereits eingepressten Rändelbolzen
- Kurze Spezial-Muttern (Fixiermuttern)
- Montageanleitung und Gutachten auf CD

System 5

- Zwei Pro-Spacer
- Längere Rändelbolzen
- Montageanleitung und Gutachten auf CD

System 6

- Zwei Pro-Spacer
- Längere Rändelbolzen
- Montageanleitung und Gutachten auf CD

Die Inhalte können variieren.

PRO SPACER | *Bill of Materials*

Contents of the Pro-Spacer-Packages

System 1

- Two Pro-Spacer
- Installation instructions and information on CD
- Longer wheel bolts must be ordered separately! As the wheel bolts can vary for example when accessory wheels are mounted, the head form and length of shaft of the wheel installed at present must be determined, so that we can supply the suitable replacement! In this case, we require the filled-out Checklist from you!

System 2

- Two Pro-Spacer
- Installation instructions and information on CD
- Longer wheel bolts must be ordered separately! As the wheel bolts can vary for example when accessory wheels are mounted, the head form and length of shaft of the wheel installed at present must be determined, so that we can supply the suitable replacement! In this case, we require the filled-out Checklist from you!

System 3 | 7

- Two Pro-Spacer
- Special mounting bolts
- Installation instructions and information on CD

System 4 | 8

- Two Pro-Spacer with pressed-in knurled studs
- Short special wheel nuts
- Installation instructions and information on CD

System 5

- Two Pro-Spacer
- Longer knurled studs
- Installation instructions and information on CD

System 6

- Two Pro-Spacer
- Longer knurled studs
- Installation instructions and information on CD

Contents may vary.



DOMINATE THE TRACK. RULE THE STREET.

Audi Sport
customer racing
official supplier

ANLEITUNG

zum Ausmessen eines Fahrzeuges zur Ermittlung der passenden Pro-Spacer

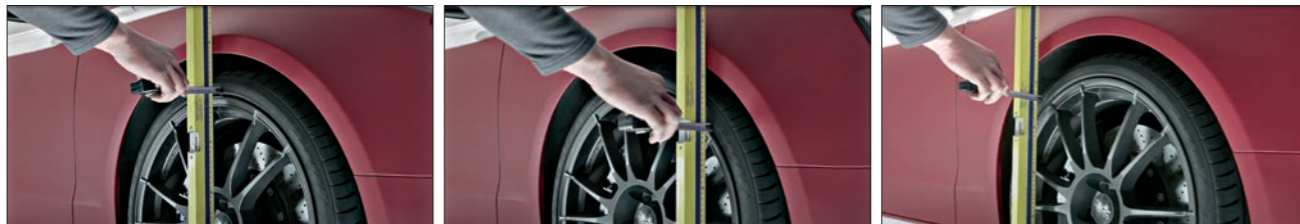
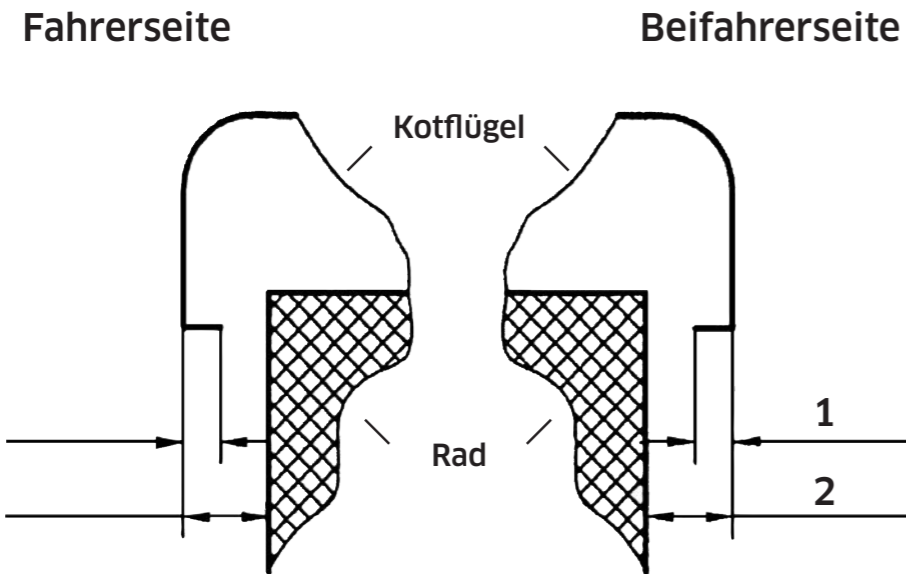

Vorgehensweise:

Am Außenkotflügel ein Lot fällen (z.B. mit einer Wasserwaage)

- Den Abstand von der Reifenflanke zur Wasserwaage messen (Maß 2)
- Die Kotflügelkante messen (Maß 1)
- Maß 1 von Maß 2 abziehen (gegebenenfalls zusätzlich 3 bis 5 mm als Sicherheit)
- So erhalten Sie ein ungefähres Maß, welches man als Spurverbreiterung pro Seite montieren kann

Bitte beachten:

Man sollte immer Fahrer und Beifahrerseite messen, da es produktionsbedingte Toleranzen und Achsverstellungen geben kann und somit die Maße von der Fahrer- zur Beifahrerseite unterschiedlich sein können.

In einem solchen Fall ist das kleinere Maß anzunehmen! Ferner sind in das Radhaus ragende Teile zu berücksichtigen (z.B. Schrauben, Ausbuchtungen des Innenkotflügels)

Das Maß 2 kann je nach verwendeter Rad-Reifenkombination stark variieren, weshalb man keine pauschale Aussage treffen kann, welcher Pro-Spacer verwendet werden sollte. Es ist immer erforderlich zu messen.

Bitte verwenden Sie die Pro-Spacer-Checkliste.

MANUAL

for Measurement of a Vehicle to Detect the Matching Pro-Spacer

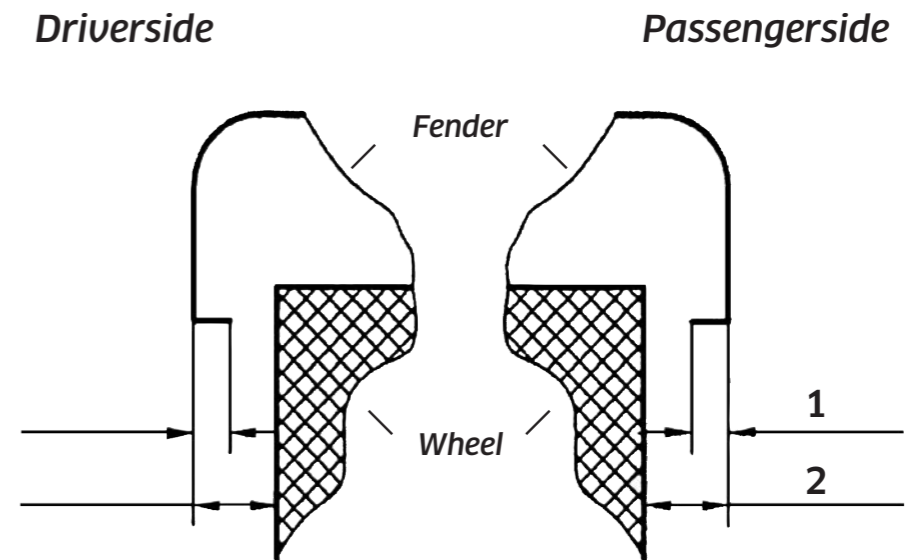

Procedure:

Measuring is very important

How to measure:

- Measure distance 1 and 2 as shown in the picture
- Subtract measurement 1 from measurement 2 (minus 3 to 5 mm safety)
- This way you will obtain an approximately measurement of which kind of spacer fits on each side

Please note:

You should always measure both - the driver and passenger side, because axle hub locations may differ slightly from side to side. In this case you choose the lower measurement! Additionally you should pay attention to parts in the fender (for example screws, inner fender linings, et cetera).

Please use the Pro-Spacer-Checklist.

More Video-Infos:



eibach.com eibach.com

CHECKLISTE

PRO-SPACER

Datum

 ANFRAGE

 BESTELLUNG

Bitte Checkliste vollständig ausfüllen und an Ihren Stützpunkthändler weiterleiten!*

Adresse: Telefon | Fax:

..... e-Mail:

KFZ-DATEN:

Hersteller|Typ: Baujahr:

Schl.-Nr.: zu 2(2.1): zu 3(2.2): Lochanzahl der Felge: 3 4 5

Bitte ermitteln Sie nun anhand der montierten Schrauben die Schraubenart und die Schaftlänge:

-
- Kegelschraube 60°
-
-
- mit beweglichem Kegel

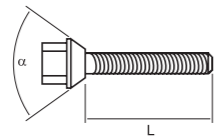

-
- Flachbundschraube

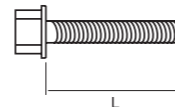

-
- Kugelschraube
-
- (z.B. VAG | MB-Original-Räder)
-
-
- mit beweglicher Kugel

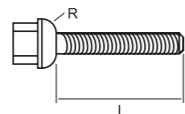

-
- Rändelbolzen
-
- (Sind im Lieferumfang enthalten - Bitte beachten Sie hierzu die Hinweise im Katalog und Internet)

Schaftlänge (L - immer angeben!): mm

Ich möchte folgende Eibach-Pro-Spacer Spurverbreiterungen montieren:

Vorderachse mm pro Seite | Hinterachse mm pro Seite

Bitte tragen Sie hier unsere Artikelnummern ein:

VORDERACHSE

Pro-Spacer-Nr.: Schrauben-Nr.:

HINTERACHSE

Pro-Spacer-Nr.: Schrauben-Nr.:

* Stützpunkthändlerliste, Katalog und Gutachten finden Sie im Internet unter eibach.com



CHECKLIST

PRO-SPACER

Date

 INQUIRY

 ORDER

Please fill out all the spaces below and forward the checklist to your distributor!*

Address: Phone | Fax:

..... e-Mail:

CAR-INFO:

Make: Year:

Model: Number of holes in the wheel: 3 4 5

Please inspect and measure the existing wheel lug bolts or studs to determine the bolt head style | size, thread diameter, shaft-length and pitch:

-
- Taper Head Bolt 60°
-
-
- with loose taper

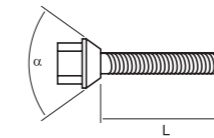

-
- Flat Head Bolt

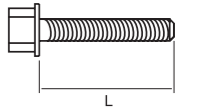

-
- Round Head Bolt
-
- (VAG-original-wheels)
-
-
- with loose round head collar

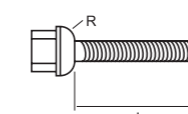

-
- Wheel Stud
-
- (Included in delivery. - Please pay attention to the catalogue- or internet-notes)

Shaft-Length (L - required!): mm

I would like to install following sizes of Eibach-Pro-Spacer:

Front Axle mm per side | Rear Axle mm per side

Please fill out with our material-numbers:

FRONT AXLE

Pro-Spacer-No.: Bolt-No.:

REAR AXLE

Pro-Spacer-No.: Bolt-No.:

* distributor-list and catalogue at eibach.com





DOMINATE THE TRACK. RULE THE STREET.

NUMMERSCHLÜSSEL

Radschrauben

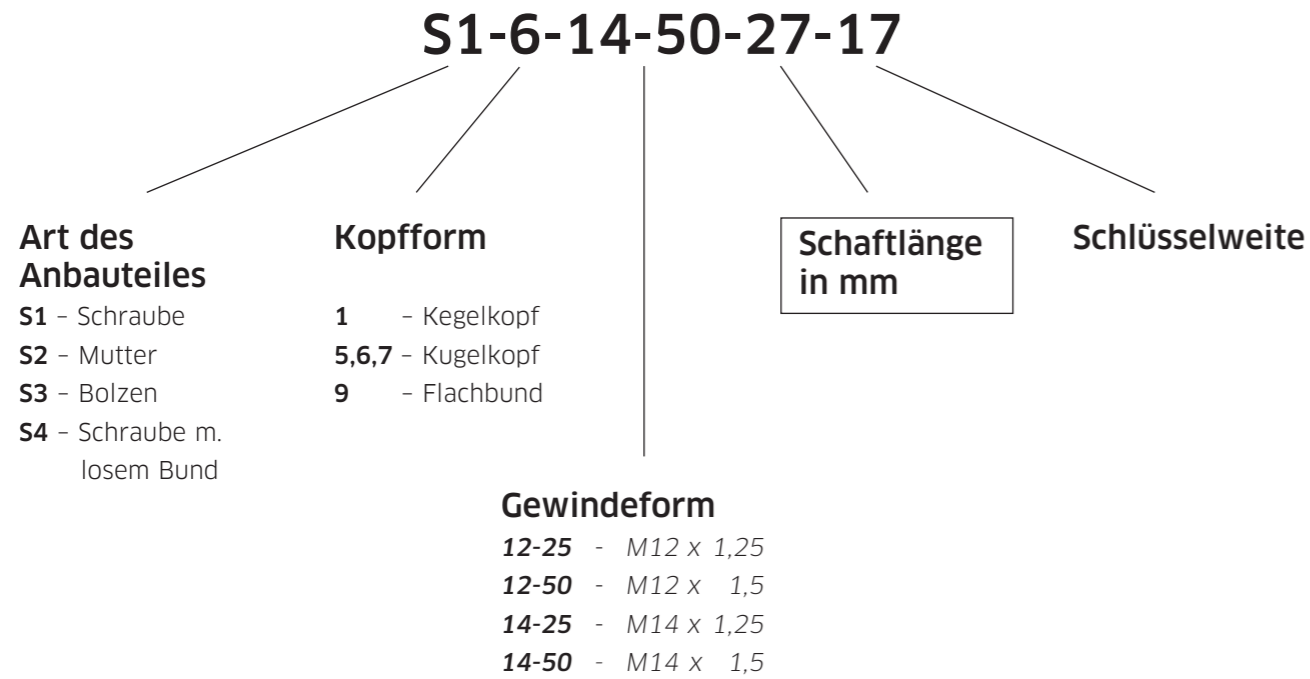

CODING

of Bolt Numbers

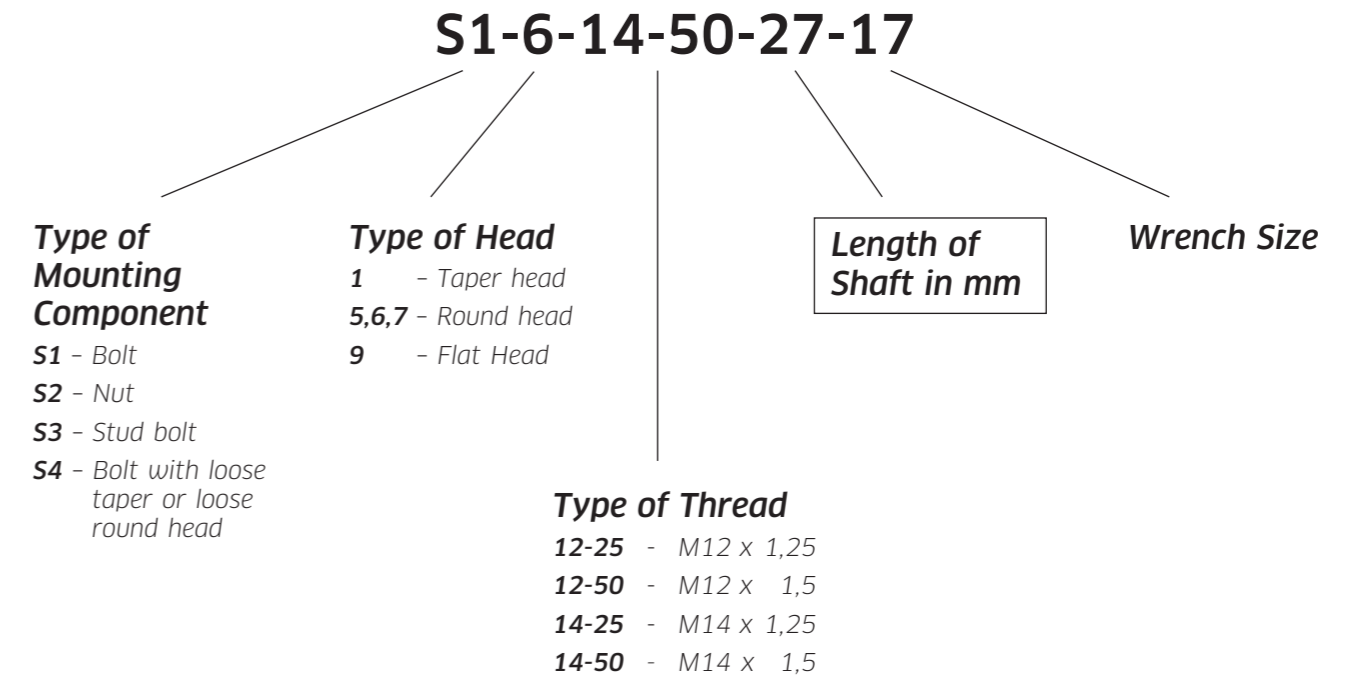

Spurverbreiterungen

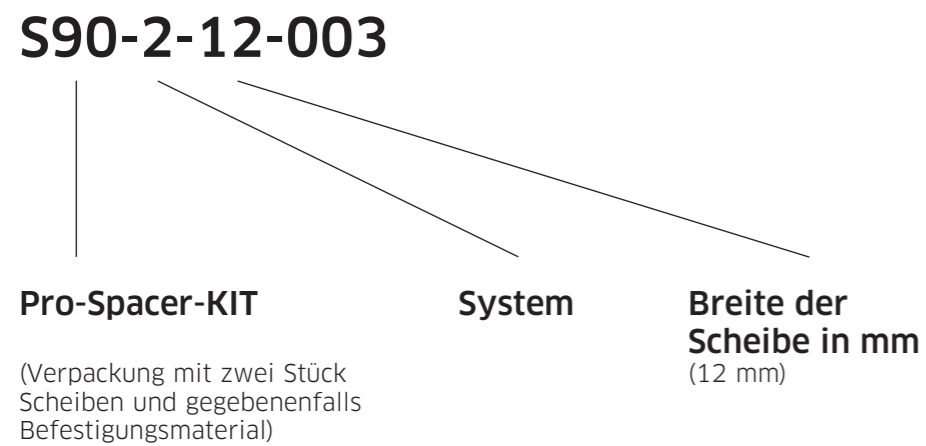

of Wheel Spacers

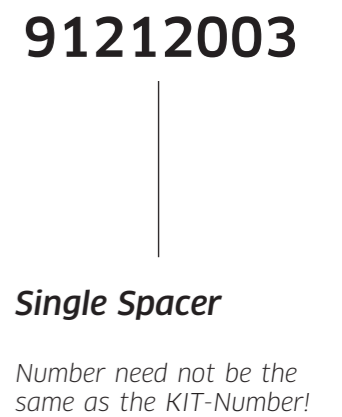
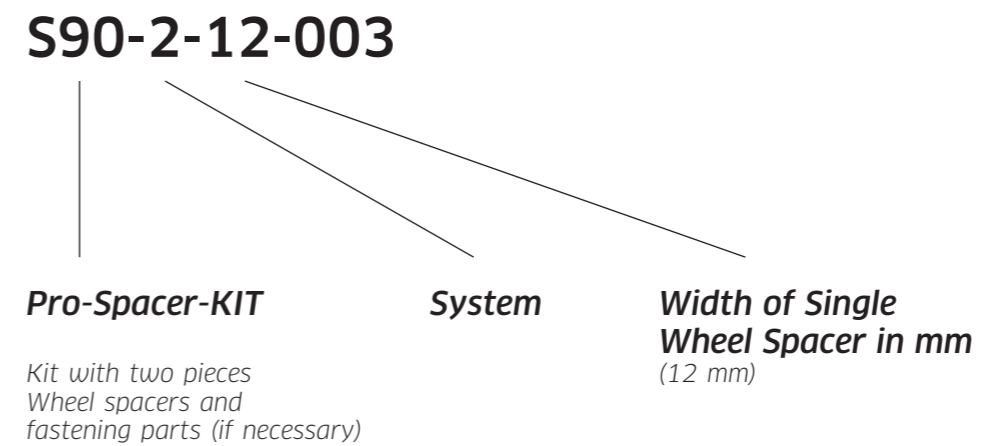

Artikelnummer Part-No.	Gewinde-Schaftlänge Thread Lengh	Schlüsselweite Wrench Size	Bundform Bolt Head Style -Size
---------------------------	-------------------------------------	-------------------------------	-------------------------------------



Kegelbund 60° M12 Taper Head Bolt 60° M12			
S1-1-12-25-19-17-1	M12x1,25x19 Kurzkopf short head	SW17	Kegel 60° Taper Head 60°
S1-1-12-25-24-17-1	M12x1,25x24 Kurzkopf short head	SW17	Kegel 60° Taper Head 60°
S1-1-12-25-27-17	M12x1,25x27	SW17	Kegel 60° Taper Head 60°
S1-1-12-25-32-17	M12x1,25x32	SW17	Kegel 60° Taper Head 60°
S1-1-12-25-37-17	M12x1,25x37	SW17	Kegel 60° Taper Head 60°
S1-1-12-25-39-17	M12x1,25x39	SW17	Kegel 60° Taper Head 60°
S1-1-12-25-42-17	M12x1,25x42	SW17	Kegel 60° Taper Head 60°
S1-1-12-25-47-17	M12x1,25x47	SW17	Kegel 60° Taper Head 60°
S1-1-12-25-52-17	M12x1,25x52	SW17	Kegel 60° Taper Head 60°
S1-1-12-25-57-17	M12x1,25x57	SW17	Kegel 60° Taper Head 60°
S1-1-12-25-26-19	M12x1,25x26	SW19	Kegel 60° Taper Head 60°
S1-1-12-25-28-19	M12x1,25x28	SW19	Kegel 60° Taper Head 60°
S1-1-12-25-32-19	M12x1,25x32	SW19	Kegel 60° Taper Head 60°
S1-1-12-25-36-19	M12x1,25x36	SW19	Kegel 60° Taper Head 60°
S1-1-12-25-38-19	M12x1,25x38	SW19	Kegel 60° Taper Head 60°
S1-1-12-25-40-19	M12x1,25x40	SW19	Kegel 60° Taper Head 60°
S1-1-12-25-43-19	M12x1,25x43	SW19	Kegel 60° Taper Head 60°
S1-1-12-25-46-19	M12x1,25x46	SW19	Kegel 60° Taper Head 60°
S1-1-12-25-50-19	M12x1,25x50	SW19	Kegel 60° Taper Head 60°
S1-1-12-25-55-19	M12x1,25x55	SW19	Kegel 60° Taper Head 60°
S1-1-12-50-19-17-1	M12x1,5x19 Kurzkopf short head	SW17	Kegel 60° Taper Head 60°
S1-1-12-50-24-17	M12x1,5x24	SW17	Kegel 60° Taper Head 60°
S1-1-12-50-24-17-1	M12x1,5x24 Kurzkopf short head	SW17	Kegel 60° Taper Head 60°
S1-1-12-50-26-17	M12x1,5x26	SW17	Kegel 60° Taper Head 60°
S1-1-12-50-28-17	M12x1,5x28	SW17	Kegel 60° Taper Head 60°
S1-1-12-50-30-17	M12x1,5x30	SW17	Kegel 60° Taper Head 60°
S1-1-12-50-32-17	M12x1,5x32	SW17	Kegel 60° Taper Head 60°
S1-1-12-50-35-17	M12x1,5x35	SW17	Kegel 60° Taper Head 60°
S1-1-12-50-39-17	M12x1,5x39	SW17	Kegel 60° Taper Head 60°
S1-1-12-50-43-17	M12x1,5x43	SW17	Kegel 60° Taper Head 60°
S1-1-12-50-45-17	M12x1,5x45	SW17	Kegel 60° Taper Head 60°
S1-1-12-50-47-17	M12x1,5x47	SW17	Kegel 60° Taper Head 60°
S1-1-12-50-50-17	M12x1,5x50	SW17	Kegel 60° Taper Head 60°
S1-1-12-50-55-17	M12x1,5x55	SW17	Kegel 60° Taper Head 60°
S1-1-12-50-60-17	M12x1,5x60	SW17	Kegel 60° Taper Head 60°
S1-1-12-50-24-17-B	M12x1,5x24 schwarz black	SW17	Kegel 60° Taper Head 60°
S1-1-12-50-26-17-B	M12x1,5x26 schwarz black	SW17	Kegel 60° Taper Head 60°
S1-1-12-50-28-17-B	M12x1,5x28 schwarz black	SW17	Kegel 60° Taper Head 60°
S1-1-12-50-30-17-B	M12x1,5x30 schwarz black	SW17	Kegel 60° Taper Head 60°
S1-1-12-50-35-17-B	M12x1,5x35 schwarz black	SW17	Kegel 60° Taper Head 60°
S1-1-12-50-39-17-B	M12x1,5x39 schwarz black	SW17	Kegel 60° Taper Head 60°
S1-1-12-50-43-17-B	M12x1,5x43 schwarz black	SW17	Kegel 60° Taper Head 60°
S1-1-12-50-45-17-B	M12x1,5x45 schwarz black	SW17	Kegel 60° Taper Head 60°
S1-1-12-75-27-19	M12x1,75x27	SW19	Kegel 60° Taper Head 60°
S1-1-12-75-35-19	M12x1,75x35	SW19	Kegel 60° Taper Head 60°
S1-1-12-75-45-19	M12x1,75x45	SW19	Kegel 60° Taper Head 60°
S1-1-12-75-50-19	M12x1,75x50	SW19	Kegel 60° Taper Head 60°



Schrauben mit losem Kegelbund 60° M12 Studs with loose Taper Head 60° M12			
S4-1-12-50-32-17	M12x1,5x32	SW17	Kegel 60° Taper Head 60°
S4-1-12-50-36-17	M12x1,5x36	SW17	Kegel 60° Taper Head 60°
S4-1-12-50-40-17	M12x1,5x40	SW17	Kegel 60° Taper Head 60°
S4-1-12-50-43-17	M12x1,5x43	SW17	Kegel 60° Taper Head 60°
S4-1-12-50-46-17	M12x1,5x46	SW17	Kegel 60° Taper Head 60°
S4-1-12-50-48-17	M12x1,5x48	SW17	Kegel 60° Taper Head 60°
S4-1-12-50-50-17	M12x1,5x50	SW17	Kegel 60° Taper Head 60°
S4-1-12-50-56-17	M12x1,5x56	SW17	Kegel 60° Taper Head 60°
S4-1-12-50-60-17	M12x1,5x60	SW17	Kegel 60° Taper Head 60°

Kegelbund 60° M14 Taper Head Bolt 60° M14			
S1-1-14-25-24-17-1	M14x1,25x24 Kurzkopf short head	SW17	Kegel 60° Taper Head 60°
S1-1-14-25-24-17	M14x1,25x24	SW17	Kegel 60° Taper Head 60°
S1-1-14-25-28-17	M14x1,25x28	SW17	Kegel 60° Taper Head 60°
S1-1-14-25-30-17	M14x1,25x30	SW17	Kegel 60° Taper Head 60°
S1-1-14-25-35-17	M14x1,25x35	SW17	Kegel 60° Taper Head 60°
S1-1-14-25-40-17	M14x1,25x40	SW17	Kegel 60° Taper Head 60°
S1-1-14-25-45-17	M14x1,25x45	SW17	Kegel 60° Taper Head 60°
S1-1-14-25-50-17	M14x1,25x50	SW17	Kegel 60° Taper Head 60°
S1-1-14-25-55-17	M14x1,25x55	SW17	Kegel 60° Taper Head 60°
S1-1-14-25-60-17	M14x1,25x60	SW17	Kegel 60° Taper Head 60°
S1-1-14-25-25-17-B	M14x1,25x25 schwarz black	SW17	Kegel 60° Taper Head 60°
S1-1-14-25-27-17-B	M14x1,25x27 schwarz black	SW17	Kegel 60° Taper Head 60°
S1-1-14-25-33-17-B	M14x1,25x33 schwarz black	SW17	Kegel 60° Taper Head 60°
S1-1-14-25-35-17-B	M14x1,25x35 schwarz black	SW17	Kegel 60° Taper Head 60°
S1-1-14-25-40-17-B	M14x1,25x40 schwarz black	SW17	Kegel 60° Taper Head 60°
S1-1-14-25-43-17-B	M14x1,25x43 schwarz black	SW17	Kegel 60° Taper Head 60°
S1-1-14-25-50-17-B	M14x1,25x50 schwarz black	SW17	Kegel 60° Taper Head 60°
S1-1-14-50-19-17-1	M14x1,5x19 Kurzkopf short head	SW17	Kegel 60° Taper Head 60°
S1-1-14-50-24-17-1	M14x1,5x24 Kurzkopf short head	SW17	Kegel 60° Taper Head 60°
S1-1-14-50-25-17	M14x1,5x25	SW17	Kegel 60° Taper Head 60°
S1-1-14-50-28-17	M14x1,5x28	SW17	Kegel 60° Taper Head 60°
S1-1-14-50-30-17	M14x1,5x30	SW17	Kegel 60° Taper Head 60°

Artikelnummer Part-No.	Gewinde-Schaftlänge Thread Lengh	Schlüsselweite Wrench Size	Bundform Bolt Head Style -Size
---------------------------	-------------------------------------	-------------------------------	-------------------------------------

Kegelbund 60° M14 Taper Head Bolt 60° M14			
S1-1-14-50-35-17	M14x1,5x35	SW17	Kegel 60° Taper Head 60°
S1-1-14-50-40-17	M14x1,5x40	SW17	Kegel 60° Taper Head 60°
S1-1-14-50-45-17	M14x1,5x45	SW17	Kegel 60° Taper Head 60°
S1-1-14-50-47-17	M14x1,5x47	SW17	Kegel 60° Taper Head 60°
S1-1-14-50-55-17	M14x1,5x55	SW17	Kegel 60° Taper Head 60°
S1-1-14-50-60-17	M14x1,5x60	SW17	Kegel 60° Taper Head 60°
S1-1-14-50-25-17-B	M14x1,5x25 schwarz black	SW17	Kegel 60° Taper Head 60°
S1-1-14-50-28-17-B	M14x1,5x28 schwarz black	SW17	Kegel 60° Taper Head 60°
S1-1-14-50-30-17-B	M14x1,5x30 schwarz black	SW17	Kegel 60° Taper Head 60°
S1-1-14-50-35-17-B	M14x1,5x35 schwarz black	SW17	Kegel 60° Taper Head 60°
S1-1-14-50-40-17-B	M14x1,5x40 schwarz black	SW17	Kegel 60° Taper Head 60°
S1-1-14-50-45-17-B	M14x1,5x45 schwarz black	SW17	Kegel 60° Taper Head 60°
S1-1-14-50-50-17-B	M14x1,5x50 schwarz black	SW17	Kegel 60° Taper Head 60°

Spezial-Schrauben 60° M14 für Ferrari Maserati - entsprechen den Serienschrauben! Special-Studs Taper Head 60° M14 for Ferrari Maserati - look alike the Original Bolts!			
S1-1-14-50-65-22	M14x1,5x65 verchromt chrome	SW22	Kegel 60° Taper Head 60°
S1-1-14-50-67-22	M14x1,5x67 verchromt chrome	SW22	Kegel 60° Taper Head 60°
S1-1-14-50-72-22	M14x1,5x72 verchromt chrome	SW22	Kegel 60° Taper Head 60°

Schrauben mit losem Kegelbund 60° M14 Studs with loose Taper Head 60° M14			
S4-1-14-50-28-19	M14x1,5x28	SW19	Kegel 60° Taper Head 60°
S4-1-14-50-37-19	M14x1,5x37	SW19	Kegel 60° Taper Head 60°
S4-1-14-50-42-19	M14x1,5x42	SW19	Kegel 60° Taper Head 60°
S4-1-14-50-45-19	M14x1,5x45	SW19	Kegel 60° Taper Head 60°
S4-1-14-50-48-19	M14x1,5x48	SW19	Kegel 60° Taper Head 60°
S4-1-14-50-53-19	M14x1,5x53	SW19	Kegel 60° Taper Head 60°
S4-1-14-50-58-19	M14x1,5x58	SW19	Kegel 60° Taper Head 60°



Kugelbund - Radius r=12 M12 Round Head Bolt - Radius r=12 M12			
S1-5-12-50-25-17	M12x1,5x25	SW17	Kugel r=12 Round Head r=12
S1-5-12-50-28-17	M12x1,5x28	SW17	Kugel r=12 Round Head r=12
S1-5-12-50-30-17	M12x1,5x30	SW17	Kugel r=12 Round Head r=12
S1-5-12-50-35-17	M12x1,5x35	SW17	Kugel r=12 Round Head r=12
S1-5-12-50-40-17	M12x1,5x40	SW17	Kugel r=12 Round Head r=12
S1-5-12-50-43-17	M12x1,5x43	SW17	Kugel r=12 Round Head r=12
S1-5-12-50-45-17	M12x1,5x45	SW17	Kugel r=12 Round Head r=12
S1-5-12-50-47-17	M12x1,5x47	SW17	Kugel r=12 Round Head r=12
S1-5-12-50-50-17	M12x1,5x50	SW17	Kugel r=12 Round Head r=12
S1-5-12-50-55-17	M12x1,5x55	SW17	Kugel r=12 Round Head r=12
S1-5-12-50-60-17	M12x1,5x60	SW17	Kugel r=12 Round Head r=12

Kugelbund - Radius r=13 M12 Round Head Bolt - Radius r=13 M12			
S1-6-12-50-25-17	M12x1,5x25	SW17	Kugel r=13 Round Head r=13
S1-6-12-50-28-17	M12x1,5x28	SW17	Kugel r=13 Round Head r=13
S1-6-12-50-35-17	M12x1,5x35	SW17	Kugel r=13 Round Head r=13
S1-6-12-50-40-17	M12x1,5x40	SW17	Kugel r=13 Round Head r=13
S1-6-12-50-45-17	M12x1,5x45	SW17	Kugel r=13 Round Head r=13

Kugelbund - Radius r=13 M14 Round Head Bolt - Radius r=13 M14			
S1-6-14-50-27-17	M14x1,5x27	SW17	Kugel r=13 Round Head r=13
S1-6-14-50-30-17	M14x1,5x30	SW17	Kugel r=13 Round Head r=13
S1-6-14-50-32-17	M14x1,5x32	SW17	Kugel r=13 Round Head r=13
S1-6-14-50-35-17	M14x1,5x35	SW17	Kugel r=13 Round Head r=13
S1-6-14-50-37-17	M14x1,5x37	SW17	Kugel r=13 Round Head r=13
S1-6-14-50-40-17	M14x1,5x40	SW17	Kugel r=13 Round Head r=13
S1-6-14-50-43-17	M14x1,5x43	SW17	Kugel r=13 Round Head r=13
S1-6-14-50-47-17	M14x1,5x47	SW17	Kugel r=13 Round Head r=13



Schrauben mit losem Kugelbund - Radius r=13 M14 Studs with loose Round Head - Radius r=13 M14			
S4-6-14-50-32-17	M14x1,5x32	SW17	Kugel r=13 Round Head r=13
S4-6-14-50-36-17	M14x1,5x36	SW17	Kugel r=13 Round Head r=13
S4-6-14-50-38-17	M14x1,5x38	SW17	Kugel r=13 Round Head r=13
S4-6-14-50-40-17	M14x1,5x40	SW17	Kugel r=13 Round Head r=13
S4-6-14-50-42-17	M14x1,5x42	SW17	Kugel r=13 Round Head r=13
S4-6-14-50-45-17	M14x1,5x45	SW17	Kugel r=13 Round Head r=13
S4-6-14-50-48-17	M14x1,5x48	SW17	Kugel r=13 Round Head r=13
S4-6-14-50-50-17	M14x1,5x50	SW17	Kugel r=13 Round Head r=13

Kugelbund - Radius r=14 M14 Round Head Bolt - Radius r=14 M14			
S1-7-14-50-27-17	M14x1,5x27	SW17	Kugel r=14 Round Head r=14
S1-7-14-50-35-17	M14x1,5x35	SW17	Kugel r=14 Round Head r=14
S1-7-14-50-40-17	M14x1,5x40	SW17	Kugel r=14 Round Head r=14
S1-7-14-50-43-17	M14x1,5x43	SW17	Kugel r=14 Round Head r=14
S1-7-14-50-45-17	M14x1,5x45	SW17	Kugel r=14 Round Head r=14
S1-7-14-50-47-17	M14x1,5x47	SW17	Kugel r=14 Round Head r=14
S1-7-14-50-50-17	M14x1,5x50	SW17	Kugel r=14 Round Head r=14
S1-7-14-50-55-17	M14x1,5x55	SW17	Kugel r=14 Round Head r=14
S1-7-14-50-60-17	M14x1,5x60	SW17	Kugel r=14 Round Head r=14
S1-7-14-50-65-17	M14x1,5x65	SW17	Kugel r=14 Round Head r=14

PRO-SPACER SCHRAUBEN | BOLTS

Artikelnummer Part-No.	Gewinde-Schaftlänge Thread Lengh	Schlüsselweite Wrench Size	Bundform Bolt Head Style -Size
Schrauben mit losem Kugelbund - Radius r=14 M14 Studs with loose Round Head - Radius r=14 M14			
S4-7-14-50-28-19	M14x1,5x28	SW19	Kugel r=14 Round Head r=14
S4-7-14-50-35-19	M14x1,5x35	SW19	Kugel r=14 Round Head r=14
S4-7-14-50-37-19	M14x1,5x37	SW19	Kugel r=14 Round Head r=14
S4-7-14-50-42-19	M14x1,5x42	SW19	Kugel r=14 Round Head r=14
S4-7-14-50-45-19	M14x1,5x45	SW19	Kugel r=14 Round Head r=14
S4-7-14-50-48-19	M14x1,5x48	SW19	Kugel r=14 Round Head r=14
S4-7-14-50-53-19	M14x1,5x53	SW19	Kugel r=14 Round Head r=14
S4-7-14-50-58-19	M14x1,5x58	SW19	Kugel r=14 Round Head r=14
Schrauben mit losem Kugelbund - Radius r=14 M14 Studs with loose Round Head - Radius r=14 M14			
S4-7-14-50-28-19-B	M14x1,5x28 schwarz black	SW19	Kugel r=14 Round Head r=14
S4-7-14-50-30-19-B	M14x1,5x30 schwarz black	SW19	Kugel r=14 Round Head r=14
S4-7-14-50-37-19-B	M14x1,5x37 schwarz black	SW19	Kugel r=14 Round Head r=14
S4-7-14-50-42-19-B	M14x1,5x42 schwarz black	SW19	Kugel r=14 Round Head r=14
S4-7-14-50-45-19-B	M14x1,5x45 schwarz black	SW19	Kugel r=14 Round Head r=14
S4-7-14-50-48-19-B	M14x1,5x48 schwarz black	SW19	Kugel r=14 Round Head r=14
S4-7-14-50-53-19-B	M14x1,5x53 schwarz black	SW19	Kugel r=14 Round Head r=14
S4-7-14-50-58-19-B	M14x1,5x58 schwarz black	SW19	Kugel r=14 Round Head r=14



Flachbundschrauben Flat Head Bolt			
S1-9-12-25-42-19	M12x1,25x42	SW19	Flachbund m. Scheibe Flat Head with washer
S1-9-12-25-52-19	M12x1,25x52	SW19	Flachbund m. Scheibe Flat Head with washer
S1-9-12-25-57-19	M12x1,25x57	SW19	Flachbund m. Scheibe Flat Head with washer
S1-9-12-25-35-17	M12x1,25x35	SW17	Flachbund für Flat-head for Citroen Peugeot
S1-9-12-25-40-17	M12x1,25x40	SW17	Flachbund für Flat-head for Citroen Peugeot
S1-9-12-25-45-17	M12x1,25x45	SW17	Flachbund für Flat-head for Citroen Peugeot
S1-9-12-25-50-17	M12x1,25x50	SW17	Flachbund für Flat-head for Citroen Peugeot
S1-9-12-25-55-17	M12x1,25x55	SW17	Flachbund für Flat-head for Citroen Peugeot
S1-9-14-50-43-19	M14x1,5x43	SW19	Flachbund Flat-head
S1-9-14-50-52-19	M14x1,5x52	SW19	Flachbund Flat-head
S1-9-14-50-60-19	M14x1,5x60	SW19	Flachbund Flat-head
S1-9-14-50-63-19	M14x1,5x63	SW19	Flachbund Flat-head
S1-9-14-50-68-19	M14x1,5x68	SW19	Flachbund Flat-head

Muttern Nuts			
S2-1-12-25-17-17-0	M12x1,25x18,5 offen open	SW17	Kegel 60° Taper Head 60°
S2-1-12-25-17-19-0	M12x1,25x17 offen open	SW19	Kegel 60° Taper Head 60°
S2-1-12-25-32-19-G	M12x1,25x32 geschlossen closed	SW19	Kegel 60° Taper Head 60°
S2-1-12-50-17-17-0	M12x1,5x18,5 offen open	SW17	Kegel 60° Taper Head 60°
S2-1-12-50-17-19-0	M12x1,5x17 offen open	SW19	Kegel 60° Taper Head 60°
S2-1-12-50-25-19-0	M12x1,5x25 offen open	SW19	Kegel 60° Taper Head 60°
S2-1-12-50-32-19-G	M12x1,5x32 geschlossen closed	SW19	Kegel 60° Taper Head 60°
S2-1-13-20-17-17-0	1/2" UNFx18,5 offen open	SW17	Kegel 60° Taper Head 60°
S2-1-13-20-17-19-0	1/2" UNFx17,5 offen open	SW19	Kegel 60° Taper Head 60°
S2-1-13-20-25-19-0	1/2" UNFx25 offen open	SW19	Kegel 60° Taper Head 60°
S2-1-14-02-17-19-0	M14x2x25 offen open	SW19	Kegel 60° Taper Head 60°
S2-1-14-50-17-19-0	M14x1,5x17 offen open	SW19	Kegel 60° Taper Head 60°
S2-1-14-50-25-19-0	M14x1,5x25 offen open	SW19	Kegel 60° Taper Head 60°
S2-5-12-50-19-19-0	M12x1,5x19 offen open	SW19	Kugel r=12 Round Head r=12
S2-7-14-50-20-19-0	M14x1,5x20 offen open	SW19	Kugel r=14 Round Head r=14
S2-7-14-50-32-19-G	M14x1,5x32 geschlossen closed	SW19	Kugel r=14 Round Head r=14



Rändelbolzen Wheel Studs			
S3-0-12-50-65-121	M12x1,50x65		Rändel knurl 12,1
S3-0-12-25-47-124	M12x1,25x47		Rändel knurl 12,4
S3-0-12-25-52-124	M12x1,25x52		Rändel knurl 12,4
S3-0-12-25-57-124	M12x1,25x57		Rändel knurl 12,4
S3-0-12-25-62-124	M12x1,25x62		Rändel knurl 12,4
S3-0-12-25-43-130	M12x1,25x43		Rändel knurl 13,0
S3-0-12-25-48-130	M12x1,25x48		Rändel knurl 13,0
S3-0-12-25-53-130	M12x1,25x53		Rändel knurl 13,0
S3-0-12-25-58-130	M12x1,25x58		Rändel knurl 13,0
S3-0-12-25-63-130	M12x1,25x63		Rändel knurl 13,0
S3-0-12-50-47-124	M12x1,5x47		Rändel knurl 12,4
S3-0-12-50-52-124	M12x1,5x52		Rändel knurl 12,4
S3-0-12-50-57-124	M12x1,5x57		Rändel knurl 12,4
S3-0-12-50-62-124	M12x1,5x62		Rändel knurl 12,4
S3-0-12-50-42-130	M12x1,5x42		Rändel knurl 13,0
S3-0-12-50-52-130	M12x1,5x52		Rändel knurl 13,0
S3-0-12-50-55-130	M12x1,5x55		Rändel knurl 13,0
S3-0-12-50-62-130	M12x1,5x62		Rändel knurl 13,0
S3-0-12-50-65-130	M12x1,5x65		Rändel knurl 13,0
S3-0-13-20-39-140	1/2" UNFx39		Rändel knurl 14,0
S3-1-12-25-37-143	M12x1,25x37		Rändel knurl 14,3
S3-0-12-25-40-143	M12x1,25x40		Rändel knurl 14,3
S3-1-12-25-42-143	M12x1,25x42		Rändel knurl 14,3
S3-0-12-25-47-143	M12x1,25x47		Rändel knurl 14,3
S3-0-12-25-52-143	M12x1,25x52		Rändel knurl 14,3
S3-0-12-25-57-143	M12x1,25x57		Rändel knurl 14,3
S3-0-12-25-62-143	M12x1,25x62		Rändel knurl 14,3

Artikelnummer Part-No.	Gewinde-Schaftlänge Thread Lengh	Schlüsselweite Wrench Size	Bundform Bolt Head Style -Size
Rändelbolzen Wheel Studs			
S3-1-12-50-37-143	M12x1,5x37		Rändel knurl 14,3
S3-0-12-50-42-143	M12x1,5x42		Rändel knurl 14,3
S3-1-12-50-42-143	M12x1,5x42		Rändel knurl 14,3
S3-0-12-50-47-143	M12x1,5x47		Rändel knurl 14,3
S3-0-12-50-52-143	M12x1,5x52		Rändel knurl 14,3
S3-0-12-50-57-143	M12x1,5x57		Rändel knurl 14,3
S3-0-12-50-62-143	M12x1,5x62		Rändel knurl 14,3
S3-0-12-50-47-149	M12x1,5x47		Rändel knurl 14,9
S3-0-12-50-52-149	M12x1,5x52		Rändel knurl 14,9
S3-0-12-50-57-149	M12x1,5x57		Rändel knurl 14,9
S3-1-14-50-36-149	M14x1,5x36		Rändel knurl 14,9
S3-0-14-50-45-149	M14x1,5x45		Rändel knurl 14,9
S3-0-14-50-66-149	M14x1,5x66		Rändel knurl 14,9
S3-0-13-20-39-157	1/2" UNFx39		Rändel knurl 15,7
S3-0-13-20-46-157	1/2" UNFx46		Rändel knurl 15,7
S3-0-14-50-39-159	M14x1,5x39		Rändel knurl 15,9
S3-0-14-02-38-159	M14x2x38		Rändel knurl 15,9
S3-0-14-02-53-159	M14x2x53		Rändel knurl 15,9
Steckschlüsseladapter Socket Wrench Adapter			
S03-09-012		SW19 - SW17	
Abdeckkappen für Radschrauben Caps for Wheel Bolts			
S17-B		für SW17 for SW17	Abdeckkappe schwarz cap black
S17-G		für SW17 for SW17	Abdeckkappe grau cap grey
S19-B		für SW19 for SW19	Abdeckkappe schwarz cap black



Qatar

M-SPORT

WORLD RALLY TEAM



N Al-Attiyah
G Bernacchini

Qatar

Castrol **EDGE**

M-SPORT

EcoBoost



vodafone rally de Portugal 6

6



PULSAR

ICAPARK

Qatar

M-SPORT

ICAPARK

Modell Model	Baujahr Year	Original-radschraube (nicht bestellbar) Original Bolt (not available)	Spurweiten-änderung Achse Total track widening (mm)	Eibach System	Artikel-Nr. Part-No.	Hinweise Notes	Kennzeichnung Stamping	Lockkreis -zahl Bolt pattern No. of holes	Zentrierung Centre bore (mm)	Gewinde Thread	Gutachten Homologation	ET-Grenze Offset frontier
ALFA ROMEO												
145 (930)	07.94 - 01.01	S1-1-12-25-36-19	10	1	S90-1-05-011		91105011	98/4	58	M12x1,25	§21	
	07.94 - 01.01	M12x1,25x36, KG60°	30	2	S90-2-15-020		91215020	98/4	58	M12x1,25	§21	
	07.94 - 01.01		50	7	S90-7-25-006	S68	91725006	98/4	58	M12x1,25	§21	
146 (930)	12.94 - 01.01	S1-1-12-25-36-19	10	1	S90-1-05-011		91105011	98/4	58	M12x1,25	§21	
	12.94 - 01.01	M12x1,25x36, KG60°	30	2	S90-2-15-020		91215020	98/4	58	M12x1,25	§21	
	12.94 - 01.01		50	7	S90-7-25-006	S68	91725006	98/4	58	M12x1,25	§21	
147 (937)	11.00 - 03.10	S1-1-12-25-22-17	10	1	S90-1-05-015		91105015	98/5	58	M12x1,25	T	17
	11.00 - 03.10	M12x1,25x22, KG60°	30	2	S90-2-15-003		91215003	98/5	58	M12x1,25	T	17
147 (937)	11.00 - 03.10	S1-1-12-25-22-17	20	2	S90-2-10-003	S26	91210003	98/5	58	M12x1,25	T	17
	11.00 - 03.10	M12x1,25x22, KG60°	40	7	S90-7-20-019		91720019	98/5	58	M12x1,25	T	17
	11.00 - 03.10		50	7	S90-7-25-022		91725022	98/5	58	M12x1,25	T	17
	11.00 - 03.10		60	7	S90-7-30-011		91730011	98/5	58	M12x1,25	T	17
155 (167)	01.92 - 12.97	S1-1-12-25-36-19	10	1	S90-1-05-011		91105011	98/4	58	M12x1,25	§21	
	01.92 - 12.97	M12x1,25x36, KG60°	30	2	S90-2-15-020		91215020	98/4	58	M12x1,25	§21	
	01.92 - 12.97		50	7	S90-7-25-006	S68	91725006	98/4	58	M12x1,25	§21	
156 (932)	09.97 - 09.05	S1-1-12-25-30-19	10	1	S90-1-05-015	S11	91105015	98/5	58	M12x1,25	T	22,5
	09.97 - 09.05	M12x1,25x30, KG60°	20	2	S90-2-10-003	S26	91210003	98/5	58	M12x1,25	T	22,5
	09.97 - 09.05		30	2	S90-2-15-003		91215003	98/5	58	M12x1,25	T	22,5
156 Sportwagon (932)	05.00 - 05.06	S1-1-12-25-30-19	10	1	S90-1-05-015	S11	91105015	98/5	58	M12x1,25	T	22,5
	05.00 - 05.06	M12x1,25x30, KG60°	20	2	S90-2-10-003	S26	91210003	98/5	58	M12x1,25	T	22,5
	05.00 - 05.06		30	2	S90-2-15-003		91215003	98/5	58	M12x1,25	T	22,5
159 (939)	09.05 - 11.11	S1-1-14-50-25-17	10	1	S90-1-05-013		91105013	110/5	65	M14x1,5	T	4
	09.05 - 11.11	M14x1,5x25, KG60°	32	2	S90-2-16-001		91216001	110/5	65	M14x1,5	T	4
	09.05 - 11.11		40	2	S90-2-20-006		91220006	110/5	65	M14x1,5	T	4
	09.05 - 11.11		40	7	S90-7-20-024		91720024	110/5	65	M14x1,5	T	4
	09.05 - 11.11		50	7	S90-7-25-027		91725027	110/5	65	M14x1,5	T	4
	09.05 - 11.11		60	7	S90-7-30-018		91730018	110/5	65	M14x1,5	T	4
159 Sportwagon (939)	03.06 - 11.11	S1-1-14-50-25-17	10	1	S90-1-05-013		91105013	110/5	65	M14x1,5	T	4
	03.06 - 11.11	M14x1,5x25, KG60°	32	2	S90-2-16-001		91216001	110/5	65	M14x1,5	T	4
	03.06 - 11.11		40	2	S90-2-20-006		91220006	110/5	65	M14x1,5	T	4
	03.06 - 11.11		40	7	S90-7-20-024		91720024	110/5	65	M14x1,5	T	4
	03.06 - 11.11		50	7	S90-7-25-027		91725027	110/5	65	M14x1,5	T	4
	03.06 - 11.11		60	7	S90-7-30-018		91730018	110/5	65	M14x1,5	T	4
164 (164)	01.87 - 09.98	S1-1-12-25-36-19	20	2	S90-2-10-003		91210003	98/5	58	M12x1,25	§21	
	01.87 - 09.98	M12x1,25x36, KG60°	30	2	S90-2-15-003		91215003	98/5	58	M12x1,25	§21	
164 (164)	01.87 - 09.98	S1-1-12-25-36-19	10	1	S90-1-05-011		91105011	98/4	58	M12x1,25	§21	
	01.87 - 09.98	M12x1,25x36, KG60°	30	2	S90-2-15-020		91215020	98/4	58	M12x1,25	§21	
	01.87 - 09.98		50	7	S90-7-25-006	S68	91725006	98/4	58	M12x1,25	§21	
166 (936)	09.98 - 06.07		10	1	S90-1-05-015		91105015	108/5	58	M12x1,25	T	26
	09.98 - 06.07		30	2	S90-2-15-003		91215003	108/5	58	M12x1,25	T	26
BRERA	01.06 -	S1-1-14-50-25-17	10	1	S90-1-05-013		91105013	110/5	65	M14x1,5	T	4
	01.06 -	M14x1,5x25, KG60°	32	2	S90-2-16-001		91216001	110/5	65	M14x1,5	T	4
	01.06 -		40	2	S90-2-20-006		91220006	110/5	65	M14x1,5	T	4
	01.06 -		40	7	S90-7-20-024		91720024	110/5	65	M14x1,5	T	4
	01.06 -		50	7	S90-7-25-027		91725027	110/5	65	M14x1,5	T	4
	01.06 -		60	7	S90-7-30-018		91730018	110/5	65	M14x1,5	T	4
GIULIETTA (940)	04.10 -	S1-1-12-25-22-17	30	2	S90-2-15-007		91215007	110/5	65	M12x1,25	T	11
	04.10 -	M12x1,25x22, KG60°	32	2	S90-2-16-001		91216001	110/5	65	M12x1,25	T	11
	04.10 -		40	2	S90-2-20-006		91220006	110/5	65	M12x1,25	T	11
	04.10 -		40	7	S90-7-20-034		91720034	110/5	65	M12x1,25	T	11
	04.10 -		50	7	S90-7-25-046		91725046	110/5	65	M12x1,25	T	11
	04.10 -		60	7	S90-7-30-054		91730054	110/5	65	M12x1,25	T	11
GT (937)	11.03 - 09.10	S1-1-12-25-22-17	10	1	S90-1-05-015		91105015	98/5	58	M12x1,25	T	17
	11.03 - 09.10	M12x1,25x22, KG60°	20	2	S90-2-10-003	S54	91210003	98/5	58	M12x1,25	T	17
	11.03 - 09.10		30	2	S90-2-15-003		91215003	98/5	58	M12x1,25	T	17
	11.03 - 09.10		40	7	S90-7-20-019		91720019	98/5	58	M12x1,25	T	17
	11.03 - 09.10		50	7	S90-7-25-022		91725022	98/5	58	M12x1,25	T	17
	11.03 - 09.10		60	7	S90-7-30-011		91730011	98/5	58	M12x1,25	T	17
GTV (916C)	09.94 - 10.05	S1-1-12-25-34-19	10	1	S90-1-05-015		91105015	98/5	58	M12x1,25	§21	
	09.94 - 10.05	M12x1,25x34, KG60°	20	2	S90-2-10-003	S3	91210003	98/5	58	M12x1,25	T	15
	09.94 - 10.05		30	2	S90-2-15-003	S13	91215003	98/5	58	M12x1,25	T	15
MITO (955)	09.08 -	S1-1-12-25-22-17	10	1	S90-1-05-011		91105011	98/4	58	M12x1,25	T	9
	09.08 -	M12x1,25x22, KG60°	30	2	S90-2-15-020		91215020	98/4	58	M12x1,25	T	9
	09.08 -		40	7	S90-7-20-012		91720012	98/4	58	M12x1,25	T	9
	09.08 -		50	7	S90-7-25-006		91725006	98/4	58	M12x1,25	T	9
	09.08 -		60	7	S90-7-30-005		91730005	98/4	58	M12x1,25	T	9
SPIDER (916S)	09.94 - 04.05	S1-1-12-25-36-19	10	1	S90-1-05-015		91105015	98/5	58	M12x1,25	§21	
	09.94 - 04.05	M12x1,25x36, KG60°	20	2	S90-2-10-003	S3	91210003	98/5	58	M12x1,25	T	15
	09.94 - 04.05		30	2	S90-2-15-003		91215003	98/5	58	M12x1,25	T	15
SPIDER (939)	09.06 -	S1-1-14-50-25-17	10	1	S90-1-05-013		91105013	110/5	65	M14x1,5	T	4
	09.06 -	M14x1,5x25, KG60°	32	2	S90-2-16-001		91216001	110/5	65	M14x1,5	T	4
	09.06 -		40	2	S90-2-20-006		91220006	110/5	65	M14x1,5	T	4
	09.06 -		40	7	S90-7-20-024		91720024	110/5	65	M14x1,5	T	4
	09.06 -		50	7	S90-7-25-027		91725027	110/5	65	M14x1,5	T	4
	09.06 -		60	7	S90-7-30-018		91730018	110/5	65	M14x1,5	T	4

Modell Model	Baujahr Year	Original-radschraube (nicht bestellbar) Original Bolt (not available)	Spurweiten-änderung Achse Total track widening (mm)	Eibach System	Artikel-Nr. Part-No.	Hinweise Notes	Kennzeichnung Stamping	Lockkreis -zahl Bolt pattern No. of holes	Zentrierung Centre bore (mm)	Gewinde Thread	Gutachten Homologation	ET-Grenze Offset frontier
AUDI												
80 (8C, B4)	09.91 - 12.94	S1-6-14-50-27-17	10	1	S90-1-05-010	S11	91105010	108/4	57	M14x1,5	§21	
	09.91 - 12.94	M14x1,5x27, KU r=13	16	1	S90-1-08-003	S11	91108003	108/4	57	M14x1,5	§21	
	09.91 - 12.94		30	2	S90-2-15-004	S13	91215004	108/4	57	M14x1,5	§21	
	09.91 - 12.94		40	2	S90-2-20-011	S13	91220011	108/4	57	M14x1,5	§21	
80 Avant (8C, B4)	09.91 - 01.96	S1-6-14-50-27-17	10	1	S90-1-05-010	S11	91105010	108/4	57	M14x1,5	§21	
	09.91 - 01.96	M14x1,5x27, KU r=13	16	1	S90-1-08-003	S11	91108003	108/4	57	M14x1,5	§21	
	09.91 - 01.96		30	2	S90-2-15-004	S13	91215004	108/4	57	M14x1,5	§21	
	09.91 - 01.96		40									

Modell Model	Baujahr Year	Original-radschraube (nicht bestellbar) Original Bolt (not available)	Spurweiten-änderung Achse Total track width-ning (mm)	Eibach System	Artikel-Nr. Part-No.	Hinweise Notes	Kennzeichnung Stamping	Lockkreis Zahl Bolt pattern No. of holes	Zentrierung Centre bore (mm)	Gewinde Thread	Gutachten Homologation	ET-Grenze Offset frontier	
AUDI A4 (8E2, B6)	11.00 - 12.04	S1-6-14-50-27-17	10	1	S90-1-05-016	S11	91105016	112/5	57	M14x1,5	T	19	
	11.00 - 12.04	M14x1,5x27, KU r=13	16	1	S90-1-08-002	S11	91108002	112/5	57	M14x1,5	T	19	
	11.00 - 12.04		20	2	S90-2-10-027	S3	91210027	112/5	57	M14x1,5	T	19	
	11.00 - 12.04		24	2	S90-2-12-003	S3	91212003	112/5	57	M14x1,5	T	19	
	11.00 - 12.04		30	2	S90-2-15-013		91215013	112/5	57	M14x1,5	T	19	
	11.00 - 12.04		40	2	S90-2-20-003		91220003	112/5	57	M14x1,5	T	19	
	11.00 - 12.04		40	7	S90-7-20-017		91720017	112/5	57	M14x1,5	T	19	
	11.00 - 12.04		50	7	S90-7-25-005		91725005	112/5	57	M14x1,5	T	19	
	A4 (8EC, B7)	11.04 - 06.08	S1-6-14-50-27-17	10	1	S90-1-05-016	S11	91105016	112/5	57	M14x1,5	T	19
		11.04 - 06.08	M14x1,5x27, KU r=13	16	1	S90-1-08-002	S11	91108002	112/5	57	M14x1,5	T	19
11.04 - 06.08			20	2	S90-2-10-027	S3	91210027	112/5	57	M14x1,5	§21	19	
11.04 - 06.08			24	2	S90-2-12-003	S3	91212003	112/5	57	M14x1,5	T	19	
11.04 - 06.08			30	2	S90-2-15-013		91215013	112/5	57	M14x1,5	T	19	
11.04 - 06.08			40	2	S90-2-20-003		91220003	112/5	57	M14x1,5	T	19	
11.04 - 06.08			40	7	S90-7-20-017		91720017	112/5	57	M14x1,5	T	19	
11.04 - 06.08			50	7	S90-7-25-005		91725005	112/5	57	M14x1,5	T	19	
A4 (8K2, B8)		11.07 -	S1-6-14-50-27-17	24	2	S90-2-12-004	S3	91212004	112/5	66,5	M14x1,5	T	9
		11.07 -	M14x1,5x27, KU r=13	30	2	S90-2-15-017		91215017	112/5	66,5	M14x1,5	T	9
	11.07 -		40	2	S90-2-20-007		91220007	112/5	66,5	M14x1,5	T	9	
	11.07 -		40	7	S90-7-20-016		91720016	112/5	66,5	M14x1,5	T	9	
	11.07 -		50	7	S90-7-25-016		91725016	112/5	66,5	M14x1,5	T	9	
	11.07 -		60	7	S90-7-30-007		91730007	112/5	66,5	M14x1,5	T	9	
	A4 Allroad (8KH, B8)	04.09 -	S1-6-14-50-27-17	24	2	S90-2-12-004	S3	91212004	112/5	66,5	M14x1,5	T	9
04.09 -		M14x1,5x27, KU r=13	30	2	S90-2-15-017		91215017	112/5	66,5	M14x1,5	T	9	
04.09 -			40	2	S90-2-20-007		91220007	112/5	66,5	M14x1,5	T	9	
04.09 -			40	7	S90-7-20-016		91720016	112/5	66,5	M14x1,5	T	9	
04.09 -			50	7	S90-7-25-016		91725016	112/5	66,5	M14x1,5	T	9	
04.09 -			60	7	S90-7-30-007		91730007	112/5	66,5	M14x1,5	T	9	
A4 Avant (8D5, B5)	11.94 - 09.01	S1-6-14-50-27-17	10	1	S90-1-05-006	S11	91105006	112/5	57	M14x1,5	T	25	
	11.94 - 09.01	M14x1,5x27, KU r=13	16	1	S90-1-08-001	S11	91108001	112/5	57	M14x1,5	T	25	
	11.94 - 09.01		30	2	S90-2-15-005	S13	91215005	112/5	57	M14x1,5	T	25	
	11.94 - 09.01		40	2	S90-2-20-004	S13	91220004	112/5	57	M14x1,5	T	25	
	11.94 - 09.01		50	7	S90-7-25-005	S68	91725005	112/5	57	M14x1,5	T	25	
A4 Avant (8E5, B6)	04.01 - 12.04	S1-6-14-50-27-17	10	1	S90-1-05-016	S11	91105016	112/5	57	M14x1,5	T	19	
	04.01 - 12.04	M14x1,5x27, KU r=13	16	1	S90-1-08-002	S11	91108002	112/5	57	M14x1,5	T	19	
	04.01 - 12.04		20	2	S90-2-10-027	S3	91210027	112/5	57	M14x1,5	T	19	
	04.01 - 12.04		24	2	S90-2-12-003	S3	91212003	112/5	57	M14x1,5	T	19	
	04.01 - 12.04		30	2	S90-2-15-013		91215013	112/5	57	M14x1,5	T	19	
	04.01 - 12.04		40	2	S90-2-20-003		91220003	112/5	57	M14x1,5	T	19	
	04.01 - 12.04		40	7	S90-7-20-017		91720017	112/5	57	M14x1,5	T	19	
	04.01 - 12.04		50	7	S90-7-25-005		91725005	112/5	57	M14x1,5	T	19	
	A4 Avant (8ED, B7)	11.04 - 06.08	S1-6-14-50-27-17	10	1	S90-1-05-016	S11	91105016	112/5	57	M14x1,5	T	19
11.04 - 06.08		M14x1,5x27, KU r=13	16	1	S90-1-08-002	S11	91108002	112/5	57	M14x1,5	T	19	
11.04 - 06.08			20	2	S90-2-10-027	S3	91210027	112/5	57	M14x1,5	T	19	
11.04 - 06.08			24	2	S90-2-12-003	S3	91212003	112/5	57	M14x1,5	T	19	
11.04 - 06.08			30	2	S90-2-15-013		91215013	112/5	57	M14x1,5	T	19	
11.04 - 06.08			40	2	S90-2-20-003		91220003	112/5	57	M14x1,5	T	19	
11.04 - 06.08			40	7	S90-7-20-017		91720017	112/5	57	M14x1,5	T	19	
11.04 - 06.08			50	7	S90-7-25-005		91725005	112/5	57	M14x1,5	T	19	
A4 Avant (8K5, B8)		11.07 -	S1-6-14-50-27-17	24	2	S90-2-12-004	S3	91212004	112/5	66,5	M14x1,5	T	9
	11.07 -	M14x1,5x27, KU r=13	30	2	S90-2-15-017		91215017	112/5	66,5	M14x1,5	T	9	
	11.07 -		40	2	S90-2-20-007		91220007	112/5	66,5	M14x1,5	T	9	
	11.07 -		40	7	S90-7-20-016		91720016	112/5	66,5	M14x1,5	T	9	
	11.07 -		50	7	S90-7-25-016		91725016	112/5	66,5	M14x1,5	T	9	
	11.07 -		60	7	S90-7-30-007		91730007	112/5	66,5	M14x1,5	T	9	
	A4 Cabriolet (8H7, B6, 8HE, B7) A4 Convertible (8H7, B6, 8HE, B7)	04.02 - 03.09	S1-6-14-50-27-17	10	1	S90-1-05-016	S11	91105016	112/5	57	M14x1,5	T	27
04.02 - 03.09		M14x1,5x27, KU r=13	16	1	S90-1-08-002	S11	91108002	112/5	57	M14x1,5	T	27	
04.02 - 03.09			30	2	S90-2-15-013		91215013	112/5	57	M14x1,5	T	27	
04.02 - 03.09			40	2	S90-2-20-003		91220003	112/5	57	M14x1,5	T	27	
04.02 - 03.09			50	7	S90-7-25-005		91725005	112/5	57	M14x1,5	T	27	
A5 (8T3)	06.07 -	S4-6-14-50-27-17	24	2	S90-2-12-004		91212004	112/5	66,5	M14x1,5	T	-1	
	06.07 -	M14x1,5x27, KU r=13	30	2	S90-2-15-017		91215017	112/5	66,5	M14x1,5	T	-1	
	06.07 -		40	2	S90-2-20-007		91220007	112/5	66,5	M14x1,5	T	-1	
	06.07 -		40	7	S90-7-20-016		91720016	112/5	66,5	M14x1,5	T	-1	
	06.07 -		50	7	S90-7-25-016		91725016	112/5	66,5	M14x1,5	T	-1	
	06.07 -		60	7	S90-7-30-007		91730007	112/5	66,5	M14x1,5	T	-1	
	A5 Cabriolet (8F7) A5 Convertible (8F7)	03.09 -	S4-6-14-50-27-17	24	2	S90-2-12-004		91212004	112/5	66,5	M14x1,5	T	-1
03.09 -		M14x1,5x27, KU r=13	30	2	S90-2-15-017		91215017	112/5	66,5	M14x1,5	T	-1	
03.09 -			40	2	S90-2-20-007		91220007	112/5	66,5	M14x1,5	T	-1	
03.09 -			40	7	S90-7-20-016		91720016	112/5	66,5	M14x1,5	T	-1	
03.09 -			50	7	S90-7-25-016		91725016	112/5	66,5	M14x1,5	T	-1	
A5 Sportback (8TA)	09.09 -	S4-6-14-50-27-17	24	2	S90-2-12-004		91212004	112/5	66,5	M14x1,5	T	-1	
	09.09 -	M14x1,5x27, KU r=13	30	2	S90-2-15-017		91215017	112/5	66,5	M14x1,5	T	-1	
	09.09 -		40	2	S90-2-20-007		91220007	112/5	66,5	M14x1,5	T	-1	
	09.09 -		40	7	S90-7-20-016		91720016	112/5	66,5	M14x1,5	T	-1	
	09.09 -		50	7	S90-7-25-016		91725016	112/5	66,5	M14x1,5	T	-1	
A6 (4A, C4)	06.94 - 10.97	S1-6-14-50-27-17	10	1	S90-1-05-006	S11	91105006	112/5	57	M14x1,5	T	20	
	06.94 - 10.97	M14x1,5x27, KU r=13	16	1	S90-1-08-001	S11	91108001	112/5	57	M14x1,5	T	20	
	06.94 - 10.97		30	2	S90-2-15-005		91215005	112/5	57	M14x1,5	T	20	
	06.94 - 10.97		40	2	S90-2-20-004		91220004	112/5	57	M14x1,5	T	20	
	06.94 - 10.97		50	7	S90-7-25-005	S68	91725005	112/5	57	M14x1,5	T	20	

Modell Model	Baujahr Year	Original-radschraube (nicht bestellbar) Original Bolt (not available)	Spurweiten-änderung Achse Total track width-ning (mm)	Eibach System	Artikel-Nr. Part-No.	Hinweise Notes	Kennzeichnung Stamping	Lockkreis Zahl Bolt pattern No. of holes	Zentrierung Centre bore (mm)	Gewinde Thread	Gutachten Homologation	ET-Grenze Offset frontier
AUDI A6 (4B, C5)	01.97 - 01.05	S1-6-14-50-27-17	10	1	S90-1-05-016	S11	91105016	112/5	57	M14x1,5	T	10
	01.97 - 01.05	M14x1,5x27, KU r=13	16	1	S90-1-08-002	S11	91108002	112/5	57	M14x1,5	T	10
	01.97 - 01.05		30	2	S90-2-15-013	S13	91215013	112/5	57	M14x1,5	T	10
	01.97 - 01.05		40	2	S90-2-20-003	S13	91220003	112/5	57	M14x1,5	T	10
	01.97 - 01.05		40	7	S90-7-20-017		91720017	112/5	57	M14x1,5	T	10
	01.97 - 01.05		50	7	S90-7-25-005		91725005	112/5	57	M14x1,5	T	10
	A6 (4F2, C6)	05.04 - 03.11	S1-6-14-50-27-17	24	2	S90-2-12-003	</					

Modell Model	Baujahr Year	Original-radschraube (nicht bestellbar) Original Bolt (not available)	Spurweiten-änderung Total track widening (mm)	Eibach System	Artikel-Nr. Part-No.	Hinweise Notes	Kennzeichnung Stamping	Lockkreis Zahn Bolt pattern No. of holes	Zentrierung Centre bore (mm)	Gewinde Thread	Gutachten Homologation	ET-Grenze Offset frontier
AUDI Q3 (8U)	06.11 -	S4-6-14-50-30-17	20	2	S90-2-10-027		91210027	112/5	57	M14x1,5	T	3
	06.11 -	M14x1,5x30, KU r=13	24	2	S90-2-12-003		91212003	112/5	57	M14x1,5	T	3
	06.11 -		30	2	S90-2-15-013		91215013	112/5	57	M14x1,5	T	3
	06.11 -		40	2	S90-2-20-003		91220003	112/5	57	M14x1,5	T	3
	06.11 -		40	7	S90-7-20-015		91720017	112/5	57	M14x1,5	T	3
	06.11 -		50	7	S90-7-25-005		91725005	112/5	57	M14x1,5	T	3
06.11 -			60	S90-7-30-012		91730012	112/5	57	M14x1,5	T	3	
Q5 (8R)	11.08 -	S4-6-14-50-30-17	24	2	S90-2-12-004		91212004	112/5	66,5	M14x1,5	T	7
	11.08 -	M14x1,5x30, KU r=13	30	2	S90-2-15-017		91215017	112/5	66,5	M14x1,5	T	7
	11.08 -		40	2	S90-2-20-007		91220007	112/5	66,5	M14x1,5	T	7
	11.08 -		50	7	S90-7-25-016		91725016	112/5	66,5	M14x1,5	T	7
	11.08 -		60	7	S90-7-30-007		91730007	112/5	66,5	M14x1,5	T	7
Q7 (4L)	03.06 -	S4-7-14-50-36-19	14	2	S90-2-07-001	S40	91207001	130/5	71,5	M14x1,5	T	29
	03.06 -	M14x1,5x36, KU r=14	30	2	S90-2-15-018		91215018	130/5	71,5	M14x1,5	T	29
	03.06 -		36	2	S90-2-18-001		91218001	130/5	71,5	M14x1,5	T	29
	03.06 -		36	7	S90-7-18-002	S46	91718001	130/5	71,5	M14x1,5	T	29
	03.06 -		42	7	S90-7-21-007	S46	91721001	130/5	71,5	M14x1,5	T	29
	03.06 -		46	2	S90-2-23-001		91223001	130/5	71,5	M14x1,5	T	29
03.06 -		46	7	S90-7-23-002	S46	91723001	130/5	71,5	M14x1,5	T	29	
TT (8N3)	10.98 - 06.06	S1-6-14-50-27-17	10	1	S90-1-05-006	S11	91105006	100/5	57	M14x1,5	T	16
	10.98 - 06.06	M14x1,5x27, KU r=13	16	1	S90-1-08-001	S11	91108001	100/5	57	M14x1,5	T	16
	10.98 - 06.06		30	2	S90-2-15-005		91215005	100/5	57	M14x1,5	T	16
	10.98 - 06.06		40	2	S90-2-20-004		91220004	100/5	57	M14x1,5	T	16
	10.98 - 06.06		50	7	S90-7-25-003		91725003	100/5	57	M14x1,5	T	16
TT (8J3)	08.06 -	S1-6-14-50-27-17	20	2	S90-2-10-027	S3	91210027	112/5	57	M14x1,5	§21	
	08.06 -	M14x1,5x27, KU r=13	24	2	S90-2-12-003	S63	91212003	112/5	57	M14x1,5	T	17
	08.06 -		30	2	S90-2-15-013		91215013	112/5	57	M14x1,5	T	17
	08.06 -		40	2	S90-2-20-003		91220003	112/5	57	M14x1,5	T	17
	08.06 -		40	7	S90-7-20-017		91720017	112/5	57	M14x1,5	T	17
	08.06 -		50	7	S90-7-25-005		91725005	112/5	57	M14x1,5	T	17
08.06 -		60	7	S90-7-30-012		91730012	112/5	57	M14x1,5	T	17	
TT Roadster (8N9)	10.99 - 06.06	S1-6-14-50-27-17	10	1	S90-1-05-006	S11	91105006	100/5	57	M14x1,5	T	16
	10.99 - 06.06	M14x1,5x27, KU r=13	16	1	S90-1-08-001	S11	91108001	100/5	57	M14x1,5	T	16
	10.99 - 06.06		30	2	S90-2-15-005		91215005	100/5	57	M14x1,5	T	16
	10.99 - 06.06		40	2	S90-2-20-004		91220004	100/5	57	M14x1,5	T	16
	10.99 - 06.06		50	7	S90-7-25-003		91725003	100/5	57	M14x1,5	T	16
TT Roadster (8J9)	03.07 -	S1-6-14-50-27-17	20	2	S90-2-10-027	S3	91210027	112/5	57	M14x1,5	§21	
	03.07 -	M14x1,5x27, KU r=13	24	2	S90-2-12-003	S63	91212003	112/5	57	M14x1,5	T	17
	03.07 -		30	2	S90-2-15-013		91215013	112/5	57	M14x1,5	T	17
	03.07 -		40	2	S90-2-20-003		91220003	112/5	57	M14x1,5	T	17
	03.07 -		40	7	S90-7-20-017		91720017	112/5	57	M14x1,5	T	17
	03.07 -		50	7	S90-7-25-005		91725005	112/5	57	M14x1,5	T	17
03.07 -		60	7	S90-7-30-012		91730012	112/5	57	M14x1,5	T	17	
BMW 1 (E87)	11.03 - 09.12	S1-1-12-50-25-17	10	1	S90-1-05-017	S11	91105017	120/5	72,5	M12x1,5	T	14
	11.03 - 09.12	M12x1,5x25, KG60°	24	2	S90-2-12-002		91212002	120/5	72,5	M12x1,5	T	14
	11.03 - 09.12		30	2	S90-2-15-001		91215001	120/5	72,5	M12x1,5	T	14
	11.03 - 09.12		40	2	S90-2-20-020		91220020	120/5	72,5	M12x1,5	T	14
	11.03 - 09.12		50	7	S90-7-25-011		91725011	120/5	72,5	M12x1,5	T	14
	11.03 - 09.12		60	7	S90-7-30-002		91730002	120/5	72,5	M12x1,5	T	14
1 (E81)	09.04 - 09.12	S1-1-12-50-25-17	10	1	S90-1-05-017	S11	91105017	120/5	72,5	M12x1,5	T	14
	09.04 - 09.12	M12x1,5x25, KG60°	24	2	S90-2-12-002		91212002	120/5	72,5	M12x1,5	T	14
	09.04 - 09.12		30	2	S90-2-15-001		91215001	120/5	72,5	M12x1,5	T	14
	09.04 - 09.12		40	2	S90-2-20-020		91220020	120/5	72,5	M12x1,5	T	14
	09.04 - 09.12		50	7	S90-7-25-011		91725011	120/5	72,5	M12x1,5	T	14
	09.04 - 09.12		60	7	S90-7-30-002		91730002	120/5	72,5	M12x1,5	T	14
1 (F20)	11.10 -	S1-1-14-25-27-17	10	1	S90-1-05-017	S11	91105017	120/5	72,5	M14x1,25	T	10
	11.10 -	M14x1,25x27, KG60°	20	2	S90-2-10-004	S3	91210004	120/5	72,5	M14x1,25	T	10
	11.10 -		24	2	S90-2-12-002		91212002	120/5	72,5	M14x1,25	T	10
	11.10 -		30	2	S90-2-15-001		91215001	120/5	72,5	M14x1,25	T	10
	11.10 -		40	2	S90-2-20-020		91220020	120/5	72,5	M14x1,25	T	10
	11.10 -		40	7	S90-7-20-036	S46	91720036	120/5	72,5	M14x1,25	T	10
	11.10 -		40	7	S90-7-25-038	S46	91725038	120/5	72,5	M14x1,25	T	10
	11.10 -		50	7	S90-7-25-038	S46	91725038	120/5	72,5	M14x1,25	T	10
	11.10 -		60	7	S90-7-30-032	S46	91730032	120/5	72,5	M14x1,25	T	10
	11.10 -		60	7	S90-7-30-032	S46	91730032	120/5	72,5	M14x1,25	T	10
1 (F21)	12.11 -	S1-1-14-25-27-17	10	1	S90-1-05-017	S11	91105017	120/5	72,5	M14x1,25	T	10
	12.11 -	M14x1,25x27, KG60°	20	2	S90-2-10-004	S3	91210004	120/5	72,5	M14x1,25	T	10
	12.11 -		24	2	S90-2-12-002		91212002	120/5	72,5	M14x1,25	T	10
	12.11 -		30	2	S90-2-15-001		91215001	120/5	72,5	M14x1,25	T	10
	12.11 -		40	2	S90-2-20-020		91220020	120/5	72,5	M14x1,25	T	10
	12.11 -		40	7	S90-7-20-036	S46	91720036	120/5	72,5	M14x1,25	T	10
	12.11 -		40	7	S90-7-25-038	S46	91725038	120/5	72,5	M14x1,25	T	10
	12.11 -		50	7	S90-7-25-038	S46	91725038	120/5	72,5	M14x1,25	T	10
	12.11 -		60	7	S90-7-30-032	S46	91730032	120/5	72,5	M14x1,25	T	10
	12.11 -		60	7	S90-7-30-032	S46	91730032	120/5	72,5	M14x1,25	T	10
1 Cabriolet (E88) 1 Convertible (E88)	03.08 -	S1-1-12-50-25-17	10	1	S90-1-05-017	S11	91105017	120/5	72,5	M12x1,5	T	14
	03.08 -	M12x1,5x25, KG60°	24	2	S90-2-12-002		91212002	120/5	72,5	M12x1,5	T	14
	03.08 -		30	2	S90-2-15-001		91215001	120/5	72,5	M12x1,5	T	14
	03.08 -		40	2	S90-2-20-020		91220020	120/5	72,5	M12x1,5	T	14
	03.08 -		50	7	S90-7-25-011		91725011	120/5	72,5	M12x1,5	T	14
03.08 -		60	7	S90-7-30-002		91730002	120/5	72,5	M12x1,5	T	14	
1 Coupe (E82)	10.07 -	S1-1-12-50-25-17	10	1	S90-1-05-017	S11	91105017	120/5	72,5	M12x1,5	T	14
	10.07 -	M12x1,5x25, KG60°	24	2	S90-2-12-002		91212002	120/5	72,5	M12x1,5	T	14
	10.07 -		30	2	S90-2-15-001		91215001	120/5	72,5	M12x1,5	T	14
	10.07 -		40	2	S90-2-20-020		91220020	120/5	72,5	M12x1,5	T	14
	10.07 -		50	7	S90-7-25-011		91725011	120/5	72,5	M12x1,5	T	14
	10.07 -		60	7	S90-7-30-002		91730002	120/5	72,5	M12x1,5	T	14

Modell Model	Baujahr Year	Original-radschraube (nicht bestellbar) Original Bolt (not available)	Spurweiten-änderung Total track widening (mm)	Eibach System	Artikel-Nr. Part-No.	Hinweise Notes	Kennzeichnung Stamping	Lockkreis Zahn Bolt pattern No. of holes	Zentrierung Centre bore (mm)	Gewinde Thread	Gutachten Homologation	ET-Grenze Offset frontier
BMW 3 (E30)	09.82 - 03.92	S1-1-12-50-25-17	10	1	S90-1-05-010	S11	91105010	100/4	57	M12x1,5	T	15
	09.82 - 03.92	M12x1,5x25, KG60°	16	1	S90-1-08-003	S11	91108003	100/4	57	M12x1,5	T	15
	09.82 - 03.92		30	2								

PRO-SPACER

Modell Model	Baujahr Year	Original- radschraube (nicht bestellbar) Original Bolt (not available)	Spurweiten- änderung Achse Total track wide- ning (mm)	Eibach System	Artikel-Nr. Part-No.	Hinweise Notes	Kennzeich- nung Stamping	Lockkreis zahl Bolt pattern No. of holes	Zentrierung Centre bore (mm)	Gewinde Thread	Gutachten Homo- logation	ET-Grenze Offset fronter
BMW 3 Coupe (E36)	03.92 - 04.99	S1-1-12-50-25-17	10	1	S90-1-05-017	S11	91105017	120/5	72,5	M12x1,5	T	15
	03.92 - 04.99	M12x1,5x25, KG60°	20	2	S90-2-10-004	S10	91210004	120/5	72,5	M12x1,5	T	15
	03.92 - 04.99		30	2	S90-2-15-001		91215001	120/5	72,5	M12x1,5	T	15
	03.92 - 04.99		40	7	S90-7-20-010		91720010	120/5	72,5	M12x1,5	T	15
	03.92 - 04.99		50	7	S90-7-25-011		91725011	120/5	72,5	M12x1,5	T	15
03.92 - 04.99		60	7	S90-7-30-002		91730002	120/5	72,5	M12x1,5	T	15	
3 Coupe (E46)	04.99 -	S1-1-12-50-25-17	10	1	S90-1-05-017		91105017	120/5	72,5	M12x1,5	T	15
	04.99 -	M12x1,5x25, KG60°	20	2	S90-2-10-004	S10	91210004	120/5	72,5	M12x1,5	T	15
	04.99 -		24	2	S90-2-12-002		91212002	120/5	72,5	M12x1,5	T	15
	04.99 -		30	2	S90-2-15-001		91215001	120/5	72,5	M12x1,5	T	15
	04.99 -		40	7	S90-2-20-020		91220020	120/5	72,5	M12x1,5	T	15
	04.99 -		40	7	S90-7-20-010	S67	91720010	120/5	72,5	M12x1,5	T	15
	04.99 -		50	7	S90-7-25-011		91725011	120/5	72,5	M12x1,5	T	15
04.99 -		60	7	S90-7-30-002		91730002	120/5	72,5	M12x1,5	T	15	
3 Coupe (E92)	06.06 -	S1-1-12-50-25-17	10	1	S90-1-05-017	S6, S11	91105017	120/5	72,5	M12x1,5	T	4
	06.06 -	M12x1,5x25, KG60°	20	2	S90-2-10-004	S10	91210004	120/5	72,5	M12x1,5	T	4
	06.06 -		24	2	S90-2-12-002		91212002	120/5	72,5	M12x1,5	T	4
	06.06 -		30	2	S90-2-15-001		91215001	120/5	72,5	M12x1,5	T	4
	06.06 -		40	2	S90-2-20-020		91220020	120/5	72,5	M12x1,5	T	4
	06.06 -		40	7	S90-7-20-010	S67, S70	91720010	120/5	72,5	M12x1,5	T	4
	06.06 -		50	7	S90-7-25-011	S70	91725011	120/5	72,5	M12x1,5	T	4
06.06 -		60	7	S90-7-30-002	S70	91730002	120/5	72,5	M12x1,5	T	4	
3 GRAN TURISMO (F34)	03.13 -	S1-1-14-25-27-17	20	2	S90-2-10-004	S3	91210004	120/5	72,5	M14x1,25	T	10
	03.13 -	M14x1,25x27, KG60°	24	2	S90-2-12-002		91212002	120/5	72,5	M14x1,25	T	10
	03.13 -		30	2	S90-2-15-001		91215001	120/5	72,5	M14x1,25	T	10
	03.13 -		40	2	S90-2-20-020		91220020	120/5	72,5	M14x1,25	T	10
	03.13 -		40	7	S90-7-20-036	S46	91720036	120/5	72,5	M14x1,25	\$21	10
	03.13 -		50	7	S90-7-25-038		91725038	120/5	72,5	M14x1,25	\$21	
	03.13 -		60	7	S90-7-30-032		91730032	120/5	72,5	M14x1,25	\$21	
3 Touring (E30)	07.87 - 10.94	S1-1-12-50-25-17	10	1	S90-1-05-010	S11	91105010	100/4	57	M12x1,5	T	15
	07.87 - 10.94	M12x1,5x25, KG60°	16	1	S90-1-08-003	S11	91108003	100/4	57	M12x1,5	T	15
	07.87 - 10.94		30	2	S90-2-15-004	S13	91215004	100/4	57	M12x1,5	T	15
	07.87 - 10.94		40	2	S90-2-20-011		91220011	100/4	57	M12x1,5	\$21	
	07.87 - 10.94		50	7	S90-7-25-001		91725001	100/4	57	M12x1,5	\$21	
3 Touring (E36)	01.95 - 10.99	S1-1-12-50-25-17	10	1	S90-1-05-017	S11	91105017	120/5	72,5	M12x1,5	T	15
	01.95 - 10.99	M12x1,5x25, KG60°	20	2	S90-2-10-004	S10	91210004	120/5	72,5	M12x1,5	T	15
	01.95 - 10.99		30	2	S90-2-15-001		91215001	120/5	72,5	M12x1,5	T	15
	01.95 - 10.99		40	7	S90-7-20-010		91720010	120/5	72,5	M12x1,5	T	15
	01.95 - 10.99		50	7	S90-7-25-011		91725011	120/5	72,5	M12x1,5	T	15
01.95 - 10.99		60	7	S90-7-30-002		91730002	120/5	72,5	M12x1,5	T	15	
3 Touring (E46)	10.99 - 02.05	S1-1-12-50-25-17	10	1	S90-1-05-017		91105017	120/5	72,5	M12x1,5	T	15
	10.99 - 02.05	M12x1,5x25, KG60°	20	2	S90-2-10-004	S10	91210004	120/5	72,5	M12x1,5	T	15
	10.99 - 02.05		24	2	S90-2-12-002		91212002	120/5	72,5	M12x1,5	T	15
	10.99 - 02.05		30	2	S90-2-15-001		91215001	120/5	72,5	M12x1,5	T	15
	10.99 - 02.05		40	2	S90-2-20-020		91220020	120/5	72,5	M12x1,5	T	15
	10.99 - 02.05		40	7	S90-7-20-010	S67	91720010	120/5	72,5	M12x1,5	T	15
	10.99 - 02.05		50	7	S90-7-25-011		91725011	120/5	72,5	M12x1,5	T	15
10.99 - 02.05		60	7	S90-7-30-002		91730002	120/5	72,5	M12x1,5	T	15	
3 Touring (E91)	09.05 -	S1-1-12-50-25-17	10	1	S90-1-05-017	S6, S11	91105017	120/5	72,5	M12x1,5	T	4
	09.05 -	M12x1,5x25, KG60°	20	2	S90-2-10-004	S10	91210004	120/5	72,5	M12x1,5	T	4
	09.05 -		24	2	S90-2-12-002		91212002	120/5	72,5	M12x1,5	T	4
	09.05 -		30	2	S90-2-15-001		91215001	120/5	72,5	M12x1,5	T	4
	09.05 -		40	2	S90-2-20-020	S70	91220020	120/5	72,5	M12x1,5	T	4
	09.05 -		40	7	S90-7-20-010	S67, S70	91720010	120/5	72,5	M12x1,5	T	4
	09.05 -		50	7	S90-7-25-011	S70	91725011	120/5	72,5	M12x1,5	T	4
09.05 -		60	7	S90-7-30-002	S70	91730002	120/5	72,5	M12x1,5	T	4	
3 Touring (F31)	10.11 -	S1-1-14-25-27-17	20	2	S90-2-10-004	S3	91210004	120/5	72,5	M14x1,25	T	1
	10.11 -	M14x1,25x27, KG60°	24	2	S90-2-12-002		91212002	120/5	72,5	M14x1,25	T	1
	10.11 -		30	2	S90-2-15-001		91215001	120/5	72,5	M14x1,25	T	1
	10.11 -		40	2	S90-2-20-020		91220020	120/5	72,5	M14x1,25	T	1
	10.11 -		40	7	S90-7-20-036	S46	91720036	120/5	72,5	M14x1,25	T	1
	10.11 -		50	7	S90-7-25-038		91725038	120/5	72,5	M14x1,25	T	1
	10.11 -		60	7	S90-7-30-032		91730032	120/5	72,5	M14x1,25	T	1
4 Coupe (F32)	07.13 -	S1-1-14-25-27-17	20	2	S90-2-10-004	S3	91210004	120/5	72,5	M14x1,25	T	4
	07.13 -	M14x1,25x27, KG60°	24	2	S90-2-12-002		91212002	120/5	72,5	M14x1,25	T	4
	07.13 -		30	2	S90-2-15-001		91215001	120/5	72,5	M14x1,25	T	4
	07.13 -		40	2	S90-2-20-020		91220020	120/5	72,5	M14x1,25	T	4
	07.13 -		40	7	S90-7-20-036	S46	91720036	120/5	72,5	M14x1,25	T	4
	07.13 -		50	7	S90-7-25-038		91725038	120/5	72,5	M14x1,25	T	4
	07.13 -		60	7	S90-7-30-032		91730032	120/5	72,5	M14x1,25	T	4
5 (E34)	12.87 - 11.95	S1-1-12-50-25-17	10	1	S90-1-05-017	S11	91105017	120/5	72,5	M12x1,5	T	5
	12.87 - 11.95	M12x1,5x25, KG60°	30	2	S90-2-15-001		91215001	120/5	72,5	M12x1,5	T	5
	12.87 - 11.95		40	7	S90-7-20-010	S67	91720010	120/5	72,5	M12x1,5	T	5
	12.87 - 11.95		50	7	S90-7-25-011		91725011	120/5	72,5	M12x1,5	T	5
	12.87 - 11.95		60	7	S90-7-30-002		91730002	120/5	72,5	M12x1,5	T	5
5 (E39)	11.95 - 06.03	S1-1-12-50-25-17	10	1	S90-1-05-007		91105007	120/5	74	M12x1,5	T	4
	11.95 - 06.03	M12x1,5x25, KG60°	30	2	S90-2-15-002		91215002	120/5	74	M12x1,5	T	4
	11.95 - 06.03		40	7	S90-7-20-002	S68	91720002	120/5	74	M12x1,5	T	4
	11.95 - 06.03		50	7	S90-7-25-010	S68	91725010	120/5	74	M12x1,5	T	4
	11.95 - 06.03		50	7	S90-7-25-010	S68	91725010	120/5	74	M12x1,5	T	4
5 (E60)	07.03 - 03.10	S1-1-12-50-25-17	10	1	S90-1-05-017	S11	91105017	120/5	72,5	M12x1,5	T	-10
	07.03 - 03.10	M12x1,5x25, KG60°	20	2	S90-2-10-004	S10	91210004	120/5	72,5	M12x1,5	T	-10
	07.03 - 03.10		24	2	S90-2-12-002		91212002	120/5	72,5	M12x1,5	T	-10
	07.03 - 03.10		30	2	S90-2-15-001		91215001	120/5	72,5	M12x1,5	T	-10
	07.03 - 03.10		40	2	S90-2-20-020		91220020	120/5	72,5	M12x1,5	T	-10
	07.03 - 03.10		40	7	S90-7-20-010	S67	91720010	120/5	72,5	M12x1,5	T	-10
	07.03 - 03.10		50	7	S90-7-25-011		91725011	120/5	72,5	M12x1,5	T	-10
	07.03 - 03.10		60	7	S90-7-30-002		91730002	120/5	72,5	M12x1,5	T	-10

Modell Model	Baujahr Year	Original- radschraube (nicht bestellbar) Original Bolt (not available)	Spurweiten- änderung Achse Total track wide- ning (mm)	Eibach System	Artikel-Nr. Part-No.	Hinweise Notes	Kennzeich-
----------------	----------------	--	--	------------------	---------------------------	---------------------	----------------

Modell Model	Baujahr Year	Original- radschraube (nicht bestellbar) Original Bolt (not available)	Spurweiten- änderung Achse Total track wide- ning (mm)	Eibach System	Artikel-Nr. Part-No.	Hinweise Notes	Kennzeich- nung Stamping	Lockkreis Bolt pattern No. of holes	Zentrierung Centre bore (mm)	Gewinde Thread	Gutachten Homo- logation	ET-Grenze Offset frontier
BMW												
7 (F01, F02, F03, F04)												
	06.08 -	S1-1-14-25-28-17	20	2	S90-2-10-004	S10	91210004	120/5	72,5	M14x1,25	T	0
	06.08 -	M14x1,25x28, KG60*	24	2	S90-2-12-002		91212002	120/5	72,5	M14x1,25	T	0
	06.08 -		30	2	S90-2-15-001		91215001	120/5	72,5	M14x1,25	T	0
	06.08 -		40	2	S90-2-20-020		91220020	120/5	72,5	M14x1,25	T	0
	06.08 -		50	7	S90-7-25-038		91725038	120/5	72,5	M14x1,25	T	0
	06.08 -		60	7	S90-7-30-032		91730032	120/5	72,5	M14x1,25	T	0
X1 (E84)												
	03.09 -	S1-1-12-50-26-17	20	2	S90-2-10-004	S10	91210004	120/5	72,5	M12x1,5	T	5
	03.09 -	M12x1,5x26, KG60*	24	2	S90-2-12-002		91212002	120/5	72,5	M12x1,5	T	5
	03.09 -		30	2	S90-2-15-001		91215001	120/5	72,5	M12x1,5	T	5
	03.09 -		40	2	S90-2-20-020		91220020	120/5	72,5	M12x1,5	T	5
	03.09 -		40	7	S90-7-20-010	S67	91720010	120/5	72,5	M12x1,5	T	5
	03.09 -		50	7	S90-7-25-011		91725011	120/5	72,5	M12x1,5	T	5
	03.09 -		60	7	S90-7-30-002		91730002	120/5	72,5	M12x1,5	T	5
X3 (E83)												
	01.04 -	S1-1-14-50-33-17	10	1	S90-1-05-017	S10	91105017	120/5	72,5	M14x1,5	T	16
	01.04 -	M14x1,5x33, KG60*	20	2	S90-2-10-004		91210004	120/5	72,5	M14x1,5	T	16
	01.04 -		24	2	S90-2-12-002		91212002	120/5	72,5	M14x1,5	T	16
	01.04 -		30	2	S90-2-15-001		91215001	120/5	72,5	M14x1,5	T	16
	01.04 -		40	2	S90-2-20-020		91220020	120/5	72,5	M14x1,5	T	16
	01.04 -		40	7	S90-7-20-033	S34	91720011	120/5	72,5	M14x1,5	T	16
	01.04 -		50	7	S90-7-25-012		91725012	120/5	72,5	M14x1,5	T	16
	01.04 -		60	7	S90-7-30-003		91730003	120/5	72,5	M14x1,5	T	16
X3 (F25)												
	09.10 -	S1-1-14-25-27-17	20	2	S90-2-10-004	S10	91210004	120/5	72,5	M14x1,25	T	2
	09.10 -	M14x1,25x27, KG60*	24	2	S90-2-12-002		91212002	120/5	72,5	M14x1,25	T	2
	09.10 -		30	2	S90-2-15-001		91215001	120/5	72,5	M14x1,25	T	2
	09.10 -		40	2	S90-2-20-020		91220020	120/5	72,5	M14x1,25	T	2
	09.10 -		40	7	S90-7-20-036	S46	91720036	120/5	72,5	M14x1,25	T	2
	09.10 -		50	7	S90-7-25-038		91725038	120/5	72,5	M14x1,25	T	2
	09.10 -		60	7	S90-7-30-032		91730032	120/5	72,5	M14x1,25	T	2
X5 (E53)												
	05.00 -	S4-1-14-50-33-17	10	1	S90-1-05-017	S10	91105017	120/5	72,5	M14x1,5	T	15
	05.00 -	M14x1,5x33, KG60*	20	2	S90-2-10-004		91210004	120/5	72,5	M14x1,5	T	15
	05.00 -		24	2	S90-2-12-002		91212002	120/5	72,5	M14x1,5	T	15
	05.00 -		30	2	S90-2-15-001		91215001	120/5	72,5	M14x1,5	T	15
	05.00 -		40	2	S90-2-20-020		91220020	120/5	72,5	M14x1,5	T	15
	05.00 -		40	7	S90-7-20-011	S35	91720011	120/5	72,5	M14x1,5	T	15
	05.00 -		50	7	S90-7-25-012		91725012	120/5	72,5	M14x1,5	T	15
	05.00 -		60	7	S90-7-30-003		91730003	120/5	72,5	M14x1,5	T	15
X5 (E70)												
	02.07 -	S1-1-14-25-27-17	8	1	S90-1-04-007	S46	91104007	120/5	74	M14x1,25	T	15
	02.07 -	M14x1,25x27, KG60*	24	2	S90-2-12-014		91212014	120/5	74	M14x1,25	T	15
	02.07 -		30	2	S90-2-15-002		91215002	120/5	74	M14x1,25	T	15
	02.07 -		40	2	S90-2-20-027		91220027	120/5	74	M14x1,25	T	15
	02.07 -		40	7	S90-7-20-035		91720035	120/5	74	M14x1,25	T	15
	02.07 -		50	7	S90-7-25-032		91725032	120/5	74	M14x1,25	T	15
	02.07 -		60	7	S90-7-30-026		91730026	120/5	74	M14x1,25	T	15
X6 (E71, E72) Hinterachse												
X6 (E71, E72) rear axle												
	05.08 -	S1-1-14-25-27-17	24	2	S90-2-12-002	S46	91212002	120/5	72,5	M14x1,25	T	5
	05.08 -	M14x1,25x27, KG60*	30	2	S90-2-15-001		91215001	120/5	72,5	M14x1,25	T	5
	05.08 -		40	2	S90-2-20-020		91220020	120/5	72,5	M14x1,25	T	5
	05.08 -		40	7	S90-7-20-036		91720036	120/5	72,5	M14x1,25	T	5
	05.08 -		50	7	S90-7-25-038		91725038	120/5	72,5	M14x1,25	T	5
	05.08 -		60	7	S90-7-30-032		91730032	120/5	72,5	M14x1,25	T	5
X6 (E71, E72) Vorderachse												
X6 (E71, E72) front axle												
	05.08 -	S1-1-14-25-27-17	24	2	S90-2-12-014	S46	91212014	120/5	74	M14x1,25	T	5
	05.08 -	M14x1,25x27, KG60*	30	2	S90-2-15-002		91215002	120/5	74	M14x1,25	T	5
	05.08 -		40	2	S90-2-20-027		91220027	120/5	74	M14x1,25	T	5
	05.08 -		40	7	S90-7-20-035		91720035	120/5	74	M14x1,25	T	5
	05.08 -		50	7	S90-7-25-032		91725032	120/5	74	M14x1,25	T	5
	05.08 -		60	7	S90-7-30-026		91730026	120/5	74	M14x1,25	T	5
Z3 (E36)												
	10.95 - 01.03	S1-1-12-50-25-17	10	1	S90-1-05-017	S11	91105017	120/5	72,5	M12x1,5	T	-7
	10.95 - 01.03	M12x1,5x25, KG60*	20	2	S90-2-10-004	S10	91210004	120/5	72,5	M12x1,5	T	-7
	10.95 - 01.03		30	2	S90-2-15-001		91215001	120/5	72,5	M12x1,5	T	-7
	10.95 - 01.03		40	7	S90-7-20-010	S68	91720010	120/5	72,5	M12x1,5	T	-7
	10.95 - 01.03		50	7	S90-7-25-011		91725011	120/5	72,5	M12x1,5	T	-7
	10.95 - 01.03		60	7	S90-7-30-002		91730002	120/5	72,5	M12x1,5	T	-7
Z3 Coupe (E36)												
	04.97 - 06.03	S1-1-12-50-25-17	10	1	S90-1-05-017	S11	91105017	120/5	72,5	M12x1,5	T	-7
	04.97 - 06.03	M12x1,5x25, KG60*	20	2	S90-2-10-004	S10	91210004	120/5	72,5	M12x1,5	T	-7
	04.97 - 06.03		30	2	S90-2-15-001		91215001	120/5	72,5	M12x1,5	T	-7
	04.97 - 06.03		40	7	S90-7-20-010	S68	91720010	120/5	72,5	M12x1,5	T	-7
	04.97 - 06.03		50	7	S90-7-25-011		91725011	120/5	72,5	M12x1,5	T	-7
	04.97 - 06.03		60	7	S90-7-30-002		91730002	120/5	72,5	M12x1,5	T	-7
Z4 (E85)												
	02.03 -	S1-1-12-50-25-17	10	1	S90-1-05-017	S11	91105017	120/5	72,5	M12x1,5	T	32
	02.03 -	M12x1,5x25, KG60*	20	2	S90-2-10-004	S10	91210004	120/5	72,5	M12x1,5	T	32
	02.03 -		24	2	S90-2-12-002		91212002	120/5	72,5	M12x1,5	T	32
	02.03 -		30	2	S90-2-15-001		91215001	120/5	72,5	M12x1,5	T	32
	02.03 -		40	2	S90-2-20-020		91220020	120/5	72,5	M12x1,5	T	32
	02.03 -		40	7	S90-7-20-010	S67	91720010	120/5	72,5	M12x1,5	T	32
	02.03 -		50	7	S90-7-25-011		91725011	120/5	72,5	M12x1,5	T	32
	02.03 -		60	7	S90-7-30-002		91730002	120/5	72,5	M12x1,5	T	32
Z4 (E89)												
	05.09 -	S1-1-12-50-25-17	20	2	S90-2-10-004	S10	91210004	120/5	72,5	M12x1,5	T	4
	05.09 -	M12x1,5x25, KG60*	24	2	S90-2-12-002		91212002	120/5	72,5	M12x1,5	T	4
	05.09 -		30	2	S90-2-15-001		91215001	120/5	72,5	M12x1,5	T	4
	05.09 -		40	2	S90-2-20-020		91220020	120/5	72,5	M12x1,5	T	4
	05.09 -		40	7	S90-7-20-010	S67	91720010	120/5	72,5	M12x1,5	T	4
	05.09 -											

Modell Model	Baujahr Year	Original- radschraube (nicht bestellbar) Original Bolt (not available)	Spurweiten- änderung Achse Total track wide- ning (mm)	Eibach System	Artikel-Nr. Part-No.	Hinweise Notes	Kennzeich- nung Stamping	Lockkreis zähl Bolt pattern No. of holes	Zentrierung Centre bore (mm)	Gewinde Thread	Gutachten Homo- logation	ET-Grenze Offset frontier	
CHRYSLER PT CRUISER (PT.) Hinterachse PT CRUISER (PT.) rear axle	06.00 - 12.10		10	5	S90-5-05-033	S11, S30, S33	91505025	100/5	57	M12x1,5	T	6,5	
	06.00 - 12.10		20	6	S90-6-10-007	S30, S33	91610001	100/5	57	M12x1,5	T	6,5	
	06.00 - 12.10		32	4	S90-4-16-001	S9, S23, S39	91416001	100/5	57	M12x1,5	T	6,5	
	06.00 - 12.10		40	6	S90-6-20-021	S30, S33	91620016	100/5	57	M12x1,5	T	6,5	
	06.00 - 12.10		60	4	S90-4-30-006	S9, S23, S39	91430006	100/5	57	M12x1,5	T	6,5	
	06.00 - 12.10												
PT CRUISER (PT.) Vorderachse PT CRUISER (PT.) front axle	06.00 - 12.10		10	5	S90-5-05-032	S11, S30, S33	91505025	100/5	57	M12x1,5	T	6,5	
	06.00 - 12.10		20	6	S90-6-10-006	S30, S33	91610001	100/5	57	M12x1,5	T	6,5	
	06.00 - 12.10		32	4	S90-4-16-001	S9, S23, S39	91416001	100/5	57	M12x1,5	T	6,5	
	06.00 - 12.10		40	6	S90-6-20-020	S30, S33	91620016	100/5	57	M12x1,5	T	6,5	
	06.00 - 12.10		60	4	S90-4-30-006	S9, S23, S39	91430006	100/5	57	M12x1,5	T	6,5	
	06.00 - 12.10												
PT CRUISER Cabriolet Hinterachse PT CRUISER Convertible rear axle	03.04 - 03.08		10	5	S90-5-05-033	S11, S30, S33	91505025	100/5	57	M12x1,5	T	6,5	
	03.04 - 03.08		20	6	S90-6-10-007	S30, S33	91610001	100/5	57	M12x1,5	T	6,5	
	03.04 - 03.08		32	4	S90-4-16-001	S9, S23, S39	91416001	100/5	57	M12x1,5	T	6,5	
	03.04 - 03.08		40	6	S90-6-20-021	S30, S33	91620016	100/5	57	M12x1,5	T	6,5	
	03.04 - 03.08		60	4	S90-4-30-006	S9, S23, S39	91430006	100/5	57	M12x1,5	T	6,5	
	03.04 - 03.08												
PT CRUISER Cabriolet Vorderachse PT CRUISER Convertible front axle	03.04 - 03.08		10	5	S90-5-05-032	S11, S30, S33	91505025	100/5	57	M12x1,5	T	6,5	
	03.04 - 03.08		20	6	S90-6-10-006	S30, S33	91610001	100/5	57	M12x1,5	T	6,5	
	03.04 - 03.08		32	4	S90-4-16-001	S9, S23, S39	91416001	100/5	57	M12x1,5	T	6,5	
	03.04 - 03.08		40	6	S90-6-20-020	S30, S33	91620016	100/5	57	M12x1,5	T	6,5	
	03.04 - 03.08		60	4	S90-4-30-006	S9, S23, S39	91430006	100/5	57	M12x1,5	T	6,5	
	03.04 - 03.08												
SEBRING Cabriolet (JR) SEBRING Convertible (JR)	04.01 - 06.07		20	6	S90-6-10-006	S30, S33	91610001	100/5	57	M12x1,5	T	26	
	04.01 - 06.07		32	4	S90-4-16-001	S9, S23	91416001	100/5	57	M12x1,5	T	26	
	04.01 - 06.07		40	6	S90-6-20-020	S30, S33	91620016	100/5	57	M12x1,5	T	26	
	04.01 - 06.07		60	4	S90-4-30-006	S9, S23	91430006	100/5	57	M12x1,5	T	26	
	04.01 - 06.07												
	04.01 - 06.07												
VOYAGER IV (RG, RS) Hinterachse VOYAGER IV (RG, RS) rear axle	02.00 - 12.08		10	5	S90-5-05-035	S33	91505026	114,3/5	71,5	M12x1,5	T	25	
	02.00 - 12.08		30	6	S90-6-15-031	S33	91615022	114,3/5	71,5	M12x1,5	T	25	
	02.00 - 12.08		50	4	S90-4-25-012	S9, S23	91425012	114,3/5	71,5	M12x1,5	T	25	
	02.00 - 12.08												
	02.00 - 12.08												
	02.00 - 12.08												
VOYAGER IV (RG, RS) Vorderachse VOYAGER IV (RG, RS) front axle	02.00 - 12.08		10	5	S90-5-05-034	S33	91505026	114,3/5	71,5	M12x1,5	T	25	
	02.00 - 12.08		30	6	S90-6-15-030	S33	91615022	114,3/5	71,5	M12x1,5	T	25	
	02.00 - 12.08		50	4	S90-4-25-012	S9, S23	91425012	114,3/5	71,5	M12x1,5	T	25	
	02.00 - 12.08												
	02.00 - 12.08												
	02.00 - 12.08												
CITROËN C-CROSSER (EP.)	02.07 -		30	4	S90-4-15-018	S9	91415002	114,3/5	67	M12x1,5	T	8	
	02.07 -		40	4	S90-4-20-024	S9	91420001	114,3/5	67	M12x1,5	T	8	
	02.07 -		50	4	S90-4-25-041	S9	91425016	114,3/5	67	M12x1,5	T	8	
	02.07 -		60	4	S90-4-30-032	S9	91430015	114,3/5	67	M12x1,5	T	8	
	02.07 -												
	02.07 -												
C-CROSSER ENTERPRISE	01.09 -		30	4	S90-4-15-018	S9	91415002	114,3/5	67	M12x1,5	T	8	
	01.09 -		40	4	S90-4-20-024	S9	91420001	114,3/5	67	M12x1,5	T	8	
	01.09 -		50	4	S90-4-25-041	S9	91425016	114,3/5	67	M12x1,5	T	8	
	01.09 -		60	4	S90-4-30-032	S9	91430015	114,3/5	67	M12x1,5	T	8	
	01.09 -												
	01.09 -												
C1 (PM, PN)	06.05 -	S1-1-12-50-20-17	20	2	S90-2-10-017	S58	91210017	100/4	54	M12x1,5	T	24	
	06.05 -	M12x1,5x20, KG60°	24	2	S90-2-12-005	S58	91212005	100/4	54	M12x1,5	T	24	
	06.05 -		30	2	S90-2-15-035	S58	91615010	100/4	54	M12x1,5	T	24	
	06.05 -		40	2	S90-2-20-023	S58	91620026	100/4	54	M12x1,5	T	24	
	06.05 -		50	7	S90-7-25-026		91725026	100/4	54	M12x1,5	T	24	
	06.05 -		70	7	S90-7-35-004		91735004	100/4	54	M12x1,5	T	24	
C2 (JM)	09.03 -	S1-9-12-25-36-17	10	1	S90-1-05-012	S11, S58	91105012	108/4	65	M12x1,25	\$21		
	09.03 -	M12x1,25x36, FB	20	2	S90-2-10-013	S58	91210013	108/4	65	M12x1,25	\$21		
	09.03 -		30	2	S90-2-15-008	S58	91215008	108/4	65	M12x1,25	\$21		
	09.03 -		40	2	S90-2-20-021	S58	91220021	108/4	65	M12x1,25	\$21		
	09.03 -		50	7	S90-7-25-019		91725019	108/4	65	M12x1,25	\$21		
	09.03 -		60	7	S90-7-30-009		91730009	108/4	65	M12x1,25	\$21		
C2 ENTERPRISE	04.09 -	S1-9-12-25-36-17	10	1	S90-1-05-012	S11, S58	91105012	108/4	65	M12x1,25	\$21		
	04.09 -	M12x1,25x36, FB	20	2	S90-2-10-013	S58	91210013	108/4	65	M12x1,25	\$21		
	04.09 -		30	2	S90-2-15-008	S58	91215008	108/4	65	M12x1,25	\$21		
	04.09 -		40	2	S90-2-20-021	S58	91220021	108/4	65	M12x1,25	\$21		
	04.09 -		50	7	S90-7-25-019		91725019	108/4	65	M12x1,25	\$21		
	04.09 -		60	7	S90-7-30-009		91730009	108/4	65	M12x1,25	\$21		
C3 (FC)	02.02 -	S1-9-12-25-36-17	10	1	S90-1-05-012	S11, S58	91105012	108/4	65	M12x1,25	T	9	
	02.02 -	M12x1,25x36, FB	20	2	S90-2-10-013	S58	91210013	108/4	65	M12x1,25	\$21		
	02.02 -		30	2	S90-2-15-008	S58	91215008	108/4	65	M12x1,25	T	9	
	02.02 -		40	2	S90-2-20-021	S58	91220021	108/4	65	M12x1,25	\$21		
	02.02 -		50	7	S90-7-25-019		91725019	108/4	65	M12x1,25	\$21		
	02.02 -		60	7	S90-7-30-009		91730009	108/4	65	M12x1,25	\$21		
C3 Pluriel (HB.)	05.03 -	S1-9-12-25-36-17	10	1	S90-1-05-012	S11, S58	91105012	108/4	65	M12x1,25	T	12	
	05.03 -	M12x1,25x36, FB	20	2	S90-2-10-013	S58	91210013	108/4	65	M12x1,25	\$21		
	05.03 -		30	2	S90-2-15-008	S58	91215008	108/4	65	M12x1,25	T	12	
	05.03 -		40	2	S90-2-20-021	S58	91220021	108/4	65	M12x1,25	\$21		
	05.03 -		50	7	S90-7-25-019		91725019	108/4	65	M12x1,25	\$21		
	05.03 -		60	7	S90-7-30-009		91730009	108/4	65	M12x1,25	\$21		

Modell Model	Baujahr Year	Original- radschraube (nicht bestellbar) Original Bolt (not available)	Spurweiten- änderung Achse Total track wide- ning (mm)	Eibach System	Artikel-Nr. Part-No.	Hinweise Notes	Kennzeich- nung Stamping	Lockkreis zähl Bolt pattern No. of holes	Zentrierung Centre bore (mm)	Gewinde Thread	Gutachten Homo- logation	ET-Grenze Offset frontier
CITROËN C4 (LC)	11.04 -	S1-9-12-25-36-17	20	2	S90-2-10-013	S58	91210013	108/4	65	M12x1,25	T	-3
	11.04 -	M12x1,25x36, FB	30	2	S90-2-15-008	S58	91215008	108/4	65	M12x1,25	T	-3
	11.04 -		40	2	S90-2-20-021	S58	91220021	108/4	65	M12x1,25	T	-3
	11.04 -		50	7	S90-7-25-019		91725019	108/4	65	M12x1,25	T	-3
	11.04 -		60	7	S90-7-30-009		91730009	108/4	65	M12x1,25	T	-3
	11.04 -											
C4 (B7)	11.09 -	S1-9-12-25-36-17	20	2	S90-2-10-013	S58	91210013	108/4	65	M12x1,25	T	-3
	11.09 -	M12x1,25x36, FB	30	2	S90-2-15-008	S58	91215008	108/4	65	M12x		

Modell Model	Baujahr Year	Original- radschraube (nicht bestellbar) Original Bolt (not available)	Spurweiten- änderung Total track wide- ning (mm)	Eibach System	Artikel-Nr. Part-No.	Hinweise Notes	Kennzeich- nung Stamping	Lockkreis zahl Bolt pattern No. of holes	Zentrierung Centre bore (mm)	Gewinde Thread	Gutachten Homolo- gation	ET-Grenze Offset frontier	
DAIHATSU SIRION (M3.)	01.05 -		20	6	S90-6-10-017	S33	91610015	100/4	54	M12x1,5	T	5	
	01.05 -		24	6	S90-6-12-001	S33	91212005	100/4	54	M12x1,5	T	5	
	01.05 -		30	6	S90-6-15-041	S33	91615010	100/4	54	M12x1,5	T	5	
	01.05 -		40	4	S90-4-20-011		91420011	100/4	54	M12x1,5	T	5	
	01.05 -		40	6	S90-6-20-032	S33	91620026	100/4	54	M12x1,5	T	5	
	01.05 -		60	4	S90-4-30-021		91430021	100/4	54	M12x1,5	T	5	
TREVIS	06.06 -		20	6	S90-6-10-017	S33	91610015	100/4	54	M12x1,5	§21		
	06.06 -		24	6	S90-6-12-001	S33	91212005	100/4	54	M12x1,5	§21		
	06.06 -		30	6	S90-6-15-041	S33	91615010	100/4	54	M12x1,5	§21		
	06.06 -		40	4	S90-4-20-011		91420011	100/4	54	M12x1,5	§21		
	06.06 -		40	6	S90-6-20-032	S33	91620026	100/4	54	M12x1,5	§21		
	06.06 -		60	4	S90-4-30-021		91430021	100/4	54	M12x1,5	§21		
WILDCAT/ROCKY (F70)	02.85 - 04.87		50	8	S90-8-25-001	S9, S11	91825001	139,7/5	106,5	M12x1,5	T	-45	
WILDCAT/ROCKY (F75)	02.85 - 04.87		50	8	S90-8-25-001	S9, S11	91825001	139,7/5	106,5	M12x1,5	T	-45	
DODGE CALIBER	06.06 -		20	6	S90-6-10-002	S33	91610002	114,3/5	67	M12x1,5	T	14	
	06.06 -		30	4	S90-4-15-018	S9, S23	91415002	114,3/5	67	M12x1,5	T	14	
	06.06 -		30	6	S90-6-15-023	S33	91615023	114,3/5	67	M12x1,5	T	14	
	06.06 -		40	4	S90-4-20-024	S9, S23	91420001	114,3/5	67	M12x1,5	T	14	
	06.06 -		40	6	S90-6-20-035	S33	91620028	114,3/5	67	M12x1,5	T	14	
	06.06 -		50	4	S90-4-25-041	S9, S23	91425016	114,3/5	67	M12x1,5	T	14	
	06.06 -		60	4	S90-4-30-032	S9	91430015	114,3/5	67	M12x1,5	T	14	
	Magnum	11.04 -		50	4	S90-4-25-030	S33	91425030	115/5	71,4	M14x1,5	T	-6
	11.04 -		60	4	S90-4-30-017	S33	91430017	115/5	71,4	M14x1,5	T	-6	
	NITRO	06.07 -		50	4	S90-4-25-015	S9, S23, S62	91425015	114,3/5	71,5	1/2"UNF	T	10,5
		06.07 -		60	4	S90-4-30-008	S9, S62	91430008	114,3/5	71,5	1/2"UNF	T	10,5
FIAT 500	10.07 -	S1-1-12-25-22-17	10	1	S90-1-05-011		91105011	98/4	58	M12x1,25	T	5	
	10.07 -	M12x1,25x22, KG60°	20	2	S90-2-10-021	S75	91210021	98/4	58	M12x1,25	T	5	
	10.07 -		30	2	S90-2-15-020		91215020	98/4	58	M12x1,25	T	5	
	10.07 -		40	7	S90-7-20-012		91720012	98/4	58	M12x1,25	T	5	
	10.07 -		50	7	S90-7-25-006		91725006	98/4	58	M12x1,25	T	5	
	10.07 -		60	7	S90-7-30-005		91730005	98/4	58	M12x1,25	T	5	
	500 C	09.09 -	S1-1-12-25-22-17	10	1	S90-1-05-011		91105011	98/4	58	M12x1,25	T	5
		09.09 -	M12x1,25x22, KG60°	20	2	S90-2-10-021	S75	91210021	98/4	58	M12x1,25	T	5
		09.09 -		30	2	S90-2-15-020		91215020	98/4	58	M12x1,25	T	5
		09.09 -		40	7	S90-7-20-012		91720012	98/4	58	M12x1,25	T	5
09.09 -			50	7	S90-7-25-006		91725006	98/4	58	M12x1,25	T	5	
09.09 -			60	7	S90-7-30-005		91730005	98/4	58	M12x1,25	T	5	
500L	09.12 -	S1-1-12-25-22-17	10	1	S90-1-05-015		91105015	98/5	58	M12x1,25	T	9	
	09.12 -	M12x1,25x22, KG60°	20	2	S90-2-10-003	S75	91210003	98/5	58	M12x1,25	T	9	
	09.12 -		30	2	S90-2-15-003		91215003	98/5	58	M12x1,25	T	9	
	09.12 -		40	7	S90-7-20-039		91720019	98/5	58	M12x1,25	T	9	
	09.12 -		50	7	S90-7-25-051		91725022	98/5	58	M12x1,25	T	9	
	09.12 -		60	7	S90-7-30-058		91730011	98/5	58	M12x1,25	T	9	
BARCETTA (183)	03.95 - 05.05	S1-1-12-25-32-19	10	1	S90-1-05-011		91105011	98/4	58	M12x1,25	§21		
	03.95 - 05.05	M12x1,25x32, KG60°	30	2	S90-2-15-020		91215020	98/4	58	M12x1,25	§21		
	03.95 - 05.05		50	7	S90-7-25-006	S68	91725006	98/4	58	M12x1,25	§21		
BRAVA (182)	10.95 - 12.02	S1-1-12-25-32-19	10	1	S90-1-05-011		91105011	98/4	58	M12x1,25	T	17	
	10.95 - 12.02	M12x1,25x32, KG60°	30	2	S90-2-15-020		91215020	98/4	58	M12x1,25	T	17	
	10.95 - 12.02		50	7	S90-7-25-006	S68	91725006	98/4	58	M12x1,25	T	17	
BRAVO I (182)	10.95 - 10.01	S1-1-12-25-32-19	10	1	S90-1-05-011		91105011	98/4	58	M12x1,25	T	17	
	10.95 - 10.01	M12x1,25x32, KG60°	30	2	S90-2-15-020		91215020	98/4	58	M12x1,25	T	17	
	10.95 - 10.01		50	7	S90-7-25-006	S68	91725006	98/4	58	M12x1,25	T	17	
BRAVO II (198)	11.06 -	S1-1-12-25-22-17	10	1	S90-1-05-011	S11	91105011	98/4	58	M12x1,25	T	1,5	
	11.06 -	M12x1,25x22, KG60°	30	2	S90-2-15-020		91215020	98/4	58	M12x1,25	T	1,5	
	11.06 -		40	7	S90-7-20-012		91720012	98/4	58	M12x1,25	T	1,5	
	11.06 -		50	7	S90-7-25-006		91725006	98/4	58	M12x1,25	T	1,5	
	11.06 -		60	7	S90-7-30-005		91730005	98/4	58	M12x1,25	T	1,5	
CINQUECENTO (170)	07.91 - 07.99	S1-1-12-25-32-19	10	1	S90-1-05-011		91105011	98/4	58	M12x1,25	T	11	
	07.91 - 07.99	M12x1,25x32, KG60°	30	2	S90-2-15-020		91215020	98/4	58	M12x1,25	T	11	
	07.91 - 07.99		50	7	S90-7-25-006	S68	91725006	98/4	58	M12x1,25	T	11	
COUPE (FA/175)	11.93 - 08.00		10	1	S90-1-05-011		91105011	98/4	58	M12x1,25	§21		
	11.93 - 08.00		30	2	S90-2-15-020		91215020	98/4	58	M12x1,25	§21		
	11.93 - 08.00		50	7	S90-7-25-006	S68	91725006	98/4	58	M12x1,25	§21		
CROMA (194)	06.05 -	S1-1-12-50-22-17	10	1	S90-1-05-013		91105013	110/5	65	M12x1,5	§21		
	06.05 -	M12x1,5x22, KG60°	32	2	S90-2-16-001		91216001	110/5	65	M12x1,5	§21		
	06.05 -		40	2	S90-2-20-006		91220006	110/5	65	M12x1,5	§21		
	06.05 -		60	7	S90-7-30-015		91730015	110/5	65	M12x1,5	§21		
PANDA (141A.)	03.80 - 07.04	S1-1-12-25-32-19	10	1	S90-1-05-011		91105011	98/4	58	M12x1,25	§21		
	03.80 - 07.04	M12x1,25x32, KG60°	30	2	S90-2-15-020		91215020	98/4	58	M12x1,25	§21		
	03.80 - 07.04		50	7	S90-7-25-006	S68	91725006	98/4	58	M12x1,25	§21		
PANDA (169)	09.03 -	S1-1-12-25-22-17	10	1	S90-1-05-011	S6	91105011	98/4	58	M12x1,25	T	20	
	09.03 -	M12x1,25x22, KG60°	30	2	S90-2-15-020		91215020	98/4	58	M12x1,25	T	20	
	09.03 -		50	7	S90-7-25-006	S68	91725006	98/4	58	M12x1,25	T	20	

Modell Model	Baujahr Year	Original- radschraube (nicht bestellbar) Original Bolt (not available)	Spurweiten- änderung Total track wide- ning (mm)	Eibach System	Artikel-Nr. Part-No.	Hinweise Notes	Kennzeich- nung Stamping	Lockkreis zahl Bolt pattern No. of holes	Zentrierung Centre bore (mm)	Gewinde Thread	Gutachten Homolo- gation	ET-Grenze Offset frontier
FIAT PANDA (312)	02.12 -	S1-1-12-25-22-17	10	1	S90-1-05-011		91105011	98/4	58	M12x1,25	T	5
	02.12 -	M12x1,25x22, KG60°	30	2	S90-2-15-020		91215020	98/4	58	M12x1,25	T	5
	02.12 -		40	7	S90-7-20-012		91720012	98/4	58	M12x1,25	T	5
	02.12 -		50	7	S90-7-25-006		91725006	98/4	58	M12x1,25	T	5
	02.12 -		60	7	S90-7-30-005		91730005	98/4	58	M12x1,25	T	5
PANDA Van (141.)	01.86 - 02.04	S1-1-12-25-32-19	10	1	S90-1-05-011		91105011	98/4	58	M12x1,25	§21	
	01.86 - 02.04	M12x1,25x32, KG60°	30	2	S90-2-15-020		91215020	98/4	58	M12x1,25	§21	
	01.86 - 02.04		50	7	S90-7-25-006	S68	91725006	98/4	58	M12x1,25	§21	
PANDA Van (169)	03.04 -	S1-1-12-25-22-17	10	1	S90-1-05-011	S6	91105011	98/4	58	M12x1,25	T	20
	03.04 -	M12x1,25x22, KG60°	30	2	S90-2-15-020		91215020	98/4	58	M12x1,25	T	20
	03.04 -		50	7	S90-7-25-006	S68	91725006	98/4	58	M12x1,25	T	20
PUNTO (176)	09.93 - 09.99	S1-1-12-25-32-19	10	1	S90-1-05-011		91105011	98/4	58	M12x1,25	T	20
	09.93 - 09.99	M12x1,25x32, KG60°	30									

PRO-SPACER

Modell Model	Baujahr Year	Original-radschraube (nicht bestellbar) Original Bolt (not available)	Spurweiten-änderung Total track widening (mm)	Eibach System	Artikel-Nr. Part-No.	Hinweise Notes	Kennzeichnung Stamping	Lockkreis Zahl Bolt pattern No. of holes	Zentrierung Centre bore (mm)	Gewinde Thread	Gutachten Homologation	ET-Grenze Offset frontier
FORD EXPLORER (U2)												
	01.93 -		50	4	S90-4-25-010	S9, S23	91425010	114,3/5	70,5	1/2"UNF	\$21	
	01.93 -		60	4	S90-4-30-005	S9, S23	91430005	114,3/5	70,5	1/2"UNF	\$21	
	01.93 -		70	4	S90-4-35-001	S9, S23	91435001	114,3/5	70,5	1/2"UNF	\$21	
	01.93 -		90	4	S90-4-45-001	S9, S23	91445001	114,3/5	70,5	1/2"UNF	\$21	
FIESTA IV (JA., JB.)												
	08.95 - 09.02		10	5	S90-5-05-004	S33	91505004	108/4	63,3	M12x1,5	T	26
	08.95 - 09.02		30	6	S90-6-15-015	S33	91615015	108/4	63,3	M12x1,5	T	26
	08.95 - 09.02		40	6	S90-6-20-005	S33	91620005	108/4	63,3	M12x1,5	T	26
	08.95 - 09.02		50	4	S90-4-25-008	S9, S23	91425008	108/4	63,3	M12x1,5	T	26
	08.95 - 09.02		60	4	S90-4-30-003	S9, S23	91430003	108/4	63,3	M12x1,5	T	26
FIESTA V (JH., JD.)												
	11.01 -		10	5	S90-5-05-004	S11, S33	91505004	108/4	63,3	M12x1,5	T	22,5
	11.01 -		30	6	S90-6-15-015	S33	91615015	108/4	63,3	M12x1,5	T	22,5
	11.01 -		40	4	S90-4-20-010	S9, S23	91420010	108/4	63,3	M12x1,5	T	22,5
	11.01 -		40	6	S90-6-20-005	S33	91620005	108/4	63,3	M12x1,5	T	22,5
	11.01 -		50	4	S90-4-25-008	S9, S23	91425008	108/4	63,3	M12x1,5	T	22,5
	11.01 -		60	4	S90-4-30-003	S9, S23	91430003	108/4	63,3	M12x1,5	T	22,5
FIESTA VI												
	10.08 -		30	4	S90-4-15-007	S9, S23	91415007	108/4	63,3	M12x1,5	T	17,5
	10.08 -		30	6	S90-6-15-015	S33	91615015	108/4	63,3	M12x1,5	T	17,5
	10.08 -		40	4	S90-4-20-010	S9, S23	91420010	108/4	63,3	M12x1,5	T	17,5
	10.08 -		40	6	S90-6-20-005	S33	91620005	108/4	63,3	M12x1,5	T	17,5
	10.08 -		50	4	S90-4-25-008	S9, S23	91425008	108/4	63,3	M12x1,5	T	17,5
	10.08 -		60	4	S90-4-30-003	S9, S23	91430003	108/4	63,3	M12x1,5	T	17,5
FOCUS (DAW, DBW)												
	10.98 - 11.04		10	5	S90-5-05-004	S33	91505004	108/4	63,3	M12x1,5	T	28,5
	10.98 - 11.04		30	6	S90-6-15-015	S33	91615015	108/4	63,3	M12x1,5	T	28,5
	10.98 - 11.04		40	6	S90-6-20-005	S33	91620005	108/4	63,3	M12x1,5	T	28,5
	10.98 - 11.04		50	4	S90-4-25-008	S9, S23	91425008	108/4	63,3	M12x1,5	T	28,5
	10.98 - 11.04		60	4	S90-4-30-003	S9, S23	91430003	108/4	63,3	M12x1,5	T	28,5
FOCUS C-MAX												
	10.03 - 03.07		30	4	S90-4-15-005	S9, S23	91415005	108/5	63,3	M12x1,5	T	37,5
	10.03 - 03.07		40	4	S90-4-20-008	S9, S23	91420008	108/5	63,3	M12x1,5	T	37,5
	10.03 - 03.07		50	4	S90-4-25-022	S9, S23	91425022	108/5	63,3	M12x1,5	T	37,5
FOCUS II (DA.)												
	11.04 -		30	4	S90-4-15-005	S9, S23	91415005	108/5	63,3	M12x1,5	T	22,5
	11.04 -		40	4	S90-4-20-008	S9, S23	91420008	108/5	63,3	M12x1,5	T	22,5
	11.04 -		50	4	S90-4-25-022	S9, S23	91425022	108/5	63,3	M12x1,5	T	22,5
	11.04 -		60	4	S90-4-30-024	S9, S23	91430024	108/5	63,3	M12x1,5	T	22,5
	11.04 -		70	4	S90-4-35-007	S9, S23	91435007	108/5	63,3	M12x1,5	T	22,5
FOCUS II Cabriolet												
FOCUS II Convertible												
	10.06 -		30	4	S90-4-15-005	S9, S23	91415005	108/5	63,3	M12x1,5	T	22,5
	10.06 -		40	4	S90-4-20-008	S9, S23	91420008	108/5	63,3	M12x1,5	T	22,5
	10.06 -		50	4	S90-4-25-022	S9, S23	91425022	108/5	63,3	M12x1,5	T	22,5
	10.06 -		60	4	S90-4-30-024	S9, S23	91430024	108/5	63,3	M12x1,5	T	22,5
	10.06 -		70	4	S90-4-35-007	S9, S23	91435007	108/5	63,3	M12x1,5	T	22,5
FOCUS II Kombi (DA.)												
FOCUS II Estate (DA.)												
	11.04 -		30	4	S90-4-15-005	S9, S23	91415005	108/5	63,3	M12x1,5	T	22,5
	11.04 -		40	4	S90-4-20-008	S9, S23	91420008	108/5	63,3	M12x1,5	T	22,5
	11.04 -		50	4	S90-4-25-022	S9, S23	91425022	108/5	63,3	M12x1,5	T	22,5
	11.04 -		60	4	S90-4-30-024	S9, S23	91430024	108/5	63,3	M12x1,5	T	22,5
	11.04 -		70	4	S90-4-35-007	S9, S23	91435007	108/5	63,3	M12x1,5	T	22,5
FOCUS II Stufenheck (DA.)												
FOCUS II Saloon (DA.)												
	04.05 -		30	4	S90-4-15-005	S9, S23	91415005	108/5	63,3	M12x1,5	T	22,5
	04.05 -		40	4	S90-4-20-008	S9, S23	91420008	108/5	63,3	M12x1,5	T	22,5
	04.05 -		50	4	S90-4-25-022	S9, S23	91425022	108/5	63,3	M12x1,5	T	22,5
	04.05 -		60	4	S90-4-30-024	S9, S23	91430024	108/5	63,3	M12x1,5	T	22,5
	04.05 -		70	4	S90-4-35-007	S9, S23	91435007	108/5	63,3	M12x1,5	T	22,5
FOCUS III												
	04.11 -		30	4	S90-4-15-005	S9, S23	91415005	108/5	63,3	M12x1,5	T	20
	04.11 -		40	4	S90-4-20-008	S9, S23	91420008	108/5	63,3	M12x1,5	T	20
	04.11 -		50	4	S90-4-25-022	S9, S23	91425022	108/5	63,3	M12x1,5	T	20
	04.11 -		60	4	S90-4-30-024	S9, S23	91430024	108/5	63,3	M12x1,5	T	20
	04.11 -		70	4	S90-4-35-007	S9, S23	91435007	108/5	63,3	M12x1,5	T	20
FOCUS III Stufenheck												
FOCUS III Saloon												
	04.11 -		30	4	S90-4-15-005	S9, S23	91415005	108/5	63,3	M12x1,5	T	20
	04.11 -		40	4	S90-4-20-008	S9, S23	91420008	108/5	63,3	M12x1,5	T	20
	04.11 -		50	4	S90-4-25-022	S9, S23	91425022	108/5	63,3	M12x1,5	T	20
	04.11 -		60	4	S90-4-30-024	S9, S23	91430024	108/5	63,3	M12x1,5	T	20
	04.11 -		70	4	S90-4-35-007	S9, S23	91435007	108/5	63,3	M12x1,5	T	20
FOCUS III Turnier												
	05.11 -		30	4	S90-4-15-005	S9, S23	91415005	108/5	63,3	M12x1,5	T	20
	05.11 -		40	4	S90-4-20-008	S9, S23	91420008	108/5	63,3	M12x1,5	T	20
	05.11 -		50	4	S90-4-25-022	S9, S23	91425022	108/5	63,3	M12x1,5	T	20
	05.11 -		60	4	S90-4-30-024	S9, S23	91430024	108/5	63,3	M12x1,5	T	20
	05.11 -		70	4	S90-4-35-007	S9, S23	91435007	108/5	63,3	M12x1,5	T	20
FOCUS Kombi (DNW)												
FOCUS Estate (DNW)												
	02.99 - 03.05		10	5	S90-5-05-004	S33	91505004	108/4	63,3	M12x1,5	T	28,5
	02.99 - 03.05		30	6	S90-6-15-015	S33	91615015	108/4	63,3	M12x1,5	T	28,5
	02.99 - 03.05		40	6	S90-6-20-005	S33	91620005	108/4	63,3	M12x1,5	T	28,5
	02.99 - 03.05		50	4	S90-4-25-008	S9, S23	91425008	108/4	63,3	M12x1,5	T	28,5
	02.99 - 03.05		60	4	S90-4-30-003	S9, S23	91430003	108/4	63,3	M12x1,5	T	28,5
FOCUS Stufenheck (DFW)												
FOCUS Saloon (DFW)												
	02.99 - 03.05		10	5	S90-5-05-004	S33	91505004	108/4	63,3	M12x1,5	T	28,5
	02.99 - 03.05		30	6	S90-6-15-015	S33	91615015	108/4	63,3	M12x1,5	T	28,5
	02.99 - 03.05		40	6	S90-6-20-005	S33	91620005	108/4	63,3	M12x1,5	T	28,5
	02.99 - 03.05		50	4	S90-4-25-008	S9, S23	91425008	108/4	63,3	M12x1,5	T	28,5
	02.99 - 03.05		60	4	S90-4-30-003	S9, S23	91430003	108/4	63,3	M12x1,5	T	28,5
FUSION (JU.)												
	08.02 -		10	5	S90-5-05-004	S33	91505004	108/4	63,3	M12x1,5	T	32,5
	08.02 -		30	6	S90-6-15-015	S33	91615015	108/4	63,3	M12x1,5	T	32,5
	08.02 -		40	6	S90-6-20-005	S33	91620005	108/4	63,3	M12x1,5	T	32,5
	08.02 -		50	4	S90-4-25-008	S9, S23	91425008	108/4	63,3	M12x1,5	T	32,5
	08.02 -		60	4	S90-4-30-003	S9, S23	91430003	108/4	63,3	M12x1,5	T	32,5
GALAXY (WGR)												
	03.95 - 05.06		10	1	S90-1-05-016	S11	91105016	112/5	57	M14x1,5	T	30
	03.95 - 05.06		30	2	S90-2-15-013		91215013	112/5	57	M14x1,5	T	30
	03.95 - 05.06		40	2	S90-2-20-003		91220003	112/5	57	M14x1,5	T	30
	03.95 - 05.06		50	7	S90-7-25-028	S68	91725005	112/5	57	M14x1,5	T	30

PRO-SPACER

Modell Model	Baujahr Year	Original-radschraube (nicht bestellbar) Original Bolt (not available)	Spurweiten-änderung Total track widening (mm)	Eibach System	Artikel-Nr. Part-No.	Hinweise Notes	Kennzeichnung Stamping	Lockkreis Zahl Bolt pattern No. of holes	Zentrierung Centre bore (mm)	Gewinde Thread	Gutachten Homologation	ET-Grenze Offset frontier
FORD GALAXY												
	05.06 -		20	6	S90-6-10-022	S6, S33	91610014	108/5	63,3	M14x1,5	T	20
	05.06 -		30	6	S90-6-15-046	S6, S33	91615011	108/5	63,3	M14x1,5	T	20
	05.06 -		40	4	S90-4-20-022	S9, S23	91420022	108/5	63,3	M14x1,5	T	20
	05.06 -		50	4	S90-4-25-039	S9, S23	91425039	108/5	63,3	M14x1,5	T	20
	05.06 -		60	4	S90-4-30-029	S9, S23	91430029	108/5	63,3	M14x1,5	T	20
GRAND C-MAX												
	12.10 -		20	6	S90-6-10-024	S33	91610024	108/5	63,3	M12x1,5	\$21	
	12.10 -		30	4	S90-4-15-005	S9, S23	91415005	108/5	63,3	M12x1,5	\$21	
	12.10 -		30	6	S90-6-15-011	S33	91615011	108/5	63,3	M12x1,5	\$21	
	12.10 -		40	4	S90-4-20-008	S9, S23	91420008	108/5	63,3	M12x1,5	\$21	
	12.10 -		50	4	S90-4-25-022	S9, S23	91425022	108/5				

PRO-SPACER

Modell Model	Baujahr Year	Original-radschraube (nicht bestellbar) Original Bolt (not available)	Spurweiten-änderung Total track widening (mm)	Eibach System	Artikel-Nr. Part-No.	Hinweise Notes	Kennzeichnung Stamping	Lockkreis Zahl Bolt pattern No. of holes	Zentrierung Centre bore (mm)	Gewinde Thread	Gutachten Homologation	ET-Grenze Offset frontier	
FORD MUSTANG (C)	09.93 -		40	4	S90-4-20-018	S9, S23	91420016	114,3/5	70,5	1/2"UNF	\$21		
	09.93 -		50	4	S90-4-25-010	S9, S23	91425010	114,3/5	70,5	1/2"UNF	\$21		
	09.93 -		60	4	S90-4-30-005	S9, S23	91430005	114,3/5	70,5	1/2"UNF	\$21		
	09.93 -		70	4	S90-4-35-001	S9, S23	91435001	114,3/5	70,5	1/2"UNF	\$21		
	09.93 -		90	4	S90-4-45-001	S9, S23	91445001	114,3/5	70,5	1/2"UNF	\$21		
	MUSTANG Hinterachse MUSTANG rear axle	12.04 -		40	4	S90-4-20-017	S23, S37	91420016	114,3/5	70,5	1/2"UNF	T	9
		12.04 -		50	4	S90-4-25-033	S23, S37	91425010	114,3/5	70,5	1/2"UNF	T	9
		12.04 -		60	4	S90-4-30-020	S23, S37	91430005	114,3/5	70,5	1/2"UNF	T	9
		12.04 -		70	4	S90-4-35-006	S23, S37	91435001	114,3/5	70,5	1/2"UNF	T	9
		12.04 -		90	4	S90-4-45-001	S23, S37	91445001	114,3/5	70,5	1/2"UNF	T	9
		MUSTANG Vorderachse MUSTANG front axle	12.04 -		40	4	S90-4-20-016	S23, S37	91420016	114,3/5	70,5	1/2"UNF	T
	12.04 -			50	4	S90-4-25-032	S23, S37	91425010	114,3/5	70,5	1/2"UNF	T	9
	12.04 -			60	4	S90-4-30-019	S23, S37	91430005	114,3/5	70,5	1/2"UNF	T	9
	12.04 -			70	4	S90-4-35-005	S23, S37	91435001	114,3/5	70,5	1/2"UNF	T	9
	12.04 -			90	4	S90-4-45-001	S23, S37	91445001	114,3/5	70,5	1/2"UNF	T	9
	MUSTANG Cabriolet Hinterachse MUSTANG Convertible rear axle		12.05 -		40	4	S90-4-20-017	S23, S37	91420016	114,3/5	70,5	1/2"UNF	T
		12.05 -		50	4	S90-4-25-033	S23, S37	91425010	114,3/5	70,5	1/2"UNF	T	9
		12.05 -		60	4	S90-4-30-020	S23, S37	91430005	114,3/5	70,5	1/2"UNF	T	9
		12.05 -		70	4	S90-4-35-006	S23, S37	91435001	114,3/5	70,5	1/2"UNF	T	9
		12.05 -		90	4	S90-4-45-001	S23, S37	91445001	114,3/5	70,5	1/2"UNF	T	9
		MUSTANG Cabriolet Vorderachse MUSTANG Convertible front axle	12.05 -		40	4	S90-4-20-016	S23, S37	91420016	114,3/5	70,5	1/2"UNF	T
	12.05 -			50	4	S90-4-25-032	S23, S37	91425010	114,3/5	70,5	1/2"UNF	T	9
	12.05 -			60	4	S90-4-30-019	S23, S37	91430005	114,3/5	70,5	1/2"UNF	T	9
	12.05 -			70	4	S90-4-35-005	S23, S37	91435001	114,3/5	70,5	1/2"UNF	T	9
12.05 -			90	4	S90-4-45-001	S23, S37	91445001	114,3/5	70,5	1/2"UNF	T	9	
MUSTANG Convertible (C)	09.93 -			40	4	S90-4-20-018	S9, S23	91420016	114,3/5	70,5	1/2"UNF	\$21	
	09.93 -		50	4	S90-4-25-010	S9, S23	91425010	114,3/5	70,5	1/2"UNF	\$21		
	09.93 -		60	4	S90-4-30-005	S9, S23	91430005	114,3/5	70,5	1/2"UNF	\$21		
	09.93 -		70	4	S90-4-35-001	S9, S23	91435001	114,3/5	70,5	1/2"UNF	\$21		
	09.93 -		90	4	S90-4-45-001	S9, S23	91445001	114,3/5	70,5	1/2"UNF	\$21		
	PUMA (EC)	03.97 - 06.02		10	5	S90-5-05-004	S33	91505004	108/4	63,3	M12x1,5	T	19
03.97 - 06.02			30	6	S90-6-15-015	S33	91615015	108/4	63,3	M12x1,5	T	19	
03.97 - 06.02			40	6	S90-6-20-005	S33	91620005	108/4	63,3	M12x1,5	T	19	
03.97 - 06.02			50	4	S90-4-25-008	S9, S23	91425008	108/4	63,3	M12x1,5	T	19	
03.97 - 06.02			60	4	S90-4-30-003	S9, S23	91430003	108/4	63,3	M12x1,5	T	19	
RANGER (TU)		03.98 - 06.06		50	8	S90-8-25-004	S9, S11, S23	91825004	139,7/6	108,5	M12x1,5	T	-25
	03.98 - 06.06		60	8	S90-8-30-004	S9, S11, S23	91830004	139,7/6	108,5	M12x1,5	T	-25	
RANGER	06.05 -		50	8	S90-8-25-004	S9, S11, S23	91825004	139,7/6	108,5	M12x1,5	T	-25	
	06.05 -		60	8	S90-8-30-004	S9, S11, S23	91830004	139,7/6	108,5	M12x1,5	T	-25	
S-MAX	05.06 -		20	6	S90-6-10-022	S6, S33	91610014	108/5	63,3	M14x1,5	T	20	
	05.06 -		30	6	S90-6-15-046	S6, S33	91615011	108/5	63,3	M14x1,5	T	20	
	05.06 -		40	4	S90-4-20-022	S9, S23	91420022	108/5	63,3	M14x1,5	T	20	
	05.06 -		50	4	S90-4-25-039	S9, S23	91425039	108/5	63,3	M14x1,5	T	20	
	05.06 -		60	4	S90-4-30-029	S9, S23	91430029	108/5	63,3	M14x1,5	T	20	
	STREET KA	05.03 - 07.05		10	5	S90-5-05-004	S33	91505004	108/4	63,3	M12x1,5	T	19
05.03 - 07.05			30	6	S90-6-15-015	S33	91615015	108/4	63,3	M12x1,5	T	19	
05.03 - 07.05			40	6	S90-6-20-005	S33	91620005	108/4	63,3	M12x1,5	T	19	
05.03 - 07.05			50	4	S90-4-25-008	S9, S23	91425008	108/4	63,3	M12x1,5	T	19	
05.03 - 07.05			60	4	S90-4-30-003	S9, S23	91430003	108/4	63,3	M12x1,5	T	19	
TOURNEO CUSTOM Bus		12.12 -		20	6	S90-6-10-027	S3	91610027	160/5	65	M14x1,5	A	46
	12.12 -		68	4	S90-4-34-001	S6, S9	91434001	160/5	65	M14x1,5	A	22	
TRANSIT CUSTOM Kasten TRANSIT CUSTOM Box	12.12 -		20	6	S90-6-10-027	S3	91610027	160/5	65	M14x1,5	A	46	
	12.12 -		68	4	S90-4-34-001	S6, S9	91434001	160/5	65	M14x1,5	A	22	
TRANSIT CUSTOM Kombi	12.12 -		20	6	S90-6-10-027	S3	91610027	160/5	65	M14x1,5	A	46	
	12.12 -		68	4	S90-4-34-001	S6, S9	91434001	160/5	65	M14x1,5	A	22	
HONDA ACCORD VI (CG, CK)	03.97 - 12.03		10	5	S90-5-05-018	S33	91505018	114,3/4	64	M12x1,5	\$21		
	03.97 - 12.03		30	6	S90-6-15-021	S33	91615021	114,3/4	64	M12x1,5	\$21		
	12.97 - 06.03		10	5	S90-5-05-018	S33	91505018	114,3/4	64	M12x1,5	\$21		
12.97 - 06.03		30	6	S90-6-15-021	S33	91615021	114,3/4	64	M12x1,5	\$21			
CIVIC IX (FK)	02.12 -		20	6	S90-6-10-012	S33	91610012	114,3/5	64	M12x1,5	\$21		
	02.12 -		30	4	S90-4-15-010	S9	91415010	114,3/5	64	M12x1,5	\$21		
	02.12 -		30	6	S90-6-15-038	S33	91615038	114,3/5	64	M12x1,5	\$21		
	02.12 -		40	6	S90-6-20-015	S33	91620015	114,3/5	64	M12x1,5	\$21		
	02.12 -		60	4	S90-4-30-027	S33	91430027	114,3/5	64	M12x1,5	\$21		
	02.12 -		60	4	S90-4-30-027	S33	91430027	114,3/5	64	M12x1,5	\$21		
CIVIC VI Aerodeck (MB, MC)	04.98 - 02.01		10	5	S90-5-05-005	S33	91505005	100/4	56	M12x1,5	T	30	
	04.98 - 02.01		10	5	S90-5-05-018	S33	91505018	114,3/4	64	M12x1,5	T	40	
04.98 - 02.01		30	6	S90-6-15-021	S33	91615021	114,3/4	64	M12x1,5	T	40		
CIVIC VI Fastback (MA, MB)	09.94 - 02.01		10	5	S90-5-05-005	S33	91505005	100/4	56	M12x1,5	T	30	

Modell Model	Baujahr Year	Original-radschraube (nicht bestellbar) Original Bolt (not available)	Spurweiten-änderung Total track widening (mm)	Eibach System	Artikel-Nr. Part-No.	Hinweise Notes	Kennzeichnung Stamping	Lockkreis Zahl Bolt pattern No. of holes	Zentrierung Centre bore (mm)	Gewinde Thread	Gutachten Homologation	ET-Grenze Offset frontier	
HONDA CIVIC VII Hatchback (EU, EP, EV)	03.99 - 02.06		10	5	S90-5-05-005	S33	91505005	100/4	56	M12x1,5	T	30	
	03.99 - 02.06		20	6	S90-6-10-012	S33	91610012	114,3/5	64	M12x1,5	\$21		
	03.99 - 02.06		30	4	S90-4-15-010	S9	91415010	114,3/5	64	M12x1,5	\$21		
	03.99 - 02.06		30	6	S90-6-15-038	S33	91615038	114,3/5	64	M12x1,5	\$21		
	03.99 - 02.06		40	6	S90-6-20-015	S33	91620015	114,3/5	64	M12x1,5	\$21		
	CIVIC VIII Hatchback (FN, FK)	09.05 -		20	6	S90-6-10-012	S33	91610012	114,3/5	64	M12x1,5	T	15
		09.05 -		30	4	S90-4-15-010	S9	91415010	114,3/5	64	M12x1,5	T	15
		09.05 -		30	6	S90-6-15-038	S33	91615038	114,3/5	64	M12x1,5	T	15
		09.05 -		40	6	S90-6-20-015	S33	91620015	114,3/5	64	M12x1,5	T	15
		09.05 -		60	4	S90-4-30-027	S33	91430027	114,3/5	64	M12x1,5	T	15
		CIVIC VIII Stufenheck (FD, FA) CIVIC VIII Saloon (FD, FA)	09.05 -		20	6	S90-6-10-012	S33	91610012	114,3/5	64	M12x1,5	T
	09.05 -			30	4	S90-4-15-010	S9	91415010	114,3/5	64	M12x1,5	T	15
	09.05 -			30	6	S90-6-15-038	S33	91615038	114,3/5	64	M12x1,5	T	15
	09.05 -			40	6	S90-6-20-015	S33	91620015	114,3/5	64	M12x1,5	T	15
	09.05 -			60	4	S90-4-30-027	S33	91430027	114,3/5	64	M12x1,5	T	15
	CR-V II (RD)		12.01 - 09.06		20	6	S90-6-10-012	S33	91610012	114,3/5	64	M12x1,5	T
		12.01 - 09.06		30	4	S90-4-15-010	S9	91415010	114,3/5	64	M12x1,5	T	20
		12.01 - 09.06		30	6	S90-6-15-038	S33	91615038	114,3/5	64	M12x1,5	T	20
		12.01 - 09.06		40	6	S90-6-20-015	S33	91620015	114,3/5				

PRO-SPACER

Modell Model	Baujahr Year	Original-radschraube (nicht bestellbar) Original Bolt (not available)	Spurweiten-änderung Total track widening (mm)	Eibach System	Artikel-Nr. Part-No.	Hinweise Notes	Kennzeichnung Stamping	Lockkreis Zahl Bolt pattern No. of holes	Zentrierung Centre bore (mm)	Gewinde Thread	Gutachten Homologation	ET-Grenze Offset frontier
HYUNDAI GRANDEUR (TG)	04.05 -		20	6	S90-6-10-005	S16, S43	91610002	114,3/5	67	M12x1,5	§21	
	04.05 -		30	4	S90-4-15-002	S9	91415002	114,3/5	67	M12x1,5	§21	
	04.05 -		30	6	S90-6-15-027	S16, S44	91615023	114,3/5	67	M12x1,5	§21	
	04.05 -		40	4	S90-4-20-001	S9	91420001	114,3/5	67	M12x1,5	§21	
	04.05 -		50	4	S90-4-25-016	S9	91425016	114,3/5	67	M12x1,5	§21	
04.05 -		60	4	S90-4-30-015	S9	91430015	114,3/5	67	M12x1,5	§21		
i10	10.07 -		20	6	S90-6-10-015	S16, S33	91610015	100/4	54	M12x1,5	§21	
	10.07 -		24	6	S90-6-12-003	S16, S33	91212005	100/4	54	M12x1,5	§21	
	10.07 -		30	6	S90-6-15-040	S16, S33	91615010	100/4	54	M12x1,5	§21	
	10.07 -		40	4	S90-4-20-011	S9, S23	91420011	100/4	54	M12x1,5	§21	
	10.07 -		40	6	S90-6-20-026	S16, S33	91620026	100/4	54	M12x1,5	§21	
10.07 -		60	4	S90-4-30-021	S9, S23	91430021	100/4	54	M12x1,5	§21		
i20 (PB, PBT)	08.08 -		20	6	S90-6-10-015	S16, S33	91610015	100/4	54	M12x1,5	T	15
	08.08 -		24	6	S90-6-12-003	S16, S33	91212005	100/4	54	M12x1,5	T	15
	08.08 -		30	6	S90-6-15-040	S16, S33	91615010	100/4	54	M12x1,5	T	15
	08.08 -		40	4	S90-4-20-011	S9, S23	91420011	100/4	54	M12x1,5	T	15
	08.08 -		40	6	S90-6-20-026	S16, S33	91620026	100/4	54	M12x1,5	T	15
08.08 -		60	4	S90-4-30-021	S9, S23	91430021	100/4	54	M12x1,5	T	15	
i30 (FD)	10.07 - 11.11		20	6	S90-6-10-005	S16, S33	91610002	114,3/5	67	M12x1,5	T	25
	10.07 - 11.11		30	4	S90-4-15-018	S9, S23	91415002	114,3/5	67	M12x1,5	T	25
	10.07 - 11.11		30	6	S90-6-15-027	S16, S33	91615023	114,3/5	67	M12x1,5	T	25
	10.07 - 11.11		40	4	S90-4-20-024	S9, S23	91420001	114,3/5	67	M12x1,5	T	25
	10.07 - 11.11		40	6	S90-6-20-028	S16, S33	91620028	114,3/5	67	M12x1,5	T	25
10.07 - 11.11		50	4	S90-4-25-041	S9, S23	91425016	114,3/5	67	M12x1,5	T	25	
10.07 - 11.11		60	4	S90-4-30-032	S9, S23	91430015	114,3/5	67	M12x1,5	T	25	
i30 (GD)	11.11 -		20	6	S90-6-10-005	S16, S33	91610002	114,3/5	67	M12x1,5	§21	
	11.11 -		30	4	S90-4-15-018	S9	91415002	114,3/5	67	M12x1,5	§21	
	11.11 -		30	6	S90-6-15-027	S16, S33	91615023	114,3/5	67	M12x1,5	§21	
	11.11 -		40	4	S90-4-20-024	S9	91420001	114,3/5	67	M12x1,5	§21	
	11.11 -		40	6	S90-6-20-028	S16, S33	91620028	114,3/5	67	M12x1,5	§21	
11.11 -		50	4	S90-4-25-041	S9	91425016	114,3/5	67	M12x1,5	§21		
11.11 -		60	4	S90-4-30-032	S9	91430015	114,3/5	67	M12x1,5	§21		
i30 CW (FD)	10.07 - 06.12		20	6	S90-6-10-005	S16, S33	91610002	114,3/5	67	M12x1,5	T	25
	10.07 - 06.12		30	4	S90-4-15-018	S9, S23	91415002	114,3/5	67	M12x1,5	T	25
	10.07 - 06.12		30	6	S90-6-15-027	S16, S33	91615023	114,3/5	67	M12x1,5	T	25
	10.07 - 06.12		40	4	S90-4-20-024	S9, S23	91420001	114,3/5	67	M12x1,5	T	25
	10.07 - 06.12		40	6	S90-6-20-028	S16, S33	91620028	114,3/5	67	M12x1,5	T	25
10.07 - 06.12		50	4	S90-4-25-041	S9, S23	91425016	114,3/5	67	M12x1,5	T	25	
10.07 - 06.12		60	4	S90-4-30-032	S9, S23	91430015	114,3/5	67	M12x1,5	T	25	
i30 CW (GD)	06.12 -		20	6	S90-6-10-005	S33	91610002	114,3/5	67	M12x1,5	T	20
	06.12 -		30	4	S90-4-15-018	S9, S23	91415002	114,3/5	67	M12x1,5	T	20
	06.12 -		30	6	S90-6-15-027	S33	91615023	114,3/5	67	M12x1,5	T	20
	06.12 -		40	4	S90-4-20-024	S9	91420001	114,3/5	67	M12x1,5	T	20
	06.12 -		40	6	S90-6-20-028	S33	91620028	114,3/5	67	M12x1,5	T	20
06.12 -		50	4	S90-4-25-041	S9	91425016	114,3/5	67	M12x1,5	T	20	
06.12 -		60	4	S90-4-30-037	S9	91430015	114,3/5	67	M12x1,5	T	20	
ix20 (JC)	11.10 -		20	6	S90-6-10-005	S16, S33	91610002	114,3/5	67	M12x1,5	§21	
	11.10 -		30	4	S90-4-15-018	S9, S23	91415002	114,3/5	67	M12x1,5	§21	
	11.10 -		30	6	S90-6-15-027	S16, S33	91615023	114,3/5	67	M12x1,5	§21	
	11.10 -		40	4	S90-4-20-024	S9, S23	91420001	114,3/5	67	M12x1,5	§21	
	11.10 -		40	6	S90-6-20-028	S16, S33	91620028	114,3/5	67	M12x1,5	§21	
11.10 -		50	4	S90-4-25-041	S9, S23	91425016	114,3/5	67	M12x1,5	§21		
11.10 -		60	4	S90-4-30-032	S9, S23	91430015	114,3/5	67	M12x1,5	§21		
ix35 (LM)	08.09 -		30	4	S90-4-15-002	S9, S23	91415002	114,3/5	67	M12x1,5	T	20
	08.09 -		40	4	S90-4-20-001	S9, S23	91420001	114,3/5	67	M12x1,5	T	20
	08.09 -		50	4	S90-4-25-016	S9, S23	91425016	114,3/5	67	M12x1,5	T	20
	08.09 -		60	4	S90-4-30-015	S9, S23	91430015	114,3/5	67	M12x1,5	T	20
ix55	01.07 -		40	4	S90-4-20-023	S9, S23	91420001	114,3/5	67	M12x1,5	T	5
	01.07 -		50	4	S90-4-25-040	S9, S23	91425016	114,3/5	67	M12x1,5	T	5
	01.07 -		60	4	S90-4-30-015	S23	91430015	114,3/5	67	M12x1,5	T	5
SANTA FÉ I (SM)	11.00 - 03.06		30	4	S90-4-15-002	S9, S23	91415002	114,3/5	67	M12x1,5	T	16
	11.00 - 03.06		40	4	S90-4-20-001	S9, S23	91420001	114,3/5	67	M12x1,5	T	16
	11.00 - 03.06		50	4	S90-4-25-016	S9, S23	91425016	114,3/5	67	M12x1,5	T	16
	11.00 - 03.06		60	4	S90-4-30-015	S9, S23	91430015	114,3/5	67	M12x1,5	T	16
SANTA FÉ II (CM)	03.06 -		20	6	S90-6-10-005	S16, S33	91610002	114,3/5	67	M12x1,5	§21	
	03.06 -		30	4	S90-4-15-017	S9, S23, S33	91415002	114,3/5	67	M12x1,5	§21	
	03.06 -		30	6	S90-6-15-027	S16, S33	91615023	114,3/5	67	M12x1,5	§21	
	03.06 -		40	4	S90-4-20-023	S9, S23, S33	91420001	114,3/5	67	M12x1,5	§21	
	03.06 -		40	6	S90-6-20-028	S16, S33	91620028	114,3/5	67	M12x1,5	§21	
03.06 -		50	4	S90-4-25-040	S9, S23, S33	91425016	114,3/5	67	M12x1,5	§21		
03.06 -		60	4	S90-4-30-037	S9, S23, S33	91430015	114,3/5	67	M12x1,5	§21		
SANTA FÉ III (DM)	09.12 -		40	4	S90-4-20-023	S9, S23	91420001	114,3/5	67	M12x1,5	T	11
	09.12 -		50	4	S90-4-25-040	S9, S23	91425016	114,3/5	67	M12x1,5	T	11
	09.12 -		60	4	S90-4-30-015	S23	91430015	114,3/5	67	M12x1,5	T	11
SONATA V (NF)	01.05 -		20	6	S90-6-10-013	S16, S33	91610002	114,3/5	67	M12x1,5	§21	
	01.05 -		30	4	S90-4-15-002	S9	91415002	114,3/5	67	M12x1,5	§21	
	01.05 -		30	6	S90-6-15-039	S16, S33	91615023	114,3/5	67	M12x1,5	§21	
	01.05 -		40	4	S90-4-20-001	S9	91420001	114,3/5	67	M12x1,5	§21	
	01.05 -		50	4	S90-4-25-016	S9	91425016	114,3/5	67	M12x1,5	§21	
01.05 -		60	4	S90-4-30-015	S9	91430015	114,3/5	67	M12x1,5	§21		

Modell Model	Baujahr Year	Original-radschraube (nicht bestellbar) Original Bolt (not available)	Spurweiten-änderung Total track widening (mm)	Eibach System	Artikel-Nr. Part-No.	Hinweise Notes	Kennzeichnung Stamping	Lockkreis Zahl Bolt pattern No. of holes	Zentrierung Centre bore (mm)	Gewinde Thread	Gutachten Homologation	ET-Grenze Offset frontier
HYUNDAI TERRACAN (HP)	06.01 - 12.06		50	8	S90-8-25-002	S9, S11	91825002	139,7/6	106,5	M12x1,5	T	-10
	06.01 - 12.06		60	8	S90-8-30-002	S9, S11	91830002	139,7/6	106,5	M12x1,5	T	-10
Tucson (EL-LM-ELH)	04.10 -		30	4	S90-4-15-002	S9, S23	91415002	114,3/5	67	M12x1,5	T	20
	04.10 -		40	4	S90-4-20-001	S9, S23	91420001	114,3/5	67	M12x1,5	T	20
	04.10 -		50	4	S90-4-25-016	S9, S23	91425016	114,3/5	67	M12x1,5	T	20
04.10 -		60	4	S90-4-30-015	S9, S23	91430						

Modell Model	Baujahr Year	Original-radschraube (nicht bestellbar) Original Bolt (not available)	Spurweiten-änderung Total track widening (mm)	Eibach System	Artikel-Nr. Part-No.	Hinweise Notes	Kennzeichnung Stamping	Lockkreis Zahl Bolt pattern No. of holes	Zentrierung Centre bore (mm)	Gewinde Thread	Gutachten Homologation	ET-Grenze Offset frontier
KIA CEE' D Sportswagon	09.12 -		20	6	S90-6-10-005	S33	91610002	114,3/5	67	M12x1,5	T	20
	09.12 -		30	4	S90-4-15-018	S9, S23	91415002	114,3/5	67	M12x1,5	T	20
	09.12 -		30	6	S90-6-15-027	S33	91615023	114,3/5	67	M12x1,5	T	20
	09.12 -		40	4	S90-4-20-024	S9	91420001	114,3/5	67	M12x1,5	T	20
	09.12 -		40	6	S90-6-20-028	S33	91620028	114,3/5	67	M12x1,5	T	20
	09.12 -		50	4	S90-4-25-041	S9	91425016	114,3/5	67	M12x1,5	T	20
	09.12 -		60	4	S90-4-30-037	S9	91430015	114,3/5	67	M12x1,5	T	20
CERATO (LD)												
	03.04 -		30	4	S90-4-15-006	S9	91415006	114,3/4	67	M12x1,5	§21	
	03.04 -		50	4	S90-4-25-024	S9	91425024	114,3/4	67	M12x1,5	§21	
	03.04 -		60	4	S90-4-30-011	S9	91430011	114,3/4	67	M12x1,5	§21	
CERATO Stufenheck (LD) CERATO Saloon (LD)												
	04.04 -		30	4	S90-4-15-006	S9	91415006	114,3/4	67	M12x1,5	§21	
	04.04 -		50	4	S90-4-25-024	S9	91425024	114,3/4	67	M12x1,5	§21	
	04.04 -		60	4	S90-4-30-011	S9	91430011	114,3/4	67	M12x1,5	§21	
OPTIMA												
	03.12 -		20	6	S90-6-10-005	S33	91610002	114,3/5	67	M12x1,5	T	24
	03.12 -		30	4	S90-4-15-018	S9	91415002	114,3/5	67	M12x1,5	T	24
	03.12 -		30	6	S90-6-15-027	S33	91615023	114,3/5	67	M12x1,5	T	24
	03.12 -		40	4	S90-4-20-024	S9	91420001	114,3/5	67	M12x1,5	T	24
	03.12 -		40	6	S90-6-20-028	S33	91620028	114,3/5	67	M12x1,5	T	24
	03.12 -		50	4	S90-4-25-041	S9	91425016	114,3/5	67	M12x1,5	§21	24
	03.12 -		60	4	S90-4-30-037	S9	91430015	114,3/5	67	M12x1,5	§21	24
PICANTO (BA)												
	04.04 -		30	6	S90-6-15-045	S33	91615010	100/4	54	M12x1,5	§21	
	04.04 -		40	4	S90-4-20-011	S9	91420011	100/4	54	M12x1,5	§21	
PRO CEE'D (ED)												
	02.08 -		20	6	S90-6-10-005	S33	91610002	114,3/5	67	M12x1,5	T	21
	02.08 -		30	4	S90-4-15-018	S9, S23	91415002	114,3/5	67	M12x1,5	T	21
	02.08 -		30	6	S90-6-15-027	S33	91615023	114,3/5	67	M12x1,5	T	21
	02.08 -		40	4	S90-4-20-024	S9	91420001	114,3/5	67	M12x1,5	T	21
	02.08 -		40	6	S90-6-20-028	S33	91620028	114,3/5	67	M12x1,5	T	21
	02.08 -		50	4	S90-4-25-041	S9	91425016	114,3/5	67	M12x1,5	T	21
	02.08 -		60	4	S90-4-30-037	S9	91430015	114,3/5	67	M12x1,5	T	21
PRO CEE'D												
	03.13 -		20	6	S90-6-10-005	S33	91610002	114,3/5	67	M12x1,5	T	20
	03.13 -		30	4	S90-4-15-018	S9, S23	91415002	114,3/5	67	M12x1,5	T	20
	03.13 -		30	6	S90-6-15-027	S33	91615023	114,3/5	67	M12x1,5	T	20
	03.13 -		40	4	S90-4-20-024	S9	91420001	114,3/5	67	M12x1,5	T	20
	03.13 -		40	6	S90-6-20-028	S33	91620028	114,3/5	67	M12x1,5	T	20
	03.13 -		50	4	S90-4-25-041	S9	91425016	114,3/5	67	M12x1,5	T	20
	03.13 -		60	4	S90-4-30-037	S9	91430015	114,3/5	67	M12x1,5	T	20
RIO II (JB)												
	03.05 -		20	6	S90-6-10-015	S33	91610015	100/4	54	M12x1,5	§21	
	03.05 -		30	6	S90-6-15-040	S33	91615010	100/4	54	M12x1,5	§21	
	03.05 -		40	6	S90-6-20-026	S33	91620026	100/4	54	M12x1,5	§21	
	03.05 -		60	4	S90-4-30-021	S9	91430021	100/4	54	M12x1,5	§21	
RIO II Stufenheck (JB) RIO II Saloon (JB)												
	03.05 -		20	6	S90-6-10-015	S33	91610015	100/4	54	M12x1,5	§21	
	03.05 -		30	6	S90-6-15-040	S33	91615010	100/4	54	M12x1,5	§21	
	03.05 -		40	6	S90-6-20-026	S33	91620026	100/4	54	M12x1,5	§21	
	03.05 -		60	4	S90-4-30-021	S9	91430021	100/4	54	M12x1,5	§21	
Rocsta (CA)												
	02.93 -		50	8	S90-8-25-001	S9, S11	91825001	139,7/5	106,5	M12x1,5	T	-5
SORENTO I (JC)												
	08.02 -		50	4	S90-4-25-038	S9	91425038	139,7/5	95,3	M12x1,5	T	15
	08.02 -		60	4	S90-4-30-028	S9	91430028	139,7/5	95,3	M12x1,5	T	15
SORENTO II (XM)												
	11.09 -		40	4	S90-4-20-023	S9, S23	91420001	114,3/5	67	M12x1,5	T	11
	11.09 -		50	4	S90-4-25-040	S9, S23	91425016	114,3/5	67	M12x1,5	T	11
	11.09 -		60	4	S90-4-30-015	S23	91430015	114,3/5	67	M12x1,5	T	11
SOUL (AM)												
	02.09 -		20	6	S90-6-10-005	S16, S33	91610002	114,3/5	67	M12x1,5	§21	
	02.09 -		30	4	S90-4-15-002	S1, S23	91415002	114,3/5	67	M12x1,5	§21	
	02.09 -		30	6	S90-6-15-027	S16, S33	91615023	114,3/5	67	M12x1,5	§21	
	02.09 -		40	4	S90-4-20-001	S1, S23	91420001	114,3/5	67	M12x1,5	§21	
	02.09 -		50	4	S90-4-25-016	S1, S23	91425016	114,3/5	67	M12x1,5	§21	
	02.09 -		60	4	S90-4-30-015	S1, S23	91430015	114,3/5	67	M12x1,5	§21	
SPORTAGE (K00)												
	04.94 - 04.04		50	4	S90-4-25-038	S9, S11	91425038	139,7/5	95,3	M12x1,5	T	15
	04.94 - 04.04		60	4	S90-4-30-028	S9, S11	91430028	139,7/5	95,3	M12x1,5	T	15
SPORTAGE (JE_)												
	09.04 -		20	6	S90-6-10-005	S33	91610002	114,3/5	67	M12x1,5	T	16
	09.04 -		30	4	S90-4-15-002	S9	91415002	114,3/5	67	M12x1,5	T	16
	09.04 -		30	6	S90-6-15-027	S33	91615023	114,3/5	67	M12x1,5	T	16
	09.04 -		40	4	S90-4-20-001	S9	91420001	114,3/5	67	M12x1,5	T	16
	09.04 -		40	6	S90-6-20-028	S33	91620028	114,3/5	67	M12x1,5	T	16
	09.04 -		50	4	S90-4-25-016	S9	91425016	114,3/5	67	M12x1,5	T	16
	09.04 -		60	4	S90-4-30-015	S9	91430015	114,3/5	67	M12x1,5	T	16
SPORTAGE (SL)												
	07.10 -		20	6	S90-6-10-005	S33	91610002	114,3/5	67	M12x1,5	T	5
	07.10 -		30	4	S90-4-15-002	S9, S23	91415002	114,3/5	67	M12x1,5	T	5
	07.10 -		30	6	S90-6-15-027	S33	91615023	114,3/5	67	M12x1,5	T	5
	07.10 -		40	4	S90-4-20-001	S9, S23	91420001	114,3/5	67	M12x1,5	T	5
	07.10 -		40	6	S90-6-20-028	S33	91620028	114,3/5	67	M12x1,5	T	5
	07.10 -		50	4	S90-4-25-016	S9, S23	91425016	114,3/5	67	M12x1,5	T	5
	07.10 -		60	4	S90-4-30-015	S9, S23	91430015	114,3/5	67	M12x1,5	T	5
LANCIA DELTA III (844)												
	09.08 -	S1-1-12-25-22-17	10	1	S90-1-05-011	S11	91105011	98/4	58	M12x1,25	§21	
	09.08 -	M12x1,25x22, KG60°	20	2	S90-2-10-021		91210021	98/4	58	M12x1,25	§21	
	09.08 -		30	2	S90-2-15-020		91215020	98/4	58	M12x1,25	§21	
	09.08 -		40	7	S90-7-20-012		91720012	98/4	58	M12x1,25	§21	
	09.08 -		50	7	S90-7-25-006		91725006	98/4	58	M12x1,25	§21	
	09.08 -		60	7	S90-7-30-005		91730005	98/4	58	M12x1,25	§21	
Y (840A)												
	11.95 - 09.03	S1-1-12-25-40-19	10	1	S90-1-05-011	S11	91105011	98/4	58	M12x1,25	§21	
	11.95 - 09.03	M12x1,25x40, KG60°	30	2	S90-2-15-020		91215020	98/4	58	M12x1,25	§21	
	11.95 - 09.03		50	7	S90-7-25-006	S68	91725006	98/4	58	M12x1,25	§21	

Modell Model	Baujahr Year	Original-radschraube (nicht bestellbar) Original Bolt (not available)	Spurweiten-änderung Total track widening (mm)	Eibach System	Artikel-Nr. Part-No.	Hinweise Notes	Kennzeichnung Stamping	Lockkreis Zahl Bolt pattern No. of holes	Zentrierung Centre bore (mm)	Gewinde Thread	Gutachten Homologation	ET-Grenze Offset frontier
LANCIA YPSILON (843)												
	10.03 - 12.11	S1-1-12-25-22-17	10	1	S90-1-05-011	S11	91105011	98/4	58	M12x1,25	§21	
	10.03 - 12.11	M12x1,25x22, KG60°	30	2	S90-2-15-020		91215020	98/4	58	M12x1,25	§21	
	10.03 - 12.11		50	7	S90-7-25-006	S68	91725006	98/4	58	M12x1,25	§21	
	10.03 - 12.11		60	7	S90-7-30-005		91730005	98/4	58	M12x1,25	§21	
LAND ROVER DISCOVERY III (TAA)												
	07.04 - 09.09		50	4	S90-4-25-057	S9, S23, S72	91425057	120/5	72,5	M14x1,5	T	23
	07.04 - 09.09		60	4	S90-4-30-052	S9, S23, S72	91430052	120/5	72,5	M14x1,5	T	23
DISCOVERY IV (LA)												
	09.09 -		50	4	S90-4-25-057	S9, S23, S72	91425057	120/5	72,5	M14x1,5	T	23
	09.09 -		60	4	S90-4-30-052	S9, S23, S72	91430052	120/5	72,5	M14x1,5</		

Modell Model	Baujahr Year	Original- radschraube (nicht bestellbar) Original Bolt (not available)	Spurweiten- änderung Achse Total track wide- ning (mm)	Eibach System	Artikel-Nr. Part-No.	Hinweise Notes	Kennzeich- nung Stamping	Lockkreis Bolt pattern No. of holes	Zentrierung Centre bore (mm)	Gewinde Thread	Gutachten Homo- logation	ET-Grenze Offset frontier	
MAZDA 6 (GG)	06.02 - 06.05		10	5	S90-5-05-031	S11, S16, S33	91505027	114,3/5	67	M12x1,5	T	35	
	06.02 - 06.05		20	6	S90-6-10-005	S3, S16, S33	91610002	114,3/5	67	M12x1,5	T	35	
	06.02 - 06.05		30	4	S90-4-15-002	S1, S23	91415002	114,3/5	67	M12x1,5	T	35	
	06.02 - 06.05		30	6	S90-6-15-027	S16, S33	91615023	114,3/5	67	M12x1,5	T	35	
	06.02 - 06.05		40	4	S90-4-20-001	S1, S23	91420001	114,3/5	67	M12x1,5	T	35	
	06.02 - 06.05		50	4	S90-4-25-016	S1, S23	91425016	114,3/5	67	M12x1,5	T	35	
	03.05 - 08.07		20	6	S90-6-10-002	S3, S16, S33	91610002	114,3/5	67	M12x1,5	T	25	
	03.05 - 08.07		30	6	S90-6-15-023	S16, S33	91615023	114,3/5	67	M12x1,5	T	25	
	03.05 - 08.07		40	4	S90-4-20-024	S1, S23	91420001	114,3/5	67	M12x1,5	T	25	
	03.05 - 08.07		40	6	S90-6-20-035	S1, S23	91620028	114,3/5	67	M12x1,5	T	25	
	03.05 - 08.07		50	4	S90-4-25-041	S1, S23	91425016	114,3/5	67	M12x1,5	T	25	
	03.05 - 08.07		60	4	S90-4-30-037	S1, S23	91430015	114,3/5	67	M12x1,5	T	25	
	6 (GH)	08.07 -		20	6	S90-6-10-002	S3, S16, S33	91610002	114,3/5	67	M12x1,5	T	20
		08.07 -		30	6	S90-6-15-023	S3, S16, S33	91615023	114,3/5	67	M12x1,5	T	20
		08.07 -		40	4	S90-4-20-024	S1, S23	91420001	114,3/5	67	M12x1,5	T	20
		08.07 -		40	6	S90-6-20-035	S16, S33	91620028	114,3/5	67	M12x1,5	T	20
		08.07 -		50	4	S90-4-25-041	S1, S23	91425016	114,3/5	67	M12x1,5	T	20
		08.07 -		60	4	S90-4-30-037	S1, S23	91430015	114,3/5	67	M12x1,5	T	20
6 Hatchback (GG)	08.02 - 06.05		10	5	S90-5-05-031	S11, S16, S33	91505027	114,3/5	67	M12x1,5	T	35	
	08.02 - 06.05		20	6	S90-6-10-005	S3, S16, S33	91610002	114,3/5	67	M12x1,5	T	35	
	08.02 - 06.05		30	4	S90-4-15-002	S1, S23	91415002	114,3/5	67	M12x1,5	T	35	
	08.02 - 06.05		30	6	S90-6-15-027	S16, S33	91615023	114,3/5	67	M12x1,5	T	35	
	08.02 - 06.05		40	4	S90-4-20-001	S1, S23	91420001	114,3/5	67	M12x1,5	T	35	
	08.02 - 06.05		50	4	S90-4-25-016	S1, S23	91425016	114,3/5	67	M12x1,5	T	35	
	03.05 - 08.07		20	6	S90-6-10-002	S3, S16, S33	91610002	114,3/5	67	M12x1,5	T	25	
	03.05 - 08.07		30	6	S90-6-15-023	S16, S33	91615023	114,3/5	67	M12x1,5	T	25	
	03.05 - 08.07		40	4	S90-4-20-024	S1, S23	91420001	114,3/5	67	M12x1,5	T	25	
	03.05 - 08.07		40	6	S90-6-20-035	S1, S23	91620028	114,3/5	67	M12x1,5	T	25	
	03.05 - 08.07		50	4	S90-4-25-041	S1, S23	91425016	114,3/5	67	M12x1,5	T	25	
	03.05 - 08.07		60	4	S90-4-30-037	S1, S23	91430015	114,3/5	67	M12x1,5	T	25	
6 Kombi (GH) 6 Estate (GH)	02.08 -		20	6	S90-6-10-002	S3, S16, S33	91610002	114,3/5	67	M12x1,5	T	20	
	02.08 -		30	6	S90-6-15-023	S3, S16, S33	91615023	114,3/5	67	M12x1,5	T	20	
	02.08 -		40	4	S90-4-20-024	S1, S23	91420001	114,3/5	67	M12x1,5	T	20	
	02.08 -		40	6	S90-6-20-035	S16, S33	91620028	114,3/5	67	M12x1,5	T	20	
	02.08 -		50	4	S90-4-25-041	S1, S23	91425016	114,3/5	67	M12x1,5	T	20	
	02.08 -		60	4	S90-4-30-037	S1, S23	91430015	114,3/5	67	M12x1,5	T	20	
6 Kombi (GJ) 6 Estate (GJ)	12.12 -		20	6	S90-6-10-005	S16, S33	91610002	114,3/5	67	M12x1,5	T	20	
	12.12 -		30	4	S90-4-15-018	S9	91415002	114,3/5	67	M12x1,5	T	20	
	12.12 -		30	6	S90-6-15-027	S16, S33	91615023	114,3/5	67	M12x1,5	T	20	
	12.12 -		40	4	S90-4-20-024	S9	91420001	114,3/5	67	M12x1,5	T	20	
	12.12 -		40	6	S90-6-20-028	S16, S33	91620028	114,3/5	67	M12x1,5	T	20	
	12.12 -		50	4	S90-4-25-041	S9	91425016	114,3/5	67	M12x1,5	T	20	
	12.12 -		60	4	S90-4-30-037	S9	91430015	114,3/5	67	M12x1,5	T	20	
	6 Schrägheck (GH) 6 Hatchback (GH)	08.07 -		20	6	S90-6-10-002	S3, S16, S33	91610002	114,3/5	67	M12x1,5	T	20
08.07 -			30	6	S90-6-15-023	S3, S16, S33	91615023	114,3/5	67	M12x1,5	T	20	
08.07 -			40	4	S90-4-20-024	S1, S23	91420001	114,3/5	67	M12x1,5	T	20	
08.07 -			40	6	S90-6-20-035	S16, S33	91620028	114,3/5	67	M12x1,5	T	20	
08.07 -			50	4	S90-4-25-041	S1, S23	91425016	114,3/5	67	M12x1,5	T	20	
08.07 -			60	4	S90-4-30-037	S1, S23	91430015	114,3/5	67	M12x1,5	T	20	
6 Station Wagon (GY)	08.02 - 06.05		10	5	S90-5-05-031	S11, S16, S33	91505027	114,3/5	67	M12x1,5	T	35	
	08.02 - 06.05		20	6	S90-6-10-005	S3, S16, S33	91610002	114,3/5	67	M12x1,5	T	35	
	08.02 - 06.05		30	4	S90-4-15-002	S1, S23	91415002	114,3/5	67	M12x1,5	T	35	
	08.02 - 06.05		30	6	S90-6-15-027	S16, S33	91615023	114,3/5	67	M12x1,5	T	35	
	08.02 - 06.05		40	4	S90-4-20-001	S1, S23	91420001	114,3/5	67	M12x1,5	T	35	
	08.02 - 06.05		50	4	S90-4-25-016	S1, S23	91425016	114,3/5	67	M12x1,5	T	35	
	03.05 - 12.07		20	6	S90-6-10-002	S3, S16, S33	91610002	114,3/5	67	M12x1,5	T	25	
	03.05 - 12.07		30	6	S90-6-15-023	S16, S33	91615023	114,3/5	67	M12x1,5	T	25	
	03.05 - 12.07		40	4	S90-4-20-024	S1, S23	91420001	114,3/5	67	M12x1,5	T	25	
	03.05 - 12.07		40	6	S90-6-20-035	S1, S23	91620028	114,3/5	67	M12x1,5	T	25	
	03.05 - 12.07		50	4	S90-4-25-041	S1, S23	91425016	114,3/5	67	M12x1,5	T	25	
	03.05 - 12.07		60	4	S90-4-30-037	S1, S23	91430015	114,3/5	67	M12x1,5	T	25	
6 Stufenheck (GJ, GH) 6 Saloon (GJ, GH)	12.12 -		20	6	S90-6-10-005	S16, S33	91610002	114,3/5	67	M12x1,5	T	20	
	12.12 -		30	4	S90-4-15-018	S9	91415002	114,3/5	67	M12x1,5	T	20	
	12.12 -		30	6	S90-6-15-027	S16, S33	91615023	114,3/5	67	M12x1,5	T	20	
	12.12 -		40	4	S90-4-20-024	S9	91420001	114,3/5	67	M12x1,5	T	20	
	12.12 -		40	6	S90-6-20-028	S16, S33	91620028	114,3/5	67	M12x1,5	T	20	
	12.12 -		50	4	S90-4-25-041	S9	91425016	114,3/5	67	M12x1,5	T	20	
	12.12 -		60	4	S90-4-30-037	S9	91430015	114,3/5	67	M12x1,5	T	20	
	323 C IV (BG)	06.89 - 09.00		10	5	S90-5-05-008	S16, S33	91505008	100/4	54	M12x1,5	§21	
		06.89 - 09.00		30	6	S90-6-15-010	S16, S33	91615010	100/4	54	M12x1,5	§21	
		06.89 - 09.00		40	4	S90-4-20-011	S9, S23	91420011	100/4	54	M12x1,5	§21	

Modell Model	Baujahr Year	Original- radschraube (nicht bestellbar) Original Bolt (not available)	Spurweiten- änderung Achse Total track wide- ning (mm)	Eibach System	Artikel-Nr. Part-No.	Hinweise Notes	Kennzeich- nung Stamping	Lockkreis Bolt pattern No. of holes	Zentrierung Centre bore (mm)	Gewinde Thread	Gutachten Homo- logation	ET-Grenze Offset frontier	
MAZDA 323 C V (BA)	08.94 - 09.00		10	5	S90-5-05-008	S16, S33	91505008	100/4	54	M12x1,5	§21		
	08.94 - 09.00		30	6	S90-6-15-010	S16, S33	91615010	100/4	54	M12x1,5	§21		
	08.94 - 09.00		40	4	S90-4-20-011	S9, S23	91420011	100/4	54	M12x1,5	§21		
	323 F IV (BG)	04.87 - 10.94		10	5	S90-5-05-008	S16, S33	91505008	100/4	54	M12x1,5	§21	
		04.87 - 10.94		30	6	S90-6-15-010	S16, S33	91615010	100/4	54	M12x1,5	§21	
		04.87 - 10.94		40	4	S90-4-20-011	S9, S23	91420011	100/4	54	M12x1,5	§21	
	323 F V (BA)	07.94 - 09.98		10	5	S90-5-05-008	S16, S33	91505008	100/4	54	M12x1,5	§21	
		07.94 - 09.98		30	6	S90-6-15-010	S16, S33	91615010	100/4	54	M12x1,5	§21	
		07.94 - 09.98		40	4	S90-4-20-011	S9, S23	91420011	100/4	54	M12x1,5	§21	
	323 F VI (BJ)	09.98 - 05.04		10	5	S90-5-05-008	S16, S33	91505008	100/4	54	M12x1,5	T	30
		09.98 - 05.04		30	6	S90-6-15-010	S16, S33	91615010	100/4	54	M12x1,5	T	30
		10.96 - 09.98		10	5	S90-5-05-008	S16, S33	91505008	100/4	54	M12x1,5	§21	
323 P V (BA)	10.96 - 09.98		30	6	S90-6-15-010	S16, S33	91615010	100/4	54	M12x1,5	§21		
	10.96 - 09.98		40	4	S90-4-20-011	S9, S23	91420011	100/4	54	M12x1,5	§21		
	06.89 - 10.94		10	5	S90-5-05-008	S16, S33							

Modell Model	Baujahr Year	Original-radschraube (nicht bestellbar) Original Bolt (not available)	Spurweiten-änderung Total track widening (mm)	Eibach System	Artikel-Nr. Part-No.	Hinweise Notes	Kennzeichnung Stamping	Lockkreis Zahl Bolt pattern No. of holes	Zentrierung Centre bore (mm)	Gewinde Thread	Gutachten Homologation	ET-Grenze Offset frontier
MERCEDES-BENZ A-CLASS (W176)												
	06.12 -	S1-7-14-50-27-17	24	2	S90-2-12-004	S50, S57	91212004	112/5	66,5	M14x1,5	T	17
	06.12 -	M14x1,5x27, KU r=14	30	2	S90-2-15-017	S51, S57	91215017	112/5	66,5	M14x1,5	T	17
	06.12 -		40	2	S90-2-20-007	S52, S57	91220007	112/5	66,5	M14x1,5	T	17
	06.12 -		40	7	S90-7-20-016		91720016	112/5	66,5	M14x1,5	T	17
	06.12 -		50	7	S90-7-25-016		91725016	112/5	66,5	M14x1,5	T	17
	06.12 -		60	7	S90-7-30-007		91730007	112/5	66,5	M14x1,5	T	17
B-CLASS (W245)												
	03.05 - 11.11	S1-7-14-50-27-17	10	1	S90-1-05-014	S11, S57	91105014	112/5	66,5	M14x1,5	T	16
	03.05 - 11.11	M14x1,5x27, KU r=14	24	2	S90-2-12-004	S50, S57	91212004	112/5	66,5	M14x1,5	T	16
	03.05 - 11.11		30	2	S90-2-15-017	S51, S57	91215017	112/5	66,5	M14x1,5	T	16
	03.05 - 11.11		40	2	S90-2-20-007	S52, S57	91220007	112/5	66,5	M14x1,5	T	16
	03.05 - 11.11		40	7	S90-7-20-016		91720016	112/5	66,5	M14x1,5	T	16
	03.05 - 11.11		50	7	S90-7-25-016		91725016	112/5	66,5	M14x1,5	T	16
	03.05 - 11.11		60	7	S90-7-30-007		91730007	112/5	66,5	M14x1,5	T	16
B-CLASS (W246)												
	11.11 -	S1-7-14-50-27-17	24	2	S90-2-12-004	S50, S57	91212004	112/5	66,5	M14x1,5	T	17
	11.11 -	M14x1,5x27, KU r=14	30	2	S90-2-15-017	S51, S57	91215017	112/5	66,5	M14x1,5	T	17
	11.11 -		40	2	S90-2-20-007	S52, S57	91220007	112/5	66,5	M14x1,5	T	17
	11.11 -		40	7	S90-7-20-016		91720016	112/5	66,5	M14x1,5	T	17
	11.11 -		50	7	S90-7-25-016		91725016	112/5	66,5	M14x1,5	T	17
	11.11 -		60	7	S90-7-30-007		91730007	112/5	66,5	M14x1,5	T	17
C-CLASS (W202)												
	03.93 - 05.00	S1-5-12-50-40-17	10	1	S90-1-05-014	S11, S57	91105014	112/5	66,5	M12x1,5	T	15
	03.93 - 05.00	M12x1,5x40, KU r=12	20	2	S90-2-10-002	S48, S57	91210002	112/5	66,5	M12x1,5	T	15
	03.93 - 05.00		30	2	S90-2-15-017	S51, S57	91215017	112/5	66,5	M12x1,5	T	15
	03.93 - 05.00		40	2	S90-2-20-007	S52, S57	91220007	112/5	66,5	M12x1,5	T	15
	03.93 - 05.00		50	7	S90-7-25-009	S6, S15, S68	91725009	112/5	66,5	M12x1,5	T	15
	03.93 - 05.00		60	7	S90-7-30-001	S6, S15	91730001	112/5	66,5	M12x1,5	T	15
C-CLASS (W203)												
	05.00 - 02.07	S1-5-12-50-40-17	10	1	S90-1-05-014	S11, S57	91105014	112/5	66,5	M12x1,5	T	2
	05.00 - 02.07	M12x1,5x40, KU r=12	20	2	S90-2-10-002	S48, S57	91210002	112/5	66,5	M12x1,5	T	2
	05.00 - 02.07		30	2	S90-2-15-017	S51, S57	91215017	112/5	66,5	M12x1,5	T	2
	05.00 - 02.07		40	2	S90-2-20-007	S52, S57	91220007	112/5	66,5	M12x1,5	T	2
	05.00 - 02.07		50	7	S90-7-25-009	S6, S15	91725009	112/5	66,5	M12x1,5	T	2
	05.00 - 02.07		60	7	S90-7-30-001	S6, S17	91730001	112/5	66,5	M12x1,5	T	2
C-CLASS (W204)												
	01.07 -	S1-7-14-50-27-17	20	2	S90-2-10-002	S57	91210002	112/5	66,5	M14x1,5	T	6
	01.07 -	M14x1,5x27, KU r=14	24	2	S90-2-12-004	S57	91212004	112/5	66,5	M14x1,5	T	6
	01.07 -		30	2	S90-2-15-017	S57	91215017	112/5	66,5	M14x1,5	T	6
	01.07 -		40	2	S90-2-20-007	S57	91220007	112/5	66,5	M14x1,5	T	6
	01.07 -		40	7	S90-7-20-016		91720016	112/5	66,5	M14x1,5	T	6
	01.07 -		50	7	S90-7-25-016		91725016	112/5	66,5	M14x1,5	T	6
	01.07 -		60	7	S90-7-30-007		91730007	112/5	66,5	M14x1,5	T	6
C-CLASS Coupe (CL203)												
	03.01 - 06.11	S1-5-12-50-40-17	20	2	S90-2-10-002	S48, S57	91210002	112/5	66,5	M12x1,5	T	1
	03.01 - 06.11	M12x1,5x40, KU r=12	30	2	S90-2-15-017	S51, S57	91215017	112/5	66,5	M12x1,5	T	1
	03.01 - 06.11		40	2	S90-2-20-007	S52, S57	91220007	112/5	66,5	M12x1,5	T	1
	03.01 - 06.11		50	7	S90-7-25-009	S6, S15	91725009	112/5	66,5	M12x1,5	T	1
	03.01 - 06.11		60	7	S90-7-30-001	S6, S17	91730001	112/5	66,5	M12x1,5	T	1
C-CLASS Coupe (C204)												
	06.11 -	S1-7-14-50-27-17	20	2	S90-2-10-002	S57	91210002	112/5	66,5	M14x1,5	T	6
	06.11 -	M14x1,5x27, KU r=14	24	2	S90-2-12-004	S57	91212004	112/5	66,5	M14x1,5	T	6
	06.11 -		30	2	S90-2-15-017	S57	91215017	112/5	66,5	M14x1,5	T	6
	06.11 -		40	2	S90-2-20-007	S57	91220007	112/5	66,5	M14x1,5	T	6
	06.11 -		40	7	S90-7-20-016		91720016	112/5	66,5	M14x1,5	T	6
	06.11 -		50	7	S90-7-25-016		91725016	112/5	66,5	M14x1,5	T	6
	06.11 -		60	7	S90-7-30-007		91730007	112/5	66,5	M14x1,5	T	6
C-CLASS Kombi (S202)												
C-CLASS Estate (S202)												
	06.96 - 03.01	S1-5-12-50-40-17	10	1	S90-1-05-014	S11, S57	91105014	112/5	66,5	M12x1,5	T	15
	06.96 - 03.01	M12x1,5x40, KU r=12	20	2	S90-2-10-002	S48, S57	91210002	112/5	66,5	M12x1,5	T	15
	06.96 - 03.01		30	2	S90-2-15-017	S51, S57	91215017	112/5	66,5	M12x1,5	T	15
	06.96 - 03.01		40	2	S90-2-20-007	S52, S57	91220007	112/5	66,5	M12x1,5	T	15
	06.96 - 03.01		50	7	S90-7-25-009	S6, S15, S68	91725009	112/5	66,5	M12x1,5	T	15
	06.96 - 03.01		60	7	S90-7-30-001	S6, S15	91730001	112/5	66,5	M12x1,5	T	15
C-CLASS T-Model (S203)												
	03.01 - 08.07	S1-5-12-50-40-17	10	1	S90-1-05-014	S11, S57	91105014	112/5	66,5	M12x1,5	T	2
	03.01 - 08.07	M12x1,5x40, KU r=12	20	2	S90-2-10-002	S48, S57	91210002	112/5	66,5	M12x1,5	T	2
	03.01 - 08.07		30	2	S90-2-15-017	S51, S57	91215017	112/5	66,5	M12x1,5	T	2
	03.01 - 08.07		40	2	S90-2-20-007	S52, S57	91220007	112/5	66,5	M12x1,5	T	2
	03.01 - 08.07		50	7	S90-7-25-009	S6, S15	91725009	112/5	66,5	M12x1,5	T	2
	03.01 - 08.07		60	7	S90-7-30-001	S6, S17	91730001	112/5	66,5	M12x1,5	T	2
C-CLASS T-Model (S204)												
	08.07 -	S1-7-14-50-27-17	20	2	S90-2-10-002	S57	91210002	112/5	66,5	M14x1,5	T	6
	08.07 -	M14x1,5x27, KU r=14	24	2	S90-2-12-004	S57	91212004	112/5	66,5	M14x1,5	T	6
	08.07 -		30	2	S90-2-15-017	S57	91215017	112/5	66,5	M14x1,5	T	6
	08.07 -		40	2	S90-2-20-007	S57	91220007	112/5	66,5	M14x1,5	T	6
	08.07 -		40	7	S90-7-20-016		91720016	112/5	66,5	M14x1,5	T	6
	08.07 -		50	7	S90-7-25-016		91725016	112/5	66,5	M14x1,5	T	6
	08.07 -		60	7	S90-7-30-007		91730007	112/5	66,5	M14x1,5	T	6
CABRIOLET (A124)												
	09.91 - 06.93	S1-5-12-50-30-17	10	1	S90-1-05-014	S11, S57	91105014	112/5	66,5	M12x1,5	T	20
	09.91 - 06.93	M12x1,5x30, KU r=12	30	2	S90-2-15-017	S51, S57	91215017	112/5	66,5	M12x1,5	T	20
	09.91 - 06.93		40	2	S90-2-20-007	S52, S57	91220007	112/5	66,5	M12x1,5	§21	
	09.91 - 06.93		50	7	S90-7-25-009	S6, S68	91725009	112/5	66,5	M12x1,5	§21	
	09.91 - 06.93		60	7	S90-7-30-001	S6	91730001	112/5	66,5	M12x1,5	§21	
CLA Coupe (C117)												
	01.13 -	S1-7-14-50-27-17	24	2	S90-2-12-004	S50, S57	91212004	112/5	66,5	M14x1,5	T	19
	01.13 -	M14x1,5x27, KU r=14	30	2	S90-2-15-017	S51, S57	91215017	112/5	66,5	M14x1,5	T	19
	01.13 -		40	2	S90-2-20-007	S52, S57	91220007	112/5	66,5	M14x1,5	T	19
	01.13 -		40	7	S90-7-20-016		91720016	112/5	66,5	M14x1,5	T	19
	01.13 -		50	7	S90-7-25-016		91725016	112/5	66,5	M14x1,5	T	19
	01.13 -		60	7	S90-7-30-007		91730007	112/5	66,5	M14x1,5	T	19

Modell Model	Baujahr Year	Original-radschraube (nicht bestellbar) Original Bolt (not available)	Spurweiten-änderung Total track widening (mm)	Eibach System	Artikel-Nr. Part-No.	Hinweise Notes	Kennzeichnung Stamping	Lockkreis Zahl Bolt pattern No. of holes	Zentrierung Centre bore (mm)	Gewinde Thread	Gutachten Homologation	ET-Grenze Offset frontier
MERCEDES-BENZ CLC-CLASS (CL203)												
	05.08 - 06.11	S1-5-12-50-40-17	20	2	S90-2-10-002	S48, S57	91210002	112/5	66,5	M12x1,5	T	1
	05.08 - 06.11	M12x1,5x40, KU r=12	30	2	S90-2-15-017	S51, S57	91215017	112/5	66,5	M12x1,5	T	1
	05.08 - 06.11		40	2	S90-2-20-007	S52, S57	91220007	112/5	66,5	M12x1,5	T	1
	05.08 - 06.11		50	7	S90-7-25-009	S6, S15	91725009	112/5	66,5	M12x1,5	T	1
	05.08 - 06.11		60	7	S90-7-30-001	S6, S17	91730001	112/5	66,5	M12x1,5	T	1
CLK (C208)												
	06.97 - 07.02	S1-5-12-50-40-17	10	1	S90-1-05-014	S11, S57	91105014	112/5	66,5	M12x1,5	T	15
	06.97 - 07.02	M12x1,5x40, KU r=12	30	2	S90-2-15-017	S51, S57	91215017	112/5	66,5	M12x1,5	T	15
	06.97 - 07.02		40	2	S90-2-20-007	S52, S57	91220007	112/5	66,5	M12x1,5	T	15
	06.97 - 07.02		50	7	S90-7-25-009	S6, S15, S68	91725009	112/5	66,5	M12x1,5	T	15
	06.97 - 07.02		60	7	S90-7-30-001	S6, S15	91730001	112/5	66,5	M12x1,5	T	15
CLK (C209)												
	06.02 - 05.09	S1-5-12-50-40-17	30									

Modell Model	Baujahr Year	Original- radschraube (nicht bestellbar) Original Bolt (not available)	Spurweiten- änderung Achse Total track wide- ning (mm)	Eibach System	Artikel-Nr. Part-No.	Hinweise Notes	Kennzeich- nung Stamping	Lockkreis zahl Bolt pattern No. of holes	Zentrierung Centre bore (mm)	Gewinde Thread	Gutachten Homo- logation	ET-Grenze Offset Frontier
MERCEDES-BENZ												
E-CLASS Cabriolet (A207)												
E-CLASS Convertible (A207)												
	01.10 -	S1-7-14-50-27-17	20	2	S90-2-10-002	S6, S57	91210002	112/5	66,5	M14x1,5	T	15
	01.10 -	M14x1,5x27, KU r=14	24	2	S90-2-12-004	S6, S57	91212004	112/5	66,5	M14x1,5	T	15
	01.10 -		30	2	S90-2-15-017	S57	91215017	112/5	66,5	M14x1,5	T	15
	01.10 -		40	2	S90-2-20-007	S57	91220007	112/5	66,5	M14x1,5	T	15
	01.10 -		40	7	S90-7-20-016		91720016	112/5	66,5	M14x1,5	T	15
	01.10 -		50	7	S90-7-25-016		91725016	112/5	66,5	M14x1,5	T	15
	01.10 -		60	7	S90-7-30-007		91730007	112/5	66,5	M14x1,5	T	15
E-CLASS Coupe (C124)												
	06.93 - 06.97	S1-5-12-50-30-17	10	1	S90-1-05-014	S11, S57	91105014	112/5	66,5	M12x1,5	T	20
	06.93 - 06.97	M12x1,5x30, KU r=12	30	2	S90-2-15-017	S51, S57	91215017	112/5	66,5	M12x1,5	T	20
	06.93 - 06.97		40	2	S90-2-20-007	S52, S57	91220007	112/5	66,5	M12x1,5	\$21	
	06.93 - 06.97		50	7	S90-7-25-009	S6, S68	91725009	112/5	66,5	M12x1,5	\$21	
	06.93 - 06.97		60	7	S90-7-30-001	S6	91730001	112/5	66,5	M12x1,5	\$21	
E-CLASS Coupe (C207)												
	01.09 -	S1-7-14-50-27-17	20	2	S90-2-10-002	S6, S57	91210002	112/5	66,5	M14x1,5	T	15
	01.09 -	M14x1,5x27, KU r=14	24	2	S90-2-12-004	S6, S57	91212004	112/5	66,5	M14x1,5	T	15
	01.09 -		30	2	S90-2-15-017	S57	91215017	112/5	66,5	M14x1,5	T	15
	01.09 -		40	2	S90-2-20-007	S57	91220007	112/5	66,5	M14x1,5	T	15
	01.09 -		40	7	S90-7-20-016		91720016	112/5	66,5	M14x1,5	T	15
	01.09 -		50	7	S90-7-25-016		91725016	112/5	66,5	M14x1,5	T	15
	01.09 -		60	7	S90-7-30-007		91730007	112/5	66,5	M14x1,5	T	15
E-CLASS Kombi (S124)												
E-CLASS Estate (S124)												
	06.93 - 06.96	S1-5-12-50-30-17	10	1	S90-1-05-014	S11, S57	91105014	112/5	66,5	M12x1,5	T	20
	06.93 - 06.96	M12x1,5x30, KU r=12	30	2	S90-2-15-017	S51, S57	91215017	112/5	66,5	M12x1,5	T	20
	06.93 - 06.96		40	2	S90-2-20-007	S52, S57	91220007	112/5	66,5	M12x1,5	\$21	
	06.93 - 06.96		50	7	S90-7-25-009	S6, S68	91725009	112/5	66,5	M12x1,5	\$21	
	06.93 - 06.96		60	7	S90-7-30-001	S6	91730001	112/5	66,5	M12x1,5	\$21	
E-CLASS Kombi (S210)												
E-CLASS Estate (S210)												
	06.96 - 03.03	S1-5-12-50-30-17	10	1	S90-1-05-014	S11, S57	91105014	112/5	66,5	M12x1,5	T	20
	06.96 - 03.03	M12x1,5x30, KU r=12	20	2	S90-2-10-002	S48, S57	91210002	112/5	66,5	M12x1,5	T	20
	06.96 - 03.03		30	2	S90-2-15-017	S51, S57	91215017	112/5	66,5	M12x1,5	T	20
	06.96 - 03.03		40	2	S90-2-20-007	S52, S57	91220007	112/5	66,5	M12x1,5	T	20
	06.96 - 03.03		50	7	S90-7-25-009	S6, S68	91725009	112/5	66,5	M12x1,5	T	20
	06.96 - 03.03		60	7	S90-7-30-001	S6	91730001	112/5	66,5	M12x1,5	T	20
E-CLASS T-Model (S211)												
	03.03 - 07.09	S1-7-14-50-27-17	20	2	S90-2-10-002	S48, S57	91210002	112/5	66,5	M14x1,5	T	3
	03.03 - 07.09	M14x1,5x27, KU r=14	30	2	S90-2-15-017	S51, S57	91215017	112/5	66,5	M14x1,5	T	3
	03.03 - 07.09		40	2	S90-2-20-007	S52, S57	91220007	112/5	66,5	M14x1,5	T	3
	03.03 - 07.09		50	7	S90-7-25-016	S6	91725016	112/5	66,5	M14x1,5	T	3
	03.03 - 07.09		60	7	S90-7-30-007	S6	91730007	112/5	66,5	M14x1,5	T	3
E-CLASS T-Model (S212)												
	08.09 -	S1-7-14-50-27-17	20	2	S90-2-10-002	S6, S57	91210002	112/5	66,5	M14x1,5	T	17
	08.09 -	M14x1,5x27, KU r=14	24	2	S90-2-12-004	S6, S57	91212004	112/5	66,5	M14x1,5	T	17
	08.09 -		30	2	S90-2-15-017	S57	91215017	112/5	66,5	M14x1,5	T	17
	08.09 -		40	2	S90-2-20-007	S57	91220007	112/5	66,5	M14x1,5	T	17
	08.09 -		40	7	S90-7-20-016		91720016	112/5	66,5	M14x1,5	T	17
	08.09 -		50	7	S90-7-25-016		91725016	112/5	66,5	M14x1,5	T	17
	08.09 -		60	7	S90-7-30-007		91730007	112/5	66,5	M14x1,5	T	17
G-CLASS (W460)												
	09.89 - 08.93	S1-7-14-50-42-17	40	7	S90-7-20-020	S15	91720020	130/5	84	M14x1,5	T	10
	09.89 - 08.93	M14x1,5x42, KU r=14	50	7	S90-7-25-023	S15	91725023	130/5	84	M14x1,5	T	10
G-CLASS (W463)												
	09.89 -	S1-7-14-50-42-17	40	7	S90-7-20-020	S15	91720020	130/5	84	M14x1,5	T	10
	09.89 -	M14x1,5x42, KU r=14	50	7	S90-7-25-023	S15	91725023	130/5	84	M14x1,5	T	10
G-CLASS (W461)												
	02.90 -	S1-7-14-50-42-17	40	7	S90-7-20-020	S15	91720020	130/5	84	M14x1,5	T	10
	02.90 -	M14x1,5x42, KU r=14	50	7	S90-7-25-023	S15	91725023	130/5	84	M14x1,5	T	10
G-CLASS Cabrio (W463)												
	09.89 -	S1-7-14-50-42-17	40	7	S90-7-20-020	S15	91720020	130/5	84	M14x1,5	T	10
	09.89 -	M14x1,5x42, KU r=14	50	7	S90-7-25-023	S15	91725023	130/5	84	M14x1,5	T	10
GLK-CLASS (X204)												
	06.08 -	S1-7-14-50-45-17	20	2	S90-2-10-002	S57	91210002	112/5	66,5	M14x1,5	T	17
	06.08 -	M14x1,5x45, KU r=14	24	2	S90-2-12-004	S57	91212004	112/5	66,5	M14x1,5	T	17
	06.08 -		30	2	S90-2-15-017	S57	91215017	112/5	66,5	M14x1,5	T	17
	06.08 -		40	2	S90-2-20-007	S57	91220007	112/5	66,5	M14x1,5	T	17
	06.08 -		40	7	S90-7-20-016		91720016	112/5	66,5	M14x1,5	T	17
	06.08 -		50	7	S90-7-25-016		91725016	112/5	66,5	M14x1,5	T	17
	06.08 -		60	7	S90-7-30-007		91730007	112/5	66,5	M14x1,5	T	17
KOMBI Kombi (S124)												
KOMBI Estate (S124)												
	09.85 - 06.93	S1-5-12-50-30-17	10	1	S90-1-05-014	S11, S57	91105014	112/5	66,5	M12x1,5	T	20
	09.85 - 06.93	M12x1,5x30, KU r=12	30	2	S90-2-15-017	S51, S57	91215017	112/5	66,5	M12x1,5	T	20
	09.85 - 06.93		40	2	S90-2-20-007	S52, S57	91220007	112/5	66,5	M12x1,5	\$21	
	09.85 - 06.93		50	7	S90-7-25-009	S6, S68	91725009	112/5	66,5	M12x1,5	\$21	
	09.85 - 06.93		60	7	S90-7-30-001	S6	91730001	112/5	66,5	M12x1,5	\$21	
M-CLASS (W163)												
	02.98 - 06.05	S1-7-14-50-27-17	10	1	S90-1-05-014	S57	91105014	112/5	66,5	M14x1,5	T	32
	02.98 - 06.05	M14x1,5x27, KU r=14	20	2	S90-2-10-002	S57	91210002	112/5	66,5	M14x1,5	T	32
	02.98 - 06.05		30	2	S90-2-15-017	S57	91215017	112/5	66,5	M14x1,5	T	32
	02.98 - 06.05		40	2	S90-2-20-007	S57	91220007	112/5	66,5	M14x1,5	T	32
	02.98 - 06.05		40	7	S90-7-20-016		91720016	112/5	66,5	M14x1,5	T	32
	02.98 - 06.05		50	7	S90-7-25-016		91725016	112/5	66,5	M14x1,5	T	32
	02.98 - 06.05		60	7	S90-7-30-007		91730007	112/5	66,5	M14x1,5	T	32
M-CLASS (W164)												
	07.05 -	S1-7-14-50-27-17	20	2	S90-2-10-002	S50, S53, S57	91210002	112/5	66,5	M14x1,5	T	26
	07.05 -	M14x1,5x27, KU r=14	24	2	S90-2-12-004	S49, S53, S57	91212004	112/5	66,5	M14x1,5	T	26
	07.05 -	S1-7-14-50-40-17	30	2	S90-2-15-017	S49, S53, S57	91215017	112/5	66,5	M14x1,5	T	26
	07.05 -	M14x1,5x40, KU r=14	40	2	S90-2-20-007	S49, S53, S57	91220007	112/5	66,5	M14x1,5	T	26
	07.05 -	S1-7-14-50-45-17	40	7	S90-7-20-016	S45	91720016	112/5	66,5	M14x1,5	T	26
	07.05 -	M14x1,5x45, KU r=14	50	7	S90-7-25-016		91725016	112/5	66,5	M14x1,5	T	26
	07.05 -		60	7	S90-7-30-007		91730007	112/5	66,5	M14x1,5	T	26

Modell Model	Baujahr Year	Original- radschraube (nicht bestellbar) Original Bolt (not available)	Spurweiten- änderung Achse Total track wide- ning (mm)	Eibach System	Artikel-Nr. Part-No.	Hinweise Notes	Kennzeich- nung Stamping	Lockkreis zahl Bolt pattern No. of holes	Zentrierung Centre bore (mm)	Gewinde Thread	Gutachten Homo- logation	ET-Grenze Offset Frontier
MERCEDES-BENZ												
M-CLASS (166)												
	06.11 -	S1-7-14-50-27-17	20	2	S90-2-10-002	S50, S53, S57	91210002	112/5	66,5	M14x1,5	T	23
	06.11 -	M14x1,5x27, KU r=14	24	2	S90-2-12-004	S49, S53, S57	91212004	112/5	66,5	M14x1,5	T	23
	06.11 -	S1-7-14-50-40-17	30	2	S90-2-15-017	S49, S53, S57	91215017	112/5	66,5	M14x1,5	T	23
	06.11 -	M14x1,5x40, KU r=14	40	2	S90-2-20-007	S49, S53, S57	91220007	112/5	66,5	M14x1,5	T	23
	06.11 -	S1-7-14-50-45-17	40	7	S90-7-20-016	S45	91720016	112/5	66,5	M14x1,5	T	23
	06.11 -	M14x1,5x45, KU r=14	50	7	S90-7-25-016		91725016	112/5	66,5	M14x1,5	T	23
	06.11 -		60	7	S90-7-30-007		91730007	112/5	66,5	M14x1,5	T	23
S-CLASS (W126)												
	10.79 - 06.91	S1-5-12-50-30-17	10	1	S90-1-05-014	S11, S57	91105014	112/5	66,5	M12x1,5	T	15
	10.79 - 06.91	M12x1,5x30, KU r=12	30	2	S90-2-15-017	S51, S57	91215017	112/5	66,5	M12x1,5	T	15
	10.79 - 06.91		40	2	S90-2-20-007	S52, S57	91220007	112/5	66,5	M12x1,5	\$21	
	10.79 - 06.91		50	7	S90-7-25-009	S6, S68	91725009	112/5	66,5	M12x1,5	\$21	
	10.79 - 06.91		60	7	S90-7-30-0							

PRO-SPACER

Modell Model	Baujahr Year	Original-radschraube (nicht bestellbar) Original Bolt (not available)	Spurweiten-änderung Total track width-ning (mm)	Eibach System	Artikel-Nr. Part-No.	Hinweise Notes	Kennzeich-nung Stamping	Lockkreis -zahl Bolt pattern No. of holes	Zentrierung Centre bore (mm)	Gewinde Thread	Gutachten Homo- logation	ET-Grenze Offset frontier
MERCEDES-BENZ Vaneo (414)												
	02.02 - 07.05	S1-5-12-50-40-17	10	1	S90-1-05-014	S57	91105014	112/5	66,5	M12x1,5	T	27
	02.02 - 07.05	M12x1,5x40, KU r=12	20	2	S90-2-10-002	S57	91210002	112/5	66,5	M12x1,5	T	27
	02.02 - 07.05		30	2	S90-2-15-017	S57	91215017	112/5	66,5	M12x1,5	T	27
	02.02 - 07.05		40	2	S90-2-20-007	S57	91220007	112/5	66,5	M12x1,5	T	27
	02.02 - 07.05		50	7	S90-7-25-009		91725009	112/5	66,5	M12x1,5	T	27
	02.02 - 07.05		60	7	S90-7-30-001		91730001	112/5	66,5	M12x1,5	T	27
VIANO (W639)												
	09.03 -	S1-7-14-50-27-17	20	2	S90-2-10-002	S57	91210002	112/5	66,5	M14x1,5	T	40
	09.03 -	M14x1,5x27, KU r=14	30	2	S90-2-15-017	S57	91215017	112/5	66,5	M14x1,5	T	40
	09.03 -		40	2	S90-2-20-007	S57	91220007	112/5	66,5	M14x1,5	T	40
	09.03 -		40	7	S90-7-20-016		91720016	112/5	66,5	M14x1,5	T	40
	09.03 -		50	7	S90-7-25-016		91725016	112/5	66,5	M14x1,5	T	40
	09.03 -		60	7	S90-7-30-007		91730007	112/5	66,5	M14x1,5	T	40
VITO / MIXTO Kasten (W639) VITO / MIXTO Box (W639)												
	09.03 -	S1-7-14-50-27-17	20	2	S90-2-10-002	S57	91210002	112/5	66,5	M14x1,5	T	40
	09.03 -	M14x1,5x27, KU r=14	30	2	S90-2-15-017	S57	91215017	112/5	66,5	M14x1,5	T	40
	09.03 -		40	2	S90-2-20-007	S57	91220007	112/5	66,5	M14x1,5	T	40
	09.03 -		40	7	S90-7-20-016		91720016	112/5	66,5	M14x1,5	T	40
	09.03 -		50	7	S90-7-25-016		91725016	112/5	66,5	M14x1,5	T	40
	09.03 -		60	7	S90-7-30-007		91730007	112/5	66,5	M14x1,5	T	40
VITO Bus (638)												
	02.96 - 07.03	S1-7-14-50-27-17	20	2	S90-2-10-002	S57	91210002	112/5	66,5	M14x1,5	§21	
	02.96 - 07.03	M14x1,5x27, KU r=14	30	2	S90-2-15-017	S57	91215017	112/5	66,5	M14x1,5	§21	
	02.96 - 07.03		40	2	S90-2-20-007	S57	91220007	112/5	66,5	M14x1,5	§21	
VITO Bus (W639)												
	09.03 -	S1-7-14-50-27-17	20	2	S90-2-10-002	S57	91210002	112/5	66,5	M14x1,5	T	40
	09.03 -	M14x1,5x27, KU r=14	30	2	S90-2-15-017	S57	91215017	112/5	66,5	M14x1,5	T	40
	09.03 -		40	2	S90-2-20-007	S57	91220007	112/5	66,5	M14x1,5	T	40
	09.03 -		40	7	S90-7-20-016		91720016	112/5	66,5	M14x1,5	T	40
	09.03 -		50	7	S90-7-25-016		91725016	112/5	66,5	M14x1,5	T	40
	09.03 -		60	7	S90-7-30-007		91730007	112/5	66,5	M14x1,5	T	40
VITO Kasten (638) VITO Box (638)												
	03.97 - 07.03	S1-7-14-50-27-17	20	2	S90-2-10-002	S57	91210002	112/5	66,5	M14x1,5	§21	
	03.97 - 07.03	M14x1,5x27, KU r=14	30	2	S90-2-15-017	S57	91215017	112/5	66,5	M14x1,5	§21	
	03.97 - 07.03		40	2	S90-2-20-007	S57	91220007	112/5	66,5	M14x1,5	§21	
MINI MINI (R50, R53)												
	06.01 - 09.06	S1-1-12-50-25-17	10	1	S90-1-05-025		91105025	100/4	56	M12x1,5	T	18
	06.01 - 09.06	M12x1,5x25, KG60°	24	2	S90-2-12-007		91212007	100/4	56	M12x1,5	T	18
	06.01 - 09.06		30	2	S90-2-15-027		91215027	100/4	56	M12x1,5	T	18
	06.01 - 09.06		40	2	S90-2-20-016		91220016	100/4	56	M12x1,5	T	18
	06.01 - 09.06		50	7	S90-7-25-029		91725029	100/4	56	M12x1,5	T	18
	06.01 - 09.06		60	7	S90-7-30-020		91730020	100/4	56	M12x1,5	T	18
MINI (R56)												
	09.06 -	S1-1-14-25-27-17	10	1	S90-1-05-025		91105025	100/4	56	M14x1,25	T	20
	09.06 -	M14x1,25x27, KG60°	24	2	S90-2-12-007		91212007	100/4	56	M14x1,25	T	20
	09.06 -		30	2	S90-2-15-027		91215027	100/4	56	M14x1,25	T	20
	09.06 -		40	2	S90-2-20-016		91220016	100/4	56	M14x1,25	T	20
	09.06 -		50	7	S90-7-25-034		91725034	100/4	56	M14x1,25	T	20
MINI Cabriolet (R52) MINI Convertible (R52)												
	07.04 - 11.07	S1-1-12-50-25-17	10	1	S90-1-05-025		91105025	100/4	56	M12x1,5	T	18
	07.04 - 11.07	M12x1,5x25, KG60°	24	2	S90-2-12-007		91212007	100/4	56	M12x1,5	T	18
	07.04 - 11.07		30	2	S90-2-15-027		91215027	100/4	56	M12x1,5	T	18
	07.04 - 11.07		40	2	S90-2-20-016		91220016	100/4	56	M12x1,5	T	18
	07.04 - 11.07		50	7	S90-7-25-029		91725029	100/4	56	M12x1,5	T	18
	07.04 - 11.07		60	7	S90-7-30-020		91730020	100/4	56	M12x1,5	T	18
MINI Cabriolet (R57) MINI Convertible (R57)												
	11.07 -	S1-1-14-25-27-17	10	1	S90-1-05-025		91105025	100/4	56	M14x1,25	T	20
	11.07 -	M14x1,25x27, KG60°	24	2	S90-2-12-007		91212007	100/4	56	M14x1,25	T	20
	11.07 -		30	2	S90-2-15-027		91215027	100/4	56	M14x1,25	T	20
	11.07 -		40	2	S90-2-20-016		91220016	100/4	56	M14x1,25	T	20
	11.07 -		50	7	S90-7-25-034		91725034	100/4	56	M14x1,25	T	20
MINI CLUBMAN (R55)												
	10.07 -	S1-1-14-25-27-17	10	1	S90-1-05-025		91105025	100/4	56	M14x1,25	T	20
	10.07 -	M14x1,25x27, KG60°	24	2	S90-2-12-007		91212007	100/4	56	M14x1,25	T	20
	10.07 -		30	2	S90-2-15-027		91215027	100/4	56	M14x1,25	T	20
	10.07 -		40	2	S90-2-20-016		91220016	100/4	56	M14x1,25	T	20
	10.07 -		50	7	S90-7-25-034		91725034	100/4	56	M14x1,25	T	20
MINI COUNTRYMAN (R60)												
	06.10 -	S1-1-14-25-27-17	24	2	S90-2-12-002		91212002	120/5	72,5	M14x1,25	T	31
	06.10 -	M14x1,25x27, KG60°	30	2	S90-2-15-001		91215001	120/5	72,5	M14x1,25	T	31
MINI Coupe (R58)												
	09.11 -	S1-1-14-25-27-17	10	1	S90-1-05-025		91105025	100/4	56	M14x1,25	T	20
	09.11 -	M14x1,25x27, KG60°	24	2	S90-2-12-007		91212007	100/4	56	M14x1,25	T	20
	09.11 -		30	2	S90-2-15-027		91215027	100/4	56	M14x1,25	T	20
	09.11 -		40	2	S90-2-20-016		91220016	100/4	56	M14x1,25	T	20
	09.11 -		50	7	S90-7-25-034		91725034	100/4	56	M14x1,25	T	20
MINI PACEMAN (R61)												
	04.12 -	S1-1-14-25-27-17	24	2	S90-2-12-002		91212002	120/5	72,5	M14x1,25	T	31
	04.12 -	M14x1,25x27, KG60°	30	2	S90-2-15-001		91215001	120/5	72,5	M14x1,25	T	31
MINI Roadster (R59)												
	02.12 -	S1-1-14-25-27-17	10	1	S90-1-05-025		91105025	100/4	56	M14x1,25	T	20
	02.12 -	M14x1,25x27, KG60°	24	2	S90-2-12-007		91212007	100/4	56	M14x1,25	T	20
	02.12 -		30	2	S90-2-15-027		91215027	100/4	56	M14x1,25	T	20
	02.12 -		40	2	S90-2-20-016		91220016	100/4	56	M14x1,25	T	20
	02.12 -		50	7	S90-7-25-034		91725034	100/4	56	M14x1,25	T	20

PRO-SPACER

Modell Model	Baujahr Year	Original-radschraube (nicht bestellbar) Original Bolt (not available)	Spurweiten-änderung Total track width-ning (mm)	Eibach System	Artikel-Nr. Part-No.	Hinweise Notes	Kennzeich-nung Stamping	Lockkreis -zahl Bolt pattern No. of holes	Zentrierung Centre bore (mm)	Gewinde Thread	Gutachten Homo- logation	ET-Grenze Offset frontier
MITSUBISHI ASX (GA_W_)												
	02.10 -		10	5	S90-5-05-027	S33	91505027	114,3/5	67	M12x1,5	T	16
	02.10 -		20	6	S90-6-10-002	S33	91610002	114,3/5	67	M12x1,5	T	16
	02.10 -		30	4	S90-4-15-002	S1	91415002	114,3/5	67	M12x1,5	T	16
	02.10 -		30	6	S90-6-15-023	S33	91615023	114,3/5	67	M12x1,5	T	16
	02.10 -		40	4	S90-4-20-001	S1	91420001	114,3/5	67	M12x1,5	T	16
	02.10 -		50	4	S90-4-25-016	S1	91425016	114,3/5	67	M12x1,5	T	16
	02.10 -		60	4	S90-4-30-015	S1	91430015	114,3/5	67	M12x1,5	T	16
ASX Van (GA_W_)												
	06.10 -		10	5	S90-5-05-027	S33	91505027	114,3/5	67	M12x1,5	T	16
	06.10 -		20	6	S90-6-10-002	S33	91610002	114,3/5	67	M12x1,5	T	16
	06.10 -		30	4	S90-4-15-0							

Modell Model	Baujahr Year	Original-radschraube (nicht bestellbar) Original Bolt (not available)	Spurweiten-änderung Total track widening (mm)	Eibach System	Artikel-Nr. Part-No.	Hinweise Notes	Kennzeichnung Stamping	Lockkreis Zahn Bolt pattern No. of holes	Zentrierung Centre bore (mm)	Gewinde Thread	Gutachten Homologation	ET-Grenze Offset frontier	
NISSAN 350 Z (Z33)	10.02 -		10	5	S90-5-05-030	S11, S16, S33	91505030	114,3/5	66	M12x1,25	T	5	
	10.02 -		20	6	S90-6-10-004	S16, S33	91610004	114,3/5	66	M12x1,25	T	5	
	10.02 -		30	4	S90-4-15-001	S9, S23	91415001	114,3/5	66	M12x1,25	T	5	
	10.02 -		30	6	S90-6-15-026	S16, S33	91615026	114,3/5	66	M12x1,25	T	5	
	10.02 -		40	4	S90-4-20-003	S9, S23	91420003	114,3/5	66	M12x1,25	T	5	
	10.02 -		40	6	S90-6-20-019	S16, S33	91620019	114,3/5	66	M12x1,25	T	5	
	10.02 -		50	4	S90-4-25-019	S9, S23	91425019	114,3/5	66	M12x1,25	T	5	
	350 Z Roadster (Z33)												
	10.03 -			10	5	S90-5-05-030	S11, S16, S33	91505030	114,3/5	66	M12x1,25	T	5
	10.03 -			20	6	S90-6-10-004	S16, S33	91610004	114,3/5	66	M12x1,25	T	5
	10.03 -			30	4	S90-4-15-001	S9, S23	91415001	114,3/5	66	M12x1,25	T	5
	10.03 -			30	6	S90-6-15-026	S16, S33	91615026	114,3/5	66	M12x1,25	T	5
	10.03 -			40	4	S90-4-20-003	S9, S23	91420003	114,3/5	66	M12x1,25	T	5
10.03 -			40	6	S90-6-20-019	S16, S33	91620019	114,3/5	66	M12x1,25	T	5	
10.03 -			50	4	S90-4-25-019	S9, S23	91425019	114,3/5	66	M12x1,25	T	5	
370 Z (Z34)													
04.09 -			20	6	S90-6-10-004	S16, S33	91610004	114,3/5	66	M12x1,25	T	-15	
04.09 -			30	4	S90-4-15-026	S9, S23	91415001	114,3/5	66	M12x1,25	T	-15	
04.09 -			30	6	S90-6-15-026	S16, S33	91615026	114,3/5	66	M12x1,25	T	-15	
04.09 -			40	4	S90-4-20-034	S9, S23	91420003	114,3/5	66	M12x1,25	T	-15	
04.09 -			40	6	S90-6-20-019	S16, S33	91620019	114,3/5	66	M12x1,25	T	-15	
04.09 -			50	4	S90-4-25-050	S9, S23	91425019	114,3/5	66	M12x1,25	T	-15	
04.09 -			60	4	S90-4-30-043	S9, S23	91430036	114,3/5	66	M12x1,25	T	-15	
370 Z Roadster (Z34)													
01.09 -			20	6	S90-6-10-004	S16, S33	91610004	114,3/5	66	M12x1,25	T	-15	
01.09 -			30	4	S90-4-15-026	S9, S23	91415001	114,3/5	66	M12x1,25	T	-15	
01.09 -			30	6	S90-6-15-026	S16, S33	91615026	114,3/5	66	M12x1,25	T	-15	
01.09 -			40	4	S90-4-20-034	S9, S23	91420003	114,3/5	66	M12x1,25	T	-15	
01.09 -			40	6	S90-6-20-019	S16, S33	91620019	114,3/5	66	M12x1,25	T	-15	
01.09 -			50	4	S90-4-25-050	S9, S23	91425019	114,3/5	66	M12x1,25	T	-15	
01.09 -			60	4	S90-4-30-043	S9, S23	91430036	114,3/5	66	M12x1,25	T	-15	
JUKE													
06.10 -			20	6	S90-6-10-004	S16, S33	91610004	114,3/5	66	M12x1,25	T	15	
06.10 -			30	4	S90-4-15-026	S9, S23	91415001	114,3/5	66	M12x1,25	T	15	
06.10 -			30	6	S90-6-15-026	S16, S33	91615026	114,3/5	66	M12x1,25	T	15	
06.10 -			40	4	S90-4-20-034	S9, S23	91420003	114,3/5	66	M12x1,25	T	15	
06.10 -			40	6	S90-6-20-019	S16, S33	91620019	114,3/5	66	M12x1,25	T	15	
06.10 -			50	4	S90-4-25-050	S9, S23	91425019	114,3/5	66	M12x1,25	T	15	
06.10 -			60	4	S90-4-30-043	S9, S23	91430036	114,3/5	66	M12x1,25	T	15	
MICRA C+C (K12)													
08.05 -		S1-1-12-50-24-19	10	1	S90-1-05-003		91105003	100/4	60	M12x1,5	T	30	
08.05 -		M12x1,5x24, KG60°	32	2	S90-2-16-002	S6	91216002	100/4	60	M12x1,5	T	30	
08.05 -			40	2	S90-2-20-010		91220010	100/4	60	M12x1,5	T	30	
08.05 -			40	7	S90-7-20-026		91720026	100/4	60	M12x1,5	T	30	
08.05 -			50	7	S90-7-25-007		91725007	100/4	60	M12x1,5	T	30	
MICRA II (K11)													
01.92 - 02.03			60	4	S90-4-30-014	S9	91430014	100/4	59	M12x1,25	§21		
MICRA III (K12)													
01.03 - 06.10		S1-1-12-50-26-19	10	1	S90-1-05-003		91105003	100/4	60	M12x1,5	T	30	
01.03 - 06.10		M12x1,5x26, KG60°	32	2	S90-2-16-002	S6	91216002	100/4	60	M12x1,5	T	30	
01.03 - 06.10			40	2	S90-2-20-010		91220010	100/4	60	M12x1,5	T	30	
01.03 - 06.10			40	7	S90-7-20-026		91720026	100/4	60	M12x1,5	T	30	
01.03 - 06.10			50	7	S90-7-25-007		91725007	100/4	60	M12x1,5	T	30	
MURANO (Z50)													
08.03 -			20	6	S90-6-10-004	S16, S33	91610004	114,3/5	66	M12x1,25	§21		
08.03 -			30	6	S90-6-15-026	S16, S33	91615026	114,3/5	66	M12x1,25	§21		
08.03 -			40	4	S90-4-20-003	S9, S23	91420003	114,3/5	66	M12x1,25	§21		
08.03 -			40	6	S90-6-20-019	S16, S33	91620019	114,3/5	66	M12x1,25	§21		
08.03 -			50	4	S90-4-25-019	S9, S23	91425019	114,3/5	66	M12x1,25	§21		
NAVARA (D40)													
10.04 -			30	4	S90-4-15-012	S9	91415012	114,3/6	66	M12x1,25	T	0	
10.04 -			40	4	S90-4-20-019	S9	91420019	114,3/6	66	M12x1,25	T	0	
10.04 -			54	4	S90-4-27-002	S9	91427002	114,3/6	66	M12x1,25	T	0	
10.04 -			60	4	S90-4-30-023	S9	91430023	114,3/6	66	M12x1,25	T	0	
NAVARA Pritsche/ Fahrgestell (D40) NAVARA Platform/Chassis (D40)													
08.08 -			30	4	S90-4-15-012	S9	91415012	114,3/6	66	M12x1,25	T	0	
08.08 -			40	4	S90-4-20-019	S9	91420019	114,3/6	66	M12x1,25	T	0	
08.08 -			54	4	S90-4-27-002	S9	91427002	114,3/6	66	M12x1,25	T	0	
08.08 -			60	4	S90-4-30-023	S9	91430023	114,3/6	66	M12x1,25	T	0	
NOTE (E11)													
03.06 -		S1-1-12-50-24-19	10	1	S90-1-05-003	S6	91105003	100/4	60	M12x1,5	T	15	
03.06 -		M12x1,5x24, KG60°	32	2	S90-2-16-002	S56	91216002	100/4	60	M12x1,5	T	15	
03.06 -			40	2	S90-2-20-010		91220010	100/4	60	M12x1,5	T	15	
03.06 -			40	7	S90-7-20-026		91720026	100/4	60	M12x1,5	T	15	
03.06 -			50	7	S90-7-25-007		91725007	100/4	60	M12x1,5	T	15	
PATHFINDER (R51)													
01.05 -			30	4	S90-4-15-012	S9	91415012	114,3/6	66	M12x1,25	T	0	
01.05 -			40	4	S90-4-20-019	S9	91420019	114,3/6	66	M12x1,25	T	0	
01.05 -			54	4	S90-4-27-002	S9	91427002	114,3/6	66	M12x1,25	T	0	
01.05 -			60	4	S90-4-30-023	S9	91430023	114,3/6	66	M12x1,25	T	0	
PATROL GR I (Y60, GR)													
08.87 - 02.98			60	8	S90-8-30-003	S9, S11	91830003	139,7/6	106	M12x1,25	T	-25	
PATROL GR II Wagon (Y61)													
06.97 -			60	8	S90-8-30-003	S9, S11	91830003	139,7/6	106	M12x1,25	T	-25	
PICK UP (D22)													
01.97 -			60	8	S90-8-30-003	S9, S11	91830003	139,7/6	106	M12x1,25	T	0	
PRIMERA (P12)													
01.02 -			20	6	S90-6-10-004	S3, S16, S33	91610004	114,3/5	66	M12x1,25	T	25	
01.02 -			40	4	S90-4-20-003	S9, S23	91420003	114,3/5	66	M12x1,25	T	25	
01.02 -			40	6	S90-6-20-019	S16, S33	91620019	114,3/5	66	M12x1,25	T	25	
PRIMERA Hatchback (P12)													
01.02 -			20	6	S90-6-10-004	S3, S16, S33	91610004	114,3/5	66	M12x1,25	T	25	
01.02 -			40	4	S90-4-20-003	S9, S23	91420003	114,3/5	66	M12x1,25	T	25	
01.02 -			40	6	S90-6-20-019	S16, S33	91620019	114,3/5	66	M12x1,25	T	25	

Modell Model	Baujahr Year	Original-radschraube (nicht bestellbar) Original Bolt (not available)	Spurweiten-änderung Total track widening (mm)	Eibach System	Artikel-Nr. Part-No.	Hinweise Notes	Kennzeichnung Stamping	Lockkreis Zahn Bolt pattern No. of holes	Zentrierung Centre bore (mm)	Gewinde Thread	Gutachten Homologation	ET-Grenze Offset frontier	
NISSAN PRIMERA Kombi (WP12) PRIMERA Estate (WP12)	01.02 -		20	6	S90-6-10-004	S3, S16, S33	91610004	114,3/5	66	M12x1,25	T	25	
	01.02 -		40	4	S90-4-20-003	S9, S23	91420003	114,3/5	66	M12x1,25	T	25	
	01.02 -		40	6	S90-6-20-019	S16, S33	91620019	114,3/5	66	M12x1,25	T	25	
	QASHQAI / QASHQAI +2 (J10, JJ10)												
	02.07 -			20	6	S90-6-10-004	S16, S33	91610004	114,3/5	66	M12x1,25	T	15
	02.07 -			30	6	S90-6-15-026	S16, S33	91615026	114,3/5	66	M12x1,25	T	15
	02.07 -			40	4	S90-4-20-003	S9, S23	91420003	114,3/5	66	M12x1,25	T	15
	02.07 -			40	6	S90-6-20-019	S16, S33	91620019	114,3/5	66	M12x1,25	T	15

Modell Model	Baujahr Year	Original-radschraube (nicht bestellbar) Original Bolt (not available)	Spurweiten-änderung Achse Total track width-ning (mm)	Eibach System	Artikel-Nr. Part-No.	Hinweise Notes	Kennzeichnung Stamping	Lockkreis Zahn Bolt pattern No. of holes	Zentrierung Centre bore (mm)	Gewinde Thread	Gutachten Homologation	ET-Grenze Offset frontier
OPEL ASTRA G Coupe (F07_)	03.00 - 05.05	S1-1-12-50-24-17	10	1	S90-1-05-013		91105013	110/5	65	M12x1,5	T	19
	03.00 - 05.05	M12x1,5x24, KG60°	20	1	S90-1-10-002	S11	91110002	110/5	65	M12x1,5	T	19
	03.00 - 05.05		32	2	S90-2-16-001	S5	91216001	110/5	65	M12x1,5	T	19
	03.00 - 05.05		40	2	S90-2-20-006		91220006	110/5	65	M12x1,5	T	19
ASTRA G Kasten (F70) ASTRA G Box (F70)	01.99 - 04.05	S1-1-12-50-24-17	10	1	S90-1-05-009		91105009	100/4	56,5	M12x1,5	T	19
	01.99 - 04.05	M12x1,5x24, KG60°	30	2	S90-2-15-012	S38	91215012	100/4	56,5	M12x1,5	T	19
	01.99 - 04.05		40	2	S90-2-20-002		91220002	100/4	56,5	M12x1,5	T	19
	01.99 - 04.05		50	7	S90-7-25-002	S68	91725002	100/4	56,5	M12x1,5	T	19
ASTRA G Kasten (F70) ASTRA G Box (F70)	01.99 - 04.05	S1-1-12-50-24-17	10	1	S90-1-05-013		91105013	110/5	65	M12x1,5	T	19
	01.99 - 04.05	M12x1,5x24, KG60°	20	1	S90-1-10-002	S11	91110002	110/5	65	M12x1,5	T	19
	01.99 - 04.05		32	2	S90-2-16-001	S5	91216001	110/5	65	M12x1,5	T	19
	01.99 - 04.05		40	2	S90-2-20-006		91220006	110/5	65	M12x1,5	T	19
ASTRA G Stufenheck (F69_) ASTRA G Saloon (F69_)	09.98 - 12.09	S1-1-12-50-24-17	10	1	S90-1-05-009		91105009	100/4	56,5	M12x1,5	T	19
	09.98 - 12.09	M12x1,5x24, KG60°	30	2	S90-2-15-012	S38	91215012	100/4	56,5	M12x1,5	T	19
	09.98 - 12.09		40	2	S90-2-20-002		91220002	100/4	56,5	M12x1,5	T	19
	09.98 - 12.09		50	7	S90-7-25-002	S68	91725002	100/4	56,5	M12x1,5	T	19
ASTRA G Stufenheck (F69_) ASTRA G Saloon (F69_)	09.98 - 12.09	S1-1-12-50-24-17	10	1	S90-1-05-013		91105013	110/5	65	M12x1,5	T	19
	09.98 - 12.09	M12x1,5x24, KG60°	20	1	S90-1-10-002	S11	91110002	110/5	65	M12x1,5	T	19
	09.98 - 12.09		32	2	S90-2-16-001	S5	91216001	110/5	65	M12x1,5	T	19
	09.98 - 12.09		40	2	S90-2-20-006		91220006	110/5	65	M12x1,5	T	19
ASTRA GTC J	10.11 -		30	4	S90-4-15-028	S9	91415028	105/5	56,5	M12x1,5	T	9
	10.11 -		40	4	S90-4-20-036	S9	91420036	105/5	56,5	M12x1,5	T	9
	10.11 -		50	4	S90-4-25-052	S9	91425052	105/5	56,5	M12x1,5	T	9
	10.11 -		60	4	S90-4-30-045	S9	91430045	105/5	56,5	M12x1,5	T	9
ASTRA GTC J	10.11 -		24	6	S90-6-12-004	S33	91612004	115/5	70,1	M12x1,5	T	9
	10.11 -		30	6	S90-6-15-049	S33	91615049	115/5	70,1	M12x1,5	T	9
	10.11 -		32	4	S90-4-16-004	S9, S47	91416004	115/5	70,1	M12x1,5	T	9
	10.11 -		40	6	S90-6-20-037	S33	91620037	115/5	70,1	M12x1,5	T	9
	10.11 -		42	4	S90-4-21-002	S9	91421002	115/5	70,1	M12x1,5	T	9
	10.11 -		50	4	S90-4-25-043	S9	91425043	115/5	70,1	M12x1,5	T	9
ASTRA H	03.04 -	S1-1-12-50-22-17	40	2	S90-2-20-002		91220002	100/4	56,5	M12x1,5	T	5
	03.04 -	M12x1,5x22, KG60°	50	7	S90-7-25-002		91725002	100/4	56,5	M12x1,5	T	5
ASTRA H	03.04 -	S1-1-12-50-22-17	10	1	S90-1-05-013	S11	91105013	110/5	65	M12x1,5	T	5
	03.04 -	M12x1,5x22, KG60°	32	2	S90-2-16-001		91216001	110/5	65	M12x1,5	T	5
	03.04 -		40	2	S90-2-20-006		91220006	110/5	65	M12x1,5	T	5
	03.04 -		60	7	S90-7-30-015		91730015	110/5	65	M12x1,5	T	5
ASTRA H Caravan ASTRA H Estate	08.04 -	S1-1-12-50-22-17	40	2	S90-2-20-002		91220002	100/4	56,5	M12x1,5	T	5
	08.04 -	M12x1,5x22, KG60°	50	7	S90-7-25-002		91725002	100/4	56,5	M12x1,5	T	5
ASTRA H Caravan ASTRA H Estate	08.04 -	S1-1-12-50-22-17	10	1	S90-1-05-013	S11	91105013	110/5	65	M12x1,5	T	5
	08.04 -	M12x1,5x22, KG60°	32	2	S90-2-16-001		91216001	110/5	65	M12x1,5	T	5
	08.04 -		40	2	S90-2-20-006		91220006	110/5	65	M12x1,5	T	5
	08.04 -		60	7	S90-7-30-015		91730015	110/5	65	M12x1,5	T	5
ASTRA H GTC	03.05 -	S1-1-12-50-22-17	40	2	S90-2-20-002		91220002	100/4	56,5	M12x1,5	T	5
	03.05 -	M12x1,5x22, KG60°	50	7	S90-7-25-002		91725002	100/4	56,5	M12x1,5	T	5
ASTRA H GTC	03.05 -	S1-1-12-50-22-17	10	1	S90-1-05-013	S11	91105013	110/5	65	M12x1,5	T	5
	03.05 -	M12x1,5x22, KG60°	32	2	S90-2-16-001		91216001	110/5	65	M12x1,5	T	5
	03.05 -		40	2	S90-2-20-006		91220006	110/5	65	M12x1,5	T	5
	03.05 -		60	7	S90-7-30-015		91730015	110/5	65	M12x1,5	T	5
ASTRA H Stufenheck ASTRA H Saloon	02.07 -	S1-1-12-50-22-17	40	2	S90-2-20-002		91220002	100/4	56,5	M12x1,5	T	5
	02.07 -	M12x1,5x22, KG60°	50	7	S90-7-25-002		91725002	100/4	56,5	M12x1,5	T	5
ASTRA H Stufenheck ASTRA H Saloon	02.07 -	S1-1-12-50-22-17	10	1	S90-1-05-013	S11	91105013	110/5	65	M12x1,5	T	5
	02.07 -	M12x1,5x22, KG60°	32	2	S90-2-16-001		91216001	110/5	65	M12x1,5	T	5
	02.07 -		40	2	S90-2-20-006		91220006	110/5	65	M12x1,5	T	5
	02.07 -		60	7	S90-7-30-015		91730015	110/5	65	M12x1,5	T	5
ASTRA H TwinTop	09.05 -	S1-1-12-50-22-17	10	1	S90-1-05-013	S11	91105013	110/5	65	M12x1,5	T	5
	09.05 -	M12x1,5x22, KG60°	32	2	S90-2-16-001		91216001	110/5	65	M12x1,5	T	5
	09.05 -		40	2	S90-2-20-006		91220006	110/5	65	M12x1,5	T	5
	09.05 -		60	7	S90-7-30-015		91730015	110/5	65	M12x1,5	T	5
ASTRA H Van	02.04 -	S1-1-12-50-22-17	40	2	S90-2-20-002		91220002	100/4	56,5	M12x1,5	T	5
	02.04 -	M12x1,5x22, KG60°	50	7	S90-7-25-002		91725002	100/4	56,5	M12x1,5	T	5
ASTRA H Van	02.04 -	S1-1-12-50-22-17	10	1	S90-1-05-013	S11	91105013	110/5	65	M12x1,5	T	5
	02.04 -	M12x1,5x22, KG60°	32	2	S90-2-16-001		91216001	110/5	65	M12x1,5	T	5
	02.04 -		40	2	S90-2-20-006		91220006	110/5	65	M12x1,5	T	5
	02.04 -		60	7	S90-7-30-015		91730015	110/5	65	M12x1,5	T	5
ASTRA J	12.09 -		30	4	S90-4-15-028	S9	91415028	105/5	56,5	M12x1,5	T	9
	12.09 -		40	4	S90-4-20-036	S9	91420036	105/5	56,5	M12x1,5	T	9
	12.09 -		50	4	S90-4-25-052	S9	91425052	105/5	56,5	M12x1,5	T	9
	12.09 -		60	4	S90-4-30-045	S9	91430045	105/5	56,5	M12x1,5	T	9
ASTRA J	12.09 -		24	6	S90-6-12-004	S33	91612004	115/5	70,1	M12x1,5	T	9
	12.09 -		30	6	S90-6-15-049	S33	91615049	115/5	70,1	M12x1,5	T	9
	12.09 -		32	4	S90-4-16-004	S9, S47	91416004	115/5	70,1	M12x1,5	T	9
	12.09 -		40	6	S90-6-20-037	S33	91620037	115/5	70,1	M12x1,5	T	9
	12.09 -		42	4	S90-4-21-002	S9	91421002	115/5	70,1	M12x1,5	T	9
	12.09 -		50	4	S90-4-25-043	S9	91425043	115/5	70,1	M12x1,5	T	9

Modell | Model

Modell Model	Baujahr Year	Original-radschraube (nicht bestellbar) Original Bolt (not available)	Spurweiten-änderung Achse Total track width-ning (mm)	Eibach System	Artikel-Nr. Part-No.	Hinweise Notes	Kennzeichnung Stamping	Lockkreis Zahn Bolt pattern No. of holes	Zentrierung Centre bore (mm)	Gewinde Thread	Gutachten Homologation	ET-Grenze Offset frontier
OPEL ASTRA J Stufenheck ASTRA J Saloon	06.12 -		30	4	S90-4-15-028	S9	91415028	105/5	56,5	M12x1,5	T	9
	06.12 -		40	4	S90-4-20-036	S9	91420036	105/5	56,5	M12x1,5	T	9
	06.12 -		50	4	S90-4-25-052	S9	91425052	105/5	56,5	M12x1,5	T	9
	06.12 -		60	4	S90-4-30-045	S9	91430045	105/5	56,5	M12x1,5	T	9
ASTRA J Stufenheck ASTRA J Saloon	06.12 -		24	6	S90-6-12-004	S33	91612004	115/5	70,1	M12x1,5	T	9
	06.12 -		30	6	S90-6-15-049	S33	91615049	115/5	70,1	M12x1,5	T	9
	06.12 -		32	4	S90-4-16-004	S9, S47	91416004	115/5	70,1	M12x1,5	T	9
	06.12 -		40	6	S90-6-20-037	S33	91620037	115/5	70,1	M12x1,5	T	9
	06.12 -		42	4	S90-4-21-002	S9	91421002	115/5	70,1	M12x1,5	T	9
	06.12 -		50	4	S90-4-25-043	S9	91425043	115/5	70,1	M12x1,5	T	9
ASTRA Sports Tourer (J)	10.10 -		30	4	S90-4-15-028	S9	91415028					

Modell Model	Baujahr Year	Original-radschraube (nicht bestellbar) Original Bolt (not available)	Spurweiten-änderung Total track widening (mm)	Eibach System	Artikel-Nr. Part-No.	Hinweise Notes	Kennzeichnung Stamping	Lockkreis Bolz pattern No. of holes	Zentrierung Centre bore (mm)	Gewinde Thread	Gutachten Homologation	ET-Grenze Offset frontier
OPEL INSIGNIA Sports Tourer	07.08 -		30	4	S90-4-15-025	S9	91415025	120/5	67	M14x1,5	T	6
	07.08 -		40	4	S90-4-20-032	S9	91420032	120/5	67	M14x1,5	T	6
	07.08 -		50	4	S90-4-25-048	S9	91425048	120/5	67	M14x1,5	T	6
	07.08 -		60	4	S90-4-30-042	S9	91430042	120/5	67	M14x1,5	T	6
	07.08 -		70	4	S90-4-35-009	S9	91435009	120/5	67	M14x1,5	T	6
INSIGNIA Stufenheck INSIGNIA Saloon	07.08 -		30	4	S90-4-15-025	S9	91415025	120/5	67	M14x1,5	T	6
	07.08 -		40	4	S90-4-20-032	S9	91420032	120/5	67	M14x1,5	T	6
	07.08 -		50	4	S90-4-25-048	S9	91425048	120/5	67	M14x1,5	T	6
	07.08 -		60	4	S90-4-30-042	S9	91430042	120/5	67	M14x1,5	T	6
	07.08 -		70	4	S90-4-35-009	S9	91435009	120/5	67	M14x1,5	T	6
MERIVA B	06.10 -	S1-1-12-50-22-17	10	1	S90-1-05-013	S11	91105013	110/5	65	M12x1,5	\$21	
	06.10 -	M12x1,5x22, KG60°	32	2	S90-2-16-001		91216001	110/5	65	M12x1,5	\$21	
	06.10 -		40	2	S90-2-20-006		91220006	110/5	65	M12x1,5	\$21	
	06.10 -		60	7	S90-7-30-015		91730015	110/5	65	M12x1,5	\$21	
	06.12 -		30	4	S90-4-15-028	S9	91415028	105/5	56,5	M12x1,5	T	8
MOKKA	06.12 -		40	4	S90-4-20-036	S9	91420036	105/5	56,5	M12x1,5	T	8
	06.12 -		50	4	S90-4-25-052	S9	91425052	105/5	56,5	M12x1,5	T	8
	06.12 -		60	4	S90-4-30-045	S9	91430045	105/5	56,5	M12x1,5	T	8
	09.91 - 07.98		50	8	S90-8-25-002	S9, S11	91825002	139,7/6	106,5	M12x1,5	T	-30
	09.91 - 07.98		60	8	S90-8-30-002	S9, S11	91830002	139,7/6	106,5	M12x1,5	T	-30
OMEGA B (25., 26., 27.)	03.94 - 07.03		10	1	S90-1-05-013		91105013	110/5	65	M12x1,5	T	18
	03.94 - 07.03		20	1	S90-1-10-002	S11	91110002	110/5	65	M12x1,5	T	18
	03.94 - 07.03		32	2	S90-2-16-001	S5	91216001	110/5	65	M12x1,5	T	18
	03.94 - 07.03		40	2	S90-2-20-006		91220006	110/5	65	M12x1,5	T	18
	03.94 - 07.03		10	1	S90-1-05-013		91105013	110/5	65	M12x1,5	T	18
OMEGA B Caravan (21., 22., 23.) OMEGA B Estate (21., 22., 23.)	03.94 - 07.03		20	1	S90-1-10-002	S11	91110002	110/5	65	M12x1,5	T	18
	03.94 - 07.03		32	2	S90-2-16-001	S5	91216001	110/5	65	M12x1,5	T	18
	03.94 - 07.03		40	2	S90-2-20-006		91220006	110/5	65	M12x1,5	T	18
	05.03 -		10	1	S90-1-05-013		91105013	110/5	65	M12x1,5	T	20
	05.03 -		20	1	S90-1-10-002	S11	91110002	110/5	65	M12x1,5	T	20
SIGNUM	05.03 -		32	2	S90-2-16-001	S5	91216001	110/5	65	M12x1,5	T	20
	05.03 -		40	2	S90-2-20-006		91220006	110/5	65	M12x1,5	T	20
	09.95 - 04.02	S1-1-12-50-24-17	10	1	S90-1-05-009		91105009	100/4	56,5	M12x1,5	T	24
	09.95 - 04.02	M12x1,5x24, KG60°	30	2	S90-2-15-012	S38	91215012	100/4	56,5	M12x1,5	T	24
	09.95 - 04.02		40	2	S90-2-20-002		91220002	100/4	56,5	M12x1,5	T	24
VECTRA B (36.)	09.95 - 04.02		50	7	S90-7-25-002	S68	91725002	100/4	56,5	M12x1,5	T	24
	09.95 - 04.02	S1-1-12-50-24-17	10	1	S90-1-05-013		91105013	110/5	65	M12x1,5	T	24
	09.95 - 04.02	M12x1,5x24, KG60°	20	1	S90-1-10-002	S11	91110002	110/5	65	M12x1,5	T	24
	09.95 - 04.02		32	2	S90-2-16-001	S5	91216001	110/5	65	M12x1,5	T	24
	09.95 - 04.02		40	2	S90-2-20-006		91220006	110/5	65	M12x1,5	T	24
VECTRA B (36.)	09.95 - 04.02	S1-1-12-50-24-17	10	1	S90-1-05-013		91105013	110/5	65	M12x1,5	T	24
	09.95 - 04.02	M12x1,5x24, KG60°	20	1	S90-1-10-002	S11	91110002	110/5	65	M12x1,5	T	24
	09.95 - 04.02		32	2	S90-2-16-001	S5	91216001	110/5	65	M12x1,5	T	24
	09.95 - 04.02		40	2	S90-2-20-006		91220006	110/5	65	M12x1,5	T	24
	11.96 - 07.03	S1-1-12-50-24-17	10	1	S90-1-05-009		91105009	100/4	56,5	M12x1,5	T	24
VECTRA B Caravan (31.) VECTRA B Estate (31.)	11.96 - 07.03	M12x1,5x24, KG60°	30	2	S90-2-15-012	S38	91215012	100/4	56,5	M12x1,5	T	24
	11.96 - 07.03		40	2	S90-2-20-002		91220002	100/4	56,5	M12x1,5	T	24
	11.96 - 07.03		50	7	S90-7-25-002	S68	91725002	100/4	56,5	M12x1,5	T	24
	11.96 - 07.03	S1-1-12-50-24-17	10	1	S90-1-05-013		91105013	110/5	65	M12x1,5	T	24
	11.96 - 07.03	M12x1,5x24, KG60°	20	1	S90-1-10-002	S11	91110002	110/5	65	M12x1,5	T	24
VECTRA B Caravan (31.) VECTRA B Estate (31.)	11.96 - 07.03		32	2	S90-2-16-001	S5	91216001	110/5	65	M12x1,5	T	24
	11.96 - 07.03		40	2	S90-2-20-006		91220006	110/5	65	M12x1,5	T	24
	10.95 - 07.03	S1-1-12-50-24-17	10	1	S90-1-05-009		91105009	100/4	56,5	M12x1,5	T	24
	10.95 - 07.03	M12x1,5x24, KG60°	30	2	S90-2-15-012	S38	91215012	100/4	56,5	M12x1,5	T	24
	10.95 - 07.03		40	2	S90-2-20-002		91220002	100/4	56,5	M12x1,5	T	24
VECTRA B CC (38.) VECTRA B Hatchback (38.)	10.95 - 07.03		50	7	S90-7-25-002	S68	91725002	100/4	56,5	M12x1,5	T	24
	10.95 - 07.03	S1-1-12-50-24-17	10	1	S90-1-05-013		91105013	110/5	65	M12x1,5	T	24
	10.95 - 07.03	M12x1,5x24, KG60°	20	1	S90-1-10-002	S11	91110002	110/5	65	M12x1,5	T	24
	10.95 - 07.03		32	2	S90-2-16-001	S5	91216001	110/5	65	M12x1,5	T	24
	10.95 - 07.03		40	2	S90-2-20-006		91220006	110/5	65	M12x1,5	T	24
VECTRA B CC (38.) VECTRA B Hatchback (38.)	10.95 - 07.03	S1-1-12-50-24-17	10	1	S90-1-05-013		91105013	110/5	65	M12x1,5	T	24
	10.95 - 07.03	M12x1,5x24, KG60°	20	1	S90-1-10-002	S11	91110002	110/5	65	M12x1,5	T	24
	10.95 - 07.03		32	2	S90-2-16-001	S5	91216001	110/5	65	M12x1,5	T	24
	10.95 - 07.03		40	2	S90-2-20-006		91220006	110/5	65	M12x1,5	T	24
	04.02 -	S1-1-12-50-22-17	10	1	S90-1-05-013		91105013	110/5	65	M12x1,5	T	20
VECTRA C	04.02 -	M12x1,5x22, KG60°	32	2	S90-2-16-001	S5	91216001	110/5	65	M12x1,5	T	20
	04.02 -		40	2	S90-2-20-006		91220006	110/5	65	M12x1,5	T	20
	10.03 -	S1-1-12-50-22-17	10	1	S90-1-05-013		91105013	110/5	65	M12x1,5	T	20
	10.03 -	M12x1,5x22, KG60°	32	2	S90-2-16-001	S5	91216001	110/5	65	M12x1,5	T	20
	10.03 -		40	2	S90-2-20-006		91220006	110/5	65	M12x1,5	T	20
VECTRA C Caravan VECTRA C Estate	10.03 -	S1-1-12-50-22-17	10	1	S90-1-05-013		91105013	110/5	65	M12x1,5	T	20
	10.03 -	M12x1,5x22, KG60°	32	2	S90-2-16-001	S5	91216001	110/5	65	M12x1,5	T	20
	10.03 -		40	2	S90-2-20-006		91220006	110/5	65	M12x1,5	T	20
	08.02 -	S1-1-12-50-22-17	10	1	S90-1-05-013		91105013	110/5	65	M12x1,5	T	20
	08.02 -	M12x1,5x22, KG60°	32	2	S90-2-16-001	S5	91216001	110/5	65	M12x1,5	T	20
ZAFIRA A (F75.)	08.02 -		40	2	S90-2-20-006		91220006	110/5	65	M12x1,5	T	20
	04.99 - 06.05		10	1	S90-1-05-013		91105013	110/5	65	M12x1,5	T	27
	04.99 - 06.05		30	2	S90-2-15-007	S17	91215007	110/5	65	M12x1,5	\$21	
	04.99 - 06.05		32	2	S90-2-16-001		91216001	110/5	65	M12x1,5	T	27
	04.99 - 06.05		40	2	S90-2-20-006		91220006	110/5	65	M12x1,5	\$21	
ZAFIRA B (A05)	07.05 -	S1-1-12-50-22-17	10	1	S90-1-05-013		91105013	110/5	65	M12x1,5	\$21	
	07.05 -	M12x1,5x22, KG60°	32	2	S90-2-16-001		91216001	110/5	65	M12x1,5	\$21	
	07.05 -		40	2	S90-2-20-006		91220006	110/5	65	M12x1,5	\$21	
	07.05 -		60	7	S90-7-30-015		91730015	110/5	65	M12x1,5	\$21	
	07.05 -		10	1	S90-1-05-013		91105013	110/5	65	M12x1,5	\$21	
ZAFIRA B Van	07.05 -	S1-1-12-50-22-17	32	2	S90-2-16-001		91216001	110/5	65	M12x1,5	\$21	
	07.05 -	M12x1,5x22, KG60°	40	2	S90-2-20-006		91220006	110/5	65	M12x1,5	\$21	
	07.05 -		60	7	S90-7-30-015		91730015	110/5	65	M12x1,5	\$21	

Modell Model	Baujahr Year	Original-radschraube (nicht bestellbar) Original Bolt (not available)	Spurweiten-änderung Total track widening (mm)	Eibach System	Artikel-Nr. Part-No.	Hinweise Notes	Kennzeichnung Stamping	Lockkreis Bolz pattern No. of holes	Zentrierung Centre bore (mm)	Gewinde Thread	Gutachten Homologation	ET-Grenze Offset frontier	
OPEL ZAFIRA C (P12)	10.11 -		24	6	S90-6-12-004	S33	91612004	115/5	70,1	M12x1,5	\$21		
	10.11 -		30	6	S90-6-15-049	S33	91615049	115/5	70,1	M12x1,5	\$21		
	10.11 -		32	4	S90-4-16-004	S9, S47	91416004	115/5	70,1	M12x1,5	\$21		
	10.11 -		40	6	S90-6-20-037	S33	91620037	115/5	70,1	M12x1,5	\$21		
	10.11 -		42	4	S90-4-21-002	S9	91421002	115/5	70,1	M12x1,5	\$21		
	10.11 -		50	4	S90-4-25-043	S9	91425043	115/5	70,1	M12x1,5	\$21		
	PEUGEOT 106 II (1)	04.96 -	S1-1-12-25-28-19	10	1	S90-1-05-012	S58	91105012	108/4	65	M12x1,25	T	5
		04.96 -	M12x1,25x28, KG60°	30	2	S90-2-15-008	S58	91215008	108/4	65	M12x1,25	T	5
		06.05 -	S1-1-12-50-20-17	10	1	S90-1-05-028	S11, S58	91505008	100/4	54	M12x1,5	T	24
		06.05 -	M12x1,5x20, KG60°	24	2	S90-2-12-005	S58						

Modell Model	Baujahr Year	Original-radschraube (nicht bestellbar) Original Bolt (not available)	Spurweiten-änderung Achse Total track widening (mm)	Eibach System	Artikel-Nr. Part-No.	Hinweise Notes	Kennzeichnung Stamping	Lockkreis Bolz pattern No. of holes	Zentrierung Centre bore (mm)	Gewinde Thread	Gutachten Homologation	ET-Grenze Offset frontier			
PEUGEOT 207 Van	04.07 - 04.07 -	S1-9-12-25-36-19 M12x1,25x36, FB	10 20 30 40 50 60	1 2 2 2 7 7	S90-1-05-012 S90-2-10-013 S90-2-15-008 S90-2-20-021 S90-7-25-019 S90-7-30-009	S6, S58 S58 S58 S58	91105012 91210013 91215008 91220021 91725019 91730009	108/4 108/4 108/4 108/4 108/4 108/4	65 65 65 65 65 65	M12x1,25 M12x1,25 M12x1,25 M12x1,25 M12x1,25 M12x1,25	T T T T T T	-2 -2 -2 -2 -2 -2			
	208	03.12 - 03.12 - 03.12 - 03.12 - 03.12 - 03.12 - 03.12 - 03.12 -	S1-9-12-25-36-19 M12x1,25x36, FB	20 30 40 42 50 60	2 2 2 7 7 7	S90-2-10-013 S90-2-15-008 S90-2-20-021 S90-7-21-004 S90-7-25-019 S90-7-30-009	S58 S58 S58	91210013 91215008 91220021 91721004 91725019 91730009	108/4 108/4 108/4 108/4 108/4 108/4	65 65 65 65 65 65	M12x1,25 M12x1,25 M12x1,25 M12x1,25 M12x1,25 M12x1,25	T T T T T T	-3 -3 -3 -3 -3 -3		
		306 (7B, N3, N5)	04.93 - 05.01 04.93 - 05.01	S1-1-12-25-28-19 M12x1,25x28, KG60°	10 30	1 2	S90-1-05-012 S90-2-15-008	S58 S58	91105012 91215008	108/4 108/4	65 65	M12x1,25 M12x1,25	§21 §21		
			306 Break (7E, N3, N5)	06.94 - 04.02 06.94 - 04.02	S1-1-12-25-28-19 M12x1,25x28, KG60°	10 30	1 2	S90-1-05-012 S90-2-15-008	S58 S58	91105012 91215008	108/4 108/4	65 65	M12x1,25 M12x1,25	§21 §21	
		306 Cabriolet (7D, N3, N5) 306 Convertible (7D, N3, N5)		03.94 - 04.02 03.94 - 04.02	S1-1-12-25-28-19 M12x1,25x28, KG60°	10 30	1 2	S90-1-05-012 S90-2-15-008	S58 S58	91105012 91215008	108/4 108/4	65 65	M12x1,25 M12x1,25	§21 §21	
306 Schrägheck (7A, 7C, N3, N5) 306 Hatchback (7A, 7C, N3, N5)			04.93 - 08.01 04.93 - 08.01	S1-1-12-25-28-19 M12x1,25x28, KG60°	10 30	1 2	S90-1-05-012 S90-2-15-008	S58 S58	91105012 91215008	108/4 108/4	65 65	M12x1,25 M12x1,25	§21 §21		
	307 (3A/C)	08.00 - 08.00 - 08.00 - 08.00 - 08.00 - 08.00 - 08.00 - 08.00 - 08.00 - 08.00 -	S1-9-12-25-35-17 M12x1,25x35, FB	10 20 30 40 50 60	1 2 2 7 7 7	S90-1-05-012 S90-2-10-013 S90-2-15-008 S90-2-20-021 S90-7-25-019 S90-7-30-009	S11, S58 S58 S58 S58	91105012 91210013 91215008 91220021 91725019 91730009	108/4 108/4 108/4 108/4 108/4 108/4	65 65 65 65 65 65	M12x1,25 M12x1,25 M12x1,25 M12x1,25 M12x1,25 M12x1,25	T T T T T T	12 12 12 12 12 12		
307 Break (3E)		03.02 - 03.02 - 03.02 - 03.02 - 03.02 - 03.02 - 03.02 - 03.02 - 03.02 - 03.02 -	S1-9-12-25-35-17 M12x1,25x35, FB	10 20 30 40 50 60	1 2 2 7 7 7	S90-1-05-012 S90-2-10-013 S90-2-15-008 S90-2-20-021 S90-7-25-019 S90-7-30-009	S11, S58 S58 S58 S58	91105012 91210013 91215008 91220021 91725019 91730009	108/4 108/4 108/4 108/4 108/4 108/4	65 65 65 65 65 65	M12x1,25 M12x1,25 M12x1,25 M12x1,25 M12x1,25 M12x1,25	T T T T T T	12 12 12 12 12 12		
		307 CC (3B)	10.03 - 10.03 - 10.03 - 10.03 - 10.03 - 10.03 - 10.03 - 10.03 - 10.03 - 10.03 -	S1-9-12-25-35-17 M12x1,25x35, FB	10 20 30 40 50 60	1 2 2 7 7 7	S90-1-05-012 S90-2-10-013 S90-2-15-008 S90-2-20-021 S90-7-25-019 S90-7-30-009	S11, S58 S58 S58 S58	91105012 91210013 91215008 91220021 91725019 91730009	108/4 108/4 108/4 108/4 108/4 108/4	65 65 65 65 65 65	M12x1,25 M12x1,25 M12x1,25 M12x1,25 M12x1,25 M12x1,25	T T T T T T	12 12 12 12 12 12	
			307 SW (3H)	03.02 - 03.02 - 03.02 - 03.02 - 03.02 - 03.02 - 03.02 - 03.02 - 03.02 - 03.02 -	S1-9-12-25-35-17 M12x1,25x35, FB	10 20 30 40 50 60	1 2 2 7 7 7	S90-1-05-012 S90-2-10-013 S90-2-15-008 S90-2-20-021 S90-7-25-019 S90-7-30-009	S11, S58 S58 S58 S58	91105012 91210013 91215008 91220021 91725019 91730009	108/4 108/4 108/4 108/4 108/4 108/4	65 65 65 65 65 65	M12x1,25 M12x1,25 M12x1,25 M12x1,25 M12x1,25 M12x1,25	T T T T T T	12 12 12 12 12 12
				308 (4A, 4C)	09.07 - 09.07 - 09.07 - 09.07 - 09.07 - 09.07 - 09.07 - 09.07 - 09.07 - 09.07 -	S1-9-12-25-36-17 M12x1,25x36, FB	10 20 30 40 42 50 60	1 2 2 7 7 7	S90-1-05-012 S90-2-10-013 S90-2-15-008 S90-2-20-021 S90-7-21-004 S90-7-25-019 S90-7-30-009	S6, S11, S58 S58 S58 S58	91105012 91210013 91215008 91220021 91721004 91725019 91730009	108/4 108/4 108/4 108/4 108/4 108/4 108/4	65 65 65 65 65 65 65	M12x1,25 M12x1,25 M12x1,25 M12x1,25 M12x1,25 M12x1,25 M12x1,25	T T T T T T T
	308 CC				04.09 - 04.09 - 04.09 - 04.09 - 04.09 - 04.09 - 04.09 - 04.09 - 04.09 - 04.09 -	S1-9-12-25-36-17 M12x1,25x36, FB	10 20 30 40 42 50 60	1 2 2 7 7 7	S90-1-05-012 S90-2-10-013 S90-2-15-008 S90-2-20-021 S90-7-21-004 S90-7-25-019 S90-7-30-009	S6, S11, S58 S58 S58 S58	91105012 91210013 91215008 91220021 91721004 91725019 91730009	108/4 108/4 108/4 108/4 108/4 108/4 108/4	65 65 65 65 65 65 65	M12x1,25 M12x1,25 M12x1,25 M12x1,25 M12x1,25 M12x1,25 M12x1,25	T T T T T T T
308 SW					09.07 - 09.07 - 09.07 - 09.07 - 09.07 - 09.07 - 09.07 - 09.07 - 09.07 - 09.07 -	S1-9-12-25-36-17 M12x1,25x36, FB	10 20 30 40 42 50 60	1 2 2 7 7 7	S90-1-05-012 S90-2-10-013 S90-2-15-008 S90-2-20-021 S90-7-21-004 S90-7-25-019 S90-7-30-009	S6, S11, S58 S58 S58 S58	91105012 91210013 91215008 91220021 91721004 91725019 91730009	108/4 108/4 108/4 108/4 108/4 108/4 108/4	65 65 65 65 65 65 65	M12x1,25 M12x1,25 M12x1,25 M12x1,25 M12x1,25 M12x1,25 M12x1,25	T T T T T T T
		405 I (15B)			01.87 - 12.93 01.87 - 12.93	S1-1-12-25-28-19 M12x1,25x28, KG60°	10 30	1 2	S90-1-05-012 S90-2-15-008	S58 S58	91105012 91215008	108/4 108/4	65 65	M12x1,25 M12x1,25	T T
			405 I Break (15E)		06.87 - 08.92 06.87 - 08.92	S1-1-12-25-28-19 M12x1,25x28, KG60°	10 30	1 2	S90-1-05-012 S90-2-15-008	S58 S58	91105012 91215008	108/4 108/4	65 65	M12x1,25 M12x1,25	T T
				405 II (4B)	08.92 - 11.99 08.92 - 11.99	S1-1-12-25-28-19 M12x1,25x28, KG60°	10 30	1 2	S90-1-05-012 S90-2-15-008	S58 S58	91105012 91215008	108/4 108/4	65 65	M12x1,25 M12x1,25	T T
	405 II Break (4E)				08.92 - 10.96 08.92 - 10.96	S1-1-12-25-28-19 M12x1,25x28, KG60°	10 30	1 2	S90-1-05-012 S90-2-15-008	S58 S58	91105012 91215008	108/4 108/4	65 65	M12x1,25 M12x1,25	T T
406 (8B)					10.95 - 05.04 10.95 - 05.04		10 30	1 2	S90-1-05-012 S90-2-15-008	S58 S58	91105012 91215008	108/4 108/4	65 65	M12x1,25 M12x1,25	T T

Modell Model	Baujahr Year	Original-radschraube (nicht bestellbar) Original Bolt (not available)	Spurweiten-änderung Achse Total track widening (mm)	Eibach System	Artikel-Nr. Part-No.	Hinweise Notes	Kennzeichnung Stamping	Lockkreis Bolz pattern No. of holes	Zentrierung Centre bore (mm)	Gewinde Thread	Gutachten Homologation	ET-Grenze Offset frontier			
PEUGEOT 406 Break (8E/F)	10.96 - 10.04 10.96 - 10.04		10 30	1 2	S90-1-05-012 S90-2-15-008	S58 S58	91105012 91215008	108/4 108/4	65 65	M12x1,25 M12x1,25	T T	3 3			
	406 Coupe (8C)	03.97 - 12.04 03.97 - 12.04		10 30	1 2	S90-1-05-012 S90-2-15-008	S58 S58	91105012 91215008	108/4 108/4	65 65	M12x1,25 M12x1,25	T T	3 3		
407 (6D)		05.04 - 05.04 - 05.04 - 05.04 - 05.04 - 05.04 - 05.04 - 05.04 - 05.04 - 05.04 -	S1-9-12-25-37-17 M12x1,25x37, FB	10 20 30 40 42	1 2 2 7 7	S90-1-05-020 S90-2-10-012 S90-2-15-016 S90-2-20-022 S90-7-21-003	S11, S58 S58 S58 S58	91105020 91210012 91215016 91220022 91721003	108/5 108/5 108/5 108/5 108/5	65 65 65 65 65	M12x1,25 M12x1,25 M12x1,25 M12x1,25 M12x1,25	T T T T T	29 29 29 29 29		
	407 Coupe (6C)	10.05 - 10.05 - 10.05 - 10.05 - 10.05 - 10.05 - 10.05 - 10.05 - 10.05 - 10.05 -	S1-9-12-25-37-17 M12x1,25x37, FB	10 20 30 40 42	1 2 2 7 7	S90-1-05-020 S90-2-10-012 S90-2-15-016 S90-2-20-022 S90-7-21-003	S11, S58 S58 S58 S58	91105020 91210012 91215016 91220022 91721003	108/5 108/5 108/5 108/5 108/5	65 65 65 65 65	M12x1,25 M12x1,25 M12x1,25 M12x1,25 M12x1,25	T T T T T	29 29 29 29 29		
		407 SW (6E)	05.04 - 05.04 - 05.04 - 05.04 - 05.04 - 05.04 - 05.04 - 05.04 - 05.04 - 05.04 -	S1-9-12-25-37-17 M12x1,25x37, FB	10 20 30 40 42	1 2 2 7 7	S90-1-05-020 S90-2-10-012 S90-2-15-016 S90-2-20-022 S90-7-21-003	S11, S58 S58 S58 S58	91105020 91210012 91215016 91220022 91721003	108/5 108/5 108/5 108/5 108/5	65 65 65 65 65	M12x1,25 M12x1,25 M12x1,25 M12x1,25 M12x1,25	T T T T T	29 29 29 29 29	
			508	11.10 - 11.10 - 11.10 - 11.10 - 11.10 - 11.10 - 11.10 - 11.10 -		20 30 40 42	2 2 2 7	S90-2-10-012 S90-2-15-016 S90-2-20-022 S90-7-21-003	S58 S58 S58	91210012 91215016 91220022 91721003	108/5 108/5 108/5 108/5	65 65 65 65	M12x1,25 M12x1,25 M12x1,25 M12x1,25	§21 §21 §21 §21	
				508 SW	11.10 - 11.10 - 11.10 - 11.10 - 11.10 - 11.10 - 11.10 - 11.10 -		20 30 40 42	2 2 2 7	S90-2-10-012 S90-2-15-016 S90-2-20-022 S90-7-21-003	S58 S58 S58	91210012 91215016 91220022 91721003	108/5 108/5 108/5 108/5	65 65 65 65	M12x1,25 M12x1,25 M12x1,25 M12x1,25	§21 §21 §21 §21
1007 (KM)					04.05 - 04.05 - 04.05 - 04.05 - 04.05 - 04.05 - 04.05 - 04.05 - 04.05 - 04.05 - 04.05 - 04.05 -	S1-9-12-25-36-19 M12x1,25x36, FB	10 20 30 40 42 50 60	1 2 2 7 7 7	S90-1-05-012 S90-2-10-013 S90-2-15-008 S90-2-20-021 S90-7-21-004 S90-7-25-019 S90-7-30-009	S6, S58 S58 S58 S58	91105012 91210013 91215008 91220021 91721004 91725019 91730009	108/4 108/4 108/4 108/4 108/4 108/4 108/4	65 65 65 65 65 65 65	M12x1,25 M12x1,25 M12x1,25 M12x1,25 M12x1,25 M12x1,25 M12x1,25	T T T T T T T
	2008				03.13 - 03.13 - 03.13 - 03.13 - 03.13 - 03.13 - 03.13 - 03.13 - 03.13 - 03.13 -	S1-9-12-25-36-19 M12x1,25x36, FB	20 30 40 42 50 60	2 2 2 7 7 7	S90-2-10-013 S90-2-15-008 S90-2-20-021 S90-7-21-004 S90-7-25-019 S90-7-30-009	S58 S58 S58	91210013 91215008 91220021 91721004 91725019 91730009	108/4 108/4 108/4 108/4 108/4 108/4	65 65 65 65 65 65	M12x1,25 M12x1,25 M12x1,25 M12x1,25 M12x1,25 M12x1,25	T T T T T T
		3008			06.09 - 06.09 - 06.09 - 06.09 - 06.09 - 06.09 - 06.09 - 06.09 - 06.09 - 06.09 -	S1-9-12-25-36-17 M12x1,25x36, FB	20 30 40 42 50 60	2 2 2 7 7 7	S90-2-10-013 S90-2-15-008 S90-2-20-021 S90-7-21-004 S90-7-25-019 S90-7-30-009	S58 S58 S58	91210013 91215008 91220021 91721004 91725019 91730009	108/4 108/4 108/4 108/4 108/4 108/4	65 65 		

Modell Model	Baujahr Year	Original-radschraube (nicht bestellbar) Original Bolt (not available)	Spurweiten-änderung Total track widening (mm)	Eibach System	Artikel-Nr. Part-No.	Hinweise Notes	Kennzeichnung Stamping	Lockkreis Bolz pattern No. of holes	Zentrierung Centre bore (mm)	Gewinde Thread	Gutachten Homologation	ET-Grenze Offset / frontier	
PORSCHE 911 (997)	07.04 -	S4-7-14-50-30-19	14	2	S90-2-07-001	S40	91207001	130/5	71,5	M14x1,5	T	35	
	07.04 -	M14x1,5x30, KU r=14	30	2	S90-2-15-018		91215018	130/5	71,5	M14x1,5	T	35	
	07.04 -		36	2	S90-2-18-001		91218001	130/5	71,5	M14x1,5	T	35	
	07.04 -		36	7	S90-7-18-001	S46	91718001	130/5	71,5	M14x1,5	T	35	
	07.04 -		42	7	S90-7-21-001		91721001	130/5	71,5	M14x1,5	T	35	
	07.04 -		46	2	S90-2-23-001		91223001	130/5	71,5	M14x1,5	T	35	
	07.04 -		46	7	S90-7-23-001		91723001	130/5	71,5	M14x1,5	T	35	
	911 (991)	12.11 -	S4-7-14-50-30-19	14	2	S90-2-07-001	S40	91207001	130/5	71,5	M14x1,5	T	36
		12.11 -	M14x1,5x30, KU r=14	30	2	S90-2-15-018		91215018	130/5	71,5	M14x1,5	T	36
		12.11 -		36	2	S90-2-18-001		91218001	130/5	71,5	M14x1,5	§21	
		12.11 -		36	7	S90-7-18-001	S46	91718001	130/5	71,5	M14x1,5	§21	
		12.11 -		42	7	S90-7-21-001		91721001	130/5	71,5	M14x1,5	§21	
12.11 -			46	2	S90-2-23-001		91223001	130/5	71,5	M14x1,5	§21		
12.11 -			46	7	S90-7-23-001		91723001	130/5	71,5	M14x1,5	§21		
911 Cabriolet 911 Convertible		08.82 - 08.89		14	6	S90-6-07-001	S25, S32, S40	91207001	130/5	71,5	M14x1,5	§21	
	08.82 - 08.89		30	6	S90-6-15-018	S33	91215018	130/5	71,5	M14x1,5	§21		
	08.82 - 08.89		36	6	S90-6-18-001	S33	91618001	130/5	71,5	M14x1,5	§21		
911 Cabriolet (964) 911 Convertible (964)	05.89 - 06.94		14	6	S90-6-07-001	S32, S40	91207001	130/5	71,5	M14x1,5	T	37	
	05.89 - 06.94		30	6	S90-6-15-018	S33	91215018	130/5	71,5	M14x1,5	T	37	
	05.89 - 06.94		36	6	S90-6-18-001	S33	91618001	130/5	71,5	M14x1,5	§21		
911 Cabriolet (993) 911 Convertible (993)	07.94 - 09.97		14	6	S90-6-07-001	S32, S40	91207001	130/5	71,5	M14x1,5	T	35	
	07.94 - 09.97		30	6	S90-6-15-018	S33	91215018	130/5	71,5	M14x1,5	T	35	
	07.94 - 09.97		36	6	S90-6-18-001	S33	91618001	130/5	71,5	M14x1,5	§21		
911 Cabriolet (996) 911 Convertible (996)	02.98 - 08.05	S4-7-14-50-30-19	14	2	S90-2-07-001	S40	91207001	130/5	71,5	M14x1,5	T	17	
	02.98 - 08.05	M14x1,5x30, KU r=14	30	2	S90-2-15-018		91215018	130/5	71,5	M14x1,5	T	17	
	02.98 - 08.05		36	2	S90-2-18-001		91218001	130/5	71,5	M14x1,5	T	17	
	02.98 - 08.05		36	7	S90-7-18-001	S46	91718001	130/5	71,5	M14x1,5	T	17	
	02.98 - 08.05		42	7	S90-7-21-001		91721001	130/5	71,5	M14x1,5	T	17	
	02.98 - 08.05		46	2	S90-2-23-001		91223001	130/5	71,5	M14x1,5	T	17	
	02.98 - 08.05		46	7	S90-7-23-001		91723001	130/5	71,5	M14x1,5	T	17	
911 Cabriolet (997) 911 Convertible (997)	04.05 -	S4-7-14-50-30-19	14	2	S90-2-07-001	S40	91207001	130/5	71,5	M14x1,5	T	35	
	04.05 -	M14x1,5x30, KU r=14	30	2	S90-2-15-018		91215018	130/5	71,5	M14x1,5	T	35	
	04.05 -		36	2	S90-2-18-001		91218001	130/5	71,5	M14x1,5	T	35	
	04.05 -		36	7	S90-7-18-001	S46	91718001	130/5	71,5	M14x1,5	T	35	
	04.05 -		42	7	S90-7-21-001		91721001	130/5	71,5	M14x1,5	T	35	
	04.05 -		46	2	S90-2-23-001		91223001	130/5	71,5	M14x1,5	T	35	
	04.05 -		46	7	S90-7-23-001		91723001	130/5	71,5	M14x1,5	T	35	
911 Cabriolet (991) 911 Convertible (991)	03.12 -	S4-7-14-50-30-19	14	2	S90-2-07-001	S40	91207001	130/5	71,5	M14x1,5	T	36	
	03.12 -	M14x1,5x30, KU r=14	30	2	S90-2-15-018		91215018	130/5	71,5	M14x1,5	T	36	
	03.12 -		36	2	S90-2-18-001		91218001	130/5	71,5	M14x1,5	§21		
	03.12 -		36	7	S90-7-18-001	S46	91718001	130/5	71,5	M14x1,5	§21		
	03.12 -		42	7	S90-7-21-001		91721001	130/5	71,5	M14x1,5	§21		
	03.12 -		46	2	S90-2-23-001		91223001	130/5	71,5	M14x1,5	§21		
	03.12 -		46	7	S90-7-23-001		91723001	130/5	71,5	M14x1,5	§21		
911 Targa	11.64 - 11.90		14	6	S90-6-07-001	S25, S32, S40	91207001	130/5	71,5	M14x1,5	§21		
	11.64 - 11.90		30	6	S90-6-15-018	S33	91215018	130/5	71,5	M14x1,5	§21		
	11.64 - 11.90		36	6	S90-6-18-001	S33	91618001	130/5	71,5	M14x1,5	§21		
911 Targa (993)	01.94 - 09.97		14	6	S90-6-07-001	S32, S40	91207001	130/5	71,5	M14x1,5	T	35	
	01.94 - 09.97		30	6	S90-6-15-018	S33	91215018	130/5	71,5	M14x1,5	T	35	
	01.94 - 09.97		36	6	S90-6-18-001	S33	91618001	130/5	71,5	M14x1,5	§21		
911 Targa (996)	12.01 - 08.05	S4-7-14-50-30-19	14	2	S90-2-07-001	S40	91207001	130/5	71,5	M14x1,5	T	17	
	12.01 - 08.05	M14x1,5x30, KU r=14	30	2	S90-2-15-018		91215018	130/5	71,5	M14x1,5	T	17	
	12.01 - 08.05		36	2	S90-2-18-001		91218001	130/5	71,5	M14x1,5	T	17	
	12.01 - 08.05		36	7	S90-7-18-001	S46	91718001	130/5	71,5	M14x1,5	T	17	
	12.01 - 08.05		42	7	S90-7-21-001		91721001	130/5	71,5	M14x1,5	T	17	
	12.01 - 08.05		46	2	S90-2-23-001		91223001	130/5	71,5	M14x1,5	T	17	
	12.01 - 08.05		46	7	S90-7-23-001		91723001	130/5	71,5	M14x1,5	T	17	
911 Targa (997)	07.06 -	S4-7-14-50-30-19	14	2	S90-2-07-001	S40	91207001	130/5	71,5	M14x1,5	T	35	
	07.06 -	M14x1,5x30, KU r=14	30	2	S90-2-15-018		91215018	130/5	71,5	M14x1,5	T	35	
	07.06 -		36	2	S90-2-18-001		91218001	130/5	71,5	M14x1,5	T	35	
	07.06 -		36	7	S90-7-18-001	S46	91718001	130/5	71,5	M14x1,5	T	35	
	07.06 -		42	7	S90-7-21-001		91721001	130/5	71,5	M14x1,5	T	35	
	07.06 -		46	2	S90-2-23-001		91223001	130/5	71,5	M14x1,5	T	35	
	07.06 -		46	7	S90-7-23-001		91723001	130/5	71,5	M14x1,5	T	35	
928	09.77 - 11.95		14	6	S90-6-07-001	S32, S40	91207001	130/5	71,5	M14x1,5	§21		
	09.77 - 11.95		30	6	S90-6-15-018	S33	91215018	130/5	71,5	M14x1,5	§21		
	09.77 - 11.95		36	6	S90-6-18-001	S33	91618001	130/5	71,5	M14x1,5	§21		
	09.77 - 11.95		36	6	S90-6-18-001	S33	91618001	130/5	71,5	M14x1,5	§21		
944	06.81 - 07.91		14	6	S90-6-07-001	S6, S32, S40	91207001	130/5	71,5	M14x1,5	§21		
	06.81 - 07.91		30	6	S90-6-15-018	S33	91215018	130/5	71,5	M14x1,5	§21		
	06.81 - 07.91		36	6	S90-6-18-001	S33	91618001	130/5	71,5	M14x1,5	§21		
944 Cabriolet 944 Convertible	12.88 - 07.91		14	6	S90-6-07-001	S6, S32, S40	91207001	130/5	71,5	M14x1,5	§21		
	12.88 - 07.91		30	6	S90-6-15-018	S33	91215018	130/5	71,5	M14x1,5	§21		
12.88 - 07.91		36	6	S90-6-18-001	S33	91618001	130/5	71,5	M14x1,5	§21			
959	01.86 - 04.91		14	6	S90-6-07-001	S32, S40	91207001	130/5	71,5	M14x1,5	§21		
	01.86 - 04.91		30	6	S90-6-15-018	S33	91215018	130/5	71,5	M14x1,5	§21		
	01.86 - 04.91		36	6	S90-6-18-001	S33	91618001	130/5	71,5	M14x1,5	§21		
	01.86 - 04.91		36	6	S90-6-18-001	S33	91618001	130/5	71,5	M14x1,5	§21		

Modell Model	Baujahr Year	Original-radschraube (nicht bestellbar) Original Bolt (not available)	Spurweiten-änderung Total track widening (mm)	Eibach System	Artikel-Nr. Part-No.	Hinweise Notes	Kennzeichnung Stamping	Lockkreis Bolz pattern No. of holes	Zentrierung Centre bore (mm)	Gewinde Thread	Gutachten Homologation	ET-Grenze Offset / frontier
PORSCHE 968	06.91 - 11.95		14	6	S90-6-07-001	S32, S40	91207001	130/5	71,5	M14x1,5	T	33
	06.91 - 11.95		30	6	S90-6-15-018	S33	91215018	130/5	71,5	M14x1,5	T	33
	06.91 - 11.95		36	6	S90-6-18-001	S33	91618001	130/5	71,5	M14x1,5	§21	
	06.91 - 11.95		36	6	S90-6-18-001	S33	91618001	130/5	71,5	M14x1,5	§21	
968 Cabriolet 968 Convertible	06.91 - 11.95		14	6	S90-6-07-001	S32, S40	91207001	130/5	71,5	M14x1,5	T	33
	06.91 - 11.95		30	6	S90-6-15-018	S33	91215018	130/5	71,5	M14x1,5	T	33
BOXSTER (986)	09.96 - 12.04	S4-7-14-50-30-19	14	2	S90-2-07-001	S22	91207001	130/5	71,5	M14x1,5	T	25
	09.96 - 12.04	M14x1,5x30, KU r=14	30	2	S90-2-15-018	S22	91215018	130/5	71,5	M14x1,5	T	25
	09.96 - 12.04		36	2								

Modell Model	Baujahr Year	Original- radschraube (nicht bestellbar) Original Bolt (not available)	Spurweiten- änderung Achse Total track wide- ning (mm)	Eibach System	Artikel-Nr. Part-No.	Hinweise Notes	Kennzeich- nung Stamping	Lockkreis Zahl Bolt pattern No. of holes	Zentrierung Centre bore (mm)	Gewinde Thread	Gutachten Homo- logation	ET-Grenze Offset frontier
RENAULT CLIO IV	11.12 -	S1-1-12-50-26-17	10	1	S90-1-05-003	S6	91105003	100/4	60	M12x1,5	T	25
	11.12 -	M12x1,5x26, KG60°	32	2	S90-2-16-002		91216002	100/4	60	M12x1,5	T	25
	11.12 -		40	2	S90-2-20-010		91220010	100/4	60	M12x1,5	T	25
	11.12 -		40	7	S90-7-20-026		91720026	100/4	60	M12x1,5	T	25
	11.12 -		50	7	S90-7-25-007		91725007	100/4	60	M12x1,5	T	25
ESPACE II (J/S63.)	01.91 - 12.96	S4-1-12-50-26-19	10	1	S90-1-05-003		91105003	100/4	60	M12x1,5	T	27
	01.91 - 12.96	M12x1,5x26, KG60°	30	2	S90-2-15-014		91215014	100/4	60	M12x1,5	T	27
	01.91 - 12.96		50	7	S90-7-25-007	S68	91725007	100/4	60	M12x1,5	\$21	
ESPACE IV (JKO/1.)	11.02 -	S4-1-14-50-28-17	40	7	S90-7-20-014		91720014	108/5	60	M14x1,5	T	35
	11.02 -	M14x1,5x28, KG60°	50	7	S90-7-25-020		91725020	108/5	60	M14x1,5	T	35
GRAND SCÉNII (JMO/1.)	04.04 -	S4-1-12-50-26-19	10	1	S90-1-05-003		91105003	100/4	60	M12x1,5	T	30
	04.04 -	M12x1,5x26, KG60°	30	2	S90-2-15-014		91215014	100/4	60	M12x1,5	T	30
	04.04 -		32	2	S90-2-16-002		91216002	100/4	60	M12x1,5	T	30
	04.04 -		40	2	S90-2-20-010		91220010	100/4	60	M12x1,5	T	30
	04.04 -		50	7	S90-7-25-007	S68	91725007	100/4	60	M12x1,5	T	30
GRAND SCÉNII III (JZO/1.)	02.09 -	S4-1-12-50-25-17	10	1	S90-1-05-032		91105032	114,3/5	66	M12x1,5	\$21	
	02.09 -	M12x1,5x25, KG60°	32	2	S90-2-16-011		91216011	114,3/5	66	M12x1,5	\$21	
	02.09 -		40	2	S90-2-20-032		91220032	114,3/5	66	M12x1,5	\$21	
	02.09 -		42	7	S90-7-21-010		91721010	114,3/5	66	M12x1,5	\$21	
	02.09 -		50	7	S90-7-25-044		91725044	114,3/5	66	M12x1,5	\$21	
KOLEOS (HY.)	02.09 -		60	7	S90-7-30-052		91730052	114,3/5	66	M12x1,5	\$21	
	09.08 -		20	6	S90-6-10-004	S16, S33	91610004	114,3/5	66	M12x1,25	T	10
	09.08 -		30	4	S90-4-15-001	S9, S23	91415001	114,3/5	66	M12x1,25	T	10
	09.08 -		30	6	S90-6-15-026	S16, S33	91615026	114,3/5	66	M12x1,25	T	10
	09.08 -		40	4	S90-4-20-003	S9, S23	91420003	114,3/5	66	M12x1,25	T	10
LAGUNA Coupe (DT0/1)	09.08 -	S4-1-14-50-28-17	10	1	S90-1-05-032		91105032	114,3/5	66	M14x1,5	\$21	
	09.08 -	M14x1,5x28, KG60°	32	2	S90-2-16-011		91216011	114,3/5	66	M14x1,5	\$21	
	09.08 -		40	2	S90-2-20-032		91220032	114,3/5	66	M14x1,5	\$21	
	09.08 -		42	7	S90-7-21-011		91721011	114,3/5	66	M14x1,5	\$21	
	09.08 -		50	7	S90-7-25-045		91725045	114,3/5	66	M14x1,5	\$21	
LAGUNA II (BGO/1.)	09.08 -		60	7	S90-7-30-053		91730053	114,3/5	66	M14x1,5	\$21	
	03.01 -	S4-1-12-50-26-19	32	2	S90-2-16-003		91216003	108/5	60	M12x1,5	T	20
	03.01 -	M12x1,5x26, KG60°	40	2	S90-2-20-024		91220024	108/5	60	M12x1,5	T	20
	03.01 -		50	7	S90-7-25-024		91725024	108/5	60	M12x1,5	T	20
	03.01 -		60	7	S90-7-30-023		91730023	108/5	60	M12x1,5	T	20
LAGUNA II Grandtour (KG0/1.)	03.01 -	S4-1-12-50-26-19	32	2	S90-2-16-003		91216003	108/5	60	M12x1,5	T	20
	03.01 -	M12x1,5x26, KG60°	40	2	S90-2-20-024		91220024	108/5	60	M12x1,5	T	20
	03.01 -		50	7	S90-7-25-024		91725024	108/5	60	M12x1,5	T	20
	03.01 -		60	7	S90-7-30-023		91730023	108/5	60	M12x1,5	T	20
	LAGUNA III (BTO/1)	10.07 -	S4-1-14-50-28-17	10	1	S90-1-05-032		91105032	114,3/5	66	M14x1,5	T
10.07 -		M14x1,5x28, KG60°	32	2	S90-2-16-011		91216011	114,3/5	66	M14x1,5	T	17
10.07 -			40	2	S90-2-20-032		91220032	114,3/5	66	M14x1,5	T	17
10.07 -			42	7	S90-7-21-011		91721011	114,3/5	66	M14x1,5	T	17
10.07 -			50	7	S90-7-25-045		91725045	114,3/5	66	M14x1,5	T	17
LAGUNA III Grandtour (KTO/1)	10.07 -		60	7	S90-7-30-053		91730053	114,3/5	66	M14x1,5	T	17
	10.07 -	S4-1-14-50-28-17	10	1	S90-1-05-032		91105032	114,3/5	66	M14x1,5	T	17
	10.07 -	M14x1,5x28, KG60°	32	2	S90-2-16-011		91216011	114,3/5	66	M14x1,5	T	17
	10.07 -		40	2	S90-2-20-032		91220032	114,3/5	66	M14x1,5	T	17
	10.07 -		42	7	S90-7-21-011		91721011	114,3/5	66	M14x1,5	T	17
MEGANE CC (EZO/1.)	10.07 -		50	7	S90-7-25-045		91725045	114,3/5	66	M14x1,5	T	17
	10.07 -		60	7	S90-7-30-053		91730053	114,3/5	66	M14x1,5	T	17
	06.10 -	S4-1-12-50-25-17	10	1	S90-1-05-032		91105032	114,3/5	66	M12x1,5	T	17
	06.10 -	M12x1,5x25, KG60°	32	2	S90-2-16-011		91216011	114,3/5	66	M12x1,5	T	17
	06.10 -		40	2	S90-2-20-032		91220032	114,3/5	66	M12x1,5	T	17
MEGANE I (BAO/1.)	06.10 -		42	7	S90-7-21-010		91721010	114,3/5	66	M12x1,5	T	17
	06.10 -		50	7	S90-7-25-044		91725044	114,3/5	66	M12x1,5	T	17
	06.10 -		60	7	S90-7-30-052		91730052	114,3/5	66	M12x1,5	T	17
	08.95 - 08.03	S1-1-12-50-26-19	10	1	S90-1-05-003		91105003	100/4	60	M12x1,5	T	18
	08.95 - 08.03	M12x1,5x26, KG60°	30	2	S90-2-15-014		91215014	100/4	60	M12x1,5	T	18
MEGANE I Cabriolet (EA0/1.)	08.95 - 08.03		40	2	S90-2-20-010		91220010	100/4	60	M12x1,5	T	18
	08.95 - 08.03		50	7	S90-7-25-007	S68	91725007	100/4	60	M12x1,5	T	18
	10.96 - 08.03	S1-1-12-50-26-19	10	1	S90-1-05-003		91105003	100/4	60	M12x1,5	T	18
	10.96 - 08.03	M12x1,5x26, KG60°	30	2	S90-2-15-014		91215014	100/4	60	M12x1,5	T	18
	10.96 - 08.03		40	2	S90-2-20-010		91220010	100/4	60	M12x1,5	T	18
MEGANE I Classic (LA0/1.)	10.96 - 08.03		50	7	S90-7-25-007	S68	91725007	100/4	60	M12x1,5	T	18
	09.96 - 08.03	S1-1-12-50-26-19	10	1	S90-1-05-003		91105003	100/4	60	M12x1,5	T	18
	09.96 - 08.03	M12x1,5x26, KG60°	30	2	S90-2-15-014		91215014	100/4	60	M12x1,5	T	18
	09.96 - 08.03		40	2	S90-2-20-010		91220010	100/4	60	M12x1,5	T	18
	09.96 - 08.03		50	7	S90-7-25-007	S68	91725007	100/4	60	M12x1,5	T	18
MEGANE I Coach (DA0/1.)	09.96 - 08.03		50	7	S90-7-25-007	S68	91725007	100/4	60	M12x1,5	T	18
	03.96 - 08.03	S1-1-12-50-26-19	10	1	S90-1-05-003		91105003	100/4	60	M12x1,5	T	18
	03.96 - 08.03	M12x1,5x26, KG60°	30	2	S90-2-15-014		91215014	100/4	60	M12x1,5	T	18
	03.96 - 08.03		40	2	S90-2-20-010		91220010	100/4	60	M12x1,5	T	18
	03.96 - 08.03		50	7	S90-7-25-007	S68	91725007	100/4	60	M12x1,5	T	18
MEGANE II (BMO/1., CM0/1.)	11.02 -	S1-1-12-50-26-19	10	1	S90-1-05-003		91105003	100/4	60	M12x1,5	T	15
	11.02 -	M12x1,5x26, KG60°	30	2	S90-2-15-014		91215014	100/4	60	M12x1,5	T	15
	11.02 -		32	2	S90-2-16-002		91216002	100/4	60	M12x1,5	T	15
	11.02 -		40	2	S90-2-20-010		91220010	100/4	60	M12x1,5	T	15
	11.02 -		40	7	S90-7-20-026		91720026	100/4	60	M12x1,5	T	15

Modell Model	Baujahr Year	Original- radschraube (nicht bestellbar) Original Bolt (not available)	Spurweiten- änderung Achse Total track wide- ning (mm)	Eibach System	Artikel-Nr. Part-No.	Hinweise Notes	Kennzeich- nung Stamping	Lockkreis Zahl Bolt pattern No. of holes	Zentrierung Centre bore (mm)	Gewinde Thread	Gutachten Homo- logation	ET-Grenze Offset frontier
RENAULT MEGANE II (BMO/1., CM0/1.)	11.02 -	S4-1-14-50-28-19	32	2	S90-2-16-003		91216003	108/5	60	M14x1,5	T	38
	11.02 -	M14x1,5x28, KG60°	40	2	S90-2-20-024		91220024	108/5	60	M14x1,5	T	38
	11.02 -		40	7	S90-7-20-014		91720014	108/5	60	M14x1,5	T	38
	11.02 -		50	7	S90-7-25-020		91725020	108/5	60	M14x1,5	T	38
	MEGANE II Coupé-Cabriolet (EM0/1.)	09.03 -	S1-1-12-50-26-19	10	1	S90-1-05-003		91105003	100/4	60	M12x1,5	T
09.03 -		M12x1,5x26, KG60°	30	2	S90-2-15-014		91215014	100/4	60	M12x1,5	T	15
09.03 -			32	2	S90-2-16-002		91216002	100/4	60	M12x1,5	T	15
09.03 -			40									

Modell Model	Baujahr Year	Original- radschraube (nicht bestellbar) Original Bolt (not available)	Spurweiten- änderung Achse Total track wide- ning (mm)	Eibach System	Artikel-Nr. Part-No.	Hinweise Notes	Kennzeich- nung Stamping	Lockkreis zahl Bolt pattern No. of holes	Zentrierung Centre bore (mm)	Gewinde Thread	Gutachten Homo- logation	ET-Grenze Offset frontier
RENAULT TWINGO (CNO)												
	03.07 -	S1-1-12-50-23-17	10	1	S90-1-05-003	S11	91105003	100/4	60	M12x1,5	T	4
	03.07 -	M12x1,5x23, KG60°	30	2	S90-2-15-014	S3	91215014	100/4	60	M12x1,5	T	4
	03.07 -		32	2	S90-2-16-002		91216002	100/4	60	M12x1,5	T	4
	03.07 -		40	2	S90-2-20-010		91220010	100/4	60	M12x1,5	T	4
	03.07 -		40	7	S90-7-20-026		91720026	100/4	60	M12x1,5	T	4
	03.07 -		50	7	S90-7-25-007		91725007	100/4	60	M12x1,5	T	4
WIND (E4M)												
	07.10 -	S1-1-12-50-23-17	30	2	S90-2-15-014		91215014	100/4	60	M12x1,5	T	29
	07.10 -	M12x1,5x23, KG60°	32	2	S90-2-16-002		91216002	100/4	60	M12x1,5	T	29
	07.10 -		40	2	S90-2-20-010		91220010	100/4	60	M12x1,5	T	29
	07.10 -		40	7	S90-7-20-026		91720026	100/4	60	M12x1,5	T	29
	07.10 -		50	7	S90-7-25-007		91725007	100/4	60	M12x1,5	T	29
SAAB 9-3 (YS3D)												
	02.98 - 08.03	S1-1-12-50-24-17	10	1	S90-1-05-013		91105013	110/5	65	M12x1,5	T	27
	02.98 - 08.03	M12x1,5x24, KG60°	20	1	S90-1-10-002	S11	91110002	110/5	65	M12x1,5	T	27
	02.98 - 08.03		32	2	S90-2-16-001		91216001	110/5	65	M12x1,5	T	27
	02.98 - 08.03		40	2	S90-2-20-006		91220006	110/5	65	M12x1,5	§21	27
9-3 (YS3F)												
	09.02 -	S1-1-12-50-26-17	10	1	S90-1-05-013		91105013	110/5	65	M12x1,5	T	11
	09.02 -	M12x1,5x26, KG60°	32	2	S90-2-16-001		91216001	110/5	65	M12x1,5	T	11
	09.02 -		40	2	S90-2-20-006		91220006	110/5	65	M12x1,5	T	11
	09.02 -		60	7	S90-7-30-015		91730015	110/5	65	M12x1,5	T	11
9-3 Cabriolet (YS3D)												
	02.98 - 08.03	S1-1-12-50-24-17	10	1	S90-1-05-013		91105013	110/5	65	M12x1,5	T	27
	02.98 - 08.03	M12x1,5x24, KG60°	20	1	S90-1-10-002	S11	91110002	110/5	65	M12x1,5	T	27
	02.98 - 08.03		32	2	S90-2-16-001		91216001	110/5	65	M12x1,5	T	27
	02.98 - 08.03		40	2	S90-2-20-006		91220006	110/5	65	M12x1,5	§21	27
9-3 Cabriolet (YS3F)												
9-3 Convertible (YS3F)												
	08.03 -	S1-1-12-50-26-17	10	1	S90-1-05-013		91105013	110/5	65	M12x1,5	T	11
	08.03 -	M12x1,5x26, KG60°	32	2	S90-2-16-001		91216001	110/5	65	M12x1,5	T	11
	08.03 -		40	2	S90-2-20-006		91220006	110/5	65	M12x1,5	T	11
	08.03 -		60	7	S90-7-30-015		91730015	110/5	65	M12x1,5	T	11
9-3 Kombi												
9-3 Estate												
	03.05 -	S1-1-12-50-26-17	10	1	S90-1-05-013		91105013	110/5	65	M12x1,5	T	11
	03.05 -	M12x1,5x26, KG60°	32	2	S90-2-16-001		91216001	110/5	65	M12x1,5	T	11
	03.05 -		40	2	S90-2-20-006		91220006	110/5	65	M12x1,5	T	11
	03.05 -		60	7	S90-7-30-015		91730015	110/5	65	M12x1,5	T	11
9-5 (YS3E)												
	09.97 -	S1-1-12-50-26-17	10	1	S90-1-05-013		91105013	110/5	65	M12x1,5	T	19
	09.97 -	M12x1,5x26, KG60°	20	1	S90-1-10-002	S11	91110002	110/5	65	M12x1,5	T	19
	09.97 -		32	2	S90-2-16-001	S3	91216001	110/5	65	M12x1,5	T	19
	09.97 -		40	2	S90-2-20-006		91220006	110/5	65	M12x1,5	T	19
	09.97 -		60	7	S90-7-30-015		91730015	110/5	65	M12x1,5	T	19
9-5 Kombi (YS3E)												
9-5 Estate (YS3E)												
	10.98 -	S1-1-12-50-26-17	10	1	S90-1-05-013		91105013	110/5	65	M12x1,5	T	19
	10.98 -	M12x1,5x26, KG60°	20	1	S90-1-10-002	S11	91110002	110/5	65	M12x1,5	T	19
	10.98 -		32	2	S90-2-16-001	S3	91216001	110/5	65	M12x1,5	T	19
	10.98 -		40	2	S90-2-20-006		91220006	110/5	65	M12x1,5	T	19
	10.98 -		60	7	S90-7-30-015		91730015	110/5	65	M12x1,5	T	19
900 II												
	07.93 - 02.98	S1-1-12-50-24-17	10	1	S90-1-05-013		91105013	110/5	65	M12x1,5	T	27
	07.93 - 02.98	M12x1,5x24, KG60°	20	1	S90-1-10-002	S11	91110002	110/5	65	M12x1,5	T	27
	07.93 - 02.98		32	2	S90-2-16-001		91216001	110/5	65	M12x1,5	T	27
	07.93 - 02.98		40	2	S90-2-20-006		91220006	110/5	65	M12x1,5	§21	27
900 II Cabriolet												
900 II Convertible												
	12.93 - 02.98	S1-1-12-50-24-17	10	1	S90-1-05-013		91105013	110/5	65	M12x1,5	T	27
	12.93 - 02.98	M12x1,5x24, KG60°	20	1	S90-1-10-002	S11	91110002	110/5	65	M12x1,5	T	27
	12.93 - 02.98		32	2	S90-2-16-001		91216001	110/5	65	M12x1,5	T	27
	12.93 - 02.98		40	2	S90-2-20-006		91220006	110/5	65	M12x1,5	§21	27
900 II Coupe												
	12.93 - 02.98	S1-1-12-50-24-17	10	1	S90-1-05-013		91105013	110/5	65	M12x1,5	T	27
	12.93 - 02.98	M12x1,5x24, KG60°	20	1	S90-1-10-002	S11	91110002	110/5	65	M12x1,5	T	27
	12.93 - 02.98		32	2	S90-2-16-001		91216001	110/5	65	M12x1,5	T	27
	12.93 - 02.98		40	2	S90-2-20-006		91220006	110/5	65	M12x1,5	§21	27
SEAT ALHAMBRA (7V8, 7V9)												
	04.96 - 03.10	S4-7-14-50-37-19	10	1	S90-1-05-016	S11	91105016	112/5	57	M14x1,5	T	30
	04.96 - 03.10	M14x1,5x37, KU r=14	30	2	S90-2-15-013		91215013	112/5	57	M14x1,5	T	30
	04.96 - 03.10		40	2	S90-2-20-003		91220003	112/5	57	M14x1,5	T	30
	04.96 - 03.10		50	7	S90-7-25-028	S68	91725005	112/5	57	M14x1,5	T	30
ALTEA (5P1)												
	03.04 -	S1-6-14-50-27-17	10	1	S90-1-05-016	S6	91105016	112/5	57	M14x1,5	T	20
	03.04 -	M14x1,5x27, KU r=13	24	2	S90-2-12-003	S3	91212003	112/5	57	M14x1,5	T	20
	03.04 -		30	2	S90-2-15-013		91215013	112/5	57	M14x1,5	T	20
	03.04 -		40	2	S90-2-20-003		91220003	112/5	57	M14x1,5	T	20
	03.04 -		40	7	S90-7-20-017		91720017	112/5	57	M14x1,5	T	20
	03.04 -		50	7	S90-7-25-005		91725005	112/5	57	M14x1,5	T	20
	03.04 -		60	7	S90-7-30-012		91730012	112/5	57	M14x1,5	T	20
ALTEA XL (5P5, 5P8)												
	10.06 -	S1-6-14-50-27-17	10	1	S90-1-05-016	S6	91105016	112/5	57	M14x1,5	T	20
	10.06 -	M14x1,5x27, KU r=13	24	2	S90-2-12-003	S3	91212003	112/5	57	M14x1,5	T	20
	10.06 -		30	2	S90-2-15-013		91215013	112/5	57	M14x1,5	T	20
	10.06 -		40	2	S90-2-20-003		91220003	112/5	57	M14x1,5	T	20
	10.06 -		40	7	S90-7-20-017		91720017	112/5	57	M14x1,5	T	20
	10.06 -		50	7	S90-7-25-005		91725005	112/5	57	M14x1,5	T	20
	10.06 -		60	7	S90-7-30-012		91730012	112/5	57	M14x1,5	T	20
AROSA (6H)												
	05.97 - 06.04		10	1	S90-1-05-010	S11	91105010	100/4	57	M12x1,5	T	15
	05.97 - 06.04		16	1	S90-1-08-003	S11	91108003	100/4	57	M12x1,5	T	15
	05.97 - 06.04		30	2	S90-2-15-004	S13	91215004	100/4	57	M12x1,5	T	15
	05.97 - 06.04		40	2	S90-2-20-011		91220011	100/4	57	M12x1,5	T	15
	05.97 - 06.04		50	7	S90-7-25-001	S68	91725001	100/4	57	M12x1,5	T	15

Modell Model	Baujahr Year	Original- radschraube (nicht bestellbar) Original Bolt (not available)	Spurweiten- änderung Achse Total track wide- ning (mm)	Eibach System	Artikel-Nr. Part-No.	Hinweise Notes	Kennzeich- nung Stamping	Lockkreis zahl Bolt pattern No. of holes	Zentrierung Centre bore (mm)	Gewinde Thread	Gutachten Homo- logation	ET-Grenze Offset frontier
SEAT CORDOBA (6K1, 6K2)												
	02.93 - 10.99		10	1	S90-1-05-010	S11	91105010	100/4	57	M12x1,5	T	23
	02.93 - 10.99		16	1	S90-1-08-003	S11	91108003	100/4	57	M12x1,5	T	23
	02.93 - 10.99		30	2	S90-2-15-004	S13	91215004	100/4	57	M12x1,5	T	23
	02.93 - 10.99		40	2	S90-2-20-011		91220011	100/4	57	M12x1,5	T	23
	02.93 - 10.99		50	7	S90-7-25-001	S68	91725001	100/4	57	M12x1,5	T	23
CORDOBA (6K2)												
	06.99 - 10.02		10	1	S90-1-05-010	S11	91105010	100/4	57	M12x1,5	T	23
	06.99 - 10.02		16	1	S90-1-08-003	S11	91108003	100/4	57	M12x1,5	T	23
	06.99 - 10.02		30	2	S90-2-15-004	S13	91215004	100/4	57	M12x1,5	T	23
	06.99 - 10.02		40	2	S90-2-20-011		91220011	100/4	57	M12x1,5	T	23
	06.99 - 10.02		50	7	S90-7-25-001	S68	91725001	100/4	57	M12x1,5	T	23
CORDOBA (6L2)												
	09.02 - 11.09	S1-6-14-50-27-17	10	1	S90-1-05-006		91105006	100/5	57	M14x1,5	T	13
	09.02 - 11.09	M14x1,5x27, KU r=13	16	1	S90-1-08-001	S6	91108001	100/5	57	M14x1,5	T	13
	09.02 - 11.09		30	2	S90-2-15-005		91215005	100/5	57	M14x1,5	T	13
	09.02 - 11.09		40	2	S90-2-20-004		91220004	100/5	57	M14x1,5	T	13
	09.02 - 11.09		50	7	S90-7-25-025		91725025	100/5	57	M14x1,5	T	13
	09.02 - 11.09		60	7	S90-7-30-016		91730016	100/5	57	M14x1,5	T	13
CORDOBA Vario (6K5)												

Modell Model	Baujahr Year	Original- radschraube (nicht bestellbar) Original Bolt (not available)	Spurweiten- änderung Achse Total track wide- ning (mm)	Eibach System	Artikel-Nr. Part-No.	Hinweise Notes	Kennzeich- nung Stamping	Lockkreis zahl Bolt pattern No. of holes	Zentrierung Centre bore (mm)	Gewinde Thread	Gutachten Homo- logation	ET-Grenze Offset Frontier
SEAT LEON (1P1)	05.05 -	S1-6-14-50-27-17	10	1	S90-1-05-016	56	91105016	112/5	57	M14x1,5	T	20
	05.05 -	M14x1,5x27, KU r=13	24	2	S90-2-12-003		91212003	112/5	57	M14x1,5	T	20
	05.05 -		30	2	S90-2-15-013		91215013	112/5	57	M14x1,5	T	20
	05.05 -		40	2	S90-2-20-003		91220003	112/5	57	M14x1,5	T	20
	05.05 -		40	7	S90-7-20-017		91720017	112/5	57	M14x1,5	T	20
	05.05 -		50	7	S90-7-25-005		91725005	112/5	57	M14x1,5	T	20
05.05 -			60	7	S90-7-30-012		91730012	112/5	57	M14x1,5	T	20
LEON (5F1)	09.12 -	S1-6-14-50-27-17	20	2	S90-2-10-027	574	91210027	112/5	57	M14x1,5	T	18
	09.12 -	M14x1,5x27, KU r=13	24	2	S90-2-12-003		91212003	112/5	57	M14x1,5	T	18
	09.12 -		30	2	S90-2-15-013		91215013	112/5	57	M14x1,5	T	18
	09.12 -		40	2	S90-2-20-003		91220003	112/5	57	M14x1,5	T	18
	09.12 -		40	7	S90-7-20-017		91720017	112/5	57	M14x1,5	T	18
	09.12 -		50	7	S90-7-25-005		91725005	112/5	57	M14x1,5	T	18
09.12 -			60	7	S90-7-30-012		91730012	112/5	57	M14x1,5	T	18
LEON SC (5F5)	01.13 -	S1-6-14-50-27-17	20	2	S90-2-10-027	574	91210027	112/5	57	M14x1,5	T	18
	01.13 -	M14x1,5x27, KU r=13	24	2	S90-2-12-003		91212003	112/5	57	M14x1,5	T	18
	01.13 -		30	2	S90-2-15-013		91215013	112/5	57	M14x1,5	T	18
	01.13 -		40	2	S90-2-20-003		91220003	112/5	57	M14x1,5	T	18
	01.13 -		40	7	S90-7-20-017		91720017	112/5	57	M14x1,5	T	18
	01.13 -		50	7	S90-7-25-005		91725005	112/5	57	M14x1,5	T	18
01.13 -			60	7	S90-7-30-012		91730012	112/5	57	M14x1,5	T	18
Mii (KF1.)	10.11 -	S1-6-12-50-27-17	24	2	S90-2-12-019	S3	91212019	100/4	57	M12x1,5	T	10
	10.11 -	M12x1,5x27, KU r=13	30	2	S90-2-15-004	S13	91215004	100/4	57	M12x1,5	T	10
	10.11 -		40	2	S90-2-20-011		91220011	100/4	57	M12x1,5	T	10
	10.11 -		50	7	S90-7-25-001	S68	91725001	100/4	57	M12x1,5	T	10
TOLEDO II (1M2)	04.99 - 05.06	S1-6-14-50-27-17	10	1	S90-1-05-006	S11	91105006	100/5	57	M14x1,5	T	23
	04.99 - 05.06	M14x1,5x27, KU r=13	16	1	S90-1-08-001	S6	91108001	100/5	57	M14x1,5	T	23
	04.99 - 05.06		24	2	S90-2-12-003		91212003	100/5	57	M14x1,5	T	23
	04.99 - 05.06		30	2	S90-2-15-005		91215005	100/5	57	M14x1,5	T	23
	04.99 - 05.06		40	2	S90-2-20-004		91220004	100/5	57	M14x1,5	T	23
	04.99 - 05.06		50	7	S90-7-25-003		91725003	100/5	57	M14x1,5	T	23
TOLEDO III (5P2)	04.04 - 05.09	S1-6-14-50-27-17	10	1	S90-1-05-016	S6	91105016	112/5	57	M14x1,5	T	20
	04.04 - 05.09	M14x1,5x27, KU r=13	24	2	S90-2-12-003	S3	91212003	112/5	57	M14x1,5	T	20
	04.04 - 05.09		30	2	S90-2-15-013		91215013	112/5	57	M14x1,5	T	20
	04.04 - 05.09		40	2	S90-2-20-003		91220003	112/5	57	M14x1,5	T	20
	04.04 - 05.09		40	7	S90-7-20-017		91720017	112/5	57	M14x1,5	T	20
	04.04 - 05.09		50	7	S90-7-25-005		91725005	112/5	57	M14x1,5	T	20
04.04 - 05.09		60	7	S90-7-30-012		91730012	112/5	57	M14x1,5	T	20	
TOLEDO IV (KG3)	07.12 -	S1-6-12-50-27-17	20	2	S90-2-10-027	574	91210027	100/5	57	M14x1,5	T	8
	07.12 -	M12x1,5x27, KU r=13	24	2	S90-2-12-003		91212003	100/5	57	M14x1,5	T	8
	07.12 -		30	2	S90-2-15-013		91215013	100/5	57	M14x1,5	T	8
	07.12 -		40	2	S90-2-20-003		91220003	100/5	57	M14x1,5	T	8
	07.12 -		50	7	S90-7-25-025		91725025	100/5	57	M14x1,5	T	8
	07.12 -		60	7	S90-7-30-016		91730016	100/5	57	M14x1,5	T	8
SKODA CITIGO	10.11 -	S1-6-12-50-27-17	24	2	S90-2-12-019	S3	91212019	100/4	57	M12x1,5	T	10
	10.11 -	M12x1,5x27, KU r=13	30	2	S90-2-15-004	S13	91215004	100/4	57	M12x1,5	T	10
	10.11 -		40	2	S90-2-20-011		91220011	100/4	57	M12x1,5	T	10
	10.11 -		50	7	S90-7-25-001	S68	91725001	100/4	57	M12x1,5	T	10
FABIA (6Y2)	08.99 - 03.08	S1-6-14-50-27-17	10	1	S90-1-05-006	S11	91105006	100/5	57	M14x1,5	T	20
	08.99 - 03.08	M14x1,5x27, KU r=13	16	1	S90-1-08-001	S11	91108001	100/5	57	M14x1,5	T	20
	08.99 - 03.08		30	2	S90-2-15-005		91215005	100/5	57	M14x1,5	T	20
	08.99 - 03.08		40	2	S90-2-20-004		91220004	100/5	57	M14x1,5	T	20
	08.99 - 03.08		50	7	S90-7-25-003		91725003	100/5	57	M14x1,5	T	20
	08.99 - 03.08											
FABIA	12.06 -	S1-6-14-50-27-17	24	2	S90-2-12-013	S3	91212013	100/5	57	M14x1,5	T	3
	12.06 -	M14x1,5x27, KU r=13	30	2	S90-2-15-005		91215005	100/5	57	M14x1,5	T	3
	12.06 -		40	2	S90-2-20-004		91220004	100/5	57	M14x1,5	T	3
	12.06 -		50	7	S90-7-25-003		91725003	100/5	57	M14x1,5	T	3
	12.06 -		60	7	S90-7-30-027		91730027	100/5	57	M14x1,5	T	3
	12.06 -											
FABIA Combi (6Y5)	04.00 - 12.07	S1-6-14-50-27-17	10	1	S90-1-05-006	S11	91105006	100/5	57	M14x1,5	T	20
	04.00 - 12.07	M14x1,5x27, KU r=13	16	1	S90-1-08-001	S11	91108001	100/5	57	M14x1,5	T	20
	04.00 - 12.07		30	2	S90-2-15-005		91215005	100/5	57	M14x1,5	T	20
	04.00 - 12.07		40	2	S90-2-20-004		91220004	100/5	57	M14x1,5	T	20
	04.00 - 12.07		50	7	S90-7-25-003		91725003	100/5	57	M14x1,5	T	20
FABIA Combi	10.07 -	S1-6-14-50-27-17	24	2	S90-2-12-013	S3	91212013	100/5	57	M14x1,5	T	3
	10.07 -	M14x1,5x27, KU r=13	30	2	S90-2-15-005		91215005	100/5	57	M14x1,5	T	3
	10.07 -		40	2	S90-2-20-004		91220004	100/5	57	M14x1,5	T	3
	10.07 -		50	7	S90-7-25-003		91725003	100/5	57	M14x1,5	T	3
	10.07 -		60	7	S90-7-30-027		91730027	100/5	57	M14x1,5	T	3
OCTAVIA (1U2)	09.96 - 12.10	S1-6-14-50-27-17	10	1	S90-1-05-006	S11	91105006	100/5	57	M14x1,5	T	18
	09.96 - 12.10	M14x1,5x27, KU r=13	16	1	S90-1-08-001	S11	91108001	100/5	57	M14x1,5	T	18
	09.96 - 12.10		30	2	S90-2-15-005		91215005	100/5	57	M14x1,5	T	18
	09.96 - 12.10		40	2	S90-2-20-004		91220004	100/5	57	M14x1,5	T	18
	09.96 - 12.10		50	7	S90-7-25-003		91725003	100/5	57	M14x1,5	T	18
OCTAVIA (1Z3)	02.04 -	S1-6-14-50-27-17	10	1	S90-1-05-016	S11	91105016	112/5	57	M14x1,5	T	32
	02.04 -	M14x1,5x27, KU r=13	16	1	S90-1-08-002	S11	91108002	112/5	57	M14x1,5	T	32
	02.04 -		30	2	S90-2-15-013		91215013	112/5	57	M14x1,5	T	32
	02.04 -		40	2	S90-2-20-003		91220003	112/5	57	M14x1,5	T	32
	02.04 -		50	7	S90-7-25-005		91725005	112/5	57	M14x1,5	T	32

Modell Model	Baujahr Year	Original- radschraube (nicht bestellbar) Original Bolt (not available)	Spurweiten- änderung Achse Total track wide- ning (mm)	Eibach System	Artikel-Nr. Part-No.	Hinweise Notes	Kennzeich- nung Stamping	Lockkreis zahl Bolt pattern No. of holes	Zentrierung Centre bore (mm)	Gewinde Thread	Gutachten Homo- logation	ET-Grenze Offset Frontier
SKODA OCTAVIA (5E3)	11.12 -	S1-6-14-50-27-17	20	2	S90-2-10-027	574	91210027	112/5	57	M14x1,5	T	18
	11.12 -	M14x1,5x27, KU r=13	24	2	S90-2-12-003		91212003	112/5	57	M14x1,5	T	18
	11.12 -		30	2	S90-2-15-013		91215013	112/5	57	M14x1,5	T	18
	11.12 -		40	2	S90-2-20-003		91220003	112/5	57	M14x1,5	T	18
	11.12 -		40	7	S90-7-20-017		91720017	112/5	57	M14x1,5	T	18
	11.12 -		50	7	S90-7-25-005		91725005	112/5	57	M14x1,5	T	18
	11.12 -		60									

Modell Model	Baujahr Year	Original-radschraube (nicht bestellbar) Original Bolt (not available)	Spurweiten-änderung Achse Total track width (mm)	Eibach System	Artikel-Nr. Part-No.	Hinweise Notes	Kennzeichnung Stamping	Lockkreis -zahl Bolt pattern No. of holes	Zentrierung Centre bore (mm)	Gewinde Thread	Gutachten Homologation	ET-Grenze Offset frontier
SMART FORTWO Coupe (451)	01.07 -	S1-5-12-50-24-17	30	2	S90-2-15-028		91215028	112/3	57	M12x1,5	T	7
	01.07 -	M12x1,5x24, KU r=12	40	2	S90-2-20-017		91220017	112/3	57	M12x1,5	T	7
	01.07 -		50	7	S90-7-25-035		91725035	112/3	57	M12x1,5	T	7
	01.07 -		60	7	S90-7-30-028		91730028	112/3	57	M12x1,5	§21	7
ROADSTER (452)	04.03 - 11.05	S1-5-12-50-26-17	10	1	S90-1-05-026		91105026	112/3	57	M12x1,5	T	-50
	04.03 - 11.05	M12x1,5x26, KU r=12	30	2	S90-2-15-028		91215028	112/3	57	M12x1,5	T	-50
	04.03 - 11.05		40	2	S90-2-20-017		91220017	112/3	57	M12x1,5	T	-50
	04.03 - 11.05		50	7	S90-7-25-035		91725035	112/3	57	M12x1,5	T	-50
	04.03 - 11.05		60	7	S90-7-30-028		91730028	112/3	57	M12x1,5	T	-50
ROADSTER Coupe (452)	04.03 - 11.05	S1-5-12-50-26-17	10	1	S90-1-05-026		91105026	112/3	57	M12x1,5	T	-50
	04.03 - 11.05	M12x1,5x26, KU r=12	30	2	S90-2-15-028		91215028	112/3	57	M12x1,5	T	-50
	04.03 - 11.05		40	2	S90-2-20-017		91220017	112/3	57	M12x1,5	T	-50
	04.03 - 11.05		50	7	S90-7-25-035		91725035	112/3	57	M12x1,5	T	-50
	04.03 - 11.05		60	7	S90-7-30-028		91730028	112/3	57	M12x1,5	T	-50
SSANGYONG KORANDO (KJ)	12.96 -		50	8	S90-8-25-002	S9, S11	91825002	139,7/6	106,5	M12x1,5	T	-8
	12.96 -		60	8	S90-8-30-002	S9, S11	91830002	139,7/6	106,5	M12x1,5	T	-8
	12.96 -		50	8	S90-8-25-002	S9, S11	91825002	139,7/6	106,5	M12x1,5	T	-8
	12.96 -		60	8	S90-8-30-002	S9, S11	91830002	139,7/6	106,5	M12x1,5	T	-8
KORANDO Cabrio (KJ)	12.96 -		50	8	S90-8-25-002	S9, S11	91825002	139,7/6	106,5	M12x1,5	T	-8
	12.96 -		60	8	S90-8-30-002	S9, S11	91830002	139,7/6	106,5	M12x1,5	T	-8
MUSSO (FJ)	03.93 -		50	8	S90-8-25-002	S9, S11	91825002	139,7/6	106,5	M12x1,5	T	-8
	03.93 -		60	8	S90-8-30-002	S9, S11	91830002	139,7/6	106,5	M12x1,5	T	-8
MUSSO SPORTS	08.04 -		50	8	S90-8-25-002	S9, S11	91825002	139,7/6	106,5	M12x1,5	T	-8
	08.04 -		60	8	S90-8-30-002	S9, S11	91830002	139,7/6	106,5	M12x1,5	T	-8
REXTON (GAB.)	04.02 -		50	8	S90-8-25-002	S9, S11	91825002	139,7/6	106,5	M12x1,5	§21	
	04.02 -		60	8	S90-8-30-002	S9, S11	91830002	139,7/6	106,5	M12x1,5	§21	
SUBARU BRZ	06.12 -		20	6	S90-6-10-003	S16, S33	91610003	100/5	56	M12x1,25	§21	13
	06.12 -		30	4	S90-4-15-016	S9	91415016	100/5	56	M12x1,25	§21	13
	06.12 -		40	4	S90-4-20-002	S9	91420002	100/5	56	M12x1,25	§21	13
	06.12 -		50	4	S90-4-25-017	S9	91425017	100/5	56	M12x1,25	§21	13
	06.12 -		60	4	S90-4-30-030	S9	91430030	100/5	56	M12x1,25	§21	13
IMPREZA Coupe (GFC)	01.93 - 12.00		10	5	S90-5-05-028	S11, S16, S32	91505028	100/5	56	M12x1,25	T	30
	01.93 - 12.00		20	6	S90-6-10-003	S16, S33	91610003	100/5	56	M12x1,25	T	30
	01.93 - 12.00		40	4	S90-4-20-002	S9	91420002	100/5	56	M12x1,25	T	30
IMPREZA Schrägheck IMPREZA Hatchback	12.02 - 12.04		10	5	S90-5-05-028	S11, S16, S32	91505028	100/5	56	M12x1,25	T	30
	12.02 - 12.04		20	6	S90-6-10-003	S16, S33	91610003	100/5	56	M12x1,25	T	30
	12.02 - 12.04		40	4	S90-4-20-002	S9	91420002	100/5	56	M12x1,25	T	30
IMPREZA Schrägheck IMPREZA Hatchback	12.02 - 12.04		50	4	S90-4-25-017	S9	91425017	100/5	56	M12x1,25	T	30
	01.05 - 12.07		24	6	S90-6-12-002	S16, S33	91612002	114,3/5	56	M12x1,25	§21	
	01.05 - 12.07		30	6	S90-6-15-042	S16, S33	91615042	114,3/5	56	M12x1,25	§21	
IMPREZA Schrägheck IMPREZA Hatchback	01.05 - 12.07		40	6	S90-6-20-027	S16, S33	91620027	114,3/5	56	M12x1,25	§21	
	01.08 -		40	4	S90-4-20-002	S9	91420002	100/5	56	M12x1,25	§21	
	01.08 -		50	4	S90-4-25-017	S9	91425017	100/5	56	M12x1,25	§21	
IMPREZA Station Wagon (GF) IMPREZA Estate (GF)	08.92 - 12.00		10	5	S90-5-05-028	S11, S16, S32	91505028	100/5	56	M12x1,25	T	30
	08.92 - 12.00		20	6	S90-6-10-003	S16, S33	91610003	100/5	56	M12x1,25	T	30
	08.92 - 12.00		40	4	S90-4-20-002	S9	91420002	100/5	56	M12x1,25	T	30
IMPREZA Station Wagon IMPREZA Estate (GD, GG)	08.92 - 12.00		50	4	S90-4-25-017	S9	91425017	100/5	56	M12x1,25	T	30
	10.00 - 12.04		10	5	S90-5-05-028	S11, S16, S32	91505028	100/5	56	M12x1,25	T	30
	10.00 - 12.04		20	6	S90-6-10-003	S16, S33	91610003	100/5	56	M12x1,25	T	30
IMPREZA Station Wagon IMPREZA Estate (GD, GG)	10.00 - 12.04		40	4	S90-4-20-002	S9	91420002	100/5	56	M12x1,25	T	30
	10.00 - 12.04		50	4	S90-4-25-017	S9	91425017	100/5	56	M12x1,25	T	30
	10.00 - 12.04		20	6	S90-6-10-003	S16, S33	91610003	100/5	56	M12x1,25	T	30
IMPREZA Station Wagon IMPREZA Estate (GD, GG)	10.00 - 12.04		40	4	S90-4-20-002	S9	91420002	100/5	56	M12x1,25	T	30
	10.00 - 12.04		50	4	S90-4-25-017	S9	91425017	100/5	56	M12x1,25	T	30
	10.00 - 12.04		20	6	S90-6-10-003	S16, S33	91610003	100/5	56	M12x1,25	T	30
IMPREZA Station Wagon IMPREZA Estate (GD, GG)	10.00 - 12.04		40	4	S90-4-20-002	S9	91420002	100/5	56	M12x1,25	T	30
	10.00 - 12.04		50	4	S90-4-25-017	S9	91425017	100/5	56	M12x1,25	T	30
	10.00 - 12.04		20	6	S90-6-10-003	S16, S33	91610003	100/5	56	M12x1,25	T	30
IMPREZA Station Wagon IMPREZA Estate (GD, GG)	10.00 - 12.04		40	4	S90-4-20-002	S9	91420002	100/5	56	M12x1,25	T	30
	10.00 - 12.04		50	4	S90-4-25-017	S9	91425017	100/5	56	M12x1,25	T	30
	10.00 - 12.04		20	6	S90-6-10-003	S16, S33	91610003	100/5	56	M12x1,25	T	30
IMPREZA Station Wagon IMPREZA Estate (GD, GG)	10.00 - 12.04		40	4	S90-4-20-002	S9	91420002	100/5	56	M12x1,25	T	30
	10.00 - 12.04		50	4	S90-4-25-017	S9	91425017	100/5	56	M12x1,25	T	30
	10.00 - 12.04		20	6	S90-6-10-003	S16, S33	91610003	100/5	56	M12x1,25	T	30
IMPREZA Station Wagon IMPREZA Estate (GD, GG)	10.00 - 12.04		40	4	S90-4-20-002	S9	91420002	100/5	56	M12x1,25	T	30
	10.00 - 12.04		50	4	S90-4-25-017	S9	91425017	100/5	56	M12x1,25	T	30
	10.00 - 12.04		20	6	S90-6-10-003	S16, S33	91610003	100/5	56	M12x1,25	T	30
IMPREZA Station Wagon IMPREZA Estate (GD, GG)	10.00 - 12.04		40	4	S90-4-20-002	S9	91420002	100/5	56	M12x1,25	T	30
	10.00 - 12.04		50	4	S90-4-25-017	S9	91425017	100/5	56	M12x1,25	T	30
	10.00 - 12.04		20	6	S90-6-10-003	S16, S33	91610003	100/5	56	M12x1,25	T	30
IMPREZA Station Wagon IMPREZA Estate (GD, GG)	10.00 - 12.04		40	4	S90-4-20-002	S9	91420002	100/5	56	M12x1,25	T	30
	10.00 - 12.04		50	4	S90-4-25-017	S9	91425017	100/5	56	M12x1,25	T	30
	10.00 - 12.04		20	6	S90-6-10-003	S16, S33	91610003	100/5	56	M12x1,25	T	30
IMPREZA Station Wagon IMPREZA Estate (GD, GG)	10.00 - 12.04		40	4	S90-4-20-002	S9	91420002	100/5	56	M12x1,25	T	30
	10.00 - 12.04		50	4	S90-4-25-017	S9	91425017	100/5	56	M12x1,25	T	30
	10.00 - 12.04		20	6	S90-6-10-003	S16, S33	91610003	100/5	56	M12x1,25	T	30
IMPREZA Station Wagon IMPREZA Estate (GD, GG)	10.00 - 12.04		40	4	S90-4-20-002	S9	91420002	100/5	56	M12x1,25	T	30
	10.00 - 12.04		50	4	S90-4-25-017	S9	91425017	100/5	56	M12x1,25	T	30
	10.00 - 12.04		20	6	S90-6-10-003	S16, S33	91610003	100/5	56	M12x1,25	T	30
IMPREZA Station Wagon IMPREZA Estate (GD, GG)	10.00 - 12.04		40	4	S90-4-20-002	S9	91420002	100/5	56	M12x1,25	T	30
	10.00 - 12.04		50	4	S90-4-25-017	S9	91425017	100/5	56	M12x1,25	T	30
	10.00 - 12.04		20	6	S90-6-10-003	S16, S33	91610003	100/5	56	M12x1,25	T	30
IMPREZA Station Wagon IMPREZA Estate (GD, GG)	10.00 - 12.04		40	4	S90-4-20-002	S9	91420002	100/5	56	M12x1,25	T	30
	10.00 - 12.04		50	4	S90-4-25-017	S9	91425017	100/5	56	M12x1,25	T	30
	10.00 - 12.04		20	6	S90-6-10-003	S16, S33	91610003	100/5	56	M12x1,25	T	30
IMPREZA Station Wagon IMPREZA Estate (GD, GG)	10.00 - 12.04		40	4	S90-4-20-002	S9	91420002	100/5	56	M12x1,25	T	30
	10.00 - 12.04</											

Modell Model	Baujahr Year	Original- radschraube (nicht bestellbar) Original Bolt (not available)	Spurweiten- änderung Achse Total track wide- ning (mm)	Eibach System	Artikel-Nr. Part-No.	Hinweise Notes	Kennzeich- nung Stamping	Lockkreis zähl Bolt pattern No. of holes	Zentrierung Centre bore (mm)	Gewinde Thread	Gutachten Homolo- gation	ET-Grenze Offset frontier
TOYOTA												
AURIS TOURING SPORTS (ZWE18_, ZRE18_)												
	07.13 -		30	4	S90-4-15-009	S9	91415009	114,3/5	60	M12x1,5	T	15
	07.13 -		30	6	S90-6-15-034	S33	91215022	114,3/5	60	M12x1,5	T	15
	07.13 -		40	4	S90-4-20-013	S9	91420013	114,3/5	60	M12x1,5	T	15
	07.13 -		40	6	S90-6-20-031	S33	91220024	114,3/5	60	M12x1,5	T	15
	07.13 -		50	4	S90-4-25-029	S9	91425029	114,3/5	60	M12x1,5	T	15
	07.13 -		60	4	S90-4-30-016	S9	91430016	114,3/5	60	M12x1,5	T	15
AURIS VAN Kasten (NDE15_)												
AURIS VAN Box (NDE15_)												
	12.06 - 04.13		30	4	S90-4-15-009	S9	91415009	114,3/5	60	M12x1,5	§21	
	12.06 - 04.13		30	6	S90-6-15-034	S33	91215022	114,3/5	60	M12x1,5	§21	
	12.06 - 04.13		40	4	S90-4-20-013	S9	91420013	114,3/5	60	M12x1,5	§21	
	12.06 - 04.13		40	6	S90-6-20-031	S33	91220024	114,3/5	60	M12x1,5	§21	
	12.06 - 04.13		50	4	S90-4-25-029	S9	91425029	114,3/5	60	M12x1,5	§21	
	12.06 - 04.13		60	4	S90-4-30-016	S9	91430016	114,3/5	60	M12x1,5	§21	
AURIS VAN Kasten (ZRE18_, NZE18_)												
AURIS VAN Box (ZRE18_, NZE18_)												
	03.13 -		30	4	S90-4-15-009	S9	91415009	114,3/5	60	M12x1,5	T	15
	03.13 -		30	6	S90-6-15-034	S33	91215022	114,3/5	60	M12x1,5	T	15
	03.13 -		40	4	S90-4-20-013	S9	91420013	114,3/5	60	M12x1,5	T	15
	03.13 -		40	6	S90-6-20-031	S33	91220024	114,3/5	60	M12x1,5	T	15
	03.13 -		50	4	S90-4-25-029	S9	91425029	114,3/5	60	M12x1,5	T	15
	03.13 -		60	4	S90-4-30-016	S9	91430016	114,3/5	60	M12x1,5	T	15
AVENSIS (T25_)												
	04.03 - 11.08		20	6	S90-6-10-011	S33	91610011	100/5	54	M12x1,5	§21	
	04.03 - 11.08		30	6	S90-6-15-037	S33	91615037	100/5	54	M12x1,5	§21	
	04.03 - 11.08		40	4	S90-4-20-015	S9	91420015	100/5	54	M12x1,5	§21	
AVENSIS (T25_)												
	04.03 - 11.08		30	4	S90-4-15-009	S9	91415009	114,3/5	60	M12x1,5	§21	
	04.03 - 11.08		30	6	S90-6-15-034	S33	91215022	114,3/5	60	M12x1,5	§21	
	04.03 - 11.08		40	4	S90-4-20-013	S9	91420013	114,3/5	60	M12x1,5	§21	
	04.03 - 11.08		40	6	S90-6-20-031	S33	91220024	114,3/5	60	M12x1,5	§21	
	04.03 - 11.08		50	4	S90-4-25-029	S9	91425029	114,3/5	60	M12x1,5	§21	
	04.03 - 11.08		60	4	S90-4-30-016	S9	91430016	114,3/5	60	M12x1,5	§21	
AVENSIS Kombi (T25)												
AVENSIS Estate (T25)												
	04.03 - 11.08		20	6	S90-6-10-011	S33	91610011	100/5	54	M12x1,5	§21	
	04.03 - 11.08		30	6	S90-6-15-037	S33	91615037	100/5	54	M12x1,5	§21	
	04.03 - 11.08		40	4	S90-4-20-015	S9	91420015	100/5	54	M12x1,5	§21	
AVENSIS Kombi (T25)												
AVENSIS Estate (T25)												
	04.03 - 11.08		30	4	S90-4-15-009	S9	91415009	114,3/5	60	M12x1,5	§21	
	04.03 - 11.08		30	6	S90-6-15-034	S33	91215022	114,3/5	60	M12x1,5	§21	
	04.03 - 11.08		40	4	S90-4-20-013	S9	91420013	114,3/5	60	M12x1,5	§21	
	04.03 - 11.08		40	6	S90-6-20-031	S33	91220024	114,3/5	60	M12x1,5	§21	
	04.03 - 11.08		50	4	S90-4-25-029	S9	91425029	114,3/5	60	M12x1,5	§21	
	04.03 - 11.08		60	4	S90-4-30-016	S9	91430016	114,3/5	60	M12x1,5	§21	
AVENSIS Station Wagon (ZRT27, ADT27)												
AVENSIS Estate (ZRT27, ADT27)												
	02.09 -		30	4	S90-4-15-009	S9	91415009	114,3/5	60	M12x1,5	§21	
	02.09 -		30	6	S90-6-15-034	S33	91215022	114,3/5	60	M12x1,5	§21	
	02.09 -		40	4	S90-4-20-013	S9	91420013	114,3/5	60	M12x1,5	§21	
	02.09 -		40	6	S90-6-20-031	S33	91220024	114,3/5	60	M12x1,5	§21	
	02.09 -		50	4	S90-4-25-029	S9	91425029	114,3/5	60	M12x1,5	§21	
	02.09 -		60	4	S90-4-30-016	S9	91430016	114,3/5	60	M12x1,5	§21	
AVENSIS Stufenheck (T25)												
AVENSIS Saloon (T25)												
	04.03 - 11.08		20	6	S90-6-10-011	S33	91610011	100/5	54	M12x1,5	§21	
	04.03 - 11.08		30	6	S90-6-15-037	S33	91615037	100/5	54	M12x1,5	§21	
	04.03 - 11.08		40	4	S90-4-20-015	S9	91420015	100/5	54	M12x1,5	§21	
AVENSIS Stufenheck (T25)												
AVENSIS Saloon (T25)												
	04.03 - 11.08		30	4	S90-4-15-009	S9	91415009	114,3/5	60	M12x1,5	§21	
	04.03 - 11.08		30	6	S90-6-15-034	S33	91215022	114,3/5	60	M12x1,5	§21	
	04.03 - 11.08		40	4	S90-4-20-013	S9	91420013	114,3/5	60	M12x1,5	§21	
	04.03 - 11.08		40	6	S90-6-20-031	S33	91220024	114,3/5	60	M12x1,5	§21	
	04.03 - 11.08		50	4	S90-4-25-029	S9	91425029	114,3/5	60	M12x1,5	§21	
	04.03 - 11.08		60	4	S90-4-30-016	S9	91430016	114,3/5	60	M12x1,5	§21	
AVENSIS Stufenheck (ZRT27, ADT27)												
AVENSIS Saloon (ZRT27, ADT27)												
	02.09 -		30	4	S90-4-15-009	S9	91415009	114,3/5	60	M12x1,5	§21	
	02.09 -		30	6	S90-6-15-034	S33	91215022	114,3/5	60	M12x1,5	§21	
	02.09 -		40	4	S90-4-20-013	S9	91420013	114,3/5	60	M12x1,5	§21	
	02.09 -		40	6	S90-6-20-031	S33	91220024	114,3/5	60	M12x1,5	§21	
	02.09 -		50	4	S90-4-25-029	S9	91425029	114,3/5	60	M12x1,5	§21	
	02.09 -		60	4	S90-4-30-016	S9	91430016	114,3/5	60	M12x1,5	§21	
AVGO (WNB1_, KGB1_)												
	02.05 -	S1-1-12-50-20-17	10	1	S90-1-05-028	S11	91505008	100/4	54	M12x1,5	T	24
	02.05 -	M12x1,5x20, KG60°	24	2	S90-2-12-005		91212005	100/4	54	M12x1,5	T	24
	02.05 -		30	2	S90-2-15-035		91615010	100/4	54	M12x1,5	T	24
	02.05 -		40	2	S90-2-20-023		91620026	100/4	54	M12x1,5	T	24
	02.05 -		50	7	S90-7-25-026		91725026	100/4	54	M12x1,5	T	24
COROLLA (ZZE12_, NDE12_, ZDE12_)												
	11.01 - 02.07		20	6	S90-6-10-017	S33	91610015	100/4	54	M12x1,5	T	15
	11.01 - 02.07		24	6	S90-6-12-001	S33	91212005	100/4	54	M12x1,5	T	15
	11.01 - 02.07		30	6	S90-6-15-041	S33	91615010	100/4	54	M12x1,5	T	15
	11.01 - 02.07		40	4	S90-4-20-011	S9	91420011	100/4	54	M12x1,5	T	15
	11.01 - 02.07		40	6	S90-6-20-032	S33	91620026	100/4	54	M12x1,5	T	15
	11.01 - 02.07		60	4	S90-4-30-021	S9	91430021	100/4	54	M12x1,5	T	15
COROLLA Kombi (E12J_, E12T_)												
COROLLA Estate (E12J_, E12T_)												
	12.01 - 02.07		20	6	S90-6-10-017	S33	91610015	100/4	54	M12x1,5	T	15
	12.01 - 02.07		24	6	S90-6-12-001	S33	91212005	100/4	54	M12x1,5	T	15
	12.01 - 02.07		30	6	S90-6-15-041	S33	91615010	100/4	54	M12x1,5	T	15
	12.01 - 02.07		40	4	S90-4-20-011	S9	91420011	100/4	54	M12x1,5	T	15
	12.01 - 02.07		40	6	S90-6-20-032	S33	91620026	100/4	54	M12x1,5	T	15
	12.01 - 02.07		60	4	S90-4-30-021	S9	91430021	100/4	54	M12x1,5	T	15

Modell Model	Baujahr Year	Original- radschraube (nicht bestellbar) Original Bolt (not available)	Spurweiten- änderung Achse Total track wide- ning (mm)	Eibach System	Artikel-Nr. Part-No.	Hinweise Notes	Kennzeich- nung Stamping	Lockkreis zähl Bolt pattern No. of holes	Zentrierung Centre bore (mm)	Gewinde Thread	Gutachten Homolo- gation	ET-Grenze Offset frontier
TOYOTA												
COROLLA Stufenheck (E12J_, E12T_)												
COROLLA Saloon (E12J_, E12T_)												
	11.01 - 07.07		20	6	S90-6-10-017	S33	91610015	100/4	54	M12x1,5	T	15
	11.01 - 07.07		24	6	S90-6-12-001	S33	91212005	100/4	54	M12x1,5	T	15
	11.01 - 07.07		30	6	S90-6-15-041	S33	91615010	100/4	54	M12x1,5	T	15
	11.01 - 07.07		40	4	S90-4-20-011	S9	91420011	100/4	54	M12x1,5	T	15
	11.01 - 07.07		40	6	S90-6-20-032	S33	91620026	100/4	54	M12x1,5	T	15
	11.01 - 07.07		60	4	S90-4-30-021	S9	91430021	100/4	54	M12x1,5	T	15
COROLLA Verso (ZDE12_, CDE12_)												
	09.01 - 05.04		20	6	S90-6-10-017	S33						

Modell Model	Baujahr Year	Original- radschraube (nicht bestellbar) Original Bolt (not available)	Spurweiten- änderung Achse Total track wide- ning (mm)	Elbch System	Artikel-Nr. Part-No.	Hinweise Notes	Kennzeich- nung Stamping	Lockkreis - zahl Bolt pattern No. of holes	Zentrierung Centre bore (mm)	Gewinde Thread	Gutachten Homo- logation	ET-Grenze Offset frontier
TOYOTA VIOS/YARIS Stufenheck (ZSP9, NCP9) VIOS/YARIS Saloon (ZSP9, NCP9)	08.07 -		20	6	S90-6-10-017	S33	91610015	100/4	54	M12x1,5	\$21	
	08.07 -		24	6	S90-6-12-001	S33	91212005	100/4	54	M12x1,5	\$21	
	08.07 -		30	6	S90-6-15-041	S33	91615010	100/4	54	M12x1,5	\$21	
	08.07 -		40	4	S90-4-20-011	S9	91420011	100/4	54	M12x1,5	\$21	
	08.07 -		40	6	S90-6-20-032	S33	91620026	100/4	54	M12x1,5	\$21	
	08.07 -		60	4	S90-4-30-021	S9	91430021	100/4	54	M12x1,5	\$21	
YARIS (SCP1, NLP1, NCP1)	04.99 - 09.05		20	6	S90-6-10-017	S33	91610015	100/4	54	M12x1,5	T	20
	04.99 - 09.05		24	6	S90-6-12-001	S33	91212005	100/4	54	M12x1,5	T	20
	04.99 - 09.05		30	6	S90-6-15-041	S33	91615010	100/4	54	M12x1,5	T	20
	04.99 - 09.05		40	4	S90-4-20-011	S9	91420011	100/4	54	M12x1,5	T	20
	04.99 - 09.05		40	6	S90-6-20-032	S33	91620026	100/4	54	M12x1,5	T	20
	04.99 - 09.05		60	4	S90-4-30-021	S9	91430021	100/4	54	M12x1,5	T	20
YARIS (SCP9, NSP9, KSP9, NCP9, ZSP9)	11.05 -		20	6	S90-6-10-017	S33	91610015	100/4	54	M12x1,5	\$21	
	11.05 -		24	6	S90-6-12-001	S33	91212005	100/4	54	M12x1,5	\$21	
	11.05 -		30	6	S90-6-15-041	S33	91615010	100/4	54	M12x1,5	\$21	
	11.05 -		40	4	S90-4-20-011	S9	91420011	100/4	54	M12x1,5	\$21	
	11.05 -		40	6	S90-6-20-032	S33	91620026	100/4	54	M12x1,5	\$21	
	11.05 -		60	4	S90-4-30-021	S9	91430021	100/4	54	M12x1,5	\$21	
YARIS (NLP13, NSP13, NCP13, KSP13)	12.10 -		20	6	S90-6-10-017	S33	91610015	100/4	54	M12x1,5	\$21	
	12.10 -		24	6	S90-6-12-001	S33	91212005	100/4	54	M12x1,5	\$21	
	12.10 -		30	6	S90-6-15-041	S33	91615010	100/4	54	M12x1,5	\$21	
	12.10 -		40	4	S90-4-20-011	S9	91420011	100/4	54	M12x1,5	\$21	
	12.10 -		40	6	S90-6-20-032	S33	91620026	100/4	54	M12x1,5	\$21	
	12.10 -		60	4	S90-4-30-021	S9	91430021	100/4	54	M12x1,5	\$21	
VOLKSWAGEN AMAROK	09.10 -	S4-7-14-50-35-19	24	2	S90-2-12-001	S73	91212001	120/5	65	M14x1,5	T	13
	09.10 -	M14x1,5x35, KU r=14	30	2	S90-2-15-034	S73	91215034	120/5	65	M14x1,5	T	13
	09.10 -		40	7	S90-7-20-013	S28, S73	91720013	120/5	65	M14x1,5	T	13
	09.10 -		50	7	S90-7-25-018	S28, S73	91725018	120/5	65	M14x1,5	T	13
	09.10 -		60	7	S90-7-30-056	S73	91730056	120/5	65	M14x1,5	T	13
BEETLE (5C1)	04.11 -	S1-6-14-50-27-17	24	2	S90-2-12-003	S3	91212003	112/5	57	M14x1,5	T	3
	04.11 -	M14x1,5x27, KU r=13	30	2	S90-2-15-013		91215013	112/5	57	M14x1,5	T	3
	04.11 -		40	2	S90-2-20-003		91220003	112/5	57	M14x1,5	T	3
	04.11 -		40	7	S90-7-20-017		91720017	112/5	57	M14x1,5	T	3
	04.11 -		50	7	S90-7-25-005		91725005	112/5	57	M14x1,5	T	3
	04.11 -		60	7	S90-7-30-012		91730012	112/5	57	M14x1,5	T	3
BORA (1J2)	10.98 - 09.05	S1-6-14-50-27-17	10	1	S90-1-05-006	S11	91105006	100/5	57	M14x1,5	T	13
	10.98 - 09.05	M14x1,5x27, KU r=13	16	1	S90-1-08-001	S11	91108001	100/5	57	M14x1,5	T	13
	10.98 - 09.05		30	2	S90-2-15-005		91215005	100/5	57	M14x1,5	T	13
	10.98 - 09.05		40	2	S90-2-20-004		91220004	100/5	57	M14x1,5	T	13
	10.98 - 09.05		50	7	S90-7-25-003		91725003	100/5	57	M14x1,5	T	13
BORA Kombi (1J6) BORA Estate (1J6)	05.99 - 05.05	S1-6-14-50-27-17	10	1	S90-1-05-006	S11	91105006	100/5	57	M14x1,5	T	13
	05.99 - 05.05	M14x1,5x27, KU r=13	16	1	S90-1-08-001	S11	91108001	100/5	57	M14x1,5	T	13
	05.99 - 05.05		30	2	S90-2-15-005		91215005	100/5	57	M14x1,5	T	13
	05.99 - 05.05		40	2	S90-2-20-004		91220004	100/5	57	M14x1,5	T	13
	05.99 - 05.05		50	7	S90-7-25-003		91725003	100/5	57	M14x1,5	T	13
CC (358)	11.11 -	S1-6-14-50-27-17	10	1	S90-1-05-016	S11	91105016	112/5	57	M14x1,5	T	14
	11.11 -	M14x1,5x27, KU r=13	24	2	S90-2-12-003	S63	91212003	112/5	57	M14x1,5	T	14
	11.11 -		30	2	S90-2-15-013		91215013	112/5	57	M14x1,5	T	14
	11.11 -		40	2	S90-2-20-003		91220003	112/5	57	M14x1,5	T	14
	11.11 -		40	7	S90-7-20-017		91720017	112/5	57	M14x1,5	T	14
	11.11 -		40	7	S90-7-20-017		91720017	112/5	57	M14x1,5	T	14
	11.11 -		50	7	S90-7-25-005		91725005	112/5	57	M14x1,5	T	14
	11.11 -		60	7	S90-7-30-012		91730012	112/5	57	M14x1,5	T	14
EOS (1F7, 1F8)	03.06 -	S1-6-14-50-27-17	24	2	S90-2-12-003	S63	91212003	112/5	57	M14x1,5	T	15
	03.06 -	M14x1,5x27, KU r=13	30	2	S90-2-15-013		91215013	112/5	57	M14x1,5	T	15
	03.06 -		40	2	S90-2-20-003		91220003	112/5	57	M14x1,5	T	15
	03.06 -		40	7	S90-7-20-017		91720017	112/5	57	M14x1,5	T	15
	03.06 -		50	7	S90-7-25-005		91725005	112/5	57	M14x1,5	T	15
	03.06 -		60	7	S90-7-30-012		91730012	112/5	57	M14x1,5	T	15
FOX (5Z1, 5Z3)	10.03 -	S1-6-14-50-27-17	10	1	S90-1-05-006	S11	91105006	100/5	57	M14x1,5	T	5
	10.03 -	M14x1,5x27, KU r=13	30	2	S90-2-15-005		91215005	100/5	57	M14x1,5	T	5
	10.03 -		40	2	S90-2-20-004		91220004	100/5	57	M14x1,5	T	5
	10.03 -		50	7	S90-7-25-003		91725003	100/5	57	M14x1,5	T	5
GOLF II (19E, 1G1)	08.83 - 12.92	S1-6-12-50-24-17	10	1	S90-1-05-010	S11	91105010	100/4	57	M12x1,5	T	20
	08.83 - 12.92	M12x1,5x24, KU r=13	16	1	S90-1-08-001	S11	91108001	100/4	57	M12x1,5	T	20
	08.83 - 12.92		30	2	S90-2-15-004	S13	91215004	100/4	57	M12x1,5	T	20
	08.83 - 12.92		40	2	S90-2-20-011		91220011	100/4	57	M12x1,5	T	20
	08.83 - 12.92		50	7	S90-7-25-001	S68	91725001	100/4	57	M12x1,5	T	20
GOLF III (1H1)	08.91 - 07.98	S1-6-12-50-27-17	10	1	S90-1-05-010	S11	91105010	100/4	57	M12x1,5	T	10
	08.91 - 07.98	M12x1,5x27, KU r=13	16	1	S90-1-08-001	S11	91108001	100/4	57	M12x1,5	T	10
	08.91 - 07.98		30	2	S90-2-15-004	S13	91215004	100/4	57	M12x1,5	T	10
	08.91 - 07.98		40	2	S90-2-20-011		91220011	100/4	57	M12x1,5	T	10
	08.91 - 07.98		50	7	S90-7-25-001	S68	91725001	100/4	57	M12x1,5	T	10
GOLF III (1H1)	08.91 - 07.98	S1-6-14-50-27-17	10	1	S90-1-05-006	S11	91105006	100/5	57	M14x1,5	T	10
	08.91 - 07.98	M14x1,5x27, KU r=13	16	1	S90-1-08-001	S11	91108001	100/5	57	M14x1,5	T	10
	08.91 - 07.98		30	2	S90-2-15-005		91215005	100/5	57	M14x1,5	T	10
	08.91 - 07.98		40	2	S90-2-20-004		91220004	100/5	57	M14x1,5	T	10
	08.91 - 07.98		50	7	S90-7-25-003		91725003	100/5	57	M14x1,5	T	10

Modell Model	Baujahr Year	Original- radschraube (nicht bestellbar) Original Bolt (not available)	Spurweiten- änderung Achse Total track wide- ning (mm)	Elbch System	Artikel-Nr. Part-No.	Hinweise Notes	Kennzeich- nung Stamping	Lockkreis - zahl Bolt pattern No. of holes	Zentrierung Centre bore (mm)	Gewinde Thread	Gutachten Homo- logation	ET-Grenze Offset frontier
VOLKSWAGEN GOLF III Cabriolet (1E7)	07.93 - 05.98	S1-6-12-50-27-17	10	1	S90-1-05-010	S11	91105010	100/4	57	M12x1,5	T	10
	07.93 - 05.98	M12x1,5x27, KU r=13	16	1	S90-1-08-001	S11	91108001	100/4	57	M12x1,5	T	10
	07.93 - 05.98		30	2	S90-2-15-004	S13	91215004	100/4	57	M12x1,5	T	10
	07.93 - 05.98		40	2	S90-2-20-011		91220011	100/4	57	M12x1,5	T	10
	07.93 - 05.98		50	7	S90-7-25-001	S68	91725001	100/4	57	M12x1,5	T	10
GOLF III Cabriolet (1E7)	07.93 - 05.98	S1-6-14-50-27-17	10	1	S90-1-05-006	S11	91105006	100/5	57	M14x1,5	T	10
	07.93 - 05.98	M14x1,5x27, KU r=13	16	1	S90-1-08-001	S11	91108001	100/5	57	M1		

Modell Model	Baujahr Year	Original-radschraube (nicht bestellbar) Original Bolt (not available)	Spurweiten-änderung Achse Total track widening (mm)	Eibach System	Artikel-Nr. Part-No.	Hinweise Notes	Kennzeichnung Stamping	Lockkreis - zahl Bolt pattern No. of holes	Zentrierung Centre bore (mm)	Gewinde Thread	Gutachten Homologation	ET-Grenze Offset frontier	
VOLKSWAGEN GOLF VII (5G1)	11.12 -	S1-6-14-50-27-17	20	2	S90-2-10-027	S74	91210027	112/5	57	M14x1,5	T	18	
	11.12 -	M14x1,5x27, KU r=13	24	2	S90-2-12-003		91212003	112/5	57	M14x1,5	T	18	
	11.12 -		30	2	S90-2-15-013		91215013	112/5	57	M14x1,5	T	18	
	11.12 -		40	2	S90-2-20-003		91220003	112/5	57	M14x1,5	T	18	
	11.12 -		40	7	S90-7-20-017		91720017	112/5	57	M14x1,5	T	18	
	11.12 -		50	7	S90-7-25-005		91725005	112/5	57	M14x1,5	T	18	
	11.12 -		60	7	S90-7-30-012		91730012	112/5	57	M14x1,5	T	18	
	GOLF VII Variant (BAS)	04.13 -	S1-6-14-50-27-17	20	2	S90-2-10-027	S74	91210027	112/5	57	M14x1,5	T	18
		04.13 -	M14x1,5x27, KU r=13	24	2	S90-2-12-003		91212003	112/5	57	M14x1,5	T	18
		04.13 -		30	2	S90-2-15-013		91215013	112/5	57	M14x1,5	T	18
		04.13 -		40	2	S90-2-20-003		91220003	112/5	57	M14x1,5	T	18
		04.13 -		40	7	S90-7-20-017		91720017	112/5	57	M14x1,5	T	18
		04.13 -		50	7	S90-7-25-005		91725005	112/5	57	M14x1,5	T	18
JETTA III (1K2)	08.05 - 10.10	S1-6-14-50-27-17	10	1	S90-1-05-016	S11	91105016	112/5	57	M14x1,5	T	17	
	08.05 - 10.10	M14x1,5x27, KU r=13	24	2	S90-2-12-003	S63	91212003	112/5	57	M14x1,5	T	17	
	08.05 - 10.10		30	2	S90-2-15-013		91215013	112/5	57	M14x1,5	T	17	
	08.05 - 10.10		40	2	S90-2-20-003		91220003	112/5	57	M14x1,5	T	17	
	08.05 - 10.10		40	7	S90-7-20-017		91720017	112/5	57	M14x1,5	T	17	
	08.05 - 10.10		50	7	S90-7-25-005		91725005	112/5	57	M14x1,5	T	17	
JETTA IV (162)	04.10 -	S1-6-14-50-27-17	20	2	S90-2-10-027	S74	91210027	112/5	57	M14x1,5	T	17	
	04.10 -	M14x1,5x27, KU r=13	24	2	S90-2-12-003	S63	91212003	112/5	57	M14x1,5	T	17	
	04.10 -		30	2	S90-2-15-013		91215013	112/5	57	M14x1,5	T	17	
	04.10 -		40	2	S90-2-20-003		91220003	112/5	57	M14x1,5	T	17	
	04.10 -		40	7	S90-7-20-017		91720017	112/5	57	M14x1,5	T	17	
	04.10 -		50	7	S90-7-25-005		91725005	112/5	57	M14x1,5	T	17	
LUPO (6X1, 6E1)	09.98 - 07.05	S1-6-12-50-24-17	10	1	S90-1-05-010	S11	91105010	100/4	57	M12x1,5	T	15	
	09.98 - 07.05	M12x1,5x24, KU r=13	16	1	S90-1-08-003	S11	91108003	100/4	57	M12x1,5	T	15	
	09.98 - 07.05		30	2	S90-2-15-004	S13	91215004	100/4	57	M12x1,5	T	15	
	09.98 - 07.05		40	2	S90-2-20-011	S20	91220011	100/4	57	M12x1,5	T	15	
	09.98 - 07.05		50	7	S90-7-25-001	S20, S68	91725001	100/4	57	M12x1,5	T	15	
	MULTIVAN V (7HM, 7HN, 7HF, 7EF, 7EM, 7EN)	04.03 -	S4-7-14-50-35-19	10	1	S90-1-05-027	S19	91105027	120/5	65	M14x1,5	T	21
04.03 -		M14x1,5x35, KU r=14	24	2	S90-2-12-001	S19	91212001	120/5	65	M14x1,5	T	21	
04.03 -			30	2	S90-2-15-034	S19	91215034	120/5	65	M14x1,5	T	21	
04.03 -			40	7	S90-7-20-013	S19, S28	91720013	120/5	65	M14x1,5	T	21	
04.03 -			50	7	S90-7-25-018	S19, S28	91725018	120/5	65	M14x1,5	T	21	
NEW BEETLE (9C1, 1C1)		01.98 -	S1-6-14-50-27-17	10	1	S90-1-05-006	S11	91105006	100/5	57	M14x1,5	T	23
	01.98 -	M14x1,5x27, KU r=13	16	1	S90-1-08-001	S11	91108001	100/5	57	M14x1,5	T	23	
	01.98 -		30	2	S90-2-15-005		91215005	100/5	57	M14x1,5	T	23	
	01.98 -		40	2	S90-2-20-004		91220004	100/5	57	M14x1,5	T	23	
	01.98 -		50	7	S90-7-25-003		91725003	100/5	57	M14x1,5	T	23	
	NEW BEETLE Cabriolet (1V7) NEW BEETLE Convertible (1V7)	09.02 - 10.10	S1-6-14-50-27-17	10	1	S90-1-05-006	S11	91105006	100/5	57	M14x1,5	T	23
09.02 - 10.10		M14x1,5x27, KU r=13	16	1	S90-1-08-001	S11	91108001	100/5	57	M14x1,5	T	23	
09.02 - 10.10			30	2	S90-2-15-005		91215005	100/5	57	M14x1,5	T	23	
09.02 - 10.10			40	2	S90-2-20-004		91220004	100/5	57	M14x1,5	T	23	
09.02 - 10.10			50	7	S90-7-25-003		91725003	100/5	57	M14x1,5	T	23	
PASSAT (3A2, 351)		02.88 - 12.97	S1-6-12-50-24-17	10	1	S90-1-05-010	S11	91105010	100/4	57	M12x1,5	T	18
	02.88 - 12.97	M12x1,5x24, KU r=13	16	1	S90-1-08-003	S11	91108003	100/4	57	M12x1,5	T	18	
	02.88 - 12.97		30	2	S90-2-15-004	S13	91215004	100/4	57	M12x1,5	T	18	
	02.88 - 12.97		40	2	S90-2-20-011		91220011	100/4	57	M12x1,5	T	18	
	02.88 - 12.97		50	7	S90-7-25-001	S68	91725001	100/4	57	M12x1,5	T	18	
	PASSAT (3A2, 351)	02.88 - 12.97	S1-6-14-50-27-17	10	1	S90-1-05-006	S11	91105006	100/5	57	M14x1,5	T	18
02.88 - 12.97		M14x1,5x27, KU r=13	16	1	S90-1-08-001	S11	91108001	100/5	57	M14x1,5	T	18	
02.88 - 12.97			30	2	S90-2-15-005		91215005	100/5	57	M14x1,5	T	18	
02.88 - 12.97			40	2	S90-2-20-004		91220004	100/5	57	M14x1,5	T	18	
02.88 - 12.97			50	7	S90-7-25-003		91725003	100/5	57	M14x1,5	T	18	
PASSAT (3B2)		08.96 - 12.01	S1-6-14-50-27-17	10	1	S90-1-05-016	S11	91105016	100/5	57	M14x1,5	T	30
	08.96 - 12.01	M14x1,5x27, KU r=13	16	1	S90-1-08-001	S11	91108001	100/5	57	M14x1,5	T	30	
	08.96 - 12.01		30	2	S90-2-15-013		91215013	100/5	57	M14x1,5	T	30	
	08.96 - 12.01		40	2	S90-2-20-003		91220003	100/5	57	M14x1,5	T	30	
	08.96 - 12.01		50	7	S90-7-25-003		91725003	100/5	57	M14x1,5	§21	30	
	PASSAT (3B2)	08.96 - 12.01	S1-6-14-50-27-17	10	1	S90-1-05-016	S11	91105016	112/5	57	M14x1,5	T	30
08.96 - 12.01		M14x1,5x27, KU r=13	16	1	S90-1-08-001	S11	91108001	112/5	57	M14x1,5	T	30	
08.96 - 12.01			30	2	S90-2-15-013		91215013	112/5	57	M14x1,5	T	30	
08.96 - 12.01			40	2	S90-2-20-003		91220003	112/5	57	M14x1,5	T	30	
08.96 - 12.01			50	7	S90-7-25-005		91725005	112/5	57	M14x1,5	T	30	
PASSAT (3B3)		11.00 - 05.05	S1-6-14-50-27-17	10	1	S90-1-05-006	S11	91105006	100/5	57	M14x1,5	T	25
	11.00 - 05.05	M14x1,5x27, KU r=13	16	1	S90-1-08-001	S11	91108001	100/5	57	M14x1,5	T	25	
	11.00 - 05.05		30	2	S90-2-15-005		91215005	100/5	57	M14x1,5	T	25	
	11.00 - 05.05		40	2	S90-2-20-004		91220004	100/5	57	M14x1,5	T	25	
	11.00 - 05.05		50	7	S90-7-25-003		91725003	100/5	57	M14x1,5	§21	25	
	PASSAT (3B3)	11.00 - 05.05	S1-6-14-50-27-17	10	1	S90-1-05-016	S11	91105016	112/5	57	M14x1,5	T	25
11.00 - 05.05		M14x1,5x27, KU r=13	24	2	S90-2-12-003		91212003	112/5	57	M14x1,5	T	25	
11.00 - 05.05			30	2	S90-2-15-013		91215013	112/5	57	M14x1,5	T	25	
11.00 - 05.05			40	2	S90-2-20-003		91220003	112/5	57	M14x1,5	T	25	
11.00 - 05.05			50	7	S90-7-25-005		91725005	112/5	57	M14x1,5	T	25	
PASSAT (3B3)		11.00 - 05.05	S1-6-14-50-27-17	10	1	S90-1-05-006	S11	91105006	100/5	57	M14x1,5	T	25
	11.00 - 05.05	M14x1,5x27, KU r=13	16	1	S90-1-08-001	S11	91108001	100/5	57	M14x1,5	T	25	
	11.00 - 05.05		30	2	S90-2-15-005		91215005	100/5	57	M14x1,5	T	25	
	11.00 - 05.05		40	2	S90-2-20-004		91220004	100/5	57	M14x1,5	T	25	
	11.00 - 05.05		50	7	S90-7-25-003		91725003	100/5	57	M14x1,5	T	25	
	PASSAT (3B3)	11.00 - 05.05	S1-6-14-50-27-17	10	1	S90-1-05-016	S11	91105016	112/5	57	M14x1,5	T	25
11.00 - 05.05		M14x1,5x27, KU r=13	24	2	S90-2-12-003		91212003	112/5	57	M14x1,5	T	25	
11.00 - 05.05			30	2	S90-2-15-013		91215013	112/5	57	M14x1,5	T	25	
11.00 - 05.05			40	2	S90-2-20-003		91220003	112/5	57	M14x1,5	T	25	
11.00 - 05.05			50	7	S90-7-25-005		91725005	112/5	57	M14x1,5	T	25	

Modell Model	Baujahr Year	Original-radschraube (nicht bestellbar) Original Bolt (not available)	Spurweiten-änderung Achse Total track widening (mm)	Eibach System	Artikel-Nr. Part-No.	Hinweise Notes	Kennzeichnung Stamping	Lockkreis - zahl Bolt pattern No. of holes	Zentrierung Centre bore (mm)	Gewinde Thread	Gutachten Homologation	ET-Grenze Offset frontier
VOLKSWAGEN PASSAT (3C2)	03.05 -	S1-6-14-50-27-17	10	1	S90-1-05-016	S11	91105016	112/5	57	M14x1,5	T	12
	03.05 -	M14x1,5x27, KU r=13	24	2	S90-2-12-003							

Modell Model	Baujahr Year	Original-radschraube (nicht bestellbar) Original Bolt (not available)	Spurweiten-änderung Achse Total track width-ning (mm)	Eibach System	Artikel-Nr. Part-No.	Hinweise Notes	Kennzeichnung Stamping	Lockkreis - zahl Bolt pattern No. of holes	Zentrierung Centre bore (mm)	Gewinde Thread	Gutachten Homologation	ET-Grenze Offset frontier
VOLKSWAGEN												
POLO (9N_)												
	10.01 - 11.09	S1-6-14-50-27-17	10	1	S90-1-05-006	S11	91105006	100/5	57	M14x1,5	T	20
	10.01 - 11.09	M14x1,5x27, KU r=13	16	1	S90-1-08-001	S11	91108001	100/5	57	M14x1,5	T	20
	10.01 - 11.09		30	2	S90-2-15-005		91215005	100/5	57	M14x1,5	T	20
	10.01 - 11.09		40	2	S90-2-20-004		91220004	100/5	57	M14x1,5	T	20
	10.01 - 11.09		50	7	S90-7-25-003		91725003	100/5	57	M14x1,5	T	20
POLO (6R_)												
	06.09 -	S1-6-14-50-27-17	24	2	S90-2-12-013	S3	91212013	100/5	57	M14x1,5	T	8
	06.09 -	M14x1,5x27, KU r=13	30	2	S90-2-15-005		91215005	100/5	57	M14x1,5	T	8
	06.09 -		40	2	S90-2-20-004		91220004	100/5	57	M14x1,5	T	8
	06.09 -		40	7	S90-7-20-028		91720028	100/5	57	M14x1,5	T	8
	06.09 -		50	7	S90-7-25-003		91725003	100/5	57	M14x1,5	T	8
	06.09 -		60	7	S90-7-30-027		91730027	100/5	57	M14x1,5	T	8
POLO CLASSIC (6KV2)												
	11.95 - 07.02	S1-6-12-50-24-17	10	1	S90-1-05-010	S11	91105010	100/4	57	M12x1,5	\$21	
	11.95 - 07.02	M12x1,5x24, KU r=13	16	1	S90-1-08-003	S11	91108003	100/4	57	M12x1,5	\$21	
	11.95 - 07.02		30	2	S90-2-15-004	S13	91215004	100/4	57	M12x1,5	\$21	
	11.95 - 07.02		40	2	S90-2-20-011		91220011	100/4	57	M12x1,5	\$21	
	11.95 - 07.02		50	7	S90-7-25-001	S68	91725001	100/4	57	M12x1,5	\$21	
POLO Kasten (6NF)												
POLO Box (6NF)												
	09.94 - 12.99	S1-6-12-50-24-17	10	1	S90-1-05-010	S11	91105010	100/4	57	M12x1,5	T	5
	09.94 - 12.99	M12x1,5x24, KU r=13	16	1	S90-1-08-003	S11	91108003	100/4	57	M12x1,5	T	5
	09.94 - 12.99		30	2	S90-2-15-004	S13	91215004	100/4	57	M12x1,5	T	5
	09.94 - 12.99		40	2	S90-2-20-011		91220011	100/4	57	M12x1,5	T	5
	09.94 - 12.99		50	7	S90-7-25-001	S68	91725001	100/4	57	M12x1,5	T	5
POLO Stufenheck (9A4)												
POLO Saloon (9A4)												
	09.02 -	S1-6-14-50-27-17	10	1	S90-1-05-006	S11	91105006	100/5	57	M14x1,5	T	20
	09.02 -	M14x1,5x27, KU r=13	16	1	S90-1-08-001	S11	91108001	100/5	57	M14x1,5	T	20
	09.02 -		30	2	S90-2-15-005		91215005	100/5	57	M14x1,5	T	20
	09.02 -		40	2	S90-2-20-004		91220004	100/5	57	M14x1,5	T	20
	09.02 -		50	7	S90-7-25-003		91725003	100/5	57	M14x1,5	T	20
POLO Stufenheck												
POLO Saloon												
	05.09 -	S1-6-14-50-27-17	24	2	S90-2-12-013	S3	91212013	100/5	57	M14x1,5	T	8
	05.09 -	M14x1,5x27, KU r=13	30	2	S90-2-15-005		91215005	100/5	57	M14x1,5	T	8
	05.09 -		40	2	S90-2-20-004		91220004	100/5	57	M14x1,5	T	8
	05.09 -		40	7	S90-7-20-028		91720028	100/5	57	M14x1,5	T	8
	05.09 -		50	7	S90-7-25-003		91725003	100/5	57	M14x1,5	T	8
	05.09 -		60	7	S90-7-30-027		91730027	100/5	57	M14x1,5	T	8
POLO Variant (6KV5)												
	04.97 - 09.01	S1-6-12-50-24-17	10	1	S90-1-05-010	S11	91105010	100/4	57	M12x1,5	\$21	
	04.97 - 09.01	M12x1,5x24, KU r=13	16	1	S90-1-08-003	S11	91108003	100/4	57	M12x1,5	\$21	
	04.97 - 09.01		30	2	S90-2-15-004	S13	91215004	100/4	57	M12x1,5	\$21	
	04.97 - 09.01		40	2	S90-2-20-011		91220011	100/4	57	M12x1,5	\$21	
	04.97 - 09.01		50	7	S90-7-25-001	S68	91725001	100/4	57	M12x1,5	\$21	
SCIROCCO (137)												
	05.08 -	S1-6-14-50-27-17	24	2	S90-2-12-003		91212003	112/5	57	M14x1,5	T	11
	05.08 -	M14x1,5x27, KU r=13	30	2	S90-2-15-013		91215013	112/5	57	M14x1,5	T	11
	05.08 -		40	2	S90-2-20-003		91220003	112/5	57	M14x1,5	T	11
	05.08 -		40	7	S90-7-20-017		91720017	112/5	57	M14x1,5	T	11
	05.08 -		50	7	S90-7-25-005		91725005	112/5	57	M14x1,5	T	11
	05.08 -		60	7	S90-7-30-012		91730012	112/5	57	M14x1,5	T	11
SHARAN (7M8, 7M9, 7M6)												
	05.95 - 03.10	S4-7-14-50-37-19	10	1	S90-1-05-016	S11	91105016	112/5	57	M14x1,5	T	30
	05.95 - 03.10	M14x1,5x37, KU r=14	30	2	S90-2-15-013		91215013	112/5	57	M14x1,5	T	30
	05.95 - 03.10		40	2	S90-2-20-003		91220003	112/5	57	M14x1,5	T	30
	05.95 - 03.10		50	7	S90-7-25-028	S68	91725005	112/5	57	M14x1,5	T	30
SHARAN (7N)												
	05.10 -	S1-6-14-50-27-17	24	2	S90-2-12-003	S63	91212003	112/5	57	M14x1,5	T	5
	05.10 -	M14x1,5x27, KU r=13	30	2	S90-2-15-013		91215013	112/5	57	M14x1,5	T	5
	05.10 -		40	2	S90-2-20-003		91220003	112/5	57	M14x1,5	T	5
	05.10 -		40	7	S90-7-20-017		91720017	112/5	57	M14x1,5	T	5
	05.10 -		50	7	S90-7-25-005		91725005	112/5	57	M14x1,5	T	5
	05.10 -		60	7	S90-7-30-012		91730012	112/5	57	M14x1,5	T	5
TIGUAN (5N_)												
	09.07 -	S1-6-14-50-27-17	24	2	S90-2-12-003		91212003	112/5	57	M14x1,5	T	3
	09.07 -	M14x1,5x27, KU r=13	30	2	S90-2-15-013		91215013	112/5	57	M14x1,5	T	3
	09.07 -		40	2	S90-2-20-003		91220003	112/5	57	M14x1,5	T	3
	09.07 -		40	7	S90-7-20-017		91720017	112/5	57	M14x1,5	T	3
	09.07 -		50	7	S90-7-25-005		91725005	112/5	57	M14x1,5	T	3
	09.07 -		60	7	S90-7-30-012		91730012	112/5	57	M14x1,5	T	3
TOUAREG (7LA, 7L6, 7L7)												
	10.02 - 05.10	S4-7-14-50-35-19	10	1	S90-1-05-027		91105027	120/5	65	M14x1,5	T	21
	10.02 - 05.10	M14x1,5x35, KU r=14	24	2	S90-2-12-001		91212001	120/5	65	M14x1,5	T	21
	10.02 - 05.10		30	2	S90-2-15-034		91215034	120/5	65	M14x1,5	T	21
	10.02 - 05.10		40	7	S90-7-20-013	S28	91720013	120/5	65	M14x1,5	T	21
	10.02 - 05.10		50	7	S90-7-25-018	S28	91725018	120/5	65	M14x1,5	T	21
TOUAREG (7LA, 7L6, 7L7)												
	10.02 - 05.10	S4-7-14-50-35-19	14	2	S90-2-07-001	S2	91207001	130/5	71,5	M14x1,5	T	30
	10.02 - 05.10	M14x1,5x35, KU r=14	30	2	S90-2-15-018	S2	91215018	130/5	71,5	M14x1,5	T	30
	10.02 - 05.10		36	2	S90-2-18-001	S2	91218001	130/5	71,5	M14x1,5	T	30
	10.02 - 05.10		46	2	S90-2-23-001	S2	91223001	130/5	71,5	M14x1,5	T	30
TOUAREG (7P5)												
	01.10 -	S4-7-14-50-36-19	14	2	S90-2-07-001		91207001	130/5	71,5	M14x1,5	T	25
	01.10 -	M14x1,5x36, KU r=14	30	2	S90-2-15-018		91215018	130/5	71,5	M14x1,5	T	25
	01.10 -		36	2	S90-2-18-001		91218001	130/5	71,5	M14x1,5	T	25
	01.10 -		36	7	S90-7-18-002	S46	91718001	130/5	71,5	M14x1,5	T	25
	01.10 -		42	7	S90-7-21-007	S46	91721001	130/5	71,5	M14x1,5	T	25
	01.10 -		46	2	S90-2-23-001		91223001	130/5	71,5	M14x1,5	T	25
	01.10 -		46	7	S90-7-23-002	S46	91723001	130/5	71,5	M14x1,5	T	25
	01.10 -		50	7	S90-7-25-050	S46	91725050	130/5	71,5	M14x1,5	T	25
TOURAN (1T1, 1T2)												
	02.03 - 05.10	S1-6-14-50-27-17	10	1	S90-1-05-016	S6, S11	91105016	112/5	57	M14x1,5	T	17
	02.03 - 05.10	M14x1,5x27, KU r=13	24	2	S90-2-12-003	S63	91212003	112/5	57	M14x1,5	T	17
	02.03 - 05.10		30	2	S90-2-15-013		91215013	112/5	57	M14x1,5	T	17
	02.03 - 05.10		40	2	S90-2-20-003		91220003	112/5	57	M14x1,5	T	17
	02.03 - 05.10		40	7	S90-7-20-017		91720017	112/5	57	M14x1,5	T	17
	02.03 - 05.10		50	7	S90-7-25-005		91725005	112/5	57	M14x1,5	T	17
	02.03 - 05.10		60	7	S90-7-30-012		91730012	112/5	57	M14x1,5	T	17

Modell Model	Baujahr Year	Original-radschraube (nicht bestellbar) Original Bolt (not available)	Spurweiten-änderung Achse Total track wide-ning (mm)	Eibach System	Artikel-Nr. Part-No.	Hinweise Notes	Kennzeichnung Stamping	Lockkreis - zahl Bolt pattern No. of holes	Zentrierung Centre bore (mm)	Gewinde Thread	Gutachten Homologation	ET-Grenze Offset frontier
----------------	----------------	---	--	---------------	------------------------	------------------	--------------------------	--	--------------------------------	------------------	--------------------------	-----------------------------

Modell Model	Baujahr Year	Original-radschraube (nicht bestellbar) Original Bolt (not available)	Spurweiten-änderung Total track widening (mm)	Eibach System	Artikel-Nr. Part-No.	Hinweise Notes	Kennzeichnung Stamping	Lochkreis -zahl Bolt pattern No. of holes	Zentrierung Centre bore (mm)	Gewinde Thread	Gutachten Homologation	ET-Grenze Offset, frontier
VOLVO S60	07.00 - 04.10	S1-1-14-50-33-19	10	1	S90-1-05-020	S12	91105020	108/5	65	M14x1,5	T	28
	07.00 - 04.10	M14x1,5x33, KG60°	20	2	S90-2-10-012	S21	91210012	108/5	65	M14x1,5	T	28
	07.00 - 04.10		30	2	S90-2-15-016	S21	91215016	108/5	65	M14x1,5	T	28
S70 (P80.)	11.96 - 11.00	S1-1-12-75-29-19	10	1	S90-1-05-012	S21	91105012	108/4	65	M12x1,75	§21	
	11.96 - 11.00	M12x1,75x29, KG60°	30	2	S90-2-15-008	S21	91215008	108/4	65	M12x1,75	§21	
S70 (P80.)	11.96 - 11.00	S1-1-12-75-29-19	10	1	S90-1-05-020	S21	91105020	108/5	65	M12x1,75	T	28
	11.96 - 11.00	M12x1,75x29, KG60°	20	2	S90-2-10-012	S21	91210012	108/5	65	M12x1,75	T	28
	11.96 - 11.00		30	2	S90-2-15-016	S21	91215016	108/5	65	M12x1,75	T	28
S80 I (TS, XY)	05.98 - 07.06	S1-1-14-50-33-19	10	1	S90-1-05-020	S21	91105020	108/5	65	M14x1,5	T	19
	05.98 - 07.06	M14x1,5x33, KG60°	20	2	S90-2-10-012	S21	91210012	108/5	65	M14x1,5	T	19
	05.98 - 07.06		30	2	S90-2-15-016	S21	91215016	108/5	65	M14x1,5	T	19
S80 II (AS)	03.06 -	S1-1-14-50-33-19	20	2	S90-2-10-022		91610014	108/5	63,3	M14x1,5	§21	
	03.06 -	M14x1,5x33, KG60°	30	2	S90-2-15-048		91615011	108/5	63,3	M14x1,5	§21	
S90	11.96 - 12.98	S1-1-12-75-29-19	10	1	S90-1-05-020	S21	91105020	108/5	65	M12x1,75	§21	
	11.96 - 12.98	M12x1,75x29, KG60°	20	2	S90-2-10-012	S21	91210012	108/5	65	M12x1,75	§21	
	11.96 - 12.98		30	2	S90-2-15-016	S21	91215016	108/5	65	M12x1,75	§21	
V40 Schrägheck V40 Hatchback	03.12 -		30	4	S90-4-15-005	S9	91415005	108/5	63,3	M12x1,5	T	30
	03.12 -		40	4	S90-4-20-008	S9	91420008	108/5	63,3	M12x1,5	T	30
	03.12 -		50	4	S90-4-25-022	S9	91425022	108/5	63,3	M12x1,5	§21	30
V50 (MW)	04.04 -		30	4	S90-4-15-005	S9	91415005	108/5	63,3	M12x1,5	T	27,5
	04.04 -		40	4	S90-4-20-008	S9	91420008	108/5	63,3	M12x1,5	T	27,5
	04.04 -		50	4	S90-4-25-022	S9	91425022	108/5	63,3	M12x1,5	T	27,5
V70 I (P80.)	11.96 - 05.00	S1-1-12-75-29-19	10	1	S90-1-05-012	S21	91105012	108/4	65	M12x1,75	§21	
	11.96 - 05.00	M12x1,75x29, KG60°	30	2	S90-2-15-008	S21	91215008	108/4	65	M12x1,75	§21	
V70 I (P80.)	11.96 - 05.00	S1-1-12-75-29-19	10	1	S90-1-05-020	S21	91105020	108/5	65	M12x1,75	T	28
	11.96 - 05.00	M12x1,75x29, KG60°	20	2	S90-2-10-012	S21	91210012	108/5	65	M12x1,75	T	28
	11.96 - 05.00		30	2	S90-2-15-016	S21	91215016	108/5	65	M12x1,75	T	28
V70 II (P80.)	03.00 - 08.07	S1-1-14-50-33-19	10	1	S90-1-05-020	S21	91105020	108/5	65	M14x1,5	T	28
	03.00 - 08.07	M14x1,5x33, KG60°	20	2	S90-2-10-012	S21	91210012	108/5	65	M14x1,5	T	28
	03.00 - 08.07		30	2	S90-2-15-016	S21	91215016	108/5	65	M14x1,5	T	28
V90 Kombi V90 Estate	11.96 - 12.98	S1-1-12-75-29-19	10	1	S90-1-05-020	S21	91105020	108/5	65	M12x1,75	§21	
	11.96 - 12.98	M12x1,75x29, KG60°	20	2	S90-2-10-012	S21	91210012	108/5	65	M12x1,75	§21	
	11.96 - 12.98		30	2	S90-2-15-016	S21	91215016	108/5	65	M12x1,75	§21	
XC70 CROSS COUNTRY	11.97 - 08.07	S1-1-14-50-33-19	10	1	S90-1-05-020	S21	91105020	108/5	65	M14x1,5	T	28
	11.97 - 08.07	M14x1,5x33, KG60°	20	2	S90-2-10-012	S21	91210012	108/5	65	M14x1,5	T	28
	11.97 - 08.07		30	2	S90-2-15-016	S21	91215016	108/5	65	M14x1,5	T	28
XC90	10.02 -	S4-1-14-50-33-19	30	2	S90-2-15-033		91215033	108/5	67	M14x1,5	T	19
	10.02 -	M14x1,5x33, KG60°	50	7	S90-7-25-017		91725017	108/5	67	M14x1,5	T	19
	10.02 -		60	7	S90-7-30-008		91730008	108/5	67	M14x1,5	T	19



MICHAEL LEWIS | FIA F3 EUROPEAN CHAMPIONSHIP



Powered by BMW N54TU

EINSER M

Eibach

17

HOCKENHEIM 4.574 (GER)
SILVERSTONE 5.891 (GBR)
LA SARTHE 13.629 (FRA)
MONZA 5.793 (ITA)
NÜRBURGRING NORDSCHLEIFE 20.832 (GER)

SSR
SPA-FRANCOCHAMPS 7.004 (BEL) CIRCUIT OF THE AMERICAS 5.516 (USA)

HINWEISE

A - Allgemeine Hinweise	Für die Artikel- / Fahrzeugzuordnung sind die Angaben im TÜV-Gutachten oder der ABE maßgeblich. Hierzu ist u.a. die EG-Betriebslaubnisnummer (Punk „K“ im Fahrzeugschein oder auf dem Typenschild des Fahrzeugs zu finden!) mit den Angaben im Gutachten vergleichen. Bitte prüfen Sie vor der Montage mittels Teilegutachten / ABE, ob die gelieferten Artikel (siehe Teilkennzeichnung) für Ihr Fahrzeug (siehe Verwendungsbereich) zugelassen sind. Die aktuellen Teilegutachten / ABE'sen finden Sie unter www.eibach.com . Bei Abweichungen dürfen die Teile nicht eingebaut werden – bitte wenden Sie sich in diesem Fall an den Verkäufer. Wir empfehlen den Einbau unserer Produkte nur in einer qualifizierten Werkstatt durchführen zu lassen, die über entsprechendes geschultes Personal sowie die benötigten Spezialwerkzeuge verfügt. Die Einbaulage können Sie an der Bedruckung „ablesen“ – lassen Sie die Feder so einbauen, dass Sie die Bedruckung lesen können. - Die Nummer darf nicht "auf dem Kopf stehen". Nach erfolgter Montage der Feder/Fahrwerkskomponenten ist zwingend eine Überprüfung der Radeinstellwerte notwendig . Sollten die Serienstoßdämpfer nicht mehr voll funktionsfähig sein und spürbar in ihrer Wirkung nachgelassen haben, empfehlen wir unbedingt den Austausch gegen neue Serienstoßdämpfer oder Sportstoßdämpfer . Bei Sportline Federn empfehlen wir den Einbau von Sportstoßdämpfern wie z.B. Bilstein B8 . Es sind alle Räder/Reifenkombinationen verwendbar, die von den Rädertypprüfstellen freigegeben sind. Die Auflagen im Rädergutachten bzw. Räder-ABE sind einzuhalten , mit Ausnahme der Forderung nach Serienfahrwerk. Je nach Motorisierung, Getriebe, Ausstattung und Toleranzen des Fahrzeuges kann die Tieferlegung um einige mm von den angegebenen Werten abweichen. Das Maß der Tieferlegung reduziert sich um das Maß der werkseitigen Tieferlegung. Die Verwendbarkeit unserer Produkte bezieht sich auf serienbelassene Fahrzeuge. Bei Umbauten wie z.B. dem Einbau einer LPG-Anlage etc. können unsere Produkte nicht verwendet werden. Die angegebenen Maße beziehen sich auf serienbelassene Neufahrzeuge. Messpunkte: Senkrechter Abstand von Mitte der Radnabe bis zur Kotflügelunterkante. Grundsätzlich sind die angegebenen Maße Sollwerte, welche je nach Fahrzeug variieren können.																										
7.	Die werkseitig verbauten Federteller sind in den Stärken 8-23 mm in DB-Fachwerkstätten erhältlich. Hierdurch kann die hier angegebene Tieferlegung variiert werden.																										
9.	Bei Bereifung 205/50/15 und Felge 7 J x 15 - Empfehlung: Montage von bauartgleichen Sport-Gasdruckstoßdämpfern.																										
10.	Lieferung in Deutschland nur über besonderen Vertriebspartner. Bei Bedarf bitte Bezugsquelle bei unserer Zentralverwaltung anfragen.																										
12.	Nicht verwendbar bei werkseitiger Tieferlegung. (OE-Sportfahrwerk)																										
15.	Ohne Vollausstattung.																										
16.	Die hier berücksichtigte Sonderausstattung beinhaltet folgendes Punktesystem: <table border="0"> <tr> <td>Klimaanlage</td> <td>7 Punkte</td> </tr> <tr> <td>Automatikgetriebe (4 + 5 Zyl.)</td> <td>4 Punkte</td> </tr> <tr> <td>Automatikgetriebe (6 Zyl.)</td> <td>2 Punkte</td> </tr> <tr> <td>Zusatzheizung</td> <td>3 Punkte</td> </tr> <tr> <td>Schiebedach</td> <td>2 Punkte</td> </tr> <tr> <td>ABS</td> <td>2 Punkte</td> </tr> <tr> <td>Airbag</td> <td>1 Punkt</td> </tr> <tr> <td>Scheinwerferreinigungsanlage</td> <td>1 Punkt</td> </tr> <tr> <td>Motorschutz</td> <td>1 Punkt</td> </tr> <tr> <td>Elektronische Sitzverstellung</td> <td>2 Punkte</td> </tr> </table> Ergeben sich aus der Zusammenstellung der Zusatzausstattung mehr als 4 Zusatzpunkte, ist der Tieferlegungsatz für Fahrzeuge mit Sonderausstattung zu verwenden. Die Wahl der Gummiunterlagen ergibt sich aus der folgende Tabelle: <table border="0"> <tr> <td>Bis einschließlich 7 Punkte</td> <td>8 mm (1 Noppe)</td> </tr> <tr> <td>Bis einschließlich 13 Punkte</td> <td>13 mm (2 Noppen)</td> </tr> <tr> <td>Bis einschließlich 21 Punkte</td> <td>23 mm (4 Noppen)</td> </tr> </table> Mehr als 21 Punkte Der Tieferlegungsatz ist nicht für diese Version geeignet.	Klimaanlage	7 Punkte	Automatikgetriebe (4 + 5 Zyl.)	4 Punkte	Automatikgetriebe (6 Zyl.)	2 Punkte	Zusatzheizung	3 Punkte	Schiebedach	2 Punkte	ABS	2 Punkte	Airbag	1 Punkt	Scheinwerferreinigungsanlage	1 Punkt	Motorschutz	1 Punkt	Elektronische Sitzverstellung	2 Punkte	Bis einschließlich 7 Punkte	8 mm (1 Noppe)	Bis einschließlich 13 Punkte	13 mm (2 Noppen)	Bis einschließlich 21 Punkte	23 mm (4 Noppen)
Klimaanlage	7 Punkte																										
Automatikgetriebe (4 + 5 Zyl.)	4 Punkte																										
Automatikgetriebe (6 Zyl.)	2 Punkte																										
Zusatzheizung	3 Punkte																										
Schiebedach	2 Punkte																										
ABS	2 Punkte																										
Airbag	1 Punkt																										
Scheinwerferreinigungsanlage	1 Punkt																										
Motorschutz	1 Punkt																										
Elektronische Sitzverstellung	2 Punkte																										
Bis einschließlich 7 Punkte	8 mm (1 Noppe)																										
Bis einschließlich 13 Punkte	13 mm (2 Noppen)																										
Bis einschließlich 21 Punkte	23 mm (4 Noppen)																										
18.	Außer Fahrzeuge mit Niveauregulierung.																										
19.	Bei Fahrzeugen mit 6-Zylinder-Motoren ist eine Umrüstung auf Sport-Dämpfer erforderlich.																										
20.	Außer Fahrzeuge mit Allrad-/4WD- Antrieb.																										
21.	Außer Fahrzeuge mit elektronisch geregelter Dämpferkraftverstellung.																										
22.	In Verbindung mit Eibach Federn oder Originalfahrwerk.																										
23.	Vorder- und Hinterachse höhenverstellbar durch Gewindefederbeine																										
24.	Vorderachse höhverstellbar durch Gewindefederbeine, Hinterachse durch Höhenverstellheit																										
25.	Um eine ausreichende Freigängigkeit zu gewährleisten, sind bei Verwendung der serienmäßigen Rad-/Reifenkombinationen ggf. Distanzscheiben erforderlich.																										
26.	Für eine Tieferlegung von mehr als 40 mm und einem Durchmesser der rechten Antriebswelle größer als 42 mm, muss eventl. der Serienstabilisator ausgetauscht werden. Der hier für erforderliche Stabilisatorsatz ist unter der Eibach Teile-Nr.: E40-85-005-01-10 im gut sortierten Fachhandel erhältlich.																										
28.	Nur für Fahrzeuge mit elektronischer Fahrstabilitätskontrolle																										
30.	Höhenverstellung nur im Bereich der im gemäß TÜV-Teilegutachten angegebenen Werte.																										
31.	Nur für Fahrzeuge mit ABC-Fahrwerken.																										
32.	Ausgenommen die Sondermodelle "Sportiv" und "Sport" (Fahrzeuge mit Bilstein-Dämpfer)																										
33.	Solange der Vorrat reicht!																										
34.	Nur für Fahrzeuge mit einem Federbeindurchmesser an der Vorderachse von 55 mm																										
35.	Nur für Fahrzeuge mit einem Federbeindurchmesser an der Vorderachse von 50 mm																										

36.	Für Fahrzeuge mit EDC sind zusätzliche Anbauteile des KFZ-Herstellers notwendig: für die Vorderachse: BMW-Teile-Nr.: Domlager 31 331 091 709 + Scheibe 31 331 116 983 + Manschette 31 331 110 196 für die Hinterachse: BMW-Teile-Nr.: Stützlager 33 521 091 710 + Stütztopf 33 521 090 282 + Scheibe 33 521 092 986 + Schutzrohr 31 331 137 932 + Elastomere 33 531 091 031
37.	Nur Vorderachse höhverstellbar durch Gewindefederbeine, Hinterachse Federn + Dämpfer
38.	Nur Vorderachse höhverstellbar durch Gewindefederbeine, Hinterachse Dämpfer
39.	Bei Ausführungen ab Baujahr 04.2002 ist die Befestigung der Kolbenstange vertieft und durch eine Abdeckklappe verdeckt (Kolbenstangengewinde nicht sichtbar)
42.	Der federwegabhängige Bremsdruckregler an der Hinterachse muss gemäß den Vorgaben des Werkstatthandbuchs überprüft und ggf. neu eingestellt werden.
43.	Der Niveaudämpfer an der Hinterachse ist gegen den Seriedämpfer der Limousine (MMC-Teile-Nr.: MR 235612) oder dem Dämpfer des Herstellers KONI, Typ 8040-1234 SPORT auszutauschen. Die Original-Endanschläge werden beibehalten.
44.	Die Dämpfer der HA sind durch die mitgelieferten Dämpfer auszutauschen.
45.	Gegebenenfalls sind für den Einbau der Fahrwerkskomponenten zusätzliche Originalteile erforderlich, die nicht im Lieferumfang enthalten sind. Bitte beachten Sie hierzu die entsprechenden technischen Dokumente (Teilegutachten, Einbauanleitung), die Sie auf unserer Homepage einsehen können.
46.	Ohne Modellvariante STOWN GO
47.	Die Dämpfer der HA sind durch konventionelle Dämpfer auszutauschen.
48.	Bei Fahrzeugen mit Niveaudämpfern (Kennzeichnung 2R oder 4R) an der HA müssen diese ausgewechselt werden gegen serienmäßige Dämpfer mit der Kennzeichnung 1U oder 3U, Teilenummer: 96 80 99 98, - Katalognummer 48 06 443.
49.	Nur für Fahrzeuge mit Allradantrieb!
50.	Nur für Fahrzeuge mit einem Klemmdurchmesser am Federbein an der Vorderachse von 51 mm
51.	Lieferung in Deutschland nur über besonderen Vertriebspartner. Bei Bedarf bitte die Fa. Hansen Styling Parts, Tel.: 04347/706970, kontaktieren.
52.	Nur für Fahrzeuge mit Einblattfederung.
53.	Nur für Fahrzeuge mit Zweiblattfederung und Einblatt mit Unterlage.
54.	Bei Fahrzeugen mit Fahrzeugklasse M1G nur dann zulässig, wenn deren Fahrgeräusch 74 dB(A) nicht überschreitet. Die Fahrzeugklasse ist dann in M1 zu ändern.
56.	Bei Fahrzeugen mit kombiniertem Nebelscheinwerfer und Begrenzungsleuchte ist zu überprüfen, ob der untere Rand des Scheinwerfers tiefer als 350 mm über dem Boden liegt. Ist dies der Fall, so müssen zusätzliche Begrenzungsleuchten oberhalb dieses Maßes angebracht werden. Die serienmäßigen Begrenzungsleuchten sind dann durch Entfernen der Glühbirne und Lösen der Kabelverbindung außer Betrieb zu setzen.
57.	Nur für Fahrzeuge mit 15 Zoll Serienbereifung.
58.	nicht geeignet für Modellvariante "Cross"
59.	Nur für Fahrzeuge mit folgenden Eigenschaften: VA: Stahlfeder, HA: Niveauregulierung.
60.	nicht geeignet für Ausführung Colt Rallyart ab 2009
61.	Federbeinbefestigung mit M14 Schraube (4-Loch Radbefestigung)
62.	Federbeinbefestigung mit M16 Schraube (5-Loch Radbefestigung)
63.	ab Nachtrag 14
64.	Bitte Fahrgestell-Nr. überprüfen: dieser Kit passt bei: 10.Stelle = Zahl (..., 8, 9)
65.	Bitte Fahrgestell-Nr. überprüfen: dieser Kit passt bei: 10.Stelle = Buchstabe (A, B, ...)
66.	für Ausführung 5-Sitzer
67.	für Ausführung 7-Sitzer
68.	Erhöhte Achslast bei Anhänger-Betrieb (siehe Teilegutachten).
69.	Liegt eine Einzel-Betriebslaubnis vor, ist eine Abnahme nach §19/2 StVZO erforderlich.
70.	Bei Fahrzeugen mit elektronischer Dämpferregelung ist diese zu deaktivieren.
71.	nicht geeignet für Ausführung 1.6 Racing (D53)
72.	Lieferung in Deutschland nur über besonderen Vertriebspartner. Bei Bedarf bitte das Autohaus Haese, Tel.: 06134/182950, kontaktieren.
73.	für Fahrzeuge mit Frontantrieb
74.	Serienfederteller muss benutzt werden
75.	ohne AC (ohne Klimaanlage)
76.	Dämpfer mit Bohrung für Gewindemaß M12
77.	Außendurchmesser Federbein vorne 45 mm
78.	Aufgrund der Verwendung der Gasdruck-Technologie der B6 / B8 Dämpfer kann das Maß der Tieferlegung fahrzeugspezifisch geringfügig abweichen.
79.	für Schraubenfeder mit Innendurchmesser 116 mm
80.	für Schraubenfeder mit Innendurchmesser 106 mm
81.	für Fahrzeuge ohne 3. Sitzreihe
82.	Abstand der Befestigungsbohrungen vorne: 58 mm
83.	Abstand der Befestigungsbohrungen vorne: 75 mm
84.	nicht geeignet für Fahrzeuge mit Xenonlicht (kein Halter für Höhenstandsgeber der Leuchtweitenregulierung am Dämpfer)
85.	Dämpfer mit Bohrung für Gewindemaß M16
86.	für Ausführung mit kurzem Radstand
87.	nur für Fahrzeuge ohne Schlechtwegeausführung

HINWEISE

88.	für Ausführung mit Standardfahrwerk
89.	Dämpfer mit Bohrung für Gewindemaß M10
90.	Dämpfer mit Bohrung für Gewindemaß M14
91.	Für Ausführungen mit Trommelbremse
92.	Für Ausführungen mit Scheibenbremse
93.	nur für Fahrzeuge mit Basisachse
94.	nur für Fahrzeuge mit Plusachse
95.	nur für verschraubte Federbeine
96.	ohne ABS
97.	nicht geeignet für Ausstattungsvariante 1BH - Schlechtwegepaket
98.	für Fahrzeuge mit Schraubenfederung
99.	Außendurchmesser Federbein vorne 47 mm
101.	Bei Verwendung des Fahrwerks entfällt die Funktionalität der elektronischen Dämpferregelung. - Die im Bordcomputer angezeigte Fehlermeldung kann durch eine Vertragswerkstatt abgestellt werden.
102.	Für Wohnmobilausführungen
103.	bis Fahrgestellnummer: 200011 ; bis Fahrgestellnummer: 3B-YE121222
104.	bis Fahrgestellnummer: 3B-YE121221
105.	bis Fahrgestellnummer: 3B-YE121222
106.	bis Fahrgestellnummer: 41999999
107.	bis Fahrgestellnummer: 48999999
108.	bis Fahrgestellnummer: 4B-Y-200000
109.	bis Fahrgestellnummer: 4D-Y-020000
110.	bis Fahrgestellnummer: 8D-1-030000
111.	bis Fahrgestellnummer: 8D-1-030001
112.	bis Fahrgestellnummer: 8D-X-200000
113.	bis Fahrgestellnummer: 8E-2-400 000
114.	bis Fahrgestellnummer: 8E-5-400 000
115.	bis Fahrgestellnummer: 8E-7-400 000
116.	bis Fahrgestellnummer: A394035
117.	bis Fahrgestellnummer: YS3E55CD1
118.	Baumuster: Avantgarde
119.	Baumuster: Avantgarde, Elegance
120.	nicht Baumuster JC Works GP
121.	nicht Baumuster "il"
122.	Baumuster: G02
123.	Baumuster: G02, GT, GTI
124.	Baumuster: G07, G08
125.	Baumuster: G07, G08, G09, G11
126.	Baumuster: G07, G08, G09, G11, GT, GTI
127.	Baumuster: G29, G30
128.	Baumuster: M 030
129.	Baumuster: M 033, außer M30 Turbo
130.	Baumuster: ohne EDC
131.	ab Fahrgestellnummer: 199008 bis 199209
132.	ab Fahrgestellnummer: 199210 ->
133.	ab Fahrgestellnummer: 3B-YE121222 ->
134.	ab Fahrgestellnummer: 4B-1-000001 ->
135.	ab Fahrgestellnummer: 4B-W-070001 ->
136.	ab Fahrgestellnummer: 4B-W-070001 bis 4B-Y-200000
137.	ab Fahrgestellnummer: 4D-1-000 001 ->
138.	ab Fahrgestellnummer: 51000001 ->
139.	ab Fahrgestellnummer: 8D-1-030000 bis 8D-W-006471
140.	ab Fahrgestellnummer: 8D-1-030001 ->
141.	ab Fahrgestellnummer: 8D-1-030001 -> ; ab Fahrgestellnummer: 200007 ->
142.	ab Fahrgestellnummer: 8D-W-006471 bis 8D-1-030000
143.	ab Fahrgestellnummer: 8D-X-200000 ->
144.	ab Fahrgestellnummer: 8D-X-200001 bis 8D-1-030000
145.	ab Fahrgestellnummer: 8E-2-400001 ->
146.	ab Fahrgestellnummer: 8E-5-400 001 ->
147.	ab Fahrgestellnummer: 8E-7-400 001 ->
148.	ab Fahrgestellnummer: A394035 ->
149.	ab Fahrgestellnummer: A394036 ->
150.	ab Fahrgestellnummer: F054768 ->
151.	ab Fahrgestellnummer: YS3E55CD2 ->
152.	für Japan
153.	nicht für den Vertrieb in China (Taiwan)
154.	nur in Verbindung mit Bilstein Teile-Nr. 50-174546 - Bezug nur über Fa. Bilstein: mail: info@bilstein.de / Tel: +49 (0) 23 33 / 7 91-44 44
155.	nur in Verbindung mit BMW Teile-Nr. 31 32 1 139 423 (2x) - Bezug nur über BMW-Originalteilehandel. (Steinschlagschutz)
156.	nur in Verbindung mit BMW Teile-Nr. 31 33 1139 436 - Bezug nur über BMW-Originalteilehandel. (Stützlager)
158.	ohne CATS
159.	ohne EDC

160.	Bei Ersatzteilbedarf: Die Teilenummern der Einzelkomponenten entnehmen Sie bitte dem Gutachten unter dem Punkt "Berichtigung der Fahrzeugpapiere". Die Gutachten finden Sie unter www.eibach.de - Im Bereich „Performance Suspension“
161.	Bei Ersatzteilbedarf nehmen Sie bitte Kontakt zu uns auf: mail: orders@eibach.de / Tel.: 0 27 21 - 511 342 - Halten Sie dazu Ihre Fahrzeugpapiere, Teilenummern und Kaufbelege bereit.
162.	Nicht für Ausführung "Caddy Maxi"
163.	Auch für Ausführung "LPG" (Gasanlage)
164.	nur in Verbindung mit BMW Teile-Nr. 33 50 6 778 572 (2x) - Bezug nur über BMW-Originalteilehandel. (Steinschlagschutz)
166.	Produktionsland: Großbritannien
167.	bis Fahrgestellnummer: 7L-9-045000
168.	Nur für Fahrzeuge mit PASM (elektronischer Dämpferregelung).
169.	Lieferung in Deutschland nur über besonderen Vertriebspartner. Bei Bedarf bitte die Toyota Deutschland GmbH, Tel: 0 22 34 - 102 - 0 kontaktieren.
170.	Für Fahrzeuge mit Mehrlenker-Hinterachse (Einzelradaufhängung)
171.	Für Fahrzeuge mit Verbundlenker-Hinterachse (Starrachse)
172.	Nur für Ausführung Gran Coupé
173.	Nur für Ausführung Coupé
174.	Nicht für Ausführung mit Federbein an der Hinterachse.
175.	Für Fahrzeuge mit elektronisch verstellbaren Dämpfern (Serienausstattung). PRO-TRONIC unterdrückt die Fehlermeldung/ Kontrollleuchte im Display nach dem Verbau von Sportstoßdämpfern/ Gewindefahrwerken (B12/PSS) ohne elektronisch verstellbare Dämpfer. Die Funktionalität der elektronischen Dämpfereinstellung entfällt.
Hinweise Spurverbreiterungen	
AS	Die Auflagen der fahrzeugspezifischen Gutachten sind zu beachten. Die Gutachten sind auf unserer Website www.eibach.com einsehbar.
- Allgemeine Hinweise Pro-Spacer	Allgemeine Hinweise zu Spurverbreiterungen: Unsere Spurverbreiterungen werden unter Berücksichtigung der Serienfelgen entwickelt. Bei der Verwendung von Zubehör- und Sonderfelgen, speziell bei Fahrzeugen mit Stehbolzen/Muttern-Befestigung ist zu prüfen, ob die entsprechenden Voraussetzungen an der Felge vorhanden sind (z.B. Aussparungen zur Aufnahme der Originalbolzen). Ferner weisen wir darauf hin, dass je größer die Felgendimension wird, desto empfindlicher reagiert die Lenkung beim Verbau von Distanzscheiben im Bezug auf Vibrationen, die z.B. durch ungenau gewuchtete Räder entstehen können. § 21-Abnahme - Distanzscheiben, die nicht im Teilegutachten eines Fahrzeugtyps benannt sind, aber dennoch auf diesem Fahrzeug verbaut werden können, müssen unter Berücksichtigung der Fahrzeugfestigkeit per Einzelabnahme in die Fahrzeugpapiere eingetragen werden (Einpresstiefengrenze nach der 2% bzw 4%-Regelung oder Nachweis einer gesonderten Fahrzeugfestigkeit). Hierzu kann das Teilegutachten eines anderen Fahrzeugtyps verwendet werden, wenn die entsprechenden Distanzscheiben in diesem Gutachten benannt werden. Vor dem Kauf sollte unbedingt mit einer geeigneten Prüfstelle die gewünschte Abnahme besprochen werden, um die Eintragungsvoraussetzungen und Kosten abzuklären. Distanzscheiben sollten immer nur von Hand montiert werden. - Auf die Verwendung eines elektrischen oder pneumatischen Schraubwerkzeuges sollte verzichtet werden, da dieses unter Umständen zu einem nicht optimalen Sitz der Distanzscheibe auf der Mittenzentrierung und somit zu unerwünschten Vibrationen im Fahrbetrieb führen kann. Bei Gutachten die ein Erstellungsdatum ab März 2011 haben, ist die Verwendung von Stahlfelgen generell ausgeschlossen, sofern nicht anders im Gutachten vermerkt!
S1	Bei Verwendung der Distanzscheibe ist darauf zu achten, dass die Felgen, bei Verwendung der 15 mm Distanzscheibe mindestens 14 mm tiefe und Gusstaschen / Aussparungen aufweisen, bei der 20 mm Distanzscheibe, mindestens 9 mm! (Bei Verwendung der 25 mm Distanzscheibe mindestens 4 mm!). Ist dies nicht der Fall, müssen die Originalradbolzen im Radträger gegen kürzere Bolzen getauscht werden (System 5, 6). Sonst ist eine Verwendung der Distanzscheiben nicht möglich.
S2	Außer Modell R5 (Tdi) - wg. LK 5/120
S3	Nur auf der Vorderachse verwendbar!
S4	Für Fahrzeuge mit (Zubehör-) Felgen ohne Gußtaschen bzw. Aussparungen zur Aufnahme der Original-Radbolzen.
S5	Verwendbar für Fahrzeuge mit einer Mittenzentrierung bis 17,5 mm Höhe.
S6	Nur auf der Hinterachse verwendbar!
S7	Nur bei Felgen mit mindestens 3,5 x 45° Innenfase verwendbar!
S8	Achtung, bei einigen S4-Modellen nur auf der Hinterachse verwendbar!
S9	Bei Verwendung der Distanzscheiben ist darauf zu achten, dass die verwendeten Felgen über geeignete Gießtaschen / Aussparungen zur Aufnahme der überstehenden Originalradbolzen verfügen, da ohne diese Aussparungen ein Verbau der Felgen bzw. Verwendung der Distanzscheiben nicht möglich ist. Bitte insbesondere die überstehende Länge des Originalstehbolzens beachten. (Beispiel: Stehbolzenlänge 25 mm - Scheibenbreite 15 mm = 10 mm Überstand des Originalbolzens. Also sollte die Tiefe der Aussparung mindestens 11 mm betragen. Ferner muss die Höhe/Breite der Aussparung mindestens 22 mm betragen, um die überstehende Anschraubmutter aufnehmen zu können.) Ferner ist es erlaubt, überstehende Radbolzen mit einer Säge entsprechend zu kürzen. ACHTUNG: bei 15 mm Scheiben ist immer eine Aussparung von mindestens 7 mm Tiefe notwendig, da die Anschraubmutter über die Scheibenanlagelfläche überstehen!
S10	Verwendbar für Fahrzeuge mit einer Mittenzentrierung bis 12,5 mm Höhe.
S11	Die Zentrierung der Felge ist nur über die Radschrauben möglich! Unter Umständen kann daher ein Auswuchten der Räder am Fahrzeug notwendig sein, um evtl. auftretende Vibrationen zu vermeiden.

HINWEISE

S12	Aufgrund der Abstufung der Rad-Mittenzentrierung kann bei manchen Modellen eine Zentrierung der Distanzscheibe nicht gewährleistet werden.
S13	Bei einigen Modellen nur auf der Vorderachse verwendbar, da die Mittenzentrierung des Hinterachs-Radträgers zu lang ist. Verwendbar bis 16 mm Zentrierhöhe! Ab Produktionsnummer 161225 -> auch für VW UPI, Seat MiI, Skoda Citigo Hinterachse, da maximal verwendbare Zentrierhöhe auf 17 mm geändert! (Prägung auf der Distanzscheibe beachten!)
S14	Bei einigen Modellen nur auf der Hinterachse verwendbar, da die Mittenzentrierung des Vorderachs-Radträgers zu lang ist.
S15	Bei Verwendung des Systems 3/7 können die Serienradschrauben zu lang sein. In diesem Fall müssen sie gegen kürzere Schrauben getauscht werden. Bitte verwenden Sie unsere Checkliste zur Angabe der Originalschraubendaten.
S16	Mazda / Nissan / Subaru / Hyundai-Fahrzeuge haben Modell-, achs- und baujahrabhängig unterschiedliche Rändelbolzen. Bitte prüfen Sie vor der Bestellung an beiden Achsen, welchen Rändeldurchmesser die Original-Rändelbolzen haben. In unseren Standardkits sind Rändelschrauben mit Rändeldurchmesser 14,9 mm (Subaru 14,3 mm) enthalten. Andere Rändeldurchmesser müssen bei der Bestellung angegeben werden!
S17	Verwendbar für Fahrzeuge mit einer Mittenzentrierung bis 16 mm Höhe.
S19	Bei Fahrzeugen mit Schiebetüren ist vorab die Verbaubarkeit der 25 mm / 30 mm Spurverbreiterung zu prüfen!
S20	Nicht zulässig für Fahrzeuge mit Leichtbaufahrwerk (Typ 6E, Lupo 3L Tdi, Lupo FS!)
S21	Ggf. ist der Lenkeinschlag zu begrenzen.
S22	In Verbindung mit Distanzringen sind 18 Zoll Rad-Reifenkombinationen nur dann zulässig, wenn diese für die Fahrzeugausführung bereits serienmäßig eingetragen sind.
S23	Nicht bei Verwendung von Stahlfelgen montierbar!
S24	Bei neueren Modellen kann die Mittenzentrierung größer als 54,1 mm Durchmesser sein. In diesem Fall ist eine Verwendung der Distanzscheibe nicht möglich.
S25	Bei einigen Turbomodellen aufgrund geänderter Mittenzentrierung der Vorderachse nicht verbaubar.
S26	Bei einigen Modellen nur auf der Vorderachse verwendbar, da die Fettkappe des Hinterachs-Radträgers zu weit aufbauen kann. Maximale Höhe der Mittenzentrierung incl. Fettkappe: 10 mm! Bitte vor der Bestellung prüfen!
S28	Die Originalradschrauben müssen bei der Verwendung des Systems 3/7 gegen kürzere Schrauben getauscht werden. Best-Nr. für Originalfelgen: S4-7-14-50-28-19. - Diese sind im Lieferumfang enthalten! Bei der Verwendung von Zubehörfelgen bitte die Checkliste ausfüllen!
S29	Nacharbeit am inneren Radhaus notwendig. (Siehe Gutachten)
S30	Radträger muss zum Austausch der Bolzen demontiert werden!
S32	Stehbolzen brauchen bei Verbau der 5 mm/7 mm Scheibe nicht getauscht werden, wenn die erforderlichen Gewindegänge (Umdrehungen der Schraube/Mutter) den Erfordernissen des Gutachtens entsprechen.
S33	Die Original-Radbolzen müssen für den Verbau der Distanzscheiben gegen die mitgelieferten längeren Radbolzen getauscht werden. (Dieses sollte in einer Fachwerkstatt erfolgen, da bei manchen Fahrzeugen (z.B. neue Volvo/Ford/Kia-Modelle) hierfür die Demontage des Radträgers und/oder Radlagers notwendig ist.)
S34	Die Originalradschrauben müssen bei der Verwendung des Systems 3/7 gegen kürzere Schrauben getauscht werden. Best-Nr. für Originalfelgen: S1-1-14-50-30-17 (Im Lieferumfang enthalten!) Bei der Verwendung von Zubehörfelgen ist zu überprüfen, ob die Felgen mit den zugehörigen Schrauben befestigt werden können. - Ggf. sind kürzere Schrauben zu bestellen. Verwenden Sie bitte die Checkliste.
S35	Die Originalradschrauben müssen bei der Verwendung des Systems 3/7 gegen kürzere Schrauben getauscht werden. Best-Nr. für Originalfelgen: S4-1-14-50-28-19 (Im Lieferumfang enthalten!) Bei der Verwendung von Zubehörfelgen ist zu überprüfen, ob die Felgen mit den zugehörigen Schrauben befestigt werden können. - Ggf. sind kürzere Schrauben zu bestellen. Verwenden Sie bitte die Checkliste.
S37	Bei Verwendung der Distanzscheiben ist darauf zu achten, dass die verwendeten Felgen über geeignete Gießtaschen / Aussparungen zur Aufnahme der überstehenden Originalradbolzen verfügen. Sollte dies nicht der Fall sein, müssen die Originalradbolzen gegen die mitgelieferten kürzeren Radbolzen getauscht werden.
S38	Verwendbar für Fahrzeuge mit einer Mittenzentrierung bis 18 mm Höhe.
S39	Nicht verwendbar mit Serienalufelge (Verchromte Felge) ab Modelljahr 2005
S40	Nur für Modelle mit 3-geteilter Mittenzentrierung.
S41	Nicht in Verbindung mit US-Modell-Felge verwendbar, da diese nicht über entsprechende Aussparungen verfügt!
S42	Außer Modell "SPORT" - dieses hat Stehbolzen!!
S43	Bei Baujahr vom 20-05-2002 bis 25-03-2004 bitte bei Bestellung für die Vorderachse 10 St. S3-0-12-50-52-143 mitbestellen!
S44	Bei Baujahr vom 20-05-2002 bis 25-03-2004 bitte bei Bestellung für die Vorderachse 10 St. S3-0-12-50-62-143 mitbestellen!
S45	Bitte beachten: Da Mercedes je nach verwendeter Originalfelge unterschiedlich lange Radschrauben einsetzt, ist es unbedingt notwendig zu prüfen, dass der Schaft der Schraube, nicht weiter als 20 mm aus Felge heraussteht. - Sollte dies der Fall sein, ist der Satz S90-2-20-007 mit entsprechend längeren Radschrauben zu verwenden. Oder es müssen zusätzlich kürzere Radschrauben zur Befestigung der Felge bestellt werden. In beiden Fällen benutzen Sie bitte die Checkliste!

S46	Dieser Kit enthält zusätzliche Radschrauben, die anstelle der Originalradschrauben verwendet werden müssen. Eine Befestigung der Felge mit den Originalradschrauben darf bei dieser Distanzscheibenbreite nicht erfolgen, da die Originalradschrauben zu lang sind und am Radträger anstossen würden.
S47	Die Originalradbolzen müssen gegen kürzere Bolzen getauscht oder entsprechend abgelängt werden.
S48	Ab Produktionswoche 24-2006 (Kennzeichnung 24E06 und folgende) auch für die Vorderachse zu verwenden! (Prägung auf der Distanzscheibe beachten!)
S49	Bei den Systemen 2 (S90-2-...) ist aufgrund der unterschiedlichen Serienlängen der Radschrauben in jedem Fall die Checkliste auszufüllen.
S50	Ab Produktionswoche 14-2006 (Kennzeichnung 14E06 und folgende) auch für die Vorderachse zu verwenden! (Prägung auf der Distanzscheibe beachten!)
S51	Ab Produktionswoche 21-2006 (Kennzeichnung 21E06 und folgende) auch für die Vorderachse zu verwenden! (Prägung auf der Distanzscheibe beachten!)
S52	Ab Produktionswoche 35-2006 (Kennzeichnung 35E06 und folgende) auch für die Vorderachse zu verwenden! (Prägung auf der Distanzscheibe beachten!)
S53	Nicht für AMG-Modelle!
S54	Bei einigen Modellen nur auf der Vorderachse verwendbar, da die Fettkappe des Hinterachs-Radträgers zu weit aufbauen kann. Maximale Höhe der Mittenzentrierung 13,5 mm! Bitte vor der Bestellung prüfen!
S55	Nur Modelle mit Luftfederung auf der Hinterachse!
S56	Erst ab Herstelldatum 28E07 verwendbar! (Prägung auf der Distanzscheibe beachten!) Frühere Herstellung nicht mit Originalfelgen verbaubar!
S57	Da die Serienfelgen von Mercedes-Fahrzeugen je nach Felgentyp mit unterschiedlichen Schraubenlängen befestigt werden, ist es immer erforderlich, die Schachtlänge der verwendeten Schraube zu messen. Bitte die Checkliste verwenden!
S58	Bei Citroen- bzw. Peugeot-Fahrzeugen werden je nach verwendeter Felge unterschiedliche Schrauben zur Befestigung der Felge verwendet. Somit sollte vor Bestellung auf jeden Fall die Checkliste ausgefüllt werden!
S59	Außer 2,0 l Turbo
S60	Da bei diesen Fahrzeugen die Mittenzentrierungsdurchmesser im Zahnbelbereich variieren können, können die Distanzscheiben nur über die Radschrauben/-muttern zentriert werden.
S62	Karosseriearbeiten im Innenkotflügel notwendig!
S63	Ab Chargennummer 123634 (Produktion März 2008 - Prägung auf der Distanzscheibe beachten!) auch für die Hinterachse geeignet!
S64	Sollte die Radlast der Hinterachse 800kg (1600kg Achslast) überschreiten, ist eine Ablastung der Hinterachse notwendig.
S66	Nicht zulässig für Fahrzeuge mit überstehenden Schraubenköpfen auf der Radanlagelfläche, da diese auf keinen Fall demontiert werden dürfen.
S67	Bei der Verwendung der 20 mm System 7 Distanzscheiben ist vorab immer zu prüfen, ob die Radschraube weniger als 20 mm über die Radanlagelfläche übersteht. - Ist das der Fall, sind die Radschrauben gegen geeignete kürzere Schrauben zu ersetzen. (Hierzu ist die Schraube in die Felge zu stecken und der Überstand der Schraube zu messen. - Siehe auch unsere Montageanleitungen!!)
S68	SYSTEMWECHSEL! Die Distanzscheiben des Systems 3 (91-3...) werden sukzessive durch Distanzscheiben des Systems 7 (91-7...) ersetzt! Sollten System 3 Scheiben nicht mehr verfügbar sein, wird automatisch System 7 geliefert. - ACHTUNG! Es wird dann auch der System 7 Preis berechnet!
S70	Außer Modell 390X - EG-Betriebserlaubnisnummer e1*2001/116*0344... in Ländern, in denen Gutachten erforderlich sind.
S71	Ab Produktionswoche 33-2010 (Kennzeichnung 146417 und folgende (Prägung auf der Distanzscheibe beachten!)) auch für die Vorderachse zu verwenden!
S72	Nur für Fahrzeuge mit Luftfederung und Niveauregulierung.
S73	Nur geeignet, wenn Außendurchmesser der Distanzscheibe größer als 165 mm. - Ab Produktionsnummer 161220 -> (Prägung auf der Distanzscheibe beachten!)
S74	Ab Chargennummer 170033 (Produktion November 2012 - Prägung auf der Distanzscheibe beachten!) auch für die Hinterachse geeignet, wenn die Fettkappe der Hinterachse entfernt und auf die Mittenzentrierung der Distanzscheibe gesteckt wird!
S75	Ab Chargennummer 172158 (Produktion Februar 2013 - Prägung auf der Distanzscheibe beachten!) auch für die Hinterachse geeignet, wenn die Fettkappe der Hinterachse entfernt und auf die Mittenzentrierung der Distanzscheibe gesteckt wird!

INSTRUCTIONS

A -	The specifications indicated in the TUV approval are for the classification of the item / vehicle. Please check the type approval number of your car and compare with the homologation. (Letter "K" in your vehicle registration certificate or to find at the type plate of your car!)																				
Common Notes	Please verify before fitting by means of TUV certificate whether the delivered items (please see marking) are approved for your vehicle (please see area of use). You can find the current TUV approval on www.eibach.de																				
	In case of non-conformance the items must not be fitted - please refer to your dealer.																				
	Mounting - we recommend to have our spring system installed by a qualified workshop only, that has skilled personnel and the required special tools available.																				
	Mounting position - you can "read" the mounting position of the springs from the imprint - have them installed just the way you read the imprint.																				
	Wheel adjustment - after completion of the spring/suspension installation, checking the wheel adjustment is required.																				
	Shock absorbers - if the standard shock absorbers are not fully operative anymore and their efficiency has worn off considerably, we strongly recommend to replace those by new standard shock absorbers or by sports shock absorbers.																				
	The installation of Sport-Shock Absorbers is recommended. As example Bilstein B8																				
	Here all wheel/tyre-combinations are possible, which are released by the wheel type testing institution. The instructions in the wheel approval have to be adhered to, except for: OE suspension is required.																				
	Depending on engine, gearbox/transmission, equipment and vehicle tolerances lowering may differ from the values given. The dimension of lowering is reduced by the dimension of lowering carried out by manufacturer.																				
	The applicability of our products deals with standard cars. In any case of reconstruction, as the installation of a LPG-(liquefied petroleum gas)-system for example, the usage of our products is excluded. The stated measurements are referring to new standard cars. Measuring points: vertical distance from the middle of the wheel hub to the bottom edge of the mud wing. Generally the stated measurements are nominal values, which can vary depending on every car.																				
7.	The spring plates installed by the manufacturer are available at DB specialist workshops in sizes 8-23 mm. This allows to vary the lowering indicated here.																				
9.	For tyre equipment 205/50/15 and rim 7J x 15. Recommendation: installation of sports gas pressure shock absorbers of similar construction.																				
10.	Part number is available only from our special distributor. Please ask for availability and price.																				
12.	Not lowered by manufacturer. (OE-sport suspension)																				
15.	Not fully equipped.																				
16.	The special equipment mentioned below contents following point system:																				
	<table border="0"> <tr> <td>air-condition</td> <td>7 points</td> </tr> <tr> <td>automatic-transmission (4+5 Cyl.)</td> <td>4 points</td> </tr> <tr> <td>automatic-transmission (6 Cyl.)</td> <td>2 points</td> </tr> <tr> <td>independent car heating</td> <td>3 points</td> </tr> <tr> <td>sunroof</td> <td>2 points</td> </tr> <tr> <td>ABS</td> <td>2 points</td> </tr> <tr> <td>Airbag</td> <td>1 point</td> </tr> <tr> <td>headlamp cleaning system</td> <td>1 point</td> </tr> <tr> <td>engine skid plate</td> <td>1 point</td> </tr> <tr> <td>electronic seat adjustment</td> <td>2 points</td> </tr> </table>	air-condition	7 points	automatic-transmission (4+5 Cyl.)	4 points	automatic-transmission (6 Cyl.)	2 points	independent car heating	3 points	sunroof	2 points	ABS	2 points	Airbag	1 point	headlamp cleaning system	1 point	engine skid plate	1 point	electronic seat adjustment	2 points
air-condition	7 points																				
automatic-transmission (4+5 Cyl.)	4 points																				
automatic-transmission (6 Cyl.)	2 points																				
independent car heating	3 points																				
sunroof	2 points																				
ABS	2 points																				
Airbag	1 point																				
headlamp cleaning system	1 point																				
engine skid plate	1 point																				
electronic seat adjustment	2 points																				
	IF THE RESULT IS MORE THAN 4 POINTS ONE HAS TO CHOOSE																				
	up to 7 points 8 mm (1 point rubber plate)																				
	up to 13 points 13 mm (2 point rubber plate)																				
	up to 21 points 23 mm (4 point rubber plate)																				
	More than 21 points the lowering Kit is for this version not possible																				
18.	Without levelling control.																				
19.	Vehicles with 6 cylinder engine require retrofit with sports shocks.																				
20.	Except vehicles with 4WD.																				
21.	Except electronic suspension systems.																				
22.	In combination with Eibach suspension springs or original suspension.																				
23.	Front and rear axle height adjustable by threaded strut.																				
24.	Front axle height adjustable by threaded strut, rear axle by height adjustable unit.																				
25.	In order to ensure sufficient clearance it may be necessary to use wheel spacers if the car is equipped with original wheel sizes.																				
26.	When the car is lowered more than 40 mm in combination with a drive shaft diameter more than 42 mm, the original equiped front stabilizer bar has to be replaced by the EIBACH Anti-Roll-Kit part.-no. E40-85-005-01-11.																				
28.	Only for vehicles with electronic drive-balance-control.																				
30.	Height adjustment only according the measurements indicated in the TUV-certificate.																				
31.	Only for vehicles with ABC-Suspensions.																				
32.	Except models "Sportive" and Sport (models were are equipped with Bilstein shock absorbers)																				
33.	While stocks last!																				
34.	Only for vehicles with front damper diameter of 55 mm																				
35.	Only for vehicles with front damper diameter of 50 mm																				

36.	For vehicles with EDC additional fitting parts of the manufacturer is necessary: front: BMW-Part-No.: top mount assembly (31 331 091 709 + 31 331 116 983 + 31 331 110 196) rear: BMW-Part-No.: top mount assembly (33 521 091 710 + 33 521 090 282 + 33 521 092 986 + 31 331 137 932 + 33 531 091 031)
37.	Only front axle height adjustable, rear axle spring and shock absorber
38.	Only front axle height adjustable, rear axle shock absorber
39.	For models from 04.2002 onwards the fixation of the piston rod is deepened and covered through a flap (piston rod thread not visible)
42.	The spring travel dependent brake-pressure regulator at the rear axle has to be inspected and, if necessary, adjusted according to the workshop manual.
43.	The original level control damper at the rear axle has to be replaced by the original rear damper of the sedan (MMC part-no.: MR 235612) or damper of the manufacture KONI, type: 8040-1234 SPORT. The original rear bumpstops are to be reused. The bumpstops have to be in technically faultless condition.
44.	The original rear dampers have to be replaced by the supplied dampers.
45.	In some cases additional OE-Parts for the installation of the suspension components are required. Therefore please take a look at the corresponding technical documents which are available on our website.
46.	Without STOW'N GO
47.	The original rear dampers have to be replaced by conventionally dampers.
48.	In the case of vehicle models with ride height control dampers (mark 2R or 4R) these must be changed to O.E. dampers with mark 1U or 3U, part number: 96 80 99 98, catalogue number: 48 06 443.
49.	For vehicles with 4WD only!
50.	Only for vehicles with 51 mm front strut clamp.
51.	Part number is available only from our special distributor. Please ask for availability and price. Contact: Hansen Styling Parts, phone-no. 0049-(0)4347/706970
52.	Only for vehicles with single leaf spring.
53.	Only for vehicles with double leaf spring and single leaf with distance part.
54.	Not for vehicles with ride-height control system. For vehicles with Off-Road Classification only allowed with pass-by-noise less than 75 dB(A) and change of classification to M1.
56.	Vehicles with combined fog- and running lights have to be checked whether the height of the lower edge of the light is not closer than 350 mm to the ground. In this case additional running lights have to be mounted higher than 350 mm. The original running lights have to be decommissioned by removing the bulbs on the cable connection.
57.	Only for vehicles with o.e. 15" tires.
58.	not suitable for model "Cross"
59.	Only for vehicles with following characteristics: front axle: steel spring, rear axle: levelling control
60.	excluded Colt Rallyart up to 2009
61.	strut fixing with screw M14 (4-hole wheel attachment)
62.	strut fixing with screw M16 (5-hole wheel attachment)
63.	from addition 14
64.	Please check your fin: this kit fits: 10th character=number (... , 8, 9)
65.	Please check your fin: this kit fits: 10th character=letter (A, B, ...)
66.	for 5-Seater
67.	for 7-Seater
68.	Increased axle-load when using trailer (see TUV approval).
69.	If a national individual type approval exist, it is necessary to approve a modification acceptance according to §19/2 StVZO.
70.	Electronic damper control systems at vehicles have to be deactivated.
71.	without type: 1.6 Racing (DS3)
72.	Part number is available only from our special distributor. Please ask for availability and price. Contact: Autohaus Haese, phone-no. +49 (0) 61 34 / 18 29 50
73.	front wheel drive
74.	original spring plate must be use
75.	without AC (Air-Condition)
76.	thread dimension: M12
77.	outer diameter front strut 45 mm
78.	Due to the usage of gas pressure technology of the B6 / B8 dampers the dimension of lowering may vary slightly vehicle-specifically.
79.	coilspring inner diameter 116 mm
80.	coilspring inner diameter 106 mm
81.	without 3. row of seats
82.	distance between fixing holes front 58 mm
83.	distance between fixing holes front 75 mm
84.	not available for vehicles with xenon headlights (any mounting for the self-levelling headlamp system at the dampers)
85.	thread dimension: M16
86.	short wheel-base
87.	without off-road type
88.	standard suspension

INSTRUCTIONS

89.	thread dimension: M10
90.	thread dimension: M14
91.	with drum brake
92.	with disk brake
93.	only for vehicles with base axle
94.	only for vehicles with plus axle
95.	only for struts, which are screwed together
96.	without ABS
97.	without 1BH (Off road package)
98.	with coil spring suspension
99.	outer diameter front strut 47 mm
101.	Once B12 kit is installed the electronic damper control will not be available anymore. You will see a trouble code. This can be re-programmed by an official garage/dealership.
102.	For campmobiles
103.	up to chassis number: 200011 ; up to chassis number: 3B-YE121222
104.	up to chassis number: 3B-YE121221
105.	up to chassis number: 3B-YE121222
106.	up to chassis number: 41999999
107.	up to chassis number: 48999999
108.	up to chassis number: 4B-Y-200000
109.	up to chassis number: 4D-Y-020000
110.	up to chassis number: 8D-1-030000
111.	up to chassis number: 8D-1-030001
112.	up to chassis number: 8D-X-200000
113.	up to chassis number: 8E-2-400 000
114.	up to chassis number: 8E-5-400 000
115.	up to chassis number: 8E-7-400 000
116.	up to chassis number: A394035
117.	up to chassis number: YS3E55CD1
118.	for type: Avantgarde
119.	for type: Avantgarde, Elegance
120.	except type: JC Works GP
121.	except type: "il"
122.	for type: G02
123.	for type: G02, GT, GTI
124.	for type: G07, G08
125.	for type: G07, G08, G09, G11
126.	for type: G07, G08, G09, G11, GT, GTI
127.	for type: G29, G30
128.	for type: M 030
129.	for type: M 033, except type M30 Turbo
130.	for type: ohne EDC
131.	from chassis number: 199008-> 199209
132.	from chassis number: 199210 ->
133.	from chassis number: 3B-YE121222 ->
134.	from chassis number: 4B-1-000001 ->
135.	from chassis number: 4B-W-070001 ->
136.	from chassis number: 4B-W-070001-> 4B-Y-200000
137.	from chassis number: 4D-1-000 001 ->
138.	from chassis number: 51000001 ->
139.	from chassis number: 8D-1-030000-> 8D-W-006471
140.	from chassis number: 8D-1-030001 ->
141.	from chassis number: 8D-1-030001 ->;from chassis number: 200007 ->
142.	from chassis number: 8D-W-006471-> 8D-1-030000
143.	from chassis number: 8D-X-200000 ->
144.	from chassis number: 8D-X-200001-> 8D-1-030000
145.	from chassis number: 8E-2-400001 ->
146.	from chassis number: 8E-5-400 001 ->
147.	from chassis number: 8E-7-400 001 ->
148.	from chassis number: A394035 ->
149.	from chassis number: A394036 ->
150.	from chassis number: F054768 ->
151.	from chassis number: YS3E55CD2 ->
152.	for Japan
153.	not for distribution in China (Taiwan)
154.	only in combination with Bilstein Teile-Nr. /part-no. ACO-H454 - only available at Bilstein: mail: info@bilstein.de / Tel: +49 (0) 23 33 / 7 91-4444
155.	only in combination with BMW part-no. 31 32 1 139 423 (2x) - only available as BMW-OE-parts (stoneguard)
156.	only in combination with BMW part-no. 31 33 1139 436 - only available as BMW-OE-parts (top mount)

157.	only in combination with Bilstein Teile-Nr. /part-no. ACO-H454 - only available at Bilstein: mail: info@bilstein.de / Tel: +49 (0) 23 33 / 7 91-4444
158.	without CATS
159.	without EDC
160.	If replacement required: You will find the components in the homologation under the point "Amendment of the vehicle documents". The homologation can be downloaded on: www.eibach.de - „Performance Suspansion“
161.	If replacement required: Please contact us by mail: orders@eibach.de or phone: +49 (0) 2721-511342 - Please have your car documents, part numbers and sales receipt ready to give us more information.
162.	Not for "Caddy Maxi"
163.	"LPG-(liquefied petroleum gas)-system"-engines included!
164.	only in combination with BMW part-no. 33 50 6 778 572 (2x) - only available as BMW-OE-parts (stoneguard)
165.	only in combination with Bilstein Teile-Nr. /part-no. 50-174546 - only available at Bilstein: mail: info@bilstein.de / Tel: +49 (0) 23 33 / 7 91-4444
166.	Land of production: Great Britain
167.	up to chassis number: 7L-9-045000
168.	Only for cars with PASM (electronic damper control).
169.	Part number is available only from our special distributor. Please ask for availability and price. Contact: Toyota Deutschland GmbH, phone: +49 (0) 22 34-102-0
170.	For cars with independent suspension at the rear axle.
171.	For cars with rear live axle.
172.	Only for Gran Coupé
173.	Only for Coupé
174.	Not for suspension strut at the rear axle.
175.	For vehicle with electronic damper control. (Series). PRO-TRONIC suppresses the error message after installation of dampers or coil-overs (B12/PSS) without electronic adjustable dampers. The functionality of electronic damper control is not applicable.
Notes Wheelspacer	
AS	You have to consider the requirements of the homologation. Homologation-requirements are available under www.eibach.com
Common Note Wheel-spacers	Our wheelspacers are produced in consideration of the original wheels. When using accessory- or specialwheels, you have to check, if these wheels comply with the necessary requirements. Especially on cars with studs/nuts. Further we point out, that the larger the wheelsize is, the sensitively reacts the steering in relation to vibrations. (Often caused by badly balanced wheels.)
§ 21-acceptance - In Germany and other European states it is necessary to approve wheelspacers by a TÜV-oragnisation. If this is necessary in your country, please contact your nearest test center to get more information about requirements and costs.	
Wheelspacers always should be mounted by hand. - Don't use electric or pneumatic tools as this could cause vibrations because of misfit on the wheelhub.	
From March 2011 the use of steel wheels in combination with Pro-Spacer-wheelspacers is prohibited if not especially allowed by the homologation.	
S1	When using 15mm wheelspacers there at least have to be 14 mm minimum cut-outs in the wheel to take up the original bolts (when using 20mm spacers 9 mm minimum cut-outs, when using 25mm spacers 4 mm minimum cut-outs). If this isn't the case shorter bolts must be used. (System 5, 6) Otherwise the use of the spacers is not allowed.
S2	Except for model R5 (Tdi) - because of bolt pattern 5/120
S3	Only for use on the front axle!
S4	For vehicles with (accessory) wheels without cut-outs.
S5	For vehicles with a centre stud height up to 17,5mm.
S6	Only for use on the rear axle!
S7	Only when using rims with 3,5x45" internal chamber.
S8	Caution, for some S4 models only for use on the rear axle!
S9	When using the wheelspacers you have to verify that the wheels being used have suitable cut-outs to take up the original bolts. Without these cut-outs it is not possible to use the wheels or wheelspacers! Please check as follows: Stud length (e.g. 25mm) minus spacer-thickness (e.g.15mm) = 10mm excess length. So the cut out should have 11mm depth to take the original stud. Further the cut out should have minimum 22mmx22mm height/width to take the overlapping nut. ATTENTION: when using 15 mm spacers at least 7 mm deep cut-outs are needed as the nuts stand over the contact surface!
S10	For vehicles with a centre stud height up to 12,5mm.
S11	The centering of the wheel is only possible with the wheelbolts! Therefore, it can be necessary to do a wheel balancing on the car, to avoid possible vibrations.
S12	Due to the gradation of the wheel centre, a centering of the wheelspacer cannot be guaranteed with some models.
S13	With some models, it is only for use on the front axle as the centering of the wheel stud on the rear axle is too long. Fits up to 16mm centre bore height! From production-No# 161225 -> (Please note the printing on the spacer!) also suitable for VW UP!, Seat MII, Skoda Citigo rear axle as changed to 17mm centre bore height!

INSTRUCTIONS

S14	With some models, it is only for use on the rear axle as the centering of the wheel stud on the front axle is too long.
S15	When using system 3/7 (50mm), the original wheel bolts can be too long. In this case, they must be changed to shorter bolts.
S16	Mazda / Nissan / Subaru have various wheel studs that are dependant on the model, axle or year they were built in. Before ordering, please check on both axles, what knurl diameter the original wheel studs have. In our kits, we include wheel studs with a knurl diameter of 14,9mm (14,3mm for Subaru). Other knurl diameter sizes need to be indicated when ordering!
S17	For vehicles with a centre stud height up to 16mm.
S19	For vehicles with sliding doors, it needs to be checked if wheelspacers of 25mm / 30mm can be installed.
S20	Not permitted for vehicles with a lightweight suspension (Type 6E, Lupo 3L Tdi, Lupo FSI)
S21	The steering angle possibly needs to be limited.
S22	In combination with spacer rings, an 18-inch wheel/rim- combination is only permitted if the wheel has been already approved by the TÜV as original equipment.
S23	Not permitted for vehicles with steel wheels!
S24	With newer models, the centre stud can be more than 54,1mm diameter. In this case, the wheelspacer cannot be used.
S25	Cannot be installed with some Turbo-models due to a changed centre stud.
S26	With some models, it can only be used on the front axle as the grease-cap of the rear axle wheel carrier can stick-out too wide. The maximum height of the centre stud including the grease-cap is 10mm!
S27	The centering of the wheel and spacer is only possible with the wheelbolts! Therefore, it can be necessary to do a wheel balancing on the car, to avoid possible vibrations.
S28	When using system 3/7, the original screws have to be changed against shorter screws. Item-No for the use with original wheels: S4-7-14-50-28-19. When using accessory wheels, please fill out the Checklist.
S29	Ist necessary to change the inner front wheel arch.
S30	The wheelcarrier has to be disassembled for changing the stud bolts.
S32	Stud bolts needn't be changed.
S33	The original stud bolts must be changed. Longer stud bolts are enclosed in the kit. At some cars (e.g. Ford, Kia, Volvo) it's necessary to disassemble the wheeltrunk and/or the wheel bearing. This only should be done by your garage.
S34	When using system 3/7, the original bolts have to be changed against shorter bolts. Item-No for the use with original wheels: S1-1-14-50-30-17. (Included in delivery) If using accessory wheels you have to check the mount of the wheels. If necessary you have to order shorter bolts. Please use our checklist.
S35	When using system 3/7, the original screws have to be changed against shorter screws. Item-No for the use with original wheels: S4-1-14-50-28-19 (included in delivery) If using accessory wheels you have to check the mount of the wheels. If necessary you have to order shorter bolts. Please use our checklist.
S37	When using the wheelspacers you have to verify that the wheels being used have suitable cut-outs to take up the original bolts. Without these cut-outs it is necessary to use the delivered studs in exchange to the original studs!
S38	For vehicles with a centre stud height up to 18mm.
S39	Not for use with 2005 standard-wheel (chrome-plated)
S40	Only for use on models with tripartite center hub.
S41	Not for use on models with US-Wheels, as these wheels don't have the necessary cut-outs!
S42	Exclusive model "SPORT" - this one has stud bolts!
S43	Year 20-05-2002 to 25-03-2004 please order 10 pc. S3-0-12-50-52-143 seperately when using for the front axle!
S44	Year 20-05-2002 to 25-03-2004 please order 10 pc. S3-0-12-50-62-143 seperately when using for the front axle!
S45	Please Note: As Mercedes uses different bolts you have to check that the bolt when put in the wheel mustn't stand over more than 20mm. If this is the case you either have to use S90-2-20-007 with longer bolts, or you have to order shorter bolts for fixing the wheel. In both cases please use the checklist!
S46	This Kit includes additional wheelbolts to fix the wheel. When using this kit you have to use these wheelbolts as the original bolts are too long to fix the wheel.
S47	The original bolts have to be changed against shorter bolts or cut to length.
S48	Also for front axle use from production date 24-2006 (Marking 24E06 - Please note the printing on the spacer!)
S49	When using System 2 (S90-2-...) you always have to fill out the checklist because of different original bolts length used on this car.
S50	Also for front axle use from production date 14-2006 (Marking 14E06 - Please note the printing on the spacer!)
S51	Also for front axle use from production date 21-2006 (Marking 21E06 - Please note the printing on the spacer!)
S52	Also for front axle use from production date 35-2006 (Marking 35E06 - Please note the printing on the spacer!)
S53	Not for AMG-Models!

S54	With some models, it can only be used on the front axle as the grease-cap of the rear axle wheel carrier can stick-out too wide. The maximum height of the centre stud 13,5mm!
S55	Only for models with air-suspension on the rear axle!
S56	Only to use from production date 29-2007 (Marking 29E07 - Please note the printing on the spacer!) . Earlier dates don't fit the original wheels!
S57	Mercedes OEM wheels may use different bolt length. Therefore you have to examine, what bolt length is used. Please fill out the checklist!
S58	Citroen, Peugeot vehicles use different OEM wheels with different bolts. It's necessary to check what bolts are used even if OEM wheels are used. Please fill out the checklist!
S59	Not for 2,0 l Turbo
S60	As the diameter of the center stud can vary, the wheelspacers only can be centered by the studbolts/nuts.
S62	It's necessary to modify metal parts of the inner wheel arch!
S63	With charge 123634 (production March 2008 - Please note the printing on the spacer!) also usable for the rear axle.
S64	If the maximum rear axle load is more than 1600kg the maximum rear axle load has to be reduced to 1600kg. (800kg per wheel)
S66	Not for vehicles with overstanding boltheads on the wheeltrunk, as these bolts mustn't be dismounted.
S67	When using 20mm System 7 spacers the wheelbolts mustn't stand over more than 19,5mm out of the wheelhub. If this is the case the bolts have to be replaced with shorter bolts. (Please follow our installation instruction!)
S68	CHANGE OF SYSTEMS! System 3 spacers (91-3...) will be changed against system 7 spacers (91-7...)! If system 3 spacers won't be available, you automatically get system 7 spacers. - ATTENTION! In that case the system 7 price will be charged.
S70	Except Model 390X - EC-type approval No. e1*2001/116*0344*.. for countries with homologation required.
S71	Also for front axle use from production date 33-2010 (Marking 146417 and following - Please note the printing on the spacer!)
S72	Only for cars with Air-ride and levelling control
S73	Only suitable if outer spacer diameter >165mm. - Suitable from production-no.# 161220 -> (Please note the printing on the spacer!)
S74	With charge 170033 (production November 2012 - Please note the printing on the spacer!) also usable for the rear axle, if grease cap directly used on the center hub of the spacer.
S75	With charge 172158 (production February 2013 - Please note the printing on the spacer!) also usable for the rear axle, if grease cap directly used on the center hub of the spacer.

Ihr Händler | Your Local Dealer:

PRODUCTION PLANTS

Europe

Germany

Heinrich Eibach GmbH
Am Lennedamm 1
57413 Finnentrop
Phone: +49 27 21 - 5 11-342
Fax: +49 27 21 - 5 11-49 101
e-Mail: eibach@eibach.de

Motorsports Requests:

Phone: +49 27 21 - 5 11-344

North America

USA

Eibach Springs, Inc.
264, Mariah Circle
Corona, CA 92879-1751
Phone: +1 951 256 - 83 00
Fax: +1 951 256 - 83 33
e-Mail: eibach@eibach.com

Asia

China

Eibach Asia Center

Eibach Springs Taicang Ltd.
No. 63 Ningbo Road
Taicang, Jiangsu
China, 215400
Phone: +86 512 8278 1666
Fax: +86 512 8278 1660
e-Mail: eibach@eibach-china.com

ENGINEERING & SALES

Australia

Eibach Suspension Technology P.T.Y. Ltd.
3 | 4 Prosperity Parade
Warriewood NSW 2102
Phone: +61 2-99 99-36 55
Fax: +61 2-99 99-38 55
e-Mail: eibach@eibach.com.au

Japan

Eibach Japan Co., Ltd.
No. 3-9-36 Yuigahama
Kanagawa-Pref.
Kamakura-City 248-0014
Phone: +81 4 67 61 - 36 10
Fax: +81 4 67 61 - 36 15
e-Mail: eibach@eibach.jp

South Africa

Eibach South Africa P.T.Y. Ltd.
P.O. Box 2495
North End 6045
Port Elizabeth
Phone: +27 41 - 4 51 53 11
Fax: +27 41 - 4 53 42 74
e-Mail: sales@eibachsa.co.za

United Kingdom

Eibach UK
25, Swannington Road
Broughton Astley
Leicestershire LE9 6TU
Phone: +44 14 55 - 285 850
Fax: +44 14 55 - 285 853
e-Mail: sales@eibach.co.uk

EPS-23-EU

Artikelnummer | Partnumber: S9950102-2014

