

Japanparts®

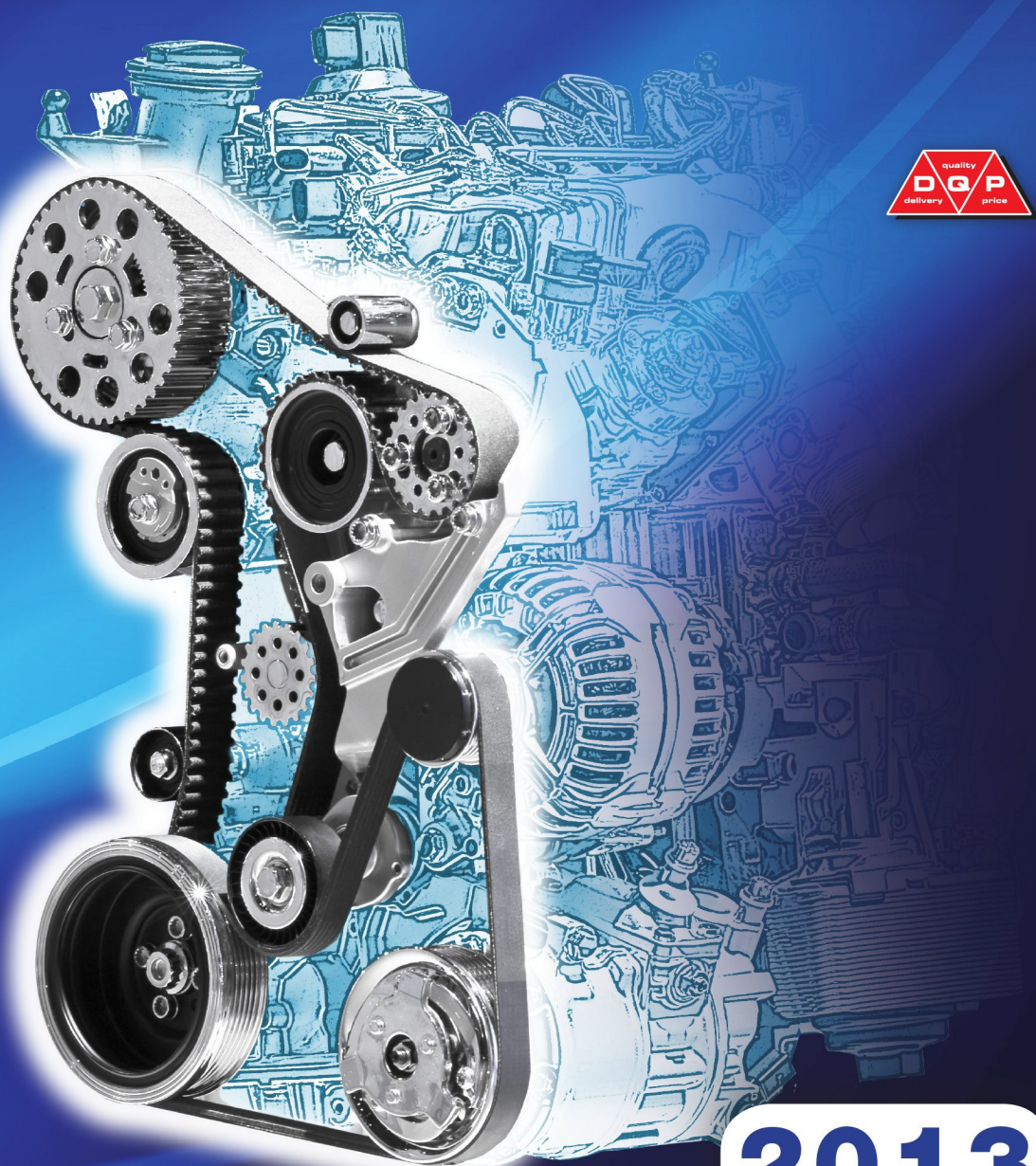

WORLDWIDE QUALITY REPLACEMENT PARTS FOR JAPANESE AND KOREAN CARS

TIMING BELT KIT TIMING CHAIN KIT



2013
2014

Table of contents
Inhaltsangabe
Tables des matières
Indice de contenido
Indice generale



product range produkte im sortiment gamme de produit gama de productos prodotti in gamma	pag. 003 > 006		
cinghie servizi BANDO - fan belts BANDO courroie BANDO - keilriemen BANDO correia de ventoinha BANDO	pag. 007 > 008		
cinghie servizi JAPANPARTS - fan belts JAPANPARTS courroie JAPANPARTS - keilriemen JAPANPARTS correia de ventoinha JAPANPARTS	pag. 009 > 011		
New codes	pag. 013		
Troubleshooting	pag. 014 > 015		
Warning / Caution	pag. 016		
ASIA MOTORS	pag. 017		
CADILLAC	pag. 016		
CHEVROLET	pag. 017 > 018		
CHRYSLER	pag. 019		
DAEWOO	pag. 020 > 021		
DAIHATSU	pag. 023 > 025		
DODGE	pag. 026		
DR	pag. 027		
GASOLONE	pag. 028		
GONOW	pag. 029		
GREAT WALL	pag. 030		
HONDA	pag. 031 > 037		
HYUNDAI	pag. 038 > 044		
ISUZU	pag. 045 > 046		
JEEP	pag. 047		
KIA	pag. 048 > 051		
LADA	pag. 052		
LAND ROVER	pag. 053		
LEXSUS	pag. 054		
MAZDA	pag. 055 > 063		
MITSUBISHI	pag. 064 > 078		
NIUSSAN	pag. 079 > 086		
PIAGGIO	pag. 087		
SHUANGHUAN AUTO	pag. 088		
SMART	pag. 089		
SUBARU	pag. 090 > 093		
SUZUKI	pag. 094 > 098		
TATA (TELCO)	pag. 099		
TOYOTA	pag. 100 > 110		
EUROPEAN VEHICLES	pag. 111 > 118		
		timing belt kit zahnriemensatz kit de distribution juego de correas dentadas kit distribuzione cinghia	pag. 119 > 151
		timing chain kit steuerkettensatz jeu de distribution à chaînes juego de cadena de distribución kit distribuzione catena	pag. 152 > 155
		water pump & timing belt kit wasserpumpe + zahnriemensatz pompe à eau + kit de courroie de distribution bomba de agua + kit correa distribución kit distribuzione cinghia + pompa acqua	pag. 156 > 157
		tensioner, timing belt riemenspanner, zahnriemen tendeur de courroie, courroie crantée tensor de correa, correa dentada tendicinghia, cinghia distribuzion	pag. 158 > 188
		freewheel clutch, alternator ruota libera alternatore rueda libre alternador poulie roue libre, alternateur generatorfreilauf	pag. 189 > 192
		deflection/guide pulley, v-ribbed belt galoppino/guidacinghia, cinghia poly-v polea inversión/guía, correa poli v poulie renvoi/transmission, courroie trapézoïdale umlenk-/führungsrolle, keilrippenriemen	pag. 193 > 212
		vibration damper, v-ribbed belt smorzatore vibrazioni, cinghia poly-v amortiguador vibraciones, correa trapez. poli v amortisseur de vibrations, courroie trapézoïdale à nervures schwingungsdämpfer, keilrippenriemen	pag. 213 > 214
		tensioner pulley, v-ribbed belt rullo tenditore, cinghia poly-v polea tensora, correa trapezoidal con dentado interior poulie-tendeur, courroie trapézoïdale à nervures spannrolle, keilrippenriemen	pag. 215 > 217
		tensioner lever, v-ribbed belt spannarm, keilrippenriemen tendeur, courroie trapézoïdale à nervures brazo tensor, correa trapezial poli v tenditore, cinghia poly-v	pag. 217 > 226
		cross reference list vergleichliste lista de referencias cruzadas lista de comparaison lista di comparazione	pag. 226 > 249

WORLDWIDE QUALITY





NOTICE: Were you see European flag means complete range for european cars.

NOTA: Bandiera Europea significa gamma completa per auto europea.

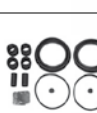

 FILTRI - FILTERS FILTRES - FILTER FILTROS - FILTROS	
	FO Filtri olio - Oil filters Filtres à huile - Ölfilter Filtrós do óleo - Filtrós de aceite
	FA Filtri aria - Air filters Filtres à air - Luftfilter Filtrós de ar - Filtrós de aire
	FAA Filtri abitacolo - Cabin filters Filtres d'habitacle - Oollenfilter Filtrós de hanbitáculo - Filtrós de purificación
	FC Filtri carburante - Fuel filters Filtres à carburant - Kraftstofffilter Filtrós de combustível - Filtrós de carburante
	FO-ECO Filtri olio eco - Eco oil filters Filtres à huile eco - Ölfilter eco Eco filtrós do óleo - Eco filtrós de aceite
	FC-ECO Filtri carburante eco - Eco fuel filters Filtres à carburant eco - Kraftstofffilter eco Eco filtrós de combustível - Eco filtrós de carburante
	KT Kit filtri per tagliando - Service filter kit Kit filtres entretien - Filter service satz Kit de filtrós da revisão - Kit filtrós para revisión
	FO-GAS Filtro depurazione gpl - Gpl purification filter Filtre purification gpl - Reinigungsfiltre gpl Filtro gás para a filtragem do gpl Gas filtro de purificación gpl
	DH Supporto filtro - Filter support Filtre d'appui - Filtre halterung Suporte do filtro - Soporte filtri

 FRENANTE - BRAKES BREMS - FREINAGE TRAVÕES - FRENS	
	PA Pastiglie freno ant. - Brake pads front Plaquettes de frein avant - Bremsklötse vorne Pastilhas dos travões da frente - Pastillas de freno ant.
	PP Pastiglie freno post. - Brake pads rear Plaquettes de frein arrière - Bremsklötse hinten Pastilhas dos travões de trás - Pastillas de freno post.
	DI Dischi freno ant. - Brake discs front Disques de frein avant - Bremsscheiben vorne Discos dos travões da frente - Discos de freno ant.
	DP Dischi freno post. - Brake discs rear Disques de frein arrière - Bremsscheiben hinten Discos dos travões de trás - Discos de freno post.
	GF Ganasce freno - Brake shoes Machoires de frein - Bremsbacken Maxilas de travão - Zapatás de freno
	TA Tamburi freno - Brake drums Tambours de frein - Bremstrommel Tambores dos travões - Tambores de freno
	CD Cilindretti freno dx - Rear wheel cylinder right Cylindre de roue droit - Radbremszylinder, rechts Cilindro de travão de trás direito - Cilindros de freno dx
	CS Cilindretti freno sx - Rear wheel cylinder left Cylindre de roue gauche - Radbremszylinder, links Cilindro de travão de trás esquerdo - Cilindros de freno sx

	PF Pompe freno - Brake master cylinders Maître cylindres - Hauptbremszylinder Bombas dos travões - Bombas de freno
	TF Tubi freno - Brake hoses Fléxibles de frein - Bremsschläuche Tubos dos travões - Tubos de freno
	KC Kit riparazione pompa freno Repair kit, brake master cylinder Kit de réparation, maître cylindre de frein Reparatursatz, hauptbremszylinder Kit reparação da bomba dos travões Kit reparación bomba de freno
	KD-PC Kit riparazione pinza freno - Brake calipers repair kit Kit de reparation etriers de frein Reparatursatz bremsattel - Kit reparação pinça travão Kit reparación pinza de freno
	BC Cavi freno - Brake Cable Câbles de frein - Bremskabel Cabo de aço - Cable de freno

 FRIZIONI - CLUTCH KUPPLUNG - EMBRAYAGE EMBRAIAGEM - EMBRAGUE	
	KF Kit frizione - Clutch kits Kit embrayages - Kupplungssätze Kit embraiagem - Kit embrague
	KV Kit frizione completo di volano - Clutch kit with flywheel Kit embrayage avec volant - Kupplungskit mit schwungra Kit de embraiagem com volante Kit embrague completo con volante de inercia
	DF Dischi frizione - Clutch discs Disques d'embrayage - Kupplungsscheiben Disco de embraiagem - Disco de embrague
	SF Spingidisco frizione - Clutch cover Mécanisme d'embrayage - Druckplatten kupplung Prato de pressão da embraiagem - Prensa de embrague
	VL Volani - Flywheels Volants - Schwungräder Volantes Bi-Massa - Volantes
	CF Cuscinetti frizione - Clutch bearings Butées d'embrayage - Kupplungs-ausrücklager Rolamento de embraiagem - Cojinetes de embrague
	BV Bullone, porta corona dentata volano Bolt, flywheel ring gear Carrier vis boulon au support du pignon pour volant d'inertie Schraube, zahnkranzträgerschwungrad Perno, soporte corona - Dentada, volante
	FR Pompe frizione - Clutch master cylinders Cylindre émetteur - Kupplungs-hauptzylinder Bombas embraiagem - Bomba embrague
	CY Cilindretti frizione - Clutch slave cylinders Cylindre récepteur - Kupplungs-nehmerzylinder Bomba secundária da embraiagem Cilindros embrague
	KR Kit riparazione pompa frizione Repair kit, clutch master cylinder Kit d'assemblage, cylindre émetteur d'embrayage Reparatursatz, kupplungsgeberzylinder Kit de reparação da bomba de embraiagem principal Kit reparación bomba de embrague

ITALY GAMMA PRODOTTI

UK PRODUCT RANGE



KY

Kit riparazione cilindretto frizione
Repair kit, clutch slave cylinder
Kit d'assemblage, cylindre récepteur d'embrayage
Reparatursatz, kupplungsnehmerzylinder
Kit de reparação da bomba de embraiagem secundária
Kit reparación cilindro embrague



DISTRIBUZIONE - DISTRIBUTION VERTEILUNG - DISTRIBUTION DISTRIBUIÇÃO - DISTRIBUCIÓN

new



KDK

Kit distribuzione catena - Timing chain kit
Kit chaines de distribution - Steuerkettensatz
Kit da corrente de distribuição
Kit distribución de cadena



KDD

Kit cinghia e tendicinghia - Timing belt kit
Kit de distribution - Zahnriemensatz
Kit de distribuição de correia - Kit correia y tensor de correia



new

SKD

Pompa acqua + kit cinghie - Water pump & timing belt kit
Pompe à eau + kit de courroie de distribution
Wasserpumpe + Zahnriemensatz
Bomba de água + kit de correia dentada
Bomba de água + kit correia distribución



BE

Cuscinetti tendicinghia - Timing belt tensioners
Galet tendeur - Spannrollen
Tensores da correia de distribuição
Cojinetes de tensor de correia



DD

Cinghie distribuzione - Timing belts
Courroies de distribution - Zahnriemen
Correia de distribuição - Correias de distribución



TT

Cinghia servizi - Fan belts
Courroie - Keilriemen
Correia de ventoinha - Correa de servicios



DT

Cinghia servizi bando - Fan belt bando
Courroie bando - Keilriemen bando
Correia de ventoinha bando - Correa de servicios bando



TV

Cinghie servizi scanalate - Fan belts - Courroies
Keilrippenriemen - Correia de ventoinha - Correa de servicios



DV

Cinghia servizi scanalata bando - Fan belt bando
Courroies bando - Keilrippenriemen bando
Correia de ventoinha bando - Correa de servicios bando



CH

Catene distribuzione - Timing chains
Chaines de distribution - Steuerketten
Correntes de distribuição - Cadenas de distribución



TS

Tenditore cinghia Poly-V - Timing belt tensioner
Tendeur, courroie trapézoïdale - Spannarm, Keilrippenriemen
Tensor, correia trapezoidal - Brazo tensor, correia Poly-V



new

RP

Galoppino/Guidacinghia, Cinghia Poly-V
Deflection/Guide Pulley, V-ribbed belt - Poulie courroie trapézoïdale - Umlenk-/Führungsrolle, Keilrippenriemen
Polea correia Poly-V - Polia correia trapezoidal



new

TP

Rullo tenditore, Cinghia Poly-V - Poly-V belt tensioner
Poulie-tendeur, courroie trapézoïdale à nervures
Spannrolle, Keilrippenriemen - Rolo tensor, correia trapezoidal estriada - Polea tensora, correia trapezoidal con dentado interior



new

TL

Smorzatore vibrazioni, Cinghia Poly-V
Vibration damper V-ribbed belt
Amortisseur de vibrations, courroie trapézoïdale à nervures
Schwingungsdämpfer, Keilrippenriemen
Amortecedor de vibrações, correia trapezoidal estriada
Amortiguador vibraciones, correia trapez. Poly-V



RAFFREDDAMENTO - COOLING ABKÜHLUNG - REFRROIDISSEMENT ARREFECIMENTO - REFRIGERACIÓN



PQ

Pompe acqua - Water pumps
Pompes à eau - Wasserpumpen
Bombas da água - Bombas de agua



VC

Giunti viscosi - Viscous couplings
Visco coupleur - Visco-kupplungen
Juntas viscosas - Juntas viscosas



VT

Valvole termostatiche - Thermostats
Thermostates - Thermostate
Termostatos - Válvulas termostáticas



new

VA

Valvola termostatica tama - Thermostat tama
Vanne thermostatique tama - Thermostatventil tama
Termostatos tama - Válvula termostática tama



new

RDA

Radiatore - Radiator
Radiateur - Kühler
Radiador - Radiador



KH

Tappi radiatore - Radiator caps
Bouchons radiateurs - Kuhler versschluss kappe
Tampões de radiator - Taponés radiator



new

CMP

Compressore - Compressor
Compresseur - Kompressor
Compresor - Compressor



new

CND

Condensatore - Condenser
Condenseur - Kondensator
Condensador - Condensador



new

EVP

Evaporatore - Evaporator
Evaporateur - Verdampfer
Evaporador - Evaporador



new

RSD

Riscaldatore - Heat Exchanger, interior heating
Système de chauffage - Heizung
Radiador de calefacción - Permutador de calor



new

VNT

Ventola, Raffreddamento motore - Fan, radiator
Ventilateur - Lüfter
Ventilador - Ventilador



GIUNTI E CUFFIE - JOINTS AND BOOTS KUPPLUNGEN UND ACHSMANSCHETTEN COUPLEUR, SOUFFLET DE CARDAN - JUNTAS DE TRANSMISSÃO E FOLAS - JUNTAS Y FUELLES



GI

Giunti omocineticici lato ruota
Costant velocity joints
Joint homocinétique - Antriebswellen
Juntas homocinéticas lado roda
Juntas homocinéticas de lado de rueda



KB

Kit cuffia - Boot kits
Soufflet de cardana - Achsmanschetten
Kit de folas - Kit de fuelles



JO

Crociere - Universal joints
Croisillons de trans - Universal gelenke
Cruzetas de cardan - Crucetas



SOSPENSIONI - SUSPENSIONS LENKUNGS UND-AUFHÄNGUNGSTEILE SUSPENSION - SUSPENSÃO SUSPENSIONA





















KK

Kit cuscinetti ruota - Wheelbearing kits
Kit de roulements de roues - Radlagersätze
Jogos de rolamentos das rodas - Kit cojinetes de rueda

GAMME DES PRODUITS

	MM	Ammortizzatori - Shock absorbers Amortisseurs - Stossdämpfer Amortecedores - Amortiguador
	RU	Gommini - Rubbers Silent blocs - Motoraufhängung Borrachas - Tapones de goma
	BS	Trapezio - Suspension triangle Triangle de suspension - Trapez Triângulo da suspensão - Trapecio
	CJ-ML	Braccio oscillante - Suspension arms Bras oscillants - Schwenkarme Braços da suspensão - Brazo oscilante
	ID	Leve rinvio sterzo - Steering relay Leviers de renvoi de la direction - Lenkradhebel Pendural da barra de direcção Levas de reenvio de la dirección
	LB	Testine sospensione - Ball joint Rotule (pour suspension et direction) Aufhängeköpfe - Rotula da suspensão Cabezales de suspensión
	SA	Barre accoppiamento - Coupling bars Barres d'accouplement - Pleuelstangen Barras da direcção - Barras de acoplamiento
	TI	Testa barra d'accoppiamento - Tie-rod end Rotule de barre de connexion Spurstangenkopf - Terminal da direcção Cabeza de barra de acoplamiento
	SI	Stabilizzatore, chassis - Stabilizer, chassis Stabilisateur, chassis - Stabilisator, fahrwerk Estabilizador, chassi - Estabilizador, chasis
	RD AX	Giunto assiale, asta trasversale - Axial rod, tie rod Rotule de direction intérieure, barre de connexion Axialgelenk, spurstange - Rótula da direcção interior Junta axial, asta transversal
	PI	Leve rinvio sterzo - Steering relay Leviers de renvoi de la direction - Lenkradhebel Braço do pendural da direcção Levas de reenvio de la dirección
	CW	Braccio oscillante, sospensione ruota Track control arm Bras de liaison, suspension de roue Lenker, radaufhängung - Braço de suspensão Brazo oscilante, suspensión de rueda
	CR	Barra d'accoppiamento - Tie rod, steering Barre de connexion spurstange Verbindungstange - Barra de junção Barra de acoplamiento
	BJ	Giunto di supporto/guida Support/steering link Rotule de suspension Trag/führungsgelenk Rótula da suspensão Junta de soporte /guía
	KB-A	Cuffie ammortizzatori universali Universal bump rubber kit Soufflet de cardan Universale dämpferkappen Kits de folas universais dos amortecedores Fuelles amortiguadores universales

PRODUKTELINIE

	IMPIANTO ELETTRICO - ELECTRICAL PARTS ELEKTRISCHE TEILE - ÉLECTRIQUE PARTS MATERIAL ELÉCTRICO - PARTES ELÉCTRICAS	
	AL	Alternatori - Alternators Alternateurs - Lichtmaschinen Alternadores - Alternadores
	MT	Motorini avviamento - Starters Démarreurs - Anlasser Motores de arranque - Arrancador
	DENSO	Candele - Spark plugs Bougies d'allumage - Kerzen Denso velas - Denso bujias
	CE	Candele - Glow plugs Bougies de pré-chauffage - Gluhkerzen Velas de incandescência - Bujias
	HKT	Candele hkt - Hkt glow plugs Bougies de préchauffage hkt - Gluhkerzen hkt Velas de incandescência hkt - Candelillas hkt
	DENSO	Candele denso - Denso glow plugs Bougies de préchauffage denso - Gluhkerzen denso Velas de incandescência denso - Candelillas denso
	OO	Sonde lambda - Oxigen sensors Sonde lambda - Lambda sonde Sondas lambda - Sensor oxigen
	DENSO	Sonde lambda denso - Oxigen sensors denso Sonde lambda denso - Lambda sonde denso Sondas lambda denso - Sondas lambda
	SS-X	Spazzole tergitristallo Wiper blades - Balais essuie glaces Wischerblätter - Escovas limpa vidros Escobillas
	SS-F	Spazzole tergitristallo universali - Universal wiper blades Balais essuie glaces universelles - Universale wischerblätter Escovas limpa vidros universais - Escobillas limpiaparabrisas universales
	SS-R	Spazzole tergitristallo universali posteriori - Universal Rear wiper Blades Balais d'essuie-glaces arrières universelles - Hintere universal Scheibenwischer Escovas limpa vidros traseiras universales Escobillas limpiaparabrisas traseras universales
	SS-RE70C - SS-RE70H SS-RE70VL - SS-RE75BH	Refill universali per spazzole normali/flat Universal refill for normal wiper blades/flat wiper blades Refill universel pour balais essuie glace norm. et balais "flat" Universal refill fuer normale/wischerblaetter Und fuer flat wischerblaetter Recargas universais para escovas flat normais Recambios universales para escobillas normales
	HY	Spazzola ibrida - Hybrid wiper blade - Hybrid balai d'essuie-glace Hybrid wischblatt - Und fuer flat wischerblaetter Escova hibrida de limpa-vidros - Escobilla hibrida
	HY-U	Spazzola Ibrida universale - Universal Hybrid wiper blade Balais d'essuie-glaces hybrid universelles - Hybrid universal Scheibenwischer Escovas limpa vidros Ibridas universales - Escobillas limpiaparabrisas Ibridas universales
	BA	Bulbi elettroventola - Temp. sensors Capteur de température - Ventilkugeln Sensores de temperatura - Sensor temperatura
	PB	Pompe benzina - Fuel pump Pompe a carburant - Benzinpumpen Bombas gasolina - Bombas de gasolina
	RE	Regolatori - Regulators Regulateur de tension - Spannungsregler Reguladores - Reguladores

GAMA DE PRODUTOS

GAMMA PRODUCTO

	SR	Spazzole accensione - Rotor arms Rotors d'allumeurs - Verteilerfinger Rotores - Rotor del distribuidor
	XX-C	Kit cavi accensione - Electric-cable ignition kit Kit câbles d'allumage - Zündkabel set Jogo de fios de vela - Kit cables de encendido
	BO	Bobina di accensione - Coil, ignition Bobine d'allumage - Zündspule Bobina de ignição - Bobina de encendido
	CO	Condensatore - Condenser, ignition Condenseur, système d'allumage Kondensator, zündanlage Condensador - Condensador
	CT	Kit contatti accensione - Contact breaker Distributor jeu de contacts d'allumage Kontaktsatz, zündverteiler Jogo de platinados - kit contactos de encendido
	GA GN GO	Gruppo universale koito - Insert, headlight koito Bloc-optique de phare koito Scheinwerfereinsatz, hauptscheinwerfer koito Óptica koito - Grupo universal koito
	IS	Interruttore stop - Interrupteur des feux de freins Brake light switch - Bremslichtschalter Interruptor stop - Interruptor de luces de freno
	IV	Interruttore temperatura, ventola radiatore Temperature switch, radiator fan Interrupteur de température, ventiateur de radiateur Temperaturschalter, kühlerlüfter Interruptor temperatura, ventoinha radiador Interruptor temperatura, ventilador radiador
	PO	Pressostato olio - Oil pressure switch Switch de pression d'huile - Öldruckschalter Interruptor da pressão do óleo - Interruptor presión de aceite
	SP	Spinterogeno - Distributor Distributeur - Verteiler Distribuidor - Distribuidor
	DE	Sensore massa aria - Mass sensor Capteur de masse - Sensorenmesser Sensor massa ar - Sensor masa de aire
	VF	Corpo farfallato elettrico - Throttle housing Boîtier de papillon - Drosselklappenstutzen Corpo de mariposa eléctrico Cuerpo de mariposa eléctrico
	RA	Puleggia alternatore - Freewheel Clutch, alternator Poulie roue libre, alternateur - Generatorfreilauf Rueda libre alternador - Roda livre do alternador
	CA	Calotte spinterogeno - Distributor caps Tête d'allumeur - Verteilekappen Tampas do distribuidor - Tapa distribuidor

	GP	Guarnizioni coperchio valvole - Valves cover gaskets Joint de couvre culbuteur - Dichtungen des Klappendeckels Juntas da cabeça - Tapa de culata de cilindro
	GT	Guarnizioni testata - Head gaskets Joints de culasses - Zylindercöpfe dichturg Jogo de juntas da cabeça - Juntas de culata
	KG	Kit guarnizioni testata - Head gaskets set Kit joints de culasses - Zylinderkopfdichtungssätze Kit guarnições cabeça - Kit juntas de culata
	KI	Kit pistoni - Pistons kit - Kit pistons Kolben rep. Sätze - Jogo de pistões - Kit pistones
	KM	Kit guarnizioni motore - Full set gasket Kit pochette joint moteur - Motor dichtungssätze Jogo de juntas completo - Kit juntas de motor
	VV	Valvole - Engine valves - Soupapes Ventile - Válvulas - Válvulas
	XX	Testate - Cylinder heads - Culasses Zylinderköpfe - Cabeças - Culata del cilindro
	BI	Bielle - Connecting roads - Bielle Pleuel - Bielas - Bielas
	PB	Boccola biella - Piston pin bushings - Bagues tête de bielle Kolben-pleuel-buchse - Casquilhos de biela - Casq. de biela
	RC	Fascia elastica - Piston ring Segment de piston - Kolbenring Segmento - Aros del pistón
	MS	Bronzina banco - Main bearings Coussinets de palier - Hauptlager Bronzes de apoio - Cojinete de bancada
	CB	Bronzina di biella - Big end bearings Coussinet de bielle - Pleuellager Bronzes de biela - Cojinete de biela
	CC	Kit canne cilindro motore - Cylinder liner kits Kit chemises - Laufbuchsensätze Jogos de camisas - Kit barras de cilindro de motor
	BZ	Bilancieri valvole - Balances valves Valves d'équilibres - Balancen ventile - Balancoen ventile Martelos - Balancines de las válvulas
	SH DB	Bronzina albero a camme - Camshaft bearings Coussinets arbre à cames - Nockenwellenlager Bronzes da árvore de cames - Cojinete de árbol de levas
	TW	Rasamenti - Thrust washers Cales latérale - Anlaufscheibe Anilhas de folga da cambota - Enrases
	BL	Bulloni testata - Cylinder head bolt Boulon de culasse de cylindre - Zylinderkopfschraube Pernos da cabeça - Pernos de cabezal
	XX	Valvola ricircolo gas di scarico Exhaust gas recirculation valve Vanne egr ventil - Abgasrückführventil Valvúla de reciclo do gás de escape Válvula de recirculación de gas de descarga
	XX	Pompa olio - Oil pump Pompe à huile - Ölpumpe Bomba óleo - Bomba de aceite
	XX	Iniettore - Injector - Injecteur Injektoren - Injector - Inyector
	XX	Motore completo - Complete engine Moteur complet - Motor komplett Motor completo - Motor completo
	XX	Turbina - Turbocharger - Turbocompresseur Turbolader - Turbo - Turbina



**MOTORE - ENGINE
MOTOR - MOTEUR
MOTOR - MOTOR**

	AA	Álberi a camme - Camshafts - Árbres a cames Nockenwellen - Árvores de cames - Árboles de levas
	AB	Alberi motore - Crankshafts - Vilebrequins Kurbelwellen - Cambotas - Árboles de moto
	PU	Puleggia albero motore - Crank shaft pulleys Poulie de vilebrequin - Motor-welle rolle Polia da cambota - Polea del eje motor

Fan belts **BANDO**

cinghie servizi

courroie

keilriemen

correia de ventoinha

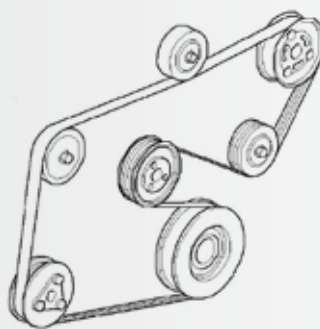

CODE	MEASURES
DV-3PK0495	3x495
DV-3PK0630	3x630
DV-3PK0645	3x645
DV-3PK0660	3x660
DV-3PK0665	3x665
DV-3PK0670	3x670
DV-3PK0675	3x675
DV-3PK0680	3x680
DV-3PK0740	3x740
DV-3PK0750	3x750
DV-3PK0760	3x760
DV-3PK0765	3x765
DV-3PK0790	3x790
DV-3PK0840	3x840
DV-3PK0850	3x850
DV-3PK0855	3x855
DV-3PK0875	3x875
DV-3PK0890	3x890
DV-3PK0910	3x910
DV-3PK0925	3x925
DV-3PK1000	3x1000
DV-3PK1075	3x1075
DV-3PK1080	3x1080
DV-4PK0595	4x595
DV-4PK0610	4x610
DV-4PK0615	4x615
DV-4PK0620	4x620
DV-4PK0635	4x635
DV-4PK0645	4x645
DV-4PK0655	4x655
DV-4PK0665	4x665
DV-4PK0675	4x675
DV-4PK0695	4x695
DV-4PK0705	4x705
DV-4PK0710	4x710
DV-4PK0720	4x720
DV-4PK0725	4x725
DV-4PK0730	4x730
DV-4PK0740	4x740
DV-4PK0750	4x750
DV-4PK0760	4x760
DV-4PK0765	4x765
DV-4PK0770	4x770
DV-4PK0775	4x775
DV-4PK0780	4x780

CODE	MEASURES
DV-4PK0785	4x785
DV-4PK0790	4x790
DV-4PK0795	4x795
DV-4PK0800	4x800
DV-4PK0805	4x805
DV-4PK0810	4x810
DV-4PK0812	4x812
DV-4PK0815	4x815
DV-4PK0820	4x820
DV-4PK0825	4x825
DV-4PK0830	4x830
DV-4PK0835	4x835
DV-4PK0840	4x840
DV-4PK0845	4x845
DV-4PK0850	4x850
DV-4PK0855	4x855
DV-4PK0860	4x860
DV-4PK0865	4x865
DV-4PK0870	4x870
DV-4PK0875	4x875
DV-4PK0880	4x880
DV-4PK0885	4x885
DV-4PK0890	4x890
DV-4PK0895	4x895
DV-4PK0900	4x900
DV-4PK0905	4x905
DV-4PK0910	4x910
DV-4PK0915	4x915
DV-4PK0920	4x920
DV-4PK0925	4x925
DV-4PK0930	4x930
DV-4PK0935	4x935
DV-4PK0940	4x940
DV-4PK0945	4x945
DV-4PK0950	4x950
DV-4PK0955	4x955
DV-4PK0960	4x960
DV-4PK0965	4x965
DV-4PK0970	4x970
DV-4PK0975	4x975
DV-4PK0980	4x980
DV-4PK0985	4x985
DV-4PK0990	4x990
DV-4PK0995	4x995
DV-4PK1000	4x1000

CODE	MEASURES
DV-4PK1005	4x1005
DV-4PK1010	4x1010
DV-4PK1015	4x1015
DV-4PK1020	4x1020
DV-4PK1025	4x1025
DV-4PK1030	4x1030
DV-4PK1035	4x1035
DV-4PK1040	4x1040
DV-4PK1045	4x1045
DV-4PK1050	4x1050
DV-4PK1055	4x1055
DV-4PK1060	4x1060
DV-4PK1065	4x1065
DV-4PK1070	4x1070
DV-4PK1080	4x1080
DV-4PK1085	4x1085
DV-4PK1090	4x1090
DV-4PK1110	4x1110
DV-4PK1115	4x1115
DV-4PK1120	4x1120
DV-4PK1170	4x1170
DV-4PK1180	4x1180
DV-4PK1185	4x1185
DV-4PK1420	4x1420
DV-4PK1540	4x1540
DV-4PK1615	4x1615
DV-4PK1710	4x1710
DV-4PK1715	4x1715
DV-4PK1770	4x1770
DV-5PK0670	5x670
DV-5PK0685	5x685
DV-5PK0775	5x775
DV-5PK0800	5x800
DV-5PK0815	5x815
DV-5PK0835	5x835
DV-5PK0850	5x850
DV-5PK0855	5x855
DV-5PK0865	5x865
DV-5PK0870	5x870
DV-5PK0875	5x875
DV-5PK0880	5x880
DV-5PK0885	5x885
DV-5PK0890	5x890
DV-5PK0905	5x905
DV-5PK0910	5x910

CODE	MEASURES
DV-5PK0915	5x915
DV-5PK0920	5x920
DV-5PK0925	5x925
DV-5PK0930	5x930
DV-5PK0935	5x935
DV-5PK0940	5x940
DV-5PK0945	5x945
DV-5PK0950	5x950
DV-5PK0955	5x955
DV-5PK0960	5x960
DV-5PK0965	5x965
DV-5PK0970	5x970
DV-5PK0975	5x975
DV-5PK0995	5x995
DV-5PK1000	5x1000
DV-5PK1010	5x1010
DV-5PK1020	5x1020
DV-5PK1025	5x1025
DV-5PK1030	5x1030
DV-5PK1050	5x1050
DV-5PK1055	5x1055
DV-5PK1060	5x1060
DV-5PK1065	5x1065
DV-5PK1070	5x1070
DV-5PK1075	5x1075
DV-5PK1080	5x1080
DV-5PK1085	5x1085
DV-5PK1090	5x1090
DV-5PK1095	5x1095
DV-5PK1100	5x1100
DV-5PK1105	5x1105
DV-5PK1110	5x1110
DV-5PK1115	5x1115
DV-5PK1120	5x1120
DV-5PK1125	5x1125
DV-5PK1130	5x1130
DV-5PK1135	5x1135
DV-5PK1140	5x1140
DV-5PK1145	5x1145
DV-5PK1150	5x1150
DV-5PK1155	5x1155
DV-5PK1165	5x1165
DV-5PK1180	5x1180
DV-5PK1190	5x1190
DV-5PK1200	5x1200

Fan belts **BANDO**

cinghie servizi

courroie

keilriemen

correia de ventoinha

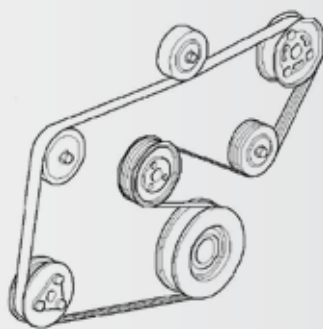

CODE	MEASURES
DV-5PK1210	5x1210
DV-5PK1220	5x1220
DV-5PK1240	5x1240
DV-5PK1250	5x1250
DV-5PK1260	5x1260
DV-5PK1280	5x1280
DV-5PK1305	5x1305
DV-5PK1330	5x1330
DV-5PK1340	5x1340
DV-5PK1355	5x1355
DV-5PK1365	5x1365
DV-5PK1390	5x1390
DV-5PK1395	5x1395
DV-5PK1545	5x1545
DV-5PK1550	5x1550
DV-5PK1555	5x1555
DV-5PK1590	5x1590
DV-5PK1640	5x1640
DV-5PK1650	5x1650
DV-5PK1670	5x1670
DV-5PK1730	5x1730
DV-5PK1785	5x1785
DV-5PK1800	5x1800
DV-5PK1840	5x1840
DV-5PK1850	5x1850
DV-6PK0680	6x680
DV-6PK0730	6x730
DV-6PK0780	6x780
DV-6PK0800	6x800
DV-6PK0815	6x815
DV-6PK0820	6x820
DV-6PK0850	6x850
DV-6PK0860	6x860
DV-6PK0880	6x880
DV-6PK0885	6x885
DV-6PK0915	6x915
DV-6PK0920	6x920
DV-6PK0940	6x940
DV-6PK0945	6x945
DV-6PK0950	6x950
DV-6PK0955	6x955
DV-6PK0965	6x965
DV-6PK0970	6x970
DV-6PK0975	6x975
DV-6PK0985	6x985
DV-6PK0995	6x995

CODE	MEASURES
DV-6PK1025	6x1025
DV-6PK1030	6x1030
DV-6PK1035	6x1035
DV-6PK1040	6x1040
DV-6PK1045	6x1045
DV-6PK1050	6x1050
DV-6PK1060	6x1060
DV-6PK1065	6x1065
DV-6PK1070	6x1070
DV-6PK1075	6x1075
DV-6PK1085	6x1085
DV-6PK1090	6x1090
DV-6PK1095	6x1095
DV-6PK1105	6x1105
DV-6PK1110	6x1110
DV-6PK1115	6x1115
DV-6PK1130	6x1130
DV-6PK1135	6x1135
DV-6PK1145	6x1145
DV-6PK1150	6x1150
DV-6PK1175	6x1175
DV-6PK1180	6x1180
DV-6PK1185	6x1185
DV-6PK1200	6x1200
DV-6PK1210	6x1210
DV-6PK1220	6x1220
DV-6PK1250	6x1250
DV-6PK1300	6x1300
DV-6PK1305	6x1305
DV-6PK1320	6x1320
DV-6PK1365	6x1365
DV-6PK1375	6x1375
DV-6PK1395	6x1395
DV-6PK1420	6x1420
DV-6PK1435	6x1435
DV-6PK1440	6x1440
DV-6PK1445	6x1445
DV-6PK1460	6x1460
DV-6PK1470	6x1470
DV-6PK1485	6x1485
DV-6PK1495	6x1495
DV-6PK1510	6x1510
DV-6PK1515	6x1515
DV-6PK1540	6x1540
DV-6PK1560	6x1560
DV-6PK1570	6x1570

CODE	MEASURES
DV-6PK1580	6x1580
DV-6PK1610	6x1610
DV-6PK1620	6x1620
DV-6PK1635	6x1635
DV-6PK1640	6x1640
DV-6PK1675	6x1675
DV-6PK1690	6x1690
DV-6PK1695	6x1695
DV-6PK1700	6x1700
DV-6PK1705	6x1705
DV-6PK1710	6x1710
DV-6PK1720	6x1720
DV-6PK1725	6x1725
DV-6PK1730	6x1730
DV-6PK1735	6x1735
DV-6PK1740	6x1740
DV-6PK1750	6x1750
DV-6PK1760	6x1760
DV-6PK1775	6x1775
DV-6PK1780	6x1780
DV-6PK1790	6x1790
DV-6PK1795	6x1795
DV-6PK1810	6x1810
DV-6PK1820	6x1820
DV-6PK1830	6x1830
DV-6PK1835	6x1835
DV-6PK1870	6x1870
DV-6PK1875	6x1875
DV-6PK1880	6x1880
DV-6PK1890	6x1890
DV-6PK1900	6x1900
DV-6PK1905	6x1905
DV-6PK1930	6x1930
DV-6PK1940	6x1940
DV-6PK1960	6x1960
DV-6PK1975	6x1975
DV-6PK2000	6x2000
DV-6PK2005	6x2005
DV-6PK2010	6x2010
DV-6PK2055	6x2055
DV-6PK2085	6x2085
DV-6PK2095	6x2095
DV-6PK2105	6x2105
DV-6PK2120	6x2120
DV-6PK2160	6x2160
DV-6PK2185	6x2185

CODE	MEASURES
DV-6PK2210	6x2210
DV-6PK2245	6x2245
DV-6PK2257	6x2257
DV-6PK2260	6x2260
DV-6PK2275	6x2275
DV-6PK2305	6x2305
DV-6PK2310	6x2310
DV-7PK1045	7x1045
DV-7PK1135	7x1135
DV-7PK1145	7x1145
DV-7PK1155	7x1155
DV-7PK1275	7x1275
DV-7PK1285	7x1285
DV-7PK1380	7x1380
DV-7PK1385	7x1385
DV-7PK1390	7x1390
DV-7PK1590	7x1590
DV-7PK1595	7x1595
DV-7PK1605	7x1605
DV-7PK1640	7x1640
DV-7PK1655	7x1655
DV-7PK1730	7x1730
DV-7PK1735	7x1735
DV-7PK1750	7x1750
DV-7PK1760	7x1760
DV-7PK1765	7x1765
DV-7PK1770	7x1770
DV-7PK1795	7x1795
DV-7PK1810	7x1810
DV-7PK1920	7x1920
DV-7PK1930	7x1930
DV-7PK1935	7x1935
DV-7PK1970	7x1970
DV-7PK1990	7x1990
DV-7PK2000	7x2000
DV-7PK2195	7x2195
DV-7PK2215	7x2215
DV-7PK2270	7x2270
DV-7PK2285	7x2285
DV-7PK2415	7x2415
DV-8PK1170	8x1170
DV-8PK1225	8x1225
DV-8PK1230	8x1230
DV-8PK1635	8x1635

Fan belts **BANDO**

cinghie servizi

courroie

keilriemen

correia de ventoinha

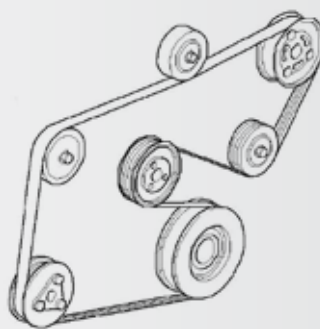

CODE	MEASURES
DT-10X1025LA	10X1025
DT-10X1065LA	10X1065
DT-10X1075LA	10X1075
DT-10X1080LA	10X1080
DT-10X1090LA	10X1090
DT-10X1100LA	10X1100
DT-10X1120LA	10X1120
DT-10X1125LA	10X1125
DT-10X1145LA	10X1145
DT-10X1150LA	10X1150
DT-10X660LA	10X660
DT-10X795LA	10X795
DT-10X800LA	10X800
DT-10X835LA	10X835
DT-10X890LA	10X890
DT-10X900LA	10X900
DT-10X915LA	10X915
DT-10X925LA	10X925
DT-10X965LA	10X965
DT-10X970LA	10X970
DT-10X975LA	10X975
DT-13X1000LA	13X1000
DT-13X1005LA	13X1005
DT-13X1010LA	13X1010
DT-13X1015LA	13X1015
DT-13X1025LA	13X1025
DT-13X1050LA	13X1050
DT-13X1065LA	13X1065
DT-13X1075LA	13X1075
DT-13X1090LA	13X1090
DT-13X1115LA	13X1115
DT-13X1125LA	13X1125
DT-13X1130LA	13X1130
DT-13X1145LA	13X1145
DT-13X1155LA	13X1155
DT-13X1170LA	13X1170
DT-13X1175LA	13X1175
DT-13X1180LA	13X1180
DT-13X1195LA	13X1195
DT-13X1200LA	13X1200
DT-13X1240LA	13X1240
DT-13X1270LA	13X1270
DT-13X1275LA	13X1275
DT-13X1400LA	13X1400

CODE	MEASURES
DT-13X1405LA	13X1405
DT-13X1510LA	13X1510
DT-13X610LA	13X610
DT-13X620LA	13X620
DT-13X630LA	13X630
DT-13X635LA	13X635
DT-13X645LA	13X645
DT-13X655LA	13X655
DT-13X660LA	13X660
DT-13X670LA	13X670
DT-13X680LA	13X680
DT-13X685LA	13X685
DT-13X725LA	13X725
DT-13X750LA	13X750
DT-13X755LA	13X755
DT-13X760LA	13X760
DT-13X775LA	13X775
DT-13X785LA	13X785
DT-13X800LA	13X800
DT-13X810LA	13X810
DT-13X825LA	13X825
DT-13X830LA	13X830
DT-13X835LA	13X835
DT-13X850LA	13X850
DT-13X860LA	13X860
DT-13X865LA	13X865
DT-13X875LA	13X875
DT-13X880LA	13X880
DT-13X885LA	13X885
DT-13X900LA	13X900
DT-13X915LA	13X915
DT-13X925LA	13X925
DT-13X935LA	13X935
DT-13X950LA	13X950
DT-13X965LA	13X965
DT-13X970LA	13X970
DT-13X975LA	13X975
DT-13X985LA	13X985
DT-13X990LA	13X990
DT-17X1025LI	17X1025
DT-17X1040LI	17X1040
DT-17X1075LI	17X1075
DT-17X1120LI	17X1120
DT-17X685LI	17X685

CODE	MEASURES
DT-17X890LI	17X890
DT-17X925LI	17X925
DT-17X940LI	17X940
DT-WA1040	1040
DT-WA1090	1090
DT-WA835	835
DT-WA890	890
DT-WA920	920
DT-WA930	930
DT-WA940	940
DT-WA965	965
DT-WN845	845
DT-WN975	975

Fan belts *Japanparts*

cinghie servizi

courroie

keilriemen

correia de ventoinha

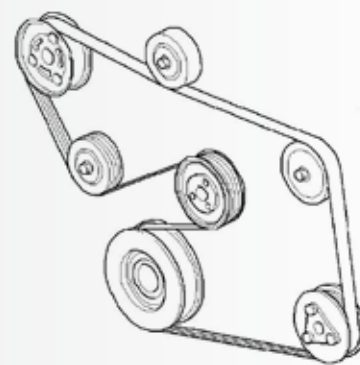

CODE	MEASURES
TR-013	17 x 1013L1
TR-025	17 x 1040 LA
TR-040	17 x 1040 L1
TR-050	17 x 1050 L1
TR-070	17 x 1075 L1
TR-087	17 x 1087 L1
TR-195	17 x 1190L1
TT-000	10 x 940 LA
TT-008	11 x 727 LA
TT-025	10 x 1025 LA
TT-037	13 x 1037 LA
TT-075	13 x 750 LA
TT-081	13 x 813 LA
TT-098	10 x 700 LA
TT-099	10 x 825 LA
TT-100	10 x 1000 LA
TT-105	13 x 1050 LA
TT-107	10 x 1075LA
TT-108	10 x 1087 LA
TT-110	13 x 1100 LA
TT-112	13 x 1125 LA
TT-113	10 x 1125 LA
TT-116	10 x 1163 LA
TT-117	13 x 1175 LA
TT-120	13 x 1200 LA
TT-122	10 x 1225 LA
TT-123	13 x 1225 LA
TT-125	13 x 1250 LA
TT-126	13 x 1263 LA
TT-142	13 x 1425 LA
TT-145	13 x 1450 LA
TT-146	13 x 1463 LA
TT-150	13 x 1500LA
TT-151	10 x 1150LA
TT-152	13 x 1525LA
TT-172	13 x 1075LA
TT-180	12,5 x 865LA
TT-181	13 x 800LA
TT-193	13 x 850LA
TT-196	13 x 950LA
TT-197	13 x 1275LA
TT-198	10 x 1050LA
TT-203	6PK1535
TT-208	6PK1885

CODE	MEASURES
TT-209	13 x 890LA
TT-294	13 x 875LA
TT-295	10 x 925LA
TT-296	10 x 875LA
TT-297	10 x 975LA
TT-298	10 x 950LA
TT-300	12.5 x 1090
TT-550	10 x 550LA
TT-589	13 x 775LA
TT-591	13 x 1150LA
TT-592	13 x 925LA
TT-596	13 x 1000LA
TT-597	17 x 1110
TT-613	10 x 613LA
TT-625	13 x 625LA
TT-626	10 x 625LA
TT-637	13 x 637LA
TT-650	10 x 650LA
TT-663	10 x 663LA
TT-675	13 x 675LA
TT-676	10 x 675LA
TT-687	10 x 687LA
TT-694	10 x 785LA
TT-696	13 x 900LA
TT-697	13 x 775LA
TT-713	10 x 713LA
TT-725	13 x 725LA
TT-750	10 x 750LA
TT-763	10 x 763LA
TT-764	13 x 763LA
TT-775	10 x 775LA
TT-798	10 x 913LA
TT-800	10 x 788
TT-813	10 x 813LA
TT-825	10 x 838LA
TT-826	13 x 825LA
TT-863	10 x 863LA
TT-888	10 x 888LA
TT-901	10 x 900LA
TT-963	10 x 963LA
TT-975	13 x 987LA
TT-987	10 x 987LA
TT-988	13 x 987LA
TT-992	13 x 1400LA

CODE	MEASURES
TT-995	13 x 1025LA
TT-997	13 x 913LA
TT-H05	13 x 750LA
TT-H06	13 x 750LA
TT-H07	10 x 1100LA
TT-H14	13 x 655LA
TT-H21	6PK1513
TT-H23	5K1848
TT-K26	10 x 1075LA
TV-001	4PK 985
TV-005	4PK 1075
TV-020	3PK 1025
TV-021	6PK 1020
TV-037	5PK 1035
TV-045	6PK 1050
TV-070	5PK 700
TV-072	6PK 725
TV-080	6PK 1080
TV-084	6PK 850
TV-092	7PK 920
TV-095	5PK 800
TV-096	6PK 965
TV-097	5PK 1215
TV-102	4PK 1025
TV-103	4PK 1040
TV-104	4PK 1045
TV-105	4PK 1065
TV-106	5PK 1060
TV-108	3PK 1080
TV-110	5PK 1100
TV-111	6PK 1100
TV-112	5PK 1125
TV-113	4PK 1100
TV-115	5PK 1150
TV-116	5PK 1165
TV-117	6PK 1150
TV-118	6K 1199
TV-119	6PK 1107
TV-120	6PK 1212
TV-121	7PK 1055
TV-122	4PK 1225
TV-123	5PK 1225
TV-124	7PK 1150
TV-130	5PK 1300

Fan belts *Japanparts*

cinghie servizi

courroie

keilriemen

correia de ventoinha

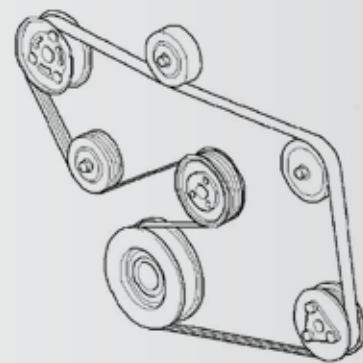

CODE	MEASURES
TV-134	5PK 1350
TV-150	4PK 1150
TV-173	6PK 950
TV-174	4PK 760
TV-178	6PK 875
TV-179	6PK 675
TV-187	4PK 910
TV-189	4PK 845
TV-190	3PK 840
TV-191	4PK 890
TV-192	4PK 730
TV-200	5PK 975
TV-202	6PK 940
TV-203	6PK 966
TV-204	5PK 1000
TV-207	4PK 1775
TV-208	6PK 2080
TV-209	6PK 1730
TV-210	6PK 1230
TV-211	7PK 1870
TV-291	5PK 1110
TV-298	5PK 825
TV-299	5PK 1015
TV-301	3PK 760
TV-397	5PK 1075
TV-398	4PK 885
TV-405	3PK 880
TV-408	3PK 805
TV-563	3PK 560
TV-588	4PK 770
TV-590	4PK 675
TV-593	5PK 1140
TV-594	4PK 755
TV-595	4PK 875
TV-599	4PK 1120
TV-600	4PK 825
TV-601	4PK 780
TV-637	4PK 640
TV-663	4PK 665
TV-695	5PK 1325
TV-700	4PK 700
TV-713	3PK 715
TV-714	4PK 715
TV-725	4PK 725

CODE	MEASURES
TV-737	3PK 735
TV-787	5PK 790
TV-788	3PK 790
TV-797	5PK 875
TV-800	4PK 815
TV-802	7K 1988
TV-803	5PK 1550
TV-804	6PK 1182
TV-805	K6 1675
TV-806	6PK 1960
TV-813	6PK 1813
TV-820	4PK 820
TV-825	3PK 825
TV-837	4PK 835
TV-851	3PK 850
TV-863	4PK 865
TV-864	5PK 865
TV-887	6PK 885
TV-898	4PK 825
TV-905	6PK 2035
TV-913	6PK 915
TV-914	3PK 910
TV-925	5PK 925
TV-937	5PK 935
TV-938	4PK 935
TV-950	5PK 950
TV-951	4PK 950
TV-955	4PK 955
TV-963	3PK 960
TV-964	5PK 960
TV-965	4PK 960
TV-975	4PK 975
TV-976	3PK 975
TV-987	4PK 990
TV-998	3PK 690
TV-999	4PK 800
TV-H04	4PK 850
TV-H05	5PK 1697
TV-H09	4PK 1060
TV-H11	4PK 845
TV-H12	4PK 875
TV-H18	4PK 855
TV-H20	4PK 945
TV-H24	4PK615

CODE	MEASURES
TV-H25	4PK0895
TV-H26	5K 1801
TV-K02	6PK 1580
TV-K04	3PK 765
TV-K08	4PK 925
TV-K14	6PK 1257
TV-K15	4PK855
TV-K16	7PK 1730
TV-K17	7PK 2284
TV-K18	7PK 2268
TV-K20	5 PK 1592
TV-K23	6PK 953
TV-K27	5K 1840
TV-K28	6PK 1510
TV-K29	6PK 2584
TV-M00	4K 738
TV-M02	3PK 806
TV-S01	6PK 2255
TV-W0	45PK 1008
TV-W07	5PK 974
TV-W09	5PK 870
TV-W11	6PK 1900
TV-W12	4PK 915
TV-W13	4PK 745
TV-W14	4PK 650
TV-W15	6PK 1875
TV-W16	6PK 1725
TV-W19	6PK 2094
TV-W20	6PK 2066

Kit catena Japanparts: Top quality from Italy



Japanparts®



WORLDWIDE QUALITY REPLACEMENT PARTS FOR JAPANESE AND KOREAN CARS



www.japanparts.eu



KIT DISTRIBUZIONE CATENA/TIMING CHAIN KIT	
KDK-107	NISSAN PATROL GR II (Y61) 3.0 DTi [05.00-]
KDK-109	NISSAN ALMERA II (N16) 1.8 [10.02-]
KDK-110	NISSAN ALMERA II (N16) 1.5[10.02-]
KDK-111	NISSAN BLUEBIRD (910) 2.0 D [01.80-12.83]
KDK-112	NISSAN PICK UP NAVARA (D22)2.5 Di[03.02-]
KDK-113	NISSAN NAVARA 2.5 dCi 4WD [07.05-]
KDK-207	TOYOTA YARIS (_CP10) 1.4 D-4D [12.01-]
KDK-208	TOYOTA YARIS VERSO 1.3 (NCP22) [01.03-]
KDK-209	TOYOTA AYGO 1.0 [07.05-]
KDK-501	MINIBUS MITSUBISHI PAJERO CLASSIC (V2_W) 3.2 DI-D [05.05-]
KDK-502	MINIBUS MITSUBISHI PAJERO II 2.8 TD (V46W) [06.94-04.00]
KDK-503	MITSUBISHI Canter 35 [07.98-]
KDK-600	DAIHATSU MATERIA 1.3 [10.06-]
KDK-801-8	FIAT 500 1.3 D Multijet [10.07-]
KDK-802	SUZUKI BALENO (EG) 1.8 GT [03.96-05.02]
KDK-M01	SMART CITY-COUPE 0.8 CDI[11.99-01.04]

KIT DISTRIBUZIONE CINGHIA/TIMING BELT KIT	
KDD-006A	CHRYSLER PT CRUISER 2.0 [06.00-]
KDD-117	NISSAN INTERSTAR dCi 120 [07.02-]
KDD-124	NISSAN KUBISTAR 1.6 16V [08.03-]
KDD-125	NISSAN KUBISTAR 1.2 [08.03-]
KDD-126	NISSAN KUBISTAR 1.2 16V [04.06-]
KDD-215A	TOYOTA CARINA II 1.6 (AT171)[12.87-11.89]
KDD-225A	LEXUS ES (F1, F2) 300 [09.91-12.97]
KDD-231	TOYOTA COROLLA 1.9D(WZE110) [02.00-01.02]
KDD-291	LEXUS IS (GXE10) 200 [04.99-]
KDD-313	MAZDA 2 1.25 [04.03-]
KDD-315	MAZDA 323 III (BF) 1.7 D [01.87-05.89]
KDD-333	MAZDA TRIBUTE (EP) 2.0 [03.00-]
KDD-334	MAZDA 5 2.0 CD [03.05-]
KDD-334A	MAZDA 6 2.0 MRZ-CD [08.07-]
KDD-336	MAZDA B-SERIE (UN) 2.5 D [06.99-]
KDD-337	MAZDA 121 I (DA) 1.1 [10.87-10.90]
KDD-383A	MAZDA 323 F V (BA) 1.5 16V [07.94-09.98]
KDD-406A	SUZUKI SWIFT II (EA, MA) 1.0 (SF310, AA44) [03.89-05.01]
KDD-407	HONDA ACCORD VII (CG) 3.0 V6 24V [02.98-06.03]

KDD-411A	HONDA PRELUDE III (BA) 2.0 i EX 16V [10.87-12.90]
KDD-502	JEEP COMPASS 2.0 CRD 4x4 [09.06-]
KDD-507	MITSUBISHI CORDIA 1.6 GSL (A212A) [10.82-12.86]
KDD-513D	MITSUBISHI CORDIA 1.6 Turbo (A212A) [10.82-05.85]
KDD-515	MITSUBISHI OUTLANDER 2.2 DI-D [08.07-]
KDD-521A	MITSUBISHI L 300 2.4 (P04W, P14V, P04V) [11.90-]
KDD-528A	MITSUBISHI 3000 GT (Z16A) 3.0 i 24V 4x4 [06.92-08.99]
KDD-542A	MITSUBISHI PAJERO III (V60) 3.5 V6 GDI (V65W, V75W) [04.00-]
KDD-601A	DAIHATSU CUORE V (L5) 0.8 [11.96-10.98]
KDD-703A	SUBARU FORESTER (SF) 2.0 [08.97-09.02]
KDD-707A	SUBARU LEGACY IV 2.5 [09.03-]
KDD-789	SUBARU VIVIO 660 4WD [03.92-10.95]
KDD-812	SUZUKI GRAND VITARA (FT, GT) 2.0 HDI 110 [07.01-]
KDD-818	SUZUKI LIANA (ER) 1.4 DDiS [03.05-]
KDD-889C	TOYOTA LAND CRUISER (J12) 3.0 D-4D (KDJ120) [01.07-]
KDD-905	DODGE NITRO 2.8 CRD [06.07-]
KDD-905A	ISUZU TROOPER (UBS) 2.6 i (UBS17) [10.87-12.91]
KDD-911	MAZDA 323 V S (BA) 1.6 TD [05.94-09.98]
KDD-H10B	HYUNDAI i30 2.0 [10.07-]
KDD-H11	HYUNDAI SANTA FÉ 2.7 [03.06-]
KDD-W10	CHEVROLET CRUZE (J3000) 1.6 [05.09-]

KIT DISTRIBUZIONE CINGHIA & POMPA ACQUA / WATER PUMP & TIMING BELT KIT	
SKD-205	TOYOTA AVENSIS (T25) 2.0 D-4D [04.03-]
SKD-205A	TOYOTA RAV 4 II (XA2) 2.0 D-4D 4WD [09.01-]
SKD-205B	TOYOTA AVENSIS VERSO 2.0 D-4D[08.01-]
SKD-211	TOYOTA AVENSIS 2.0 (ST220_) [09.97-10.00]
SKD-297A	TOYOTA AVENSIS 2.0 TD (CT220_) [09.97-02.03]
SKD-327	MAZDA 6 (GG) 2.0 DI [06.02-]
SKD-387	CHEVROLET KALOS 1.4 [03.05-]
SKD-393	DAEWOO ESPERO (KLEJ) 1.5 16V [02.95-06.99]
SKD-393A	DAEWOO LANOS (KLAT) 1.6 16V [05.97-]
SKD-393B	CHEVROLET KALOS 1.4 16V [03.05-]
SKD-399	KIA SPORTAGE (K00) 2.0 TD 4WD[10.97-08.03]
SKD-540B	CHEVROLET KALOS 1.2[03.05-]

Troubleshooting for **RAW EDGE BELTS & V-RIBBED BELT**

	SYMPTOMS	PROBABLE CAUSE	SOLUTIONS
CRACKS	 Deep cracks at regular intervals	<ul style="list-style-type: none"> - Pulleys too small - Excessively hot drive environment - Dust or chemicals in drive 	<ul style="list-style-type: none"> - Increase pulley diameter, check drive design - Improve ventilation - Use adequate guard
	 Small cracks at irregular intervals	<ul style="list-style-type: none"> - Belt used for too long 	<ul style="list-style-type: none"> - Replace belt
	 Broken	<ul style="list-style-type: none"> - Excessive load or shock load - Foreign materials in drive - Damaged tension members 	<ul style="list-style-type: none"> - Check drive design, redesign - Use adequate guard - Follow correct installation procedures
	 Glossy or shiny side walls	<ul style="list-style-type: none"> - Oil contamination - Belt slip 	<ul style="list-style-type: none"> - Clean oil contamination - Readjust tension
	 Layer separation	<ul style="list-style-type: none"> - Oil contamination - Belt slip or insufficient tension - Misalignment - Small pulley diameter 	<ul style="list-style-type: none"> - Clean oil contamination - Readjust tension - Check alignment and correct - Increase pulley diameter, check drive design
TURNOVER OR TWIST	 Occurring early	<ul style="list-style-type: none"> - Misalignment - Foreign materials in pulley - Insufficient tension - Damaged cord - Mismatched belt set 	<ul style="list-style-type: none"> - Check alignment - Clean pulley - Readjust tension - Replace belt, follow correct installation - Replace with a new matched set of belts
	 Occurring late	<ul style="list-style-type: none"> - Worn or damaged pulley - Insufficient tension - Poor drive design 	<ul style="list-style-type: none"> - Replace pulley - Readjust tension - Redesign drive load

Troubleshooting for **TIMING BELT**

	SYMPTOMS	PROBABLE CAUSE	SOLUTIONS
WEAR	 Edge wear	<ul style="list-style-type: none"> - Misalignment - Bent, rough or damaged flange - Improper tension - Belt too wide 	<ul style="list-style-type: none"> - Check alignment and correct - Straighten or replace flange - Readjust tension - Replace with correct belt
	 Tooth wear	<ul style="list-style-type: none"> - Excessive load - Insufficient tension - Misalignment - Incorrect belt - Worn, damaged or rough sprocket 	<ul style="list-style-type: none"> - Increase drive load - Readjust tension - Check alignment and correct - Replace with correct belt for sprocket - Replace sprocket
	 Tooth Shear	<ul style="list-style-type: none"> - Excessive load - Less than 6 teeth in mesh - Misalignment - Incorrect belt - Worn sprocket - Insufficient tension 	<ul style="list-style-type: none"> - Increase drive load - Redesign drive - Check alignment and correct - Replace with correct belt for sprocket - Readjust tension
	 Cracks on back	<ul style="list-style-type: none"> - Diameter too small - Improper ambient temperature - Backside idler 	<ul style="list-style-type: none"> - Increase diameter or redesign drive load - Eliminate cause and change the belt - Use inside idler
	 Broken belt	<ul style="list-style-type: none"> - Excessive shock load - Diameter too small - Damaged belt - Foreign materials in drive 	<ul style="list-style-type: none"> - Redesign drive load - Increase diameter or redesign - Follow correct installation procedures - Use adequate guard
	 Over heating	<ul style="list-style-type: none"> - Misalignment - Excessive tension - Incorrect belt 	<ul style="list-style-type: none"> - Check alignment and correct - Readjust tension - Replace with correct belt for sprocket
	Tension loss	<ul style="list-style-type: none"> - Excessive load - Diameter too small - Worn sprocket - Excessive temperature 	<ul style="list-style-type: none"> - Adjust drive load - Increase diameter or redesign - Replace sprocket - Check tension or conductive heat transfer
	Noise	<ul style="list-style-type: none"> - Improper tension - Misalignment - Incorrect belt - Diameter too small - Worn sprocket - Bent guide flange 	<ul style="list-style-type: none"> - Readjust tension - Check alignment and correct - Replace with correct belt for sprocket - Increase diameter or redesign - Replace sprocket - Replace guide flange
	Vibration	<ul style="list-style-type: none"> - Improper tension - Incorrect belt - Bushing or key loose 	<ul style="list-style-type: none"> - Readjust tension - Replace with correct belt for sprocket - Check and tighten

WARNING / CAUTION



WARNING

- Automotive belts are for use in cars only.
- Be sure that operators have no loose articles of clothing, or loose hair, as there is a danger that they may be pulled into the rotating part of the pulley belt.
- When proceeding with repair, check or exchange of a belt, be sure that the belt is stopped after switching it off.
- Be sure that no one switches on the machine in the middle of repair, check and exchange of a belt.



CAUTION

- When replacing a belt or pulley, use one with the same specifications as the original one.
- Do not attempt to cut part of a belt with a knife or a scissors when tension is applied to the belt. It may cause the belt to bounce and hurt someone nearby.
- Align a belt along the center of the pulley. Otherwise, the surface of the belt will wear unevenly, causing reduced durability.



GOOD



BAD



BAD







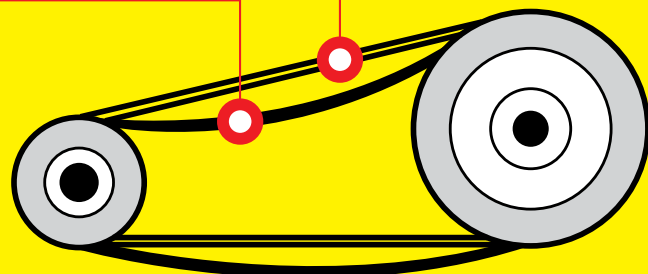

CAUTION

- Do not touch a belt or pulley immediately after operation. It is hot and you may get burned.
- Any attempt to change a belt should be made with no tension applied to the belt otherwise belt life may be reduced.
- Always maintain specified tension applied to a belt or noise or damage may result.
- In case more than one belt is used with a pulley, be sure to exchange all belts at the same time. Otherwise, the belts may have reduced durability.

New Belt





Used Belt



	KW			KDK- KIT CATENA TIMING BELT KIT	KDD- KIT CINGHIA TIMING CHAIN KIT <small>(Nr. of Teeth x Width)</small>	SKD KDD+POMPA ACQUA KDD+WATER PUMP
ROCSTA						
1.8 i 4x4	57	06.93	F804		KDD-312  Pag.129	104x25
2.2 D 4x4	45	06.93	R2		KDD-321A  Pag.130	164x25

CADILLAC



	KW			KDK- KIT CATENA TIMING BELT KIT	KDD- KIT CINGHIA TIMING CHAIN KIT <small>(Nr. of Theet x Width)</small>	SKD KDD+POMPA ACQUA KDD+WATER PUMP
BLS						
1.9 D	110	04.06	Z19DTH		KDD-007  Pag.121	199x24
1.9 D	132	12.07	Z 19 DTR		KDD-007  Pag.121	199x24







NEW CODES - NEUE CODES - NOUVEAUX CODES - NUEVOS CODIGOS - NUOVI CODICI

	KW			KDK- KIT CATENA TIMING BELT KIT	KDD- KIT CINGHIA TIMING CHAIN KIT <i>(Nr. of Teeth x Width)</i>	SKD KDD+POMPA ACQUA KDD+WATER PUMP
AVEO						
1.4	74	01.08	F14D4		KDD-W10  Pag.153	146x24
CAPTIVA						
2.0 D	110	09.07	Z 20 S		KDD-W07  Pag.153	151x22
2.4	100	06.06	Z 24 SED		KDD-W09  Pag.153	171x24
CRUZE						
2.0 CDI	90	05.09			KDD-W07  Pag.153	151x22
CRUZE (J3000)						
1.6	83	05.09	F16D4		KDD-W10  Pag.153	146x24
EPICA						
2.0 D	110	01.07	Z 20 S		KDD-W07  Pag.153	151x22
EVANDA						
2.0	96	03.05	X20SED		KDD-W04A  Pag.152	169x24
KALOS						
1.2	53	03.05	B12S1		KDD-540B  Pag.140	109x24.7 SKD-540B  Pag. 159
1.4	61	03.05	F14S3		KDD-387  Pag.132	111x17 SKD-387  Pag. 158
1.4 16V	69	03.05	F14D3		KDD-393  Pag.133	127x25 SKD-393B  Pag. 159
LACETTI						
1.4 16V	70	03.05	F14D3		KDD-393  Pag.133	127x25 SKD-393B  Pag. 159
1.6	80	03.05	F16D3		KDD-393  Pag.133	127x25 SKD-393B  Pag. 159
1.8	89	08.05	F18D3		KDD-W04B  Pag.153	169x24
1.8	90	03.05	T18SED		KDD-W04B  Pag.153	169x24
MATIZ						
0.8	38	03.05	F8CV		KDD-W02  Pag.152	107x25 SKD-W02  Pag. 159
1.0	47	03.05	B10S		KDD-540B  Pag.140	109x24.7 SKD-540B  Pag. 159
1.0	49	03.05	B10S1		KDD-540B  Pag.140	109x24.7 SKD-540B  Pag. 159
NUBIRA						
1.6	80	03.05	F16D3		KDD-393  Pag.133	127x25 SKD-393B  Pag. 159
1.8	89	08.05	F18D3		KDD-393  Pag.133	127x25









NEW CODES - NEUE CODES - NOUVEAUX CODES - NUEVOS CODIGOS - NUOVI CODICI

CHEVROLET



		KW			KDK- KIT CATENA TIMING BELT KIT	KDD- KIT CINGHIA TIMING CHAIN KIT <i>(Nr. of Teeth x Width)</i>	SKD KDD+POMPA ACQUA KDD+WATER PUMP
NUBIRA							
1.8		90	03.05	T18SED		KDD-393  Pag.133	127x25
ORLANDO							
1.8		104	12.10	F18D4		KDD-W10  Pag.153	146x24
TRAX							
1.6		85	03.13			KDD-W10  Pag.153	146x24
1.7 D		96	03.13			KDD-W11  Pag.153	131x25





NEW CODES - NEUE CODES - NOUVEAUX CODES - NUEVOS CODIGOS - NUOVI CODICI

	KW			KDK- KIT CATENA TIMING BELT KIT	KDD- KIT CINGHIA TIMING CHAIN KIT <i>(Nr. of Teeth x Width)</i>	SKD KDD+POMPA ACQUA KDD+WATER PUMP
GRAND VOYAGER V (RT)						
2.8 CRD	120	10.07			KDD-905  Pag.147	171x24
PT CRUISER						
2.0	104	06.00	ECC		KDD-006 →01.05  Pag.121 KDD-006A 01.05→  Pag.121	150x29 150x29
VOYAGER II (ES)						
3.0 i	108	08.84 →09.95	6G72 300		KDD-525  Pag.138	149x24.7
VOYAGER IV (RG)						
2.5 CRD	105	02.00	ENC		KDD-005  Pag.121	220x28
2.8 CRD	110	06.04	ENR		KDD-005  Pag.121	220x28

	KW			KDK- KIT CATENA TIMING BELT KIT	KDD- KIT CINGHIA TIMING CHAIN KIT <small>(Nr. of Teeth x Width)</small>	SKD KDD+POMPA ACQUA KDD+WATER PUMP
ESPERO (KLEJ)						
1.5 16V	65	10.93 → 09.94			KDD-393  Pag.133 127x25	SKD-393  Pag. 158
1.5 16V	66	02.95 → 06.99	A15MF		KDD-393  Pag.133 127x25	SKD-393  Pag. 158
1.8	66	02.95 → 09.99	C18LE		KDD-392  Pag.133 125x20	
1.8	70	02.95 → 06.99	C18LE		KDD-392  Pag.133 125x20	
2.0	74	10.91 → 09.93	C20LZ		KDD-392 C20LE  Pag.133 125x20	
2.0	77	02.95 → 06.99	C20LE		KDD-392  Pag.133 125x20	
2.0	81	10.93 → 09.94	C20LE		KDD-392  Pag.133 125x20	
EVANDA (KLAL)						
2.0	96	08.02	X20SED L88		KDD-W04A  Pag.152 169x24	
KALOS (KLAS)						
1.2	53	04.03	B12S1		KDD-540B  Pag.140 109x24.7	SKD-540B  Pag. 159
1.4	61	09.02	F14S3		KDD-387  Pag.132 111x17	SKD-387  Pag. 158
1.4 16V	69	04.03	F14D3		KDD-387  Pag.132 111x17	SKD-387  Pag. 158
LACETTI (KLAN)						
1.4	70	02.04	F14D3		KDD-393  Pag.133 127x25	SKD-393B  Pag. 159
1.6	80	02.04	F16D3		KDD-393  Pag.133 127x25	SKD-393B  Pag. 159
1.8	90	02.04	T18SED		KDD-W04B  Pag.153 169x24	
LANOS (KLAT)						
1.4	55	05.97	A14SMS		KDD-387  Pag.132 111x17	SKD-387  Pag. 158
1.5	63	05.97	A15SMS		KDD-387  Pag.132 111x17	SKD-387  Pag. 158
1.6 16V	78	05.97	A16DMS		KDD-393  Pag.133 127x25	SKD-393A  Pag. 158
LEGANZA (KLAV)						
1.8 CD	70	06.97 → 07.03	C18LE		KDD-393  Pag.133 127x25	
2.0 16V	93	07.00	T20SED		KDD-W04A  Pag.152 169x24	
2.0 16V	98	06.97 → 12.02	X20SED		KDD-W04A  Pag.152 169x24	
2.2 16V	100	04.99 → 12.02	T22SED		KDD-W09  Pag.153 171x24	



NEW CODES - NEUE CODES - NOUVEAUX CODES - NUEVOS CODIGOS - NUOVI CODICI









	KW			KDK- KIT CATENA TIMING BELT KIT	KDD- KIT CINGHIA TIMING CHAIN KIT <i>(Nr. of Teeth x Width)</i>	SKD KDD+POMPA ACQUA KDD+WATER PUMP
MATIZ (KLYA)						
0.8	38	09.98	F8CV		KDD-W02  Pag.152 107x25	SKD-W02  Pag. 159
1.0	47	01.03	B10S		KDD-540B  Pag.140 109x24.7	SKD-540B  Pag. 159
NEXIA (KLETN)						
1.5	44	08.96 → 08.97	G15MF		KDD-387  Pag.132 111x17	SKD-387  Pag. 158
1.5	52	02.95 → 08.97	G15MF		KDD-387  Pag.132 111x17	SKD-387  Pag. 158
1.5	55	02.95 → 08.97	G15MF		KDD-387  Pag.132 111x17	SKD-387  Pag. 158
1.5 16V	66	02.95 → 08.97	A15MF		KDD-393  Pag.133 127x25	SKD-393A  Pag. 158
1.8	0	10.97			KDD-393  Pag.133 127x25	
1.8	74	10.95 → 08.97			KDD-393  Pag.133 127x25	
NUBIRA (KLAJ)						
1.6 16V	76	07.00	A16DMS		KDD-393  Pag.133 127x25	SKD-393B  Pag. 159
1.6 16V	78	05.97	A16DMS		KDD-393  Pag.133 127x25	SKD-393B  Pag. 159
2.0 16V	93	12.00	T20SED		KDD-W04A C20SE  Pag.152 169x24 KDD-W04B X20SED  Pag.153 169x24	
2.0 16V	98	05.97	X20SED Z20L		KDD-W04A C20SE  Pag.152 169x24 KDD-W04B X20SED  Pag.153 169x24	
NUBIRA SW(KLAJ)						
1.6 16V	66	06.97			KDD-393  Pag.133 127x25	SKD-393B  Pag. 159
TACUMA (KLAU)						
1.6	77	09.00	A16DMS		KDD-393 01.01 →  Pag.133 127x25	SKD-393B  Pag. 159
2.0	89	09.01	X20SED		KDD-W04B X20SE  Pag.153 169x24	





	KW			KDK- KIT CATENA TIMING BELT KIT	KDD- KIT CINGHIA TIMING CHAIN KIT <i>(Nr. of Teeth x Width)</i>	SKD KDD+POMPA ACQUA KDD+WATER PUMP
APPLAUSE I (A101, A111)						
1.6 16V (A101)	66	06.89 → 07.97	HD		KDD-616  Pag.143	95x25
1.6 16V (A101)	77	06.89 → 07.97	HD-E		KDD-616  Pag.143	95x25
CHARADE II (G11, G30)						
1.0 (G11)	38	10.83 → 03.87	CB 20 CB 22		KDD-103A  Pag.122	91x19
1.0 D (G30)	27	10.83 → 03.87	CL 10		KDD-605  Pag.142	102x19
1.0 TD (G30)	34	02.85 → 03.87	CL 60		KDD-608  Pag.143	103x19
1.0 Turbo (G11)	50	10.83 → 03.87	CB 60		KDD-103A  Pag.122	91x19
CHARADE III (G100, G101, G102)						
1.0 (G100)	38	03.87 → 12.92	CB 23		KDD-697  Pag.143	91x19
1.0 D (G101)	27	03.87 → 12.92	CL 11		KDD-605  Pag.142	102x19
1.0 GTi (G100)	74	03.87 → 12.92	CB 80		KDD-613  Pag.143	155x19
1.0 Turbo (G100)	50	03.87 → 10.90	CB 61		KDD-103A  Pag.122	91x19
1.3 i (G102)	66	06.88 → 12.92	HCE		KDD-611  Pag.143	93x25
CHARADE IV (G200, G202)						
1.3	44	09.96 → 11.99	HC		KDD-611  Pag.143	93x25
1.3 16V	55	05.96 → 11.99	HCE		KDD-611  Pag.143	93x25
1.3 16V	62	01.93 → 11.99	HC		KDD-611  Pag.143	93x25
1.6 GTi	77	03.93 → 11.99	HD-E		KDD-616  Pag.143	95x25
CHARADE IV (G203)						
1.5	55	10.94	HEE HE		KDD-616  Pag.143	95x25
1.5 16V	66	08.94	HEE		KDD-616  Pag.143	95x25
CHARMANT (A)						
1.6 (A60)	57	09.85 → 07.87	4A		KDD-201C  Pag.124	88x19
1.6 (A60)	60	05.86 → 07.87	4A		KDD-201C  Pag.124	88x19
1.6 (A60)	61	08.83 → 07.87	4A		KDD-201C  Pag.124	88x19
COPEN						
1.3	64	03.06	K3-VE	KDK-600  Pag. 156		











NEW CODES - NEUE CODES - NOUVEAUX CODES - NUEVOS CODIGOS - NUOVI CODICI

	KW			KDK- KIT CATENA TIMING BELT KIT	KDD- KIT CINGHIA TIMING CHAIN KIT <i>(Nr. of Teeth x Width)</i>	SKD KDD+POMPA ACQUA KDD+WATER PUMP
CUORE I (L55, L60)						
0.5 (L55)	20	10.80 → 09.85	AB 30		KDD-600A 90x19  Pag.142	
0.6 (L60)	22	08.82 → 09.85	AD 10		KDD-600A 90x19  Pag.142	
CUORE II (L80, L81)						
0.8 (L80)	32	09.85 → 06.90	ED 10		KDD-607A 103x16 →04.89  Pag.142 KDD-614 103x18.5 04.89→  Pag.143	
CUORE III (L201)						
0.8	30	10.90 → 12.94	ED 10 K		KDD-614 103x18.5  Pag.143	
CUORE IV (L501)						
0.8	32	01.95 → 11.96	ED 20		KDD-614 103x18.5  Pag.143	
CUORE V (L5)						
0.8	31	11.96 → 10.98	ED 20		KDD-601A 111x25  Pag.142	
CUORE VI						
1.0 i (L701)	41	10.98 → 05.03	EJDE		KDD-601 111x25  Pag.142	
CUORE VII						
1.0	43	05.03	EJ-VE		KDD-601 111x25  Pag.142	
FEROZA (F300)						
1.6 16V	63	10.88	HDC		KDD-616 95x25  Pag.143	
1.6 i 16V	70	10.88	HD-E		KDD-616 95x25  Pag.143	
GRAN MOVE (G3)						
1.5 16V (G303)	66	10.96 → 07.98	HEEG		KDD-616 95x25  Pag.143	
1.6 16V (G301)	67	05.98	HDEP		KDD-616 95x25  Pag.143	
HIJET I						
0.8	29	06.86 → 12.89	CD		KDD-697 91x19  Pag.143	
1.0	33	06.86 → 12.89	CB		KDD-697 91x19  Pag.143	
MATERIA						
1.3	67	10.06	K3-VE	KDK-600  Pag. 156		

	KW			KDK- KIT CATENA TIMING BELT KIT	KDD- KIT CINGHIA TIMING CHAIN KIT <i>(Nr. of Teeth x Width)</i>	SKD KDD+POMPA ACQUA KDD+WATER PUMP
MOVE (L6, L9)						
0.8	31	10.96	ED 20		KDD-614 103x18.5  Pag.143 KDD-601A 111x25  Pag.142	
ROCKY (F7, F8)						
2.8 D	54	02.85	DL		KDD-615 108x31.8  Pag.143	
2.8 TD	67	12.87 → 04.93	DL 51		KDD-615 108x31.8  Pag.143	
2.8 TD	72	05.93	DL 52 DLT-C		KDD-615 108x31.8  Pag.143	
SIRION						
1.3	64	01.05	K3-VE	KDK-600  Pag. 156		
1.3	67	03.08	K3-VE	KDK-600  Pag. 156		
SIRION (M1)						
1.0 i	43	09.00 → 01.05	EJ-VE		KDD-601 111x25  Pag.142	
1.0 i (M100)	41	04.98 → 09.00	EJDE		KDD-601 111x25  Pag.142	
1.3 DVVT 16V	75	02.01 → 04.05	K3-VE	KDK-600  Pag. 156		
1.3 Sport	75	08.00 → 01.05	K3-VE2	KDK-600  Pag. 156	KDD-611 93x25  Pag.143	
SPARCAR/BUS WIDE						
0.55	20	01.80 → 12.86			KDD-600A 90x19  Pag.142	
0.55	20	01.80 → 12.86			KDD-600A 90x19  Pag.142	
0.8	29	09.83 → 05.86	CD		KDD-103A 91x19  Pag.122	
1.0	33	09.83 → 05.86	CB		KDD-103A 91x19  Pag.122	
TAFT						
2.8 D 4x4 (F60, F65)	51	08.82 → 02.85	DL		KDD-615 108x31.8  Pag.143	
TERIOS						
1.3 DVVT 4x4	63	11.05		KDK-600  Pag. 156		
TERIOS (J1)						
1.3	63	09.01 → 10.05	K3-VE	KDK-600  Pag. 156		
1.3 4WD	61	10.97 → 10.00	HE-EJ		KDD-611 93x25  Pag.143	
TREVIS						





	KW			KDK- KIT CATENA TIMING BELT KIT	KDD- KIT CINGHIA TIMING CHAIN KIT <i>(Nr. of Teeth x Width)</i>	SKD KDD+POMPA ACQUA KDD+WATER PUMP
TREVIS						
1.0	43	06.06	EJ-VE		KDD-601  Pag.142	111x25
WILDCAT/ROCKY (F70)						
2.8 D	54	02.85 → 03.87	DL		KDD-615  Pag.143	108x31.8
2.8 TD	65	09.85 → 04.87	DL 50		KDD-615  Pag.143	108x31.8
YRV (M2)						
1.0	43	02.01	EJ-VE		KDD-601  Pag.142	111x25
1.3	64	02.01	K3-VE	KDK-600  Pag. 156		
1.3 GTti	95	07.02	K3-VET		KDD-611  Pag.143	93x25

	KW			KDK- KIT CATENA TIMING BELT KIT	KDD- KIT CINGHIA TIMING CHAIN KIT <small>(Nr. of Theet x Width)</small>	SKD KDD+POMPA ACQUA KDD+WATER PUMP
NITRO						
2.8 CRD	130	06.07	ENR ENS		KDD-905  Pag.147	171x24
4.0 V6	191	07.07			KDD-002  Pag.121	201x30









	KW			KDK- KIT CATENA TIMING BELT KIT	KDD- KIT CINGHIA TIMING CHAIN KIT <small>(Nr. of Teeth x Width)</small>	SKD KDD+POMPA ACQUA KDD+WATER PUMP
DR 1						
1.3 Flex	61	03.10			KDD-009  Pag.121	167x25
1.3 LPG	61	03.10			KDD-009  Pag.121	167x25
DR 2						
1.3 Flex	61	09.10			KDD-009  Pag.121	167x25
1.3 LPG	61	09.10			KDD-009  Pag.121	167x25
DR 5						
1.6	80	01.11			KDD-008  Pag.121	173x25
1.6	87	01.11			KDD-008  Pag.121	173x25
1.6 Flex	80	01.11			KDD-008  Pag.121	173x25
1.6 GPL	80	01.11			KDD-008  Pag.121	173x25
1.9 D	88	01.11			KDD-811  Pag.145	190x24

GASOLONE









	KW			KDK- KIT CATENA TIMING BELT KIT	KDD- KIT CINGHIA TIMING CHAIN KIT <small>(Nr. of Teeth x Width)</small>	SKD KDD+POMPA ACQUA KDD+WATER PUMP
GASOLONE						
35 2.5 D	59				KDD-M02  <i>Pag.151</i>	99x18.5 163x25.1

NEW CODES - NEUE CODES - NOUVEAUX CODES - NUEVOS CODIGOS - NUOVI CODICI

	KW			KDK- KIT CATENA TIMING BELT KIT	KDD- KIT CINGHIA TIMING CHAIN KIT <small>(Nr. of Teeth x Width)</small>	SKD KDD+POMPA ACQUA KDD+WATER PUMP
GA200 PICK UP						
2.0 4X4	93	01.10			KDD-530A  Pag.139	123x29
GX6 OFF ROAD						
2.0 4X4	93	01.10			KDD-530A  Pag.139	123x29
TROY						
1.9 TD 4X4	81	05.06			KDD-001  Pag.121	173x22
2.0 16V	93	05.06			KDD-530A  Pag.139	123x29
VICTORY						
1.9 TD 4X4	81	05.06			KDD-001  Pag.121	173x22
2.0 16V	93	05.06			KDD-530A  Pag.139	123x29

GREAT WALL



	KW			KDK- KIT CATENA TIMING BELT KIT	KDD- KIT CINGHIA TIMING CHAIN KIT <i>(Nr. of Teeth x Width)</i>	SKD KDD+POMPA ACQUA KDD+WATER PUMP
HOVER						
CUV 2.4	93	01.07			KDD-591 65x13 124x29  <i>Pag.141</i> KDD-591B 124x29  <i>Pag.141</i>	
STEED						
2.0 D	105	01.10			KDD-012 171x25	
2.4	93	01.10			KDD-591 65x13 124x29  <i>Pag.141</i>	

NEW CODES - NEUE CODES - NOUVEAUX CODES - NUEVOS CODIGOS - NUOVI CODICI

	KW			KDK- KIT CATENA TIMING BELT KIT	KDD- KIT CINGHIA TIMING CHAIN KIT <i>(Nr. of Teeth x Width)</i>	SKD KDD+POMPA ACQUA KDD+WATER PUMP
ACCORD III (CA4, CA5)						
1.6 L (CA4)	65	11.85 → 12.89	A16A1		KDD-405  Pag.133	108x24
2.0 EX (CA5)	75	11.85 → 12.89	A20A1		KDD-405  Pag.133	108x24
2.0 EX (CA5)	76	11.85 → 12.89	A20A1		KDD-405  Pag.133	108x24
2.0 EX (CA5)	78	11.85 → 05.89	A20A2		KDD-405  Pag.133	108x24
2.0 EXi (CA5)	85	01.86 → 12.89	A20A3		KDD-405  Pag.133	108x24
2.0 EXi (CA5)	90	11.85 → 12.87	A20A4		KDD-405  Pag.133	108x24
ACCORD IV (CB3, CB7)						
1.8	77	01.90 → 12.91			KDD-415  Pag.134	113x24 70x16
2.0 16V (CB3)	66	01.90 → 03.93	F20A6		KDD-415  Pag.134	113x24 70x16
2.0 16V (CB3)	81	01.90 → 03.93	F20A2 F20A3		KDD-415  Pag.134	113x24 70x16
2.0 i 16V (CB3)	98	01.90 → 03.93	F20A4 F20A8		KDD-415  Pag.134	113x24 70x16
2.2 i 16V (CB7)	110	01.90 → 03.93	F22A3		KDD-415  Pag.134	113x24 70x16
ACCORD IV (CB8, CC)						
2.0 i 16V (CC9)	98	03.93 → 12.93	F20Z3		KDD-415  Pag.134	113x24 70x16
2.2 i 16V (CB8)	108	01.91 → 12.93	F22A8		KDD-415  Pag.134	113x24 70x16
2.2 i 16V (CB8)	110	01.91 → 12.93	F22A7		KDD-415  Pag.134	113x24 70x16
ACCORD IV CC1)						
2.0 i 16V	98	01.92 → 09.93	F20A7		KDD-415  Pag.134	113x24 70x16
ACCORD V (CC7)						
2.0 i	85	03.93 → 01.96	F20Z2		KDD-415  Pag.134	113x24 70x16
2.0 i S	96	03.93 → 01.96	F20Z1		KDD-415  Pag.134	113x24 70x16

	KW			KDK- KIT CATENA TIMING BELT KIT	KDD- KIT CINGHIA TIMING CHAIN KIT <i>(Nr. of Teeth x Width)</i>	SKD KDD+POMPA ACQUA KDD+WATER PUMP
ACCORD V (CC7)						
2.3 i SR	116	03.93 → 01.96	H23A3		KDD-416 127x25 70x16  Pag.134	
ACCORD V (CE)						
2.0 i LS 16V (CE2)	100	09.93 → 02.98	F20B3		KDD-415 113x24 70x16  Pag.134	
2.2 i ES (CE1)	110	09.93 → 02.98	F22B5		KDD-415 113x24 70x16  Pag.134	
ACCORD VI (CE, CF)						
1.9 i (CE7)	85	02.96 → 10.98	F18A3		KDD-415 113x24 70x16  Pag.134	
2.0 i LS (CE8)	96	02.96 → 10.98	F20Z1		KDD-415 113x24 70x16  Pag.134	
2.2 i VTEC (CE9)	110	02.96 → 10.98	F22Z2		KDD-424 70x16 112x24  Pag.135	
ACCORD VII (CG)						
1.6 i	85	10.98 → 12.02	D16B6		KDD-418B 104x25  Pag.135	
1.8 i	100	10.98 → 12.02	F18B2		KDD-424 70x16 112x24  Pag.135	
2.0 i	108	10.98 → 01.01	F20B6		KDD-424 70x16 112x24  Pag.135	
2.0 i 16V	108	02.98 → 06.03	F20B5 F20B7		KDD-424 70x16 112x24  Pag.135	
2.0 Turbo DI	77	02.99 → 12.02	20T2N		KDD-482 78x22 112x28  Pag.135	
2.2 Type-R	156	02.99 → 12.02	H22A7		KDD-424 70x16 112x24  Pag.135	
2.3	113	01.01 → 12.02	F23A1 F23Z5		KDD-424 70x16 112x24  Pag.135	
3.0 V6 24V	147	02.98 → 06.03	J30A1		KDD-407 197x26	
ACCORD VII (CH)						
1.8 i (CH6)	100	12.99 → 12.02	F18B2		KDD-424 70x16 112x24  Pag.135	
2.0 (CH7)	108	12.99 → 12.02	F20B6		KDD-424 70x16 112x24  Pag.135	

NEW CODES - NEUE CODES - NOUVEAUX CODES - NUEVOS CODIGOS - NUOVI CODICI

	KW			KDK- KIT CATENA TIMING BELT KIT	KDD- KIT CINGHIA TIMING CHAIN KIT <small>(Nr. of Teeth x Width)</small>	SKD KDD+POMPA ACQUA KDD+WATER PUMP
ACCORD VII (CH)						
2.0 TDi	77	12.99 → 10.00	20T2N		KDD-482 78x22 112x28  Pag.135	
BALLADE EV						
1.3 AG / AJ	0	09.83			KDD-404  Pag.133	101x24
BALLADE EW2 EW3						
1.5 16V	0	01.83 → 12.89			KDD-404  Pag.133	101x24
CIVIC II						
1.5 GL	63	10.83 → 10.87	EW2		KDD-404  Pag.133	101x24
1.5 GT	74	01.85 → 10.87	EW3		KDD-404  Pag.133	101x24
1.5 GTI	66	03.86 → 10.87	EW4		KDD-404  Pag.133	101x24
CIVIC III (EC, ED, EE)						
1.3 (EC8)	55	10.87 → 12.89	D13B1		KDD-412  Pag.134	106x24
1.3 16 V (EC8) Cat.	55	09.89 → 09.91	D13B2		KDD-412  Pag.134	106x24
1.4 L (EC9)	66	10.87 → 12.89	D14A1		KDD-412  Pag.134	106x24
1.5 i 16V	66	10.88 → 09.91	D15B2		KDD-412  Pag.134	106x24
1.5 i 16V (ED6)	69	10.88 → 09.91	D15B2		KDD-412  Pag.134	106x24
1.6 i 16V	96	09.87 → 09.91	D16A9 D16A7		KDD-411  Pag.134	124x24
1.6 i 16V (ED7)	80	10.87 → 09.91	D16A6		KDD-413A  Pag.134	107x24
1.6 i 16V (ED7)	81	10.87 → 09.91	D16Z2		KDD-413B  Pag.134	107x24
1.6 i 16V Vtec (EE9)	110	10.89 → 09.91	B16A1		KDD-422  Pag.135	124x26
CIVIC IV (EG)						
1.3 16V (EG3)	55	10.91 → 11.95	D13B2		KDD-412  Pag.134	106x24
1.5 i 16V	66	10.91 → 11.95	D15B2 D15Z2		KDD-412  Pag.134	106x24
CIVIC IV (EG, EH)						
1.5 i 16V (EG8)	69	10.91 → 11.95	D15Z1 D15B2		KDD-412  Pag.134	106x24
1.6 16V Vtec (EH9)	92	10.91 → 11.95	D16Z7 D16Z6		KDD-487  Pag.136	103x23.5
1.6 VTi (EG9)	118	10.91 → 11.95	B16A2		KDD-422  Pag.135	124x26
CIVIC IV (EJ)						

NEW CODES - NEUE CODES - NOUVEAUX CODES - NUEVOS CODIGOS - NUOVI CODICI











	KW			KDK- KIT CATENA TIMING BELT KIT	KDD- KIT CINGHIA TIMING CHAIN KIT <i>(Nr. of Teeth x Width)</i>	SKD KDD+POMPA ACQUA KDD+WATER PUMP
CIVIC IV (EJ)						
1.5 i LSi (EJ2)	74	01.94 → 11.95	D15B7		KDD-412  Pag.134	106x24
1.6 i Vtec (EJ1)	92	01.94 → 03.96	D16Z9 D16Y6		KDD-412  Pag.134	106x24
CIVIC IV (MA, MB)						
1.6 i (MB1)	83	09.94 → 01.97	D16Y3		KDD-413A  Pag.134	107x24
1.6 i Vtec (MB1)	93	09.94 → 01.97	D16Y2		KDD-418A  Pag.135	104x25
CIVIC Shuttle I (AN, AR)						
1.5 (AN)	63	10.83 → 10.87	EW2		KDD-404  Pag.133	101x24
CIVIC Shuttle II (EE)						
1.5 i 16V (EE2)	69	01.88 → 11.91	D15B2		KDD-404  Pag.133	101x24
1.6 16V 4WD D16Z2	0	01.90			KDD-413A  Pag.134	107x24
1.6 i 16V 4WD (EE4)	80	01.88 → 12.89	D16A6		KDD-413A  Pag.134	107x24
1.6 i 16V 4WD (EE4)	81	01.88 → 02.95	D16A6		KDD-413A  Pag.134	107x24
CIVIC V (EJ9, EK3/4)						
1.4 i (EJ9)	66	11.95 → 02.01	D14A4 D14Z2		KDD-487  Pag.136	103x23.5
1.5 i (EK3)	84	11.95 → 02.01	D15Z6		KDD-487  Pag.136	103x23.5
1.6 VTi (EK4)	118	11.95 → 02.01	B16A2		KDD-422  Pag.135	124x26
CIVIC V (MB)						
1.4 16V (MB2)	55	01.97 → 02.01	D14A7		KDD-487  Pag.136	103x23.5
1.5 16V (MB3)	84	01.97 → 02.01	D15Z8		KDD-487  Pag.136	103x23.5
1.8 16V (MB6)	124	01.97 → 02.01	B18C4		KDD-481  Pag.135	126x26
CIVIC VI						
1.4 (ES4)	66	02.01 → 09.05	D14Z5		KDD-423B  Pag.135	103x22
1.6	81	02.01 → 09.05	D16V1		KDD-900B  Pag.147	104x22
1.7	85	02.01 → 09.05	D17A6		KDD-900B  Pag.147	104x22
CIVIC VI (EJ,EK)						
1.4 i (EJ9)	55	11.95 → 02.01	D14A3 D14Z1		KDD-487  Pag.136	103x23.5
1.4 i S (EJ9)	66	11.95 → 02.01	D14A4 D14Z2		KDD-487  Pag.136	103x23.5

	KW			KDK- KIT CATENA TIMING BELT KIT	KDD- KIT CINGHIA TIMING CHAIN KIT <i>(Nr. of Teeth x Width)</i>	SKD KDD+POMPA ACQUA KDD+WATER PUMP
CIVIC VI (EJ,EK)						
1.5 i (EK3)	84	11.95 → 02.01	D15Z6		KDD-487  Pag.136	103x23.5
1.6 VTi (EK4)	118	11.95 → 02.01	B16A2		KDD-422  Pag.135	124x26
CIVIC VI (EM)						
1.7 i	88	05.01 → 12.05	D17A8		KDD-900B  Pag.147	104x22
1.7 i VTEC	92	05.01 → 12.05	D17A5 D17A9		KDD-900B  Pag.147	104x22
CIVIC VI (EU_, EP_)						
1.4 i	55	02.01 → 09.05	D14Z6		KDD-423B  Pag.135	103x22
1.7 CTDi	74	01.02 → 09.05	4EE-2		KDD-425  Pag.135	129x25
CIVIC VI (MB,MC)						
1.5 16V (MB9)	84	04.98 → 02.01	D15Z8		KDD-487  Pag.136	103x23.5
1.6 16V (MC1)	85	04.98 → 02.01	D16B2		KDD-413A  Pag.134	107x24
1.8 16V (MC2)	124	04.98 → 02.01	B18C4		KDD-481  Pag.135	126x26
CONCERTO (HW)						
1.4	61	10.89 → 10.92	D14A1		KDD-413A  Pag.134	107x24
1.4	66	08.89 → 10.91	D14A1 D14A8		KDD-413A  Pag.134	107x24
1.5 i 16V	66	08.89 → 03.95	D15B2		KDD-412  Pag.134	106x24
1.6 i 16V	82	08.89 → 03.95	D16Z2		KDD-413A  Pag.134	107x24
1.6 i 16V	90	08.89 → 03.95	D16A8		KDD-411  Pag.134	124x24
CR-V I (RD)						
2.0 16V (RD1, RD3)	108	01.99 → 02.02	B20Z1		KDD-485  Pag.136	125x26
2.0 16V (RD1, RD3)	94	10.95 → 01.99	B20B		KDD-485  Pag.136	125x26
CRX II (ED, EE)						
1.6 i 16V	79	10.87 → 05.88	D16A6 D16A		KDD-413B  Pag.134	107x24
1.6 i 16V (ED9)	96	10.87 → 12.89	D16A8 D16A9		KDD-411  Pag.134	124x24
1.6 i 16V Vtec (EE8)	110	10.89 → 02.92	B16A1		KDD-422  Pag.135	124x26
CRX III (EH, EG)						
1.6 ESi (EH6)	92	03.92 → 12.98	D16Y8 D16Z6		KDD-418A  Pag.135	104x25

NEW CODES - NEUE CODES - NOUVEAUX CODES - NUEVOS CODIGOS - NUOVI CODICI

	KW			KDK- KIT CATENA TIMING BELT KIT	KDD- KIT CINGHIA TIMING CHAIN KIT <small>(Nr. of Theet x Width)</small>	SKD KDD+POMPA ACQUA KDD+WATER PUMP
CRX III (EH, EG)						
1.6 i VTi (EG2)	118	03.92 → 12.98	B16A2		KDD-422  Pag.135	124x26
FR-V						
1.7	92	02.05	D17A2		KDD-900B  Pag.147	104x22
HR-V (GH)						
1.6 16V	77	03.99	D16W1		KDD-418A  Pag.135	104x25
1.6 16V 4WD	91	10.99	D16W5		KDD-418A  Pag.135	104x25
INTEGRA (DA_)						
1.5	63	10.85 → 08.89	D15A1		KDD-481  Pag.135	126x26
INTEGRA (DC2)						
1.8 Type-R	140	11.97 → 10.01	B18C6		KDD-481  Pag.135	126x26
JAZZ (AA)						
45 1.2	33	02.84 → 10.86	ER2		KDD-406  Pag.133	97x19
55 1.2	40	09.84 → 10.86	ER4		KDD-406  Pag.133	97x19
56 1.2	41	10.83 → 10.86	ER1		KDD-406  Pag.133	97x19
LEGEND I (HS, KA)						
2.5 i (HS)	110	01.86 → 12.87	C25A1		KDD-410  Pag.134	192x28
2.7 i 24V (KA4)	124	01.88 → 12.90	C27A1		KDD-410  Pag.134	192x28
LEGEND II (KA7)						
3.2 i 24V	151	01.91 → 02.96	C32A2		KDD-417  Pag.135	196x28
LOGO (GA3)						
1.3	48	03.99 → 03.02	D13B7		KDD-423  Pag.135	103x22
PRELUDE III (BA)						
2.0 (BA4)	84	08.87 → 01.92	B20A4		KDD-414  Pag.134	107x24
2.0 EX (BA4)	80	04.87 → 01.92	B20A3		KDD-414  Pag.134	107x24
2.0 i EX 16V	101	04.86 → 12.87	B20A1		KDD-409  Pag.134	133x24
2.0 i EX 16V	110	10.87 → 12.90	B20A7		KDD-411A  Pag.134	124x24
2.0 i EX 16V (BA4)	103	04.90 → 01.92	B20A9		KDD-411A  Pag.134	124x24
2.0 i EX 16V (BA4) Cat.	101	04.87 → 01.92	B20A5		KDD-411A  Pag.134	124x24

NEW CODES - NEUE CODES - NOUVEAUX CODES - NUEVOS CODIGOS - NUOVI CODICI

	KW			KDK- KIT CATENA TIMING BELT KIT	KDD- KIT CINGHIA TIMING CHAIN KIT <i>(Nr. of Teeth x Width)</i>	SKD KDD+POMPA ACQUA KDD+WATER PUMP
PRELUDE IV (BB)						
2.0 i 16V (BB3)	98	02.92 → 09.96	F20A4		KDD-415 113x24 70x16  Pag.134	
2.2 i 16V Vtec (BB1)	136	02.93 → 09.96	H22A2		KDD-498 70x16 155x24  Pag.136	
2.3 i 16V (BB2)	118	02.92 → 09.96	H23A2		KDD-416 127x25 70x16  Pag.134	
PRELUDE V (BB)						
2.2 16V	147	10.96 → 10.00	H22A5		KDD-498 70x16 155x24  Pag.136	
2.2 16V (BB6, BB8)	136	10.96 → 10.00	H22A5		KDD-498 70x16 155x24  Pag.136	
SHUTTLE (RA)						
2.2 16V	110	10.94 → 02.98	F22B8		KDD-415 113x24 70x16  Pag.134	
2.3 16V	110	10.97 → 06.02	F23A7		KDD-415 113x24 70x16  Pag.134	
STREAM (RN)						
1.7 16V	92	05.01	D17A2		KDD-900B 104x22  Pag.147	

	KW			KDK- KIT CATENA TIMING BELT KIT	KDD- KIT CINGHIA TIMING CHAIN KIT <small>(Nr. of Theet x Width)</small>	SKD KDD+POMPA ACQUA KDD+WATER PUMP
ACCENT (LC)						
1.3	55	01.00	G4E-A		KDD-H14  Pag.150	110x22
1.3	61	01.00	G4E-A		KDD-H14  Pag.150	110x22
1.3	63	01.00	G4E-A		KDD-H14  Pag.150	110x22
1.5	66	01.00	G4EB		KDD-H14  Pag.150	110x22
1.5	75	09.00	G4EC-G		KDD-H07 G4ECG/G4FK  Pag.149	105x22
1.5 CRDi	60	04.02	D3-EA		KDD-H08  Pag.149	123x28 SKD-H08  Pag. 159
1.6	77	12.02	G4ED-G		KDD-H07B  Pag.149	105x22
ACCENT (MC)						
1.4 GL	71	11.05	G4EE		KDD-H07B  Pag.149	105x22
ACCENT/EXCEL (X-3)						
1.3	44	10.94 → 01.00	G4EH		KDD-533B  Pag.139	92x22
1.3	55	10.94 → 01.00	G4EH		KDD-533B  Pag.139	92x22
1.3 i 12V	62	10.94 → 01.00	G4EH		KDD-533B  Pag.139	92x22
1.5 i 12V	65	10.94 → 01.00	G4EK		KDD-533B  Pag.139	92x22
1.5 i 16V	73	12.95 → 01.00	G4ER		KDD-H07 G4FK DOCH  Pag.149	105x22
ATOS (MX)						
1.0 i	40	02.98 → 03.02	G4HC		KDD-571  Pag.140	101x20
1.0 i	43	03.01	G4HC-E		KDD-571  Pag.140	101x20
ATOS PRIME (MX)						
1.0 i	40	08.99	G4HC		KDD-571  Pag.140	101x20
1.0 i	43	03.01	G4HC-E		KDD-571  Pag.140	101x20
1.1	43	06.03	G4HD		KDD-571  Pag.140	101x20
1.1	46	09.05	G4HG		KDD-571  Pag.140	101x20
COUPE						
1.6	77	02.06			KDD-H07B  Pag.149	105x22

	KW			KDK- KIT CATENA TIMING BELT KIT	KDD- KIT CINGHIA TIMING CHAIN KIT <i>(Nr. of Teeth x Width)</i>	SKD KDD+POMPA ACQUA KDD+WATER PUMP
COUPE						
2.0	105	02.06			KDD-H10A 113x24  <i>Pag.149</i>	
2.7 V6	121	02.06			KDD-H03A 207x32  <i>Pag.149</i>	
COUPE (GK)						
1.6 16V	77	03.02	G4ED-G		KDD-H07B 105x22  <i>Pag.149</i>	
1.6 16V	79	03.02	G4ED-G		KDD-H07B 105x22  <i>Pag.149</i>	
2.0	102	03.02	G4GC-G		KDD-H10 113x24  <i>Pag.149</i>	
2.0 GLS	105	02.03	G4GC-G		KDD-H10 113x24  <i>Pag.149</i> KDD-H10B 113x24 10.06→  <i>Pag.150</i>	
2.7 V6	123	03.02	G6BA-G		KDD-H03 207x32  <i>Pag.149</i>	
COUPE (RD)						
1.6 16V	85	03.98 → 04.02	G4GR		KDD-581 111x25  <i>Pag.141</i>	
1.6 i 16V	84	12.96 → 04.02	4G61		KDD-581 111x25  <i>Pag.141</i>	
2.0 16V	102	08.96 → 04.02	G4GF		KDD-H10 113x24  <i>Pag.149</i>	
ELANTRA (XD)						
1.6	79	06.00	G4ED-G		KDD-H07B 105x22  <i>Pag.149</i>	
2.0	102	06.00	G4GC-G		KDD-H10 113x24  <i>Pag.149</i>	
2.0	104	06.00	G4GC		KDD-H10 113x24  <i>Pag.149</i>	
2.0 CRDi	83	04.01	D4EA		KDD-H08 123x28  <i>Pag.149</i>	SKD-H08  <i>Pag. 159</i>
GALLOPER I						
2.5 TD	62	08.91 → 07.98	4D56T		KDD-M02 99x18.5 163x25.1  <i>Pag.151</i>	
2.5 TD intercooler	70	08.91 → 07.98	4D56T		KDD-M02 99x18.5 163x25.1  <i>Pag.151</i>	
GALLOPER II (JK-01)						
2.5 TCI D	77	08.98	D4BH		KDD-M02 99x18.5 163x25.1  <i>Pag.151</i>	
2.5 TD	65	08.98	D4BA		KDD-M02 99x18.5 163x25.1  <i>Pag.151</i>	

	KW			KDK- KIT CATENA TIMING BELT KIT	KDD- KIT CINGHIA TIMING CHAIN KIT <small>(Nr. of Teeth x Width)</small>	SKD KDD+POMPA ACQUA KDD+WATER PUMP
GALLOPER II (JK-01)						
2.5 TD intercooler	73	08.98	D4BH		KDD-M02 99x18.5 163x25.1  Pag.151	
3.0 V6	104	08.98	G6AT		KDD-525  Pag.138	149x24.7
GETZ (TB)						
1.1	46	09.02	G4HD		KDD-571  Pag.140	101x20
1.1	49	09.05	G4HD		KDD-571  Pag.140	101x20
1.3	60	09.02	G4E-A		KDD-H14  Pag.150	110x22
1.3	63	09.03	G4E-A		KDD-H14  Pag.150	110x22
1.5 CRDi	60	03.03	D3-EA		KDD-H08  Pag.149	123x28 SKD-H08  Pag. 159
1.6	77	09.02	G4ED-G		KDD-H07B  Pag.149	105x22
H-1/H-200						
2.5 TD	59	03.00 → 09.00	D4BF		KDD-M02 99x18.5 163x25.1  Pag.151	
2.5 TD	73	03.00	D4BH		KDD-M02 99x18.5 163x25.1  Pag.151	
2.5 TD	74	10.01	D4BH		KDD-M02 99x18.5 163x25.1  Pag.151	
H100 (P)						
2.4	84	01.97 → 03.00	G4CS		KDD-592 55x12.8 123x24  Pag.142	
2.4	90	07.93 → 03.00	G4CS		KDD-592 55x12.8 123x24  Pag.142	
2.5 D	55	07.93 → 12.94	D4BA D4BX		KDD-M01 163x25 83x19  Pag.151	
2.5 D	57	12.94 → 03.00	D4BA		KDD-M01 163x25 83x19  Pag.151	
2.5 TD	59	07.93 → 03.00	D4BF		KDD-M01 163x25 83x19  Pag.151	
i10						
1.1	48	12.07	G4HG		KDD-571  Pag.140	101x20
1.1	49	01.08	G4HG		KDD-571  Pag.140	101x20
i30						

	KW			KDK- KIT CATENA TIMING BELT KIT	KDD- KIT CINGHIA TIMING CHAIN KIT <small>(Nr. of Theet x Width)</small>	SKD KDD+POMPA ACQUA KDD+WATER PUMP
i30						
2.0	105	10.07	G4GC-G G4GC		KDD-H10B  Pag.150	113x24
2.0 CRDi	103	10.07	D4EA		KDD-H08  Pag.149	123x28
LANTRA I (J-1)						
1.5 i.e.	63	10.90 → 11.95	G15B G4DJ		KDD-H01  Pag.148	92x18.8
1.6 i.e. 16V	78	10.90 → 11.95	G4CR		KDD-590 06.91 →  Pag.141	65x13 151x29
1.6 i.e. 16V	84	10.90 → 11.95	G4CR		KDD-590 06.91 →  Pag.141	65x13 151x29
1.8 i.e. 16V	93	10.90 → 11.95	G4CN		KDD-526 06.92 →  Pag.138	153x29 65x13
LANTRA II (J-2)						
1.5 12V	65	12.96 → 09.00	G4EK		KDD-533B  Pag.139	92x22
1.6 i	66	11.95 → 09.00	G4GR		KDD-581  Pag.141	111x25
1.8 16V	94	11.95 → 09.00	G4GM		KDD-581  Pag.141	111x25
1.9 D	50	03.98 → 09.00	DJY		KDD-880A  Pag.146	136x25
2.0 16V	102	08.96 → 09.00	G4GF		KDD-H10  Pag.149	113x24
MATRIX (FC)						
1.5 CRDi	60	10.01	D3-EA		KDD-H08  Pag.149	123x28
						SKD-H08  Pag. 159
1.5 CRDi	75	12.04	D4FA		KDD-H08  Pag.149	123x28
1.6	76	06.01	G4ED-G		KDD-H07B  Pag.149	105x22
1.8	90	06.01	G4GB-G		KDD-581  Pag.141	111x25
PONY						
1.3	50	10.85 → 09.89	G13B		KDD-H01  Pag.148	92x18.8
1.5	53	10.85 → 09.89	G15B G4DJ		KDD-H01  Pag.148	92x18.8
PONY (X-2)						
1.3	43	10.89 → 01.95	G4DG		KDD-519 07.91 →  Pag.137	92x18.8













	KW			KDK- KIT CATENA TIMING BELT KIT	KDD- KIT CINGHIA TIMING CHAIN KIT <small>(Nr. of Teeth x Width)</small>	SKD KDD+POMPA ACQUA KDD+WATER PUMP
PONY (X-2)						
1.5 i	61	10.89 → 01.95	G15B G4DJ		KDD-519 92x18.8 08.92 →  Pag.137	
1.5 i	62	10.89 → 01.95	G15B G4DJ		KDD-519 92x18.8 08.92 →  Pag.137	
S COUPE (SLC)						
1.5 i	62	02.90 → 05.96	G15B G4DJ		KDD-H01 92x18.8  Pag.148	
1.5 i	65	04.92 → 05.96	G4EK		KDD-533C 92x22  Pag.139	
1.5 i Turbo	85	04.91 → 05.96	G4EK-TC		KDD-533C 92x22  Pag.139	
SANTA FÉ						
2.2 CRDi	102	03.06			KDD-H08 123x28  Pag.149	SKD-H08  Pag. 159
2.2 CRDi	114	03.06	D4EB		KDD-H08 123x28  Pag.149	SKD-H08  Pag. 159
2.2 CRDi GLS	110	03.06	D4EB		KDD-H08 123x28  Pag.149	SKD-H08  Pag. 159
2.7	125	03.06			KDD-H11 219x32  Pag.150	
2.7 V6 GLS	139	03.06	G6EA		KDD-H11 219x32  Pag.150	
SANTA FE' (SM)						
2.0	99	08.01	G4BP		KDD-H02 65x13 173x29  Pag.148	
2.0 CRDi	83	08.01	D4EA		KDD-H08 123x28  Pag.149	SKD-H08  Pag. 159
2.0 CRDi 4x4	92	08.03	D4EA		KDD-H08 123x28  Pag.149	SKD-H08  Pag. 159
2.2 CRDi	110	10.05	D4EB		KDD-H08 123x28  Pag.149	SKD-H08  Pag. 159
2.4 16V	100	02.01	G4JS-G		KDD-H09 65x13 175x29  Pag.149	
2.4 16V	107	02.01	G4JS-G		KDD-H09 65x13 175x29  Pag.149	
2.7	139	10.05	G6EA		KDD-H11 219x32  Pag.150	
2.7 V6 4x4	127	02.01	G6BA-G		KDD-H03B 207x32  Pag.149	
SANTAMO						
2.0	77	10.98 → 10.02			KDD-526D 153x29 65x13  Pag.138	









	KW			KDK- KIT CATENA TIMING BELT KIT	KDD- KIT CINGHIA TIMING CHAIN KIT <small>(Nr. of Teeth x Width)</small>	SKD KDD+POMPA ACQUA KDD+WATER PUMP
SANTAMO						
2.0 16V	102	05.99			KDD-526 153x29 65x13  Pag.138	
SONATA I (Y-2)						
1.8 i	70	09.88 → 10.93	4G62		KDD-513B 122x19 55x12.8  Pag.137	
2.0 i	74	09.88 → 08.91	G4CP		KDD-513B 122x19 55x12.8  Pag.137	
2.4 i	83	09.88 → 08.91	G4CS		KDD-521 55x12.8 123x19 01.90→  Pag.137	
3.0 i V6	107	01.91 → 10.93	G6AT		KDD-525 149x24.7  Pag.138	
SONATA II (Y-3)						
1.8 i	72	05.93 → 06.98	G4CM		KDD-513B 122x19 55x12.8  Pag.137	
2.0 i	77	06.94 → 08.96	G4CP		KDD-526 153x29 65x13  Pag.138	
2.0 i 16V	102	05.93 → 06.98	G4CP-D		KDD-526 153x29 65x13  Pag.138	
3.0 i V6	107	05.93 → 06.98	G6AT		KDD-525 149x24.7  Pag.138	
SONATA III (EF)						
2.0 16V	100	06.98 → 10.01	G4JP-G		KDD-H02 65x13 173x29  Pag.148	
2.5 V6 24V	118	06.98 → 10.01	G6BV-G		KDD-H03 207x32  Pag.149	
SONATA IV/ SONICA						
2.0	96	10.01 → 11.04	G4JP-EG		KDD-H02 65x13 173x29  Pag.148	
2.7 V6	127	10.01 → 11.04	G6BA-G		KDD-H03 207x32  Pag.149	
2.7 V6	129	11.02 → 11.04	G6BA		KDD-H03 207x32  Pag.149	
SONATA V						
2.0 CRDi	100	02.06	D4EA		KDD-H08 123x28  Pag.149	SKD-H08  Pag. 159
2.0 CRDi	103	02.06	D4EA		KDD-H08 123x28  Pag.149	SKD-H08  Pag. 159
2.0 CRDi	110	03.09	D4EA		KDD-H08 123x28  Pag.149	SKD-H08  Pag. 159

	KW			KDK- KIT CATENA TIMING BELT KIT	KDD- KIT CINGHIA TIMING CHAIN KIT <small>(Nr. of Teeth x Width)</small>	SKD KDD+POMPA ACQUA KDD+WATER PUMP
SONATA V						
2.2 CRDi GLS	110	02.06	D4EB		KDD-H08  Pag.149	123x28  Pag. 159
STAREX (H1)						
2.5 TD	59	06.97	D4BF		KDD-M02  Pag.151	99x18.5 163x25.1
STELLAR						
2.0 (4G63B)	61	01.86 → 12.89			KDD-513B  Pag.137	122x19 55x12.8
TERRACAN (HP)						
2.5 TD	74	12.01	D4BH		KDD-M02  Pag.151	99x18.5 163x25.1
2.9 CRDi	110	12.01	J3		KDD-K11  Pag.150	152x30
2.9 CRDi	120	11.03	J3		KDD-K11  Pag.150	152x30
3.5 i V6 4WD	143	12.01	G6CU		KDD-K13  Pag.151	259x32
3.5 i V6 4WD	147	12.01	G6CU		KDD-K13  Pag.151	259x32
TRAJET (FO)						
2.0	100	03.00	G4JP-G		KDD-H02  Pag.148	65x13 173x29
2.0	103	01.04	G4GC-G		KDD-H10B  Pag.150	113x24
2.0	104	11.03	G4GC		KDD-H10B  Pag.150	113x24
2.0 CRDi	83	04.01	D4EA		KDD-H08  Pag.149	123x28  Pag. 159
2.7 V6	127	09.00	G6BA-G		KDD-H03  Pag.149	207x32
TUCSON (JM)						
2.0	104	08.04	G4GC		KDD-H10B 05.06→  Pag.150	113x24
2.0 CRDi	100	01.06	D4EA		KDD-H08  Pag.149	123x28  Pag. 159
2.0 CRDi	103	01.06	D4EA-V		KDD-H08  Pag.149	123x28  Pag. 159
2.0 CRDi	83	08.04	D4EA		KDD-H08  Pag.149	123x28  Pag. 159

	KW			KDK- KIT CATENA TIMING BELT KIT	KDD- KIT CINGHIA TIMING CHAIN KIT <i>(Nr. of Teeth x Width)</i>	SKD KDD+POMPA ACQUA KDD+WATER PUMP
CAMPO (KB)						
1.6 (KB26/41)	59	01.83			KDD-902  Pag.147	115x18.5
2.0 (KB23)	52	01.83 → 03.88	4ZC1		KDD-902  Pag.147	115x18.5
2.0 (KB28)	58	06.85 → 12.88	G200Z		KDD-902  Pag.147	115x18.5
2.2 D (KBD27)	39	04.86 → 12.90	C223		KDD-901A 08.88 →  Pag.147	87x34.7
2.2 D (KBD27)	45	01.83 → 12.91	C223		KDD-901A  Pag.147	87x34.7
2.3 (TFR16)	68	08.88			KDD-902  Pag.147	115x18.5
2.5 D 4WD (KBD47)	55	01.83 → 12.90	4JA1		KDD-906B  Pag.148	119x32
3.1 TD (TFR/S 54) Pick-Up	0	01.98			KDD-906B  Pag.148	119x32
GEMINI						
1.7 TD	65	01.90 → 12.93			KDD-907A  Pag.148	136x25
GEMINI (JT)						
1.5	52	02.88 → 12.90	4XC1U Kat.		KDD-992  Pag.148	112x19
1.5 D	37	02.88 → 12.90	4EC1		KDD-907A  Pag.148	136x25
1.5 TD	49	02.88 → 12.90	4EC1T		KDD-907A  Pag.148	136x25
KB D (4JA1) TFR54/TFS54						
2.5 Pick-Up	56	08.88			KDD-906B  Pag.148	119x32
MIDI (94000, 98000)						
1.8	56	01.83 → 12.90			KDD-903  Pag.147	111x19
2.0 (98000)	61	01.89	4ZC1		KDD-903  Pag.147	111x19
2.0 D 4WD 4FC1	0	06.88			KDD-904A  Pag.147	137x30
2.0 TD (98000)	51	01.89	4FC1T		KDD-904A  Pag.147	137x30
2.2 D (98000)	45	01.89	4FD1		KDD-904A  Pag.147	137x30
MIDI (98000N)						
2.0	61	06.88	4ZC1		KDD-903  Pag.147	111x19
2.2 D	45	01.89	4FD1		KDD-904A  Pag.147	137x30
2.4 TD	56	02.94	4FG1T		KDD-904A  Pag.147	137x30

NEW CODES - NEUE CODES - NOUVEAUX CODES - NUEVOS CODIGOS - NUOVI CODICI

	KW			KDK- KIT CATENA TIMING BELT KIT	KDD- KIT CINGHIA TIMING CHAIN KIT <small>(Nr. of Teeth x Width)</small>	SKD KDD+POMPA ACQUA KDD+WATER PUMP
TROOPER						
3.0 DTI	118	04.00	4 JX1		KDD-900  Pag.147	104x22
3.5 V6 24V	158	04.00	6 VE1		KDD-910  Pag.148	191x32
TROOPER (UB)						
3.1 TD	84	08.91 → 07.98	4 JG2 T		KDD-906B  Pag.148	119x32
TROOPER (UBS)						
2.2 D (UBS52)	45	01.83 → 12.83	C223T		KDD-901B  Pag.147	87x34.7
2.2 D 4x4	39	05.84 → 12.89	C223		KDD-901B  Pag.147	87x34.7
2.2 TD (UBS52)	53	03.84 → 12.91	C223T		KDD-901B  Pag.147	87x34.7
2.6 i (UBS17)	85	10.87 → 12.91	4ZE1		KDD-905A  Pag.148	137x24.5
2.8 TD (UBS55)	71	10.87 → 12.91	4JB1T		KDD-906B  Pag.148	119x32
2.8 TD (UBS55)	78	10.88 → 12.91	4JB1TC		KDD-906B  Pag.148	119x32

	KW			KDK- KIT CATENA TIMING BELT KIT	KDD- KIT CINGHIA TIMING CHAIN KIT <small>(Nr. of Teeth x Width)</small>	SKD KDD+POMPA ACQUA KDD+WATER PUMP
CHEROKEE (KJ)						
2.5 CRD	105	09.01	R 425 DOHC		KDD-005  Pag.121	220x28
2.8 CRD	110	11.02			KDD-005  Pag.121	220x28
CHEROKEE (KK)						
2.8 CRD	130	05.08			KDD-905  Pag.147	171x24
COMPASS						
2.0 CRD 4x4	103	09.06	ECE		KDD-502  Pag.136	141x30
WRANGLER III (JK)						
2.8 CRD	130	04.07	ENS		KDD-905  Pag.147	171x24

	KW			KDK- KIT CATENA TIMING BELT KIT	KDD- KIT CINGHIA TIMING CHAIN KIT <small>(Nr. of Teeth x Width)</small>	SKD KDD+POMPA ACQUA KDD+WATER PUMP
AVELLA DELTA (B5DI)						
1.5 GSDI	0	01.95			KDD-303  Pag.129	107x19
AVELLA DELTA (B3)						
1.3 GXI/GLXI	0	03.94			KDD-320A  Pag.130	107x22
1.5 G/LS/LXI	0	01.95			KDD-320A  Pag.130	107x22
BESTA						
2.0	0	01.90			KDD-308  Pag.129	108x25
2.2 D	48	02.96	R2		KDD-320A TA24  Pag.130	107x22
CAPITAL						
1.5	0	01.89			KDD-320A  Pag.130 KDD-K21 145x22 01.90→  Pag.151	107x22
CARENS I (FC)						
1.8	81	11.00 → 07.02	T8		KDD-K14  Pag.151	154x21.5
CARENS II						
1.6	77	07.02			KDD-K10  Pag.150	137x22
1.8	93	07.02			KDD-K14  Pag.151	154x21.5
2.0 CRDi	83	07.02	D4EA		KDD-H08  Pag.149	123x28 SKD-H08  Pag. 159
2.0 CVVT	102	08.04	G4GC		KDD-H10  Pag.149	113x24
CARENS III						
2.0 CRDi	103	09.06	D4EA		KDD-H08  Pag.149	123x28 SKD-H08  Pag. 159
2.0 CVVT	106	09.06	G4KA		KDD-H10B  Pag.150	113x24
CARNIVAL (UP)						
2.5 V6	121	08.99 → 10.01			KDD-K01  Pag.150	176x28 59x22
2.9 TD	93	08.99 → 10.01	J3		KDD-K03  Pag.150	151x30
CARNIVAL II						
2.5 V6	110	10.01	K5		KDD-K01  Pag.150	176x28 59x22
2.9 CRDi	106	10.01	J3		KDD-K11  Pag.150	152x30





















NEW CODES - NEUE CODES - NOUVEAUX CODES - NUEVOS CODIGOS - NUOVI CODICI









	KW			KDK- KIT CATENA TIMING BELT KIT	KDD- KIT CINGHIA TIMING CHAIN KIT <i>(Nr. of Theet x Width)</i>	SKD KDD+POMPA ACQUA KDD+WATER PUMP
CARNIVAL II						
2.9 CRDi	136	06.06	J3		KDD-K11A  Pag.150	152x30
CEE'D						
2.0	105	12.06	G4GC		KDD-H10B  Pag.150	113x24
2.0 CRDi	103	09.07	D4EA-F		KDD-H08  Pag.149	123x28 SKD-H08  Pag. 159
CERATO						
1.6	77	07.04	G4ED		KDD-H07B  Pag.149	105x22
2.0	105	04.04	G4GC		KDD-H10  Pag.149	113x24
2.0 CRDi	83	04.04	D4EA		KDD-H08  Pag.149	123x28 SKD-H08  Pag. 159
CLARUS (K9A)						
1.8 i 16V	85	07.96	T8		KDD-K00  Pag.150	154x21.5
2.0 i 16V	98	07.96	FE (16 V)		KDD-K04  Pag.150	168x25
CONCORD (F8)						
1.8 (GTX/LX/LPG)	0	01.88			KDD-311  Pag.129	106x22
CONCORD (FE/RF)						
2.0 (GTX/LX/DSL)	0	01.87			KDD-311  Pag.129	106x22
CONCORD (FEDI)						
2.0 (GLX)	0	01.92			KDD-308  Pag.129	108x25
JOICE						
2.0	102	02.00	G4CP		KDD-526C  Pag.138	153x29 65x13
2.0	88	09.01			KDD-526C  Pag.138	153x29 65x13
K2500						
2.5 D	69	01.03	D4BH		KDD-M02  Pag.151	99x18.5 163x25.1
MAGENTIS (GD)						
2.0	100	05.01	G4JP		KDD-H02B  Pag.148	173x29
					KDD-H02C  Pag.149	173x29
2.5 V6	124	05.01	G6BV		KDD-H03B  Pag.149	207x32









	KW			KDK- KIT CATENA TIMING BELT KIT	KDD- KIT CINGHIA TIMING CHAIN KIT <i>(Nr. of Teeth x Width)</i>	SKD KDD+POMPA ACQUA KDD+WATER PUMP
PICANTO						
1.0	45	09.05	G4HE		KDD-571  Pag.140	101x20
1.0	46	02.08	G4HE		KDD-571  Pag.140	101x20
1.1	48	02.08			KDD-571  Pag.140	101x20
1.1	48	04.04	G4HG		KDD-571  Pag.140	101x20
POTENTIA (FE22/FE20)						
2.2 (5F/L)	0	01.92			KDD-308  Pag.129	108x25
PREGIO (TB)						
2.5 TCI D	69	09.02	D4BH		KDD-M02  Pag.151	99x18.5 163x25.1
PRIDE (DA)						
1.1 i	38	01.91	Mazda B1		KDD-320A  Pag.130	107x22
1.3 16V	44	01.90	B3		KDD-320A  Pag.130	107x22
1.3 16V	53	01.90	B3		KDD-320A  Pag.130	107x22
1.3 i	51	01.90			KDD-320A  Pag.130	107x22
PRIDE SW						
1.3	47	08.99			KDD-320A  Pag.130	107x22
PRO CEE'D						
2.0 CRDi	103	02.08	D4EA-F		KDD-H08  Pag.149	123x28 SKD-H08  Pag. 159
RIO						
1.3	55	09.00 → 02.05			KDD-320A  Pag.130	107x22
1.3	60	08.02 → 02.05			KDD-320A  Pag.130	107x22
1.5	72	09.00 → 02.05			KDD-K10  Pag.150	137x22
RIO II						
1.4 16V	71	03.05	G4EE		KDD-H07B  Pag.149	105x22
1.6 16V	82	03.05	G4ED		KDD-H07B  Pag.149	105x22
SEPHIA (FA)						
1.5 i 16V	59	02.96	B5		KDD-320A  Pag.130	107x22
1.6 i	59	01.95	B6		KDD-320A  Pag.130	107x22

NEW CODES - NEUE CODES - NOUVEAUX CODES - NUEVOS CODIGOS - NUOVI CODICI

	KW			KDK- KIT CATENA TIMING BELT KIT	KDD- KIT CINGHIA TIMING CHAIN KIT <i>(Nr. of Teeth x Width)</i>	SKD KDD+POMPA ACQUA KDD+WATER PUMP
SEPHIA (FA)						
1.8 i 16V	82	01.95	OK24N OK26Y		KDD-K00 154x21.5  Pag.150	
SHUMA (FB)						
1.5	59	03.96 → 12.98	OK280		KDD-K21 145x22  Pag.151	
1.5 i 16V	65	10.97 → 03.01			KDD-K21 145x22  Pag.151	
1.8 i 16V	81	10.97 → 03.01	T8		KDD-K00 154x21.5  Pag.150	
SHUMA II (FB)						
1.6	75	05.01 → 08.04	GA6D		KDD-K21 145x22  Pag.151	
SORENTO (JC)						
2.4	102	08.02	G4JS		KDD-H09 65x13 175x29  Pag.149	
3.5 V6	143	08.02	G6CU		KDD-K13 259x32  Pag.151	
SPORTAGE						
2.0 16V	104	09.04	G4GC		KDD-H10B 113x24 05.06→  Pag.150	
2.0 CRDi 4WD	103	01.06	D4EA-V D4EA-F		KDD-H08 123x28  Pag.149	SKD-H08  Pag. 159
2.0 CRDi 4WD	83	09.04	D4EA		KDD-H08 123x28  Pag.149	SKD-H08  Pag. 159
SPORTAGE (K00)						
2.0 i 16V 4WD	94	04.94 → 08.03	FE (16 V)		KDD-308 108x25 FE  Pag.129 KDD-K04 168x25 FEDI  Pag.150	
2.0 i 4WD	70	04.94 → 08.99	FE		KDD-308 108x25 FE  Pag.129 KDD-K04 168x25 FEDI  Pag.150	
2.0 TD 4WD	61	10.97 → 08.03	RF		KDD-399 162x25  Pag.133	SKD-399  Pag. 159
2.2 D 4x4	52	08.94 → 04.99			KDD-321B 164x25  Pag.130	

	KW			KDK- KIT CATENA TIMING BELT KIT	KDD- KIT CINGHIA TIMING CHAIN KIT <small>(Nr. of Teeth x Width)</small>	SKD KDD+POMPA ACQUA KDD+WATER PUMP
NIVA (2121)						
1900 Diesel	47	01.93	XUD9A		KDD-880A  Pag.146	136x25
SAMARA (2108, 2109)						
1100	39	02.88 → 12.94			KDD-295  Pag.128	111x19
1100	43	02.96			KDD-295  Pag.128	111x19
1300	45	09.91			KDD-295  Pag.128	111x19
1300	46	01.88			KDD-295  Pag.128	111x19
1300	48	01.86 → 12.94			KDD-295  Pag.128	111x19
1300	50	02.96			KDD-295  Pag.128	111x19
1500	50	09.91			KDD-295  Pag.128	111x19
1500	52	02.95			KDD-295  Pag.128	111x19
1500	53	01.88			KDD-295  Pag.128	111x19
SAMARA FORMA (21099)						
1100	39	07.91			KDD-295  Pag.128	111x19
1300	45	07.91			KDD-295  Pag.128	111x19
1300	46	05.90			KDD-295  Pag.128	111x19
1300	48	05.89 → 07.97			KDD-295  Pag.128	111x19
1300	50	02.96			KDD-295  Pag.128	111x19
1500	50	07.91			KDD-295  Pag.128	111x19
1500	52	11.94			KDD-295  Pag.128	111x19
1500	53	09.91			KDD-295  Pag.128	111x19

	KW			KDK- KIT CATENA TIMING BELT KIT	KDD- KIT CINGHIA TIMING CHAIN KIT <small>(Nr. of Teeth x Width)</small>	SKD KDD+POMPA ACQUA KDD+WATER PUMP
FREELANDER 2						
2.2 TD4	112	01.07	224DT		KDD-515  Pag.137	118x26
2.2 TD4	118	10.06	224DT		KDD-515  Pag.137	118x26
2.2 TD4 4x4	115	10.06	224DT		KDD-515  Pag.137	118x26
RANGE ROVER EVOQUE						
2.2 SD4	140	06.11			KDD-515  Pag.137	118x26
2.2 TD4	110	06.11			KDD-515  Pag.137	118x26

	KW			KDK- KIT CATENA TIMING BELT KIT	KDD- KIT CINGHIA TIMING CHAIN KIT <small>(Nr. of Teeth x Width)</small>	SKD KDD+POMPA ACQUA KDD+WATER PUMP
ES (F1, F2)						
300	138	09.91 → 12.97	3VZ-FE		KDD-225A  Pag.127	191x32
GS (JZS147)						
300	156	03.93 → 08.97	2JZ-GE		KDD-286A  Pag.128	143x25
GS (JZS160)						
300 T3	163	08.97 → 10.00	2JZ-GE		KDD-286A  Pag.128	143x25
IS (GXE10)						
200	114	04.99	1G-FE		KDD-291  Pag.128	129x27
RX						
300	150	05.03	1MZ-FE		KDD-214  Pag.125	211x32
RX (XU1)						
300 V6	148	10.00 → 05.03	1MZ-FE		KDD-214  Pag.125	211x32

	KW			KDK- KIT CATENA TIMING BELT KIT	KDD- KIT CINGHIA TIMING CHAIN KIT <i>(Nr. of Teeth x Width)</i>	SKD KDD+POMPA ACQUA KDD+WATER PUMP
121 I (DA)						
1.1	42	10.87 → 10.90	B1 B116		KDD-320A 107x22  Pag.130 KDD-337	
1.3	40	04.89 → 10.90	B3		KDD-320A 107x22  Pag.130	
1.3	44	10.87 → 11.90	B3		KDD-320A 107x22  Pag.130 KDD-337 01.88→02.89	
1.4 16V (DA1)	71	11.87 → 12.94			KDD-320A 107x22 11.93→  Pag.130	
121 II (DB)						
1.3 16V	39	11.90 → 03.96	B3 (16V)		KDD-320A 107x22  Pag.130	
1.3 16V	53	11.90 → 03.96	B3 (16V)		KDD-320A 107x22  Pag.130	
121 III (JASM, JBSM)						
1.25	55	03.96	DHF DHG		KDD-385 107x22  Pag.132	
1.3	37	03.96	JJK JJM		KDD-385 107x22  Pag.132	
1.3	44	03.96	J4R J4T		KDD-385 107x22  Pag.132	
1.8 D	44	03.96	RTJ RTK		KDD-330 116x22 85x22  Pag.131	
1300						
1.3	44	01.75 → 01.77	TC		KDD-320A 107x22  Pag.130	
2						
1.25	55	04.03	FUJA		KDD-313 117x22  Pag.130	
1.4	59	04.03	FXJA		KDD-313 117x22  Pag.130	
1.4 CD	50	04.03	F6JA F6JB		KDD-318 144x25  Pag.130	
1.4 MZR-CD	50	01.08			KDD-812A 144x26  Pag.146	
1.6	74	04.03	FYJA		KDD-313 117x22  Pag.130	
1.6 MZ-CD	66	10.08			KDD-325 137x25  Pag.131	
3						
1.6 DI Turbo	80	06.04	Y601		KDD-325 137x25  Pag.131	
1.6 DI Turbo	80	06.04	Y601		KDD-325 137x25  Pag.131	

NEW CODES - NEUE CODES - NOUVEAUX CODES - NUEVOS CODIGOS - NUOVI CODICI

	KW			KDK- KIT CATENA TIMING BELT KIT	KDD- KIT CINGHIA TIMING CHAIN KIT <small>(Nr. of Theet x Width)</small>	SKD KDD+POMPA ACQUA KDD+WATER PUMP
3						
1.6 MZR-CD	80	06.09	Y601		KDD-325  Pag.131	137x25
323 F IV (BG)						
1.6	62	09.89 → 06.91	B6E		KDD-320A  Pag.130	107x22
1.6 16V	65	03.91 → 10.94	B6		KDD-320A  Pag.130	107x22
1.8 16V	103	09.89 → 03.93	BP31		KDD-320A  Pag.130	107x22
1.8 16V	76	08.89 → 07.94	BP		KDD-320A  Pag.130	107x22
1.8 16V GT	94	08.89 → 07.94	BP (DOHC)		KDD-320A  Pag.130	107x22
323 F V (BA)						
1.5 16V	65	07.94 → 09.98	Z5-DE		KDD-383  Pag.132 KDD-383A →10.97	125x22
1.8 16V	84	08.94 → 09.98	BP-ZE		KDD-322 05.98→  Pag.131	133x25
2.0 24V	106	08.94 → 09.98	KF		KDD-388  Pag.132	192x30
323 F VI (BJ)						
1.4	53	01.01 → 05.04	B3 (16V)		KDD-320A  Pag.130	107x22
1.4 16V	54	09.98 → 01.01	B3 ME		KDD-320A  Pag.130	107x22
1.5 16V	65	09.98 → 01.01			KDD-324  Pag.131	123x22
1.6	70	01.01 → 05.04	ZM		KDD-324  Pag.131	123x22
1.6	72	01.01 → 05.04	ZM		KDD-324  Pag.131	123x22
2.0	96	01.01 → 05.04	FS7E FS7G		KDD-397  Pag.133	135x25
2.0 D	52	09.98 → 05.04	RF1G		KDD-302  Pag.129	149x24
2.0 TD	66	09.98 → 01.01			KDD-378  Pag.132	153x27
2.0 TD	74	01.01 → 05.04	RF4F		KDD-378  Pag.132	153x27
323 II (BD)						
1.1	40	11.80 → 10.85	E1		KDD-320A  Pag.130	107x22
1.3	44	09.81 → 10.85	E3		KDD-320A  Pag.130	107x22

	KW			KDK- KIT CATENA TIMING BELT KIT	KDD- KIT CINGHIA TIMING CHAIN KIT <i>(Nr. of Teeth x Width)</i>	SKD KDD+POMPA ACQUA KDD+WATER PUMP
323 II (BD)						
1.3	50	11.80 → 10.89	E3		KDD-320A  Pag.130 107x22	
1.5	55	05.81 → 12.85	E5		KDD-320A  Pag.130 107x22	
1.5	59	11.80 → 07.85	E5		KDD-320A  Pag.130 107x22	
1.5	65	03.82 → 09.86	E5		KDD-320A  Pag.130 107x22	
323 III (BF)						
1.1	40	08.85 → 04.90	E1		KDD-320A DA 13-124779  Pag.130 107x22	
1.3	44	08.85 → 05.89	E3		KDD-320A  Pag.130 107x22	
1.4	44	04.87 → 07.89	B3		KDD-320A  Pag.130 107x22	
1.5	54	09.87 → 10.89	B5		KDD-320A BF-563074  Pag.130 KDD-337 →02.89 107x22	
1.5	55	08.85 → 05.89	E5		KDD-320A BF-563074  Pag.130 107x22	
1.5 i	70	08.85 → 05.89	E5E3		KDD-320A BF-563074  Pag.130 107x22	
1.6	54	09.87 → 10.89	B68		KDD-337 →02.89	
1.6 GT	63	11.86 → 10.89	B6		KDD-K21  Pag.151 145x22	
1.6 GT	77	01.86 → 12.88	B6		KDD-K21  Pag.151 145x22	
1.6 GT Turbo	103	10.85 → 11.91	B6		KDD-303  Pag.129 KDD-320A 06.86 →  Pag.130 107x19 107x22	
1.6 GT Turbo 4WD (BF2)	110	08.87 → 10.89			KDD-K21  Pag.151 145x22	
1.7 D	40	09.86 → 05.89	PN27		KDD-315  Pag.130 152x25	
1.7 D	42	01.87 → 05.89	PN46		KDD-315  Pag.130 152x25	
323 III SW (BW)						
1.7 D	40	11.86 → 08.87	PN26		KDD-315  Pag.130 152x25	
323 IV C (BG)						

NEW CODES - NEUE CODES - NOUVEAUX CODES - NUEVOS CODIGOS - NUOVI CODICI

	KW			KDK- KIT CATENA TIMING BELT KIT	KDD- KIT CINGHIA TIMING CHAIN KIT <small>(Nr. of Theet x Width)</small>	SKD KDD+POMPA ACQUA KDD+WATER PUMP
323 IV C (BG)						
1.3	49	09.89 → 07.94	B3E		KDD-320A  Pag.130	107x22
1.3 16V	54	09.89 → 07.94			KDD-320A  Pag.130	107x22
1.6 16V	65	03.91 → 10.94	B6		KDD-320A  Pag.130	107x22
1.7 D	41	08.89 → 07.94	PN54		KDD-315  Pag.130	152x25
1.8 16V	103	09.89 → 03.93	BP22 BP31		KDD-320A  Pag.130	107x22
1.8 16V 4WD	76	11.91 → 12.93	BP		KDD-320A  Pag.130	107x22
1.8 16V GT	94	09.89 → 03.93	BP (DOHC)		KDD-K21  Pag.151	145x22
323 IV S (BG)						
1.3	49	09.89 → 06.91	B3E B383		KDD-320A  Pag.130	107x22
1.3 16V	54	04.91 → 07.94	B3 (16V)		KDD-320A  Pag.130	107x22
1.6 16V	65	08.89 → 10.94	B6		KDD-K21  Pag.151	145x22
1.7 D	41	08.89 → 07.94	PN46 PN54 PN62		KDD-315  Pag.130	152x25
1.8 16V	76	08.89 → 07.94	BP52		KDD-320A  Pag.130	107x22
1.8 16V GT	94	06.89 → 07.94	BP (DOHC)		KDD-K21  Pag.151	145x22
323 V C (BA)						
1.3 16V	54	08.94 → 09.98	B3 (16V)		KDD-320A  Pag.130	107x22
1.5 16V	65	08.94 → 09.98	Z5-DE		KDD-383  Pag.132 KDD-383A →10.97	125x22 125x22
323 V P (BA)						
1.3 16V	54	10.96	B3 (16V)		KDD-320A  Pag.130	107x22
1.5 16V	65	10.96	Z5-DE		KDD-383  Pag.132 KDD-383A →10.97	125x22 125x22
2.0 D	52	10.96	RF1G		KDD-302  Pag.129	149x24
323 V S (BA)						
1.3 16V	54	08.94 → 09.98	B3 (16V)		KDD-320A  Pag.130	107x22

	KW			KDK- KIT CATENA TIMING BELT KIT	KDD- KIT CINGHIA TIMING CHAIN KIT <i>(Nr. of Teeth x Width)</i>	SKD KDD+POMPA ACQUA KDD+WATER PUMP
323 V S (BA)						
1.5 16V	65	08.94 → 09.98	Z5-DE		KDD-383 125x22  Pag.132 KDD-383A 125x22 →10.97	
1.6 TD	60	05.94 → 09.98	4EE1-T		KDD-911 136x25  Pag.148	
2.0 D	52	10.96 → 09.98	RF1G		KDD-302 149x24  Pag.129	
323 VI S (BJ)						
1.4	53	01.01 → 05.04	B3 (16V)		KDD-320A 107x22  Pag.130	
1.5 16V	65	09.98 → 01.01			KDD-324 123x22  Pag.131	
1.6	70	01.01 → 05.04	ZM		KDD-324 123x22  Pag.131	
1.6	72	01.01 → 05.04	ZM		KDD-324 123x22  Pag.131	
2.0	96	01.01 → 05.04	FS7E FS7G		KDD-397 135x25  Pag.133	
2.0 D	52	09.98 → 05.04			KDD-302 149x24  Pag.129	
2.0 TD	66	09.98 → 05.04	RF3F		KDD-302 149x24  Pag.129	
5						
2.0 CD	105	06.05	RF7J		KDD-334 150x30  Pag.131	
2.0 CD	81	03.05			KDD-334 150x30  Pag.131	
6						
2.0 MRZ-CD	103	08.07	RF7J		KDD-334A 150x30  Pag.131	
6 (GG)						
2.0 DI	100	06.02	RF5C		KDD-327 153x30  Pag.131	SKD-327  Pag. 158
2.0 DI	89	08.02	RF5C		KDD-327 153x30  Pag.131	SKD-327  Pag. 158
626 I (CB)						
2.0	66	05.79 → 05.82	HE3 MA M		KDD-307A 109x22  Pag.129	
626 II (GC)						
1.6	55	03.83 → 09.87			KDD-300 106x19  Pag.129	
1.6	59	11.82 → 06.87	F6		KDD-300 106x19  Pag.129	
2.0	68	11.86 → 09.87	FE		KDD-308 108x25  Pag.129	
2.0	74	03.83 → 09.87	FE		KDD-308 108x25  Pag.129	

















NEW CODES - NEUE CODES - NOUVEAUX CODES - NUEVOS CODIGOS - NUOVI CODICI





	KW			KDK- KIT CATENA TIMING BELT KIT	KDD- KIT CINGHIA TIMING CHAIN KIT <i>(Nr. of Theet x Width)</i>	SKD KDD+POMPA ACQUA KDD+WATER PUMP
626 II (GC)						
2.0	88	01.86 → 09.87	FE		KDD-308  Pag.129	108x25
2.0 D	46	01.83 → 06.87	RF46		KDD-389  Pag.132	78x19 148x25
626 III (GD)						
1.8	65	11.87 → 05.92	F8		KDD-312  Pag.129	104x25
2.0	66	09.87 → 10.90	FE		KDD-K04 Double Camshaft  Pag.150 KDD-308 Single Camshaft  Pag.129	168x25 108x25
2.0 12V	79	09.87 → 05.92	FE (12V)		KDD-308  Pag.129	108x25
2.0 D	44	07.87 → 07.91	RF-N		KDD-314  Pag.130	162x30
2.2 12V	85	11.87 → 07.91	F2		KDD-317  Pag.130	110x25
626 IV (GE)						
1.8 i	77	01.92 → 04.97	FP		KDD-322  Pag.131	133x25
2.0 D GLX Complex	55	10.92 → 04.97	RF OHC		KDD-314  Pag.130	162x30
2.0 i	85	01.92 → 04.97	FS		KDD-397  Pag.133	135x25
2.5 24V	120	08.94 → 04.97	KL		KDD-388  Pag.132	192x30
626 V (GF)						
1.8	74	12.99 → 10.02	FP9A		KDD-322  Pag.131	133x25
2.0	100	04.98 → 10.02	FS2C		KDD-397  Pag.133	135x25
2.0	85	05.97 → 10.02	FS		KDD-397  Pag.133	135x25
2.0 TD	81	10.00 → 10.02			KDD-378  Pag.132	153x27
2.0 Turbo DI	74	04.98 → 10.02			KDD-378  Pag.132	153x27
818 SW						
1.3	44	01.74 → 10.78	TC		KDD-320A  Pag.130	107x22
929 I (LA)						
2.0	66	05.79 → 07.86	MA M		KDD-307A  Pag.129	109x22
929 II (HB)						

		KW			KDK- KIT CATENA TIMING BELT KIT	KDD- KIT CINGHIA TIMING CHAIN KIT <i>(Nr. of Teeth x Width)</i>	SKD KDD+POMPA ACQUA KDD+WATER PUMP
929 II (HB)							
2.0		66	05.82 → 03.84	HEE MA		KDD-307A  Pag.129	109x22
2.0		74	03.84 → 07.87	FE		KDD-301  Pag.129	109x19
2.0 i GLX		88	10.84 → 07.87	FE		KDD-301  Pag.129	109x19
929 III (HC)							
2.0		85	06.87 → 12.88	FE FEFA		KDD-308  Pag.129	108x25
2.2 12V		85	01.88 → 04.89	F2 F21 F2E		KDD-317  Pag.130	110x25
2.2 12V		94	04.89 → 06.91	F2-C		KDD-317  Pag.130	110x25
2.2 i		100	05.87 → 12.88	F2-EGI		KDD-317  Pag.130	110x25
3.0		123	01.90 → 06.91	JE3		KDD-319  Pag.130	173x30
3.0		125	01.88 → 12.89	JE3		KDD-319  Pag.130	173x30
3.0		140	06.87 → 06.91	JE		KDD-319  Pag.130	173x30
B-SERIE (UD)							
2.0		57	01.83 → 12.84			KDD-300  Pag.129	106x19
B-SERIE (UF)							
2.2		68	08.91 → 12.96	F2L8		KDD-317  Pag.130	110x25
2.2 D		47	01.85 → 03.96	R290		KDD-321A  Pag.130	164x25
2.5 D		63	02.96 → 06.99			KDD-380  Pag.132	101x30
2.5 D 4WD		57	09.98 → 06.99			KDD-380  Pag.132	101x30
B-SERIE (UN)							
2.5 D		57	06.99	MD25NA		KDD-336  Pag.132	104x30
2.5 D 4WD		62	12.02	WLE7		KDD-336  Pag.132	104x30
2.5 TD 4WD		80	06.99	MD25TI		KDD-380  Pag.132	101x30
BT-50							
2.5 CD 4WD		105	12.06	WLAA		KDD-329  Pag.131	103x27
DEMIO (DW)							
1.3 16V		46	08.98	B3 ME		KDD-320B  Pag.130	107x22

	KW			KDK- KIT CATENA TIMING BELT KIT	KDD- KIT CINGHIA TIMING CHAIN KIT <i>(Nr. of Theet x Width)</i>	SKD KDD+POMPA ACQUA KDD+WATER PUMP
DEMIO (DW)						
1.3 16V	53	08.98 → 04.00	B3 (16V)		KDD-320B  Pag.130	107x22
1.5 16V	55	04.00	B5 E		KDD-320B  Pag.130	107x22
E 2000,2200 (SR1)						
2.0	63	11.84 → 02.88	FE18 FEV4		KDD-308  Pag.129	108x25
2.2 D	46	01.84 → 02.88	R207		KDD-321A  Pag.130	164x25
E 2000,2200 (SR2)						
2.0	60	03.91 → 05.94	FE FE60 FE61		KDD-308  Pag.129	108x25
2.0	63	05.85 → 04.89	FE18 FE58		KDD-308  Pag.129	108x25
2.0	70	06.94	FE		KDD-308  Pag.129	108x25
2.2 D	46	05.85 → 02.88	R203 R207		KDD-321A  Pag.130	164x25
2.2 D	52	02.97 → 08.02	R2		KDD-321A  Pag.130	164x25
2.2 D 4WD	52	02.97	R2		KDD-321A  Pag.130	164x25
MPV I (LV)						
2.5 TD	85	05.96 → 09.99	WL-T		KDD-380  Pag.132	101x30
MPV II (LW)						
2.0	88	08.00 → 07.02	FS		KDD-397  Pag.133	135x25
2.0	90	09.99 → 08.00	FS-DS		KDD-397  Pag.133	135x25
2.0 DI	100	07.02	RF5C		KDD-327  Pag.131	153x30 SKD-327  Pag. 158
MX-3 (EC)						
1.6 i	65	07.91	B69		KDD-320A  Pag.130	107x22
1.8 i V6	98	01.92 → 01.94	K819		KDD-388A  Pag.132	192x30
MX-5 I (NA)						
1.6	85	05.90 → 01.94	B64F		KDD-K21  Pag.151	145x22
1.8	96	02.94 → 04.98	BP (DOHC) BPF1		KDD-K21  Pag.151	145x22
MX-5 II (NB)						
1.6 16V	81	05.98 → 10.05	B6D		KDD-K21  Pag.151	145x22
1.8 16V	103	05.98 → 10.05	BP-ZE		KDD-K21  Pag.151	145x22

NEW CODES - NEUE CODES - NOUVEAUX CODES - NUEVOS CODIGOS - NUOVI CODICI

	KW			KDK- KIT CATENA TIMING BELT KIT	KDD- KIT CINGHIA TIMING CHAIN KIT <i>(Nr. of Teeth x Width)</i>	SKD KDD+POMPA ACQUA KDD+WATER PUMP
MX-6 (GE6)						
2.0	85	02.92	FS		KDD-397  Pag.133	135x25
2.5 i 24V	120	08.94	KL		KDD-388  Pag.132	192x30
PREMACY (CP)						
1.8	74	07.99	FP		KDD-322  Pag.131	133x25
1.9	84	07.99	FP		KDD-322  Pag.131	133x25
2.0 TD	66	10.99 → 07.00	RF3F		KDD-378  Pag.132	153x27
TRIBUTE (EP)						
2.0	91	03.00	YF		KDD-333  Pag.131	129x25
XEDOS 6 (CA)						
1.6 16V	79	06.94	B6		KDD-K21  Pag.151	145x22
1.6 16V	83	08.92 → 05.94	B69		KDD-K21  Pag.151	145x22
2.0 V6	103	06.94	KF1		KDD-K21 →04.98  Pag.151	145x22
2.0 V6	106	01.92 → 05.94	KF1		KDD-K21  Pag.151	145x22
XEDOS 9 (TA)						
2.0 24V	105	08.93 → 01.00	KF		KDD-388  Pag.132	192x30
2.3 24V	155	02.95 → 01.00	KJ-ZEM		KDD-323  Pag.131	201x30
2.5 24V	123	07.93 → 07.00	KL		KDD-388  Pag.132	192x30
2.5 V6	120	07.00	KL		KDD-388B  Pag.132	192x30

	KW			KDK- KIT CATENA TIMING BELT KIT	KDD- KIT CINGHIA TIMING CHAIN KIT <i>(Nr. of Theet x Width)</i>	SKD KDD+POMPA ACQUA KDD+WATER PUMP
3000 GT (Z16A)						
3.0 i 24V 4x4	210	06.92 → 08.99	6G72		KDD-528 257x32  Pag.138 KDD-528A 257x32 →05.93  Pag.138	
CARISMA (DA_)						
1.6	66	07.95 → 06.06	4 G 92		KDD-579 111x29  Pag.141	
1.6	70	12.98 → 06.06	4 G 92		KDD-579 111x29  Pag.141	
1.6	73	05.97 → 06.06	4 G 92		KDD-579 111x29  Pag.141	
1.8	85	07.95 → 06.06	4G93		KDD-578 116x29  Pag.141	
1.8 16V	103	07.95 → 06.06	4G93		KDD-578 116x29  Pag.141	
1.8 16V GDI	92	09.97 → 06.06	4G93		KDD-504 154x28.7  Pag.136	
1.9 DI-D	75	09.00 → 06.06	F9Q1		KDD-538 132x26  Pag.139	
1.9 DI-D	85	09.00 → 06.06	F9Q2		KDD-538 132x26  Pag.139	
1.9 TD	66	10.96 → 09.00	F8QT		KDD-575 153x24.7  Pag.140	
CELESTE (A7_)						
1.6 ST (A73)	54	01.77 → 06.81	4G32		KDD-500 122x19 55x13  Pag.136	
COLT I (A15_A)						
1.2 GL (A151A)	40	12.78 → 01.84	4 G 11		KDD-H01 92x18.8  Pag.148	
1.4 GLX,GT (A152A)	51	05.79 → 01.84	4 G 12		KDD-H01 92x18.8  Pag.148	
1.4 Turbo (A152A)	77	09.81 → 01.84	4 G 12 T		KDD-H01 92x18.8 08.82 →  Pag.148	
COLT II (C1_A)						
1.2 EL,GL (C15A)	40	02.84 → 09.86	4G16		KDD-H01 92x18.8  Pag.148	
1.2 EL,GL (C15A)	44	09.86 → 04.88	4G16		KDD-H01 92x18.8  Pag.148	
1.5 GLX (C12A)	51	09.85 → 04.88	G15B		KDD-519 92x18.8  Pag.137	
1.5 GLX (C12A)	55	09.84 → 04.88	4 G 15		KDD-H01 92x18.8  Pag.148	
1.6 Turbo ECi (C13A)	92	02.84 → 04.88	4 G 32 T/C		KDD-508A 120x19  Pag.136	

	KW			KDK- KIT CATENA TIMING BELT KIT	KDD- KIT CINGHIA TIMING CHAIN KIT <i>(Nr. of Teeth x Width)</i>	SKD KDD+POMPA ACQUA KDD+WATER PUMP
COLT II (C1_A)						
1.8 GL Diesel (C14A)	43	02.84 → 09.86	4 D 65		KDD-509 157x32 55x12.8  Pag.136	
1.8 GL Diesel (C14A)	44	09.86 → 04.88	4 D 65		KDD-509 157x32 55x12.8  Pag.136	
COLT III (C5_A)						
1.3 (C51A)	51	04.88 → 05.92	4 G 13		KDD-533A 92x22  Pag.139	
1.3 12V (C51A)	55	04.88 → 05.92	4 G 13 (BJ90-92, 12V)		KDD-533A 92x22  Pag.139	
1.3 GL	44	04.88 → 12.90	4 G 13		KDD-533A 92x22  Pag.139	
1.5 (C52A) Cat.	66	07.90 → 05.92	4 G 15		KDD-533A 92x22  Pag.139	
1.5 GLXi (C52A)	62	04.88 → 05.92	4 G 15		KDD-519 92x18.8  Pag.137	
1.6 GTi 16V (C53A)	91	04.88 → 05.90	4G61		KDD-590 65x13 151x29  Pag.141	
1.8 Diesel GLX (C54A)	44	04.88 → 05.92	4 D 65		KDD-509 157x32 55x12.8  Pag.136	
1.8 GTi 16V (C58A) Cat.	100	06.90 → 05.92	4G67		KDD-526 153x29 65x13  Pag.138	
COLT IV (CA_A)						
1.3 GLi 12V (CA1A)	55	04.92 → 04.96	4 G 13 (BJ92-..., 12V)		KDD-533A 92x22  Pag.139	
1.6	66	02.94 → 04.96	4 G 92		KDD-534 117x29  Pag.139	
1.6 GLXi 16V (CA4A)	83	04.92 → 04.96	4 G 92		KDD-534 117x29  Pag.139	
1.8 GTi 16V (CA5A)	103	04.92 → 04.96	4G93		KDD-535 156x28.7  Pag.139	
2.0 D (4D68)	0	01.92			KDD-531 158x31.7 65x13  Pag.139	
COLT V (CJ_A)						
1300 GL, GLX (CJ1A)	55	05.96 → 09.00	4 G 13 (BJ90-92, 12V)		KDD-576 107x25  Pag.141	
1600 GLX (CJ4A)	66	05.96 → 09.00	4 G 92		KDD-579 111x29  Pag.141	
CORDIA (A21_A)						
1.6 GSL (A212A)	55	10.82 → 12.86	4G32		KDD-507 120x19 →08.84  Pag.136 KDD-513D 122x19 55x12.8  Pag.137	

NEW CODES - NEUE CODES - NOUVEAUX CODES - NUEVOS CODIGOS - NUOVI CODICI

	KW			KDK- KIT CATENA TIMING BELT KIT	KDD- KIT CINGHIA TIMING CHAIN KIT <small>(Nr. of Teeth x Width)</small>	SKD KDD+POMPA ACQUA KDD+WATER PUMP
CORDIA (A21_A)						
1.6 Turbo (A212A)	84	10.82 → 05.85	4G32 T		KDD-513D 122x19 55x12.8  Pag.137 KDD-507 120x19 →08.84  Pag.136	
1.6 Turbo (A212A)	85	07.83 → 05.85	4G32 T		KDD-513D 122x19 55x12.8  Pag.137 KDD-507 120x19 →08.84  Pag.136	
1.8 GSL (A215A)	66	10.86 → 12.86	4G37		KDD-513A 122x19 55x12.8  Pag.137	
ECLIPSE I (D2_A)						
2.0 i 16V (D22A)	110	04.91 → 11.95	4 G 63		KDD-526 153x29 65x13  Pag.138	
ECLIPSE II (D3_)						
2000 GS 16V	107	12.95 → 04.99	4 G 63		KDD-526 153x29 65x13  Pag.138	
2000 GT 16V	157	12.95 → 04.99			KDD-526 153x29 65x13  Pag.138	
2400 GS 16V	105	09.98 → 04.99			KDD-591 65x13 124x29  Pag.141	
GALANT I (A12_)						
1.6	55	01.77 → 08.80	4G32		KDD-500 122x19 55x13  Pag.136	
GALANT II (A16_)						
1.6 GLX (A161A)	55	09.80 → 05.84	4G32		KDD-513A 122x19 55x12.8  Pag.137	
2.0 GLS (A163)	75	09.80 → 05.84	4G63		KDD-513A 122x19 55x12.8  Pag.137	
2.0 Turbo ECi (A164)	125	05.82 → 05.84	4 G 63 T (ECi)		KDD-513A 122x19 55x12.8  Pag.137	
2.3 Turbo-D (A167)	62	09.80 → 05.84	4 D 55 T		KDD-M01 163x25 83x19  Pag.151	
GALANT III (E1_A)						
1.6 GLX (E11A)	55	06.84 → 12.87	4G32		KDD-513A 122x19 55x12.8  Pag.137	

	KW			KDK- KIT CATENA TIMING BELT KIT	KDD- KIT CINGHIA TIMING CHAIN KIT <i>(Nr. of Teeth x Width)</i>	SKD KDD+POMPA ACQUA KDD+WATER PUMP
GALANT III (E1_A)						
1.8 Turbo-D (E14A)	60	06.84 → 12.87	4 D 65 T		KDD-509 157x32 55x12.8  Pag.136	
2.0 GLS (E15A)	66	06.86 → 12.87	G63B		KDD-513B 122x19 55x12.8  Pag.137	
2.0 GLS (E15A)	75	06.84 → 12.87	4G63		KDD-513A 122x19 55x12.8  Pag.137	
2.0 Turbo ECi (E15A)	110	06.84 → 05.85	4 G 63 T		KDD-513A 122x19 55x12.8  Pag.137	
2.4 GLS (E16A)	82	07.85 → 12.87	G64B		KDD-521 55x12.8 123x19  Pag.137	
GALANT IV (E3_A)						
1.6	55	01.88 → 10.92	4G32		KDD-508A 120x19  Pag.136	
1.8 (E32A)	66	11.88 → 10.92	4G37		KDD-513A 122x19 55x12.8  Pag.137	
1.8 Turbo-D (E34A)	55	11.88 → 10.92	4 D 65 T		KDD-509 157x32 55x12.8  Pag.136	
2.0 (E33A)	80	04.89 → 10.92	4G63		KDD-522A 55x12.8 122x24  Pag.138	
2.0 GTI 16V (E33A)	106	11.88 → 10.92	4 G 63		KDD-526 153x29 65x13  Pag.138	
2.0 GTI 16V (E33A)	107	11.88 → 10.92	4 G 63		KDD-526 153x29 65x13  Pag.138	
2.0 GTI 16V 4x4 Cat.	110	09.91 → 10.92	4 G 63		KDD-526 153x29 65x13  Pag.138	
GALANT V (E5_A, E7_A, E8_A)						
1.8 (E52A)	85	02.94 → 08.96	4G93		KDD-529 121x28.7  Pag.138	
1.8 GLSI (E52A)	93	11.92 → 08.96	4G93		KDD-529 121x28.7  Pag.138	
2.0 GLSI (E55A)	101	11.92 → 08.96	4G63		KDD-522B 122x24 65x13  Pag.138	
2.0 GLSTD (E57A)	66	11.92 → 08.96	4 D 68		KDD-531 158x31.7 65x13  Pag.139	
2.5 V6-24 4x4 (E88A)	125	11.92 → 08.96	6G73		KDD-528A 257x32 →04.95  Pag.138	

	KW			KDK- KIT CATENA TIMING BELT KIT	KDD- KIT CINGHIA TIMING CHAIN KIT <small>(Nr. of Teeth x Width)</small>	SKD KDD+POMPA ACQUA KDD+WATER PUMP
GALANT VI (EA_)						
2.0	98	09.00 → 10.04	4 G 63		KDD-539B 65x13 122x29 →06.03  Pag.139	
2.0 (EA2A)	100	09.96 → 09.00	4 G 63		KDD-539 65x13 122x29  Pag.139	
2.0 TDI (EA6A)	66	09.96 → 10.04	4D68 SOHC		KDD-531 158x31.7 65x13 →02.00  Pag.139	
2.4 GDI	106	09.00 → 10.04	4G64 (GDI)		KDD-589 65x13 154x29  Pag.141	
GRANDIS						
2.0 DI-D	100	09.05	BSY		KDD-502 141x30  Pag.136	
L 200						
2.5 DiD [RWD]	100	11.05	4 D 56 HP		KDD-510 154x25.4 99x18.5  Pag.136	
L 200 (K__T)						
2.0 (K62T)	90	06.96	4G63		KDD-530 123x29 65x13  Pag.138	
2.5 D (K14T)	51	11.86 → 08.96	4 D 56		KDD-M02 99x18.5 163x25.1  Pag.151 KDD-M01 163x25 83x19  Pag.151	
2.5 D (K64T)	55	06.96	4 D 56		KDD-M02 99x18.5 163x25.1  Pag.151	
2.5 TD 4WD	98	08.03	4 D 56 T		KDD-M02 99x18.5 163x25.1  Pag.151	
2.5 TD 4WD (K34T)	64	11.92 → 08.96	4 D 56 T		KDD-M01 163x25 83x19 08.93→  Pag.151	
2.5 TD 4WD (K74T)	85	09.01	4 D 56 T		KDD-M02 99x18.5 163x25.1  Pag.151	
2.5 TD 4x4	74	11.01	4 D 56 T		KDD-M02 99x18.5 163x25.1  Pag.151	
2.5 TD 4x4 (K74T)	73	06.96	4 D 56 TD		KDD-M02 99x18.5 163x25.1  Pag.151	

NEW CODES - NEUE CODES - NOUVEAUX CODES - NUEVOS CODIGOS - NUOVI CODICI

	KW			KDK- KIT CATENA TIMING BELT KIT	KDD- KIT CINGHIA TIMING CHAIN KIT <i>(Nr. of Teeth x Width)</i>	SKD KDD+POMPA ACQUA KDD+WATER PUMP
L 300 (L03_P)						
2.3 D (L038P, L068P)	50	09.83 → 10.86	4 D 55		KDD-M01 163x25 83x19  Pag.151	
L 300 (LO3_P/G, L0_2P)						
1.6 (L032P, L062P)	48	09.81 → 10.86	4G32		KDD-508A 120x19  Pag.136	
1.6 (L032P, L062P)	51	11.84 → 02.87	4G32		KDD-508A 120x19  Pag.136	
2.0 4x4 (L037G)	65	11.86 → 02.87	4G63		KDD-513B 122x19 55x12.8  Pag.137	
2.3 D (L038P)	50	04.83 → 10.86	4 D 55		KDD-M01 163x25 83x19  Pag.151	
L 300 (P0_W, P1_W, P2_W)						
2.0 (P03W)	64	11.86	G63B		KDD-513B 122x19 55x12.8  Pag.137 KDD-594 55x12.8 122x19.1 05.92 →  Pag.142	
2.0 (P03W, P03V, P13V)	66	11.86	4G63		KDD-513B 122x19 55x12.8 →04.92  Pag.137 KDD-594 55x12.8 122x19.1 05.92 →  Pag.142	
2.4 (P04W, P14V, P04V)	82	11.90	4G64		KDD-521A 123x19 65x13 05.92 → 05.94  Pag.137 KDD-521 55x12.8 123x19  Pag.137	
2.4 4WD (P24W, P24V)	80	11.86 → 12.90	G64B		KDD-521 55x12.8 123x19  Pag.137	
2.5 D (P05W, P05V, P15V)	51	11.86	4 D 56		KDD-M01 163x25 83x19  Pag.151 KDD-M02 99x18.5 163x25.1  Pag.151	
2.5 TD 4WD (P25W, P25V)	64	11.88	4 D 56 T		KDD-M01 163x25 83x19  Pag.151 KDD-M02 99x18.5 163x25.1  Pag.151	

NEW CODES - NEUE CODES - NOUVEAUX CODES - NUEVOS CODIGOS - NUOVI CODICI

	KW			KDK- KIT CATENA TIMING BELT KIT	KDD- KIT CINGHIA TIMING CHAIN KIT <small>(Nr. of Theet x Width)</small>	SKD KDD+POMPA ACQUA KDD+WATER PUMP
L 300 (P1_T)						
2.0 (P13T)	85	07.94	4 G 63		KDD-530 123x29 65x13  Pag.138	
L 400 (PAOV)						
2500 TD	64	06.96	4 D 56 T		KDD-M02 99x18.5 163x25.1  Pag.151	
LANCER F II (A17_)						
1.2 GLX (A171)	40	03.83 → 01.84	4 G 11		KDD-H01 92x18.8  Pag.148	
1.4 GLX (A172)	51	03.83 → 01.84	4 G 12		KDD-H01 92x18.8  Pag.148	
1.4 Turbo	77	03.83 → 01.84	4 G 12 T		KDD-H01 92x18.8  Pag.148	
LANCER I (A17_)						
1.2 (A171)	40	01.80 → 12.81	4 G 11		KDD-H01 92x18.8  Pag.148	
1.4 GLX (A172)	50	09.79 → 02.83	4 G 12		KDD-H01 92x18.8  Pag.148	
LANCER III (C1_A, C6_A)						
1.2 (C65A)	44	08.86 → 04.88	4G16		KDD-519 92x18.8  Pag.137	
1.2 GL (C15AS)	40	01.84 → 10.86	4G16		KDD-H01 92x18.8  Pag.148	
1.5 GLX (C12AS)	51	06.85 → 04.88	G15B		KDD-519 92x18.8  Pag.137	
1.5 GLX (C12AS)	55	11.83 → 04.88	4 G 15		KDD-H01 92x18.8  Pag.148	
1.8 Diesel (C14AS)	43	01.84 → 09.86	4 D 65		KDD-509 157x32 55x12.8  Pag.136	
1.8 Diesel (C14AS)	44	09.86 → 04.88	4 D 65		KDD-509 157x32 55x12.8  Pag.136	
LANCER III SW (C1_V, C3_V)						
1.5 (C12V)	61	09.88 → 12.90	4 G 15		KDD-H01 92x18.8  Pag.148	
1.8 4x4 (C37V)	61	01.87 → 08.89	G37B		KDD-508A 120x19  Pag.136	
1.8 4x4 (C37V)	63	03.89 → 12.90	4G37		KDD-508A 120x19  Pag.136	
1.8 4x4 (C37V)	66	01.87 → 12.87	4G37		KDD-508A 120x19  Pag.136	
1.8 4x4 (C37V)	69	08.90 → 06.92	4G37		KDD-508A 120x19  Pag.136	
LANCER IV (C6_A, C7_A)						
1.3 12V (C61A)	55	06.92 → 05.94	4 G 13 (BJ90-92, 12V)		KDD-533A 92x22  Pag.139	

	KW			KDK- KIT CATENA TIMING BELT KIT	KDD- KIT CINGHIA TIMING CHAIN KIT <i>(Nr. of Teeth x Width)</i>	SKD KDD+POMPA ACQUA KDD+WATER PUMP
LANCER IV (C6_A, C7_A)						
1.5	62	06.88 → 05.92	4 G 15		KDD-H01 92x18.8  Pag.148	
1.5 12V (C62A)	66	05.89 → 05.92	4G15 (12V)		KDD-H01 92x18.8  Pag.148	
1.6 16V (C66A)	83	06.92 → 05.94	4 G 92		KDD-534 117x29  Pag.139	
1.8 4x4 (C77A)	71	09.89 → 06.92	4G37		KDD-508A 120x19  Pag.136	
1.8 D (C64A)	44	04.88 → 05.92	4 D 65		KDD-509 157x32 55x12.8  Pag.136	
1.8 GTi 16V (C68A)	100	11.89 → 05.92	4G67		KDD-526 153x29 65x13  Pag.138	
1.8 GTi 16V (C69A)	103	06.92 → 12.93	4G93		KDD-535 156x28.7  Pag.139	
LANCER SPORTBACK						
2.0 DI-D	103	06.08	BKD		KDD-502 141x30  Pag.136	
LANCER SW						
1.6	72	09.03	4G18		KDD-540 109x24.7  Pag.140	
2.0	99	09.03	4 G 63		KDD-526C 153x29 65x13 →08.05  Pag.138	
LANCER V (CB/D_A)						
1.3 (CB1A)	55	06.92	4 G 13 (BJ92-..., 12V)		KDD-533A 92x22  Pag.139	
1.6	66	02.94	4 G 92		KDD-534 117x29  Pag.139	
1.6 16V (CB4A)	83	06.92	4 G 92		KDD-534 117x29  Pag.139	
LANCER VI (CK/P_A)						
1.3 12V (CK1A)	55	12.95 → 08.03	4 G 13 (BJ90-92, 12V)		KDD-576 107x25  Pag.141	
1.5 16V (CK2A)	69	12.95 → 08.03	4 G 15 (16V)		KDD-533A 92x22  Pag.139	
1.6 16V (CK4A)	66	12.95 → 08.03	4 G 92		KDD-579 111x29  Pag.141	
2.0 16V EVO IX	206	01.06	4 G 63 Turbo		KDD-526C 153x29 65x13  Pag.138	
2.0 16V EVO VIII	195	03.04			KDD-526C 153x29 65x13  Pag.138	
OUTLANDER						







	KW			KDK- KIT CATENA TIMING BELT KIT	KDD- KIT CINGHIA TIMING CHAIN KIT <i>(Nr. of Teeth x Width)</i>	SKD KDD+POMPA ACQUA KDD+WATER PUMP
OUTLANDER						
2.0	100	05.03	4 G 63		KDD-526C 153x29 65x13  Pag.138	
2.0 4WD	177	05.03			KDD-526C 153x29 65x13  Pag.138	
2.0 4WD	93	05.03	4 G 63		KDD-526C 153x29 65x13  Pag.138	
2.0 DI-D	103	02.07	BSY		KDD-502 141x30  Pag.136	
2.0 Turbo 4WD	148	04.04	4 G 63 T		KDD-526C 153x29 65x13  Pag.138	
2.2 DI-D	115	08.07	4HK 4HN		KDD-515 118x26  Pag.137	
2.4 4WD	102	05.03	4G64 (SOHC 16V)		KDD-513 122x19 65x13  Pag.137	
2.4 4WD	118	11.03	4G69		KDD-513 122x19 65x13  Pag.137	
2.4 4WD	119	05.03	4G69		KDD-513 122x19 65x13  Pag.137	
PAJERO CLASSIC (V2_W)						
2.5 TD	85	07.02	4 D 56 T		KDD-M02 99x18.5 163x25.1  Pag.151	
3.2 DI-D	118	05.05	4M41	KDK-501  Pag. 156		
PAJERO I (L04_G)						
2.3 TD (L043G, L048G)	62	12.82 → 04.86	4 D 55 T		KDD-M01 163x25 83x19  Pag.151	
2.5 TD (L044G, L049G)	62	05.86 → 10.89	4 D 56 T		KDD-M01 163x25 83x19  Pag.151	
PAJERO I (L04_G, L14_G)						
2.5 TD (L044G, L049G)	64	01.90 → 12.91	4 D 56 T		KDD-M01 163x25 83x19  Pag.151	
2.5 TD (L044G, L049G)	70	11.89 → 11.90	4 D 56 T		KDD-M01 163x25 83x19  Pag.151	
3.0 V6 (L141G, L146G)	104	11.88 → 11.90	6G72		KDD-525 149x24.7  Pag.138	
PAJERO II (V2_W, V4_W)						
1.8 GDI	96	06.98 → 04.00	4G93		KDD-504 154x28.7  Pag.136	

	KW			KDK- KIT CATENA TIMING BELT KIT	KDD- KIT CINGHIA TIMING CHAIN KIT <i>(Nr. of Teeth x Width)</i>	SKD KDD+POMPA ACQUA KDD+WATER PUMP
PAJERO II (V2_W, V4_W)						
2.4	82	04.91 → 04.00	4G64		KDD-521 55x12.8 123x19  Pag.137 KDD-521A 123x19 65x13 05.92→05.94  Pag.137	
2.5 TD (V24C, V24W)	73	12.90 → 04.00	4 D 56 TD		KDD-M01 163x25 83x19 →10.93  Pag.151 KDD-M02 99x18.5 163x25.1 11.93→  Pag.151	
2.8 TD (V46W)	92	06.94 → 04.00	4M40-T	KDK-500 →01.00  Pag. 156 KDK-502  Pag. 156		
3.0 V6 (V23W, V43W, V23C)	110	12.90 → 12.95	6G72 6G72		KDD-525 149x24.7  Pag.138	
3.0 V6 24V	130	06.97 → 04.00	6G72		KDD-541 187x32  Pag.140	
3.0 V6 24V	133	06.94 → 05.97	6G72		KDD-541 187x32  Pag.140	
3.5 V6 24V (V25W, V45W)	153	06.94 → 04.00	6G74 DOHC		KDD-542 265x32  Pag.140	
PAJERO III (V60)						
3.2 DI-D (V68W, V78W)	118	10.01	4M41	KDK-501  Pag. 156		
3.2 DI-D (V68W, V78W)	121	04.00 → 10.01	4M41	KDK-501  Pag. 156		
3.5 V6 GDI (V65W, V75W)	149	04.00	6G74 DOHC		KDD-542A 265x32  Pag.140	
PAJERO PININ (H6_W, H7_W)						
1.8 GDI (H66W)	88	10.99	4G93		KDD-504 154x28.7  Pag.136	
2.0 GDI (H67W, H77W)	95	10.00	4G94		KDD-543 159x29  Pag.140	
PAJERO SPORT (K90)						
2.5 TD	73	11.98	4 D 56 T		KDD-M02 99x18.5 163x25.1  Pag.151	
2.5 TD	85	07.02	4 D 56 T		KDD-M02 99x18.5 163x25.1  Pag.151	
2.5 TD	98	08.03	4 D 56 T		KDD-M02 99x18.5 163x25.1  Pag.151	

	KW			KDK- KIT CATENA TIMING BELT KIT	KDD- KIT CINGHIA TIMING CHAIN KIT <i>(Nr. of Teeth x Width)</i>	SKD KDD+POMPA ACQUA KDD+WATER PUMP
PAJERO SPORT (K90)						
3.0 V6	123	03.03	6G72		KDD-541 187x32  Pag.140	
3.0 V6	125	06.00	6G72		KDD-541 187x32  Pag.140	
SAPPORO I (A12_)						
1.6 SL,GL (A121)	55	04.78 → 07.80	4G32		KDD-500 122x19 55x13  Pag.136	
SAPPORO II (A16_A)						
1.6 GLX (A161A)	55	08.80 → 09.84	4G32		KDD-500 122x19 55x13 →06.81  Pag.136	
2.0 GSL (A164A)	75	08.80 → 08.83	4G63		KDD-513A 122x19 55x12.8  Pag.137	
2.0 GSR (A164A)	82	08.80 → 09.84	4G63		KDD-513A 122x19 55x12.8  Pag.137	
SAPPORO III (E16A)						
2.4 (E16A)	91	06.87 → 08.90	4G64		KDD-521 55x12.8 123x19  Pag.137	
SIGMA (F16A)						
3.0 V6 (F16A)	130	12.90 → 07.96	6G72		KDD-525 149x24.7  Pag.138 KDD-528 257x32 Per modelli a 24 Val  Pag.138 KDD-528A 257x32 →03.95  Pag.138	
3.0 V6 (F16A)	151	12.90 → 07.96	6G72		KDD-525 149x24.7  Pag.138 KDD-528 257x32 Per modelli 24V  Pag.138 KDD-528A 257x32 →03.95  Pag.138	
SIGMA SW (F07W)						
3.0 (V6)	125	01.93 → 07.96	6G72		KDD-525 149x24.7  Pag.138 KDD-528 257x32  Pag.138	
SPACE GEAR (PA/B/D_V/W)						
2.0 16V (PA3V/W, PB3V)	83	08.96 → 05.00	4 G 63		KDD-530 123x29 65x13  Pag.138	



	KW			KDK- KIT CATENA TIMING BELT KIT	KDD- KIT CINGHIA TIMING CHAIN KIT <i>(Nr. of Teeth x Width)</i>	SKD KDD+POMPA ACQUA KDD+WATER PUMP
SPACE GEAR (PA/B/D_V/W)						
2.0 16V (PA3V/W, PB3V)	85	05.95 → 05.00	4 G 63		KDD-530 123x29 65x13  Pag.138	
2.4 i (PA4W)	97	05.95 → 05.00	4G64		KDD-591 65x13 124x29  Pag.141	
2.5 TD (PA5V/W, PB5V)	64	05.95 → 05.00	4 D 56 T		KDD-M02 99x18.5 163x25.1  Pag.151	
2.5 TD (PA5V/W, PB5V)	73	05.95 → 05.00	4 D 56 TD		KDD-M02 99x18.5 163x25.1  Pag.151	
SPACE RUNNER (N1_W, N2_W)						
1.8 (N11W)	85	06.96 → 08.99	4G93		KDD-529 121x28.7  Pag.138	
1.8 (N11W)	90	10.91 → 08.99	4G93		KDD-529 121x28.7  Pag.138	
2.0 16V	98	06.97 → 08.99	4 G 63		KDD-530 123x29 65x13  Pag.138	
2.0 TD (N18W)	60	10.92 → 08.99	4 D 68		KDD-531 158x31.7 65x13  Pag.139	
SPACE RUNNER (N50)						
2.0	100	08.99	4 G 63		KDD-539B 65x13 122x29 →06.03  Pag.139	
2.4 GDI	110	08.99	4G64 (GDI)		KDD-589 65x13 154x29 →06.03  Pag.141	
SPACE STAR (DG0)						
1.3 16V	61	12.98	4 G 13 (16 V)		KDD-540 109x24.7  Pag.140	
1.3 16V	63	06.98	4 G 13 (16 V)		KDD-540 109x24.7  Pag.140	
1.6 16V	72	01.01	4G18		KDD-540 109x24.7 4G16  Pag.140	
1.8 GDI	82	10.02	4G93		KDD-578B 116x29 08.03→  Pag.141 KDD-504 154x28.7 →07.03  Pag.136	
1.8 GDI	87	06.98	4G93		KDD-504 154x28.7  Pag.136	
1.8 GDI	90	06.98	4G93		KDD-504 154x28.7  Pag.136	

	KW			KDK- KIT CATENA TIMING BELT KIT	KDD- KIT CINGHIA TIMING CHAIN KIT <small>(Nr. of Teeth x Width)</small>	SKD KDD+POMPA ACQUA KDD+WATER PUMP
SPACE STAR (DG0)						
1.9 DI-D	75	02.01	F9Q1		KDD-538  Pag.139	132x26
SPACE WAGON (D0_V/W)						
1.8 GLX (D05V, D05W)	66	01.84 → 12.88	4G37		KDD-513A  Pag.137	122x19 55x12.8
1.8 TD (D09W)	55	06.86 → 04.91	4 D 65 T		KDD-509  Pag.136	157x32 55x12.8
2.0 4x4 (D08W)	75	03.85 → 04.91	4G63		KDD-513B  Pag.137	122x19 55x12.8
2.0 GLX (D04W)	62	06.86 → 05.88	G63B		KDD-513B  Pag.137	122x19 55x12.8
2.0 GLXi (D04W)	74	06.88 → 04.91	4G63		KDD-513B  Pag.137	122x19 55x12.8
SPACE WAGON (N3_W, N4_W)						
1.8 (N31W)	90	10.91 → 10.98	4G93		KDD-529  Pag.138	121x28.7
1.8 D	0	10.96 → 12.98			KDD-509  Pag.136	157x32 55x12.8
1.8 TD (N35W)	55	10.91 → 10.98	4 D 65 T		KDD-509  Pag.136	157x32 55x12.8
2.0 (N33W)	98	10.92 → 10.98	4 G 63		KDD-530  Pag.138	123x29 65x13
2.0 TD (N38W)	60	10.92 → 10.98	4D68 T		KDD-531  Pag.139	158x31.7 65x13
SPACE WAGON (N5_W)						
2.0 GDI	98	04.02	4 G 63		KDD-539C  Pag.140	65x13 122x29
2.4 GDI	108	09.00	4G64 (GDI)		KDD-589B  Pag.141	65x13 154x29
TREDIA (A21_)						
1.4 GLX (A211)	51	10.82 → 08.85	4 G 12		KDD-H01  Pag.148	92x18.8
1.8 GLS (A215)	66	08.84 → 07.86	4G37		KDD-513A  Pag.137	122x19 55x12.8

	KW			KDK- KIT CATENA TIMING BELT KIT	KDD- KIT CINGHIA TIMING CHAIN KIT <small>(Nr. of Teeth x Width)</small>	SKD KDD+POMPA ACQUA KDD+WATER PUMP
TREDIA (A21_)						
1.8 Turbo	100	08.84 → 07.86	G62B		KDD-513A 122x19 55x12.8  <i>Pag.137</i> KDD-513B 122x19 55x12.8  <i>Pag.137</i>	
GLS 1.6 (A212)	55	09.82 → 10.87	4G32		KDD-513A 122x19 55x12.8  <i>Pag.137</i>	



MITSUBISHI Comm.



	KW			KDK- KIT CATENA TIMING BELT KIT	KDD- KIT CINGHIA TIMING CHAIN KIT <i>(Nr. of Teeth x Width)</i>	SKD KDD+POMPA ACQUA KDD+WATER PUMP
Canter						
Canter 35	85	07.98	4M40-2AT	KDK-503  Pag. 156		

NEW CODES - NEUE CODES - NOUVEAUX CODES - NUEVOS CODIGOS - NUOVI CODICI

	KW			KDK- KIT CATENA TIMING BELT KIT	KDD- KIT CINGHIA TIMING CHAIN KIT <small>(Nr. of Teeth x Width)</small>	SKD KDD+POMPA ACQUA KDD+WATER PUMP
100 NX (B13)						
1.6	66	03.90 → 10.94	GA16DS	KDK-100  Pag. 154		
300 ZX (Z31)						
3.0	125	01.84 → 12.87	VG30E		KDD-110 133x25  Pag.123	
3.0 Turbo	149	05.87 → 10.90	VG30ET		KDD-110 133x25  Pag.123	
3.0 Turbo	168	04.84 → 10.90	VG30T		KDD-110 133x25  Pag.123	
300 ZX (Z32)						
3.0 Twin Turbo	197	05.90 → 09.95	VG30DETT		KDD-122 228x32  Pag.123	
3.0 Twin Turbo	208	05.90 → 09.95	VG30DETT		KDD-122 228x32  Pag.123	
ALMERA I (N15)						
1.4	64	09.95 → 03.00	GA14DE	KDK-100  Pag. 154		
1.4 S,GX,LX	55	09.95 → 03.00	GA14DE	KDK-100  Pag. 154		
1.6	73	09.95 → 07.00	GA16DE	KDK-100  Pag. 154		
1.6 SLX	66	09.95 → 07.00	GA16DE	KDK-100  Pag. 154		
2.0 D	55	11.95 → 07.00	CD20		KDD-192B 76x19 111x25  Pag.124	
ALMERA II (N16)						
1.5	66	07.00	QG15DE	KDK-110  Pag. 154		
1.5	72	10.02	QG15DE	KDK-110  Pag. 154		
1.5	77	03.01	GA15DE QG15DE	KDK-110  Pag. 154		
1.5 dCi	60	01.03	K9K 722		KDD-114 123x27 K9K722  Pag.123	SKD-114 K9K722  Pag. 158
1.8	85	10.02	QG18DE	KDK-109  Pag. 154		
ALMERA TINO (V10)						
1.8	84	08.00	QG18DE	KDK-109  Pag. 154		
1.8	85	12.02	QG18DE	KDK-109  Pag. 154		
BLUEBIRD (910)						
2.0 D	44	01.80 → 12.83	LD20	KDK-111 03.80 →  Pag. 154	KDD-102 69x19  Pag.122	

	KW			KDK- KIT CATENA TIMING BELT KIT	KDD- KIT CINGHIA TIMING CHAIN KIT <i>(Nr. of Teeth x Width)</i>	SKD KDD+POMPA ACQUA KDD+WATER PUMP
BLUEBIRD (910)						
2.0 TD	57	01.83 → 09.83	LD20T		KDD-107  Pag.122	143x30
BLUEBIRD (T72 , T12)						
1.6	61	03.86 → 06.90	CA16S		KDD-400B  Pag.133	95x19
1.8 i 16V (RLT72)	95	02.89 → 12.90	CA18D		KDD-108  Pag.122	151x19
1.8 Turbo	99	12.85 → 05.90	CA18T		KDD-400B  Pag.133	95x19
2.0 (T12)	75	12.85 → 12.87	CA20S		KDD-106  Pag.122	98x19
2.0 D (SLT72, T12)	49	03.86 → 12.90	LD20		KDD-107  Pag.122	143x30
2.0 i	85	09.88 → 09.90	CA20E		KDD-106  Pag.122	98x19
2.0 i (HLT72, T12)	77	12.85 → 12.90	CA20E		KDD-106  Pag.122	98x19
BLUEBIRD (U11)						
1.8	66	11.83 → 06.88	CA18S		KDD-400B  Pag.133	95x19
1.8 Turbo	99	04.84 → 05.90	CA18T		KDD-400B 12.85 →  Pag.133	95x19
2.0 D	43	04.84 → 01.88	LD20		KDD-107 12.85 →  Pag.122	143x30
2.0 i	77	04.84 → 01.88	CA20E		KDD-106  Pag.122	98x19
CHERRY (N12)						
1.0	37	05.82 → 05.86	E10		KDD-100  Pag.122	102x19
1.3	44	05.82 → 10.86	E13		KDD-100  Pag.122	102x19
1.5	55	11.83 → 10.86	E15S		KDD-101  Pag.122	106x19
1.5 Turbo	77	01.83 → 12.85	E15ET		KDD-101  Pag.122	106x19
1.6	51	05.84 → 07.86	E16		KDD-101  Pag.122	106x19
1.7 D	40	10.82 → 12.86	CD17		KDD-104 07.86 →  Pag.122	117x25.5 76x19
EVALIA						
1.5 dCI	66	01.11			KDD-114  Pag.123	123x27 SKD-114  Pag. 158
1.5 dCI	81	01.11			KDD-114  Pag.123	123x27 SKD-114  Pag. 158

	KW			KDK- KIT CATENA TIMING BELT KIT	KDD- KIT CINGHIA TIMING CHAIN KIT <i>(Nr. of Teeth x Width)</i>	SKD KDD+POMPA ACQUA KDD+WATER PUMP
INTERSTAR						
dCi 120	84	07.02	G9U 720		KDD-117  Pag.123	89x25
dCi 90	66	07.02	G9T 722		KDD-117  Pag.123	89x25
Juke						
1.5 dCi	81	10.10			KDD-114  Pag.123	123x27
KUBISTAR						
1.2	44	08.03	D7F 764		KDD-125  Pag.124	87x17
1.2 16V	55	04.06	D4F 712		KDD-126  Pag.124	95x23.5
1.5 dCi	48	08.03	K9K 704		KDD-114  Pag.123	123x27 SKD-114  Pag. 158
1.5 dCi	60	08.03	K9K 722		KDD-114  Pag.123	123x27 SKD-114  Pag. 158
1.5 dCi 70	50	04.06	K9K 700		KDD-114  Pag.123	123x27 SKD-114  Pag. 158
1.5 dCi 85	62	04.06	K9K 276		KDD-114  Pag.123	123x27 SKD-114  Pag. 158
1.6 16V	70	08.03	K4M 752		KDD-124  Pag.123	132x27
LAUREL (JC31)						
2.0 D	44	04.81 → 10.84	LD20		KDD-106  Pag.122	98x19
LAUREL (JC32)						
2.8 D	66	01.85 → 12.89	RD28		KDD-113 02.87 →  Pag.123	149x30
MAXIMA (J30)						
3.0 i	125	10.88 → 06.94	VG30E		KDD-110  Pag.123	133x25
MICRA (K10)						
1.0	37	12.82 → 12.89	MA10S		KDD-103B →11.88  Pag.122	91x19
					KDD-195 12.88 →  Pag.124	107x19
1.0	40	12.82 → 05.89	MA10S		KDD-103B →11.88  Pag.122	91x19
					KDD-195 12.88 →  Pag.124	107x19

	KW			KDK- KIT CATENA TIMING BELT KIT	KDD- KIT CINGHIA TIMING CHAIN KIT <i>(Nr. of Teeth x Width)</i>	SKD KDD+POMPA ACQUA KDD+WATER PUMP
MICRA (K10)						
1.0	43	12.82 → 05.91			KDD-103B 91x19 →11.88  Pag.122 KDD-195 107x19 12.88→  Pag.124	
1.2	40	07.86 → 07.92	MA12S		KDD-121 110x19 12.88→  Pag.123 KDD-115 93x19.4 02.87→11.88  Pag.123	
1.2	44	07.86 → 07.92	MA12S		KDD-121 110x19 12.88→  Pag.123 KDD-115 93x19.4 02.87→11.88  Pag.123	
MICRA (K11)						
1.0 i 16V	40	08.92 → 09.00	CG10DE	KDK-105 →07.00  Pag. 154		
1.3 i 16V	55	08.92 → 09.00	CG13DE	KDK-105 →07.00  Pag. 154		
1.5 D	42	02.98 → 02.03	TD15		KDD-105 136x25  Pag.122	
MICRA (K12)						
1.2 16V	48	01.03	CR12DE CG12DE	KDK-106  Pag. 154		
1.2 16V	59	01.03	CR12DE CG12DE	KDK-106  Pag. 154		
1.4 16V	65	01.03	CR14DE	KDK-106  Pag. 154		
1.5 dCi	48	01.03	K9K 704		KDD-114 123x27  Pag.123	SKD-114  Pag. 158
1.5 dCi	60	09.03	K9K 722		KDD-114 123x27  Pag.123	SKD-114  Pag. 158
NAVARA						
2.5 dCi	106	07.05	YD25DDTi	KDK-113  Pag. 155		
2.5 dCi 4WD	126	10.06	YD25DDTi	KDK-113  Pag. 155		
2.5 dCi 4WD	128	07.05	YD25DDTi	KDK-113  Pag. 155		
NAVARA (D40)						
2.5 dCi	140	03.10		KDK-113  Pag. 155		
NV200						

NEW CODES - NEUE CODES - NOUVEAUX CODES - NUEVOS CODIGOS - NUOVI CODICI







	KW			KDK- KIT CATENA TIMING BELT KIT	KDD- KIT CINGHIA TIMING CHAIN KIT <small>(Nr. of Teeth x Width)</small>	SKD KDD+POMPA ACQUA KDD+WATER PUMP
NV200						
1.5 dci	63	02.10			KDD-114  Pag.123	123x27 SKD-114  Pag. 158
PATROL (K260)						
2.8 TD	85	05.86 → 06.90	RD28T		KDD-N01 09.88 →  Pag.151	149x30
PATROL GR I (Y60)						
2.8 TD (Y60A)	85	09.88 → 06.97	RD28T		KDD-N01 →08.94  Pag.151	149x30
					KDD-113 09.94 →  Pag.123	149x30
4.2 D (Y60GR)	85	11.88 → 06.97	TD42		KDD-113  Pag.123	149x30
PATROL GR II (Y61)						
2.8 TD	95	06.97 → 05.00	RD28Ti		KDD-N01  Pag.151	149x30
3.0 DTi	116	05.00	ZD30DDTi	KDK-107  Pag. 154		
3.0 DTi	118	05.00	ZD30DDTi	KDK-107  Pag. 154		
PICK UP/KING CAB (D21)						
2.4 i 12V	91	04.92 → 02.98	KA24E	KDK-108  Pag. 154		
PICK UP/KING CAB/NAVARA (D22)						
2.4 i	88	02.98	KA24E	KDK-108  Pag. 154		
2.4 i 4WD	98	03.02	KA24DE	KDK-104  Pag. 154		
2.5 Di	98	03.02	YD25DDTi	KDK-112  Pag. 154		
PRAIRIE (M10, NM10)						
1.5 S (M10)	55	01.84 → 12.87	E15S		KDD-101  Pag.122	106x19
1.8 SGL (M10)	65	07.83 → 12.85	CA18S		KDD-400B  Pag.133	95x19
1.8 SGL (M10)	66	05.85 → 10.87	CA18S		KDD-400B  Pag.133	95x19
2.0 4x4 (NM10)	68	06.86 → 09.88	CA20S		KDD-106  Pag.122	98x19
PRAIRIE PRO (M11)						
2.0 i	72	10.88 → 04.92	CA20E		KDD-106  Pag.122	98x19
2.4 i	98	04.92 → 07.94	KA24E	KDK-108  Pag. 154		
PRIMASTAR						







	KW			KDK- KIT CATENA TIMING BELT KIT	KDD- KIT CINGHIA TIMING CHAIN KIT <i>(Nr. of Theet x Width)</i>	SKD KDD+POMPA ACQUA KDD+WATER PUMP
PRIMASTAR						
dCi 140	99	07.03	G9U730		KDD-117  Pag.123	89x25
PRIMERA (P10)						
2.0 D	55	01.91 → 01.96	CD20		KDD-192B  Pag.124	76x19 111x25
PRIMERA (P11)						
1.8 16V	84	08.99 → 12.01	QG18DE	KDK-109  Pag. 154		
2.0 TD	66	09.96 → 12.01	CD20T		KDD-192A  Pag.124	79x19 111x25
PRIMERA (P12)						
1.8	85	03.02	QG18DE	KDK-109  Pag. 154		
1.9 dCi	85	08.02			KDD-120  Pag.123	133x26
1.9 dCi	88	04.03			KDD-120  Pag.123	133x26
QASHQAI						
1.5 dCi	78	02.07			KDD-114  Pag.123	123x27 SKD-114  Pag. 158
SERENA (C23M)						
2.0 D	49	11.92	LD20		KDD-N02  Pag.151	141x30
2.3 D	55	01.95	LD23		KDD-112  Pag.123	145x30
SILVIA (S12)						
1.8	90	07.86 → 04.88	CA18ET		KDD-400B  Pag.133	95x19
STANZA (T11)						
1.6	60	08.81 → 12.85	CA16S		KDD-400B  Pag.133	95x19
1.8 SGL	66	03.83 → 12.85	CA18S		KDD-400B  Pag.133	95x19
SUNNY (Y10)						
1.7 D	40	11.90 → 03.00	CD17		KDD-104  Pag.122	117x25.5 76x19
SUNNY I (B11)						
1.3	44	03.82 → 09.87	E13		KDD-100  Pag.122	102x19
1.5	55	03.82 → 10.86	E15S		KDD-101  Pag.122	106x19
1.7 D	40	03.82 → 10.86	CD17		KDD-104  Pag.122	117x25.5 76x19
SUNNY II (B12)						

NEW CODES - NEUE CODES - NOUVEAUX CODES - NUEVOS CODIGOS - NUOVI CODICI

	KW			KDK- KIT CATENA TIMING BELT KIT	KDD- KIT CINGHIA TIMING CHAIN KIT <i>(Nr. of Theet x Width)</i>	SKD KDD+POMPA ACQUA KDD+WATER PUMP
SUNNY II (B12)						
1.8 GTI 16V	92	01.89 → 06.91	CA18D		KDD-108  Pag.122	151x19
SUNNY II (N13)						
1.3	44	07.86 → 10.91	E13S		KDD-100  Pag.122	102x19
1.5	52	06.86 → 10.88	E15S		KDD-101  Pag.122	106x19
1.6 GTI 16V	81	02.87 → 10.88	CA16D		KDD-108  Pag.122	151x19
1.6 i	54	06.86 → 10.90	E16i		KDD-101  Pag.122	106x19
1.7 D	40	06.86 → 05.89	CD17		KDD-104  Pag.122	117x25.5 76x19
SUNNY III (N14)						
1.4 i 16V	64	10.90 → 06.95	GA14DE	KDK-100  Pag. 154		
1.6 i	66	10.90 → 05.95	GA16DE GA16DS GA16DEL	KDK-101  Pag. 154		
1.6 i 16V	75	10.92 → 05.95	GA16DE	KDK-101  Pag. 154		
2.0 D	55	10.90 → 05.95	CD20		KDD-192B  Pag.124	76x19 111x25
TERRANO I (WD21)						
3.0 i 4WD	109	01.90 → 12.95	VG30E		KDD-110  Pag.123	133x25
TERRANO II (R20)						
2.4 4WD	85	05.96 → 01.02	KA24E	KDK-108  Pag. 154		
2.4 4WD	87	05.96	KA24E	KDK-108  Pag. 154		
2.4 i 12V 4WD	91	02.93 → 06.96	KA24E	KDK-108 08.93 →  Pag. 154		
TIIDA (C11X)						
1.5 dCi	78	09.07	K9K 728		KDD-114  Pag.123	123x27
						SKD-114  Pag. 158
TRADE						
2.0 D	44	11.86 → 03.93	LD20		KDD-N02  Pag.151	141x30
2.3 D	55	06.96 → 10.01			KDD-112  Pag.123	145x30
URVAN (E23)						
2.3 D	50	11.82 → 05.87	SD23		KDD-112  Pag.123	145x30
2.3 D (E23B)	51	04.85 → 11.88	SD23		KDD-112  Pag.123	145x30





NEW CODES - NEUE CODES - NOUVEAUX CODES - NUEVOS CODIGOS - NUOVI CODICI

	KW			KDK- KIT CATENA TIMING BELT KIT	KDD- KIT CINGHIA TIMING CHAIN KIT <i>(Nr. of Teeth x Width)</i>	SKD KDD+POMPA ACQUA KDD+WATER PUMP
VANETTE (C22)						
2.0 D (ULC22)	47	10.86 → 12.95	LD20		KDD-N02 141x30 Spagna  Pag.151	
2.0 D (ULC22)	49	10.86 → 12.95	LD20		KDD-N02 141x30  Pag.151	
VANETTE CARGO (HC 23)						
2.3 D	55	01.96	LD23		KDD-112 145x30  Pag.123	











		KW			KDK- KIT CATENA TIMING BELT KIT	KDD- KIT CINGHIA TIMING CHAIN KIT <small>(Nr. of Theet x Width)</small>	SKD KDD+POMPA ACQUA KDD+WATER PUMP
PORTER							
1.0		33	05.95→05.98	CB41		KDD-697  Pag.143	91x19
1.2 D		26	05.95	LDW12		KDD-602  Pag.142	113x25
1.3 i 16V		48	05.98			KDD-611  Pag.143	93x25
1.4 D		28	04.98			KDD-602  Pag.142	113x25

SHUANGHUAN AUTO



	KW			KDK- KIT CATENA TIMING BELT KIT	KDD- KIT CINGHIA TIMING CHAIN KIT <small>(Nr. of Teeth x Width)</small>	SKD KDD+POMPA ACQUA KDD+WATER PUMP
CEO						
2.4 16V Bi-Fuel	93	06.10			KDD-591  Pag.141	65x13 124x29





NEW CODES - NEUE CODES - NOUVEAUX CODES - NUEVOS CODIGOS - NUOVI CODICI

	KW			KDK- KIT CATENA TIMING BELT KIT	KDD- KIT CINGHIA TIMING CHAIN KIT <i>(Nr. of Teeth x Width)</i>	SKD KDD+POMPA ACQUA KDD+WATER PUMP
CABRIO						
0.6 (S1OLD2)	45	01.01 → 01.04	M 160 E6AL B05	KDK-M00  Pag. 157		
CITY-COUPÉ (MC01)						
0.6	45	01.01 → 01.04	M 160 E6AL B05	KDK-M00  Pag. 157		
0.6	52	06.02 → 01.04	M 160.910	KDK-M00  Pag. 157		
0.6 (S1CLA1)	40	07.98 → 01.04	M 160 E6AL B03	KDK-M00  Pag. 157		
0.6 (S1CLB1)	33	07.98 → 01.04	M 160 E6AL B04	KDK-M00  Pag. 157		
0.8 CDI (S1CLC1)	30	11.99 → 01.04	OM 660 DE 8LA	KDK-M01  Pag. 157		
FORTWO						
0.7 (450.330)	37	01.04	M 160.920	KDK-M00  Pag. 157		

	KW			KDK- KIT CATENA TIMING BELT KIT	KDD- KIT CINGHIA TIMING CHAIN KIT <i>(Nr. of Theet x Width)</i>	SKD KDD+POMPA ACQUA KDD+WATER PUMP
1800 XT COUPE (XT)						
Turbo 4WD	100	11.84 → 12.90	EA82		KDD-700 98x19 119x19  Pag.144	
FORESTER (SF)						
2.0	90	08.97 → 09.02	EJ20		KDD-703 211x29.6  Pag.144 KDD-703A 211x29.6 EJ20J	
2.0	92	06.98 → 09.02	EJ20		KDD-707 223x27  Pag.144 KDD-703A 211x29.6 EJ20J	
2.0 S Turbo	125	06.98 → 04.01	EJ20		KDD-791E 281x30  Pag.145	
2.0 S Turbo	130	04.01 → 09.02	EJ205		KDD-791E 281x30  Pag.145	
FORESTER (SG)						
2.0	92	09.02	EJ20		KDD-707B 223x27  Pag.144	
2.0 S Turbo	130	09.02	EJ20		KDD-707C 223x27  Pag.144	
FORESTER (SH)						
2.0	110	01.08	EJ20		KDD-791A 281x30  Pag.145	
IMPREZA						
1.5	79	02.08			KDD-791A 281x30  Pag.145	
2.0R	110	08.07			KDD-791A 281x30  Pag.145	
IMPREZA (GC)						
1.6 i	70	06.98 → 12.00	EJ161		KDD-707A 223x27  Pag.144	
1.6 i 4WD	66	08.92 → 12.00	EJ16		KDD-703 211x29.6  Pag.144	
2.0 i 4WD	85	10.95 → 12.00	EJ20		KDD-703 211x29.6  Pag.144	
2.0 i 4WD	92	06.98 → 12.00	EJ20		KDD-707 223x27  Pag.144	
2.0 Turbo GT 4WD	155	03.94 → 12.00	EJ20 (Turbo)		KDD-791E 281x30  Pag.145	
IMPREZA (GD, GG)						
1.6 AWD	70	12.00	EJ16		KDD-707B 223x27  Pag.144	
2.0	92	12.00	EJ20		KDD-707B 223x27  Pag.144	

	KW			KDK- KIT CATENA TIMING BELT KIT	KDD- KIT CINGHIA TIMING CHAIN KIT <i>(Nr. of Theet x Width)</i>	SKD KDD+POMPA ACQUA KDD+WATER PUMP
IMPREZA (GD, GG)						
2.0 WRX STI	195	11.01	EJ207		KDD-791C 281x30 09.02→  Pag.145	
					KDD-791E 281x30  Pag.145	
2.0 WRX Turbo	160	12.00	EJ205		KDD-791C 281x30 09.02→  Pag.145	
					KDD-791B 281x30 →08.02  Pag.145	
2.0 WRX Turbo	165	12.02	EJ205		KDD-791D 281x30  Pag.145	
JUSTY I (KAD)						
1000	37	05.87 → 10.95	EF10		KDD-201A 88x19 08.90→  Pag.124	
1000	40	11.84 → 06.89	EF10		KDD-201A 88x19  Pag.124	
1200	49	05.87 → 10.95	EF12		KDD-702 89x19  Pag.144	
1200 4WD	55	10.90 → 12.94	EF12		KDD-702 89x19  Pag.144	
JUSTY II (JMA, MS)						
1.3 4x4	63	04.01 → 11.03	G13BB		KDD-884 89x25  Pag.146	
1.3 GX 4x4	50	10.95 → 11.03	EF13		KDD-702 89x19  Pag.144	
LEGACY I (BC)						
1.6i 16V	0	02.89			KDD-703 211x29.6  Pag.144	
1800	76	01.89 → 12.93	EJ18 SPI		KDD-703 211x29.6  Pag.144	
2000 4WD	85	08.91 → 07.94	EJ20 EMPI		KDD-703 211x29.6  Pag.144	
2000 Turbo 4WD	147	05.92 → 07.94	EJ20-GN		KDD-791 281x30  Pag.144	
2200 4WD	100	01.89 → 07.94	EJ22 EMPI		KDD-703 211x29.6  Pag.144	
LEGACY II (BD, BG)						
2.0 i 4WD	85	09.94 → 03.99	EJ20		KDD-707 223x27  Pag.144	
2.2 i 4WD	94	09.94 → 03.99	EJ22 EMPI		KDD-707 223x27  Pag.144	
2.2 i 4WD	96	06.96 → 03.99	EJ22 EMPI		KDD-707 223x27  Pag.144	

	KW			KDK- KIT CATENA TIMING BELT KIT	KDD- KIT CINGHIA TIMING CHAIN KIT <small>(Nr. of Teeth x Width)</small>	SKD KDD+POMPA ACQUA KDD+WATER PUMP
LEGACY III (BE, BH)						
2.5	115	10.98 → 08.03	EJ25		KDD-707B →05.02  Pag.144	223x27
LEGACY III SW(BE, BH)						
2.0	92	12.98 → 08.03	EJ20		KDD-707A  Pag.144	223x27
LEGACY IV						
2.0	101	09.03	EJ20		KDD-707A  Pag.144	223x27
2.5	121	09.03	EJ25		KDD-707A  Pag.144	223x27
LEONE II						
1.8	77	06.85 → 07.86			KDD-700  Pag.144	98x19 119x19
1800 4WD	66	11.84 → 12.90	EA82		KDD-700  Pag.144	98x19 119x19
1800 4WD Cat.	70	07.86 → 09.91	EA82		KDD-700  Pag.144	98x19 119x19
1800 Turbo 4WD	100	11.84 → 12.90	EA82		KDD-700 01.86→  Pag.144	98x19 119x19
LIBERO (E10, E12)						
1.0 4WD (E10, KJ6)	37	01.83 → 12.87	EF10		KDD-201A  Pag.124	88x19
1.2 4WD (E12, KJ8)	38	08.86 → 02.00	EF12		KDD-704  Pag.144	91x19
1.2 i 4WD (E12, FA)	40	08.91 → 02.00	EF12		KDD-704  Pag.144	91x19
MINIBUS (EF10)						
1.0 4WD (KJ5)	0	01.86			KDD-201A  Pag.124	88x19
1.0 4WD (KJ6)	0	10.83			KDD-201A  Pag.124	88x19
MINIBUS (EF12)						
1.2 4WD (KJ8)	0	08.86			KDD-201A  Pag.124	88x19
MINIBUS (EK42)						
0.7 VAN (KR3)	0	01.83			KDD-201A  Pag.124	88x19
OUTBACK (BE, BH)						
2.5	115	10.00 → 08.03	EJ25		KDD-707B  Pag.144	223x27
REX II/ MINI JUMBO						

	KW			KDK- KIT CATENA TIMING BELT KIT	KDD- KIT CINGHIA TIMING CHAIN KIT <small>(Nr. of Theet x Width)</small>	SKD KDD+POMPA ACQUA KDD+WATER PUMP
REX II/ MINI JUMBO						
700	27	08.82 → 06.89	EK42		KDD-201A  Pag.124	88x19
VIVIO						
660 4WD	32	03.92 → 10.95	EN07E		KDD-789  Pag.144	104x16









	KW			KDK- KIT CATENA TIMING BELT KIT	KDD- KIT CINGHIA TIMING CHAIN KIT <small>(Nr. of Theet x Width)</small>	SKD KDD+POMPA ACQUA KDD+WATER PUMP
ALTO I (SS80)						
0.8 (SS80F, SS80G)	29	06.82 → 12.85	F8B		KDD-S01  Pag.152	88x19
ALTO II (EC)						
0.8 (SB308/CA)	29	01.86 → 11.93	F8B		KDD-S01  Pag.152	88x19
ALTO III (EF)						
1.0	39	09.94 → 06.02	G10B		KDD-884  Pag.146	89x25
BALENO (EG)						
1.3	52	09.96 → 05.02	G13BA		KDD-889  Pag.146	97x25
1.3 i 16V	63	07.95 → 05.02	G13B		KDD-889  Pag.146	97x25
1.6 i 16V	72	07.95 → 05.02	G16B		KDD-803  Pag.145	103x25
1.8 GT	89	03.96 → 05.02	J18A	KDK-802  Pag. 156		
1.9 TD	55	04.98 → 05.02			KDD-880A  Pag.146	136x25
BALENO SW(EG)						
1.3 16V	63	03.97 → 05.02	G13BB		KDD-889  Pag.146	97x25
CARRY (FD)						
0.8 (DA21) F8A	29	01.86			KDD-401  Pag.133	84x19
1.3	58	03.99	G13B		KDD-889  Pag.146	97x25
COUPE'						
1.0 (SC100GX) F10A	0	05.79			KDD-401  Pag.133	84x19
GRAND VITARA						
1.9 DDIS	95	10.05			KDD-120  Pag.123	133x26
2.0 4 ruote motrici	103	10.05	J20A	KDK-802  Pag. 156		
GRAND VITARA (FT, GT)						
1.6	69	03.98	G16B		KDD-803  Pag.145	103x25
2.0	94	03.98	J20A	KDK-802  Pag. 156		
2.0 HDI 110	80	07.01	RHW		KDD-883 →10.03  Pag.146 KDD-812 06.03→09.05  Pag.146	141x25 144x26









	KW			KDK- KIT CATENA TIMING BELT KIT	KDD- KIT CINGHIA TIMING CHAIN KIT <small>(Nr. of Teeth x Width)</small>	SKD KDD+POMPA ACQUA KDD+WATER PUMP
GRAND VITARA (FT, GT)						
2.0 TD Intercooler	64	03.98	RF		KDD-808  Pag.145	162x25
IGNIS II						
1.3 DDIS	51	09.03	Z13DT	KDK-801-8  Pag. 156		
JIMNY (FJ)						
1.3 16V	59	09.98	G13BB		KDD-889  Pag.146	97x25
1.5 DDIS 4WD	48	12.03	K9K 700		KDD-114  Pag.123	123x27 SKD-114  Pag. 158
1.5 DDIS 4x4	63	08.05	K9K 266		KDD-114  Pag.123	123x27 SKD-114  Pag. 158
LIANA (ER)						
1.4 DDIS	66	03.05	8HY		KDD-818  Pag.146	135x25
LJ 80						
0.8	29	01.80 → 01.84	F8A		KDD-401  Pag.133	84x19
SAMURAI (SJ)						
1.3 (SJ 413)	44	11.88	G13A		KDD-S06 SJ50/70  Pag.152 KDD-S05 SJ70  Pag.152	88x19 89x18.8
1.3 (SJ 413)	47	11.88	G13A		KDD-S06 SJ50/70  Pag.152 KDD-S05 SJ70  Pag.152	88x19 89x18.8
1.3 (SJ 413)	51	11.88	G13BA		KDD-S06 SJ50/70  Pag.152	88x19
SANTANA						
1.0 (SJ410) F10A MADE IN SPAIN	0	04.82 → 03.88			KDD-S04  Pag.152	95x19
1.3 (SJ413)	0	01.85			KDD-S05  Pag.152	89x18.8
SJ 410						

	KW			KDK- KIT CATENA TIMING BELT KIT	KDD- KIT CINGHIA TIMING CHAIN KIT <i>(Nr. of Teeth x Width)</i>	SKD KDD+POMPA ACQUA KDD+WATER PUMP
SJ 410						
1.0	33	09.81 → 12.88	F10A		KDD-S03 84x19 →12.84  Pag.152	
					KDD-S01 88x19 01.85→  Pag.152	
					KDD-S02 89x18.8 01.85→  Pag.152	
SJ 413						
1.3	44	08.86 → 08.90	G13A		KDD-S05 89x18.8  Pag.152	
					KDD-S06 88x19 11.88→  Pag.152	
1.3	47	09.84 → 12.88	G13A		KDD-S05 89x18.8  Pag.152	
					KDD-S06 88x19 11.88→  Pag.152	
SUPER CARRY (SK410)						
1.0 (F10A)	33	01.86			KDD-S01 88x19  Pag.152	
SUPER CARRY (ED)						
1.0	31	10.92 → 03.99	F10A		KDD-S01 88x19  Pag.152	
1.0	33	10.85 → 03.99	F10A		KDD-S01 88x19  Pag.152	
SWIFT (SF413)						
1.3 (SF413, AK35)	50	09.91 → 10.96	G13BA		KDD-S05 89x18.8  Pag.152	
SWIFT I (AA)						
1.0 (SA310, AA41/43)	37	10.83 → 03.89	G10A G10		KDD-S05 89x18.8  Pag.152	
1.3 (SA413, AA51)	50	10.84 → 03.89	G13A		KDD-S05 89x18.8  Pag.152	
1.3 (SA413, AA51/53)	54	10.84 → 03.89	G13A		KDD-S05 89x18.8  Pag.152	
1.3 (SA413, AA53)	47	08.86 → 03.89	G13A		KDD-S05 89x18.8  Pag.152	
1.3 GTi/GXi (SA413, AA33)	74	08.86 → 03.89	G13B		KDD-801 119x19  Pag.145	
SWIFT II (AH, AJ)						
1.3 (SF413, AH35)	52	03.89 → 12.91	G13A		KDD-S05 89x18.8  Pag.152	

	KW			KDK- KIT CATENA TIMING BELT KIT	KDD- KIT CINGHIA TIMING CHAIN KIT <i>(Nr. of Teeth x Width)</i>	SKD KDD+POMPA ACQUA KDD+WATER PUMP
SWIFT II (AH, AJ)						
1.3 (SF413, AH35, MA)	50	03.89 → 05.01	G13A		KDD-S05 89x18.8  Pag.152 KDD-803 103x25 11.96 →  Pag.145	
1.6 (SF416, AH14)	70	11.89 → 12.91	G16B		KDD-803 103x25  Pag.145	
1.6 i (SF416, AH14)	68	01.90 → 05.01	G16B		KDD-803 103x25  Pag.145	
SWIFT II (EA, MA)						
1.0 (SF310, AA44)	37	03.89 → 05.01	G10A		KDD-879 97x18.8 147247  Pag.146 KDD-406A 97x19 →05.96	
1.0 i (SF310, AA44)	39	09.91 → 05.01	G10A		KDD-406A 97x19 →05.96	
1.0 i (SF310, AA44)	40	03.89 → 12.91	G10A		KDD-879 97x18.8 147247  Pag.146 KDD-406A 97x19	
1.3 GTi (SF413, AA34)	74	03.89 → 05.01	G13B		KDD-804 119x25  Pag.145	
SWIFT III (SG)						
1.3 DDiS	51	08.05	Z13DT	KDK-801-8  Pag. 156		
1.3 DDiS	55	08.05	D13A Z13DTJ	KDK-801-8  Pag. 156		
1.6	92	05.06	M16A		KDD-803 103x25  Pag.145	
SX4						
1.6 DDiS	66	04.07	9HX		KDD-811 190x24  Pag.145	
1.9 DDiS	88	06.06	D19AA		KDD-811 190x24  Pag.145	
2.0 DDiS	99	07.09	D20AA		KDD-811 190x24  Pag.145	
VITARA (ET, TA)						
1.6 (ET)	60	07.88 → 12.91	G16A		KDD-S04 95x19  Pag.152	
1.6 (TA)	59	07.88 → 03.98	G16A		KDD-S04 95x19  Pag.152	
1.6 16V (ET)	71	07.90 → 03.98	G16B		KDD-803 103x25  Pag.145	
1.9 D (ET)	50	01.95 → 03.98	XUD9A		KDD-880A 136x25  Pag.146	
1.9 D (ET)	55	08.96 → 03.98	XUD9SD		KDD-880A 136x25  Pag.146	

NEW CODES - NEUE CODES - NOUVEAUX CODES - NUEVOS CODIGOS - NUOVI CODICI

	KW			KDK- KIT CATENA TIMING BELT KIT	KDD- KIT CINGHIA TIMING CHAIN KIT <small>(Nr. of Teeth x Width)</small>	SKD KDD+POMPA ACQUA KDD+WATER PUMP
VITARA (ET, TA)						
2.0 16V (ET)	97	12.96 → 03.98	J20A	KDK-800  Pag. 156		
2.0 TD (ET)	52	12.94 → 03.98	RF		KDD-808 162x25 01.98 →  Pag.145	
2.0 TD Intercooler (ET)	64	12.95 → 03.98	RF		KDD-808 162x25 01.98 →  Pag.145	
WAGON R+ (MM)						
1.3	56	05.00	G13BB		KDD-889 97x25  Pag.146	
1.3 DDiS	51	09.03	Z13DT	KDK-801-8  Pag. 156		
X-90 (EL)						
1.6 i 16V	71	09.95	G16B		KDD-803 103x25  Pag.145	

		KW			KDK- KIT CATENA TIMING BELT KIT	KDD- KIT CINGHIA TIMING CHAIN KIT <i>(Nr. of Teeth x Width)</i>	SKD KDD+POMPA ACQUA KDD+WATER PUMP
2000 D							
2.0 D		0				KDD-003  Pag.121	136x25
2000 TD							
2.0 TD		0				KDD-003  Pag.121	136x25
ARIA							
2.2 Dicor		110	06.11			KDD-575A  Pag.140	153x24.7
INDIGO							
1.4		62	01.03			KDD-013	106x24
SAFARI							
1.9 D		66	04.00	483 DL		KDD-004  Pag.121	136x25
2.0 TD 4X4 (403.001)		0	02.01			KDD-004  Pag.121	136x25
2.2 TDiC		103	07.06			KDD-575A  Pag.140	153x24.7
VISTA							
1.4		55	06.10			KDD-011	129x22
XENON							
2.2 DICOR		103	01.09			KDD-575A  Pag.140	153x24.7

	KW			KDK- KIT CATENA TIMING BELT KIT	KDD- KIT CINGHIA TIMING CHAIN KIT <small>(Nr. of Teeth x Width)</small>	SKD KDD+POMPA ACQUA KDD+WATER PUMP
4 RUNNER						
3.0 Turbo-D	92	11.95	1KZ-T		KDD-288B  Pag.128	102x25
4 RUNNER (_N130)						
2.4 TD 4x4	66	08.89 → 11.95	2L-T		KDD-T01  Pag.152	129x31
3.0 Turbo-D (KZN 130)	92	10.93 → 03.96	1KZ-T		KDD-288B  Pag.128	102x25
3.0 V6 (VZN 130)	105	07.90 → 11.95	3VZ-E		KDD-220 →08.92  Pag.126 KDD-220A 09.92→  Pag.126	193x36 193x36
3.4 i 4x4	136	11.95 → 03.96	5VZ-FE		KDD-230  Pag.127	191x36
AVENSIS (T25)						
2.0 D-4D	85	04.03	1CD-FTV		KDD-205  Pag.125	178x25 SKD-205  Pag. 158
AVENSIS (_T22_)						
1.6 (AT220_)	74	09.97 → 10.00	4A-FE		KDD-227  Pag.127	117x21
1.6 (AT220_)	81	09.97 → 10.00	4A-FE		KDD-227  Pag.127	117x21
1.8 (AT221_)	81	09.97 → 10.00	7A-FE		KDD-226  Pag.127	121x21
2.0 (ST220_)	94	09.97 → 10.00	3S-FE		KDD-211  Pag.125	163x27 SKD-211  Pag. 158
2.0 D-4D (CDT220_)	81	10.99 → 02.03	1CD-FTV		KDD-205  Pag.125	178x25 SKD-205  Pag. 158
2.0 TD (CT220_)	66	09.97 → 02.03	2C-TE		KDD-297A  Pag.128	177x25 SKD-297A  Pag. 158
AVENSIS VERSO						
2.0 D-4D	85	08.01	1CD-FTV		KDD-205  Pag.125	178x25 SKD-205B  Pag. 158
AYGO						
1.0	50	07.05	1KR-FE	KDK-209  Pag. 156		
1.4 HDi	40	07.05	2WZ-TV		KDD-318  Pag.130	144x25
CAMRY (V1)						
1.8 Turbo-D	54	10.84 → 01.88	1C-TL		KDD-297A  Pag.128	177x25 SKD-297A  Pag. 158
2.0	73	04.86 → 01.88	2S-ELC		KDD-204  Pag.124	139x25
CAMRY (_V1_)						
2.2 (SXV10)	100	06.91 → 08.96	5S-FE		KDD-211  Pag.125	163x27

	KW			KDK- KIT CATENA TIMING BELT KIT	KDD- KIT CINGHIA TIMING CHAIN KIT <small>(Nr. of Teeth x Width)</small>	SKD KDD+POMPA ACQUA KDD+WATER PUMP
CAMRY (_V1_)						
3.0 (VCV10)	138	06.91 → 08.96	3VZ-FE		KDD-225  Pag.127	191x32
CAMRY (_V20)						
3.0 24V (MCV20_)	140	08.96 → 11.01	1MZ-FE		KDD-286A  Pag.128	143x25
CAMRY (_V2_)						
1.8 i (SV20_)	66	10.86 → 08.88	1S-L		KDD-204  Pag.124	139x25
2.0 (SV21_, SV25_)	94	11.86 → 05.91	3S-FE		KDD-204  Pag.124	139x25
2.0 Gli 16V (SV21_, SV25_)	89	11.86 → 05.91	3S-FE		KDD-204 2SEL  Pag.124	139x25
2.0 Turbo-D (CV20_)	62	11.86 → 05.91	2C-T		KDD-297A  Pag.128	177x25 SKD-297A  Pag. 158
2.5 V6 GXI (VZV21_)	118	02.88 → 05.91	2VZ-FE		KDD-213  Pag.125	179x32
CAMRY (_V30)						
3.0 V6	137	11.01	1MZ-FE		KDD-214B  Pag.126	211x32
CARINA (TA4L, TA6_L)						
1.8 D	48	04.82 → 09.83	1C		KDD-297A  Pag.128	177x25 SKD-297A  Pag. 158
CARINA E (_T19_)						
1.6 (AT190)	73	12.93 → 09.97	4A-FE		KDD-227  Pag.127	117x21
1.6 (AT190)	85	12.93 → 09.97	4A-FE		KDD-227  Pag.127	117x21
1.6 GLI (AT190)	79	04.92 → 09.97	4A-FE		KDD-227  Pag.127	117x21
1.8 (AT191)	79	01.95 → 09.97	7A-FE		KDD-226  Pag.127	121x21
2.0 D (CT190)	54	04.92 → 01.96	2C		KDD-297A  Pag.128	177x25 SKD-297A  Pag. 158
2.0 GLI (ST191)	98	04.92 → 09.97	3S-FE		KDD-211  Pag.125	163x27 SKD-211  Pag. 158
2.0 GTi (ST191)	116	04.92 → 02.94	3S-GE		KDD-216A  Pag.126	178x25
2.0 GTi 16V (ST191_)	129	03.94 → 09.97	3S-GE		KDD-221  Pag.126	177x25
2.0 i (ST191)	93	12.93 → 09.97	3S-FE		KDD-211  Pag.125	163x27 SKD-211  Pag. 158
2.0 TD (CT190)	61	01.96 → 09.97	2C-T		KDD-297A  Pag.128	177x25 SKD-297A  Pag. 158
CARINA II (_T15_)						
1.6 (AT151)	62	10.83 → 11.87	4A-L		KDD-201C  Pag.124	88x19

NEW CODES - NEUE CODES - NOUVEAUX CODES - NUEVOS CODIGOS - NUOVI CODICI

	KW			KDK- KIT CATENA TIMING BELT KIT	KDD- KIT CINGHIA TIMING CHAIN KIT <i>(Nr. of Theet x Width)</i>	SKD KDD+POMPA ACQUA KDD+WATER PUMP
CARINA II (_T15_)						
1.6 (AT151)	63	10.86 → 11.87	4A-L		KDD-201C  Pag.124	88x19
1.8 GLI (ST150)	74	10.83 → 11.87	1S-L		KDD-204  Pag.124	139x25
2.0 D	50	02.84 → 05.88	2C-L		KDD-297A  Pag.128	177x25 SKD-297A  Pag. 158
CARINA II (_T17_)						
1.6 (AT171)	66	12.87 → 11.89	4A-F		KDD-215A  Pag.126	94x19
1.6 (AT171)	72	12.87 → 03.92	4A-FE		KDD-215A  Pag.126	94x19
1.6 (AT171)	75	12.87 → 03.92	4A-FE		KDD-215A  Pag.126	94x19
2.0 D	54	03.88 → 06.93	2C-L		KDD-297A  Pag.128	177x25 SKD-297A  Pag. 158
2.0 GLI (ST171)	89	12.87 → 03.92	3S-FE		KDD-211  Pag.125	163x27 SKD-211  Pag. 158
CARINA SW(TA4K, TA6K)						
1.8 D	48	04.82 → 09.83	1C		KDD-297A  Pag.128	177x25 SKD-297A  Pag. 158
CELICA (ST16_)						
1.6 GT 16V	91	04.86 → 08.89	4A-GEL		KDD-212  Pag.125	113x19
2.0	110	01.87 → 08.90	3S-GEL		KDD-216B  Pag.126	178x25
CELICA (T16F)						
2.0 Turbo 4x4	136	03.88 → 08.90	3S-GTE		KDD-216B  Pag.126	178x25
CELICA (_T18_)						
1.6 STI (AT180)	77	10.89 → 01.94	4A-FE		KDD-215A  Pag.126	94x19
2.0 GTi (ST182)	115	05.91 → 01.94	3S-GE		KDD-216A  Pag.126	178x25
2.0 Turbo 4WD (ST185)	150	10.89 → 01.94	3S-GTE		KDD-216C →07.91  Pag.126 KDD-216A 178x25 08.91→  Pag.126	178x25
2.0 Turbo 4WD (ST185)	153	10.89 → 01.94	3S-GTE		KDD-216C →07.91  Pag.126 KDD-216A 178x25 08.91→  Pag.126	178x25
CELICA (_T20_)						
1.8 i 16V (AT200/ST)	85	11.93 → 11.99	7A-FE		KDD-226  Pag.127	121x21

NEW CODES - NEUE CODES - NOUVEAUX CODES - NUEVOS CODIGOS - NUOVI CODICI

	KW			KDK- KIT CATENA TIMING BELT KIT	KDD- KIT CINGHIA TIMING CHAIN KIT <i>(Nr. of Teeth x Width)</i>	SKD KDD+POMPA ACQUA KDD+WATER PUMP
CELICA (_T20_)						
2.0 i 16V	125	04.96 → 11.99	3S-GE		KDD-221 177x25  Pag.126	
2.0 i 16V	125	04.96 → 11.99	3S-GE		KDD-221 177x25  Pag.126	
2.0 i 16V (ST202/GT)	129	11.93 → 11.99	3S-GE		KDD-221 177x25 03.94 →  Pag.126	
2.0 i Turbo 4WD (ST205)	178	02.94 → 11.99	3S-GTE		KDD-221 177x25 05.94 →  Pag.126	
COROLLA (_E10_)						
1.3 12V (EE100_)	53	07.92 → 04.97	2E		KDD-228 124x26  Pag.127	
1.3 XLI 16V (EE101)	65	07.92 → 09.95	4E-FE		KDD-228 124x26  Pag.127	
1.6 Si (AE101_)	84	09.95 → 04.97	4A-FE		KDD-227 117x21  Pag.127	
2.0 D (CE100_)	53	07.92 → 04.97	2C		KDD-297A 177x25  Pag.128	SKD-297A  Pag. 158
COROLLA (_E11_)						
1.3 16V	63	01.97 → 12.00			KDD-228 124x26  Pag.127	
1.4 (EE111_)	63	04.97 → 02.00	4E-FE		KDD-228 124x26  Pag.127	
1.4 16V (ZZE111_)	71	02.00 → 01.02	4ZZ-FE	KDK-201  Pag. 155		
1.6 (AE111_)	81	04.97 → 02.00	4A-FE		KDD-227 117x21  Pag.127	
1.6 16V (ZZE112_)	81	02.00 → 01.02	3ZZ-FE	KDK-201  Pag. 155		
1.6 Aut. (AE111_)	79	04.97 → 02.00	4A-FE		KDD-227 117x21  Pag.127	
1.9 D (WZE110_)	51	02.00 → 01.02	1WZ		KDD-231  Pag.127	
2.0 D (CE110_)	53	04.97 → 02.00	2C-E		KDD-297A 177x25  Pag.128	SKD-297A  Pag. 158
2.0 D-4D	66	09.00 → 01.02	1CD-FTV		KDD-205 178x25  Pag.125	SKD-205B  Pag. 158
COROLLA (_E12U_)						
1.4 VVT-i	71	01.02	4ZZ-FE	KDK-201  Pag. 155		
1.6 VVT-i	81	01.02	3ZZ-FE	KDK-201  Pag. 155		
1.8 VVTL-i TS	141	01.02	2ZZ-GE	KDK-204  Pag. 155		
2.0 D-4D	66	01.02	1CD-FTV		KDD-205 178x25  Pag.125	SKD-205B  Pag. 158

	KW			KDK- KIT CATENA TIMING BELT KIT	KDD- KIT CINGHIA TIMING CHAIN KIT <small>(Nr. of Teeth x Width)</small>	SKD KDD+POMPA ACQUA KDD+WATER PUMP
COROLLA (_E12U_)						
2.0 D-4D	81	01.02	1CD-FTV		KDD-205  Pag.125	178x25 SKD-205B  Pag. 158
2.0 D-4D	85	05.03	1CD-FTV		KDD-205  Pag.125	178x25 SKD-205B  Pag. 158
COROLLA (_E7_)						
1.8 D (CE70)	43	01.83 → 09.83	1C		KDD-297A  Pag.128	177x25 SKD-297A  Pag. 158
COROLLA (_E8_)						
1.3 (AE80)	51	06.83 → 10.84	2A-L		KDD-201C  Pag.124	88x19
1.3 (AE80/EE80)	55	10.84 → 08.87	2E-LC 2E-L		KDD-207  Pag.125	123x20
1.6	54	12.85 → 05.88	4A-LC		KDD-201C  Pag.124	88x19
1.6 (AE82)	53	08.85 → 08.87	4A-LC		KDD-201C  Pag.124	88x19
1.6 (AE82)	62	06.83 → 08.87	4A-L		KDD-201C  Pag.124	88x19
1.8 D	43	06.83 → 05.88	1C		KDD-297A  Pag.128	177x25 SKD-297A  Pag. 158
COROLLA (_E9_)						
1.3 i (EE90)	55	08.87 → 12.92	2E 2E-E		KDD-210  Pag.125	123x24
1.6 (AE92)	66	08.87 → 12.89	4A-F		KDD-215A  Pag.126	94x19
1.6 GL 4x4	70	10.87 → 08.90	4A-F		KDD-215A  Pag.126	94x19
1.6 i	77	11.89 → 06.93	4A-FE		KDD-215A  Pag.126	94x19
1.6 i 4WD	77	10.87 → 08.90	4A-FE		KDD-215A  Pag.126	94x19
1.8 D	47	07.87 → 06.93	1C		KDD-297A  Pag.128	177x25 SKD-297A  Pag. 158
1.8 D	49	11.89 → 06.93	1C		KDD-297A  Pag.128	177x25 SKD-297A  Pag. 158
COROLLA Verso						
1.8	95	04.04	1ZZ-FE	KDK-200  Pag. 155		
2.0 D-4D	85	04.04	1CD-FTV		KDD-205  Pag.125	178x25 SKD-205  Pag. 158
COROLLA Verso (_E12J_)						
1.4 VVT-i	71	01.02 → 05.04	4ZZ-FE	KDK-201  Pag. 155		
1.6 VVT-i	81	01.02 → 05.04	3ZZ-FE	KDK-201  Pag. 155		
1.8 VVT-i	99	01.02 → 05.04	1ZZ-FE	KDK-200  Pag. 155		

	KW			KDK- KIT CATENA TIMING BELT KIT	KDD- KIT CINGHIA TIMING CHAIN KIT <i>(Nr. of Teeth x Width)</i>	SKD KDD+POMPA ACQUA KDD+WATER PUMP
COROLLA Verso (_E12J_)						
2.0 D-4D	66	01.02 → 05.04	1CD-FTV		KDD-205  Pag.125	178x25 SKD-205B  Pag. 158
CRESSIDA (_X6_)						
2.0 GLI	80	11.82 → 12.84	1G-E		KDD-296  Pag.128	111x25
2.2 D (LX60)	49	09.80 → 07.84	L		KDD-206B  Pag.125	130x25
2.4 D	63	08.84			KDD-206B  Pag.125	130x25
2.4 TD	66	05.85 → 09.88	2L-T		KDD-206B  Pag.125	130x25
2.8	106	05.85 → 09.88	5M-E		KDD-200  Pag.124	142x25
CRESSIDA SW(X6K)						
2.2 D	49	06.81 → 03.85	L		KDD-202 05.82 →  Pag.124	127x25
CROWN (_S1_)						
2.0	0	01.85			KDD-296  Pag.128	111x25
2.2 D (LS110_)	53	04.80 → 07.83	L		KDD-202 06.82 →  Pag.124	127x25
2.8 i Super Saloon (S12)	125	02.84 → 03.85	5M-GE		KDD-200  Pag.124	142x25
DYNA						
2.4 D	55	08.77 → 02.79			KDD-T03  Pag.152	130x25
2.4 D	55	09.84 → 08.87	2J		KDD-T03  Pag.152	130x25
DYNA (3L)						
2.8 D (LY60/61)	60	01.88 → 12.94			KDD-T01  Pag.152	129x31
DYNA 100 (2Y)						
2.4 D (LH80-LH81)	69	08.87 → 04.95			KDD-206C  Pag.125	130x25
DYNA 150 (3L / 5L)						
2.8 D (LY211 / LY212)	0	05.95 → 11.97			KDD-T01  Pag.152	129x31
DYNA D (2L)						
2.8 D (LY100)	53	01.95			KDD-T01  Pag.152	129x31
DYNA D (3B)						
3.0 D (BU)	0	08.80			KDD-T01 05.98 →  Pag.152	129x31
HIACE I (_H_)						

NEW CODES - NEUE CODES - NOUVEAUX CODES - NUEVOS CODIGOS - NUOVI CODICI



















	KW			KDK- KIT CATENA TIMING BELT KIT	KDD- KIT CINGHIA TIMING CHAIN KIT <small>(Nr. of Teeth x Width)</small>	SKD KDD+POMPA ACQUA KDD+WATER PUMP
HIACE I (_H_)						
2.2 D (LH20-30)	46	01.79 → 03.83	L		KDD-T03  Pag.152	130x25
HIACE II (H5_)						
2.2 D	49	03.83 → 11.89	L		KDD-T03  Pag.152	130x25
2.4 D	55	05.84 → 11.89	2L		KDD-T03  Pag.152	130x25
HIACE III (_H10_)						
2.4 D	57	10.93 → 08.95	2L		KDD-T01  Pag.152	129x31
2.4 Diesel	55	02.90 → 08.95	2L		KDD-T01  Pag.152	129x31
HIACE IV (_H1_, _H2_)						
2.4 TD (LXH12_, LXH22_)	66	08.95	2L-T		KDD-T01  Pag.152	129x31
2.4 TD (LXH12_, LXH22_)	66	08.95	2L-T		KDD-T01  Pag.152	129x31
2.5 D-4D	65	11.01	2KD-FTV		KDD-889B  Pag.146 KDD-889C  Pag.147	97x25 97x25
2.5 D-4D	75	11.01	2KD-FTV		KDD-889B  Pag.146 KDD-889C  Pag.147	97x25 97x25
HILUX Pick-up						
2.5 D	88	12.07	2KD-FTV		KDD-889B  Pag.146 KDD-889C  Pag.147	97x25 97x25
3.0 D 4x4	126	12.07	1KD-FTV		KDD-889B  Pag.146 KDD-889C  Pag.147	97x25 97x25
HILUX Pick-up (_N_)						
2.4 D	55	07.98 → 01.02	2L		KDD-T01  Pag.152	129x31
2.4 D	61	08.88	2L		KDD-T01  Pag.152	129x31
2.4 i 4WD	103	08.97	2RZ-FE		KDD-T01  Pag.152	129x31
2.4 i 4WD	84	06.89	22R		KDD-T03  Pag.152	130x25
2.4 i 4WD	84	06.89	22RE		KDD-T03  Pag.152	130x25
2.4 TD 4WD	66	08.98 → 01.02	2L-T		KDD-T01  Pag.152	129x31

	KW			KDK- KIT CATENA TIMING BELT KIT	KDD- KIT CINGHIA TIMING CHAIN KIT <i>(Nr. of Teeth x Width)</i>	SKD KDD+POMPA ACQUA KDD+WATER PUMP
HILUX Pick-up (_N_)						
2.5 D-4D	65	11.01	2KD-FTV		KDD-889B 97x25  Pag.146 KDD-889C 97x25  Pag.147	
2.5 D-4D 4WD	75	11.01	2KD-FTV		KDD-889B 97x25  Pag.146 KDD-889C 97x25  Pag.147	
LAND CRUISER (J12)						
3.0 D-4D (KDJ120)	120	01.03	1KD-FTV		KDD-889B 97x25  Pag.146 KDD-889C 97x25  Pag.147	
3.0 D-4D (KDJ120)	122	08.04	1KD-FTV		KDD-889B 97x25  Pag.146 KDD-889C 97x25  Pag.147	
3.0 D-4D (KDJ120)	127	01.07	1KD-FTV		KDD-889C 97x25  Pag.147 KDD-889B 97x25  Pag.146	
LAND CRUISER (_J7_)						
2.4 D (LJ70_)	53	11.84 → 10.85	2L		KDD-T03 130x25  Pag.152	
2.4 TD (LJ70)	66	01.90 → 05.93	2L-T		KDD-T01 129x31  Pag.152	
2.4 TD (LJ70_, LJ73_)	63	10.85 → 05.90	2L-T		KDD-T03 130x25  Pag.152	
3.0 TD (KZJ70_, KZJ73_, KZJ77_)	92	05.93 → 05.96	1KZ-T		KDD-288B 102x25  Pag.128	
3.5 D	85	01.90 → 12.93	1PZ		KDD-222 94x25  Pag.127	
4.2 TD (HZJ7__V)	96	01.90	1H-Z		KDD-222 94x25  Pag.127	
LAND CRUISER 100 (_J10_)						
4.2 TD (HDJ100_)	150	01.98	1HD-FTE		KDD-283 105x25  Pag.128	
LAND CRUISER 80 (_J8_)						
4.2 D (HZJ80_)	99	01.90 → 12.97	1H-Z		KDD-222 94x25  Pag.127	
4.2 TD (HDJ80)	118	10.92 → 12.97	1HD-T		KDD-222 94x25  Pag.127	
4.2 TD (HDJ80)	123	01.90 → 12.97	1HD-T		KDD-222 94x25  Pag.127	
4.2 TD 24V (HDJ80_)	125	03.95 → 12.97	1HD-FT		KDD-283 105x25  Pag.128	
LAND CRUISER 90 (_J9_)						

	KW			KDK- KIT CATENA TIMING BELT KIT	KDD- KIT CINGHIA TIMING CHAIN KIT <i>(Nr. of Teeth x Width)</i>	SKD KDD+POMPA ACQUA KDD+WATER PUMP
LAND CRUISER 90 (_J9_)						
3.0 D-4D	120	10.00	1KD-FTV		KDD-889B 97x25  Pag.146 KDD-889C 97x25  Pag.147	
3.0 TD (KZJ90_, KZJ95_)	92	04.96	1KZ-TE		KDD-288B 102x25  Pag.128	
3.4 i 24V (VZJ90_, VZJ95_)	131	04.96	5VZ-FE		KDD-230 191x36  Pag.127	
LAND CRUISER V8						
4.7 V8	212	01.08	2UZ-FE		KDD-229 211x34  Pag.127	
LITEACE (CM30_G, KM30_G)						
2.0 D (CM30LG)	53	08.88 → 01.92	2C		KDD-297A 177x25  Pag.128	SKD-297A  Pag. 158
LITEACE (CM3_V, KM3_V)						
1.8 D (CM35_V)	46	10.85 → 08.88	1C		KDD-297A 177x25  Pag.128	SKD-297A  Pag. 158
LITEACE (M2_G)						
1.8 D	41	10.82 → 09.85	1C		KDD-297A 177x25  Pag.128	SKD-297A  Pag. 158
LITEACE (_R2_LG)						
2.0 D (CR21LG)	53	01.92 → 05.94	2C		KDD-297A 177x25  Pag.128	SKD-297A  Pag. 158
MODEL F						
2.0 D	49	04.85 → 08.88	2C		KDD-297A 177x25  Pag.128	SKD-297A  Pag. 158
MR 2 (_W1_)						
1.6 16V (AW11)	85	11.84 → 06.90	4A-GELC		KDD-212 113x19  Pag.125	
1.6 16V (AW11)	91	11.84 → 06.90	4A-GEL		KDD-212 113x19  Pag.125	
MR 2 (_W2_)						
2.0 16V	125	12.89 → 05.00	3S-GE		KDD-221 177x25 05.96 →  Pag.126	
2.0 16V	129	12.89 → 05.00	3S-GE		KDD-221 177x25 02.94 →  Pag.126	
2.0 16V (SW20)	115	12.89 → 05.00	3S-GE		KDD-221 177x25 12.93 →  Pag.126	
MR 2 (_W3_)						
1.8 16V VT-i (ZZW30)	103	04.00	1ZZ-FE	KDK-200  Pag. 155		
PASEO (EL54)						
1.5 16V	66	08.95 → 07.99	5E-FE		KDD-292 128x26  Pag.128	

NEW CODES - NEUE CODES - NOUVEAUX CODES - NUEVOS CODIGOS - NUOVI CODICI

	KW			KDK- KIT CATENA TIMING BELT KIT	KDD- KIT CINGHIA TIMING CHAIN KIT <i>(Nr. of Teeth x Width)</i>	SKD KDD+POMPA ACQUA KDD+WATER PUMP
PICNIC						
2.0 TD (1CDFTV) CLM20	0	05.01			KDD-205  Pag.125	178x25
PICNIC (_XM10)						
2.0 16V (SXM10_)	94	05.96 → 12.01	3S-FE		KDD-211 01.97→  Pag.125	163x27 SKD-211 01.97  Pag. 158
2.2 D (CMX10_)	66	08.97 → 12.01	3C-TE		KDD-297A  Pag.128	177x25 SKD-297A  Pag. 158
PREVIA						
2.2 D (3CT)	0	01.92			KDD-297A  Pag.128	177x25 SKD-297A  Pag. 158
PREVIA (ACR3_)						
2.0 D-4D	85	03.01	1CD-FTV		KDD-205  Pag.125	178x25 SKD-205B  Pag. 158
RAV 4 I (SXA1_)						
2.0 16V	94	12.97 → 06.00	3S-FE		KDD-211  Pag.125	163x27 SKD-211  Pag. 158
2.0 16V	95	06.94 → 06.00	3S-FE		KDD-211  Pag.125	163x27 SKD-211  Pag. 158
RAV 4 II (XA2)						
2.0 D-4D 4WD	85	09.01	1CD-FTV		KDD-205  Pag.125	178x25 SKD-205A  Pag.125
						178x25 SKD-205B  Pag. 158
2.0 VVTi 4WD	110	06.00	1AZ-FE	KDK-205  Pag. 155		
STARLET (EP91)						
1.3	55	04.96 → 03.99	4E-FE		KDD-228  Pag.127	124x26
STARLET (_P7_)						
1.0 (EP70L)	40	10.84 → 12.89	1E-L		KDD-224 04.86→  Pag.127	121x24
1.3 (EP71L)	55	10.84 → 12.89	2E-LC		KDD-210 04.86→  Pag.125	123x24
1.5 D (NP70L)	40	12.86 → 12.89	1N		KDD-239  Pag.128	127x25
STARLET (_P8_)						
1.3 12V (EP81) Cat.	55	12.89 → 03.96	2E-E		KDD-210  Pag.125	123x24
SUPRA (JZA80)						
3.0 i Bi-Turbo	243	05.93 → 08.98	2JZ-GTE		KDD-286A  Pag.128	143x25
SUPRA (MA70)						
3.0 24V	150	01.86 → 08.88	7M-GE		KDD-218  Pag.126	159x25

	KW			KDK- KIT CATENA TIMING BELT KIT	KDD- KIT CINGHIA TIMING CHAIN KIT <small>(Nr. of Theet x Width)</small>	SKD KDD+POMPA ACQUA KDD+WATER PUMP
SUPRA (MA70)						
3.0 Turbo	173	09.87 → 04.93	7M-GTE		KDD-218  Pag.126	159x25
TERCEL (AL2_)						
1.5 4WD	52	10.82 → 01.88	3A		KDD-201C  Pag.124	88x19
1.5 4WD (AL25)	50	05.86 → 01.88	3A-C		KDD-201C  Pag.124	88x19
YARIS (_CP10)						
1.0 16V	48	03.03	1SZ-FE	KDK-206  Pag. 155		
1.0 16V (SCP10_)	50	04.99	1SZ-FE	KDK-206  Pag. 155		
1.3	64	04.02	2SZ-FE	KDK-210  Pag. 156		
1.3 16V (NCP10_)	63	11.99	2NZ-FE	KDK-203  Pag. 155		
1.4 D-4D	55	12.01	1ND-TV	KDK-207  Pag. 155		
1.5 TS (NCP13)	77	01.03	1NZ-FE	KDK-202  Pag. 155		
1.5 VVT-i TS	78	04.01	1NZ-FE	KDK-202  Pag. 155		
YARIS VERSO (NC/LP2_)						
1.3 (NCP22)	62	01.03	2NZ-FE	KDK-203  Pag. 155 KDK-208 Francia  Pag. 155		
1.3 (NCP22)	63	11.99	2NZ-FE	KDK-203  Pag. 155		
1.5 (NCP21)	77	05.03	1NZ-FE	KDK-202  Pag. 155		
1.5 (NCP21)	78	03.00	1NZ-FE	KDK-202  Pag. 155		

	KW			KDK- KIT CATENA TIMING BELT KIT	KDD- KIT CINGHIA TIMING CHAIN KIT <i>(Nr. of Teeth x Width)</i>	SKD KDD+POMPA ACQUA KDD+WATER PUMP
BEDFORD MIDI						
1.8	63	09.84 → 05.88	4ZB1		KDD-903  Pag.147	111x19
2.0	62	06.88 → 08.92	20PET		KDD-903  Pag.147	111x19
2.0 D	42	08.84 → 05.88			KDD-904A  Pag.147	137x30
2.2 D	45	06.88 → 08.92	22DIE		KDD-904A  Pag.147	137x30
BEDFORD RASCAL						
1.0	34	07.86 → 06.90	FA10A		KDD-S01  Pag.152	88x19
CITROEN C1						
1.0	50	06.05	1KR-FE	KDK-209  Pag. 156		
1.4 HDi	40	06.05	DV4D		KDD-318  Pag.130	144x25
DACIA DUSTER						
1.5 dCi	63	04.10	K9K 796		KDD-114  Pag.123	123x27 SKD-114  Pag. 158
1.5 dCi	66	10.10	K9K 892		KDD-114  Pag.123	123x27 SKD-114  Pag. 158
1.5 dCi	79	06.10	K9K 896		KDD-114  Pag.123	123x27 SKD-114  Pag. 158
DACIA LOGAN						
1.5 dCi	63	09.07			KDD-114  Pag.123	123x27 SKD-114  Pag. 158
1.5 dCi (LS0J)	48	09.05			KDD-114  Pag.123	123x27 SKD-114  Pag. 158
1.5 dCi (LS0K)	50	01.06			KDD-114  Pag.123	123x27 SKD-114  Pag. 158
DACIA SANDERO						
1.5 dCi	50	11.08			KDD-114  Pag.123	123x27 SKD-114  Pag. 158
1.5 dCi	63	11.08			KDD-114  Pag.123	123x27 SKD-114  Pag. 158
FIAT 500						
1.3 D Multijet	55	10.07		KDK-801-8  Pag. 156		
FIAT DOBLO (223)						
1.3 JTD 16V	51	05.04		KDK-801-8  Pag. 156		
FIAT GRANDE PUNTO (199)						
1.3 D Multijet	55	10.05		KDK-801-8  Pag. 156		
FIAT IDEA						
1.3 JTD	51	01.04		KDK-801-8  Pag. 156		

NEW CODES - NEUE CODES - NOUVEAUX CODES - NUEVOS CODIGOS - NUOVI CODICI

European Vehicles

	KW			KDK- KIT CATENA TIMING BELT KIT	KDD- KIT CINGHIA TIMING CHAIN KIT <i>(Nr. of Teeth x Width)</i>	SKD KDD+POMPA ACQUA KDD+WATER PUMP
FIAT PANDA (169)						
1.3 D Multijet	51	09.03		KDK-801-8  Pag. 156		
FIAT PUNTO (188)						
1.3 JTD 16V	51	06.03		KDK-801-8  Pag. 156		
FIAT SEDICI						
1.9 D Multijet	88	06.06	D19AA		KDD-811 190x24  Pag.145	
FORD MAVERICK (UDS, UNS)						
2.4 i	91	02.93 → 08.96		KDK-108 08.93 →  Pag. 154		
INNOCENTI MINI						
0.55	24	01.87 → 12.91	Daihatsu-EB		KDD-600A 90x19  Pag.142	
0.65	23	01.84 → 12.87			KDD-600A 90x19  Pag.142	
1.0	27	10.85 → 10.91	BLM C 99 H		KDD-103A 91x19 Z900  Pag.122 KDD-600B 90x19 Z670  Pag.142	
1.0 D	0	10.85			KDD-605 102x19 CL 10  Pag.142 KDD-609 102x19 CL 11  Pag.143 KDD-600B 90x19 3CYL  Pag.142	
MINI TURBO	0				KDD-103A 91x19  Pag.122	
INNOCENTI MINITRE						
1.0	0	04.82			KDD-600B 90x19  Pag.142	
INNOCENTI SMALL						
500	0	01.90			KDD-600A 90x19  Pag.142	
900	0	04.90			KDD-699 99x16  Pag.143 KDD-697 91x19  Pag.143	
OPEL AGILA (H00)						
1.3 CDTI	51	08.03		KDK-801-8  Pag. 156		

NEW CODES - NEUE CODES - NOUVEAUX CODES - NUEVOS CODIGOS - NUOVI CODICI

	KW			KDK- KIT CATENA TIMING BELT KIT	KDD- KIT CINGHIA TIMING CHAIN KIT <i>(Nr. of Teeth x Width)</i>	SKD KDD+POMPA ACQUA KDD+WATER PUMP
OPEL ASTRA F (56_, 57_)						
1.7 D	44	07.92 → 09.98	17 DR		KDD-OP1 146x24  Pag.151	
1.7 TDS	60	03.92 → 09.98	17 DT (TC4EE1) X 17 DT (TC4EE1)		KDD-OP1 146x24  Pag.151	
OPEL ASTRA H						
1.9 CDTI	110	09.04			KDD-811 190x24  Pag.145	
1.9 CDTI	74	09.05			KDD-811 190x24  Pag.145	
1.9 CDTI	88	06.04			KDD-811 190x24  Pag.145	
OPEL CAMPO (TF_)						
2.2 D (TFR52)	39	08.91 → 09.96			KDD-901A 87x34.7  Pag.147	
2.2 D (TFR52)	45	08.87 → 08.90			KDD-901A 87x34.7  Pag.147	
2.5 D (TFR54)	56	08.91 → 06.94	4 JA1		KDD-906B 119x32  Pag.148	
2.5 DTI	74	12.01	4 JA1		KDD-906B 119x32  Pag.148	
2.5 TD (TFR54)	56	07.94	4 JA1T		KDD-906B 119x32  Pag.148	
OPEL COMBO						
1.3 CDTI 16V	51	10.04		KDK-801-8  Pag. 156		
1.3 CDTI 16V	55	10.05		KDK-801-8  Pag. 156		
OPEL CORSA A (93_, 94_, 98_, 9						
1.5 TD	49	03.88 → 03.93			KDD-907A 136x25  Pag.148 KDD-904B 137x30 08.90 →  Pag.147	
OPEL CORSA A TR (91_, 92_, 96_, 97_)						
1.5 D	37	10.87 → 11.92			KDD-907A 136x25  Pag.148	
OPEL CORSA B (73_, 78_, 79_, F35_)						
1.5 D	37	03.93 → 09.00	15 D (4EC1)		KDD-907A 136x25  Pag.148	
1.5 TD	49	03.93 → 09.00	15 DT (T4EC1) X 15 DT (T4EC1)		KDD-904B 137x30  Pag.147 KDD-907A 136x25  Pag.148	
OPEL CORSA C (F08, F68)						
1.3 CDTI	51	06.03		KDK-801-8  Pag. 156		

European Vehicles

	KW			KDK- KIT CATENA TIMING BELT KIT	KDD- KIT CINGHIA TIMING CHAIN KIT <i>(Nr. of Teeth x Width)</i>	SKD KDD+POMPA ACQUA KDD+WATER PUMP
OPEL CORSA D						
1.3 CDTI	55	07.06		KDK-801-8  Pag. 156		
OPEL FRONTERA A (5_MWL4)						
2.8 TD (5BMW4)	83	03.95 → 10.98			KDD-906B 119x32  Pag.148	
OPEL FRONTERA A (5_SUD2)						
2.8 TD (53SUD2)	83	03.95 → 08.96			KDD-906B 119x32  Pag.148	
OPEL KADETT E (39_, 49_)						
1.5 TD	53	07.88 → 08.91	15 DT (T4EC1)		KDD-907A 136x25 →07.90  Pag.148 KDD-904B 137x30 08.90→  Pag.147	
OPEL MERIVA						
1.3 CDTI	51	04.05		KDK-801-8  Pag. 156		
1.3 CDTI	55	09.03		KDK-801-8  Pag. 156		
OPEL MOKKA						
1.7 CDTI	96	06.12			KDD-W11 131x25  Pag.153	
OPEL MONTEREY A (UBS_)						
3.1 TD (UBS69_)	84	09.91 → 07.98	4 JG2TC		KDD-906B 119x32  Pag.148	
OPEL MONTEREY B						
3.0 DTI	117	07.98 → 08.99			KDD-900 104x22  Pag.147	
3.5 V6 24V	158	07.98 → 08.99			KDD-910 191x32  Pag.148	
OPEL TIGRA TwinTop						
1.3 CDTI	51	06.04		KDK-801-8  Pag. 156		
OPEL VECTRA A (86_, 87_)						
1.7 TD	60	03.90 → 11.95	17 DT (TC4EE1) X 17 DT (TC4EE1)		KDD-OP1 146x24 4EE1T  Pag.151	
OPEL VECTRA B (36_)						
1.7 TD	60	10.95 → 12.98	X 17 DT (TC4EE1)		KDD-OP1 146x24  Pag.151	
PEUGEOT 107						
1.0	50	06.05	1KR (384 F)	KDK-209  Pag. 156		
1.4 HDi	40	06.05	8HT (DV4TD)		KDD-318 144x25  Pag.130	

NEW CODES - NEUE CODES - NOUVEAUX CODES - NUEVOS CODIGOS - NUOVI CODICI

	KW			KDK- KIT CATENA TIMING BELT KIT	KDD- KIT CINGHIA TIMING CHAIN KIT <i>(Nr. of Theet x Width)</i>	SKD KDD+POMPA ACQUA KDD+WATER PUMP
PROTON PERSONA 300						
313i	55	03.96	Mitsubishi G13B		KDD-533A 92x22  Pag.139	
315 GLi/GLSi	66	03.96			KDD-533A 92x22  Pag.139	
315 GLSi	64	09.96	Mitsubishi G15B		KDD-533A 92x22  Pag.139	
316	70	03.96	4G92		KDD-534 117x29  Pag.139	
316 GLXi	83	03.96	4G92		KDD-534 117x29  Pag.139	
PROTON PERSONA 400						
413	55	01.94			KDD-533A 92x22  Pag.139	
415 GLi/GLSi	66	01.94	4G15		KDD-533A 92x22  Pag.139	
416 GLXi	83	01.94	4G92		KDD-534 117x29  Pag.139	
418	85	05.96	4 G 93		KDD-529 121x28.7  Pag.138	
420 GLS D	48	05.96	4 D 68		KDD-531 158x31.7 65x13  Pag.139	
PROTON SAGA						
1.3 GLS	50	10.88 → 06.91			KDD-533A 92x22  Pag.139	
1.5 8 VALV.	0	06.90			KDD-533A 92x22  Pag.139	
PROTON SALOON						
1.5	66	01.91 → 11.96			KDD-533A 92x22  Pag.139	
RENAULT CLIO III						
1.5 dCi	48	05.05 → 10.06			KDD-114 123x27  Pag.123	SKD-114  Pag. 158
ROVER 200 (XH)						
213 S	54	09.85 → 09.89	EV 2		KDD-404 101x24  Pag.133	
ROVER 200 (XW)						
214 Si/Gsi	66	10.89 → 10.95	14 K4C 14 K4D		KDD-413A 107x24  Pag.134	
216 GSi	82	10.89 → 10.95	D 16 Z2		KDD-411 124x24 DOUBLE CAMSHAFT  Pag.134 KDD-413A 107x24 SINGLE CAMSHAFT  Pag.134	

European Vehicles







	KW			KDK- KIT CATENA TIMING BELT KIT	KDD- KIT CINGHIA TIMING CHAIN KIT <i>(Nr. of Teeth x Width)</i>	SKD KDD+POMPA ACQUA KDD+WATER PUMP
ROVER 200 (XW)						
216 GSi	85	10.89 → 10.95	D 16 A7		KDD-411 124x24 DOUBLE CAMSHAFT  Pag.134 KDD-413A 107x24 SINGLE CAMSHAFT  Pag.134	
ROVER 400 (XW)						
416 GSi	82	04.90 → 04.95	D 16 Z2		KDD-411 124x24 DOUBLE CAMSHAFT  Pag.134 KDD-413A 107x24 SINGLE CAMSHAFT  Pag.134	
416 GSi/GSE	85	04.90 → 04.95	D 16 A7		KDD-411 124x24 DOUBLE CAMSHAFT  Pag.134 KDD-413A 107x24 SINGLE CAMSHAFT  Pag.134	
ROVER 600 (RH)						
618 i/Si	85	03.96 → 02.99			KDD-415 113x24 70x16  Pag.134	
620 Si	96	08.93 → 02.99			KDD-415 113x24 70x16  Pag.134	
623 Si	116	08.93 → 02.99			KDD-416 127x25 70x16  Pag.134	
ROVER 800						
825 Si/Sterling (XS)	123	10.86 → 10.88	C 25 A2		KDD-410 192x28  Pag.134	
825 Si/Sterling (XS)	127	01.87 → 12.91	C 25 A2		KDD-410 192x28  Pag.134	
825 Si/Sterling (XS) Cat.	110	10.86 → 12.91	C 25 A1		KDD-410 192x28  Pag.134	
827 Si/Sterling (XS)	130	02.88 → 12.91	C 27 A2		KDD-410 192x28  Pag.134	
827 Si/Sterling (XS) Cat.	124	02.88 → 02.99	C 27 A1		KDD-410 192x28  Pag.134	
827 Vitesse (XS) Cat.	124	10.88 → 12.91	C 27 A1		KDD-410 192x28  Pag.134	
827 Vitesse/SLI	130	10.88 → 12.91	C 27 A2		KDD-410 192x28  Pag.134	
VAUXHALL ASTRA Mk II Belmont						
1.5 DT	49	01.88 → 08.90			KDD-904B 137x30  Pag.147 KDD-907A 136x25  Pag.148	

NEW CODES - NEUE CODES - NOUVEAUX CODES - NUEVOS CODIGOS - NUOVI CODICI



	KW			KDK- KIT CATENA TIMING BELT KIT	KDD- KIT CINGHIA TIMING CHAIN KIT <small>(Nr. of Teeth x Width)</small>	SKD KDD+POMPA ACQUA KDD+WATER PUMP
VAUXHALL ASTRA Mk II SW						
1.5 DT	49	01.88 → 08.91			KDD-904B 137x30  Pag.147 KDD-907A 136x25  Pag.148	
VAUXHALL ASTRA Mk III						
1.7 TD	60	12.91 → 09.98	17 DT (TC4EE1)		KDD-OP1 146x24  Pag.151	
1.7 TD	60	12.91 → 02.98	17 DT (TC4EE1)		KDD-OP1 146x24  Pag.151	
VAUXHALL ASTRA Mk III SW						
1.7 TD	60	12.91 → 02.98			KDD-OP1 146x24  Pag.151	
VAUXHALL BRAVA Pick-up						
2.2 D (TFR52)	39	08.91 → 09.96			KDD-901A 87x34.7  Pag.147	
2.2 D 4x4 (TFS52)	39	08.91 → 09.96			KDD-901A 87x34.7  Pag.147	
VAUXHALL CAVALIER Mk III						
1.7 TD	60	09.88 → 11.95			KDD-OP1 146x24  Pag.151	
1.7 TD	60	09.88 → 11.95			KDD-OP1 146x24  Pag.151	
VAUXHALL CORSA						
1.5 D	37	03.93 → 09.00			KDD-907A 136x25  Pag.148	
1.5 TD	49	03.93 → 10.96			KDD-904B 137x30  Pag.147 KDD-907A 136x25  Pag.148	
VAUXHALL NOVA						
1.5 D	37	09.87 → 03.93			KDD-907A 136x25  Pag.148	
1.5 D	37	09.87 → 02.93			KDD-907A 136x25  Pag.148	
1.5 TD	49	01.90 → 03.93			KDD-904B 137x30  Pag.147 KDD-907A 136x25  Pag.148	
1.5 TD	49	01.90 → 02.93			KDD-904B 137x30  Pag.147 KDD-907A 136x25  Pag.148	
VAUXHALL NOVAVAN						
1.5 D	37	01.91 → 10.94			KDD-907A 136x25  Pag.148	
VAUXHALL VECTRA						
1.7 TD	60	10.95 → 11.96	X 17 DT (TC4EE1)		KDD-OP1 146x24  Pag.151	

NEW CODES - NEUE CODES - NOUVEAUX CODES - NUEVOS CODIGOS - NUOVI CODICI



European Vehicles



	KW			KDK- KIT CATENA TIMING BELT KIT	KDD- KIT CINGHIA TIMING CHAIN KIT <small>(Nr. of Teeth x Width)</small>	SKD KDD+POMPA ACQUA KDD+WATER PUMP
VAUXHALL VECTRA						
1.7 TD	60	10.95 → 11.96			KDD-OP1  <i>Pag.151</i>	146x24
VW TARO						
2.4 D	59	09.91 → 07.94	2L		KDD-T01  <i>Pag.152</i>	129x31
2.4 D	61	06.89 → 03.97	2L		KDD-T01  <i>Pag.152</i>	129x31

KDD-001	
	Number of Teeth 1/N° denti 1
	173
	Width 1/Largh. 1 [mm]
	22
GONOW	BE-012 / BE-013 / DD-001

KDD-006	
	Number of Teeth 1/N° denti 1
	150
	Width 1/Largh. 1 [mm]
	29
CHRYSLER	BE-007 / BE-008 / DD-006

KDD-002	
	Number of Teeth 1/N° denti 1
	201
	Width 1/Largh. 1 [mm]
	30
DODGE	BE-011 / DD-002

KDD-006A	
	Number of Teeth 1/N° denti 1
	150
	Width 1/Largh. 1 [mm]
	29
CHRYSLER	BE-008 / BE-016 / DD-006

KDD-003	
	Number of Teeth 1/N° denti 1
	136
	Width 1/Largh. 1 [mm]
	25
TATA (TELCO)	BE-003 / DD-003

KDD-007	
	Number of Teeth 1/N° denti 1
	199
	Width 1/Largh. 1 [mm]
	24
CADILLAC	BE-810 / BE-811 / DD-007

KDD-004	
	Number of Teeth 1/N° denti 1
	136
	Width 1/Largh. 1 [mm]
	25
TATA (TELCO)	BE-006 / DD-003

KDD-008	
	Number of Teeth 1/N° denti 1
	173
	Width 1/Largh. 1 [mm]
	25
DR	BE-015 / BE-017 / BE-021 / DD-008

KDD-005	
	Number of Teeth 1/N° denti 1
	220
	Width 1/Largh. 1 [mm]
	28
JEEP - CHRYSLER	BE-009 / BE-010 / DD-005

KDD-009	
	Number of Teeth 1/N° denti 1
	167
	Width 1/Largh. 1 [mm]
	25
DR	BE-017 / BE-018 / DD-010

KDD-100	
	Number of Teeth 1/N° denti 1
	102
	Width 1/Largh. 1 [mm]
	19
NISSAN	BE-102 / DD-100

KDD-104	
	Number of Teeth 1/N° denti 1
	117
	Width 1/Largh. 1 [mm]
	25.5
	Number of Teeth 2/N° denti 2
	76
	Width 2/Largh. 2 [mm]
	19
NISSAN	BE-103 / BE-111 / BE-116 / DD-104 / DD-119

KDD-101	
	Number of Teeth 1/N° denti 1
	106
	Width 1/Largh. 1 [mm]
	19
NISSAN	BE-102 / DD-101

KDD-105	
	Number of Teeth 1/N° denti 1
	136
	Width 1/Largh. 1 [mm]
	25
NISSAN	BE-120 / BE-121 / DD-003

KDD-102	
	Number of Teeth 1/N° denti 1
	69
	Width 1/Largh. 1 [mm]
	19
NISSAN	BE-105 / DD-102

KDD-106	
	Number of Teeth 1/N° denti 1
	98
	Width 1/Largh. 1 [mm]
	19
NISSAN	BE-105 / DD-106

KDD-103A	
	Number of Teeth 1/N° denti 1
	91
	Width 1/Largh. 1 [mm]
	19
DAIHATSU - INNOCENTI	BE-601 / DD-103

KDD-107	
	Number of Teeth 1/N° denti 1
	143
	Width 1/Largh. 1 [mm]
	30
NISSAN	BE-112 / BE-113 / DD-107

KDD-103B	
	Number of Teeth 1/N° denti 1
	91
	Width 1/Largh. 1 [mm]
	19
NISSAN	BE-115 / DD-103

KDD-108	
	Number of Teeth 1/N° denti 1
	151
	Width 1/Largh. 1 [mm]
	19
NISSAN	BE-107 / BE-108 / DD-108

KDD-110	
	Number of Teeth 1/N° denti 1
	133
	Width 1/Largh. 1 [mm]
	25
NISSAN	BE-104 / DD-110

KDD-117	
	Number of Teeth 1/N° denti 1
	89
	Width 1/Largh. 1 [mm]
	25
NISSAN	BE-124 / BE-125 / DD-117

KDD-112	
	Number of Teeth 1/N° denti 1
	145
	Width 1/Largh. 1 [mm]
	30
NISSAN	BE-112 / BE-113 / DD-112

KDD-120	
	Number of Teeth 1/N° denti 1
	133
	Width 1/Largh. 1 [mm]
	26
NISSAN - SUZUKI	BE-123 / DD-120

KDD-113	
	Number of Teeth 1/N° denti 1
	149
	Width 1/Largh. 1 [mm]
	30
NISSAN	BE-100 / BE-101 / DD-113

KDD-121	
	Number of Teeth 1/N° denti 1
	110
	Width 1/Largh. 1 [mm]
	19
NISSAN	BE-115 / DD-121

KDD-114	
	Number of Teeth 1/N° denti 1
	123
	Width 1/Largh. 1 [mm]
	27
SUZUKI - NISSAN - DACIA - RENAULT	BE-122 / DD-114

KDD-122	
	Number of Teeth 1/N° denti 1
	228
	Width 1/Largh. 1 [mm]
	32
NISSAN	BE-109 / BE-110 / DD-122

KDD-115	
	Number of Teeth 1/N° denti 1
	93
	Width 1/Largh. 1 [mm]
	19.4
NISSAN	BE-115 / DD-115

KDD-124	
	Number of Teeth 1/N° denti 1
	132
	Width 1/Largh. 1 [mm]
	27
NISSAN	BE-126 / BE-127 / DD-124

KDD-125	
 <p>125</p>	Number of Teeth 1/N° denti 1
	87
	Width 1/Largh. 1 [mm]
	17
NISSAN	BE-128 / DD-125

KDD-200	
	Number of Teeth 1/N° denti 1
	142
	Width 1/Largh. 1 [mm]
	25
TOYOTA	BE-211 / DD-200

KDD-126	
 <p>126</p>	Number of Teeth 1/N° denti 1
	95
	Width 1/Largh. 1 [mm]
	23.5
NISSAN	BE-129 / DD-126

KDD-201A	
 <p>201A</p>	Number of Teeth 1/N° denti 1
	88
	Width 1/Largh. 1 [mm]
	19
SUBARU	BE-706 / DD-201

KDD-192A	
	Number of Teeth 1/N° denti 1
	79
	Width 1/Largh. 1 [mm]
	19
	Number of Teeth 2/N° denti 2
	111
Width 2/Largh. 2 [mm]	25
NISSAN	BE-106 / BE-111 / BE-116 / DD-111 / DD-581

KDD-201C	
 <p>201C</p>	Number of Teeth 1/N° denti 1
	88
	Width 1/Largh. 1 [mm]
	19
TOYOTA - DAIHATSU	BE-208 / DD-201

KDD-192B	
 <p>192B</p>	Number of Teeth 1/N° denti 1
	76
	Width 1/Largh. 1 [mm]
	19
	Number of Teeth 2/N° denti 2
	111
Width 2/Largh. 2 [mm]	25
NISSAN	BE-106 / BE-111 / BE-116 / DD-119 / DD-581

KDD-202	
	Number of Teeth 1/N° denti 1
	127
	Width 1/Largh. 1 [mm]
	25
TOYOTA	BE-200 / BE-201 / DD-202

KDD-195	
 <p>195</p>	Number of Teeth 1/N° denti 1
	107
	Width 1/Largh. 1 [mm]
	19
NISSAN	BE-115 / DD-303

KDD-204	
	Number of Teeth 1/N° denti 1
	139
	Width 1/Largh. 1 [mm]
	25
TOYOTA	BE-206 / BE-220 / DD-204

KDD-205	
	Number of Teeth 1/N° denti 1
	178
	Width 1/Largh. 1 [mm]
	25
TOYOTA	BE-245 / BE-246 / DD-205

KDD-210	
	Number of Teeth 1/N° denti 1
	123
	Width 1/Largh. 1 [mm]
	24
TOYOTA	BE-207 / BE-230 / DD-210

KDD-205A	
	con cilindretto idraulico
	Number of Teeth 1/N° denti 1
	178
	Width 1/Largh. 1 [mm]
	25
TOYOTA	BE-241 / BE-245 / BE-246 / DD-205

KDD-211	
	Number of Teeth 1/N° denti 1
	163
	Width 1/Largh. 1 [mm]
	27
TOYOTA	BE-206 / BE-213 / DD-211

KDD-206B	
	Number of Teeth 1/N° denti 1
	130
	Width 1/Largh. 1 [mm]
	25
TOYOTA	BE-201 / BE-217 / DD-206

KDD-212	
	Number of Teeth 1/N° denti 1
	113
	Width 1/Largh. 1 [mm]
	19
TOYOTA	BE-209 / DD-212

KDD-206C	
	Number of Teeth 1/N° denti 1
	130
	Width 1/Largh. 1 [mm]
	25
TOYOTA	BE-202 / BE-203 / DD-206

KDD-213	
	Number of Teeth 1/N° denti 1
	179
	Width 1/Largh. 1 [mm]
	32
TOYOTA	BE-223 / BE-225 / DD-213

KDD-207	
	Number of Teeth 1/N° denti 1
	123
	Width 1/Largh. 1 [mm]
	20
TOYOTA	BE-207 / BE-229 / DD-207

KDD-214	
	Number of Teeth 1/N° denti 1
	211
	Width 1/Largh. 1 [mm]
	32
LEXUS	BE-221 / BE-223 / DD-214

KDD-214B	
	Number of Teeth 1/N° denti 1
	211
	Width 1/Largh. 1 [mm]
	32
TOYOTA	BE-232 / DD-214

KDD-216C	
	Number of Teeth 1/N° denti 1
	178
	Width 1/Largh. 1 [mm]
	25
TOYOTA	BE-206 / BE-227 / DD-216

KDD-215	
	Number of Teeth 1/N° denti 1
	94
	Width 1/Largh. 1 [mm]
	19
	BE-204 / DD-215

KDD-218	
	Number of Teeth 1/N° denti 1
	159
	Width 1/Largh. 1 [mm]
	25
TOYOTA	BE-211 / DD-991

KDD-215A	
	Number of Teeth 1/N° denti 1
	94
	Width 1/Largh. 1 [mm]
	19
TOYOTA	BE-208 / DD-215

KDD-220	
	Number of Teeth 1/N° denti 1
	193
	Width 1/Largh. 1 [mm]
	36
TOYOTA	BE-225 / BE-240 / DD-220

KDD-216A	
	Number of Teeth 1/N° denti 1
	178
	Width 1/Largh. 1 [mm]
	25
TOYOTA	BE-206 / BE-222 / DD-216

KDD-220A	
	Number of Teeth 1/N° denti 1
	193
	Width 1/Largh. 1 [mm]
	36
TOYOTA	BE-225 / BE-242 / DD-220

KDD-216B	
	Number of Teeth 1/N° denti 1
	178
	Width 1/Largh. 1 [mm]
	25
TOYOTA	BE-206 / BE-228 / DD-216

KDD-221	
	Number of Teeth 1/N° denti 1
	177
	Width 1/Largh. 1 [mm]
	25
TOYOTA	BE-206 / BE-235 / DD-221

KDD-222	
	Number of Teeth 1/N° denti 1
	94
	Width 1/Largh. 1 [mm]
	25
TOYOTA	BE-243 / DD-222

KDD-227	
	Number of Teeth 1/N° denti 1
	117
	Width 1/Largh. 1 [mm]
	21
TOYOTA	BE-226 / DD-227

KDD-224	
	Number of Teeth 1/N° denti 1
	121
	Width 1/Largh. 1 [mm]
	24
TOYOTA	BE-207 / BE-230 / DD-224

KDD-228	
	Number of Teeth 1/N° denti 1
	124
	Width 1/Largh. 1 [mm]
	26
TOYOTA	BE-215 / BE-216 / DD-228

KDD-225	
	Number of Teeth 1/N° denti 1
	191
	Width 1/Largh. 1 [mm]
	32
TOYOTA	BE-223 / BE-225 / DD-225



KDD-229	
	Number of Teeth 1/N° denti 1
	211
	Width 1/Largh. 1 [mm]
	34
TOYOTA	BE-249 / BE-250 / BE-251 / DD-229



KDD-225A	
	Number of Teeth 1/N° denti 1
	191
	Width 1/Largh. 1 [mm]
	32
LEXUS	BE-221 / BE-223 / DD-225

KDD-230	
	Number of Teeth 1/N° denti 1
	191
	Width 1/Largh. 1 [mm]
	36
TOYOTA	BE-221 / BE-252 / DD-230



KDD-226	
	Number of Teeth 1/N° denti 1
	121
	Width 1/Largh. 1 [mm]
	21
TOYOTA	BE-226 / DD-294

KDD-231	
	Number of Teeth 1/N° denti 1
	140
	Width/Largh. [mm]
	25
TOYOTA	BE-254 / BE-255 / DD-231

KDD-239	
	Number of Teeth 1/N° denti 1
	127
	Width 1/Largh. 1 [mm]
	25
TOYOTA	BE-239 / DD-393



KDD-291	
	Number of Teeth 1/N° denti 1
	129
	Width 1/Largh. 1 [mm]
	27
LEXUS	BE-218 / BE-248 / DD-291

KDD-283	
	Number of Teeth 1/N° denti 1
	105
	Width 1/Largh. 1 [mm]
	25
TOYOTA	BE-244 / DD-283

KDD-292	
	Number of Teeth 1/N° denti 1
	128
	Width 1/Largh. 1 [mm]
	26
TOYOTA	BE-215 / BE-216 / DD-292

KDD-286A	
	Number of Teeth 1/N° denti 1
	143
	Width 1/Largh. 1 [mm]
	25
LEXUS - TOYOTA	BE-233 / DD-286

KDD-295	
	Number of Teeth 1/N° denti 1
	111
	Width 1/Largh. 1 [mm]
	19
LADA	BE-000 / DD-295

KDD-288A	
	Number of Teeth 1/N° denti 1
	102
	Width 1/Largh. 1 [mm]
	25
	BE-242 / DD-288

KDD-296	
	Number of Teeth 1/N° denti 1
	111
	Width 1/Largh. 1 [mm]
	25
TOYOTA	BE-217 / BE-219 / DD-296

KDD-288B	
	Number of Teeth 1/N° denti 1
	102
	Width 1/Largh. 1 [mm]
	25
TOYOTA	BE-236 / DD-288



KDD-297A	
	Number of Teeth 1/N° denti 1
	177
	Width 1/Largh. 1 [mm]
	25
TOYOTA	BE-224 / BE-225 / DD-297



KDD-297B	
	Number of Teeth 1/N° denti 1
	177
	Width 1/Largh. 1 [mm]
	25
BE-206 / BE-235 / DD-297	

KDD-307A	
	Number of Teeth 1/N° denti 1
	109
	Width 1/Largh. 1 [mm]
	22
MAZDA	
BE-307 / DD-307	

KDD-300	
	Number of Teeth 1/N° denti 1
	106
	Width 1/Largh. 1 [mm]
	19
MAZDA	
BE-303 / DD-300	

KDD-307B	
	Number of Teeth 1/N° denti 1
	109
	Width 1/Largh. 1 [mm]
	22
MAZDA	
BE-313 / DD-307	

KDD-301	
	Number of Teeth 1/N° denti 1
	109
	Width 1/Largh. 1 [mm]
	19
MAZDA	
BE-303 / DD-301	

KDD-308	
	Number of Teeth 1/N° denti 1
	108
	Width 1/Largh. 1 [mm]
	25
KIA - MAZDA	
BE-305 / BE-308 / DD-308	

KDD-302	
	Number of Teeth 1/N° denti 1
	149
	Width 1/Largh. 1 [mm]
	24
MAZDA	
BE-338 / BE-344 / DD-332	

KDD-311	
	Number of Teeth 1/N° denti 1
	106
	Width 1/Largh. 1 [mm]
	22
KIA	
BE-307 / DD-311	

KDD-303	
	Number of Teeth 1/N° denti 1
	107
	Width 1/Largh. 1 [mm]
	19
MAZDA - KIA	
BE-301 / DD-303	

KDD-312	
	Number of Teeth 1/N° denti 1
	104
	Width 1/Largh. 1 [mm]
	25
ASIA MOTORS - MAZDA	
BE-305 / BE-308 / DD-418	

KDD-313	
 <p>313</p>	Number of Teeth 1/N° denti 1
	117
	Width 1/Largh. 1 [mm]
	22
MAZDA	BE-333 / DD-313

KDD-319	
 <p>319</p>	Number of Teeth 1/N° denti 1
	173
	Width 1/Largh. 1 [mm]
	30
MAZDA	BE-322 / BE-323 / BE-324 / DD-319

KDD-314	
 <p>314</p>	Number of Teeth 1/N° denti 1
	162
	Width 1/Largh. 1 [mm]
	30
MAZDA	BE-319 / BE-320 / DD-314

KDD-320A	
 <p>320A</p>	Number of Teeth 1/N° denti 1
	107
	Width 1/Largh. 1 [mm]
	22
KIA - MAZDA	BE-300 / DD-320

KDD-315	
 <p>315</p>	Number of Teeth 1/N° denti 1
	152
	Width 1/Largh. 1 [mm]
	25
MAZDA	BE-350 / DD-315

KDD-320B	
 <p>320B</p>	Number of Teeth 1/N° denti 1
	107
	Width 1/Largh. 1 [mm]
	22
MAZDA	BE-300 / BE-306 / DD-320

KDD-317	
 <p>317</p>	Number of Teeth 1/N° denti 1
	110
	Width 1/Largh. 1 [mm]
	25
MAZDA	BE-305 / BE-308 / DD-317

KDD-321A	
 <p>321A</p>	Number of Teeth 1/N° denti 1
	164
	Width 1/Largh. 1 [mm]
	25
ASIA MOTORS - MAZDA	BE-310 / DD-321

KDD-318	
 <p>318</p>	Number of Teeth 1/N° denti 1
	144
	Width 1/Largh. 1 [mm]
	25
MAZDA - PEUGEOT - TOYOTA - CITROEN	BE-334 / BE-335 / DD-318

KDD-321B	
 <p>321B</p>	Number of Teeth 1/N° denti 1
	164
	Width 1/Largh. 1 [mm]
	25
KIA	BE-K05 / DD-321

KDD-322	
	Number of Teeth 1/N° denti 1 133
	Width 1/Largh. 1 [mm] 25
MAZDA	BE-312 / BE-313 / DD-322

KDD-329	
	Number of Teeth 1/N° denti 1 103
	Width 1/Largh. 1 [mm] 27
MAZDA	BE-342 / BE-343 / DD-329

KDD-323	
	Number of Teeth 1/N° denti 1 201
	Width 1/Largh. 1 [mm] 30
MAZDA	BE-314 / BE-315 / BE-316 / DD-323

KDD-330	
	Number of Teeth 1/N° denti 1 116
	Width 1/Largh. 1 [mm] 22
	Number of Teeth 2/N° denti 2 85
	Width 2/Largh. 2 [mm] 22
MAZDA	BE-339 / BE-340 / DD-330 / DD-331

KDD-324	
	Number of Teeth 1/N° denti 1 123
	Width 1/Largh. 1 [mm] 22
MAZDA	BE-301 / BE-306 / DD-324

KDD-333	
	Number of Teeth 1/N° denti 1 129
	Width 1/Largh. 1 [mm] 25
MAZDA	BE-346 / BE-347 / DD-425

KDD-325	
	Number of Teeth 1/N° denti 1 137
	Width 1/Largh. 1 [mm] 25
MAZDA	BE-334 / BE-335 / DD-325

KDD-334	
	Number of Teeth 1/N° denti 1 150
	Width 1/Largh. 1 [mm] 30
MAZDA	BE-336 / BE-337 / BE-348 / DD-334

KDD-327	
	Number of Teeth 1/N° denti 1 153
	Width 1/Largh. 1 [mm] 30
MAZDA	BE-336 / BE-337 / DD-327

KDD-334A	
	Number of Teeth 1/N° denti 1 150
	Width 1/Largh. 1 [mm] 30
MAZDA	BE-336 / BE-337 / DD-334

KDD-336	
	Number of Teeth 1/N° denti 1
	104
	Width 1/Largh. 1 [mm]
	30
MAZDA	BE-351 / DD-336

KDD-387	
	Number of Teeth 1/N° denti 1
	111
	Width 1/Largh. 1 [mm]
	17
CHEVROLET - DAEWOO	BE-W02 / DD-387

KDD-378	
	Number of Teeth 1/N° denti 1
	153
	Width 1/Largh. 1 [mm]
	27
MAZDA	BE-327 / BE-328 / DD-378

KDD-388	
	Number of Teeth 1/N° denti 1
	192
	Width 1/Largh. 1 [mm]
	30
MAZDA	BE-314 / BE-315 / BE-316 / DD-388

KDD-380	
	Number of Teeth 1/N° denti 1
	101
	Width 1/Largh. 1 [mm]
	30
MAZDA	BE-329 / DD-380

KDD-388A	
	Number of Teeth 1/N° denti 1
	192
	Width 1/Largh. 1 [mm]
	30
MAZDA	BE-314 / BE-315 / BE-345 / DD-388

KDD-383	
	Number of Teeth 1/N° denti 1
	125
	Width 1/Largh. 1 [mm]
	22
MAZDA	BE-301 / BE-306 / DD-383

KDD-388B	
	Number of Teeth 1/N° denti 1
	192
	Width 1/Largh. 1 [mm]
	30
MAZDA	BE-315 / BE-316 / DD-388

KDD-385	
	Number of Teeth 1/N° denti 1
	107
	Width 1/Largh. 1 [mm]
	22
MAZDA	BE-330 / DD-320

KDD-389	
	Number of Teeth 1/N° denti 1
	78
	Width 1/Largh. 1 [mm]
	19
	Number of Teeth 2/N° denti 2
	148
	Width 2/Largh. 2 [mm]
	25
MAZDA	BE-317 / BE-318 / BE-320 / DD-305 / DD-389

KDD-392	
	Number of Teeth 1/N° denti 1
	125
	Width 1/Largh. 1 [mm]
	20
DAEWOO	BE-W03 / DD-392

KDD-400B	
	Number of Teeth 1/N° denti 1
	95
	Width 1/Largh. 1 [mm]
	19
NISSAN	BE-105 / DD-400

KDD-393	
	Number of Teeth 1/N° denti 1
	127
	Width 1/Largh. 1 [mm]
	25
CHEVROLET - DAEWOO	BE-W00 / BE-W01 / DD-393

KDD-401	
	Number of Teeth 1/N° denti 1
	84
	Width 1/Largh. 1 [mm]
	19
SUZUKI	BE-802 / DD-401

KDD-397	
	Number of Teeth 1/N° denti 1
	135
	Width 1/Largh. 1 [mm]
	25
MAZDA	BE-312 / BE-313 / DD-397

KDD-404	
	Number of Teeth 1/N° denti 1
	101
	Width 1/Largh. 1 [mm]
	24
ROVER - HONDA	BE-401 / DD-404

KDD-399	
	Number of Teeth 1/N° denti 1
	162
	Width 1/Largh. 1 [mm]
	25
KIA	BE-K05 / DD-399

KDD-405	
	Number of Teeth 1/N° denti 1
	108
	Width 1/Largh. 1 [mm]
	24
HONDA	BE-400 / DD-405

KDD-400A	
	Number of Teeth 1/N° denti 1
	95
	Width 1/Largh. 1 [mm]
	19
	BE-400 / DD-400

KDD-406	
	Number of Teeth 1/N° denti 1
	97
	Width 1/Largh. 1 [mm]
	19
HONDA	BE-403 / DD-406

KDD-409	
	Number of Teeth 1/N° denti 1
	133
	Width 1/Largh. 1 [mm]
	24
HONDA	BE-407 / DD-409

KDD-413A	
	Number of Teeth 1/N° denti 1
	107
	Width 1/Largh. 1 [mm]
	24
ROVER - HONDA	BE-413 / DD-413

KDD-410	
	Number of Teeth 1/N° denti 1
	192
	Width 1/Largh. 1 [mm]
	28
ROVER - HONDA	BE-405 / DD-410

KDD-413B	
	Number of Teeth 1/N° denti 1
	107
	Width 1/Largh. 1 [mm]
	24
HONDA	BE-414 / DD-413

KDD-411	
	Number of Teeth 1/N° denti 1
	124
	Width 1/Largh. 1 [mm]
	24
HONDA - ROVER	BE-413 / DD-411

KDD-414	
	Number of Teeth 1/N° denti 1
	107
	Width 1/Largh. 1 [mm]
	24
HONDA	BE-407 / DD-413

KDD-411A	
	Number of Teeth 1/N° denti 1
	124
	Width 1/Largh. 1 [mm]
	24
HONDA	BE-407 / DD-411

KDD-415	
	Number of Teeth 1/N° denti 1
	113
	Width 1/Largh. 1 [mm]
	24
	Number of Teeth 2/N° denti 2
	70
	Width 2/Largh. 2 [mm]
	16
ROVER - HONDA	BE-404 / BE-409 / DD-415 / DD-419

KDD-412	
	Number of Teeth 1/N° denti 1
	106
	Width 1/Largh. 1 [mm]
	24
HONDA	BE-413 / DD-412

KDD-416	
	Number of Teeth 1/N° denti 1
	127
	Width 1/Largh. 1 [mm]
	25
	Number of Teeth 2/N° denti 2
	70
	Width 2/Largh. 2 [mm]
	16
HONDA - ROVER	BE-404 / BE-409 / DD-416 / DD-419

KDD-417	
	Number of Teeth 1/N° denti 1
	196
	Width 1/Largh. 1 [mm]
	28
HONDA	BE-406 / DD-417

KDD-423B	
	Number of Teeth 1/N° denti 1
	103
	Width 1/Largh. 1 [mm]
	22
HONDA	BE-419 / DD-423

KDD-418A	
	Number of Teeth 1/N° denti 1
	104
	Width 1/Largh. 1 [mm]
	25
HONDA	BE-414 / DD-418

KDD-424	
	Number of Teeth 1/N° denti 1
	70
	Width 1/Largh. 1 [mm]
	16
	Number of Teeth 2/N° denti 2
	112
	Width 2/Largh. 2 [mm]
	24
HONDA	BE-404 / BE-409 / DD-419 / DD-424

KDD-418B	
	Number of Teeth 1/N° denti 1
	104
	Width 1/Largh. 1 [mm]
	25
HONDA	BE-409 / DD-418

KDD-425	
	Number of Teeth 1/N° denti 1
	129
	Width 1/Largh. 1 [mm]
	25
HONDA	BE-418 / DD-425

KDD-422	
	Number of Teeth 1/N° denti 1
	124
	Width 1/Largh. 1 [mm]
	26
HONDA	BE-415 / DD-422

KDD-481	
	Number of Teeth 1/N° denti 1
	126
	Width 1/Largh. 1 [mm]
	26
HONDA	BE-415 / DD-481

KDD-423	
	Number of Teeth 1/N° denti 1
	103
	Width 1/Largh. 1 [mm]
	22
HONDA	BE-414 / DD-423

KDD-482	
	Number of Teeth 1/N° denti 1
	78
	Width 1/Largh. 1 [mm]
	22
	Number of Teeth 2/N° denti 2
	112
	Width 2/Largh. 2 [mm]
	28
HONDA	BE-420 / BE-421 / BE-422 / DD-426 / DD-482

KDD-485	
	Number of Teeth 1/N° denti 1
	125
	Width 1/Largh. 1 [mm]
	26
HONDA	BE-415 / DD-485

KDD-504	
	Number of Teeth 1/N° denti 1
	154
	Width 1/Largh. 1 [mm]
	28.7
MITSUBISHI	BE-513 / BE-515 / DD-504

KDD-487	
	Number of Teeth 1/N° denti 1
	103
	Width 1/Largh. 1 [mm]
	23.5
HONDA	BE-414 / DD-487

KDD-507	
	Number of Teeth 1/N° denti 1
	120
	Width 1/Largh. 1 [mm]
	19
MITSUBISHI	BE-502 / DD-507

KDD-498	
	Number of Teeth 1/N° denti 1
	70
	Width 1/Largh. 1 [mm]
	16
	Number of Teeth 2/N° denti 2
	155
	Width 2/Largh. 2 [mm]
	24
HONDA	BE-416 / BE-417 / DD-419 / DD-498

KDD-508A	
	Number of Teeth 1/N° denti 1
	120
	Width 1/Largh. 1 [mm]
	19
MITSUBISHI	BE-505 / DD-508

KDD-500	
	Number of Teeth 1/N° denti 1
	122
	Width 1/Largh. 1 [mm]
	19
	Number of Teeth 2/N° denti 2
	55
	Width 2/Largh. 2 [mm]
	13
MITSUBISHI	BE-502 / BE-510 / DD-500 / DD-501

KDD-509	
	Number of Teeth 1/N° denti 1
	157
	Width 1/Largh. 1 [mm]
	32
	Number of Teeth 2/N° denti 2
	55
	Width 2/Largh. 2 [mm]
	12.8
MITSUBISHI	BE-506 / BE-516 / BE-517 / DD-509 / DD-514

KDD-502	
	Number of Teeth 1/N° denti 1
	141
	Width 1/Largh. 1 [mm]
	30
MITSUBISHI - JEEP	BE-530 / BE-531 / BE-535 / DD-502

KDD-510	
	Number of Teeth 1/N° denti 1
	154
	Width 1/Largh. 1 [mm]
	25.4
	Number of Teeth 2/N° denti 2
	99
	Width 2/Largh. 2 [mm]
	18.5
MITSUBISHI	BE-500 / BE-532 / BE-533 / BE-534 / DD-510 / DD-587

KDD-512	
	Number of Teeth 1/N° denti 1
	195
	Width 1/Largh. 1 [mm]
	32
BE-H14 / BE-H15 / DD-512	

KDD-513D	
	Number of Teeth 1/N° denti 1
	122
	Width 1/Largh. 1 [mm]
	19
	Number of Teeth 2/N° denti 2
55	
Width 2/Largh. 2 [mm]	
12.8	
BE-502 / BE-510 / DD-513 / DD-514	

KDD-513	
	Number of Teeth 1/N° denti 1
	122
	Width 1/Largh. 1 [mm]
	19
Number of Teeth 2/N° denti 2	
65	
Width 2/Largh. 2 [mm]	
13	
BE-525 / BE-H22 / DD-513 / DD-532	

KDD-515	
	Number of Teeth 1/N° denti 1
	118
	Width 1/Largh. 1 [mm]
26	
BE-536 / BE-537 / DD-515	

KDD-513A	
	Number of Teeth 1/N° denti 1
	122
	Width 1/Largh. 1 [mm]
	19
Number of Teeth 2/N° denti 2	
55	
Width 2/Largh. 2 [mm]	
12.8	
BE-505 / BE-510 / DD-513 / DD-514	

KDD-519	
	Number of Teeth 1/N° denti 1
	92
Width 1/Largh. 1 [mm]	
18.8	
BE-503 / DD-519	

KDD-513B	
	Number of Teeth 1/N° denti 1
	122
	Width 1/Largh. 1 [mm]
	19
Number of Teeth 2/N° denti 2	
55	
Width 2/Largh. 2 [mm]	
12.8	
BE-506 / BE-508 / DD-513 / DD-514	

KDD-521	
	Number of Teeth 1/N° denti 1
	55
	Width 1/Largh. 1 [mm]
	12.8
Number of Teeth 2/N° denti 2	
123	
Width 2/Largh. 2 [mm]	
19	
BE-506 / BE-508 / DD-514 / DD-521	

KDD-513C	
	Number of Teeth 1/N° denti 1
	122
	Width 1/Largh. 1 [mm]
	19
Number of Teeth 2/N° denti 2	
65	
Width 2/Largh. 2 [mm]	
13	
BE-506 / BE-508 / DD-513 / DD-532	

KDD-521A	
	Number of Teeth 1/N° denti 1
	123
	Width 1/Largh. 1 [mm]
	19
Number of Teeth 2/N° denti 2	
65	
Width 2/Largh. 2 [mm]	
13	
BE-508 / BE-514 / DD-521 / DD-532	

KDD-522A	
	Number of Teeth 1/N° denti 1
	55
	Width 1/Largh. 1 [mm]
	12.8
Number of Teeth 2/N° denti 2	122
	Width 2/Largh. 2 [mm]
24	
MITSUBISHI	BE-506 / BE-508 / BE-513 / DD-514 / DD-522

KDD-526D	
	Number of Teeth 1/N° denti 1
	153
	Width 1/Largh. 1 [mm]
	29
Number of Teeth 2/N° denti 2	65
	Width 2/Largh. 2 [mm]
13	
HYUNDAI	BE-506 / BE-508 / DD-526 / DD-532

KDD-522B	
	Number of Teeth 1/N° denti 1
	122
	Width 1/Largh. 1 [mm]
	24
Number of Teeth 2/N° denti 2	65
	Width 2/Largh. 2 [mm]
13	
MITSUBISHI	BE-506 / BE-508 / BE-513 / DD-522 / DD-532

KDD-528	
	Number of Teeth 1/N° denti 1
	257
Width 1/Largh. 1 [mm]	32
MITSUBISHI	BE-509 / DD-528

KDD-525	
	Number of Teeth 1/N° denti 1
	149
	Width 1/Largh. 1 [mm]
24.7	
HYUNDAI - CHRYSLER - MITSUBISHI	BE-509 / DD-525

KDD-528A	
	Number of Teeth 1/N° denti 1
	257
Width 1/Largh. 1 [mm]	32
MITSUBISHI	BE-H14 / BE-H15 / DD-528

KDD-526	
	Number of Teeth 1/N° denti 1
	153
	Width 1/Largh. 1 [mm]
	29
Number of Teeth 2/N° denti 2	65
	Width 2/Largh. 2 [mm]
13	
MITSUBISHI - HYUNDAI	BE-507 / BE-513 / BE-514 / DD-526 / DD-532

KDD-529	
	Number of Teeth 1/N° denti 1
	121
Width 1/Largh. 1 [mm]	28.7
MITSUBISHI - PROTON	BE-512 / DD-529

KDD-526C	
	Number of Teeth 1/N° denti 1
	153
	Width 1/Largh. 1 [mm]
	29
Number of Teeth 2/N° denti 2	65
	Width 2/Largh. 2 [mm]
13	
KIA - MITSUBISHI	BE-513 / BE-519 / BE-H22 / DD-526 / DD-532

KDD-530	
	Number of Teeth 1/N° denti 1
	123
	Width 1/Largh. 1 [mm]
	29
Number of Teeth 2/N° denti 2	65
	Width 2/Largh. 2 [mm]
13	
MITSUBISHI	BE-513 / BE-514 / BE-519 / DD-530 / DD-532

KDD-530A	
	Number of Teeth 1/N° denti 1 123
	Width 1/Largh. 1 [mm] 29
GONOW	BE-519 / DD-530

KDD-534	
	Number of Teeth 1/N° denti 1 117
	Width 1/Largh. 1 [mm] 29
PROTON - MITSUBISHI	BE-512 / DD-534

KDD-531	
	Number of Teeth 1/N° denti 1 158
	Width 1/Largh. 1 [mm] 31.7
	Number of Teeth 2/N° denti 2 65
	Width 2/Largh. 2 [mm] 13
mitsubishi - PROTON	BE-514 / BE-517 / BE-521 / DD-531 / DD-532

KDD-535	
	Number of Teeth 1/N° denti 1 156
	Width 1/Largh. 1 [mm] 28.7
MITSUBISHI	BE-513 / BE-515 / DD-535

KDD-533A	
	Number of Teeth 1/N° denti 1 92
	Width 1/Largh. 1 [mm] 22
MITSUBISHI - PROTON	BE-511 / DD-533

KDD-538	
	Number of Teeth 1/N° denti 1 132
	Width 1/Largh. 1 [mm] 26
MITSUBISHI	BE-527 / DD-538

KDD-533B	
	Number of Teeth 1/N° denti 1 92
	Width 1/Largh. 1 [mm] 22
HYUNDAI	BE-H01 / DD-533

KDD-539	
	Number of Teeth 1/N° denti 1 65
	Width 1/Largh. 1 [mm] 13
	Number of Teeth 2/N° denti 2 122
	Width 2/Largh. 2 [mm] 29
MITSUBISHI	BE-507 / BE-513 / BE-514 / DD-532 / DD-539

KDD-533C	
	Number of Teeth 1/N° denti 1 92
	Width 1/Largh. 1 [mm] 22
HYUNDAI	BE-507 / DD-533

KDD-539B	
	Number of Teeth 1/N° denti 1 65
	Width 1/Largh. 1 [mm] 13
	Number of Teeth 2/N° denti 2 122
	Width 2/Largh. 2 [mm] 29
MITSUBISHI	BE-513 / BE-519 / BE-H22 / DD-532 / DD-539

KDD-539C	
	Number of Teeth 1/N° denti 1
	65
	Width 1/Largh. 1 [mm]
	13
	Number of Teeth 2/N° denti 2
	122
	Width 2/Largh. 2 [mm]
	29
mitsubishi	BE-519 / BE-H22 / DD-532 / DD-539

KDD-542A	
	Number of Teeth 1/N° denti 1
	265
	Width 1/Largh. 1 [mm]
	32
mitsubishi	BE-H14 / BE-H15 / DD-542

KDD-540	
	Number of Teeth 1/N° denti 1
	109
	Width 1/Largh. 1 [mm]
	24.7
mitsubishi	BE-529 / DD-540

KDD-543	
	Number of Teeth 1/N° denti 1
	159
	Width 1/Largh. 1 [mm]
	29
mitsubishi	BE-513 / BE-515 / DD-543

KDD-540B	
	Number of Teeth 1/N° denti 1
	109
	Width 1/Largh. 1 [mm]
	24.7
DAEWOO - CHEVROLET	BE-808 / DD-540

KDD-571	
	Number of Teeth 1/N° denti 1
	101
	Width 1/Largh. 1 [mm]
	20
KIA - HYUNDAI	BE-H08 / DD-571

KDD-541	
	Number of Teeth 1/N° denti 1
	187
	Width 1/Largh. 1 [mm]
	32
mitsubishi	BE-H14 / BE-H15 / DD-541

KDD-575	
	Number of Teeth 1/N° denti 1
	153
	Width 1/Largh. 1 [mm]
	24.7
mitsubishi	BE-527 / BE-528 / DD-575

KDD-542	
	Number of Teeth 1/N° denti 1
	265
	Width 1/Largh. 1 [mm]
	32
mitsubishi	BE-509 / DD-542

KDD-575A	
	Number of Teeth 1/N° denti 1
	153
	Width 1/Largh. 1 [mm]
	24.7
TATA (TELCO)	BE-014 / DD-575

KDD-576	
	Number of Teeth 1/N° denti 1
	107
	Width 1/Largh. 1 [mm]
	25
mitsubishi	BE-529 / DD-W02

KDD-589	
	Number of Teeth 1/N° denti 1
	65
	Width 1/Largh. 1 [mm]
	13
	Number of Teeth 2/N° denti 2
	154
	Width 2/Largh. 2 [mm]
	29
mitsubishi	BE-513 / BE-519 / BE-H22 / DD-532 / DD-589

KDD-578	
	Number of Teeth 1/N° denti 1
	116
	Width 1/Largh. 1 [mm]
	29
mitsubishi	BE-512 / DD-578

KDD-589B	
	Number of Teeth 1/N° denti 1
	65
	Width 1/Largh. 1 [mm]
	13
	Number of Teeth 2/N° denti 2
	154
	Width 2/Largh. 2 [mm]
	29
mitsubishi	BE-513 / BE-514 / BE-519 / DD-532 / DD-589

KDD-578B	
	Number of Teeth 1/N° denti 1
	116
	Width 1/Largh. 1 [mm]
	29
mitsubishi	BE-513 / BE-515 / DD-578

KDD-590	
	Number of Teeth 1/N° denti 1
	65
	Width 1/Largh. 1 [mm]
	13
	Number of Teeth 2/N° denti 2
	151
	Width 2/Largh. 2 [mm]
	29
mitsubishi - hyundai	BE-507 / BE-513 / BE-514 / DD-532 / DD-590

KDD-579	
	Number of Teeth 1/N° denti 1
	111
	Width 1/Largh. 1 [mm]
	29
mitsubishi	BE-526 / DD-579

KDD-591	
	Number of Teeth 1/N° denti 1
	65
	Width 1/Largh. 1 [mm]
	13
	Number of Teeth 2/N° denti 2
	124
	Width 2/Largh. 2 [mm]
	29
GREAT WALL - MITSUBISHI - SHUANGHUAN AUTO	BE-513 / BE-514 / BE-519 / DD-532 / DD-591

KDD-581	
	Number of Teeth 1/N° denti 1
	111
	Width 1/Largh. 1 [mm]
	25
hyundai	BE-H03 / BE-H04 / DD-581

KDD-591B	
	Number of Teeth 1/N° denti 1
	124
	Width 1/Largh. 1 [mm]
	29
GREAT WALL	BE-514 / DD-591

KDD-592	
	Number of Teeth 1/N° denti 1
	55
	Width 1/Largh. 1 [mm]
	12.8
	Number of Teeth 2/N° denti 2
	123
	Width 2/Largh. 2 [mm]
	24
HYUNDAI	BE-506 / DD-514 / DD-592

KDD-601	
	Number of Teeth 1/N° denti 1
	111
	Width 1/Largh. 1 [mm]
	25
DAIHATSU	BE-611 / DD-601

KDD-593	
	Number of Teeth 1/N° denti 1
	65
	Width 1/Largh. 1 [mm]
	13
	Number of Teeth 2/N° denti 2
	123
	Width 2/Largh. 2 [mm]
	18.7
	BE-508 / BE-514 / DD-532 / DD-593

KDD-601A	
	Number of Teeth 1/N° denti 1
	111
	Width 1/Largh. 1 [mm]
	25
DAIHATSU	BE-608 / DD-601

KDD-594	
	Number of Teeth 1/N° denti 1
	55
	Width 1/Largh. 1 [mm]
	12.8
	Number of Teeth 2/N° denti 2
	122
	Width 2/Largh. 2 [mm]
	19.1
MITSUBISHI	BE-506 / BE-513 / DD-514 / DD-594

KDD-602	
	Number of Teeth 1/N° denti 1
	113
	Width 1/Largh. 1 [mm]
	25
PIAGGIO	BE-612 / DD-602

KDD-600A	
	Number of Teeth 1/N° denti 1
	90
	Width 1/Largh. 1 [mm]
	19
INNOCENTI - DAIHATSU	BE-602 / DD-600

KDD-605	
	Number of Teeth 1/N° denti 1
	102
	Width 1/Largh. 1 [mm]
	19
DAIHATSU - INNOCENTI	BE-601 / DD-605

KDD-600B	
	Number of Teeth 1/N° denti 1
	90
	Width 1/Largh. 1 [mm]
	19
INNOCENTI	BE-601 / DD-600

KDD-607A	
	Number of Teeth 1/N° denti 1
	103
	Width 1/Largh. 1 [mm]
	16
DAIHATSU	BE-607 / DD-607

KDD-607B	
	Number of Teeth 1/N° denti 1
	103
	Width 1/Largh. 1 [mm]
	16
BE-611 / DD-607	

KDD-614	
	Number of Teeth 1/N° denti 1
	103
	Width 1/Largh. 1 [mm]
	18.5
DAIHATSU	
BE-608 / DD-614	

KDD-608	
	Number of Teeth 1/N° denti 1
	103
	Width 1/Largh. 1 [mm]
	19
DAIHATSU	
BE-601 / DD-608	

KDD-615	
	Number of Teeth 1/N° denti 1
	108
	Width 1/Largh. 1 [mm]
	31.8
DAIHATSU	
BE-609 / BE-610 / DD-615	

KDD-609	
	Number of Teeth 1/N° denti 1
	102
	Width 1/Largh. 1 [mm]
	19
INNOCENTI	
BE-601 / DD-609	

KDD-616	
	Number of Teeth 1/N° denti 1
	95
	Width 1/Largh. 1 [mm]
	25
DAIHATSU	
BE-600 / DD-610	

KDD-611	
	Number of Teeth 1/N° denti 1
	93
	Width 1/Largh. 1 [mm]
	25
PIAGGIO - DAIHATSU	
BE-600 / DD-611	

KDD-697	
	Number of Teeth 1/N° denti 1
	91
	Width 1/Largh. 1 [mm]
	19
INNOCENTI - PIAGGIO - DAIHATSU	
BE-601 / DD-697	

KDD-613	
	Number of Teeth 1/N° denti 1
	155
	Width 1/Largh. 1 [mm]
	19
DAIHATSU	
BE-603 / BE-604 / BE-605 / DD-613	

KDD-699	
	Number of Teeth 1/N° denti 1
	99
	Width 1/Largh. 1 [mm]
	16
INNOCENTI	
BE-607 / DD-699	

KDD-700	
	Number of Teeth 1/N° denti 1
	98
	Width 1/Largh. 1 [mm]
	19
	Number of Teeth 2/N° denti 2
	119
	Width 2/Largh. 2 [mm]
	19
SUBARU	BE-703 / BE-704 / BE-705 / DD-106 / DD-700

KDD-707A	
	Number of Teeth 1/N° denti 1
	223
	Width 1/Largh. 1 [mm]
	27
SUBARU	BE-701 / BE-702 / BE-707 / BE-711 / DD-707

KDD-702	
	Number of Teeth 1/N° denti 1
	89
	Width 1/Largh. 1 [mm]
	19
SUBARU	BE-706 / DD-890

KDD-707B	
	Number of Teeth 1/N° denti 1
	223
	Width 1/Largh. 1 [mm]
	27
SUBARU	BE-701 / BE-702 / BE-707 / BE-710 / DD-707

KDD-703	
	Number of Teeth 1/N° denti 1
	211
	Width 1/Largh. 1 [mm]
	29.6
SUBARU	BE-700 / BE-701 / BE-702 / DD-703



KDD-707C	
	Number of Teeth 1/N° denti 1
	223
	Width 1/Largh. 1 [mm]
	27
SUBARU	BE-701 / BE-702 / BE-708 / BE-710 / DD-707

KDD-704	
	Number of Teeth 1/N° denti 1
	91
	Width 1/Largh. 1 [mm]
	19
SUBARU	BE-706 / DD-697

KDD-789	
	Number of Teeth 1/N° denti 1
	104
	Width 1/Largh. 1 [mm]
	16
SUBARU	BE-712 / DD-789

KDD-707	
	Number of Teeth 1/N° denti 1
	223
	Width 1/Largh. 1 [mm]
	27
SUBARU	BE-700 / BE-701 / BE-702 / DD-707

KDD-791	
	Number of Teeth 1/N° denti 1
	281
	Width 1/Largh. 1 [mm]
	30
SUBARU	BE-700 / BE-701 / BE-702 / DD-791

KDD-791A	
	Number of Teeth 1/N° denti 1
	281
	Width 1/Largh. 1 [mm]
	30
SUBARU	BE-701 / BE-708 / BE-711 / DD-791



KDD-801	
	Number of Teeth 1/N° denti 1
	119
	Width 1/Largh. 1 [mm]
	19
SUZUKI	BE-805 / DD-801

KDD-791B	
	Number of Teeth 1/N° denti 1
	281
	Width 1/Largh. 1 [mm]
	30
SUBARU	BE-701 / BE-702 / BE-707 / BE-709 / BE-710 / DD-791



KDD-803	
	Number of Teeth 1/N° denti 1
	103
	Width 1/Largh. 1 [mm]
	25
SUZUKI	BE-801 / DD-803



KDD-791C	
	Number of Teeth 1/N° denti 1
	281
	Width 1/Largh. 1 [mm]
	30
SUBARU	BE-701 / BE-702 / BE-707 / BE-708 / BE-710 / DD-791

KDD-804	
	Number of Teeth 1/N° denti 1
	119
	Width 1/Largh. 1 [mm]
	25
SUZUKI	BE-806 / DD-804

KDD-791D	
	Number of Teeth 1/N° denti 1
	281
	Width 1/Largh. 1 [mm]
	30
SUBARU	BE-701 / BE-702 / BE-707 / BE-710 / DD-791

KDD-808	
	Number of Teeth 1/N° denti 1
	162
	Width 1/Largh. 1 [mm]
	25
SUZUKI	BE-812 / DD-399

KDD-791E	
	Number of Teeth 1/N° denti 1
	281
	Width 1/Largh. 1 [mm]
	30
SUBARU	BE-701 / BE-702 / BE-709 / BE-711 / DD-791

KDD-811	
	Number of Teeth 1/N° denti 1
	190
	Width 1/Largh. 1 [mm]
	24
OPEL - SUZUKI - FIAT	BE-810 / BE-811 / DD-811

KDD-812	
 <p>812</p>	Number of Teeth 1/N° denti 1
	144
	Width 1/Largh. 1 [mm]
	26
SUZUKI	BE-816 / BE-819 / DD-812

KDD-880B	
	Number of Teeth 1/N° denti 1
	136
	Width 1/Largh. 1 [mm]
	25
	BE-002 / BE-003 / DD-907

KDD-812A	
 <p>812A</p>	Number of Teeth 1/N° denti 1
	144
	Width 1/Largh. 1 [mm]
	26
MAZDA	BE-334 / BE-335 / DD-812

KDD-883	
 <p>883</p>	Number of Teeth 1/N° denti 1
	141
	Width 1/Largh. 1 [mm]
	25
SUZUKI	BE-816 / BE-817 / DD-883

KDD-818	
 <p>818</p>	Number of Teeth 1/N° denti 1
	135
	Width 1/Largh. 1 [mm]
	25
SUZUKI	BE-818 / DD-818

KDD-884	
 <p>884</p>	Number of Teeth 1/N° denti 1
	89
	Width 1/Largh. 1 [mm]
	25
SUZUKI - SUBARU	BE-801 / DD-884

KDD-879	
 <p>879</p>	Number of Teeth 1/N° denti 1
	97
	Width 1/Largh. 1 [mm]
	18.8
SUZUKI	BE-805 / DD-879



KDD-889	
 <p>889</p>	Number of Teeth 1/N° denti 1
	97
	Width 1/Largh. 1 [mm]
	25
SUZUKI	BE-801 / DD-889



KDD-880A	
 <p>880A</p>	Number of Teeth 1/N° denti 1
	136
	Width 1/Largh. 1 [mm]
	25
HYUNDAI - LADA - SUZUKI	BE-004 / BE-005 / DD-907

KDD-889B	
 <p>889B</p>	Number of Teeth 1/N° denti 1
	97
	Width 1/Largh. 1 [mm]
	25
TOYOTA	BE-236 / DD-889



KDD-889C	
	Number of Teeth 1/N° denti 1
	97
	Width 1/Largh. 1 [mm]
	25
TOYOTA	BE-236 / BE-253 / DD-889

KDD-902	
	Number of Teeth 1/N° denti 1
	115
	Width 1/Largh. 1 [mm]
	18.5
ISUZU	BE-902 / DD-902

KDD-900	
	Number of Teeth 1/N° denti 1
	104
	Width 1/Largh. 1 [mm]
	22
OPEL - ISUZU	BE-914 / DD-900

KDD-903	
	Number of Teeth 1/N° denti 1
	111
	Width 1/Largh. 1 [mm]
	19
BEDFORD - ISUZU	BE-900 / BE-902 / DD-903



KDD-900B	
	Number of Teeth 1/N° denti 1
	104
	Width 1/Largh. 1 [mm]
	22
HONDA	BE-419 / DD-900



KDD-904A	
	Number of Teeth 1/N° denti 1
	137
	Width 1/Largh. 1 [mm]
	30
ISUZU - BEDFORD	BE-904 / BE-905 / DD-904



KDD-901A	
	Number of Teeth 1/N° denti 1
	87
	Width 1/Largh. 1 [mm]
	34.7
OPEL - ISUZU - VAUXHALL	BE-906 / DD-901



KDD-904B	
	Number of Teeth 1/N° denti 1
	137
	Width 1/Largh. 1 [mm]
	30
VAUXHALL - OPEL	BE-913 / BE-916 / DD-904

KDD-901B	
	Number of Teeth 1/N° denti 1
	87
	Width 1/Largh. 1 [mm]
	34.7
ISUZU	BE-902 / DD-901

KDD-905	
	Number of Teeth 1/N° denti 1
	171
	Width 1/Largh. 1 [mm]
	24
CHRYSLER - JEEP - DODGE	BE-917 / DD-W09



KDD-905A	
	Number of Teeth 1/N° denti 1
	137
	Width 1/Largh. 1 [mm]
	24.5
ISUZU	BE-903 / DD-905



KDD-911	
	Number of Teeth 1/N° denti 1
	136
	Width 1/Largh. 1 [mm]
	25
MAZDA	BE-349 / BE-916 / DD-911

KDD-906B	
	Number of Teeth 1/N° denti 1
	119
	Width 1/Largh. 1 [mm]
	32
OPEL - ISUZU	BE-907 / BE-908 / DD-993



KDD-992	
	Number of Teeth 1/N° denti 1
	112
	Width 1/Largh. 1 [mm]
	19
ISUZU	BE-900 / DD-992



KDD-907A	
	Number of Teeth 1/N° denti 1
	136
	Width 1/Largh. 1 [mm]
	25
OPEL - ISUZU - VAUXHALL	BE-913 / BE-916 / DD-911

KDD-H01	
	Number of Teeth 1/N° denti 1
	92
	Width 1/Largh. 1 [mm]
	18.8
MITSUBISHI - HYUNDAI	BE-503 / DD-503

KDD-907B	
	Number of Teeth 1/N° denti 1
	136
	Width 1/Largh. 1 [mm]
	25
	BE-913 / DD-907

KDD-H02	
	Number of Teeth 1/N° denti 1
	65
	Width 1/Largh. 1 [mm]
	13
	Number of Teeth 2/N° denti 2
	173
	Width 2/Largh. 2 [mm]
	29
HYUNDAI	BE-513 / BE-H05 / BE-H22 / DD-532 / DD-H02

KDD-910	
	Number of Teeth 1/N° denti 1
	191
	Width 1/Largh. 1 [mm]
	32
OPEL - ISUZU	BE-915 / DD-225

KDD-H02B	
	Number of Teeth 1/N° denti 1
	173
	Width 1/Largh. 1 [mm]
	29
KIA	BE-513 / BE-H05 / BE-H22 / BE-H26 / DD-H02

KDD-H02C	
	Number of Teeth 1/N° denti 1
	173
	Width 1/Largh. 1 [mm]
	29
KIA	BE-513 / BE-H05 / BE-H22 / DD-H02

KDD-H07B	
	Number of Teeth 1/N° denti 1
	105
	Width 1/Largh. 1 [mm]
	22
KIA - HYUNDAI	BE-H01 / BE-H02 / DD-H07

KDD-H03	
	Number of Teeth 1/N° denti 1
	207
	Width 1/Largh. 1 [mm]
	32
HYUNDAI	BE-H07 / BE-H25 / DD-H03

KDD-H08	
	Number of Teeth 1/N° denti 1
	123
	Width 1/Largh. 1 [mm]
	28
KIA - HYUNDAI	BE-H23 / BE-H24 / DD-H08

KDD-H03A	
	Number of Teeth 1/N° denti 1
	207
	Width 1/Largh. 1 [mm]
	32
HYUNDAI	BE-H07 / BE-H25 / BE-H27 / DD-H03

KDD-H09	
	Number of Teeth 1/N° denti 1
	65
	Width 1/Largh. 1 [mm]
	13
	Number of Teeth 2/N° denti 2
	175
	Width 2/Largh. 2 [mm]
	29
KIA - HYUNDAI	BE-513 / BE-H05 / BE-H22 / DD-532 / DD-H09

KDD-H03B	
	Number of Teeth 1/N° denti 1
	207
	Width 1/Largh. 1 [mm]
	32
HYUNDAI - KIA	BE-H06 / BE-H07 / DD-H03

KDD-H10	
	Number of Teeth 1/N° denti 1
	113
	Width 1/Largh. 1 [mm]
	24
KIA - HYUNDAI	BE-H03 / BE-H04 / DD-415

KDD-H07	
	Number of Teeth 1/N° denti 1
	105
	Width 1/Largh. 1 [mm]
	22
HYUNDAI	BE-H01 / DD-H07

KDD-H10A	
	Number of Teeth 1/N° denti 1
	113
	Width 1/Largh. 1 [mm]
	24
HYUNDAI	BE-H07 / BE-H25 / DD-415

KDD-H10B	
 <p>H10B</p>	Number of Teeth 1/N° denti 1
	113
	Width 1/Largh. 1 [mm]
	24
HYUNDAI - KIA	BE-H04 / BE-H29 / DD-415

KDD-K03	
 <p>K03</p>	Number of Teeth 1/N° denti 1
	151
	Width 1/Largh. 1 [mm]
	30
KIA	BE-K09 / BE-K14 / BE-K17 / DD-K03

KDD-H11	
 <p>H11</p>	Number of Teeth 1/N° denti 1
	219
	Width 1/Largh. 1 [mm]
	32
HYUNDAI	BE-H07 / BE-H28 / DD-H11

KDD-K04	
 <p>K04</p>	Number of Teeth 1/N° denti 1
	168
	Width 1/Largh. 1 [mm]
	25
MAZDA - KIA	BE-305 / BE-308 / DD-K02

KDD-H14	
 <p>H14</p>	Number of Teeth 1/N° denti 1
	110
	Width 1/Largh. 1 [mm]
	22
HYUNDAI	BE-H01 / DD-H14



KDD-K10	
 <p>K10</p>	Number of Teeth 1/N° denti 1
	137
	Width 1/Largh. 1 [mm]
	22
KIA	BE-301 / BE-306 / DD-K10



KDD-K00	
 <p>K00</p>	Number of Teeth 1/N° denti 1
	154
	Width 1/Largh. 1 [mm]
	21.5
KIA	BE-301 / BE-K06 / DD-K00

KDD-K11	
 <p>K11</p>	Number of Teeth 1/N° denti 1
	152
	Width 1/Largh. 1 [mm]
	30
KIA - HYUNDAI	BE-K14 / BE-K16 / BE-K17 / BE-K18 / DD-K11

KDD-K01	
 <p>K01</p>	Number of Teeth 1/N° denti 1
	59
	Width 1/Largh. 1 [mm]
	22
	Number of Teeth 2/N° denti 2
	176
	Width 2/Largh. 2 [mm]
	28
KIA	BE-K00 / BE-K04 / BE-K07 / BE-K22 / DD-K01 / DD-K12



KDD-K11A	
 <p>K11A</p>	Number of Teeth 1/N° denti 1
	152
	Width 1/Largh. 1 [mm]
	30
KIA	BE-K16 / BE-K17 / BE-K18 / BE-K21 / DD-K11



KDD-K13	
	Number of Teeth 1/N° denti 1
	259
	Width 1/Largh. 1 [mm]
	32
KIA - HYUNDAI	BE-H14 / BE-H15 / DD-K13



KDD-N01	
	Number of Teeth 1/N° denti 1
	149
	Width 1/Largh. 1 [mm]
	30
NISSAN	BE-100 / BE-101 / DD-116

KDD-K14	
	Number of Teeth 1/N° denti 1
	154
	Width 1/Largh. 1 [mm]
	21.5
KIA	BE-306 / BE-K06 / DD-K00



KDD-N02	
	Number of Teeth 1/N° denti 1
	141
	Width 1/Largh. 1 [mm]
	30
NISSAN	BE-112 / BE-113 / DD-118

KDD-K21	
	Number of Teeth 1/N° denti 1
	145
	Width 1/Largh. 1 [mm]
	22
KIA - MAZDA	BE-301 / BE-306 / DD-K06

KDD-N03	
	Number of Teeth 1/N° denti 1
	69
	Width 1/Largh. 1 [mm]
	19.4
	BE-113 / DD-199

KDD-M01	
	Number of Teeth 1/N° denti 1
	163
	Width 1/Largh. 1 [mm]
	25
	Number of Teeth 2/N° denti 2
	83
	Width 2/Largh. 2 [mm]
	19
HYUNDAI - MITSUBISHI	BE-500 / BE-501 / DD-505 / DD-506

KDD-N04	
	Number of Teeth 1/N° denti 1
	98
	Width 1/Largh. 1 [mm]
	19
	BE-113 / DD-106

KDD-M02	
	Number of Teeth 1/N° denti 1
	99
	Width 1/Largh. 1 [mm]
	18.5
	Number of Teeth 2/N° denti 2
	163
	Width 2/Largh. 2 [mm]
	25.1
MITSUBISHI - KIA - HYUNDAI - GASOLONE	BE-500 / BE-501 / DD-587 / DD-588

KDD-OP1	
	Number of Teeth 1/N° denti 1
	146
	Width 1/Largh. 1 [mm]
	24
VAUXHALL - OPEL	BE-913 / DD-998

KDD-S01	
	Number of Teeth 1/N° denti 1
	88
	Width 1/Largh. 1 [mm]
	19
SUZUKI - BEDFORD	BE-802 / DD-201

KDD-S06	
	Number of Teeth 1/N° denti 1
	88
	Width 1/Largh. 1 [mm]
	19
SUZUKI	BE-800 / DD-201

KDD-S02	
	Number of Teeth 1/N° denti 1
	89
	Width 1/Largh. 1 [mm]
	18.8
SUZUKI	BE-802 / DD-800

KDD-T01	
	Number of Teeth 1/N° denti 1
	129
	Width 1/Largh. 1 [mm]
	31
VW - TOYOTA	BE-202 / BE-203 / DD-219

KDD-S03	
	Number of Teeth 1/N° denti 1
	84
	Width 1/Largh. 1 [mm]
	19
SUZUKI	BE-803 / DD-401

KDD-T03	
	Number of Teeth 1/N° denti 1
	130
	Width 1/Largh. 1 [mm]
	25
TOYOTA	BE-200 / BE-201 / DD-206

KDD-S04	
	Number of Teeth 1/N° denti 1
	95
	Width 1/Largh. 1 [mm]
	19
SUZUKI	BE-800 / DD-805

KDD-W02	
	Number of Teeth 1/N° denti 1
	107
	Width 1/Largh. 1 [mm]
	25
DAEWOO - CHEVROLET	BE-808 / DD-W02

KDD-S05	
	Number of Teeth 1/N° denti 1
	89
	Width 1/Largh. 1 [mm]
	18.8
SUZUKI	BE-800 / DD-800

KDD-W04A	
	Number of Teeth 1/N° denti 1
	169
	Width 1/Largh. 1 [mm]
	24
DAEWOO - CHEVROLET	BE-W05 / BE-W08 / BE-W09 / DD-W04

KDD-W04B	
 <p>W04B</p>	Number of Teeth 1/N° denti 1
	169
	Width 1/Largh. 1 [mm]
	24
CHEVROLET - DAEWOO	BE-W05 / BE-W08 / DD-W04

KDD-W07	
 <p>W07</p>	Number of Teeth 1/N° denti 1
	151
	Width 1/Largh. 1 [mm]
	22
CHEVROLET	BE-W11 / BE-W12 / DD-W07

KDD-W09	
 <p>W09</p>	Number of Teeth 1/N° denti 1
	171
	Width 1/Largh. 1 [mm]
	24
DAEWOO - CHEVROLET	BE-W06 / BE-W08 / DD-W09

KDD-W10	
 <p>W10</p>	Number of Teeth 1/N° denti 1
	146
	Width 1/Largh. 1 [mm]
	24
CHEVROLET	BE-W13 / BE-W14 / DD-W10

KDD-W11	
 <p>W11</p>	Number of Teeth 1/N° denti 1
	131
	Width 1/Largh. 1 [mm]
	25
CHEVROLET - OPEL	BE-418 / BE-W15 / DD-W11

KDK-100	
	NISSAN
	GA14DE
	NISSAN
	GA16DE
NISSAN	GA16DS
NISSAN	

KDK-107	
	NISSAN
	ZD30DDTi
NISSAN	

KDK-101	
	NISSAN
	GA16DE
	NISSAN
	GA16DEL
NISSAN	GA16DS
NISSAN	

KDK-109	
	NISSAN
	QG18DE
NISSAN	

KDK-104	
	NISSAN
	KA24DE
NISSAN	





KDK-110	
	NISSAN
	GA15DE
	NISSAN
QG15DE	
NISSAN	

KDK-105	
	NISSAN
	CG10DE
	NISSAN
	CG13DE
NISSAN	

KDK-111	
	NISSAN
	LD20
NISSAN	

KDK-106	
	NISSAN
	CG12DE
	NISSAN
	CR12DE
NISSAN	CR14DE
NISSAN	

KDK-112	
	NISSAN
	YD25DDTi
NISSAN	

 <p>KDK-113</p> <p>NISSAN</p> <p>YD25DDTi</p> <p>113</p> <p>NISSAN</p>		 <p>KDK-204</p> <p>TOYOTA</p> <p>2ZZ-GE</p> <p>204</p> <p>TOYOTA</p>	
 <p>KDK-200</p> <p>TOYOTA</p> <p>1ZZ-FE</p> <p>200</p> <p>TOYOTA</p>		 <p>KDK-205</p> <p>TOYOTA</p> <p>1AZ-FE</p> <p>TOYOTA</p>	
 <p>KDK-201</p> <p>TOYOTA</p> <p>3ZZ-FE</p> <p>TOYOTA</p> <p>4ZZ-FE</p> <p>201</p> <p>TOYOTA</p>		 <p>KDK-206</p> <p>TOYOTA</p> <p>1SZ-FE</p> <p>206</p> <p>TOYOTA</p>	
 <p>KDK-202</p> <p>TOYOTA</p> <p>1NZ-FE</p> <p>KDK-202</p> <p>TOYOTA</p>		 <p>KDK-207</p> <p>TOYOTA</p> <p>1ND-TV</p> <p>TOYOTA</p>	
 <p>KDK-203</p> <p>TOYOTA</p> <p>2NZ-FE</p> <p>KDK-203</p> <p>TOYOTA</p>		 <p>KDK-208</p> <p>TOYOTA</p> <p>2NZ-FE</p> <p>KDK-208</p> <p>TOYOTA</p>	

KDK-209	
	European Vehicles
	1KR (384 F)
	TOYOTA
	1KR-FE
	European Vehicles
	1KR-FE
TOYOTA - CITROEN - PEUGEOT	

KDK-503	
	MITSUBISHI 4M40-2AT
MITSUBISHI	

KDK-210	
	TOYOTA
	2SZ-FE
TOYOTA	

KDK-600	
	DAIHATSU
	K3-VE
	DAIHATSU
	K3-VE2
DAIHATSU	

KDK-500	
	MITSUBISHI 4M40-T
MITSUBISHI	

KDK-800	
	SUZUKI J20A
SUZUKI	

KDK-501	
	MITSUBISHI 4M41
MITSUBISHI	

KDK-801-8	
	SUZUKI
	D13A
	SUZUKI
	Z13DT
	Z13DTJ
FIAT - OPEL - SUZUKI	
KDK-801-6 / XX-GC013 / XX-PARAOLIO	

KDK-502	
	MITSUBISHI 4M40-T
MITSUBISHI	

KDK-802	
	SUZUKI
	J18A
	SUZUKI
	J20A
SUZUKI	

KDK-M00	
	SMART
	M 160 E6AL B03
	SMART
	M 160 E6AL B04
	SMART
M 160 E6AL B05	
SMART	
M 160.910	
SMART	
M 160.920	

KDK-M01	
	SMART
	OM 660 DE 8LA

SKD-114	
	Number of Teeth 1/N° denti 1
	123
	Width/Largh. 1 [mm]
	27
NISSAN - SUZUKI - DACIA - RENAULT	BE-122 / DD-114 / PQ-170

SKD-297A	
	Number of Teeth/N° denti
	177
	Width/Largh. [mm]
	25
TOYOTA	BE-224 / BE-225 / DD-297 / PQ-258

SKD-205	
	Number of Teeth/N° denti
	178
	Width/Largh. [mm]
	25
TOYOTA	BE-245 / BE-246 / DD-205 / PQ-283

SKD-327	
	Number of Teeth/N° denti
	153
	Width/Largh. [mm]
	30
MAZDA	BE-336 / BE-337 / DD-327 / PQ-336

SKD-205A	
	Number of Teeth/N° denti
	178
	Width/Largh. [mm]
	25
TOYOTA	BE-241 / BE-245 / BE-246 / DD-205 / PQ-271

SKD-387	
	Number of Teeth/N° denti
	111
	Width/Largh. [mm]
	17
CHEVROLET - DAEWOO	BE-W02 / DD-387 / PQ-W02

SKD-205B	
	Number of Teeth/N° denti
	178
	Width/Largh. [mm]
	25
TOYOTA	BE-245 / BE-246 / DD-205 / PQ-271

SKD-393	
	Number of Teeth/N° denti
	127
	Width/Largh. [mm]
	25
DAEWOO	BE-W00 / BE-W01 / DD-393 / PQ-W09

SKD-211	
	Number of Teeth/N° denti
	163
	Width/Largh. [mm]
	27
TOYOTA	BE-206 / BE-213 / DD-211 / PQ-244

SKD-393A	
	Number of Teeth/N° denti
	127
	Width/Largh. [mm]
	25
DAEWOO	BE-W00 / BE-W01 / DD-393 / PQ-W02

SKD-393B	
 <p>393B</p>	Number of Teeth/N° denti
	127
	Width/Largh. [mm]
	25
DAEWOO - CHEVROLET	BE-W00 / BE-W01 / DD-393 / PQ-W00

SKD-399	
 <p>399</p>	Number of Teeth/N° denti
	162
	Width/Largh. [mm]
	25
KIA	BE-K05 / DD-399 / PQ-K05

SKD-540B	
 <p>540B</p>	Number of Teeth/N° denti
	109
	Width/Largh. [mm]
	24,7
CHEVROLET - DAEWOO	BE-808 / DD-540 / PQ-W04

SKD-H08	
 <p>H08</p>	Number of Teeth/N° denti
	123
	Width/Largh. [mm]
	28
HYUNDAI - KIA	BE-H23 / BE-H24 / DD-H08 / PQ-H06

SKD-W02	
 <p>W02</p>	Number of Teeth/N° denti
	107
	Width/Largh. [mm]
	25
DAEWOO - CHEVROLET	

BE-000	
	Diam./Diam. [mm]
	Height/Altezza [mm]
	Overall Height/Altezza ingombro[mm]
57	
26	
44	
LADA	

BE-006	
	Diam./Diam. [mm]
	Height/Altezza [mm]
	Overall Height/Altezza ingombro[mm]
	Overall Height/Altezza ingombro[mm]
61	
37	
44	
44	
TATA (TELCO)	

BE-002	
	Diam./Diam. [mm]
	Height/Altezza [mm]
	Overall Height/Altezza ingombro[mm]
	Overall Height/Altezza ingombro[mm]
60	
34	
44	
44	

BE-007	
	Diam./Diam. [mm]
	Height/Altezza [mm]
	Overall Height/Altezza ingombro[mm]
	Overall Height/Altezza ingombro[mm]
67	
33	
44,3	
44,3	
CHRYSLER	

BE-003	
	Diam./Diam. [mm]
	Height/Altezza [mm]
	Overall Height/Altezza ingombro[mm]
	Overall Height/Altezza ingombro[mm]
60	
34	
44	
44	
TATA (TELCO)	

BE-008	
	Diam./Diam. [mm]
	Height/Altezza [mm]
	Overall Height/Altezza ingombro[mm]
62	
35	
35	
CHRYSLER	

BE-004	
	Diam./Diam. [mm]
	Height/Altezza [mm]
	Overall Height/Altezza ingombro[mm]
	Overall Height/Altezza ingombro[mm]
60	
34	
45	
45	
HYUNDAI - SUZUKI - LADA	

BE-009	
	Diam./Diam. [mm]
	Height/Altezza [mm]
	Overall Height/Altezza ingombro[mm]
	Overall Height/Altezza ingombro[mm]
76	
32	
64,5	
64,5	
JEEP - CHRYSLER	

BE-005	
	Diam./Diam. [mm]
	Height/Altezza [mm]
	Overall Height/Altezza ingombro[mm]
	Overall Height/Altezza ingombro[mm]
60	
34	
45	
45	
SUZUKI - HYUNDAI - LADA	

BE-010	
	Diam./Diam. [mm]
	Height/Altezza [mm]
	Overall Height/Altezza ingombro[mm]
	Overall Height/Altezza ingombro[mm]
67	
33	
48,3	
48,3	
JEEP - CHRYSLER	

BE-011	
	Diam./Diam. [mm] 62
	Height/Altezza [mm] 35
DODGE	

BE-016	
	Diam./Diam. [mm] 23
	Height/Altezza [mm] 48
CHRYSLER	

BE-012	
	Diam./Diam. [mm] 61
	Height/Altezza [mm] 33
	Overall Height/Altezza ingombro[mm] 57
012 GONOW	

BE-017	
	Diam./Diam. [mm] 60
	Height/Altezza [mm] 30
	Overall Height/Altezza ingombro[mm] 42
017 DR	

BE-013	
	Diam./Diam. [mm] 61
	Height/Altezza [mm] 33
	Overall Height/Altezza ingombro[mm] 57
013 GONOW	

BE-018	
	Diam./Diam. [mm] 67
	Height/Altezza [mm] 28
	Overall Height/Altezza ingombro[mm] 40
018 DR	

BE-014	
	Diam./Diam. [mm] 59
	Height/Altezza [mm] 32
	Overall Height/Altezza ingombro[mm] 42
014 TATA (TELCO)	

BE-019	
	Diam./Diam. [mm] 55
	Height/Altezza [mm] 26
	Overall Height/Altezza ingombro[mm] 31
019 TATA (TELCO)	

BE-015	
	Diam./Diam. [mm] 67
	Height/Altezza [mm] 28
	Overall Height/Altezza ingombro[mm] 39
015 DR	

BE-021	
	Inner Diam./Diam. int. [mm] 28,5
	Height/Altezza [mm] 27
021 DR	

BE-100	
 <p>100</p> <p>NISSAN</p>	Diam./Diam. [mm]
	60
	Height/Altezza [mm]
37	
Overall Height/Altezza ingombro[mm]	
48,5	

BE-105	
 <p>105</p> <p>NISSAN</p>	Diam./Diam. [mm]
	60
	Height/Altezza [mm]
27	
Overall Height/Altezza ingombro[mm]	
38	

BE-101	
 <p>101</p> <p>NISSAN</p>	Diam./Diam. [mm]
	60
	Height/Altezza [mm]
37	
Overall Height/Altezza ingombro[mm]	
53,8	

BE-106	
 <p>106</p> <p>NISSAN</p>	Diam./Diam. [mm]
	70
	Height/Altezza [mm]
30,5	
Overall Height/Altezza ingombro[mm]	
43,5	

BE-102	
 <p>102</p> <p>NISSAN</p>	Diam./Diam. [mm]
	60
	Height/Altezza [mm]
26	
Overall Height/Altezza ingombro[mm]	
32	

BE-107	
 <p>107</p> <p>NISSAN</p>	Diam./Diam. [mm]
	60
	Height/Altezza [mm]
24	
Overall Height/Altezza ingombro[mm]	
31	

BE-103	
 <p>103</p> <p>NISSAN</p>	Diam./Diam. [mm]
	66
	Height/Altezza [mm]
29	
Overall Height/Altezza ingombro[mm]	
43	

BE-108	
 <p>108</p> <p>NISSAN</p>	Diam./Diam. [mm]
	52
	Height/Altezza [mm]
24	
Overall Height/Altezza ingombro[mm]	
55	

BE-104	
 <p>104</p> <p>NISSAN</p>	Diam./Diam. [mm]
	60
	Height/Altezza [mm]
30,5	
Overall Height/Altezza ingombro[mm]	
60	

BE-109	
 <p>109</p> <p>NISSAN</p>	Diam./Diam. [mm]
	60
	Height/Altezza [mm]
36	
Overall Height/Altezza ingombro[mm]	
74	

BE-110	
	Diam./Diam. [mm]
	Height/Altezza [mm]
	Overall Height/Altezza ingombro[mm]
NISSAN	

BE-115	
	Diam./Diam. [mm]
	Height/Altezza [mm]
	Overall Height/Altezza ingombro[mm]
NISSAN	

BE-111	
	Diam./Diam. [mm]
	Height/Altezza [mm]
	Overall Height/Altezza ingombro[mm]
NISSAN	

BE-116	
	Diam./Diam. [mm]
	Height/Altezza [mm]
	Overall Height/Altezza ingombro[mm]
NISSAN	

BE-112	
	Diam./Diam. [mm]
	Height/Altezza [mm]
	Overall Height/Altezza ingombro[mm]
NISSAN	

BE-120	
	Diam./Diam. [mm]
	Height/Altezza [mm]
	Overall Height/Altezza ingombro[mm]
NISSAN	

BE-113	
	Diam./Diam. [mm]
	Height/Altezza [mm]
	Overall Height/Altezza ingombro[mm]
NISSAN	

BE-121	
	Diam./Diam. [mm]
	Height/Altezza [mm]
	Overall Height/Altezza ingombro[mm]
NISSAN	

BE-114	
	Diam./Diam. [mm]
	Height/Altezza [mm]
	Overall Height/Altezza ingombro[mm]
NISSAN	

BE-122	
	Diam./Diam. [mm]
	Height/Altezza [mm]
	Overall Height/Altezza ingombro[mm]
NISSAN - DACIA - SUZUKI	

BE-123	
	Diam./Diam. [mm]
	50
	Height/Altezza [mm]
	31
Overall Height/Altezza ingombro[mm]	
52	
SUZUKI - NISSAN	

BE-128	
	Diam./Diam. [mm]
	50
	Height/Altezza [mm]
	22
NISSAN	

BE-124	
	Diam./Diam. [mm]
	70
	Height/Altezza [mm]
	32
NISSAN	

BE-129	
	Diam./Diam. [mm]
	59
	Height/Altezza [mm]
	28,5
	Overall Height/Altezza ingombro[mm]
37,5	
NISSAN	

BE-125	
	Diam./Diam. [mm]
	75,5
	Height/Altezza [mm]
	31,8
NISSAN	

BE-200	
	Diam./Diam. [mm]
	60
	Height/Altezza [mm]
	32,5
Overall Height/Altezza ingombro[mm]	
42,5	
TOYOTA	

BE-126	
	Diam./Diam. [mm]
	53,5
	Height [cm]/Altezza [cm]
	32
NISSAN	

BE-201	
	Diam./Diam. [mm]
	60
	Height/Altezza [mm]
30	
TOYOTA	

BE-127	
	Diam./Diam. [mm]
	66
	Height/Altezza [mm]
	32
	Overall Height/Altezza ingombro[mm]
35	
NISSAN	

BE-202	
	Diam./Diam. [mm]
	62
	Height/Altezza [mm]
	35
	Overall Height/Altezza ingombro[mm]
44	
TOYOTA - VW	

BE-203	
	Diam./Diam. [mm]
	83
	Height/Altezza [mm]
35	
Overall Height/Altezza ingombro[mm]	
35	
TOYOTA - VW	

BE-208	
	Diam./Diam. [mm]
	52
	Height/Altezza [mm]
23	
Overall Height/Altezza ingombro[mm]	
30,5	
TOYOTA - DAIHATSU	

BE-204	
	Diam./Diam. [mm]
	50
	Height/Altezza [mm]
27	
Overall Height/Altezza ingombro[mm]	
42	
TOYOTA	

BE-209	
	Diam./Diam. [mm]
	55
	Height/Altezza [mm]
23	
Overall Height/Altezza ingombro[mm]	
30	
TOYOTA	

BE-205	
	Diam./Diam. [mm]
	60
	Height/Altezza [mm]
30	
Overall Height/Altezza ingombro[mm]	
36,3	
TOYOTA	

BE-211	
	Diam./Diam. [mm]
	62
	Height/Altezza [mm]
28,5	
Overall Height/Altezza ingombro[mm]	
36,5	
TOYOTA	

BE-206	
	Diam./Diam. [mm]
	57,5
	Height/Altezza [mm]
29	
Overall Height/Altezza ingombro[mm]	
29	
TOYOTA	

BE-212	
	Diam./Diam. [mm]
	62
	Height/Altezza [mm]
35	
Overall Height/Altezza ingombro[mm]	
44	
TOYOTA	

BE-207	
	Diam./Diam. [mm]
	50
	Height/Altezza [mm]
27	
Overall Height/Altezza ingombro[mm]	
42	
TOYOTA	

BE-213	
	Diam./Diam. [mm]
	57,5
	Height/Altezza [mm]
29	
Overall Height/Altezza ingombro[mm]	
33,6	
TOYOTA	

BE-214	
	Diam./Diam. [mm]
	50
	Height/Altezza [mm]
	23
Overall Height/Altezza ingombro[mm]	
38	

BE-219	
	Diam./Diam. [mm]
	59
	Height/Altezza [mm]
	32
Overall Height/Altezza ingombro[mm]	
32	

TOYOTA

BE-215	
	Diam./Diam. [mm]
	56
	Height/Altezza [mm]
	29
Overall Height/Altezza ingombro[mm]	
42,2	

TOYOTA

BE-220	
	Diam./Diam. [mm]
	57,5
	Height/Altezza [mm]
	29
Overall Height/Altezza ingombro[mm]	
33,5	

TOYOTA

BE-216	
	Diam./Diam. [mm]
	54
	Height/Altezza [mm]
	29,3
Overall Height/Altezza ingombro[mm]	
29,3	

TOYOTA

BE-221	
	Diam./Diam. [mm]
	62
	Height/Altezza [mm]
	36,5
Overall Height/Altezza ingombro[mm]	
44	

LEXUS - TOYOTA

BE-217	
	Diam./Diam. [mm]
	52
	Height/Altezza [mm]
	30
Overall Height/Altezza ingombro[mm]	
45	

TOYOTA

BE-222	
	Diam./Diam. [mm]
	57,5
	Height/Altezza [mm]
	29
Overall Height/Altezza ingombro[mm]	
33	

TOYOTA

BE-218	
	Diam./Diam. [mm]
	57,5
	Height/Altezza [mm]
30	

LEXUS

BE-223	
	Diam./Diam. [mm]
	62
	Height/Altezza [mm]
36,5	

TOYOTA - LEXUS

BE-224	
	Diam./Diam. [mm]
	62
	Height/Altezza [mm]
	31
Overall Height/Altezza ingombro[mm]	
41	
TOYOTA	

BE-229	
	Diam./Diam. [mm]
	50
	Height/Altezza [mm]
	23
Overall Height/Altezza ingombro[mm]	
23	
TOYOTA	

BE-225	
	Diam./Diam. [mm]
	62
	Height/Altezza [mm]
	28,5
TOYOTA	

BE-230	
	Diam./Diam. [mm]
	50
	Height/Altezza [mm]
	27
Overall Height/Altezza ingombro[mm]	
27	
TOYOTA	

BE-226	
	Diam./Diam. [mm]
	57
	Height/Altezza [mm]
	25
Overall Height/Altezza ingombro[mm]	
46	
TOYOTA	

BE-232	
	Diam./Diam. [mm]
	62
	Height/Altezza [mm]
	36,5
Overall Height/Altezza ingombro[mm]	
44	
TOYOTA	

BE-227	
	Diam./Diam. [mm]
	57,5
	Height/Altezza [mm]
	30
Overall Height/Altezza ingombro[mm]	
38	
TOYOTA	

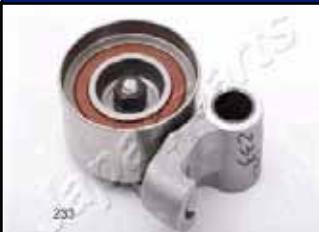
BE-233	
	Diam./Diam. [mm]
	62
	Height/Altezza [mm]
	28,5
Overall Height/Altezza ingombro[mm]	
37	
TOYOTA - LEXUS	

BE-228	
	Diam./Diam. [mm]
	57,5
	Height/Altezza [mm]
	29
Overall Height/Altezza ingombro[mm]	
40	
TOYOTA	

BE-235	
	Diam./Diam. [mm]
	57,5
	Height/Altezza [mm]
	29
Overall Height/Altezza ingombro[mm]	
37	
TOYOTA	

BE-236	
	Diam./Diam. [mm]
	62
	Height/Altezza [mm]
	28,5
	Overall Height/Altezza ingombro[mm]
	38
TOYOTA	

BE-242	
	Diam./Diam. [mm]
	62
	Height/Altezza [mm]
	40
	Overall Height/Altezza ingombro[mm]
	47
TOYOTA	

BE-237	
	Diam./Diam. [mm]
	54
	Height/Altezza [mm]
	32
	Overall Height/Altezza ingombro[mm]
	46,5
TOYOTA	

BE-243	
	Diam./Diam. [mm]
	60
	Height/Altezza [mm]
	30
	Overall Height/Altezza ingombro[mm]
	38
TOYOTA	

BE-239	
	Diam./Diam. [mm]
	62
	Height/Altezza [mm]
	28,5
	Overall Height/Altezza ingombro[mm]
	42
TOYOTA	

BE-244	
	Diam./Diam. [mm]
	62
	Height/Altezza [mm]
	28,5
	Overall Height/Altezza ingombro[mm]
	38
TOYOTA	

BE-240	
	Diam./Diam. [mm]
	62
	Height/Altezza [mm]
	40
	Overall Height/Altezza ingombro[mm]
	49
TOYOTA	

BE-245	
	Diam./Diam. [mm]
	62
	Height/Altezza [mm]
	30,5
	Overall Height/Altezza ingombro[mm]
	39
TOYOTA	

BE-241	
	Diam./Diam. [mm]
	32
	Height/Altezza [mm]
	67
TOYOTA	

BE-246	
	Diam./Diam. [mm]
	62
	Height/Altezza [mm]
	28,5
TOYOTA	

NEW		BE-248	
 <p>248</p>	Diam./Diam. [mm]	65	
	Height/Altezza [mm]	32	
	Overall Height/Altezza ingombro[mm]	41	
	LEXUS		

NEW		BE-253	
	Operating Mode/Tipo funzionamento	Idraulico/Hydraulic	
	Length/Lungh. [mm]	90	
	TOYOTA		

BE-249		
 <p>249</p>	Diam./Diam. [mm]	62
	Height/Altezza [mm]	37,5
	Overall Height/Altezza ingombro[mm]	47
	TOYOTA	

NEW		BE-254	
 <p>254</p>	Diam./Diam. [mm]	60	
	Height/Altezza [mm]	30	
	Overall Height/Altezza ingombro[mm]	40	
	TOYOTA		

BE-250		
 <p>250</p>	Diam./Diam. [mm]	66
	Height/Altezza [mm]	37,5
	TOYOTA	

NEW		BE-255	
 <p>255</p>	Diam./Diam. [mm]	60	
	Height/Altezza [mm]	30	
	Overall Height/Altezza ingombro[mm]	40,3	
	TOYOTA		

BE-251		
 <p>251</p>	Diam./Diam. [mm]	25
	Height/Altezza [mm]	45
	TOYOTA	

NEW		BE-256	
 <p>256</p>	Diam./Diam. [mm]	62	
	Height/Altezza [mm]	28,5	
	Overall Height/Altezza ingombro[mm]	37	
	TOYOTA		

BE-252		
 <p>252</p>	Diam./Diam. [mm]	62
	Height/Altezza [mm]	41
	TOYOTA	

BE-300		
 <p>300</p>	Diam./Diam. [mm]	52
	Height/Altezza [mm]	25
	Overall Height/Altezza ingombro[mm]	32
	MAZDA - KIA	

BE-301	
	Diam./Diam. [mm] 52
	Height/Altezza [mm] 25
	Overall Height/Altezza ingombro[mm] 32
KIA - MAZDA	

BE-307	
	Diam./Diam. [mm] 52
	Height/Altezza [mm] 26
	Overall Height/Altezza ingombro[mm] 33
KIA - MAZDA	

BE-302	
	Diam./Diam. [mm] 47
	Height/Altezza [mm] 32
	Overall Height/Altezza ingombro[mm] 57

BE-308	
	Diam./Diam. [mm] 52
	Height/Altezza [mm] 28,5
	Overall Height/Altezza ingombro[mm] 37
MAZDA - ASIA MOTORS - KIA	

BE-303	
	Diam./Diam. [mm] 52
	Height/Altezza [mm] 26
	Overall Height/Altezza ingombro[mm] 35
MAZDA	

BE-309	
	Diam./Diam. [mm] 52
	Height/Altezza [mm] 33
	Overall Height/Altezza ingombro[mm] 40,5

BE-305	
	Diam./Diam. [mm] 60
	Height/Altezza [mm] 28,5
	Overall Height/Altezza ingombro[mm] 31
KIA - ASIA MOTORS - MAZDA	

BE-312	
	Diam./Diam. [mm] 52
	Height/Altezza [mm] 28,5
	Overall Height/Altezza ingombro[mm] 35
MAZDA	

BE-306	
	Diam./Diam. [mm] 52
	Height/Altezza [mm] 25
	Overall Height/Altezza ingombro[mm] 31
KIA - MAZDA	

BE-313	
	Diam./Diam. [mm] 62
	Height/Altezza [mm] 28,5
	Overall Height/Altezza ingombro[mm] 52
MAZDA	

BE-314	
	Diam./Diam. [mm]
	60
	Height/Altezza [mm]
	33
Overall Height/Altezza ingombro[mm]	
39	
MAZDA	

BE-319	
	Diam./Diam. [mm]
	58
	Height/Altezza [mm]
	35
Overall Height/Altezza ingombro[mm]	
39	
MAZDA	

BE-315	
	Diam./Diam. [mm]
	60
	Height/Altezza [mm]
	33
Overall Height/Altezza ingombro[mm]	
36	
MAZDA	

BE-320	
	Diam./Diam. [mm]
	58
	Height/Altezza [mm]
	34
Overall Height/Altezza ingombro[mm]	
34	
MAZDA	

BE-316	
	Diam./Diam. [mm]
	60
	Height/Altezza [mm]
	35
Overall Height/Altezza ingombro[mm]	
45	
MAZDA	

BE-321	
	Diam./Diam. [mm]
	52
	Height/Altezza [mm]
	36,5
Overall Height/Altezza ingombro[mm]	
47,5	
MAZDA	

BE-317	
	Diam./Diam. [mm]
	58
	Height/Altezza [mm]
	31
Overall Height/Altezza ingombro[mm]	
36	
MAZDA	

BE-322	
	Diam./Diam. [mm]
	60
	Height/Altezza [mm]
	38
Overall Height/Altezza ingombro[mm]	
54	
MAZDA	

BE-318	
	Diam./Diam. [mm]
	60
	Height/Altezza [mm]
	26
Overall Height/Altezza ingombro[mm]	
31,9	
MAZDA	

BE-323	
	Diam./Diam. [mm]
	60
	Height/Altezza [mm]
	41,5
Overall Height/Altezza ingombro[mm]	
51	
MAZDA	

BE-324	
	Diam./Diam. [mm]
	60
	Height/Altezza [mm]
	41,5
Overall Height/Altezza ingombro[mm]	
60	
MAZDA	

BE-329	
	Diam./Diam. [mm]
	58
	Height/Altezza [mm]
	32
Overall Height/Altezza ingombro[mm]	
37	
MAZDA	

BE-325	
	Diam./Diam. [mm]
	60,3
	Height/Altezza [mm]
	41,6
	Overall Height/Altezza ingombro[mm]
51,1	
Fitting Position/Lato montaggio	
Superiore/Upper	
MAZDA	

BE-330	
	Diam./Diam. [mm]
	62
	Height/Altezza [mm]
	27
Overall Height/Altezza ingombro[mm]	
57	
MAZDA	

BE-326	
	Diam./Diam. [mm]
	60
	Height/Altezza [mm]
	41,7
	Overall Height/Altezza ingombro[mm]
59,6	
Fitting Position/Lato montaggio	
Inferiore/Lower	
MAZDA	

BE-333	
	Diam./Diam. [mm]
	62
	Height/Altezza [mm]
	26,6
Overall Height/Altezza ingombro[mm]	
50	
MAZDA	

BE-327	
	Diam./Diam. [mm]
	58
	Height/Altezza [mm]
	30
Overall Height/Altezza ingombro[mm]	
30	
MAZDA	

BE-334	
	Diam./Diam. [mm]
	60
	Height/Altezza [mm]
30	
MAZDA - TOYOTA - CITROEN - PEUGEOT	

BE-328	
	Diam./Diam. [mm]
	58
	Overall Height/Altezza ingombro[mm]
	25
Height/Altezza [mm]	
30	
MAZDA	

BE-335	
	Diam./Diam. [mm]
	60
	Height/Altezza [mm]
	29
Overall Height/Altezza ingombro[mm]	
38	
CITROEN - TOYOTA - PEUGEOT - MAZDA	

BE-336	
 <p>336</p>	Diam./Diam. [mm] 58
	Height/Altezza [mm] 33
MAZDA	

BE-342	
 <p>342</p>	Diam./Diam. [mm] 72
	Height/Altezza [mm] 31
	Overall Height/Altezza ingombro[mm] 55
	MAZDA

BE-337	
 <p>337</p>	Diam./Diam. [mm] 58
	Height/Altezza [mm] 33
MAZDA	

BE-343	
 <p>343</p>	Diam./Diam. [mm] 58
	Height/Altezza [mm] 30
	Overall Height/Altezza ingombro[mm] 39
	MAZDA

BE-338	
	Diam./Diam. [mm] 58
	Height/Altezza [mm] 27
MAZDA	

BE-344	
	Diam./Diam. [mm] 58
	Height/Altezza [mm] 27
MAZDA	

BE-339	
 <p>339</p>	Diam./Diam. [mm] 52
	Height/Altezza [mm] 25
	Overall Height/Altezza ingombro[mm] 28
	MAZDA

BE-345	
	Mounting Bores Distance/Distanza fori di fissaggio [mm] 73
	MAZDA

BE-340	
 <p>340</p>	Diam./Diam. [mm] 60
	Height/Altezza [mm] 27,5
	Overall Height/Altezza ingombro[mm] 32,5
	MAZDA

BE-346	
 <p>346</p>	Diam./Diam. [mm] 60
	Height/Altezza [mm] 29
	MAZDA

BE-347	
 <p>347</p> <p>MAZDA</p>	Diam./Diam. [mm]
	60
	Height/Altezza [mm]
	29

BE-400	
 <p>400</p> <p>HONDA</p>	Diam./Diam. [mm]
	55
	Height/Altezza [mm]
	29
	Overall Height/Altezza ingombro[mm]
	38

BE-348	
 <p>348</p> <p>MAZDA</p>	Diam./Diam. [mm]
	31
	Height/Altezza [mm]
	54

BE-401	
 <p>401</p> <p>ROVER - HONDA</p>	Diam./Diam. [mm]
	55
	Height/Altezza [mm]
	28
	Overall Height/Altezza ingombro[mm]
	43

BE-349	
 <p>349</p> <p>MAZDA</p>	Diam./Diam. [mm]
	65
	Height/Altezza [mm]
	28
	Overall Height/Altezza ingombro[mm]
	34

BE-402	
 <p>402</p>	Diam./Diam. [mm]
	52,4
	Height/Altezza [mm]
	27,8
	Overall Height/Altezza ingombro[mm]
	33,6

BE-350	
 <p>350</p> <p>MAZDA</p>	Diam./Diam. [mm]
	60
	Height/Altezza [mm]
	34

BE-403	
 <p>403</p> <p>HONDA</p>	Diam./Diam. [mm]
	60
	Height/Altezza [mm]
	27
	Overall Height/Altezza ingombro[mm]
	33

BE-351	
 <p>351</p> <p>MAZDA</p>	Diam./Diam. [mm]
	58
	Height/Altezza [mm]
	31,8
	Overall Height/Altezza ingombro[mm]
	37,7

BE-404	
 <p>404</p> <p>HONDA - ROVER</p>	Diam./Diam. [mm]
	62
	Height/Altezza [mm]
	27
	Overall Height/Altezza ingombro[mm]
	35

BE-405	
	Diam./Diam. [mm]
	65
	Height/Altezza [mm]
	32
Overall Height/Altezza ingombro[mm]	
36	
HONDA - ROVER	

BE-413	
	Diam./Diam. [mm]
	57
	Height/Altezza [mm]
	26
Overall Height/Altezza ingombro[mm]	
43	
ROVER - HONDA	

BE-406	
	Diam./Diam. [mm]
	55
	Height/Altezza [mm]
	32
Overall Height/Altezza ingombro[mm]	
37	
HONDA	

BE-414	
	Diam./Diam. [mm]
	53
	Height/Altezza [mm]
	26
Overall Height/Altezza ingombro[mm]	
43	
HONDA	

BE-407	
	Diam./Diam. [mm]
	55
	Height/Altezza [mm]
	28
Overall Height/Altezza ingombro[mm]	
40,5	
HONDA	

BE-415	
	Diam./Diam. [mm]
	55
	Height/Altezza [mm]
	30
Overall Height/Altezza ingombro[mm]	
41	
HONDA	

BE-408	
	Diam./Diam. [mm]
	60
	Height/Altezza [mm]
	25
Overall Height/Altezza ingombro[mm]	
31	
HONDA	

BE-416	
	Diam./Diam. [mm]
	55
	Height/Altezza [mm]
	27
Overall Height/Altezza ingombro[mm]	
47,5	
HONDA	

BE-411	
	Diam./Diam. [mm]
	60,3
	Height/Altezza [mm]
	28,5
Overall Height/Altezza ingombro[mm]	
46	
HONDA	

BE-417	
	Diam./Diam. [mm]
	70
	Height/Altezza [mm]
	19
Overall Height/Altezza ingombro[mm]	
21,5	
HONDA	

BE-418	
	Diam./Diam. [mm]
	Height/Altezza [mm]
	Overall Height/Altezza ingombro[mm]
HONDA - OPEL - CHEVROLET	

BE-500	
	Diam./Diam. [mm]
	Height/Altezza [mm]
	Overall Height/Altezza ingombro[mm]
HYUNDAI - GASOLONE - MITSUBISHI	

BE-419	
	Diam./Diam. [mm]
	Height/Altezza [mm]
	Overall Height/Altezza ingombro[mm]
HONDA	

BE-501	
	Diam./Diam. [mm]
	Height/Altezza [mm]
	Overall Height/Altezza ingombro[mm]
MITSUBISHI - KIA - HYUNDAI - GASOLONE	

BE-420	
	Diam./Diam. [mm]
	Height/Altezza [mm]
	Overall Height/Altezza ingombro[mm]
HONDA	

BE-502	
	Diam./Diam. [mm]
	Height/Altezza [mm]
	Overall Height/Altezza ingombro[mm]
MITSUBISHI	

BE-421	
	Diam./Diam. [mm]
	Height/Altezza [mm]
	Overall Height/Altezza ingombro[mm]
HONDA	

BE-503	
	Diam./Diam. [mm]
	Height/Altezza [mm]
	Overall Height/Altezza ingombro[mm]
MITSUBISHI - HYUNDAI	

BE-422	
	Diam./Diam. [mm]
	Height/Altezza [mm]
	Overall Height/Altezza ingombro[mm]
HONDA	

BE-505	
	Diam./Diam. [mm]
	Height/Altezza [mm]
	Overall Height/Altezza ingombro[mm]
MITSUBISHI	

BE-506	
	Diam./Diam. [mm]
	60
	Height/Altezza [mm]
	19,5
Overall Height/Altezza ingombro[mm]	24,5
HYUNDAI - MITSUBISHI	

BE-511	
	Diam./Diam. [mm]
	60
	Height/Altezza [mm]
	29
Overall Height/Altezza ingombro[mm]	43,6
MITSUBISHI - PROTON	

BE-507	
	Diam./Diam. [mm]
	60
	Height/Altezza [mm]
	33
HYUNDAI - MITSUBISHI	

BE-512	
	Diam./Diam. [mm]
	57,5
	Height/Altezza [mm]
	34
Overall Height/Altezza ingombro[mm]	39,8
PROTON - MITSUBISHI	

BE-508	
	Diam./Diam. [mm]
	60
	Height/Altezza [mm]
	26
Overall Height/Altezza ingombro[mm]	32
MITSUBISHI - HYUNDAI	

BE-513	
	Diam./Diam. [mm]
	60
	Height/Altezza [mm]
	32
Overall Height/Altezza ingombro[mm]	39,5
MITSUBISHI - SHUANGHUAN AUTO - KIA - GREAT WALL - HYUNDAI	

BE-509	
	Diam./Diam. [mm]
	60
	Height/Altezza [mm]
	32
Overall Height/Altezza ingombro[mm]	36
MITSUBISHI - CHRYSLER - HYUNDAI	

BE-514	
	Diam./Diam. [mm]
	55
	Height/Altezza [mm]
	19,5
Overall Height/Altezza ingombro[mm]	23
PROTON - GREAT WALL - SHUANGHUAN AUTO - HYUNDAI - MITSUBISHI	

BE-510	
	Diam./Diam. [mm]
	60
	Height/Altezza [mm]
	19,5
Overall Height/Altezza ingombro[mm]	23
MITSUBISHI	

BE-515	
	Diam./Diam. [mm]
	57,5
	Height/Altezza [mm]
	34
Overall Height/Altezza ingombro[mm]	34
MITSUBISHI	

BE-516	
	Diam./Diam. [mm]
	60
	Height/Altezza [mm]
	37,5
Overall Height/Altezza ingombro[mm]	43
MITSUBISHI	

BE-524	
	Diam./Diam. [mm]
	55
	Height/Altezza [mm]
	23,6
Overall Height/Altezza ingombro[mm]	40

BE-517	
	Diam./Diam. [mm]
	60
	Height/Altezza [mm]
	39
Overall Height/Altezza ingombro[mm]	39
MITSUBISHI - PROTON	

BE-525	
	Diam./Diam. [mm]
	60
	Height/Altezza [mm]
25,5	

BE-519	
	Diam./Diam. [mm]
	60
	Height/Altezza [mm]
33	
KIA - GONOW - SHUANGHUAN AUTO - MITSUBISHI - GREAT WALL	

BE-526	
	Diam./Diam. [mm]
	57,5
	Height/Altezza [mm]
	34
Overall Height/Altezza ingombro[mm]	39,5
MITSUBISHI	

BE-521	
	Diam./Diam. [mm]
	60
	Height/Altezza [mm]
	35,5
Overall Height/Altezza ingombro[mm]	42,3
MITSUBISHI - PROTON	

BE-527	
	Diam./Diam. [mm]
	50
	Height/Altezza [mm]
	30,5
Overall Height/Altezza ingombro[mm]	33
MITSUBISHI	

BE-523	
	Diam./Diam. [mm]
	90
	Height/Altezza [mm]
	26
Overall Height/Altezza ingombro[mm]	28
MITSUBISHI - HYUNDAI	

BE-528	
	Diam./Diam. [mm]
	50
	Height/Altezza [mm]
	30
Overall Height/Altezza ingombro[mm]	42
MITSUBISHI	

BE-529	
	Diam./Diam. [mm]
	57,7
	Height/Altezza [mm]
	31
Overall Height/Altezza ingombro[mm]	39
529	
MITSUBISHI	

BE-534	
	Diam./Diam. [mm]
	60
	Height/Altezza [mm]
	28,5
Overall Height/Altezza ingombro[mm]	37
534	
MITSUBISHI	

BE-530	
	Diam./Diam. [mm]
	68
	Height/Altezza [mm]
	36
Overall Height/Altezza ingombro[mm]	48
530	
MITSUBISHI - JEEP	

BE-535	
	Diam./Diam. [mm]
	80
	Height/Altezza [mm]
	34
535	
JEEP - MITSUBISHI	

BE-531	
	Diam./Diam. [mm]
	40
	Height/Altezza [mm]
	36
Overall Height/Altezza ingombro[mm]	51
531	
JEEP - MITSUBISHI	

BE-536	
	Diam./Diam. [mm]
	60
	Height/Altezza [mm]
	29
Overall Height/Altezza ingombro[mm]	44
536	
LAND ROVER - MITSUBISHI	

BE-532	
	Diam./Diam. [mm]
	60
	Height/Altezza [mm]
	28,5
532	
MITSUBISHI	

BE-537	
	Diam./Diam. [mm]
	60
	Height/Altezza [mm]
	30
Overall Height/Altezza ingombro[mm]	41
537	
LAND ROVER - MITSUBISHI	

BE-533	
	Diam./Diam. [mm]
	32
	Height/Altezza [mm]
	54
533	
MITSUBISHI	

BE-538	
	Diam./Diam. [mm]
	60
	Height/Altezza [mm]
	32
Overall Height/Altezza ingombro[mm]	39,5
538	
MITSUBISHI	

BE-600	
	Diam./Diam. [mm]
	50
	Height/Altezza [mm]
	27
Overall Height/Altezza ingombro[mm]	45
DAIHATSU - PIAGGIO	

BE-605	
	Diam./Diam. [mm]
	50
	Height/Altezza [mm]
	24
Overall Height/Altezza ingombro[mm]	21
DAIHATSU	

BE-601	
	Diam./Diam. [mm]
	50
	Height/Altezza [mm]
	21
Overall Height/Altezza ingombro[mm]	36
DAIHATSU - INNOCENTI - PIAGGIO	

BE-607	
	Diam./Diam. [mm]
	50
	Height/Altezza [mm]
	19,5
Overall Height/Altezza ingombro[mm]	20
INNOCENTI - DAIHATSU	

BE-602	
	Diam./Diam. [mm]
	60
	Height/Altezza [mm]
	26,5
Overall Height/Altezza ingombro[mm]	33
DAIHATSU - INNOCENTI	

BE-608	
	Diam./Diam. [mm]
	50
	Height/Altezza [mm]
	22,5
Overall Height/Altezza ingombro[mm]	23
DAIHATSU	

BE-603	
	Diam./Diam. [mm]
	52
	Height/Altezza [mm]
	24
Overall Height/Altezza ingombro[mm]	28,5
DAIHATSU	

BE-609	
	Diam./Diam. [mm]
	60
	Height/Altezza [mm]
	35
Construction Height 1/Altezza d'ingombro 1 [mm]	42
DAIHATSU	

BE-604	
	Diam./Diam. [mm]
	50
	Height/Altezza [mm]
	24
Overall Height/Altezza ingombro[mm]	48
DAIHATSU	

BE-610	
	Diam./Diam. [mm]
	55
	Height/Altezza [mm]
	36
Overall Height/Altezza ingombro[mm]	42,5
DAIHATSU	

BE-611	
	Diam./Diam. [mm]
	50
	Height/Altezza [mm]
	27
Overall Height/Altezza ingombro[mm]	41,2
DAIHATSU	

BE-703	
	Diam./Diam. [mm]
	52
	Height/Altezza [mm]
	27,5
Overall Height/Altezza ingombro[mm]	40
SUBARU	

BE-612	
	Diam./Diam. [mm]
	66,5
	Height/Altezza [mm]
	29
Overall Height/Altezza ingombro[mm]	61
PIAGGIO	

BE-704	
	Diam./Diam. [mm]
	52
	Height/Altezza [mm]
	27,5
Overall Height/Altezza ingombro[mm]	38
SUBARU	

BE-700	
	Diam./Diam. [mm]
	70
	Height/Altezza [mm]
	34
Overall Height/Altezza ingombro[mm]	55
SUBARU	

BE-705	
	Diam./Diam. [mm]
	53
	Height/Altezza [mm]
	25
Overall Height/Altezza ingombro[mm]	38
SUBARU	

BE-701	
	Diam./Diam. [mm]
	60
	Height/Altezza [mm]
	35
SUBARU	

BE-706	
	Diam./Diam. [mm]
	52
	Height/Altezza [mm]
	28
Overall Height/Altezza ingombro[mm]	39
SUBARU	

BE-702	
	Diam./Diam. [mm]
	60
	Height/Altezza [mm]
	35
Overall Height/Altezza ingombro[mm]	35
SUBARU	

BE-707	
	Diam./Diam. [mm]
	60
	Height/Altezza [mm]
34	
SUBARU	

BE-708	
	Diam./Diam. [mm]
	31
	Height/Altezza [mm]
34	
Overall Height/Altezza ingombro[mm]	45
SUBARU	

BE-800	
	Diam./Diam. [mm]
	58
	Height/Altezza [mm]
24	
Overall Height/Altezza ingombro[mm]	25
SUZUKI	

BE-709	
	Diam./Diam. [mm]
	31
	Height/Altezza [mm]
34	
Overall Height/Altezza ingombro[mm]	45
SUBARU	

BE-801	
	Diam./Diam. [mm]
	51
	Height/Altezza [mm]
28,5	
Overall Height/Altezza ingombro[mm]	31
SUZUKI - SUBARU	

BE-710	
	Diam./Diam. [mm]
	59,8
	Height/Altezza [mm]
34	
SUBARU	

BE-802	
	Diam./Diam. [mm]
	52
	Height/Altezza [mm]
28	
Overall Height/Altezza ingombro[mm]	33,5
SUZUKI - BEDFORD	

BE-711	
	Diam./Diam. [mm]
	60
	Height/Altezza [mm]
34	
Overall Height/Altezza ingombro[mm]	49
SUBARU	

BE-803	
	Diam./Diam. [mm]
	52
	Height/Altezza [mm]
22	
Overall Height/Altezza ingombro[mm]	31
SUZUKI	

BE-712	
	Diam./Diam. [mm]
	57
	Height/Altezza [mm]
19	
Overall Height/Altezza ingombro[mm]	23
SUBARU	

BE-805	
	Diam./Diam. [mm]
	42
	Height/Altezza [mm]
24	
Overall Height/Altezza ingombro[mm]	24,5
SUZUKI	

BE-806	
	Diam./Diam. [mm]
	42
	Height/Altezza [mm]
	28
Overall Height/Altezza ingombro[mm]	30,5
SUZUKI	

BE-812	
	Diam./Diam. [mm]
	58
	Height/Altezza [mm]
	30
Overall Height/Altezza ingombro[mm]	34
SUZUKI	

BE-807	
	Diam./Diam. [mm]
	62
	Height/Altezza [mm]
	29
Overall Height/Altezza ingombro[mm]	32
SUZUKI - FIAT - OPEL	

BE-816	
	Diam./Diam. [mm]
	60
	Height/Altezza [mm]
	31
Overall Height/Altezza ingombro[mm]	40
SUZUKI	

BE-808	
	Diam./Diam. [mm]
	42
	Height/Altezza [mm]
	28
Overall Height/Altezza ingombro[mm]	44,6
CHEVROLET - DAEWOO	

BE-817	
	Diam./Diam. [mm]
	60
	Height/Altezza [mm]
	34
Overall Height/Altezza ingombro[mm]	42
SUZUKI	

BE-810	
	Diam./Diam. [mm]
	65
	Height/Altezza [mm]
	30
Overall Height/Altezza ingombro[mm]	41
OPEL - SUZUKI - FIAT - CADILLAC	

BE-818	
	Diam./Diam. [mm]
	60
	Height/Altezza [mm]
	29
Overall Height/Altezza ingombro[mm]	34,1
SUZUKI	

BE-811	
	Diam./Diam. [mm]
	53
	Height/Altezza [mm]
	29
Overall Height/Altezza ingombro[mm]	31
OPEL - SUZUKI - FIAT	

BE-819	
	Diam./Diam. [mm]
	62
	Height/Altezza [mm]
	30
Overall Height/Altezza ingombro[mm]	40
SUZUKI	

BE-899	
	Diam./Diam. [mm]
	51
	Height/Altezza [mm]
	28
Overall Height/Altezza ingombro[mm]	30,7

BE-905	
	Diam./Diam. [mm]
	60
	Height/Altezza [mm]
	35
Overall Height/Altezza ingombro[mm]	35

ISUZU - BEDFORD

BE-900	
	Diam./Diam. [mm]
	52
	Height/Altezza [mm]
	22
Overall Height/Altezza ingombro[mm]	27

BEDFORD - ISUZU

BE-906	
	Diam./Diam. [mm]
	62
	Height/Altezza [mm]
38	

OPEL - ISUZU - VAUXHALL

BE-902	
	Diam./Diam. [mm]
	60
	Height/Altezza [mm]
	27
Overall Height/Altezza ingombro[mm]	33

ISUZU - BEDFORD

BE-907	
	Diam./Diam. [mm]
	67
	Height/Altezza [mm]
	38,5
Overall Height/Altezza ingombro[mm]	43

ISUZU - OPEL

BE-903	
	Diam./Diam. [mm]
	59,9
	Height/Altezza [mm]
	29,9
Overall Height/Altezza ingombro[mm]	36,2

ISUZU

BE-908	
	Diam./Diam. [mm]
	67
	Height/Altezza [mm]
	38
Overall Height/Altezza ingombro[mm]	40,5

OPEL - ISUZU

BE-904	
	Diam./Diam. [mm]
	60
	Height/Altezza [mm]
	35
Overall Height/Altezza ingombro[mm]	38,5

ISUZU - BEDFORD

BE-909	
	Diam./Diam. [mm]
	60,6
	Height/Altezza [mm]
	30,6
Overall Height/Altezza ingombro[mm]	61,6

BE-910	
	Diam./Diam. [mm]
	Height/Altezza [mm]
	Overall Height/Altezza ingombro[mm]

BE-916	
	Diam./Diam. [mm]
	Height/Altezza [mm]
	Overall Height/Altezza ingombro[mm]

BE-911	
	Diam./Diam. [mm]
	Height/Altezza [mm]
	Overall Height/Altezza ingombro[mm]

BE-917	
	Diam./Diam. [mm]
	Height/Altezza [mm]
	Overall Height/Altezza ingombro[mm]

BE-913	
	Diam./Diam. [mm]
	Height/Altezza [mm]
	Overall Height/Altezza ingombro[mm]

BE-999	
	Diam./Diam. [mm]
	Height/Altezza [mm]
	Overall Height/Altezza ingombro[mm]

BE-914	
	Diam./Diam. [mm]
	Height/Altezza [mm]
	Overall Height/Altezza ingombro[mm]

BE-H01	
	Diam./Diam. [mm]
	Height/Altezza [mm]
	Overall Height/Altezza ingombro[mm]

BE-915	
	Diam./Diam. [mm]
	Height/Altezza [mm]
	Overall Height/Altezza ingombro[mm]

BE-H02	
	Diam./Diam. [mm]
	Height/Altezza [mm]
	Overall Height/Altezza ingombro[mm]

BE-H03	
	Diam./Diam. [mm]
	70
	Height/Altezza [mm]
	30
Overall Height/Altezza ingombro[mm]	
40	
HYUNDAI - KIA	

BE-H08	
	Diam./Diam. [mm]
	57
	Height/Altezza [mm]
	26
Overall Height/Altezza ingombro[mm]	
32,8	
KIA - HYUNDAI	

BE-H04	
	Diam./Diam. [mm]
	60
	Height/Altezza [mm]
	28,5
Overall Height/Altezza ingombro[mm]	
30	
KIA - HYUNDAI	

BE-H13	
	Diam./Diam. [mm]
	66,6
	Height/Altezza [mm]
	17
Overall Height/Altezza ingombro[mm]	
40	

BE-H05	
	Diam./Diam. [mm]
	60
	Height/Altezza [mm]
	32,5
HYUNDAI - KIA	

BE-H14	
	Diam./Diam. [mm]
	60,5
	Height/Altezza [mm]
	35
HYUNDAI - MITSUBISHI	

BE-H06	
	Diam./Diam. [mm]
	60
	Height/Altezza [mm]
	35
KIA	

BE-H15	
	Diam./Diam. [mm]
	57,7
	Height/Altezza [mm]
	38,2
MITSUBISHI - HYUNDAI	

BE-H07	
	Diam./Diam. [mm]
	58
	Height/Altezza [mm]
	38,5
KIA - HYUNDAI	

BE-H16	
	Diam./Diam. [mm]
	100
	Height/Altezza [mm]
	30,6
Overall Height/Altezza ingombro[mm]	
30,6	

BE-H17	
	Diam./Diam. [mm]
	68
	Height/Altezza [mm]
	17,2
Overall Height/Altezza ingombro[mm]	30,3

BE-H26	
	Diam./Diam. [mm]
	21
	Height/Altezza [mm]
	96
Overall Height/Altezza ingombro[mm]	36,3

KIA

BE-H22	
	Diam./Diam. [mm]
	55
	Height/Altezza [mm]
	18
Overall Height/Altezza ingombro[mm]	22,5

mitsubishi - KIA - HYUNDAI

BE-H27	
	Diam./Diam. [mm]
	60
	Height/Altezza [mm]
	35
Overall Height/Altezza ingombro[mm]	59

HYUNDAI

BE-H23	
	Diam./Diam. [mm]
	60
	Height/Altezza [mm]
	32
Overall Height/Altezza ingombro[mm]	50

HYUNDAI - KIA

BE-H28	
	Diam./Diam. [mm]
	60
	Height/Altezza [mm]
	36
Overall Height/Altezza ingombro[mm]	48

HYUNDAI

BE-H24	
	Diam./Diam. [mm]
	58
	Height/Altezza [mm]
	32

KIA - HYUNDAI

BE-H29	
	Diam./Diam. [mm]
	70
	Height/Altezza [mm]
	31
Overall Height/Altezza ingombro[mm]	54

KIA - HYUNDAI

BE-H25	
	Diam./Diam. [mm]
	21
	Height/Altezza [mm]
	98
Overall Height/Altezza ingombro[mm]	36,3

HYUNDAI

BE-H30	
	Diam./Diam. [mm]
	32
	Height/Altezza [mm]
	27
Overall Height/Altezza ingombro[mm]	35,5

BE-H31	
	Diam./Diam. [mm]
	29
	Height/Altezza [mm]
	43,3
Overall Height/Altezza ingombro[mm]	
49,3	

BE-K06	
	Diam./Diam. [mm]
	52
	Height/Altezza [mm]
	28,5
Overall Height/Altezza ingombro[mm]	
33	

BE-K00	
	Diam./Diam. [mm]
	60
	Height/Altezza [mm]
	26
Overall Height/Altezza ingombro[mm]	
35	

BE-K07	
	Diam./Diam. [mm]
	60
	Height/Altezza [mm]
	26
Overall Height/Altezza ingombro[mm]	
45,7	

BE-K03	
	Diam./Diam. [mm]
	60
	Height/Altezza [mm]
	30
Overall Height/Altezza ingombro[mm]	
32	

BE-K09	
	Diam./Diam. [mm]
	60
	Height/Altezza [mm]
	34
Overall Height/Altezza ingombro[mm]	
41,5	

BE-K04	
	Diam./Diam. [mm]
	70,4
	Height/Altezza [mm]
	35,4
Overall Height/Altezza ingombro[mm]	
51,7	

BE-K14	
	Diam./Diam. [mm]
	60
	Height/Altezza [mm]
	34
Overall Height/Altezza ingombro[mm]	
39,5	

BE-K05	
	Diam./Diam. [mm]
	58
	Height/Altezza [mm]
	29
Overall Height/Altezza ingombro[mm]	
34	

BE-K16	
	Diam./Diam. [mm]
	59
	Height/Altezza [mm]
	34
Overall Height/Altezza ingombro[mm]	
41	

BE-K17	
	Diam./Diam. [mm]
	55
	Height/Altezza [mm]
	34
Overall Height/Altezza ingombro[mm]	
57	
KIA - HYUNDAI	

BE-K29	
	Outer Diam./Diam. est. [mm]
	78
	Inner Diam./Diam. int. [mm]
	15
	Height/Altezza [mm]
21	
Per Cinghia Servizi	
KIA	

BE-K18	
	Diam./Diam. [mm]
	28,5
	Height/Altezza [mm]
	34
Overall Height/Altezza ingombro[mm]	
36,5	
KIA - HYUNDAI	

BE-W00	
	Diam./Diam. [mm]
	60
	Height/Altezza [mm]
	28,7
Overall Height/Altezza ingombro[mm]	
51,5	
CHEVROLET - DAEWOO	

BE-K21	
	Diam./Diam. [mm]
	59,8
	Height/Altezza [mm]
	34
Overall Height/Altezza ingombro[mm]	
39,5	
KIA	

BE-W01	
	Diam./Diam. [mm]
	64
	Height/Altezza [mm]
	29
Overall Height/Altezza ingombro[mm]	
34,2	
DAEWOO - CHEVROLET	

BE-K22	
	Diam./Diam. [mm]
	25
	Mounting Bores Distance/Distanza fori di fissaggio [mm]
28	
KIA	

BE-W02	
	Diam./Diam. [mm]
	59
	Height/Altezza [mm]
	19
Overall Height/Altezza ingombro[mm]	
31	
DAEWOO - CHEVROLET	

BE-K26	
	Diam./Diam. [mm]
	60
	Height/Altezza [mm]
	32
Overall Height/Altezza ingombro[mm]	
49,5	
KIA	

BE-W03	
	Diam./Diam. [mm]
	72
	Height/Altezza [mm]
	22
Overall Height/Altezza ingombro[mm]	
52,2	
DAEWOO	

BE-W05	
	Diam./Diam. [mm]
	59
	Height/Altezza [mm]
	26
Overall Height/Altezza ingombro[mm]	41
W05	
CHEVROLET - DAEWOO	

BE-W12	
	Diam./Diam. [mm]
	65
Height/Altezza [mm]	26
W12	
CHEVROLET	

BE-W06	
	Diam./Diam. [mm]
	59
	Height/Altezza [mm]
	22
Overall Height/Altezza ingombro[mm]	39,4
W06	
DAEWOO - CHEVROLET	

BE-W13	
	Diam./Diam. [mm]
	61
Height/Altezza [mm]	27,5
W13	
CHEVROLET	

BE-W08	
	Diam./Diam. [mm]
	52
Height/Altezza [mm]	29,5
W08	
DAEWOO - CHEVROLET	

BE-W14	
	Diam./Diam. [mm]
	66
	Height/Altezza [mm]
	30
Overall Height/Altezza ingombro[mm]	47
W14	
CHEVROLET	

BE-W09	
	Diam./Diam. [mm]
	63
	Height/Altezza [mm]
	27
Overall Height/Altezza ingombro[mm]	29,5
W09	
CHEVROLET - DAEWOO	

BE-W11	
	Diam./Diam. [mm]
	60
	Height/Altezza [mm]
	27
Overall Height/Altezza ingombro[mm]	45
W11	
CHEVROLET	

RA-100		23151-6N200	
	Outer Diam./Diam. est. [mm]	56,5	
	Height/Altezza [mm]	35	
	Overall Height/Altezza ingombro[mm]	40	
	Inner Diam./Diam. int. [mm]	17	
NISSAN PRIMERA (P12) 2.0 [07.02-] NISSAN X-TRAIL (T30) 2.0 [07.01-]			

RA-202		274150T010	
	Diam./Diam. [mm]	62	
	Height/Altezza [mm]	39	
	Overall Height/Altezza ingombro[mm]	43	
	Inner Diam./Diam. int. [mm]	17	
TOYOTA AURIS 1.8 [02.09-] TOYOTA VERSO 1.6 [04.09-]			

RA-101		A660C300EX	
	Outer Diam./Diam. est. [mm]	61	
	Height/Altezza [mm]	37	
	Overall Height/Altezza ingombro[mm]	41	
	Inner Diam./Diam. int. [mm]	17	
NISSAN ALMERA II (N16) 1.5 dCi [01.03-] NISSAN MICRA (K12) 1.5 dCi [01.03-]			

RA-203		27415-0T020	
	Outer Diam./Diam. est. [mm]	62	
	Height/Altezza [mm]	38	
	Overall Height/Altezza ingombro[mm]	41	
	Inner Diam./Diam. int. [mm]	17	
TOYOTA AURIS 1.6 VVTi [03.07-]			

RA-102		23150-2W200	
	Outer Diam./Diam. est. [mm]	64	
	Height/Altezza [mm]	37	
	Overall Height/Altezza ingombro[mm]	40	
	Inner Diam./Diam. int. [mm]	17	
NISSAN PATROL GR II (Y61) 3.0 DTi [05.00-] NISSAN TERRANO II (R20) 3.0 Di 4WD [05.02-]			

RA-204		27415-27011	
	Outer Diam./Diam. est. [mm]	64	
	Height/Altezza [mm]	32	
	Overall Height/Altezza ingombro[mm]	37	
	Inner Diam./Diam. int. [mm]	17	
TOYOTA RAV 4 II (XA2) 2.0 D-4D 4WD [09.01-]			

RA-200			
	Outer Diam./Diam. est. [mm]	68	
	Height/Altezza [mm]	29,5	
	Overall Height/Altezza ingombro[mm]	33	
	Inner Diam./Diam. int. [mm]	17	
TOYOTA AURIS 1.4 D-4D [03.07-] TOYOTA AURIS 2.2 D [03.07-]			

RA-205		27415-30010	
	Outer Diam./Diam. est. [mm]	65	
	Height/Altezza [mm]	38	
	Overall Height/Altezza ingombro[mm]	41	
	Pitch Circle Ø/Foro int.-Ø [mm]	17	
TOYOTA LAND CRUISER (J12) 3.0 D-4D (KDJ120) [01.03-] TOYOTA LAND CRUISER (J12) 3.0 D-4D (KDJ120) [01.07-]			

RA-201			
	Outer Diam./Diam. est. [mm]	65	
	Height/Altezza [mm]	35	
	Overall Height/Altezza ingombro[mm]	38	
	Inner Diam./Diam. int. [mm]	17	
TOYOTA AURIS 2.0 D-4D [03.07-] TOYOTA RAV 4 II (XA2) 2.0 D-4D 4WD [09.01-]			

RA-300		LF1818330	
	Outer Diam./Diam. est. [mm]	59	
	Height/Altezza [mm]	33	
	Overall Height/Altezza ingombro[mm]	36,5	
	Inner Diam./Diam. int. [mm]	19	
MAZDA 6 (GG) 2.0 [06.02-]			

RA-301	GY02-11-W11A	
	Outer Diam./Diam. est. [mm]	65
	Height/Altezza [mm]	33
	Overall Height/Altezza ingombro[mm]	37
	Inner Diam./Diam. int. [mm]	17
MAZDA MPV II (LW) 2.5 V6 [09.99-03.02]		

RA-500	S30638577	
	Outer Diam./Diam. est. [mm]	53,5
	Height/Altezza [mm]	34,5
	Overall Height/Altezza ingombro[mm]	38,5
	Inner Diam./Diam. int. [mm]	17
MITSUBISHI CARISMA (DA_) 1.9 DI-D [09.00-06.06]		
NISSAN INTERSTAR dCi 150 [09.06-]		

RA-302	GY0218330	
	Outer Diam./Diam. est. [mm]	65
	Height/Altezza [mm]	33
	Overall Height/Altezza ingombro[mm]	37
	Pitch Circle Ø/Foro int.-Ø [mm]	17
MAZDA 323 F V (BA) 2.0 24V [08.94-09.98]		
MAZDA 626 IV (GE) 2.5 24V [01.92-04.97]		

RA-501	77 01 055 871	
	Outer Diam./Diam. est. [mm]	61
	Height/Altezza [mm]	35
	Overall Height/Altezza ingombro[mm]	40
	Inner Diam./Diam. int. [mm]	17
MITSUBISHI CARISMA (DA_) 1.9 DI-D [09.00-06.06]		

RA-303	RF5C-18-330	
	Outer Diam./Diam. est. [mm]	65
	Height/Altezza [mm]	35
	Overall Height/Altezza ingombro[mm]	39
	Inner Diam./Diam. int. [mm]	17
MAZDA 3 2.0 MZR-CD [12.06-]		
MAZDA 5 2.0 CD [03.05-]		

RA-502	23151-00Q0A	
	Outer Diam./Diam. est. [mm]	54
	Height/Altezza [mm]	34
	Overall Height/Altezza ingombro[mm]	38
	Inner Diam./Diam. int. [mm]	17
MITSUBISHI CARISMA (DA_) 1.9 DI-D [09.00-06.06]		
MITSUBISHI SPACE STAR (DG0) 1.9 DI-D [02.01-]		

RA-400	10 511 026	
	Outer Diam./Diam. est. [mm]	64
	Height/Altezza [mm]	35
	Overall Height/Altezza ingombro[mm]	40
	Inner Diam./Diam. int. [mm]	17
HONDA CIVIC VI (EU_, EP_) 1.7 CTDi [01.02-09.05]		

RA-800	31771-85E00-000	
	Outer Diam./Diam. est. [mm]	59
	Height/Altezza [mm]	34
	Overall Height/Altezza ingombro[mm]	38
	Pitch Circle Ø/Foro int.-Ø [mm]	20
SUZUKI IGNIS II 1.3 DDiS [09.03-]		
SUZUKI SWIFT III (SG) 1.3 DDiS [08.05-]		

RA-401	31141-RL0-G01	
	Outer Diam./Diam. est. [mm]	70
	Height/Altezza [mm]	32,7
	Overall Height/Altezza ingombro[mm]	38
	Inner Diam./Diam. int. [mm]	17
HONDA ACCORD IX 2.2 i-DTEC [07.08-]		
HONDA CR-V II 2.2 i-CTDi [01.07-]		

RA-801	77363954	
	Diam./Diam. [mm]	55
	Height/Altezza [mm]	46
	Overall Height/Altezza ingombro[mm]	51
	Pitch Circle Ø/Foro int.-Ø [mm]	20
SUZUKI IGNIS II 1.3 DDiS [09.03-]		
SUZUKI SWIFT III (SG) 1.3 DDiS [08.05-]		

RA-900		53013554AD	
	Outer Diam./Diam. est. [mm]	63	
	Height/Altezza [mm]	42	
	Overall Height/Altezza ingombro[mm]	45	
	Inner Diam./Diam. int. [mm]	17	
JEEP CHEROKEE (KJ) 2.5 CRD [09.01-] JEEP CHEROKEE (KJ) 2.8 CRD [11.04-]			

RA-905		021040-1450	
	Outer Diam./Diam. est. [mm]	63	
	Height/Altezza [mm]	41	
	Overall Height/Altezza ingombro[mm]	45	
	Inner Diam./Diam. int. [mm]	17	
JEEP CHEROKEE (KJ) 2.5 CRD [09.01-] JEEP GRAND CHEROKEE II (WJ, WG) 3.1 TD [04.99-]			

RA-901			
	Outer Diam./Diam. est. [mm]	61	
	Height/Altezza [mm]	35	
	Inner Diam./Diam. int. [mm]	17	
CHRYSLER VOYAGER III (GS) 2.5 TD [01.95-03.01]			

RA-906		K04861513AC	
	Outer Diam./Diam. est. [mm]	64	
	Height/Altezza [mm]	48	
	Overall Height/Altezza ingombro[mm]	51	
	Inner Diam./Diam. int. [mm]	17	
CHRYSLER VOYAGER IV (RG) 2.5 CRD [02.00-]			

RA-902		05019860AA	
	Outer Diam./Diam. est. [mm]	54	
	Height/Altezza [mm]	37	
	Overall Height/Altezza ingombro[mm]	41	
	Inner Diam./Diam. int. [mm]	17	
CHRYSLER VOYAGER IV (RG) 2.8 CRD [06.04-] JEEP GRAND CHEROKEE II (WJ, WG) 3.1 TD [04.99-]			

RA-H00		37322-27500	
	Outer Diam./Diam. est. [mm]	66	
	Height/Altezza [mm]	39	
	Inner Diam./Diam. int. [mm]	15	
HYUNDAI ACCENT (LC) 1.5 CRDi [04.02-] HYUNDAI GETZ (TB) 1.5 CRDi [03.03-]			

RA-903			
	Outer Diam./Diam. est. [mm]	61	
	Height/Altezza [mm]	35	
	Inner Diam./Diam. int. [mm]	17	
CHRYSLER 300 M (LR) 3.5 V6 24V [08.00-09.04]			

RA-H01		37322-27010	
	Outer Diam./Diam. est. [mm]	64	
	Height/Altezza [mm]	36	
	Inner Diam./Diam. int. [mm]	17	
HYUNDAI SANTA FÉ 2.2 CRDi 4x4 [03.06-] HYUNDAI SONATA V 2.0 CRDi [02.06-]			

RA-904		TN021040-1180	
	Outer Diam./Diam. est. [mm]	64	
	Height/Altezza [mm]	47	
	Overall Height/Altezza ingombro[mm]	51	
	Inner Diam./Diam. int. [mm]	17	
CHRYSLER VOYAGER IV (RG) 2.5 CRD [02.00-]			

RA-K00		D373224A000	
	Outer Diam./Diam. est. [mm]	74	
	Height/Altezza [mm]	31.5	
	Overall Height/Altezza ingombro[mm]	41	
	Inner Diam./Diam. int. [mm]	19	
KIA SORENTO (JC) 2.5 CRDi [08.02-]			

**FREEWHEEL CLUTCH, ALTERNATOR
GENERATORFREILAUF
POULIE ROUE LIBRE, ALTERNATEUR
RUEDA LIBRE ALTERNADOR
RUOTA LIBERA ALTERNATORE**

RA-K01		OK588 18 W11	
	Outer Diam./Diam. est. [mm]	64	
	Height/Altezza [mm]	34	
	Inner Diam./Diam. int. [mm]	17	
HYUNDAI TERRACAN (HP) 2.9 CRDi [11.03-] KIA CARNIVAL (UP) 2.9 TD [08.99-10.01]			

RA-M00		MN960267	
	Outer Diam./Diam. est. [mm]	50	
	Height/Altezza [mm]	33	
	Overall Height/Altezza ingombro[mm]	38	
	Inner Diam./Diam. int. [mm]	17	
MITSUBISHI COLT VI 1.5 DI-D [08.04-] SMART FORFOUR 1.5 CDI (454.000) [09.04-]			

RA-S00			
	Outer Diam./Diam. est. [mm]	61	
	Height/Altezza [mm]	35	
	Inner Diam./Diam. int. [mm]	17	
SSANGYONG KORANDO (KJ) 2.3 D (KJ) [12.96-] SSANGYONG MUSSO (FJ) 2.3 D [10.95-]			

RA-W00		4805492	
	Outer Diam./Diam. est. [mm]	61	
	Height/Altezza [mm]	36	
	Inner Diam./Diam. int. [mm]	17	
CHEVROLET CAPTIVA 2.0 D 4WD [10.06-] OPEL ANTARA 2.0 CDTI [03.07-]			

RP-001	
	Outer Diam./Diam. est. [mm]
	Height/Altezza [mm]
	Inner Diam./Diam. int. [mm]
	80
	26
	17
HUMMER HUMMER H2 SUT 6.0 [09.04-] HUMMER HUMMER H2 6.0 4WD [09.02-09.04]	

RP-006	701070006
	Diam./Diam. [mm]
	Height/Altezza [mm]
	Overall Height/Altezza ingombro[mm]
	Inner Diam./Diam. int. [mm]
	80
	25
	28
	10
DR DR 5 1.9 D[01.11-]	

RP-002	
	Diam./Diam. [mm]
	Height/Altezza [mm]
	Overall Height/Altezza ingombro[mm]
	70
	21
	27
LADA NIVA (2121) 1900 Diesel [01.93-]	

RP-100	11925-VC801
	Outer Diam./Diam. est. [mm]
	Height/Altezza [mm]
	Overall Height/Altezza ingombro[mm]
	84
	19
	35
NISSAN NAVARA 2.5 dCi 4WD [07.05-] NISSAN PATHFINDER 2.5 dCi 4WD [10.06-]	

RP-003	
	Diam./Diam. [mm]
	Height/Altezza [mm]
	Overall Height/Altezza ingombro[mm]
	70
	24
	27
LADA NIVA (2121) 1900 Diesel [01.93-]	

RP-101	11925-4W000
	Outer Diam./Diam. est. [mm]
	Height/Altezza [mm]
	84
	23
NISSAN 350 Z 3.5 [10.03-] NISSAN PATHFINDER (R50) 3.3 V6 4WD [09.97-12.04]	

RP-004	
	Diam./Diam. [mm]
	Height/Altezza [mm]
	Overall Height/Altezza ingombro[mm]
	70
	24
	28
LADA NIVA (2121) 1900 Diesel [01.93-]	

RP-102	11925-2M300
	Outer Diam./Diam. est. [mm]
	Height/Altezza [mm]
	85
	22
NISSAN SUNNY III (N14) 1.6 i 16V 4x4 [10.92-05.95] NISSAN SUNNY III Traveller (Y10) 1.6 16V 4x4 [11.90-05.95]	

RP-005	
	Diam./Diam. [mm]
	Height/Altezza [mm]
	Overall Height/Altezza ingombro[mm]
	Pitch Circle Ø/Foro int.-Ø [mm]
	70
	29
	34
	17
TATA (TELCO) SAFARI 2.2 TDiC 4WD [07.06-] TATA (TELCO) SAFARI 2.2 TDiC [07.06-]	

RP-103	11925-43G02
	Diam./Diam. [mm]
	Height/Altezza [mm]
	Overall Height/Altezza ingombro[mm]
	80
	18
	27
NISSAN TERRANO II (R20) 2.7 TD 4WD [02.93-01.02] NISSAN TERRANO II (R20) 2.7 TDi 4WD [05.96-]	

RP-104		11925-AX011	
	Outer Diam./Diam. est. [mm]	84.5	
	Height/Altezza [mm]	22	
NISSAN MICRA (K12) 1.0 16V [01.03-] NISSAN NOTE 1.4 [03.06-]			

RP-109		11925-77A10	
	Diam./Diam. [mm]	85	
	Height/Altezza [mm]	20	
	Overall Height/Altezza ingombro[mm]	39	
NISSAN BLUEBIRD (U11) 1.8 Turbo [04.84-05.90] NISSAN SUNNY II (N13) 1.8 GTI 16V [01.89-06.91]			

RP-105		11925-00QAE	
	Diam./Diam. [mm]	60	
	Height/Altezza [mm]	31	
	Pitch Circle Ø/Foro int.-Ø [mm]	17	
NISSAN KUBISTAR 1.5 dCi 70 [04.06-] NISSAN MICRA (K12) 1.5 dCi [06.05-]			

RP-110			
	Diam./Diam. [mm]	86	
	Height/Altezza [mm]	22	
	Pitch Circle Ø/Foro int.-Ø [mm]	12	
MITSUBISHI ECLIPSE I (D2_A) 2.0 i 16V (D22A) [04.91-11.95] MITSUBISHI SPACE WAGON (D0_V/W) 2.0 GLXi (D04W) [06.88-04.91]			

RP-106			
	Diam./Diam. [mm]	64	
	Height/Altezza [mm]	19	
	Overall Height/Altezza ingombro[mm]	38	
NISSAN MICRA (K10) 1.0 [12.82-05.89] NISSAN MICRA (K10) 1.2 [07.86-07.92]			

RP-111			
	Diam./Diam. [mm]	120	
	Height/Altezza [mm]	20	
	Pitch Circle Ø/Foro int.-Ø [mm]	20	
NISSAN ALMERA I (N15) 2.0 D [11.95-03.00] NISSAN SERENA (C23M) 2.3 D [01.95-]			

RP-107			
	Diam./Diam. [mm]	93	
	Height/Altezza [mm]	22.5	
	Overall Height/Altezza ingombro[mm]	37	
NISSAN TERRANO I (WD21) 3.0 i 4WD [01.90-12.95]			

RP-112			
	Diam./Diam. [mm]	65	
	Height/Altezza [mm]	26	
	Pitch Circle Ø/Foro int.-Ø [mm]	17	
MAZDA 2 1.4 MZR-CD [01.08-] NISSAN INTERSTAR dCi 120 [07.02-]			

RP-108			
	Diam./Diam. [mm]	85	
	Height/Altezza [mm]	27	
NISSAN PICK UP/KING CAB (D21) 3.0 i V6 4WD [09.90-02.98] NISSAN TERRANO I (WD21) 3.0 i 4WD [01.90-12.95]			

RP-113			
	Diam./Diam. [mm]	80	
	Height/Altezza [mm]	26	
	Pitch Circle Ø/Foro int.-Ø [mm]	20	
NISSAN PATROL GR I (Y60) 2.8 TD (Y60A) [09.88-06.97] NISSAN PATROL GR II (Y61) 2.8 TD [06.97-05.00]			

RP-114		11925-77A12	
	Diam./Diam. [mm]	85	
	Height/Altezza [mm]	23	
	Pitch Circle Ø/Foro int.-Ø [mm]	12	
NISSAN ALMERA I (N15) 1.6 SR,SLX [09.95-03.00] NISSAN PRIMERA (P11) 1.6 16V [09.96-12.01]			

RP-119		11923-BN700	
	Diam./Diam. [mm]	132	
	Height/Altezza [mm]	27	
	Overall Height/Altezza ingombro[mm]	104	
NISSAN ALMERA II (N16) 1.5 dCi [01.03-] NISSAN MICRA (K12) 1.5 dCi [01.03-]			

RP-115			
	Diam./Diam. [mm]	66	
	Height/Altezza [mm]	26	
	Pitch Circle Ø/Foro int.-Ø [mm]	17	
NISSAN KUBISTAR 1.5 dCi 85 [04.06-] NISSAN MICRA (K12) 1.5 dCi [01.03-]			

RP-120		11925-00QAF	
	Diam./Diam. [mm]	60	
	Height/Altezza [mm]	25,5	
	Pitch Circle Ø/Foro int.-Ø [mm]	17	
NISSAN INTERSTAR dCi 90 [07.02-] NISSAN KUBISTAR 1.6 16V [08.03-]			

RP-116		11925-41B10	
	Diam./Diam. [mm]	84	
	Height/Altezza [mm]	24	
	Pitch Circle Ø/Foro int.-Ø [mm]	12	
NISSAN 300 ZX (Z31) 3.0 Turbo [05.87-10.90] NISSAN MICRA (K10) 1.2 [07.86-07.92]			

RP-121		23150-7F001	
	Diam./Diam. [mm]	80	
	Height/Altezza [mm]	18	
NISSAN TERRANO II (R20) 2.7 TDi 4WD [05.96-]			

RP-117			
	Diam./Diam. [mm]	85	
	Height/Altezza [mm]	31	
	Pitch Circle Ø/Foro int.-Ø [mm]	17	
NISSAN PATROL GR II (Y61) 3.0 DTi [05.00-] NISSAN TERRANO II (R20) 3.0 Di 4WD [05.02-]			

RP-122			
	Diam./Diam. [mm]	85	
	Height/Altezza [mm]	23	
	Pitch Circle Ø/Foro int.-Ø [mm]	17	
NISSAN BLUEBIRD (T72, T12) 1.6 [03.86-06.90] NISSAN SUNNY II (N13) 1.8 GTI 16V [01.89-06.91]			

RP-118		77 00 313 302	
	Diam./Diam. [mm]	125	
	Height/Altezza [mm]	26	
	Pitch Circle Ø/Foro int.-Ø [mm]	10	
NISSAN INTERSTAR dCi 90 [07.02-]			

RP-123			
	Diam./Diam. [mm]	85	
	Height/Altezza [mm]	22	
	Pitch Circle Ø/Foro int.-Ø [mm]	17	
NISSAN BLUEBIRD (T72, T12) 1.6 [03.86-06.90] NISSAN SUNNY II Coupe (B12) 1.6 GTI 16V [05.87-05.89]			

RP-124	
	Diam./Diam. [mm]
	75
	Height/Altezza [mm]
14	
Pitch Circle Ø/Foro int.-Ø [mm]	
12	

NISSAN ALMERA I (N15) 2.0 D [11.95-03.00]
 NISSAN SUNNY I (B11) 1.7 D [03.82-10.86]

RP-203		16603-27010
	Outer Diam./Diam. est. [mm]	90
	Height/Altezza [mm]	21

TOYOTA RAV 4 II (XA2) 2.0 D-4D 4WD [09.01-]

RP-125	
	Diam./Diam. [mm]
	84
	Height/Altezza [mm]
19	
Pitch Circle Ø/Foro int.-Ø [mm]	
12	

NISSAN MICRA (K10) 1.0 [12.82-05.89]
 NISSAN MICRA (K10) 1.2 [07.86-07.92]

RP-204		16604-50010
	Outer Diam./Diam. est. [mm]	75
	Height/Altezza [mm]	30
	Pitch Circle Ø/Foro int.-Ø [mm]	12

LEXUS GS (JZS160) 400 [12.97-11.00]
 LEXUS LS (UCF10) 400 [12.89-12.94]

RP-200	
	Outer Diam./Diam. est. [mm]
	79
	Height/Altezza [mm]
28.5	

TOYOTA AURIS 2.0 D-4D [03.07-]
 TOYOTA AURIS 2.2 D [03.07-]

RP-205	
	Outer Diam./Diam. est. [mm]
	70
	Height/Altezza [mm]
32	
Pitch Circle Ø/Foro int.-Ø [mm]	
17	

TOYOTA AVENSIS (T25) 1.6 VVT-i [04.03-]
 TOYOTA COROLLA (_E12U_) 1.4 VVT-i [01.02-]

RP-201	
	Diam./Diam. [mm]
	70
	Height/Altezza [mm]
28	
Inner Diam./Diam. int. [mm]	
17	

TOYOTA AURIS 2.0 D-4D [03.07-]
 TOYOTA AURIS 2.2 D [03.07-]

RP-206	
	Outer Diam./Diam. est. [mm]
	70
	Height/Altezza [mm]
29	
Pitch Circle Ø/Foro int.-Ø [mm]	
17	

TOYOTA YARIS (_CP10) 1.4 D-4D [12.01-]

RP-202		16604-23020
	Outer Diam./Diam. est. [mm]	85
	Height/Altezza [mm]	21
	Overall Height/Altezza ingombro[mm]	25
	Pitch Circle Ø/Foro int.-Ø [mm]	10

TOYOTA YARIS (_CP10) 1.0 16V (SCP10_) [04.99-]
 TOYOTA YARIS VERSO (NC/LP2_) 1.3 (NCP22) [01.03-]

RP-207	
	Diam./Diam. [mm]
	74
	Height/Altezza [mm]
19	
Overall Height/Altezza ingombro[mm]	
42	

TOYOTA HIACE III (_H10_) 2.4 D 4WD [08.89-08.95]
 TOYOTA HILUX Pick-up (_N_) 2.2 D 2WD/ 4WD [01.79-12.95]

RP-208		
	Diam./Diam. [mm]	75
	Height/Altezza [mm]	21
	Pitch Circle Ø/Foro int.-Ø [mm]	17
TOYOTA AVENSIS (_T22_) 1.6 (AT220_) [09.97-10.00] TOYOTA COROLLA (_E11_) 1.6 (AE111_) [04.97-02.00]		

RP-213		88440-52020
	Diam./Diam. [mm]	84
	Height/Altezza [mm]	27
	Pitch Circle Ø/Foro int.-Ø [mm]	17
TOYOTA AYGO 1.0 [07.05-] TOYOTA YARIS (_CP10) 1.0 16V (SCP10_) [04.99-]		

RP-209		
	Diam./Diam. [mm]	75
	Height/Altezza [mm]	20
	Pitch Circle Ø/Foro int.-Ø [mm]	17
TOYOTA AVENSIS (_T22_) 1.6 (AT220_) [09.97-10.00] TOYOTA COROLLA (_E10_) 1.6 Si (AE101_) [09.95-04.97]		

RP-214		88440-12170
	Diam./Diam. [mm]	75
	Height/Altezza [mm]	23
TOYOTA COROLLA (_E10_) 2.0 D (CE100_) [07.92-04.97] TOYOTA COROLLA (_E10_) 1.3 12V (EE100_) [07.92-04.97]		

RP-210		
	Diam./Diam. [mm]	75
	Height/Altezza [mm]	20
TOYOTA AVENSIS (_T22_) 1.6 (AT220_) [09.97-10.00]		

RP-215		88440-17010
	Diam./Diam. [mm]	75
	Height/Altezza [mm]	20
TOYOTA CARINA E (_T19_) 1.6 (AT190_) [12.93-09.97] TOYOTA COROLLA (_E10_) 1.6 Si (AE101_) [09.95-04.97]		

RP-211		
	Diam./Diam. [mm]	70
	Height/Altezza [mm]	26
	Pitch Circle Ø/Foro int.-Ø [mm]	17
TOYOTA 4 RUNNER 3.0 Turbo-D [11.95-]		

RP-216		88440-12190
	Diam./Diam. [mm]	90
	Height/Altezza [mm]	20
TOYOTA COROLLA (_E10_) 2.0 D (CE100_) [07.92-04.97] TOYOTA COROLLA Compact (_E10_) 2.0 D (CE100_) [07.92-04.97]		

RP-212		8844026070
	Diam./Diam. [mm]	82
	Height/Altezza [mm]	20
	Pitch Circle Ø/Foro int.-Ø [mm]	12
TOYOTA 4 RUNNER (_N130) 2.4 TD 4x4 [08.89-11.95] TOYOTA CARINA E (_T19_) 2.0 GTi (ST191) [04.92-02.94]		

RP-217		88440-52010
	Diam./Diam. [mm]	88
	Height/Altezza [mm]	25
TOYOTA AYGO 1.0 [07.05-] TOYOTA YARIS (_CP10) 1.3 16V (NCP10_) [11.99-]		

RP-218		16604-31010	
	Inner Diam./Diam. int. [mm]	10	
	Outer Diam./Diam. est. [mm]	70	
	Height/Altezza [mm]	32	
LEXUS GS 3.0 [04.05-] TOYOTA CAMRY (_V30) 3.5 VVTi XLE [01.06-]			

RP-304			
	Diam./Diam. [mm]	70	
	Height/Altezza [mm]	27	
	Pitch Circle Ø/Foro int.-Ø [mm]	17	
KIA SPORTAGE (K00) 2.0 i 16V 4WD [04.94-08.03] MAZDA MX-3 (EC) 1.6 i [07.91-]			

RP-218		16604-31010	
	Inner Diam./Diam. int. [mm]	10	
	Outer Diam./Diam. est. [mm]	70	
	Height/Altezza [mm]	32	
LEXUS GS 3.0 [04.05-] TOYOTA CAMRY (_V30) 3.5 VVTi XLE [01.06-]			

RP-305			
	Diam./Diam. [mm]	77	
	Height/Altezza [mm]	26	
	Pitch Circle Ø/Foro int.-Ø [mm]	17	
MAZDA 121 I (DA) 1.3 [04.89-10.90] MAZDA MX-3 (EC) 1.6 i [07.91-]			

RP-301		L32715940A	
	Outer Diam./Diam. est. [mm]	70	
	Height/Altezza [mm]	25	
	Pitch Circle Ø/Foro int.-Ø [mm]	8	
MAZDA MX-5 III (NC) 1.8 [03.05-] MAZDA MX-5 III (NC) 2.0 [03.05-]			

RP-306			
	Diam./Diam. [mm]	78	
	Height/Altezza [mm]	20	
	Pitch Circle Ø/Foro int.-Ø [mm]	15	
MAZDA MX-3 (EC) 1.6 i [01.94-] MAZDA XEDOS 6 (CA) 1.6 16V [08.92-05.94]			

RP-302			
	Outer Diam./Diam. est. [mm]	55	
	Height/Altezza [mm]	26	
	Pitch Circle Ø/Foro int.-Ø [mm]	17	
MAZDA 2 1.4 CD [04.03-]			

RP-307			
	Diam./Diam. [mm]	86	
	Height/Altezza [mm]	22	
	Overall Height/Altezza ingombro[mm]	49	
MAZDA MX-3 (EC) 1.6 i [01.94-] MAZDA XEDOS 9 (TA) 2.0 [08.98-08.00]			

RP-303		Y401-15-930	
	Diam./Diam. [mm]	51	
	Height/Altezza [mm]	26	
	Overall Height/Altezza ingombro[mm]	47	
MAZDA 2 1.4 CD [04.03-] MAZDA 2 1.4 MZR-CD [01.08-]			

RP-308			
	Diam./Diam. [mm]	73	
	Height/Altezza [mm]	29	
	Pitch Circle Ø/Foro int.-Ø [mm]	17	
MAZDA 5 1.8 [03.05-] MAZDA 6 (GG) 2.0 [06.02-]			

RP-309		
	Diam./Diam. [mm]	85
	Height/Altezza [mm]	27
	Overall Height/Altezza ingombro[mm]	31
MAZDA 929 I (LA) 1.8 [01.74-12.81] MAZDA 929 I (LA) 2.0 [05.79-07.86]		

RP-314		
	Diam./Diam. [mm]	71
	Height/Altezza [mm]	36
	Pitch Circle Ø/Foro int.-Ø [mm]	17
MAZDA 5 2.0 CD [06.05-] MAZDA 6 (GG) 2.0 DI [06.05-]		

RP-310		
	Diam./Diam. [mm]	60
	Height/Altezza [mm]	22
	Pitch Circle Ø/Foro int.-Ø [mm]	17
MAZDA 121 III (JASM, JBSM) 1.8 D [03.96-]		

RP-315		
	Diam./Diam. [mm]	74
	Height/Altezza [mm]	22
	Pitch Circle Ø/Foro int.-Ø [mm]	17
MAZDA 121 III (JASM, JBSM) 1.8 D [03.96-]		

RP-311		928F19A216AA	
	Diam./Diam. [mm]	70	
	Height/Altezza [mm]	25	
MAZDA 121 III (JASM, JBSM) 1.25 [03.96-] MAZDA 2 1.6 [04.03-]			

RP-316		Y602-15-940	
	Diam./Diam. [mm]	60	
	Height/Altezza [mm]	31	
	Overall Height/Altezza ingombro[mm]	46	
CITROEN C1 1.4 HDi [06.05-] TOYOTA AYGO 1.4 HDi [07.05-]			

RP-312		
	Diam./Diam. [mm]	73
	Height/Altezza [mm]	25
	Pitch Circle Ø/Foro int.-Ø [mm]	17
MAZDA 2 1.6 [04.03-]		

RP-317		
	Diam./Diam. [mm]	90
	Height/Altezza [mm]	22
	Overall Height/Altezza ingombro[mm]	50
MAZDA 929 III (HC) 3.0 [01.88-12.89] MAZDA 929 III (HC) 3.0 [01.90-06.91]		

RP-313		
	Diam./Diam. [mm]	71
	Height/Altezza [mm]	35
	Pitch Circle Ø/Foro int.-Ø [mm]	17
MAZDA 5 2.0 CD [03.05-] MAZDA 6 2.0 CD [04.08-]		

RP-318		L327-15-940B	
	Diam./Diam. [mm]	75	
	Height/Altezza [mm]	27	
MAZDA MX-5 III (NC) 1.8 [03.05-] MAZDA MX-5 III (NC) 2.0 [03.05-]			

RP-319		B366-15-940	
	Diam./Diam. [mm]	75	
	Height/Altezza [mm]	22	
	Pitch Circle Ø/Foro int.-Ø [mm]	15	
MAZDA 323 F IV (BG) 1.8 4WD [01.91-04.94] MAZDA 323 IV C (BG) 1.6 [09.89-06.91]			

RP-324			
	Diam./Diam. [mm]	82	
	Height/Altezza [mm]	31	
	Pitch Circle Ø/Foro int.-Ø [mm]	17	
MAZDA 929 III (HC) 3.0 [01.88-12.89] MAZDA 929 III (HC) 3.0 [01.90-06.91]			

RP-320		F201-15-940A	
	Diam./Diam. [mm]	80	
	Height/Altezza [mm]	26	
	Pitch Circle Ø/Foro int.-Ø [mm]	17	
MAZDA 626 IV (GE) 2.5 24V [01.92-04.97] MAZDA MX-6 (GE6) 2.5 24V [02.92-]			

RP-400			
	Diam./Diam. [mm]	75	
	Height/Altezza [mm]	21	
	Pitch Circle Ø/Foro int.-Ø [mm]	17	
HONDA LOGO (GA3) 1.3 [03.99-03.02] HONDA SHUTTLE (RA) 2.2 16V [10.94-02.98]			

RP-321			
	Diam./Diam. [mm]	103	
	Height/Altezza [mm]	28	
	Pitch Circle Ø/Foro int.-Ø [mm]	17	
MAZDA 121 III (JASM, JBSM) 1.25 [03.96-] MAZDA 2 1.4 [04.03-]			

RP-401		38940-PLZ-D00	
	Diam./Diam. [mm]	76	
	Height/Altezza [mm]	26	
	Overall Height/Altezza ingombro [mm]	29	
HONDA CIVIC VI (EU_, EP_) 1.7 CTDi [01.02-09.05]			

RP-322		ZJ01-15-940	
	Diam./Diam. [mm]	73	
	Height/Altezza [mm]	28	
	Pitch Circle Ø/Foro int.-Ø [mm]	17	
MAZDA 2 1.3 [10.07-] MAZDA 3 1.6 [10.03-]			

RP-402		38942-P01-003	
	Diam./Diam. [mm]	76	
	Height/Altezza [mm]	18	
	Pitch Circle Ø/Foro int.-Ø [mm]	17	
HONDA ACCORD VII (CG) 1.6 i [10.98-12.02] HONDA CIVIC IV (EG) 1.5 i 16V [10.91-11.95]			

RP-323			
	Diam./Diam. [mm]	79	
	Height/Altezza [mm]	15	
	Pitch Circle Ø/Foro int.-Ø [mm]	17	
MAZDA 121 I (DA) 1.3 [04.89-10.90] MAZDA 121 II (DB) 1.3 16V [11.90-03.96]			

RP-403		31190-RNA-003	
	Diam./Diam. [mm]	80	
	Height/Altezza [mm]	28	
	Pitch Circle Ø/Foro int.-Ø [mm]	17	
HONDA CIVIC VII 1.8 [01.06-] HONDA CR-V II 2.0 i-VTEC [01.07-]			

RP-404		38942-PM3-000	
	Diam./Diam. [mm]	76	
	Height/Altezza [mm]	17	
	Pitch Circle Ø/Foro int.-Ø [mm]	17	
HONDA CIVIC III (EC, ED, EE) 1.5 i 16V (ED6) [10.88-09.91] HONDA CIVIC III (ED) 1.6 i 16V (ED4) [10.87-09.91]			

RP-500			
	Diam./Diam. [mm]	50	
	Height/Altezza [mm]	26	
MITSUBISHI CARISMA (DA_) 1.9 TD [10.96-09.00]			

RP-405		56980-RSR-E01	
	Diam./Diam. [mm]	75	
	Height/Altezza [mm]	30	
	Pitch Circle Ø/Foro int.-Ø [mm]	17	
HONDA CIVIC VII 2.2 CTDi [01.06-]			

RP-501			
	Diam./Diam. [mm]	82	
	Height/Altezza [mm]	18	
	Overall Height/Altezza ingombro[mm]	36	
MITSUBISHI CARISMA Tre volumi (DA_) 2.0 16V GT EVO VI/VII [11.99-06.06] MITSUBISHI L 200 (K_T) 2.0 (K62T) [06.96-]			

RP-406		38942-PHM-004	
	Diam./Diam. [mm]	80	
	Height/Altezza [mm]	26	
	Pitch Circle Ø/Foro int.-Ø [mm]	17	
HONDA JAZZ (GD) 1.2 [03.02-] HONDA JAZZ (GD) 1.4 [03.02-]			

RP-502			
	Diam./Diam. [mm]	70	
	Height/Altezza [mm]	18	
	Pitch Circle Ø/Foro int.-Ø [mm]	12	
MITSUBISHI ECLIPSE I (D2_A) 2.0 i 16V 4x4 [04.91-11.95] MITSUBISHI L 200 (K_T) 2.0 (K62T) [06.96-]			

RP-407			
	Diam./Diam. [mm]	76	
	Height/Altezza [mm]	33	
	Pitch Circle Ø/Foro int.-Ø [mm]	17	
HONDA ACCORD VIII 2.0 (CL7) [02.03-] HONDA CR-V II 2.4 Vtec [03.02-09.06]			

RP-503		MD308882	
	Diam./Diam. [mm]	90	
	Height/Altezza [mm]	30	
	Overall Height/Altezza ingombro[mm]	46	
MITSUBISHI CARISMA (DA_) 1.6 [07.95-06.06] MITSUBISHI COLT II (C1_A) 1.6 Turbo ECi (C13A) [07.86-04.88]			

RP-408			
	Diam./Diam. [mm]	74	
	Height/Altezza [mm]	14	
	Pitch Circle Ø/Foro int.-Ø [mm]	15	
HONDA LOGO (GA3) 1.3 [03.99-03.02]			

RP-504		MW30621270	
	Diam./Diam. [mm]	50	
	Height/Altezza [mm]	26	
	Pitch Circle Ø/Foro int.-Ø [mm]	8	
MITSUBISHI CARISMA (DA_) 1.9 TD [10.96-09.00]			

RP-505		
	Diam./Diam. [mm]	86
	Height/Altezza [mm]	22
	Pitch Circle Ø/Foro int.-Ø [mm]	17
MITSUBISHI CARISMA (DA_) 1.6 [05.97-06.06] MITSUBISHI COLT IV (CA_A) 1.6 GLXi 16V (CA4A) [04.92-04.96]		

RP-510		
	Diam./Diam. [mm]	93
	Height/Altezza [mm]	23
MITSUBISHI L 200 (K_T) 2.5 D (K64T) [06.96-] MITSUBISHI PAJERO III (V60) 2.5 TDi (V64W, V74W) [09.01-]		

RP-506		
	Diam./Diam. [mm]	88
	Height/Altezza [mm]	21
	Overall Height/Altezza ingombro[mm]	40
	MITSUBISHI CARISMA (DA_) 1.6 [07.95-06.06] MITSUBISHI GALANT I (A12_) 1.6 [01.77-08.80]	

RP-511		
	Diam./Diam. [mm]	65
	Height/Altezza [mm]	30
	Pitch Circle Ø/Foro int.-Ø [mm]	17
MITSUBISHI CARISMA Tre volumi (DA_) 1.9 DI-D [09.00-06.06] MITSUBISHI SPACE STAR (DG0) 1.9 DI-D [02.01-]		

RP-507		
	Diam./Diam. [mm]	80
	Height/Altezza [mm]	20
	Overall Height/Altezza ingombro[mm]	41
	MITSUBISHI SPACE RUNNER (N1_W, N2_W) 1.8 (N11W) [06.96-08.99] MITSUBISHI SPACE WAGON (N3_W, N4_W) 1.8 (N31W) [10.91-10.98]	

RP-513		MD374877
	Diam./Diam. [mm]	90
	Height/Altezza [mm]	30
	Pitch Circle Ø/Foro int.-Ø [mm]	10
MITSUBISHI LANCER Station wagon 2.0 [09.03-] MITSUBISHI OUTLANDER 2.0 [05.03-]		

RP-508		
	Diam./Diam. [mm]	90
	Height/Altezza [mm]	25
	Overall Height/Altezza ingombro[mm]	40
MITSUBISHI SPACE RUNNER (N1_W, N2_W) 1.8 (N11W) [10.91-08.99] MITSUBISHI SPACE STAR (DG0) 1.3 16V [12.98-]		

RP-514		
	Diam./Diam. [mm]	65
	Height/Altezza [mm]	22
	Pitch Circle Ø/Foro int.-Ø [mm]	17
MITSUBISHI COLT VI 1.1 [10.04-] SMART FORFOUR 1.3 (454.031) [01.04-]		

RP-509		
	Diam./Diam. [mm]	110
	Height/Altezza [mm]	33
	Overall Height/Altezza ingombro[mm]	57
MITSUBISHI COLT I (A15_A) 1.2 GL (A151A) [12.78-01.84] MITSUBISHI GALANT I (A12_) 1.6 [01.77-08.80]		

RP-515		
	Diam./Diam. [mm]	86
	Height/Altezza [mm]	21.5
	Pitch Circle Ø/Foro int.-Ø [mm]	15
MITSUBISHI GALANT I (A12_) 1.6 [01.77-08.80] MITSUBISHI LANCER I (A17_) 1.2 (A171) [01.80-12.81]		

RP-516	
	Diam./Diam. [mm]
	80
	Height/Altezza [mm]
	20
HYUNDAI GALLOPER II (JK-01) 3.0 V6 [08.98-] MITSUBISHI PAJERO II (V2_W, V4_W) 3.0 V6 24V [06.94-05.97]	

RP-521		5751.F7	
	Diam./Diam. [mm]		70
	Height/Altezza [mm]		26
	Pitch Circle Ø/Foro int.-Ø [mm]		10
MITSUBISHI OUTLANDER 2.2 DI-D [08.07-] PEUGEOT 4007 2.2 HDi [02.07-]			

RP-517		MD318872	
	Diam./Diam. [mm]		90
	Height/Altezza [mm]		19
MITSUBISHI GALANT VI (EA_) 2.0 (EA2A) [09.96-09.00] MITSUBISHI SPACE WAGON (N5_W) 2.0 GDI [04.02-]			

RP-522			
	Diam./Diam. [mm]		66
	Height/Altezza [mm]		26
	Pitch Circle Ø/Foro int.-Ø [mm]		17
MITSUBISHI OUTLANDER 2.2 DI-D [08.07-] PEUGEOT 4007 2.2 HDi [02.07-]			

RP-518		MB918552	
	Diam./Diam. [mm]		83
	Height/Altezza [mm]		19
MITSUBISHI PAJERO III (V60) 3.2 DI-D (V68W, V78W) [04.00-10.01] MITSUBISHI PAJERO III (V60) 3.2 DI-D (V68W, V78W) [10.01-]			

RP-523			
	Diam./Diam. [mm]		71
	Height/Altezza [mm]		17
	Pitch Circle Ø/Foro int.-Ø [mm]		12
MITSUBISHI CARISMA (DA_) 1.8 16V [07.95-06.06] MITSUBISHI COLT III (C5_A) 1.8 GTi 16V (C58A) Cat. [06.90-05.92]			

RP-519			
	Diam./Diam. [mm]		80
	Height/Altezza [mm]		29
	Pitch Circle Ø/Foro int.-Ø [mm]		17
MITSUBISHI OUTLANDER 2.0 4WD [05.03-] MITSUBISHI OUTLANDER 2.4 4WD [11.03-]			



RP-600		16603-97401	
	Outer Diam./Diam. est. [mm]		88
	Height/Altezza [mm]		21
	Inner Diam./Diam. int. [mm]		10
DAIHATSU MATERIA 1.3 [10.06-] DAIHATSU TERIOS (J1) 1.3 DVVT Turbo 4WD [10.02-10.05]			



RP-520			
	Diam./Diam. [mm]		80
	Height/Altezza [mm]		30
	Pitch Circle Ø/Foro int.-Ø [mm]		17
MITSUBISHI L 200 (K_T) 2.5 DI-D [11.05-] MITSUBISHI L 200 2.5 DiD [RWD] [11.05-]			

RP-601			
	Diam./Diam. [mm]		84
	Height/Altezza [mm]		20
	Overall Height/Altezza ingombro [mm]		40
DAIHATSU SIRION (M1) 1.0 i 4WD [04.99-09.00] DAIHATSU SIRION (M1) 1.0 i [09.00-01.05]			

RP-602		16603-23021	
	Diam./Diam. [mm]	82	
	Height/Altezza [mm]	20	
	Pitch Circle Ø/Foro int.-Ø [mm]	17	
DAIHATSU SIRION (M1) 1.0 i 4WD [04.99-09.00]		DAIHATSU TERIOS (J1) 1.5 4WD [05.06-] DAIHATSU TERIOS 1.5 [11.05-]	

RP-603		13505-87703	
	Diam./Diam. [mm]	50	
	Height/Altezza [mm]	23	
	Overall Height/Altezza ingombro[mm]	28	
DAIHATSU CHARADE III (G100, G101, G102) 1.0 D (G101) [03.87-12.92] DAIHATSU CHARADE III (G100, G101, G102) 1.0 TD (G101) [03.87-12.92]		SUBARU IMPREZA (GC) 1.6 i [08.92-12.00] SUBARU LEGACY I (BC) 1.6 [05.89-12.93]	

RP-604		49160-65D40	
	Diam./Diam. [mm]	83	
	Height/Altezza [mm]	20	
DAIHATSU YRV (M2) 1.0 [02.01-] DAIHATSU YRV (M2) 1.3 [02.01-]		SUZUKI GRAND VITARA (FT, GT) 2.0 HDI 110 [07.01-]	

RP-605		49160-70AA0	
	Diam./Diam. [mm]	84	
	Height/Altezza [mm]	20	
	Pitch Circle Ø/Foro int.-Ø [mm]	17	
DAIHATSU YRV (M2) 1.0 [02.01-] DAIHATSU YRV (M2) 1.3 [02.01-]		SUZUKI SPLASH 1.3 CDTI [01.08-] SUZUKI SWIFT III (SG) 1.3 DDiS [08.05-]	

RP-606		49160-70AA0	
	Diam./Diam. [mm]	88	
	Height/Altezza [mm]	18	
	Pitch Circle Ø/Foro int.-Ø [mm]	10	
DAIHATSU COPEN 1.3 [03.06-]		SUZUKI IGNIS II 1.5 [09.03-] SUZUKI SWIFT III (SG) 1.6 [05.06-]	

RP-803			
	Diam./Diam. [mm]	66	
	Height/Altezza [mm]	20	
	Overall Height/Altezza ingombro[mm]	22	
	Pitch Circle Ø/Foro int.-Ø [mm]	17	
SUZUKI VITARA (ET, TA) 1.6 (ET) [07.88-12.91]			
SUZUKI VITARA (ET, TA) 2.0 16V (ET) [12.96-03.98]			

RP-808		55190812	
	Diam./Diam. [mm]	71	
	Height/Altezza [mm]	26	
SUZUKI SX4 1.9 DDiS 4x4 [06.06-]			
SUZUKI SX4 1.9 DDiS [06.06-]			

RP-804			
	Diam./Diam. [mm]	85	
	Height/Altezza [mm]	22	
	Pitch Circle Ø/Foro int.-Ø [mm]	17	
SUZUKI ALTO I (SS80) 0.8 (SS80F, SS80G) [06.82-12.85]			
SUZUKI IGNIS (FH) 1.3 [10.00-09.03]			

RP-809		55190811	
	Diam./Diam. [mm]	70	
	Height/Altezza [mm]	26	
SUZUKI SX4 1.9 DDiS 4x4 [06.06-]			
SUZUKI SX4 1.9 DDiS [06.06-]			

RP-805			
	Diam./Diam. [mm]	72	
	Height/Altezza [mm]	20	
	Overall Height/Altezza ingombro[mm]	22	
SUZUKI GRAND VITARA (FT, GT) 1.6 [03.98-]			

RP-810			
	Diam./Diam. [mm]	75	
	Height/Altezza [mm]	21	
	Pitch Circle Ø/Foro int.-Ø [mm]	10	
SUZUKI SPLASH 1.0 [01.08-]			
SUZUKI SPLASH 1.2 [01.08-]			

RP-806			
	Outer Diam./Diam. est. [mm]	66	
	Height/Altezza [mm]	26	
	Pitch Circle Ø/Foro int.-Ø [mm]	17	
SUZUKI IGNIS II 1.3 DDiS [09.03-]			
SUZUKI SWIFT III (SG) 1.3 DDiS [08.05-]			

RP-811			
	Diam./Diam. [mm]	90	
	Height/Altezza [mm]	24	
	Pitch Circle Ø/Foro int.-Ø [mm]	17	
SUZUKI GRAND VITARA (FT, GT) 2.0 [03.98-]			
SUZUKI GRAND VITARA (FT, GT) 2.5 V6 24V (FT) [04.98-]			

RP-807		17530-77E00	
	Diam./Diam. [mm]	85	
	Height/Altezza [mm]	23	
	Pitch Circle Ø/Foro int.-Ø [mm]	10	
SUZUKI GRAND VITARA (FT, GT) 2.0 [03.98-]			

RP-812		49160-67J00-000	
	Diam./Diam. [mm]	64	
	Height/Altezza [mm]	30	
	Pitch Circle Ø/Foro int.-Ø [mm]	10	
SUZUKI GRAND VITARA 1.9 DDiS [10.05-]			

RP-900	
	Outer Diam./Diam. est. [mm]
	Height/Altezza [mm]
	Pitch Circle Ø/Foro int.-Ø [mm]
	95
	26
	17
CHRYSLER CROSSFIRE 3.2 [07.03-] CHRYSLER CROSSFIRE Roadster 3.2 [05.04-]	

RP-905	
	Diam./Diam. [mm]
	Height/Altezza [mm]
	Pitch Circle Ø/Foro int.-Ø [mm]
	70
	28
	17
CHRYSLER PT CRUISER 2.2 CRD [03.02-]	

RP-901		05080422AA	
	Diam./Diam. [mm]		
	Height/Altezza [mm]		
	Pitch Circle Ø/Foro int.-Ø [mm]		
	70		
	28		
	8		
JEEP GRAND CHEROKEE II (WJ, WG) 2.7 CRD 4x4 [10.01-]			

RP-906	
	Diam./Diam. [mm]
	Height/Altezza [mm]
	Pitch Circle Ø/Foro int.-Ø [mm]
	70
	26
	17
CHRYSLER CROSSFIRE 3.2 [07.03-] CHRYSLER PT CRUISER 2.2 CRD [03.02-]	

RP-902	
	Diam./Diam. [mm]
	Height/Altezza [mm]
	Pitch Circle Ø/Foro int.-Ø [mm]
	99
	30
	17
CHRYSLER NEON (PL) 2.0 16V [05.94-08.99] CHRYSLER VOYAGER III (GS) 2.0 i [01.95-03.01]	

RP-907	
	Diam./Diam. [mm]
	Height/Altezza [mm]
	Pitch Circle Ø/Foro int.-Ø [mm]
	92
	36
	20
CHRYSLER VOYAGER III (GS) 2.5 TD [01.95-03.01] JEEP CHEROKEE (XJ) 2.5 TD [01.88-]	

RP-903	
	Diam./Diam. [mm]
	Height/Altezza [mm]
	Pitch Circle Ø/Foro int.-Ø [mm]
	90
	29
	12
CHRYSLER NEON (PL) 2.0 16V [05.94-08.99] CHRYSLER VOYAGER III (GS) 2.0 i [01.95-03.01]	

RP-908	
	Diam./Diam. [mm]
	Height/Altezza [mm]
	Pitch Circle Ø/Foro int.-Ø [mm]
	70
	24
	17
DODGE CALIBER 2.0 CRD [06.06-]	

RP-904	
	Diam./Diam. [mm]
	Height/Altezza [mm]
	Overall Height/Altezza ingombro[mm]
	Pitch Circle Ø/Foro int.-Ø [mm]
	66
	27
	31
	11
JEEP WRANGLER I 2.5 [01.88-12.91] JEEP WRANGLER I 2.5 [12.91-08.96]	

RP-909	
	Diam./Diam. [mm]
	Height/Altezza [mm]
	Pitch Circle Ø/Foro int.-Ø [mm]
	70
	19
	17
CHRYSLER PT CRUISER 2.4 [06.00-] CHRYSLER PT CRUISER GT 2.4 [08.03-]	

RP-910		05175589AB	
	Diam./Diam. [mm]	54	
	Height/Altezza [mm]	30	
	Pitch Circle Ø/Foro int.-Ø [mm]	17	
CHRYSLER 300 C 3.0 CRD [09.05-] JEEP GRAND CHEROKEE III 3.0 CRD [06.05-]			

RP-915			
	Diam./Diam. [mm]	85	
	Height/Altezza [mm]	28	
	Pitch Circle Ø/Foro int.-Ø [mm]	25	
CHRYSLER VOYAGER III (GS) 2.5 TD [01.95-03.01] JEEP CHEROKEE (XJ) 2.5 TD [01.88-]			

RP-911		04863737	
	Diam./Diam. [mm]	70	
	Height/Altezza [mm]	29	
	Pitch Circle Ø/Foro int.-Ø [mm]	9	
CHRYSLER VOYAGER III (GS) 2.5 TD [01.95-03.01] JEEP CHEROKEE (XJ) 2.5 TD [01.88-]			

RP-916			
	Diam./Diam. [mm]	70	
	Height/Altezza [mm]	24	
	Pitch Circle Ø/Foro int.-Ø [mm]	17	
JEEP COMPASS 2.0 CRD 4x4 [09.06-] JEEP PATRIOT 2.0 CRD [01.08-]			

RP-912			
	Diam./Diam. [mm]	70	
	Height/Altezza [mm]	31	
	Pitch Circle Ø/Foro int.-Ø [mm]	17	
CHRYSLER VOYAGER III (GS) 2.5 TD [01.95-03.01] JEEP CHEROKEE (XJ) 2.5 TD [01.88-]			

RP-917		04668588AA	
	Diam./Diam. [mm]	88	
	Height/Altezza [mm]	21	
	Pitch Circle Ø/Foro int.-Ø [mm]	17	
CHRYSLER PT CRUISER 2.4 [06.00-] CHRYSLER PT CRUISER GT 2.4 [08.03-]			

RP-913			
	Diam./Diam. [mm]	58	
	Height/Altezza [mm]	35	
	Pitch Circle Ø/Foro int.-Ø [mm]	17	
JEEP CHEROKEE (XJ) 2.5 i 4x4 [12.91-] JEEP CHEROKEE (XJ) 2.5 i [11.96-]			

RP-918		05066938AA	
	Diam./Diam. [mm]	70	
	Height/Altezza [mm]	26	
	Pitch Circle Ø/Foro int.-Ø [mm]	17	
CHRYSLER VOYAGER IV (RG) 2.5 CRD [02.00-] JEEP CHEROKEE (KJ) 2.8 CRD [11.02-]			

RP-914		04792112	
	Diam./Diam. [mm]	90	
	Height/Altezza [mm]	29	
	Pitch Circle Ø/Foro int.-Ø [mm]	17	
CHRYSLER VOYAGER III (GS) 3.3 i [01.95-03.01] CHRYSLER VOYAGER IV (RG) 3.8 [02.00-]			

RP-919		04723298	
	Diam./Diam. [mm]	70	
	Height/Altezza [mm]	22	
	Pitch Circle Ø/Foro int.-Ø [mm]	17	
CHRYSLER VOYAGER III (GS) 2.5 TD [01.95-03.01]			

RP-920	
	Diam./Diam. [mm]
	Height/Altezza [mm]
	Pitch Circle Ø/Foro int.-Ø [mm]
	90
	29
	17
CHRYSLER STRATUS (JA) 2.5 LX V6 [12.95-04.01] JEEP CHEROKEE (XJ) 2.5 [10.95-]	

RP-925		05080246AA
	Diam./Diam. [mm]	
	Height/Altezza [mm]	
	Pitch Circle Ø/Foro int.-Ø [mm]	
	69	
	27	
	17	
JEEP GRAND CHEROKEE III 3.0 CRD [06.05-]		

RP-921	
	Diam./Diam. [mm]
	Height/Altezza [mm]
	Pitch Circle Ø/Foro int.-Ø [mm]
	95
	19
	12
CHRYSLER NEON II 2.4 [10.01-09.05] JEEP CHEROKEE (XJ) 2.5 [10.95-]	

RP-926	
	Diam./Diam. [mm]
	Height/Altezza [mm]
	Pitch Circle Ø/Foro int.-Ø [mm]
	70
	25
	17
CHRYSLER VOYAGER IV (RG) 2.5 CRD [02.00-] CHRYSLER VOYAGER IV (RG) 2.8 CRD [06.04-]	

RP-922	
	Diam./Diam. [mm]
	Height/Altezza [mm]
	Pitch Circle Ø/Foro int.-Ø [mm]
	70
	26
	17
CHRYSLER PT CRUISER 2.0 [06.00-] CHRYSLER SEBRING Cabriolet (JR) 2.4 [04.01-]	

RP-927	
	Diam./Diam. [mm]
	Height/Altezza [mm]
	Pitch Circle Ø/Foro int.-Ø [mm]
	96
	17
	12
CHRYSLER NEON II 2.4 [10.01-09.05] JEEP CHEROKEE (XJ) 2.5 [10.95-]	

RP-923		05080319AA
	Diam./Diam. [mm]	
	Height/Altezza [mm]	
	Pitch Circle Ø/Foro int.-Ø [mm]	
	54	
	26	
	17	
CHRYSLER PT CRUISER 2.2 CRD [03.02-]		

RP-H00		25286-37100
	Diam./Diam. [mm]	
	Height/Altezza [mm]	
	Pitch Circle Ø/Foro int.-Ø [mm]	
	82	
	26	
	17	
HYUNDAI SONATA III (EF) 2.5 V6 24V [06.98-10.01] HYUNDAI TRAJET (FO) 2.7 V6 [09.00-]		

RP-924		04861633AA
	Diam./Diam. [mm]	
	Height/Altezza [mm]	
	70	
	26	
CHRYSLER VOYAGER IV (RG) 2.5 CRD [02.00-] JEEP CHEROKEE (KJ) 2.8 CRD [11.02-]		

RP-H01		25287-27000
	Diam./Diam. [mm]	
	Height/Altezza [mm]	
	Pitch Circle Ø/Foro int.-Ø [mm]	
	70	
	26	
	17	
HYUNDAI ACCENT (LC) 1.5 CRDi [04.02-] HYUNDAI GETZ (TB) 1.5 CRDi [03.03-]		

RP-H02		
	Diam./Diam. [mm]	78
	Height/Altezza [mm]	20
MITSUBISHI L 200 (K_T) 2.5 TD 4WD (K74T) [09.01-] MITSUBISHI PAJERO SPORT (K90) 2.5 TD [07.02-]		

RP-H07		25286-3E001
	Diam./Diam. [mm]	82
	Height/Altezza [mm]	29
HYUNDAI SANTA FÉ 2.7 4x4 [03.06-] KIA CARNIVAL II 2.7 V6 [06.06-]		

RP-H03		
	Diam./Diam. [mm]	70
	Height/Altezza [mm]	26
	Pitch Circle Ø/Foro int.-Ø [mm]	17
HYUNDAI ACCENT (LC) 1.5 CRDi [04.02-] HYUNDAI SANTA FE' (SM) 2.0 CRDi 4x4 [08.03-]		

RP-H08		97834-22100
	Diam./Diam. [mm]	78
	Height/Altezza [mm]	20
	Pitch Circle Ø/Foro int.-Ø [mm]	12
HYUNDAI ACCENT (MC) 1.4 GL [11.05-] HYUNDAI MATRIX (FC) 1.6 [06.01-]		

RP-H04		57212-3A000
	Diam./Diam. [mm]	90
	Height/Altezza [mm]	25
	Pitch Circle Ø/Foro int.-Ø [mm]	17
HYUNDAI SANTA FE' (SM) 2.4 16V 4x4 [02.01-] KIA SORENTO (JC) 2.4 [08.02-]		

RP-K00		
	Outer Diam./Diam. est. [mm]	64
	Height/Altezza [mm]	22.5
HYUNDAI i30 CW Station wagon 1.6 CRDi [02.08-] KIA CEE'D 1.6 CRDi 90 [12.06-]		

RP-H05		25288-27000
	Diam./Diam. [mm]	119
	Height/Altezza [mm]	27
	Pitch Circle Ø/Foro int.-Ø [mm]	17
HYUNDAI ACCENT (LC) 1.5 CRDi [04.02-] HYUNDAI MATRIX (FC) 1.5 CRDi [10.01-]		

RP-K01		25286-2B000
	Diam./Diam. [mm]	95
	Height/Altezza [mm]	30
	Inner Diam./Diam. int. [mm]	17
HYUNDAI i30 1.4 [10.07-] KIA CEE'D 1.4 [12.06-]		

RP-H06		
	Diam./Diam. [mm]	65
	Height/Altezza [mm]	22
	Pitch Circle Ø/Foro int.-Ø [mm]	17
HYUNDAI GETZ (TB) 1.5 CRDi GLS [08.05-] HYUNDAI i10 1.1 CRDi [01.08-]		

RP-K02		
	Diam./Diam. [mm]	95
	Height/Altezza [mm]	25
	Pitch Circle Ø/Foro int.-Ø [mm]	17
KIA CLARUS (K9A) 1.8 i 16V [07.96-] KIA SPORTAGE (K00) 2.0 i 4WD [04.94-08.99]		

RP-K03		25286-4A000	
	Diam./Diam. [mm]	76	
	Height/Altezza [mm]	33	
	Pitch Circle Ø/Foro int.-Ø [mm]	17	
HYUNDAI H-1/H-200/SATELLITE 2.5 CRDi 4WD [12.02-] KIA SORENTO (JC) 2.5 CRDi [08.02-]			

RP-L02		1 726 343	
	Diam./Diam. [mm]	71	
	Height/Altezza [mm]	25	
	Pitch Circle Ø/Foro int.-Ø [mm]	10	
LAND ROVER RANGE ROVER II (LP) 2.5 D [07.94-03.02] LAND ROVER RANGE ROVER II (LP) 2.5 D [08.94-03.02]			

RP-K03		25286-4A000	
	Diam./Diam. [mm]	76	
	Height/Altezza [mm]	33	
	Pitch Circle Ø/Foro int.-Ø [mm]	17	
HYUNDAI H-1/H-200/SATELLITE 2.5 CRDi 4WD [12.02-] KIA SORENTO (JC) 2.5 CRDi [08.02-]			

RP-L03			
	Diam./Diam. [mm]	65	
	Height/Altezza [mm]	21	
	Pitch Circle Ø/Foro int.-Ø [mm]	17	
LAND ROVER RANGE ROVER III (LM) 3.0 TD 6 [03.02-]			

RP-K04		0K88R-15983	
	Outer Diam./Diam. est. [mm]	76	
	Inner Diam./Diam. int. [mm]	17	
	Height/Altezza [mm]	22	
HYUNDAI TERRACAN (HP) 2.9 CRDi [11.03-] KIA CARNIVAL II 2.9 CRDi [06.06-]			

RP-L04			
	Diam./Diam. [mm]	76	
	Height/Altezza [mm]	37	
	Pitch Circle Ø/Foro int.-Ø [mm]	17	
LAND ROVER DISCOVERY III 4.4 [10.04-] LAND ROVER RANGE ROVER III (LM) 4.4 [05.05-]			

RP-L00			
	Outer Diam./Diam. est. [mm]	70	
	Height/Altezza [mm]	31	
	Pitch Circle Ø/Foro int.-Ø [mm]	17	
LAND ROVER DEFENDER (LD) 2.5 Td5 4WD [06.98-] LAND ROVER DISCOVERY III 2.7 TD [10.04-]			

RP-L05		7H12-10A216-CA	
	Diam./Diam. [mm]	78	
	Height/Altezza [mm]	31	

RP-L01		LGQ000040	
	Outer Diam./Diam. est. [mm]	70	
	Height/Altezza [mm]	26	
	Overall Height/Altezza ingombro[mm]	47	
LAND ROVER RANGE ROVER III (LM) 3.0 TD 6 [03.02-]			

RP-L06		LR004877	
	Diam./Diam. [mm]	70	
	Height/Altezza [mm]	26	
	Pitch Circle Ø/Foro int.-Ø [mm]	10	
LAND ROVER FREELANDER 2 2.2 TD4 4x4 [10.06-] LAND ROVER FREELANDER 2 2.2 TD4 [01.07-]			

RP-M00			
	Outer Diam./Diam. est. [mm]	70	
	Height/Altezza [mm]	25	
	Inner Diam./Diam. int. [mm]	17	
MITSUBISHI COLT VI 1.1 [10.04-] SMART FORFOUR 1.5 CDI (454.000) [09.04-]			

RP-S03		1192001470	
	Diam./Diam. [mm]	92	
	Height/Altezza [mm]	31	
	Pitch Circle Ø/Foro int.-Ø [mm]	15	
SSANGYONG KORANDO (KJ) 3.2 [06.97-] SSANGYONG KORANDO Cabrio (KJ) 3.2 [06.97-]			

RP-M01			
	Diam./Diam. [mm]	60	
	Height/Altezza [mm]	19	
	Pitch Circle Ø/Foro int.-Ø [mm]	17	
SMART FORTWO Cabrio 1.0 (451.431) [01.07-] SMART FORTWO Coupé 1.0 (451.331) [01.07-]			

RP-W00		96084381	
	Outer Diam./Diam. est. [mm]	82	
	Height/Altezza [mm]	19.5	
DAEWOO ESPERO (KLEJ) 1.8 [02.95-06.99] DAEWOO ESPERO (KLEJ) 1.8 [02.95-09.99]			

RP-S00		6012000970	
	Diam./Diam. [mm]	80	
	Height/Altezza [mm]	25	
	Overall Height/Altezza ingombro[mm]	31	
SSANGYONG KORANDO (KJ) 2.0 [05.97-] SSANGYONG KORANDO (KJ) 2.3 D (KJ) [12.96-]			

RP-W01		96344236	
	Diam./Diam. [mm]	70	
	Height/Altezza [mm]	26	
	Pitch Circle Ø/Foro int.-Ø [mm]	17	
CHEVROLET EVANDA 2.0 [03.05-] DAEWOO TACUMA (KLAU) 2.0 [09.01-]			

RP-S01			
	Diam./Diam. [mm]	70	
	Height/Altezza [mm]	26	
	Overall Height/Altezza ingombro[mm]	32	
	Pitch Circle Ø/Foro int.-Ø [mm]	8	
SSANGYONG KORANDO (KJ) 2.0 [05.97-] SSANGYONG MUSSO (FJ) 2.0 [10.96-]			

RP-W02			
	Diam./Diam. [mm]	80	
	Height/Altezza [mm]	27	
	Overall Height/Altezza ingombro[mm]	31	
	Pitch Circle Ø/Foro int.-Ø [mm]	8	
CHEVROLET EVANDA 2.0 [03.05-] CHEVROLET NUBIRA 2.0 [01.05-]			

RP-S02		6012001270	
	Diam./Diam. [mm]	80	
	Height/Altezza [mm]	26	
	Overall Height/Altezza ingombro[mm]	31,5	
	Pitch Circle Ø/Foro int.-Ø [mm]	8	
SSANGYONG KORANDO (KJ) 2.0 [05.97-] SSANGYONG MUSSO (FJ) 2.0 [10.96-]			

RP-W03			
	Outer Diam./Diam. est. [mm]	76	
	Height/Altezza [mm]	26	
	Pitch Circle Ø/Foro int.-Ø [mm]	17	
CHEVROLET AVEO 1.2 [04.08-] CHEVROLET KALOS 1.4 [03.05-]			

DEFLECTION/GUIDE PULLEY, V-RIBBED BELT
 UMLENK-/FÜHRUNGSROLLE, KEILRIPPENRIEMEN
 POULIE RENVOI/TRANSMISSION, COURROIE TRAPÉZOÏDALE
 POLEA INVERSIÓN/GUÍA, CORREA POLI V
 GALOPPINO/GUIDACINGHIA, CINGHIA POLY-V

RP-W04		51758383	
 <p>W04</p>	Diam./Diam. [mm]	65	
	Height/Altezza [mm]	26	
	Pitch Circle Ø/Foro int.-Ø [mm]	10	
CADILLAC BLS 1.9 D [04.06-] CADILLAC BLS Wagon 1.9 D [12.07-]			

RP-W05		96440417	
 <p>W05</p>	Outer Diam./Diam. est. [mm]	65	
	Height/Altezza [mm]	26	
CHEVROLET CAPTIVA 2.0 D [09.07-] CHEVROLET CRUZE (J3000) 2.0 CDI [05.09-]			

TL-200		35612004	
	Length/Lungh. [mm]	120	
	Diam./Diam. [mm]	37	
	Inner Diam./Diam. int. [mm]	8	
TOYOTA AVENSIS (_T22_) 1.8 (AT221_) [09.97-10.00]		CHRYSLER VOYAGER III (GS) 2.5 TD [01.95-03.01]	
TOYOTA CELICA (_T20_) 1.8 i 16V (AT200/ST) [11.93-11.99]		JEEP CHEROKEE (XJ) 2.5 TD [01.88-]	

TL-400		TL-L00		64 55 7 786 711	
	Length/Lungh. [mm]	119		Diam./Diam. [mm]	65
	Diam./Diam. [mm]	37		Height/Altezza [mm]	32
	Inner Diam./Diam. int. [mm]	8		Length/Lungh. [mm]	103
HONDA CR-V II 2.0 i-VTEC [01.07-]		LAND ROVER RANGE ROVER III (LM) 3.0 TD 6 [03.02-]			

TL-500		TL-L01		11 28 7 786 880	
	Length/Lungh. [mm]	131		Diam./Diam. [mm]	65
	Pitch Circle Ø/Foro int.-Ø [mm]	8		Height/Altezza [mm]	45
MITSUBISHI CARISMA (DA_) 1.9 TD [10.96-09.00]		LAND ROVER RANGE ROVER III (LM) 3.0 TD 6 [03.02-]			
MITSUBISHI CARISMA Tre volumi (DA_) 1.9 TD [10.96-09.00]					

TL-900		TL-L02		11 28 2 243 510	
	Length/Lungh. [mm]	121		Length/Lungh. [mm]	121
	Diam./Diam. [mm]	33		Diam./Diam. [mm]	33
	Inner Diam./Diam. int. [mm]	8		Inner Diam./Diam. int. [mm]	15
CHRYSLER VOYAGER III (GS) 2.5 TD [01.95-03.01]		LAND ROVER RANGE ROVER II (LP) 2.5 D [07.94-03.02]			
JEEP CHEROKEE (XJ) 2.5 TD [01.88-]		LAND ROVER RANGE ROVER II (LP) 2.5 D [08.94-03.02]			

TL-901		TL-S00	
	Length/Lungh. [mm]	117	
	Diam./Diam. [mm]	32.5	
	Inner Diam./Diam. int. [mm]	8	
CHRYSLER VOYAGER III (GS) 2.5 TD [01.95-03.01]		SSANGYONG ACTYON 200 Xdi 4WD [10.06-]	
JEEP CHEROKEE (XJ) 2.5 TD [01.88-]		SSANGYONG KYRON 2.0 Xdi [05.05-]	

TL-900		TL-901	
	Length/Lungh. [mm]	121	
	Diam./Diam. [mm]	33	
	Inner Diam./Diam. int. [mm]	8	
CHRYSLER VOYAGER III (GS) 2.5 TD [01.95-03.01]		CHRYSLER VOYAGER III (GS) 2.5 TD [01.95-03.01]	
JEEP CHEROKEE (XJ) 2.5 TD [01.88-]		JEEP CHEROKEE (XJ) 2.5 TD [01.88-]	

TL-901		TL-S00	
	Length/Lungh. [mm]	117	
	Diam./Diam. [mm]	32.5	
	Inner Diam./Diam. int. [mm]	8	
CHRYSLER VOYAGER III (GS) 2.5 TD [01.95-03.01]		SSANGYONG ACTYON 200 Xdi 4WD [10.06-]	
JEEP CHEROKEE (XJ) 2.5 TD [01.88-]		SSANGYONG KYRON 2.0 Xdi [05.05-]	

TL-901		TL-S00	
	Length/Lungh. [mm]	117	
	Diam./Diam. [mm]	32.5	
	Inner Diam./Diam. int. [mm]	8	
CHRYSLER VOYAGER III (GS) 2.5 TD [01.95-03.01]		SSANGYONG ACTYON 200 Xdi 4WD [10.06-]	
JEEP CHEROKEE (XJ) 2.5 TD [01.88-]		SSANGYONG KYRON 2.0 Xdi [05.05-]	

TL-901		TL-S00	
	Length/Lungh. [mm]	117	
	Diam./Diam. [mm]	32.5	
	Inner Diam./Diam. int. [mm]	8	
CHRYSLER VOYAGER III (GS) 2.5 TD [01.95-03.01]		SSANGYONG ACTYON 200 Xdi 4WD [10.06-]	
JEEP CHEROKEE (XJ) 2.5 TD [01.88-]		SSANGYONG KYRON 2.0 Xdi [05.05-]	

TL-901		TL-S00	
	Length/Lungh. [mm]	117	
	Diam./Diam. [mm]	32.5	
	Inner Diam./Diam. int. [mm]	8	
CHRYSLER VOYAGER III (GS) 2.5 TD [01.95-03.01]		SSANGYONG ACTYON 200 Xdi 4WD [10.06-]	
JEEP CHEROKEE (XJ) 2.5 TD [01.88-]		SSANGYONG KYRON 2.0 Xdi [05.05-]	

VIBRATION DAMPER, V-RIBBED BELT
 SCHWINGUNGSDÄMPFER, KEILRIPPENRIEMEN
 AMORTISSEUR DE VIBRATIONS, COURROIE TRAPÉZOÏDALE À NERVURES
 AMORTIGUADOR VIBRACIONES, CORREA TRAPEZ. POLI V
 SMORZATORE VIBRAZIONI, CINGHIA POLY-V

TL-S01		102 200 0814
 <p>S01</p>	Length/Lungh. [mm]	233
	SSANGYONG KORANDO (KJ) 2.0 [05.97-] SSANGYONG MUSSO (FJ) 2.0 [10.96-]	

TL-S02		6012000314
 <p>S02</p>	Length/Lungh. [mm]	210
	SSANGYONG KORANDO (KJ) 2.3 D (KJ) [12.96-] SSANGYONG KORANDO (KJ) 2.9 D (KJ) [12.96-]	

TL-S03		1032000114
 <p>S03</p>	Length/Lungh. [mm]	221
	SSANGYONG KORANDO (KJ) 3.2 (KJ) [12.96-] SSANGYONG MUSSO (FJ) 3.2 [06.96-]	

TL-S04		1122000014
 <p>S04</p>	Length/Lungh. [mm]	254
	SSANGYONG KORANDO Cabrio (KJ) 3.2 [01.99-] SSANGYONG REXTON 3.2 [04.02-]	

TP-001		
	Diam./Diam. [mm]	85
	Height/Altezza [mm]	27
	Overall Height/Altezza ingombro[mm]	43
LADA NIVA (2121) 1900 Diesel [01.93-]		

TP-103		
	Diam./Diam. [mm]	84
	Height/Altezza [mm]	24
	Length/Lungh. [mm]	158
NISSAN 300 ZX (Z31) 3.0 Turbo [04.84-10.90] NISSAN MAXIMA (J30) 3.0 i [10.88-06.94]		

TP-002		254723120162	
	Diam./Diam. [mm]	93	
	Height/Altezza [mm]	18	
	Overall Height/Altezza ingombro[mm]	71	
TATA (TELCO) SAFARI 2.0 TD 4X4 (403.001) [02.01-]			

TP-104		11944-4F100	
	Diam./Diam. [mm]	85	
	Height/Altezza [mm]	24	
	Length/Lungh. [mm]	167	
NISSAN 300 ZX (Z31) 3.0 [01.84-12.87] NISSAN MAXIMA (J30) 3.0 i [10.88-06.94]			

TP-100		11944-6F901	
	Diam./Diam. [mm]	69	
	Height/Altezza [mm]	25	
	Overall Height/Altezza ingombro[mm]	36	
NISSAN MICRA (K11) 1.5 D [02.98-02.03]			

TP-105		1175000QAJ	
	Diam./Diam. [mm]	65	
	Height/Altezza [mm]	27	
	Overall Height/Altezza ingombro[mm]	35	
NISSAN ALMERA II (N16) 1.5 dCi [01.03-] NISSAN MICRA (K12) 1.5 dCi [01.03-]			

TP-101		5751.26	
	Diam./Diam. [mm]	69	
	Height/Altezza [mm]	24	
	Overall Height/Altezza ingombro[mm]	36	
NISSAN MICRA (K11) 1.5 D [02.98-02.03]			

TP-200		11287-7908-78	
	Diam./Diam. [mm]	70	
	Height/Altezza [mm]	29	
TOYOTA YARIS (_CP10) 1.4 D-4D [12.01-]			

TP-102		
	Diam./Diam. [mm]	84
	Height/Altezza [mm]	24
	Overall Height/Altezza ingombro[mm]	47
NISSAN 300 ZX (Z31) 3.0 [01.84-12.87] NISSAN MICRA (K10) 1.0 [12.82-05.91]		

TP-201		16620-0W093	
	Diam./Diam. [mm]	70	
	Height/Altezza [mm]	26	
TOYOTA AURIS 1.4 VVTi [03.07-] TOYOTA AURIS 1.6 VVTi [03.07-]			

TP-202		
	Diam./Diam. [mm]	82
	Height/Altezza [mm]	20
TOYOTA AVENSIS (_T22_) 1.8 (AT221_) [09.97-10.00]		
TOYOTA CELICA (_T20_) 1.8 i 16V (AT200/ST) [11.93-11.99]		

TP-400		
	Diam./Diam. [mm]	75
	Height/Altezza [mm]	21
	Overall Height/Altezza ingombro[mm]	36
HONDA LOGO (GA3) 1.3 [03.99-03.02]		

TP-300		1E07-15-930B	
	Diam./Diam. [mm]	73	
	Height/Altezza [mm]	22	
	Mounting Bores Distance/Distanza fori di fissaggio [mm]	93	
MAZDA 121 III (JASM, JB5M) 1.8 D [03.96-]			

TP-500		A639 200 08 70	
	Diam./Diam. [mm]	106	
	Height/Altezza [mm]	22	
	Length/Lungh. [mm]	192	
	Width/Largh. [mm]	140	
MITSUBISHI COLT CZC Cabriolet 1.5 [05.06-]			
SMART FORFOUR 1.3 (454.031) [01.04-]			

TP-301		1E12-15-930A	
	Diam./Diam. [mm]	60	
	Height/Altezza [mm]	22	
	Overall Height/Altezza ingombro[mm]	51	
	Length/Lungh. [mm]	166	
MAZDA 121 III (JASM, JB5M) 1.8 D [03.96-]			

TP-501			
	Diam./Diam. [mm]	80	
	Height/Altezza [mm]	20	
	Length/Lungh. [mm]	237	
MITSUBISHI GALANT II (A16_) 2.3 Turbo-D (A167) [09.80-05.84]			
MITSUBISHI PAJERO SPORT (K90) 2.5 TD [11.98-]			

TP-302			
	Diam./Diam. [mm]	92	
	Height/Altezza [mm]	23	
	Overall Height/Altezza ingombro[mm]	67	
MAZDA 929 III (HC) 3.0 [01.88-12.89]			
MAZDA XEDOS 9 (TA) 2.5 24V [07.93-07.00]			

TP-502			
	Diam./Diam. [mm]	99	
	Height/Altezza [mm]	34	
	Overall Height/Altezza ingombro[mm]	60	
MITSUBISHI PAJERO SPORT (K90) 3.0 V6 [03.03-]			
MITSUBISHI PAJERO II (V2_W, V4_W) 3.5 V6 24V (V25W, V45W) [06.94-04.00]			

TP-303			
	Diam./Diam. [mm]	70	
	Height/Altezza [mm]	27	
	Overall Height/Altezza ingombro[mm]	33	
KIA CLARUS (K9A) 1.8 i 16V [07.96-]			
MAZDA MX-5 I (NA) 1.6 [05.90-01.94]			

TP-503			
	Diam./Diam. [mm]	93	
	Height/Altezza [mm]	22	
	Overall Height/Altezza ingombro[mm]	55	
MITSUBISHI PAJERO SPORT (K90) 3.0 V6 [03.03-]			
MITSUBISHI PAJERO SPORT (K90) 3.0 V6 [11.98-]			

TP-800		49170-65D40	
	Outer Diam./Diam. est. [mm]	80	
	Height/Altezza [mm]	27	
	Overall Height/Altezza ingombro[mm]	35	
SUZUKI GRAND VITARA (FT, GT) 2.0 HDI 110 [07.01-]			

TP-H00		ZJ820005	
	Diam./Diam. [mm]	78	
	Height/Altezza [mm]	16	
	Overall Height/Altezza ingombro[mm]	39	
	Length/Lungh. [mm]	243	
HYUNDAI GALLOPER II (JK-01) 2.5 TCI D [08.98-] HYUNDAI TERRACAN (HP) 2.5 TD [12.01-]			

TP-801			
	Diam./Diam. [mm]	72	
	Height/Altezza [mm]	20	
	Overall Height/Altezza ingombro[mm]	22	
SUZUKI GRAND VITARA (FT, GT) 1.6 [03.98-]			

TP-H01			
	Diam./Diam. [mm]	80	
	Height/Altezza [mm]	20	
HYUNDAI GALLOPER II (JK-01) 3.0 V6 [08.98-] MITSUBISHI L 200 (K__T) 2.4 4x4 (K75T) [06.96-]			

TP-802		575115	
	Diam./Diam. [mm]	85	
	Height/Altezza [mm]	26	
	Length/Lungh. [mm]	205	
SUZUKI SAMURAI (SJ) 1.9 TD [11.98-]			

TP-M00		0015956 V001 0000 00	
	Diam./Diam. [mm]	60	
	Height/Altezza [mm]	18	
	Length/Lungh. [mm]	149	
SMART CABRIO 0.6 (S10LA1) [03.00-01.04] SMART CABRIO 0.7 [01.03-01.04]			

TP-803		17140-77E06	
	Diam./Diam. [mm]	82	
	Height/Altezza [mm]	27	
	Overall Height/Altezza ingombro[mm]	46	
SUZUKI GRAND VITARA (FT, GT) 2.0 [03.98-]			

TP-M01			
	Diam./Diam. [mm]	60	
	Height/Altezza [mm]	18	
	Length/Lungh. [mm]	149	
SMART CABRIO 0.6 (S10LD2) [01.01-01.04] SMART CABRIO 0.7 [01.03-01.04]			

TP-900			
	Diam./Diam. [mm]	76	
	Height/Altezza [mm]	19	
	Mounting Bores Distance/Distanza fori di fissaggio [mm]	79	
ISUZU TROOPER 3.0 DTI [04.00-] ISUZU TROOPER Fuoristrada aperto 3.0 DTI [04.00-]			

TS-001		701070036	
	Diam./Diam. [mm]		65
	Height/Altezza [mm]		29
	Overall Height/Altezza ingombro[mm]		78
NISSAN QASHQAI 2.0 4 ruote motrici [02.07-] NISSAN X-TRAIL (T31) 2.0 [06.07-]			

TS-104		11955JD20A	
	Diam./Diam. [mm]		70
	Height/Altezza [mm]		27
	Overall Height/Altezza ingombro[mm]		39
NISSAN QASHQAI 2.0 4 ruote motrici [02.07-] NISSAN X-TRAIL (T31) 2.0 [06.07-]			

TS-100		11750-00Q0B	
	Diam./Diam. [mm]		66
	Height/Altezza [mm]		26
	Overall Height/Altezza ingombro[mm]		84
NISSAN NOTE 1.5 dCi [03.06-] NISSAN QASHQAI 1.5 dCi [02.07-]			

TS-105		11955-00QAG	
	Diam./Diam. [mm]		66
	Height/Altezza [mm]		26
	Overall Height/Altezza ingombro[mm]		82
NISSAN ALMERA II (N16) 1.5 dCi [01.03-] NISSAN MICRA (K12) 1.5 dCi [01.03-]			

TS-101		11750-00QAD	
	Diam./Diam. [mm]		65
	Height/Altezza [mm]		30
	Overall Height/Altezza ingombro[mm]		86
NISSAN 350 Z Roadster 3.5 [03.05-] NISSAN PATHFINDER (R50) 3.3 V6 4WD [03.98-10.00]			

TS-105		11955-00QAG	
	Diam./Diam. [mm]		66
	Height/Altezza [mm]		26
	Overall Height/Altezza ingombro[mm]		82
NISSAN ALMERA II (N16) 1.5 dCi [01.03-] NISSAN MICRA (K12) 1.5 dCi [01.03-]			

TS-102		1195500QAA	
	Diam./Diam. [mm]		60
	Height/Altezza [mm]		31
	Overall Height/Altezza ingombro[mm]		93
NISSAN INTERSTAR dCi 120 [07.02-] NISSAN SUNNY III (N14) 1.6 i [10.90-05.95]			

TS-106		1175000QAE	
	Diam./Diam. [mm]		65
	Height/Altezza [mm]		26
	Overall Height/Altezza ingombro[mm]		83
NISSAN PRIMASTAR Autobus 2.0 [03.01-] NISSAN PRIMASTAR Furgonato 2.0 [02.03-]			

TS-103			
	Diam./Diam. [mm]		65
	Height/Altezza [mm]		26
	Overall Height/Altezza ingombro[mm]		89
NISSAN INTERSTAR Autobus dCi 120 [07.02-] NISSAN INTERSTAR Furgonato dCi 120 [07.02-]			

TS-200		16620-31040	
	Outer Diam./Diam. est. [mm]		70
	Height/Altezza [mm]		34
	Overall Height/Altezza ingombro[mm]		124
LEXUS IS 250 (GSE20) [10.05-] TOYOTA AURIS 2.0 D-4D [03.07-]			

TS-201		16620-0R010	
	Diam./Diam. [mm]		71
	Height/Altezza [mm]		28
	Overall Height/Altezza ingombro[mm]		38
LEXUS IS 220 d (ALE20) [10.05-] TOYOTA AURIS 2.0 D-4D [03.07-]			

TS-300		Y401-15-980B	
	Diam./Diam. [mm]		55
	Height/Altezza [mm]		25
	Overall Height/Altezza ingombro[mm]		74
MAZDA 2 1.4 CD [04.03-] MAZDA MX-6 (GE6) 2.5 24V [02.92-]			

TS-202		16620-27020	
	Diam./Diam. [mm]		90
	Height/Altezza [mm]		25
	Overall Height/Altezza ingombro[mm]		104
TOYOTA RAV 4 II (XA2) 2.0 D-4D 4WD [09.01-]			

TS-301		1E05-15-980A	
	Diam./Diam. [mm]		103
	Height/Altezza [mm]		30
	Overall Height/Altezza ingombro[mm]		81
MAZDA 121 III (JASM, JBSM) 1.25 [03.96-] MAZDA 2 1.4 [04.03-]			

TS-203		Y60115980	
	Diam./Diam. [mm]		65
	Height/Altezza [mm]		25
MAZDA 2 1.4 MZR-CD [01.08-] MAZDA 3 1.6 DI Turbo [06.04-]			

TS-301		1E05-15-980A	
	Diam./Diam. [mm]		103
	Height/Altezza [mm]		30
	Overall Height/Altezza ingombro[mm]		81
MAZDA 121 III (JASM, JBSM) 1.25 [03.96-] MAZDA 2 1.4 [04.03-]			

TS-204		16620-0W110	
	Diam./Diam. [mm]		70
	Height/Altezza [mm]		32
	Overall Height/Altezza ingombro[mm]		42
TOYOTA AVENSIS (_T22_) 2.0 VVT-i [10.00-02.03] TOYOTA RAV 4 II (XA2) 2.0 VVTi 4WD [06.00-]			

TS-302		1 044 515	
	Diam./Diam. [mm]		103
	Height/Altezza [mm]		30
	Overall Height/Altezza ingombro[mm]		81
MAZDA 2 1.4 [04.03-]			

TS-205		16620-31012	
	Diam./Diam. [mm]		70
	Height/Altezza [mm]		32
	Overall Height/Altezza ingombro[mm]		125
TOYOTA LAND CRUISER (J12) 4.0 (GRJ12) [01.03-] TOYOTA LAND CRUISER (J12) 4.0 [09.02-08.04]			

TS-303			
	Diam./Diam. [mm]		73
	Height/Altezza [mm]		25
	Overall Height/Altezza ingombro[mm]		170
MAZDA 2 1.6 [04.03-]			

TS-304		LF17-15-980A	
	Diam./Diam. [mm]		73
	Height/Altezza [mm]		29
	Overall Height/Altezza ingombro[mm]		103
	MAZDA 3 2.3 DiSi Turbo MPS [06.06-] MAZDA 6 (GG) 2.0 [03.05-]		

TS-309		ZJ3815980B	
	Diam./Diam. [mm]		75
	Height/Altezza [mm]		29
	Overall Height/Altezza ingombro[mm]		96
	MAZDA 2 1.3 [10.07-] MAZDA 2 1.5 [10.07-]		

TS-305		1004481	
	Diam./Diam. [mm]		103
	Height/Altezza [mm]		27
	Overall Height/Altezza ingombro[mm]		174
	MAZDA 121 III (JASM, JBSM) 1.25 [03.96-] MAZDA 2 1.4 [04.03-]		

TS-310		LF50-15-980	
	Diam./Diam. [mm]		73
	Height/Altezza [mm]		29
	Overall Height/Altezza ingombro[mm]		100
	MAZDA 3 2.0 [10.03-] MAZDA 5 1.8 [03.05-]		

TS-306		ZJ01-15-980B	
	Diam./Diam. [mm]		79
	Height/Altezza [mm]		29
	Overall Height/Altezza ingombro[mm]		93
	MAZDA 3 1.4 [02.04-] MAZDA 3 1.6 [10.03-]		

TS-312		R2AA-15-980D	
	Overall Height/Altezza ingombro[mm]		64
	Diam./Diam. [mm]		70
	Height/Altezza [mm]		31
	MAZDA 6 2.2 CD [04.08-] MAZDA 6 2.2 MRZ-CD [01.09-]		

TS-307		L372-15-980C	
	Diam./Diam. [mm]		75
	Height/Altezza [mm]		27
	Overall Height/Altezza ingombro[mm]		99
	MAZDA 3 2.0 [10.03-] MAZDA 5 1.8 [03.05-]		

TS-400		56900-P5T-G00	
	Diam./Diam. [mm]		70
	Height/Altezza [mm]		26
	Overall Height/Altezza ingombro[mm]		83
	HONDA ACCORD VI (CE, CF) 2.0 TDi (CF1) [04.96-10.98] HONDA CIVIC VI (EJ,EK) 2.0 TDiC [11.98-10.00]		

TS-308		LFG1-15-980B	
	Diam./Diam. [mm]		74
	Height/Altezza [mm]		27
	Overall Height/Altezza ingombro[mm]		111
	MAZDA 6 1.8 MRZ [08.07-] MAZDA 6 2.0 [04.08-]		

TS-401		31170-RBD-E02	
	Diam./Diam. [mm]		70
	Height/Altezza [mm]		33
	Overall Height/Altezza ingombro[mm]		112
	HONDA ACCORD IX 2.2 i-DTEC [07.08-] HONDA CR-V II 2.2 i-CTDi [01.07-]		

TS-402		31170-PNA-003	
	Diam./Diam. [mm]		76
	Height/Altezza [mm]		33
	Overall Height/Altezza ingombro[mm]		104
HONDA ACCORD VIII 2.0 (CL7) [02.03-] HONDA CR-V II 2.0 [07.02-09.06]			

TS-500		MD852898	
	Diam./Diam. [mm]		60
	Height/Altezza [mm]		25.5
	Overall Height/Altezza ingombro[mm]		
MITSUBISHI CARISMA (DA_) 1.9 TD [10.96-09.00] MITSUBISHI CARISMA Tre volumi (DA_) 1.9 TD [10.96-09.00]			

TS-403		31170-RWK-005	
	Diam./Diam. [mm]		70
	Height/Altezza [mm]		31
	Overall Height/Altezza ingombro[mm]		43
HONDA CIVIC VII 1.8 [09.05-] HONDA FR-V 1.8 [01.07-]			

TS-501		11750-2W200	
	Diam./Diam. [mm]		85
	Height/Altezza [mm]		31
	Overall Height/Altezza ingombro[mm]		
NISSAN PATROL GR II (Y61) 3.0 DTi [05.00-] NISSAN TERRANO II (R20) 3.0 Di 4WD [05.02-]			

TS-404		31170-PCX-003	
	Diam./Diam. [mm]		80
	Height/Altezza [mm]		26
	Overall Height/Altezza ingombro[mm]		92
HONDA S2000 (AP) 2.0 [06.99-]			

TS-502		MW30621284	
	Diam./Diam. [mm]		65
	Height/Altezza [mm]		30
	Overall Height/Altezza ingombro[mm]		85
MITSUBISHI CARISMA (DA_) 1.9 DI-D [09.00-06.06] MITSUBISHI SPACE STAR (DG0) 1.9 DI-D [10.02-]			

TS-405		31170-P8F-A020	
	Diam./Diam. [mm]		85
	Height/Altezza [mm]		31
	Overall Height/Altezza ingombro[mm]		88
HONDA ACCORD VII (CG) 3.0 Vtec [10.98-12.02] HONDA ACCORD VII Coupe (CG) 3.0 V6 24V [02.98-06.03]			

TS-503		1345A001	
	Diam./Diam. [mm]		70
	Height/Altezza [mm]		25
	Overall Height/Altezza ingombro[mm]		164
MITSUBISHI COLT VI 1.1 [10.04-] SMART FORFOUR 1.3 (454.031) [01.04-]			

TS-406		31170-RB0-J01	
	Diam./Diam. [mm]		70
	Height/Altezza [mm]		25
	Overall Height/Altezza ingombro[mm]		50
HONDA JAZZ 1.2 [07.08-] HONDA JAZZ 1.4 [07.08-]			

TS-504		MN149179	
	Diam./Diam. [mm]		80
	Height/Altezza [mm]		28
	Overall Height/Altezza ingombro[mm]		69
MITSUBISHI GRANDIS 2.4 [04.04-] MITSUBISHI OUTLANDER 2.0 [05.03-]			

TS-505		1345A013	
	Diam./Diam. [mm]		70
	Height/Altezza [mm]		24
	Overall Height/Altezza ingombro[mm]		60
JEEP PATRIOT 2.0 CRD [01.08-] MITSUBISHI GRANDIS 2.0 DI-D [09.05-]			

TS-803		55190813	
	Diam./Diam. [mm]		65
	Height/Altezza [mm]		26
	Overall Height/Altezza ingombro[mm]		84
CADILLAC BLS 1.9 D [04.06-] SUZUKI SX4 1.9 DDiS 4x4 [06.06-]			

TS-506			
	Diam./Diam. [mm]		65
	Height/Altezza [mm]		25
	Overall Height/Altezza ingombro[mm]		68
MITSUBISHI OUTLANDER 2.2 DI-D [08.07-] PEUGEOT 4007 2.2 HDi [02.07-]			

TS-804		17540-85E00	
	Diam./Diam. [mm]		65
	Height/Altezza [mm]		26
	Overall Height/Altezza ingombro[mm]		80
SUZUKI SPLASH 1.3 CDTI [01.08-] SUZUKI SWIFT III (SG) 1.3 DDiS [08.05-]			

TS-800		17540-77E10	
	Diam./Diam. [mm]		90
	Height/Altezza [mm]		23
	Overall Height/Altezza ingombro[mm]		82
SUZUKI GRAND VITARA (FT, GT) 2.0 HDI 110 [07.01-] SUZUKI GRAND VITARA 1.9 DDiS [10.05-]			

TS-900		04668519AD	
	Outer Diam./Diam. est. [mm]		70
	Height/Altezza [mm]		19
	Overall Height/Altezza ingombro[mm]		46
CHRYSLER PT CRUISER 1.6 [11.01-]			

TS-801		17540-67JA0	
	Diam./Diam. [mm]		60
	Height/Altezza [mm]		31
	Overall Height/Altezza ingombro[mm]		56
	Length/Lungh. [mm]		248
SUZUKI GRAND VITARA 1.9 DDiS [10.05-]			

TS-901		04861630AB	
	Diam./Diam. [mm]		70
	Height/Altezza [mm]		25
	Overall Height/Altezza ingombro[mm]		79
CHRYSLER VOYAGER IV (RG) 2.5 CRD [02.00-] CHRYSLER VOYAGER IV (RG) 2.8 CRD [06.04-]			

TS-802		46819146	
	Outer Diam./Diam. est. [mm]		66
	Height/Altezza [mm]		26
	Overall Height/Altezza ingombro[mm]		77
SUZUKI IGNIS II 1.3 DDiS [09.03-] SUZUKI WAGON R+ (MM) 1.3 DDiS [09.03-]			

TS-902		05066936AA	
	Diam./Diam. [mm]		70
	Height/Altezza [mm]		26
	Overall Height/Altezza ingombro[mm]		80
JEEP CHEROKEE (KJ) 2.5 CRD [09.01-]			

TS-903		04668509AB	
	Diam./Diam. [mm]	70	
	Height/Altezza [mm]	19	
	Overall Height/Altezza ingombro[mm]	68	
CHRYSLER PT CRUISER 2.4 [06.00-] CHRYSLER PT CRUISER GT 2.4 [08.03-]			

TS-908		K5175588AA	
	Diam./Diam. [mm]	65	
	Height/Altezza [mm]	30	
	Overall Height/Altezza ingombro[mm]	71	
CHRYSLER 300 C 3.0 V6 CRD [11.10-] JEEP COMMANDER 3.0 CRD [04.06-]			

TS-904		611 200 0270	
	Diam./Diam. [mm]	71	
	Height/Altezza [mm]	25	
	Overall Height/Altezza ingombro[mm]	99	
JEEP GRAND CHEROKEE II (WJ, WG) 2.7 CRD 4x4 [10.01-]			

TS-909		8973124620	
	Diam./Diam. [mm]	70	
	Height/Altezza [mm]	26	
	Overall Height/Altezza ingombro[mm]	36	
ISUZU TROOPER 3.0 DTI [04.00-] ISUZU TROOPER Fuoristrada aperto 3.0 DTI [04.00-]			

TS-905		112 200 0070	
	Diam./Diam. [mm]	95	
	Height/Altezza [mm]	26	
	Overall Height/Altezza ingombro[mm]	85	
CHRYSLER CROSSFIRE 3.2 [07.03-] CHRYSLER CROSSFIRE Roadster 3.2 [05.04-]			

TS-910		5072440AB	
	Diam./Diam. [mm]	70	
	Height/Altezza [mm]	26	
	Overall Height/Altezza ingombro[mm]	80	
DODGE NITRO 2.8 CRD 4WD [06.07-] JEEP CHEROKEE (KJ) 2.8 CRD [11.02-]			

TS-906		05080243AA	
	Diam./Diam. [mm]	71	
	Height/Altezza [mm]	28	
	Overall Height/Altezza ingombro[mm]	100	
CHRYSLER PT CRUISER 2.2 CRD [03.02-]			

TS-911		05080312AC	
	Diam./Diam. [mm]	70	
	Height/Altezza [mm]	26	
	Overall Height/Altezza ingombro[mm]	71	
CHRYSLER PT CRUISER 2.2 CRD [03.02-]			

TS-907		04897159AB	
	Diam./Diam. [mm]	70	
	Height/Altezza [mm]	31	
	Overall Height/Altezza ingombro[mm]	47	
CHRYSLER VOYAGER III (GS) 2.5 TD [01.95-03.01] JEEP CHEROKEE (XJ) 2.5 TD [01.88-]			

TS-912		5636736	
	Diam./Diam. [mm]	82	
	Height/Altezza [mm]	31	
	Overall Height/Altezza ingombro[mm]	95	
ISUZU TROOPER 3.5 V6 24V [04.00-] ISUZU TROOPER Fuoristrada aperto 3.5 V6 24V [04.00-]			

TS-913		047 924 95AB	
	Diam./Diam. [mm]		70
	Height/Altezza [mm]		26
	Overall Height/Altezza ingombro[mm]		40
CHRYSLER PT CRUISER 2.0 [06.00-] CHRYSLER SEBRING (JR) 2.4 [04.01-]			

TS-H01		25281-27400	
	Diam./Diam. [mm]		70
	Height/Altezza [mm]		29
	Overall Height/Altezza ingombro[mm]		106
HYUNDAI SANTA FÉ 2.2 CRDi GLS [03.06-] HYUNDAI TUCSON (JM) 2.0 CRDi [01.06-]			

TS-914		04593822AB	
	Diam./Diam. [mm]		70
	Height/Altezza [mm]		25
	Overall Height/Altezza ingombro[mm]		82
CHRYSLER GRAND VOYAGER V (RT) 2.8 CRD [10.07-]			

TS-H02		25281-37101	
	Diam./Diam. [mm]		82
	Height/Altezza [mm]		26
	Length/Lungh. [mm]		185
HYUNDAI SANTA FE' (SM) 2.7 V6 4x4 [02.01-] HYUNDAI SONATA IV/ SONICA 2.7 V6 [10.01-11.04]			

TS-H00		25281-2A000	
	Diam./Diam. [mm]		65
	Height/Altezza [mm]		22
	Overall Height/Altezza ingombro[mm]		91
HYUNDAI ACCENT Tre volumi (MC) 1.5 CRDi GLS [11.05-] HYUNDAI GETZ (TB) 1.5 CRDi GLS [08.05-]			

TS-H03		25281-3E000	
	Diam./Diam. [mm]		90
	Height/Altezza [mm]		30
	Overall Height/Altezza ingombro[mm]		115
HYUNDAI SANTA FE' (SM) 2.7 4x4 [10.05-] KIA CARNIVAL II 2.7 V6 [06.06-]			

TS-H00		25281-2A000	
	Diam./Diam. [mm]		65
	Height/Altezza [mm]		22
	Overall Height/Altezza ingombro[mm]		91
HYUNDAI ACCENT Tre volumi (MC) 1.5 CRDi GLS [11.05-] HYUNDAI GETZ (TB) 1.5 CRDi GLS [08.05-]			

TS-H04		25281-27000	
	Diam./Diam. [mm]		70
	Height/Altezza [mm]		25,5
	Overall Height/Altezza ingombro[mm]		101
HYUNDAI ACCENT (LC) 1.5 CRDi [04.02-] HYUNDAI GETZ (TB) 1.5 CRDi [03.03-]			

TS-H01		25281-27400	
	Diam./Diam. [mm]		70
	Height/Altezza [mm]		29
	Overall Height/Altezza ingombro[mm]		106
HYUNDAI SANTA FÉ 2.2 CRDi GLS [03.06-] HYUNDAI TUCSON (JM) 2.0 CRDi [01.06-]			

TS-K00		0K551-15-981	
	Diam./Diam. [mm]		75
	Height/Altezza [mm]		22
	Overall Height/Altezza ingombro[mm]		89
KIA CARNIVAL (UP) 2.9 TD [08.99-10.01] KIA CEE'D 1.6 CRDi 115 [12.06-]			

TS-K01		25281-4A000	
	Diam./Diam. [mm]		76
	Height/Altezza [mm]		30
	Overall Height/Altezza ingombro[mm]		107
HYUNDAI H-1/H-200/SATELLITE 2.5 CRDi [12.02-] KIA SORENTO (JC) 2.5 CRDi [12.06-]			

TS-S00			
	Diam./Diam. [mm]		80
	Height/Altezza [mm]		25
	Overall Height/Altezza ingombro[mm]		108
SSANGYONG KORANDO (KJ) 2.0 [05.97-] SSANGYONG MUSSO (FJ) 2.0 [10.96-]			

TS-K02		OK88R-15-981	
	Diam./Diam. [mm]		76
	Height/Altezza [mm]		22
	Overall Height/Altezza ingombro[mm]		90
HYUNDAI TERRACAN (HP) 2.9 CRDi [11.03-] KIA CARNIVAL II 2.9 CRDi [10.01-]			

TS-S00			
	Diam./Diam. [mm]		80
	Height/Altezza [mm]		25
	Overall Height/Altezza ingombro[mm]		108
SSANGYONG KORANDO (KJ) 2.0 [05.97-] SSANGYONG MUSSO (FJ) 2.0 [10.96-]			

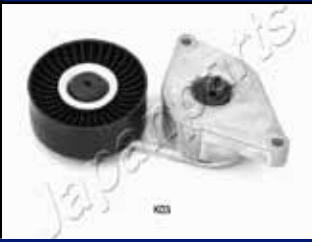
TS-K03		OK9BV-10-770	
	Diam./Diam. [mm]		96
	Height/Altezza [mm]		26
	Overall Height/Altezza ingombro[mm]		42
KIA CARNIVAL (UP) 2.5 V6 [08.99-10.01] KIA CARNIVAL II 2.5 V6 [10.01-]			

TS-S01			
	Diam./Diam. [mm]		
	Height/Altezza [mm]		66
DAEWOO KORANDO (KJ) 3.2 [01.99-] DAEWOO MUSSO (FJ) 3.2 [01.99-]			

TS-L00		PQG 10008	
	Diam./Diam. [mm]		70
	Height/Altezza [mm]		26
	Overall Height/Altezza ingombro[mm]		84
LAND ROVER DISCOVERY I 2.0 16 V [09.93-06.94]			

TS-W00		96183115	
	Outer Diam./Diam. est. [mm]		77
	Height/Altezza [mm]		26
	Overall Height/Altezza ingombro[mm]		95
CHEVROLET AVEO 1.2 [04.08-] CHEVROLET KALOS 1.4 [03.05-]			

TS-L01			
	Diam./Diam. [mm]		76
	Height/Altezza [mm]		35
	Overall Height/Altezza ingombro[mm]		51
LAND ROVER DEFENDER (LD) 2.4 Td4 [05.07-] LAND ROVER DEFENDER Pick-up 2.4 Td4 [05.07-]			

TS-W01		1340533	
	Diam./Diam. [mm]		70
	Height/Altezza [mm]		26
	Overall Height/Altezza ingombro[mm]		99
CHEVROLET EVANDA 2.0 [03.05-] DAEWOO TACUMA (KLAU) 1.8 [09.00-]			

TENSIONER LEVER, V-RIBBED BELT
 SPANNARM, KEILRIPPENRIEMEN
 TENDEUR, COURROIE TRAPÉZOÏDALE À NERVURES
 BRAZO TENSOR, CORREA TRAPICIAL POLI V
 TENDITORE, CINGHIA POLY-V

TS-W02		96184932	
 <p>W02</p>	Diam./Diam. [mm]		70
	Height/Altezza [mm]		26
	Overall Height/Altezza ingombro[mm]		92
	CHEVROLET EPICA 2.0 [01.05-12.06] CHEVROLET EVANDA 2.0 [03.05-]		

TS-W03		4805513	
 <p>W03</p>	Diam./Diam. [mm]		65
	Height/Altezza [mm]		24,5
	Overall Height/Altezza ingombro[mm]		82
	CHEVROLET CAPTIVA 2.0 D 4WD [10.06-] CHEVROLET EPICA 2.0 D [01.07-]		

CINGHIA DISTRIBUZIONE - TIMING BELT

CHEVROLET	JAPANPARTS			DR	JAPANPARTS
24422964	DD-W10	13514-87704	DD-600	481H-1007073BA	DD-008
55183528	DD-007	13514-87707	DD-608	701050038	DD-811
92063917	DD-W04	13514-87709	DD-600	701060033	DD-010
92065902	DD-W09	13514-87710	DD-608	FORD JAPANPARTS	
96183352	DD-393	13514-87711	DD-697G	1449040	DD-329
96183353	DD-387	13514-87711	DD-697	GONOW JAPANPARTS	
96352407	DD-387	13514-87713	DD-608	701060001	DD-001
96352965	DD-W02	13514-87781	DD-608	GREAT WALL JAPANPARTS	
96417177	DD-393	13514-87782	DD-600	1021013ED01	DD-012
96440343	DD-W07	13514-87785	DD-608	SMD182294	DD-591
96610029	DD-540	13514-97201	DD-601	HONDA JAPANPARTS	
96814098	DD-393	13514-97204	DD-601	06141-611-305	DD-497
98014186	DD-W11	13568-87101	DD-611	06141-642-305	DD-496
CHRYSLER JAPANPARTS		13568-87103	DD-610	06141-679-305	DD-496
05142579AA	DD-005	13568-87103	DD-610G	06141-679-306	DD-493
4667611	DD-006	13568-87104	DD-610G	06141-679-306	DD-493
68001309AA	DD-502	13568-87104	DD-610	06141-PC0-305	DD-406
CITROEN JAPANPARTS		13568-87181	DD-611	06141-PH9-306	DD-492
0816J5	DD-515	13568-87181	DD-611	06141-PK2-305	DD-411
9662187580	DD-515	13568-87183	DD-610	06141-PK2-305	DD-411
DAEWOO JAPANPARTS		13568-87183	DD-610G	06141-PN4-305	DD-489
90231883	DD-W00	13568-87306	DD-615	06141-PR3-305	DD-422
90324698	DD-W00	13568-87702	DD-103	06141-PR4-305	DD-485
90324699	DD-W00	13568-87703	DD-605	06141-PR7-305	DD-483
90354783	DD-W00	13568-87703	DD-605	06141-PS4-305	DD-490
92063918	DD-W03	13568-87704	DD-606	06141-PT2-305	DD-484
DAIHATSU JAPANPARTS		13568-87705	DD-103	06141-PV0-305	DD-486
12761-74000	DD-600	13568-87706	DD-609	06141-PV1-305	DD-486
13514-87201	DD-699	13568-87707	DD-613	06141-PZ1-305	DD-488
13514-87201	DD-699G	13568-87707	DD-613	11407-60B10	DD-406
13514-87202	DD-607	13568-87708	DD-697G	12761-60B01	DD-406
13514-87205	DD-103	13568-87708	DD-697	12761-60B10	DD-406
13514-87205	DD-587G	6551002303	DD-699	12761-73000	DD-401
13514-87205	DD-587	6551002303	DD-699G	13028-D0100	DD-400
13514-87206	DD-614	6551002309	DD-103	13405-PT0-004	DD-419
13514-87208	DD-695	6551002309	DD-587	14320-P5T-G00	DD-426
13514-87211	DD-614	6551002309	DD-587G	14400-371-014	DD-496
13514-87282	DD-695	6551010303	DD-606	14400-371-305	DD-496
13514-87701	DD-600	6551010307	DD-605	14400-611-014	DD-497
13514-87702	DD-600	65511303	DD-609	14400-611-024	DD-497
13514-87703	DD-600	6561008309	DD-697G	14400-611-024	DD-496
		6561008309	DD-697	14400-611-040	DD-497
		DODGE JAPANPARTS		14400-634-003	DD-401
		4792353	DD-002		

CINGHIA DISTRIBUZIONE - TIMING BELT

HONDA		JAPANPARTS					
14400-634-004	DD-401	14400-PH7-004	DD-410	24312-02501	DD-572		
14400-634-005	DD-401	14400-PH7-014	DD-410	24312-02701	DD-571		
14400-634-005EH	DD-401	14400-PH9-004	DD-201G	24312-21040	DD-519		
14400-634-014	DD-401	14400-PH9-004	DD-201	24312-22010	DD-533		
14400-642-004	DD-496	14400-PH9-014	DD-492	24312-22611	DD-H14		
14400-642-305	DD-496	14400-PJ7-004	DD-490	24312-22612	DD-H14		
14400-657-000	DD-215	14400-PK1-004	DD-413	24312-23001	DD-581		
14400-657-004	DD-215	14400-PK2-004	DD-411	24312-23002	DD-581		
14400-657-014	DD-215	14400-PK3-004	DD-411	24312-23202	DD-415		
14400-657-024	DD-400	14400-PLM-014	DD-900	24312-23400	DD-415		
14400-657-024H	DD-400	14400-PLZ-D00	DD-425	24312-26000	DD-H07		
14400-673-004	DD-503	14400-PM3-004	DD-412G	24312-26001	DD-H07		
14400-673-004	DD-503G	14400-PM3-004	DD-412	24312-26002	DD-H07		
14400-679-000	DD-496	14400-PM6-004	DD-413	24312-26050	DD-H07		
14400-679-003	DD-496	14400-PN4-004	DD-489	24312-27000	DD-H08		
14400-679-004	DD-496	14400-PO8-004	DD-487	24312-27250	DD-H08		
14400-679-024	DD-493	14400-PR3-004	DD-422	24312-32820	DD-513		
14400-679-624	DD-493	14400-PR4-004	DD-485	24312-32830	DD-513		
14400-P04-004	DD-424	14400-PR4-A01	DD-485	24312-33130	DD-526		
14400-P08-004	DD-487	14400-PR7-004	DD-483	24312-33140	DD-526		
14400-P08-305	DD-487	14400-PS4-004	DD-490	24312-33160	DD-526		
14400-P13-004	DD-498	14400-PT2-004	DD-484	24312-35000	DD-525		
14400-P14-004	DD-416	14400-PV0-004	DD-486	24312-35040	DD-525		
14400-P28-004	DD-418	14400-PV1-004	DD-486	24312-37100	DD-H03		
14400-P5A-004	DD-480	14400-PY3-004	DD-417	24312-37500	DD-H03		
14400-P5T-G00	DD-482	14400-PZ1-004	DD-488	24312-38010	DD-H02		
14400-P72-004	DD-481	14400P45000	DD-415	24312-38210	DD-H09		
14400-P72-014	DD-481	14400P45010	DD-415	24312-3E500	DD-H11		
14400-P7A-004	DD-423	14400P45G00	DD-415	243123E100	DD-H11		
14400-P7J-004	DD-485	14400P45G01	DD-415	24315-42200	DD-588G		
14400-PC0-004	DD-406	14400P8AA01	DD-407	24315-42200	DD-588		
14400-PC6-004	DD-405	14400P8AA02	DD-407				
14400-PC6-004EH	DD-405	14400PT0004	DD-415	ISUZU	JAPANPARTS		
14400-PDA-E01	DD-424	14400PT0004EH	DD-415	4294125	DD-903		
14400-PE0-004	DD-404			4295417	DD-904		
14400-PE0-004EH	DD-404	HYUNDAI	JAPANPARTS	4300156	DD-902		
14400-PE3-004	DD-404	23356-32020	DD-514	4303362	DD-901		
14400-PE3-004H	DD-404	23356-32030	DD-514	4317859	DD-904		
14400-PG6-004	DD-408	23356-33130	DD-532	4318261	DD-905		
14400-PG6-014	DD-408	23356-33140	DD-532	4320917	DD-903		
14400-PH3-004	DD-409	23356-38000	DD-532	4394125	DD-903		
		23356-42500	DD-587G	5-12536-006-0	DD-997		
		23356-42500	DD-587	5-12536-007-0	DD-997		

CINGHIA DISTRIBUZIONE - TIMING BELT

ISUZU		JAPANPARTS					
5-12536-016-0	DD-901	0K88R-12-205	DD-K11	B6S7-12-205A	DD-K06		
5-12536-017-0	DD-997	0K954-12-205	DD-K02	BP01-12-205	DD-320		
636364	DD-998	0K9BV-12-206	DD-K01	BP01-12-205A	DD-320		
636366	DD-911	0K9BV-12205	DD-K12	BP01-12-205B	DD-320		
8-94119-112-1	DD-992	24312-2Y000	DD-K00	BP02-12-205	DD-320		
8-94156-821-0	DD-902	24312-33160	DD-526	F202-12-205	DD-317		
8-94158-327-0	DD-903	24312-37500	DD-H03	F203-12-205	DD-317		
8-94160-656-0	DD-902	24312-38010	DD-H02	F203-12-205X	DD-317		
8-94174-306-0	DD-905	24312-39800	DD-K13	F210-12-205	DD-317		
8-94215-254-0	DD-903	24312-39810	DD-K13	F801-12-205	DD-101		
8-94218-782-0	DD-301	24312-4X000	DD-K11	F802-12-205	DD-101		
8-94220-422-0	DD-908	K201-12-205	DD-320	F803-12-205	DD-300		
8-94220-922-0	DD-908	KK350-12-205	DD-320	F804-12-205	DD-300		
8-94221-435-0	DD-904	MBP01-12-205B	DD-320	F805-12-205	DD-311		
8-94235-362-0	DD-301	OK954-12-205	DD-K02	F806-12-205	DD-311		
8-94240-549-0	DD-994	LADA JAPANPARTS		F807-12-205	DD-300		
8-94380-679-0	DD-993	2108-1006040	DD-295	F808-12-205	DD-311		
8-94416-145-0	DD-301	2108-1006040-00	DD-295	F809-12-205	DD-311		
8-94419-856-0	DD-993	LAND ROVER JAPANPARTS		F809-12-205X	DD-311		
8-94429-486-0	DD-991	LR004257	DD-515	F8B2-12-205	DD-418		
8-94449-169-0	DD-904	LEXUS JAPANPARTS		F8B2-12-205A	DD-418		
8-94449-307-1	DD-911	13568-29025	DD-214	F8B3-12-205	DD-418		
8-94459-925-0	DD-994	MAZDA JAPANPARTS		F8B3-12-205A	DD-418		
8-97041-784-0	DD-902	0FE3R-14-302	DD-K02	F8Y8-12-205	DD-300		
8-97065-986-0	DD-993	0K054-12-205	DD-399	F8Y9-12-205	DD-300		
8-97136-321-0	DD-225	10068553	DD-392	F8Y9-12-205X	DD-300		
8-97143-724-0	DD-900	1E0612205	DD-313	FE01-12-205	DD-301		
894385561	DD-911	1E07-13-823A	DD-331	FE01-12-205X	DD-301		
94029834	DD-901	1E12-12-205B	DD-330	FE02-12-205	DD-301		
94158327	DD-903	90410223	DD-387	FE05-12-205	DD-307		
94160656	DD-902	B360-12-205D	DD-320	FE06-12-205	DD-307		
94174306	DD-905	B630-12-205A	DD-303	FE08-12-205	DD-307		
94215254	DD-903	B630-12-205E	DD-320	FE09-12-205	DD-307		
94419856	DD-993	B630-12-205X	DD-303	FE09-12-205X	DD-307		
94449-169	DD-904	B63012205A9A	DD-337	FE1H-12-205	DD-308		
KIA JAPANPARTS		B632-12-205	DD-320	FE1H-12-205A	DD-308		
0K054-12-205	DD-399	B632-12-205X	DD-320	FE1J-12-205	DD-308		
0K203-12-205	DD-K06	B657-12-205	DD-K06	FE3N-12-205	DD-K02		
0K247-12-205	DD-K00	B657-12-205B	DD-K06	FEY8-12-205	DD-310		
0K30E-12-205	DD-K10	B660-12-205B	DD-K06	FEY9-12-205	DD-310		
0K551-12-205B	DD-K03	B660-12-205C	DD-K06	FEY9-12-205X	DD-310		
		B660-12-205X	DD-K06	FH1H-12-205	DD-308		

CINGHIA DISTRIBUZIONE - TIMING BELT

MAZDA		JAPANPARTS		MITSUBISHI		JAPANPARTS	
FH1H-12-205A	DD-308	YF71-12-205A	DD-425	MD050175	DD-506	MD060461	DD-505G
FP01-12-205	DD-322	YF7112205	DD-425	MD060461	DD-505	MD060461	DD-505
FP01-12-205A	DD-322	Z501-12-205	DD-383	MD071052	DD-509	MD071052	DD-509
FS01-12-205	DD-397	Z502-12-205	DD-324	MD095266	DD-509	MD095266	DD-509
JF01-12-205	DD-319			MD095866	DD-508	MD095866	DD-508
JF01-12-205C	DD-319			MD098491	DD-513	MD098491	DD-513
K906-12-205	DD-311			MD098492	DD-521	MD098492	DD-521
KJ01-12-205	DD-323			MD099706	DD-503	MD099706	DD-503
KL01-12-205	DD-388			MD099706	DD-503G	MD099706	DD-503G
OK054-12-205	DD-399			MD099707	DD-505G	MD099707	DD-505G
OK740-12-205	DD-320			MD099707	DD-505	MD099707	DD-505
OK954-12-205	DD-K02			MD100619	DD-507	MD100619	DD-507
PN11-12-005	DD-315			MD100620	DD-500	MD100620	DD-500
PN11-12-205	DD-315			MD100632	DD-501	MD100632	DD-501
PN12-12-205	DD-315			MD100814	DD-519	MD100814	DD-519
R201-12-205	DD-321			MD102048	DD-879	MD102048	DD-879
R201-12-205A	DD-321			MD102049	DD-595	MD102049	DD-595
RF03-12-205	DD-389			MD102248	DD-508	MD102248	DD-508
RF03-12-206A	DD-305			MD102249	DD-513	MD102249	DD-513
RF03-12-206X	DD-305			MD106103	DD-514	MD106103	DD-514
RF1G-12-205	DD-332			MD110029	DD-526	MD110029	DD-526
RF2A12205	DD-378			MD110041	DD-590	MD110041	DD-590
RF43-12-205	DD-389			MD110709	DD-521	MD110709	DD-521
RF43-12-206	DD-305			MD111427	DD-525	MD111427	DD-525
RF5C-12-205A	DD-327			MD113561	DD-507	MD113561	DD-507
RF71-12-205	DD-314			MD113562	DD-500	MD113562	DD-500
RF79-12-205	DD-314			MD113563	DD-503G	MD113563	DD-503G
RF7J-12-205	DD-334			MD113563	DD-503	MD113563	DD-503
W90112205	DD-336			MD113564	DD-519	MD113564	DD-519
W90212205	DD-336			MD113790	DD-513	MD113790	DD-513
WE01-12205	DD-329			MD116786	DD-519	MD116786	DD-519
WL01-12-205	DD-380			MD120487	DD-522	MD120487	DD-522
WL81-12-205	DD-380			MD127424	DD-879	MD127424	DD-879
Y401-12-205A	DD-318			MD133115	DD-526	MD133115	DD-526
Y40112205B	DD-812			MD133116	DD-590	MD133116	DD-590
Y601-12-205	DD-325			MD134377	DD-505G	MD134377	DD-505G
Y603-12-201	DD-325			MD134377	DD-505	MD134377	DD-505
Y651-12-205	DD-335			MD140227	DD-522	MD140227	DD-522
Y655-12-205	DD-335			MD140228	DD-513	MD140228	DD-513
Y701-12-205	DD-911			MD140229	DD-521	MD140229	DD-521
YF09-12-205	DD-425			MD142750	DD-586	MD142750	DD-586

CINGHIA DISTRIBUZIONE - TIMING BELT

MITSUBISHI		JAPANPARTS					
MD145713	DD-526	MD197146	DD-583	13028-12G00	DD-110		
MD145714	DD-590	MD197147	DD-542	13028-16A01	DD-104		
MD145716	DD-532	MD197152	DD-531	13028-16A10	DD-104		
MD145813	DD-533	MD198116	DD-585	13028-16E00	DD-110		
MD152622	DD-506G	MD199072	DD-585	13028-16E10	DD-110		
MD152622	DD-506	MD199418	DD-590	13028-16V00	DD-122		
MD153723	DD-585	MD300470	DD-588	13028-18V01	DD-193		
MD153724	DD-584	MD300470	DD-588G	13028-18V25	DD-193		
MD154243	DD-592	MD300473	DD-587	13028-20R00	DD-106		
MD161427	DD-528	MD300473	DD-587G	13028-24B10	DD-303		
MD171748	DD-526	MD303375	DD-504	13028-24B25	DD-303		
MD171749	DD-532	MD307487	DD-541	13028-2J600	DD-581		
MD172201	DD-590	MD310474	DD-587G	13028-2J685	DD-581		
MD176386	DD-534	MD310474	DD-587	13028-31B10	DD-121		
MD176387	DD-529	MD310484	DD-587	13028-31B85	DD-121		
MD176388	DD-585	MD313447	DD-590	13028-33E00	DD-196		
MD176389	DD-535	MD314456	DD-579	13028-33E85	DD-196		
MD179179	DD-583	MD319023	DD-504	13028-48L00	DD-194		
MD179620	DD-583	MD322641	DD-512	13028-48L25	DD-194		
MD182291	DD-526	MD329639	DD-539	13028-50A00	DD-100		
MD182292	DD-589	MD331076	DD-589	13028-50A25	DD-100		
MD182293	DD-530	MD340625	DD-W02	13028-51E00	DD-108		
MD182294	DD-591	MD342154	DD-540	13028-51E10	DD-108		
MD182295	DD-532	MD357703	DD-531	13028-54A00	DD-104		
MD189521	DD-594	MD369960	DD-543	13028-54A01	DD-104		
MD189522	DD-593	MD378163	DD-543	13028-54A10	DD-104		
MD191982	DD-578	MN980100	DD-502	13028-57J01	DD-581		
MD192319	DD-531	MN982125	DD-515	13028-61A00	DD-101		
MD193874	DD-583	XD008969	DD-501	13028-61A25	DD-101		
MD197121	DD-879	XD009352	DD-500	13028-6F900	DD-003		
MD197122	DD-879	XD030600	DD-503	13028-6F900	DD-004G		
MD197123	DD-586	XD030600	DD-503G	13028-81T00	DD-116G		
MD197126	DD-584	NISSAN JAPANPARTS		13028-81T25	DD-116G		
MD197130	DD-507	13028-00QAC	DD-120	13028-85E00	DD-110		
MD197133	DD-585	13028-01B00	DD-103	13028-85E85	DD-110		
MD197134	DD-535	13028-01M00	DD-100	13028-AW301	DD-120		
MD197135	DD-500	13028-01M10	DD-100	13028-BN700	DD-114		
MD197138	DD-521	13028-01M25	DD-100	13028-D1700	DD-106		
MD197139	DD-590	13028-05B00	DD-115	13028-D2800	DD-104		
MD197142	DD-526	13028-05B10	DD-115	13028-V4000	DD-197		
MD197144	DD-591	13028-11M00	DD-101	13028-V4025	DD-197		
		13028-11M10	DD-101	13028-V4310	DD-507		

CINGHIA DISTRIBUZIONE - TIMING BELT

NISSAN		JAPANPARTS					
13028-V5000	DD-196	16806-V7200	DD-113	13028-KA090	DD-789		
13028-V5001	DD-196	16806-V7210	DD-113	13028-KA100	DD-789		
13028-V5010	DD-196	16806-V7225	DD-113	13028-KA110	DD-795		
13028-V5020	DD-196	16806-Y9701	DD-199	13028-KA161	DD-789		
13028-V5021	DD-196	1680600QAD	DD-117	13029-AA010	DD-700		
13028-V5200	DD-110	1680600QAH	DD-117	13029-AA011	DD-700		
13028-V5201	DD-110	6551021404	DD-103	13160-AA060	DD-791		
13028-V7211	DD-116G	8200127627	DD-117	13160-AA090	DD-791		
13028-V7211	DD-116	A16806-G5510	DD-118	13160-KA010	DD-798		
13028-V7225	DD-116G	A16806-G5510	DD-118G	13160-KA020	DD-796		
13028-V7225	DD-116	OPEL JAPANPARTS		13160-KA030	DD-789		
13028-V7285	DD-116	5636463	DD-811	13160-KA060	DD-789		
13028-V7285	DD-116G	93178812	DD-007	13160-KA090	DD-697		
13568-87702	DD-103	PIAGGIO JAPANPARTS		13160-KA090	DD-697G		
16806-00QOE	DD-117	493070	DD-602	13160-KA100	DD-789		
16806-00QA0	DD-126	RENAULT JAPANPARTS		13160-KA110	DD-789		
16806-00QA1	DD-124	8200542743	DD-120	31470-2100	DD-497		
16806-00QA7	DD-124	SUBARU JAPANPARTS		31470-2110	DD-497		
16806-00QAA	DD-124	11407-63E00	DD-890	31470-2121	DD-497		
16806-00QAM	DD-125	12761-72F00	DD-884	31470-7111	DD-497		
16806-00QAN	DD-125	13027-AA102	DD-703	38498-1001	DD-401		
16806-00QBF	DD-125	13028-AA010	DD-106	38498-2100	DD-497		
16806-05E00	DD-107	13028-AA040	DD-793	41470-0900	DD-497		
16806-05E10	DD-107	13028-AA070	DD-791	41470-1001	DD-401		
16806-16A00	DD-119	13028-AA071	DD-791	41470-5401	DD-508		
16806-16A10	DD-119	13028-AA072	DD-791	41470-5601	DD-401		
16806-2J600	DD-111	13028-AA080	DD-707	48498-1001	DD-401		
16806-54A00	DD-119	13028-AA101	DD-703	A759YU34M/M 241T	DD-706		
16806-54A10	DD-119	13028-AA102	DD-703	A885YU30MM 281T	DD-791		
16806-54A25	DD-119	13028-AA120	DD-706	SUZUKI JAPANPARTS			
16806-9C600	DD-112	13028-AA181	DD-707	11407-53A10	DD-892		
16806-D5610	DD-107	13028-AA200	DD-791	11407-53B01	DD-804		
16806-G5500	DD-118G	13028-AA220	DD-791	11407-53B01	DD-804G		
16806-G5500	DD-118	13028-AA231	DD-707	11407-60C11	DD-894		
16806-G5510	DD-118	13028-AA240	DD-791	11407-60D00	DD-895		
16806-G5510	DD-118G	13028-KA010	DD-798	11407-60E00	DD-879		
16806-G5525	DD-118	13028-KA020	DD-890	11407-61D00	DD-886		
16806-G5525	DD-118G	13028-KA021	DD-890	11407-63E00	DD-890		
16806-V0700	DD-102	13028-KA030	DD-697G	11407-70B00	DD-895		
16806-V0710	DD-102	13028-KA030	DD-697	11407-70B01	DD-895		
16806-V0711	DD-102	13028-KA060	DD-798	11407-70C00	DD-889		
		13028-KA080	DD-796	11407-70C00-SET	DD-889		

CINGHIA DISTRIBUZIONE - TIMING BELT

SUZUKI		JAPANPARTS					
11407-70D00	DD-895	12761-71C00	DD-803	06141-PO8-305	DD-487		
11407-71B11	DD-886	12761-71D10	DD-886	06141-PR7-305	DD-483		
11407-71C00	DD-803	12761-72B00	DD-891	06141-PT2-305	DD-484		
11407-71C00	DD-803G	12761-72B10	DD-891	06141-PZ1-305	DD-488		
11407-71D10	DD-886	12761-72F00	DD-884	2547 0511 6312	DD-003		
11407-72B10	DD-891	12761-73G00	DD-884	25470511-6302	DD-004G		
11407-73001	DD-899	12761-73G01	DD-884	25470511-6310	DD-004G		
11407-78101	DD-899	12761-73J00-000	DD-818	25470511-6310	DD-003		
11407-81400	DD-896	12761-78100	DD-899	278905116301	DD-575		
11407-83C00	DD-888	12761-78101	DD-899	278905116305	DD-575		
11407-84050	DD-898	12761-78110	DD-899	2791-0511-63-03	DD-013		
11407-85100	DD-897	12761-79J50-000	DD-811	571105119902	DD-011		
11407-86501	DD-801	12761-81400	DD-896			TOYOTA	JAPANPARTS
12761-53A10	DD-892	12761-82000	DD-800G	12761-78101	DD-201		
12761-53B00	DD-804	12761-82000	DD-800	12761-78101	DD-201G		
12761-53B00	DD-804G	12761-83C00	DD-888	12761-78400	DD-201G		
12761-53B01	DD-804	12761-84000	DD-898	12761-78400	DD-201		
12761-53B01	DD-804G	12761-84001	DD-898	13568-09130	DD-889		
12761-60A00	DD-805G	12761-84050	DD-898	13568-10010	DD-208		
12761-60A00	DD-805	12761-84100	DD-898	13568-10011	DD-224		
12761-60A01	DD-805G	12761-85100	DD-897	13568-10012	DD-224		
12761-60A01	DD-805	12761-85C00	DD-805	13568-10013	DD-224		
12761-60C10	DD-894	12761-85C00	DD-805G	13568-10014	DD-224		
12761-60D00	DD-895	12761-86500	DD-801	13568-10020	DD-208		
12761-60E00	DD-879	12761-86501	DD-801	13568-10021	DD-224		
12761-61D00	DD-886	12761-86CA0	DD-907	13568-10022	DD-224		
12761-61D10	DD-886	12761-F00F10	DD-884	13568-10023	DD-224		
12761-63B00	DD-800	12761-M72F10	DD-884	13568-10024	DD-224		
12761-63B00	DD-800G	12761-N72F10	DD-884	13568-10030	DD-208		
12761-63B00-000	DD-800G	1276173J00	DD-818	13568-10031	DD-208		
12761-63B00-000	DD-800	9400831409	DD-883	13568-10032	DD-208		
12761-63E00	DD-890			13568-10070	DD-207		
12761-66G00	DD-907	TATA (TELCO)	JAPANPARTS	13568-11010	DD-207		
12761-67G00	DD-883	06141-611-305	DD-497	13568-11020	DD-207		
12761-67J00-000	DD-812	06141-657-305	DD-215	13568-11030	DD-293		
12761-70B01	DD-895	06141-673-305	DD-503	13568-11031	DD-293		
12761-70C00	DD-889	06141-673-305	DD-503G	13568-11032	DD-293		
12761-70D00	DD-895	06141-PC0-305	DD-406	13568-11033	DD-293		
12761-71B00	DD-886	06141-PH9-305	DD-201	13568-11040	DD-293		
12761-71B10	DD-886	06141-PH9-305	DD-201G	13568-11041	DD-293		
12761-71C00	DD-803G	06141-PH9-306	DD-492	13568-11041	DD-293		
		06141-PJ7-305	DD-490	13568-11050	DD-210		
		06141-PK2-305	DD-411	13568-11051	DD-210		

CINGHIA DISTRIBUZIONE - TIMING BELT

TOYOTA	JAPANPARTS				
		13568-19116	DD-292	13568-62020	DD-213
13568-11052	DD-210	13568-19125	DD-201	13568-62030	DD-225
13568-11053	DD-210	13568-19125	DD-201G	13568-62040	DD-213
13568-11061	DD-210	13568-19145	DD-212	13568-62050	DD-230
13568-11070	DD-207	13568-19155	DD-208	13568-63010	DD-204
13568-11071	DD-207	13568-19165	DD-207	13568-63020	DD-204
13568-11072	DD-207	13568-19175	DD-283	13568-63022	DD-204
13568-11080	DD-227	13568-29035	DD-205	13568-63023	DD-204
13568-11080	DD-228	13568-39015	DD-889	13568-64010	DD-297
13568-11081	DD-228	13568-42010	DD-991	13568-64011	DD-297
13568-11090	DD-228	13568-42011	DD-991	13568-64012	DD-297
13568-11100	DD-292	13568-43010	DD-200	13568-64021	DD-297
13568-11101	DD-292	13568-43020	DD-200	13568-65010	DD-220
13568-11110	DD-292	13568-43030	DD-200	13568-65020	DD-220
13568-15010	DD-201G	13568-46010	DD-287	13568-67010	DD-288
13568-15010	DD-201	13568-46020	DD-286	13568-69025	DD-225
13568-15040	DD-215	13568-49015	DD-991	13568-69035	DD-213
13568-15041	DD-215	13568-49025	DD-287	13568-69045	DD-204
13568-15050	DD-215	13568-49035	DD-286	13568-69055	DD-220
13568-16010	DD-212	13568-49036	DD-286	13568-69065	DD-297
13568-16020	DD-212	13568-49046	DD-200	13568-69066	DD-297
13568-16030	DD-295	13568-54010	DD-202	13568-69075	DD-220
13568-16050	DD-227	13568-54030	DD-202	13568-69085	DD-288
13568-16060	DD-294	13568-54050	DD-206	13568-69095	DD-230
13568-16070	DD-294	13568-54050	DD-206G	13568-70010	DD-296
13568-17010	DD-222	13568-54070	DD-219	13568-70020	DD-296
13568-19015	DD-224	13568-54070	DD-219G	13568-70030	DD-290
13568-19016	DD-224	13568-55010	DD-393	13568-70040	DD-290
13568-19025	DD-210	13568-59015	DD-202	13568-70050	DD-290
13568-19035	DD-295	13568-59016	DD-202	13568-70080	DD-291
13568-19045	DD-227	13568-59025	DD-206G	13568-74010	DD-211
13568-19046	DD-227	13568-59025	DD-206	13568-74011	DD-211
13568-19055	DD-294	13568-59026	DD-206G	13568-74012	DD-211
13568-19056	DD-208	13568-59026	DD-206	13568-74020	DD-211
13568-19065	DD-222	13568-59027	DD-206G	13568-78401	DD-297
13568-19075	DD-208	13568-59027	DD-206	13568-79025	DD-211
13568-19085	DD-293	13568-59055	DD-393	13568-79035	DD-289
13568-19086	DD-293	13568-59065	DD-219G	13568-79045	DD-216
13568-19095	DD-207	13568-59065	DD-219	13568-79055	DD-296
13568-19105	DD-228	13568-59066	DD-219	13568-79065	DD-290
13568-19106	DD-228	13568-59066	DD-219G	13568-79075	DD-290
13568-19115	DD-292	13568-59095	DD-229	13568-79085	DD-291

CINGHIA DISTRIBUZIONE - TIMING BELT

TOYOTA	JAPANPARTS
13568-79095	DD-211
13568-79105	DD-221
13568-79225	DD-211
13568-79235	DD-291
13568-88300	DD-289
13568-88301	DD-289
13568-88340	DD-289
13568-88361	DD-216
13568-88381	DD-216
13568-88382	DD-216
13568-88460	DD-221
41470-5601	DD-201G
41470-5601	DD-201
96223131	DD-231
96252153	DD-231
9653226080	DD-318
9653226280	DD-318
SU001-00085	DD-231
SU00100544	DD-318

CUSCINETTO DISTRIBUZIONE - TENSIONER, TIMING BELT

CHEVROLET	JAPANPARTS				
09128738	BE-W08	13505-87102	BE-600	14510-P8A-A01	BE-423
12810-81401	BE-808	13505-87201	BE-607	14510-PC0-005	BE-403
24436052	BE-W13	13505-87203	BE-608	14510-PC6-013	BE-400
5094008601	BE-W00	13505-87205	BE-608	14510-PD2-003	BE-400
55562217	BE-W14	13505-87206-000	BE-608	14510-PD2-004	BE-400
55570289	BE-W14	13505-87303	BE-609	14510-PE0-003	BE-401
55574864	BE-W14	13505-87701	BE-602	14510-PE0-005	BE-401
90499401	BE-W02	13505-87704	BE-603	14510-PG6-013	BE-411
90528603	BE-W06	13505-97201	BE-611	14510-PGE-A01	BE-423
94580139	BE-808	DODGE JAPANPARTS		14510-PH1-003	BE-400
96103222	BE-W01	04663515AC	BE-011	14510-PH1-004	BE-400
96350526	BE-W01	DR JAPANPARTS		14510-PH3-003	BE-407
96350550	BE-W00	473H-1007060	BE-015	14510-PH3-004	BE-407
96440326	BE-W12	481H1007071	BE-021	14510-PH7-003	BE-405
96440336	BE-W11	701050036	BE-811	14510-PH7-004	BE-405
96941103	BE-W11	701050040	BE-810	14510-PM7-003	BE-413
97249945	BE-418	701060032	BE-018	14510-PM7-004	BE-413
97376296	BE-W15	701070017	BE-017	14510-PT0-002	BE-404
CHRYSLER JAPANPARTS		701070018	BE-021	14510-PT0-003	BE-404
04777393AC	BE-008	FIAT JAPANPARTS		14510-PT0-004	BE-404
04777394	BE-008	71747799	BE-810	14510-PTO-003	BE-404
04884320AA	BE-007	9617188680	BE-004	14510-PTO-004	BE-404
05142573AA	BE-009	GONOW JAPANPARTS		14510-PY3-003	BE-406
05142798AA	BE-010	701060002	BE-013	14510-PY3-0031	BE-406
35612027H	BE-917	701060003	BE-012	14510-PY3-0041	BE-406
4667283	BE-016	GREAT WALL JAPANPARTS		14510-PY3-C04	BE-406
4777394	BE-008	1021200-ED01	BE-020	14520-P5T-G00	BE-421
68000816AA	BE-530	SMD115976	BE-514	14520-PLC-305	BE-419
CITROEN JAPANPARTS		HONDA JAPANPARTS		14520-PLC-335	BE-419
083013	BE-005	04145-PLC-315	BE-419	14530-PLZ-D00	BE-418
DAEWOO JAPANPARTS		0K972-12-730	BE-305	14550-P8A-A01	BE-424
90411773	BE-W09	13404-P13-003	BE-417	14550-PGE-A01	BE-424
90530124	BE-W06	13404-PT0-003	BE-409	HYUNDAI JAPANPARTS	
90530126	BE-W05	13404-PT0-004	BE-409	23357-32000	BE-506
9128738	BE-W08	14325-P5T-G00	BE-422	23357-32010	BE-506
93202400	BE-W03	14510-657-013	BE-403	23357-32020	BE-506
DAIHATSU JAPANPARTS		14510-689-003	BE-408	23357-32030	BE-506
13503-87701	BE-605	14510-P08-003	BE-414	23357-32040	BE-506
13504-87301	BE-610	14510-P08-004	BE-414	23357-32050	BE-506
13504-87701	BE-604	14510-P13-003	BE-416	23357-33120	BE-514
13505-15041	BE-208	14510-P30-003	BE-415	23357-33130	BE-514
		14510-P5T-G00	BE-420	23357-33350	BE-H22

CUSCINETTO DISTRIBUZIONE - TENSIONER, TIMING BELT

HYUNDAI	JAPANPARTS				
23357-42030	BE-500	25281-35060	BE-523	0K938-12-700	BE-301
24317-42020	BE-501	25281-35530	BE-H16	0K938-12-730	BE-306
24317-4X000	BE-K21	57250-37330	BE-H13	0K95K-12-750	BE-K26
24375-47280	BE-H10	57250-37510	BE-H17	0K95K-12770	BE-K22
24410-02510	BE-H08	ISUZU JAPANPARTS		0K973-12-700	BE-308
24410-02750	BE-H08	5-12539-013-2	BE-906	0K9BV-12-730	BE-K04
24410-21010	BE-503	70HM6K254A	BE-999	0K9BV-12-780	BE-K07
24410-22000	BE-H01	8-94100-223-0	BE-900	0K9BV-12790	BE-K00
24410-22020	BE-H01	8-94123-972-0	BE-904	23357-38001	BE-H22
24410-23011	BE-H03	8-94215-197-0	BE-902	23357-42030	BE-500
24410-23050	BE-H29	8-94215-197-1	BE-902	24317-42000	BE-501
24410-23400	BE-H03	8-94220-900-1	BE-905	24317-42020	BE-501
24410-23500	BE-H03	8-94220-900-2	BE-905	24317-4X001	BE-K21
24410-26000	BE-H01	8-94220-901-1	BE-904	24322-4X000	BE-K16
24410-27000	BE-H23	8-94382-214-0	BE-907	24410-2X000	BE-300
24410-27250	BE-H23	8-94382-214-1	BE-907	24410-2X701	BE-301
24410-32020	BE-508	8-94382-215-0	BE-908	24450-38010	BE-H05
24410-35010	BE-509	8-94382-215-1	BE-908	24450-3Y100	BE-K07
24410-35020	BE-509	8-94433-820-0	BE-908	24450-3Y200	BE-K00
24410-35060	BE-509	8-94433-821-0	BE-907	24810-2X700	BE-306
24410-37100	BE-H25	8-94472-349-0	BE-903	25281-35060	BE-523
24410-38001	BE-H26	8-94472-349-1	BE-903	K151-12-700	BE-300
24450-33010	BE-507	8-97136-256-0	BE-915	K955-12-730	BE-K03
24450-35530	BE-H14	8-97137-148-0	BE-914	K973-12-700	BE-308
24450-37100	BE-H06	94106001	BE-916	KK150-12-700B	BE-300
24810-23011	BE-H04	GM 636418	BE-910	OK551-12-740	BE-K17
24810-23500	BE-H04	GM 636422	BE-909	OK88R-15-983	BE-301
24810-26020	BE-H02	GM 636731	BE-913	OK938-12-700	BE-301
24810-27000	BE-H24	GM 636735	BE-911	OK954-12-730	BE-305
24810-27250	BE-H24	KIA JAPANPARTS		OK972-12-700	BE-308
24810-33021	BE-513	OK016-12-700	BE-310	OK972-12-700A	BE-308
24810-33024	BE-513	OK054-12700A	BE-K05	OK972-12-730	BE-305
24810-35530	BE-H15	OK247-12-700	BE-K06	LADA JAPANPARTS	
24810-37100	BE-H07	OK551-12-700B	BE-K09	21215-1006120	BE-003
24810-37120	BE-H07	OK551-12-730	BE-K14	21215-1006138	BE-002
24810-37120	BE-H07	OK551-12-740	BE-K17	LAND ROVER JAPANPARTS	
24810-39810	BE-H15	OK551-12730A	BE-K21	LR000660	BE-537
24840-37100	BE-H31	OK552-15-P13	BE-K29	LR009395	BE-536
24840-37120	BE-H27	OK88R-12-700	BE-K16	LEXUS JAPANPARTS	
24840-38011	BE-H30	OK88R-12-730	BE-K14	13503-70080	BE-218
24840-3E500	BE-H28	OK88R-12-740	BE-K17	13505-46020	BE-256
25281-35020	BE-523	OK88R-12-750	BE-K18	13505-46070	BE-256

CUSCINETTO DISTRIBUZIONE - TENSIONER, TIMING BELT

LEXUS		JAPANPARTS					
13540-70020		BE-248		JE26-12-750	BE-322	Y70112730	BE-916
13540-70021		BE-248		JE48-12-730	BE-326	YF09-12-700	BE-347
				JE48-12-740	BE-325	YF09-12-730	BE-346
MAZDA		JAPANPARTS		JF01-12-750D	BE-309	Z501-12-730	BE-352
0JE-12-730A		BE-324		JF01-12-750E	BE-309	MITSUBISHI	
0JE-12-740A		BE-323		JF01-12-750F	BE-309	1145A020	BE-534
14510-634-000		BE-402		K938-12-700	BE-301	1145A031	BE-533
14510-634-003		BE-402		K973-12-730	BE-305	13505-87702	BE-601
1E05-12-730		BE-330		K978-12-730	BE-306	22357-33120	BE-514
1E07-12-700		BE-339		KL01-12-730	BE-315	23357-32000	BE-506
1E07-12-720		BE-340		KL01-12-730A	BE-315	23357-32010	BE-506
1E1012700C		BE-333		KL01-12-740	BE-316	23357-32020	BE-506
B630-12-700C		BE-300		KL0112770B	BE-345	23357-32030	BE-506
B630-12-700D		BE-300		KL02-12-750	BE-314	23357-32040	BE-506
B630-12-700E		BE-300		KL02-12-750A	BE-314	23357-32050	BE-506
B660-12-700B		BE-301		KLY2-12-SJ0	BE-314	23357-33130	BE-514
B660-12-700C		BE-301		OJE-12-730A	BE-324	24410-21014	BE-503
B660-12-700D		BE-301		OJE-12-740A	BE-323	24410-32000	BE-508
B660-12-700F		BE-301		PN11-12-700	BE-350	24410-32010	BE-508
B660-12-730		BE-306		R201-12-700A	BE-310	24410-32553	BE-507
B660-12-730C		BE-306		RF03-12-700A	BE-317	24410-32560	BE-508
E5EE-6K254-AA		BE-302		RF03-12-720	BE-318	24410-35010	BE-509
F801-12-700B		BE-303		RF1G-12-700A	BE-344	24410-35020	BE-509
F801-12-700C		BE-303		RF1G-12-730	BE-338	24410-35060	BE-509
F802-12-700		BE-303		RF2A-12-700	BE-327	24450-33010	BE-507
F805-12-700A		BE-307		RF2A-12-730	BE-328	24810-33020	BE-513
F805-12-700C		BE-303		RF2A-12-770A	BE-348	25281-35020	BE-523
F806-12-700		BE-307		RF2A-12-770B	BE-348	HY 24410-21010	BE-503
F806-12-700A		BE-307		RF5C-12-700	BE-337	M343741	BE-527
FE1H-12-700A		BE-308		RF5C-12-730	BE-336	M855992	BE-528
FE1H-12-730A		BE-305		RF71-12-700C	BE-319	M855993	BE-527
FE3N-12-730		BE-305		RF71-12-730A	BE-320	MD 175 375	BE-512
FP01-12-700		BE-313		RFC6-12-700	BE-319	MD 185544	BE-H22
FP01-12-700A		BE-313		WE01-12700	BE-342	MD 192068	BE-H22
FS01-12-700A		BE-313		WE01-12730	BE-343	MD 352473	BE-H22
FS01-12-730A		BE-312		WL01-12-700	BE-329	MD008965	BE-502
JE15-12-730		BE-321		WL81-12-700	BE-351	MD009650	BE-510
JE15-12-730A		BE-321		Y401-12-730	BE-334	MD011536	BE-508
JE15-12-730E		BE-309		Y401-12-770A	BE-335	MD012587	BE-517
JE15-12-750		BE-309		Y401-12-770C	BE-335	MD030605	BE-503
JE26-12-730A		BE-324		Y650-12-730	BE-334	MD040754	BE-506
JE26-12-740A		BE-323		Y70112700A	BE-349	MD040774	BE-508

CUSCINETTO DISTRIBUZIONE - TENSIONER, TIMING BELT

MITSUBISHI		JAPANPARTS					
MD050125	BE-500	13070-16A00	BE-103	13077-V7200	BE-101		
MD050135	BE-501	13070-16A01	BE-103	OPEL		JAPANPARTS	
MD064641	BE-516	13070-16A02	BE-103	5636745	BE-810		
MD104578	BE-509	13070-16A03	BE-103	93186866	BE-810		
MD109958	BE-505	13070-16A10	BE-111	GM636418	BE-910		
MD114691	BE-524	13070-16A11	BE-111	GM636422	BE-909		
MD115976	BE-514	13070-24B00	BE-115	GM636731	BE-913		
MD128765	BE-506	13070-2J600	BE-106	GM636735	BE-911		
MD129033	BE-508	13070-42L00	BE-104	PIAGGIO		JAPANPARTS	
MD129355	BE-507	13070-57J00	BE-106	493105	BE-612		
MD140071	BE-H14	13070-57J01	BE-106	RENAULT		JAPANPARTS	
MD146186	BE-511	13070-57J10	BE-106	82 00 071 267	BE-123		
MD156604	BE-513	13070-5L300	BE-104	82001-02941	BE-122		
MD169592	BE-515	13070-5L302	BE-104	SUBARU		JAPANPARTS	
MD174352	BE-521	13070-6F900	BE-120	13033-AA040	BE-710		
MD182537	BE-519	13070-6F901	BE-120	13033-AA042	BE-711		
MD192731	BE-513	13070-73L00	BE-104	13069-AA034	BE-700		
MD308882	BE-523	13070-AW300	BE-123	13069-AA036	BE-700		
MD315265	BE-512	13070-BN700	BE-122	13070-AA000	BE-704		
MD320174	BE-526	13070-D0100	BE-105	13070-AA001	BE-704		
MD329976	BE-529	13070-D4200	BE-107	13070-AA002	BE-704		
MD356509	BE-529	13070-V5001	BE-104	13070-KA020	BE-706		
MD377198	BE-538	13070-V7201	BE-100	13070KA071	BE-712		
MN137247	BE-525	13070-V7203	BE-100	13070KA073	BE-712		
MN176844	BE-532	13074-05E00	BE-113	13070KA120	BE-712		
MN980101	BE-530	13074-16A00	BE-114	13071-AA001	BE-703		
MN980104	BE-531	13074-16A01	BE-114	13071-AA002	BE-703		
MN980107	BE-535	13077-00QAA	BE-125	13073-AA000	BE-705		
MN982126	BE-536	13077-00QAD	BE-128	13073-AA001	BE-705		
MN982127	BE-537	13077-00QAG	BE-129	13073-AA002	BE-705		
NISSAN		13077-00QAL	BE-129	13073-AA081	BE-701		
13070-00QAA	BE-126	13077-35F00	BE-108	13073-AA082	BE-701		
13070-00QAB	BE-127	13077-45V00	BE-109	13073-AA140	BE-701		
13070-00QAD	BE-124	13077-54A00	BE-116	13073-AA142	BE-701		
13070-00QAE	BE-124	13077-54A01	BE-116	13073-AA180	BE-701		
13070-00QAF	BE-124	13077-6F900	BE-121	13073-AA190	BE-707		
13070-01B00	BE-115	13077-6F901	BE-121	13073-AA200	BE-709		
13070-01B01	BE-115	13077-D4200	BE-108	13073-AA230	BE-708		
13070-01M00	BE-102	13077-F6200	BE-109	13085-AA010	BE-702		
13070-05E00	BE-112	13077-F6510	BE-110	13085-AA080	BE-702		
13070-05E10	BE-112	13077-F6511	BE-110	SUZUKI		JAPANPARTS	
		13077-F6512	BE-109	12631-79J50-000	BE-807		

CUSCINETTO DISTRIBUZIONE - TENSIONER, TIMING BELT

SUZUKI		JAPANPARTS		TOYOTA		JAPANPARTS	
12781-79J50-000	BE-811	2790-0511-01-08	BE-022	13505-10010	BE-214	13505-10010	BE-214
12810-53A00	BE-802	2791-0511-01-01	BE-023	13505-11010	BE-207	13505-11010	BE-207
12810-53A00	BE-803	279705110101	BE-014	13505-11011	BE-207	13505-11011	BE-207
12810-53B00	BE-806	570405119904	BE-019	13505-11020	BE-207	13505-11020	BE-207
12810-53B01	BE-806			13505-11040	BE-215	13505-11040	BE-215
12810-67G01	BE-816	13503-10010	BE-229	13505-11050	BE-215	13505-11050	BE-215
12810-70C00	BE-899	13503-10011	BE-230	13505-15020	BE-208	13505-15020	BE-208
12810-71C00	BE-801	13503-10021	BE-230	13505-15031	BE-208	13505-15031	BE-208
12810-71C01	BE-801	13503-1002100	BE-230	13505-15040	BE-208	13505-15040	BE-208
12810-71C02	BE-801	13503-11010	BE-204	13505-15041	BE-208	13505-15041	BE-208
12810-73001	BE-802	13503-11030	BE-216	13505-15050	BE-226	13505-15050	BE-226
12810-73002	BE-803	13503-11040	BE-216	13505-15060	BE-226	13505-15060	BE-226
12810-73003	BE-803	13503-27010	BE-246	13505-16010	BE-209	13505-16010	BE-209
12810-73J00-000	BE-818	13503-50011	BE-250	13505-16011	BE-209	13505-16011	BE-209
12810-78E01	BE-812	13503-54010	BE-205	13505-16020	BE-209	13505-16020	BE-209
12810-79J50-000	BE-810	13503-54020	BE-201	13505-16021	BE-209	13505-16021	BE-209
12810-79J51-000	BE-810	13503-54030	BE-203	13505-17010	BE-243	13505-17010	BE-243
12810-79J52-000	BE-810	13503-54040	BE-203	13505-17020	BE-244	13505-17020	BE-244
12810-81400	BE-808	13503-62010	BE-223	13505-20010	BE-221	13505-20010	BE-221
12810-82001	BE-800	13503-62011	BE-223	13505-20020	BE-221	13505-20020	BE-221
12810-82002	BE-800	13503-62030	BE-223	13505-20020	BE-212	13505-20020	BE-212
12810-82003	BE-800	13503-62040	BE-252	13505-20030	BE-232	13505-20030	BE-232
12810-84000	BE-802	13503-63010	BE-206	13505-27010	BE-245	13505-27010	BE-245
12810-84000	BE-803	13503-63011	BE-206	13505-27010-F	BE-245	13505-27010-F	BE-245
12810-84001	BE-803	13503-63020	BE-220	13505-42010	BE-211	13505-42010	BE-211
12810-86500	BE-805	13503-63020	BE-206	13505-42020	BE-211	13505-42020	BE-211
12810-86501	BE-805	13503-63021	BE-206	13505-43010	BE-211	13505-43010	BE-211
12810-86CA0	BE-005	13503-63021	BE-220	13505-43020	BE-211	13505-43020	BE-211
12823-67G10-000	BE-819	13503-64010	BE-225	13505-46041	BE-233	13505-46041	BE-233
1283086CA0	BE-004	13503-64020	BE-225	13505-50030	BE-249	13505-50030	BE-249
9400830289	BE-817	13503-70020	BE-219	13505-54010	BE-200	13505-54010	BE-200
TATA (TELCO)		13503-70040	BE-206	13505-54020	BE-202	13505-54020	BE-202
0915 8004	BE-W05	13503-70060	BE-218	13505-54021	BE-202	13505-54021	BE-202
0K954-12-730	BE-305	13503-70061	BE-218	13505-55020	BE-239	13505-55020	BE-239
0K972-12-700	BE-308	13503-88360	BE-206	13505-62010	BE-212	13505-62010	BE-212
0K972-12-700A	BE-308	13503-88361	BE-206	13505-62020	BE-221	13505-62020	BE-221
2105-1006118	BE-000	13503-88380	BE-206	13505-62031	BE-212	13505-62031	BE-212
2105-1006124	BE-000	13505-01010	BE-208	13505-62050	BE-212	13505-62050	BE-212
254705110115	BE-003	13505-01011	BE-208	13505-62060	BE-212	13505-62060	BE-212
254705110120	BE-003	13505-02020	BE-209	13505-62070	BE-221	13505-62070	BE-221
254705110126	BE-006	13505-02030	BE-226	13505-63010	BE-220	13505-63010	BE-220
		13505-0L010	BE-236	13505-63020	BE-220	13505-63020	BE-220

CUSCINETTO DISTRIBUZIONE - TENSIONER, TIMING BELT

TOYOTA	JAPANPARTS
13505-63021	BE-220
13505-64011	BE-224
13505-64012	BE-246
13505-64020	BE-246
13505-64020	BE-224
13505-64021	BE-224
13505-65020	BE-240
13505-65040	BE-242
13505-67040	BE-236
13505-67041	BE-236
13505-70010	BE-237
13505-70012	BE-217
13505-70020	BE-217
13505-70021	BE-217
13505-70030	BE-237
13505-70040	BE-237
13505-74010	BE-222
13505-74011	BE-222
13505-74011	BE-213
13505-74020	BE-222
13505-74021	BE-222
13505-74030	BE-228
13505-88300	BE-217
13505-88301	BE-217
13505-88360	BE-228
13505-88361	BE-228
13505-88382	BE-227
13505-88382/3	BE-227
13505-88383	BE-227
13505-88480	BE-235
13540-0L010	BE-253
13540-27011	BE-241
13540-50030	BE-251
13540-67020	BE-253
SU001-00088	BE-255
SU001-00784	BE-254

GALOPPINO CINGHIA POLY-V - DEFLECTION/GUIDE PULLEY,V-RIBBED BELT

BMW		JAPANPARTS		38942-PM3-000	RP-404	MD308882	RP-503
11 28 1 726 343		RP-L02		38942-PWA-004	RP-406	MD318872	RP-517
11 28 1 748 131		RP-L02		38950-P2K-305	RP-402	MD362028	RP-517
CHEVROLET		JAPANPARTS		56980-RSR-E01	RP-405	MD374877	RP-513
96440417		RP-W05		HYUNDAI		MW30621270	RP-504
CHRYSLER		JAPANPARTS		0K88R-15983	RP-K04	NISSAN	
04668588AA		RP-917		25286-37100	RP-H00	11923-BN700	RP-119
04723298		RP-919		25286-37110	RP-H00	11925-00QAE	RP-105
04792112		RP-914		25286-3E001	RP-H07	11925-00QAF	RP-120
04861633AA		RP-924		25287-27000	RP-H01	11925-00QAP	RP-105
04863737		RP-911		25287-27001	RP-H01	11925-2M300	RP-102
05066938AA		RP-918		25288-27000	RP-H05	11925-41B10	RP-116
05080246AA		RP-925		57212-3A000	RP-H04	11925-43G02	RP-103
05080319AA		RP-923		97834-22100	RP-H08	11925-4W000	RP-101
05080422AA		RP-901		97834-29010	RP-H08	11925-77A10	RP-109
05175589AB		RP-910		97834-2D520	RP-H08	11925-77A12	RP-114
68020888AA		RP-925		KIA		11925-77A13	RP-114
CITROEN		JAPANPARTS		0K552-15-983C	RP-K04	11925-AG300	RP-101
5751.F7		RP-521		0K88R-15-983	RP-K04	11925-AG30A	RP-101
5751.G1		RP-521		25286-2B000	RP-K01	11925-AW300	RP-105
DAEWOO		JAPANPARTS		25286-4A000	RP-K03	11925-AX011	RP-104
96084381		RP-W00		25286-4X000	RP-K04	11925-VC801	RP-100
96344236		RP-W01		25287-27001	RP-H01	11927-00QAA	RP-120
DAIHATSU		JAPANPARTS		LAND ROVER		11927-00QAB	RP-119
13505-87703		RP-603		7H12-10A216-CA	RP-L05	11927-AX010	RP-104
16603-23021		RP-607		LGQ000040	RP-L01	11944-00QAC	RP-119
16603-97401		RP-600		LR004877	RP-L06	23150-7F001	RP-121
16630-B2010		RP-606		MAZDA		OPEL	
DR		JAPANPARTS		B366-15-940	RP-319	51758383	RP-W04
701070006		RP-006		F201-15-940A	RP-320	RENAULT	
FIAT		JAPANPARTS		K805-15-94YA	RP-300	77 00 313 302	RP-118
55190811		RP-809		L327-15-940B	RP-318	SSANGYONG	
55190812		RP-808		L32715940A	RP-301	6012001270	RP-S02
FORD		JAPANPARTS		LFH115940	RP-301	SUZUKI	
928F19A216AA		RP-311		Y401-15-930	RP-303	17530-77E00	RP-807
95NF19A216AD		RP-311		Y602-15-940	RP-316	49160-65D40	RP-800
YS4E19A218AA		RP-311		ZJ01-15-940	RP-322	49160-67J00-000	RP-812
HONDA		JAPANPARTS		MERCEDES-BENZ		49160-70AA0	RP-802
31190-RNA-003		RP-403		1192001470	RP-S03	TOYOTA	
38940-PLZ-D00		RP-401		6012000970	RP-S00	13570-YV010	RP-316
38942-P01-003		RP-402		MITSUBISHI		16603-27010	RP-203
38942-PHM-004		RP-406		MB918552	RP-518	16603-27011	RP-203

GALOPPINO CINGHIA POLY-V - DEFLECTION/GUIDE PULLEY,V-RIBBED BELT

TOYOTA	JAPANPARTS
16604-23020	RP-202
16604-31010	RP-218
16604-31020	RP-218
16604-50010	RP-204
16604-50030	RP-204
88440-12170	RP-214
88440-12190	RP-216
88440-17010	RP-215
88440-20160	RP-215
88440-20170	RP-215
88440-52010	RP-217
88440-52020	RP-213
8844026070	RP-212

KIT CINGHIE DISTRIBUZIONE - TIMING BELT KIT

JEEP	JAPANPARTS
68031478AA	KDD-905
MINI	JAPANPARTS
MN982128	KDD-515
MN982388	KDD-515
NISSAN	JAPANPARTS
16806-00QAT	KDD-125
16806-00QBB	KDD-114

PULEGGIA ALTERNATORE - FREEWHEEL CLUTCH,ALTERNATOR

CHEVROLET	JAPANPARTS	MN960267	RA-M00
93743440	RA-W00	S30638577	RA-500
CHRYSLER	JAPANPARTS	NISSAN	JAPANPARTS
021040-1450	RA-905	23150-2W200	RA-102
05019860AA	RA-902	23151-00Q0A	RA-502
53013554AD	RA-905	23151-00Q0B	RA-500
53013554AE	RA-905	23151-6N200	RA-100
K04861513AC	RA-906	23151-6N20A	RA-100
K04861513AD	RA-906	23151-6N20B	RA-100
TN021040-1180	RA-904	A660C300EX	RA-101
FIAT	JAPANPARTS	OPEL	JAPANPARTS
77363954	RA-801	10 511 026	RA-400
HONDA	JAPANPARTS	12 04 366	RA-400
31141-RL0-G01	RA-401	4805492	RA-W00
HYUNDAI	JAPANPARTS	RENAULT	JAPANPARTS
37322-27010	RA-H01	77 01 055 871	RA-501
37322-27012	RA-H01	77 01 207 807	RA-501
37322-27500	RA-H00	SMART	JAPANPARTS
37322-27501	RA-H00	640 150 0360	RA-M00
JEEP	JAPANPARTS	640 150 0560	RA-M00
53013554AD	RA-900	SUZUKI	JAPANPARTS
53013554AE	RA-900	31771-68D00	RA-802
KIA	JAPANPARTS	31771-68D01	RA-802
0K588 18 W11	RA-K01	31771-85E00-000	RA-800
D373224A000	RA-K00	TOYOTA	JAPANPARTS
D373224A001	RA-K00	27415-0T020	RA-203
OK55218300B	RA-K01	27415-27011	RA-204
OK58818W11	RA-K01	27415-30010	RA-205
MAZDA	JAPANPARTS	274150T010	RA-202
GY02-11-W11A	RA-301	274150T011	RA-202
GY02-18-330A	RA-301		
GY02-18-330B	RA-301		
GY02-18-W37Z	RA-301		
GY0218330	RA-302		
K80118W11	RA-302		
LF1818330	RA-300		
LW1818W11	RA-300		
RF5C-18-330	RA-303		
RF5C-18-330A	RA-303		
RF5C-18-W11	RA-303		
MITSUBISHI	JAPANPARTS		
A 628 X 91171	RA-300		

RULLO TENDITORE, CINGHIA POLY-V - TENSIONER PULLEY,V-RIBBED BELT

BMW	JAPANPARTS
11287-7908-78	TP-200
CITROEN	JAPANPARTS
5751.26	TP-101
96 156 400	TP-101
HYUNDAI	JAPANPARTS
ZJ820005	TP-H00
MAZDA	JAPANPARTS
1E07-15-930B	TP-300
1E12-15-930A	TP-301
NISSAN	JAPANPARTS
1175000QAJ	TP-105
1175000QAP	TP-105
11944-4F100	TP-104
11944-6F901	TP-100
11955BN702	TP-105
PEUGEOT	JAPANPARTS
575115	TP-802
SMART	JAPANPARTS
0015956 V001 0000 00	TP-M00
160 200 03 70	TP-M00
A639 200 08 70	TP-500
SUZUKI	JAPANPARTS
17140-77E06	TP-803
17140-77E07	TP-803
49170-65D40	TP-800
TATA (TELCO)	JAPANPARTS
254723120162	TP-002
TOYOTA	JAPANPARTS
16620-0W093	TP-201
16620-22010	TP-201
16620-22011	TP-201
16620-22012	TP-201
16620-22013	TP-201

SMORZATORE VIBRAZIONI, CINGHIA POLY-V - VIBRATION DAMPER, V-RIBBED BELT

BMW	JAPANPARTS
11 28 2 243 510	TL-L02
11 28 2 244 424	TL-L02
11 28 2 246 769	TL-L02
11 28 2 248 168	TL-L02
11 28 7 786 880	TL-L01
64 55 7 786 711	TL-L00
7 786 880	TL-L01
CHRYSLER	JAPANPARTS
04720714	TL-900
35612004	TL-902
45612030F	TL-900
JEEP	JAPANPARTS
35612002F	TL-901
MERCEDES-BENZ	JAPANPARTS
102 200 0814	TL-S01
102 200 1214	TL-S01
102 200 1414	TL-S01
1032000114	TL-S03
1122000014	TL-S04
6012000314	TL-S02
6012000514	TL-S02
6032000114	TL-S02
6032000314	TL-S02
6042000114	TL-S02

TENDITORE, CINGHIA POLY-V - TENSIONER LEVER, V-RIBBED BELT

CHEVROLET	JAPANPARTS				
96440419	TS-W03	31170-RWK-005	TS-403	LF17-15-980B	TS-304
		31170-RWK-015	TS-403	LF17-15-980C	TS-304
		31170-RWK-025	TS-403	LF17-15-980D	TS-304
CHRYSLER	JAPANPARTS	31170-RZP-G01	TS-403	LF50-15-980	TS-310
04593822AB	TS-914	56900-P5T-G00	TS-400	LF50-15-980A	TS-310
04668509AB	TS-903	56900-P5T-G01	TS-400	LF50-15-980B	TS-310
04668509AC	TS-903	56900-P5T-G02	TS-400	LFG1-15-980B	TS-308
04668519AD	TS-900			LFG1-15-980C	TS-308
047 924 95AB	TS-913	HYUNDAI	JAPANPARTS	LFG1-15-980C	TS-308
047 924 95AC	TS-913	25281-27000	TS-H04	R2AA-15-980D	TS-312
04861630AB	TS-901	25281-27001	TS-H04	RF7J15980	TS-311
04897159AB	TS-907	25281-2A000	TS-H00	Y401-15-980B	TS-300
04897259AC	TS-907	25281-37101	TS-H02	Y401-15-980C	TS-300
05014344B	TS-907	25281-37120	TS-H02	Y60115980	TS-203
05080243AA	TS-906	25281-3E000	TS-H03	Y60215980	TS-203
05080312AC	TS-911	25281-4A000	TS-K01	ZJ01-15-980B	TS-306
5072440AB	TS-910			ZJ3815980B	TS-309
K5175588AA	TS-908	ISUZU	JAPANPARTS		
		8973124620	TS-909	MERCEDES-BENZ	JAPANPARTS
DAEWOO	JAPANPARTS			112 200 0070	TS-905
1340533	TS-W01	JEEP	JAPANPARTS	611 200 0270	TS-904
90411025	TS-W01	05066936AA	TS-902	611 200 0370	TS-904
96183115	TS-W00			611 200 0370	TS-904
96184932	TS-W02	KIA	JAPANPARTS	611 200 0470	TS-904
96298799	TS-W02	0K551-15-981	TS-K00	611 200 0570	TS-904
96349976	TS-W00	0K551-15-981A	TS-K00	646 200 0270	TS-904
96435138	TS-W02	0K551-15-981B	TS-K00	646 200 0370	TS-904
96459042	TS-W02	0K88R-15-981	TS-K02		
		0K88R-15981	TS-K02	MITSUBISHI	JAPANPARTS
DR	JAPANPARTS	0K9BV-10-770	TS-K03	1345A001	TS-503
701070036	TS-001	25281-27400	TS-H01	1345A013	TS-505
		25281-4A000	TS-K01	MD852898	TS-500
FIAT	JAPANPARTS	25281-4X000	TS-K02	MN149179	TS-504
46819146	TS-802	25281-4X100	TS-K02	MW30621284	TS-502
55190813	TS-803			MW30638574	TS-502
		LAND ROVER	JAPANPARTS	MW30638633	TS-502
FORD	JAPANPARTS	PQG 10008	TS-L00		
1004481	TS-305	PQG 100200	TS-400	NISSAN	JAPANPARTS
96MF6A228BD	TS-305	PQG 100230	TS-400	11750-00Q0B	TS-100
				11750-00Q0D	TS-100
HONDA	JAPANPARTS			11750-00QAD	TS-101
31170-P8F-A020	TS-405	MAZDA	JAPANPARTS	11750-00QAR	TS-100
31170-PCX-003	TS-404	1 044 515	TS-302	11750-00QAU	TS-100
31170-PNA-003	TS-402	1E05-15-980A	TS-301	11750-2W200	TS-501
31170-PNA-013	TS-402	L372-15-980C	TS-307	11750-2W201	TS-501
31170-PNA-023	TS-402	L37215980	TS-307	11750-2W202	TS-501
31170-RB0-J01	TS-406	L37215980A	TS-307	11750-2W203	TS-501
31170-RBD-E02	TS-401	L37215980B	TS-307		
		LF17-15-980A	TS-304		

TENDITORE, CINGHIA POLY-V - TENSIONER LEVER,V-RIBBED BELT

NISSAN	JAPANPARTS
11750-2W20C	TS-501
1175000QAE	TS-106
11955-00QAG	TS-105
11955-AW300	TS-101
11955-BN701	TS-105
11955-BN703	TS-105
1195500QAA	TS-102
1195500QAD	TS-102
1195500QAE	TS-102
11955JD20A	TS-104
OPEL	JAPANPARTS
4805513	TS-W03
5636736	TS-912
97125860	TS-912
SUZUKI	JAPANPARTS
17540-67JA0	TS-801
17540-67JA0-000	TS-801
17540-67JA2	TS-801
17540-77E10	TS-800
17540-79J50-000	TS-803
17540-85E00	TS-804
49160-73J00	TS-300
TOYOTA	JAPANPARTS
16601YV010	TS-203
16620-0R010	TS-201
16620-0W110	TS-204
16620-27020	TS-202
16620-27021	TS-202
16620-31012	TS-205
16620-31040	TS-200

Certificate of Registration



The Governing Board of
Q.A. International Certification Limited
hereby grants to:

JAPANPARTS S.r.l.

Registration No. : QAIC / IT / 90039 - A

(hereinafter called the Registered Company) the right to be listed in the Directory of Registered Companies in respect of the services listed below. These services shall be offered by the Registered Company at or from only the address given below in accordance with the quality management system in compliance with ISO 9001:2008.

Address to which this Certificate refers :

Via Della Meccanica, 1/A 37139 VERONA - Italy

Approved Scope to which this Certificate refers
(Scopo della Certificazione cui il Certificato riferisce)

**Commercialisation of Automotive Parts and Accessories
(Commercializzazione di Ricambi per Autoveicoli)**

(Further clarification regarding the Scope of this Certificate and the applicability of ISO 9001:2008 requirements may be obtained by consulting the organisation)

Signed for and on behalf of the Board

CHAIRMAN
A. J. Duffield

SCHEME MANAGER
A. Carter

Certificate Issue Date : 9th February 2012 - Certificate Expiry Date : 24th January 2013
Date of Initial Registration : 25th January 2000 - Re-assessment Date : 24th January 2015
This Certificate of Registration is granted subject to the Regulations approved by the Board.

QA INTERNATIONAL

Q.A. International Certification Ltd.
Dudley Court
Dudley Road
Darlington
Co. Durham
DL1 4GG

Tel: +44 (0)1325 384272
Fax: +44 (0)1325 480980
www.qai.co.uk



The use of the accreditation logo indicates accreditation in respect of the activities covered by the accreditation certificate number 944.