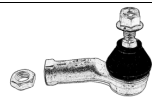

## INDICE – CONTENTS

	PAG. - PAGE
<b>IMPIEGO DEL CATALOGO - HOW TO USE THE CATALOGUE</b>	<b>A-2</b>
<b>DESCRIZIONE DEI PARTICOLARI - ITEMS DESCRIPTION</b>	<b>A-3</b>
<b>ABBREVIAZIONI - TRADUZIONI - ABBREVIATIONS - TRANSLATIONS</b>	<b>A-4</b>
<b>NUOVI MODELLI - NEW MODELS</b>	<b>A-5</b>
<b>RIFERIMENTI NON INSERITI – REMOVED ITEMS</b>	<b>A-6</b>
<b>DAEWOO – CHEVROLET</b>	<b>1-1</b>
<b>DAIHATSU</b>	<b>2-1</b>
<b>HONDA</b>	<b>3-1</b>
<b>HYUNDAI</b>	<b>4-1</b>
<b>ISUZU</b>	<b>5-1</b>
<b>KIA</b>	<b>6-1</b>
<b>MAZDA</b>	<b>7-1</b>
<b>MITSUBISHI</b>	<b>8-1</b>
<b>NISSAN</b>	<b>9-1</b>
<b>SSANGYONG</b>	<b>10-1</b>
<b>SUBARU</b>	<b>11-1</b>
<b>SUZUKI</b>	<b>12-1</b>
<b>TOYOTA</b>	<b>13-1</b>
<b>CORRISPONDENZE CODICI - CROSS REFERENCE:</b>	
<b>CODICE ORIGINALE &gt; CODICE OCAP - ORIGINAL NR. &gt; OCAP NR.</b>	<b>14-1</b>
<b>CODICE OCAP &gt; CODICE ORIGINALE - OCAP NR. &gt; ORIGINAL NR.</b>	<b>15-1</b>

# UTILIZZO DEL CATALOGO

## HOW TO USE THE CATALOGUE

RIF. ORIG O.E. REF.	RIF.OCAP OCAP REF.	NOTE REMARKS	DESTRO RIGHT	SINISTRO LEFT
Anno - Year <b>[2]</b> 1978 > 1985	<b>[4]</b> SA22C	Serie - Series	<b>[6]</b> RX 7	Modello - Model
<b>[1]</b> 1E00-32-280A	<b>[3]</b> 0281485	<b>[5]</b> TESTA STERZO TIE ROD END	<b>[7]</b> 	
1757-32-220	0303426	BARRA STERZO TIE ROD	<b>[8]</b> 	
1E01-32-280A	0291485	TESTA STERZO TIE ROD END	<b>[9]</b> 	

	I	GB	D	F	E
<b>[1]</b>	Riferimento originale	Original number	Originalnummern	Numero original	Numero original
<b>[2]</b>	Fino A 1990 Da 1991	Until 1990 Since 1991	Bis 1990 Ab 1991	Jusqu'en 1990 Depuis 1991	Hasta 1990 Desde 1991
<b>[3]</b>	Riferimento OCAP	OCAP References	OCAP Nummern	Références OCAP	Referencias OCAP
<b>[4]</b>	Serie	Series	Baureihe	Serie	Serie
<b>[5]</b>	Note	Remarks	Bemerkungen	Remarques	Observaciones
<b>[6]</b>	Modello	Model	Modell	Modell	Modelo
<b>[7]</b>	Pezzo destro	Right hand fitment	Rechtes teil	Pièce droit	Pieza derecha
<b>[8]</b>	Pezzo centrale	Central fitment	Mittleres teil	Pièce central	Pieza central
<b>[9]</b>	Pezzo sinistro	Left hand fitment	Linkes teil	Pièce gauche	Pieza izquierda

FABBRICANTI, MARCHE E CODICI PRODOTTI SONO ELENCATI SOLO PER L'IDENTIFICAZIONE DEL VEICOLO PER CUI I PARTICOLARI SONO ADATTI.

ALL VEHICLE MANUFACTURES NAMES AND ORIGINAL PART NUMBER IN THIS CATALOG ARE FOR REFERENCE PURPOSES ONLY.







DIE GENANNTEN ORIGINAL NRN. DIENEN NUR ZU VERGLEICHSZWECKEN.

LE NOMS DES FABRICANTS DE VEHICULES AINSI QUE LES NUMEROS DE PIECES INDIQUES DANS CE CATALOGUE DOIVENT ETRE UTILISES UNIQUEMENT COMME REFERENCES.

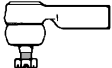
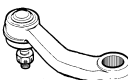
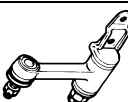
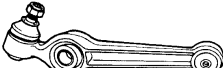
TODOS LAS DENOMINACIONES DE FABRICANTES Y NUMEROS DE PIEZAS ORIGINALES INDICADOS EN ESTE CATALOGO SON UNICAMENTE PARA USO DE COMPARACION.

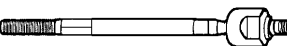

## DESCRIZIONE DEI PARTICOLARI - *ITEMS DESCRIPTION*

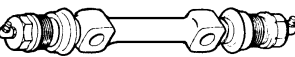
	<b>SIMBOLI</b> Symbols - Symbole Illustration - Ilustraciones	<b>ITALIANO</b>	<b>ENGLISH</b>	<b>DEUTSCH</b>	<b>FRANCAIS</b>	<b>ESPANOL</b>
<b>01</b>		Testa sterzo	Tie rod end	Kugelgelenk	Rotule	Ròtula
<b>02</b>		Testa sterzo	Tie rod end	Kugelgelenk	Rotule	Ròtula
<b>03</b>		Leva sterzo	Pitman arm	Spurstange	Levier de direction	Barra de mando reenvio
<b>03</b>		Braccio sterzo	Idler arm	Spurstange	Relais de direction	Barra de mando direcciòn
<b>03</b>		Braccio oscillante	Track control arm	Querlenker	Bras de suspension	Brazo de suspensiòn
<b>04</b>		Snodo sospensione	Suspension ball joint	Führungsgelenk	Rotule de suspension	Rotula de suspension
<b>05</b>		Barra Sterzo	Tie rod, Track rod Drag link	Spursstange Lenkstange	Barre D'accouplement Barre de direction	Barra de acoplamiento Barra de direcciòn
<b>05</b>		Stabilizzatore	Stabilizer	Spurstange	Stabilisateur	Bieleta de barra estabilizadora
<b>06</b>		Snodo assiale	Axial joint	Axialgelenk	Rotule axiale	Ròtula axial
<b>07</b>		Braccio oscillante in lamiera	Stamped plate arm	Querlenker	Bras de suspension	Brazo de suspensiòn
<b>09</b>		Kit riparazione	Repairing kit	Reparture satz	Kit de reparation	Kit de reparacion

## ABBREVIAZIONI – TRADUZIONI

### ABBREVIATIONS - TRANSLATIONS









ABBREVIAZ.	ITALIANO	ENGLISH	DEUTSCHE	FRANCAIS	ESPANOL
4WD	4 Ruote Motrici	Four Wheel Drive	Allradantrieb	4 Roues Motrices	4 Ruedas Motrizes
> C.H.	Sino al telaio n°	Up to chassis number	Bis fahrgestell nr.	Jusq'à chassis nr.	Hasta chasis no.
C.H. >	Dal telaio n°	From chassis number	Ab fahrgestell nr.	Depuis chassis nr.	Desde el chasis no.
DIAM.	Diametro	Diameter	Diameter	Diamètre	Diámetro
EXCEPT	Eccetto	Except	Ausgenommen	Sauf	Sin
FRONT AXLE	Assale anteriore	Front Axle	Vorn Achse	Axe avant	Eje delante
LHD	Guida Sinistra	Left Hand Drive	Linkslenkung	Conduite à gauche	Dirección all'izquierda
LHT	Filettatura Sinistra	Left Hand Thread	Linksgewinge	Filetage à gauche	Rosca a l'izquierda
LOWER	Inferiore	Lower	Unteres	Inférieure	Inferior
MOD.	Modello	Model	Modell	Modèle	Modelo
M.S.	Sterzo manuale	Manual Steering	Manuelle Lenkung	Direction non assistée	Dirección maual
ONLY	Solamente	Only	Nur	Seulement	Solamente
P.S.	Servosterzo	Power Steering	Servolenkung	Direction Assistée	Dirección Hidráulica
REAR AXLE	Assale Posteriore	Rear axle	Hintere Achse	Axe Arrière	Eje Trasero
RHD	Guida Destra	Right Hand Drive	Rechtslenkung	Conduite à Droite	Dirección a la derecha
RHT	Filettatura destra	Right Hand Thread	Rechtsgewinge	Filetage à droite	Rosca a la derecha
UPPER	Superiore	Upper	Unteres	Supérieure	Superior
WITH STEERING DAMPER	Con Ammortizzatore Sterzo	With Steering Damper	Mit Lenkungsdampfer	Direction Avec Amortisseur	Dirección con amortiguador





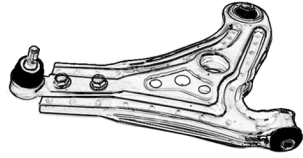
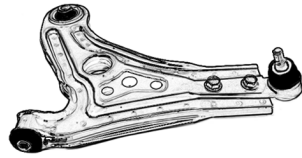



## NUOVI MODELLI - *NEW MODELS*





<b>MARCA - MAKE</b>	<b>MODELLO - MODEL</b>	<b>ANNO - YEAR</b>
DAEWOO – CHEVROLET	AVEO	2005 >
“ “	AVEO	2011 >
“ “	CRUZE	2009 >
“ “	CRUZE 2	2011 >
“ “	CRUZE SW	2012 >
HONDA	CRV – III	2007 >
HYUNDAI	H1	2008 >
KIA	K2500	2003 >
“	K2700	1999 >
MAZDA	XEDOS 6	1992 >
“	TRIBUTE	2000 >
MITSUBISHI	GALANT VI	1996 >
“	SIGMA	1990 >
NISSAN	100 NX	1990 >
“	MURANO	2005 >
“	JUKE	2010 >
“	NAVARA	2005 >
“	PATHFINDER	2005 >
“	X-TRAIL	2007 >
SSANGYONG	ACTYON	2005 >
“	KYRON	2005 >
“	REXTON	2002 >
SUBARU	LEGACY V	2009 >
“	IMPREZA III	2008 >
SUZUKI	SPLASH	2008 >
TOYOTA	AVENSIS	2009 >
“	COROLLA AURIS	2007 >
“	COROLLA VERSO	2004 >
“	VERSO	2009 >







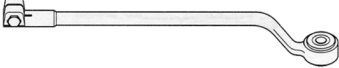
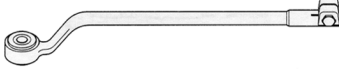

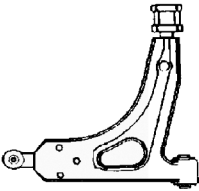
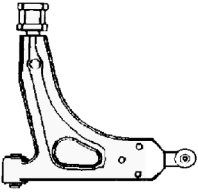
## RIFERIMENTI NON INSERITI – REMOVED ITEMS

OCAP	NOTE	OCAP	OCAP	NOTE	OCAP
0180421	AD ESAURIMENTO - TILL SELL-OFF		0500991	AD ESAURIMENTO - TILL SELL-OFF	
0181769	AD ESAURIMENTO - TILL SELL-OFF		0501227	AD ESAURIMENTO - TILL SELL-OFF	
0181944	SOSTITUITO DA - REPLACED BY	0183608	0501783	AD ESAURIMENTO - TILL SELL-OFF	
0182985	SOSTITUITO DA - REPLACED BY	0183623	0501822	AD ESAURIMENTO - TILL SELL-OFF	
0182987	SOSTITUITO DA - REPLACED BY	0183623	0501823	AD ESAURIMENTO - TILL SELL-OFF	
0182987-K	SOSTITUITO DA - REPLACED BY	0183623-K	0501831	AD ESAURIMENTO - TILL SELL-OFF	
0183747	AD ESAURIMENTO - TILL SELL-OFF		0503343	AD ESAURIMENTO - TILL SELL-OFF	
0183761	SOSTITUITO DA - REPLACED BY	0183762	0503347	AD ESAURIMENTO - TILL SELL-OFF	
0183797	AD ESAURIMENTO - TILL SELL-OFF		0503428	AD ESAURIMENTO - TILL SELL-OFF	
0183798	AD ESAURIMENTO - TILL SELL-OFF		0503515	AD ESAURIMENTO - TILL SELL-OFF	
0190421	AD ESAURIMENTO - TILL SELL-OFF		0503518	AD ESAURIMENTO - TILL SELL-OFF	
0191768	AD ESAURIMENTO - TILL SELL-OFF		0503519	AD ESAURIMENTO - TILL SELL-OFF	
0193745	AD ESAURIMENTO - TILL SELL-OFF		0503689	AD ESAURIMENTO - TILL SELL-OFF	
0193748	AD ESAURIMENTO - TILL SELL-OFF		0503771	AD ESAURIMENTO - TILL SELL-OFF	
0193749	AD ESAURIMENTO - TILL SELL-OFF		0503772	AD ESAURIMENTO - TILL SELL-OFF	
0281289	AD ESAURIMENTO - TILL SELL-OFF		0503773	AD ESAURIMENTO - TILL SELL-OFF	
0282959	AD ESAURIMENTO - TILL SELL-OFF		0503789	AD ESAURIMENTO - TILL SELL-OFF	
0282975	AD ESAURIMENTO - TILL SELL-OFF		0503790	AD ESAURIMENTO - TILL SELL-OFF	
0283402	AD ESAURIMENTO - TILL SELL-OFF		0580189	AD ESAURIMENTO - TILL SELL-OFF	
0283511	AD ESAURIMENTO - TILL SELL-OFF		0583300	AD ESAURIMENTO - TILL SELL-OFF	
0292959	AD ESAURIMENTO - TILL SELL-OFF		0590189	AD ESAURIMENTO - TILL SELL-OFF	
0301770	AD ESAURIMENTO - TILL SELL-OFF		0593300	AD ESAURIMENTO - TILL SELL-OFF	
0301782	AD ESAURIMENTO - TILL SELL-OFF		0602960	SOSTITUITO DA - REPLACED BY	0603964
0303410	AD ESAURIMENTO - TILL SELL-OFF		0603367	AD ESAURIMENTO - TILL SELL-OFF	
0303415	AD ESAURIMENTO - TILL SELL-OFF		0703407	AD ESAURIMENTO - TILL SELL-OFF	
0303418	AD ESAURIMENTO - TILL SELL-OFF		0703408	AD ESAURIMENTO - TILL SELL-OFF	
0303420	AD ESAURIMENTO - TILL SELL-OFF		0703604	NON PIU' DISPONIBILE - NOT MORE AVAILABLE	
0303431	AD ESAURIMENTO - TILL SELL-OFF		0781757	AD ESAURIMENTO - TILL SELL-OFF	
0303482	AD ESAURIMENTO - TILL SELL-OFF		0791757	AD ESAURIMENTO - TILL SELL-OFF	
0303483	AD ESAURIMENTO - TILL SELL-OFF		0903734	AD ESAURIMENTO - TILL SELL-OFF	
0303485	AD ESAURIMENTO - TILL SELL-OFF		0903735	AD ESAURIMENTO - TILL SELL-OFF	
0303517	AD ESAURIMENTO - TILL SELL-OFF		0903736	AD ESAURIMENTO - TILL SELL-OFF	
0303521	AD ESAURIMENTO - TILL SELL-OFF		0903737	AD ESAURIMENTO - TILL SELL-OFF	
0303522	AD ESAURIMENTO - TILL SELL-OFF		0903750	AD ESAURIMENTO - TILL SELL-OFF	
0303524	AD ESAURIMENTO - TILL SELL-OFF		0903751	AD ESAURIMENTO - TILL SELL-OFF	
0303539	AD ESAURIMENTO - TILL SELL-OFF		0903752	AD ESAURIMENTO - TILL SELL-OFF	
0303562	AD ESAURIMENTO - TILL SELL-OFF		0903753	AD ESAURIMENTO - TILL SELL-OFF	
0303563	AD ESAURIMENTO - TILL SELL-OFF		0903754	AD ESAURIMENTO - TILL SELL-OFF	
0303580	AD ESAURIMENTO - TILL SELL-OFF		0903755	AD ESAURIMENTO - TILL SELL-OFF	
0303610	AD ESAURIMENTO - TILL SELL-OFF		0903780	AD ESAURIMENTO - TILL SELL-OFF	
0303627	AD ESAURIMENTO - TILL SELL-OFF		0903796	AD ESAURIMENTO - TILL SELL-OFF	
0303655	AD ESAURIMENTO - TILL SELL-OFF				
0303657	AD ESAURIMENTO - TILL SELL-OFF				
0303714	AD ESAURIMENTO - TILL SELL-OFF				
0303729	AD ESAURIMENTO - TILL SELL-OFF				
0303775	AD ESAURIMENTO - TILL SELL-OFF				
0381480	SOSTITUITO DA - REPLACED BY	0383410			
0383670	AD ESAURIMENTO - TILL SELL-OFF				
0391480	SOSTITUITO DA - REPLACED BY	0393410			
0393670	AD ESAURIMENTO - TILL SELL-OFF				
0401291	AD ESAURIMENTO - TILL SELL-OFF				
0401292	AD ESAURIMENTO - TILL SELL-OFF				
0402961	AD ESAURIMENTO - TILL SELL-OFF				
0403314	AD ESAURIMENTO - TILL SELL-OFF				
0403345	AD ESAURIMENTO - TILL SELL-OFF				
0403346	AD ESAURIMENTO - TILL SELL-OFF				
0403787	AD ESAURIMENTO - TILL SELL-OFF				
0500989	AD ESAURIMENTO - TILL SELL-OFF				



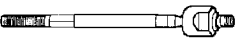
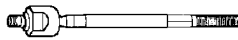
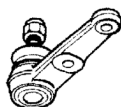
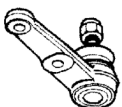
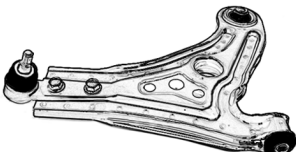
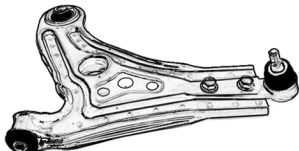













RIF. ORIG O.E. NUMBER	RIF. OCAP REF. OCAP	NOTE REMARKS	DESTRO RIGHT	SINISTRO LEFT
Anno - Year <b>2005 &gt;</b> <b>2011 &gt;</b>		Serie - Series <b>T200 - T250</b> <b>T300</b>	Modello - Model <b>AVEO</b> <b>AVEO</b>	
93740723	<b>0284258</b>	TESTA STERZO - SERVOSTERZO - RHT M12x1,5 TIE ROD END - POWER STEERING - RHT M12x1,5		
93740722	<b>0294258</b>	TESTA STERZO - SERVOSTERZO - RHT M12x1,5 TIE ROD END - POWER STEERING - RHT M12x1,5		
96061907	<b>0602454</b>	SNODO ASSIALE - RHT M12x1,5 AXIAL JOINT - RHT M12x1,5		
96535089	<b>0404259</b>	SNODO SOSPENSIONE - ASSE ANTERIORE - INFERIORE SUSPENSION JOINT - FRONT AXLE - LOWER		
96535082	<b>0784259</b>	BRACCIO OSCILLANTE - ASSE ANTERIORE - INFERIORE TRACK CONTROL ARM - TRACK CONTROL ARM - FRONT AXLE		
96535081	<b>0794259</b>	BRACCIO OSCILLANTE - ASSE ANTERIORE - INFERIORE TRACK CONTROL ARM - FRONT AXLE - LOWER		
96391875 96275798 96288865	<b>0504256</b>	STABILIZZATORE - ASSE ANTERIORE STABILIZER LINK - FRONT AXLE		
Anno - Year <b>06/2006 &gt;</b>		Serie - Series	Modello - Model <b>CAPTIVA</b>	
96626667 4803429	<b>0283951</b>	TESTA STERZO - RHT M16x1,5 TIE ROD END - RHT M16x1,5		
-	<b>0603952</b>	SNODO ASSIALE - RHT M16x1,5 AXIAL JOINT - RHT M16x1,5		
4806301 Z 4806300 Z 96626236 Z 96626235 Z	<b>0403953</b>	SNODO SOSPENSIONE - ASSE ANTERIORE - INFERIORE BALL JOINT - FRONT AXLE - LOWER		







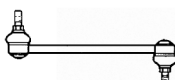
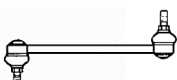

RIF. ORIG O.E. NUMBER	RIF. OCAP REF. OCAP	NOTE REMARKS	DESTRO RIGHT	SINISTRO LEFT
Anno - Year <b>06/2006 &gt;</b>		Serie - Series	Modello - Model <b>CAPTIVA</b>	
4806301 96626236 96819162	<b>0783953</b>	BRACCIO OSCILLANTE - ASSE ANTERIORE - INFERIORE TRACK CONTROL ARM - FRONT AXLE - LOWER		
4806300 96626235 96819161	<b>0793953</b>	BRACCIO OSCILLANTE - ASSE ANTERIORE - INFERIORE TRACK CONTROL ARM - FRONT AXLE - LOWER		
4806305 96626248	<b>0583954</b>	STABILIZZATORE - ASSE ANTERIORE STABILIZER LINK - FRONT AXLE		
4806304 96626247	<b>0593954</b>	STABILIZZATORE - ASSE ANTERIORE STABILIZER LINK - FRONT AXLE		
96626150 4804642	<b>0503955</b>	STABILIZZATORE - ASSE POSTERIORE STABILIZER LINK - REAR AXLE		
Anno - Year <b>05/2009 &gt;</b> <b>06/2011 &gt;</b> <b>08/2012 &gt;</b>		Serie - Series <b>J300</b> <b>J305</b> <b>J308</b>	Modello - Model <b>CRUZE</b> <b>CRUZE 2</b> <b>CRUZE SW</b>	
13278359 13286686 13272000	<b>0288080</b>	TESTA STERZO - RHT M16x1,5 TIE ROD END - RHT M16x1,5		
13278358	<b>0608080</b>	SNODO ASSIALE - RHT M16x1,5 AXIAL JOINT - RHT M16x1,5		
13272606 13334023	<b>0388080</b>	BRACCIO OSCILLANTE - ASSE ANTERIORE - INFERIORE - ALLUMINIO TRACK CONTROL ARM - FRONT AXLE - LOWER - ALUMINIUM		
13272605 13334022	<b>0398080</b>	BRACCIO OSCILLANTE - ASSE ANTERIORE - INFERIORE - ALLUMINIO TRACK CONTROL ARM - FRONT AXLE - LOWER - ALUMINIUM		

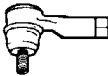
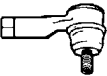
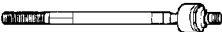
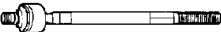
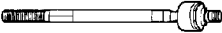
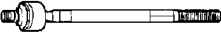
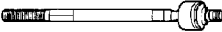
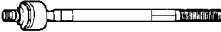



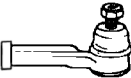
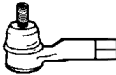
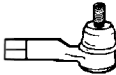
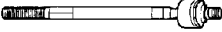
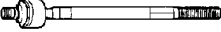

RIF. ORIG O.E. NUMBER	RIF. OCAP REF. OCAP	NOTE REMARKS	DESTRO RIGHT	SINISTRO LEFT
Anno - Year <b>05/2009 &gt;</b> <b>06/2011</b> <b>08/2012 &gt;</b>		Serie - Series <b>J300</b> <b>J305</b> <b>J308</b>	Modello - Model <b>CRUZE</b> <b>CRUZE 2</b> <b>CRUZE SW</b>	
13219141 13258052	<b>0508080</b>	STABILIZZATORE - ASSE ANTERIORE STABILIZER LINK - FRONT AXLE		
Anno - Year <b>1991 &gt;</b> <b>1997 &gt;</b>		Serie - Series	Modello - Model <b>ESPERO - NEXIA</b> <b>LANOS</b>	
26001806 90140006 96275019 324038	<b>0283301</b>	TESTA STERZO - LHT M16x1,5 TIE ROD END - LHT M16x1,5		
26001807 90140007 96275018 324039	<b>0293301</b>	TESTA STERZO - RHT M16x1,5 TIE ROD END - RHT M16x1,5		
07848282	<b>0283300</b>	TESTA STERZO INTERNA - RHT M16x1,5 TIE ROD END INNER - RHT M16x1,5		
07848281	<b>0293300</b>	TESTA STERZO INTERNA - LHT M16x1,5 TIE ROD END INNER - LHT M16x1,5		
07846696 322575	<b>0900760</b>	GIUNTO COLLEGAMENTO ADJUSTMENT BOLT		
90375505 94788122	<b>0403302</b>	SNODO SOSPENSIONE INFERIORE SUSPENSIONE JOINT LOWER		
96218398	<b>0784213</b>	BRACCIO OSCILLANTE - COMPLETO TRACK CONTROL ARM - COMPLETE		
96218397	<b>0794213</b>	BRACCIO OSCILLANTE - COMPLETO TRACK CONTROL ARM - COMPLETE		



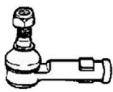
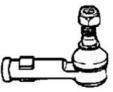

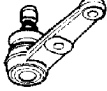
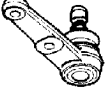
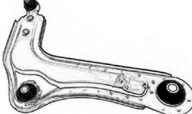

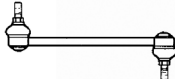
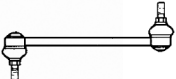
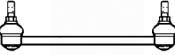
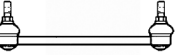
RIF. ORIG O.E. NUMBER	RIF. OCAP REF. OCAP	NOTE REMARKS	DESTRO RIGHT	SINISTRO LEFT
Anno - Year <b>2002 &gt;</b>		Serie - Series	Modello - Model <b>KALOS</b>	
93740623	<b>0284257</b>	TESTA STERZO - STERZO MANUALE TIE ROD END - MANUAL STEERING		
93740622	<b>0294257</b>	TESTA STERZO - STERZO MANUALE TIE ROD END - MANUAL STEERING		
93740723	<b>0284258</b>	TESTA STERZO - SERVOSTERZO TIE ROD END - POWER STEERING		
93740722	<b>0294258</b>	TESTA STERZO - SERVOSTERZO TIE ROD END - POWER STEERING		
96061907	<b>0602454</b>	SNODO ASSIALE AXIAL JOINT		
96535089	<b>0404259</b>	SNODO SOSPENSIONE SUSPENSION JOINT		
96535082	<b>0784259</b>	BRACCIO OSCILLANTE TRACK CONTROL ARM		
96535081	<b>0794259</b>	BRACCIO OSCILLANTE TRACK CONTROL ARM		
96391875 96275798 96288865	<b>0504256</b>	STABILIZZATORE - ANTERIORE STABILIZER LINK - FRONT		
Anno - Year <b>1999 &gt;</b> <b>1999 &gt;</b>		Serie - Series <b>KJ</b> <b>FJ</b>	Modello - Model <b>KORANDO</b> <b>MUSSO</b>	
4666005501 4666005500	<b>0282443</b>	TESTA STERZO - RHT M14x 1,5 TIE ROD END - RHT M14x1,5		
-	<b>0603276</b>	SNODO ASSIALE - RHT M14x 1,5 AXIAL JOINT - RHT M14x1,5		

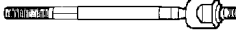
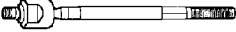
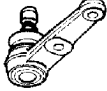
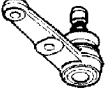
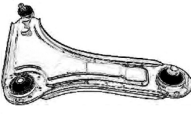

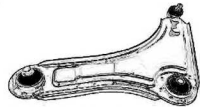
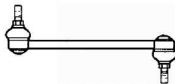
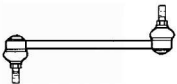
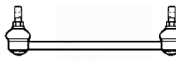
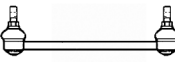
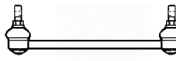
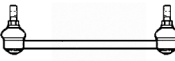







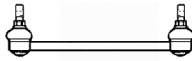
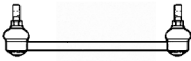
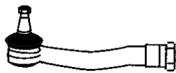

RIF. ORIG O.E. NUMBER	RIF. OCAP REF. OCAP	NOTE REMARKS	DESTRO RIGHT	SINISTRO LEFT
Anno - Year <b>1999 &gt;</b> <b>1999 &gt;</b>		Serie - Series <b>KJ</b> <b>FJ</b>	Modello - Model <b>KORANDO</b> <b>MUSSO</b>	
4443003011 4443003010 4443003000	<b>0402446</b>	SNODO SOSPENSIONE - ASSE ANTERIORE - SUPERIORE BALL JOINT - FRONT AXLE - UPPER		
4450505000 4450505001	<b>0402445</b>	SNODO SOSPENSIONE - ASSE ANTERIORE - INFERIORE BALL JOINT - FRONT AXLE - LOWER		
4475005000 4475005001	<b>0502447</b>	STABILIZZATORE - ASSE ANTERIORE STABILIZER LINK - FRONT AXLE		
Anno - Year <b>1997 &gt; 2002</b> <b>08/2002 &gt;</b>		Serie - Series	Modello - Model <b>LEGANZA</b> <b>EVANDA</b>	
96205809 96129753 96205798	<b>0282892</b>	TESTA STERZO - RHT M14x1,5 TIE ROD END - RHT M14x1,5		
520808	<b>0602895</b>	SNODO ASSIALE- RHT M14x1,5 AXIAL JOINT - RHT M14x1,5		
96213119	<b>0402894</b>	SNODO SOSPENSIONE SOLO LEGANZA SUSPENSION JOINT ONLY LEGANZA		
96213118	<b>0782894</b>	BRACCIO OSCILLANTE - SOLO LEGANZA TRACK CONTROL ARM - ONLY LEGANZA		
96213117	<b>0792894</b>	BRACCIO OSCILLANTE - SOLO LEGANZA TRACK CONTROL ARM - ONLY LEGANZA		
96225859	<b>0584529</b>	STABILIZZATORE - ANTERIORE STABILIZER LINK - FRONT		
96225858	<b>0594529</b>	STABILIZZATORE - ANTERIORE STABILIZER LINK - FRONT		
96207628	<b>0504530</b>	STABILIZZATORE - POSTERIORE SOLO LEGANZA STABILIZER LINK - REAR ONLY LEGANZA		

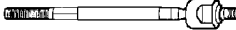
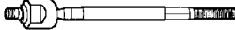
RIF. ORIG O.E. NUMBER	RIF. OCAP REF. OCAP	NOTE REMARKS	DESTRO RIGHT	SINISTRO LEFT
Anno - Year <b>1998 &gt; 2000</b>		Serie - Series	Modello - Model <b>MATIZ</b>	
521136	<b>0282914</b>	TESTA STERZO - RHT M12x1,5 TIE ROD END - RHT M12x1,5		
521255	<b>0602915</b>	SNODO ASSIALE - RHT M12x1,5 - L 273 - STERZO MANUALE - DIM. RUOTE 145/155 AXIAL JOINT - RHT M12x1,5 - L 273 - MANUAL STEERING - WHEELS 145/155		
521257	<b>0604211</b>	SNODO ASSIALE - RHT M12x1,5 - L 273 - STERZO MANUALE - DIM. RUOTE 175 AXIAL JOINT - RHT M12x1,5 - L 273 - MANUAL STEERING - WHEELS 175		
KBJR45	<b>0604212</b>	SNODO ASSIALE - RHT M12x1,5 - L 268 - SERVOSTERZO AXIAL JOINT - RHT M12x1,5 - L 268 - POWER STEERING		
96316765 9631-6765	<b>0702916</b>	BRACCIO OSCILLANTE TRACK CONTROL ARM		
Anno - Year <b>2000 &gt;</b>		Serie - Series	Modello - Model <b>MATIZ</b>	
93741077 08810A78B00-00	<b>0284263</b>	TESTA STERZO - RHT M12x1,5 - STERZO MANUALE TIE ROD END - RHT M12x1,5 - STERZO MANUALE		
93741091	<b>0284265</b>	TESTA STERZO - SERVOSTERZO TIE ROD END - POWER STEERING		
93741074	<b>0604264</b>	SNODO ASSIALE - STERZO MANUALE AXIAL JOINT - MANUAL STEERING		
93741092	<b>0604266</b>	SNODO ASSIALE - SERVOSTERZO AXIAL JOINT - POWER STEERING		
96316765 9631-6765	<b>0702916</b>	BRACCIO OSCILLANTE TRACK CONTROL ARM		

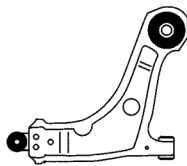
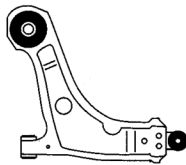



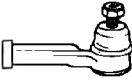
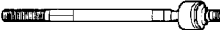
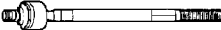
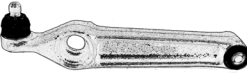



RIF. ORIG O.E. NUMBER	RIF. OCAP REF. OCAP	NOTE REMARKS	DESTRO RIGHT	SINISTRO LEFT
Anno - Year <b>1997 &gt; 1999</b>		Serie - Series <b>J100</b>	Modello - Model <b>NUBIRA</b>	
96205809 96129753 96205798	<b>0282892</b>	TESTA STERZO - RHT M14x1,5 TIE ROD END - RHT M14x1,5		
520672 520838	<b>0602893</b>	SNODO ASSIALE AXIAL JOINT		
96300048 96300648 9630-0048	<b>0402896</b>	SNODO SOSPENSIONE SUSPENSION JOINT		
96268440 96305975	<b>0784219</b>	BRACCIO OSCILLANTE - INFERIORE > 07/1999 TRACK CONTROL ARM - LOWER > 07/1999		
96268439 96305974	<b>0794219</b>	BRACCIO OSCILLANTE - INFERIORE > 07/1999 TRACK CONTROL ARM - LOWER > 07/1999		
96300627	<b>0504225</b>	STABILIZZATORE - ANTERIORE STABILIZER LINK - FRONT		
96300222	<b>0504226</b>	STABILIZZATORE - POSTERIORE STABILIZER LINK - REAR		
Anno - Year <b>1999 &gt; 2002</b>		Serie - Series <b>J150</b>	Modello - Model <b>NUBIRA</b>	
96205809 96129753 96205798	<b>0282892</b>	TESTA STERZO - RHT M14x1,5 TIE ROD END - RHT M14x1,5		
520672 520838	<b>0602893</b>	SNODO ASSIALE AXIAL JOINT		
96300048 96300648 9630-0048	<b>0402896</b>	SNODO SOSPENSIONE SUSPENSION JOINT		
96268455	<b>0784220</b>	BRACCIO OSCILLANTE - INFERIORE 08/1999> TRACK CONTROL ARM - LOWER 08/1999>		

RIF. ORIG O.E. NUMBER	RIF. OCAP REF. OCAP	NOTE REMARKS	DESTRO RIGHT	SINISTRO LEFT
Anno - Year <b>1999 &gt; 2002</b>		Serie - Series <b>J150</b>	Modello - Model <b>NUBIRA</b>	
96268454	<b>0794220</b>	BRACCIO OSCILLANTE - INFERIORE 08/1999> TRACK CONTROL ARM - LOWER 08/1999>		
96275798	<b>0504227</b>	STABILIZZATORE - ANTERIORE STABILIZER LINK - FRONT		
96300222	<b>0504226</b>	STABILIZZATORE - POSTERIORE > CH. 698544 STABILIZER LINK - REAR > CH. 698544		
96391876	<b>0504245</b>	STABILIZZATORE - POSTERIORE CH. 698545 > STABILIZER LINK - REAR CH. 698545 >		
Anno - Year <b>2002 &gt; 04/2004 &gt;</b>		Serie - Series <b>J200</b>	Modello - Model <b>NUBIRA LACETTI</b>	
96407486	<b>0284247</b>	TESTA STERZO TIE ROD END		
96407485	<b>0294247</b>	TESTA STERZO TIE ROD END		
96490218	<b>0404248</b>	SNODO SOSPENSIONE SUSPENSION JOINT		
96391851 96415064	<b>0784248</b>	BRACCIO OSCILLANTE - ASSE ANTERIORE - INFERIORE TRACK CONTROL ARM - FRONT AXLE - LOWER		
96391850 96415063	<b>0794248</b>	BRACCIO OSCILLANTE - ASSE ANTERIORE - INFERIORE TRACK CONTROL ARM - FRONT AXLE - LOWER		

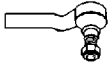
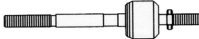

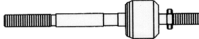
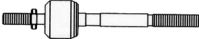

RIF. ORIG O.E. NUMBER	RIF. OCAP REF. OCAP	NOTE REMARKS	DESTRO RIGHT	SINISTRO LEFT
Anno - Year <b>2002 &gt;</b> <b>04/2004 &gt;</b>		Serie - Series <b>J200</b>	Modello - Model <b>NUBIRA LACETTI</b>	
96403100	<b>0584251</b>	STABILIZZATORE - ASSE ANTERIORE STABILIZER LINK - FRONT AXLE		
96403099	<b>0594251</b>	STABILIZZATORE - ASSE ANTERIORE STABILIZER LINK - FRONT AXLE		
96561754	<b>0504252</b>	STABILIZZATORE - POSTERIORE STABILIZER LINK - REAR		
Anno - Year <b>2000 &gt;</b>		Serie - Series	Modello - Model <b>TACUMA</b>	
96261379	<b>0284253</b>	TESTA STERZO TIE ROD END		
96261378	<b>0294253</b>	TESTA STERZO TIE ROD END		
93740621 521564	<b>0604254</b>	SNODO ASSIALE AXIAL JOINT		
96261108	<b>0404255</b>	SNODO SOSPENSIONE SUSPENSION JOINT		
96378348	<b>0784255</b>	BRACCIO OSCILLANTE TRACK CONTROL ARM		
96378347	<b>0794255</b>	BRACCIO OSCILLANTE TRACK CONTROL ARM		
96391875 96275798 96288865	<b>0504256</b>	STABILIZZATORE - ANTERIORE STABILIZER LINK - FRONT		

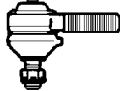
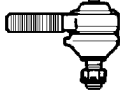
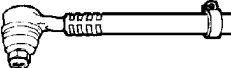
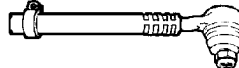



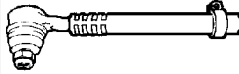
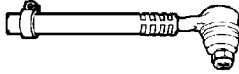

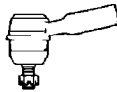
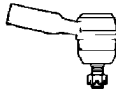
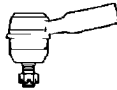
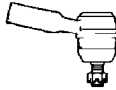
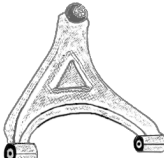
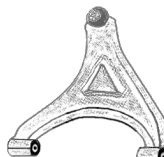
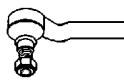
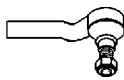
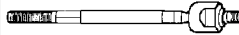
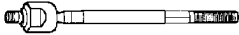
RIF. ORIG O.E. NUMBER	RIF. OCAP REF. OCAP	NOTE REMARKS	DESTRO RIGHT	SINISTRO LEFT
Anno - Year <b>1991 &gt;</b>		Serie - Series	Modello - Model <b>TICO</b>	
93741077 08810A78B00-00	<b>0284263</b>	TESTA STERZO - RHT M12x1,5 TIE ROD END - RHT M12x1,5		
48830A78B00	<b>0604293</b>	SNODO ASSIALE AXIAL JOINT		
96316765 9631-6765	<b>0702916</b>	BRACCIO OSCILLANTE TRACK CONTROL ARM		



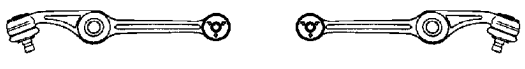
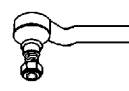
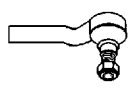



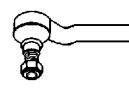
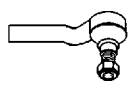



RIF. ORIG O.E. NUMBER	RIF. OCAP REF. OCAP	NOTE REMARKS	DESTRO RIGHT	SINISTRO LEFT
Anno - Year <b>1989 &gt; 1997</b> 1997 >		Serie - Series <b>A101-A111</b>		Modello - Model <b>APPLAUSE I</b> <b>APPLAUSE II</b>
45046-87781 45046-87782 45046-87783 45046-87784	<b>0283307</b>	TESTA STERZO - ESTERNA - RHT M12x1,25 TIE ROD END - OUTER - RHT M12x1,25		
45047-87781 45047-87782 45047-87783 45047-87784	<b>0293307</b>	TESTA STERZO - ESTERNA - RHT M12x1,25 TIE ROD END - OUTER - RHT M12x1,25		
Anno - Year <b>1977 &gt; 1981</b>		Serie - Series <b>G10</b>		Modello - Model <b>CHARADE I</b>
45046-87701	<b>0283303</b>	TESTA STERZO - ESTERNA - RHT M12x1,25 TIE ROD END - OUTER - RHT M12x1,25		
45503-87702	<b>0603317</b>	SNODO ASSIALE - RHT M12x1,25 AXIAL JOINT - RHT M12x1,25		
48068-87704	<b>0783324</b>	BRACCIO OSCILLANTE - INFERIORE TRACK CONTROL ARM - LOWER		
48069-87704	<b>0793324</b>	BRACCIO OSCILLANTE - INFERIORE TRACK CONTROL ARM - LOWER		
Anno - Year <b>1983 &gt; 1987</b>		Serie - Series <b>G11-G26-G30</b>		Modello - Model <b>CHARADE II</b>
45046-87780 445046-87282 45046-87283	<b>0283304</b>	TESTA STERZO - ESTERNA - RHT M12x1,25 TIE ROD END - OUTER - RHT M12x1,25		
45047-87280 45047-87780	<b>0293304</b>	TESTA STERZO - ESTERNA - RHT M12x1,25 TIE ROD END - OUTER - RHT M12x1,25		
45503-87703	<b>0603305</b>	SNODO ASSIALE - RHT M12x1,25 AXIAL JOINT - RHT M12x1,25		
48068-87705 48068-87706	<b>0383306</b>	BRACCIO OSCILLANTE - INFERIORE TRACK CONTROL ARM - LOWER		







RIF. ORIG O.E. NUMBER	RIF. OCAP REF. OCAP	NOTE REMARKS	DESTRO RIGHT	SINISTRO LEFT
Anno - Year <b>1983 &gt; 1987</b>		Serie - Series <b>G11-G26-G30</b>	Modello - Model <b>CHARADE II</b>	
48069-87705 48069-87706	<b>0393306</b>	BRACCIO OSCILLANTE - INFERIORE TRACK CONTROL ARM - LOWER		
Anno - Year <b>1987 &gt; 1993</b> <b>1993 &gt;</b>		Serie - Series <b>G100-G101-G102-G112</b> <b>G200-G201-G203-G213</b>	Modello - Model <b>CHARADE III</b> <b>CHARADE IV</b>	
45046-87781 45046-87782 45046-87783 45046-87784	<b>0283307</b>	TESTA STERZO - ESTERNA - RHT M12x1,25 TIE ROD END - OUTER - RHT M12x1,25		
45047-87781 45047-87782 45047-87783 45047-87784	<b>0293307</b>	TESTA STERZO - ESTERNA - RHT M12x1,25 TIE ROD END - OUTER - RHT M12x1,25		
45503-87705	<b>0603308</b>	SNODO ASSIALE - RHT M12x1,25 - STERZO MANUALE - > 1988 AXIAL JOINT - RHT M12x1,25 - MANUAL STEERING - > 1988		
45503-87708 45503-87711	<b>0602955</b>	SNODO ASSIALE - RHT M12x1,25 - STERZO MANUALE - 1989 > AXIAL JOINT - RHT M12x1,25 - MANUAL STEERING - 1989 >		
45503-87710	<b>0602444</b>	SNODO ASSIALE - SERVOSTERZO - SOLO CHARADE IV AXIAL JOINT - POWER STEERING - ONLY CHARADE IV		
48068-87706	<b>0383325</b>	BRACCIO OSCILLANTE - INFERIORE > 1993 TRACK CONTROL ARM - LOWER 1993		
48069-87706	<b>0393325</b>	BRACCIO OSCILLANTE - INFERIORE > 1993 TRACK CONTROL ARM - LOWER > 1993		
Anno - Year <b>1974 &gt; 1983</b>		Serie - Series <b>A10-A20-A30-A40-A45</b>	Modello - Model <b>CHARMANT</b>	
45046-19065 45046-29075	<b>0193312</b>	TESTA STERZO - LHT M14x1,5 TIE ROD END - LHT M14x1,5		
45460-19095 45460-19135	<b>0283313</b>	TESTA STERZO TIE ROD END		





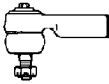
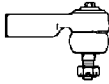



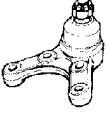
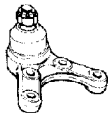
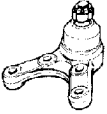

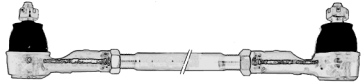
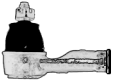
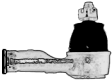
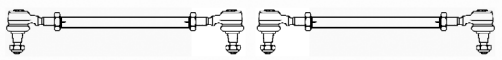
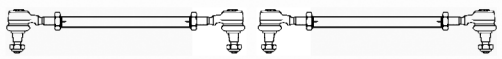
RIF. ORIG O.E. NUMBER	RIF. OCAP REF. OCAP	NOTE REMARKS	DESTRO RIGHT	SINISTRO LEFT
Anno - Year <b>1981 &gt;</b>		Serie - Series <b>A35-A55-A60</b>	Modello - Model <b>CHARMANT</b>	
45460-19125	<b>0283315</b>	TESTA STERZO TIE ROD END		
43308-12030 43308-19035	<b>0403316</b>	SNODO SOSPENSIONE - INFERIORE SUSPENSION JOINT - LOWER		
Anno - Year <b>1977 &gt; 1985</b>		Serie - Series <b>L40-L55-L60</b>	Modello - Model <b>CUORE I</b>	
45046-87203	<b>0283309</b>	TESTA STERZO - ESTERNA - RHT M12x1,5 - SERIE L40-L45 - > 1980 TIE ROD END - OUTER - RHT M12x1,5 - SERIES L40-L45 - > 1980		
45046-87280	<b>0283310</b>	TESTA STERZO - ESTERNA - RHT M12x1,5 - SERIE L55-L56L55V-L56V - 1980 > 1985 TIE ROD END - OUTER - RHT M12x1,5 - SERIES L55-L56L55V-L56V - 1980 > 1985		
48068-87205	<b>0783326</b>	BRACCIO OSCILLANTE - INFERIORE TRACK CONTROL ARM - LOWER		
48069-87205	<b>0793326</b>	BRACCIO OSCILLANTE - INFERIORE TRACK CONTROL ARM - LOWER		
Anno - Year <b>1985 &gt; 1990</b> <b>1990 &gt; 1994</b>		Serie - Series <b>L80</b> <b>L201</b>	Modello - Model <b>CUORE II</b> <b>CUORE III</b>	
45046-87780 445046-87282 45046-87283	<b>0283304</b>	TESTA STERZO - ESTERNA - RHT M12x1,25 TIE ROD END - OUTER - RHT M12x1,25		
45047-87280 45047-87780	<b>0293304</b>	TESTA STERZO - ESTERNA - RHT M12x1,25 TIE ROD END - OUTER - RHT M12x1,25		
45503-87215 45503-87210 45503-87208	<b>0602466</b>	SNODO ASSIALE ANTERIORE AXIAL JOINT FRONT		
48068-87206	<b>0403322</b>	SNODO SOSPENSIONE - INFERIORE SUSPENSION JOINT - LOWER		

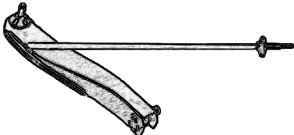
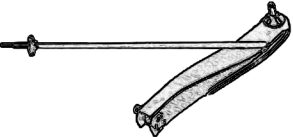

RIF. ORIG O.E. NUMBER	RIF. OCAP REF. OCAP	NOTE REMARKS	DESTRO RIGHT	SINISTRO LEFT
Anno - Year <b>1985 &gt; 1990</b> <b>1990 &gt; 1994</b>		Serie - Series <b>L80</b> <b>L201</b>	Modello - Model <b>CUORE II</b> <b>CUORE III</b>	
48068-87208 48069-87208	<b>0303328</b>	BRACCIO OSCILLANTE - INFERIORE SOLO CUORE III TRACK CONTROL ARM - LOWER ONLY CUORE III		
Anno - Year <b>1995 &gt; 1996</b> <b>1996 &gt;</b>		Serie - Series <b>L501</b> <b>L6 - L9</b>	Modello - Model <b>CUORE IV</b> <b>MOVE</b>	
45046-87780 445046-87282 45046-87283	<b>0283304</b>	TESTA STERZO - ESTERNA - RHT M12x1,25 TIE ROD END - OUTER - RHT M12x1,25		
45047-87280 45047-87780	<b>0293304</b>	TESTA STERZO - ESTERNA - RHT M12x1,25 TIE ROD END - OUTER - RHT M12x1,25		
45503-87215 45503-87210 45503-87208	<b>0602466</b>	SNODO ASSIALE ANTERIORE - SOLO MOVE AXIAL JOINT FRONT - ONLY MOVE		
48068-87209	<b>0382469</b>	BRACCIO OSCILLANTE INFERIORE TRACK CONTROL ARM LOWER		
48069-87209	<b>0392469</b>	BRACCIO OSCILLANTE INFERIORE TRACK CONTROL ARM LOWER		
48802-87703	<b>0502448</b>	STABILIZZATORE POSTERIORE - SOLO MOVE STABILIZER LINK REAR - ONLY MOVE		
Anno - Year <b>1996 &gt; 1998</b> <b>10/98 &gt; 05/03</b> <b>03/2003 &gt;</b>		Serie - Series <b>L5</b> <b>L7</b> <b>L251</b>	Modello - Model <b>CUORE V</b> <b>CUORE VI</b> <b>CUORE VII</b>	
45046-87780 445046-87282 45046-87283	<b>0283304</b>	TESTA STERZO - ESTERNA - RHT M12x1,25 TIE ROD END - OUTER - RHT M12x1,25		
45047-87280 45047-87780	<b>0293304</b>	TESTA STERZO - ESTERNA - RHT M12x1,25 TIE ROD END - OUTER - RHT M12x1,25		
45503-97203	<b>0602467</b>	SNODO ASSIALE ANTERIORE - STERZO MANUALE AXIAL JOINT FRONT - MANUAL STEERING		



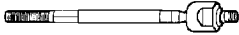
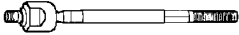
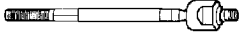
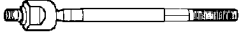

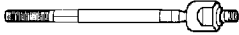
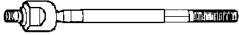
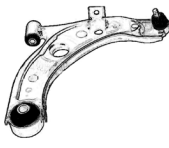
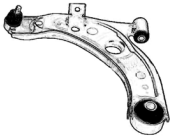
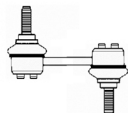
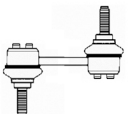

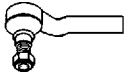
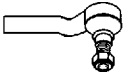
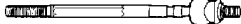
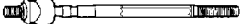
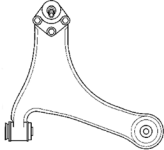
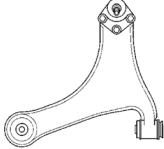







RIF. ORIG O.E. NUMBER	RIF. OCAP REF. OCAP	NOTE REMARKS	DESTRO RIGHT	SINISTRO LEFT
Anno - Year <b>1996 &gt; 1998</b> <b>10/98 &gt; 05/03</b> <b>03/2003 &gt;</b>		Serie - Series <b>L5</b> <b>L7</b> <b>L251</b>	Modello - Model <b>CUORE V</b> <b>CUORE VI</b> <b>CUORE VII</b>	
45503-97204	<b>0602468</b>	SNODO ASSIALE ANTERIORE - SERVOSTERZO AXIAL JOINT FRONT - POWER STEERING		
48068-87209	<b>0382469</b>	BRACCIO OSCILLANTE INFERIORE SOLO SU CUORE V TRACK CONTROL ARM LOWER ONLY CUORE VI		
48069-87209	<b>0392469</b>	BRACCIO OSCILLANTE INFERIORE SOLO SU CUORE V TRACK CONTROL ARM LOWER ONLY CUORE V		
48068-97202	<b>0382779</b>	BRACCIO OSCILLANTE INFERIORE SOLO SU CUORE VI -VII TRACK CONTROL ARM LOWER ONLY CUORE VI - VII		
48069-97202	<b>0392779</b>	BRACCIO OSCILLANTE INFERIORE SOLO SU CUORE VI- VII TRACK CONTROL ARM LOWER ONLY CUORE VI -VII		
Anno - Year <b>1996 &gt; 1998</b> <b>1998 &gt;</b>		Serie - Series <b>G3 1.5 16V</b> <b>G3 1.6 16V</b>	Modello - Model <b>GRAN MOVE</b>	
45046-87707	<b>0282449</b>	TESTA STERZO - ESTERNA TIE ROD END - OUTER		
45047-87706	<b>0292449</b>	TESTA STERZO - ESTERNA TIE ROD END - OUTER		
45503-87710	<b>0602444</b>	SNODO ASSIALE - SERVOSTERZO - MOD. 1.5 16V AXIAL JOINT - POWER STEERING - ONLY MOD. 1.5 16V		
45503-87714	<b>0602620</b>	SNODO ASSIALE - MOD. 1.6 16V AXIAL JOINT - ONLY MOD. 1.6 16V		
4806887711	<b>0383277</b>	BRACCIO OSCILLANTE - ASSE ANTERIORE TRACK CONTROL ARM - FRONT AXLE		

RIF. ORIG O.E. NUMBER	RIF. OCAP REF. OCAP	NOTE REMARKS	DESTRO RIGHT	SINISTRO LEFT
Anno - Year <b>1996 &gt; 1998</b> 1998 >		Serie - Series <b>G3 1.5 16V</b> <b>G3 1.6 16V</b>	Modello - Model <b>GRAN MOVE</b>	
4806887710	<b>0393277</b>	BRACCIO OSCILLANTE - ASSE ANTERIORE TRACK CONTROL ARM - FRONT AXLE		
48802-87703	<b>0502448</b>	STABILIZZATORE POSTERIORE STABILIZER LINK REAR		
Anno - Year <b>1968 &gt; 1985</b>		Serie - Series <b>S37-L37-S38-S40-S60-S10-S70</b>	Modello - Model <b>HIJET</b>	
45047-87501 45047-87502	<b>0283311</b>	TESTA STERZO - INTERNA - ESTERNA - RHT M14x1,5 TIE ROD END - INNER - OUTER - RHT M14x1,5		
45057-87501 45057-87502	<b>0293311</b>	TESTA STERZO - INTERNA - ESTERNA - RHT M14x1,5 TIE ROD END - INNER - OUTER - RHT M14x1,5		
43350-87501 43370-87501	<b>0483318</b>	SNODO SOSPENSIONE - SUPERIORE - TUTTI I MODELLI SUSPENSION JOINT - UPPER - ALL MODEL		
43380-87501 43360-87501	<b>0493318</b>	SNODO SOSPENSIONE - SUPERIORE - TUTTI I MODELLI SUSPENSION JOINT - UPPER - ALL MODEL		
43330-87501 43330-87580	<b>0483319</b>	SNODO SOSPENSIONE - INFERIORE - > 1976 - SERIE S37-L37-S38-S40 SUSPENSION JOINT - LOWER - > 1976 - SERIES S37-L37-S38-S40		
43340-87501 43340-87580	<b>0493319</b>	SNODO SOSPENSIONE - INFERIORE - > 1976 - SERIE S37-L37-S38-S40 SUSPENSION JOINT - LOWER - > 1976 - SERIES S37-L37-S38-S40		
43330-87581	<b>0483320</b>	SNODO SOSPENSIONE - INFERIORE - 1976 > 1981 - SERIE S38-S40-S60 SUSPENSION JOINT - LOWER - 1976 > 1981 - SERIES S38-S40-S60		
43340-87581	<b>0493320</b>	SNODO SOSPENSIONE - INFERIORE - 1976 > 1981 - SERIE S38-S40-S60 SUSPENSION JOINT - LOWER - 1976 > 1981 - SERIES S38-S40-S60		



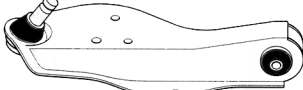

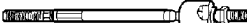
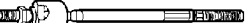

RIF. ORIG O.E. NUMBER	RIF. OCAP REF. OCAP	NOTE REMARKS	DESTRO RIGHT	SINISTRO LEFT
Anno - Year <b>1986 &gt; 1989</b> 1992 >		Serie - Series <b>Autobus - Furgonato</b>	Modello - Model <b>HIJET I</b> <b>HIJET II</b>	
45460-87587	<b>0503321</b>	BARRA STERZO - > 04/1995 TIE ROD - > 04/1995		
45046-87503 45046-87504 45046-87580	<b>0283321</b>	TESTA STERZO - RHT M14x1,5 - > 04/1995 TIE ROD END - RHT M14x1,5 - > 04/1995		
45047-87503 45047-87504 45047-87580	<b>0293321</b>	TESTA STERZO - RHT M14x1,5 - > 04/1995 TIE ROD END - RHT M14x1,5 - > 04/1995		
45460-87586	<b>0502690</b>	BARRA STERZO - 05/1995 > TIE ROD - 05/1995 >		
45047-87Z02	<b>0182690</b>	TESTA STERZO - 05/1995 > - RHT M14x1,5 TIE ROD END - 05/1995 > - RHT M14x1,5		
45046-87Z02	<b>0192690</b>	TESTA STERZO - 05/1995 > TIE ROD END - 05/1995 >		
48068-87507	<b>0783327</b>	BRACCIO OSCILLANTE - INFERIORE TRACK CONTROL ARM - LOWER		
48069-87507	<b>0793327</b>	BRACCIO OSCILLANTE - INFERIORE TRACK CONTROL ARM - LOWER		
Anno - Year <b>1985 &gt; 1993</b>		Serie - Series <b>F7 - F8</b>	Modello - Model <b>ROCKY - RUGGER</b>	
45047-87380	<b>0193323</b>	L H D - TESTA STERZO - LHT M20x1,5 L H D - TIE ROD END - LHT M20x1,5		
45046-87680	<b>0183323</b>	R H D - TESTA STERZO - RHT M20x1,5 R H D - TIE ROD END - RHT M20x1,5		



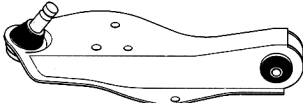
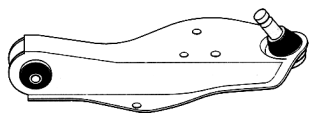

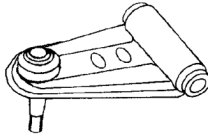
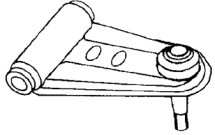
RIF. ORIG O.E. NUMBER	RIF. OCAP REF. OCAP	NOTE REMARKS	DESTRO RIGHT	SINISTRO LEFT
Anno - Year <b>1998 &gt; 2005</b>		Serie - Series <b>M1</b>	Modello - Model <b>SIRION</b>	
45046-87707	<b>0282449</b>	TESTA STERZO - ESTERNA TIE ROD END - OUTER		
45047-87706	<b>0292449</b>	TESTA STERZO - ESTERNA TIE ROD END - OUTER		
45503-97201	<b>0602455</b>	SNODO ASSIALE - SOLO PER MOD. 1.0 4WD - 1.3 SPORT 4WD AXIAL JOINT ONLY FOR 1.0 4WD - 1.3 SPORT 4WD MODELS		
45503-97401	<b>0602456</b>	SNODO ASSIALE AXIAL JOINT		
Anno - Year <b>2005 &gt;</b>		Serie - Series <b>M3</b>	Modello - Model <b>SIRION</b>	
45046-87707	<b>0282449</b>	TESTA STERZO - ESTERNA TIE ROD END - OUTER		
45047-87706	<b>0292449</b>	TESTA STERZO - ESTERNA TIE ROD END - OUTER		
45503-B1010	<b>0602780</b>	SNODO ASSIALE AXIAL JOIN		
48068-B1020	<b>0782781</b>	BRACCIO OSCILLANTE TRACK CONTROL ARM		
48069-B1020	<b>0792781</b>	BRACCIO OSCILLANTE TRACK CONTROL ARM		
48821-B1010	<b>0582457</b>	STABILIZZATORE - ASSE ANTERIORE STABILIZER LINK - FRONT AXLE		
48831-B1010	<b>0592457</b>	STABILIZZATORE - ASSE ANTERIORE STABILIZER LINK - FRONT AXLE		



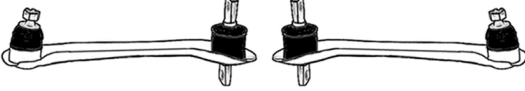

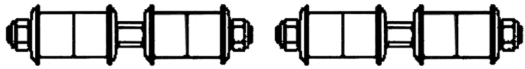
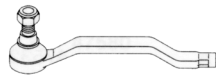
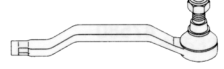

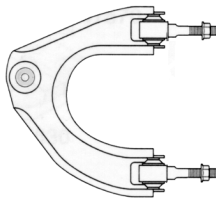
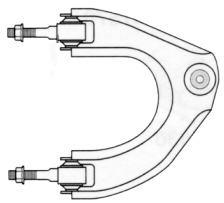
RIF. ORIG O.E. NUMBER	RIF. OCAP REF. OCAP	NOTE REMARKS	DESTRO RIGHT	SINISTRO LEFT
Anno - Year <b>05/97 &gt; 10/05</b>		Serie - Series <b>J1</b>	Modello - Model <b>TERIOS</b>	
45046-87402	<b>0282458</b>	TESTA STERZO - ESTERNA - RHT M14x1,5 TIE ROD END - OUTER -RHT M14x1,5		
45503-87401 45460-87401	<b>0602459</b>	SNODO ASSIALE - RHT M14x1,5 AXIAL JOINT - RHT M14x1,5		
43068-87401 48068-87405	<b>0782460</b>	BRACCIO OSCILLANTE - INFERIORE TRACK CONTROL ARM - LOWER		
43069-87401 48069-87405	<b>0792460</b>	BRACCIO OSCILLANTE - INFERIORE TRACK CONTROL ARM - LOWER		
48822-87401	<b>0502461</b>	STABILIZZATORE - ANTERIORE STABILIZER LINK - FRONT		

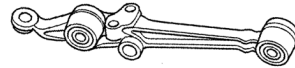
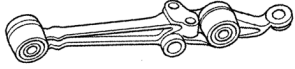





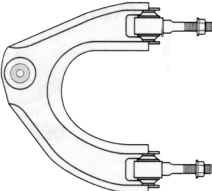
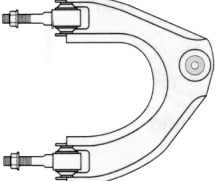

RIF. ORIG O.E. NUMBER	RIF. OCAP REF. OCAP	NOTE REMARKS	DESTRO RIGHT	SINISTRO LEFT
Anno - Year <b>1976 &gt; 1983</b>		Serie - Series <b>SJ-SM-SV</b>	Modello - Model <b>ACCORD I</b>	
53540-SB2-003 53540-SB2-013 53540-SC2-003 53540-SC2-004	<b>0280987</b>	TESTA STERZO - ESTERNA RHT M12x1.5 TIE ROD END - OUTER RHT M12x1.5		
53521-671-010 53521-689-003 53521-671-000	<b>0601228</b>	SNODO ASSIALE - RHT M12x1.5 AXIAL JOINT - RHT M12x1.5		
51350-671-003 51350-671-033 51350-634-003	<b>0783336</b>	BRACCIO OSCILLANTE - INFERIORE TRACK CONTROL ARM - LOWER		
51360-671-003 51360-671-033 51360-634-003	<b>0793336</b>	BRACCIO OSCILLANTE - INFERIORE TRACK CONTROL ARM - LOWER		
Anno - Year <b>1981 &gt; 1983</b>		Serie - Series <b>SY-SZ</b>	Modello - Model <b>ACCORD I</b>	
53540-SB2-003 53540-SB2-013 53540-SC2-003 53540-SC2-004	<b>0280987</b>	TESTA STERZO - ESTERNA RHT M12x1.5 TIE ROD END - OUTER RHT M12x1.5		
53521-SA0-003 53521-SE0-003 53521-SE0-013 53521-SE0-951 53521-692-003	<b>0600988</b>	SNODO ASSIALE - RHT M12x1.5 AXIAL JOINT - RHT M12x1.5		
51350-SA5-013 51350-SA5-003	<b>0783337</b>	BRACCIO OSCILLANTE - INFERIORE TRACK CONTROL ARM - LOWER		
51360-SA5-013	<b>0793337</b>	BRACCIO OSCILLANTE - INFERIORE TRACK CONTROL ARM - LOWER		
Anno - Year <b>1983 &gt; 1985</b>		Serie - Series <b>AC 1.6-AD 1.8</b>	Modello - Model <b>ACCORD II</b>	
53540-SB2-003 53540-SB2-013 53540-SC2-003 53540-SC2-004	<b>0280987</b>	TESTA STERZO - ESTERNA RHT M12x1.5 TIE ROD END - OUTER RHT M12x1.5		
53521-SA5-000 53521-SA5-003	<b>0603347</b>	SNODO ASSIALE - RHT M12x1.5 AXIAL JOINT - RHT M12x1.5		



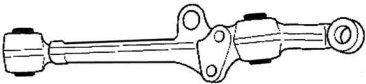
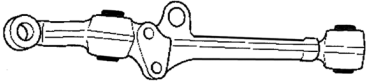





RIF. ORIG O.E. NUMBER	RIF. OCAP REF. OCAP	NOTE REMARKS	DESTRO RIGHT	SINISTRO LEFT
Anno - Year <b>1983 &gt; 1985</b>		Serie - Series <b>AC 1.6-AD 1.8</b>	Modello - Model <b>ACCORD II</b>	
51350-SA5-020 51350-SA5-010	<b>0783338</b>	BRACCIO OSCILLANTE - INFERIORE TRACK CONTROL ARM - LOWER		
51360-SA5-020 51360-SA5-010	<b>0793338</b>	BRACCIO OSCILLANTE - INFERIORE TRACK CONTROL ARM - LOWER		
Anno - Year <b>1985 &gt; 1989</b>		Serie - Series <b>CA1-CA2-CA3-CA4-CA5 AERODECK (CA5)</b>	Modello - Model <b>ACCORD III</b>	
53540-SB2-003 53540-SB2-013 53540-SC2-003 53540-SC2-004	<b>0280987</b>	TESTA STERZO - ESTERNA RHT M12x1.5 TIE ROD END - OUTER RHT M12x1.5		
53521-SA0-003 53521-SE0-003 53521-SE0-013 53521-SE0-951 53521-692-003	<b>0600988</b>	SNODO ASSIALE - RHT M12x1.5 AXIAL JOINT - RHT M12x1.5		
51459-SE0-000 51459-SE0-003	<b>0783339</b>	BRACCIO OSCILLANTE - SUPERIORE TRACK CONTROL ARM - UPPER		
51469-SE0-000 51469-SE0-003	<b>0793339</b>	BRACCIO OSCILLANTE - SUPERIORE TRACK CONTROL ARM - UPPER		
51220-SK7-013 51220-SM0-A01 51220-SR3-003 51220-S04-003	<b>0401679</b>	SNODO SOSPENSIONE - INFERIORE SUSPENSION JOINT - LOWER		
51355-SE0-010	<b>0783340</b>	BRACCIO OSCILLANTE - INFERIORE TRACK CONTROL ARM - LOWER		
51365-SE0-010	<b>0793340</b>	BRACCIO OSCILLANTE - INFERIORE TRACK CONTROL ARM - LOWER		
52390-SE0-023 52390-SE0-043	<b>0703341</b>	ASSE POSTERIORE - BRACCIO SOSPENSIONE SUPERIORE REAR AXLE - SUSPENSION CONTROL ARM UPPER		



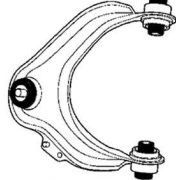
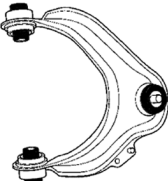

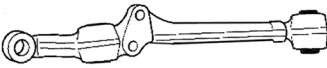

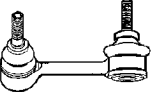
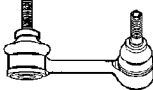
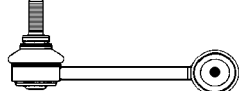
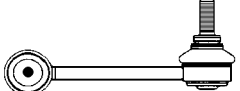

RIF. ORIG O.E. NUMBER	RIF. OCAP REF. OCAP	NOTE REMARKS	DESTRO RIGHT	SINISTRO LEFT
Anno - Year <b>1985 &gt; 1989</b>	Serie - Series <b>CA1-CA2-CA3-CA4-CA5 AERODECK (CA5)</b>		Modello - Model <b>ACCORD III</b>	
90112-SE0-000	<b>0504532</b>	STABILIZZATORE - ASSE ANTERIORE STABILIZER LINK - FRONT AXLE		
Anno - Year <b>1990 &gt; 1993</b> <b>1991 &gt; 1993</b> <b>1992 &gt; 1993</b>	Serie - Series <b>CB - CC - CD</b> <b>AERODECK (CB8-CC)</b> <b>COUPE' (CC1)</b>		Modello - Model <b>ACCORD IV</b>	
53540-SM4-003 53540-SM4-004 53540-SV4-003 53540-SX0-013	<b>0283349</b>	TESTA STERZO - RHT M14x1,5 L 217,5 TIE ROD END - RHT M14x1,5 L 217,5		
53560-SM4-003 53560-SM4-004 53560-SV4-003 53560-SX0-013	<b>0293349</b>	TESTA STERZO - LHT M14x1,5 L 217,5 TIE ROD END - LHT M14x1,5 L 217,5		
53521-SM4-013 53521-SM4-003	<b>0600388</b>	SNODO ASSIALE AXIAL JOINT		
51450-SM4-A03 51450-SM4-013 51450-SM4-023 51450-SM4-A02	<b>0783342</b>	BRACCIO OSCILLANTE SUPERIORE TRACK CONTROL ARM UPPER		
51460-SM4-A03 51460-SM4-013 51460-SM4-023 51460-SM4-A02	<b>0793342</b>	BRACCIO OSCILLANTE SUPERIORE TRACK CONTROL ARM UPPER		
51220-SM4-013 51220-SM4-003 51220-SM1-A01	<b>0403350</b>	SNODO SOSPENSIONE INFERIORE SUSPENSION JOINT LOWER		
51355-SM4-040 51355-SM4-030	<b>0384228</b>	BRACCIO OSCILLANTE INFERIORE TRACK CONTROL ARM LOWER		
51365-SM4-040 51365-SM4-030	<b>0394228</b>	BRACCIO OSCILLANTE INFERIORE TRACK CONTROL ARM LOWER		

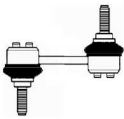
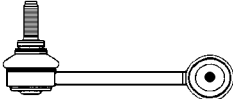
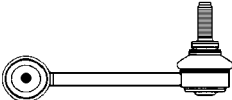











RIF. ORIG O.E. NUMBER	RIF. OCAP REF. OCAP	NOTE REMARKS	DESTRO RIGHT	SINISTRO LEFT
Anno - Year <b>1990 &gt; 1993</b> <b>1991 &gt; 1993</b> <b>1992 &gt; 1993</b>		Serie - Series <b>CB - CC - CD</b> <b>AERODECK (CB8-CC)</b> <b>COUPE' (CC1)</b>	Modello - Model <b>ACCORD IV</b>	
90112-SM4-020 90112-SM4-000	<b>0502763</b>	STABILIZZATORE - ASSE ANTERIORE STABILIZER LINK - FRONT AXLE		
52390-SM1-A03 52390-SM4-033 52390-SM4-A04	<b>0783348</b>	BRACCIO SOSPENSIONE ASSE POSTERIORE SUSPENSION CONTROL ARM REAR AXLE		
52400-SM1-A03 52400-SM4-033 52400-SM4-A04 52400-SM5-A03	<b>0793348</b>	BRACCIO SOSPENSIONE ASSE POSTERIORE SUSPENSION CONTROL ARM REAR AXLE		
Anno - Year <b>1993 &gt; 1996</b> <b>1993 &gt; 1998</b> <b>1996 &gt; 1998</b> <b>1998 &gt; 2001</b>		Serie - Series <b>CC7</b> <b>AERODECK (CE) COUPE' (CD7-CD9)</b> <b>CE, CF</b> <b>RA</b>	Modello - Model <b>ACCORD V</b> <b>ACCORD V</b> <b>ACCORD VI</b> <b>SHUTTLE</b>	
53540-SM4-003 53540-SM4-004 53540-SV4-003 53540-SX0-013	<b>0283349</b>	TESTA STERZO - RHT M14x1,5 L 217,5 TIE ROD END - RHT M14x1,5 L 217,5		
53560-SM4-003 53560-SM4-004 53560-SV4-003 53560-SX0-013	<b>0293349</b>	TESTA STERZO - LHT M14x1,5 L 217,5 TIE ROD END - LHT M14x1,5 L 217,5		
53010-SV4-000	<b>0602926</b>	SNODO ASSIALE AXIAL JOINT		
-	<b>0403351</b>	SNODO SOSPENSIONE - B.O. SUPERIORE BALL JOINT - UPPER CONTROL ARM		
51450-SV4-000 51450-SV4-A00	<b>0783351</b>	BRACCIO OSCILLANTE - SUPERIORE TRACK CONTROL ARM - UPPER		
51460-SV4-000 51460-SV4-A00	<b>0793351</b>	BRACCIO OSCILLANTE - SUPERIORE TRACK CONTROL ARM - UPPER		

RIF. ORIG O.E. NUMBER	RIF. OCAP REF. OCAP	NOTE REMARKS	DESTRO RIGHT	SINISTRO LEFT
Anno - Year <b>1993 &gt; 1996</b> <b>1993 &gt; 1998</b> <b>1996 &gt; 1998</b> <b>1998 &gt; 2001</b>		Serie - Series <b>CC7</b> <b>AERODECK (CE) COUPE' (CD7-CD9)</b> <b>CE, CF</b> <b>RA</b>	Modello - Model <b>ACCORD V</b> <b>ACCORD V</b> <b>ACCORD VI</b> <b>SHUTTLE</b>	
51220-SM4-013 51220-SM4-003 51220-SM1-A01	<b>0403350</b>	SNODO SOSPENSIONE INFERIORE SUSPENSION JOINT LOWER		
51355-SV4-000 51355-SV7-A00	<b>0384241</b>	BRACCIO OSCILLANTE - INFERIORE SOLO ACCORD V E ACCORD VI TRACK CONTROL ARM - LOWER ONLY ACCORD V AND ACCORD VI		
51365-SV4-000 51365-SV7-A00	<b>0394241</b>	BRACCIO OSCILLANTE - INFERIORE SOLO ACCORD V E ACCORD VI TRACK CONTROL ARM - LOWER ONLY ACCORD V AND ACCORD VI		
90112-SM4-020 90112-SM4-000	<b>0502763</b>	STABILIZZATORE - ASSE ANTERIORE STABILIZER LINK - FRONT AXLE		
52390-SM1-A03 52390-SM4-033 52390-SM4-A04	<b>0783348</b>	BRACCIO SOSPENSIONE ASSE POSTERIORE SOLO ACCORD V E ACCORD VI SUSPENSION CONTROL ARM REAR AXLE ONLY ACCORD V AND ACCORD VI		
52400-SM1-A03 52400-SM4-033 52400-SM4-A04 52400-SM5-A03	<b>0793348</b>	BRACCIO SOSPENSIONE ASSE POSTERIORE SOLO ACCORD V E ACCORD VI SUSPENSION CONTROL ARM REAR AXLE ONLY ACCORD V AND ACCORD VI		
Anno - Year <b>1998 &gt; 2002</b> <b>1999 &gt; 2002</b> <b>1998 &gt; 2003</b>		Serie - Series <b>CG: 1.6i-1.8i-2.0i-2.2i-2.3</b> <b>HATCHBACK (CH): 1.8-2.0-2.3</b> <b>COUPE' (CG): 2.0i-3.0</b>	Modello - Model <b>ACCORD VII</b>	
53540-S1A-E01	<b>0281935</b>	TESTA STERZO - RHT M14x1,5 TIE ROD END - RHT M14x1,5		
53560-S1A-E01	<b>0291935</b>	TESTA STERZO - RHT M14x1,5 TIE ROD END - RHT M14x1,5		
53010-S84-A01	<b>0603278</b>	SNODO ASSIALE - RHT M14x1,5 AXIAL JOINT - RHT M14x1,5		





RIF. ORIG O.E. NUMBER	RIF. OCAP REF. OCAP	NOTE REMARKS	DESTRO RIGHT	SINISTRO LEFT
Anno - Year 1998 > 2002 1999 > 2002 1998 > 2003		Serie - Series CG: 1.6i-1.8i-2.0i-2.2i-2.3 HATCHBACK (CH): 1.8-2.0-2.3 COUPE' (CG): 2.0i-3.0	Modello - Model <b>ACCORD VII</b>	
-	<b>0404242</b>	SNODO SOSPENSIONE - SUPERIORE BALL JOINT - UPPER		
51450-S1A-E01 51450-S84-A01	<b>0784242</b>	BRACCIO OSCILLANTE - SUPERIORE TRACK CONTROL ARM - UPPER		
51460-S1A-E01 51460-S584-A01	<b>0794242</b>	BRACCIO OSCILLANTE - SUPERIORE TRACK CONTROL ARM - UPPER		
51220-SM4-013 51220-SM4-003 51220-SM1-A01	<b>0403350</b>	SNODO SOSPENSIONE - INFERIORE SUSPENSION JOINT - LOWER		
51355-S1A-E00 51355-S84-A00	<b>0384292</b>	BRACCIO OSCILLANTE - INFERIORE TRACK CONTROL ARM - LOWER		
51365-S1A-E00 51365-S84-A00	<b>0394292</b>	BRACCIO OSCILLANTE - INFERIORE TRACK CONTROL ARM - LOWER		
51320-S84-A01	<b>0581936</b>	STABILIZZATORE STABILIZER LINK		
51321-S84-A01	<b>0591936</b>	STABILIZZATORE STABILIZER LINK		
52320-S84-A01	<b>0584531</b>	STABILIZZATORE - POSTERIORE STABILIZER LINK - REAR		
52325-S84-A01	<b>0594531</b>	STABILIZZATORE - POSTERIORE STABILIZER LINK -REAR		





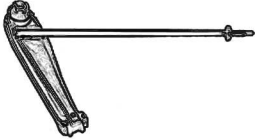
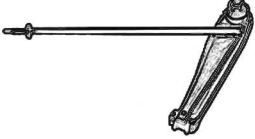

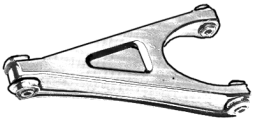
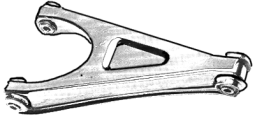
RIF. ORIG O.E. NUMBER	RIF. OCAP REF. OCAP	NOTE REMARKS	DESTRO RIGHT	SINISTRO LEFT
Anno - Year <b>2003 &gt;</b>		Serie - Series	Modello - Model <b>ACCORD VIII</b>	
53540-SDA-A01	<b>0284363</b>	TESTA STERZO - RHT M14x1,5 TIE ROD END - RHT M14x1,5		
53560-SDA-A01	<b>0294363</b>	TESTA STERZO - RHT M14x1,5 TIE ROD END - RHT M14x1,5		
53010-SDA-A01	<b>0604364</b>	SNODO ASSIALE AXIAL JOINT		
-	<b>0404365</b>	SNODO SOSPENSIONE - ASSE ANTERIORE - SUPERIORE BALL JOINT - FRONT AXLE - UPPER		
51450-SDA-A01	<b>0784365</b>	BRACCIO OSCILLANTE - SUPERIORE TRACK CONTROL ARM - UPPER		
51460-SDA-A01	<b>0794365</b>	BRACCIO OSCILLANTE - SUPERIORE TRACK CONTROL ARM - UPPER		
-	<b>0404366</b>	SNODO SOSPENSIONE - INFERIORE BALL JOINT - LOWER		
51350-SEA-E01	<b>0384366</b>	BRACCIO OSCILLANTE - INFERIORE TRACK CONTROL ARM - LOWER		
51360-SEA-E01	<b>0394366</b>	BRACCIO OSCILLANTE - INFERIORE TRACK CONTROL ARM - LOWER		
51320-SEA-E01	<b>0584367</b>	STABILIZZATORE ASSALE ANTERIORE STABILIZER LINK FRONT AXLE		

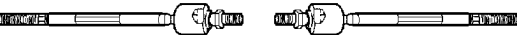
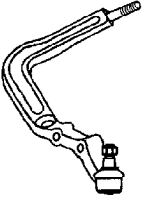

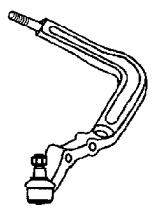
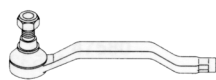
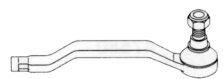

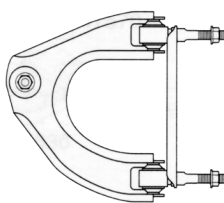
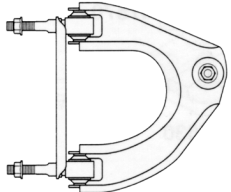

RIF. ORIG O.E. NUMBER	RIF. OCAP REF. OCAP	NOTE REMARKS	DESTRO RIGHT	SINISTRO LEFT
Anno - Year <b>2003 &gt;</b>		Serie - Series	Modello - Model <b>ACCORD VIII</b>	
51321-SEA-E01	<b>0594367</b>	STABILIZZATORE ASSALE ANTERIORE STABILIZER LINK FRONT AXLE		
52320-S84-A01	<b>0584531</b>	STABILIZZATORE - POSTERIORE STABILIZER LINK - REAR		
52325-S84-A01	<b>0594531</b>	STABILIZZATORE - POSTERIORE STABILIZER LINK - REAR		
Anno - Year <b>07/2008 &gt;</b>		Serie - Series	Modello - Model <b>ACCORD IX</b>	
53540-TA0-A01	<b>0283279</b>	TESTA STERZO - RHT M14x1,5 TIE ROD END - RHT M14x1,5		
53560-TA0-A01	<b>0293279</b>	TESTA STERZO - RHT M14x1,5 TIE ROD END - RHT M14x1,5		
53610-TL1-G01	<b>0603280</b>	SNODO ASSIALE - RHT M14x1,5 AXIAL JOINT - RHT M14x1,5		
-	<b>0404365</b>	SNODO SOSPENSIONE - ASSE ANTERIORE - SUPERIORE BALL JOINT - FRONT AXLE - UPPER		
51510-TA0-A03 51510TA0A03	<b>0783281</b>	BRACCIO OSCILLANTE - ASSE ANTERIORE - SUPERIORE TRACK CONTROL ARM - FRONT AXLE - UPPER		
51520-TA0-A03 51520TA0A03	<b>0793281</b>	BRACCIO OSCILLANTE - ASSE ANTERIORE - SUPERIORE TRACK CONTROL ARM - FRONT AXLE - UPPER		
51220-TA0-A02 51220TA0A02	<b>0403282</b>	SNODO SOSPENSIONE - ASSE ANTERIORE - INFERIORE BALL JOINT - FRONT AXLE - LOWER		

RIF. ORIG O.E. NUMBER	RIF. OCAP REF. OCAP	NOTE REMARKS	DESTRO RIGHT	SINISTRO LEFT
Anno - Year <b>07/2008 &gt;</b>		Serie - Series	Modello - Model <b>ACCORD IX</b>	
51350-TA0-A00 51350TA0A00	<b>0383282</b>	BRACCIO OSCILLANTE - ASSE ANTERIORE - INFERIORE TRACK CONTROL ARM - FRONT AXLE - LOWER		
51360-TA0-A00 51360TA0A00	<b>0393282</b>	BRACCIO OSCILLANTE - ASSE ANTERIORE - INFERIORE TRACK CONTROL ARM - FRONT AXLE - LOWER		
51320-SEA-E01 51320-TA0-A01 51320SEAE01 51320TA0A01	<b>0583283</b>	STABILIZZATORE - ASSE ANTERIORE STABILIZER LINK - FRONT AXLE		
51321-SEA-E01 51321-TA0-A01 51321SEAE01 51321TA0A01	<b>0593283</b>	STABILIZZATORE - ASSE ANTERIORE STABILIZER LINK - FRONT AXLE		
52320-TAO-A01 52320TA0A01	<b>0583284</b>	STABILIZZATORE - ASSE POSTERIORE STABILIZER LINK - REAR AXLE		
52325-TAO-A01 52325TA0A01	<b>0593284</b>	STABILIZZATORE - ASSE POSTERIORE STABILIZER LINK - REAR AXLE		
Anno - Year <b>1972 &gt; 1983</b> <b>1978 &gt; 1983</b> <b>1980 &gt; 1983</b>		Serie - Series <b>SB</b> <b>SS-ST</b>	Modello - Model <b>CIVIC I</b> <b>CIVIC II</b> <b>BALLADE</b>	
53540-SB2-003 53540-SB2-013 53540-SC2-003 53540-SC2-004	<b>0280987</b>	TESTA STERZO - ESTERNA RHT M12x1.5 TIE ROD END - OUTER RHT M12x1.5		
53521-634-000	<b>0600990</b>	SNODO ASSIALE - > 1979 AXIAL JOINT - > 1979		
53521-SA0-003 53521-SE0-003 53521-SE0-013 53521-SE0-951 53521-692-003	<b>0600988</b>	SNODO ASSIALE - 1979 > AXIAL JOINT - 1979 >		

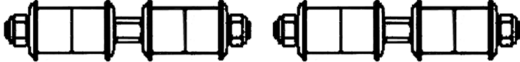



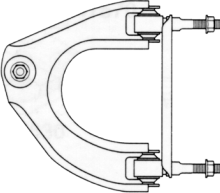
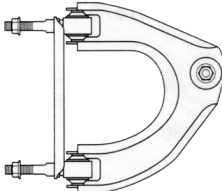



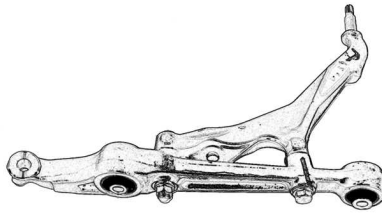
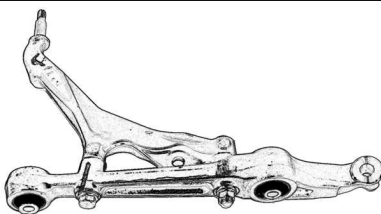
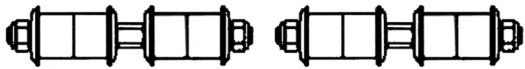
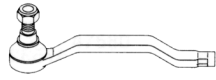
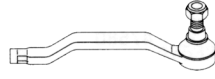
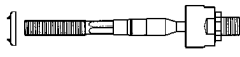
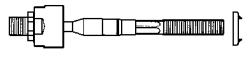
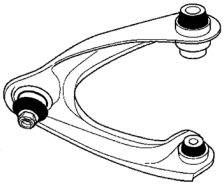

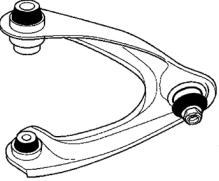

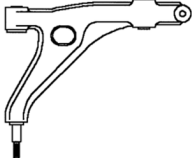
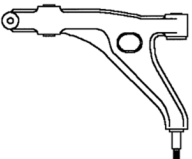
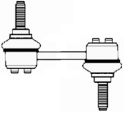
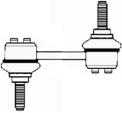

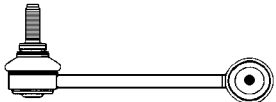
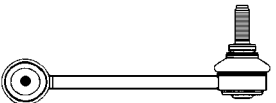
RIF. ORIG O.E. NUMBER	RIF. OCAP REF. OCAP	NOTE REMARKS	DESTRO RIGHT	SINISTRO LEFT
Anno - Year <b>1972 &gt; 1983</b> <b>1978 &gt; 1983</b> <b>1980 &gt; 1983</b>		Serie - Series <b>SB</b> <b>SS-ST</b>	Modello - Model <b>CIVIC I</b> <b>CIVIC II</b> <b>BALLADE</b>	
51350-634-000	<b>0783329</b>	ASSE ANTERIORE - BRACCIO OSCILLANTE - INFERIORE - > 1975 FRONT AXLE - TRACK CONTROL ARM - LOWER - > 1975		
51360-634-000	<b>0793329</b>	ASSE ANTERIORE - BRACCIO OSCILLANTE - INFERIORE - > 1975 FRONT AXLE - LOWER - > 1975		
51350-659-325 51350-659-010 51350-673-000	<b>0703330</b>	BRACCIO OSCILL. ANTERIORE-INFERIORE - 1975>1979 TRACK CONTROL ARM FRONT-LOWER -1975>1979		
51350-SA0-000 51350-SA0-010 51350-SA0-030	<b>0703332</b>	ASSE ANTERIORE - BRACCIO OSCILLANTE INFERIORE - 1979 > FRONT AXLE - TRACK CONTROL ARM LOWER - 1979 >		
52350-659-315	<b>0783331</b>	BRACCIO OSCILLANTE POSTERIORE-INFERIORE - 1975 > 1979 TRACK CONTROL ARM REAR-LOWER - 1975 > 1979		
52360-659-315	<b>0793331</b>	BRACCIO OSCILLANTE POSTERIORE-INFERIORE -1975 > 1979 TRACK CONTROL ARM REAR-LOWER - 1975 > 1979		
Anno - Year <b>1983 &gt; 1987</b> <b>1983 &gt; 1987</b> <b>1983 &gt; 1986</b> <b>1984 &gt; 1988</b>		Serie - Series <b>AG-AJ-AH-AK-AT-AU-VJ-AR</b> <b>AE-AF-AS</b> <b>AJ-AK</b> <b>AN-AR</b>	Modello - Model <b>CIVIC III</b> <b>CRX I</b> <b>BALLADE</b> <b>SHUTTLE</b>	
53540-SB2-003 53540-SB2-013 53540-SC2-003 53540-SC2-004	<b>0280987</b>	TESTA STERZO - ESTERNA RHT M12x1.5 TIE ROD END - OUTER RHT M12x1.5		
53521-SB2-013 53521-SB2-003	<b>0603343</b>	SNODO ASSIALE AXIAL JOINT		
51351-SB2-013 51351-SB2-672 51351-SB6-931 51351-SD2-003	<b>0783333</b>	ASSE ANTERIORE - BRACCIO OSCILLANTE INFERIORE FRONT AXLE - TRACK CONTROL ARM LOWER		

RIF. ORIG O.E. NUMBER	RIF. OCAP REF. OCAP	NOTE REMARKS	DESTRO RIGHT	SINISTRO LEFT
Anno - Year 1983 > 1987 1983 > 1987 1983 > 1986 1984 > 1988		Serie - Series <b>AG-AJ-AH-AK-AT-AU-VJ-AR</b> <b>AE-AF-AS</b> <b>AJ-AK</b> <b>AN-AR</b>		Modello - Model <b>CIVIC III</b> <b>CRX I</b> <b>BALLADE</b> <b>SHUTTLE</b>
51361-SB2-013 51361-SB2-672 51361-SB6-931 51361-SD2-003	<b>0793333</b>	ASSE ANTERIORE - BRACCIO OSCILLANTE INFERIORE FRONT AXLE - TRACK CONTROL ARM LOWER		
Anno - Year 1987 > 1991 1987 > 1992 1988 > 1991		Serie - Series <b>EF1-EF2-EF3-EF4-EF5-E42</b> <b>EF6-EF7</b> <b>EE</b>		Modello - Model <b>CIVIC IV</b> <b>CRX II</b> <b>SHUTTLE</b>
53540-SR0-A01 53540-SH3-003 53540-SH3-013 53540-SR3-003	<b>0280283</b>	TESTA STERZO - RHT M14x1,5 TIE ROD END - RHT M14x1,5		
53560-SH3-003 53560-SH3-013 53560-SR3-003	<b>0290283</b>	TESTA STERZO - RHT M14x1,5 TIE ROD END - RHT M14x1,5		
53521-SH3-003	<b>0600189</b>	SNODO ASSIALE - RHT M14x1,5 AXIAL JOINT - RHT M14x1,5		
51450-SH3-000 51450-SH3-020 51450-SH3-023 51450-SH3-030	<b>0783334</b>	BRACCIO OSCILLANTE - SUPERIORE TRACK CONTROL ARM - UPPER		
51460-SH3-000 51460-SH3-010 51460-SH3-023 51460-SH3-030	<b>0793334</b>	BRACCIO OSCILLANTE - SUPERIORE TRACK CONTROL ARM - UPPER		
51220-SK7-013 51220-SM0-A01 51220-SR3-003 51220-S04-003	<b>0401679</b>	SNODO SOSPENSIONE - INFERIORE SUSPENSION JOINT - LOWER		
51355-SH3-010 51355-SH3-020	<b>0783335</b>	BRACCIO OSCILLANTE - INFERIORE TRACK CONTROL ARM - LOWER		

RIF. ORIG O.E. NUMBER	RIF. OCAP REF. OCAP	NOTE REMARKS	DESTRO RIGHT	SINISTRO LEFT
Anno - Year <b>1987 &gt; 1991</b> <b>1987 &gt; 1992</b> <b>1988 &gt; 1991</b>		Serie - Series <b>EF1-EF2-EF3-EF4-EF5-E42</b> <b>EF6-EF7</b> <b>EE</b>	Modello - Model <b>CIVIC IV</b> <b>CRX II</b> <b>SHUTTLE</b>	
51365-SH3-010 51365-SH3-020	<b>0793335</b>	BRACCIO OSCILLANTE - INFERIORE TRACK CONTROL ARM - LOWER		
90112-SE0-000	<b>0504532</b>	STABILIZZATORE - ASSE ANTERIORE STABILIZER LINK - FRONT AXLE		
Anno - Year <b>1991 &gt; 1995</b> <b>1991 &gt; 1998</b>		Serie - Series <b>EG4-EG6-EG8-EG9-EH</b> <b>EG2-EH6</b>	Modello - Model <b>CIVIC V</b> <b>CRX III</b>	
53540-SR0-A01 53540-SH3-003 53540-SH3-013 53540-SR3-003	<b>0280283</b>	TESTA STERZO - RHT M14x1,5 TIE ROD END - RHT M14x1,5		
53560-SH3-003 53560-SH3-013 53560-SR3-003	<b>0290283</b>	TESTA STERZO - RHT M14x1,5 TIE ROD END - RHT M14x1,5		
53010-SR3-010	<b>0602925</b>	SNODO ASSIALE - RHT M14x1,5 AXIAL JOINT - RHT M14x1,5		
-	<b>0404472</b>	SNODO SOSPENSIONE - SUPERIORE SUSPENSION JOINT -UPPER		
51450-SR3-013 51450-SR3-023 51450-ST3-E02 51450-SR0-A02 51450-SR3-003	<b>0783344</b>	BRACCIO OSCILLANTE SUPERIORE TRACK CONTROL ARM UPPER		
51460-SR3-013 51460-SR3-023 51460-ST3-E02 51460-SR0-A02 51460-SR3-003	<b>0793344</b>	BRACCIO OSCILLANTE SUPERIORE TRACK CONTROL ARM UPPER		
51220-SK7-013 51220-SM0-A01 51220-SR3-003 51220-S04-003	<b>0401679</b>	SNODO SOSPENSIONE - INFERIORE SUSPENSION JOINT - LOWER		

RIF. ORIG O.E. NUMBER	RIF. OCAP REF. OCAP	NOTE REMARKS	DESTRO RIGHT	SINISTRO LEFT
Anno - Year <b>1991 &gt; 1995</b> <b>1991 &gt; 1998</b>		Serie - Series <b>EG4-EG6-EG8-EG9-EH</b> <b>EG2-EH6</b>		Modello - Model <b>CIVIC V</b> <b>CRX III</b>
51350-SR3-020 51350-SR3-A01 51350-SR3-A02 51350-ST7-010	<b>0384230</b>	BRACCIO OSCILLANTE - INFERIORE TRACK CONTROL ARM - LOWER		
51360-SR3-020 51360-SR3-A01 51360-SR3-A02 51360-ST7-010	<b>0394230</b>	BRACCIO OSCILLANTE - INFERIORE TRACK CONTROL ARM - LOWER		
90112-SE0-000	<b>0504532</b>	STABILIZZATORE - ASSE ANTERIORE STABILIZER LINK - FRONT AXLE		
Anno - Year <b>1996 &gt; 2001</b>		Serie - Series		Modello - Model <b>CIVIC VI</b>
53540-SR0-A01 53540-SR3-003 53540-S04-003 53540-S04-013	<b>0281932</b>	TESTA STERZO - RHT M14x1,5 TIE ROD END - RHT M14x1,5		
53560-SR0-A01 53560-SR3-003 53560-S04-003 53560-S04-013	<b>0291932</b>	TESTA STERZO - RHT M14x1,5 TIE ROD END - RHT M14x1,5		
53010-S04-000	<b>0601933</b>	SNODO ASSIALE - RHT M14x1,5 AXIAL JOINT - RHT M14x1,5		
51450-S04-003 51450-S04-013 51450-S04-023 51450-S01-023 51450-S01-A02	<b>0784233</b>	BRACCIO OSCILLANTE - SUPERIORE TRACK CONTROL ARM - UPPER		

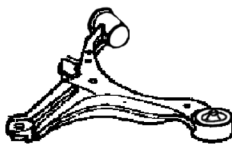
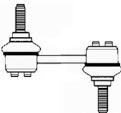
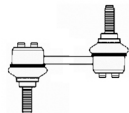
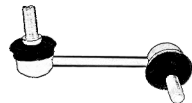
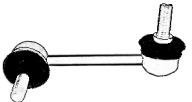





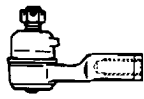
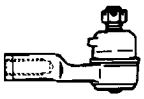
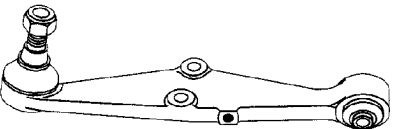
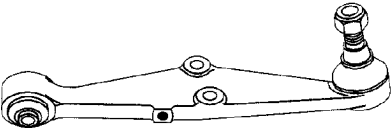
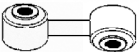
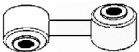
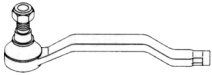
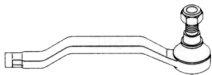
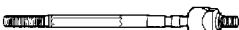
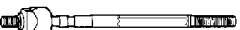
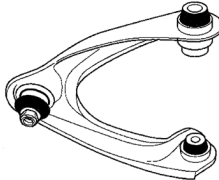
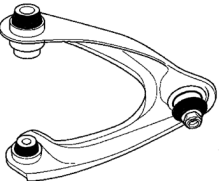

RIF. ORIG O.E. NUMBER	RIF. OCAP REF. OCAP	NOTE REMARKS	DESTRO RIGHT	SINISTRO LEFT
Anno - Year <b>1996 &gt; 2001</b>		Serie - Series	Modello - Model <b>CIVIC VI</b>	
51460-S04-003 51460-S04-023 51460-S04-023	<b>0794233</b>	BRACCIO OSCILLANTE - SUPERIORE TRACK CONTROL ARM - UPPER		
51220-SK7-013 51220-SM0-A01 51220-SR3-003 51220-S04-003	<b>0401679</b>	SNODO SOSPENSIONE - INFERIORE SUSPENSION JOINT - LOWER		
51350-S04-G00	<b>0784234</b>	BRACCIO OSCILLANTE - INFERIORE TRACK CONTROL ARM - LOWER		
51360-S04-G00	<b>0794234</b>	BRACCIO OSCILLANTE - INFERIORE TRACK CONTROL ARM - LOWER		
51320-S04-003	<b>0501940</b>	STABILIZZATORE - ASSE ANTERIORE STABILIZER LINK - FRONT AXLE		
52390-SR3-000 52390SR3000 52390-SH3-030 52390SH3030	<b>0783285</b>	BRACCIO SOSPENSIONE - ASSE POSTERIORE SUSPENSION ARM - REAR AXLE		
52400-SR3-000 52400SR3000 52400-SH3-030 52400SH3030	<b>0793285</b>	BRACCIO SOSPENSIONE - ASSE POSTERIORE SUSPENSION ARM - REAR AXLE		
52320-S04-003	<b>0584246</b>	STABILIZZATORE - ASSE POSTERIORE STABILIZER LINK - REAR AXLE		
52321-S04-003	<b>0594246</b>	STABILIZZATORE - ASSE POSTERIORE STABILIZER LINK - REAR AXLE		





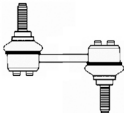
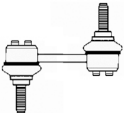
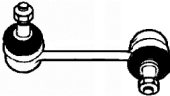
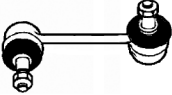

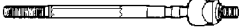
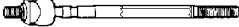

RIF. ORIG O.E. NUMBER	RIF. OCAP REF. OCAP	NOTE REMARKS	DESTRO RIGHT	SINISTRO LEFT
Anno - Year <b>2001 &gt; 2005</b>		Serie - Series	Modello - Model <b>CIVIC VII</b>	
53541-S5A-003	<b>0284294</b>	TESTA STERZO - RHT M14x1,5 TIE ROD END - RHT M14x1,5		
53541-S5A-000 53521-S5A-003	<b>0604295</b>	SNODO ASSIALE AXIAL JOINT		
51220-S5A-003 51220-S5A-J10 51220-S5A-J30	<b>0404291</b>	SNODO SOSPENSIONE - ASSE ANTERIORE BALL JOINR - FRONT AXLE		
51350-S5A-E50 51350-S5A-A03 51350-S5A-A10	<b>0784291</b>	BRACCIO OSCILLANTE - INFERIORE TRACK CONTROL ARM - LOWER		
51360-S5A-E50 51360-S5A-A03 51360-S5A-A10	<b>0794291</b>	BRACCIO OSCILLANTE - INFERIORE TRACK CONTROL ARM - LOWER		
51320-S5A-003	<b>0584296</b>	STABILIZZATORE - ASSE ANTERIORE STABILIZER LINK - FRONT AXLE		
51321-S5A-003	<b>0594296</b>	STABILIZZATORE - ASSE ANTERIORE STABILIZER LINK - FRONT AXLE		
52320-S5A-013	<b>0584297</b>	STABILIZZATORE - ASSE POSTERIORE STABILIZER LINK - REAR AXLE		
52321-S5A-013	<b>0594297</b>	STABILIZZATORE - ASSE POSTERIORE STABILIZER LINK - REAR AXLE		
Anno - Year <b>01/2006 &gt;</b>		Serie - Series	Modello - Model <b>CIVIC VIII</b>	
53540-SMG-003 53540SMG003	<b>0283286</b>	TESTA STERZO - RHT M14x1,5 - MOD. 1.4 - 1.8 TIE ROD END - RHT M14x1,5 - MOD. 1.4 - 1.8		



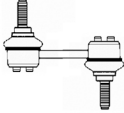
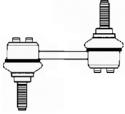



RIF. ORIG O.E. NUMBER	RIF. OCAP REF. OCAP	NOTE REMARKS	DESTRO RIGHT	SINISTRO LEFT
Anno - Year <b>01/2006 &gt;</b>		Serie - Series	Modello - Model <b>CIVIC VIII</b>	
53560-SMG-003 53560SMG003	<b>0293286</b>	TESTA STERZO - RHT M14x1,5 - MOD. 1.4 - 1.8 TIE ROD END - RHT M14x1,5 - MOD. 1.4 - 1.8		
53540-SMJ-003 53540SMJ003	<b>0283287</b>	TESTA STERZO - RHT M14x1,5 - MOD. 2.2 D TIE ROD END - RHT M14x1,5 - MOD. 2.2 D		
53560-SMJ-003 53560SMJ003	<b>0293287</b>	TESTA STERZO - RHT M14x1,5 - MOD. 2.2 D TIE ROD END - RHT M14x1,5 - MOD. 2.2 D		
53011-SMG-E01 53011SMGE01	<b>0683288</b>	SNODO ASSIALE - RHT M14X1,5 AXIAL JOINT - RHT M14x1,5		
53010-SMG-E01 53010SMGE01	<b>0693288</b>	SNODO ASSIALE - RHT M14X1,5 AXIAL JOINT - RHT M14x1,5		
51350-SMG-E05 51350SMGE05	<b>0383289</b>	BRACCIO OSCILLANTE - ASSE ANTERIORE - INFERIORE - ALLUMINIO TRACK CONTROL ARM - FRONT AXLE - LOWER - ALUMINIUM		
51360-SMG-E05 51360SMGE05	<b>0393289</b>	BRACCIO OSCILLANTE - ASSE ANTERIORE - INFERIORE - ALLUMINIO TRACK CONTROL ARM - FRONT AXLE - LOWER - ALUMINIUM		
51320-SMG-E01 51320SMGE01	<b>0503290</b>	STABILIZZATORE - ASSE ANTERIORE STABILIZER LINK - FRONT AXLE		
52320-SNA-A01 52320SNAA01	<b>0583291</b>	STABILIZZATORE - ASSE POSTERIORE STABILIZER LINK - REAR AXLE		
52321-SNA-A01 52321SNAA01	<b>0593291</b>	STABILIZZATORE - ASSE POSTERIORE STABILIZER LINK - REAR AXLE		





RIF. ORIG O.E. NUMBER	RIF. OCAP REF. OCAP	NOTE REMARKS	DESTRO RIGHT	SINISTRO LEFT
Anno - Year <b>1990 &gt; 1995</b>		Serie - Series	Modello - Model <b>CONCERTO</b>	
53540-SK3-E01	<b>0282534</b>	TESTA STERZO - RHT M14x1,5 TIE ROD END		
51355-SK3-000	<b>0382535</b>	BRACCIO OSCILLANTE - INFERIORE TRACK CONTROL ARM - LOWER		
51365-SK3-000	<b>0392535</b>	BRACCIO OSCILLANTE - INFERIORE TRACK CONTROL ARM - LOWER		
51320-SK3-000	<b>0504237</b>	STABILIZZATORE - ANTERIORE STABILIZER LINK - FRONT		
Anno - Year <b>1995 &gt; 2001</b>		Serie - Series <b>I</b>	Modello - Model <b>CR-V</b>	
53540-SR0-A01 53540-SR3-003 53540-S04-003 53540-S04-013	<b>0281932</b>	TESTA STERZO - RHT M14x1,5 TIE ROD END - RHT M14x1,5		
53560-SR0-A01 53560-SR3-003 53560-S04-003 53560-S04-013	<b>0291932</b>	TESTA STERZO - RHT M14x1,5 TIE ROD END - RHT M14x1,5		
53010-S10-000 53010-S10-003	<b>0604533</b>	SNODO ASSIALE AXIAL JOINT		
51450-S10-020	<b>0784316</b>	BRACCIO OSCILLANTE - SUPERIORE TRACK CONTROL ARM - UPPER		
51460-S10-020	<b>0794316</b>	BRACCIO OSCILLANTE - SUPERIORE TRACK CONTROL ARM - UPPER		

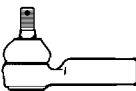
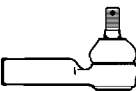
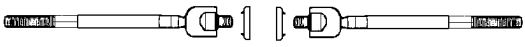

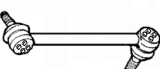
RIF. ORIG O.E. NUMBER	RIF. OCAP REF. OCAP	NOTE REMARKS	DESTRO RIGHT	SINISTRO LEFT
Anno - Year <b>1995 &gt; 2001</b>		Serie - Series <b>I</b>	Modello - Model <b>CR-V</b>	
51220-SK7-013 51220-SM0-A01 51220-SR3-003 51220-S04-003	<b>0401679</b>	SNODO SOSPENSIONE - INFERIORE SUSPENSION JOINT - LOWER		
51350-S10-G00 51350-S10-A00	<b>0784317</b>	BRACCIO OSCILLANTE - INFERIORE TRACK CONTROL ARM - LOWER		
51360-S10-G00 51360-S10-A00	<b>0794317</b>	BRACCIO OSCILLANTE - INFERIORE TRACK CONTROL ARM - LOWER		
51320-S04-003	<b>0501940</b>	STABILIZZATORE - ANTERIORE STABILIZER LINK - FRONT		
51320-S10-003 52320-S10-003	<b>0584268</b>	STABILIZZATORE - POSTERIORE STABILIZER LINK - REAR		
51321-S10-003 52321-S10-003	<b>0594268</b>	STABILIZZATORE - POSTERIORE STABILIZER LINK - REAR		
Anno - Year <b>03/02 &gt; 09/06</b>		Serie - Series <b>II</b>	Modello - Model <b>CR-V</b>	
53541-S5A-003	<b>0284294</b>	TESTA STERZO - RHT M14x1,5 TIE ROD END - RHT M14x1,5		
53521-S9A-003	<b>0604361</b>	SNODO ASSIALE - RHT M14x1,5 AXIAL JOINT - RHT M14x1,5		
51220-S9A-982	<b>0402765</b>	SNODO SOSPENSIONE - INFERIORE SUSPENSION JOINT - LOWER		

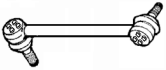
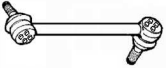
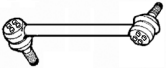

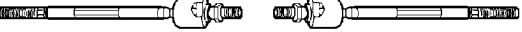
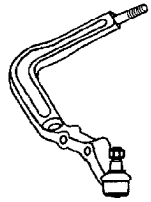
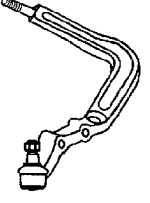

RIF. ORIG O.E. NUMBER	RIF. OCAP REF. OCAP	NOTE REMARKS	DESTRO RIGHT	SINISTRO LEFT
Anno - Year <b>03/02 &gt; 09/06</b>		Serie - Series <b>II</b>	Modello - Model <b>CR-V</b>	
51350-S9A-010	<b>0782476</b>	BRACCIO OSCILLANTE - INFERIORE TRACK CONTROL ARM - LOWER		
51360-S9A-010	<b>0792476</b>	BRACCIO OSCILLANTE - INFERIORE TRACK CONTROL ARM - LOWER		
51320-S5A-003	<b>0584296</b>	STABILIZZATORE - ASSE ANTERIORE STABILIZER LINK - FRONT AXLE		
51321-S5A-003	<b>0594296</b>	STABILIZZATORE - ASSE ANTERIORE STABILIZER LINK - FRONT AXLE		
52320-S9A-003	<b>0584362</b>	STABILIZZATORE - ASSE POSTERIORE STABILIZER LINK - REAR AXLE		
52321-S9A-003	<b>0594362</b>	STABILIZZATORE - ASSE POSTERIORE STABILIZER LINK - REAR AXLE		
Anno - Year <b>2007 &gt; 09/2012</b>		Serie - Series <b>III</b>	Modello - Model <b>CR-V</b>	
53540-SWA-A01 53540-SWA-A02	<b>0288063</b>	TESTA STERZO - RHT M14x1,5 TIE ROD END - RHT M14x1,5		
53010-SWA-A01	<b>0608063</b>	SNODO ASSIALE - RHT M14x1,5 AXIAL JOINT - RHT M14x1,5		
51220-STK-A01	<b>0408063</b>	SNODO SOSPENSIONE - ASSE ANTERIORE - INFERIORE BALL JOINT - FRONT AXLE - LOWER		



RIF. ORIG O.E. NUMBER	RIF. OCAP REF. OCAP	NOTE REMARKS	DESTRO RIGHT	SINISTRO LEFT
Anno - Year <b>2007 &gt; 09/2012</b>		Serie - Series <b>III</b>	Modello - Model <b>CR-V</b>	
51350-SWA-E01	<b>0788063</b>	BRACCIO OSCILLANTE - ASSE ANTERIORE - INFERIORE TRACK CONTROL ARM - FRONT AXLE - LOWER		
51360-SWA-E01	<b>0798063</b>	BRACCIO OSCILLANTE - ASSE ANTERIORE - INFERIORE TRACK CONTROL ARM - FRONT AXLE - LOWER		
51320-STK-A01	<b>0508063</b>	STABILIZZATORE - ASSE ANTERIORE STABILIZER LINK - FRONT AXLE		
52320-SWA-A01	<b>0588064</b>	STABILIZZATORE - ASSE POSTERIORE STABILIZER LINK - REAR AXLE		
52321-SWA-A01	<b>0598064</b>	STABILIZZATORE - ASSE POSTERIORE STABILIZER LINK - REAR AXLE		
Anno - Year <b>1999 &gt;</b>		Serie - Series <b>GH</b>	Modello - Model <b>HR-V</b>	
53540-SX8-T01	<b>0281941</b>	TESTA STERZO - RHT M12x1,25 TIE ROD END - RHT M12x1,25		
53010-S2H-J01 53010-S2H-J02	<b>0601942</b>	SNODO ASSIALE - RHT M12x1,25 AXIAL JOINT - RHT M12x1,25		
51350-S2H-G02	<b>0782789</b>	BRACCIO OSCILLANTE - INFERIORE TRACK CONTROL ARM - LOWER		
51360-S2H-G02	<b>0792789</b>	BRACCIO OSCILLANTE - INFERIORE TRACK CONTROL ARM - LOWER		
51320-S2H-003	<b>0581943</b>	STABILIZZATORE ANTERIORE STABILIZER LINK FRONT		

RIF. ORIG O.E. NUMBER	RIF. OCAP REF. OCAP	NOTE REMARKS	DESTRO RIGHT	SINISTRO LEFT
Anno - Year <b>1999 &gt;</b>		Serie - Series <b>GH</b>	Modello - Model <b>HR-V</b>	
51321-S2H-003	<b>0591943</b>	STABILIZZATORE ANTERIORE STABILIZER LINK FRONT		
52320-S2H-003	<b>0582477</b>	STABILIZZATORE - POSTERIORE STABILIZER LINK - REAR		
52321-S2H-003	<b>0592477</b>	STABILIZZATORE - POSTERIORE STABILIZER LINK - REAR		
Anno - Year <b>1983 &gt; 1986</b>		Serie - Series	Modello - Model <b>JAZZ I</b>	
53540-SB2-003 53540-SB2-013 53540-SC2-003 53540-SC2-004	<b>0280987</b>	TESTA STERZO - RHT M12x1,5 TIE ROD END - RHT M12x1,5		
53521-SB2-013 53521-SB2-003	<b>0603343</b>	SNODO ASSIALE - RHT M12x1,5 AXIAL JOINT - RHT M12x1,5		
51351-SB2-013 51351-SB2-672 51351-SB6-931 51351-SD2-003	<b>0783333</b>	BRACCIO OSCILLANTE - ASSE ANTERIORE - INFERIORE TRACK CONTROL ARM - FRONT AXLE - LOWER		
51361-SB2-013 51361-SB2-672 51361-SB6-931 51361-SD2-003	<b>0793333</b>	BRACCIO OSCILLANTE - ASSE ANTERIORE - INFERIORE TRACK CONTROL ARM - FRONT AXLE - LOWER		
Anno - Year <b>2002 &gt; 07/2008</b>		Serie - Series <b>GD</b>	Modello - Model <b>JAZZ II</b>	
53540-SAA-003	<b>0284368</b>	TESTA STERZO - RHT TIE ROD END - RHT		
53560-SAA-003	<b>0294368</b>	TESTA STERZO - LHT TIE ROD END - LHT		

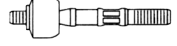
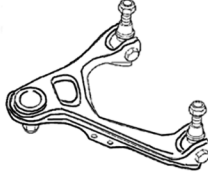
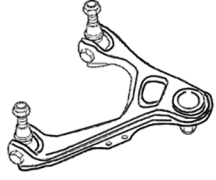
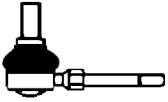
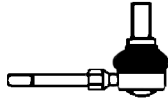
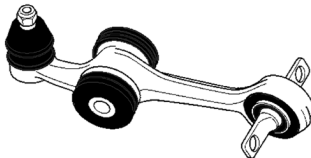
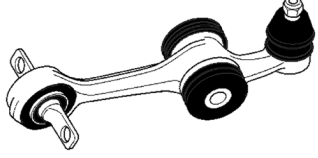

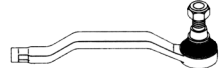

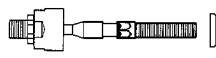
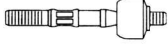
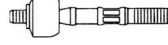
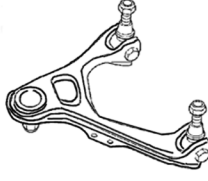
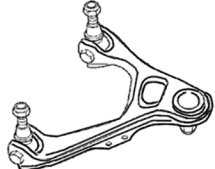
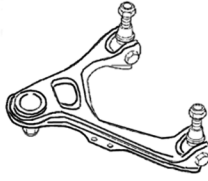
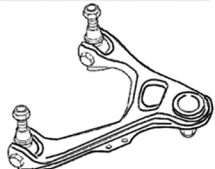
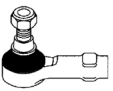
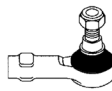
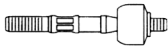
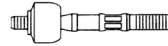





RIF. ORIG O.E. NUMBER	RIF. OCAP REF. OCAP	NOTE REMARKS	DESTRO RIGHT	SINISTRO LEFT
Anno - Year <b>2002 &gt; 07/2008</b>		Serie - Series <b>GD</b>	Modello - Model <b>JAZZ II</b>	
53010-SAA-J01	<b>0684369</b>	SNODO ASSIALE - RHT AXIAL JOINT		
53011-SAA-J01	<b>0694369</b>	SNODO ASSIALE - LHT AXIAL JOINT		
51220-SAA-013 51220-SAA-E01 51220-SEL-T01 51220-S2H-013	<b>0404370</b>	SNODO SOSPENSIONE - INFERIORE SUSPENSION JOINT - LOWER		
51350-SAA-E01	<b>0784370</b>	BRACCIO OSCILLANTE - INFERIORE TRACK CONTROL ARM - LOWER		
51306-SAA-E01 51360-SAA-E01	<b>0794370</b>	BRACCIO OSCILLANTE - INFERIORE TRACK CONTROL ARM - LOWER		
51320-SAA-003	<b>0584371</b>	STABILIZZATORE - ASSE ANTERIORE STABILIZER LINK - FRONT AXLE		
51321-SAA-003	<b>0594371</b>	STABILIZZATORE - ASSE ANTERIORE STABILIZER LINK - FRONT AXLE		
Anno - Year <b>07/2008 &gt;</b>		Serie - Series <b>GE</b>	Modello - Model <b>JAZZ III</b>	
53540-TF0-003 53540TF0003	<b>0283293</b>	TESTA STERZO - RHT M14x1,5 TIE ROD END - RHT M14x1,5		
53560-TF0-003 53560TF0003	<b>0293293</b>	TESTA STERZO - RHT M14x1,5 TIE ROD END - RHT M14x1,5		
53010-TF0-003 53010TF0003	<b>0603294</b>	SNODO ASSIALE - RHT M14x1,5 AXIAL JOINT - RHT M14x1,5		

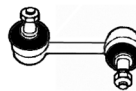
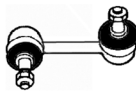



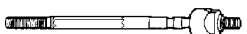
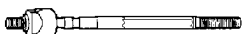
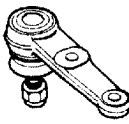
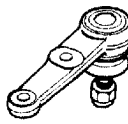

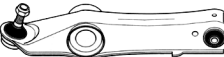
RIF. ORIG O.E. NUMBER	RIF. OCAP REF. OCAP	NOTE REMARKS	DESTRO RIGHT	SINISTRO LEFT
Anno - Year <b>07/2008 &gt;</b>		Serie - Series <b>GE</b>	Modello - Model <b>JAZZ III</b>	
-	<b>0403295</b>	SNODO SOSPENSIONE - ASSE ANTERIORE - INFERIORE BALL JOINT - FRONT AXLE - LOWER		
51350-TF0-030 51350TF0030	<b>0783295</b>	BRACCIO OSCILLANTE - ASSE ANTERIORE - INFERIORE TRACK CONTROL ARM - FRONT AXLE - LOWER		
51360-TF0-030 51360TF0030	<b>0793295</b>	BRACCIO OSCILLANTE - ASSE ANTERIORE - INFERIORE TRACK CONTROL ARM - FRONT AXLE - LOWER		
51320-TF0-003 51320TF0003	<b>0503296</b>	STABILIZZATORE - ASSE ANTERIORE STABILIZER LINK - FRONT AXLE		
Anno - Year <b>1986 &gt; 1990</b>		Serie - Series <b>KA1-KA2-KA3-KA4</b>	Modello - Model <b>LEGEND - ACURA - REGEND</b>	
53540-SD4-003	<b>0283352</b>	TESTA STERZO - ESTERNA - RHT M12x1.25 TIE ROD END - OUTER - RHT M12x1.25		
53560-SD4-003	<b>0293352</b>	TESTA STERZO - ESTERNA - RHT M12x1.25 TIE ROD END - OUTER - RHT M12x1.25		
53521-SD4-003 53521-SD4-013 53521-SD4-023	<b>0600387</b>	SNODO ASSIALE - RHT M12x1.25 AXIAL JOINT - RHT M12x1.25		
51220-SD4-004 51220-SD4-013 51220-SD4-023	<b>0403353</b>	SNODO SOSPENSIONE - INFERIORE SUSPENSION JOINT - LOWER		
Anno - Year <b>1990 &gt; 1996</b>		Serie - Series <b>KA7 - K8 (COUPE')</b>	Modello - Model <b>LEGEND II</b>	
51220-SD4-004 51220-SD4-013 51220-SD4-023	<b>0403353</b>	SNODO SOSPENSIONE INFERIORE SUSPENSION JOINT LOWER		





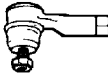
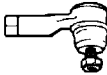
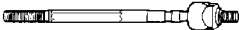
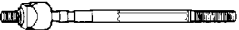
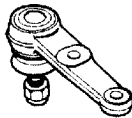
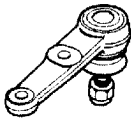

RIF. ORIG O.E. NUMBER	RIF. OCAP REF. OCAP	NOTE REMARKS	DESTRO RIGHT	SINISTRO LEFT
Anno - Year <b>1990 &gt; 1996</b>		Serie - Series <b>KA7 - K8 (COUPE')</b>	Modello - Model <b>LEGEND II</b>	
53540-SP0-013 53540-SP0-023	<b>0284534</b>	TESTA STERZO - ESTERNA RHT M14x1.50 TIE ROD END - OUTER RHT M14x1.50		
53560-SP0-013 53560-SP0-023	<b>0294534</b>	TESTA STERZO - ESTERNA RHT M14x1.50 TIE ROD END - OUTER RHT M14x1.50		
53521-SP0-004	<b>0604535</b>	SNODO ASSIALE RHT M14x1.50 AXIAL JOINT RHT M14x1.50		
51450-SP0-033	<b>0784536</b>	BRACCIO OSCILLANTE SUPERIORE TRACK CONTROL ARM UPPER		
51460-SP0-033	<b>0794536</b>	BRACCIO OSCILLANTE SUPERIORE TRACK CONTROL ARM UPPER		
51320-SP0-003	<b>0504538</b>	STABILIZZATORE ASSE ANTERIORE STABILIZER LINK FRONT AXLE		
52390-SP0-013	<b>0384537</b>	BRACCIO OSCILLANTE POSTERIORE TRACK CONTROL ARM REAR		
52400-SP0-013	<b>0394537</b>	BRACCIO OSCILLANTE POSTERIORE TRACK CONTROL ARM REAR		
Anno - Year <b>1996 &gt;</b>		Serie - Series <b>KA9</b>	Modello - Model <b>LEGEND III</b>	
53540-SZ3-003	<b>0284539</b>	TESTA STERZO RHT M14x1.50 TIE ROD END RHT M14x1.50		
53560-SZ3-003	<b>0294539</b>	TESTA STERZO RHT M14x1.50 TIE ROD END RHT M14x1.50		

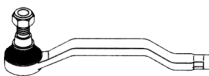
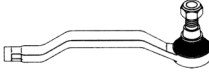
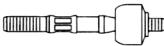
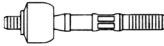
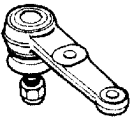
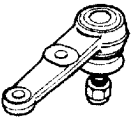





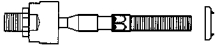
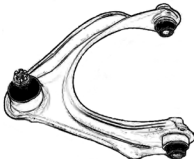
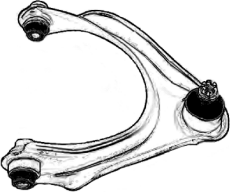

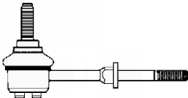
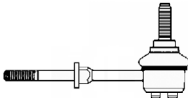
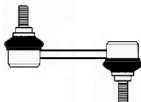
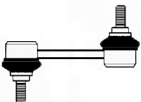

RIF. ORIG O.E. NUMBER	RIF. OCAP REF. OCAP	NOTE REMARKS	DESTRO RIGHT	SINISTRO LEFT
Anno - Year <b>1996 &gt;</b>		Serie - Series <b>KA9</b>	Modello - Model <b>LEGEND III</b>	
53010-SW5-000	<b>0601938</b>	SNODO ASSIALE RHT M14x1.50 - > CH. WC002641 AXIAL JOINT RHT M14x1.50 - > CH. WC002641		
53010-SW5-003	<b>0604540</b>	SNODO ASSIALE RHT M14x1.50 - CH. WC002642 > AXIAL JOINT RHT M14x1.50 - CH. WC002642 >		
51450-SZ3-013	<b>0784541</b>	BRACCIO OSCILLANTE SUPERIORE - > 1999 TRACK CONTROL ARM UPPER - >1999		
51460-SZ3-013	<b>0794541</b>	BRACCIO OSCILLANTE SUPERIORE - > 1999 TRACK CONTROL ARM UPPER - >1999		
51450-SZ3-901	<b>0784542</b>	BRACCIO OSCILLANTE SUPERIORE - 1999 > TRACK CONTROL ARM UPPER - 1999 >		
51460-SZ3-901	<b>0794542</b>	BRACCIO OSCILLANTE SUPERIORE - 1999 > TRACK CONTROL ARM UPPER - 1999 >		
Anno - Year <b>1999 &gt; 2002</b>		Serie - Series <b>GA3</b>	Modello - Model <b>LOGO</b>	
53540-SX8-T01	<b>0284543</b>	TESTA STERZO RHT M12x1.25 TIE ROD END RHT M12x1.25		
53010-S50-003	<b>0604545</b>	SNODO ASSIALE RHT M12x1.25 AXIAL JOINT RHT M12x1.25		
-	<b>0402788</b>	SNODO SOSPENSIONE BALL JOINT		







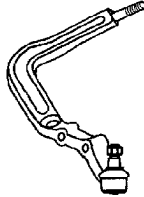
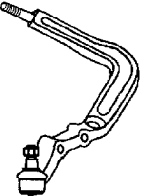

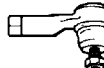
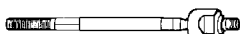
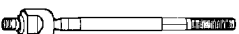
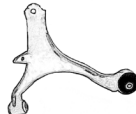

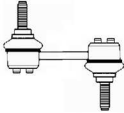
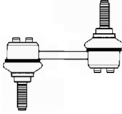
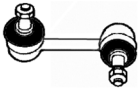
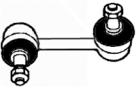

RIF. ORIG O.E. NUMBER	RIF. OCAP REF. OCAP	NOTE REMARKS	DESTRO RIGHT	SINISTRO LEFT
Anno - Year <b>1999 &gt; 2002</b>		Serie - Series <b>GA3</b>	Modello - Model <b>LOGO</b>	
51350-S50-G01	<b>0782788</b>	BRACCIO OSCILLANTE INFERIORE TRACK CONTROL ARM LOWER		
51360-S50-G01	<b>0792788</b>	BRACCIO OSCILLANTE INFERIORE TRACK CONTROL ARM LOWER		
51320-S2G-003	<b>0584546</b>	STABILIZZATORE - ASSE ANTERIORE STABILIZER LINK - FRONT AXLE		
51321-S2G-003	<b>0594546</b>	STABILIZZATORE - ASSE ANTERIORE STABILIZER LINK - FRONT AXLE		
Anno - Year <b>1978 &gt; 1987</b>		Serie - Series <b>SN-AB-BA</b>	Modello - Model <b>PRELUDE</b>	
53540-SB2-003 53540-SB2-013 53540-SC2-003 53540-SC2-004	<b>0280987</b>	TESTA STERZO - ESTERNA RHT M12x1.5 TIE ROD END - OUTER RHT M12x1.5		
53521-SA0-003 53521-SE0-003 53521-SE0-013 53521-SE0-951 53521-692-003	<b>0600988</b>	SNODO ASSIALE - RHT M12x1.5 - > 1983 AXIAL JOINT - RHT M12x1.5 - > 1983		
53521-SB0-000 53521-SB0-003 53521-SF1-003	<b>0600190</b>	SNODO ASSIALE - RHT M12x1.5 - 1983 > AXIAL JOINT - RHT M12x1.5 - 1983 >		
51270-SB0-003 51270-SB0-013	<b>0403354</b>	SNODO SOSPENSIONE SUPERIORE - 1983 > SUSPENSION JOINT UPPER - 1983 >		
51220-SK7-013 51220-SM0-A01 51220-SR3-003 51220-S04-003	<b>0401679</b>	SNODO SOSPENSIONE - INFERIORE SUSPENSION JOINT - LOWER		
51350-692-000 51350-692-010 51350-692-050	<b>0703355</b>	BRACCIO OSCILLANTE - INFERIORE > 1983 TRACK CONTROL ARM - LOWER > 1983		















RIF. ORIG O.E. NUMBER	RIF. OCAP REF. OCAP	NOTE REMARKS	DESTRO RIGHT	SINISTRO LEFT
Anno - Year <b>1987 &gt; 1992</b>		Serie - Series <b>BA4-BA5</b>	Modello - Model <b>PRELUDE</b>	
-	<b>0500190</b>	BARRA STERZO TIE ROD		
53540-SF1-004	<b>0280191</b>	TESTA STERZO - ESTERNA RHT M12x1.25 TIE ROD END - OUTER RHT M12x1.25		
53521-SB0-000 53521-SB0-003 53521-SF1-003	<b>0600190</b>	SNODO ASSIALE L= 260 - RHT M12x1.25 AXIAL JOINT L= 260 - RHT M12x1.25		
51270-SF1-003	<b>0400284</b>	ASSE ANTERIORE SNODO SOSPENSIONE - SUPERIORE FRONT AXLE SUSPENSION JOINT - UPPER		
51220-SK7-013 51220-SM0-A01 51220-SR3-003 51220-S04-003	<b>0401679</b>	SNODO SOSPENSIONE INFERIORE SUSPENSION JOINT LOWER		
52391-SF1-003	<b>0483356</b>	ASSE POSTERIORE SNODO SOSPENSIONE - SUPERIORE REAR AXLE SUSPENSION JOINT - UPPER		
52401-SF1-003	<b>0493356</b>	ASSE POSTERIORE SNODO SOSPENSIONE - SUPERIORE REAR AXLE SUSPENSION JOINT - UPPER		
Anno - Year <b>1992 &gt; 1997</b>		Serie - Series <b>BB1-BB2-BB3</b>	Modello - Model <b>PRELUDE</b>	
53540-SS0-003 53540-SS0-004	<b>0284547</b>	TESTA STERZO - ESTERNA RHT M14x1.5 TIE ROD END - OUTER RHT M14x1.5		
53560-SS0-003 53560-SS0-004	<b>0294547</b>	TESTA STERZO - ESTERNA RHT M14x1.5 TIE ROD END - OUTER RHT M14x1.5		
53010-SS0-000	<b>0604548</b>	SNODO ASSIALE - RHT M14x1,5 AXIAL JOINT - RHT M14x1,5		
51270-SF1-003	<b>0400284</b>	ASSE ANTERIORE SNODO SOSPENSIONE SUPERIORE FRONT AXLE SUSPENSION JOINT UPPER		



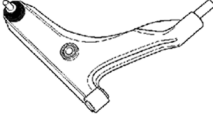
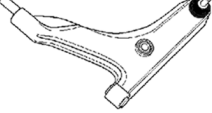



RIF. ORIG O.E. NUMBER	RIF. OCAP REF. OCAP	NOTE REMARKS	DESTRO RIGHT	SINISTRO LEFT
Anno - Year <b>1992 &gt; 1997</b>		Serie - Series <b>BB1-BB2-BB3</b>	Modello - Model <b>PRELUDE</b>	
51220-SK7-013 51220-SM0-A01 51220-SR3-003 51220-S04-003	<b>0401679</b>	SNODO SOSPENSIONE INFERIORE SUSPENSION JOINT LOWER		
Anno - Year <b>1996 &gt; 2000</b>		Serie - Series <b>BB6-BB8-BB9</b>	Modello - Model <b>PRELUDE</b>	
53540-S30-005	<b>0281937</b>	TESTA STERZO - RHT M14x1,5 TIE ROD END - RHT M14x1,5		
53560-S30-005	<b>0291937</b>	TESTA STERZO - RHT M14x1,5 TIE ROD END - RHT M14x1,5		
53010-SW5-000	<b>0601938</b>	SNODO ASSIALE - RHT M14x1,5 AXIAL JOINT - RHT M14x1,5		
51450-S30-003	<b>0782766</b>	BRACCIO OSCILLANTE - SUPERIORE TRACK CONTROL ARM - UPPER		
51460-S30-003	<b>0792766</b>	BRACCIO OSCILLANTE - SUPERIORE TRACK CONTROL ARM - UPPER		
51220-SL5-003	<b>0404549</b>	SNODO SOSPENSIONE ANTERIORE - INFERIORE SUSPENSION JOINT FRONT - LOWER		
51320-S30-003	<b>0501939</b>	STABILIZZATORE STABILIZER LINK		
52320-S30-003	<b>0501563</b>	STABILIZZATORE POSTERIORE STABILIZER LINK REAR		

RIF. ORIG O.E. NUMBER	RIF. OCAP REF. OCAP	NOTE REMARKS	DESTRO RIGHT	SINISTRO LEFT
Anno - Year <b>1980 &gt; 1984</b> <b>1985 &gt; 1989</b>		Serie - Series <b>SU</b> <b>DA_</b>	Modello - Model <b>QUINTET</b> <b>INTEGRA</b>	
53540-SB2-003 53540-SB2-013 53540-SC2-003 53540-SC2-004	<b>0280987</b>	TESTA STERZO - ESTERNA RHT M12x1.25 TIE ROD END - OUTER RHT M12x1.25		
53521-SA0-003 53521-SE0-003 53521-SE0-013 53521-SE0-951 53521-692-003	<b>0600988</b>	SNODO ASSIALE - RHT M12x1.5 - ECCETTO MOD. INTEGRA AXIAL JOINT - RHT M12x1.5 - EXCEPT MOD. INTEGRA		
53521-SB2-013 53521-SB2-003	<b>0603343</b>	SNODO ASSIALE - MOD. INTEGRA AXIAL JOINT - MOD. INTEGRA		
51350-692-000 51350-692-010 51350-692-050	<b>0703355</b>	BRACCIO OSCILLANTE - INFERIORE ECCETTO MOD. INTEGRA TRACK CONTROL ARM - LOWER EXCEPT MOD. INTEGRA		
51351-SB2-013 51351-SB2-672 51351-SB6-931 51351-SD2-003	<b>0783333</b>	ASSE ANTERIORE - BRACCIO OSCILLANTE INFERIORE FRONT AXLE - TRACK CONTROL ARM LOWER		
51361-SB2-013 51361-SB2-672 51361-SB6-931 51361-SD2-003	<b>0793333</b>	ASSE ANTERIORE - BRACCIO OSCILLANTE INFERIORE FRONT AXLE - TRACK CONTROL ARM LOWER		
Anno - Year <b>2001 &gt;</b>		Serie - Series <b>RN</b>	Modello - Model <b>STREAM</b>	
53541-S7A-003	<b>0282464</b>	TESTA STERZO TIE ROD END		
53521-S7A-003	<b>0602465</b>	SNODO ASSIALE AXIAL JOINT		
51350-S7A-010 51350-S7C-010	<b>0782807</b>	BRACCIO OSCILLANTE - ASSE ANTERIORE - INFERIORE TRACK CONTROL ARM - FRONT AXLE - LOWER		

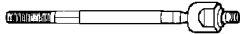
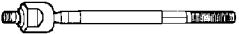

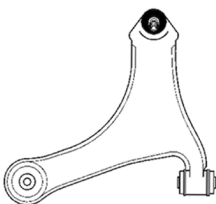
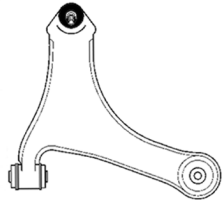

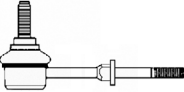
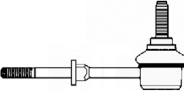



RIF. ORIG O.E. NUMBER	RIF. OCAP REF. OCAP	NOTE REMARKS	DESTRO RIGHT	SINISTRO LEFT
Anno - Year <b>2001 &gt;</b>		Serie - Series <b>RN</b>	Modello - Model <b>STREAM</b>	
51360-S7A-010 51360-S7C-010	<b>0792807</b>	BRACCIO OSCILLANTE - ASSE ANTERIORE - INFERIORE TRACK CONTROL ARM - FRONT AXLE LOWER		
51320-S5A-003	<b>0584296</b>	STABILIZZATORE - ASSE ANTERIORE STABILIZER LINK - FRONT AXLE		
51321-S5A-003	<b>0594296</b>	STABILIZZATORE - ASSE ANTERIORE STABILIZER LINK - FRONT AXLE		
52320-S7A-003	<b>0582481</b>	STABILIZZATORE - ASSE POSTERIORE STABILIZER LINK - REAR AXLE		
52321-S7A-003	<b>0592481</b>	STABILIZZATORE - ASSE POSTERIORE STABILIZER LINK - REAR AXLE		
Anno - Year <b>2001 &gt;</b>		Serie - Series <b>AP</b>	Modello - Model <b>S2000</b>	
53540-S47-951	<b>0282641</b>	TESTA STERZO - RHT M16x1,5 TIE ROD END - RHT M16x1,5		
53010-S2A-003	<b>0602641</b>	SNODO ASSIALE - RHT M16x1,5 AXIAL JOINT - RHT M16x1,5		
51350-S2A-000	<b>0382767</b>	BRACCIO OSCILLANTE ANTERIORE INFERIORE TRACK CONTROL ARM FRONT LOWER		
51360-S2A-000	<b>0392767</b>	BRACCIO OSCILLANTE ANTERIORE INFERIORE TRACK CONTROL ARM FRONT LOWER		
51320-S2A-003	<b>0582642</b>	STABILIZZATORE - ASSE ANTERIORE STABILIZER LINK - FRONT AXLE		











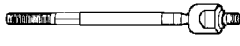
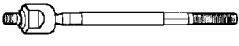

RIF. ORIG O.E. NUMBER	RIF. OCAP REF. OCAP	NOTE REMARKS	DESTRO RIGHT	SINISTRO LEFT
Anno - Year <b>2001 &gt;</b>		Serie - Series <b>AP</b>		Modello - Model <b>S2000</b>
51321-S2A-003	<b>0592642</b>	STABILIZZATORE - ASSE ANTERIORE STABILIZER LINK - FRONT AXLE		
52320-S2A-003	<b>0502643</b>	STABILIZZATORE - ASSE POSTERIORE STABILIZER LINK - REAR AXLE		





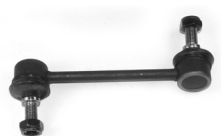
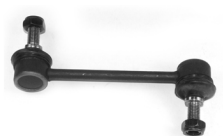

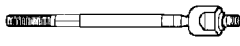
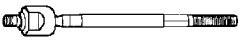
RIF. ORIG O.E. NUMBER	RIF. OCAP REF. OCAP	NOTE REMARKS	DESTRO RIGHT	SINISTRO LEFT
Anno - Year <b>10/94 &gt; 01/00</b>		Serie - Series <b>X-3</b>	Modello - Model <b>ACCENT</b>	
56820-22000 56820-28500 56820-28520	<b>0281290</b>	TESTA STERZO - RHT M14x1,5 TIE ROD END - RHT M14x1,5		
56540-22000	<b>0601287</b>	SNODO ASSIALE - RHT M14x1,5 STERZO MANUALE AXIAL JOINT - RHT M14x1,5 MANUAL STEERING		
57755-22000	<b>0604518</b>	SNODO ASSIALE - RHT M14x1,5 SERVOSTERZO AXIAL JOINT - RHT M14x1,5 POWER STEERING		
54503-25A00 54503-22A00 54503-31600 54503-38A00 54530-25000 54500-31600 54530-25A00	<b>0401288</b>	SNODO SOSPENSIONE - INFERIORE SUSPENSION JOINT - LOWER		
54501-22200 54501-22100 54501-22000	<b>0784467</b>	BRACCIO OSCILLANTE - INFERIORE TRACK CONTROL ARM - LOWER		
54500-22200 54500-22100 54500-22000	<b>0794467</b>	BRACCIO OSCILLANTE - INFERIORE TRACK CONTROL ARM - LOWER		
54825-22000	<b>0502778</b>	STABILIZZATORE - ASSE ANTERIORE E POSTERIORE STABILIZER LINK - FRONT AND REAR AXLE		
Anno - Year <b>01/2000 &gt;</b>		Serie - Series <b>LC</b>	Modello - Model <b>ACCENT</b>	
56820-25000	<b>0284452</b>	TESTA STERZO - RHT M14x1,5 TIE ROD END - RHT M14x1,5		
56542-43010 56540-22000 56540-24000 56540-42001 56540-43000 56540-43010 56540-25000	<b>0601564</b>	SNODO ASSIALE STERZO MANUALE AXIAL JOINT - MANUAL STEERING		





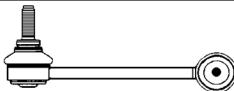
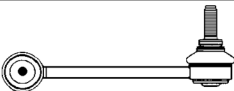



RIF. ORIG O.E. NUMBER	RIF. OCAP REF. OCAP	NOTE REMARKS	DESTRO RIGHT	SINISTRO LEFT
Anno - Year <b>01/2000 &gt;</b>		Serie - Series <b>LC</b>	Modello - Model <b>ACCENT</b>	
57775-25000 57755-25000 57730-43010 57730-24000	<b>0604453</b>	SNODO ASSIALE - SERVOSTERZO AXIAL JOINT - POWER STEERING		
54503-25A00 54530-25000	<b>0404454</b>	SNODO SOSPENSIONE - INFERIORE SUSPENSION JOINT - LOWER		
54501-25000	<b>0784515</b>	BRACCIO OSCILLANTE - INFERIORE TRACK CONTROL ARM - LOWER		
54500-25000	<b>0794515</b>	BRACCIO OSCILLANTE - INFERIORE TRACK CONTROL ARM - LOWER		
54830-17020 54830-25020	<b>0584455</b>	STABILIZZATORE - ASSE ANTERIORE STABILIZER LINK - FRONT AXLE		
54830-17010 54830-25010	<b>0594455</b>	STABILIZZATORE - ASSE ANTERIORE STABILIZER LINK - FRONT AXLE		
54830-25000 55830-25000	<b>0504456</b>	STABILIZZATORE - ASSE POSTERIORE STABILIZER LINK - REAR AXLE		
Anno - Year <b>11/2005 &gt;</b>		Serie - Series <b>MC</b>	Modello - Model <b>ACCENT</b>	
56820-1E900	<b>0282769</b>	TESTA STERZO - RHT M14x1,5 TIE ROD END - RHT M14x1,5		
56820-1E000	<b>0292769</b>	TESTA STERZO - RHT M14x1,5 TIE ROD END - RHT M14x1,5		









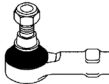
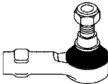
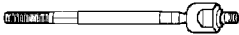
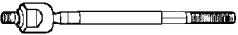

RIF. ORIG O.E. NUMBER	RIF. OCAP REF. OCAP	NOTE REMARKS	DESTRO RIGHT	SINISTRO LEFT
Anno - Year <b>11/2005 &gt;</b>		Serie - Series <b>MC</b>	Modello - Model <b>ACCENT</b>	
57724-1E000	<b>0602770</b>	SNODO ASSIALE - RHT M14x1,5 AXIAL JOINT - RHT M14x1,5		
51760-1G000	<b>0402771</b>	SNODO SOSPENSIONE - INFERIORE SUSPENSION JOINT - LOWER		
54501-1E100	<b>0782773</b>	BRACCIO OSCILLANTE - INFERIORE STERZO MANUALE TRACK CONTROL ARM - LOWER MANUAL STEERING		
54500-1E100	<b>0792773</b>	BRACCIO OSCILLANTE - INFERIORE STERZO MANUALE TRACK CONTROL ARM - LOWER MANUAL STEERING		
54501-1E000	<b>0782774</b>	BRACCIO OSCILLANTE - INFERIORE SERVOSTERZO TRACK CONTROL ARM - LOWER POWER STEERING		
54500-1E000	<b>0792774</b>	BRACCIO OSCILLANTE - INFERIORE SERVOSTERZO TRACK CONTROL ARM - LOWER POWER STEERING		
54840-1G000	<b>0582772</b>	STABILIZZATORE - ASSE ANTERIORE STABILIZER LINK - FRONT AXLE		
54830-1G000	<b>0592772</b>	STABILIZZATORE - ASSE ANTERIORE STABILIZER LINK - FRONT AXLE		
Anno - Year <b>02/1998 &gt;</b> <b>08/1999 &gt;</b>		Serie - Series <b>MX</b> <b>MX</b>	Modello - Model <b>ATOS</b> <b>ATOS PRIME</b>	
56820-02500	<b>0284519</b>	TESTA STERZO - RHT M14x1,5 TIE ROD END - RHT M14x1,5		

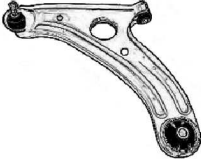

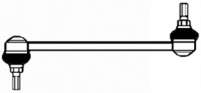
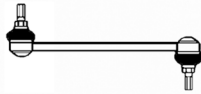

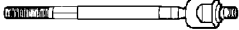
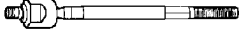





RIF. ORIG O.E. NUMBER	RIF. OCAP REF. OCAP	NOTE REMARKS	DESTRO RIGHT	SINISTRO LEFT
Anno - Year <b>02/1998 &gt;</b> <b>08/1999 &gt;</b>		Serie - Series <b>MX</b> <b>MX</b>	Modello - Model <b>ATOS</b> <b>ATOS PRIME</b>	
56540-02000	<b>0601565</b>	SNODO ASSIALE STERZO MANUALE AXIAL JOINT MANUAL STEERING		
57755-02000	<b>0604458</b>	SNODO ASSIALE SERVOSTERZO AXIAL JOINT POWER STEERING		
54530-02050 54530-02500	<b>0404457</b>	SNODO SOSPENSIONE - ASSE ANTERIORE INFERIORE SUSPENSION JOINT - FRONT AXLE LOWER		
54501-02051	<b>0784457</b>	BRACCIO OSCILLANTE - INFERIORE TRACK CONTROL ARM - LOWER		
54500-02051	<b>0794457</b>	BRACCIO OSCILLANTE - INFERIORE TRACK CONTROL ARM - LOWER		
54820-02000	<b>0504459</b>	STABILIZZATORE - ASSE ANTERIORE STABILIZER LINK - FRONT AXLE		
55530-29000 55530-29500	<b>0501575</b>	STABILIZZATORE - ASSE POSTERIORE STABILIZER LINK - REAR AXLE		
Anno - Year <b>2000 &gt;</b> <b>03/2002 &gt;</b>		Serie - Series <b>XD</b> <b>GK</b>	Modello - Model <b>ELANTRA</b> <b>COUPE</b>	
56820-25000	<b>0284452</b>	TESTA STERZO - RHT M14x1,5 TIE ROD END - RHT M14x1,5		
57724-2D000	<b>0601566</b>	SNODO ASSIALE - RHT M14x1,5 AXIAL JOINT - RHT M14x1,5		
54503-31600 54520-31600 54530-31600 54503-38A00 54503-25A00	<b>0403357</b>	SNODO SOSPENSIONE - INFERIORE BALL JOINT - LOWER		







RIF. ORIG O.E. NUMBER	RIF. OCAP REF. OCAP	NOTE REMARKS	DESTRO RIGHT	SINISTRO LEFT
Anno - Year <b>2000 &gt;</b> <b>03/2002 &gt;</b>		Serie - Series <b>XD</b> <b>GK</b>	Modello - Model <b>ELANTRA</b> <b>COUPE</b>	
54501-2D002 54501-2D000	<b>0782846</b>	BRACCIO OSCILLANTE - INFERIORE SOLO MOD. ELANTRA TRACK CONTROL ARM - LOWER ONLY MOD. ELANTRA		
54500-2D002 54500-2D000	<b>0792846</b>	BRACCIO OSCILLANTE - INFERIORE SOLO MOD. ELANTRA TRACK CONTROL ARM - LOWER ONLY MOD. ELANTRA		
54830-34500 54830-34000 54830-36010 54850-36010	<b>0501576</b>	STABILIZZATORE - ASSE ANTERIORE SOLO ELANTRA STABILIZER LINK - FRONT AXLE ONLY ELANTRA		
54840-2C000	<b>0581567</b>	STABILIZZATORE - ASSE ANTERIORE SOLO COUPE STABILIZER LINK - FRONT AXLE ONLY COUPE		
54830-2C000	<b>0591567</b>	STABILIZZATORE - ASSE ANTERIORE SOLO COUPE STABILIZER LINK - FRONT AXLE ONLY COUPE		
55530-29000 55530-29500	<b>0501575</b>	STABILIZZATORE - ASSE POSTERIORE STABILIZER LINK - REAR AXLE		
Anno - Year <b>08/1998 &gt;</b>		Serie - Series <b>JK-01</b>	Modello - Model <b>GALLOPER II</b>	
HB568100	<b>0503460</b>	BARRA STERZO TIE ROD		
HB568110 MB-241206 MB-315776 MR-296274	<b>0183460</b>	TESTA STERZO - RHT M14x1,5 - INTERNA TIE ROD - RHT M14x1,5 - INNER		
HB568120 MB-241171 MB-315775 MR-241032	<b>0193459</b>	TESTA STERZO - LHT M16x1,5 - ESTERNA TIE ROD - LHT M16x1,5 - OUTER		

RIF. ORIG O.E. NUMBER	RIF. OCAP REF. OCAP	NOTE REMARKS	DESTRO RIGHT	SINISTRO LEFT
Anno - Year <b>08/1998 &gt;</b>		Serie - Series <b>JK-01</b>	Modello - Model <b>GALLOPER II</b>	
5441744000 5443144000 MB-176309	<b>0400555</b>	SNODO SOSPENSIONE - ASSE ANTERIORE - SUPERIORE BALL JOINT - FRONT AXLE - UPPER		
MB109631A 5443144000 54431-44000	<b>0783297</b>	BRACCIO OSCILLANTE - ASSE ANTERIORE - SUPERIORE TRACK CONTROL ARM - FRONT AXLE - UPPER		
MB109630A	<b>0793297</b>	BRACCIO OSCILLANTE - ASSE ANTERIORE - SUPERIORE TRACK CONTROL ARM - FRONT AXLE - UPPER		
HB212100 HB212200 MB-176308	<b>0403465</b>	SNODO SOSPENSIONE - ASSE ANTERIORE - INFERIORE BALL JOINT - FRONT AXLE - LOWER		
HB212004	<b>0783298</b>	BRACCIO OSCILLANTE - ASSE ANTERIORE - INFERIORE TRACK CONTROL ARM - FRONT AXLE - LOWER		
HB212003	<b>0793298</b>	BRACCIO OSCILLANTE - ASSE ANTERIORE - INFERIORE TRACK CONTROL ARM - FRONT AXLE - LOWER		
Anno - Year <b>09/2002 &gt;</b>		Serie - Series <b>TB</b>	Modello - Model <b>GETZ</b>	
56820-3B000	<b>0284461</b>	TESTA STERZO - RHT M14x1,5 TIE ROD END - RHT M14x1,5		
57755-1C000	<b>0601568</b>	SNODO ASSIALE - RHT M14x1,5 AXIAL JOINT - RHT M14x1,5		

RIF. ORIG O.E. NUMBER	RIF. OCAP REF. OCAP	NOTE REMARKS	DESTRO RIGHT	SINISTRO LEFT
Anno - Year <b>09/2002 &gt;</b>		Serie - Series <b>TB</b>	Modello - Model <b>GETZ</b>	
54503-25A00 54530-25000	<b>0404454</b>	SNODO SOSPENSIONE - INFERIORE SUSPENSION JOINT - LOWER		
54501-1C000	<b>0784468</b>	BRACCIO OSCILLANTE - INFERIORE TRACK CONTROL ARM - LOWER		
54500-1C000	<b>0794468</b>	BRACCIO OSCILLANTE - INFERIORE TRACK CONTROL ARM - LOWER		
54840-1C000	<b>0584462</b>	STABILIZZATORE - ASSE ANTERIORE STABILIZER LINK - FRONT AXLE		
54830-1C000	<b>0594462</b>	STABILIZZATORE - ASSE ANTERIORE STABILIZER LINK - FRONT AXLE		
Anno - Year <b>10/1997 &gt;</b> <b>03/2000 &gt;</b> <b>06/1997 &gt;</b>		Serie - Series <b>Autobus (Bus) KMF</b> <b>Furgonato (Van)</b>	Modello - Model <b>H-1</b> <b>H-1</b> <b>STAREX</b>	
56872-43000 56872-43010 57705-56820B	<b>0284469</b>	TESTA STERZO - RHT M14x1,5 TIE ROD END - RHT M14x1,5		
57729-4A000	<b>0602808</b>	SNODO ASSIALE - RHT M14X1,5 AXIAL JOINT - RHT M14X1,5		
54417-43001 54417-4A000 54417-4AA00 54417-43A00 54417-43A01 54417-47000 54417-4BA00 MB-527349 MB-527350 MR-241623	<b>0402940</b>	SNODO SOSPENSIONE SUPERIORE SUSPENSION JOINT UPPER		

RIF. ORIG O.E. NUMBER	RIF. OCAP REF. OCAP	NOTE REMARKS	DESTRO RIGHT	SINISTRO LEFT
Anno - Year <b>10/1997 &gt;</b> <b>03/2000 &gt;</b> <b>06/1997 &gt;</b>		Serie - Series <b>Autobus (Bus) KMF</b> <b>Furgonato (Van)</b>	Modello - Model <b>H-1</b> <b>H-1</b> <b>STAREX</b>	
54401-4A000	<b>0782810</b>	BRACCIO OSCILLANTE - ASSE ANTERIORE - SUPERIORE TRACK CONTROL ARM - FRONT AXLE - UPPER		
54400-4A000	<b>0792810</b>	BRACCIO OSCILLANTE - ASSE ANTERIORE - SUPERIORE TRACK CONTROL ARM - FRONT AXLE - UPPER		
54530-4A000 54530-4AA00	<b>0402809</b>	SNODO SOSPENSIONE - INFERIORE SUSPENSION JOINT - LOWER		
54501-4A000	<b>0782809</b>	BRACCIO OSCILLANTE - ASSE ANTERIORE - INFERIORE TRACK CONTROL ARM - FRONT AXLE - LOWER		
54500-4A000	<b>0792809</b>	BRACCIO OSCILLANTE - ASSE ANTERIORE - INFERIORE TRACK CONTROL ARM - FRONT AXLE - LOWER		
54830-4A000 54830-4A003 54830-4A800 54830-4A802	<b>0502811</b>	STABILIZZATORE - ASSE ANTERIORE STABILIZER LINK - FRONT AXLE		
55530-4A000 55530-4A001 55530-4A800 55530-4A801	<b>0502812</b>	STABILIZZATORE - ASSE POSTERIORE STABILIZER LINK - REAR AXLE		
Anno - Year <b>02/2008 &gt;</b>		Serie - Series <b>CARGO - TRAVEL</b>	Modello - Model <b>H-1</b>	
56820-4H100	<b>0285193</b>	TESTA STERZO - RHT M14x1,5 TIE ROD END - RHT M14x1,5		
56820-4H000	<b>0295193</b>	TESTA STERZO - RHT M14x1,5 TIE ROD END - RHT M14x1,5		
57724-4H100	<b>0685194</b>	SNODO ASSIALE - RHT M14x1,5 AXIAL JOINT - RHT M14x1,5		

RIF. ORIG O.E. NUMBER	RIF. OCAP REF. OCAP	NOTE REMARKS	DESTRO RIGHT	SINISTRO LEFT
Anno - Year <b>02/2008 &gt;</b>		Serie - Series <b>CARGO - TRAVEL</b>		Modello - Model <b>H-1</b>
57724-4H000	<b>0695194</b>	SNODO ASSIALE - RHT M14x1,5 AXIAL JOINT - RHT M14x1,5		
54530-3J000	<b>0405195</b>	SNODO SOSPENSIONE - ASSE ANTERIORE - INFERIORE BALL JOINT - FRONT AXLE - LOWER		
54501-4H000	<b>0785195</b>	BRACCIO OSCILLANTE - ASSE ANTERIORE - INFERIORE TRACK CONTROL ARM - FRONT AXLE - LOWER		
54500-4H000	<b>0795195</b>	BRACCIO OSCILLANTE - ASSE ANTERIORE - INFERIORE TRACK CONTROL ARM - FRONT AXLE - LOWER		
54840-4H200	<b>0585196</b>	STABILIZZATORE - ASSE ANTERIORE STABILIZER LINK - FRONT AXLE		
54830-4H200	<b>0595196</b>	STABILIZZATORE - ASSE ANTERIORE STABILIZER LINK - FRONT AXLE		
55540-4H000	<b>0585197</b>	STABILIZZATORE - ASSE POSTERIORE STABILIZER LINK - REAR AXLE		
55530-4H000	<b>0595197</b>	STABILIZZATORE - ASSE POSTERIORE STABILIZER LINK - REAR AXLE		
Anno - Year <b>07/93 &gt; 02/04</b>		Serie - Series		Modello - Model <b>H100</b>
56872-43000 56872-43010 57705-56820B	<b>0284469</b>	TESTA STERZO - RHT M14x1,5 TIE ROD END - RHT M14x1,5		







RIF. ORIG O.E. NUMBER	RIF. OCAP REF. OCAP	NOTE REMARKS	DESTRO RIGHT	SINISTRO LEFT
Anno - Year <b>07/93 &gt; 02/04</b>		Serie - Series	Modello - Model <b>H100</b>	
56542-43010 56540-22000 56540-24000 56540-42001 56540-43000 56540-43010 56540-25000	<b>0602120</b>	SNODO ASSIALE STERZO MANUALE AXIAL JOINT MANUAL STEERING		
57775-25000 57755-25000 57730-43010 57730-24000	<b>0604453</b>	SNODO ASSIALE - SERVOSTERZO AXIAL JOINT - POWER STEERING		
54417-43001 54417-4A000 54417-4AA00 54417-43A00 54417-43A01 54417-47000 54417-4BA00 MB-527349 MB-527350 MR-241623	<b>0402940</b>	SNODO SOPENSIONE SUPERIORE - SOLO PER MODELLI PICK-UP SUSPENSION JOINT UPPER - ONLY FOR PICK-UP MODELS		
54417-43000 5441743000	<b>0403495</b>	SNODO SOPENSIONE - ASSE ANTERIORE - SUPERIORE - SOLO PER MOD. VAN SUSPENSION JOINT UPPER - UPPER - ONLY FOR VAN MODELS		
54430-43004 54430-43005	<b>0783495</b>	BRACCIO OSCILLANTE - ASSE ANTERIORE - SUPERIORE - SOLO PER MOD. VAN TRACK CONTROL ARM - FRONT AXLE - UPPER - ONLY VAN MODELS		
54410-43004 54410-43005	<b>0793495</b>	BRACCIO OSCILLANTE - ASSE ANTERIORE - SUPERIORE - SOLO PER MOD. VAN TRACK CONTROL ARM - FRONT AXLE - UPPER - ONLY VAN MODELS		
MB-527383-01 MB-527384-01 MB-598018-Y	<b>0403507</b>	SNODO SOSPENSIONE ASSE ANTERIORE - INFERIORE - PER TUTTI I MODELLI BALL JOINT - FRONT AXLE - LOWER - FOR ALL MODELS		



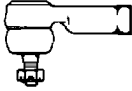
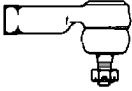
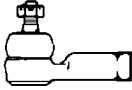
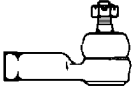
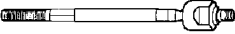
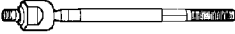
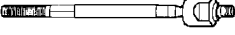
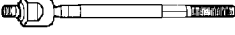
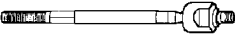
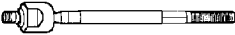
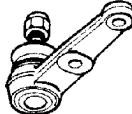
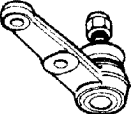







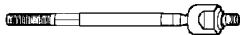
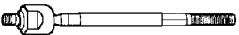



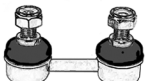
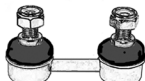



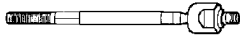
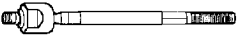



RIF. ORIG O.E. NUMBER	RIF. OCAP REF. OCAP	NOTE REMARKS	DESTRO RIGHT	SINISTRO LEFT
Anno - Year <b>07/93 &gt; 02/04</b>		Serie - Series	Modello - Model <b>H100</b>	
54540-4B001	<b>0783507</b>	BRACCIO OSCILLANTE - ASSE ANTERIORE - INFERIORE - SOLO PER MOD. PICK-UP TRACK CONTROL ARM - FRONT AXLE - LOWER - ONLY FOR PICK-UP MODELS		
54510-4B001	<b>0793507</b>	BRACCIO OSCILLANTE - ASSE ANTERIORE - INFERIORE - SOLO PER MOD. PICK-UP TRACK CONTROL ARM - FRONT AXLE - LOWER - ONLY FOR PICK-UP MODELS		
MB-430113 MB-527384 MB-598018 54540-43150	<b>0783499</b>	BRACCIO OSCILLANTE - ASSE ANTERIORE - INFERIORE - SOLO PER MOD. VAN TRACK CONTROL ARM - FRONT AXLE - LOWER - ONLY FOR VAN MODELS		
MB-430112 MB-527383 MB-598017 54510-43150	<b>0793499</b>	BRACCIO OSCILLANTE - ASSE ANTERIORE - INFERIORE - SOLO PER MOD. VAN TRACK CONTROL ARM - FRONT AXLE - LOWER - ONLY FOR VAN MODELS		
Anno - Year <b>2008 &gt;</b>		Serie - Series	Modello - Model <b>i10</b>	
56820-0X010 56820-0X900 56820-0X000	<b>0283956</b>	TESTA STERZO - RHT M12x1,25 TIE ROD END - RHT M12x1,25		
57724-0X000	<b>0603958</b>	SNODO ASSIALE - RHT M12x1,25 AXIAL JOINT - RHT M12x1,25		
54530-07000	<b>0402793</b>	SNODO SOSPENSIONE - ASSE ANTERIORE - INFERIORE BALL JOINT - FRONT AXLE - LOWER		
54501-0X000 54501-0X200	<b>0783959</b>	BRACCIO OSCILLANTE - ASSE ANTERIORE - INFERIORE TRACK CONTROL ARM - FRONT AXLE - LOWER		
54500-0X000 54500-0X200	<b>0793959</b>	BRACCIO OSCILLANTE - ASSE ANTERIORE - INFERIORE TRACK CONTROL ARM - FRONT AXLE - LOWER		



RIF. ORIG O.E. NUMBER	RIF. OCAP REF. OCAP	NOTE REMARKS	DESTRO RIGHT	SINISTRO LEFT
Anno - Year <b>2008 &gt;</b>		Serie - Series	Modello - Model <b>i10</b>	
54840-0X000	<b>0583960</b>	STABILIZZATORE - ASSE ANTERIORE STABILIZER LINK - FRONT AXLE		
54830-0X000	<b>0593960</b>	STABILIZZATORE - ASSE ANTERIORE STABILIZER LINK - FRONT AXLE		
Anno - Year <b>09/2008 &gt;</b>		Serie - Series	Modello - Model <b>i20</b>	
56820-2K050	<b>0284075</b>	TESTA STERZO - RHT M12x1,25 TIE ROD END - RHT M12x1,25		
56820-2K000	<b>0294075</b>	TESTA STERZO - RHT M12x1,25 TIE ROD END - RHT M12x1,25		
57724-1J000	<b>0604076</b>	SNODO ASSIALE - RHT M12x1,25 AXIAL JOINT - RHT M12x1,25		
54503-25A00 54503-22A00 54503-31600 54503-38A00 54530-25000 54500-31600 54530-25A00	<b>0401288</b>	SNODO SOSPENSIONE - ASSE ANTERIORE BALL JOINT - FRONT AXLE		
54501-1J500	<b>0784077</b>	BRACCIO OSCILLANTE - ASSE ANTERIORE TRACK CONTROL ARM - FRONT AXLE		
54500-1J500	<b>0794077</b>	BRACCIO OSCILLANTE - ASSE ANTERIORE TRACK CONTROL ARM - FRONT AXLE		
54840-1J000	<b>0584078</b>	STABILIZZATORE - ASSE ANTERIORE STABILIZER LINK - FRONT AXLE		





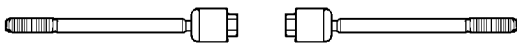

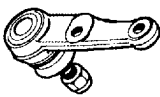
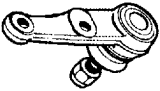
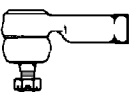
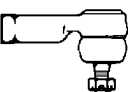
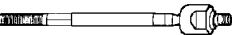
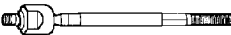
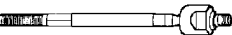
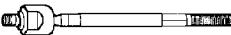
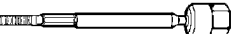
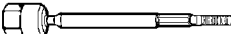
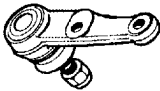
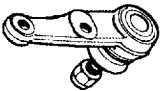
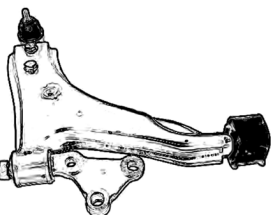
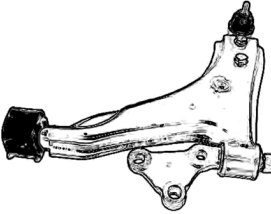



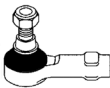
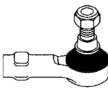

RIF. ORIG O.E. NUMBER	RIF. OCAP REF. OCAP	NOTE REMARKS	DESTRO RIGHT	SINISTRO LEFT
Anno - Year <b>09/2008 &gt;</b>		Serie - Series	Modello - Model <b>i20</b>	
54830-1J000	<b>0594078</b>	STABILIZZATORE - ASSE ANTERIORE STABILIZER LINK - FRONT AXLE		
Anno - Year <b>10/2007 &gt;</b>		Serie - Series	Modello - Model <b>i30</b>	
56820-2H090	<b>0284069</b>	TESTA STERZO - RHT M14x1,5 TIE ROD END - RHT M14x1,5		
56820-2H000	<b>0294069</b>	TESTA STERZO - RHT M14x1,5 TIE ROD END - RHT M14x1,5		
56540-2H000	<b>0604070</b>	SNODO ASSIALE - RHT M14x1,5 AXIAL JOINT - RHT M14x1,5		
51760-0Q000 51760-2H000 51760-2G000	<b>0404071</b>	SNODO SOSPENSIONE - ASSE ANTERIORE BALL JOITN - FRONT AXLE		
54501-2H000	<b>0784071</b>	BRACCIO OSCILLANTE - ASSE ANTERIORE TRACK CONTROL ARM - FRONT AXLE		
54500-2H000	<b>0794071</b>	BRACCIO OSCILLANTE - ASSE ANTERIORE TRACK CONTROL ARM - FRONT AXLE		
54830-2H100 54830-2H000	<b>0504072</b>	STABILIZZATORE - ASSE ANTERIORE STABILIZER LINK - FRONT AXLE		
55250-2H000 55250-1H000	<b>0304073</b>	BRACCIO SOSPENSIONE - ASSE POSTERIORE SUSPENSION ARM - REAR AXLE		
55530-1H100 55530-1H000	<b>0504074</b>	STABILIZZATORE - ASSE POSTERIORE STABILIZER LINK - REAR AXLE		

RIF. ORIG O.E. NUMBER	RIF. OCAP REF. OCAP	NOTE REMARKS	DESTRO RIGHT	SINISTRO LEFT
Anno - Year <b>1991 &gt; 1995</b>		Serie - Series <b>J-1</b>	Modello - Model <b>LANTRA I</b>	
56820-28000	<b>0281284</b>	TESTA STERZO - RHT M12x1/25 - > 04/1992 TIE ROD END - RHT M12x1/25 - > 04/1992		
56820-28500	<b>0284460</b>	TESTA STERZO - RHT M14x1/5 - 04/1992 > TIE ROD END - RHT M14x1/5 - 04/1992 >		
57730-28000 57730-24000	<b>0603800</b>	SNODO ASSIALE - RHT M12x1,25 SERVOSTERZO - 1991 > 1992 L=300 mm AXIAL JOINT - RHT M12x1,25 POWER STEERING - 1991 > 1992 L= 300 mm		
57730-28500	<b>0601294</b>	SNODO ASSIALE - RHT M14x1,50 SERVOSTERZO - 04/1992 > 06/1993 L= 295 mm AXIAL JOINT - RHT M14x1,50 POWER STEERING - 04/1992 > 06/1993 L= 295 mm		
57730-33100	<b>0601569</b>	SNODO ASSIALE - RHT M14x1,50 SERVOSTERZO - 1993 L= 300 mm AXIAL JOINT - RHT M14x1,50 POWER STEERING - 1993 L= 300 mm		
54530-28A00 54530-28000	<b>0403374</b>	SNODO SOSPENSIONE - INFERIORE SUSPENSION JOINT - LOWER		
54503-28010	<b>0783374</b>	BRACCIO OSCILLANTE - INFERIORE TRACK CONTROL ARM - LOWER		
54502-28070	<b>0793374</b>	BRACCIO OSCILLANTE - INFERIORE TRACK CONTROL ARM - LOWER		
54830-28000 54830-37010 54830-37020	<b>0504079</b>	STABILIZZATORE - ASSE ANTERIORE STABILIZER LINK - FRONT AXLE		
Anno - Year <b>1995 &gt; 2000</b> <b>1996 &gt; 2002</b>		Serie - Series <b>J-2</b> <b>RD</b>	Modello - Model <b>LANTRA II</b> <b>COUPE</b>	
56820-22000 56820-28500 56820-28520	<b>0281290</b>	TESTA STERZO - RHT M14x1,5 TIE ROD END - RHT M14x1,5		

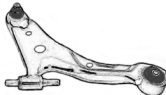
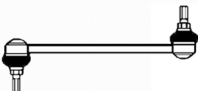
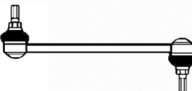







RIF. ORIG O.E. NUMBER	RIF. OCAP REF. OCAP	NOTE REMARKS	DESTRO RIGHT	SINISTRO LEFT
Anno - Year <b>1995 &gt; 2000</b> <b>1996 &gt; 2002</b>		Serie - Series <b>J-2</b> <b>RD</b>	Modello - Model <b>LANTRA II</b> <b>COUPE</b>	
57730-29000 57730-29001	<b>0601285</b>	SNODO ASSIALE - RHT M14x1,5 AXIAL JOINT - RHT M14x1,5		
54503-22A00 54503-25A00 54503-31600	<b>0401295</b>	SNODO SOSPENSIONE - INFERIORE BALL JOINT - LOWER		
54501-29500 54501-29000	<b>0782655</b>	BRACCIO OSCILLANTE - INFERIORE TRACK CONTROL ARM - LOWER		
54500-29500 54500-29000	<b>0792655</b>	BRACCIO OSCILLANTE - INFERIORE TRACK CONTROL ARM - LOWER		
54830-29000 54830-29500	<b>0501574</b>	STABILIZZATORE - ASSE ANTERIORE STABILIZER LINK - FRONT AXLE		
55530-29000 55530-29500	<b>0501575</b>	STABILIZZATORE - ASSE POSTERIORE STABILIZER LINK - REAR AXLE		
Anno - Year <b>06/2001 &gt;</b>		Serie - Series <b>FC</b>	Modello - Model <b>MATRIX</b>	
56820-25000	<b>0284452</b>	TESTA STERZO - RHT M14x1,5 TIE ROD END - RHT M14x1,5		
57755-17000	<b>0604516</b>	SNODO ASSIALE AXIAL JOINT		
54503-31600 54520-31600 54530-31600 54503-38A00 54503-25A00	<b>0403357</b>	SNODO SOSPENSIONE - INFERIORE SUSPENSION JOINT - LOWER		







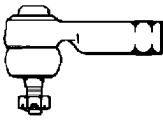
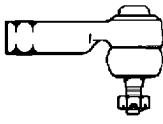





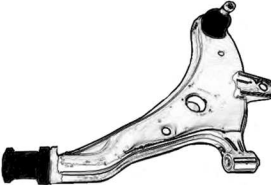
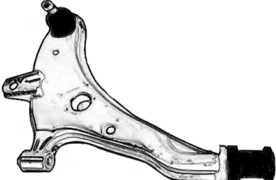

RIF. ORIG O.E. NUMBER	RIF. OCAP REF. OCAP	NOTE REMARKS	DESTRO RIGHT	SINISTRO LEFT
Anno - Year <b>06/2001 &gt;</b>		Serie - Series <b>FC</b>	Modello - Model <b>MATRIX</b>	
54501-17000	<b>0782768</b>	BRACCIO OSCILLANTE - INFERIORE TRACK CONTROL ARM - LOWER		
54500-17000	<b>0792768</b>	BRACCIO OSCILLANTE - INFERIORE TRACK CONTROL ARM - LOWER		
54830-17020 54830-25020	<b>0584455</b>	STABILIZZATORE - ASSE ANTERIORE STABILIZER LINK - FRONT AXLE		
54830-17010 54830-25010	<b>0594455</b>	STABILIZZATORE - ASSE ANTERIORE STABILIZER LINK - FRONT AXLE		
55530-17000	<b>0504080</b>	STABILIZZATORE - ASSE POSTERIORE STABILIZER LINK - REAR AXLE		
Anno - Year <b>1978 &gt; 1985</b>		Serie - Series <b>X1</b>	Modello - Model <b>PONY</b>	
56810-11000 56810-11060	<b>0193368</b>	TESTA STERZO ESTERNA - RHT M14x1.5 TIE ROD END OUTER - RHT M14x1.5		
56820-11000 56820-11060	<b>0183369</b>	TESTA STERZO INTERNA - LHT M14x1.5 TIE ROD END INNER - LHT M14x1.5		
54503-14200 54520-11011 54520-14200 54530-14200	<b>0403370</b>	SNODO SOSPENSIONE - INFERIORE SUSPENSION JOINT - LOWER		
Anno - Year <b>1985 &gt; 1990</b>		Serie - Series	Modello - Model <b>PONY - EXCEL I</b>	
56820-21000 56820-21100 56820-21110 56820-21120	<b>0283361</b>	TESTA STERZO - RHT M14x1.5 TIE ROD END - RHT M14x1.5		
56540-21001 56540-21010	<b>0603363</b>	SNODO ASSIALE - RHT M14x1.5 SERVOSTERZO AXIAL JOINT - RHT M14x1.5 POWER STEERING		









RIF. ORIG O.E. NUMBER	RIF. OCAP REF. OCAP	NOTE REMARKS	DESTRO RIGHT	SINISTRO LEFT
Anno - Year <b>1985 &gt; 1990</b>		Serie - Series	Modello - Model <b>PONY - EXCEL I</b>	
54540-21A00 54540-21000 54540-21100	<b>0483358</b>	SNODO SOSPENSIONE SUSPENSION JOINT		
54530-21A00 54530-21000 54530-21100	<b>0493358</b>	SNODO SOSPENSIONE SUSPENSION JOINT		
Anno - Year <b>1990 &gt; 1994</b> <b>02/90 &gt; 05/96</b>		Serie - Series	Modello - Model <b>PONY (X2) - EXCEL II</b> <b>S COUPE</b>	
56820-21000 56820-21100 56820-21110 56820-21120	<b>0283361</b>	TESTA STERZO - RHT M14x1,5 TIE ROD END - RHT M14x1,5		
56540-22000 56540-24000 56540-24001	<b>0603365</b>	SNODO ASSIALE - RHT M14x1,5 STERZO MANUALE AXIAL JOINT - RHT M14x1,5 MANUAL STEERING		
57730-24000	<b>0603366</b>	SNODO ASSIALE - RHT M14x1,5 SERVOSTERZO - 05/1992 > 05/1993 AXIAL JOINT - RHT M14x1,5 POWER STEERING - 05/1992 > 05/1993		
57730-24100	<b>0603364</b>	SNODO ASSIALE - RHT M14x1,5 SERVOSTERZO - 06/1993 > AXIAL JOINT - RHT M14x1,5 POWER STEERING - 06/1993 >		
54530-24A00 54530-24000	<b>0403359</b>	SNODO SOSPENSIONE SUSPENSION JOINT		
54501-24000	<b>0782658</b>	BRACCIO OSCILLANTE - ASSE ANTERIORE - INFERIORE TRACK CONTROL ARM - FRONT AXLE - LOWER		
54500-24000	<b>0792658</b>	BRACCIO OSCILLANTE - ASSE ANTERIORE - INFERIORE TRACK CONTROL ARM - FRONT AXLE - LOWER		
MB-518892 MB-573043 MB-892982 4056A014	<b>0501767</b>	STABILIZZATORE - ASSALE ANTERIORE STABILIZER LINK - FRONT AXLE		

RIF. ORIG O.E. NUMBER	RIF. OCAP REF. OCAP	NOTE REMARKS	DESTRO RIGHT	SINISTRO LEFT
Anno - Year <b>2001 &gt; 02/2006</b>		Serie - Series <b>SM</b>	Modello - Model <b>SANTA FE'</b>	
56820-3B000	<b>0284461</b>	TESTA STERZO - RHT M14x1,5 TIE ROD END - RHT M14x1,5		
57785-26200	<b>0604517</b>	SNODO ASSIALE AXIAL JOINT		
54530-3B000 54503-3BA00 54530-2B000	<b>0404465</b>	SNODO SOSPENSIONE - ASSE ANTERIORE BALL JOINT - FRONT AXLE		
54502-26000	<b>0784465</b>	BRACCIO OSCILLANTE - ASSE ANTERIORE - INFERIORE TRACK CONTROL ARM - FRONT AXLE - LOWER		
54501-26000	<b>0794465</b>	BRACCIO OSCILLANTE - ASSE ANTERIORE - INFERIORE TRACK CONTROL ARM - FRONT AXLE - LOWER		
54840-26000 54840-26010	<b>0584466</b>	STABILIZZATORE - ASSE ANTERIORE STABILIZER LINK - FRONT AXLE		
54830-26000 54830-26010	<b>0594466</b>	STABILIZZATORE - ASSE ANTERIORE STABILIZER LINK - FRONT AXLE		
55540-26600 55540-26700	<b>0582764</b>	STABILIZZATORE - ASSE POSTERIORE STABILIZER LINK - REAR AXLE		
55530-26600 55530-26700	<b>0592764</b>	STABILIZZATORE - ASSE POSTERIORE STABILIZER LINK - REAR AXLE		
Anno - Year <b>03/2006 &gt;</b>		Serie - Series <b>CM</b>	Modello - Model <b>SANTA FE'</b>	
56820-2B900	<b>0284081</b>	TESTA STERZO - RHT M16x1,5 TIE ROD END - RHT M16x1,5		
56820-2B000	<b>0294081</b>	TESTA STERZO - RHT M16x1,5 TIE ROD END - RHT M16x1,5		
57724-2B000	<b>0604082</b>	SNODO ASSIALE - RHT M16x1,5 AXIAL JOINT - RHT M16x1,5		















RIF. ORIG O.E. NUMBER	RIF. OCAP REF. OCAP	NOTE REMARKS	DESTRO RIGHT	SINISTRO LEFT
Anno - Year <b>03/2006 &gt;</b>		Serie - Series <b>CM</b>	Modello - Model <b>SANTA FE'</b>	
54530-3B000 54503-3BA00 54530-2B000	<b>0404465</b>	SNODO SOSPENSIONE - ASSE ANTERIORE BALL JOINT - FRONT AXLE		
54501-2B100	<b>0784083</b>	BRACCIO OSCILLANTE - ASSE ANTERIORE TRACK CONTROL ARM - FRONT AXLE		
54500-2B100	<b>0794083</b>	BRACCIO OSCILLANTE - ASSE ANTERIORE TRACK CONTROL ARM - FRONT AXLE		
54840-2B000	<b>0584084</b>	STABILIZZATORE - ASSE ANTERIORE STABILIZER LINK - FRONT AXLE		
54830-2B000	<b>0594084</b>	STABILIZZATORE - ASSE ANTERIORE STABILIZER LINK - FRONT AXLE		
55530-2B000	<b>0504085</b>	STABILIZZATORE - ASSE POSTERIORE STABILIZER LINK - REAR AXLE		
Anno - Year <b>09/88 &gt; 10/93</b>		Serie - Series <b>Y-2</b>	Modello - Model <b>SONATA II - SONICA II</b>	
56820-36000	<b>0283360</b>	TESTA STERZO - RHT M14x1,5 TIE ROD END - RHT M14x1,5		
57730-33200	<b>0603362</b>	SNODO ASSIALE RHT M14x1,5 SERVOSTERZO AXIAL JOINT RHT M14x1,5 - POWER STEERING		
57730-33100	<b>0601569</b>	SNODO ASSIALE - RHT M14x1,50 L= 300 mm AXIAL JOINT - RHT M14x1,50 L= 300 mm		

RIF. ORIG O.E. NUMBER	RIF. OCAP REF. OCAP	NOTE REMARKS	DESTRO RIGHT	SINISTRO LEFT
Anno - Year <b>09/88 &gt; 10/93</b>		Serie - Series <b>Y-2</b>	Modello - Model <b>SONATA II - SONICA II</b>	
54503-31600 54520-31600 54530-31600 54503-38A00 54503-25A00	<b>0403357</b>	SNODO SOSPENSIONE - INFERIORE SUSPENSION JOINT - LOWER		
54501-33000	<b>0783357</b>	BRACCIO OSCILLANTE - INFERIORE TRACK CONTROL ARM - LOWER		
54500-33000	<b>0793357</b>	BRACCIO OSCILLANTE - INFERIORE TRACK CONTROL ARM - LOWER		
54830-36000 54830-36100 54830-36101	<b>0504086</b>	STABILIZZATORE - ASSE ANTERIORE STABILIZER LINK - FRONT AXLE		
55130-34A00 55130-37000	<b>0402483</b>	SNODO SOSPENSIONE - ASSE POSTERIORE BALL JOINT - REAR AXLE		
55580-37020	<b>0501577</b>	STABILIZZATORE ASSE POSTERIORE STABILIZER LINK REAR		
Anno - Year <b>05/93 &gt; 08/98</b>		Serie - Series <b>Y-3</b>	Modello - Model <b>SONATA III - SONICA III</b>	
56820-22000 56820-28500 56820-28520	<b>0281290</b>	TESTA STERZO - RHT M14x1,5 TIE ROD END - RHT M14x1,5		
57716-34000 57724-3A000	<b>0601579</b>	SNODO ASSIALE - RHT M14x1/50 L= 320 mm AXIAL JOINT - RHT M14x1/50 L= 320 mm		
54503-34A01 54503-34A00	<b>0402482</b>	SNODO SOSPENSIONE ASSE ANTERIORE - INFERIORE SUSPENSION JOINT FRONT AXLE - LOWER		











RIF. ORIG O.E. NUMBER	RIF. OCAP REF. OCAP	NOTE REMARKS	DESTRO RIGHT	SINISTRO LEFT
Anno - Year <b>05/93 &gt; 08/98</b>		Serie - Series <b>Y-3</b>	Modello - Model <b>SONATA III - SONICA III</b>	
54501-34000 54501-34010	<b>0785159</b>	BRACCIO OSCILLANTE - ASSE ANTERIORE - INFERIORE TRACK CONTROL ARM - FRONT AXLE - LOWER		
54500-34000 54500-34010	<b>0795159</b>	BRACCIO OSCILLANTE - ASSE ANTERIORE - INFERIORE TRACK CONTROL ARM - FRONT AXLE - LOWER		
55250-34000 55250-34010 55250-37000 55250-37010	<b>0705160</b>	BRACCIO OSCILLANTE - ASSE ANTERIORE - SUPERIORE TRACK CONTROL ARM - FRONT AXLE - UPPER		
54830-34500 54830-34000 54830-36010 54850-36010	<b>0501576</b>	STABILIZZATORE - ASSE ANTERIORE STABILIZER LINK - FRONT AXLE		
55130-34A00 55130-37000	<b>0402483</b>	SNODO SOSPENSIONE - ASSE POSTERIORE - INFERIORE BALL JOINT - REAR AXLE - LOWER		
55201-37010 55201-37110 55201-34000	<b>0705161</b>	BRACCIO OSCILLANTE - ASSE POSTERIORE TRACK CONTROL ARM - REAR AXLE		
55580-37020	<b>0501577</b>	STABILIZZATORE ASSE POSTERIORE STABILIZER LINK REAR		
Anno - Year <b>03/98 &gt; 10/01 12/1998 &gt;</b>		Serie - Series <b>EF XG</b>	Modello - Model <b>SONATA IV XG (25 - 30)</b>	
56820-38900	<b>0282485</b>	TESTA STERZO - LHT M14x1,5 TIE ROD END - LHT M14x1,5		
56820-38000	<b>0292485</b>	TESTA STERZO - RHT M14x1,5 TIE ROD END - RHT M14x1,5		

RIF. ORIG O.E. NUMBER	RIF. OCAP REF. OCAP	NOTE REMARKS	DESTRO RIGHT	SINISTRO LEFT
Anno - Year <b>03/98 &gt; 10/01</b> 12/1998 >		Serie - Series <b>EF</b> <b>XG</b>	Modello - Model <b>SONATA IV</b> <b>XG (25 - 30)</b>	
57724-38000	<b>0602486</b>	SNODO ASSIALE - RHT M14x1,50 AXIAL JOINT - RHT M14x1,50		
54403-38A00	<b>0402484</b>	SNODO SOSPENSIONE - ASSE ANTERIORE - SUPERIORE BALL JOINT - FRONT AXLE - UPPER		
54420-38000	<b>0782484</b>	BRACCIO OSCILLANTE - ASSE ANTERIORE - SUPERIORE TRACK CONTROL ARM - FRONT AXLE - UPPER		
54410-38000	<b>0792484</b>	BRACCIO OSCILLANTE - ASSE ANTERIORE - SUPERIORE TRACK CONTROL ARM - FRONT AXLE - UPPER		
51760-38000	<b>0404087</b>	SNODO SOSPENSIONE - ASSE ANTERIORE - INFERIORE BALL JOINT - FRONT AXLE - LOWER		
54501-38000 54501-38010	<b>0784087</b>	BRACCIO OSCILLANTE - ASSE ANTERIORE - INFERIORE TRACK CONTROL ARM - FRONT AXLE - LOWER		
54500-38000 54500-38010	<b>0794087</b>	BRACCIO OSCILLANTE - ASSE ANTERIORE - INFERIORE TRACK CONTROL ARM - FRONT AXLE - LOWER		
54830-38100 54830-38110	<b>0502488</b>	STABILIZZATORE - ASSE ANTERIORE STABILIZER LINK - FRONT AXLE		
54503-31600 54520-31600 54530-31600 54503-38A00 54503-25A00	<b>0403357</b>	SNODO SOSPENSIONE - ASSE POSTERIORE - INFERIORE BALL JOINT - REAR AXLE - LOWER		









RIF. ORIG O.E. NUMBER	RIF. OCAP REF. OCAP	NOTE REMARKS	DESTRO RIGHT	SINISTRO LEFT
Anno - Year <b>03/98 &gt; 10/01</b> 12/1998 >		Serie - Series <b>EF</b> <b>XG</b>	Modello - Model <b>SONATA IV</b> <b>XG (25 - 30)</b>	
55210-38000	<b>0704096</b>	BRACCIO OSCILLANTE - ASSE POSTERIORE - INFERIORE TRACK CONTROL ARM - REAR AXLE - LOWER		
55120-38000	<b>0784097</b>	BRACCIO OSCILLANTE - ASSE POSTERIORE - SUPERIORE TRACK CONTROL ARM - REAR AXLE - UPPER		
55110-38000	<b>0794097</b>	BRACCIO OSCILLANTE - ASSE POSTERIORE - SUPERIORE TRACK CONTROL ARM - REAR AXLE - UPPER		
55530-38000 55530-38010	<b>0501578</b>	STABILIZZATORE - ASSE POSTERIORE - > 2000 STABILIZER LINK - REAR AXLE - > 2000		
55530-38600	<b>0502487</b>	STABILIZZATORE - ASSE POSTERIORE - 2000 > STABILIZER LINK - REAR AXLE - 2000 >		
Anno - Year <b>10/01 &gt; 05/05</b>		Serie - Series <b>EF</b>	Modello - Model <b>SONATA IV</b>	
56820-38900	<b>0282485</b>	TESTA STERZO - LHT M14x1,5 TIE ROD END - LHT M14x1,5		
56820-38000	<b>0292485</b>	TESTA STERZO - RHT M14x1,5 TIE ROD END - RHT M14x1,5		
57724-38010	<b>0602559</b>	SNODO ASSIALE - RHT M14x1,50 AXIAL JOINT - RHT M14x1,50		
54403-38A00	<b>0402484</b>	SNODO SOSPENSIONE - ASSE ANTERIORE - SUPERIORE BALL JOINT - FRONT AXLE - UPPER		

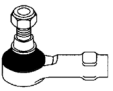
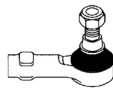
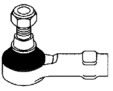
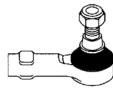



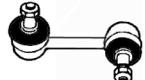

RIF. ORIG O.E. NUMBER	RIF. OCAP REF. OCAP	NOTE REMARKS	DESTRO RIGHT	SINISTRO LEFT
Anno - Year <b>10/01 &gt; 05/05</b>		Serie - Series <b>EF</b>	Modello - Model <b>SONATA IV</b>	
54420-38000	<b>0782484</b>	BRACCIO OSCILLANTE - ASSE ANTERIORE - SUPERIORE TRACK CONTROL ARM - FRONT AXLE - UPPER		
54410-38000	<b>0792484</b>	BRACCIO OSCILLANTE - ASSE ANTERIORE - SUPERIORE TRACK CONTROL ARM - FRONT AXLE - UPPER		
51760-38000	<b>0404087</b>	SNODO SOSPENSIONE - ASSE ANTERIORE - INFERIORE BALL JOINT - FRONT AXLE - LOWER		
54501-38011	<b>0784088</b>	BRACCIO OSCILLANTE - ASSE ANTERIORE - INFERIORE TRACK CONTROL ARM - FRONT AXLE - LOWER		
54500-38011	<b>0794088</b>	BRACCIO OSCILLANTE - ASSE ANTERIORE - INFERIORE TRACK CONTROL ARM - FRONT AXLE - LOWER		
54830-38100 54830-38110	<b>0502488</b>	STABILIZZATORE - ASSE ANTERIORE STABILIZER LINK - FRONT AXLE		
55530-38600	<b>0502487</b>	STABILIZZATORE - ASSE POSTERIORE STABILIZER LINK - REAR AXLE		
Anno - Year <b>01/2005 &gt;</b>		Serie - Series <b>NF</b>	Modello - Model <b>SONATA V</b>	
56820-3K010	<b>0284089</b>	TESTA STERZO - RHT M16x1,5 TIE ROD END - RHT M16x1,5		







RIF. ORIG O.E. NUMBER	RIF. OCAP REF. OCAP	NOTE REMARKS	DESTRO RIGHT	SINISTRO LEFT
Anno - Year <b>01/2005 &gt;</b>		Serie - Series <b>NF</b>	Modello - Model <b>SONATA V</b>	
56820-3K000	<b>0294089</b>	TESTA STERZO - RHT M16x1,5 TIE ROD END - RHT M16x1,5		
57724-3K000	<b>0604090</b>	SNODO ASSIALE - RHT M16x1,5 AXIAL JOINT - RHT M16x1,5		
54403-38A00	<b>0402484</b>	SNODO SOSPENSIONE - ASSE ANTERIORE - SUPERIORE - > 07/2006 BALL JOINT - FRONT AXLE - UPPER - > 07/2006		
54420-3K000	<b>0784091</b>	BRACCIO OSCILLANTE - ASSE ANTERIORE - SUPERIORE - > 07/2006 TRACK CONTROL ARM - FRONT AXLE - UPPER - > 07/2006		
54410-3K000	<b>0794091</b>	BRACCIO OSCILLANTE - ASSE ANTERIORE - SUPERIORE - > 07/2006 TRACK CONTROL ARM - FRONT AXLE - UPPER - > 07/2006		
54430-3F600	<b>0404092</b>	SNODO SOSPENSIONE - ASSE ANTERIORE - SUPERIORE - 08/2006 > BALL JOINT - FRONT AXLE - UPPER - 08/2006 >		
54420-3F600	<b>0784092</b>	BRACCIO OSCILLANTE - ASSE ANTERIORE - SUPERIORE - 08/2006 > TRACK CONTROL ARM - FRONT AXLE - UPPER - 08/2006 >		
54410-3F600	<b>0794092</b>	BRACCIO OSCILLANTE - ASSE ANTERIORE - SUPERIORE - 08/2006 > TRACK CONTROL ARM - FRONT AXLE - UPPER - 08/2006 >		
51760-3K000	<b>0404093</b>	SNODO SOSPENSIONE - ASSE ANTERIORE - INFERIORE BALL JOINT - FRONT AXLE - LOWER		



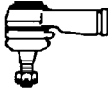
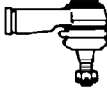

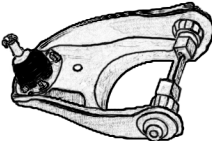
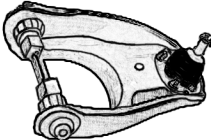

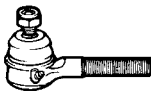

RIF. ORIG O.E. NUMBER	RIF. OCAP REF. OCAP	NOTE REMARKS	DESTRO RIGHT	SINISTRO LEFT
Anno - Year <b>01/2005 &gt;</b>		Serie - Series <b>NF</b>	Modello - Model <b>SONATA V</b>	
54501-3K000	<b>0784093</b>	BRACCIO OSCILLANTE - ASSE ANTERIORE - INFERIORE TRACK CONTROL ARM - FRONT AXLE - LOWER		
54500-3K000	<b>0794093</b>	BRACCIO OSCILLANTE - ASSE ANTERIORE - INFERIORE TRACK CONTROL ARM - FRONT AXLE - LOWER		
54830-3L000 54830-3K000 54830-3K010	<b>0504094</b>	STABILIZZATORE - ASSE ANTERIORE STABILIZER LINK - FRONT AXLE		
55530-3K001 55530-3K000	<b>0504095</b>	STABILIZZATORE - ASSE POSTERIORE STABILIZER LINK - REAR AXLE		
Anno - Year <b>06/2001 &gt;</b>		Serie - Series <b>HP</b>	Modello - Model <b>TERRACAN</b>	
56850-H1011	<b>0502813</b>	BARRA STERZO TIE ROD		
HB568120 MB166765 S2370706 SB000037	<b>0182813</b>	TESTA STERZO - RHT M16x1,5 TIE ROD END - RHT M16x1,5		
HB568110 MB166766 S2370704 SB000036	<b>0182814</b>	TESTA STERZO - RHT M16x1,5 INTERNA TIE ROD END - RHT M16x1,5 INNER		
54440-H1000	<b>0402815</b>	SNODO SOSPENSIONE - SUPERIORE SUSPENSION JOINT - UPPER		
54550-H1000 54550-H1010	<b>0402816</b>	SNODO SOSPENSIONE - INFERIORE SUSPENSION JOINT - LOWER		
54823-H1000	<b>0582817</b>	STABILIZZATORE - ASSE ANTERIORE STABILIZER LINK - FRONT AXLE		

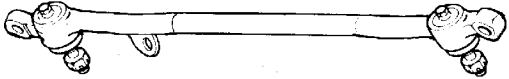
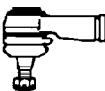
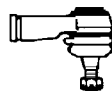

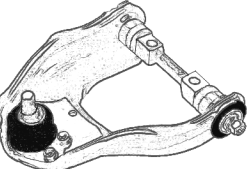
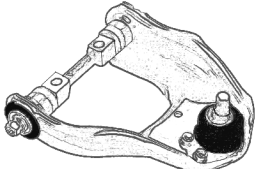







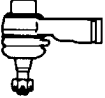
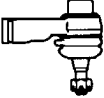

RIF. ORIG O.E. NUMBER	RIF. OCAP REF. OCAP	NOTE REMARKS	DESTRO RIGHT	SINISTRO LEFT
Anno - Year <b>06/2001 &gt;</b>		Serie - Series <b>HP</b>	Modello - Model <b>TERRACAN</b>	
54822-H1000	<b>0592817</b>	STABILIZZATORE - ASSE ANTERIORE STABILIZER LINK - FRONT AXLE		
Anno - Year <b>2000 &gt;</b>		Serie - Series <b>FO</b>	Modello - Model <b>TRAJET</b>	
56820-3B000	<b>0284461</b>	TESTA STERZO - RHT M14x1,5 RHD TIE ROD END - RHT M14x1,5 RHD		
57780-3B000	<b>0281580</b>	TESTA STERZO - RHT M14x1,5 LHD TIE ROD END - RHT M14x1,5 LHD		
57716-34000 57724-3A000	<b>0601579</b>	SNODO ASSIALE - RHT M14x1,50 L= 320 mm AXIAL JOINT - RHT M14x1,50 L= 320 mm		
54530-3B000 54503-3BA00 54530-2B000	<b>0404465</b>	SNODO SOSPENSIONE - ASSE ANTERIORE BALL JOINT - FRONT AXLE		
54502-3A100	<b>0782489</b>	BRACCIO OSCILLANTE INFERIORE TRACK CONTROL ARM LOWER		
54501-3A100	<b>0792489</b>	BRACCIO OSCILLANTE INFERIORE TRACK CONTROL ARM LOWER		
54840-3A000	<b>0581581</b>	STABILIZZATORE - ASSE ANTERIORE STABILIZER LINK - FRONT AXLE		
54830-3A000	<b>0591581</b>	STABILIZZATORE - ASSE ANTERIORE STABILIZER LINK - FRONT AXLE		
Anno - Year <b>08/2004 &gt;</b>		Serie - Series <b>JM</b>	Modello - Model <b>TUCSON</b>	
56820-2E900	<b>0282496</b>	TESTA STERZO - RHT M16x1,5 TIE ROD END - RHT M16x1,5		

RIF. ORIG O.E. NUMBER	RIF. OCAP REF. OCAP	NOTE REMARKS	DESTRO RIGHT	SINISTRO LEFT
Anno - Year <b>08/2004 &gt;</b>		Serie - Series <b>JM</b>	Modello - Model <b>TUCSON</b>	
56820-2E000	<b>0292496</b>	TESTA STERZO - RHT M16x1,5 TIE ROD END - RHT M16x1,5		
57724-2E000	<b>0602497</b>	SNODO ASSIALE - RHT M16x1,50 AXIAL JOINT - RHT M16x1,50		
51760-2E000	<b>0402498</b>	SNODO SOSPENSIONE - ASSE ANTERIORE - INFERIORE BALL JOINT - FRONT AXLE - LOWER		
54501-1F100 54501 2E000 54501 2E001	<b>0782498</b>	BRACCIO OSCILLANTE - ASSE ANTERIORE - INFERIORE TRACK CONTROL ARM - FRONT AXLE - LOWER		
54500-1F000 54500 2E000 54500 2E001	<b>0792498</b>	BRACCIO OSCILLANTE - ASSE ANTERIORE - INFERIORE TRACK CONTROL ARM - FRONT AXLE - LOWER		
54830-2E000 54830-1F000	<b>0502499</b>	STABILIZZATORE - ASSE ANTERIORE STABILIZER LINK - FRONT AXLE		
55530-2E000 55530-1F000	<b>0502525</b>	STABILIZZATORE - ASSE POSTERIORE STABILIZER LINK - REAR AXLE		

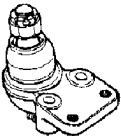
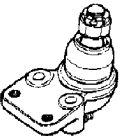
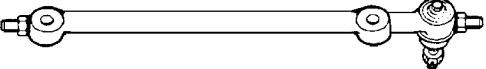
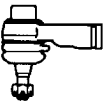
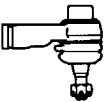
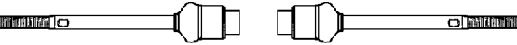
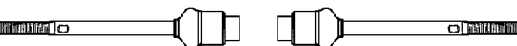



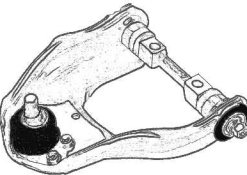
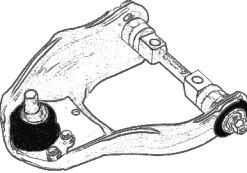
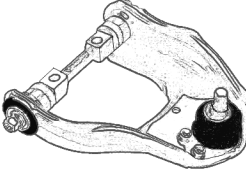
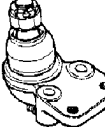
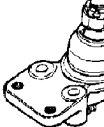
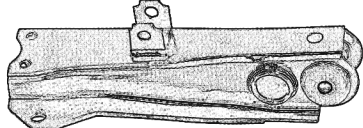
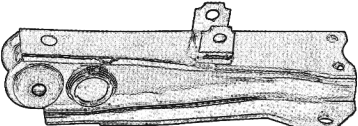

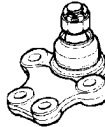

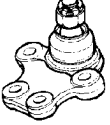

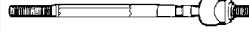
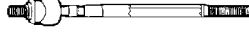

RIF. ORIG O.E. NUMBER	RIF. OCAP REF. OCAP	NOTE REMARKS	DESTRO RIGHT	SINISTRO LEFT
Anno - Year <b>02/89 &gt; 10/94</b> <b>04/77 &gt; 12/91</b> <b>08/91 &gt; 07/98</b> <b>04/00 &gt;</b>		Serie - Series - <b>KB</b> <b>UB</b> -	Modello - Model <b>AMIGO</b> <b>CAMPO</b> <b>TROOPER</b> <b>TROOPER</b>	
8-94419-408-0 8-94459-480-0	<b>0280456</b>	TESTA STERZO TIE ROD END		
8-94419-409-0 8-94459-481-0	<b>0290456</b>	TESTA STERZO TIE ROD END		
8-94459-453-4 8-94459-453-3 8-94459-453-2 8-97940-625-0	<b>0400420</b>	SNODO SOSPENSIONE SUPERIORE SOLO MODELLO CAMPO SUSPENSION JOINT UPPER ONLY MODEL CAMPO		
8-94445-550-1	<b>0783376</b>	BRACCIO OSCILLANTE SUPERIORE SOLO MODELLO CAMPO 2.2 D 4WD TRACK CONTROL ARM UPPER ONLY MODEL CAMPO 2.2 D 4WD		
8-94445-551-0	<b>0793376</b>	BRACCIO OSCILLANTE SUPERIORE SOLO MODELLO CAMPO 2.2 D 4WD TRACK CONTROL ARM UPPER ONLY MODEL CAMPO 2.2 D 4WD		
8-94374-424-0	<b>0402956</b>	SNODO SOSPENSIONE SUPERIORE SOLO MODELLI TROOPER SUSPENSION JOINT UPPER ONLY MODELS TROOPER		
Anno - Year <b>1973 &gt;</b> <b>1961 &gt;</b>		Serie - Series <b>BL-BE</b>	Modello - Model <b>BUS</b> <b>ELF - ELF ROUTE VAN</b>	
9-43150-605-0 9-43150-610-0	<b>0180425</b>	TESTA STERZO - RHT M18x1,5 TIE ROD END - RHT M18x1,5		
9-43150-606-0 9-43150-613-0	<b>0190425</b>	TESTA STERZO - LHT M18x1,5 TIE ROD END - LHT M18x1,5		

RIF. ORIG O.E. NUMBER	RIF. OCAP REF. OCAP	NOTE REMARKS	DESTRO RIGHT	SINISTRO LEFT
Anno - Year <b>1988 &gt;</b> <b>1988 &gt;</b> <b>1984 &gt;1991</b>		Serie - Series <b>TFR</b> <b>TFS</b> <b>UBS</b>	Modello - Model <b>FASTER</b> <b>FASTER 4WD</b> <b>BIGHORN - TROOPER</b>	
8-94389-210-0	<b>0500458</b>	BARRA STERZO CENTRALE CENTER LINK		
8-94419-408-0 8-94459-480-0	<b>0280456</b>	TESTA STERZO TIE ROD END		
8-94419-409-0 8-94459-481-0	<b>0290456</b>	TESTA STERZO TIE ROD END		
8-94459-453-4 8-94459-453-3 8-94459-453-2 8-97940-625-0	<b>0400420</b>	SNODO SOSPENSIONE SUPERIORE SERIE TFR-TFS SUSPENSION JOINT UPPER SERIES TFR-TFS		
8-94323-562-1	<b>0780420</b>	BRACCIO OSCILLANTE SUPERIORE SERIE TFS TRACK CONTROL ARM UPPER SERIES TFS		
8-94323-563-1	<b>0790420</b>	BRACCIO OSCILLANTE SUPERIORE SERIE TFS TRACK CONTROL ARM UPPER SERIES TFS		
8-94224-550-3 8-94243-234-0 9-94224-550-4	<b>0403012</b>	SNODO SOSPENSIONE SUPERIORE SERIE UBS SUSPENSION JOINT - UPPER SERIES UBS		
8-94459-464-0 8-94459-464-1 8-94459-464-2 94459464	<b>0400422</b>	SNODO SOSPENSIONE INFERIORE SERIE TFR SUSPENSION JOINT - LOWER SERIES TFR		
8-94246-419-0 8-94459-460-2	<b>0783377</b>	BRACCIO OSCILLANTE - INFERIORE SERIE TFR TRACK CONTROL ARM - LOWER SERIES TFR		
8-94246-420-0 8-94459-461-2	<b>0793377</b>	BRACCIO OSCILLANTE - INFERIORE SERIE TFR TRACK CONTROL ARM - LOWER SERIES TFR		









RIF. ORIG O.E. NUMBER	RIF. OCAP REF. OCAP	NOTE REMARKS	DESTRO RIGHT	SINISTRO LEFT
Anno - Year <b>1988 &gt;</b> <b>1988 &gt;</b> <b>1984 &gt;1991</b>		Serie - Series <b>TFR</b> <b>TFS</b> <b>UBS</b>	Modello - Model <b>FASTER</b> <b>FASTER 4WD</b> <b>BIGHORN - TROOPER</b>	
8-94452-102-0 8-94452-102-1 8-94459-465-2	<b>0403373</b>	SNODO SOSPENSIONE INFERIORE - SERIE UBS-TFS SUSPENSION JOINT - SERIES UBS-TFS		
Anno - Year <b>1983 &gt;</b>		Serie - Series <b>UFR</b>	Modello - Model <b>PANEL TRUCK</b>	
8-94237-351-1 5-44352-026-0 94224701 94237351	<b>0280455</b>	TESTA STERZO TIE ROD END		
8-94217-221-3 94217221	<b>0600424</b>	SNODO ASSIALE AXIAL JOINT		
8-94224-550-3 8-94243-234-0 9-94224-550-4	<b>0403012</b>	SNODO SOSPENSIONE - SUPERIORE SUSPENSION JOINT - UPPER		
8-94246-475-1 8-94224-552-2 94224552 94246475	<b>0403013</b>	SNODO SOSPENSIONE - INFERIORE SUSPENSION JOINT - LOWER		
Anno - Year <b>1981 &gt; 1988</b> <b>1979 &gt; 1988</b> <b>1981 &gt; 1986</b>		Serie - Series <b>KB21-KB22-KB26-KB27</b> <b>KB41-KB42-KB46-KB47</b> <b>UBS</b>	Modello - Model <b>PICK-UP FASTER - LUV</b> <b>PICK-UP FASTER 4WD - LUV 4WD</b> <b>BIGHORN - TROOPER</b>	
8-94237-366-1	<b>0500426</b>	BARRA STERZO CENTRALE CENTER LINK		
8-94237-351-1 5-44352-026-0 94224701 94237351	<b>0280455</b>	TESTA STERZO - ESTERNA - RHT M14x1.5 TIE ROD END - OUTER - RHT M14x1.5		
5-44350-095-3 5-44350-095-0 5-44350-095-1 5-44350-095-2	<b>0603371</b>	SNODO ASSIALE - RHT M14x1.5 MOD. FASTER 4WD- LUV 1.6 BIGHORN-TROOPER AXIAL JOINT - RHT M14x1.5 MOD. FASTER 4WD- LUV 1.6 BIGHORN-TROOPER		
8-94217-221-3 94217221	<b>0600424</b>	SNODO ASSIALE - RHT M14x1.5 - MOD. FASTER AXIAL JOINT - RHT M14x1.5- MOD. FASTER		



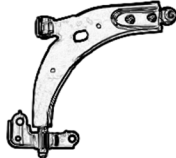
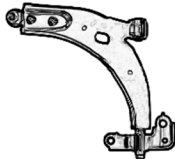







RIF. ORIG O.E. NUMBER	RIF. OCAP REF. OCAP	NOTE REMARKS	DESTRO RIGHT	SINISTRO LEFT
Anno - Year 1981 > 1988 1979 > 1988 1981 > 1986		Serie - Series KB21-KB22-KB26-KB27 KB41-KB42-KB46-KB47 UBS	Modello - Model PICK-UP FASTER - LUV PICK-UP FASTER 4WD - LUV 4WD BIGHORN - TROOPER	
8-94224-550-3 8-94243-234-0 9-94224-550-4	<b>0403012</b>	SNODO SOSPENSIONE SUPERIORE 1981 > SUSPENSION JOINT UPPER 1981 >		
8-94226-936-1	<b>0703012</b>	BRACCIO OSCILLANTE SUPERIORE MOD. FASTER TRACK CONTROL ARM UPPER MOD. FASTER		
8-94243-232-0	<b>0783012</b>	BRACCIO OSCILLANTE SUPERIORE MOD. FASTER 4WD TRACK CONTROL ARM UPPER MOD. FASTER 4WD		
8-94243-233-0	<b>0793012</b>	BRACCIO OSCILLANTE SUPERIORE MOD. FASTER 4WD TRACK CONTROL ARM UPPER MOD. FASTER 4WD		
8-94246-475-1 8-94224-552-2 94224552 94246475	<b>0403013</b>	SNODO SOSPENSIONE - INFERIORE MOD. FASTER SUSPENSION JOINT - LOWER MOD. FASTER		
8-94223-221-2	<b>0783013</b>	BRACCIO OSCILLANTE - INFERIORE MOD. FASTER TRACK CONTROL ARM - LOWER MOD. FASTER		
8-94223-222-2	<b>0793013</b>	BRACCIO OSCILLANTE - INFERIORE MOD. FASTER TRACK CONTROL ARM - LOWER MOD. FASTER		
5-51227-033-0	<b>0403372</b>	SNODO SOSPENSIONE - INFERIORE MOD. FASTER 4WD-BIGHORN-TROOPER SUSPENSION JOINT - LOWER MOD. FASTER 4WD-BIGHORN-TROOPER		







RIF. ORIG O.E. NUMBER	RIF. OCAP REF. OCAP	NOTE REMARKS	DESTRO RIGHT	SINISTRO LEFT
Anno - Year <b>1981 &gt; 1988</b> <b>1979 &gt; 1988</b> <b>1981 &gt; 1986</b>		Serie - Series <b>KB21-KB22-KB26-KB27</b> <b>KB41-KB42-KB46-KB47</b> <b>UBS</b>	Modello - Model <b>PICK-UP FASTER - LUV</b> <b>PICK-UP FASTER 4WD - LUV 4WD</b> <b>BIGHORN - TROOPER</b>	
8-94452-106-1	<b>0403375</b>	SNODO SOSPENSIONE - INFERIORE MOD. FASTER 4WD - 1986 > SUSPENSION JOINT - LOWER MOD. FASTER 4WD - 1986 >		



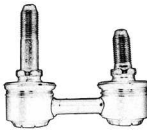
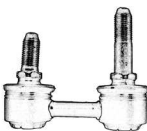

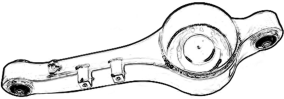
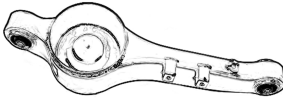



RIF. ORIG O.E. NUMBER	RIF. OCAP REF. OCAP	NOTE REMARKS	DESTRO RIGHT	SINISTRO LEFT
Anno - Year <b>1996 &gt;</b>		Serie - Series	Modello - Model <b>BESTA</b>	
S083-99-324	<b>0280337</b>	TESTA STERZO ESTERNA RHT M14x1.5 TIE ROD END OUTER RHT M14x1.5		
S083-32-115	<b>0600338</b>	SNODO ASSIALE RHT M14x1.5 AXIAL JOINT RHT M14x1.5		
S083-99-354	<b>0400339</b>	SNODO SOSPENSIONE - ASSE ANTERIORE - SUPERIORE BALL JOINT - FRONT AXLE - UPPER		
0SE46-34-250 SE46-34-250	<b>0780339</b>	BRACCIO OSCILLANTE - ASSE ANTERIORE - SUPERIORE TRACK CONTROL ARM - FRONT AXLE - UPPER		
0SE46-34-200 SE46-34-200	<b>0790339</b>	BRACCIO OSCILLANTE - ASSE ANTERIORE - SUPERIORE TRACK CONTROL ARM - FRONT AXLE - UPPER		
S083-99-356	<b>0400340</b>	SNODO SOSPENSIONE - ASSE ANTERIORE - INFERIORE BALL JOINT - FRONT AXLE - LOWER		
0KX43-34-300 KX43-34-300	<b>0780340</b>	BRACCIO OSCILLANTE - ASSE ANTERIORE - INFERIORE TRACK CONTROL ARM - FRONT AXLE - LOWER		
0KX43-34-350 KX43-34-350	<b>0790340</b>	BRACCIO OSCILLANTE - ASSE ANTERIORE - INFERIORE TRACK CONTROL ARM - FRONT AXLE - LOWER		
Anno - Year <b>11/00 &gt; 07/02</b> <b>07/02 &gt; 09/06</b>		Serie - Series <b>FC</b> <b>FJ</b>	Modello - Model <b>CARENS I</b> <b>CARENS II</b>	
0K201-32-280 0K9A2-32-280	<b>0281973</b>	TESTA STERZO - RHT M14x1,5 TIE ROD END - RHT M14x1,5		

















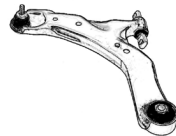
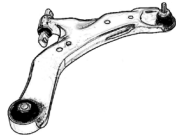

RIF. ORIG O.E. NUMBER	RIF. OCAP REF. OCAP	NOTE REMARKS	DESTRO RIGHT	SINISTRO LEFT
Anno - Year <b>11/00 &gt; 07/02</b> <b>07/02 &gt; 09/06</b>		Serie - Series <b>FC</b> <b>FJ</b>	Modello - Model <b>CARENS I</b> <b>CARENS II</b>	
0K2A1-32-240	<b>0681975</b>	SNODO ASSIALE - RHT M14x1,5 AXIAL JOINT - RHT M14x1,5		
0K2A2-32-240	<b>0691975</b>	SNODO ASSIALE - RHT M14x1,5 AXIAL JOINT - RHT M14x1,5		
0K2A1-34-550A	<b>0402549</b>	SNODO SOSPENSIONE INFERIORE SUSPENSIONE JOINT LOWER		
0K2FA-34-300	<b>0782549</b>	BRACCIO OSCILLANTE ASSE ANTERIORE INFERIORE TRACK CONTROL ARM FRONT AXLE LOWER		
0K2FA-34-350	<b>0792549</b>	BRACCIO OSCILLANTE ASSE ANTERIORE INFERIORE TRACK CONTROL ARM FRONT AXLE LOWER		
0K2FA-34150	<b>0584098</b>	STABILIZZATORE - ASSE ANTERIORE STABILIZER LINK - FRONT AXLE		
0K2FA-34170	<b>0594098</b>	STABILIZZATORE - ASSE ANTERIORE STABILIZER LINK - FRONT AXLE		
0K2A1-34-150A 0K2A1-34-150B	<b>0501583</b>	STABILIZZATORE - POSTERIORE STABILIZER LINK - REAR		
Anno - Year <b>09/2006 &gt;</b>		Serie - Series <b>UN</b>	Modello - Model <b>CARENS III</b>	
56820-2G900	<b>0284107</b>	TESTA STERZO - RHT M16x1,5 TIE ROD END - RHT M16x1,5		
56820-2G000	<b>0294107</b>	TESTA STERZO - RHT M16x1,5 TIE ROD END - RHT M16x1,5		







RIF. ORIG O.E. NUMBER	RIF. OCAP REF. OCAP	NOTE REMARKS	DESTRO RIGHT	SINISTRO LEFT
Anno - Year <b>09/2006 &gt;</b>		Serie - Series <b>UN</b>	Modello - Model <b>CARENS III</b>	
57724-2G000	<b>0604108</b>	SNODO ASSIALE - RHT M16x1,5 AXIAL JOINT - RHT M16x1,5		
51760-2G000	<b>0404071</b>	SNODO SOSPENSIONE - ASSE ANTERIORE - INFERIORE BALL JOINT - FRONT AXLE - LOWER		
54501-1D000	<b>0784109</b>	BRACCIO OSCILLANTE - ASSE ANTERIORE - INFERIORE TRACK CONTROL ARM - FRONT AXLE - LOWER		
54500-1D000	<b>0794109</b>	BRACCIO OSCILLANTE - ASSE ANTERIORE - INFERIORE TRACK CONTROL ARM - FRONT AXLE - LOWER		
54830-2G000	<b>0504110</b>	STABILIZZATORE - ASSE ANTERIORE STABILIZER LINK - FRONT AXLE		
55530-1D000	<b>0504111</b>	STABILIZZATORE - ASSE POSTERIORE STABILIZER LINK - REAR AXLE		
Anno - Year <b>08/99 &gt; 10/01</b> <b>10/2001 &gt;</b>		Serie - Series <b>UP</b> <b>GQ</b>	Modello - Model <b>CARNIVAL I</b> <b>CARNIVAL II</b>	
0K552-32-280	<b>0281977</b>	TESTA STERZO - RHT M14x1,5 TIE ROD END - RHT M14x1,5		
0K552-32-240	<b>0291977</b>	TESTA STERZO - RHT M14x1,5 TIE ROD END - RHT M14x1,5		
0K552-32-250	<b>0681990</b>	SNODO ASSIALE - RHT M14x1,5 AXIAL JOINT - RHT M14x1,5		
0K552-32-270	<b>0691991</b>	SNODO ASSIALE - RHT M14x1,5 AXIAL JOINT - RHT M14x1,5		













RIF. ORIG O.E. NUMBER	RIF. OCAP REF. OCAP	NOTE REMARKS	DESTRO RIGHT	SINISTRO LEFT
Anno - Year <b>08/99 &gt; 10/01</b> <b>10/2001 &gt;</b>		Serie - Series <b>UP</b> <b>GQ</b>	Modello - Model <b>CARNIVAL I</b> <b>CARNIVAL II</b>	
0K552-34-160B 0K552-34-150B 0K552-34-151B	<b>0501976</b>	STABILIZZATORE STABILIZER LINK		
0K552-34-300A 0K552-34-300B 0K552-34-300C	<b>0382551</b>	BRACCIO OSCILLANTE ANTERIORE - INFERIORE TRACK CONTROL ARM FRONT - LOWER		
0K552-34-350A 0K552-34-350B	<b>0392551</b>	BRACCIO OSCILLANTE ANTERIORE - LOWER TRACK CONTROL ARM FRONT - LOWER		
0K552-28-300B 0K552-28-300C	<b>0382791</b>	BRACCIO OSCILLANTE POSTERIORE TRACK CONTROL ARM REAR		
0K552-28-350B 0K552-28-350C	<b>0392791</b>	BRACCIO OSCILLANTE POSTERIORE TRACK CONTROL ARM REAR		
Anno - Year <b>04/2006 &gt;</b>		Serie - Series <b>VQ</b>	Modello - Model <b>CARNIVAL III</b>	
56820-4D100	<b>0284099</b>	TESTA STERZO - RHT M16x1,5 TIE ROD END - RHT M16x1,5		
56820-4D000	<b>0294099</b>	TESTA STERZO - RHT M16x1,5 TIE ROD END - RHT M16x1,5		
57724-4D000	<b>0604566</b>	SNODO ASSIALE - RHT M16x1,5 AXIAL JOINT - RHT M16x1,5		
54530-4D000	<b>0404567</b>	SNODO SOSPENSIONE - ASSE ANTERIORE - INFERIORE BALL JOINT - FRONT AXLE - LOWER		

RIF. ORIG O.E. NUMBER	RIF. OCAP REF. OCAP	NOTE REMARKS	DESTRO RIGHT	SINISTRO LEFT
Anno - Year <b>04/2006 &gt;</b>		Serie - Series <b>VQ</b>	Modello - Model <b>CARNIVAL III</b>	
54501-4D001	<b>0784567</b>	BRACCIO OSCILLANTE - ASSE ANTERIORE - INFERIORE TRACK CONTROL ARM - FRONT AXLE - LOWER		
54500-4D001	<b>0794567</b>	BRACCIO OSCILLANTE - ASSE ANTERIORE - INFERIORE TRACK CONTROL ARM - FRONT AXLE - LOWER		
54840-4D000	<b>0584568</b>	STABILIZZATORE - ASSE ANTERIORE STABILIZER LINK - FRONT AXLE		
54830-4D000	<b>0594568</b>	STABILIZZATORE - ASSE ANTERIORE STABILIZER LINK - FRONT AXLE		
55530-4D000	<b>0504569</b>	STABILIZZATORE - ASSE POSTERIORE STABILIZER LINK - REAR AXLE		
Anno - Year <b>12/2006 &gt;</b> <b>02/2008 &gt;</b>		Serie - Series <b>ED</b> <b>ED</b>	Modello - Model <b>CEE'D</b> <b>PRO CEE'D</b>	
56820-2H090	<b>0284069</b>	TESTA STERZO - RHT M14x1,5 TIE ROD END - RHT M14x1,5		
56820-2H000	<b>0294069</b>	TESTA STERZO - RHT M14x1,5 TIE ROD END - RHT M14x1,5		
56540-2H000	<b>0604070</b>	SNODO ASSIALE - RHT M14x1,5 AXIAL JOINT - RHT M14x1,5		
51760-2G000	<b>0404071</b>	SNODO SOSPENSIONE - ASSE ANTERIORE - INFERIORE BALL JOINT - FRONT AXLE - LOWER		

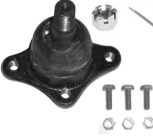









RIF. ORIG O.E. NUMBER	RIF. OCAP REF. OCAP	NOTE REMARKS	DESTRO RIGHT	SINISTRO LEFT
Anno - Year <b>12/2006 &gt;</b> <b>02/2008 &gt;</b>		Serie - Series <b>ED</b> <b>ED</b>	Modello - Model <b>CEE'D</b> <b>PRO CEE'D</b>	
54501-2H000	<b>0784071</b>	BRACCIO OSCILLANTE - ASSE ANTERIORE - INFERIORE TRACK CONTROL ARM - FRONT AXLE - LOWER		
54500-2H000	<b>0794071</b>	BRACCIO OSCILLANTE - ASSE ANTERIORE - INFERIORE TRACK CONTROL ARM - FRONT AXLE - LOWER		
54830-2H000	<b>0504072</b>	STABILIZZATORE - ASSE ANTERIORE STABILIZER LINK - FRONT AXLE		
55530-1H000	<b>0504074</b>	STABILIZZATORE - ASSE POSTERIORE STABILIZER LINK - REAR AXLE		
Anno - Year <b>04/2004 &gt;</b> <b>07/2004 &gt;</b>		Serie - Series <b>Saloon</b>	Modello - Model <b>CERATO</b>	
56820-22000 56820-25000 56820-37000 35820-37010	<b>0281290</b>	TESTA STERZO - RHT M14x1,5 TIE ROD END - RHT M14x1,5		
57724-2D000	<b>0601566</b>	SNODO ASSIALE - RHT M14x1,5 AXIAL JOINT - RHT M14x1,5		
54503-22A00 54503-25A00 54503-31600	<b>0401295</b>	SNODO SOSPENSIONE - INFERIORE BALL JOINT - LOWER		
54501-2F000 54501-2F001	<b>0782790</b>	BRACCIO OSCILLANTE TRACK CONTROL ARM		
54500-2F000 54500-2F001	<b>0792790</b>	BRACCIO OSCILLANTE TRACK CONTROL ARM		















RIF. ORIG O.E. NUMBER	RIF. OCAP REF. OCAP	NOTE REMARKS	DESTRO RIGHT	SINISTRO LEFT
Anno - Year <b>04/2004 &gt;</b> <b>07/2004 &gt;</b>		Serie - Series <b>Saloon</b>	Modello - Model <b>CERATO</b>	
54840-2F000	<b>0582553</b>	STABILIZZATORE - ASSE ANTERIORE STABILIZER LINK - FRONT AXLE		
54830-2F000	<b>0592553</b>	STABILIZZATORE - ASSE ANTERIORE STABILIZER LINK - FRONT AXLE		
55530-17000	<b>0504080</b>	STABILIZZATORE - ASSE POSTERIORE STABILIZER LINK - REAR AXLE		
Anno - Year <b>1983 &gt;</b>		Serie - Series <b>K670-K672-K675-K676-K677-K678-K862-K863-KW26-KW28</b>	Modello - Model <b>CERES</b>	
0K670-32-510	<b>0182930</b>	TESTA STERZO - RHT M18x1,5 TIE ROD END - RHT M18x1,5		
0K670-32-450	<b>0192930</b>	TESTA STERZO - RHT M18x1,5 TIE ROD END - RHT M18x1,5		
Anno - Year <b>07/1996 &gt;</b> <b>05/1998 &gt;</b>		Serie - Series <b>K9A GC</b>	Modello - Model <b>CLARUS CLARUS SW</b>	
0K201-32-280 0K9A2-32-280	<b>0281973</b>	TESTA STERZO - RHT M14x1,5 TIE ROD END - RHT M14x1,5		
0K9A2-32-240	<b>0601971</b>	SNODO ASSIALE - RHT M14x1,5 AXIAL JOINT - RHT M14x1,5		
0G030-34-550B	<b>0400349</b>	SNODO SOSPENSIONE - ASSE ANTERIORE - INFERIORE BALL JOINT - FRONT AXLE - LOWER		
0K9A2-34-300	<b>0784571</b>	BRACCIO OSCILLANTE - ASSE ANTERIORE - INFERIORE - > 04/1998 TRACK CONTROL ARM - FRONT AXLE - LOWER - > 04/1998		







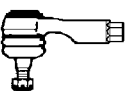
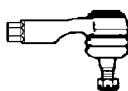



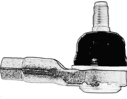



RIF. ORIG O.E. NUMBER	RIF. OCAP REF. OCAP	NOTE REMARKS	DESTRO RIGHT	SINISTRO LEFT
Anno - Year <b>07/1996 &gt;</b> <b>05/1998 &gt;</b>		Serie - Series <b>K9A</b> <b>GC</b>	Modello - Model <b>CLARUS</b> <b>CLARUS SW</b>	
OK9A2-34-350	<b>0794571</b>	BRACCIO OSCILLANTE - ASSE ANTERIORE - INFERIORE - > 04/1998 TRACK CONTROL ARM - FRONT AXLE - LOWER - > 04/1998		
OK9A6-34-300	<b>0784572</b>	BRACCIO OSCILLANTE - ASSE ANTERIORE - INFERIORE - 05/1998 > TRACK CONTROL ARM - FRONT AXLE - LOWER - 05/1998 >		
OK9A6-34-350	<b>0794572</b>	BRACCIO OSCILLANTE - ASSE ANTERIORE - INFERIORE - 05/1998 > TRACK CONTROL ARM - FRONT AXLE - LOWER - 05/1998 >		
KGA2A-34-150	<b>0581970</b>	STABILIZZATORE - ASSE ANTERIORE STABILIZER LINK - FRONT AXLE		
KGA2A-34-170	<b>0591970</b>	STABILIZZATORE - ASSE ANTERIORE STABILIZER LINK - FRONT AXLE		
OK0A3-28-170A K9A3-28-170A	<b>0501582</b>	STABILIZZATORE - ASSE POSTERIORE STABILIZER LINK - REAR AXLE		
Anno - Year <b>01/2003 &gt;</b> <b>10/1997 &gt;</b>		Serie - Series <b>SD</b> <b>SD</b>	Modello - Model <b>K2500</b> <b>K2700</b>	
OK710-32-240	<b>0284573</b>	TESTA STERZO - RHT M14x1,5 TIE ROD END - RHT M14x1,5		
OK72A-32-270	<b>0604574</b>	SNODO ASSIALE - RHT M14x1,5 AXIAL JOINT - RHT M14x1,5		
OK60A-32-270	<b>0604575</b>	SNODO ASSIALE - RHT M14x1,5 - SERVOSTERZO AXIAL JOINT - RHT M14x1,5 - POWER STEERING		









RIF. ORIG O.E. NUMBER	RIF. OCAP REF. OCAP	NOTE REMARKS	DESTRO RIGHT	SINISTRO LEFT
Anno - Year <b>01/2003 &gt;</b> <b>10/1997 &gt;</b>		Serie - Series <b>SD</b> <b>SD</b>	Modello - Model <b>K2500</b> <b>K2700</b>	
0K72A-34-510A	<b>0404580</b>	SNODO SOSPENSIONE - ASSE ANTERIORE - INFERIORE BALL JOINT - FRONT AXLE - LOWER		
0K710-34-540	<b>0404576</b>	SNODO SOSPENSIONE - ASSE ANTERIORE - SUPERIORE BALL JOINT - FRONT AXLE - UPPER		
0SE46-34-250 0SE46-34-250A	<b>0784576</b>	BRACCIO OSCILLANTE - ASSE ANTERIORE - SUPERIORE TRACK CONTROL ARM - FRONT AXLE - UPPER		
0SE46-34-200 0SE46-34-200A	<b>0794576</b>	BRACCIO OSCILLANTE - ASSE ANTERIORE - SUPERIORE TRACK CONTROL ARM - FRONT AXLE - UPPER		
0K710-34-510	<b>0404577</b>	SNODO SOSPENSIONE - ASSE ANTERIORE - INFERIORE BALL JOINT - FRONT AXLE - LOWER		
Anno - Year <b>05/2001 &gt;</b> <b>09/2003 &gt;</b>		Serie - Series <b>GD</b>	Modello - Model <b>MAGENTIS</b> <b>OPIRUS</b>	
56820-38900	<b>0282485</b>	TESTA STERZO - LHT 14x1,5 TIE ROD END - LHT M14x1,5		
56820-38000	<b>0292485</b>	TESTA STERZO - RHT M14x1,5 TIE ROD END - RHT M14x1,5		
57724-38010	<b>0602559</b>	SNODO ASSIALE - RHT M14x1,50 AXIAL JOINT - RHT M14x1,50		
54420-38000	<b>0782484</b>	BRACCIO OSCILLANTE SUPERIORE TRACK CONTROL ARM UPPER		









RIF. ORIG O.E. NUMBER	RIF. OCAP REF. OCAP	NOTE REMARKS	DESTRO RIGHT	SINISTRO LEFT
Anno - Year <b>05/2001 &gt;</b> <b>09/2003 &gt;</b>		Serie - Series <b>GD</b>	Modello - Model <b>MAGENTIS OPIRUS</b>	
54410-38000	<b>0792484</b>	BRACCIO OSCILLANTE SUPERIORE TRACK CONTROL ARM UPPER		
54830-38100 54830-38110	<b>0502488</b>	STABILIZZATORE - ASSE ANTERIORE STABILIZER LINK - FRONT AXLE		
55530-38600	<b>0502487</b>	STABILIZZATORE ASSE POSTERIORE STABILIZER LINK REAR		
Anno - Year <b>04/2004 &gt;</b>		Serie - Series	Modello - Model <b>PICANTO</b>	
MDX50-32-280 56820-07000 F4BZ-3A130-A K9992-11-201	<b>0281584</b>	TESTA STERZO - RHT M12x1,25 TIE ROD END - RHT M12x1,25		
57724-07000 57724-07001 57724-07100	<b>0602792</b>	SNODO ASSIALE - RHT M12x1,25 - SERVOSTERZO AXIAL JOINT - RHT M12x1,25 - POWER STEERING		
57724-07100	<b>0604578</b>	SNODO ASSIALE - RHT M12x1,25 - STERZO MANUALE AXIAL JOINT - RHT M12x1,25 - MANUAL STEERING		
54530-07000	<b>0402793</b>	SNODO SOSPENSIONE INFERIORE SUSPENSION JOINT LOWER		
54501-07100	<b>0782793</b>	BRACCIO OSCILLANTE INFERIORE TRACK CONTROL ARM LOWER		
54500-07100	<b>0792793</b>	BRACCIO OSCILLANTE INFERIORE TRACK CONTROL ARM LOWER		
54840-07000	<b>0582794</b>	STABILIZZATORE - ASSE ANTERIORE STABILIZER LINK - FRONT AXLE		





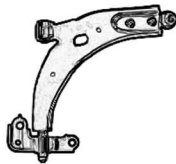
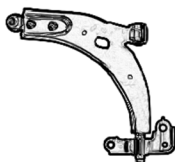
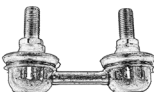
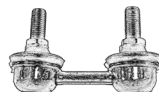
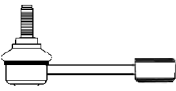
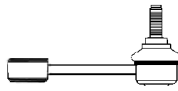



RIF. ORIG O.E. NUMBER	RIF. OCAP REF. OCAP	NOTE REMARKS	DESTRO RIGHT	SINISTRO LEFT
Anno - Year <b>04/2004 &gt;</b>		Serie - Series	Modello - Model <b>PICANTO</b>	
54830-07000	<b>0592794</b>	STABILIZZATORE - ASSE ANTERIORE STABILIZER LINK - FRONT AXLE		
Anno - Year <b>08/95 &gt; 01/05</b>		Serie - Series	Modello - Model <b>PREGIO</b>	
0K72A-32-240	<b>0284579</b>	TESTA STERZO - RHT M14x1,5 TIE ROD END - RHT M14x1,5		
0K72A-32-270	<b>0604574</b>	TESTA STERZO - RHT M14x1,5 TIE ROD END - RHT M14x1,5		
0K72A-34-200A 0K72A-34-200	<b>0304584</b>	BRACCIO OSCILLANTE - ASSE ANTERIORE - SUPERIORE - > 04/2004 TRACK CONTROL ARM - FRONT AXLE - UPPER - > 04/2004		
0K72A-34-510A	<b>0404580</b>	SNODO SOSPENSIONE - ASSE ANTERIORE - INFERIORE BALL JOINT - FRONT AXLE - LOWER		
0K72A-34-300A 0K72A-34-300B	<b>0304582</b>	BRACCIO OSCILLANTE - ASSE ANTERIORE - INFERIORE - > 04/2004 TRACK CONTROL ARM - FRONT AXLE - LOWER - > 04/2004		
0K72A-34-150A	<b>0504581</b>	STABILIZZATORE - ASSE ANTERIORE STABILIZER LINK - FRONT AXLE		
Anno - Year <b>1990 &gt;</b>		Serie - Series <b>DA</b>	Modello - Model <b>PRIDE</b>	
8AB1-32-280 KKY01-32-280	<b>0283379</b>	TESTA STERZO RHT M12x1,25 TIE ROD END RHT M12x1,25		
KK150-32-240	<b>0602928</b>	SNODO ASSIALE - RHT M12x1,25 AXIAL JOINT - RHT M12x1,25		

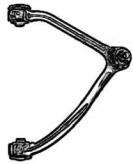

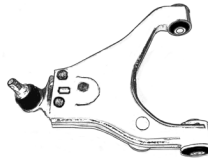
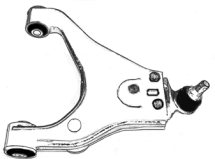
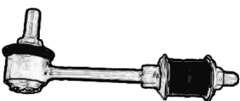
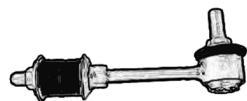







RIF. ORIG O.E. NUMBER	RIF. OCAP REF. OCAP	NOTE REMARKS	DESTRO RIGHT	SINISTRO LEFT
Anno - Year <b>1999 &gt;</b>		Serie - Series <b>Station wagon</b>	Modello - Model <b>PRIDE</b>	
KB092-32-280	<b>0281969</b>	TESTA STERZO - RHT M12x1,25 TIE ROD END - RHT M12x1,25		
KK150-32-240	<b>0602928</b>	SNODO ASSIALE - RHT M12x1,25 AXIAL JOINT - RHT M12x1,25		
KKY01-34-310	<b>0303865</b>	BRACCIO OSCILLANTE TRACK CONTROL ARM		
Anno - Year <b>2000 &gt; 02/2005</b>		Serie - Series <b>DC</b>	Modello - Model <b>RIO I</b>	
MDX50-32-280 56820-07000 F4BZ-3A130-A K9992-11-201	<b>0281584</b>	TESTA STERZO TIE ROD END		
KDX53-32-240B	<b>0601585</b>	SNODO ASSIALE AXIAL JOINT		
0K30B-34-300B	<b>0382552</b>	BRACCIO OSCILLANTE- INFERIORE - > 2002 TRACK CONTROL ARM - LOWER - > 2002		
0K30B-34-350B	<b>0392552</b>	BRACCIO OSCILLANTE - INFERIORE - > 2002 TRACK CONTROL ARM - LOWER - > 2002		
54501-FD000	<b>0383260</b>	BRACCIO OSCILLANTE- INFERIORE - 2002 > TRACK CONTROL ARM - LOWER - 2002 >		
54500-FD000	<b>0393260</b>	BRACCIO OSCILLANTE- INFERIORE - 2002 > TRACK CONTROL ARM - LOWER - 2002 >		
0K33C-34-150A	<b>0581586</b>	STABILIZZATORE - ASSE ANTERIORE - > 06/2002 STABILIZER LINK - FRONT AXLE - > 06/2002		
0K33C-34-160A	<b>0591586</b>	STABILIZZATORE - ASSE ANTERIORE - > 06/2002 STABILIZER LINK - FRONT AXLE - > 06/2002		
54830-FD000	<b>0583260</b>	STABILIZZATORE - ASSE ANTERIORE - 07/2002 > STABILIZER LINK - FRONT AXLE - 07/2002 >		

RIF. ORIG O.E. NUMBER	RIF. OCAP REF. OCAP	NOTE REMARKS	DESTRO RIGHT	SINISTRO LEFT
Anno - Year <b>2000 &gt; 02/2005</b>		Serie - Series <b>DC</b>	Modello - Model <b>RIO I</b>	
54820-FD000	<b>0593260</b>	STABILIZZATORE - ASSE ANTERIORE - 07/2002 > STABILIZER LINK - FRONT AXLE - 07/2002 >		
Anno - Year <b>03/2005 &gt;</b>		Serie - Series <b>JB</b>	Modello - Model <b>RIO II</b>	
56820-1E900	<b>0282769</b>	TESTA STERZO - RHT M14x1,5 TIE ROD END - RHT M14x1,5		
56820-1E000	<b>0292769</b>	TESTA STERZO - RHT M14x1,5 TIE ROD END - RHT M14x1,5		
57724-1E000	<b>0602770</b>	SNODO ASSIALE - RHT M14x1,5 AXIAL JOINT - RHT M14x1,5		
51760-1G000	<b>0402771</b>	SNODO SOSPENSIONE - ASSE ANTERIORE - INFERIORE BALL JOINT - FRONT AXLE - LOWER		
54501-1E100	<b>0782773</b>	BRACCIO OSCILLANTE - ASSE ANTERIORE - INFERIORE - STERZO MANUALE TRACK CONTROL ARM - FRONT AXLE - LOWER - MANUAL STEERING		
54500-1E100	<b>0792773</b>	BRACCIO OSCILLANTE - ASSE ANTERIORE - INFERIORE - STERZO MANUALE TRACK CONTROL ARM - FRONT AXLE - LOWER - MANUAL STEERING		
54501-1E000	<b>0782774</b>	BRACCIO OSCILLANTE - ASSE ANTERIORE - INFERIORE - SERVOSTERZO TRACK CONTROL ARM - FRONT AXLE - LOWER - POWER STEERING		
54500-1E000	<b>0792774</b>	BRACCIO OSCILLANTE - ASSE ANTERIORE - INFERIORE - SERVOSTERZO TRACK CONTROL ARM - FRONT AXLE - LOWER - POWER STEERING		











RIF. ORIG O.E. NUMBER	RIF. OCAP REF. OCAP	NOTE REMARKS	DESTRO RIGHT	SINISTRO LEFT
Anno - Year <b>03/2005 &gt;</b>		Serie - Series <b>JB</b>	Modello - Model <b>RIO II</b>	
54840-1G000	<b>0582772</b>	STABILIZZATORE - ASSE ANTERIORE STABILIZER LINK - FRONT AXLE		
54830-1G000	<b>0592772</b>	STABILIZZATORE - ASSE ANTERIORE STABILIZER LINK - FRONT AXLE		
Anno - Year <b>1993 &gt; 1997</b> <b>1995 &gt; 1997</b>		Serie - Series <b>FA Saloon</b> <b>FA</b>	Modello - Model <b>SEPHIA</b>	
0K201-32-280 0K9A2-32-280	<b>0281973</b>	TESTA STERZO - RHT M14x1,5 TIE ROD END - RHT M14x1,5		
0K203-32-240	<b>0601972</b>	SNODO ASSIALE - RHT M14x1,5 AXIAL JOINT - RHT M14x1,5		
0K201-34-550E 0K201-34-550C	<b>0402931</b>	SNODO SOSPENSIONE INFERIORE SUSPENSIONE JOINT LOWER		
0K2A5-34-150A 0K2A5-34-150B	<b>0501974</b>	STABILIZZATORE - ANTERIORE - SOLO MODELLI BERLINA STABILIZER LINK - FRONT - ONLY SALOON MODELS		
0K2A1-34-150A 0K2A1-34-150B	<b>0501583</b>	STABILIZZATORE - POSTERIORE STABILIZER LINK - REAR		
Anno - Year <b>03/96 &gt; 10/01</b> <b>10/97 &gt; 03/01</b> <b>05/01 &gt; 05/04</b> <b>05/01 &gt; 08/04</b>		Serie - Series <b>FB Saloon</b> <b>FB</b> <b>FB Saloon</b> <b>F</b>	Modello - Model <b>SHUMA I</b> <b>SHUMA I</b> <b>SHUMA II</b> <b>SHUMA II</b>	
0K201-32-280 0K9A2-32-280	<b>0281973</b>	TESTA STERZO - RHT M14x1,5 TIE ROD END - RHT M14x1,5		
0K2A1-32-240	<b>0681975</b>	SNODO ASSIALE - RHT M14x1,5 AXIAL JOINT - RHT M14x1,5		
0K2A2-32-240	<b>0691975</b>	SNODO ASSIALE - RHT M14x1,5 AXIAL JOINT - RHT M14x1,5		







RIF. ORIG O.E. NUMBER	RIF. OCAP REF. OCAP	NOTE REMARKS	DESTRO RIGHT	SINISTRO LEFT
Anno - Year <b>03/96 &gt; 10/01</b> <b>10/97 &gt; 03/01</b> <b>05/01 &gt; 05/04</b> <b>05/01 &gt; 08/04</b>		Serie - Series <b>FB Saloon</b> <b>FB</b> <b>FB Saloon</b> <b>F</b>	Modello - Model <b>SHUMA I</b> <b>SHUMA I</b> <b>SHUMA II</b> <b>SHUMA II</b>	
0K2A1-34-550A	<b>0402549</b>	SNODO SOSPENSIONE INFERIORE SUSPENSIONE JOINT LOWER		
0K2NA-34-300B	<b>0782847</b>	BRACCIO OSCILLANTE- INFERIORE TRACK CONTROL ARM - LOWER		
0K2NA-34-350B	<b>0792847</b>	BRACCIO OSCILLANTE- INFERIORE TRACK CONTROL ARM - LOWER		
0K2A5-34-150A 0K2A5-34-150B	<b>0501974</b>	STABILIZZATORE - ANTERIORE - SOLO PER MODELLI BERLINA STABILIZER LINK - FRONT - ONLY SALOON MODELS		
0K2A1-34-150A 0K2A1-34-150B	<b>0501583</b>	STABILIZZATORE - POSTERIORE STABILIZER LINK - REAR		
Anno - Year <b>08/2002 &gt;</b>		Serie - Series <b>JC</b>	Modello - Model <b>SORENTO</b>	
56820-3E-900	<b>0282470</b>	TESTA STERZO - RHT M14x1,5 TIE ROD END - RHT M14x1,5		
56820-3E-000	<b>0292470</b>	TESTA STERZO - RHT M14x1,5 TIE ROD END - RHT M14x1,5		
57731-3E-010	<b>0682471</b>	SNODO ASSIALE AXIAL JOINT		
57732-3E-010	<b>0692471</b>	SNODO ASSIALE AXIAL JOINT		









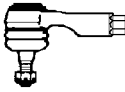
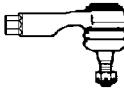

RIF. ORIG O.E. NUMBER	RIF. OCAP REF. OCAP	NOTE REMARKS	DESTRO RIGHT	SINISTRO LEFT
Anno - Year <b>08/2002 &gt;</b>		Serie - Series <b>JC</b>	Modello - Model <b>SORENTO</b>	
54420-3E-000	<b>0382473</b>	BRACCIO OSCILLANTE ASSE ANTERIORE SUPERIORE TRACK CONTROL ARM FRONT AXLE UPPER		
54410-3E-000	<b>0392473</b>	BRACCIO OSCILLANTE ASSE ANTERIORE SUPERIORE TRACK CONTROL ARM FRONT AXLE UPPER		
54570-3E-000	<b>0402472</b>	SNODO SOSPENSIONE INFERIORE SUSPENSIONE JOINT LOWER		
54520-3E-001 54520-3E-000	<b>0782474</b>	BRACCIO OSCILLANTE ASSE ANTERIORE INFERIORE TRACK CONTROL ARM FRONT AXLE LOWER		
54510-3E-001 54510-3E-000	<b>0792474</b>	BRACCIO OSCILLANTE ASSE ANTERIORE INFERIORE TRACK CONTROL ARM FRONT AXLE LOWER		
54810-3E-000	<b>0502475</b>	STABILIZZATORE ANTERIORE STABILIZER LINK FRONT		
Anno - Year <b>11/2009 &gt;</b>		Serie - Series <b>XM</b>	Modello - Model <b>SORENTO</b>	
56820-2B900	<b>0284081</b>	TESTA STERZO - RHT M16x1,5 TIE ROD END - RHT M16x1,5		
56820-2B000	<b>0294081</b>	TESTA STERZO - RHT M16x1,5 TIE ROD END - RHT M16x1,5		
57724-2B000	<b>0604082</b>	SNODO ASSIALE - RHT M16x1,5 AXIAL JOINT - RHT M16x1,5		
54530-2B000	<b>0404465</b>	SNODO SOSPENSIONE - ASSE ANTERIORE BALL JOINT - FRONT AXLE		

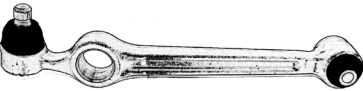
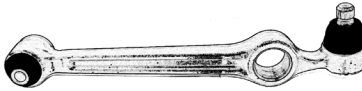



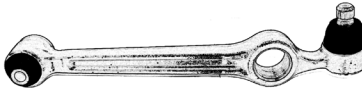



RIF. ORIG O.E. NUMBER	RIF. OCAP REF. OCAP	NOTE REMARKS	DESTRO RIGHT	SINISTRO LEFT
Anno - Year 11/2009 >		Serie - Series XM	Modello - Model SORENTO	
54501-2B100	0784083	BRACCIO OSCILLANTE - ASSE ANTERIORE TRACK CONTROL ARM - FRONT AXLE		
54500-2B100	0794083	BRACCIO OSCILLANTE - ASSE ANTERIORE TRACK CONTROL ARM - FRONT AXLE		
54840-2B000	0584084	STABILIZZATORE - ASSE ANTERIORE STABILIZER LINK - FRONT AXLE		
54830-2B000	0594084	STABILIZZATORE - ASSE ANTERIORE STABILIZER LINK - FRONT AXLE		
55530-2B000	0504085	STABILIZZATORE - ASSE POSTERIORE STABILIZER LINK - REAR AXLE		
Anno - Year 04/94 > 08/03 06/99 > 01/03		Serie - Series	Modello - Model SPORTAGE RETONA	
0K011-32-260A	0501992	BARRA STERZO TIE ROD		
0K011-32-290A	0581993	BARRA STERZO TIE ROD		
0K011-32-240A	0281993	TESTA STERZO - LHT M18x1,5 TIE ROD END - LHT M18x1,5		
0K011-32-230	0291994	TESTA STERZO - RHT M18x1,5 TIE ROD END - RHT M18x1,5		
0K011-32-270A	0591993	BARRA STERZO TIE ROD		







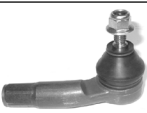











RIF. ORIG O.E. NUMBER	RIF. OCAP REF. OCAP	NOTE REMARKS	DESTRO RIGHT	SINISTRO LEFT
Anno - Year <b>04/94 &gt; 08/03</b> <b>06/99 &gt; 01/03</b>		Serie - Series	Modello - Model <b>SPORTAGE</b> <b>RETONA</b>	
OK011-32-250A	<b>0291993</b>	TESTA STERZO - LHT M18x1,5 TIE ROD END - LHT M18x1,5		
OK011-32-280	<b>0281994</b>	TESTA STERZO - RHT M18x1,5 TIE ROD END - RHT M18x1,5		
-	<b>0901995</b>	GIUNTO - RHT M18x1,5 - LHT M18x1,5 JOINT - RHT M18x1,5 - LHT M18x1,5		
OK011-34-200 OK011-34-200A	<b>0302848</b>	BRACCIO OSCILLANTE ASSE ANTERIORE SUPERIORE TRACK CONTROL ARM FRONT AXLE UPPER		
OK011-34-510B	<b>0401996</b>	SNODO SOSPENSIONE INFERIORE SUSPENSION JOINT LOWER		
OK011-34-300D OK011-34-300E OK011-34-300F	<b>0702849</b>	BRACCIO OSCILLANTE ASSE ANTERIORE - INFERIORE TRACK CONTROL ARM FRONT AXLE - LOWER		
OK011-34-160A	<b>0501997</b>	STABILIZZATORE STABILIZER LINK		
Anno - Year <b>09/2004 &gt;</b>		Serie - Series	Modello - Model <b>SPORTAGE</b>	
56820-2E900 56820-2E-900	<b>0282496</b>	TESTA STERZO - RHT M16x1,5 TIE ROD END - RHT M16x1,5		
56820-2E000 56820-2E-000	<b>0292496</b>	TESTA STERZO - RHT M16x1,5 TIE ROD END - RHT M16x1,5		
57724-2E000 57724-2E-000	<b>0602497</b>	SNODO ASSIALE - RHT M16x1,50 AXIAL JOINT - RHT M16x1,50		







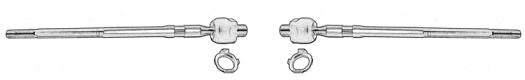

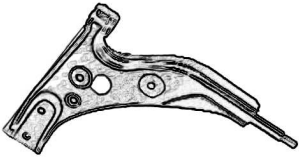
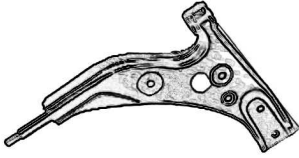

RIF. ORIG O.E. NUMBER	RIF. OCAP REF. OCAP	NOTE REMARKS	DESTRO RIGHT	SINISTRO LEFT
Anno - Year <b>09/2004 &gt;</b>		Serie - Series	Modello - Model <b>SPORTAGE</b>	
51760-2E000 51760-2E-000	<b>0402498</b>	SNODO SOSPENSIONE - INFERIORE SUSPENSION JOINT - LOWER		
54501-1F100 54501 2E000 54501 2E001	<b>0782498</b>	BRACCIO OSCILLANTE - ASSE ANTERIORE - INFERIORE TRACK CONTROL ARM - FRONT AXLE - LOWER		
54500-1F000 54500 2E000 54500 2E001	<b>0792498</b>	BRACCIO OSCILLANTE - ASSE ANTERIORE - INFERIORE TRACK CONTROL ARM - FRONT AXLE - LOWER		
54830-1F000 54830-1F-000	<b>0502499</b>	STABILIZZATORE - ASSE ANTERIORE STABILIZER LINK - FRONT AXLE		
55530-2E000 55530-1F000 55530-2E-000 55530-1F-000	<b>0502525</b>	STABILIZZATORE - ASSE POSTERIORE STABILIZER LINK - REAR AXLE		

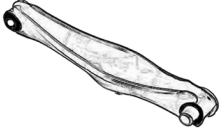

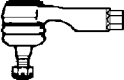

RIF. ORIG O.E. NUMBER	RIF. OCAP REF. OCAP	NOTE REMARKS	DESTRO RIGHT	SINISTRO LEFT
Anno - Year <b>10/87 &gt; 10/90</b>		Serie - Series <b>DA</b>	Modello - Model <b>121 I</b>	
8AB1-32-280	<b>0283379</b>	TESTA STERZO ESTERNA RHT M12x1,25 TIE ROD END OUTER RHT M12x1,25		
KK150-32-240	<b>0602928</b>	SNODO ASSIALE - RHT M12x1,25 AXIAL JOINT - RHT M12x1,25		
KKY0-IE34310 D031-34-310A D061-34-300	<b>0383410</b>	BRACCIO OSCILLANTE INFERIORE TRACK CONTROL ARM LOWER		
KKY0-IE34320 D031-34-320A D061-34-350	<b>0393410</b>	BRACCIO OSCILLANTE INFERIORE TRACK CONTROL ARM LOWER		
Anno - Year <b>1990 &gt; 1996</b>		Serie - Series <b>DB</b>	Modello - Model <b>121 II</b>	
8AB2-32-280	<b>0281482</b>	TESTA STERZO ESTERNA - RHT 12 x 1,25 TIE ROD END OUTER - RHT 12 x 1,25		
D061-32-24XA	<b>0601481</b>	SNODO ASSIALE AXIAL JOINT		
KKY0-IE34310 D031-34-310A D061-34-300	<b>0383410</b>	BRACCIO OSCILLANTE TRACK CONTROL ARM		
KKY0-IE34320 D031-34-320A D061-34-350	<b>0393410</b>	BRACCIO OSCILLANTE TRACK CONTROL ARM		
Anno - Year <b>1996 &gt;</b>		Serie - Series <b>JASM - JBSM</b>	Modello - Model <b>121 III</b>	
1E00-32-280A	<b>0281485</b>	TESTA STERZO ESTERNA TIE ROD END OUTER		
1E01-32-280A	<b>0291485</b>	TESTA STERZO ESTERNA TIE ROD END OUTER		
1E00-32-240	<b>0601486</b>	SNODO ASSIALE AXIAL JOINT		

RIF. ORIG O.E. NUMBER	RIF. OCAP REF. OCAP	NOTE REMARKS	DESTRO RIGHT	SINISTRO LEFT
Anno - Year <b>1996 &gt;</b>		Serie - Series <b>JASM - JBSM</b>		Modello - Model <b>121 III</b>
-	<b>0401483</b>	SNODO SOSPENSIONE INFERIORE - TUTTI I MODELLI LOWER BALL JOINT - ALL MODELS		
1E00-34-300E	<b>0781483</b>	BRACCIO OSCILLANTE STERZO MANUALE TRACK CONTROL ARM MANUAL STEERING		
1E00-34-350E	<b>0791483</b>	BRACCIO OSCILLANTE STERZO MANUALE TRACK CONTROL ARM MANUAL STEERING		
1E01-34-300E	<b>0781484</b>	BRACCIO OSCILLANTE SERVOSTERZO TRACK CONTROL ARM POWER STEERING		
1E01-34-350E	<b>0791484</b>	BRACCIO OSCILLANTE SERVOSTERZO TRACK CONTROL ARM POWER STEERING		
1E00-34-170	<b>0504436</b>	STABILIZZATORE - ASSE ANTERIORE STABILIZER LINK - FRONT AXLE		
Anno - Year <b>04/2003 &gt;</b>		Serie - Series		Modello - Model <b>2</b>
DD32-32-280 DE90-32-280	<b>0284427</b>	TESTA STERZO - RHT M14x1,5 TIE ROD END - RHT M14x1,5		
DD32-32-290 DE90-32-290	<b>0294427</b>	TESTA STERZO - LHT M14x1,5 TIE ROD END - RHT M14x1,5		
DE90-32-240	<b>0602560</b>	SNODO ASSIALE AXIAL JOINT		

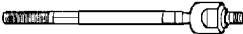
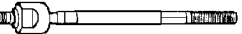
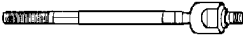
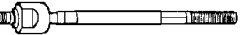

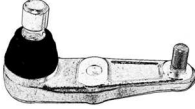
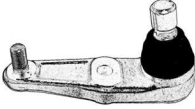
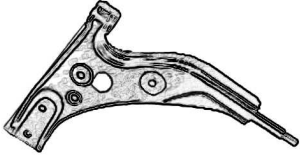
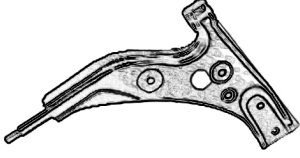

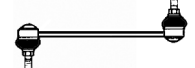
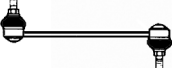

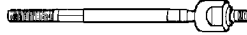
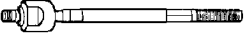
RIF. ORIG O.E. NUMBER	RIF. OCAP REF. OCAP	NOTE REMARKS	DESTRO RIGHT	SINISTRO LEFT
Anno - Year <b>04/2003 &gt;</b>		Serie - Series	Modello - Model <b>2</b>	
-	<b>0402320</b>	SNODO SOSPENSIONE ASSE ANTERIORE - INFERIORE SUSPENSION JOINT FRONT AXLE - LOWER		
DD32-34-300	<b>0784425</b>	BRACCIO OSCILLANTE ASSE ANTERIORE - INFERIORE TRACK CONTROL ARM FRONT AXLE - LOWER		
DD32-34-350	<b>0794425</b>	BRACCIO OSCILLANTE TRACK CONTROL ARM FRONT AXLE - LOWER		
DD32-34-170	<b>0504426</b>	STABILIZZATORE - ASSE ANTERIORE STABILIZER LINK - FRONT AXLE		
Anno - Year <b>06/00 &gt; 06/06 02/2005 &gt;</b>		Serie - Series <b>BK CR19</b>	Modello - Model <b>3 5</b>	
BP4L-32-280	<b>0284429</b>	TESTA STERZO TIE ROD END		
BP4L-32-290	<b>0294429</b>	TESTA STERZO TIE ROD END		
BP4L-32-240	<b>0604522</b>	SNODO ASSIALE AXIAL JOINT		
BK3P-34-300D	<b>0404428</b>	SNODO SOSPENSIONE - ANTERIORE - INFERIORE - SOLO MODELLO 3 BALL JOINT - FRONT AXLE - LOWER ONLY 3 MODEL		
B32H-34-300 BP4K-34-300E B32H-34-300D	<b>0784428</b>	BRACCIO OSCILLANTE ANTERIORE - INFERIORE SOLO MODELLO 3 TRACK CONTROL ARM FRONT - LOWER ONLY MODEL 3		







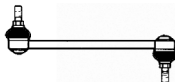
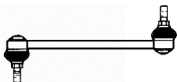
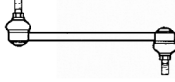
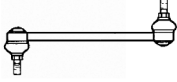
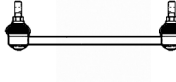
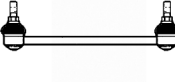
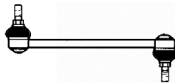
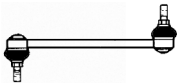

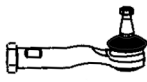
RIF. ORIG O.E. NUMBER	RIF. OCAP REF. OCAP	NOTE REMARKS	DESTRO RIGHT	SINISTRO LEFT
Anno - Year <b>06/00 &gt; 06/06</b> <b>02/2005 &gt;</b>		Serie - Series <b>BK</b> <b>CR19</b>	Modello - Model <b>3</b> <b>5</b>	
B32H-34-350 BP4K-34-350E B32H-34-350D	<b>0794428</b>	BRACCIO OSCILLANTE ANTERIORE - INFERIORE SOLO MODELLO 3 TRACK CONTROL ARM FRONT - LOWER ONLY MODEL 3		
BP4K-34-170D BP4K-34-170C	<b>0504446</b>	STABILIZZATORE - ASSE ANTERIORE STABILIZER LINK - FRONT AXLE		
BP4K-28-C10B	<b>0302856</b>	BRACCIO OSCILLANTE - ASSE POSTERIORE - SUPERIORE TRACK CONTROL ARM - REAR AXLE - UPPER		
BP4K-28-500C BP4K-28-500D BP4K-28-500E	<b>0704591</b>	BRACCIO OSCILLANTE - ASSE POSTERIORE - INFERIORE TRACK CONTROL ARM - REAR AXLE - LOWER		
BP4K-28-170D BP4K-28-170C	<b>0502795</b>	STABILIZZATORE - ASSE POSTERIORE STABILIZER LINK - REAR AXLE		
Anno - Year <b>1989 &gt; 1994</b>		Serie - Series <b>BG</b>	Modello - Model <b>323 IV</b>	
8AB2-32-280	<b>0283395</b>	TESTA STERZO - ESTERNA TIE ROD END - OUTER		
B455-32-24X BS06-32-240	<b>0603396</b>	SNODO ASSIALE - STERZO MANUALE AXIAL JOINT - MANUAL STEERING		
B456-32-25X B455-32-25X	<b>0603397</b>	SNODO ASSIALE SERVOSTERZO AXIAL JOINT POWER STEERING		
B455-34-550	<b>0403398</b>	SNODO SOSPENSIONE INFERIORE > CH. 1-630911 SUSPENSION JOINT LOWER > CH. 1-630911		
B01A-34-550 B01A-34-500A	<b>0403399</b>	SNODO SOSPENSIONE INFERIORE CH. 1-630912 > SUSPENSION JOINT LOWER CH. 1-630912 >		







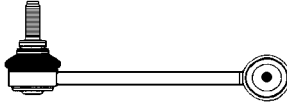
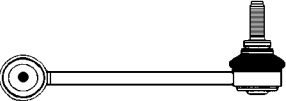

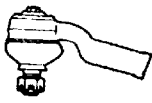
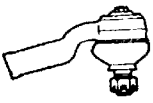

RIF. ORIG O.E. NUMBER	RIF. OCAP REF. OCAP	NOTE REMARKS	DESTRO RIGHT	SINISTRO LEFT
Anno - Year <b>1989 &gt; 1994</b>		Serie - Series <b>BG</b>	Modello - Model <b>323 IV</b>	
B455-34-300 B455-34-300E	<b>0783400</b>	BRACCIO OSCILLANTE INFERIORE TRACK CONTROL ARM LOWER		
B455-34-350 B455-34-350E	<b>0793400</b>	BRACCIO OSCILLANTE INFERIORE TRACK CONTROL ARM LOWER		
B092-28-500B	<b>0783406</b>	BRACCIO OSCILLANTE - ASSE POSTERIORE TRACK CONTROL ARM - REAR AXLE		
B092-28-550B	<b>0793406</b>	BRACCIO OSCILLANTE - ASSE POSTERIORE TRACK CONTROL ARM - REAR AXLE		
B029-34-159	<b>0504586</b>	STABILIZZATORE - ASSE ANTERIORE STABILIZER LINK - FRONT AXLE		
B029-34-159	<b>0504586</b>	STABILIZZATORE - ASSE ANTERIORE STABILIZER LINK - FRONT AXLE		
8AG1-28-100A	<b>0504587</b>	STABILIZZATORE - ASSE POSTERIORE STABILIZER LINK - REAR AXLE		
8AG1-28-100A	<b>0504587</b>	STABILIZZATORE - ASSE POSTERIORE STABILIZER LINK - REAR AXLE		
Anno - Year <b>1994 &gt; 1998</b>		Serie - Series <b>BA</b>	Modello - Model <b>323 V</b>	
8AB2-32-280	<b>0283395</b>	TESTA STERZO - ESTERNA TIE ROD END - OUTER		
8AB2-32-280	<b>0283395</b>	TESTA STERZO - ESTERNA TIE ROD END - OUTER		
E016-32-250	<b>0604588</b>	SNODO ASSIALE - RHT M12x1,25 - STERZO MANUALE AXIAL JOINT - RHT M12x1,25 - MANUAL STEERING		
E016-32-250	<b>0604588</b>	SNODO ASSIALE - RHT M12x1,25 - STERZO MANUALE AXIAL JOINT - RHT M12x1,25 - MANUAL STEERING		
E016-32-25X	<b>0604437</b>	SNODO ASSIALE - M 12x1,25 RHT MOTORE 1.8 - SERVOSTERZO AXIAL JOINT - M 12x1,25 RHT 1.8 ENGINE - POWER STEERING		
E016-32-25X	<b>0604437</b>	SNODO ASSIALE - M 12x1,25 RHT MOTORE 1.8 - SERVOSTERZO AXIAL JOINT - M 12x1,25 RHT 1.8 ENGINE - POWER STEERING		
B21H-32-25X	<b>0604438</b>	SNODO ASSIALE - M 12x1,25 RHT MOTORE 1.5 - SERVOSTERZO AXIAL JOINT - M 12x1,25 RHT 1.5 ENGINE - POWER STEERING		
B21H-32-25X	<b>0604438</b>	SNODO ASSIALE - M 12x1,25 RHT MOTORE 1.5 - SERVOSTERZO AXIAL JOINT - M 12x1,25 RHT 1.5 ENGINE - POWER STEERING		



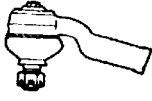
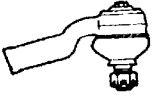



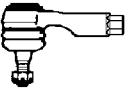
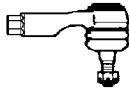
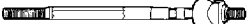
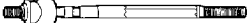

RIF. ORIG O.E. NUMBER	RIF. OCAP REF. OCAP	NOTE REMARKS	DESTRO RIGHT	SINISTRO LEFT
Anno - Year <b>1994 &gt; 1998</b>		Serie - Series <b>BA</b>	Modello - Model <b>323 V</b>	
B01A-34-550 B01A-34-500A	<b>0403399</b>	SNODO SOSPENSIONE INFERIORE CH. 1-630912 > SUSPENSION JOINT LOWER CH. 1-630912 >		
B01A-34-300E	<b>0783399</b>	BRACCIO OSCILLANTE INFERIORE TRACK CONTROL ARM LOWER		
B01A-34-350E	<b>0793399</b>	BRACCIO OSCILLANTE INFERIORE TRACK CONTROL ARM LOWER		
GA2A-34-150A GA2A-34-150 GD1E-34-150	<b>0583801</b>	STABILIZZATORE - ASSE ANTERIORE STABILIZER LINK - FRONT AXLE		
GA2A-34-170A GA2A-34-170 GD1E-34-170	<b>0593801</b>	STABILIZZATORE - ASSE ANTERIORE STABILIZER LINK - FRONT AXLE		
BC1D-28-170A	<b>0504439</b>	STABILIZZATORE - ASSE POSTERIORE STABILIZER LINK - REAR AXLE		
Anno - Year <b>1998 &gt; 2004</b>		Serie - Series <b>BJ</b>	Modello - Model <b>323 VI</b>	
GA2A-32-280A 8AG4-32-280 8AG3-32-280	<b>0284435</b>	TESTA STERZO - RHT M14x1.5 - ESTERNA TIE ROD END - RHT M14x1.5 - OUTER		
B25D-32-250	<b>0684434</b>	SNODO ASSIALE AXIAL JOINT		
B25D-32-240	<b>0694434</b>	SNODO ASSIALE AXIAL JOINT		





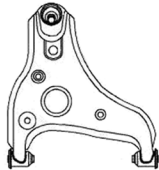
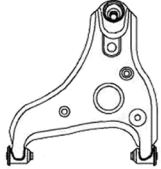



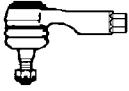
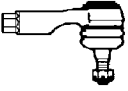
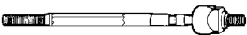
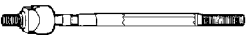



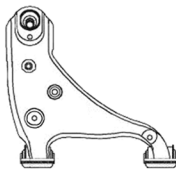
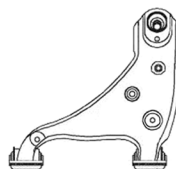









RIF. ORIG O.E. NUMBER	RIF. OCAP REF. OCAP	NOTE REMARKS	DESTRO RIGHT	SINISTRO LEFT
Anno - Year <b>1998 &gt; 2004</b>		Serie - Series <b>BJ</b>	Modello - Model <b>323 VI</b>	
LC62-34-550	<b>0402640</b>	SNODO SOSPENSIONE - ASSE ANTERIORE - INFERIORE BALL JOINT - FRONT AXLE - LOWER		
B25D-34-300A B25D-34-300B B25D-34-300C B25D-34-300D	<b>0782640</b>	BRACCIO OSCILLANTE - ASSE ANTERIORE - INFERIORE TRACK CONTROL ARM - FRONT AXLE - LOWER		
B25D-34-350A B25D-34-350B B25D-34-350C B25D-34-350D	<b>0792640</b>	BRACCIO OSCILLANTE - ASSE ANTERIORE - INFERIORE TRACK CONTROL ARM - FRONT AXLE - LOWER		
B26R-34-170	<b>0504433</b>	STABILIZZATORE - ASSE ANTERIORE STABILIZER LINK - FRONT AXLE		
LC62-34-170 LC62-34-170A LC62-34-170B	<b>0501595</b>	STABILIZZATORE - ASSE ANTERIORE 08/2000 > STABILIZER LINK - FRONT AXLE 08/2000 >		
B26R-28-170	<b>0501588</b>	STABILIZZATORE - ASSE POSTERIORE > 08/2000 - L= 190 STABILIZER LINK - REAR AXLE > 08/2000 - L= 190		
B30H-28-170B	<b>0502797</b>	STABILIZZATORE - ASSE POSTERIORE 08/2000 > - L= 160 STABILIZER LINK - REAR AXLE 08/2000 > - L= 160		
Anno - Year <b>06/2002 &gt;</b>		Serie - Series <b>GG - GY</b>	Modello - Model <b>6</b>	
GJ6E-32-280A	<b>0284430</b>	TESTA STERZO - RHT M14x1,5 TIE ROD END - RHT M14x1,5		
GJ6E-32-290A	<b>0294430</b>	TESTA STERZO - RHT M14x1,5 TIE ROD END - RHT M14x1,5		







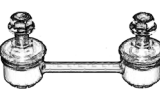
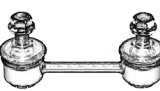





RIF. ORIG O.E. NUMBER	RIF. OCAP REF. OCAP	NOTE REMARKS	DESTRO RIGHT	SINISTRO LEFT
Anno - Year <b>06/2002 &gt;</b>		Serie - Series <b>GG - GY</b>	Modello - Model <b>6</b>	
GJ6E-32-240	<b>0604592</b>	SNODO ASSIALE - RHT M14x1,5 AXIAL JOINT - RHT M14x1,5		
GJ6A-34-J00B GJ6A-34-J00C GJ6A-34-J00D	<b>0382759</b>	BRACCIO OSCILLANTE - ASSE ANTERIORE - INFERIORE TRACK CONTROL ARM - FRONT AXLE - LOWER		
GJ6A-34-J50B GJ6A-34-J50C GJ6A-34-J50D	<b>0392759</b>	BRACCIO OSCILLANTE - ASSE ANTERIORE - INFERIORE TRACK CONTROL ARM - FRONT AXLE - LOWER		
GJ6A-34-300B GJ6A-34-300C GJ6A-34-300D GJ6A-34-300E	<b>0302775</b>	BRACCIO OSCILLANTE ANTERIORE - INFERIORE TRACK CONTROL ARM FRONT LOWER		
GJ6A-34-540	<b>0404431</b>	SNODO SOSPENSIONE ASSE ANTERIORE - SUPERIORE SUSPENSION JOINT FRONT AXLE - UPPER		
GJ6A-34-200B	<b>0784431</b>	BRACCIO OSCILLANTE - ANTERIORE SUPERIORE TRACK CONTROL ARM - FRONT UPPER		
GJ6A-34-250B	<b>0794431</b>	BRACCIO OSCILLANTE - ANTERIORE SUPERIORE TRACK CONTROL ARM - FRONT UPPER		
GJ6A-34-150A	<b>0584432</b>	STABILIZZATORE - ASSE ANTERIORE STABILIZER LINK - FRONT AXLE		
GJ6A-34-170A	<b>0594432</b>	STABILIZZATORE - ASSE ANTERIORE STABILIZER LINK - FRONT AXLE		
GJ6A-28-170A	<b>0501587</b>	STABILIZZATORE POSTERIORE STABILIZER LINK REAR		



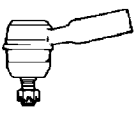
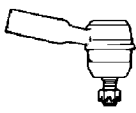

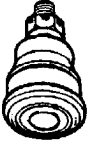

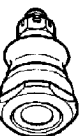

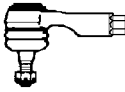
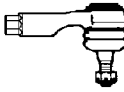
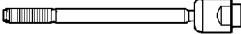
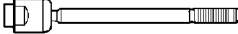
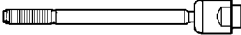
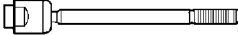
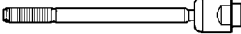
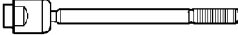

RIF. ORIG O.E. NUMBER	RIF. OCAP REF. OCAP	NOTE REMARKS	DESTRO RIGHT	SINISTRO LEFT
Anno - Year <b>1970 &gt; 1974</b>		Serie - Series <b>SU2A-SNA-S122A</b>	Modello - Model <b>626 - CAPELLA</b>	
0305-99-324A 0483-99-324 2370-99-324	<b>0293380</b>	TESTA STERZO ESTERNA RHT M14x1.5 TIE ROD END OUTER RHT M14x1.5		
0305-99-322A 2370-99-322	<b>0283381</b>	TESTA STERZO INTERNA - RHT M14x1.5 TIE ROD END INNER - RHT M14x1.5		
0305-99-356A	<b>0403382</b>	SNODO SOSPENSIONE INFERIORE SUSPENSION JOINT LOWER		
Anno - Year <b>1978 &gt; 1982</b>		Serie - Series <b>CB2NS-CB2VS-CB2MS</b>	Modello - Model <b>626 - CAPELLA</b>	
0866-99-324 4084-99-324B 8531-99-324	<b>0291265</b>	TESTA STERZO ESTERNA LHT M14x1.5 TIE ROD END OUTER LHT M14x1.5		
8173-99-322	<b>0281268</b>	TESTA STERZO INTERNA RHT M14x1.5 - 1978 > 1980 TIE ROD END INNER RHT M14x1.5 - 1978 > 1980		
8021-99-322 8531-99-322A	<b>0281266</b>	TESTA STERZO INTERNA RHT M14x1.5 - 1980 > 1982 TIE ROD END INNER RHT M14x1.5 - 1980 > 1982		
8173-99-356 8531-99-356	<b>0403383</b>	SNODO SOSPENSIONE INFERIORE SUSPENSION JOINT LOWER		
Anno - Year <b>1982 &gt; 1987</b>		Serie - Series <b>GC6P-GC8P-GCEP-GCFP</b>	Modello - Model <b>626 - CAPELLA - TELSTAR (FORD)</b>	
H001-99-324 8AH1-32-280	<b>0280347</b>	TESTA STERZO ESTERNA RHT M14x1.5 TIE ROD END OUTER RHT M14x1.5		
G030-32-240A	<b>0680348</b>	SNODO ASSIALE RHT M14x1.5 - STERZO MANUALE AXIAL JOINT RHT M14x1.5 - MANUAL STEERING		
G030-32-250A	<b>0690348</b>	SNODO ASSIALE RHT M14x1.5 - STERZO MANUALE AXIAL JOINT RHT M14x1.5 - MANUAL STEERING		

RIF. ORIG O.E. NUMBER	RIF. OCAP REF. OCAP	NOTE REMARKS	DESTRO RIGHT	SINISTRO LEFT
Anno - Year <b>1982 &gt; 1987</b>		Serie - Series <b>GC6P-GC8P-GCEP-GCFP</b>	Modello - Model <b>626 - CAPELLA - TELSTAR (FORD)</b>	
G037-32-240C	<b>0683401</b>	SNODO ASSIALE SERVOSTERZO - RHT M14x1.5 AXIAL JOINT POWER STEERING - RHT M14x1.5		
G037-32-250C	<b>0693401</b>	SNODO ASSIALE SERVOSTERZO - RHT M14x1.5 AXIAL JOINT POWER STEERING - RHT M14x1.5		
G030-99-356 GA6B-99-356 GA6B-99-356A GA6A-99-356	<b>0400349</b>	SNODO SOSPENSIONE INFERIORE SNODO SOSPENSIONE LOWER		
G030-34-300F	<b>0783404</b>	BRACCIO OSCILLANTE INFERIORE TRACK CONTROL ARM LOWER		
G030-34-350F	<b>0793404</b>	BRACCIO OSCILLANTE INFERIORE TRACK CONTROL ARM LOWER		
GA2A-34-150A GA2A-34-150 GD1E-34-150	<b>0583801</b>	ASSE ANTERIORE - STABILIZZATORE FRONT AXLE - STABILIZER LINK		
GA2A-34-170A GA2A-34-170 GD1E-34-170	<b>0593801</b>	ASSE ANTERIORE - STABILIZZATORE FRONT AXLE - STABILIZER LINK		
8AG1-28-100A	<b>0504587</b>	STABILIZZATORE - ASSE POSTERIORE STABILIZER LINK - REAR AXLE		
Anno - Year <b>1987 &gt; 1991</b>		Serie - Series <b>GDFP-GD6P-GD8P-GD8S-GDEP-GDES-GDER</b>	Modello - Model <b>626 - CAPELLA - TELSTAR (FORD)</b>	
H001-99-324 8AH1-32-280	<b>0280347</b>	TESTA STERZO ESTERNA RHT M14x1.5 TIE ROD END OUTER RHT M14x1.5		
GJ21-32-240	<b>0603403</b>	SNODO ASSIALE - RHT M14x1.5 AXIAL JOINT - RHT M14x1.5		

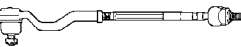



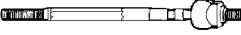
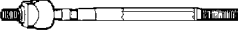







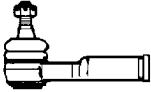
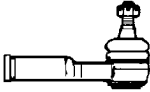
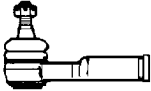
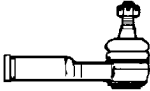

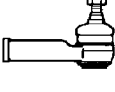
RIF. ORIG O.E. NUMBER	RIF. OCAP REF. OCAP	NOTE REMARKS	DESTRO RIGHT	SINISTRO LEFT
Anno - Year <b>1987 &gt; 1991</b>	Serie - Series <b>GDGP-GD6P-GD8P-GD8S-GDEP-GDES-GDER</b>		Modello - Model <b>626 - CAPELLA - TELSTAR (FORD)</b>	
GJ22-32-240	<b>0603508</b>	SNODO ASSIALE SERVOSTERZO - RHT M14x1.5 AXIAL JOINT POWER STEERING - RHT M14x1.5		
G030-99-356 GA6B-99-356 GA6B-99-356A GA6A-99-356	<b>0400349</b>	SNODO SOSPENSIONE INFERIORE SUSPENSION JOINT LOWER		
GF22-34-300A GJ22-34-300A	<b>0783405</b>	BRACCIO OSCILLANTE INFERIORE TRACK CONTROL ARM LOWER		
GF22-34-350A GJ22-34-350A	<b>0793405</b>	BRACCIO OSCILLANTE INFERIORE TRACK CONTROL ARM LOWER		
GA2A-34-150A GA2A-34-150 GD1E-34-150	<b>0583801</b>	ASSE ANTERIORE - STABILIZZATORE FRONT AXLE - STABILIZER LINK		
GA2A-34-170A GA2A-34-170 GD1E-34-170	<b>0593801</b>	ASSE ANTERIORE - STABILIZZATORE FRONT AXLE - STABILIZER LINK		
8AG1-34-100	<b>0502656</b>	STABILIZZATORE - ASSE ANTERIORE STABILIZER LINK - FRONT AXLE		
8AG1-28-100A	<b>0504587</b>	STABILIZZATORE - ASSE POSTERIORE STABILIZER LINK - REAR AXLE		
Anno - Year <b>1992 &gt; 1997</b>	Serie - Series <b>GE</b>		Modello - Model <b>626 - CAPELLA</b>	
GA2A-32-280A 8AG4-32-280 8AG3-32-280	<b>0284435</b>	TESTA STERZO ESTERNA RHT M14x1.5 TIE ROD END OUTER RHT M14x1.5		
GA2A-32-250 6A2A-32-240	<b>0604450</b>	SNODO ASSIALE - RHT M14x1,5 AXIAL JOINT - RHT M14x1,5		











RIF. ORIG O.E. NUMBER	RIF. OCAP REF. OCAP	NOTE REMARKS	DESTRO RIGHT	SINISTRO LEFT
Anno - Year <b>1992 &gt; 1997</b>		Serie - Series <b>GE</b>		Modello - Model <b>626 - CAPELLA</b>
G030-99-356 GA6B-99-356 GA6B-99-356A GA6A-99-356	<b>0403409</b>	SNODO SOSPENSIONE INFERIORE SUSPENSION JOINT LOWER		
GA2A-34-300 GA6BE-34-300	<b>0783409</b>	BRACCIO OSCILLANTE INFERIORE TRACK CONTROL ARM LOWER		
GA2A-34-350 GA6BE-34-350	<b>0793409</b>	BRACCIO OSCILLANTE INFERIORE TRACK CONTROL ARM LOWER		
GA2A-34-150A GA2A-34-150 GD1E-34-150	<b>0583801</b>	STABILIZZATORE - ASSE ANTERIORE STABILIZER LINK - FRONT AXLE		
GA2A-34-170A GA2A-34-170 GD1E-34-170	<b>0593801</b>	STABILIZZATORE - ASSE ANTERIORE STABILIZER LINK - FRONT AXLE		
GA2B-28-170B GA2B-28-170A GA2C-28-170A GA2C-28-170B	<b>0503706</b>	STABILIZZATORE POSTERIORE - > CH. 130204 STABILIZER LINK REAR - > CH. 130204		
GA2B-28-170A GA2B-28-170B	<b>0501590</b>	STABILIZZATORE POSTERIORE - CH. 130205 > STABILIZER LINK REAR - CH. 130205 >		
Anno - Year <b>05/97 &gt; 10/02</b>		Serie - Series <b>GF</b>		Modello - Model <b>626</b>
GA2A-32-280A 8AG4-32-280 8AG3-32-280	<b>0284435</b>	TESTA STERZO ESTERNA RHT M14x1.5 TIE ROD END OUTER RHT M14x1.5		
GE4T-32-240 GE4T-32-240A	<b>0601589</b>	SNODO ASSIALE AXIAL JOINT		







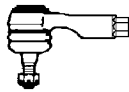
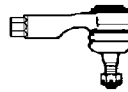
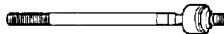
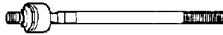

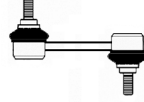
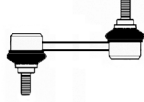

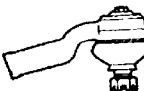
RIF. ORIG O.E. NUMBER	RIF. OCAP REF. OCAP	NOTE REMARKS	DESTRO RIGHT	SINISTRO LEFT
Anno - Year <b>05/97 &gt; 10/02</b>		Serie - Series <b>GF</b>	Modello - Model <b>626</b>	
G030-99-356 GA6B-99-356 GA6B-99-356A GA6A-99-356	<b>0403409</b>	SNODO SOSPENSIONE INFERIORE SUSPENSION JOINT LOWER		
GD7A-34-300A GE4T-31-300 GE4T-31-300C GE4T-31-300E GE4T-34-300C	<b>0782798</b>	BRACCIO OSCILLANTE - ASSE ANTERIORE - INFERIORE TRACK CONTROL ARM - FRONT AXLE - LOWER		
GD7A-34-350A GE4T-31-350 GE4T-31-350C GE4T-31-350E GE4T-34-350C	<b>0792798</b>	BRACCIO OSCILLANTE - ASSE ANTERIORE - INFERIORE TRACK CONTROL ARM - FRONT AXLE - LOWER		
GA2A-34-150A GA2A-34-150 GD1E-34-150	<b>0583801</b>	STABILIZZATORE - ASSE ANTERIORE STABILIZER LINK - FRONT AXLE		
GA2A-34-170A GA2A-34-170 GD1E-34-170	<b>0593801</b>	STABILIZZATORE - ASSE ANTERIORE STABILIZER LINK - FRONT AXLE		
GE4T-28-170	<b>0502657</b>	STABILIZZATORE - ASSE POSTERIORE STABILIZER LINK - REAR AXLE		
Anno - Year <b>1974 &gt; 1981</b>		Serie - Series <b>LA2VS-LA3VS-LA2VV-LA22S(RE)-LA33S(RE)-LA33V (RE)-LA4VS-LA4MS-</b>	Modello - Model <b>929 - LUCE - RX4 - RX9</b>	
1175-99-324A	<b>0293413</b>	TESTA STERZO ESTERNA LHT M14x1.5 TIE ROD END OUTER LHT M14x1.5		
1175-99-322A 8038-99-322	<b>0283414</b>	TESTA STERZO INTERNA RHT M14x1.5 TIE ROD END INNER RHT M14x1.5		
8650-99-356	<b>0403417</b>	SNODO SOSPENSIONE INFERIORE > 1978 SUSPENSION JOINT LOWER > 1978		
8559-99-354	<b>0403419</b>	SNODO SOSPENSIONE INFERIORE 1978 > SUSPENSION JOINT LOWER 1978 >		

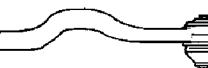

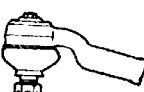
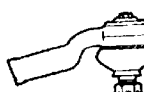
RIF. ORIG O.E. NUMBER	RIF. OCAP REF. OCAP	NOTE REMARKS	DESTRO RIGHT	SINISTRO LEFT
Anno - Year <b>1981 &gt; 1991</b>	Serie - Series <b>HBPHE-HBPHE-HBSHE-HBPS2-HBEP-HBES-HBEJ HBSN2(RE)-HB3S(RE)-HCED-HCFS-HCSS-HC3S(RE)</b>		Modello - Model <b>929 - LUCE - RX4 - RX9</b>	
H001-99-324 8AH1-32-280	<b>0280347</b>	TESTA STERZO ESTERNA RHT M14x1.5 TIE ROD END OUTER RHT M14x1.5		
H001-32-240	<b>0603421</b>	SNODO ASSIALE - RHT M14x1.5 STERZO MANUALE - > 1986 AXIAL JOINT - RHT M14x1.5 MANUAL STEERING - > 1986		
H002-32-240	<b>0603422</b>	SNODO ASSIALE SERVOSTERZO - RHT M14x1.5 - > 1986 AXIAL JOINT POWER STEERING - RHT M14x1.5 - > 1986		
H261-32-240A	<b>0680423</b>	SNODO ASSIALE - 1986 > AXIAL JOINT - 1986 >		
H260-32-240A	<b>0690423</b>	SNODO ASSIALE - 1986 > AXIAL JOINT - 1986 >		
H2Y0-99-356	<b>0403424</b>	SNODO SOSPENSIONE INFERIORE - 1986 > SUSPENSION JOINT LOWER - 1986 >		
OK0A3-28-170A K9A3-28-170A	<b>0501582</b>	STABILIZZATORE POSTERIORE STABILIZER LINK REAR		
Anno - Year <b>1983 &gt; 1999 01/84 &gt; 07/99</b>	Serie - Series <b>SR-SS-SD SR1</b>		Modello - Model <b>BONGO E2000 - E 2200</b>	
-	<b>0500338</b>	BARRA STERZO TIE ROD		
S083-99-324	<b>0280337</b>	TESTA STERZO ESTERNA RHT M14x1.5 TIE ROD END OUTER RHT M14x1.5		
S083-32-115	<b>0600338</b>	SNODO ASSIALE RHT M14x1.5 AXIAL JOINT RHT M14x1.5		
S083-99-354	<b>0400339</b>	SNODO SOSPENSIONE SUPERIORE SUSPENSION JOINT UPPER		

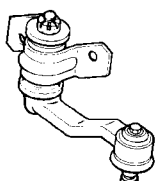

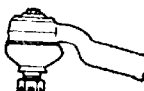
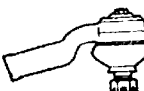

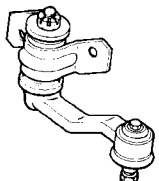



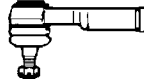
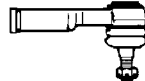
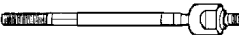
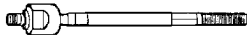
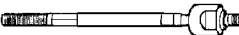
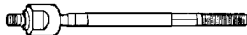
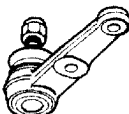
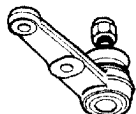
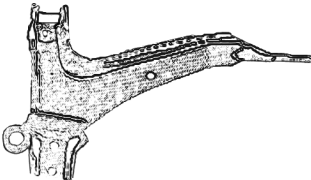
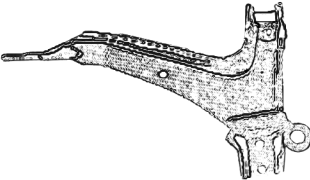
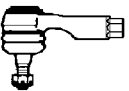
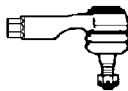



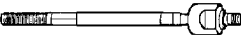
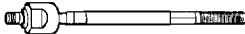

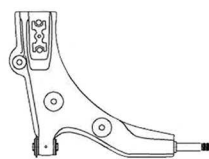
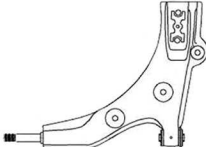

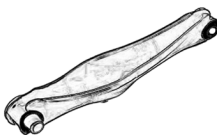

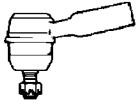
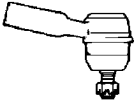
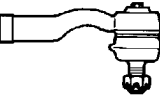
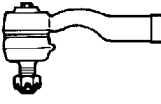
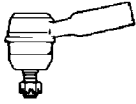
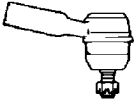

RIF. ORIG O.E. NUMBER	RIF. OCAP REF. OCAP	NOTE REMARKS	DESTRO RIGHT	SINISTRO LEFT
Anno - Year <b>1983 &gt; 1999</b> 01/84 > 07/99		Serie - Series <b>SR-SS-SD</b> SR1	Modello - Model <b>BONGO</b> E2000 - E 2200	
S083-99-356	<b>0400340</b>	SNODO SOSPENSIONE INFERIORE SUSPENSIONE JOINT LOWER		
Anno - Year <b>1984 &gt; 06/99</b>		Serie - Series <b>UB-UC-UD-UE-UF-UT</b>	Modello - Model <b>B1600 &gt; B2600 (PICK-UP)</b>	
UB39-99-322	<b>0282932</b>	TESTA STERZO ESTERNA RHT M14x1,5 - > 1987 TIE ROD END OUTER RHT M14x1,5 - > 1987		
UB39-99-324	<b>0292933</b>	TESTA STERZO ESTERNA LHT M14x1,5 - 2WD TIE ROD END OUTER LHT M14x1,5 - 2WD		
8AU2-32-270	<b>0282934</b>	TESTA STERZO INTERNA RHT M14x1,5 - 1987 > TIE ROD END INNER RHT M14x1,5 - 1987 >		
8AU1-32-280	<b>0292935</b>	TESTA STERZO INTERNA LHT M14x1,5 - 4WD - 1987 > TIE ROD END INNER LHT M14x1,5 - 4WD - 1987 >		
8AU1-34-540 UH71-34-540	<b>0402936</b>	SNODO SOSPENSIONE - ASSE ANTERIORE - SUPERIORE BALL JOINT - FRONT AXLE - UPPER		
8AU2-34-510 UH74-34-550	<b>0402937</b>	SNODO SOSPENSIONE - ASSE ANTERIORE - INFERIORE BALL JOINT - FRONT AXLE - LOWER		
8AU3-34-510	<b>0404589</b>	SNODO SOSPENSIONE INFERIORE - SOLO PER MOD. 2600 - 1987 > SUSPENSION JOINT LOWER - ONLY FOR 2600 MOD. - 1987 >		
Anno - Year <b>02/99 &gt; 03/05</b>		Serie - Series <b>UN</b>	Modello - Model <b>B 2.5 - 2.6</b>	
UH74-32-250	<b>0284112</b>	TESTA STERZO INTERNA - RHT M14x1,5 INNER TIE ROD END -RHT M14x1,5		

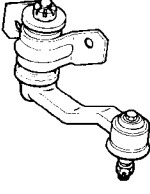



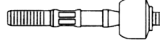
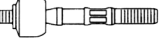

RIF. ORIG O.E. NUMBER	RIF. OCAP REF. OCAP	NOTE REMARKS	DESTRO RIGHT	SINISTRO LEFT
Anno - Year <b>02/99 &gt; 03/05</b>		Serie - Series <b>UN</b>	Modello - Model <b>B 2.5 - 2.6</b>	
UH71-32-280	<b>0294113</b>	TESTA STERZO ESTERNA - LHT M14x1,5 - SOLO PER MOD. 2WD OUTER TIE ROD END - LHT M14x1,5 - ONLY 2WD MODELS		
UH74-32-280	<b>0294114</b>	TESTA STERZO ESTERNA - LHT M14x1,5 - SOLO PER MOD. 4WD OUTER TIE ROD END - LHT M14x1,5 - ONLY 4WD MODELS		
8AU1-34-540 UH71-34-540	<b>0402936</b>	SNODO SOSPENSIONE - ASSE ANTERIORE - SUPERIORE BALL JOINT - FRONT AXLE - UPPER		
8AU2-34-510 UH74-34-550	<b>0402937</b>	SNODO SOSPENSIONE - ASSE ANTERIORE - INFERIORE BALL JOINT - FRONT AXLE - LOWER		
Anno - Year <b>08/1998 &gt;</b>		Serie - Series <b>DW</b>	Modello - Model <b>DEMIO</b>	
8AB2-32-280	<b>0283395</b>	TESTA STERZO - ESTERNA TIE ROD END - OUTER		
D10232250A	<b>0684444</b>	SNODO ASSIALE - M12x1,25 RHT AXIAL JOINT - M12x1,25 RHT		
D10232240A	<b>0694444</b>	SNODO ASSIALE - M12x1,25 RHT AXIAL JOINT - M12x1,25 RHT		
D201-34-300E	<b>0384590</b>	BRACCIO OSCILLANTE - ASSE ANTERIORE - INFERIORE TRACK CONTROL ARM - FRONT AXLE - LOWER		
D201-34-350A	<b>0394590</b>	BRACCIO OSCILLANTE - ASSE ANTERIORE - INFERIORE TRACK CONTROL ARM - FRONT AXLE - LOWER		
EA03-34-170A	<b>0504440</b>	STABILIZZATORE - ASSE ANTERIORE STABILIZER LINK - FRONT AXLE		





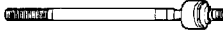
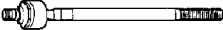



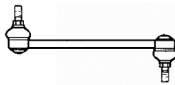
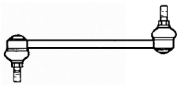
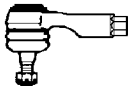
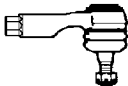
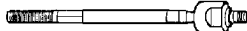
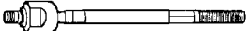
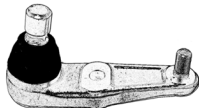
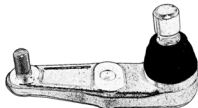
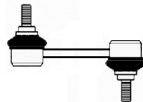
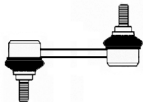
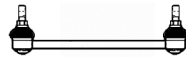
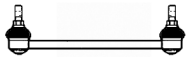



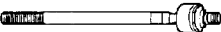
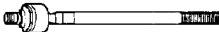



RIF. ORIG O.E. NUMBER	RIF. OCAP REF. OCAP	NOTE REMARKS	DESTRO RIGHT	SINISTRO LEFT
Anno - Year <b>1970 &gt; 1976</b>	Serie - Series <b>SPC-SPCV-STB-STBV-M10A-FA3PS-FA3TS</b>		Modello - Model <b>FAMILIA - PRESTO</b>	
0305-99-324A 0483-99-324 2370-99-324	<b>0293380</b>	TESTA STERZO ESTERNA RHT M14x1.5 - > 1975 TIE ROD END OUTER RHT M14x1.5 - > 1975		
0305-99-322A 2370-99-322	<b>0283381</b>	TESTA STERZO INTERNA - RHT M14x1.5 > 1972 TIE ROD END INNER - RHT M14x1.5 > 1972		
0483-99-322 0662-99-322A 2113-99-322A 2469-99-322	<b>0283378</b>	TESTA STERZO INTERNA RHT M14x1.5 - 1972 > 1975 TIE ROD END INNER RHT M14x1.5 - 1972 > 1975		
8021-99-324	<b>0293425</b>	TESTA STERZO ESTERNA LHT M14x1.5 - 1975 > 1976 TIE ROD END OUTER LHT M14x1.5 - 1975 > 1976		
8021-99-322 8531-99-322A	<b>0281266</b>	TESTA STERZO INTERNA RHT M14x1.5 - 1975 > 1976 TIE ROD END INNER RHT M14x1.5 - 1975 > 1976		
8021-32-320A	<b>0303392</b>	R H D - BRACCIO STERZO 1975 > 1976 R H D - IDLER ARM 1975 > 1976		
0305-99-356A	<b>0403382</b>	SNODO SOSPENSIONE INFERIORE SUSPENSION JOINT LOWER		
Anno - Year <b>1976 &gt; 1985</b>	Serie - Series <b>FA4TS-FA4TV-FA4US-FA4UV</b>		Modello - Model <b>FAMILIA - 323 I LASER (FORD)</b>	
0866-99-324 4084-99-324B 8531-99-324	<b>0291265</b>	TESTA STERZO ESTERNA LHT M14x1.5 TIE ROD END OUTER LHT M14x1.5		
8021-99-322 8531-99-322A	<b>0281266</b>	TESTA STERZO INTERNA RHT M14x1.5 TIE ROD END INNER RHT M14x1.5		
8531-32-320	<b>0303393</b>	R H D - BRACCIO STERZO R H D - IDLER ARM		

RIF. ORIG O.E. NUMBER	RIF. OCAP REF. OCAP	NOTE REMARKS	DESTRO RIGHT	SINISTRO LEFT
Anno - Year <b>1976 &gt; 1985</b>		Serie - Series <b>FA4TS-FA4TV-FA4US-FA4UV</b>		Modello - Model <b>FAMILIA - 323 I LASER (FORD)</b>
8173-99-356 8531-99-356	<b>0403383</b>	SNODO SOSPENSIONE INFERIORE SUSPENSION JOINT LOWER		
Anno - Year <b>1980 &gt; 1985</b>		Serie - Series <b>BD1031-BD1051</b>		Modello - Model <b>FAMILIA - 323 II</b>
B001-99-324 B037-99-324	<b>0280357</b>	TESTA STERZO ESTERNA RHT M12x1.25 TIE ROD END OUTER RHT M12x1.25		
B001-99-325 B037-99-325	<b>0290357</b>	TESTA STERZO ESTERNA RHT M12x1.25 TIE ROD END OUTER RHT M12x1.25		
B001-32-135	<b>0603384</b>	SNODO ASSIALE - RHT M12x1.25 STERZO MANUALE AXIAL JOINT - RHT M12x1.25 MANUAL STEERING		
BA29-32135 B038-32-135	<b>0603385</b>	SNODO ASSIALE SERVOSTERZO RHT M12x1.25 AXIAL JOINT POWER STEERING RHT M12x1.25		
B001-34-550	<b>0400358</b>	SNODO SOSPENSIONE INFERIORE SUSPENSION JOINT LOWER		
B001-34-310C	<b>0783386</b>	BRACCIO OSCILLANTE INFERIORE TRACK CONTROL ARM LOWER		
B001-34-360C	<b>0793386</b>	BRACCIO OSCILLANTE INFERIORE TRACK CONTROL ARM LOWER		
Anno - Year <b>1985 &gt; 1990 1985 &gt; 1990</b>		Serie - Series <b>BF3P-BF5P-BFMP-BFSP-BFTP-BF7P BF3V-BF5V-BF7V-BF5V</b>		Modello - Model <b>FAMILIA - 323 III LASER (FORD)</b>
8AB1-32-280	<b>0283379</b>	TESTA STERZO ESTERNA RHT M12x1.25 TIE ROD END OUTER RHT M12x1.25		







RIF. ORIG O.E. NUMBER	RIF. OCAP REF. OCAP	NOTE REMARKS	DESTRO RIGHT	SINISTRO LEFT
Anno - Year 1985 > 1990 1985 > 1990		Serie - Series <b>BF3P-BF5P-BFMP-BFSP-BFTP-BF7P BF3V-BF5V-BF7V-BF5V</b>	Modello - Model <b>FAMILIA - 323 III LASER (FORD)</b>	
B092-32-240	<b>0603388</b>	SNODO ASSIALE TIPO C.G.R. AXIAL JOINT C.G.R. TYPE		
B094-32-240	<b>0603389</b>	SNODO ASSIALE TIPO V.G.R. AXIAL JOINT V.G.R. TYPE		
BF67-32-240 B093-32-240	<b>0683387</b>	SNODO ASSIALE SERVOSTERZO AXIAL JOINT POWER STEERING		
B093-32-250	<b>0693387</b>	SNODO ASSIALE SERVOSTERZO AXIAL JOINT POWER STEERING		
B092-34-550	<b>0403390</b>	SNODO SOSPENSIONE - ASSE ANTERIORE - INFERIORE BALL JOINT - FRONT AXLE - LOWER		
B092-34-310A	<b>0783391</b>	BRACCIO OSCILLANTE - ASSE ANTERIORE - INFERIORE TRACK CONTROL ARM - FRONT AXLE - LOWER		
B092-34-360A	<b>0793391</b>	BRACCIO OSCILLANTE - ASSE ANTERIORE - INFERIORE TRACK CONTROL ARM - FRONT AXLE - LOWER		
B029-34-159	<b>0504586</b>	STABILIZZATORE - ASSE ANTERIORE STABILIZER LINK - FRONT AXLE		
B092-28-500B	<b>0783406</b>	BRACCIO OSCILLANTE - ASSE POSTERIORE TRACK CONTROL ARM - REAR AXLE		
B092-28-550B	<b>0793406</b>	BRACCIO OSCILLANTE - ASSE POSTERIORE TRACK CONTROL ARM - REAR AXLE		



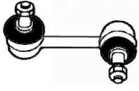
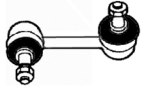



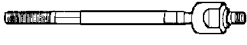

RIF. ORIG O.E. NUMBER	RIF. OCAP REF. OCAP	NOTE REMARKS	DESTRO RIGHT	SINISTRO LEFT
Anno - Year 1971 > 1978	Serie - Series STC-SUA4-SN3A-SN4A-STCV-SU4AV-SN3AV		Modello - Model GRAND FAMILIA - STC	
0866-99-324A 1524-99-324	0293411	TESTA STERZO ESTERNA LHT M14x1.5 - > 1975 TIE ROD END OUTER LHT M14x1.5 - > 1975		
0866-99-322	0283412	TESTA STERZO INTERNA - RHT M14x1.5 - > 1975 TIE ROD END INNER - RHT M14x1.5 - > 1975		
1175-99-324A	0293413	TESTA STERZO ESTERNA LHT M14x1.5 - 1975 > TIE ROD END OUTER LHT M14x1.5 - 1975 >		
1175-99-322A 8038-99-322	0283414	TESTA STERZO INTERNA RHT M14x1.5 -1975 > TIE ROD END INNER RHT M14x1.5 -1975 >		
8531-32-320	0303393	R H D - BRACCIO STERZO R H D - IDLER ARM		
0866-99-356A	0403416	SNODO SOSPENSIONE INFERIORE - > 1977 SUSPENSION JOINT LOWER > 1977		
8650-99-356	0403417	SNODO SOSPENSIONE INFERIORE 1977 > SUSPENSION JOINT LOWER 1977 >		
Anno - Year 03/95 > 09/99	Serie - Series LV		Modello - Model MPV I	
8AL1-32-280	0281591	TESTA STERZO RHT M14x1,5 TIE ROD END RHT M14x1,5		
LA01-32-115	0601592	SNODO ASSIALE AXIAL JOINT		
LB82-34-300	0303394	BRACCIO OSCILLANTE - ASSE ANTERIORE - INFERIORE TRACK CONTROL ARM - FRONT AXLE - LOWER		

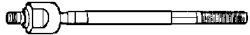
RIF. ORIG O.E. NUMBER	RIF. OCAP REF. OCAP	NOTE REMARKS	DESTRO RIGHT	SINISTRO LEFT
Anno - Year <b>09/1999 &gt;</b>		Serie - Series <b>LW</b>	Modello - Model <b>MPV II</b>	
GA2A-32-280A 8AG4-32-280	<b>0281593</b>	TESTA STERZO RHT M14x1,5 TIE ROD END RHT M14x1,5		
LC62-32-240B	<b>0601594</b>	SNODO ASSIALE AXIAL JOINT		
LC62-32-280	<b>0403121</b>	SNODO SOSPENSIONE INFERIORE SUSPENSION JOINT LOWER		
LC62-34-300C	<b>0783121</b>	BRACCIO OSCILLANTE - ANTERIORE INFERIORE TRACK CONTROL ARM - FRONT LOWER		
LC62-34-350C	<b>0793121</b>	BRACCIO OSCILLANTE - ANTERIORE INFERIORE TRACK CONTROL ARM - FRONT LOWER		
LC62-34-170 LC62-34-170A LC62-34-170B	<b>0501595</b>	STABILIZZATORE - ASSE ANTERIORE STABILIZER LINK - FRONT AXLE		
Anno - Year <b>1991 &gt;</b>		Serie - Series	Modello - Model <b>MX-3</b>	
8AB2-32-280	<b>0283395</b>	TESTA STERZO - ESTERNA TIE ROD END - OUTER		
E016-32-25X	<b>0604437</b>	SNODO ASSIALE - M 12x1,25 AXIAL JOINT - M 12x1,25		
B01A-34-550 B01A-34-500A	<b>0403399</b>	SNODO SOSPENSIONE INFERIORE CH. 1-630912 > SUSPENSION JOINT LOWER CH. 1-630912 >		
EA03-34-170A	<b>0504440</b>	STABILIZZATORE - ASSE ANTERIORE STABILIZER LINK - FRONT AXLE		
EA01-28-170 EA01-28-170D	<b>0504441</b>	STABILIZZATORE - ASSE POSTERIORE STABILIZER LINK - REAR AXLE		







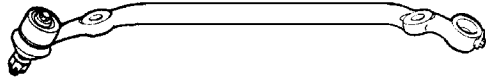

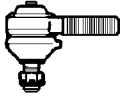
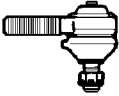
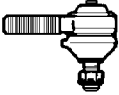
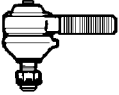
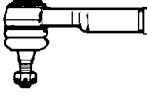
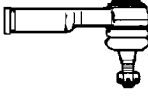
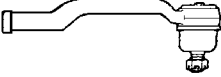
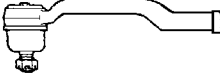
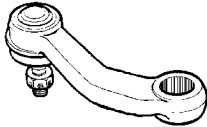
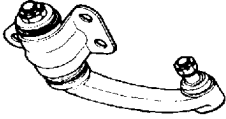
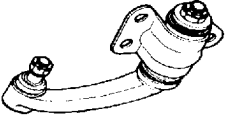
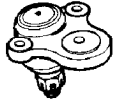
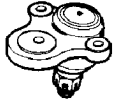
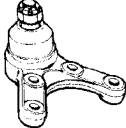
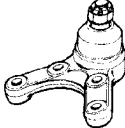
RIF. ORIG O.E. NUMBER	RIF. OCAP REF. OCAP	NOTE REMARKS	DESTRO RIGHT	SINISTRO LEFT
Anno - Year <b>09/89 &gt; 04/98</b>		Serie - Series <b>NA</b>	Modello - Model <b>MX-5 I</b>	
8AN1-32-280	<b>0284490</b>	TESTA STERZO - ESTERNA RHT M12X1,25 TIE ROD END - OUTER RHT M12X1,25		
NA01-32-240	<b>0604443</b>	SNODO ASSIALE AXIAL JOINT		
NA01-34-550	<b>0404447</b>	SNODO SOSPENSIONE - ASSE ANTERIORE INFERIORE SUSPENSION JOINT - FRONT AXLE LOWER		
NA01-34-170	<b>0504442</b>	STABILIZZATORE - ASSE ANTERIORE STABILIZER LINK - FRONT AXLE		
Anno - Year <b>01/98 &gt; 10/05</b>		Serie - Series <b>NB</b>	Modello - Model <b>MX-5 II</b>	
8AN1-32-280	<b>0284490</b>	TESTA STERZO - ESTERNA RHT M12X1,25 TIE ROD END - OUTER RHT M12X1,25		
NC10-32-240A	<b>0682799</b>	SNODO ASSIALE AXIAL JOINT		
NC10-32-250A	<b>0692799</b>	SNODO ASSIALE AXIAL JOINT		
N068-34-200	<b>0782800</b>	BRACCIO OSCILLANTE SUPERIORE TRACK CONTROL ARM UPPER		
N068-34-250	<b>0792800</b>	BRACCIO OSCILLANTE SUPERIORE TRACK CONTROL ARM UPPER		
NA01-34-550	<b>0404447</b>	SNODO SOSPENSIONE - ASSE ANTERIORE INFERIORE SUSPENSION JOINT - FRONT AXLE LOWER		
N066-34-310	<b>0782801</b>	BRACCIO OSCILLANTE INFERIORE TRACK CONTROL ARM LOWER		

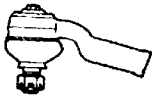
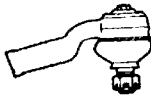

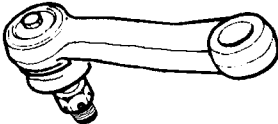

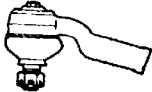
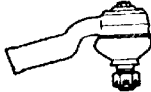
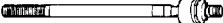
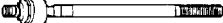

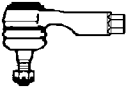
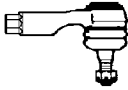
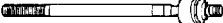
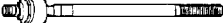













RIF. ORIG O.E. NUMBER	RIF. OCAP REF. OCAP	NOTE REMARKS	DESTRO RIGHT	SINISTRO LEFT
Anno - Year <b>01/98 &gt; 10/05</b>		Serie - Series <b>NB</b>	Modello - Model <b>MX-5 II</b>	
N066-34-360	<b>0792801</b>	BRACCIO OSCILLANTE INFERIORE TRACK CONTROL ARM LOWER		
NC10-34-150	<b>0582802</b>	STABILIZZATORE - ASSE ANTERIORE STABILIZER LINK - FRONT AXLE		
NC10-34-170	<b>0592802</b>	STABILIZZATORE - ASSE ANTERIORE STABILIZER LINK - FRONT AXLE		
GA2A-34-150A GA2A-34-150 GD1E-34-150	<b>0583801</b>	STABILIZZATORE - ASSE POSTERIORE STABILIZER LINK - REAR AXLE		
GA2A-34-170A GA2A-34-170 GD1E-34-170	<b>0593801</b>	STABILIZZATORE - ASSE POSTERIORE STABILIZER LINK - REAR AXLE		
Anno - Year <b>07/1991 &gt;</b>		Serie - Series <b>GE6</b>	Modello - Model <b>MX-6</b>	
GA2A-32-280A 8AG4-32-280 8AG3-32-280	<b>0284435</b>	TESTA STERZO ESTERNA RHT M14x1,5 TIE ROD END OUTER RHT M14x1,5		
GA2A-32-250 6A2A-32-240	<b>0604450</b>	SNODO ASSIALE AXIAL JOINT		
G030-99-356 GA6B-99-356 GA6B-99-356A GA6A-99-356	<b>0400349</b>	SNODO SOSPENSIONE INFERIORE SNODO SOSPENSIONE LOWER		
Anno - Year <b>07/1999 &gt;</b>		Serie - Series	Modello - Model <b>PREMACY</b>	
GA2A-32-280A 8AG4-32-280 8AG3-32-280	<b>0284435</b>	TESTA STERZO ESTERNA RHT M14x1,5 TIE ROD END OUTER RHT M14x1,5		
B25D-32-250	<b>0684434</b>	SNODO ASSIALE AXIAL JOINT		







RIF. ORIG O.E. NUMBER	RIF. OCAP REF. OCAP	NOTE REMARKS	DESTRO RIGHT	SINISTRO LEFT
Anno - Year <b>07/1999 &gt;</b>		Serie - Series	Modello - Model <b>PREMACY</b>	
B25D-32-240	<b>0694434</b>	SNODO ASSIALE AXIAL JOINT		
LC62-34-550	<b>0402640</b>	SNODO SOSPENSIONE - ASSE ANTERIORE - INFERIORE BALL JOINT - FRONT AXLE - LOWER		
C100-34-300B C100-34-300A	<b>0784594</b>	BRACCIO OSCILLANTE - ASSE ANTERIORE - INFERIORE TRACK CONTROL ARM - FRONT AXLE - LOWER		
C100-34-350B C100-34-350A	<b>0794594</b>	BRACCIO OSCILLANTE - ASSE ANTERIORE - INFERIORE TRACK CONTROL ARM - FRONT AXLE - LOWER		
B26R-34-170	<b>0504433</b>	STABILIZZATORE - ASSE ANTERIORE > 08/2000 STABILIZER LINK - FRONT AXLE > 08/2000		
LC62-34-170 LC62-34-170A LC62-34-170B	<b>0501595</b>	STABILIZZATORE - ASSE ANTERIORE 08/2000 > STABILIZER LINK - FRONT AXLE 08/2000 >		
B26R-28-170	<b>0501588</b>	STABILIZZATORE - ASSE POSTERIORE > 08/2000 STABILIZER LINK - REAR AXLE > 08/2000		
B30H-28-170B	<b>0502797</b>	STABILIZZATORE - ASSE POSTERIORE 08/2000 > - L= 160 STABILIZER LINK - REAR AXLE 08/2000 > - L= 160		
Anno - Year <b>1965 &gt;</b>		Serie - Series <b>BUD61-BNA61-BTA67-PE2N6-PE2V6-PE2N7 PE2V7-UDX021-UDY021-RE2N6</b>	Modello - Model <b>PROCED - COURIER - B 1600 &gt; B 2200</b>	
D77Z-3304B 2541-32-250 2677-32-250 8637-32-250	<b>0503427</b>	L H D - BARRA STERZO > 1980 L H D - TIE ROD > 1980		



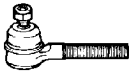
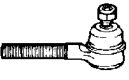
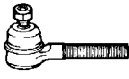

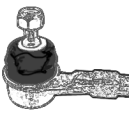
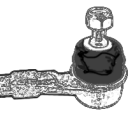

RIF. ORIG O.E. NUMBER	RIF. OCAP REF. OCAP	NOTE REMARKS	DESTRO RIGHT	SINISTRO LEFT
Anno - Year <b>1965 &gt;</b>		Serie - Series <b>BUD61-BNA61-BTA67-PE2N6-PE2V6-PE2N7 PE2V7-UDX021-UDY021-RE2N6</b>	Modello - Model <b>PROCED - COURIER - B 1600 &gt; B 2200</b>	
D27Z-3A131A D77Z-3A131A 0603-99-324 0603-99-325 2541-99-324A 3874-99-324	<b>0193429</b>	TESTA STERZO ESTERNA LHT M16x1.5 - > 1980 TIE ROD END OUTER LHT M16x1.5 - > 1980		
D27Z-3A130A D77Z-3A130A 0603-99-322 0603-99-323 2541-99-322A 3874-99-322	<b>0183430</b>	TESTA STERZO INTERNA RHT M16x1.5 - > 1980 TIE ROD END INNER RHT M16x1.5 - > 1980		
E17Z-3A131A UA01-99-324	<b>0280341</b>	TESTA STERZO ESTERNA LHT M14x1.5 - 1980 > TIE ROD END OUTER LHT M14x1.5 - 1980 >		
E17Z-3A130A E17Z-3A130B UA01-99-322 UA01-99-323	<b>0280342</b>	TESTA STERZO INTERNA RHT M14x1.5 - 1980 > TIE ROD END INNER RHT M14x1.5 - 1980 >		
E17Z-3350A UA04-32-220	<b>0300345</b>	L H D - LEVA STERZO L H D - PITMAN ARM		
UA04-32-320	<b>0300346</b>	L H D - BRACCIO STERZO L H D - IDLER ARM		
UA01-32-320	<b>0303432</b>	R H D - BRACCIO STERZO R H D - IDLER ARM		
E17Z-3049A UA01-99-354	<b>0400343</b>	SNODO SOSPENSIONE SUPERIORE SUSPENSION JOINT UPPER		
E17Z-3050A UA01-99-356	<b>0400344</b>	SNODO SOSPENSIONE INFERIORE SUSPENSION JOINT LOWER		

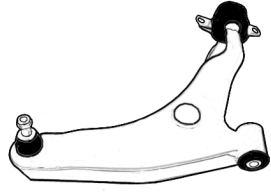
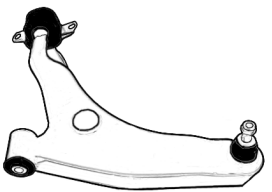
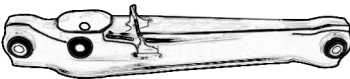
RIF. ORIG O.E. NUMBER	RIF. OCAP REF. OCAP	NOTE REMARKS	DESTRO RIGHT	SINISTRO LEFT
Anno - Year <b>03/78 &gt; 03/86</b>		Serie - Series <b>SA</b>	Modello - Model <b>RX7 I</b>	
8021-99-324	<b>0293425</b>	TESTA STERZO ESTERNA - LHT M14x1,5 TIE ROD END OUTER - LHT M14x1,5		
8021-99-322 8531-99-322A	<b>0281266</b>	TESTA STERZO INTERNA - RHT M14x1,5 TIE ROD END INNER - RHT M14x1,5		
1757-32-220 8559-32-220	<b>0303426</b>	LEVA STERZO PITMAN ARM		
8173-99-356 8531-99-356	<b>0403383</b>	SNODO SOSPENSIONE INFERIORE SUSPENSION JOINT LOWER		
Anno - Year <b>11/85 &gt; 12/91</b>		Serie - Series <b>FC</b>	Modello - Model <b>RX7 II</b>	
8AF1-32-280	<b>0282563</b>	TESTA STERZO - ESTERNA TIE ROD END - OUTER		
FB01-32-240A	<b>0602564</b>	SNODO ASSIALE AXIAL JOINT		
8173-99-356 8531-99-356	<b>0403383</b>	SNODO SOSPENSIONE BALL JOINT		
Anno - Year <b>07/1992 &gt;</b>		Serie - Series <b>FD</b>	Modello - Model <b>RX7 III</b>	
8AB2-32-280	<b>0283395</b>	TESTA STERZO - ESTERNA TIE ROD END - OUTER		
FD01-32-240	<b>0601597</b>	SNODO ASSIALE AXIAL JOINT		
8173-99-356 8531-99-356	<b>0403383</b>	SNODO SOSPENSIONE BALL JOINT		

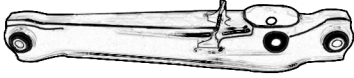
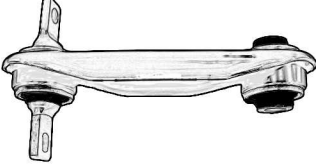
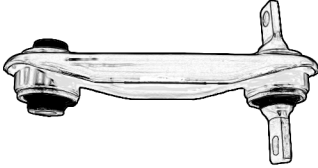
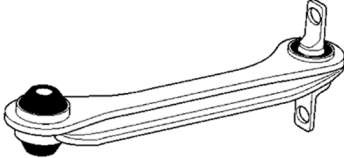
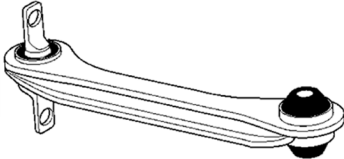





RIF. ORIG O.E. NUMBER	RIF. OCAP REF. OCAP	NOTE REMARKS	DESTRO RIGHT	SINISTRO LEFT
Anno - Year <b>2000 &gt; 2008</b>		Serie - Series <b>EP</b>	Modello - Model <b>TRIBUTE</b>	
EC01-32-280A EC01-32-280 YL8Z-3A130-GA	<b>0288072</b>	TESTA STERZO - RHT M 16x1,5 TIE ROD END - RHT M16x1,5		
EC01-32-240A EC01-32-240 YL8Z-3280-EA	<b>0608072</b>	SNODO ASSIALE - RHT M 16x1,5 AXIAL JOINT- RHT M16x1,5		
G030-99-356 GA6B-99-356 GA6B-99-356A GA6A-99-356	<b>0400349</b>	SNODO SOSPENSIONE - ASSE ANTERIORE BALL JOINT - FRONT AXLE		
EC01-34-300F EC01-34-300G EC01-34-300H EC01-34-300J EC01-34-300K EC01-34-300L	<b>0788072</b>	BRACCIO OSCILLANTE - ASSE ANTERIORE - INFERIORE TRACK CONTROL ARM - FRONT AXLE - LOWER		
EC01-34-350F EC01-34-350G EC01-34-350H EC01-34-350J EC01-34-350K EC01-34-350L	<b>0798072</b>	BRACCIO OSCILLANTE - ASSE ANTERIORE - INFERIORE TRACK CONTROL ARM - FRONT AXLE - LOWER		
EC01-34-150F EC01-34-150A YL8Z-5K-483-AA EC01-34-150 BC1D-28-170	<b>0508072</b>	STABILIZZATORE - ASSE ANTERIORE STABILIZER LINK - FRONT AXLE		
Anno - Year <b>01/1992 &gt;</b>		Serie - Series <b>CA</b>	Modello - Model <b>XEDOS 6</b>	
GA2A-32-280A 8AG4-32-280 8AG3-32-280	<b>0284435</b>	TESTA STERZO - RHT M 14x1,5 TIE ROD END - RHT M14x1,5		
GA2A-32-250 6A2A-32-240	<b>0604450</b>	TESTA STERZO - RHT M 14x1,5 TIE ROD END - RHT M14x1,5		
G030-99-356 GA6B-99-356 GA6B-99-356A GA6A-99-356	<b>0403409</b>	SNODO ASSIALE - RHT M 14x1,5 AXIAL JOINT - RHT M14x1,5		
GD7A-34-300A GE4T-31-300 GE4T-31-300C GE4T-31-300E GE4T-34-300C	<b>0782798</b>	BRACCIO OSCILLANTE - ASSE ANTERIORE - INFERIORE TRACK CONTROL ARM - FRONT AXLE - LOWER		



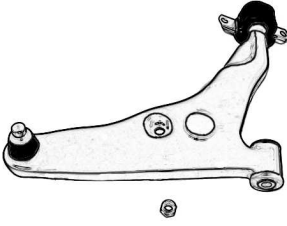
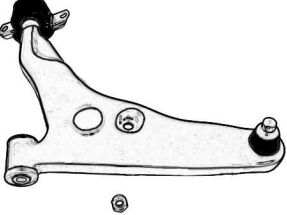

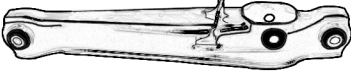
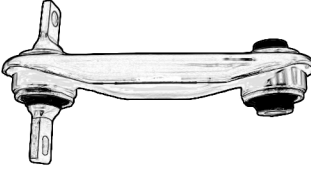
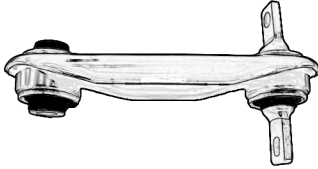

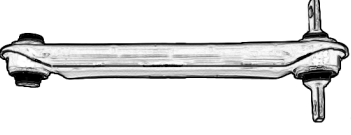

RIF. ORIG O.E. NUMBER	RIF. OCAP REF. OCAP	NOTE REMARKS	DESTRO RIGHT	SINISTRO LEFT
Anno - Year <b>01/1992 &gt;</b>		Serie - Series <b>CA</b>	Modello - Model <b>XEDOS 6</b>	
GD7A-34-350A GE4T-31-350 GE4T-31-350C GE4T-31-350E GE4T-34-350C	<b>0792798</b>	BRACCIO OSCILLANTE - ASSE ANTERIORE - INFERIORE TRACK CONTROL ARM - FRONT AXLE - LOWER		
GA2A-34-150A GA2A-34-150 GD1E-34-150	<b>0583801</b>	STABILIZZATORE - ASSE ANTERIORE STABILIZER LINK - FRONT AXLE		
GA2A-34-170A GA2A-34-170 GD1E-34-170	<b>0593801</b>	STABILIZZATORE - ASSE ANTERIORE STABILIZER LINK - FRONT AXLE		
GA2B-28-170B GA2B-28-170A GA2C-28-170A GA2C-28-170B	<b>0503706</b>	STABILIZZATORE - ASSE POSTERIORE STABILIZER LINK - REAR AXLE		

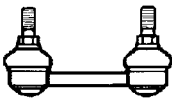
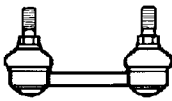
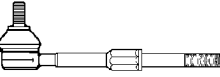
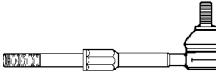
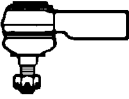
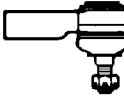

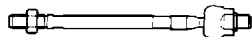
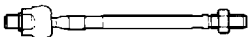



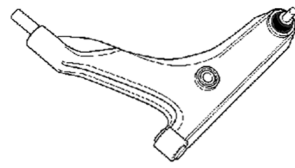
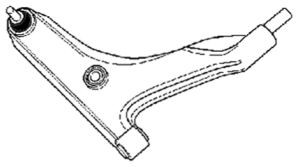





RIF. ORIG O.E. NUMBER	RIF. OCAP REF. OCAP	NOTE REMARKS	DESTRO RIGHT	SINISTRO LEFT
Anno - Year 1973 >		Serie - Series T210-T220-FE-FB-FC	Modello - Model CANTER	
MW-033301	0182944	TESTA STERZO - RHT M20x1,5 > 1985 TIE ROD END - RHT M20x1,5 > 1985		
MW-033300	0192944	TESTA STERZO - LHT M20x1,5 > 1985 TIE ROD END - LHT M20x1,5 > 1985		
MB-162811	0182945	TESTA STERZO - 1985 > TIE ROD END - 1985 >		
MB-162810	0192945	TESTA STERZO - 1985 > TIE ROD END - 1985 >		
Anno - Year 1995 >1999		Serie - Series	Modello - Model CARISMA	
MB-527169 MB-597605 MB-598023 MB-912076	0283440	TESTA STERZO - RHT M12x1,25 TIE ROD END - RHT M12x1,25		
MR-244901	0601999	SNODO ASSIALE - RHT M12x1,25 TIE ROD END - RHT M12x1,25		
MB-241883 MB-303374 MB-303375 MB-518712-01	0403434	SNODO SOSPENSIONE INFERIORE SUSPENSION JOINT LOWER		
MR-915770 MR-179480	0781749	BRACCIO OSCILLANTE ASSE ANTERIORE INFERIORE TRACK CONTROL ARM FRONT AXLE LOWER		
MR-915769 MR-179479	0791749	BRACCIO OSCILLANTE ASSE ANTERIORE INFERIORE TRACK CONTROL ARM FRONT AXLE LOWER		
MR-171308	0781965	BRACCIO OSCILLANTE ASSE POSTERIORE TRACK CONTROL ARM REAR AXL		



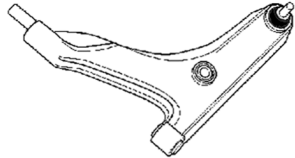
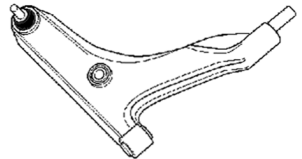



RIF. ORIG O.E. NUMBER	RIF. OCAP REF. OCAP	NOTE REMARKS	DESTRO RIGHT	SINISTRO LEFT
Anno - Year <b>1995 &gt;1999</b>		Serie - Series	Modello - Model <b>CARISMA</b>	
MR-171307	<b>0791965</b>	BRACCIO OSCILLANTE ASSE POSTERIORE TRACK CONTROL ARM REAR AXLE		
MB-809223	<b>0781958</b>	BRACCIO SOSPENSIONE ASSE POSTERIORE SUSPENSION LINK REAR AXLE		
MB-809222	<b>0791958</b>	BRACCIO SOSPENSIONE ASSE POSTERIORE SUSPENSION LINK REAR AXLE		
MB-809221	<b>0783506</b>	BRACCIO SOSPENSIONE ASSE POSTERIORE SUSPENSION LINK REAR AXLE		
MB-809220	<b>0793506</b>	BRACCIO SOSPENSIONE ASSE POSTERIORE SUSPENSION LINK REAR AXLE		
MR-272116 MR-131680	<b>0504470</b>	STABILIZZATORE - ASSE ANTERIORE STABILIZER LINK - FRONT AXLE		
MR-272117	<b>0504471</b>	STABILIZZATORE ASSE POSTERIORE STABILIZER LINK REAR AXLE		
Anno - Year <b>06/1999 &gt;</b>		Serie - Series	Modello - Model <b>CARISMA</b>	
MR-476457 MR-485672	<b>0281750</b>	TESTA STERZO - RHT M12x1,25 TIE ROD END - RHT M12x1,25		
MR-244901	<b>0601999</b>	SNODO ASSIALE - RHT M12x1,25 TIE ROD END - RHT M12x1,25		
MB-241883 MB-303374 MB-303375 MB-518712-01	<b>0403434</b>	SNODO SOSPENSIONE INFERIORE SUSPENSION JOINT LOWER		







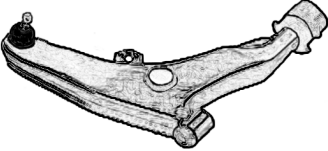
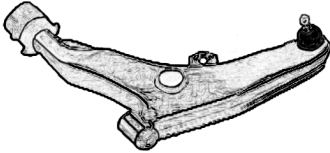
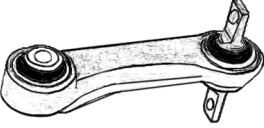
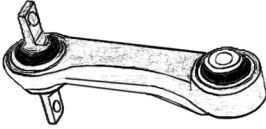
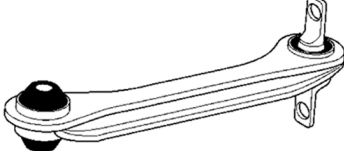





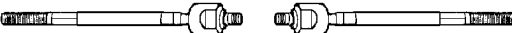

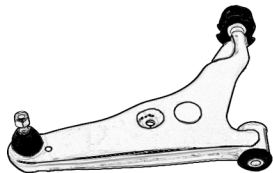
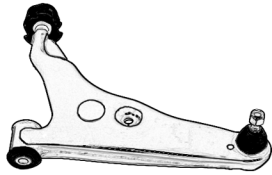

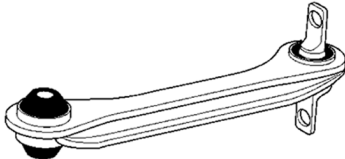
RIF. ORIG O.E. NUMBER	RIF. OCAP REF. OCAP	NOTE REMARKS	DESTRO RIGHT	SINISTRO LEFT
Anno - Year <b>06/1999 &gt;</b>		Serie - Series	Modello - Model <b>CARISMA</b>	
MR-911569	<b>0781751</b>	BRACCIO OSCILLANTE ASSE ANTERIORE TRACK CONTROL ARM FRONT AXLE		
MR-911570	<b>0791751</b>	BRACCIO OSCILLANTE ASSE ANTERIORE TRACK CONTROL ARM FRONT AXLE		
MR-171308	<b>0781965</b>	BRACCIO OSCILLANTE ASSE POSTERIORE TRACK CONTROL ARM REAR AXLE		
MR-171307	<b>0791965</b>	BRACCIO OSCILLANTE ASSE POSTERIORE TRACK CONTROL ARM REAR AXLE		
MB-809223	<b>0781958</b>	BRACCIO SOSPENSIONE ASSE POSTERIORE SUSPENSION LINK REAR AXLE		
MB-809222	<b>0791958</b>	BRACCIO SOSPENSIONE ASSE POSTERIORE SUSPENSION LINK REAR AXLE		
MR-130480	<b>0781998</b>	BRACCIO SOSPENSIONE ASSE POSTERIORE SUSPENSION LINK REAR AXLE		
MR-130479	<b>0791998</b>	BRACCIO SOSPENSIONE ASSE POSTERIORE SUSPENSION LINK REAR AXLE		
MR-272116 MR-131680	<b>0504470</b>	STABILIZZATORE - ASSE ANTERIORE STABILIZER LINK - FRONT AXLE		

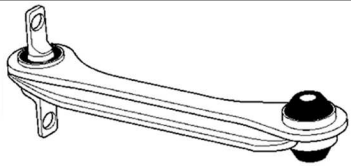
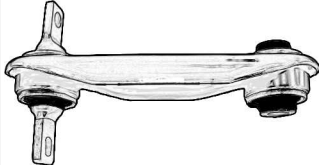
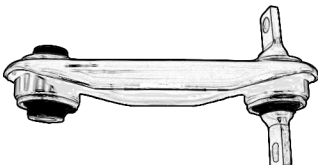





RIF. ORIG O.E. NUMBER	RIF. OCAP REF. OCAP	NOTE REMARKS	DESTRO RIGHT	SINISTRO LEFT
Anno - Year <b>06/1999 &gt;</b>		Serie - Series	Modello - Model <b>CARISMA</b>	
MR-272117	<b>0504471</b>	STABILIZZATORE ASSE POSTERIORE > 10/1999 STABILIZER LINK REAR AXLE > 10/1999		
MR-272118	<b>0504475</b>	STABILIZZATORE ASSE POSTERIORE - 11/1999 > STABILIZER LINK REAR AXLE - 11/1999 >		
Anno - Year <b>02/84 &gt; 04/88</b> <b>11/83 &gt; 06/92</b>		Serie - Series <b>C12A-C13A-C14A-C15A</b> <b>C12AS-C14AS-C15AS-C12V-C14V-C37V</b>	Modello - Model <b>COLT II</b> <b>LANCER III - MIRAGE</b>	
MB-241982	<b>0283437</b>	TESTA STERZO - RHT - > 1986 TIE ROD END - RHT - > 1986		
MB-527169 MB-597605 MB-598023 MB-912076	<b>0283440</b>	TESTA STERZO - RHT - 1986 > - RHT M12x1,5 TIE ROD END - RHT - 1986 > - RHT M12x1,5		
MB-347666	<b>0603443</b>	SNODO ASSIALE - RHT AXIAL JOINT - RHT		
MB-350718 MB-501530	<b>0603442</b>	SNODO ASSIALE - RHT SERVOSTERZO AXIAL JOINT - RHT POWER STEERING		
MB-241883 MB-303374 MB-303375 MB-518712-01	<b>0403434</b>	SNODO SOSPENSIONE INFERIORE SUSPENSION JOINT LOWER		
MB-349445	<b>0783500</b>	BRACCIO OSCILLANTE TRACK CONTROL ARM		
MB-349446	<b>0793500</b>	BRACCIO OSCILLANTE TRACK CONTROL ARM		
MB-518892 MB-573043 MB-892982 4056A014	<b>0501767</b>	STABILIZZATORE - ASSE ANTERIORE STABILIZER LINK - FRONT AXLE		



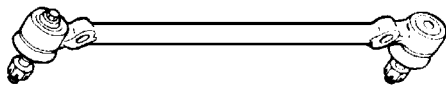
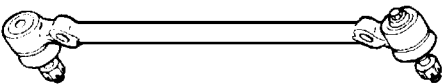

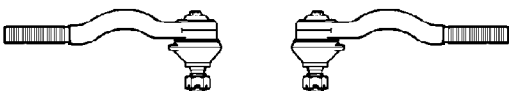

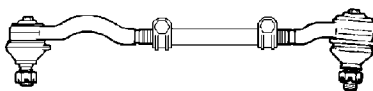

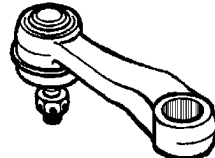
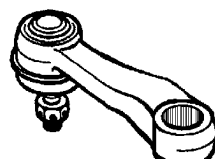
RIF. ORIG O.E. NUMBER	RIF. OCAP REF. OCAP	NOTE REMARKS	DESTRO RIGHT	SINISTRO LEFT
Anno - Year <b>04/88 &gt; 05/92</b> <b>04/88 &gt; 05/92</b>		Serie - Series <b>C51A-C52A-C53A-C54A-C58A</b> <b>C61A-C62A-C63A-C64A-C66A-C68A-C69A-C77A</b>	Modello - Model <b>COLT III</b> <b>LANCER IV - MIRAGE</b>	
MB-527169 MB-597605 MB-598023 MB-912076	<b>0283440</b>	TESTA STERZO - RHT M12x1,25 TIE ROD END - RHT M12x1,25		
MB-553249	<b>0603444</b>	SNODO ASSIALE - RHT M16x1,5 - STERZO MANUALE AXIAL JOINT - RHT M16x1,5 - MANUAL STEERING		
MB-910934	<b>0603445</b>	SNODO ASSIALE - RHT M16x1,5 - SERVO STERZO AXIAL JOINT - RHT M16x1,5 - POWER STEERING		
MB-241883 MB-303374 MB-303375 MB-518712-01	<b>0403434</b>	SNODO SOSPENSIONE INFERIORE SUSPENSION JOINT LOWER		
MB-518807	<b>0783501</b>	BRACCIO OSCILLANTE TRACK CONTROL ARM		
MB-518806	<b>0793501</b>	BRACCIO OSCILLANTE TRACK CONTROL ARM		
MB-518892 MB-573043 MB-892982 4056A014	<b>0501767</b>	STABILIZZATORE - ASSE ANTERIORE STABILIZER LINK - FRONT AXLE		
MB-518780 MB-573540 MB-518781 4056A038	<b>0183623</b>	STABILIZZATORE - ASSE ANTERIORE STABILIZER LINK - FRONT AXLE		
MB-518780 Z MB-573540 Z MB-518781 Z 4056A038 Z	<b>0183623-K</b>	KIT STABILIZZATORE - ASSE ANTERIORE STABILIZER LINK KIT - FRONT AXLE		

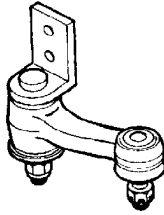
RIF. ORIG O.E. NUMBER	RIF. OCAP REF. OCAP	NOTE REMARKS	DESTRO RIGHT	SINISTRO LEFT
Anno - Year <b>04/92 &gt; 08/95</b> <b>06/92 &gt; 11/95</b>		Serie - Series <b>CA1A-CA4A-CA5A</b> <b>CB1A-CB4A-CD4A-CB8A-CB4W-CD4W-CB8W</b>	Modello - Model <b>COLT IV</b> <b>LANCER V - MIRAGE</b>	
MB-527169 MB-597605 MB-598023 MB-912076	<b>0283440</b>	TESTA STERZO - RHT M12x1,25 TIE ROD END - RHT M12x1,25		
MB-910934	<b>0603445</b>	SNODO ASSIALE - RHT M16x1,5 AXIAL JOINT - RHT M16x1,5		
MB-241883 MB-303374 MB-303375 MB-518712-01	<b>0403434</b>	SNODO SOSPENSIONE INFERIORE SUSPENSION JOINT LOWER		
MB-907116 MB-912078	<b>0783504</b>	BRACCIO OSCILLANTE ASSE ANTERIORE TRACK CONTROL ARM FRONT AXLE		
MB-907115 MB-912077	<b>0793504</b>	BRACCIO OSCILLANTE ASSE ANTERIORE TRACK CONTROL ARM FRONT AXLE		
MB-910841	<b>0783505</b>	BRACCIO SOSPENSIONE ASSE POSTERIORE SUSPENSION LINK REAR AXLE		
MB-910842	<b>0793505</b>	BRACCIO SOSPENSIONE ASSE POSTERIORE SUSPENSION LINK REAR AXLE		
MB-809221	<b>0783506</b>	BRACCIO SOSPENSIONE ASSE POSTERIORE SUSPENSION LINK REAR AXLE		
MB-809220	<b>0793506</b>	BRACCIO SOSPENSIONE ASSE POSTERIORE SUSPENSION LINK REAR AXLE		







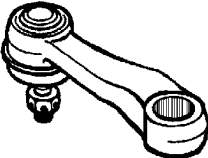
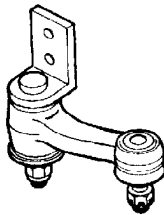

RIF. ORIG O.E. NUMBER	RIF. OCAP REF. OCAP	NOTE REMARKS	DESTRO RIGHT	SINISTRO LEFT
Anno - Year <b>04/92 &gt; 08/95</b> <b>06/92 &gt; 11/95</b>		Serie - Series <b>CA1A-CA4A-CA5A</b> <b>CB1A-CB4A-CD4A-CB8A-CB4W-CD4W-CB8W</b>	Modello - Model <b>COLT IV</b> <b>LANCER V - MIRAGE</b>	
MB-241974 MR-954888	<b>0504596</b>	STABILIZZATORE - ASSE ANTERIORE STABILIZER LINK - FRONT AXLE		
MB-809354 4056A021	<b>0502803</b>	STABILIZZATORE - ASSE POSTERIORE STABILIZER LINK - REAR AXLE		
Anno - Year <b>09/95 &gt; 07/05</b> <b>12/1995 &gt;</b>		Serie - Series	Modello - Model <b>COLT V</b> <b>LANCER VI</b>	
MB-527169 MB-597605 MB-598023 MB-912076	<b>0283440</b>	TESTA STERZO - RHT M12x1,5 TIE ROD END - RHT M12x1,5		
MR-297969	<b>0602993</b>	SNODO ASSIALE - RHT M12x1,5 AXIAL JOINT - RHT M12x1,5		
MB-241883 MB-303374 MB-303375 MB-518712-01	<b>0403434</b>	SNODO SOSPENSIONE INFERIORE SUSPENSION JOINT LOWER		
MR-241342	<b>0781959</b>	BRACCIO OSCILLANTE ASSE ANTERIORE TRACK CONTROL ARM FRONT AXLE		
MR-241341	<b>0791959</b>	BRACCIO OSCILLANTE ASSE ANTERIORE TRACK CONTROL ARM FRONT AXLE		
MR-197284	<b>0701960</b>	BRACCIO SOSPENSIONE ASSE POSTERIORE SUSPENSION LINK REAR AXLE		
MB-809221	<b>0783506</b>	BRACCIO SOSPENSIONE ASSE POSTERIORE SUSPENSION LINK REAR AXLE		

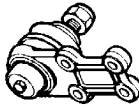
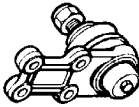
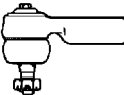
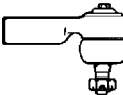
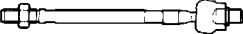
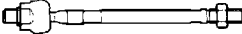
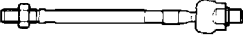
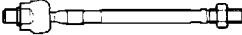
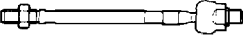
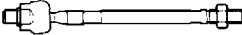







RIF. ORIG O.E. NUMBER	RIF. OCAP REF. OCAP	NOTE REMARKS	DESTRO RIGHT	SINISTRO LEFT
Anno - Year <b>09/95 &gt; 07/05</b> <b>12/1995 &gt;</b>		Serie - Series	Modello - Model <b>COLT V</b> <b>LANCER VI</b>	
MB-809220	<b>0793506</b>	BRACCIO SOSPENSIONE ASSE POSTERIORE SUSPENSION LINK REAR AXLE		
MB-809223	<b>0781958</b>	BRACCIO SOSPENSIONE ASSE POSTERIORE SUSPENSION LINK REAR AXLE		
MB-809222	<b>0791958</b>	BRACCIO SOSPENSIONE ASSE POSTERIORE SUSPENSION LINK REAR AXLE		
Anno - Year <b>06/2004 &gt;</b>		Serie - Series	Modello - Model <b>COLT VI</b>	
MR-977606	<b>0282804</b>	TESTA STERZO TIE ROD END		
-	<b>0402805</b>	SNODO SOSPENSIONE INFERIORE SUSPENSION JOINT LOWER		
MN-186218	<b>0782805</b>	BRACCIO OSCILLANTE ASSE ANTERIORE TRACK CONTROL ARM FRONT AXLE		
MN-186217	<b>0792805</b>	BRACCIO OSCILLANTE ASSE ANTERIORE TRACK CONTROL ARM FRONT AXLE		
MR-961477	<b>0502806</b>	STABILIZZATORE - ASSE ANTERIORE STABILIZER LINK -FRONT AXLE		

RIF. ORIG O.E. NUMBER	RIF. OCAP REF. OCAP	NOTE REMARKS	DESTRO RIGHT	SINISTRO LEFT
Anno - Year <b>1969 &gt; 1986</b>		Serie - Series <b>A51-A52-A53-A55-A112-A114-A115-A117 A121A-A131A-A122A-A123A-A123V- -A132A-A133A-A161A-A162A-A161V</b>	Modello - Model <b>GALANT - SAPPORO - ETERNA</b>	
MA-151985 MA-169605	<b>0503466</b>	L H D - BARRA STERZO - > 1976 L H D - TIE ROD - > 1976		
MA-159887	<b>0503467</b>	R H D - BARRA STERZO - > 1976 R H D - TIE ROD - > 1976		
MA-159984 MB-166982 MB-378704 MB-122782	<b>0190359</b>	TESTA STERZO ESTERNA LHT M14x1.5 - > 1976 TIE ROD OUTER LHT M14x1.5 - > 1976		
MA-159982 MA-169613	<b>0183468</b>	TESTA STERZO INTERNA RHT M14x1.5 - > 1976 TIE ROD INNER RHT M14x1.5 - > 1976		
MB-076002	<b>0583472</b>	BARRA STERZO - 1976 > 1986 TIE ROD - 1976 > 1986		
MB-076004 MB-076664 MB-378702	<b>0293469</b>	TESTA STERZO INTERNA LHT M14x1.5 - 1976 > 1986 TIE ROD INNER LHT M14x1.5 - 1976 > 1986		
MB-076001	<b>0593473</b>	BARRA STERZO 1976 > 1986 TIE ROD - 1976 > 1986		
MB-076003 MB-076663 MB-122779 MB-166980 MB-378701	<b>0183458</b>	TESTA STERZO INTERNA RHT M14x1.5 - 1976 > 1986 TIE ROD END RHT M14x1.5 - 1976 > 1986		
MB-076010 MB-241165	<b>0303474</b>	LEVA STERZO - > 1976 PITMAN ARM - > 1976		
MB-076009 MB-166566	<b>0303461</b>	LEVA STERZO - 1976 > PITMAN ARM - 1976 >		















RIF. ORIG O.E. NUMBER	RIF. OCAP REF. OCAP	NOTE REMARKS	DESTRO RIGHT	SINISTRO LEFT
Anno - Year 1969 > 1986		Serie - Series A51-A52-A53-A55-A112-A114-A115-A117 A121A-A131A-A122A-A123A-A123V- -A132A-A133A-A161A-A162A-A161V	Modello - Model GALANT - SAPPORO - ETERNA	
MB-192297 MB-241495	0303475	BRACCIO STERZO - 1976 > 1986 IDLER ARM - 1976 > 1986		
MA-150801 MB-001695	0403476	SNODO SOSPENSIONE INFERIORE > 1973 SUSPENSION JOINT LOWER > 1973		
MB-001696 MB-001699 MB-001715	0403477	SNODO SOSPENSIONE INFERIORE 1973 > 1986 SUSPENSION JOINT LOWER 1973 > 1986		
Anno - Year 1980 > 1986		Serie - Series A163A-A164A-A166A-A167A-A168V	Modello - Model GALANT - SAPPORO - ETERNA	
MA-159984 MB-166982 MB-378704 MB-122782	0190359	TESTA STERZO ESTERNA LHT M14x1.5 TIE ROD OUTER LHT M14x1.5		
MB-109858	0293470	TESTA STERZO INTERNA - LHT M14x1.5 TIE ROD END INNER - LHT M14x1.5		
MB-076003 MB-076663 MB-122779 MB-166980 MB-378701	0183458	TESTA STERZO INTERNA RHT M14x1.5 TIE ROD END INNER RHT M14x1.5		
MB-076009 MB-166566	0303461	LEVA STERZO PITMAN ARM		
MB-192297 MB-241495	0303475	BRACCIO STERZO IDLER ARM		

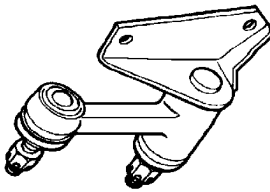









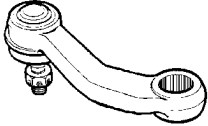
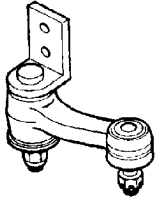

RIF. ORIG O.E. NUMBER	RIF. OCAP REF. OCAP	NOTE REMARKS	DESTRO RIGHT	SINISTRO LEFT
Anno - Year <b>1980 &gt; 1986</b>	Serie - Series <b>A163A-A164A-A166A-A167A-A168V</b>		Modello - Model <b>GALANT - SAPPORO - ETERNA</b>	
MB-185329	<b>0403478</b>	SNODO SOSPENSIONE INFERIORE SUSPENSION JOINT LOWER		
Anno - Year <b>1983 &gt; 1992</b>	Serie - Series <b>E12A-E13A-E15A-E17A-E31A-E32A-E33A-E35A-E37 A-E38A-E39A</b>		Modello - Model <b>GALANT - ETERNA</b>	
MB-192499 MB-489434	<b>0283471</b>	TESTA STERZO ESTERNA - RHT M14x1.5 TIE ROD END OUTER - RHT M14x1.5		
MB-266152 MB-315160	<b>0603479</b>	SNODO ASSIALE - RHT M14x1.5 STERZO MANUALE - > 1987 AXIAL JOINT - RHT M14x1.5 MANUAL STEERING - > 1987		
MB-350577	<b>0603480</b>	SNODO ASSIALE - RHT M14x1.5 SERVOSTERZO - > 1987 AXIAL JOINT - RHT M14x1.5 POWER STEERING - > 1987		
MB-243329 MB-501721 MB-532281	<b>0603481</b>	SNODO ASSIALE RHT M14x1.5 - 1987 > AXIAL JOINT RHT M14x1.5 - 1987 >		
MB-241883 MB-303374 MB-303375 MB-518712-01	<b>0403434</b>	SNODO SOSPENSIONE INFERIORE SUSPENSION JOINT LOWER		
MB-518892 MB-573043 MB-892982 4056A014	<b>0501767</b>	STABILIZZATORE - ASSALE ANTERIORE STABILIZER LINK - FRONT AXLE		
Anno - Year <b>11/92 &gt; 08/96</b> <b>04/91 &gt; 12/95</b> <b>1996 &gt;</b>	Serie - Series		Modello - Model <b>GALANT V ECLIPSE I ECLIPSE II</b>	
MB-192430	<b>0283433</b>	TESTA STERZO RHT M14x1,5 TIE ROD END RHT M14x1,5		
MR-403872 MB-949343 MB-532281 MR-594674	<b>0601760</b>	SNODO ASSIALE - RHT M14x1,5 AXIAL JOINT - RHT M14x1,5		

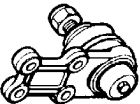
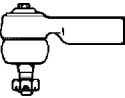
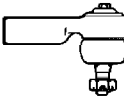
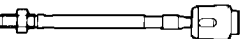
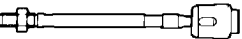

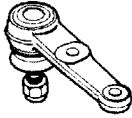
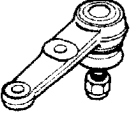

RIF. ORIG O.E. NUMBER	RIF. OCAP REF. OCAP	NOTE REMARKS	DESTRO RIGHT	SINISTRO LEFT
Anno - Year <b>11/92 &gt; 08/96</b> <b>04/91 &gt; 12/95</b> <b>1996 &gt;</b>		Serie - Series		Modello - Model <b>GALANT V</b> <b>ECLIPSE I</b> <b>ECLIPSE II</b>
MR-162804 MB-912506	<b>0781763</b>	BRACCIO OSCILLANTE - ASSE ANTERIORE - SUPERIORE TRACK CONTROL ARM - FRONT AXLE - UPPER		
MR-162803 MB-912505	<b>0791763</b>	BRACCIO OSCILLANTE SUPERIORE UPPER TRACK CONTROL ARM		
MB-912512 MR-162582 MR-296290 MR-296320	<b>0381762</b>	BRACCIO OSCILLANTE - ASSE ANTERIORE - INFERIORE TRACK CONTROL ARM - FRONT AXLE - LOWER		
MB-912511 MR-162581 MR-296289	<b>0391762</b>	BRACCIO OSCILLANTE INFERIORE LOWER TRACK CONTROL ARM		
MR-296296 MB-912510 MR-162580 MR-325577	<b>0381761</b>	BRACCIO OSCILLANTE - ASSE ANTERIORE - INFERIORE TRACK CONTROL ARM - FRONT AXLE - LOWER		
MR-296295 MB-912509 MR-162579 MR-325576	<b>0391761</b>	BRACCIO OSCILLANTE - ASSE ANTERIORE - INFERIORE TRACK CONTROL ARM - FRONT AXLE - LOWER		
MB-892981	<b>0501764</b>	STABILIZZATORE - ASSE ANTERIORE STABILIZER LINK - FRONT AXLE		
MB-518892 MB-573043 MB-892982 4056A014	<b>0501767</b>	STABILIZZATORE - ASSALE POSTERIORE STABILIZER LINK - REAR AXLE		

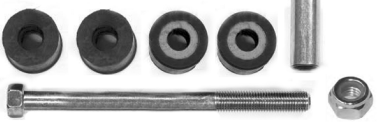



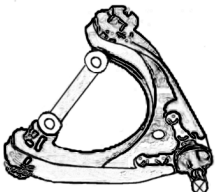
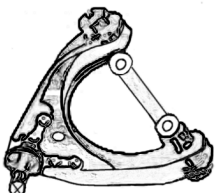
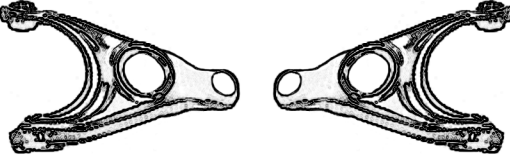



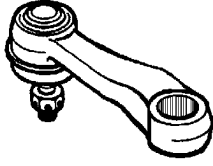

RIF. ORIG O.E. NUMBER	RIF. OCAP REF. OCAP	NOTE REMARKS	DESTRO RIGHT	SINISTRO LEFT
Anno - Year <b>09/96 &gt; 10/04</b>		Serie - Series <b>EA</b>	Modello - Model <b>GALANT VI</b>	
MB-192430	<b>0283433</b>	TESTA STERZO - RHT M14x1,5 TIE ROD END - RHT M14x1,5		
MR-403872 MB-949343 MB-532281 MR-594674	<b>0601760</b>	SNODO ASSIALE - RHT M14x1,5 AXIAL JOINT - RHT M14x1,5		
MR-162804 MB-912506	<b>0781763</b>	BRACCIO OSCILLANTE - ASSE ANTERIORE - SUPERIORE TRACK CONTROL ARM - FRONT AXLE - UPPER		
MR-162803 MB-912505	<b>0791763</b>	BRACCIO OSCILLANTE - ASSE ANTERIORE - SUPERIORE TRACK CONTROL ARM - FRONT AXLE - UPPER		
MB-912512 MR-162582 MR-296290 MR-296320	<b>0381762</b>	BRACCIO OSCILLANTE - ASSE ANTERIORE - INFERIORE TRACK CONTROL ARM - FRONT AXLE - LOWER		
MB-912511 MR-162581 MR-296289	<b>0391762</b>	BRACCIO OSCILLANTE - ASSE ANTERIORE - INFERIORE TRACK CONTROL ARM - FRONT AXLE - LOWER		
MR-296296 MB-912510 MR-162580 MR-325577	<b>0381761</b>	BRACCIO OSCILLANTE - ASSE ANTERIORE - INFERIORE TRACK CONTROL ARM - FRONT AXLE - LOWER		
MR-296295 MB-912509 MR-162579 MR-325576	<b>0391761</b>	BRACCIO OSCILLANTE - ASSE ANTERIORE - INFERIORE TRACK CONTROL ARM - FRONT AXLE - LOWER		
MB-892981	<b>0501764</b>	STABILIZZATORE - ASSE ANTERIORE STABILIZER LINK - FRONT AXLE		

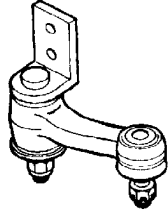
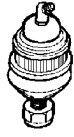
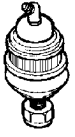
RIF. ORIG O.E. NUMBER	RIF. OCAP REF. OCAP	NOTE REMARKS	DESTRO RIGHT	SINISTRO LEFT
Anno - Year <b>09/96 &gt; 10/04</b>		Serie - Series <b>EA</b>	Modello - Model <b>GALANT VI</b>	
MR-131732	<b>0501577</b>	STABILIZZATORE - ASSE POSTERIORE STABILIZER LINK - REAR AXLE		
Anno - Year <b>1973 &gt; 1977</b> <b>1975 &gt; 1980</b> <b>1979 &gt; 1984</b>		Serie - Series <b>A71-A72-A73-A75</b> <b>A72M-A73M-A142M-A144M-A142A-A144A-A146A</b> <b>A141V-A142V-A148V-A149V</b>	Modello - Model <b>LANCER</b> <b>LANCER CELESTE</b> <b>LANCER - VAN</b>	
MA-159984 MB-166982 MB-378704 MB-122782	<b>0190359</b>	TESTA STERZO ESTERNA LHT M14x1,5 TIE ROD END OUTER LHT M14x1,5		
MA-159982 MA-169613	<b>0183468</b>	TESTA STERZO INTERNA RHT M14x1,5 TIE ROD INNER RHT M14x1,5		
MB-006571 MB-241497 MB-241498 MT-402861	<b>0303484</b>	L H D - BRACCIO STERZO L H D - IDLER ARM		
MB-001696 MB-001699 MB-001715	<b>0403477</b>	SNODO SOSPENSIONE INFERIORE SUSPENSION JOINT LOWER		
Anno - Year <b>1979 &gt; 1987</b>		Serie - Series <b>A171A-A172A-A174A-A175A</b>	Modello - Model <b>LANCER - EX (MK III) - COLT</b>	
MA-159984 MB-166982 MB-378704 MB-122782	<b>0190359</b>	TESTA STERZO ESTERNA - LHT M14x1,5 TIE ROD END OUTER - LHT M14x1,5		
MB-076004 MB-076664 MB-378702	<b>0293469</b>	TESTA STERZO INTERNA - LHT M14x1,5 - ESC.: NFU - NFG TIE ROD END INNER - LHT M14x1,5 - EXC.: NFU - NFG		
MB-076003 MB-076663 MB-122779 MB-166980 MB-378701	<b>0183458</b>	TESTA STERZO INTERNA - RHT M14x1,5 - ESC.: NFU - NFG TIE ROD END INNER - RHT M14x1,5 - EXC.: NFU - NFG		
MB-109858	<b>0293470</b>	TESTA STERZO INTERNA - LHT M14x1,5 - MOD. NFU - NFG TIE ROD END INNER - LHT M14x1,5 - MOD. NFU - NFG		

RIF. ORIG O.E. NUMBER	RIF. OCAP REF. OCAP	NOTE REMARKS	DESTRO RIGHT	SINISTRO LEFT
Anno - Year <b>1979 &gt; 1987</b>	Serie - Series <b>A171A-A172A-A174A-A175A</b>		Modello - Model <b>LANCER - EX (MK III) - COLT</b>	
MB-076003 MB-076663 MB-122779 MB-166980 MB-378701	<b>0183458</b>	TESTA STERZO INTERNA - RHT M14x1,5 - MOD. NFU - NFG TIE ROD END INNER - RHT M14x1,5 - MOD. NFU - NFG		
MB-122396	<b>0303486</b>	LEVA STERZO ESCLUSO MOD. COLT PITMAN ARM EXC. MOD. COLT		
MB-122400	<b>0303487</b>	BRACCIO STERZO ESCLUSO MOD. COLT IDLER ARM EXC. MOD. COLT		
MB-001696 MB-001699 MB-001715	<b>0403477</b>	SNODO SOSPENSIONE INFERIORE ESCLUSI MOD. NFU - NFG SUSPENSION JOINT LOWER - EXC.MOD. NFU - NFG		
MB-185329	<b>0403478</b>	SNODO SOSPENSIONE INFERIORE MOD. NFU - NFG SUSPENSION JOINT LOWER - MOD. NFU - NFG		
Anno - Year <b>1982 &gt; 1983</b> <b>1978 &gt; 1984</b>	Serie - Series <b>A155A-A156A</b> <b>A151A-A152A-A153A-A155A-A156A-A157A</b>		Modello - Model <b>LANCER - FIORE</b> <b>COLT I - MIRAGE</b>	
MB-166426 MB-006314 MB-006358 MB-076531 MB-185441 MB-241172 MB-315629 MB-844695 MT-142181	<b>0283435</b>	TESTA STERZO ESTERNA RHT M14x1,5 TIE ROD END OUTER RHT M14x1,5		
MB-122135	<b>0603436</b>	SNODO ASSIALE - RHT M14x1,5 AXIAL JOINT - RHT M14x1,5		
MB-243373 MB-315586	<b>0603441</b>	SNODO ASSIALE - RHT M14x1,5 - SERVOSTERZO AXIAL JOINT - RHT M14x1,5 - POWER STEERING		

RIF. ORIG O.E. NUMBER	RIF. OCAP REF. OCAP	NOTE REMARKS	DESTRO RIGHT	SINISTRO LEFT
Anno - Year <b>1982 &gt; 1983</b> <b>1978 &gt; 1984</b>		Serie - Series <b>A155A-A156A</b> <b>A151A-A152A-A153A-A155A-A156A-A157A</b>	Modello - Model <b>LANCER - FIORE</b> <b>COLT I - MIRAGE</b>	
MB-109169	<b>0483438</b>	SNODO SOSPENSIONE INFERIORE SUSPENSION JOINT LOWER		
MB-109168	<b>0493438</b>	SNODO SOSPENSIONE INFERIORE SUSPENSION JOINT LOWER		
Anno - Year <b>09/2003 &gt;</b>		Serie - Series <b>CS</b>	Modello - Model <b>LANCER VII</b>	
MB-527169 MB-597605 MB-598023 MB-912076	<b>0283440</b>	TESTA STERZO - RHT M12x1,25 TIE ROD END - RHT M12x1,25		
MR-491358	<b>0604129</b>	SNODO ASSIALE - RHT M12x1,25 AXIAL JOINT - RHT M12x1,25		
MR-403420 4013A274	<b>0784130</b>	BRACCIO OSCILLANTE - ASSE ANTERIORE - INFERIORE TRACK CONTROL ARM - FRONT AXLE - LOWER		
MR-403419	<b>0794130</b>	BRACCIO OSCILLANTE - ASSE ANTERIORE - INFERIORE TRACK CONTROL ARM - FRONT AXLE - LOWER		
MR-954887 4056A161	<b>0504131</b>	STABILIZZATORE - ASSE ANTERIORE STABILIZER LINK - FRONT AXLE		
MR-403485	<b>0704132</b>	BRACCIO OSCILLANTE - ASSE POSTERIORE - TRACK CONTROL ARM - REAR AXLE		











RIF. ORIG O.E. NUMBER	RIF. OCAP REF. OCAP	NOTE REMARKS	DESTRO RIGHT	SINISTRO LEFT
Anno - Year <b>09/2003 &gt;</b>		Serie - Series <b>CS</b>	Modello - Model <b>LANCER VII</b>	
MR-403771 MR-476595 4056A037	<b>0504133</b>	STABILIZZATORE - ASSE POSTERIORE STABILIZER LINK - REAR AXLE		
Anno - Year -		Serie - Series	Modello - Model <b>L100</b>	
LMB-002583	<b>0783494</b>	BRACCIO OSCILLANTE SUPERIORE TRACK CONTROL ARM UPPER		
LMB-002584	<b>0793494</b>	BRACCIO OSCILLANTE SUPERIORE TRACK CONTROL ARM UPPER		
LMB-002307	<b>0700495</b>	BRACCIO OSCILLANTE INFERIORE TRACK CONTROL ARM LOWER		
Anno - Year <b>1978 &gt; 10/86</b>		Serie - Series <b>L021P-L025P-K01T-K02T-K04T-K11T-K12T-K14T</b>	Modello - Model <b>L200 - FORTE</b>	
MA-159984 MB-166982 MB-378704 MB-122782	<b>0190359</b>	TESTA STERZO ESTERNA LHT M14x1,5 TIE ROD END OUTER LHT M14x1,5		
MB-076003 MB-076663 MB-122779 MB-166980 MB-378701	<b>0183458</b>	TESTA STERZO INTERNA RHT M14x1,5 TIE ROD END INNER RHT M14x1,5		
MB-122011 MB-122012	<b>0290328</b>	TESTA STERZO INTERNA - LHT M14x1,5 TIE ROD END INNER - LHT M14x1,5		

RIF. ORIG O.E. NUMBER	RIF. OCAP REF. OCAP	NOTE REMARKS	DESTRO RIGHT	SINISTRO LEFT
Anno - Year <b>1978 &gt; 10/86</b>	Serie - Series <b>L021P-L025P-K01T-K02T-K04T-K11T-K12T-K14T</b>		Modello - Model <b>L200 - FORTE</b>	
MB-076009 MB-166566	<b>0303461</b>	LEVA STERZO - > 1980 PITMAN ARM - > 1980		
MB-166281 MB-241166	<b>0300589</b>	LEVA STERZO - 1980 > PITMAN ARM - 1980 >		
MB-241421	<b>0303462</b>	BRACCIO STERZO - 1980 > 1986 IDLER ARM - 1980 > 1986		
MB-002475 MB-002476 MB-109585 MB-112476 MB-112477	<b>0403463</b>	SNODO SOPENSIONE SUPERIORE > 1980 SUSPENSION JOINT UPPER > 1980		
MB-176309	<b>0400555</b>	SNODO SOPENSIONE SUPERIORE 1980 > SUSPENSION JOINT UPPER 1980 >		
MB-109587 MB-109588 MB-175544	<b>0403464</b>	SNODO SOPENSIONE INFERIORE > 1980 SUSPENSION JOINT LOWER > 1980		
MB-109587 MB-109588 MB-175544 MB-175812 MB-176273 MB-176283 MB-241818	<b>0400329</b>	SNODO SOPENSIONE SUPERIORE 1980 > SUSPENSION JOINT UPPER 1980 >		
Anno - Year <b>10/86 &gt; 08/96</b>	Serie - Series <b>K - T</b>		Modello - Model <b>L200 (2WD)</b>	
MA-159984 MB-166982 MB-378704 MB-122782	<b>0190359</b>	TESTA STERZO ESTERNA - LHT M14x1,5 TIE ROD END OUTER - LHT M14x1,5		















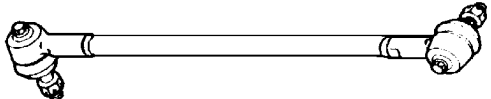
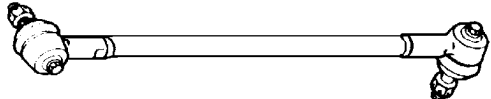





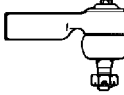
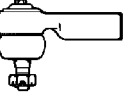
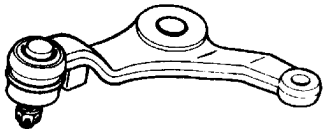

RIF. ORIG O.E. NUMBER	RIF. OCAP REF. OCAP	NOTE REMARKS	DESTRO RIGHT	SINISTRO LEFT
Anno - Year <b>10/86 &gt; 08/96</b>		Serie - Series <b>K - T</b>		Modello - Model <b>L200 (2WD)</b>
MB-076003 MB-076663 MB-122779 MB-166980 MB-378701	<b>0183458</b>	TESTA STERZO INTERNA - LHT M14x1,5 TIE ROD END INNER - LHT M14x1,5		
MB-122011 MB-122012	<b>0290328</b>	TESTA STERZO INTERNA - LHT M14x1,5 TIE ROD END INNER - LHT M14x1,5		
MB-166281 MB-241166	<b>0300589</b>	LEVA STERZO PITMAN ARM		
-	<b>0404115</b>	SNODO SOSPENSIONE - ASSE ANTERIORE - SUPERIORE BALL JOINT - FRONT AXLE - UPPER		
MB-860408	<b>0784115</b>	BRACCIO OSCILLANTE - ASSE ANTERIORE - SUPERIORE TRACK CONTROL ARM - FRONT AXLE - UPPER		
MB-527159	<b>0794115</b>	BRACCIO OSCILLANTE - ASSE ANTERIORE - SUPERIORE TRACK CONTROL ARM - FRONT AXLE - UPPER		
MB-109587 MB-109588 MB-175544 MB-175812 MB-176273 MB-176283 MB-241818	<b>0403455</b>	SNODO SOSPENSIONE - ASSE ANTERIORE - INFERIORE BALL JOINT - FRONT AXLE - LOWER		
MB-109513	<b>0784116</b>	BRACCIO OSCILLANTE - ASSE ANTERIORE - INFERIORE TRACK CONTROL ARM - FRONT AXLE - LOWER		
MB-109512	<b>0794116</b>	BRACCIO OSCILLANTE - ASSE ANTERIORE - INFERIORE TRACK CONTROL ARM - FRONT AXLE - LOWER		











RIF. ORIG O.E. NUMBER	RIF. OCAP REF. OCAP	NOTE REMARKS	DESTRO RIGHT	SINISTRO LEFT
Anno - Year <b>08/1996 &gt;</b>		Serie - Series <b>K - T</b>	Modello - Model <b>L200 (2WD)</b>	
MB-241171 MB-315775 MR-241032	<b>0193459</b>	TESTA STERZO ESTERNA - LHT M16x1,5 TIE ROD END OUTER - LHT M16x1,5		
MR-241031	<b>0184117</b>	TESTA STERZO INTERNA - RHT M16x1,5 TIE ROD END OUTER - RHT M16x1,5		
MB-166281 MB-241166	<b>0300589</b>	LEVA STERZO PITMAN ARM		
-	<b>0404118</b>	SNODO SOSPENSIONE - ASSE ANTERIORE - SUPERIORE BALL JOINT - FRONT AXLE - UPPER		
MR-241024	<b>0784118</b>	BRACCIO OSCILLANTE - ASSE ANTERIORE - SUPERIORE TRACK CONTROL ARM - FRONT AXLE - UPPER		
MR-241023	<b>0794118</b>	BRACCIO OSCILLANTE - ASSE ANTERIORE - SUPERIORE TRACK CONTROL ARM - FRONT AXLE - UPPER		
MR-241027	<b>0404119</b>	SNODO SOSPENSIONE - ASSE ANTERIORE - INFERIORE BALL JOINT - FRONT AXLE - LOWER		
MR-241026 MR-296028	<b>0784119</b>	BRACCIO OSCILLANTE - ASSE ANTERIORE - INFERIORE TRACK CONTROL ARM - FRONT AXLE - LOWER		
MR-241025 MR-296027	<b>0794119</b>	BRACCIO OSCILLANTE - ASSE ANTERIORE - INFERIORE TRACK CONTROL ARM - FRONT AXLE - LOWER		
Anno - Year <b>11/86 &gt; 08/96</b>		Serie - Series <b>L022G-L026G-K22T-K24T-K32T-K34T</b>	Modello - Model <b>L200 4WD - FORTE 4WD</b>	
MB-241171 MB-315775 MR-241032	<b>0193459</b>	TESTA STERZO ESTERNA - LHT M16x1,5 TIE ROD END OUTER - LHT M16x1,5		



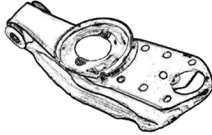
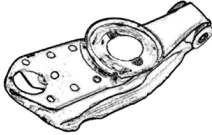
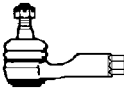
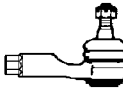
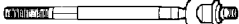
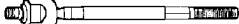
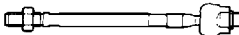



RIF. ORIG O.E. NUMBER	RIF. OCAP REF. OCAP	NOTE REMARKS	DESTRO RIGHT	SINISTRO LEFT
Anno - Year 11/86 > 08/96	Serie - Series L022G-L026G-K22T-K24T-K32T-K34T		Modello - Model L200 4WD - FORTE 4WD	
MB-241206 MB-315776	0183460	TESTA STERZO INTERNA - RHT M16x1,5 TIE ROD END INNER - RHT M16x1,5		
MB-241168	0304120	LEVA STERZO PITMAN ARM		
MB-241423	0304121	BRACCIO STERZO IDLER ARM		
MB-176309	0400555	SNODO SOPENSIONE SUPERIORE SUSPENSION JOINT UPPER		
MB-176308	0403465	SNODO SOPENSIONE INFERIORE SUSPENSION JOINT LOWER		
Anno - Year 06/96 > 10/05	Serie - Series K74T-K75T		Modello - Model L200 4WD	
MB-831043	0182942	TESTA STERZO ESTERNA - LHT M16x1,5 TIE ROD END OUTER - LHT M16x1,5		
MR-296274	0184122	TESTA STERZO INTERNA - RHT M16x1,5 TIE ROD END INNER - RHT M16x1,5		
MR-296272	0304123	BRACCIO STERZO IDLER ARM		
MB-860829 MB-860830	0403492	SNODO SOSPENSIONE SUPERIORE SUSPENSION JOINT UPPER		
MB-831038 MR-296270	0483493	SNODO SOSPENSIONE INFERIORE SUSPENSION JOINT LOWER		

RIF. ORIG O.E. NUMBER	RIF. OCAP REF. OCAP	NOTE REMARKS	DESTRO RIGHT	SINISTRO LEFT
Anno - Year <b>06/96 &gt; 10/05</b>		Serie - Series <b>K74T-K75T</b>		Modello - Model <b>L200 4WD</b>
MB-831037 MR-296269	<b>0493493</b>	SNODO SOSPENSIONE INFERIORE SUSPENSION JOINT LOWER		
Anno - Year <b>11/2005 &gt;</b>		Serie - Series <b>KAOT</b>		Modello - Model <b>L200 4WD</b>
4422A010	<b>0284124</b>	TESTA STERZO - RHT M16x1,5 TIE ROD END - RHT M16x1,5		
4422A009	<b>0294124</b>	TESTA STERZO - RHT M16x1,5 TIE ROD END - RHT M16x1,5		
4410A173	<b>0604125</b>	SNODO ASSIALE - RHT M16x1,5 AXIAL JOINT - RHT M16x1,5		
4010A015 MR-496792 4010A099	<b>0403088</b>	SNODO SOSPENSIONE - ASSE ANTERIORE - SUPERIORE BALL JOINT - FRONT AXLE - UPPER		
4010A014	<b>0784126</b>	BRACCIO OSCILLANTE - ASSE ANTERIORE - SUPERIORE TRACK CONTROL ARM - FRONT AXLE - UPPER		
4010A013	<b>0794126</b>	BRACCIO OSCILLANTE - ASSE ANTERIORE - SUPERIORE TRACK CONTROL ARM - FRONT AXLE - UPPER		
4013A090	<b>0404128</b>	SNODO SOSPENSIONE - ASSE ANTERIORE - INFERIORE BALL JOINT - FRONT AXLE - LOWER		

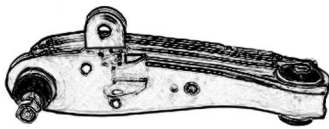
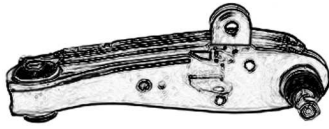







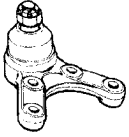
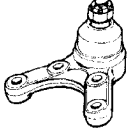

RIF. ORIG O.E. NUMBER	RIF. OCAP REF. OCAP	NOTE REMARKS	DESTRO RIGHT	SINISTRO LEFT
Anno - Year <b>11/2005 &gt;</b>		Serie - Series <b>KAOT</b>	Modello - Model <b>L200 4WD</b>	
4013A088 4013A330	<b>0784128</b>	BRACCIO OSCILLANTE - ASSE ANTERIORE - INFERIORE TRACK CONTROL ARM - FRONT AXLE - LOWER		
4013A087	<b>0794128</b>	BRACCIO OSCILLANTE - ASSE ANTERIORE - INFERIORE TRACK CONTROL ARM - FRONT AXLE - LOWER		
MR-992310	<b>0584127</b>	STABILIZZATORE - ASSE ANTERIORE STABILIZER LINK - FRONT AXLE		
MR-992309	<b>0594127</b>	STABILIZZATORE - ASSE ANTERIORE STABILIZER LINK - FRONT AXLE		
Anno - Year <b>1968 &gt; 1986</b>		Serie - Series <b>T100-T120-T121-L031P-L034P-L031PV-L032PV-L033 PW-L035PW-L036P</b>	Modello - Model <b>L300 - DELICA</b>	
MB-166422	<b>0503448</b>	L H D - BARRA STERZO 1979 > 1983 L H D - TIE ROD 1979 > 1983		
MB-166420	<b>0503449</b>	R H D - BARRA STERZO 1979 > 1983 R H D - TIE ROD 1979 > 1983		
MB-166426 MB-006314 MB-006358 MB-076531 MB-185441 MB-241172 MB-315629 MB-844695 MT-142181	<b>0283435</b>	TESTA STERZO ESTERNA RHT M14x1,5 - > 1982 TIE ROD END OUTER RHT M14x1,5 - > 1982		
MB-006315	<b>0283446</b>	TESTA STERZO INTERNA LHT M14x1,5 - > 1982 TIE ROD END INNER LHT M14x1,5 - > 1982		









RIF. ORIG O.E. NUMBER	RIF. OCAP REF. OCAP	NOTE REMARKS	DESTRO RIGHT	SINISTRO LEFT
Anno - Year <b>1968 &gt; 1986</b>		Serie - Series <b>T100-T120-T121-L031P-L034P-L031PV-L032PV-L033 PW-L035PW-L036P</b>		Modello - Model <b>L300 - DELICA</b>
MB-192430	<b>0283433</b>	TESTA STERZO ESTERNA RHT M14x1,5 - 1982 > TIE ROD END OUTER RHT M14x1,5 - 1982 >		
MB-288119	<b>0283447</b>	TESTA STERZO INTERNA LHT M14x1,5 - 1982 > TIE ROD END INNER LHT M14x1,5 - 1982 >		
MB-166424	<b>0303450</b>	L H D - LEVA STERZO - > 1983 L H D - PITMAN ARM - > 1983		
MB-166423	<b>0303451</b>	R H D - LEVA STERZO > 1983 R H D - PITMAN ARM > 1983		
MB-315770	<b>0304595</b>	L H D - BRACCIO STERZO L H D - IDLER ARM		
MB-002433	<b>0403452</b>	SNODO SOSPENSIONE SUPERIORE > 1976 SUSPENSION JOINT UPPER > 1976		
MB-109993	<b>0403453</b>	SNODO SOSPENSIONE INFERIORE > 1976 SUSPENSION JOINT LOWER > 1976		
MB-002475	<b>0403454</b>	SNODO SOSPENSIONE SUSPERIORE 1976 > 1983 SUSPENSION JOINT UPPER 1976 > 1983		
MB-109587 MB-109588 MB-175544 MB-175812 MB-176273 MB-176283 MB-241818	<b>0403455</b>	SNODO SOSPENSIONE INFERIORE 1979 > 1983 SUSPENSION JOINT LOWER 1979 > 1983		
MB-176309	<b>0403456</b>	SNODO SOSPENSIONE SUPERIORE 1983 > SUSPENSION JOINT UPPER 1983 >		







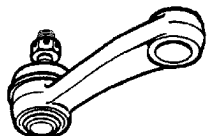

RIF. ORIG O.E. NUMBER	RIF. OCAP REF. OCAP	NOTE REMARKS	DESTRO RIGHT	SINISTRO LEFT
Anno - Year <b>1968 &gt; 1986</b>		Serie - Series <b>T100-T120-T121-L031P-L034P-L031PV-L032PV-L033 PW-L035PW-L036P</b>		Modello - Model <b>L300 - DELICA</b>
MB-175812	<b>0403457</b>	SNODO SOSPENSIONE INFERIORE 1983 > SUSPENSION JOINT LOWER 1983 >		
MB-109893	<b>0703497</b>	BRACCIO OSCILLANTE SUPERIORE > 1986 TRACK CONTROL ARM UPPER > 1986		
MB-109343	<b>0703498</b>	BRACCIO OSCILLANTE INFERIORE > 1986 TRACK CONTROL ARM LOWER > 1986		
Anno - Year <b>1986 &gt; 1997</b>		Serie - Series <b>P01V-P02V-P05V-P12V-P15V-P03W-P05W-P15W</b>		Modello - Model <b>L300 - DELICA</b>
MB-527650	<b>0282938</b>	TESTA STERZO - RHT M14x1,5 TIE ROD END - RHT M14x1,5		
MB-532971	<b>0602939</b>	SNODO ASSIALE RHT M14x1,5 STERZO MANUALE AXIAL JOINT RHT M14x1,5 MANUAL STEERING		
MB-350577	<b>0603480</b>	SNODO ASSIALE RHT M14x1,5 - SERVOSTERZO AXIAL JOINT RHT M14x1,5 - POWER STEERING		
54417-43001 54417-4A000 54417-4AA00 54417-43A00 54417-43A01 54417-47000 54417-4BA00 MB-527349 MB-527350 MR-241623	<b>0402940</b>	SNODO SOSPENSIONE SUPERIORE SUSPENSION JOINT UPPER		
MB-527383-01 MB-527384-01 MB-598018-Y	<b>0403507</b>	SNODO SOSPENSIONE INFERIORE SUSPENSION JOINT LOWER		

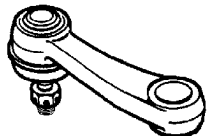



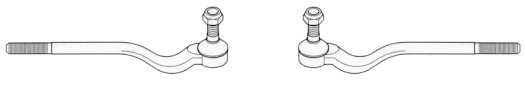



RIF. ORIG O.E. NUMBER	RIF. OCAP REF. OCAP	NOTE REMARKS	DESTRO RIGHT	SINISTRO LEFT
Anno - Year <b>1986 &gt; 1997</b>	Serie - Series <b>P01V-P02V-P05V-P12V-P15V-P03W-P05W-P15W</b>		Modello - Model <b>L300 - DELICA</b>	
MB-430113 MB-527384 MB-598018	<b>0783499</b>	BRACCIO OSCILLANTE INFERIORE TRACK CONTROL ARM LOWER		
MB-430112 MB-527383 MB-598017	<b>0793499</b>	BRACCIO OSCILLANTE INFERIORE TRACK CONTROL ARM LOWER		
Anno - Year <b>1982 &gt; 1986</b>	Serie - Series <b>L035GV-L037GV-L038GV-L035GW-L037GW-L038GW</b>		Modello - Model <b>L300 4WD - DELICA</b>	
MB-241171 MB-315775 MR-241032	<b>0193459</b>	TESTA STERZO ESTERNA - LHT M16x1,5 TIE ROD END OUTER - LHT M16x1,5		
MB-241206 MB-315776	<b>0183460</b>	TESTA STERZO INTERNA - RHT M16x1,5 TIE ROD END INNER - RHT M16x1,5		
MB-176309	<b>0400555</b>	SNODO SOSPENSIONE SUPERIORE SUSPENSIONE JOINT UPPER		
MB-176308	<b>0403465</b>	SNODO SOSPENSIONE INFERIORE SUSPENSIONE JOINT LOWER		
Anno - Year <b>1986 &gt;</b>	Serie - Series <b>P23V-P25V-P45V-P23W-P24W-P25W-P35W</b>		Modello - Model <b>L300 4WD - DELICA</b>	
MB-527650	<b>0282938</b>	TESTA STERZO - RHT M14x1,5 TIE ROD END - RHT M14x1,5		
54417-43001 54417-4A000 54417-4AA00 54417-43A00 54417-43A01 54417-47000 54417-4BA00 MB-527349 MB-527350 MR-241623	<b>0402940</b>	SNODO SOSPENSIONE SUPERIORE SUSPENSIONE JOINT UPPER		







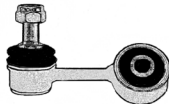
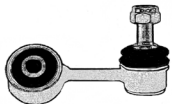



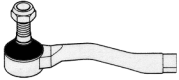
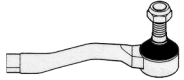





RIF. ORIG O.E. NUMBER	RIF. OCAP REF. OCAP	NOTE REMARKS	DESTRO RIGHT	SINISTRO LEFT
Anno - Year <b>1986 &gt;</b>	Serie - Series <b>P23V-P25V-P45V-P23W-P24W-P25W-P35W</b>		Modello - Model <b>L300 4WD - DELICA</b>	
MB-527352	<b>0482941</b>	SNODO SOSPENSIONE INFERIORE SUSPENSIONE JOINT LOWER		
MB-527351	<b>0492941</b>	SNODO SOSPENSIONE INFERIORE SUSPENSIONE JOINT LOWER		
Anno - Year —	Serie - Series		Modello - Model <b>MINICAR - PICK-UP - WAGON</b>	
HMB-303401	<b>0783496</b>	BRACCIO OSCILLANTE INFERIORE TRACK CONTROL ARM LOWER		
HMB-303402	<b>0793496</b>	BRACCIO OSCILLANTE INFERIORE TRACK CONTROL ARM LOWER		
Anno - Year <b>2003 &gt; 10/2006</b>	Serie - Series		Modello - Model <b>OUTLANDER</b>	
MR-508650 MR-548285	<b>0282818</b>	TESTA STERZO - RHT M16x1,5 TIE ROD END - RHT M16x1,5		
MR-403100	<b>0602819</b>	SNODO ASSIALE - RHT M16x1,5 AXIAL JOINT - RHT M16x1,5		
MR-319147	<b>0502820</b>	STABILIZZATORE - ASSE ANTERIORE STABILIZER LINK - FRONT AXLE		
MR-316368	<b>0502821</b>	STABILIZZATORE - ASSE POSTERIORE STABILIZER LINK - REAR AXLE		
Anno - Year <b>11/2006 &gt;</b>	Serie - Series <b>CW</b>		Modello - Model <b>OUTLANDER II</b>	
4422A018	<b>0284134</b>	TESTA STERZO - RHT M14x1,5 TIE ROD END - RHT M14x1,5		



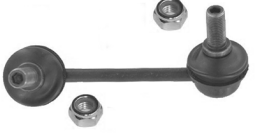







RIF. ORIG O.E. NUMBER	RIF. OCAP REF. OCAP	NOTE REMARKS	DESTRO RIGHT	SINISTRO LEFT
Anno - Year <b>11/2006 &gt;</b>		Serie - Series <b>CW</b>	Modello - Model <b>OUTLANDER II</b>	
4422A012	<b>0604135</b>	SNODO ASSIALE - RHT M14x1,5 AXIAL JOINT - RHT M14x1,5		
4013A010 Z 4013A009 Z	<b>0404136</b>	SNODO SOSPENSIONE - ASSE ANTERIORE - INFERIORE BALL JOINT - FRONT AXLE - LOWER		
4013A010	<b>0784136</b>	BRACCIO OSCILLANTE - ASSE ANTERIORE - INFERIORE TRACK CONTROL ARM - FRONT AXLE - LOWER		
4013A009	<b>0794136</b>	BRACCIO OSCILLANTE - ASSE ANTERIORE - INFERIORE TRACK CONTROL ARM - FRONT AXLE - LOWER		
MN-101368	<b>0504137</b>	STABILIZZATORE - ASSE ANTERIORE STABILIZER LINK - FRONT AXLE		
MN-184194	<b>0584138</b>	STABILIZZATORE - ASSE POSTERIORE STABILIZER LINK - REAR AXLE		
4156A014	<b>0594138</b>	STABILIZZATORE - ASSE POSTERIORE STABILIZER LINK - REAR AXLE		
Anno - Year <b>1982 &gt; 1990</b>		Serie - Series <b>L041G-L043G-L044G-L046G-L048G-L049G-L141G-L144G-L146G-L149G</b>	Modello - Model <b>PAJERO I</b>	
MB-241171 MB-315775 MR-241032	<b>0193459</b>	TESTA STERZO ESTERNA - LHT M16x1,5 TIE ROD END OUTER - LHT M16x1,5		
MB-241206 MB-315776	<b>0183460</b>	TESTA STERZO INTERNA - RHT M16x1,5 TIE ROD END INNER - RHT M16x1,5		
MB-241973	<b>0303488</b>	LEVA STERZO - > 1989 PITMAN ARM - > 1989		

















RIF. ORIG O.E. NUMBER	RIF. OCAP REF. OCAP	NOTE REMARKS	DESTRO RIGHT	SINISTRO LEFT
Anno - Year <b>1982 &gt; 1990</b>	Serie - Series <b>L041G-L043G-L044G-L046G-L048G-L049G-L141G-L144G-L146G-L149G</b>		Modello - Model <b>PAJERO I</b>	
MB-598489	<b>0303490</b>	LEVA STERZO - 1989 > PITMAN ARM - 1989 >		
MB-241830	<b>0303489</b>	BRACCIO STERZO IDLER ARM		
MB-176309	<b>0400555</b>	SNODO SOSPENSIONE SUPERIORE SUSPENSION JOINT UPPER		
MB-176308	<b>0403465</b>	SNODO SOSPENSIONE INFERIORE SUSPENSION JOINT LOWER		
Anno - Year <b>1990 &gt; 2000</b>	Serie - Series <b>V14V-V23C-V23W-V24C-V24V-V24W-V24WG-V34V-V43W-V44W-V44WG</b>		Modello - Model <b>PAJERO II - MONTERO II</b>	
MB-831043	<b>0182942</b>	TESTA STERZO ESTERNA - LHT M16x1,5 TIE ROD END OUTER - LHT M16x1,5		
MB-831044	<b>0192943</b>	TESTA STERZO INTERNA TIE ROD END INNER		
MB-831040	<b>0303491</b>	LEVA STERZO PITMAN ARM		
MB-831042	<b>0301988</b>	BRACCIO STERZO IDLER ARM		
MB-860829 MB-860830	<b>0403492</b>	SNODO SOSPENSIONE SUPERIORE SUSPENSION JOINT UPPER		

RIF. ORIG O.E. NUMBER	RIF. OCAP REF. OCAP	NOTE REMARKS	DESTRO RIGHT	SINISTRO LEFT
Anno - Year <b>1990 &gt; 2000</b>		Serie - Series <b>V14V-V23C-V23W-V24C-V24V-V24W-V24WG-V34V-V43W-V44W-V44WG</b>		Modello - Model <b>PAJERO II - MONTERO II</b>
MR-296094 MR-296096 MR-124880 MB-831036	<b>0783492</b>	BRACCIO OSCILLANTE ASSE ANTERIORE - SUPERIORE TRACK CONTROL ARM FRONT AXLE - UPPER		
MR-296093 MR-296095 MR-124879 MB-831035	<b>0793492</b>	BRACCIO OSCILLANTE ASSE ANTERIORE - SUPERIORE TRACK CONTROL ARM FRONT AXLE - UPPER		
MB-831038 MR-296270	<b>0483493</b>	SNODO SOSPENSIONE INFERIORE SUSPENSION JOINT LOWER		
MB-831037 MR-296269	<b>0493493</b>	SNODO SOSPENSIONE INFERIORE SUSPENSION JOINT LOWER		
MB-860382	<b>0783493</b>	BRACCIO OSCILLANTE - ASSE ANTERIORE - INFERIORE TRACK CONTROL ARM - FRONT AXLE - LOWER		
MB-860381	<b>0793493</b>	BRACCIO OSCILLANTE - ASSE ANTERIORE - INFERIORE TRACK CONTROL ARM - FRONT AXLE - LOWER		
MR-267877 MR-132552	<b>0582571</b>	STABILIZZATORE - ASSE ANTERIORE - ESTERNO STABILIZER LINK - FRONT AXLE - OUTER		
MR-267876 MR-132551	<b>0592571</b>	STABILIZZATORE - ASSE ANTERIORE - ESTERNO STABILIZER LINK - FRONT AXLE - OUTER		
MB-633926 MB-831039	<b>0504597</b>	STABILIZZATORE - ASSE ANTERIORE - INTERNO STABILIZER LINK - FRONT AXLE - INNER		







RIF. ORIG O.E. NUMBER	RIF. OCAP REF. OCAP	NOTE REMARKS	DESTRO RIGHT	SINISTRO LEFT
Anno - Year <b>04/2000 &gt; 2006</b>		Serie - Series <b>V60</b>		Modello - Model <b>PAJERO III</b>
MR-508136	<b>0282565</b>	TESTA STERZO ESTERNA TIE ROD END OUTER		
MR-508135	<b>0292565</b>	TESTA STERZO ESTERNA OUTER TIE ROD END		
MR-510267	<b>0602566</b>	SNODO ASSIALE - RHT M16x1,5 AXIAL JOINT - RHT M16x1,5		
4010A015 MR-496792 4010A099	<b>0403088</b>	SNODO SOSPENSIONE - ASSE ANTERIORE - SUPERIORE BALL JOINT - FRONT AXLE - UPPER		
MR-496794 4010A038	<b>0783088</b>	BRACCIO OSCILLANTE ASSE ANTERIORE - SUPERIORE TRACK CONTROL ARM FRONT AXLE - UPPER		
MR-496793 4010A037	<b>0793088</b>	BRACCIO OSCILLANTE ASSE ANTERIORE - SUPERIORE TRACK CONTROL ARM FRONT AXLE - UPPER		
4013A211 MR-496799	<b>0404141</b>	SNODO SOSPENSIONE - ASSE ANTERIORE - INFERIORE BALL JOINT - FRONT AXLE - LOWER		
MR-496796	<b>0784598</b>	BRACCIO OSCILLANTE - ASSE ANTERIORE - INFERIORE TRACK CONTROL ARM - FRONT AXLE - LOWER		
MR-496795	<b>0794598</b>	BRACCIO OSCILLANTE - ASSE ANTERIORE - INFERIORE TRACK CONTROL ARM - FRONT AXLE - LOWER		





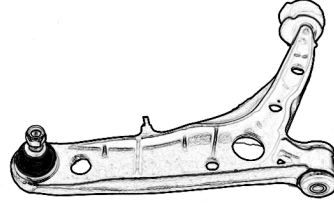
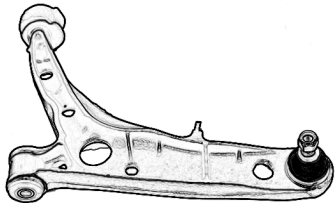
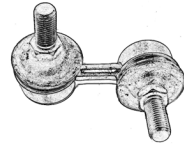
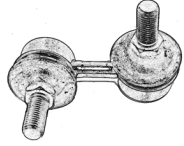

RIF. ORIG O.E. NUMBER	RIF. OCAP REF. OCAP	NOTE REMARKS	DESTRO RIGHT	SINISTRO LEFT
Anno - Year <b>04/2000 &gt; 2006</b>		Serie - Series <b>V60</b>	Modello - Model <b>PAJERO III</b>	
MR-374522 MB-267876	<b>0582568</b>	STABILIZZATORE - ANTERIORE STABILIZER LINK - FRONT		
MR-374521 MB-267877	<b>0592568</b>	STABILIZZATORE - ANTERIORE STABILIZER LINK - FRONT		
MR-508130	<b>0404599</b>	SNODO SOSPENSIONE - ASSE POSTERIORE BALL JOINT - REAR AXLE		
MR-418053	<b>0582569</b>	STABILIZZATORE - ASSE POSTERIORE STABILIZER LINK - REAR AXLE		
MR-418052	<b>0592569</b>	STABILIZZATORE - ASSE POSTERIORE STABILIZER LINK - REAR AXLE		
Anno - Year <b>02/2007 &gt;</b>		Serie - Series <b>V80 - V90</b>	Modello - Model <b>PAJERO IV</b>	
4422A038	<b>0284139</b>	TESTA STERZO - RHT M16x1,5 TIE ROD END - RHT M16x1,5		
4422A037	<b>0294139</b>	TESTA STERZO - RHT M16x1,5 TIE ROD END - RHT M16x1,5		
4422A036	<b>0604140</b>	SNODO ASSIALE - RHT M16x1,5 AXIAL JOINT - RHT M16x1,5		
4013A211 MR-496799	<b>0404141</b>	SNODO SOSPENSIONE - ASSE ANTERIORE - INFERIORE BALL JOINT - FRONT AXLE - LOWER		



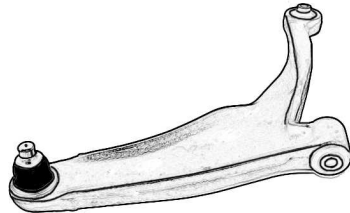
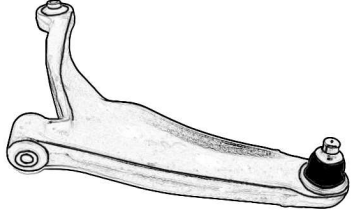
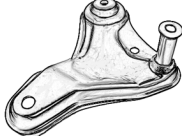
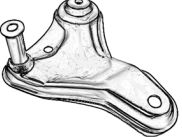
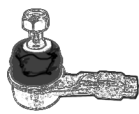

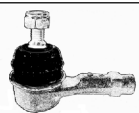
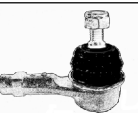

RIF. ORIG O.E. NUMBER	RIF. OCAP REF. OCAP	NOTE REMARKS	DESTRO RIGHT	SINISTRO LEFT
Anno - Year <b>02/2007 &gt;</b>		Serie - Series <b>V80 - V90</b>	Modello - Model <b>PAJERO IV</b>	
4013A210	<b>0784141</b>	BRACCIO OSCILLANTE - ASSE ANTERIORE - INFERIORE TRACK CONTROL ARM - FRONT AXLE - LOWER		
4013A209	<b>0794141</b>	BRACCIO OSCILLANTE - ASSE ANTERIORE - INFERIORE TRACK CONTROL ARM - FRONT AXLE - LOWER		
4010A015 MR-496792 4010A099	<b>0403088</b>	SNODO SOSPENSIONE - ASSE ANTERIORE - SUPERIORE BALL JOINT - FRONT AXLE - UPPER		
MR-496794 4010A038	<b>0783088</b>	BRACCIO OSCILLANTE - ASSE ANTERIORE - SUPERIORE TRACK CONTROL ARM - FRONT AXLE - UPPER		
MR-496793 4010A037	<b>0793088</b>	BRACCIO OSCILLANTE - ASSE ANTERIORE - SUPERIORE TRACK CONTROL ARM - FRONT AXLE - UPPER		
4056A134 MR-992192	<b>0584142</b>	STABILIZZATORE - ASSE ANTERIORE STABILIZER LINK - FRONT AXLE		
4056A133 MR-992191	<b>0594142</b>	STABILIZZATORE - ASSE ANTERIORE STABILIZER LINK - FRONT AXLE		
MR-418053	<b>0582569</b>	STABILIZZATORE - ASSE POSTERIORE STABILIZER LINK - REAR AXLE		
MR-418052	<b>0592569</b>	STABILIZZATORE - ASSE POSTERIORE STABILIZER LINK - REAR AXLE		



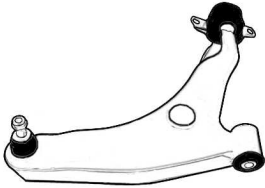
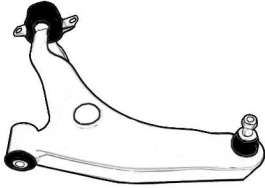



RIF. ORIG O.E. NUMBER	RIF. OCAP REF. OCAP	NOTE REMARKS	DESTRO RIGHT	SINISTRO LEFT
Anno - Year <b>1999 &gt;</b>		Serie - Series	Modello - Model <b>PAJERO PININ</b>	
MB-192430	<b>0283433</b>	TESTA STERZO RHT M14x1,5 TIE ROD END RHT M14x1,5		
MR-448255	<b>0601765</b>	SNODO ASSIALE - RHT M14x1,5 AXIAL JOINT - RHT M14x1,5		
MR-414940	<b>0781766</b>	BRACCIO OSCILLANTE ASSE ANTERIORE TRACK CONTROL ARM FRONT AXLE		
MR-414939	<b>0791766</b>	BRACCIO OSCILLANTE ASSE ANTERIORE TRACK CONTROL ARM FRONT AXLE		
MB-518892 MB-573043 MB-892982 4056A014	<b>0501767</b>	STABILIZZATORE STABILIZER LINK		
Anno - Year <b>12/90 &gt; 10/96</b> <b>01/93 &gt; 07/96</b>		Serie - Series <b>F16A</b> <b>F07W</b>	Modello - Model <b>SIGMA</b> <b>SIGMA SW</b>	
MB-192430	<b>0283433</b>	TESTA STERZO - RHT M14x1,5 TIE ROD END - RHT M14x1,5		
MB-241883 MB-303374 MB-303375 MB-518712-01	<b>0403434</b>	SNODO SOSPENSIONE - ASSE ANTERIORE - INFERIORE BALL JOINT - FRONT AXLE - LOWER		
MB-518892 MB-573043 MB-892982 4056A014	<b>0501767</b>	STABILIZZATORE - ASSE ANTERIORE STABILIZER LINK - FRONT AXLE		
MR-131732	<b>0501577</b>	STABILIZZATORE - ASSE POSTERIORE STABILIZER LINK - REAR AXLE		
Anno - Year <b>1991 &gt;</b>		Serie - Series <b>N11W</b>	Modello - Model <b>SPACE RUNNER</b>	
MB-192430	<b>0283433</b>	TESTA STERZO RHT M14x1,5 TIE ROD END RHT M14x1,5		

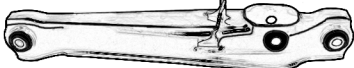
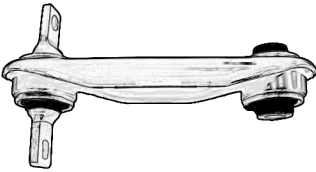

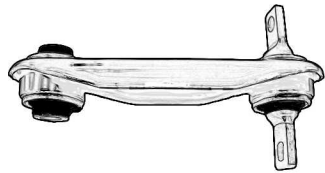



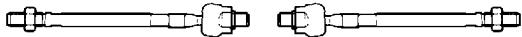
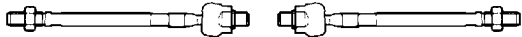
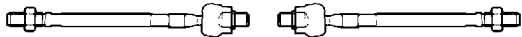



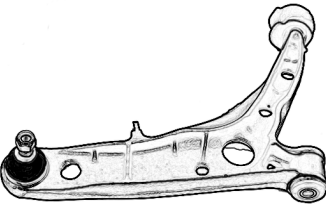
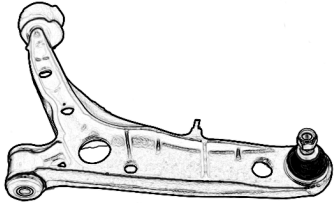
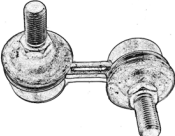
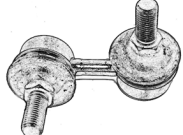

RIF. ORIG O.E. NUMBER	RIF. OCAP REF. OCAP	NOTE REMARKS	DESTRO RIGHT	SINISTRO LEFT
Anno - Year <b>1991 &gt;</b>		Serie - Series <b>N11W</b>	Modello - Model <b>SPACE RUNNER</b>	
MR-131857	<b>0601752</b>	SNODO ASSIALE - RHT M14x1,5 AXIAL JOINT - RHT M14x1,5		
MB-241883 MB-303374 MB-303375 MB-518712-01	<b>0403434</b>	SNODO SOSPENSIONE INFERIORE SUSPENSION JOINT LOWER		
MB-831556	<b>0381753</b>	BRACCIO OSCILLANTE ASSE ANTERIORE TRACK CONTROL ARM FRONT AXLE		
MB-831555	<b>0391753</b>	BRACCIO OSCILLANTE ASSE ANTERIORE TRACK CONTROL ARM FRONT AXLE		
MB-808076	<b>0581754</b>	STABILIZZATORE STABILIZER LINK		
MB-672370	<b>0591754</b>	STABILIZZATORE STABILIZER LINK		
Anno - Year <b>1999 &gt;</b>		Serie - Series	Modello - Model <b>SPACE RUNNER</b>	
MB-192430	<b>0283433</b>	TESTA STERZO RHT M14x1,5 TIE ROD END RHT M14x1,5		
MR-455090	<b>0681755</b>	SNODO ASSIALE - RHT M14x1,5 AXIAL JOINT - RHT M14x1,5		
MR-455089	<b>0691755</b>	SNODO ASSIALE - RHT M14x1,5 AXIAL JOINT - RHT M14x1,5		



RIF. ORIG O.E. NUMBER	RIF. OCAP REF. OCAP	NOTE REMARKS	DESTRO RIGHT	SINISTRO LEFT
Anno - Year <b>1999 &gt;</b>		Serie - Series	Modello - Model <b>SPACE RUNNER</b>	
MR-316052	<b>0381756</b>	ASSE ANTERIORE - BRACCIO OSCILLANTE FRONT AXLE - TRACK CONTROL ARM		
MR-316051	<b>0391756</b>	BRACCIO OSCILLANTE ASSE ANTERIORE TRACK CONTROL ARM FRONT AXLE		
MR-316298	<b>0781757</b>	ASSE POSTERIORE - SUPPORTO SOSPENSIONE REAR AXLE - SUSPENSION SUPPORT		
MR-316297	<b>0791757</b>	ASSE POSTERIORE - SUPPORTO SOSPENSIONE REAR AXLE - SUSPENSION SUPPORT		
Anno - Year <b>1998 &gt;</b>		Serie - Series <b>DG0</b>	Modello - Model <b>SPACE STAR</b>	
MB-527169 MB-597605 MB-598023 MB-912076	<b>0283440</b>	TESTA STERZO - > 06/2000 - RHT M12x1,5 TIE ROD END - > 06/2000 - RHT M12x1,5		
MR-476457 MR-485672	<b>0281750</b>	TESTA STERZO - RHT M12x1,25 - 07/2000 > TIE ROD END - RHT M12x1,25 - 07/2000 >		
MR-403027	<b>0601963</b>	SNODO ASSIALE AXIAL JOINT		
MB-241883 MB-303374 MB-303375 MB-518712-01	<b>0403434</b>	SNODO SOSPENSIONE - ASSE ANTERIORE - INFERIORE - > 03/1999 BALLN JOINT - FRONT AXLE - LOWER - > 03/1999		

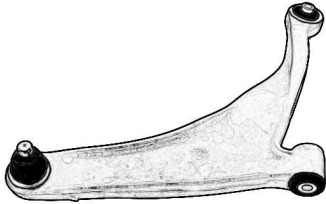
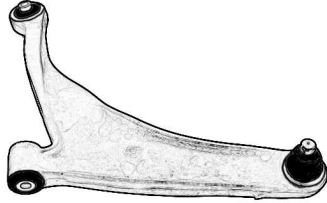
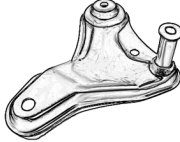
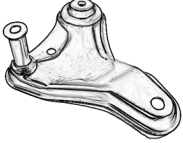
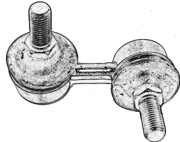
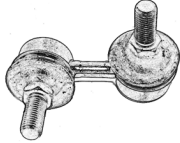









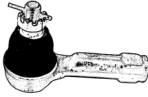
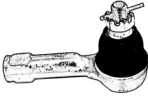
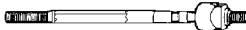
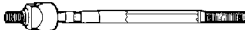

RIF. ORIG O.E. NUMBER	RIF. OCAP REF. OCAP	NOTE REMARKS	DESTRO RIGHT	SINISTRO LEFT
Anno - Year <b>1998 &gt;</b>		Serie - Series <b>DG0</b>	Modello - Model <b>SPACE STAR</b>	
MR-915770 MR-179480	<b>0781749</b>	BRACCIO OSCILLANTE - ASSE ANTERIORE - > 03/1999 TRACK CONTROL ARM - FRONT AXLE - > 03/1999 >		
MR-915769 MR-179479	<b>0791749</b>	BRACCIO OSCILLANTE - ASSE ANTERIORE - > 03/1999 TRACK CONTROL ARM - FRONT AXLE - > 03/1999 >		
-	<b>0401964</b>	SNODO SOSPENSIONE - ASSE ANTERIORE - INFERIORE - 03/1999 > BALL JOINT - FRONT AXLE - LOWER - 03/1999 >		
MR-297242 MR-911569 MR-916134	<b>0781964</b>	BRACCIO OSCILLANTE - ASSE ANTERIORE - INFERIORE - 03/1999 > TRACK CONTROL ARM - FRONT AXLE - LOWER - 03/1999 >		
MR-297241 MR-911570 MR-916133	<b>0791964</b>	BRACCIO OSCILLANTE - ASSE ANTERIORE - INFERIORE - 03/1999 > TRACK CONTROL ARM - FRONT AXLE - LOWER - 03/1999 >		
MR-171308	<b>0781965</b>	BRACCIO OSCILLANTE ASSE POSTERIORE TRACK CONTROL ARM REAR AXLE		
MR-171307	<b>0791965</b>	BRACCIO OSCILLANTE ASSE POSTERIORE TRACK CONTROL ARM REAR AXLE		
MB-809223	<b>0781958</b>	BRACCIO OSCILLANTE ASSE POSTERIORE TRACK CONTROL ARM REAR AXLE		

RIF. ORIG O.E. NUMBER	RIF. OCAP REF. OCAP	NOTE REMARKS	DESTRO RIGHT	SINISTRO LEFT
Anno - Year <b>1998 &gt;</b>		Serie - Series <b>DG0</b>	Modello - Model <b>SPACE STAR</b>	
MB-809222	<b>0791958</b>	BRACCIO OSCILLANTE ASSE POSTERIORE TRACK CONTROL ARM REAR AXLE		
MR-130480	<b>0781998</b>	BRACCIO SOSPENSIONE ASSE POSTERIORE - > 03/01 SUSPENSION LINK REAR AXLE - > 03/01		
MR-130479	<b>0791998</b>	BRACCIO SOSPENSIONE ASSE POSTERIORE - > 03/01 SUSPENSION LINK REAR AXLE - > 03/01		
MR-272118	<b>0504475</b>	STABILIZZATORE ASSE POSTERIORE STABILIZER LINK REAR AXLE		
Anno - Year <b>1983 &gt;</b> <b>1982 &gt; 1989</b>		Serie - Series <b>D02W-D03W-D05W-D08W</b> <b>A211A-A212A-A213A-A213G-A215G</b>	Modello - Model <b>SPACE WAGON - CHARIOT</b> <b>CORDIA - TREDIA</b>	
MB-192430	<b>0283433</b>	TESTA STERZO - RHT M14x1,5 TIE ROD END - RHT M14x1,5		
MB-266152 MB-315160	<b>0603479</b>	SNODO ASSIALE - RHT M14x1,5 AXIAL JOINT - RHT M14x1,5		
MB-243329 MB-501721 MB-532281	<b>0603481</b>	SNODO ASSIALE SERVOSTERZO - RHT M14x1,5 AXIAL JOINT POWER STEERING - RHT M14x1,5		
MB-350577	<b>0603480</b>	SNODO ASSIALE 4WD RHT M14x1,5 AXIAL JOINT 4WD RHT M14x1,5		
MB-241883 MB-303374 MB-303375 MB-518712-01	<b>0403434</b>	SNODO SOSPENSIONE INFERIORE ECCETTO 4WD SUSPENSION JOINT LOWER EXCEPT 4WD		

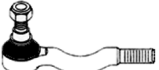

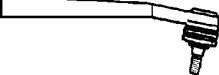







RIF. ORIG O.E. NUMBER	RIF. OCAP REF. OCAP	NOTE REMARKS	DESTRO RIGHT	SINISTRO LEFT
Anno - Year <b>1992 &gt;</b>		Serie - Series	Modello - Model <b>SPACE WAGON</b>	
MB-192430	<b>0283433</b>	TESTA STERZO - RHT M14x1,5 TIE ROD END - RHT M14x1,5		
MR-131857	<b>0601752</b>	SNODO ASSIALE - RHT M14x1,5 AXIAL JOINT - RHT M14x1,5		
MB-831556	<b>0381753</b>	BRACCIO OSCILLANTE ASSE ANTERIORE TRACK CONTROL ARM FRONT AXLE		
MB-831555	<b>0391753</b>	BRACCIO OSCILLANTE ASSE ANTERIORE TRACK CONTROL ARM FRONT AXLE		
MB-808076	<b>0581754</b>	STABILIZZATORE STABILIZER LINK		
MB-672370	<b>0591754</b>	STABILIZZATORE STABILIZER LINK		
Anno - Year <b>1999 &gt;</b>		Serie - Series	Modello - Model <b>SPACE WAGON</b>	
MB-192430	<b>0283433</b>	TESTA STERZO - RHT M14x1,5 TIE ROD END - RHT M14x1,5		
MR-455092	<b>0681759</b>	SNODO ASSIALE - RHT M14x1,5 AXIAL JOINT - RHT M14x1,5		
MR-455091	<b>0691759</b>	SNODO ASSIALE - RHT M14x1,5 AXIAL JOINT - RHT M14x1,5		



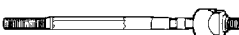
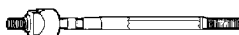
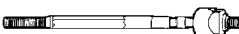
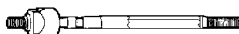

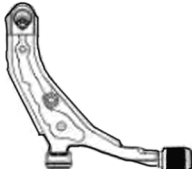
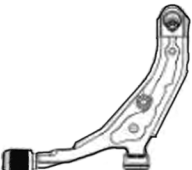



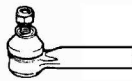
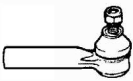

RIF. ORIG O.E. NUMBER	RIF. OCAP REF. OCAP	NOTE REMARKS	DESTRO RIGHT	SINISTRO LEFT
Anno - Year <b>1999 &gt;</b>		Serie - Series	Modello - Model <b>SPACE WAGON</b>	
MR-316054	<b>0381758</b>	BRACCIO OSCILLANTE ASSE ANTERIORE TRACK CONTROL ARM FRONT AXLE		
MR-316053	<b>0391758</b>	BRACCIO OSCILLANTE ASSE ANTERIORE TRACK CONTROL ARM FRONT AXLE		
MR-316298	<b>0781757</b>	ASSE POSTERIORE - SUPPORTO SOSPENSIONE REAR AXLE - SUSPENSION SUPPORT		
MR-316297	<b>0791757</b>	ASSE POSTERIORE - SUPPORTO SOSPENSIONE REAR AXLE - SUSPENSION SUPPORT		
MB-808076	<b>0581754</b>	STABILIZZATORE STABILIZER LINK		
MB-672370	<b>0591754</b>	STABILIZZATORE STABILIZER LINK		
Anno - Year <b>1982 &gt; 1990</b>		Serie - Series <b>A182A-A182A-A184A-A187A</b>	Modello - Model <b>STARION</b>	
MA-159984 MB-166982 MB-378704 MB-122782	<b>0190359</b>	TESTA STERZO ESTERNA - LHT M14x1,5 TIE ROD END - OUTER - LHT M14x1,5	 	
MB-076003 MB-076663 MB-122779 MB-166980 MB-378701	<b>0183458</b>	TESTA STERZO INTERNA RHT M14x1,5 TIE ROD END - INNER RHT M14x1,5		



RIF. ORIG O.E. NUMBER	RIF. OCAP REF. OCAP	NOTE REMARKS	DESTRO RIGHT	SINISTRO LEFT
Anno - Year <b>1982 &gt; 1990</b>		Serie - Series <b>A182A-A182A-A184A-A187A</b>	Modello - Model <b>STARION</b>	
MB-109858	<b>0293470</b>	TESTA STERZO INTERNA RHT M14x1,5 TIE ROD END - INNER RHT M14x1,5		
MB-185329	<b>0403478</b>	SNODO SOSPENSIONE INFERIORE SUSPENSION JOINT LOWER		



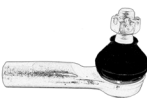
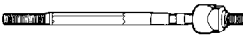

RIF. ORIG O.E. NUMBER	RIF. OCAP REF. OCAP	NOTE REMARKS	DESTRO RIGHT	SINISTRO LEFT
Anno - Year <b>03/90 &gt; 01/96</b>		Serie - Series <b>B13</b>	Modello - Model <b>100 NX</b>	
48520-Q9000 48520-01E00 48520-01E25 48520-01E26 48520-02E00 48520-02E25 48520-50Y25	<b>0283525</b>	TESTA STERZO - RHT M12x1,25 TIE ROD END - RHT M12x1,25		
48521-50Y00 48521-50400 48521-Y02G0	<b>0602889</b>	SNODO ASSIALE - RHT M12x1,25 AXIAL JOINT - RHT M12x1,25		
40160-Y02G0 40160-50Y10 40160-52Y00 40160-60Y10 40160-60Y20 40160-69Y00 40160-69Y10 40160-50Y00	<b>0403586</b>	SNODO SOSPENSIONE - ASSE ANTERIORE - INFERIORE BALL JOINT - FRONT AXLE - LOWER		
54618-50Y00 54618-58820 54618-D5010	<b>0504395</b>	STABILIZZATORE - ASSE ANTERIORE L= 85 mm STABILIZER LINK - FRONT AXLE L= 85 mm		
Anno - Year <b>1978 &gt; 1983</b> <b>1983 &gt; 1986</b>		Serie - Series <b>S 130</b> <b>Z 31</b>	Modello - Model <b>280 ZX</b> <b>300 ZX</b>	
48521-Q0125 48521-S0101 48521-S0102 48521-S0103 48521-S0125 48521-S0126	<b>0181221</b>	TESTA STERZO INTERNA - RHT M14x1,5 - SERIE S 130 TIE ROD END INTERNA - RHT M14x1,5 - SERIES S 130		
48520-21P25	<b>0283582</b>	TESTA STERZO ESTERNA - RHT M14x1,5 - SERIE Z 31 TIE ROD END OUTER - RHT M14x1,5 - SERIE Z 31		
48521-P9001 48521-W1000 48521-W1001 48521-01F00 48521-01F06	<b>0691223</b>	SNODO ASSIALE - RHT M14x1.5 1981 > AXIAL JOINT - RHT M14x1.5 1981 >		
40160-S0125 40160-S0126 40160-S0127 40160-S0128	<b>0401226</b>	SNODO SOSPENSIONE INFERIORE SERIE S 130 SUSPENSION JOINT LOWER SERIES S 130		



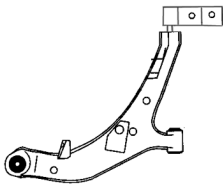
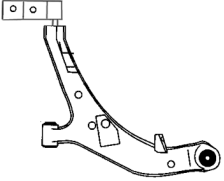
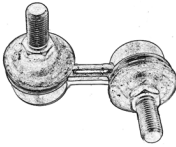
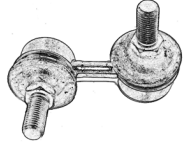
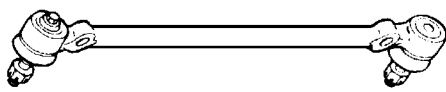
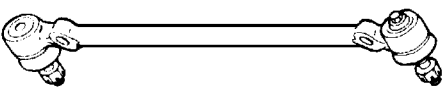
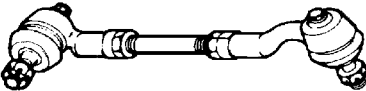
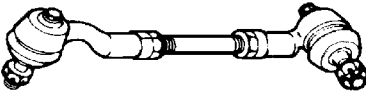

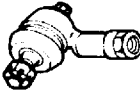
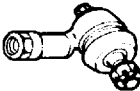

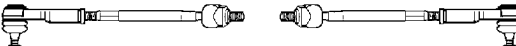

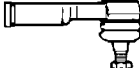
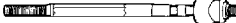
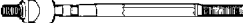
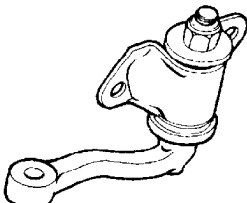
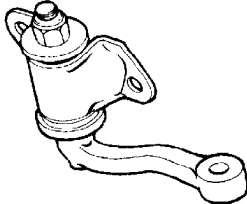

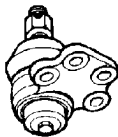
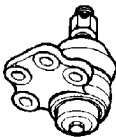
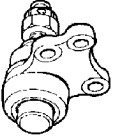
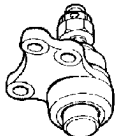
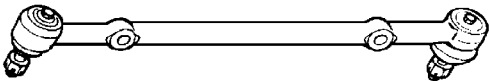
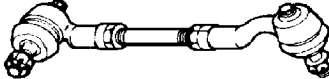
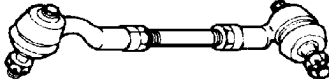
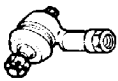
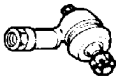

RIF. ORIG O.E. NUMBER	RIF. OCAP REF. OCAP	NOTE REMARKS	DESTRO RIGHT	SINISTRO LEFT
Anno - Year <b>1995 &gt; 2000</b>		Serie - Series <b>N 15</b>	Modello - Model <b>ALMERA I</b>	
48520-0M025	<b>0284177</b>	TESTA STERZO - RHT M12X1,25 - ECCEP MOD. 2.0 D - 2.0 GTI TIE ROD END - RHT M12X1,25 - EXCEPT: 2.0 D - 2.0 GTI MOD.		
48520-0M085 48520-15U25 48520-15U26	<b>0284178</b>	TESTA STERZO - RHT M14X1,5 - SOLO PER : MOD. 2.0 D - 2.0 GTI TIE ROD END - RHT M14X1,5 - SUITABLE FOR : 2.0 D - 2.0 GTI MOD.		
48521-50Y00 48521-50400 48521-Y02G0	<b>0602889</b>	SNODO ASSIALE - RHT M12x1,25 - STERZO MANUALE AXIAL JOINT - RHT M12x1,25 - MANUAL STEERING		
48521-1M226 48521-1M225 48521-1M210	<b>0604510</b>	SNODO ASSIALE - RHT M12x1,25 - SERVOSTERZO AXIAL JOINT - RHT M12x1,25 - POWER STEERING		
40160-60Y00 40160-50Y00	<b>0404399</b>	SNODO SOSPENSIONE INFERIORE SUSPENSION JOINT LOWER		
54500-OM060 54500-F4300 54500-OM020 54500-OM010	<b>0783587</b>	BRACCIO OSCILLANTE ASSE ANTERIORE TRACK CONTROL ARM FRONT AXLE		
54501-OM060 54501-F4300 54501-OM020 54501-OM010	<b>0793587</b>	BRACCIO OSCILLANTE ASSE ANTERIORE TRACK CONTROL ARM FRONT AXLE		
54618-50Y00 54618-58820 54618-D5010	<b>0504395</b>	STABILIZZATORE - ASSE ANTERIORE STABILIZER LINK - FRONT AXLE		
54618-D5010 (1) 56112-V0100 (2) 56113-60U0A (3) 08912-3401A (4)	<b>0504395-K</b>	KIT STABILIZZATORE - ASSE ANTERIORE STABILIZER LINK KIT - FRONT AXLE		

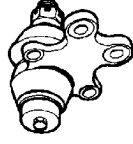
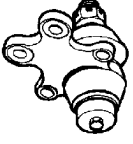
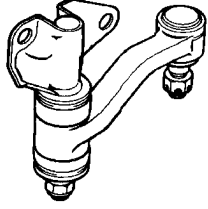



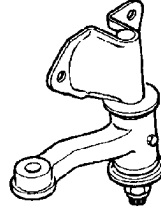

RIF. ORIG O.E. NUMBER	RIF. OCAP REF. OCAP	NOTE REMARKS	DESTRO RIGHT	SINISTRO LEFT
Anno - Year <b>2000 &gt;</b>		Serie - Series <b>N 16</b>	Modello - Model <b>ALMERA II</b>	
48520-BM425	<b>0284397</b>	TESTA STERZO - RHT M12X1,25 TIE ROD END - RHT M12X1,25		
48521-4M587 48521-4M528 48521-4M500 48521-4M527	<b>0602574</b>	SNODO ASSIALE AXIAL JOINT		
54500-BM410 Z 54501-BM410 Z	<b>0404398</b>	SNODO SOSPENSIONE - ASSE ANTERIORE BALL JOINT - FRONT AXLE		
54500-BM410 54500-BN300 54500-4M410 54500-4M400	<b>0784398</b>	BRACCIO OSCILLANTE - ASSE ANTERIORE TRACK CONTROL ARM - FRONT AXLE		
54501-BM410 54501-BN300 54501-4M410 54501-4M400	<b>0794398</b>	BRACCIO OSCILLANTE - ASSE ANTERIORE TRACK CONTROL ARM - FRONT AXLE		
54618-4M400	<b>0504396</b>	STABILIZZATORE - ASSE ANTERIORE STABILIZER LINK - FRONT AXLE		
54618-4M400 (1) 56112-BM400 (2) 56113-50Y0A (3) 01223-00291 (4)	<b>0504396-K</b>	KIT STABILIZZATORE - ASSE ANTERIORE STABILIZER LINK KIT - FRONT AXLE		
Anno - Year <b>08/2000 &gt;</b>		Serie - Series <b>V10</b>	Modello - Model <b>ALMERA TINO</b>	
48520-0M085 48520-15U25 48520-15U26	<b>0284178</b>	TESTA STERZO - RHT M14X1,5 TIE ROD END - RHT M14X1,5		
48521-4U110 48521-4U185 48521-4U186	<b>0602822</b>	SNODO ASSIALE AXIAL JOINT		







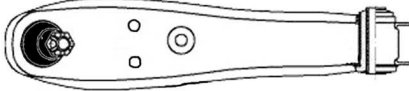
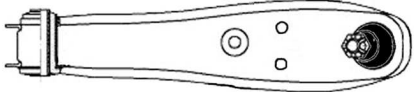

RIF. ORIG O.E. NUMBER	RIF. OCAP REF. OCAP	NOTE REMARKS	DESTRO RIGHT	SINISTRO LEFT
Anno - Year <b>08/2000 &gt;</b>		Serie - Series <b>V10</b>	Modello - Model <b>ALMERA TINO</b>	
40160-2Y000	<b>0402823</b>	SNODO SOSPENSIONE INFERIORE SUSPENSION JOINT LOWER		
54500-4U002 54500-4U012	<b>0782823</b>	BRACCIO OSCILLANTE ASSE ANTERIORE - INFERIORE TRACK CONTROL ARM FRONT AXLE - LOWER		
54501-4U002 54501-4U012	<b>0792823</b>	BRACCIO OSCILLANTE ASSE ANTERIORE - INFERIORE TRACK CONTROL ARM FRONT AXLE - LOWER		
54618-4U000	<b>0582824</b>	STABILIZZATORE - ASSE ANTERIORE STABILIZER LINK - FRONT AXLE		
54618-4U000	<b>0592824</b>	STABILIZZATORE - ASSE ANTERIORE STABILIZER LINK - FRONT AXLE		
Anno - Year <b>1977 &gt; 1985</b> <b>08/81 &gt; 12/85</b>		Serie - Series <b>A10 - A11</b> <b>T11</b>	Modello - Model <b>AUSTER</b> <b>STANZA</b>	
48560-W5700 48560-W5725	<b>0503565</b>	L H D - BARRA STERZO SERIE A10 - A11 > 1981 L H D - TIE ROD SERIES A10 - A11 > 1981		
48560-W5000	<b>0503566</b>	R H D - BARRA STERZO SERIE A10 - A11 > 1981 R H D - TIE ROD SERIES A10 - A11 > 1981		
48510-W5000 48510-W5025	<b>0583564</b>	BARRA STERZO - SERIE A10 - A11 > 1981 TIE ROD - SERIES A10 - A11 > 1981		
48630-W5000 48630-W5025	<b>0593564</b>	BARRA STERZO - SERIE A10 - A11 > 1981 TIE ROD - SERIES A10 - A11 > 1981		

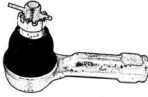
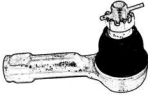
RIF. ORIG O.E. NUMBER	RIF. OCAP REF. OCAP	NOTE REMARKS	DESTRO RIGHT	SINISTRO LEFT
Anno - Year <b>1977 &gt; 1985</b> <b>08/81 &gt; 12/85</b>		Serie - Series <b>A10 - A11</b> <b>T11</b>		Modello - Model <b>AUSTER</b> <b>STANZA</b>
48520-H5025 48520-W5025	<b>0283553</b>	TESTA STERZO ESTERNA - RHT M14x1,5 - SERIE A10 - A11 > 1981 TIE ROD END OUTER - RHT M14x1,5 - SERIES A10 - A11 > 1981		
48640-H5025 48640-W5025	<b>0293553</b>	TESTA STERZO ESTERNA - LHT M14x1,5 - SERIE A10 - A11 > 1981 TIE ROD END OUTER - LHT M14x1,5 - SERIES A10 - A11 > 1981		
48521-H1001 48521-H5025 48521-W5025	<b>0293554</b>	TESTA STERZO INTERNA - LHT M14x1,5 - SERIE A10 - A11 > 1981 TIE ROD END INNER - LHT M14x1,5 - SERIES A10 - A11 > 1981		
48641-H1001 48641-H5025 48641-W5025	<b>0283554</b>	TESTA STERZO INTERNA - RHT M14x1,5 - SERIE A10 - A11 > 1981 TIE ROD END INNER - RHT M14x1,5 - SERIES A10 - A11 > 1981		
48510-D0100 48510-D0125 48510-11A27 48510-35A26 48510-35A27 48510-70A25 48510-70A27	<b>0500994</b>	BARRA STERZO - SERIE T11 - > 1985 TIE ROD - SERIES T11 - > 1985		
48520-D0100 48520-D0125 48520-D0126 48520-02E26	<b>0280992</b>	TESTA STERZO - RHT M12x1,25 - SERIE T11 -> 1985 TIE ROD END - RHT M12x1,25 - SERIES T11 - > 1985		
48521-D0100 48521-35F00 48521-70A00 48521-70A06 48521-70A16	<b>0600993</b>	SNODO ASSIALE - RHT M12x1,25 - SERIE T11 - > 1985 AXIAL JOINT - RHT M12x1,25 - SERIES T11 - > 1985		
48530-H6100	<b>0303568</b>	L H D - BRACCIO STERZO SERIE A 10 - A 11 L H D - IDLER ARM SERIES A 10 - A 11		
48530-H5000	<b>0303569</b>	R H D - BRACCIO STERZO SERIE A 10 - A 11 R H D - IDLER ARM SERIES A 10 - A 11		

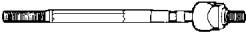
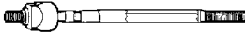
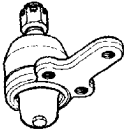
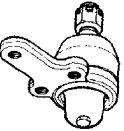



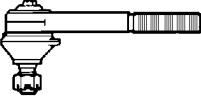
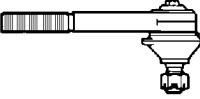

RIF. ORIG O.E. NUMBER	RIF. OCAP REF. OCAP	NOTE REMARKS	DESTRO RIGHT	SINISTRO LEFT
Anno - Year <b>1977 &gt; 1985</b> <b>08/81 &gt; 12/85</b>		Serie - Series <b>A10 - A11</b> <b>T11</b>	Modello - Model <b>AUSTER</b> <b>STANZA</b>	
40160-W5000	<b>0403555</b>	SNODO SOSPENSIONE INFERIORE SERIE A10 - A11 - > 1981 SUSPENSION JOINT LOWER SERIES A10 - A11 - > 1981		
40160-D0125	<b>0483567</b>	SNODO SOSPENSIONE INFERIORE SERIE T11 - > 1985 SUSPENSION JOINT LOWER SERIES T11 - > 1985		
40161-D0125	<b>0493567</b>	SNODO SOSPENSIONE INFERIORE SERIE T11 - > 1985 SUSPENSION JOINT LOWER SERIES T11 - > 1985		
Anno - Year <b>1968 &gt; 1976</b>		Serie - Series <b>P 510 &gt; 610</b>	Modello - Model <b>BLUEBIRD</b>	
48560-U2000 48560-U5200 48560-21400	<b>0503514</b>	L H D - BARRA STERZO L H D - TIE ROD		
48510-A0600 48510-U0100	<b>0583512</b>	BARRA STERZO TIE ROD		
48630-A0600 48630-U0100	<b>0593512</b>	BARRA STERZO TIE ROD		
48520-A0600 48520-U0100 48520-U5200 48640-G2525	<b>0283509</b>	TESTA STERZO ESTERNA - RHT M14x1,5 TIE ROD END - OUTER - RHT M14x1,5		
48520-G2525 48640-A0600 48640-U0100 48640-U5200	<b>0293509</b>	TESTA STERZO ESTERNA - LHT M14x1,5 TIE ROD END - OUTER - LHT M14x1,5		
48641-U5200 48641-A0600 48521-G2525 48641-U0100	<b>0283510</b>	TESTA STERZO INTERNA - RHT M14x1,5 TIE ROD END - INNER - RHT M14x1,5		
48521-A0600 48521-U0100 48521-U5200 48641-G2525	<b>0293510</b>	TESTA STERZO INTERNA - LHT M14x1,5 TIE ROD END - INNER - LHT M14x1,5		

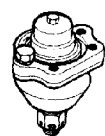
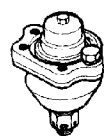
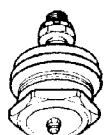
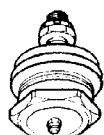

RIF. ORIG O.E. NUMBER	RIF. OCAP REF. OCAP	NOTE REMARKS	DESTRO RIGHT	SINISTRO LEFT
Anno - Year <b>1968 &gt; 1976</b>		Serie - Series <b>P 510 &gt; 610</b>	Modello - Model <b>BLUEBIRD</b>	
48530-21000 40160-A8600 40160-A8610 40160-A8625 40160-U7000	<b>0403513</b>	SNODO SOSPENSIONE INFERIORE SUSPENSION JOINT LOWER		
48530-21400	<b>0303516</b>	L H D - BRACCIO STERZO L H D - IDLER ARM		
Anno - Year <b>1976 &gt; 1979</b> <b>1972 &gt; 1981</b>		Serie - Series <b>810-RG810-RG811</b> <b>C110-C111-C210-C211</b>	Modello - Model <b>BLUEBIRD</b> <b>SKYLINE</b>	
48510-Q0125 48510-S0125 48630-S0125	<b>0501221</b>	BARRA STERZO TIE ROD		
48521-Q0125 48521-S0101 48521-S0102 48521-S0103 48521-S0125 48521-S0126	<b>0181221</b>	TESTA STERZO INTERNA - RHT M18x1,5 TIE ROD END - INNER - RHT M18x1,5		
48520-Q0125 48520-S0101 48520-S0102 48520-S0125	<b>0191217</b>	TESTA STERZO ESTERNA - LHT M18x1,5 TIE ROD END - OUTER - LHT M18x1,5		
48530-U8701	<b>0303523</b>	L H D - BRACCIO STERZO MOD. RG810-RG811-C210-C210 L H D - IDLER ARM MOD. RG810-RG811-C210-C210		
40160-S0125 40160-S0126 40160-S0127 40160-S0128	<b>0401226</b>	SNODO SOSPENSIONE INFERIORE SUSPENSION JOINT LOWER		
Anno - Year <b>1979 &gt; 1983</b>		Serie - Series <b>910</b>	Modello - Model <b>BLUEBIRD</b>	
48520-W1025 48520-01F25	<b>0281222</b>	TESTA STERZO - RHT M14x1,5 TIE ROD END - RHT M14x1,5		





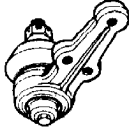
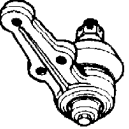
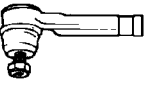
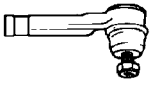
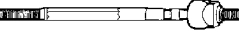
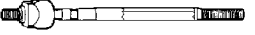
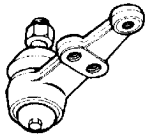
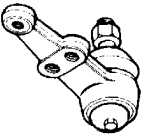
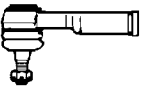
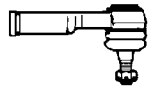
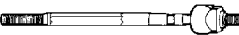
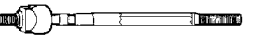
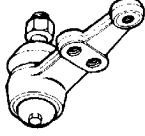
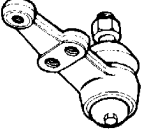

RIF. ORIG O.E. NUMBER	RIF. OCAP REF. OCAP	NOTE REMARKS	DESTRO RIGHT	SINISTRO LEFT
Anno - Year <b>1979 &gt; 1983</b>		Serie - Series <b>910</b>	Modello - Model <b>BLUEBIRD</b>	
48640-W1025 48640-01F25	<b>0291222</b>	TESTA STERZO - RHT M14x1,5 TIE ROD END - RHT M14x1,5		
48521-P9001 48521-W1000 48521-W1001 48521-01F00 48521-01F06	<b>0691223</b>	SNODO ASSIALE - RHT M14x1,5 AXIAL JOINT - RHT M14x1,5		
48510-Q0125 48510-S0125 48630-S0125	<b>0501221</b>	BARRA STERZO MOD. PJ910P (Z18P) TIE ROD MOD. PJ910P (Z18P)		
48521-Q0125 48521-S0101 48521-S0102 48521-S0103 48521-S0125 48521-S0126	<b>0181221</b>	TESTA STERZO INTERNA - RHT M18x1,5 - MOD. PJ910P(Z18P) TIE ROD END - INNER - RHT M18x1,5 - MOD. PJ910P(Z18P)		
48520-Q0125 48520-S0101 48520-S0102 48520-S0125	<b>0191217</b>	TESTA STERZO ESTERNA - LHT M18x1,5 MOD. PJ910P(Z18P) TIE ROD END - OUTER - LHT M18x1,5 MOD. PJ910P(Z18P)		
40160-W1000 40160-W1001 40160-W2200	<b>0401225</b>	SNODO SOSPENSIONE INFERIORE SUSPENSION JOINT LOWER		
40160-S0125 40160-S0126 40160-S0127 40160-S0128	<b>0401226</b>	SNODO SOSPENSIONE INFERIORE MOD. PJ910P(Z18P) SUSPENSION JOINT LOWER MOD. PJ910P(Z18P)		
54499-W1000 54499-W2210	<b>0783537</b>	BRACCIO OSCILLANTE TRACK CONTROL ARM		
54500-W1000 54500-W2210	<b>0793537</b>	BRACCIO OSCILLANTE TRACK CONTROL ARM		



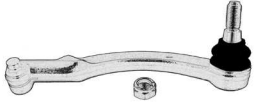

RIF. ORIG O.E. NUMBER	RIF. OCAP REF. OCAP	NOTE REMARKS	DESTRO RIGHT	SINISTRO LEFT
Anno - Year <b>1983 &gt; 1987</b> 1987 >		Serie - Series <b>U 11</b> <b>U 12</b>	Modello - Model <b>BLUEBIRD</b>	
48520-Q9000 48520-01E00 48520-01E25 48520-01E26 48520-02E00 48520-02E25 48520-50Y25	<b>0283525</b>	TESTA STERZO - RHT M12x1,25 - SERIE U 11 TIE ROD END - RHT M12x1,25 - SERIES U 11		
48520-53E25	<b>0283526</b>	TESTA STERZO - RHT M12x1,25 - SERIE U 12 TIE ROD END - RHT M12x1,25 - SERIES U 12		
48521-D0100 48521-35F00 48521-70A00 48521-70A06 48521-70A16	<b>0600993</b>	SNODO ASSIALE - RHT M12x1,25 - SERIE U 12 AXIAL JOINT - RHT M12x1,25 - SERIES U 12		
40160-01E00 40160-01E25 40160-51E00 40160-85E00	<b>0403527</b>	SNODO SOSPENSIONE INFERIORE SUSPENSION JOINT LOWER		
54618-50Y00 54618-58820 54618-D5010	<b>0504395</b>	STABILIZZATORE - ASSE ANTERIORE STABILIZER LINK - FRONT AXLE		
54618-D5010 (1) 56112-V0100 (2) 56113-60U0A (3) 08912-3401A (4)	<b>0504395-K</b>	KIT STABILIZZATORE - ASSE ANTERIORE STABILIZER LINK KIT - FRONT AXLE		
Anno - Year <b>1976 &gt; 1981</b>		Serie - Series <b>F20 - F21</b>	Modello - Model <b>CABSTAR - HOMER</b>	
48571-T3001 48571-T3025	<b>0193529</b>	TESTA STERZO - LHT M20x1,5 TIE ROD END - LHT M20x1,5		
48561-T3001 48561-T3025	<b>0183529</b>	TESTA STERZO - RHT M20x1,5 TIE ROD END - RHT M20x1,5		
48510-R8000 48510-R8025 48510-T3026 48510-T3060 48510-T3065	<b>0583530</b>	BARRA STERZO - 1978 > TIE ROD - 1978 >		



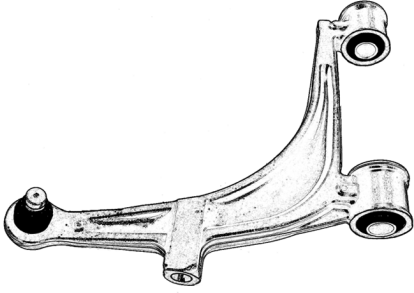
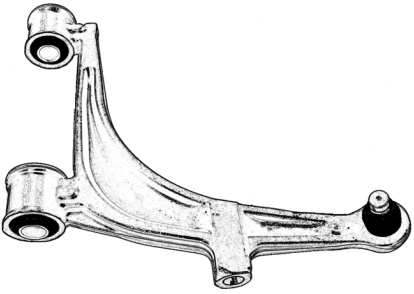
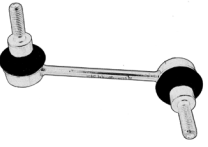
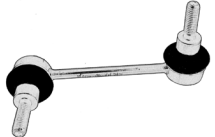











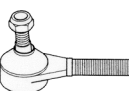
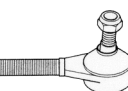
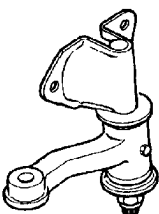



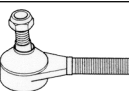
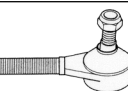

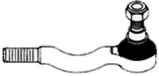



RIF. ORIG O.E. NUMBER	RIF. OCAP REF. OCAP	NOTE REMARKS	DESTRO RIGHT	SINISTRO LEFT
Anno - Year <b>1976 &gt; 1981</b>		Serie - Series <b>F20 - F21</b>		Modello - Model <b>CABSTAR - HOMER</b>
48520-R8000 48520-R8025 48520-T3026 48520-T3060 48520-T3065 48630-R8025	<b>0593530</b>	BARRA STERZO - 1978 > TIE ROD - 1978 >		
34004-6402P 34005-6402P 40110-J0125 40110-T3002 40110-T3025 40111-J0100 40111-J0125 40111-T3002 40111-T3025	<b>0403531</b>	SNODO SOSPENSIONE SUPERIORE > 1978 SUSPENSION JOINT UPPER > 1978		
34006-6401P 40160-J0100 40160-J0125 40160-T3002 40160-T3025 40160-T3026	<b>0403532</b>	SNODO SOSPENSIONE INFERIORE > 1978 SUSPENSION JOINT LOWER > 1978		
40110-B9500 40110-T3060 40110-T6000 40110-T6025 40110-V0100 40110-01G00 40110-01G25 40110-01G26	<b>0403533</b>	SNODO SOSPENSIONE SUPERIORE 1978 > SUSPENSION JOINT UPPER 1978 >		
40160-T3060 40160-B9500 40160-F1700 40160-48W00 40160-48W25	<b>0483534</b>	SNODO SOSPENSIONE INFERIORE - 1978 > SUSPENSION JOINT LOWER - 1978 >		
40161-T3060 40161-B9500 40161-F1700 40161-48W00 40161-48W25	<b>0493534</b>	SNODO SOSPENSIONE INFERIORE - 1978 > SUSPENSION JOINT LOWER - 1978 >		
Anno - Year <b>1974 &gt; 1978</b>		Serie - Series <b>F10-F11</b>		Modello - Model <b>CHERRY</b>
48520-M0225 48520-M3025	<b>0280360</b>	TESTA STERZO - RHT M12x1,25 TIE ROD END - RHT M12x1,25		



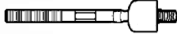
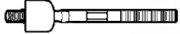
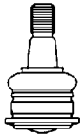
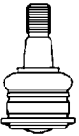





RIF. ORIG O.E. NUMBER	RIF. OCAP REF. OCAP	NOTE REMARKS	DESTRO RIGHT	SINISTRO LEFT
Anno - Year <b>1974 &gt; 1978</b>		Serie - Series <b>F10-F11</b>	Modello - Model <b>CHERRY</b>	
40160-M0225 40160-M3025	<b>0403535</b>	SNODO SOSPENSIONE INFERIORE SUSPENSION JOINT LOWER		
Anno - Year <b>1978 &gt; 1982</b>		Serie - Series <b>N10-N11</b>	Modello - Model <b>CHERRY</b>	
48520-M0225 48520-M3025	<b>0280360</b>	TESTA STERZO - RHT M12x1,25 TIE ROD END - RHT M12x1,25		
48521-M3070 48521-M7000	<b>0603577</b>	SNODO ASSIALE - RHT M12x1,25 AXIAL JOINT - RHT M12x1,25		
40160-M7025	<b>0403536</b>	SNODO SOSPENSIONE INFERIORE SUSPENSION JOINT LOWER		
Anno - Year <b>1982 &gt; 1986</b> <b>1986 &gt;</b>		Serie - Series <b>N12</b> <b>HNN13-HNN13P</b>	Modello - Model <b>CHERRY</b>	
48520-D0100 48520-D0125 48520-D0126 48520-02E26	<b>0280992</b>	TESTA STERZO - RHT M12x1,25 TIE ROD END - RHT M12x1,25		
48521-D0100 48521-35F00 48521-70A00 48521-70A06 48521-70A16	<b>0600993</b>	SNODO ASSIALE RHT M12x1,25 AXIAL JOINT RHT M12x1,25		
40160-A03G0 40160-A06G0 40160-01A00 40160-01A25	<b>0400996</b>	SNODO SOSPENSIONE INFERIORE SUSPENSION JOINT LOWER		
40160-50A00	<b>0400092</b>	SNODO SOSPENSIONE INFERIORE - MOD. 4WD SUSPENSION JOINT LOWER - MOD. 4WD		

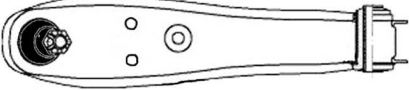

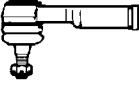
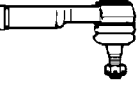

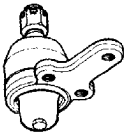
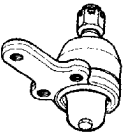
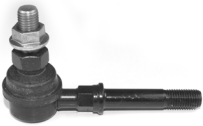

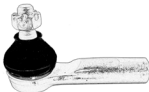
RIF. ORIG O.E. NUMBER	RIF. OCAP REF. OCAP	NOTE REMARKS	DESTRO RIGHT	SINISTRO LEFT
Anno - Year <b>07/2002 &gt;</b>		Serie - Series <b>X70</b>	Modello - Model <b>INTERSTAR</b>	
48520-00QAJ	<b>0282825</b>	TESTA STERZO - RHT M16x1,5 TIE ROD END - RHT M16x1,5		
48520-00QAH	<b>0292825</b>	TESTA STERZO - RHT M16x1,5 TIE ROD END - RHT M16x1,5		
48521-00QAF	<b>0602826</b>	SNODO ASSIALE AXIAL JOINT		
40160-00QAB 4500254	<b>0404614</b>	SNODO SOSPENSIONE SUPERIORE UPPER BALL JOINT		
40160-00QAD 40160-00QAC	<b>0402827</b>	SNODO SOSPENSIONE INFERIORE LOWER BALL JOINT		
54500-00QAC 54501-00QAC 54500-00QAE	<b>0382827</b>	BRACCIO OSCILLANTE TRACK CONTROL ARM		
54501-00QAC 54501-00QAD 54501-00QAE	<b>0392827</b>	BRACCIO OSCILLANTE TRACK CONTROL ARM		
54618-00QAA	<b>0582828</b>	STABILIZZATORE - ASSE ANTERIORE STABILIZER LINK - FRONT AXLE		
54618-00QAB	<b>0592828</b>	STABILIZZATORE - ASSE ANTERIORE STABILIZER LINK - FRONT AXLE		

RIF. ORIG O.E. NUMBER	RIF. OCAP REF. OCAP	NOTE REMARKS	DESTRO RIGHT	SINISTRO LEFT
Anno - Year <b>06/2010 &gt;</b>		Serie - Series	Modello - Model <b>JUKE</b>	
D8520-1KA0A	<b>0288071</b>	TESTA STERZO - RHT M12x1,25 TIE ROD END - RHT M12x1,25		
D8640-1KA0A	<b>0298071</b>	TESTA STERZO - RHT M12x1,25 TIE ROD END - RHT M12x1,25		
54500-1KA0B Z 54501-1KA0B Z	<b>0408071</b>	SNODO SOSPENSIONE - ASSE ANTERIORE - INFERIORE BALL JOINT - FRONT AXLE - LOWER		
54500-1KA0B	<b>0788071</b>	BRACCIO OSCILLANTE - ASSE ANTERIORE - INFERIORE TRACK CONTROL ARM - FRONT AXLE - LOWER		
54501-1KA0B	<b>0798071</b>	BRACCIO OSCILLANTE - ASSE ANTERIORE - INFERIORE TRACK CONTROL ARM - FRONT AXLE - LOWER		
54618-CY00A	<b>0508071</b>	STABILIZZATORE - ASSE ANTERIORE STABILIZER LINK - FRONT AXLE		
Anno - Year <b>08/2003 &gt;</b>		Serie - Series	Modello - Model <b>KUBISTAR</b>	
48520-00QAP	<b>0282829</b>	TESTA STERZO - RHT M14x1,5 TIE ROD END - RHT M14x1,5		
48520-00QAN	<b>0292829</b>	TESTA STERZO - RHT M14x1,5 TIE ROD END - RHT M14x1,5		
48521-00QAG	<b>0602830</b>	SNODO ASSIALE - SERVOSTERZO AXIAL JOINT - POWER STEERING		
48521-00QAA	<b>0602831</b>	SNODO ASSIALE - STERZO MANUALE AXIAL JOINT - MANUAL STEERING		
-	<b>0402832-K</b>	SNODO SOSPENSIONE BALL JOINT		

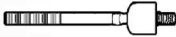
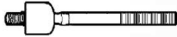

RIF. ORIG O.E. NUMBER	RIF. OCAP REF. OCAP	NOTE REMARKS	DESTRO RIGHT	SINISTRO LEFT
Anno - Year <b>08/2003 &gt;</b>		Serie - Series	Modello - Model <b>KUBISTAR</b>	
54500-00QAH	<b>0782832</b>	BRACCIO OSCILLANTE TRACK CONTROL ARM		
54501-00QAH	<b>0792832</b>	BRACCIO OSCILLANTE TRACK CONTROL ARM		
54616-00QAA	<b>0902833</b>	KIT BARRA STABILIZZATRICE KIT FOR STABILIZER BAR		
Anno - Year <b>1972 &gt; 1980</b>		Serie - Series <b>C130 - C131 - C230 - C231</b>	Modello - Model <b>LAUREL</b>	
48510-Q0125 48510-S0125 48630-S0125	<b>0501221</b>	BARRA STERZO TIE ROD		
48520-Q0125 48520-S0101 48520-S0102 48520-S0125	<b>0191217</b>	TESTA STERZO ESTERNA - LHT M18x1,5 TIE ROD END - OUTER - LHT M18x1,5		
48530-U8701	<b>0303538</b>	L H D - BRACCIO STERZO - 1977 > L H D - IDLER ARM - 1977 >		
40160-S0125 40160-S0126 40160-S0127 40160-S0128	<b>0401226</b>	SNODO SOSPENSIONE INFERIORE SUSPENSION JOINT LOWER		
Anno - Year <b>1980 &gt; 1984</b> <b>1984 &gt; 1988</b> <b>1988 &gt; 1993</b>		Serie - Series <b>C31</b> <b>C32</b> <b>C33</b>	Modello - Model <b>LAUREL</b>	
48510-01L25	<b>0502946</b>	BARRA STERZO - SERIE C31 TIE ROD - SERIES C31		
48520-01L01 48520-01L01 48520-01L25	<b>0192947</b>	TESTA STERZO ESTERNA - LHT M14x1,5 - SERIE C31 TIE ROD END - OUTER - LHT M14x1,5 - SERIES C31		



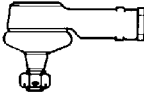
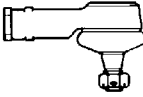
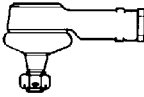
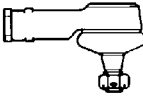
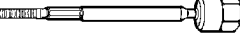
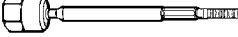



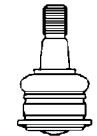
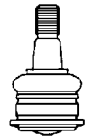
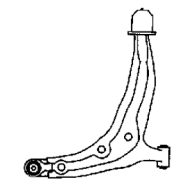
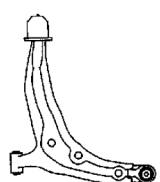
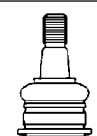
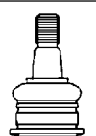
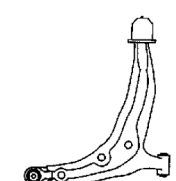
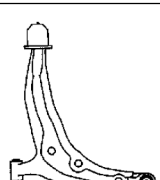

RIF. ORIG O.E. NUMBER	RIF. OCAP REF. OCAP	NOTE REMARKS	DESTRO RIGHT	SINISTRO LEFT
Anno - Year <b>1980 &gt; 1984</b> 1984 > 1988 1988 > 1993		Serie - Series <b>C31</b> <b>C32</b> <b>C33</b>	Modello - Model <b>LAUREL</b>	
48521-01L01 48521-01L25	<b>0182948</b>	TESTA STERZO INTERNA - RHT M14x1,5 - SERIE C31 TIE ROD END - INNER - RHT M14x1,5 - SERIES C31		
48520-41L00 48520-41L25 48520-41L26 48520-41L27	<b>0282949</b>	TESTA STERZO - RHT M14x1,5 SERIE C32 TIE ROD END - RHT M14x1,5 SERIES C32		
48520-71L25	<b>0282950</b>	TESTA STERZO - RHT M14x1,5 SERIE C33 TIE ROD END - RHT M14x1,5 SERIES C33		
48521-P9001 48521-W1000 48521-W1001 48521-01F00 48521-01F06	<b>0691223</b>	SNODO ASSIALE - RHT M14x1,5 - SERIE C32 AXIAL JOINT - RHT M14x1,5 - SERIES C32		
48521-06R05 48521-71C00 48521-71V06 48521-72E00 48521-72E06	<b>0602951</b>	SNODO ASSIALE - RHT M14x1,5 - SERIE C33 AXIAL JOINT - RHT M14x1,5 - SERIES C33		
40160-41L00 40160-67L00	<b>0402952</b>	SNODO SOSPENSIONE INFERIORE SERIE C32 SUSPENSION JOINT LOWER SERIES C32		
Anno - Year <b>1981 &gt; 1984</b>		Serie - Series	Modello - Model <b>MAXIMA 810</b>	
48520-W1025 48520-01F25	<b>0281222</b>	TESTA STERZO - RHT M14x1,5 TIE ROD END - RHT M14x1,5		
48640-W1025 48640-01F25	<b>0291222</b>	TESTA STERZO - RHT M14x1,5 TIE ROD END - RHT M14x1,5		
48521-P9001 48521-W1000 48521-W1001 48521-01F00 48521-01F06	<b>0691223</b>	SNODO ASSIALE - RHT M14x1,5 AXIAL JOINT - RHT M14x1,5		
40160-W1000 40160-W1001 40160-W2200	<b>0401225</b>	SNODO SOSPENSIONE INFERIORE SUSPENSION JOINT LOWER		

RIF. ORIG O.E. NUMBER	RIF. OCAP REF. OCAP	NOTE REMARKS	DESTRO RIGHT	SINISTRO LEFT
Anno - Year <b>1981 &gt; 1984</b>		Serie - Series	Modello - Model <b>MAXIMA 810</b>	
54499-W1000 54499-W2210	<b>0783537</b>	BRACCIO OSCILLANTE TRACK CONTROL ARM		
54500-W1000 54500-W2210	<b>0793537</b>	BRACCIO OSCILLANTE TRACK CONTROL ARM		
Anno - Year <b>1988 &gt; 1994</b>		Serie - Series <b>J30</b>	Modello - Model <b>MAXIMA</b>	
48520-88E25	<b>0282957</b>	TESTA STERZO - RHT M14x1,5 TIE ROD END - RHT M14x1,5		
48521-06R05 48521-71C00 48521-71V06 48521-72E00 48521-72E06	<b>0602951</b>	SNODO ASSIALE - RHT M14x1,5 AXIAL JOINT - RHT M14x1,5		
40160-01E00 40160-01E25 40160-51E00 40160-85E00	<b>0403527</b>	SNODO SOSPENSIONE INFERIORE SUSPENSION JOINT LOWER		
54618-50Y00 54618-58820 54618-D5010	<b>0504395</b>	STABILIZZATORE - ASSE ANTERIORE STABILIZER LINK - FRONT AXLE		
54618-D5010 (1) 56112-V0100 (2) 56113-60U0A (3) 08912-3401A (4)	<b>0504395-K</b>	KIT STABILIZZATORE - ASSE ANTERIORE STABILIZER LINK KIT - FRONT AXLE		
Anno - Year <b>10/94 &gt; 08/00</b>		Serie - Series <b>A32</b>	Modello - Model <b>MAXIMA QX</b>	
48520-0M085 48520-15U25 48520-15U26	<b>0284178</b>	TESTA STERZO - RHT M14X1,5 - SOLO PER MOD. 2.0 D - 2.0 GTI TIE ROD END - RHT M14X1,5 - SUITABLE FOR : 2.0 D - 2.0 GTI MOD.		











RIF. ORIG O.E. NUMBER	RIF. OCAP REF. OCAP	NOTE REMARKS	DESTRO RIGHT	SINISTRO LEFT
Anno - Year <b>10/94 &gt; 08/00</b>		Serie - Series <b>A32</b>	Modello - Model <b>MAXIMA QX</b>	
48521-40U25	<b>0604491</b>	SNODO ASSIALE AXIAL JOINT		
54500-41U00	<b>0784492</b>	BRACCIO OSCILLANTE - ASSE ANTERIORE - INFERIORE TRACK CONTROL ARM - FRONT AXLE - LOWER		
54501-41U00	<b>0794492</b>	BRACCIO OSCILLANTE - ASSE ANTERIORE - INFERIORE TRACK CONTROL ARM - FRONT AXLE - LOWER		
54618-0E000	<b>0504400</b>	STABILIZZATORE - ASSE ANTERIORE STABILIZER LINK - FRONT AXLE		
54618-0E000 (1) 56112-V0100 (2) 56113-60U0A (3) 01223-00291 (4)	<b>0504400-K</b>	KIT STABILIZZATORE - ASSE ANTERIORE STABILIZER LINK KIT - FRONT AXLE		
Anno - Year <b>12/82 &gt; 11/92</b> <b>08/92 &gt; 02/03</b>		Serie - Series <b>K 10</b> <b>K 11</b>	Modello - Model <b>MICRA</b> <b>MICRA L-LX-SLX</b>	
48520-01B25 48520-17B25	<b>0283540</b>	TESTA STERZO - RHT 12x1,25 SERIE K 10 TIE ROD END - RHT 12x1,25 SERIES K 10		
48520-6F625 48520-4F125	<b>0280914</b>	TESTA STERZO - RHT 12x1,25 SERIE K 11 TIE ROD END - RHT 12x1,25 SERIES K 11		
48521-01B25 48521-1725 48251-1700	<b>0602953</b>	SNODO ASSIALE - SERIE K 10 AXIAL JOINT - SERIES K 10		

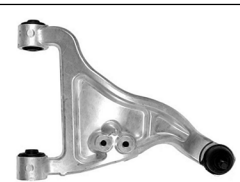



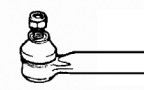
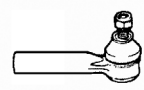



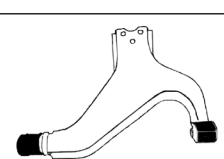

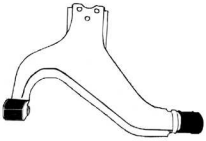
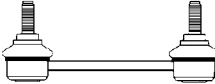
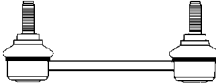











RIF. ORIG O.E. NUMBER	RIF. OCAP REF. OCAP	NOTE REMARKS	DESTRO RIGHT	SINISTRO LEFT
Anno - Year <b>12/82 &gt; 11/92</b> <b>08/92 &gt; 02/03</b>		Serie - Series <b>K 10</b> <b>K 11</b>	Modello - Model <b>MICRA</b> <b>MICRA L-LX-SLX</b>	
48521-70A00	<b>0602954</b>	SNODO ASSIALE SERIE K10: 1.0 > 02/1985 - 1.2 > 02/1987 - K11 TUTTI I MODELLI AXIAL JOINT K10 MOD. - 1.0 > 02/1985 - 1.2 > 02/1987 - K 11 ALL MODELS		
40160-01B25	<b>0401521</b>	SNODO SOSPENSIONE INFERIORE SERIE K 10 SUSPENSION JOINT LOWER SERIES K 10		
54500-21B00	<b>0781987</b>	BRACCIO OSCILLANTE ANTERIORE - SERIE K 10 FRONT TRACK CONTROL ARM - SERIES K 10		
54501-21B00	<b>0791987</b>	BRACCIO OSCILLANTE ANTERIORE - SERIE K 10 FRONT TRACK CONTROL ARM - SERIES K 10		
40160-4F100	<b>0403542</b>	SNODO SOSPENSIONE INFERIORE - SERIE K 11 SUSPENSION JOINT LOWER - SERIES K 11		
54500-4F102 54500-4F105 54500-44B00 54500-4F150	<b>0780915</b>	BRACCIO OSCILLANTE - SERIE K 11 - > 02/1998 TRACK CONTROL ARM - SERIES K 11 - > 02/1998		
54501-4F102 54501-4F105 54501-44B00 54501-4F150	<b>0790915</b>	BRACCIO OSCILLANTE - SERIE K 11 - > 02/1998 TRACK CONTROL ARM - SERIES K 11 - > 02/1998		
54500-6F600 Z	<b>0404615</b>	SNODO SOSPENSIONE INFERIORE - SERIE K 11 - 03/1998 > SUSPENSION JOINT LOWER - SERIES K 11 - 03/1998 >		

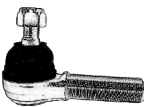

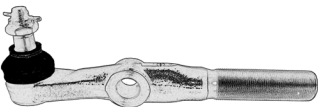



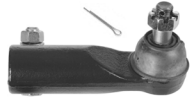

RIF. ORIG O.E. NUMBER	RIF. OCAP REF. OCAP	NOTE REMARKS	DESTRO RIGHT	SINISTRO LEFT
Anno - Year <b>12/82 &gt; 11/92</b> <b>08/92 &gt; 02/03</b>		Serie - Series <b>K 10</b> <b>K 11</b>		Modello - Model <b>MICRA</b> <b>MICRA L-LX-SLX</b>
54500-6F600 54500-2U711	<b>0784615</b>	BRACCIO OSCILLANTE INFERIORE - SERIE K 11 - 03/1998 > TRACK CONTROL ARM LOWER - SERIES K 11 - 03/1998 >		
54501-6F600 54501-2U711	<b>0794615</b>	BRACCIO OSCILLANTE INFERIORE - SERIE K 11 - 03/1998 > TRACK CONTROL ARM LOWER - SERIES K 11 - 03/1998 >		
56261-47B01 56261-4F702 56261-4F705 56261-6F600 56261-4F701 56261-4F710 56261-4F725 45261-4F702 56261-0F600	<b>0503541</b>	STABILIZZATORE - ASSE POSTERIORE SERIE K 11 STABILIZER LINK - REAR AXLE SERIES K 11		
Anno - Year <b>02/2003 &gt;</b> <b>03/2006 &gt;</b>		Serie - Series <b>K 12</b> <b>E 11</b>		Modello - Model <b>MICRA</b> <b>NOTE</b>
48520-AX600	<b>0284379</b>	TESTA STERZO - RHT 14x1,25 TIE ROD END - RHT 14x1,25		
48640-AX600	<b>0294379</b>	TESTA STERZO - RHT 14x1,25 TIE ROD END - RHT 14x1,25		
48520-AX602	<b>0282664</b>	TESTA STERZO - RHT 14x1,25 - 04/2004 > 09/2007 TIE ROD END - RHT 14x1,25 - 04/2004 > 09/2007		
48640-AX602	<b>0292664</b>	TESTA STERZO - RHT 14x1,25 - 04/2004 > 09/2007 TIE ROD END - RHT 14x1,25 - 04/2004 > 09/2007		
48527-1U61A 48657-1U61A	<b>0282665</b>	TESTA STERZO - RHT 14x1,25 09/2007 > TIE ROD END - RHT 14x1,25 09/2007 >		
48647-1U61A	<b>0292665</b>	TESTA STERZO - RHT 14x1,25 09/2007 > TIE ROD END - RHT 14x1,25 09/2007 >		



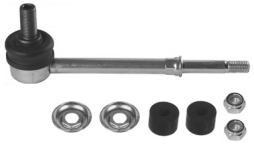





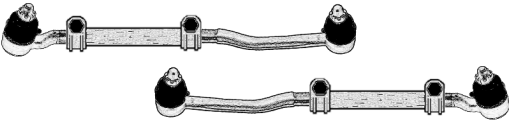





RIF. ORIG O.E. NUMBER	RIF. OCAP REF. OCAP	NOTE REMARKS	DESTRO RIGHT	SINISTRO LEFT
Anno - Year <b>02/2003 &gt;</b> <b>03/2006 &gt;</b>		Serie - Series <b>K 12</b> <b>E 11</b>	Modello - Model <b>MICRA</b> <b>NOTE</b>	
40160-AX000 6040135517	<b>0404298</b>	SNODO SOSPENSIONE INFERIORE SUSPENSION JOINT LOWER		
54500-AX600	<b>0784298</b>	BRACCIO OSCILLANTE ANTERIORE FRONT TRACK CONTROL ARM		
54501-AX600	<b>0794298</b>	BRACCIO OSCILLANTE ANTERIORE FRONT TRACK CONTROL ARM		
54618-AX600	<b>0504380</b>	STABILIZZATORE - ASSE ANTERIORE - SOLO PER MOD. MICRA STABILIZER LINK - FRONT AXLE - ONLY FOR MICRA MOD.		
54618-JX00A 54618-9U00A	<b>0504622</b>	STABILIZZATORE - ASSE ANTERIORE - SOLO PER MOD. NOTE STABILIZER LINK - FRONT AXLE - ONLY FOR NOTE MOD.		
Anno - Year <b>2005 &gt;</b>		Serie - Series <b>Z50 - Z51</b>	Modello - Model <b>MURANO</b>	
48520-CA025	<b>0286500</b>	TESTA STERZO - RHT 16x1,25 TIE ROD END - RHT 16x1,25		
48521-CA025	<b>0606500</b>	SNODO ASSIALE - RHT 16x1,25 AXIAL JOINT - RHT 16x1,25		
40160-9W200 40160-9Y000 40160-CA010 40160-CC40A	<b>0403124</b>	SNODO SOSPENSIONE - ASSE ANTERIORE - INFERIORE BALL JOINT - FRONT AXLE - LOWER		
54500-CC40A	<b>0786500</b>	BRACCIO OSCILLANTE - ASSE ANTERIORE - INFERIORE TRACK CONTROL ARM - FRONT AXLE - LOWER		
54501-CC40A	<b>0796500</b>	BRACCIO OSCILLANTE - ASSE ANTERIORE - INFERIORE TRACK CONTROL ARM - FRONT AXLE - LOWER		

RIF. ORIG O.E. NUMBER	RIF. OCAP REF. OCAP	NOTE REMARKS	DESTRO RIGHT	SINISTRO LEFT
Anno - Year <b>2005 &gt;</b>		Serie - Series <b>Z50 - Z51</b>	Modello - Model <b>MURANO</b>	
54618-CA000 54618-CA00E	<b>0586500</b>	STABILIZZATORE - ASSE ANTERIORE STABILIZER LINK - FRONT AXLE		
54668-CA000 54668-CA00E	<b>0596500</b>	STABILIZZATORE - ASSE ANTERIORE STABILIZER LINK - FRONT AXLE		
55501-CA00A 55501-CA000	<b>0388062</b>	BRACCIO OSCILLANTE - ASSE POSTERIORE - SUPERIORE TRACK CONTROL ARM - REAR AXLE - UPPER		
55502-CA00A 55502-CA000	<b>0398062</b>	BRACCIO OSCILLANTE - ASSE POSTERIORE - SUPERIORE TRACK CONTROL ARM - REAR AXLE - UPPER		
54618-CA010	<b>0588062</b>	STABILIZZATORE - ASSE POSTERIORE STABILIZER LINK - REAR AXLE		
54668-CA010	<b>0598062</b>	STABILIZZATORE - ASSE POSTERIORE STABILIZER LINK - REAR AXLE		
Anno - Year <b>09/1997 &gt;</b>		Serie - Series <b>R50</b>	Modello - Model <b>PATHFINDER</b>	
48520-0P725 48520-0W025 48520-3S500 48520-3S525 D8520-VK90A	<b>0284511</b>	TESTA STERZO ESTERNA TIE ROD END - OUTER		
48521-0W025 48521-0W026	<b>0602575</b>	SNODO ASSIALE RHT AXIAL JOINT RHT		
40160-0W025	<b>0402576</b>	SNODO SOSPENSIONE - INFERIORE SUSPENSION JOINT - LOWER		
54500-0W000 54500-0W001	<b>0782576</b>	BRACCIO OSCILLANTE ANTERIORE INFERIORE FRONT TRACK CONTROL ARM LOWER		

RIF. ORIG O.E. NUMBER	RIF. OCAP REF. OCAP	NOTE REMARKS	DESTRO RIGHT	SINISTRO LEFT
Anno - Year <b>09/1997 &gt;</b>		Serie - Series <b>R50</b>	Modello - Model <b>PATHFINDER</b>	
54501-0W000 54501-0W001	<b>0792576</b>	BRACCIO OSCILLANTE ANTERIORE INFERIORE FRONT TRACK CONTROL ARM LOWER		
54618-0W000 54618-0W001 54618-3W400	<b>0502577</b>	STABILIZZATORE - ASSE ANTERIORE STABILIZER LINK - FRONT AXLE		
56260-0W001 56260-41G11	<b>0502578</b>	STABILIZZATORE - ASSE POSTERIORE STABILIZER LINK - REAR AXLE		
Anno - Year <b>01/2005 &gt;</b> <b>07/2005 &gt;</b>		Serie - Series <b>R51</b> <b>D40</b>	Modello - Model <b>PATHFINDER</b> <b>NAVARA</b>	
48640-EA01J	<b>0284616</b>	TESTA STERZO - M16x1,5 - 09/2006 > TIE ROD END - M16x1,5 - 09/2006 >		
48520-EA01J	<b>0294616</b>	TESTA STERZO - M16x1,5 - 09/2006 > TIE ROD END - M16x1,5 - 09/2006 >		
48521-EA000	<b>0604617</b>	SNODO ASSIALE - M16x1,5 AXIAL JOINT - M16x1,5		
54525-EB30A Z 54524-EB30A Z	<b>0404620</b>	SNODO SOSPENSIONE - ASSE ANTERIORE - SUPERIORE BALL JOINT - FRONT AXLE - UPPER		
54500-EB30C Z 54501-EB30C Z	<b>0404621</b>	SNODO SOSPENSIONE - ASSE ANTERIORE - INFERIORE BALL JOINT - FRONT AXLE - LOWER		
54618-EA010	<b>0584618</b>	STABILIZZATORE - ASSE ANTERIORE STABILIZER LINK - FRONT AXLE		
54668-EA010	<b>0594618</b>	STABILIZZATORE - ASSE ANTERIORE STABILIZER LINK - FRONT AXLE		
56261-EA500	<b>0584619</b>	STABILIZZATORE - ASSE POSTERIORE - SOLO PER MOD. PATHFINDER STABILIZER LINK - REAR AXLE - ONLY FOR PATHFINDER MOD.		

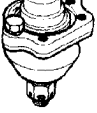
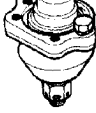







RIF. ORIG O.E. NUMBER	RIF. OCAP REF. OCAP	NOTE REMARKS	DESTRO RIGHT	SINISTRO LEFT
Anno - Year <b>01/2005 &gt; 07/2005 &gt;</b>		Serie - Series <b>R51 D40</b>		Modello - Model <b>PATHFINDER NAVARA</b>
56261-EA510	<b>0594619</b>	STABILIZZATORE - ASSE POSTERIORE - SOLO PER MOD. PATHFINDER STABILIZER LINK - REAR AXLE - ONLY FOR PATHFINDER MOD.		
Anno - Year <b>11/79 &gt; 08/88</b>		Serie - Series <b>W160 K160</b>		Modello - Model <b>PATROL</b>
48580-J5100 48580-82100	<b>0193544</b>	TESTA STERZO - LHT M22x1,5 TIE ROD END - LHT M22x1,5		
48570-J5100 48570-82100	<b>0183544</b>	TESTA STERZO - RHT M22x1,5 TIE ROD END - RHT M22x1,5		
Anno - Year <b>08/88 &gt; 11/95 05/86 &gt; 06/90</b>		Serie - Series <b>W260 K260</b>		Modello - Model <b>PATROL</b>
48520-G9502	<b>0193835</b>	TESTA STERZO - LHT M25x1,5 - LHD TIE ROD END - LHT M25x1,5 - LHD		
48570-G9501	<b>0183835</b>	TESTA STERZO - RHT M25x1,5 TIE ROD END - RHT M25x1,5		
Anno - Year <b>08/87 &gt; 06/97</b>		Serie - Series <b>GR I (Y60)</b>		Modello - Model <b>PATROL</b>
48520-01J00	<b>0184143</b>	TESTA STERZO - RHT M22x1,5 - > 06/1992 TIE ROD END - RHT M22x1,5 - > 06/1992		
48520-01J10	<b>0284144</b>	TESTA STERZO - RHT M30x1,5 - 07/1992 > TIE ROD END - RHT M30x1,5 - 07/1992 >		
48570-01J10	<b>0294144</b>	TESTA STERZO - RHT M30x1,5 - 07/1992 > TIE ROD END - RHT M30x1,5 - 07/1992 >		
56260-01J10	<b>0504145</b>	STABILIZZATORE - ASSE ANTERIORE - ASSE POSTERIORE STABILIZER LINK - FRONT AXLE - REAR AXLE		

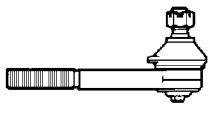
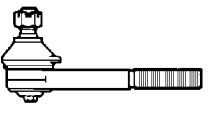
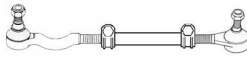
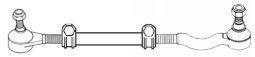

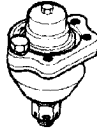
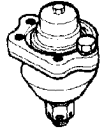







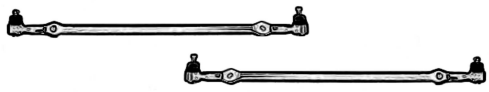



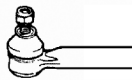
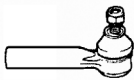



RIF. ORIG O.E. NUMBER	RIF. OCAP REF. OCAP	NOTE REMARKS	DESTRO RIGHT	SINISTRO LEFT
Anno - Year <b>06/1997 &gt;</b>		Serie - Series <b>GR II (Y61)</b>	Modello - Model <b>PATROL</b>	
48520-VB025	<b>0184146</b>	TESTA STERZO TIE ROD END		
48570-VB025	<b>0194146</b>	TESTA STERZO TIE ROD END		
54618-VB000	<b>0504147</b>	STABILIZZATORE - ASSE ANTERIORE - > 2001 STABILIZER LINK - FRONT AXLE - > 2001		
54618-VC300	<b>0504148</b>	STABILIZZATORE - ASSE ANTERIORE - 2001 > 2008 STABILIZER LINK - FRONT AXLE - 2001 > 2008		
56260-01J10	<b>0504145</b>	STABILIZZATORE - ASSE POSTERIORE - > 2001 STABILIZER LINK - REAR AXLE - > 2001		
56260-VB010	<b>0504551</b>	STABILIZZATORE - ASSE POSTERIORE - > 2001 STABILIZER LINK - REAR AXLE - > 2001		
56260-VC300	<b>0504552</b>	STABILIZZATORE - ASSE POSTERIORE - 2001 > 2008 STABILIZER LINK - REAR AXLE - 2001 > 2008		
56260-VC310	<b>0504553</b>	STABILIZZATORE - ASSE POSTERIORE - 2001 > 2008 STABILIZER LINK - REAR AXLE - 2001 > 2008		
Anno - Year <b>1979 &gt; 1986</b> <b>1985 &gt; 1998</b>		Serie - Series <b>720</b> <b>D21 2WD</b>	Modello - Model <b>PICK UP</b>	
48510-01W00 48630-01W00	<b>0500164</b>	BARRA STERZO SERIE 720 TIE ROD SERIES 720		









RIF. ORIG O.E. NUMBER	RIF. OCAP REF. OCAP	NOTE REMARKS	DESTRO RIGHT	SINISTRO LEFT
Anno - Year <b>1979 &gt; 1986</b> <b>1985 &gt; 1998</b>		Serie - Series <b>720</b> <b>D21 2WD</b>	Modello - Model <b>PICK UP</b>	
48521-01W00	<b>0180163</b>	TESTA STERZO - INTERNA RHT M18x1,5 - SERIE 720 TIE ROD END - INNER - RHT M18x1,5 - SERIES 720		
48520-01W00	<b>0190162</b>	TESTA STERZO - ESTERNA LHT M18x1,5 - SERIE 720 TIE ROD END - OUTER - LHT M18x1,5 - SERIES 720		
48560-01G25	<b>0503258</b>	BARRA STERZO SERIE D21 TIE ROD SERIES D21		
48510-01G25 48630-01G25	<b>0504174</b>	BARRA STERZO SERIE D21 TIE ROD SERIES D21		
48521-01G25	<b>0184174</b>	TESTA STERZO - INTERNA - RHT M18x1,5 - SERIE D21 TIE ROD END - INNER - RHT M18x1,5 - SERIES D21		
48520-01G25	<b>0194175</b>	TESTA STERZO - ESTERNA - LHT M18x1,5 - SERIE D21 TIE ROD END - OUTER - LHT M18x1,5 - SERIES D21		
40110-B9500 40110-T3060 40110-T6000 40110-T6025 40110-V0100 40110-01G00 40110-01G25 40110-01G26	<b>0400361</b>	SNODO SOSPENSIONE - SUPERIORE SERIE 720 - D21 SUSPENSION JOINT - UPPER SERIES 720 - D21		
40160-T3060 40160-B9500 40160-F1700 40160-48W00 40160-48W25	<b>0480146</b>	SNODO SOSPENSIONE - INFERIORE SERIE 720 SUSPENSION JOINT - LOWER SERIE 720		
40161-T3060 40161-B9500 40161-F1700 40161-48W00 40161-48W25	<b>0490146</b>	SNODO SOSPENSIONE - INFERIORE SERIE 720 SUSPENSION JOINT - LOWER SERIES 720		
40160-01G00 40160-01G25 40160-01G50 40160-01G90 40160-01N25 40160-2S485 40160-55G90	<b>0400437</b>	SNODO SOSPENSIONE - INFERIORE SERIE D21 SUSPENSION JOINT - LOWER D21		



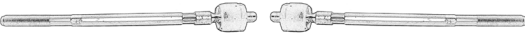

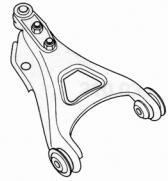



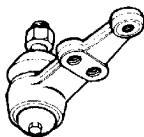
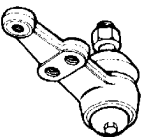



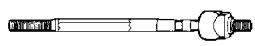
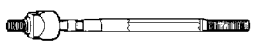
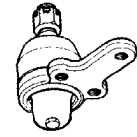
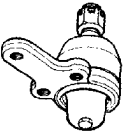



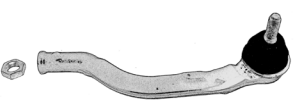





RIF. ORIG O.E. NUMBER	RIF. OCAP REF. OCAP	NOTE REMARKS	DESTRO RIGHT	SINISTRO LEFT
Anno - Year <b>1979 &gt; 1986</b> <b>1985 &gt; 1998</b>		Serie - Series <b>720</b> <b>D21 2WD</b>	Modello - Model <b>PICK UP</b>	
54502-01G90	<b>0784493</b>	BRACCIO OSCILLANTE - ANTERIORE INFERIORE - SERIE D21 TRACK CONTROL ARM - FRONT LOWER - SERIES D21		
54503-01G90	<b>0794493</b>	BRACCIO OSCILLANTE - ANTERIORE INFERIORE - SERIE D21 TRACK CONTROL ARM - FRONT LOWER - SERIES D21		
54618-01G00	<b>0504623</b>	STABILIZZATORE - ASSE ANTERIORE - SERIE D21 STABILIZER LINK - FRONT AXLE - SERIES D21		
Anno - Year <b>1983 &gt; 1986</b> <b>1985 &gt; 1998</b>		Serie - Series <b>720</b> <b>D21 4WD</b>	Modello - Model <b>PICK UP</b>	
48521-50W00 48521-50W00	<b>0193547</b>	TESTA STERZO - ESTERNA - LHT M16x1,5 - SERIE 720 TIE ROD END - OUTER - LHT M16x1,5 - SERIES 720		
48641-50W00	<b>0183547</b>	TESTA STERZO ESTERNA - RHT M16x1,5 - SERIE 720 TIE ROD END - OUTER - RHT M16x1,5 - SERIE 720		
48520-50W00	<b>0183546</b>	TESTA STERZO - INTERNA - RHT M16x1,5 - SERIE 720 TIE ROD END - INNER - RHT M16x1,5 - SERIE 720		
48640-50W00	<b>0193546</b>	TESTA STERZO - INTERNA - LHT M16x1,5 - SERIE 720 TIE ROD END - INNER - LHT M16x1,5 - SERIES 720		
48510-31G25 48510-7F000	<b>0503589</b>	BARRA STERZO - SERIE D21 TIE ROD SERIES D21		
48520-7F000 48520-31G25	<b>0183587</b>	TESTA STERZO - ESTERNA - RHT M16x1,5 - SERIE D21 TIE ROD END - OUTER - RHT M16x1,5 - SERIES D21		
48520-61G25	<b>0182890</b>	TESTA STERZO ESTERNA - 1992 > TIE ROD END OUTER - 1992 >		
48521-31G25 48570-31G25 48520-7F001	<b>0193588</b>	TESTA STERZO - INTERNA - LHT M16x1,5 - SERIE D21 TIE ROD END- INNER - LHT M16x1,5 -SERIES D21		





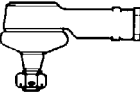
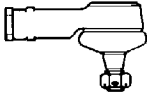

RIF. ORIG O.E. NUMBER	RIF. OCAP REF. OCAP	NOTE REMARKS	DESTRO RIGHT	SINISTRO LEFT
Anno - Year <b>1983 &gt; 1986</b> <b>1985 &gt; 1998</b>		Serie - Series <b>720</b> <b>D21 4WD</b>	Modello - Model <b>PICK UP</b>	
48570-61G25	<b>0192891</b>	TESTA STERZO INTERNA - 1992 > TIE ROD END INNER - 1992 >		
48510-50W00	<b>0583545</b>	BARRA STERZO - SERIE 720 TIE ROD - SERIES 720		
48630-50W00	<b>0593545</b>	BARRA STERZO - SERIE 720 TIE ROD - 1983 > SERIES 720		
48530-01G25 48530-01G00	<b>0303259</b>	BRACCIO STERZO - SERIE D21 4WD IDLER ARM - D21 4WD SERIES		
40110-B9500 40110-T3060 40110-T6000 40110-T6025 40110-V0100 40110-01G00 40110-01G25 40110-01G26	<b>0400361</b>	SNODO SOSPENSIONE SUPERIORE - SERIE 720 -D21 SUSPENSION JOINT UPPER - SERIES 720 - D21		
40160-T3060 40160-B9500 40160-F1700 40160-48W00 40160-48W25	<b>0480146</b>	SNODO SOSPENSIONE - INFERIORE > 1986 - SERIE 720 SUSPENSION JOINT - LOWER > 1986 - SERIE 720		
40161-T3060 40161-B9500 40161-F1700 40161-48W00 40161-48W25	<b>0490146</b>	SNODO SOSPENSIONE - INFERIORE > 1986 - SERIE 720 SUSPENSION JOINT - LOWER > 1986 - SERIE 720		
40160-0F000 40160-S0W25 40160-50W00 40160-50W01 40160-50W10	<b>0403548</b>	SNODO SOSPENSIONE - INFERIORE 1983 > 720 - D21 SUSPENSION JOINT - LOWER 1983 > 720 - D21		
54618-02E00	<b>0504624</b>	STABILIZZATORE - ASSE ANTERIORE - SERIE D21 STABILIZER LINK - FRONT AXLE - SERIES D21		





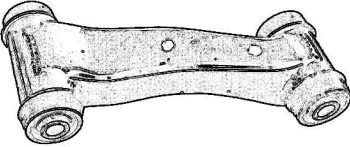
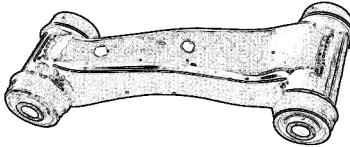
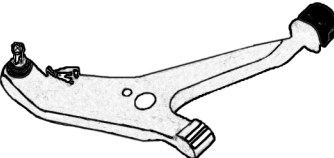
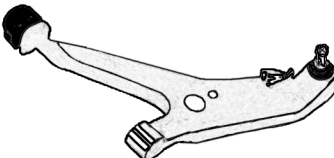

RIF. ORIG O.E. NUMBER	RIF. OCAP REF. OCAP	NOTE REMARKS	DESTRO RIGHT	SINISTRO LEFT
Anno - Year <b>01/1997 &gt;</b>		Serie - Series <b>D22</b>	Modello - Model <b>PICK UP</b>	
48560-3S125	<b>0503117</b>	BARRA STERZO TIE ROD		
48560-3S525 D8560-VK90A	<b>0503118</b>	BARRA STERZO - MOD. 4WD TIE ROD - MOD. 4WD		
48570-3S525 48570-3S500 D8570-VK90A	<b>0283114</b>	TESTA STERZO INTERNA MOD. 4WD TIE ROD END INNER MOD. 4WD		
48520-0P725 48520-0W025 48520-3S500 48520-3S525 D8520-VK90A	<b>0284511</b>	TESTA STERZO ESTERNA MOD. 4WD TIE ROD END - OUTER MOD. 4WD		
48521-2S425 48521-2S485	<b>0183115</b>	TESTA STERZO INTERNA RHT M18x1,5 TIE ROD END - INNER RHT M18x1,5		
48520-2S425 48520-2S485	<b>0193116</b>	TESTA STERZO ESTERNA LHT M18x1,5 TIE ROD END - OUTER LHT M18x1,5		
40160-01G00 40160-01G25 40160-01G50 40160-01G90 40160-01N25 40160-2S485 40160-55G90	<b>0400437</b>	SNODO SOSPENSIONE - INFERIORE - 2WD SUSPENSION JOINT - LOWER - 2WD		
40160-2S601	<b>0404625</b>	SNODO SOSPENSIONE - INFERIORE - 4WD SUSPENSION JOINT - LOWER - 4WD		
40110-2S485 40110-2S486 40110-2S685 40110-2S686	<b>0404626</b>	SNODO SOSPENSIONE - SUPERIORE - TUTTI I MODELLI SUSPENSION JOINT - UPPER - ALL MODELS		
54618-01G00	<b>0504623</b>	STABILIZZATORE - ASSE ANTERIORE - SOLO MOD. 2WD STABILIZER LINK - FRONT AXLE - ONLY FOR 2WD MOD.		
54618-02E00	<b>0504624</b>	STABILIZZATORE - ASSE ANTERIORE - SOLO MOD. 4WD STABILIZER LINK - FRONT AXLE - ONLY FOR 4WD MOD.		

RIF. ORIG O.E. NUMBER	RIF. OCAP REF. OCAP	NOTE REMARKS	DESTRO RIGHT	SINISTRO LEFT
Anno - Year <b>2001 &gt;</b>		Serie - Series	Modello - Model <b>PLATINA</b>	
48520-00QAP	<b>0282829</b>	TESTA STERZO - RHT M14x1,5 TIE ROD END - RHT M14x1,5		
48520-00QAN	<b>0292829</b>	TESTA STERZO - RHT M14x1,5 TIE ROD END - RHT M14x1,5		
48521-00QAG	<b>0602830</b>	SNODO ASSIALE - SERVOSTERZO AXIAL JOINT - POWER STEERING		
48521-00QAA	<b>0602831</b>	SNODO ASSIALE - STERZO MANUALE AXIAL JOINT - MANUAL STEERING		
-	<b>0402832-K</b>	SNODO SOSPENSIONEE BALL JOINT		
54500-00QAH	<b>0782832</b>	BRACCIO OSCILLANTE TRACK CONTROL ARM		
54501-00QAH	<b>0792832</b>	BRACCIO OSCILLANTE TRACK CONTROL ARM		
54616-00QAA	<b>0902833</b>	KIT BARRA STABILIZZATRICE KIT FOR STABILIZER BAR		
Anno - Year <b>05/83 &gt; 02/88</b>		Serie - Series <b>M10</b>	Modello - Model <b>PRAIRIE</b>	
48521-D0100 48521-35F00 48521-70A00 48521-70A06 48521-70A16	<b>0600993</b>	SNODO ASSIALE - RHT M12x1,25 AXIAL JOINT - RHT M12x1,25		
40160-A03G0 40160-A06G0 40160-01A00 40160-01A25	<b>0400996</b>	SNODO SOSPENSIONE INFERIORE SUSPENSION JOINT LOWER		



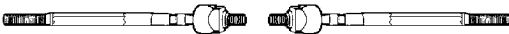

RIF. ORIG O.E. NUMBER	RIF. OCAP REF. OCAP	NOTE REMARKS	DESTRO RIGHT	SINISTRO LEFT
Anno - Year <b>03/88 &gt; 09/94</b>		Serie - Series <b>M11</b>	Modello - Model <b>PRAIRIE</b>	
48520-53E25	<b>0283526</b>	TESTA STERZO - RHT M12x1,25 TIE ROD END - RHT M12x1,25		
48521-D0100 48521-35F00 48521-70A00 48521-70A06 48521-70A16	<b>0600993</b>	SNODO ASSIALE - RHT M12x1,25 AXIAL JOINT - RHT M12x1,25		
40160-01E00 40160-01E25 40160-51E00 40160-85E00	<b>0403527</b>	SNODO SOSPENSIONE INFERIORE SUSPENSION JOINT LOWER		
54618-50Y00 54618-58820 54618-D5010	<b>0504395</b>	STABILIZZATORE - ASSE ANTERIORE STABILIZER LINK - FRONT AXLE		
54618-D5010 (1) 56112-V0100 (2) 56113-60U0A (3) 08912-3401A (4)	<b>0504395-K</b>	KIT STABILIZZATORE - ASSE ANTERIORE STABILIZER LINK KIT - FRONT AXLE		
Anno - Year <b>2002 &gt;</b>		Serie - Series	Modello - Model <b>PRIMASTAR</b>	
48520-00QAL	<b>0284392</b>	TESTA STERZO - RHT 14x1,5 TIE ROD END - RHT 14x1,5		
48520-00QAK	<b>0294392</b>	TESTA STERZO - LHT 14x1,5 TIE ROD END - RHT 14x1,5		
48520-00QAM	<b>0602322</b>	SNODO ASSIALE - RHT M14x1.5 AXIAL JOINT - RHT M14x1.5		
-	<b>0404393</b>	SNODO SOSPENSIONE - ASSE ANTERIORE - INFERIORE - > 10/2006 BALL JOINT - FRONT AXLE - LOWER - > 10/2006		





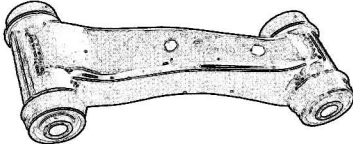
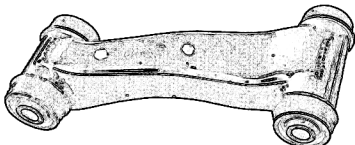

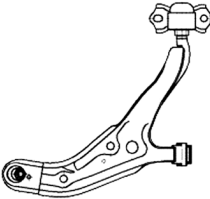
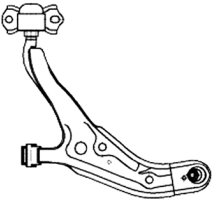
RIF. ORIG O.E. NUMBER	RIF. OCAP REF. OCAP	NOTE REMARKS	DESTRO RIGHT	SINISTRO LEFT
Anno - Year <b>2002 &gt;</b>		Serie - Series	Modello - Model <b>PRIMASTAR</b>	
54502-00QAA	<b>0782321</b>	BRACCIO OSCILLANTE ASSE ANTERIORE - INFERIORE - > 10/2006 UPPER CONTROL ARM FRONT AXLE - LOWER - > 10/2006		
54503-00QAA	<b>0792321</b>	BRACCIO OSCILLANTE ASSE ANTERIORE - INFERIORE - > 10/2006 TRACK CONTROL ARM FRONT AXLE - LOWER - > 10/2006		
40160-00Q0A	<b>0404628</b>	SNODO SOSPENSIONE - ASSE ANTERIORE - INFERIORE - 11/2006 > BALL JOINT - FRONT AXLE - LOWER - 11/2006 >		
54502-00Q0C	<b>0384628</b>	BRACCIO OSCILLANTE ASSE ANTERIORE - INFERIORE - 11/2006 > TRACK CONTROL ARM FRONT AXLE - LOWER - 11/2006 >		
54503-00Q0C	<b>0394628</b>	BRACCIO OSCILLANTE ASSE ANTERIORE - INFERIORE - 11/2006 > TRACK CONTROL ARM FRONT AXLE - LOWER - 11/2006 >		
54616-00QAC 54616-00Q0A	<b>0504394</b>	STABILIZZATORE STABILIZER LINK		
Anno - Year <b>1990 &gt; 1996</b>		Serie - Series <b>P 10</b>	Modello - Model <b>PRIMERA</b>	
48520-9C025 48520-9C000 48520-73J25	<b>0283550</b>	TESTA STERZO - RHT M12X1,25 TIE ROD END - RHT M12X1,25		
48521-06R05 48521-71C00 48521-71V06 48521-72E00 48521-72E06	<b>0602951</b>	SNODO ASSIALE - RHT M14x1,5 AXIAL JOINT - RHT M14x1,5		



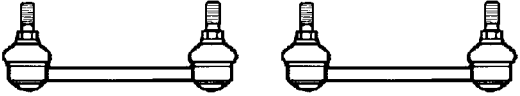



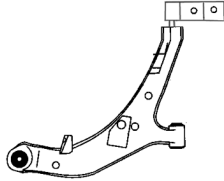
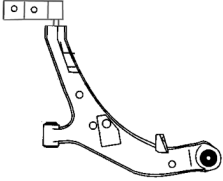

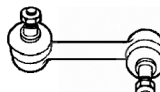

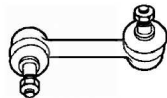
RIF. ORIG O.E. NUMBER	RIF. OCAP REF. OCAP	NOTE REMARKS	DESTRO RIGHT	SINISTRO LEFT
Anno - Year <b>1990 &gt; 1996</b>		Serie - Series <b>P 10</b>	Modello - Model <b>PRIMERA</b>	
40160-50J25 40160-70J00 40160-86M00 40160-60Y60 40160-J7500 40160-69C00	<b>0403552</b>	SNODO SOSPENSIONE INFERIORE SUSPENSION JOINT LOWER		
54524-2F010 54524-50J00 54524-86J10	<b>0781818</b>	BRACCIO OSCILLANTE SUPERIORE UPPER CONTROL ARM		
54525-2F010 54525-50J00 54525-86J10	<b>0791818</b>	BRACCIO OSCILLANTE SUPERIORE UPPER CONTROL ARM		
54500-86J00 54500-90J00 54500-50J10	<b>0783549</b>	BRACCIO OSCILLANTE INFERIORE LOWER TRACK CONTROL ARM		
54501-86J00 54501-90J00 54501-50J10	<b>0793549</b>	BRACCIO OSCILLANTE INFERIORE LOWER TRACK CONTROL ARM		
54618-50Y00 54618-58820 54618-D5010	<b>0504395</b>	STABILIZZATORE - ASSE ANTERIORE L= 85 mm SERIE P10 1.6 STABILIZER LINK - FRONT AXLE L= 85 mm SERIES P10 1.6		
54618-D5010 (1) 56112-V0100 (2) 56113-60U0A (3) 08912-3401A (4)	<b>0504395-K</b>	KIT STABILIZZATORE ASSE ANTERIORE - L=85 mm - SERIE P10 1.6 STABILIZER LINK KIT - FRONT AXLE - L=85 mm. - P10 1.6 SERIES		
54618-90J11 54618-50J11 54618-50J20 54618-86J00 54618-86J25 54618-2F010	<b>0504387</b>	STABILIZZATORE - ASSE ANTERIORE L= 165 mm SERIE P10 2.0 STABILIZER LINK - FRONT AXLE L= 165 mm SERIES P10 2.0		







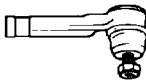
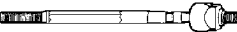
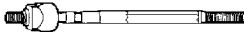
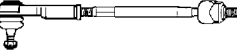
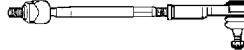
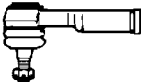
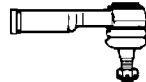

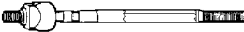

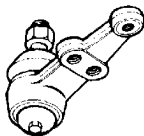
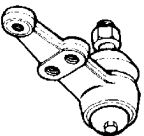
RIF. ORIG O.E. NUMBER	RIF. OCAP REF. OCAP	NOTE REMARKS	DESTRO RIGHT	SINISTRO LEFT
Anno - Year <b>1990 &gt; 1996</b>		Serie - Series <b>P 10</b>	Modello - Model <b>PRIMERA</b>	
-	<b>0504387-K</b>	KIT STABILIZZATORE - ASSE ANTERIORE - SERIE P10 MOD. 2.0 - L=165 MM. STABILIZER LINK KIT - FRONT AXLE - SERIE P10 MOD. 2.0 - L=165 MM.		
56261-90J01 56261-86J25 56261-86J00 56561-50J00	<b>0503551</b>	STABILIZZATORE - ASSE POSTERIORE STABILIZER LINK - REAR AXLE		
Anno - Year <b>07/90 &gt; 03/98</b>		Serie - Series <b>W 10</b>	Modello - Model <b>PRIMERA</b>	
48520-Q9000 48520-01E00 48520-01E25 48520-01E26 48520-02E00 48520-02E25 48520-50Y25	<b>0283525</b>	TESTA STERZO - RHT M12x1,25 - SERIE U 11 TIE ROD END - RHT M12x1,25 - SERIES U 11		
48521-50Y00 48521-50400 48521-Y02G0	<b>0602889</b>	SNODO ASSIALE - RHT M12x1,25 AXIAL JOINT - RHT M12x1,25		
40160-01E00 40160-01E25 40160-51E00 40160-85E00	<b>0403527</b>	SNODO SOSPENSIONE INFERIORE SUSPENSION JOINT LOWER		
54618-50Y00 54618-58820 54618-D5010	<b>0504395</b>	STABILIZZATORE - ASSE ANTERIORE L= 85 mm STABILIZER LINK - FRONT AXLE L= 85 mm		
54618-D5010 (1) 56112-V0100 (2) 56113-60U0A (3) 08912-3401A (4)	<b>0504395-K</b>	KIT STABILIZZATORE ASSE ANTERIORE - L=85 mm. STABILIZER LINK KIT - FRONT AXLE - L=85mm.		
Anno - Year <b>06/1996 &gt; 04/98 &gt; 12/01</b>		Serie - Series <b>P 11 W11</b>	Modello - Model <b>PRIMERA</b>	
48520-9C025 48520-9C000 48520-73J25	<b>0283550</b>	TESTA STERZO - RHT M12X1,25 TIE ROD END - RHT M12X1,25		

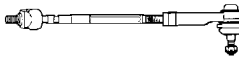
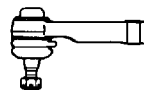
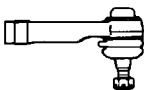
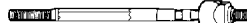
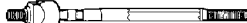

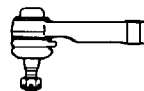
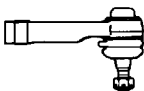













RIF. ORIG O.E. NUMBER	RIF. OCAP REF. OCAP	NOTE REMARKS	DESTRO RIGHT	SINISTRO LEFT
Anno - Year <b>06/1996 &gt; 04/98 &gt; 12/01</b>		Serie - Series <b>P 11 W11</b>	Modello - Model <b>PRIMERA</b>	
48521-06R05 48521-71C00 48521-71V06 48521-72E00 48521-72E06	<b>0602951</b>	SNODO ASSIALE - RHT M14x1,5 AXIAL JOINT - RHT M14x1,5		
54524-2F010 54524-50J00 54524-86J10	<b>0781818</b>	BRACCIO OSCILLANTE SUPERIORE UPPER CONTROL ARM		
54525-2F010 54525-50J00 54525-86J10	<b>0791818</b>	BRACCIO OSCILLANTE SUPERIORE UPPER CONTROL ARM		
40160-50J25 40160-70J00 40160-86M00 40160-60Y60 40160-J7500 40160-69C00	<b>0403552</b>	SNODO SOSPENSIONE INFERIORE SUSPENSION JOINT LOWER		
54500-2F500 54500-9F500	<b>0784384</b>	BRACCIO OSCILLANTE INFERIORE LOWER TRACK CONTROL ARM		
54501-2F500	<b>0794384</b>	BRACCIO OSCILLANTE INFERIORE LOWER TRACK CONTROL ARM		
54618-90J11 54618-50J11 54618-50J20 54618-86J00 54618-86J25 54618-2F010	<b>0504387</b>	STABILIZZATORE - ASSE ANTERIORE L= 165 mm STABILIZER LINK - FRONT AXLE L= 165 mm		
-	<b>0504387-K</b>	KIT STABILIZZATORE - ASSE ANTERIORE - L= 165 MM. STABILIZER LINK KIT - FRONT AXLE - L= 165 MM.		





RIF. ORIG O.E. NUMBER	RIF. OCAP REF. OCAP	NOTE REMARKS	DESTRO RIGHT	SINISTRO LEFT
Anno - Year <b>06/1996 &gt;</b> <b>04/98 &gt; 12/01</b>		Serie - Series <b>P 11</b> <b>W11</b>	Modello - Model <b>PRIMERA</b>	
45261-90J11 56261-90J11	<b>0504388</b>	STABILIZZATORE - ASSE POSTERIORE STABILIZER LINK - REAR AXLE		
Anno - Year <b>2002 &gt;</b> <b>2002 &gt;</b>		Serie - Series <b>P 12</b> <b>W 12</b>	Modello - Model <b>PRIMERA</b>	
48520-9C025 48520-9C000 48520-73J25	<b>0283550</b>	TESTA STERZO - RHT M12X1,25 TIE ROD END - RHT M12X1,25		
49001-BA210 Z	<b>0604630</b>	SNODO ASSIALE - RHT M12X1,25 AXIAL JOINT - RHT M12X1,25		
-	<b>0404385</b>	SNODO SOSPENSIONE INFERIORE SUSPENSION JOINT LOWER		
54500-AV600 54500-AV606 54500-AV605	<b>0784385</b>	BRACCIO OSCILLANTE - ASSE ANTERIORE - INFERIORE TRACK CONTROL ARM - FRONT AXLE - LOWER		
54501-AV600 54501-AV606 54501-AV605	<b>0794385</b>	BRACCIO OSCILLANTE - ASSE ANTERIORE - INFERIORE TRACK CONTROL ARM - FRONT AXLE - LOWER		
54524-AV600 54524-AV601	<b>0384629</b>	BRACCIO OSCILLANTE - ASSE ANTERIORE - SUPERIORE TRACK CONTROL ARM - FRONT AXLE - UPPER		
54525-AV600 54525-AV6001	<b>0394629</b>	BRACCIO OSCILLANTE - ASSE ANTERIORE - SUPERIORE TRACK CONTROL ARM - FRONT AXLE - UPPER		
54618-AU000	<b>0584391</b>	STABILIZZATORE - ASSE ANTERIORE STABILIZER LINK - FRONT AXLE		



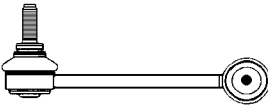
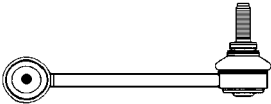
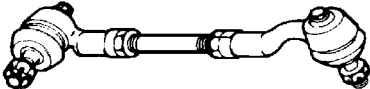
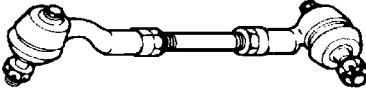
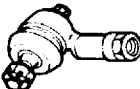
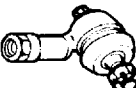

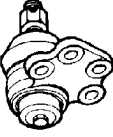
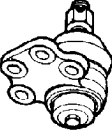
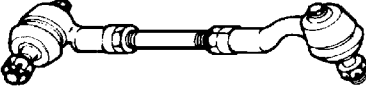
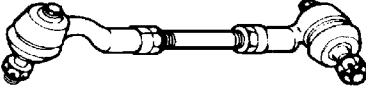
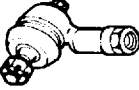
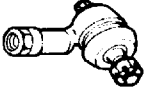

RIF. ORIG O.E. NUMBER	RIF. OCAP REF. OCAP	NOTE REMARKS	DESTRO RIGHT	SINISTRO LEFT
Anno - Year <b>2002 &gt;</b> <b>2002 &gt;</b>		Serie - Series <b>P 12</b> <b>W 12</b>	Modello - Model <b>PRIMERA</b>	
54668-AU000	<b>0594391</b>	STABILIZZATORE - ASSE ANTERIORE STABILIZER LINK - FRONT AXLE		
56261-0E000	<b>0504631</b>	STABILIZZATORE - ASSE POSTERIORE - > 10/2002 STABILIZER LINK - REAR AXLE - > 10/2002		
56261-AV610	<b>0504632</b>	STABILIZZATORE - ASSE POSTERIORE - 11/2002 > STABILIZER LINK - REAR AXLE - 11/2002 >		
Anno - Year <b>1978 &gt; 1982</b>		Serie - Series <b>N10 - N11</b>	Modello - Model <b>PULSAR - LANGLEY - LIBERTA</b>	
48510-M7025 48510-M7026	<b>0503578</b>	BARRA STERZO TIE ROD		
48520-M0225 48520-M3025	<b>0280360</b>	TESTA STERZO - RHT M12x1,25 TIE ROD END - RHT M12x1,25		
48521-M3070 48521-M7000	<b>0603577</b>	SNODO ASSIALE - RHT M12x1,25 AXIAL JOINT - RHT M12x1,25		
Anno - Year <b>1982 &gt; 1986</b>		Serie - Series <b>N12</b>	Modello - Model <b>PULSAR - LANGLEY - LIBERTA</b>	
48510-D0100 48510-D0125 48510-11A27 48510-35A26 48510-35A27 48510-70A25 48510-70A27	<b>0500994</b>	BARRA STERZO TIE ROD		
48520-D0100 48520-D0125 48520-D0126 48520-02E26	<b>0280992</b>	TESTA STERZO - RHT M12x1,25 TIE ROD END - RHT M12x1,25		
48521-D0100 48521-35F00 48521-70A00 48521-70A06 48521-70A16	<b>0600993</b>	SNODO ASSIALE RHT M12x1,25 AXIAL JOINT RHT M12x1,25		

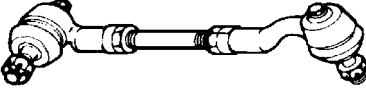
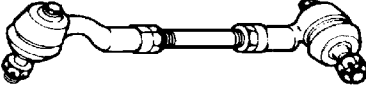
RIF. ORIG O.E. NUMBER	RIF. OCAP REF. OCAP	NOTE REMARKS	DESTRO RIGHT	SINISTRO LEFT
Anno - Year <b>1982 &gt; 1986</b>		Serie - Series <b>N12</b>	Modello - Model <b>PULSAR - LANGLEY - LIBERTA</b>	
40160-A03G0 40160-A06G0 40160-01A00 40160-01A25	<b>0400996</b>	SNODO SOSPENSIONE INFERIORE SUSPENSION JOINT LOWER		
Anno - Year <b>1986 &gt;</b>		Serie - Series <b>N 13 - KN 13</b>	Modello - Model <b>PULSAR - LANGLEY - LIBERTA</b>	
48510-50A26	<b>0503577</b>	BARRA STERZO - STERZO MANUALE TIE ROD - MANUAL STEERING		
48520-50A00 48520-50A25 48520-50A26	<b>0280139</b>	TESTA STERZO - RHT M12x1,25 TIE ROD END - RHT M12x1,25		
48521-35A00 48521-35A06	<b>0603575</b>	SNODO ASSIALE - RHT M12x1,25 AXIAL JOINT - RHT M12x1,25		
48510-50A25 48510-51A25 48510-53A25 48510-53A26	<b>0503576</b>	BARRA STERZO SERVOSTERZO TIE ROD POWER STEERING		
48520-50A00 48520-50A25 48520-50A26	<b>0280139</b>	TESTA STERZO - RHT M12x1,25 TIE ROD END - RHT M12x1,25		
48521-D0100 48521-35F00 48521-70A00 48521-70A06 48521-70A16	<b>0600993</b>	SNODO ASSIALE RHT M12x1,25 AXIAL JOINT RHT M12x1,25		
40160-50A00	<b>0400092</b>	SNODO SOSPENSIONE INFERIORE SUSPENSION JOINT LOWER		
Anno - Year <b>02/2007 &gt;</b>		Serie - Series <b>J10</b>	Modello - Model <b>QASHQAI</b>	
48527-JD01A	<b>0283123</b>	TESTA STERZO TIE ROD END		
48647-JD01A	<b>0293123</b>	TESTA STERZO TIE ROD END		

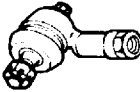
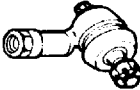

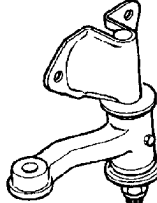
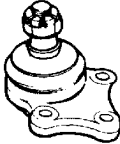
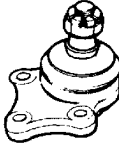
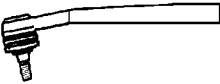
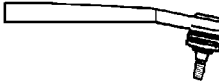
RIF. ORIG O.E. NUMBER	RIF. OCAP REF. OCAP	NOTE REMARKS	DESTRO RIGHT	SINISTRO LEFT
Anno - Year <b>02/2007 &gt;</b>		Serie - Series <b>J10</b>	Modello - Model <b>QASHQAI</b>	
D8521-JG00A 48001-JD90B D8521-JD00B	<b>0603271</b>	SNODO ASSIALE AXIAL JOINT		
40160-9W200 40160-9Y000 40160-CA010 40160-CC40A	<b>0403124</b>	SNODO SOSPENSIONE - ASSE ANTERIORE - INFERIORE BALL JOINT - FRONT AXLE - LOWER		
54500-JD000 54500-BR30A	<b>0783124</b>	BRACCIO OSCILLANTE - ASSE ANTERIORE - INFERIORE TRACK CONTROL ARM - FRONT AXLE - LOWER		
54501-JD000 54501-BR30A	<b>0793124</b>	BRACCIO OSCILLANTE - ASSE ANTERIORE - INFERIORE TRACK CONTROL ARM - FRONT AXLE - LOWER		
54618-JD00A 54618-1AA0A 54618-1AA0E	<b>0583125</b>	STABILIZZATORE ASSE ANTERIORE STABILIZER LINK - FRONT AXLE		
54668-JD00A 54668-1AA0A 54668-1AA0E	<b>0593125</b>	STABILIZZATORE ASSE ANTERIORE STABILIZER LINK - FRONT AXLE		
55618-JD00A 55618-JY00B	<b>0584633</b>	STABILIZZATORE - ASSE POSTERIORE STABILIZER LINK - REAR AXLE		
55619-JD00A 55619-JY00B	<b>0594633</b>	STABILIZZATORE - ASSE POSTERIORE STABILIZER LINK - REAR AXLE		
Anno - Year <b>1992 &gt;</b> <b>1995 &gt;</b>		Serie - Series <b>C 23 M</b> <b>HC 23</b>	Modello - Model <b>SERENA</b> <b>VANETTE CARGO</b>	
48520-9C025 48520-9C000 48520-73J25	<b>0283550</b>	TESTA STERZO - RHT M12X1,25 TIE ROD END - RHT M12X1,25		
-	<b>0604639</b>	SNODO ASSIALE - RHT M12X1,25 AXIAL JOINT - RHT M12X1,25		





RIF. ORIG O.E. NUMBER	RIF. OCAP REF. OCAP	NOTE REMARKS	DESTRO RIGHT	SINISTRO LEFT
Anno - Year <b>1992 &gt;</b> <b>1995 &gt;</b>		Serie - Series <b>C 23 M</b> <b>HC 23</b>	Modello - Model <b>SERENA</b> <b>VANETTE CARGO</b>	
40160-9C500	<b>0484179</b>	SNODO SOSPENSIONE - ASSE ANTERIORE INFERIORE SUSPENSIONE JOINT - FRONT AXLE LOWER		
40161-9C500	<b>0494179</b>	SNODO SOSPENSIONE - ASSE ANTERIORE INFERIORE SUSPENSIONE JOINT - FRONT AXLE LOWER		
54500-7C350	<b>0784640</b>	BRACCIO OSCILLANTE - ASSE ANTERIORE - INFERIORE TRACK CONTROL ARM - FRONT AXLE - LOWER		
54501-7C350	<b>0794640</b>	BRACCIO OSCILLANTE - ASSE ANTERIORE - INFERIORE TRACK CONTROL ARM - FRONT AXLE - LOWER		
54618-9C002	<b>0581599</b>	STABILIZZATORE ASSE ANTERIORE STABILIZER LINK - FRONT AXLE		
54668-9C000	<b>0591599</b>	STABILIZZATORE ASSE ANTERIORE STABILIZER LINK - FRONT AXLE		
Anno - Year <b>1979 &gt; 1981</b>		Serie - Series <b>Z18S &gt; Z18E</b>	Modello - Model <b>SILVIA - GAZELLE</b>	
48510-N8225	<b>0583553</b>	BARRA STERZO TIE ROD		
48630-N8225	<b>0593553</b>	BARRA STERZO TIE ROD		
48520-H5025 48520-W5025	<b>0283553</b>	TESTA STERZO ESTERNA - RHT M14x1,5 TIE ROD END - INNER - RHT M14x1,5		
48640-H5025 48640-W5025	<b>0293553</b>	TESTA STERZO ESTERNA - LHT M14x1,5 TIE ROD END - INNER - LHT M14x1,5		

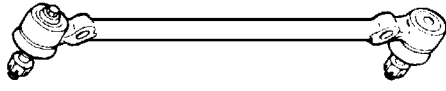
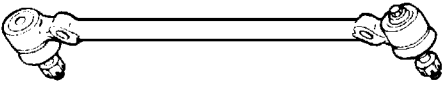
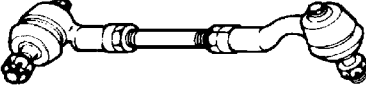
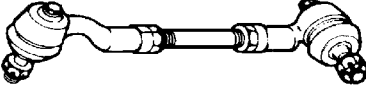
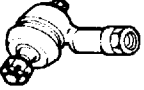
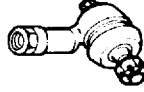

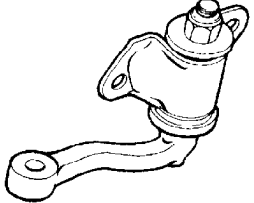
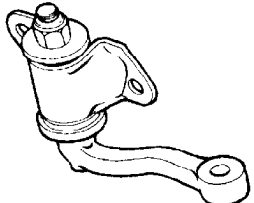
RIF. ORIG O.E. NUMBER	RIF. OCAP REF. OCAP	NOTE REMARKS	DESTRO RIGHT	SINISTRO LEFT
Anno - Year <b>1979 &gt; 1981</b>		Serie - Series <b>Z18S &gt; Z18E</b>	Modello - Model <b>SILVIA - GAZELLE</b>	
48521-H1001 48521-H5025 48521-W5025	<b>0293554</b>	TESTA STERZO INTERNA - LHT M14x1,5 TIE ROD END - INNER - LHT M14x1,5		
48641-H1001 48641-H5025 48641-W5025	<b>0283554</b>	TESTA STERZO INTERNA - RHT M14x1,5 TIE ROD END - INNER - RHT M14x1,5		
40160-W5000	<b>0403555</b>	SNODO SOSPENSIONE INFERIORE SUSPENSION JOINT LOWER		
Anno - Year <b>1981 &gt; 1983</b>		Serie - Series <b>Z18P - Z20E - Z18ET</b>	Modello - Model <b>SILVIA - GAZELLE</b>	
48510-N8425	<b>0583556</b>	BARRA STERZO - SERIE Z18P - Z20E TIE ROD - SERIES Z18P - Z20E		
48630-N8425	<b>0593556</b>	BARRA STERZO - SERIE Z18P - Z20E TIE ROD - SERIES Z18P - Z20E		
48520-N8425	<b>0283557</b>	TESTA STERZO ESTERNA - RHT M14x1,5 TIE ROD END - OUTER - RHT M14x1,5		
48640-N8425	<b>0293557</b>	TESTA STERZO ESTERNA - LHT M14x1,5 TIE ROD END - OUTER - LHT M14x1,5		
48521-N8425	<b>0293558</b>	TESTA STERZO INTERNA - LHT M14x1,5 - SERIES Z18P - Z20E TIE ROD END - INNER - LHT M14x1,5 - SERIES Z18P - Z20E		
48641-N8425	<b>0283558</b>	TESTA STERZO INTERNA - RHT M14x1,5 - SERIES Z18P - Z20E TIE ROD END - INNER - RHT M14x1,5 - SERIES Z18P - Z20E		
48510-N8425	<b>0583556</b>	BARRA STERZO - SERIES Z18ET TIE ROD - SERIES Z18ET		
48630-D8025	<b>0593559</b>	BARRA STERZO - SERIES Z18ET TIE ROD - SERIES Z18ET		

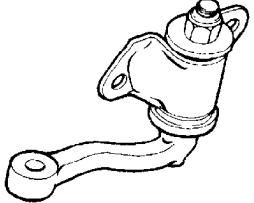
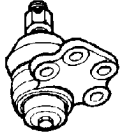
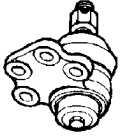

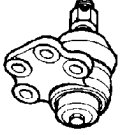
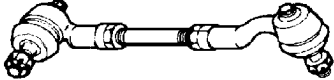
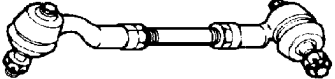
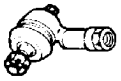
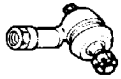
RIF. ORIG O.E. NUMBER	RIF. OCAP REF. OCAP	NOTE REMARKS	DESTRO RIGHT	SINISTRO LEFT
Anno - Year 1981 > 1983		Serie - Series Z18P - Z20E - Z18ET	Modello - Model SILVIA - GAZELLE	
48520-N8425	0283557	TESTA STERZO ESTERNA - RHT M14x1,5 TIE ROD END - OUTER - RHT M14x1,5		
48640-N8425	0293557	TESTA STERZO ESTERNA - LHT M14x1,5 TIE ROD END - OUTER - LHT M14x1,5		
48521-N8425	0293558	TESTA STERZO INTERNA - LHT M14x1,5 - SERIE Z18ET TIE ROD END - INNER - LHT M14x1,5 - SERIES Z18T		
48641-D8025	0283559	TESTA STERZO INTERNA - RHT M14x1,5 - SERIE Z18ET TIE ROD END - INNER - RHT M14x1,5 - SERIES Z18T		
48530-N8500	0303560	BRACCIO STERZO IDLER ARM		
40160-N8400	0403561	SNODO SOSPENSIONE INFERIORE SUSPENSION JOINT LOWER		
Anno - Year 1983 >		Serie - Series Z18P - Z20E - Z18ET	Modello - Model SILVIA - GAZELLE	
48520-W1025 48520-01F25	0281222	TESTA STERZO - RHT M14x1,5 TIE ROD END - RHT M14x1,5		
48640-W1025 48640-01F25	0291222	TESTA STERZO - RHT M14x1,5 TIE ROD END - RHT M14x1,5		
48521-P9001 48521-W1000 48521-W1001 48521-01F00 48521-01F06	0691223	SNODO ASSIALE - RHT M14x1,5 AXIAL JOINT - RHT M14x1,5		
40160-W1000 40160-W1001 40160-W2200	0401225	SNODO SOSPENSIONE INFERIORE SUPSPENSION JOINT LOWER		



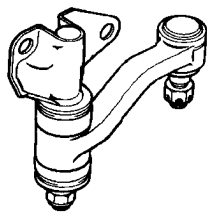
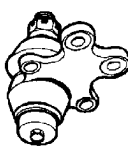
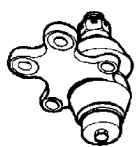
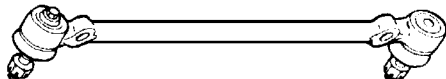
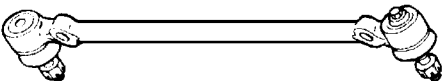
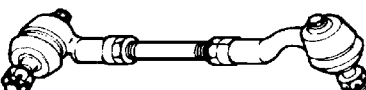
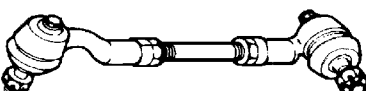
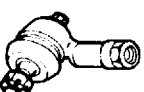
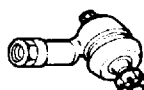



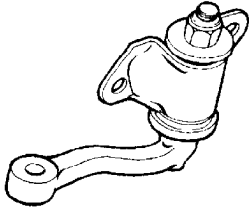
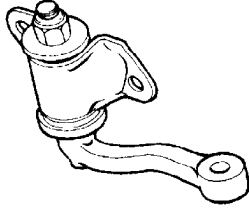
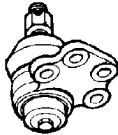
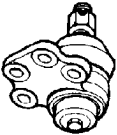
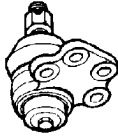
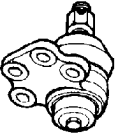
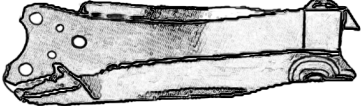
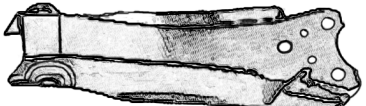

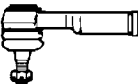
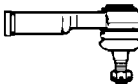





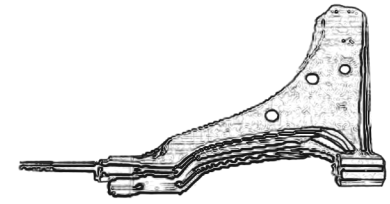
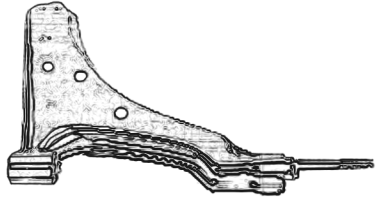

RIF. ORIG O.E. NUMBER	RIF. OCAP REF. OCAP	NOTE REMARKS	DESTRO RIGHT	SINISTRO LEFT
Anno - Year 1973 > 1977 1975 >		Serie - Series B 210 - B 211 B 120 C- B 121 - B 122		Modello - Model SUNNY SUNNY TRUCK
48560-H6100 48560-H6125	0503570	L H D - BARRA STERZO SOLO B 210 - B 211 L H D - TIE ROD ONLY B 210 - B 211		
48560-H5000	0503571	R H D - BARRA STERZO SOLO B 210 - B 211 R H D - TIE ROD ONLY B 210 - B 211		
48510-H1025 48510-H5025	0583572	BARRA STERZO TIE ROD		
48560-H1025 48630-H5025	0593572	BARRA STERZO TIE ROD		
48520-H5025 48520-W5025	0283553	TESTA STERZO ESTERNA - RHT M14x1,5 TIE ROD END - OUTER - RHT M14x1,5		
48640-H5025 48640-W5025	0293553	TESTA STERZO ESTERNA - LHT M14x1,5 TIE ROD END - OUTER - LHT M14x1,5		
48521-H1001 48521-H5025 48521-W5025	0293554	TESTA STERZO INTERNA - LHT M14x1,5 TIE ROD END - INNER - LHT M14x1,5		
48641-H1001 48641-H5025 48641-W5025	0283554	TESTA STERZO INTERNA - RHT M14x1,5 TIE ROD END - INNER - RHT M14x1,5		
48530-H6100	0303568	L H D - BRACCIO STERZO SOLO B 210 - B 211 L H D - IDLER ARM ONLY B 210 - B 211		
48530-H5000	0303569	R H D - BRACCIO STERZO SOLO B 210 - B 211 R H D - IDLER ARM ONLY B 210 - B 211		







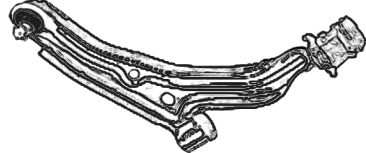
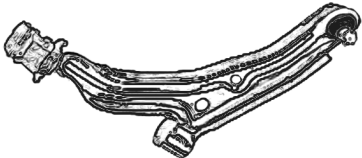

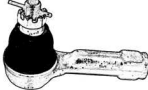

RIF. ORIG O.E. NUMBER	RIF. OCAP REF. OCAP	NOTE REMARKS	DESTRO RIGHT	SINISTRO LEFT
Anno - Year <b>1973 &gt; 1977</b> 1975 >		Serie - Series <b>B 210 - B 211</b> <b>B 120 C- B 121 - B 122</b>	Modello - Model <b>SUNNY</b> <b>SUNNY TRUCK</b>	
48530-H1600	<b>0303579</b>	L H D - BRACCIO STERZO SOLO B 120 C- B 121 - B 122 L H D - IDLER ARM ONLY B 120 C- B 121 - B 122		
40160-H1001	<b>0403573</b>	SNODO SOSPENSIONE INFERIORE > 1975 SUSPENSION JOINT LOWER > 1975		
40160-H7400	<b>0403574</b>	SNODO SOSPENSIONE INFERIORE 1975 > SUSPENSION JOINT LOWER 1975 >		
Anno - Year <b>1971 &gt; 1977</b>		Serie - Series <b>PB110-PB210-GB210-GB211-LB210</b>	Modello - Model <b>SUNNY</b>	
48510-A0600 48510-U0100	<b>0583512</b>	BARRA STERZO TIE ROD		
48630-A0600 48630-U0100	<b>0593512</b>	BARRA STERZO TIE ROD		
48520-A0600 48520-U0100 48520-U5200 48640-G2525	<b>0283509</b>	TESTA STERZO ESTERNA - RHT M14x1,5 TIE ROD END - OUTER - RHT M14x1,5		
48520-G2525 48640-A0600 48640-U0100 48640-U5200	<b>0293509</b>	TESTA STERZO ESTERNA - LHT M14x1,5 TIE ROD END - OUTER - LHT M14x1,5		
48521-A0600 48521-U0100 48521-U5200 48641-G2525	<b>0293510</b>	TESTA STERZO INTERNA - LHT M14x1,5 TIE ROD END - INNER - LHT M14x1,5		
48641-U5200 48641-A0600 48521-G2525 48641-U0100	<b>0283510</b>	TESTA STERZO INTERNA - RHT M14x1,5 TIE ROD END - INNER - RHT M14x1,5		

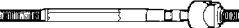
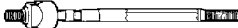

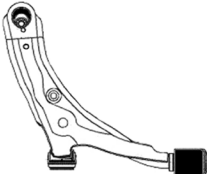
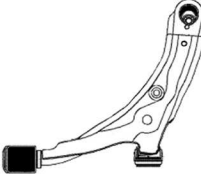
RIF. ORIG O.E. NUMBER	RIF. OCAP REF. OCAP	NOTE REMARKS	DESTRO RIGHT	SINISTRO LEFT
Anno - Year 1971 > 1977		Serie - Series <b>PB110-PB210-GB210-GB211-LB210</b>	Modello - Model <b>SUNNY</b>	
48530-21400	<b>0303516</b>	L H D - BRACCIO STERZO L H D - IDLER ARM		
48530-21000 40160-A8600 40160-A8610 40160-A8625 40160-U7000	<b>0403513</b>	SNODO SOSPENSIONE INFERIORE SUSPENSION JOINT LOWER		
Anno - Year 1977 > 1981		Serie - Series <b>B310 - HB310</b>	Modello - Model <b>SUNNY</b>	
48560-W5700 48560-W5725	<b>0503565</b>	L H D - BARRA STERZO L H D - TIE ROD		
48560-W5000	<b>0503566</b>	R H D - BARRA STERZO R H D - TIE ROD		
48510-W5000 48510-W5025	<b>0583564</b>	BARRA STERZO TIE ROD		
48630-W5000 48630-W5025	<b>0593564</b>	BARRA STERZO TIE ROD		
48520-H5025 48520-W5025	<b>0283553</b>	TESTA STERZO ESTERNA - RHT M14x1,5 TIE ROD END - OUTER - RHT M14x1,5		
48640-H5025 48640-W5025	<b>0293553</b>	TESTA STERZO ESTERNA - LHT M14x1,5 TIE ROD - OUTER - LHT M14x1,5		
48521-H1001 48521-H5025 48521-W5025	<b>0293554</b>	TESTA STERZO INTERNA - LHT M14x1,5 TIE ROD - INNER - LHT M14x1,5		
48641-H1001 48641-H5025 48641-W5025	<b>0283554</b>	TESTA STERZO INTERNA - RHT M14x1,5 TIE ROD - INNER - RHT M14x1,5		

RIF. ORIG O.E. NUMBER	RIF. OCAP REF. OCAP	NOTE REMARKS	DESTRO RIGHT	SINISTRO LEFT
Anno - Year 1977 > 1981		Serie - Series B310 - HB310	Modello - Model SUNNY	
48530-H6100	0303568	L H D - BRACCIO STERZO L H D - IDLER ARM		
48530-H5000	0303569	R H D - BRACCIO STERZO R H D - IDLER ARM		
40160-H7400	0403574	SNODO SOSPENSIONE INFERIORE SERIE B310 SUSPENSION JOINT LOWER SERIES B310		
40160-W5000	0403555	SNODO SOSPENSIONE INFERIORE SERIE HB310 SUSPENSION JOINT LOWER SERIES HB310		
54100-H8500	0783583	BRACCIO OSCILLANTE TRACK CONTROL ARM		
54101-H1000 54101-H8500	0793583	BRACCIO OSCILLANTE TRACK CONTROL ARM		
Anno - Year 1981 > 1985		Serie - Series B 11	Modello - Model SUNNY	
48510-D0100 48510-D0125 48510-11A27 48510-35A26 48510-35A27 48510-70A25 48510-70A27	0500994	BARRA STERZO STERZO MANUALE TIE ROD MANUAL STEERING		
48520-D0100 48520-D0125 48520-D0126 48520-02E26	0280992	TESTA STERZO - RHT M12x1,25 TIE ROD END - RHT M12x1,25		

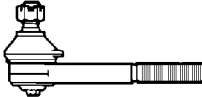



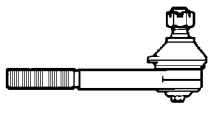
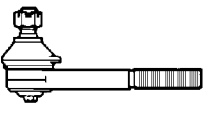
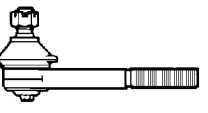
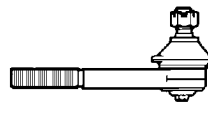
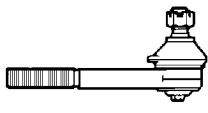
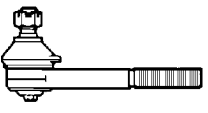
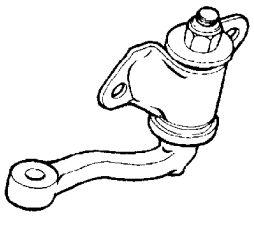
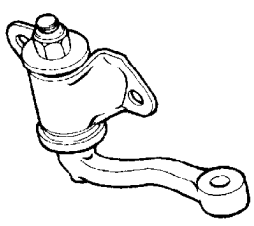

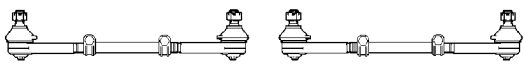

RIF. ORIG O.E. NUMBER	RIF. OCAP REF. OCAP	NOTE REMARKS	DESTRO RIGHT	SINISTRO LEFT
Anno - Year <b>1981 &gt; 1985</b>		Serie - Series <b>B 11</b>	Modello - Model <b>SUNNY</b>	
48521-D0100 48521-35F00 48521-70A00 48521-70A06 48521-70A16	<b>0600993</b>	SNODO ASSIALE - RHT M12x1,25 AXIAL JOINT - RHT M12x1,25		
48510-35A25	<b>0503575</b>	BARRA STERZO SERVOSTERZO TIE ROD POWER STEERING		
48520-D0100 48520-D0125 48520-D0126 48520-02E26	<b>0280992</b>	TESTA STERZO - RHT M12x1,25 TIE ROD END - RHT M12x1,25		
48521-35A00 48521-35A06	<b>0603575</b>	SNODO ASSIALE - RHT M12x1,25 - SERVOSTERZO AXIAL JOINT - RHT M12x1,25 - POWER STEERING		
40160-A03G0 40160-A06G0 40160-01A00 40160-01A25	<b>0400996</b>	SNODO SOSPENSIONE INFERIORE SUSPENSION JOINT LOWER		
54529-01A00 54529-04A00	<b>0783584</b>	BRACCIO OSCILLANTE TRACK CONTROL ARM		
54530-01A00 54530-04A00	<b>0793584</b>	BRACCIO OSCILLANTE TRACK CONTROL ARM		
Anno - Year <b>01/86 &gt; 08/90</b> <b>06/86 &gt; 10/90</b>		Serie - Series <b>B12</b> <b>N13</b>	Modello - Model <b>SUNNY</b>	
48510-50A25 48510-51A25 48510-53A25 48510-53A26	<b>0503576</b>	BARRA STERZO ESCLUSO ARABIA S. - GOLFO TIE ROD EXCEPT S. ARABIEN - GOLF		
48520-50A00 48520-50A25 48520-50A26	<b>0280139</b>	TESTA STERZO - RHT M12x1,25 TIE ROD END - RHT M12x1/25		

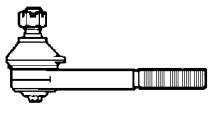
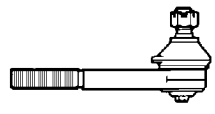
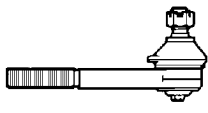
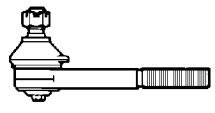





RIF. ORIG O.E. NUMBER	RIF. OCAP REF. OCAP	NOTE REMARKS	DESTRO RIGHT	SINISTRO LEFT
Anno - Year <b>01/86 &gt; 08/90</b> <b>06/86 &gt; 10/90</b>		Serie - Series <b>B12</b> <b>N13</b>	Modello - Model <b>SUNNY</b>	
48521-D0100 48521-35F00 48521-70A00 48521-70A06 48521-70A16	<b>0600993</b>	SNODO ASSIALE - RHT M12x1,25 AXIAL JOINT - RHT M12x1,25		
48510-50A26	<b>0503577</b>	BARRA STERZO SERIE S. ARABIA - GOLFO TIE ROD SERIES S. ARABIEN - GOLF		
48520-50A00 48520-50A25 48520-50A26	<b>0280139</b>	TESTA STERZO - RHT M12x1,25 TIE ROD END - RHT M12x1,25		
48521-35A00 48521-35A06	<b>0603575</b>	SNODO ASSIALE - RHT M12x1,25 AXIAL JOINT - RHT M12x1,25		
40160-50A00	<b>0400092</b>	SNODO SOSPENSIONE INFERIORE SUSPENSION JOINT LOWER		
54500-50A00	<b>0783585</b>	BRACCIO OSCILLANTE TRACK CONTROL ARM		
54501-50A00	<b>0793585</b>	BRACCIO OSCILLANTE TRACK CONTROL ARM		
46630-60B00 46630-60B01	<b>0501927</b>	STABILIZZATORE - RHT M8x1,25 STABILIZER LINK - RHT M8x1,25		
-	<b>0501927-K</b>	KIT STABILIZZATORE - RHT M8x1,25 STABILIZER LINK KIT - RHT M8x1,25		

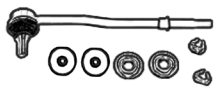
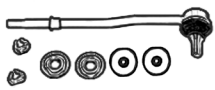
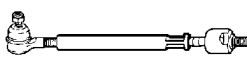
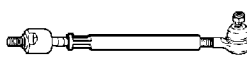
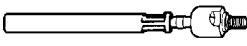
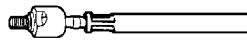
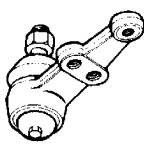
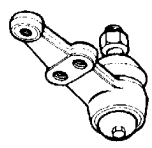

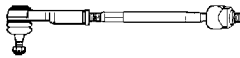
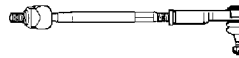
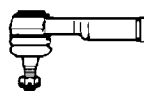
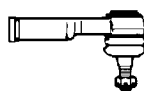
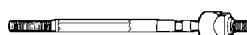
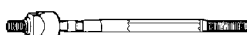

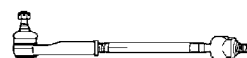
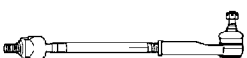

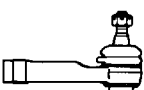
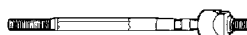
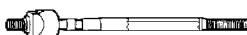

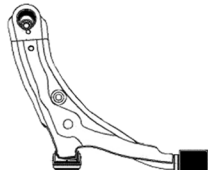
RIF. ORIG O.E. NUMBER	RIF. OCAP REF. OCAP	NOTE REMARKS	DESTRO RIGHT	SINISTRO LEFT
Anno - Year <b>1991 &gt; 1994</b> <b>1990 &gt; 1995</b>		Serie - Series <b>B13</b> <b>N14</b>	Modello - Model <b>SUNNY</b> <b>SUNNY</b>	
48520-Q9000 48520-01E00 48520-01E25 48520-01E26 48520-02E00 48520-02E25 48520-50Y25	<b>0283525</b>	TESTA STERZO - RHT M12x1,25 TIE ROD END - RHT M12x1,25		
48521-50Y00 48521-50400 48521-Y02G0	<b>0602889</b>	SNODO ASSIALE - RHT M12x1,25 AXIAL JOINT - RHT M12x1,25		
40160-Y02G0 40160-50Y10 40160-52Y00 40160-60Y10 40160-60Y20 40160-69Y00 40160-69Y10 40160-50Y00	<b>0403586</b>	SNODO SOSPENSIONE - ASSE ANTERIORE - INFERIORE BALL JOINT - FRONT AXLE - LOWER		
54500-52Y10 54500-52Y15 54500-52Y60 54500-52Y70	<b>0783586</b>	BRACCIO OSCILLANTE TRACK CONTROL ARM		
54501-52Y10 54501-52Y15 54501-52Y60 54501-52Y70	<b>0793586</b>	BRACCIO OSCILLANTE TRACK CONTROL ARM		
54618-50Y00 54618-58820 54618-D5010	<b>0504395</b>	STABILIZZATORE - ASSE ANTERIORE L= 85 mm STABILIZER LINK - FRONT AXLE L= 85 mm		
54618-D5010 (1) 56112-V0100 (2) 56113-60U0A (3) 08912-3401A (4)	<b>0504395-K</b>	KIT STABILIZZATORE ASSE ANTERIORE - L=85 mm. STABILIZER LINK KIT - FRONT AXLE - L=85 mm.		
Anno - Year <b>1987 &gt;1996</b>		Serie - Series <b>WD21</b>	Modello - Model <b>TERRANO I</b>	
48520-7F000 48520-31G25	<b>0183587</b>	TESTA STERZO ESTERNA - RHT M16x1,5 - > 1992 TIE ROD END - OUTER - RHT M16x1,5 - > 1992		

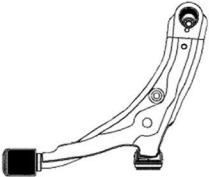
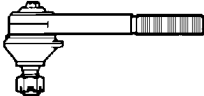
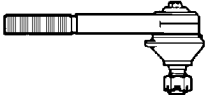





RIF. ORIG O.E. NUMBER	RIF. OCAP REF. OCAP	NOTE REMARKS	DESTRO RIGHT	SINISTRO LEFT
Anno - Year <b>1987 &gt;1996</b>		Serie - Series <b>WD21</b>	Modello - Model <b>TERRANO I</b>	
48521-31G25 48570-31G25 48520-7F001	<b>0193588</b>	TESTA STERZO INTERNA - LHT M16x1,5 - > 1992 TIE ROD END - INNER - LHT M16x1,5 - > 1992		
48520-61G25	<b>0182890</b>	TESTA STERZO ESTERNA - 1992 > TIE ROD END - OUTER - 1992 >		
48570-61G25	<b>0192891</b>	TESTA STERZO INTERNA - 1992 > TIE ROD END - INNER - 1992 >		
48530-31G25	<b>0303590</b>	L H D - BRACCIO STERZO L H D - IDLER ARM		
48530-35G25	<b>0303591</b>	R H D - BRACCIO STERZO R H D - IDLER ARM		
40110-B9500 40110-T3060 40110-T6000 40110-T6025 40110-V0100 40110-01G00 40110-01G25 40110-01G26	<b>0403533</b>	SNODO SOSPENSIONE SUPERIORE SUSPENSION JOINT UPPER		
40160-0F000 40160-S0W25 40160-50W00 40160-50W01 40160-50W10	<b>0403548</b>	SNODO SOSPENSIONE INFERIORE SUSPENSION JOINT LOWER		
Anno - Year <b>02/1993 &gt;</b>		Serie - Series <b>R20</b>	Modello - Model <b>TERRANO II</b>	
48510-31G25 48510-7F000	<b>0503589</b>	BARRA STERZO - 1996 >1999 TIE ROD 1996 > 1999		







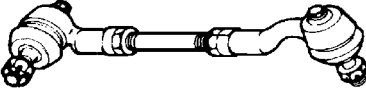
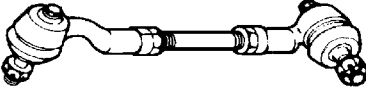
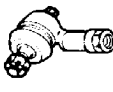
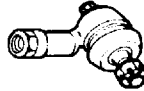







RIF. ORIG O.E. NUMBER	RIF. OCAP REF. OCAP	NOTE REMARKS	DESTRO RIGHT	SINISTRO LEFT
Anno - Year <b>02/1993 &gt;</b>		Serie - Series <b>R20</b>	Modello - Model <b>TERRANO II</b>	
48520-7F000 48520-31G25	<b>0183587</b>	TESTA STERZO ESTERNA - RHT M16x1,5 TIE ROD END - OUTER - RHT M16x1,5		
48521-31G25 48570-31G25 48520-7F001	<b>0193588</b>	TESTA STERZO INTERNA - LHT M16x1,5 TIE ROD END - INNER - LHT M16x1,5		
40110-B9500 40110-T3060 40110-T6000 40110-T6025 40110-V0100 40110-01G00 40110-01G25 40110-01G26	<b>0403533</b>	SNODO SOSPENSIONE - SUPERIORE SUSPENSION JOINT - UPPER		
40160-0F000 40160-S0W25 40160-50W00 40160-50W01 40160-50W10	<b>0403548</b>	SNODO SOSPENSIONE INFERIORE -> 05/1996 SUSPENSION JOINT LOWER -> 05/1996		
54618-0F000	<b>0504401</b>	STABILIZZATORE - ASSE ANTERIORE STABILIZER LINK - FRONT AXLE		
54618-0F000 Z	<b>0504401-K</b>	KIT STABILIZZATORE - ASSE ANTERIORE STABILIZER LINK KIT - FRONT AXLE		
56260-0F001	<b>0504402</b>	STABILIZZATORE - ASSE POSTERIORE STABILIZER LINK - REAR AXLE		
Anno - Year <b>1982 &gt; 1989</b>		Serie - Series	Modello - Model <b>TSURU I - SENTRA I</b>	
-	<b>0500089</b>	BARRA STERZO TIE ROD		
48521-A03G0	<b>0600089</b>	SNODO ASSIALE AXIAL JOINT		
40160-A03G0 40160-A06G0 40160-01A00 40160-01A25	<b>0400996</b>	SNODO SOSPENSIONE INFERIORE SUSPENSION JOINT LOWER		



RIF. ORIG O.E. NUMBER	RIF. OCAP REF. OCAP	NOTE REMARKS	DESTRO RIGHT	SINISTRO LEFT
Anno - Year <b>1989 &gt; 1992</b>		Serie - Series	Modello - Model <b>TSURU II - SENTRA II</b>	
-	<b>0500091</b>	BARRA STERZO TIE ROD		
48520-D0100 48520-D0125 48520-D0126 48520-02E26	<b>0280090</b>	TESTA STERZO TIE ROD END		
48521-D0100 48521-35F00 48521-70A00 48521-70A06 48521-70A16	<b>0600993</b>	SNODO ASSIALE AXIAL JOINT		
40160-50A00	<b>0400092</b>	SNODO SOSPENSIONE INFERIORE SUSPENSION JOINT LOWER		
Anno - Year <b>1992 &gt; 1995</b>		Serie - Series	Modello - Model <b>TSURU III - SENTRA III</b>	
-	<b>0503602</b>	BARRA STERZO TIE ROD		
48520-50A00 48520-50A25 48520-50A26	<b>0283601</b>	TESTA STERZO TIE ROD END		
48521-X08G1	<b>0603602</b>	SNODO ASSIALE AXIAL JOINT		
40160-Y02G0 40160-50Y10 40160-52Y00 40160-60Y10 40160-60Y20 40160-69Y00 40160-69Y10 40160-50Y00	<b>0403603</b>	SNODO SOSPENSIONE INFERIORE SUSPENSION JOINT LOWER		
54500-52Y10 54500-52Y15 54500-52Y60 54500-52Y70	<b>0783586</b>	BRACCIO OSCILLANTE TRACK CONTROL ARM		



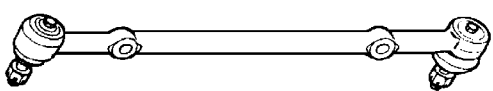

RIF. ORIG O.E. NUMBER	RIF. OCAP REF. OCAP	NOTE REMARKS	DESTRO RIGHT	SINISTRO LEFT
Anno - Year <b>1992 &gt; 1995</b>		Serie - Series	Modello - Model <b>TSURU III - SENTRA III</b>	
54501-52Y10 54501-52Y15 54501-52Y60 54501-52Y70	<b>0793586</b>	BRACCIO OSCILLANTE TRACK CONTROL ARM		
Anno - Year <b>1978 &gt; 1986</b>		Serie - Series <b>E21 - E22 - E23</b>	Modello - Model <b>URVAN</b>	
48571-T3001 48571-T3025	<b>0193529</b>	TESTA STERZO - LHT M20x1,5 TIE ROD END - LHT M20x1,5		
48561-T3001 48561-T3025	<b>0183529</b>	TESTA STERZO - RHT M20x1,5 TIE ROD END - RHT M20x1,5		
40110-B9500 40110-T3060 40110-T6000 40110-T6025 40110-V0100 40110-01G00 40110-01G25 40110-01G26	<b>0403533</b>	SNODO SOSPENSIONE SUPERIORE SUSPENSION JOINT UPPER		
40160-T3060 40160-B9500 40160-F1700 40160-48W00 40160-48W25	<b>0483534</b>	SNODO SOSPENSIONE INFERIORE SUSPENSION JOINT LOWER		
40161-T3060 40161-B9500 40161-F1700 40161-48W00 40161-48W25	<b>0493534</b>	SNODO SOSPENSIONE INFERIORE SUSPENSION JOINT LOWER		
Anno - Year <b>02/87 &gt; 05/97</b>		Serie - Series <b>E24</b>	Modello - Model <b>URVAN</b>	
48640-01N25 48521-01N25	<b>0294641</b>	TESTA STERZO - LHT M16x1,5 - ESTERNA - > 09/1988 TIE ROD END - LHT M16x1,5 - OUTER - > 09/1988		
48641-01N25 48520-01N25	<b>0284642</b>	TESTA STERZO - RHT M16x1,5 - INTERNA - > 09/1988 TIE ROD END - RHT M16x1,5 - INNER - > 09/1988		

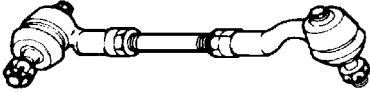
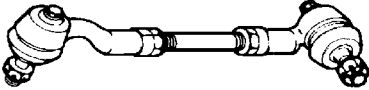
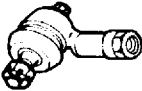
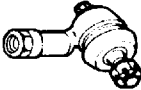
RIF. ORIG O.E. NUMBER	RIF. OCAP REF. OCAP	NOTE REMARKS	DESTRO RIGHT	SINISTRO LEFT
Anno - Year <b>02/87 &gt; 05/97</b>		Serie - Series <b>E24</b>	Modello - Model <b>URVAN</b>	
48520-27N25	<b>0284643</b>	TESTA STERZO - RHT M14x1,5 - 10/1988 > TIE ROD END - RHT M14x1,5 - 10/1988 >		
48521-27N00	<b>0604644</b>	SNODO ASSIALE - RHT M14x1,5 - 10/1988 > AXIAL JOINT - RHT M14x1,5 - 10/1988 >		
40110-B9500 40110-T3060 40110-T6000 40110-T6025 40110-V0100 40110-01G00 40110-01G25 40110-01G26	<b>0403533</b>	SNODO SOSPENSIONE - SUPERIORE BALL JOINT - UPPER		
40160-01G00 40160-01G25 40160-01G50 40160-01G90 40160-01N25 40160-2S485 40160-55G90	<b>0400437</b>	SNODO SOSPENSIONE - SUPERIORE BALL JOINT - UPPER		
Anno - Year <b>1978 &gt; 1985</b>		Serie - Series <b>C120 - C121 - C122</b>	Modello - Model <b>VANETTE</b>	
48510-G2525	<b>0583581</b>	BARRA STERZO TIE ROD		
48630-G2525	<b>0593581</b>	BARRA STERZO TIE ROD		
48520-G2525 48640-A0600 48640-U0100 48640-U5200	<b>0293509</b>	TESTA STERZO ESTERNA - LHT M14x1,5 TIE ROD END - OUTER - LHT M14x1,5		
48520-A0600 48520-U0100 48520-U5200 48640-G2525	<b>0283509</b>	TESTA STERZO ESTERNA - RHT M14x1,5 TIE ROD END - OUTER - RHT M14x1,5		
48641-U5200 48641-A0600 48521-G2525 48641-U0100	<b>0283510</b>	TESTA STERZO INTERNA - RHT M14x1,5 TIE ROD END - INNER - RHT M14x1,5		
48521-A0600 48521-U0100 48521-U5200 48641-G2525	<b>0293510</b>	TESTA STERZO INTERNA - LHT M14x1,5 TIE ROD END - INNER - LHT M14x1,5		

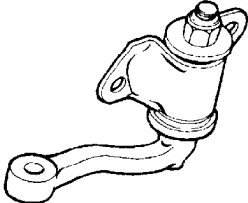
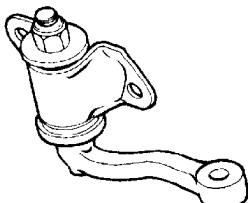
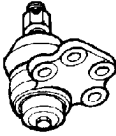
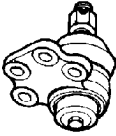

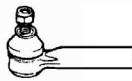
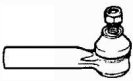
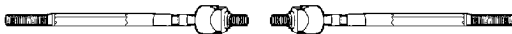
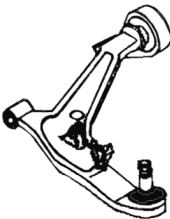
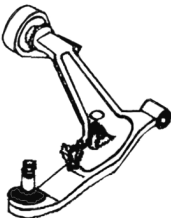
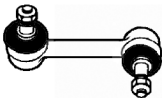





RIF. ORIG O.E. NUMBER	RIF. OCAP REF. OCAP	NOTE REMARKS	DESTRO RIGHT	SINISTRO LEFT
Anno - Year <b>1978 &gt; 1985</b>		Serie - Series <b>C120 - C121 - C122</b>	Modello - Model <b>VANETTE</b>	
40110-G3700 40110-G5100 40110-G5110	<b>0404645</b>	SNODO SOSPENSIONE - ASSE ANTERIORE - SUPERIORE - SOLO PER SERIE C120 BALL JOINT - FRONT AXLE - UPPER - ONLY FOR C120 SERIES		
40160-G5400 40160-G4010 40160-G2525 40160-G2500	<b>0404646</b>	SNODO SOSPENSIONE - ASSE ANTERIORE - INFERIORE - SOLO PER SERIE C120 BALL JOINT - FRONT AXLE - LOWER - ONLY FOR C120 SERIES		
Anno - Year <b>10/86 &gt; 12/95</b>		Serie - Series <b>C22</b>	Modello - Model <b>VANETTE</b>	
48520-G5125 48521-G5101	<b>0294647</b>	TESTA STERZO - ESTERNA - LHT M14x1,5 TIE ROD END - OUTER - LHT M14x1,5		
48521-G5125 48521-G5101	<b>0284648</b>	TESTA STERZO - INTERNA - RHT M14x1,5 TIE ROD END - INNER - RHT M14x1,5		
48641-G5125 48641-G5101	<b>0294648</b>	TESTA STERZO - INTERNA - LHT M14x1,5 TIE ROD END - INNER - LHT M14x1,5		
48640-G5125 48640-G5101	<b>0284647</b>	TESTA STERZO - ESTERNA - RHT M14x1,5 TIE ROD END - OUTER - RHT M14x1,5		
40110-G3700 40110-G5100 40110-G5110	<b>0404645</b>	SNODO SOSPENSIONE - ASSE ANTERIORE - SUPERIORE BALL JOINT - FRONT AXLE - UPPER		
40160-G5400 40160-G4010 40160-G2525 40160-G2500	<b>0404646</b>	SNODO SOSPENSIONE - ASSE ANTERIORE - INFERIORE BALL JOINT - FRONT AXLE - LOWER		
Anno - Year <b>1973 &gt; 1977</b>		Serie - Series <b>710 - 711</b>	Modello - Model <b>VIOLET</b>	
48560-U2000 48560-U5200 48560-21400	<b>0503514</b>	L H D - BARRA STERZO L H D - TIE ROD		

















RIF. ORIG O.E. NUMBER	RIF. OCAP REF. OCAP	NOTE REMARKS	DESTRO RIGHT	SINISTRO LEFT
Anno - Year <b>1973 &gt; 1977</b>		Serie - Series <b>710 - 711</b>	Modello - Model <b>VIOLET</b>	
48510-A0600 48510-U0100	<b>0583512</b>	BARRA STERZO TIE ROD		
48630-A0600 48630-U0100	<b>0593512</b>	BARRA STERZO TIE ROD		
48520-A0600 48520-U0100 48520-U5200 48640-G2525	<b>0283509</b>	TESTA STERZO ESTERNA - RHT M14x1,5 TIE ROD END - OUTER - RHT M14x1,5		
48520-G2525 48640-A0600 48640-U0100 48640-U5200	<b>0293509</b>	TESTA STERZO ESTERNA - LHT M14x1,5 TIE ROD END - OUTER - LHT M14x1,5		
48521-A0600 48521-U0100 48521-U5200 48641-G2525	<b>0293510</b>	TESTA STERZO INTERNA - LHT M14x1,5 TIE ROD END - INNER - LHT M14x1,5		
48641-U5200 48641-A0600 48521-G2525 48641-U0100	<b>0283510</b>	TESTA STERZO INTERNA - RHT M14x1,5 TIE ROD END INNER - RHT M14x1,5		
48530-21400	<b>0303516</b>	L H D - BRACCIO STERZO L H D - IDLER ARM		
48530-21000 40160-A8600 40160-A8610 40160-A8625 40160-U7000	<b>0403513</b>	SNODO SOSPENSIONE INFERIORE SUSPENSION JOINT LOWER		
Anno - Year <b>1977 &gt; 1981</b>		Serie - Series <b>A 10 - A 11</b>	Modello - Model <b>VIOLET</b>	
48560-W5700 48560-W5725	<b>0503565</b>	L H D - BARRA STERZO L H D - TIE ROD		
48560-W5000	<b>0503566</b>	R H D - BARRA STERZO R H D - TIE ROD		

RIF. ORIG O.E. NUMBER	RIF. OCAP REF. OCAP	NOTE REMARKS	DESTRO RIGHT	SINISTRO LEFT
Anno - Year 1977 > 1981		Serie - Series A 10 - A 11	Modello - Model VIOLET	
48510-W5000 48510-W5025	0583564	BARRA STERZO TIE ROD		
48630-W5000 48630-W5025	0593564	BARRA STERZO TIE ROD		
48520-H5025 48520-W5025	0283553	TESTA STERZO ESTERNA - RHT M14x1,5 TIE ROD END - OUTER - RHT M14x1,5		
48640-H5025 48640-W5025	0293553	TESTA STERZO ESTERNA - LHT M14x1,5 TIE ROD END - OUTER - LHT M14x1,5		
48521-H1001 48521-H5025 48521-W5025	0293554	TESTA STERZO INTERNA - LHT M14x1,5 TIE ROD END - INNER - LHT M14x1,5		
48641-H1001 48641-H5025 48641-W5025	0283554	TESTA STERZO INTERNA - RHT M14x1,5 TIE ROD END - INNER - RHT M14x1,5		
48530-H6100	0303568	L H D - BRACCIO STERZO L H D - IDLER ARM		
48530-H5000	0303569	R H D - BRACCIO STERZO R H D - IDLER ARM		
40160-W5000	0403555	SNODO SOSPENSIONE INFERIORE SUSPENSION JOINT LOWER		









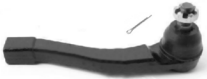

RIF. ORIG O.E. NUMBER	RIF. OCAP REF. OCAP	NOTE REMARKS	DESTRO RIGHT	SINISTRO LEFT
Anno - Year <b>07/2001 &gt;</b>		Serie - Series <b>T30</b>	Modello - Model <b>X-TRAIL</b>	
48520-0P725 48520-0W025 48520-3S500 48520-3S525 D8520-VK90A	<b>0284511</b>	TESTA STERZO ESTERNA TIE ROD END - OUTER		
48521-8H300 48521-8H385 48521-8H325	<b>0604512</b>	SNODO ASSIALE AXIAL JOINT		
54500-8H310	<b>0384514</b>	BRACCIO OSCILLANTE TRACK CONTROL ARM		
54501-8H310	<b>0394514</b>	BRACCIO OSCILLANTE TRACK CONTROL ARM		
54618-8H300	<b>0584513</b>	STABILIZZATORE - ASSE ANTERIORE STABILIZER LINK - FRONT AXLE		
54668-8H300	<b>0594513</b>	STABILIZZATORE - ASSE ANTERIORE STABILIZER LINK - FRONT AXLE		
56261-EQ000	<b>0502834</b>	STABILIZZATORE - ASSE POSTERIORE STABILIZER LINK - REAR AXLE		
Anno - Year <b>06/2007 &gt;</b>		Serie - Series <b>T31</b>	Modello - Model <b>X-TRAIL</b>	
48527-JD01A	<b>0283123</b>	TESTA STERZO TIE ROD END		
48647-JD01A	<b>0293123</b>	TESTA STERZO TIE ROD END		





















RIF. ORIG O.E. NUMBER	RIF. OCAP REF. OCAP	NOTE REMARKS	DESTRO RIGHT	SINISTRO LEFT
Anno - Year <b>06/2007 &gt;</b>		Serie - Series <b>T31</b>	Modello - Model <b>X-TRAIL</b>	
D8521-JG00A 48001-JD90B D8521-JD00B	<b>0603271</b>	SNODO ASSIALE AXIAL JOINT		
40160-9W200 40160-9Y000 40160-CA010 40160-CC40A	<b>0403124</b>	SNODO SOSPENSIONE - ASSE ANTERIORE - INFERIORE BALL JOINT - FRONT AXLE - LOWER		
54500-JD000 54500-BR30A	<b>0783124</b>	BRACCIO OSCILLANTE - ASSE ANTERIORE - INFERIORE TRACK CONTROL ARM - FRONT AXLE - LOWER		
54501-JD000 54501-BR30A	<b>0793124</b>	BRACCIO OSCILLANTE - ASSE ANTERIORE - INFERIORE TRACK CONTROL ARM - FRONT AXLE - LOWER		
54618-JD00A 54618-1AA0A 54618-1AA0E	<b>0583125</b>	STABILIZZATORE ASSE ANTERIORE STABILIZER LINK - FRONT AXLE		
54668-JD00A 54668-1AA0A 54668-1AA0E	<b>0593125</b>	STABILIZZATORE ASSE ANTERIORE STABILIZER LINK - FRONT AXLE		
55618-JD00A 55618-JY00B	<b>0584633</b>	STABILIZZATORE - ASSE POSTERIORE STABILIZER LINK - REAR AXLE		
55619-JD00A 55619-JY00B	<b>0594633</b>	STABILIZZATORE - ASSE POSTERIORE STABILIZER LINK - REAR AXLE		

RIF. ORIG O.E. NUMBER	RIF. OCAP REF. OCAP	NOTE REMARKS	DESTRO RIGHT	SINISTRO LEFT
Anno - Year <b>11/2005 &gt;</b>		Serie - Series	Modello - Model <b>ACTYON</b>	
4666008011 4666009011	<b>0284649</b>	TESTA STERZO - RHT M16x1,5 TIE ROD END - RHT M16x1,5		
4666008001 4666009002	<b>0294649</b>	TESTA STERZO - RHT M16x1,5 TIE ROD END - RHT M16x1,5		
4454109002	<b>0404649</b>	SNODO SOSPENSIONE - ASSE ANTERIORE - INFERIORE BALL JOINT - FRONT AXLE - LOWER		
4440109001	<b>0304649</b>	BRACCIO OSCILLANTE - ASSE ANTERIORE - SUPERIORE TRACK CONTROL ARM - FRONT AXLE - UPPER		
4475209000	<b>0584649</b>	STABILIZZATORE - ASSE ANTERIORE STABILIZER LINK - FRONT AXLE		
4475109000	<b>0594649</b>	STABILIZZATORE - ASSE ANTERIORE STABILIZER LINK - FRONT AXLE		
4475005001 4475005000	<b>0502447</b>	STABILIZZATORE - ASSE POSTERIORE STABILIZER LINK - REAR AXLE		
Anno - Year <b>1999 &gt;</b> <b>1999 &gt;</b>		Serie - Series <b>KJ</b> <b>FJ</b>	Modello - Model <b>KORANDO</b> <b>MUSSO</b>	
4666005501	<b>0282443</b>	TESTA STERZO - RHT M14x 1,5 TIE ROD END - RHT M14x1,5		
-	<b>0603276</b>	SNODO ASSIALE - RHT M14x 1,5 AXIAL JOINT - RHT M14x1,5		
4443003011	<b>0402446</b>	SNODO SOSPENSIONE - ASSE ANTERIORE - SUPERIORE BALL JOINT - FRONT AXLE - UPPER		
4450505001	<b>0402445</b>	SNODO SOSPENSIONE - ASSE ANTERIORE - INFERIORE BALL JOINT - FRONT AXLE - LOWER		









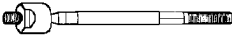



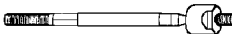
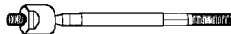

RIF. ORIG O.E. NUMBER	RIF. OCAP REF. OCAP	NOTE REMARKS	DESTRO RIGHT	SINISTRO LEFT
Anno - Year <b>1999 &gt;</b> <b>1999 &gt;</b>		Serie - Series <b>KJ</b> <b>FJ</b>	Modello - Model <b>KORANDO</b> <b>MUSSO</b>	
4475005001 4475005000	<b>0502447</b>	STABILIZZATORE - ASSE ANTERIORE STABILIZER LINK - FRONT AXLE		
Anno - Year <b>05/2005 &gt;</b>		Serie - Series	Modello - Model <b>KYRON</b>	
4666008011 4666009011	<b>0284649</b>	TESTA STERZO - RHT M16x1,5 TIE ROD END - RHT M16x1,5		
4666008001 4666009002	<b>0294649</b>	TESTA STERZO - RHT M16x1,5 TIE ROD END - RHT M16x1,5		
4454109004	<b>0408065</b>	SNODO SOSPENSIONE - ASSE ANTERIORE -INFERIORE - > 04/2007 BALL JOINT - FRONT AXLE - LOWER - > 04/2007		
4454109002	<b>0404649</b>	SNODO SOSPENSIONE - ASSE ANTERIORE -INFERIORE - 04/2007 > BALL JOINT - FRONT AXLE - LOWER - 04/2007 >		
4450209001	<b>0788065</b>	BRACCIO OSCILLANTE - ASSE ANTERIORE - INFERIORE - > 07/2006 TRACK CONTROL ARM - FRONT AXLE - LOWER - 10/2004 > 07/2006		
4450109001	<b>0798065</b>	BRACCIO OSCILLANTE - ASSE ANTERIORE - INFERIORE - > 07/2006 TRACK CONTROL ARM - FRONT AXLE - LOWER - 10/2004 > 07/2006		
4440209011 4440209010	<b>0388065</b>	BRACCIO OSCILLANTE - ASSE ANTERIORE - SUPERIORE - > 04/2007 TRACK CONTROL ARM - FRONT AXLE - UPPER - > 04/2007		
4440109011 4440109010	<b>0398065</b>	BRACCIO OSCILLANTE - ASSE ANTERIORE - SUPERIORE - > 04/2007 TRACK CONTROL ARM - FRONT AXLE - UPPER - > 04/2007		

RIF. ORIG O.E. NUMBER	RIF. OCAP REF. OCAP	NOTE REMARKS	DESTRO RIGHT	SINISTRO LEFT
Anno - Year <b>05/2005 &gt;</b>		Serie - Series	Modello - Model <b>KYRON</b>	
4475005001 4475005000	<b>0502447</b>	STABILIZZATORE - ASSE ANTERIORE - MOD. 4WD STABILIZER LINK - FRONT AXLE - 4WD MOD.		
4475209000	<b>0588066</b>	STABILIZZATORE - ASSE ANTERIORE - SOLOMOD. 2WD STABILIZER LINK - FRONT AXLE - ONLY 2WD MOD.		
4475109000	<b>0598066</b>	STABILIZZATORE - ASSE ANTERIORE - SOLOMOD. 2WD STABILIZER LINK - FRONT AXLE - ONLY 2WD MOD.		
4575109001 4575109000	<b>0588067</b>	STABILIZZATORE - ASSE POSTERIORE - SOLO MOD. 2WD STABILIZER LINK - REAR AXLE - ONLY 2WD MOD.		
4575009001 4575009000	<b>0598067</b>	STABILIZZATORE - ASSE POSTERIORE - SOLO MOD. 2WD STABILIZER LINK - REAR AXLE - ONLY 2WD MOD.		
Anno - Year <b>04/2002 &gt;</b>		Serie - Series <b>GAB</b>	Modello - Model <b>REXTON</b>	
4666008011 4666009011	<b>0284649</b>	TESTA STERZO - RHT M16x1,5 TIE ROD END - RHT M16x1,5		
4666008001 4666009002	<b>0294649</b>	TESTA STERZO - RHT M16x1,5 TIE ROD END - RHT M16x1,5		
4450208005	<b>0785174</b>	BRACCIO OSCILLANTE - ASSE ANTERIORE - INFERIORE - > 10/2004 TRACK CONTROL ARM - FRONT AXLE - LOWER - > 10/2004		
4450108005	<b>0795174</b>	BRACCIO OSCILLANTE - ASSE ANTERIORE - INFERIORE - > 10/2004 TRACK CONTROL ARM - FRONT AXLE - LOWER - > 10/2004		
4454109004	<b>0408065</b>	SNODO SOSPENSIONE - ASSE ANTERIORE -INFERIORE - > 04/2007 BALL JOINT - FRONT AXLE - LOWER - > 04/2007		





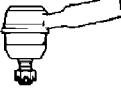
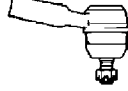

RIF. ORIG O.E. NUMBER	RIF. OCAP REF. OCAP	NOTE REMARKS	DESTRO RIGHT	SINISTRO LEFT
Anno - Year <b>04/2002 &gt;</b>		Serie - Series <b>GAB</b>	Modello - Model <b>REXTON</b>	
4454109002	<b>0404649</b>	SNODO SOSPENSIONE - ASSE ANTERIORE -INFERIORE - 04/2007 > BALL JOINT - FRONT AXLE - LOWER - 04/2007 >		
4450209001	<b>0788065</b>	BRACCIO OSCILLANTE - ASSE ANTERIORE - INFERIORE - 10/2004 > 07/2006 TRACK CONTROL ARM - FRONT AXLE - LOWER - 10/2004 > 07/2006		
4450109001	<b>0798065</b>	BRACCIO OSCILLANTE - ASSE ANTERIORE - INFERIORE - 10/2004 > 07/2006 TRACK CONTROL ARM - FRONT AXLE - LOWER - 10/2004 > 07/2006		
4443003011	<b>0402446</b>	SNODO SOSPENSIONE - ASSE ANTERIORE - SUPERIORE BALL JOINT - FRONT AXLE - UPPER		
4440208000	<b>0385175</b>	BRACCIO OSCILLANTE - ASSE ANTERIORE - SUPERIORE - > 2005 TRACK CONTROL ARM - FRONT AXLE - UPPER - > 2005		
4440108000	<b>0395175</b>	BRACCIO OSCILLANTE - ASSE ANTERIORE - SUPERIORE - > 2005 TRACK CONTROL ARM - FRONT AXLE - UPPER - > 2005		
4440209011 4440209010	<b>0388065</b>	BRACCIO OSCILLANTE - ASSE ANTERIORE - SUPERIORE - 2005 > 04/2007 TRACK CONTROL ARM - FRONT AXLE - UPPER - 2005 > 04/2007		
4440109011 4440109010	<b>0398065</b>	BRACCIO OSCILLANTE - ASSE ANTERIORE - SUPERIORE - 2005 > 04/2007 TRACK CONTROL ARM - FRONT AXLE - UPPER - 2005 > 04/2007		
4475209000	<b>0588066</b>	STABILIZZATORE - ASSE ANTERIORE - 03/2006 > STABILIZER LINK - FRONT AXLE - 03/2006 >		







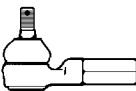
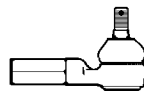
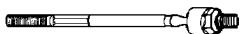
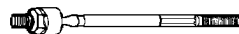

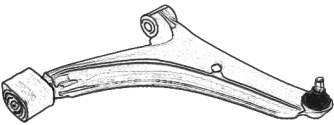
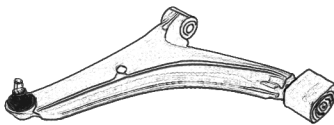
RIF. ORIG O.E. NUMBER	RIF. OCAP REF. OCAP	NOTE REMARKS	DESTRO RIGHT	SINISTRO LEFT
Anno - Year <b>04/2002 &gt;</b>		Serie - Series <b>GAB</b>	Modello - Model <b>REXTON</b>	
4475109000	<b>0598066</b>	STABILIZZATORE - ASSE ANTERIORE - 03/2006 > STABILIZER LINK - FRONT AXLE - 03/2006 >		
4475008000	<b>0508066</b>	STABILIZZATORE - ASSE ANTERIORE - > 01/2004 STABILIZER LINK - FRONT AXLE - > 01/2004		
4475508000	<b>0585176</b>	STABILIZZATORE - ASSE ANTERIORE - > 03/2006 STABILIZER LINK - FRONT AXLE - > 03/2006		
4475008001	<b>0595176</b>	STABILIZZATORE - ASSE ANTERIORE - > 03/2006 STABILIZER LINK - FRONT AXLE - > 03/2006		
4540108000	<b>0508065</b>	ASTA SOSPENSIONE - ASSE POSTERIORE SUSPENSION ARM - REAR AXLE		
4575109001 4575109000	<b>0588067</b>	STABILIZZATORE - ASSE POSTERIORE - SOLO MOD. 2W2 STABILIZER LINK - REAR AXLE - ONLY 2WD MOD.		
4575009001 4575009000	<b>0598067</b>	STABILIZZATORE - ASSE POSTERIORE - SOLO MOD. 2WD STABILIZER LINK - REAR AXLE - ONLY 2WD MOD.		







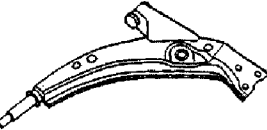
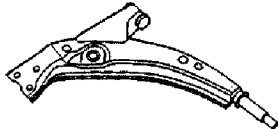



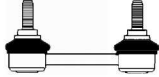
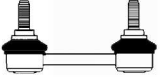



RIF. ORIG O.E. NUMBER	RIF. OCAP REF. OCAP	NOTE REMARKS	DESTRO RIGHT	SINISTRO LEFT
Anno - Year <b>08/97 &gt; 09/02</b> <b>08/92 &gt; 12/00</b> <b>01/89 &gt; 08/94</b>		Serie - Series <b>SF</b> <b>GC- GF-GFC</b> <b>BC-BJF</b>	Modello - Model <b>FORESTER I</b> <b>IMPREZA I</b> <b>LEGACY I</b>	
31320-GA190	<b>0281928</b>	TESTA STERZO - RHT M14x1,5 - MOD/ IMPREZA I SENZA ABS TIE ROD END - RHT M14x1,5 - MOD/ IMPREZA I WITHOUT ABS		
31320-GA200	<b>0291928</b>	TESTA STERZO - RHT M14x1,5 - MOD/ IMPREZA I SENZA ABS TIE ROD END - RHT M14x1,5 - MOD/ IMPREZA I WITHOUT ABS		
34141-AA041 34161-SA000 34141-AA042	<b>0281929</b>	TESTA STERZO - RHT M14x1,5 - L = 139 MM TIE ROD END - RHT M14x1,5 - L: 139 MM		
34140-FC000 34140-AA040	<b>0601930</b>	SNODO ASSIALE - RHT M14x1,5 SOLO FORESTER I - IMPREZA I AXIAL JOINT - RHT M14x1,5 ONLY FORESTER I - IMPREZA I		
21067-GA050	<b>0403605</b>	SNODO SOSPENSIONE - ASSE ANTERIORE - INFERIORE - PER TUTTI I MODELLI BALL JOINT - FRONT AXLE - LOWER - FOR ALL MODELS		
200200AC200F 20200-AA200	<b>0784494</b>	BRACCIO OSCILLANTE TRACK CONTROL ARM		
200200AC210F 20200-AA210	<b>0794494</b>	BRACCIO OSCILLANTE - 12/1993 > 1998 TRACK CONTROL ARM - 12/1993 > 1998		
20200FC120	<b>0785177</b>	BRACCIO OSCILLANTE - ASSE ANTERIORE - INFERIORE - SOLO PER FORESTER - 08/1999 > TRACK CONTROL ARM - FRONT AXLE - LOWER - ONLY FOR FORESTER - 08/1999 >		
20200FC130	<b>0795177</b>	BRACCIO OSCILLANTE - ASSE ANTERIORE - INFERIORE - SOLO PER FORESTER - 08/1999 > TRACK CONTROL ARM - FRONT AXLE - LOWER - ONLY FOR FORESTER - 08/1999 >		







RIF. ORIG O.E. NUMBER	RIF. OCAP REF. OCAP	NOTE REMARKS	DESTRO RIGHT	SINISTRO LEFT
Anno - Year <b>08/97 &gt; 09/02</b> <b>08/92 &gt; 12/00</b> <b>01/89 &gt; 08/94</b>		Serie - Series <b>SF</b> <b>GC- GF-GFC</b> <b>BC-BJF</b>	Modello - Model <b>FORESTER I</b> <b>IMPREZA I</b> <b>LEGACY I</b>	
20420-AA004 20420-AA003 20420-AA002	<b>0501931</b>	STABILIZZATORE - ASSE ANTERIORE STABILIZER LINK - FRONT AXLE		
20481AA000 20481AA001	<b>0505178</b>	STABILIZZATORE - ASSE POSTERIORE STABILIZER LINK - REAR AXLE		
Anno - Year <b>09/2002 &gt;</b> <b>12/2000 &gt;</b> <b>09/94 &gt;03/98</b>		Serie - Series <b>SG</b> <b>GD-GG</b> <b>BD-BG</b>	Modello - Model <b>FORESTER II</b> <b>IMPREZA II</b> <b>LEGACY II</b>	
34141-AA041 34161-SA000 34141-AA042	<b>0281929</b>	TESTA STERZO - RHT M14x1,5 TIE ROD END - RHT M14x1,5		
34140-FC000 34140-AA040	<b>0601930</b>	SNODO ASSIALE - RHT M14x1,5 SOLO IMPREZA, LEGACY AXIAL JOINT - RHT M14x1,5 ONLY IMPREZA AND LEGACY		
34160-AE001 34160-AE000	<b>0601929</b>	SNODO ASSIALE - RHT M14x1,5 SOLO FORESTER AXIAL JOINT - RHT M14x1,5 ONLY FORESTER		
21067-GA050	<b>0403605</b>	SNODO SOSPENSIONE - ASSE ANTERIORE - INFERIORE BALL JOINT - FRONT AXLE - LOWER		
20470-SA000 20470-FE000	<b>0502835</b>	STABILIZZATORE - ASSE ANTERIORE STABILIZER LINK - FRONT AXLE		
20470-SA011	<b>0503119</b>	STABILIZZATORE ASSE POSTERIORE - SOLO PER MOD. FORESTER-IMPREZA STABILIZER LINK - REAR AXLE - ONLY FOR FORESTER-IMPREZA MOD.		
Anno - Year <b>1984 &gt; 1995</b>		Serie - Series <b>KA5-KA6-KA7-KA8 (4WD)</b>	Modello - Model <b>JUSTY</b>	
7313-20020	<b>0283592</b>	TESTA STERZO TIE ROD END		



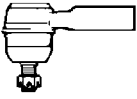
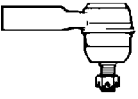
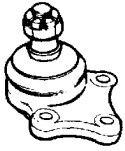
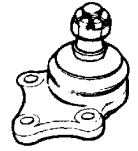

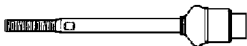
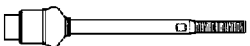



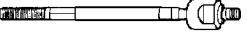
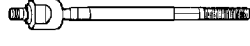
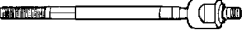
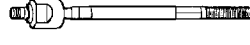









RIF. ORIG O.E. NUMBER	RIF. OCAP REF. OCAP	NOTE REMARKS	DESTRO RIGHT	SINISTRO LEFT
Anno - Year <b>1984 &gt; 1995</b>		Serie - Series <b>KA5-KA6-KA7-KA8 (4WD)</b>	Modello - Model <b>JUSTY</b>	
7313-10140	<b>0603593</b>	SNODO ASSIALE AXIAL JOINT		
7210-67020 7210-67021 7210-67022	<b>0403594</b>	SNODO SOSPENSIONE INFERIORE SUSPENSION JOINT LOWER		
7210-60520 7210-60380 7210-60530 7210-60560	<b>0783604</b>	BRACCIO OSCILLANTE TRACK CONTROL ARM		
7210-60570	<b>0793604</b>	BRACCIO OSCILLANTE TRACK CONTROL ARM		
Anno - Year <b>10/95 &gt; 11/03</b>		Serie - Series	Modello - Model <b>JUSTY</b>	
48810-82000 48810-60B00	<b>0283616</b>	TESTA STERZO - RHT M12x1,25 TIE ROD END - RHT M12x1,25		
48830-63B10	<b>0601926</b>	SNODO ASSIALE - RHT M12x1,25 AXIAL JOINT - RHT M12x1,25		
7210-67020 7210-67021 7210-67022	<b>0403594</b>	SNODO SOSPENSIONE INFERIORE SUSPENSION JOINT LOWER		
-	<b>0781949</b>	BRACCIO OSCILLANTE ASSE ANTERIORE TRACK CONTROL ARM FRONT AXLE		
-	<b>0791949</b>	BRACCIO OSCILLANTE ASSE ANTERIORE TRACK CONTROL ARM FRONT AXLE		







RIF. ORIG O.E. NUMBER	RIF. OCAP REF. OCAP	NOTE REMARKS	DESTRO RIGHT	SINISTRO LEFT
Anno - Year <b>10/95 &gt; 11/03</b>		Serie - Series	Modello - Model <b>JUSTY</b>	
46630-60B00 46630-60B01	<b>0501927</b>	STABILIZZATORE - RHT M8x1,25 STABILIZER LINK - RHT M8x1,25		
-	<b>0501927-K</b>	KIT STABILIZZATORE - RHT M8x1,25 STABILIZER LINK KIT - RHT M8x1,25		
Anno - Year <b>10/98 &gt; 08/03</b> <b>09/2003 &gt;</b> <b>10/00 &gt; 08/03</b>		Serie - Series <b>BE - BH</b> <b>BE - BH</b>	Modello - Model <b>LEGACY III</b> <b>LEGACY IV</b> <b>OUTBACK</b>	
34141-AA041 34161-SA000 34141-AA042	<b>0281929</b>	TESTA STERZO - RHT M14x1,5 TIE ROD END - RHT M14x1,5		
34140-FC000 34140-AA040	<b>0601930</b>	SNODO ASSIALE - RHT M14x1,5 ECCETTO MOD. LEGACY IV AXIAL JOINT - RHT M14x1,5 EXCEPT MOD. LEGACY IV		
34160-AE001 34160-AE000	<b>0601929</b>	SNODO ASSIALE - RHT M14x1,5 SOLO PER MOD. LEGACY IV AXIAL JOINT - RHT M14x1,5 ONLY FOR LEGACY IV MODEL		
21067-GA050	<b>0403605</b>	SNODO SOSPENSIONE - ASSE ANTERIORE - INFERIORE BALL JOINT - FRONT AXLE - LOWER		
200200AC200F 20200-AA200	<b>0784494</b>	BRACCIO OSCILLANTE SOLO MOD. LEGACY III TRACK CONTROL ARM ONLY MOD. LEGACY III		
200200AC210F 20200-AA210	<b>0794494</b>	BRACCIO OSCILLANTE SOLO MOD. LEGACY III TRACK CONTROL ARM ONLY MOD. LEGACY III		
20420-AA004 20420-AA003 20420-AA002	<b>0501931</b>	STABILIZZATORE ASSE ANTERIORE STABILIZER LINK - FRONT AXLE		

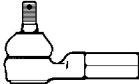
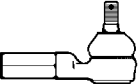
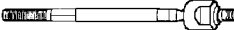
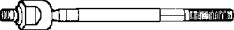

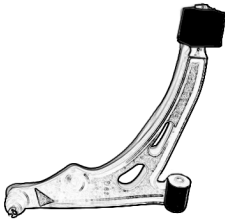
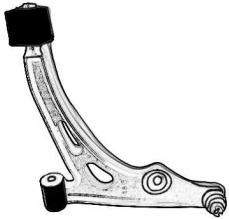



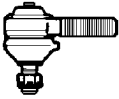
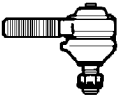

RIF. ORIG O.E. NUMBER	RIF. OCAP REF. OCAP	NOTE REMARKS	DESTRO RIGHT	SINISTRO LEFT
Anno - Year <b>10/98 &gt; 08/03</b> <b>09/2003 &gt;</b> <b>10/00 &gt; 08/03</b>		Serie - Series <b>BE - BH</b> <b>BE - BH</b>	Modello - Model <b>LEGACY III</b> <b>LEGACY IV</b> <b>OUTBACK</b>	
20470-AE000 20470-AE001 20470-AE010	<b>0502836</b>	STABILIZZATORE ASSE POSTERIORE ECCETTO MOD. OUTBACK STABILIZER LINK - REAR AXLE EXCEPT MOD. OUTBACK		
Anno - Year <b>09/2009 &gt;</b> <b>01/2008 &gt;</b>		Serie - Series <b>GR</b>	Modello - Model <b>LEGACY V</b> <b>IMPREZA III</b>	
34141-AA041 34161-SA000 34141-AA042	<b>0281929</b>	TESTA STERZO - RHT M14x1,5 TIE ROD END - RHT M14x1,5		
34160-AE001 34160-AE000	<b>0601929</b>	SNODO ASSIALE - RHT M14x1,5 AXIAL JOINT - RHT M14x1,5		
21067-GA050	<b>0403605</b>	SNODO SOSPENSIONE - ASSE ANTERIORE - INFERIORE BALL JOINT - FRONT AXLE - LOWER		
20202-AG181 20202-AG180	<b>0783605</b>	BRACCIO OSCILLANTE - ASSE ANTERIORE - INFERIORE - SOLO PER IMPREZA TRACK CONTROL ARM - FRONT AXLE - LOWER - ONLY FOR IMPREZA		
20202-AG191 20202-AG190	<b>0793605</b>	BRACCIO OSCILLANTE - ASSE ANTERIORE - INFERIORE - SOLO PER IMPREZA TRACK CONTROL ARM - FRONT AXLE - LOWER - ONLY FOR IMPREZA		
20470-SA000 20470-FE000	<b>0502835</b>	STABILIZZATORE - ASSE ANTERIORE - SOLO PER IMPREZA STABILIZER LINK - FRONT AXLE - ONLY FOR IMPREZA		
20420-AJ000	<b>0504494</b>	STABILIZZATORE - ASSE ANTERIORE - SOLO PER LEGACY STABILIZER LINK - FRONT AXLE - ONLY FOR LEGACY		
20470-FG000 20470-AJ000	<b>0503605</b>	STABILIZZATORE - ASSE POSTERIORE STABILIZER LINK - REAR AXLE		

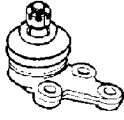
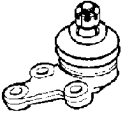
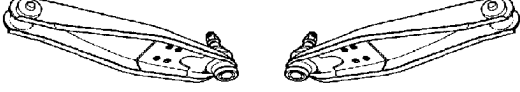
RIF. ORIG O.E. NUMBER	RIF. OCAP REF. OCAP	NOTE REMARKS	DESTRO RIGHT	SINISTRO LEFT
Anno - Year <b>1971 &gt; 1979</b>		Serie - Series <b>A21 &gt; A67</b>	Modello - Model <b>LEONE</b>	
6315-10040 6315-10070	<b>0283595</b>	TESTA STERZO - RHT M14x1,5 TIE ROD END - RHT M14x1,5		
6232-20042 6232-20043	<b>0402511</b>	SNODO SOSPENSIONE INFERIORE SUSPENSION JOINT LOWER		
Anno - Year <b>1979 &gt; 1984</b>		Serie - Series <b>A</b>	Modello - Model <b>LEONE I</b>	
7313-20000	<b>0282512</b>	TESTA STERZO - RHT M14x1,5 TIE ROD END - RHT M14x1,5		
7313-20010	<b>0282513</b>	TESTA STERZO - RHT M14x1,5 TIE ROD END - RHT M14x1,5		
7313-10010	<b>0602514</b>	SNODO ASSIALE - RHT M14x1,5 AXIAL JOINT - RHT M14x1,5		
7210-67000 7210-67001 7210-67002 7210-67003	<b>0402515</b>	SNODO SOSPENSIONE INFERIORE SUSPENSION JOINT LOWER		
Anno - Year <b>1984 &gt; 1992</b>		Serie - Series <b>A</b>	Modello - Model <b>LEONE II</b>	
31320-GA101	<b>0283596</b>	TESTA STERZO - RHT M14x1,5 TIE ROD END - RHT M14x1,5		
31320-GA111	<b>0293596</b>	TESTA STERZO - RHT M14x1,5 TIE ROD END - RHT M14x1,5		
31310-GA170	<b>0603597</b>	SNODO ASSIALE - STERZO MANUALE - RHT M14x1,5 - ESCLUSI: 5B-7B-8D (TURBO)-SEDAN 3M-4M-4S AXIAL JOINT MANUAL STEERING - RHT M14x1,5 - EXC.: 5B-7B-8D (TURBO)-SEDAN 3M-4M-4S		
31310-GA120	<b>0603598</b>	SNODO ASSIALE - STERZO MANUALE - RHT M14x1,5 - MOD. 5B-7B-8D (TURBO)-SEDAN 3M-4M-4S AXIAL JOINT MANUAL STEERING - RHT M14x1,5		





RIF. ORIG O.E. NUMBER	RIF. OCAP REF. OCAP	NOTE REMARKS	DESTRO RIGHT	SINISTRO LEFT
Anno - Year <b>1984 &gt; 1992</b>		Serie - Series <b>A</b>	Modello - Model <b>LEONE II</b>	
31310-GA151	<b>0603599</b>	SNODO ASSIALE - SERVOSTERZO - RHT M14x1,5 AXIAL JOINT POWER STEERING - RHT M14x1,5		
7210-67000 7210-67001 7210-67002 7210-67003	<b>0402515</b>	SNODO SOSPENSIONE SUSPENSION JOINT		
Anno - Year <b>1978 &gt; 1981 &gt;</b>		Serie - Series	Modello - Model <b>MV PICKUP 4WD SHIFTER PICKUP 2WD</b>	
7210-67000 7210-67001 7210-67002 7210-67003	<b>0402515</b>	SNODO SOSPENSIONE INFERIORE SUSPENSION JOINT LOWER		











RIF. ORIG O.E. NUMBER	RIF. OCAP REF. OCAP	NOTE REMARKS	DESTRO RIGHT	SINISTRO LEFT
Anno - Year <b>06/82 &gt; 12/85</b>		Serie - Series <b>SS80</b>	Modello - Model <b>ALTO I</b>	
48810-78000 48810-78001 48810-78002	<b>0183606</b>	TESTA STERZO - RHT M12x1,25 TIE ROD END - RHT M12x1,25		
48830-78000 48830-78001	<b>0603607</b>	SNODO ASSIALE - RHT M12x1,25 AXIAL JOINT - RHT M12x1,25		
45200-50E00 45200-69D00 45200-84000	<b>0701946</b>	BRACCIO OSCILLANTE TRACK CONTROL ARM		
Anno - Year <b>01/86 &gt; 11/93</b> <b>09/94 &gt; 06/02</b> <b>06/2002 &gt; 2008</b>		Serie - Series <b>EC</b> <b>EF</b> <b>FF</b>	Modello - Model <b>ALTO II</b> <b>ALTO III</b> <b>ALTO IV</b>	
48810-84000 48810-84001 48810-M84010	<b>0183608</b>	TESTA STERZO - RHT M12x1,25 TIE ROD END - RHT M12x1,25		
48830-84000	<b>0603609</b>	SNODO ASSIALE - RHT M12x1,25 - SOLO PER ALTO II AXIAL JOINT - RHT M12x1,25 - ONLY FOR ALTO II		
48830-M70F00	<b>0601945</b>	SNODO ASSIALE - RHT M12x1,25 - SOLO PER ALTO III-IV AXIAL JOINT - RHT M12x1,25 - ONLY FOR ALTO III-IV		
45200-50E00 45200-69D00 45200-84000	<b>0701946</b>	BRACCIO OSCILLANTE TRACK CONTROL ARM		
Anno - Year <b>03/95 &gt; 05/02</b>		Serie - Series <b>EG</b>	Modello - Model <b>BALENO</b>	
48810-76G00	<b>0282988</b>	TESTA STERZO - RHT M12x1,25 TIE ROD END - RHT M12x1,25		
48830-60G00	<b>0601947</b>	SNODO ASSIALE - RHT M12x1,25 AXIAL JOINT - RHT M12x1,25		









RIF. ORIG O.E. NUMBER	RIF. OCAP REF. OCAP	NOTE REMARKS	DESTRO RIGHT	SINISTRO LEFT
Anno - Year <b>03/95 &gt; 05/02</b>		Serie - Series <b>EG</b>	Modello - Model <b>BALENO</b>	
45201-63G01	<b>0381948</b>	BRACCIO OSCILLANTE TRACK CONTROL ARM		
45202-63G01	<b>0391948</b>	BRACCIO OSCILLANTE TRACK CONTROL ARM		
46630-60B00 46630-60B01	<b>0501927</b>	STABILIZZATORE - ASSE ANTERIORE STABILIZER LINK - FRONT AXLE		
-	<b>0501927-K</b>	KIT STABILIZZATORE - ASSE ANTERIORE STABILIZER LINK KIT - FRONT AXLE		
46630-80F00	<b>0585179</b>	STABILIZZATORE - ASSE POSTERIORE STABILIZER LINK - REAR AXLE		
46640-80F00	<b>0595179</b>	STABILIZZATORE - ASSE POSTERIORE STABILIZER LINK - REAR AXLE		
Anno - Year <b>1980 &gt; 1985</b>		Serie - Series <b>ST90V</b>	Modello - Model <b>CARRY</b>	
48810-60001	<b>0183611</b>	TESTA STERZO - RHT M14x1,5 - > 02/1981 TIE ROD END - RHT M14x1,5 - > 02/1981		
48820-60001	<b>0193611</b>	TESTA STERZO - LHT M14x1,5 - > 02/1981 TIE ROD END - LHT M14x1,5 - > 02/1981		
48810-79000	<b>0183612</b>	TESTA STERZO - RHT M14x1,5 - 03/1981 > TIE ROD END - RHT M14x1,5 - 03/1981 >		





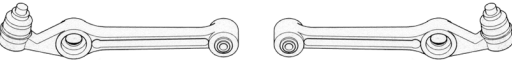



RIF. ORIG O.E. NUMBER	RIF. OCAP REF. OCAP	NOTE REMARKS	DESTRO RIGHT	SINISTRO LEFT
Anno - Year <b>1980 &gt; 1985</b>		Serie - Series <b>ST90V</b>	Modello - Model <b>CARRY</b>	
48820-79000	<b>0193612</b>	TESTA STERZO - LHT M14x1,5 - 03/1981 > TIE ROD END - LHT M14x1,5 - 03/1981 >		
45700-67001	<b>0403613</b>	SNODO SOSPENSIONE INFERIORE SUSPENSION JOINT LOWER		
45200-79001	<b>0703614</b>	BRACCIO OSCILLANTE INFERIORE - > 1985 TRACK CONTROL ARM LOWER - > 1985		
Anno - Year <b>1985 &gt; 1999</b>		Serie - Series <b>ED (Bus/Autobus)</b>	Modello - Model <b>SUPER CARRY</b>	
48810-79000	<b>0183612</b>	TESTA STERZO - RHT M14x1,5 TIE ROD END - RHT M14x1,5		
48820-79000	<b>0193612</b>	TESTA STERZO - LHT M14x1,5 TIE ROD END - LHT M14x1,5		
45200-85001	<b>0703615</b>	BRACCIO OSCILLANTE INFERIORE TRACK CONTROL ARM LOWER		
Anno - Year <b>1999&gt;</b>		Serie - Series	Modello - Model <b>CARRY</b>	
48810-78A00 48810-78A01	<b>0282990</b>	TESTA STERZO - RHT M12x1,25 TIE ROD END - RHT M12x1,25		
48820-78A00 48820-78A01	<b>0292990</b>	TESTA STERZO - RHT M12x1,25 TIE ROD END - RHT M12x1,25		
48830-77A00 48830-76G00	<b>0602991</b>	SNODO ASSIALE - RHT M12x1,25 - LHD AXIAL JOINT - RHT M12x1,25 - LHD		
48830-78A00	<b>0605180</b>	SNODO ASSIALE - RHT M12x1,25 - RHD AXIAL JOINT - RHT M12x1,25 - RHD		



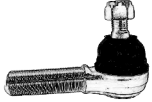



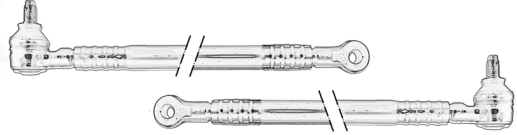
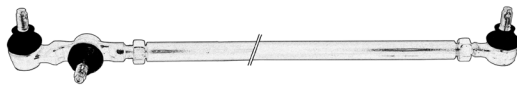



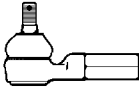
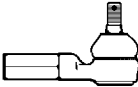
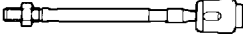
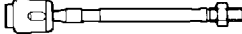
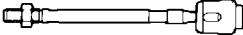
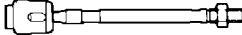

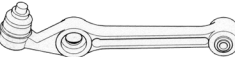

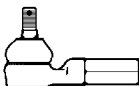
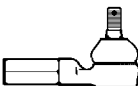
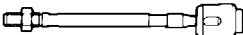
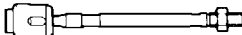
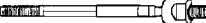

RIF. ORIG O.E. NUMBER	RIF. OCAP REF. OCAP	NOTE REMARKS	DESTRO RIGHT	SINISTRO LEFT
Anno - Year <b>1999&gt;</b>		Serie - Series	Modello - Model <b>CARRY</b>	
45201-77A10 45201-77A01	<b>0782760</b>	BRACCIO OSCILLANTE INFERIORE TRACK CONTROL ARM LOWER		
45202-77A10 45202-77A01	<b>0792760</b>	BRACCIO OSCILLANTE INFERIORE TRACK CONTROL ARM LOWER		
42420-77A00	<b>0502992</b>	STABILIZZATORE ANTERIORE STABILIZER LINK FRONT		
Anno - Year <b>1998 &gt; 03/2005</b>		Serie - Series <b>FT - GT</b>	Modello - Model <b>GRAND VITARA</b>	
48810-65D00 48810-67D00	<b>0282986</b>	TESTA STERZO - RHT M14x1,5 TIE ROD - RHT M14x1,5		
48820-65D00 48820-67D00	<b>0292986</b>	TESTA STERZO - RHT M14x1,5 TIE ROD - RHT M14x1,5		
48830-67D00	<b>0602984</b>	SNODO ASSIALE - RHT M14x1,5 AXIAL JOINT - RHT M14x1,5		
48830-65D00	<b>0601784</b>	SNODO ASSIALE - RHT M14x1,5 - SOLO PER MOD. TDI AXIAL JOINT - RHT M14x1,5 - ONLY FOR TDI MODEL		
45201-65D00	<b>0784496</b>	BRACCIO OSCILLANTE ASSE ANTERIORE > 06/2001 TRACK CONTROL ARM FRONT AXLE >06/2001		
45202-65D00	<b>0794496</b>	BRACCIO OSCILLANTE ASSE ANTERIORE >06/2001 TRACK CONTROL ARM FRONT AXLE >06/2001		

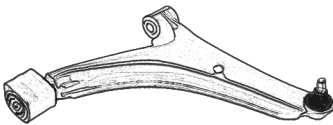

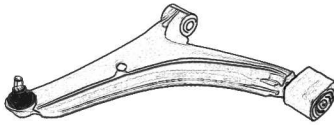
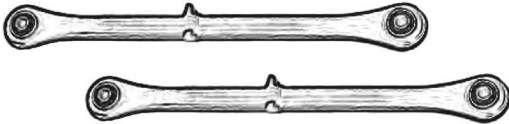



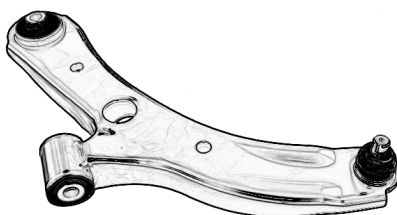

RIF. ORIG O.E. NUMBER	RIF. OCAP REF. OCAP	NOTE REMARKS	DESTRO RIGHT	SINISTRO LEFT
Anno - Year <b>1998 &gt; 03/2005</b>		Serie - Series <b>FT - GT</b>		Modello - Model <b>GRAND VITARA</b>
45201-65D01	<b>0385181</b>	BRACCIO OSCILLANTE - ASSE ANTERIORE - 06/2001 > TRACK CONTROL ARM - FRONT AXLE - 06/2001 >		
45202-65D01	<b>0395181</b>	BRACCIO OSCILLANTE - ASSE ANTERIORE - 06/2001 > TRACK CONTROL ARM - FRONT AXLE - 06/2001 >		
42420-60A00 42311-60A00 42420-65D00 42420-85C00	<b>0183623</b>	KIT STABILIZZATORE - ASSE ANTERIORE STABILIZER LINK KIT - FRONT AXLE		
-	<b>0183623-K</b>	KIT STABILIZZATORE - ASSE ANTERIORE STABILIZER LINK KIT - FRONT AXLE		
-	<b>0903623</b>	KIT STABILIZZATORE - ASSE ANTERIORE STABILIZER LINK KIT - FRONT AXLE		
Anno - Year <b>04/2005 &gt;</b>		Serie - Series		Modello - Model <b>GRAND VITARA</b>
48810-79J01 48810-79J00 48810-65J00	<b>0282839</b>	TESTA STERZO - RHT M14X1,5 TIE ROD END - RHT M14X1,5		
48830-65J00	<b>0603126</b>	SNODO ASSIALE - RHT M14X1,5 AXIAL JOINT - RHT M14X1,5		
45201-78K00 45201-65J00	<b>0783142</b>	BRACCIO OSCILLANTE - ASSE ANTERIORE TRACK CONTROL ARM - FRONT AXLE		





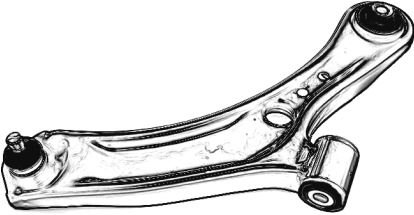
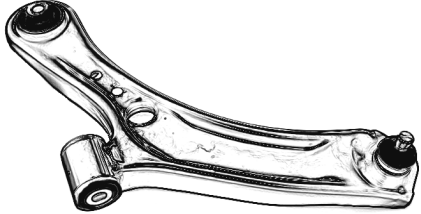

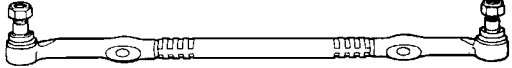





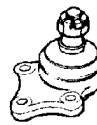

RIF. ORIG O.E. NUMBER	RIF. OCAP REF. OCAP	NOTE REMARKS	DESTRO RIGHT	SINISTRO LEFT
Anno - Year <b>04/2005 &gt;</b>		Serie - Series	Modello - Model <b>GRAND VITARA</b>	
45202-78K00 45202-65J00	<b>0793142</b>	BRACCIO OSCILLANTE - ASSE ANTERIORE TRACK CONTROL ARM - FRONT AXLE		
42420-65J00	<b>0503127</b>	STABILIZZATORE - ASSE ANTERIORE STABILIZER LINK - FRONT AXLE		
Anno - Year <b>10/00 &gt; 09/03</b>		Serie - Series <b>FH</b>	Modello - Model <b>IGNIS</b>	
48810-60B00 48810-82000 48810-76G00	<b>0283616</b>	TESTA STERZO - RHT M12x1,25 TIE ROD END - RHT M12x1,25		
48830-75F01	<b>0602989</b>	SNODO ASSIALE - RHT M12x1,25 AXIAL JOINT - RHT M12x1,25		
45200-76G00 45200-76G20	<b>0302838</b>	BRACCIO OSCILLANTE ANTERIORE - INFERIORE TRACK CONTROL ARM FRONT - LOWER		
46630-60B00 46630-60B01	<b>0501927</b>	STABILIZZATORE - RHT M8x1,25 STABILIZER LINK - RHT M8x1,25		
-	<b>0501927-K</b>	KIT STABILIZZATORE - RHT M8x1,25 STABILIZER LINK KIT - RHT M8x1,25		
Anno - Year <b>09/2003 &gt;</b>		Serie - Series	Modello - Model <b>IGNIS II</b>	
48810-83E00 48810-83E01 48810-83E02	<b>0284489</b>	TESTA STERZO - RHT M12x1,25 TIE ROD END - RHT M12x1,25		
48830-83E00 48830-86G00	<b>0604488</b>	SNODO ASSIALE - RHT M12x1,25 AXIAL JOINT - RHT M12x1,25		

RIF. ORIG O.E. NUMBER	RIF. OCAP REF. OCAP	NOTE REMARKS	DESTRO RIGHT	SINISTRO LEFT
Anno - Year <b>09/2003 &gt;</b>		Serie - Series	Modello - Model <b>IGNIS II</b>	
45200-83E00 45200-84E00 45200-85E00	<b>0302787</b>	BRACCIO OSCILLANTE - ASSE ANTERIORE TRACK CONTROL ARM - FRONT AXLE		
Anno - Year <b>1999 &gt;</b>		Serie - Series <b>FJ</b>	Modello - Model <b>JIMNY</b>	
48810-81A00	<b>0182762</b>	TESTA STERZO - RHT M16x1,5 TIE ROD - RHT M16x1,5		
48820-81A00	<b>0192762</b>	TESTA STERZO - RHT M16x1,5 TIE ROD - RHT M16x1,5		
48830-77A00 48830-76G00	<b>0602991</b>	SNODO ASSIALE - RHT M12x1,25 AXIAL JOINT - RHT M12x1,25		
42420-81A10	<b>0502786</b>	STABILIZZATORE - ASSE ANTERIORE STABILIZER LINK - FRONT AXLE		
45200-81A10	<b>0303143</b>	BRACCIO OSCILLANTE - ASSE ANTERIORE TRACK CONTROL ARM - FRONT AXLE		
Anno - Year <b>1988 &gt;</b>		Serie - Series	Modello - Model <b>SAMURAI</b>	
48900-84C50 48900A83301	<b>0501781</b>	BARRA STERZO TIE ROD		
48800-84C50	<b>0501782</b>	BARRA STERZO TIE ROD		
48810-60A00 48810-80000 48810-83300	<b>0183620</b>	TESTA STERZO - RHT M16x1,5 TIE ROD END - RHT M16x1,5		

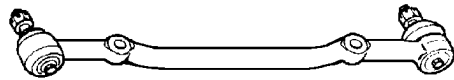







RIF. ORIG O.E. NUMBER	RIF. OCAP REF. OCAP	NOTE REMARKS	DESTRO RIGHT	SINISTRO LEFT
Anno - Year <b>10/83 &gt; 12/89</b>		Serie - Series <b>AA</b>	Modello - Model <b>SWIFT I</b>	
48810-60B00 48810-82000 48810-76G00	<b>0283616</b>	TESTA STERZO - RHT M12x1,25 TIE ROD END - RHT M12x1,25		
48830-82000	<b>0602958</b>	SNODO ASSIALE - RHT M12x1,25 - > 1988 AXIAL JOINT - RHT M12x1,25 - > 1988		
48830-60B00	<b>0603084</b>	SNODO ASSIALE - RHT M12x1,25 - 1988 > AXIAL JOINT - RHT M12x1,25 - 1988 >		
45203-70C00	<b>0403083</b>	SNODO SOSPENSIONE INFERIORE SUSPENSION JOINT LOWER		
45200-82000	<b>0303617</b>	BRACCIO OSCILLANTE INFERIORE TRACK CONTROL ARM LOWER		
46630-60B11	<b>0502291</b>	STABILIZZATORE STABILIZER LINK		
Anno - Year <b>03/89 &gt; 05/01</b>		Serie - Series <b>AH, AJ</b>	Modello - Model <b>SWIFT II</b>	
48810-60B00 48810-82000 48810-76G00	<b>0283616</b>	TESTA STERZO - RHT M12x1,25 TIE ROD END - RHT M12x1,25		
48830-60B00	<b>0603084</b>	SNODO ASSIALE - RHT M12x1,25 STERZO MANUALE AXIAL JOINT - RHT M12x1,25 MANUAL STEERING		
48830-50G10	<b>0601950</b>	SNODO ASSIALE - RHT M12x1,25 SERVOSTERZO AXIAL JOINT - RHT M12x1,25 POWER STEERING		
45201-70C00 45201-60B01 45201-60E01 45201-50G10	<b>0781949</b>	BRACCIO OSCILLANTE ASSE ANTERIORE TRACK CONTROL ARM FRONT AXLE		



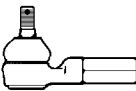
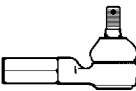
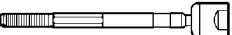
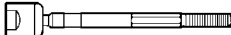



RIF. ORIG O.E. NUMBER	RIF. OCAP REF. OCAP	NOTE REMARKS	DESTRO RIGHT	SINISTRO LEFT
Anno - Year <b>03/89 &gt; 05/01</b>		Serie - Series <b>AH, AJ</b>	Modello - Model <b>SWIFT II</b>	
45202-70C00 45202-60B01 45202-60E01 45202-50G10	<b>0791949</b>	BRACCIO OSCILLANTE ASSE ANTERIORE TRACK CONTROL ARM FRONT AXLE		
46300-60B00 46300-60B10	<b>0702785</b>	BRACCIO OSCILLANTE ASSE POSTERIORE TRACK CONTROL ARM REAR AXLE		
46630-60B11	<b>0502291</b>	STABILIZZATORE - ASSE ANTERIORE STABILIZER LINK - FRONT AXLE		
46630-60B10	<b>0504495</b>	STABILIZZATORE - ASSE POSTERIORE STABILIZER LINK - REAR AXLE		
Anno - Year <b>02/2005 &gt; 01/2008 &gt;</b>		Serie - Series <b>SG</b>	Modello - Model <b>SWIFT III SPLASH</b>	
48810-63J00 48810-60810 48810-60J00	<b>0282688</b>	TESTA STERZO - RHT M12x1,25 TIE ROD END - RHT M12x1,25		
48830-63J00	<b>0602689</b>	SNODO ASSIALE - RHT M12x1,25 AXIAL JOINT - RHT M12x1,25		
45201-62J00 Z 45202-62J00 Z 45201-63J00 Z 45202-63J00 Z	<b>0402659</b>	SNODO SOSPENSIONE - ASSE ANTERIORE BALL JOINT - FRONT AXLE		
45201-62J00 45201-63J00 45201-72K00 45201-57K00	<b>0782659</b>	BRACCIO OSCILLANTE - ASSE ANTERIORE TRACK CONTROL ARM - FRONT AXLE		
45202-62J00 45202-63J00 45202-72K00 45202-57K00	<b>0792659</b>	BRACCIO OSCILLANTE - ASSE ANTERIORE TRACK CONTROL ARM - FRONT AXLE		



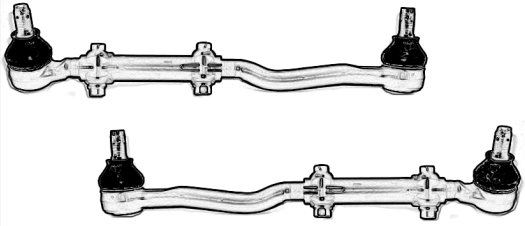



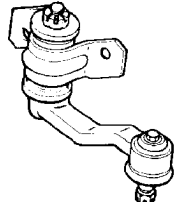
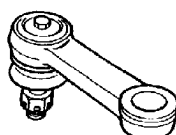



RIF. ORIG O.E. NUMBER	RIF. OCAP REF. OCAP	NOTE REMARKS	DESTRO RIGHT	SINISTRO LEFT
Anno - Year <b>02/2005 &gt; 01/2008 &gt;</b>		Serie - Series <b>SG</b>	Modello - Model <b>SWIFT III SPLASH</b>	
42420-62J00	<b>0502761</b>	STABILIZZATORE - ASSE ANTERIORE STABILIZER LINK - FRONT AXLE		
Anno - Year <b>06/2006 &gt;</b>		Serie - Series	Modello - Model <b>SX4</b>	
48810-79J01 48810-79J00 48810-65J00	<b>0282839</b>	TESTA STERZO - RHT M14x1,5 TIE ROD END - RHT M14x1,5		
48830-79J00	<b>0685184</b>	SNODO ASSIALE - RHT M14x1,5 AXIAL JOINT - RHT M14x1,5		
48830-79J10	<b>0695184</b>	SNODO ASSIALE - RHT M14x1,5 AXIAL JOINT - RHT M14x1,5		
45201-79J00	<b>0782840</b>	BRACCIO OSCILLANTE ASSE ANTERIORE TRACK CONTROL ARM FRONT AXLE		
45202-79J00	<b>0792840</b>	BRACCIO OSCILLANTE ASSE ANTERIORE TRACK CONTROL ARM FRONT AXLE		
42420-80J00	<b>0502841</b>	STABILIZZATORE - ASSE ANTERIORE STABILIZER LINK - FRONT AXLE		
Anno - Year <b>1988 &gt; 1999</b>		Serie - Series <b>ET-TA</b>	Modello - Model <b>VITARA</b>	
48850-60A00	<b>0503618</b>	BARRA STERZO TIE ROD		
48800-60A00	<b>0503619</b>	BARRA STERZO TIE ROD		



RIF. ORIG O.E. NUMBER	RIF. OCAP REF. OCAP	NOTE REMARKS	DESTRO RIGHT	SINISTRO LEFT
Anno - Year <b>1988 &gt; 1999</b>		Serie - Series <b>ET-TA</b>	Modello - Model <b>VITARA</b>	
48810-60A00 48810-80000 48810-83300	<b>0183620</b>	TESTA STERZO ESTERNA - RHT M16x1,5 TIE ROD END - OUTER RHT M16x1,5		
48820-60A00	<b>0193621</b>	TESTA STERZO INTERNA - LHT M 16x1,5 TIE ROD END - INNER - LHT M 16x1,5		
45700-60A00	<b>0403622</b>	SNODO SOSPENSIONE INFERIORE SUSPENSION JOINT LOWER		
42420-60A00 42311-60A00 42420-65D00 42420-85C00	<b>0183623</b>	TESTA BARRA STABILIZZATRICE STABILIZER LINK		
-	<b>0183623-K</b>	KIT STABILIZZATORE - ASSE ANTERIORE STABILIZER LINK KIT - FRONT AXLE		
-	<b>0903623</b>	KIT STABILIZZATORE - ASSE ANTERIORE STABILIZER LINK KIT - FRONT AXLE		
Anno - Year <b>1994 &gt; 1998</b>		Serie - Series	Modello - Model <b>VITARA V6</b>	
48850-77E00	<b>0502979</b>	BARRA STERZO TIE ROD		
48810-77E00	<b>0182980</b>	TESTA STERZO ESTERNA - RHT M16x1,5 TIE ROD END - OUTER - RHT M16x1,5		
48820-77E00	<b>0192981</b>	TESTA STERZO INTERNA - LHT M16x1,5 TIE ROD END - INNER - LHT M16x1,5		
42420-60A00 42311-60A00 42420-65D00 42420-85C00	<b>0183623</b>	STABILIZZATORE STABILIZER LINK		











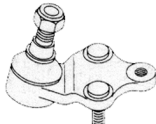
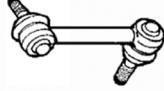
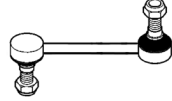
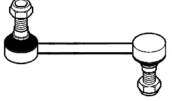





RIF. ORIG O.E. NUMBER	RIF. OCAP REF. OCAP	NOTE REMARKS	DESTRO RIGHT	SINISTRO LEFT
Anno - Year <b>1994 &gt; 1998</b>		Serie - Series	Modello - Model <b>VITARA V6</b>	
-	<b>0183623-K</b>	KIT STABILIZZATORE - ASSE ANTERIORE STABILIZER LINK KIT - FRONT AXLE		
-	<b>0903623</b>	KIT STABILIZZATORE - ASSE ANTERIORE STABILIZER LINK KIT - FRONT AXLE		
Anno - Year <b>02/98 &gt; 05/00</b>		Serie - Series <b>EM</b>	Modello - Model <b>WAGON R+</b>	
48810-76G00	<b>0282988</b>	TESTA STERZO - RHT M12x1,25 TIE ROD END - RHT M12x1,25		
48830-75F01	<b>0602989</b>	SNODO ASSIALE - RHT M12x1,25 AXIAL JOINT - RHT M12x1,25		
45200-75F00	<b>0304487</b>	BRACCIO OSCILLANTE TRACK CONTROL ARM		
Anno - Year <b>05/2000 &gt;</b>		Serie - Series <b>MM</b>	Modello - Model <b>WAGON R+</b>	
48810-83E00 48810-83E01 48810-83E02	<b>0284489</b>	TESTA STERZO - RHT M12x1,25 TIE ROD END - RHT M12x1,25		
48830-83E00 48830-86G00	<b>0604488</b>	SNODO ASSIALE - RHT M12x1,25 AXIAL JOINT - RHT M12x1,25		
45200-75F20	<b>0301518</b>	BRACCIO OSCILLANTE L= 290 mm TRACK CONTROL ARM L= 290 mm		
45200-83E00 45200-84E00 45200-85E00	<b>0302787</b>	BRACCIO OSCILLANTE L= 295 mm TRACK CONTROL ARM L= 295 mm		

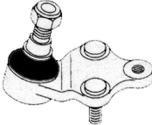
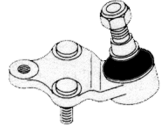





RIF. ORIG O.E. NUMBER	RIF. OCAP REF. OCAP	NOTE REMARKS	DESTRO RIGHT	SINISTRO LEFT
Anno - Year <b>1987 &gt; 1996</b>		Serie - Series <b>N130</b>	Modello - Model <b>4 RUNNER</b>	
45460-39505	<b>0503762</b>	BARRA STERZO TIE ROD		
45046-29115 45046-29125 45046-39105 45046-39165 45046-39175 45046-39235	<b>0193759</b>	TESTA STERZO ESTERNA - LHT M17x1,5 TIE ROD END OUTER - LHT M17x1,5		
45465-35020	<b>0903760</b>	TUBO COLLEGAMENTO ADJUSTMENT TUBE		
45406-39135	<b>0183762</b>	TESTA STERZO INTERNA - RHT M17x1,5 TIE ROD END INNER - RHT M17x1,5		
45490-39245	<b>0303763</b>	BRACCIO STERZO IDLER ARM		
45401-35190	<b>0303764</b>	LEVA STERZO PITMAN ARM		
43350-39045	<b>0403765</b>	SNODO SOSPENSIONE SUPERIORE SUSPENSION JOINT UPPER		
43340-39235 43340-39175 43330-39195 43330-39255	<b>0403766</b>	SNODO SOSPENSIONE INFERIORE SUSPENSION JOINT LOWER		







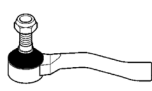
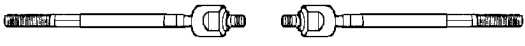

RIF. ORIG O.E. NUMBER	RIF. OCAP REF. OCAP	NOTE REMARKS	DESTRO RIGHT	SINISTRO LEFT
Anno - Year <b>1995 &gt;</b>		Serie - Series	Modello - Model <b>4 RUNNER</b>	
45046-39335	<b>0182479</b>	TESTA STERZO - RHT M20x1,5 TIE ROD END - RHT M20x1,5		
45047-39215	<b>0192479</b>	TESTA STERZO - RHT M20x1,5 TIE ROD END - RHT M20x1,5		
45503-39075	<b>0602480</b>	SNODO ASSIALE STERZO - RHT M20x1,5 AXIAL JOINT - RHT M20x1,5		
43310-39016	<b>0402621</b>	SNODO SOSPENSIONE - ASSE ANTERIORE - SUPERIORE BALL JOINT - FRONT AXLE - UPPER		
48610-32040	<b>0782624</b>	BRACCIO OSCILLANTE - ASSE ANTERIORE - SUPERIORE TRACK CONTROL ARM - FRONT AXLE - UPPER		
48630-35020	<b>0792624</b>	BRACCIO OSCILLANTE - ASSE ANTERIORE - SUPERIORE TRACK CONTROL ARM - FRONT AXLE - UPPER		
43330-39415 43330-39466 43330-39585	<b>0482622</b>	SNODO SOSPENSIONE - ASSE ANTERIORE - INFERIORE BALL JOINT - FRONT AXLE - LOWER		
43340-39325 43340-39356 43340-39465	<b>0492622</b>	SNODO SOSPENSIONE - ASSE ANTERIORE - INFERIORE BALL JOINT - FRONT AXLE - LOWER		
48068-35080 48068-35081	<b>0782622</b>	BRACCIO OSCILLANTE - ASSE ANTERIORE - INFERIORE TRACK CONTROL ARM - FRONT AXLE - LOWER		
48069-35080 48069-35081	<b>0792622</b>	BRACCIO OSCILLANTE - ASSE ANTERIORE - INFERIORE TRACK CONTROL ARM - FRONT AXLE - LOWER		

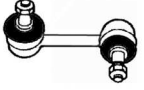
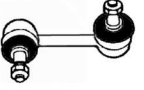
RIF. ORIG O.E. NUMBER	RIF. OCAP REF. OCAP	NOTE REMARKS	DESTRO RIGHT	SINISTRO LEFT
Anno - Year <b>1995 &gt;</b>		Serie - Series	Modello - Model <b>4 RUNNER</b>	
48820-35030 48820-AD010	<b>0502623</b>	STABILIZZATORE - ASSE ANTERIORE STABILIZER LINK - FRONT AXLE		
48830-35020	<b>0502624</b>	STABILIZZATORE - ASSE POSTERIORE STABILIZER LINK - REAR AXLE		
Anno - Year <b>03/2007 &gt;</b>		Serie - Series <b>ZZE15-ADE15-ZRE15-NDE15</b>	Modello - Model <b>AURIS</b>	
45046-19415 45046-09570 45046-19405	<b>0288073</b>	TESTA STERZO - RHT M15x1,5 TIE ROD END - RHT M15x1,5		
45047-19205 45047-09270 45047-19215	<b>0298073</b>	TESTA STERZO - RHT M15x1,5 TIE ROD END - RHT M15x1,5		
45046-19415 Z 45047-19215 Z	<b>0608073</b>	SNODO ASSIALE - RHT M15x1,5 AXIAL JOINT - RHT M15x1,5		
43330-49095 43330-19245 43330-09630	<b>0403095</b>	SNODO SOSPENSIONE - ASSE ANTERIORE - INFERIORE BALL JOINT - FRONT AXLE - LOWER		
48068-12300 48068-0F030 48068-02130	<b>0788073</b>	BRACCIO OSCILLANTE - ASSE ANTERIORE - INFERIORE TRACK CONTROL ARM - FRONT AXLE - LOWER		
48069-12300 48069-0F030 48069-02130	<b>0798073</b>	BRACCIO OSCILLANTE - ASSE ANTERIORE - INFERIORE TRACK CONTROL ARM - FRONT AXLE - LOWER		
48820-42030	<b>0503096</b>	STABILIZZATORE - ASSE ANTERIORE STABILIZER LINK - FRONT AXLE		





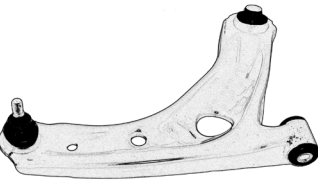
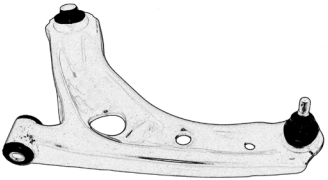

RIF. ORIG O.E. NUMBER	RIF. OCAP REF. OCAP	NOTE REMARKS	DESTRO RIGHT	SINISTRO LEFT
Anno - Year <b>09/97 &gt; 02/03</b>		Serie - Series <b>AT22-CT220-ST220</b>	Modello - Model <b>AVENSIS I</b>	
45046-09050 45046-09100 45046-29365	<b>0282998</b>	TESTA STERZO - RHT M14x1,5 TIE ROD END - RHT M14x1,5		
45047-09010 45047-09030 45047-29125	<b>0292998</b>	TESTA STERZO - RHT M14x1,5 TIE ROD END - RHT M14x1,5		
45503-05020	<b>0602999</b>	SNODO ASSIALE - RHT M14x1,5 AXIAL JOINT - RHT M14x1,5		
43330-19095 43330-29265 43330-29375 43330-09030 43330-02020	<b>0403671</b>	SNODO SOSPENSIONE INFERIORE SUSPENSIONE JOINT LOWER		
48068-05050	<b>0784418</b>	BRACCIO OSCILLANTE - ASSE ANTERIORE - INFERIORE TRACK CONTROL ARM - FRONT AXLE - LOWER		
48069-05050	<b>0794418</b>	BRACCIO OSCILLANTE - ASSE ANTERIORE - INFERIORE TRACK CONTROL ARM - FRONT AXLE - LOWER		
48820-05012 48810-20040 48820-20040	<b>0581922</b>	STABILIZZATORE - ASSE ANTERIORE STABILIZER LINK - FRONT AXLE		
48810-05012 48810-20020 48820-20020	<b>0591922</b>	STABILIZZATORE - ASSE ANTERIORE STABILIZER LINK - FRONT AXLE		
48650-20020	<b>0505185</b>	STABILIZZATORE - ASSE ANTERIORE STABILIZER LINK - FRONT AXLE		
48830-05020	<b>0502581</b>	STABILIZZATORE - ASSE POSTERIORE STABILIZER LINK - REAR AXLE		



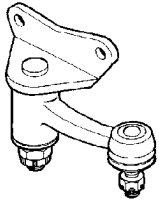
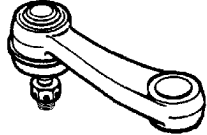

RIF. ORIG O.E. NUMBER	RIF. OCAP REF. OCAP	NOTE REMARKS	DESTRO RIGHT	SINISTRO LEFT
Anno - Year <b>04/2003 &gt;</b>		Serie - Series <b>T25</b>	Modello - Model <b>AVENSIS II</b>	
45046-09230	<b>0282584</b>	TESTA STERZO - MOD. 1.6 - 1.8 TIE ROD END - MOD. 1.6 - 1.8		
45046-29425	<b>0282585</b>	TESTA STERZO - MOD. 2.0 - 2.2 - 2.4 TIE ROD END - MOD. 2.0 - 2.2 - 2.4		
45503-20170 45503-0F010 45503-0R010	<b>0603122</b>	SNODO ASSIALE - RHT M16x1,5 AXIAL JOINT - RHT M16x1,5		
43330-09210	<b>0402590</b>	SNODO SOSPENSIONE INFERIORE SUSPENSIONE JOINT LOWER		
48068-05070	<b>0782590</b>	BRACCIO OSCILLANTE - ANTERIORE - INFERIORE TRACK CONTROL ARM - FRONT - LOWER		
48069-05070	<b>0792590</b>	BRACCIO OSCILLANTE - ANTERIORE - INFERIORE TRACK CONTROL ARM - FRONT - LOWER		
48820-47010	<b>0502591</b>	STABILIZZATORE - ANTERIORE STABILIZER LINK - FRONT		
48830-21020	<b>0582592</b>	STABILIZZATORE - ASSE POSTERIORE STABILIZER LINK - REAR AXLE		
48840-21010	<b>0592592</b>	STABILIZZATORE - ASSE POSTERIORE STABILIZER LINK - REAR AXLE		
Anno - Year <b>02/2009 &gt;</b>		Serie - Series <b>T27</b>	Modello - Model <b>AVENSIS III</b>	
45046-09660 45046-05070	<b>0283096</b>	TESTA STERZO - RHT M16x1,5 TIE ROD END - RHT M16x1,5		
45047-09320 45047-05060	<b>0293096</b>	TESTA STERZO - RHT M16x1,5 TIE ROD END - RHT M16x1,5		





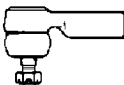
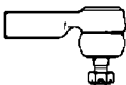
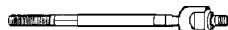
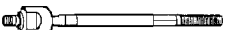

RIF. ORIG O.E. NUMBER	RIF. OCAP REF. OCAP	NOTE REMARKS	DESTRO RIGHT	SINISTRO LEFT
Anno - Year <b>02/2009 &gt;</b>		Serie - Series <b>T27</b>	Modello - Model <b>AVENSIS III</b>	
43330-09770	<b>0403096</b>	SNODO SOSPENSIONE - ASSE ANTERIORE - INFERIORE BALL JOINT - FRONT AXLE - LOWER		
48068-05080	<b>0783096</b>	BRACCIO OSCILLANTE - ASSE ANTERIORE - INFERIORE TRACK CONTROL ARM - FRONT AXLE - LOWER		
48069-05080	<b>0793096</b>	BRACCIO OSCILLANTE - ASSE ANTERIORE - INFERIORE TRACK CONTROL ARM - FRONT AXLE - LOWER		
48820-42030	<b>0503096</b>	STABILIZZATORE - ASSE ANTERIORE STABILIZER LINK - FRONT AXLE		
48830-05030	<b>0503104</b>	STABILIZZATORE - ASSE POSTERIORE STABILIZER LINK - REAR AXLE		
Anno - Year <b>08/2001 &gt;</b>		Serie - Series	Modello - Model <b>AVENSIS VERSO</b>	
45046-49125	<b>0282628</b>	TESTA STERZO TIE ROD END		
45047-49055	<b>0292628</b>	TESTA STERZO TIE ROD END		
45503-49105	<b>0602629</b>	SNODO ASSIALE AXIAL JOINT		
43330-19095 43330-29265 43330-29375 43330-09030 43330-02020	<b>0403671</b>	SNODO SOSPENSIONE INFERIORE SUSPENSIONE JOINT LOWER		
48068-49045	<b>0783104</b>	BRACCIO OSCILLANTE - ANTERIORE - INFERIORE TRACK CONTROL ARM - FRONT - LOWER		

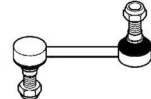
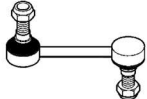
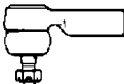
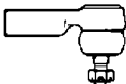
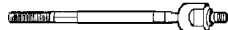
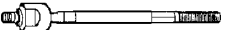
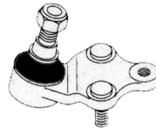
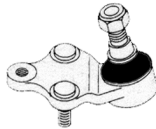



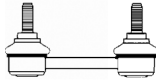
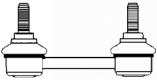
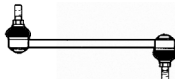
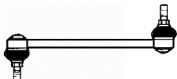

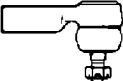
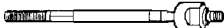
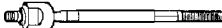
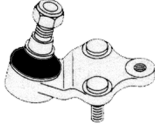
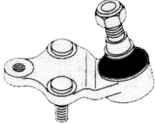
RIF. ORIG O.E. NUMBER	RIF. OCAP REF. OCAP	NOTE REMARKS	DESTRO RIGHT	SINISTRO LEFT
Anno - Year <b>08/2001 &gt;</b>		Serie - Series	Modello - Model <b>AVENSIS VERSO</b>	
48069-49045	<b>0793104</b>	BRACCIO OSCILLANTE - ANTERIORE - INFERIORE TRACK CONTROL ARM - FRONT - LOWER		
48820-44020	<b>0502630</b>	STABILIZZATORE - ASSE ANTERIORE STABILIZER LINK - FRONT AXLE		
Anno - Year <b>07/2005 &gt;</b>		Serie - Series	Modello - Model <b>AYGO</b>	
45046-09295	<b>0282844</b>	TESTA STERZO - RHT M12x1,25 TIE ROD END - RHT M12X1,25		
45047-09125	<b>0292844</b>	TESTA STERZO - RHT M12x1,25 TIE ROD END - RHT M12X1,25		
45500-0H010	<b>0605186</b>	SNODO ASSIALE - RHT M12x1,25 AXIAL JOINT - RHT M12X1,25		
-	<b>0401516</b>	SNODO SOSPENSIONE BALL JOINT		
48068-0H010	<b>0782845</b>	BRACCIO OSCILLANTE ANTERIORE - INFERIORE TRACK CONTROL ARM FRONT - LOWER		
48069-0H010	<b>0792845</b>	BRACCIO OSCILLANTE ANTERIORE - INFERIORE TRACK CONTROL ARM FRONT - LOWER		
48819-70010	<b>0505187</b>	STABILIZZATORE - ASSE ANTERIORE STABILIZER LINK - FRONT AXLE		

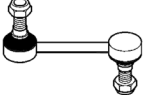

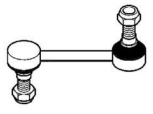



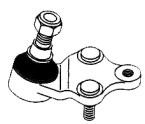
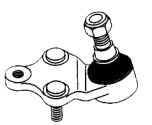

RIF. ORIG O.E. NUMBER	RIF. OCAP REF. OCAP	NOTE REMARKS	DESTRO RIGHT	SINISTRO LEFT
Anno - Year <b>1980 &gt; 1982</b>		Serie - Series <b>RA - TA</b>	Modello - Model <b>CAMRY - VISTA</b>	
45460-19025	<b>0503632</b>	BARRA STERZO TIE ROD		
45046-19065 45046-19135 45046-29075 45046-29155	<b>0190748</b>	TESTA STERZO ESTERNA - LHT M14x1,5 TIE ROD OUTER - LHT M14x1,5		
45406-19016	<b>0183633</b>	TESTA STERZO INTERNA - RHT M14x1,5 INNER TIE ROD - RHT M14x1,5		
45490-29295	<b>0303626</b>	L H D - BRACCIO STERZO L H D - IDLER ARM		
45401-19125	<b>0303628</b>	LEVA STERZO - MOD. STERZO MANUALE PITMAN ARM - MOD. MANUAL STEERING		
43308-12030 43308-19035	<b>0400963</b>	SNODO SOSPENSIONE INFERIORE SUSPENSION JOINT LOWER		
Anno - Year <b>1982 &gt; 1986</b>		Serie - Series <b>SV - CV</b>	Modello - Model <b>CAMRY - VISTA</b>	
45460-39165	<b>0283624</b>	TESTA STERZO - RHT M14x1,5 TIE ROD END - RHT M14x1,5		
45503-39015 45503-19085 45503-29175	<b>0603625</b>	SNODO ASSIALE - RHT M14x1,5 AXIAL JOINT - RHT M14x1,5		





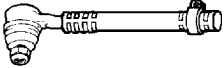
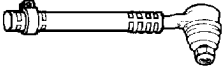
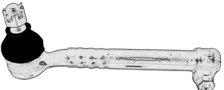
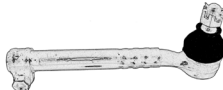

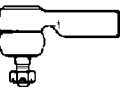
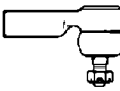
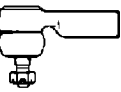
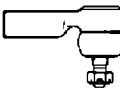
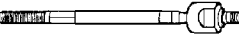
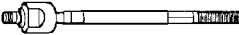
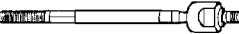
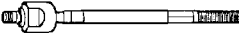
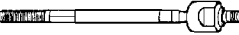
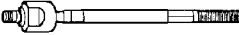

RIF. ORIG O.E. NUMBER	RIF. OCAP REF. OCAP	NOTE REMARKS	DESTRO RIGHT	SINISTRO LEFT
Anno - Year <b>1982 &gt; 1986</b>		Serie - Series <b>SV - CV</b>	Modello - Model <b>CAMRY - VISTA</b>	
43330-39135 43330-39225 43330-39245 43330-39275 43330-39295 43330-39345 43340-39225	<b>0403629</b>	SNODO SOSPENSIONE INFERIORE SUSPENSION JOINT LOWER		
Anno - Year <b>1986 &gt; 1991</b>		Serie - Series <b>SV20-VZV20-CV30-SV30-VZV30-CV40</b>	Modello - Model <b>CAMRY - VISTA</b>	
45046-19175 45046-29305	<b>0280141</b>	TESTA STERZO - RHT M14x1,5 TIE ROD END - RHT M14x1,5		
45503-29105 45503-39025 45503-39105	<b>0603631</b>	SNODO ASSIALE - RHT M14x1,5 AXIAL JOINT - RHT M14x1,5		
43330-39135 43330-39225 43330-39245 43330-39275 43330-39295 43330-39345 43340-39225	<b>0403629</b>	SNODO SOSPENSIONE INFERIORE SUSPENSION JOINT LOWER		
48830-20010 48830-32010	<b>0504413</b>	STABILIZZATORE - POSTERIORE STABILIZER LINK - REAR		
Anno - Year <b>06/91 &gt; 08/96</b> <b>06/91 &gt; 06/97</b>		Serie - Series <b>V1</b> <b>V10</b>	Modello - Model <b>CAMRY</b>	
45046-29255	<b>0283668</b>	TESTA STERZO - RHT M15x1,5 TIE ROD END - RHT M15x1,5		
45503-29355 45503-39135	<b>0603669</b>	SNODO ASSIALE - RHT M15x1,5 AXIAL JOINT - RHT M15x1,5		
43330-39435 43330-09050	<b>0402776</b>	SNODO SOSPENSIONE INFERIORE SUSPENSION JOINT LOWER		



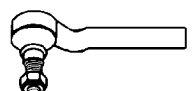
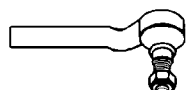

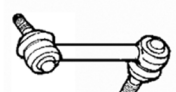
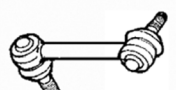

RIF. ORIG O.E. NUMBER	RIF. OCAP REF. OCAP	NOTE REMARKS	DESTRO RIGHT	SINISTRO LEFT
Anno - Year <b>06/91 &gt; 08/96</b> <b>06/91 &gt; 06/97</b>		Serie - Series <b>V1</b> <b>V10</b>	Modello - Model <b>CAMRY</b>	
48068-33020 48068-33010	<b>0782776</b>	BRACCIO OSCILLANTE ANTERIORE TRACK CONTROL ARM FRONT		
48069-33020 48069-33010	<b>0792776</b>	BRACCIO OSCILLANTE ANTERIORE TRACK CONTROL ARM FRONT		
48820-33010	<b>0504416</b>	STABILIZZATORE - ANTERIORE STABILIZER LINK - FRONT		
48830-33010 48820-06020 48830-06020	<b>0502292</b>	STABILIZZATORE - ASSE POSTERIORE STABILIZER LINK - REAR AXLE		
Anno - Year <b>08/96 &gt; 11/01</b>		Serie - Series <b>V20</b>	Modello - Model <b>CAMRY</b>	
45046-29255	<b>0283668</b>	TESTA STERZO - RHT M15x1,5 TIE ROD END - RHT M15x1,5		
45503-29355 45503-39135	<b>0603669</b>	SNODO ASSIALE - RHT M15x1,5 AXIAL JOINT - RHT M15x1,5		
43330-39435 43330-09050	<b>0402776</b>	SNODO SOSPENSIONE INFERIORE SUSPENSION JOINT LOWER		
48068-33030	<b>0782777</b>	BRACCIO OSCILLANTE ANTERIORE TRACK CONTROL ARM FRONT		
48069-33030	<b>0792777</b>	BRACCIO OSCILLANTE ANTERIORE TRACK CONTROL ARM FRONT		
48820-33020	<b>0582293</b>	STABILIZZATORE - ASSE ANTERIORE STABILIZER LINK - FRONT AXLE		

RIF. ORIG O.E. NUMBER	RIF. OCAP REF. OCAP	NOTE REMARKS	DESTRO RIGHT	SINISTRO LEFT
Anno - Year <b>08/96 &gt; 11/01</b>		Serie - Series <b>V20</b>	Modello - Model <b>CAMRY</b>	
48810-33010	<b>0592293</b>	STABILIZZATORE - ASSE ANTERIORE STABILIZER LINK - FRONT AXLE		
48830-33010 48820-06020 48830-06020	<b>0502292</b>	STABILIZZATORE - ASSE POSTERIORE STABILIZER LINK - REAR AXLE		
Anno - Year <b>2001 &gt;</b>		Serie - Series <b>V30</b>	Modello - Model <b>CAMRY</b>	
45460-29425 45460-09010 45460-39615	<b>0284330</b>	TESTA STERZO - RHT M15x1,5 TIE ROD END - RHT M15x1,5		
45470-29185 45470-09010 45470-39215 45470-59055	<b>0294330</b>	TESTA STERZO - RHT M15x1,5 TIE ROD END - RHT M15x1,5		
45503-39225 45503-09230	<b>0602842</b>	SNODO ASSIALE - RHT M15x1,5 AXIAL JOINT - RHT M15x1,5		
43330-29405 43330-09160	<b>0484338</b>	SNODO SOSPENSIONE INFERIORE SUSPENSION JOINT LOWER		
43340-29175 43340-09010	<b>0494338</b>	SNODO SOSPENSIONE INFERIORE SUSPENSION JOINT LOWER		
48068-28120 48068-33050 48068-33060	<b>0784338</b>	BRACCIO OSCILLANTE - ASSE ANTERIORE - INFERIORE TRACK CONTROL ARM - FRONT AXLE - LOWER		
48069-28120 48069-33050 48069-33060	<b>0794338</b>	BRACCIO OSCILLANTE - ASSE ANTERIORE - INFERIORE TRACK CONTROL ARM - FRONT AXLE - LOWER		



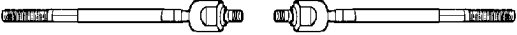
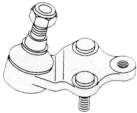
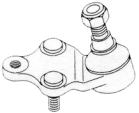
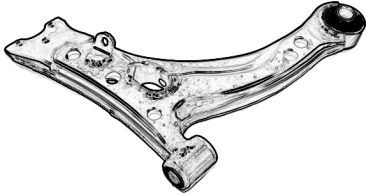

RIF. ORIG O.E. NUMBER	RIF. OCAP REF. OCAP	NOTE REMARKS	DESTRO RIGHT	SINISTRO LEFT
Anno - Year <b>2001 &gt;</b>		Serie - Series <b>V30</b>	Modello - Model <b>CAMRY</b>	
48820-28050 48820-06040	<b>0502294</b>	STABILIZZATORE - ASSE ANTERIORE STABILIZER LINK - FRONT AXLE		
48830-48010 48830-06030	<b>0502843</b>	STABILIZZATORE - ASSE POSTERIORE STABILIZER LINK - REAR AXLE		
Anno - Year <b>1970 &gt; 1975</b>		Serie - Series <b>TA10-TA20-RA10-RA20</b>	Modello - Model <b>CARINA - CELICA</b>	
45460-19055 45460-19065 45460-19085	<b>0500962</b>	BARRA STERZO TIE ROD		
45046-19065 45046-19135 45046-29075 45046-29155	<b>0190748</b>	TESTA STERZO ESTERNA - LHT M14x1,5 TIE ROD END - OUTER - LHT M14x1,5		
45406-19015 45406-19025 45406-19045 45406-19048	<b>0180749</b>	TESTA STERZO - INTERNA - RHT M14x1,5 TIE ROD END - INNER - RHT M14x1,5		
43308-12030 43308-19035	<b>0400963</b>	SNODO SOSPENSIONE INFERIORE SUSPENSION JOINT LOWER		
Anno - Year <b>1975 &gt; 1977</b> <b>1977 &gt; 1981</b> <b>1981 &gt;</b>		Serie - Series <b>TA10-RA10-TA20-RA20-TA30-RA30</b> <b>TA40-RA40-TA50-RA50-MA40-MA50</b> <b>TA67V-CA67V-KA67V</b>	Modello - Model <b>CARINA - CELICA</b>	
45460-19025	<b>0503632</b>	BARRA STERZO TIE ROD		
45046-19065 45046-19135 45046-29075 45046-29155	<b>0190748</b>	TESTA STERZO ESTERNA - LHT M14x1,5 TIE ROD END - OUTER - LHT M14x1,5		
45406-19016	<b>0183633</b>	TESTA STERZO INTERNA - RHT M14x1,5 TIE ROD END - INNER - RHT M14x1,5		

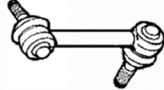
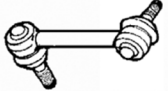
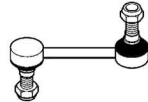
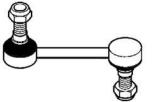



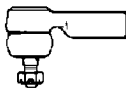
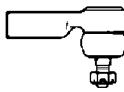
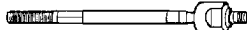
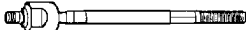
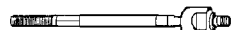
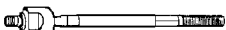
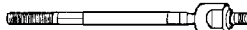
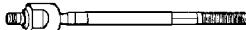

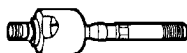

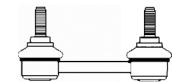
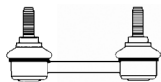
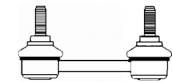
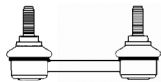
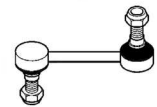
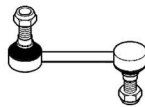
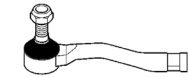
RIF. ORIG O.E. NUMBER	RIF. OCAP REF. OCAP	NOTE REMARKS	DESTRO RIGHT	SINISTRO LEFT
Anno - Year <b>1975 &gt; 1977</b> <b>1977 &gt; 1981</b> <b>1981 &gt;</b>		Serie - Series <b>TA10-RA10-TA20-RA20-TA30-RA30</b> <b>TA40-RA40-TA50-RA50-MA40-MA50</b> <b>TA67V-CA67V-KA67V</b>	Modello - Model <b>CARINA - CELICA</b>	
43308-12030 43308-19035	<b>0400963</b>	SNODO SOSPENSIONE INFERIORE SUSPENSION JOINT LOWER		
Anno - Year <b>1981 &gt; 1986</b>		Serie - Series <b>TA61-TA63-TA64-AA63-SA60-SA63-CA60-RA63-AA60-SA60G-GA61-MA6</b>	Modello - Model <b>CARINA - CELICA</b>	
45460-19165	<b>0283634</b>	BARRA STERZO - STERZO MANUALE - RHT M14x1,5 TIE ROD END - MANUAL STEERING - RHT M14x1,5		
45460-19155	<b>0283635</b>	BARRA STERZO - SERVOSTERZO - RHT M14x1,5 TIE ROD - POWER STEERING - RHT M14x1,5		
45503-29125 45503-29010 45503-29015 45503-29016	<b>0603636</b>	BARRA STERZO - SERVOSTERZO - RHT M14x1,5 TIE ROD - POWER STEERING - RHT M14x1,5		
43308-12030 43308-19035	<b>0400963</b>	SNODO SOSPENSIONE INFERIORE SUSPENSION JOINT LOWER		
Anno - Year <b>10/83 &gt; 05/88</b>		Serie - Series <b>AT15-ST15-CT15</b>	Modello - Model <b>CARINA II</b>	
45046-29135	<b>0283638</b>	TESTA STERZO - RHT M12x1,25 - > 1984 TIE ROD END - RHT M12x1,25 - > 1984		
45046-19175 45046-29305	<b>0280141</b>	TESTA STERZO - RHT M14x1,5 - 1984 > TIE ROD END - RHT M14x1,5 - 1984 >		
45503-19035	<b>0603639</b>	SNODO ASSIALE - STERZO MANUALE - RHT M12x1,25 - L=315 - >1984 AXIAL JOINT MANUAL STEERING - RHT M12x1,25 - L=315 - >1984		
45503-19055	<b>0603640</b>	SNODO ASSIALE - SERVOSTERZO - RHT M12x1,25 - L=295 - > 1984 AXIAL JOINT POWER STEERING - RHT M12x1,25 - L=295 - > 1984		
45503-19036	<b>0603641</b>	SNODO ASSIALE - STERZO MANUALE - RHT M14x1,5 - 1984 > AXIAL JOINT MANUAL STEERING - RHT M14x1,5 - 1984 >		



RIF. ORIG O.E. NUMBER	RIF. OCAP REF. OCAP	NOTE REMARKS	DESTRO RIGHT	SINISTRO LEFT
Anno - Year <b>10/83 &gt; 05/88</b>		Serie - Series <b>AT15-ST15-CT15</b>	Modello - Model <b>CARINA II</b>	
45503-19056	<b>0603642</b>	SNODO ASSIALE - SERVOSTERZO - RHT M14x1,5 - 1984 > AXIAL JOINT POWER STEERING - RHT M14x1,5 - 1984 >		
43330-29135 43330-29136 43330-29137 43330-29138 43330-29139 43330-29205	<b>0403643</b>	SNODO SOSPENSIONE INFERIORE SUSPENSION JOINT LOWER		
Anno - Year <b>1987 &gt; 1992</b>		Serie - Series <b>AT170-AT171-ET176-ST170-CT17</b>	Modello - Model <b>CARINA</b>	
45046-29165	<b>0283646</b>	TESTA STERZO - RHT M15x1,5 TIE ROD END - RHT M15x1,5		
45047-29045	<b>0293646</b>	TESTA STERZO - RHT M15x1,5 TIE ROD END - RHT M15x1,5		
45503-29155	<b>0603648</b>	SNODO ASSIALE - STERZO MANUALE - RHT M15x1,5 TIE ROD END - MANUAL STEERING - RHT M15x1,5		
45503-29165	<b>0603647</b>	SNODO ASSIALE SERVOSTERZO - RHT M15x1,5 TIE ROD END - POWER STEERING - RHT M15x1,5		
43330-29145 43330-29146 43330-29185	<b>0403645</b>	SNODO SOSPENSIONE INFERIORE SUSPENSION JOINT LOWER		
48820-20030	<b>0582295</b>	STABILIZZATORE STABILIZER LINK		
48810-20010	<b>0592295</b>	STABILIZZATORE STABILIZER LINK		
Anno - Year <b>04/92 &gt; 09/97</b>		Serie - Series <b>19</b>	Modello - Model <b>CARINA E</b>	
45046-29335 45046-29275	<b>0283693</b>	TESTA STERZO - RHT M15x1,5 TIE ROD END - RHT M15x1,5		

RIF. ORIG O.E. NUMBER	RIF. OCAP REF. OCAP	NOTE REMARKS	DESTRO RIGHT	SINISTRO LEFT
Anno - Year <b>04/92 &gt; 09/97</b>		Serie - Series <b>19</b>	Modello - Model <b>CARINA E</b>	
45047-29075 45047-29105	<b>0293693</b>	TESTA STERZO - RHT M15x1,5 TIE ROD END - RHT M15x1,5		
45046-09050 45046-09100 45046-29365	<b>0282998</b>	TESTA STERZO - RHT M14x1,5 - 1995 > 1997 TIE ROD END - RHT M14x1,5 - 1995 > 1997		
45047-09010 45047-09030 45047-29125	<b>0292998</b>	TESTA STERZO - RHT M14x1,5 - 1995 > 1997 TIE ROD END - RHT M14x1,5 - 1995 > 1997		
45503-29435 45503-29615	<b>0603694</b>	SNODO ASSIALE - RHT M15x1,5 - 1992 > 1995 AXIAL JOINT - RHT M15x1,5 - 1992 > 1995		
45503-05010	<b>0604419</b>	SNODO ASSIALE - 1995 > 1997 AXIAL JOINT - 1995 > 1997		
43330-29265 43330-29375	<b>0402961</b>	SNODO SOSPENSIONE INFERIORE SUSPENSIONE JOINT LOWER		
48068-20260	<b>0784407</b>	BRACCIO OSCILLANTE TRACK CONTROL ARM		
48069-20260	<b>0794407</b>	BRACCIO OSCILLANTE TRACK CONTROL ARM		
48820-05012 48810-20040 48820-20040	<b>0581922</b>	STABILIZZATORE - ASSE ANTERIORE STABILIZER LINK - FRONT AXLE		
48810-05012 48810-20020 48820-20020	<b>0591922</b>	STABILIZZATORE - ASSE ANTERIORE STABILIZER LINK - FRONT AXLE		
48830-20010	<b>0504497</b>	STABILIZZATORE - ASSE POSTERIORE STABILIZER LINK - REAR AXLE		

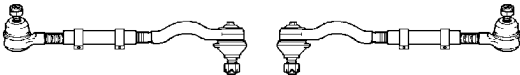

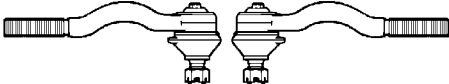

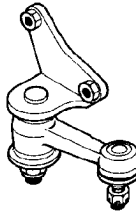
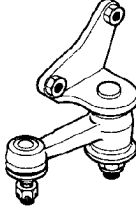
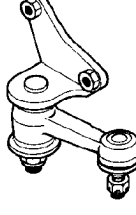
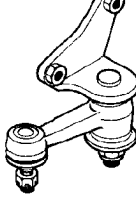
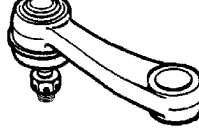

RIF. ORIG O.E. NUMBER	RIF. OCAP REF. OCAP	NOTE REMARKS	DESTRO RIGHT	SINISTRO LEFT
Anno - Year <b>1985 &gt; 1999</b>		Serie - Series <b>T16-T18-T20</b>	Modello - Model <b>CELICA</b>	
45046-19175 45046-29305	<b>0280141</b>	TESTA STERZO - RHT M14x1,5 MOD. T16 TIE ROD END - RHT M14x1,5 MOD. T16		
45503-29075	<b>0603644</b>	SNODO ASSIALE - RHT M14x1,5 MOD. T16 AXIAL JOINT - RHT M14x1,5 MOD. T16		
45503-29105 45503-39025 45503-39105	<b>0603631</b>	SNODO ASSIALE - RHT M14x1,5 MOD. T16 AXIAL JOINT - RHT M14x1,5 MOD. T16		
45503-29245	<b>0603092</b>	SNODO ASSIALE - RHT M14x1,5 MOD. T18 AXIAL JOINT - RHT M14x1,5 MOD. T18		
45503-29125 45503-29010 45503-29015 45503-29016	<b>0603636</b>	SNODO ASSIALE - SERVOSTERZO - RHT M14x1,5 MOD. T16 - T20 AXIAL JOINT - POWER STEERING - RHT M14x1,5 MOD. T16 - T20		
43330-29145 43330-29146 43330-29185	<b>0403645</b>	SNODO SOSPENSIONE INFERIORE MOD. T16 SUSPENSION JOINT LOWER MOD. T16		
48820-20010	<b>0504412</b>	STABILIZZATORE - ANTERIORE MOD. T18 STABILIZER LINK - FRONT MOD. T18		
48820-33010	<b>0504416</b>	STABILIZZATORE - ANTERIORE MOD. T20 STABILIZER LINK - FRONT MOD. T20		
48830-20010	<b>0504497</b>	STABILIZZATORE - ASSE POSTERIORE STABILIZER LINK - REAR AXLE		
Anno - Year <b>11/1999 &gt;</b>		Serie - Series <b>ZZT23</b>	Modello - Model <b>CELICA</b>	
45046-49085	<b>0284320</b>	TESTA STERZO - RHT M14x1,5 TIE ROD END - RHT M14x1,5		

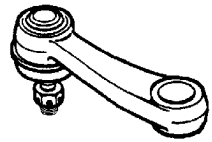
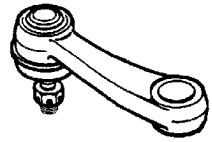
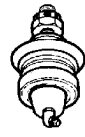
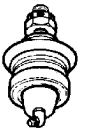
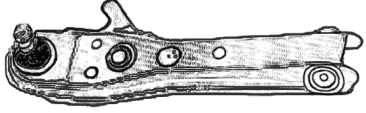
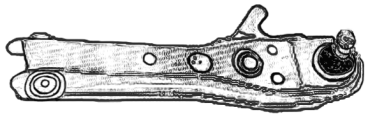
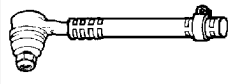
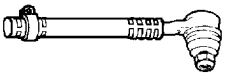
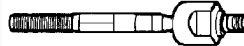
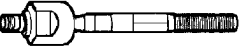
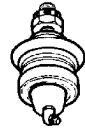
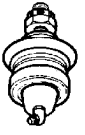
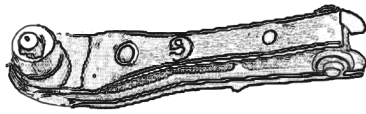

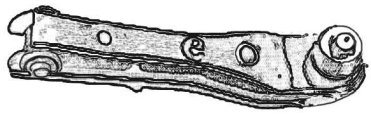
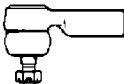
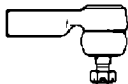
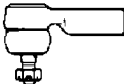
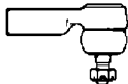
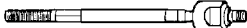
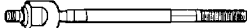
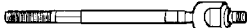
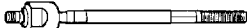
RIF. ORIG O.E. NUMBER	RIF. OCAP REF. OCAP	NOTE REMARKS	DESTRO RIGHT	SINISTRO LEFT
Anno - Year 11/1999 >		Serie - Series ZZT23	Modello - Model CELICA	
45047-49015	<b>0294320</b>	TESTA STERZO - RHT M14x1,5 TIE ROD END - RHT M14x1,5		
45503-49035	<b>0604420</b>	SNODO ASSIALE - RHT M14x1,5 AXIAL JOINT - RHT M14x1,5		
43330-19115 43330-09070	<b>0404409</b>	SNODO SOSPENSIONE INFERIORE SUSPENSION JOINT LOWER		
48068-20380 48068-20381	<b>0783089</b>	BRACCIO OSCILLANTE INFERIORE TRACK CONTROL ARM LOWER		
48069-20380 48069-20381	<b>0793089</b>	BRACCIO OSCILLANTE INFERIORE TRACK CONTROL ARM LOWER		
48820-32010	<b>0503090</b>	STABILIZZATORE - ANTERIORE STABILIZER LINK - FRONT		
48820-24010	<b>0504565</b>	STABILIZZATORE - ASSE POSTERIORE STABILIZER LINK - REAR AXLE		
Anno - Year 1974 > 1979 1979 > 1981 1981 > 1983 1982 > 1987		Serie - Series KE3-KE4-KE5-KE6-TE3-TE4-TE5-TE6 AE70-KE71V-TE70-TE73V-TE70GL-SE-SL KE72V-TE74V-TE71(LEVIN,TRUENO) KE72V-KE74V-TE74-CE7	Modello - Model COROLLA - SPRINTER	
45460-19055 45460-19065 45460-19085	<b>0500962</b>	BARRA STERZO - > 1979 TIE ROD - > 1979		
45046-19065 45046-19135 45046-29075 45046-29155	<b>0190748</b>	TESTA STERZO ESTERNA - LHT M14x1,5 - > 1979 TIE ROD END - OUTER - LHT M14x1,5 - > 1979		
45406-19015 45406-19025 45406-19045 45406-19048	<b>0180749</b>	TESTA STERZO INTERNA - RHT M14x1,5 - > 1979 TIE ROD END - INNER- RHT M14x1,5 - > 1979		

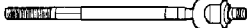
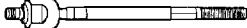
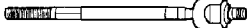
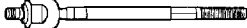
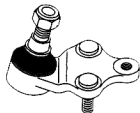
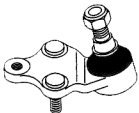
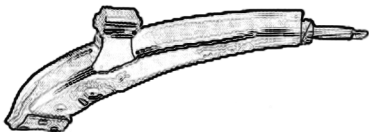

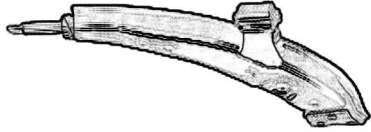
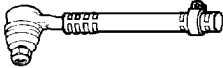
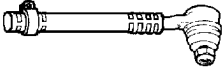
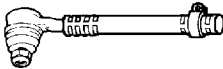
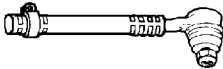
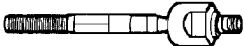
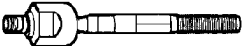
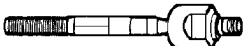
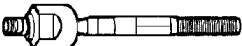

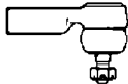
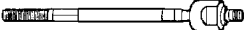
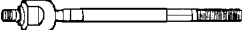
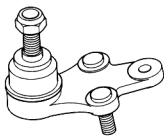
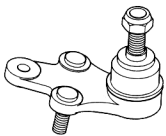

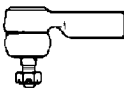
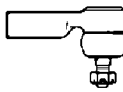
RIF. ORIG O.E. NUMBER	RIF. OCAP REF. OCAP	NOTE REMARKS	DESTRO RIGHT	SINISTRO LEFT
Anno - Year 1974 > 1979 1979 > 1981 1981 > 1983 1982 > 1987		Serie - Series KE3-KE4-KE5-KE6-TE3-TE4-TE5-TE6 AE70-KE71V-TE70-TE73V-TE70GL-SE-SL KE72V-TE74V-TE71(LEVIN,TRUENO) KE72V-KE74V-TE74-CE7	Modello - Model COROLLA - SPRINTER	
45460-19025	0503632	BARRA STERZO - 1979 > TIE ROD - 1979 >		
45046-19065 45046-19135 45046-29075 45046-29155	0190748	TESTA STERZO ESTERNA - LHT M14x1,5 - 1979 > TIE ROD END - OUTER - LHT M14x1,5 - 1979 >		
45406-19016	0183633	TESTA STERZO INTERNA - RHT M14x1,5 - 1979 > TIE ROD END - INNER - RHT M14x1,5 - 1979 >		
45490-19135	0303649	L H D - BRACCIO STERZO - > 1979 L H D - IDLER ARM - > 1979		
45490-19125	0303650	R H D - BRACCIO STERZO - > 1979 R H D - IDLER ARM - > 1979		
45490-19225	0303651	L H D - BRACCIO STERZO - 1979 > L H D - IDLER ARM - 1979 >		
45490-19215	0303652	R H D - BRACCIO STERZO - 1979 > R H D - IDLER ARM - 1979 >		
45401-19095	0303653	L H D - LEVA STERZO - > 1979 L H D - PITMAN ARM - > 1979		

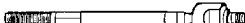
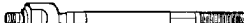
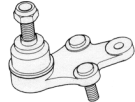
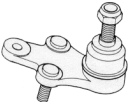
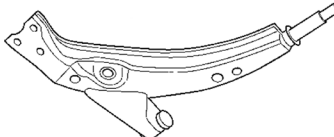
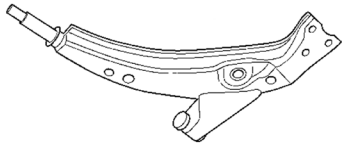
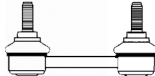
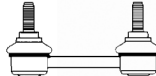
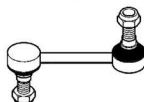
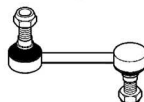
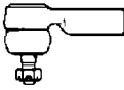
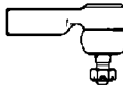
RIF. ORIG O.E. NUMBER	RIF. OCAP REF. OCAP	NOTE REMARKS	DESTRO RIGHT	SINISTRO LEFT
Anno - Year 1974 > 1979 1979 > 1981 1981 > 1983 1982 > 1987		Serie - Series KE3-KE4-KE5-KE6-TE3-TE4-TE5-TE6 AE70-KE71V-TE70-TE73V-TE70GL-SE-SL KE72V-TE74V-TE71(LEVIN,TRUENO) KE72V-KE74V-TE74-CE7	Modello - Model COROLLA - SPRINTER	
45401-19105	0303654	L H D - LEVA STERZO - > 1979 - MOD. USA L H D - PITMAN ARM - > 1979 - MOD. USA		
45401-19195	0303656	L H D - LEVA STERZO - 1979 > L H D - PITMAN ARM - 1979 >		
43308-12030 43308-19035	0400963	SNODO SOSPENSIONE INFERIORE SUSPENSION JOINT LOWER		
48068-19045	0783661	BRACCIO OSCILLANTE TRACK CONTROL ARM		
48069-19045	0793661	BRACCIO OSCILLANTE TRACK CONTROL ARM		
Anno - Year 1979 > 1983 1981 > 1983 1982 > 1987		Serie - Series KE 70 AE70-KE73E KE 73G	Modello - Model COROLLA - SPRINTER	
45460-19125	0283658	TESTA STERZO - RHT M14x1,5 TIE ROD END - RHT M14x1,5		
45503-19035 45460-19115 45503-10020 45503-19015 45503-19045	0603659	SNODO ASSIALE - RHT M14x1,5 AXIAL JOINT - RHT M14x1,5		
43308-12030 43308-19035	0400963	SNODO SOSPENSIONE INFERIORE SUSPENSION JOINT LOWER		
48068-19065	0783662	BRACCIO OSCILLANTE TRACK CONTROL ARM		

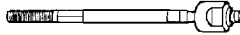
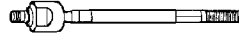
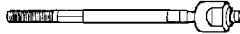
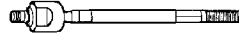
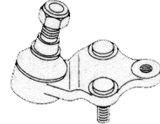
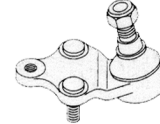
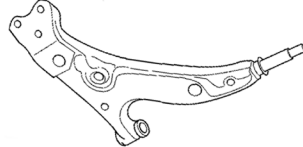
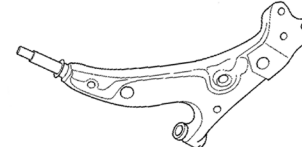
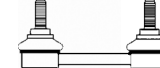

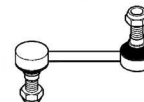
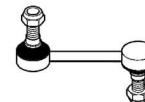

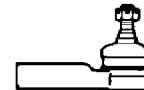
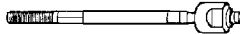
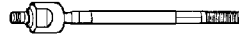

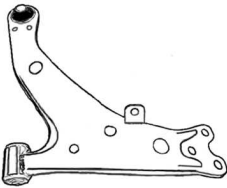
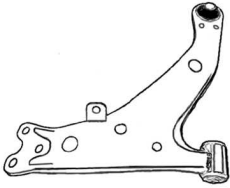

RIF. ORIG O.E. NUMBER	RIF. OCAP REF. OCAP	NOTE REMARKS	DESTRO RIGHT	SINISTRO LEFT
Anno - Year <b>1979 &gt; 1983</b> <b>1981 &gt; 1983</b> <b>1982 &gt; 1987</b>		Serie - Series <b>KE 70</b> <b>AE70-KE73E</b> <b>KE 73G</b>	Modello - Model <b>COROLLA - SPRINTER</b>	
48069-19065	<b>0793662</b>	BRACCIO OSCILLANTE TRACK CONTROL ARM		
Anno - Year <b>1983 &gt; 1987</b>		Serie - Series <b>AE80-AE81-AE82-CE8-EE8</b>	Modello - Model <b>COROLLA - SPRINTER</b>	
45046-29135	<b>0283638</b>	TESTA STERZO ESTERNA - RHT M12x1,25 - > 1984 TIE ROD END OUTER - RHT M12x1,25 - > 1984		
45046-19175 45046-29305	<b>0280141</b>	TESTA STERZO ESTERNA - RHT M14x1,25 - 1984 > TIE ROD END - OUTER - RHT M14x1,25 - 1984 >		
45503-19035	<b>0603639</b>	SNODO ASSIALE - RHT M12x1,25 - STERZO MANUALE - > 1984 AXIAL JOINT - RHT M12x1,25 - MANUAL STEERING - > 1984		
45503-19055	<b>0603640</b>	SNODO ASSIALE - RHT M12x1,25 - SERVOSTERZO - > 1984 AXIAL JOINT - RHT M12x1,25 - POWER STEERING - > 1984		
43308-12030 43308-19035	<b>0400963</b>	SNODO SOSPENSIONE INFERIORE SUSPENSION JOINT LOWER		
45503-19036	<b>0603641</b>	SNODO ASSIALE - RHT M14x1,25 - STERZO MANUALE - 1984 > AXIAL JOINT - RHT M14x1,25 - MANUAL STEERING - 1984 >		
45503-19056	<b>0603642</b>	SNODO ASSIALE - RHT M14x1,25 - SERVOSTERZO - 1984 > AXIAL JOINT - RHT M14x1,25 - POWER STEERING - 1984 >		
43330-29135 43330-29136 43330-29137 43330-29138 43330-29139 43330-29205	<b>0403643</b>	SNODO SOSPENSIONE INFERIORE SUSPENSION JOINT LOWER		
48068-20150 48068-20151	<b>0783663</b>	BRACCIO OSCILLANTE TRACK CONTROL ARM		

RIF. ORIG O.E. NUMBER	RIF. OCAP REF. OCAP	NOTE REMARKS	DESTRO RIGHT	SINISTRO LEFT
Anno - Year <b>1983 &gt; 1987</b>		Serie - Series <b>AE80-AE81-AE82-CE8-EE8</b>	Modello - Model <b>COROLLA - SPRINTER</b>	
48069-20150 48069-20151	<b>0793663</b>	BRACCIO OSCILLANTE TRACK CONTROL ARM		
Anno - Year <b>1983 &gt; 1987</b>		Serie - Series <b>AE85-AE86(LEVIN-TRUENO)</b>	Modello - Model <b>COROLLA - SPRINTER</b>	
45460-19125	<b>0283658</b>	TESTA STERZO - RHT M14x1,5 - ECCETTO AE86 GTV TIE ROD END - RHT M14x1,5 - EXCEPT AE86 GTV		
45046-19175 45046-19105 45460-19105 45460-19215	<b>0283660</b>	TESTA STERZO - RHT M14x1,5 - MOD. AE86 GTV TIE ROD END - RHT M14x1,5 - MOD. AE86 GTV		
45503-19035 45460-19115 45503-10020 45503-19015 45503-19045	<b>0603659</b>	SNODO ASSIALE - RHT M14x1,5 - STERZO MANUALE AXIAL JOINT - RHT M14x1,5 - MANUAL STEERING		
45503-19025	<b>0603676</b>	SNODO ASSIALE - RHT M14x1,5 - SERVOSTERZO - 1985 > AXIAL JOINT - RHT M14x1,5 - POWER STEERING - 1985 >		
Anno - Year <b>1986 &gt;</b>		Serie - Series <b>EL3-NL3</b>	Modello - Model <b>COROLLA II - CORSA - TERCEL</b>	
45046-19175 45046-29305	<b>0280141</b>	TESTA STERZO - RHT M14x1.5 TIE ROD END - RHT M14x1.5		
45503-19116	<b>0603679</b>	SNODO ASSIALE - RHT M14x1.5 AXIAL JOINT - RHT M14x1.5		
43330-19045	<b>0403680</b>	SNODO SOSPENSIONE INFERIORE SUSPENSION JOINT LOWER		









RIF. ORIG O.E. NUMBER	RIF. OCAP REF. OCAP	NOTE REMARKS	DESTRO RIGHT	SINISTRO LEFT
Anno - Year <b>07/87 &gt; 06/92</b>		Serie - Series <b>AE9-CE9-EE9</b>	Modello - Model <b>COROLLA - SPRINTER</b>	
45046-19175 45046-29305	<b>0280141</b>	TESTA STERZO - RHT M14x1,5 TIE ROD END - RHT M14x1,5		
45503-19125	<b>0603664</b>	SNODO ASSIALE - RHT M14x1,5 - STERZO MANUALE TIE ROD END - RHT M14x1,5 - MANUAL STEERING		
45503-19135	<b>0603665</b>	SNODO ASSIALE - RHT M14x1,5 - SERVOSTERZO TIE ROD END - RHT M14x1,5 - POWER STEERING		
43330-19065 43330-19066	<b>0483666</b>	SNODO SOSPENSIONE INFERIORE SUSPENSION JOINT LOWER		
43340-19015 43340-19016	<b>0493666</b>	SNODO SOSPENSIONE INFERIORE SUSPENSION JOINT LOWER		
48068-12110	<b>0783667</b>	BRACCIO OSCILLANTE TRACK CONTROL ARM		
48069-12110	<b>0793667</b>	BRACCIO OSCILLANTE TRACK CONTROL ARM		
48820-20010	<b>0504412</b>	STABILIZZATORE - ANTERIORE STABILIZER LINK - FRONT		
48830-20010 48830-32010	<b>0504413</b>	STABILIZZATORE - POSTERIORE STABILIZER LINK - REAR		
Anno - Year <b>07/92 &gt; 04/97</b>		Serie - Series <b>AE100-CE100-AE101-CE101</b>	Modello - Model <b>COROLLA</b>	
45046-19175 45046-29305	<b>0280141</b>	TESTA STERZO - RHT M14x1,5 TIE ROD END - RHT M14x1,5		



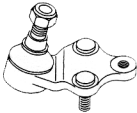
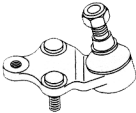





RIF. ORIG O.E. NUMBER	RIF. OCAP REF. OCAP	NOTE REMARKS	DESTRO RIGHT	SINISTRO LEFT
Anno - Year <b>07/92 &gt; 04/97</b>		Serie - Series <b>AE100-CE100-AE101-CE101</b>	Modello - Model <b>COROLLA</b>	
45503-29365 45503-19215	<b>0601923</b>	SNODO ASSIALE - RHT M14x1,5 - STERZO MANUALE AXIAL JOINT - RHT M14x1,5 - MANUAL STEERING		
45503-19205 45503-29385	<b>0604319</b>	SNODO ASSIALE - RHT M14x1,5 - SERVOSTERZO AXIAL JOINT - RHT M14x1,5 - POWER STEERING		
43330-19095 43330-29265 43330-29375 43330-09030 43330-02020	<b>0403671</b>	SNODO SOSPENSIONE INFERIORE SUSPENSION JOINT LOWER		
48068-12130 48068-12140	<b>0783672</b>	BRACCIO OSCILLANTE TRACK CONTROL ARM		
48069-12130	<b>0793672</b>	BRACCIO OSCILLANTE TRACK CONTROL ARM		
48820-33010	<b>0504416</b>	STABILIZZATORE - ANTERIORE STABILIZER LINK - FRONT		
48830-20010 48830-32010	<b>0504413</b>	STABILIZZATORE - POSTERIORE STABILIZER LINK - REAR		
Anno - Year <b>04/97 &gt; 01/02</b>		Serie - Series <b>E11</b>	Modello - Model <b>COROLLA</b>	
45046-29305	<b>0282996</b>	TESTA STERZO - RHT M14x1,5 TIE ROD END - RHT M14x1,5		
45503-19205 45503-29385	<b>0604319</b>	SNODO ASSIALE - RHT M14x1,5 - SERVOSTERZO AXIAL JOINT - RHT M14x1,5 - POWER STEERING		
43330-09090	<b>0402997</b>	SNODO SOSPENSIONE - 09/1998 > SUSPENSION JOINT - 09/1998 >		

















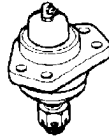
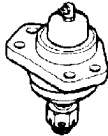

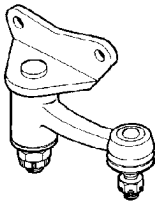

RIF. ORIG O.E. NUMBER	RIF. OCAP REF. OCAP	NOTE REMARKS	DESTRO RIGHT	SINISTRO LEFT
Anno - Year <b>04/97 &gt; 01/02</b>		Serie - Series <b>E11</b>	Modello - Model <b>COROLLA</b>	
48068-12180	<b>0784414</b>	BRACCIO OSCILLANTE - INFERIORE TRACK CONTROL ARM - LOWER		
48069-12180	<b>0794414</b>	BRACCIO OSCILLANTE TRACK CONTROL ARM		
48820-20021	<b>0504417</b>	STABILIZZATORE - ANTERIORE STABILIZER LINK - FRONT		
48830-12060	<b>0504415</b>	STABILIZZATORE - POSTERIORE STABILIZER LINK - REAR		
Anno - Year <b>01/2002 &gt; 08/2002 &gt; 01/2002 &gt;</b>		Serie - Series <b>E12U E12 Saloon E12J Station wagon</b>	Modello - Model <b>COROLLA</b>	
45046-49115 45046-19265 45046-09360	<b>0282614</b>	TESTA STERZO - RHT M14x1,5 TIE ROD END - RHT M14x1,5		
45047-49045 45047-19115 45047-09150	<b>0292614</b>	TESTA STERZO - RHT M14x1,5 TIE ROD END - RHT M14x1,5		
45503-12130 45503-19255	<b>0602594</b>	SNODO ASSIALE - RHT M14x1,5 AXIAL JOINT - RHT M14x1,5		
43330-09090	<b>0402997</b>	SNODO SOSPENSIONE - INFERIORE SUSPENSION JOINT - LOWER		
48068-12260	<b>0783113</b>	BRACCIO OSCILLANTE - INFERIORE > 09/2002 TRACK CONTROL ARM - LOWER > 09/2002		

RIF. ORIG O.E. NUMBER	RIF. OCAP REF. OCAP	NOTE REMARKS	DESTRO RIGHT	SINISTRO LEFT
Anno - Year <b>01/2002 &gt;</b> <b>08/2002 &gt;</b> <b>01/2002 &gt;</b>		Serie - Series <b>E12U</b> <b>E12 Saloon</b> <b>E12J Station wagon</b>		Modello - Model <b>COROLLA</b>
48069-12260	<b>0793113</b>	BRACCIO OSCILLANTE - INFERIORE > 09/2002 TRACK CONTROL ARM - LOWER > 09/2002		
48068-12260 Z	<b>0788078</b>	BRACCIO OSCILLANTE - INFERIORE > 09/2002 - COMPLETO TRACK CONTROL ARM - LOWER > 09/2002 - COMPLETE		
48069-12260 Z	<b>0798078</b>	BRACCIO OSCILLANTE - INFERIORE > 09/2002 - COMPLETO TRACK CONTROL ARM - LOWER > 09/2002 - COMPLETE		
48068-02070 48068-13010	<b>0783091</b>	BRACCIO OSCILLANTE - INFERIORE 09/2002 > TRACK CONTROL ARM - LOWER 09/2002		
48069-02070 48069-13010	<b>0793091</b>	BRACCIO OSCILLANTE - INFERIORE 09/2002 TRACK CONTROL ARM - LOWER 09/2002		
48068-02070 Z 48068-13010 Z	<b>0788079</b>	BRACCIO OSCILLANTE - INFERIORE 09/2002 > - COMPLETO TRACK CONTROL ARM - LOWER 09/2002 - COMPLETE		
48069-02070 Z 48069-13010 Z	<b>0798079</b>	BRACCIO OSCILLANTE - INFERIORE 09/2002 > - COMPLETO TRACK CONTROL ARM - LOWER 09/2002 - COMPLETE		
48820-47010	<b>0502591</b>	STABILIZZATORE - ANTERIORE STABILIZER LINK - FRONT		

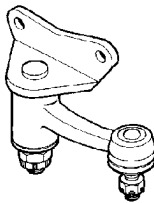
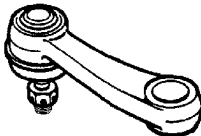
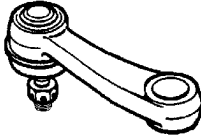

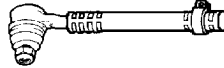
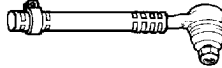
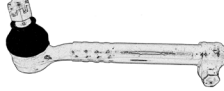
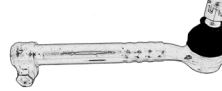

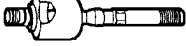

RIF. ORIG O.E. NUMBER	RIF. OCAP REF. OCAP	NOTE REMARKS	DESTRO RIGHT	SINISTRO LEFT
Anno - Year <b>10/01 &gt; 05/04</b>		Serie - Series <b>E12J</b>	Modello - Model <b>COROLLA VERSO</b>	
45046-49115 45046-19265 45046-09360	<b>0282614</b>	TESTA STERZO - RHT M14x1,5 TIE ROD END - RHT M14x1,5		
45047-49045 45047-19115 45047-09150	<b>0292614</b>	TESTA STERZO - RHT M14x1,5 TIE ROD END - RHT M14x1,5		
45503-12130 45503-19255	<b>0602594</b>	SNODO ASSIALE - RHT M14x1,5 AXIAL JOINT - RHT M14x1,5		
43330-19115 43330-09070	<b>0404409</b>	SNODO SOSPENSIONE INFERIORE SUSPENSION JOINT LOWER		
48820-47010	<b>0502591</b>	STABILIZZATORE - ANTERIORE STABILIZER LINK - FRONT		
Anno - Year <b>03/2004 &gt;</b>		Serie - Series <b>ZER - ZZE - R1</b>	Modello - Model <b>COROLLA VERSO</b>	
45046-09430	<b>0285188</b>	TESTA STERZO - RHT M16x1,5 TIE ROD END - RHT M16x1,5		
45503-20170 45503-0F010 45503-0R010	<b>0603122</b>	SNODO ASSIALE - RHT M16x1,5 AXIAL JOINT - RHT M16x1,5		
43330-09360	<b>0405189</b>	SNODO SOSPENSIONE - ASSE ANTERIORE - INFERIORE BALL JOINT - FRONT AXLE - LOWER		
48068-0F010	<b>0785189</b>	BRACCIO OSCILLANTE - ASSE ANTERIORE - INFERIORE TRACK CONTROL ARM - FRONT AXLE - LOWER		

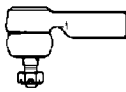
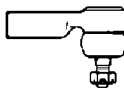
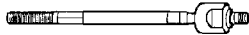
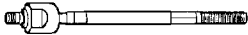
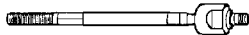
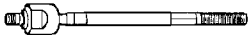
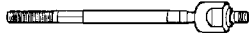
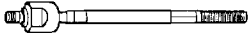
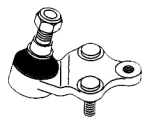
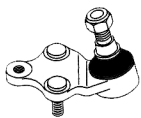
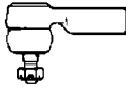
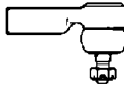
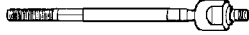
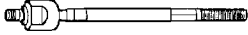
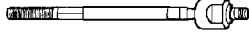
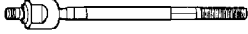
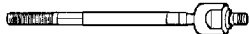
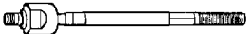
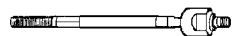
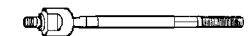
RIF. ORIG O.E. NUMBER	RIF. OCAP REF. OCAP	NOTE REMARKS	DESTRO RIGHT	SINISTRO LEFT
Anno - Year <b>03/2004 &gt;</b>		Serie - Series <b>ZER - ZZE - R1</b>	Modello - Model <b>COROLLA VERSO</b>	
48069-0F010	<b>0795189</b>	BRACCIO OSCILLANTE - ASSE ANTERIORE - INFERIORE TRACK CONTROL ARM - FRONT AXLE - LOWER		
48820-47010	<b>0502591</b>	STABILIZZATORE - ASSE ANTERIORE STABILIZER LINK - FRONT AXLE		
Anno - Year <b>1964 &gt; 1973</b>		Serie - Series <b>RT4-RT5-RT8-RT9</b>	Modello - Model <b>CORONA</b>	
45460-20020 45460-29035 45470-20020	<b>0503681</b>	BARRA STERZO - > 1970 TIE ROD - > 1970		
45046-29035 45046-29045 45047-29015	<b>0193681</b>	TESTA STERZO ESTERNA - LHT M14x1.5 TIE ROD END OUTER - LHT M14x1.5		
45406-20010 45406-29025	<b>0183682</b>	TESTA STERZO INTERNA - RHT M14x1.5 TIE ROD END INNER - RHT M14x1.5		
45460-29045	<b>0503683</b>	BARRA STERZO - 1970 > TIE ROD - 1970 >		
45046-29035 45046-29045 45047-29015	<b>0193681</b>	TESTA STERZO ESTERNA - LHT M14x1.5 TIE ROD END OUTER - LHT M14x1.5		
45406-29015 45406-29016	<b>0183684</b>	TESTA STERZO INTERNA - RHT M14x1.5 TIE ROD END INNER - RHT M14x1.5		
04436-20031 43308-20030 43330-29035 43340-29015	<b>0403685</b>	SNODO SOSPENSIONE INFERIORE SUSPENSION JOINT LOWER		

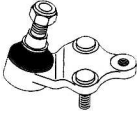
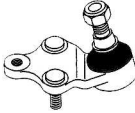

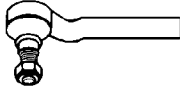
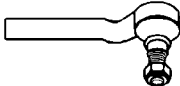
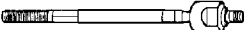
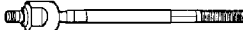
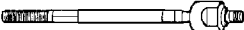
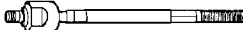

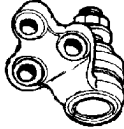
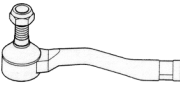



RIF. ORIG O.E. NUMBER	RIF. OCAP REF. OCAP	NOTE REMARKS	DESTRO RIGHT	SINISTRO LEFT
Anno - Year <b>1973 &gt; 1978</b>		Serie - Series <b>RT/TT10-RT/TT11-RT/TT12</b>	Modello - Model <b>CORONA</b>	
45460-29085	<b>0583686</b>	BARRA STERZO TIE ROD		
45470-29046	<b>0593686</b>	BARRA STERZO TIE ROD		
45046-19065 45046-19135 45046-29075 45046-29155	<b>0190748</b>	TESTA STERZO ESTERNA - LHT M14x1.5 TIE ROD END OUTER - LHT M14x1.5		
45406-29055 45406-29056 45406-29065	<b>0183686</b>	TESTA STERZO INTERNA - RHT M14x1.5 TIE ROD END INNER - RHT M14x1.5		
45407-29015 45407-29016	<b>0193686</b>	TESTA STERZO INTERNA - RHT M14x1.5 TIE ROD END INNER - RHT M14x1.5		
43350-29015 43360-29035 43360-29045	<b>0403687</b>	SNODO SOSPENSIONE SUPERIORE SUSPENSION JOINT UPPER		
43330-29056 43330-29066 43340-29026 43340-29036	<b>0403688</b>	SNODO SOSPENSIONE INFERIORE SUSPENSION JOINT LOWER		
Anno - Year <b>1978 &gt; 1982</b> <b>1982 &gt; 1987</b> <b>1982 &gt;</b>		Serie - Series <b>RT13-TT13</b> <b>TT147V-CT147V-KT147V</b> <b>YT140-CT140STD</b>	Modello - Model <b>CORONA</b>	
45046-19065 45046-19135 45046-29075 45046-29155	<b>0190748</b>	TESTA STERZO ESTERNA - LHT M14x1.5 TIE ROD END OUTER - LHT M14x1.5		
45406-19016	<b>0183633</b>	TESTA STERZO INTERNA - RHT M14x1.5 TIE ROD END INNER - RHT M14x1.5		
45401-29095	<b>0303691</b>	BRACCIO STERZO - > 1978 IDLER ARM - > 1978		







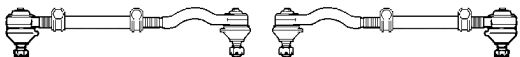

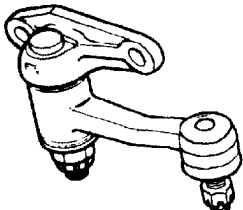
RIF. ORIG O.E. NUMBER	RIF. OCAP REF. OCAP	NOTE REMARKS	DESTRO RIGHT	SINISTRO LEFT
Anno - Year 1978 > 1982 1982 > 1987 1982 >		Serie - Series RT13-TT13 TT147V-CT147V-KT147V YT140-CT140STD	Modello - Model <b>CORONA</b>	
45490-29295	<b>0303626</b>	L H D - BRACCIO STERZO 1978 > L H D - IDLER ARM 1978 >		
45490-29135	<b>0303690</b>	LEVA STERZO - > 1978 PITMAN ARM - > 1978		
45401-19125	<b>0303628</b>	LEVA STERZO - 1978 > STERZO MANUALE PITMAN ARM - 1978 > MANUAL STEERING		
43308-12030 43308-19035	<b>0400963</b>	SNODO SOSPENSIONE INFERIORE SUSPENSION JOINT LOWER		
Anno - Year 1982 > 1987		Serie - Series AT140-ST140-TT142-CT140	Modello - Model <b>CORONA</b>	
45460-19165	<b>0283634</b>	TESTA STERZO - STERZO MANUALE - RHT M14x1.5 TIE ROD END - MANUAL STEERING - RHT M14x1.5		
45460-19155	<b>0283635</b>	TESTA STERZO - SERVOSTERZO - RHT M14x1.5 TIE ROD END - POWER STEERING - RHT M14x1.5		
45503-29125 45503-29010 45503-29015 45503-29016	<b>0603636</b>	SNODO ASSIALE - RHT M14x1.5 AXIAL JOINT - RHT M14x1.5		
43308-12030 43308-19035	<b>0400963</b>	SNODO SOSPENSIONE INFERIORE SUSPENSION JOINT LOWER		

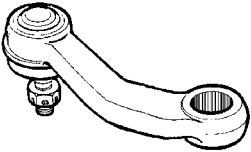



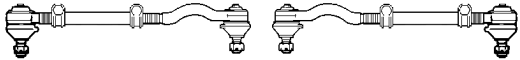

RIF. ORIG O.E. NUMBER	RIF. OCAP REF. OCAP	NOTE REMARKS	DESTRO RIGHT	SINISTRO LEFT
Anno - Year <b>1983 &gt; 1984</b>		Serie - Series <b>ST150-AT15-ST15-CT15</b>	Modello - Model <b>CORONA</b>	
45046-29135	<b>0283638</b>	TESTA STERZO - RHT M12x1.25 TIE ROD END - RHT M12x1.25		
45503-19035	<b>0603639</b>	SNODO ASSIALE - STERZO MANUALE - RHT M12x1.25 AXIAL JOINT - MANUAL STEERING - RHT M12x1.25		
45503-19085 45503-29025 45503-29105 45503-29175 45503-39015 45503-39025	<b>0603692</b>	SNODO ASSIALE - SERVOSTERZO - RHT M12x1.25 - SERIE ST 150 AXIAL JOINT - POWER STEERING - RHT M12x1.25 - SERIES ST 150		
45503-19055	<b>0603640</b>	SNODO ASSIALE - SERVOSTERZO - RHT M12x1.25 - SERIE AT/ST/CT15 AXIAL JOINT - POWER STEERING - RHT M12x1.25 - SERIES AT/ST/CT15		
43330-29135 43330-29136 43330-29137 43330-29138 43330-29139 43330-29205	<b>0403643</b>	SNODO SOSPENSIONE INFERIORE SUSPENSION JOINT LOWER		
Anno - Year <b>1984 &gt; 1987</b> <b>1985 &gt;</b>		Serie - Series <b>AT15-ST15-CT15</b> <b>AT16-ST16</b>	Modello - Model <b>CORONA</b>	
45046-19175 45046-29305	<b>0280141</b>	TESTA STERZO - RHT M14x1.5 TIE ROD END - RHT M14x1.5		
45503-19036	<b>0603641</b>	SNODO ASSIALE - STERZO MANUALE - RHT M14x1.5 - SERIE AT15/ST15/CT15 AXIAL JOINT - MANUAL STEERING - RHT M14x1.5 - SERIES AT15/ST15/CT15		
45503-19056	<b>0603642</b>	SNODO ASSIALE - SERVO STERZO - RHT M14x1.5 - SERIE AT15/ST15/CT15 AXIAL JOINT - POWER STEERING - RHT M14x1.5 - SERIES AT15/ST15/CT15		
45503-29075	<b>0603644</b>	SNODO ASSIALE - RHT M14x1.5 - SERIE AT16/ST16 SEDAN AXIAL JOINT - RHT M14x1.5 - SERIES AT16/ST16 SEDAN		
45503-29105 45503-39025 45503-39105	<b>0603631</b>	SNODO ASSIALE - RHT M14x1.5 - SERIE AT16/ST16 COUPE' AXIAL JOINT - RHT M14x1.5 - SERIES AT16/ST16 COUPE'		

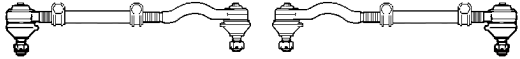

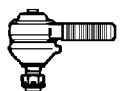
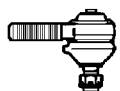
RIF. ORIG O.E. NUMBER	RIF. OCAP REF. OCAP	NOTE REMARKS	DESTRO RIGHT	SINISTRO LEFT
Anno - Year <b>1984 &gt; 1987</b> <b>1985 &gt;</b>		Serie - Series <b>AT15-ST15-CT15</b> <b>AT16-ST16</b>	Modello - Model <b>CORONA</b>	
43330-29135 43330-29136 43330-29137 43330-29138 43330-29139 43330-29205	<b>0403643</b>	SNODO SOSPENSIONE INFERIORE - SERIE AT15/ST15/CT15 SUSPENSION JOINT LOWER - SERIES AT15/ST15/CT15		
43330-29145 43330-29146 43330-29185	<b>0403645</b>	SNODO SOSPENSIONE INFERIORE - SERIE AT16/ST16 SUSPENSION JOINT LOWER - SERIES AT16/ST16		
Anno - Year <b>1987 &gt; 1992</b>		Serie - Series <b>AT170-CT170-ET176V-CT176V-ST17</b>	Modello - Model <b>CORONA</b>	
45046-29165	<b>0283646</b>	TESTA STERZO - RHT M15x1.5 TIE ROD END - RHT M15x1.5		
45047-29045	<b>0293646</b>	TESTA STERZO - RHT M15x1.5 TIE ROD END - RHT M15x1.5		
45503-29155	<b>0603648</b>	SNODO ASSIALE - STERZO MANUALE - RHT M15x1.5 AXIAL JOINT - MANUAL STEERING - RHT M15x1.5		
45503-29165	<b>0603647</b>	SNODO ASSIALE - SERVOSTERZO - RHT M15x1.5 AXIAL JOINT - POWER STEERING - RHT M15x1.5		
43330-29145 43330-29146 43330-29185	<b>0403645</b>	SNODO SOSPENSIONE INFERIORE SUSPENSION JOINT LOWER		
Anno - Year <b>1992 &gt;</b>		Serie - Series <b>ST191-AT190</b>	Modello - Model <b>CORONA</b>	
45046-29335 45046-29275	<b>0283693</b>	TESTA STERZO TIE ROD END		
45047-29075 45047-29105	<b>0293693</b>	TESTA STERZO TIE ROD END		

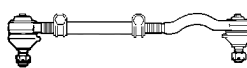
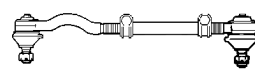
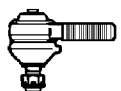
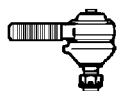

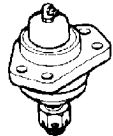
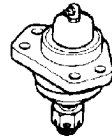

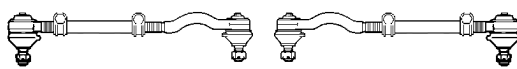
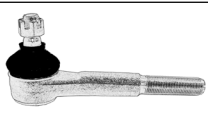
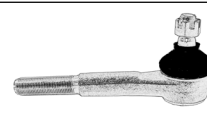
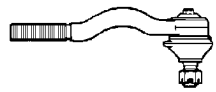
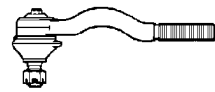

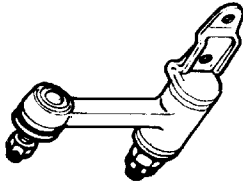
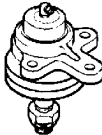
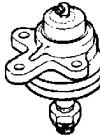
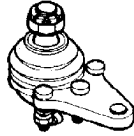
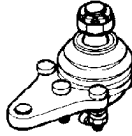
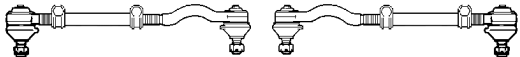
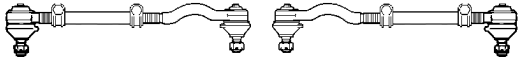

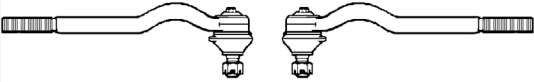
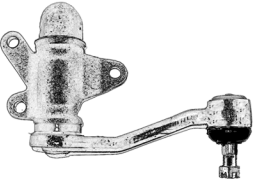
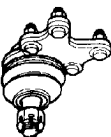
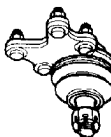



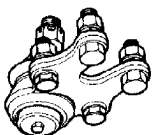
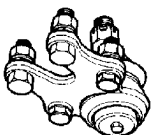

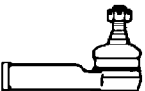

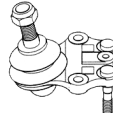
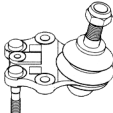





RIF. ORIG O.E. NUMBER	RIF. OCAP REF. OCAP	NOTE REMARKS	DESTRO RIGHT	SINISTRO LEFT
Anno - Year <b>1992 &gt;</b>		Serie - Series <b>ST191-AT190</b>	Modello - Model <b>CORONA</b>	
45503-29435 45503-29615	<b>0603694</b>	SNODO ASSIALE AXIAL JOINT		
45330-19095	<b>0403695</b>	SNODO SOSPENSIONE INFERIORE SUSPENSION JOINT LOWER		
Anno - Year <b>1967 &gt; 1970</b> <b>1971 &gt; 1974</b> <b>1974 &gt; 1979</b> <b>1979 &gt; 1983</b>		Serie - Series <b>RS5-MS5</b> <b>RS6-MS6-MS7</b> <b>RS8/10-MS8/9/10-LS10</b> <b>RS11-MS11-LS11-GS11</b>	Modello - Model <b>CROWN</b>	
45046-39016 45046-39026	<b>0193696</b>	TESTA STERZO ESTERNA - LHT M17x1.5 - > 1970 TIE ROD END OUTER - LHT M17x1.5 - > 1970		
45406-39016 45406-39026	<b>0183697</b>	TESTA STERZO INTERNA - RHT M17x1.5 - > 1970 TIE ROD END INNER - RHT M17x1.5 - > 1970		
45046-39075	<b>0193698</b>	TESTA STERZO ESTERNA - LHT M17x1.5 - 1971 > 1983 TIE ROD END OUTER - LHT M17x1.5 - 1971 > 1983		
45406-39055 45406-39075	<b>0183699</b>	TESTA STERZO INTERNA - RHT M17x1.5 - 1971 > 1983 TIE ROD END INNER - RHT M17x1.5 - 1971 > 1974		
45460-39075	<b>0503709</b>	BARRA STERZO - 1974 > 1983 TIE ROD - 1974 > 1983		
45046-39075	<b>0193698</b>	TESTA STERZO ESTERNA - LHT M17x1.5 - 1971 > 1983 TIE ROD END OUTER - LHT M17x1.5 - 1971 > 1983		
45406-39055	<b>0183710</b>	TESTA STERZO - RHT M17x1.5 1974 > 1983 TIE ROD END - RHT M17x1.5 1974 > 1983		
45490-39165	<b>0303713</b>	L H D - BRACCIO STERZO L H D - IDLER ARM		







RIF. ORIG O.E. NUMBER	RIF. OCAP REF. OCAP	NOTE REMARKS	DESTRO RIGHT	SINISTRO LEFT
Anno - Year <b>1967 &gt; 1970</b> <b>1971 &gt; 1974</b> <b>1974 &gt; 1979</b> <b>1979 &gt; 1983</b>		Serie - Series <b>RS5-MS5</b> <b>RS6-MS6-MS7</b> <b>RS8/10-MS8/9/10-LS10</b> <b>RS11-MS11-LS11-GS11</b>	Modello - Model <b>CROWN</b>	
45401-39185	<b>0303716</b>	L H D - LEVA STERZO - 1979 > 1983 L H D - PITMAN ARM - 1979 > 1983		
43350-39015 43350-39016 43350-39025 43350-39065	<b>0400431</b>	SNODO SOSPENSIONE SUPERIORE CON KIT SUSPENSION JOINT UPPER WITH KIT		
43330-39015	<b>0403711</b>	SNODO SOSPENSIONE INFERIORE - > 1974 SUSPENSION JOINT LOWER - > 1974		
43340-39125 43340-39135 43340-39205 43340-39215	<b>0403712</b>	SNODO SOSPENSIONE INFERIORE 1974 > SUSPENSION JOINT LOWER 1974 >		
Anno - Year <b>1983 &gt; 1987</b>		Serie - Series <b>YS12-MS12-LS12-GS12</b>	Modello - Model <b>CROWN</b>	
45460-39195	<b>0503718</b>	BARRRA STERZO TIE ROD		
45046-39155	<b>0193718</b>	TESTA STERZO ESTERNA - LHT M17x1.5 TIE ROD END OUTER - LHT M17x1.5		
45406-39105	<b>0183719</b>	TESTA STERZO INTERNA - RHT M17x1.5 TIE ROD END INNER - RHT M17x1.5		
43350-39015 43350-39016 43350-39025 43350-39065	<b>0400431</b>	SNODO SOSPENSIONE SUPERIORE SUSPENSION JOINT UPPER		
43340-39125 43340-39135 43340-39205 43340-39215	<b>0403712</b>	SNODO SOSPENSIONE INFERIORE SUSPENSION JOINT LOWER		
Anno - Year <b>1987 &gt;</b>		Serie - Series <b>YS130-MS13-LS130-GS13</b>	Modello - Model <b>CROWN</b>	
45460-39275 45470-39075	<b>0503720</b>	BARRA STERZO - STERZO MANUALE TIE ROD - MANUAL STEERING		

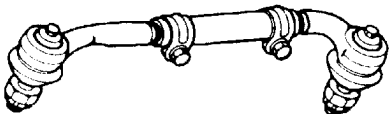

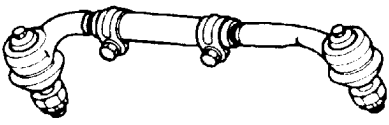

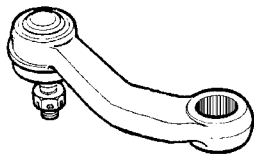
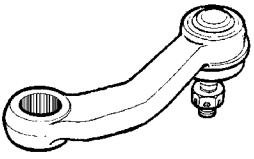

RIF. ORIG O.E. NUMBER	RIF. OCAP REF. OCAP	NOTE REMARKS	DESTRO RIGHT	SINISTRO LEFT
Anno - Year <b>1987 &gt;</b>		Serie - Series <b>YS130-MS13-LS130-GS13</b>	Modello - Model <b>CROWN</b>	
45046-39155	<b>0193718</b>	TESTA STERZO ESTERNA - STERZO MANUALE - LHT M17x1.5 TIE ROD END OUTER- MANUAL STEERING - LHT M17x1.5		
45406-39145	<b>0183721</b>	TESTA STERZO INTERNA - RHT M17x1.5 TIE ROD END OUTER- RHT M17x1.5		
45460-39265	<b>0583722</b>	BARRA STERZO - SERVOSTERZO TIE ROD - POWER STEERING		
45470-39065	<b>0593722</b>	BARRA STERZO - SERVOSTERZO TIE ROD - POWER STEERING		
45046-39195	<b>0193722</b>	TESTA STERZO ESTERNA - SERVOSTERZO - LHT M17x1.5 TIE ROD END OUTER- POWER STEERING - LHT M17x1.5		
45406-39145	<b>0183721</b>	TESTA STERZO INTERNA - RHT M17x1.5 TIE ROD END INNER - RHT M17x1.5		
43350-39055 43350-39065	<b>0403723</b>	SNODO SOSPENSIONE SUPERIORE SUSPENSION JOINT UPPER		
43340-39125 43340-39135 43340-39205 43340-39215	<b>0403712</b>	SNODO SOSPENSIONE INFERIORE SUSPENSION JOINT LOWER		
Anno - Year <b>1972 &gt; 1977</b> <b>1977 &gt; 1982</b> <b>1977 &gt; 1985</b>		Serie - Series <b>PH1-RH10</b> <b>RH11-RH2RH3-RH4-LH2-LH3</b> <b>RH11-RH24-LH24</b>	Modello - Model <b>HIACE</b>  <b>HIACE TRUCK</b>	
45460-29066	<b>0503767</b>	BARRA STERZO TIE ROD		
45045-29035	<b>0193768</b>	TESTA STERZO ESTERNA - LHT M17x1.5 TIE ROD END OUTER - LHT M17x1.5		
45406-29035 45406-29095	<b>0183769</b>	TESTA STERZO INTERNA - RHT M17x1.5 TIE ROD END INNER - RHT M17x1.5		

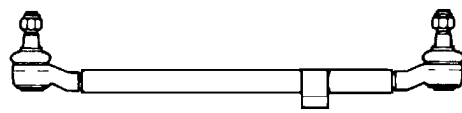
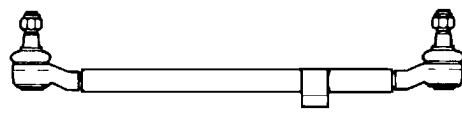
RIF. ORIG O.E. NUMBER	RIF. OCAP REF. OCAP	NOTE REMARKS	DESTRO RIGHT	SINISTRO LEFT
Anno - Year <b>1972 &gt; 1977</b> <b>1977 &gt; 1982</b> <b>1977 &gt; 1985</b>		Serie - Series <b>PH1-RH10</b> <b>RH11-RH2RH3-RH4-LH2-LH3</b> <b>RH11-RH24-LH24</b>	Modello - Model <b>HIACE</b>  <b>HIACE TRUCK</b>	
45490-29245	<b>0303774</b>	L H D - BRACCIO STERZO L H D - IDLER ARM		
43350-29025	<b>0403770</b>	SNODO SOSPENSIONE SUPERIORE SUSPENSION JOINT UPPER		
43330-39045 43330-39075 43340-39075	<b>0400429</b>	SNODO SOSPENSIONE INFERIORE CON KIT SUSPENSION JOINT LOWER WITH KIT		
Anno - Year <b>1982 &gt;</b> <b>1985 &gt;</b>		Serie - Series <b>YH5-YH6-YH7-LH50-LH60-LH70-LH51-LH61-LH71</b> <b>YH80-LH80</b>	Modello - Model <b>HIACE VAN - VAGON - COMMUTER</b> <b>HIACE TRUCK</b>	
45460-29265	<b>0503781</b>	BARRA STERZO - > 1985 TIE ROD - > 1985		
45460-29285 45470-29075	<b>0503782</b>	BARRA STERZO - 1985 > TIE ROD - 1985 >		
45046-29115 45046-29125 45046-39105 45046-39165 45046-39175 45046-39235	<b>0193759</b>	TESTA STERZO ESTERNA - LHT M17x1.5 TIE ROD END OUTER - LHT M17x1.5		
45406-29145 45406-29175 45047-39085	<b>0183783</b>	TESTA STERZO INTERNA - RHT M17x1.5 TIE ROD END INNER - RHT M17x1.5		
45490-29465	<b>0301789</b>	L H D - BRACCIO STERZO ECCETTO SERIE: YH80-LH80 L H D - IDELR ARM EXCEPT SERIES: YH80-LH80		
43350-29045 43350-29056 43360-29065 43360-29076	<b>0403784</b>	SNODO SOSPENSIONE SUPERIORE SUSPENSION JOINT UPPER		

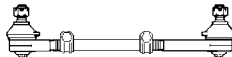
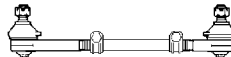



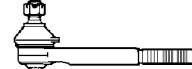
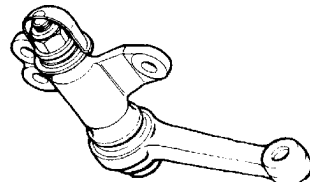
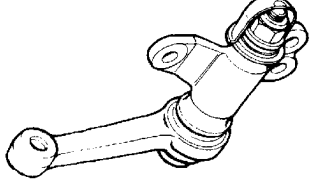

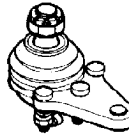
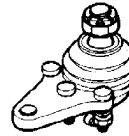
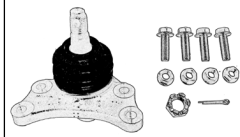
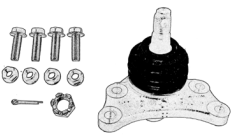

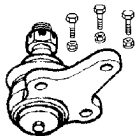
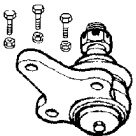
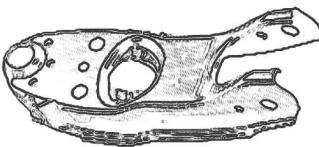
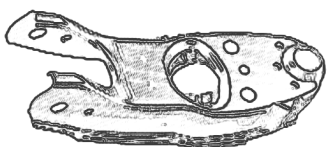

RIF. ORIG O.E. NUMBER	RIF. OCAP REF. OCAP	NOTE REMARKS	DESTRO RIGHT	SINISTRO LEFT
Anno - Year <b>1982 &gt;</b> <b>1985 &gt;</b>		Serie - Series <b>YH5-YH6-YH7-LH50-LH60-LH70-LH51-LH61-LH71</b> <b>YH80-LH80</b>	Modello - Model <b>HIACE VAN - VAGON - COMMUTER</b> <b>HIACE TRUCK</b>	
43330-29125	<b>0403785</b>	SNODO SOSPENSIONE INFERIORE - SERIE YH5-YH6-YH7-LH50-LH60-LH70 > 1985 - YH80-LH80 1985 > SUSPENSION JOINT LOWER - SERIES YH5-YH6-YH7-LH50-LH60-LH70 > 1985 - YH80-LH80 1985 >		
43330-29155	<b>0403786</b>	SNODO SOSPENSIONE INFERIORE - SERIE YH5-YH6-YH7-LH51-LH61-LH71 1985 > SUSPENSION JOINT LOWER - SERIES YH5-YH6-YH7-LH51-LH61-LH71 1985 >		
Anno - Year <b>1989 &gt; 1995</b>		Serie - Series <b>_H10_</b>	Modello - Model <b>HIACE III</b>	
45046-29215	<b>0282970</b>	TESTA STERZO - RHT M17x1,5 TIE ROD END - RHT M17x1,5		
45503-29255	<b>0602971</b>	SNODO ASSIALE - RHT M17x1,5 AXIAL JOINT - RHT M17x1,5		
43350-29095 43350-29065	<b>0402972</b>	SNODO SOSPENSIONE SUPERIORE SUSPENSION JOINT UPPER		
48610-29085	<b>0782972</b>	BRACCIO OSCILLANTE SUPERIORE TRACK CONTROL ARM UPPER		
48610-29075	<b>0792972</b>	BRACCIO OSCILLANTE SUPERIORE TRACK CONTROL ARM UPPER		
43330-29125	<b>0403785</b>	SNODO SOSPENSIONE INFERIORE SUSPENSION JOINT LOWER		

RIF. ORIG O.E. NUMBER	RIF. OCAP REF. OCAP	NOTE REMARKS	DESTRO RIGHT	SINISTRO LEFT
Anno - Year <b>08/1995 &gt;</b>		Serie - Series <b>H1</b>	Modello - Model <b>HIACE IV</b>	
45046-29325 45046-29375	<b>0283099</b>	TESTA STERZO - RHT M15x1,5 TIE ROD END - RHT M15x1,5		
45503-29565	<b>0603100</b>	SNODO ASSIALE - RHT M15x1,5 AXIAL JOINT - RHT M15x1,5		
48066-29075	<b>0383102</b>	BRACCIO OSCILLANTE - ASSE ANTERIORE - SUPERIORE TRACK CONTROL ARM FRONT AXLE - UPPER		
48067-29085	<b>0393102</b>	BRACCIO OSCILLANTE - ASSE ANTERIORE - SUPERIORE TRACK CONTROL ARM - FRONT AXLE - UPPER		
43330-29125	<b>0403101</b>	SNODO SOSPENSIONE - ASSE ANTERIORE - INFERIORE BALL JOINT - FRONT AXLE - LOWER		
48068-26070 48068-26071	<b>0783101</b>	BRACCIO OSCILLANTE - ASSE ANTERIORE - INFERIORE TRACK CONTROL ARM - FRONT AXLE - LOWER		
48069-26070 48069-26071	<b>0793101</b>	BRACCIO OSCILLANTE - ASSE ANTERIORE - INFERIORE TRACK CONTROL ARM - FRONT AXLE - LOWER		
48820-26030	<b>0583103</b>	STABILIZZATORE - ANTERIORE STABILIZER LINK - FRONT		
48810-26030	<b>0593103</b>	STABILIZZATORE - ANTERIORE STABILIZER LINK - FRONT		
Anno - Year <b>1972 &gt; 1978</b>		Serie - Series <b>RN2</b>	Modello - Model <b>HILUX</b>	
45460-39065	<b>0583776</b>	BARRA STERZO TIE ROD		

RIF. ORIG O.E. NUMBER	RIF. OCAP REF. OCAP	NOTE REMARKS	DESTRO RIGHT	SINISTRO LEFT
Anno - Year <b>1972 &gt; 1978</b>		Serie - Series <b>RN2</b>	Modello - Model <b>HILUX</b>	
45470-39035	<b>0593776</b>	BARRA STERZO TIE ROD		
45046-39085	<b>0183776</b>	TESTA STERZO ESTERNA - LHT M17x1,5 TIE ROD END - OUTER - LHT M17x1,5		
45047-39055	<b>0193776</b>	TESTA STERZO ESTERNA - LHT M17x1,5 TIE ROD END - OUTER - LHT M17x1,5		
45406-39065	<b>0183777</b>	TESTA STERZO INTERNA - RHT M17x1,5 TIE ROD END - INNER - RHT M17x1,5		
45401-39115	<b>0303778</b>	LEVA STERZO - > 1973 PITMAN ARM - > 1973		
45401-39116 45401-39145	<b>0303779</b>	LEVA STERZO - 1973 > 1978 PITMAN ARM - 1973 > 1978		
43350-39015 43350-39016 43350-39025 43350-39065	<b>0400431</b>	SNODO SOSPENSIONE SUPERIORE CON KIT SUSPENSION JOINT UPPER WITH KIT		
43330-39045 43330-39075 43340-39075	<b>0400429</b>	SNODO SOSPENSIONE INFERIORE CON KIT SUSPENSION JOINT INFERIORE WITH KIT		
Anno - Year <b>1978 &gt; 1983</b> <b>1983 &gt;</b>		Serie - Series <b>RN30-RN33-RN35-RN40-RN43-RN45-LN30-LN40 LN5-YN5</b>	Modello - Model <b>HILUX</b>	
45450-39015 45450-39016 45450-39055 45450-39065	<b>0503788</b>	R H D - BARRA STERZO - > 1983 R H D - TIE ROD - > 1983		
45450-39145	<b>0503791</b>	BARRA STERZO - MOD. USA - SERVOSTERZO - 1983 > TIE ROD - MOD. USA - POWER STEERING - 1983 >		

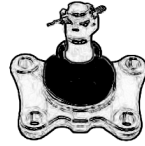
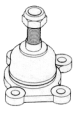

RIF. ORIG O.E. NUMBER	RIF. OCAP REF. OCAP	NOTE REMARKS	DESTRO RIGHT	SINISTRO LEFT
Anno - Year <b>1978 &gt; 1983</b> <b>1983 &gt;</b>		Serie - Series <b>RN30-RN33-RN35-RN40-RN43-RN45-LN30-LN40</b> <b>LN5-YN5</b>	Modello - Model <b>HILUX</b>	
45460-29215 45460-39095 45460-39096 45460-39155 45460-39215 45460-39225	<b>0503792</b>	BARRA STERZO TIE ROD		
45046-29115 45046-29125 45046-39105 45046-39165 45046-39175 45046-39235	<b>0193759</b>	TESTA STERZO ESTERNA - LHT M17x1,5 TIE ROD END OUTER - LHT M17x1,5		
45406-29115 45406-39085 45406-39086 45406-39095 45406-39115 45406-39125	<b>0183793</b>	TESTA STERZO INTERNA - RHT M17x1,5 TIE ROD END INNER - RHT M17x1,5		
45490-35140	<b>0303794</b>	L H D - BRACCIO STERZO - MOD. LN5-YN5 L H D - IDLER ARM - MOD. LN5-YN5		
45490-35130	<b>0303795</b>	R H D - BRACCIO STERZO - MOD. LN5-YN5 R H D - IDLER ARM - MOD. LN5-YN5		
43350-39015 43350-39016 43350-39025 43350-39065	<b>0400431</b>	SNODO SOSPENSIONE SUPERIORE CON KIT SUSPENSION JOINT UPPER WITH KIT		
43330-39045 43330-39075 43340-39075	<b>0400429</b>	SNODO SOSPENSIONE INFERIORE CON KIT SUSPENSION JOINT LOWER WITH KIT		
43350-39035 43350-39075	<b>0400430</b>	SNODO SOSPENSIONE SUPERIORE CON KIT - MOD. LN5-YN5 SUSPENSION JOINT UPPER WITH KIT - MOD. LN5-YN5		



RIF. ORIG O.E. NUMBER	RIF. OCAP REF. OCAP	NOTE REMARKS	DESTRO RIGHT	SINISTRO LEFT
Anno - Year 1978 > 1983 1983 >	Serie - Series RN30-RN33-RN35-RN40-RN43-RN45-LN30-LN40 LN5-YN5		Modello - Model HILUX	
43330-39165 43340-39145	0400428	SNODO SOSPENSIONE INFERIORE CON KIT - MOD. LN5-YN5 SUSPENSION JOINT LOWER WITH KIT - MOD. LN5-YN5		
48605-35030	0783799	BRACCIO OSCILLANTE TRACK CONTROL ARM		
48606-35030	0793799	BRACCIO OSCILLANTE TRACK CONTROL ARM		
Anno - Year 1985 >	Serie - Series YN61-YN63-LN61-LN66-RN61-RN66-YZN61-VZN66-R N101-RN106-RN110-		Modello - Model HILUX 4WD	
45046-29115 45046-29125 45046-39105 45046-39165 45046-39175 45046-39235	0193759	TESTA STERZO - LHT M17x1,5 TIE ROD END - LHT M17x1,5		
45406-39135	0183762	TESTA STERZO - INTERNA - RHT M17x1,5 TIE ROD END - INNER - RHT M17x1,5		
43350-39045	0403765	SNODO SOSPENSIONE SUPERIORE SUSPENSION JOINT UPPER		
43340-39235 43340-39175 43330-39195 43330-39255	0403766	SNODO SOSPENSIONE INFERIORE - > 1989 SUSPENSION JOINT LOWER - > 1989		
43330-39315 43330-39265 43340-39254	0402973	SNODO SOSPENSIONE INFERIORE - 1989 > SUSPENSION JOINT LOWER - 1989 >		

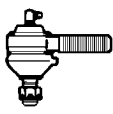
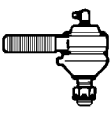
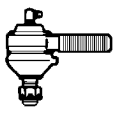
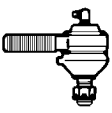
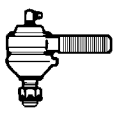
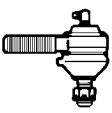
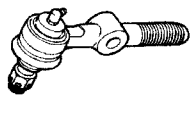
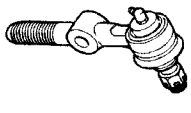
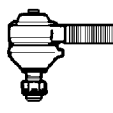
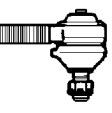
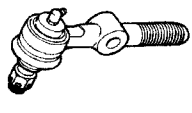
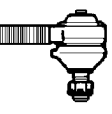

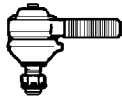
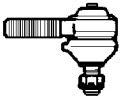
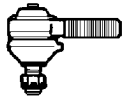
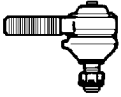
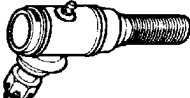
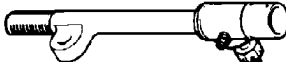
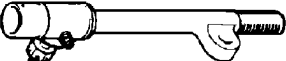
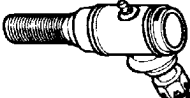
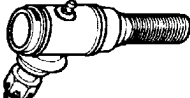
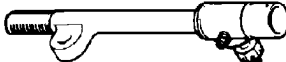







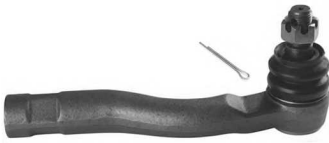

RIF. ORIG O.E. NUMBER	RIF. OCAP REF. OCAP	NOTE REMARKS	DESTRO RIGHT	SINISTRO LEFT
Anno - Year <b>08/2005 &gt;</b>		Serie - Series	Modello - Model <b>HILUX III PICK-UP</b>	
45046-09281 45046-09280 45046-09310	<b>0285198</b>	TESTA STERZO - RHT M14x1,5 TIE ROD END - RHT M14x1,5		
45503-09321	<b>0605199</b>	SNODO ASSIALE - RHT M14x1,5 AXIAL JOINT - RHT M14x1,5		
43310-09015 43310-09030 43310-0K010 43310-0K040	<b>0405200</b>	SNODO SOSPENSIONE - ASSE ANTERIORE - SUPERIORE BALL JOINT - FRONT AXLE - UPPER		
48610-0K040	<b>0785200</b>	BRACCIO OSCILLANTE - ASSE ANTERIORE - SUPERIORE TRACK CONTROL ARM - FRONT AXLE - UPPER		
48630-0K040	<b>0795200</b>	BRACCIO OSCILLANTE - ASSE ANTERIORE - SUPERIORE TRACK CONTROL ARM - FRONT AXLE - UPPER		
43330-09510 43330-09295 43330-09490	<b>0404149</b>	SNODO SOSPENSIONE - ASSE ANTERIORE - INFERIORE BALL JOINT - FRONT AXLE - LOWER		
48068-0K040	<b>0784149</b>	BRACCIO OSCILLANTE - ASSE ANTERIORE - INFERIORE TRACK CONTROL ARM - FRONT AXLE - LOWER		
48069-0K040	<b>0794149</b>	BRACCIO OSCILLANTE - ASSE ANTERIORE - INFERIORE TRACK CONTROL ARM - FRONT AXLE - LOWER		
48820-60050 48820-0K030	<b>0584562</b>	STABILIZZATORE - ASSE ANTERIORE STABILIZER LINK - FRONT AXLE		

RIF. ORIG O.E. NUMBER	RIF. OCAP REF. OCAP	NOTE REMARKS	DESTRO RIGHT	SINISTRO LEFT
Anno - Year <b>08/2005 &gt;</b>		Serie - Series	Modello - Model <b>HILUX III PICK-UP</b>	
48810-60040	<b>0594562</b>	STABILIZZATORE - ASSE ANTERIORE STABILIZER LINK - FRONT AXLE		
Anno - Year <b>1964 &gt; 1984</b>		Serie - Series <b>FJ4-FJ5-BJ4</b>	Modello - Model <b>LAND CRUISER</b>	
45046-60030 45046-60033 45046-69025	<b>0180971</b>	TESTA STERZO - RHT M17x1,5 TIE ROD END - RHT M17x1,5		
45045-60H00 45045-60010 45045-60013 45045-69015	<b>0190971</b>	TESTA STERZO - LHT M17x1,5 TIE ROD END - LHT M17x1,5		
45046-60040 45046-60042 45046-69035	<b>0180973</b>	TESTA STERZO - RHT M21x1,5 TIE ROD END - RHT M21x1,5		
45046-60021 45046-60023 45046-60081 45046-69055	<b>0190973</b>	L H D - TESTA STERZO - LHT M21x1,5 L H D - TIE ROD END - LHT M21x1,5		
45046-60011	<b>0193733</b>	R H D - TESTA STERZO - RHT M21x1,5 R H D - TIE ROD END - RHT M21x1,5		
45047-60H00 45047-60010 45047-60013 45047-69025	<b>0190972</b>	TESTA STERZO LHT M17x1,5 TIE ROD END LHT M17x1,5		
Anno - Year <b>1980 &gt; 1990</b> <b>1980 &gt; 1990</b> <b>1980 &gt; 1990</b>		Serie - Series <b>BJ6-FJ6-HJ6</b> <b>BJ7-FJ7-HJ75</b> <b>RJ70-LJ70-LJ71</b>	Modello - Model <b>LAND CRUISER</b>	
45046-69116 45046-69115	<b>0193738</b>	L H D - TESTA STERZO - LHT M23x1,5 - SERIE BJ6-FJ6-HJ6-BJ7-FJ7-HJ75 L H D - TIE ROD END - LHT M23x1,5 - SERIES BJ6-FJ6-HJ6-BJ7-FJ7-HJ75		
45047-60H02	<b>0183739</b>	L H D - TESTA STERZO - RHT M23x1,5 - SERIE BJ6-FJ6-HJ6-BJ7-FJ7-HJ75 L H D - TIE ROD END - RHT M23x1,5 - SERIES BJ6-FJ6-HJ6-BJ7-FJ7-HJ75		

RIF. ORIG O.E. NUMBER	RIF. OCAP REF. OCAP	NOTE REMARKS	DESTRO RIGHT	SINISTRO LEFT
Anno - Year 1980 > 1990 1980 > 1990 1980 > 1990		Serie - Series BJ6-FJ6-HJ6 BJ7-FJ7-HJ75 RJ70-LJ70-LJ71		Modello - Model LAND CRUISER
45047-60H02	0183739	R H D - TESTA STERZO - RHT M23x1,5 - SERIE BJ6-FJ6-HJ6-BJ7-FJ7-HJ75 R H D - TIE ROD END - RHT M23x1,5 - SERIES BJ6-FJ6-HJ6-BJ7-FJ7-HJ75		
45046-69105 45046-60H04	0193742	R H D - TESTA STERZO - LHT M23x1,5 - SERIE BJ6-FJ6-HJ6-BJ7-FJ7-HJ75 R H D - TIE ROD END - LHT M23x1,5 - SERIES BJ6-FJ6-HJ6-BJ7-FJ7-HJ75		
45047-60H02	0183739	TESTA STERZO - RHT M23x1,5 - SERIE RJ70-LJ70-LJ71 TIE ROD END - RHT M23x1,5 - SERIES RJ70-LJ70-LJ71		
45046-60H03	0193746	TESTA STERZO - LHT M23x1,5 - SERIE RJ70-LJ70-LJ71 TIE ROD END - LHT M23x1,5 - SERIES RJ70-LJ70-LJ71		
45045-69035	0183740	L H D - TESTA STERZO DI COLLEGAMENTO - RHT M21x1,5 - SERIE BJ6-FJ6-HJ6-BJ7-FJ7-HJ75 L H D - RELAY ROD END - RHT M21x1,5 - SERIES BJ6-FJ6-HJ6-BJ7-FJ7-HJ75		
45044-69035	0193741	L H D - TESTA STERZO DI COLLEGAMENTO - LHT M21x1,5 - SERIE BJ6-FJ6-HJ6 L H D - RELAY ROD END - LHT M21x1,5 - SERIES BJ6-FJ6-HJ6		
45044-69045	0193743	R H D - TESTA STERZO DI COLLEGAMENTO - LHT M21x1,5 - SERIE BJ6-FJ6-HJ6 R H D - RELAY ROD END - LHT M21x1,5 - SERIES BJ6-FJ6-HJ6		
45045-69035	0183740	R H D - TESTA STERZO DI COLLEGAMENTO - RHT M21x1,5 - SERIE BJ6-FJ6-HJ6-BJ7-FJ7-HJ75 R H D - RELAY ROD END - RHT M21x1,5 - SERIES BJ6-FJ6-HJ6-BJ7-FJ7-HJ75		
45045-69035	0183740	L H D - TESTA STERZO DI COLLEGAMENTO - RHT M21x1,5 - SERIE BJ6-FJ6-HJ6-BJ7-FJ7-HJ75 L H D - RELAY ROD END - RHT M21x1,5 - SERIES BJ6-FJ6-HJ6-BJ7-FJ7-HJ75		
45044-60H03	0193744	L H D - TESTA STERZO DI COLLEGAMENTO - LHT M21x1,5 - SERIE BJ7-FJ7-HJ75 L H D - RELAY ROD END - LHT M21x1,5 - SERIES BJ7-FJ7-HJ75		
45045-69035	0183740	R H D - TESTA STERZO DI COLLEGAMENTO - RHT M21x1,5 MOD. BJ7-FJ7-HJ75 R H D - RELAY ROD END - RHT M21x1,5 - MOD. BJ7-FJ7-HJ75		









RIF. ORIG O.E. NUMBER	RIF. OCAP REF. OCAP	NOTE REMARKS	DESTRO RIGHT	SINISTRO LEFT
Anno - Year <b>1980 &gt; 1990</b> 1980 > 1990 1980 > 1990		Serie - Series <b>BJ6-FJ6-HJ6</b> <b>BJ7-FJ7-HJ75</b> <b>RJ70-LJ70-LJ71</b>	Modello - Model <b>LAND CRUISER</b>	
48820-60010	<b>0582627</b>	STABILIZZATORE - ASSE ANTERIORE STABILIZER LINK - FRONT AXLE		
48810-60010	<b>0592627</b>	STABILIZZATORE - ASSE ANTERIORE STABILIZER LINK - FRONT AXLE		
Anno - Year <b>01/90 &gt; 01/98</b>		Serie - Series <b>FJ80-HDJ81-HZJ81-FZJ80</b>	Modello - Model <b>LAND CRUISER 80</b>	
45046-69135	<b>0182965</b>	TESTA STERZO - LHT M23x1,5 TIE ROD END - LHT M23x1,5		
45047-69085	<b>0192966</b>	TESTA STERZO - LHT M23x1,5 TIE ROD END - LHT M23x1,5		
45045-69065	<b>0182967</b>	TESTA STERZO - RHT M21x1,5 - L H D LATO DESTRO - R H D LATO SINISTRO TIE ROD END - RHT M21x1,5 - L H D RIGHT SIDE - R H D LEFT SIDE		
45044-69125	<b>0192968</b>	TESTA STERZO - LHT M21x1,5 - L H D TIE ROD END - LHT M21x1,5 - L H D		
45044-69115	<b>0192969</b>	TESTA STERZO - LHT M21x1,5 - R H D TIE ROD END - LHT M21x1,5 - R H D		
Anno - Year <b>1996 &gt;</b>		Serie - Series <b>J9</b>	Modello - Model <b>LAND CRUISER 90</b>	
45046-39335	<b>0182479</b>	TESTA STERZO - RHT M20x1,5 TIE ROD END - RHT M20x1,5		
45047-39215	<b>0192479</b>	TESTA STERZO - RHT M20x1,5 TIE ROD END - RHT M20x1,5		
45503-39075	<b>0602480</b>	SNODO ASSIALE STERZO - RHT M20x1,5 AXIAL JOINT - RHT M20x1,5		









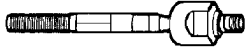

RIF. ORIG O.E. NUMBER	RIF. OCAP REF. OCAP	NOTE REMARKS	DESTRO RIGHT	SINISTRO LEFT
Anno - Year <b>1996 &gt;</b>		Serie - Series <b>J9</b>	Modello - Model <b>LAND CRUISER 90</b>	
43310-39016	<b>0402621</b>	SNODO SOSPENSIONE SUPERIORE SUSPENSION JOINT UPPER		
48610-32040	<b>0782624</b>	BRACCIO OSCILLANTE - ASSE ANTERIORE - SUPERIORE TRACK CONTROL ARM - FRONT AXLE - UPPER		
48630-35020	<b>0792624</b>	BRACCIO OSCILLANTE - ASSE ANTERIORE - SUPERIORE TRACK CONTROL ARM - FRONT AXLE - UPPER		
43330-39415 43330-39466 43330-39585	<b>0482622</b>	SNODO SOSPENSIONE INFERIORE SUSPENSION JOINT LOWER		
43340-39325 43340-39356 43340-39465	<b>0492622</b>	SNODO SOSPENSIONE INFERIORE SUSPENSION JOINT LOWER		
48068-35080 48068-35081	<b>0782622</b>	BRACCIO OSCILLANTE - ASSE ANTERIORE - INFERIORE TRACK CONTROL ARM - FRONT AXLE - LOWER		
48069-35080 48069-35081	<b>0792622</b>	BRACCIO OSCILLANTE - ASSE ANTERIORE - INFERIORE TRACK CONTROL ARM - FRONT AXLE - LOWER		
48820-35030 48820-AD010	<b>0502623</b>	STABILIZZATORE - ASSE ANTERIORE STABILIZER LINK - FRONT AXLE		
48830-35020	<b>0502624</b>	STABILIZZATORE - ASSE POSTERIORE STABILIZER LINK - REAR AXLE		

RIF. ORIG O.E. NUMBER	RIF. OCAP REF. OCAP	NOTE REMARKS	DESTRO RIGHT	SINISTRO LEFT
Anno - Year <b>01/1998 &gt;</b>		Serie - Series <b>J10</b>	Modello - Model <b>LAND CRUISER 100</b>	
45046-69195	<b>0284554</b>	TESTA STERZO - RHT M20x1,5 - > 08/2002 TIE ROD END - RHT M20x1,5 - > 08/2002		
45047-69100	<b>0294554</b>	TESTA STERZO - RHT M20x1,5 - > 08/2002 TIE ROD END - RHT M20x1,5 - > 08/2002		
45503-69015	<b>0604556</b>	SNODO ASSIALE - RHT M20x1,5 - > 08/2002 AXIAL JOINT - RHT M20x1,5 - > 08/2002		
45046-69205	<b>0284555</b>	TESTA STERZO - RHT M20x1,5 - 09/2002 > TIE ROD END - RHT M20x1,5 - 09/2002 >		
45047-69115	<b>0294555</b>	TESTA STERZO - RHT M20x1,5 - 09/2002 > TIE ROD END - RHT M20x1,5 - 09/2002 >		
45503-69025	<b>0604557</b>	SNODO ASSIALE - RHT M20x1,5 - 09/2002 > AXIAL JOINT - RHT M20x1,5 - 09/2002 >		
-	<b>0404558</b>	SNODO SOSPENSIONE - ASSE ANTERIORE - SUPERIORE BALL JOINT - FRONT AXLE - UPPER		
48610-60030	<b>0784558</b>	BRACCIO OSCILLANTE - ASSE ANTERIORE - SUPERIORE TRACK CONTROL ARM - FRONT AXLE - UPPER		
48630-60010	<b>0794558</b>	BRACCIO OSCILLANTE - ASSE ANTERIORE - SUPERIORE TRACK CONTROL ARM - FRONT AXLE - UPPER		
-	<b>0404559</b>	SNODO SOSPENSIONE - ASSE ANTERIORE - INFERIORE BALL JOINT - FRONT AXLE - LOWER		

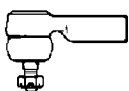
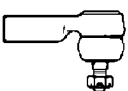
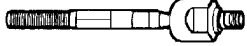
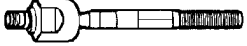

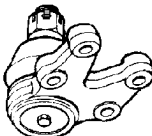
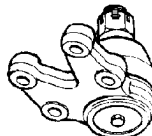
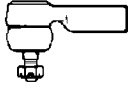
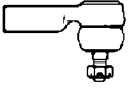
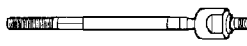
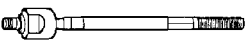



RIF. ORIG O.E. NUMBER	RIF. OCAP REF. OCAP	NOTE REMARKS	DESTRO RIGHT	SINISTRO LEFT
Anno - Year <b>01/1998 &gt;</b>		Serie - Series <b>J10</b>	Modello - Model <b>LAND CRUISER 100</b>	
48620-60010	<b>0784559</b>	BRACCIO OSCILLANTE - ASSE ANTERIORE - INFERIORE TRACK CONTROL ARM - FRONT AXLE - LOWER		
48640-60010	<b>0794559</b>	BRACCIO OSCILLANTE - ASSE ANTERIORE - INFERIORE TRACK CONTROL ARM - FRONT AXLE - LOWER		
Anno - Year <b>09/2002 &gt;</b>		Serie - Series <b>J12</b>	Modello - Model <b>LAND CRUISER 120</b>	
45046-39505	<b>0282625</b>	TESTA STERZO - RHT M15x1,5 TIE ROD END - RHT M15x1,5		
45503-39235 45503-39265	<b>0602626</b>	SNODO ASSIALE - RHT M15x1,5 AXIAL JOINT - RHT M15x1,5		
-	<b>0404560</b>	SNODO SOSPENSIONE - ASSE ANTERIORE - SUPERIORE BALL JOINT - FRONT AXLE - UPPER		
48610-60050	<b>0784560</b>	BRACCIO OSCILLANTE - ASSE ANTERIORE - SUPERIORE TRACK CONTROL ARM - FRONT AXLE - UPPER		
48630-60020	<b>0794560</b>	BRACCIO OSCILLANTE - ASSE ANTERIORE - SUPERIORE TRACK CONTROL ARM - FRONT AXLE - UPPER		
48068-60010	<b>0784561</b>	BRACCIO OSCILLANTE - ASSE ANTERIORE - INFERIORE TRACK CONTROL ARM - FRONT AXLE - LOWER		



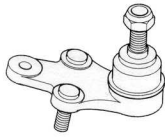
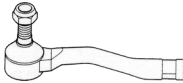





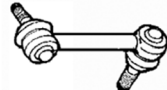
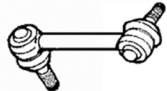





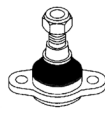
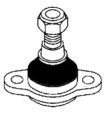





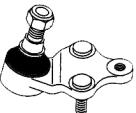
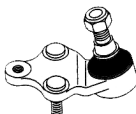

RIF. ORIG O.E. NUMBER	RIF. OCAP REF. OCAP	NOTE REMARKS	DESTRO RIGHT	SINISTRO LEFT
Anno - Year <b>09/2002 &gt;</b>		Serie - Series <b>J12</b>	Modello - Model <b>LAND CRUISER 120</b>	
48069-60010	<b>0794561</b>	BRACCIO OSCILLANTE - ASSE ANTERIORE - INFERIORE TRACK CONTROL ARM - FRONT AXLE - LOWER		
48820-60050 48820-0K030	<b>0584562</b>	STABILIZZATORE - ASSE ANTERIORE STABILIZER LINK - FRONT AXLE		
48810-60040	<b>0594562</b>	STABILIZZATORE - ASSE ANTERIORE STABILIZER LINK - FRONT AXLE		
48830-60030	<b>0504563</b>	STABILIZZATORE - ASSE POSTERIORE STABILIZER LINK - REAR AXLE		
Anno - Year <b>1982 &gt; 1985</b>		Serie - Series <b>KM21V-YM20-CM20</b>	Modello - Model <b>LITEACE VAN - LITEACE WAGON</b>	
45046-19065 45046-19135 45046-29075 45046-29155	<b>0190748</b>	TESTA STERZO ESTERNA - LHT M14x1,5 TIE ROD END - OUTER - LHT M14x1,5		
45406-19016	<b>0183633</b>	TESTA STERZO INTERNA - RHT M14x1,5 TIE ROD END - INNER - RHT M14x1,5		
43350-29035 43350-29036 43360-29055 43360-29056	<b>0402974</b>	SNODO SOSPENSIONE SUPERIORE SUSPENSION JOINT UPPER		
43330-29115 43330-29175 43340-29095	<b>0403758</b>	SNODO SOSPENSIONE INFERIORE SUSPENSION JOINT LOWER		
Anno - Year <b>1985 &gt; 1992</b>		Serie - Series <b>KM30-CM30-YM30</b>	Modello - Model <b>LITEACE</b>	
45460-29315 45470-29085	<b>0282350</b>	TESTA STERZO - > 07/1988 - RHT M14x1,5 TIE ROD END - > 07/1988 - RHT M14x1,5		







RIF. ORIG O.E. NUMBER	RIF. OCAP REF. OCAP	NOTE REMARKS	DESTRO RIGHT	SINISTRO LEFT
Anno - Year <b>1985 &gt; 1992</b>		Serie - Series <b>KM30-CM30-YM30</b>	Modello - Model <b>LITEACE</b>	
45503-29095 45503-29135	<b>0602976</b>	SNODO ASSIALE - STERZO MANUALE - RHT M14x1,5 - > 1988 AXIAL JOINT - MANUAL STEERING - RHT M14x1,5 - > 1988		
45503-29125 45503-29010 45503-29015 45503-29016	<b>0603636</b>	SNODO ASSIALE - SERVOSTERZO - RHT M14x1,5 - > 1988 AXIAL JOINT - POWER STEERING - RHT M14x1,5 - > 1988		
45046-29185	<b>0282977</b>	TESTA STERZO - 08/1988 > TIE ROD END - 08/1988 >		
45503-29215	<b>0602978</b>	SNODO ASSIALE - STERZO MANUALE - 1988 > AXIAL JOINT - MANUAL STEERING - 1988 >		
43350-29035 43350-29036 43360-29055 43360-29056	<b>0402974</b>	SNODO SOSPENSIONE SUPERIORE - > 1988 SUSPENSION JOINT UPPER - > 1988		
43330-29115 43330-29175 43340-29095	<b>0403758</b>	SNODO SOSPENSIONE INFERIORE - > 1988 SUSPENSION JOINT LOWER - > 1988		
Anno - Year <b>11/84 &gt; 06/90</b>		Serie - Series <b>W1</b>	Modello - Model <b>MR 2</b>	
45046-29135	<b>0283638</b>	TESTA STERZO - RHT M12x1,25 TIE ROD END - RHT M12x1,25		
45503-19066	<b>0603105</b>	SNODO ASSIALE - RHT M12X1,25 AXIAL JOINT - RHT M12X1,25		
43330-19025	<b>0403678</b>	SNODO SOSPENSIONE INFERIORE SUSPENSION JOINT LOWER		
48820-17010	<b>0503110</b>	STABILIZZATORE - ANTERIORE STABILIZER LINK - FRONT		
48830-17010	<b>0503111</b>	STABILIZZATORE - POSTERIORE > 08/1986 STABILIZER LINK - POSTERIORE > 08/1986		



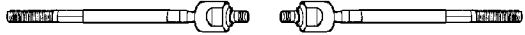

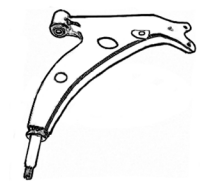
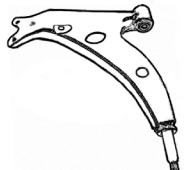

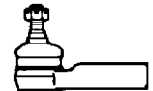
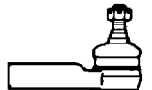

RIF. ORIG O.E. NUMBER	RIF. OCAP REF. OCAP	NOTE REMARKS	DESTRO RIGHT	SINISTRO LEFT
Anno - Year <b>11/84 &gt; 06/90</b>		Serie - Series <b>W1</b>	Modello - Model <b>MR 2</b>	
48830-17020	<b>0503112</b>	STABILIZZATORE - POSTERIORE 08/1986 > STABILIZER LINK - POSTERIORE 08/1986 >		
Anno - Year <b>12/89 &gt; 05/00</b>		Serie - Series <b>W2</b>	Modello - Model <b>MR 2</b>	
45046-19195 45047-19075	<b>0283107</b>	TESTA STERZO - RHT M14x1,5 TIE ROD END - RHT M14x1,5		
45046-19195 45047-19075	<b>0293107</b>	TESTA STERZO - RHT M14x1,5 TIE ROD END - RHT M14x1,5		
45503-19145	<b>0603106</b>	SNODO ASSIALE AXIAL JOINT		
43330-19025	<b>0403678</b>	SNODO SOSPENSIONE INFERIORE SUSPENSION JOINT LOWER		
48820-17020 48820-17030 48820-17040	<b>0503108</b>	STABILIZZATORE - ANTERIORE STABILIZER LINK - FRONT		
48830-17030 48830-17040 48830-17050	<b>0503109</b>	STABILIZZATORE - POSTERIORE STABILIZER LINK - REAR		
Anno - Year <b>08/95 &gt; 12/99</b>		Serie - Series <b>EL54</b>	Modello - Model <b>PASEO</b>	
45046-19213 45046-19206 45046-19205	<b>0283731</b>	TESTA STERZO - RHT M12x1,25 TIE ROD END - RHT M12x1,25		
45503-19155	<b>0602963</b>	SNODO ASSIALE - RHT M12x1,25 AXIAL JOINT - RHT M12x1,25		
43330-19085	<b>0482964</b>	SNODO SOSPENSIONE - ASSE ANTERIORE - INFERIORE BALL JOINT - FRONT AXLE - LOWER		

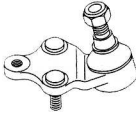
RIF. ORIG O.E. NUMBER	RIF. OCAP REF. OCAP	NOTE REMARKS	DESTRO RIGHT	SINISTRO LEFT
Anno - Year <b>08/95 &gt; 12/99</b>		Serie - Series <b>EL54</b>	Modello - Model <b>PASEO</b>	
43340-19025	<b>0492964</b>	SNODO SOSPENSIONE - ASSE ANTERIORE - INFERIORE BALL JOINT - FRONT AXLE - LOWER		
Anno - Year <b>1996 &gt; 2000</b>		Serie - Series <b>XM10</b>	Modello - Model <b>PICNIC</b>	
45046-29335 45046-29275	<b>0283693</b>	TESTA STERZO - RHT M15x1,5 TIE ROD END - RHT M15x1,5		
45047-29075 45047-29105	<b>0293693</b>	TESTA STERZO - RHT M15x1,5 TIE ROD END - RHT M15x1,5		
45503-29435 45503-29615	<b>0603694</b>	SNODO ASSIALE - RHT M15x1,5 AXIAL JOINT - RHT M15x1,5		
43330-19095 43330-29265 43330-29375 43330-09030 43330-02020	<b>0403671</b>	SNODO SOSPENSIONE INFERIORE SUSPENSION JOINT LOWER		
48068-44010	<b>0783098</b>	BRACCIO OSCILLANTE ANTERIORE FRONT TRACK CONTROL ARM		
48069-44010	<b>0793098</b>	BRACCIO OSCILLANTE ANTERIORE FRONT TRACK CONTROL ARM		
48820-05012 48810-20040 48820-20040	<b>0581922</b>	STABILIZZATORE - ASSE ANTERIORE STABILIZER LINK - FRONT AXLE		
48810-05012 48810-20020 48820-20020	<b>0591922</b>	STABILIZZATORE - ASSE ANTERIORE STABILIZER LINK - FRONT AXLE		



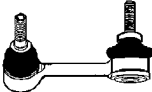
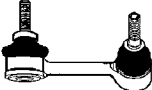

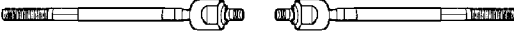



RIF. ORIG O.E. NUMBER	RIF. OCAP REF. OCAP	NOTE REMARKS	DESTRO RIGHT	SINISTRO LEFT
Anno - Year <b>05/90 &gt; 08/00</b>		Serie - Series <b>TCR1</b>	Modello - Model <b>PREVIA</b>	
45046-29235	<b>0284321</b>	TESTA STERZO - RHT M14x1,5 TIE ROD END - RHT M14x1,5		
45047-29065	<b>0294321</b>	TESTA STERZO - RHT M14x1,5 TIE ROD END - RHT M14x1,5		
45503-29295	<b>0604322</b>	SNODO ASSIALE - RHT M14x1,5 AXIAL JOINT - RHT M14x1,5		
43330-29235	<b>0404324</b>	SNODO SOSPENSIONE INFERIORE SUSPENSION JOINT LOWER		
48820-28010	<b>0584323</b>	STABILIZZATORE - ANTERIORE STABILIZER LINK - FRONT		
48810-28010	<b>0594323</b>	STABILIZZATORE - ANTERIORE STABILIZER LINK - FRONT		
Anno - Year <b>08/2000 &gt;</b>		Serie - Series <b>ACR3</b>	Modello - Model <b>PREVIA</b>	
45460-29425 45460-09010 45460-39615	<b>0284330</b>	TESTA STERZO - RHT M15x1,5 TIE ROD END - RHT M15x1,5		
45470-29185 45470-09010 45470-39215 45470-59055	<b>0294330</b>	TESTA STERZO - RHT M15x1,5 TIE ROD END - RHT M15x1,5		
45504-28030	<b>0604331</b>	SNODO ASSIALE - RHT M15x1,5 AXIAL JOINT - RHT M15x1,5		
43330-29405 43330-09160	<b>0484338</b>	SNODO SOSPENSIONE INFERIORE SUSPENSION JOINT LOWER		
43340-29175 43340-09010	<b>0494338</b>	SNODO SOSPENSIONE INFERIORE SUSPENSION JOINT LOWER		











RIF. ORIG O.E. NUMBER	RIF. OCAP REF. OCAP	NOTE REMARKS	DESTRO RIGHT	SINISTRO LEFT
Anno - Year <b>08/2000 &gt;</b>		Serie - Series <b>ACR3</b>	Modello - Model <b>PREVIA</b>	
48068-28120 48068-33050 48068-33060	<b>0784338</b>	BRACCIO OSCILLANTE - ASSE ANTERIORE - INFERIORE TRACK CONTROL ARM - FRONT AXLE - LOWER		
48069-28120 48069-33050 48069-33060	<b>0794338</b>	BRACCIO OSCILLANTE - ASSE ANTERIORE - INFERIORE TRACK CONTROL ARM - FRONT AXLE - LOWER		
48820-28050 48820-06040	<b>0502294</b>	STABILIZZATORE - ANTERIORE STABILIZER LINK		
Anno - Year <b>05/00 &gt; 01/04</b>		Serie - Series <b>NHW11</b>	Modello - Model <b>PRIUS</b>	
45046-49115 45046-19265 45046-09360	<b>0282614</b>	TESTA STERZO - RHT M14x1,5 TIE ROD END - RHT M14x1,5		
45047-49045 45047-19115 45047-09150	<b>0292614</b>	TESTA STERZO - RHT M14x1,5 TIE ROD END - RHT M14x1,5		
45503-49075	<b>0603120</b>	SNODO ASSIALE AXIAL JOINT - RHT M14x1,5		
43330-19115 43330-09070	<b>0404409</b>	SNODO SOSPENSIOENE INFERIORE SUSPENSION JOINT LOWER		
48820-47010	<b>0502591</b>	STABILIZZATORE - ANTERIORE STABILIZER LINK - FRONT		
Anno - Year <b>01/94 &gt; 06/00</b>		Serie - Series <b>SXA10-SXA11</b>	Modello - Model <b>RAV 4 I</b>	
45046-29305	<b>0282996</b>	TESTA STERZO - RHT M14x1,5 TIE ROD END - RHT M14x1,5		

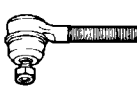



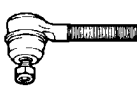

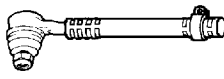
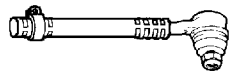
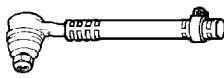
RIF. ORIG O.E. NUMBER	RIF. OCAP REF. OCAP	NOTE REMARKS	DESTRO RIGHT	SINISTRO LEFT
Anno - Year <b>01/94 &gt; 06/00</b>		Serie - Series <b>SXA10-SXA11</b>	Modello - Model <b>RAV 4 I</b>	
45503-29365 45503-19215	<b>0601923</b>	SNODO ASSIALE - RHT M14x1,5 AXIAL JOINT - RHT M14x1,5		
45503-19215	<b>0601924</b>	SNODO ASSIALE - RHT M14x1,5 - SERIE SXA11 - > 03/1995 AXIAL JOINT - RHT M14x1,5- SXA11 SERIES - > 03/1995		
43330-49025	<b>0404411</b>	SNODO SOSPENSIONE ASSE ANTERIORE - INFERIORE BALL JOINT - FRONT AXLE - LOWER		
48068-42012 48068-42022	<b>0784411</b>	BRACCIO OSCILLANTE - ASSE ANTERIORE - INFERIORE TRACK CONTROL ARM - FRONT AXLE - LOWER		
48069-42012 48069-42022	<b>0794411</b>	BRACCIO OSCILLANTE - ASSE ANTERIORE - INFERIORE TRACK CONTROL ARM - FRONT AXLE - LOWER		
48820-33010	<b>0504416</b>	STABILIZZATORE - ASSE ANTERIORE - > 1997 STABILIZER LINK - FRONT AXLE - > 1997		
48820-42010	<b>0504421</b>	STABILIZZATORE - ASSE ANTERIORE - 1997 >2000 STABILIZER LINK - FRONT AXLE - 1997 >2000		
Anno - Year <b>06/2000 &gt;</b>		Serie - Series <b>XA2</b>	Modello - Model <b>RAV 4 II</b>	
45046-49095 45046-49025	<b>0284408</b>	TESTA STERZO - RHT M15x1,5 TIE ROD END - RHT M15x1,5		
45047-49095 45047-49025	<b>0294408</b>	TESTA STERZO - RHT M15x1,5 TIE ROD END - RHT M15x1,5		
45503-49055	<b>0602609</b>	SNODO ASSIALE - RHT M15x1,5 AXIAL JOINT - RHT M15x1,5		

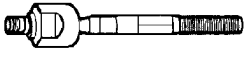
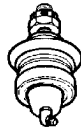
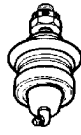
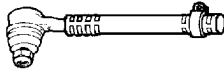
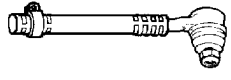

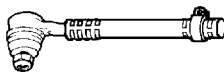
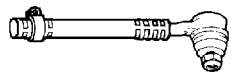
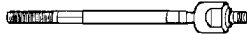
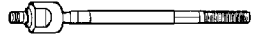
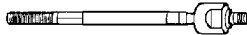
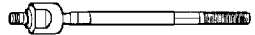
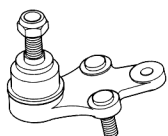
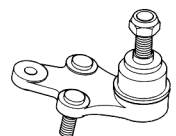
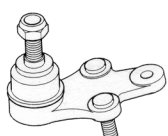
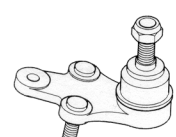



RIF. ORIG O.E. NUMBER	RIF. OCAP REF. OCAP	NOTE REMARKS	DESTRO RIGHT	SINISTRO LEFT
Anno - Year <b>06/2000 &gt;</b>		Serie - Series <b>XA2</b>	Modello - Model <b>RAV 4 II</b>	
43330-19115 43330-09070	<b>0404409</b>	SNODO SOSPENSIONE INFERIORE SUSPENSION JOINT LOWER		
48068-42040 48068-42041	<b>0784409</b>	BRACCIO OSCILLANTE ANTERIORE INFERIORE TRACK CONTROL ARM FRONT - LOWER		
48069-42040 48069-42041	<b>0794409</b>	BRACCIO OSCILLANTE ANTERIORE INFERIORE TRACK CONTROL ARM FRONT - LOWER		
48820-42020	<b>0502610</b>	STABILIZZATORE - ANTERIORE STABILIZER LINK - FRONT		
48830-42010	<b>0582784</b>	STABILIZZATORE - POSTERIORE STABILIZER LINK - REAR		
48840-42010	<b>0592784</b>	STABILIZZATORE - POSTERIORE STABILIZER LINK - REAR		
Anno - Year <b>11/2005 &gt;</b>		Serie - Series	Modello - Model <b>RAV 4 III</b>	
45046-49195	<b>0283093</b>	TESTA STERZO TIE ROD END		
45047-49135	<b>0293093</b>	TESTA STERZO TIE ROD END		
45503-42020	<b>0603094</b>	SNODO ASSIALE AXIAL JOINT		
43330-49095 43330-19245 43330-09630	<b>0403095</b>	SNODO SOSPENSIONE - ASSE ANTERIORE - INFERIORE BALL JOINT - FRONT AXLE - LOWER		



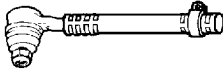
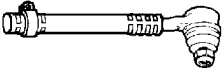
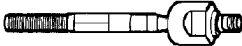
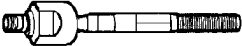

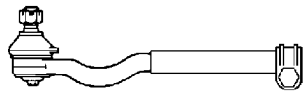
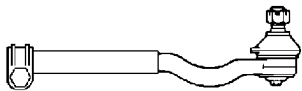
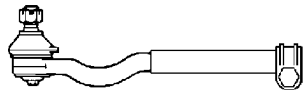
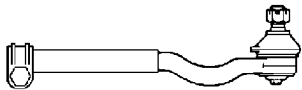
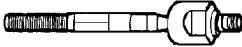
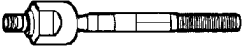









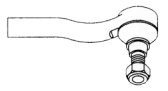
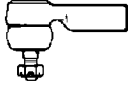

RIF. ORIG O.E. NUMBER	RIF. OCAP REF. OCAP	NOTE REMARKS	DESTRO RIGHT	SINISTRO LEFT
Anno - Year <b>11/2005 &gt;</b>		Serie - Series	Modello - Model <b>RAV 4 III</b>	
48068-42050 48068-42051	<b>0783095</b>	BRACCIO OSCILLANTE - ASSE ANTERIORE - INFERIORE TRACK CONTROL ARM - FRONT AXLE - LOWER		
48069-42050 48069-42051	<b>0793095</b>	BRACCIO OSCILLANTE - ASSE ANTERIORE - INFERIORE TRACK CONTROL ARM - FRONT AXLE - LOWER		
48820-42030	<b>0503096</b>	STABILIZZATORE - ASSE ANTERIORE STABILIZER LINK - FRONT AXLE		
48830-42020 48830-42021	<b>0503095</b>	STABILIZZATORE - ASSE POSTERIORE STABILIZER LINK - REAR AXLE		
Anno - Year <b>1976 &gt; 1985</b>		Serie - Series <b>KR-TR-YR-CR</b>	Modello - Model <b>SPACE CRUISER 2WD</b>	
45046-19065 45046-19135 45046-29075 45046-29155	<b>0190748</b>	TESTA STERZO ESTERNA - LHT M14x1,5 - > 1985 TIE ROD END - OUTER - LHT M14x1,5 - > 1985		
45406-19016	<b>0183633</b>	TESTA STERZO INTERNA - RHT M14x1,5 - > 1982 TIE ROD END - INNER - RHT M14x1,5 - > 1982		
45406-29135	<b>0183756</b>	TESTA STERZO INTERNA - RHT M14x1,5 - 1982 > 1985 TIE ROD END - INNER - RHT M14x1,5 - 1982 > 1985		
43350-29035 43350-29036 43360-29055 43360-29056	<b>0403757</b>	SNODO SOSPENSIONE SUPERIORE SUSPENSION JOINT UPPER		
43330-29115 43330-29175 43340-29095	<b>0403758</b>	SNODO SOSPENSIONE INFERIORE SUSPENSION JOINT LOWER		





RIF. ORIG O.E. NUMBER	RIF. OCAP REF. OCAP	NOTE REMARKS	DESTRO RIGHT	SINISTRO LEFT
Anno - Year <b>1973 &gt; 1984</b>		Serie - Series <b>KP4-KP5-KP61-KP62</b>	Modello - Model <b>STARLET</b>	
45460-19025 45460-19056 45460-19175 45460-29135 45460-29145 45470-19025	<b>0503724</b>	BARRA STERZO - SERIE KP4-KP5 - > 1974 TIE ROD - SERIES KP4-KP5 - > 1974		
45046-20010 45046-21010 45046-29025 45046-29035 45046-29045 45047-19035 45047-19055 45047-20010 45047-29015	<b>0193725</b>	TESTA STERZO ESTERNA - LHT M14x1,5 - SERIE KP4-KP5 - > 1974 TIE ROD END - OUTER - LHT M14x1,5 - SERIES KP4-KP5 - > 1974		
45046-19055	<b>0183726</b>	TESTA STERZO INTERNA - RHT M14x1,5 - SERIE KP4-KP5 - > 1974 TIE ROD END - INNER - RHT M14x1,5 - SERIES KP4-KP5 - > 1974		
45046-19065 45046-19135 45046-29075 45046-29155	<b>0190748</b>	TESTA STERZO ESTERNA - LHT M14x1,5 - SERIE KP4-KP5 - 1974 > 1978 TIE ROD END - OUTER - LHT M14x1,5 - SERIES KP4-KP5 - 1974 > 1978		
45046-19175 45046-19105 45460-19105 45460-19215	<b>0283660</b>	TESTA STERZO - RHT M14x1,5 - SERIE KP61-KP62 - > 1980 TIE ROD END - RHT M14x1,5 - SERIES KP61-KP62 - > 1980		
45460-19145	<b>0283727</b>	TESTA STERZO - RHT M14x1,5 - SERIE KP61-KP62 - 1980 > 1984 TIE ROD END - RHT M14x1,5 - SERIES KP61-KP62 - 1980 > 1984		
45503-19035 45460-19115 45503-10020 45503-19015 45503-19045	<b>0603659</b>	SNODO ASSIALE - RHT M14x1,5 - SERIE KP61-KP62 AXIAL JOINT - RHT M14x1,5 - SERIES KP61-KP62		
43308-12020	<b>0403728</b>	SNODO SOSPENSIONE INFERIORE - SERIE KP4-KP5 SUSPENSION JOINT LOWER - SERIES KP4-KP5		
Anno - Year <b>1984 &gt; 1989</b> <b>1989 &gt;</b>		Serie - Series <b>EP7-NP7</b> <b>EP8-NP8</b>	Modello - Model <b>STARLET</b>	
45046-19165	<b>0283730</b>	TESTA STERZO - RHT M12x1,25 - SERIE EP7-NP7 TIE ROD END - RHT M12x1,25 - SERIES EP7-NP7		

RIF. ORIG O.E. NUMBER	RIF. OCAP REF. OCAP	NOTE REMARKS	DESTRO RIGHT	SINISTRO LEFT
Anno - Year <b>1984 &gt; 1989</b> <b>1989 &gt;</b>		Serie - Series <b>EP7-NP7</b> <b>EP8-NP8</b>	Modello - Model <b>STARLET</b>	
45046-19213 45046-19206 45046-19205	<b>0283731</b>	TESTA STERZO - RHT M12x1,25 - SERIE EP8-NP8 TIE ROD END - RHT M12x1,25 - SERIES EP8-NP8		
45503-19075	<b>0603732</b>	SNODO ASSIALE - RHT M12x1,25 - SERIE EP7-NP7 AXIAL JOINT - RHT M12x1,25 - SERIES EP7-NP7		
45503-19155	<b>0602963</b>	SNODO ASSIALE - RHT M12x1,25 - SERIE EP8-NP8 AXIAL JOINT - RHT M12x1,25 - SERIES EP8-NP8		
43330-19045	<b>0403680</b>	SNODO SOSPENSIONE INFERIORE - SERIE EP7-NP7 SUSPENSION JOINT LOWER - SERIES EP7-NP7		
43330-19085	<b>0482964</b>	SNODO SOSPENSIONE INFERIORE - SERIE EP8-NP8 SUSPENSION JOINT LOWER - SERIES EP8-NP8		
43340-19025	<b>0492964</b>	SNODO SOSPENSIONE INFERIORE - SERIE EP8-NP8 SUSPENSION JOINT LOWER - SERIES EP8-NP8		
Anno - Year <b>08/90 &gt; 08/98</b>		Serie - Series <b>JZA70 - JZA80</b>	Modello - Model <b>SUPRA</b>	
45460-19235	<b>0284564</b>	TESTA STERZO - RHT M14x1,5 TIE ROD END - RHT M14x1,5		
45470-19065	<b>0294564</b>	TESTA STERZO - RHT M14x1,5 TIE ROD END - RHT M14x1,5		
48810-28010	<b>0594323</b>	STABILIZZATORE - ASSE ANTERIORE STABILIZER LINK - FRONT AXLE		
48820-24010	<b>0504565</b>	STABILIZZATORE - ASSE POSTERIORE STABILIZER LINK - REAR AXLE		

RIF. ORIG O.E. NUMBER	RIF. OCAP REF. OCAP	NOTE REMARKS	DESTRO RIGHT	SINISTRO LEFT
Anno - Year <b>1979 &gt; 1988</b>		Serie - Series <b>AL10-AL11</b>	Modello - Model <b>TERCEL</b>	
45047-19065 45460-19115 45470-19015	<b>0283673</b>	TESTA STERZO - RHT M14x1,5 TIE ROD END - RHT M14x1,5		
45503-19035 45460-19115 45503-10020 45503-19015 45503-19045	<b>0603659</b>	SNODO ASSIALE - RHT M14x1,5 AXIAL JOINT - RHT M14x1,5		
43308-16010	<b>0403674</b>	SNODO SOSPENSIONE INFERIORE SUSPENSION JOINT LOWER		
Anno - Year <b>1982 &gt; 1988</b>		Serie - Series <b>AL2 - AL25G</b>	Modello - Model <b>TERCEL</b>	
45460-19185	<b>0283675</b>	TESTA STERZO - RHT M14x1,5 - STERZO MANUALE TIE ROD END - RHT M14x1,5 - MANUAL STEERING		
45470-19035	<b>0293675</b>	TESTA STERZO - RHT M14x1,5 - STERZO MANUALE TIE ROD END - RHT M14x1,5 - MANUAL STEERING		
45460-19195 45460-19205	<b>0283677</b>	TESTA STERZO - RHT M14x1,5 - SERVOSTERZO TIE ROD END - RHT M14x1,5 - POWER STEERING		
45470-19045 45470-19055	<b>0293677</b>	TESTA STERZO - RHT M14x1,5 - SERVOSTERZO TIE ROD END - RHT M14x1,5 - POWER STEERING		
45503-19025	<b>0603676</b>	SNODO ASSIALE - RHT M14x1,5 AXIAL JOINT - RHT M14x1,5		
43330-19025	<b>0403678</b>	SNODO SOSPENSIONE INFERIORE SUSPENSION JOINT LOWER		
Anno - Year <b>04/2009 &gt;</b>		Serie - Series <b>AUR2 - ZGR2</b>	Modello - Model <b>VERSO</b>	
45046-09430	<b>0285188</b>	TESTA STERZO - RHT M16x1,5 TIE ROD END - RHT M16x1,5		

RIF. ORIG O.E. NUMBER	RIF. OCAP REF. OCAP	NOTE REMARKS	DESTRO RIGHT	SINISTRO LEFT
Anno - Year <b>04/2009 &gt;</b>		Serie - Series <b>AUR2 - ZGR2</b>	Modello - Model <b>VERSO</b>	
45503-20170 45503-0F010 45503-0R010	<b>0603122</b>	SNODO ASSIALE - RHT M16x1,5 AXIAL JOINT - RHT M16x1,5		
43330-49095 43330-19245 43330-09630	<b>0403095</b>	SNODO SOSPENSIONE - ASSE ANTERIORE - INFERIORE BALL JOINT - FRONT AXLE - LOWER		
48068-12300 48068-0F030 48068-02130	<b>0788073</b>	BRACCIO OSCILLANTE - ASSE ANTERIORE - INFERIORE TRACK CONTROL ARM - FRONT AXLE - LOWER		
48069-12300 48069-0F030 48069-02130	<b>0798073</b>	BRACCIO OSCILLANTE - ASSE ANTERIORE - INFERIORE TRACK CONTROL ARM - FRONT AXLE - LOWER		
48820-42030	<b>0503096</b>	STABILIZZATORE - ASSE ANTERIORE STABILIZER LINK - FRONT AXLE		
Anno - Year <b>04/1999 &gt;</b> <b>11/1999 &gt;</b>		Serie - Series	Modello - Model <b>YARIS</b> <b>YARIS VERSO</b>	
45046-59025 45046-59026	<b>0282994</b>	TESTA STERZO - RHT M12x1,25 - YARIS JPP DAL 04/1999 TUTTI I MOD. YARIS FRP DAL 01/2001 TUTTI I MOD. NO SERVOSTERZO TIE ROD END - RHT M12x1,25 - YARIS JPP FROM 04/1999 ALL MOD. YARIS FRP FROM 01/2001 ALL MOD. NO POWER STEERING		
45047-59025 45047-59026	<b>0292994</b>	TESTA STERZO - RHT M12x1,25 - YARIS JPP DAL 04/1999 TUTTI I MOD. YARIS FRP DAL 01/2001 TUTTI I MOD. NO SERVOSTERZO TIE ROD END - RHT M12x1,25 YARIS JPP FROM 04/1999 ALL MOD. YARIS FRP FROM 01/2001 ALL MOD. NO POWER STEERING		
45046-19175 45046-29305	<b>0280141</b>	TESTA STERZO - RHT M14x1,5 - YARIS JPP DAL 01/2001 MOD. TS TIE ROD END - RHT M14x1,5 YARIS JPP FROM 01/2001 MOD. TS		

RIF. ORIG O.E. NUMBER	RIF. OCAP REF. OCAP	NOTE REMARKS	DESTRO RIGHT	SINISTRO LEFT
Anno - Year <b>04/1999 &gt;</b> <b>11/1999 &gt;</b>		Serie - Series	Modello - Model <b>YARIS</b> <b>YARIS VERSO</b>	
45503-52010 45503-59045	<b>0602995</b>	SNODO ASSIALE - RHT M12x1,25 - YARIS JPP DAL 04/1999 TUTTI I MOD. YARIS FRP DAL 01/2001 AL 02/2003 TUTTI I MOD. AXIAL JOINT - RHT M12x1,25 YARIS JPP FROM 04/1999 ALL MOD. YARIS FRP FROM 01/2001 TO 02/2003 ALL MOD.		
45503-0D030	<b>0602994</b>	SNODO ASSIALE - RHT M12x1,25 - 02/2003 > - ECCETTO RUOTE 185/55/15 AXIAL JOINT - RHT M12x1,25 - 02/2003 > - EXCEPT TYRES 185/55/15		
-	<b>0401516</b>	SNODO SOSPENSIONE BALL JOINT		
48068-59035	<b>0781516</b>	BRACCIO OSCILLANTE ANTERIORE - YARIS JPP DAL 04/1999 al 05/2003 TUTTI I MOD. YARIS VERSO DAL 11/1999 AL 05/2003 TUTTI I MOD. FRONT TRACK CONTROL ARM - YARIS JPP FROM 04/1999 TO 05/2003 ALL MOD. YARIS VERSO FROM 11/1999 TO 05/2003 ALL MOD.		
48069-59035	<b>0791516</b>	BRACCIO OSCILLANTE ANTERIORE - YARIS JPP DAL 04/1999 al 05/2003 TUTTI I MOD. YARIS VERSO DAL 11/1999 AL 05/2003 TUTTI I MOD. FRONT TRACK CONTROL ARM - YARIS JPP FROM 04/1999 TO 05/2003 ALL MOD. YARIS VERSO FROM 11/1999 TO 05/2003 ALL MOD.		
48819-52010 (1) 48817-0D010 (2) 90948-02178 (3) 90948-02179 (4) 94182-10800 (5)	<b>0502567</b>	KIT STABILIZZATORE - ASSE ANTERIORE STABILIZER LINK KIT - FRONT AXLE#1) PERNO - PIN N. 1#2) GOMMINO - RUBBER RING N. 4#3) RONDELLA - WASHER N. 1#4) RONDELLA - WASHER N. 4#5) DADO - NUT N. 2		
Anno - Year <b>2006 &gt;</b>		Serie - Series <b>P90</b>	Modello - Model <b>YARIS II</b>	
45046-09480 4504609480	<b>0283292</b>	TESTA STERZO - RHT M14x1,5 TIE ROD END - RHT M14x1,5		
45047-09220 4504709220	<b>0293292</b>	TESTA STERZO - RHT M14x1,5 TIE ROD END - RHT M14x1,5		

RIF. ORIG O.E. NUMBER	RIF. OCAP REF. OCAP	NOTE REMARKS	DESTRO RIGHT	SINISTRO LEFT
Anno - Year <b>2006 &gt;</b>		Serie - Series <b>P90</b>	Modello - Model <b>YARIS II</b>	
45503-52070 45503-0D080	<b>0602782</b>	SNODO ASSIALE - RHT M14x1,5 AXIAL JOINT - RHT M14x1,5		
-	<b>0401516</b>	SNODO SOSPENSIONE BALL JOINT		
48068-09040 48068-09015 48068-09030	<b>0783299</b>	BRACCIO OSCILLANTE - ASSE ANTERIORE TRACK CONTROL ARM - FRONT AXLE		
48069-09040 48069-09015 48069-09030	<b>0793299</b>	BRACCIO OSCILLANTE - ASSE ANTERIORE TRACK CONTROL ARM - FRONT AXLE		
48820-0D010	<b>0502783</b>	STABILIZZATORE - ASSE ANTERIORE STABILIZER LINK - FRONT AXLE		

RIF. ORIG O.E. NUMBER	RIF. OCAP REF. OCAP	MARCA	PAG.	RIF. ORIG O.E. NUMBER	RIF. OCAP REF. OCAP	MARCA	PAG.
0305-99-322A	0283381	MAZDA	7-9	0K552-28-300C	0382791	KIA	6-4
0305-99-324A	0293380	MAZDA	7-9	0K552-28-350B	0392791	KIA	6-4
0305-99-356A	0403382	MAZDA	7-9	0K552-28-350C	0392791	KIA	6-4
04436-20031	0403685	TOYOTA	13-27	0K552-32-240	0291977	KIA	6-3
0483-99-322	0283378	MAZDA	7-17	0K552-32-250	0681990	KIA	6-3
0483-99-324	0293380	MAZDA	7-9	0K552-32-270	0691991	KIA	6-3
0603-99-322	0183430	MAZDA	7-25	0K552-32-280	0281977	KIA	6-3
0603-99-323	0183430	MAZDA	7-25	0K552-34-150B	0501976	KIA	6-4
0603-99-324	0193429	MAZDA	7-25	0K552-34-151B	0501976	KIA	6-4
0603-99-325	0193429	MAZDA	7-25	0K552-34-160B	0501976	KIA	6-4
0662-99-322A	0283378	MAZDA	7-17	0K552-34-300A	0382551	KIA	6-4
07846696	0900760	DAEWOO - CHEVROLET	1-3	0K552-34-300B	0382551	KIA	6-4
07848281	0293300	DAEWOO - CHEVROLET	1-3	0K552-34-300C	0382551	KIA	6-4
07848282	0283300	DAEWOO - CHEVROLET	1-3	0K552-34-350A	0392551	KIA	6-4
0866-99-322	0283412	MAZDA	7-20	0K552-34-350B	0392551	KIA	6-4
0866-99-324	0291265	MAZDA	7-9	0K60A-32-270	0604575	KIA	6-8
0866-99-324A	0293411	MAZDA	7-20	0K670-32-450	0192930	KIA	6-7
0866-99-356A	0403416	MAZDA	7-20	0K670-32-510	0182930	KIA	6-7
08810A78B00-00	0284263	DAEWOO - CHEVROLET	1-6	0K710-32-240	0284573	KIA	6-8
0G030-34-550B	0400349	KIA	6-7	0K710-34-510	0404577	KIA	6-9
0K011-32-230	0291994	KIA	6-17	0K710-34-540	0404576	KIA	6-9
0K011-32-240A	0281993	KIA	6-17	0K72A-32-240	0284579	KIA	6-11
0K011-32-250A	0291993	KIA	6-18	0K72A-32-270	0604574	KIA	6-8
0K011-32-260A	0501992	KIA	6-17	0K72A-34-150A	0504581	KIA	6-11
0K011-32-270A	0591993	KIA	6-17	0K72A-34-200	0304584	KIA	6-11
0K011-32-280	0281994	KIA	6-18	0K72A-34-200A	0304584	KIA	6-11
0K011-32-290A	0581993	KIA	6-17	0K72A-34-300A	0304582	KIA	6-11
0K011-34-160A	0501997	KIA	6-18	0K72A-34-300B	0304582	KIA	6-11
0K011-34-200	0302848	KIA	6-18	0K72A-34-510A	0404580	KIA	6-9
0K011-34-200A	0302848	KIA	6-18	0K9A2-32-240	0601971	KIA	6-7
0K011-34-300D	0702849	KIA	6-18	0K9A2-32-280	0281973	KIA	6-1
0K011-34-300E	0702849	KIA	6-18	0K9A2-34-300	0784571	KIA	6-7
0K011-34-300F	0702849	KIA	6-18	0K9A2-34-350	0794571	KIA	6-8
0K011-34-510B	0401996	KIA	6-18	0K9A6-34-300	0784572	KIA	6-8
0K0A3-28-170A	0501582	KIA	6-8	0K9A6-34-350	0794572	KIA	6-8
0K0A3-28-170A	0501582	MAZDA	7-14	0KX43-34-300	0780340	KIA	6-1
0K201-32-280	0281973	KIA	6-1	0KX43-34-350	0790340	KIA	6-1
0K201-34-550C	0402931	KIA	6-14	0SE46-34-200	0790339	KIA	6-1
0K201-34-550E	0402931	KIA	6-14	0SE46-34-200A	0794576	KIA	6-9
0K203-32-240	0601972	KIA	6-14	0SE46-34-250	0780339	KIA	6-1
0K2A1-32-240	0681975	KIA	6-2	0SE46-34-250A	0784576	KIA	6-9
0K2A1-34-150A	0501583	KIA	6-2	1175-99-322A	0283414	MAZDA	7-13
0K2A1-34-150B	0501583	KIA	6-2	1175-99-324A	0293413	MAZDA	7-13
0K2A1-34-550A	0402549	KIA	6-2	13219141	0508080	DAEWOO - CHEVROLET	1-3
0K2A2-32-240	0691975	KIA	6-2	13258052	0508080	DAEWOO - CHEVROLET	1-3
0K2A5-34-150A	0501974	KIA	6-14	13272000	0288080	DAEWOO - CHEVROLET	1-2
0K2A5-34-150B	0501974	KIA	6-14	13272605	0398080	DAEWOO - CHEVROLET	1-2
0K2FA-34-300	0782549	KIA	6-2	13272606	0388080	DAEWOO - CHEVROLET	1-2
0K2FA-34-350	0792549	KIA	6-2	13278358	0608080	DAEWOO - CHEVROLET	1-2
0K2FA-34150	0584098	KIA	6-2	13278359	0288080	DAEWOO - CHEVROLET	1-2
0K2FA-34170	0594098	KIA	6-2	13286686	0288080	DAEWOO - CHEVROLET	1-2
0K2NA-34-300B	0782847	KIA	6-15	13334022	0398080	DAEWOO - CHEVROLET	1-2
0K2NA-34-350B	0792847	KIA	6-15	13334023	0388080	DAEWOO - CHEVROLET	1-2
0K30B-34-300B	0382552	KIA	6-12	1524-99-324	0293411	MAZDA	7-20
0K30B-34-350B	0392552	KIA	6-12	1757-32-220	0303426	MAZDA	7-26
0K33C-34-150A	0581586	KIA	6-12	1E00-32-240	0601486	MAZDA	7-1
0K33C-34-160A	0591586	KIA	6-12	1E00-32-280A	0281485	MAZDA	7-1
0K552-28-300B	0382791	KIA	6-4	1E00-34-170	0504436	MAZDA	7-2



RIF. ORIG O.E. NUMBER	RIF. OCAP REF. OCAP	MARCA	PAG.	RIF. ORIG O.E. NUMBER	RIF. OCAP REF. OCAP	MARCA	PAG.
1E00-34-300E	0781483	MAZDA	7-2	34160-AE001	0601929	SUBARU	11-2
1E00-34-350E	0791483	MAZDA	7-2	34161-SA000	0281929	SUBARU	11-1
1E01-32-280A	0291485	MAZDA	7-1	35820-37010	0281290	KIA	6-6
1E01-34-300E	0781484	MAZDA	7-2	3874-99-322	0183430	MAZDA	7-25
1E01-34-350E	0791484	MAZDA	7-2	3874-99-324	0193429	MAZDA	7-25
200200AC200F	0784494	SUBARU	11-1	4010A013	0794126	MINITUBISHI	8-22
200200AC210F	0794494	SUBARU	11-1	4010A014	0784126	MINITUBISHI	8-22
20200-AA200	0784494	SUBARU	11-1	4010A015	0403088	MINITUBISHI	8-22
20200-AA210	0794494	SUBARU	11-1	4010A037	0793088	MINITUBISHI	8-31
20200FC120	0785177	SUBARU	11-1	4010A038	0783088	MINITUBISHI	8-31
20200FC130	0795177	SUBARU	11-1	4010A099	0403088	MINITUBISHI	8-22
20202-AG180	0783605	SUBARU	11-5	40110-01G00	0400361	NISSAN	9-25
20202-AG181	0783605	SUBARU	11-5	40110-01G25	0400361	NISSAN	9-25
20202-AG190	0793605	SUBARU	11-5	40110-01G26	0400361	NISSAN	9-25
20202-AG191	0793605	SUBARU	11-5	40110-2S485	0404626	NISSAN	9-28
20420-AA002	0501931	SUBARU	11-2	40110-2S486	0404626	NISSAN	9-28
20420-AA003	0501931	SUBARU	11-2	40110-2S685	0404626	NISSAN	9-28
20420-AA004	0501931	SUBARU	11-2	40110-2S686	0404626	NISSAN	9-28
20420-AJ000	0504494	SUBARU	11-5	40110-B9500	0400361	NISSAN	9-25
20470-AE000	0502836	SUBARU	11-5	40110-G3700	0404645	NISSAN	9-54
20470-AE001	0502836	SUBARU	11-5	40110-G5100	0404645	NISSAN	9-54
20470-AE010	0502836	SUBARU	11-5	40110-G5110	0404645	NISSAN	9-54
20470-AJ000	0503605	SUBARU	11-5	40110-J0125	0403531	NISSAN	9-10
20470-FE000	0502835	SUBARU	11-2	40110-T3002	0403531	NISSAN	9-10
20470-FG000	0503605	SUBARU	11-5	40110-T3025	0403531	NISSAN	9-10
20470-SA000	0502835	SUBARU	11-2	40110-T3060	0400361	NISSAN	9-25
20470-SA011	0503119	SUBARU	11-2	40110-T6000	0400361	NISSAN	9-25
20481AA000	0505178	SUBARU	11-2	40110-T6025	0400361	NISSAN	9-25
20481AA001	0505178	SUBARU	11-2	40110-V0100	0400361	NISSAN	9-25
21067-GA050	0403605	SUBARU	11-1	40111-J0100	0403531	NISSAN	9-10
2113-99-322A	0283378	MAZDA	7-17	40111-J0125	0403531	NISSAN	9-10
2370-99-322	0283381	MAZDA	7-9	40111-T3002	0403531	NISSAN	9-10
2370-99-324	0293380	MAZDA	7-9	40111-T3025	0403531	NISSAN	9-10
2469-99-322	0283378	MAZDA	7-17	4013A009	0794136	MINITUBISHI	8-28
2541-32-250	0503427	MAZDA	7-24	4013A009 Z	0404136	MINITUBISHI	8-28
2541-99-322A	0183430	MAZDA	7-25	4013A010	0784136	MINITUBISHI	8-28
2541-99-324A	0193429	MAZDA	7-25	4013A010 Z	0404136	MINITUBISHI	8-28
26001806	0283301	DAEWOO - CHEVROLET	1-3	4013A087	0794128	MINITUBISHI	8-23
26001807	0293301	DAEWOO - CHEVROLET	1-3	4013A088	0784128	MINITUBISHI	8-23
2677-32-250	0503427	MAZDA	7-24	4013A090	0404128	MINITUBISHI	8-22
31310-GA120	0603598	SUBARU	11-6	4013A209	0794141	MINITUBISHI	8-33
31310-GA151	0603599	SUBARU	11-7	4013A210	0784141	MINITUBISHI	8-33
31310-GA170	0603597	SUBARU	11-6	4013A211	0404141	MINITUBISHI	8-31
31320-GA101	0283596	SUBARU	11-6	4013A274	0784130	MINITUBISHI	8-16
31320-GA111	0293596	SUBARU	11-6	4013A330	0784128	MINITUBISHI	8-23
31320-GA190	0281928	SUBARU	11-1	40160-00Q0A	0404628	NISSAN	9-31
31320-GA200	0291928	SUBARU	11-1	40160-00QAB	0404614	NISSAN	9-12
322575	0900760	DAEWOO - CHEVROLET	1-3	40160-00QAC	0402827	NISSAN	9-12
324038	0283301	DAEWOO - CHEVROLET	1-3	40160-00QAD	0402827	NISSAN	9-12
324039	0293301	DAEWOO - CHEVROLET	1-3	40160-01A00	0400996	NISSAN	9-11
34004-6402P	0403531	NISSAN	9-10	40160-01A25	0400996	NISSAN	9-11
34005-6402P	0403531	NISSAN	9-10	40160-01B25	0401521	NISSAN	9-18
34006-6401P	0403532	NISSAN	9-10	40160-01E00	0403527	NISSAN	9-9
34140-AA040	0601930	SUBARU	11-1	40160-01E25	0403527	NISSAN	9-9
34140-FC000	0601930	SUBARU	11-1	40160-01G00	0400437	NISSAN	9-25
34141-AA041	0281929	SUBARU	11-1	40160-01G25	0400437	NISSAN	9-25
34141-AA042	0281929	SUBARU	11-1	40160-01G50	0400437	NISSAN	9-25
34160-AE000	0601929	SUBARU	11-2	40160-01G90	0400437	NISSAN	9-25

RIF. ORIG O.E. NUMBER	RIF. OCAP REF. OCAP	MARCA	PAG.	RIF. ORIG O.E. NUMBER	RIF. OCAP REF. OCAP	MARCA	PAG.
40160-01N25	0400437	NISSAN	9-25	40160-S0125	0401226	NISSAN	9-1
40160-0F000	0403548	NISSAN	9-27	40160-S0126	0401226	NISSAN	9-1
40160-0W025	0402576	NISSAN	9-21	40160-S0127	0401226	NISSAN	9-1
40160-2S485	0400437	NISSAN	9-25	40160-S0128	0401226	NISSAN	9-1
40160-2S601	0404625	NISSAN	9-28	40160-S0W25	0403548	NISSAN	9-27
40160-2Y000	0402823	NISSAN	9-4	40160-T3002	0403532	NISSAN	9-10
40160-41L00	0402952	NISSAN	9-15	40160-T3025	0403532	NISSAN	9-10
40160-48W00	0480146	NISSAN	9-25	40160-T3026	0403532	NISSAN	9-10
40160-48W25	0480146	NISSAN	9-25	40160-T3060	0480146	NISSAN	9-25
40160-4F100	0403542	NISSAN	9-18	40160-U7000	0403513	NISSAN	9-7
40160-50A00	0400092	NISSAN	9-11	40160-W1000	0401225	NISSAN	9-8
40160-50J25	0403552	NISSAN	9-32	40160-W1001	0401225	NISSAN	9-8
40160-50W00	0403548	NISSAN	9-27	40160-W2200	0401225	NISSAN	9-8
40160-50W01	0403548	NISSAN	9-27	40160-W5000	0403555	NISSAN	9-6
40160-50W10	0403548	NISSAN	9-27	40160-Y02G0	0403586	NISSAN	9-1
40160-50Y00	0403586	NISSAN	9-1	40161-48W00	0490146	NISSAN	9-25
40160-50Y10	0403586	NISSAN	9-1	40161-48W25	0490146	NISSAN	9-25
40160-51E00	0403527	NISSAN	9-9	40161-9C500	0494179	NISSAN	9-39
40160-52Y00	0403586	NISSAN	9-1	40161-B9500	0490146	NISSAN	9-25
40160-55G90	0400437	NISSAN	9-25	40161-D0125	0493567	NISSAN	9-6
40160-60Y00	0404399	NISSAN	9-2	40161-F1700	0490146	NISSAN	9-25
40160-60Y10	0403586	NISSAN	9-1	40161-T3060	0490146	NISSAN	9-25
40160-60Y20	0403586	NISSAN	9-1	4056A014	0501767	HYUNDAI	4-17
40160-60Y60	0403552	NISSAN	9-32	4056A014	0501767	MITSUBISHI	8-4
40160-67L00	0402952	NISSAN	9-15	4056A021	0502803	MITSUBISHI	8-7
40160-69C00	0403552	NISSAN	9-32	4056A037	0504133	MITSUBISHI	8-17
40160-69Y00	0403586	NISSAN	9-1	4056A038	0183623	MITSUBISHI	8-5
40160-69Y10	0403586	NISSAN	9-1	4056A038 Z	0183623-K	MITSUBISHI	8-5
40160-70J00	0403552	NISSAN	9-32	4056A133	0594142	MITSUBISHI	8-33
40160-85E00	0403527	NISSAN	9-9	4056A134	0584142	MITSUBISHI	8-33
40160-86M00	0403552	NISSAN	9-32	4056A161	0504131	MITSUBISHI	8-16
40160-9C500	0484179	NISSAN	9-39	4084-99-324B	0291265	MAZDA	7-9
40160-9W200	0403124	NISSAN	9-20	4156A014	0594138	MITSUBISHI	8-28
40160-9Y000	0403124	NISSAN	9-20	42311-60A00	0183623	SUZUKI	12-5
40160-A03G0	0400996	NISSAN	9-11	42420-60A00	0183623	SUZUKI	12-5
40160-A06G0	0400996	NISSAN	9-11	42420-62J00	0502761	SUZUKI	12-10
40160-A8600	0403513	NISSAN	9-7	42420-65D00	0183623	SUZUKI	12-5
40160-A8610	0403513	NISSAN	9-7	42420-65J00	0503127	SUZUKI	12-6
40160-A8625	0403513	NISSAN	9-7	42420-77A00	0502992	SUZUKI	12-4
40160-AX000	0404298	NISSAN	9-20	42420-80J00	0502841	SUZUKI	12-10
40160-B9500	0480146	NISSAN	9-25	42420-81A10	0502786	SUZUKI	12-7
40160-CA010	0403124	NISSAN	9-20	42420-85C00	0183623	SUZUKI	12-5
40160-CC40A	0403124	NISSAN	9-20	43068-87401	0782460	DAIHATSU	2-9
40160-D0125	0483567	NISSAN	9-6	43069-87401	0792460	DAIHATSU	2-9
40160-F1700	0480146	NISSAN	9-25	43308-12020	0403728	TOYOTA	13-57
40160-G2500	0404646	NISSAN	9-54	43308-12030	0400963	TOYOTA	13-8
40160-G2525	0404646	NISSAN	9-54	43308-12030	0403316	DAIHATSU	2-3
40160-G4010	0404646	NISSAN	9-54	43308-16010	0403674	TOYOTA	13-59
40160-G5400	0404646	NISSAN	9-54	43308-19035	0400963	TOYOTA	13-8
40160-H1001	0403573	NISSAN	9-43	43308-19035	0403316	DAIHATSU	2-3
40160-H7400	0403574	NISSAN	9-43	43308-20030	0403685	TOYOTA	13-27
40160-J0100	0403532	NISSAN	9-10	43310-09015	0405200	TOYOTA	13-41
40160-J0125	0403532	NISSAN	9-10	43310-09030	0405200	TOYOTA	13-41
40160-J7500	0403552	NISSAN	9-32	43310-0K010	0405200	TOYOTA	13-41
40160-M0225	0403535	NISSAN	9-11	43310-0K040	0405200	TOYOTA	13-41
40160-M3025	0403535	NISSAN	9-11	43310-39016	0402621	TOYOTA	13-2
40160-M7025	0403536	NISSAN	9-11	43330-02020	0403671	TOYOTA	13-4
40160-N8400	0403561	NISSAN	9-41	43330-09030	0403671	TOYOTA	13-4

RIF. ORIG O.E. NUMBER	RIF. OCAP REF. OCAP	MARCA	PAG.	RIF. ORIG O.E. NUMBER	RIF. OCAP REF. OCAP	MARCA	PAG.
43330-09050	0402776	TOYOTA	13-9	43330-49095	0403095	TOYOTA	13-3
43330-09070	0404409	TOYOTA	13-17	43330-87501	0483319	DAIHATSU	2-6
43330-09090	0402997	TOYOTA	13-23	43330-87580	0483319	DAIHATSU	2-6
43330-09160	0484338	TOYOTA	13-11	43330-87581	0483320	DAIHATSU	2-6
43330-09210	0402590	TOYOTA	13-5	43340-09010	0494338	TOYOTA	13-11
43330-09295	0404149	TOYOTA	13-41	43340-19015	0493666	TOYOTA	13-22
43330-09360	0405189	TOYOTA	13-26	43340-19016	0493666	TOYOTA	13-22
43330-09490	0404149	TOYOTA	13-41	43340-19025	0492964	TOYOTA	13-51
43330-09510	0404149	TOYOTA	13-41	43340-29015	0403685	TOYOTA	13-27
43330-09630	0403095	TOYOTA	13-3	43340-29026	0403688	TOYOTA	13-28
43330-09770	0403096	TOYOTA	13-6	43340-29036	0403688	TOYOTA	13-28
43330-19025	0403678	TOYOTA	13-49	43340-29095	0403758	TOYOTA	13-48
43330-19045	0403680	TOYOTA	13-21	43340-29175	0494338	TOYOTA	13-11
43330-19065	0483666	TOYOTA	13-22	43340-39075	0400429	TOYOTA	13-35
43330-19066	0483666	TOYOTA	13-22	43340-39125	0403712	TOYOTA	13-33
43330-19085	0482964	TOYOTA	13-50	43340-39135	0403712	TOYOTA	13-33
43330-19095	0403671	TOYOTA	13-4	43340-39145	0400428	TOYOTA	13-40
43330-19115	0404409	TOYOTA	13-17	43340-39175	0403766	TOYOTA	13-1
43330-19245	0403095	TOYOTA	13-3	43340-39205	0403712	TOYOTA	13-33
43330-29035	0403685	TOYOTA	13-27	43340-39215	0403712	TOYOTA	13-33
43330-29056	0403688	TOYOTA	13-28	43340-39225	0403629	TOYOTA	13-9
43330-29066	0403688	TOYOTA	13-28	43340-39235	0403766	TOYOTA	13-1
43330-29115	0403758	TOYOTA	13-48	43340-39254	0402973	TOYOTA	13-40
43330-29125	0403101	TOYOTA	13-37	43340-39325	0492622	TOYOTA	13-2
43330-29135	0403643	TOYOTA	13-14	43340-39356	0492622	TOYOTA	13-2
43330-29136	0403643	TOYOTA	13-14	43340-39465	0492622	TOYOTA	13-2
43330-29137	0403643	TOYOTA	13-14	43340-87501	0493319	DAIHATSU	2-6
43330-29138	0403643	TOYOTA	13-14	43340-87580	0493319	DAIHATSU	2-6
43330-29139	0403643	TOYOTA	13-14	43340-87581	0493320	DAIHATSU	2-6
43330-29145	0403645	TOYOTA	13-14	43350-29015	0403687	TOYOTA	13-28
43330-29146	0403645	TOYOTA	13-14	43350-29025	0403770	TOYOTA	13-35
43330-29155	0403786	TOYOTA	13-36	43350-29035	0402974	TOYOTA	13-48
43330-29175	0403758	TOYOTA	13-48	43350-29036	0402974	TOYOTA	13-48
43330-29185	0403645	TOYOTA	13-14	43350-29045	0403784	TOYOTA	13-35
43330-29205	0403643	TOYOTA	13-14	43350-29056	0403784	TOYOTA	13-35
43330-29235	0404324	TOYOTA	13-52	43350-29065	0402972	TOYOTA	13-36
43330-29265	0402961	TOYOTA	13-15	43350-29095	0402972	TOYOTA	13-36
43330-29375	0402961	TOYOTA	13-15	43350-39015	0400431	TOYOTA	13-33
43330-29405	0484338	TOYOTA	13-11	43350-39016	0400431	TOYOTA	13-33
43330-39015	0403711	TOYOTA	13-33	43350-39025	0400431	TOYOTA	13-33
43330-39045	0400429	TOYOTA	13-35	43350-39035	0400430	TOYOTA	13-39
43330-39075	0400429	TOYOTA	13-35	43350-39045	0403765	TOYOTA	13-1
43330-39135	0403629	TOYOTA	13-9	43350-39055	0403723	TOYOTA	13-34
43330-39165	0400428	TOYOTA	13-40	43350-39065	0400431	TOYOTA	13-33
43330-39195	0403766	TOYOTA	13-1	43350-39075	0400430	TOYOTA	13-39
43330-39225	0403629	TOYOTA	13-9	43350-87501	0483318	DAIHATSU	2-6
43330-39245	0403629	TOYOTA	13-9	43360-29035	0403687	TOYOTA	13-28
43330-39255	0403766	TOYOTA	13-1	43360-29045	0403687	TOYOTA	13-28
43330-39265	0402973	TOYOTA	13-40	43360-29055	0402974	TOYOTA	13-48
43330-39275	0403629	TOYOTA	13-9	43360-29056	0402974	TOYOTA	13-48
43330-39295	0403629	TOYOTA	13-9	43360-29065	0403784	TOYOTA	13-35
43330-39315	0402973	TOYOTA	13-40	43360-29076	0403784	TOYOTA	13-35
43330-39345	0403629	TOYOTA	13-9	43360-87501	0493318	DAIHATSU	2-6
43330-39415	0482622	TOYOTA	13-2	43370-87501	0483318	DAIHATSU	2-6
43330-39435	0402776	TOYOTA	13-9	43380-87501	0493318	DAIHATSU	2-6
43330-39466	0482622	TOYOTA	13-2	4410A173	0604125	MINIBISHI	8-22
43330-39585	0482622	TOYOTA	13-2	4422A009	0294124	MINIBISHI	8-22
43330-49025	0404411	TOYOTA	13-54	4422A010	0284124	MINIBISHI	8-22

RIF. ORIG O.E. NUMBER	RIF. OCAP REF. OCAP	MARCA	PAG.	RIF. ORIG O.E. NUMBER	RIF. OCAP REF. OCAP	MARCA	PAG.
4422A012	0604135	mitsubishi	8-28	45046-09480	0283292	TOYOTA	13-61
4422A018	0284134	mitsubishi	8-27	45046-09570	0288073	TOYOTA	13-3
4422A036	0604140	mitsubishi	8-32	45046-09660	0283096	TOYOTA	13-5
4422A037	0294139	mitsubishi	8-32	45046-19055	0183726	TOYOTA	13-57
4422A038	0284139	mitsubishi	8-32	45046-19065	0190748	TOYOTA	13-8
4440108000	0395175	SSANGYONG	10-4	45046-19065	0193312	DAIHATSU	2-2
4440109001	0304649	SSANGYONG	10-1	45046-19105	0283660	TOYOTA	13-21
4440109010	0398065	SSANGYONG	10-2	45046-19135	0190748	TOYOTA	13-8
4440109011	0398065	SSANGYONG	10-2	45046-19165	0283730	TOYOTA	13-57
4440208000	0385175	SSANGYONG	10-4	45046-19175	0280141	TOYOTA	13-9
4440209010	0388065	SSANGYONG	10-2	45046-19195	0283107	TOYOTA	13-50
4440209011	0388065	SSANGYONG	10-2	45046-19205	0283731	TOYOTA	13-50
4443003000	0402446	DAEWOO - CHEVROLET	1-5	45046-19206	0283731	TOYOTA	13-50
4443003010	0402446	DAEWOO - CHEVROLET	1-5	45046-19213	0283731	TOYOTA	13-50
4443003011	0402446	DAEWOO - CHEVROLET	1-5	45046-19265	0282614	TOYOTA	13-24
4443003011	0402446	SSANGYONG	10-1	45046-19405	0288073	TOYOTA	13-3
4450108005	0795174	SSANGYONG	10-3	45046-19415	0288073	TOYOTA	13-3
4450109001	0798065	SSANGYONG	10-2	45046-19415 Z	0608073	TOYOTA	13-3
4450208005	0785174	SSANGYONG	10-3	45046-20010	0193725	TOYOTA	13-57
4450209001	0788065	SSANGYONG	10-2	45046-21010	0193725	TOYOTA	13-57
445046-87282	0283304	DAIHATSU	2-1	45046-29025	0193725	TOYOTA	13-57
4450505000	0402445	DAEWOO - CHEVROLET	1-5	45046-29035	0193681	TOYOTA	13-27
4450505001	0402445	DAEWOO - CHEVROLET	1-5	45046-29045	0193681	TOYOTA	13-27
4450505001	0402445	SSANGYONG	10-1	45046-29075	0190748	TOYOTA	13-8
4454109002	0404649	SSANGYONG	10-1	45046-29075	0193312	DAIHATSU	2-2
4454109004	0408065	SSANGYONG	10-2	45046-29115	0193759	TOYOTA	13-1
4475005000	0502447	DAEWOO - CHEVROLET	1-5	45046-29125	0193759	TOYOTA	13-1
4475005000	0502447	SSANGYONG	10-1	45046-29135	0283638	TOYOTA	13-13
4475005001	0502447	DAEWOO - CHEVROLET	1-5	45046-29155	0190748	TOYOTA	13-8
4475005001	0502447	SSANGYONG	10-1	45046-29165	0283646	TOYOTA	13-14
4475008000	0508066	SSANGYONG	10-5	45046-29185	0282977	TOYOTA	13-49
4475008001	0595176	SSANGYONG	10-5	45046-29215	0282970	TOYOTA	13-36
4475109000	0594649	SSANGYONG	10-1	45046-29235	0284321	TOYOTA	13-52
4475209000	0584649	SSANGYONG	10-1	45046-29255	0283668	TOYOTA	13-9
4475508000	0585176	SSANGYONG	10-5	45046-29275	0283693	TOYOTA	13-14
4500254	0404614	NISSAN	9-12	45046-29305	0280141	TOYOTA	13-9
45044-60H03	0193744	TOYOTA	13-43	45046-29325	0283099	TOYOTA	13-37
45044-69035	0193741	TOYOTA	13-43	45046-29335	0283693	TOYOTA	13-14
45044-69045	0193743	TOYOTA	13-43	45046-29365	0282998	TOYOTA	13-4
45044-69115	0192969	TOYOTA	13-44	45046-29375	0283099	TOYOTA	13-37
45044-69125	0192968	TOYOTA	13-44	45046-29425	0282585	TOYOTA	13-5
45045-29035	0193768	TOYOTA	13-34	45046-39016	0193696	TOYOTA	13-32
45045-60010	0190971	TOYOTA	13-42	45046-39026	0193696	TOYOTA	13-32
45045-60013	0190971	TOYOTA	13-42	45046-39075	0193698	TOYOTA	13-32
45045-60H00	0190971	TOYOTA	13-42	45046-39085	0183776	TOYOTA	13-38
45045-69015	0190971	TOYOTA	13-42	45046-39105	0193759	TOYOTA	13-1
45045-69035	0183740	TOYOTA	13-43	45046-39155	0193718	TOYOTA	13-33
45045-69065	0182967	TOYOTA	13-44	45046-39165	0193759	TOYOTA	13-1
45046-05070	0283096	TOYOTA	13-5	45046-39175	0193759	TOYOTA	13-1
45046-09050	0282998	TOYOTA	13-4	45046-39195	0193722	TOYOTA	13-34
45046-09100	0282998	TOYOTA	13-4	45046-39235	0193759	TOYOTA	13-1
45046-09230	0282584	TOYOTA	13-5	45046-39335	0182479	TOYOTA	13-2
45046-09280	0285198	TOYOTA	13-41	45046-39505	0282625	TOYOTA	13-47
45046-09281	0285198	TOYOTA	13-41	45046-49025	0284408	TOYOTA	13-54
45046-09295	0282844	TOYOTA	13-7	45046-49085	0284320	TOYOTA	13-16
45046-09310	0285198	TOYOTA	13-41	45046-49095	0284408	TOYOTA	13-54
45046-09360	0282614	TOYOTA	13-24	45046-49115	0282614	TOYOTA	13-24
45046-09430	0285188	TOYOTA	13-26	45046-49125	0282628	TOYOTA	13-6

RIF. ORIG O.E. NUMBER	RIF. OCAP REF. OCAP	MARCA	PAG.	RIF. ORIG O.E. NUMBER	RIF. OCAP REF. OCAP	MARCA	PAG.
45046-49195	0283093	TOYOTA	13-55	45047-29065	0294321	TOYOTA	13-52
45046-59025	0282994	TOYOTA	13-60	45047-29075	0293693	TOYOTA	13-15
45046-59026	0282994	TOYOTA	13-60	45047-29105	0293693	TOYOTA	13-15
45046-60011	0193733	TOYOTA	13-42	45047-29125	0292998	TOYOTA	13-4
45046-60021	0190973	TOYOTA	13-42	45047-39055	0193776	TOYOTA	13-38
45046-60023	0190973	TOYOTA	13-42	45047-39085	0183783	TOYOTA	13-35
45046-60030	0180971	TOYOTA	13-42	45047-39215	0192479	TOYOTA	13-2
45046-60033	0180971	TOYOTA	13-42	45047-49015	0294320	TOYOTA	13-17
45046-60040	0180973	TOYOTA	13-42	45047-49025	0294408	TOYOTA	13-54
45046-60042	0180973	TOYOTA	13-42	45047-49045	0292614	TOYOTA	13-24
45046-60081	0190973	TOYOTA	13-42	45047-49055	0292628	TOYOTA	13-6
45046-60H03	0193746	TOYOTA	13-43	45047-49095	0294408	TOYOTA	13-54
45046-60H04	0193742	TOYOTA	13-43	45047-49135	0293093	TOYOTA	13-55
45046-69025	0180971	TOYOTA	13-42	45047-59025	0292994	TOYOTA	13-60
45046-69035	0180973	TOYOTA	13-42	45047-59026	0292994	TOYOTA	13-60
45046-69055	0190973	TOYOTA	13-42	45047-60010	0190972	TOYOTA	13-42
45046-69105	0193742	TOYOTA	13-43	45047-60013	0190972	TOYOTA	13-42
45046-69115	0193738	TOYOTA	13-42	45047-60H00	0190972	TOYOTA	13-42
45046-69116	0193738	TOYOTA	13-42	45047-60H02	0183739	TOYOTA	13-42
45046-69135	0182965	TOYOTA	13-44	45047-69025	0190972	TOYOTA	13-42
45046-69195	0284554	TOYOTA	13-46	45047-69085	0192966	TOYOTA	13-44
45046-69205	0284555	TOYOTA	13-46	45047-69100	0294554	TOYOTA	13-46
45046-87203	0283309	DAIHATSU	2-3	45047-69115	0294555	TOYOTA	13-46
45046-87280	0283310	DAIHATSU	2-3	45047-87280	0293304	DAIHATSU	2-1
45046-87283	0283304	DAIHATSU	2-1	45047-87380	0193323	DAIHATSU	2-7
45046-87402	0282458	DAIHATSU	2-9	45047-87501	0283311	DAIHATSU	2-6
45046-87503	0283321	DAIHATSU	2-7	45047-87502	0283311	DAIHATSU	2-6
45046-87504	0283321	DAIHATSU	2-7	45047-87503	0293321	DAIHATSU	2-7
45046-87580	0283321	DAIHATSU	2-7	45047-87504	0293321	DAIHATSU	2-7
45046-87680	0183323	DAIHATSU	2-7	45047-87580	0293321	DAIHATSU	2-7
45046-87701	0283303	DAIHATSU	2-1	45047-87706	0292449	DAIHATSU	2-5
45046-87707	0282449	DAIHATSU	2-5	45047-87780	0293304	DAIHATSU	2-1
45046-87780	0283304	DAIHATSU	2-1	45047-87781	0293307	DAIHATSU	2-1
45046-87781	0283307	DAIHATSU	2-1	45047-87782	0293307	DAIHATSU	2-1
45046-87782	0283307	DAIHATSU	2-1	45047-87783	0293307	DAIHATSU	2-1
45046-87783	0283307	DAIHATSU	2-1	45047-87784	0293307	DAIHATSU	2-1
45046-87784	0283307	DAIHATSU	2-1	45047-87Z02	0182690	DAIHATSU	2-7
45046-87Z02	0192690	DAIHATSU	2-7	4504709220	0293292	TOYOTA	13-61
4504609480	0283292	TOYOTA	13-61	45057-87501	0293311	DAIHATSU	2-6
45047-05060	0293096	TOYOTA	13-5	45057-87502	0293311	DAIHATSU	2-6
45047-09010	0292998	TOYOTA	13-4	45200-50E00	0701946	SUZUKI	12-1
45047-09030	0292998	TOYOTA	13-4	45200-69D00	0701946	SUZUKI	12-1
45047-09125	0292844	TOYOTA	13-7	45200-75F00	0304487	SUZUKI	12-12
45047-09150	0292614	TOYOTA	13-24	45200-75F20	0301518	SUZUKI	12-12
45047-09220	0293292	TOYOTA	13-61	45200-76G00	0302838	SUZUKI	12-6
45047-09270	0298073	TOYOTA	13-3	45200-76G20	0302838	SUZUKI	12-6
45047-09320	0293096	TOYOTA	13-5	45200-79001	0703614	SUZUKI	12-3
45047-19035	0193725	TOYOTA	13-57	45200-81A10	0303143	SUZUKI	12-7
45047-19055	0193725	TOYOTA	13-57	45200-82000	0303617	SUZUKI	12-8
45047-19065	0283673	TOYOTA	13-59	45200-83E00	0302787	SUZUKI	12-7
45047-19075	0283107	TOYOTA	13-50	45200-84000	0701946	SUZUKI	12-1
45047-19115	0292614	TOYOTA	13-24	45200-84E00	0302787	SUZUKI	12-7
45047-19205	0298073	TOYOTA	13-3	45200-85001	0703615	SUZUKI	12-3
45047-19215	0298073	TOYOTA	13-3	45200-85E00	0302787	SUZUKI	12-7
45047-19215 Z	0608073	TOYOTA	13-3	45201-50G10	0781949	SUZUKI	12-8
45047-20010	0193725	TOYOTA	13-57	45201-57K00	0782659	SUZUKI	12-9
45047-29015	0193681	TOYOTA	13-27	45201-60B01	0781949	SUZUKI	12-8
45047-29045	0293646	TOYOTA	13-14	45201-60E01	0781949	SUZUKI	12-8

<b>RIF. ORIG O.E. NUMBER</b>	<b>RIF. OCAP REF. OCAP</b>	<b>MARCA</b>	<b>PAG.</b>	<b>RIF. ORIG O.E. NUMBER</b>	<b>RIF. OCAP REF. OCAP</b>	<b>MARCA</b>	<b>PAG.</b>
45201-62J00	0782659	SUZUKI	12-9	45406-29056	0183686	TOYOTA	13-28
45201-62J00 Z	0402659	SUZUKI	12-9	45406-29065	0183686	TOYOTA	13-28
45201-63G01	0381948	SUZUKI	12-2	45406-29095	0183769	TOYOTA	13-34
45201-63J00	0782659	SUZUKI	12-9	45406-29115	0183793	TOYOTA	13-39
45201-63J00 Z	0402659	SUZUKI	12-9	45406-29135	0183756	TOYOTA	13-56
45201-65D00	0784496	SUZUKI	12-4	45406-29145	0183783	TOYOTA	13-35
45201-65D01	0385181	SUZUKI	12-5	45406-29175	0183783	TOYOTA	13-35
45201-65J00	0783142	SUZUKI	12-5	45406-39016	0183697	TOYOTA	13-32
45201-70C00	0781949	SUZUKI	12-8	45406-39026	0183697	TOYOTA	13-32
45201-72K00	0782659	SUZUKI	12-9	45406-39055	0183699	TOYOTA	13-32
45201-77A01	0782760	SUZUKI	12-4	45406-39065	0183777	TOYOTA	13-38
45201-77A10	0782760	SUZUKI	12-4	45406-39075	0183699	TOYOTA	13-32
45201-78K00	0783142	SUZUKI	12-5	45406-39085	0183793	TOYOTA	13-39
45201-79J00	0782840	SUZUKI	12-10	45406-39086	0183793	TOYOTA	13-39
45202-50G10	0791949	SUZUKI	12-9	45406-39095	0183793	TOYOTA	13-39
45202-57K00	0792659	SUZUKI	12-9	45406-39105	0183719	TOYOTA	13-33
45202-60B01	0791949	SUZUKI	12-9	45406-39115	0183793	TOYOTA	13-39
45202-60E01	0791949	SUZUKI	12-9	45406-39125	0183793	TOYOTA	13-39
45202-62J00	0792659	SUZUKI	12-9	45406-39135	0183762	TOYOTA	13-1
45202-62J00 Z	0402659	SUZUKI	12-9	45406-39145	0183721	TOYOTA	13-34
45202-63G01	0391948	SUZUKI	12-2	45407-29015	0193686	TOYOTA	13-28
45202-63J00	0792659	SUZUKI	12-9	45407-29016	0193686	TOYOTA	13-28
45202-63J00 Z	0402659	SUZUKI	12-9	45450-39015	0503788	TOYOTA	13-38
45202-65D00	0794496	SUZUKI	12-4	45450-39016	0503788	TOYOTA	13-38
45202-65D01	0395181	SUZUKI	12-5	45450-39055	0503788	TOYOTA	13-38
45202-65J00	0793142	SUZUKI	12-6	45450-39065	0503788	TOYOTA	13-38
45202-70C00	0791949	SUZUKI	12-9	45450-39145	0503791	TOYOTA	13-38
45202-72K00	0792659	SUZUKI	12-9	45460-09010	0284330	TOYOTA	13-11
45202-77A01	0792760	SUZUKI	12-4	45460-19025	0503632	TOYOTA	13-8
45202-77A10	0792760	SUZUKI	12-4	45460-19055	0500962	TOYOTA	13-12
45202-78K00	0793142	SUZUKI	12-6	45460-19056	0503724	TOYOTA	13-57
45202-79J00	0792840	SUZUKI	12-10	45460-19065	0500962	TOYOTA	13-12
45203-70C00	0403083	SUZUKI	12-8	45460-19085	0500962	TOYOTA	13-12
45261-4F702	0503541	NISSAN	9-19	45460-19095	0283313	DAIHATSU	2-2
45261-90J11	0504388	NISSAN	9-35	45460-19105	0283660	TOYOTA	13-21
45330-19095	0403695	TOYOTA	13-32	45460-19115	0283673	TOYOTA	13-59
45401-19095	0303653	TOYOTA	13-18	45460-19125	0283315	DAIHATSU	2-3
45401-19105	0303654	TOYOTA	13-19	45460-19125	0283658	TOYOTA	13-19
45401-19125	0303628	TOYOTA	13-8	45460-19135	0283313	DAIHATSU	2-2
45401-19195	0303656	TOYOTA	13-19	45460-19145	0283727	TOYOTA	13-57
45401-29095	0303691	TOYOTA	13-28	45460-19155	0283635	TOYOTA	13-13
45401-35190	0303764	TOYOTA	13-1	45460-19165	0283634	TOYOTA	13-13
45401-39115	0303778	TOYOTA	13-38	45460-19175	0503724	TOYOTA	13-57
45401-39116	0303779	TOYOTA	13-38	45460-19185	0283675	TOYOTA	13-59
45401-39145	0303779	TOYOTA	13-38	45460-19195	0283677	TOYOTA	13-59
45401-39185	0303716	TOYOTA	13-33	45460-19205	0283677	TOYOTA	13-59
4540108000	0508065	SSANGYONG	10-5	45460-19215	0283660	TOYOTA	13-21
45406-19015	0180749	TOYOTA	13-12	45460-19235	0284564	TOYOTA	13-58
45406-19016	0183633	TOYOTA	13-8	45460-20020	0503681	TOYOTA	13-27
45406-19025	0180749	TOYOTA	13-12	45460-29035	0503681	TOYOTA	13-27
45406-19045	0180749	TOYOTA	13-12	45460-29045	0503683	TOYOTA	13-27
45406-19048	0180749	TOYOTA	13-12	45460-29066	0503767	TOYOTA	13-34
45406-20010	0183682	TOYOTA	13-27	45460-29085	0583686	TOYOTA	13-28
45406-29015	0183684	TOYOTA	13-27	45460-29135	0503724	TOYOTA	13-57
45406-29016	0183684	TOYOTA	13-27	45460-29145	0503724	TOYOTA	13-57
45406-29025	0183682	TOYOTA	13-27	45460-29215	0503792	TOYOTA	13-39
45406-29035	0183769	TOYOTA	13-34	45460-29265	0503781	TOYOTA	13-35
45406-29055	0183686	TOYOTA	13-28	45460-29285	0503782	TOYOTA	13-35

RIF. ORIG O.E. NUMBER	RIF. OCAP REF. OCAP	MARCA	PAG.	RIF. ORIG O.E. NUMBER	RIF. OCAP REF. OCAP	MARCA	PAG.
45460-29315	0282350	TOYOTA	13-48	45503-12130	0602594	TOYOTA	13-24
45460-29425	0284330	TOYOTA	13-11	45503-19015	0603659	TOYOTA	13-19
45460-39065	0583776	TOYOTA	13-37	45503-19025	0603676	TOYOTA	13-21
45460-39075	0503709	TOYOTA	13-32	45503-19035	0603639	TOYOTA	13-13
45460-39095	0503792	TOYOTA	13-39	45503-19036	0603641	TOYOTA	13-13
45460-39096	0503792	TOYOTA	13-39	45503-19045	0603659	TOYOTA	13-19
45460-39155	0503792	TOYOTA	13-39	45503-19055	0603640	TOYOTA	13-13
45460-39165	0283624	TOYOTA	13-8	45503-19056	0603642	TOYOTA	13-14
45460-39195	0503718	TOYOTA	13-33	45503-19066	0603105	TOYOTA	13-49
45460-39215	0503792	TOYOTA	13-39	45503-19075	0603732	TOYOTA	13-58
45460-39225	0503792	TOYOTA	13-39	45503-19085	0603625	TOYOTA	13-8
45460-39265	0583722	TOYOTA	13-34	45503-19116	0603679	TOYOTA	13-21
45460-39275	0503720	TOYOTA	13-33	45503-19125	0603664	TOYOTA	13-22
45460-39505	0503762	TOYOTA	13-1	45503-19135	0603665	TOYOTA	13-22
45460-39615	0284330	TOYOTA	13-11	45503-19145	0603106	TOYOTA	13-50
45460-87401	0602459	DAIHATSU	2-9	45503-19155	0602963	TOYOTA	13-50
45460-87586	0502690	DAIHATSU	2-7	45503-19205	0604319	TOYOTA	13-23
45460-87587	0503321	DAIHATSU	2-7	45503-19215	0601923	TOYOTA	13-23
45465-35020	0903760	TOYOTA	13-1	45503-19255	0602594	TOYOTA	13-24
45470-09010	0294330	TOYOTA	13-11	45503-20170	0603122	TOYOTA	13-5
45470-19015	0283673	TOYOTA	13-59	45503-29010	0603636	TOYOTA	13-13
45470-19025	0503724	TOYOTA	13-57	45503-29015	0603636	TOYOTA	13-13
45470-19035	0293675	TOYOTA	13-59	45503-29016	0603636	TOYOTA	13-13
45470-19045	0293677	TOYOTA	13-59	45503-29025	0603692	TOYOTA	13-30
45470-19055	0293677	TOYOTA	13-59	45503-29075	0603644	TOYOTA	13-16
45470-19065	0294564	TOYOTA	13-58	45503-29095	0602976	TOYOTA	13-49
45470-20020	0503681	TOYOTA	13-27	45503-29105	0603631	TOYOTA	13-9
45470-29046	0593686	TOYOTA	13-28	45503-29125	0603636	TOYOTA	13-13
45470-29075	0503782	TOYOTA	13-35	45503-29135	0602976	TOYOTA	13-49
45470-29085	0282350	TOYOTA	13-48	45503-29155	0603648	TOYOTA	13-14
45470-29185	0294330	TOYOTA	13-11	45503-29165	0603647	TOYOTA	13-14
45470-39035	0593776	TOYOTA	13-38	45503-29175	0603625	TOYOTA	13-8
45470-39065	0593722	TOYOTA	13-34	45503-29215	0602978	TOYOTA	13-49
45470-39075	0503720	TOYOTA	13-33	45503-29245	0603092	TOYOTA	13-16
45470-39215	0294330	TOYOTA	13-11	45503-29255	0602971	TOYOTA	13-36
45470-59055	0294330	TOYOTA	13-11	45503-29295	0604322	TOYOTA	13-52
45490-19125	0303650	TOYOTA	13-18	45503-29355	0603669	TOYOTA	13-9
45490-19135	0303649	TOYOTA	13-18	45503-29365	0601923	TOYOTA	13-23
45490-19215	0303652	TOYOTA	13-18	45503-29385	0604319	TOYOTA	13-23
45490-19225	0303651	TOYOTA	13-18	45503-29435	0603694	TOYOTA	13-15
45490-29135	0303690	TOYOTA	13-29	45503-29565	0603100	TOYOTA	13-37
45490-29245	0303774	TOYOTA	13-35	45503-29615	0603694	TOYOTA	13-15
45490-29295	0303626	TOYOTA	13-8	45503-39015	0603625	TOYOTA	13-8
45490-29465	0301789	TOYOTA	13-35	45503-39025	0603631	TOYOTA	13-9
45490-35130	0303795	TOYOTA	13-39	45503-39075	0602480	TOYOTA	13-2
45490-35140	0303794	TOYOTA	13-39	45503-39105	0603631	TOYOTA	13-9
45490-39165	0303713	TOYOTA	13-32	45503-39135	0603669	TOYOTA	13-9
45490-39245	0303763	TOYOTA	13-1	45503-39225	0602842	TOYOTA	13-11
45500-0H010	0605186	TOYOTA	13-7	45503-39235	0602626	TOYOTA	13-47
45503-05010	0604419	TOYOTA	13-15	45503-39265	0602626	TOYOTA	13-47
45503-05020	0602999	TOYOTA	13-4	45503-42020	0603094	TOYOTA	13-55
45503-09230	0602842	TOYOTA	13-11	45503-49035	0604420	TOYOTA	13-17
45503-09321	0605199	TOYOTA	13-41	45503-49055	0602609	TOYOTA	13-54
45503-0D030	0602994	TOYOTA	13-61	45503-49075	0603120	TOYOTA	13-53
45503-0D080	0602782	TOYOTA	13-62	45503-49105	0602629	TOYOTA	13-6
45503-0F010	0603122	TOYOTA	13-5	45503-52010	0602995	TOYOTA	13-61
45503-0R010	0603122	TOYOTA	13-5	45503-52070	0602782	TOYOTA	13-62
45503-10020	0603659	TOYOTA	13-19	45503-59045	0602995	TOYOTA	13-61

RIF. ORIG O.E. NUMBER	RIF. OCAP REF. OCAP	MARCA	PAG.	RIF. ORIG O.E. NUMBER	RIF. OCAP REF. OCAP	MARCA	PAG.
45503-69015	0604556	TOYOTA	13-46	48068-05050	0784418	TOYOTA	13-4
45503-69025	0604557	TOYOTA	13-46	48068-05070	0782590	TOYOTA	13-5
45503-87208	0602466	DAIHATSU	2-3	48068-05080	0783096	TOYOTA	13-6
45503-87210	0602466	DAIHATSU	2-3	48068-09015	0783299	TOYOTA	13-62
45503-87215	0602466	DAIHATSU	2-3	48068-09030	0783299	TOYOTA	13-62
45503-87401	0602459	DAIHATSU	2-9	48068-09040	0783299	TOYOTA	13-62
45503-87702	0603317	DAIHATSU	2-1	48068-0F010	0785189	TOYOTA	13-26
45503-87703	0603305	DAIHATSU	2-1	48068-0F030	0788073	TOYOTA	13-3
45503-87705	0603308	DAIHATSU	2-2	48068-0H010	0782845	TOYOTA	13-7
45503-87708	0602955	DAIHATSU	2-2	48068-0K040	0784149	TOYOTA	13-41
45503-87710	0602444	DAIHATSU	2-2	48068-12110	0783667	TOYOTA	13-22
45503-87711	0602955	DAIHATSU	2-2	48068-12130	0783672	TOYOTA	13-23
45503-87714	0602620	DAIHATSU	2-5	48068-12140	0783672	TOYOTA	13-23
45503-97201	0602455	DAIHATSU	2-8	48068-12180	0784414	TOYOTA	13-24
45503-97203	0602467	DAIHATSU	2-4	48068-12260	0783113	TOYOTA	13-24
45503-97204	0602468	DAIHATSU	2-5	48068-12260 Z	0788078	TOYOTA	13-25
45503-97401	0602456	DAIHATSU	2-8	48068-12300	0788073	TOYOTA	13-3
45503-B1010	0602780	DAIHATSU	2-8	48068-13010	0783091	TOYOTA	13-25
45504-28030	0604331	TOYOTA	13-52	48068-13010 Z	0788079	TOYOTA	13-25
45700-60A00	0403622	SUZUKI	12-11	48068-19045	0783661	TOYOTA	13-19
45700-67001	0403613	SUZUKI	12-3	48068-19065	0783662	TOYOTA	13-19
4575009000	0598067	SSANGYONG	10-3	48068-20150	0783663	TOYOTA	13-20
4575009001	0598067	SSANGYONG	10-3	48068-20151	0783663	TOYOTA	13-20
4575109000	0588067	SSANGYONG	10-3	48068-20260	0784407	TOYOTA	13-15
4575109001	0588067	SSANGYONG	10-3	48068-20380	0783089	TOYOTA	13-17
46300-60B00	0702785	SUZUKI	12-9	48068-20381	0783089	TOYOTA	13-17
46300-60B10	0702785	SUZUKI	12-9	48068-26070	0783101	TOYOTA	13-37
46630-60B00	0501927	NISSAN	9-47	48068-26071	0783101	TOYOTA	13-37
46630-60B00	0501927	SUBARU	11-4	48068-28120	0784338	TOYOTA	13-11
46630-60B00	0501927	SUZUKI	12-2	48068-33010	0782776	TOYOTA	13-10
46630-60B01	0501927	NISSAN	9-47	48068-33020	0782776	TOYOTA	13-10
46630-60B01	0501927	SUBARU	11-4	48068-33030	0782777	TOYOTA	13-10
46630-60B01	0501927	SUZUKI	12-2	48068-33050	0784338	TOYOTA	13-11
46630-60B10	0504495	SUZUKI	12-9	48068-33060	0784338	TOYOTA	13-11
46630-60B11	0502291	SUZUKI	12-8	48068-35080	0782622	TOYOTA	13-2
46630-80F00	0585179	SUZUKI	12-2	48068-35081	0782622	TOYOTA	13-2
46640-80F00	0595179	SUZUKI	12-2	48068-42012	0784411	TOYOTA	13-54
4666005500	0282443	DAEWOO - CHEVROLET	1-4	48068-42022	0784411	TOYOTA	13-54
4666005501	0282443	DAEWOO - CHEVROLET	1-4	48068-42040	0784409	TOYOTA	13-55
4666005501	0282443	SSANGYONG	10-1	48068-42041	0784409	TOYOTA	13-55
4666008001	0294649	SSANGYONG	10-1	48068-42050	0783095	TOYOTA	13-56
4666008011	0284649	SSANGYONG	10-1	48068-42051	0783095	TOYOTA	13-56
4666009002	0294649	SSANGYONG	10-1	48068-44010	0783098	TOYOTA	13-51
4666009011	0284649	SSANGYONG	10-1	48068-49045	0783104	TOYOTA	13-6
48001-JD90B	0603271	NISSAN	9-38	48068-59035	0781516	TOYOTA	13-61
4803429	0283951	DAEWOO - CHEVROLET	1-1	48068-60010	0784561	TOYOTA	13-47
4804642	0503955	DAEWOO - CHEVROLET	1-2	48068-87205	0783326	DAIHATSU	2-3
4806300	0793953	DAEWOO - CHEVROLET	1-2	48068-87206	0403322	DAIHATSU	2-3
4806300 Z	0403953	DAEWOO - CHEVROLET	1-1	48068-87208	0303328	DAIHATSU	2-4
4806301	0783953	DAEWOO - CHEVROLET	1-2	48068-87209	0382469	DAIHATSU	2-4
4806301 Z	0403953	DAEWOO - CHEVROLET	1-1	48068-87405	0782460	DAIHATSU	2-9
4806304	0593954	DAEWOO - CHEVROLET	1-2	48068-87507	0783327	DAIHATSU	2-7
4806305	0583954	DAEWOO - CHEVROLET	1-2	48068-87704	0783324	DAIHATSU	2-1
48066-29075	0383102	TOYOTA	13-37	48068-87705	0383306	DAIHATSU	2-1
48067-29085	0393102	TOYOTA	13-37	48068-87706	0383306	DAIHATSU	2-1
48068-02070	0783091	TOYOTA	13-25	48068-97202	0382779	DAIHATSU	2-5
48068-02070 Z	0788079	TOYOTA	13-25	48068-B1020	0782781	DAIHATSU	2-8
48068-02130	0788073	TOYOTA	13-3	4806887710	0393277	DAIHATSU	2-6



RIF. ORIG O.E. NUMBER	RIF. OCAP REF. OCAP	MARCA	PAG.	RIF. ORIG O.E. NUMBER	RIF. OCAP REF. OCAP	MARCA	PAG.
4806887711	0383277	DAIHATSU	2-5	48069-B1020	0792781	DAIHATSU	2-8
48069-02070	0793091	TOYOTA	13-25	48251-1700	0602953	NISSAN	9-17
48069-02070 Z	0798079	TOYOTA	13-25	48510-01G25	0504174	NISSAN	9-25
48069-02130	0798073	TOYOTA	13-3	48510-01L25	0502946	NISSAN	9-14
48069-05050	0794418	TOYOTA	13-4	48510-01W00	0500164	NISSAN	9-24
48069-05070	0792590	TOYOTA	13-5	48510-11A27	0500994	NISSAN	9-5
48069-05080	0793096	TOYOTA	13-6	48510-31G25	0503589	NISSAN	9-26
48069-09015	0793299	TOYOTA	13-62	48510-35A25	0503575	NISSAN	9-46
48069-09030	0793299	TOYOTA	13-62	48510-35A26	0500994	NISSAN	9-5
48069-09040	0793299	TOYOTA	13-62	48510-35A27	0500994	NISSAN	9-5
48069-0F010	0795189	TOYOTA	13-27	48510-50A25	0503576	NISSAN	9-37
48069-0F030	0798073	TOYOTA	13-3	48510-50A26	0503577	NISSAN	9-37
48069-0H010	0792845	TOYOTA	13-7	48510-50W00	0583545	NISSAN	9-27
48069-0K040	0794149	TOYOTA	13-41	48510-51A25	0503576	NISSAN	9-37
48069-12110	0793667	TOYOTA	13-22	48510-53A25	0503576	NISSAN	9-37
48069-12130	0793672	TOYOTA	13-23	48510-53A26	0503576	NISSAN	9-37
48069-12180	0794414	TOYOTA	13-24	48510-70A25	0500994	NISSAN	9-5
48069-12260	0793113	TOYOTA	13-25	48510-70A27	0500994	NISSAN	9-5
48069-12260 Z	0798078	TOYOTA	13-25	48510-7F000	0503589	NISSAN	9-26
48069-12300	0798073	TOYOTA	13-3	48510-A0600	0583512	NISSAN	9-6
48069-13010	0793091	TOYOTA	13-25	48510-D0100	0500994	NISSAN	9-5
48069-13010 Z	0798079	TOYOTA	13-25	48510-D0125	0500994	NISSAN	9-5
48069-19045	0793661	TOYOTA	13-19	48510-G2525	0583581	NISSAN	9-53
48069-19065	0793662	TOYOTA	13-20	48510-H1025	0583572	NISSAN	9-42
48069-20150	0793663	TOYOTA	13-21	48510-H5025	0583572	NISSAN	9-42
48069-20151	0793663	TOYOTA	13-21	48510-M7025	0503578	NISSAN	9-36
48069-20260	0794407	TOYOTA	13-15	48510-M7026	0503578	NISSAN	9-36
48069-20380	0793089	TOYOTA	13-17	48510-N8225	0583553	NISSAN	9-39
48069-20381	0793089	TOYOTA	13-17	48510-N8425	0583556	NISSAN	9-40
48069-26070	0793101	TOYOTA	13-37	48510-Q0125	0501221	NISSAN	9-7
48069-26071	0793101	TOYOTA	13-37	48510-R8000	0583530	NISSAN	9-9
48069-28120	0794338	TOYOTA	13-11	48510-R8025	0583530	NISSAN	9-9
48069-33010	0792776	TOYOTA	13-10	48510-S0125	0501221	NISSAN	9-7
48069-33020	0792776	TOYOTA	13-10	48510-T3026	0583530	NISSAN	9-9
48069-33030	0792777	TOYOTA	13-10	48510-T3060	0583530	NISSAN	9-9
48069-33050	0794338	TOYOTA	13-11	48510-T3065	0583530	NISSAN	9-9
48069-33060	0794338	TOYOTA	13-11	48510-U0100	0583512	NISSAN	9-6
48069-35080	0792622	TOYOTA	13-2	48510-W5000	0583564	NISSAN	9-4
48069-35081	0792622	TOYOTA	13-2	48510-W5025	0583564	NISSAN	9-4
48069-42012	0794411	TOYOTA	13-54	48520-00QAH	0292825	NISSAN	9-12
48069-42022	0794411	TOYOTA	13-54	48520-00QAJ	0282825	NISSAN	9-12
48069-42040	0794409	TOYOTA	13-55	48520-00QAK	0294392	NISSAN	9-30
48069-42041	0794409	TOYOTA	13-55	48520-00QAL	0284392	NISSAN	9-30
48069-42050	0793095	TOYOTA	13-56	48520-00QAM	0602322	NISSAN	9-30
48069-42051	0793095	TOYOTA	13-56	48520-00QAN	0292829	NISSAN	9-13
48069-44010	0793098	TOYOTA	13-51	48520-00QAP	0282829	NISSAN	9-13
48069-49045	0793104	TOYOTA	13-7	48520-01B25	0283540	NISSAN	9-17
48069-59035	0791516	TOYOTA	13-61	48520-01E00	0283525	NISSAN	9-1
48069-60010	0794561	TOYOTA	13-48	48520-01E25	0283525	NISSAN	9-1
48069-87205	0793326	DAIHATSU	2-3	48520-01E26	0283525	NISSAN	9-1
48069-87208	0303328	DAIHATSU	2-4	48520-01F25	0281222	NISSAN	9-7
48069-87209	0392469	DAIHATSU	2-4	48520-01G25	0194175	NISSAN	9-25
48069-87405	0792460	DAIHATSU	2-9	48520-01J00	0184143	NISSAN	9-23
48069-87507	0793327	DAIHATSU	2-7	48520-01J10	0284144	NISSAN	9-23
48069-87704	0793324	DAIHATSU	2-1	48520-01L01	0192947	NISSAN	9-14
48069-87705	0393306	DAIHATSU	2-2	48520-01L25	0192947	NISSAN	9-14
48069-87706	0393306	DAIHATSU	2-2	48520-01N25	0284642	NISSAN	9-52
48069-97202	0392779	DAIHATSU	2-5	48520-01W00	0190162	NISSAN	9-25

RIF. ORIG O.E. NUMBER	RIF. OCAP REF. OCAP	MARCA	PAG.	RIF. ORIG O.E. NUMBER	RIF. OCAP REF. OCAP	MARCA	PAG.
48520-02E00	0283525	NISSAN	9-1	48520-S0102	0191217	NISSAN	9-7
48520-02E25	0283525	NISSAN	9-1	48520-S0125	0191217	NISSAN	9-7
48520-02E26	0280090	NISSAN	9-51	48520-T3026	0593530	NISSAN	9-10
48520-0M025	0284177	NISSAN	9-2	48520-T3060	0593530	NISSAN	9-10
48520-0M085	0284178	NISSAN	9-2	48520-T3065	0593530	NISSAN	9-10
48520-0P725	0284511	NISSAN	9-21	48520-U0100	0283509	NISSAN	9-6
48520-0W025	0284511	NISSAN	9-21	48520-U5200	0283509	NISSAN	9-6
48520-15U25	0284178	NISSAN	9-2	48520-VB025	0184146	NISSAN	9-24
48520-15U26	0284178	NISSAN	9-2	48520-W1025	0281222	NISSAN	9-7
48520-17B25	0283540	NISSAN	9-17	48520-W5025	0283553	NISSAN	9-5
48520-21P25	0283582	NISSAN	9-1	48521-00QAA	0602831	NISSAN	9-13
48520-27N25	0284643	NISSAN	9-53	48521-00QAF	0602826	NISSAN	9-12
48520-2S425	0193116	NISSAN	9-28	48521-00QAG	0602830	NISSAN	9-13
48520-2S485	0193116	NISSAN	9-28	48521-01B25	0602953	NISSAN	9-17
48520-31G25	0183587	NISSAN	9-26	48521-01F00	0691223	NISSAN	9-1
48520-3S500	0284511	NISSAN	9-21	48521-01F06	0691223	NISSAN	9-1
48520-3S525	0284511	NISSAN	9-21	48521-01G25	0184174	NISSAN	9-25
48520-41L00	0282949	NISSAN	9-15	48521-01L01	0182948	NISSAN	9-15
48520-41L25	0282949	NISSAN	9-15	48521-01L25	0182948	NISSAN	9-15
48520-41L26	0282949	NISSAN	9-15	48521-01N25	0294641	NISSAN	9-52
48520-41L27	0282949	NISSAN	9-15	48521-01W00	0180163	NISSAN	9-25
48520-4F125	0280914	NISSAN	9-17	48521-06R05	0602951	NISSAN	9-15
48520-50A00	0280139	NISSAN	9-37	48521-0W025	0602575	NISSAN	9-21
48520-50A25	0280139	NISSAN	9-37	48521-0W026	0602575	NISSAN	9-21
48520-50A26	0280139	NISSAN	9-37	48521-1725	0602953	NISSAN	9-17
48520-50W00	0183546	NISSAN	9-26	48521-1M210	0604510	NISSAN	9-2
48520-50Y25	0283525	NISSAN	9-1	48521-1M225	0604510	NISSAN	9-2
48520-53E25	0283526	NISSAN	9-9	48521-1M226	0604510	NISSAN	9-2
48520-61G25	0182890	NISSAN	9-26	48521-27N00	0604644	NISSAN	9-53
48520-6F625	0280914	NISSAN	9-17	48521-2S425	0183115	NISSAN	9-28
48520-71L25	0282950	NISSAN	9-15	48521-2S485	0183115	NISSAN	9-28
48520-73J25	0283550	NISSAN	9-31	48521-31G25	0193588	NISSAN	9-26
48520-7F000	0183587	NISSAN	9-26	48521-35A00	0603575	NISSAN	9-37
48520-7F001	0193588	NISSAN	9-26	48521-35A06	0603575	NISSAN	9-37
48520-88E25	0282957	NISSAN	9-16	48521-35F00	0600993	NISSAN	9-5
48520-9C000	0283550	NISSAN	9-31	48521-40U25	0604491	NISSAN	9-17
48520-9C025	0283550	NISSAN	9-31	48521-4M500	0602574	NISSAN	9-3
48520-A0600	0283509	NISSAN	9-6	48521-4M527	0602574	NISSAN	9-3
48520-AX600	0284379	NISSAN	9-19	48521-4M528	0602574	NISSAN	9-3
48520-AX602	0282664	NISSAN	9-19	48521-4M587	0602574	NISSAN	9-3
48520-BM425	0284397	NISSAN	9-3	48521-4U110	0602822	NISSAN	9-3
48520-CA025	0286500	NISSAN	9-20	48521-4U185	0602822	NISSAN	9-3
48520-D0100	0280090	NISSAN	9-51	48521-4U186	0602822	NISSAN	9-3
48520-D0125	0280090	NISSAN	9-51	48521-50400	0602889	NISSAN	9-1
48520-D0126	0280090	NISSAN	9-51	48521-50W00	0193547	NISSAN	9-26
48520-EA01J	0294616	NISSAN	9-22	48521-50Y00	0602889	NISSAN	9-1
48520-G2525	0293509	NISSAN	9-6	48521-70A00	0600993	NISSAN	9-5
48520-G5125	0294647	NISSAN	9-54	48521-70A06	0600993	NISSAN	9-5
48520-G9502	0193835	NISSAN	9-23	48521-70A16	0600993	NISSAN	9-5
48520-H5025	0283553	NISSAN	9-5	48521-71C00	0602951	NISSAN	9-15
48520-M0225	0280360	NISSAN	9-10	48521-71V06	0602951	NISSAN	9-15
48520-M3025	0280360	NISSAN	9-10	48521-72E00	0602951	NISSAN	9-15
48520-N8425	0283557	NISSAN	9-40	48521-72E06	0602951	NISSAN	9-15
48520-Q0125	0191217	NISSAN	9-7	48521-8H300	0604512	NISSAN	9-57
48520-Q9000	0283525	NISSAN	9-1	48521-8H325	0604512	NISSAN	9-57
48520-R8000	0593530	NISSAN	9-10	48521-8H385	0604512	NISSAN	9-57
48520-R8025	0593530	NISSAN	9-10	48521-A03G0	0600089	NISSAN	9-50
48520-S0101	0191217	NISSAN	9-7	48521-A0600	0293510	NISSAN	9-6

RIF. ORIG O.E. NUMBER	RIF. OCAP REF. OCAP	MARCA	PAG.	RIF. ORIG O.E. NUMBER	RIF. OCAP REF. OCAP	MARCA	PAG.
48521-CA025	0606500	NISSAN	9-20	48570-82100	0183544	NISSAN	9-23
48521-D0100	0600993	NISSAN	9-5	48570-G9501	0183835	NISSAN	9-23
48521-EA000	0604617	NISSAN	9-22	48570-J5100	0183544	NISSAN	9-23
48521-G2525	0283510	NISSAN	9-6	48570-VB025	0194146	NISSAN	9-24
48521-G5101	0284648	NISSAN	9-54	48571-T3001	0193529	NISSAN	9-9
48521-G5125	0284648	NISSAN	9-54	48571-T3025	0193529	NISSAN	9-9
48521-H1001	0293554	NISSAN	9-5	48580-82100	0193544	NISSAN	9-23
48521-H5025	0293554	NISSAN	9-5	48580-J5100	0193544	NISSAN	9-23
48521-M3070	0603577	NISSAN	9-11	48605-35030	0783799	TOYOTA	13-40
48521-M7000	0603577	NISSAN	9-11	48606-35030	0793799	TOYOTA	13-40
48521-N8425	0293558	NISSAN	9-40	48610-0K040	0785200	TOYOTA	13-41
48521-P9001	0691223	NISSAN	9-1	48610-29075	0792972	TOYOTA	13-36
48521-Q0125	0181221	NISSAN	9-1	48610-29085	0782972	TOYOTA	13-36
48521-S0101	0181221	NISSAN	9-1	48610-32040	0782624	TOYOTA	13-2
48521-S0102	0181221	NISSAN	9-1	48610-60030	0784558	TOYOTA	13-46
48521-S0103	0181221	NISSAN	9-1	48610-60050	0784560	TOYOTA	13-47
48521-S0125	0181221	NISSAN	9-1	48620-60010	0784559	TOYOTA	13-47
48521-S0126	0181221	NISSAN	9-1	48630-01G25	0504174	NISSAN	9-25
48521-U0100	0293510	NISSAN	9-6	48630-01W00	0500164	NISSAN	9-24
48521-U5200	0293510	NISSAN	9-6	48630-0K040	0795200	TOYOTA	13-41
48521-W1000	0691223	NISSAN	9-1	48630-35020	0792624	TOYOTA	13-2
48521-W1001	0691223	NISSAN	9-1	48630-50W00	0593545	NISSAN	9-27
48521-W5025	0293554	NISSAN	9-5	48630-60010	0794558	TOYOTA	13-46
48521-X08G1	0603602	NISSAN	9-51	48630-60020	0794560	TOYOTA	13-47
48521-Y02G0	0602889	NISSAN	9-1	48630-A0600	0593512	NISSAN	9-6
48527-1U61A	0282665	NISSAN	9-19	48630-D8025	0593559	NISSAN	9-40
48527-JD01A	0283123	NISSAN	9-37	48630-G2525	0593581	NISSAN	9-53
48530-01G00	0303259	NISSAN	9-27	48630-H5025	0593572	NISSAN	9-42
48530-01G25	0303259	NISSAN	9-27	48630-N8225	0593553	NISSAN	9-39
48530-21000	0403513	NISSAN	9-7	48630-N8425	0593556	NISSAN	9-40
48530-21400	0303516	NISSAN	9-7	48630-R8025	0593530	NISSAN	9-10
48530-31G25	0303590	NISSAN	9-49	48630-S0125	0501221	NISSAN	9-7
48530-35G25	0303591	NISSAN	9-49	48630-U0100	0593512	NISSAN	9-6
48530-H1600	0303579	NISSAN	9-43	48630-W5000	0593564	NISSAN	9-4
48530-H5000	0303569	NISSAN	9-5	48630-W5025	0593564	NISSAN	9-4
48530-H6100	0303568	NISSAN	9-5	48640-01F25	0291222	NISSAN	9-8
48530-N8500	0303560	NISSAN	9-41	48640-01N25	0294641	NISSAN	9-52
48530-U8701	0303523	NISSAN	9-7	48640-50W00	0193546	NISSAN	9-26
48560-01G25	0503258	NISSAN	9-25	48640-60010	0794559	TOYOTA	13-47
48560-21400	0503514	NISSAN	9-6	48640-A0600	0293509	NISSAN	9-6
48560-3S125	0503117	NISSAN	9-28	48640-AX600	0294379	NISSAN	9-19
48560-3S525	0503118	NISSAN	9-28	48640-AX602	0292664	NISSAN	9-19
48560-H1025	0593572	NISSAN	9-42	48640-EA01J	0284616	NISSAN	9-22
48560-H5000	0503571	NISSAN	9-42	48640-G2525	0283509	NISSAN	9-6
48560-H6100	0503570	NISSAN	9-42	48640-G5101	0284647	NISSAN	9-54
48560-H6125	0503570	NISSAN	9-42	48640-G5125	0284647	NISSAN	9-54
48560-U2000	0503514	NISSAN	9-6	48640-H5025	0293553	NISSAN	9-5
48560-U5200	0503514	NISSAN	9-6	48640-N8425	0293557	NISSAN	9-40
48560-W5000	0503566	NISSAN	9-4	48640-U0100	0293509	NISSAN	9-6
48560-W5700	0503565	NISSAN	9-4	48640-U5200	0293509	NISSAN	9-6
48560-W5725	0503565	NISSAN	9-4	48640-W1025	0291222	NISSAN	9-8
48561-T3001	0183529	NISSAN	9-9	48640-W5025	0293553	NISSAN	9-5
48561-T3025	0183529	NISSAN	9-9	48641-01N25	0284642	NISSAN	9-52
48570-01J10	0294144	NISSAN	9-23	48641-50W00	0183547	NISSAN	9-26
48570-31G25	0193588	NISSAN	9-26	48641-A0600	0283510	NISSAN	9-6
48570-3S500	0283114	NISSAN	9-28	48641-D8025	0283559	NISSAN	9-41
48570-3S525	0283114	NISSAN	9-28	48641-G2525	0293510	NISSAN	9-6
48570-61G25	0192891	NISSAN	9-27	48641-G5101	0294648	NISSAN	9-54

RIF. ORIG O.E. NUMBER	RIF. OCAP REF. OCAP	MARCA	PAG.	RIF. ORIG O.E. NUMBER	RIF. OCAP REF. OCAP	MARCA	PAG.
48641-G5125	0294648	NISSAN	9-54	48820-0D010	0502783	TOYOTA	13-62
48641-H1001	0283554	NISSAN	9-5	48820-0K030	0584562	TOYOTA	13-41
48641-H5025	0283554	NISSAN	9-5	48820-17010	0503110	TOYOTA	13-49
48641-N8425	0283558	NISSAN	9-40	48820-17020	0503108	TOYOTA	13-50
48641-U0100	0283510	NISSAN	9-6	48820-17030	0503108	TOYOTA	13-50
48641-U5200	0283510	NISSAN	9-6	48820-17040	0503108	TOYOTA	13-50
48641-W5025	0283554	NISSAN	9-5	48820-20010	0504412	TOYOTA	13-16
48647-1U61A	0292665	NISSAN	9-19	48820-20020	0591922	TOYOTA	13-4
48647-JD01A	0293123	NISSAN	9-37	48820-20021	0504417	TOYOTA	13-24
48650-20020	0505185	TOYOTA	13-4	48820-20030	0582295	TOYOTA	13-14
48657-1U61A	0282665	NISSAN	9-19	48820-20040	0581922	TOYOTA	13-4
48800-60A00	0503619	SUZUKI	12-10	48820-24010	0504565	TOYOTA	13-17
48800-84C50	0501782	SUZUKI	12-7	48820-26030	0583103	TOYOTA	13-37
48802-87703	0502448	DAIHATSU	2-4	48820-28010	0584323	TOYOTA	13-52
48810-05012	0591922	TOYOTA	13-4	48820-28050	0502294	TOYOTA	13-12
48810-20010	0592295	TOYOTA	13-14	48820-32010	0503090	TOYOTA	13-17
48810-20020	0591922	TOYOTA	13-4	48820-33010	0504416	TOYOTA	13-10
48810-20040	0581922	TOYOTA	13-4	48820-33020	0582293	TOYOTA	13-10
48810-26030	0593103	TOYOTA	13-37	48820-35030	0502623	TOYOTA	13-3
48810-28010	0594323	TOYOTA	13-52	48820-42010	0504421	TOYOTA	13-54
48810-33010	0592293	TOYOTA	13-11	48820-42020	0502610	TOYOTA	13-55
48810-60001	0183611	SUZUKI	12-2	48820-42030	0503096	TOYOTA	13-3
48810-60010	0592627	TOYOTA	13-44	48820-44020	0502630	TOYOTA	13-7
48810-60040	0594562	TOYOTA	13-42	48820-47010	0502591	TOYOTA	13-5
48810-60810	0282688	SUZUKI	12-9	48820-60001	0193611	SUZUKI	12-2
48810-60A00	0183620	SUZUKI	12-7	48820-60010	0582627	TOYOTA	13-44
48810-60B00	0283616	SUBARU	11-3	48820-60050	0584562	TOYOTA	13-41
48810-60B00	0283616	SUZUKI	12-6	48820-60A00	0193621	SUZUKI	12-11
48810-60J00	0282688	SUZUKI	12-9	48820-65D00	0292986	SUZUKI	12-4
48810-63J00	0282688	SUZUKI	12-9	48820-67D00	0292986	SUZUKI	12-4
48810-65D00	0282986	SUZUKI	12-4	48820-77E00	0192981	SUZUKI	12-11
48810-65J00	0282839	SUZUKI	12-5	48820-78A00	0292990	SUZUKI	12-3
48810-67D00	0282986	SUZUKI	12-4	48820-78A01	0292990	SUZUKI	12-3
48810-76G00	0282988	SUZUKI	12-1	48820-79000	0193612	SUZUKI	12-3
48810-77E00	0182980	SUZUKI	12-11	48820-81A00	0192762	SUZUKI	12-7
48810-78000	0183606	SUZUKI	12-1	48820-AD010	0502623	TOYOTA	13-3
48810-78001	0183606	SUZUKI	12-1	48821-B1010	0582457	DAIHATSU	2-8
48810-78002	0183606	SUZUKI	12-1	48822-87401	0502461	DAIHATSU	2-9
48810-78A00	0282990	SUZUKI	12-3	48830-05020	0502581	TOYOTA	13-4
48810-78A01	0282990	SUZUKI	12-3	48830-05030	0503104	TOYOTA	13-6
48810-79000	0183612	SUZUKI	12-2	48830-06020	0502292	TOYOTA	13-10
48810-79J00	0282839	SUZUKI	12-5	48830-06030	0502843	TOYOTA	13-12
48810-79J01	0282839	SUZUKI	12-5	48830-12060	0504415	TOYOTA	13-24
48810-80000	0183620	SUZUKI	12-7	48830-17010	0503111	TOYOTA	13-49
48810-81A00	0182762	SUZUKI	12-7	48830-17020	0503112	TOYOTA	13-50
48810-82000	0283616	SUBARU	11-3	48830-17030	0503109	TOYOTA	13-50
48810-82000	0283616	SUZUKI	12-6	48830-17040	0503109	TOYOTA	13-50
48810-83300	0183620	SUZUKI	12-7	48830-17050	0503109	TOYOTA	13-50
48810-83E00	0284489	SUZUKI	12-6	48830-20010	0504413	TOYOTA	13-9
48810-83E01	0284489	SUZUKI	12-6	48830-21020	0582592	TOYOTA	13-5
48810-83E02	0284489	SUZUKI	12-6	48830-32010	0504413	TOYOTA	13-9
48810-84000	0183608	SUZUKI	12-1	48830-33010	0502292	TOYOTA	13-10
48810-84001	0183608	SUZUKI	12-1	48830-35020	0502624	TOYOTA	13-3
48810-M84010	0183608	SUZUKI	12-1	48830-42010	0582784	TOYOTA	13-55
48819-70010	0505187	TOYOTA	13-7	48830-42020	0503095	TOYOTA	13-56
48820-05012	0581922	TOYOTA	13-4	48830-42021	0503095	TOYOTA	13-56
48820-06020	0502292	TOYOTA	13-10	48830-48010	0502843	TOYOTA	13-12
48820-06040	0502294	TOYOTA	13-12	48830-50G10	0601950	SUZUKI	12-8

RIF. ORIG O.E. NUMBER	RIF. OCAP REF. OCAP	MARCA	PAG.	RIF. ORIG O.E. NUMBER	RIF. OCAP REF. OCAP	MARCA	PAG.
48830-60030	0504563	TOYOTA	13-48	51270-SB0-003	0403354	HONDA	3-26
48830-60B00	0603084	SUZUKI	12-8	51270-SB0-013	0403354	HONDA	3-26
48830-60G00	0601947	SUZUKI	12-1	51270-SF1-003	0400284	HONDA	3-27
48830-63B10	0601926	SUBARU	11-3	51306-SAA-E01	0794370	HONDA	3-22
48830-63J00	0602689	SUZUKI	12-9	51320-S04-003	0501940	HONDA	3-14
48830-65D00	0601784	SUZUKI	12-4	51320-S10-003	0584268	HONDA	3-18
48830-65J00	0603126	SUZUKI	12-5	51320-S2A-003	0582642	HONDA	3-30
48830-67D00	0602984	SUZUKI	12-4	51320-S2G-003	0584546	HONDA	3-26
48830-75F01	0602989	SUZUKI	12-6	51320-S2H-003	0581943	HONDA	3-20
48830-76G00	0602991	SUZUKI	12-3	51320-S30-003	0501939	HONDA	3-28
48830-77A00	0602991	SUZUKI	12-3	51320-S5A-003	0584296	HONDA	3-15
48830-78000	0603607	SUZUKI	12-1	51320-S84-A01	0581936	HONDA	3-6
48830-78001	0603607	SUZUKI	12-1	51320-SAA-003	0584371	HONDA	3-22
48830-78A00	0605180	SUZUKI	12-3	51320-SEA-E01	0583283	HONDA	3-9
48830-79J00	0685184	SUZUKI	12-10	51320-SK3-000	0504237	HONDA	3-17
48830-79J10	0695184	SUZUKI	12-10	51320-SMG-E01	0503290	HONDA	3-16
48830-82000	0602958	SUZUKI	12-8	51320-SP0-003	0504538	HONDA	3-24
48830-83E00	0604488	SUZUKI	12-6	51320-STK-A01	0508063	HONDA	3-20
48830-84000	0603609	SUZUKI	12-1	51320-TA0-A01	0583283	HONDA	3-9
48830-86G00	0604488	SUZUKI	12-6	51320-TF0-003	0503296	HONDA	3-23
48830-M70F00	0601945	SUZUKI	12-1	51320SEAE01	0583283	HONDA	3-9
48830A78B00	0604293	DAEWOO - CHEVROLET	1-10	51320SMGE01	0503290	HONDA	3-16
48831-B1010	0592457	DAIHATSU	2-8	51320TA0A01	0583283	HONDA	3-9
48840-21010	0592592	TOYOTA	13-5	51320TF0003	0503296	HONDA	3-23
48840-42010	0592784	TOYOTA	13-55	51321-S10-003	0594268	HONDA	3-18
48850-60A00	0503618	SUZUKI	12-10	51321-S2A-003	0592642	HONDA	3-31
48850-77E00	0502979	SUZUKI	12-11	51321-S2G-003	0594546	HONDA	3-26
48900-84C50	0501781	SUZUKI	12-7	51321-S2H-003	0591943	HONDA	3-21
48900A83301	0501781	SUZUKI	12-7	51321-S5A-003	0594296	HONDA	3-15
49001-BA210 Z	0604630	NISSAN	9-35	51321-S84-A01	0591936	HONDA	3-6
5-44350-095-0	0603371	ISUZU	5-3	51321-SAA-003	0594371	HONDA	3-22
5-44350-095-1	0603371	ISUZU	5-3	51321-SEA-E01	0593283	HONDA	3-9
5-44350-095-2	0603371	ISUZU	5-3	51321-TA0-A01	0593283	HONDA	3-9
5-44350-095-3	0603371	ISUZU	5-3	51321SEAE01	0593283	HONDA	3-9
5-44352-026-0	0280455	ISUZU	5-3	51321TA0A01	0593283	HONDA	3-9
5-51227-033-0	0403372	ISUZU	5-4	51350-634-000	0783329	HONDA	3-10
51220-S04-003	0401679	HONDA	3-2	51350-634-003	0783336	HONDA	3-1
51220-S2H-013	0404370	HONDA	3-22	51350-659-010	0703330	HONDA	3-10
51220-S5A-003	0404291	HONDA	3-15	51350-659-325	0703330	HONDA	3-10
51220-S5A-J10	0404291	HONDA	3-15	51350-671-003	0783336	HONDA	3-1
51220-S5A-J30	0404291	HONDA	3-15	51350-671-033	0783336	HONDA	3-1
51220-S9A-982	0402765	HONDA	3-18	51350-673-000	0703330	HONDA	3-10
51220-SAA-013	0404370	HONDA	3-22	51350-692-000	0703355	HONDA	3-26
51220-SAA-E01	0404370	HONDA	3-22	51350-692-010	0703355	HONDA	3-26
51220-SD4-004	0403353	HONDA	3-23	51350-692-050	0703355	HONDA	3-26
51220-SD4-013	0403353	HONDA	3-23	51350-S04-G00	0784234	HONDA	3-14
51220-SD4-023	0403353	HONDA	3-23	51350-S10-A00	0784317	HONDA	3-18
51220-SEL-T01	0404370	HONDA	3-22	51350-S10-G00	0784317	HONDA	3-18
51220-SK7-013	0401679	HONDA	3-2	51350-S2A-000	0382767	HONDA	3-30
51220-SL5-003	0404549	HONDA	3-28	51350-S2H-G02	0782789	HONDA	3-20
51220-SM0-A01	0401679	HONDA	3-2	51350-S50-G01	0782788	HONDA	3-26
51220-SM1-A01	0403350	HONDA	3-3	51350-S5A-A03	0784291	HONDA	3-15
51220-SM4-003	0403350	HONDA	3-3	51350-S5A-A10	0784291	HONDA	3-15
51220-SM4-013	0403350	HONDA	3-3	51350-S5A-E50	0784291	HONDA	3-15
51220-SR3-003	0401679	HONDA	3-2	51350-S7A-010	0782807	HONDA	3-29
51220-STK-A01	0408063	HONDA	3-19	51350-S7C-010	0782807	HONDA	3-29
51220-TA0-A02	0403282	HONDA	3-8	51350-S9A-010	0782476	HONDA	3-19
51220TA0A02	0403282	HONDA	3-8	51350-SA0-000	0703332	HONDA	3-10

RIF. ORIG O.E. NUMBER	RIF. OCAP REF. OCAP	MARCA	PAG.	RIF. ORIG O.E. NUMBER	RIF. OCAP REF. OCAP	MARCA	PAG.
51350-SA0-010	0703332	HONDA	3-10	51360-ST7-010	0394230	HONDA	3-13
51350-SA0-030	0703332	HONDA	3-10	51360-SWA-E01	0798063	HONDA	3-20
51350-SA5-003	0783337	HONDA	3-1	51360-TA0-A00	0393282	HONDA	3-9
51350-SA5-010	0783338	HONDA	3-2	51360-TF0-030	0793295	HONDA	3-23
51350-SA5-013	0783337	HONDA	3-1	51360SMGE05	0393289	HONDA	3-16
51350-SA5-020	0783338	HONDA	3-2	51360TA0A00	0393282	HONDA	3-9
51350-SAA-E01	0784370	HONDA	3-22	51360TF0030	0793295	HONDA	3-23
51350-SEA-E01	0384366	HONDA	3-7	51361-SB2-013	0793333	HONDA	3-11
51350-SMG-E05	0383289	HONDA	3-16	51361-SB2-672	0793333	HONDA	3-11
51350-SR3-020	0384230	HONDA	3-13	51361-SB6-931	0793333	HONDA	3-11
51350-SR3-A01	0384230	HONDA	3-13	51361-SD2-003	0793333	HONDA	3-11
51350-SR3-A02	0384230	HONDA	3-13	51365-S1A-E00	0394292	HONDA	3-6
51350-ST7-010	0384230	HONDA	3-13	51365-S84-A00	0394292	HONDA	3-6
51350-SWA-E01	0788063	HONDA	3-20	51365-SE0-010	0793340	HONDA	3-2
51350-TA0-A00	0383282	HONDA	3-9	51365-SH3-010	0793335	HONDA	3-12
51350-TF0-030	0783295	HONDA	3-23	51365-SH3-020	0793335	HONDA	3-12
51350SMGE05	0383289	HONDA	3-16	51365-SK3-000	0392535	HONDA	3-17
51350TA0A00	0383282	HONDA	3-9	51365-SM4-030	0394228	HONDA	3-3
51350TF0030	0783295	HONDA	3-23	51365-SM4-040	0394228	HONDA	3-3
51351-SB2-013	0783333	HONDA	3-10	51365-SV4-000	0394241	HONDA	3-5
51351-SB2-672	0783333	HONDA	3-10	51365-SV7-A00	0394241	HONDA	3-5
51351-SB6-931	0783333	HONDA	3-10	51450-S01-023	0784233	HONDA	3-13
51351-SD2-003	0783333	HONDA	3-10	51450-S01-A02	0784233	HONDA	3-13
51355-S1A-E00	0384292	HONDA	3-6	51450-S04-003	0784233	HONDA	3-13
51355-S84-A00	0384292	HONDA	3-6	51450-S04-013	0784233	HONDA	3-13
51355-SE0-010	0783340	HONDA	3-2	51450-S04-023	0784233	HONDA	3-13
51355-SH3-010	0783335	HONDA	3-11	51450-S10-020	0784316	HONDA	3-17
51355-SH3-020	0783335	HONDA	3-11	51450-S1A-E01	0784242	HONDA	3-6
51355-SK3-000	0382535	HONDA	3-17	51450-S30-003	0782766	HONDA	3-28
51355-SM4-030	0384228	HONDA	3-3	51450-S84-A01	0784242	HONDA	3-6
51355-SM4-040	0384228	HONDA	3-3	51450-SDA-A01	0784365	HONDA	3-7
51355-SV4-000	0384241	HONDA	3-5	51450-SH3-000	0783334	HONDA	3-11
51355-SV7-A00	0384241	HONDA	3-5	51450-SH3-020	0783334	HONDA	3-11
51360-634-000	0793329	HONDA	3-10	51450-SH3-023	0783334	HONDA	3-11
51360-634-003	0793336	HONDA	3-1	51450-SH3-030	0783334	HONDA	3-11
51360-671-003	0793336	HONDA	3-1	51450-SM4-013	0783342	HONDA	3-3
51360-671-033	0793336	HONDA	3-1	51450-SM4-023	0783342	HONDA	3-3
51360-S04-G00	0794234	HONDA	3-14	51450-SM4-A02	0783342	HONDA	3-3
51360-S10-A00	0794317	HONDA	3-18	51450-SM4-A03	0783342	HONDA	3-3
51360-S10-G00	0794317	HONDA	3-18	51450-SP0-033	0784536	HONDA	3-24
51360-S2A-000	0392767	HONDA	3-30	51450-SR0-A02	0783344	HONDA	3-12
51360-S2H-G02	0792789	HONDA	3-20	51450-SR3-003	0783344	HONDA	3-12
51360-S50-G01	0792788	HONDA	3-26	51450-SR3-013	0783344	HONDA	3-12
51360-S5A-A03	0794291	HONDA	3-15	51450-SR3-023	0783344	HONDA	3-12
51360-S5A-A10	0794291	HONDA	3-15	51450-ST3-E02	0783344	HONDA	3-12
51360-S5A-E50	0794291	HONDA	3-15	51450-SV4-000	0783351	HONDA	3-4
51360-S7A-010	0792807	HONDA	3-30	51450-SV4-A00	0783351	HONDA	3-4
51360-S7C-010	0792807	HONDA	3-30	51450-SZ3-013	0784541	HONDA	3-25
51360-S9A-010	0792476	HONDA	3-19	51450-SZ3-901	0784542	HONDA	3-25
51360-SA5-010	0793338	HONDA	3-2	51459-SE0-000	0783339	HONDA	3-2
51360-SA5-013	0793337	HONDA	3-1	51459-SE0-003	0783339	HONDA	3-2
51360-SA5-020	0793338	HONDA	3-2	51460-S04-003	0794233	HONDA	3-14
51360-SAA-E01	0794370	HONDA	3-22	51460-S04-023	0794233	HONDA	3-14
51360-SEA-E01	0394366	HONDA	3-7	51460-S10-020	0794316	HONDA	3-17
51360-SMG-E05	0393289	HONDA	3-16	51460-S1A-E01	0794242	HONDA	3-6
51360-SR3-020	0394230	HONDA	3-13	51460-S30-003	0792766	HONDA	3-28
51360-SR3-A01	0394230	HONDA	3-13	51460-S584-A01	0794242	HONDA	3-6
51360-SR3-A02	0394230	HONDA	3-13	51460-SDA-A01	0794365	HONDA	3-7

RIF. ORIG O.E. NUMBER	RIF. OCAP REF. OCAP	MARCA	PAG.	RIF. ORIG O.E. NUMBER	RIF. OCAP REF. OCAP	MARCA	PAG.
51460-SH3-000	0793334	HONDA	3-11	52321-S2H-003	0592477	HONDA	3-21
51460-SH3-010	0793334	HONDA	3-11	52321-S5A-013	0594297	HONDA	3-15
51460-SH3-023	0793334	HONDA	3-11	52321-S7A-003	0592481	HONDA	3-30
51460-SH3-030	0793334	HONDA	3-11	52321-S9A-003	0594362	HONDA	3-19
51460-SM4-013	0793342	HONDA	3-3	52321-SNA-A01	0593291	HONDA	3-16
51460-SM4-023	0793342	HONDA	3-3	52321-SWA-A01	0598064	HONDA	3-20
51460-SM4-A02	0793342	HONDA	3-3	52321SNAA01	0593291	HONDA	3-16
51460-SM4-A03	0793342	HONDA	3-3	52325-S84-A01	0594531	HONDA	3-6
51460-SP0-033	0794536	HONDA	3-24	52325-TAO-A01	0593284	HONDA	3-9
51460-SR0-A02	0793344	HONDA	3-12	52325TA0A01	0593284	HONDA	3-9
51460-SR3-003	0793344	HONDA	3-12	52350-659-315	0783331	HONDA	3-10
51460-SR3-013	0793344	HONDA	3-12	52360-659-315	0793331	HONDA	3-10
51460-SR3-023	0793344	HONDA	3-12	52390-SE0-023	0703341	HONDA	3-2
51460-ST3-E02	0793344	HONDA	3-12	52390-SE0-043	0703341	HONDA	3-2
51460-SV4-000	0793351	HONDA	3-4	52390-SH3-030	0783285	HONDA	3-14
51460-SV4-A00	0793351	HONDA	3-4	52390-SM1-A03	0783348	HONDA	3-4
51460-SZ3-013	0794541	HONDA	3-25	52390-SM4-033	0783348	HONDA	3-4
51460-SZ3-901	0794542	HONDA	3-25	52390-SM4-A04	0783348	HONDA	3-4
51469-SE0-000	0793339	HONDA	3-2	52390-SP0-013	0384537	HONDA	3-24
51469-SE0-003	0793339	HONDA	3-2	52390-SR3-000	0783285	HONDA	3-14
51510-TA0-A03	0783281	HONDA	3-8	52390SH3030	0783285	HONDA	3-14
51510TA0A03	0783281	HONDA	3-8	52390SR3000	0783285	HONDA	3-14
51520-TA0-A03	0793281	HONDA	3-8	52391-SF1-003	0483356	HONDA	3-27
51520TA0A03	0793281	HONDA	3-8	52400-SH3-030	0793285	HONDA	3-14
51760-0Q000	0404071	HYUNDAI	4-13	52400-SM1-A03	0793348	HONDA	3-4
51760-1G000	0402771	HYUNDAI	4-3	52400-SM4-033	0793348	HONDA	3-4
51760-1G000	0402771	KIA	6-13	52400-SM4-A04	0793348	HONDA	3-4
51760-2E-000	0402498	KIA	6-19	52400-SM5-A03	0793348	HONDA	3-4
51760-2E000	0402498	HYUNDAI	4-28	52400-SP0-013	0394537	HONDA	3-24
51760-2E000	0402498	KIA	6-19	52400-SR3-000	0793285	HONDA	3-14
51760-2G000	0404071	HYUNDAI	4-13	52400SH3030	0793285	HONDA	3-14
51760-2G000	0404071	KIA	6-3	52400SR3000	0793285	HONDA	3-14
51760-2H000	0404071	HYUNDAI	4-13	52401-SF1-003	0493356	HONDA	3-27
51760-38000	0404087	HYUNDAI	4-22	53010-S04-000	0601933	HONDA	3-13
51760-3K000	0404093	HYUNDAI	4-25	53010-S10-000	0604533	HONDA	3-17
520672	0602893	DAEWOO - CHEVROLET	1-7	53010-S10-003	0604533	HONDA	3-17
520808	0602895	DAEWOO - CHEVROLET	1-5	53010-S2A-003	0602641	HONDA	3-30
520838	0602893	DAEWOO - CHEVROLET	1-7	53010-S2H-J01	0601942	HONDA	3-20
521136	0282914	DAEWOO - CHEVROLET	1-6	53010-S2H-J02	0601942	HONDA	3-20
521255	0602915	DAEWOO - CHEVROLET	1-6	53010-S50-003	0604545	HONDA	3-25
521257	0604211	DAEWOO - CHEVROLET	1-6	53010-S84-A01	0603278	HONDA	3-5
521564	0604254	DAEWOO - CHEVROLET	1-9	53010-SAA-J01	0684369	HONDA	3-22
52320-S04-003	0584246	HONDA	3-14	53010-SDA-A01	0604364	HONDA	3-7
52320-S10-003	0584268	HONDA	3-18	53010-SMG-E01	0693288	HONDA	3-16
52320-S2A-003	0502643	HONDA	3-31	53010-SR3-010	0602925	HONDA	3-12
52320-S2H-003	0582477	HONDA	3-21	53010-SS0-000	0604548	HONDA	3-27
52320-S30-003	0501563	HONDA	3-28	53010-SV4-000	0602926	HONDA	3-4
52320-S5A-013	0584297	HONDA	3-15	53010-SW5-000	0601938	HONDA	3-25
52320-S7A-003	0582481	HONDA	3-30	53010-SW5-003	0604540	HONDA	3-25
52320-S84-A01	0584531	HONDA	3-6	53010-SWA-A01	0608063	HONDA	3-19
52320-S9A-003	0584362	HONDA	3-19	53010-TF0-003	0603294	HONDA	3-22
52320-SNA-A01	0583291	HONDA	3-16	53010SMGE01	0693288	HONDA	3-16
52320-SWA-A01	0588064	HONDA	3-20	53010TF0003	0603294	HONDA	3-22
52320-TAO-A01	0583284	HONDA	3-9	53011-SAA-J01	0694369	HONDA	3-22
52320SNAA01	0583291	HONDA	3-16	53011-SMG-E01	0683288	HONDA	3-16
52320TA0A01	0583284	HONDA	3-9	53011SMGE01	0683288	HONDA	3-16
52321-S04-003	0594246	HONDA	3-14	53521-634-000	0600990	HONDA	3-9
52321-S10-003	0594268	HONDA	3-18	53521-671-000	0601228	HONDA	3-1

RIF. ORIG O.E. NUMBER	RIF. OCAP REF. OCAP	MARCA	PAG.	RIF. ORIG O.E. NUMBER	RIF. OCAP REF. OCAP	MARCA	PAG.
53521-671-010	0601228	HONDA	3-1	53540SMG003	0283286	HONDA	3-15
53521-689-003	0601228	HONDA	3-1	53540SMJ003	0283287	HONDA	3-16
53521-692-003	0600988	HONDA	3-1	53540TF0003	0283293	HONDA	3-22
53521-S5A-003	0604295	HONDA	3-15	53541-S5A-000	0604295	HONDA	3-15
53521-S7A-003	0602465	HONDA	3-29	53541-S5A-003	0284294	HONDA	3-15
53521-S9A-003	0604361	HONDA	3-18	53541-S7A-003	0282464	HONDA	3-29
53521-SA0-003	0600988	HONDA	3-1	53560-S04-003	0291932	HONDA	3-13
53521-SA5-000	0603347	HONDA	3-1	53560-S04-013	0291932	HONDA	3-13
53521-SA5-003	0603347	HONDA	3-1	53560-S1A-E01	0291935	HONDA	3-5
53521-SB0-000	0600190	HONDA	3-26	53560-S30-005	0291937	HONDA	3-28
53521-SB0-003	0600190	HONDA	3-26	53560-SAA-003	0294368	HONDA	3-21
53521-SB2-003	0603343	HONDA	3-10	53560-SD4-003	0293352	HONDA	3-23
53521-SB2-013	0603343	HONDA	3-10	53560-SDA-A01	0294363	HONDA	3-7
53521-SD4-003	0600387	HONDA	3-23	53560-SH3-003	0290283	HONDA	3-11
53521-SD4-013	0600387	HONDA	3-23	53560-SH3-013	0290283	HONDA	3-11
53521-SD4-023	0600387	HONDA	3-23	53560-SM4-003	0293349	HONDA	3-3
53521-SE0-003	0600988	HONDA	3-1	53560-SM4-004	0293349	HONDA	3-3
53521-SE0-013	0600988	HONDA	3-1	53560-SMG-003	0293286	HONDA	3-16
53521-SE0-951	0600988	HONDA	3-1	53560-SMJ-003	0293287	HONDA	3-16
53521-SF1-003	0600190	HONDA	3-26	53560-SP0-013	0294534	HONDA	3-24
53521-SH3-003	0600189	HONDA	3-11	53560-SP0-023	0294534	HONDA	3-24
53521-SM4-003	0600388	HONDA	3-3	53560-SR0-A01	0291932	HONDA	3-13
53521-SM4-013	0600388	HONDA	3-3	53560-SR3-003	0290283	HONDA	3-11
53521-SP0-004	0604535	HONDA	3-24	53560-SS0-003	0294547	HONDA	3-27
53540-S04-003	0281932	HONDA	3-13	53560-SS0-004	0294547	HONDA	3-27
53540-S04-013	0281932	HONDA	3-13	53560-SV4-003	0293349	HONDA	3-3
53540-S1A-E01	0281935	HONDA	3-5	53560-SX0-013	0293349	HONDA	3-3
53540-S30-005	0281937	HONDA	3-28	53560-SZ3-003	0294539	HONDA	3-24
53540-S47-951	0282641	HONDA	3-30	53560-TA0-A01	0293279	HONDA	3-8
53540-SAA-003	0284368	HONDA	3-21	53560-TF0-003	0293293	HONDA	3-22
53540-SB2-003	0280987	HONDA	3-1	53560SMG003	0293286	HONDA	3-16
53540-SB2-013	0280987	HONDA	3-1	53560SMJ003	0293287	HONDA	3-16
53540-SC2-003	0280987	HONDA	3-1	53560TF0003	0293293	HONDA	3-22
53540-SC2-004	0280987	HONDA	3-1	53610-TL1-G01	0603280	HONDA	3-8
53540-SD4-003	0283352	HONDA	3-23	54100-H8500	0783583	NISSAN	9-45
53540-SDA-A01	0284363	HONDA	3-7	54101-H1000	0793583	NISSAN	9-45
53540-SF1-004	0280191	HONDA	3-27	54101-H8500	0793583	NISSAN	9-45
53540-SH3-003	0280283	HONDA	3-11	54400-4A000	0792810	HYUNDAI	4-8
53540-SH3-013	0280283	HONDA	3-11	54401-4A000	0782810	HYUNDAI	4-8
53540-SK3-E01	0282534	HONDA	3-17	54403-38A00	0402484	HYUNDAI	4-22
53540-SM4-003	0283349	HONDA	3-3	54410-38000	0792484	HYUNDAI	4-22
53540-SM4-004	0283349	HONDA	3-3	54410-38000	0792484	KIA	6-10
53540-SMG-003	0283286	HONDA	3-15	54410-3E-000	0392473	KIA	6-16
53540-SMJ-003	0283287	HONDA	3-16	54410-3F600	0794092	HYUNDAI	4-25
53540-SP0-013	0284534	HONDA	3-24	54410-3K000	0794091	HYUNDAI	4-25
53540-SP0-023	0284534	HONDA	3-24	54410-43004	0793495	HYUNDAI	4-10
53540-SR0-A01	0280283	HONDA	3-11	54410-43005	0793495	HYUNDAI	4-10
53540-SR3-003	0280283	HONDA	3-11	54417-43000	0403495	HYUNDAI	4-10
53540-SS0-003	0284547	HONDA	3-27	54417-43001	0402940	HYUNDAI	4-7
53540-SS0-004	0284547	HONDA	3-27	54417-43001	0402940	MITSUBISHI	8-25
53540-SV4-003	0283349	HONDA	3-3	54417-43A00	0402940	HYUNDAI	4-7
53540-SWA-A01	0288063	HONDA	3-19	54417-43A00	0402940	MITSUBISHI	8-25
53540-SWA-A02	0288063	HONDA	3-19	54417-43A01	0402940	HYUNDAI	4-7
53540-SX0-013	0283349	HONDA	3-3	54417-43A01	0402940	MITSUBISHI	8-25
53540-SX8-T01	0281941	HONDA	3-20	54417-47000	0402940	HYUNDAI	4-7
53540-SZ3-003	0284539	HONDA	3-24	54417-47000	0402940	MITSUBISHI	8-25
53540-TA0-A01	0283279	HONDA	3-8	54417-4A000	0402940	HYUNDAI	4-7
53540-TF0-003	0283293	HONDA	3-22	54417-4A000	0402940	MITSUBISHI	8-25



RIF. ORIG O.E. NUMBER	RIF. OCAP REF. OCAP	MARCA	PAG.	RIF. ORIG O.E. NUMBER	RIF. OCAP REF. OCAP	MARCA	PAG.
54417-4AA00	0402940	HYUNDAI	4-7	54500-31600	0401288	HYUNDAI	4-1
54417-4AA00	0402940	mitsubishi	8-25	54500-33000	0793357	HYUNDAI	4-20
54417-4BA00	0402940	HYUNDAI	4-7	54500-34000	0795159	HYUNDAI	4-21
54417-4BA00	0402940	mitsubishi	8-25	54500-34010	0795159	HYUNDAI	4-21
5441743000	0403495	HYUNDAI	4-10	54500-38000	0794087	HYUNDAI	4-22
5441744000	0400555	HYUNDAI	4-6	54500-38010	0794087	HYUNDAI	4-22
54420-38000	0782484	HYUNDAI	4-22	54500-38011	0794088	HYUNDAI	4-24
54420-38000	0782484	KIA	6-9	54500-3K000	0794093	HYUNDAI	4-26
54420-3E-000	0382473	KIA	6-16	54500-41U00	0784492	NISSAN	9-17
54420-3F600	0784092	HYUNDAI	4-25	54500-44B00	0780915	NISSAN	9-18
54420-3K000	0784091	HYUNDAI	4-25	54500-4A000	0792809	HYUNDAI	4-8
54430-3F600	0404092	HYUNDAI	4-25	54500-4D001	0794567	KIA	6-5
54430-43004	0783495	HYUNDAI	4-10	54500-4F102	0780915	NISSAN	9-18
54430-43005	0783495	HYUNDAI	4-10	54500-4F105	0780915	NISSAN	9-18
54431-44000	0783297	HYUNDAI	4-6	54500-4F150	0780915	NISSAN	9-18
5443144000	0400555	HYUNDAI	4-6	54500-4H000	0795195	HYUNDAI	4-9
54440-H1000	0402815	HYUNDAI	4-26	54500-4M400	0784398	NISSAN	9-3
54499-W1000	0783537	NISSAN	9-8	54500-4M410	0784398	NISSAN	9-3
54499-W2210	0783537	NISSAN	9-8	54500-4U002	0782823	NISSAN	9-4
54500-00QAC	0382827	NISSAN	9-12	54500-4U012	0782823	NISSAN	9-4
54500-00QAE	0382827	NISSAN	9-12	54500-50A00	0783585	NISSAN	9-47
54500-00QAH	0782832	NISSAN	9-14	54500-50J10	0783549	NISSAN	9-32
54500-02051	0794457	HYUNDAI	4-4	54500-52Y10	0783586	NISSAN	9-48
54500-07100	0792793	KIA	6-10	54500-52Y15	0783586	NISSAN	9-48
54500-0W000	0782576	NISSAN	9-21	54500-52Y60	0783586	NISSAN	9-48
54500-0W001	0782576	NISSAN	9-21	54500-52Y70	0783586	NISSAN	9-48
54500-0X000	0793959	HYUNDAI	4-11	54500-6F600	0784615	NISSAN	9-19
54500-0X200	0793959	HYUNDAI	4-11	54500-6F600 Z	0404615	NISSAN	9-18
54500-17000	0792768	HYUNDAI	4-16	54500-7C350	0784640	NISSAN	9-39
54500-1C000	0794468	HYUNDAI	4-7	54500-86J00	0783549	NISSAN	9-32
54500-1D000	0794109	KIA	6-3	54500-8H310	0384514	NISSAN	9-57
54500-1E000	0792774	HYUNDAI	4-3	54500-90J00	0783549	NISSAN	9-32
54500-1E000	0792774	KIA	6-13	54500-9F500	0784384	NISSAN	9-34
54500-1E100	0792773	HYUNDAI	4-3	54500-AV600	0784385	NISSAN	9-35
54500-1E100	0792773	KIA	6-13	54500-AV605	0784385	NISSAN	9-35
54500-1F000	0792498	HYUNDAI	4-28	54500-AV606	0784385	NISSAN	9-35
54500-1F000	0792498	KIA	6-19	54500-AX600	0784298	NISSAN	9-20
54500-1J500	0794077	HYUNDAI	4-12	54500-BM410	0784398	NISSAN	9-3
54500-1KA0B	0788071	NISSAN	9-13	54500-BM410 Z	0404398	NISSAN	9-3
54500-1KA0B Z	0408071	NISSAN	9-13	54500-BN300	0784398	NISSAN	9-3
54500-21B00	0781987	NISSAN	9-18	54500-BR30A	0783124	NISSAN	9-38
54500-22000	0794467	HYUNDAI	4-1	54500-CC40A	0786500	NISSAN	9-20
54500-22100	0794467	HYUNDAI	4-1	54500-EB30C Z	0404621	NISSAN	9-22
54500-22200	0794467	HYUNDAI	4-1	54500-F4300	0783587	NISSAN	9-2
54500-24000	0792658	HYUNDAI	4-17	54500-FD000	0393260	KIA	6-12
54500-25000	0794515	HYUNDAI	4-2	54500-JD000	0783124	NISSAN	9-38
54500-29000	0792655	HYUNDAI	4-15	54500-OM010	0783587	NISSAN	9-2
54500-29500	0792655	HYUNDAI	4-15	54500-OM020	0783587	NISSAN	9-2
54500-2B100	0794083	HYUNDAI	4-19	54500-OM060	0783587	NISSAN	9-2
54500-2B100	0794083	KIA	6-17	54500-W1000	0793537	NISSAN	9-8
54500-2D000	0792846	HYUNDAI	4-5	54500-W2210	0793537	NISSAN	9-8
54500-2D002	0792846	HYUNDAI	4-5	54500 2E000	0792498	HYUNDAI	4-28
54500-2F000	0792790	KIA	6-6	54500 2E000	0792498	KIA	6-19
54500-2F001	0792790	KIA	6-6	54500 2E001	0792498	HYUNDAI	4-28
54500-2F500	0784384	NISSAN	9-34	54500 2E001	0792498	KIA	6-19
54500-2H000	0794071	HYUNDAI	4-13	54501-00QAC	0382827	NISSAN	9-12
54500-2H000	0794071	KIA	6-6	54501-00QAD	0392827	NISSAN	9-12
54500-2U711	0784615	NISSAN	9-19	54501-00QAE	0392827	NISSAN	9-12

RIF. ORIG O.E. NUMBER	RIF. OCAP REF. OCAP	MARCA	PAG.	RIF. ORIG O.E. NUMBER	RIF. OCAP REF. OCAP	MARCA	PAG.
54501-00QAH	0792832	NISSAN	9-14	54501-4M410	0794398	NISSAN	9-3
54501-02051	0784457	HYUNDAI	4-4	54501-4U002	0792823	NISSAN	9-4
54501-07100	0782793	KIA	6-10	54501-4U012	0792823	NISSAN	9-4
54501-0M010	0793587	NISSAN	9-2	54501-50A00	0793585	NISSAN	9-47
54501-0M020	0793587	NISSAN	9-2	54501-50J10	0793549	NISSAN	9-32
54501-0M060	0793587	NISSAN	9-2	54501-52Y10	0793586	NISSAN	9-48
54501-0W000	0792576	NISSAN	9-22	54501-52Y15	0793586	NISSAN	9-48
54501-0W001	0792576	NISSAN	9-22	54501-52Y60	0793586	NISSAN	9-48
54501-0X000	0783959	HYUNDAI	4-11	54501-52Y70	0793586	NISSAN	9-48
54501-0X200	0783959	HYUNDAI	4-11	54501-6F600	0794615	NISSAN	9-19
54501-17000	0782768	HYUNDAI	4-16	54501-7C350	0794640	NISSAN	9-39
54501-1C000	0784468	HYUNDAI	4-7	54501-86J00	0793549	NISSAN	9-32
54501-1D000	0784109	KIA	6-3	54501-8H310	0394514	NISSAN	9-57
54501-1E000	0782774	HYUNDAI	4-3	54501-90J00	0793549	NISSAN	9-32
54501-1E000	0782774	KIA	6-13	54501-AV600	0794385	NISSAN	9-35
54501-1E100	0782773	HYUNDAI	4-3	54501-AV605	0794385	NISSAN	9-35
54501-1E100	0782773	KIA	6-13	54501-AV606	0794385	NISSAN	9-35
54501-1F100	0782498	HYUNDAI	4-28	54501-AX600	0794298	NISSAN	9-20
54501-1F100	0782498	KIA	6-19	54501-BM410	0794398	NISSAN	9-3
54501-1J500	0784077	HYUNDAI	4-12	54501-BM410 Z	0404398	NISSAN	9-3
54501-1KA0B	0798071	NISSAN	9-13	54501-BN300	0794398	NISSAN	9-3
54501-1KA0B Z	0408071	NISSAN	9-13	54501-BR30A	0793124	NISSAN	9-38
54501-21B00	0791987	NISSAN	9-18	54501-CC40A	0796500	NISSAN	9-20
54501-22000	0784467	HYUNDAI	4-1	54501-EB30C Z	0404621	NISSAN	9-22
54501-22100	0784467	HYUNDAI	4-1	54501-F4300	0793587	NISSAN	9-2
54501-22200	0784467	HYUNDAI	4-1	54501-FD000	0383260	KIA	6-12
54501-24000	0782658	HYUNDAI	4-17	54501-JD000	0793124	NISSAN	9-38
54501-25000	0784515	HYUNDAI	4-2	54501 2E000	0782498	HYUNDAI	4-28
54501-26000	0794465	HYUNDAI	4-18	54501 2E000	0782498	KIA	6-19
54501-29000	0782655	HYUNDAI	4-15	54501 2E001	0782498	HYUNDAI	4-28
54501-29500	0782655	HYUNDAI	4-15	54501 2E001	0782498	KIA	6-19
54501-2B100	0784083	HYUNDAI	4-19	54502-00Q0C	0384628	NISSAN	9-31
54501-2B100	0784083	KIA	6-17	54502-00QAA	0782321	NISSAN	9-31
54501-2D000	0782846	HYUNDAI	4-5	54502-01G90	0784493	NISSAN	9-26
54501-2D002	0782846	HYUNDAI	4-5	54502-26000	0784465	HYUNDAI	4-18
54501-2F000	0782790	KIA	6-6	54502-28070	0793374	HYUNDAI	4-14
54501-2F001	0782790	KIA	6-6	54502-3A100	0782489	HYUNDAI	4-27
54501-2F500	0794384	NISSAN	9-34	54503-00Q0C	0394628	NISSAN	9-31
54501-2H000	0784071	HYUNDAI	4-13	54503-00QAA	0792321	NISSAN	9-31
54501-2H000	0784071	KIA	6-6	54503-01G90	0794493	NISSAN	9-26
54501-2U711	0794615	NISSAN	9-19	54503-14200	0403370	HYUNDAI	4-16
54501-33000	0783357	HYUNDAI	4-20	54503-22A00	0401288	HYUNDAI	4-1
54501-34000	0785159	HYUNDAI	4-21	54503-22A00	0401295	KIA	6-6
54501-34010	0785159	HYUNDAI	4-21	54503-25A00	0401288	HYUNDAI	4-1
54501-38000	0784087	HYUNDAI	4-22	54503-25A00	0401295	KIA	6-6
54501-38010	0784087	HYUNDAI	4-22	54503-25A00	0403357	HYUNDAI	4-4
54501-38011	0784088	HYUNDAI	4-24	54503-28010	0783374	HYUNDAI	4-14
54501-3A100	0792489	HYUNDAI	4-27	54503-31600	0401288	HYUNDAI	4-1
54501-3K000	0784093	HYUNDAI	4-26	54503-31600	0401295	KIA	6-6
54501-41U00	0794492	NISSAN	9-17	54503-31600	0403357	HYUNDAI	4-4
54501-44B00	0790915	NISSAN	9-18	54503-34A00	0402482	HYUNDAI	4-20
54501-4A000	0782809	HYUNDAI	4-8	54503-34A01	0402482	HYUNDAI	4-20
54501-4D001	0784567	KIA	6-5	54503-38A00	0401288	HYUNDAI	4-1
54501-4F102	0790915	NISSAN	9-18	54503-3BA00	0404465	HYUNDAI	4-18
54501-4F105	0790915	NISSAN	9-18	54510-3E-000	0792474	KIA	6-16
54501-4F150	0790915	NISSAN	9-18	54510-3E-001	0792474	KIA	6-16
54501-4H000	0785195	HYUNDAI	4-9	54510-43150	0793499	HYUNDAI	4-11
54501-4M400	0794398	NISSAN	9-3	54510-4B001	0793507	HYUNDAI	4-11

## CORRISPONDENZE RIFERIMENTI ORIGINALI

## Cross Reference Guide - Vergleichenummern List - Liste D'equivalence - Guia De Intercambios

RIF. ORIG O.E. NUMBER	RIF. OCAP REF. OCAP	MARCA	PAG.	RIF. ORIG O.E. NUMBER	RIF. OCAP REF. OCAP	MARCA	PAG.
54520-11011	0403370	HYUNDAI	4-16	54618-0E000	0504400	NISSAN	9-17
54520-14200	0403370	HYUNDAI	4-16	54618-0F000	0504401	NISSAN	9-50
54520-31600	0403357	HYUNDAI	4-4	54618-0F000 Z	0504401-K	NISSAN	9-50
54520-3E-000	0782474	KIA	6-16	54618-0W000	0502577	NISSAN	9-22
54520-3E-001	0782474	KIA	6-16	54618-0W001	0502577	NISSAN	9-22
54524-2F010	0781818	NISSAN	9-32	54618-1AA0A	0583125	NISSAN	9-38
54524-50J00	0781818	NISSAN	9-32	54618-1AA0E	0583125	NISSAN	9-38
54524-86J10	0781818	NISSAN	9-32	54618-2F010	0504387	NISSAN	9-32
54524-AV600	0384629	NISSAN	9-35	54618-3W400	0502577	NISSAN	9-22
54524-AV601	0384629	NISSAN	9-35	54618-4M400	0504396	NISSAN	9-3
54524-EB30A Z	0404620	NISSAN	9-22	54618-4U000	0582824	NISSAN	9-4
54525-2F010	0791818	NISSAN	9-32	54618-50J11	0504387	NISSAN	9-32
54525-50J00	0791818	NISSAN	9-32	54618-50J20	0504387	NISSAN	9-32
54525-86J10	0791818	NISSAN	9-32	54618-50Y00	0504395	NISSAN	9-1
54525-AV600	0394629	NISSAN	9-35	54618-58820	0504395	NISSAN	9-1
54525-AV6001	0394629	NISSAN	9-35	54618-86J00	0504387	NISSAN	9-32
54525-EB30A Z	0404620	NISSAN	9-22	54618-86J25	0504387	NISSAN	9-32
54529-01A00	0783584	NISSAN	9-46	54618-8H300	0584513	NISSAN	9-57
54529-04A00	0783584	NISSAN	9-46	54618-90J11	0504387	NISSAN	9-32
54530-01A00	0793584	NISSAN	9-46	54618-9C002	0581599	NISSAN	9-39
54530-02050	0404457	HYUNDAI	4-4	54618-9U00A	0504622	NISSAN	9-20
54530-02500	0404457	HYUNDAI	4-4	54618-AU000	0584391	NISSAN	9-35
54530-04A00	0793584	NISSAN	9-46	54618-AX600	0504380	NISSAN	9-20
54530-07000	0402793	HYUNDAI	4-11	54618-CA000	0586500	NISSAN	9-21
54530-07000	0402793	KIA	6-10	54618-CA00E	0586500	NISSAN	9-21
54530-14200	0403370	HYUNDAI	4-16	54618-CA010	0588062	NISSAN	9-21
54530-21000	0493358	HYUNDAI	4-17	54618-CY00A	0508071	NISSAN	9-13
54530-21100	0493358	HYUNDAI	4-17	54618-D5010	0504395	NISSAN	9-1
54530-21A00	0493358	HYUNDAI	4-17	54618-EA010	0584618	NISSAN	9-22
54530-24000	0403359	HYUNDAI	4-17	54618-JD00A	0583125	NISSAN	9-38
54530-24A00	0403359	HYUNDAI	4-17	54618-JX00A	0504622	NISSAN	9-20
54530-25000	0401288	HYUNDAI	4-1	54618-VB000	0504147	NISSAN	9-24
54530-25A00	0401288	HYUNDAI	4-1	54618-VC300	0504148	NISSAN	9-24
54530-28000	0403374	HYUNDAI	4-14	54668-1AA0A	0593125	NISSAN	9-38
54530-28A00	0403374	HYUNDAI	4-14	54668-1AA0E	0593125	NISSAN	9-38
54530-2B000	0404465	HYUNDAI	4-18	54668-8H300	0594513	NISSAN	9-57
54530-2B000	0404465	KIA	6-16	54668-9C000	0591599	NISSAN	9-39
54530-31600	0403357	HYUNDAI	4-4	54668-AU000	0594391	NISSAN	9-36
54530-3B000	0404465	HYUNDAI	4-18	54668-CA000	0596500	NISSAN	9-21
54530-3J000	0405195	HYUNDAI	4-9	54668-CA00E	0596500	NISSAN	9-21
54530-4A000	0402809	HYUNDAI	4-8	54668-CA010	0598062	NISSAN	9-21
54530-4AA00	0402809	HYUNDAI	4-8	54668-EA010	0594618	NISSAN	9-22
54530-4D000	0404567	KIA	6-4	54668-JD00A	0593125	NISSAN	9-38
54540-21000	0483358	HYUNDAI	4-17	54810-3E-000	0502475	KIA	6-16
54540-21100	0483358	HYUNDAI	4-17	54820-02000	0504459	HYUNDAI	4-4
54540-21A00	0483358	HYUNDAI	4-17	54820-FD000	0593260	KIA	6-13
54540-43150	0783499	HYUNDAI	4-11	54822-H1000	0592817	HYUNDAI	4-27
54540-4B001	0783507	HYUNDAI	4-11	54823-H1000	0582817	HYUNDAI	4-26
54550-H1000	0402816	HYUNDAI	4-26	54825-22000	0502778	HYUNDAI	4-1
54550-H1010	0402816	HYUNDAI	4-26	54830-07000	0592794	KIA	6-11
54570-3E-000	0402472	KIA	6-16	54830-0X000	0593960	HYUNDAI	4-12
54616-00Q0A	0504394	NISSAN	9-31	54830-17010	0594455	HYUNDAI	4-2
54616-00QAA	0902833	NISSAN	9-14	54830-17020	0584455	HYUNDAI	4-2
54616-00QAC	0504394	NISSAN	9-31	54830-1C000	0594462	HYUNDAI	4-7
54618-00QAA	0582828	NISSAN	9-12	54830-1F-000	0502499	KIA	6-19
54618-00QAB	0592828	NISSAN	9-12	54830-1F000	0502499	HYUNDAI	4-28
54618-01G00	0504623	NISSAN	9-26	54830-1F000	0502499	KIA	6-19
54618-02E00	0504624	NISSAN	9-27	54830-1G000	0592772	HYUNDAI	4-3

RIF. ORIG O.E. NUMBER	RIF. OCAP REF. OCAP	MARCA	PAG.	RIF. ORIG O.E. NUMBER	RIF. OCAP REF. OCAP	MARCA	PAG.
54830-1G000	0592772	KIA	6-14	55110-38000	0794097	HYUNDAI	4-23
54830-1J000	0594078	HYUNDAI	4-13	55120-38000	0784097	HYUNDAI	4-23
54830-25000	0504456	HYUNDAI	4-2	55130-34A00	0402483	HYUNDAI	4-20
54830-25010	0594455	HYUNDAI	4-2	55130-37000	0402483	HYUNDAI	4-20
54830-25020	0584455	HYUNDAI	4-2	55201-34000	0705161	HYUNDAI	4-21
54830-26000	0594466	HYUNDAI	4-18	55201-37010	0705161	HYUNDAI	4-21
54830-26010	0594466	HYUNDAI	4-18	55201-37110	0705161	HYUNDAI	4-21
54830-28000	0504079	HYUNDAI	4-14	55210-38000	0704096	HYUNDAI	4-23
54830-29000	0501574	HYUNDAI	4-15	55250-1H000	0304073	HYUNDAI	4-13
54830-29500	0501574	HYUNDAI	4-15	55250-2H000	0304073	HYUNDAI	4-13
54830-2B000	0594084	HYUNDAI	4-19	55250-34000	0705160	HYUNDAI	4-21
54830-2B000	0594084	KIA	6-17	55250-34010	0705160	HYUNDAI	4-21
54830-2C000	0591567	HYUNDAI	4-5	55250-37000	0705160	HYUNDAI	4-21
54830-2E000	0502499	HYUNDAI	4-28	55250-37010	0705160	HYUNDAI	4-21
54830-2F000	0592553	KIA	6-7	55501-CA000	0388062	NISSAN	9-21
54830-2G000	0504110	KIA	6-3	55501-CA00A	0388062	NISSAN	9-21
54830-2H000	0504072	HYUNDAI	4-13	55502-CA000	0398062	NISSAN	9-21
54830-2H000	0504072	KIA	6-6	55502-CA00A	0398062	NISSAN	9-21
54830-2H100	0504072	HYUNDAI	4-13	55530-17000	0504080	HYUNDAI	4-16
54830-34000	0501576	HYUNDAI	4-5	55530-17000	0504080	KIA	6-7
54830-34500	0501576	HYUNDAI	4-5	55530-1D000	0504111	KIA	6-3
54830-36000	0504086	HYUNDAI	4-20	55530-1F-000	0502525	KIA	6-19
54830-36010	0501576	HYUNDAI	4-5	55530-1F000	0502525	HYUNDAI	4-28
54830-36100	0504086	HYUNDAI	4-20	55530-1F000	0502525	KIA	6-19
54830-36101	0504086	HYUNDAI	4-20	55530-1H000	0504074	HYUNDAI	4-13
54830-37010	0504079	HYUNDAI	4-14	55530-1H000	0504074	KIA	6-6
54830-37020	0504079	HYUNDAI	4-14	55530-1H100	0504074	HYUNDAI	4-13
54830-38100	0502488	HYUNDAI	4-22	55530-26600	0592764	HYUNDAI	4-18
54830-38100	0502488	KIA	6-10	55530-26700	0592764	HYUNDAI	4-18
54830-38110	0502488	HYUNDAI	4-22	55530-29000	0501575	HYUNDAI	4-4
54830-38110	0502488	KIA	6-10	55530-29500	0501575	HYUNDAI	4-4
54830-3A000	0591581	HYUNDAI	4-27	55530-2B000	0504085	HYUNDAI	4-19
54830-3K000	0504094	HYUNDAI	4-26	55530-2B000	0504085	KIA	6-17
54830-3K010	0504094	HYUNDAI	4-26	55530-2E-000	0502525	KIA	6-19
54830-3L000	0504094	HYUNDAI	4-26	55530-2E000	0502525	HYUNDAI	4-28
54830-4A000	0502811	HYUNDAI	4-8	55530-2E000	0502525	KIA	6-19
54830-4A003	0502811	HYUNDAI	4-8	55530-38000	0501578	HYUNDAI	4-23
54830-4A800	0502811	HYUNDAI	4-8	55530-38010	0501578	HYUNDAI	4-23
54830-4A802	0502811	HYUNDAI	4-8	55530-38600	0502487	HYUNDAI	4-23
54830-4D000	0594568	KIA	6-5	55530-38600	0502487	KIA	6-10
54830-4H200	0595196	HYUNDAI	4-9	55530-3K000	0504095	HYUNDAI	4-26
54830-FD000	0583260	KIA	6-12	55530-3K001	0504095	HYUNDAI	4-26
54840-07000	0582794	KIA	6-10	55530-4A000	0502812	HYUNDAI	4-8
54840-0X000	0583960	HYUNDAI	4-12	55530-4A001	0502812	HYUNDAI	4-8
54840-1C000	0584462	HYUNDAI	4-7	55530-4A800	0502812	HYUNDAI	4-8
54840-1G000	0582772	HYUNDAI	4-3	55530-4A801	0502812	HYUNDAI	4-8
54840-1G000	0582772	KIA	6-14	55530-4D000	0504569	KIA	6-5
54840-1J000	0584078	HYUNDAI	4-12	55530-4H000	0595197	HYUNDAI	4-9
54840-26000	0584466	HYUNDAI	4-18	55540-26600	0582764	HYUNDAI	4-18
54840-26010	0584466	HYUNDAI	4-18	55540-26700	0582764	HYUNDAI	4-18
54840-2B000	0584084	HYUNDAI	4-19	55540-4H000	0585197	HYUNDAI	4-9
54840-2B000	0584084	KIA	6-17	55580-37020	0501577	HYUNDAI	4-20
54840-2C000	0581567	HYUNDAI	4-5	55618-JD00A	0584633	NISSAN	9-38
54840-2F000	0582553	KIA	6-7	55618-JY00B	0584633	NISSAN	9-38
54840-3A000	0581581	HYUNDAI	4-27	55619-JD00A	0594633	NISSAN	9-38
54840-4D000	0584568	KIA	6-5	55619-JY00B	0594633	NISSAN	9-38
54840-4H200	0585196	HYUNDAI	4-9	55830-25000	0504456	HYUNDAI	4-2
54850-36010	0501576	HYUNDAI	4-5	56260-01J10	0504145	NISSAN	9-23

RIF. ORIG O.E. NUMBER	RIF. OCAP REF. OCAP	MARCA	PAG.	RIF. ORIG O.E. NUMBER	RIF. OCAP REF. OCAP	MARCA	PAG.
56260-0F001	0504402	NISSAN	9-50	56820-28000	0281284	HYUNDAI	4-14
56260-0W001	0502578	NISSAN	9-22	56820-28500	0281290	HYUNDAI	4-1
56260-41G11	0502578	NISSAN	9-22	56820-28520	0281290	HYUNDAI	4-1
56260-VB010	0504551	NISSAN	9-24	56820-2B000	0294081	HYUNDAI	4-18
56260-VC300	0504552	NISSAN	9-24	56820-2B000	0294081	KIA	6-16
56260-VC310	0504553	NISSAN	9-24	56820-2B900	0284081	HYUNDAI	4-18
56261-0E000	0504631	NISSAN	9-36	56820-2B900	0284081	KIA	6-16
56261-0F600	0503541	NISSAN	9-19	56820-2E-000	0292496	KIA	6-18
56261-47B01	0503541	NISSAN	9-19	56820-2E-900	0282496	KIA	6-18
56261-4F701	0503541	NISSAN	9-19	56820-2E000	0292496	HYUNDAI	4-28
56261-4F702	0503541	NISSAN	9-19	56820-2E000	0292496	KIA	6-18
56261-4F705	0503541	NISSAN	9-19	56820-2E900	0282496	HYUNDAI	4-27
56261-4F710	0503541	NISSAN	9-19	56820-2E900	0282496	KIA	6-18
56261-4F725	0503541	NISSAN	9-19	56820-2G000	0294107	KIA	6-2
56261-6F600	0503541	NISSAN	9-19	56820-2G900	0284107	KIA	6-2
56261-86J00	0503551	NISSAN	9-33	56820-2H000	0294069	HYUNDAI	4-13
56261-86J25	0503551	NISSAN	9-33	56820-2H000	0294069	KIA	6-5
56261-90J01	0503551	NISSAN	9-33	56820-2H090	0284069	HYUNDAI	4-13
56261-90J11	0504388	NISSAN	9-35	56820-2H090	0284069	KIA	6-5
56261-AV610	0504632	NISSAN	9-36	56820-2K000	0294075	HYUNDAI	4-12
56261-EA500	0584619	NISSAN	9-22	56820-2K050	0284075	HYUNDAI	4-12
56261-EA510	0594619	NISSAN	9-23	56820-36000	0283360	HYUNDAI	4-19
56261-EQ000	0502834	NISSAN	9-57	56820-37000	0281290	KIA	6-6
56540-02000	0601565	HYUNDAI	4-4	56820-38000	0292485	HYUNDAI	4-21
56540-21001	0603363	HYUNDAI	4-16	56820-38000	0292485	KIA	6-9
56540-21010	0603363	HYUNDAI	4-16	56820-38900	0282485	HYUNDAI	4-21
56540-22000	0601287	HYUNDAI	4-1	56820-38900	0282485	KIA	6-9
56540-24000	0601564	HYUNDAI	4-1	56820-3B000	0284461	HYUNDAI	4-6
56540-24001	0603365	HYUNDAI	4-17	56820-3E-000	0292470	KIA	6-15
56540-25000	0601564	HYUNDAI	4-1	56820-3E-900	0282470	KIA	6-15
56540-2H000	0604070	HYUNDAI	4-13	56820-3K000	0294089	HYUNDAI	4-25
56540-2H000	0604070	KIA	6-5	56820-3K010	0284089	HYUNDAI	4-24
56540-42001	0601564	HYUNDAI	4-1	56820-4D000	0294099	KIA	6-4
56540-43000	0601564	HYUNDAI	4-1	56820-4D100	0284099	KIA	6-4
56540-43010	0601564	HYUNDAI	4-1	56820-4H000	0295193	HYUNDAI	4-8
56542-43010	0601564	HYUNDAI	4-1	56820-4H100	0285193	HYUNDAI	4-8
56561-50J00	0503551	NISSAN	9-33	56850-H1011	0502813	HYUNDAI	4-26
56810-11000	0193368	HYUNDAI	4-16	56872-43000	0284469	HYUNDAI	4-7
56810-11060	0193368	HYUNDAI	4-16	56872-43010	0284469	HYUNDAI	4-7
56820-02500	0284519	HYUNDAI	4-3	57705-56820B	0284469	HYUNDAI	4-7
56820-07000	0281584	KIA	6-10	57716-34000	0601579	HYUNDAI	4-20
56820-0X000	0283956	HYUNDAI	4-11	57724-07000	0602792	KIA	6-10
56820-0X010	0283956	HYUNDAI	4-11	57724-07001	0602792	KIA	6-10
56820-0X900	0283956	HYUNDAI	4-11	57724-07100	0602792	KIA	6-10
56820-11000	0183369	HYUNDAI	4-16	57724-0X000	0603958	HYUNDAI	4-11
56820-11060	0183369	HYUNDAI	4-16	57724-1E000	0602770	HYUNDAI	4-3
56820-1E000	0292769	HYUNDAI	4-2	57724-1E000	0602770	KIA	6-13
56820-1E000	0292769	KIA	6-13	57724-1J000	0604076	HYUNDAI	4-12
56820-1E900	0282769	HYUNDAI	4-2	57724-2B000	0604082	HYUNDAI	4-18
56820-1E900	0282769	KIA	6-13	57724-2B000	0604082	KIA	6-16
56820-21000	0283361	HYUNDAI	4-16	57724-2D000	0601566	HYUNDAI	4-4
56820-21100	0283361	HYUNDAI	4-16	57724-2D000	0601566	KIA	6-6
56820-21110	0283361	HYUNDAI	4-16	57724-2E-000	0602497	KIA	6-18
56820-21120	0283361	HYUNDAI	4-16	57724-2E000	0602497	HYUNDAI	4-28
56820-22000	0281290	HYUNDAI	4-1	57724-2E000	0602497	KIA	6-18
56820-22000	0281290	KIA	6-6	57724-2G000	0604108	KIA	6-3
56820-25000	0281290	KIA	6-6	57724-38000	0602486	HYUNDAI	4-22
56820-25000	0284452	HYUNDAI	4-1	57724-38010	0602559	HYUNDAI	4-23

RIF. ORIG O.E. NUMBER	RIF. OCAP REF. OCAP	MARCA	PAG.	RIF. ORIG O.E. NUMBER	RIF. OCAP REF. OCAP	MARCA	PAG.
57724-38010	0602559	KIA	6-9	8-94243-233-0	0793012	ISUZU	5-4
57724-3A000	0601579	HYUNDAI	4-20	8-94243-234-0	0403012	ISUZU	5-2
57724-3K000	0604090	HYUNDAI	4-25	8-94246-419-0	0783377	ISUZU	5-2
57724-4D000	0604566	KIA	6-4	8-94246-420-0	0793377	ISUZU	5-2
57724-4H000	0695194	HYUNDAI	4-9	8-94246-475-1	0403013	ISUZU	5-3
57724-4H100	0685194	HYUNDAI	4-8	8-94323-562-1	0780420	ISUZU	5-2
57729-4A000	0602808	HYUNDAI	4-7	8-94323-563-1	0790420	ISUZU	5-2
57730-24000	0603366	HYUNDAI	4-17	8-94374-424-0	0402956	ISUZU	5-1
57730-24100	0603364	HYUNDAI	4-17	8-94389-210-0	0500458	ISUZU	5-2
57730-28000	0603800	HYUNDAI	4-14	8-94419-408-0	0280456	ISUZU	5-1
57730-28500	0601294	HYUNDAI	4-14	8-94419-409-0	0290456	ISUZU	5-1
57730-29000	0601285	HYUNDAI	4-15	8-94445-550-1	0783376	ISUZU	5-1
57730-29001	0601285	HYUNDAI	4-15	8-94445-551-0	0793376	ISUZU	5-1
57730-33100	0601569	HYUNDAI	4-14	8-94452-102-0	0403373	ISUZU	5-3
57730-33200	0603362	HYUNDAI	4-19	8-94452-102-1	0403373	ISUZU	5-3
57730-43010	0604453	HYUNDAI	4-2	8-94452-106-1	0403375	ISUZU	5-5
57731-3E-010	0682471	KIA	6-15	8-94459-453-2	0400420	ISUZU	5-1
57732-3E-010	0692471	KIA	6-15	8-94459-453-3	0400420	ISUZU	5-1
57755-02000	0604458	HYUNDAI	4-4	8-94459-453-4	0400420	ISUZU	5-1
57755-17000	0604516	HYUNDAI	4-15	8-94459-460-2	0783377	ISUZU	5-2
57755-1C000	0601568	HYUNDAI	4-6	8-94459-461-2	0793377	ISUZU	5-2
57755-22000	0604518	HYUNDAI	4-1	8-94459-464-0	0400422	ISUZU	5-2
57755-25000	0604453	HYUNDAI	4-2	8-94459-464-1	0400422	ISUZU	5-2
57775-25000	0604453	HYUNDAI	4-2	8-94459-464-2	0400422	ISUZU	5-2
57780-3B000	0281580	HYUNDAI	4-27	8-94459-465-2	0403373	ISUZU	5-3
57785-26200	0604517	HYUNDAI	4-18	8-94459-480-0	0280456	ISUZU	5-1
6040135517	0404298	NISSAN	9-20	8-94459-481-0	0290456	ISUZU	5-1
6232-20042	0402511	SUBARU	11-6	8-97940-625-0	0400420	ISUZU	5-1
6232-20043	0402511	SUBARU	11-6	8021-32-320A	0303392	MAZDA	7-17
6315-10040	0283595	SUBARU	11-6	8021-99-322	0281266	MAZDA	7-9
6315-10070	0283595	SUBARU	11-6	8021-99-324	0293425	MAZDA	7-17
6A2A-32-240	0604450	MAZDA	7-11	8038-99-322	0283414	MAZDA	7-13
7210-60380	0783604	SUBARU	11-3	8173-99-322	0281268	MAZDA	7-9
7210-60520	0783604	SUBARU	11-3	8173-99-356	0403383	MAZDA	7-9
7210-60530	0783604	SUBARU	11-3	8531-32-320	0303393	MAZDA	7-17
7210-60560	0783604	SUBARU	11-3	8531-99-322A	0281266	MAZDA	7-9
7210-60570	0793604	SUBARU	11-3	8531-99-324	0291265	MAZDA	7-9
7210-67000	0402515	SUBARU	11-6	8531-99-356	0403383	MAZDA	7-9
7210-67001	0402515	SUBARU	11-6	8559-32-220	0303426	MAZDA	7-26
7210-67002	0402515	SUBARU	11-6	8559-99-354	0403419	MAZDA	7-13
7210-67003	0402515	SUBARU	11-6	8637-32-250	0503427	MAZDA	7-24
7210-67020	0403594	SUBARU	11-3	8650-99-356	0403417	MAZDA	7-13
7210-67021	0403594	SUBARU	11-3	8AB1-32-280	0283379	KIA	6-11
7210-67022	0403594	SUBARU	11-3	8AB1-32-280	0283379	MAZDA	7-1
7313-10010	0602514	SUBARU	11-6	8AB2-32-280	0281482	MAZDA	7-1
7313-10140	0603593	SUBARU	11-3	8AF1-32-280	0282563	MAZDA	7-26
7313-20000	0282512	SUBARU	11-6	8AG1-28-100A	0504587	MAZDA	7-5
7313-20010	0282513	SUBARU	11-6	8AG1-34-100	0502656	MAZDA	7-11
7313-20020	0283592	SUBARU	11-2	8AG3-32-280	0284435	MAZDA	7-6
8-94217-221-3	0600424	ISUZU	5-3	8AG4-32-280	0281593	MAZDA	7-21
8-94223-221-2	0783013	ISUZU	5-4	8AH1-32-280	0280347	MAZDA	7-9
8-94223-222-2	0793013	ISUZU	5-4	8AL1-32-280	0281591	MAZDA	7-20
8-94224-550-3	0403012	ISUZU	5-2	8AN1-32-280	0284490	MAZDA	7-22
8-94224-552-2	0403013	ISUZU	5-3	8AU1-32-280	0292935	MAZDA	7-15
8-94226-936-1	0703012	ISUZU	5-4	8AU1-34-540	0402936	MAZDA	7-15
8-94237-351-1	0280455	ISUZU	5-3	8AU2-32-270	0282934	MAZDA	7-15
8-94237-366-1	0500426	ISUZU	5-3	8AU2-34-510	0402937	MAZDA	7-15
8-94243-232-0	0783012	ISUZU	5-4	8AU3-34-510	0404589	MAZDA	7-15

RIF. ORIG O.E. NUMBER	RIF. OCAP REF. OCAP	MARCA	PAG.	RIF. ORIG O.E. NUMBER	RIF. OCAP REF. OCAP	MARCA	PAG.
9-43150-605-0	0180425	ISUZU	5-1	96316765	0702916	DAEWOO - CHEVROLET	1-6
9-43150-606-0	0190425	ISUZU	5-1	96378347	0794255	DAEWOO - CHEVROLET	1-9
9-43150-610-0	0180425	ISUZU	5-1	96378348	0784255	DAEWOO - CHEVROLET	1-9
9-43150-613-0	0190425	ISUZU	5-1	96391850	0794248	DAEWOO - CHEVROLET	1-8
9-94224-550-4	0403012	ISUZU	5-2	96391851	0784248	DAEWOO - CHEVROLET	1-8
90112-SE0-000	0504532	HONDA	3-3	96391875	0504256	DAEWOO - CHEVROLET	1-1
90112-SM4-000	0502763	HONDA	3-4	96391876	0504245	DAEWOO - CHEVROLET	1-8
90112-SM4-020	0502763	HONDA	3-4	96403099	0594251	DAEWOO - CHEVROLET	1-9
90140006	0283301	DAEWOO - CHEVROLET	1-3	96403100	0584251	DAEWOO - CHEVROLET	1-9
90140007	0293301	DAEWOO - CHEVROLET	1-3	96407485	0294247	DAEWOO - CHEVROLET	1-8
90375505	0403302	DAEWOO - CHEVROLET	1-3	96407486	0284247	DAEWOO - CHEVROLET	1-8
93740621	0604254	DAEWOO - CHEVROLET	1-9	96415063	0794248	DAEWOO - CHEVROLET	1-8
93740622	0294257	DAEWOO - CHEVROLET	1-4	96415064	0784248	DAEWOO - CHEVROLET	1-8
93740623	0284257	DAEWOO - CHEVROLET	1-4	96490218	0404248	DAEWOO - CHEVROLET	1-8
93740722	0294258	DAEWOO - CHEVROLET	1-1	96535081	0794259	DAEWOO - CHEVROLET	1-1
93740723	0284258	DAEWOO - CHEVROLET	1-1	96535082	0784259	DAEWOO - CHEVROLET	1-1
93741074	0604264	DAEWOO - CHEVROLET	1-6	96535089	0404259	DAEWOO - CHEVROLET	1-1
93741077	0284263	DAEWOO - CHEVROLET	1-6	96561754	0504252	DAEWOO - CHEVROLET	1-9
93741091	0284265	DAEWOO - CHEVROLET	1-6	96626150	0503955	DAEWOO - CHEVROLET	1-2
93741092	0604266	DAEWOO - CHEVROLET	1-6	96626235	0793953	DAEWOO - CHEVROLET	1-2
94217221	0600424	ISUZU	5-3	96626235 Z	0403953	DAEWOO - CHEVROLET	1-1
94224552	0403013	ISUZU	5-3	96626236	0783953	DAEWOO - CHEVROLET	1-2
94224701	0280455	ISUZU	5-3	96626236 Z	0403953	DAEWOO - CHEVROLET	1-1
94237351	0280455	ISUZU	5-3	96626247	0593954	DAEWOO - CHEVROLET	1-2
94246475	0403013	ISUZU	5-3	96626248	0583954	DAEWOO - CHEVROLET	1-2
94459464	0400422	ISUZU	5-2	96626667	0283951	DAEWOO - CHEVROLET	1-1
94788122	0403302	DAEWOO - CHEVROLET	1-3	96819161	0793953	DAEWOO - CHEVROLET	1-2
96061907	0602454	DAEWOO - CHEVROLET	1-1	96819162	0783953	DAEWOO - CHEVROLET	1-2
96129753	0282892	DAEWOO - CHEVROLET	1-5	B001-32-135	0603384	MAZDA	7-18
96205798	0282892	DAEWOO - CHEVROLET	1-5	B001-34-310C	0783386	MAZDA	7-18
96205809	0282892	DAEWOO - CHEVROLET	1-5	B001-34-360C	0793386	MAZDA	7-18
96207628	0504530	DAEWOO - CHEVROLET	1-5	B001-34-550	0400358	MAZDA	7-18
96213117	0792894	DAEWOO - CHEVROLET	1-5	B001-99-324	0280357	MAZDA	7-18
96213118	0782894	DAEWOO - CHEVROLET	1-5	B001-99-325	0290357	MAZDA	7-18
96213119	0402894	DAEWOO - CHEVROLET	1-5	B01A-34-300E	0783399	MAZDA	7-6
96218397	0794213	DAEWOO - CHEVROLET	1-3	B01A-34-350E	0793399	MAZDA	7-6
96218398	0784213	DAEWOO - CHEVROLET	1-3	B01A-34-500A	0403399	MAZDA	7-4
96225858	0594529	DAEWOO - CHEVROLET	1-5	B01A-34-550	0403399	MAZDA	7-4
96225859	0584529	DAEWOO - CHEVROLET	1-5	B029-34-159	0504586	MAZDA	7-5
96261108	0404255	DAEWOO - CHEVROLET	1-9	B037-99-324	0280357	MAZDA	7-18
96261378	0294253	DAEWOO - CHEVROLET	1-9	B037-99-325	0290357	MAZDA	7-18
96261379	0284253	DAEWOO - CHEVROLET	1-9	B038-32-135	0603385	MAZDA	7-18
96268439	0794219	DAEWOO - CHEVROLET	1-7	B092-28-500B	0783406	MAZDA	7-5
96268440	0784219	DAEWOO - CHEVROLET	1-7	B092-28-550B	0793406	MAZDA	7-5
96268454	0794220	DAEWOO - CHEVROLET	1-8	B092-32-240	0603388	MAZDA	7-19
96268455	0784220	DAEWOO - CHEVROLET	1-7	B092-34-310A	0783391	MAZDA	7-19
96275018	0293301	DAEWOO - CHEVROLET	1-3	B092-34-360A	0793391	MAZDA	7-19
96275019	0283301	DAEWOO - CHEVROLET	1-3	B092-34-550	0403390	MAZDA	7-19
96275798	0504227	DAEWOO - CHEVROLET	1-8	B093-32-240	0683387	MAZDA	7-19
96288865	0504256	DAEWOO - CHEVROLET	1-1	B093-32-250	0693387	MAZDA	7-19
9630-0048	0402896	DAEWOO - CHEVROLET	1-7	B094-32-240	0603389	MAZDA	7-19
96300048	0402896	DAEWOO - CHEVROLET	1-7	B21H-32-25X	0604438	MAZDA	7-5
96300222	0504226	DAEWOO - CHEVROLET	1-7	B25D-32-240	0694434	MAZDA	7-6
96300627	0504225	DAEWOO - CHEVROLET	1-7	B25D-32-250	0684434	MAZDA	7-6
96300648	0402896	DAEWOO - CHEVROLET	1-7	B25D-34-300A	0782640	MAZDA	7-7
96305974	0794219	DAEWOO - CHEVROLET	1-7	B25D-34-300B	0782640	MAZDA	7-7
96305975	0784219	DAEWOO - CHEVROLET	1-7	B25D-34-300C	0782640	MAZDA	7-7
9631-6765	0702916	DAEWOO - CHEVROLET	1-6	B25D-34-300D	0782640	MAZDA	7-7

RIF. ORIG O.E. NUMBER	RIF. OCAP REF. OCAP	MARCA	PAG.	RIF. ORIG O.E. NUMBER	RIF. OCAP REF. OCAP	MARCA	PAG.
B25D-34-350A	0792640	MAZDA	7-7	D8521-JD00B	0603271	NISSAN	9-38
B25D-34-350B	0792640	MAZDA	7-7	D8521-JG00A	0603271	NISSAN	9-38
B25D-34-350C	0792640	MAZDA	7-7	D8560-VK90A	0503118	NISSAN	9-28
B25D-34-350D	0792640	MAZDA	7-7	D8570-VK90A	0283114	NISSAN	9-28
B26R-28-170	0501588	MAZDA	7-7	D8640-1KA0A	0298071	NISSAN	9-13
B26R-34-170	0504433	MAZDA	7-7	DD32-32-280	0284427	MAZDA	7-2
B30H-28-170B	0502797	MAZDA	7-7	DD32-32-290	0294427	MAZDA	7-2
B32H-34-300	0784428	MAZDA	7-3	DD32-34-170	0504426	MAZDA	7-3
B32H-34-300D	0784428	MAZDA	7-3	DD32-34-300	0784425	MAZDA	7-3
B32H-34-350	0794428	MAZDA	7-4	DD32-34-350	0794425	MAZDA	7-3
B32H-34-350D	0794428	MAZDA	7-4	DE90-32-240	0602560	MAZDA	7-2
B455-32-24X	0603396	MAZDA	7-4	DE90-32-280	0284427	MAZDA	7-2
B455-32-25X	0603397	MAZDA	7-4	DE90-32-290	0294427	MAZDA	7-2
B455-34-300	0783400	MAZDA	7-5	E016-32-250	0604588	MAZDA	7-5
B455-34-300E	0783400	MAZDA	7-5	E016-32-25X	0604437	MAZDA	7-5
B455-34-350	0793400	MAZDA	7-5	E17Z-3049A	0400343	MAZDA	7-25
B455-34-350E	0793400	MAZDA	7-5	E17Z-3050A	0400344	MAZDA	7-25
B455-34-550	0403398	MAZDA	7-4	E17Z-3350A	0300345	MAZDA	7-25
B456-32-25X	0603397	MAZDA	7-4	E17Z-3A130A	0280342	MAZDA	7-25
BA29-32135	0603385	MAZDA	7-18	E17Z-3A130B	0280342	MAZDA	7-25
BC1D-28-170	0508072	MAZDA	7-27	E17Z-3A131A	0280341	MAZDA	7-25
BC1D-28-170A	0504439	MAZDA	7-6	EA01-28-170	0504441	MAZDA	7-21
BF67-32-240	0683387	MAZDA	7-19	EA01-28-170D	0504441	MAZDA	7-21
BK3P-34-300D	0404428	MAZDA	7-3	EA03-34-170A	0504440	MAZDA	7-16
BP4K-28-170C	0502795	MAZDA	7-4	EC01-32-240	0608072	MAZDA	7-27
BP4K-28-170D	0502795	MAZDA	7-4	EC01-32-240A	0608072	MAZDA	7-27
BP4K-28-500C	0704591	MAZDA	7-4	EC01-32-280	0288072	MAZDA	7-27
BP4K-28-500D	0704591	MAZDA	7-4	EC01-32-280A	0288072	MAZDA	7-27
BP4K-28-500E	0704591	MAZDA	7-4	EC01-34-150	0508072	MAZDA	7-27
BP4K-28-C10B	0302856	MAZDA	7-4	EC01-34-150A	0508072	MAZDA	7-27
BP4K-34-170C	0504446	MAZDA	7-4	EC01-34-150F	0508072	MAZDA	7-27
BP4K-34-170D	0504446	MAZDA	7-4	EC01-34-300F	0788072	MAZDA	7-27
BP4K-34-300E	0784428	MAZDA	7-3	EC01-34-300G	0788072	MAZDA	7-27
BP4K-34-350E	0794428	MAZDA	7-4	EC01-34-300H	0788072	MAZDA	7-27
BP4L-32-240	0604522	MAZDA	7-3	EC01-34-300J	0788072	MAZDA	7-27
BP4L-32-280	0284429	MAZDA	7-3	EC01-34-300K	0788072	MAZDA	7-27
BP4L-32-290	0294429	MAZDA	7-3	EC01-34-300L	0788072	MAZDA	7-27
BS06-32-240	0603396	MAZDA	7-4	EC01-34-350F	0798072	MAZDA	7-27
C100-34-300A	0784594	MAZDA	7-24	EC01-34-350G	0798072	MAZDA	7-27
C100-34-300B	0784594	MAZDA	7-24	EC01-34-350H	0798072	MAZDA	7-27
C100-34-350A	0794594	MAZDA	7-24	EC01-34-350J	0798072	MAZDA	7-27
C100-34-350B	0794594	MAZDA	7-24	EC01-34-350K	0798072	MAZDA	7-27
D031-34-310A	0383410	MAZDA	7-1	EC01-34-350L	0798072	MAZDA	7-27
D031-34-320A	0393410	MAZDA	7-1	F4BZ-3A130-A	0281584	KIA	6-10
D061-32-24XA	0601481	MAZDA	7-1	FB01-32-240A	0602564	MAZDA	7-26
D061-34-300	0383410	MAZDA	7-1	FD01-32-240	0601597	MAZDA	7-26
D061-34-350	0393410	MAZDA	7-1	G030-32-240A	0680348	MAZDA	7-9
D10232240A	0694444	MAZDA	7-16	G030-32-250A	0690348	MAZDA	7-9
D10232250A	0684444	MAZDA	7-16	G030-34-300F	0783404	MAZDA	7-10
D201-34-300E	0384590	MAZDA	7-16	G030-34-350F	0793404	MAZDA	7-10
D201-34-350A	0394590	MAZDA	7-16	G030-99-356	0400349	MAZDA	7-10
D27Z-3A130A	0183430	MAZDA	7-25	G037-32-240C	0683401	MAZDA	7-10
D27Z-3A131A	0193429	MAZDA	7-25	G037-32-250C	0693401	MAZDA	7-10
D77Z-3304B	0503427	MAZDA	7-24	GA2A-32-250	0604450	MAZDA	7-11
D77Z-3A130A	0183430	MAZDA	7-25	GA2A-32-280A	0281593	MAZDA	7-21
D77Z-3A131A	0193429	MAZDA	7-25	GA2A-34-150	0583801	MAZDA	7-6
D8520-1KA0A	0288071	NISSAN	9-13	GA2A-34-150A	0583801	MAZDA	7-6
D8520-VK90A	0284511	NISSAN	9-21	GA2A-34-170	0593801	MAZDA	7-6



RIF. ORIG O.E. NUMBER	RIF. OCAP REF. OCAP	MARCA	PAG.	RIF. ORIG O.E. NUMBER	RIF. OCAP REF. OCAP	MARCA	PAG.
GA2A-34-170A	0593801	MAZDA	7-6	HB212003	0793298	HYUNDAI	4-6
GA2A-34-300	0783409	MAZDA	7-12	HB212004	0783298	HYUNDAI	4-6
GA2A-34-350	0793409	MAZDA	7-12	HB212100	0403465	HYUNDAI	4-6
GA2B-28-170A	0501590	MAZDA	7-12	HB212200	0403465	HYUNDAI	4-6
GA2B-28-170B	0501590	MAZDA	7-12	HB568100	0503460	HYUNDAI	4-5
GA2C-28-170A	0503706	MAZDA	7-12	HB568110	0182814	HYUNDAI	4-26
GA2C-28-170B	0503706	MAZDA	7-12	HB568120	0182813	HYUNDAI	4-26
GA6A-99-356	0400349	MAZDA	7-10	HMB-303401	0783496	MITSUBISHI	8-27
GA6B-99-356	0400349	MAZDA	7-10	HMB-303402	0793496	MITSUBISHI	8-27
GA6B-99-356A	0400349	MAZDA	7-10	K9992-11-201	0281584	KIA	6-10
GA6BE-34-300	0783409	MAZDA	7-12	K9A3-28-170A	0501582	KIA	6-8
GA6BE-34-350	0793409	MAZDA	7-12	K9A3-28-170A	0501582	MAZDA	7-14
GD1E-34-150	0583801	MAZDA	7-6	KB092-32-280	0281969	KIA	6-12
GD1E-34-170	0593801	MAZDA	7-6	KBJR45	0604212	DAEWOO - CHEVROLET	1-6
GD7A-34-300A	0782798	MAZDA	7-13	KDX53-32-240B	0601585	KIA	6-12
GD7A-34-350A	0792798	MAZDA	7-13	KGA2A-34-150	0581970	KIA	6-8
GE4T-28-170	0502657	MAZDA	7-13	KGA2A-34-170	0591970	KIA	6-8
GE4T-31-300	0782798	MAZDA	7-13	KK150-32-240	0602928	KIA	6-11
GE4T-31-300C	0782798	MAZDA	7-13	KK150-32-240	0602928	MAZDA	7-1
GE4T-31-300E	0782798	MAZDA	7-13	KKY0-IE34310	0383410	MAZDA	7-1
GE4T-31-350	0792798	MAZDA	7-13	KKY0-IE34320	0393410	MAZDA	7-1
GE4T-31-350C	0792798	MAZDA	7-13	KKY01-32-280	0283379	KIA	6-11
GE4T-31-350E	0792798	MAZDA	7-13	KKY01-34-310	0303865	KIA	6-12
GE4T-32-240	0601589	MAZDA	7-12	KX43-34-300	0780340	KIA	6-1
GE4T-32-240A	0601589	MAZDA	7-12	KX43-34-350	0790340	KIA	6-1
GE4T-34-300C	0782798	MAZDA	7-13	LA01-32-115	0601592	MAZDA	7-20
GE4T-34-350C	0792798	MAZDA	7-13	LB82-34-300	0303394	MAZDA	7-20
GF22-34-300A	0783405	MAZDA	7-11	LC62-32-240B	0601594	MAZDA	7-21
GF22-34-350A	0793405	MAZDA	7-11	LC62-32-280	0403121	MAZDA	7-21
GJ21-32-240	0603403	MAZDA	7-10	LC62-34-170	0501595	MAZDA	7-7
GJ22-32-240	0603508	MAZDA	7-11	LC62-34-170A	0501595	MAZDA	7-7
GJ22-34-300A	0783405	MAZDA	7-11	LC62-34-170B	0501595	MAZDA	7-7
GJ22-34-350A	0793405	MAZDA	7-11	LC62-34-300C	0783121	MAZDA	7-21
GJ6A-28-170A	0501587	MAZDA	7-8	LC62-34-350C	0793121	MAZDA	7-21
GJ6A-34-150A	0584432	MAZDA	7-8	LC62-34-550	0402640	MAZDA	7-7
GJ6A-34-170A	0594432	MAZDA	7-8	LMB-002307	0700495	MITSUBISHI	8-17
GJ6A-34-200B	0784431	MAZDA	7-8	LMB-002583	0783494	MITSUBISHI	8-17
GJ6A-34-250B	0794431	MAZDA	7-8	LMB-002584	0793494	MITSUBISHI	8-17
GJ6A-34-300B	0302775	MAZDA	7-8	MA-150801	0403476	MITSUBISHI	8-10
GJ6A-34-300C	0302775	MAZDA	7-8	MA-151985	0503466	MITSUBISHI	8-9
GJ6A-34-300D	0302775	MAZDA	7-8	MA-159887	0503467	MITSUBISHI	8-9
GJ6A-34-300E	0302775	MAZDA	7-8	MA-159982	0183468	MITSUBISHI	8-9
GJ6A-34-540	0404431	MAZDA	7-8	MA-159984	0190359	MITSUBISHI	8-9
GJ6A-34-J00B	0382759	MAZDA	7-8	MA-169605	0503466	MITSUBISHI	8-9
GJ6A-34-J00C	0382759	MAZDA	7-8	MA-169613	0183468	MITSUBISHI	8-9
GJ6A-34-J00D	0382759	MAZDA	7-8	MB-001695	0403476	MITSUBISHI	8-10
GJ6A-34-J50B	0392759	MAZDA	7-8	MB-001696	0403477	MITSUBISHI	8-10
GJ6A-34-J50C	0392759	MAZDA	7-8	MB-001699	0403477	MITSUBISHI	8-10
GJ6A-34-J50D	0392759	MAZDA	7-8	MB-001715	0403477	MITSUBISHI	8-10
GJ6E-32-240	0604592	MAZDA	7-8	MB-002433	0403452	MITSUBISHI	8-24
GJ6E-32-280A	0284430	MAZDA	7-7	MB-002475	0403454	MITSUBISHI	8-24
GJ6E-32-290A	0294430	MAZDA	7-7	MB-002476	0403463	MITSUBISHI	8-18
H001-32-240	0603421	MAZDA	7-14	MB-006314	0283435	MITSUBISHI	8-15
H001-99-324	0280347	MAZDA	7-9	MB-006315	0283446	MITSUBISHI	8-23
H002-32-240	0603422	MAZDA	7-14	MB-006358	0283435	MITSUBISHI	8-15
H260-32-240A	0690423	MAZDA	7-14	MB-006571	0303484	MITSUBISHI	8-14
H261-32-240A	0680423	MAZDA	7-14	MB-076001	0593473	MITSUBISHI	8-9
H2Y0-99-356	0403424	MAZDA	7-14	MB-076002	0583472	MITSUBISHI	8-9

RIF. ORIG O.E. NUMBER	RIF. OCAP REF. OCAP	MARCA	PAG.	RIF. ORIG O.E. NUMBER	RIF. OCAP REF. OCAP	MARCA	PAG.
MB-076003	0183458	mitsubishi	8-9	MB-241206	0183460	mitsubishi	8-21
MB-076004	0293469	mitsubishi	8-9	MB-241421	0303462	mitsubishi	8-18
MB-076009	0303461	mitsubishi	8-9	MB-241423	0304121	mitsubishi	8-21
MB-076010	0303474	mitsubishi	8-9	MB-241495	0303475	mitsubishi	8-10
MB-076531	0283435	mitsubishi	8-15	MB-241497	0303484	mitsubishi	8-14
MB-076663	0183458	mitsubishi	8-9	MB-241498	0303484	mitsubishi	8-14
MB-076664	0293469	mitsubishi	8-9	MB-241818	0400329	mitsubishi	8-18
MB-109168	0493438	mitsubishi	8-16	MB-241830	0303489	mitsubishi	8-29
MB-109169	0483438	mitsubishi	8-16	MB-241883	0403434	mitsubishi	8-1
MB-109343	0703498	mitsubishi	8-25	MB-241973	0303488	mitsubishi	8-28
MB-109512	0794116	mitsubishi	8-19	MB-241974	0504596	mitsubishi	8-7
MB-109513	0784116	mitsubishi	8-19	MB-241982	0283437	mitsubishi	8-4
MB-109585	0403463	mitsubishi	8-18	MB-243329	0603481	mitsubishi	8-11
MB-109587	0400329	mitsubishi	8-18	MB-243373	0603441	mitsubishi	8-15
MB-109588	0400329	mitsubishi	8-18	MB-266152	0603479	mitsubishi	8-11
MB-109858	0293470	mitsubishi	8-10	MB-267876	0582568	mitsubishi	8-32
MB-109893	0703497	mitsubishi	8-25	MB-267877	0592568	mitsubishi	8-32
MB-109993	0403453	mitsubishi	8-24	MB-288119	0283447	mitsubishi	8-24
MB-112476	0403463	mitsubishi	8-18	MB-303374	0403434	mitsubishi	8-1
MB-112477	0403463	mitsubishi	8-18	MB-303375	0403434	mitsubishi	8-1
MB-122011	0290328	mitsubishi	8-17	MB-315160	0603479	mitsubishi	8-11
MB-122012	0290328	mitsubishi	8-17	MB-315586	0603441	mitsubishi	8-15
MB-122135	0603436	mitsubishi	8-15	MB-315629	0283435	mitsubishi	8-15
MB-122396	0303486	mitsubishi	8-15	MB-315770	0304595	mitsubishi	8-24
MB-122400	0303487	mitsubishi	8-15	MB-315775	0193459	hyundai	4-5
MB-122779	0183458	mitsubishi	8-9	MB-315775	0193459	mitsubishi	8-20
MB-122782	0190359	mitsubishi	8-9	MB-315776	0183460	hyundai	4-5
MB-162810	0192945	mitsubishi	8-1	MB-315776	0183460	mitsubishi	8-21
MB-162811	0182945	mitsubishi	8-1	MB-347666	0603443	mitsubishi	8-4
MB-166281	0300589	mitsubishi	8-18	MB-349445	0783500	mitsubishi	8-4
MB-166420	0503449	mitsubishi	8-23	MB-349446	0793500	mitsubishi	8-4
MB-166422	0503448	mitsubishi	8-23	MB-350577	0603480	mitsubishi	8-11
MB-166423	0303451	mitsubishi	8-24	MB-350718	0603442	mitsubishi	8-4
MB-166424	0303450	mitsubishi	8-24	MB-378701	0183458	mitsubishi	8-9
MB-166426	0283435	mitsubishi	8-15	MB-378702	0293469	mitsubishi	8-9
MB-166566	0303461	mitsubishi	8-9	MB-378704	0190359	mitsubishi	8-9
MB-166980	0183458	mitsubishi	8-9	MB-430112	0793499	hyundai	4-11
MB-166982	0190359	mitsubishi	8-9	MB-430112	0793499	mitsubishi	8-26
MB-175544	0400329	mitsubishi	8-18	MB-430113	0783499	hyundai	4-11
MB-175812	0400329	mitsubishi	8-18	MB-430113	0783499	mitsubishi	8-26
MB-176273	0400329	mitsubishi	8-18	MB-489434	0283471	mitsubishi	8-11
MB-176283	0400329	mitsubishi	8-18	MB-501530	0603442	mitsubishi	8-4
MB-176308	0403465	hyundai	4-6	MB-501721	0603481	mitsubishi	8-11
MB-176308	0403465	mitsubishi	8-21	MB-518712-01	0403434	mitsubishi	8-1
MB-176309	0400555	hyundai	4-6	MB-518780	0183623	mitsubishi	8-5
MB-176309	0400555	mitsubishi	8-18	MB-518780 Z	0183623-K	mitsubishi	8-5
MB-185329	0403478	mitsubishi	8-11	MB-518781	0183623	mitsubishi	8-5
MB-185441	0283435	mitsubishi	8-15	MB-518781 Z	0183623-K	mitsubishi	8-5
MB-192297	0303475	mitsubishi	8-10	MB-518806	0793501	mitsubishi	8-5
MB-192430	0283433	mitsubishi	8-11	MB-518807	0783501	mitsubishi	8-5
MB-192499	0283471	mitsubishi	8-11	MB-518892	0501767	hyundai	4-17
MB-241165	0303474	mitsubishi	8-9	MB-518892	0501767	mitsubishi	8-4
MB-241166	0300589	mitsubishi	8-18	MB-527159	0794115	mitsubishi	8-19
MB-241168	0304120	mitsubishi	8-21	MB-527169	0283440	mitsubishi	8-1
MB-241171	0193459	hyundai	4-5	MB-527349	0402940	hyundai	4-7
MB-241171	0193459	mitsubishi	8-20	MB-527349	0402940	mitsubishi	8-25
MB-241172	0283435	mitsubishi	8-15	MB-527350	0402940	hyundai	4-7
MB-241206	0183460	hyundai	4-5	MB-527350	0402940	mitsubishi	8-25

RIF. ORIG O.E. NUMBER	RIF. OCAP REF. OCAP	MARCA	PAG.	RIF. ORIG O.E. NUMBER	RIF. OCAP REF. OCAP	MARCA	PAG.
MB-527351	0492941	mitsubishi	8-27	MB-910842	0793505	mitsubishi	8-6
MB-527352	0482941	mitsubishi	8-27	MB-910934	0603445	mitsubishi	8-5
MB-527383	0793499	hyundai	4-11	MB-912076	0283440	mitsubishi	8-1
MB-527383	0793499	mitsubishi	8-26	MB-912077	0793504	mitsubishi	8-6
MB-527383-01	0403507	hyundai	4-10	MB-912078	0783504	mitsubishi	8-6
MB-527383-01	0403507	mitsubishi	8-25	MB-912505	0791763	mitsubishi	8-12
MB-527384	0783499	hyundai	4-11	MB-912506	0781763	mitsubishi	8-12
MB-527384	0783499	mitsubishi	8-26	MB-912509	0391761	mitsubishi	8-12
MB-527384-01	0403507	hyundai	4-10	MB-912510	0381761	mitsubishi	8-12
MB-527384-01	0403507	mitsubishi	8-25	MB-912511	0391762	mitsubishi	8-12
MB-527650	0282938	mitsubishi	8-25	MB-912512	0381762	mitsubishi	8-12
MB-532281	0601760	mitsubishi	8-11	MB-949343	0601760	mitsubishi	8-11
MB-532971	0602939	mitsubishi	8-25	MB109630A	0793297	hyundai	4-6
MB-553249	0603444	mitsubishi	8-5	MB109631A	0783297	hyundai	4-6
MB-573043	0501767	hyundai	4-17	MB166765	0182813	hyundai	4-26
MB-573043	0501767	mitsubishi	8-4	MB166766	0182814	hyundai	4-26
MB-573540	0183623	mitsubishi	8-5	MDX50-32-280	0281584	kia	6-10
MB-573540 Z	0183623-K	mitsubishi	8-5	MN-101368	0504137	mitsubishi	8-28
MB-597605	0283440	mitsubishi	8-1	MN-184194	0584138	mitsubishi	8-28
MB-598017	0793499	hyundai	4-11	MN-186217	0792805	mitsubishi	8-8
MB-598017	0793499	mitsubishi	8-26	MN-186218	0782805	mitsubishi	8-8
MB-598018	0783499	hyundai	4-11	MR-124879	0793492	mitsubishi	8-30
MB-598018	0783499	mitsubishi	8-26	MR-124880	0783492	mitsubishi	8-30
MB-598018-Y	0403507	hyundai	4-10	MR-130479	0791998	mitsubishi	8-3
MB-598018-Y	0403507	mitsubishi	8-25	MR-130480	0781998	mitsubishi	8-3
MB-598023	0283440	mitsubishi	8-1	MR-131680	0504470	mitsubishi	8-2
MB-598489	0303490	mitsubishi	8-29	MR-131732	0501577	mitsubishi	8-14
MB-633926	0504597	mitsubishi	8-30	MR-131857	0601752	mitsubishi	8-35
MB-672370	0591754	mitsubishi	8-35	MR-132551	0592571	mitsubishi	8-30
MB-808076	0581754	mitsubishi	8-35	MR-132552	0582571	mitsubishi	8-30
MB-809220	0793506	mitsubishi	8-2	MR-162579	0391761	mitsubishi	8-12
MB-809221	0783506	mitsubishi	8-2	MR-162580	0381761	mitsubishi	8-12
MB-809222	0791958	mitsubishi	8-2	MR-162581	0391762	mitsubishi	8-12
MB-809223	0781958	mitsubishi	8-2	MR-162582	0381762	mitsubishi	8-12
MB-809354	0502803	mitsubishi	8-7	MR-162803	0791763	mitsubishi	8-12
MB-831035	0793492	mitsubishi	8-30	MR-162804	0781763	mitsubishi	8-12
MB-831036	0783492	mitsubishi	8-30	MR-171307	0791965	mitsubishi	8-2
MB-831037	0493493	mitsubishi	8-22	MR-171308	0781965	mitsubishi	8-1
MB-831038	0483493	mitsubishi	8-21	MR-179479	0791749	mitsubishi	8-1
MB-831039	0504597	mitsubishi	8-30	MR-179480	0781749	mitsubishi	8-1
MB-831040	0303491	mitsubishi	8-29	MR-197284	0701960	mitsubishi	8-7
MB-831042	0301988	mitsubishi	8-29	MR-241023	0794118	mitsubishi	8-20
MB-831043	0182942	mitsubishi	8-21	MR-241024	0784118	mitsubishi	8-20
MB-831044	0192943	mitsubishi	8-29	MR-241025	0794119	mitsubishi	8-20
MB-831555	0391753	mitsubishi	8-35	MR-241026	0784119	mitsubishi	8-20
MB-831556	0381753	mitsubishi	8-35	MR-241027	0404119	mitsubishi	8-20
MB-844695	0283435	mitsubishi	8-15	MR-241031	0184117	mitsubishi	8-20
MB-860381	0793493	mitsubishi	8-30	MR-241032	0193459	hyundai	4-5
MB-860382	0783493	mitsubishi	8-30	MR-241032	0193459	mitsubishi	8-20
MB-860408	0784115	mitsubishi	8-19	MR-241341	0791959	mitsubishi	8-7
MB-860829	0403492	mitsubishi	8-21	MR-241342	0781959	mitsubishi	8-7
MB-860830	0403492	mitsubishi	8-21	MR-241623	0402940	hyundai	4-7
MB-892981	0501764	mitsubishi	8-12	MR-241623	0402940	mitsubishi	8-25
MB-892982	0501767	hyundai	4-17	MR-244901	0601999	mitsubishi	8-1
MB-892982	0501767	mitsubishi	8-4	MR-267876	0592571	mitsubishi	8-30
MB-907115	0793504	mitsubishi	8-6	MR-267877	0582571	mitsubishi	8-30
MB-907116	0783504	mitsubishi	8-6	MR-272116	0504470	mitsubishi	8-2
MB-910841	0783505	mitsubishi	8-6	MR-272117	0504471	mitsubishi	8-2

RIF. ORIG O.E. NUMBER	RIF. OCAP REF. OCAP	MARCA	PAG.	RIF. ORIG O.E. NUMBER	RIF. OCAP REF. OCAP	MARCA	PAG.
MR-272118	0504475	mitsubishi	8-4	MR-508130	0404599	mitsubishi	8-32
MR-296027	0794119	mitsubishi	8-20	MR-508135	0292565	mitsubishi	8-31
MR-296028	0784119	mitsubishi	8-20	MR-508136	0282565	mitsubishi	8-31
MR-296093	0793492	mitsubishi	8-30	MR-508650	0282818	mitsubishi	8-27
MR-296094	0783492	mitsubishi	8-30	MR-510267	0602566	mitsubishi	8-31
MR-296095	0793492	mitsubishi	8-30	MR-548285	0282818	mitsubishi	8-27
MR-296096	0783492	mitsubishi	8-30	MR-594674	0601760	mitsubishi	8-11
MR-296269	0493493	mitsubishi	8-22	MR-911569	0781751	mitsubishi	8-3
MR-296270	0483493	mitsubishi	8-21	MR-911570	0791751	mitsubishi	8-3
MR-296272	0304123	mitsubishi	8-21	MR-915769	0791749	mitsubishi	8-1
MR-296274	0183460	hyundai	4-5	MR-915770	0781749	mitsubishi	8-1
MR-296274	0184122	mitsubishi	8-21	MR-916133	0791964	mitsubishi	8-37
MR-296289	0391762	mitsubishi	8-12	MR-916134	0781964	mitsubishi	8-37
MR-296290	0381762	mitsubishi	8-12	MR-954887	0504131	mitsubishi	8-16
MR-296295	0391761	mitsubishi	8-12	MR-954888	0504596	mitsubishi	8-7
MR-296296	0381761	mitsubishi	8-12	MR-961477	0502806	mitsubishi	8-8
MR-296320	0381762	mitsubishi	8-12	MR-977606	0282804	mitsubishi	8-8
MR-297241	0791964	mitsubishi	8-37	MR-992191	0594142	mitsubishi	8-33
MR-297242	0781964	mitsubishi	8-37	MR-992192	0584142	mitsubishi	8-33
MR-297969	0602993	mitsubishi	8-7	MR-992309	0594127	mitsubishi	8-23
MR-316051	0391756	mitsubishi	8-36	MR-992310	0584127	mitsubishi	8-23
MR-316052	0381756	mitsubishi	8-36	MT-142181	0283435	mitsubishi	8-15
MR-316053	0391758	mitsubishi	8-40	MT-402861	0303484	mitsubishi	8-14
MR-316054	0381758	mitsubishi	8-40	MW-033300	0192944	mitsubishi	8-1
MR-316297	0791757	mitsubishi	8-36	MW-033301	0182944	mitsubishi	8-1
MR-316298	0781757	mitsubishi	8-36	N066-34-310	0782801	mazda	7-22
MR-316368	0502821	mitsubishi	8-27	N066-34-360	0792801	mazda	7-23
MR-319147	0502820	mitsubishi	8-27	N068-34-200	0782800	mazda	7-22
MR-325576	0391761	mitsubishi	8-12	N068-34-250	0792800	mazda	7-22
MR-325577	0381761	mitsubishi	8-12	NA01-32-240	0604443	mazda	7-22
MR-374521	0592568	mitsubishi	8-32	NA01-34-170	0504442	mazda	7-22
MR-374522	0582568	mitsubishi	8-32	NA01-34-550	0404447	mazda	7-22
MR-403027	0601963	mitsubishi	8-36	NC10-32-240A	0682799	mazda	7-22
MR-403100	0602819	mitsubishi	8-27	NC10-32-250A	0692799	mazda	7-22
MR-403419	0794130	mitsubishi	8-16	NC10-34-150	0582802	mazda	7-23
MR-403420	0784130	mitsubishi	8-16	NC10-34-170	0592802	mazda	7-23
MR-403485	0704132	mitsubishi	8-16	S083-32-115	0600338	kia	6-1
MR-403771	0504133	mitsubishi	8-17	S083-32-115	0600338	mazda	7-14
MR-403872	0601760	mitsubishi	8-11	S083-99-324	0280337	kia	6-1
MR-414939	0791766	mitsubishi	8-34	S083-99-324	0280337	mazda	7-14
MR-414940	0781766	mitsubishi	8-34	S083-99-354	0400339	kia	6-1
MR-418052	0592569	mitsubishi	8-32	S083-99-354	0400339	mazda	7-14
MR-418053	0582569	mitsubishi	8-32	S083-99-356	0400340	kia	6-1
MR-448255	0601765	mitsubishi	8-34	S083-99-356	0400340	mazda	7-15
MR-455089	0691755	mitsubishi	8-35	S2370704	0182814	hyundai	4-26
MR-455090	0681755	mitsubishi	8-35	S2370706	0182813	hyundai	4-26
MR-455091	0691759	mitsubishi	8-39	SB000036	0182814	hyundai	4-26
MR-455092	0681759	mitsubishi	8-39	SB000037	0182813	hyundai	4-26
MR-476457	0281750	mitsubishi	8-2	SE46-34-200	0790339	kia	6-1
MR-476595	0504133	mitsubishi	8-17	SE46-34-250	0780339	kia	6-1
MR-485672	0281750	mitsubishi	8-2	UA01-32-320	0303432	mazda	7-25
MR-491358	0604129	mitsubishi	8-16	UA01-99-322	0280342	mazda	7-25
MR-496792	0403088	mitsubishi	8-22	UA01-99-323	0280342	mazda	7-25
MR-496793	0793088	mitsubishi	8-31	UA01-99-324	0280341	mazda	7-25
MR-496794	0783088	mitsubishi	8-31	UA01-99-354	0400343	mazda	7-25
MR-496795	0794598	mitsubishi	8-31	UA01-99-356	0400344	mazda	7-25
MR-496796	0784598	mitsubishi	8-31	UA04-32-220	0300345	mazda	7-25
MR-496799	0404141	mitsubishi	8-31	UA04-32-320	0300346	mazda	7-25

RIF. ORIG O.E. NUMBER	RIF. OCAP REF. OCAP	MARCA	PAG.	RIF. ORIG O.E. NUMBER	RIF. OCAP REF. OCAP	MARCA	PAG.
UB39-99-322	0282932	MAZDA	7-15				
UB39-99-324	0292933	MAZDA	7-15				
UH71-32-280	0294113	MAZDA	7-16				
UH71-34-540	0402936	MAZDA	7-15				
UH74-32-250	0284112	MAZDA	7-15				
UH74-32-280	0294114	MAZDA	7-16				
UH74-34-550	0402937	MAZDA	7-15				
YL8Z-3280-EA	0608072	MAZDA	7-27				
YL8Z-3A130-GA	0288072	MAZDA	7-27				
YL8Z-5K-483-AA	0508072	MAZDA	7-27				

RIF. OCAP REF. OCAP	RIF. ORIG O.E. NUMBER	MARCA	PAG.	RIF. OCAP REF. OCAP	RIF. ORIG O.E. NUMBER	MARCA	PAG.
0180163	48521-01W00	NISSAN	9-25	0183835	48570-G9501	NISSAN	9-23
0180425	9-43150-605-0	ISUZU	5-1	0184117	MR-241031	MITSUBISHI	8-20
0180749	45406-19015	TOYOTA	13-12	0184122	MR-296274	MITSUBISHI	8-21
0180971	45046-60030	TOYOTA	13-42	0184143	48520-01J00	NISSAN	9-23
0180973	45046-60040	TOYOTA	13-42	0184146	48520-VB025	NISSAN	9-24
0181221	48521-Q0125	NISSAN	9-1	0184174	48521-01G25	NISSAN	9-25
0182479	45046-39335	TOYOTA	13-2	0190162	48520-01W00	NISSAN	9-25
0182690	45047-87Z02	DAIHATSU	2-7	0190359	MA-159984	MITSUBISHI	8-9
0182762	48810-81A00	SUZUKI	12-7	0190425	9-43150-606-0	ISUZU	5-1
0182813	HB568120	HYUNDAI	4-26	0190748	45046-19065	TOYOTA	13-8
0182814	HB568110	HYUNDAI	4-26	0190971	45045-60010	TOYOTA	13-42
0182890	48520-61G25	NISSAN	9-26	0190972	45047-60010	TOYOTA	13-42
0182930	OK670-32-510	KIA	6-7	0190973	45046-60021	TOYOTA	13-42
0182942	MB-831043	MITSUBISHI	8-21	0191217	48520-Q0125	NISSAN	9-7
0182944	MW-033301	MITSUBISHI	8-1	0192479	45047-39215	TOYOTA	13-2
0182945	MB-162811	MITSUBISHI	8-1	0192690	45046-87Z02	DAIHATSU	2-7
0182948	48521-01L01	NISSAN	9-15	0192762	48820-81A00	SUZUKI	12-7
0182965	45046-69135	TOYOTA	13-44	0192891	48570-61G25	NISSAN	9-27
0182967	45045-69065	TOYOTA	13-44	0192930	OK670-32-450	KIA	6-7
0182980	48810-77E00	SUZUKI	12-11	0192943	MB-831044	MITSUBISHI	8-29
0183115	48521-2S425	NISSAN	9-28	0192944	MW-033300	MITSUBISHI	8-1
0183323	45046-87680	DAIHATSU	2-7	0192945	MB-162810	MITSUBISHI	8-1
0183369	56820-11000	HYUNDAI	4-16	0192947	48520-01L01	NISSAN	9-14
0183430	0603-99-322	MAZDA	7-25	0192966	45047-69085	TOYOTA	13-44
0183458	MB-076003	MITSUBISHI	8-9	0192968	45044-69125	TOYOTA	13-44
0183460	HB568110	HYUNDAI	4-5	0192969	45044-69115	TOYOTA	13-44
0183468	MA-159982	MITSUBISHI	8-9	0192981	48820-77E00	SUZUKI	12-11
0183529	48561-T3001	NISSAN	9-9	0193116	48520-2S425	NISSAN	9-28
0183544	48570-82100	NISSAN	9-23	0193312	45046-19065	DAIHATSU	2-2
0183546	48520-50W00	NISSAN	9-26	0193323	45047-87380	DAIHATSU	2-7
0183547	48641-50W00	NISSAN	9-26	0193368	56810-11000	HYUNDAI	4-16
0183587	48520-31G25	NISSAN	9-26	0193429	0603-99-324	MAZDA	7-25
0183606	48810-78000	SUZUKI	12-1	0193459	HB568120	HYUNDAI	4-5
0183608	48810-84000	SUZUKI	12-1	0193529	48571-T3001	NISSAN	9-9
0183611	48810-60001	SUZUKI	12-2	0193544	48580-82100	NISSAN	9-23
0183612	48810-79000	SUZUKI	12-2	0193546	48640-50W00	NISSAN	9-26
0183620	48810-60A00	SUZUKI	12-7	0193547	48521-50W00	NISSAN	9-26
0183623	4056A038	MITSUBISHI	8-5	0193588	48520-7F001	NISSAN	9-26
0183623-K	-	SUZUKI	12-5	0193611	48820-60001	SUZUKI	12-2
0183633	45406-19016	TOYOTA	13-8	0193612	48820-79000	SUZUKI	12-3
0183682	45406-20010	TOYOTA	13-27	0193621	48820-60A00	SUZUKI	12-11
0183684	45406-29015	TOYOTA	13-27	0193681	45046-29035	TOYOTA	13-27
0183686	45406-29055	TOYOTA	13-28	0193686	45407-29015	TOYOTA	13-28
0183697	45406-39016	TOYOTA	13-32	0193696	45046-39016	TOYOTA	13-32
0183699	45406-39055	TOYOTA	13-32	0193698	45046-39075	TOYOTA	13-32
0183710	45406-39055	TOYOTA	13-32	0193718	45046-39155	TOYOTA	13-33
0183719	45406-39105	TOYOTA	13-33	0193722	45046-39195	TOYOTA	13-34
0183721	45406-39145	TOYOTA	13-34	0193725	45046-20010	TOYOTA	13-57
0183726	45046-19055	TOYOTA	13-57	0193733	45046-60011	TOYOTA	13-42
0183739	45047-60H02	TOYOTA	13-42	0193738	45046-69115	TOYOTA	13-42
0183740	45045-69035	TOYOTA	13-43	0193741	45044-69035	TOYOTA	13-43
0183756	45406-29135	TOYOTA	13-56	0193742	45046-60H04	TOYOTA	13-43
0183762	45406-39135	TOYOTA	13-1	0193743	45044-69045	TOYOTA	13-43
0183769	45406-29035	TOYOTA	13-34	0193744	45044-60H03	TOYOTA	13-43
0183776	45046-39085	TOYOTA	13-38	0193746	45046-60H03	TOYOTA	13-43
0183777	45406-39065	TOYOTA	13-38	0193759	45046-29115	TOYOTA	13-1
0183783	45047-39085	TOYOTA	13-35	0193768	45045-29035	TOYOTA	13-34
0183793	45406-29115	TOYOTA	13-39	0193776	45047-39055	TOYOTA	13-38

RIF. OCAP REF. OCAP	RIF. ORIG O.E. NUMBER	MARCA	PAG.	RIF. OCAP REF. OCAP	RIF. ORIG O.E. NUMBER	MARCA	PAG.
0193835	48520-G9502	NISSAN	9-23	0282625	45046-39505	TOYOTA	13-47
0194146	48570-VB025	NISSAN	9-24	0282628	45046-49125	TOYOTA	13-6
0194175	48520-01G25	NISSAN	9-25	0282641	53540-S47-951	HONDA	3-30
0280090	48520-02E26	NISSAN	9-51	0282664	48520-AX602	NISSAN	9-19
0280139	48520-50A00	NISSAN	9-37	0282665	48527-1U61A	NISSAN	9-19
0280141	45046-19175	TOYOTA	13-9	0282688	48810-60810	SUZUKI	12-9
0280191	53540-SF1-004	HONDA	3-27	0282769	56820-1E900	HYUNDAI	4-2
0280283	53540-SH3-003	HONDA	3-11	0282804	MR-977606	MITSUBISHI	8-8
0280337	S083-99-324	KIA	6-1	0282818	MR-508650	MITSUBISHI	8-27
0280341	E17Z-3A131A	MAZDA	7-25	0282825	48520-00QAJ	NISSAN	9-12
0280342	E17Z-3A130A	MAZDA	7-25	0282829	48520-00QAP	NISSAN	9-13
0280347	8AH1-32-280	MAZDA	7-9	0282839	48810-65J00	SUZUKI	12-5
0280357	B001-99-324	MAZDA	7-18	0282844	45046-09295	TOYOTA	13-7
0280360	48520-M0225	NISSAN	9-10	0282892	96129753	DAEWOO - CHEVROLET	1-5
0280455	5-44352-026-0	ISUZU	5-3	0282914	521136	DAEWOO - CHEVROLET	1-6
0280456	8-94419-408-0	ISUZU	5-1	0282932	UB39-99-322	MAZDA	7-15
0280914	48520-4F125	NISSAN	9-17	0282934	8AU2-32-270	MAZDA	7-15
0280987	53540-SB2-003	HONDA	3-1	0282938	MB-527650	MITSUBISHI	8-25
0280992	48520-02E26	NISSAN	9-5	0282949	48520-41L00	NISSAN	9-15
0281222	48520-01F25	NISSAN	9-7	0282950	48520-71L25	NISSAN	9-15
0281266	8021-99-322	MAZDA	7-9	0282957	48520-88E25	NISSAN	9-16
0281268	8173-99-322	MAZDA	7-9	0282970	45046-29215	TOYOTA	13-36
0281284	56820-28000	HYUNDAI	4-14	0282977	45046-29185	TOYOTA	13-49
0281290	35820-37010	KIA	6-6	0282986	48810-65D00	SUZUKI	12-4
0281482	8AB2-32-280	MAZDA	7-1	0282988	48810-76G00	SUZUKI	12-1
0281485	1E00-32-280A	MAZDA	7-1	0282990	48810-78A00	SUZUKI	12-3
0281580	57780-3B000	HYUNDAI	4-27	0282994	45046-59025	TOYOTA	13-60
0281584	56820-07000	KIA	6-10	0282996	45046-29305	TOYOTA	13-23
0281591	8AL1-32-280	MAZDA	7-20	0282998	45046-09050	TOYOTA	13-4
0281593	8AG4-32-280	MAZDA	7-21	0283093	45046-49195	TOYOTA	13-55
0281750	MR-476457	MITSUBISHI	8-2	0283096	45046-05070	TOYOTA	13-5
0281928	31320-GA190	SUBARU	11-1	0283099	45046-29325	TOYOTA	13-37
0281929	34141-AA041	SUBARU	11-1	0283107	45046-19195	TOYOTA	13-50
0281932	53540-S04-003	HONDA	3-13	0283114	48570-3S500	NISSAN	9-28
0281935	53540-S1A-E01	HONDA	3-5	0283123	48527-JD01A	NISSAN	9-37
0281937	53540-S30-005	HONDA	3-28	0283279	53540-TA0-A01	HONDA	3-8
0281941	53540-SX8-T01	HONDA	3-20	0283286	53540-SMG-003	HONDA	3-15
0281969	KB092-32-280	KIA	6-12	0283287	53540-SMJ-003	HONDA	3-16
0281973	OK201-32-280	KIA	6-1	0283292	45046-09480	TOYOTA	13-61
0281977	OK552-32-280	KIA	6-3	0283293	53540-TF0-003	HONDA	3-22
0281993	OK011-32-240A	KIA	6-17	0283300	07848282	DAEWOO - CHEVROLET	1-3
0281994	OK011-32-280	KIA	6-18	0283301	26001806	DAEWOO - CHEVROLET	1-3
0282350	45460-29315	TOYOTA	13-48	0283303	45046-87701	DAIHATSU	2-1
0282443	4666005500	DAEWOO - CHEVROLET	1-4	0283304	445046-87282	DAIHATSU	2-1
0282449	45046-87707	DAIHATSU	2-5	0283307	45046-87781	DAIHATSU	2-1
0282458	45046-87402	DAIHATSU	2-9	0283309	45046-87203	DAIHATSU	2-3
0282464	53541-S7A-003	HONDA	3-29	0283310	45046-87280	DAIHATSU	2-3
0282470	56820-3E-900	KIA	6-15	0283311	45047-87501	DAIHATSU	2-6
0282485	56820-38900	HYUNDAI	4-21	0283313	45460-19095	DAIHATSU	2-2
0282496	56820-2E-900	KIA	6-18	0283315	45460-19125	DAIHATSU	2-3
0282512	7313-20000	SUBARU	11-6	0283321	45046-87503	DAIHATSU	2-7
0282513	7313-20010	SUBARU	11-6	0283349	53540-SM4-003	HONDA	3-3
0282534	53540-SK3-E01	HONDA	3-17	0283352	53540-SD4-003	HONDA	3-23
0282563	8AF1-32-280	MAZDA	7-26	0283360	56820-36000	HYUNDAI	4-19
0282565	MR-508136	MITSUBISHI	8-31	0283361	56820-21000	HYUNDAI	4-16
0282584	45046-09230	TOYOTA	13-5	0283378	0483-99-322	MAZDA	7-17
0282585	45046-29425	TOYOTA	13-5	0283379	8AB1-32-280	KIA	6-11
0282614	45046-09360	TOYOTA	13-24	0283381	0305-99-322A	MAZDA	7-9

RIF. OCAP REF. OCAP	RIF. ORIG O.E. NUMBER	MARCA	PAG.	RIF. OCAP REF. OCAP	RIF. ORIG O.E. NUMBER	MARCA	PAG.
0283395	8AB2-32-280	MAZDA	7-4	0284253	96261379	DAEWOO - CHEVROLET	1-9
0283412	0866-99-322	MAZDA	7-20	0284257	93740623	DAEWOO - CHEVROLET	1-4
0283414	1175-99-322A	MAZDA	7-13	0284258	93740723	DAEWOO - CHEVROLET	1-1
0283433	MB-192430	MITSUBISHI	8-11	0284263	08810A78B00-00	DAEWOO - CHEVROLET	1-6
0283435	MB-006314	MITSUBISHI	8-15	0284265	93741091	DAEWOO - CHEVROLET	1-6
0283437	MB-241982	MITSUBISHI	8-4	0284294	53541-S5A-003	HONDA	3-15
0283440	MB-527169	MITSUBISHI	8-1	0284320	45046-49085	TOYOTA	13-16
0283446	MB-006315	MITSUBISHI	8-23	0284321	45046-29235	TOYOTA	13-52
0283447	MB-288119	MITSUBISHI	8-24	0284330	45460-09010	TOYOTA	13-11
0283471	MB-192499	MITSUBISHI	8-11	0284363	53540-SDA-A01	HONDA	3-7
0283509	48520-A0600	NISSAN	9-6	0284368	53540-SAA-003	HONDA	3-21
0283510	48521-G2525	NISSAN	9-6	0284379	48520-AX600	NISSAN	9-19
0283525	48520-01E00	NISSAN	9-1	0284392	48520-00QAL	NISSAN	9-30
0283526	48520-53E25	NISSAN	9-9	0284397	48520-BM425	NISSAN	9-3
0283540	48520-01B25	NISSAN	9-17	0284408	45046-49025	TOYOTA	13-54
0283550	48520-73J25	NISSAN	9-31	0284427	DD32-32-280	MAZDA	7-2
0283553	48520-H5025	NISSAN	9-5	0284429	BP4L-32-280	MAZDA	7-3
0283554	48641-H1001	NISSAN	9-5	0284430	GJ6E-32-280A	MAZDA	7-7
0283557	48520-N8425	NISSAN	9-40	0284435	8AG3-32-280	MAZDA	7-6
0283558	48641-N8425	NISSAN	9-40	0284452	56820-25000	HYUNDAI	4-1
0283559	48641-D8025	NISSAN	9-41	0284460	56820-28500	HYUNDAI	4-14
0283582	48520-21P25	NISSAN	9-1	0284461	56820-3B000	HYUNDAI	4-6
0283592	7313-20020	SUBARU	11-2	0284469	56872-43000	HYUNDAI	4-7
0283595	6315-10040	SUBARU	11-6	0284489	48810-83E00	SUZUKI	12-6
0283596	31320-GA101	SUBARU	11-6	0284490	8AN1-32-280	MAZDA	7-22
0283601	48520-50A00	NISSAN	9-51	0284511	48520-0P725	NISSAN	9-21
0283616	48810-60B00	SUBARU	11-3	0284519	56820-02500	HYUNDAI	4-3
0283624	45460-39165	TOYOTA	13-8	0284534	53540-SP0-013	HONDA	3-24
0283634	45460-19165	TOYOTA	13-13	0284539	53540-SZ3-003	HONDA	3-24
0283635	45460-19155	TOYOTA	13-13	0284543	53540-SX8-T01	HONDA	3-25
0283638	45046-29135	TOYOTA	13-13	0284547	53540-SS0-003	HONDA	3-27
0283646	45046-29165	TOYOTA	13-14	0284554	45046-69195	TOYOTA	13-46
0283658	45460-19125	TOYOTA	13-19	0284555	45046-69205	TOYOTA	13-46
0283660	45046-19105	TOYOTA	13-21	0284564	45460-19235	TOYOTA	13-58
0283668	45046-29255	TOYOTA	13-9	0284573	0K710-32-240	KIA	6-8
0283673	45047-19065	TOYOTA	13-59	0284579	0K72A-32-240	KIA	6-11
0283675	45460-19185	TOYOTA	13-59	0284616	48640-EA01J	NISSAN	9-22
0283677	45460-19195	TOYOTA	13-59	0284642	48520-01N25	NISSAN	9-52
0283693	45046-29275	TOYOTA	13-14	0284643	48520-27N25	NISSAN	9-53
0283727	45460-19145	TOYOTA	13-57	0284647	48640-G5101	NISSAN	9-54
0283730	45046-19165	TOYOTA	13-57	0284648	48521-G5101	NISSAN	9-54
0283731	45046-19205	TOYOTA	13-50	0284649	4666008011	SSANGYONG	10-1
0283951	4803429	DAEWOO - CHEVROLET	1-1	0285188	45046-09430	TOYOTA	13-26
0283956	56820-0X000	HYUNDAI	4-11	0285193	56820-4H100	HYUNDAI	4-8
0284069	56820-2H090	HYUNDAI	4-13	0285198	45046-09280	TOYOTA	13-41
0284075	56820-2K050	HYUNDAI	4-12	0286500	48520-CA025	NISSAN	9-20
0284081	56820-2B900	HYUNDAI	4-18	0288063	53540-SWA-A01	HONDA	3-19
0284089	56820-3K010	HYUNDAI	4-24	0288071	D8520-1KAOA	NISSAN	9-13
0284099	56820-4D100	KIA	6-4	0288072	EC01-32-280	MAZDA	7-27
0284107	56820-2G900	KIA	6-2	0288073	45046-09570	TOYOTA	13-3
0284112	UH74-32-250	MAZDA	7-15	0288080	13272000	DAEWOO - CHEVROLET	1-2
0284124	4422A010	MITSUBISHI	8-22	0290283	53560-SH3-003	HONDA	3-11
0284134	4422A018	MITSUBISHI	8-27	0290328	MB-122011	MITSUBISHI	8-17
0284139	4422A038	MITSUBISHI	8-32	0290357	B001-99-325	MAZDA	7-18
0284144	48520-01J10	NISSAN	9-23	0290456	8-94419-409-0	ISUZU	5-1
0284177	48520-0M025	NISSAN	9-2	0291222	48640-01F25	NISSAN	9-8
0284178	48520-0M085	NISSAN	9-2	0291265	0866-99-324	MAZDA	7-9
0284247	96407486	DAEWOO - CHEVROLET	1-8	0291485	1E01-32-280A	MAZDA	7-1



RIF. OCAP REF. OCAP	RIF. ORIG O.E. NUMBER	MARCA	PAG.	RIF. OCAP REF. OCAP	RIF. ORIG O.E. NUMBER	MARCA	PAG.
0291928	31320-GA200	SUBARU	11-1	0293677	45470-19045	TOYOTA	13-59
0291932	53560-S04-003	HONDA	3-13	0293693	45047-29075	TOYOTA	13-15
0291935	53560-S1A-E01	HONDA	3-5	0294069	56820-2H000	HYUNDAI	4-13
0291937	53560-S30-005	HONDA	3-28	0294075	56820-2K000	HYUNDAI	4-12
0291977	0K552-32-240	KIA	6-3	0294081	56820-2B000	HYUNDAI	4-18
0291993	0K011-32-250A	KIA	6-18	0294089	56820-3K000	HYUNDAI	4-25
0291994	0K011-32-230	KIA	6-17	0294099	56820-4D000	KIA	6-4
0292449	45047-87706	DAIHATSU	2-5	0294107	56820-2G000	KIA	6-2
0292470	56820-3E-000	KIA	6-15	0294113	UH71-32-280	MAZDA	7-16
0292485	56820-38000	HYUNDAI	4-21	0294114	UH74-32-280	MAZDA	7-16
0292496	56820-2E-000	KIA	6-18	0294124	4422A009	MITSUBISHI	8-22
0292565	MR-508135	MITSUBISHI	8-31	0294139	4422A037	MITSUBISHI	8-32
0292614	45047-09150	TOYOTA	13-24	0294144	48570-01J10	NISSAN	9-23
0292628	45047-49055	TOYOTA	13-6	0294247	96407485	DAEWOO - CHEVROLET	1-8
0292664	48640-AX602	NISSAN	9-19	0294253	96261378	DAEWOO - CHEVROLET	1-9
0292665	48647-1U61A	NISSAN	9-19	0294257	93740622	DAEWOO - CHEVROLET	1-4
0292769	56820-1E000	HYUNDAI	4-2	0294258	93740722	DAEWOO - CHEVROLET	1-1
0292825	48520-00QAH	NISSAN	9-12	0294320	45047-49015	TOYOTA	13-17
0292829	48520-00QAN	NISSAN	9-13	0294321	45047-29065	TOYOTA	13-52
0292844	45047-09125	TOYOTA	13-7	0294330	45470-09010	TOYOTA	13-11
0292933	UB39-99-324	MAZDA	7-15	0294363	53560-SDA-A01	HONDA	3-7
0292935	8AU1-32-280	MAZDA	7-15	0294368	53560-SAA-003	HONDA	3-21
0292986	48820-65D00	SUZUKI	12-4	0294379	48640-AX600	NISSAN	9-19
0292990	48820-78A00	SUZUKI	12-3	0294392	48520-00QAK	NISSAN	9-30
0292994	45047-59025	TOYOTA	13-60	0294408	45047-49025	TOYOTA	13-54
0292998	45047-09010	TOYOTA	13-4	0294427	DD32-32-290	MAZDA	7-2
0293093	45047-49135	TOYOTA	13-55	0294429	BP4L-32-290	MAZDA	7-3
0293096	45047-05060	TOYOTA	13-5	0294430	GJ6E-32-290A	MAZDA	7-7
0293107	45046-19195	TOYOTA	13-50	0294534	53560-SP0-013	HONDA	3-24
0293123	48647-JD01A	NISSAN	9-37	0294539	53560-SZ3-003	HONDA	3-24
0293279	53560-TA0-A01	HONDA	3-8	0294547	53560-SS0-003	HONDA	3-27
0293286	53560-SMG-003	HONDA	3-16	0294554	45047-69100	TOYOTA	13-46
0293287	53560-SMJ-003	HONDA	3-16	0294555	45047-69115	TOYOTA	13-46
0293292	45047-09220	TOYOTA	13-61	0294564	45470-19065	TOYOTA	13-58
0293293	53560-TF0-003	HONDA	3-22	0294616	48520-EA01J	NISSAN	9-22
0293300	07848281	DAEWOO - CHEVROLET	1-3	0294641	48521-01N25	NISSAN	9-52
0293301	26001807	DAEWOO - CHEVROLET	1-3	0294647	48520-G5125	NISSAN	9-54
0293304	45047-87280	DAIHATSU	2-1	0294648	48641-G5101	NISSAN	9-54
0293307	45047-87781	DAIHATSU	2-1	0294649	4666008001	SSANGYONG	10-1
0293311	45057-87501	DAIHATSU	2-6	0295193	56820-4H000	HYUNDAI	4-8
0293321	45047-87503	DAIHATSU	2-7	0298071	D8640-1KA0A	NISSAN	9-13
0293349	53560-SM4-003	HONDA	3-3	0298073	45047-09270	TOYOTA	13-3
0293352	53560-SD4-003	HONDA	3-23	0300345	E17Z-3350A	MAZDA	7-25
0293380	0305-99-324A	MAZDA	7-9	0300346	UA04-32-320	MAZDA	7-25
0293411	0866-99-324A	MAZDA	7-20	0300589	MB-166281	MITSUBISHI	8-18
0293413	1175-99-324A	MAZDA	7-13	0301518	45200-75F20	SUZUKI	12-12
0293425	8021-99-324	MAZDA	7-17	0301789	45490-29465	TOYOTA	13-35
0293469	MB-076004	MITSUBISHI	8-9	0301988	MB-831042	MITSUBISHI	8-29
0293470	MB-109858	MITSUBISHI	8-10	0302775	GJ6A-34-300B	MAZDA	7-8
0293509	48520-G2525	NISSAN	9-6	0302787	45200-83E00	SUZUKI	12-7
0293510	48521-A0600	NISSAN	9-6	0302838	45200-76G00	SUZUKI	12-6
0293553	48640-H5025	NISSAN	9-5	0302848	0K011-34-200	KIA	6-18
0293554	48521-H1001	NISSAN	9-5	0302856	BP4K-28-C10B	MAZDA	7-4
0293557	48640-N8425	NISSAN	9-40	0303143	45200-81A10	SUZUKI	12-7
0293558	48521-N8425	NISSAN	9-40	0303259	48530-01G00	NISSAN	9-27
0293596	31320-GA111	SUBARU	11-6	0303328	48068-87208	DAIHATSU	2-4
0293646	45047-29045	TOYOTA	13-14	0303392	8021-32-320A	MAZDA	7-17
0293675	45470-19035	TOYOTA	13-59	0303393	8531-32-320	MAZDA	7-17

RIF. OCAP REF. OCAP	RIF. ORIG O.E. NUMBER	MARCA	PAG.	RIF. OCAP REF. OCAP	RIF. ORIG O.E. NUMBER	MARCA	PAG.
0303394	LB82-34-300	MAZDA	7-20	0381758	MR-316054	MITSUBISHI	8-40
0303426	1757-32-220	MAZDA	7-26	0381761	MB-912510	MITSUBISHI	8-12
0303432	UA01-32-320	MAZDA	7-25	0381762	MB-912512	MITSUBISHI	8-12
0303450	MB-166424	MITSUBISHI	8-24	0381948	45201-63G01	SUZUKI	12-2
0303451	MB-166423	MITSUBISHI	8-24	0382469	48068-87209	DAIHATSU	2-4
0303461	MB-076009	MITSUBISHI	8-9	0382473	54420-3E-000	KIA	6-16
0303462	MB-241421	MITSUBISHI	8-18	0382535	51355-SK3-000	HONDA	3-17
0303474	MB-076010	MITSUBISHI	8-9	0382551	0K552-34-300A	KIA	6-4
0303475	MB-192297	MITSUBISHI	8-10	0382552	0K30B-34-300B	KIA	6-12
0303484	MB-006571	MITSUBISHI	8-14	0382759	GJ6A-34-J00B	MAZDA	7-8
0303486	MB-122396	MITSUBISHI	8-15	0382767	51350-S2A-000	HONDA	3-30
0303487	MB-122400	MITSUBISHI	8-15	0382779	48068-97202	DAIHATSU	2-5
0303488	MB-241973	MITSUBISHI	8-28	0382791	0K552-28-300B	KIA	6-4
0303489	MB-241830	MITSUBISHI	8-29	0382827	54500-00QAC	NISSAN	9-12
0303490	MB-598489	MITSUBISHI	8-29	0383102	48066-29075	TOYOTA	13-37
0303491	MB-831040	MITSUBISHI	8-29	0383260	54501-FD000	KIA	6-12
0303516	48530-21400	NISSAN	9-7	0383277	4806887711	DAIHATSU	2-5
0303523	48530-U8701	NISSAN	9-7	0383282	51350-TA0-A00	HONDA	3-9
0303538	48530-U8701	NISSAN	9-14	0383289	51350-SMG-E05	HONDA	3-16
0303560	48530-N8500	NISSAN	9-41	0383306	48068-87705	DAIHATSU	2-1
0303568	48530-H6100	NISSAN	9-5	0383325	48068-87706	DAIHATSU	2-2
0303569	48530-H5000	NISSAN	9-5	0383410	D031-34-310A	MAZDA	7-1
0303579	48530-H1600	NISSAN	9-43	0384228	51355-SM4-030	HONDA	3-3
0303590	48530-31G25	NISSAN	9-49	0384230	51350-SR3-020	HONDA	3-13
0303591	48530-35G25	NISSAN	9-49	0384241	51355-SV4-000	HONDA	3-5
0303617	45200-82000	SUZUKI	12-8	0384292	51355-S1A-E00	HONDA	3-6
0303626	45490-29295	TOYOTA	13-8	0384366	51350-SEA-E01	HONDA	3-7
0303628	45401-19125	TOYOTA	13-8	0384514	54500-8H310	NISSAN	9-57
0303649	45490-19135	TOYOTA	13-18	0384537	52390-SP0-013	HONDA	3-24
0303650	45490-19125	TOYOTA	13-18	0384590	D201-34-300E	MAZDA	7-16
0303651	45490-19225	TOYOTA	13-18	0384628	54502-00Q0C	NISSAN	9-31
0303652	45490-19215	TOYOTA	13-18	0384629	54524-AV600	NISSAN	9-35
0303653	45401-19095	TOYOTA	13-18	0385175	4440208000	SSANGYONG	10-4
0303654	45401-19105	TOYOTA	13-19	0385181	45201-65D01	SUZUKI	12-5
0303656	45401-19195	TOYOTA	13-19	0388062	55501-CA000	NISSAN	9-21
0303690	45490-29135	TOYOTA	13-29	0388065	4440209010	SSANGYONG	10-2
0303691	45401-29095	TOYOTA	13-28	0388080	13272606	DAEWOO - CHEVROLET	1-2
0303713	45490-39165	TOYOTA	13-32	0391753	MB-831555	MITSUBISHI	8-35
0303716	45401-39185	TOYOTA	13-33	0391756	MR-316051	MITSUBISHI	8-36
0303763	45490-39245	TOYOTA	13-1	0391758	MR-316053	MITSUBISHI	8-40
0303764	45401-35190	TOYOTA	13-1	0391761	MB-912509	MITSUBISHI	8-12
0303774	45490-29245	TOYOTA	13-35	0391762	MB-912511	MITSUBISHI	8-12
0303778	45401-39115	TOYOTA	13-38	0391948	45202-63G01	SUZUKI	12-2
0303779	45401-39116	TOYOTA	13-38	0392469	48069-87209	DAIHATSU	2-4
0303794	45490-35140	TOYOTA	13-39	0392473	54410-3E-000	KIA	6-16
0303795	45490-35130	TOYOTA	13-39	0392535	51365-SK3-000	HONDA	3-17
0303865	KKY01-34-310	KIA	6-12	0392551	0K552-34-350A	KIA	6-4
0304073	55250-1H000	HYUNDAI	4-13	0392552	0K30B-34-350B	KIA	6-12
0304120	MB-241168	MITSUBISHI	8-21	0392759	GJ6A-34-J50B	MAZDA	7-8
0304121	MB-241423	MITSUBISHI	8-21	0392767	51360-S2A-000	HONDA	3-30
0304123	MR-296272	MITSUBISHI	8-21	0392779	48069-97202	DAIHATSU	2-5
0304487	45200-75F00	SUZUKI	12-12	0392791	0K552-28-350B	KIA	6-4
0304582	0K72A-34-300A	KIA	6-11	0392827	54501-00QAC	NISSAN	9-12
0304584	0K72A-34-200	KIA	6-11	0393102	48067-29085	TOYOTA	13-37
0304595	MB-315770	MITSUBISHI	8-24	0393260	54500-FD000	KIA	6-12
0304649	4440109001	SSANGYONG	10-1	0393277	4806887710	DAIHATSU	2-6
0381753	MB-831556	MITSUBISHI	8-35	0393282	51360-TA0-A00	HONDA	3-9
0381756	MR-316052	MITSUBISHI	8-36	0393289	51360-SMG-E05	HONDA	3-16

RIF. OCAP REF. OCAP	RIF. ORIG O.E. NUMBER	MARCA	PAG.	RIF. OCAP REF. OCAP	RIF. ORIG O.E. NUMBER	MARCA	PAG.
0393306	48069-87705	DAIHATSU	2-2	0402549	0K2A1-34-550A	KIA	6-2
0393325	48069-87706	DAIHATSU	2-2	0402576	40160-0W025	NISSAN	9-21
0393410	D031-34-320A	MAZDA	7-1	0402590	43330-09210	TOYOTA	13-5
0394228	51365-SM4-030	HONDA	3-3	0402621	43310-39016	TOYOTA	13-2
0394230	51360-SR3-020	HONDA	3-13	0402640	LC62-34-550	MAZDA	7-7
0394241	51365-SV4-000	HONDA	3-5	0402659	45201-62J00 Z	SUZUKI	12-9
0394292	51365-S1A-E00	HONDA	3-6	0402765	51220-S9A-982	HONDA	3-18
0394366	51360-SEA-E01	HONDA	3-7	0402771	51760-1G000	HYUNDAI	4-3
0394514	54501-8H310	NISSAN	9-57	0402776	43330-09050	TOYOTA	13-9
0394537	52400-SP0-013	HONDA	3-24	0402788	-	HONDA	3-25
0394590	D201-34-350A	MAZDA	7-16	0402793	54530-07000	HYUNDAI	4-11
0394628	54503-00Q0C	NISSAN	9-31	0402805	-	MITSUBISHI	8-8
0394629	54525-AV600	NISSAN	9-35	0402809	54530-4A000	HYUNDAI	4-8
0395175	4440108000	SSANGYONG	10-4	0402815	54440-H1000	HYUNDAI	4-26
0395181	45202-65D01	SUZUKI	12-5	0402816	54550-H1000	HYUNDAI	4-26
0398062	55502-CA000	NISSAN	9-21	0402823	40160-2Y000	NISSAN	9-4
0398065	4440109010	SSANGYONG	10-2	0402827	40160-00QAC	NISSAN	9-12
0398080	13272605	DAEWOO - CHEVROLET	1-2	0402832-K	-	NISSAN	9-13
0400092	40160-50A00	NISSAN	9-11	0402894	96213119	DAEWOO - CHEVROLET	1-5
0400284	51270-SF1-003	HONDA	3-27	0402896	9630-0048	DAEWOO - CHEVROLET	1-7
0400329	MB-109587	MITSUBISHI	8-18	0402931	0K201-34-550C	KIA	6-14
0400339	S083-99-354	KIA	6-1	0402936	8AU1-34-540	MAZDA	7-15
0400340	S083-99-356	KIA	6-1	0402937	8AU2-34-510	MAZDA	7-15
0400343	E17Z-3049A	MAZDA	7-25	0402940	54417-43001	HYUNDAI	4-7
0400344	E17Z-3050A	MAZDA	7-25	0402952	40160-41L00	NISSAN	9-15
0400349	0G030-34-550B	KIA	6-7	0402956	8-94374-424-0	ISUZU	5-1
0400358	B001-34-550	MAZDA	7-18	0402961	43330-29265	TOYOTA	13-15
0400361	40110-01G00	NISSAN	9-25	0402972	43350-29065	TOYOTA	13-36
0400420	8-94459-453-2	ISUZU	5-1	0402973	43330-39265	TOYOTA	13-40
0400422	8-94459-464-0	ISUZU	5-2	0402974	43350-29035	TOYOTA	13-48
0400428	43330-39165	TOYOTA	13-40	0402997	43330-09090	TOYOTA	13-23
0400429	43330-39045	TOYOTA	13-35	0403012	8-94224-550-3	ISUZU	5-2
0400430	43350-39035	TOYOTA	13-39	0403013	8-94224-552-2	ISUZU	5-3
0400431	43350-39015	TOYOTA	13-33	0403083	45203-70C00	SUZUKI	12-8
0400437	40160-01G00	NISSAN	9-25	0403088	4010A015	MITSUBISHI	8-22
0400555	5441744000	HYUNDAI	4-6	0403095	43330-09630	TOYOTA	13-3
0400963	43308-12030	TOYOTA	13-8	0403096	43330-09770	TOYOTA	13-6
0400996	40160-01A00	NISSAN	9-11	0403101	43330-29125	TOYOTA	13-37
0401225	40160-W1000	NISSAN	9-8	0403121	LC62-32-280	MAZDA	7-21
0401226	40160-S0125	NISSAN	9-1	0403124	40160-9W200	NISSAN	9-20
0401288	54500-31600	HYUNDAI	4-1	0403282	51220-TA0-A02	HONDA	3-8
0401295	54503-22A00	HYUNDAI	4-15	0403295	-	HONDA	3-23
0401483	-	MAZDA	7-2	0403302	90375505	DAEWOO - CHEVROLET	1-3
0401516	-	TOYOTA	13-7	0403316	43308-12030	DAIHATSU	2-3
0401521	40160-01B25	NISSAN	9-18	0403322	48068-87206	DAIHATSU	2-3
0401679	51220-S04-003	HONDA	3-2	0403350	51220-SM1-A01	HONDA	3-3
0401964	-	MITSUBISHI	8-37	0403351	-	HONDA	3-4
0401996	0K011-34-510B	KIA	6-18	0403353	51220-SD4-004	HONDA	3-23
0402320	-	MAZDA	7-3	0403354	51270-SB0-003	HONDA	3-26
0402445	4450505000	DAEWOO - CHEVROLET	1-5	0403357	54503-25A00	HYUNDAI	4-4
0402446	4443003000	DAEWOO - CHEVROLET	1-5	0403359	54530-24000	HYUNDAI	4-17
0402472	54570-3E-000	KIA	6-16	0403370	54503-14200	HYUNDAI	4-16
0402482	54503-34A00	HYUNDAI	4-20	0403372	5-51227-033-0	ISUZU	5-4
0402483	55130-34A00	HYUNDAI	4-20	0403373	8-94452-102-0	ISUZU	5-3
0402484	54403-38A00	HYUNDAI	4-22	0403374	54530-28000	HYUNDAI	4-14
0402498	51760-2E-000	KIA	6-19	0403375	8-94452-106-1	ISUZU	5-5
0402511	6232-20042	SUBARU	11-6	0403382	0305-99-356A	MAZDA	7-9
0402515	7210-67000	SUBARU	11-6	0403383	8173-99-356	MAZDA	7-9

RIF. OCAP REF. OCAP	RIF. ORIG O.E. NUMBER	MARCA	PAG.	RIF. OCAP REF. OCAP	RIF. ORIG O.E. NUMBER	MARCA	PAG.
0403390	B092-34-550	MAZDA	7-19	0403728	43308-12020	TOYOTA	13-57
0403398	B455-34-550	MAZDA	7-4	0403757	43350-29035	TOYOTA	13-56
0403399	B01A-34-500A	MAZDA	7-4	0403758	43330-29115	TOYOTA	13-48
0403409	G030-99-356	MAZDA	7-12	0403765	43350-39045	TOYOTA	13-1
0403416	0866-99-356A	MAZDA	7-20	0403766	43330-39195	TOYOTA	13-1
0403417	8650-99-356	MAZDA	7-13	0403770	43350-29025	TOYOTA	13-35
0403419	8559-99-354	MAZDA	7-13	0403784	43350-29045	TOYOTA	13-35
0403424	H2Y0-99-356	MAZDA	7-14	0403785	43330-29125	TOYOTA	13-36
0403434	MB-241883	MITSUBISHI	8-1	0403786	43330-29155	TOYOTA	13-36
0403452	MB-002433	MITSUBISHI	8-24	0403953	4806300 Z	DAEWOO - CHEVROLET	1-1
0403453	MB-109993	MITSUBISHI	8-24	0404071	51760-0Q000	HYUNDAI	4-13
0403454	MB-002475	MITSUBISHI	8-24	0404087	51760-38000	HYUNDAI	4-22
0403455	MB-109587	MITSUBISHI	8-19	0404092	54430-3F600	HYUNDAI	4-25
0403456	MB-176309	MITSUBISHI	8-24	0404093	51760-3K000	HYUNDAI	4-25
0403457	MB-175812	MITSUBISHI	8-25	0404115	-	MITSUBISHI	8-19
0403463	MB-002475	MITSUBISHI	8-18	0404118	-	MITSUBISHI	8-20
0403464	MB-109587	MITSUBISHI	8-18	0404119	MR-241027	MITSUBISHI	8-20
0403465	HB212100	HYUNDAI	4-6	0404128	4013A090	MITSUBISHI	8-22
0403476	MA-150801	MITSUBISHI	8-10	0404136	4013A009 Z	MITSUBISHI	8-28
0403477	MB-001696	MITSUBISHI	8-10	0404141	4013A211	MITSUBISHI	8-31
0403478	MB-185329	MITSUBISHI	8-11	0404149	43330-09295	TOYOTA	13-41
0403492	MB-860829	MITSUBISHI	8-21	0404242	-	HONDA	3-6
0403495	54417-43000	HYUNDAI	4-10	0404248	96490218	DAEWOO - CHEVROLET	1-8
0403507	MB-527383-01	HYUNDAI	4-10	0404255	96261108	DAEWOO - CHEVROLET	1-9
0403513	40160-A8600	NISSAN	9-7	0404259	96535089	DAEWOO - CHEVROLET	1-1
0403527	40160-01E00	NISSAN	9-9	0404291	51220-S5A-003	HONDA	3-15
0403531	34004-6402P	NISSAN	9-10	0404298	40160-AX000	NISSAN	9-20
0403532	34006-6401P	NISSAN	9-10	0404324	43330-29235	TOYOTA	13-52
0403533	40110-01G00	NISSAN	9-10	0404365	-	HONDA	3-7
0403535	40160-M0225	NISSAN	9-11	0404366	-	HONDA	3-7
0403536	40160-M7025	NISSAN	9-11	0404370	51220-S2H-013	HONDA	3-22
0403542	40160-4F100	NISSAN	9-18	0404385	-	NISSAN	9-35
0403548	40160-0F000	NISSAN	9-27	0404393	-	NISSAN	9-30
0403552	40160-50J25	NISSAN	9-32	0404398	54500-BM410 Z	NISSAN	9-3
0403555	40160-W5000	NISSAN	9-6	0404399	40160-50Y00	NISSAN	9-2
0403561	40160-N8400	NISSAN	9-41	0404409	43330-09070	TOYOTA	13-17
0403573	40160-H1001	NISSAN	9-43	0404411	43330-49025	TOYOTA	13-54
0403574	40160-H7400	NISSAN	9-43	0404428	BK3P-34-300D	MAZDA	7-3
0403586	40160-50Y00	NISSAN	9-1	0404431	GJ6A-34-540	MAZDA	7-8
0403594	7210-67020	SUBARU	11-3	0404447	NA01-34-550	MAZDA	7-22
0403603	40160-50Y00	NISSAN	9-51	0404454	54503-25A00	HYUNDAI	4-2
0403605	21067-GA050	SUBARU	11-1	0404457	54530-02050	HYUNDAI	4-4
0403613	45700-67001	SUZUKI	12-3	0404465	54503-3BA00	HYUNDAI	4-18
0403622	45700-60A00	SUZUKI	12-11	0404472	-	HONDA	3-12
0403629	43330-39135	TOYOTA	13-9	0404549	51220-SL5-003	HONDA	3-28
0403643	43330-29135	TOYOTA	13-14	0404558	-	TOYOTA	13-46
0403645	43330-29145	TOYOTA	13-14	0404559	-	TOYOTA	13-46
0403671	43330-02020	TOYOTA	13-4	0404560	-	TOYOTA	13-47
0403674	43308-16010	TOYOTA	13-59	0404567	54530-4D000	KIA	6-4
0403678	43330-19025	TOYOTA	13-49	0404576	0K710-34-540	KIA	6-9
0403680	43330-19045	TOYOTA	13-21	0404577	0K710-34-510	KIA	6-9
0403685	04436-20031	TOYOTA	13-27	0404580	0K72A-34-510A	KIA	6-9
0403687	43350-29015	TOYOTA	13-28	0404589	8AU3-34-510	MAZDA	7-15
0403688	43330-29056	TOYOTA	13-28	0404599	MR-508130	MITSUBISHI	8-32
0403695	45330-19095	TOYOTA	13-32	0404614	40160-00QAB	NISSAN	9-12
0403711	43330-39015	TOYOTA	13-33	0404615	54500-6F600 Z	NISSAN	9-18
0403712	43340-39125	TOYOTA	13-33	0404620	54524-EB30A Z	NISSAN	9-22
0403723	43350-39055	TOYOTA	13-34	0404621	54500-EB30C Z	NISSAN	9-22

RIF. OCAP REF. OCAP	RIF. ORIG O.E. NUMBER	MARCA	PAG.	RIF. OCAP REF. OCAP	RIF. ORIG O.E. NUMBER	MARCA	PAG.
0404625	40160-2S601	NISSAN	9-28	0501577	55580-37020	HYUNDAI	4-20
0404626	40110-2S485	NISSAN	9-28	0501578	55530-38000	HYUNDAI	4-23
0404628	40160-00Q0A	NISSAN	9-31	0501582	0K0A3-28-170A	KIA	6-8
0404645	40110-G3700	NISSAN	9-54	0501583	0K2A1-34-150A	KIA	6-2
0404646	40160-G2500	NISSAN	9-54	0501587	GJ6A-28-170A	MAZDA	7-8
0404649	4454109002	SSANGYONG	10-1	0501588	B26R-28-170	MAZDA	7-7
0405189	43330-09360	TOYOTA	13-26	0501590	GA2B-28-170A	MAZDA	7-12
0405195	54530-3J000	HYUNDAI	4-9	0501595	LC62-34-170	MAZDA	7-7
0405200	43310-09015	TOYOTA	13-41	0501764	MB-892981	MITSUBISHI	8-12
0408063	51220-STK-A01	HONDA	3-19	0501767	4056A014	HYUNDAI	4-17
0408065	4454109004	SSANGYONG	10-2	0501781	48900-84C50	SUZUKI	12-7
0408071	54500-1KA0B Z	NISSAN	9-13	0501782	48800-84C50	SUZUKI	12-7
0480146	40160-48W00	NISSAN	9-25	0501927	46630-60B00	NISSAN	9-47
0482622	43330-39415	TOYOTA	13-2	0501927-K	-	NISSAN	9-47
0482941	MB-527352	MITSUBISHI	8-27	0501931	20420-AA002	SUBARU	11-2
0482964	43330-19085	TOYOTA	13-50	0501939	51320-S30-003	HONDA	3-28
0483318	43350-87501	DAIHATSU	2-6	0501940	51320-S04-003	HONDA	3-14
0483319	43330-87501	DAIHATSU	2-6	0501974	0K2A5-34-150A	KIA	6-14
0483320	43330-87581	DAIHATSU	2-6	0501976	0K552-34-150B	KIA	6-4
0483356	52391-SF1-003	HONDA	3-27	0501992	0K011-32-260A	KIA	6-17
0483358	54540-21000	HYUNDAI	4-17	0501997	0K011-34-160A	KIA	6-18
0483438	MB-109169	MITSUBISHI	8-16	0502291	46630-60B11	SUZUKI	12-8
0483493	MB-831038	MITSUBISHI	8-21	0502292	48820-06020	TOYOTA	13-10
0483534	40160-48W00	NISSAN	9-10	0502294	48820-06040	TOYOTA	13-12
0483567	40160-D0125	NISSAN	9-6	0502447	4475005000	DAEWOO - CHEVROLET	1-5
0483666	43330-19065	TOYOTA	13-22	0502448	48802-87703	DAIHATSU	2-4
0484179	40160-9C500	NISSAN	9-39	0502461	48822-87401	DAIHATSU	2-9
0484338	43330-09160	TOYOTA	13-11	0502475	54810-3E-000	KIA	6-16
0490146	40161-48W00	NISSAN	9-25	0502487	55530-38600	HYUNDAI	4-23
0492622	43340-39325	TOYOTA	13-2	0502488	54830-38100	HYUNDAI	4-22
0492941	MB-527351	MITSUBISHI	8-27	0502499	54830-1F-000	KIA	6-19
0492964	43340-19025	TOYOTA	13-51	0502525	55530-1F-000	KIA	6-19
0493318	43360-87501	DAIHATSU	2-6	0502577	54618-0W000	NISSAN	9-22
0493319	43340-87501	DAIHATSU	2-6	0502578	56260-0W001	NISSAN	9-22
0493320	43340-87581	DAIHATSU	2-6	0502581	48830-05020	TOYOTA	13-4
0493356	52401-SF1-003	HONDA	3-27	0502591	48820-47010	TOYOTA	13-5
0493358	54530-21000	HYUNDAI	4-17	0502610	48820-42020	TOYOTA	13-55
0493438	MB-109168	MITSUBISHI	8-16	0502623	48820-35030	TOYOTA	13-3
0493493	MB-831037	MITSUBISHI	8-22	0502624	48830-35020	TOYOTA	13-3
0493534	40161-48W00	NISSAN	9-10	0502630	48820-44020	TOYOTA	13-7
0493567	40161-D0125	NISSAN	9-6	0502643	52320-S2A-003	HONDA	3-31
0493666	43340-19015	TOYOTA	13-22	0502656	8AG1-34-100	MAZDA	7-11
0494179	40161-9C500	NISSAN	9-39	0502657	GE4T-28-170	MAZDA	7-13
0494338	43340-09010	TOYOTA	13-11	0502690	45460-87586	DAIHATSU	2-7
0500089	-	NISSAN	9-50	0502761	42420-62J00	SUZUKI	12-10
0500091	-	NISSAN	9-51	0502763	90112-SM4-000	HONDA	3-4
0500164	48510-01W00	NISSAN	9-24	0502778	54825-22000	HYUNDAI	4-1
0500190	-	HONDA	3-27	0502783	48820-0D010	TOYOTA	13-62
0500338	-	MAZDA	7-14	0502786	42420-81A10	SUZUKI	12-7
0500426	8-94237-366-1	ISUZU	5-3	0502795	BP4K-28-170C	MAZDA	7-4
0500458	8-94389-210-0	ISUZU	5-2	0502797	B30H-28-170B	MAZDA	7-7
0500962	45460-19055	TOYOTA	13-12	0502803	4056A021	MITSUBISHI	8-7
0500994	48510-11A27	NISSAN	9-5	0502806	MR-961477	MITSUBISHI	8-8
0501221	48510-Q0125	NISSAN	9-7	0502811	54830-4A000	HYUNDAI	4-8
0501563	52320-S30-003	HONDA	3-28	0502812	55530-4A000	HYUNDAI	4-8
0501574	54830-29000	HYUNDAI	4-15	0502813	56850-H1011	HYUNDAI	4-26
0501575	55530-29000	HYUNDAI	4-4	0502820	MR-319147	MITSUBISHI	8-27
0501576	54830-34000	HYUNDAI	4-5	0502821	MR-316368	MITSUBISHI	8-27

RIF. OCAP REF. OCAP	RIF. ORIG O.E. NUMBER	MARCA	PAG.	RIF. OCAP REF. OCAP	RIF. ORIG O.E. NUMBER	MARCA	PAG.
0502834	56261-EQ000	NISSAN	9-57	0503782	45460-29285	TOYOTA	13-35
0502835	20470-FE000	SUBARU	11-2	0503788	45450-39015	TOYOTA	13-38
0502836	20470-AE000	SUBARU	11-5	0503791	45450-39145	TOYOTA	13-38
0502841	42420-80J00	SUZUKI	12-10	0503792	45460-29215	TOYOTA	13-39
0502843	48830-06030	TOYOTA	13-12	0503955	4804642	DAEWOO - CHEVROLET	1-2
0502946	48510-01L25	NISSAN	9-14	0504072	54830-2H000	HYUNDAI	4-13
0502979	48850-77E00	SUZUKI	12-11	0504074	55530-1H000	HYUNDAI	4-13
0502992	42420-77A00	SUZUKI	12-4	0504079	54830-28000	HYUNDAI	4-14
0503090	48820-32010	TOYOTA	13-17	0504080	55530-17000	HYUNDAI	4-16
0503095	48830-42020	TOYOTA	13-56	0504085	55530-2B000	HYUNDAI	4-19
0503096	48820-42030	TOYOTA	13-3	0504086	54830-36000	HYUNDAI	4-20
0503104	48830-05030	TOYOTA	13-6	0504094	54830-3K000	HYUNDAI	4-26
0503108	48820-17020	TOYOTA	13-50	0504095	55530-3K000	HYUNDAI	4-26
0503109	48830-17030	TOYOTA	13-50	0504110	54830-2G000	KIA	6-3
0503110	48820-17010	TOYOTA	13-49	0504111	55530-1D000	KIA	6-3
0503111	48830-17010	TOYOTA	13-49	0504131	4056A161	MITSUBISHI	8-16
0503112	48830-17020	TOYOTA	13-50	0504133	4056A037	MITSUBISHI	8-17
0503117	48560-3S125	NISSAN	9-28	0504137	MN-101368	MITSUBISHI	8-28
0503118	48560-3S525	NISSAN	9-28	0504145	56260-01J10	NISSAN	9-23
0503119	20470-SA011	SUBARU	11-2	0504147	54618-VB000	NISSAN	9-24
0503127	42420-65J00	SUZUKI	12-6	0504148	54618-VC300	NISSAN	9-24
0503258	48560-01G25	NISSAN	9-25	0504174	48510-01G25	NISSAN	9-25
0503290	51320-SMG-E01	HONDA	3-16	0504225	96300627	DAEWOO - CHEVROLET	1-7
0503296	51320-TF0-003	HONDA	3-23	0504226	96300222	DAEWOO - CHEVROLET	1-7
0503321	45460-87587	DAIHATSU	2-7	0504227	96275798	DAEWOO - CHEVROLET	1-8
0503427	2541-32-250	MAZDA	7-24	0504237	51320-SK3-000	HONDA	3-17
0503448	MB-166422	MITSUBISHI	8-23	0504245	96391876	DAEWOO - CHEVROLET	1-8
0503449	MB-166420	MITSUBISHI	8-23	0504252	96561754	DAEWOO - CHEVROLET	1-9
0503460	HB568100	HYUNDAI	4-5	0504256	96275798	DAEWOO - CHEVROLET	1-1
0503466	MA-151985	MITSUBISHI	8-9	0504380	54618-AX600	NISSAN	9-20
0503467	MA-159887	MITSUBISHI	8-9	0504387	54618-2F010	NISSAN	9-32
0503514	48560-21400	NISSAN	9-6	0504387-K	-	NISSAN	9-33
0503541	45261-4F702	NISSAN	9-19	0504388	45261-90J11	NISSAN	9-35
0503551	56261-86J00	NISSAN	9-33	0504394	54616-00Q0A	NISSAN	9-31
0503565	48560-W5700	NISSAN	9-4	0504395	54618-50Y00	NISSAN	9-1
0503566	48560-W5000	NISSAN	9-4	0504395-K	-	NISSAN	9-2
0503570	48560-H6100	NISSAN	9-42	0504396	54618-4M400	NISSAN	9-3
0503571	48560-H5000	NISSAN	9-42	0504396-K	-	NISSAN	9-3
0503575	48510-35A25	NISSAN	9-46	0504400	54618-0E000	NISSAN	9-17
0503576	48510-50A25	NISSAN	9-37	0504400-K	-	NISSAN	9-17
0503577	48510-50A26	NISSAN	9-37	0504401	54618-0F000	NISSAN	9-50
0503578	48510-M7025	NISSAN	9-36	0504401-K	54618-0F000 Z	NISSAN	9-50
0503589	48510-31G25	NISSAN	9-26	0504402	56260-0F001	NISSAN	9-50
0503602	-	NISSAN	9-51	0504412	48820-20010	TOYOTA	13-16
0503605	20470-AJ000	SUBARU	11-5	0504413	48830-20010	TOYOTA	13-9
0503618	48850-60A00	SUZUKI	12-10	0504415	48830-12060	TOYOTA	13-24
0503619	48800-60A00	SUZUKI	12-10	0504416	48820-33010	TOYOTA	13-10
0503632	45460-19025	TOYOTA	13-8	0504417	48820-20021	TOYOTA	13-24
0503681	45460-20020	TOYOTA	13-27	0504421	48820-42010	TOYOTA	13-54
0503683	45460-29045	TOYOTA	13-27	0504426	DD32-34-170	MAZDA	7-3
0503706	GA2B-28-170A	MAZDA	7-12	0504433	B26R-34-170	MAZDA	7-7
0503709	45460-39075	TOYOTA	13-32	0504436	1E00-34-170	MAZDA	7-2
0503718	45460-39195	TOYOTA	13-33	0504439	BC1D-28-170A	MAZDA	7-6
0503720	45460-39275	TOYOTA	13-33	0504440	EA03-34-170A	MAZDA	7-16
0503724	45460-19025	TOYOTA	13-57	0504441	EA01-28-170	MAZDA	7-21
0503762	45460-39505	TOYOTA	13-1	0504442	NA01-34-170	MAZDA	7-22
0503767	45460-29066	TOYOTA	13-34	0504446	BP4K-34-170C	MAZDA	7-4
0503781	45460-29265	TOYOTA	13-35	0504456	54830-25000	HYUNDAI	4-2

RIF. OCAP REF. OCAP	RIF. ORIG O.E. NUMBER	MARCA	PAG.	RIF. OCAP REF. OCAP	RIF. ORIG O.E. NUMBER	MARCA	PAG.
0504459	54820-02000	HYUNDAI	4-4	0582772	54840-1G000	HYUNDAI	4-3
0504470	MR-131680	MITSUBISHI	8-2	0582784	48830-42010	TOYOTA	13-55
0504471	MR-272117	MITSUBISHI	8-2	0582794	54840-07000	KIA	6-10
0504475	MR-272118	MITSUBISHI	8-4	0582802	NC10-34-150	MAZDA	7-23
0504494	20420-AJ000	SUBARU	11-5	0582817	54823-H1000	HYUNDAI	4-26
0504495	46630-60B10	SUZUKI	12-9	0582824	54618-4U000	NISSAN	9-4
0504497	48830-20010	TOYOTA	13-15	0582828	54618-00QAA	NISSAN	9-12
0504530	96207628	DAEWOO - CHEVROLET	1-5	0583103	48820-26030	TOYOTA	13-37
0504532	90112-SE0-000	HONDA	3-3	0583125	54618-1AA0A	NISSAN	9-38
0504538	51320-SP0-003	HONDA	3-24	0583260	54830-FD000	KIA	6-12
0504551	56260-VB010	NISSAN	9-24	0583283	51320-SEA-E01	HONDA	3-9
0504552	56260-VC300	NISSAN	9-24	0583284	52320-TAO-A01	HONDA	3-9
0504553	56260-VC310	NISSAN	9-24	0583291	52320-SNA-A01	HONDA	3-16
0504563	48830-60030	TOYOTA	13-48	0583472	MB-076002	MITSUBISHI	8-9
0504565	48820-24010	TOYOTA	13-17	0583512	48510-A0600	NISSAN	9-6
0504569	55530-4D000	KIA	6-5	0583530	48510-R8000	NISSAN	9-9
0504581	OK72A-34-150A	KIA	6-11	0583545	48510-50W00	NISSAN	9-27
0504586	B029-34-159	MAZDA	7-5	0583553	48510-N8225	NISSAN	9-39
0504587	8AG1-28-100A	MAZDA	7-5	0583556	48510-N8425	NISSAN	9-40
0504596	MB-241974	MITSUBISHI	8-7	0583564	48510-W5000	NISSAN	9-4
0504597	MB-633926	MITSUBISHI	8-30	0583572	48510-H1025	NISSAN	9-42
0504622	54618-9U00A	NISSAN	9-20	0583581	48510-G2525	NISSAN	9-53
0504623	54618-01G00	NISSAN	9-26	0583686	45460-29085	TOYOTA	13-28
0504624	54618-02E00	NISSAN	9-27	0583722	45460-39265	TOYOTA	13-34
0504631	56261-0E000	NISSAN	9-36	0583776	45460-39065	TOYOTA	13-37
0504632	56261-AV610	NISSAN	9-36	0583801	GA2A-34-150	MAZDA	7-6
0505178	20481AA000	SUBARU	11-2	0583954	4806305	DAEWOO - CHEVROLET	1-2
0505185	48650-20020	TOYOTA	13-4	0583960	54840-0X000	HYUNDAI	4-12
0505187	48819-70010	TOYOTA	13-7	0584078	54840-1J000	HYUNDAI	4-12
0508063	51320-STK-A01	HONDA	3-20	0584084	54840-2B000	HYUNDAI	4-19
0508065	4540108000	SSANGYONG	10-5	0584098	OK2FA-34150	KIA	6-2
0508066	4475008000	SSANGYONG	10-5	0584127	MR-992310	MITSUBISHI	8-23
0508071	54618-CY00A	NISSAN	9-13	0584138	MN-184194	MITSUBISHI	8-28
0508072	BC1D-28-170	MAZDA	7-27	0584142	4056A134	MITSUBISHI	8-33
0508080	13219141	DAEWOO - CHEVROLET	1-3	0584246	52320-S04-003	HONDA	3-14
0581567	54840-2C000	HYUNDAI	4-5	0584251	96403100	DAEWOO - CHEVROLET	1-9
0581581	54840-3A000	HYUNDAI	4-27	0584268	51320-S10-003	HONDA	3-18
0581586	OK33C-34-150A	KIA	6-12	0584296	51320-S5A-003	HONDA	3-15
0581599	54618-9C002	NISSAN	9-39	0584297	52320-S5A-013	HONDA	3-15
0581754	MB-808076	MITSUBISHI	8-35	0584323	48820-28010	TOYOTA	13-52
0581922	48810-20040	TOYOTA	13-4	0584362	52320-S9A-003	HONDA	3-19
0581936	51320-S84-A01	HONDA	3-6	0584367	51320-SEA-E01	HONDA	3-7
0581943	51320-S2H-003	HONDA	3-20	0584371	51320-SAA-003	HONDA	3-22
0581970	KGA2A-34-150	KIA	6-8	0584391	54618-AU000	NISSAN	9-35
0581993	OK011-32-290A	KIA	6-17	0584432	GJ6A-34-150A	MAZDA	7-8
0582293	48820-33020	TOYOTA	13-10	0584455	54830-17020	HYUNDAI	4-2
0582295	48820-20030	TOYOTA	13-14	0584462	54840-1C000	HYUNDAI	4-7
0582457	48821-B1010	DAIHATSU	2-8	0584466	54840-26000	HYUNDAI	4-18
0582477	52320-S2H-003	HONDA	3-21	0584513	54618-8H300	NISSAN	9-57
0582481	52320-S7A-003	HONDA	3-30	0584529	96225859	DAEWOO - CHEVROLET	1-5
0582553	54840-2F000	KIA	6-7	0584531	52320-S84-A01	HONDA	3-6
0582568	MB-267876	MITSUBISHI	8-32	0584546	51320-S2G-003	HONDA	3-26
0582569	MR-418053	MITSUBISHI	8-32	0584562	48820-0K030	TOYOTA	13-41
0582571	MR-132552	MITSUBISHI	8-30	0584568	54840-4D000	KIA	6-5
0582592	48830-21020	TOYOTA	13-5	0584618	54618-EA010	NISSAN	9-22
0582627	48820-60010	TOYOTA	13-44	0584619	56261-EA500	NISSAN	9-22
0582642	51320-S2A-003	HONDA	3-30	0584633	55618-JD00A	NISSAN	9-38
0582764	55540-26600	HYUNDAI	4-18	0584649	4475209000	SSANGYONG	10-1

RIF. OCAP REF. OCAP	RIF. ORIG O.E. NUMBER	MARCA	PAG.	RIF. OCAP REF. OCAP	RIF. ORIG O.E. NUMBER	MARCA	PAG.
0585176	4475508000	SSANGYONG	10-5	0593801	GA2A-34-170	MAZDA	7-6
0585179	46630-80F00	SUZUKI	12-2	0593954	4806304	DAEWOO - CHEVROLET	1-2
0585196	54840-4H200	HYUNDAI	4-9	0593960	54830-0X000	HYUNDAI	4-12
0585197	55540-4H000	HYUNDAI	4-9	0594078	54830-1J000	HYUNDAI	4-13
0586500	54618-CA000	NISSAN	9-21	0594084	54830-2B000	HYUNDAI	4-19
0588062	54618-CA010	NISSAN	9-21	0594098	0K2FA-34170	KIA	6-2
0588064	52320-SWA-A01	HONDA	3-20	0594127	MR-992309	MITSUBISHI	8-23
0588066	4475209000	SSANGYONG	10-3	0594138	4156A014	MITSUBISHI	8-28
0588067	4575109000	SSANGYONG	10-3	0594142	4056A133	MITSUBISHI	8-33
0591567	54830-2C000	HYUNDAI	4-5	0594246	52321-S04-003	HONDA	3-14
0591581	54830-3A000	HYUNDAI	4-27	0594251	96403099	DAEWOO - CHEVROLET	1-9
0591586	0K33C-34-160A	KIA	6-12	0594268	51321-S10-003	HONDA	3-18
0591599	54668-9C000	NISSAN	9-39	0594296	51321-S5A-003	HONDA	3-15
0591754	MB-672370	MITSUBISHI	8-35	0594297	52321-S5A-013	HONDA	3-15
0591922	48810-05012	TOYOTA	13-4	0594323	48810-28010	TOYOTA	13-52
0591936	51321-S84-A01	HONDA	3-6	0594362	52321-S9A-003	HONDA	3-19
0591943	51321-S2H-003	HONDA	3-21	0594367	51321-SEA-E01	HONDA	3-8
0591970	KGA2A-34-170	KIA	6-8	0594371	51321-SAA-003	HONDA	3-22
0591993	0K011-32-270A	KIA	6-17	0594391	54668-AU000	NISSAN	9-36
0592293	48810-33010	TOYOTA	13-11	0594432	GJ6A-34-170A	MAZDA	7-8
0592295	48810-20010	TOYOTA	13-14	0594455	54830-17010	HYUNDAI	4-2
0592457	48831-B1010	DAIHATSU	2-8	0594462	54830-1C000	HYUNDAI	4-7
0592477	52321-S2H-003	HONDA	3-21	0594466	54830-26000	HYUNDAI	4-18
0592481	52321-S7A-003	HONDA	3-30	0594513	54668-8H300	NISSAN	9-57
0592553	54830-2F000	KIA	6-7	0594529	96225858	DAEWOO - CHEVROLET	1-5
0592568	MB-267877	MITSUBISHI	8-32	0594531	52325-S84-A01	HONDA	3-6
0592569	MR-418052	MITSUBISHI	8-32	0594546	51321-S2G-003	HONDA	3-26
0592571	MR-132551	MITSUBISHI	8-30	0594562	48810-60040	TOYOTA	13-42
0592592	48840-21010	TOYOTA	13-5	0594568	54830-4D000	KIA	6-5
0592627	48810-60010	TOYOTA	13-44	0594618	54668-EA010	NISSAN	9-22
0592642	51321-S2A-003	HONDA	3-31	0594619	56261-EA510	NISSAN	9-23
0592764	55530-26600	HYUNDAI	4-18	0594633	55619-JD00A	NISSAN	9-38
0592772	54830-1G000	HYUNDAI	4-3	0594649	4475109000	SSANGYONG	10-1
0592784	48840-42010	TOYOTA	13-55	0595176	4475008001	SSANGYONG	10-5
0592794	54830-07000	KIA	6-11	0595179	46640-80F00	SUZUKI	12-2
0592802	NC10-34-170	MAZDA	7-23	0595196	54830-4H200	HYUNDAI	4-9
0592817	54822-H1000	HYUNDAI	4-27	0595197	55530-4H000	HYUNDAI	4-9
0592824	54618-4U000	NISSAN	9-4	0596500	54668-CA000	NISSAN	9-21
0592828	54618-00QAB	NISSAN	9-12	0598062	54668-CA010	NISSAN	9-21
0593103	48810-26030	TOYOTA	13-37	0598064	52321-SWA-A01	HONDA	3-20
0593125	54668-1AA0A	NISSAN	9-38	0598066	4475109000	SSANGYONG	10-3
0593260	54820-FD000	KIA	6-13	0598067	4575009000	SSANGYONG	10-3
0593283	51321-SEA-E01	HONDA	3-9	0600089	48521-A03G0	NISSAN	9-50
0593284	52325-TAO-A01	HONDA	3-9	0600189	53521-SH3-003	HONDA	3-11
0593291	52321-SNA-A01	HONDA	3-16	0600190	53521-SB0-000	HONDA	3-26
0593473	MB-076001	MITSUBISHI	8-9	0600338	S083-32-115	KIA	6-1
0593512	48630-A0600	NISSAN	9-6	0600387	53521-SD4-003	HONDA	3-23
0593530	48520-R8000	NISSAN	9-10	0600388	53521-SM4-003	HONDA	3-3
0593545	48630-50W00	NISSAN	9-27	0600424	8-94217-221-3	ISUZU	5-3
0593553	48630-N8225	NISSAN	9-39	0600988	53521-692-003	HONDA	3-1
0593556	48630-N8425	NISSAN	9-40	0600990	53521-634-000	HONDA	3-9
0593559	48630-D8025	NISSAN	9-40	0600993	48521-35F00	NISSAN	9-5
0593564	48630-W5000	NISSAN	9-4	0601228	53521-671-000	HONDA	3-1
0593572	48560-H1025	NISSAN	9-42	0601285	57730-29000	HYUNDAI	4-15
0593581	48630-G2525	NISSAN	9-53	0601287	56540-22000	HYUNDAI	4-1
0593686	45470-29046	TOYOTA	13-28	0601294	57730-28500	HYUNDAI	4-14
0593722	45470-39065	TOYOTA	13-34	0601481	D061-32-24XA	MAZDA	7-1
0593776	45470-39035	TOYOTA	13-38	0601486	1E00-32-240	MAZDA	7-1



RIF. OCAP REF. OCAP	RIF. ORIG O.E. NUMBER	MARCA	PAG.	RIF. OCAP REF. OCAP	RIF. ORIG O.E. NUMBER	MARCA	PAG.
0601564	56540-22000	HYUNDAI	4-1	0602770	57724-1E000	HYUNDAI	4-3
0601565	56540-02000	HYUNDAI	4-4	0602780	45503-B1010	DAIHATSU	2-8
0601566	57724-2D000	HYUNDAI	4-4	0602782	45503-0D080	TOYOTA	13-62
0601568	57755-1C000	HYUNDAI	4-6	0602792	57724-07000	KIA	6-10
0601569	57730-33100	HYUNDAI	4-14	0602808	57729-4A000	HYUNDAI	4-7
0601579	57716-34000	HYUNDAI	4-20	0602819	MR-403100	MINI	8-27
0601585	KDX53-32-240B	KIA	6-12	0602822	48521-4U110	NISSAN	9-3
0601589	GE4T-32-240	MAZDA	7-12	0602826	48521-00QAF	NISSAN	9-12
0601592	LA01-32-115	MAZDA	7-20	0602830	48521-00QAG	NISSAN	9-13
0601594	LC62-32-240B	MAZDA	7-21	0602831	48521-00QAA	NISSAN	9-13
0601597	FD01-32-240	MAZDA	7-26	0602842	45503-09230	TOYOTA	13-11
0601752	MR-131857	MINI	8-35	0602889	48521-50400	NISSAN	9-1
0601760	MB-532281	MINI	8-11	0602893	520672	DAEWOO - CHEVROLET	1-7
0601765	MR-448255	MINI	8-34	0602895	520808	DAEWOO - CHEVROLET	1-5
0601784	48830-65D00	SUZUKI	12-4	0602915	521255	DAEWOO - CHEVROLET	1-6
0601923	45503-19215	TOYOTA	13-23	0602925	53010-SR3-010	HONDA	3-12
0601924	45503-19215	TOYOTA	13-54	0602926	53010-SV4-000	HONDA	3-4
0601926	48830-63B10	SUBARU	11-3	0602928	KK150-32-240	KIA	6-11
0601929	34160-AE000	SUBARU	11-2	0602939	MB-532971	MINI	8-25
0601930	34140-AA040	SUBARU	11-1	0602951	48521-06R05	NISSAN	9-15
0601933	53010-S04-000	HONDA	3-13	0602953	48251-1700	NISSAN	9-17
0601938	53010-SW5-000	HONDA	3-25	0602954	48521-70A00	NISSAN	9-18
0601942	53010-S2H-J01	HONDA	3-20	0602955	45503-87708	DAIHATSU	2-2
0601945	48830-M70F00	SUZUKI	12-1	0602958	48830-82000	SUZUKI	12-8
0601947	48830-60G00	SUZUKI	12-1	0602963	45503-19155	TOYOTA	13-50
0601950	48830-50G10	SUZUKI	12-8	0602971	45503-29255	TOYOTA	13-36
0601963	MR-403027	MINI	8-36	0602976	45503-29095	TOYOTA	13-49
0601971	OK9A2-32-240	KIA	6-7	0602978	45503-29215	TOYOTA	13-49
0601972	OK203-32-240	KIA	6-14	0602984	48830-67D00	SUZUKI	12-4
0601999	MR-244901	MINI	8-1	0602989	48830-75F01	SUZUKI	12-6
0602120	56540-22000	HYUNDAI	4-10	0602991	48830-76G00	SUZUKI	12-3
0602322	48520-00QAM	NISSAN	9-30	0602993	MR-297969	MINI	8-7
0602444	45503-87710	DAIHATSU	2-2	0602994	45503-0D030	TOYOTA	13-61
0602454	96061907	DAEWOO - CHEVROLET	1-1	0602995	45503-52010	TOYOTA	13-61
0602455	45503-97201	DAIHATSU	2-8	0602999	45503-05020	TOYOTA	13-4
0602456	45503-97401	DAIHATSU	2-8	0603084	48830-60B00	SUZUKI	12-8
0602459	45460-87401	DAIHATSU	2-9	0603092	45503-29245	TOYOTA	13-16
0602465	53521-S7A-003	HONDA	3-29	0603094	45503-42020	TOYOTA	13-55
0602466	45503-87208	DAIHATSU	2-3	0603100	45503-29565	TOYOTA	13-37
0602467	45503-97203	DAIHATSU	2-4	0603105	45503-19066	TOYOTA	13-49
0602468	45503-97204	DAIHATSU	2-5	0603106	45503-19145	TOYOTA	13-50
0602480	45503-39075	TOYOTA	13-2	0603120	45503-49075	TOYOTA	13-53
0602486	57724-38000	HYUNDAI	4-22	0603122	45503-0F010	TOYOTA	13-5
0602497	57724-2E-000	KIA	6-18	0603126	48830-65J00	SUZUKI	12-5
0602514	7313-10010	SUBARU	11-6	0603271	48001-JD90B	NISSAN	9-38
0602559	57724-38010	HYUNDAI	4-23	0603276	-	DAEWOO - CHEVROLET	1-4
0602560	DE90-32-240	MAZDA	7-2	0603278	53010-S84-A01	HONDA	3-5
0602564	FB01-32-240A	MAZDA	7-26	0603280	53610-TL1-G01	HONDA	3-8
0602566	MR-510267	MINI	8-31	0603294	53010-TF0-003	HONDA	3-22
0602574	48521-4M500	NISSAN	9-3	0603305	45503-87703	DAIHATSU	2-1
0602575	48521-0W025	NISSAN	9-21	0603308	45503-87705	DAIHATSU	2-2
0602594	45503-12130	TOYOTA	13-24	0603317	45503-87702	DAIHATSU	2-1
0602609	45503-49055	TOYOTA	13-54	0603343	53521-SB2-003	HONDA	3-10
0602620	45503-87714	DAIHATSU	2-5	0603347	53521-SA5-000	HONDA	3-1
0602626	45503-39235	TOYOTA	13-47	0603362	57730-33200	HYUNDAI	4-19
0602629	45503-49105	TOYOTA	13-6	0603363	56540-21001	HYUNDAI	4-16
0602641	53010-S2A-003	HONDA	3-30	0603364	57730-24100	HYUNDAI	4-17
0602689	48830-63J00	SUZUKI	12-9	0603365	56540-22000	HYUNDAI	4-17

RIF. OCAP REF. OCAP	RIF. ORIG O.E. NUMBER	MARCA	PAG.	RIF. OCAP REF. OCAP	RIF. ORIG O.E. NUMBER	MARCA	PAG.
0603366	57730-24000	HYUNDAI	4-17	0604129	MR-491358	MITSUBISHI	8-16
0603371	5-44350-095-0	ISUZU	5-3	0604135	4422A012	MITSUBISHI	8-28
0603384	B001-32-135	MAZDA	7-18	0604140	4422A036	MITSUBISHI	8-32
0603385	B038-32-135	MAZDA	7-18	0604211	521257	DAEWOO - CHEVROLET	1-6
0603388	B092-32-240	MAZDA	7-19	0604212	KBJR45	DAEWOO - CHEVROLET	1-6
0603389	B094-32-240	MAZDA	7-19	0604254	521564	DAEWOO - CHEVROLET	1-9
0603396	B455-32-24X	MAZDA	7-4	0604264	93741074	DAEWOO - CHEVROLET	1-6
0603397	B455-32-25X	MAZDA	7-4	0604266	93741092	DAEWOO - CHEVROLET	1-6
0603403	GJ21-32-240	MAZDA	7-10	0604293	48830A78B00	DAEWOO - CHEVROLET	1-10
0603421	H001-32-240	MAZDA	7-14	0604295	53521-S5A-003	HONDA	3-15
0603422	H002-32-240	MAZDA	7-14	0604319	45503-19205	TOYOTA	13-23
0603436	MB-122135	MITSUBISHI	8-15	0604322	45503-29295	TOYOTA	13-52
0603441	MB-243373	MITSUBISHI	8-15	0604331	45504-28030	TOYOTA	13-52
0603442	MB-350718	MITSUBISHI	8-4	0604361	53521-S9A-003	HONDA	3-18
0603443	MB-347666	MITSUBISHI	8-4	0604364	53010-SDA-A01	HONDA	3-7
0603444	MB-553249	MITSUBISHI	8-5	0604419	45503-05010	TOYOTA	13-15
0603445	MB-910934	MITSUBISHI	8-5	0604420	45503-49035	TOYOTA	13-17
0603479	MB-266152	MITSUBISHI	8-11	0604437	E016-32-25X	MAZDA	7-5
0603480	MB-350577	MITSUBISHI	8-11	0604438	B21H-32-25X	MAZDA	7-5
0603481	MB-243329	MITSUBISHI	8-11	0604443	NA01-32-240	MAZDA	7-22
0603508	GJ22-32-240	MAZDA	7-11	0604450	6A2A-32-240	MAZDA	7-11
0603575	48521-35A00	NISSAN	9-37	0604453	57730-24000	HYUNDAI	4-2
0603577	48521-M3070	NISSAN	9-11	0604458	57755-02000	HYUNDAI	4-4
0603593	7313-10140	SUBARU	11-3	0604488	48830-83E00	SUZUKI	12-6
0603597	31310-GA170	SUBARU	11-6	0604491	48521-40U25	NISSAN	9-17
0603598	31310-GA120	SUBARU	11-6	0604510	48521-1M210	NISSAN	9-2
0603599	31310-GA151	SUBARU	11-7	0604512	48521-8H300	NISSAN	9-57
0603602	48521-X08G1	NISSAN	9-51	0604516	57755-17000	HYUNDAI	4-15
0603607	48830-78000	SUZUKI	12-1	0604517	57785-26200	HYUNDAI	4-18
0603609	48830-84000	SUZUKI	12-1	0604518	57755-22000	HYUNDAI	4-1
0603625	45503-19085	TOYOTA	13-8	0604522	BP4L-32-240	MAZDA	7-3
0603631	45503-29105	TOYOTA	13-9	0604533	53010-S10-000	HONDA	3-17
0603636	45503-29010	TOYOTA	13-13	0604535	53521-SP0-004	HONDA	3-24
0603639	45503-19035	TOYOTA	13-13	0604540	53010-SW5-003	HONDA	3-25
0603640	45503-19055	TOYOTA	13-13	0604545	53010-S50-003	HONDA	3-25
0603641	45503-19036	TOYOTA	13-13	0604548	53010-SS0-000	HONDA	3-27
0603642	45503-19056	TOYOTA	13-14	0604556	45503-69015	TOYOTA	13-46
0603644	45503-29075	TOYOTA	13-16	0604557	45503-69025	TOYOTA	13-46
0603647	45503-29165	TOYOTA	13-14	0604566	57724-4D000	KIA	6-4
0603648	45503-29155	TOYOTA	13-14	0604574	0K72A-32-270	KIA	6-8
0603659	45460-19115	TOYOTA	13-19	0604575	0K60A-32-270	KIA	6-8
0603664	45503-19125	TOYOTA	13-22	0604578	57724-07100	KIA	6-10
0603665	45503-19135	TOYOTA	13-22	0604588	E016-32-250	MAZDA	7-5
0603669	45503-29355	TOYOTA	13-9	0604592	GJ6E-32-240	MAZDA	7-8
0603676	45503-19025	TOYOTA	13-21	0604617	48521-EA000	NISSAN	9-22
0603679	45503-19116	TOYOTA	13-21	0604630	49001-BA210 Z	NISSAN	9-35
0603692	45503-19085	TOYOTA	13-30	0604639	-	NISSAN	9-38
0603694	45503-29435	TOYOTA	13-15	0604644	48521-27N00	NISSAN	9-53
0603732	45503-19075	TOYOTA	13-58	0605180	48830-78A00	SUZUKI	12-3
0603800	57730-24000	HYUNDAI	4-14	0605186	45500-0H010	TOYOTA	13-7
0603952	-	DAEWOO - CHEVROLET	1-1	0605199	45503-09321	TOYOTA	13-41
0603958	57724-0X000	HYUNDAI	4-11	0606500	48521-CA025	NISSAN	9-20
0604070	56540-2H000	HYUNDAI	4-13	0608063	53010-SWA-A01	HONDA	3-19
0604076	57724-1J000	HYUNDAI	4-12	0608072	EC01-32-240	MAZDA	7-27
0604082	57724-2B000	HYUNDAI	4-18	0608073	45046-19415 Z	TOYOTA	13-3
0604090	57724-3K000	HYUNDAI	4-25	0608080	13278358	DAEWOO - CHEVROLET	1-2
0604108	57724-2G000	KIA	6-3	0680348	G030-32-240A	MAZDA	7-9
0604125	4410A173	MITSUBISHI	8-22	0680423	H261-32-240A	MAZDA	7-14

RIF. OCAP REF. OCAP	RIF. ORIG O.E. NUMBER	MARCA	PAG.	RIF. OCAP REF. OCAP	RIF. ORIG O.E. NUMBER	MARCA	PAG.
0681755	MR-455090	MITSUBISHI	8-35	0781749	MR-179480	MITSUBISHI	8-1
0681759	MR-455092	MITSUBISHI	8-39	0781751	MR-911569	MITSUBISHI	8-3
0681975	0K2A1-32-240	KIA	6-2	0781757	MR-316298	MITSUBISHI	8-36
0681990	0K552-32-250	KIA	6-3	0781763	MB-912506	MITSUBISHI	8-12
0682471	57731-3E-010	KIA	6-15	0781766	MR-414940	MITSUBISHI	8-34
0682799	NC10-32-240A	MAZDA	7-22	0781818	54524-2F010	NISSAN	9-32
0683288	53011-SMG-E01	HONDA	3-16	0781949	-	SUBARU	11-3
0683387	B093-32-240	MAZDA	7-19	0781958	MB-809223	MITSUBISHI	8-2
0683401	G037-32-240C	MAZDA	7-10	0781959	MR-241342	MITSUBISHI	8-7
0684369	53010-SAA-J01	HONDA	3-22	0781964	MR-297242	MITSUBISHI	8-37
0684434	B25D-32-250	MAZDA	7-6	0781965	MR-171308	MITSUBISHI	8-1
0684444	D10232250A	MAZDA	7-16	0781987	54500-21B00	NISSAN	9-18
0685184	48830-79J00	SUZUKI	12-10	0781998	MR-130480	MITSUBISHI	8-3
0685194	57724-4H100	HYUNDAI	4-8	0782321	54502-00QAA	NISSAN	9-31
0690348	G030-32-250A	MAZDA	7-9	0782460	43068-87401	DAIHATSU	2-9
0690423	H260-32-240A	MAZDA	7-14	0782474	54520-3E-000	KIA	6-16
0691223	48521-01F00	NISSAN	9-1	0782476	51350-S9A-010	HONDA	3-19
0691755	MR-455089	MITSUBISHI	8-35	0782484	54420-38000	HYUNDAI	4-22
0691759	MR-455091	MITSUBISHI	8-39	0782489	54502-3A100	HYUNDAI	4-27
0691975	0K2A2-32-240	KIA	6-2	0782498	54501-1F100	HYUNDAI	4-28
0691991	0K552-32-270	KIA	6-3	0782549	0K2FA-34-300	KIA	6-2
0692471	57732-3E-010	KIA	6-15	0782576	54500-0W000	NISSAN	9-21
0692799	NC10-32-250A	MAZDA	7-22	0782590	48068-05070	TOYOTA	13-5
0693288	53010-SMG-E01	HONDA	3-16	0782622	48068-35080	TOYOTA	13-2
0693387	B093-32-250	MAZDA	7-19	0782624	48610-32040	TOYOTA	13-2
0693401	G037-32-250C	MAZDA	7-10	0782640	B25D-34-300A	MAZDA	7-7
0694369	53011-SAA-J01	HONDA	3-22	0782655	54501-29000	HYUNDAI	4-15
0694434	B25D-32-240	MAZDA	7-6	0782658	54501-24000	HYUNDAI	4-17
0694444	D10232240A	MAZDA	7-16	0782659	45201-57K00	SUZUKI	12-9
0695184	48830-79J10	SUZUKI	12-10	0782760	45201-77A01	SUZUKI	12-4
0695194	57724-4H000	HYUNDAI	4-9	0782766	51450-S30-003	HONDA	3-28
0700495	LMB-002307	MITSUBISHI	8-17	0782768	54501-17000	HYUNDAI	4-16
0701946	45200-50E00	SUZUKI	12-1	0782773	54501-1E100	HYUNDAI	4-3
0701960	MR-197284	MITSUBISHI	8-7	0782774	54501-1E000	HYUNDAI	4-3
0702785	46300-60B00	SUZUKI	12-9	0782776	48068-33010	TOYOTA	13-10
0702849	0K011-34-300D	KIA	6-18	0782777	48068-33030	TOYOTA	13-10
0702916	9631-6765	DAEWOO - CHEVROLET	1-6	0782781	48068-B1020	DAIHATSU	2-8
0703012	8-94226-936-1	ISUZU	5-4	0782788	51350-S50-G01	HONDA	3-26
0703330	51350-659-010	HONDA	3-10	0782789	51350-S2H-G02	HONDA	3-20
0703332	51350-SA0-000	HONDA	3-10	0782790	54501-2F000	KIA	6-6
0703341	52390-SE0-023	HONDA	3-2	0782793	54501-07100	KIA	6-10
0703355	51350-692-000	HONDA	3-26	0782798	GD7A-34-300A	MAZDA	7-13
0703497	MB-109893	MITSUBISHI	8-25	0782800	N068-34-200	MAZDA	7-22
0703498	MB-109343	MITSUBISHI	8-25	0782801	N066-34-310	MAZDA	7-22
0703614	45200-79001	SUZUKI	12-3	0782805	MN-186218	MITSUBISHI	8-8
0703615	45200-85001	SUZUKI	12-3	0782807	51350-S7A-010	HONDA	3-29
0704096	55210-38000	HYUNDAI	4-23	0782809	54501-4A000	HYUNDAI	4-8
0704132	MR-403485	MITSUBISHI	8-16	0782810	54401-4A000	HYUNDAI	4-8
0704591	BP4K-28-500C	MAZDA	7-4	0782823	54500-4U002	NISSAN	9-4
0705160	55250-34000	HYUNDAI	4-21	0782832	54500-00QAH	NISSAN	9-14
0705161	55201-34000	HYUNDAI	4-21	0782840	45201-79J00	SUZUKI	12-10
0780339	0SE46-34-250	KIA	6-1	0782845	48068-0H010	TOYOTA	13-7
0780340	0KX43-34-300	KIA	6-1	0782846	54501-2D000	HYUNDAI	4-5
0780420	8-94323-562-1	ISUZU	5-2	0782847	0K2NA-34-300B	KIA	6-15
0780915	54500-44B00	NISSAN	9-18	0782894	96213118	DAEWOO - CHEVROLET	1-5
0781483	1E00-34-300E	MAZDA	7-2	0782972	48610-29085	TOYOTA	13-36
0781484	1E01-34-300E	MAZDA	7-2	0783012	8-94243-232-0	ISUZU	5-4
0781516	48068-59035	TOYOTA	13-61	0783013	8-94223-221-2	ISUZU	5-4

RIF. OCAP REF. OCAP	RIF. ORIG O.E. NUMBER	MARCA	PAG.	RIF. OCAP REF. OCAP	RIF. ORIG O.E. NUMBER	MARCA	PAG.
0783088	4010A038	MITSUBISHI	8-31	0783507	54540-4B001	HYUNDAI	4-11
0783089	48068-20380	TOYOTA	13-17	0783537	54499-W1000	NISSAN	9-8
0783091	48068-02070	TOYOTA	13-25	0783549	54500-50J10	NISSAN	9-32
0783095	48068-42050	TOYOTA	13-56	0783583	54100-H8500	NISSAN	9-45
0783096	48068-05080	TOYOTA	13-6	0783584	54529-01A00	NISSAN	9-46
0783098	48068-44010	TOYOTA	13-51	0783585	54500-50A00	NISSAN	9-47
0783101	48068-26070	TOYOTA	13-37	0783586	54500-52Y10	NISSAN	9-48
0783104	48068-49045	TOYOTA	13-6	0783587	54500-F4300	NISSAN	9-2
0783113	48068-12260	TOYOTA	13-24	0783604	7210-60380	SUBARU	11-3
0783121	LC62-34-300C	MAZDA	7-21	0783605	20202-AG180	SUBARU	11-5
0783124	54500-BR30A	NISSAN	9-38	0783661	48068-19045	TOYOTA	13-19
0783142	45201-65J00	SUZUKI	12-5	0783662	48068-19065	TOYOTA	13-19
0783281	51510-TA0-A03	HONDA	3-8	0783663	48068-20150	TOYOTA	13-20
0783285	52390-SH3-030	HONDA	3-14	0783667	48068-12110	TOYOTA	13-22
0783295	51350-TF0-030	HONDA	3-23	0783672	48068-12130	TOYOTA	13-23
0783297	54431-44000	HYUNDAI	4-6	0783799	48605-35030	TOYOTA	13-40
0783298	HB212004	HYUNDAI	4-6	0783953	4806301	DAEWOO - CHEVROLET	1-2
0783299	48068-09015	TOYOTA	13-62	0783959	54501-0X000	HYUNDAI	4-11
0783324	48068-87704	DAIHATSU	2-1	0784071	54501-2H000	HYUNDAI	4-13
0783326	48068-87205	DAIHATSU	2-3	0784077	54501-1J500	HYUNDAI	4-12
0783327	48068-87507	DAIHATSU	2-7	0784083	54501-2B100	HYUNDAI	4-19
0783329	51350-634-000	HONDA	3-10	0784087	54501-38000	HYUNDAI	4-22
0783331	52350-659-315	HONDA	3-10	0784088	54501-38011	HYUNDAI	4-24
0783333	51351-SB2-013	HONDA	3-10	0784091	54420-3K000	HYUNDAI	4-25
0783334	51450-SH3-000	HONDA	3-11	0784092	54420-3F600	HYUNDAI	4-25
0783335	51355-SH3-010	HONDA	3-11	0784093	54501-3K000	HYUNDAI	4-26
0783336	51350-634-003	HONDA	3-1	0784097	55120-38000	HYUNDAI	4-23
0783337	51350-SA5-003	HONDA	3-1	0784109	54501-1D000	KIA	6-3
0783338	51350-SA5-010	HONDA	3-2	0784115	MB-860408	MITSUBISHI	8-19
0783339	51459-SE0-000	HONDA	3-2	0784116	MB-109513	MITSUBISHI	8-19
0783340	51355-SE0-010	HONDA	3-2	0784118	MR-241024	MITSUBISHI	8-20
0783342	51450-SM4-013	HONDA	3-3	0784119	MR-241026	MITSUBISHI	8-20
0783344	51450-SR0-A02	HONDA	3-12	0784126	4010A014	MITSUBISHI	8-22
0783348	52390-SM1-A03	HONDA	3-4	0784128	4013A088	MITSUBISHI	8-23
0783351	51450-SV4-000	HONDA	3-4	0784130	4013A274	MITSUBISHI	8-16
0783357	54501-33000	HYUNDAI	4-20	0784136	4013A010	MITSUBISHI	8-28
0783374	54503-28010	HYUNDAI	4-14	0784141	4013A210	MITSUBISHI	8-33
0783376	8-94445-550-1	ISUZU	5-1	0784149	48068-0K040	TOYOTA	13-41
0783377	8-94246-419-0	ISUZU	5-2	0784213	96218398	DAEWOO - CHEVROLET	1-3
0783386	B001-34-310C	MAZDA	7-18	0784219	96268440	DAEWOO - CHEVROLET	1-7
0783391	B092-34-310A	MAZDA	7-19	0784220	96268455	DAEWOO - CHEVROLET	1-7
0783399	B01A-34-300E	MAZDA	7-6	0784233	51450-S01-023	HONDA	3-13
0783400	B455-34-300	MAZDA	7-5	0784234	51350-S04-G00	HONDA	3-14
0783404	G030-34-300F	MAZDA	7-10	0784242	51450-S1A-E01	HONDA	3-6
0783405	GF22-34-300A	MAZDA	7-11	0784248	96391851	DAEWOO - CHEVROLET	1-8
0783406	B092-28-500B	MAZDA	7-5	0784255	96378348	DAEWOO - CHEVROLET	1-9
0783409	GA2A-34-300	MAZDA	7-12	0784259	96535082	DAEWOO - CHEVROLET	1-1
0783492	MB-831036	MITSUBISHI	8-30	0784291	51350-S5A-A03	HONDA	3-15
0783493	MB-860382	MITSUBISHI	8-30	0784298	54500-AX600	NISSAN	9-20
0783494	LMB-002583	MITSUBISHI	8-17	0784316	51450-S10-020	HONDA	3-17
0783495	54430-43004	HYUNDAI	4-10	0784317	51350-S10-A00	HONDA	3-18
0783496	HMB-303401	MITSUBISHI	8-27	0784338	48068-28120	TOYOTA	13-11
0783499	54540-43150	HYUNDAI	4-11	0784365	51450-SDA-A01	HONDA	3-7
0783500	MB-349445	MITSUBISHI	8-4	0784370	51350-SAA-E01	HONDA	3-22
0783501	MB-518807	MITSUBISHI	8-5	0784384	54500-2F500	NISSAN	9-34
0783504	MB-907116	MITSUBISHI	8-6	0784385	54500-AV600	NISSAN	9-35
0783505	MB-910841	MITSUBISHI	8-6	0784398	54500-4M400	NISSAN	9-3
0783506	MB-809221	MITSUBISHI	8-2	0784407	48068-20260	TOYOTA	13-15

RIF. OCAP REF. OCAP	RIF. ORIG O.E. NUMBER	MARCA	PAG.	RIF. OCAP REF. OCAP	RIF. ORIG O.E. NUMBER	MARCA	PAG.
0784409	48068-42040	TOYOTA	13-55	0791949	-	SUBARU	11-3
0784411	48068-42012	TOYOTA	13-54	0791958	MB-809222	MITSUBISHI	8-2
0784414	48068-12180	TOYOTA	13-24	0791959	MR-241341	MITSUBISHI	8-7
0784418	48068-05050	TOYOTA	13-4	0791964	MR-297241	MITSUBISHI	8-37
0784425	DD32-34-300	MAZDA	7-3	0791965	MR-171307	MITSUBISHI	8-2
0784428	B32H-34-300	MAZDA	7-3	0791987	54501-21B00	NISSAN	9-18
0784431	GJ6A-34-200B	MAZDA	7-8	0791998	MR-130479	MITSUBISHI	8-3
0784457	54501-02051	HYUNDAI	4-4	0792321	54503-00QAA	NISSAN	9-31
0784465	54502-26000	HYUNDAI	4-18	0792460	43069-87401	DAIHATSU	2-9
0784467	54501-22000	HYUNDAI	4-1	0792474	54510-3E-000	KIA	6-16
0784468	54501-1C000	HYUNDAI	4-7	0792476	51360-S9A-010	HONDA	3-19
0784492	54500-41U00	NISSAN	9-17	0792484	54410-38000	HYUNDAI	4-22
0784493	54502-01G90	NISSAN	9-26	0792489	54501-3A100	HYUNDAI	4-27
0784494	200200AC200F	SUBARU	11-1	0792498	54500-1F000	HYUNDAI	4-28
0784496	45201-65D00	SUZUKI	12-4	0792549	0K2FA-34-350	KIA	6-2
0784515	54501-25000	HYUNDAI	4-2	0792576	54501-0W000	NISSAN	9-22
0784536	51450-SP0-033	HONDA	3-24	0792590	48069-05070	TOYOTA	13-5
0784541	51450-SZ3-013	HONDA	3-25	0792622	48069-35080	TOYOTA	13-2
0784542	51450-SZ3-901	HONDA	3-25	0792624	48630-35020	TOYOTA	13-2
0784558	48610-60030	TOYOTA	13-46	0792640	B25D-34-350A	MAZDA	7-7
0784559	48620-60010	TOYOTA	13-47	0792655	54500-29000	HYUNDAI	4-15
0784560	48610-60050	TOYOTA	13-47	0792658	54500-24000	HYUNDAI	4-17
0784561	48068-60010	TOYOTA	13-47	0792659	45202-57K00	SUZUKI	12-9
0784567	54501-4D001	KIA	6-5	0792760	45202-77A01	SUZUKI	12-4
0784571	0K9A2-34-300	KIA	6-7	0792766	51460-S30-003	HONDA	3-28
0784572	0K9A6-34-300	KIA	6-8	0792768	54500-17000	HYUNDAI	4-16
0784576	0SE46-34-250	KIA	6-9	0792773	54500-1E100	HYUNDAI	4-3
0784594	C100-34-300A	MAZDA	7-24	0792774	54500-1E000	HYUNDAI	4-3
0784598	MR-496796	MITSUBISHI	8-31	0792776	48069-33010	TOYOTA	13-10
0784615	54500-2U711	NISSAN	9-19	0792777	48069-33030	TOYOTA	13-10
0784640	54500-7C350	NISSAN	9-39	0792781	48069-B1020	DAIHATSU	2-8
0785159	54501-34000	HYUNDAI	4-21	0792788	51360-S50-G01	HONDA	3-26
0785174	4450208005	SSANGYONG	10-3	0792789	51360-S2H-G02	HONDA	3-20
0785177	20200FC120	SUBARU	11-1	0792790	54500-2F000	KIA	6-6
0785189	48068-0F010	TOYOTA	13-26	0792793	54500-07100	KIA	6-10
0785195	54501-4H000	HYUNDAI	4-9	0792798	GD7A-34-350A	MAZDA	7-13
0785200	48610-0K040	TOYOTA	13-41	0792800	N068-34-250	MAZDA	7-22
0786500	54500-CC40A	NISSAN	9-20	0792801	N066-34-360	MAZDA	7-23
0788063	51350-SWA-E01	HONDA	3-20	0792805	MN-186217	MITSUBISHI	8-8
0788065	4450209001	SSANGYONG	10-2	0792807	51360-S7A-010	HONDA	3-30
0788071	54500-1KA0B	NISSAN	9-13	0792809	54500-4A000	HYUNDAI	4-8
0788072	EC01-34-300F	MAZDA	7-27	0792810	54400-4A000	HYUNDAI	4-8
0788073	48068-02130	TOYOTA	13-3	0792823	54501-4U002	NISSAN	9-4
0788078	48068-12260 Z	TOYOTA	13-25	0792832	54501-00QAH	NISSAN	9-14
0788079	48068-02070 Z	TOYOTA	13-25	0792840	45202-79J00	SUZUKI	12-10
0790339	0SE46-34-200	KIA	6-1	0792845	48069-0H010	TOYOTA	13-7
0790340	0KX43-34-350	KIA	6-1	0792846	54500-2D000	HYUNDAI	4-5
0790420	8-94323-563-1	ISUZU	5-2	0792847	0K2NA-34-350B	KIA	6-15
0790915	54501-44B00	NISSAN	9-18	0792894	96213117	DAEWOO - CHEVROLET	1-5
0791483	1E00-34-350E	MAZDA	7-2	0792972	48610-29075	TOYOTA	13-36
0791484	1E01-34-350E	MAZDA	7-2	0793012	8-94243-233-0	ISUZU	5-4
0791516	48069-59035	TOYOTA	13-61	0793013	8-94223-222-2	ISUZU	5-4
0791749	MR-179479	MITSUBISHI	8-1	0793088	4010A037	MITSUBISHI	8-31
0791751	MR-911570	MITSUBISHI	8-3	0793089	48069-20380	TOYOTA	13-17
0791757	MR-316297	MITSUBISHI	8-36	0793091	48069-02070	TOYOTA	13-25
0791763	MB-912505	MITSUBISHI	8-12	0793095	48069-42050	TOYOTA	13-56
0791766	MR-414939	MITSUBISHI	8-34	0793096	48069-05080	TOYOTA	13-6
0791818	54525-2F010	NISSAN	9-32	0793098	48069-44010	TOYOTA	13-51

RIF. OCAP REF. OCAP	RIF. ORIG O.E. NUMBER	MARCA	PAG.	RIF. OCAP REF. OCAP	RIF. ORIG O.E. NUMBER	MARCA	PAG.
0793101	48069-26070	TOYOTA	13-37	0793586	54501-52Y10	NISSAN	9-48
0793104	48069-49045	TOYOTA	13-7	0793587	54501-0M010	NISSAN	9-2
0793113	48069-12260	TOYOTA	13-25	0793604	7210-60570	SUBARU	11-3
0793121	LC62-34-350C	MAZDA	7-21	0793605	20202-AG190	SUBARU	11-5
0793124	54501-BR30A	NISSAN	9-38	0793661	48069-19045	TOYOTA	13-19
0793142	45202-65J00	SUZUKI	12-6	0793662	48069-19065	TOYOTA	13-20
0793281	51520-TA0-A03	HONDA	3-8	0793663	48069-20150	TOYOTA	13-21
0793285	52400-SH3-030	HONDA	3-14	0793667	48069-12110	TOYOTA	13-22
0793295	51360-TF0-030	HONDA	3-23	0793672	48069-12130	TOYOTA	13-23
0793297	MB109630A	HYUNDAI	4-6	0793799	48606-35030	TOYOTA	13-40
0793298	HB212003	HYUNDAI	4-6	0793953	4806300	DAEWOO - CHEVROLET	1-2
0793299	48069-09015	TOYOTA	13-62	0793959	54500-0X000	HYUNDAI	4-11
0793324	48069-87704	DAIHATSU	2-1	0794071	54500-2H000	HYUNDAI	4-13
0793326	48069-87205	DAIHATSU	2-3	0794077	54500-1J500	HYUNDAI	4-12
0793327	48069-87507	DAIHATSU	2-7	0794083	54500-2B100	HYUNDAI	4-19
0793329	51360-634-000	HONDA	3-10	0794087	54500-38000	HYUNDAI	4-22
0793331	52360-659-315	HONDA	3-10	0794088	54500-38011	HYUNDAI	4-24
0793333	51361-SB2-013	HONDA	3-11	0794091	54410-3K000	HYUNDAI	4-25
0793334	51460-SH3-000	HONDA	3-11	0794092	54410-3F600	HYUNDAI	4-25
0793335	51365-SH3-010	HONDA	3-12	0794093	54500-3K000	HYUNDAI	4-26
0793336	51360-634-003	HONDA	3-1	0794097	55110-38000	HYUNDAI	4-23
0793337	51360-SA5-013	HONDA	3-1	0794109	54500-1D000	KIA	6-3
0793338	51360-SA5-010	HONDA	3-2	0794115	MB-527159	MITSUBISHI	8-19
0793339	51469-SE0-000	HONDA	3-2	0794116	MB-109512	MITSUBISHI	8-19
0793340	51365-SE0-010	HONDA	3-2	0794118	MR-241023	MITSUBISHI	8-20
0793342	51460-SM4-013	HONDA	3-3	0794119	MR-241025	MITSUBISHI	8-20
0793344	51460-SR0-A02	HONDA	3-12	0794126	4010A013	MITSUBISHI	8-22
0793348	52400-SM1-A03	HONDA	3-4	0794128	4013A087	MITSUBISHI	8-23
0793351	51460-SV4-000	HONDA	3-4	0794130	MR-403419	MITSUBISHI	8-16
0793357	54500-33000	HYUNDAI	4-20	0794136	4013A009	MITSUBISHI	8-28
0793374	54502-28070	HYUNDAI	4-14	0794141	4013A209	MITSUBISHI	8-33
0793376	8-94445-551-0	ISUZU	5-1	0794149	48069-0K040	TOYOTA	13-41
0793377	8-94246-420-0	ISUZU	5-2	0794213	96218397	DAEWOO - CHEVROLET	1-3
0793386	B001-34-360C	MAZDA	7-18	0794219	96268439	DAEWOO - CHEVROLET	1-7
0793391	B092-34-360A	MAZDA	7-19	0794220	96268454	DAEWOO - CHEVROLET	1-8
0793399	B01A-34-350E	MAZDA	7-6	0794233	51460-S04-003	HONDA	3-14
0793400	B455-34-350	MAZDA	7-5	0794234	51360-S04-G00	HONDA	3-14
0793404	G030-34-350F	MAZDA	7-10	0794242	51460-S1A-E01	HONDA	3-6
0793405	GF22-34-350A	MAZDA	7-11	0794248	96391850	DAEWOO - CHEVROLET	1-8
0793406	B092-28-550B	MAZDA	7-5	0794255	96378347	DAEWOO - CHEVROLET	1-9
0793409	GA2A-34-350	MAZDA	7-12	0794259	96535081	DAEWOO - CHEVROLET	1-1
0793492	MB-831035	MITSUBISHI	8-30	0794291	51360-S5A-A03	HONDA	3-15
0793493	MB-860381	MITSUBISHI	8-30	0794298	54501-AX600	NISSAN	9-20
0793494	LMB-002584	MITSUBISHI	8-17	0794316	51460-S10-020	HONDA	3-17
0793495	54410-43004	HYUNDAI	4-10	0794317	51360-S10-A00	HONDA	3-18
0793496	HMB-303402	MITSUBISHI	8-27	0794338	48069-28120	TOYOTA	13-11
0793499	54510-43150	HYUNDAI	4-11	0794365	51460-SDA-A01	HONDA	3-7
0793500	MB-349446	MITSUBISHI	8-4	0794370	51306-SAA-E01	HONDA	3-22
0793501	MB-518806	MITSUBISHI	8-5	0794384	54501-2F500	NISSAN	9-34
0793504	MB-907115	MITSUBISHI	8-6	0794385	54501-AV600	NISSAN	9-35
0793505	MB-910842	MITSUBISHI	8-6	0794398	54501-4M400	NISSAN	9-3
0793506	MB-809220	MITSUBISHI	8-2	0794407	48069-20260	TOYOTA	13-15
0793507	54510-4B001	HYUNDAI	4-11	0794409	48069-42040	TOYOTA	13-55
0793537	54500-W1000	NISSAN	9-8	0794411	48069-42012	TOYOTA	13-54
0793549	54501-50J10	NISSAN	9-32	0794414	48069-12180	TOYOTA	13-24
0793583	54101-H1000	NISSAN	9-45	0794418	48069-05050	TOYOTA	13-4
0793584	54530-01A00	NISSAN	9-46	0794425	DD32-34-350	MAZDA	7-3
0793585	54501-50A00	NISSAN	9-47	0794428	B32H-34-350	MAZDA	7-4

RIF. OCAP REF. OCAP	RIF. ORIG O.E. NUMBER	MARCA	PAG.	RIF. OCAP REF. OCAP	RIF. ORIG O.E. NUMBER	MARCA	PAG.
0794431	GJ6A-34-250B	MAZDA	7-8				
0794457	54500-02051	HYUNDAI	4-4				
0794465	54501-26000	HYUNDAI	4-18				
0794467	54500-22000	HYUNDAI	4-1				
0794468	54500-1C000	HYUNDAI	4-7				
0794492	54501-41U00	NISSAN	9-17				
0794493	54503-01G90	NISSAN	9-26				
0794494	200200AC210F	SUBARU	11-1				
0794496	45202-65D00	SUZUKI	12-4				
0794515	54500-25000	HYUNDAI	4-2				
0794536	51460-SP0-033	HONDA	3-24				
0794541	51460-SZ3-013	HONDA	3-25				
0794542	51460-SZ3-901	HONDA	3-25				
0794558	48630-60010	TOYOTA	13-46				
0794559	48640-60010	TOYOTA	13-47				
0794560	48630-60020	TOYOTA	13-47				
0794561	48069-60010	TOYOTA	13-48				
0794567	54500-4D001	KIA	6-5				
0794571	0K9A2-34-350	KIA	6-8				
0794572	0K9A6-34-350	KIA	6-8				
0794576	0SE46-34-200	KIA	6-9				
0794594	C100-34-350A	MAZDA	7-24				
0794598	MR-496795	MITSUBISHI	8-31				
0794615	54501-2U711	NISSAN	9-19				
0794640	54501-7C350	NISSAN	9-39				
0795159	54500-34000	HYUNDAI	4-21				
0795174	4450108005	SSANGYONG	10-3				
0795177	20200FC130	SUBARU	11-1				
0795189	48069-0F010	TOYOTA	13-27				
0795195	54500-4H000	HYUNDAI	4-9				
0795200	48630-0K040	TOYOTA	13-41				
0796500	54501-CC40A	NISSAN	9-20				
0798063	51360-SWA-E01	HONDA	3-20				
0798065	4450109001	SSANGYONG	10-2				
0798071	54501-1KA0B	NISSAN	9-13				
0798072	EC01-34-350F	MAZDA	7-27				
0798073	48069-02130	TOYOTA	13-3				
0798078	48069-12260 Z	TOYOTA	13-25				
0798079	48069-02070 Z	TOYOTA	13-25				
0900760	07846696	DAEWOO - CHEVROLET	1-3				
0901995	-	KIA	6-18				
0902833	54616-00QAA	NISSAN	9-14				
0903623	-	SUZUKI	12-5				
0903760	45465-35020	TOYOTA	13-1				