

Power Pumps

Lenkhilfpumpen

Stuurpompen

Pompes de direction assistée

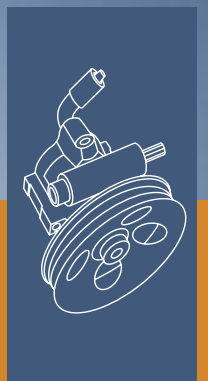

Edition 2009



General information

1. As a producer of original equipment GKN Driveline supplies vehicle manufactures on a world wide basis.
2. SPIDAN is the trade mark of GKN Driveline in the European Automotive Aftermarket.
3. SPIDAN stands for quality, service reliability and profitability.
4. Please accept slight differences in detail between real products and the pictures in this catalogue.
5. Reference numbers of parts or designation of types by vehicle manufacturers or competitors are stated for purposes of comparison only. The use of such details in invoices to vehicle owners is not allowed. Damage claims based on statements made in this catalogue are excluded. Subject to change without notice.
6. Copyright by GKN Driveline. Copies, even extracts, are only allowed with the permission in writing of GKN Service International GmbH.



Allgemeine Hinweise

1. GKN Driveline beliefert mit ihren Produkten als Erstausrüster weltweit die Hersteller von Kraftfahrzeugen.
2. SPIDAN ist das europaweit eingeführte Warenzeichen für Kfz-Ersatzteile der GKN Driveline.
3. SPIDAN steht für Qualität, hohen Servicegrad und Gewinn für unsere Kunden.
4. Die Abbildungen im Katalog können aus drucktechnischen Gründen geringfügig vom Originalteil abweichen.
5. Die Angaben von Ersatzteilnummern oder Typenbezeichnungen der Fahrzeughersteller oder des Wettbewerbs dienen nur zu Vergleichszwecken. Eine Verwendung von solchen Angaben ist in Rechnungen an Fahrzeugbesitzer nicht statthaft. Ersatzansprüche auf Grund von Angaben in diesem Katalog sind ausgeschlossen. Änderungen vorbehalten.
6. Copyright GKN Driveline. Vervielfältigungen, auch auszugsweise, sind nur mit schriftlicher Genehmigung der GKN Service International GmbH zulässig.



Algemene informatie

1. GKN Driveline levert haar producten als eerste montage leverancier aan de automobielproducenten over heel de wereld.
2. SPIDAN is het handelsmerk van de GKN Driveline in de Europese vervangingsmarkt automobiellonderdelen.
3. SPIDAN staat voor kwaliteit, service, betrouwbaarheid en rendement.
4. Kleine afwijkingen tussen de producten en afbeeldingen zijn mogelijk.
5. Vermeldingen van onderdeelnummers of typeaanduidingen van de automobiefabrikanten of van andere aanbieders dienen alleen ter vergelijking. Gebruik van zulke vermeldingen op rekeningen aan de autobezitter is niet toegestaan. Schadeclaims op grond van vermeldingen in deze catalogus worden niet erkend. Veranderingen voorbehouden.
6. Copyright GKN Driveline. Vermenigvuldiging, ook gedeeltelijk, is alleen toegestaan met schriftelijke toestemming van GKN Service International GmbH.



Information générale

1. GKN Driveline, fabricant de pièces d'origine, fournit ses produits aux constructeurs automobiles du monde entier.
2. SPIDAN est la marque commerciale de GKN Driveline pour le marché européen de la pièce de rechange.
3. SPIDAN signifie qualité, service fiabilité et profit.
4. Pour des raisons techniques d'impression, les pièces peuvent être très légèrement différentes des photos figurant dans ce catalogue.
5. Les références des pièces détachées ou la désignation des types des constructeurs ou de leurs concurrents ne sont mentionnées qu'à être indicatif. Ces données ne doivent en aucun cas apparaître sur les factures transmises aux clients. Un droit de recours concernant l'utilisation des données figurant dans de catalogue est exclu. Contenu indicatif, sous réserve de modifications.
6. Copyright GKN Driveline. Toute reproduction intégrale ou partielle ne peut être effectuée sans une autorisation écrite de la société GKN Service International GmbH.



Información general

1. Como fabricante de piezas originales GKN Driveline es el proveedor de los principales fabricantes de automóviles en todo el mundo.
2. SPIDAN es la marca registrada con la que GKN Driveline comercializa sus productos en el mercado de recambio de automoción.
3. SPIDAN es sinónimo de calidad, servicio, fiabilidad y rentabilidad.
4. Por razones técnicas de Impresión pueden existir pequeñas diferencias entre las fotografías del catalogo y el producto real.
5. Las referencias de las piezas o las descripciones de los modelos de los fabricantes de vehículos o de la competencia aparecen solo con el propósito de poder comparar. El uso de dicha información en las facturas del propietario del vehículo no está permitido. Las reclamaciones por daños y perjuicios basadas en declaraciones hechas en este catalogo están excluidas. Sujeto a cambios sin previo aviso.
6. Copyright de GKN Driveline. Cualquier copia, total o parcial de este documento solo estará permitida con la aprobación por escrito de GKN Service International GmbH.

	GB	D	NL	F
	POWER PUMPS	Lenkhilfpumpe	Stuurpompen	pompe de direction assistée
✱	not; without; none	nicht; ohne; keine	Niet; zonder; geen	pas ; sans ; pas de
A/C	air condition	Klimaanlage	Klimaatregeling (Airco)	air conditionné
ASC	active stability control	automatisches Stabilitätsprogramm	Automatische stabiliteits controle	contrôle de stabilité automatique
ASC/T	active stability control + traction	automatisches Stabilitätsprogramm mit Traktionskontrolle	Automatische stabiliteits controle met anti doorslip regeling	contrôle de stabilité automatique et traction assistée
ASD	anti skid device	automatisches Sperrdifferential	Automatisch sperrdifferential	blocage automatique du différentiel
AUTO	automatic gearbox	Automatikgetriebe	Automatische versnellingsbak	boîte de vitesses automatique
AWD	all wheel drive	Allradantrieb	4 wielaandrijving	traction intégrale
BELT	belt driven	durch Keilriemen angetrieben	Door riem aangedreven	entraînement par courroie
✱ BELT	no belt driven	nicht Keilriemen getrieben	Niet door riem aangedreven	sans entraînement par courroie
combi	estate	Kombi	Stationcar / Kombi	break
ELEKTR.	electric pump	elektrisch angetriebene Pumpe	Electrische pomp	pompe électrique
EXCL.	excluded	ausschließend/außer	Exclusief (niet geschikt voor)	sauf
FWD	front wheel drive	Frontantrieb	Voorwiel aandrijving	traction
GEAR	driven by gearbox	angetrieben durch Getriebe	Door versnellingsbak aangedreven	entraînement par la boîte de vitesse
H->xxmm<-	thickness mounting bracket	Halterdicke	Dikte van de montagebeugel	épaisseur de la collerette
H->28mm<-F	thickness mounting bracket flat	Halterdicke 28mm/flach	Montagebeugeldikte 28 mm (vlak)	épaisseur de la collerette plate
H->28mm<-G	thickness mounting bracket curved	Halterdicke 28mm/gebogen	Montagebeugeldikte 28 mm (gebogen)	épaisseur de la collerette courbe
✱ H	without fixed mounting bracket	ohne Halter	Zonder montagebeugel	sans collerette de fixation
H	with fixed mounting bracket	Halter	Met montagebeugel	avec collerette de fixation
HEAVY DUTY	heavy duty	verstärkt	Versterkte uitvoering	renforcé
HYDR.	hydraulic	hydraulisch	Hydraulisch	hydraulique
IN- ---	straight inlet pipe	Eingang gerade	Aansluiting aanvoer recht	admission droite
IN- ↘	angled suction pipe	Eingang gewinkelt	Aansluiting aanvoer onder een hoek	admission coudeée
IN- ↘ TO OUT	inlet pipe at right angle to outlet ports	Eingang rechtwinklig zum Ausgang	Aansluiting aanvoer haaks (of onder hoek) op uitgang	admission à 90° par rapport aux orifices de sortie
IN/OUT ----	inlet pipe in line with outlet ports	Eingang/Ausgang in einer Linie	Aansluiting aanvoer in lijn met uitgang	admission en ligne avec les orifices de sortie
INCL.	included	einschließlich	Inclusief	inclus
IN-FE	steel suction pipe	Saugrohr Metall	Metalen aanvoerbuis	tube d'aspiration en acier
IN-P	plastic suction pipe	Saugrohr Plastik	Kunststof aanvoerbuis	tube d'aspiration en plastic
IR	integral reservoir	integrierter Vorratsbehälter	Geïntegreerd vloeistof reservoir	réservoir d'alimentation intégré
IR-B	integral pear shaped reservoir	integrierter Vorratsbehälter birnenförmig	Geïntegreerd vloeistof reservoir "peervormig" (Saab)	réservoir d'alimentation intégré
IR-Fe	integral reservoir steel	integrierter Vorratsbehälter aus Metall	Geïntegreerd vloeistof reservoir (metalen uitvoering)	réservoir d'alimentation intégré en métal
IR-P	integral reservoir plastic	integrierter Vorratsbehälter aus Plastik	Geïntegreerd vloeistof reservoir (kunststof uitvoering)	réservoir d'alimentation intégré en plastique
KW	crankshaft driven	kw-getrieben	Door krukas aangedreven	entraînement par vilebrequin
L-	overall pump length	Gesamtlänge	Totale lengte	dimension hors tout
MANUAL	manual transmission	manuelles Getriebe	Handgeschakelde versnellingsbak	boîte de vitesses mécanique
NW	camshaft driven	nw-getrieben-hinten	Door nokkenas aangedreven	entraînement par arbre à cames
●	round pulley flange	Flansch-rund	Ronde aansluitflens (voor poelie)	bride ronde de poulie
▼	triangular pulley flange	Flansch-dreieckig	Driehoekige aansluitflens (voor poelie)	bride triangulaire de poulie
● Ø	Diameter round pulley flange	Flansch ø	Diameter van de aansluitflens	diamètre de la bride ronde de poulie
PULLEY	pulley	Riemenscheibe	Poelie	poulie
P	pressed on pulley	gepresste Riemenscheibe	Gepreste poelieaansluiting (aan flens)	poulie emmanchée serrée
S	bolt on pulley	geschraubte Riemenscheibe	Poelie met bouten gemonteerd aan flens	poulie vissée
LIMO.	Saloon	Limousine	4 deurs uitvoering	A trois volumes
PUMP-AL	pump alloy	Pumpe aus Aluminium	Pomphuis uitgevoerd in aluminium	pompe en aluminium
PUMP-AL/FE	half alloy/half cast unit	Pumpe aus Aluminium/Guss	Pomphuis uitgevoerd in aluminium en gietijzer	pompe en fonte d'aluminium
PUMP-FE	pump cast	Pumpe aus Guss	Pomphuis uitgevoerd in gietijzer	pompe moulée
R -->	remote reservoir	enfernt liegender Vorratsbehälter	Separaat vloeistofreservoir (niet aan pomp)	réservoir d'alimentation séparé
RS-1x	pulley with 1 bolt	Riemenscheibe mit 1x Befestigungsschraube	Poelie met 1 bout gemonteerd aan flens	poulie à 1 boulon
RS-3x	pulley with 3 bolts	Riemenscheibe mit 3x Befestigungsschrauben	Poelie met 3 bouten gemonteerd aan flens	poulie à 3 boulons
RS-P	plastic pulley	Riemenscheibe aus Plastik	Kunststof poelie	poulie plastique
RS-S-Ø	diameter between centres of pulley mounting holes	Riemenscheibe mit Lochkreis	Diameter gatenpatroon van de poelie	diamètre inscrit des trous de fixation
SENSOR	with sensor	mit Sensor	Met sensor	avec sonde
SAGL	Saginaw	Saginaw	Saginaw	Saginaw
SLS	level control system	Niveauregulierung	Niveauregeling	contrôle du niveau
SSP	speed sensitive steering	geschwindigkeitsabhängige Lenkung	Snelheid afhankelijke stuurbekrachting	direction à assistance variable
TANDEM PUMP	tandem pump	Tandempumpe	Tandempomp	pompe tandem
CARB	carburettor	Vergaser	Carburateur uitvoering	carburateur
A1	flush fitting	flacher Ausgang	Horizontale aansluiting drukleiding	sortie affleurante
A2	raised fitting	angehobener Ausgang	Aansluiting drukleiding naar boven wijzend	sortie surélevée
A3	pump located on gearbox housing	am Getriebegehäuse montiert	Pomp aan versnellingsbakhuis gemonteerd	pompe sur carter de boîte de vitesses
A4	pump located on engine block	am Motorblock montiert	Pomp aan motor gemonteerd	pompe sur le bloc moteur
A5	water pump drive	Antrieb für Wasserpumpe	Met aandrijving voor waterpomp	entraînement pompe à eau
A6	threaded mounting holes	Befestigungslöcher mit Gewinde	Bevestigingsgaten met schroefdraad	trous de fixation taraudés
A7	plain mounting holes	Befestigungslöcher ohne Gewinde	Bevestigingsgaten zonder schroefdraad	trous lisses
A8	clamp type mounting	geklammerte Befestigung	Bevestiging middels slangklem	montage par clips
A9	bolt on inlet pipe	Hohlschraube am Eingang	Holle bout aan aanvoerbuis	écrou sur le tuyau d'admission
A10	with bearing on shaft	Kugellager an der welle	Met kogellager aan as	avec roulement sur l'arbre
A11	with copper sleeve on shaft	Kupferhülse an der welle	Met koperen huls aan as	avec coussinet en cuivre sur l'arbre
A12	with keyway	mit Keilnut	Met spiebaan	avec clavetage
A13	53mm hose OE 129974682 needed if replacing Vickers pump	OE 1299974682 bei Ersatz der Vickers Pumpe (Schlauch 53mm)	53 mm slang (OE 1299974682) benodigd bij vervanging Vickers pomp	utiliser le tuyau OE 129974682 de 53mm si remplacement de la pompe Vickers
A14	76mm hose OE 129975182 needed if replacing Vickers pump	OE 1299975182 bei Ersatz der Vickers Pumpe (schlauch 76mm)	76 Mm slang (OE 1299975182) benodigd bij vervanging Vickers pomp	utiliser le tuyau OE 129975182 de 76mm si remplacement de la pompe Vickers
A15	return hose OE 1094953 & pressure hose OE 1096737 may be required	Rücklauf OE 1094953 - Druckleitung OE 1096737 erforderlich	Retourleiding OE 1094953 & drukleiding OE 1096737 benodigd	le tuyau de sortie OE 1094953 et le tuyau d'admission OE 1096737 doivent être remplacés
A16	return hose OE 6752008 & pressure hose OE 6750157 may be required	Rücklauf OE 6752008 - Druckleitung OE 6750157 erforderlich	Retourleiding OE 6752008 & drukleiding OE 6750157 benodigd	le tuyau de sortie OE 6752008 et le tuyau d'admission OE 6750157 doivent être remplacés
A17	tin case enclosed pump	Pumpe von Gehäuse umschlossen	Pomp en reservoir in zinken huis gemonteerd (Chrysler)	pompe enfermée dans un carter

GB**Surcharge Refund**

Units with broken components or excessive wear cannot be remanufactured. Please note that old unit power steering pumps returned for credit with any of the faults will not be passed for credit. Credit will not be passed for obsolete, damaged or scrapyard reclaimed units.

D**Pfandwertvergütung**

Hydraulik-Pumpen, die bei der Altteilerückgabe einen oder mehrere der genannten Fehler aufweisen, können nicht gutgeschrieben werden. Ebenso können wir keine Gutschrift erteilen für offensichtlich vom Schrottplatz zugekaufte Aggregate, die beschädigt, verrostet oder überliefert sind.

NL**Statiegeld Creditering**

Gaarne aandacht voor het retourneren van de oude stuurbekrachtigspomp. Indien één van onderstaande defecten van toepassing zijn, dan komt deze pomp niet in aanmerking voor statiegeld. Ook wordt er geen statiegeld gecrediteerd voor verouderde, beschadigde of sloop pompen.

F**Remboursement Carcasses**

Les pompes présentant un ou plusieurs défauts détaillés ci-contre ne peuvent être reprises. Les pièces ayant été visiblement achetées et endommagées, rouillées ou livrées en surplus, ne seront pas non plus créditées.

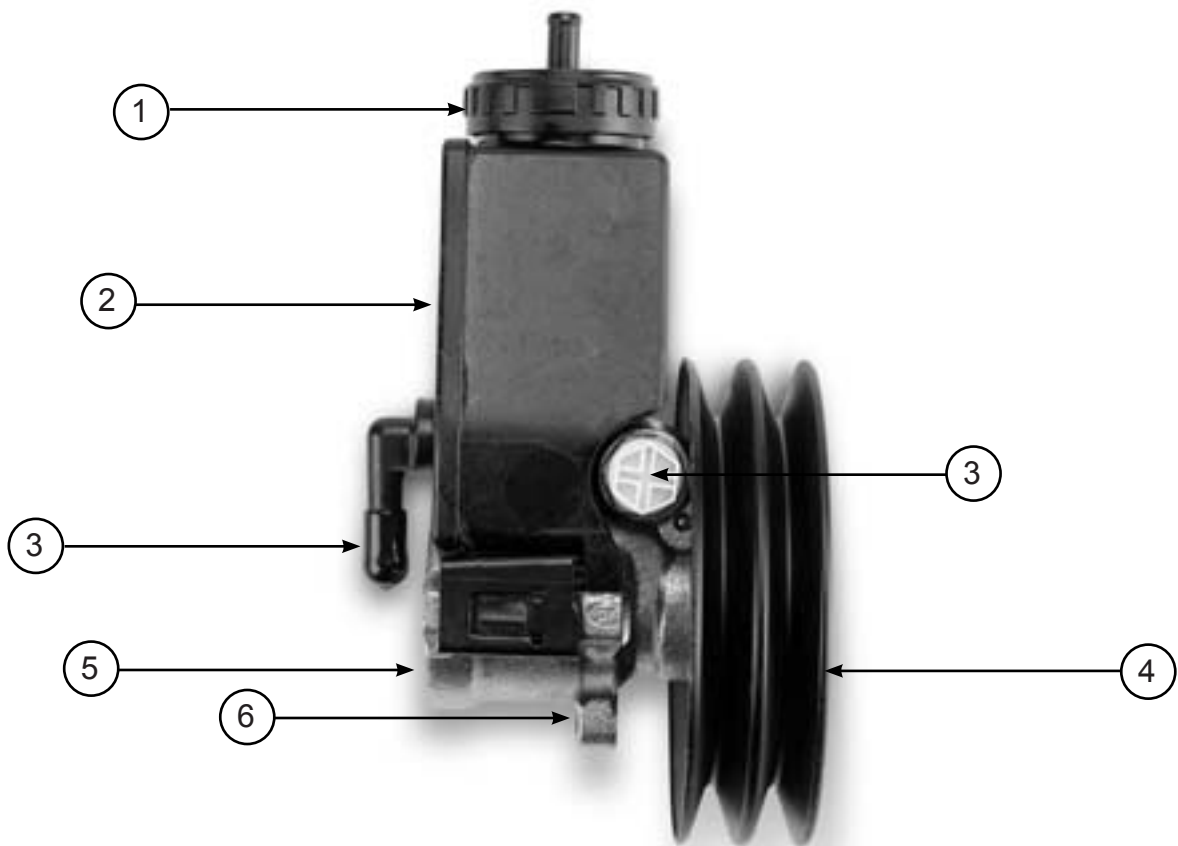

1 Damaged or missing cap (where fitted)

2 Damaged reservoir

3 Damage to inlet or outlet pipe

4 Missing, bent or damaged pully / flange

5 Broken castings

6 Broken lugs

1 Fehlender oder beschädigter Deckel

2 Beschädigter Flüssigkeitsbehälter

3 Beschädigung an der Eingangs- oder Ausgangsleitung

4 Verbogene oder fehlende Riemenscheibe / Flansch

5 Gebrochenes Gehäuse

6 Gebrochene Befestigungsbohrungen

1 Ontbrekende of beschadigde dop

2 Beschadigde reservoir

3 Schade aan invoer of uitvoer leiding

4 Ontbrekende, verbogen of beschadigde poelie / flens

5 Beschadigde behuizing

6 Beschadigde of afgebroken steunen

1 Bouchon endommagé ou manquant

2 Réservoir endommagé

3 Raccords d'entrée ou sortie endommagés

4 Poulie endommagée voilée ou manquante

5 Bâti cassé

6 Fixations cassées

Defective Steering System - Now What?

Checklist for Workshops

Always observe the manufacturer's instructions in all work!

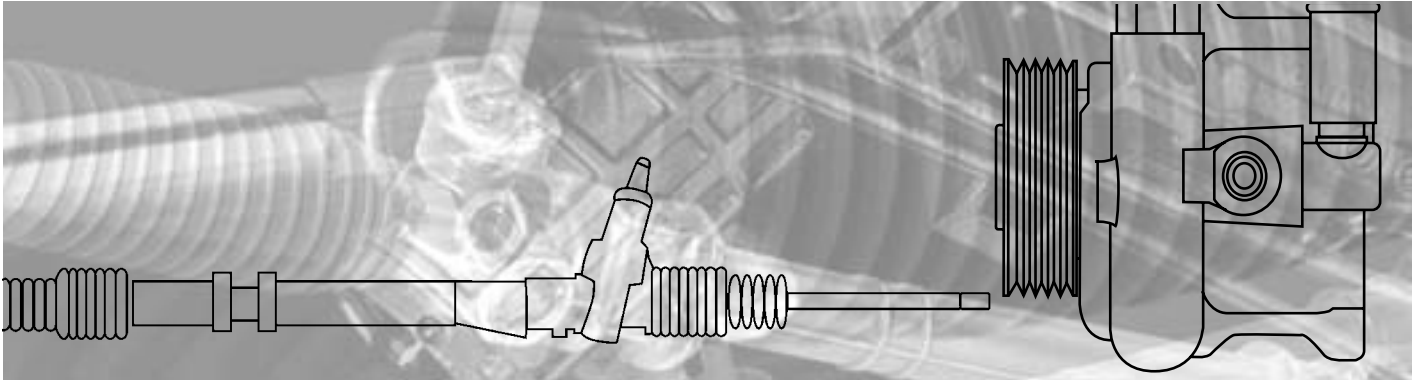

- | | |
|---|---|
| 1. Visual inspection for tightness (leaks) and damage: | ✓ |
| 1.1 Lines | ● |
| 1.2 High-pressure pump and drive belt | ● |
| 1.3 Steering rack | ● |
| 1.4 Steering system add-ons (tyres, axle suspension, supporting joints, etc.) | ● |
| 2. Check of the steering system: | ✓ |
| 2.1 Hydraulic fluid level OK and at operating temperature (50 °C - 80 °C) | ● |
| 2.2 Check oil-pressure switch of steering system | ● |
| 2.3 Check steering-wheel torque | ● |
| 2.4 Check system pressures (maximum pressure, system pressure, etc.) | ● |
| 3. Replacement of the steering rack: | ✓ |
| 3.1 Drain hydraulic fluid and dispose of correctly | ● |
| 3.2 Dismantle steering rack according to manufacturer's instructions | ● |
| 3.3 Flush remaining steering system with correct, fresh hydraulic fluid | ● |
| 3.4 Compare new steering rack with old one (switch tie rods, if necessary) | ● |
| 3.5 Install new steering rack according to manufacturer's instructions | ● |
| 3.6 Fill steering system with prescribed hydraulic fluid and bleed | ● |
| 4. Replacement of the power-steering pump: | ✓ |
| 4.1 Drain hydraulic fluid and dispose of correctly | ● |
| 4.2 Release and remove drive belt | ● |
| 4.3 Remove power-steering pump according to manufacturer's instructions | ● |
| 4.4 Flush remaining steering system with prescribed, fresh hydraulic fluid | ● |
| 4.5 Compare new power-steering pump with old one | ● |
| 4.6 Install power-steering pump according to manufacturer's instructions | ● |
| 4.7 If necessary, install and tension new drive belt | ● |
| 4.8 Fill steering system with prescribed, fresh hydraulic fluid and bleed | ● |
| 5. Test drive and repeat visual inspection for tightness (leaks) | ✓ |



Finding	Cause	Remedy
Hissing/humming	Noises occur in all hydraulic steering systems. They are most clearly perceptible at low speeds and in the steering stop position. The intensity of the noise is not related to the output of the power-steering pump. Do not replace the pump or the steering rack unless the noises are unmistakable. A replaced power-steering pump or steering rack generates a slight humming noise.	
Poor self-alignment of steering wheel	Steering column drags	Align steering column
	Steering linkage or wheel suspension stiff (supporting joint, suspension strut bearing)	Replace
	Steering rack stiff	Set play according to manufacturer's instructions
	Steering column not aligned with steering rack	Align steering column
	Steering-column joint stiff	Adjust or replace
	Too little air pressure in tyres	Correct tyre pressure according to manufacturer's instructions
	Front wheels set incorrectly	Check steering geometry and adjust, if necessary
Jerky movement when turning steering wheel	Too little fluid in steering system	Correct as necessary
	Drive belt of power-steering pump loose	Tighten drive belt according to manufacturer's instructions
	Sticky control valve in steering box	Check condition of hydraulic fluid for contamination / wear
	Engine idling speed too low	Correct engine idling speed
	Low pump pressure	Check pump pressure
	Steering linkage movement restricted	Check steering angle
	Wrong direction of flow - connecting lines switched	Assign connections correctly
Vehicle pulls to one side	Incorrect wheel alignment	Check/adjust steering geometry
	Steering control valve broken	Replace steering rack
	Broken steering linkage or defective wheel bearing	Replace defective parts
Increase in steering effort when turning wheel fast	Pump drive loose or drive belt slipping	Check drive; secure; replace, if necessary
	Internal leak in pump	Check pump pressure; replace pump, if necessary
	Too little fluid in steering system	Correct as necessary
Excessive self-alignment of steering wheel; loose steering	Steering linkage or wheel bearings worn or damaged	Replacement necessary
	Steering rack loose	Secure steering rack according to manufacturer's instructions
	Insufficient play of rack in steering rack	Check; set according to manufacturer's instructions, if necessary
	Loose steering-column joint	Secure steering column according to manufacturer's instructions
	Foamy steering fluid	Check hydraulic connections
Fluid deficiency in power-steering pump reservoir	Leaks in steering system	Eliminate leaks; correct fluid level and bleed system
Insufficient fluid pressure of power-steering pump	Leak in hydraulic system; pressure control valve sticks	Check complete system for leaks and seal; then correct fluid level and bleed system; check power-steering pump and replace, if necessary
Steering stiff	Low pump output	Check pump pressure
	Constriction in system	Eliminate constriction (e.g. swollen hoses)
	Drive belt of power-steering pump loose	Tension drive belt according to manufacturer's instructions
	Too little fluid in reservoir	Check for leaks; top up, if necessary
	Sticky/congested control valve in steering box	Check condition of hydraulic fluid for contamination / wear (flush system)
	Too little air pressure in tyres	Correct tyre pressure according to manufacturer's instructions
	Insufficient lubrication	Lubricate moving wheel control parts
	Steering column stiff	Replace worn components and align/adjust
	Steering rack stiff	Secure steering column according to manufacturer's instructions
	The recirculating-ball thread on the steering screw or in the piston has play. The steering screw has axial play.	Replace steering rack
Loud noises	Steering column or its connections loose	Check; secure or, if necessary, replace
Groan	Too little fluid in steering system	Check for leaks; top up, if necessary
	Foamy steering fluid	Check hydraulic connections
Droning/growling	Constriction in gear rack or lines	Eliminate constriction
	Blades, rollers and/or rotor of power-steering pump damaged	Replace pump
	Pump drive shaft bearings worn	Replace pump
	Insufficient fluid, resulting in entrainment of air in high-pressure fluid pump	Look for leaks in hydraulic system. To do so, turn steering to left and right-hand position to obtain max. pressure. Clean all parts beforehand. Eliminate leak and correct fluid level. Bleed system.
Howling	Pump drive shaft bearings worn	Replace pump
Squeaking/twittering	Loose or worn drive belt	Tension or replace drive belt
Whistling/rustling	Control valve defective	Replace pump
Rattling/grating	High-pressure lines of steering system touch other parts of vehicle or are loose in their mounts	Secure; lock, if necessary
	Belt pulley of power-steering pump loose on drive shaft	Check pulley and shaft for wear; if necessary, replace and secure
	Blades or rollers sticking in rotor	Flush system
	Pump or steering rack loose	Secure pump or steering rack according to manufacturer's instructions
	Steering linkage loose	Replace, if necessary
	Insufficient rack play in steering rack	Check; if necessary, adjust according to manufacturer's instructions

Defektes Lenksystem - Was nun?

Checkliste für die Werkstatt

Beachten Sie bei allen Arbeiten grundsätzlich die Herstellerangaben!

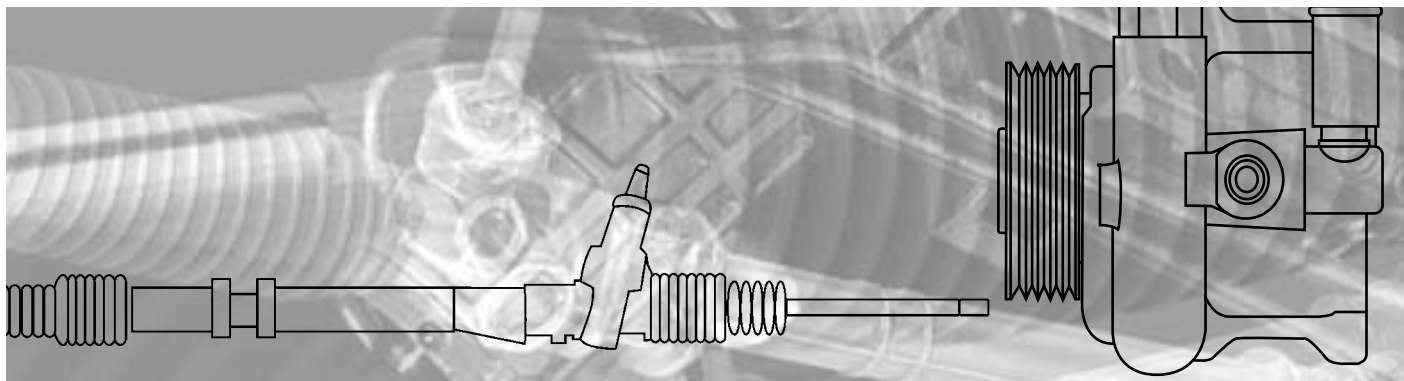

1. Optische Sichtprüfung auf Dichtheit (Leckagen) und Beschädigungen: ✓

- | | | |
|-----|---|---|
| 1.1 | Leitungen | ● |
| 1.2 | Hochdruckpumpe mit Antriebsriemen | ● |
| 1.3 | Lenkgetriebe | ● |
| 1.4 | Lenkungsanbauteile (Reifen, Achsaufhängung, Traggelenke etc.) | ● |

2. Überprüfen des Lenksystems: ✓

- | | | |
|-----|---|---|
| 2.1 | Hydrauliköl-Füllstand i. O. und auf Betriebstemperatur (50° - 80°C) | ● |
| 2.2 | Öldruckschalter des Lenksystems überprüfen | ● |
| 2.3 | Lenkraddrehmoment überprüfen | ● |
| 2.4 | Systemdruckprüfungen durchführen (Höchstdruck, Systemdruck etc.) | ● |

3. Auswechseln des Lenkgetriebes: ✓

- | | | |
|-----|--|---|
| 3.1 | Hydrauliköl ablassen und fachgerecht entsorgen | ● |
| 3.2 | Lenkgetriebe nach Herstellerangaben ausbauen | ● |
| 3.3 | Restliches Lenksystem mit neuer und richtiger Hydraulikflüssigkeit durchspülen | ● |
| 3.4 | Neues Lenkgetriebe mit altem vergleichen (falls nötig, Spurstangen umbauen) | ● |
| 3.5 | Neues Lenkgetriebe einsetzen (nach Herstellerangaben) | ● |
| 3.6 | Lenksystem mit vorgeschriebener Hydraulikflüssigkeit befüllen und entlüften | ● |

4. Auswechseln der Lenkhilfpumpe: ✓

- | | | |
|-----|--|---|
| 4.1 | Hydrauliköl ablassen und fachgerecht entsorgen | ● |
| 4.2 | Antriebsriemen lösen und entfernen | ● |
| 4.3 | Lenkhilfpumpe nach Herstellerangaben entfernen | ● |
| 4.4 | Restliches Lenksystem mit neuer vorgeschriebener Hydraulikflüssigkeit spülen | ● |
| 4.5 | Neue und alte Lenkhilfpumpe vergleichen | ● |
| 4.6 | Lenkhilfpumpe nach Herstellerangaben einbauen | ● |
| 4.7 | Bei Bedarf neuen Antriebsriemen montieren und spannen | ● |
| 4.8 | Lenksystem mit neuem vorgeschriebenem Hydrauliköl befüllen und entlüften | ● |

5. Probefahrt und nochmalige Sichtkontrolle auf Dichtheit (Leckagen) ✓



Feststellung	Ursache	Abhilfe
Zischen/surren	In allen hydraulischen Lenksystemen treten Geräusche auf. Bei geringer Geschwindigkeit und bei der Position Lenkansschlag sind diese am deutlichsten wahrnehmbar. Die Stärke des Geräusches steht nicht im Verhältnis mit der Leistung der Lenkhilfpumpe. Pumpe oder Lenkgetriebe nicht ersetzen, es sei denn die Geräusche sind eindeutig. Eine ersetzte Lenkhilfpumpe bzw. ein ersetztes Lenkgetriebe haben leicht surrende Geräusche.	
schwache Rückstellung am Lenkrad	Lenksäule schleift	Lenksäule ausrichten
	Lenkgestänge oder Radaufhängung schwergängig (Traggelenk, Domlager)	ersetzen
	Lenkgetriebe schwergängig	Lenkspiel nach Herstellerangaben einstellen
	Lenksäule nicht zum Lenkgetriebe ausgerichtet	Lenksäule ausrichten
	Lenksäulengelenk schwergängig	einstellen oder ersetzen
	Luftdruck in den Reifen zu gering	Reifendruck nach Herstellerangaben korrigieren
ruckartige Bewegung bei Drehung am Lenkrad	Einstellung der Vorderräder nicht korrekt	Radstellungsgrößen überprüfen ggf. einstellen
	zu geringe Flüssigkeitsmenge im Lenksystem	nach Bedarf korrigieren
	Antriebsriemen der Lenkhilfpumpe lose	Antriebsriemen nach Herstellerangaben spannen
	verklebtes Steuerventil im Lenksteuergehäuse	Kontrolle des Zustandes der Hydraulikflüssigkeit auf Verunreinigung / Verschleiß
	Leerlaufdrehzahl des Motors zu niedrig	Leerlaufdrehzahl des Motors korrigieren
	geringer Pumpendruck	Kontrolle des Pumpendruckes
Fahrzeug zieht einseitig	Bewegung des Lenkgestänges eingeschränkt	Kontrolle des Einschlagwinkels
	falsche Durchflußrichtung - vertauschte Anschlußleitungen	Zuordnung der Anschlüsse richtig stellen
	Spureinstellung nicht korrekt	Radstellungsgrößen überprüfen / einstellen
	Lenksteuerventil gebrochen	Lenkgetriebe ersetzen
	gebrochenes Lenkgestänge oder defektes Radlager	defekte Teile ersetzen
	Pumpenantrieb lose oder Antriebsriemen rutscht durch	Antrieb überprüfen; befestigen; ggf. ersetzen
Anstieg der Lenkkräfte bei schneller Lenkraddrehung	interne Undichtigkeit in der Pumpe	Überprüfung des Pumpendruckes; ggf. ersetzen
	zu geringe Flüssigkeitsmenge im Lenksystem	nach Bedarf korrigieren
	verschlissene bzw. beschädigte Lenkgestänge oder Radlager	Austausch notwendig
übermäßige Rückstellung des Lenkrads; lose Lenkung	Lenkgetriebe lose	Lenkgetriebe nach Herstellerangaben befestigen
	unzureichendes Spiel der Zahnstange im Lenkgetriebe	überprüfen; ggf. nach Herstellerangaben einstellen
	loses Lenksäulengelenk	Lenksäule nach Herstellerangaben befestigen
	aufgeschäumtes Lenköl	hydraulische Anschlüsse überprüfen
Ölmangel im Vorratsbehälter der Lenkhilfpumpe	Leckagen im Lenksystem	Leckagen beseitigen; Ölstand korrigieren und System entlüften
Öldruck der Lenkhilfpumpe zu gering	Hydraulische Anlage undicht; Druckregelventil bleibt hängen	Komplette Anlage auf Dichtigkeit überprüfen und abdichten, danach Ölstand korrigieren und Anlage entlüften; Lenkhilfpumpe überprüfen und bei Bedarf auswechseln
schwergängige Lenkung	geringe Pumpenleistung	Pumpendruck überprüfen
	Verengung im System	Verengung beseitigen (z.B. aufgequollenen Schläuche)
	Antriebsriemen der Lenkhilfpumpe lose	Antriebsriemen nach Herstellerangaben spannen
	Flüssigkeitsmenge im Vorratsbehälter zu gering	Überprüfen auf Leckagen; bei Bedarf nachfüllen
	verklebtes / verstopftes Steuerventil im Lenksteuergehäuse	Kontrolle des Zustandes der Hydraulikflüssigkeit auf Verunreinigung / Verschleiß (System spülen)
	Luftdruck in den Reifen zu gering	Reifendruck nach Herstellerangaben korrigieren
	das Fehlen von Schmierung	Schmierungen der beweglichen Teile der Radführung
	Lenksäule schwergängig	Austausch der verschlissenen Bauteile und ausrichten / einstellen
	Lenkgetriebe schwergängig	Lenksäule nach Herstellerangaben befestigen
	Das Kugelumlaufgewinde auf der Lenkschraube bzw. im Kolben hat Spiel. Die Lenkschraube hat Axialspiel	Lenkgetriebe ersetzen
starke Geräusche	Lenksäule lose bzw. deren Verbindungen	überprüfen; befestigen oder ggf. ersetzen
knarzen	zu geringe Flüssigkeitsmenge im Lenksystem	überprüfen auf Leckagen; bei Bedarf nachfüllen
	aufgeschäumtes Lenköl	hydraulische Anschlüsse überprüfen
brummen/knurren	Verengung im Lenkgetriebe bzw. in den Leitungen	Verengung beseitigen
	Flügel, Rollen und/oder Rotor der Lenkhilfpumpe beschädigt	Pumpe ersetzen
	Lagerung der Antriebswelle der Pumpe verschlissen	Pumpe ersetzen
	Ölmangel und dadurch Mitansaugen von Luft in der Hochdruck-Ölpumpe	Leckstellen in der Hydraulikanlage suchen. Dazu Lenkung in Links- und Rechtslage drehen, damit max. Druck erreicht wird. Alle Teile vorher reinigen. Leckstelle beseitigen und Ölstand korrigieren; System entlüften.
jaulen	Lagerung der Antriebswelle der Pumpe beschädigt	Pumpe ersetzen
quietschen / zwitschern	loser oder verschlissener Antriebsriemen	Antriebsriemen spannen bzw. ersetzen
sausen/rascheln	Regelventil defekt	Pumpe ersetzen
klappern / knarren	Hochdruckleitungen des Lenksystems berühren andere Teile des Fahrzeugs bzw. sind in ihren Halterungen gelöst	befestigen, ggf. sichern
	Riemenscheibe der Lenkhilfpumpe auf der Antriebswelle gelöst	Riemenscheibe und Welle auf Verschleiß prüfen, ggf. ersetzen und befestigen
	Flügel bzw. Rollen sind im Rotor verklebt	System spülen
	Pumpe oder Lenkgetriebe gelöst	Pumpe oder Lenkgetriebe nach Herstellerangaben befestigen
	Lenkgestänge gelöst	wenn notwendig ersetzen
	unzureichendes Spiel der Zahnstange im Lenkgetriebe	prüfen, ggf. nach Herstellerangaben einstellen

Defecte stuurinrichting – Wat Nu?

Checklist voor de garage

Raadpleeg bij alle werkzaamheden de voorschriften van de afabrikant nauwkeurig.

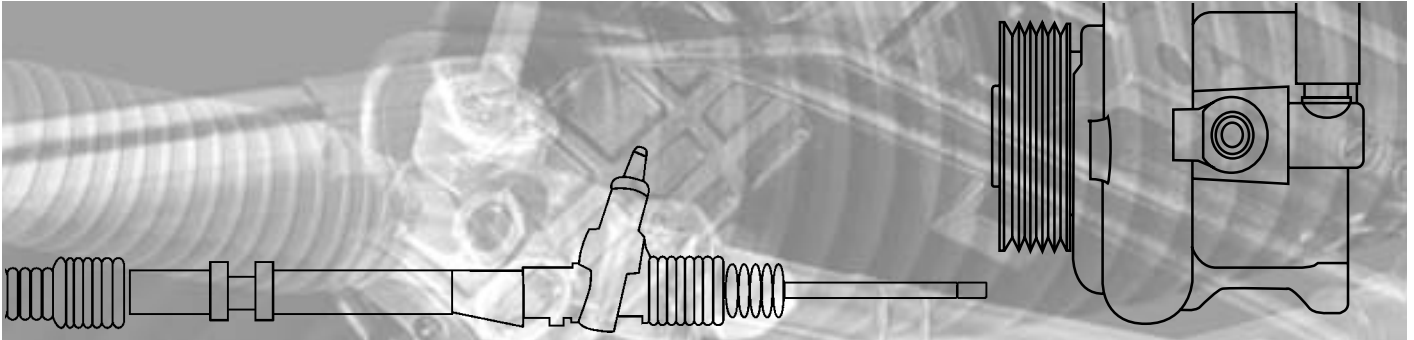

- | | |
|--|-------------------------------------|
| 1. Raadpleeg bij alle werkzaamheden de voorschriften van de afabrikant nauwkeurig: | <input checked="" type="checkbox"/> |
| 1.1 Leidingen | <input type="checkbox"/> |
| 1.2 Hogedrukpomp met aandrijfriem | <input type="checkbox"/> |
| 1.3 Stuurhuis | <input type="checkbox"/> |
| 1.4 Stuursysteem aanbouwdelen (Banden, wielophanging, Fuseekogels, etc.) | <input type="checkbox"/> |
| 2. Controle van de stuurinrichting: | <input checked="" type="checkbox"/> |
| 2.1 Niveau hydraulische vloeistof en bedrijfstemperatuur OK (50 - 80 Celcius) | <input type="checkbox"/> |
| 2.2 Oliedrukschakelaar van de stuurinrichting controleren (Drukregelaar) | <input type="checkbox"/> |
| 2.3 Draaimoment stuurwiel controleren (zwaar draaien) | <input type="checkbox"/> |
| 2.4 Systeemdruk controleren (maximale druk, systeemdruk) | <input type="checkbox"/> |
| 3. Het vervangen van het stuurhuis: | <input checked="" type="checkbox"/> |
| 3.1 Hydraulische olie verwijderen en correct afvoeren | <input type="checkbox"/> |
| 3.2 Stuurhuis volgens instructies van de fabrikant uitbouwen | <input type="checkbox"/> |
| 3.3 Het niet te vervangen gedeelte van het stuursysteem doorspoelen met nieuwe (door de fabrikant) voorgeschreven hydraulische vloeistof | <input type="checkbox"/> |
| 3.4 Het nieuwe stuurhuis met de oude vergelijken (indien nodig spoorstangen overzetten) | <input type="checkbox"/> |
| 3.5 Stuurhuis inbouwen volgens instructies van de fabrikant | <input type="checkbox"/> |
| 3.6 Stuursysteem met nieuwe (door de fabrikant) voorgeschreven hydraulische vloeistof vullen en ontluchten | <input type="checkbox"/> |
| 4. Het vervangen van de stuurpomp: | <input checked="" type="checkbox"/> |
| 4.1 Hydraulische olie verwijderen en correct afvoeren | <input type="checkbox"/> |
| 4.2 Aandrijfriem(en) ontspannen en verwijderen | <input type="checkbox"/> |
| 4.3 Stuurpomp volgens instructies van de fabrikant uitbouwen | <input type="checkbox"/> |
| 4.4 Het niet te vervangen gedeelte van het stuursysteem doorspoelen met nieuwe (door de fabrikant) voorgeschreven hydraulische vloeistof | <input type="checkbox"/> |
| 4.5 De nieuwe stuurpomp met de oude vergelijken | <input type="checkbox"/> |
| 4.6 Stuurpomp inbouwen volgens instructies van de fabrikant | <input type="checkbox"/> |
| 4.7 Indien nodig, aandrijfriem vervangen en spannen volgens instructies van de fabrikant | <input type="checkbox"/> |
| 4.8 Stuursysteem met nieuwe (door de fabrikant) voorgeschreven hydraulische vloeistof vullen en ontluchten | <input type="checkbox"/> |
| 5. Proefrit maken en herhaalde visuele controle uitvoeren op dichtheid. (lekkages) | <input checked="" type="checkbox"/> |



Gevonden klacht	Oorzaak	Mogelijke oplossing
Sissen / zoemen	In alle hydraulische stuursystemen treden bijgeluiden op. Bij geringe snelheid en het stuur volledig in linker of rechter positie (voll-edige stuuruitslag) zijn deze het duidelijkst waarneembaar. De sterkte van het geluid staat niet in verhouding met het gevraagde vermogen van de stuurpomp. De stuurpomp en/of stuurhuis niet vervangen tenzij het zeker is dat het geluid veroorzaakt wordt door een defect! Een stuurhuis of stuurpomp dat vervangen is zal een licht zoemend geluid maken.	
Stuurwiel komt niet, of slecht terug in neutrale stand	Stuurkolom loop aan Fuseekogels en/of stuurstangen of veerpotlagers van de wielophan-ging lopen zwaar Stuurhuis loopt zwaar Stuurkolom niet in lijn met aansluiting op het stuurhuis Stuurkoppeling van de stuurkolom gaat zwaar Bandenspanning onjuist (te laag) Slechte uitlijning Camber, Caster	Stuurkolom uitlijnen Vervangen Speling volgens gegevens van de fabrikant afstellen Lijn stuurkolom uit Afstellen, of indien nodig; vervangen Bandenspanning wijzigen (vlgs. voorschriften fabrikant) Uitlijnen
Stotterend (niet vloeiend) gevoel bij het bewegen van het stuur	Te weinig stuurbekrachtigings vloeistof in het systeem (niveau te laag) Aandrijfriem spanning pomp te laag Vastzittende plunjer van de systeemdrukregelaar Stationair toerental motor te laag Pompdruk te laag Stuuruitslag onvoldoende Doorstroomrichting verkeerd (leidingen verkeerd aangesloten)	Vloeistof niveau op peil brengen Aandrijfriem spannen volgens gegevens van de fabrikant Hydraulische vloeistof controleren op verontreiniging Stationair toerental aanpassen Pompdruk controleren Stuuruitslag hoek controleren en afstellen (aanslag) Leidingen correct aansluiten
Voertuig trek naar een kant	Voertuig niet correct uitgelijnd Afsluitklep in stuurhuis gebroken Gebroken stuurstang of defect wiellager	Uitlijning controleren / afstellen Stuurhuis vervangen Defecte delen vervangen
Verhoogde weerstand (bekrachtiging verdwijnt) bij snelle beweging aan het stuur	Aandrijfriem pomp slipt door Pomp lekt intern Te weinig stuurbekrachtigings vloeistof in het systeem	Pompaandrijving en controleren / bevestiging / Indien nodig; vervangen Pompdruk controleren; pomp vervangen indien nodig Vloeistof niveau op peil brengen
Stuur komt te snel terug in middenstand; te veel speling	Versleten en/of beschadigde stuurstangen of wiellager(s) Stuurhuis bevestiging losgelopen Ontoelaatbare speling in het stuurhuis Stuurkolom zit los Hydraulische vloeistof schuimt (niveau ok)	Versleten onderdelen vervangen Stuurhuis vastzetten volgens gegevens van de fabrikant Controleren, afstellen volgens gegevens fabrikant. Indien nodig; vervangen Stuurkolom vastzetten volgens gegevens van de fabrikant Aansluitingen controleren
Niveau stuurbekrachtigings vloeistof in reservoir te laag	Lekkage in systeem	Lekkage opsporen en opheffen; vloeistofniveau controleren en systeem ontluchten
Te weinig opbrengst (druk) stuurpomp	Hydraulisch systeem ondicht; drukregelklep pomp blijft hangen	Komplete systeem controleren op lekkage(s) eventuele lekkages opheffen en systeem ontluchten.
Stuur draait (te) zwaar	Opbrengst stuurpomp te weinig (pompdruk te laag) Blokkeage / vernauwing in het systeem Aandrijfriemspanning pomp te laag Te weinig stuurbekrachtigings vloeistof in het systeem (niveau te laag) Afluitklep in stuurhuis opent niet (verkleeft, verstopt) Bandenspanning te laag Smearing ontbreekt Stuurkolom loop aan / loopt zwaar Stuurhuis loopt zwaar Axiale speling in het stuurhuis. (kogelkringloop)	Opbrengst (druk) stuurpomp controleren, indien nodig; vervangen Vernauwing (en) opheffen. (bijv. gezwollen slang) Aandrijfriem spannen volgens gegevens van de fabrikant Systeem op lekkage(s) controleren vloeistof niveau op peil brengen Stuurbekrachtigings vloeistof controleren op verontreiniging (vervuiling) en indien nodig; doorspoelen. Oorzaak vervuiling achterhalen (bijv. slijtage) Bandenspanning corrigeren. (vlgs.gegevens fabrikant) Bewegende delen van de wielophanging (stuurinrichting) controleren en smeren Speling volgens gegevens van de fabrikant afstellen; Stuurkolom volgens gegevens fabrikant bevestigen Stuurhuis vervangen
Sterke / harde geluiden(maakt veel lawaai)	Stuurkolom of bevestiging daarvan zit los	Controleren; vastzetten of indien nodig vervangen
Knarsen	Te weinig stuurbekrachtigings vloeistof in het systeem (niveau te laag) Stuurbekrachtigings vloeistof schuimt	Systeem op lekkage(s) controleren vloeistof niveau op peil brengen Aansluitingen controleren
Zoemen / brommen	Blokkeage / vernauwing in stuurhuis en/of in de leidingen Pomp inwendig versleten, of beschadigd Lager van de aandrijfas van de stuurpomp (waar poelie aan gemonteerd is) versleten Tekort aan stuurbekrachtigings vloeistof. Stuurpomp zuigt lucht aan!	Vernauwing (en) opheffen. (bijv. gezwollen slang) Pomp vervangen Pomp vervangen Lekkage in het hydraulische systeem opsporen. Beweeg het stuur langzaam naar uiterst links en dan helemaal naar (uiterst) rechts.
Janken	Lager van de aandrijfas van de stuurpomp beschadigd	Pomp vervangen
Piepen / gillen	Losgelopen of versleten aandrijfriem (V snaar)	Riem spannen indien versleten; vervangen
Suizen	Drukregelklep defect	Pomp vervangen
Klapperen / bonken	(Hoge) drukleidingen raken elkaar en of ander delen van het voertuig, of zitten los in de behuizing Poelie van de stuurpomp is losgekomen van de as (bouten losgelopen) "Vleugels" van pomp rotor verkleeft (inwendige vervuiling) Stuurpomp of stuurhuis losgelopen (losgetrild) Stuurstang(en) los Ontoelaatbare speling in het stuurhuis	Op verantwoorde manier vastzetten en eventueel borgen Poelie en as op slijtage controleren en vastzetten, indien nodig; vervangen Systeem doorspoelen met voorgeschreven vloeistof Pomp en / of stuurhuis volgens voorschriften van de fabrikant vastzetten Vastzetten, indien nodig; vervangen Controleren, afstellen volgens gegevens fabrikant. Indien nodig; vervangen

Problèmes de direction assistée - que faire?

Liste des vérifications pour tous les garages.

Dans tous les cas, observer les recommandations du constructeur.

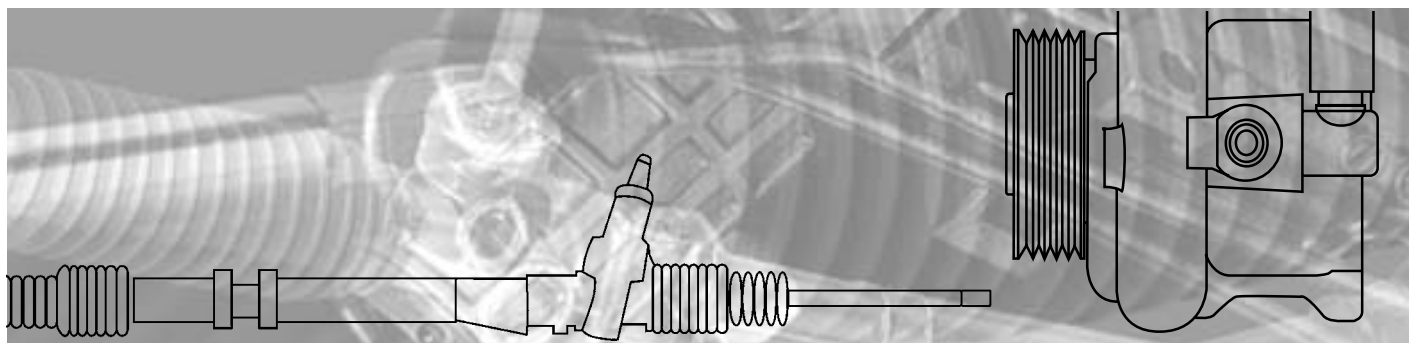

- | | |
|---|---|
| 1. Inspection visuelle pour l'étanchéité (fuites) et dommages: | ✓ |
| 1.1 Tubulures | ● |
| 1.2 Pompe haute pression et courroie | ● |
| 1.3 Crémaillère de direction | ● |
| 1.4 Eléments environnant au système de direction | ● |
| 2. Contrôle du système de direction: | ✓ |
| 2.1 Niveau du fluide hydraulique et température de fonctionnement (50°C-80°) | ● |
| 2.2 Vérifiez le commutateur de pression d'huile de la commande de direction | ● |
| 2.3 Vérifiez le couple direction-roue | ● |
| 2.4 Vérifiez les différentes pressions du système (pression maximum, pression de système, etc.....) | ● |
| 3. Remplacement de la crémaillère de direction: | ✓ |
| 3.1 Vidangez le fluide hydraulique et dépose | ● |
| 3.2 Dépose de la crémaillère en respect des recommandations constructeurs | ● |
| 3.3 Nettoyer la crémaillère avec un liquide propre et adéquat. | ● |
| 3.4 Comparez la nouvelle crémaillère à l'ancienne (démonter les rotules si nécessaire) | ● |
| 3.5 Repose de la nouvelle crémaillère selon les recommandations constructeurs | ● |
| 3.6 Remplissage avec le nouveau fluide hydraulique prescrit et purge | ● |
| 4. Remplacement de la pompe de direction assistée: | ✓ |
| 4.1 Vidangez le fluide hydraulique et dépose | ● |
| 4.2 Libérez et enlevez la courroie d'entraînement | ● |
| 4.3 Dépose de la pompe de direction en respect des recommandations constructeur | ● |
| 4.4 Nettoyer la pompe hydraulique avec un liquide propre et adéquat. | ● |
| 4.5 Comparez la nouvelle pompe avec l'ancienne | ● |
| 4.6 Repose de la nouvelle pompe de direction selon les recommandations constructeurs | ● |
| 4.7 Si nécessaire remplacer, et tendre la courrie | ● |
| 4.8 Remplissage avec le nouveau fluide hydraulique prescrit et purge | ● |
| 5. Testez la direction et répétez l'inspection visuelle pour l'étanchéité (fuites) | ✓ |





Constatations	Causes	Actions
Sifflement, Ronflement	Des bruits se produisent dans toutes les commandes de direction hydrauliques. Ils sont le plus souvent perceptibles à basses vitesses et à l'arrêt. L'intensité du bruit n'est pas liée au rendement de la pompe de direction. Ne remplacez pas la pompe ou la crémaillère de direction à moins que les bruits soient indubitables. Une pompe ou une crémaillère de direction remplacée génèrent un léger bruit de ronflement.	
Le volant ne reprend pas sa position normale	Colonne de direction bruyante	Aligner la colonne de direction
	Tringlerie de direction ou suspension de roue raide (joint, rotule butée de suspension)	Remplacer
	Crémaillère dure	Remplacer suivant les instructions constructeurs
	Colonne de direction non alignée avec la crémaillère	Aligner la colonne de direction
	Joint de colonne de direction dur	Régler ou remplacer le joint
	Pression des pneus trop faible	Regonfler à la pression indiquée par le constructeur
Mouvement saccadé en braquage	Roues avant non parallèles	Contrôler la géométrie du train avant, régler si nécessaire
	Manque de fluide hydraulique dans le système de direction	Refaire le niveau
	Courroie de pompe de direction détendue ou arrachée	Retendre ou Changer et tendre la courroie si nécessaire
	Valve d'admission obstruée	Fluide hydraulique contaminé ou usagé
	Régime moteur trop bas	Régler le ralenti
	Pression de pompe de direction trop faible	Contrôler la pression
	Mouvement de tringlerie de direction limité	Contrôler les angles de braquage
Le véhicule tire d'un côté	Circulation inversée du fluide hydraulique	Rebrancher correctement les connexions
	Alignement des roues incorrect	Contrôler et régler le parallélisme
	Valve d'admission cassée	Valve d'admission cassée
Augmentation de l'effort au braquage	Tringlerie de direction cassée ou roulement de roue défectueux	Remplacer les pièces usagées
	Commande de pompe lâche ou glissement de courroie	Vérifiez la commande ; refixez ; remplacez la commande et la courroie au besoin
	Fuite interne dans la pompe	Contrôler la pression de la pompe, la remplacer si nécessaire
Désaxage important du volant; direction lâche	Manque de liquide dans le système hydraulique	Refaire le niveau
	Tringlerie ou portée de roulement de roue endommagés	Remplacer si nécessaire
	Crémaillère lâche	Refixer la crémaillère en fonction des instructions constructeurs
Manque de liquide dans le réservoir de pompe de direction	Jeu insuffisant au boîtier de direction	Contrôler et régler suivant données constructeurs
	Joint de colonne de direction défectueux	Refixer la colonne de direction suivant les données constructeurs
	Le fluide de direction mousse	Contrôler les connexions des raccords
	Fuite sur le système hydraulique	Contrôle complet des joints, connexions, etc....;refaire le niveau d'huile et purger; contôler la pompe de direction et remplacer si nécessaire
Pression insuffisante de la pompe de direction	Fuite sur le système hydraulique; Clapet de régulation de pression défectueux	Rechercher les fuites; refaire le niveau de liquide et purger; contrôler le débit de la pompe; remplacer la pompe si nécessaire
Direction dure	Rendement de la pompe trop faible	Contrôler la pression de la pompe
	Ecrasement des tubulures	Remplacer les tubulures
	Courroie de pompe de direction détendue ou arrachée	Retendre ou Changer et tendre la courroie si nécessaire
	Manque de liquide dans le réservoir	Contrôler les fuites, refaire le niveau
	Valve d'admission bloquée ou obstruée	Contrôler la qualité du liquide (usagé ou contaminé)
	Pression des pneus trop faible	Regonfler à la pression indiquée par le constructeur
	Lubrification insuffisante	Lubrifier les pièces de direction en mouvement
	Colonne de direction dure	Remplacer les composants usagés et régler
	Crémaillère dure	Remplacer suivant les instructions constructeurs
La crémaillère a du jeu	Remplacer la crémaillère	
Bruits	Colonne de direction lâche ou connexions adm.et sortie lâches	Contrôler, régler, remplacer si nécessaire
Crissements	Manque de fluide hydraulique dans le système de direction	Contrôler les fuites, refaire le niveau
	Le fluide de direction mousse	Contrôler les connexions des raccords
Bourdonnements, Grognements	Ecrasements dans la crémaillère ou des tubulures	Remplacer
	Les ailettes et/ou le rotor de la pompe de direction sont endommagées	Remplacer la pompe
	Roulements de pompe usagés	Remplacer la pompe
	Manque de fluide, ayant pour résultat l'entraînement d'air dans la pompe	Rechercher la fuite. Pour ce faire, tourner le volant de droite à gauche pour obtenir le maximum de pression. Nettoyer les pièces. Eliminer les fuites et refaire le niveau. Purger.
Bruits stridents	Roulements de pompe usagés	Remplacer la pompe
Grincements, Ronflements	Courroie de pompe de direction détendue ou usagée	Retendre ou Changer et tendre la courroie si nécessaire
Bourdonnements, Bruissements	Contrôler la valve défectueuse	Remplacer la pompe
Cliquetis, Claquemets	Les tubulures de la crémaillère touchent des éléments du véhicule ou sont mal fixées	Rebloquer si nécessaire
	Poulie de pompe desserrée	Contrôler la poulie et son axe. Remplacer si nécessaire
	Lames collées dans le rotor	Remplacer la pompe
	Tringlerie de direction lâche	Contrôler et remplacer si nécessaire
	Jeu insuffisant du boîtier de direction	Contrôler, régler suivant données constructeurs, remplacer si nécessaire





FAHRZEUGHERSTELLER / CAR MANUFACTURER

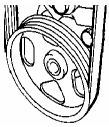

ALFA ROMEO	2 - 3	HYUNDAI	28	MAZDA	31 - 32	SAAB	65 - 66
AUDI	3 - 8	ISUZU	28	MERCEDES BENZ	32 - 48	SEAT	66 - 68
BMW	8 - 15	IVECO	28	MITSUBISHI	48	SKODA	68
CHRYSLER	15	JAGUAR	29	NISSAN	49 - 50	SSANGYONG	68 - 69
CITROËN	15 - 18	JEEP	29	OPEL	51 - 54	SUBARU	69
DAEWOO	18 - 19	KIA	29	PEUGEOT	54 - 57	SUZUKI	69
DAIHATSU	19	LANCIA	30	PORSCHE	58	TOYOTA	70 - 71
FIAT	19 - 22	LANDROVER	30	PROTON	58	VAUXHALL	71 - 75
FORD	22 - 26	LDV	30 - 31	RENAULT	58 - 62	VOLKSWAGEN	75 - 82
HONDA	27 - 28	LEXUS	31	ROVER	63 - 65	VOLVO	82 - 84



OE-No. - SPIDAN - COMPETITOR No.

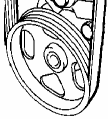

OE-No. - SPIDAN	85 - 91
COMPETITOR No - SPIDAN	92 - 103

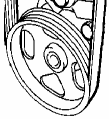

				OE	SPIDAN	 Ø mm	Ports	NOTICE
ALFA ROMEO								
33 (907)								
1.4		6/91 - 9/94		ZF	53871	114	Single S	
1.5		10/90 - 1/93		ZF	53871	114	Single S	
1.7		6/90 - 10/94		ZF	53871	114	Single S	
1.8 TD		7/90 - 9/94		ZF	53871	114	Single S	
75 (162B)								
2.0		9/87 - 1/93	T-Spark	ZF	53870	90	Single S	
2.5 V6		6/86 - 5/90		ZF	53869	93	Single S	
3.0 V6		9/87 - 1/93		ZF	53870	90	Single S	
90 (162)								
2.5 V6		2/84 - 10/87		ZF	53869	93	Single S	
145 (930)								
1.4 16V		12/96 - 1/01		ZF	53867	128	6 S	
1.6 8V		10/94 - 3/97		SAGI/ZF	53868		Single S	IN- ----
1.6 8V		10/94 - 3/97		SAGI.	54140		Single S	IN- 丏
1.6 16V		3/97 - 1/01	T-Spark	ZF	53867	128	6 S	
1.7 16V		10/94 - 3/97		SAGI/ZF	53868		Single S	IN- ----
1.7 16V		10/94 - 3/97		SAGI.	54140		Single S	IN- 丏
1.8 16V		3/97 - 1/01	T-Spark	ZF	53867	128	6 S	
2.0 16V		2/96 - 1/01	T-Spark	ZF	53867	128	6 S	
1.9 TDS		10/94 - 2/99		ZF/SAGI.	53682	130	6 S	
1.9 JTD		02/99 - 2000		ZF	53604	130	6 S	
146 (930)								
1.4 16V		11/96 - 1/01		ZF	53867	128	6 S	
1.6 8V		6/95 - 3/97		SAGI/ZF	53868		Single S	IN- ----
1.6 8V		6/95 - 3/97		SAGI.	54140		Single S	IN- 丏
1.6 16V		3/97 - 1/01	T-Spark	ZF	53867	128	6 S	
1.7 16V		6/95 - 9/96		SAGI/ZF	53868		Single S	IN- ----
1.7 16V		6/95 - 9/96		SAGI.	54140		Single S	IN- 丏
1.8 16V		3/97 - 1/01	T-Spark	ZF	53867	128	6 S	
2.0 16V TI		2/96 - 1/01	T-Spark	ZF	53867	128	6 S	
1.9 TDS		10/94 - 2/99		ZF/SAGI.	53682	130	6 S	
1.9 JTD		02/99 - 2000		ZF	53604	130	6 S	
155 (167)								
1.8 8V		7/92 - 5/96	T-Spark	ZF	53866	115	4 S	
1.8 16V		6/96 - 3/98	T-Spark	ZF	53867	128	6 S	

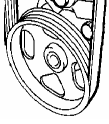

					OE	SPIDAN	 Ø mm	Ports	NOTICE
ALFA ROMEO									
155 (167)									
2.0 8V	7/92 - 6/95		T-Spark		ZF	53866	115	4	S
2.0 16V	6/95 - 3/98		T-Spark	* TURBO	ZF	53867	128		S
2.0 16V TURBO	10/92 - 9/94		4WD		ZF	54011		Single	S
2.5 V6	7/92 - 5/96				ZF	53865	120	4	S
156 (932)									
1.6 16V	7/00 -		T-Spark		ZF	54213			S
1.8 16V	5/98 -		T-Spark		ZF	53867	128	6	S
2.0 16V	5/98 -		T-Spark		ZF	53867	128		S
2.5 V6	5/98 -				ZF	53720	103	6	S
1.9 JTD	09/97 - 2002			OE:46533006		53604	130	6	S
2.4 JTD	6/99 -				SAGI.	54175		6	S
164 (164)									
2.0	7/90 - 5/93		T-Spark		ZF	53864	118	5	S
2.0	5/93 - 3/98		T-Spark		ZF	53866	115	4	S
3.0 12V	10/88 - 92			-->eng 1250	ZF	53864	118	5	S
3.0 12V	92 - 5/93			eng 1251-->	ZF	54012	99	4	S
3.0 24V	5/93 - 3/98				ZF	53891		7	S
166 (936)									
2.0 16V	1/99 -		T-Spark		ZF	53867	128		S
2.5 24V	1/99 -				ZF	53720	103	6	S
3.0 24V	1/99 -				ZF	53720	103	6	S
2.4 JTD	01/98 - 2002			OE:46533006		53604	130	6	S
GTV/SPIDER (916)									
2.0 16V	4/96 -				ZF	53867	128		S
2.0 16V	4/96 -				SAGI.	54140		Single	S
3.0 24V	1/98 -				ZF	53720	103	6	S
SPIDER (115)									
2.0 8V	8/90 - 4/93				ZF	53871	114	Single	S
AUDI									
80 (81/85/B2)									
1.6	10/83 - 6/86				ZF	53659	130	Single	S
1.8 Quattro	7/85 - 7/86				ZF	53659	130	Single	S
1.9	9/81 - 10/83		CD		ZF	53659	130	Single	S
2.0	10/83 - 5/84		CD		ZF	53659	130	Single	S
2.1 Quattro	3/83 - 7/85				ZF	53659	130	Single	S

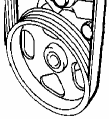

				OE	SPIDAN	 Ø mm	Ports	NOTICE
AUDI								
80 (89/89Q/8A/B3)								
1.8 8V		9/89 - 11/91		ZF	53586	130	Single S	
2.0 8V		9/89 - 11/91	INCL.QUATTRO	ZF	53586	117	Single S	
2.0/2.0 16V		10/90 - 11/91	QUATTRO	ZF	53881	130	S 2	
2.0/2.0 16V		10/90 - 11/91	QUATTRO	ZF	53882	117	S 3	
1.6 TD		12/88 - 11/91		ZF	53586	130	Single S	
80 (8C/B4)								
1.6 8V		9/93 - 6/95		ZF	53638	130	Single S	
1.6 8V		9/93 - 6/95		ZF	53546	117	5 S	
2.0 8V		11/91 - 6/95		ZF	53638	130	Single S	
2.0 8V		11/91 - 6/95		ZF	53546	117	5 S	
2.0 16V		11/91 - 6/95	QUATTRO	ZF	53949	117	S 2	
2.0 16V		11/91 - 6/95	QUATTRO	ZF	53546	117	5 S	
2.2 TURBO		1/93 - 6/95	QUATTRO	ZF	53546	117	5 S	
2.3 10V		11/91 - 1/96		ZF	53638	130	Single S	
2.3 10V		11/91 - 1/96		VICKERS	54087	130	Single S	
2.3 10V		11/91 - 6/92		ZF	53546	117	5 S	
2.6 12V		9/92 - 6/95	INCL.QUATTRO	ZF	53887	117	S 2	
2.6 12V		9/92 - 6/95	INCL.QUATTRO	ZF	53546	117	5 S	
2.8 12V		11/91 - 8/93	INCL.QUATTRO	ZF	53887	117	S 2	
2.8 12V		11/91 - 8/93	INCL.QUATTRO	ZF	53546	117	5 S	
1.9 TD		1/92 - 6/95		ZF	53638	130	Single S	
1.9 TD		1/92 - 6/95		ZF	53546	117	5 S	
90 (81, 85, B2)								
2.0 10V		10/84 - 8/86		ZF	53659	130	Single S	
2.2 10V		7/84 - 8/86	QUATTRO	ZF	53659	130	Single S	
90 (89/89Q/8A/B3)								
2.0 10V		7/87 - 8/89		ZF	53586	130	Single S	
2.2 10V		7/87 - 8/89		VICKERS	54087	130	Single S	
2.2 10V		7/87 - 8/89		ZF	54048	117	S 3	
2.3 10V/20V		9/89 - 11/91		ZF	53586	130	Single S	
2.3 10V/20V		9/89 - 11/91		VICKERS	54087	130	Single S	
2.3 10V/20V		9/89 - 11/91		ZF	53882	117	S 3	
100 (44/44Q/C3)								
1.8 8V		8/83 - 8/86		ZF	53863	113	Single S	
1.9 10V		1/83 - 7/83		ZF	53518	113	Single S	
2.0 10V		2/83 - 11/91		ZF	53518	113	Single S	

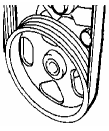

			OE	SPIDAN	 Ports Ø mm	NOTICE
AUDI						
100 (44/44Q/C3)						
2.1 10V	1/83 - 1/85				113	Single S 3
2.2 10V	7/84 - 8/89	INCL.QUATTRO	ZF	53518	113	Single S 3
2.2 TURBO	9/89 - 11/91	INCL.QUATTRO	ZF	53518	113	Single S 3
2.3 10V	9/89 - 11/91	INCL.QUATTRO	ZF	53518	113	Single S 3
100 (4A/C4)						
2.0 8V	5/91 - 6/94		ZF	53658	155	6 S 2
2.0 8V	5/91 - 6/94		VICKERS/LUK	54096		S 2
2.0 8V	5/91 - 6/94		ZF	54023	162	6 S 3
2.3 10V	5/91 - 9/92	INCL.QUATTRO	ZF	53658	155	6 S 2
2.3 10V	5/91 - 9/92		VICKERS/LUK	54096		S 2
2.3 10V	5/91 - 9/94	INCL.QUATTRO	ZF	54023	162	6 S 3
2.6 12V	9/92 - 6/94		ZF	53658	155	6 S 2
2.6 12V	9/92 - 6/94		VICKERS/LUK	54096		S 2
2.6 12V	9/92 - 6/94		ZF	54023	162	6 S 3
2.8 12V	5/91 - 6/94	INCL.QUATTRO	ZF	53658	155	6 S 2
2.8 12V	5/91 - 6/94		VICKERS/LUK	54096		S 2
2.8 12V	5/91 - 6/94	INCL.QUATTRO	ZF	54023	162	6 S 3
S4 4.2	8/91 - 6/94	INCL.Turbo	ZF	54023	162	6 S 3
2.0 TD	2/83 - 11/91		ZF	53518	113	Single S 3
2.5 TD	9/91 - 6/94		ZF	53658	155	6 S 2
2.5 TD	9/91 - 6/94		VICKERS/LUK	54096		S 2
2.5 TD	9/91 - 6/94		ZF	54023	162	6 S 3
200 (44, 44Q)						
2.1 10V TURBO	8/83 - 1/88		ZF	53518	113	Single S
2.2 10V TURBO	8/85 - 9/91	INCL.QUATTRO	ZF	53518	113	Single S
2.3	11/86 - 9/91		ZF	53518	113	Single S
A3 (8L1)						
1.6 8V	9/96 -		ZF	53862		S
1.6 8V	9/96 -		KAYABA	54179		S
1.8 20V	9/96 -	INCL.TURBO	ZF	53862		S
1.8 20V	9/96 -		KAYABA	54179		S
1.9 TD	12/96 -		ZF	53950		S
A4 (8D2/B5)						
1.6	9/96 - 3/97		ZF	53663		S
1.6	3/97 - 9/01	-->8D-V-180000 8D-V-180001-->	ZF	53742		S
1.8	3/95 - 3/97	-->8D-V-180000	ZF	53663		S

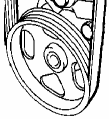

			OE	SPIDAN	 Ports Ø mm	NOTICE
AUDI						
A4 (8D2/B5)						
1.8	3/97 - 9/01		ZF	53742	S	
1.8 Quattro	3/95 - 3/97		ZF	53663	S	
1.8 Quattro	3/97 - 9/01		ZF	53742	S	
1.8 TURBO	3/95 - 3/97		ZF	53717	S	
1.8 TURBO	3/97 - 9/01		ZF	53742	S	
1.8 TURBO Quattro	3/95 - 3/97		ZF	53717	S	
1.8 TURBO Quattro	3/97 - 9/01		ZF	53742	S	
2.4 30V	9/97 - 9/01		ZF	53951	S	
2.4 30V Quattro	3/97 - 11/00		ZF	53951	S	
2.6	1/95 - 11/00		ZF	53663	S	
2.6 Quattro	1/95 - 11/00		ZF	53663	S	
2.7 Quattro	9/97 - 9/01		ZF	54013	S	
2.8 30V	4/96 - 3/97		ZF	53663	S	
2.8 30V	4/97 - 9/01		ZF	53951	S	
2.8 30V Quattro	4/96 - 3/97		ZF	53663	S	
2.8 30V Quattro	4/97 - 9/01		ZF	53951	S	
1.9 TD	3/95 - 9/01		ZF	53742	S	
1.9 TD	3/95 - 9/01		ZF	53719	S	
1.9 TD Quattro	3/95 - 9/01		ZF	53742	S	
1.9 TD Quattro	3/95 - 9/01		ZF	53719	S	
2.5 TD	5/98 - 9/01		ZF	53915	S	
2.5 TD Quattro	9/97 - 11/00		ZF	53915	S	
A4 (8E2/B6)						
1.8 TURBO	11/00 - 7/02		ZF	53742	S	
1.9 TD	1/01 -		ZF	53719	S	
1.9 TD	1/01 -		KAYABA	54183	6 P	
1.9 TD Quattro	11/01 -		ZF	53719	S	
1.9 TD Quattro	11/01 -		KAYABA	54183	6 P	
A6 (4A/C4)						
1.8 20V	6/94 - 12/96		ZF	53658	S	
1.8 20V	6/94 - 12/96		VICKERS/LUK	54096	S	
2.0 8V	6/94 - 12/95		ZF	53658	S	
2.0 8V	6/94 - 12/95		VICKERS/LUK	54096	S	
2.6	6/94 - 12/96		ZF	53658	S 2	
2.6	6/94 - 12/96		VICKERS/LUK	54096	S 2	
2.6	6/94 - 12/96		ZF	54023	S 3	

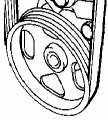

				OE	SPIDAN	 Ø mm	Ports	NOTICE
AUDI								
A6 (4A/C4)								
2.8		6/94 - 12/96		ZF	53658		S 2	
2.8		6/94 - 12/96		VICKERS/LUK	54096		S 2	
2.8		6/94 - 12/96		ZF	54023		S 3	
1.9 TD		1/95 - 12/96		ZF	53658		S	
1.9 TD		1/95 - 12/96		VICKERS/LUK	54096		S	
2.5 TD		6/94 - 12/96		ZF	53658		S 2	
2.5 TD		6/94 - 12/96		VICKERS/LUK	54096		S 2	
2.5 TD		6/94 - 12/96		ZF	54023		S 3	
A6 (4B/C6)								
1.8 TURBO		5/97 -		ZF	53750		S	
2.4		5/97 -		ZF	53923		S	IN/OUT-270/90°
2.4		5/97 -		ZF	54249		S	IN/OUT-90°
2.7 TURBO		6/99 -		ZF	54014		S	
2.8		5/97 - 7/01		ZF	53923		S	IN/OUT-270/90°
2.8		5/97 - 7/01		ZF	54249		S	IN/OUT-90°
1.9 TD		5/97 -		ZF	53750		S	
2.5 TD		11/97 -		ZF	53923		S	IN/OUT-270/90°
2.5 TD		11/97 -		ZF	54249		S	IN/OUT-90°
A8 (4D2/4D8)								
2.8		10/94 - 4/96		ZF	53861	158	S 2	
2.8		10/94 -		ZF	54015		S 3	
3.7		10/95 -		ZF	53861	158	S 2	
3.7		10/95 -		ZF	54015		S 3	
4.2		10/94 -		ZF	53861	158	S 2	
4.2		10/94 -		ZF	54015	158	S 3	
CABRIOLET (8G7/B4)								
1.8 20V		3/97 - 6/00		ZF	54048		S 3	
1.8 20V		3/97 - 6/00		ZF	53546	113	S 3	
1.8 20V		3/97 - 6/00		ZF	53638	130	Single	
2.0 8V		7/93 - 12/96		ZF	53638	130	Single	
2.0 8V		7/93 - 12/96		ZF	53546	117	S 3	
2.3 10V		7/92 - 5/94		ZF	53638	130	Single	
2.3 10V		7/92 - 5/94		VICKERS	54087	130	Single	
2.3 10V		7/92 - 5/94		ZF	53546	117	S 3	
2.6 12V		5/94 - 6/00		ZF	53887		S 2	
2.6 12V		5/94 - 6/00		ZF	53546	113	S 3	
2.8 12V		5/96 - 6/00		ZF	53887		S 2	
2.8 12V		5/96 - 6/00		ZF	53546	117	S 3	

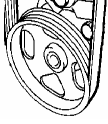

				OE	SPIDAN	 Ø mm	Ports	NOTICE
AUDI								
COUPE (81/85)								
1.8 8V		10/84 - 1/88		ZF	53659	130	Single S	
2.1 10V		7/82 - 8/84		ZF	53659	130	Single S	
2.2 10V		7/84 - 10/87		ZF	53659	130	Single S	
2.2 10V		7/84 - 10/87		VICKERS	54087	130	Single S	
COUPE (89/8B)								
2.0 8V		9/89 - 91		ZF	53586		Single S	
2.0 8V		91 - 9/96	* SLS	ZF	53638		Single S	
2.0 8V		91 - 9/96	SLS	ZF	53546		5 S	
2.0 16V		10/92 - 12/95	* SLS	ZF	53949		S	
2.0 16V		10/92 - 12/95	SLS	ZF	53546		5 S	
2.2		10/88 - 8/89	* SLS	ZF	53586		Single S	
2.2		10/88 - 8/89	SLS	ZF	54048		S	
S2 2.2 TURBO		10/90 - 1/96	SLS	ZF	53546		5 S	
2.3 10V/20V		9/89 - 7/92	* SLS	ZF	53586		Single S	
2.3 10V/20V		9/89 - 7/92	SLS	ZF	53882		S	
2.6 12V		9/92 - 9/96	* SLS	ZF	53887		S	
2.6 12V		9/92 - 9/96	SLS	ZF	53546		5 S	
2.8 12V		11/91 - 12/95	* SLS	ZF	53887		S	
2.8 12V		11/91 - 12/95	SLS	ZF	53546		5 S	
V8 (D1)								
3.6 V8		6/90 - 2/92	SLS	ZF	54016		S	
4.2 V8		2/92 - 8/93	SLS	ZF	54016		S	
BMW								
3'er (E21)								
320		8/79 - 4/81		ZF	-		S	RS-1x
320		4/81 - 10/82		ZF	53983		S	RS-3x
323i		8/79 - 4/81		ZF	-		S	RS-1x
323i		4/81 - 10/82		ZF	53983		S	RS-3x
3'er (E30)								
316i	1.6 LIMO.	87 - 88	eng.M10	ZF	53695	125	Single S	
316i	1.6 LIMO.	9/88 - 4/91	eng.M40	ZF	53607	109	Single S	
318i	1.8 LIMO.	3/83 - 9/88	eng.M10	ZF	53695	125	Single S	
318i	1.8 LIMO.	9/83 - 10/87	eng.M10	ZF	53695	125	Single S	
318i	1.8 LIMO.	10/87 - 4/91	eng.M40	ZF	53607	109	Single S	
318i	1.8 CABRIO	9/83 - 2/94	eng.M40	ZF	53607	109	Single S	
318i	1.8 KOMBI	4/89 - 2/94	eng.M40	ZF	53607	109	Single S	
318is	1.8 LIMO.	6/90 - 4/91	eng.M42	ZF	53607	109	Single S	

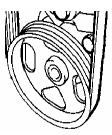

						OE		SPIDAN		 Ø mm		Ports		NOTICE	
BMW															
3'er (E30)															
320i	2.0 LIMO.	3/83	-	12/90				ZF		125	Single	S			
320i	2.0 CABRIO	7/84	-	1/93				ZF				S			
320i	2.0	7/84	-	1/93				LUK		125	Single	S			
320i	2.0	7/84	-	1/93				VICKERS		125	Single	S			
320i	2.0 KOMBI	87	-	4/91				ZF	* SLS			S	2		
320i	2.0	87	-	4/91				LUK		125	Single	S	2		
320i	2.0	87	-	4/91				VICKERS		125	Single	S	2		
320i	2.0 KOMBI	87	-	4/91				ZF		126	Single	S	3		
323i	2.3 LIMO.	3/83	-	7/85				ZF		125	Single	S			
325e	2.5 LIMO.	85	-	87				ZF		125	Single	S			
325i	2.5 LIMO.	10/85	-	12/90				ZF		125	Single	S			
325i	2.5 CABRIO	9/86	-	12/92				ZF				S			
325i	2.5	9/86	-	12/92				LUK		125	Single	S			
325i	2.5	9/86	-	12/92				VICKERS		125	Single	S			
325i	2.5 KOMBI	4/88	-	12/93				ZF	* SLS			S	2		
325i	2.5 KOMBI	4/88	-	12/93				ZF		126	Single	S	3		
325i	2.5	4/88	-	12/93				LUK		125	single	S	2		
325i	2.5	4/88	-	12/93				VICKERS		125	single	S	2		
324	2.4 D/TD LIMO.	85	-	91				ZF				S			
324	2.4 TD KOMBI	87	-	92				ZF				S	2		
324	2.4 TD	87	-	92				LUK		125	Single	S	2		
324	2.4 TD	87	-	92				VICKERS		125	Single	S	2		
324	2.4 TD KOMBI	87	-	92				ZF		126	Single	S	3		
3'er (E36)															
316i	1.6 LIMO.	6/91	-	9/93				ZF		115	Single	S			
316i	1.6 LIMO.	10/93	-	9/95				ZF		142	6	S			
316i	1.6	10/93	-	9/95				LUK				S			
316i	1.6 LIMO.	10/95	-	3/98				ZF		142	6	S			
316i	1.6	10/95	-	3/98				LUK				S			
316i	1.6 COUPE	1/94	-	9/95				ZF		142	6	S			
316i	1.6	1/94	-	9/95				LUK				S			
316i	1.6	10/95	-	3/99				ZF		142	6	S			
316i	1.6	10/95	-	3/99				LUK				S			
316i	1.6 KOMBI	4/97	-	8/99				ZF		142	6	S			
316i	1.6 KOMBI	4/97	-	8/99				LUK				S			
318i	1.8 LIMO.	4/91	-	9/93				ZF		115	Single	S			
318i	1.8 LIMO.	10/93	-	9/95				ZF		142	6	S			

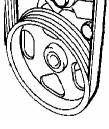

						OE		SPIDAN		 Ø mm		Ports		NOTICE	
BMW															
3'er (E36)															
318i	1.8	10/93	-	9/95			LUK	53593			S				
318i	1.8 LIMO.	10/95	-	4/98	eng.M43		ZF	53756	142	6	S				
318i	1.8	10/95	-	4/98			LUK	54080			S				
318i	1.8 CABRIO	5/94	-	9/95	eng.M43		ZF	53756	142	6	S				
318i	1.8 CABRIO	10/95	-	12/99	eng.M43		ZF	53756	142	6	S				
318i	1.8	10/95	-	12/99			LUK	54080			S				
318i	1.8 KOMBI	1/96	-	8/99	eng.M43		ZF	53756	142	6	S				
318i	1.8 KOMBI	1/96	-	8/99			LUK	54080			S				
318is	1.8 COUPE	4/92	-	9/95	eng.M42		ZF	53669	115	Single	S				
318is	1.8	4/92	-	9/95			LUK	53593			S				
318is	1.8 COUPE	10/95	-	4/96	eng.M42		ZF	53669	115	Single	S				
318is	1.8	10/95	-	4/96			LUK	54080			S				
318is	1.9 LIMO.	2/98	-	1/99	eng.M44		ZF	53756	142	6	S				
318is	1.9	2/98	-	1/99			LUK	54080			S				
318is	1.9 COUPE	4/96	-	3/99	eng.M44		ZF	53756	142	6	S				
318is	1.9	4/96	-	3/99			LUK	54080			S				
320i	2.0 LIMO.	4/91	-	1/95	eng.M50/52		ZF	53615	130	6	S				
320i	2.0 LIMO.	1/95	-	9/95	eng.M50/52		LUK	54075	130	6	S				
320i	2.0	1/95	-	9/95			VICKERS	54094	130	6	S				
320i	2.0 LIMO.	10/95	-	9/96	eng.M50/52		LUK	54064	135	6	S				
320i	2.0 COUPE	4/92	-	9/95	eng.M50/52		ZF	53615	130	6	S				
320i	2.0 COUPE	10/95	-	99	eng.M50/52		LUK	54064	135	6	S				
320i	2.0 CABRIO	5/94	-	9/95	eng.M50/52		ZF	53615	130	6	S				
320i	2.0 CABRIO	10/95	-	12/97	eng.M50/52		LUK	54064	135	6	S				
320i	2.0 KOMBI	3/95	-	9/95	eng.M50/52		ZF	53615	130	6	S				
320i	2.0 KOMBI	3/95	-	9/95			LUK	54075	130	6	S				
320i	2.0 KOMBI	3/95	-	9/95			VICKERS	54094	130	6	S				
320i	2.0 KOMBI	10/95	-	12/97	eng.M50/52		LUK	54064	135	6	S				
323i	2.5 LIMO.	9/96	-	5/98	eng.M52		LUK	54064	135	6	S				
323i	2.5 COUPE	3/95	-	9/95	eng.M52		ZF	53615	125	5	S				
323i	2.5 COUPE	10/95	-	3/99	eng.M52		LUK	54064	135	6	S				
323i	2.5 CABRIO	1/97	-	5/00	eng.M52		LUK	54064	135	6	S				
325i	2.5 LIMO.	4/91	-	9/95	eng.M50/52		ZF	53615	130	6	S				
325i	2.5	4/91	-	9/95			LUK	54075	130	6	S				
325i	2.5	4/91	-	9/95			VICKERS	54094	130	6	S				
325i	2.5 COUPE	4/92	-	9/95	eng.M52		ZF	53615	130	6	S				
325i	2.5 CABRIO	7/93	-	9/95			ZF	53615	130	6	S				

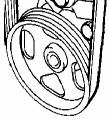

BMW						OE		SPIDAN		 Ports Ø mm		NOTICE	
3'er (E36)													
328i	2.8 LIMO.	3/95	-	9/95	eng.M52		ZF		53615	130	6	S	
328i	2.8	3/95	-	9/95			LUK		54075	130	6	S	
328i	2.8	3/95	-	9/95			VICKERS		54094	130	6	S	
328i	2.8 LIMO.	10/95	-	3/98	eng.M52		LUK		54064	135	6	S	
328i	2.8 COUPE	4/92	-	9/95	eng.M52		ZF		53615	130	6	S	
328i	2.8 COUPE	10/95	-	99	eng.M52		LUK		54064	135	6	S	
328i	2.8 CABRIO	3/95	-	9/95	eng.M52		ZF		53615	130	6	S	
328i	2.8 CABRIO	10/95	-	12/99	eng.M52		LUK		54064	135	6	S	
328i	2.8 KOMBI	3/95	-	9/95	eng.M50/52		ZF		53615	130	6	S	
328i	2.8 KOMBI	3/95	-	9/95			LUK		54075	130	6	S	
328i	2.8 KOMBI	3/95	-	9/95			VICKERS		54094	130	6	S	
328i	2.8 KOMBI	10/95	-	8/99	eng.M50/52		LUK		54064	135	6	S	
318 TD	1.7 TD LIMO.	8/95	-	3/98	eng.M41		ZF		53677	125	5	S	
318 TD	1.7 TD KOMBI	9/95	-	8/99	eng.M41		ZF		53677	125	5	S	
325 TD/TDS	2.5 TD/TDS LIMO.	7/93	-	3/98	eng.M51		ZF		53718	125	5	S	
325 TD/TDS	2.5 TD/TDS	7/93	-	3/98			LUK		54093			S	
325 TDS	2.5 TDS KOMBI	1/96	-	8/99	eng.M51		ZF		53718	125	5	S	
325 TDS	2.5 TDS KOMBI	1/96	-	8/99			LUK		54093			S	
3'er COMPACT (E36)													
316i	1.6	9/94	-	9/95	eng.M43		ZF		53756	142	6	S	
316i	1.6	9/94	-	9/95			LUK		53593			S	
316i	1.6	10/95	-	1/01	eng.M43/44		ZF		53756	142	6	S	
316i	1.6	10/95	-	1/01			LUK		54080			S	
316i	1.9	1/99	-	1/01	eng.M44		ZF		53756	142	6	S	
316i	1.9	1/99	-	1/01			LUK		54080			S	
318 Ti	1.8	9/94	-	7/95	eng.M44		LUK		53593			S	
318 Ti	1.8	8/95	-	4/96	eng.M44		ZF		53756	142	6	S	
318 Ti	1.8	8/95	-	4/96			LUK		54080			S	
318 Ti	1.9	4/96	-	1/01	eng.M44		ZF		53756	142	6	S	
318 Ti	1.9	4/96	-	1/01			LUK		54080			S	
323 Ti	2.5	8/97	-	01	eng.M52		LUK		54064	135	6	S	
318 TD	1.7 TD	9/95	-	1/01	eng.M41		ZF		53677	125	5	S	
3'er (E46)													
316i/C/ti	1.8	1/02	-		eng.N42		ZF		54216	135	6	S	
316i	1.9	3/99	-	12/01	eng.M44		ZF		54221			S	
318i	1.9	9/98	-	9/01	eng.M43		ZF		53952			S	
318i	1.9	5/99	-		eng.M44		ZF		54221			S	

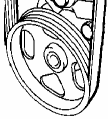

					OE	SPIDAN	 Ø mm	Ports	NOTICE
BMW									
3'er (E46)									
318i/Citi	2.0	9/01	-	eng.N42	ZF	54216	135	6	S
320i	2.2	3/98	-	eng.M62	LUK	54211			S
320i	2.2	10/99	-	eng.M62	LUK	54050			S
323i	2.5	3/98	-	eng.M62	LUK	54211			S
323i	2.5	10/99	-	eng.M62	LUK	54050			S
325i	2.5	3/98	-	eng.M64	LUK	54211			S
325i/iTi	2.5	7/00	-	eng.M64	LUK	54211			S A15
328i	2.8	2/98	-	eng.M62	LUK	54211			S
328i	2.8	10/99	-	eng.M62	LUK	54050			S
330i	3.0	6/00	-	eng.M64	LUK	54050			S
320 D	2.0	9/99	-	eng.M47	ZF	53953			S
5'er (E12)									
518	1.8	1/75	-	4/81	ZF	-			S RS-1x
518	1.8	1/75	-	4/81	ZF	53983			S RS-3x
520/i	2.0	2/73	-	7/81	ZF	-			S RS-1x
520/i	2.0	2/73	-	7/81	ZF	53983			S RS-3x
525	2.5	12/73	-	10/81	ZF	-			S RS-1x
525	2.5	12/73	-	10/81	ZF	53983			S RS-3x
528/i	2.8	4/75	-	10/81	ZF	-			S RS-1x
528/i	2.8	4/75	-	10/81	ZF	53983			S RS-3x
5'er (E28)									
518	1.8	10/81	-	10/83	ZF	53983			S
518/i	1.8	10/83	-	12/87	ZF	53695	125	Single	S
520i	2.0	10/81	-	10/83	ZF	53983			S
520i	2.0	10/83	-	1/87	ZF	53695	125	Single	S
520i	2.0	1/87	-	12/87	LUK	54077	125	Single	S
520i	2.0	1/87	-	12/87	VICKERS	54091	125	Single	S
525i	2.5	10/81	-	4/84	ZF	53983			S
525i	2.5	4/84	-	10/87	ZF	53695	125	Single	S
525e	2.7	10/81	-	10/83	ZF	53983			S
525e	2.7	10/83	-	12/87	ZF	53695	125	Single	S
525e	2.7	10/83	-	12/87	LUK	54077	125	Single	S
525e	2.7	10/83	-	12/87	VICKERS	54091	125	Single	S
528i	2.8	10/81	-	4/84	ZF	53983			S
528i	2.8	4/84	-	11/87	ZF	53695	125	Single	S
535i	3.4	1/85	-	11/87	ZF	53695	125	Single	S

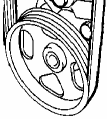

						OE		SPIDAN		 Ports		NOTICE	
										Ø mm			
BMW													
5'er (E28)													
524 D/TD	2.4	1/83	-	1/88			ZF		53695	125	Single	S	
524 D/TD	2.4	1/83	-	1/88			LUK		54077	125	Single	S	
524 D/TD	2.4	1/83	-	1/88			VICKERS		54091	125	Single	S	
5'er (E34)													
518i	1.8 LIMO.	8/89	-	9/96	eng.M40/43		ZF		53716	110	Single	S	
518i	1.8 KOMBI	3/93	-	9/96	eng.M40/43		ZF		53886	125	5	S	2
520i	2.0 12V	1/88	-	8/91	eng.M20		ZF	*SLS	53678	109	Single	S	2
520i	2.0 12V	1/88	-	8/91	eng.M20		ZF	SLS	53955			S	3
520i	2.0 24V	88	-	9/91	eng.M50		ZF	*SLS	53757	135	6	S	2
520i	2.0 24V	10/91	-	9/96	eng.M50		LUK	*SLS	54082	130	6	S	2
520i	2.0 24V	88	-	9/96	eng.M50		ZF	SLS	53909			S	3
525i	2.5 12V	6/88	-	9/90	eng.M20		ZF	*SLS	53678	109	Single	S	2
525i	2.5 12V	6/88	-	9/90	eng.M20		ZF	SLS	53955			S	3
525i	2.5 24V	9/90	-	9/91	eng.M50		ZF	*SLS	53757	135	6	S	2
525i	2.5 24V	10/91	-	9/96	eng.M50		LUK	*SLS	54082	130	6	S	2
525i	2.5 24V	9/90	-	9/96	eng.M50		ZF	SLS	53909			S	3
525i	2.5 24V	91	-	9/96	eng.M50	4WD	ZF	SLS	53954			S	3
530i	3.0 12V	6/88	-	7/90	eng.M30		ZF	*SLS	53758	120	Single	S	
530i	3.0 12V	6/88	-	7/90	eng.M30		ZF	SLS	53909			S	3
530i	3.0 32V LIMO.	1/93	-	3/96	eng.M60		LUK	*SLS/ASC	54076	118	6	S	
535i	3.4	1/88	-	9/95	eng.M30		ZF	*SLS	53758	120	Single	S	2
535i	3.4	1/88	-	9/95	eng.M30		ZF	SLS	53909			S	3
540i	4.0 LIMO.	1/93	-	3/96	eng.M60		LUK	*SLS/ASC	54076	118	6	S	
524 TD	2.4	3/88	-	9/95	eng.M21		ZF	*SLS	54212			S	2
524 TD	2.4	3/88	-	9/95	eng.M21		ZF	SLS	53955			S	3
525 TD/TDS	2.5	6/88	-	9/96	eng.M51		ZF	*SLS	53886	125	5	S	2
525 TD/TDS	2.5	6/88	-	9/96	eng.M51		ZF	SLS	53955			S	3
5'er (E39)													
520i	2.0	4/96	-	9/98	eng.M52		ZF		53956			S	
520i	2.0	9/98	-	8/00	eng.M52		LUK		54081			S	
520i	2.2	9/00	-		eng.M54		LUK		54081			S	
523i	2.5	4/96	-	9/98	eng.M52		ZF		53956			S	
523i	2.5	9/98	-	9/00	eng.M52		LUK		54081			S	
525i	2.5	9/00	-		eng.M54		LUK		54081			S	
528i	2.8	4/96	-	9/98	eng.M52		ZF		53956			S	
528i	2.8	9/98	-	9/00	eng.M52		LUK		54081			S	
530i	3.0	9/00	-		eng.M54		LUK		54081			S	

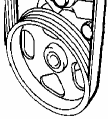

				OE	SPIDAN	 Ø mm	Ports	NOTICE
BMW								
5'er (E39)								
535i	3.5	9/96 -		eng.M62	LUK	118	6 S	
540i	4.4	4/96 -		eng.M62	LUK	118	6 S	
525 TD	2.5 12V	4/96 -	9/98	eng.M51	ZF	124	5 S	
6'er (E24)								
628 CSI	2.8	9/80 -	4/81		ZF	-	S	RS-1x
628 CSI	2.8	4/81 -	4/84		ZF	53983	S	RS-3x
628 CSI	2.8	4/84 -	5/87		ZF	53695	125 Single	S
633 CSI	3.2	10/76 -	4/81		ZF	-	S	RS-1x
635 CSI	3.4	6/82 -	4/84		ZF	53983	S	RS-3x
635 CSI	3.4	4/84 -	6/87		ZF	53695	125 Single	S
635 CSI	3.4	6/87 -	9/89		ZF	54019	S	
635 CSI	3.5	10/78 -	4/81		ZF	-	S	RS-1x
635 CSI	3.5	4/81 -	6/82		ZF	53983	S	RS-3x
7'er (E23)								
728i	2.8	12/79 -	5/86		ZF	54004	140 Single	S
732i	3.2	9/79 -	2/86		ZF	54004	140 Single	S
735i	3.4/3.5	10/79 -	3/86		ZF	54004	140 Single	S
7'er (E22)								
730i	3.0 12V	5/87 -	8/90	eng.M30	ZF	53636	120 Single	S 2
730i	3.0 12V	5/87 -	8/90		VICKERS	54090	120 Single	S 2
730i	3.0 12V	2/87 -	8/94	eng.M30	ZF	53731	120 Single	S 3 TANDEM PUMP
735i	3.4	2/87 -	8/90	eng.M30	ZF	53636	120 Single	S 2
735i	3.4	2/87 -	8/90		VICKERS	54090	120 Single	S 2
735i	3.4	2/87 -	7/92	eng.M30	ZF	53731		S 3 TANDEM PUMP
750i	5.0	10/87 -	8/94	eng.M70	ZF	53731		S 3 TANDEM PUMP
7'er (E38)								
728i	2.8	2/96 -	2/02	eng.M62	ZF	53883		S 3 TANDEM PUMP
730i	3.0	8/94 -	5/96	eng.M60	LUK	54126		S
730i	3.0	8/94 -	5/96	eng.M60	LUK	54123		S 3 TANDEM PUMP
735i	3.5	3/96 -	2/02	eng.M62	LUK	54126		S
735i	3.5	3/96 -	2/02	eng.M62	LUK	54123		S 3 TANDEM PUMP
740i	4.0	8/94 -	5/96	eng.M60	LUK	54126		S
740i	4.0	8/94 -	5/96	eng.M60	LUK	54123		S 3 TANDEM PUMP
740i	4.4	3/96 -	2/02	eng.M62	LUK	54126		S
740i	4.4	3/96 -	2/02	eng.M62	LUK	54123		S 3 TANDEM PUMP
750i	5.4	1/95 -	2/02	eng.M72	LUK	54123		S 3 TANDEM PUMP
725 TDS	2.5	4/96 -	01	eng.M51	ZF	53883		S 3 TANDEM PUMP

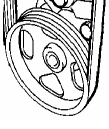

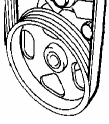

				OE	SPIDAN	 Ø mm	Ports	NOTICE
BMW								
M-MODELLE								
M3 (E36)	3.0 LIMO.	7/94 - 9/95	eng.S50	ZF	54017		S	
M3 (E36)	3.0 COUPE	5/93 - 9/95	eng.S50	ZF	54017		S	
M3 (E36)	3.0 CABRIO	7/94 - 9/95	eng.S50	ZF	54017		S	
M3 (E36)	3.2 LIMO.	3/96 - 1/98	eng.S52	ZF	54017		S	
M3 (E36)	3.2 COUPE	3/96 - 3/99	eng.S52	ZF	54017		S	
M3 (E36)	3.2 CABRIO	3/96 - 10/99	eng.S52	ZF	54017		S	
M5 (E12)	3.5	1/80 - 10/81		ZF	-		S	RS-1x
M5 (E12)	3.5	1/80 - 10/81		ZF	53983		S	RS-3x
M5 (E28)	3.4	1/85 - 11/87		ZF	53695	125	Single	S
M6 (E24)	3.5	6/87 - 9/89		ZF	54019		S	
Z3 M	3.2	1/98 -		ZF	54017		S	
Z-SERIE								
Z1	2.5	10/89 - 6/91		ZF	54021		S	
Z3	1.8/1.9	9/96 -		ZF	53888		S	
Z3	2.8	6/97 - 6/00		ZF	53889		S	
CHRYSLER								
NEON (PL)								
1.8		3/98 - 9/99			53860	138	Single	P
2.0		6/96 - 9/99			53860	138	Single	P
VOYAGER (GS)								
2.0		3/97 - 3/01			53656	124	4	P
3.3		3/97 - 3/01		SAGI.	54086	158	6	P
CITROËN								
BERLINGO								
1.4		10/98 -			53670			S
1.4		10/98 -			53661	142	5	P
1.4		10/98 -			54069	125	6	P
1.4		10/98 -			54068	75	Single	P
1.4		10/98 -			54069	125	6	P
1.8		6/88 - 10/00			53898	133	6	P
1.8		6/98 - 10/00			53924			P
1.8		6/88 - 10/00			53918	114	6	P
1.9 D		10/96 -	** TURBO		53898	133	6	P
1.9 D		10/96 -	** TURBO		53918	114	6	P
1.9 D		10/96 -	** TURBO		53675	114	6	P
1.9 D		4/98 - 11/98	** TURBO		53959	114	6	P
1.9 D		11/98 -	** TURBO		53959	114	6	P

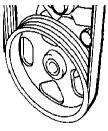

				OE	SPIDAN	 Ports	NOTICE
						Ø mm	
CITROËN							
BERLINGO							
1.9 D	4/99	-	* TURBO	SAGI.	53918	114 6 P	PUMP-AL
1.9 D	4/99	-	* TURBO	SAGI.	53959	114 6 P	PUMP-AL
1.9 TD	4/98	-		SAGI.	53662	114 6 P	PUMP-AL
2.0 Hdi	3/00	-		SAGI.	53945	142 6 P	PUMP-AL
2.0 Hdi	11/02	-		SAGI.	53928	6 P	
EVASION (22/U6)							
1.9 TD	10/95	5/00		ZF	53655	114 6 P	L-113mm
1.9 TD	10/95	5/00		ZF	54196	114 6 P	L-107mm
1.9 TD	10/95	5/00		ZF	54018	140 6 P	
XANTIA (X1/X2)							
1.6/1.8	5/93	4/01			53527	117 6 P 2	* HYDRAKTIV
1.6/1.8	5/93	4/01			53542	141 6 P 2	* HYDRAKTIV
2.0	5/93	4/01			53527	117 6 P 2	* HYDRAKTIV
2.0	5/93	4/01			53666	106 6 P 3	HYDRAKTIV
2.0	5/93	4/01			53542	141 6 P 2	* HYDRAKTIV
2.0	5/93	4/01			53598	117 6 P 3	HYDRAKTIV
2.0	5/93	4/01			54230	130 6 P 3	HYDRAKTIV
2.0	5/93	4/01			53576	141 6 P 3	HYDRAKTIV
2.0	5/93	4/01			54173	141 6 P 3	HYDRAKTIV
1.9 D	7/93	10/95			53527	117 6 P 2	* HYDRAKTIV
1.9 D	7/93	10/95			53542	141 6 P 2	* HYDRAKTIV
1.9 TD	7/93	10/00			53527	117 6 P 2	* HYDRAKTIV
1.9 TD	7/93	10/00			53542	141 6 P 2	* HYDRAKTIV
1.9 TD	7/93	10/00			53666	106 6 P 3	HYDRAKTIV
1.9 TD	7/93	10/00			53598	117 6 P 3	HYDRAKTIV
1.9 TD	7/93	10/00			54230	130 6 P 3	HYDRAKTIV
1.9 TD	7/93	10/00			53576	141 6 P 3	HYDRAKTIV
1.9 TD	7/93	10/00			54173	141 6 P 3	HYDRAKTIV
2.0 D	5/93	4/01			53527	117 6 P 2	* HYDRAKTIV
2.0 D	5/93	4/01			53666	106 6 P 3	HYDRAKTIV
2.1 TD	6/97	1/99			53527	117 6 P 2	* HYDRAKTIV
2.1 TD	6/97	1/99			53542	141 6 P 2	* HYDRAKTIV
2.1 TD	6/97	1/99			53666	106 6 P 3	HYDRAKTIV
2.1 TD	6/97	1/99			53598	117 6 P 3	HYDRAKTIV
2.1 TD	6/97	1/99			54230	130 6 P 3	HYDRAKTIV
2.1 TD	6/97	1/99			53576	141 6 P 3	HYDRAKTIV
2.1 TD	6/97	1/99			54173	141 6 P 3	HYDRAKTIV



				OE	SPIDAN	 Ø mm	Ports	NOTICE
CITROËN								
XANTIA (X1/X2)								
3.0		6/97 - 10/00		HYDRAKTIV	53666	106	6 P 3	IN/OUT ----
3.0		6/97 - 10/00		HYDRAKTIV	53598	117	6 P 3	IN/OUT ----
3.0		6/97 - 10/00		HYDRAKTIV	54230	130	6 P 3	IN- 1 TO OUT
3.0		6/97 - 10/00		HYDRAKTIV	53576	141	6 P 3	IN/OUT ----
3.0		6/97 - 10/00		HYDRAKTIV	54173	141	6 P 3	IN- 1 TO OUT
XSARA (N1/N2/N0)								
1.4		11/97 -		* A/C	53630		S	IN- 1
1.4		11/97 -			53670		S	IN- ----
1.4		11/97 -			54067	142	5 P	IN- 1
1.4		11/97 -			53661	142	5 P	IN- ----
1.4		11/97 -			54069	125	6 P	
1.4		11/97 -			54068	75	Single P	
1.4		11/97 -		A/C	53670		S	
1.4		11/97 -			53661	142	5 P	
1.4		11/97 -			54069	125	6 P	
1.4		11/97 -			54068	75	Single P	
1.6		11/97 -		* A/C	53630		S	IN- 1
1.6		11/97 -			53670		S	IN- ----
1.6		11/97 -			53661	142	5 P	IN- ----
1.6		11/97 -			54067	142	5 P	IN- 1
1.6		11/97 -			53898	133	6 P	
1.6		11/97 -			53918	114	6 P	
1.6		11/97 -			54069	125	6 P	
1.6		11/97 -			54068	75	Single P	
1.6		11/97 -		A/C	53670		S	
1.6		11/97 -			53661	142	5 P	
1.6		11/97 -			54069	125	6 P	
1.6		11/97 -			54068	75	Single P	
1.8		11/97 -		* A/C	53898	133	6 P	SAGINAW. * 9632335080
1.8		11/97 -			53918	114	6 P	SAGINAW. * 9632335080
1.8		11/97 -			53958	142	6 P	SAGINAW. * 9636676280
1.8		11/97 -		A/C	53924	142	6 P	
1.8		11/97 -			53960	142	6 P	
2.0 16V		11/97 - 3/98			53754	107	6 P	PUMP-FE
2.0 16V		3/98 -			53961		P	PUMP-AL
1.9 D		11/97 -		* TURBO	53898	133	6 P	
1.9 D		11/97 -		* TURBO	53918	114	6 P	
1.9 D		11/97 - 11/98		* TURBO	53675	114	6 P	PUMP-FE
1.9 D		4/98 -		* TURBO	53959	114	6 P	PUMP-AL



				OE	SPIDAN	 Ports Ø mm	NOTICE
CITROËN							
XSARA (N1/N2/N0)							
1.9 TD		11/97 -		SAGI.	53926	114 6 P	
1.9 TD		11/97 -		SAGI.	54057	133 6 P	
2.0 Hdi		11/98 - 10/00		SAGI.	53729	125 6 P	
2.0 Hdi		10/00 -		SAGI.	54217	125 6 P	
XSARA PICASSO (N68)							
1.6		6/00 -		SAGI.	53925	136 6 P	6 pcs. A7
1.6		6/00 -		SAGI.	54251	136 6 P	5 pcs. A7
1.8		6/00 -		SAGI.	53927	137 6 P	
2.0 Hdi		6/00 -		SAGI.	53928	6 P	
ZX (N2)							
1.4/1.6		6/91 - 2/98		SAGI.	53505	114 6 P	
1.4/1.6		6/91 - 2/98		SAGI.	53872	142 4 S	
1.8i		10/92 - 11/97		SAGI.	53503	133 6 P	
1.9		6/91 - 2/98		SAGI.	53505	114 6 P	
1.9		6/91 - 2/98		SAGI.	53503	133 6 P	
1.9 D/TD		6/91 - 2/98		SAGI.	53505	114 6 P	
1.9 D/TD		6/91 - 2/98		SAGI.	53503	133 6 P	
2.0 8V/16V		10/92 - 6/96		SAGI.	53651	142 6 P	
2.0 16V		10/92 - 6/96		SAGI.	53832	142 6 P	
C15/25							
C15 (VD)		10/92 -	1.8 D	SAGI.	53743	75 Single P	
C25 (280/290)		4/87 - 6/94	all Models	SAGI.	53523	75 Single P	
C25 (280/290)		4/87 - 6/94	all Models	SAGI.	53505	114 6 P	
JUMPY (J6U)							
1.9 D		9/96 -		SAGI.	53859	114 6 P	L- 113mm
1.9 D		9/96 -		ZF	54196	114 6 P	L- 107mm
1.9 TD		9/96 - 6/00		SAGI.	53859	114 6 P	L- 113mm
1.9 TD		9/96 - 6/00		ZF	54196	114 6 P	L- 107mm
JUMPER (230)							
1.9 D		6/94 - 10/01		ZF	54189	107 4 P	
2.5 D/TD		6/94 - 10/01		SAGI.	53608	108 6 S	
DAEWOO							
ESPERO (KLEJ)							
1.5		4/95 - 10/97		SAGI.	53606	142 5 S	
1.8		4/95 - 10/97		SAGI.	54051	125 5 S	
1.8		4/95 - 10/97		YOUNGSHIN	54190	125 5 S	
2.0		4/95 - 10/97		YOUNGSHIN	54199	140 6 S	

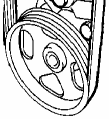

			OE	SPIDAN	 Ports Ø mm	NOTICE
DAEWOO						
KORANDO (KJ)						
2.3	3/99 - 7/01		YOUNGSHIN	-	127 6 S	
2.9 TD	3/99 - 7/01		YOUNGSHIN	-	127 6 S	
LEGANZA (KLAV)						
2.0 CDX	9/97 - 5/98		SAGI.	53920	142 6 P	
2.0 CDX	5/98 - 6/02		SAGI.	54207	142 6 P	
2.0 SX	9/97 - 6/02		SAGI.	54041		S
MIATIZ (KLYA)						
800	9/98 -			54137	100 4 S	
MUSSO (FJ)						
2.3	3/99 - 12/01			53997	6 S	
2.9 TD	3/99 - 12/01			53997	6 S	
NEXIA (KLEIN)						
1.5	4/95 - 10/97		SAGI.	53606	142 5 S	
NUBIRA (KLAJ)						
1.6 SE	9/97 - 7/99		SAGI.	54136	128 6 P	
1.6 SE	7/99 - 6/02		SAGI.	54206	128 6 P	A9
2.0 CDX	9/97 - 6/02		SAGI.	54052	140 6 P	
DAIHATSU						
APPLAUSE (A101, A111)						
1.6	1/90 - 12/95			53858	100 3 S	
CHARADE (G100, G101, G102)						
1.0 TD	5/87 - 6/93		ATSUGI	-	115 5 S	
CHARADE (G200, G202)						
1.3	6/93 - 3/01	[G200]	ATSUGI	53793	113 5 S	
1.5	10/94 - 4/00	[G201]	ATSUGI	53793	113 5 S	
1.6	7/93 - 3/96	[G203]	ATSUGI	53793	113 5 S	
WILDCAT/ROCKY (F70/F75)						
2.8 TD	10/85 - 7/93		TOYOTA	53984	102 5 S	
2.8 TD	7/93 - 3/02	INDEPENDENT	TOYOTA	54024		S
GRAND MOVE (G3)						
1.5	3/97 - 10/98		KOYO	54163	88 3 S	
TERIOS (J1)						
1.3	8/97 -			53884		
FIAT						
BARCETTA (183)						
1.8 16V	9/95 -		SAGI./ZF	53604	130 6 S	
BRAVA (182)						
1.2 16V	2/99 - 12/01		SAGI.	53697	127 3 S	

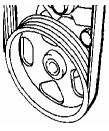

				OE	SPIDAN	 Ø mm	Ports	NOTICE
FIAT								
BRAVA (182)								
1.4		12/95 - 2/99		SAGI./ZF	53604	130	6 S	
1.6		12/95 - 12/01		SAGI.	53654	133	3 S	
1.8		12/95 - 3/01		SAGI./ZF	53604	130	6 S	
1.9 TD		10/96 - 12/01		SAGI./ZF	53604	130	6 S	
BRAVO (182)								
1.2 16V		2/99 - 12/01		SAGI.	53697	127	3 S	
1.4		12/95 - 2/99		SAGI./ZF	53604	130	6 S	
1.6		6/96 - 12/01		SAGI.	53654	133	3 S	
1.8		12/95 - 3/01		SAGI./ZF	53604	130	6 S	
2.0 HGT		3/97 - 10/00		ZF	53736		S	
1.9 TD		10/96 - 12/01		SAGI./ZF	53604	130	6 S	
COUPE (FA/175)								
2.0 16V/16V TURBO		6/95 - 10/96	* A/C	SAGI./ZF	53610		S	
2.0 16V/16V TURBO		6/95 - 10/96	A/C	SAGI./ZF	53857		S	
2.0 20V/20V TURBO		11/96 - 2/00		ZF	53741		S	
CROMA (154)								
2.0 8V/8V TURBO		5/86 - 1/94		ZF	53595	135	Single S	
2.0 16V		8/91 - 1/94		ZF	53890		S	
MAREA (185)								
1.6		3/97 - 4/02		SAGI.	53654	133	3 S	
1.8		3/97 - 12/00		SAGI./ZF	53604	130	6 S	
2.0		3/97 - 4/02		ZF	53736		S	
1.9 TD		3/97 - 4/02		SAGI./ZF	53604	130	6 S	
2.4 TD		3/97 - 12/00		ZF	53735		S	
PUNTO (176)								
1.2		3/94 -		SAGI./ZF	53697	127	3 S	
1.4 GT TURBO		3/94 - 9/99		SAGI./ZF	53585	145	Single S	
1.6		8/94 - 5/97		SAGI./ZF	53585	145	Single S	
1.7 D/TD		3/94 - 9/99		SAGI./ZF	53682	143	3 S	
REGATA (138)								
1.6		8/86 - 9/90		ZF	53855		S	
TEMPRA (159)								
1.4		9/90 - 4/92		ZF	53595	135	Single S	
1.6		9/90 - 7/93	MANUAL	ZF	53595	135	Single S	
1.6		7/93 - 12/95	MANUAL	SAGI./ZF	53585	145	Single S	
1.6		9/90 - 12/95	AUTO	ZF	53957	140	Single S	
1.8		9/90 - 5/92		ZF	53679	136	Single S	
2.0		6/92 - 7/93		ZF	53679	136	Single S	

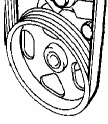

				OE	SPIDAN	 Ports Ø mm	NOTICE
FIAT							
TEMPRA (169)							
2.0	7/93 - 12/95			SAGLI./ZF	53610	S	
1.9 D/TD	9/90 - 7/93			ZF	53612	Single S	
1.9 D/TD	7/93 - 12/95			SAGLI./ZF	53682	3 S	
TIPO (160)							
1.4	6/88 - 10/92			ZF	53595	Single S	
1.4	6/88 - 10/92			SAGLI./ZF	53585	Single S	
1.6	6/88 - 10/92	MANUAL	-->8127852-->	ZF	53595	Single S	
1.6	6/88 - 93	MANUAL	8127852-->	SAGLI./ZF	53585	Single S	
1.6	93 - 10/95	MANUAL	-->8860208	ZF	53957	Single S	
1.6	93 - 10/95		8860208-->9132449	SAGLI./ZF	53585	Single S	
1.6	88 - 10/95	AUTO		ZF	53957	Single S	
1.8	9/90 - 1/92			ZF	53679	Single S	
1.8	1/92 - 93			ZF	53595	Single S	
1.8	93 - 95			SAGLI./ZF	53610	Single S	
2.0 8V	2/93 - 10/95			ZF	53610	Single S	
2.0 16V	1/92 - 93			ZF	53595	Single S	
2.0 16V	93 - 10/95		A/C	ZF	53857	Single S	
1.7 D	10/88 - 93			ZF	53730	Single S	
1.7 D	10/88 - 93			TOYOTA	53728	Single S	
1.7 D	93 - 10/95			SAGLI.	53682	3 S	
1.9 TD	6/88 - 93			ZF	53730	Single S	
1.9 TD	6/88 - 93			TOYOTA	53728	Single S	
1.9 TD	93 - 10/95			SAGLI./ZF	53682	3 S	
ULYSSE (220)							
1.9 TD	10/95 - 1/00			ZF	53655	6 P	L--113mm
1.9 TD	10/95 - 1/00			ZF	54196	6 P	L--107mm
1.9 TD	10/95 - 1/00			ZF	54018	6 P	
DUCATO (230)							
2.0	6/94 - 12/96			ZF	53734	Single S	
2.0	6/94 - 12/96		[10/14]	ZF	54189	4 P	
1.9 D/TD	6/94 - 4/02		[10]	SAGLI./ZF	53585	Single S	BELT
1.9 D/TD	6/94 - 4/02			ZF	54189	4 P	BELT
1.9 D/TD	6/94 - 4/02			ZF	53605	4 P	**BELT
1.9 D/TD	6/94 - 4/02			ZF	53577		**BELT
2.5 D/TD	6/94 - 4/98		[10/14]	ZF	53605		**BELT
2.5 D/TD	6/94 - 4/98			ZF	53577		**BELT
2.5 D/TD	6/94 - 4/98		[18/MAXI]	ZF	53605		**BELT
2.5 D/TD	6/94 - 4/98			ZF	53577		**BELT

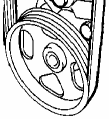

			OE	SPIDAN	 Ø mm	Ports	NOTICE
FIAT							
DUCATO (230)							
2.8 D/TD	4/98 - 4/02	[14]	ZF	53605			* BELT
2.8 D/TD	4/98 - 4/02		ZF	53577			* BELT
2.8 D/TD	4/98 - 4/02	[18/MAXI]	ZF	53605			* BELT
2.8 D/TD	4/98 - 4/02		ZF	53577			* BELT
SCUDO (220L/P)							
1.9 D/TD	9/96 -		ZF	53854	114	6	P L--113mm
1.9 D/TD	9/96 -		ZF	54236	114	6	P L--107mm
FORD							
CORTINA							
2.0/2.3	9/79 - 7/82		SAGI.	53587		S	IR
COUGAR (EC_)							
2.5 V6	10/88 - 10/00	eng.Duratec	VISTEON	53875	152	6	S
ESCORT (GAL)							
1.3 8V	9/90 - 1/95		SAGI.	53536		S	
1.4 8V	9/90 - 1/95		SAGI.	53536		S	
1.6 8V SOHC	9/90 - 10/92		SAGI.	53536		S	
1.6 16V DOHC	10/92 - 10/94	eng.Zetec	SAGI.	53521	147	5	S
1.6 16V DOHC	10/94 - 1/95	eng.Zetec	VISTEON	53853	142	6	S
1.6 16V DOHC	1/92 - 10/94	eng.Zetec	SAGI.	53521	147	5	S
1.6 16V DOHC	10/94 - 5/95	eng.Zetec	VISTEON	53853	142	6	S
2.0 RS2000	9/91 - 1/95	eng.Zetec	SAGI.	53653	116	6	S
2.0 Cosworth TURBO	6/92 - 1/95		SAGI.	53715		S	
1.8 D/TD	8/90 - 1/95		SAGI.	53519	147	5	S
1.8 D/TD	9/90 - 9/94		SAGI.	53519	147	5	S
1.8 D/TD	9/94 - 1/95		VISTEON	53714	80	4	S ID.- HBD Cg
ESCORT (GAL, AAL, ABL)							
1.3 8V	1/95 - 1/99		VISTEON	53560	142	6	S ID.- HBD BD & HBD Bu
1.4 8V	1/95 - 1/99		VISTEON	53560	142	6	S ID.- HBD BD & HBD Bu
1.4 8V	1/95 - 1/99		SAGI.	53536		S	
1.6 16V	1/95 - 7/00	eng.Zetec	VISTEON	53560	142	6	S ID.- HBD BD & HBD Bu
1.8 16V	1/95 - 1/99	eng.Zetec	VISTEON	53560	142	6	S ID.- HBD BD & HBD Bu
2.0 RS2000	1/95 - 7/96	eng.Zetec	SAGI.	53653	116	6	S
2.0 Cosworth TURBO	1/95 - 12/95		SAGI.	53715		S	
1.8 D	1/95 - 1/97	* TURBO	SAGI.	53519	147	S	
1.8 TD	1/95 - 7/00		VISTEON	53584	110	5	P ID.- HBD Bz & HBD Ey
1.8 TD	1/95 - 7/00		VISTEON	53714	80	4	S ID.- HBD Cg
ESCORT (AVL)							
1.3 8V	12/91 - 2/94		SAGI.	53536		S	

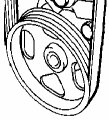

			OE	SPIDAN	 Ø mm	Ports	NOTICE
FORD							
ESCORT (AVL)							
1.4 8V	11/97 -		VISTEON	53560	142	6 S	ID.- HBD BD & HBD Bu
1.8 D	1/91 -		SAGI.	53519	147	5 S	
1.8 TD	10/95 -		VISTEON	53584	110	5 P	ID.- HBD Bz
EXPLORER (U2)							
4.0 V6	1/97 -	5/01		53851			
FIESTA (GF-J)							
1.1 8V	1/94 -	12/95	VISTEON	53534	110	4 S	ID.- HBD Bf
1.3 8V	1/94 -	12/95	VISTEON	53534	110	4 S	ID.- HBD Bf
1.4 8V	2/94 -	12/95	VISTEON	53850		S	ID.- HBD AW
1.6 16V	2/94 -	12/95	eng.Zetec	53627	122	6 S	ID.- HBD Ar
1.8 D	1/94 -	12/95	VISTEON	53652	80	4 S	ID.- HBD Cc
1.8 D	4/94 -	12/95	VISTEON	53849		S	ID.- HBD AS
FIESTA (JA_, JB_)							
1.25 16V	10/95 -	4/99	eng.Zetec	53667	120	6 P	ID.- HBD Bj
1.25 16V	4/99 -	2/02	eng.Zetec	54105	120	6 P	ID.- HBD Cm
1.3 8V	10/95 -	1/98		53846	120	6 P	
1.3 8V	1/98 -	2/02	eng.JJ	53846	120	6 P	
1.3 8V	1/98 -	2/02	eng.J4	53603	120	6 P	L-107mm /A1 RS.No. 96mf3a733ae
1.3 8V	1/98 -	2/02		53979	120	6 P	L-116mm /A2 RS.No. 96bf3a733ad
1.4	3/96 -	99	eng.Zetec	53667	120	6 P	ID.- HBD Bj
1.4	99 -	10/00	eng.Zetec	54174	120	6 P	ID.- HBD Bh
1.6 16V	3/00 -	2/02	eng.Zetec	54020	125	6 P	ID.- HBD Fx
1.8 D	12/95 -	99		53584	110	5 P	ID.- HBD Bz
1.8 D	99 -	3/00	* TURBO				
1.8 TD	2/00 -	2/02		54188	116	6 P	ID.- HBD Fg
FIESTA (JH_)							
1.4 TDG/ITD	3/02 -		KAYABA	54224	126	6 P	
1.25 16V	3/02 -		VISTEON	54252	124	6 P	ID.- HBD Ho
1.25 16V	3/02 -		VISTEON	54253	77	5 P	ID.- HBD Hp
FIESTA COURIER (F3L, F5L)							
1.8 D	2/94 -	9/96	VISTEON	53652	80	4 S	ID.- HBD Cc
1.8 D	2/94 -	9/96	VISTEON	53849		S	ID.- HBD AS

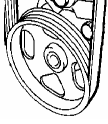

				OE	SPIDAN	 Ø mm	Ports	NOTICE
FORD								
FIESTA COURIER (J5_ J3_)								
1.3		9/96 - 9/98		VISTEON	53846	120	6 P	
1.8 D		9/96 - 99		VISTEON	53584	110	5 P	ID.- HBD Bz
1.8 TD		3/00 -		VISTEON	54188	116	6 P	ID.- HBD Fg
FOCUS (DAW/DBW/DFW/DNW)								
1.4 16V		10/98 -	eng.Zetec		54061	135	6 P	ID.- HBD Cx & HBD Ga
1.6 16V		10/98 -	eng.Zetec	A/C	54061	135	6 P	ID.- HBD Cx & HBD Ga
1.6 16V		10/98 -	eng.Zetec	A/C	54153	125	6 P	ID.- HBD Cy
1.6 16V		10/98 -	eng.Zetec	SENSOR	54020	125	6 P	ID.- HBD Fx
1.8 16V		10/98 -	eng.Zetec		53732	127	6 P	ID.- HBD CV & HBD Fy
2.0 16V		10/98 -	eng.Zetec		53732	127	6 P	ID.- HBD CV & HBD Fy
2.0 16V ST170		3/02 -	eng.Duratec VVT		54185	126	6 P	ID.- HBD Ha
1.8 Tdi/TD		10/98 -		VISTEON	53980	127	6 P	ID.- HBD Ct
FUSION (JU_)								
1.4 TDCi/TD		8/02 -		KAYABA	54224	126	6 P	
GALAXY (VX, VY)								
2.0 8V		6/95 - 2/99		ZF	53843	112	6 S	
2.3 16V		1/97 -		ZF	53843	112	6 S	
2.8 V6		6/95 - 9/96		ZF	53845		S	
2.8 V6		9/96 -		ZF	53844		S	
1.9 TD		6/95 -		ZF	53583	104	Single S	
1.9 TD		6/95 -		KAYABA	54203	120	6 S	L-108mm
1.9 TD		6/95 -		KAYABA	54262	120	6 S	L-98mm
KA (RB_)								
1.3		9/96 -		VISTEON	53603	120	6 P	L-107mm /A1 RS.No. 96mf3a733ae
1.3		9/96 -		VISTEON	53979	120	6 P	L-116mm /A2 RS.No. 96bf3a733ad
MAVERICK (JDS, UNS)								
2.4		7/93 - 12/97		KAYABA	53712	127	Single S	
2.7 TD		7/93 - 12/97		ZF	53541	135	Single P	
MONDEO (GBP/BNP/BAP/BFP)								
1.6		2/93 - 9/00	eng.Zetec	VISTEON	53510	129	6 P	ID.- HBD Ae
1.8		2/93 - 2/99	eng.Zetec	VISTEON	53510	129	6 P	ID.- HBD Ae
1.8		2/99 -	eng.Zetec	VISTEON	54232	125	6 P	ID.- HBD Fs
2.0		2/99 -	eng.Zetec	VISTEON	54215	135	6 P	ID.- HBD Ec
2.0		2/93 - 2/99	eng.Zetec	VISTEON	53510	129	6 P	ID.- HBD Ae
2.0		2/99 - 9/00	eng.Zetec	VISTEON	53725	127	6 P	ID.- HBD Eb

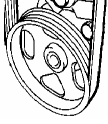

				OE	SPIDAN	 Ports Ø mm	NOTICE
FORD							
MONDEO (GBP/BNP/BAP/BFP)							
2.0		10/00 -		VISTEON	54215	135	ID.- HBD Ec
2.0 Di/TD Sohc		10/00 - 5/02	eng.Duratec	ZF	54205	63	P
2.0 TDC/ITD Dohc		11/01 -		HOB.	54219	64	5 P
2.5 V6		10/94 - 8/96		VISTEON	53650	152	4 S
2.5 V6		8/96 - 9/00		VISTEON	53875	152	6 S
1.8 TD		2/93 - 8/96		SAGI.	53502	63	6 S
1.8 TD		8/96 - 9/00		SAGI.	53533	63	5 P
ORION (GAL)							
1.4 8V		9/90 - 8/93		SAGI.	53536		S
1.6 8V SOHC		9/90 - 10/92		SAGI.	53536		S
1.6 16V DOHC		10/92 - 8/93	eng.Zetec	SAGI.	53521	147	5 S
1.8 16V DOHC		1/92 - 8/93	eng.Zetec	SAGI.	53521	147	5 S
1.8 D		9/90 - 8/93		SAGI.	53519	147	5 S
PROBE (ECP)							
2.0 16V		3/94 - 9/97		KAYABA	53711	130	5 S
2.5 24V		3/94 - 9/97		KAYABA	53626	119	4 S
PUMA (EC_)							
1.4		2/98 - 10/00		VISTEON	53837	119	6 P
1.6		10/00 -		VISTEON	53837	119	6 P
1.7		6/97 - 6/02		VISTEON	53837	119	6 P
SCORPIO							
1.8 8V		5/85 - 8/88		SAGI.	53587		S
2.0 SOHC		1/86 - 6/89		SAGI.	53587		S
2.0 DOHC		1/89 - 1/92		SAGI.	53513	150	6 S
2.0		10/94 - 10/97		ZF	53545	134	6 S
2.3		5/96 - 6/98		ZF	53545	134	6 S
2.4 V6		1/87 - 8/89		SAGI.	53525		S
2.9 12V		1/87 - 1/92		SAGI.	53525		S
2.9 24V		2/91 - 1/92		SAGI.	53842		S
2.9 12V		2/92 - 7/92		SAGI.	53841		S
2.9 12V		7/92 - 3/95		SAGI.	53525		S
2.9 24V		2/92 - 10/94	eng.COSWORTH	SAGI.	53582		S
2.9		10/94 - 6/98		ZF	53545	134	6 S
2.5 D		1/86 - 1/88		SAGI.	53513	150	6 S
2.5 TD		12/88 - 1/92		SAGI.	53795	137	Single S
2.5 TD		9/93 - 3/95		SAGI.	53565		S
2.5 TD		10/94 - 6/98		ZF	53602		S

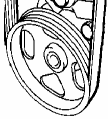

				OE	SPIDAN	 Ports Ø mm	NOTICE
HONDA							
ACCORD (CA)							
2.0 SOHC	11/85 - 11/89		eng.A20A	HONDA	53830	110 Single S	ID.- Ph1
2.0 SOHC	11/85 - 11/89			HONDA	-	110 Single S	ID.- HF12
ACCORD (CB/CC)							
2.0	9/89 - 6/94		eng.F20A	HONDA	54152	116 4 S	ID.- P10
2.2	9/89 - 6/94		eng.F22A	HONDA	54152	116 4 S	ID.- P10
2.2	4/91 - 6/94		eng.F22A	HONDA	54152	116 4 S	ID.- P10
ACCORD							
2.0	5/96 - 9/98		eng.F20Z1	LUK	-	110 4 P	
2.0	6/94 - 11/97		eng.F20B	HONDA	54158	110 4 S	ID.- P0a
2.0	6/94 - 11/97		eng.F20B	HONDA	54158	110 4 S	ID.- P0a
2.2	3/96 - 9/98		eng.S22Z2	LUK	-	110 4 P	
2.2	6/94 - 11/97		eng.F22B	HONDA	54158	110 4 S	ID.- P0a
2.2	6/94 - 11/97		eng.F22B	HONDA	54158	110 4 S	ID.- P0a
ACCORD (CG/CH)							
2.0	10/88 - 1/03		eng.F20B	HONDA	54157	103 4 S	
BALLADE (HJ)							
1.5	10/86 - 11/89		eng.EW	HONDA	53829	110 Single S	
CIVIC							
1.35	2/84 - 2/85		eng.EV2	HONDA	53829	110 Single S	
1.5 CARB.	2/84 - 3/88		eng.EW2	HONDA	53829	110 Single S	
1.5i	2/84 - 8/87		eng.EW3	HONDA	53829	110 Single S	
1.6i	4/86 - 8/87		eng.ZC1	HONDA	53827	110 Single S	
1.35	8/87 - 11/91		eng.D13B	HONDA	54151	110 Single S	ID.- Pm3
1.35	11/91 - 3/96		eng.D13B	HONDA	53625	110 4 S	ID.- P02
1.5	11/91 - 3/96		eng.D15B	HONDA	53625	110 4 S	ID.- P02
1.6 VTI DOHC	11/91 - 3/96		eng.B16A	HONDA	-	112 3 S	ID.- P30a
1.5 SOHC	3/95 - 12/00		eng.D15Z	HONDA	53912	110 4 S	
CONCERTO (HW)							
1.4	10/89 - 8/91		eng.D14A1	HONDA	53828	110 Single S	
1.5	8/91 - 9/94		eng.D15B2	HONDA	54151	110 Single S	ID.- Pm3
1.6 SOHC	10/89 - 9/94		eng.D16Z	HONDA	54151	110 Single S	ID.- Pm3
1.6 DOHC	10/89 - 9/94		eng.D16A	HOB.	53591	118 Single S	Pump-FE
CR-V							
2.0 (RD18)	6/97 - 1/02		eng.B20B3	HONDA	54220	110 4 S	
2.0 (RD87/RD88)	2/02 -		eng.K20A4		54223	S	
INTEGRA (DA17)							
1.6	3/86 - 11/89		eng.D16A	HONDA	53827	110 Single S	

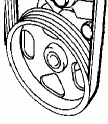

					OE	SPIDAN	 Ø mm	Ports	NOTICE
HONDA									
LEGEND (KA)									
2.7		88 - 4/91	eng.C27A2		HONDA	53826	Single	S	
3.2		4/91 - 6/96	eng.C32A		HONDA	53852	120	4	S
PRELUDE									
2.0 (BA)		10/87 - 4/92	eng.B20A	INCL.4WS	HONDA	53825	110	Single	S
2.2 (BB)		2/93 - 9/96	eng.H22A		HONDA	53713	103	3	S
HYUNDAI									
ACCENT (X-3)									
1.5 16V		10/94 - 12/99			YOUNGSHIN	53722	95	4	S
ATOS (MX)									
1.0 12V		5/98 - 10/00			YOUNGSHIN	54055	106	Single	S
COUPE (RD)									
2.0 16V		10/96 - 1/02			YOUNGSHIN	53840	107	Single	S
LANTRA									
1.5 8V		10/93 - 10/95	(J-1)		YOUNGSHIN	-	112	Single	S
1.6 16V		6/91 - 10/95	(J-1)		KAYABA	53647		Single	P
1.6 16V		11/95 - 3/01	(J-2)		YOUNGSHIN	53840	107	Single	S
1.8 16V		10/92 - 10/95	(J-1)		KAYABA	53647		Single	P
1.8 16V		11/95 - 2/97	(J-2)		YOUNGSHIN	53840	107	Single	S
2.0 16V		2/97 - 3/01	(J-2)		YOUNGSHIN	53840	107	Single	S
S COUPE (SLC)									
1.5		7/90 - 10/95			KAYABA	53624	94	4	S
SONATA II (Y-3)									
1.8 8V		6/89 - 10/92				53708			
2.0 8V/16V		6/89 - 12/93				53708			
2.4 8V		6/89 - 1/92				53708			
ISUZU									
TROOPER									
2.6		1/88 - 10/91	(UBS)		KAYABA	-	102	Single	S
2.2 TD		2/87 - 1/88	(UBS)		SAGI	-	117	2	P
2.8 TD		1/88 - 10/91	(UBS)		KAYABA	53559	102	2	P
3.2 V6		2/92 - 5/98	(UB)		KAYABA	54008	139	Single	S
3.1 TD		2/92 - 5/98	(UB)		KAYABA	53559	102	2	P
IVECO									
DAILY									
2.0		89 - 91			ZF	53856			
2.5 D/TD		89 - 91			ZF	53856			

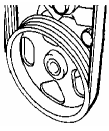

				OE	SPIDAN	 Ø mm	Ports	NOTICE
JAGUAR								
S-TYPE (CCX)								
2.5 V6		3/02 -		VISTEON	54167	135	6 P	ID.- HBD Dk
3.0 V6		3/99 -		VISTEON	54167	135	6 P	ID.- HBD Dk
X-TYPE (CF1)								
2.5 V6		5/01 -		VISTEON	54167	135	6 P	ID.- HBD Dk
3.0 V6		5/01 -		VISTEON	54167	135	6 P	ID.- HBD Dk
XJ6/8/12								
2.9		10/86 - 9/90		SAGI.	53985			GEAR
3.2		9/90 - 9/94		SAGI.	53985			GEAR
3.6		10/86 - 9/89		SAGI.	53985			GEAR
4.0		9/89 - 9/94		SAGI.	53985			GEAR
5.3		10/86 - 9/92		SAGI.	53985			GEAR
6.0		2/93 - 9/94		SAGI.	53985			GEAR
3.2		9/94 - 1/03		ZF	-			GEAR
4.0		9/94 - 1/03		ZF	-			GEAR
XJS								
3.6		86 - 5/91		SAGI.	53985			GEAR
5.3		86 - 5/91		SAGI.	53985			GEAR
6.0		9/89 - 5/91		SAGI.	53985			GEAR
XK8 (Q_)								
4.0		10/96 - 7/02		HOB.	53987		S	
4.0		8/98 - 7/02		HOB.	54204		S	
JEEP								
CHEROKEE (XJ)								
2.5i		1/93 - 3/01		SAGI.	53621	135	6 P	
4.0		1/93 - 9/01		SAGI.	53621	135	6 P	
2.5 TD		3/95 - 9/01		SAGI.	-			
2.5 TD		3/95 - 9/01		SAGI.	-		S	
3.1 TD		6/99 - 12/01		SAGI.	-		S	
GRAND CHEROKEE I (Z)								
4.0		1/96 - 5/99		SAGI.	-			
2.5 TD		12/96 - 5/99		SAGI.	-			
GRAND CHEROKEE II (WJ, WG)								
3.1 TD		6/99 - 12/01		SAGI.	-			
KIA								
SPORTAGE (K00)								
2.0		7/95 - 7/02		YOUNGSHIN	54198	112	Single S	

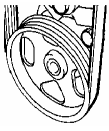

			OE	SPIDAN	 Ø mm	Ports	NOTICE
LANCIA							
DEDRA (835)							
1.6	3/90 - 1/94	-->450502	SAGI./ZF	53822		S	
1.6	3/90 - 1/94	450502-->	SAGI./ZF	53585	145	Single	S
1.8/2.0	3/90 - 1/94		SAGI./ZF	53822		S	
DELTA							
2.0	5/87 - 1/95	4x4/Integrale	ZF	54001	150	5	S
LAND ROVER							
DISCOVERY							
3.5 V8	9/90 - 9/93		HOB.	-	140	2	S
3.9 V8	9/93 - 10/98		ZF	54007		S	
2.5 TD	11/89 - 3/94	4 CYLINDER	HOB.	53563	96	2	S
2.5 TD	4/94 -	4 CYLINDER	HOB.	53515			S PUMP-AL/FE
2.5 TD5	10/88 -	5 CYLINDER	HOB.	53515			S PUMP-AL/FE
2.5 TD5	4/01 -	5 CYLINDER	HOB.	54254			S A5
FREELANDER (LN)							
1.8	12/97 -	4 CYLINDER	HOB.	53877		S	
2.0 TD	12/97 -	4 CYLINDER	HOB.	54180		S	A5
RANGE ROVER II (LP)							
4.0 V8	9/94 - 2/02		ZF	54025			
4.6 V8	9/94 - 2/02		ZF	54025			
2.5 TD	9/94 - 2/02	6 CYLINDER	ZF	53880		S	BMW-ENGINE
DEFENDER (LD)							
2.5	9/90 - 7/94		HOB.	53563	96	2	S
3.5 V8	9/90 - 7/94		HOB.	-	140	2	S
2.5 D/TD	9/90 - 3/94	4 CYLINDER	HOB.	53563	96	2	S
2.5 D/TD	3/94 - 1/98	4 CYLINDER	HOB.	53515			S PUMP-AL/FE
2.5 TD	11/88 -	5 CYLINDER	HOB.	53515			S PUMP-AL/FE
LDV							
200							
1.9	9/94 - 6/96		SAGI.	53995	139	Single	S
2.0	4/89 - 12/94		SAGI.	53995	139	Single	S
2.0 D	4/89 - 12/94		SAGI.	53995	139	Single	S
400							
2.5 D	4/89 - 4/96	eng.PEUGEOT	SAGI.	54170	140	Single	S
CONVOY							
2.5 D/TD	4/96 - 10/97		SAGI.	53513	150	6	S
2.5 D	10/97 -	* TURBO	SAGI.	54101	150	Single	S PUMP-AL

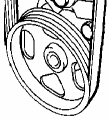

					OE	SPIDAN	 Ports Ø mm	NOTICE
LDV								
CUB								
2.3 D		7/98 - 12/02			UNISIAJECS	-	126 Single S	
PILOT								
1.9 D		4/96 -			SAGI.	53522	114 4 S	
1.9 D		4/96 -			SAGI.	-	114 6 P	
1.9 D		4/96 -			SAGI.	54100	141 5 P	
LEXUS								
GS 300								
3.0		10/93 - 10/97				53988	6 S	
LS/IS								
IS200								
		3/99 -			TOYOTA	-	135 3 S	
LS400								
		6/90 - 10/00				53989	6 S	
MAZDA								
121								
1.3		2/91 - 10/95 (DB)				53821	117 6 P	
1.25		3/96 - 10/98 (JA,JB)		eng.ZETEC	SAGI.	53848	120 6 P	
1.3		3/96 - 1/98 (JA,JB) EFIL LOW PRESSURE			SAGI.	53846	120 6 P	
1.3		1/98 - 10/98 (JA,JB) EFIL NORMAL PRESSURE			SAGI.	53846	120 6 P	
1.3		1/98 - 10/98 (JA,JB)			SAGI.	53603	120 6 P	
1.8 D		3/96 - 7/97 (JA,JB)			SAGI.	53584	110 5 P	
323								
1.3		3/88 - 1/90 (BF)			KAYABA	53707	140 4 S	
1.6		10/86 - 10/89 (BF)		INCL.Turbo	KAYABA	53707	140 4 S	
1.3		10/89 - 6/94 (BG)			KAYABA	53820	140 4 P	
1.5 KOMBI								
1.6		1/90 - 5/91 (BW)			KAYABA	53707	140 4 S	
1.6		10/89 - 6/94 (BG)			KAYABA	53820	140 4 P	
1.8		10/89 - 6/94 (BG)			KAYABA	53820	140 4 P	
1.3 16V								
1.3 16V		6/94 - 5/98 (BA)			KAYABA	53819	118 4 P	IN-FE
1.3 16V								
1.3 16V		6/94 - 5/98 (BA)			KAYABA	54237	118 4 P	IN-P
1.5 16V								
1.5 16V		8/94 - 10/98 (BA)			KAYABA	53819	118 4 P	IN-FE
1.5 16V								
1.5 16V		8/94 - 10/98 (BA)			KAYABA	54237	118 4 P	IN-P
1.8 16V								
1.8 16V		11/94 - 10/98 (BA)			KAYABA	53819	118 4 P	IN-FE
1.8 16V								
1.8 16V		11/94 - 10/98 (BA)			KAYABA	54237	118 4 P	IN-P
626								
2.0								
		5/83 - 10/87 (GC)			ATSUGI	54000	140 5 S	
1.8								
		10/87 - 2/92 (GD.GV)			KAYABA	53592	140 5 S	
2.0								
		10/87 - 1/93 (GD.GV)			KAYABA	53592	140 5 S	

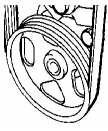

				OE	SPIDAN	 Ports Ø mm	NOTICE
MAZDA							
626							
2.0 Gti 4WS	3/88 - 92	(GD.GV)		ATSUGI	-	138 5 S	TANDEM PUMP
2.2	1/90 - 1/93	(GD.GV)		KAYABA	53592	140 5 S	
1.8 16V	2/92 - 6/97	(GE)		KAYABA	53644	129 5 S	
2.0 16V	2/92 - 6/97	(GE)		KAYABA	53644	129 5 S	
2.5 V6	2/92 - 12/94	(GE)		KAYABA	53626	119 4 S	
MX3 (EC)							
1.6/1.8	9/91 - 10/98			UNISIAJECs	53706	120 4 S	
1.6/1.8	9/91 - 10/98			KAYABA	54161	118 4 P	
MX5							
1.6/1.8	1/90 - 4/98	(NA)			53818	124 4 P	
1.6/1.8	5/98 -	(NB)			54187	124 4 P	
MX6 (GE)							
2.5	2/92 - 6/97			KAYABA	53626	119 4 S	
XEDOS 6 (CA)							
1.6	10/83 - 10/87			KAYABA	53644	129 5 S	
2.0	6/92 - 1/00			KAYABA	53644	129 5 S	
XEDOS 9 (TA)							
2.3	10/88 - 8/01				53816	S	
2.5	1/94 - 10/98				53816	S	
E SERIES (SR)							
2.2 D	6/85 - 5/02			KAYABA	-	S	
MERCEDES BENZ							
190							
1.8 Manual	6/90 - 9/93	eng.102.910/102.919		ZF	53600	165 6 S	
1.8	6/90 - 9/93	eng.102.910/102.919		VICKERS	54092	160 6 S	
1.8 AUTO	6/90 - 9/93	eng.102.910/102.919		ZF	53929	160 6 S	
1.8	6/90 - 9/93	eng.102.910/102.919		VICKERS	54097	160 6 S	
2.0 Manual	9/83 - 9/90	eng.102924	CARB	MOTORCODE -->034587	53600	165 6 S	
2.0	9/83 - 9/90	eng.102924	CARB		54092	160 6 S	
2.0 Manual	9/83 - 9/90	eng.102924	CARB	MOTORCODE 034588-->	53929	160 6 S	
2.0	9/83 - 9/90	eng.102924	CARB		54097	160 6 S	
2.0 AUTO	9/83 - 9/90	eng.102924	CARB	MOTORCODE -->008906	53600	165 6 S	
2.0	9/83 - 9/90	eng.102924	CARB		54092	160 6 S	
2.0 AUTO	9/83 - 9/90	eng.102924	CARB	MOTORCODE 008907-->	53929	160 6 S	
2.0	9/83 - 9/90	eng.102924	CARB		54097	160 6 S	
2.0 E Manual	9/83 - 9/93	eng.102962	83/85/87 Kw	MOTORCODE -->034587	53600	165 6 S	

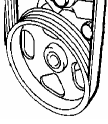

					OE	SPIDAN	 Ø mm	Ports	NOTICE
MERCEDES BENZ									
190									
2.0i E	9/83	-	9/93	eng.102962					
2.0i E Manual	9/83	-	9/93	eng.102962	83/85/87 Kw	MOTORCODE 034588-->	160	6 S	
2.0i E	9/83	-	9/93	eng.102962			160	6 S	
2.0i E AUTO	9/83	-	9/93	eng.102962	83/85/87 Kw	MOTORCODE -->008906	165	6 S	
2.0i E	9/83	-	9/93	eng.102962			160	6 S	
2.0i E AUTO	9/83	-	9/93	eng.102962	83/85/87 Kw	MOTORCODE 008907-->	160	6 S	
2.0i E	9/83	-	9/93	eng.102962			160	6 S	
2.0i E Manual	9/83	-	9/93	eng.102962	90kw	MOTORCODE -->135684	165	6 S	
2.0i E	9/83	-	9/93	eng.102962			160	6 S	
2.0i E Manual	9/83	-	9/93	eng.102962	90kw	MOTORCODE 135685-->	160	6 S	
2.0i E	9/83	-	9/93	eng.102962			160	6 S	
2.0i E AUTO	9/83	-	9/93	eng.102962	90kw	MOTORCODE -->068666	165	6 S	
2.0i E	9/83	-	9/93	eng.102962			160	6 S	
2.0i E AUTO	9/83	-	9/93	eng.102962	90kw	MOTORCODE 068667-->	160	6 S	
2.0i E	9/83	-	9/93	eng.102962			160	6 S	
2.3 E 8V Manual	9/86	-	8/93	eng.102985		MOTORCODE -->004391	165	6 S	
2.3 E 8V	9/86	-	8/93	eng.102985			160	6 S	
2.3 E 8V Manual	9/86	-	8/93	eng.102985		MOTORCODE 004392-->	160	6 S	
2.3 E 8V	9/86	-	8/93	eng.102985			160	6 S	
2.3 E 8V AUTO	9/86	-	8/93	eng.102985		MOTORCODE --> 040748	165	6 S	
2.3 E 8V	9/86	-	8/93	eng.102985			160	6 S	
2.3 E 8V AUTO	9/86	-	8/93	eng.102985		MOTORCODE 040749-->	160	6 S	
2.3 E 8V	9/86	-	8/93	eng.102985			160	6 S	
2.3 E 16V Manual	4/84	-	8/88	eng.102983		MOTORCODE -->001631			IR
2.3 E 16V Manual	4/84	-	8/88	eng.102983		MOTORCODE 001532-->			
2.3 E 16V	4/84	-	8/88	eng.102983			160	6 S	
2.3 E 16V AUTO	4/84	-	8/88	eng.102983			160	6 S	
2.5 16V	9/88	-	1/93	eng.102990					
2.5 16V	9/88	-	1/93	eng.102990			160	6 S	
2.6 E	3/87	-	9/93	eng.103942	* SLS		132	6 S	
2.0 D Manual	10/84	-	9/93	eng.601911		MOTORCODE -->066453			IR
2.0 D Manual	10/84	-	9/93	eng.601911			165	6 S	
2.0 D	10/84	-	9/93	eng.601911		MOTORCODE 066454-->098425	160	6 S	
2.0 D Manual	10/84	-	9/93	eng.601911		MOTORCODE 098426-->	160	6 S	
2.0 D	10/84	-	9/93	eng.601911			160	6 S	

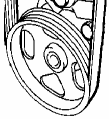
				OE	SPIDAN	 Ports Ø mm	NOTICE
MERCEDES BENZ							
190							
2.0 D AUTO	10/84 - 9/93	eng.601911		ZF	53723	S	IR
2.0 D AUTO	10/84 - 9/93	eng.601911	MOTORCODE -->006847	ZF	53600	6 S	
2.0 D	10/84 - 9/93	eng.601911	MOTORCODE 006848-->	VICKERS	54092	6 S	
2.0 D AUTO	10/84 - 9/93	eng.601911	MOTORCODE 009625-->	ZF	53929	6 S	
2.0 D	10/84 - 9/93	eng.601911		VICKERS	54097	6 S	
2.5 D Manual	4/85 - 9/93	eng.602911	MOTORCODE -->000721	ZF	53600	6 S	
2.5 D	4/85 - 9/93	eng.602911		VICKERS	54092	6 S	
2.5 D Manual	4/85 - 9/93	eng.602911	MOTORCODE 000722-->	ZF	53929	6 S	
2.5 D	4/85 - 9/93	eng.602911		VICKERS	54097	6 S	
2.5 D AUTO	4/85 - 9/93	eng.602911	MOTORCODE -->000203	ZF	53600	6 S	
2.5 D	4/85 - 9/93	eng.602911		VICKERS	54092	6 S	
2.5 D AUTO	4/85 - 9/93	eng.602911	MOTORCODE 000204-->	ZF	53929	6 S	
2.5 D	4/85 - 9/93	eng.602911		VICKERS	54097	6 S	
2.5 TD	2/88 - 8/93	eng.602961	* SLS	ZF	53929	6 S	
2.5 TD	2/88 - 8/93	eng.602961		VICKERS	54097	6 S	
W168							
A140	1.4 9/98 -			LUK	53978		ELEKTRISCH
A160	1.6 9/98 -			LUK	53978		ELEKTRISCH
A170	1.7 D 7/98 -			LUK	53978		ELEKTRISCH
W202							
C180	1.8 Manual 10/93 - 8/00	eng.111920	* SLS/ASD	ZF	53745	6 S	IR
C180	1.8 10/93 - 8/00	eng.111920		LUK	54125	S	
C180	1.8 Manual 10/93 - 8/00	eng.111920	* SLS/ASD	ZF	53815	S	IR
C180	1.8 10/93 - 8/00	eng.111920		LUK	54109	6 P	IR
C180	1.8 Manual 10/93 - 8/00	eng.111920	SLS/ASD	ZF	53964	S	IRS
C180	1.8 Manual 10/93 - 8/00	eng.111921	* SLS/ASD	ZF	53815	S	IR
C180	1.8 10/93 - 8/00	eng.111921		LUK	54109	6 P	IR
C180	1.8 Manual 10/93 - 8/00	eng.111921	SLS/ASD	ZF	53964	S	IRS
C180	1.8 Auto 10/93 - 8/00	eng.111920	* SLS/ASD	ZF	53745	6 S	IR
C180	1.8 10/93 - 8/00	eng.111920		LUK	54125	S	
C180	1.8 Auto 10/93 - 8/00	eng.111920	* SLS/ASD	ZF	53815	S	IR
C180	1.8 10/93 - 8/00	eng.111920		LUK	54109	6 P	IR
C180	1.8 Auto 10/93 - 8/00	eng.111920	SLS/ASD	ZF	53964	S	IRS
C180	1.8 Auto 10/93 - 8/00	eng.111921	* SLS/ASD	ZF	53815	S	IR
C180	1.8 10/93 - 8/00	eng.111921		LUK	54109	6 P	IR
C180	1.8 Auto 10/93 - 8/00	eng.111921	SLS/ASD	ZF	53964	S	IRS
C200	2.0 Manual 1/94 - 8/00	eng.111941	* SLS/ASD	ZF	53745	6 S	IR

						OE		SPIDAN		 Ø mm		Ports		NOTICE	
MERCEDES BENZ															
W202															
C200	2.0	1/94	-	8/00	eng.111941										
C200	2.0 Manual	1/94	-	8/00	eng.111941	* SLS/ASD	MOTORCODE 028944-->	LUK	54116			S		IRS	
C200	2.0	1/94	-	8/00	eng.111941			LUK	54109	130	6	P		IR	
C200	2.0 Manual	1/94	-	8/00	eng.111941	SLS/ASD		ZF	53964			S		IRS	
C200	2.0	1/94	-	8/00	eng.111944	* SLS/ASD		ZF	53815			S		IR	
C200	2.0	1/94	-	8/00	eng.111944			LUK	54109			P		IR	
C200	2.0	1/94	-	8/00	eng.111944	SLS/ASD		ZF	53964			S		IRS	
C200	2.0 Manual	1/94	-	8/00	eng.111945	* SLS/ASD		ZF	53815			S		IR	
C200	2.0	1/94	-	8/00	eng.111945			LUK	54109	130	6	P		IR	
C200	2.0 Manual	1/94	-	8/00	eng.111945	SLS/ASD		ZF	53964			S		IRS	
C200	2.0 Auto	1/94	-	8/00	eng.111941	* SLS/ASD	MOTORCODE -->034154	ZF	53745	165	6	S		IR	
C200	2.0	1/94	-	8/00	eng.111941			LUK	54116			S		IRS	
C200	2.0 Auto	1/94	-	8/00	eng.111941	* SLS/ASD	MOTORCODE 034155-->	ZF	53815			S		IR	
C200	2.0	1/94	-	8/00	eng.111941			LUK	54109	130	6	P		IR	
C200	2.0 Auto	1/94	-	8/00	eng.111941	SLS/ASD		ZF	53964			S		IRS	
C200	2.0 Auto	1/94	-	8/00	eng.111945	* SLS/ASD		ZF	53815			S		IR	
C200	2.0	1/94	-	8/00	eng.111945			LUK	54109	130	6	P		IR	
C200	2.0 Auto	1/94	-	8/00	eng.111945	SLS/ASD		ZF	53964			S		IRS	
C220	2.2 Manual	10/93	-	8/95	eng.111961	* SLS/ASD	MOTORCODE -->024580	ZF	53745	165	6	S		IR	
C220	2.2	10/93	-	8/95	eng.111961			LUK	54125			S		IR	
C220	2.2 Manual	9/95	-	7/96	eng.111961	* SLS/ASD	MOTORCODE 024581-->	ZF	53815			S		IR	
C220	2.2 Manual	10/93	-	7/96	eng.111961	SLS/ASD		ZF	53964			S		IRS	
C220	2.2 Auto	10/93	-	8/95	eng.111961	* SLS/ASD	MOTORCODE -->084259	ZF	53745	165	6	S		IR	
C220	2.2	10/93	-	8/95	eng.111961			LUK	54125			S		IR	
C220	2.2 Auto	9/95	-	7/96	eng.111961	* SLS/ASD	MOTORCODE 084260-->	ZF	53815			S		IR	
C220	2.2 Auto	10/93	-	7/96	eng.111961	SLS/ASD		ZF	53964			S		IRS	
C230	2.3	6/96	-	8/97	eng.111974	* SLS/ASD		ZF	53815			S		IR	
C230	2.3	6/96	-	8/97	eng.111974			LUK	54109	130	6	P		IR	
C230	2.3	6/96	-	8/97	eng.111974	SLS/ASD		ZF	53964			S		IRS	
C230	2.3	10/95	-	8/00	eng.111975	* SLS/ASD		ZF	53815			S		IR	
C230	2.3	10/95	-	8/00	eng.111975			LUK	54109	130	6	P		IR	
C230	2.3	10/95	-	8/00	eng.111975	SLS/ASD		ZF	53964			S		IRS	
C240	2.4 Auto	6/97	-	8/00	eng.112910	* SLS/ASD		ZF	53966			S		IR	
C240	2.4	6/97	-	8/00	eng.112910			LUK	54209	130	6	P		IR	
C240	2.4 Auto	6/97	-	8/00	eng.112910	SLS/ASD		ZF	53967			S		IR	
C280	2.8 SOHC V6	3/97	-	8/00	eng.112920	* SLS/ASD		ZF	53966			S		IR	
C280	2.8 SOHC V6	3/97	-	8/00	eng.112920			LUK	54209	130	6	P		IR	

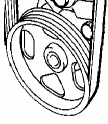

						OE		SPIDAN		 Ports Ø mm		NOTICE	
MERCEDES BENZ													
W202													
C280	2.8 SOHC V6	3/97	-	8/00	eng.111920	SLS/ASD	ZF	53967	130	6	S	IR	
C280	2.8 DOHC Manual	7/94	-	1/96	eng.104941	* SLS/ASD	LUK	54112	130	6	P	IRP	
C280	2.8 DOHC Manual	1/96	-	5/00	eng.104941	* SLS/ASD	ZF	54026	132	6	S	IR	
C280	2.8 DOHC	1/96	-	5/00	eng.104941		LUK	54227			S	IRS	
C280	2.8 DOHC Manual	3/94	-	6/97	eng.104941	SLS/ASD	ZF	54027	132	6	S	IRS	
C280	2.8 DOHC Manual	6/97	-	12/97	eng.104941	SLS/ASD	ZF	53964			S	IRS	
C280	2.8 DOHC Auto	7/94	-	1/96	eng.104941	* SLS/ASD	LUK	54112	160	6	P	IRP	
C280	2.8 DOHC Auto	1/96	-	5/00	eng.104941	* SLS/ASD	ZF	54026	132	6	S	IR	
C280	2.8 DOHC	1/96	-	5/00	eng.104941		LUK	54227			S	IRS	
C280	2.8 DOHC Auto	3/94	-	6/97	eng.104941	SLS/ASD	ZF	54027	132	6	S	IRS	
C280	2.8 DOHC Auto	6/97	-	12/97	eng.104941	SLS/ASD	ZF	53964			S	IRS	
C36 AMG	3.6 Manual	7/94	-	1/96	eng.104941	* SLS/ASD	LUK	54112	130	6	P	IRP	
C36 AMG	3.6 Manual	1/96	-	5/00	eng.104941	* SLS/ASD	ZF	54026	132	6	S	IR	
C36 AMG	3.6	1/96	-	5/00	eng.104941		LUK	54227			S	IRS	
C36 AMG	3.6 Auto	7/94	-	6/97	eng.104941	SLS/ASD	ZF	54027	132	6	S	IRS	
C36 AMG	3.6 Auto	6/97	-	5/00	eng.104941	SLS/ASD	ZF	53964			S	IRS	
C43 AMG	4.3 Auto	8/97	-	3/01	eng.113944		ZF	53966			S		
C43 AMG	4.3	8/97	-	3/01	eng.113944		LUK	54209	130	6	P		
C220 D	2.2 D Manual	10/93	-	8/95	eng.604910	* SLS/ASD	ZF	53745	165	6	S	IR	
C220 D	2.2 D	10/93	-	8/95	eng.604910		LUK	54074	143	6	S	IRP	TANDEM PUMP
C220 D	2.2 D	10/93	-	8/95	eng.604910		LUK	54116			S	IRS	
C220 D	2.2 D Manual	9/95	-	5/98	eng.604910	* SLS/ASD	ZF	53721				IR	
C220 D	2.2 D Manual	10/93	-	5/98	eng.604910	SLS/ASD	ZF	53964				IRS	
C220 D	2.2 D	10/93	-	5/98	eng.604910		LUK	54125					TANDEM PUMP
C220 D	2.2 D Auto	10/93	-	8/95	eng.604910	* SLS/ASD	ZF	53745	165	6	S	IR	
C220 D	2.2 D	10/93	-	8/95	eng.604910		LUK	54074	143	6	S	IR	TANDEM PUMP
C220 D	2.2 D	10/93	-	8/95	eng.604910		LUK	54116				IRS	
C220 D	2.2 D Auto	9/95	-	5/98	eng.604910	* SLS/ASD	ZF	53721				IR	
C220 D	2.2 D Auto	10/93	-	7/96	eng.604910	SLS/ASD	ZF	53964				IRS	
C220 D	2.2 D	10/93	-	7/96	eng.604910		LUK	54125					TANDEM PUMP
C220 TD	2.2 TD	2/99	-	8/00	eng.611960	* SLS/ASD	ZF	53721				IR	
C220 TD	2.2 TD	2/99	-	8/00	eng.611960		LUK	54074	143	6	S	IRP	TANDEM PUMP

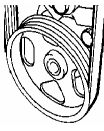

					OE	SPIDAN	 Ø mm	Ports	NOTICE	
MERCEDES BENZ										
W202										
C220 TD	2.2 TD	2/99	-	8/00	eng.611960	SLS/ASD	ZF	53964	IRS	
C220 TD	2.2 TD	2/99	-	8/00	eng.611960		LUK	54125		TANDEM PUMP
C250 D	2.5 D	10/93	-	12/95	eng.605910	* SLS/ASD	ZF	53968	6 S	IRS
C250 D	2.5 D	1/96	-	7/96	eng.605910	* SLS/ASD	ZF	53721	S	IRS
C250 D	2.5 D	10/93	-	7/96	eng.605910	SLS/ASD	ZF	53969	S	IRS
C250 TD	2.5 TD	1/96	-	8/00	eng.605960	* SLS/ASD	ZF	53721	S	IR
C250 TD	2.5 TD	1/96	-	8/00	eng.605960		LUK	54074	6 S	IR
C250 TD	2.5 TD	1/96	-	8/00	eng.605960	SLS/ASD	ZF	53969	S	IRS
W203										
C180	2.0	9/00	-	6/02		* SLS	LUK	54210	130	6 P
C200	2.0 Kompressor	9/00	-	6/02	eng.111955	* SLS	LUK	54210	130	6 P
C230	2.3 Kompressor	5/01	-	6/02	eng.111983		LUK	54210	130	6 P
W208										
CLK200	2.0	6/97	-	6/00	eng.111945	* SLS/ASD	ZF	53815	S	IR
CLK200	2.0	6/97	-	6/00	eng.111945		LUK	54109	130	6 P
CLK200	2.0	6/97	-	6/00	eng.111945	SLS/ASD	ZF	53964	S	IRS
CLK200	2.0 Kompressor	6/00	-	5/02	eng.111944	* SLS/ASD	ZF	53815	S	IR
CLK200	2.0 Kompressor	6/00	-	5/02	eng.111944		LUK	54109	130	6 P
CLK200	2.0 Kompressor	6/00	-	5/02	eng.111944	SLS/ASD	ZF	53964	S	IRS
W208										
CLK230	2.3 Kompressor	6/97	-	5/02	eng.111975	* SLS/ASD	ZF	53815	S	IR
CLK230	2.3 Kompressor	6/97	-	5/02	eng.111975		LUK	54109	130	6 P
CLK230	2.3 Kompressor	6/97	-	5/02	eng.111975	SLS/ASD	ZF	53964	S	IRS
CLK320	3.2	6/97	-	5/02	eng.112940	* SLS/ASD	ZF	53966	S	
CLK320	3.2	6/97	-	5/02	eng.112940		LUK	54209	130	6 P
CLK320	3.2	6/97	-	5/02	eng.112940	SLS/ASD	ZF	53967	S	IR
CLK430	4.3	5/99	-	5/02	eng.113943		ZF	53966	S	
CLK430	4.3	5/99	-	5/02	eng.113943		LUK	54209	130	6 P
CLK55	5.4	5/99	-	5/02	eng.113980	AMG	ZF	53966	S	
CLK55	5.4	5/99	-	5/02	eng.113980	AMG	LUK	54209	130	6 P
W123										
230/i	2.3	9/76	-	12/85			ZF	53705	S	IR
250	2.5	9/76	-	12/85			ZF	53705	S	IR
280	2.7	9/76	-	11/85			ZF	53705	S	IR
200 D	2.0 D	9/76	-	11/85			ZF	53705	S	IR
240 D	2.4 D	9/76	-	11/85			ZF	53705	S	IR
300 D	3.0 D	9/76	-	11/85			ZF	53705	S	IR



						OE		SPIDAN		 Ports Ø mm		NOTICE	
E200 T	2.0	10/85	-	9/88	eng.102922		ZF	53965	160	6	S		
E200 T	2.0	10/85	-	9/88	eng.102922		VICKERS	54131			S		IRS
E200 E/TE	2.0 Manual	9/88	-	8/92	eng.102963		ZF	53965	160	6	S		
E200 E/TE	2.0 Manual	9/88	-	8/92	eng.102963	MOTORCODE-->113167	ZF	53745	165	6	S		IR
E200 E/TE	2.0	9/88	-	8/92	eng.102963	MOTORCODE 113168-->	VICKERS	54131			S		IRS
E200 E/TE	2.0	9/88	-	8/92	eng.102963		LUK	54116			S		IRS
E200 E/TE	2.0	9/88	-	8/92	eng.102963		VICKERS	54128			S		IRS
E200 E/TE	2.0 Auto	9/88	-	8/92	eng.102963	MOTORCODE -->032138	ZF	53965	160	6	S		
E200 E/TE	2.0 Auto	9/88	-	8/92	eng.102963	MOTORCODE 032169-->	ZF	53745	165	6	S		IR
E200 E/TE	2.0	9/88	-	8/92	eng.102963		VICKERS	54131			S		IRS
E200 E/TE	2.0	9/88	-	8/92	eng.102963		LUK	54116			S		IRS
E200 E/TE	2.0	9/88	-	8/92	eng.102963		VICKERS	54128			S		IRS
E200 E/TE	2.0	9/88	-	10/95	eng.111940	* SLS/ASD	ZF	53745	165	6	S		IR
E200 E/TE	2.0	9/88	-	10/95	eng.111940		LUK	54116			S		IRS
E200 E/TE	2.0	9/88	-	10/95	eng.111940		VICKERS	54128			S		IRS
E200 E/TE	2.0	9/88	-	10/95	eng.111940	SLS/ASD	ZF	53964			S		IRS
E200 E/TE	2.0	9/88	-	10/95	eng.111940		LUK	54125			S		IRS
E200 E/TE	2.0	9/88	-	10/95	eng.111940		VICKERS	54125			S		IRS
E200 E/TE	2.0	9/88	-	10/95	eng.111940		ZF	53964			S		IRS
E200 E/TE	2.0	9/88	-	10/95	eng.111940		LUK	54134			S		IRS
E200 E/TE	2.0	9/88	-	10/95	eng.111940		VICKERS	54125			S		IRS
E200 E/TE	2.0	9/88	-	10/95	eng.111940		ZF	53745	165	6	S		IR
E200 E/TE	2.0	9/88	-	10/95	eng.111940		LUK	54125			S		IRS
E200 E/TE	2.0	9/88	-	10/95	eng.111940		ZF	53964			S		IRS
E200 E/TE	2.0	9/88	-	10/95	eng.111940		LUK	54125			S		IRS
E200 E/TE	2.3 Manual	10/85	-	10/92	eng.102982	MOTORCODE -->191947	ZF	54134	160	6	S		TANDEM PUMP
E200 E/TE	2.3 Manual	10/85	-	10/92	eng.102982	MOTORCODE 191948-->	ZF	53965	165	6	S		TANDEM PUMP
E200 E/TE	2.3	10/85	-	10/92	eng.102982		VICKERS	54131			S		IRS
E200 E/TE	2.3	10/85	-	10/92	eng.102982		LUK	54116			S		IRS
E200 E/TE	2.3	10/85	-	10/92	eng.102982		VICKERS	54128			S		IRS
E200 E/TE	2.3 Auto	10/85	-	10/92	eng.102982	MOTORCODE -->207643	ZF	53965	160	6	S		IR
E200 E/TE	2.3 Auto	10/85	-	10/92	eng.102982	MOTORCODE 207644-->	ZF	53745	165	6	S		IR
E200 E/TE	2.3	10/85	-	10/92	eng.102982		VICKERS	54131			S		IRS
E200 E/TE	2.3	10/85	-	10/92	eng.102982		LUK	54116			S		IRS
E200 E/TE	2.3	10/85	-	10/92	eng.102982		VICKERS	54128			S		IRS
E260 E	2.6	10/85	-	10/92	eng.103940	SLS/ASD	ZF	53962			S		IRS
E260 E	2.6	10/85	-	10/92	eng.103940		VICKERS	54088			S		IR
E260 E	2.6	10/85	-	10/92	eng.103940		VICKERS	54108			S		IR
E280 E	2.8 Manual	10/92	-	10/95	eng.104942	* SLS/ASD	ZF	54026	132	6	S		IR
E280 E	2.8 Manual	10/92	-	10/95	eng.104942	* SLS/ASD	ZF	53745	165	6	S		IR

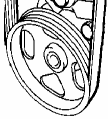

MERCEDES BENZ

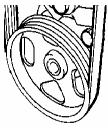

W124

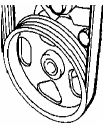

					OE	SPIDAN	 Ø mm	Ports	NOTICE
MERCEDES BENZ									
W124									
E280 E	2.8	10/92	-	eng.104942	LUK			S	IRS
E280 E	2.8	10/92	-	eng.104942	VICKERS			S	IRS
E280 E	2.8 Manual	10/92	-	eng.104942	* SLS/ASD	MOTORCODE 006364-->006367	160	S	IRS
E280 E	2.8 Manual	10/92	-	eng.104942	* SLS/ASD	MOTORCODE 006368-->	165	S	IR
E280 E	2.8	10/92	-	eng.104942	LUK			S	IRS
E280 E	2.8	10/92	-	eng.104942	VICKERS			S	IRS
E280 E	2.8 Manual	10/92	-	eng.104942	ZF	MOTORCODE -->005789	132	S	IRS
E280 E	2.8 Manual	10/92	-	eng.104942	ZF	MOTORCODE 005790-->		S	IRS
E280 E	2.8	10/92	-	eng.104942	LUK			S	IRS
E280 E	2.8	10/92	-	eng.104942	LUK			S	IRS
E280 E	2.8 Auto	10/92	-	eng.104942	* SLS/ASD	MOTORCODE -->048696	132	S	TANDEM PUMP
E280 E	2.8 Auto	10/92	-	eng.104942	* SLS/ASD	MOTORCODE 048697-->056361	165	S	TANDEM PUMP
E280 E	2.8	10/92	-	eng.104942	LUK			S	IRS
E280 E	2.8	10/92	-	eng.104942	VICKERS			S	IRS
E280 E	2.8 Auto	10/92	-	eng.104942	* SLS/ASD	MOTORCODE 056362-->056823	160	S	IRS
E280 E	2.8 Auto	10/92	-	eng.104942	* SLS/ASD	MOTORCODE 056824-->	165	S	IR
E280 E	2.8	10/92	-	eng.104942	LUK			S	IRS
E280 E	2.8	10/92	-	eng.104942	VICKERS			S	IRS
E300 CE	3.0 12V	10/85	-	eng.103.980/103.983	SLS/ASD			S	IR
E300 CE	3.0 12V	10/85	-	eng.103.980/103.983	ZF			S	IR
E300 CE	3.0 12V	10/85	-	eng.103.980/103.983	VICKERS			S	IR
E300 CE	3.0 12V	10/85	-	eng.103.980/103.983	VICKERS			S	IR
E300 CE	3.0 24V	9/89	-	eng.104980	ZF			S	IR
E300 CE	3.0 24V	9/89	-	eng.104980	VICKERS			S	IR
E300 CE	3.0 24V	9/89	-	eng.104980	VICKERS			S	IR
E320 CE	3.2 Manual	10/92	-	eng.104992	* SLS/ASD	MOTORCODE -->004356	132	S	IR
E320 CE	3.2 Manual	10/92	-	eng.104992	* SLS/ASD	MOTORCODE 004357-->004871	165	S	IR
E320 CE	3.2	10/92	-	eng.104992	LUK			S	IRS
E320 CE	3.2 Manual	10/92	-	eng.104992	ZF	MOTORCODE -->004356	132	S	IRS
E320 CE	3.2 Manual	10/92	-	eng.104992	ZF	MOTORCODE 004957-->	165	S	IR
E320 CE	3.2 Manual	10/92	-	eng.104992	ZF	MOTORCODE 004357-->		S	IRS
E320 CE	3.2	10/92	-	eng.104992	LUK			S	IRS
E320 CE	3.2 Auto	10/92	-	eng.104992	* SLS/ASD	MOTORCODE -->072236	132	S	TANDEM PUMP
E320 CE	3.2 Auto	10/92	-	eng.104992	* SLS/ASD	MOTORCODE 072237-->086682	165	S	IR
E320 CE	3.2	10/92	-	eng.104992	LUK			S	IRS
E320 CE	3.2 Auto	10/92	-	eng.104992	* SLS/ASD	MOTORCODE 087757-->	165	S	IR
E320 CE	3.2 Auto	10/92	-	eng.104992	SLS/ASD	MOTORCODE -->072236	132	S	IRS
E320 CE	3.2 Auto	10/92	-	eng.104992	SLS/ASD	MOTORCODE 072237-->		S	IRS

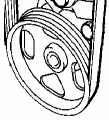

						OE		SPIDAN		 Ø mm		Ports		NOTICE	
MERCEDES BENZ															
W124															
E320 CE	3.2	10/92	-	10/95	eng.104992		LUK		54135			S	4	IRS	TANDEM PUMP
E400 E	4.2	10/92	-	6/95	eng.119975	* SLS/ASD	ZF	-	-			S			
E400 E	4.2	10/92	-	6/95	eng.119975		LUK		-			S			
E400 E	4.2	10/92	-	6/95	eng.111975		VICKERS		54130			S	4		TANDEM PUMP
E500 E	5.0	3/91	-	10/95	eng.111974		VICKERS		54130			S	4		TANDEM PUMP
E200 D	2.0 Manual	10/85	-	10/95	eng.601912	* SLS/ASD	ZF	MOTORCODE -->177811	53965	160	6	S			
E200 D	2.0 Manual	10/85	-	10/95	eng.601912	* SLS/ASD	ZF	MOTORCODE 177812-->	53745	165	6	S		IR	
E200 D	2.0	10/85	-	10/95	eng.601912		VICKERS		54131			S		IRS	
E200 D	2.0	10/85	-	10/95	eng.601912		LUK		54116			S		IRS	
E200 D	2.0	10/85	-	10/95	eng.601912		VICKERS		54128			S		IRS	
E200 D	2.0 Auto	10/85	-	10/95	eng.601912	* SLS/ASD	ZF	MOTORCODE -->016741	53965	160	6	S			
E200 D	2.0 Auto	10/85	-	10/95	eng.601912	* SLS/ASD	ZF	MOTORCODE 016742-->	53745	165	6	S		IR	
E200 D	2.0	10/85	-	10/95	eng.601912		VICKERS		54131			S		IRS	
E200 D	2.0	10/85	-	10/95	eng.601912		LUK		54116			S		IRS	
E200 D	2.0	10/85	-	10/95	eng.601912		VICKERS		54128			S		IRS	
E200 D	2.0	10/85	-	10/95	eng.601912	SLS/ASD	ZF		53970			S		IRS	
E200 D	2.0	10/85	-	10/95	eng.601912		LUK		54125			S	3		TANDEM PUMP
E200 D	2.0	10/85	-	10/95	eng.601912		LUK		54134			S	4		TANDEM PUMP
E250 D	2.5 Manual	10/85	-	10/95	eng.602912	* SLS/ASD	ZF	MOTORCODE -->207624	53971	160	6	S		IR	
E250 D	2.5 Manual	10/85	-	10/95	eng.602912	* SLS/ASD	ZF	MOTORCODE 207625-->	53968	160	6	S		IRS	
E250 D	2.5	10/85	-	10/95	eng.602912		VICKERS		54120			S		IRS	
E250 D	2.5 Auto	10/85	-	10/95	eng.602912	* SLS/ASD	ZF	MOTORCODE -->033431	53971	160	6	S		IR	
E250 D	2.5 Auto	10/85	-	10/95	eng.602912	* SLS/ASD	ZF	MOTORCODE 033432-->	53968	160	6	S		IRS	
E250 D	2.5	10/85	-	10/95	eng.602912		VICKERS		54120			S		IRS	
E250 D	2.5	8/93	-	10/95	eng.605911	SLS/ASD	ZF		53969			S		IRS	
E250 D	2.5 Manual	9/88	-	10/95	eng.602962	* SLS/ASD	ZF	MOTORCODE -->17907	53971	160	6	S		IR	
E250 D	2.5 Manual	9/88	-	10/95	eng.602962	* SLS/ASD	ZF	MOTORCODE 17908-->	53968	160	6	S		IRS	
E250 D	2.5	9/88	-	10/95	eng.602962		VICKERS		54120			S		IRS	
E250 D	2.5 Auto	9/88	-	10/95	eng.602962	* SLS/ASD	ZF	MOTORCODE -->012820	53971	160	6	S		IR	
E250 D	2.5 Auto	9/88	-	10/95	eng.602962	* SLS/ASD	ZF	MOTORCODE 012821-->	53968	160	6	S		IRS	
E250 D	2.5	9/88	-	10/95	eng.602962		VICKERS		54120			S		IRS	
E250 D	2.5	10/85	-	10/95	eng.602962	SLS/ASD	ZF		53969			S		IRS	
E300 D	3.0 12V Manual	10/85	-	8/93	eng.603912		ZF	MOTORCODE -->070267	53971	160	6	S		IR	
E300 D	3.0 12V Manual	10/85	-	8/93	eng.603912		ZF	MOTORCODE 070268-->	53968	160	6	S		IRS	
E300 D	3.0 12V	10/85	-	8/93	eng.603912		VICKERS		54120			S		IRS	
E300 D	3.0 12V Auto	10/85	-	8/93	eng.603912		ZF	MOTORCODE -->047341	53971	160	6	S		IR	
E300 D	3.0 12V Auto	10/85	-	8/93	eng.603912		ZF	MOTORCODE 047342-->	53968	160	6	S		IRS	

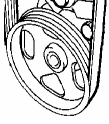

						OE		SPIDAN		 Ports Ø mm		NOTICE	
MERCEDES BENZ													
W124													
E300 D	3.0 12V	10/85	-	8/93	eng.603912		VICKERS		54120		S		IRS
E300 D	3.0 24V	8/93	-	10/95	eng.606910	SLS/ASD	ZF		53969		S		IRS
E300 D	3.0 24V	8/93	-	10/95	eng.606910	* SLS/ASD	ZF		53968	160	6	S	IRS
E300 D	3.0 4-matic	10/85	-	8/93	eng.603913		ZF		53971	160	6	S	IR
E300 D	3.0 Auto	10/85	-	10/95	eng.603960	* SLS/ASD	MOTORCODE -->038820		54120		S		IRS
E300 D	3.0 Auto	10/85	-	10/95	eng.603960	SLS/ASD	MOTORCODE -->038820		54108		S	4	IRS
E300 D	3.0 Auto	10/85	-	10/95	eng.603960	SLS/ASD	MOTORCODE 038821-->		53969	160	6	S	IRS
E300 D	3.0 4-matic Auto	10/85	-	10/95	eng.603963	SLS/ASD	MOTORCODE 038821-->		53969	160	6	S	IRS
W210													
E200	2.0	10/95	-	6/00	eng.111942	* SLS/ASD	ZF		53815		S		IR
E200	2.0	10/95	-	6/00	eng.111942		LUK		54109	130	6	P	IR
E200	2.0	10/95	-	6/00	eng.111942	SLS/ASD	LUK		54132		S	3	
E200	2.0 KOMRESSOR	6/97	-	3/02	eng.111947	* SLS/ASD	ZF		53815		S		IR
E200	2.0 KOMRESSOR	6/97	-	3/02	eng.111947		LUK		54109	130	6	P	IR
E200	2.0 KOMRESSOR	6/97	-	3/02	eng.111947	SLS/ASD	LUK		54132	130	6	S	
E200	2.0 KOMRESSOR	8/00	-		eng.111957	* SLS/ASD	ZF		53815		S		IR
E200	2.0 KOMRESSOR	8/00	-		eng.111957		LUK		54109	130	6	P	IR
E230	2.3	10/95	-	9/97	eng.111970	* SLS/ASD	ZF		53815		S		IR
E230	2.3	10/95	-	9/97	eng.111970		LUK		54109	130	6	P	IR
E230	2.3	10/95	-	9/97	eng.111970	SLS/ASD	LUK		54132	130	6	S	
E240	2.4	6/97	-	3/02	eng.112.911/112.914	* SLS/ASD	ZF		53966		S		
E240	2.4	6/97	-	3/02	eng.112.911/112.914		LUK		54209	130	6	P	
E280	2.8	10/95	-		eng.104945	* SLS/ASD	ZF		54028		S		
E280	2.8	10/95	-		eng.104945		LUK		54112	130	6	P	IRP
E280	2.8	10/95	-		eng.104945	SLS/ASD	LUK		-	130	6	P	
E280	2.8	12/96	-	3/02	eng.112921	* SLS/ASD	ZF		53966		S		
E280	2.8	12/96	-	3/02	eng.112921		LUK		54209	130	6	P	
E320	3.2	6/95	-	6/97	eng.104992	* SLS/ASD	ZF		54028		S		
E320	3.2	6/97	-	3/02	eng.112941	* SLS/ASD	ZF		53966		S		
E320	3.2	6/97	-	3/02	eng.112941		LUK		54209	130	6	P	
E420	4.2	10/95	-		eng.111985	* SLS/ASD	ZF		54035		S		IR
E430	4.3	6/97	-	3/02	eng.113940	* SLS/ASD	ZF		53966		S		
E430	4.3	6/97	-	3/02	eng.113940		LUK		54209	130	6	P	
E50 AMG	5.0	10/95	-		eng.119980	* SLS/ASD	ZF		54032		S		IRP
E55 AMG	5.4	8/97	-		eng.113980	* SLS/ASD	ZF		53966		S		
E55 AMG	5.4	8/97	-		eng.113980		LUK		54209	130	6	P	
E200 CDI	2.0	7/99	-	3/02		* SLS/ASD	LUK		53982		S		

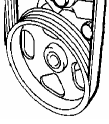

					OE	SPIDAN	 Ports Ø mm	NOTICE					
MERCEDES BENZ													
W210													
E220 D	2.2	9/98	-	5/03	eng.604912	* SLS/ASD	ZF	53721	IRP				
E220 D	2.2	9/98	-	5/03	eng.604912		LUK	54074	143	6	S	IR	TANDEM PUMP
E220 D	2.2	6/95	-	7/99	eng.604912	SLS/ASD		54114			S	IR	TANDEM PUMP
E220 TD	2.2	9/98	-	5/03	eng.611961	* SLS/ASD	ZF	53721			S	IRP	
E220 TD	2.2	9/98	-	5/03	eng.611961		LUK	53982			S	IRP	
E200 D	2.0	10/95	-		eng.604917	* SLS/ASD	ZF	53721			S	IRP	
E200 D	2.0	10/95	-		eng.604917		LUK	54074	143	6	S	IRP	
E200 D	2.0	10/95	-		eng.604917	SLS/ASD	LUK	54114			S	IR	TANDEM PUMP
E250 D	2.5	10/95	-	5/98	eng.605912	* SLS/ASD	ZF	53721			S	IRP	
E250 D	2.5	10/95	-	5/98	eng.605912		LUK	54074	143	6	S	IR	TANDEM PUMP
E250 D	2.5	10/95	-	5/98	eng.605912	SLS/ASD	LUK	54114			S	IR	TANDEM PUMP
E250 TD	2.5	10/95	-	5/98	eng.605962	* SLS/ASD	ZF	53721			S	IRP	
E250 TD	2.5	10/95	-	5/98	eng.605962		LUK	54074	143	6	S	IR	TANDEM PUMP
E250 TD	2.5	10/95	-	5/98	eng.605962	SLS/ASD	LUK	54114			S	IR	TANDEM PUMP
E270 D	2.7	7/99	-		eng.612961	* SLS/ASD	LUK	53982			S	IRP	
E290 TD	2.9	95	-	7/99	eng.602982	* SLS/ASD	ZF	53721			S	IRP	
E290 TD	2.9	95	-	7/99	eng.602982		LUK	54074	143	6	S	IRP	TANDEM PUMP
E290 TD	2.9	6/95	-	7/99	eng.602982	SLS/ASD	LUK	54114			S	IR	TANDEM PUMP
E300 D	3.0	10/95	-	3/97	eng.606912	* SLS/ASD	ZF	53721			S	IRP	
E300 D	3.0	10/95	-	3/97	eng.606912		LUK	54074	143	6	S	IRP	TANDEM PUMP
E300 D	3.0	10/95	-	3/97	eng.606912	SLS/ASD	LUK	54114			S	IR	TANDEM PUMP
E300 TD	3.0	3/97	-	8/99	eng.606962	* SLS/ASD	ZF	53721			S	IRP	
E300 TD	3.0	3/97	-	8/99	eng.606962		LUK	54074	143	6	S	IRP	TANDEM PUMP
E300 TD	3.0	3/97	-	8/99	eng.606962	SLS/ASD	LUK	54114			S	IR	TANDEM PUMP
G WAGEN													
200 GE	2.0	89	-	1/93	eng.102965	[W463]	ZF	53813			S		
200 GE	2.0	89	-	1/93	eng.102965	[W463]	ZF	54029			S		
230 GE	2.3 MANUAL	6/90	-	6/93	eng.102989	[W463]	VICKERS	54115			S	IRS	
230 GE	2.3 MANUAL	6/90	-	6/93	eng.102989	[W463]	ZF	54029			S		
230 GE	2.3	6/90	-	6/93	eng.102989	[W463]	LUK	-			S	IR	
230 GE	2.3 AUTO	6/90	-	6/93	eng.102989	[W463]	VICKERS	54115			S	IRS	
230 GE	2.3 AUTO	6/90	-	6/93	eng.102989	[W463]	ZF	54029			S		
230 GE	2.3	6/90	-	6/93	eng.102989	[W461]	LUK	-			S	IR	
230 GE	2.3	2/93	-		eng.102979	[W461]	ZF	54029			S		
230 GE	2.3	2/93	-		eng.102979	[W461]	LUK	-			S	IR	
230 GE	2.3	6/93	-		eng.102996	[W461]	ZF	54029			S		
230 GE	2.3	6/93	-		eng.102996	[W461]	LUK	-			S	IR	

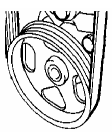

						OE		SPIDAN		 Ports Ø mm		NOTICE	
MERCEDES BENZ													
G WAGEN													
300 GE	3.0 MANUAL	6/90	-	eng.103987	[W463]	MOTORCODE -->001032	VICKERS	54113		S	IRS		
300 GE	3.0 AUTO	6/90	-	eng.103987	[W463]	MOTORCODE -->002605	VICKERS	54113		S	IRS		
320 GE	3.2	9/94	-	12/97	eng.104996		ZF	54029		S	IR		
320 GE	3.2	9/94	-	12/97	eng.104996		LUK	-		S	IR		
350 TD	3.5	9/91	-	eng.603972			LUK	-		S	IR		
250 GD	2.5	6/90	-	eng.602931	[W463]	MOTORCODE -->002536	VICKERS	54115		S	IRS		
250 GD	2.5	6/90	-	eng.602931	[W463]	MOTORCODE 002537 -->	ZF	54029		S	IRS		
250 GD	2.5 MANUAL	2/90	-	eng.602939	[W461]	MOTORCODE -->006541	VICKERS	54115		S	IRS		
250 GD	2.5 MANUAL	2/90	-	eng.602939	[W461]	MOTORCODE 006542 -->	ZF	54029		S	IRS		
250 GD	2.5	2/90	-	eng.602939			LUK	-		S	IR		
250 GD	2.5	6/90	-	eng.602931			LUK	-		S	IR		
290 GD	2.9	4/92	-	eng.602942	[W461]		ZF	54029		S	IR		
290 GD	2.9	4/92	-	eng.602942			LUK	-		S	IR		
290 TD	2.9	7/97	-	eng.602983	[W461]	* A/C	ZF	54029		S	IR		
290 TD	2.9	7/97	-	eng.602983			LUK	-		S	IR		
300 GD	3.0 MANUAL	9/89	-	eng.603931	[W463]	MOTORCODE -->002536	VICKERS	54115		S	IRS		
300 GD	3.0 MANUAL	9/89	-	eng.603931	[W463]	MOTORCODE 002537 -->	ZF	54029		S	IRS		
300 GD	3.0	9/89	-	eng.603931			LUK	-		S	IR		
300 GD	3.0 AUTO	9/89	-	eng.603931	[W463]	MOTORCODE -->001015	VICKERS	54115		S	IRS		
300 GD	3.0 AUTO	9/89	-	eng.603931	[W463]	MOTORCODE 01016 -->	ZF	54029		S	IRS		
300 GD	3.0	9/89	-	eng.603931			LUK	-		S	IR		
350 TD	3.5	9/91	-	eng.603972	[W463]		ZF	54029		S	IR		
W1163													
ML320	3.2	2/98	-	eng.112942			LUK	54229	130	6	P		
ML430	4.3	2/98	-	eng.113942			LUK	54229	130	6	P		
ML55 AMG	5.4	2/00	-	eng.113981			LUK	54229	130	6	P		
ML270	2.7	10/99	-	eng.612963			LUK	54235			S		
W1126													
260 SE	2.6	9/85	-	eng.103941	* SLS		VICKERS	54113		S	IRS		
280 SE	2.7	10/80	-	9/85			ZF	53813		S	IR		
300 SE/SEL	3.0	9/85	-	eng.103981	* SLS		VICKERS	54113		S	IR		
380 SE/SEC/SEL	3.8	10/85	-	eng.116.961/111.963			ZF	53813		S	IR		
420 SE/SEC/SEL	4.2	2/86	-	12/91		EXCL. SAFETY PACK	ZF	53813		S	IR		
500 SE/SEC/SEL	5.0	10/80	-	eng.117.961/117.963		EXCL. SAFETY PACK	ZF	53813		S	IR		
560 SEC/SEL	5.6	8/86	-	12/91		EXCL. SAFETY PACK	ZF	53813		S	IR		

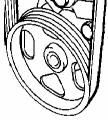

						OE	SPIDAN	 Ports Ø mm	NOTICE		
MERCEDES BENZ											
W140											
S280	2.8	1/93	-	3/99	eng.104944	* SLS/ASD	-->ENG 007447	ZF	53893	S	
S280	2.8	1/93	-	3/99	eng.104944	* SLS/ASD	eng 007448-->	ZF	54030	S	
S280	2.8	1/93	-	3/99	eng.104944	SLS/ASD	-->ENG 007447	ZF	53894	S	
300 SE/SEL	3.2	3/91	-	3/99	eng.104990	* SLS/ASD		ZF	53893	S	
300 SE/SEL	3.2	3/91	-	3/99	eng.104990	SLS/ASD		ZF	53894	S	
S320	3.2	3/91	-	3/99	eng.104994	* SLS/ASD	-->ENG 031209	ZF	53893	S	
S320	3.2	3/91	-	3/99	eng.104994	* SLS/ASD	eng 031210-->	ZF	54030	S	
S320	3.2	3/91	-	3/99	eng.104994	SLS/ASD	-->ENG 031209	ZF	53894	S	
400 SE/SEL	4.2	2/91	-	3/99	eng.119971	* SLS/ASD	EXCL. SAFETY PACK	VICKERS	54122	S	
400 SE/SEL	4.2	2/91	-	3/99	eng.119971	SLS/ASD		LUK	54121		A14
400 SE/SEL	4.2	2/91	-	3/99	eng.119971	SLS/ASD		ZF	54031		A13
400 SE/SEL	4.2	2/91	-	3/99	eng.119971	SLS/ASD	EXCL. SAFETY PACK	VICKERS	54124	S	
400 SE/SEL	4.2	2/91	-	3/99	eng.119971	* SLS/ASD		LUK	54127	S	
S400	4.2	2/91	-	3/99	eng.119971	* SLS/ASD	EXCL. SAFETY PACK	VICKERS	54122	S	
S400	4.2	2/91	-	3/99	eng.119971	SLS/ASD		LUK	54121		A14
S420	4.2	2/91	-	3/99	eng.119971	SLS/ASD	EXCL. SAFETY PACK	ZF	54031		A13
S420	4.2	2/91	-	3/99	eng.119971	SLS/ASD	EXCL. SAFETY PACK	VICKERS	54124	S	
CL420	4.2	9/91	-	3/99	eng.119981	* SLS/ASD	EXCL. SAFETY PACK	LUK	54127	S	
500 S/SE/SEC/SEL	5.0	9/91	-	3/99	eng.119970	* SLS/ASD	EXCL. SAFETY PACK	ZF	54032	S	IRP
500 S/SE/SEC/SEL	5.0	9/91	-	3/99	eng.119970	SLS/ASD		VICKERS	54122	S	
500 S/SE/SEC/SEL	5.0	9/91	-	3/99	eng.119970	SLS/ASD		LUK	54121		A14
500 S/SE/SEC/SEL	5.0	9/91	-	3/99	eng.119970	SLS/ASD	EXCL. SAFETY PACK	ZF	54031		A13
500 S/SE/SEC/SEL	5.0	9/91	-	3/99	eng.119970	SLS/ASD	EXCL. SAFETY PACK	VICKERS	54124	S	
C1500	5.0	3/91	-	3/99	eng.119980	* SLS/ASD	EXCL. SAFETY PACK	LUK	54127	S	
600 S/SE/SEC/SEL	6.0	9/91	-	3/99	eng.120980	SLS/ASD	EXCL. SAFETY PACK	ZF	54032	S	IRP
C1600	6.0	9/91	-	3/99	eng.120982	SLS/ASD	EXCL. SAFETY PACK	ZF	54033	S	
(W220)									54033	S	
S55 AMG	5.4	4/99	-		eng.113986	* SLS		LUK	54209	130	6
S55 AMG	5.4	4/99	-		eng.113986			ZF	53966		
(W107)											
280 SL/SLC	2.7	10/80	-	10/85	eng.110986/110990			ZF	53705	S	IRS
300 SL/SLC	3.0	9/85	-	8/89	eng.103982			VICKERS	54113	S	IRS
350 SL/SLC	3.5	1/72	-	8/81	eng.116982	MANUAL	MOTORCODE 005801-->	ZF	53705	S	IR
350 SL/SLC	3.5	1/72	-	8/81	eng.116982	AUTO	MOTORCODE 016547-->	ZF	53705	S	IRS
350 SL/SLC	3.5	1/72	-	8/81	eng.116984			ZF	53705	S	IR

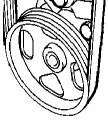

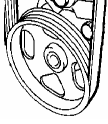

MERCEDES BENZ						OE		SPIDAN		 Ports Ø mm		NOTICE	
(W107)													
380 SL/SLC	3.8	10/80	-	10/85	eng.116962		ZF		53705		S	IR	
450 SL/SLC	4.5	5/73	-	4/80	eng.117985		ZF		53705		S	IR	
500 SL	5.0	10/60	-	8/69	eng.117.960/117.964		ZF		53705		S	IR	
(W129)													
SL280	2.8 18V SOHC	5/98	-	3/02	eng.112923	* SLS/ASD	ZF		53966		S		
SL280	2.8 18V SOHC	5/98	-	3/02	eng.112923		LUK		54209	130	6	P	
SL280	2.8 24V DOHC MANUAL	8/93	-	10/01	eng.104943	* SLS/ASD	ZF	MOTORCODE -->000900	54026	132	6	S	IR
SL280	2.8 24V DOHC	8/93	-	10/01			LUK		54227			S	IRS
SL280	2.8 24V DOHC MANUAL	8/93	-	10/01	eng.104943	* SLS/ASD	ZF	MOTORCODE 000901-->001038	53745	165	6	S	IR
SL280	2.8 24V DOHC MANUAL	8/93	-	10/01	eng.104943	* SLS/ASD	ZF	MOTORCODE 001039-->001047	53968	160	6	S	IRS
SL280	2.8 24V DOHC MANUAL	8/93	-	10/01	eng.104943	* SLS/ASD	ZF	MOTORCODE 001048-->	53745	165	6	S	IR
SL280	2.8 24V DOHC MANUAL	5/98	-	3/02	eng.104943	SLS/ASD	ZF	MOTORCODE000034-->000900	54027	132	6	S	
SL280	2.8 24V DOHC MANUAL	5/98	-	3/02	eng.104943	SLS/ASD	ZF	MOTORCODE 000901-->	53964			S	IRS
SL280	2.8 24V DOHC AUTO	8/93	-	10/01	eng.104943	* SLS/ASD	ZF	MOTORCODE -->003620	54026	132	6	S	IR
SL280	2.8 24V DOHC	8/93	-	10/01	eng.104943		LUK		54227			S	IRS
SL280	2.8 24V DOHC AUTO	8/93	-	10/01	eng.104943	* SLS/ASD	ZF	MOTORCODE 003621 -->004325	53745	165	6	S	IR
SL280	2.8 24V DOHC AUTO	8/93	-	10/01	eng.104943	* SLS/ASD	ZF	MOTORCODE 004326-->004353	53968	160	6	S	IRS
SL280	2.8 24V DOHC AUTO	8/93	-	10/01	eng.104943	* SLS/ASD	ZF	MOTORCODE 004354-->	53745	165	6	S	IR
SL280	2.8 24V DOHC AUTO	8/93	-	10/01	eng.104943	SLS/ASD	ZF	MOTORCODE 000115-->003620	54027	132	6	S	
SL280	2.8 24V DOHC AUTO	8/93	-	10/01	eng.104943	SLS/ASD	ZF	MOTORCODE 003621 -->	53964			S	IRS
SL300	3.0 12V SOHC	3/89	-	8/93	eng.103984	* SLS/ASD	ZF		53962			S	TANDEM PUMP
SL300	3.0 12V SOHC	3/89	-	8/93	eng.103984	SLS/ASD	VICKERS		54088			S	TANDEM PUMP
SL300	3.0 24V DOHC	3/89	-	8/93	eng.104981	* SLS/ASD	ZF		53962			S	TANDEM PUMP
SL300	3.0 24V DOHC	3/89	-	8/93	eng.104981	SLS/ASD	VICKERS		54088			S	TANDEM PUMP
SL320	3.2 18V SOHC	5/98	-	3/02	eng.112943	* SLS/ASD	ZF		53966			S	
SL320	3.2 18V SOHC	5/98	-	3/02	eng.112943		LUK		54209	130	6	P	
SL320	3.2 24V DOHC	8/93	-	3/02	eng.104991	* SLS/ASD	ZF	MOTORCODE -->009985	54026	132	6	S	IR
SL320	3.2 24V DOHC	5/98	-	3/02	eng.104991	* SLS/ASD	ZF	MOTORCODE 009986-->012959	53745	165	6	S	IR
SL320	3.2 24V DOHC	5/98	-	3/02	eng.104991	* SLS/ASD	ZF	MOTORCODE 012960-->013080	53968	160	6	S	IRS
SL320	3.2 24V DOHC	8/93	-	3/02	eng.104991	* SLS/ASD	ZF	MOTORCODE 013081-->	53745	165	6	S	IR
(W129)													
SL320	3.2 24V DOHC	8/93	-	3/02	eng.104991	SLS/ASD	LUK	MOTORCODE--> 001795	54117			S	
SL320	3.2 24V DOHC	8/93	-	3/02	eng.104991	SLS/ASD	ZF	MOTORCODE 001796-->009985	54027	132	6	S	
SL320	3.2 24V DOHC	8/93	-	3/02	eng.104991	SLS/ASD	ZF	MOTORCODE 009986-->	53964			S	IRS
SL500	5.0	9/89	-	8/92	eng.119960	* SLS/ASD	VICKERS	MOTORCODE 666-->	54119			S	
SL500	5.0	9/89	-	8/92	eng.119960	SLS/ASD	LUK	MOTORCODE 666-->	-			S	4
SL500	5.0	9/89	-	8/92	eng.119960	SLS/ASD	VICKERS		-			S	4

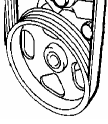

					OE	SPIDAN	 Ø mm	Ports	NOTICE	
MERCEDES BENZ										
(W129)										
SL500	5.0	9/92	-	3/02	eng.119972	* SLS/ASD	LUK		S	A14
SL500	5.0	9/92	-	3/02	eng.119972		ZF		S	A13
SL500	5.0	9/92	-	3/02	eng.119982	* SLS/ASD	ZF		S	IR
SL500	5.0	5/98	-	10/01	eng.113961	* SLS/ASD	LOW EMISSION	130	P	
SL600	6.0	10/92	-	11/00	eng.120981		ZF		S	
(W170)										
SLK200	2.0	9/96	-	7/00	eng.111946	* SLS/ASD	ZF		S	
SLK200	2.0	9/96	-	7/00	eng.111946		LUK	130	P	
SLK200	2.0 KOMPRESSOR	10/96	-	3/00	eng.111943	* SLS/ASD	ZF		S	
SLK200	2.0 KOMPRESSOR	10/96	-	3/00	eng.111943		LUK	130	P	
SLK200	2.0 KOMPRESSOR	3/00	-		eng.111958		ZF		S	
SLK200	2.0 KOMPRESSOR	3/00	-		eng.111958		LUK	130	P	
SLK230	2.3 KOMPRESSOR	9/96	-	3/00	eng.111973	* SLS/ASD	ZF		S	
SLK230	2.3 KOMPRESSOR	3/00	-		eng.111983		ZF		S	
SLK230	2.3 KOMPRESSOR	3/00	-		eng.111983		LUK	130	P	
SLK320	3.2	2/00	-		eng.112947	* SLS	ZF		S	
SLK320	3.2	2/00	-		eng.112947		LUK	130	P	
V-CLASS										
V200	2.0	2/97	-		eng.111948		ZF			
V200	2.0	2/97	-		eng.111948	-->011399	LUK	130	6	S
V230	2.3	10/96	-		eng.111978		ZF			
V230	2.3	10/96	-		eng.111978	-->012082	LUK	130	6	S
V220 TD	2.3	9/96	-		eng.601970		LUK		S	
601/602										
208 D	2.3	8/88	-	6/95	eng.601940		VICKERS	130	6	S
208 D	2.3	8/88	-	6/95	eng.601940	MOTORCODE -->221937	LUK		S	
210	2.3 MANUAL	5/89	-	2/96	eng.102945	MOTORCODE 221938-->	LUK		S	
210	2.3 AUTO	5/89	-	2/96	eng.102945	MOTORCODE 015293-->	LUK		S	
210 D	2.9	6/89	-	2/96	eng.602940	MOTORCODE 001971-->	VICKERS	130	6	S
210 D	2.9	6/89	-	2/96	eng.602940	MOTORCODE -->221936	LUK		S	
308 D	2.3	11/88	-	2/96	eng.601940	MOTORCODE -->221937	VICKERS	130	6	S
308 D	2.3	11/88	-	2/96	eng.601940	MOTORCODE 221938-->	LUK		S	
310 D	2.9	6/89	-	2/96	eng.602940	MOTORCODE -->221936	VICKERS	130	6	S
310 D	2.9	6/89	-	2/96	eng.601940	MOTORCODE 221937-->	LUK		S	



						OE		SPIDAN		 Ports		NOTICE		
MERCEDES BENZ														
T1/TN														
408 D	2.3	8/88	-	4/95	eng.601940			MOTORCODE -->221937	VICKERS	54095	130	6	S	
408 D	2.3	8/88	-	4/95	eng.601940			MOTORCODE 221938-->	LUK	54078			S	
410 D	2.9	6/89	-	2/96	eng.602940			MOTORCODE -->221936	VICKERS	54095	130	6	S	
410 D	2.9	6/89	-	2/96	eng.602940			MOTORCODE 221937-->	LUK	54078			S	
T2/LN1														
508 D	2.3	3/86	-	12/94	eng.601940			MOTORCODE -->221937	VICKERS	54095	130	6	S	
508 D	2.3	3/86	-	12/94	eng.601940			MOTORCODE 221938-->	LUK	54078			S	
SPRINTER														
214/314/414	2.3 Manual	2/95	-		eng.111979			MOTORCODE -->002028	LUK	53814	143	6	S	IRS
214/314/414	2.3	2/95	-		eng.111979				ZF	53847				
214/314/414	2.3 Auto	2/95	-		eng.111979			MOTORCODE -->000441	LUK	53814	143	6	S	IRS
214/314/414	2.3	2/95	-		eng.111979				ZF	53847				
211/213/311	2.2 CDI	4/00	-		eng.611981				LUK	54162			S	IRP
313/411/413	2.2 CDI	4/00	-		eng.611981				LUK	54162			S	IRP
208/308	2.2 CDI	4/00	-		eng.611987				LUK	54162			S	IRP
408/413	2.2 CDI	4/00	-		eng.611987				LUK	54162			S	IRP
208/308/408	2.3 D	1/95	-	4/00	eng.601943			MOTORCODE -->530440	LUK	53814	143	6	S	IRS
208/308/408	2.3 D	1/95	-	4/00	eng.601943			MOTORCODE 530441-->	ZF/LUK	53933			S	IRP
216/316/416	2.7 CDI	4/00	-		eng.612981				LUK	54162			S	IRP
212/312	2.9 D Manual	2/95	-	4/00	eng.602980			MOTORCODE -->066378	LUK	53814	143	6	S	IRS
410/412	2.9 D Manual	2/95	-	4/00	eng.602980			MOTORCODE 066379-->	ZF/LUK	53933			S	IRP
410/412	2.9 D	2/95	-	4/00	eng.602980				ZF/LUK	53933			S	IRP
212/312	2.9 D Auto	2/95	-	4/00	eng.602980				LUK	53814	143	6	S	IRS
410/412	2.9 D Auto	2/95	-	4/00	eng.602980			MOTORCODE -->003321	LUK	53814	143	6	S	IRS
212/312	2.9 D Auto	2/95	-	4/00	eng.602980			MOTORCODE 003322-->	ZF/LUK	53933			S	IRP
410/412	2.9 D	2/95	-	4/00	eng.602980				ZF/LUK	53933			S	IRP
VITO														
113	2.0	2/96	-	7/03	eng.111948			-->011399	ZF	53847	130	6	P	
113	2.0	2/96	-	7/03	eng.111948			-->011399	LUK	54255	130	6	P	
113	2.0	2/96	-	7/03	eng.111948			011400-->	ZF	54256	130	6	P	
113	2.0	2/96	-	7/03	eng.111948			011400-->	LUK	54089	130	6	S	
112 Cdi	2.2	3/99	-	7/03	eng.611980				ZF	54257			S	
112 Cdi	2.2	3/99	-	7/03	eng.611980				LUK	54258			S	
114	2.3	12/96	-	7/03	eng.111978			-->012082	ZF	53847				
114	2.3	12/96	-	7/03	eng.111978			-->012082	LUK	54255	130	6	P	



				OE	SPIDAN	 Ø mm	Ports	NOTICE
MERCEDES BENZ								
VITO								
114	2.3	12/96 - 7/03	eng.111978	ZF	54256	130	6 P	
114	2.3	12/96 - 7/03	eng.111978	LUK	54089	130	6 S	
108D	2.3	2/96 - 7/03	eng.601942	ZF/LUK	53933		S	
108D	2.3	2/96 - 7/03	eng.601942	LUK	54259		S	
110D/TD	2.3	2/96 - 7/03	eng.601970	LUK	54117		S	
MINI								
MITSUBISHI								
3000 GT								
3.0		8/92 - 11/99	Z16A	KAYABA	53810	95	4 P	
CARISMA								
1.6		10/95 -	DA1A	SAGI.	53704	145	5 P	
1.8 DOHC		10/97 - 10/02	DA2A	KAYABA	54176	147	5 P	
COLT								
1.3 8V		6/88 - 9/90	(C51A)		53812			
1.5 8V		4/89 - 9/89	(C52A)		53812			
1.5 12V		9/90 - 1/92	(C52A)		53812			
1.6		7/88 - 3/89	(C53A)		53812			
GALANT								
1.8		8/87 - 7/90	(E32A)	KAYABA	53811			
2.0		8/87 - 7/90	(E33A)	KAYABA	53811			
1.8 TD		3/88 - 7/90	(E34A)	KAYABA	53811			
2.5		4/97 -	(E45A/E45W)	KAYABA	53664	145	5 P	
LANCER								
1.6		10/92 - 9/95	(C66A)	KAYABA	53897	148	5 P	
1.8		10/92 - 9/95	(C69A)	KAYABA	53897	148	5 P	
L200 (K74T)								
2.5 TD		10/96 -		UNISIAJECS	-	128	4 S	
PAJERO								
2.5 TD		9/86 - 4/91	(L044/L049)	KAYABA	53990	106	Single P	
2.5 TD		4/91 - 4/00	(V24W/V44W)	KAYABA	54222	133	Single P	
2.8 TD		2/94 - 4/00	(V46W)	KAYABA	53839		A9	KW
SIGMA (F16A/F07W)								
3.0		4/91 - 7/95		KAYABA	53703	95	Single P	
SPACE WAGON								
1.8		9/86 - 10/91	(D05W)	KAYABA	53702	95	Single S	
1.8		10/91 - 8/92	(N31W)	KAYABA	53838	107	Single P	
2.0		8/92 - 10/98	(N33W)	KAYABA	53838	107	Single P	
2.0 TD		8/92 - 2/96	(N38W)	KAYABA	53838	107	Single P	

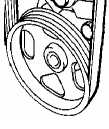

					OE	SPIDAN	 Ø mm	Ports	NOTICE
NISSAN									
100NX (B13)									
1.6		1/92 - 9/95				53609	115	4 S	
200SX									
1.8		4/89 - 9/94 (S13)			KAYABA	53701	112	3 S	
2.0		10/94 - 10/00 (S14)			UNISIAJECS	53836	113	3 S	
300ZX									
3.0 (Z32)		3/90 - 12/94			KAYABA	53809	112	4 S 3	
3.0		3/90 - 12/94			ATSUGI		112	3 S 2	
ALMERA (N15)									
1.4/1.6		10/95 - 2/00			KAYABA	53609	115	4 S	
2.0 GTI		6/96 - 2/00			UNISIAJECS	-	112	4 S	
2.0 D		10/95 - 2/00			UNISIAJECS	54102	97	Single S	
BLUEBIRD									
1.6		3/86 - 9/90 (T12/T72)			KAYABA	53570	127	4 S	
1.8		2/84 - 3/86 (U11)			UNISIAJECS	53613	128	Single S	
1.8		3/86 - 9/90 (T12/T72)			KAYABA	53570	127	4 S	
2.0		2/84 - 3/86 (U11)			UNISIAJECS	53613	128	Single S	
2.0		3/86 - 9/90 (U11/T12/T72)			KAYABA	53570	127	4 S	
2.0 D		3/86 - 9/90 (T12/T72)			ATSUGI	53727	107	Single S	
LAUREL (C32)									
2.4		9/85 - 1/89				53808			
MAXIMA (J30)									
3.0		6/89 - 6/94				53807	122	4 S	
MICRA (K11)									
1.3		1/93 - 4/98			KAYABA	53806	108	3 S	
1.0/1.3/1.4		4/98 - 12/02			UNISIAJECS	53752	93	4 S	
PATROL									
2.8		1/84 - 9/89 (160/26)				53646		S	
3.0		9/89 - 7/93 (260/Y743)				53646		S	
2.8 TD		9/89 - 7/93 (260/Y743)				53748	160	Single S	
2.8 TD		10/95 - 3/98 (Y60)			UNISIAJECS	-	113	Single S	
PRAIRIE									
1.8		5/84 - 4/89 (M10)				53805		Single S	
2.0		4/89 - 12/91 (M11)			UNISIAJECS	53581	127	4 S	
PRIMERA (P10/W10)									
1.6		9/90 - 11/96			KAYABA	53618	115	4 S	
2.0		9/90 - 3/98			KAYABA	54238	112	4 S	
2.0 D		6/92 - 11/96			UNISIAJECS	53902	110	Single S	

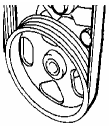

				OE	SPIDAN	 Ports Ø mm	NOTICE
NISSAN							
PRIMERA (P11/W11)							
1.6		10/96 - 2/02		ZF	54142	124 4 P	
1.8		9/99 - 2/02		KAYABA	54238	112 4 S	
1.8		9/99 - 2/02		ZF	53558	112 4 S	
2.0		9/90 - 3/98		ZF	53558	112 4 S	
2.0		6/99 - 2/02		ZF	53914	98 4 P	
2.0 TD		10/96 - 2/02		ZF	53632	120 Single P	
QX							
2.0/3.0		3/95 - 10/00	QX (A32/A33)		53804		
SERENA							
1.6/2.0		1/93 - 9/00	(C23E)	UNISIA JECS	53645	112 4 S	
2.0/2.3 D		1/93 - 1/95	(C23N)	KAYABA	53668	125 Single S	
SILVIA (S12)							
1.8 ZX Turbo/2.0 ZX		6/84 - 3/89			53700	99 Single S	
SUNNY							
1.5		9/87 - 3/90	(B12)	ATSUGI	-	115 4 S	
1.6 8V		9/86 - 3/89	(N13/B12)	KAYABA	53699	103 Single S	
1.6 12V		3/89 - 12/91	(N13/B12)	ATSUGI	53907	137 4 S	
1.6 ZX 16V		8/87 - 5/89	(B12)	ATSUGI	53907	137 4 S	
1.8 GTI/ZX		3/89 - 1/92	(N13/B12)		53906	4 S	
1.7 D		9/86 - 1/92	(N13/B12)	ATSUGI	53905	100 Single S	
1.4		4/91 - 10/95	(N14)	KAYABA	53609	115 4 S	
1.6		4/91 - 10/95	(N14/Y10)	KAYABA	53609	115 4 S	
2.0 GTI		1/92 - 8/94	(N14)	UNISIA JECS	-	112 4 S	
2.0 D		6/92 - 10/95	(N14)	UNISIA JECS	54102	97 Single S	
TERRANO II (R20)							
2.4i		7/93 - 8/01		KAYABA	53712	127 Single S	
2.7 TD		7/93 -		ZF	53541	135 Single P	
INTERSTAR							
2.2		4/02 -		SAGI.	54184	126 5 P	
2.2		4/02 -		SAGI.	54264	126 6 P	
2.2		4/02 -		SAGI.	54228	S	
2.5 D		4/02 -		ZF	53577		* BELT
PRIMASTAR							
1.9 TD		9/02 -		SAGI.	54184	126 5 P	
1.9 TD		9/02 -		SAGI.	54264	126 6 P	
1.9 TD		9/02 -		SAGI.	54228	S	
VANETTE (C23)							
2.3 D		12/95 - 10/02		KAYABA	53668	125 Single S	

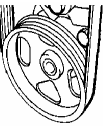

				OE	SPIDAN	 Ports Ø mm	NOTICE
OPEL							
ASCONA C							
1.3/1.6/D		8/81 - 8/88		SAGI.	53874	140 Single P	
1.8/2.0		8/81 - 8/88		SAGI.	53874	140 Single P	
ASTRA F							
1.4		10/91 - 8/92	->-PREFIX 'N'	SAGI.	53549	142 5 S	
1.4		8/92 - 3/98	PREFIX 'P'-->	SAGI.	53504	143 6 P	
1.6		10/91 - 8/92	->-PREFIX 'N'	SAGI.	53549	142 5 S	
1.6		8/92 - 3/98	PREFIX 'P'-->	SAGI.	53504	143 6 P	
1.8		10/91 - 8/92	->-PREFIX 'N'	SAGI.	53506	130 Single P	
1.8		8/92 - 3/98	PREFIX 'P'-->	SAGI.	53504	140 6 P	
2.0 8V		10/91 - 8/92	->-PREFIX 'N'	SAGI.	53506	130 Single P	
2.0 8V		8/92 - 3/98	PREFIX 'P'-->	SAGI.	53504	140 6 P	
2.0 16V		10/91 - 95	->-PREFIX 'N'	SAGI.	53506	130 Single P	
2.0 16V		95 - 3/98	PREFIX 'P'-->	SAGI.	53504	140 6 P	
1.7 D		10/91 - 8/94		SAGI.	53501	116 Single P	
1.7 TD		4/92 - 3/98		SAGI.	53501	116 Single P	
1.7 TD		4/92 - 3/98		SAGI.	53507	120 Single P	
ASTRA F VAN (Kasten)							
1.6		10/91 - 8/92	->-PREFIX 'N'	SAGI.	53549	142 5 S	
1.6		8/92 - 3/98	PREFIX 'P'-->	SAGI.	53504	143 6 P	
1.7 D		10/91 - 8/94		SAGI.	53501	116 Single P	
1.7 TD		4/92 - 3/98		SAGI.	53501	116 Single P	
1.7 TD		4/92 - 3/98		SAGI.	53507	120 Single P	
BELMONT							
1.8		1/89 - 10/91		SAGI.	53506	130 Single P	
CALIBRA A (85_)							
2.0 8V		6/90 - 12/96	Prefix 'L'/M'/N' * A/C	SAGI.	53506	130 Single P	
2.0 8V		6/90 - 12/96	Prefix 'L'/M'/N' A/C	SAGI.	53501	116 Single P	
2.0 8V		6/90 - 12/96	Prefix 'P' INCL.A/C	SAGI.	53504	143 6 P	
2.0 16V INCL.TURBO		6/90 - 8/98 [eng.* Ecotec]	Prefix 'L'/M'/N' * A/C	SAGI.	53506	130 Single P	
2.0 16V INCL.TURBO		6/90 - 8/98 [eng.* Ecotec]	Prefix 'L'/M'/N' A/C	SAGI.	53501	116 Single P	
2.0 16V INCL.TURBO		6/90 - 8/98 [eng.* Ecotec]	Prefix 'P' INCL.A/C	SAGI.	53504	143 6 P	
2.0		6/90 - 8/98 [eng.Ecotec]	INCL.A/C	SAGI.	53684	140 6 P	
2.5 V6		4/93 - 8/98	->-PREFIX 'T'	SAGI.	53683	152 6 S	
2.5 V6		4/93 - 8/98	PREFIX 'U'-->		53770		
COMBO (71_)							
1.4		10/93 - 2/01 [eng.C14NZ/C14SE]		SAGI.	53531	142 6 P	
1.7 D		10/93 - 9/01 [eng.X17D]		SAGI.	53507	120 Single P	

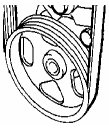

			OE	SPIDAN	 Ø mm	Ports	NOTICE
OPEL							
CORSA B (73_ 78_ 79_ F35_)							
1.0/1.2/1.4	4/93 - 9/00		SAGI.	53531	142	6 P	
1.6	4/93 - 9/00		SAGI.	53531	142	6 P	
1.5 D/TD	4/93 - 9/00		SAGI.	53507	120	Single P	
1.7 D	2/96 - 9/00		SAGI.	53507	120	Single P	
FRONTERA A (5_MWL4)							
2.0 8V	10/91 - 8/98	[eng.C20NE]	SAGI.	53506	130	Single P	
2.0 16V	10/91 - 8/98	[eng.X20SE]	SAGI.	53681	140	6 P	
2.2 16V	4/95 - 8/98	[eng.X22XE]	SAGI.	53681	140	6 P	
2.4 8V	10/91 - 4/95	[eng.C24NE]	SAGI.	53506	130	Single P	
2.3 TD	10/91 - 4/95	[eng.23DTR]	SAGI.	53506	130	Single P	
2.5 TD	8/96 - 8/98	[eng.25TDS]	SAGI.	53769			
2.8 TD	4/95 - 12/96	[eng.C4JG2]	KAYABA	53768		2 S	
FRONTERA B (6B_)							
2.2 16V	10/98 -	[eng.X22XE]	SAGI.	53681	140	6 P	
2.2 16V	10/98 -		KAYABA	54182	131	6 P	
2.2 TD	10/98 -	[eng.X22DTH]	KAYABA	54177	132	6 P	
3.2 24V	10/98 -	[eng.6VD1]					
KADETT E							
1.6	10/84 - 10/91		SAGI.	53506	130	Single P	
1.7	1/89 - 10/91		SAGI.	53506	130	Single P	
1.8	10/84 - 10/91		SAGI.	53506	130	Single P	
2.0	3/87 - 10/91		SAGI.	53506	130	Single P	
MONTEREY A (UBS_)							
3.2 V6	5/94 - 8/98	[eng.6VD1]				S	
3.1 TD	5/94 - 8/98	[eng.4JG2TC]	KAYABA	53559	102	2 P	
OMEGA A							
1.8	11/86 - 8/92		SAGI.	53506	130	Single P	
2.0	11/86 - 5/94		SAGI.	53506	130	Single P	
2.6	9/90 - 5/94		SAGI.	53617	141	6 P	
3.0 12V	3/87 - 9/90	[eng.30NE/C30NE]	SAGI.	53506	130	Single P	
3.0 12V	3/87 - 9/90	[eng.30NE/C30NE]	SAGI.	53617	141	6 P	
3.0 12V	3/87 - 9/90	[eng.30LE]	SAGI.	53501	116	Single P	
3.0 24V	10/89 - 5/94	[eng.C30SE]	SAGI.	53617	141	6 P	
2.3 D/TD	11/86 - 5/94		SAGI.	53506	130	Single P	
OMEGA B							
2.0 8V/16V	4/94 -	[eng.X20SE/X20XEV]	SAGI.	53588	142	6 P	
2.5 V6	4/94 -	[eng.X25XE]	SAGI.	53628	150	6 S	A7
2.5 V6	4/94 -		SAGI.	54049	150	6 S	A6

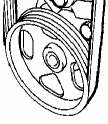

			OE	SPIDAN	 Ports Ø mm	NOTICE
OPEL						
OMEGA B						
3.0 24V	6/94 -			SAGI.	53628 150 6 S	A7
3.0 24V	6/94 -	[eng.X30XE]		SAGI.	54049 150 6 S	A6
2.0 TD	4/94 -	[eng.X20D TH]		SAGI.	53767 S	
2.5 TD	4/94 -	[eng.U25DT/X25DT]		SAGI./ZF	53616 125 5 S	
SENATOR B						
2.5 12V	9/87 -	9/90		SAGI.	53506 130 Single	P
2.6 12V	9/90 -	8/93		SAGI.	53617 142 6	P
3.0 12V	9/87 -	10/92		SAGI.	53506 130 Single	P
3.0 12V	9/87 -	8/93	-->L1999999	SAGI.	53617 142 6	P
3.0 12V	9/87 -	10/92	M1000001-->	SAGI.	53501 116 Single	P
3.0 24V	10/89 -	8/93		SAGI.	53617 142 6	P
SINTRA						
2.2 16V	11/96 -	7/99		ZF	53596 115 6 S	
2.2 16V	11/96 -	7/99		SAGI.	53665 142 6	P
2.2 TD	7/97 -	7/99		ZF	53975 S	
TIGRA (95_)						
1.4 16V	11/94 -	6/00		SAGI.	53531 142 6 S	
1.6 16V	11/94 -	6/00		SAGI.	53531 142 6 S	
VECTRA A						
1.6	10/88 -	10/95		SAGI.	53537 142 5 S	
1.8	8/89 -	10/95		SAGI.	53506 130 Single	P
1.8	8/89 -	10/95		SAGI.	53501 116 Single	P
1.8	8/89 -	10/95		SAGI.	53504 143 6 P	
2.0 TURBO	10/88 -	10/95		SAGI.	53506 130 Single	P
2.0 TURBO	10/88 -	10/95		SAGI.	53501 116 Single	P
2.0 TURBO	10/88 -	10/95		SAGI.	53504 143 6 P	
2.5 V6	2/93 -	10/95		SAGI.	53683 152 6 S	
1.7 D	89 -	95		SAGI.	53501 116 Single	P
1.7 TD	3/90 -	10/95		SAGI.	53507 120 Single	P
VECTRA B						
1.6 8V	10/95 -	9/00		SAGI.	53514 140 6 P	
1.6 16V	10/95 -	5/02		SAGI.	53514 140 6 P	
1.8 16V	10/95 -	5/02		SAGI.	53514 140 6 P	
2.0 16V	10/95 -	9/00		SAGI.	53514 140 6 P	
2.5 24V	10/95 -	10/00		SAGI.	53766 S	
1.7 TD	10/95 -	8/96		SAGI.	53507 120 Single	P
1.7 TD	10/95 -	8/96		SAGI.	54178 120 2 P	
2.0 TD	8/96 -	5/02		KAYABA	53572 120 Single	P
2.0 TD	8/96 -	5/02		ZF	53596 115 6 S	

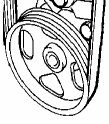

				OE	SPIDAN	 Ø mm	Ports	NOTICE
OPEL								
MOVANO								
2.2 TD		9/00 -		SAGI.	54184	126	5 P	
2.2 TD		9/00 -		SAGI.	54264	126	6 P	
2.2 TD		9/00 -		SAGI.	54228		S	
2.5 D		1/99 - 9/00		SAGI.	53577			* BELT
2.5 TD		1/02 -		SAGI.	53577			* BELT
2.8 TD		1/99 - 12/01		SAGI.	53577			* BELT
VIVARO								
2.0i		7/02 -		SAGI.	54184	126	5 P	
2.0i		7/02 -		SAGI.	54264	126	6 P	
2.0i		7/02 -		SAGI.	54228		S	
1.9 TD		6/01 -		SAGI.	54184	126	5 P	
1.9 TD		6/01 -		SAGI.	54264	126	6 P	
1.9 TD		6/01 -		SAGI.	54228		S	
PEUGEOT								
106								
1.0		11/91 - 6/96		SAGI.	54195	112	5 P	
1.1		11/91 - 1/97		SAGI.	54195	112	5 P	
1.3		1/94 - 6/96		SAGI.	54195	112	5 P	
1.3		1/94 - 6/96		HPI				ELEKTRISCH
1.4		1/94 - 12/96		SAGI.	54195	112	5 P	
1.6		8/94 - 12/96		SAGI.	54195	112	5 P	
1.4 D		1/93 - 8/94		SAGI.	54195	112	5 P	
205								
1.0/1.1/1.4/1.6		10/83 - 5/96		SAGI.	53522	141	4 S	
1.9		1/87 - 1/94		SAGI.	53522	141	4 S	
1.8 D		10/83 - 6/91		HOB.	53575	83	Single P	
1.8 D		10/83 - 6/91		SAGI.	53801			
1.8 D		6/91 - 5/96		SAGI.	53523	75	Single P	
1.8 TD		7/90 - 5/96		SAGI.	53523	75	Single P	
206								
1.1		10/98 -		SAGI.	53671	132	6 P	
1.4		10/98 -		SAGI.	53671	132	6 P	
1.4		10/98 -		SAGI.	54191	142	6 P	
1.6		10/98 -		SAGI.	53671	132	6 P	
2.0 16V		6/99 -		SAGI.	53740	132	6 P	
2.0 16V		6/99 -		SAGI.	54171	137	6 P	
1.9 D		10/98 - 12/01		SAGI.	54042	114	6 P	5 pcs. A7
1.9 D		10/98 - 12/01		SAGI.	54250	114	6 P	6 pcs. A7
2.0 HDI		11/99 -		SAGI.	53751	125	6 P	

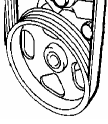

					OE	SPIDAN	 Ø mm	Ports	NOTICE
PEUGEOT									
305									
1.6	8/83	7/88			SAGI.	53522	141	4 S	
1.9	10/84	88			SAGI.	53522	141	4 S	
1.9	88	-			SAGI.	53803			
306									
1.4	4/93	2/98			SAGI.	53522	141	4 S	
1.4	4/93	2/98			SAGI.	54100	141	5 P	
1.4	2/98	-			SAGI.	53670		S	
1.4	2/98	-			SAGI.	53661	142	5 P	
1.4	2/98	-			SAGI.	54069	125	6 P	
1.4	2/98	-			SAGI.	54068	75	Single	
1.6	4/93	2/98			SAGI.	53522	141	4 S	
1.6	4/93	2/98			SAGI.	54100	141	5 P	
1.6	2/98	-			SAGI.	53670		S	
1.6	2/98	-			SAGI.	53661	142	5 P	
1.6	2/98	-			SAGI.	54069	125	6 P	
1.6	2/98	-			SAGI.	53898	133	6 P	
1.6	2/98	-			SAGI.	53918	114	6 P	
1.6	2/98	-			SAGI.	54068	75	Single	
1.8	2/98	2/98			SAGI.	54068	75	Single	
1.8	2/98	2/98			SAGI.	53661	142	5 P	
1.8	2/98	2/98			SAGI.	54069	125	6 P	
1.8	2/98	2/98			SAGI.	53898	133	6 P	
1.8	2/98	2/98			SAGI.	53918	114	6 P	
1.8	2/98	2/98			SAGI.	53958			
1.8	4/93	2/98			SAGI.	53802	142	6 P	
1.8	2/98	-			SAGI.	53924			
1.8	2/98	-			SAGI.	53960	142	6 P	
1.8	4/93	2/98			SAGI.	53554	142	6 P	
1.8	2/98	-			SAGI.	53934			
1.8	2/98	-			SAGI.	53935			
2.0	4/93	7/99			SAGI.	53554	142	6 P	
2.0	7/99	-			SAGI.	53958			
2.0	4/93	7/99			SAGI.	53800			
2.0	7/99	-			SAGI.	53960	142	6 P	
1.9 D/TD	4/93	2/98			SAGI.	53503	133	6 P	
1.9 D/TD	2/98	-			SAGI.	53898	133	6 P	
1.9 D/TD	2/98	-			SAGI.	53918	114	6 P	
1.9 D/TD	2/98	-			SAGI.	53917	114	6 P	
1.9 D/TD	4/93	96			SAGI.	53505	114	6 P	
1.9 D/TD	96	11/98			SAGI.	53675	114	6 P	
2.0 HDI	5/99	-			SAGI.	53729	125	6 P	

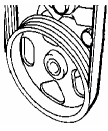
				OE	SPIDAN	 Ø mm	Ports	NOTICE
PEUGEOT								
309								
1.6	2/86 - 6/93			SAGI.	53522	141	4 S	
1.9i	4/87 - 9/91			SAGI.	53522	141	4 S	
1.8 TD	9/89 - 6/93			SAGI.	53523	75	Single P	
1.9 D	9/86 - 6/91			HOB.	53575	83	Single P	
1.9 D	9/86 - 6/91			SAGI.	53801			
1.9 D	6/91 - 6/93			SAGI.	53523	75	Single P	
405								
1.4	10/92 - 8/93	eng.TU3/TU3M		SAGI.	53522	141	4 S	
1.6 CARB.	1/88 - 10/92	eng.XU5		SAGI.	53522	141	4 S	
1.6i	2/91 - 9/93	eng.XU5C		SAGI.	53522	141	4 S	
1.6i	9/93 - 9/95	eng.XU5M/XU52C		SAGI.	53522	141	4 S	
1.6i	9/93 - 9/95	eng.XU5JP		SAGI.	53802	142	6 P	
1.8	10/92 - 2/97	eng.XU7JP		SAGI.	53802	142	6 P	
1.9 CARB.	1/88 - 10/92	eng.XU9		SAGI.	53522	141	4 S	
1.9i 8V	1/88 - 10/92	eng.XU9J2		SAGI.	53522	141	4 S	
1.9i Mi16	10/88 - 10/92	eng.XU9J4		SAGI.	53523	75	Single P	
2.0 8V	10/92 - 2/97	eng.XU10J1		SAGI.	53554	142	6 P	
1.8 TD	8/88 - 10/92	eng.XUD7TE		SAGI.	53523	75	Single P	A3
1.8 TD	8/88 - 10/92			SAGI.	53505	114	6 P	A4
1.9 D	8/88 - 92	eng.XUD9		SAGI.	53523	75	Single P	
1.9 D	8/88 - 92			SAGI.	53505	114	6 P	
1.9 D	92 - 2/97	eng.XUD9		SAGI.	53503	133	6 P	
1.9 D	92 - 2/97			SAGI.	53505	114	6 P	
1.9 TD	10/92 - 2/97	eng.XUD9TE		SAGI.	53503	133	6 P	
1.9 TD	10/92 - 2/97			SAGI.	53505	114	6 P	
406								
1.8i	2/96 -		* A/C	ZF	53566	142	6 P	
2.0	2/96 - 4/99			SAGI./ZF	53561	114	6 P	
2.0	2/96 - 4/99			ZF	54047	106	6 P	
2.0	4/99 -			ZF	54181	126	6 P	
3.0 V6	1/97 -			SAGI.	53737		S	
1.9 TD	2/96 -		* A/C	SAGI./ZF	53561	114	6 P	
2.0 TD/HDI	12/98 -			SAGI.	53899	126	6 P	
2.1 TD	7/96 - 11/98			ZF	53561	114	6 P	
505								
2.8 V6	9/86 - 6/89		* A/C	SAGI.	53772		S	
2.3 D/TD	10/79 - 9/85			SAGI.	53733		S 3	
2.5 D/TD	3/82 - 2/92			SAGI.	53733		S 3	

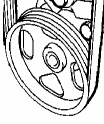

			OE	SPIDAN	 Ports Ø mm	NOTICE
PEUGEOT						
605						
2.0 8V TURBO	9/90 - 1/95		SAGI.	53799	96 Single P	
2.0 16V	1/95 - 5/96		SAGI.	-	141 6 P	
3.0 V6	90 -		SAGI.	53698	67 4 P	
1.9 D	96 - 12/98		SAGI.	53753	106 6 P	
2.1 TD	90 -		SAGI.	53552	90 4 P	
2.5 TD	96 - 12/98		SAGI.	53753	106 6 P	
806						
2.0	10/95 - 7/02		SAGI.	53561	114 6 P	
2.0	10/95 - 7/02		ZF	54063	142 6 P	
1.9 TD	10/95 - 8/99		ZF	53798	114 6 P	L- 113mm
1.9 TD	10/95 - 8/99		ZF	54196	114 6 P	L- 107mm
2.0 HDI	8/99 - 7/02		ZF	54239	125 6 P	
PARTNER						
1.4	6/01 -		SAGI.	53661	142 5 P	
1.4	6/01 -		SAGI.	54069	125 6 P	
1.4	10/96 -		SAGI.	53670	- S	
1.4	10/96 -		SAGI.	53661	142 5 P	
1.4	10/96 -		SAGI.	54069	125 6 P	
1.4	10/96 -		SAGI.	54068	75 Single P	
1.9 D	10/96 -		SAGI.	53918	114 6 P	
1.9 D	10/96 -		SAGI.	53898	133 6 P	
1.9 D	10/96 -		SAGI.	53675	114 6 P	
1.9 D	10/96 -		SAGI.	53918	114 6 P	
1.9 D	6/01 -		SAGI.	53898	133 6 P	
1.9 D	6/01 -		SAGI.	53675	114 6 P	
1.9 TD	7/98 -		SAGI.	53662	114 6 P	
2.0 HDI	2/99 -		SAGI.	53945	142 6 P	
BOXER						
2.5 D/TD	6/94 - 3/02		SAGI.	53608	108 6 S	
EXPERT						
1.9 D/TD	9/96 -		ZF	53797	114 6 P	L- 113mm
1.9 D/TD	9/96 -		ZF	54196	114 6 P	L- 107mm
J5						
1.9 D	87 - 94		SAGI.	53773	133 6 P	
2.5 D/TD	87 - 94		SAGI.	53523	75 Single P	
2.5 D/TD	87 - 94		SAGI.	53773	133 6 P	

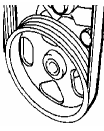

				OE	SPIDAN	 Ø mm	Ports	NOTICE
PORSCHE								
924								
2.5 S		9/85 - 6/88		ZF	53992	109	Single S	
928								
4.7 S		9/83 - 7/86		ZF	53993		S	
5.0 GT		9/86 - 5/92		ZF	53993		S	
5.4 GTS		5/92 - 1/95		ZF	53993		S	
944								
2.5/S		4/82 - 5/92		ZF	53992	109	Single S	
2.7		9/88 - 6/89		ZF	53992	109	Single S	
3.0 S2		1/89 - 5/92		ZF	53992	109	Single S	
968								
3.0		5/92 - 10/95		ZF	53992	109	Single S	
PROTON								
PERSONA								
1.6/1.8		1/93 - 3/00		KAYABA	53994	148	5 P	
PROTON								
1.3/1.5		3/89 - 8/96		KAYABA	53796	107	Single P	
RENAULT								
5								
1.4 Manual		2/85 - 1/93 [eng.C2J]		SAGI.	53785	100	Single S	
1.7		7/86 - 10/90 [eng.F2N/F3N]		SAGI.	53786		6 S	
9								
1.4 TURBO		2/86 - 1/88 [eng.C1J]		SAGI.	53785	100	Single S	
1.7		3/82 - 1/89 [eng.F2N/F3N]		SAGI.	53786		6 S	
1.6 D		12/82 - 7/87 [eng.F8M]		SAGI.	53786		6 S	
11								
1.4 TURBO		4/84 - 6/89 [eng.C1J]		SAGI.	53785	100	Single S	
1.7		9/83 - 6/89 [eng.F2N/F3N]		SAGI.	53786		6 S	
1.6 D		4/84 - 1/89 [eng.F8M]		SAGI.	53786		6 S	
19								
1.4		2/89 - 5/92 [eng.E6J/E7J]		SAGI.	53633	125	6 P	
1.4		5/92 - 2/96 [eng.E6J/E7J/C3J]		SAGI.	53739	97	3 S	
1.7		2/89 - 5/92 [eng.F2N/F3N]		SAGI.	53633	125	6 P	
1.8 8V		5/92 - 10/95 [eng.F3P]		SAGI.	53633	125	6 P	
1.8 16V		3/91 - 9/95 [eng.F7P]		SAGI.	53599	111	6 P	
1.9 D/TD		2/89 - 2/96 [eng.F8Q]		SAGI.	53633	125	6 P	

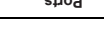
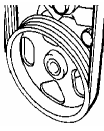

				OE	SPIDAN	 Ø mm	Ports	NOTICE
RENAULT								
21								
1.7	6/86 - 10/95	[eng.F2NF3N]		SAGI.	53633	125	6 P	
2.0 8V/12V/TURBO	6/86 - 10/95	[eng.J7R/J7T]	★ 4WD	SAGI.	53562	125	Single P	H-> 28mm/F
2.0 8V/12V/TURBO	6/86 - 10/95			SAGI.	53981	125	Single P	H-> 14mm
1.9 D	9/89 - 10/95	[eng.F8Q]		SAGI.	53633	125	6 P	
2.1 D/TD	6/86 - 10/95	[eng.J8S]		SAGI.	53562	125	Single P	H-> 28mm/F
2.1 D/TD	6/86 - 10/95			SAGI.	53981	125	Single P	H-> 14mm
25								
2.0 8V/12V	7/84 - 10/92	[eng.J6R/J7R]		SAGI.	53562	125	Single P	H-> 28mm/F
2.0 8V/12V	7/84 - 10/92			SAGI.	53578	125	Single P	H-> 28mm/G
2.0 8V/12V	7/84 - 10/92			SAGI.	53981	125	Single P	H-> 14mm
2.2	7/84 - 1/90	[eng.J7T]		SAGI.	53562	125	Single P	H-> 28mm/F
2.2	7/84 - 1/90			SAGI.	53578	125	Single P	H-> 28mm/G
2.2	7/84 - 1/90			SAGI.	53981	125	Single P	H-> 14mm
2.1 D/TD	7/84 - 10/92	[eng.J8S]		SAGI.	53562	125	Single P	H-> 28mm/F
2.1 D/TD	7/84 - 10/92			SAGI.	53578	125	Single P	H-> 28mm/G
2.1 D/TD	7/84 - 10/92			SAGI.	53981	125	Single P	H-> 14mm
CLIO I								
1.2 8V	1/91 -	[eng.D7F/E7F]		SAGI.	53590	95	3 S	
1.2 8V	1/91 -			SAGI.	53672	104	5 S	RS-S-Ø 35mm
1.2 8V	1/91 -			SAGI.	53921	92	6 S	RS-S-Ø 55mm
1.2 8V	1/91 -			SAGI.	53676	93	6 S	●
1.2 8V	1/91 -			SAGI.	53922	120	4 P	
1.2 8V	1/91 -			SAGI.	53913	135	4 P	
1.4 8V	1/91 -	[eng.E6J/E7J]		SAGI.	53590	95	3 S	
1.4 8V	1/91 -			SAGI.	53676	93	6 S	
1.4 8V	1/91 -			SAGI.	53948	127	6 S	
1.4 8V	1/91 -			SAGI.	54043	132	6 P	
1.4 8V	1/91 -			SAGI.	53913	136	4 P	
1.7	3/91 - 4/98			SAGI.	53633	125	6 P	HYDR.
1.8 8V	3/91 - 10/97			SAGI.	53633	125	6 P	HYDR.
1.9 D	3/91 - 4/01	[eng.F8Q]		SAGI.	53590	95	3 S	
1.9 D	3/91 - 4/01			SAGI.	53672	104	5 S	RS-S-Ø 35mm
1.9 D	3/91 - 4/01			SAGI.	53921	92	6 S	RS-S-Ø 55mm
1.9 D	3/91 - 4/01			SAGI.	53922	120	4 P	
CLIO II								
1.6 8V	9/98 -	[eng.K7M]		SAGI.	53948	127	6 S	
1.6 8V	9/98 -			SAGI.	54043	132	4 P	
2.0 16V	3/00 -	[eng.F4R]		SAGI.	54044		S	

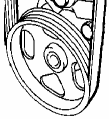

					OE	SPIDAN	 Ø mm	Ports	NOTICE
RENAULT									
ESPACE I (J11_)									
2.0		7/85 - 12/87	[eng.J6R]		SAGI.	53687	138	Single	P
2.0		1/88 - 6/91	[eng.J6R/J7R]	FWD	SAGI.	53764			
2.0		3/89 - 1/91	[eng.J7R]	4WD	SAGI.	53562	125	Single	P
2.0		3/89 - 1/91			SAGI.	53981	125	Single	P
2.2		7/86 - 12/87	[eng.J7T]		SAGI.	53687	138	Single	P
2.2		1/88 - 12/90	[eng.J7T]		SAGI.	53764			
2.1 TD		10/84 - 12/87	[eng.J8S]		SAGI.	53687	138	Single	P
2.1 TD		1/88 - 12/90	[eng.J8S]		SAGI.	53764			
ESPACE II (J163_)									
2.0		6/91 - 6/97	[eng.J7R]		SAGI.	53562	125	Single	P
2.0		6/91 - 6/97			SAGI.	53981	125	Single	P
2.2		9/94 - 6/97	[eng.J7T]		SAGI.	53562	125	Single	P
2.2		9/94 - 6/97			SAGI.	53981	125	Single	P
2.9		6/91 - 2/96	[eng.Z7W]		SAGI.	53547	138	Single	P
2.9		6/91 - 2/96			SAGI.	53936	138	Single	P
2.1 TD		1/93 - 6/97	[eng.J8S]		SAGI.	53562	125	Single	P
2.1 TD		1/93 - 6/97			SAGI.	53981	125	Single	P
ESPACE III (JE_)									
2.0 8V		4/97 - 1/01	[eng.F_R]		SAGI.	53911			S
2.0 16V		7/99 - 12/02	[eng.E4R]		SAGI.	54228			S
2.2 TD		4/97 - 12/02	[eng.G8T]	★ A/C	SAGI.	53947	115 6		P
2.2 TD		4/97 - 12/02	[eng.G8T]	A/C	SAGI.	53946	115 6		P
3.0 12V		4/97 - 1/99	[eng.Z7X]	INCL A/C	SAGI.	53763			
3.0 24V		1/99 - 12/02	[eng.L7X]						
KANGOO									
1.2		5/98 -			SAGI.	53948	127	6	S
1.2		5/98 -			SAGI.	54043	132	4	P
1.2		5/98 -			SAGI.	54247			S
1.4		10/99 -			SAGI.	53948	127	6	S
1.4		10/99 -			SAGI.	54043	132	4	P
1.9 D		5/98 -			SAGI.	53672	104	5	S
1.9 D		5/98 -			SAGI.	53921	92	6	S
1.9 D		5/98 -			SAGI.	53922	120	4	P
LAGUNA									
1.6 16V		5/98 - 1/01	[eng.K4M]		SAGI.	54169			▼
1.8 8V		4/94 - 4/98	[eng.F3P]		SAGI.	53538	99	6	S
1.8 8V		4/94 - 4/98			SAGI.	53579	99	6	S
1.8 16V		9/98 - 1/01	[eng.F4P]		SAGI.	53538	99	6	S

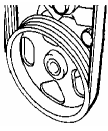



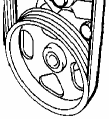

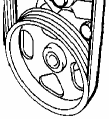

					OE	SPIDAN	 Ø mm	Ports	NOTICE
RENAULT									
LAGUNA									
1.8 16V		9/98 - 1/01			SAGI.	53579	99	6 S	▼
1.8 16V		2/01 -	[eng.F4P]		SAGI.	54226	126	6 P	
1.9 TD/DTI		5/98 - 1/01	[eng.F9Q]	*A/C	SAGI.	53937			
1.9 TD/DTI		5/98 - 1/01	[eng.F9Q]	A/C	SAGI.	53916		S	▼
1.9 TD/DTI		12/99 - 1/01	[eng.F9Q]	INCL.A/C	SAGI.	54165	125	6 P	
2.0 8V		4/98 - 1/01	[eng.F3R]		SAGI.	53538	99	6 S	●
2.0 8V		4/98 - 1/01			SAGI.	53579	99	6 S	▼
2.0 16V		4/95 - 5/99	[eng.N7Q]		SAGI.	53972	140	6 P	
3.0 12V		4/94 - 10/96	[eng.Z7X]	A/C	SAGI.	54038	85	5 P	
2.2 D		4/95 - 4/98	[eng.G8T]	*A/C	SAGI.	53771	132	6 P	
2.2 D		4/95 - 4/98	[eng.G8T]	A/C	SAGI.	53938			
2.2 TD		6/96 -	[eng.G8T]	*A/C	SAGI.	53674	118	6 P	
2.2 TD		6/96 - 1/01	[eng.G8T]	A/C	SAGI.	53900	118	6 P	
MEGANE									
1.4 8V		4/96 - 11/00	[eng.E7J]	*A/C	SAGI.	53940	113	6 S	FLANSCH Ø50mm
1.4 8V		4/96 - 11/00			SAGI.	53939	113	6 S	▼
1.4 8V		4/96 - 11/00			SAGI.	53948	127	6 S	▼
1.4 8V		4/96 - 11/00			SAGI.	53568	97	3 S	FLANSCH Ø64mm
1.4 8V		4/96 - 11/00			SAGI.	54043	132	4 P	
1.4 8V		4/96 - 4/99	[eng.E7J]	A/C	SAGI.	53973		S	▼
1.4 16V		4/99 - 3/03	[eng.K4J]		SAGI.	54172	132	6 P	
1.6 8V		4/96 - 4/99	[eng.K7M]	INCL.A/C	SAGI.	53738		S	
1.6 8V		4/96 - 4/99			SAGI.	53940	113	6 S	● Ø50mm
1.6 8V		4/96 - 4/99			SAGI.	53939	113	6 S	▼
1.6 8V		4/96 - 4/99			SAGI.	53948	127	6 S	RS-S-Ø 55mm
1.6 8V		4/96 - 4/99			SAGI.	53921	92	6 S	RS-S-Ø 55mm
1.6 8V		4/96 - 4/99			SAGI.	53672	104	5 S	RS-S-Ø 35mm
1.6 8V		4/96 - 4/99			SAGI.	54043	132	4 P	
1.6 8V		4/96 - 4/99			SAGI.	53922	120	4 P	
1.6 16V		4/99 - 5/03			SAGI.	54168		S	O.E.26090956/8200112299 8200113599
1.6 16V		4/99 - 5/03			SAGI.	54039		S	O.E.7700431283 7700431286
2.0 8V/16V		4/96 - 4/99	[eng.F3R/F7R]	*A/C	SAGI.	53614	126	6 S	●
2.0 8V/16V		4/96 - 4/99			SAGI.	54073		S	▼
2.0 8V/16V		4/96 - 4/99	[eng.F3R/F7R]	A/C	SAGI.	53973		S	SAGINAW.77004171 ▼
2.0 8V/16V		4/96 - 4/99			SAGI.	54044		S	SAGINAW.77008401 ▼

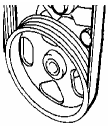

					OE	SPIDAN	 Ø mm	Ports	NOTICE
RENAULT									
MEGANE									
1.9 D/TD	4/96 - 3/03	[eng.F8Q/F9Q]	INCL-A/C	SAGI.	53940	113	6 S	● Ø50mm	
1.9 D/TD	4/96 - 3/03			SAGI.	53939	113	6 S	▼ RS-S-Ø 55mm	
1.9 D/TD	4/96 - 3/03			SAGI.	53908	110	6 S	▼ RS-S-Ø 55mm	
1.9 D/TD	4/96 - 3/03			SAGI.	53921	92	6 S	▼ RS-S-Ø 55mm	
1.9 D/TD	4/96 - 3/03			SAGI.	53672	104	5 S	▼ RS-S-Ø 35mm	
1.9 D/TD	4/96 - 3/03			SAGI.	53568	97	3 S	● Ø64mm	
1.9 D/TD	4/96 - 3/03			SAGI.	53922	120	4 P		
SAFRANE									
2.0 8V/12V	11/92 - 11/96	[eng.J7R]		SAGI.	53673	130	Single P		
2.0 16V	11/96 - 1/00	[eng.N7Q]		SAGI.	53972	140	6 P		
2.2 12V	3/94 - 11/96	[eng.J7T]		SAGI.	53673	130	Single P		
3.0 12V	11/92 - 11/96	[eng.Z7X]		SAGI.	53910	120	4 P		
2.1 TD	11/92 - 11/96	[eng.J8S]		SAGI.	53556	114	6 S		
2.2 TD	11/96 - 1/00	[eng.G8T]		SAGI.	53674	118	6 P		
2.5 20V	11/96 - 1/00	[eng.N7U]		SAGI.	53972	140	6 P		
2.5 TD	6/95 - 11/96	[eng.N7U]		SAGI.	53556	140	6 S		
MASTER II (D)									
2.2 TD	11/00 -			SAGI.	54184	126	5 P		
2.2 TD	11/00 -			SAGI.	54264	126	6 P		
2.2 TD	11/00 -			SAGI.	54228		S		
2.5 D/TD	3/98 -			ZF	53605			** BELT	
2.5 D/TD	3/98 -			ZF	53577			** BELT	
2.8 TD	3/98 - 10/00			ZF	53605			** BELT	
2.8 TD	3/98 - 10/00			ZF	53577			** BELT	
TRAFIC (X)									
2.0 8V	6/86 - 9/94	[eng.J6R]		SAGI.	53556	114	6 S		
2.1 D	7/94 - 3/98	[eng.J6S]		SAGI.	53556	114	6 S		
2.4 D	95 - 00			SAGI.	54083	92	6 P		
TRAFIC (L)									
1.9 TD	9/01 -			SAGI.	54184	126	5 P		
1.9 TD	9/01 -			SAGI.	54264	126	6 P		
1.9 TD	9/01 -			SAGI.	54228		S		
2.0 16V	9/01 -			SAGI.	54184	126	5 P		
2.0 16V	9/01 -			SAGI.	54264	126	6 P		
2.0 16V	9/01 -			SAGI.	54228		S		



					OE	SPIDAN	 Ø mm	Ports	NOTICE
ROVER									
25									
1.1 16V		4/01 -	[eng.K]		HOB.	54164	110	3 S	
1.4 16V		11/99 -	[eng.K]		HOB.	54164	110	3 S	
1.6 16V		11/99 -	[eng.K]		HOB.	54164	110	3 S	
1.8 16V		11/99 -	[eng.K]		HOB.	54164	110	3 S	
45									
1.4 16V		1/00 -	[eng.K]		HOB.	54164	110	3 S	
1.6 16V		1/00 -	[eng.K]		HOB.	54164	110	3 S	
1.8 16V		1/00 -	[eng.K]		HOB.	54164	110	3 S	
75									
2.0 V6		3/99 -			HOB.	-	125	5 S	
2.5 V6		3/99 -			HOB.	54214	130	6 S	
200-SERIE (RF)									
1.8		10/96 -	[eng.VVC]		HOB.	53509	109	3 S	
1.4		11/95 -	10/99		HOB.	53509	109	3 S	
1.6		11/95 -	10/99		HOB.	53509	109	3 S	
1.6 DOHC		3/96 -	6/99	CABRIO/COUPE	HOB.	53509	109	3 S	
1.8 COUPE		3/96 -	6/99	[eng.VVC]	HOB.	53509	109	3 S	
2.0 TD		11/95 -	10/99		HOB.	53512		S	A5
2.0 TD		11/95 -	10/99		HOB.	53574	129	5 S	A5
200-SERIE (XW)									
214	1.4 16V	10/89 -	10/95		HOB.	53508	108	3 S	
216	1.6 SOHC	10/89 -	10/95		HOB.	53580	119	Single S	
216	1.6 DOHC	9/90 -	10/95		HOB.	53591	118	Single S	
218	1.8 TD	3/91 -	10/95		HOB.	53528	85	Single S	
218	1.8 TD	3/91 -	10/95		HOB.	53532		S	
218	1.9 D	3/91 -	10/95		HOB.	53528	85	Single S	
218	1.9 D	3/91 -	10/95		HOB.	53532		S	
220	2.0 16V	6/91 -	10/95		HOB.	53564	137	5 S	
220	2.0 16V	10/92 -	10/95	COUPE	HOB.	53567		S	PUMP-FE A5
400-SERIE (RT)									
414	1.4 LIMO	3/90 -	10/95		HOB.	53508	108	3 S	
416	1.6 SOHC LIMO	3/90 -	10/95		HOB.	53580	119	Single S	
416	1.6 DOHC GT LIMO	3/90 -	11/91		HOB.	53591	118	Single S	
418	1.8 KOMBI	3/96 -	12/96	[eng.VVC]	HOB.	53508	108	3 S	
418	1.8 TD LIMO	3/91 -	10/95		HOB.	53528	85	Single S	
418	1.8 TD LIMO	3/91 -	10/95		HOB.	53532		S	
418	1.8 TD KOMBI	6/94 -	12/96		HOB.	53532		S	
418	1.9 D LIMO	10/92 -	10/95		HOB.	53528	85	Single S	
418	1.9 D LIMO	10/92 -	10/95		HOB.	53532		S	

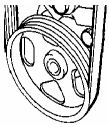

ROVER						OE		SPIDAN		 Ports Ø mm		NOTICE	
400-SERIE (RT)	2.0 LIMO.	10/92	-	10/95		HOB.		53564	137	5	S		
400-SERIE (XW)													
414	1.4	5/95	-	12/99			-->AD039996	53508	108	3	S		
414	1.4	5/95	-	12/99			AD039997-->	53509	109	3	S		
416	1.6 DOHC MANUAL	5/95	-	12/99			-->AD039996	53508	108	3	S		
416	1.6 DOHC MANUAL	5/95	-	12/99			AD039997-->	53509	109	3	S		
416	1.6 SOHC AUTO	5/95	-	12/99			-->AD250028	53794					
416	1.6 SOHC AUTO	5/95	-	12/99			AD250029-->	53696					
420	2.0 16V	11/95	-	12/99			**A/C	53512			S	A5	
420	2.0 16V	11/95	-	12/99			A/C	53574	129	5	S	A5	
420	2.0 TD	11/95	-	12/99			**A/C	53512			S	A5	
420	2.0 TD	11/95	-	12/99			A/C	53574	129	5	S	A5	
420	2.0 TD	11/95	-	12/99			INTERCOOLER	54005	130	6	S		
600-SERIE (RH)													
618	1.8	10/93	-	96				53622	117	4	S		
618	1.8	96	-	10/99			**A/C	53693			S	A5	
618	1.8	96	-	10/99			A/C	53692			S	A5	
620	2.0 16V	4/93	-	96			-->AM246796	53622	117	4	S		
620	2.0 16V	4/93	-	96				-	110	4	P		
620	2.0 16V	96	-	10/99			**A/C	53693			S	A5	
620	2.0 16V	96	-	10/99			BM246797-->	-	110	4	P		
620	2.0 16V	96	-	10/99			A/C	53692			S	A5	
620	2.0 16V	96	-	10/99				-	110	4	P		
620	2.0 16V TURBO	7/94	-	96			**A/C	53573			S	A5	
620	2.0 16V TURBO	7/94	-	96			A/C	-	110	4	P		
620	2.0 16V TURBO	7/94	-	96				53694			S		
620	2.0 16V TURBO	7/94	-	96				-	110	4	P		
620	2.0 16V TURBO	96	-	10/99			**A/C	53693			S		
620	2.0 16V TURBO	96	-	10/99			A/C	-	110	4	P		
620	2.0 16V TURBO	96	-	10/99				53692			S	A5	
620	2.0 16V TURBO	96	-	10/99			**A/C	-	110	4	P		
620	2.0 TD	12/94	-	96			A/C	53573			S	A5	
620	2.0 TD	12/94	-	96				53694			S	A5	
620	2.0 TD	96	-	10/99			**A/C	53693			S	A5	
620	2.0 TD	96	-	10/99			A/C	53692			S	A5	
623	2.3 16V	10/93	-	96				53622	117	4	S		
623	2.3 16V	96	-	10/99			**A/C	53693			S	A5	
623	2.3 16V	96	-	10/99			A/C	53692			S	A5	

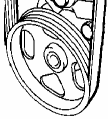

					OE	SPIDAN		Ports	NOTICE
ROVER									
800-SERIE (XS/RS)									
820	2.0	7/86	-	10/88				S	NW
820	2.0	7/86	-	10/88	HOB.	53569		S	KW
820	2.0	10/88	-	10/91	HOB.	53539	150	5	
820	2.0	7/86	-	10/91	HOB.	53792	150	5	
820	2.0	11/91	-	8/98	HOB.	53551		S	A5
820	2.0	11/91	-	8/98	HOB.	54200		S	PUMP-FE A5
820	2.0	11/91	-	8/98	HOB.	53557		S	A5
825	2.5 V6	7/86	-	2/88	HONDA	53691	110	Single	S
825	2.5 V6	1/96	-	4/99	HOB.	53690		S	
825	2.5 TD	9/90	-	8/91	HOB.	53550	150	5	IR
825	2.5 TD	12/91	-	8/98	HOB.	53550	150	5	IR
827	2.7 V6	2/88	-	8/91	HONDA	53691	110	Single	S
827	2.7 V6	11/91	-	3/96	HONDA	53691	110	Single	S
MAESTRO									
2.0		10/84	-	11/91	HOB.	53996	132	Single	S
2.0 D		3/90	-	1/95	HOB.	53526		S	A12
2.0 D		3/90	-	1/95	HOB.	54010		S	A12
MONTEGO									
1.6		2/88	-	7/91	HOB.	53623	90	Single	S
2.0		4/84	-	12/94	HOB.	53996	132	Single	S
2.0 D		10/88	-	11/94	HOB.	53526		S	A12
2.0 D		10/88	-	11/94	HOB.	54010		S	A12
SD1									
2.0/2.3/2.6		6/76	-	1/87	HOB.	53790	150	Single	S
3.5 V8		6/76	-	1/87	HOB.	53791	140	Single	S
3.5 V8		6/76	-	1/87	HOB.	53642	148	Single	S
SAAB									
9-3 (YS3D)									
2.0		3/98	-	8/02	INCL.TURBO	SAGI.	126	6	P
2.0		3/98	-	8/02	INCL.TURBO	SAGI.	126	6	P
2.3		3/98	-	10/00	INCL.TURBO	SAGI.	126	6	P
2.3		3/98	-	10/00	INCL.TURBO	SAGI.	126	6	P
2.2 TD		3/98	-	8/02	ZF	53895			
9-5									
2.3 TURBO		10/97	-		ZF	54234	125	6	P
900									
900 I	2.0	2/79	-	10/93	SAGI.	53620	145	Single	P
900 I	2.0	2/79	-	10/93	SAGI.	53689	145	Single	P
900 I	2.0	2/79	-	10/93	SAGI.	53789	130	5	P

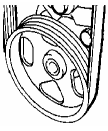

				OE	SPIDAN	 Ø mm	Ports	NOTICE
SAAB								
900								
900 II	2.0 16V	10/93 - 1/98	INCL.TURBO	SAGI.	53637	125	6 P	
900 II	2.3 16V	10/93 - 1/98	INCL.TURBO	SAGI.	53637	125	6 P	
900 II	2.5 24V	10/93 - 11/97		SAGI.	54240		S	
9000								
2.0/2.3	10/85 - 93			SAGI.	53619	130	5 P	
2.0/2.3	93 - 10/98			SAGI.	53571	142	6 P	
3.0	10/94 - 8/96			SAGI.	54002	153	6 S	
SEAT								
ALHAMBRA								
2.0i	5/96 -			ZF	53843	112	Single S	
2.0i	5/96 -		-->7M-T-503994	ZF	53583	104	Single S	
1.9 TD	5/96 -		7M-T-503995-->	ZF	53583	104	Single S	
1.9 TD	5/96 -			KAYABA	54203	120	6 S	L-108mm
1.9 TD	5/96 -			KAYABA	54262	120	6 S	L-98mm
AROSA								
1.0	6/97 -		**A/C	SAGI.	53755	115	6 S	
1.0	6/97 -		A/C	ZF	53942		S	
1.4 8V/16V	6/97 -		**A/C	SAGI.	53755	115	6 S	
1.4 8V/16V	6/97 -		A/C	ZF	53942		S	
1.4 TD	2/01 -			ZF	53629	120	5 S	
1.7 D	2/98 -			ZF	53629	120	5 S	
CORDOBA								
1.0	9/96 - 10/02		**A/C	ZF	53941		S	
1.0	9/96 - 6/99		A/C	SAGI.	53530		S	
1.0	6/99 - 10/02		A/C	ZF	53942		S	
1.4 8V/16V	6/94 - 6/99		**A/C	ZF	53629		S	
1.4 8V/16V	6/99 -		**A/C	ZF	53941		S	
1.4 8V/16V	6/94 - 6/99		A/C	SAGI.	53530		S	
1.4 8V/16V	6/99 -		A/C	ZF	53942		S	
1.6 8V	10/93 - 6/99			SAGI.	53530		S	
1.6 8V	6/99 -			ZF	53629		S	
1.8 8V/16V	10/93 - 6/99			SAGI.	53530		S	
1.8 20V	7/00 -			ZF	53629		S	
1.9 D/TD	2/93 - 6/99			SAGI.	53530		S	
1.9 D/TD	6/99 -			ZF	53629		S	
2.0 8V/16V	2/93 - 6/99			SAGI.	53530		S	

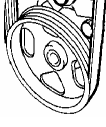

					OE	SPIDAN	 Ø mm	Ports	NOTICE
SEAT									
IBIZA									
1.0 8V		3/93 - 9/96			ZF	53941		S	
1.0 8V		10/96 - 1/98			SAGI.	53755	115	6	S
1.0 16V		5/00 - 2/02	**A/C		ZF	53941		S	
1.0 16V		5/00 - 2/02	A/C		ZF	53942		S	
1.3		3/93 - 8/99			ZF	53941		S	
1.4		9/93 - 8/99			ZF	53941		S	
1.4		8/99 - 4/02	**A/C		ZF	53941		S	
1.4		8/99 - 4/02	A/C		ZF	53942		S	
1.6		10/93 - 3/96			SAGI.	53517	98	Single	S
1.6		4/96 - 8/99			SAGI.	53530		S	
1.6		8/99 - 2/02			ZF	53629		S	
1.8 8V/16V		3/93 - 8/99			SAGI.	53530		S	
1.8 TURBO		6/00 - 4/02			ZF	53629		S	
2.0 8V/16V		3/93 - 9/99			ZF	53517	98	Single	S
1.9 D		4/93 - 8/96			SAGI.	53530		S	
1.9 D		9/96 - 1/01			SAGI.	53744		S	
1.9 TD		3/93 - 8/99			SAGI.	53530		S	
1.9 TD		8/99 - 2/02			ZF	53629		S	
LEON									
1.4 16V		4/00 -			ZF	53862		S	
1.6 8V/16V		4/00 -			ZF	53862		S	
1.8 20V		4/00 -	INCL. TURBO		ZF	53862		S	
1.9 TD		4/00 -			ZF	53950		S	
TOLEDO I (1L)									
1.6 CARB.		10/91 - 6/92			SAGI.	53511	98	Single	S
1.6i		10/91 - 11/93	**A/C		SAGI.	53511	98	Single	S
1.6i		11/93 - 3/99	**A/C		SAGI.	53530	115	6	S
1.6i		10/95 - 3/99	A/C		SAGI.	53517	98	Single	S
1.8 8V/16V		10/91 - 11/93	**A/C		SAGI.	53511	98	Single	S
1.8 8V/16V		11/93 - 10/95	**A/C		SAGI.	53530	115	6	S
1.8 8V		10/95 - 3/99	A/C		SAGI./ZF	53517	98	Single	S
2.0 8V/16V		10/91 - 11/93	**A/C		SAGI.	53511	98	Single	S
2.0 8V/16V		11/93 - 10/95	**A/C		SAGI.	53530	115	6	S
2.0 8V/16V		10/95 - 3/99	A/C		SAGI./ZF	53517	98	Single	S
1.9 TD		10/91 - 11/93	**A/C		SAGI.	53511	98	Single	S
1.9 D/TD		11/93 - 10/95	**A/C		SAGI.	53530	115	6	S
1.9 D/TD		10/95 - 3/99	A/C		SAGI./ZF	53517	98	Single	S

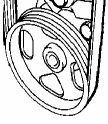

				OE	SPIDAN	 Ø mm	Ports	NOTICE
SEAT								
TOLEDO II (1M2)								
1.4 16V		7/99 - 9/00		SAGI.	53974		S	
1.4 16V		7/99 - 9/00		ZF	53862		S	
1.6 8V/16V		3/99 - 9/00		SAGI.	53974		S	
1.6 8V/16V		3/99 - 9/00		ZF	53862		S	
1.8 20V		3/99 -		SAGI.	53974	120	6	
1.8 20V		3/99 -		ZF	53862		S	
2.3 10V/20V		3/99 -		SAGI.	53726		S	
1.9 TD		3/99 -		SAGI.	53726		S	
1.9 TD		3/99 -		ZF	53950		S	
INCA								
1.4 8V		11/95 -		ZF	53629	120	5	
1.4 16V		4/00 -	*A/C	ZF	53941		S	
1.4 16V		4/00 -	A/C	ZF	53942		S	
1.7 D		1/96 -		ZF	53555		S	
1.9 D		11/95 -		ZF	53555		S	
SKODA								
FELICIA								
1.3		10/94 - 6/01		ZF	53941		S	
1.6		8/95 - 6/01		ZF	53941		S	
1.9 D		10/95 - 6/01		ZF	53629	120	5	
OCTAVIA								
1.4		4/99 -	[eng.AMD]	ZF	53629	120	5	
1.4		8/00 -	[eng.AXP]	ZF	53862		S	
1.6		9/96 -		ZF	53862		S	
1.8		9/96 -	INCL.TURBO	ZF	53862		S	
2.0		4/99 -	INCL.4WD	ZF	53862		S	
1.9 D		9/96 -	INCL.TURBO	ZF	53950		S	
SUPERB								
1.8 TURBO		2/02 -		ZF	53742		S	
2.0		2/02 -		ZF	53742		S	
2.8 V6		2/02 -		ZF	53951		S	
1.9 TD		2/02 -		ZF	53719		S	
2.5 TD		2/02 -		ZF	53915	120	6	
SSANGYONG								
KORANDO								
2.3		8/97 - 3/99		YOUNGSHIN	-	127	6	
2.9 TD		8/97 - 3/99		YOUNGSHIN	-	127	6	

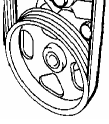

				OE	SPIDAN	 Ø mm	Ports	NOTICE
SSANGYONG								
MUSSO								
2.3		6/97 - 3/99			53997		6 S	
2.9 D/TD		5/95 - 3/99			53997		6 S	
3.2		1/97 - 3/99			53997		6 S	
SUBARU								
IMPREZA								
1.6		11/92 - 8/96	[eng.EJ16]		53641	113	5 S	
1.8		11/92 - 8/96	[eng.EJ18]		53641	113	5 S	
JUSTY		3/96 - 2/02	[eng.G13BA]	KAYABA	-	113	4 P	
LEGACY I (BC/BJF)								
1.8		10/89 - 9/92	[eng.EJ18]		53686	115	5 S	
2.0 TURBO		10/91 - 4/94	[eng.EJ20.EJ20T]		53686	115	5 S	
2.2		10/89 - 4/94	[eng.EJ22E]		53686	115	5 S	
L-SERIE								
1.8		9/86 - 1/93	[eng.EA82]		53784			
SVX								
3.3		5/92 - 12/96	[eng.EG33D]		53783			
SUZUKI								
BALENO								
1.6		5/95 - 6/99	[eng.G16B]		53782	124	4 P	
1.8		8/96 - 7/01	[eng.J18A]		53782	124	4 P	
GRAND VITARA								
1.6		3/98 -	[eng.G16B]	KAYABA	53589	134	4 S	
2.0 16V		5/99 -	[eng.J20A]					
2.0 TD		8/98 -	[eng.RF-T]	KAYABA	-	112	Single S	
SWIFT								
1.0		6/86 - 1/93	[eng.G10A]	KAYABA	53901	115	4 S	
1.0		1/95 -	[eng.G10B]	KAYABA	53781			
1.3		6/86 - 1/93	[eng.G13A.G13B]	KAYABA	53901	115	4 S	
1.3		4/92 - 10/00	[eng.G13B]	KAYABA	53781			
1.6		6/89 - 1/93	[eng.G16B]	KAYABA	53901	115	4 S	
VITARA								
1.6		10/88 - 8/99	[eng.G16A.G16B]	KAYABA	53589	134	4 S	
2.0 V6		7/95 - 4/98	[eng.H20A]	KAYABA	-	133	4 P	
2.0 TD		12/04 - 8/99	[eng.RF-T]	KAYABA	-	112	Single S	
X-90								
1.6		4/96 - 4/98	[eng.G16B]		53780	134	4 P	

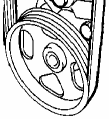

					OE	SPIDAN	 Ø mm	Ports	NOTICE
TOYOTA									
AVENSIS									
1.6		9/97 - 7/00	[eng.4A-FE]		ZF	53944			
1.8		9/97 - 7/00	[eng.7A-FE]		ZF	53944			
1.8 VVTi		8/00 -	[eng.1ZZ-FE]		TOYOTA	54155	120	6	P
2.0		9/97 - 10/00	[eng.3S-FE]		ZF	53919	105	3	P
2.0 VVTi		8/00 -	[eng.1AZ-FSE]		ZF	53919	105	3	P
2.0 TD		11/97 - 7/00	[eng.2CE-TE]		TOYOTA	53904	120	5	S
CAMRY									
2.0 16V		1/87 - 9/91	[eng.3S-FE]		TOYOTA	53779	105	3	S
2.2 16V		9/91 - 11/96	[eng.5S-FE]		TOYOTA	53762			
2.2 16V		11/96 - 10/01	[eng.5S-FE]			-	107	3	S
3.0 V6		11/96 - 10/01	[eng.1MZ-FE]		TOYOTA	54003	110	4	S
CARINA									
CARINA II	1.6	3/88 - 5/92	[eng.4A-F]		TOYOTA	53685	130	3	S
CARINA E	1.6 E 16V	5/92 - 3/96	[eng.4A-FE]		TOYOTA	53543	130	3	S
CARINA E	1.6 E 16V	5/92 - 3/96			ZF	53544	130	3	P
CARINA E	1.8 E 16V	3/95 - 11/97	[eng.7A-FE]		TOYOTA	53543	130	3	S
CARINA E	1.8 E 16V	3/95 - 11/97			ZF	53544	130	3	P
CARINA E	2.0 E 16V	5/92 - 11/97	[eng.3S-FE/3S-GE]		TOYOTA	54156	105	3	S
CARINA E	2.0 E 16V	5/92 - 11/97			ZF	53903	105	3	P
CARINA E	2.0 D/TD	5/92 - 11/97	[eng.2C]		TOYOTA	53904	120	5	S
CELICA									
(T16_)	2.0 GT	11/85 - 1/90	[eng.3S-GE]	FWD		53594	105	3	S
(T16_)	2.0 GT-4	3/88 - 1/90	[eng.3S-GTE]	4WD		53594	105	3	S
(T18_)	2.0 GT	2/90 - 2/94	[eng.3S-GE]	FWD	TOYOTA	53761	106	3	S
(T18_)	2.0 GT-4	2/90 - 1/93	[eng.3S-GTE]	4WD	TOYOTA	53761	106	3	S
(T20_)	1.8 ST	7/95 - 9/99	[eng.7A-FE]		TOYOTA	53760			IR
(T20_)	1.8 ST	7/95 - 9/99	[eng.7A-FE]		TOYOTA	53543			IR-Fe
(T20_)	2.0 GT	3/94 - 9/99	[eng.3S-GE]	FWD	TOYOTA	53760			
(T20_)	2.0 GT-4	3/94 - 8/96	[eng.3S-GTE]	4WD	TOYOTA	53760			
(ZZT23_)	1.8 VVTi	10/99 -	[eng.1ZZ-FE]		TOYOTA	54197	121	6	P
COROLLA									
(EE90R)	1.3	8/87 - 8/92	[eng.2E]		TOYOTA	53640			S
(AE92R)	1.6 CARB.	8/87 - 8/92	[eng.4A-F]		TOYOTA	53640			S
(AE92R)	1.6 GTi	8/87 - 8/92	[eng.4A-GE]		TOYOTA	-	150	5	S
(AE95R)	1.6 4x4	3/88 - 4/91	[eng.4A-F]	4WD	TOYOTA	53640			S
(EE101R)	1.3	8/92 - 6/97	[eng.4E-FE]		TOYOTA	53873			S
(CE100R)	2.0 D	3/93 - 6/97	[eng.2C]		TOYOTA	53885	132	3	S
(EE111R)	1.3	6/97 - 2/00	[eng.4E-FE]		TOYOTA	53759			P

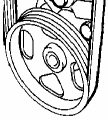

			OE	SPIDAN	 Ø mm	Ports	NOTICE
TOYOTA							
COROLLA							
1.6	6/97 - 2/00	[eng.4A-FE]		53759		P	
(ZZE120)	1/02 -	[eng.4ZZ-FE]	TOYOTA	54192	121	6	P
MIR2							
2.0	4/90 - 11/99	[eng.3S-FE/3S-GE]		53778			ELEKTR.
PASEO							
1.5	3/96 - 3/98	[eng.5E-FE]		53774	130	4	S
PICNIC							
2.0	1/97 - 8/01	[eng.3S-FE]		53594	105	3	S
PREVIA							
2.4	9/90 - 6/00	[eng.2TZ-FE]	TOYOTA	53776	132	6	P
RAV-4							
2.0	6/94 - 7/00	[eng.3S-FE]	TOYOTA	53775	105	3	S
2.0	8/00 -	[eng.1AZ-FE]	TOYOTA	54166	122	7	P
SPACE CRUISER							
2.0	10/85 - 9/90	[eng.3Y]	TOYOTA	53998		Single	S
STARLET							
1.3	4/96 - 2/99	[eng.4E-FE]		53774	130	4	S
SUPRA							
3.0	7/86 - 5/93	[eng.7M-GE/7M-GTE]	TOYOTA	53999	135	4	S
YARIS							
1.0	3/99 -	[eng.1SZ-FE]	TOYOTA	54053	132	4	P
1.3	9/99 -	[eng.2NZ-FE]	TOYOTA	54053	132	4	P
1.5	4/01 -	[eng.1NZ-FE]	TOYOTA	54233	140	3	P
HI-ACE							
2.4	1/96 - 10/98	[eng.1NZ-FE]	TOYOTA	-	128	Single	S
2.4 TD	1/96 - 10/01	[eng.2L]	TOYOTA	54084	110	4	S
HILUX							
1.8	3/89 - 12/93	[eng.2Y]		53747	124	Single	S
2.2	3/89 - 4/95	[eng.4Y]		53747	124	Single	S
2.4 D/TD	10/97 -	[eng.2L/2L-TE]		-			
2.5 TD	11/01 -	[eng.2KDF-TV]		-			
LITE-ACE							
2.0 D	4/92 - 8/94	[eng.2C]	TOYOTA	-			
VAUXHALL							
ASTRA							
1.6	10/84 - 10/91		SAGI.	53506	130	Single	P
1.7	1/89 - 10/91		SAGI.	53506	130	Single	P
1.8	10/84 - 10/91		SAGI.	53506	130	Single	P

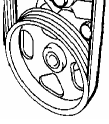

				OE	SPIDAN	 Ø mm	Ports	NOTICE
VAUXHALL								
ASTRA								
2.0		3/87 - 10/91		SAGI.	53506	130	Single	P
1.4		10/91 - 8/92	-->PREFIX 'N'	SAGI.	53549	142	5	S
1.4		8/92 - 3/98	PREFIX 'P'-->	SAGI.	53504	143	6	P
1.6		10/91 - 8/92	-->PREFIX 'N'	SAGI.	53549	142	5	S
1.6		8/92 - 3/98	PREFIX 'P'-->	SAGI.	53504	143	6	P
1.8		10/91 - 8/92	-->PREFIX 'N'	SAGI.	53506	130	Single	P
1.8		8/92 - 3/98	PREFIX 'P'-->	SAGI.	53504	140	6	P
2.0 8V		10/91 - 8/92	-->PREFIX 'N'	SAGI.	53506	130	Single	P
2.0 8V		8/92 - 3/98	PREFIX 'P'-->	SAGI.	53504	140	6	P
2.0 16V		10/91 - 95	-->PREFIX 'N'	SAGI.	53506	130	Single	P
2.0 16V		95 - 3/98	PREFIX 'P'-->	SAGI.	53504	140	6	P
1.7 D		10/91 - 8/94		SAGI.	53501	116	Single	P
1.7 TD		4/92 - 3/98		SAGI.	53501	116	Single	P
1.7 TD		4/92 - 3/98		SAGI.	53507	120	Single	P
ASTRA VAN								
1.6		10/91 - 8/92	-->PREFIX 'N'	SAGI.	53549	142	5	S
1.6		8/92 - 3/98	PREFIX 'P'-->	SAGI.	53504	143	6	P
1.7 D		10/91 - 8/94		SAGI.	53501	116	Single	P
1.7 TD		4/92 - 3/98		SAGI.	53501	116	Single	P
1.7 TD		4/92 - 3/98		SAGI.	53507	120	Single	P
BELMONT								
1.8		1/89 - 10/91		SAGI.	53506	130	Single	P
CALIBRA								
2.0 8V		6/90 - 12/96	[Prefix 'L'/M'/N'] *A/C	SAGI.	53506	130	Single	P
2.0 8V		6/90 - 12/96	[Prefix 'L'/M'/N'] A/C	SAGI.	53501	116	Single	P
2.0 8V		6/90 - 12/96	[Prefix 'P'] INCL A/C	SAGI.	53504	143	6	P
2.0 16V INCL.TURBO		6/90 - 8/98	[Prefix 'L'/M'/N'] *A/C	SAGI.	53506	130	Single	P
2.0 16V INCL.TURBO		6/90 - 8/98	[Prefix 'L'/M'/N'] A/C	SAGI.	53501	116	Single	P
2.0 16V INCL.TURBO		6/90 - 8/98	[Prefix 'P'] INCL A/C	SAGI.	53504	143	6	P
2.0		6/90 - 8/98	[eng. Ecotec]	SAGI.	53684	140	6	P
2.5 V6		4/93 - 8/98	- PREFIX 'T'	SAGI.	53683	152	6	S
CARLTON								
1.8		11/86 - 8/92		SAGI.	53506	130	Single	P
2.0		11/86 - 5/94		SAGI.	53506	130	Single	P
2.6		9/90 - 5/94		SAGI.	53617	141	6	P
3.0 12V		3/87 - 9/90	[eng.30NE/C30NE]	SAGI.	53506	130	Single	P
3.0 12V		3/87 - 9/90	[eng.30NE/C30NE]	SAGI.	53617	141	6	P
3.0 12V		3/87 - 9/90	[eng.30LE]	SAGI.	53501	116	Single	P

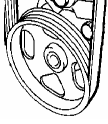

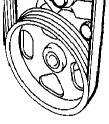

				OE	SPIDAN	 Ø mm	Ports	NOTICE
VAUXHALL								
CARLTON								
3.0 24V		10/89 - 5/94	[eng.C30SE]	SAGI.	53617	141	6 P	
2.3 D/TD		11/86 - 5/94		SAGI.	53506	130	Single P	
CAVALIER								
1.3/1.6/D		8/81 - 8/88		SAGI.	53874	140	Single P	
1.8/2.0		8/81 - 8/88		SAGI.	53874	140	Single P	
1.6		10/88 - 10/95		SAGI.	53537	142	5 S	
1.8		8/89 - 10/95	-->PREFIX 'N'	SAGI.	53506	130	Single P	
1.8		8/89 - 10/95	-->PREFIX 'N'	SAGI.	53501	116	Single P	
1.8		8/89 - 10/95	PREFIX 'P'-->	SAGI.	53504	143	6 P	
2.0/TURBO		10/88 - 10/95	-->PREFIX 'N'	SAGI.	53506	130	Single P	
2.0/TURBO		10/88 - 10/95	-->PREFIX 'N'	SAGI.	53501	116	Single P	
2.0/TURBO		10/88 - 10/95	PREFIX 'P'-->	SAGI.	53504	143	6 P	
2.5 V6		2/93 - 10/95		SAGI.	53683	152	6 S	
1.7 D		89 - 95		SAGI.	53501	116	Single P	
1.7 TD		3/90 - 10/95		SAGI.	53507	120	Single P	
COMBO								
1.4		10/93 - 2/01	[eng.C14NZ/C14SE]	SAGI.	53531	142	6 P	
1.7 D		10/93 - 9/01	[eng.X17D]	SAGI.	53507	120	Single P	
CORSA								
1.0/1.2/1.4		4/93 - 9/00		SAGI.	53531	142	6 P	
1.5 D/TD		4/93 - 9/00		SAGI.	53507	120	Single P	
1.6		4/93 - 9/00		SAGI.	53531	142	6 P	
1.7 D		2/96 - 9/00		SAGI.	53507	120	Single P	
FRONTERA								
2.0 8V		10/91 - 8/98	[eng.C20NE]	SAGI.	53506	130	Single P	
2.0 16V		10/91 - 8/98	[eng.X20SE]	SAGI.	53681	140	6 P	
2.2 16V		4/95 - 8/98	[eng.X22XE]	SAGI.	53681	140	6 P	
2.4 8V		10/91 - 4/95	[eng.C24NE]	SAGI.	53506	130	Single P	
2.3 TD		10/91 - 4/95	[eng.23DTR]	SAGI.	53506	130	Single P	
2.5 TD		8/96 - 8/98	[eng.25TDS]	SAGI.	53769			
2.8 TD		4/95 - 12/96	[eng.C4JG2]	KAYABA	53768		2 S	
2.2 16V		10/98 -	[eng.X22XE]	SAGI.	53681	140	6 P	
2.2 16V		10/98 -		KAYABA	54182	131	6 P	
2.2 TD		10/98 -	[eng.X22DTH]	KAYABA	54177	132	6 P	
MONTEREY								
3.1 TD		5/94 - 8/98	[eng.4JG2TC]	KAYABA	53559	102	2 P	
OMEGA								
2.0 8V/16V		4/94 -	[eng.X20SE/X20XEV]	SAGI.	53588	142	6 P	
2.5 V6		4/94 -	[eng.X25XE]	SAGI.	53628	150	6 S	A7

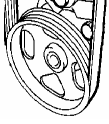

					OE	SPIDAN		Ports	NOTICE
							Ø mm		
VAUXHALL									
OMEGA									
2.5 V6		4/94 -			SAGI.	54049	150	6 S	A6
3.0 24V		6/94 -	[eng.X30XE]		SAGI.	53628	150	6 S	A7
3.0 24V		6/94 -			SAGI.	54049	150	6 S	A6
2.0 TD		4/94 -	[eng.X20DTH]		SAGI.	53767		S	
2.5 TD		4/94 -	[eng.U25DT/X25DT]		SAGI./ZF	53616	125	5 S	
SENATOR									
2.5 12V		9/87 -	9/90		SAGI.	53506	130	Single P	
2.6 12V		9/90 -	8/93		SAGI.	53617	142	6 P	
3.0 12V		9/87 -	10/92	-->L1999999	SAGI.	53506	130	Single P	
3.0 12V		9/87 -	8/93	M1000001-->	SAGI.	53617	142	6 P	
3.0 12V		9/87 -	10/92		SAGI.	53501	116	Single P	
3.0 24V		10/89 -	8/93		SAGI.	53617	142	6 P	
SINTRA									
2.2 16V		11/96 -	7/99		ZF	53596	115	6 S	
2.2 16V		11/96 -	7/99		SAGI.	53665	142	6 P	
2.2 TD		7/97 -	7/99		ZF	53975		S	
TIGRA									
1.4 16V		11/94 -	6/00		SAGI.	53531	142	6 S	
1.6 16V		11/94 -	6/00		SAGI.	53531	142	6 S	
VECTRA									
1.6 8V		10/95 -	9/00	[eng.X16SZR/16LZ2]	SAGI.	53514	140	6 P	
1.6 16V		10/95 -	5/02	[eng.X16XEL]	SAGI.	53514	140	6 P	
1.8 16V		10/95 -	5/02	[eng.X18XEL]	SAGI.	53514	140	6 P	
2.0 16V		10/95 -	9/00	[eng.X20XEV]	SAGI.	53514	140	6 P	
2.5 24V		10/95 -	10/00	[eng.X25XE]	SAGI.	53766		S	
1.7 TD		10/95 -	8/96	[eng.X17TD]	SAGI.	53507	120	Single P	
1.7 TD		10/95 -	8/96	[eng.X17TD]	SAGI.	54178	120	2 P	
2.0 TD		8/96 -	5/02	[eng.X20DTL/X20DTH]	KAYABA	53572	120	Single P	
2.0 TD		8/96 -	5/02		ZF	53596	115	6 S	
MOVANO									
2.2 TD		9/00 -			SAGI.	54184	126	5 P	
2.2 TD		9/00 -			SAGI.	54264	126	6 P	
2.2 TD		9/00 -			SAGI.	54228		S	
2.5 D		1/99 -	9/00		SAGI.	53577			* BELT
2.5 TD		1/02 -			SAGI.	53577			* BELT
2.8 TD		1/99 -	12/01		SAGI.	53577			* BELT
VIVARO									
2.0i		7/02 -			SAGI.	54184	126	5 P	
2.0i		7/02 -			SAGI.	54264	126	6 P	



				OE	SPIDAN	 Ø mm	Ports	NOTICE
VAUXHALL								
VIVARO								
2.0i		7/02 -		SAGI.	54228		S	
1.9 TD		6/01 -		SAGI.	54184	126	5	P
1.9 TD		6/01 -		SAGI.	54264	126	6	P
1.9 TD		6/01 -		SAGI.	54228		S	
VOLKSWAGEN								
BEETLE								
1.4		11/01 -	* A/C	ZF	53629	120	5	S
1.4		11/01 -	A/C	SAGI.	53974	120	6	S
1.4		11/01 -		ZF	53862	120	6	S
1.6		10/99 -		SAGI.	53974	120	6	S
1.6		10/99 -		ZF	53862	120	6	S
1.8 TURBO		10/99 -		SAGI.	53974	120	6	S
1.8 TURBO		10/99 -		ZF	53862	120	6	S
2.0		1/98 -		SAGI.	53974	120	6	S
2.0		1/98 -		ZF	53862	120	6	S
2.3 V5		10/00 -		SAGI.	53726		S	
1.9 TD		1/98 -		SAGI.	53726		S	
1.9 TD		1/98 -		ZF	53950		S	
BORA								
1.4		10/98 -		ZF	53862	120	6	S
1.6		10/98 -		ZF	53862	120	6	S
1.8 TURBO		10/98 -		ZF	53862	120	6	S
2.0		10/98 -		ZF	53862	120	6	S
2.3 V5		10/98 -	[eng.AGZ]	ZF	53950		S	
1.9 D/TD		10/98 -		ZF	53950		S	
CORRADO								
1.8		4/89 -	* G60	ZF	53555		Single	S
2.0 8V		4/93 -		ZF	53555		Single	S
2.0 16V		8/91 -		SAGI./ZF	53511	98	Single	S
2.9 VR6		8/91 -		ZF	53629	120	5	S
GOLF II (19E, 1G1)								
1.05/1.3/1.6		8/83 -	INCL. Diesel	SAGI./ZF	53511	98	Single	S
1.8		8/83 -	* G60	SAGI./ZF	53511	98	Single	S
GOLF III (1H, 1E7)								
1.4		10/91 -	S-CHECK/KOMBI	ZF	53629	120	5	S
1.4		10/91 -		SAGI.	54059		S	Alu Steel
1.6		9/92 -	S-CHECK	ZF	53555		Single	S



					OE	SPIDAN	 Ø mm	Ports	NOTICE
VOLKSWAGEN									
GOLF III (1H_/1E7)									
1.6		9/92 - 3/98			ZF	53629	120	5	S
1.6		9/92 - 3/98			SAGI.	54059			S
1.6		7/94 - 4/99		KOMBI	SAGI./ZF	53517	98	Single	S
1.6		7/94 - 4/99		KOMBI	ZF	53555			S
1.6		10/94 - 5/98		CABRIO	ZF	53555			S
1.8		11/91 - 7/99		S-CHECK/KOMBI	SAGI./ZF	53517	98	Single	S
1.8		11/91 - 7/99		S-CHECK/KOMBI	ZF	53555		Single	S
1.8		7/93 - 5/98		CABRIO	ZF	53555			S
2.0 8V/16V		11/91 - 3/98			SAGI./ZF	53517	98	Single	S
2.0 8V/16V		11/91 - 3/98		S-CHECK/KOMBI	ZF	53555			S
2.0 8V		7/93 - 5/98		CABRIO	ZF	53555			S
2.8 VR6		1/92 - 3/98		S-CHECK	ZF	53896			S
2.8 VR6		1/92 - 3/98		S-CHECK	ZF	53629	120	5	S
2.9 VR6		10/94 - 8/97		S-CHECK/KOMBI	ZF	53896			S
2.9 VR6		10/94 - 8/97		S-CHECK/KOMBI	ZF	53629	120	5	S
1.9 D		11/91 - 7/99	[eng.1Y]	S-CHECK/KOMBI	SAGI./ZF	53517	98	Single	S
1.9 D		11/91 - 7/99	[eng.1Y]	S-CHECK/KOMBI	ZF	53555			S
1.9 SDI		4/97 - 8/97	[eng.AEY]	S-CHECK/KOMBI	ZF	53555			S
1.9 GTD/TD/TDI		11/91 - 7/99	[eng.AAZ]	S-CHECK/KOMBI	SAGI./ZF	53517	98	Single	S
1.9 GTD/TD/TDI		11/91 - 7/99	[eng.AAZ]	S-CHECK/KOMBI	ZF	53555			S
1.9 TDI/TD		4/96 - 8/97	[eng.AFN]	S-CHECK/KOMBI	ZF	53555			S
1.9 TDI/TD		9/93 - 8/97	[eng.1ZIAHU/ALE]	S-CHECK/KOMBI	SAGI./ZF	53517	98	Single	S
1.9 TDI/TD		9/93 - 8/97	[eng.1ZIAHU/ALE]	S-CHECK/KOMBI	ZF	53555			S
1.9 TDI/TDI		7/96 - 5/98		CABRIO	ZF	53555			S
GOLF IV (1J_/1E7)									
1.4		8/97 -			ZF	53862			S
1.4		8/97 -			SAGI.	53974	120	6	S
1.6		8/97 -			KAYABA	54179			S
1.6		8/97 -			SAGI.	53974	120	6	S
1.6		8/97 -			ZF	53862	120	6	S
1.8/TURBO		8/97 -			KAYABA	54179			S
1.8/TURBO		8/97 -			SAGI.	53974	120	6	S
1.8/TURBO		8/97 -			ZF	53862	120	6	S
2.0		7/98 -			SAGI.	53974	120	6	S
2.0		7/98 -			ZF	53862	120	6	S
2.3 V5		8/97 -	10/00		ZF	53950			S
2.3 V5		1/00 -			SAGI.	53726			S
1.9 D/TD		8/97 -			SAGI.	53726			S
1.9 D/TD		8/97 -			ZF	53950			S

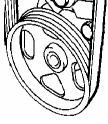

			OE	SPIDAN	 Ø mm	Ports	NOTICE
VOLKSWAGEN							
JETTA II (19E, 1G2)							
1.3	6/87 - 12/91		SAGL./ZF	53511	98	Single S	
1.6	1/84 - 11/92		SAGL./ZF	53511	98	Single S	
1.8	1/84 - 11/92		SAGL./ZF	53511	98	Single S	
1.6 D/TD	1/84 - 12/91		SAGL./ZF	53511	98	Single S	
LUPO (6X1, 6E1)							
1.0	9/98 -		ZF	53941		S	* A/C
1.0	9/98 -		SAGL.	53755	115	6 S	
1.0	9/98 -		ZF	53942		S	A/C
1.4 16V	9/98 -		ZF	53941		S	* A/C
1.4 16V	9/98 -		ZF	53942		S	A/C
1.6 GTI	9/00 -		ZF	53942		S	A/C
1.2 TD	11/98 -		ZF	53629	120	5 S	
1.4 TD	1/99 -		ZF	53629	120	5 S	
1.7 D	9/98 -		ZF	53629	120	5 S	
PASSAT (32B)							
1.8	8/81 - 12/88		ZF	53659	130	Single S	
1.9	10/81 - 8/83		ZF	53659	130	Single S	
2.0	8/83 - 12/88		ZF	53659	130	Single S	
2.3	8/81 - 12/88		ZF	53659	130	Single S	
PASSAT (3A_/35I)							
1.6	2/88 - 9/91	[eng.1F/EZ]	SAGL./ZF	53511	98	Single S	
1.6	10/94 - 8/96	[eng.AEK]	SAGL./ZF	53555		Single S	
1.8 8V	2/88 - 9/96	[eng.AAM/ABS/RP]	SAGL./ZF	53511	98	Single S	-->31-N-500000
1.8 8V	2/88 - 9/96	[eng.AAM/ABS/RP]	SAGL./ZF	53555	98	Single S	31-P-000001-->
1.8 8V	4/88 - 7/93	[eng.PF/PB]	SAGL./ZF	53511	98	Single S	
1.8 16V	4/88 - 12/89	[eng.KR]	SAGL./ZF	53511	98	Single S	EXCL.G60
1.8 G60	8/88 - 8/96	[eng.PG]	ZF	53517	98	Single S	A/C
2.0 8V	2/90 - 9/96	[eng.2E/ADY/AGG]	SAGL./ZF	53511	98	Single S	-->31-N-500000 ; * A/C
2.0 8V	2/90 - 9/96	[eng.2E/ADY/AGG]	SAGL./ZF	53517		Single S	31-P-000001--> ; * A/C
2.0 8V	2/90 - 9/96	[eng.2E/ADY/AGG]	SAGL./ZF	53555		Single S	A/C
2.0 8V	3/95 - 9/96	[eng.AEP]	SAGL./ZF	53555		Single S	
2.0 16V	8/88 - 9/93	[eng.9A]	SAGL./ZF	53511	98	Single S	
2.0 16V	1/94 - 8/96	[eng.ABF]	SAGL./ZF	53555		Single S	
2.0 16V	10/90 - 94	[eng.2E/ADY/AGG]	SAGL./ZF	53511	98	Single S	Syncro
2.0 16V	94 - 8/96	[eng.2E/ADY/AGG]	SAGL./ZF	53517	98	Single S	Syncro
2.0 16V	10/90 - 5/97	[eng.2E/ADY/AGG]	SAGL./ZF	53511	98	Single S	Syncro
2.0 16V	10/90 - 5/97	[eng.2E/ADY/AGG]	SAGL./ZF	53555		Single S	Syncro

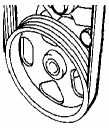

			OE	SPIDAN	 Ø mm	Ports	NOTICE
VOLKSWAGEN							
PASSAT (3A_/35l)							
2.8 VR6	6/91 - 8/96	[eng.AAA]		ZF	53896	S	
2.8 VR6	6/91 - 8/96	[eng.AAA]	-->31-N-049999	ZF	53629	5	
2.9 VR6 Syncro	1/94 - 5/97	[eng.ABV]	31-N-050000-->	ZF	53629	5	
1.6 TD	1/88 - 12/93			SAGI/ZF	53511	Single	
1.9 D	5/89 - 10/93			SAGI/ZF	53555	Single	
1.9 TD	3/91 - 9/96			SAGI/ZF	53555	Single	
PASSAT (3B_)							
1.6	10/96 -			ZF	53742	S	
1.6	10/96 -			KAYABA	54241	S	
1.8	1/97 - 12/00	[eng.AFY]	-->3B-VP-113282	ZF	53663	S	
1.8	1/97 - 12/00	[eng.AFY]	3B-VP-113283-->	ZF	53742	S	
1.8	1/97 - 12/00	[eng.AFY]		KAYABA	54241	S	
1.8	10/96 - 12/00	[eng.ADR/APT/ARG]	-->3B-VP-113282 -->3B-VE-116998	ZF	53663	S	
1.8	10/96 - 12/00	[eng.ADR/APT/ARG]	3B-VP-113283--> 3B-VE-116999-->	ZF	53742	S	
1.8	10/96 - 12/00	[eng.ADR/APT/ARG]		KAYABA	54241	S	
1.8 Syncro	10/96 - 12/00			ZF	53742	S	
1.8 Syncro	10/96 - 12/00			KAYABA	54241	S	
1.8 TURBO	10/96 - 12/00	[eng.AEB/ANB/APUJ]	-->3B-VP-113282 -->3B-VE-116998	ZF	53717	S	
1.8 TURBO	10/96 - 12/00	[eng.AEB/ANB/APUJ]	3B-VP-113283--> 3B-VE-116999-->	ZF	53742	S	
1.8 TURBO	10/96 - 12/00	[eng.AEB/ANB/APUJ]		KAYABA	54241	S	
1.8 TURBO	2/01 -	[eng.AWM/AWT]		ZF	53742	S	
1.8 TURBO	2/01 -	[eng.AWM/AWT]		KAYABA	54241	S	
2.0	4/00 -			ZF	53742	S	
2.0	4/00 -			KAYABA	54241	S	
2.0 4-motion	4/00 -			ZF	53742	S	
2.0 4-motion	4/00 -			KAYABA	54241	S	
2.3	10/96 -	[V5/VR5]		ZF	54241	S	
2.3	10/96 -	[V5/VR5]		KAYABA	54241	S	
2.3 Syncro	10/97 - 11/00	[VR5]		ZF	53742	S	
2.3 Syncro	10/97 - 11/00	[VR5]		KAYABA	54241	S	
2.8 V6	5/97 - 11/00			ZF	53951	S	
2.8 4-motion	9/99 -			ZF	53951	S	
2.8 Syncro	10/96 - 11/00	[eng.ACK/ALG]	-->3B-V-175000	ZF	53663	S	
2.8 Syncro	10/96 - 11/00	[eng.ACK/ALG]	3B-V-175001-->	ZF	53951	S	
4.0 W8 4-motion	9/01 -	[eng.BDN/BDP]		ZF	54014	S	

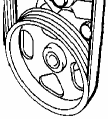
			OE	SPIDAN	 Ports Ø mm	NOTICE	
VOLKSWAGEN							
PASSAT (3B_)							
1.9 TD	10/96 -	11/00	[eng.AFN/AVG/AHU/AHH]	ZF	53742	S	
1.9 TD	10/96 -	11/00	[eng.AFN/AVG/AHU/AHH]	KAYABA	54241	S	
1.9 TD	10/96 -	11/00	[eng.AFN/AVG/AHU/AHH]	ZF	53719	S	
1.9 TD	10/96 -	11/00	[eng.AFN/AVG/AHU/AHH]	KAYABA	54183	6 P	
1.9 TD	8/98 -	11/00	[eng.AJM/AT/J]	ZF	53719	S	
1.9 TD	8/98 -	11/00	[eng.AJM/AT/J]	KAYABA	54183	6 P	
1.9 TD	2/00 -		[eng.AVB/AVF/AVX]	ZF	53719	S	
1.9 TD	2/00 -		[eng.AVB/AVF/AVX]	KAYABA	54183	6 P	
1.9 4-motion/ TD Syncro	8/99 -	11/00	[eng.AJM/AT/JAFN/AVG]	ZF	53742	S	
1.9 4-motion/ TD Syncro	8/99 -	11/00	[eng.AJM/AT/JAFN/AVG]	KAYABA	54241	S	
1.9 4-motion/ TD Syncro	8/99 -	11/00	[eng.AJM/AT/JAFN/AVG]	ZF	53719	S	
1.9 4-motion/ TD Syncro	8/99 -	11/00	[eng.AJM/AT/JAFN/AVG]	KAYABA	54183	S	
1.9 TD 4-motion	11/00 -		[eng.AVF/AVX]	ZF	53719	S	
1.9 TD 4-motion	11/00 -		[eng.AVF/AVX]	KAYABA	54183	S	
2.5 TD	7/98 -			ZF	53915	120 6 S	
2.5 TD	7/98 -			KAYABA	54242	120 6 S	
2.5 4-motion/ TD Syncro	12/98 -			ZF	53915	120 6 S	
2.5 4-motion/ TD Syncro	12/98 -			KAYABA	54242	120 6 S	
POLO							
1.0 8V	S-CHECK	10/94 -	9/01	[eng.AEV/AER/ALL/ALD]	* A/C	53755	115 6 S
1.0 8V		10/94 -	9/01		SAGI.	54022	S
1.0 8V		10/94 -	9/01		ZF	53941	S
1.0 8V	S-CHECK	8/96 -	9/01	[eng.AER/ALL/ALD]	A/C	53942	S
1.3 8V	S-CHECK	10/94 -	7/95	[eng.ADX]	* A/C	53941	S
1.3 8V	S-CHECK	10/94 -	7/95	[eng.ADX]	A/C	53942	S
1.4 8V	S-CHECK	7/95 -	9/01	[eng.AEX/AKK/AKP/AUD]	* A/C	53941	S
1.4 8V	S-CHECK	7/95 -	9/01	[eng.AEX/AKK/AKP/AUD]	A/C	53942	S
1.4 8V	LIMO	12/95 -	9/01	[eng.AEX/AKV/AKK]	ZF	53629	120 5 S
1.4 8V	KOMBI	5/97 -	9/01	[eng.AEX/AKV]	ZF	53629	120 5 S
1.4 8V	KOMBI	5/97 -	9/01	[eng.AEX/AKV]	A/C	53555	S
1.4 16V	S-CHECK	4/96 -		[eng.AFH/AFK/AHW AU/AUB/BBY]	* A/C	53941	S
1.4 16V	S-CHECK	4/96 -		[eng.AFH/AFK/AHW AU/AUB/BBY]	A/C	53942	S
1.6 8V	S-CHECK	9/94 -	10/99	[eng.AEA/AEE]	* A/C	53941	S
1.6 8V	S-CHECK	9/94 -	10/99	[eng.AEA/AEE]	A/C	53942	S
1.6 8V	LIMO	12/95 -	9/01	[eng.1FAEE/AF]	ZF	53555	S

					OE	SPIDAN	 Ports Ø mm	NOTICE
VOLKSWAGEN								
POLO								
1.6 8V	KOMBI	5/97 -	9/01	[eng.AEE]			120	
1.6 8V	KOMBI	5/97 -	9/01	[eng.AEE]	* A/C		5	S
1.6 8V	KOMBI	5/97 -	9/01	[eng.AFT]	A/C			S
1.6 16V	S-CHECK	9/94 -	9/01	[eng.AJV/ARC]				S
1.6 16V	S-CHECK	9/98 -	10/99	[eng.AJV/ARC]	* A/C			S
2.0	LIMO.	8/99 -	9/01	[eng.ADC]	A/C			S
1.4 TD	S-CHECK	10/99 -		[eng.AMF]				S
1.4 TD		10/99 -					120	5
1.7 D	S-CHECK	6/97 -	9/01	[eng.AHG]	SAGI./HOB.		120	5
1.7 D		6/97 -	9/01		ZF		120	5
1.7 D	LIMO.	7/97 -	9/01	[eng.AKW]	SAGI./HOB.		120	5
1.7 D	KOMBI	8/97 -	9/01	[eng.AKW]	ZF			S
1.9 D	S-CHECK	10/94 -		[eng.AEF/AGD/ASY]	ZF		120	5
1.9 D		10/94 -			SAGI./HOB.		120	5
1.9 D	LIMO.	12/95 -	9/01	[eng.AEY]	ZF			S
1.9 D	KOMBI	6/97 -	9/01	[eng.AEY]	ZF			S
1.9 TD	LIMO.	9/96 -	9/01	[eng.AFN/ASV/ALE/AHU/ALH]	ZF			S
1.9 TD	KOMBI	5/97 -	9/01	[eng.ALE/AHU/AFN]	ZF			S
POLO Kasten (6NF)								
1.4		5/98 -						S
1.4		5/98 -			* A/C			S
1.7 D		8/97 -			A/C		120	5
1.7 D		8/97 -					120	5
1.9 D		10/94 -			SAGI./HOB.		120	5
1.9 D		10/94 -			ZF		120	5
1.9 D		10/94 -			SAGI./HOB.		120	5
SANTANA								
2.0		8/82 -	3/85		ZF		130	Single
SCIROCCO								
1.6		1/83 -	7/90	[eng.EW/RE]			98	Single
1.8 8V		8/82 -	7/92	[eng.DX/EV/EX/JH/PB]	SAGI./ZF		98	Single
1.8 16V		10/85 -	7/92	[eng.KR/PL]	SAGI./ZF		98	Single
SHARAN								
2.0		8/95 -					112	6
2.0		8/95 -					104	Single
2.8 12V		8/95 -	8/96	[VR6]	INCL.Synro			S
2.8 12V		9/96 -	5/00	[VR6]	INCL.Synro			S
1.9 TD		8/95 -					104	Single
1.9 TD		11/02 -			90/110 bar -->7M-Y-010001		120	6
1.9 TD		11/02 -			130 bar	KAYABA	120	6
1.9 TD		11/02 -			130 bar	KAYABA	120	6

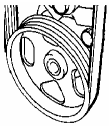
					OE	SPIDAN	 Ø mm	Ports	NOTICE
VOLKSWAGEN									
VENTO (1H2)									
1.4		11/91 - 9/98			ZF	53629	120	5	S
1.6		9/92 - 9/98	[eng.ABU/AEA/AEE]		ZF	53629	120	5	S
1.6		10/94 - 9/98	[eng.AEK/AF T]		ZF	53517	98	Single	S
1.6		10/94 - 9/98	[eng.AEK/AF T]		ZF	53555			S
1.8		11/91 - 9/98			ZF	53517	98	Single	S
1.8		11/91 - 9/98			ZF	53555			S
2.0		11/91 - 9/98			ZF	53517	98	Single	S
2.0		11/91 - 9/98			ZF	53555			S
2.8 VR6		1/92 - 9/98			ZF	53896			S
2.8 VR6		1/92 - 9/98			ZF	53629	120	5	S
1.9 D		11/91 - 9/98	[eng.1Y]		ZF	53517	98	Single	S
1.9 D		11/91 - 9/98	[eng.1Y]		ZF	53555			S
1.9 SDI		4/97 - 9/98	[eng.AEY]		ZF	53555			S
1.9 TD		11/91 - 9/98	[eng.AAZ]		ZF	53517	98	Single	S
1.9 TD		11/91 - 9/98	[eng.AAZ]		ZF	53555			S
1.9 TD/TD		4/96 - 9/98	[eng.AFN]		ZF	53555			S
1.9 TD/TD		9/93 - 9/98	[eng.1ZIAHU]		ZF	53517	98	Single	S
1.9 TD/TD		9/93 - 9/98	[eng.1ZIAHU]		ZF	53555			S
CADDY II									
1.4 Van		1/95 -			ZF	53629	120	5	S
1.6 Van		11/95 -			ZF	53629	120	5	S
1.6 Pick up		10/97 -		* A/C	ZF	53941			S
1.6 Pick up		10/97 -		A/C	ZF	53942			S
1.9 D Van		11/95 -			SAGL/ZF	53555			S
1.9 D Pick Up		10/97 -			ZF	53629			S
1.9 TD Van		9/96 -			SAGL/ZF	53555			S
LT I									
2.4 CARB.		12/82 - 7/92		[28,40,55]	ZF	53746	130	Single	S
2.4i		8/89 - 6/96		[28,40,55]	ZF	53746	130	Single	S
2.4 D		12/78 - 6/96		[28,40,55]	ZF	53746	130	Single	S
2.4 TD		12/82 - 6/96		[28,40,55]	ZF	53746	130	Single	S
LT II									
2.5 D		7/96 -		[28,35]	LUK	54118			S
2.5 TD		7/96 -		[28,32,35,46]	LUK	54118			S
2.8 TD		1/99 -			LUK	54244			
T3									
1.9		2/85 - 7/92			ZF	54243			
2.1		8/85 - 7/92			ZF	54243			

					OE	SPIDAN	 Ø mm	Ports	NOTICE
VOLKSWAGEN									
T4									
2.0		9/90 -			ZF	53611	113	Single S	
2.0		9/90 -		-->70-T-199000	ZF	53634	112	Single S	
2.0		9/90 -		70-T-200001-->	KAYABA	54148			PUMP-AL
2.5		11/90 -			KAYABA	54148			PUMP-AL
2.8		11/95 -			ZF	53634	112	Single S	
2.8		11/95 -			KAYABA	54148			PUMP-AL
1.9 D		9/90 -		-->70-T-199000	ZF	53611	113	Single S	
1.9 D		9/90 -		70-T-200001-->	ZF	53634	112	Single S	
1.9 D		9/90 -			KAYABA	54148			PUMP-AL
1.9 TD		10/92 -		-->70-T-199000	ZF	53611	113	Single S	
1.9 TD		10/92 -		70-T-200001-->	ZF	53634	112	Single S	
1.9 TD		10/92 -			KAYABA	54148			PUMP-AL
2.4 D		9/90 -		-->70-T-199000	ZF	53611	113	Single S	
2.4 D		9/90 -		70-T-200001-->	ZF	53749	152	6 S	
2.4 D		9/90 -			KAYABA	54148			PUMP-AL
2.5		11/90 -		INCL.Diesel & Turbo	ZF	53611	113	Single S	
2.5		11/90 -		INCL.Diesel & Turbo	ZF	53749	152	6 S	
2.5		11/90 -		INCL.Diesel & Turbo	KAYABA	54148			PUMP-AL
VOLVO									
200-SERIE									
2.0		1/84 -	1/91		SAGI.	53765	155	Single S	
2.0		1/91 -	8/93		SAGI.	53520	150	Single P	
2.3		1/84 -	1/91		SAGI.	53765	155	Single S	
2.3		1/91 -	8/93		SAGI.	53520	150	Single P	
2.7/2.8		85 -	87		SAGI.	54006	150	Single P	
300-SERIE									
2.0		9/82 -	12/91		SAGI.	53680	150	Single P	
400-SERIE									
1.6/1.7/1.8		5/87 -	8/94		SAGI.	53516	130	6 P	
1.6/1.7/1.8		8/94 -	10/96		SAGI.	53631	130	6 P	
1.9 TD		6/94 -	10/96		SAGI.	53688	130	6 P	
700-SERIE									
2.0/2.3		7/82 -	10/91		SAGI.	53520	150	Single P	PUMP-FE
2.0/2.3		7/82 -	10/91		SAGI.	54070	152	2 P	
2.0/2.3		7/82 -	10/91		ZF	53540	150	Single P	PUMP-AL
2.8		8/84 -	9/90		SAGI.	53635	115	Single S	
2.4 TD		1/87 -	12/93		SAGI.	53788	130	Single P	

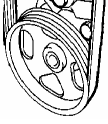
			OE	SPIDAN	 Ø mm	Ports	NOTICE
VOLVO							
850							
2.0 10V/20V	6/92 - 12/96		SAGI.	53548	141	6 P	
2.3 TURBO	6/92 - 12/96		SAGI.	53548	141	6 P	
2.5 10V/20V	6/92 - 12/96	* Turbo	SAGI.	53548	141	6 P	
2.5 TD	10/95 - 12/96		SAGI.	53597	130	6 P	
900-SERIE							
2.0	9/90 - 8/94	* Turbo	SAGI.	53788	130	Single P	
2.0 TURBO	4/91 - 8/94		SAGI.	53520	150	Single P	
2.3	9/90 - 2/95	* Turbo	SAGI.	53788	130	Single P	
2.3 TURBO	9/90 - 11/97		SAGI.	53520	150	Single P	
2.5	8/94 - 1/97		SAGI.	53643	142	6 P	
2.5	8/94 - 1/97		SAGI.	54065	130	6 P	
3.0	9/90 - 91		SAGI.	53635	155	Single S	
3.0	91 - 1/97		SAGI.	53643	142	6 P	
3.0	91 - 1/97		SAGI.	54065	130	6 P	
2.4 TD	9/90 - 1/97		SAGI.	53788	130	Single P	
S40/V40							
1.6	4/97 -		SAGI.	53639	140	6 P	
1.8	3/96 -		SAGI.	53639	140	6 P	
1.8 GDI	4/99 -	* GDI	ZF	54071	142	6 P	
1.9 16V	6/97 - 5/00		SAGI.	53639	140	6 P	
2.0 16V	3/96 -		SAGI.	53639	140	6 P	
2.0 TURBO	10/97 -		SAGI.	53639	140	6 P	
2.0 TURBO	10/97 -		ZF	54071	142	6 P	
1.9 TD	12/96 -	* A/C	SAGI.	53977		S	
1.9 TD	12/96 -	A/C	SAGI.	53535	109	6 S	
C70							
2.0 CABRIO	3/98 -	1100-->	ZF	54066	130	6 P	
2.0 COUPE	3/97 - 9/02	8500-->	ZF	54066	130	6 P	
2.5 CABRIO	3/98 -	1100-->	ZF	54066	130	6 P	
2.5 COUPE	3/97 - 9/02	8500-->	ZF	54066	130	6 P	
2.3 CABRIO	3/98 -	1100-->	ZF	54066	130	6 P	
2.3 COUPE	3/97 - 9/02	8500-->	ZF	54066	130	6 P	
S70							
2.0	1/97 - 11/00	565000-->	ZF	54066	130	6 P	
2.3	1/97 - 11/00	565000-->	ZF	54066	130	6 P	
2.4	1/97 - 11/00	565000-->	ZF	54066	130	6 P	
2.5	6/98 - 11/00	565000-->	ZF	54066	130	6 P	
2.5 TD	12/96 - 4/01		SAGI.	53597	130	6 P	

OE	SPIDAN
Aifa	
26064414	54175
46413329	53868
46473842	54140
46473843	53867
46534757	53867
46763561	54213
604587318	53866
60524943	53871
60531766	53869
60533802	53870
60561557	53864
60562019	53868
60577398	53866
60587317	53865
60593248	53891
60596742	54012
60618477	53867
60813339	53720
7764220	54011
BMW	
2106384	54126
32411091911	54126
32411091912	54123
32411092015	54126
32411092016	54123
32411092433	54080
32411092817	54093
32411092954	54080
32411093577	54064
32411094089	54093
32411094965	54211
32411097149	54081

OE	SPIDAN
BMW	
32411123356	54004
32411123476	54004
32411130084	54077
32411130084	54091
32411131239	54090
32411132987	54212
32411133078	54077
32411133078	54091
32411134090	54019
32411134091	54019
32411136213	54077
32411136213	54091
32411136295	54090
32411137013	54082
32411137083	54082
32411137597	54090
32411137951	54075
32411137951	54094
32411138127	54075
32411138127	54094
32411140367	54075
32411140367	54094
32411140831	54075
32411140831	54094
32411141202	54021
32411141209	54021
32411141239	54077
32411141239	54091
32411141243	54077
32411141243	54091
32411141569	54076
32412227196	54017

OE	SPIDAN
BMW	
32412227197	54017
32412294403	54021
32412294479	54021
3241675011	54221
32416750423	54050
32416756611	54216
32416758595	54216
32411092086	53883
32411092432	53756
32411092433	53756
32411092603	53888
32411092604	53888
32411092741	53956
32411092742	53956
32411092744	53724
32411092898	53889
32411092954	53756
32411093124	53724
32411093580	53883
32411094964	53952
32411095155	53953
324111199	53892
32411126845	53695
32411127046	53695
32411128040	53695
32411130556	53636
32411131239	53636
32411132254	53607
32411132277	53731
32411132567	53909
32411132726	53731
32411132830	53758

OE	SPIDAN
BMW	
32411132842	53716
32411132934	53758
32411132935	53716
32411132956	53955
32411133065	53607
32411133158	53678
32411133386	53678
32411133969	53695
32411133970	53695
32411135597	53909
32411135598	53955
32411136205	53879
32411136212	53879
32411136213	53879
32411136214	53879
32411136295	53636
32411137366	53607
32411137457	53607
32411137597	53636
32411137835	53669
32411137951	53615
32411137952	53615
32411138122	53669
32411138123	53886
32411138124	53718
32411138126	53718
32411138129	53615
32411138132	53886
32411138841	53615
32411140367	53615
32411140420	53615
32411140458	53615

OE	SPIDAN
BMW	
32411141036	53615
32411141037	53615
32411141039	53669
32411141040	53669
32411141042	53718
32411141043	53718
32411141045	53669
32411141046	53669
32411141051	53716
32411141052	53716
32411141054	53886
32411141055	53886
32411141057	53758
32411141058	53758
32411141198	53607
32411141201	53607
32411141204	53879
32411141205	53607
32411141206	53607
32411141207	53879
32411141208	53892
32411141239	53695
32411141243	53695
32411141245	53615
32411141246	53615
32411141249	53909
32411141250	53955
32411141283	53909
32411141284	53955
32411141417	53669
32411141419	53669
32411141516	53593

OE	SPIDAN
BMW	
32411141516	53669
32411141627	53677
32411141629	53677
32411141681	53593
32411141681	53669
32411141937	53883
32412245855	53677
32419057379	53695
CHRYSLER	
04684156	54086
CITROEN	
26045330	53898
26050704	53754
26054760	53675
26071206	53670
26071208	53918
26075747	53630
26078691	53729
26082229	54217
4007.03	53608
4007.57	53872
4007.90	53832
DAEWOO	
26071637	53920
540415	54206
96215322	54199
96225377	54190
DAIHATSU	
U312-01013	53793

OE	SPIDAN
FIAT	
1461315080	53734
1477396080	54189
46401703	53610
46401704	53857
46406957	53682
46407976	53736
46408075	53697
46410955	53682
46410956	53610
46413324	53857
46413326	53736
46413332	53697
46416001	53741
46436958	53604
46438817	53577
46442644	53735
46459346	53654
46460675	53577
46473841	53604
46475018	53604
46478840	53735
46524141	53604
46541004	53697
46763559	53604
4808780	53856
4817645	53605
55186442	53697
5992422	53679
60577460	53730
6144978	53612
7552629	53855
7604215	53730

OE	SPIDAN
FIAT	
7617059	53595
7658069	53957
7703175	53682
7707425	53610
77465850	53890
FORD	
1114344	54205
1357620	53603
1357620	53979
1954619	53712
1958453	53541
1C153A674AE	54186
256C3A696DB	54224
3907535	53603
3907535	53979
4048773	53603
4048773	53979
7D0422155DES	54262
83BB3A674CA	53587
85BB3A674AA	53525
86GB3A674AA	53991
86GB3A674EA	53513
87GB3A674AB	53525
88VB3A674AA	53835
88VB3A674BC	53649
89VB3A674AA	53648
90VB3A674AC	53657
90VB3A674CB	53710
90VB3A674DA	53553
91AB3A674AA	53536
91AB3A674BA	53519
91AB3A674CA	53653

OE	SPIDAN
FORD	
91GB3A674AB	53842
92AB3A674AA	53715
92AB3A674AB	53521
92BB3A674AA	53601
92GB3A674BA	53841
92GB3A674CB	53582
92VB3A674AA	53833
93BB3A674CB	53502
94GB3A674AA	53565
95AB3A674AB	53536
95AB3A674BA	53519
95AB3A674CA	53653
95GB3A674AA	53602
95GB3A674AC	53545
95VW3A674AD	53843
95VW3A674AE	53843
95VW3A674DA	53583
95VW3A674DC	53583
95VW3A674DD	53583
95VW3A674EA	53844
95VW3A674EB	53844
97BG3A674AA	53533
97VB3A674FA	54203
99VW3A674AA	54203
F2RC3A674AB	53529
F33CA674BA	53510
F3ZZ3A674D	53711
F43C3D639AA	53875
F43C3K770AA	53650
F4RC3A674AD	53627
F4RC3A674BD	53652
F4RC3A674EC	53850

OE	SPIDAN
FORD	
F4RC3A674GD	53534
F4ZZ3A674A	53626
F5RC3A674CB	53831
F5RC3A674DC	53853
F5RC3A674FA	53560
F5RC3A674GA	53714
F5RC3A674HA	53849
F6RC3A674BB	53848
F6RC3A674DC	53846
F6RC3A674EA	53584
F7Z3A674EA	53851
F7RC3A674BC	53603
F7RC3A674BC	53979
F7RC3A674FA	53524
HBDO	54252
HDBHP	54253
RMXS6J3A674H	53603
RMXS6J3A674H	53979
XS6C3A674FA	53603
XS6C3A674FA	53979
XS712A696AA	54205
XS713A674BE	54219
GM	
26008257	53507
26046426	53681
5948195	53596
90169158	53874
90295552	53506
90350605	53506
90352753	53507
90392650	53617
90392912	53506

OE	SPIDAN
GM	
90409239	53504
90410957	53683
90466998	53531
90466999	53588
90467000	53628
90468138	53616
90469057	53504
90469202	53537
90469202	53549
90495029	53683
90499957	53514
90501830	53514
90502551	53596
90531706	53770
90540019	53766
90543246	53665
90573227	53628
90573619	53975
91153771	53769
9129098	53514
948077	53665
948078	53975
97129593	53768
HONDA	
56110-PE0-040	53829
56110-PE0-050	53829
56110-PG6-010	53827
56110-PH1-020	53830
56110-PH1-040	53830
56110-PH7-000	53826
56110-PH7-020	53826
56110-PH7-030	53826

OE	SPIDAN
HONDA	
56110-PH7-040	53826
56110-PM3-010	54151
56110-PM3-020	54151
56110-PM3-030	54151
56110-PO2-020	53625
56110-POA-013	54158
56110-PT0-050	54152
56110-PT0-350	54152
56110-PT0-J60	54152
56110-PT0-J61	54152
56110-PY3-030	53852
HYUNDAI	
57110-22002	53722
JAGUAR	
MJA8111BE	53987
MJA8111BH	54204
KIA	
OK02232680	54198
LANCIA	
46413323	53585
7617059	53822
LAND ROVER	
2245243	53880
ANR2157	53515
ERR4066	54007
ERR4462	54025
ERR4622	54007
ERR4727	54025
ERR5407	54025
QVB101050	54180
QVB101070	54180
QVB101090	54025

OE	SPIDAN
LAND ROVER	
QVB101110	54007
LDV	
26048736	54170
4007-57	53522
7847017	53522
CER3059	54101
MAZDA	
25154308	53644
B093-32-600C	53707
B457-32-600C	53820
G037-326-600B	54000
G211-32-600A	53592
GA2A32650D	53644
MERDEDES	
4604080	54134
246603101	54132
24660901	54028
24660901	54112
24661001	54074
24661201	53966
24661901	54114
24662101	54028
24662101	54112
24662201	54074
24662301	54117
24662401	54209
24662401	53966
24662901	54109
24663001	54109
24663801	54229
24664801	54089
24667501	54162

OE	SPIDAN
MERDEDES	
24669001	54235
0024661001	53721
0024662201	53721
0024662501	53847
0024662501	54255
0024662701	53847
0024662801	53933
0024662901	53815
0024663001	53815
0024664801	54256
0024664901	54259
0024668801	53982
1024600180	53813
1104602180	53813
1154602080	53705
1164601780	53705
1164602080	53705
1164602480	53705
1164602580	53813
1164602680	53705
1164602780	53813
1244600280	54120
1244600680	54120
1244600980	54131
1244601580	54088
1244601680	54108
1244601780	54120
1244602380	54131
1244600280	53971
1244601180	53962
1244601780	53971
1244601880	53962

OE	SPIDAN
MERDEDES	
1244602380	53965
1244600980	53965
1264602280	54115
1264603580	54113
1264600080	53705
1264600180	53813
1264600280	53705
1264600380	53813
1264600780	53705
1264600880	53813
1264600980	53705
1264601080	53813
1264601380	53705
1264601580	53705
1264601680	53813
1294600680	54119
1294601880	54130
1294601980	54130
1294661601	54036
1294662301	54035
1294662501	53967
1404600480	54031
1404600480	54121
1404600480	54122
1404600580	54031
1404600580	54121
1404600580	54122
1404600680	54124
1404600680	54127
1404600780	54124
1404600780	54127
1404660201	54032

OE	SPIDAN
MERDEDES	
1404663401	54033
1404663501	54033
1404664201	54033
1404664501	54033
1404666001	54030
1404661901	53893
1404662001	53893
1404662101	53894
1404662201	53894
1404665001	53893
1404665101	53893
1404665201	53894
1404665301	53894
1684660101	53978
1684660301	53978
1684660401	53978
2014601180	54092
2014601280	54092
2014601780	54097
2014600580	53723
2014600980	53723
2014601180	53600
2014601280	53600
2014601480	53723
2014601580	53723
2014601780	53929
2014601880	53929
2014602180	53963
2014602480	53963
2014603380	53930
2104660001	54128
2104660101	54128

OE	SPIDAN
MERDEDES	
2104660501	54026
2104661001	54027
2104661001	54135
2104661101	54027
2104661201	54116
2104661301	54116
2104661401	54125
2104661501	54125
2104662001	54026
2104662201	54027
2104660201	53968
21046602180	53968
2104660301	53968
210466030180	53968
2104660801	53969
2104660901	53969
2104661201	53745
2104661301	53745
2104661401	53964
2104661401	53970
2104661501	53964
2104661501	53970
2104661901	53745
2104662101	53964
2104662601	53745
2104662701	53964
4604660001	54029
4604660101	54029
541020210	54258
769295511	54257
9014660301	53814

OE	SPIDAN
MITSUBISHI	
MB553463	53811
MB553511	53812
MIR297492	53838
MIR297493	53838
NISSAN	
4911059Y00	54102
491109F600	54142
4911001E01	53613
4911004R11	53805
491101C700	53645
491102F600	53632
4911032R00	53581
4911035F00	53701
4911043L60	53808
4911043P00	53809
4911052Y00	53609
4911054A00	53905
4911055M00	53907
4911065F00	53836
4911070J00	53558
4911070N00	53618
4911072B00	53752
4911074N00	53902
4911076J00	53618
OPEL	
26029798	54049
8200024738	54264
90473168	54049
905773827	53767
PEUGEOT	
26086355	53751
4007A6	53797

OE	SPIDAN
PEUGEOT	
96311411680	53751
9631411580	53671
9638364580	53751
PORSCHÉ	
928.347.089.00	53993
928.347.089.01	53993
944.347.432.00	53992
944.347.432.03	53992
944.347.432.08	53992
PSA	
26017500	53799
26045330	53898
26050703	53753
26050704	53754
26054760	53675
26071206	53670
26071208	53918
26075747	53630
26078691	53729
26079836	54171
26079836	54191
4003.91	53803
4007.03	53608
4007.57	53872
4007.58	53772
4007.61	53523
4007.66	53552
4007.90	53832
7847017	54100
9610519980	53554
9632334880	54069

OE	SPIDAN
RENAULT	
26002593	53599
26010400	53547
26014539	53633
26018507	53578
26025249	53556
26044897	53674
26046187	53738
26069257	53578
26077781	54165
26077782	54172
26081335	54184
26081335	54228
26088276	54226
26090956	54168
460460475	53577
6006003645	54083
7700840105	54247
7700840107	54044
7700840805	54247
8200024738	54184
8200024738	54228
8200024778	54184
8200024778	54228
8200054528	54226
9140244	53972
ROVER	
34517092130	53567
QVB10003	53691
QVB10007	53550
QVB10012	53591
QVB10013	53580
QVB10016	53792

OE	SPIDAN
ROVER	
QVB10018	53539
QVB10025	53528
QVB10031	53569
QVB10037	53564
QVB10050	53622
QVB10060	53508
QVB100610	53532
QVB100640	53573
QVB100650	53694
QVB100670	53512
QVB100680	53574
QVB100680E	53574
QVB100690	53509
QVB100780	53794
QVB100830	53693
QVB100840	53692
QVB100850	53690
QVB100900	53551
QVB100910	53557
QVB101210	53696
QVB10014	53526
QVB10015	53996
QVB10017	53623
QVB10042	53567
QVB101050	54005
QVB101421	54214
QVB101581	54164
SAAB	
4106704	53689
4106712	53789
4400370	53637
440038	53637

OE	SPIDAN
SAAB	
4647376	53878
4647392	54240
4647418	54002
4647426	53571
4647442	53689
4647491	53637
7691974146	54234
SUBARU	
31052-GA042	53784
70-05004	53641
SUZUKI	
49100-60A00	53589
49110-60B11	53901
TOYOTA	
15XF06747	54166
44310-05010	53544
44310-05020	53903
44310-05040	53944
44310-05050	53919
44320-20121	53594
4432020201	53685
44320-20271	53761
44320-20310	53761
44320-20410	53543
44320-20471	53760
44320-32071	53779
44320-33060	53762
44320-35470	53747
U05-32100	54155

OE	SPIDAN
VAG	
026145155A	53863
026145155B	53586
026145155BX	53586
026145155D	53863
026145155E	53863
026145155EX	53863
026145155G	53881
027145157	53511
028145157B	53555
028145157D	53555
028145157DX	53555
028145157F	53634
028145157FX	53634
30145157	54059
030145157D	54022
030145157D	53941
032145157A	53942
032145157AX	53942
34145165	54048
034145155	53518
034145155C	53518
034145155G	53518
034145159J	53586
034145159L	53949
037145157C	53517
037145157D	53517
037145157DX	53517
037145157G	53517
038145157	53950
044145157A	53611
044145157AX	53611
048145155F	54096

OE	SPIDAN
VAG	
048145155B	53658
048145155C	53658
048145155F	53658
048145155FX	53658
049145155	53659
050145155A	53638
050145155AX	53638
050145155B	53949
050145155C	53887
050145155CX	53887
054145165D	54023
054145165L	54023
054145165A	53546
054145165B	53882
054145165G	53882
054145165H	53546
054145165K	53546
054145165KX	53546
62145165	54244
06A145157	53862
074145157C	53749
074145157CX	53749
077145155B	54016
077145155C	54016
077145155D	54016
1H0145157	53896
1H0422155A	53530
1H0422155B	53517
1H0422155D	53517
1H0422155E	53530
1H0422155E	53555
1J0422154B	54179

OE	SPIDAN	
	VAG	
1J0422154	53950	
1J0422154A	53726	
1J0422154C	53974	
1J0422154D	53726	
1J0422154E	53862	
1J0422154H	53862	
1J0422154HX	53862	
1J0422154J	53950	
1J0422154JX	53950	
251422155	54243	
2D0422155	54118	
357422155G	53511	
4B0145156A	54014	
4B0145155D	53750	
4B0145155E	53923	
4B0145155R	53923	
4B0145155RX	53923	
4B0145155T	53750	
4B0145155TX	53750	
4B0145156	53923	
4B0145156X	53923	
4D0145165J	54015	
4D0145165K	54015	
4D0145165L	54015	
4D0145153	53923	
4D0145155F	53861	
4D0145155H	53861	
6K0422154	53555	
6K0422154X	53555	
6N0145157	53629	
6N0145157X	53629	
6N0422154A	53744	

OE	SPIDAN	
	VAG	
701422155B	53611	
701422155E	53634	
701422155F	53749	
75145155	53746	
7D0422155	54148	
7D0422155DES	54262	
8D0145156N	54013	
8D0145145L	53742	
8D0145155M	53717	
8D0145155Q	53742	
8D0145156	53663	
8D0145156A	53717	
8D0145156F	53951	
8D0145156FX	53951	
8D0145156K	53742	
8D0145156KX	53742	
8D0145156L	53742	
8D0145156M	53663	
8D0145156T	53719	
8D0145156TX	53719	
8D0145156X	53663	
8D0145177D	53915	
8E0145153	54183	
8G0145155AX	53887	
8G0145165X	53546	
VAUXHALL		
90297049	53501	
90540019	54178	
VOLVO		
1273950	54006	
1359649	53788	
1373973	54006	

OE	SPIDAN	
	VOLVO	
1387249	53635	
1387286	53540	
1387724	53635	
3470031	53688	
3470284	53631	
3524419	54071	
3546907	53548	
413725	53516	
6819751	53643	
7613955119	54248	
8603043	53520	
8649636	54225	
8649637	54072	
9125202	53639	
9140195	53597	
9157037	54066	
9157904	54065	
9485904	54066	

OE	SPIDAN	

COMPETITORS	SPIDAN
DA SILVA	
DP0003	53730
DP0003	53871
DP0008	53682
DP0012	53869
DP0013	53862
DP0013	53950
DP0015	53915
DP0016	53951
DP0021	53923
DP0022	54015
DP0024	54023
DP0027	54048
DP0029	53882
DP0030	54016
DP0032	53659
DP0033	53586
DP0034	53638
DP0036	53949
DP0042	54245
DP0043	53863
DP0045	53518
DP0046	53945
DP0049	53926
DP0050	53918
DP0051	53868
DP0051	54140
DP0052	53682
DP0054	53866
DP0055	54011
DP0056	53865
DP0060	53720
DP0061	53736
DP0062	53728
DP0063	53610
DP0064	53857
DP0065	53741

COMPETITORS	SPIDAN
DA SILVA	
DP0072	53682
DP0076	53605
DP0077	53697
DP0078	53577
DP0079	53735
DP0082	53682
DP0083	54012
DP0088	53860
DP0111	53978
DP0133	54039
DP0133	54172
DP0142	53873
DP0146	53885
DP0173	54003
DP0186	54053
DP0194	53778
DP0195	53920
DP0235	54065
DP0236	53516
DP0245	53521
DP0247	53560
DP0248	53519
DP0249	53536
DP0252	53653
DP0254	53853
DP0262	53534
DP0263	53850
DP0265	53849
DP0266	53627
DP0269	53846
DP0270	53603
DP0272	53584
DP0273	53513
DP0273	54170
DP0277	53525
DP0277	53582

COMPETITORS	SPIDAN
DA SILVA	
DP0277	53601
DP0278	53732
DP0279	53837
DP0281	53843
DP0282	53587
DP0283	53864
DP0284	53502
DP0284	53533
DP0285	53650
DP0285	53875
DP0286	53941
DP0286	54022
DP0287	53848
DP0296	53649
DP0296	53657
DP0296	53835
DP0298	53524
DP0298	53831
DP0299	53710
DP0304	53545
DP0304	53565
DP0306	53529
DP0307	53929
DP0309	54170
DP0310	53652
DP0312	53583
DP0320	54219
DP0323	53647
DP0323	53840
DP0336	53606
DP0343	53821
DP0344	53820
DP0345	53707
DP0346	53819
DP0352	53818
DP0355	53816

COMPETITORS	SPIDAN
DA SILVA	
DP0359	53793
DP0362	53704
DP0366	53695
DP0367	53644
DP0367	53897
DP0369	53810
DP0374	53591
DP0377	53696
DP0382	53532
DP0386	53512
DP0386	53528
DP0386	53574
DP0392	53569
DP0397	53692
DP0402	53996
DP0403	53526
DP0403	54010
DP0405	53658
DP0405	54087
DP0412	54214
DP0413	53550
DP0414	53815
DP0416	53551
DP0416	53557
DP0418	53691
DP0441	53561
DP0442	53733
DP0442	53773
DP0453	53720
DP0454	53608
DP0476	53554
DP0476	53651
DP0476	53832
DP0482	53675
DP0487	53554
DP0488	53918

COMPETITORS	SPIDAN
DA SILVA	
DP0497	53523
DP0497	53743
DP0498	53671
DP0498	54191
DP0499	54042
DP0507	53604
DP0508	53867
DP0510	53899
DP0511	53799
DP0512	53753
DP0518	53753
DP0527	53537
DP0527	53549
DP0530	53683
DP0531	53617
DP0533	53874
DP0535	53555
DP0535	53726
DP0535	53974
DP0537	53681
DP0539	53769
DP0544	53559
DP0552	53514
DP0554	54178
DP0555	53504
DP0556	53501
DP0557	53507
DP0558	53596
DP0563	53975
DP0564	53740
DP0564	54171
DP0565	53506
DP0569	53531
DP0571	53751
DP0601	53719

COMPETITORS	SPIDAN
DA SILVA	
DP0602	53843
DP0604	53896
DP0605	53517
DP0607	53746
DP0609	54118
DP0613	54243
DP0614	53634
DP0616	54148
DP0617	53672
DP0618	53505
DP0619	53540
DP0621	53548
DP0621	54066
DP0624	53643
DP0625	53631
DP0626	53734
DP0628	53639
DP0628	54071
DP0629	53511
DP0630	53616
DP0631	53597
DP0633	53535
DP0634	53977
DP0635	53750
DP0638	54072
DP0646	53658
DP0646	54096
DP0648	53629
DP0648	53744
DP0648	54059
DP0651	53742
DP0653	53925
DP0655	53927
DP0657	53663
DP0658	53717

COMPETITORS	SPIDAN
DA SILVA	
DP0711	53872
DP0731	54021
DP0736	53669
DP0737	53756
DP0741	53615
DP0741	53677
DP0741	54017
DP0743	53678
DP0746	54075
DP0748	53593
DP0749	53716
DP0751	54211
DP0752	53953
DP0755	54019
DP0764	53902
DP0766	53632
DP0767	53807
DP0773	53668
DP0775	53581
DP0776	53804
DP0783	53905
DP0784	53906
DP0789	53836
DP0798	53956
DP0803	53552
DP0812	54126
DP0813	54123
DP0822	53888
DP0822	53889
DP0825	53636
DP0827	53808
DP0828	53805
DP0830	53604
DP0830	53654
DP0834	53921

COMPETITORS	SPIDAN
DA SILVA	
DP0838	53633
DP0840	53595
DP0840	53679
DP0845	53562
DP0845	53578
DP0846	53547
DP0846	53936
DP0850	53946
DP0851	53947
DP0852	53763
DP0855	53538
DP0855	53579
DP0859	53916
DP0859	53937
DP0860	53972
DP0861	53900
DP0862	53674
DP0862	53771
DP0865	54038
DP0870	53738
DP0870	54168
DP0871	53568
DP0871	53908
DP0878	53556
DP0878	53673
DP0879	53833
DP0883	53910
DP0884	54083
DP0891	53599
DP0902	53578
DP0903	53578
DP0939	53637
DP0940	54240
DP0941	53957
DP0943	54002

COMPETITORS	DA SILVA	SPIDAN
DP0948		53895
DP0949		54234
DP0952		53530
DP0960		53515
DP0961		53641
DP0963		53784
DP0967		53554
DP0975		53877
DP0980		53782
DP0981		53781
DP0981		53901
DP0987		53867
DP0994		53997
DP1005		53944
DP1007		53779
DP1008		53904
DP1010		54155
DP1011		53543
DP1027		53999
DP1049		53558
DP1052		53747
DP1054		54084
DP1063		53824
DP1065		53682
DP1067		53930
DP1074		53963
DP1080		53788
DP1081		53520
DP1110		53554
DP1117		53749
DP1118		54050
DP1139		53510
DP1142		53870

COMPETITORS	DECAR	SPIDAN
DSP008		53682
DSP270		53569
DSP408		53617
XLP5117		53555
	DEL COREMY	
DSP0001		53968
DSP001		53745
DSP004		53867
DSP011		53871
DSP014		53869
DSP015		53862
DSP015		53950
DSP019		53915
DSP020		53951
DSP021		53915
DSP022		54013
DSP025		54096
DSP027		53923
DSP028		54015
DSP0280		53971
DSP029		54023
DSP030		53861
DSP034		53882
DSP035		54016
DSP038		53586
DSP039		53638
DSP040		53881
DSP042		53586
DSP044		53546
DSP045		53887
DSP046		53546
DSP048		54245
DSP050		53863
DSP052		53518
DSP054		54196

COMPETITORS	DEL COREMY	SPIDAN
DSP055		53608
DSP057		53662
DSP060		53682
DSP067		54175
DSP068		53720
DSP074		53728
DSP076		53610
DSP077		53857
DSP078		53741
DSP082		53890
DSP084		53695
DSP085		53682
DSP086		53730
DSP088		53605
DSP089		53697
DSP0955		53682
DSP096		53864
DSP0980		54131
DSP0987		53891
DSP100		53860
DSP1007		53745
DSP101		54086
DSP1011		54117
DSP1017		53721
DSP1018		54114
DSP1021		54097
DSP1028		53978
DSP1029		53978
DSP1031		54235
DSP1033		53982
DSP1041		53989
DSP1045		53903
DSP1047		53762
DSP1048		53594
DSP105		54247

COMPETITORS	DEL COREMY	SPIDAN
DSP1050		53761
DSP1051		53761
DSP1052		53760
DSP1053		53760
DSP1055		53640
DSP1056		53640
DSP1058		53873
DSP1059		53759
DSP106		53854
DSP1060		53759
DSP111		53844
DSP1110		53838
DSP1112		53778
DSP1121		53664
DSP1125		53990
DSP1130		53839
DSP1140		53702
DSP1150		53811
DSP1151		53811
DSP1152		53811
DSP1157		53677
DSP1159		53516
DSP1159		53688
DSP1160		53520
DSP1172		53749
DSP1180		53962
DSP119		53536
DSP120		53521
DSP1201		53745
DSP121		53560
DSP1210		54050
DSP1211		54050
DSP122		53519
DSP1221		54162
DSP1228		54184

COMPETITORS	DEL COREMY	SPIDAN
DSP1229	54228	
DSP123	53536	
DSP125	53519	
DSP126	53653	
DSP127	53715	
DSP128	53853	
DSP129	53854	
DSP130	53714	
DSP131	53725	
DSP132	53725	
DSP136	53534	
DSP137	53850	
DSP138	53652	
DSP139	53849	
DSP1391	53510	
DSP140	53627	
DSP141	53837	
DSP142	53846	
DSP145	53584	
DSP147	54020	
DSP1480	54108	
DSP149	53525	
DSP150	53732	
DSP153	53843	
DSP154	53587	
DSP156	53502	
DSP156	53533	
DSP157	53650	
DSP157D	53755	
DSP157D	53941	
DSP158	53848	
DSP1580	54088	
DSP159	53842	
DSP160	53582	
DSP161	53565	

COMPETITORS	DEL COREMY	SPIDAN
DSP162	53711	
DSP163	53533	
DSP164	53525	
DSP165	53712	
DSP166	53541	
DSP171	53710	
DSP176	53565	
DSP177	53545	
DSP178	53529	
DSP1780	54097	
DSP181	53652	
DSP182	53583	
DSP183	53583	
DSP185	53626	
DSP189	53835	
DSP192	54219	
DSP193	53722	
DSP194	53840	
DSP196	53722	
DSP197	53708	
DSP201	53851	
DSP202	53979	
DSP203	54105	
DSP206	53606	
DSP214	53524	
DSP215	53831	
DSP216	53533	
DSP217	53821	
DSP218	53820	
DSP219	53707	
DSP223	53592	
DSP224	53644	
DSP225	53626	
DSP226	53706	
DSP227	53818	

COMPETITORS	DEL COREMY	SPIDAN
DSP230	53816	
DSP231	53644	
DSP235	53858	
DSP236	53793	
DSP237	54163	
DSP240	53704	
DSP2401	54121	
DSP241	53812	
DSP243	53703	
DSP244	53812	
DSP247	53810	
DSP248	54176	
DSP252	54164	
DSP253	53509	
DSP254	53512	
DSP255	53696	
DSP256	53508	
DSP257	53508	
DSP258	53580	
DSP260	53528	
DSP261	53564	
DSP262	53794	
DSP263	53509	
DSP264	53574	
DSP266	53532	
DSP268	53591	
DSP271	53691	
DSP272	53690	
DSP273	53622	
DSP275	53573	
DSP276	53693	
DSP277	53694	
DSP2770	53571	
DSP278	53623	
DSP279	53996	

COMPETITORS	DEL COREMY	SPIDAN
DSP280	53526	
DSP2807	53870	
DSP281	53692	
DSP2810	53658	
DSP283	53574	
DSP284	53792	
DSP285	53539	
DSP288	53690	
DSP289	53550	
DSP2901	54109	
DSP292	54200	
DSP294	53691	
DSP295	53551	
DSP296	53557	
DSP297	53622	
DSP300	53515	
DSP301	53985	
DSP317	53561	
DSP327	53666	
DSP329	53598	
DSP334	53608	
DSP337	54047	
DSP340	53576	
DSP342	54230	
DSP353	53630	
DSP354	53670	
DSP358	53802	
DSP361	53754	
DSP3637	53604	
DSP364	53613	
DSP366	53918	
DSP367	53554	
DSP368	53918	
DSP370	53618	
DSP3700	53520	

COMPETITORS	SPIDAN
DELCOREMY	
DSP3725	53516
DSP375	53801
DSP376	53523
DSP378	54042
DSP379	53554
DSP383	53561
DSP384	53566
DSP385	53737
DSP386	53899
DSP387	53799
DSP388	53753
DSP3933	53619
DSP394	53753
DSP403	53549
DSP407	53683
DSP410	53874
DSP4113	53555
DSP414	53588
DSP415	53681
DSP416	53506
DSP417	53769
DSP418	53768
DSP422	54177
DSP423	53559
DSP426	53628
DSP427	53987
DSP432	53514
DSP433	53514
DSP434	53766
DSP435	54178
DSP436	53504
DSP437	53501
DSP438	53507
DSP439	53596
DSP440	53549

COMPETITORS	SPIDAN
DELCOREMY	
DSP443	53559
DSP446	53975
DSP447	54171
DSP448	53506
DSP449	53542
DSP450	53542
DSP452	53531
DSP454	53751
DSP455	53917
DSP456	53729
DSP457	54181
DSP457	54184
DSP462	53506
DSP464	53503
DSP465	53505
DSP479	53630
DSP482	53729
DSP485	53719
DSP486	53555
DSP4861	54116
DSP490	53517
DSP490R	53588
DSP491	53746
DSP499	53634
DSP49P	53575
DSP500	53611
DSP501R	53505
DSP5017	53675
DSP502	53540
DSP5020	54248
DSP504	53548
DSP506	53765
DSP507	53597
DSP508	53516
DSP5080	53734

COMPETITORS	SPIDAN
DELCOREMY	
DSP510	53631
DSP5101	53511
DSP510R	53616
DSP511	53548
DSP511	53597
DSP5117	53555
DSP512	53535
DSP513	53977
DSP514	54071
DSP515	54225
DSP5157	53511
DSP520	53643
DSP521	53635
DSP5213	53629
DSP5235	53742
DSP524	54217
DSP527	53927
DSP528	53927
DSP5280	53663
DSP536	54152
DSP537	53713
DSP539	53878
DSP544	54158
DSP545	54158
DSP547	54158
DSP549	54151
DSP550	54151
DSP550R	54049
DSP551	54151
DSP553	53625
DSP555	53625
DSP556	53912
DSP557	53912
DSP570	53591
DSP571	53828

COMPETITORS	SPIDAN
DELCOREMY	
DSP57C	53522
DSP57C	53872
DSP581	53852
DSP591	54198
DSP595	53713
DSP596	53713
DSP601	53983
DSP605	53892
DSP606	53669
DSP608	53607
DSP609	53607
DSP609	53669
DSP613	54082
DSP614	54093
DSP615	54064
DSP616	54077
DSP619	53758
DSP620	54211
DSP621	53953
DSP623	54082
DSP627	53909
DSP632	54238
DSP633	53902
DSP634	53727
DSP635	53632
DSP636	53807
DSP6402	53668
DSP642	53581
DSP643	53804
DSP644	53645
DSP645	53645
DSP646	53668
DSP647	53700
DSP650	53905
DSP651	53906

COMPETITORS	SPIDAN
DELCOREMY	
DSP652	54102
DSP653	53541
DSP655	53701
DSP656	53836
DSP658	53809
DSP662	53625
DSP664	53955
DSP665	54081
DSP666	54076
DSP667	53724
DSP668	53609
DSP669	53907
DSP66P	53552
DSP670	53609
DSP676	53731
DSP679	54123
DSP688	53888
DSP690	53593
DSP693	53808
DSP695	53805
DSP6958	53604
DSP700	53672
DSP700	53921
DSP701	53948
DSP702	53590
DSP705	53633
DSP708	53687
DSP709	53764
DSP713	53911
DSP715	53946
DSP716	53947
DSP717	53763
DSP718	53771
DSP719	54169
DSP720	53538

COMPETITORS	SPIDAN
DELCOREMY	
DSP721	53579
DSP722	53538
DSP723	53579
DSP724	53579
DSP726	53900
DSP727	53674
DSP728	53938
DSP729	53771
DSP730	54038
DSP731	54038
DSP733	53577
DSP735	53921
DSP737	53939
DSP742	53673
DSP7424	53553
DSP744	53556
DSP746	53910
DSP747	53556
DSP749	53785
DSP750	53786
DSP754	53599
DSP756	53633
DSP760	53585
DSP761	54000
DSP766	53562
DSP767	53562
DSP768	53562
DSP781	53992
DSP784	53993
DSP786	53992
DSP787	53992
DSP788	53992
DSP789	53748
DSP801	53620
DSP802	53689

COMPETITORS	SPIDAN
DELCOREMY	
DSP804	53637
DSP805	54240
DSP807	53619
DSP8080	54116
DSP810	53878
DSP812	53895
DSP813	54234
DSP816	53530
DSP816	53755
DSP817	53530
DSP817	53726
DSP818	53583
DSP824	53515
DSP827	53784
DSP828	53686
DSP829	53515
DSP82C	53918
DSP82P	53918
DSP837	53877
DSP839	54180
DSP840R	53596
DSP841	53782
DSP842	53901
DSP843	53589
DSP8477	53867
DSP851	53880
DSP867	54102
DSP868	53712
DSP869	53944
DSP870	53779
DSP871	53904
DSP874	53685
DSP875	53919
DSP884	53594
DSP885	53776

COMPETITORS	SPIDAN
DELCOREMY	
DSP892	53543
DSP894	53919
DSP897	53904
DSP898	53544
DSP900	53613
DSP906	53558
DSP907	53618
DSP915	53747
DSP920	53747
DSP925	53559
DSP930	53824
DSP9346	53654
DSP948	53723
DSP952	54115
DSP955	53813
DSP957	54088
DSP963	54030
DSP9652	53520
DSP967	53721
DSP968	54112
DSP969	54027
DSP970	53814
DSP973	53964
DSP974	53847
DSP975	54088
DSP978	54132
DSP979	53966
DSP981	54229
DSP983	54209
DSP986	54119
DSP988	54125
DSP992	54127
DSP994	54032
DSP996	54035
DSPA3P	53503

COMPETITORS	SPIDAN
DELCoreMY	
DSPE3C	53608
DSPQ1P	53800
KOYO	
8602064	54163
LUK	
1274601280	53705
2105073	54135
2105135	54078
2105543	54134
2105738	54121
2105744	54227
2105760	54116
2106447	54112
2106448	54074
2106454	54117
2106467	54255
2106468	53933
2106469	54109
2106471	53814
2107206	54081
2107250	54118
2107369	54089
2107370	54259
2107536	54229
2107619	54112
2107620	54074
2107621	54109
2107622	54209
2107624	54114
2107625	54132
2107638	54211
2107901	54064
2107902	54080
2107908	54093
2107929	54109

COMPETITORS	SPIDAN
LUK	
2108007	54162
2108051	54244
2108230	53978
2108429	54235
2108430	53982
2110068	54210
541 0001 10	54097
541 0002 10	54113
541 0004 10	53993
541 0005 10	54108
541 0006 10	54088
541 0009 10	54120
541 0011 10	54131
541 0015 10	54092
541 0016 10	54115
541 0017 10	54090
541 0018 10	54075
541 0019 10	54130
541 0021 10	54124
541 0021 10	54127
541 0022 10	54082
541 0023 10	54096
541 0025 10	54135
541 0028 10	54087
541 0031 10	54125
541 0034 10	54121
541 0034 10	54122
541 0036 10	54227
541 0038 10	54128
541 0040 10	54116
541 0048 10	54076
541 0052 10	54126
541 0053 10	54123
541 0054 10	54064
541 0055 10	54089

COMPETITORS	SPIDAN
LUK	
541 0056 10	54112
541 0057 10	54074
541 0058 10	54109
541 0060 10	54114
541 0061 10	54132
541 0062 10	54255
541 0063 10	54117
541 0068 10	53593
541 0069 10	54080
541 0070 10	54077
541 0071 10	53814
541 0073 10	54209
541 0074 10	54093
541 0077 10	54081
541 0080 10	54259
541 0082 10	54229
541 0084 10	54211
541 0125 10	53978
541 0125 10	53978
541 0127 10	54244
541 0150 10	54162
541 0154 10	53982
541 0155 10	54235
541 0193 10	54210
541 0202 10	54258
542 0006 10	54095
542 0011 10	54078
542 0035 10	53933
542 0046 10	54118
542 0422 10	54134
8102748	54125

COMPETITORS	SPIDAN
SAGINAW	
1359649	53788
1359652	53520
1387249	53635
1387724	53635
26071637	53920
3470031	53688
3470284	53631
3546907	53548
4106712	53789
413725	53516
440038	53637
46459346	53654
4647376	53678
4908281	53678
6819751	53643
7700413944	53908
7700417137	53973
7700417308	53908
7700419117	53948
7700419155	53937
7700419156	53916
7700674708	53687
7700766954	53786
7700779564	53785
7700788378	53764
7700795293	53599
7700795295	53633
7700802364	53562
7700805017	53676
7700805017	53913
7700814453	53556
7700814454	53910
7700815010	53673
7700819308	53556
7700823735	53538

COMPETITORS	SPIDAN
SAGINAW	
7700823735	53579
7700823737	53771
7700823738	53938
7700830487	53676
7700830487	53913
7700830787	53674
7700830788	53900
7700840103	53614
7700840105	53672
7700840105	53921
7700840105	53922
7700840106	53568
7700840106	53939
7700840106	53940
7700840649	53900
7700840724	53590
7700840724	53738
7700840806	53738
7700872157	53977
7700872160	53535
7700875707	53911
7700875708	53763
7700875709	53947
7700875710	53946
77094310	53682
7847017	53522
8963993	53619
8972424	53571
9101577	53620
9125202	53639
9140195	53597
9140244	53972
948077	53665
96144288	53651
96144290	53832

COMPETITORS	SPIDAN
SAGINAW	
9120146480	53803
9153618180	53733
9602201380	53552
9610519980	53505
9614378180	53934
9614378280	53935
9617753380	53608
9622072380	53799
9623680180	53753
9623814680	53754
9624660480	53561
9625148380	53675
9628973580	53740
9631411680	53751
9631914180	53925
9631914280	53928
9631923480	53926
9631923680	53662
9632252880	53927
9632334880	53661
9632334880	53670
9632335080	53898
9632335080	53918
9632335580	53918
9632335580	53924
9633889690	53961
9634070580	53630
9634816080	54042
9635445780	53729
9635445880	53945
9636070380	53917
9636676280	53958
9636676380	53960
MR131033	53704

COMPETITORS	SPIDAN
TRISCAN	
8151-27600	53516
8515-10601	53561
8515-10602	53584
8515-10603	53583
8515-10606	53846
8515-10607	53652
8515-10608	54184
8515-10609	54228
8515-11600	53695
8515-11601	53607
8515-11602	53593
8515-11603	53669
8515-11604	53756
8515-11605	53677
8515-11606	53615
8515-11607	53718
8515-11608	54221
8515-11609	53952
8515-11610	53953
8515-11611	53678
8515-11612	53955
8515-11613	53909
8515-11615	53956
8515-11618	54050
8515-13600	53944
8515-13601	53919
8515-13602	53779
8515-13603	53762
8515-13604	53685
8515-13605	53543
8515-13606	53544
8515-13607	53903
8515-13608	53640
8515-13609	53873
8515-13610	53885

COMPETITORS	SPIDAN
TRISCAN	
8515-13611	53759
8515-13612	53594
8515-13613	53776
8515-13614	53775
8515-14600	53609
8515-14601	53570
8515-14602	53806
8515-14603	53752
8515-14604	53558
8515-14605	53645
8515-15600	53604
8515-15601	53867
8515-15602	53697
8515-15603	53654
8515-15604	53595
8515-15605	53585
8515-15606	53612
8515-15607	53577
8515-15608	53605
8515-15609	53854
8515-15611	53856
8515-15612	54189
8515-15613	54236
8515-16600	53502
8515-16601	53510
8515-16602	53513
8515-16603	53519
8515-16604	53521
8515-16605	53524
8515-16606	53525
8515-16607	53529
8515-16608	53533
8515-16609	53534
8515-16610	53536
8515-16611	53545

COMPETITORS	TRISCAN	
	TRISCAN	SPIDAN
8515-16612		53553
8515-16613		53560
8515-16614		53725
8515-16616		53714
8515-16617		53732
8515-16618		53603
8515-16620		53627
8515-16621		53849
8515-16622		53667
8515-16623		53850
8515-16624		53980
8515-16624		54061
8515-16625		53650
8515-16627		53979
8515-18600		53823
8515-23600		53600
8515-23604		53745
8515-23605		53815
8515-23606		53964
8515-23607		53721
8515-23608		53966
8515-23609		53967
8515-23610		53968
8515-23611		53969
8515-23612		54026
8515-23613		54027
8515-23616		54028
8515-23619		53847
8515-23620		53933
8515-23621		54117
8515-24600		53501
8515-24601		53504
8515-24602		53506
8515-24603		53507
8515-24604		53514

COMPETITORS	TRISCAN	
	TRISCAN	SPIDAN
8515-24605		53531
8515-24606		53537
8515-24607		53549
8515-24608		53665
8515-24609		53975
8515-24611		53572
8515-24612		53596
8515-25600		53538
8515-25601		53547
8515-25602		53556
8515-25603		53633
8515-25604		53599
8515-25605		53687
8515-25606		53764
8515-25607		53562
8515-25608		53940
8515-25609		53937
8515-25611		53568
8515-25612		53939
8515-25613		53948
8515-25614		53973
8515-25615		53672
8515-25616		53921
8515-25617		53922
8515-25618		53673
8515-25619		53910
8515-25621		53590
8515-25622		53676
8515-25623		53913
8515-25624		53738
8515-25626		53614
8515-25627		53579
8515-25628		53911
8515-25629		54165
8515-27601		53520

COMPETITORS	TRISCAN	
	TRISCAN	SPIDAN
8515-27602		53540
8515-27603		53548
8515-27604		53631
8515-27605		53788
8515-27606		53597
8515-27607		53635
8515-27608		53643
8515-27609		53639
8515-27610		53977
8515-27611		53535
8515-27613		53688
8515-28600		53503
8515-28601		53505
8515-28602		53522
8515-28603		53523
8515-28604		53552
8515-28605		53554
8515-28606		53661
8515-28608		53918
8515-28609		53924
8515-28610		53675
8515-28611		53566
8515-28612		53958
8515-28613		53960
8515-28614		53608
8515-28617		53671
8515-28618		53802
8515-28619		53934
8515-28620		53935
8515-28621		53917
8515-28622		53800
8515-28623		53797
8515-28624		53773
8515-28626		53662
8515-28627		53945

COMPETITORS	TRISCAN	
	TRISCAN	SPIDAN
8515-28628		53729
8515-28629		53899
8515-28630		53754
8515-29600		53511
8515-29601		53517
8515-29602		53518
8515-29603		53530
8515-29604		53555
8515-29605		53663
8515-29606		53659
8515-29607		53586
8515-29608		53638
8515-29609		53887
8515-29610		53863
8515-29611		53658
8515-29614		53726
8515-29615		53950
8515-29616		53742
8515-29617		53717
8515-29618		53719
8515-29619		53915
8515-29620		53750
8515-29621		53923
8515-29622		53755
8515-29624		53629
8515-29626		53611
8515-29627		53634
8515-29628		53749
8515-29630		54118
8515-38601		53542
8515-38602		53670
8515-38605		53630
8515-38606		53925
8515-38606		53926
8515-38607		53927

COMPETITORS	TRISCAN	SPIDAN
	8515-38608	53751
	8515-38611	53666
	8515-38612	53576
	8515-38613	53598
	8515-38614	54217
	8515-38615	54230
	8515-40600	53830
	8515-40601	53625
	8515-40602	53825
	8515-40603	53713
	8515-42600	53704
	8515-42601	53812
	8515-42602	53811
	8515-42604	53839
	8515-43600	53647
	8515-43601	53840
	8515-43602	53722
	8515-43603	53624
	8515-50600	53820
	8515-50601	53819
	8515-50602	53592
	8515-50603	53644
	8515-65600	53620
	8515-65601	53689
	8515-65602	53789
	8515-65603	53637
	8515-65604	53571
	8515-65605	53878
	8515-65606	53895
	8515-65607	53619
	8515-68600	53784
	8515-68601	53686
	8515-69600	53782

COMPETITORS	VICKERS	SPIDAN
	863384	54095
VISTEON		
	HBD AD	53650
	HBD AE	53510
	HBD AL	53529
	HBD AR	53627
	HBD AS	53849
	HBD AW	53850
	HBD AZ	53834
	HBD BB	53831
	HBD BD	53560
	HBD BF	53534
	HBD BH	54174
	HBD BJ	53848
	HBD BJ*	53667
	HBD BK	53846
	HBD BS*	53603
	HBD BS*	53979
	HBD BU	53560
	HBD BZ	53584
	HBD CB	53851
	HBD CC	53652
	HBD CG	53714
	HBD CL	53837
	HBD CP	53524
	HBD CT	53980
	HBD CV	53732
	HBD CX	54061
	HBD CY	54153
	HBD DZ	53875
	HBD EB	53725
	HBD EC	54215
	HBD EX*	54139
	HBD EX*	54174
	HBD EY	53584

COMPETITORS	VISTEON	SPIDAN
	HBD EZ*	53603
	HBD EZ*	53979
	HBD FB	53837
	HBD FG*	54188
	HBD FS	54232
	HBD FY	53732
	HBD FZ	54020
	HBD GA	54061
	HBD GK	53524
	HBD HA	54185
	HBD HO	54252
	HBD HP	54253
	HBD JC	53980
ZF		
	7612955101	53596
	7612955104	53895
	7612955106	53975
	7613955101	53919
	7613955102	54142
	7613955103	54066
	7613955112	54071
	7613955116	54221
	7613955118	54066
	7613955119	54248
	7613955135	54072
	7613955136	54225
	7613955141	54225
	7613955505	54213
	7614955107	54216
	7617955502	54181
	7671900402	53723
	7671900406	53723
	7671955140	53659
	7671955166	53746
	7671955172	54001

COMPETITORS	ZF	SPIDAN
	7672900404	53705
	7672900422	53813
	7672900424	53705
	7672900426	53813
	7672900428	53705
	7672900432	53813
	7672900434	53705
	7672900436	53813
	7672900442	53813
	7672900444	53705
	7672900446	53813
	7672900448	53705
	7672955270	54004
	7673955544	53856
	7673955570	53605
	7681900501	53745
	7681900502	54026
	7681900503	53745
	7681955102	53695
	7681955103	54243
	7681955108	53679
	7681955109	53992
	7681955110	53695
	7681955112	53695
	7681955115	53992
	7681955118	53993
	7681955119	53992
	7681955123	53855
	7681955128	53586
	7681955130	53540
	7681955140	53612
	7681955142	53695
	7681955144	53695
	7681955146	53758
	7681955147	54212

COMPETITORS	SPIDAN
ZF	
7681955154	53607
7681955155	53595
7681955162	53865
7681955164	53871
7681955165	54212
7681955166	53758
7681955167	53716
7681955168	53678
7681955171	53957
7681955172	54021
7681955180	53879
7681955184	53730
7681955185	53607
7681955186	53638
7681955196	53992
7681955197	53669
7681955198	53615
7681955199	53718
7681955200	53886
7681955205	53658
7681955210	53881
7681955211	53949
7681955215	53730
7681955219	53866
7681955220	53887
7681955228	53615
7681955230	53615
7681955231	53669
7681955232	53718
7681955233	53669
7681955235	53716
7681955236	53886
7681955237	53758
7681955240	53866
7681955247	53607

COMPETITORS	SPIDAN
ZF	
7681955248	54021
7681955249	53879
7681955250	53607
7681955251	53992
7681955252	53669
7681955253	53891
7681955256	54012
7681955259	54017
7681955260	53677
7681955261	53616
7681955264	53638
7681955265	53658
7681955266	53887
7681955268	53880
7681955272	53949
7681955278	53720
7681955280	53663
7681955281	53717
7681974103	53677
7682900108	53971
7682900110	53965
7682900111	53929
7682900112	53962
7682900114	53963
7682900115	53930
7682900502	53968
7682900504	54026
7682900508	53745
7682900511	54035
7682955102	53636
7682955105	54019
7682955109	53600
7682955117	53861
7682955122	53861
7682955123	53861

COMPETITORS	SPIDAN
ZF	
7682955128	53861
7683900502	53893
7683900506	54029
7683900514	53893
7683900520	54030
7683900522	54032
7683955114	53577
7683955501	54031
7684955124	53577
7690955102	53719
7690955104	53915
7690955105	53862
7691900502	53721
7691900504	53815
7691900505	53815
7691900506	53721
7691900513	53953
7691955102	53585
7691955103	53950
7691955105	53682
7691955108	53611
7691955110	53610
7691955111	53530
7691955112	53868
7691955119	53890
7691955122	53864
7691955150	53734
7691955152	53545
7691955155	53822
7691955158	53697
7691955159	53610
7691955160	53857
7691955161	53734
7691955166	53942
7691955169	53585

COMPETITORS	SPIDAN
ZF	
7691955170	53890
7691955171	53682
7691955179	53843
7691955180	53602
7691955182	53735
7691955185	53742
7691955190	53843
7691955195	53562
7691955196	53655
7691955200	53604
7691955202	53736
7691955204	53867
7691955205	53634
7691955207	53749
7691955213	53629
7691955220	53942
7691955224	53583
7691955227	53951
7691955229	53941
7691955231	53844
7691955234	53726
7691955234	53950
7691955235	53742
7691955236	53583
7691955237	53741
7691955241	53862
7691955241	53974
7691955243	53604
7691955247	53585
7691955250	53736
7691955259	53735
7691955262	53844
7691955263	53867
7691955264	53741
7691955267	53923

Notes / Notizen

Blank lined area for notes on the left side of the page.

Blank lined area for notes on the right side of the page.

Notes / Notizen

Lined writing area for notes on the left side of the page.

Lined writing area for notes on the right side of the page.



GKN Driveline Industrial & Distribution Services

Headquarters:

GKN Service International GmbH

Nussbaumweg 19-21

51503 Rösrath / Germany

www.gknservice.com

© GKN Driveline. All rights reserved.

