

Propshafts for

Passenger Cars
Sports Utility Vehicles
Vans

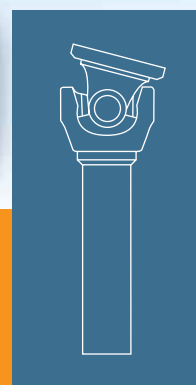

Edition 2013



General Information

1. As a producer of original equipment GKN supplies vehicle manufacturers on a world-wide basis.
2. SPIDAN is the trade mark of GKN in the European Automotive Aftermarket.
3. SPIDAN stands for quality, service reliability and profitability.
4. Reference numbers of parts or designation of types by vehicle manufacturers or competitors are stated for purpose of comparison only. The use of such details in invoices to vehicle owners is not allowed. Damage claims based on statements made in this catalogue are excluded. Subject to change without notice.
5. In case of doubt please check the parts before mounting them. If in doubt contact us for details of your nearest IDS workshop, where your driveshaft / propshaft can be professionally repaired. We recommend that all propshafts are dynamically balanced after service work has been carried out.
6. Copyright by GKN. Copies, even extracts, are only allowed with the written approval of GKN Service International GmbH.



Allgemeine Hinweise

1. GKN beliefert mit ihren Produkten als Erstausrüster weltweit die Hersteller von Kraftfahrzeugen.
2. SPIDAN ist das europaweit eingeführte Warenzeichen für Ersatzteile der GKN.
3. SPIDAN steht für Qualität, hohen Servicegrad und Gewinn für unsere Kunden.
4. Die Angaben von Ersatzteilnummern oder Typenbezeichnungen der Fahrzeughersteller oder des Wettbewerbs dienen nur zu Vergleichszwecken. Eine Verwendung von solchen Angaben ist in Rechnungen an Fahrzeugbesitzer nicht statthaft. Ersatzansprüche auf Grund von Angaben in diesem Katalog sind ausgeschlossen. Änderungen vorbehalten.
5. Bitte überprüfen Sie im Zweifelsfall die Teile vor dem Einbau. In Zweifelsfällen kontaktieren Sie uns oder die nächste Werkstatt für weitere Details, wo Ihre Welle / Längswelle auch professionell repariert werden kann. Wir empfehlen, dass alle Längswellen dynamisch ausgewuchtet werden, bevor Sie ausgeliefert werden.
6. Copyright bei GKN. Vervielfältigungen, auch auszugsweise, sind nur mit schriftlicher Genehmigung der GKN Service International GmbH zulässig.



Informations générales

1. Fabriquant pour la première monte GKN fournit les constructeurs du monde entier.
2. SPIDAN est une marque de distribution de GKN pour le marché Européen de la rechange des véhicules.
3. SPIDAN est l'assurance de la qualité, de la compétence et de la rentabilité.
4. Les références d'origine ou les désignations des types de véhicules selon les constructeurs ou les concurrents sont données à titre indicatif exclusivement. L'utilisation de ce type d'information pour la facturation au propriétaire du véhicule n'est pas autorisée. Toutes réclamations, faisant suite à l'utilisation des informations de ce catalogue ne seront pas recevables. Peut être modifié sans préavis.
5. En cas de doute prière de vérifier les pièces à remplacer avant les monter sur le véhicule. En cas de doute contactez votre atelier IDS le plus proche, afin que votre transmission soit réparée dans les règles de l'art. Il est recommandé que toutes les transmissions soient équilibrées dynamiquement après toute intervention.
6. GKN est une marque déposée. Toute reproduction même partielle n'est autorisée qu'avec l'accord écrit de GKN Service International GmbH.



Información general

1. Como fabricante de piezas originales GKN es el proveedor de los principales fabricantes de automóviles en todo el mundo.
2. SPIDAN es la marca con la que GKN comercializa sus productos en el mercado de automoción Europeo.
3. SPIDAN representa calidad, servicio, fiabilidad y rentabilidad
4. Las referencias de las piezas o las descripciones de los modelos de los fabricantes de vehículos o de la competencia aparecen solo con el propósito de poder comparar. El uso de dicha información en las facturas del propietario del vehículo no está permitido. Las reclamaciones por daños y perjuicios basadas en declaraciones hechas en este catálogo están excluidas. Sujeto a cambios sin previo aviso.
5. En caso de duda compruebe la pieza antes de montarla en el vehículo. En caso de duda contacta con nosotros para informarte sobre el taller IDS más cercano donde tu transmisión será reparada profesionalmente. Recomendamos que todas las transmisiones sean equilibradas después de su reparación en el taller
6. Copyright by GKN. Cualquier copia, total o parcial de este catálogo, estará solamente permitida con la aprobación por escrito de GKN Service International GmbH.



Algemene informatie

1. Als producent van originele onderdelen levert GKN onderdelen aan automobiefabrikanten over de hele wereld.
2. SPIDAN is een merknaam van GKN in de Europese Automobiel aftermarket.
3. SPIDAN staat voor kwaliteit, service en winstgevendheid.
4. Vermeldingen van onderdeelnummers of typeaanduidingen van de automobiefabrikanten of van andere aanbieders dienen alleen ter vergelijking. Gebruik van zulke vermeldingen op rekeningen aan de autobezitter is niet toegestaan. Schadeclaims op grond van vermeldingen in deze catalogus worden niet erkend. Veranderingen voorbehouden.
5. In geval van twijfel verzoeken wij u de onderdelen goed te controleren (voordat) u het onderdeel monteert. Bij twijfel kunt u contact opnemen voor details bij de dichtstbijzijnde IDS vestiging, waar uw cardanas professioneel kan worden gerepareerd. Wij adviseren alle assen na servicewerkzaamheden te laten balanceren.
6. Copyright GKN. Kopieën, zelfs uittreksels, zijn alleen toegestaan met schriftelijke toestemming van GKN Service International GmbH.



Informazioni generali

1. GKN fornisce componenti di primo equipaggiamento ai principali costruttori leader nella produzione di veicoli in tutto il mondo.
2. SPIDAN è un marchio della GKN nel mercato Europeo dell'aftermarket per l'auto e veicoli industriali.
3. SPIDAN significa qualità, affidabilità nel servizio e redditività.
4. I numeri di riferimento dei componenti o la specifica del costruttore per tipologia di veicolo sono indicati al solo scopo comparativo. Non è consentito l'utilizzo di queste informazioni sulle fatture inviate ai proprietari dei veicoli. Non sono ammesse richieste di danni fondate sulle specifiche contenute in questo catalogo. Eventuali modifiche saranno effettuate senza ulteriore preavviso.
5. In caso di dubbio vi preghiamo di controllare le parti da sostituire prima di montarle sul veicolo. In caso di dubbio vi preghiamo di volere contattare la nostra azienda o l'officina IDS a voi più vicina dove la vostra trasmissione potrà essere riparata da personale esperto. Si raccomanda che tutti gli alberi di trasmissione vengano equilibrati dinamicamente dopo essere stati riparati.
6. Tutti i diritti sono riservati a GKN. Copie o estratti del presente catalogo sono concessi solo previa autorizzazione scritta di GKN Service International GmbH.



Общая информация

1. Являясь производителем оригинального оборудования фирма GKN осуществляет поставки производителям транспортных средств по всему миру.
2. SPIDAN это торговая марка GKN на Европейском Автомобильном Рынке Эапчастей.
3. SPIDAN гарантирует качество и надёжный сервис и рентабельность.
4. Для сравнения приведены оригинальные номера производителей транспортных средств или других производителей данной продукции. Использование данной информации в счетах, предоставляемых владельцам транспортных средств запрещено. Претензии по возмещению ущерба на основании каталога исключаются. GKN сохраняет за собой право на изменения.
5. Если у Вас есть, какие либо сомнения, пожалуйста, проверьте заменяемые части, прежде чем устанавливать их на автомобиль. В транспортных средствах могут быть использованы альтернативные детали, поэтому перед установкой детали необходимо проверить. В случае возникновения каких-либо сомнений, Вы можете обратиться к нам или в ближайшую сервисную мастерскую, где ваш карданный вал смогут профессионально отремонтировать. Мы рекомендуем проводить балансировку всех карданных валов перед отправкой заказчику.
6. GKN сохраняет за собой авторское право. Копии, а также краткие выдержки, разрешены только с письменного разрешения GKN Service International GmbH.



内容概要

1. GKN传动系统公司是一家给全球范围内各大汽车整车制造商提供优质传动系统产品和服务的世界级原厂零配件供应商。
2. SPIDAN是GKN传动轴系列产品在欧洲汽车售后市场的商标之一
3. SPIDAN商标代表着GKN的优异的质量，可靠的服务及高性价比
4. 整车生产商及竞争者的参考零部件号或类型名称仅供对比所用。此类信息不可用于给车主的票据中。本手册中叙述的损坏情况不属于赔偿范围，如有更改恕不另行通知。
5. 为了避免任何不便请在安装替换件之前先对其进行检查。如果您相关的问题需要咨询，请联系我们或离您最近的GKN维修服务点，我们会提供给您及时专业的传动轴产品维修服务。
6. GKN传动系统公司保留其所有权。本文及其所有内容未经GKN授权不得随意转载。

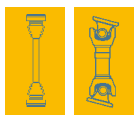

Service locations

Service-Standorte

Locations / Standorte

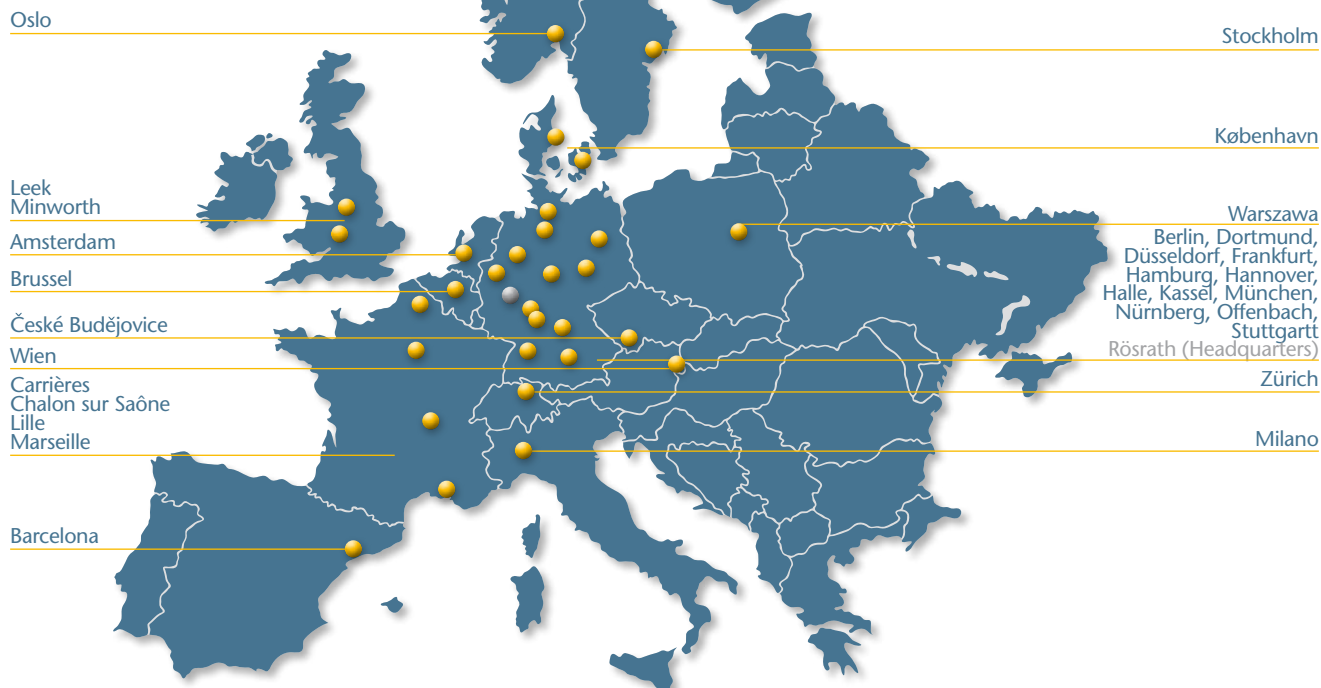

Austria / Österreich

Central Service Hotline - 24 hrs:

+43 (0) 664 92 17 868

Service Centre Wien

GKN Service Austria GmbH

Slamastraße 32

1230 Wien

Phone: +43 16 16 38 80 0

Fax: +43 16 16 38 80 15

Belgium / Belgien

Central Service Hotline - 24 hrs:

+32 475 416 845

Service Centre Brussel / Bruxelles

GKN Service Benelux BV

Rue Emile Pathéstraat 410

1190 Brussel / Bruxelles

Phone: +32 (0) 2 334 98 61

Fax: +32 (0) 2 334 98 88

Czech Republic / Tschechien

Central Service Hotline - 24 hrs:

+420 602 125 019

Service Centre České Budějovice

GKN Service Austria GmbH

Pekárenská 54

370 04 České Budějovice

Phone: +420 387 314 125

Fax: +420 387 314 126

Denmark / Dänemark

Central Service Hotline - 24 hrs:

+45 22 24 92 25

Service Centre København

GKN Service Scandinavia AB

Baldershøj 11 A+B

2635 Ishøj

Phone: +45 44 86 68 44

Fax: +45 44 68 88 22

France / Frankreich

Central Service Hotline - 24 hrs:

0820.204.497

(0.09 € TTC / min.)

Siège social Paris

GKN Service Fance SA

Ecoparc des Cettons

Secteur 1 Jaune

8 Rue Panhard Levassor

78570 Chanteloup les Vignes

Phone: +33 1 30 06 84 00

Fax: +33 1 30 06 84 39

Service Centre Chalon sur Saône

GKN Service Fance SA

11 Rue Julien Leneveu

71380 Saint Marcel

Phone: +33 3 85 90 02 05

Fax: +33 3 85 48 43 98

Service Centre Lille

GKN Service Fance SA

ZAC de l'Épinette

Rue des Clauwiers

59113 Seclin

Phone: +33 3 20 96 98 30

Fax: +33 3 20 96 85 37

Service Centre Marseille

GKN Service Fance SA

22, Boulevard de l'Europe

13127 Vitrolles

Phone: +33 4 42 41 86 55

Fax: +33 4 42 41 86 59

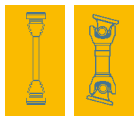

Service locations

Service-Standorte

Germany / Deutschland

Central Service Hotline - 24 hrs:
+49 800 1 65 65 00
Fax: +49 800 1 65 65 01

Service Centre Berlin
GKN Service International GmbH
Marzahner Chaussee 211
12681 Berlin
Phone: +49 (0)30 54 99 82 50
Fax: +49 (0)30 54 99 82 60

Service Centre Dortmund
GKN Service International GmbH
Frydagstraße 21
44536 Lünen-Lippolthausen
Phone: +49 (0)2306 20 07 0
Fax: +49 (0)2306 20 07 10

Service Centre Düsseldorf
GKN Service International GmbH
Gutenbergweg 2 / Max Planck
Straße
40699 Erkrath
Phone: +49 (0)2104 93 37 46
Fax: +49 (0)2104 93 37 43

Service Centre Frankfurt
GKN Service International GmbH
Am Erlenbruch 5
63505 Langenselbold
Phone: +49 (0)6184 93 94 11
Fax: +49 (0)6184 93 94 19

Service Centre Halle
GKN Service International GmbH
Mägdeberge 9
06188 Landsberg / OT Braschwitz
Phone: +49 (0)34604 257 0
Fax: +49 (0)34604 257 30

Service Centre Hamburg
GKN Service International GmbH
Ottensener Straße 150
22525 Hamburg
Phone: +49 (0)40 54 00 90 0
Fax: +49 (0)40 54 00 90 44

Service Centre Hannover
GKN Service International GmbH
Max-Müller-Straße 23
30179 Hannover
Phone: +49 (0)511 39 08 95 0
Fax: +49 (0)511 39 08 95 29

Service Centre Kassel
GKN Service International GmbH
Dormannweg 48
34123 Kassel
Phone: +49 (0)561 51 05 10
Fax: +49 (0)561 51 05 129

Service Centre München
GKN Service International GmbH
Siemensstraße 11
85221 Dachau
Phone: +49 (0)8131 90 80 40
Fax: +49 (0)8131 90 80 425

Service Centre Nürnberg
GKN Service International GmbH
Am Keuper 1
90475 Nürnberg
Phone: +49 (0)9128 92 75 3
Fax: +49 (0)9128 92 75 40

Service Centre Stuttgart
GKN Service International GmbH
Max-Eyth-Straße 12
71254 Ditzingen
Phone: +49 (0)7156 93 94 0
Fax: +49 (0)7156 93 94 25

Italy / Italien

Central Service Hotline - 24 hrs:
+39 800.009.110

Service Centre Milan
GKN Service Italia S.p.A.
Via G. Carducci 133
20093 Cologno Monzese (MI)
Phone: +39 02 38338.1
Fax: +39 02 33301030

The Netherlands / Holland

Central Service Hotline - 24 hrs:
0800 - CARDANAS (0800 - 22732627)
Service Centre Amsterdam
GKN Service Benelux BV
Haarlemmerstraatweg 153-157
1165 MK Halfweg
Phone: +31 20 40 70 207
Fax: +31 20 40 70 217

Norway / Norwegen

Central Service Hotline - 24 hrs:
+47 22 30 55 75
Service Centre Oslo
GKN Driveline Service Scandinavia AB
Karihaugveien 102
1086 Oslo
Phone: +47 23 28 68 10
Fax: +47 23 28 68 19

Poland / Polen

Central Service Hotline - 24 hrs:
+ 48 519 115 534
Service Centre Warszawa
GKN Service Polska Sp. z o.o.
Aleja Katowicka 33
05-830 Wolica, gmina Nadarzyn
Phone: +48 22 43 59 704
Fax: +48 22 43 59 705

Spain / Spanien

Central Service Hotline - 24 hrs:
+34 93 718 64 85

Service Centre Barcelona
GKN Ayra Servicio S.A.
Pol. Ind. Can Salvatella
Avenida Arrahona, 54
08210 Barberá del Vallés (Barcelona)
Phone: +34 93 718 64 85
Fax: +34 93 729 47 59

Service Centre Madrid
GKN Ayra Servicio S.A.
c/ Pico de la Mira 9
28944 Fuenlabrada (Madrid)
Phone: +34 91 690 95 77
Fax: +34 91 492 07 68

Sweden / Schweden

Central Service Hotline - 24 hrs:
+ 46 020 100 170

Service Centre Stockholm
GKN Driveline Service Scandinavia AB
Alfred Nobels Allé 110
146 48 Tullinge
Phone: +46 08 603 97 00
Fax: +46 08 603 97 01

Switzerland / Schweiz

Central Service Hotline - 24 hrs:
+41 79 424 83 58

Service Centre Zürich
GKN Service International GmbH
Althardstraße 141
8105 Regensdorf
Phone: +41 44 87 16 070
Fax: +41 44 87 16 080

United Kingdom / England

Central Service Hotline - 24 hrs:
+44 (0)800 917 2867

Service Centre Leek
GKN Driveline Service Ltd.
Higher Woodcroft
Leek
Staffordshire ST13 5QF
Phone: +44 15 38 38 42 78
Fax: +44 15 38 37 12 65

Service Centre Minworth
Unit 5, Kingsbury Business Park
Minworth
Sutton Coldfield
West Midlands B76 9DL
Phone: +44 12 13 13 16 61
Fax: +44 12 13 13 20 75

(GB)	(D)	(F)
GKN part no.	GKN Teile Nr.	réf GKN
OE part no.	OE. Teile Nr.	réf OE
Engine	Motor	Moteur
kW (kilowatt)	kW (Kilowatt)	kW (Kilowatt)
6 year of manufacture	Baujahr	Année de construction
Transmisson	Getriebe	Transmisson
MT	Manuell	Transmission Manuel
AT	Automatik	Transmission Automatique
(GB)	(E)	(NL)
GKN part no.	Ref. GKN	ref. GKN
OE part no.	Ref. Original	ref. OE
Engine	Motor	Motor
kW (kilowatt)	Kilovatio	kW (Kilowatt)
6 year of manufacture	Año de Construcción	Bouwjaar
Transmisson	Engranaje	Versnellingsbak
MT	Caja de Cambios	Handgeschakeld
AT	Cambio Automático	Automaat
(GB)	(I)	(S)
GKN part no.	rif. GKN	GKN artikelnummer
OE part no.	rif. OE	OE artikelnummer
Engine	Motore	Motor
kW (kilowatt)	Kilowatt	kW (kilowatt)
6 year of manufacture	Anno di Costruzione	tillverkningsår
Transmisson	Cambio	Transmission
MT	Cambio Manuale	Manuell
AT	Cambio Automatico	Automat
(GB)	(RUS)	(NC)
GKN part no.	Номер ГКН	GKN 产品编号
OE part no.	Оригинальный номер	OE 产品编号
Engine	Мотор	发动机
kW (kilowatt)	КВ (Киловат)	千瓦 (功率)
6 year of manufacture	Год производства	生产年份
Transmisson	Трансмиссия	变速箱
MT	Механическая Коробка передач	手动
AT	Автоматическая Коробка передач	自动

Passenger Cars, Sports Utility Vehicles & Vans	Page
---	-------------

Audi	
-------------	--

A6	2-3
A8	4-5
Q5	6-7
Q7	8-9

Dacia	
--------------	--

Duster	10
--------	----

Fiat	
-------------	--

Fiat Panda 4x4	11
----------------	----

Jeep	
-------------	--

Grand Cherokee II	12
-------------------	----

Landrover	
------------------	--

Freelander	13
Discovery	13-14
Defender	15
Range Rover	16
Misc.	17-18

Mercedes	
-----------------	--

Vito / Viano	19
--------------	----

Porsche	
----------------	--

Cayenne	20
---------	----

Seat	
-------------	--

Alhambra	21
----------	----

Toyota	
---------------	--

Hilux	22
-------	----

Volkswagen	
-------------------	--

Touareg	23-24
T4 bus / box wagon / pickup	25-26
T5 bus / box wagon / pickup / multi van	27-28
Phaeton	29
Tiguan	29
Sharan	30
Amarok	31
Caddy	32

A6 (C6/4F) sedan / station wagon

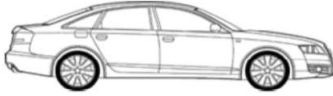

Engine	kW	⌚	Transm.	OE Part No.	L f.c.	A	B	6xd	D	Position	GKN No.
			MT Manual AT Autom.								

RS6 Quattro 5.0	426	04.08-08.10	AT	4F0 521 101 G/H	1583	86	86	8,1	50	rear	28142
-----------------	-----	-------------	----	-----------------	------	----	----	-----	----	------	--------------

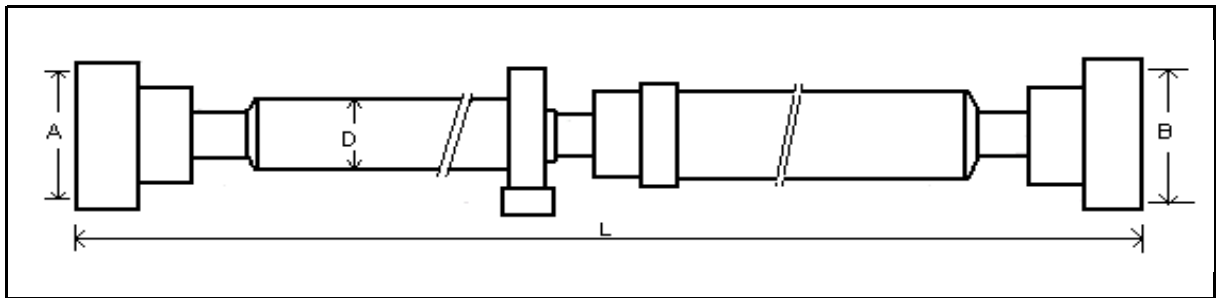

A6 (C6/4F) sedan / station wagon / allroad (C6/4FH)

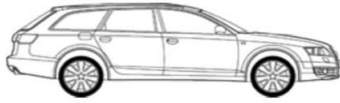

Engine	kW		Transm.	OE Part No.	L f.c.	A	B	6xd	D	Position	GKN No.
			MT Manual AT Autom.								

2.4 Quattro	130	01.05-10.08	MT 6-gear	4F0 521 101 B/F	1744	86	86	8,1	60	rear	28143
2.8 FSI Quattro	140-162	06.07-08.11	AT/MT 6-gear								
3.2 FSI Quattro	183-188	05.04-10.08	AT/MT 6-gear								
4.2 FSI Quattro	246-257	05.04-08.11	AT 6-gear								
2.7 TDI Quattro	120-140	11.04-08.11	AT/MT 6-gear								
3.0 TDI Quattro	155-176	05.04-08.11	AT/MT 6-gear								

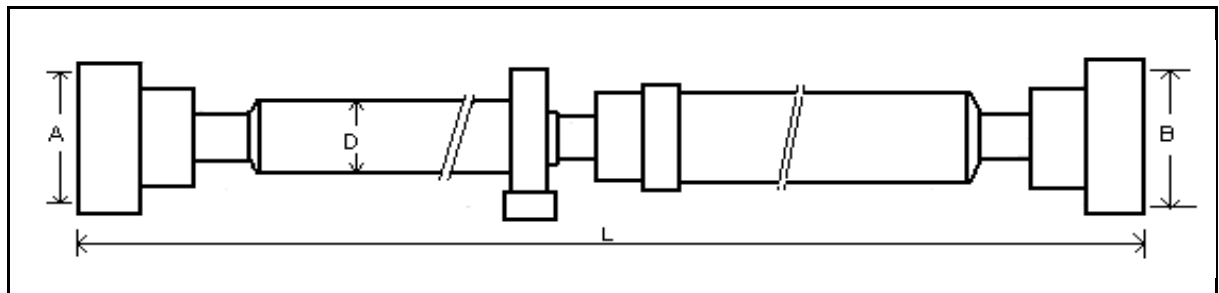

A8



Engine	kW		Transm.	OE Part No.	L	A	B	6xd	D	Position	GKN No.
			MT Manual AT Autom.								

4.2 Quattro	228	11.98 - 09.02	MT	4D0 521 101 R	1912	86	86	8,1	63	rear	28130
4.2 Quattro	175	02.99 - 04.00	MT								
S 8 Quattro 4.2	265	06.99 - 09.02	MT								
S 8 Quattro 4.2	250	07.98 - 06.99	MT								

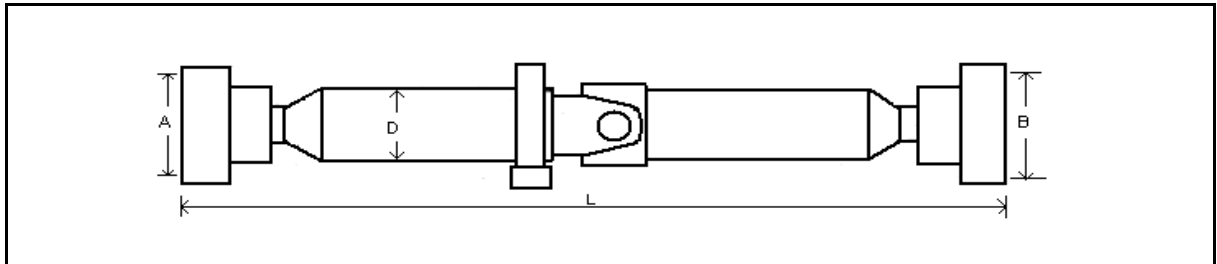

A8 long wheelbase (D3/4E)

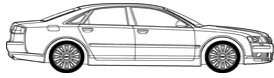

Engine	kW		Transm.	OE Part No.	L	A	B	6xd	D	Position	GKN No.
			MT Manual AT Autom.								

4.2 FSI	257	06.06 - 07.10	AT	4E4 521 101 D	2014	86	86	8,1	60	rear	28128
---------	-----	---------------	----	---------------	------	----	----	-----	----	------	--------------

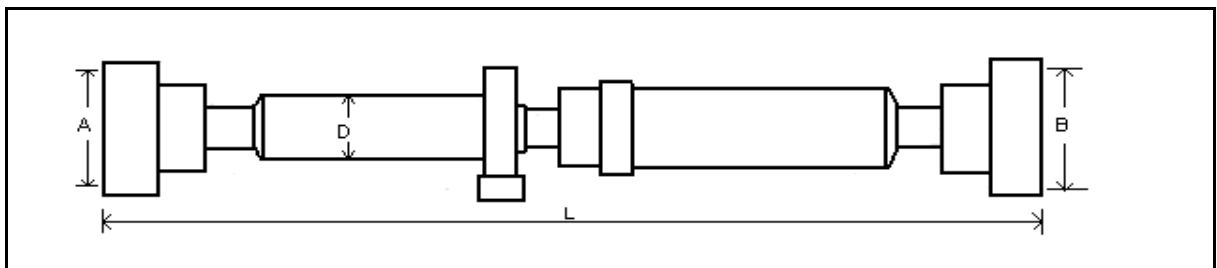

A8 long wheelbase (D3/4E)

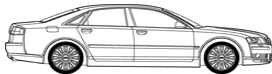

Engine	kW		Transm.	OE Part No.	L	A	B	6xd	D	Position	GKN No.
			MT Manual AT Autom.								

4.2 Otto	246	10.02 - 07.10	AT	4E4 521 101 F	1853	86	86	8,1	60	rear	28118
S8 5.2 Otto	331	06.06 - 07.10	AT								
6.0 W12 Otto	331	12.03 - 07.10	AT								
4.0 TDI	202	03.03 - 07.10	AT								
4.2 TDI	240	07.05 - 07.10	AT								

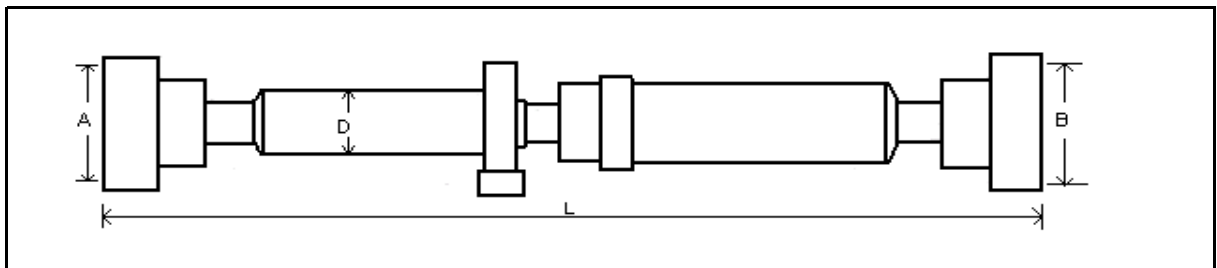

Q 5



Engine	kW		Transm.	OE Part No.	L f.c.	A	B	6xd	D	Position	GKN No.
			MT Manual AT Autom.								

2.0 TSFI	132	08.09-08.10	only AT 7-gear	8R0 521 101 B	1475	86	86	8,1	60	rear	28131
2.0 TSFI	155	11.08-08.10									
3.2 FSI	199	11.08-08.10									
2.0 TDI	105	08.09-08.10									
2.0 TDI	125	11.08-08.10									
3.0 TDI	155	11.08-08.10									
3.0 TDI	176	11.08-08.10									

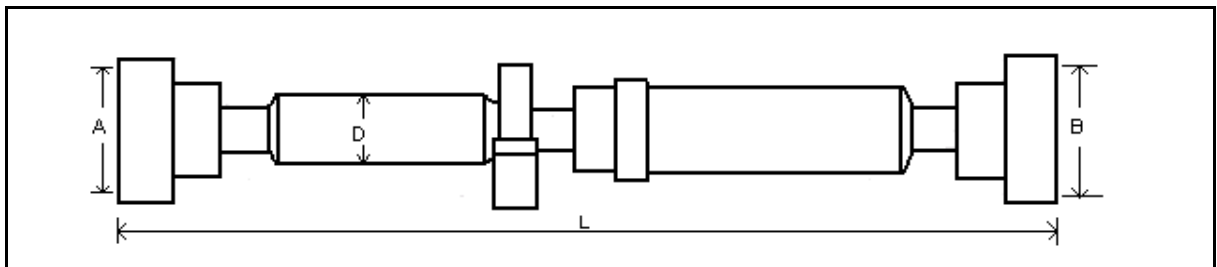

Q 5



Engine	kW		Transm.	OE Part No.	L f.c.	A	B	6xd	D	Position	GKN No.
			MT Manual AT Autom.								

2.0 TSFI	132	09.10-	only AT 7-/8- gear	8R0 521 101 E/K	1509	81	86	8,1	60	rear	28132
2.0 TSFI	155	09.10-									
3.2 FSI	199	09.10-									
2.0 TDI	105	09.10-									
2.0 TDI	125	09.10-									
3.0 TDI	155	09.10-									
3.0 TDI	176	09.10-									

3.2 FSI	199	09.10-	only AT 6-gear	8R0 521 101 F/ L/M	1525	81	86	8,1	60	rear	28133
---------	-----	--------	-------------------	-----------------------	------	----	----	-----	----	------	--------------

2.0 TSFI	132	09.10-	MT	8R0 521 101 D/J	1661	81	86	8,1	60	rear	28134
2.0 TSFI	155	09.10-									
2.0 TDI	105	09.10-									
2.0 TDI	125	09.10-									

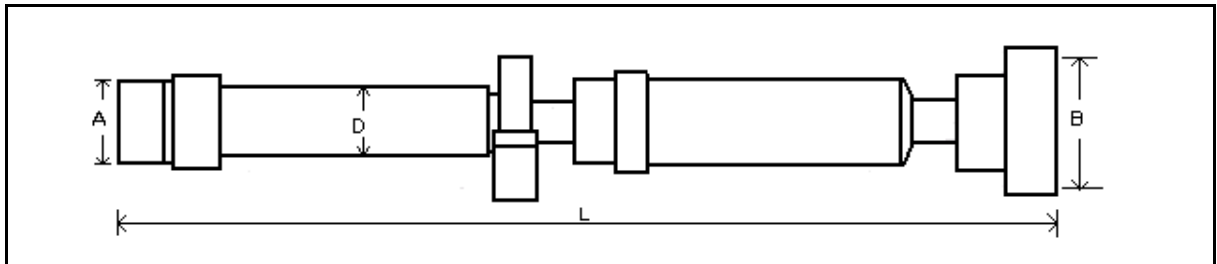

Q7

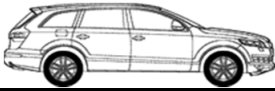

Engine	kW		Transm.	OE Part No.	L	A	B	6xd	D	Position	GKN No.
			MT Manual AT Autom.								

3.0 TDI	155	03.06-	AT/MT	7L0 521 101 A/B/D/F/G/H	631,9	86	86	10,2	50	front	28052
3.0 TDI	171	03.06-	AT/MT								
3.0 TDI	176	11.07-	AT/MT	7L6 521 101D/ F/H/P							
3.6 FSI	206	08.06-	AT/MT								
4.2 FSI	257	03.06-	AT/MT								



Q7

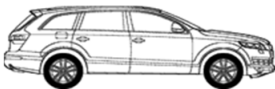

Engine	kW		Transm.	OE Part No.	L	A	B	6xd	D	Position	GKN No.
			MT Manual AT Autom.								

3.6 FSI	206	08.06-	AT/MT	7L8 521 102F/M	1455	86	86	10,2	50	rear	28119
4.2 FSI	257	03.06-	AT/MT								

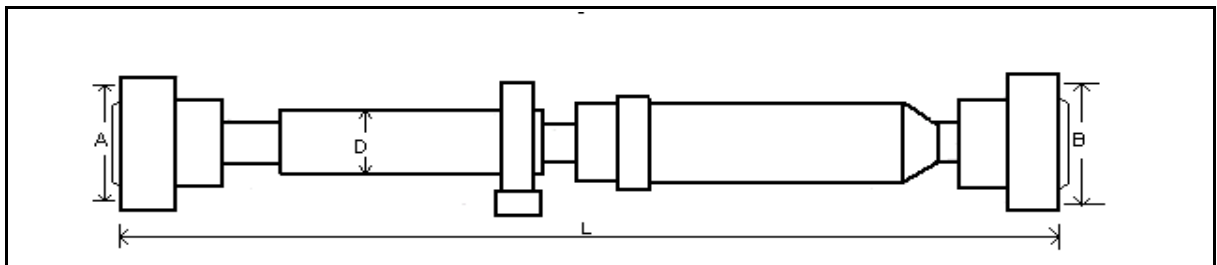

Q7

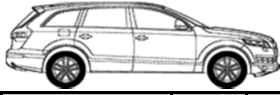

Engine	kW	⌚	Transm.	OE Part No.	L	A	B	6xd	D	Position	GKN No.
			MT Manual AT Autom.								

3.0 TDI	150 - 180	03.06-	AT/MT	7L8 521 102 C/G/L	1455	86	86	10,3	50	rear	28137
---------	-----------	--------	-------	-------------------	------	----	----	------	----	------	--------------

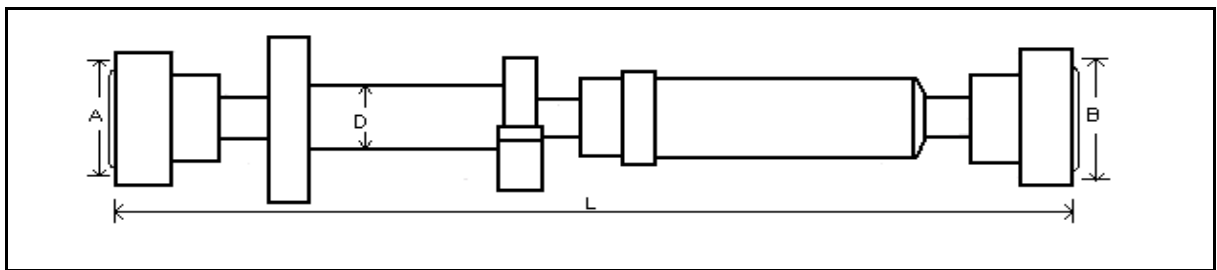

Q7



Engine	kW	⌚	Transm.	OE Part No.	L f.c.	A	B	No. of gaps	D	Position	GKN No.
			MT Manual AT Autom.								

3.0 TFSI	200 - 245	05.10-	AT/MT	7L8 521 102 S	1562	32	29	A:37 B:34	50	rear	28140
----------	-----------	--------	-------	---------------	------	----	----	--------------	----	------	--------------

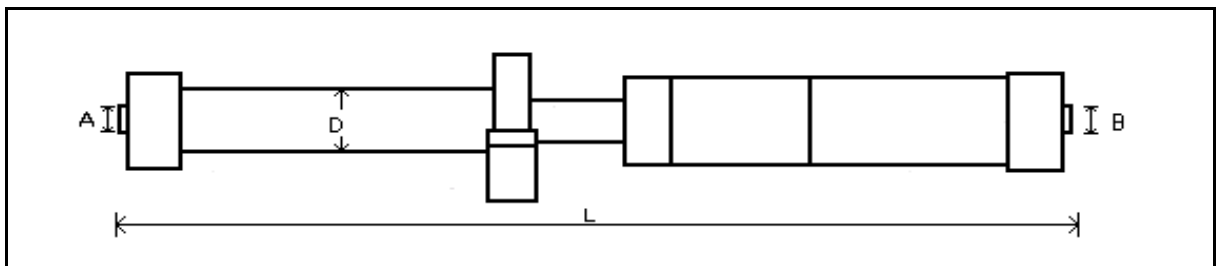

Duster



Engine	kW		Transm.	OE Part No.	L f.c.	A	B	4xd	D	Position	GKN No.
			MT Manual AT Autom.								

1.6 16V	77	01.10-	MT	37000 2820R	2078	95	95	10,7	57	rear	28141
1,5 dCi	66-81										

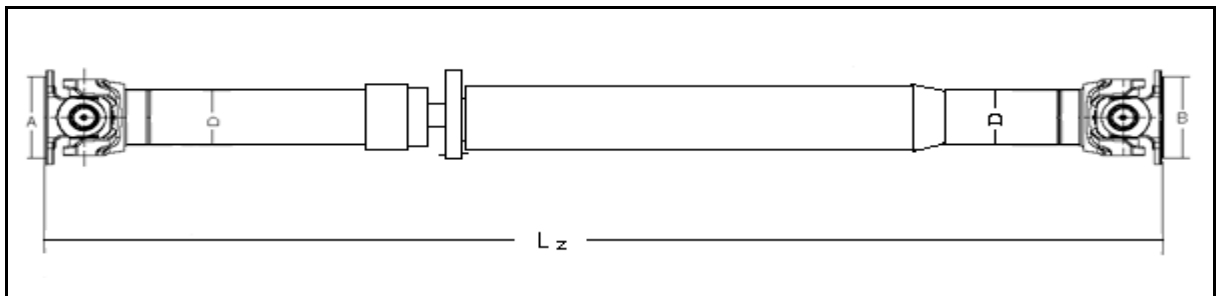

Panda 4x4 (169/139)



Engine	kW		Transm.	OE Part No.	L	A	B	Position	GKN No.
			MT Manual AT Autom.						

1.2i 4x4	44	10.04 -	MT/AT	55193595 55197051	1729,5	74	74	rear	28125
1.3d 4x4	51	10.04 -	MT/AT	552221070	1729,5	74	74		28125

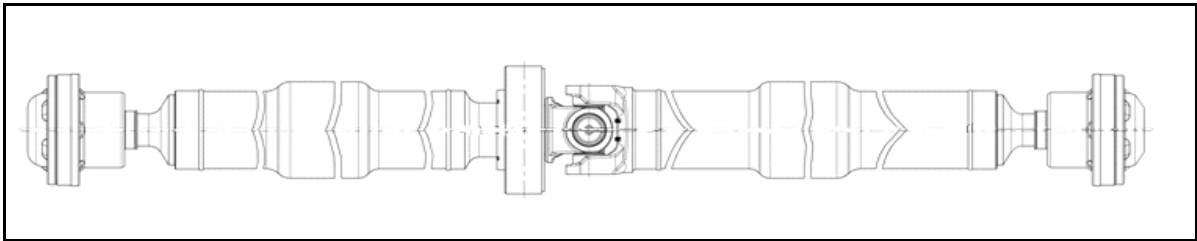

Grand Cherokee II



Engine	kW		Transm.	OE Part No.	L	A	B	D	Position	GKN No.
			MT Manual AT Autom.							

3.1 TD	162	04.99 - 09.05	AT/MT	52099499AG	804	86	86	45,7	front	28081
4.0	140	04.99 -	AT/MT	52099497AE	830	86	86	45,7		28082
4.7 V8	162	04.99 - 08.00	AT/MT	52099498AE	791	86	86	45,7		28080

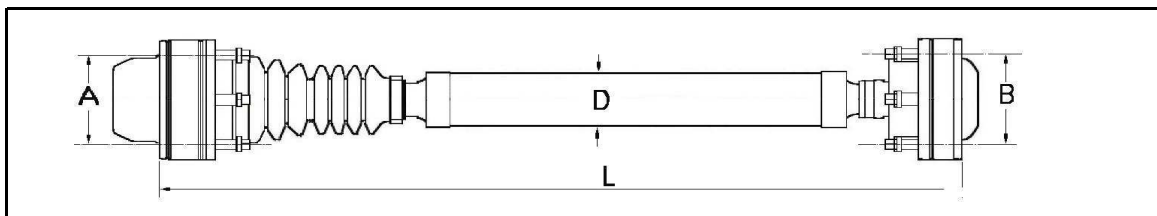

Landrover

Passenger Cars, Sports Utility Vehicles & Vans

Freelander



Engine	kW	⌚	Transm.	OE Part No.	L	A	B	D	Position	GKN No.
			MT Manual AT Autom.							

1.8 i 16V	88	02.98 - 11.00	MT	TVB000170	2010	95	57	60	rear	28087
1.8 i 16V	88	11.00 -	MT	TVB000170	2010	95	57	60		28087
2.0 DI	72	02.98	MT	TVB000170	2010	95	57	60		28087
2.0 TD4	82	11.00 -	MT	TVB000170	2010	95	57	60		28087
2.0 TD4	80	11.01 -	MT	TVB000170	2010	95	57	60		28087

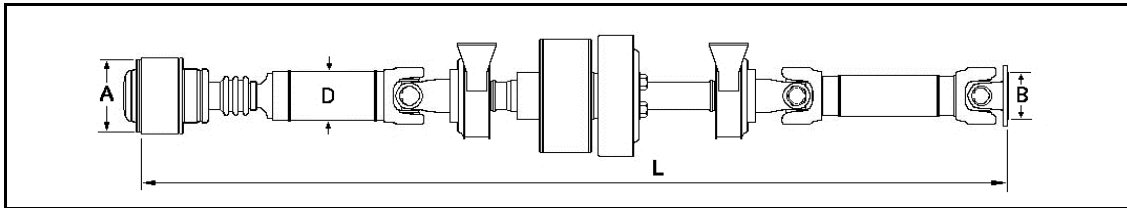

Discovery



Engine	kW	⌚	Transm.	OE Part No.	L	A	B	D	Position	GKN No.
			MT Manual AT Autom.							

2.5 TD4	102	01.99 -	MT/AT	TVB000100	604	60	65	50	front	28088
---------	-----	---------	-------	-----------	-----	----	----	----	-------	--------------

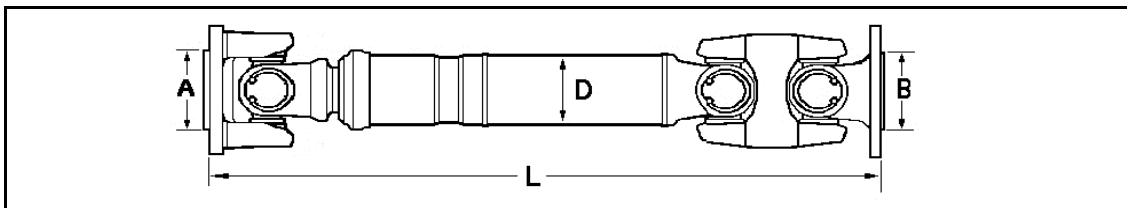

Landrover

Passenger Cars, Sports Utility Vehicles & Vans

Discovery



Engine	kW	⌚	Transm.	OE Part No.	L	A	B	D	Position	GKN No.
			MT Manual AT Autom.							

3.9 V8	134	09.93 - 06.94	MT/AT	FRC8386	604	60	60	51	front	27924
3.9 V8	134	09.93 - 06.94	MT/AT	TVB100610	604	60	60	51		27930
3.9 V8	134	09.93 - 06.94	MT/AT	FRC8387	861	60	60	51		27927

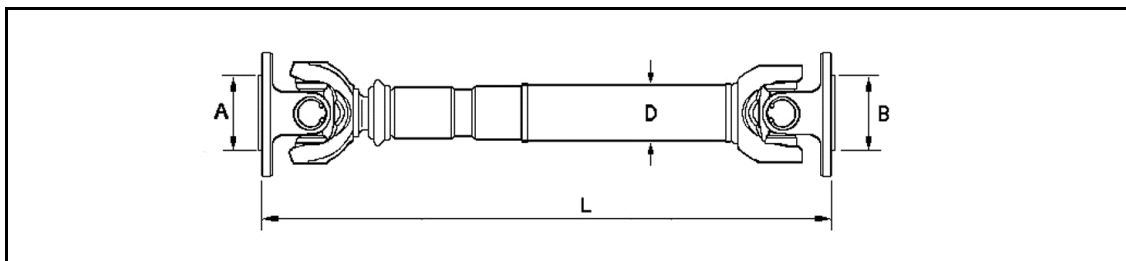

Landrover

Passenger Cars, Sports Utility Vehicles & Vans

Defender



Engine	kW	⌚	Transm.	OE Part No.	L	A	B	D	Position	GKN No.
			MT Manual AT Autom.							

2.5D	83	09.90 - 12.98	MT/AT	FRC8390	650	60	60	51	front	27925
2.5TDI	83	09.90	MT/AT	FRC8390	650	60	60	51		27925
2.5D	83	09.90 - 12.98	MT/AT	FRC8392	635	60	60	51		27926
2.5TDI	83	09.90	MT/AT	FRC8392	635	60	60	51		27926

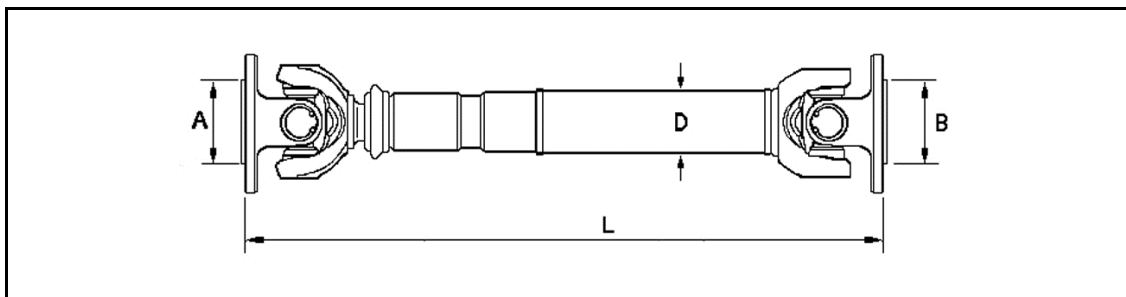

Defender

Engine	kW	⌚	Transm.	OE Part No.	L	A	B	D	Position	GKN No.
			MT Manual AT Autom.							

2.5D	83	09.90 - 12.98	MT/AT	FRC 5566	650	60	60	51	front	27920
2.5TDI	83	09.90	MT/AT	FRC 5566	650	60	60	51		27920

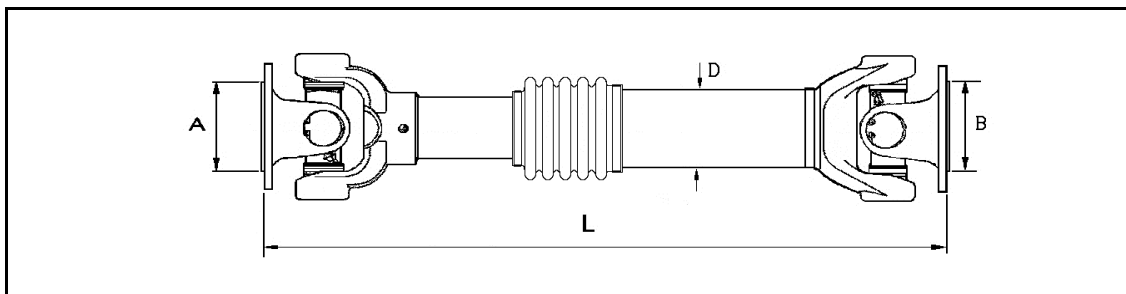

Landrover

Passenger Cars, Sports Utility Vehicles & Vans

Range Rover



Engine	kW		Transm.	OE Part No.	L	A	B	D	Position	GKN No.
			MT Manual AT Autom.							

2.4D	78	04.86 - 12.90	MT/AT	FRC8386	604	60	60	51	front	27924
3.5i	107	01.87 - 09.90	MT/AT	FRC8386	604	60	60	51		27924
3.5 Vouge	120	10.85 - 09.90	MT/AT	FRC8386	604	60	60	51		27924
3.5 Vouge SEI	134	11.88 - 07.94	MT/AT	FRC8386	604	60	60	51		27924
3.9	127	11.88 - 07.94	MT/AT	FRC 8386	604	60	60	51		27924

2.4D	78	04.86 - 12.90	MT/AT	FRC8387	861	60	60	51	front	27927
3.5i	107	01.87 - 09.90	MT/AT	FRC8387	861	60	60	51		27927
3.5i	113	09.98 - 06.94	MT/AT	FRC8387	861	60	60	51		27927
3.5 Vouge	120	10.85 - 09.90	MT/AT	FRC8387	861	60	60	51		27927
3.5 Vouge SEI	134	11.88 - 07.94	MT/AT	FRC8387	861	60	60	51		27927
3.9	127	11.88 - 07.94	MT/AT	FRC8387	861	60	60	51		27927
4.3 Vouge LSE	149	09.92 - 07.94	MT/AT	FRC8387	861	60	60	51	27927	

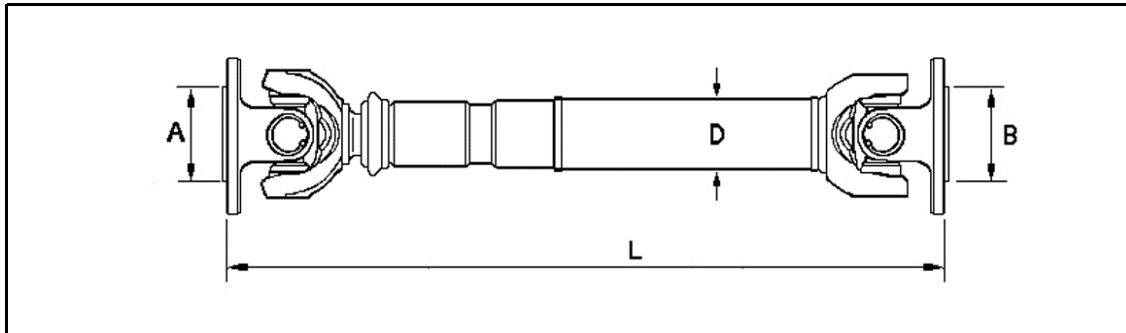

Landrover

Passenger Cars, Sports Utility Vehicles & Vans

Misc.

Engine	kW		Transm.	OE Part No.	L	A	B	D	Position	GKN No.
			MT Manual AT Autom.							

				553000	580	60	60	51	front	27916
				FRC 6243	605	60	60	51		27917
				571955	620	60	60	51		27918
				FRC 4799	620	60	60	51		27919

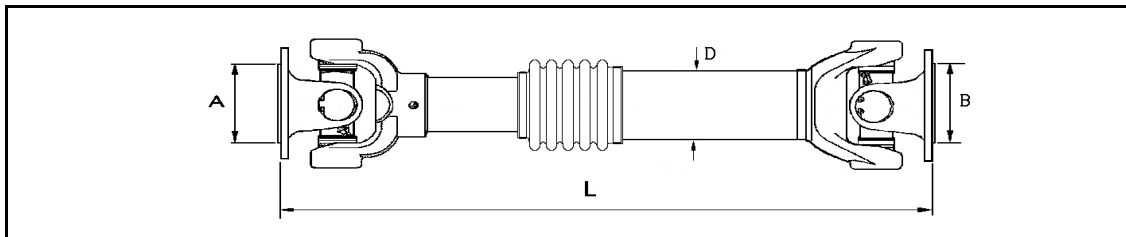

Misc.

Engine	kW		Transm.	OE Part No.	L	A	B	D	Position	GKN No.
			MT Manual AT Autom.							

				571973	852	60	60	51	front	27915
--	--	--	--	--------	-----	----	----	----	-------	--------------

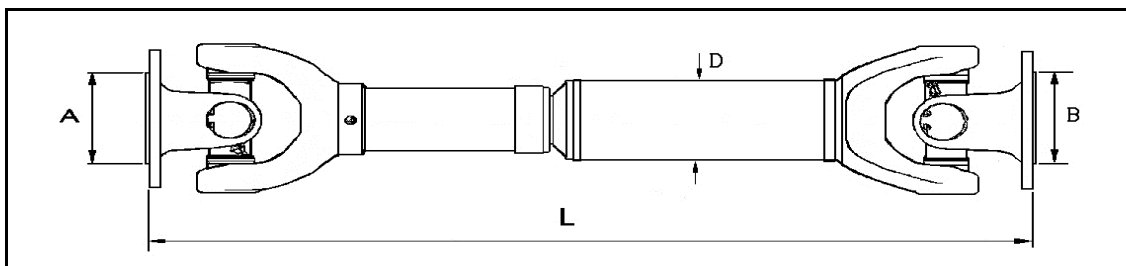

Misc.

Engine	kW		Transm.	OE Part No.	L	A	B	D	Position	GKN No.
			MT Manual AT Autom.							

				591278	528	60	60	51	front	27922
				594361	618	60	60	51		27923

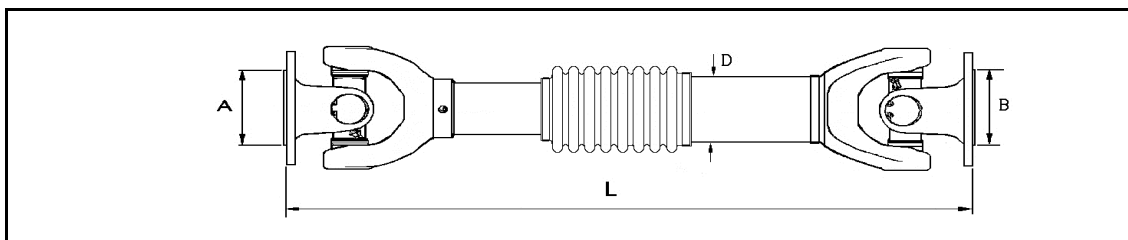

Mercedes

Passenger Cars, Sports Utility Vehicles & Vans

Vito / Viano

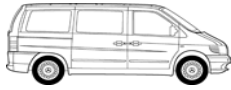

Engine	kW		Transm.	OE Part No.	L	A	B	D	Position	GKN No.
			MT Manual AT Autom.							

CDI 2.2 4x4	80	09.07 -	MT	A6393370010	430			103	front	28083
CDI 2.2 4x4	110	09.07 -	MT	A6393370010	430			103		28083
CDI 2.2 4x4 4-matic	80	09.07 -	AT	A6393370010	430			103		28083
CDI 2.2 4x4 4-matic	110	09.07 -	AT	A6393370010	430			103		28083
				A6393370110	480			103		28084

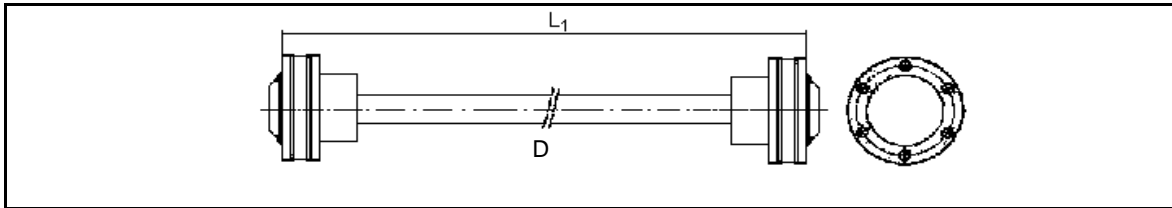

Porsche

Passenger Cars, Sports Utility Vehicles & Vans

Cayenne



Engine	kW	⌚	Transm.	OE Part No.	L	A	B	D	Position	GKN No.
			MT Manual AT Autom.							

V6 3.0 TDI	176	02.09 -	MT/AT	955.421.020.03	631,9	86	86	50	front	28052
V8 S 4.5	250	09.02 -	MT/AT	955.421.020.03	631,9	86	86	50	front	28052
V8 Turbo 4.5	330	09.02 -	MT/AT	955.421.020.03	631,9	86	86	50	front	28052

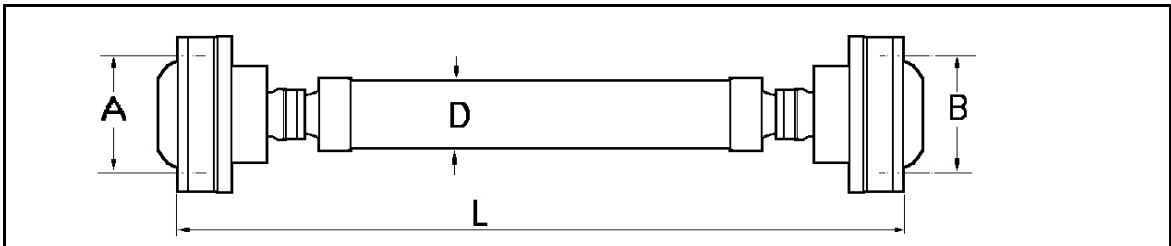

Engine	kW	⌚	Transm.	OE Part No.	L	A	B	D	Position	GKN No.
			MT Manual AT Autom.							

V6 3.0 TDI	176	02.09 -	MT/AT	955.421.020.11 - .15	1246	110	99.5	70	rear	28054
V8 S 4.5	250	09.02 -	MT/AT	955.421.020.11 - .15	1246	110	99.5	70	rear	28054
V8 Turbo 4.5	330	09.02 -	MT/AT	955.421.020.11 - .15	1246	110	99.5	70	rear	28054

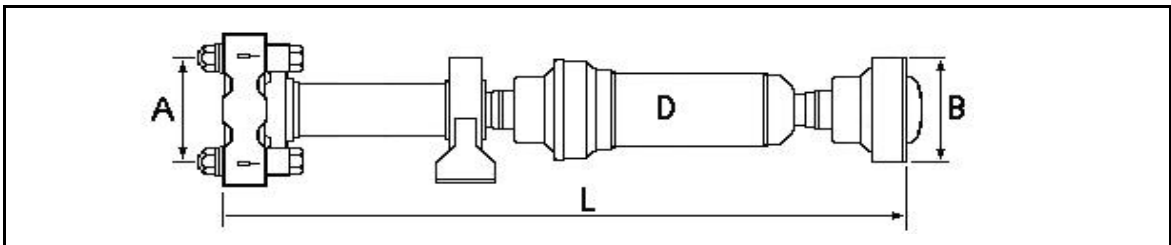

Alhambra

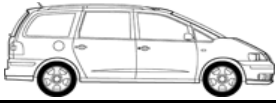

Engine	kW	⌚	Transm.	OE Part No.	L	A	B	D	Position	GKN No.
			MT Manual AT Autom.							

1.9 TDI 4Motion	85	02.01 -	MT/AT	7M3 521 102 95VW 4680 AD	873	99,5	99,5	35	front	28110
2.8 V6 4Motion	150	02.01 -	MT/AT	7M3 521 102 95VW 4680 AD	873	99,5	99,5	35		28110

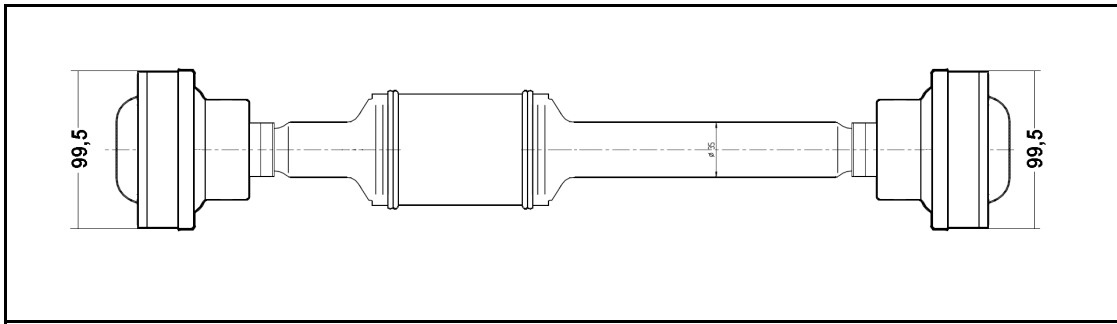

Engine	kW	⌚	Transm.	OE Part No.	L				Position	GKN No.
			MT Manual AT Autom.							

1.9 TDI 4Motion	85	02.01 -	MT/AT	7M3 521 103 B	1570				rear	28109
2.8 V6 4Motion	150	02.01 -	MT/AT	7M3 521 103 B	1570					28109

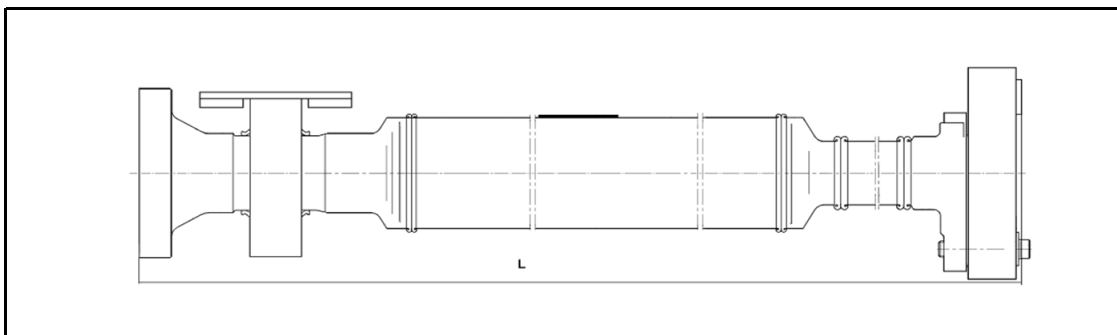

Toyota

Passenger Cars, Sports Utility Vehicles & Vans

Hilux



Engine	kW		Transm.	OE Part No.	L	A	B	Position	GKN No.
			MT Manual AT Autom.						

				37140-0K060A	610			front	28116
				37100-0K260A	1629			rear	28117

Touareg



Engine	kW		Transm.	OE Part No.	L	A	B	D	Position	GKN No.
			MT Manual AT Autom.							

2.5 R5 TDI	128	01.03 -	AT	7L6 521 101 C/E/G/L/N	694,3	86	86	50	front	28051
5.0 V10 TDI	230	10.02 -	AT	7L6 521 101 C/E/G/L/N	694,3	86	86	50		28051

3.0 V6 TDI	165	11.04 -	AT	7L0 521 101 A/B/D/F/G/H 7L6 521 101 D/F/H/P	631,9	86	86	50	front	28052
3.2 V6	162	10.02 - 11.06	AT	7L0 521 101 A/B/D/F/G/H 7L6 521 101 D/F/H/P	631,9	86	86	50		28052
3.2 V6	177	11.04 - 11.06	AT	7L0 521 101 A/B/D/F/G/H 7L6 521 101 D/F/H/P	631,9	86	86	50		28052
3.6 V6 FSI	206	03.06 -	AT	7L0 521 101 A/B/D/F/G/H 7L6 521 101 D/F/H/P	631,9	86	86	50		28052
4.2 V8	228	12.02 - 11.06	AT	7L0 521 101 A/B/D/F/G/H 7L6 521 101 D/F/H/P	631,9	86	86	50		28052
4.2 V8 FSI	257	12.06 -	AT	7L0 521 101 A/B/D/F/G/H 7L6 521 101 D/F/H/P	631,9	86	86	50		28052
6.0 W12	331	03.05 -	AT	7L0 521 101 A/B/D/F/G/H 7L6 521 101 D/F/H/P	631,9	86	86	50		28052

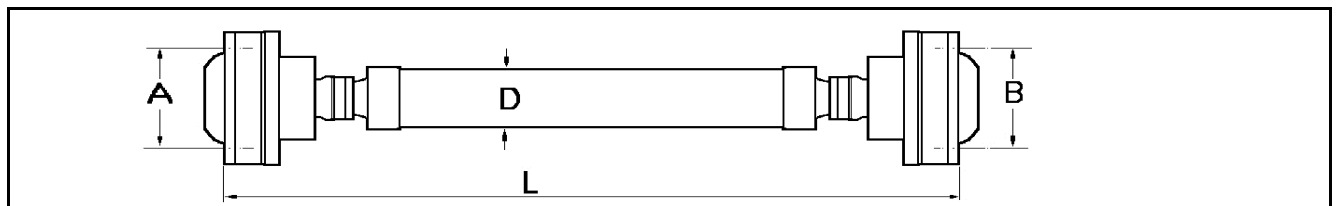

Volkswagen

Passenger Cars, Sports Utility Vehicles & Vans

Touareg

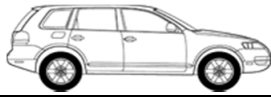

Engine	kW		Transm.	OE Part No.	L	A	B	D	Position	GKN No.
			MT Manual AT Autom.							

3.0 V6 TDI	165	11.04 -	AT	7L0 521 102 B/D/G/H/M/N	1246,4	110	99,5	70	rear	28054
3.2 V6	162	10.02 - 11.06	AT	7L0 521 102 B/D/G/H/M/N	1246,4	110	99,5	70		28054
3.2 V6	177	11.04 - 11.06	AT	7L0 521 102 B/D/G/H/M/N	1246,4	110	99,5	70		28054
3.6 V6 FSI	206	03.06 -	AT	7L0 521 102 B/D/G/H/M/N	1246,4	110	99,5	70		28054
4.2 V8	228	12.02 - 11.06	AT	7L6 521 102 G/J/M/P	1246,4	110	99,5	70		28054
4.2 V8 FSI	257	12.06 -	AT	7L6 521 102 G/J/M/P	1246,4	110	99,5	70		28054
6.0 W12	331	03.05 -	AT	7L0 521 102 B/D/G/H/M/N	1246,4	110	99,5	70	28054	

2.5 R5 TDI	128	01.03 -	AT	7L6 521 102B/C/ D/E/F/H/N/Q	1185,2	110	99,5	70	rear	28055
5.0 V10 TDI	230	10.02 -	AT	7L6 521 102B/C/ D/E/F/H/N/Q	1185,2	110	99,5	70		28055

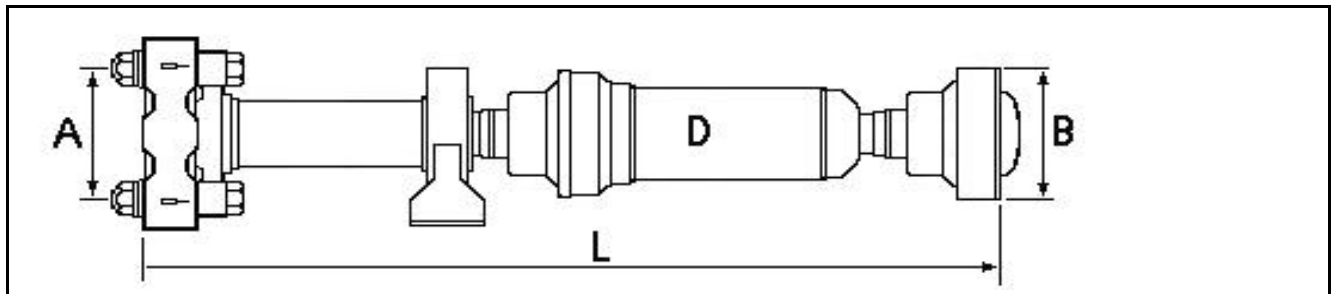

Volkswagen

Passenger Cars, Sports Utility Vehicles & Vans

T4 bus / box wagon / pickup



Engine	kW		Transm.	OE Part No.	L	A	B	D	Position	GKN No.
			MT Manual AT Autom.							
2.4 D Syncro	57	10.92 - 09.98	AT/MT	7D0 521 103	955				front	28103
2.4 i Syncro	85	07.96 - 04.03	AT/MT	7D0 521 103	955			28103		
2.5 i Syncro	81	11.92 - 04.03	AT/MT	7D0 521 103	955			28103		
2.5 TDI Syncro	75	07.96 - 04.03	AT/MT	7D0 521 103 B	953			28115		

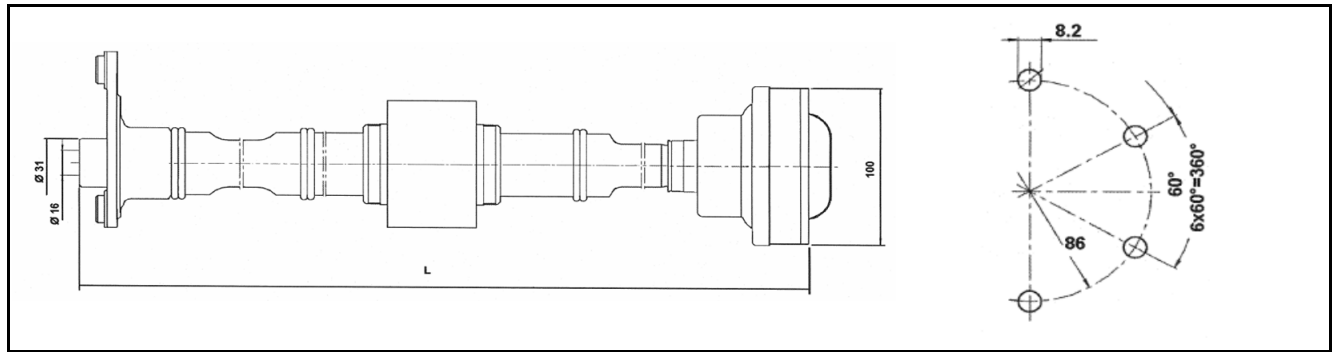

T4 bus / box wagon / pickup

Engine	kW		Transm.	OE Part No.	L	A	B	D	Position	GKN No.
			MT Manual AT Autom.							
				7D0 521 109	1621				rear	28104

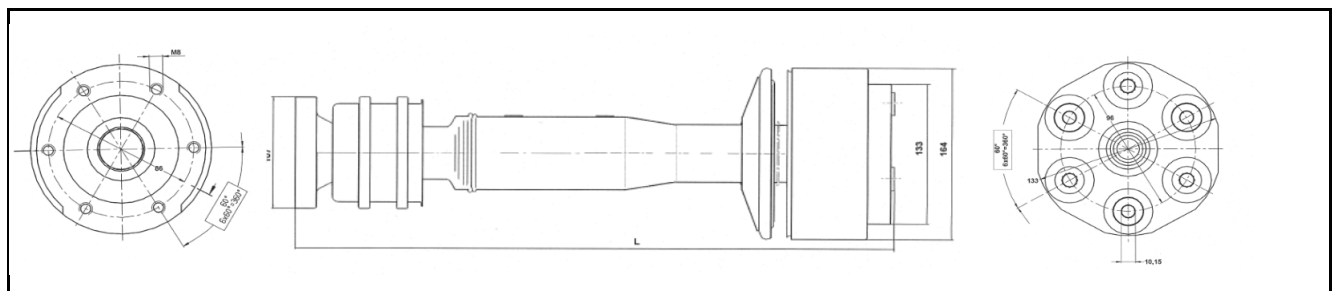

T4 Syncro bus / box wagon / pickup



Engine	kW		Transm.	OE Part No.	L	A	B	D	Position	GKN No.
			MT Manual AT Autom.							

2.4 D Syncro	57	10.92 - 09.98	MT/AT	7D0 521 102 A	2020				rear	28105
2.5 Syncro	81	11.92 - 04.03	MT/AT	7D0 521 102 A	2020			28105		
2.5 Syncro	85	07.96 - 04.03	MT/AT	7D0 521 102 A	2020			28105		
2.5 TDI Syncro	75	01.96 - 04.03	MT/AT	7D0 521 102 A	2020			28105		

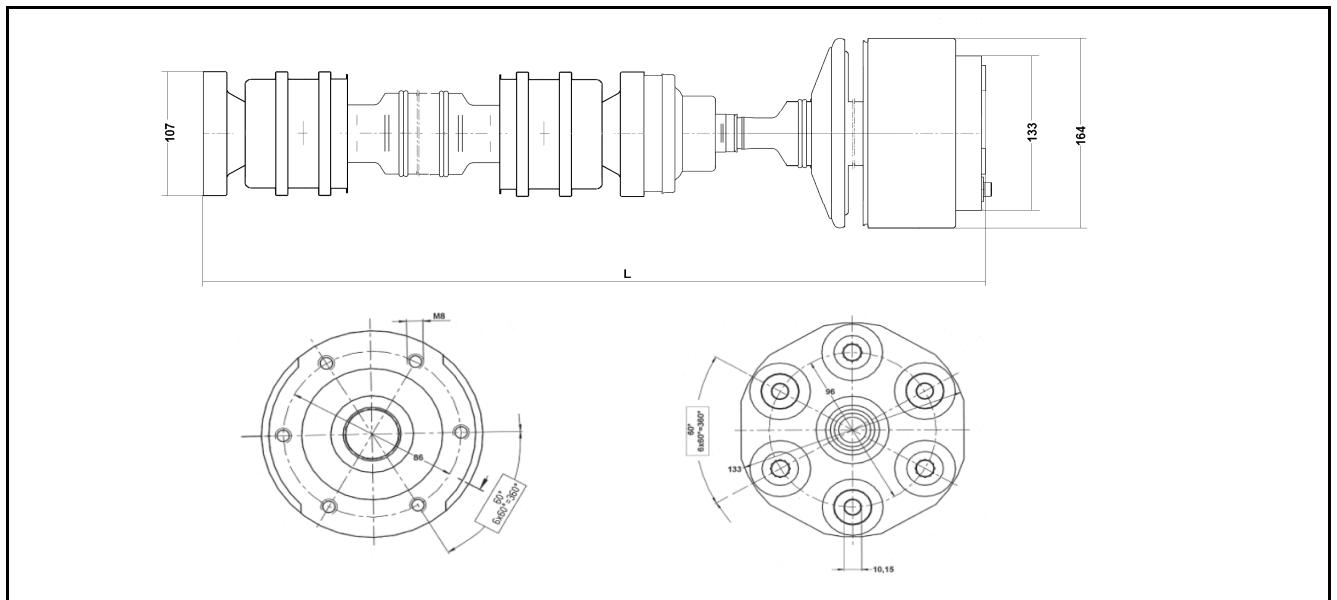

Volkswagen

Passenger Cars, Sports Utility Vehicles & Vans

T5 Transporter bus / box wagon / T5 multi van

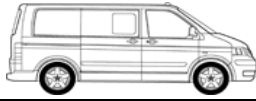

Engine	kW		Transm.	OE Part No.	L	A	B	D	Position	GKN No.
			MT Manual AT Autom.							

2.5 TDI 4Motion	96	07.04 -	MT/AT	7H0 521 101	820				front	28106
2.5 TDI 4Motion	128	07.04 -	MT/AT	7H0 521 101	820			28106		
3.2 V6 4Motion	175	07.04 -	MT/AT	7H0 521 101	820			28106		

T5 Pickup chassis frame (7JD, 7JE, 7JL, 7JY, 7JZ)

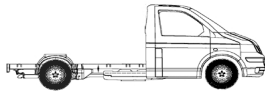

Engine	kW		Transm.	OE Part No.	L	A	B	D	Position	GKN No.
			MT Manual AT Autom.							

2.5 TDI 4Motion	96	07.04 -	MT/AT	7H0 521 101	820				front	28106
-----------------	----	---------	-------	-------------	-----	--	--	--	-------	--------------

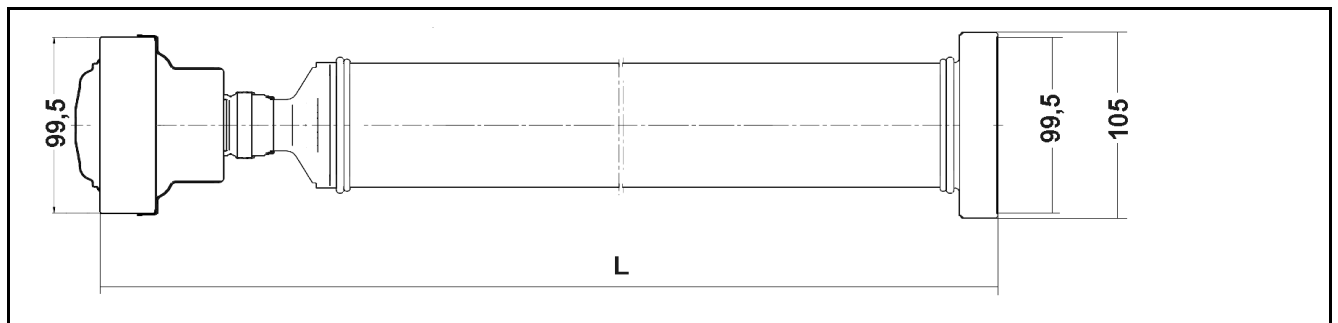

T5 Transporter bus / box wagon / T5 multi van

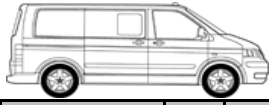

Engine	kW		Transm.	OE Part No.	L	A	B	D	Position	GKN No.
			MT Manual AT Autom.							

2.5 TDI 4Motion	96	07.04 -	MT/AT	7H3 521 102 A	1947				rear	28107
2.5 TDI 4Motion	96	07.04 -	MT/AT	7H1 521 102 A	1582					28108
2.5 TDI 4Motion	128	07.04 -	MT/AT	7H3 521 102 A	1947					28107
2.5 TDI 4Motion	128	07.04 -	MT/AT	7H1 521 102 A	1582					28108
3.2 V6 4Motion	175	07.04 -	MT/AT	7H3 521 102 A	1947					28107
3.2 V6 4Motion	175	07.04 -	MT/AT	7H1 521 102 A	1582					28108

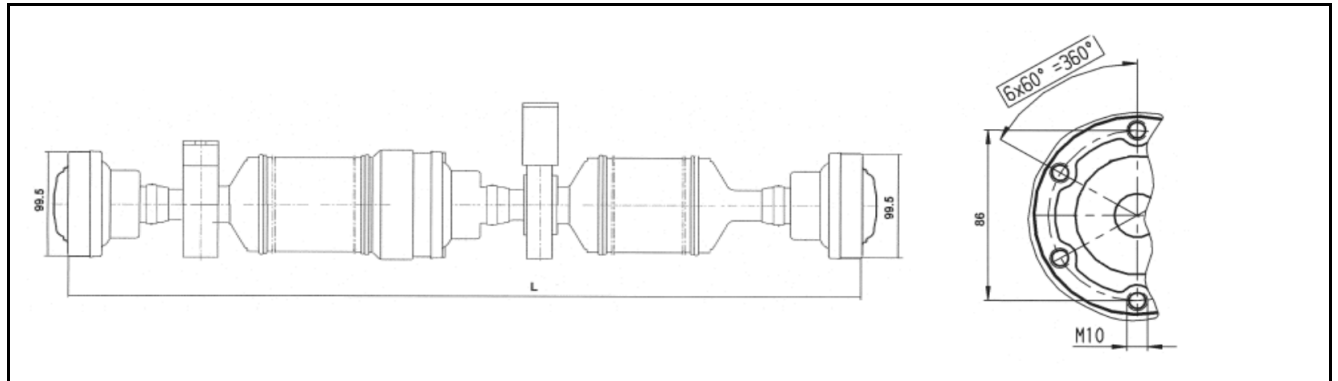

Volkswagen

Passenger Cars, Sports Utility Vehicles & Vans

Phaeton



Engine	kW		Transm.	OE Part No.	L			Wheel Base (mm)	Position	GKN No.
			MT Manual AT Autom.							

5.0 V10 TDI	230	11.02 -	AT	3D0 521 101 R	1745			2881	rear	28126
5.0 V10 TDI	230	11.02 -	AT	3D7 521 101 J	1882			3001		28127

Tiguan



Engine	kW		Transm.	OE Part No.	L				Position	GKN No.
			MT Manual AT Autom.							

1.4 TSI	110	09.07 -	MT/AT	5N0 521 101 C/E/H	2160				rear	28114
2.0 TFSI	125	09.07 -	MT/AT	5N0 521 101 C/E/H	2160					28114
2.0 TFSI	147	09.07 -	MT/AT	5N0 521 101 C/E/H	2160					28114
2.0 TDI	103	09.07 -	MT/AT	5N0 521 101 C/E/H	2160					28114
2.0 TDI	125	09.07 -	MT/AT	5N0 521 101 C/E/H	2160					28114

Volkswagen

Passenger Cars, Sports Utility Vehicles & Vans

Sharan



Engine	kW		Transm.	OE Part No.	L				Position	GKN No.
			MT Manual AT Autom.							

1.9 TDI 4Motion	85	04.00 -	MT/AT	7M3 521 102 95VW 4680 AD	873				front	28110
2.8 V6 4Motion	150	04.00 -	MT/AT	7M3 521 102 95VW 4680 AD	873					28110

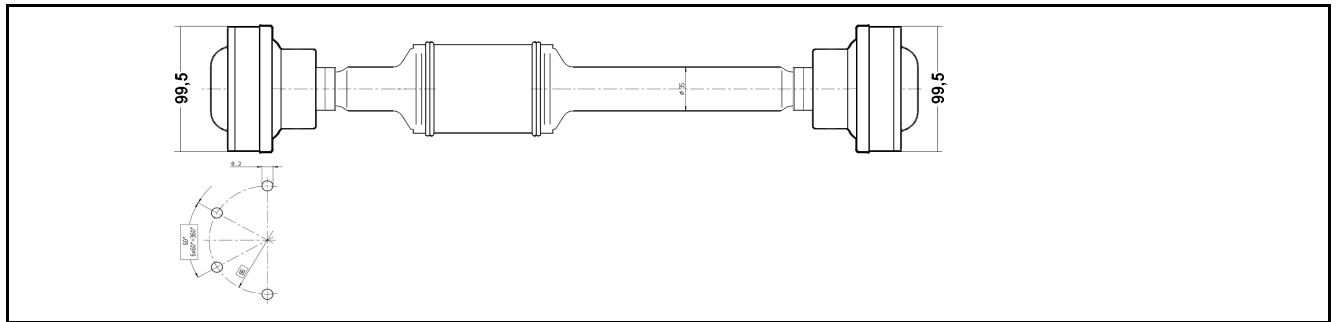

Engine	kW		Transm.	OE Part No.	L				Position	GKN No.
			MT Manual AT Autom.							

1.9 TDI 4Motion	85	04.00 -	MT/AT	7M3 521 103 B	1570				rear	28109
2.8 V6 4Motion	150	04.00 -	MT/AT	7M3 521 103 B	1570					28109

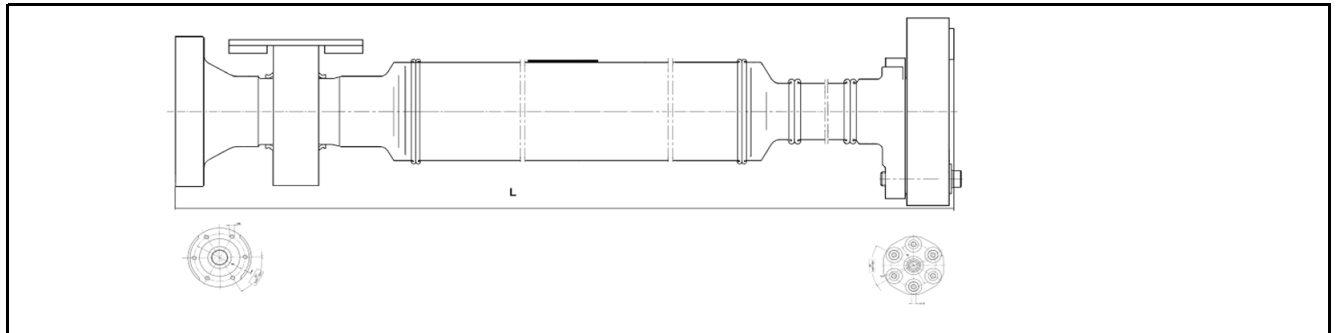

Amarok

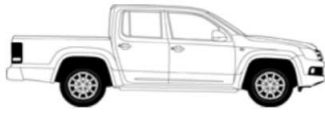

Engine	kW		Transm.	OE Part No.	L f.c.	A	B	No. of teeth	Position	GKN No.
			MT Manual AT Autom.							

2.0 TDI 4Motion	90- 132	03.10-	AT/MT	2H0 521 101 B/C	605	27	29	A:32 B:34	front	28146
2.0 TDI Bi-Turbo 4Motion	120	09.10-	AT/MT							

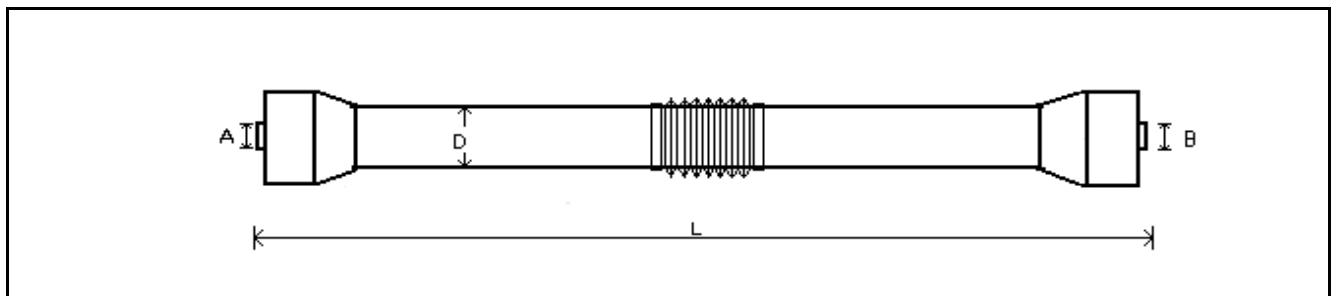

Volkswagen

Passenger Cars, Sports Utility Vehicles & Vans

Caddy III (2K) station wagon / box wagon

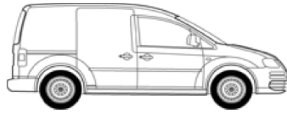

Engine	kW		Transm.	OE Part No.	L f.c.	A	B	D	Position	GKN No.
			MT Manual AT Autom.							

1.9 TDI 4Motion	77	05.08-08.10	AT/MT	2K0 521 101 C/ E/H/M	2180	150	86	64	rear	28147
2.0 TDI 4Motion	81	08.10-	AT/MT							
2.0 TDI 16V 4Motion	103	11.10-	AT/MT							

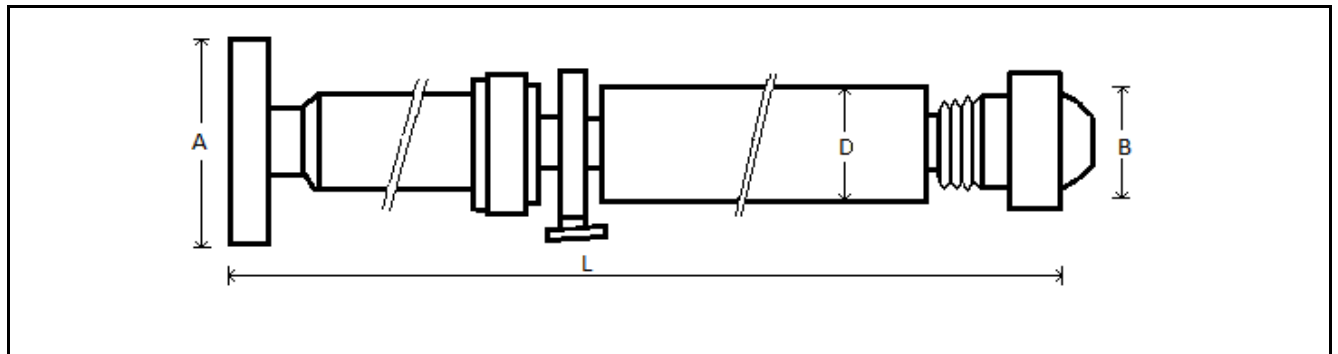



GKN Land Systems
PowerTrain Systems & Services

Headquarters:

GKN Service International GmbH

Nussbaumweg 19-21

51503 Rösrath / Germany

www.gknservice.com

© GKN. All rights reserved.

